



**US Army Corps
of Engineers®**
Engineer Research and
Development Center

Wetlands Research Program

A Regional Guidebook for Applying the Hydrogeomorphic Approach to Assessing Wetland Functions of Wet Pine Flats on Mineral Soils in the Atlantic and Gulf Coastal Plains

Richard D. Rheinhardt, Martha Craig Rheinhardt,
and Mark M. Brinson

May 2002



FHWA



USDA NRCS
Natural Resources Conservation Service



The contents of this report are not to be used for advertising, publication, or promotional purposes. Citation of trade names does not constitute an official endorsement or approval of the use of such commercial products.

The findings of this report are not to be construed as an official Department of the Army position, unless so designated by other authorized documents.



PRINTED ON RECYCLED PAPER

A Regional Guidebook for Applying the Hydrogeomorphic Approach to Assessing Wetland Functions of Wet Pine Flats on Mineral Soils in the Atlantic and Gulf Coastal Plains

by Richard D. Rheinhardt, Martha Craig Rheinhardt, Mark M. Brinson
Department of Biology
East Carolina University
Greenville, NC 27858-4353

Final report

Approved for public release; distribution is unlimited



Assessing Wetland Functions

A Regional Guidebook for Applying the Hydrogeomorphic Approach to Assessing Wetland Functions of Wet Pine Flats on Mineral Soils in the Atlantic and Gulf Coastal Plains (ERDC/EL TR-02-9)

ISSUE: Section 404 of the Clean Water Act directs the U.S. Army Corps of Engineers to administer a regulatory program for permitting the discharge of dredged or fill material in “waters of the United States.” As part of the permit review process, the impact of discharging dredged or fill material on wetland functions must be assessed. On 16 August 1996 a National Action Plan to Implement the Hydrogeomorphic Approach (NAP) for developing Regional Guidebooks to assess wetland functions was published.

RESEARCH OBJECTIVE: The objective of this research was to develop a Regional Guidebook for applying the Hydrogeomorphic Approach to wet pine flats on mineral soils in the Atlantic and Gulf coastal plains in the context of the 404 Regulatory Program.

SUMMARY: The Hydrogeomorphic (HGM) Approach is a collection of concepts and methods for developing functional indices and subsequently using them to assess the capacity of

a wetland to perform functions relative to similar wetlands in a region. The Approach was initially designed to be used in the context of the Clean Water Act Section 404 Regulatory Program permit review sequence to consider alternatives, minimize impacts, assess unavoidable project impacts, determine mitigation requirements, and monitor the success of mitigation projects. However, a variety of other potential applications for the Approach have been identified, including: determining minimal effects under the Food Security Act, designing mitigation projects, and managing wetlands.

AVAILABILITY OF REPORT: The report is available at the following Web site: <http://www.wes.army.mil/el/wetlands/wlpubs.html>. The report is also available on Interlibrary Loan Service from the U.S. Army Engineer Research and Development Center (ERDC) Research Library, telephone (601) 634-2355, or the following Web site: <http://libweb.wes.army.mil/index.htm>.

About the Authors: Dr. Richard D. Rheinhardt is a Research Associate Professor in the Biology Department, East Carolina University, Greenville, NC. Ms. Martha Craig Rheinhardt is a Visiting Scientist in the Biology Department, East Carolina University. Dr. Mark M. Brinson is a Professor in the Biology Department, East Carolina University.

Contents

Preface	xi
1—Introduction	1
2—Overview of the Hydrogeomorphic Approach	4
Hydrogeomorphic Classification.....	5
Reference Wetlands.....	8
Assessment Models and Functional Indices.....	9
Application Procedures	9
3—Characterization of Wet Pine Flats on Mineral Soil	11
Organic and Mineral Soil Wet Flats in the Southeastern United States ..	11
Wet Pine Flats on Mineral Soils.....	12
Historic condition and exploitation of Wet Pine Flats	12
Present condition of remnant Wet Pine Flats	13
Reference Domain of Wet Pine Flats	14
Climate	16
Hydrologic regime.....	17
Subclassification of mineral soil Wet Pine Flats.....	17
Effects of fire exclusion in Wet Pine Flats.....	23
Hardwood and Successional Pine/Hardwood Wet Flats on Mineral Soils.....	23
4—Wetland Functions and Assessment Models	26
Function 1: Maintain Characteristic Water Level Regime.....	27
Definition	27
Rationale for selecting the function.....	28
Characteristics and processes that influence the function	28
Description of model variables.....	29
Functional Capacity Index	45
Function 2: Maintain Characteristic Plant Community.....	48
Definition	48
Rationale for selecting the function.....	48
Characteristics and processes that influence the function	49
Description of model variables.....	51
Functional Capacity Index	65

Function 3: Maintain Characteristic Animal Community	68
Definition	68
Rationale for selecting the function.....	68
Characteristics and processes that influence the function	68
Description of model variables.....	70
Functional Capacity Index	73
Function 4: Maintain Characteristic Biogeochemical Processes.....	74
Definition	74
Rationale for selecting function	74
Characteristics and processes that influence the function	75
Functional Capacity Index	76
5—Assessment Protocol for Assessing Wet Pine Flats.....	78
Preliminary Tasks.....	78
Defining Assessment Objectives.....	78
Characterizing the Project Area	79
Identifying Factors that Preclude Assessment.....	79
Defining the Wetland Assessment Area (Bounding Criteria)	80
Collecting Field Data.....	82
Analyzing Field Data.....	89
Applying and Interpreting Assessment Results.....	89
References	90
Appendix A: Field Supplement: Summary of Functions, Models, and Methods	A1
Collecting Field Data.....	A1
Function 1: Maintain Characteristic Water Level Regime.....	A5
Function 2: Maintain Characteristic Plant Community.....	A6
Function 3: Maintain Characteristic Animal Community	A7
Function 4: Maintain Characteristic Biogeochemical Processes.....	A8
Summary of Model Variable Definitions, Measurement Method, and Conversion to Subindices	A9
Blank Field Data Sheets	A16
Appendix B: Indicator Species.....	B1
Appendix C: The van Schilfgaarde Equation.....	C1
Water Table Elevations	C1
Development of Lateral Effect Distances for Bounding WAA by $V_{OUTFLOW}$	C1
Appendix D: Model Development and Collection and Analysis of Reference Data.....	D1
Workshop	D1
Data Collection at Reference Sites	D1

Environmental Parameters	D7
Results and Discussion	D9
Appendix E: Reference Field Data	E1
Appendix F: Glossary	F1
SF 298	

List of Figures

Figure 1.	Reference Domain for Wet Pine Flats.....	15
Figure 2.	Classification of Wet Flats of the Atlantic and Gulf coastal plains of the United States.....	19
Figure 3.	Alteration to hydrologic regime caused by an impediment to surface flow ($V_{SURFLOW}$)	30
Figure 4.	Relationship between surface flow of water and functional capacity	32
Figure 5.	Lateral drainage effect of ditches on subsurface water storage	33
Figure 6.	Relationship between artificial drainage and functional capacity	34
Figure 7.	Interactive effects of several types of alterations to hydrology associated with a dam and ditch.....	35
Figure 8.	Relationship between surface water storage and functional capacity	36
Figure 9.	Relationship between fire/mowing and functional capacity	38
Figure 10.	Relationship between LAI and functional capacity for Bunchgrass/Pine Savannas	41
Figure 11.	Relationship between LAI and functional capacity for Cypress/Pine and Switchcane/Pine Savannas	41
Figure 12.	Relationship between inflow of water from an exogenous basin and functional capacity	42
Figure 13.	Relationship between microtopography and functional capacity	44
Figure 14.	Relationship between alterations to soil porosity and functional capacity	47

Figure 15.	Relationship between herbaceous indicator scores in Bunchgrass/Pine Savanna and functional capacity	55
Figure 16.	Relationship between herbaceous indicator scores in Cypress/Pine Savanna and functional capacity	56
Figure 17.	Relationship between bunchgrass cover and functional capacity	57
Figure 18.	Relationship between sedge cover and functional capacity	58
Figure 19.	Relationship between pine density and functional capacity	60
Figure 20.	Relationship between subcanopy density and functional capacity	61
Figure 21.	Relationship between pond cypress physiognomy and functional capacity	63
Figure 22.	Relationship between canopy-size longleaf and pond pine density and functional capacity	65
Figure 23.	Determination of the landscape variable ($V_{LANDSCP}$).....	71
Figure 24.	Relationship between contiguous area of fire-maintained landscape and functional capacity	72
Figure 25.	Orientation and dimensions of nested plots for measuring field indicators.....	86
Figure 26.	PVC piping used to mark boundaries of nested quadrats.....	87
Figure A1.	Interactive effects of several types of alterations to hydrologic regime	A37
Figure A2.	Lateral drainage effect of ditches on subsurface water storage	A38
Figure A3.	Alteration to hydrologic regime caused by an impediment to flow ($V_{SURFFLOW}$).....	A39
Figure A4.	PVC piping used to mark boundaries of nested quadrats.....	A40
Figure A5.	Orientation and dimensions of nested plots for measuring field indicators.....	A41
Figure A6.	Determination of the landscape variable ($V_{LANDSCP}$).....	A42
Figure A7.	Dot grid overlay to estimate area from an aerial photograph..	A43
Figure C1.	The ARS National Sedimentation Laboratory/NRCS Wetland Science Institute web page for calculating Lateral Drainage Distance (L_e) used to bound a WAA by $V_{OUTFLOW}$	C4
Figure D1.	Reference Domain for Wet Pine Flats and locations of reference sites.....	D2

Figure D2.	Aerial photograph of roads damming Wet Pine Flats	D8
Figure D3.	Species-area curve for indicator species among selected reference sites.....	D17

List of Tables

Table 1.	Interdisciplinary Team of Scientists Participating in Workshop Held in Ichuaway, GA, at Joseph W. Jones Ecological Research Center, 27-31 January 1997.....	2
Table 2.	Hydrogeomorphic Wetland Classes at a Continental Scale	6
Table 3.	Potential Regional Subclasses in Relation to Geomorphic Setting, Dominant Water Source, and Hydrodynamics.....	8
Table 4.	Cover Classes and Midpoint Values for Each Class	38
Table 5.	Example Worksheet Estimating Leaf Area Index (LAI).....	40
Table 6.	Calculation of Microtopography Variable (V_{MICRO}) by Type of Alteration and Area.....	43
Table 7.	Calculation of Soil Porosity Variable (V_{PORE}) by Type of Alteration and Area	46
Table 8.	Calculation of Herbaceous Indicator Scores for Bunchgrass/Pine and Cypress/Pine Cover Types.....	52
Table 9.	Correlation Matrix Relating Bunchgrass Cover and Herbaceous Indicator Scores to Species Richness	54
Table 10.	Calculation of Cypress Stand Physiognomy from Density Data	63
Table 11.	Typical Red Flag Features and Respective Program and/or Agency	80
Table 12.	Field Gear for Assessing Wet Pine Flats.....	83
Table 13.	Calculation of Lateral Drainage Distance Used to Partition a WAA by $V_{OUTFLOW}$	84
Table A1.	Key for Bounding Wetland Assessment Areas (WAAs) in Wet Pine Flats into One or More Partial WAAs.....	A26
Table A2.	Field Gear for Assessing Wet Pine Flats.....	A31
Table A3.	Calculation of Lateral Drainage Distance Used to Partition a WAA by $V_{OUTFLOW}$	A32

Table A4.	Calculation of Leaf Area Index (LAI).....	A33
Table A5.	Calculation of Microtopography (V_{MICRO}) and Soil Porosity (V_{PORE}) by Type of Alteration and Area.....	A34
Table A6.	Calculation of Herbaceous Indicator Scores for Bunchgrass/Pine and Cypress/Pine Cover Types.....	A35
Table A7.	Calculation of Cypress Stand Physiognomy from Density Data	A36
Table D1.	Reference Sites by Subclass	D3
Table D2.	Differences Between Mean Microtopographic Elevation Ranges by Type of Alteration Using Paired T-Tests.....	D10
Table D3.	Ranking of Alterations to Microtopography	D11
Table D4.	Bulk Densities of Soil in Reference Sites	D12
Table D5.	Ranking of Soil Alterations.....	D13
Table D6.	Hydric Soils in Reference Sites, by State.....	D14
Table D7.	Relationship Between Distance from Dam on Reservoir Side and Herbaceous Indicator Scores	D15
Table D8.	Correlation Matrix for Various Estimated Leaf Area Index (LAI) Values Among Reference Sites.....	D19
Table E1.	Data Used to Determine Reference Standards for FCI Models.....	E2
Table E2.	Data Collected at Reference Sites, but Not Used to Model Functions	E4
Table E3.	Density of Canopy and Midcanopy Strata for Wet Pine Flats on Mineral Soil.....	E16
Table E4.	Density of Subcanopy Strata for Wet Pine Flats on Mineral Soil	E20
Table E5.	Relative Frequency Data for All Herbaceous Species in Reference Sites.....	E24

Preface

This Regional Guidebook was authorized by Headquarters, U.S. Army Corps of Engineers (HQUSACE), as part of the Characterization and Restoration of Wetlands Research Program (CRWRP). It is published as an Operational Draft for field testing for a 2-year period. Comments should be submitted via the Internet at the following address: <http://www.wes.army.mil/el/wetlands/hgmhp.html>. Written comments should be addressed to: Department of the Army, Research and Development Center, CEERD-EE-W, 3909 Halls Ferry Road, Vicksburg, MS 39180-6199.

The work was performed under Work Unit 32985, “Technical Development of HGM,” for which Dr. Ellis J. Clairain, Jr., Environmental Laboratory (EL), Vicksburg, MS, U.S. Army Engineer Research and Development Center (ERDC), was the Principal Investigator. Mr. Dave Mathis, CERD-C, was the CRWRP Coordinator at the Directorate of Research and Development, HQUSACE; Ms. Colleen Charles, CECW-OR, served as the CRWRP Technical Monitor’s Representative; Dr. Russell F. Theriot, EL, was the CRWRP Program Manager; and Dr. Clairain was the Task Area Manager. Funding was provided by the U.S. Environmental Protection Agency (EPA) Regions IV and VI, the U.S. Federal Highway Administration, and the ERDC.

The report was prepared by Dr. Richard D. Rheinhardt, Ms. Martha Craig Rheinhardt, and Dr. Mark M. Brinson, Biology Department, East Carolina University, Greenville, NC. Dr. James Wakeley, EL, provided critical review. Mr. William B. Ainslie, Project Manager, EPA Region IV, and Dr. Clairain provided assistance and support. This work took place under the general supervision of Dr. Morris Mauney, Jr., Chief, Wetlands and Coastal Ecology Branch, EL; Dr. David J. Tazik, Chief, Ecosystem Evaluation and Engineering Division, EL; and Dr. Edwin A. Theriot, Director, EL.

Preparation of this Regional Guidebook began with a workshop held at the Ichuaway Joseph W. Jones Ecological Research Center in Newton, Georgia, 26-31 January 1997. Workshop participants were particularly instrumental in establishing the framework for sampling and modeling functions, in suggesting reference sites in their regions, in providing the names of others who could help locate sites, and in providing critical comments on various drafts of the Guidebook. In particular, Jeff Glitzenstein and Donna Streng were helpful in showing the myriad of plants that inhabit Wet Pine Flats, pointing out their distinguishing characteristics, and suggesting possible sampling protocols for plant variables. They also helped identify pressed plants near the end of data

collection. Tom Williams showed sites at Belle Baruch Lab that differed by hydrologic condition and discussed the ramifications of hydrologic alterations on functioning. Steve Faulkner (Louisiana State University) took us to some of his research sites and helped fine-tune measurements of biogeochemical indicators. Eric Fleming and Glenn Sandifer helped develop several variables, especially drainage indicators by soil type.

In traveling over 10,000 miles (mostly on back-roads) in nine southeastern states in the summer heat, we relied on the resources, talent, and goodwill of many people in addition to workshop participants. Numerous ecologists and land managers assisted in locating sites and, in some cases, helped collect field data. These ecologists worked with universities, private hunting preserves and land trusts, state natural resource agencies and land management agencies, and various Federal land management agencies, including the U.S. Department of Defense, USDA Forest Service, U.S. National Park Service, U.S. Army Corps of Engineers, and USDA Natural Resources Conservation Service. We appreciate all the help we received and regret if anyone has been left unacknowledged.

Jeff Twomey at Francis Marion National Forest, Rhonda and Earl Stewart at Kisatchie National Forest, and Guy Anglin at Apalachicola National Forest helped locate sites on USDA Forest Service lands. Doug Hutter showed us around Big Thicket National Preserve and provided accommodations at the research station there. Dena Thompson (Fort Stewart Army Base) and Bruce Hagedorn (Eglin Air Force Base) helped locate sites on their bases in Florida and Georgia, respectively, and provided camping accommodations. Tony Wilder (Sandhill Crane National Wildlife Refuge) provided us with access to and air photos of hundreds of hectares of restored sites and sites being restored on the Refuge. Jennifer McCarthy of the U.S. Army Corps of Engineers (Norfolk, Virginia) showed us wet hardwood flats all over southeastern Virginia.

Latimore Smith (Louisiana Natural Heritage Program), Mike Schafale (North Carolina Natural Heritage Program), and Al Schotz (Alabama Natural Heritage Program) helped locate sites in Louisiana, North Carolina, and Alabama, respectively. Wade Kallinowski helped locate sites at the Webb Center in South Carolina, while Tom Swaynham provided camping accommodations at the Center. Bob McCormack and Maureen Nation (Week's Bay National Estuarine Research Reserve (NERR) in Alabama) permitted us to sample a site being restored on NERR's property.

Bert Shiflett and Virgil Dugan allowed us to sample sites on the private quail plantations that they each managed. These sites were among the best managed Wet Pine Flats still intact. Sam Pearsall permitted us to sample The Nature Conservancy (TNC) sites throughout the Southeast. Ike McWhorter (TNC, Texas) and Margit Bucher (TNC, North Carolina) directed us to intact sites and to sites under restoration on TNC land. Dave Ruple (TNC, Alabama) directed us to TNC sites near Mobile, Alabama, and provided air photos of potential reference sites.

Judy Stout and Lee Stanton (Dauphin Island Marine Lab) directed us to their research sites and to other nearby sites in southern Alabama and assisted in

sampling one site. Judy also arranged for us to stay in research housing at the Dauphin Island Lab while we were working in the area. While there, we were able to organize our data and plant specimens and acquire much needed (and overdue) rejuvenation. We also greatly appreciate the assistance of Angus Gholson (Chattahoochee, Florida) in identifying plants, many of which were incomplete specimens. His private, speciose herbarium would be the envy of most universities.

Tom Thornhill, acting manager of the Sandhill Crane National Wildlife Refuge, allowed us to test the Guidebook on refuge lands, February 9-11, 1999. Participants in the field-testing help provide critical feedback for improving the Guidebook. Participants included Ellis J. Clairain, Jr., and Steve Sprecher (U.S. Army Engineer Research and Development Center, Vicksburg, MS), Rhonda Evans (U.S. EPA Region IV), Sue Grace (USGS National Wetlands Research Center), Guy Anglin (USDA Forest Service), James Barlow, Karen Dove, Jake Duncan, Art Hosey, Cindy House-Pearson, Frank Hubiak, Richard Legere, Scott McLendon, and Medrick Northrop (all from Corps of Engineers field offices), Hildreth Cooper and Bruce Porter (U.S. Fish and Wildlife Service), George Ramseur (The Nature Conservancy), Latimore Smith (Louisiana Natural Heritage Survey), Durk Stevenson (Fort Stewart Fish and Wildlife Branch), Ronnie Thomas and Ralph Thorton (USDA Natural Resource Conservation Service), Angie Yelverton (CZR, Inc.), David Borland (A.F. Clewell, Inc.), and Steve Faulkner (LSU). We are especially grateful to Sue Grace for helping locate appropriate field-testing sites on the Refuge and for providing logistical and instructional support.

At the time of publication of this report, Dr. James R. Houston was Director of ERDC, and COL John W. Morris III, EN, was Commander and Executive Director.

This report should be cited as follows:

Rheinhardt, R. D., Rheinhardt, M. C., and Brinson, M. M. (2002). "A regional guidebook for applying the hydrogeomorphic approach to assessing wetland functions of wet pine flats on mineral soils in the Atlantic and Gulf coastal plains," ERDC/EL TR-02-9, U.S. Army Engineer Research and Development Center, Vicksburg, MS.

The contents of this report are not to be used for advertising, publication, or promotional purposes. Citation of trade names does not constitute an official endorsement or approval of the use of such commercial products.

1 Introduction

The Hydrogeomorphic (HGM) Approach is a collection of concepts and methods used in concert to develop functional indices and apply them to the assessment of wetland functions. The functional indices developed using the HGM Approach were initially intended to be used in assessing the impact of dredge and fill projects on wetland functions under the Clean Water Act Section 404 Regulatory Program. However, their potential for use in a wide variety of situations requiring the assessment of wetland functions has subsequently become clear. Potential applications that have been identified include the avoidance or minimization of project impacts, comparison of project alternatives, minimal effects determinations (Food Security Act), assessment of project impacts, determination of mitigation requirements, monitoring of mitigation success, design of mitigation projects, and testing wetland management strategies.

On June 20, 1997, the National Action Plan to Implement the Hydrogeomorphic Approach (NAP) was published (National Interagency Implementation Team 1996). The NAP, developed cooperatively by the U.S. Army Corps of Engineers (USACE), U.S. Environmental Protection Agency (USEPA), Natural Resources Conservation Service (NRCS), Federal Highways Administration (FHWA), and U.S. Fish and Wildlife Service (USFWS), was designed to promote the development of Regional Guidebooks for assessing wetland functions using the HGM Approach and to solicit broad cooperation and participation by Federal, State, and local agencies, academia, and the private sector. In addition, the NAP updated the status of Regional Guidebook development and provided guidance for future development of Regional Guidebooks.

This Regional Guidebook is a result of applying the HGM Approach to Wet Pine Flats on mineral soils in the Atlantic and Gulf coastal plains. In developing the Regional Guidebook, preliminary data from Wet Pine Flats in North Carolina (Rheinhardt et al. 1997) were used to provide a starting template for a workshop held at the Ichuaway Joseph W. Jones Ecological Research Center in Newton, Georgia January 27-31, 1997. This workshop was attended by hydrologists, biogeochemists, soil scientists, wildlife biologists, and plant ecologists from the public, private, and academic sectors who had extensive knowledge of Wet Pine Flats (Table 1).

Table 1 Interdisciplinary Team of Scientists Participating in Workshop Held in Ichuaway, GA, at Joseph W. Jones Ecological Research Center, 27-31 January 1997	
Expertise	Name (Organization)
Hydrology	Hans Riekerk (University of Florida)
	Tom Williams (Clemson University)
	Mary Davis (U.S. Army Engineer Waterways Experiment Station)
	Eric Fleming (NRCS SE Wetlands Team, Columbia, SC)
	Robert Tighe (NW Florida Water Management District)
	Karl Faser (East Carolina University)
Biogeochemistry	Mark Brinson (East Carolina University)
	Steve Faulkner (Louisiana State University)
	Larry West (University of Georgia)
	Glenn Sandifer (NRCS SE Wetlands Team, Columbia, SC)
	Kathrine Trott (U.S. Army Engineer, West Palm Beach, FL)
	Martha Rheinhardt (East Carolina University)
Biology	Rick Rheinhardt (East Carolina University)
	Jeff Glitzenstein (Tall Timbers Research Lab)
	Kay Kirkman (Jones Ecological Research Lab)
	Bruce Means (Coastal Plains Institute)
	Brian Watts (College of William and Mary)
	Michael Duever (The Nature Conservancy)

The objectives of this Regional Guidebook are to: (a) characterize mineral soil Wet Pine Flats, (b) document the selection of wetland functions and the development of assessment models, (c) document the location of reference wetlands and the use of reference wetland data in calibrating functional indices, and (d) present a method for applying functional indices to the assessment of wetland functions.

The remainder of this document is organized as follows: Chapter 2 provides a brief overview of the components and application of the HGM Approach. Chapter 3 characterizes mineral soil Wet Pine Flats in terms of historic condition, geographical extent, climate, geomorphic setting, hydrologic regime, vegetation, soils, and other relevant factors. Chapter 4 discusses the wetland functions and assessment models that have been developed for Wet Pine Flats. For each function the discussion includes a definition, a description of the wetland ecosystem and landscape characteristics that influence the function, a definition and description of model variables, a discussion of how model variables were aggregated in the assessment model, and the rationale used in calibrating the model using data from reference wetlands. Chapter 5 outlines the steps that are necessary to conduct an assessment and includes the necessary field forms and other information. Appendix A (Field Supplement) contains a summary of definitions

for all model variables and Functional Capacity Indices, mechanisms for calculations, and field data sheets.

2 Overview of the Hydrogeomorphic Approach

The HGM Approach consists of four major components that include hydrogeomorphic classification, reference wetlands, assessment models and functional indices, and application procedures. The first three components of the HGM Approach are addressed during a Development Phase by an interdisciplinary team of experts, or A-Team (Assessment Team). The Development Phase begins with the A-Team classifying the wetlands within a region into regional subclasses using the principles and criteria of the Hydrogeomorphic Classification (Brinson 1993). Next, focusing on a specific Regional Wetland Subclass, the A-Team characterizes the historic and current ecological condition of the subclass. The team then identifies the important wetland functions, defines the factors that influence each function, and conceptualizes an assessment model for each function. Next, the team identifies and collects field data from a group of reference wetlands that represent the range of variability, both natural and anthropogenically induced, exhibited by the regional subclass. Field data from reference wetlands is then used to calibrate variables and fine-tune initially conceptualized assessment models. Finally, the A-Team develops a set of procedures for applying the functional indices to the assessment of wetland functions. The product resulting from the Development Phase is a Regional Guidebook for assessing the functions of a Regional Wetland Subclass. During the Application Phase of the HGM Approach, the application procedures outlined in the Regional Guidebook are applied to specific projects requiring the assessment of wetland functions by regulators, managers, consultants, and other end users.

Hydrogeomorphic classification, reference wetlands, assessment models and functional indices, and application procedures are discussed briefly below. More extensive discussions can be found in Brinson (1993, 1995), Brinson (1996a,b), Smith et al. (1995), Brinson and Rheinhardt (1996, 1997), Rheinhardt, Brinson, and Farley (1997), Smith and Wakeley (in preparation), Brinson et al. (1999), and Rheinhardt et al. (1999).

Hydrogeomorphic Classification

Wetlands ecosystems share a number of attributes including hydroperiods that produce anaerobic conditions for long periods, dominance by hydrophytic vegetation, and presence of hydric soils. However, despite these common features, wetlands exist under a wide range of climatic, geologic, and physiographic situations and exhibit a wide variety of physical, chemical, and biological characteristics. The variability exhibited by wetlands coupled with the short time frames for conducting assessments present challenges in developing accurate and practical methods for assessing wetland condition. More “generic” methods, designed to assess multiple types of wetlands, lack the level of detail necessary to detect significant changes in function. In order to assess wetland functions at the appropriate level of resolution and within a short time frame, the amount of natural variability exhibited by the wetlands under consideration must be considered in assessment (Smith et al. 1995). This is done by first separating (classifying) wetlands by regional subclass. A wetland's potential to function is then determined relative to reference data obtained from relatively unaltered sites belonging to wetlands within its Regional Wetland Subclass.

The HGM Classification (Brinson 1993) was developed specifically to accomplish this task. Its objective was to identify broad groups of wetlands that function similarly using three criteria that fundamentally influence how wetlands function: geomorphic setting, water source, and hydrodynamics. Geomorphic setting refers to the landform in which the wetland occurs, its geologic evolution, and its topographic position in the landscape. Water source refers to the origination of water just prior to entering the wetland. The three primary water sources are precipitation, overbank flow (in riverine systems), and groundwater discharge. Hydrodynamics refers to the level of energy and the direction that water moves in a wetland.

Based on these three classification criteria, any number of “functional” wetland groups can be identified at different spatial or temporal scales. For example, at a broad continental scale, Brinson (1993) identified five hydrogeomorphic wetland classes. These were later expanded (Smith et al. 1995) to the seven classes described in Table 2. In most cases, the level of variability encompassed by each of these broad hydrogeomorphic classes is too wide to allow development of assessment models that can be applied rapidly while being sensitive enough to detect significant change in function. For example, the depression wetland class includes wetland ecosystems in different regions as diverse as vernal pools in California (Zedler 1987), prairie potholes in North and South Dakota (Hubbard 1988; Kantrud, Krapu, and Swanson 1989), playa lakes in the High Plains of Texas (Bolen, Smith, and Schramm 1989), kettles in New England, and cypress domes in Florida (Kurz and Wagner 1953, Ewel and Odum 1984). These depressional wetlands all differ from one another with respect to hydrologic regime, vegetation, soils, type of surrounding landscape, and climatic influences.

In order to make an assessment method tractable, one must first identify the Regional Wetland Subclass of a wetland by applying the classification criteria at a spatial scale that reduces both inter-regional and intra-regional variability. In

**Table 2
Hydrogeomorphic Wetland Classes at a Continental Scale**

Hydrogeomorphic Wetland Class	Definition
Depressional	Depressional wetlands occur in topographic depressions. Dominant water sources are precipitation, groundwater discharge, and interflow from adjacent uplands. The direction of flow is normally from the surrounding uplands toward the center of the depression. Elevation contours are closed, thus allowing the accumulation of surface water. Depressional wetlands may have any combination of inlets and outlets or may lack them completely. Dominant hydrodynamics are vertical fluctuations, primarily seasonal. Depressional wetlands may lose water through intermittent or perennial drainage from an outlet and by evapotranspiration and, if they are not receiving groundwater discharge, may slowly contribute to groundwater. Peat deposits may develop in depressional wetlands. A prairie pothole is an example of a depressional wetland.
Slope	Slope wetlands normally are found where there is a discharge of groundwater to the land surface. They normally occur on sloping land; elevation gradients may range from steep hillsides to slight slopes. Slope wetlands are usually incapable of depressional storage because they lack the necessary closed contours. Principal water sources are usually groundwater return flow and interflow from surrounding uplands as well as precipitation. Hydrodynamics are dominated by downslope unidirectional water flow. Slope wetlands can occur in nearly flat landscapes if groundwater discharge is a dominant source to the wetland surface. Slope wetlands lose water primarily by saturation subsurface and surface flows and by evapotranspiration. Slope wetlands may develop channels, but the channels serve only to convey water away from the slope wetland. A fen is an example of a slope wetland.
Riverine	Riverine wetlands occur in floodplains and riparian corridors in association with stream channels. Dominant water sources are overbank flow from the channel or subsurface hydraulic connections between the stream channel and wetlands. Additional water sources may be interflow and return flow from adjacent uplands, occasional overland flow from adjacent uplands, tributary inflow, and precipitation. When overbank flow occurs, surface flows down the floodplain may dominate hydrodynamics. At their headwater, most extension, riverine wetlands often intergrade with slope or depressional wetlands as the channel (bed) and bank disappear, or they may intergrade with poorly drained flats or uplands. Perennial flow is not required. Riverine wetlands lose surface water via the return of floodwater to the channel after flooding and through saturation surface flow to the channel during rainfall events. They lose subsurface water by discharge to the channel, movement to deeper groundwater (for losing streams), and evapotranspiration. Peat may accumulate in off-channel depressions (oxbows) that have become isolated from riverine processes and are subjected to long periods of saturation from groundwater sources. A forested floodplain of a bottomland hardwood forest is an example of a riverine wetland.
Mineral Soil Flats	Mineral soil flats are most common on interfluves, extensive relic lake bottoms, or large floodplain terraces where the main source of water is precipitation. They receive virtually no groundwater discharge, which distinguishes them from depressions and slopes. Dominant hydrodynamics are vertical fluctuations. Mineral soil flats lose water by evapotranspiration, saturation overland flow, and seepage to underlying groundwater. They are distinguished from flat upland areas by their poor vertical drainage, often due to hardpans, and low lateral drainage, usually due to low hydraulic gradients. Mineral soil flats that accumulate peat can eventually become the class organic soil flats. A pine savanna with hydric soils is an example of a mineral soil flat wetland.
Organic Soil Flats	Organic soil flats, or extensive peatlands, differ from mineral soil flats, in part because their elevation and topography are controlled by vertical accretion of organic matter. They occur commonly on flat interfluves, but may also be located where depressions have become filled with peat to form a relatively large flat surface. Water source is dominated by precipitation, while water loss is by evapotranspiration, saturation overland flow, and seepage to underlying groundwater. Raised bogs share many of these characteristics, but may be considered a separate class because of their convex upward form and distinct edaphic conditions for plants. A pocosin is an example of an organic soil flat wetland.
<i>(Continued)</i>	

Table 2 (Concluded)	
Hydrogeomorphic Wetland Class	Definition
Estuarine Fringe	Tidal fringe wetlands occur along coasts and estuaries and are under the influence of sea level. They intergrade landward with riverine wetlands where tidal current diminishes and river flow becomes the dominant water source. Additional water sources may be groundwater discharge and precipitation. The interface between the tidal fringe and riverine classes is where bidirectional flows from tides dominate over unidirectional ones controlled by floodplain slope of riverine wetlands. Because tidal fringe wetlands frequently flood and water table elevations are controlled mainly by sea surface elevation, tidal fringe wetlands seldom dry for significant periods. Tidal fringe wetlands lose water by tidal exchange, by saturated overland flow to tidal creek channels, and by evapotranspiration. Organic matter normally accumulates in higher elevation marsh areas where flooding is less frequent and the wetlands are isolated from shoreline wave erosion by intervening areas of low marsh. A <i>Spartina alterniflora</i> salt marsh is an example of an estuarine fringe wetland.
Lacustrine Fringe	Lacustrine fringe wetlands are adjacent to lakes where the water elevation of the lake maintains the water table in the wetland. In some cases, these wetlands consist of a floating mat attached to land. Additional sources of water are precipitation and groundwater discharge, the latter dominating where lacustrine fringe wetlands intergrade with uplands or slope wetlands. Surface water flow is bidirectional, usually controlled by water-level fluctuations such as seiches in the adjoining lake. Lacustrine fringe wetlands are indistinguishable from depression wetlands where the size of the lake becomes so small relative to fringe wetlands that the lake is incapable of stabilizing water tables. Lacustrine wetlands lose water by flow returning to the lake after flooding, by saturation surface flow, and by evapotranspiration. Organic matter normally accumulates in areas sufficiently protected from shoreline wave erosion. An unpounded marsh bordering one of the Great Lakes is an example of lacustrine fringe wetland.

many parts of the country, wetland classifications exist to serve as a starting point for developing a regional HGM Classification (Stewart and Kantrud 1971; Golet and Larson 1974; Wharton et al. 1982; Rheinhardt, Brinson, and Farley 1997; Rheinhardt et al. 1998; and Rheinhardt and Rheinhardt 2000). Regional Wetland Subclasses, like the wetland classes, can be distinguished on the basis of geomorphic setting, water source, and hydrodynamics. In addition, certain ecosystem or landscape characteristics may also be useful for distinguishing regional subclasses in certain regions. For example, regional depression subclasses might be based on water source (i.e., groundwater versus precipitation) or the degree of connection between the wetland and other surface waters (i.e., the flow of surface water into or out of the depression through defined channels). In the estuarine fringe class, subclasses could be based on salinity gradients or whether water level fluctuations are controlled by lunar tides or wind. Regional slope subclasses might be based on the degree of slope, landscape position, the source of water (i.e., overland flow versus groundwater discharge), or other factors. Regional riverine subclasses could be based on their primary water source (over-bank flow or groundwater discharge), position in the watershed, stream order, watershed size, channel gradient, or floodplain width. Examples of potential regional subclasses are shown in Table 3; data on these subclasses are provided by Smith et al. (1995), Rheinhardt, Brinson, and Farley (1997), Rheinhardt et al. (1998), Ainslie et al. (1999), Rheinhardt et al. (2000), Rheinhardt and Rheinhardt (2000). Regional Guidebooks include a thorough characterization of a Regional Wetland Subclass in terms of its geomorphic setting, water sources, hydrodynamics,

Table 3 Potential Regional Subclasses in Relation to Geomorphic Setting, Dominant Water Source, and Hydrodynamics				
Geomorphic Setting	Dominant Water Source	Dominant Hydrodynamics	Potential Regional Subclasses	
			Eastern USA	Western USA/Alaska
Riverine	Overbank flow from channel	Unidirectional, horizontal	Bottomland hardwood forests	Riparian forested wetlands
Depressional	Return flow from groundwater and interflow	Vertical	Prairie pothole marshes	California vernal pools
Slope	Return flow from groundwater	Unidirectional, horizontal	Fens	Avalanche chutes
Mineral soil flats	Precipitation	Vertical	Wet pine flats	Large playas
Organic soil flats	Precipitation	Vertical	Peat bogs; portions of Everglades	Peat bogs
Estuarine fringe	Overbank flow from estuary	Bidirectional, horizontal	Chesapeake Bay marshes	San Francisco Bay marshes
Lacustrine fringe	Overbank flow from lake	Bidirectional, horizontal	Great Lakes marshes	Flathead Lake marshes

vegetation, soil, and other attributes that were taken into consideration during the classification process.

Reference Wetlands

Reference wetlands are wetland sites that represent the range of variability that occurs in a Regional Wetland Subclass as a result of natural processes (e.g., succession, channel migration, fire, erosion, and sedimentation) and anthropogenic alterations. The HGM Approach uses reference wetlands to accomplish several objectives. First, they provide concrete physical examples of wetlands from a regional subclass whose characteristics can be observed and measured. Thus, reference wetlands can be used to further research and increase public awareness of their value to society. Second, reference wetlands establish the range of variability that exists in the regional subclass within the Reference Domain (the geographic area from which reference wetlands are selected). Finally, they provide data for calibration of assessment model variables and functional indices (see Chapter 3).

Reference standard wetlands are a subset of reference wetlands that achieve a level of functioning that is both characteristic for the subclass and sustainable across the suite of functions inherent to the subclass. Generally, they are the least altered wetland sites in the least altered landscapes. By definition, the functional index for all functions in reference standard wetlands is 1.0. Reference standards are the range of conditions exhibited by assessment model variables in reference standard wetlands. By definition, the variable subindex for assessment model variables in reference standard wetlands is 1.0 (Brinson, 1995, Smith et al. 1995,

Brinson and Rheinhardt 1996, Rheinhardt et al. 1999). The Glossary presents reference wetland terms and definitions used in the HGM Approach.

Assessment Models and Functional Indices

In the HGM Approach, assessment models are simple representations of functions performed by a regional wetland subclass initially identified by the A-Team during the development phase and revised after an analysis of reference data. Assessment model variables represent attributes of a wetland ecosystem of a given subclass, and in some cases, attributes of surrounding landscape. Assessment models, in turn, define the relationship between one or more of these attributes and the functional capacity or condition of a wetland ecosystem.

Functional capacity is simply the ability of a given wetland subclass to perform a function at a level characteristic to the subclass. The condition of model variables used to determine functional capacity vary depending on degree to which a given wetland has been altered and is measured relative to the range of conditions exhibited the least altered wetlands of the regional subclass (reference standard wetlands). For example, plant species richness can be more or less rich, overbank flow can be more or less frequent, and soils can be more or less permeable than the least altered wetlands of the Regional Wetland Subclass. Model variables are assigned a subindex ranging from 0.0-1.0 based on the degree to which a wetland's condition varies relative to the range of conditions exhibited by reference standard wetlands (reference standard). When the condition of a variable is similar to the reference standard, it is assigned a subindex of 1.0. The conditions of variables that deviate from the range of conditions exhibited by reference standard wetlands are assigned lower values; the more a variable deviates from the reference standard, the lower its variable subindex will be. Lower subindices are reflected in lower functional capacities (i.e., the more a given wetland deviates from reference standard wetlands in its characteristic functioning)

In addition to defining the relationship between each variable and functional capacity, the assessment model defines the relationship among variables. Variables are combined to produce a functional capacity index (FCI) using an aggregation equation. The FCI, ranging from 0.0-1.0, is a measure of the functional capacity of a wetland to perform a function relative to the level characteristic of the regional subclass to which it belongs. Thus, wetlands with a functional capacity index of 1.0 exhibit conditions similar to reference standard wetlands (i.e., within the range of natural variability for the functional capacity of the subclass). The FCI decreases as conditions deviate from reference standards.

Application Procedures

Once the Development Phase is completed, the application procedures outlined in the Regional Guidebook can be used to assess wetland functions in the context of regulatory, planning, or management programs (Brinson, 1995, Smith

et al. 1995, Brinson and Rheinhardt 1996, Rheinhardt et al. 1999). The Application Phase includes a characterization, assessment and analysis, and application component. Characterization involves describing the wetland ecosystem and the surrounding landscape, describing the proposed project and its potential impacts, and identifying the wetland areas to be assessed. Assessment and analysis involves collecting the field data necessary to run the assessment models and calculating functional indices for the wetland assessment areas under existing (i.e., preproject conditions), and if necessary, postproject conditions. Application involves applying the results of the assessment to alternative analysis, assessing potential impacts, determining compensatory mitigation, designing restoration projects, monitoring the success of mitigation compliance, comparing wetland management alternatives or their results, determining restoration potential, or identifying sites for acquisition (Smith et al. 1995).

3 Characterization of Wet Pine Flats on Mineral Soil

Organic and Mineral Soil Wet Flats in the Southeastern United States

Wet (hydric) flats include wetlands on both organic and mineral soils. In the southeastern United States wet flats occur on the subdued and poorly dissected interfluvial marine terraces of the coastal plain. Hydric conditions have developed on these interfluvial flats primarily in response to abundant rainfall and slow drainage associated with a landscape of low relief. Based on the extent of hydric soils mapped in each state, wet flats (mineral and organic) may comprise 20-30 percent of the coastal plain landscape from southeastern Virginia to southeastern Texas.

Wet flats on organic soils (Histosols) are called pocosins in the Carolinas and baygalls or bayheads elsewhere. These southern ombrotrophic peatlands tend to differ from flats of mineral soil in both geomorphology and vegetation. Pocosins are generally located on topographic highs; they are dominated by evergreen shrubs, and most burn as a normal occurrence about every 15-30 years (Richardson 1981). Although the hydrologic regime of pocosins is precipitation driven, water flows outward from the center and eventually coalesces to form headwater streams near its outer boundaries (Brinson 1991).

Wet flats on mineral soils are primarily associated with poorly drained sandy and loamy Ultisols and Alfisols (mostly Aquults and Aqualfs, respectively), but also are associated with various Spodosols, Inceptisols, and Mollisols. Two types (subclasses) of wet flats occur on mineral soils: (a) Wet Hardwood Flats, characterized by a closed canopy of mixed hardwoods; and (b) Wet Pine Flats, characterized by an open savanna of shade-intolerant forbs and graminoids with widely scattered pines. Differences in origin and physiognomy between these two distinct subclasses are discussed more thoroughly in the following paragraphs.

Wet Pine Flats on Mineral Soils

Historic condition and exploitation of Wet Pine Flats

To understand the relationships among Wet Pine Flats and Wet Hardwood Flats (both occurring on mineral soils) and pocosins (occurring on organic soils), it is necessary to understand the evolution and maintenance of these ecosystems prior to the arrival of Europeans and the effect that anthropogenic alterations have had since then. This perspective is important because, in many cases, alterations have made it difficult to distinguish among the three types of wet flats.

Fire was such a pervasive and regular feature of the terrestrial landscape prior to European colonization that the structure and functioning of entire ecosystems depended on frequent fire (Ware, Frost, and Doerr. 1993). Both floral and faunal components of many southeastern ecosystems evolved not only to tolerate frequent fire but to require fire to complete critical phases of their life cycles. Fire also prevented fire-intolerant species from competing successfully with fire-evolved species.

In describing his botanical excursions throughout the Southeast, Bartram (1791) described vast open, parklike savannas through which he traveled unobstructed on horseback for days at a time. In riding through coastal south Georgia, Bartram wrote, "The next day's progress, in general, presented scenes similar to the preceding, though the land is lower, more level, and humid, and the produce (vegetation) more varied: high, open forests of stately pines, flowery plains, and extensive green savannas..."

Open forests and extensive savannas could only have been maintained by frequent fire. An examination of pollen records suggests that prior to the arrival of Native Americans (12,000-15,000 years ago) and until the time of European colonization, it is likely that vast areas of the southeastern coastal plain burned frequently (Buell 1946, Delcourt 1980, Cohen et al. 1984). Fires were caused by lightning (Komarek 1964, 1974) and by indigenous people to improve habitat for game (Catesby 1654, Lawson 1714, Bartram 1791, Pyne 1982). Extensive areas of the lower (outer) coastal plain were covered with such a contiguous ground layer of flammable grasses and herbs that one lightning strike could initiate a burn that could spread over vast areas of the landscape (Ware, Frost, and Doerr 1993), burning both wet flats and adjacent upland flatwoods. Even summer rains were unlikely to extinguish such fires because embers could smolder for days in fallen logs and snags and spread from there when rains ceased. The only areas immune to frequent fires were small areas isolated by open water or areas where soils were saturated for long periods (i.e., pocosins, stream bottom swamps, marshes, and wet hardwood forests on fine-textured soils).

In studying the frequency and distribution of lightning strikes, Komarek (1964, 1974) estimated that lightning alone could have burned all coastal plain flats every year if there were enough fuel available. At a frequency of 1-3 years, fire kept the woody understory clear and kept fuel loads low. Thus, fires were almost always "cool" ground fires. Destructive crown fires were probably

extremely rare and probably never occurred in savannas. Frequent fire not only prevented the invasion of fire-intolerant hardwoods into savannas but kept shrub density and cover very low. The combination of sparse canopy and clear understory enabled the evolution of a rich and multilayered community of grasses and showy forbs (Frost, Walker, and Peet 1986). Some of these species, in turn, evolved to perpetuate themselves by developing flammable leaves.

Although Native Americans used fire to drive game and manage open habitat, lightning-set fires would have been frequent enough in the outer coastal plain to preclude the necessity of setting fires. Lightning-set fires would have been less common in the inner coastal plain where the landscape is more dissected by drainages (Harcomb et al. 1993). Thus, the frequency of fire in the inner coastal plain may have increased somewhat following habitation of the area by Native Americans.

Ware, Frost, and Doerr (1993), in their overview of the vegetation and exploitation of lowland forests in the Southeast, calculated that 94 percent of the presettlement coastal plain landscape from Virginia to southeastern Texas (excluding riverine and coastal wetlands) was fire maintained. Although they did not separate wet flats from upland flatwoods in their estimates, trends in exploitation were likely similar. By 1900, 50 percent of natural fire-maintained longleaf pine flatwoods (and wet pine flats) had been severely altered, and by 1990, almost all of the remaining flats had been altered (Ware, Frost, and Doerr 1993). Thus, less than 2 percent of the pre-colonial, fire-maintained landscape remained intact by 2000.

A number of anthropogenic alterations have been responsible for the demise of intact and fully functioning wet flats in the Southeast, including (a) landscape fragmentation caused by development associated with an expanding human population, particularly near urban areas, (b) conversion of wet flats to short rotation pine silviculture that relies on bedding and other mechanical manipulations of the soil and groundcover, (c) widespread fire exclusion, primarily to protect agri-forestry interests, and (d) drainage and conversion to agriculture. As a result of these manipulations, unaltered Wet Pine Flats are extremely rare today.

Present condition of remnant Wet Pine Flats

Near the coast, Wet Pine Flats tend to grade directly into coastal or estuarine wetlands. On more inland marine terraces, where land is a bit more dissected, Wet Pine Flats are sinuous, interdigitating geomorphic features (tens to hundreds of meters across) that flow through uplands of low relief. Interspersed within these Wet Pine Flats are forested depressions through which water flows as it follows gradients in the landscape. Sometimes, Wet Pine Flats gain enough water to support a sparse canopy of pond cypress (*Taxodium ascendens*). Eventually, these systems accumulate sufficient water to form headwater streams, which are dominated by a closed canopy of deciduous mixed hardwoods.

Some areas that appear to be flats may actually be expansive, precipitation-driven depressional system areas with no discernible outlet. Such depressions

would be identifiable only with precise surveying since they would be impossible to identify in the field. In any case, some expansive depressions probably function in a similar manner as flats because the source and fate of water (precipitation and evapotranspiration (ET), respectively) are similar, the main difference being that broad depressions lack sheet flow. Therefore, they tend to be located toward the wettest end of the moisture gradient for wet flats. Because flooding duration is similar, many large depressions are also similar in vegetation, soils, and fire return interval. Therefore, evaluations of broad depressions using the models provided in this guidebook could be useful for assessment purposes, as long as one realizes that hydrologic functioning differs and, therefore, alterations involving filling, damming, and importation of water could not be assessed correctly with the hydrologic model. Likewise, fire-maintained slope wetlands, such as those occurring in Kisatchie National Forest (Louisiana) and in the Sandhills of North Carolina, are similar to Wet Pine Flats in the plant and animal species they support. However, slope wetlands differ from flats in hydrologic and biogeochemical functions as a consequence of groundwater, rather than of precipitation, being their primary source of water.

Many relatively unaltered, extant sites are located on public lands such as National Forests, U.S. Department of Defense bases, state game lands, etc. However, many private organizations also own intact sites. In fact, some of the best managed sites belong to private quail hunting preserves that have been managed with prescribed burning for decades, presumably initiated after natural fires became too infrequent to maintain an open understory required for quail.

Reference Domain of Wet Pine Flats

Reference Domain is defined as the geographic region within which all reference wetlands of a specific HGM subclass occur (Smith et al. 1995). In general, the Reference Domain for Wet Pine Flats coincides with the following Major Land Resource Areas (MLRA) mapped by the United States Department of Agriculture (USDA) (1981): 152A, 152B, most of 153A (excluding only the northern section north of the Tar River in North Carolina), and the very southern portion of unit 153B (including only the southern section south of the Neuse River in North Carolina). Thus, the geographic region for Wet Pine Flats covered by this guidebook encompasses most of the Atlantic and Gulf coastal plains from southeastern North Carolina (approximately 35 deg north latitude) southward to coastal northeast Florida and westward from the eastern Florida panhandle to the Big Thicket area in southeastern Texas (Figure 1).

The western limit (in eastern Texas) of Wet Pine Flats is somewhat distinct due to the sharp drop in annual rainfall west of the Big Thicket area in East Texas. Unfortunately, the historic northernmost limit of Wet Pine Flats (in MLRA 153A and 153B) is somewhat indistinct because no intact pine flats remain north and east of Pender County, North Carolina, even though seemingly suitable soil types occur there. However, it appears that Wet Pine Flats historically occurred in the outer coastal plain at least as far north as the Neuse River (in Carteret and Craven Counties) and in the inner coastal plain perhaps as far north as the Tar River.

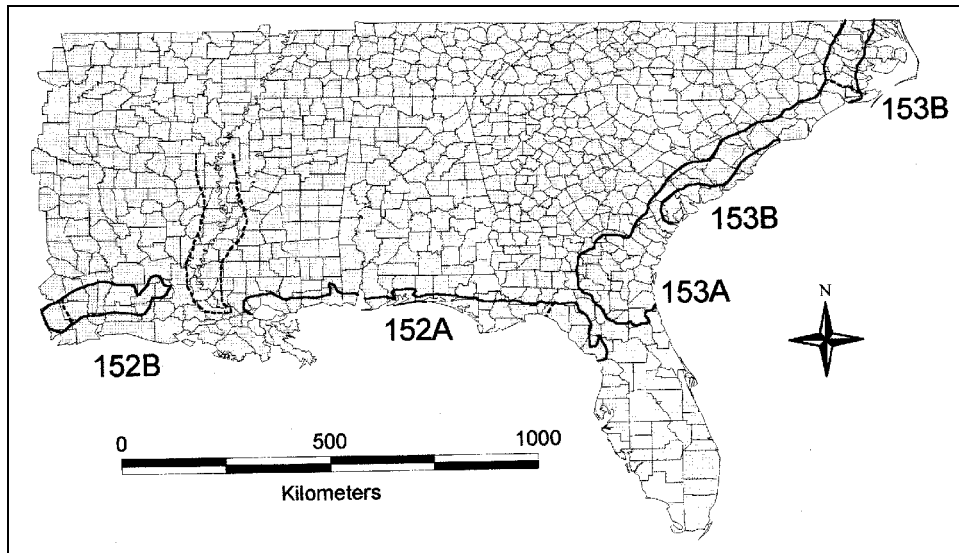

Figure 1. Reference Domain for Wet Pine Flats. Numbers refer to Major Land Resource Areas (MLRA) mapped by the United States Department of Agriculture (USDA 1981). Dashed lines denote location of mineral soil Wet Hardwood Flats: to the west of dashed line in MLRA 1252B, within lines in Mississippi alluvial belt, to the east of dashed line in MLRA 152A, and to the north of dashed line in MLRA 153B

Interestingly, wet flats appear to be absent from south-central Georgia and north-central Florida. This may be related to the slightly drier climate there. However, north-central Florida and south-central Georgia are also underlain by calcareous substrate, which may also facilitate subsurface drainage. Thus, the Reference Domain for mineral soil Wet Pine Flats excludes peninsular Florida (except coastal northeastern Florida) and south-central Georgia. However, south Florida supports very similar Wet Pine Flat ecosystems, and, although no reference sites were included from south Florida, this guidebook could probably be successfully used there with little or no modification.

At the northern limit of the Reference Domain, organic soils (supporting pocosins) and clay-rich mineral soils (supporting Wet Hardwood Flats) occur over extensive areas. Both soil types tend to hold water longer than the loams and sandy loams associated with most Wet Pine Flats. Thus, fires were probably restricted to periods of drought, which occur on a longer return interval than the 1-3 years required for maintaining Wet Pine Flats. In fact, pocosins burn about every 15-25 years, while hardwood flats probably burn even less frequently. This means that any areas of loamy or sandy loam mineral soils that could conceivably support Wet Pine Flats may be too isolated from the frequent fires required to maintain open, grassy savannas. Thus, Wet Pine Flats may have been naturally rare north of the Neuse River in North Carolina, and those that once occurred there may have burned less frequently (see discussion of Switchcane/Pine Savanna).

From the distribution of remnant Wet Hardwood Flats and the fine-textured soils normally associated with them, it appears that hardwood-dominated wet

flats overlap the Reference Domain of Wet Pine Flats in eastern North Carolina (in MLRA 153A south of the Tar River and 153B south of the Neuse River). Although little quantitative information is available on Wet Hardwood Flats, it is clear that Wet Hardwood Flats and Wet Pine Flats are so different from one another in their structure and species composition that they should be recognized as separate subclasses of mineral soil flats. These differences will be discussed in more detail in a later chapter.

Because remnant unaltered sites provide the most reliable information on historic conditions, intact sites were sought to identify appropriate HGM subclasses and develop reference standards. Reference sites were also chosen to represent the types of alterations typical in Wet Pine Flats, the biogeographic and climatic range over which they occur or once occurred, and their inherent range of natural variation (with respect to soils, wetness, fire regime, etc.). In addition, sites were selected to define the range of conditions for which models of functions and reference standards would be applicable. Although the relationship between Wet Pine Flats and Wet Hardwood Flats is discussed, assessment procedures and reference standards provided in this Regional Guidebook are restricted to Wet Pine Flats located in the Reference Domain previously identified.

Climate

Temperatures of the coastal plain from Virginia to Texas are ameliorated by the proximity of the Atlantic Ocean and the Gulf of Mexico. As a consequence, winters are mild, with the growing season ranging from 200-350 days per year throughout the Reference Domain (USDA 1981). Mean annual precipitation is relatively high (100-150 cm/year) throughout the Reference Domain, but varies temporally with latitude. Annual precipitation gradually increases from Virginia southward along the Atlantic coast and westward across the Florida panhandle. Precipitation reaches a maximum between north Florida and central Louisiana and then declines steeply westward to southeastern Texas.

Along most of the Atlantic coast, rainfall is fairly evenly distributed throughout the year, while along the Gulf coast, greater amounts of precipitation occur during summer as a result of convective thunderstorms and tropical storms. However, rainfall along both the Atlantic and Gulf coastal plains is insufficient for maintaining saturated surface conditions during much of the summer. Localized exceptions to this pattern sometimes occur in late summer and fall where a hurricane or tropical storm makes landfall. However, flooding and saturated soils in flats primarily occur during winter and early spring when ET rates are low.

Potential ET (indexed by annual temperature) increases rapidly from Virginia southward to Georgia and then slowly from Georgia to Texas. As a result, the annual water balance (the combination of precipitation and potential ET) indicates that runoff and soil wetness decrease steadily southward from Virginia, reach a minimum in Georgia, increase westward to a maximum between north Florida and central Louisiana, and decline westward to Texas (Chow 1964, Wenger 1984). Thus, long periods of mild temperatures, annual water surpluses,

and poor drainage combine to provide the anoxic conditions needed to sustain wetlands among interfluvial flats in the Southeast.

Hydrologic regime

Wet Pine Flats are distinguished from adjacent upland areas of low relief by their poorer vertical drainage and slower lateral drainage. Poor drainage in Wet Pine Flats is primarily due to their very low hydraulic gradients (<0.5 percent slope). In addition, soils in Wet Pine Flats often have an argillic (clay) horizon, which slows subsurface drainage.

Since Wet Pine Flats are flat and poorly drained, water level fluctuations are primarily determined by the balance between input from precipitation and loss due to ET. (Groundwater input appears to be negligible since the landscape in which Wet Pine Flats occur is also relatively flat, and slow down-gradient surface and subsurface flows balance groundwater input.) Thus, hydrologic regime in Wet Pine Flats is closely related to seasonal fluctuations in both precipitation and ET, which vary across the Southeast (as discussed earlier).

Wet Pine Flats with unaltered hydrology never flood deeply (10-15 cm maximum), but water tables can drop 1.0 m or more below ground when rainfall is low and ET is high. Although outflow via surface (sheet) flow is slow and intermittent, at a landscape scale, outflow of water via overland flow may substantially contribute to the water supply in down-gradient areas (e.g., coastal estuaries and headwater streams) (Wolaver and Williams 1986, Williams et al. 1992).

Subclassification of mineral soil Wet Pine Flats

Classifications are designed to help the human mind organize data and perceptions. Plant species distribute themselves individualistically with respect to environmental parameters (Gleason 1926, Curtis and McIntosh 1951) because certain environmental conditions are repeated in the landscape. These patterns are used to classify vegetation. However, difficulties in classification arise in places where environmental gradients are gradual (e.g., in flats where elevation, and hence soil wetness, changes gradually over long distances). Therefore, past classifications of fire-maintained pine flats are reviewed here and Wet Pine Flats are reclassified in a way that is useful for differentiating wetlands from nonwetlands in order to assess functions. Also provided is insight into transitional conditions among Wet Pine Flat cover classes, between Wet Pine Flats and uplands, and between Wet Pine Flats and seepage (slope) pine savanna.

Past classifications of southern pyrophytic pine forests have been based on differences in vegetation and soil moisture regime (see Christensen (1989) for an overview). Unfortunately, nomenclature offered by various workers has often been inconsistent and contradictory, particularly regarding moisture conditions (e.g., mesic pine forest, wet savanna, flatwoods, etc.). In addition, most current classifications do not differentiate wetlands from nonwetlands, thus making current nomenclature difficult to apply for differentiating wetland classes. Further,

alterations that affect vegetation (especially fire exclusion) tend to obscure distinctions among various classes, making it difficult to attribute differences solely to natural variation (Glitzenstein, Platt, and Streng 1995). Therefore, nomenclature is herein introduced to further subclassify Wet Pine Flats and show how these newly recognized cover types correspond to classifications already in use for pine savannas (both upland and wetland).

Over most of the Atlantic and Gulf coastal plain, unaltered Wet Pine Flats on hydric mineral soil are fire-maintained ecosystems with few or no trees. It is believed that trees are sparse or absent because the combined stress of both prolonged soil saturation and frequent fire inhibits tree recruitment and survival (Wells 1928). Therefore, all Wet Pine Flats, regardless of degree of wetness, are open “savannas,” and correspond to the definition set forth by Peet and Allard (1993) for savanna, “seasonally wet pinelands with widely spaced trees on mineral soil with graminoid-dominated ground layers, few shrubs, and often an exceptionally rich herbaceous layer.” Therefore wet pine savannas (*sensu* Peet and Allard 1993) are Wet Pine Flats as defined here.

Herein, the term “mesic savanna” is used to designate the transition from wet savanna to upland savanna or upland flatwoods. The term “flatwoods” is herein restricted to upland pine forests with a moderately dense canopy and a dense understory of shrubs; soils of mesic savannas and flatwoods are not hydric (*sensu* USDA 1996) and hence are not jurisdictional wetlands.

Peet and Allard (1983) classified wet pine savannas into two distinct physiographic and biogeographic regions: (a) the Atlantic Coast Region from southern North Carolina to the extreme northeastern tip of Florida (roughly corresponding to MLRA 153A, 153B) and (b) the Eastern Gulf Coast Region from the panhandle of Florida to the Mississippi River (roughly corresponding to MLRA 152A). This biogeographic separation was based on the composition of the full suite of wet pine savanna species examined from both areas and endemic plants restricted to one or the other physiographic region. However, wet pine savannas in both regions have many species in common. As a consequence, wet pine savannas in both regions are more similar to one another in hydrology, biogeochemistry, and habitat characteristics than intact wet pine savannas are to altered wet pine savannas within either region.

Based on broad similarities and differences among wet pine savannas, all Wet Pine Flats were grouped into a single geographic region for determining reference standards, but classified sites were grouped into three cover types based on vegetation (Figure 2). The term “cover type” is used to designate the three main subclasses of the Wet Pine Flats in order to differentiate them from other subclasses of wet flats. The three cover types of Wet Pine Flats on mineral soil are: (a) Bunchgrass/Pine Savanna (which corresponds most closely to wet pine savanna, *sensu* Peet and Allard (1993)), (b) Cypress/Pine Savanna, and (c) Switchcane/Pine Savanna. This classification scheme is clearly not as detailed as other classifications (Bridges and Orzell 1989, Schafale 1994), but rather was designed to be the most practical for providing reference standards for use in the functional assessment of Wet Pine Flats.

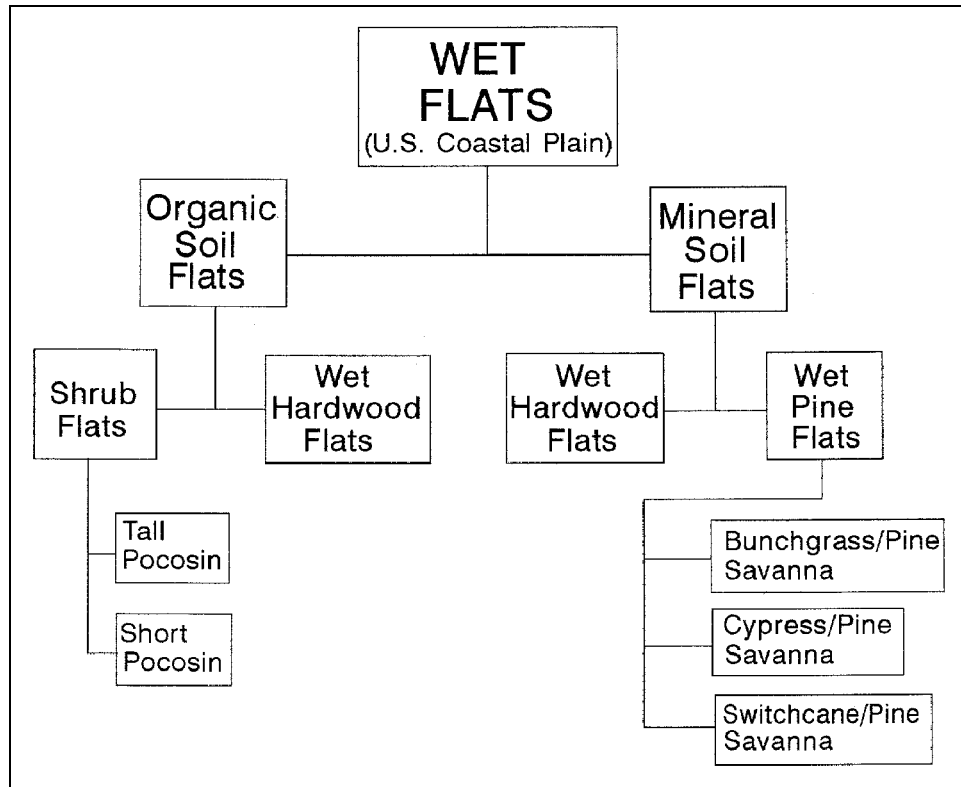

Figure 2. Classification of Wet Flats of the Atlantic and Gulf coastal plains of the United States. This guidebook focuses on Wet Pine Flats on mineral soil

In their least altered condition, Wet Pine Flats have either few trees or no trees (hence, the qualifier “savanna” in this classification of cover types). Where trees are present, pine is usually a component of the canopy (hence, the qualifier “pine”). Longleaf pine, pond pine, and, occasionally, slash or loblolly pine are naturally associated with Wet Pine Flats, but pine composition in any given site reflects its wetness, the natural biogeographic distribution of the four pine species, and fire return interval (i.e., loblolly pine invades sites where fire frequency has been reduced (Garren 1943)).

Pine is almost always present in savannas that support trees. Pond pine (*Pinus serotina*) inhabits the wetter end of the wetness gradient in the Carolinas, while longleaf pine (*Pinus palustris*) inhabits the more mesic end. Slash pine (*P. elliotii*) sometimes shares the canopy with longleaf pine from southern South Carolina to coastal Alabama (Penfound and Watkins 1937). Loblolly pine (*Pinus taeda*) sometimes occurs in low abundance where switchcane (*Arundinaria tecta*) cover is high. All four pine species can tolerate ground fires by the time they reach 2-3 m (6-10 ft) in height, but longleaf is the only pine species whose seedlings are adapted to tolerate fire.

The subcanopy stratum is relatively sparse in Wet Pine Flats that burn regularly. Shrubs are also sparse and tend to be distributed in patches. Patches appear to be associated with two factors: (a) shrubs are found on small areas of slightly

higher topography scattered throughout many Wet Pine Flats and (b) many shrub species that grow in Wet Pine Flats can resprout from roots following fire. Species that produce root sprouts include several wax myrtle species (*Myrica cerifera*, *M. heterophylla*, and *M. indora*), evergreen hollies (*Ilex glabra*, *I. coriacea*), titi (*Cyrilla racemiflora*), black titi (*Cliftonia monophylla*), sweetbay (*Magnolia virginiana*), huckleberry (*Gaylussacia dumosa*), fetterbushes (*Lyonia lucida* and *L. mariana*), various species of St. John's wort (*Hypericum* spp.), and running oak (*Quercus pumila*). Numerous other shrub species inhabit savannas (Appendix D) and all of them displace herbaceous groundcover when fire becomes infrequent (Lewis and Harshbarger 1976).

Fire also prevents fire-intolerant pines and hardwood trees from invading Wet Pine Flats. When fire is excluded, trees invade wet savannas and shade out herbaceous groundcover species. Typical invaders include loblolly pine, slash pine, blackgum (*Nyssa biflora*), red maple (*Acer rubrum*), sweetgum (*Liquidambar styraciflua*), and the exotic Chinese tallow (*Sapium sebiferum*). Invasion of trees and shrubs into wet savannas in the wake of long-term fire exclusion may eventually lead to the accumulation of peat and less frequent fires. However, the buildup of fuel makes it more likely that catastrophic crown fires will occur during periods of drought.

The combined stress of fire and wetness has been responsible for the evolution of the extremely rich herbaceous flora for which Wet Pine Flats are best known (Wells 1928; Frost, Walker, and Peet 1986; Peet and Allard 1993). More than 40 herbaceous species per square meter have been recorded in some Wet Pine Flats; thus, small-scale species richness of the herbaceous groundcover in these communities ranks among the highest in the world (Walker and Peet 1983). However, not all Wet Pine Flats are naturally so rich in species at such a small scale; some Wet Pine Flats are overwhelmingly dominated by switchcane in the understory with few other species present there. Other Wet Pine Flats are dominated by sedges (Cyperaceae) in the herb stratum with a sparse overstory of pond cypress (*Taxodium ascendens*). Differences among these types are outlined in the following classification.

Bunchgrass/Pine Savanna. A Bunchgrass/Pine Savanna includes all mineral soil Wet Pine Flats that support, or once supported, native bunchgrass species, including toothache grass (*Ctenium aromaticum*), Muhly grass (*Muhlenbergii expansa*), northern wiregrass (*Aristida stricta*), southern wiregrass (*Aristida beyrichiana*), and several dropseed species (*Sporobolus* spp.). These species are called bunchgrasses because they grow in clumps and produce small tussocks 10-15 cm high. This apparently maintains their elevation at or above water level during periods of flooding. Wiry beakrush species (Cyperaceae: *Rhynchospora* spp.), which also grow in bunches, fill the ecological niche of bunchgrasses along the western Gulf coast.

All the bunchgrasses and wiry *Rhynchospora* spp. are highly flammable (pyrophytic) and resprout quickly following fire. As a consequence, these long-lived graminoids help maintain sparsely treed or treeless savannas by encouraging frequent, but "cool," ground fires. Frequent fires eliminate fire-intolerant competitors and prevent the invasion of hardwoods and ericaceous shrubs that

would otherwise shade out and eliminate bunchgrasses (Schwarz 1907; Christensen 1981; Platt, Evans, and Rathbun 1988; Stout and Marion 1993). In effect, savanna bunchgrasses influence the structure and function of the ecosystem (Christensen 1989).

Numerous showy forbs take advantage of the elevated habitat produced by bunchgrasses and wiry *Rhynchospora* spp, particularly species of asters (e.g., *Eupatorium* spp., *Carphephorus* spp., *Liatris* spp., *Erigeron vernus*, *Solidago* spp., *Coreopsis* spp. *Balduina* spp., *Marshallia* spp.), orchids (e.g., *Habenaria* spp., *Cleistes divaricata*, *Spiranthes* spp., *Calopogon* spp.), and lilies (*Aletris* spp., *Tolfieldia* spp., *Zigadensus* spp., *Pleea tenuifolia*). Other, more flood-tolerant species grow in the substrate between tussocks: pitcher plants (*Sarracenia* spp.), yellow-eyed grasses (*Xyris* spp.), club mosses (*Lycopodium* spp.), sundews (*Drosera* spp.), and pipeworts (*Eriocaulon* spp.).

Unaltered Bunchgrass/Pine Savannas support many rare plant species, some of which are threatened and endangered (Frost, Walker, and Peet 1986) in the Southeast, primarily because the rich array of herbaceous species characteristic of fire-maintained Wet Pine Flats are endemic to this ecosystem and intact systems are extremely rare today.

When trees are present in a Bunchgrass/Pine Savanna, it is sparsely populated by longleaf pine or both longleaf and pond pine in the Carolinas or by longleaf and slash pine from Georgia to Texas. At the transition from Bunchgrass/Pine Savanna to mesic upland, pines increase in density, and legume species are more prevalent (Peet and Allard 1983, Taggart 1994). In the Carolinas, hydrophytic bunchgrasses and forbs are displaced by northern wiregrass (*Aristida stricta*) toward the mesic end of the moisture gradient and rarely occur in Wet Pine Flats. In contrast, southern wiregrass (*A. beyrichiana*) is common in Wet Pine Flats along the Gulf coast.

Cypress/Pine Savanna. A Cypress/Pine Savanna occurs toward the wettest end of the hydrologic gradient of Wet Pine Flats. Usually, soils in Cypress/Pine Savannas have a fine-textured silt or clay subsoil that significantly impedes drainage. In this cover type, pond cypress shares a sparse canopy with pines. Longleaf pine is associated with cypress at the least wet end of the wetness gradient, near the transition to Bunchgrass/Pine Savanna. Either pond pine (on the Atlantic coast) or slash pine (on the Gulf coast) occurs with cypress toward the wetter end of the hydrologic gradient, toward its transition with wetlands of headwater streams.

The above transitional relationships also occur from Wet Pine Flats to the cypress-hardwood depressions scattered throughout wet flats, except that the transition is compressed. Soils in depressions also tend to be clayey, but, due to their geomorphology and lower elevation, depressions hold water longer than Cypress/Pine Savannas. Because depressions hold water for long periods, they support both cypress and a mixture of hydric hardwood species that are intolerant of fire as seedlings: red maple, blackgum, and sweetgum (however, older blackgum and sweetgum will often produce root sprouts following dieback from fire).

At the least wet end of the wetness gradient, the herbaceous stratum is usually dominated by the bunchgrass and forb species previously listed for Bunchgrass/Pine Savanna, while toward the wetter end, the herb stratum is primarily dominated by various sedge species, primarily *Carex* spp., *Scleria* spp., and non-wiry *Rhynchospora* spp. (esp., *R. carreyana*). Although small-scale species richness is low in sedge-dominated sites, Cypress/Pine Savannas can be quite rich at a larger scale (> 0.10 ha). Associated species often include *Coreopsis falcata*, *C. gladiata*, *Polygala cymosa*, *Eriocaulon* spp., *Rhexia virginica*, *R. aristosa*, *Iris virginica*, *I. tridentata*, *Aristida palustris*, *Lobelia boykinii*, *L. canbi*, and *Lycopodium* spp. (J. Glitzenstein, pers. comm.).

Switchcane/Pine Savanna. A Switchcane/Pine Savanna, as the name implies, supports a preponderance of switchcane (*Arundinaria tecta*) in the herb stratum. The following description is based on two intact sites located in Francis Marion National Forest, South Carolina. In both sites, longleaf pine dominated the canopy and switchcane dominated the understory. Many species indicative of intact Bunchgrass/Pine Savannas were rare or absent, even though the Switchcane/Pine Savannas appeared to burn regularly. It seems that switchcane was dense enough to have outcompeted savanna herbs typically associated with Bunchgrass/Pine Savannas. It is possible, however, that switchcane also displaces native bunchgrasses when fire is excluded for a long period or fire return intervals are lengthened.

Switchcane is tolerant of a wide range of conditions. It grows in upland flatwoods, on floodplains of headwater streams, and in some Wet Pine Flats. Perhaps switchcane displaces other savanna herbaceous plants in wet flats whose soils are richer in nutrients than those of Bunchgrass/Pine Savannas. This could provide one reason why the Switchcane/Pine Savanna is so rare: the most nutrient-rich soils have been converted to other uses (e.g., agriculture, silviculture). In addition, the naturally higher nutrient content in Switchcane/Pine Savannas may have enabled understory shrubs (*Lyonia* spp., *Ilex* spp., *Leucothoe* spp., etc.) to become so firmly established in fire-excluded sites that it is impossible to eradicate shrubs and restore such sites without intensive manipulation.

Although it is uncertain how extensive Switchcane/Pine Savannas may have been in the past, it is suspected that this subclass mainly occurred in the Carolinas, particularly eastern North Carolina. However, Switchcane/Pine Savannas may have once occurred in isolated pockets as far north as southeastern Virginia. This conjecture is based on the fact that most pyrophytic savanna forbs and native bunchgrasses reach their northern distributional limit south of the Neuse River (Radford, Ahles, and Bell 1968), while switchcane occurs northward into Virginia.

Two factors complicate reconstructing the historic northern distribution of Switchcane/Pine Savanna and the usefulness of this guidebook north of the Neuse River in North Carolina: (a) hydric hardwood forests and shrub peatlands (pocosins) cover most interfluvial wet flats north of the Neuse River and (b) exclusion of fire in places that might have carried fire historically (i.e., the Great Dismal Swamp) is so widespread that it is unlikely that natural, fire-maintained Wet Pine Flats now exist north of the Neuse River.

Effects of fire exclusion in Wet Pine Flats

Frequent fire prevents the accumulation of woody fuel in the shrub and subcanopy strata of Wet Pine Flats, thus perpetuating herbaceous savannas (Heyward 1939) and a rapid turnover of nutrients (Christensen 1981, 1993); less frequent fires (5- to 10-year interval) produce a shrubby understory and a more dense midstory (Lewis and Harshberger 1976, Waldrop, Walker, and Peet 1993). The exclusion of fire for long periods leads to a large increase in standing woody biomass (primarily shrubs and subcanopy stems) and a higher probability of a destructive crown fire (Waldrop, White, and Jones 1992), conditions that perpetuate a longer fire return interval and more intense fires (Christensen 1993).

Historically, lightning usually started ground fires in upland and wet savannas during summer months when convective thunderstorms are most prevalent (Komarek 1974, 1977). It appears that summer burns stimulate flowering and seed set in many savanna plants (Streng, Glitzenstein, and Platt 1991). However, today, most prescribed (managed) burns are set in winter, which fails to stimulate flowering of some savanna species, particularly the bunchgrasses. It is unclear what the long-term consequences will be with this management strategy. Further, in many areas where uplands are managed with prescribed burning, firebreaks are maintained along wetland boundaries, thus preventing fires from spreading from upland savannas to adjacent Wet Pine Flats.

Although much has been written about the effects of fire exclusion in upland savannas, little is known about successional trends in Wet Pine Flats following the exclusion of fire. From a limited number of studies in Texas (Streng and Harcombe 1982) and Florida (Veno 1976), it appears that fire exclusion in wet sites does not always lead to an invasion of trees; rather, shrub and subcanopy cover increases while herbaceous cover and species richness declines. However, degree of wetness, soil type, and nutrient status may affect the direction of succession in Wet Pine Flats following fire exclusion (pers. obs). At the wet end of the wetness gradient, in apparently more fertile soils and near borders of pocosins, many Wet Pine Flats begin to resemble pocosins in vegetative characteristics over time: pocosin shrubs invade, a histic epipedon forms, and plants indicative of Wet Pine Flats disappear (Kologiski 1977). Where soils are more clay-rich, various hydric hardwoods invade: sweetgum, blackgum, red maple, and swamp laurel oak (*Quercus laurifolia*). In contrast, Wet Pine Flats closer to the mesic end of the moisture gradient begin to superficially resemble upland pine flatwoods in vegetative composition (i.e., shrubs such as inkberry and sweet bay invade and become dense). More studies of controlled burning with attention paid to nutrient status and hydrologic regime could shed light on the range of structural and compositional changes that can occur over time after fire is excluded.

Hardwood and Successional Pine/Hardwood Wet Flats on Mineral Soils

On silty soils, fire exclusion does not appear to cause Wet Pine Flats to succeed to hardwood forests (Streng and Harcombe 1982), even though slash pine,

red maple, and sweet bay saplings often become more dense. However, it appears that on loamy and sandy loam soils (which tend to be more prevalent toward the northern end of the Reference Domain), fire-excluded Wet Pine Flats sometimes develop a mixed canopy of pine and hardwoods that superficially resembles seral Wet Hardwood Flats. However, there is a fundamental difference in the canopy composition between successional Wet Hardwood Flats and fire-excluded Wet Pine Flats: Wet Hardwood Flats support one to several oak species (*Quercus michauxii*, *Q. pagoda*, *Q. nigra*, and *Q. laurifolia*) while oaks are largely absent in former savannas.

Differences in vegetation are presumably due to differences in soil texture and the radically different fire frequencies under which the two communities have evolved (Harcombe et al. 1993). Because of greater water storage capacity and lower rates of infiltration, fine-textured soils of Wet Hardwood Flats remain saturated near the surface for long periods and are thus less likely to carry fire. As a Wet Hardwood Flat succeeds toward maturity, it becomes more humid as the forest floor becomes more shaded. Therefore, a combination of moist conditions over prolonged periods, a buildup of humus, and a humid subcanopy would have made hardwood flats resistant to fire, particularly the frequent low-temperature ground fires characteristic of wet pine savannas. In contrast, soils in Wet Pine Flats tend to be coarser in texture and, as a result, usually dry out in summer. Therefore, the longer a Wet Pine Flat goes without burning, the more fuel it accumulates, the more susceptible it becomes to burning, and the more likely it will carry a catastrophic crown fire when fire inevitably occurs.

Except in four areas (see following paragraph), Wet Hardwood Flats may have always been rare within the Reference Domain of Wet Pine Flats. Historically, the only places locally immune to frequent fire in the Southeast were those naturally isolated from fire by open water, pocosins, drainages (stream bottom swamps), and very poorly drained, clay-rich soils. (However, even pocosins naturally burn once every 15-30 years.)

In the southeastern coastal plain, there are four large areas where natural fire would have been infrequent on hydric mineral soil: (a) the outer coastal plain from Delaware (pers. obs.) to the Neuse River in North Carolina (Cazier 1992, Rheinhardt and Rheinhardt 2000), (b) the Big Bend area of northwestern peninsular Florida (pers. obs), (c) the loessial belt along both sides of the lower Mississippi River beyond the Mississippi valley alluvium (pers. obs.), and (d) the Big Thicket area of east Texas (Marks and Harcombe 1981, Harcombe et al. 1993). In all four areas, extensive flats occur on very poorly drained clay-rich mineral soils which were probably too wet to carry frequent fire. Hardwoods are favored on these fine-textured soils, and, although few Wet Hardwood Flats are intact today, those remaining provide information on their historic composition.

In most of the rest of the Reference Domain, hydric hardwoods are primarily restricted wetlands associated with headwater areas, those both with channels and without discernible channels). It appears that fire occasionally burns through hardwoods in headwater areas, though at a much lower frequency than in adjacent pine savannas. In light of similarities in canopy composition and

geomorphic position, hardwood forests in headwater reaches without channels should be more aptly classified within riverine headwater systems than with flats.

4 Wetland Functions and Assessment Models

The structure and sustained functioning of unaltered mineral soil Wet Pine Flats depend upon three conditions: seasonally saturated soil conditions, frequent fire, and unaltered soils. Hydrologic regime and fire drive ecosystem processes in Wet Pine Flats and provide the environmental conditions under which specialized assemblages of plants and animals have evolved. In addition, many of the plants normally associated with Wet Pine Flats are sensitive to soil alterations, even when hydrology and fire regime have not been altered. With these requirements in mind, four functions are recognized for this subclass:

- a. **Maintain Characteristic Water Level Regime.** Conditions in a Wet Pine Flat that affect fluctuations in water level, including variations in depth, duration, frequency, and season of flooding.
- b. **Maintain Characteristic Plant Community.** The ability of a Wet Pine Flat to maintain plant communities characteristic of unaltered, fire-maintained Wet Pine Flats.
- c. **Maintain Characteristic Animal Community.** Conditions within a site and its surrounding landscape that together provide all the resources required for maintaining the entire suite of animals characteristic of unaltered Wet Pine Flats.
- d. **Maintain Characteristic Biogeochemical Processes.** Conditions that are necessary for a Wet Pine Flat to maintain biogeochemical processes at the rate, magnitude, and timing characteristic for unaltered Wet Pine Flats, including nutrient and elemental cycling, biogeochemical transformations, and export of dissolved organic compounds.

The following sequence is used to present and document each function and assessment model:

- a. *Definition.* Defines the function and an independent quantitative measure that can be used to validate the assessment model.
- b. *Rationale for selecting function.* Presents the rationale for why the function was selected, including potential onsite and offsite effects of impacts.

- c. *Characteristics and processes that influence the function.* Describes the characteristics and processes of the wetland being assessed, factors in the surrounding landscape that influence the function, and lays the groundwork for selecting model variables.
- d. *Description of assessment variables.* Describes the model variables selected to represent the characteristics and processes that most influence the function in relation to functional capacity.
- e. *Functional Capacity Index.* Provides the aggregation equation for deriving the functional capacity index (FCI) and discusses how wetland ecosystem characteristics and processes, reflected in model variables, interact to influence the magnitude of the function.

Function 1: Maintain Characteristic Water Level Regime

Definition

This function reflects the capacity of a Wet Pine Flat to maintain variations in water level characteristic of the ecosystem, including variations in depth, duration, frequency, and season of flooding or ponding. The function models the effects that alterations to hydrologic regime have on fluctuations in water level. The model assumes that a Wet Pine Flat will maintain its characteristic water level fluctuations if it is not hydrologically modified. Water table monitoring (with wells) over long time periods would be required to independently characterize seasonal and inter-annual variations in water level in unaltered (reference standard) Wet Pine Flats.

To quantitatively determine the effects that alterations have on hydrologic regime on water level fluctuations and test the validity of the model, one would compare hydrographs from hydrologically altered sites with those derived from reference standard sites. Each submodel and variable used in the function would have to be tested independently (i.e., each alteration would have to be tested with none of the other hydrologic factors being altered). In doing so, one would have to control for natural variations in soil drainage characteristics and regional climatic differences.

Since the hydrologic function affects the other functions identified in the Regional Guidebook, it would also be worthwhile to determine how specific alterations to hydrologic regime affect the other functions as well. For example, one could determine how drainage affects the plant composition of Bunchgrass/Pine Savannas by comparing plant community composition (and/or indicator scores) relative to distance from a drainage ditch. In so doing, one would have to account for variations in ditch depth, soil type, climate, and time since alteration.

Rationale for selecting the function

Hydrologic regime is one of the main factors controlling ecosystem functions in wetlands, including those of Wet Pine Flats. The timing, duration, and depth of fluctuations in water level affect biogeochemical processes and plant distribution patterns. Flats differ from other wetland types in that fluctuations in water level are primarily vertical, driven by a balance between precipitation and ET. Alterations to the input, export, or storage of water all change the pattern of spatial and temporal variations in hydrodynamics, which in turn affect biogeochemical and habitat functions. These alterations include impounding water, surface and subsurface drainage (ditching), fill or excavation of soil, transport of water into a site from another catchment, and changes in potential ET, microtopography, and soil porosity.

Characteristics and processes that influence the function

Precipitation is by far the major source of water into Wet Pine Flats; groundwater discharge to these systems is minimal. ET is the major export pathway, but the slow export of water downgradient (via surface and subsurface flow) is another pathway. Detailed data on hydrologic regimes in Wet Pine Flats are sparse, but the limited data show that subsurface hydraulic conductivity is extremely low (10-12 cm/day) (Riekerk 1992). Surface flow rates are generally higher than groundwater rates but are still relatively slow (20-80 cm/hr), primarily due to low topographic gradients (Carlisle et al. 1981). In addition, hydraulic gradients of groundwater may sometimes flow counter to surface topographic gradients in the vicinity of depressions, a response to differences in transpiration rates in adjacent areas (Crownover et al. 1995).

Although downgradient flows are slow, Wet Pine Flats tend to be extensive and so export large quantities of water downgradient (Wolaver and Williams 1986, Williams et al. 1992). Because Wet Pine Flats are low gradient, and thus not hydrodynamically energetic, most alterations to hydrologic regime (with the exception of artificial drainage) are very localized in their effect on biogeochemical processes and habitat quality. For example, a dam (even a low one such as a road fill) can impede surface flow and back water up over a large area, thus inundating the area upgradient from the dam for a longer-than-normal period. Input of excess water from offsite can likewise increase the duration and depth of water levels. On a more local scale, fill and excavations of soil alter flooding depth and duration in the footprint of the fill or excavation. An increase in leaf area index (LAI) due to fire exclusion or a decrease due to mechanical clearing alters the rate that water is lost to the atmosphere via ET. These alterations to water balance change the duration and timing of flooding and the saturation of soil in the upper horizons. In contrast, artificial drainage also affects conditions offsite in that water conveyance structures (ditches and tile drains) transport water, nutrients, and dissolved organic matter to streams at a higher rate of outflow than would occur in the absence of drainage, thus altering the hydrologic regime of streams downgradient and contributing additional nutrients to them.

Water level fluctuations can be quantified with data obtained from monitoring wells over time. However, the collection of monitoring well data is time consuming and expensive and therefore not practical for rapidly assessing functions. The approach taken here was to model alterations to the hydrologic regime and to evaluate the effects of hydrologic alterations (where possible) on other field indicators. The assumption taken is that if there has been no alteration to the hydrologic regime of a Wet Pine Flat, then it will maintain its hydrologic regime, and that regime will be within the natural range of variability characteristic for unaltered Wet Pine Flats. In other words, this function models alterations to hydrologic regime.

To calibrate a model variable designed to indicate degree of alteration, it is necessary to isolate the effect that a single alteration has on the function. Unfortunately, it was difficult, and for some variables not possible, to locate reference sites wherein only one selected hydrologic parameter had been altered. Fortunately, water table behavior can be calibrated from hydrodynamic principles derived from research on the effects of alterations in a variety of soil types. Hydrologic monitoring should be undertaken to better calibrate the indirect indicators (model variables) used here to model alterations to water level regime.

Description of model variables

Indicators of hydrologic alterations are used both to determine the FCI and to divide a Wetland Assessment Area (WAA) into partial WAAs. In most cases, once a WAA has been defined by a given type of hydrologic alteration, only the hydrologic field indicator specific to that alteration is relevant to the function (i.e., all other field indicators are usually trivial in their effect). Thus, hydrologic field indicators both guide one in determining boundaries of WAAs (see Defining the WAA in Chapter 5) and provide variables for the hydrologic submodels that determine FCIs.

Surface Flow of Water ($V_{SURFFLOW}$). This variable represents the surface flow of water across a wet flat. Any obstruction placed perpendicular to the gradient of a wet flat will alter the water level regime of a Wet Pine Flat by impeding the flow of surface water through it. An impediment to flow (dam) causes water to flood more deeply, more frequently, and for a longer period on the upgradient side of the dam than it would have, had a dam not been in place. In contrast, a water deficit (relative to the undammed condition) occurs on the downgradient side of a dam (i.e., water generally floods less deeply, less frequently, and for a shorter duration). Therefore, a dam increases surface water storage upgradient and decreases surface water storage downgradient.

Dams caused by roads are not usually very high (0.5 m or less), but because gradients are so low in flats, even a low dam can create a relatively large reservoir upgradient and a reservoir shadow downgradient. For example, if a given wet flat has a slope of 0.2 percent and a dam crossing it is 0.5 m high at its lowest point, the area impacted by the dam will extend 250 m in both the upgradient and downgradient directions (distance determined by dividing dam height by slope of flat) (Figure 3a). Because water levels in Wet Pine Flats are primarily

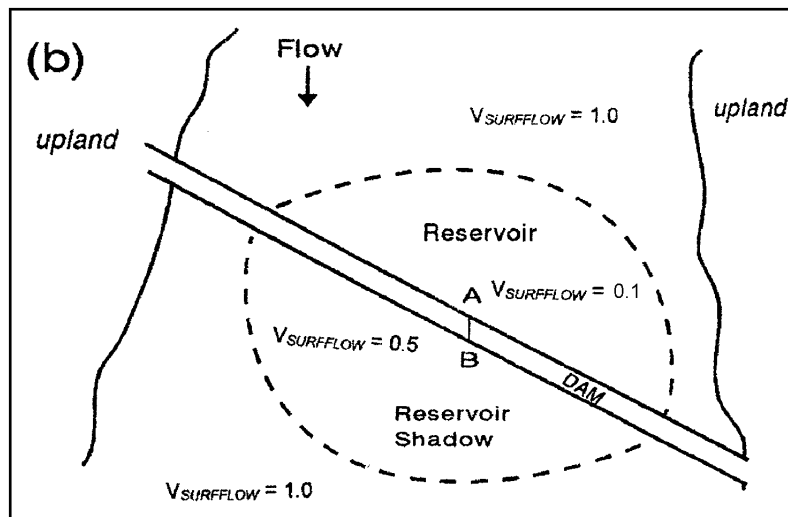
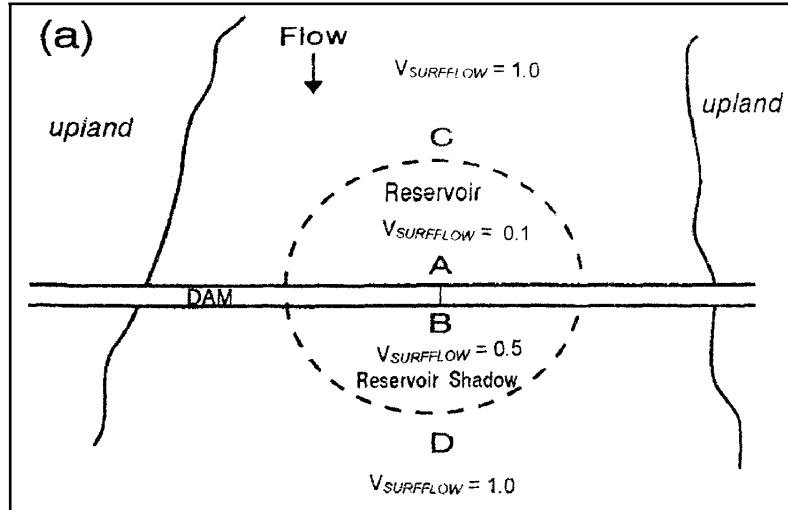

Figure 3. Alteration to hydrologic regime caused by an impediment to surface flow ($V_{SURFFLOW}$). (a) For dams that cross a flat perpendicular to the direction of flow, the elevation of the overflow point (A) is the same as that of the reservoir boundary (area within dotted line below C). The distance from A to C equals the distance from the outlet point (B) to the boundary of the reservoir shadow (area within dotted line above D). Assuming a constant gradient, if the gradient of the wet flat is 0.002 (0.2%) and the overflow point on the dam is 0.5 m high, then the distance from A to C and B to D is 250 m ($0.5/0.002$). Note: footprint of dam is treated as a fill (see $V_{STORAGE}$). (b) Dam crossing a wet flat at angle that is not perpendicular to flow. The area upslope is determined by circumscribing a boundary of elevation equal to that of the outlet point, but its precise shape is unknown. The reservoir shadow is assumed to be the same size as the reservoir. The sub-index for $V_{SURFFLOW}$ is 0.1 in the reservoir and 0.5 in the reservoir shadow in both examples.

controlled by a balance between precipitation and ET, a reservoir may only fill with water completely when precipitation exceeds ET for extended periods or when a major precipitation event occurs.

Roads are the most common type of impediment constructed across Wet Pine Flats. Most roadbeds are constructed using material excavated along one or both sides of a road's route, thus creating adjacent ditches. Usually, enough material is excavated to ensure that the road will be above the normal flooding height. However, roadside ditches are sometimes designed so that they will also drain water away from the road and the Wet Pine Flat through which it traverses. For situations in which a ditch adjacent to a dam drains a Wet Pine Flat, the effect of the ditch supersedes the effect of the dam (see $V_{OUTFLOW}$ and Chapter 5 on defining WAA boundaries).

To determine the area over which a given dam alters hydrologic regime, one must know the height of the dam and the gradient (slope) of the flat over which the dam crosses. Gradients are extremely low in Wet Pine Flats (in reference sites, mean gradient was 0.0018) and so a laser level or equivalent surveying equipment would be required to obtain accurate measurements of gradients. Since access to a laser level or surveying equipment may not always be possible, two methods for determining area altered by a dam are provided: one method requires a laser level or surveying station and the other requires a hand level, a stadia rod, and information from reference data.

Method 1. Determine the lowest point on the dam (overflow point). The lowest point could be located on the upper surface of the dam (if no culvert is present) or at the base of the lowest culvert under the dam. If culverts are present and their base elevations (overflow points) are at or below ground level, then there is no obstruction of surface flow. However, if the overflow point is above ground level, use a laser level or surveying station to locate a point or points upgradient from the dam that are at the same elevation as the overflow elevation.

All points upgradient from the dam that are at the same elevation as the overflow point are used to map the reservoir boundary (the perimeter of the area altered on the upgradient side of the dam). If the obstruction lies perpendicular or nearly perpendicular to the gradient, the dam is low, and the gradient is uniform across the entire flat, the reservoir boundary will usually circumscribe a 180-degree arc centered on the overflow point (Figure 3a). However, if the upgradient surface or slope is irregular, the shape of the reservoir will be irregular as well.

If the obstruction is not perpendicular to the direction of flow, the area upslope can be determined by circumscribing a boundary of elevation equal to that of the outlet point. Its precise shape is unknown, but may be in the shape of ellipsoid with the focus at the overflow point (Figure 3b). If areas of slightly higher elevation border the flat near the dam, then a survey of elevations equal to that of the outlet point is required. The reservoir shadow can be assumed to be the same size as the reservoir. The area altered on the downgradient side of the dam (reservoir shadow) should be assumed to be a mirror image of the area altered on the upgradient side. High dams may form a dendritically shaped reservoir, the boundary of which will follow the contour of the outlet elevation.

Method 2. Because a hand-level is used with this method, this method can only be used for low elevation dams where the reservoir is expected to be small. It assumes a gradient of 0.2 percent (0.002), which was derived from the mean gradient of reference sites. To determine dam height, place the hand-level at a selected height (on a pole or tripod) above the overflow point and sight a level line toward a plumb stadia rod directly upgradient from the dam. The stadia rod should be placed as closely as possible to the dam, but on unaltered topography (i.e., not in an adjacent ditch if one is present or atop a hummock). Subtract the elevation of the hand-level (pole or tripod height) from the elevation read on the stadia rod; this difference is the height of the dam. If the dam is perpendicular to the gradient, calculate the radius of the 180-degree arc that defines the upgradient (reservoir) and downgradient (reservoir shadow) by dividing dam height by 0.002. For example, a 0.5-m-high dam would be expected to alter a circular area with a radius of 250 m ($0.5 \text{ m}/0.002$), half of which is located upgradient and half downgradient from the dam. Each area (partial WAA) would cover $[(\pi * r^2)/2] = 9.82 \text{ ha}$ (24.3 acres).

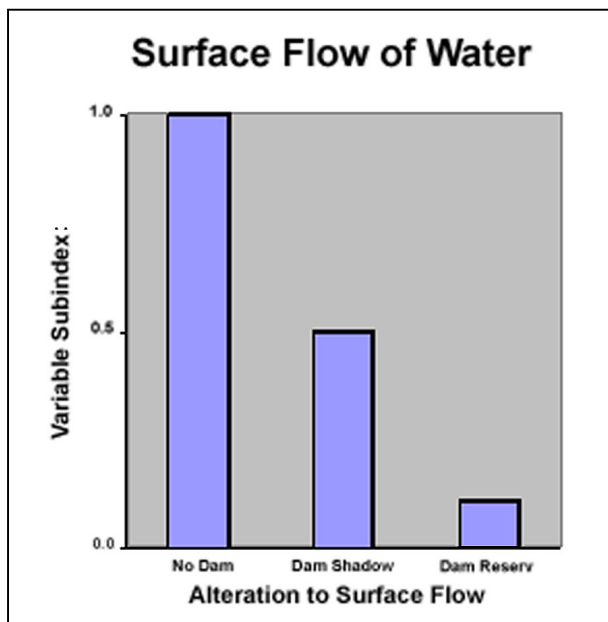

Figure 4. Relationship between surface flow of water and functional capacity

To calculate the subindex for $V_{SURFFLOW}$, assume that the entire area within a dam's reservoir is completely altered hydrologically by the dam (i.e., $V_{SURFFLOW} = 0.1$). Likewise, assume that hydrology in the reservoir shadow is partially altered (i.e., $V_{SURFFLOW} = 0.5$). All area outside the reservoir and reservoir shadow are completely unaltered by the dam (i.e., $V_{SURFFLOW} = 1.0$). A graphical illustration of the relationship between the variable subindex and functional capacity is provided in Figure 4.

Outflow ($V_{OUTFLOW}$). This variable represents the flow of water in the downgradient direction. The rate of downgradient flow is altered by drainage conveyance structures such as ditches and tile drains. Drainage conveyances alter water level regime in wet flats by more rapidly exporting subsurface water located in the vicinity of a drainage feature. Soil in a Wet Pine Flat adjacent to a drainage feature is saturated for a shorter duration and less frequently than it would have been had the drainage feature not been present. The lateral distance over which the hydrologic regime is altered is related to the depth of the drainage feature, the saturated hydraulic conductivity of the soil through which water is being drained, and the drainable porosity of the soil. Fine-textured, clayey soils impede groundwater flow more than porous loamy or sandy soils; thus, fine-textured soils naturally drain more slowly than coarse-textured soils. Likewise, deep drainage features drain over greater lateral distances than shallow drainage features.

The lateral effect of drainage features can be determined by matching soil series with the effective depth of the drainage feature (see Chapter 5 on bounding the WAA). The lateral distance over which a given drainage feature will drain a given soil type was derived using the van Schilfgaarde equation (Appendix C). This algorithm was developed to determine the optimum depth and spacing of ditches for draining agricultural fields. The equation uses the depth of a drainage feature and information on soil permeability and porosity, and then integrates these data over time to estimate the distance over which a given drainage conveyance will remove water (its lateral drainage distance) over a given period of time (Figure 5).

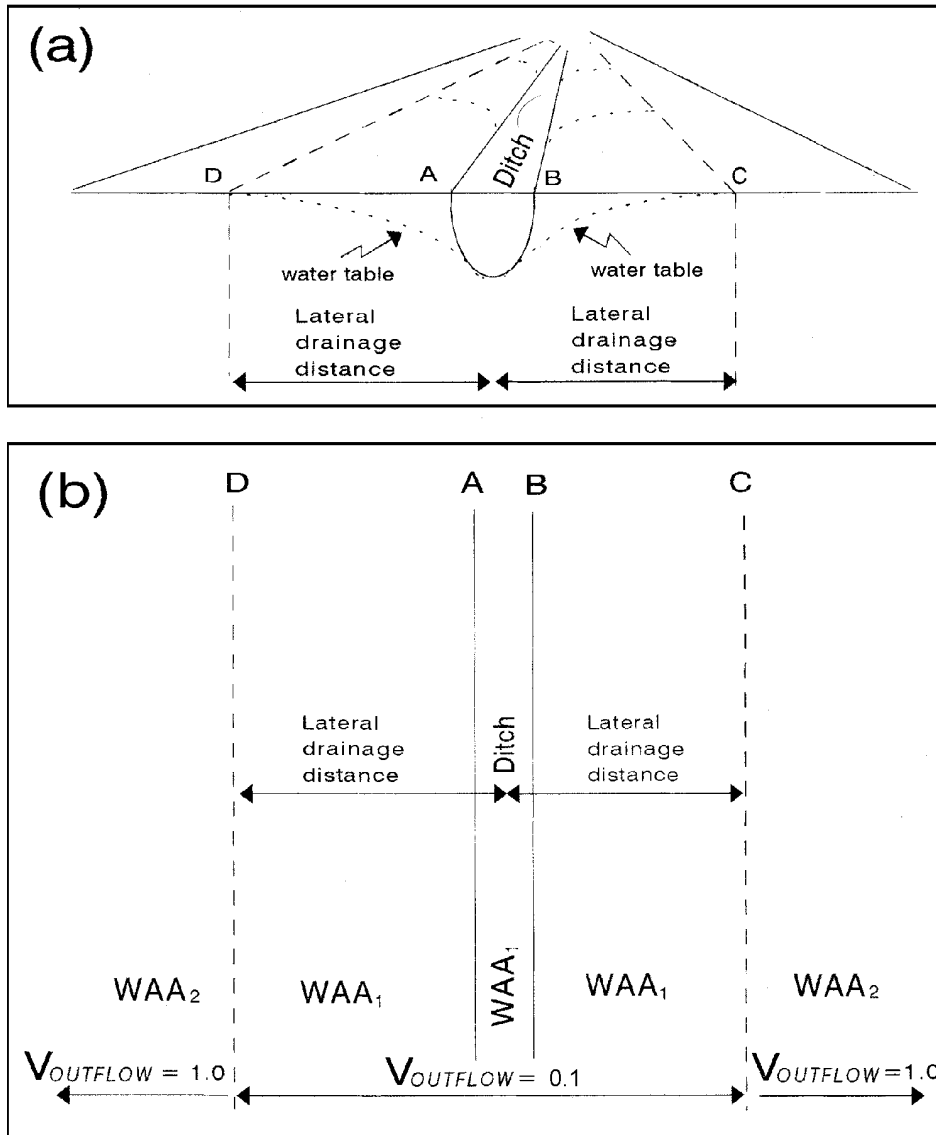

Figure 5. Lateral drainage effect of ditches on subsurface water storage. (a) Dashed line shows extent of altered water table (lateral distance) on both sides of ditch: from A to D and from B to C. (b) Plan view. Wetland Assessment Area (WAA) should be split into two partial WAAs (WAA₁ and WAA₂) based on lateral effect of drainage from ditch

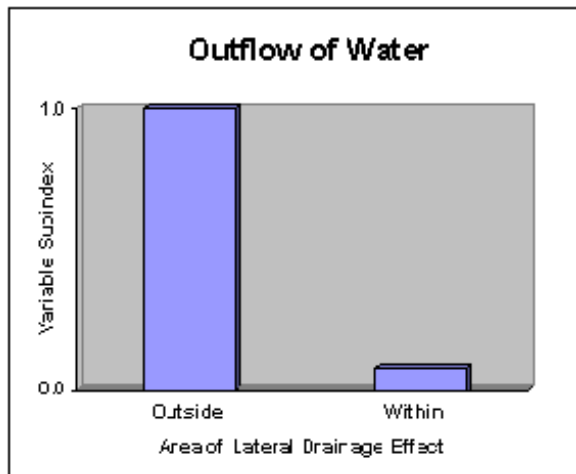

Figure 6. Relationship between artificial drainage and functional capacity

The van Schilfhaarde equation was used to determine lateral drainage distance based on saturated soil conditions for 5 percent of the growing season in coastal South Carolina (for the derivation, see Appendix C). It was assumed that the hydrologic regime of any area that falls within the effective lateral distance of drainage will be completely altered (i.e., the subindex for $V_{OUTFLOW} = 0.1$). A graphical illustration of the relationship between the variable subindex and functional capacity is provided in Figure 6.

Any WAA within the lateral drainage distance should be treated as a partial WAA (see Defining WAAs in Chapter 5). In preproject assessments, this area may have already been designated as upland and excluded from the delineated wetland to be assessed. However, the lateral drainage area would be assessed when estimating the potential gain in functions that could be achieved by restoring a ditched area or in assessing the loss in functions caused by ditching that was not permitted.

Any part of the WAA outside (beyond) the area of lateral drainage effect would not be altered by drainage (i.e., $V_{OUTFLOW} = 1.0$) and should be treated as another partial WAA. In assessing this variable, care should be taken to determine if a ditch or other drainage feature is effective in draining a portion of the WAA. To be effective in draining, a conveyance structure must be capable of transporting water away from the WAA (note, sometimes a ditch is created to provide fill material for an adjacent road but does not export water from a site). If the drainage feature does not drain any portion of a WAA, the ditch should be treated as an excavation (see $V_{STORAGE}$) and the $V_{OUTFLOW}$ variable is not applicable (i.e., the subindex for $V_{OUTFLOW} = 1.0$). Sometimes, a ditch transports water into a wet flat from elsewhere, thus increasing the flow of water into or through the flat (see V_{INFLOW}).

The variable $V_{OUTFLOW}$ was calibrated using a database on soil drainage characteristics of soil types identified in reference sites and other soils in which Wet Pine Flats are likely to be associated (see Appendix C); it was not calibrated with onsite hydrologic data. Further calibration and refinement of this variable should be derived from studies with monitoring wells in Wet Pine Flats.

Surface Water Storage ($V_{STORAGE}$). This variable represents material placed on or excavated from a Wet Pine Flat. Removal or addition of material alters water storage capacity, which in turn alters water level regime at the location of the fill material or excavation. Placing material (soil, debris, etc.) on a Wet Pine Flat alters water level regime by reducing the capacity of the flat to store surface water, while excavating material reduces the capacity to store water in subsurface pore spaces. Roads are the main type of fill material placed in Wet Pine Flats,

while ditches are the most common excavation. Usually, ditches on one or both sides of a road are excavations from which the road is constructed. If the ditches are not designed to drain water from a WAA and culverts allow water to flow unimpeded under the road, then both the road and ditches are together used to demarcate a partial WAA (Figure 7c) wherein the subindex for $V_{STORAGE} = 0.1$.

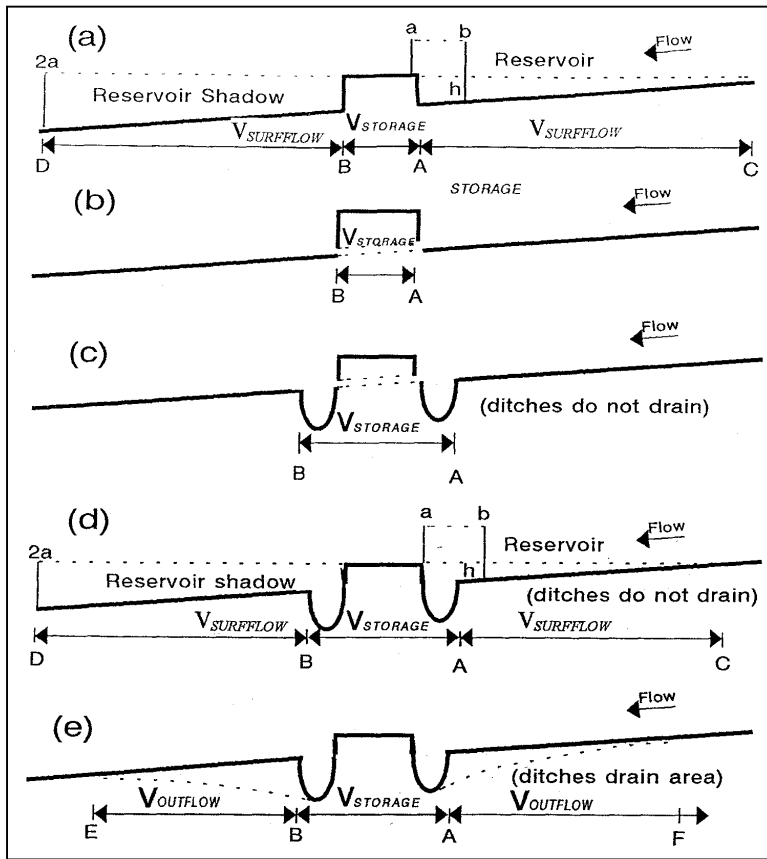

Figure 7. Interactive effects of several types of alterations to hydrology associated with a dam and ditch. See Fig. 3 for plan view. (a) Site with a dam (road), but no ditch. Height of dam (h) = b minus a , where b = distance from ground to hand level and a = top of dam to hand level. Hydrologic alteration by $V_{SURFFLOW}$ occurs from A to C (reservoir) and from B to D (reservoir shadow). Hydrologic alteration of fill ($V_{STORAGE}$) is determined by footprint of dam (from A to B). (b) Site with a road culvert under road, no ditches. Only $V_{STORAGE}$ is applicable between A and B . (c) Site with a road, ditches alongside road, and culverts under road, but ditches do not drain site. Hydrologic alteration is restricted to footprint of road and ditches ($V_{STORAGE}$) from A to B . (d) Site with a road, ditches that do not drain site and no culverts under road. Hydrologic alteration occurs in reservoir and reservoir shadow ($V_{SURFFLOW}$) from A to C and from B to D ; alteration due to footprint of road and ditches ($V_{STORAGE}$) occurs from A to B . (e) Site with a road and ditches that drain the site. Hydrologic alteration is due to drainage effect of ditches ($V_{OUTFLOW}$) occurs from B to E and from A to F ; alteration due to footprint of road ($V_{STORAGE}$) occurs from A to B .

However, sometimes a road (or other addition of material) across a Wet Pine Flat also impedes (dams) surface water flow (i.e., there are no culverts under the road). In this case, at least three partial WAAs would have to be determined: one for the road (and ditches if present) wherein the subindex for $V_{STORAGE} = 0.1$, one for the reservoir wherein the subindex for $V_{SURFFLOW} = 0.1$, and one for the reservoir shadow wherein the subindex for $V_{SURFFLOW} = 0.5$ (Figure 7d).

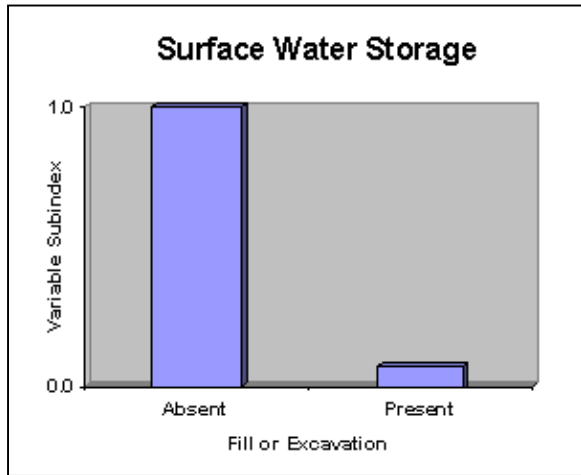

Figure 8. Relationship between surface water storage and functional capacity

Usually, ditches alongside roads are also designed to drain water. In such cases, at least two partial WAAs would have to be demarcated: one for the area where the road and ditch or ditches occur, wherein the subindex for $V_{STORAGE} = 0.1$, and one for the area drained by the ditch or ditches, wherein the subindex for $V_{OUTFLOW} = 0.1$ (Figure 7e). A graphical illustration of the relationship between the variable subindex and functional capacity is provided in Figure 8.

It was assumed that adding or removing material displaces surface area available for storage in the area displaced by the fill material or excavation. This assumption was made because flooding is usually shallow in wet flats (10-20 cm) and the addition of material is designed to bring the land surface above the usual depth of flooding (i.e., the height of fill material is nearly always greater than the maximum flooding depth). Therefore, alteration of surface storage capacity can be directly determined by area covered by fill material. Likewise, an excavation (e.g., borrow pit) reduces subsurface storage capacity (see soil porosity variable). (A ditch with no outlet is treated as an excavation, see $V_{STORAGE}$). Therefore, alteration of subsurface storage capacity can be directly determined by area of excavation. In preproject assessment, areas with fill are excluded from delineated wetlands and thus not subject to a functional assessment. However, the area would be assessed if it were being considered for potential restoration (by removing fill) or to determine loss in function if the fill were not permitted.

Since Wet Pine Flats are not completely flat (mean slope = 0.2 percent), it is not necessary to determine the proportion of the entire wet flat that has been covered or excavated to estimate an alteration in hydrologic regime (as would be necessary in a depressional system). That is, the effect of fill material or excavation is restricted to the footprint of the alteration in a flat. However, one must determine whether fill material is placed across the gradient of the wet flat, thus creating an impediment to surface water flow (see $V_{SURFFLOW}$).

One can use a tape measure or surveying equipment to estimate the area covered by fill material or removed by excavation. Alternatively, one could determine the area covered by fill material or area excavated from high-resolution aerial photos and then digitize the area or overlay a dot grid overlay.

Evapotranspiration Potential (V_{ET}). This variable represents the potential loss of water to the atmosphere via evaporation and plant transpiration. Groundwater input is negligible in Wet Pine Flats and any input from groundwater from slightly higher elevations is insignificant relative to input via precipitation. Rather, water level fluctuations are primarily controlled by the balance between precipitation and ET under the influence of local climatic conditions. Local climatic conditions are not under anthropogenic control, but both evaporation and transpiration rates can be anthropogenically altered by excluding fire or planting trees for silviculture.

The balance between evaporation and transpiration is controlled by seasonal climatic influences and vegetation cover. Removing vegetation reduces transpiration rates, thus allowing the water table to rise. (Ponding and evaporation occur during periods when the water table rises above ground.) Planting trees increases transpiration somewhat relative to the unaltered condition (i.e., sparsely canopied savanna).

Water is rapidly lost during the growing season in Wet Pine Flats via evaporation from standing (ponded) water and transpiration by vegetation from soil water. When there is no vegetation to transpire water to the atmosphere, the water table remains near the surface for longer than it would have naturally, had vegetation been left intact. Excluding fire or planting trees for silviculture increases leaf area index (LAI) and hence ET rates. However, in the southern portion of the Reference Domain (north Florida and along the Gulf coast), open-water evaporation may be greater than ET (Liu, Riekerk, and Gholz 1998), meaning that removal of vegetation can augment the rate of water loss during periods when the water level is above ground. Therefore, any alterations in Wet Pine Flats that affect vegetation cover, a primary determinant of ET rates, affect the timing, duration, and depth of flooding and soil saturation.

The most widely used estimate of transpiration potential is LAI, which is the ratio of leaf area per unit of ground area. Thus, LAI declines when vegetation is removed and increases when fire is excluded or trees are planted. Two approaches are available for determining V_{ET} subindex scores. The first approach requires knowing site history (i.e., types and timing of specific alterations that affect LAI); the second is based on the condition of vegetation, derived from estimated LAI values from all strata. However, if the WAA has burned within the prior 6 weeks, the assessment should either be conducted at least 6 weeks after the fire or assume that the subindex for $V_{ET} = 1.0$.

- a. *Site history known.* Site history can be provided by land managers or from anyone familiar with the site's management history. If the last fire (LF) was within the past 0-3 years, assign a subindex of 1.0 to V_{ET} . If the last fire occurred 3-10 years ago, $V_{ET} = (0.30 (10 - LF)/7) + 0.70$, where LF is the number of years since last fire. For sites in which fire has been excluded for 10 years or more, $V_{ET} = 0.70$. If a site is being periodically mowed to maintain a utility right-of-way (power line, gas line, etc.) or is periodically mowed for some other reason, treat mowing the same as a burn (i.e., $V_{ET} = (0.30 (10 - LM)/7) + 0.70$, where LM is the number of years since last mowing). A graphical illustration of the relationship

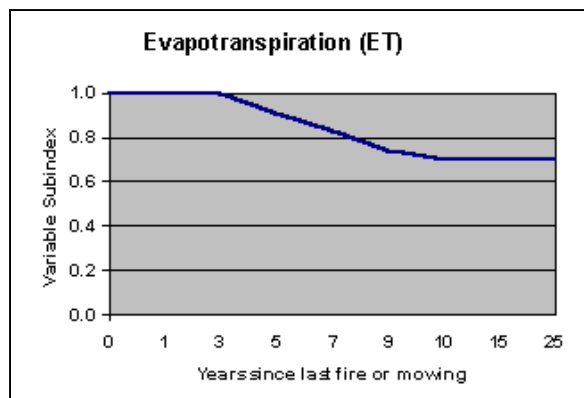

Figure 9. Relationship between fire/mowing and functional capacity

between the variable subindex and functional capacity is provided in Figure 9. The form of this equation was based on a combination of published data on ET rates in flats (Liu, Riekerk, and Gholz 1998) and measured LAI in Wet Pine Flats reference sites.

- b. *Site history is not known or if WAA has been planted with pines.* If the fire history is not known or the site has been planted with pines, then quantitative data are needed to determine V_{ET} . Conduct the following measurements at

each sample point in an imaginary 2-m-radius cylinder reaching skyward. In each cylinder, first partition vegetation by the following strata: (1) groundcover (herbaceous plants < 1 m tall), (2) low shrubs (woody plants < 1 m tall), (3) woody subcanopy (woody plants > 1 m tall, but < 7.5 cm dbh), (4) midcanopy (trees with stems 7.5-15 cm dbh), and (5) canopy (trees with stems > 15 cm dbh). Next, within the 2-m cylinder, determine the cover category (Table 4) that best represents the percent cover for each stratum listed above and assign the midpoint of each cover category to the stratum.

Table 4 Cover Classes and Midpoint Values for Each Class		
Cover Class %	Class Midpoint %	Cover Value
0	0.0	0.000
0-5	2.5	0.025
5-25	15.0	0.150
25-50	37.5	0.375
50	50.0	0.500
50-75	62.5	0.625
75-95	85.0	0.850
95-100	97.5	0.975
100	100.0	1.000
> 100	100.0	1.000

Note: These midpoint values are used to estimate cover in plots. First determine if cover is more, less, or equal to 50%. If cover is > 50%, decide if cover is more or less than 75%. If > 75%, decide if cover is more or less than 95%. If cover is < 95%, then cover is 75-95% with a midpoint of 85% (0.85).

Multiply the assigned constant LAI values for each stratum by the midpoint of the cover category for the stratum: 1 x groundcover, 2 x low shrub, 3 x

subcanopy, 4 x midcanopy, 5 x canopy. This provides a composite LAI value for each stratum in the plot. Sum the composite LAI scores across all strata to obtain a plot LAI score. Sum all plot LAI scores and divide by the number of plots sampled to obtain a mean site LAI score for the WAA. For an example, see Table 5. To derive an indicator for LAI for Bunchgrass/Pine Savanna, if the site LAI < 2.0, then $V_{ET} = 1.0$; if site LAI is between 2.0 and 3.0, then $V_{ET} = 1.0 - [0.3 (LAI - 2.0)]$, if site LAI > 3.0, then $V_{ET} = 0.7$. For Cypress/Pine and Switchcane/Pine Savannas, if site LAI < 3.5, then $V_{ET} = 1.0$, if site LAI is between 3.5 and 5.0, then $V_{ET} = 1.0 - [0.2 (LAI - 3.5)]$, if site LAI > 5.0, then $V_{ET} = 0.7$. A graphical illustration of the relationship between the variable subindex and functional capacity is provided in Figure 10 for Bunchgrass/Pine and Figure 11 for the other two cover types.

Inflow of Water from an Exogenous Basin (V_{INFLOW}). This variable represents the proportional increase in water table elevation caused by water transported into a WAA from other drainage basins. Water transported into a Wet Pine Flat can increase the volume of water the flat must transport downgradient, thus increasing the depth, duration, and timing of hydrologic fluctuations downgradient from the point at which water is imported. Some ditches along major roads or highways may bring water into Wet Pine Flats from adjacent drainage basins. Also, development near urbanizing areas can shunt surface runoff to wet flats if appropriate grading and storm runoff controls are not applied.

To estimate the amount of excess water entering a WAA, one must know the size of the drainage basin from which the excess water is being transported relative to the size of the natural drainage basin of the WAA. If part of the WAA is located upgradient from the point of water importation, the WAA must be partitioned into at least two separate WAAs, one above the water input point (where $V_{INFLOW} = 1.0$) and one below the input point.

Use aerial photographs and county drainage maps (where available) in conjunction with U.S. Geological Survey (USGS) topographic maps to establish the boundaries of the drainage basins (natural and exogenous basins). Air photos and county drainage maps could be used to determine the source of ditches or other artificial water transport structures; USGS maps are used to determine drainage basin boundaries (topographic boundaries). (Note: this may be difficult in Wet Pine Flats because elevation contours provided on USGS maps are not at the detail required for delineating drainage basins in flats.) Estimate (a) the size of the exogenous drainage basin from which excess water is being imported and (b) the size of the natural drainage basin at the point where excess water is being imported. The size of the exogenous drainage area could be obtained by subtracting the size of the natural drainage basin from the size of the total drainage basin at the point where water is being imported. In other words, $EB = TB - NB$, where EB is the exogenous drainage basin size, TB is the total drainage basin size, and NB is the natural drainage basin size. Either digitize the drainage basin areas or use a planimeter or dot grid overlay to determine areas.

Another possible way to measure the extent of alterations by water importation may be to determine marked changes in vegetation caused by excessive

Table 5
Example Worksheet Estimating Leaf Area Index (LAI)

Stratum ¹	Cover ¹ of living plants (2-m radius)									
	Plot 1			Plot 2			Plot 3			
	Cover ²	LAI	Composite LAI score ³	Cover ²	LAI	Composite LAI score ³	Cover ²	LAI	Composite LAI score ³	
Groundcover	0.625	1	0.63	0.850	1	0.85	0.975	1	0.95	
Low Shrub	0.150	2	0.30	0.025	2	0.05	0.025	2	0.00	
Subcanopy	0.025	3	0.08	0.375	3	1.13	0.150	3	0.02	
Midcanopy	0.025	4	0.10	0.025	4	0.10	0.150	4	0.02	
Canopy	0.150	5	0.75	0.025	5	0.13	0.150	5	0.02	
Total LAI score			1.85			2.25			1.02	
Mean LAI score (total/ number of plots)									1.71	
				Bunchgrass/Pine Savanna					14. V_{ET}⁴:	1.0
				Cypress/Pine and Switchcane/Pine Savanna					15. V_{ET}⁵:	1.0

¹ Living vegetation: Groundcover = herbaceous stratum); Low Shrub = woody plants < 1m tall, Subcanopy = woody plants > 1 m tall and < 7.5 cm dbh; Midcanopy = stems 7.5-15 cm dbh; Canopy= trees > 15 cm dbh.

² Record midpoint of cover classes: 0% (0), 0-5% (0.025), 5-25% (0.15), 25-50% (0.375), 50% (0.50), 50-75% (0.625), 75-95% (0.85), 95-100% (0.975), 100% (1.0).

³ Composite LAI = Cover x LAI

⁴ V_{ET} for Bunchgrass/Pine Savanna, if Site LAI < 2.0, then V_{ET} = 1.0, if the Site LAI is between 2.0 and 3.0, then V_{ET} = 1.0 - [0.3 (LAI - 2.0)], if Site LAI > 3.0, then V_{ET} = 0.7).

⁵ V_{ET} for Cypress/Pine and Switchcane/Pine Savannas, if Site LAI < 3.5, then V_{ET} = 1.0, if Site LAI is between 3.5 and 5.0, then V_{ET} = 1.0 - [0.2 (LAI - 3.5)], if Site LAI > 5.0, then V_{ET} = 0.7

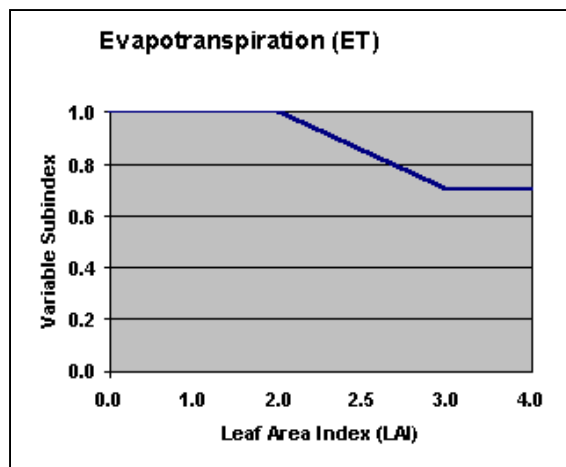

Figure 10. Relationship between LAI and functional capacity for Bunchgrass/Pine Savannas

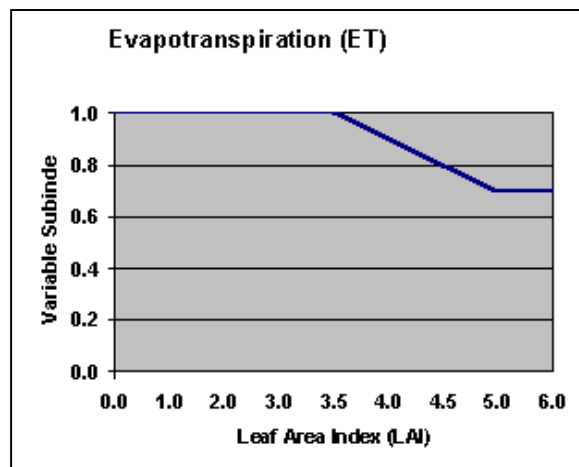

Figure 11. Relationship between LAI and functional capacity for Cypress/Pine and Switchcane/Pine Savannas

flooding. If an effect can be seen, delineate a partial WAA along the boundary where excess water has altered vegetation. Altered vegetation would include an abrupt change to more hydrophytic plants (e.g., bunchgrasses to sedges) or large areas of unvegetated ground resulting from flooding over long periods. However, near the outer edges of the reach of the alteration, one might not be able to find abrupt differences in vegetation patterns.

Calibration of this variable was not based on reference sites, because no reference sites could be located that had been altered by the importation of water from outside a natural drainage basin. (It is not certain that this alteration has ever occurred in a Wet Pine Flat, but there is a potential for it to occur.) In calibrating V_{INFLOW} , it was assumed (see equation below) that the importation of water has an additive negative effect on water level regime such that a doubling of water volume completely alters water level regime (i.e., $V_{INFLOW} = 0.0$ when water volume is doubled) and that less than twice the water input alters hydrology, but not completely. Further research is needed to determine the effect importation of water has on water level regime in Wet Pine Flats and how far downgradient from the water input point hydrologic effects should be expected to occur.

To determine the subindex for V_{INFLOW} , divide the size of the exogenous basin by the natural drainage basin (the exogenous basin is the total basin size minus the size of the natural drainage basin) and subtract from 1.0. For example, if the size of the WAA's natural drainage basin is 100 ha and the total size of the drainage basin is 125 ha, the size of the exogenous drainage basin is 25 ha (125 ha - 100 ha). Therefore, the subindex for V_{INFLOW} is derived from the ratio (in size) of the excess basin to the natural basin, where $V_{INFLOW} = 1.0 - (25/100) = 0.75$. If the drainage basin area from which excess water is imported is larger than the natural drainage basin (i.e., equation above provides a negative number), then assign 0.0 to V_{INFLOW}). A graphical illustration of the relationship between the variable subindex and functional capacity is provided in Figure 12.

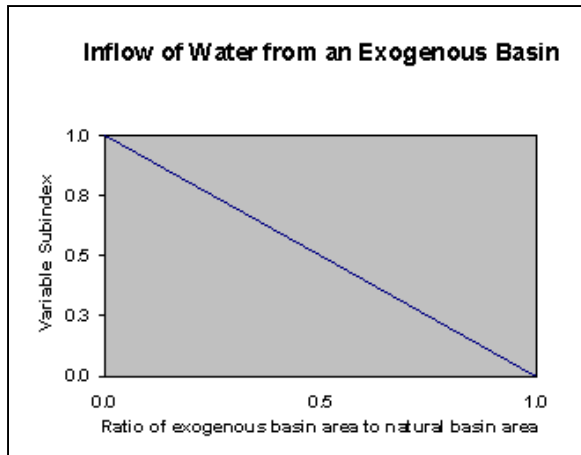

Figure 12. Relationship between inflow of water from an exogenous basin and functional capacity

Microtopographic Features

(V_{MICRO}). This field variable represents the integrity of natural microtopographic features in a wet flat. Microtopographic features are variations of 5-20 cm in elevation that occur over small spatial scales (25-200 cm^2). These small-scale features slow the flow of surface water, thus increasing surface storage capacity. Therefore, altering microtopography will alter the duration and depth of flooding in a Wet Pine Flat.

Natural microtopographic variation in Wet Pine Flats is primarily due to hummocks created by herbaceous vegetation, especially graminoid tussocks formed by native bunchgrasses.

These tussocks generally range between 5 and 20 cm in height. Variations in tussock height among sites may be due to natural differences among Wet Pine Flats in depth and duration of flooding, but no hydrologic data are available to test this hypothesis. Tip-up mounds and associated divots from wind-thrown trees show a wider range in elevation, but because trees are sparse in savannas, tip ups are extremely sparse and thus not important as topographic features affecting surface water storage.

Microtopographic variations have proven difficult to quantify in a way that provides useful indices for comparing deflection from the natural condition among sites. Therefore, the approach taken in this guidebook was to determine the relative degree to which natural topographic complexity has been altered, using data collected from reference sites as ranking criteria. Alterations common in Wet Pine Flats (firebreaks, rutting from off-road vehicle traffic, bedding for silviculture, etc.) produce microtopographic features that are both higher and lower in elevation than natural features. The microtopographic alteration value column in Table 6 ranks common microtopographic alterations by degree to which such alterations differ from unaltered conditions in Wet Pine Flats.

To obtain the subindex for V_{MICRO} , (a) identify the types of alterations to microtopography that occur in the WAA and (b) determine the proportion of the WAA altered by each type of alteration. The proportion of the WAA altered is determined by estimating the mean coverage of each type of microtopographic alteration in a series of plots. Coverages can be estimated in a number of rectangular or circular plots as long as at least three plots (150 m^2) are sampled. Cover can be estimated in the same 50- m^2 square plots from which subcanopy density (V_{SUBC}) is determined. To mark the boundaries of the 50- m^2 plot, measure 5 m from the center point outward in each of the four cardinal directions (N, S, E, W). Place a marker (pole or auger) in the ground at each 5-m mark. These markers will then be the corners of a square 7.07 m per side and 50 m^2 in area. The 5-m marks can be determined using a meter tape or a sonic distance measurer.

Table 6
Calculation of Microtopography Variable (V_{MICRO}) by Type of Alteration and Area

Type of alteration to microtopography	Cover 1 (midpoint) of 50-m ² plots			Mean Cover	Microtopo Alteration Value	Score (Mean cover X Value)
	Plot 1	Plot 2	Plot 3			
None, natural ² (unaltered)	0.175	0.000	0.850	0.34	1.0	0.34
Lightly grazed, rutted				0.00	0.8	0.00
Intensively grazed, rutted				0.00	0.6	0.00
Light artillery divots	0.675	0.850	0.150	0.56	0.4	0.22
Fire breaks or deep ruts (< 20 cm from rut to ridge)	0.150	0.150	0.000	0.10	0.3	0.03
Tilled cropland				0.00	0.3	0.00
Recent feral hog rooting				0.00	0.2	0.00
Bedded for silviculture				0.00	0.2	0.00
Ruts from off road vehicles (> 20 cm deep)				0.00	0.1	0.00
Gasline right of way				0.00	0.1	0.00
Impervious				0.00	0.0	0.00
SUM	1.000	1.000	1.000			
Total microtopographic alteration score (sum last column)					$V_{MICRO} =$	0.60

Note: At least three 50-m² plots (150 m²) should be sampled per WAA. This variable is only measured if the site is otherwise hydrologically unaltered.

¹ Record midpoint of cover classes (in parentheses): 0% (0), 0-5% (0.025), 5-25% (.015), 25-50% (0.375), 50% (0.50), 50-75% (0.625), 75-95% (0.85), 95-100% (0.975), 100% (1.0).

² First determine cover for all other categories (alterations), sum, and subtract sum from 1.0 to obtain area unaltered (row 1).

In each of the 50-m² sample plots, determine the cover category (Table 4) that best represents the proportion of the area covered by each type of microtopographic alteration in the plot and record the midpoint of the cover category by

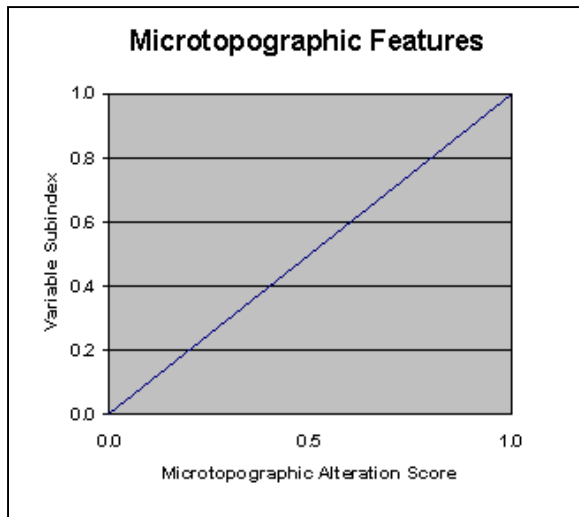

Figure 13. Relationship between microtopography and functional capacity

type of alteration. Insert the proportion of the plot altered, by type of alteration, into the appropriate rows in the microtopographic alteration worksheet (Table 6). Sum the midpoints and subtract the sum from 1.0 to determine the proportion of the plot that has not been altered (natural microtopography). Then sum the cover midpoint values across all plots and divide by the number of plots to find a mean cover for each category of alteration. Multiply each microtopographic alteration value (0.0 to 1.0) by its mean cover to obtain a score by category. Sum all scores (last column) to obtain the subindex for V_{MICRO} . A graphical illustration of the relationship between the variable subindex and functional capacity is provided in Figure 13.

Soil Porosity (V_{PORE}). This variable represents soil porosity, which controls the space available for subsurface storage of water. Alterations to soil porosity (estimated by changes in bulk density) occur when soil is compacted or tilled. Compaction decreases soil porosity (increases bulk density) and hence decreases subsurface water storage capacity. In contrast, some tilling practices may increase porosity.

The redistribution of water storage and movement as a result of compaction is contingent upon the rate and amount of rainfall. For example, reduction in soil storage capacity increases surface storage (ponding) and evaporation rates when the water surface is exposed. An increase in soil storage capacity decreases surface storage and may temporarily increase rates of infiltration. Therefore, alteration to soil water storage capacity alters the depth, duration, and timing of water level fluctuations both above and below ground.

Unaltered soils on which Wet Pine Flats occur naturally vary in porosity: fine-textured soils are less porous than coarse-textured soils and so naturally possess a lower capacity to store water. Alterations also vary in the magnitude at which they alter bulk density (see Table D4). One could argue that a given type of alteration might be more or less destructive to a fine-textured soil than a more coarse-textured soil. However, no studies have been conducted to confirm the hydrologic implications of these two extremes. Therefore, the assumption made here is that an alteration to a given type of soil changes subsurface water storage capacity by increasing or decreasing porosity and bulk density beyond the range normally exhibited by unaltered soils of the same type.

Alterations that commonly occur to soils in Wet Pine Flats were ranked by comparing the absolute difference in bulk density between altered and unaltered soils from the limited number of soil types and types of alteration that occurred in the reference set (Table D5, Appendix D). (Note: no bulk density data were obtained from either the “impervious” or the “tilled cropland” categories.) Further research is needed to compare soil bulk density for various combinations of soil type and types of alterations that typically occur to soils in Wet Pine Flats.

The subindex for V_{PORE} in a WAA is determined by the type of soil alteration and the area over which each alteration occurs without regard to soil type. The soil alteration value column in Table 7 provides a value for each type of soil alteration to reflect the degree to which the alteration affects soil bulk density, ranging from no alteration (soil alteration value = 1.0) to soil altered by conversion to an impervious surface (soil alteration value = 0.0).

To obtain the subindex for V_{PORE} , (a) identify the types of soil alterations that occur in the WAA and (b) determine the proportion of the WAA altered by each type of soil alteration. The proportion of the WAA altered is determined by estimating the mean coverage of each type of soil alteration in a series of plots. Coverages can be estimated in a number of rectangular or circular plots as long as a minimum of 150 m² is examined. Cover can be estimated in the same three 50-m² square plots from which V_{SUBC} (subcanopy density) is determined. To mark the boundaries of the 50-m² plot, measure 5 m from the center point outward in each of the four cardinal directions (N,S,E,W). Place a marker (pole or auger) in the ground at each 5-m mark. These markers will then be the corners of a square 7.07 m per side and 50 m² in area. The 5-m marks can be determined using a meter tape or a sonic distance measurer.

In each of the 50-m² sample plots, determine the cover category (Table 4) that best represents the proportion of the area covered by each type of soil alteration in the plot and record the midpoint of the cover category by type of alteration. Insert the proportion of the plot altered, by type of alteration, into the appropriate rows in the soil alteration worksheet (Table 7). Sum the midpoints and subtract the sum from 1.0 to determine the proportion of the plot that has not been altered (natural soil). Insert this cover value in row one. Then sum the cover midpoint values across all plots and divide by the number of plots to find a mean cover for each category of alteration. Multiply each soil alteration value (0.0 to 1.0) by its mean cover to obtain a score by category. Sum all scores (last column) to obtain the subindex for V_{PORE} . A graphical illustration of the relationship between the variable subindex and functional capacity is provided in Figure 14.

Functional Capacity Index

Most of the parameters used to model the function Maintain Characteristic Water Level Regime are processes controlled by physical conditions. This means that the impact of many of the hydrologic alterations supersede impacts caused by other types of hydrologic alterations. For example, a road crossing a Wet Pine Flat increases the duration and depth of flooding on the upgradient side of a road, but an adjacent ditch that drains water from the site would negate any effect that

Table 7
Calculation of Soil Porosity Variable (V_{PORE}) by Type of Alteration and Area

Type of alteration to soil porosity	Cover ¹ (midpoint) of 50-m ² plots			Mean Cover	Soil Alteration Value	Score (Mean cover x Value)	
	Plot 1	Plot 2	Plot 3				
None, natural ² (unaltered)	0.475	0.700	0.475	0.55	1.0	0.55	
Recent feral hog rooting				0.00	0.9	0.00	
Ruts from off road vehicles (< 20 cm deep)	0.150	0.150	0.375	0.23	0.6	0.14	
Fire breaks or deep ruts (> 20 cm from rut to ridge)	0.375	0.150	0.150	0.23	0.4	0.09	
Bedding for silviculture				0.00	0.4	0.00	
Light artillery				0.00	0.3	0.00	
Compacted by grazing cattle				0.00	0.2	0.00	
Graded or excavated for pipeline				0.00	0.1	0.00	
Tilled cropland				0.00	0.1	0.00	
Impervious				0.00	0.0	0.00	
SUM	1.000	1.000	1.000				
Total soil alteration score (sum last column)						$V_{PORE} =$	0.78

Note: At least three 50-m² plots (150 m²) should be sampled per WAA. This variable is only measured if the site is otherwise hydrologically unaltered.

¹ Record midpoint of cover classes (in parentheses): 0% (0), 0-5% (0.025), 5-25% (0.15), 25-50% (0.375), 50% (0.50), 50-75% (0.625), 75-95% (0.85), 95-100% (0.975), 100% (1.0).

² First determine cover for all other categories (alterations), sum, and subtract sum from 1.0 to obtain area unaltered category (row 1).

the road would have otherwise had on its hydrologic regime. Given the nature of hydrologic interactions, the model for the hydrologic function was constructed using five submodels, with the caveat that the lowest scoring submodel defines the FCI for the function. Therefore,

$$FCI_{HYDROLOGY} = \text{MIN} [V_{SURFFLOW}, V_{OUTFLOW}, V_{STORAGE}, V_{INFLOW}, (V_{ET} \times ((V_{MICRO} + V_{PORE})/2))^{1/2}]$$

Each submodel potentially provides an FCI for the function. However, the effects of dams, ditches, fill, excavations, and input of water from other drainage basins (modeled by $V_{SURFFLOW}$, $V_{OUTFLOW}$, $V_{STORAGE}$, V_{INFLOW} , respectively) are also boundary criteria used to define partial WAAs (see Defining WAAs in Chapter 5). Therefore, if a partial WAA were defined by one of these submodels, usually only the submodel defining the WAA would be relevant for that WAA; all other submodels and variables would be irrelevant. (Note, however, that $V_{SURFFLOW}$ has three possible values: 1.0, 0.5 (dam shadow), 0.1 (dam reservoir.) For example, if a WAA were partitioned into two partial WAAs (one WAA within an area affected by drainage from a ditch and one WAA beyond the effects of drainage), $V_{OUTFLOW}$ would be the only submodel pertinent to the hydrologic function within the area defined by the lateral drainage distance. The other variables would be irrelevant within the partial WAA defined by the lateral drainage area because $V_{OUTFLOW}$ would equal 0.1 and the FCI is determined by the lowest scoring submodel. To determine the FCI for the other WAA, the WAA might have to be further partitioned (depending on if and how the area is hydrologically altered) and then one or more of the other hydrologic variables measured.

If there are no dams, ditches, fill, excavations, or input of water from other drainage basins in the WAA, then the hydrologic variables V_{ET} , V_{MICRO} , and V_{PORE} must be measured. However, these three variables might still have to be measured for the downgradient side of a dam because the FCI submodel using these variables could potentially score lower than 0.5 (the minimum for $V_{SURFFLOW}$).

Microtopography (V_{MICRO}) affects surface water storage (ponding), which in turn affects surface area available for evaporation. Alterations to soil porosity (V_{PORE}) affect subsurface water storage, which in turn affects the volume of water available for transpiration. Thus, V_{ET} is related to both V_{MICRO} and V_{PORE} . In addition, whenever V_{MICRO} or V_{PORE} is altered, the other variable (V_{PORE} or V_{MICRO} , respectively) is usually altered as well.

The FCI submodel algorithm averages V_{PORE} and V_{MICRO} scores (which together model water storage capacity), multiplies the average by the V_{ET} score,

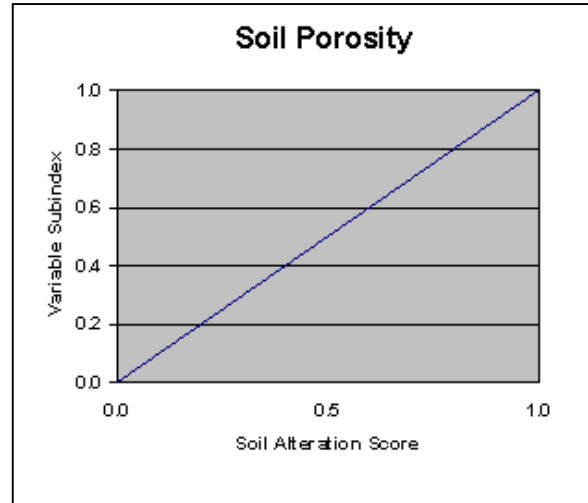

Figure 14. Relationship between alterations to soil porosity and functional capacity

and provides the geometric mean of the product. The main driving process in the submodel is ET, which is directly affected by altering LAI or indirectly affected by altering surface and near-surface water storage capacity (V_{PORE} and V_{MICRO}).

Function 2: Maintain Characteristic Plant Community

Definition

This function reflects the capacity of a WAA to maintain the characteristic attributes of plant communities normally associated with natural, fire-maintained Wet Pine Flat ecosystems. Community attributes include characteristic spatial patterns of plant species (including richness and diversity at small spatial scales) and the relative importance of component species (including cover, density, biomass, etc.).

To quantitatively determine the effects that alterations have on plant communities in Wet Pine Flats, one could measure the aforementioned community attributes at different spatial scales for altered and unaltered sites and compare these attributes with plant indicator scores and other structural components used to model the function. One could compare community attributes using similarity indices, multivariate statistics, cluster analysis, association analysis, etc., with indicator scores. Each of the three cover types (Bunchgrass/Pine Savanna, Cypress/Pine Savanna, and Switchcane/Pine Savanna) would have to be examined independently because different reference standards apply to each type.

Rationale for selecting the function

The condition of a plant community in a Wet Pine Flat is determined by habitat conditions that occur within the site itself (onsite conditions). This is because plants are immobile and therefore do not obtain resources from elsewhere. In contrast, because animals are mobile, animals depend not only on onsite habitat quality, but also on conditions offsite (beyond the WAA). Therefore, maintenance of characteristic animal communities is modeled with a separate function that incorporates onsite and offsite habitat condition.

Plant communities characteristic of unaltered Wet Pine Flats are maintained by an appropriate hydrologic regime, fire regime, and biogeochemical processes that require intact soil conditions. Under relatively unaltered conditions, these three parameters combine to maintain a grassy savanna of few or no trees and support (in some sites) an extremely rich herbaceous plant community. In fact, for Bunchgrass/Pine Savanna, small-scale species richness of the herbaceous stratum is the highest recorded in the Western Hemisphere (Walker and Peet 1983). This rich herbaceous assemblage is extremely sensitive to alteration and, as a consequence, many species associated with this ecosystem are rare or threatened with extinction (Walker, Waldrop, and Peet 1993, Walker 1993).

Because the herbaceous community of Wet Pine Flats is so sensitive to alteration (fire exclusion, hydrologic alteration, and soil disturbance), its condition provides information on habitat quality.

In Switchcane/Pine and Cypress/Pine Savanna, spatial attributes of savannas and the size-class distribution of dominant savanna trees are better indicators of plant community condition than is herb species richness. This is because neither of these cover types is naturally as rich in herbaceous species as Bunchgrass/Pine Savannas. Therefore, changes in these structural attributes indicate alteration to plant communities in Cypress/Pine and Switchcane/Pine Savannas.

Characteristics and processes that influence the function

Alterations to fire regime, hydrologic regime, and soil conditions alter ecosystem processes in Wet Pine Flats, which in turn alter their characteristic spatial and compositional attributes. Fires maintain open, sometimes treeless, savannas by precluding species that would otherwise shade out characteristic savanna plants and provide nutrients in discrete pulses utilized by savanna plants (Christensen 1987, 1993). Hydrologic fluctuations determine the composition of fire-tolerant vegetation, and soil conditions control the dynamics of biogeochemical transformations by soil microbes.

Plant populations in Wet Pine Flats have evolved to both withstand and require frequent fire. In fact, fire stimulates flowering and seed set in many wet savanna species (e.g., toothache grass, wiregrass). As a result, species composition and spatial habitat structure reflect fire frequency. However, Wet Pine Flats occur over a range of natural hydrologic and edaphic conditions, which in turn are responsible for variations in vegetation. To minimize the amount of natural variation that must be accounted for in setting reference standards for maintaining characteristic plant communities, Wet Pine Flats were further subclassified into three cover types based on vegetation attributes (Figure 2). Therefore, one must first determine the cover type for which one is assessing functions in order to determine which model aggregation equations are applicable. (See Chapter 5 on defining WAA).

The most commonly occurring cover type of Wet Pine Flat is the Bunchgrass/Pine Savanna type (wet pine savanna, *sensu* Peet and Allard 1993), though, as is the case for all three cover types of Wet Pine Flats, relatively few intact examples remain. In remnant Bunchgrass/Pine Savannas, one to several species of native bunchgrasses usually dominate the herb stratum. These graminoids are called bunchgrasses because they create tussocks (hummocks) 10-15 cm wide and 5-20 cm high, which provide a variety of hydrologic conditions within a small spatial scale. The variety of microtopographic conditions provided by tussocks is believed to be partly responsible for the high species richness for which Bunchgrass/Pine Savanna is renowned. Therefore, bunchgrass cover is one useful indicator of the condition of plant communities in Bunchgrass/Pine Savannas.

Some Bunchgrass/Pine Savannas, particularly those located west of the Mississippi River, are dominated by tussock-producing *Dicanthelium* spp. and *Rhynchospora* spp., which are difficult to identify by nonbotanists during all seasons. However, in most Bunchgrass/Pine Savannas, even those west of the Mississippi River, the herbaceous plant community is extremely rich in forbs at small spatial scales. Indicator plants are useful for determining the condition of the plant community in Wet Pine Flats across the entire Reference Domain.

Not all Wet Pine Flats are naturally as rich in species as Bunchgrass/Pine Savannas (mean =17 species per m²). Some Wet Pine Flats (Switchcane/Pine Savannas) are overwhelmingly dominated by switchcane in the understory. Unfortunately, the historic range and attributes of this cover type are neither well documented nor understood. However, based on the few reference sites available, it does not appear that bunchgrass cover or indicator plants would be very useful for determining the condition of the plant community in Switchcane/Pine Savannas. Instead, structural characteristics of unaltered sites are more useful because they indicate the presence of frequent fire, regeneration through time, and lack of other alterations to structure.

From the few examples located and sampled, it appears that although the canopy of the Switchcane/Pine Savanna is relatively sparse, tree and shrub densities are sometimes naturally higher than they are in most Bunchgrass/Pine Savannas. Therefore, these structural attributes were useful for assessing the condition of the plant community. It may be that high switchcane cover and relatively higher woody biomass reflect a greater availability of nutrients in Switchcane/Pine Savannas relative to Bunchgrass/Pine Savannas. It is also possible that fire exclusion allows switchcane to competitively displace bunchgrass and other herb species, so that current switchcane dominance merely reflects a past period of fire exclusion. Further research is needed to determine the relative nutrient status and past fire history (if possible) of Bunchgrass/Pine and Switchcane/Pine Savannas.

A third cover type, Cypress/Pine Savanna, is sparsely dominated by pond cypress in the overstory. Its herbaceous stratum varies from one closely resembling Bunchgrass/Pine Savanna at the more mesic end of its hydrologic range to one dominated by various sedges (esp. *Carex* spp., *Scleria* spp., and *Rhynchospora* spp.) at the wetter end of the hydrologic range. (Sedges are uncommon in the other two cover types of Wet Pine Flats.) Thus, the herbaceous stratum of the least wet Cypress/Pine Savanna is similar to the wettest Bunchgrass/Pine Savanna: both support a rich herbaceous assemblage and high bunchgrass cover. Therefore, both selected herbaceous plants and bunchgrass cover are useful for assessing site quality in the least wet Cypress/Pine Savanna.

Because various sedges overwhelmingly dominate the herbaceous stratum in the wettest Cypress/Pine Savanna, neither herbaceous indicator plants nor bunchgrass cover is useful for determining the condition of the plant community. Rather, a combination of sedge cover and structural attributes of woody plants are more useful. Therefore, both sedge cover and structural attributes are used for assessing the condition of the plant community at the wet end of the moisture gradient.

Description of model variables

Although there are seven model variables associated with this function, only a subset of these variables needs to be measured in a given WAA. This is because there are three distinct cover classes of Wet Pine Flats, each of which requires only a subset of these variables. Therefore, in order to determine which variables need to be measured in a given WAA, one must first determine which of the three cover classes one is assessing (see Defining WAAs in Chapter 5).

Herbaceous Indicator Score (V_{HERB}). This variable represents the frequency at which a select group of herbaceous species, indicative of the condition of the plant community, occurs in a WAA. This variable is used for measuring the condition of plant community in Bunchgrass/Pine and Cypress/Pine Savanna cover types only. Some herbaceous species occur throughout the entire Reference Domain from North Carolina to Texas; other closely related and morphologically similar species occur in restricted and nonoverlapping portions of the geographic range. Considering only the most widespread species and genera, relatively unaltered Wet Pine Flats are much more similar to one another (in composition and species richness) across the entire Reference Domain than they are to altered Wet Pine Flats nearby.

Herbaceous species in Bunchgrass/Pine Savannas and Cypress/Pine Savannas are sensitive to alterations in fire frequency; a reduction in fire frequency leads to a decline in herbaceous species richness, presumably due to increased competition from fire- and shade-tolerant species. Likewise, many Bunchgrass/Pine Savanna species are sensitive to alterations to both hydrologic regime and soils, particularly alterations associated with silvicultural site preparation. Chopping and bedding, followed by shading from planted pines, draining, and the exclusion of fire can entirely extirpate herbaceous species characteristic of unaltered Wet Pine Flats.

A selected group of 20 indicator plants (Table 8) was chosen to indicate degree of alteration to the condition of the plant community (V_{HERB}). Indicator plants (species and genera) were selected based on the following criteria: (a) many were initially identified by workshop participants representing appropriate plant composition and overall site quality, (b) they can be easily identified by vegetative characteristics in all seasons (except immediately following a fire), and (c) they occur throughout most of the Reference Domain. Color plates showing distinguishing characteristics of these indicator plants are located in Appendix B.

One might argue that an assessment of this function could be more directly determined by simply identifying the total number of plant species in a site. However, there would be several problems with this approach. First, so many species look similar to one another in Bunchgrass/Pine Savannas that only a few botanists in the world would be able to differentiate among species at any given time. Second, as site quality degrades, the relative abundances of species shift even though total species richness remains similar (weedy species tend to become more prevalent). Third, as site quality degrades further, small-scale species richness begins to decline even though larger-scale richness may remain

Table 8 Calculation of Herbaceous Indicator Scores for Bunchgrass/Pine and Cypress/Pine Cover Types			
Herb Indicator Species	Plot 1	Plot 2	Plot 3
<i>Aletris</i> spp. (<i>A. farinosa</i> , <i>A. aurea</i>)	1.0	0.5	1.0
<i>Aristida</i> spp. (<i>A. stricta</i> , <i>A. beyrichiana</i>), <i>Sporobolus</i> spp.			1.0
<i>Balduina</i> spp.		0.5	
<i>Bigelowia nudata</i>	1.0	0.5	0.5
<i>Carphephorus</i> spp.		0.5	
<i>Chaptalia tomentosa</i>	0.5	0.5	
<i>Coreopsis</i> spp.	1.0		1.0
<i>Ctenium aromaticum</i>		1.0	1.0
<i>Dichromena</i> spp.			
<i>Erigeron vernus</i>	0.5	0.5	
<i>Eriocaulon</i> spp.	0.5	1.0	
<i>Eryngium integrifolium</i>			0.5
<i>Eupatorium leucolepis</i>	0.5		0.5
<i>Helianthus</i> spp.	1.0		
<i>Lycopodium</i> spp. (especially <i>L. alopecuroides</i>)			0.5
<i>Muhlenbergia expansa</i>	1.0	1.0	
<i>Rhexia</i> spp.		0.5	0.5
<i>Sarracenia</i> spp.	0.5		
<i>Schizachyrium scoparium</i>	0.5	0.5	
<i>Xyris</i> spp.			
Total Indicator Score	8.0	7.0	6.5
Mean (total/ no. of 1-m ² plots)			7.2
Bunchgrass/Pine Savanna score (divide Mean by 8.0)	V_{HERB} :	0.90	
Cypress/Pine Savanna score (divide Mean by 7.0)	V_{HERB} :	1.00	
Note: For each indicator species/genus that occurs in the 1-m ² nested plot, record 1.0. For each indicator plant that occurs in the 2-m-radius plot, but does not occur in the 1-m ² nested plot, record 0.5. To determine the indicator score, total all scores and divide by the total number of 1-m ² plots (sample at least 3 plots). Record 1.0 if score > 1.0.			

stable for awhile. Thus, a simple count of species numbers would not be sensitive to some degradations even if an accurate count were possible.

The herbaceous indicator species, identified at the workshop and subsequently revised after reference data collection, were chosen to assess species composition, and when present at small scales, indicate the small-scale richness characteristic of unaltered Bunchgrass/Pine Savannas. Because many of the

indicator species begin to disappear as a site becomes progressively more altered, these species are sensitive to degradation of site quality.

In developing this model, a highly significant correlation ($P \ll 0.001$) was found between herbaceous indicator scores and the number of species in plots of various sizes: 1 m², 12.6 m² (2-m-radius), 50 m², 150 m², and 1 ha (Table 9). Although more research should be done to validate the relationship between indicator score and plant composition, there is good evidence that indicator scores are sensitive to small-scale species richness.

To measure V_{HERB} , first apply a random or stratified-random approach to select the first sampling point in the WAA and mark it with a stake or pole (see Defining WAAs in Chapter 5 and Appendix D for directions on constructing sampling equipment and laying out plots). Place a 1-m² quadrat on the ground and orient it so that each side faces one of the four cardinal directions. Next, identify each indicator plant that occurs in a 1-m² plot and record a “1.0” for each of those species (Table 8). Then circumscribe a 2-m-radius plot (12.6 m²), centered on the center stake of the 1-m² plot. Record each additional indicator plant present in the 2-m-radius plot that was not present in the 1-m² plot and record a “0.5” for each of those species. Sum all indicator scores from the two nested plots. Repeat the previous measurements in at least two additional nested plots located at least 15 m from one another. Sum the score for all nested plots sampled and divide the sum by the total number of nested plots sampled. Sample a minimum of three plots per WAA; more plots may be necessary in large areas or if the area does not appear to be homogeneous (plants are patchily distributed).

Alterations to hydrology, soil disturbance, and a reduction in fire frequency reduce small-scale species richness and the relative abundance of species intolerant of such alterations. The composition attained by an herbaceous assemblage in response to a particular alteration depends on the type and intensity of the alteration. Many wet savanna species are very sensitive to low-grade, but chronic, alterations (soil compaction, mowing, reduction in fire frequency, etc.) and are unlikely to recover without intensive restoration efforts when the alterations are eliminated.

For example, although some fire-adapted herbaceous species can persist for several decades without fire, small-scale species richness declines over time, and eventually many characteristic species disappear, including native bunchgrass species. However, if frequent fire is restored before too many herbaceous species disappear, the ecosystem can probably be restored without excessive intervention. On the other hand, a significant loss of characteristic herbaceous species indicates that successful restoration will require more effort, time, and money.

Because many Bunchgrass/Pine Savanna species decline in frequency at small spatial scales when site conditions are altered, frequency relationships among characteristic wet savanna species are used to assess the condition of the plant community. In the unaltered Bunchgrass/Pine Savanna reference sites, a mean of 13-30 species (including 4-11 indicator plants) occurred in 1-m² plots and 19-45 (including 8-16 indicator plants) in 2-m-radius plots. The list of indicator plants used here was designed to be used in Bunchgrass/Pine Savannas

Table 9
Correlation Matrix¹ Relating Bunchgrass Cover and Herbaceous Indicator Scores to Species Richness. "Total"
Refers to Number of Species

	Bunchgrass Cover	Herb Indicator Score	Total 1 m ²	Total 12.6 m ² (2-m radius)	Total 50 m ²	Total 150 m ²	Total per site (1 ha)	Avg # indicator spp (1 m ²)	Avg # Indicator spp. per 12.6 m ² (2-m radius)	Avg # Indicator spp. per 50 m ²
Bunchgrass Cover	1.000									
Herb Indicator Score	0.723	1.000								
Total 1 m ²	0.519	0.847	1.000							
Total 12.6 m ² (2-m radius)	0.476	0.788	0.949	1.000						
Total 50 m ²	0.458	0.743	0.886	0.970	1.000					
Total 150 m ²	0.407	0.669	0.808	0.917	0.973	1.000				
Total per site (1 ha)	0.402	0.657	0.803	0.912	0.970	0.998	1.000			
Avg # indicator spp (1 m ²)	0.736	0.982	0.848	0.779	0.733	0.668	0.659	1.000		
Avg # Indicator spp. per 12.6 m ² (2-m radius)	0.738	0.976	0.839	0.806	0.791	0.740	0.732	0.978	1.000	
Avg # Indicator spp. per 50 m ²	0.680	0.889	0.759	0.781	0.817	0.795	0.788	0.870	0.952	1.000

¹For all plot sizes, $P < 0.001$ ($df = 64$, critical value = 0.396).

across a range of hydrologic conditions, soil types, and geographic locations. Hence, no one site would be expected to support all indicator plants. However, V_{HERB} was calibrated using all indicator species across the entire Reference Domain, and, therefore, not all indicator plants would be expected to occur in any one site.

Theoretically, the maximum herbaceous indicator score for any given WAA is 20 (equivalent to all indicators plants occurring in every 1-m² plot); however, due to hydrologic, edaphic, and geographic differences across the Reference Domain, unaltered reference sites of Bunchgrass/Pine Savannas scored from 8.0 to 12.0. Therefore, a WAA must score at least 8.0 to be considered within reference standard for this variable. In order to calculate the subindex for V_{HERB} in Bunchgrass/Pine Savannas, divide the herbaceous indicator score derived from the plots in the WAA by 8.0. If the resulting subindex > 1.0, reduce the subindex to 1.0. If the WAA was burned within the prior 6 weeks, either wait at least 6 weeks after the fire to measure this variable or assign 1.0 to the subindex for V_{HERB} as a default. An assumption is made that the subindex for V_{HERB} declines linearly from 1.0 (herb indicator score = 8.0) to 0.0 (herb indicator score = 0.0). A graphical illustration of the relationship between the variable subindex in the Bunchgrass/Pine Savanna and functional capacity is provided in Figure 15. Calibration of this variable assumes a positive linear relationship between herbaceous indicator score and the overall condition of the plant community.

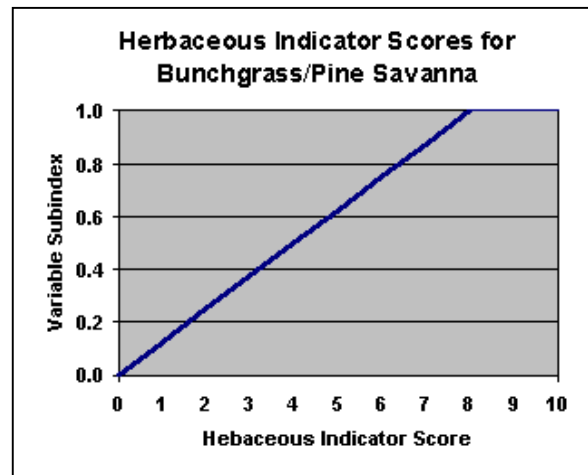

Figure 15. Relationship between herbaceous indicator scores in Bunchgrass/Pine Savanna and functional capacity

Some Cypress/Pine Savannas (the least wet ones) also support a high density of indicator herbaceous plants, but they tend to score slightly lower than Bunchgrass/Pine Savannas (likely due to their slightly wetter condition); therefore, to calculate the herbaceous subindex for a Cypress/Pine Savanna, divide the herbaceous indicator score by 7.0. If the resulting subindex > 1.0, reduce the subindex to 1.0. If the WAA was burned within the prior 6 weeks, either wait at least 6 weeks to measure this variable or assign 1.0 to the subindex for V_{HERB} as a default. An assumption is made that the subindex for V_{HERB} declines linearly from 1.0 (herb indicator score = 7.0) to 0.0 (herb indicator score = 0.0). A graphical illustration of the relationship between the variable subindex in the Cypress/Pine Savanna and functional capacity is provided in Figure 16. Calibration of this variable assumes a positive linear relationship between herbaceous indicator score and the overall condition of the plant community.

Cover of Selected Native Bunchgrasses (V_{NBG}). This variable represents the percent cover of native bunchgrasses in a WAA, including one or any combination of the following species: *Ctenium aromaticum* (toothache grass), *Muhlenbergia expansa* (Muhly grass), *Aristida stricta* (northern wiregrass),

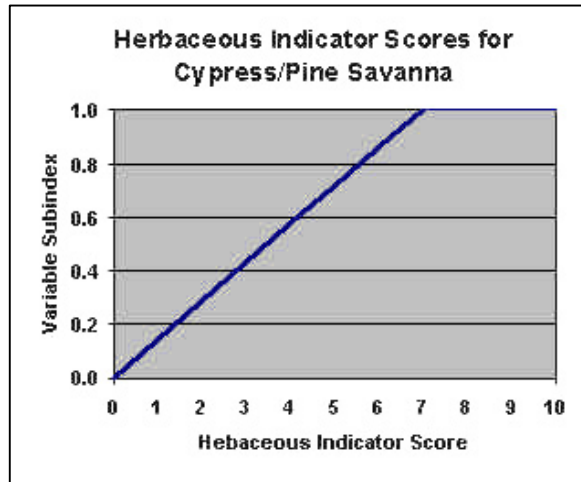

Figure 16. Relationship between herbaceous indicator scores in Cypress/Pine Savanna and functional capacity

Aristida beyrichiana (southern wiregrass), various *Sporobolus* spp. (dropseeds), *Schizachyrium scoparium* (little bluestem), and native wiry *Rhynchospora* spp. (west of the Mississippi River only). These native bunchgrass and *Rhynchospora* species are relatively easy to identify in the field at all times of year, except soon after a fire. Some of these species are also indicator species used in V_{HERB} , but in sites where they are prevalent, cover alone is indicative of the condition of the plant community.

Bunchgrass/Pine Savannas and the more mesic end of the hydrologic gradient in Cypress/Pine Savannas are noted for supporting dense stands of

native bunchgrasses. These bunchgrasses are highly flammable and are adapted to carry frequent but “cool” ground fires. They are so dependent on frequent fire that reduction in fire frequency leads to a drastic decline in abundance and living biomass of native bunchgrasses. Likewise, they are sensitive to hydrologic alterations and soil alterations, particularly soil alterations associated with silvicultural site preparation. Chopping and bedding, followed by shading by planted pines, draining, and the exclusion of fire can entirely extirpate native bunchgrasses and permanently alter characteristic fire regime in Wet Pine Flats. Therefore, the presence and cover of native bunchgrasses indicate the condition of the plant community.

To measure native bunchgrass cover, a series of plots should either be established randomly in a WAA or along a randomly oriented transect. Use the same 2-m-radius plots used to record the presence of herbaceous indicator species. In each plot, estimate the combined cover of the bunchgrass species into one of nine coverage categories listed in Table 4. Also include native wiry *Rhynchospora* species in cover estimates if the Wet Pine Flat is located west of the Mississippi River. Record the midpoint of the coverage category. Sample a minimum of three 2-m-radius (37.7-m²) plots per WAA. Sample a minimum of three plots per WAA. More plots may be necessary in large areas or if the area does not appear to be homogeneous (plants are patchily distributed). Average the recorded midpoint values across all plots sampled in the WAA (i.e., divide the cover values by the number of plots to obtain mean cover).

Mean cover of selected native bunchgrasses (exclusive of *Rhynchospora* spp.) in relatively unaltered reference sites east of the Mississippi River ranged between 12.5 percent and 97.5 percent. West of the Mississippi River, the cover of these selected native bunchgrasses tended to be lower, mostly because other, more difficult to identify, tussock-producing graminoids (primarily *Rhynchospora* spp.) dominate groundcover in this region. In western Louisiana and east Texas, wiry *Rhynchospora* species seem to inhabit the ecological niche

of bunchgrasses elsewhere; so, cover of these wiry native *Rhynchospora* spp. can be estimated in the place of true bunchgrasses.

Any WAA with more than 50 percent cover of native bunchgrasses is within the variation exhibited by relatively unaltered Bunchgrass/Pine and Cypress/Pine Savannas. Thus, in order to determine a subindex for V_{NBG} , divide the percent cover of the above-defined bunchgrass species by 50 percent. If the resulting subindex is > 1.0 , reduce the subindex to 1.0. An assumption is made that the subindex for V_{NBG} declines linearly from 1.0 (50 percent cover) to 0.0 (0 percent cover). A graphical illustration of the relationship between the variable subindex and functional capacity is provided in Figure 17. Calibration of this variable assumes a positive linear relationship between bunchgrass cover and the overall condition of the plant community.

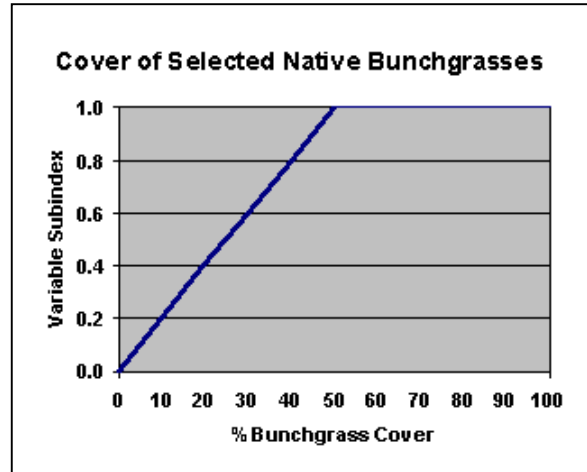

Figure 17. Relationship between bunchgrass cover and functional capacity

Cover of Sedges (V_{SEDGES}). This variable represents the percent cover of sedge (Cyperaceae) genera in a WAA. This variable is applicable only in WAAs in which pond cypress (*Taxodium ascendens*) occurs or would have naturally occurred in the absence of alterations. If a WAA has been recently logged and is part of a similar and contiguous habitat that has not been logged, then the historic presence of pond cypress in the WAA can be assumed if pond cypress occurs in the contiguous habitat.

The unaltered Cypress/Pine Savanna tends to support an understory of grasses and/or sedges and a sparse canopy of pond cypress, pond pine, longleaf pine, and, along the Gulf coast, slash pine. Little is known about fire return interval of these systems. However, it appears that they are maintained by fire, the frequency of which is likely determined by a given site's position along the wetness gradient over which pond cypress occurs.

Many of the same bunchgrasses and herbaceous species that occur in Bunchgrass/Pine Savannas also occur at the least wet end of the hydrologic gradient over which Cypress/Pine Savannas occur. However, the wettest end of the wetness gradient is too wet to support typical native bunchgrasses and wet savanna species; instead, such sites are overwhelmingly dominated by sedges (primarily *Carex* spp., *Scleria* spp., and nonwiry, native *Rhynchospora* spp.). In unaltered sites, sedges comprise > 50 percent of herbaceous groundcover. An alteration to the fire regime would encourage denser canopy and subcanopy cover and reduce sedge cover. Alterations to the hydrologic regime or soil disturbance would also tend to increase the cover of wiry *Rhynchospora* and *Panicum* spp. And, in turn, reduce sedge cover. Therefore, sedge cover is used as

a model variable to indicate the condition of the plant community in Cypress/Pine Savannas.

Although it is fairly difficult for persons untrained in sedge taxonomy to identify sedges to species only by vegetative characteristics, sedges are fairly easy to differentiate from other taxa without flowers or fruit. Therefore, one only needs to be able to differentiate sedges from other taxa to measure this variable. The only caveat is that wiry *Rhynchospora* be excluded from total coverage estimates because these species typically increase in relative dominance following alterations to soil and microtopography.

Sedge cover is measured in the same 2-m-radius (12.6 m²) plots used to record the presence of herbaceous indicator species. In each plot, estimate the combined cover of sedges into one of the nine coverage categories listed in Table 4 and record the midpoint of the coverage category. Sample a minimum of three plots (37.8 m²) per WAA. Average the recorded midpoint values across all plots sampled in the WAA (i.e., divide the sum of cover values by the number of 2-m-radius plots sampled) to obtain the mean cover of sedges across all plots.

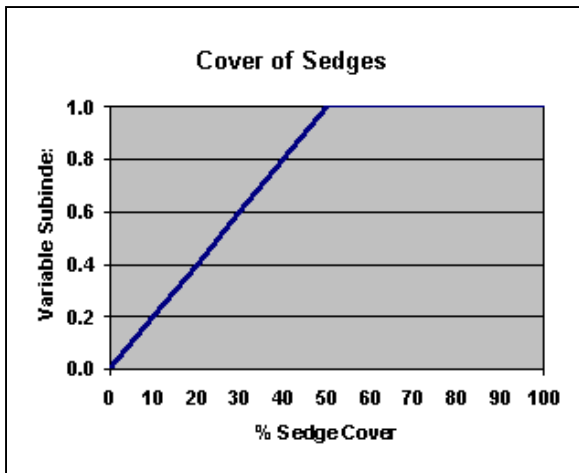

Figure 18. Relationship between sedge cover and functional capacity

It is assumed that any alteration of a Cypress/Pine Savanna would decrease sedge cover, thus altering the condition of the plant community. For example, fire exclusion, soil compaction, draining, etc. all reduce sedge cover (with the exception of wiry *Rhynchospora*). To determine the subindex for V_{SEDGES} , divide the mean percent cover of sedge species in the WAA by 50 percent. If the resulting subindex is > 1.0 , reduce the subindex to 1.0. A graphical illustration of the relationship between the variable subindex and functional capacity is provided in Figure 18. Calibration of this variable assumes a positive linear relationship between sedge cover and the overall condition of the plant community.

Pine Density (V_{PINES}). This variable represents the density of canopy-sized pine species >15 cm dbh (diameter at 1.5 m above ground) in a WAA. All of the following pines should be counted: longleaf pine (*Pinus palustris*), loblolly pine (*P. taeda*), pond pine (*P. serotina*), and slash pine (*P. elliottii* is not native north of southern South Carolina). Pine density, an attribute of structure, is measured only in Switchcane/Pine Savannas because there are few herbaceous species other than switchcane (*Arundinaria tecta*). Therefore, herbaceous plants are not useful for indicating the condition of the plant community.

The least altered Switchcane/Pine Savannas tend to support a sparse canopy of pines (primarily longleaf, but loblolly and pond pine may also occur) and a fairly sparse subcanopy. However, canopy trees are generally more dense in the

Switchcane/Pine Savanna than in the Bunchgrass/Pine Savanna. This may be due to higher nutrient status or a slightly less frequent fire regime in Switchcane/Pine Savannas; research is needed to determine the reason for the naturally more dense canopy. Further, it is not known if the occasional presence of loblolly pine in Switchcane/Pine Savannas indicates past fire exclusion or a naturally less frequent fire regime. In either case, although canopy density is relatively low in Switchcane/Pine Savannas, it is similar (75-300 trees/ha) to Bunchgrass/Pine Savannas located at the more northern end of the Reference Domain in southeastern North Carolina (Frost, Walker, and Peet 1986).

Sampling pine density can be accomplished using any variety of plot sizes and shapes as long as at least 300 m² is sampled (density is normally sparse in pine savannas and so a minimal plot size is required to measure density). Tree counts can be made rapidly on 10-m-radius (314-m²) circular plots. In each plot, count all pine trees >15 cm dbh. A caliper or dbh tape can be used to verify whether a tree is > 15 cm dbh. (A fixed-width caliper can be inexpensively constructed with PVC piping material.) Distance from center point to the boundary of the 10-m radius can be measured with a meter tape, a sonic distance measurer, or an angle gauge. Obtain counts from at least three plots, sum them, and divide by the number of plots sampled to obtain mean count per plot for canopy-sized pine trees in the WAA. Multiply the mean count by 31.8 to obtain absolute density of pine trees per unit hectare.

Unfortunately, Switchcane/Pine Savannas are extremely rare and little is known about them. Only four Switchcane/Pine Savanna reference sites were located, so calibration of V_{PINES} was based on these four sites and on densities of pines in Bunchgrass/Pine Savannas at the more northern part of the Reference Domain. This approach was used because Bunchgrass/Pine Savannas located toward the more northern end of their range (North Carolina) typically have a slightly denser canopy than more southerly sites (along the Gulf coast). In addition, typical alterations to the canopy and midcanopy are similar to those that occur in drier Bunchgrass/Pine Savannas: timber harvesting, conversion to loblolly or slash pine silviculture, fire exclusion, and land development. For all these typical alterations, the condition of the plant community can be partly inferred by the density of tree-size pines. Alterations caused by urban development or timber harvesting reduce density, while silvicultural management increases density. Therefore, densities outside the variation exhibited by unaltered sites indicate an alteration to the condition of the plant community.

Both the least wet Bunchgrass/Pine Savannas and Switchcane/Pine Savannas typically support no more than 75-300 canopy-sized (> 15 cm dbh) pine trees/ha. The exclusion of fire typically leads to densities of 300-600 trees/ha, while pine silviculture typically manages for 600+ trees/ha. These densities were used to calibrate the subindex for V_{PINES} .

If the density of pines in the WAA is < 75 trees/ha, divide the density by 75 to obtain the subindex for V_{PINES} . If pine density in the WAA is between 75 and 300 trees/ha, assign a subindex of 1.0 to the subindex for V_{PINES} . If the density of pines in the WAA is between 300 and 600, subtract 300 from the density, divide this by 300 and subtract from 1.0 (i.e., Variable Subindex = 1.0 - ((pine tree

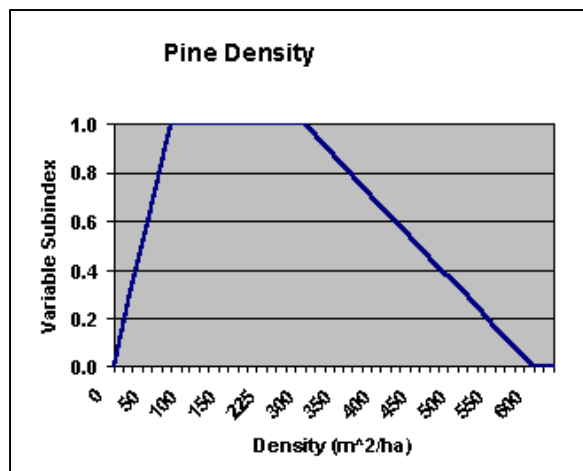

Figure 19. Relationship between pine density and functional capacity

density - 300)/300)). If the density of pine trees is > 600, assign 0.0 to the subindex for V_{PINES} . Calibration of this variable assumes a relationship between pine tree density and the overall condition of the plant community, with the reference standard ranging from 75-300 trees per hectare and declining condition at densities outside this range. A graphical illustration of the relationship between the variable subindex and functional capacity is provided in Figure 19.

Subcanopy Density (V_{SUBC}). This variable represents the density of woody subcanopy stems (> 1 m tall, but < 7.5 cm dbh) in a WAA. In both

Switchcane/Pine Savannas and the wettest Cypress/Pine Savannas, neither herbaceous species richness nor bunchgrass cover is useful for indicating the condition of the plant community. Rather, structural attributes (e.g., tree and subcanopy density) are better indicators. The least altered sites of both cover types tend to support a sparse canopy of trees (longleaf pine in Switchcane/Pine Savannas and pond cypress in Cypress/Pine Savannas) and a fairly sparse subcanopy. Both conditions indicate frequent fire and lack of alteration to microtopography or soils. Therefore, subcanopy density was useful for modeling the condition of the plant community in Switchcane/Pine and wet Cypress/Pine Savannas.

Density of subcanopy stems can be determined in any number of ways, as long as at least 150 m² is sampled. Counts can be made in rectangular or circular plots in randomly distributed plots or along a randomly oriented transect. One way to determine density is to make counts of subcanopy stems in the same 50-m² plots in which V_{MICRO} and V_{PORE} are determined. In the plots, count all living woody stems > 1 m tall and < 7.5 cm dbh. Some shrubs and tree saplings produce clustered root sprouts after fire (e.g., sweetbay magnolia (*Magnolia virginiana*), wax myrtle (*Myrica cerifera*), and pond cypress). Therefore, if multiple stems originate from the same plant (root sprouts), count the clump of stems as one individual if it is certain they originate from the same plant.

Only four Switchcane/Pine Savanna reference sites were located, so calibration for Switchcane/Pine Savannas is based on these four sites and subcanopy densities of Bunchgrass/Pine sites located toward the northern end of the Reference Domain (where subcanopy densities are naturally higher) and six Cypress/Pine Savannas. This approach is probably reasonable because the drier Bunchgrass/Pine Savannas are similar in structure to Switchcane/Pine Savannas, and typical alterations to the subcanopy are similar in both cover types: timber harvesting, conversion to loblolly or slash pine silviculture, fire exclusion, and development. Additional data from Switchcane/Pine Savannas would be needed to base reference standards entirely on the natural condition of the subclass, and an effort should be made to locate all extant, unaltered examples.

In reference standard sites, subcanopy densities were 300 - 6,500 stems/ha in Cypress/Pine Savannas and 0 - 3,900 stems/ha in Switchcane/Pine Savannas. This reflects the impact of frequent fire on maintaining a low density of woody understory vegetation. Fire exclusion leads to subcanopy densities more than 6,500 stems/ha (site LA38) which reduces the cover of shade-intolerant herbaceous species, alters microsite climatic regimes on the forest floor, allows for the accumulation of organic debris, and displaces wildlife species that require an open understory for foraging or nesting. Therefore, the subcanopy must be calibrated to reflect degradation of the condition of the plant community caused by both land-clearing activities and an excessive density (>19,500 stems/ha) of subcanopy stems. In the model, if the site has been mechanically cleared, then $V_{SUBC} = 0.0$. If subcanopy density is < 6,500 stems/ha, then $V_{SUBC} = 1.0$. If subcanopy density is between 6,500 and 19,500 stems/ha, subtract the measured density from 19,500 and divide the answer by 13,000 (i.e., $V_{SUBC} = (19,500 - \text{density}) / 13,000$). If subcanopy density > 19,500 stems/ha, then $V_{SUBC} = 0.0$. A graphical illustration of the relationship between the variable subindex and functional capacity is provided in Figure 20.

Calibration of the reference standard condition is based primarily on data from Cypress/Pine Savannas because only four Switchcane/Pine Savannas were located.

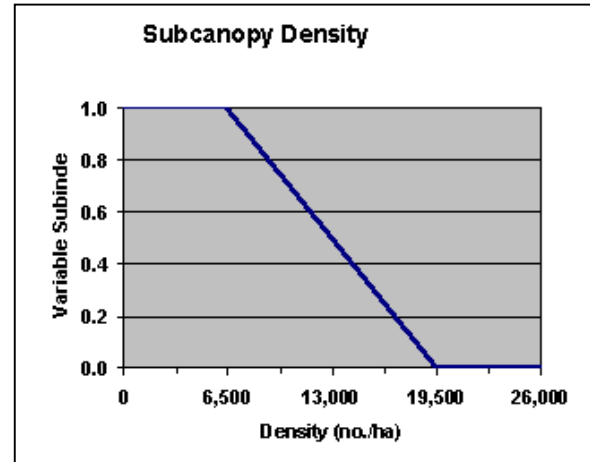

Figure 20. Relationship between subcanopy density and functional capacity

Physiognomic Structure of Pond Cypress ($V_{CYPRESS}$). This variable represents the contribution of pond cypress to the overall physiognomy (physical structure) of the community. It is determined by the density of pond cypress in each of three size classes (strata): sapling, midcanopy, and canopy. Densities are determined by counts in plots or by the nearest individual analysis (a plotless technique).

Pond cypress is one of only a few canopy trees adapted to tolerate long periods of inundation and frequent fire. The Cypress/Pine Savanna occurs at the wettest end of the hydrologic gradient over which Wet Pine Flats occur. At the wettest end of the moisture gradient for Cypress/Pine Savannas, the herb indicator score is not a reliable indicator of the condition of the plant community. However, physiognomic (structural) indicators are more useful. This variable provides information on the size class distribution of pond cypress and whether it is regenerating in the site.

The condition of the canopy stratum suggests the potential for continued regeneration and maintenance of the plant community into the near future and lack of recent logging or other degradation of the plant community. The condition of the sapling stratum indicates recent regeneration; hence, suitable habitat conditions in the recent past and the potential for future maintenance of the characteristic plant community. The condition of the midcanopy stratum

indicates regeneration from the more distant past to the more recent past and the potential for the maintenance of characteristic plant communities into the future. Since pond cypress is the dominant tree in Cypress/Pine Savannas, its densities in the sapling, midcanopy, and canopy strata are used to determine the physiognomic condition of the overall plant community. A characteristic density of pond cypress in all stages of development from sapling to canopy-size individuals indicates long periods of deep flooding, a frequent and uninterrupted fire regime, and lack of excessive timber removal, all conditions that are required for maintaining the appropriate plant community.

To measure $V_{CYPRESS}$, one could obtain counts from plots and calculate density (number of stems per hectare) in the three size classes of pond cypress: (a) saplings (stems > 1-m tall and < 7.5 cm dbh), (b) midcanopy (stems 7.5-15 cm dbh), and (c) canopy (trees > 15 cm dbh). Another way is to determine the distance to the closest individual in each size class from randomly selected points in the WAA. To do this, at each center point, measure the distance (in meters) from the center point to the nearest sapling, midcanopy, and canopy stem of pond cypress. (Sample at least three points; more is better.) Determine the average distance to individuals in each of the three size classes. Calculate density as follows: $Density = 10,000/[2 \times (\text{average distance})^2]$. (The “2” is a correction factor constant (Barbour et al. 1999).)

Physiognomic information, relative to each size class (stratum) is derived from density data. Table 10 shows how “Physiognomy” is calculated. For the sapling stratum, Physiognomy = Density/250 (if the resulting score is > 1.0, reduce to 1.0). For the midcanopy stratum, Physiognomy = Density/50 (if the resulting score is > 1.0, reduce to 1.0). For the canopy stratum, Physiognomy = Density/100 (if the resulting score is > 1.0, reduce to 1.0). The mean of “Physiognomy” scores for all three strata is used to calculate $V_{CYPRESS}$. A graphical illustration of the relationship between the variable subindex and functional capacity is provided in Figure 21.

Physiognomic Structure of Canopy Longleaf and Pond Pine (V_{LONGL}).

This variable represents the contribution of canopy-sized longleaf and pond pine to the overall physiognomy (physical structure) of the community. It is determined by the density of longleaf and pond pines in the canopy stratum (stems > 15 cm dbh). Density is determined by counts in plots.

The Switchcane/Pine Savanna is a fire-maintained ecosystem and, as such, typically supports longleaf pine and, north of Georgia, pond pine. This is because in fire-maintained Switchcane/Pine Savannas, fire enables longleaf and pond pine to outcompete potential competitors. In the few reference sites available, the density of these two pine species varied tremendously in the smallest size classes (stems < 15 cm dbh). Thus, the smaller stems were not useful for providing indicators of suitable fire regime and habitat conditions. In contrast, all relatively unaltered Switchcane/Pine Savanna reference sites supported a sparse canopy of pines (primarily longleaf, but pond pine occasionally occurred as well).

Table 10
Calculation of Cypress Stand Physiognomy from Density Data

	Distance (m) ⁴			Mean	Density ⁵	Physiognomy ⁶
	Plot #1	Plot #2	Plot #3	Distance		
Sapling ¹	3.3	6.2	4.2	4.6	240	0.96
Midcanopy ²	8.7	7.0	7.3	7.7	85	1.00
Canopy ³	5.0	6.8	11.5	7.8	83	0.83
Mean					16. V _{CYPRESS} ⁷	0.93

¹ Stems > 1 m tall, but < 7.5 cm dbh

² Stems 7.5-15 cm dbh

³ Stems > 15 cm dbh

⁴ Measure distance in meters to nearest individual in each size class

⁵ Density = 10,000/[2 X (Mean Distance)²]

⁶ Sapling Physiognomy = Density/250, if > 1.0, reduce to 1.0

Midcanopy Physiognomy = Density/50, if > 1.0, reduce to 1.0

Canopy Physiognomy = Density/100, if > 1.0, reduce to 1.0

⁷ V_{CYPRESS} is the mean of all three physiognomy scores

Therefore, the density of longleaf and/or pond pine canopy-sized trees was useful for indicating a frequent and uninterrupted fire regime and the lack of excessive timber removal.

Canopy-sized longleaf and pond pines are generally more dense in Switchcane/Pine Savannas than in Bunchgrass/Pine Savannas. This may be due to higher nutrient status or a slightly less frequent fire regime in Switchcane/Pine Savannas; further research is needed to determine the reason for the naturally more dense canopy. Although longleaf and pond pine density is relatively low in Switchcane/Pine Savannas, it is similar (75-300 trees/ha) to Bunchgrass/Pine Savannas located at the more northern end of the Reference Domain in southeastern North Carolina (Frost, Walker, and Peet 1986).

Longleaf and pond pine density can be determined using any variety of plot sizes and shapes as long as at least 300 m² is sampled in each WAA (density is normally sparse in pine savannas and so a minimal plot size is required to measure density). Longleaf and pond pine tree counts can be made rapidly on

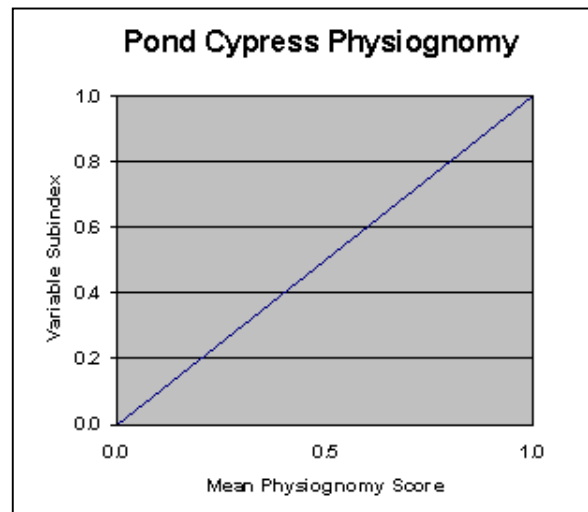

Figure 21. Relationship between pond cypress physiognomy and functional capacity

10-m-radius (314 m²) circular plots centered on the 1-m² plots used to assess cover of sedges. In each plot, count all longleaf and pond pine trees >15 cm dbh (diameter at 1.5 m above ground). A caliper or dbh tape can be used to verify whether a tree is > 15 cm dbh. (A fixed-width caliper can be inexpensively constructed with PVC piping material.) Distance from center point to the boundary of the 10-m radius can be measured with a meter tape, a sonic distance measurer, or an angle gauge. Obtain counts from at least three plots, sum them, and divide by the number of plots sampled to obtain mean count per plot for canopy-sized longleaf and pond pine trees. Multiply the mean count by 31.8 to obtain absolute density of longleaf and pond pine trees per unit hectare.

Unfortunately, Switchcane/Pine Savannas are extremely rare and little is known about them. Only four Switchcane/Pine Savanna reference sites were located, so calibration of V_{LONGGL} was based on these four sites and on densities of longleaf and pond pine in Bunchgrass/Pine Savannas at the more northern part of the Reference Domain. This approach was used because Bunchgrass/Pine Savannas located toward the more northern end of their range (North Carolina) typically have a slightly denser canopy of longleaf (and other pine species) than more southerly sites (along the Gulf coast). In addition, typical alterations to the canopy are similar to those that occur in drier Bunchgrass/Pine Savannas: timber harvesting, conversion to loblolly or slash pine silviculture, fire exclusion, and land development. For all these typical alterations, the condition of the plant community can be partly inferred by the density of tree-size, fire-adapted pines (longleaf and pond pine). Alterations caused by development or timber harvesting reduce density, while silvicultural management for longleaf increases density (pond pine is not grown for silviculture). Therefore, densities outside the variation exhibited by unaltered sites indicate an alteration to condition of the plant community.

Both the least wet Bunchgrass/Pine Savannas and Switchcane/Pine Savannas typically support no more than 75-300 canopy-sized (> 15 cm dbh) longleaf and pond pine trees per hectare. Timber removal reduces density, while longleaf silviculture typically manages for > 600 trees/ha. Therefore, these densities were used to calibrate the subindex for V_{LONGGL} .

If the density of longleaf and pond pines in the WAA is < 75 trees/ha, divide the density by 75 to obtain the subindex for V_{LONGGL} . If longleaf and pond pine density in the WAA is between 75 and 300 trees/ha, assign a subindex of 1.0 to the subindex for V_{LONGGL} . If the density of longleaf and pond pine in the WAA is between 300 and 600, subtract 300 from the density, divide this by 300 and subtract from 1.0 (i.e., Variable Subindex = 1.0 - ((longleaf and pond pine tree density - 300)/300)). If the density of longleaf and pond pine trees is > 600, assign 0.0 to the subindex for V_{LONGGL} . Calibration of this variable assumes a relationship between longleaf and pond pine canopy density and the overall condition of the plant community, with the reference standard ranging from 75-300 trees per hectare and declining condition at densities outside this range. A graphical illustration of the relationship between the variable subindex and functional capacity is provided in Figure 22.

Functional Capacity Index

Three distinct cover types of Wet Pine Flats are recognized: Bunchgrass/Pine Savanna, Switchcane/Pine Savanna, and Cypress/Pine Savanna. A different aggregation equation is required for deriving the FCI for each of these cover types.

Bunchgrass/Pine Savanna.

Unaltered Bunchgrass/Pine Savannas vary widely in canopy structure in that trees are much less sparse in the southern parts of the Reference Domain than in the more northerly portions.

However, throughout the Reference

Domain, Bunchgrass/Pine Savannas support a rich array of herbaceous species, including many that are rare or federally listed as threatened or endangered. Throughout the entire Reference Domain, both native bunchgrasses (via cover) and herbaceous indicator plants (via herb indicator scores) are sensitive to alterations and the condition of the plant community. Structural attributes (i.e., subcanopy density) could also be used to model the function, but additional variables would just mask the robustness of herbaceous indicators and so are not needed for this cover type.

Old growth (never altered) Bunchgrass/Pine Savannas have both high cover (> 50 percent) of bunchgrass or, west of the Mississippi River, wiry, native *Rhynchospora* spp. and high small-scale species richness (indicated by V_{HERB}). Probably less than 2 percent of the historic acreage remains intact (unaltered). In contrast to old growth sites, those that have been slightly degraded by recent fire suppression are reduced in species richness at small scales. This reduction in small-scale species richness accelerates over time and can lose almost all species if fire is excluded for more than about 20 years. (It appears that each species varies in the amount of time its seeds can remain viable in the soil without fire, but few last longer than 20 years.) Therefore, the earlier fire is reestablished, the more likely species richness can be restored.

Bunchgrasses are probably the most sensitive plants to the exclusion of fire. Once bunchgrasses are eliminated, it is extremely difficult to impossible to restore the ecosystem without planting bunchgrasses. In this respect, bunchgrasses can be considered keystone species in that they are responsible for perpetuating frequent ground fires.

Bunchgrass cover usually declines in sites degraded by mechanical soil disturbance, to which native bunchgrasses are particularly sensitive, but can sometimes retain relatively high species richness at small scales if frequent fire is maintained after the soil disturbance. With growing season fires (to allow bunchgrasses to set seed) and lack of further soil disturbances, such sites can be expected to recover with time.

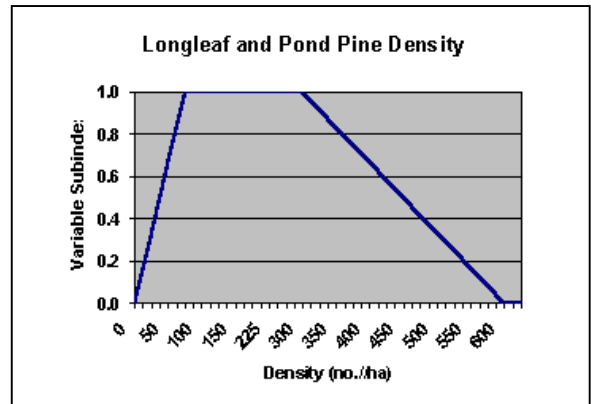

Figure 22. Relationship between canopy-size longleaf and pond pine density and functional capacity

Slightly altered sites and the best old growth sites probably constitute about 3-5 percent of all Bunchgrass/Pine Savannas. Because such sites could be restored with relatively little effort, they are included in the population of reference standard sites used to determine the condition of the plant community. In order to encompass slightly altered, but more easily restored, sites in reference standards, both the condition of bunchgrasses (V_{NBG}) and small-scale species richness (V_{HERB}) are required to assess the function Maintain Characteristic Plant Community.

The FCI for Bunchgrass/Pine Savannas is determined by the *higher* of the following two subindex scores:

$$FCI_{PLANTS} = \text{MAX} (V_{NBG}, V_{HERB})$$

Therefore the condition of the plant community is determined by either (a) relatively high cover (> 50 percent) of bunchgrass or, west of the Mississippi River, wiry, native *Rhynchospora* spp. or (b) high small-scale species richness as determined by a herbaceous indicator score > 8.0.

Cypress/Pine Savanna. For Cypress/Pine Savannas located along the transitional gradient to Bunchgrass/Pine Savannas, both variables that model alterations to the condition of the plant community (V_{NBG} and V_{HERB}) are likewise applicable to Cypress/Pine Savannas. The only caveat is that for a Cypress/Pine Savanna to obtain an FCI score of 1.0 for V_{HERB} , a subindex score of only 7.0 is required (rather than the 8.0 required for Bunchgrass/Pine Savannas). In the wettest Cypress/Pine Savannas, bunchgrasses and a rich herb stratum are not characteristic of unaltered conditions and therefore are not useful indicators of the condition of the plant community. Rather, sedge cover and structural conditions are better indicators.

To assess the function Maintain Characteristic Plant Community, two or three of the following five variables are measured, depending on which part of the wetness gradient of the Cypress/Pine Savanna is being assessed: V_{NBG} , V_{HERB} , $V_{CYPRESS}$, V_{SEDGES} , and V_{SUBC} . If in doubt about a site's location along the wetness gradient, all five indicators should be measured. The FCI for a Cypress/Pine Savanna is provided by the *highest* of the following three values:

$$FCI_{PLANTS} = \text{MAX} [V_{NBG}, V_{HERB}, (V_{CYPRESS} \times ((V_{SEDGES} + V_{SUBC})/2))^{1/2}]$$

Alterations to the groundcover (V_{SEDGES}) and subcanopy (V_{SUBC}) provide information on the current structural condition of the habitat. Therefore, indices for the two parameters are averaged to determine the present condition of the plant community. However, the present structural condition provides no information on past or potential future conditions, which must be maintained over a long period to maintain conditions suitable for a characteristic plant community into the future. Therefore, $V_{CYPRESS}$ is used to determine the appropriate condition of the plant community over time (see previous discussion on $V_{CYPRESS}$).

The assessment model assumes that past alterations and present conditions are independent indicators of the condition of the plant community. Therefore, the geometric mean is used in the aggregation equation. V_{SUBC} and V_{SEDGES}

represent two components of the present condition of the plant community, while $V_{CYPRESS}$ indicates the maintenance of the condition of the plant community over time.

$V_{CYPRESS}$ also represents potential future conditions if the site is not altered further. For example, if habitat conditions were altered over a long period (only one size class of cypress present, $V_{CYPRESS} = 0.25$), much time and effort would be required to restore cypress to the site even if sedge cover and subcanopy density were relatively unaltered.

Switchcane/Pine Savanna. The condition of the plant community in a Switchcane/Pine Savanna is best determined by structural attributes because the overwhelming dominance of switchcane in the groundcover stratum prevents bunchgrasses and herbaceous species from being useful as a reliable indicator of the condition of the plant community. Therefore, to assess the function Maintain Characteristic Plant Community, the conditions of the following three variables are required: V_{LONGL} , V_{SUBC} , and V_{PINES} . The FCI aggregation equation for Switchcane/Pine Savannas is:

$$FCI_{PLANTS} = [V_{LONGL} \times ((V_{SUBC} + V_{PINES})/2)]^{1/2}$$

This model incorporates variables that indicate alterations to characteristic spatial structure of a Switchcane/Pine Savanna caused by alterations and fire exclusion. V_{LONGL} is used as a multiplier in the equation because past alterations and current conditions strongly affect future conditions of the plant community in a WAA.

Both V_{SUBC} and V_{PINES} provide information on the current structural condition of the WAA in that a relatively sparse canopy and understory are indicative of characteristic plant habitat for unaltered Switchcane/Pine Savannas. Indices for the two parameters are averaged to determine present conditions. However, present structural condition provides no information on the potential for a site to sustain conditions required to maintain the appropriate plant community into the future. Therefore, the geometric mean is calculated for the two indicators of present conditions ($V_{SUBC} + V_{PINES}$) and the indicator for potential future conditions (V_{LONGL}).

If habitat conditions have been altered over a long period ($V_{LONGL} < 0.50$), much effort would be required to restore the site. If present structural conditions are partially or completely altered, but V_{LONGL} is > 0.50 , then there is a reasonably good chance restoration could prove successful by restoring habitat structure (reinitiating fire, clearing understory, etc.).

Function 3: Maintain Characteristic Animal Community

Definition

This function is defined as the capacity of a WAA and its surrounding landscape to provide all the resources required for maintaining the entire suite of animal species characteristic of unaltered, fire-maintained Wet Pine Flats. This function includes maintaining the characteristic abundance of animal species at characteristic spatial and temporal scales.

The model for this function could be validated by comparing seasonally adjusted animal census data with FCI scores derived from the model. One could compare density data using similarity indices, multivariate statistics, cluster analysis, association analysis, etc. with FCI scores. Each of the three cover types (Bunchgrass/Pine Savanna, Cypress/Pine Savanna, and Switchcane/Pine Savanna) would have to be examined independently because different reference standards apply to each type.

Rationale for selecting the function

Animals are an important part of the biota of any ecosystem. Animals that use unaltered Wet Pine Flats for all, or part, of their lives are adapted to habitats maintained by frequent fire. Because fire frequency has been drastically reduced in most areas of the Southeast, many animal species that require habitat maintained by frequent fire are threatened or endangered over most of their historic range.

Characteristics and processes that influence the function

The area and types of habitats required to maintain a characteristic animal assemblage depend upon the life-history requirements of species that utilize Wet Pine Flats. For animals that would use a particular WAA, there are two major determinants of habitat quality: (a) habitat quality within the site (onsite quality) and (b) the quality of the surrounding landscape that provides supplemental resources to animals that would normally use the site (landscape quality).

Onsite habitat quality can be inferred by the structure and composition of the plant community within a given WAA, modeled previously under the function Maintain Characteristic Plant Communities. To determine the contribution that surrounding landscape has on site quality in a given WAA, one must determine: (a) whether there are any species that, during some portion of their life cycle, require a resource that can be found only in Wet Pine Flats and (b) whether the type of habitat provided by unaltered Wet Pine Flats is used by species that require similar habitat in the surrounding landscape.

If unaltered Wet Pine Flats provide a critical resource for an animal species that cannot be obtained in another habitat type, then the total area of an unaltered Wet Pine Flat would be crucial for assessing habitat quality. The area required would depend upon (a) the minimum area of unaltered, contiguous Wet Pine Flats required to support the species requiring the largest area and (b) the total area and quality of surrounding habitats required to maintain the species. At this time, it does not appear that Wet Pine Flats provide a resource critical for any species. For example, crayfish (*Procambarus* spp.) are abundant in Wet Pine Flats, but, because crayfish are not restricted to Wet Pine Flats, Wet Pine Flats do not provide any crayfish species with a resource that could not be obtained elsewhere. Therefore, because Wet Pine Flats do not provide a critical resource, the total area of contiguous Wet Pine Flats is not critical in maintaining a characteristic animal community.

If Wet Pine Flats provide resources that are similar to resources provided by other habitat types (supplemental resources), then the area of an unaltered Wet Pine Flat and the area, accessibility, and quality of the other critical habitats would be crucial in assessing site quality. Frequent fire maintains open savanna, which is a habitat characteristic important to some animal species using Wet Pine Flats. For animal species that utilize both unaltered Wet Pine Flats and similar (fire-maintained) landscape, the total area of fire-maintained landscape (both wetland and upland) would be important to these animals. Therefore, alterations to the surrounding landscape (fire exclusion, development, etc.) that produce conditions unlike those provided by a frequently burned landscape could detrimentally affect habitat quality in a WAA by reducing the accessibility of resources needed to sustain the suite of animal species that depend on landscape attributes maintained by frequent fire.

Although there are no animal species that rely on resources that only occur in Wet Pine Flats, a number of species rely on fire-maintained pine ecosystems of which wet flats are a part. For example, birds and other wide-ranging animals that rely on fire-maintained systems do not appear to differentiate Wet Pine Flats from uplands, as long as both are fire maintained. Thus, fire-maintained uplands supplement resources available in fire-maintained wet flats and vice versa.

The contribution that supplemental habitat provides to site quality at any given location depends on the minimum area required to sustain the entire suite of animal species characteristic of a fire-maintained ecosystem of which a Wet Pine Flat is one component. This is because for animal communities, habitat size is a reliable predictor of species richness (MacArthur and Wilson 1967). Smaller areas contain species that are nested subsets of those supported by larger areas, suggesting that this area/richness relationship is not due to random sampling effects (Cutlar 1991). One reason that larger areas support more species than smaller areas is that the rate of extinction for local populations is lower at larger patch sizes (Hanski and Thomas 1994, Hanski 1996). This means that patches of larger habitats are more likely to support a local population that is a subset of a larger metapopulation (Hanski 1994).

The proximity of like-habitat patches to one another also affects local rates of extinction because such areas of like habitat can supply immigrants to areas that

lose populations (i.e., due to source/sink dynamics) (Hanski and Gyllenberg 1993, Pulliam 1996). Although individual species differ in their rates of extinction in the wake of habitat reduction and habitat fragmentation, both reduction and fragmentation of habitat interact to increase local extinction rates (Hanski 1996). Therefore, it is more likely that all resources required by an assemblage of animals characteristic of a given type of habitat (e.g., Wet Pine Flat) can be obtained if the surrounding landscape is similar to the site being examined (Watts 1996). In addition, a larger area of a given habitat type is more likely than a smaller area to provide the resources needed to sustain the suite of animals characteristic of the habitat under consideration. Therefore, for Wet Pine Flats, the animal species with the largest areal requirement of fire-maintained landscape would be the species on which to model the function because its requirements would encompass those of all populations requiring smaller areas.

In taking this approach, one must determine if there are any habitat alterations that would be detrimental to the animal whose requirements define habitat quality (e.g., fire-maintained landscape). For example, several amphibian species are associated with fire-maintained landscapes and travel across wet flats to breeding ponds (cypress depressions). There is evidence that intensive silviculture may detrimentally affect herpetofaunal populations (Enge and Marion 1986; Means, Palis, and Bagett 1996) because intensive silviculture relies on a series of raised parallel-aligned beds on which pine seedlings are planted. Standing water in the troughs between beds may cue amphibians to lay their eggs in these troughs (where water is too ephemeral to support larval development) rather than in deeper, more permanent cypress depressions (which occur scattered throughout Wet Pine Flats).

If bedding in Wet Pine Flats does indeed reduce local amphibian populations by blocking migration routes, then onsite habitat quality would be important to amphibians that migrate across Wet Pine Flats (e.g., the flatwoods salamander, *Ambystoma cingulatum*). In addition, bedded Wet Pine Flats contiguous to the assessment area could effectively lower the quality of the site if the alterations reduced the total area needed to maintain a local breeding population. Onsite habitat quality is effectively assessed by the Plant Community function. To account for habitat quality of surrounding landscape, bedded areas would have to be excluded from contiguous suitable habitat even if the bedded areas were maintained by frequent fire (e.g., where bedding is used in conjunction with longleaf pine silviculture).

Description of model variables

Area of Contiguous Fire-Maintained Landscape ($V_{LANDSCP}$). This variable represents the area of fire-maintained supplemental landscape contiguous to and including the WAA; supplemental landscape includes fire-maintained areas of both Wet Pine Flats and uplands. Other types of habitat (nonsavanna) are not included in $V_{LANDSCP}$ because, at this time, there are no known animal species that require both Wet Pine Flats and supplemental habitat of a different type.

To determine $V_{LANDSCP}$, the boundary of contiguous fire-maintained habitat should be delineated from recent (< 5 years old), high resolution, aerial photography (Figure 23). All fire-maintained Wet Pine Flats and upland pine savannas should be included within delineated boundaries, but any discontinuities in fire-maintained habitat wider than 50 m (150 ft) should be excluded, as well as all bedded areas. Subtract any area of dissimilar cover (fire-excluded habitat, development, highways, etc.) enveloped by the contiguous boundary from the total area delineated if the discontinuity exceeds 1 ha (2.5 acres) in size. Include the area of the WAA if it is a fire-maintained savanna. Area can be determined by digitizing fire-maintained landscape or by overlaying a dot grid matrix.

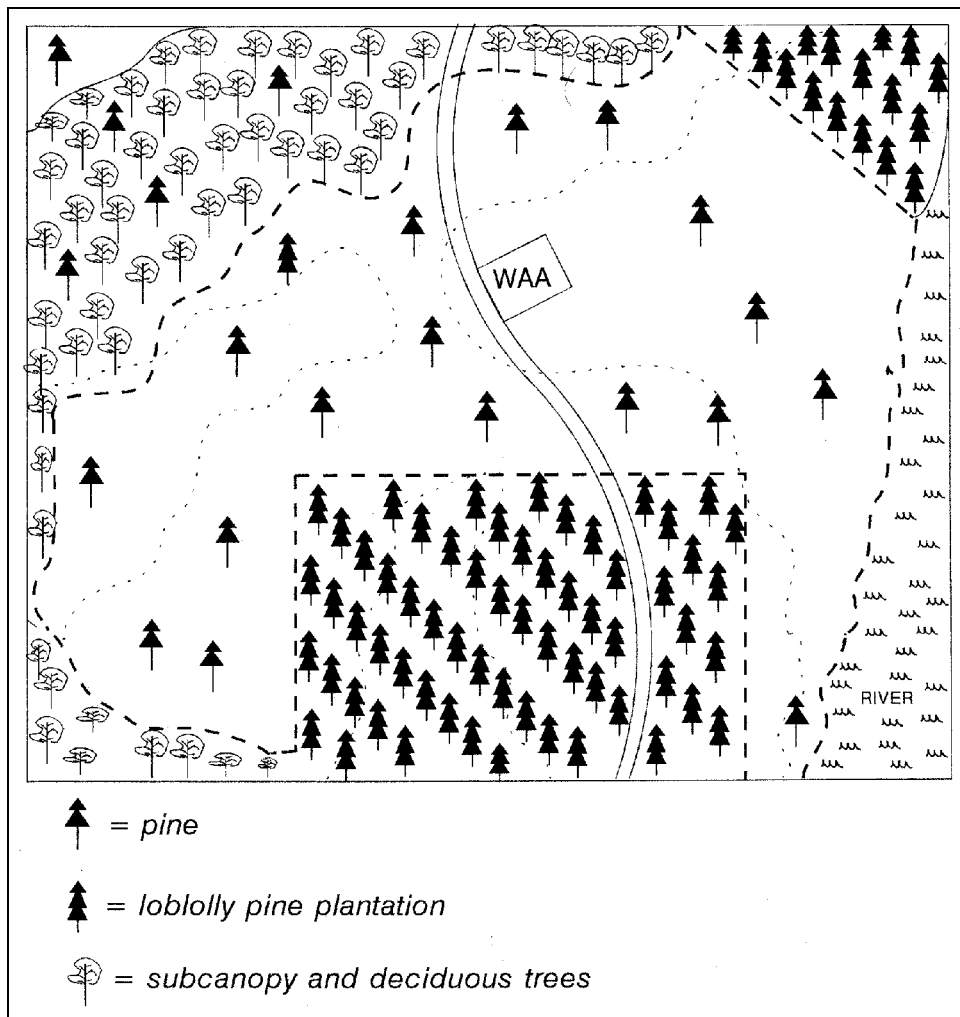

Figure 23. Determination of the landscape variable ($V_{LANDSCP}$). Dotted line delineates boundary of Wet Pine Flat, subcanopy and deciduous tree symbol designates fire-excluded areas, and dashed line delineates area of fire-maintained landscape used to calculate $V_{LANDSCP}$.

Fire-maintained habitat is recognized in aerial photos as sparsely treed areas with relatively open understories (lighter colored than closed forests). If aerial photos are not available, one should try to estimate the area of fire-maintained landscape using aerial and on-ground surveillance. Fire-maintained landscape is identified by sparse canopy (10-300 stems/ha of pines and/or pond cypress > 15 cm dbh) and a very sparse midstory (<140 stems/ha). Charcoaled bark of canopy trees is the most indicative evidence of recent fire.

To determine the minimum area required to sustain the full suite of animal species characteristic of Wet Pine Flats, we must utilize information on the minimum area required by the species that requires the largest area of fire-maintained landscape to sustain a local population. Although cougar (*Felis concolor*) and black bear (*Ursus americanus*) are normal components of large, relatively unaltered landscapes, these species are not unique to fire-maintained ecosystems. Therefore, their area requirements are not reasonable for establishing an upper threshold for maintaining habitat quality for faunal populations. In contrast, there are animal species whose niches occur entirely within habitat maintained by frequent fire, including the pine barrens tree frog (*Hyla andersonia*), Bachman's sparrow (*Aimophila aestivalis*), and red-cockaded woodpecker (*Picoides borealis*). Therefore, information on the minimum area required by these and other species requiring fire-dependent habitat was used to determine the minimum area of supplemental habitat required to maximize habitat quality in a Wet Pine Flat.

The red-cockaded woodpecker requires the largest area (50-200 ha, depending on habitat quality) to sustain a local population or clan (DeLotelle, Epting, and Newman 1987). Therefore, the availability of 100 ha (250 acres) of contiguous fire-maintained habitat is a reasonable threshold to use for assessing the ability of an area to sustain all animals uniquely associated with fire-maintained ecosystems (of which Wet Pine Flats are one component).

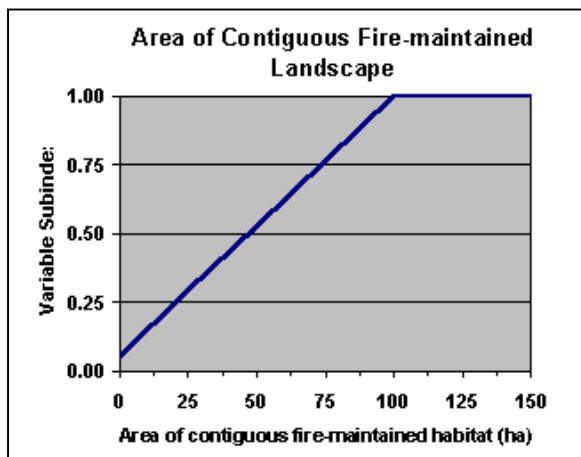

Figure 24. Relationship between contiguous area of fire-maintained landscape and functional capacity

Therefore, in order to determine the quality of supplemental landscape ($V_{LANDSCP}$), first determine the total area of fire-maintained landscape adjacent to the WAA, excluding any bedded areas even if maintained by fire. Calculate the subindex using the following equation: $V_{LANDSCP} = 0.0095 \times (\text{area in hectares}) + 0.05$. A graphical illustration of the relationship between the variable subindex and functional capacity is provided in Figure 24.

It is assumed that there is a direct linear relationship between habitat quality contributed by the surrounding landscape and the size of the contributing area. The rationale for this relationship is that there is a suite of species that

require fire-maintained systems, but they vary in the amount of supporting habitat required. As total area of contiguous, fire-maintained habitat declines in size, progressively fewer of these species are able to obtain the needed resources to maintain a viable local population (Dunning, Danielson, and Pulliam 1992) and site quality declines accordingly. When there is no fire-maintained landscape available, some fire-adapted species may still persist, although most fire-adapted species will become locally extinct. However, it is not clear whether the relationship between potential habitat size and number of species is linear (i.e., that number of species decline linearly as area of potential habitat is reduced). Island biogeography theory provides evidence that there is a negative exponential loss of species with a reduction in area (MacArthur and Wilson 1967, Simberloff and Wilson 1970), but this relationship has not been tested in Wet Pine Flats.

Functional Capacity Index

Both the landscape quality variable ($V_{LANDSCP}$) and onsite habitat quality (determined by the FCI for the function Maintain Characteristic Plant Community) are used to model this function. The FCI_{PLANTS} was used because it reflects onsite conditions on which animals depend (i.e., plant community composition and spatial patterns). To determine the FCI for the Maintain Characteristic Animal Community function, apply the following aggregation equation:

$$FCI_{ANIMALS} = (FCI_{PLANTS} \times V_{LANDSCP})^{1/2}$$

As previously stated, there are two major determinants of habitat quality for animals using a WAA: (a) habitat quality within the WAA (onsite habitat quality) and (b) the quality of landscape contiguous to and including the WAA (landscape quality). Both conditions are assumed to be equally important for determining habitat quality for animals. Thus, the FCI is determined by the geometric mean of onsite habitat quality of the WAA (FCI_{PLANTS}) and landscape quality. Since FCI_{PLANTS} is computed for each of the three vegetation cover types, $FCI_{ANIMALS}$ should also be computed differently for each cover type using variables appropriate for that cover type.

If none of the surrounding landscape of a WAA is fire maintained (i.e., it cannot provide supplemental resources to animals in the WAA), then site quality is determined entirely by the onsite habitat quality of the WAA. If the landscape contiguous to a WAA is fire maintained, but onsite habitat quality of the WAA is completely altered ($FCI_{PLANTS} = 0.0$), then supplemental resources that the surrounding landscape would provide are of no benefit to animals that would have occurred in the WAA before alteration. However, in this situation, a significant restoration of onsite habitat quality for animals could be achieved by restoring the WAA.

This model reflects the fact that if a WAA is located in a landscape that has little or no contiguous fire-maintained landscape and there is no chance of restoring the landscape (e.g., in an urbanizing area), the $FCI_{ANIMALS}$ will never be

any higher (even after restoration) than the contribution to habitat quality that can be achieved onsite.

Function 4: Maintain Characteristic Biogeochemical Processes

Definition

This function reflects the capacity of a Wet Pine Flat to maintain biogeochemical processes at the rate, magnitude, and timing characteristic of the ecosystem, including nutrient and elemental cycling, biogeochemical transformations, and export of dissolved organic constituents. This function models the effects that alterations have on biogeochemical processes and assumes that Wet Pine Flats will maintain characteristic biogeochemical processes if not altered.

Many elements and compounds could be used to validate this function. The most commonly studied elemental constituents in freshwater wetlands include various forms of nitrogen (N_2 , NO_2 , NO_3 , NH_4), extractable phosphorus, inorganic carbon (dissolved and particulate), and organic carbon (in living and dead biomass). To independently validate this function, one would have to sample these constituents seasonally to quantify temporal changes between wet and dry periods and compare season fluctuations with those of altered sites. Alterations to hydrologic regime, soil, and fire return interval all affect biogeochemical processes and so these alterations would have to be tested independently relative to reference conditions

Rationale for selecting function

The processes involved in biogeochemically transforming elements and compounds from one form to another is fundamental to all ecosystems. However, wetlands differ from uplands in that biogeochemical processes that require anoxic conditions (denitrification, fermentation, methanogenesis, etc.) are much more prevalent in wetlands than uplands. By supporting anaerobic biogeochemical processes, wetlands help maintain and improve water quality. This is one reason why wetlands receive special regulatory protection.

The rate, magnitude, and timing of biogeochemical processes are determined by living components of an ecosystem. Primary producers (plants) assimilate nutrients and elements in soil and use energy from sunlight to fix carbon. When they die, they depend upon microbial organisms in soil to transform those fixed elements and compounds to forms that are available to other plants. Therefore, conditions that maintain plants and soil microbial populations are those that drive characteristic biogeochemical processes, such as the assimilation and cycling of nutrients from dead to living biomass and the export of dissolved organic matter.

Characteristics and processes that influence the function

Wet Pine Flats differ from other wetlands due to a combination of factors that do not occur together in any other wetland type. These factors combine to control the biogeochemical processes characteristic of Wet Pine Flats: (a) the source of water is dominated by precipitation, thus nutrient subsidy is generally low, (b) when flooding occurs, it may do so for long periods, but never very deeply (10-20 cm) and never with much flow velocity, (c) microtopographic complexity is high, thus providing a diverse array of aerated and anoxic conditions for soil microbial organisms within the normal range of flooding level, and (d) nutrient recycling occurs in pulses following fires, which recur on a frequent basis, thus enabling a rapid turnover of nutrients. These four attributes enable Wet Pine Flats to tightly and rapidly cycle nutrients, which in turn allows Wet Pine Flats to rapidly recover characteristic biomass and structure following fires.

Considering the characteristic biogeochemical attributes of Wet Pine Flats listed above, three parameters stand out as being essential for determining the degree to which biogeochemical processes are altered in a WAA: (a) the degree to which hydrologic regime is altered, (b) the degree to which fire regime is altered, and (c) the degree to which soil is altered. These three parameters are discussed in the following paragraphs.

Because most biogeochemical processes in wetlands depend on the spatial and temporal balance between oxic and anoxic conditions, the timing and duration of flooding and soil saturation (hydrologic regime) affect biogeochemical processes. Therefore, alterations that affect hydrologic regime also affect biogeochemical processes. For example, draining a Wet Pine Flat eliminates flooding and soil saturation, which in turn alters processes that depend on anoxic conditions (fermentation, denitrification, etc.).

Frequent fire is essential in effecting biogeochemical processes in Wet Pine Flats. Fire combusts organic matter that accumulates between fires, which leads to a brief, but rapid, release of inorganic nutrients. This rapid turnover of nutrients is unusual among wetlands. Fire leads to a rapid increase in herbaceous plant production following fire (Christensen 1977, 1993) and there is very little accumulation of biomass in detritus. Hence, unaltered Wet Pine Flats are open savannas with few trees and very little coarse woody debris. Fire exclusion increases standing stocks of living biomass (primarily subcanopy shrubs) and stocks of detrital biomass (primarily standing dead herbaceous plants) and may reduce nutrient cycling rates.

At first glance, it seems reasonable that measurements of stocks of living and dead biomass could be used to measure alterations to biogeochemical processes; however, measurements of living and detrital biomass confer no information about past or present fire regime, and hence nutrient and elemental turnover rates. In addition, standing stocks of detrital biomass are low in unaltered Wet Pine Flats. Any measure of biomass must incorporate information on the turnover of biomass and nutrients caused by fire.

Edaphic (soil) condition is another important parameter affecting biogeochemical processes in Wet Pine Flats. This is because microbial organisms and plants are adapted to characteristic microtopographic structure, soil texture, and nutrient regime. Alterations to soils affect these conditions upon which soil microbes and plants depend, and this, in turn, alters biogeochemical cycling processes. For example, if soil is bedded to plant loblolly or slash pine, bulk density is altered both on the beds and in the trenches between, thus altering interstitial pore space and substrate conditions on which soil microbes and plants depend. In addition, microtopographic variation changes from a regular distribution of small, low (10-20 cm high), regularly distributed hummocks to a parallel array of trenches and high ridges (15-30+ cm high). In bedded sites, duration and frequency of flooding are increased in trenches and decreased on beds relative to unaltered conditions; this in turn alters the rate, timing, and magnitude of biogeochemical processes.

Functional Capacity Index

Modeling biogeochemical attributes in Wet Pine Flats must encompass the three essential elements discussed above: hydrologic regime, fire regime, and edaphic conditions. Hydrologic regime is thoroughly modeled under the function called Maintain Characteristic Water Levels, while fire regime is one of the major processes subsumed under the function called Maintain Characteristic Plant Community. Degree of soil alteration is specifically modeled in a subfunction under the Maintain Characteristic Water Level function and indirectly subsumed in all of the submodels for the plant community function. Therefore, all conditions that affect biogeochemical processes can be determined by the hydrologic function model and the plant community model. The aggregate equation for this function is:

$$FCI_{\text{BIOGEOCHEM}} = (FCI_{\text{HYDROLOGY}} \times FCI_{\text{PLANTS}})^{1/2}$$

Modeling alterations to biogeochemical processes using the hydrologic regime model and plant community model incorporates the three main factors controlling biogeochemical processes: hydrologic regime, fire regime, and soil condition. The model assumes that the two terms are not entirely independent of one another. The site quality function incorporates excessive alterations to hydrology (i.e., draining, damming, filling, soil disturbance). Hence, alterations to hydrologic regime would alter site quality as well. Likewise, fire regime, one of the main factors controlling the site quality function, is also incorporated in the ET variable under one of the hydrologic subfunctions. However, only a major alteration to ET (conversion to cropland or to an impervious surface) would be expected to produce a large effect in the hydrologic function.

Conversion to intensive silviculture or other alterations causing excessive soil disturbance would be incorporated by both the hydrologic regime function (as submodel #5) and the plant community function (herbaceous plants are extremely sensitive to such alterations). Note, however, that the site quality model for Switchcane/Pine and the wettest Cypress/Pine Savannas do not require measurements of herbaceous plants; for these cover types, it is assumed that

alterations to spatial structure (strata) caused by clear-cutting, conversion to silviculture, land development, etc. would also alter soils. In addition, soil alterations would also be incorporated in the hydrologic function. Therefore, all alterations that affect biogeochemical functioning in Switchcane/Pine or Cypress/Pine Savannas would be accounted for by this model.

5 Assessment Protocol for Assessing Wet Pine Flats

Preliminary Tasks

This chapter outlines the protocol for collecting and analyzing data needed for assessing the functional capacity of a wetland in the context of a 404 permit review process or similar assessment scenario. Typically, this means comparing FCIs obtained from preproject conditions at a site with projected postproject conditions (i.e., following an alteration or restoration). An HGM assessment can also be used to track the success of restoration and enhancement projects through time.

This chapter discusses each of the tasks required to complete an assessment of Wet Pine Flats on mineral soil in the Atlantic and Gulf coastal plains:

- a.* Define assessment objectives
- b.* Characterize the project site
- c.* Screen for red flags
- d.* Define the Wetland Assessment Area (WAA)
- e.* Partition a WAA and collect field data
- f.* Analyze field data
- g.* Apply and interpret assessment results

Defining Assessment Objectives

Begin the assessment process by clearly stating the purpose for conducting the assessment. There may be one or more reasons for conducting an assessment, including: (a) to determine how a proposed project will impact wetland functions, (b) to compare several wetland sites as part of an alternatives analysis,

(c) to identify specific actions that could be taken to minimize project impacts, (d) to document baseline conditions at a wetland site, (e) to determine mitigation requirements, (f) to determine mitigation success, or (g) to determine the effects of a specific manipulation (management or restoration). Defining objectives of an assessment will prevent misunderstanding among stakeholders and other interested parties. It will also help focus the interpretation of assessment results on the specific requirements of the project.

Characterizing the Project Area

Describe the project area, including its climatic regime, surficial geology, geomorphic setting, hydrologic regime, vegetation, soils, current land use, proposed impacts, and any other attributes or processes that influence how wetlands in the project area perform functions. The characterization should include maps, photos, and figures showing project area boundaries, jurisdictional wetlands, WAA (see below), location of proposed alterations, roads, ditches, buildings, streams, soil types, plant communities, habitat of threatened or endangered species, and any other pertinent features.

Some of the following maps and photos would be useful for characterizing a project area, for partitioning the area into partial WAAs, and for determining the subindex of several model variables:

- a.* High-resolution aerial photographs
- b.* USDA Natural Resources Conservation Service county soil surveys
- c.* U.S. Geological Survey topographic maps
- d.* County drainage maps, if available
- e.* Metes and bounds survey, if available

Identifying Factors that Preclude Assessment

Certain factors preclude the need to conduct functional assessment due to local, regional, or Federal regulatory constraints that supersede protections afforded by the Clean Water Act Section 404 program. These constraints include, but are not limited to, (a) protection of threatened or endangered species habitat, (b) protection of significant historic or archeological sites, and (c) specially protected watersheds and coastal zones. Sometimes such protected features are called “Red Flag Features” (Table 11).

Table 11 Typical Red Flag Features and Respective Program and/or Agency	
Red Flag Features	Authority¹
Native Lands and areas protected under American Indian Religious Freedom Act	A
Hazardous waste sites identified under CERCLA or RCRA	G
Areas providing habitat for species listed as endangered or threatened	J
Areas covered under the Farmland Protection Act	J
Floodplains, floodways, or flood-prone areas	I
Areas with structures/artifacts of historic or archeological significance	E
Areas protected under the Land and Water Conservation Fund Act	J
National wildlife refuges and special management areas	H
Areas identified as significant under the RAMSAR Treaty	H
Areas supporting rare or unique plant communities	F
Areas designated as sole source groundwater aquifers	G
Areas protected by the Safe Drinking Water Act	G
City, county, state, and parks and refuges	B, D, K,L
Areas supporting threatened or endangered species and listed critical habitat	C, D, F, H
Areas protected by the Wilderness Act	L
¹ Program or Authority Agency A. Bureau of Indian Affairs B. National Park Service C. State coastal zone offices D. State Departments of Natural Resources, Fish and Game, etc. E. State historic preservation offices F. State Natural Heritage Program offices G. U.S. Environmental Protection Agency H. U.S. Fish and Wildlife Service I. Federal Emergency Management Administration J. National Resources Conservation Service K. Local government agencies Service L. U.S. Forest Service	

Defining the Wetland Assessment Area (Bounding Criteria)

Before a functional assessment is performed, one must determine whether the WAA needs to be partitioned into two or more partial WAAs. However, Wet Pine Flats possess certain hydrogeomorphic and vegetative attributes that may make partitioning less intuitive than is the case for most other HGM subclasses. In determining whether a given WAA should be divided into partial WAAs, one must determine whether or not (a) one or more vegetation cover types are, or

would normally have been, present at the site (Bunchgrass/Pine, Cypress/Pine, or Switchcane/Pine Savanna), (b) vegetation has been altered by conversion to pine plantation, exclusion of fire, mowing, etc., (c) soils have been altered by bedding, rutting from vehicles, compaction by grazing animals, etc., and (d) there have been alterations to the hydrologic regime (dams, ditches, fill, etc.). The extent (boundaries) of hydrologic alterations are often the least obvious because there are often several alterations in close proximity to one another (e.g., a dam, ditches, and fill material). Note that in preproject assessments fill, excavations, ditches, and areas drained by ditches may have already been delineated as non-wetland and so functional assessments of such areas would not normally be required. However, such areas could likely be assessed prior to restoration if their removal would be a part of the restoration. Likewise, such alterations could be assessed to determine the magnitude of an alteration in cases where the alteration is a violation of Section 404 regulations (i.e., to determine compensation in cases where no permit had been issued for the impact).

Appendix A (Table A1) provides a key that can help determine how and where to partition Wet Pine Flats. For any area defined as a partial WAA, a complete assessment should be conducted in each area (i.e., all pertinent field indicators should be measured in each area). However, depending on the cover type and/or hydrologic alteration used to define the WAA, some variables may not have to be measured. The following discussion explains how various hydrologic alterations interact in a Wet Pine Flat.

A dam impedes the surface flow of water in a wet flat if constructed across the gradient of the flat, either perpendicularly (Figure 3a) or at an angle (Figure 3b). A dam across a flat creates a reservoir on the upgradient side of the dam and a reservoir shadow on the downgradient side (Figure 3, 7a, 7d). In this case, a separate WAA should be identified for both the upgradient and downgradient sides of the dam. However, if culverts at ground level were present, they would allow water to flow under the potential impediment and prevent water from being detained upgradient (Figure 7b). In this case, only the footprint of the dam should be identified as a partial WAA. (Note however, if culverts are above ground level, then there is an impediment to flow and the height of the dam is the lowest point of the lowest culvert.) Also, for preproject assessments, roads will likely already be delineated as uplands and so there would be no need to assess the footprint of the dam.

Most (perhaps all) dams are roads, and most roads have a ditch or ditches running parallel to them. Sometimes these ditches are simply elongated borrow pits from which fill was excavated to raise the road surface above the usual flooding elevation (Figure 7c); rarely is fill obtained from elsewhere. Usually, however, adjacent ditches are also designed to transport water away from a site. If ditches adjacent to the road (or other impediment) transport water from the WAA, care must be taken to determine the general direction of flow through the wet flat, the alignment and effectiveness of ditches, and the presence of culverts under the dam.

If a ditch or ditches designed to drain a site are located adjacent to a road (potential dam), then the road would be ineffective in impeding the flow of water

because the ditches would remove water from the site before it could accumulate upgradient (Figure 7e). In this case, at least two WAAs must be demarcated, one for area drained by ditches (determined by the lateral drainage distance) and one for the area covered by the road adjacent to the ditches.

If ditches adjacent to a road do not transport water from the WAA, then the road impedes water flow, and the road and ditches act as a fill and excavation, respectively (Figure 7d). In this case, at least three separate partial WAAs must be defined: one for the area constituting the reservoir of the dam, one for the reservoir shadow, and one for the combined area of the road (fill material) and ditches (excavation). However, if the road has culverts that allow water to flow under it, then no damming effect is created; in this case, a separate partial WAA should be demarcated only for the combined area over which the road and ditches occur.

If there is no road or other impediment to flow, but there is a ditch running through the WAA, then one must determine whether the ditch has been maintained sufficiently so that it does indeed drain. If the ditch is capable of draining the area, then a partial WAA must be defined that encompasses the lateral drainage distance of the ditch (Table 13 and Figure 5).

It is possible that a given WAA may be subjected to water imported from elsewhere. In such a circumstance, at least two partial WAAs will have to be determined, one for the area above the point of water import and one below.

Variations in alterations to soils and microtopography are also sufficient for establishing two or more partial WAAs. Alterations occur following land-clearing activities, industrial silvicultural activities, creation and maintenance of utility rights-of-way, traffic from off-road vehicles, and explosions from light artillery fire. Alterations to vegetation, such as fire exclusion, livestock grazing, and hog rooting are also used to partition a WAA into two or more partial WAAs.

Collecting Field Data

Before assessing a WAA, gather all necessary field gear. Obtain appropriate topographic maps, county soil surveys, and the most recent high-resolution aerial photos that can be obtained for the area. These maps and surveys will be used onsite and in the office following fieldwork. Table 12 provides a list of field gear that should be taken to collect field data.

Field measurements of model variables are collected at several spatial scales. Field data sheets, located in Appendix A (Field Supplement), are organized by decreasing spatial scale from landscape-scale variables to site-scale variables to plot-scale variables. A maximum of 18 variables are available for assessing the 4 wetland functions modeled in the 3 region subclasses in this Regional Guidebook. However, in any given WAA, only 4-8 variables are needed to assess these functions, depending on the cover type being assessed and the types of alterations that are present.

Table 12
Field Gear for Assessing Wet Pine Flats

- ___ a. data sheets
- ___ b. pencils
- ___ c. soil probe and/or sharpshooter shovel and/or bucket auger
- ___ d. binoculars
- ___ e. hand lens
- ___ f. hand calculator
- ___ g. compass
- ___ h. hand-level and stadia rod or laser level
- ___ i. meter tape (100 m) and/or sonar distance measurer
- ___ j. tree caliper or dbh tape or pre-formed calipers fixed at 7.5 and 15 cm width
- ___ k. center pole and quadrat poles (Figure 25)
- ___ l. high resolution aerial photographs of WAA and surrounding landscape
- ___ m. transparent dot grid overlay
- ___ n. Munsell color chart
- ___ o. USDA/NRCS Hydric Soils Indicator list
- ___ p. appropriate USDA county soil surveys
- ___ q. appropriate USGS topographic maps
- ___ r. insect repellent
- ___ s. sun block, hat
- ___ t. GPS
- ___ u. cell phone
- v. plant identification guides and/or botanical manuals
 - ___ 1. Radford, Ahles, and Bell (1968): *Manual of the Vascular Flora of the Carolinas*
 - ___ 2. Ajilvsgi (1979): *Wild Flowers of the Big Thicket, East Texas, and Western Louisiana*
 - ___ 3. Godfey and Wooten (1979): *Aquatic and Wetland Plants of the Southeastern United States (Volume I: Monocots; Volume II: Dicots)*
 - ___ 4. Clewell (1985): *Guide to the Vascular Flora of the Florida Panhandle from Louisiana to Massachusetts, exclusive of lower Peninsular Florida*
 - ___ 5. Duncan and Duncan (1987): *Seaside Plants of the Gulf and Atlantic Coasts*
 - ___ 6. Porcher (1995): *Wildflowers of the Carolina Low Country and Lower Pee Dee*
 - ___ 7. Weakley (in prep.): *Flora of the Carolinas and Virginia (Working Draft)*

Table 13

Calculation of Lateral Drainage Distance Used to Partition a WAA by $V_{OUTFLOW}$

NRCS Soil Series		
Category 1 Soils	Category 2 Soils	Category 3 Soils
Adaton	Atmore	Alapaha
Alusa	Balahack	Allanton
Argent	Bayou	Arapohoe
Bayboro	Bleakwood	Bleakwood
Bethera	Coxville	Demory
Bladen	Deloss	Elloree
Byers	Ellabelle	Haggerty
Caddo	Fortescue	Kings Ferry
Cantey	Gourdin	Leagueville
Cape Fear	Grantham	Leon
Daleville	Grifton	Lynn Haven
Derly	Henco	Mulat
Estes	Hobcaw	Murville
Eureka	Hyde	Naconiche
Evadale	Liddell	Nakina
Grady	Mashulaville	Pelham
Guyton	Merryville	Pickney
Jasco	Myatt	Plummer
Kanebreak	Pantego	Rutledge
Kinder	Pasquotank	Stono
Leaf	Paxville	Surrency
McColl	Perquimans	Waccasassa
Meggett	Plank	Woodington
Mollville	Rains	
Mouzon	Smithton	
Oakly	Steens	
Ozias	Talco	
Paisley	Tohunta	
Percilla	Toisnot	
Pooler	Tomotley	
Rembert	Trebloc	
Santee	Wadmalaw	
Sorter	Weeksville	
Vimville	Williman	
Waller	Yonges	
Wilbanks		
Wrightsville		

Depth of Drainage Feature in meters	Lateral Drainage Distance ¹ in meters		
	Category 1 Soils	Category 2 Soils	Category 3 Soils
0.4	17	31	46
0.5	21	38	56
0.6	24	44	65
0.7	27	49	72
0.8	29	53	78
0.9	31	57	83
1.0	33	60	88
1.1	35	63	92
1.2	37	66	96
1.3	38	69	100
1.4	39	71	103
1.5	40	73	106
1.6	42	75	109
1.7	45	77	111
1.8	43	78	113
1.9	44	79	115
2.0	45	81	117
2.1	46	82	119
2.2	46	83	120
2.3	47	84	122
2.4	47	84	123
2.5	47	85	124

¹ Match NRCS Soil Series with soil drainage category. If soil series is not on list, determine hydraulic conductivity (K) and drainable porosity (f). For Category 1 soils (K = 0.38 cm/hr and f = 0.016), Category 2 soils (K = 2.5 cm/hr and f = 0.033), and Category 3 soils (K = 19 cm/h and f = 0.117). Drainage distance is from each side of ditch and based on 13.2 day drainage period (5% of growing season in South Carolina).

Landscape variables (area of fire-maintained landscape and water inflow from exogenous drainage basins) are based on both onsite reconnaissance and interpretation of maps and aerial photos. Therefore, these variables are most practically measured in the office after the WAA and surrounding area have been observed and mapped and the other field data have been collected.

After arriving at the WAA, cruise the entire site to determine whether the WAA should be partitioned by vegetation cover type (Bunchgrass/Pine, Cypress/Pine, and/or Switchcane/Pine Savanna) and/or by alterations to hydrologic regime. Use the key in Table A1 (Appendix A) to determine where and how to bound partial WAAs based on these factors. After the WAA has been partitioned into partial WAAs (if required), determine subindices for site-scale hydrologic variables that have been altered (surface flow of water, outflow of water, surface water storage). Hydrologic variables are determined first because once a WAA has been partitioned by hydrologic condition, these variables are quickly assessed; all but one variable ($V_{SURFFLOW}$) require only knowing if these hydrologic alterations are present (subindex=0.1) or absent (subindex=1.0). For $V_{SURFFLOW}$, the subindex is either 0.1 or 1.0 upgradient from the dam and 0.5 or 1.0 downgradient (Figure 3).

For preproject assessments, areas altered by ditches (alteration of outflow) or fill (alteration of surface water storage) may have been delineated as uplands and so partitioning by these factors would not be required. However, in pre-restoration assessments or in assessments designed to predict postproject impacts, one would need to determine the change in function between the before and after conditions (i.e., pre- and post-restoration and pre- and postproject). To do this, one might need to assess areas where wetlands have been converted to uplands due to ditches or fill.

After all site-scale variables have been obtained, obtain data for plot-based variables from nested plots at random locations throughout the WAA (note that V_{ET} can be measured at one of two different scales, depending on whether or not site history is available). All subindices can be calculated on the data sheets after field data have been recorded. The number and location of plots is dictated by the size and heterogeneity of the WAA (Barbour et al. 1999, Smith and Wakeley 2001). If the WAA is relatively small (i.e., <1 ha or 2.5 acres) and homogeneous, then three nested plots are probably adequate for assessing functions. However, larger and/or more heterogeneous WAAs may require more nested plots to achieve an accurate assessment.

Plot-specific variables are sampled in a series of nested plots (Figure 25). V_{HERB} is sampled in two plot sizes: within 1-m² plots and 2-m-radius (12.6-m²) plots. Cover of native bunchgrasses and sedges are sampled in 2-m-radius plots; alterations to microtopography, soil porosity, and subcanopy density are sampled in 50-m² plots; pine density and longleaf density are sampled in 10-m-radius (314-m²) plots. Note that some of the above field indicators need not be measured in all WAAs because they are needed only for assessing functions in a specific vegetation cover type. Detailed methods for collecting plot data are provided in the following paragraphs.

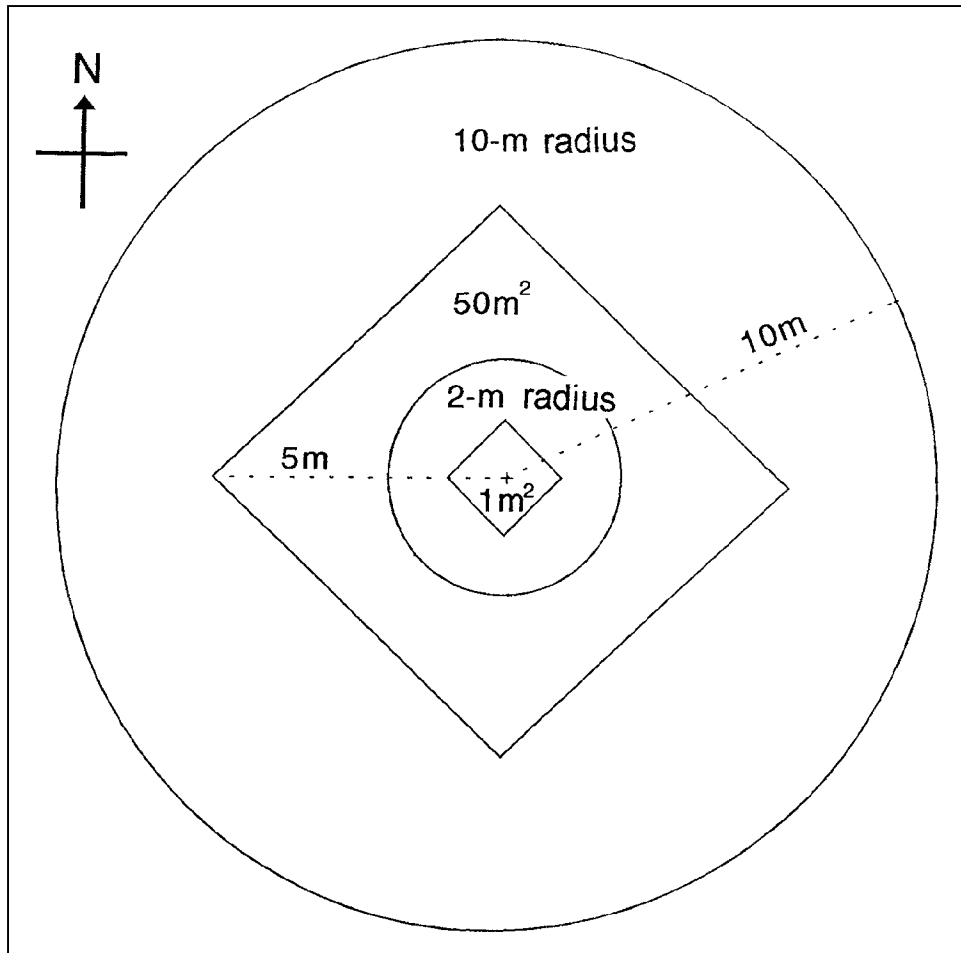

Figure 25. Orientation and dimensions of nested plots for measuring field indicators (not drawn to scale). Measurements of field variables are restricted to specific plot sizes. In 1-m² plot: V_{HERB} ; in 2-m-radius plot: V_{HERB} , V_{ET} (using composite LAI scores), V_{NBG} , and V_{SEDGES} ; in 50-m² plot: V_{SUBC} , V_{MICRO} , and V_{PORE} ; in 10-m-radius plot: V_{PINES} ; in areas outside nested plots: $V_{CYPRESS}$, V_{LONGGL} , and $V_{LANDSCP}$

To begin collecting plot data, randomly locate the first sampling point near the middle of the WAA. Do this by walking a predetermined number of paces toward the center of the WAA. (Do not specifically choose the precise sampling center point.) After the first sample point has been located, place a pole vertically into the ground to mark the center of a series of three nested plots. The center pole should be approximately 1 m long and constructed of polyvinyl chloride (PVC) pipe material with a solid steel rod partially inserted into one end (Figure 26). (The steel rod facilitates driving the pole into the ground.) When driven vertically into the ground, the top of the pole should be 1 m high. A PVC T-coupling should be attached to the top of one of the poles that will form the 1-m² quadrat. If the T-coupling is secured with glue, make sure that the vertical end of the “T” faces perpendicularly to the pole. This will allow the coupling to accommodate two sides of a 1-m² quadrat (by forming a right angle) and couple two 1-m-long poles to form a 2-m-long pole.

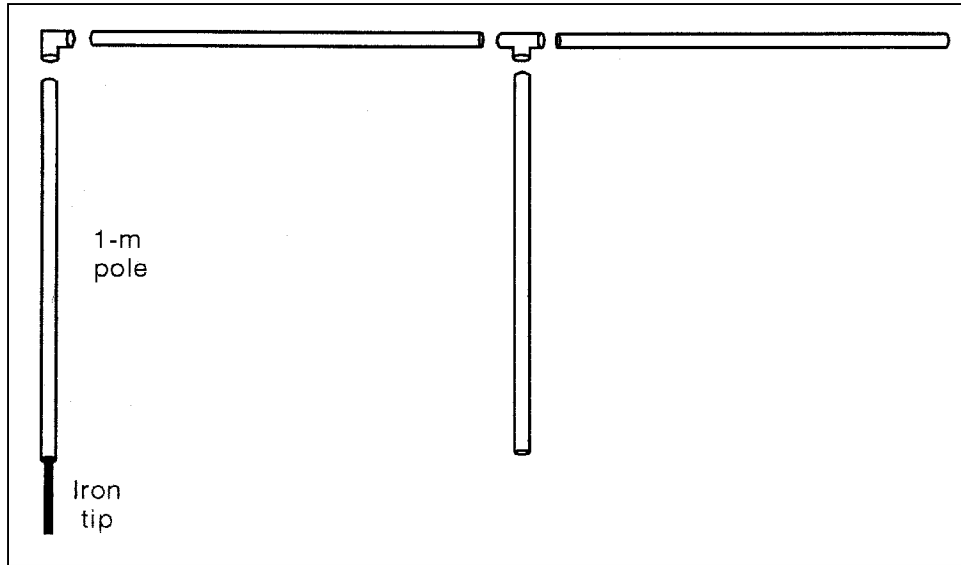

Figure 26. PVC piping used to mark boundaries of nested quadrats. Center pole (1-m tall) with iron tip is used to mark the center of nested plots. Two 1-m sections of PVC are used to construct the 1-m² quadrat and circumscribe a 1-m-high by 2-m-radius circle from center point. Three PVC poles and an auger are used to mark the corners of the 50-m² plot

With the PVC pole marking the center point of the nested plots, place a 1-m² quadrat on the ground and orient it so that the sides face the four cardinal directions (N, E, S, W). Construct the 1-m² quadrat by joining together 1-m-long pieces of PVC pipe at 90 deg with a PVC T-coupler (Figure 26). (The quadrat can be constructed by joining only two 1-m-long pieces together at a right angle; the other two sides of the quadrat could then be visualized.) In Bunchgrass/Pine and Cypress/Pine Savannas, record the presence of every indicator plant that occurs within the 1-m² plot. Color plates of indicator plants are provided in Appendix B.

Next, disconnect the two 1-m sections of the 1-m² PVC quadrat at the T-coupler and reconnect them so that they form one 2-m-long section. Attach this 2-m section to the top of the PVC center pole using the T-coupler to extend the 2-m section horizontally outward. Rotate the 2-m-long PVC section through 360 deg to circumscribe a 2-m-radius plot at a height of 1-m elevation. If a center pole is not available, use a tape measure anchored to the center point to circumscribe a 2-m-radius plot. Within the 2-m-radius plot, and if in a Bunchgrass/Pine Savanna or a Cypress/Pine Savanna, record the presence of any indicator plant that occurs within the 2-m-radius plot but did not occur within the 1-m² plot. Next, record the midpoint cover value, by cover category (Table 4), for the combined cover of the following native bunchgrasses: *Aristida stricta* or *A. beyrichiana*, *Ctenium aromaticum*, *Muhlenbergia expansa*, and *Sporobolus* species. If west of the Mississippi River, include the cover of all native wiry *Rhynchospora* species. If in a Cypress/Pine Savanna, also estimate the combined cover of all sedge species (*Carex* spp., *Scleria* spp., and nonwiry *Rhynchospora* spp.), and record the midpoint cover value.

If the site has not been hydrologically altered by an impediment to flow, a drainage conveyance, fill, excavation, or by excess water imported into the site, then indicators of evapotranspiration potential, microtopographic alterations, and soil porosity alterations must be assessed. Evapotranspiration potential can be obtained from site history (if available and reliable) or by sampling LAI in 2-m-radius plots. To do this, imagine a 2-m-radius cylinder, centered on the center pole and reaching skyward; for vegetation within the 2-m cylinder (regardless of where rooted), record the midpoint cover value, by cover category, for each of the following 5 strata: (a) herbaceous groundcover < 1 m tall, (b) low shrubs (woody plants < 1 m tall), (c) subcanopy (woody plants > 1 m tall, but < 7.5 cm dbh), (d) midcanopy (plants with stems 7.5-15 cm dbh), and (e) canopy (trees with stems > 15 cm dbh). For each stratum, multiply the midpoint value for the estimated cover category by the constants assigned in Table 5 (1 for the herb stratum, 2 for woody groundcover, 3 for subcanopy, 4 for midcanopy, and 5 for canopy). This provides a composite LAI score by stratum, which is then summed to obtain a total LAI for the plot.

If in a wet Cypress/Pine Savanna, determine densities for cypress saplings, midcanopy, and canopy stems using a nearest individual method. (Densities could also be determined from counts in plots, if preferred.) To apply the nearest individual method, locate the nearest individual to the center point for each of the three size classes: sapling (stem > 1 m tall and < 7.5 cm dbh), midcanopy (stem 7.5-15 cm dbh), and canopy (stem > 15 cm dbh). Measure and record the distance from the center point to each individual.

Indicators of alterations to soil porosity and microtopography should be measured in 50-m² plots. From the center point (pole), measure 5 m in north, south, east, and west directions and place a pole or marker in the ground at each 5-m point to mark the plot corners (Figure 25). (This produces a square 7.07 m per side and 50 m² in area, centered on the center pole and with the 2 smaller, previously sampled plots nested within it.) Within the 50-m² plot, estimate (by cover class) extent of alterations to microtopography and soils and identify each alteration by type of alteration (Tables 6 and 7).

In wet Cypress/Pine Savannas and Switchcane/Pine Savannas, count all woody subcanopy plants (woody stems > 1 m tall and < 7.5 cm dbh) within the 50-m² plot. Clusters of multiple stems originating from the same plant (root sprouts) are counted as separate stems. A number of shrubs and tree saplings will produce root sprout after fire (e.g., sweetbay magnolia (*Magnolia virginiana*), wax myrtle (*Myrica cerifera*), and pond cypress (*Taxodium ascendens*)). Multiply count by 200 to obtain density in stems per hectare.

In Switchcane/Pine Savannas, determine pine tree density within a 10-m-radius plot, centered on the center pole. Count and record the number of canopy pines (trees \geq 15 cm dbh). Multiply the count by 31.8 to obtain pine tree density in stems per hectare. Separately determine the density of longleaf pine, a subset of total pine density.

Repeat the above nested plot measurements in at least two additional locations within the WAA. Additional plots beyond three may be needed in large

WAAs or if the WAA does not appear to be homogeneous. Sum all measurements (cover, site LAI score, density, etc.) by category and calculate the average (divide by the number of plots sampled).

After data have been obtained from onsite at the WAA, landscape-scale variables (area of fire-maintained landscape and inflow of water from an exogenous drainage basin) should be determined from aerial photographs and USGS topographic maps in conjunction with field sketches made during field reconnaissance of the area surrounding the WAA. To determine area of fire-maintained landscape, use high-resolution aerial photos to delineate the boundary of the fire-maintained habitat that is contiguous to the WAA up to 100 ha. Include all Wet Pine Flats and upland pine savannas within the delineated boundaries, but exclude from the contiguous category any discontinuities in fire-maintained habitat wider than 50 m. Subtract any area of dissimilar cover (fire-excluded habitat, development, etc.) enveloped by the contiguous boundary from the total delineated area if the dissimilar habitat exceeds 1 ha (2.5 acres) in size. Include the area of the WAA if the discontinuity is a fire-maintained savanna.

To determine the effect of inflow of water from an exogenous drainage basin, use aerial photographs and county drainage maps (where available) in conjunction with USGS topographic maps to establish the boundaries of the drainage basin. Aerial photos and county drainage maps can be used to determine the source of ditches or other artificial water transport structures; USGS maps are used to determine drainage basin boundaries (topographic boundaries). With these maps, estimate (a) the size of the drainage basin from which excess water is imported and (b) the size of the natural drainage basin of the wet flat upgradient from the water input point. Either digitize drainage basin areas or use a dot grid overlay or planimeter to determine areas.

Analyzing Field Data

The analysis of field data requires two steps. The first step is to transform the measure of each assessment variable into a variable subindex. This can be done using the equations provided on the data sheets in Appendix A. The second step is to insert the variable subindices into the assessment model and calculate the FCI using the relationships defined in the assessment models.

Applying and Interpreting Assessment Results

Once the assessment and analysis phases are complete, the results can be used to compare the same wetland assessment area at different points in time, compare different wetland assessment areas at the same point in time, or compare different alternatives to a project (Smith et al. 1995, Smith and Wakeley 2001).

References

- Ainslie, W. B., Smith, R. D., Pruitt, B. A., Roberts, T. H., Sparks, E. J., West, L., Godshalk, G. L., and Miller, M. V. (1999). "A regional guidebook for assessing the functions of low gradient, riverine wetlands in western Kentucky," Wetlands Research Program Technical Report WRP-DE-17. U.S. Army Engineer Waterways Experiment Station, Vicksburg, MS.
- Ajilvsgi, G. (1979). *Wild flowers of the big thicket, east Texas, and western Louisiana*. Texas A&M University Press, College Station, TX.
- Barbour, M. G., and Billings, W. D., eds. (1988). *North American terrestrial vegetation*. Cambridge University Press, Melbourne, Australia.
- Barbour, M. G., Burk, J. H., Pitts, W. D., Gilliam, F. S., and Schwartz, M. W. (1999). *Terrestrial plant ecology*, 3rd ed. Benjamin/Cummings, Addison Wesley Longman, Inc., Menlo Park, CA.
- Bartram, W. (1791). *Travels through North and South Carolina, Georgia, east and west Florida*, 1955 ed. Dover Publications Reprint, New York.
- Bolen, E. G., Smith, L. M., and Schramm, H. L. (1989). "Playa lakes - prairie wetlands of the southern high plains," *BioScience* 39, 615-23.
- Bridges, E. L., and Orzell, S. L. (1989). "Longleaf pine communities of the west Gulf coastal plain," *Natural Areas Journal* 9, 246-62.
- Brinson, M. M. (1991). "Landscape properties of pocosins and associated wetlands," *Wetlands* 11, 441-65.
- _____. (1993). "A hydrogeomorphic classification for wetlands," Wetlands Research Program Technical Report WRP-DE-4, U.S. Army Engineer Waterways Experiment Station, Vicksburg, MS.
- _____. (1995). "The hydrogeomorphic approach explained," National Wetlands Newsletter, November/December. Environmental Law Institute, Washington, DC.
- _____. (1996). "Assessing wetland functions using HGM," National Wetlands Newsletter, January/February. Environmental Law Institute, Washington, DC.
- Brinson, M. M., and Rheinhardt, R. D. (1996). "The role of reference wetlands in functional assessment and mitigation," *Ecological Applications* 6, 69-76.

- Brinson, M. M., and Rheinhardt, R. D. (1997). "Wetland functions and relations to societal values." *Southern forested wetlands ecology and management*. M.G. Messina and W.H. Conner, eds., Lewis Publishers, Boca Raton, FL, 29-48.
- Brinson, M. M., Smith, R. D., Whigham, D. F., Lee, L. C., Rheinhardt, R. D., and Nutter, W. L. (1999). "Progress in development of the hydrogeomorphic approach for assessing the functioning of wetlands." *Wetlands of the future*. The International Society of Ecology's V International Wetlands Conference. Gleneagle Press, Adelaide, Australia. (In press).
- Buell, M. F. (1946). "Jerome Bog, a peat-filled Carolina bay," *Bulletin of the Torrey Botanical Club* 66, 483-87.
- Carlisle, V. W., Hallmark, C. T., Sodek III, F., Cadwell, R. E., Hammond, L. C., and Berkheiser, V. E. (1981). "Characterization data for selected Florida soils," *Soil Science Research Institute Report* 81-1. Soil and Water Science Department, University of Florida, Gainesville, FL.
- Catesby, M. (1654). *The natural history of Carolina, Florida, and the Bahama Islands*. C. Marsh et al., London, England.
- Cazier, P. W. (1992). "Hardwood forests in the coastal plain of Virginia, east of the Suffolk Scarp." Master's Thesis. The College of William and Mary.
- Chow, V. T. (1964). *Handbook of applied hydrology*. McGraw-Hill, New York.
- Christensen, N. L. (1977). "Fire and soil-plant nutrient relations in pine-wiregrass savanna on the coastal plain of North Carolina," *Oecologia* 31, 27-44.
- _____. (1981). "Fire regimes in southeastern ecosystems." *Fire regimes and ecosystem properties*. Gen. Tech. Rep. WO-26. H. A. Mooney, T. M. Bonnick, N. L. Christensen, J. E. Lotan, and W. A. Reiners, ed., United States Department of Agriculture Forest Service.
- _____. (1987). "The biogeochemical consequences of fire and their effects on the vegetation of the coastal plain of the southeastern United States." *The role of fire in ecological systems*, L. Trabaud, ed., SPB Academic Publishing, The Hague, The Netherlands, 1-121.
- _____. (1989). "Vegetation of the southeastern coastal plain." *North American terrestrial vegetation*. M. G. Barbour and W. D. Billings, ed., Cambridge University Press, New York, 317-63.
- _____. (1993). "The effects of fire on nutrient cycles in longleaf pine ecosystems," *Proceedings, Tall Timbers Fire Ecology Conference* 18, 205-14.
- Clewell, A. (1985). *Guide to the vascular flora of the Florida panhandle*. Florida State University Press, Tallahassee, FL.
- Cohen, A. D., Andrejko, M. J., Spackman, W., and Corrinus, D. (1984). "Peat deposits of the Okefenokee Swamp-marsh complex of southern Georgia." *The Okefenokee Swamp. Wetland surveys*. A. D. Cohen, D. J. Casagrande, M. J. Andrejko, and G. R. Best, ed., Los Alamos, NM. 493-553.
- Cottam, G., and Curtis, J. T. (1956). "The use of distance measures in phytosociological sampling," *Ecology* 37, 451-60.

- Crownover, S. H., Comerford, N. B., Neary, D. G., and Montgomery, J. (1995). "Horizontal groundwater flow patterns through a cypress swamp-pine flatwoods landscape," *Journal of Soil Science Society of America* 59, 1199-1205.
- Curtis, J. T., and McIntosh, R. P. (1951). "An upland forest continuum in the prairie-forest border region of Wisconsin," *Ecology* 32, 476-96.
- Cutlar, A. (1991). "Nested faunas and extinction in fragmented habitats," *Conservation Biology* 5, 496-505.
- Delcourt, P.A. (1980). "Goshen Springs: late Quaternary vegetation record for southern Alabama," *Ecology* 61, 371-86.
- Delottelle, R. S., Epting, R. J., and Newman, J. R. (1987). "Habitat use and territory characteristics of red-cockaded woodpeckers in central Florida," *Wilson Bulletin* 99, 202-17.
- Duncan, W., and Duncan, M. (1987). *Seaside plants of the Gulf and Atlantic coasts from Louisiana to Massachusetts, exclusive of lower peninsular Florida*. Smithsonian Institution Press, Washington, DC.
- Dunning, J. B., Jr., Danielson, B. J., and Pulliam, H. R. (1992). "Ecological processes that affect populations in complex landscapes," *Oikos* 65, 169-75.
- Enge, K. M., and Marion, W. R. (1986). "Effects of clear-cutting and site preparation on herpetofauna of a northern Florida flatwoods," *Forest Ecology and Management* 14, 177-92.
- Environmental Laboratory. (1987). "Corps of Engineers wetland delineation manual," Technical Report Y-87-1, U.S. Army Engineer Waterways Experiment Station, Vicksburg, MS.
- Ewel, K. C., and Odum, H. T., ed. (1984). *Cypress swamps*. University Presses of Florida, Gainesville, FL.
- Frost, C. C., Walker, J., and Peet, R. K. (1986). "Fire-dependent savannas and prairies of the Southeast: original extent, preservation status, and management problems." *Wilderness and natural areas in the eastern United States: a management challenge*. D. L. Kulhavy and R. N. Conner, ed., Center for Applied Studies, Stephen F. Austin University, Nacogdoches, TX, 348-57.
- Garren, K. H. (1943). "Effects of fire on vegetation of the southeastern United States," *Botanical Review* 9, 617-54.
- Gleason, H. A. (1926). "The individualistic concept of the plant association," *Bulletin of the Torrey Botanical Club* 53, 7-26.
- Glitzenstein, J. S., Platt, W. J., Streng, D. R. (1995). "Effects of fire regime and habitat on tree dynamics in north Florida longleaf pine savannas," *Ecological Monographs* 65, 441-76.
- Godfrey, R., and Wooten, W. (1979). *Aquatic and wetland plants of the southeastern United States (Volume I: Monocotyledons; Volume II: Dicotyledons)*. The University of Georgia Press, Athens, GA.

- Golet, F. C., and Larson, J. S. (1974). "Classification of freshwater wetlands in the glaciated Northeast," Resource Publication 116, U.S. Fish and Wildlife Service, Washington, DC.
- Grosenbaugh, L. R. (1952). "Plotless timber estimates - new, fast, easy," *Journal of Forestry* 50, 32-7.
- Hanski, I. (1994). "A practical model of metapopulation dynamics," *Journal of Animal Ecology* 63, 151-62.
- _____. (1996). "Metapopulation ecology." *Population dynamic in ecological space and time*. O. Rhodes, Jr., R. Chesser, and M. Smith, ed., University of Chicago Press, Chicago, IL, 13-43.
- Hanski, I., and Gyllenberg, M. (1993). "Two general metapopulation models and the core-satellite species hypothesis." *American Naturalist* 142, 17-41.
- Hanski, I., and Thomas, C. (1994). "Metapopulation dynamics: Brief history and conceptual domain." *Metapopulation dynamics*. M. Gilpin and I. Hanski, ed., Academic Press, London, 3-16.
- Harcombe, P. A., Glitzenstein, J. S., Knox, R. G., Orzell, S. L., and Bridges, E. L. (1993). "Vegetation of the longleaf pine region of the west Gulf coastal plain," Proceedings, Tall Timbers Fire Ecology Conference 18, 83-103.
- Heyward, F. (1939). "The relation of fire to stand composition of longleaf pine forests," *Ecology* 20, 287-304.
- Hubbard, D. E. (1988). "Glaciated prairie wetland functions and values: A synthesis of the literature," Biological Report 88:43, U.S. Fish and Wildlife Service, Washington, DC.
- Kantrud, J. A., Krapu, G. L., and Swanson, G. A. (1989). "Prairie basin wetlands of the Dakotas: a community profile," Biological Report 85, U.S. Fish and Wildlife Service, Washington, DC.
- Kologiski, R. L. (1977). "The phytosociology of the Green Swamp, North Carolina," *North Carolina Agricultural Experiment Station Technical Bulletin* 250.
- Komarek, E. V., Sr. (1964). "The natural history of lightning," Proceedings, Tall Timbers Fire Ecology Conference 3, 139-83.
- _____. (1974). "Effects of fire on temperate forests and related ecosystems: southeastern United States." *Fire and ecosystems*. T. T. Kowalski and C. E. Ahlgren, ed., Academic Press, New York, 251-78.
- Kollmorgen Instruments Corporation. (1994). *Munsell soil color charts*. Munsell Color, Baltimore, MD.
- Kurz, H. and Wagner, K. A. (1953). "Factors in cypress dome development," *Ecology* 34, 157-64.
- Lawson, J. (1714). *Lawson's history of North Carolina*. Garrett and Massil Publ., Richmond, VA.

- Lewis, C. E., and Harshbarger, T. J. (1976). "Shrub and herbaceous vegetation after 20 years of prescribed burning in the South Carolina coastal plain," *Journal of Range Management* 29, 13-8.
- Liu, S., Riekerk, H., Gholz, H. (1998). "Simulation of evapotranspiration from Florida pine flatwoods," *Ecological Modelling* 114, 19-34.
- MacArthur, R. H., and Wilson, E. O. (1967). *The theory of island biogeography*. Princeton University Press, Princeton, NJ.
- Marks, P. L., and Harcombe, P. A. (1981). "Forest vegetation of the Big Thicket, southeast Texas," *Ecological Monographs* 51, 287-305.
- Means, D. B., Palis, J. G., and Baggett, M. (1996) "Effects of slash pine silviculture on a Florida population of flatwoods salamander (*Ambystoma cingulatum*)," *Conservation Biology* 10, 426-37.
- National Interagency Implementation Team. (1996). "National action plan to implement the hydrogeomorphic approach (NAP)," *Federal Register* 61, 42593-603.
- Peet, R. K., and Allard, D. J. (1993). "Longleaf pine vegetation of the southern Atlantic and eastern Gulf Coast regions: a preliminary classification," Proceedings, Tall Timbers Fire Ecology Conference 18, 45-81.
- Penfound, W. T., and Watkins, A. G. (1937). "Phytosociological studies in the pinelands of southeastern Louisiana," *American Midland Naturalist* 18, 661-82.
- Platt, W.J., Evans, G. W., and Rathbun, S. L. (1988). "The population dynamics of a long-lived conifer (*Pinus palustris*)," *The American Naturalist* 131, 491-525.
- Porcher, R. (1995). *Wildflowers of the Carolina low country and lower Pee Dee*. University of South Carolina Press, Columbia, SC.
- Pulliam, H. 1996. "Sources and sinks: Empirical evidence and population consequences." *Metapopulation dynamics*. M. Gilpin and I. Hanski, ed., Academic Press, London, 45-69.
- Pyne, S. J. (1982). *Fire in America: A cultural history of wildland and rural fire*. Princeton University Press, Princeton, NJ.
- Radford, A. E., Ahles, H. E., and Bell, C. R. (1968). *Manual of the vascular flora of the Carolinas*. University of North Carolina Press, Chapel Hill, NC.
- Rheinhardt, R. D., Brinson, M. M., Farley, P. M. (1997). "Applying reference wetland data to functional assessment, mitigation, and restoration," *Wetlands* 17, 195-215.
- Rheinhardt, M. C., and Rheinhardt, R. D. (1998). "Canopy and woody subcanopy composition of non-riverine wet hardwood forests in eastern North Carolina," North Carolina Natural Heritage Program Division of Parks and Recreation, North Carolina Department of Environment and Natural Resources, Raleigh, NC.

- Rheinhardt, M. C., and Rheinhardt, R. D. (2000). "Canopy and woody subcanopy composition of wet hardwood flats in eastern North Carolina and southeastern Virginia," *Journal of the Torrey Botanical Society* 127, 33-43.
- Rheinhardt, R. D., Rheinhardt, M. C., Brinson, M. M., and Faser, K. E. (1998). "Forested wetlands of low order streams in the inner coastal plain of North Carolina, USA," *Wetlands* 18, 365-78.
- Rheinhardt, R., Rheinhardt, M., Brinson, M., and Faser, K. (1999). "Application of reference data for assessing and restoring headwater ecosystems," *Restoration Ecology* 7, 241-51.
- Rheinhardt, R., Whigham, D., Khan, H., and Brinson, M. (2000). "Floodplain vegetation of headwater streams in the inner coastal plain of Virginia and Maryland," *Castanea* 65, 21-35.
- Richardson, C. J. (1981). *Pocosin wetlands*. C. J. Richardson, ed., Hutchinson Ross Publishing, Stroudsburg, PA.
- Riekerk, H. (1992). "Groundwater movement between pine uplands and cypress wetlands." Proceedings Society of Wetland Scientists Conference, New Orleans, 31 May-6 June 1992. M.C. Landon, ed., 644-645.
- Schafale, M. P. (1994). "Inventory of longleaf pine natural communities in North Carolina," North Carolina Natural Heritage Program, Department of Environment, Health, and Natural Resources. Raleigh, NC.
- Schwarz, G. F. (1907). *The longleaf pine in virgin forest, a silvical study*. John Wiley and Sons, New York.
- Simberloff, D. S., and Wilson, E. O. (1970). "Experimental zoogeography of islands: a two year record of colonization," *Ecology* 51, 934-37.
- Smith, R. D., Ammann, A., Bartoldus, C., and Brinson, M. M. (1995). "An approach for assessing wetland functions using hydrogeomorphic classification, reference wetlands, and functional indices," Wetlands Research Program Technical Report WRP-DE-9, U.S. Army Engineer Waterways Experiment Station, Vicksburg, MS.
- Smith, R. D., and Wakeley, J. S. (2001). "Hydrogeomorphic approach to assessing wetland functions: Guidelines for developing regional guidebooks – Chapter 4, Developing assessment models," Wetlands Research Program Technical Report, U.S. Army Engineer Research and Development Center, Vicksburg, MS.
- Stout, I. J., and Marion, W. R. (1993). "Pine flatwoods and xeric pine forests of the southern (lower) coastal plain." *Biodiversity of the southeast: Lowland terrestrial communities*. W. H. Martin, S. G. Boyce, and A. C. Echternacht, ed., John Wiley and Sons, New York, 373-446.
- Streng, D. R., and Harcombe, P. A. (1982). "Why don't east Texas savannas grow up to be forests?" *American Midland Naturalist* 108, 278-94.

- Streng, D. R., Glitzenstein, J. S., Platt, W. J. (1991). Evaluating effects of season of burn in longleaf pine forests: a critical literature review and some results from an ongoing long-term study. Proceedings, 18th Tall Timbers Fire Ecology Conference, The longleaf pine ecosystem: ecology, restoration and management, 227-63.
- Stewart, R. E., and Kantrud, H. A. (1971). "Classification of natural ponds and lakes in the glaciated prairie region," Resource Publication 92, U.S. Fish and Wildlife Service, Washington, DC.
- Taggart, J. B. (1994). "Ordination as an aid in determining priorities for plant community protection," *Biological Conservation* 68, 135-41.
- Thein, S. J. (1979). "A flow diagram for teaching texture-by-feel analysis," *Journal of Agronomic Education* 40, 54-5.
- U.S. Department of Agriculture. (1981). "Land resource regions and major land resource areas of the United States," Agricultural Handbook 296, Soil Conservation Service, Washington, DC.
- _____. (1996). *Field indicators of hydric soils in the United States*. G. W. Hurt, P. M. Whited, R. F. Pringle, ed., Natural Resources Conservation Service, Fort Worth, TX.
- _____. (1997). "Hydrology tools for wetland determination," Engineering Field Handbook, Part 650, Natural Resources Conservation Service.
- Veno, P. A. 1976. "Successional relationships of five Florida plant communities," *Ecology* 57, 498-508.
- Waldrop, T. A., White, D. L., and Jones, S. M. (1992). "Fire regimes for pine-grassland communities in the southeastern United States," *Forest Ecology and Management* 47, 195-210.
- Walker, J. (1993). Rare vascular plant taxa associated with the longleaf pine ecosystem: patterns in taxonomy and ecology. Proceedings, 18th Tall Timbers Fire Ecology Conference, The longleaf pine ecosystem ecology, restoration and management, 105-25.
- Walker, J., and Peet, R. K. (1983). "Composition and species diversity of pine-wiregrass savannas of the Green Swamp, North Carolina," *Vegetatio* 55, 163-79.
- Walker, J., Waldrop, T. A., and Peet, R. K. (1993). "Management effects on plant species diversity in fire-dependent communities of the Southeastern coastal plain. Abstract," 78th Annual ESA Meeting, Ecology and Global Sustainability, Supplement to Bulletin of the Ecological Society of America 74 (June 1993). University of Wisconsin, Madison, 31 July-4 August.
- Ware, S. A., Frost, C., and Doerr, P. D. (1993). "Southern mixed hardwood forest: the former longleaf pine forest." *Biodiversity of the southeast: Lowland terrestrial communities*. W. H. Martin, S. G. Boyce, and A. C. Echternacht, ed., John Wiley and Sons, New York, 447-93.
- Watts, B. D. (1996). "Landscape configuration and diversity hotspots in wintering sparrows," *Oecologia* 108, 512-17.

- Weakley (in prep.). *Flora of the Carolinas and Virginia*. Working draft, The Nature Conservancy, Southeast Regional Office, Chapel Hill, NC.
- Wells, B. W. (1928). "Plant communities of the coastal plain of North Carolina and their successional relations," *Ecology* 9, 230-42.
- Wharton, C. H., Kitchens, W. M., Pendleton, E. C., and Sipe, T. W. (1982). "The ecology of bottomland hardwood swamps of the Southeast: A community profile," Biological Services Report FWS/OBS-81/37, U.S. Fish and Wildlife Service, Washington, DC.
- Williams, T. M., Wolaver, T. G., Dame, R. F., and Spurrier, J. D. (1992). "The Bly Creek ecosystem study - organic carbon transport within a euhaline salt marsh basin, North Inlet, South Carolina," *Journal of Experimental Marine Biology and Ecology* 163, 125-39.
- Wenger, K. F. (1984). *Forestry handbook*. Wiley and Sons, New York.
- Wolaver, T. G., and Williams, T. M. (1986). "Streamwater chemistry of a small forested watershed on the South Carolina coast," *Southeast Geology* 27, 45-52.
- Zedler, P. H. (1987). "The ecology of southern California vernal pools: A community profile," Biological Report 85, U.S. Fish and Wildlife Service, Washington, DC.

Appendix A

Field Supplement: Summary of Functions, Models, and Methods

This appendix summarizes methods for collecting each field variable and conversion to subindex scores for conducting a functional assessment of Wet Pine Flats. Chapter 5 should be consulted for step-by-step procedures for quantitatively measuring field indicators. In order to first partition the Wetland Assessment Area (WAA) into partial WAAs prior to sampling field indicators, Figure A1 and the key in Table A1 should be consulted. Pertinent tables and figures from previous chapters are also provided so that this Appendix can be separated from the guidebook for use in the field. For convenience, tables and figures are grouped at the end of the appendix.

Care should be taken to determine which field measurements are appropriate in a given situation. For example, if a WAA has been hydrologically altered by an impediment to flow (reservoir), a fill or excavation, a drainage structure, or excess water imported into the site, then the three variables used in the model of the hydrologic function (V_{SUBC} , V_{PORE} , V_{ET}) need not be measured. This is because the lowest submodel score takes precedent over all other scores (i.e., a score cannot be less than 0.0).

Collecting Field Data

Before assessing a WAA, gather all necessary field gear. Obtain appropriate topographic maps, county soil surveys, and the most recent high-resolution aerial photos that can be obtained for the area. These maps and surveys will be used onsite and in the office following fieldwork. Table A2 provides a list of field gear that should be taken to collect field data.

Field measurements of model variables are collected at several spatial scales. Field data sheets, located at the end of this section, are organized by decreasing spatial scale from landscape-scale variables to site-scale variables to plot-scale

variables. Eighteen variables are available for assessing the four wetland functions modeled in this Regional Guidebook. However, in any given WAA, only 4-8 variables are needed to assess these functions, depending on the cover type being assessed and the types of alterations that are present.

Landscape variables (area of fire-maintained landscape and water inflow from exogenous drainage basins) are based on both onsite reconnaissance and interpretation of maps. Therefore, these variables are most practically measured in the office after the WAA and surrounding area have been observed and mapped and the other field data have been collected.

After arriving at the WAA, cruise the entire site to determine whether the WAA should be partitioned by vegetation cover type (Bunchgrass/Pine, Cypress/Pine, and/or Switchcane/Pine Savanna) and/or by alterations to hydrologic regime. Use the key in Table A1 to determine where and how to bound partial WAAs based on these factors. After the WAA has been partitioned into partial WAAs (if required), determine subindices for site-scale hydrologic variables that have been altered (surface flow of water, outflow of water, surface water storage). Hydrologic variables are determined first because once a WAA has been partitioned by hydrologic condition, these variables are quickly assessed; they require only knowing if these hydrologic alterations are present (subindex=0.0) or absent (subindex=1.0).

For preproject assessments, areas altered by ditches (alteration of outflow) or fill (alteration of surface water storage) has been delineated as uplands and so partitioning by these factors would not be required. However, in pre-restoration assessments or in assessments designed to predict postproject impacts, one would need to determine the change in function between the before and after conditions (i.e., pre- and post-restoration and pre- and postproject). To do this, one might need to assess uplands (i.e., former wetland areas changed to uplands due to ditches or fill).

After all site-scale variables have been obtained, obtain data for site-specific (plot-based) variables from nested plots at random locations throughout the WAA (note, V_{ET} can be measured at one of two different scales, depending on whether or not site history is available). All subindices can be calculated on the data sheets after field data have been recorded. The number and location of plots are dictated by the size and heterogeneity of the WAA (Barbour et al. 1999, Smith and Wakeley 2001). If the WAA is relatively small (i.e., <1 ha or 2.5 acres) and homogeneous, then three nested plots are probably adequate for assessing functions. However, larger and/or more heterogeneous WAAs may require more nested plots to accurately assess a WAA.

Plot-specific variables are sampled in a series of nested plots (Figure A5). V_{HERB} is sampled in two plot sizes: within 1-m² plots and 2-m-radius plots (12.6 m²). Cover of native bunchgrasses and sedges are sampled in 2-m-radius plots, alterations to microtopography, soil porosity, and subcanopy density are sampled in 50-m² plots, while pine density and longleaf density are sampled in 10-m-radius (314 m²) plots. Note that some of the above field indicators need not be measured in all WAAs because they are needed only for assessing functions in

a specific vegetation cover type. Detailed methods for collecting plot data are provided in the following paragraphs.

To begin collecting plot data, randomly locate the first sampling point near the middle of the WAA. Do this by walking a predetermined number of paces toward the center of the WAA. (Do not specifically choose the precise sampling center point.) After the first sample point has been located, place a pole vertically into the ground to mark the center of a series of three nested plots. The center pole should be approximately 1-m long and constructed of polyvinyl chloride (PVC) pipe material with a solid steel rod partially inserted into one end (Figure A4). (The steel rod facilitates driving the pole into the ground.) When driven vertically into the ground, the top of the pole should be 1-m high. A PVC T-coupling should be attached to the top of one of the poles that will form the 1-m² quadrat. If the T-coupling is secured with glue, make sure that the vertical end of the “T” faces perpendicularly to the pole. This will allow the coupling to accommodate two sides of a 1-m² quadrat (by forming a right angle) and couple two 1-m long poles to form a 2-m long pole.

With the PVC pole marking the center point of the nested plots, place a 1-m² quadrat on the ground and orient it so that the sides face the four cardinal directions (N, E, S, W). Construct the 1-m² quadrat by joining together 1-m-long pieces of PVC pipe at 90 degrees with a PVC T-coupler (Figure A4). (The quadrat can be constructed by joining only two 1-m-long pieces together at a right angle; the other two sides of the quadrat could then be visualized.) In Bunchgrass/Pine and Cypress/Pine Savannas, record the presence of every indicator plant that occurs within the 1-m² plot. Color plates of indicator plants are provided in the web version of Appendix B.

Next, disconnect the two 1-m sections of the 1-m² PVC quadrat at the T-elbow and reconnect them so that they form one 2-m-long section. Attach this 2-m section to the top of the PVC center pole using the T-elbow to extend the 2-m section perpendicularly (horizontally) outward. Rotate the 2-m-long PVC section through 360 degrees to circumscribe a 2-m-radius plot at a height of 1-m elevation. If a center pole is not available, use a tape measure anchored to the center point to circumscribe a 2-m-radius plot. Within the 2-m-radius plot, and if in a Bunchgrass/Pine Savanna or a Cypress/Pine Savanna, record the presence of any indicator plant that occurs within the 2-m-radius plot, but did not occur within the 1-m² plot. Next, record the midpoint cover value, by cover category (Table 4), for the combined cover of the following native bunchgrasses: *Aristida stricta* or *A. beyrichiana*, *Ctenium aromaticum*, *Muhlenbergia expansa*, *Sporobolus* species. If west of the Mississippi River, include the cover of all native wiry *Rhynchospora* species. If in a Cypress/Pine Savanna, also estimate the combined cover of all sedge species, and record the midpoint cover value.

If site has not been hydrologically altered by an impediment to flow, a drainage conveyance, fill, excavation, or by excess water imported into the site, then indicators of evapotranspiration potential, microtopographic alterations and soil porosity alterations must be assessed. Evapotranspiration potential can be obtained from site history (if available and reliable) or by sampling LAI in 2-m-radius plots. To do this, imagine a 2-m-radius cylinder, centered on the center pole

and reaching skyward; for vegetation within the 2-m cylinder (regardless of where rooted), record the midpoint cover value, by cover category, for each of the following five strata: (a) herbaceous groundcover < 1-m tall, (b) low shrubs (woody plants < 1-m tall), (c) subcanopy (woody plants > 1-m tall, but < 7.5 cm dbh), (d) midcanopy (plants with stems 7.5-15 cm dbh), and (e) canopy (trees with stems > 15 cm dbh). For each stratum, multiply the midpoint value for the estimated cover category by the constants assigned in Table 5 (1 for the herb stratum, 2 for woody groundcover, 3 for subcanopy, 4 for midcanopy, and 5 for canopy). This provides a composite LAI score by stratum, which is then summed to obtain a total LAI for the plot.

If in a wet Cypress/Pine Savanna, determine densities for cypress saplings, midcanopy, and canopy stems using a nearest individual method. (Densities could also be determined from counts in plots, if preferred). To apply the nearest individual method, locate the nearest individual to the center point for each of the three size classes: sapling (stem > 1-m tall and < 7.5 cm dbh), midcanopy (stem 7.5-15 cm dbh), and canopy (stem > 15 cm dbh). Measure and record the distance from the center point to each individual.

Indicators of alterations to soil porosity and microtopography should be measured in 50-m² plots. From the center point (pole), measure 5 m in north, south, east, and west directions and place a pole or marker in the ground at each 5-m point to mark the plot corners (Figure A5). (This produces a square 7.07 m per side and 50 m² in area, centered on the center pole and with the 2 smaller, previously sampled plots nested within it.) Within the 50-m² plot, estimate (by cover class) extent of alterations to microtopography and soils and identify each alteration by type of alteration (Table A5).

In wet Cypress/Pine Savanna and Switchcane/Pine Savanna, count all woody subcanopy plants (woody stems > 1 m tall and < 7.5 cm dbh) within the 50-m² plot. Clusters of multiple stems originating from the same plant (root sprouts) are counted as separate stems. (A number of shrubs and tree saplings will produce root sprout after fire (e.g., sweetbay magnolia (*Magnolia virginiana*), wax myrtle (*Myrica cerifera*), and pond cypress). Multiply count by 200 to obtain density in stems per hectare.

In Switchcane/Pine Savanna, determine pine tree density within a 10-m-radius plot, centered on the center pole. Count and record the number of canopy pines (trees > or = 15 cm dbh). Multiply the count by 31.8 to obtain pine tree density in stems per hectare. Separately determine the density of longleaf pine, a subset of total pine density.

Repeat the above nested plot measurements in at least two additional locations within the WAA. Additional plots beyond three may be needed in large WAAs or if the WAA does not appear to be homogeneous. Sum all measurements (cover, site LAI score, density, etc.) by category and calculate the average (divide by the number of plots sampled).

After data have been obtained from onsite at the WAA, landscape-scale variables (area of fire-maintained landscape and inflow of water from an

exogenous drainage basin) should be determined from aerial photographs, USGS topographic maps in conjunction with field sketches made during field reconnaissance of the area surrounding the WAA. To determine area of fire-maintained landscape, use high-resolution aerial photos to delineate the boundary of the fire-maintained habitat that is contiguous to the WAA. Include all Wet Pine Flats and upland pine savannas within the delineated boundaries, but exclude any discontinuities in fire-maintained habitat wider than 50 m. Subtract any area of dissimilar cover (fire-excluded habitat, development, etc.) enveloped by the contiguous boundary from the total delineated area if the dissimilar habitat exceeds 1 ha (2.5 acres) in size. Include the area of the WAA if the discontinuity is a fire-maintained savanna.

To determine the effect of inflow of water from an exogenous drainage basin, use aerial photographs and county drainage maps (where available) in conjunction with USGS topographic maps to establish the boundaries of the drainage basin. Air photos and county drainage maps can be used to determine the source of ditches or other artificial water transport structures; USGS maps are used to determine drainage basin boundaries (topographic boundaries). With these maps, estimate (a) the size of the drainage basin from which excess water is imported and (b) the size of the natural drainage basin of the wet flat upgradient from the water input point. Either digitize drainage basin areas or use a dot grid overlay or planimeter to determine areas.

Function 1: Maintain Characteristic Water Level Regime

Definition

This function reflects the capacity of a Wet Pine Flat to maintain variations in water-level characteristic of the ecosystem, including variations in depth, duration, frequency, and season of flooding or ponding. The function models effects that alterations to hydrologic regime have on water level fluctuations. Precipitation is by far the major natural source of water into Wet Pine Flats; groundwater discharge to these systems is minimal. ET is the major natural export pathway, but the slow export of water downgradient (via surface and subsurface flow) is another export pathway. Characteristic water level regime is altered by (a) impediments to flow (dams), (b) drainage of water from the site, (c) surface water storage effected by an addition of material (fill) or excavation of material, (d) importation of water into a site from elsewhere, (e) alterations to evapotranspiration rates by removal of vegetation or fire exclusion, and (f) alterations to microtopography or (g) to soil porosity.

Model variable - symbols - measure - units

Surface Flow ($V_{SURFFLOW}$): impediment to the throughflow of water determined by presence/absence data.

Outflow ($V_{OUTFLOW}$): increase in the rate of downgradient water flow (outflow) by drainage features (e.g., ditches or tile drains), determined by presence/absence data.

Surface Water Storage ($V_{STORAGE}$): addition (fill) or excavation of material, determined by presence/absence data.

Inflow of Water from an Exogenous Basin (V_{INFLOW}): proportional increase in watershed area determined by ratio of the size of an exogenous basin to the size of the natural drainage basin.

Evapotranspiration Potential (V_{ET}): vegetation available for ET determined by Leaf Area Index (LAI) or site history information.

Microtopographic Features (V_{MICRO}): microtopographic relief available for storing surface water, determined by the type of alterations present and the area altered.

Soil Porosity (V_{PORE}): soil porosity available for storing subsurface water, determined by the type of alterations present and the area altered.

Assessment models

The lowest scoring of these five independent submodels are used to determine the Functional Capacity Index (FCI) for this hydrologic function:

$$FCI_{HYDROLOGY} = \text{MIN} [V_{SURFFLOW}, V_{OUTFLOW}, V_{STORAGE}, V_{INFLOW}, (V_{ET} \times ((V_{MICRO} + V_{PORE})/2))^{1/2}]$$

Function 2: Maintain Characteristic Plant Community

Definition

This function reflects the capacity of a WAA to maintain the characteristic attributes of plant communities normally associated with natural, fire-maintained Wet Pine Flat ecosystems. Characteristic plant communities are sensitive to alterations in (a) vegetation, (b) fire frequency, (c) soil and/or microtopographic condition, and (d) hydrologic regime. Therefore, onsite habitat quality for the plant community is assessed using either scale-dependent distribution of herbaceous indicator species or structural conditions, depending on the vegetation cover type being assessed.

Model variable - symbols - measure - units

Herbaceous Indicator Score (V_{HERB}): occurrence for selected indicator plants at small-scale scales, determined by a unitless index.

Cover of Selected Native Bunchgrasses (V_{NBG}): cover of selected bunchgrass species, determined by percent cover.

Cover of Sedges (V_{SEDGES}): cover of sedges, determined by percent cover.

Pine Density (V_{PINES}): density of pine species, determined by number of stems per hectare.

Subcanopy Density (V_{SUBC}): density of subcanopy stems determined by number of stems per hectare.

Physiognomic Structure of Pond Cypress ($V_{CYPRESS}$): density of pond cypress in each of three size classes (strata): sapling, midcanopy, and canopy.

Physiognomic Structure of Canopy Longleaf Pine (V_{LONGGL}): density (number per hectare) of longleaf pines > 15 cm dbh

Assessment model

For Bunchgrass/Pine Savannas, the FCI is the highest index of the two:

$$FCI_{PLANTS} = \text{MAX} (V_{HERB}, V_{NBG})$$

For Cypress/Pine Savannas, the FCI is the highest index of the three equations:

$$FCI_{PLANTS} = \text{MAX} [V_{NBG}, V_{HERB}, (V_{CYPRESS} \times ((V_{SEDGES} + V_{SUBC})/2))^{1/2}]$$

For Switchcane/Pine Savannas:

$$FCI_{PLANTS} = [V_{LONGGL} \times ((V_{SUBC} + V_{PINES})/2)]^{1/2}$$

Function 3: Maintain Characteristic Animal Community

Definition

This function is defined as the capacity of a WAA and its surrounding landscape to provide all the resources required for maintaining the entire suite of animal species characteristic of unaltered, fire-maintained Wet Pine Flats. The area and types of habitats required to maintain a characteristic animal assemblage

depend upon the life-history requirements of species that utilize Wet Pine Flats. For animals that would use a particular WAA, there are two major determinants of habitat quality: (a) habitat quality within the site (onsite quality) and (b) the quality of the surrounding landscape that provides supplemental resources to animals that would normally use the site (landscape quality).

Model variable - symbols - measure - units

Area of Contiguous Fire-Maintained Landscape ($V_{LANDSCP}$): area of contiguous fire-maintained landscape minus any area of bedded pines, determined as a proportion of 100 ha.

Site Quality: determined by the FCI_{PLANTS} .

Assessment model

$$FCI_{ANIMALS} = (FCI_{PLANTS} \times V_{LANDSCP})^{1/2}$$

Function 4: Maintain Characteristic Biogeochemical Processes

Definition

This function reflects the capacity of a Wet Pine Flat to maintain biogeochemical processes at the rate, magnitude, and timing characteristic of the ecosystem, including nutrient and elemental cycling, biogeochemical transformations, and export of dissolved organic constituents. This function assesses the effects that alterations have on biogeochemical processes and assumes that a Wet Pine Flat will maintain characteristic biogeochemical processes if not altered. Biogeochemical processes are sensitive to alterations in (a) hydrologic regime, (b) fire regime, and (c) soil integrity. The FCI_{PLANTS} is sensitive to alterations to fire regime and soil integrity.

Model variable - symbols - measure - units

Site Quality: determined by the FCI_{PLANTS} .

Hydrologic Regime: determined by the $FCI_{HYDROLOGY}$.

Assessment model

$$FCI_{\text{BIOGEOCHEM}} = (FCI_{\text{HYDROLOGY}} \times FCI_{\text{PLANTS}})^{1/2}$$

Summary of Model Variable Definitions, Measurement Method, and Conversion to Subindices

Before measuring field indicators, determine whether or not the WAA should be partitioned by hydrologic alterations, alterations to soils or microtopography, or by vegetation cover type. Use the key in Table A1 to partition (bound) the WAA prior to assessing field indicators.

1. Inflow of Water from an Exogenous Basin (V_{INFLOW})

Measure/Units: Proportional increase in watershed area caused by importation of water into a WAA from elsewhere.

- Method:
1. Using aerial photographs (where available) in conjunction with USGS topographic maps or county drainage basin maps, determine the entire drainage basin boundary (topographic boundaries) of the WAA upgradient from the point where water is being imported. Either digitize the area or use a dot grid overlay to determine area. This is the total basin (TB) area.
 2. Determine the size of the natural drainage basin (NB).
 3. Subtract the size of the natural basin (NB) from the size of the total basin (TB) to obtain the size of the exogenous basin (EB).
 4. Divide the size of the exogenous basin (EB) by the size of the natural drainage basin (NB) and subtract from 1.0 (i.e., $1.0 - (EB/NB)$). If the drainage basin area from which excess water is imported is larger than the natural drainage basin (i.e., $1.0 - (EB/NB)$ is negative), then assign 0.0 to V_{INFLOW} .

2. Surface Flow (V_{SURFFLOW})

Measure/Units: Impediment to water flow.

- Method:
1. Determine presence/absence of surface flow by determining if there is a dam present. Note: WAA is partitioned by presence/absence of a dam prior to measuring this variable. Distance of dam effect is determined by slope of wetland and height of dam (Figure A1). A dam effect occurs upgradient to the same elevation as dam height and downgradient at an elevation that is the dam elevation minus the dam height.
 2. If WAA is within dam reservoir, then $V_{\text{SURFFLOW}} = 0.1$. If WAA is within the reservoir shadow, then $V_{\text{SURFFLOW}} = 0.5$. If WAA is not within a dam reservoir or reservoir shadow, then $V_{\text{SURFFLOW}} = 1.0$.

3. Outflow of Water ($V_{OUTFLOW}$)

Measure/Units: Removal of water by ditches or tile drains.

- Method:
1. Determine the presence/absence of ditches or tile drains that drain the WAA. Note: WAA is partitioned by presence/absence of effective drainage features prior to measuring this variable. Soil series and depth of drainage feature are used to estimate the lateral drainage distance (Figure A2) using Table A3.
 2. If the WAA is within the lateral drainage distance of drainage feature, then $V_{OUTFLOW} = 0.1$. If WAA is not within the lateral drainage distance of drainage feature, then $V_{OUTFLOW} = 1.0$.

4. Surface Water Storage ($V_{STORAGE}$)

Measure/Units: Addition (fill) or excavation of material

- Method:
1. Determine presence/absence of fill material or an excavation in WAA. Note: WAA is partitioned by presence/absence of fill or excavation prior to measuring this variable by measuring area onsite or with high-resolution photos or maps.
 2. If WAA is within an area to which material has been added or excavated, then $V_{STORAGE} = 0.1$. If WAA is not within an area to which material has been added or excavated, then $V_{STORAGE} = 1.0$.

5. Evapotranspiration Potential (V_{ET})

Measure/Units: Vegetation available for evapotranspiration.

Method A (fire history known): Fire history can be provided by land managers or from anyone familiar with the site's fire history. If a WAA is being periodically mowed (for a power line, gas line, etc.), treat the mowing the same as burning.

1. If the last fire (or mowing) occurred within the past 0-3 years, assign a subindex of 1.0 to V_{ET} .
2. If the last fire (or mowing) occurred 3-10 years ago, $V_{ET} = (0.30(10 - LF)/7) + 0.70$, where LF is the number of years since last fire (or Mowing).
3. For sites in which fire (and mowing) has been excluded for 10 years or more, $V_{ET} = 0.70$.

Method B (fire history not known or WAA is planted with pines): If fire history is not known or if the WAA has been planted with pines, then conduct the following measurements at each sample point in an imaginary 2-m-radius cylinder reaching skyward.

1. Within a 2-m cylinder circumscribed by the 2-m-radius plot, determine the cover category that best represents the proportion of the area covered for each stratum listed below and assign the midpoint of each cover category to each stratum: (1) ground-cover (herbaceous plants < 1 m tall), (2) low shrub (woody

plants <1 m tall), (3) subcanopy (woody plants > 1-m tall, but < 7.5 cm dbh), (4) midcanopy (plants with stems 7.5-15 cm dbh), and (5) canopy (trees with stems > 15 cm dbh).

2. Multiply the assigned constant LAI values for each stratum by the midpoint of the cover category for the stratum: 1 x groundcover, 2 x low shrub, 3 x subcanopy, 4 x midcanopy, 5 x canopy. This provides a composite LAI value for each stratum in the plot.
3. Sum the composite LAI scores across all strata to obtain a plot LAI score.
4. Sum all plot LAI scores and divide by the number of plots sampled to obtain a mean site LAI score for the WAA. (For example, see Table A4).
5. For Bunchgrass/Pine Savanna, if the site LAI < 2.0, then $V_{ET} = 1.0$; if site LAI is between 2.0 and 3.0, then $V_{ET} = 1.0 - [0.3 (LAI - 2.0)]$, if site LAI > 3.0, then $V_{ET} = 0.7$. For Cypress/Pine and Switchcane/Pine Savannas, if site LAI < 3.5, then $V_{ET} = 1.0$, if site LAI is between 3.5 and 5.0, then $V_{ET} = 1.0 - [0.2 (LAI - 3.5)]$, if site LAI > 5.0, then $V_{ET} = 0.7$.

6. Microtopographic Features (V_{MICRO})

Measure/Units: Alterations to microtopography determined by proportion of WAA altered. Sample at least three randomly chosen 50-m² plots.

- Method:
1. In 50-m² plots, determine the cover category that best represents the proportion of the area covered by each type of alteration to microtopography.
 2. Record the midpoint of the cover category in the appropriate rows (i.e., by type of alteration). Sum covers by alteration types.
 3. Sum all midpoint cover values in the plot and subtract sum from 1.0 to determine portion of plot that is unaltered. Record in top row (natural, unaltered).
 4. Repeat above for each additional 50-m² plot and sum across rows (i.e., by type of alteration) for all plots (minimum of 3 plots).
 5. Sum the cover values across plots and divide by the number of plots sampled to obtain the mean cover for each type of alteration.
 6. Multiply the mean cover of each microtopographic alteration score by the assigned microtopographic alteration value (see example in Table A5).
 7. Sum all scores (products of mean cover by value) to obtain V_{MICRO} .

7. Soil Porosity (V_{PORE})

Measure/Units: Alterations to soil porosity determined by proportion of WAA altered. Sample at least three randomly chosen 50-m² plots.

- Method:
1. In 50-m² plots, determine the cover category that best represents the proportion of the area covered by each type of alteration to soils (Table A5).
 2. Record the midpoint of the cover category in the appropriate rows (i.e., by type of alteration).
 3. Sum all midpoint cover values in the plot and subtract sum from 1.0 to determine portion of plot that is unaltered. Record in top row (natural, unaltered).
 4. Repeat above for each additional 50-m² plot and sum across rows (i.e., by type of alteration) for all plots (minimum of 3 plots).
 5. Sum the cover values across plots and divide by the number of plots sampled to obtain the mean cover for each type of alteration.
 6. Multiply mean cover of each soil alteration score by the assigned soil alteration value.
 7. Sum all scores (products of mean cover by value) to obtain V_{PORE} .

8. Herbaceous Indicator Score (V_{HERB})

Measure/Units: Frequency of occurrence for selected indicator plants. Indicator scores only measured in Bunchgrass/Pine and Cypress/Pine Savannas.

- Method:
1. At each sampling location, identify which of the 20 indicator plants (Table A6) are present in a 1-m² quadrat and record a "1.0" for each species present.
 2. Circumscribe a 2-m-radius plot centered on center of the 1-m² plot, identify each additional indicator plant that occurs in a 2-m-radius plot, and record "0.5" for each additional species.
 3. Sum all indicator scores from the two nested plots.
 4. Repeat the previous measurements in at least two additional nested plots located at least 15 m away from one another.
 5. Sum the score for all nested plots sampled and divide the sum by the number of nested plots sampled to obtain a mean score for all plots.
 6. To determine V_{HERB} for Bunchgrass/Pine Savannas, divide the herbaceous indicator score derived by 8.0; for Cypress/Pine Savannas, divide the herbaceous indicator score by 7.0. If the resulting subindex > 1.0, then $V_{HERB} = 1.0$. If the WAA was

burned within the prior 6 weeks, assign 1.0 to V_{HERB} or wait at least 6 weeks to measure V_{HERB} .

9. Cover of Selected Native Bunchgrasses (V_{NBG})

Measure/Units: Cover of selected bunchgrass species determined by midpoint of percent cover. Indicator only measured in Bunchgrass/Pine and Cypress/Pine Savannas.

- Method:
1. Apply a random or stratified-random approach to locate at least three sampling locations in the WAA. Use the same 2-m-radius (12.6-m^2) plots used to record the presence of herbaceous indicator species.
 2. In each plot, estimate the combined cover of the following bunchgrass species into one of nine coverage categories: *Ctenium aromaticum* (toothache grass), *Muhlenbergia expansa* (Muhly grass), *Aristida stricta* (northern wiregrass), *Aristida beyrichiana* (southern wiregrass), various *Sporobolus* spp. (dropseeds), and *Schizachyrium scoparium* (little bluestem). If west of the Mississippi, include native wiry *Rhynchospora* species.
 4. Record the midpoint of the coverage category.
 5. Average the recorded midpoint values across all plots sampled in the WAA (i.e., divide the sum of cover values by the number of plots to obtain mean cover for the selected list of native bunchgrasses).
 6. To determine V_{NBG} , divide the percent cover of the above-defined bunchgrass species by 50 percent. If cover is > 50 percent, then $V_{NBG} = 1.0$.

10. Cover of Sedges (V_{SEDGES})

Measure/Units: Cover of sedges (primarily *Carex* spp., *Scleria* spp., nonwiry *Rhynchospora* spp., etc.) determined by percent midpoint of percent cover. This indicator is only measured in Cypress/Pine Savannas.

- Method:
1. Apply a random or stratified-random approach to locate at least three sampling locations in the WAA. Use the same 2-m-radius (12.6-m^2) plots used to record the presence of herbaceous indicator species.
 2. Estimate the combined cover of sedges into one of nine coverage categories and record the midpoint of the coverage category.
 3. Average the recorded midpoint values across all plots sampled in the WAA (i.e., divide the sum of cover values by the number of 2-m-radius plots sampled) to obtain mean cover for sedges.

4. To determine the subindex for V_{SEDGES} , divide the mean percent cover of sedge species in the WAA by 50 percent. If the resulting subindex is > 1.0 , then $V_{SEDGES} = 1.0$.

11. Pine Density (V_{PINES})

Measure/Units: Density of pines (trees > 15 cm dbh) determined by number of stems per hectare. Measure only in Switchcane/Pine Savannas.

- Method:
1. Apply a random or stratified-random approach to locate at least three 10-m-radius sampling plots in the WAA. Center these plots on the 1-m² quadrats used to sample herbaceous plants if V_{HERB} is to be determined.
 2. Obtain counts from at least three plots and average the sum of all plots by the number of plots sampled to obtain mean density for canopy-size pine trees in the WAA.
 3. Multiply the mean count by 31.8 to obtain density of pine trees per hectare.
 4. If the density of pines in the WAA is < 75 trees/ha, divide the density by 75 to obtain the index for V_{PINES} . If pine density in the WAA is between 75 and 300 trees/ha, then $V_{PINES} = 1.0$. If the density of pines in the WAA is between 300 and 600, subtract 300 from the density, divide this by 300 and subtract from 1.0, i.e., $V_{PINES} = 1.0 - ((\text{pine tree density} - 300)/300)$. If the density of pine trees is > 600 , then $V_{PINES} = 0.0$.

12. Subcanopy Density (V_{SUBC})

Measure/Units: Density of subcanopy stems (woody stems > 1 m tall and < 7.5 cm dbh) determined by number of stems per hectare. Measure in at least three randomly chosen 50-m² plots (the same plots in which V_{MICRO} and V_{PORE} are determined).

- Method:
1. In each 50-m² plot, count all subcanopy stems. Count each stem as one individual even if they appear to originate from the same plant (via root sprouts).
 2. If the density of subcanopy stems in the WAA is $< 6,500$ stems/ha, then $V_{SUBC} = 1.0$. If subcanopy density is 6,500-19,500 stems/ha, then $V_{SUBC} = (19,500 - \text{density})/13,000$. If subcanopy density is $> 19,500$ stems/ha, then $V_{SUBC} = 0.0$.

13. Physiognomic Structure of Pond Cypress ($V_{CYPRESS}$)

Measure/Units: Densities of three size classes of pond cypress: sapling (stems > 1 m tall and 7.5 cm dbh), midcanopy (stems 7.5-15 cm dbh), canopy (stems > 15 cm dbh).

- Method:
1. Measure the distance (in meters) from the center point to the nearest sapling, midcanopy, and canopy stem of pond cypress.

2. Calculate density as follows, $Density = 10,000 / [(2 \times (\text{average distance})^2)]$. Physiognomic information, relative to each size class (stratum) is derived from density data.
3. For the sapling stratum, “Physiognomy” = $Density/450$ (if the resulting score > 1.0, reduce to 1.0). For the midcanopy stratum, “Physiognomy” = $Density/50$ (if the resulting score > 1.0, reduce to 1.0). For the canopy stratum, “Physiognomy” = $Density/100$ (if the resulting score > 1.0, reduce to 1.0).
4. $V_{CYPRESS}$ is equal to the mean of “Physiognomy” scores for all three strata.

14. Physiognomic Structure of Canopy Longleaf and Pond Pine (V_{LONGL})

Measure/Units: Density of longleaf pines (trees > 15 cm dbh) determined by number of stems per hectare. Measure only in Switchcane/Pine Savanna at the same time as measuring V_{PINES} .

- Method:
1. Apply a random or stratified-random approach to locate at least three 10-m-radius sampling plots in the WAA. Center these plots on the 1-m² quadrats used to sample herbaceous plants, if V_{HERB} is to be determined.
 2. Obtain counts from at least three plots and average the sum of all plots by the number of plots sampled to obtain mean count per plot for canopy-sized longleaf and pond pine trees in the WAA.
 3. Multiply the mean count by 31.8 to obtain density of pine trees per hectare.
 4. If the density of longleaf and pond pines in the WAA is < 75 trees/ha, divide the density by 75 to obtain the index for V_{LONGL} . If pine density in the WAA is between 75 and 300 trees/ha, then $V_{LONGL} = 1.0$. If the density of longleaf and pond pines in the WAA is between 300 and 600, subtract 300 from the density, divide this by 300 and subtract from 1.0, i.e., $V_{LONGL} = 1.0 - ((\text{longleaf and pond pine tree density} - 300)/300)$. If the density of longleaf and pond pine trees is > 600, then $V_{LONGL} = 0.0$.

15. Area of Contiguous Fire-Maintained Landscape ($V_{LANDSCP}$)

Measure/Units: Area of contiguous fire-maintained landscape determined as a proportion of 100 ha.

- Method:
1. Delineate area of contiguous fire-maintained landscape from recent (< 5 years old) high-resolution aerial photography. All fire-maintained Wet Pine Flats and upland pine savannas should be included within delineated boundaries, but any discontinuities in fire-maintained habitat wider than 50 m (150 ft) should be excluded (Figure A6).

2. Subtract any area of dissimilar cover (fire-excluded habitat, development, etc.) enveloped by the contiguous boundary from the total area if the discontinuity exceeds 1 ha (2.5 acres) in size. Exclude any areas bedded for silviculture. Total area can be determined by digitizing or by overlaying a dot grid at the correct scale (Figure A7).
3. $V_{LANDSCP} = 0.0095 \times (\text{area in hectares}) + 0.05$. If the resulting index is > 1.0 , reduce $V_{LANDSCP}$ to 1.0.

Blank Field Data Sheets

The following pages are blank field data sheets.

- a. Sheet 1: Sketch of WAA
- b. Sheet 2: $V_{LANDSCP}$, V_{INFLOW} , $V_{SURFFLOW}$, $V_{OUTFLOW}$, $V_{STORAGE}$, V_{ET}
- c. Sheet 3: V_{HERB}
- d. Sheet 4: V_{SUBC}
- e. Sheet 5: V_{MICRO} , V_{PORE}
- f. Sheet 6: V_{NBG} , V_{SEDGES} , V_{ET}
- g. Sheet 7: $V_{CYPRESS}$
- h. Sheet 8: V_{LONGL} , V_{PINES}
- i. Sheet 9: Summary Worksheet

Field Data Sheet 1: Mineral Soil Wet Pine Flats of the Atlantic and Gulf Coastal Plain

Assessment Team: _____

Date: _____

Project Name/Location: _____

Sketch WAA below (provide north arrow, major landmarks)

Be sure to partition WAA into partial WAAs first (use key in Table A1).

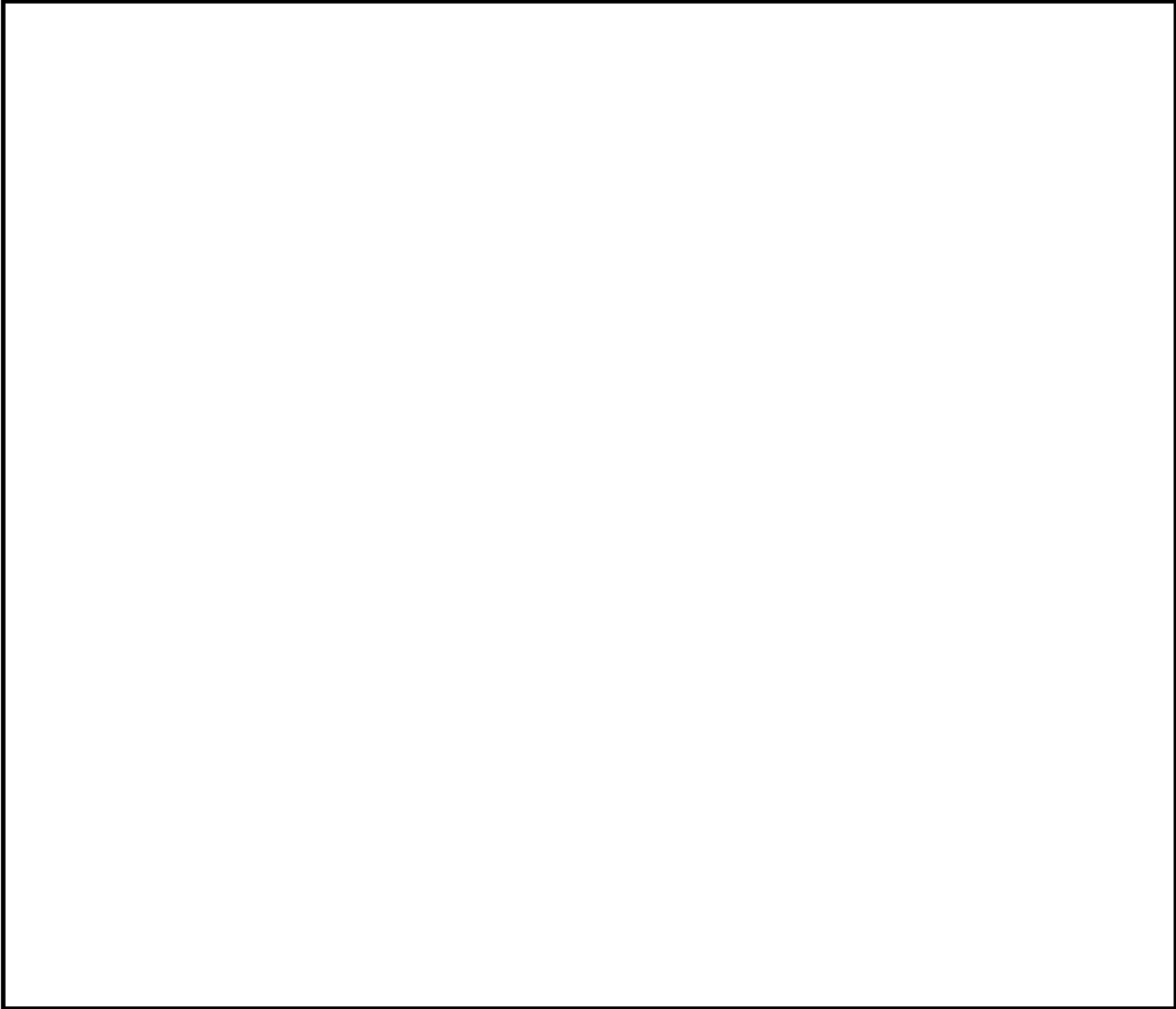

Notes:

Sheet 2: Wet Pine Flats ($V_{LANDSCP}$, V_{INFLOW} , $V_{SURFFLOW}$, $V_{OUTFLOW}$, $V_{STORAGE}$, V_{ET})

Assessment Team: _____

Project Name/Location: _____

1. $V_{LANDSCP}$ Area of contiguous savanna (upland and wetland, including WAA) which has burned within the past 3 years: _____ (do not include fire-excluded areas or barriers to fire exclusion > 50 m wide). Also, exclude all bedded areas, even if manged with fire.
 $V_{LANDSCP} = 0.0095 \times (\text{area in hectares}) + 0.05$.

1. $V_{LANDSCP}$:

2. V_{INFLOW} Inflow of water from an exogenous basin (calculate from county drainage maps, aerial photos, topographic maps, and/or site reconnaissance). If no water is imported, $V_{INFLOW} = 1.0$. Otherwise, calculate from information below (basin areas determined from upgradient of point of water inflow).

- Size of total drainage basin (TB) _____ minus size of total natural drainage basin (NB) _____ equals size of exogenous basin (EB) _____.
- Divide EB by NB, subtract from 1.0 ($1.0 - EB/NB$). If answer is negative, assign 0.0 to score.

2. V_{INFLOW}

Variables 3-8 are obtained from partitioning the WAA .

3. $V_{SURFFLOW}$ Absence of reservoir (1.0) caused by an impediment (dam) to throughflow:
 [within reservoir (0.1); within reservoir shadow (0.5)]

3. $V_{SURFFLOW}$

4. $V_{OUTFLOW}$ Within (0.1) or outside (1.0) lateral effect distance

4. $V_{OUTFLOW}$

5. $V_{STORAGE}$ Presence (0.1) or absence (1.0) of fill or excavation

5. $V_{STORAGE}$

6. V_{ET} Evapotranspiration potential

If site history is not known or WAA has been planted with pines for silviculture, then obtain LAI data from plots (Data Sheet 4). Otherwise, assign V_{ET} subindex from site history conditions (below). Note: Treat mowing (utility rights-of-way, etc.) the same as fire.

(a) If the WAA has not been planted with pines for silviculture and fire has occurred within past 3 years, then $V_{ET} = 1.0$

(b) If fire has been excluded for the past 3-10 years, record the number of years since last mowing or fire (LF) _____. $V_{ET} = 0.30((10 - LF)/7) + 0.70$

(c) If fire has been excluded for more than 10 years, then, $V_{ET} = 0.70$.

6. V_{ET}

Sheet 3: Wet Pine Flats (V_{HERB})

Assessment Team: _____

Date: _____

Project Name/Location: _____

WAA: _____

Measure only in Bunchgrass/Pine Savannas and Cypress/Pine Savannas (least wet end of wetness gradient).

- (a) For each indicator species/genus that occurs in the 1-m² nested plot, record "1.0".
- (b) For each indicator plant that occurs in the 2-m-radius plot, but does not occur in the 1-m² nested plot, record "0.5".

Herb Indicator Species	Plot 1	Plot 2	Plot 3
<i>Aletris</i> spp. (<i>A. farinosa</i> , <i>A. aurea</i>)			
<i>Aristida</i> spp. (<i>A. stricta</i> , <i>A. beyrichiana</i>), <i>Sporobolus</i> spp.			
<i>Balduina</i> spp.			
<i>Bigelowia nudata</i>			
<i>Carphephorus</i> spp.			
<i>Chaptalia tomentosa</i>			
<i>Coreopsis</i> spp.			
<i>Ctenium aromaticum</i>			
<i>Dichromena</i> spp.			
<i>Erigeron vernus</i>			
<i>Eriocaulon</i> spp.			
<i>Eryngium integrifolium</i>			
<i>Eupatorium leucolepis</i>			
<i>Helianthus</i> spp.			
<i>Lycopodium</i> spp. (especially <i>L. alopecuroides</i>)			
<i>Muhlenbergia expansa</i>			
<i>Rhexia</i> spp.			
<i>Sarracenia</i> spp.			
<i>Schizachyrium scoparium</i>			
<i>Xyris</i> spp.			
Total Indicator Score for each plot			
Mean for all plots			

- (c) To determine the mean score, total all scores and divide by the number of 1-m² plots (at least 3).
- (d) Divide the mean by 8.0 for Bunchgrass/Pine Savanna or by 7.0 for Cypress/Pine Savanna. If score > 1.0, reduce score to 1.0.

Bunchgrass/Pine Savanna score (divide Mean by 8.0)	8. V_{HERB} :	
Cypress/Pine Savanna score (divide Mean by 7.0)	9. V_{HERB} :	

Sheet 4: Wet Pine Flats (V_{SUBC})

Assessment Team: _____

Date: _____

Project Name/Location: _____

WAA: _____

Measure only in wet Cypress/ Pine Savannas and in Switchcane/Pine Savannas

Plot size: 50 m². V_{SUBC} (subcanopy density): woody stems > 1 m tall and < 7.5 cm dbh rooted within plots. Count all stems (not limbs) at 1 m height.

Species	Subcanopy stem count			Total	Mean
	Plot 1	Plot 2	Plot 3		
Total					
Total Subcanopy Density for Site (mean x 200)					
					11. V_{SUBC}¹:

¹If site has been mechanically cleared, then $V_{SUBC} = 0.0$; otherwise, if subcanopy density < 6,500 stems/ha, then $V_{SUBC} = 1.0$. If subcanopy density is between 6,500 and 19,500 stems/ha, then $V_{SUBC} = (19,500 - \text{density})/13,000$. If subcanopy density is > 19,500 stems/ha, then $V_{SUBC} = 0.0$.

Sheet 5: Wet Pine Flats (V_{MICRO} , V_{PORE})

Assessment Team: _____

Date: _____

Project Name/Location: _____

WAA: _____

Do not measure if Hydrologic submodels 1-4 (i.e., $V_{SURFFLOW}$, $V_{OUTFLOW}$, V_{INFLOW} , or $V_{STORAGE} = 0.0$).

Type of alteration to microtopography	Cover 1 (midpoint) of 50-m ² plots			Mean Cover	Microtopo Alteration Value	Score (Mean cover x Value)	
	Plot 1	Plot 2	Plot 3				
None, natural ² (unaltered)					1.0		
Lightly grazed, rutted					0.8		
Intensively grazed, rutted					0.6		
Light artillery divots					0.4		
Fire breaks or deep ruts (< 20 cm from rut to ridge)					0.3		
Tilled cropland					0.3		
Recent feral hog rooting					0.2		
Bedded for silviculture					0.2		
Ruts from off-road vehicles (> 20 cm deep)					0.1		
Gasline ROW					0.1		
Impervious					0.0		
SUM	1.000	1.000	1.000				
Total microtopographic alteration score (sum last column)							9. $V_{MICRO} =$

Type of alteration to soil porosity	Cover 1 (midpoint) of 50-m ² plots			Mean Cover	Soil Alteration Value	Score (Mean cover x Value)	
	Plot 1	Plot 2	Plot 3				
None, natural ² (unaltered)					1.0		
Recent feral hog rooting					0.9		
Ruts from off-road vehicles (< 20 cm deep)					0.6		
Fire breaks or deep ruts (> 20 cm from rut to ridge)					0.4		
Bedding for silviculture					0.4		
Light artillery					0.3		
Compacted by grazing cattle					0.2		
Graded or excavated for pipeline					0.1		
Tilled cropland					0.1		
Impervious					0.0		
SUM	1.000	1.000	1.000				
Total soil alteration score (sum last column)							10. $V_{PORE} =$

Note: At least three 50 m² plots (150 m²) should be sampled per WAA. This variable is only measured if the site is otherwise hydrologically unaltered.

¹ Record midpoint of cover classes (in parentheses): 0% (0), 0-5% (0.025), 5-25% (0.15), 25-50% (0.375), 50% (0.50), 50-75% (0.625), 75-95% (0.85), 95-100% (0.975), 100% (1.0).

² First determine cover for all other categories (alterations), sum, and subtract sum from 1.0 to obtain area unaltered (row 1).

Sheet 6: Wet Pine Flats (V_{NBG} , V_{SEDES} , V_{ET})

Assessment Team: _____ Date: _____
 Project Name/Location: _____ WAA: _____

	Percent cover (living plants in 2-m radius) ¹			Cover
	Plot 1	Plot 2	Plot 3	
Native bunchgrasses ²				
Sedges ³				12. V_{NBG} ⁴ : 13. V_{SEDES} ⁵ :

Stratum ⁶	Cover of living plants (2-m radius)					
	Plot 1		Plot 2		Plot 3	
	Cover ¹	LAI	Composite LAI score ⁸	Cover ¹	LAI	Composite LAI score ⁸
Groundcover	1			1		
Low Shrub	2			2		
Subcanopy	3			3		
Midcanopy	4			4		
Canopy	5			5		
Total LAI score						
Mean LAI score (total/ number of plots)	Bunchgrass/Pine Savanna		14. V_{ET} ⁸ :			
	Cypress/Pine and Switchcane/Pine Savanna		15. V_{ET} ⁹ :			

Note: Cover is midpoint of cover categories from Table 4.

¹ Record midpoint of cover classes: 0% (0), 0-5% (0.025), 5-25% (0.15), 25-50% (0.375), 50% (0.50), 50-75% (0.625), 75-95% (0.85), 95-100% (0.975), 100% (1.0).

² Includes *Cenium aromaticum* (toothache grass), *Muhlenbergia expansa* (Muhly grass), *Aristida stricta* (northern wiregrass), *Aristida beyrichiana* (southern wiregrass), *Schizachyrium scoparium* (little bluestem), *Sporobolus* spp. (dropseed), and wiry native *Rhynchospora* spp. (if west of the Mississippi River).

³ Includes *Carex*, *Scleria*, and non-wiry *Rhynchospora* spp. (Measure only in Cypress/Pine Savannas)

⁴ V_{NBG} (if mean cover > 0.50, then $V_{NBG} = 1.0$; if mean cover < 0.50, then $V_{NBG} = \text{mean cover}/0.50$).

⁵ V_{SEDES} (if mean cover > 0.50, then $V_{SEDES} = 1.0$; if mean cover < 0.50, then $V_{SEDES} = \text{mean cover}/0.50$).

⁶ Living vegetation: Groundcover = herbaceous stratum; Low Shrub = woody plants < 1m tall, Subcanopy = woody plants > 1 m tall and < 7.5 cm dbh; Midcanopy = stems 7.5-15 cm dbh; Canopy= trees > 15 cm dbh.

⁷ Composite LAI = Cover X LAI

⁸ V_{ET} for Bunchgrass/Pine Savanna, if Site LAI < 2.0, then $V_{ET} = 1.0$, if the Site LAI is between 2.0 and 3.0, then $V_{ET} = 1.0 - [0.3 (LAI - 2.0)]$, if Site LAI > 3.0, then $V_{ET} = 0.7$.

⁹ V_{ET} for Cypress/Pine and Switchcane/Pine Savannas, if Site LAI < 3.5, then $V_{ET} = 1.0$, if Site LAI is between 3.5 and 5.0, then $V_{ET} = 1.0 - [0.2 (LAI - 3.5)]$, if Site LAI > 5.0, then $V_{ET} = 0.7$.

Sheet 7: Wet Pine Flats ($V_{CYPRESS}$)

Assessment Team: _____

Project Name/Location: _____ Date: _____

Measure only *Taxodium ascendens* (pond pine) in Cypress/Pine Savannas.

	Distance (m) ⁴			Mean	Density ⁵	Physiognomy ⁶
	Plot #1	Plot #2	Plot #3	Distance		
Sapling ¹						
Midcanopy ²						
Canopy ³						
Mean				16. $V_{CYPRESS}$ ⁷ :		

¹ Stems > 1 m tall, but < 7.5 cm dbh

² Stems 7.5-15 cm dbh

³ Stems > 15 cm dbh

⁴ Measure distance in meters to nearest individual in each size class

⁵ Density = $10,000/[2 \times (\text{Mean Distance})^2]$

⁶ Sapling Physiognomy = Density/450, if > 1.0, reduce to 1.0

Midcanopy Physiognomy = Density/50, if > 1.0, reduce to 1.0

Canopy Physiognomy = Density/100, if > 1.0, reduce to 1.0

⁷ $V_{CYPRESS}$ is the mean of all three Physiognomy scores

Sheet 8: Wet Pine Flats (V_{LONGGL} , V_{PINES})

Assessment Team: _____

Date: _____

Project Name/Location: _____

WAA: _____

Measure only in Switchcane/Pine Savannas.

Plot size = 10-m radius. V_{PINES} (pine tree density): trees > 15 cm dbh

Species	Pine tree count			Total	Mean
	Plot 1	Plot 2	Plot 3		
<i>Pinus palustris</i>					
<i>Pinus serotina</i>					
<i>Pinus taeda</i>					
<i>Pinus elliottii</i>					
Total Density of all Pine species (mean x 31.8)					
Total Density of Longleaf and Pond Pines (mean x 31.8)					
				17. V_{LONGGL}^1 :	
				18. V_{PINES}^2 :	

¹ V_{LONGGL} (If longleaf and pond pine density is 75-300 stems/ha, then $V_{LONGGL} = 1.0$; if longleaf and pond pine density < 75 stems/ha, then $V_{LONGGL} = \text{density}/75$; if longleaf and pond pine density > 300 stems/ha, then $V_{LONGGL} = 1.0 - ((\text{longleaf and pond pine density} - 300)/300)$; if longleaf and pond pine density > 600 stems/ha, then $V_{LONGGL} = 0.0$.)

² V_{PINES} (If pine density 75-300 stems/ha, then $V_{PINES} = 1.0$; if pine density < 75 stems/ha, then $V_{PINES} = \text{density}/75$; if pine density > 300 stems/ha, then $V_{PINES} = 1.0 - ((\text{pine tree density} - 300)/300)$; if pine density > 600 stems/ha, then $V_{PINES} = 0.0$.)

Summary Worksheet for Mineral Soil Wet Pine Flats

Assessment Team: _____ Date: _____
 Project Name/Location: _____ WAA: _____

Note: All scores must be between 0.0 and 1.0

F1: Maintain Characteristic Water Level Regime

<ol style="list-style-type: none"> 2. V_{INFLOW} Inflow of water from an exogenous basin 3. $V_{SURFFLOW}$ Surface flow (inhibited by a dam) 4. $V_{OUTFLOW}$ Outflow (via drainage conveyance) 5. $V_{STORAGE}$ Added (fill) or Excavated Material 6. V_{ET} Evapotranspiration Potential (from site history) 14. V_{ET} BPS Evapotranspiration Potential (from LAI) 15. V_{ET} CPS Evapotranspiration Potential (from LAI) 9. V_{MICRO} Microtopographic Alterations 10. V_{PORE} Soil Alterations 	<div style="border: 1px solid black; width: 100%; height: 100%;"></div>
--	---

$FCI_{HYDROLOGY}$ = The lowest score of the following 5 submodels (note: submodel # 5 need not be calculated if any indices for submodels 1-4 = 0.0)

<ol style="list-style-type: none"> 1. V_{INFLOW} 2. $V_{SURFFLOW}$ 3. $V_{OUTFLOW}$ 4. $V_{STORAGE}$ 5. $(V_{ET} \times ((V_{MICRO} + V_{PORE})/2))^{1/2}$ 	<div style="border: 1px solid black; width: 100%; height: 100%;"></div>
--	---

[Use either V_{ET} (# 6) or V_{ET} (# 14 or 15) in above equation]

F2: Maintain Characteristic Plant Community

For Bunchgrass/Pine Savanna, FCI_{PLANTS} = the highest score of:

<ol style="list-style-type: none"> 1. V_{HERB} (# 9) and 2. V_{NBG} (# 11) 	<div style="border: 1px solid black; width: 100%; height: 100%;"></div>
--	---

For Cypress/Pine Savanna, FCI_{PLANTS} = the highest score of:

<ol style="list-style-type: none"> 3. V_{HERB} (# 10) and 4. V_{NBG} and 5. $[V_{CYPRESS} \times ((V_{SEDGES} + V_{SUBC})/2)]^{1/2}$ 	<div style="border: 1px solid black; width: 100%; height: 100%;"></div>
--	---

For Switchcane/Pine Savanna, FCI_{PLANTS} =

<ol style="list-style-type: none"> 6. $[V_{LONGL} \times ((V_{PINES} + V_{SUBC})/2)]^{1/2}$ 	<div style="border: 1px solid black; width: 100%; height: 100%;"></div>
---	---

F3: Maintain Characteristic Animal Community

$$FCI_{ANIMALS} = [FCI_{PLANTS} \times V_{LANDSCP}]^{1/2} =$$

F4: Maintain Characteristic Biogeochemical Processes

$$FCI_{BIOGEOCHEM} = [FCI_{PLANTS} \times FCI_{HYDROLOGY}]^{1/2} =$$

1. $V_{LANDSCP}$ Area of contiguous fire-maintained landscape

**Table A1
Key for Bounding Wetland Assessment Areas (WAAs) in Wet Pine Flats into One or More Partial WAAs**

All functions are assessed in each partial WAA after the WAA has been partitioned using the key below. However, depending on the cover type and/or hydrologic alteration used to define the WAA, some field indicators may not have to be measured.

A. Pond cypress occurs or, under unaltered conditions, would have naturally occurred in the WAA. (Note: if the WAA is only a very small portion of a much larger, but similar and contiguous, habitat that contains pond cypress, then assume that pond cypress could or would have occurred in the WAA).....
.....**Cypress/Pine Savanna**

Cypress/Pine Savanna is the second most prevalent cover type Wet Pine Flat. It occurs at the wettest end of the wetness gradient over which mineral soil Wet Pine Flats occur. Usually, soils are very finely textured (clayey subsoils). Although this cover type burns frequently, it is usually too wet to convert to pine plantation, except near its transition to Bunchgrass/Pine Savanna (at the least wet end of its wetness gradient). Care should be taken in judging that a WAA with cypress in it is not a depression. **(CONTINUE AT #1)**

A. Pond cypress does not occur, nor under unaltered conditions would have naturally occurred in the WAA. (Note: if the WAA is only a very small portion of a much larger, but similar and contiguous, habitat that does not contain pond cypress, then pond cypress would not have occurred in the site either.)

B. Switchcane cover in the WAA comprises less than 35% of groundcover in the WAA.....**Bunchgrass/Pine Savanna**

Bunchgrass/Pine Savanna is the most prevalent Wet Pine Flat cover type, even though less than 2% of the original distribution remains unaltered today. It occurs on loamy, silty, and sandy soils and is less wet than Cypress/Pine Savanna (discussed above). The herbaceous stratum of the Bunchgrass/Pine Savanna supports the highest small-scale species richness in the world. If cypress (of any size) is absent in a WAA, the WAA probably is or was once a Bunchgrass/Pine Savanna. **(CONTINUE AT #1)**

B. Switchcane (*Arundinaria tecta*) cover comprises more than 35% of groundcover in the WAA.....**Switchcane/Pine Savanna**

Switchcane/Pine Savanna is the rarest cover type of Wet Pine Flat. Only a few sites were located in the Southeast (both in South Carolina) and so this cover type will be rarely encountered. It is possible that Switchcane/Pine Savanna was much more prevalent historically, but because it may have occurred on more nutrient-rich sites than the Bunchgrass/Pine Savanna, perhaps most sites have been eliminated by conversion to pine plantation or agriculture. It is also possible that, historically, most Switchcane/Pine Savannas occurred in the northern range of mineral soil wet flats and that this cover type overlapped Wet Hardwood Flats in geographic distribution. Widespread fire exclusion and land conversion in the northerly range may have altered all Switchcane/Pine Savannas there. The prevalence of switchcane and the absence of oaks separate Switchcane/Pine Savannas from Wet Hardwood Flats in the northerly portion of the biogeographic range. **(CONTINUE AT #1)**

Table A1 (continued)

1. There is a road or other potential impediment to flow that crosses the perceived direction of flow (i.e., the raised road or structure does not run parallel to the direction of flow). **(If not true, go to #1, next page)**

2. A ditch or ditches run alongside the road or potential impediment to flow.

3. The ditch or ditches drain water away from the site, i.e., ditches connect to a network of ditches downgradient.

Partition the WAA into at least two partial WAAs (Figure A1e): one for the area drained by ditches (determined from lateral drainage distance) and one for both the fill (road) and the excavation (ditches) adjacent to the road. To determine the area where material has been added to or excavated from the WAA, **GO TO $V_{STORAGE}$** . For determining the area drained by the ditch(es), **GO TO $V_{OUTFLOW}$** .

3. The ditch or ditches do not drain water from the site. (If the impediment to flow is a road, the ditch was probably dug to provide fill for the road.)

4. There are culverts under the road (or potential impediment to flow) that are at ground level (i.e., bottom of culverts are at ground level).

Partition the road (or raised surface) and adjacent ditches into a partial WAA (Figure A1c). To determine the area where material has been added to or excavated from the WAA, **GO TO $V_{STORAGE}$** .

4. There are no culverts under the road, or the bottom of the culverts is above ground level.

Potentially partition the WAA into at least three WAAs (Figure A1d): one for the area comprising the reservoir of the dam (based on the overflow elevation, i.e., top of road or bottom of culvert), one comprising the reservoir shadow, and one comprising both the road (or raised surface) and the area excavated for the ditches. To determine the area where material has been added to or excavated from the WAA, **GO TO $V_{STORAGE}$** . To determine the area where water collects upgradient (reservoir) and where there is a water deficit (reservoir shadow), **GO TO $V_{SURFFLOW}$** . ***If all or part of the WAA is not within the reservoir, GO TO #1, next page, for any portion of the WAA not within the reservoir.***

2. No ditches run alongside the road or potential impediment to flow.

3. There are culverts under the road (or potential impediment to flow) that are at ground level (i.e., bottom of culverts are at ground level). Partition the road (or raised surface) into a partial WAA. To determine the area where material has been added to the WAA, **GO TO $V_{STORAGE}$** .

3. There are no culverts under the road or the bottom of the culverts are above ground level.

Partition the WAA into at least two WAAs: one for the area comprising the reservoir of the dam (upgradient) and one comprising the reservoir shadow (downgradient). To determine the area where water collects upgradient (reservoir) and where there is a water deficit (reservoir shadow), **GO TO $V_{SURFFLOW}$** .

Table A1 (continued)

1. A road or other structure, if present, does not cross the direction of flow (if a structure is present, it runs parallel to direction of flow).
 2. There is a ditch or tile drain in the WAA.
 3. The ditch or tile drain is effective in removing water from the WAA, i.e., it has been regularly maintained (sediment removed, etc.) so that it still works as designed.

Partition WAA into at least one partial WAA for area drained (determined by lateral drainage distance). Separate WAAs may have to be partitioned if several soil types belonging to different soil drainage classes are present. **GO TO** $V_{OUTFLOW}$.
 3. The ditch or tile drain is either ineffective in removing water from the WAA (i.e., it has not been sufficiently maintained) or it carries water into the WAA from elsewhere.
 4. The ditch or tile drain is ineffective in removing water from the WAA and does not transport water to the WAA from elsewhere.

Partition WAA into at least one partial WAA determined by the area excavated for the ditch and area of spoil, if present. To determine the area where material has been added to and excavated from the WAA, **GO TO** $V_{STORAGE}$.
 4. The ditch or tile drain transports water to the WAA from elsewhere.

Partition WAA into at least two partial WAAs: one for the portion of the WAA upgradient and one downgradient from the point where water is being imported. To determine the subindex for V_{INFLOW} , the area of both the contributing and natural drainage basins must be determined; **GO TO** V_{INFLOW} .
 2. There is neither a ditch nor tile drain in the WAA.
 3. Soil and microtopography have been altered in the WAA.
 4. Soil and microtopography in all or part of the WAA have been altered by bedding for silviculture, plowing for cropland, compaction by livestock grazing, grading for or burial of utilities along a utility right-of-way, divots created by explosions of light artillery, or conversion to an impervious surface.

Partition WAA into one or more WAAs defined by each of the above types of alterations to soil and microtopography.
 4. Soil and microtopography in all or part of the WAA have been altered by the creation of fire breaks, by traffic from off-road vehicles, by tree stump removal, or by the rooting of hogs.

No need to partition WAA into a partial WAA for assessment of hydrologic regime as long as sample locations are randomly distributed.
 3. Neither soil nor microtopography have been altered in the WAA.
 4. Part of the WAA has been altered by fire exclusion, periodic mowing (e.g., along a utility right-of-way), or any silvicultural conversions and other land clearing activities that have not altered soils.

Partition WAA into one or more partial WAAs based on the presence of each of the above broad-scale alterations.
 4. None of the WAA has been altered by fire exclusion, mowing, or any silvicultural conversions or other land clearing activities.

No need for further partitioning beyond that required to separate vegetation cover type.

Table A1 (continued)

Methods for partitioning WAA into partial WAAs after bounding criteria have been determined using above key:

$V_{STORAGE}$ (bounding by addition or excavation of material): Partition the WAA over which fill and excavation occurs into a partial WAA. High-resolution aerial photos might be useful and as accurate as measuring area in the field. Area can be determined from digitized data or by using a transparent dot grid overlay of the appropriate scale. The subindex for $V_{STORAGE}$ will equal 0.0 in this area.

$V_{OUTFLOW}$ (bounding by lateral drainage distance): Determine soil series (using the appropriate USDA County Soil Survey) through which the ditch has been constructed. Some soil series map soils as complexes of several soil series and are therefore not very reliable. If reliability is questionable, examine and describe the soil profile (to at least 50-cm depth) and compare it with the description of the soil series mapped for the site by NRCS. If the soil profile does not match the mapped soil series, determine if it matches any other soils series mapped for the county.

Next, determine the depth of the drainage feature. Measure relative to the elevation of the wet flat adjacent to the drainage feature, not from the surface of an adjacent berm or spoil bank. If water stands in the ditch over long periods, measure depth to the usual water table elevation (water surface) rather than to the bottom of the ditch. (The usual water table elevation can be estimated at the point where there is an abrupt change from wetland to aquatic vegetation or to lack of vegetation. Recent rains may cause water in the ditch to temporarily rise higher than usual. Wait a few days for the water to subside before measuring if no abrupt vegetation change can be located or measure to the bottom of the ditch.) Determine the lateral distance over which there is an alteration to hydrologic regime by using Table A3 (lateral drainage distance by depth of drainage feature). If none of the soil series in Table A3 matches the series being drained, determine the porosity (f) and hydraulic conductivity (K) of the soil series as reported in the Physical Properties Table in the County Soil Survey or SCS Soil Interpretation record. Then assign the soil series to one of the following drainage categories in Table A3: Category 1 ($K < 1$ cm/hr and $f < 0.02$), Category 2 ($K > 1$ and < 3.3 cm/hr and $f < 0.1$), and Category 3 ($K > 3.3$ cm/hr or $K > 1$ cm/hr and $f > 0.1$). Then determine the lateral drainage distance from Table A3. Linearly extrapolate the lateral distance if the measured depth of the ditch lies between the 1-ft increments in Table A3. Use the lateral distance to determine the portion of the WAA that is drained by the ditch and assess the area as a partial WAA.

Separate WAAs may have to be partitioned if several soil types belonging to different soil drainage classes are present or if some of the WAA is located beyond the lateral drainage distance. The subindex $V_{OUTFLOW} = 0.1$ in areas located within lateral drainage distance (Figure A2). $V_{OUTFLOW} = 1.0$ for areas beyond (outside) the lateral drainage distance. For example, if a ditch draining Murville soil (Category 3 soil) is 1.0 m deep, the lateral distance of effective drainage (Table A3) is 88 m. Thus, any portion of the WAA within 88 m of the ditch should be partitioned into a partial WAA; $V_{OUTFLOW} = 0.1$ within this partial WAA. $V_{OUTFLOW} = 1.0$ for the partial WAA located beyond 100 m of the ditch.

V_{INFLOW} (bounding by importation of water from elsewhere): If water is entering the WAA from another area, determine the source of the water and approximate size of the drainage basin from which the water originates. Aerial photos and ground-truthing may be necessary. Also, at the point where excess water is being imported, estimate the size of the drainage basin that would have naturally fed the point under unaltered conditions. Aerial photos, county drainage maps, and USGS topographic maps will be required to trace the drainage basin. Area can be determined from digitized data or by using a transparent dot grid overlay at the appropriate scale.

Table A1 (concluded)

$V_{SURFFLOW}$ (bounding by impediment to flow): To determine the area over which a dam affects hydrologic regime, determine the lowest point on the dam (outlet point). The lowest point could be located on the upper surface of the dam (if no culvert is present) or at the base of culverts under the dam. If culverts are present and their base elevation (outlet points) are at ground level, then there would be no obstruction of surface flow and hence no impediment to flow. However, if the outlet point is above ground level, use a laser level or surveying station to locate a point, or points, upgradient from the dam that is at the same elevation as the outlet elevation. (All points upgradient from the dam that occur at the same elevation as the outlet point delineate the reservoir boundary.) Next, calculate the distance from the outlet point to one of the points delineating the reservoir boundary. This distance is the radius of a 180-deg arc, centered on the outlet point, which delineates the area altered by the dam on the upgradient side. $V_{SURFFLOW}$ equals 0.1 in the reservoir and 0.5 in the reservoir shadow.

Assuming the gradient of the Wet Pine Flat is uniform in the upgradient and downgradient directions, the area altered on the downgradient side of the dam (reservoir shadow) is a mirror image of the area altered on the upgradient side (Figure A3). To delineate area of the reservoir shadow, locate the point at which water exits the dam (on the downgradient side of the impediment) and circumscribe another 180-deg arc with its radius centered on the downgradient outlet point. These two semicircular areas, one upgradient and the other downgradient from the dam, delineate the area that is hydrologically altered by the dam. If the area does not have a uniform gradient, use a laser level to flag points that are the same elevation as the dam outlet.

If there is no laser level or surveying equipment available, use a hand-level and stadia rod to determine the elevation of the dam. Place the hand-level at a selected height above the outlet point and sight a level line toward a plumb stadia rod directly upgradient from the dam. Try to place the stadia rod as closely as possible to the dam, but on unaltered topography (i.e., not in an adjacent excavation if one is present). Subtract the elevation of the hand-level from the elevation read on the stadia rod; this difference is the height of the dam. Assume a gradient of 0.002 (the mean gradient for Wet Pine Flat reference sites). Calculate the radius of the 180-deg arc that defines the upgradient (reservoir) and downgradient (reservoir shadow) areas of alteration by dividing dam height by the gradient. For example, a 0.5-m-high-dam on a 0.002 gradient alters a circular area with a radius of 250 m (0.5 m/0.002), half of which is located upgradient and half downgradient from the dam. Thus, the total area of alteration would be 19.63 ha (48.7 acres). If no surveying equipment is available, try to use vegetation to estimate where water remains for longer periods and determine the area affected by the dam.

Table A2 Field Gear for Assessing Wet Pine Flats

- ___ a. data sheets
- ___ b. pencils
- ___ c. soil probe and/or sharpshooter shovel and/or bucket auger
- ___ d. binoculars
- ___ e. hand lens
- ___ f. hand calculator
- ___ g. compass
- ___ h. hand-level and stadia rod or laser level
- ___ i. meter tape (100 m) and/or sonar distance measurer
- ___ j. tree caliper or dbh tape or pre-formed calipers fixed at 7.5- and 15-cm width
- ___ k. center pole and quadrat poles (Figure A5)
- ___ l. high-resolution aerial photographs of WAA and surrounding landscape
- ___ m. transparent dot grid overlay
- ___ n. Munsell color chart
- ___ o. USDA/NRCS Hydric Soils Indicator list
- ___ p. appropriate USDA county soil surveys
- ___ q. appropriate USGS topographic maps
- ___ r. insect repellent
- ___ s. sun block, hat
- ___ t. GPS
- ___ u. cell phone
- v. plant identification guides and/or botanical manuals
 - ___ 1. Radford, Ahles, and Bell (1968): *Manual of the Vascular Flora of the Carolinas*
 - ___ 2. Ajilvsgi (1979): *Wild Flowers of the Big Thicket, East Texas, and Western Louisiana*
 - ___ 3. Godfrey and Wooten (1979): *Aquatic and Wetland Plants of the Southeastern United States (Volume I: Monocots; Volume II: Dicots)*
 - ___ 4. Clewell (1985): *Guide to the Vascular Flora of the Florida Panhandle from Louisiana to Massachusetts, Exclusive of Lower Peninsular Florida*
 - ___ 5. Duncan and Duncan (1987): *Seaside Plants of the Gulf and Atlantic Coasts*
 - ___ 6. Porcher (1995): *Wildflowers of the Carolina Low Country and Lower Pee Dee*
 - ___ 7. Weakley (in prep.): *Flora of the Carolinas and Virginia (Working Draft)*

NRCS Soil Series			Depth of Drainage Feature in meters	Lateral Drainage Distance ¹ in meters		
Category 1 Soils	Category 2 Soils	Category 3 Soils		Category 1 Soils	Category 2 Soils	Category 3 Soils
Adaton	Atmore	Alapaha	0.4	17	31	46
Alusa	Balahack	Allanton	0.5	21	38	56
Argent	Bayou	Arapohoe	0.6	24	44	65
Bayboro	Bleakwood	Bleakwood	0.7	27	49	72
Bethera	Coxville	Demory	0.8	29	53	78
Bladen	Deloss	Elloree	0.9	31	57	83
Byers	Ellabelle	Haggerty	1.0	33	60	88
Caddo	Fortescue	Kings Ferry	1.1	35	63	92
Cantey	Gourdin	Leaugueville	1.2	37	66	96
Cape Fear	Grantham	Leon	1.3	38	69	100
Daleville	Grifton	Lynn Haven	1.4	39	71	103
Derly	Henco	Mulat	1.5	40	73	106
Estes	Hobcaw	Murville	1.6	42	75	109
Eureka	Hyde	Naconiche	1.7	45	77	111
Evadale	Liddell	Nakina	1.8	43	78	113
Grady	Mashulaville	Pelham	1.9	44	79	115
Guyton	Merryville	Pickney	2.0	45	81	117
Jasco	Myatt	Plummer	2.1	46	82	119
Kanebreak	Pantego	Rutledge	2.2	46	83	120
Kinder	Pasquotank	Stono	2.3	47	84	122
Leaf	Paxville	Surrency	2.4	47	84	123
McCull	Perquimans	Waccasassa	2.5	47	85	124
Meggett	Plank	Woodington				
Mollville	Rains					
Mouzon	Smithton					
Oakly	Steens					
Ozias	Talco					
Paisley	Tohunta					
Percilla	Toisnot					
Pooler	Tomotley					
Rembert	Trebloc					
Santee	Wadmalaw					
Sorter	Weeksville					
Vimville	Williman					
Waller	Yonges					
Wilbanks						
Wrightsville						

¹ Match NRCS Soil Series with soil drainage category. If soil series is not on list, determine hydraulic conductivity (K) and drainable porosity (f). For Category 1 soils (K = 0.38 cm/hr and f = 0.016), Category 2 soils (K = 2.5 cm/hr and f = 0.033), and Category 3 soils (K = 19 cm/h and f = 0.117). Drainage distance is from each side of ditch and based on 13.2 day drainage period (5% of growing season in South Carolina).

Table A4
Calculation of Leaf Area Index (LAI)

Stratum ¹	Cover ² of Living Plants (2-m radius)								
	Plot 1			Plot 2			Plot 3		
	Cover ³	LAI	Composite LAI score ³	Cover ³	LAI	Composite LAI score ³	Cover ³	LAI	Composite LAI score ³
Groundcover	0.625	1	0.63	0.850	1	0.85	0.975	1	0.95
Low Shrub	0.150	2	0.30	0.025	2	0.05	0.025	2	0.00
Subcanopy	0.025	3	0.08	0.375	3	1.13	0.150	3	0.02
Midcanopy	0.025	4	0.10	0.025	4	0.10	0.150	4	0.02
Canopy	0.150	5	0.75	0.025	5	0.13	0.150	5	0.02
Total LAI score			1.85			2.25			1.02
Mean LAI score (total/ number of plots)									1.71
Bunchgrass/Pine Savanna							14. V_{ET}^4 :	1.0	
Cypress/Pine and Switchcane/Pine Savanna							15. V_{ET}^5 :	1.0	

¹ Living vegetation: Groundcover = herbaceous stratum); Low Shrub = woody plants < 1m tall, Subcanopy = woody plants > 1 m tall and < 7.5 cm dbh; Midcanopy = stems 7.5-15 cm dbh; Canopy= trees > 15 cm dbh.

² Record midpoint of cover classes: 0% (**0**), 0-5% (**0.025**), 5-25% (**0.15**), 25-50% (**0.375**), 50% (**0.50**), 50-75% (**0.625**), 5-95% (**0.85**), 95-100% (**0.975**), 100% (**1.0**).

³ Composite LAI = Cover x LAI

⁴ V_{ET} for Bunchgrass/Pine Savanna, if Site LAI < 2.0, then $V_{ET} = 1.0$, if the Site LAI is between 2.0 and 3.0, then $V_{ET} = 1.0 - [0.3 (LAI - 2.0)]$, if Site LAI > 3.0, then $V_{ET} = 0.7$.

⁵ V_{ET} for Cypress/Pine and Switchcane/Pine Savannas, if Site LAI < 3.5, then $V_{ET} = 1.0$, if Site LAI is between 3.5 and 5.0, then $V_{ET} = 1.0 - [0.2 (LAI - 3.5)]$, if Site LAI > 5.0, then $V_{ET} = 0.7$

Table A5
Calculation of Microtopography (V_{MICRO}) and Soil Porosity (V_{PORE}) by Type of Alteration and Area

Type of Alteration to Microtopography	Cover ¹ (midpoint) of 50-m ² plots			Mean Cover	Microtopography Alteration Value	Score (Mean cover x Value)
	Plot 1	Plot 2	Plot 3			
None, natural ² (unaltered)	0.175	0.000	0.850	0.34	1.0	0.34
Lightly grazed, rutted				0.00	0.8	0.00
Intensively grazed, rutted				0.00	0.6	0.00
Light artillery divots	0.675	0.850	0.150	0.56	0.4	0.22
Firebreaks or deep ruts (< 20 cm from rut to ridge)	0.150	0.150	0.000	0.10	0.3	0.03
Tilled cropland				0.00	0.3	0.00
Recent feral hog rooting				0.00	0.2	0.00
Bedded for silviculture				0.00	0.2	0.00
Ruts from off road vehicles (> 20 cm deep)				0.00	0.1	0.00
Gasline ROW				0.00	0.1	0.00
Impervious				0.00	0.0	0.00
SUM	1.000	1.000	1.000			
Total microtopographic alteration score (sum last column)					$V_{MICRO} =$	0.60
Type of Alteration to Soil Porosity	Cover ¹ (midpoint) of 50-m ² plots			Mean Cover	Soil Alteration Value	Score (Mean cover x Value)
	Plot 1	Plot 2	Plot 3			
None, natural ² (unaltered)	0.475	0.700	0.475	0.55	1.0	0.55
Recent feral hog rooting				0.00	0.9	0.00
Ruts from off road vehicles (< 20 cm deep)	0.150	0.150	0.375	0.23	0.6	0.14
Fire breaks or deep ruts (> 20 cm from rut to ridge)	0.375	0.150	0.150	0.23	0.4	0.09
Bedding for silviculture				0.00	0.4	0.00
Light artillery				0.00	0.3	0.00
Compacted by grazing cattle				0.00	0.2	0.00
Graded or excavated for pipeline				0.00	0.1	0.00
Tilled cropland				0.00	0.1	0.00
Impervious				0.00	0.0	0.00
SUM	1.000	1.000	1.000			
Total soil alteration score (sum last column)					$V_{PORE} =$	0.78
¹ Record midpoint of cover classes (in parentheses): 0% (0), 0-5% (0.025), 5-25% (.015), 25-50% (0.375), 50% (0.50), 50-75% (0.625), 75-95% (0.85), 95-100% (0.975), 100% (1.0).						
² First determine cover for all other categories (alterations), sum, and subtract sum from 1.0 to obtain area unaltered (row 1).						

Table A6
Calculation of Herbaceous Indicator Scores for Bunchgrass/Pine and
Cypress/Pine Cover Types

Herb Indicator Species	Plot 1	Plot 2	Plot 3
<i>Aletris</i> spp. (<i>A. farinosa</i> , <i>A. aurea</i>)	1.0	0.5	1.0
<i>Aristida</i> spp. (<i>A. stricta</i> , <i>A. beyrichiana</i>), <i>Sporobolus</i> spp.			1.0
<i>Balduina</i> spp.		0.5	
<i>Bigelowia nudata</i>	1.0	0.5	0.5
<i>Carphephorus</i> spp.		0.5	
<i>Chaptalia tomentosa</i>	0.5	0.5	
<i>Coreopsis</i> spp.	1.0		1.0
<i>Ctenium aromaticum</i>		1.0	1.0
<i>Dichromena</i> spp.			
<i>Erigeron vernus</i>	0.5	0.5	
<i>Eriocaulon</i> spp.	0.5	1.0	
<i>Eryngium integrifolium</i>			0.5
<i>Eupatorium leucolepis</i>	0.5		0.5
<i>Helianthus</i> spp.	1.0		
<i>Lycopodium</i> spp. (especially <i>L. alopecuroides</i>)			0.5
<i>Muhlenbergia expansa</i>	1.0	1.0	
<i>Rhexia</i> spp.		0.5	0.5
<i>Sarracenia</i> spp.	0.5		
<i>Schizachyrium scoparium</i>	0.5	0.5	
<i>Xyris</i> spp.			
Total Indicator Score	8.0	7.0	6.5
Mean (total/ no. of 1-m ² plots)			7.2

Bunchgrass/Pine Savanna score (divide Mean by 8.0)	V _{HERB} :	0.90
Cypress/Pine Savanna score (divide Mean by 7.0)	V _{HERB} :	1.00

Note: For each indicator species/genus that occurs in the 1-m² nested plot, record 1.0. For each indicator plant that occurs in the 2-m-radius plot, but does not occur in the 1-m² nested plot, record 0.5. To determine the indicator score, total all scores and divide by the total number of 1-m² plots (sample at least 3 plots).

Table A7 Calculation of Cypress Stand Physiognomy from Density Data						
	Distance (m)⁴			Mean Distance (m)	Density⁵	Physiognomy⁶
	Plot #1	Plot #2	Plot #3			
Sapling ¹	3.3	6.2	4.2	4.6	240	0.96
Midcanopy ²	8.7	7.0	7.3	7.7	85	1.00
Canopy ³	5.0	6.8	11.5	7.8	83	0.83
Mean					16. $V_{CYPRESS}$ ⁷ :	0.93
¹ Stems > 1 m tall, but < 7.5 cm dbh ² Stems 7.5-15 cm dbh ³ Stems > 15 cm dbh ⁴ Measure distance in meters to nearest individual in each size class ⁵ Density = 10,000/[2 x (Mean Distance) ²] ⁶ Sapling Physiognomy = Density/250, if > 1.0, reduce to 1.0 Midcanopy Physiognomy = Density/50, if > 1.0, reduce to 1.0 Canopy Physiognomy = Density/100, if > 1.0, reduce to 1.0 ⁷ $V_{CYPRESS}$ is the mean of all three physiognomy scores						

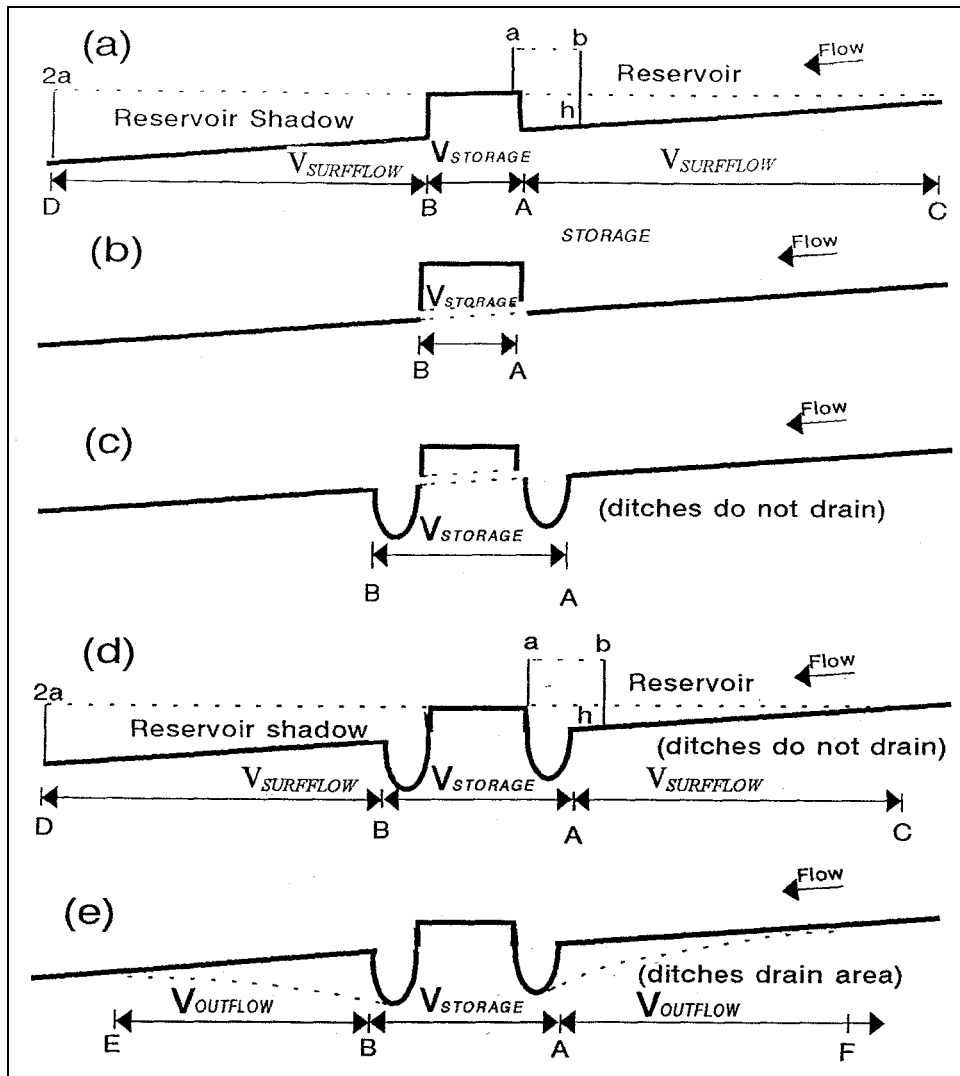

Figure A1. Interactive effects of several types of alterations to hydrologic regime. See Figure A2 for plan view. **(a)** Site with a dam (road), but no ditch. Height of dam (h) = $b - a$, where b = distance from ground to hand level and a = top of dam to hand level. Hydrologic alteration by $V_{SURFFLOW}$ occurs from A to C (reservoir) and from B to D (reservoir shadow). Hydrologic alteration of fill ($V_{STORAGE}$) is determined by footprint of dam (from A to B). **(b)** Site with a road culvert under road, no ditches. Only $V_{STORAGE}$ is applicable between A and B. **(c)** Site with a road, ditches alongside road, and culverts under road, but ditches do not drain site. Hydrologic alteration restricted to footprint of road and ditch ($V_{STORAGE}$) from A to B. **(d)** Site with a road, ditches that do not drain site and no culverts under road. Hydrologic alteration occurs in reservoir and reservoir shadow ($V_{SURFFLOW}$) from A to C and from B to D; alteration due to footprint of road and ditches ($V_{STORAGE}$) occurs from A to B. **(e)** Site with a road and ditches that drain the site. Hydrologic alteration due to drainage effect of ditches ($V_{OUTFLOW}$) occurs from B to E and from A to F; alteration due to footprint of road ($V_{STORAGE}$) occurs from A to B.

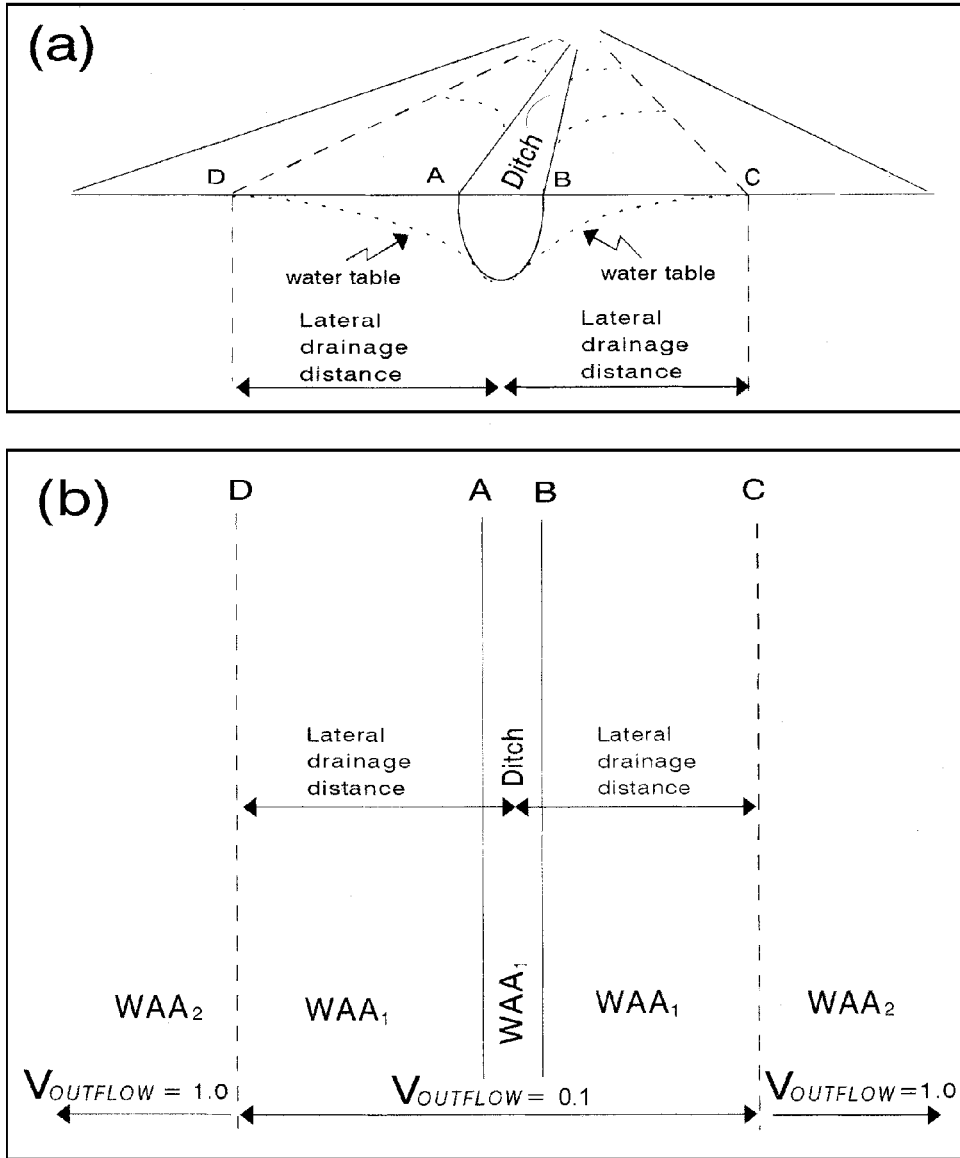

Figure A2. Lateral drainage effect of ditches on subsurface water storage. (a) Dashed line shows extent of altered water table (lateral distance) on both sides of ditch: from A to D and from B to C. (b) Plan view. Wetland Assessment Area (WAA) should be split into two partial WAAs based on lateral effect of drainage from ditch.

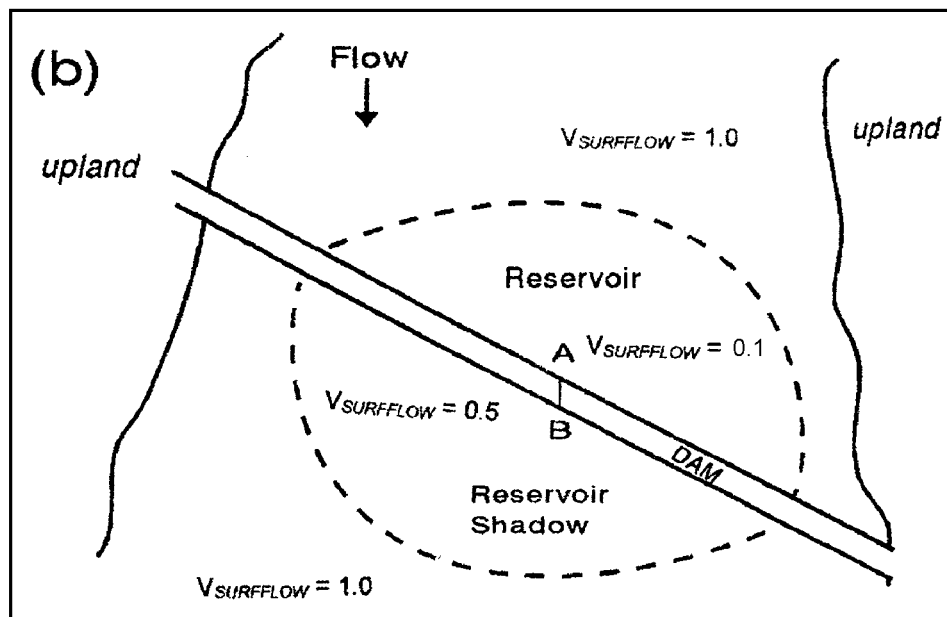
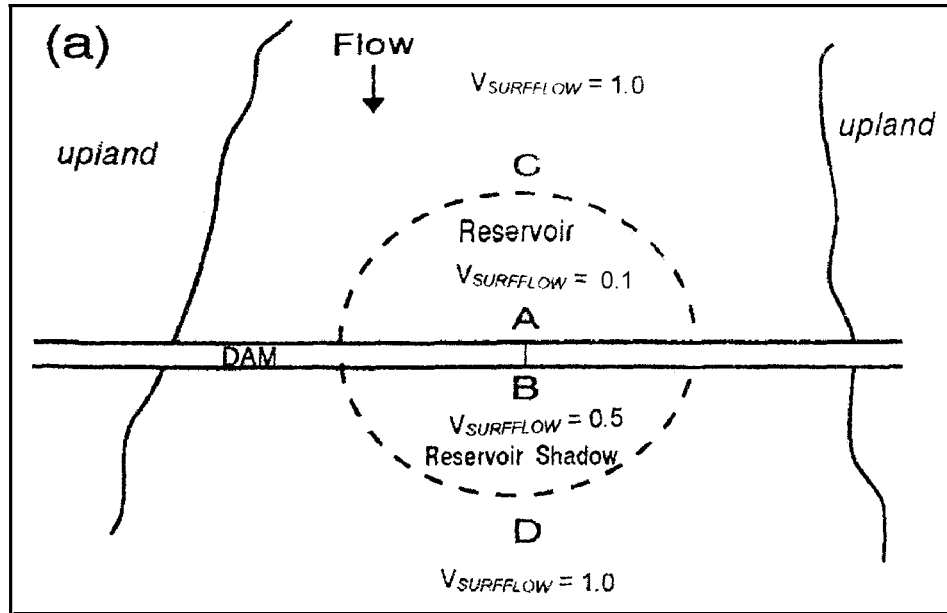

Figure A3. Alteration to hydrologic regime caused by an impediment to flow ($V_{SURFFLOW}$). (a) For dams that cross a flat perpendicular to the direction of flow, the elevation of the overflow point (A) is the same as that of the reservoir boundary (C). The distance from A to C equals the distance from the outlet point (B) to the boundary of the reservoir shadow (D). If the gradient of the wet flat is 0.002 and the overflow point on the dam is 0.5 m high, then the distance from A to C and B to D is 250 m ($0.5/0.002$). Note: footprint of dam is treated as a fill (see $V_{STORAGE}$). (b) Dam crossing a wet flat at angle that is not perpendicular to flow. Precise shape of area alteration is unknown. The subindex for $V_{SURFFLOW}$ is 0.1 in the reservoir and 0.5 in the reservoir shadow.

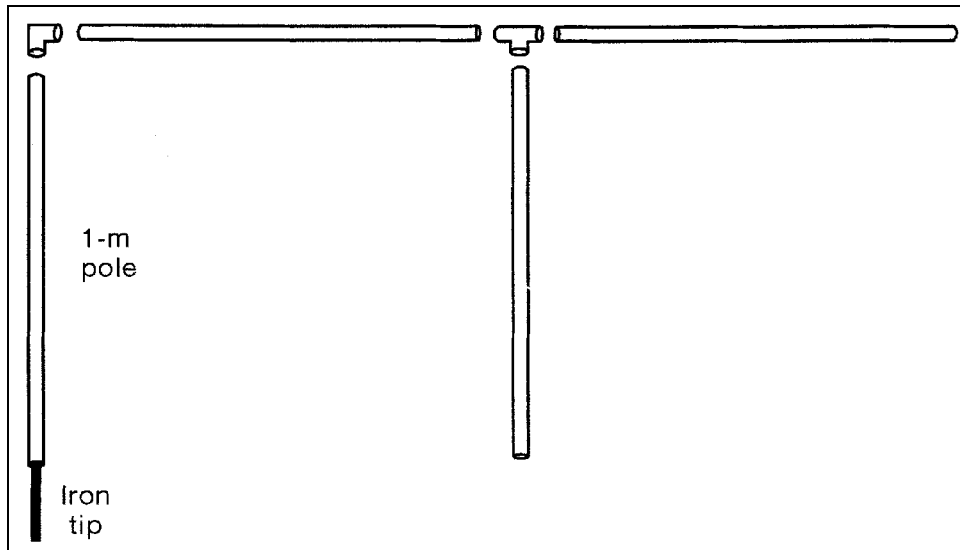

Figure A4. PVC piping used to mark boundaries of nested quadrats. Center pole (1 m tall) with iron tip is used to mark the center of nested plots. Two 1-m sections of PVC are used to construct the 1-m² quadrat and circumscribe a 1-m-high by 2-m-radius circle from center point. Three PVC poles and auger are used to mark corners of the 50-m² plot

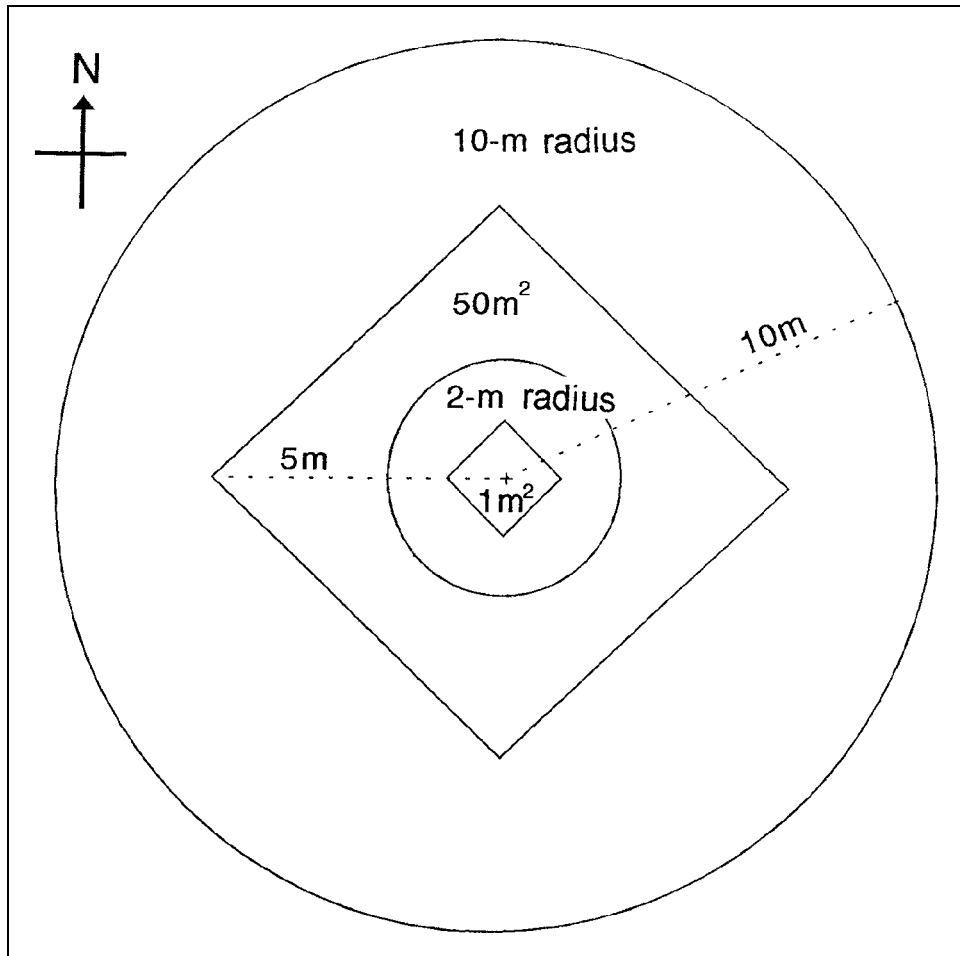

Figure A5. Orientation and dimensions of nested plots for measuring field indicators (not drawn to scale). Measurements of field variables are restricted to specific plot sizes. In 1-m^2 plot: V_{HERB} ; in 2-m-radius plot: V_{HERB} , V_{ET} (using composite LAI scores), V_{NBG} , and V_{SEDGES} ; in 50-m^2 plot: V_{SUBC} , V_{MICRO} , and V_{PORE} ; in 10-m-radius plot: V_{PINES} ; in areas outside nested plots: $V_{CYPRESS}$, V_{LONGL} , and $V_{LANDSCP}$

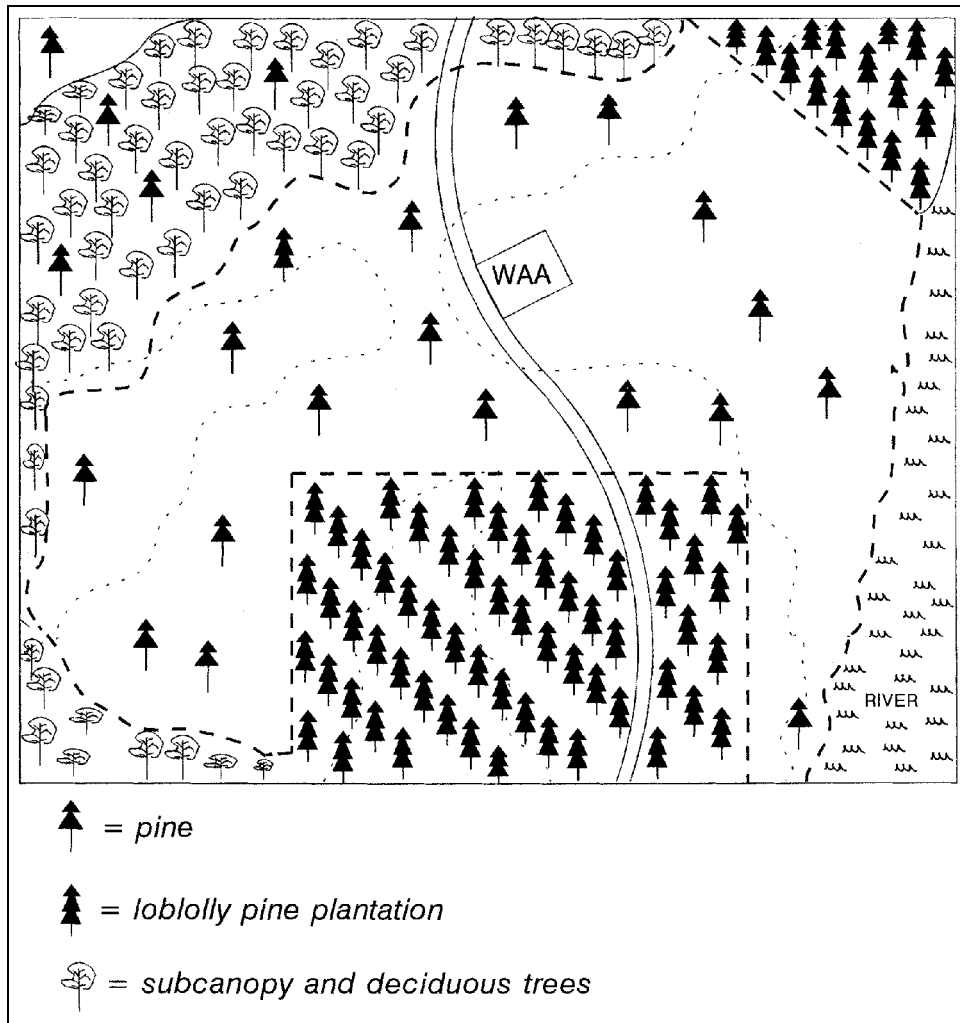

Figure A6. Determination of the landscape variable ($V_{LANDSCP}$). Dotted line delineates boundary of Wet Pine Flat; subcanopy and deciduous tree symbol designates fire-excluded areas; and dashed line delineates area of contiguous fire-maintained landscape used to calculate $V_{LANDSCP}$. Contiguous fire-maintained landscape drawn from recent air photos; wherein discontinuities of fire-maintained area > 50 m wide (boundaries) and > 1 ha in size are excluded

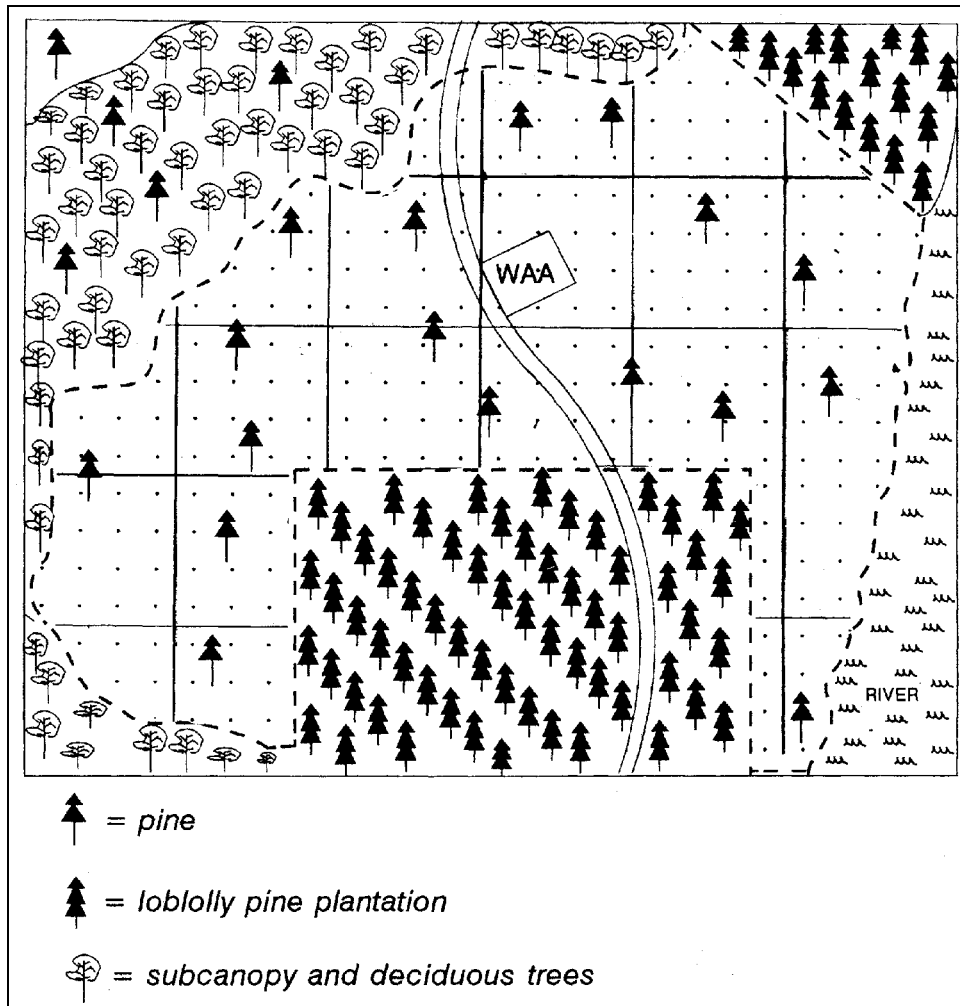

Figure A7. Dot grid overlay to estimate area from an aerial photograph. To determine area, place a transparent overlay of the dot grid matrix on the air photo, trace the outline of the area to be measured, and determine the enclosed area based on the scale of the photo or map by (1) counting all dots lying within the boundary, (2) adding to that count 1/2 the number of dots that lie on the boundary line, and (3) multiplying the total dot count by a constant appropriate to the scale of the map or photo being traced. If the scale of the photo or map is 1:24,000, then the distance between dots (0.63 cm) is equivalent to 15,158 cm (151.58 m). Therefore, an imaginary square surrounding each dot is 0.3969 cm^2 and represents $2.289 \times 10^4 \text{ m}^2$ or 2.29 ha (5.66 acres). In the example above, there are 244.5 dots within the hatched savanna boundary, equivalent to 559 ha (1,383 acres).

Appendix B

Indicator Species

Indicator Plants

Indicator species are alphabetically listed and described on the following pages.
Digital color images may be viewed at <http://www.wes.army.mil/el/wetlands/wlpubs.html>

POF = period of flowering



1. *Aletris* spp. (includes *A. aurea*, *A. farinosa*, *A. obovata*) (colic-root): Prominent basal rosette with leaves 10 cm long, linear with narrow tips. Stem leaves minute. Flowering stalk 0.4-1.2 m tall with inflorescences alternating along stalk. Flower stalk somewhat sticky. (POF: May-Jun.)



2. *Aristida* spp. (includes *A. stricta*, *A. beyrichiana*) (wiregrass): Wiry-leaved bunchgrass with rolled-in leaves appearing cylindrical in cross section. Fine hairs occur at base of leaves. (Note: *A. stricta* has two rows of fine hairs along stem.) Flowers are three-branched awns that occur along stem. (POF: Jul.-Sep. following growing season fire)



3. *Bigelovia nudata* (rayless goldenrod): Basal rosette with one flowering stem that is round in cross section. Stem has 5-15 elliptic leaves that alternate along stem. Numerous yellow flowers occur in a flat-topped head. (POF: Aug.-Oct.)



4. *Carphophorus* spp. (includes *C. corymbosus*, *C. paniculatus*, and esp. *C. odoratissimus*) (deer's-tongue): Basal rosette leaves vary in size by species (4-50 cm long, 0.5-10 cm wide), entire (smooth margins), with prominent midrib. Stem leaves are alternate and decrease in size upwards. Flowering stalk to 1.8 m tall. Flowers in short, flat-topped, discoid heads (corymbs), pink to lavender in color. The most common species is *C. odoratissimus*. Its leaves can become very large, are purple toward base, white toward tip, and smell like vanilla when dried (sometimes used to flavor cigarettes).



5a. Basal rosette

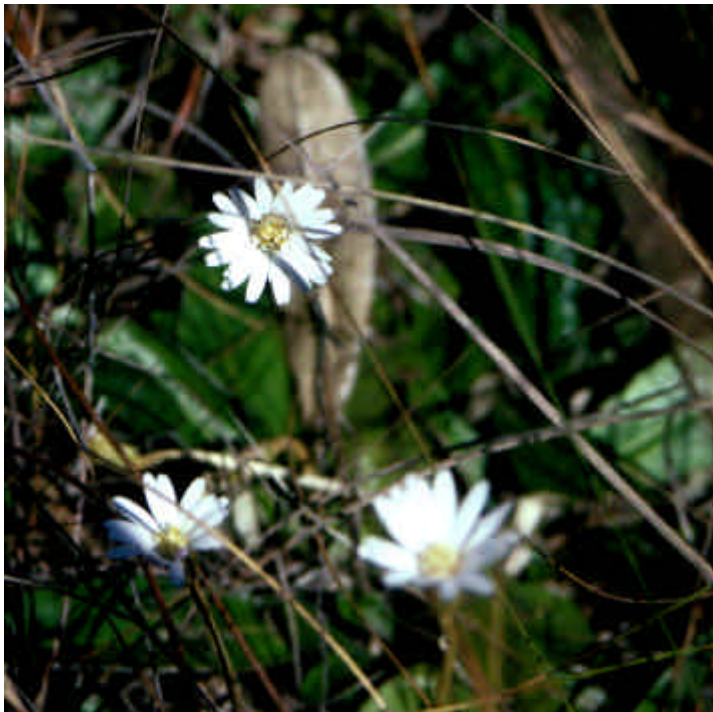

5b. Flower

5. *Chaptalia tomentosa* (sunbonnet): Leaves basal, undersides of leaves are white and densely pubescent (fuzzy), topsides are pubescent when new, but turn glabrate (smooth, somewhat glossy) with age. Nodding 1- to 4-cm-wide daisylike flowers solitary atop 20- to 35-cm-tall scape (stalk). Ray flowers white above, deep pink on back; inner disk flowers cream colored. (POF: Feb.-May, depending on latitude)



6a. Basal leaves



6b. Back-lit basal leaf



6c. Flowers

6. *Coreopsis* spp. (particularly *C. linifolia* or *C. oniscicarpa*): Leaves are thick (1 mm) and rubbery. Basal leaves have long petioles and are 1 cm across at widest part. Veins in leaves are regularly distributed. Black dots apparent on leaf when back-lit. (POF: Aug.-Oct.).



7a. Fruiting head



7b. Blades and fruiting head

7. *Ctenium aromaticum* (toothache grass): Perennial bunchgrass with leaves along stem at base of plant. Leaves long (0.2 m) and 5-20 mm wide, rough along edges, smooth above, and minutely pubescent (fuzzy) and light green below. Flowers on a solitary, recurved spike with spikelets in two rows along one side of flower spike (resembles a comb). Spike persists over winter. (POF: Jun.-Aug.)



8. *Dichromena* spp. (*D. latifolia*, *D. colorata*) (whitetop): Leaves primarily basal, 1-10 mm wide, smooth on both surfaces, but rough along margins. Inflorescence terminal with 5-10 long (3-6 cm), narrow (0.5-1.0 cm), pointed, petallike bracts that are white near base and green nearer tips. *D. latifolia* has more than 7 bracts; *D. colorata* has fewer than 7. (POF: Jun.-Nov.) Note: *Bigelowia nudata* (yellow flowers) is in background.



9. *Erigeron vernus* (whiteweed fleabane): Basal leaves variable, glabrous (smooth) to slightly hairy, entire (smooth) to coarsely toothed, fleshy, 2-8 cm long, 0.6-3.0 cm wide, base tapering, with or without a stalk (petiole). Flowering stalk 0.2-0.6 m tall, stem hollow. Inflorescence flat-topped (corymb) with 3-20 heads. Ray flowers white to lavender; disk flowers yellow. (POF: Mar.-Jun.)



10a. Basal rosette



10b. Flowering heads

10. *Eriocaulon* spp. (includes *E. decangulare*, *E. compressum*) (pipewort or pincushion): Basal rosette of 8-12 ridged, pointed leaves that curl inward and have visible air spaces within. Inflorescences at end of a single long (20- to 80-cm) leafless stalk. *E. compressum* has flower heads that can be easily compressed between fingers. (POF: Jun.-Oct.)



11a. Basal rosette



11b. Flowers

11. *Eryngium integrifolium*: Erect perennial 0.2-0.8 m tall with solitary, branching stems toward top. Basal leaves variable, but most with long stalk at base (petiolate), 2-10 cm long, margins entire (smooth) or wavy edged (crenate). Five-parted flowers, whitish to bluish to purplish, in globular heads with spiny bracts (short leaflike structures) below flower head. (POF: Aug.-Oct.)



12. *Eupatorium leucolepis* (savanna thoroughwort): Leaves triple-nerved, opposite, serrated (toothed on margins), sessile (lacking a leaf stalk), less than 1 cm wide. Flowers in flat, paniced heads, white, often persisting through winter. (POF: Aug.-Oct)



13. *Helianthus* spp. (many species, particularly *H. angustifolius*, *H. floridanus*, *H. heterophyllus*) (savanna sunflower): Ray flowers red, purple, or yellow with black or purple disk (centers). Leaves very scabrous (sandpapery), basal and opposite along lower stalk, usually alternate along upper stalk. (POF: Jul.-frost)

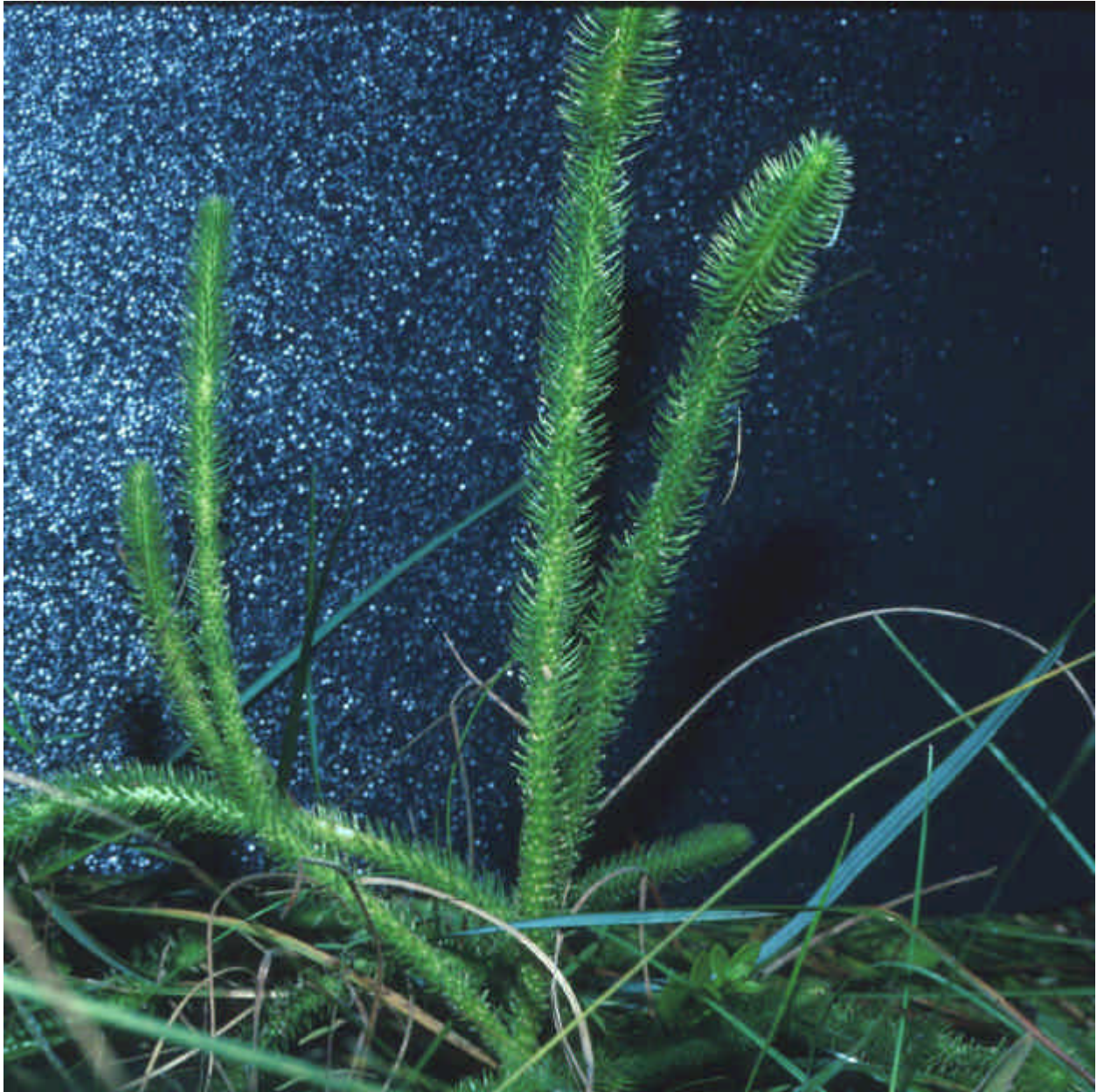

14. *Lycopodium* spp. (or *Lycopodiella* spp.) (club moss): Nonflowering vascular plants. Stems are prostrate to weakly erect, 1.5-15 mm in diameter (including leaves). Leaves are small, narrow, whorled (or occur in an overlapping spiral). Includes *L. alopecuriodes*, *L. appressa*, and *L. prostrata*.



15. *Muhlenbergia expansa* (muhly grass): Perennial bunchgrass with stiff, flat leaves about 2 mm wide. (Bent leaves instantly spring back into place when released.) Leaves a bit turquoise in color. Inflorescences are an open panicle (widely spreading) and fragile (unlikely to persist over winter). Dense population in seed look purplish and wave in the wind. (POF: Sep.-Oct.)



16a. Entire plant



16b. Close-up of flower

16. *Rhexia* spp. (meadow-beauty): Perennial with lance-shaped, serrated, opposite leaves with a prominent midvein. Flowers are 4 parted and asymmetrical. Fruit is urn-shaped. Petals vary in color depending on species. Note: *R. mariana* has sparse, coarse hairs along stem and leaf margins. (POF: May-Oct.)



17. *Sarracenia* spp. (pitcher-plant): At least six species occur in wet savannas from North Carolina to Texas, each with a distinct range: *S. minor*, *S. flava*, *S. rubra*, *S. leucophylla*, *S. purpurea*, and *S. alata*. All are carnivorous perennials with hooded, hollow leaves evolved to attract, capture, and digest insects and other small invertebrates. (POF: all year)



18. *Xyris* spp. (yellow-eyed grass): Flowering stalk 0.3-1.0 m tall with pale to bright yellow flowers in axils of woody scales occurring atop a leafless stem that is flattened and wider at the top below flowers. Leaves basal, linear, and in-rolled toward upper surface at tip. Leaves are brownish or reddish at base and admixed among dead leaf bases. (POF: Jun.-Sep.)



19. Bunchgrass/Pine Savanna: Green Swamp, NC



20. Cypress/Pine Savanna: less wet end of gradient



21. Cypress/Pine Savanna: wetter end of gradient



22. Switchcane/Pine Savanna – Example A



23. Switchcane/Pine Savanna – Example B



24. Bunchgrass/Pine Savanna: 6 weeks after burning



25. Bunchgrass/Pine Savanna: close-up of ground layer (1-m² plot)



26. Fire-suppressed Bunchgrass/Pine Savanna



27. Bunchgrass/Pine Savanna converted to a pine plantation



28. Powerline right-of-way through a Cypress/Pine Savanna



29. Road damming water in a Bunchgrass/Pine Savanna: left side is upgradient

Not pictured

Balduina spp. (*B. uniflora*, *B. atropurpurea*) (honeycomb-head): Erect perennial with one to several branches. Stems round in cross section, fuzzy, and ribbed. Leaves alternate, slightly rubbery, similar to those of *Coreopsis linifolia*. Leaves of *B. uniflora* longer and more narrow than those of *B. atropurpurea*. Flowers of *B. uniflora* yellow, those of *B. atropurpurea* purple.

Schizachyrium scoparium (little bluestem): Grass 0.75-1.5 m tall, blades to 0.25 m long and 4 mm wide. Flower stalk (peduncle) projecting 2-10 cm beyond main stalk, but very stiff and upright. Spikelet flower is solitary on each peduncle; a sharp, hollowed base when flower drops off.

Also (for Louisiana)

Rhynchospora spp. (native wiry species only) (beaksedge): Cyperaceae with wiregrasslike life form. Dominates herb layer in wet savanna along the Gulf coast west of the Mississippi River.

Appendix C

The van Schilfgaarde Equation

Water Table Elevations

Numerous water table equations have been developed to determine the minimal spacing and depth of drainage needed to maximize crop production. The usual requirement was to lower the water table below the root zone in 24 to 48 hr after saturation (USDA-NRCS 1997).¹ Most of these equations have been applied to analyzing the removal of soil saturation in wetlands, a process called “Scope and Effect.” Several Scope and Effect equations have been used, one of which is the van Schilfgaarde equation. The objective of utilizing the van Schilfgaarde equation in this Regional Guidebook was to assess the lateral distance over which a drainage feature would be expected to affect water table fluctuations in a Wet Pine Flat. The water table slope in a wetland assessment area (WAA) is assumed to mimic the wetland surface except when a drainage feature (ditches, tile drains, etc.) in the vicinity of the drainage feature depresses it. The van Schilfgaarde equation is used to develop an indicator for alteration to water table slope by providing an approximation of the lateral distance over which a drainage feature affects the water table regime. The following is a summary of how the van Schilfgaarde equation was used to develop the $V_{OUTFLOW}$ indicator. Most of the model development was provided by the Natural Resources Soil Conservation Service (NRCS) Southeast Coastal States Wetland Team with assistance from various NRCS soil scientists and other hydrologists throughout the Southeast.

Development of Lateral Effect Distances for Bounding WAA by $V_{OUTFLOW}$

A list of soil series that are likely to be found in mineral soil Wet Pine Flats was developed by sorting an NRCS soils database by aquic suborder and by Major Land Resource Area (USDA 1981) encompassed by the Reference Domain. The initial soils list was shortened by eliminating nonhydic soils, organic soils, and soil series that are known to be associated with riverine

¹ References cited in this appendix are listed in the References at the end of the main text.

floodplains and salt marshes. The final soils list was checked against soil series identified in reference sites to ensure that soil series in all reference soils were included (Table 13).

Each soil series was then placed into one of three soil categories on the basis of its permeability from the A-horizon to an approximate 75-cm (30-in.) depth and its drainable porosity. Category 1 soils were defined as having a permeability (K) < 1.0 cm/hr and a porosity (f) < 0.02 (these soils are generally fine textured or clayey). Category 2 soils were defined as having a permeability (K) > 1.0 and < 3.3 cm/hr and a porosity (f) < 0.1 (these soils are generally silts and fine loams). Category 3 soils were defined as having a permeability (K) > 3.3 cm/hr or K > 1 cm/hr and porosity (f) > 0.1 (these are generally loams, coarse loams, and sands).

The van Schilfgaarde equation was used to determine the lateral distance (L_e) over which a drainage feature would be expected to alter the hydrologic regime in a Wet Pine Flat:

$$S = 2L_e = \{(9KtD) / [f(\ln m_0(2D + m) - \ln m (2D + m_0))]\}^{1/2}$$

where

S = drain spacing distance

L_e = 1/2 S = horizontal distance of lateral drainage effect

K = hydraulic conductivity (distance per unit time)

t = time for water table to drop from height m_0 to depth m

D = equivalent depth from drainage feature to impermeable layer

f = drainable porosity of the water-conducting soil expressed as a fraction

m_0 = height of water table above the center of drainage feature at time $t = 0$

m = height of water table above the center of the drainage feature at time t

Data were entered into a van Schilfgaarde equation at the ARS National Sedimentation Laboratory/NRSC Wetland Science Institute web page site:

http://www.sedlab.olemiss.edu/java/schilfgaarde_java.html . (Figure C1). In doing so, permeability (K) and drainable porosity (f) for each soil category were determined from the mean values for K and f in each soil category:

d = depth of drainage feature (ditch or tile drain) in feet

f = drainable porosity varied, depending on Soil Drainage Category
(Category 1 = 0.15, Category 2 = 0.033, Category 3 = 0.117)

m_0 = height of water table in feet above the center of drainage feature at time $t = 0$ (in this case, $m_0 = d$)

t = 13.2 days for all calculations (time in days for water table to drop from ground level to -12 in.). In this case, t is equivalent to 5 percent of the growing season in South Carolina)

D = 10 (depth to impermeable layer in feet), held constant for all calculations

s = 0.0 (surface storage), held constant for all calculations

m = $d-1$ (assuming regulatory criterion of soil saturation to 1 ft required to meet wetland definition (sensu Environmental Laboratory 1987))

K = hydraulic conductivity varied, depending on Soil Drainage Category (Category 1 = 0.15 in./hr, Category 2 = 1.0 in./hr, Category 3 = 7.48 in./hr)

When the above parameters are entered into the ARS National Sedimentation Laboratory model, *S* and *Le* are provided as output. Lateral drainage effect distances (*Le*) are the values provided in Table 13 and are used to partition WAAs by $V_{OUTFLOW}$. Thus, a Wet Pine Flat is expected to be drained ($V_{OUTFLOW} = 0.0$) a distance of *Le* on both sides of a ditch. For example, a 1.2-m-deep ditch in a Murville soil (Category 2) would drain an area 66 m on both sides of the ditch (e.g., if $d = m_0 = 3.94$, $m = 2.94$, $K = 1$, $f = 0.033$ are model input parameters, then $S = 434$ and $Le = 217$ will be output values)

These calculations were based on average conditions in the coastal plain of South Carolina. One could calculate a more precise lateral drainage distance (L_c) for a specific soil type and locale with the above model if one knows the *f* and *K* values for the soil type and local growing season information. Bear in mind that growing season information in soil surveys was developed for crops and not specifically for wetlands. A true growing season for wetlands is longer than that estimated for crops and could constitute almost the entire year in many areas of the Atlantic and Gulf coasts. Soil microbes, responsible for denitrification and producing many indicators of hydric soils, probably thrive year-round in Wet Pine Flats because subsoils rarely ever reach biological zero.

van Schilfgaarde Equation

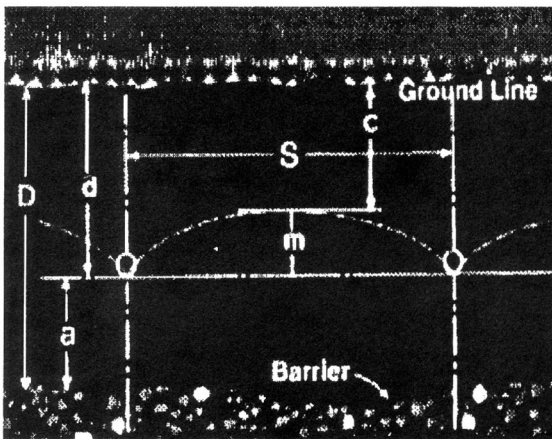

Example tile drainage system

Input Parameters

d = 3 ft	D = 10 ft
f = 0.016	s = 0 in
m_0 = 3 ft	m = 2 ft
t = 33 days	<input checked="" type="radio"/> Ditch (any size)
Tile D_t = N/A in	Drain tube n = N/A in
K = 0.15 in/h	<input type="checkbox"/> Calculate K N/A

Intermediary Results

a = 7 ft	d_e = 6.7803 ft
f' = 0.016	r_e = 1 ft

Final Results

S = 332 ft	L_e = 166 ft
--------------	----------------

Figure C1. The ARS National Sedimentation Laboratory/NRCS Wetland Science Institute web page for calculating Lateral Drainage Distance (L_e) used to bound a WAA by $V_{OUTFLOW}$. The web site address is: http://www.sedlab.olemiss.edu/java/schilfgaarde_java.html

Appendix D

Model Development and Collection and Analysis of Reference Data

Workshop

This appendix provides information on how field data were collected from reference sites and analyzed to calibrate function models and develop reference standards for Wet Pine Flats. Prior to undertaking field work, the authors convened a workshop to develop draft functional assessment models, identify potential field indicators, and recommend methods for collecting reference data. The workshop was conducted at the Joseph W. Jones Ecological Research Center in Newton, Georgia, 27-31 January 1997, and included a field trip to Wet Pine Flats in Apalachicola National Forest in Florida.

Workshop participants comprised an interdisciplinary group of scientists and regulatory personnel (including biologists, hydrologists, and biogeochemists) with expertise in the structure and functioning of ecosystems associated with wet flats (Table 1, main text). As a group, workshop participants were familiar with Wet Pine Flats throughout the Reference Domain from eastern Texas to eastern North Carolina. Many workshop participants were regularly consulted to help fine-tune the function models and sampling protocol. In the process of collecting reference data, many of the members helped locate and sample reference sites. Members also provided critical reviews of the guidebook, particularly those sections in which they had the most expertise.

Data Collection at Reference Sites

Data were collected from 71 reference sites between May and October 1997 (Figure D1). Throughout the geographic Reference Domain, local experts assisted in locating sites representing the range of variation exhibited by Wet Pine Flats,

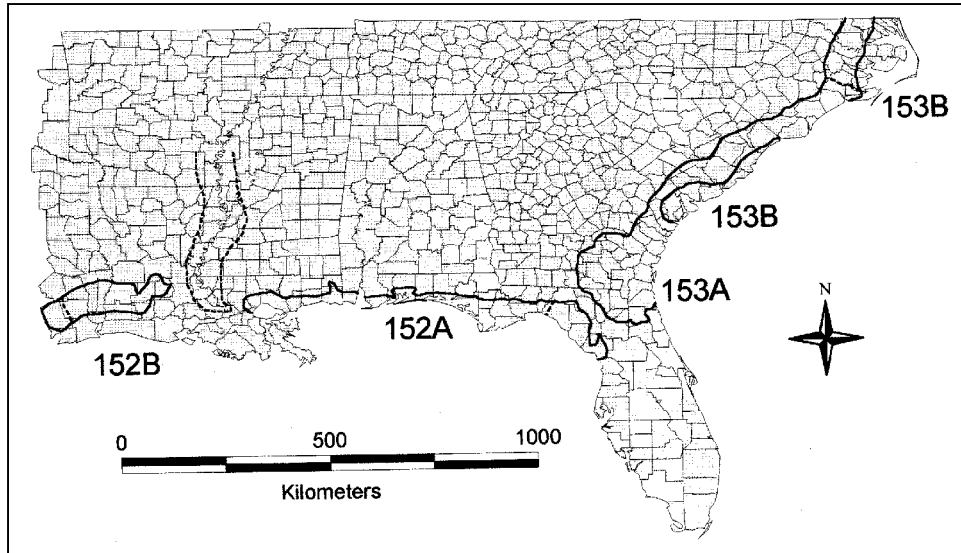

Figure D1. Reference Domain for Wet Pine Flats and locations of reference sites (dots). Dashed lines show location of Wet Hardwood Flats within range of Wet Pine Flats: in eastern North Carolina (north of dashed line), in the Big Bend area of northwest Florida (south of dashed line), in the aeolian belt near the Mississippi River basin (between dashed lines), and the western end in the Big Thicket area of Texas (west of dashed lines)

including (a) biogeographic variation, (b) edaphic variation, (c) natural variations in response to wetness or moisture, and (d) variations due to anthropogenic alterations commonly inflicted upon Wet Pine Flats. Experts included biologists with state Natural Heritage Programs, plant ecologists with The Nature Conservancy, forest ecologists with the U.S. Department of Agriculture (USDA) Forest Service, soil scientists with USDA Natural Resources Conservation Service (NRCS), state wildlife biologists, hydrologists, fire ecologists, land managers, and members of the Ichuaway workshop.

One reason for collecting reference data is to determine the boundaries of the Reference Domain (i.e., to determine the region over which reference standards are applicable). Therefore, a subset of reference sites were specifically sought near biogeographic, geomorphic, and wetland boundaries of the Reference Domain. Two sites were sampled that did not possess regionally specific field indicators for hydric soils outlined by USDA (1996), although vegetation met jurisdictional criteria (Environmental Laboratory 1987). Two sites were seepage pine savannas (slope wetlands in Kisatchie National Forest) located in the inner coastal plain, and one site was a flatwoods pond (a depressional wetland in Louisiana). One regularly burned Wet Pine Flat was vegetationally unlike any of the other reference sites and could not be assigned a cover type. Thus, the reference data set consisted of 66 Wet Pine Flats, 3 cover type outliers, and 2 nonjurisdictional flatwoods (Table D1).

Table D1
Reference Sites by Subclass

Subclass	Reference Standard Sites	Altered Sites	Total
Pine Flats			
Bunchgrass/Pine Savanna	31	24	55
Cypress/Pine Savanna	7	1	8
Canebrake/Pine Savanna	2	0	2
Outlier (unclassified)	1	0	1
Total # of pine flats	41	25	66
Flatwoods Pond	1		1
Seepage Pine Savanna	2		2
Total # of wetlands			69
Nonjurisdictional flatwoods			2
Total # of reference sites			71

Sites were chosen that appeared to have homogeneous vegetation, soil type, hydrologic regime, and fire history. Small-scale natural disturbances (e.g., tip-up features) and anthropogenic alterations (e.g., firebreaks, tire ruts, etc.) occurring within a site did not disqualify it from being considered homogeneous. An array of sites ranging from the wettest to the driest extremes of the wetness gradient were sampled. In order to acquire information that could be used to scale variables relative to the magnitude of a given alteration, altered sites that possessed only one type of a given alteration were located and sampled. Sometimes, this was difficult because most Wet Pine Flats have been subjected to a multiplicity of alterations (e.g., drainage and fire exclusion, fire exclusion and silviculture).

Generally, a reference site had to be at least 1 ha in size in order to fit three non-overlapping and randomly placed sample plots within it. When an appropriate site was found, a predetermined number of paces (50-150) were walked toward the middle of the site in order to randomly locate the first (and center) sampling location. In other words, a quasi-stratified random approach to sampling was taken: the type of site to sample was specifically chosen, but the locations of the plots within the site were chosen at random.

At the middle of the sampling area (near the first sample plot), the geographic position was obtained using a hand-held GPS (geographic positioning system) instrument. The types of alterations present at the site, if any, were recorded: artificial drainage, firebreaks, fill or excavation, long-term fire exclusion, impoundments, timber removal, grazing by livestock, ongoing silviculture, site preparation for silviculture, compaction, bedding, or other soil disturbances.

Degree of slope over 100 m was measured using a laser level and the general downgradient direction of slope was recorded. Whether or not fire had occurred in the site within the past 3 years was determined from specific site-history information from site managers or the presence of onsite indicators (charcoaled tree trunks, lack of standing dead graminoids, lack of shrub layer, etc.). Recent fire was recorded only as present or absent.

Next, cover was estimated for each of 5 vegetative strata for the entire 1-ha study area: groundcover (herbaceous plants < 1 m tall), shrubs (woody plants < 1 m tall), subcanopy (woody plants > 1 m tall, but < 7.5 cm dbh), midcanopy (plants with stems 7.5-15 cm dbh), and canopy (trees with stems > 15 cm dbh). Cover of each stratum within one of the following cover classes was estimated and the midpoint value (in parentheses) was recorded for the cover categories: 0 (0), 0-5 percent (0.025), 5-25 percent (0.15), 25-50 percent (0.375), 50 percent (0.50), 50-75 percent (0.625), 75-95 percent (0.85), 95-100 percent (0.975), 100 percent (1.0). Hereafter, cover refers to the midpoint value of cover category estimates.

An indicator of leaf area index (LAI) was qualitatively derived by first assigning one of three possible values to each of the above-defined strata: 0 (no cover), 1 (sparse foliage), 2 (dense foliage, several layers present within stratum). Next, the estimated LAI value for each stratum was multiplied by the midpoint of the estimated cover category for each stratum to obtain a composite (site) LAI score for each stratum. Finally, the LAI scores for all strata were summed to obtain a total (site) LAI score for all strata in the entire reference site. These site-scale LAI indicator scores were later compared with plot-specific LAI indicator estimates (see below).

At the first sampling location, a bulb planter was used to remove a core of soil, approximately 6 cm in diameter by 11 cm deep, from unaltered substrate. In sites where microtopography or soils had been altered (compacted, plowed, etc.), soil cores were also obtained from the altered spots in order to obtain quantitative information on the effects of various alterations on soil bulk density in relation to soil type. Soil cores were placed in sealable plastic bags for transportation to the lab. At the lab, each soil core was dried to constant mass at 105 °C and weighed for bulk density determination as grams per cubic centimeter.

At each reference site, a bucket auger and/or slip auger were used to obtain a vertical soil profile to a depth of at least 50 cm (20 in.). Soil texture (Thein 1979) was recorded, as were soil hue, value, and chroma using a Munsell soil color chart (Kollmorgen Instruments Corporation 1994); depths at which any discontinuities occurred in color or texture were also recorded. Soil color was determined for both the matrix and inclusions (redoximorphic features). The soil profile was then compared with the description of the soil series mapped for the site in the NRSC county soil survey. If the soil profile matched the mapped soil series for the site, the series name was recorded. For sites mapped coarsely as soil complexes, the profile description was compared with each of the soil series in the complex, and the series that best matched the soil description was recorded. If the profile did not match any of the soil series mapped by NRCS for the site, the profile was compared with other soils occurring in the county, and the series that matched

most closely was recorded. In many counties, soil surveys are currently being revised and soils series renamed.

At the first sampling location, a pole was placed vertically into the ground to mark the center of the sampling area. (The pole was constructed of 2.1-cm- (0.75-in.-) diam polyvinyl chloride (PVC) pipe material with a solid steel rod partially inserted into one end and designed so that when the steel end was driven into the ground, it stood 1 m high.) With the PVC pole marking the center point, a derivation of the point-quarter method (Cottam and Curtis 1956) was used to obtain density and basal area (cross-sectional area at 1.5 m) of snags (standing dead trees) in two classes (>10 cm dbh and >20 cm dbh) and volume of coarse woody debris (CWD) (CWD: prostrate stems > 10 cm diam and > 1 m long). To do this, three equal-angled slices of a 100-m-radius circle centered on the PVC center pole were divided and marked off. The orientation of the slices was derived from a list of random compass directions generated by computer prior to field sampling; one random direction provided the slice boundaries by adding +/- 120 deg to the random direction. Distance and dbh of the nearest snag >10 cm dbh and the nearest snag >20 cm dbh were measured in each 120-deg slice. When the nearest 20+ cm dbh snag was nearer than the nearest 10-20 cm dbh snag, measurement of the 20+ cm dbh snag sufficed for both snag size classes (i.e., a snag > 20 cm dbh is also > 10 cm dbh). If the nearest snag in a slice was 0-50 m away, its distance was measured with a tape and its dbh with a caliper; if the nearest snag was 50-100 m away, its distance was estimated to the nearest 5 m and its dbh to the nearest 5 cm; if the nearest snag was estimated to be >100 m away, 100 m was recorded for its distance and the minimum dbh of the size class (10 or 20 cm) was recorded.

Density (number of stems per hectare) for each snag size class was calculated by dividing 10,000 (number per hectare) by the square of the mean distance to the snags in the three slices (i.e., density (stems/ha) = $10,000/(\text{mean distance to snags})^2$). Basal area of each snag size class was calculated by dividing the square of mean basal area (0.7854 times the mean dbh of the closest snags) by the square of the average distance to the closest snags (i.e., basal area (m²/ha) = $(0.7854 \times \text{mean dbh})^2/(\text{mean distance})^2$). This means that, by default, the minimal detectable density for a site was 1 snag/ha for each snag size class, and the minimal detectable basal area was 0.03141 m²/ha for the 20+ cm dbh size class and 0.007854 m²/ha for the 10+ cm dbh size class.

Volume of CWD was determined in a similar manner. Distance to the closest piece of CWD in each of the three slices was measured as far out as 50 m from the center point; CWD >50 m from the center point was not measured. Length and average diameter of each CWD stem were measured to determine volume, calculated by multiplying cross-sectional area per hectare (substitute average diameter for average dbh in above equation) by average length.

Three locations were sampled at each site, with locations 2 and 3 lying approximately 30-40 m in opposite directions from location 1. At each sampling location, the iron-tipped PVC pole was placed vertically into the ground to mark the center of the sampling area. A t-coupler was attached to the top end so that a

2-m-long PVC pipe could be fitted into it and extended horizontally (perpendicularly) from the top of the center pole (Figure A4).

At each sampling location, vegetation was sampled in a series of three nested plots centered on the PVC center pole. The most interior nested plot was a 1-m² quadrat oriented so that each side faced one of the four cardinal directions. Two sides of the 1-m² quadrat were formed with two 1-m-long by 2.1-cm-diam PVC pipes fitted together at right angles with a PVC t-coupler. The following data were collected from within the 1-m² quadrat: (a) cover of litter, (b) dominant type of litter (graminoid, forb, leaves of broad-leaved trees, or conifer needles), (c) average depth of litter, (d) cover of fine woody debris (twigs, tree bark, branches <10 cm diam), (e) average range in microtopographic relief of natural features (bunchgrass tussocks, etc.), (f) identity of each woody shrub < 1 m tall, and (g) identity of each herbaceous species that occurred within the quadrat.

Species that could not be identified immediately were collected and pressed for later identification, compared with herbarium specimens, or sent to appropriate taxonomic authorities for identification and/or verification. Due to the lack of reproductive and/or vegetative material for every collected specimen, some unknown plants were never identified to species level. However, these unknowns accounted for <10 percent of the approximately 150 species encountered.

Twenty-four wet pine savanna herbaceous plants (species and genera) were identified by workshop participants (before sampling was initiated) as being indicative of groundcover associated with relatively unaltered Wet Pine Flats. The species and/or genera were chosen because they were particularly well suited for rapid assessment: they are relatively easy to recognize with little training and they are easy to differentiate from other species (and genera) at all times of the year except soon after fire. These indicator species/genera were examined at the conclusion of reference data collection to determine if they indeed met the criteria outlined above. The list was then adjusted based on field experience and analysis of reference data.

Next, the two 1-m sections of the PVC quadrat were disconnected at the t-coupler and then reconnected so that they formed one 2-m-long piece. This 2-m piece was then attached to the t-elbow at the top of the PVC center pole and extended perpendicularly (horizontally) outward. By swinging this 2-m piece through 360 deg, it was possible to circumscribe a 2-m-radius plot (12.6 m²) at 1-m elevation (Appendix A, Figure A5).

In the 2-m-radius plot, every herbaceous groundcover species and shrub species (< 1 m tall) that occurred in the 2-m radius plot but did not occur in the 1-m² nested plot was recorded. In addition, the following information was recorded: (a) cover of live and standing dead groundcover < 1 m tall, (b) combined cover of native bunchgrasses (toothache grass, wiregrass, Muhly grass, dropseed, and little bluestem), (c) cover of switchcane, (d) cover of sedges in Cypress/Pine Savanna, and (e) cover and estimated LAI indicator of foliage in each of the 5 strata identified previously (cover was estimated within an imaginary 2-m-radius cylinder reaching skyward using a densiometer). As with site-level

LAI indicator scores, the cover estimate for each stratum was multiplied by its LAI indicator score.

Next, from the center point, a distance of 5 m in a random compass direction (previously generated by computer) was marked off, and a pole or auger was placed in the ground at the 5-m mark. Three additional points were marked off 5 m from the center pole, each at 90 and 180 deg from the direction to the first point. This produced a square 7.07 m per side and 50 m² in area (Figure A5). Within the 50-m² plot, herbaceous groundcover species and shrubs < 1 m tall that did not occur in the 1-m² plot or the 2-m-radius plot (12.6 m²) were identified and recorded; all woody stems >1 m tall and <7.5 cm dbh (subcanopy stratum) were also identified and counted.

The extent of alterations (by cover category) to microtopography and soils was estimated within the 50-m² plot, and each alteration was identified by type of alteration (Tables 6 and 7, main text). Counts and identification of midcanopy trees (stems 7.5-15 cm dbh) and canopy trees (stems > 15 cm dbh) were made in a 10-m-radius plot (314 m²) centered on the center pole. Counts for all three sampling locations were averaged to obtain density (number of stems/ha) for each reference site. Relative density was obtained for each species by dividing each species' density by total density.

Using a Spiegel Relaskop, the Bitterlich plotless technique (Grosenbaugh 1952) was applied to determine basal area of canopy trees (stems > 15 cm dbh) by species. Basal area was determined at sampling locations 2 and 3 only (to prevent overlap with location 1). Basal area was averaged across both sampling locations to obtain site basal area. Relative basal area for each species was determined by dividing the mean basal area for a species by site basal area. Canopy tree density was determined by counting all stems within 10 m of the Bitterlich (center point) (Figure A5). Importance value for each canopy species was determined by averaging its relative density and relative basal area.

One wet flat in which a damming effect was evident was located. The upgradient side was burned frequently, but the downgradient side was fire suppressed. At the time the flat was located, the reservoir behind the dam was full and excess water was flowing over the lowest point in the road (Figure D2). Two breaks (changes) in vegetation upgradient from the flat were marked. The elevation of the lowest point on the road where water was flowing was obtained (with a laser level), the distance from that point to both vegetational breaks was measured, and an elevation at the vegetational breaks relative to that of the low point in the road was obtained. The flat was then partitioned into three wetland reference sites, and reference data were obtained from each area.

Environmental Parameters

A groundcover indicator score was derived for each site in the following manner: (a) each indicator plant was counted, (b) each additional indicator plant (species/genus) that occurred in the 2-m-radius plot (12.6-m² plot) but did not

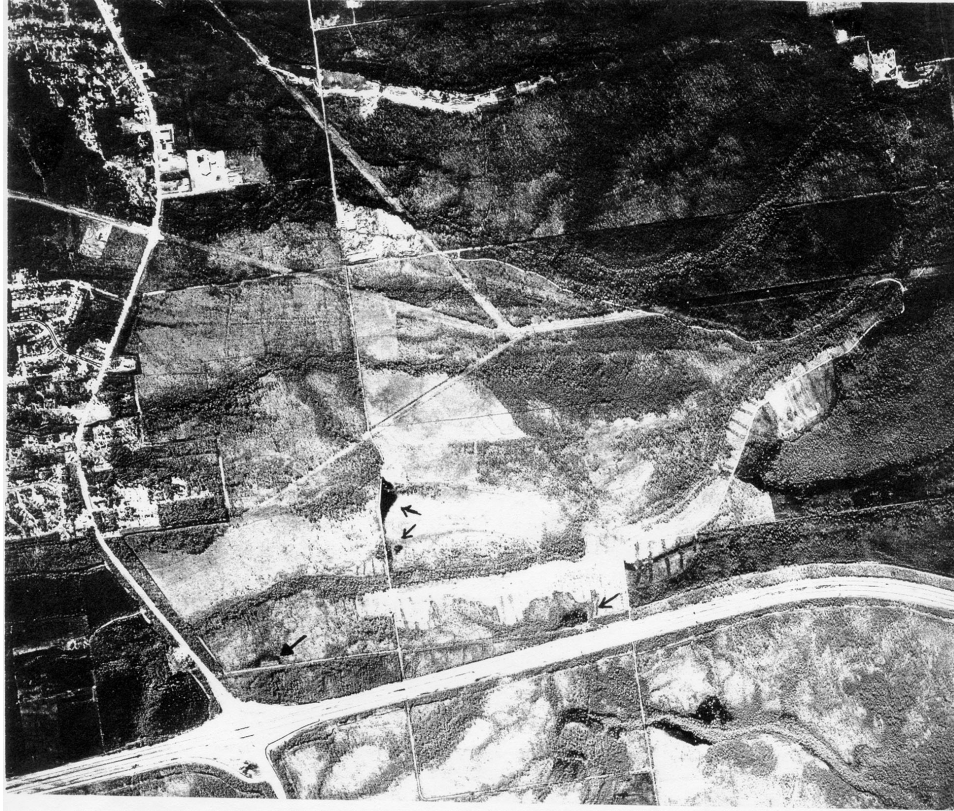

Figure D2. Aerial photograph of roads damming Wet Pine Flats (at arrows). Note flooding signature on upgradient side. Scale is 1:24,00

occur in the 1-m² plot was counted and divided by 12.6 (to normalize for plot area), (c) each additional indicator plant that occurred in neither the 1-m² plot nor the 2-m-radius plot, but occurred in the 50-m² plot was counted and divided by 50, (d) counts from all nested plots were totaled for each of the three sampling locations per site and averaged (divided by 3).

The occurrence of a species in a specific nested plot is directly related to its frequency of occurrence in a site (i.e., species that always occurred in the 1-m² plot tended to occur 12.6 times more frequently than species that occurred only in the 2-m-radius (12.6-m²) plot and 50 times more frequently than species that occurred only in the 50-m² plot). Therefore, since the nested plot design provided frequency data for every species, it provided a relative indication of species richness at several spatial scales per site from 1 m² to 150 m².

Locating and identifying herbaceous species was one of the most time-consuming components of field data collection, particularly in the 50-m² plot size in relatively unaltered sites. It appeared that in relatively intact sites, most indicator species were encountered within the 12.6-m² plot size (2-m-radius plot). Therefore, to determine if sufficient information on groundcover indicator status could be derived more rapidly, the degree of correlation was examined between herbaceous indicator scores derived from only the two smallest nested plots (1 m² and 12.6 m²) with indicator species scores derived from all three plot sizes.

Degree of correlation was examined to determine if subjective indicators of LAI were as reliable as more time-consuming, objective measurements. Comparisons were made between estimated LAI indicator scores among strata and each stratum measured. Indicator scores that had been estimated across the whole site were compared with LAI scores that had been estimated in the 2-m-radius plots. In addition, objective measurements of density (of subcanopy, midcanopy, and canopy stems) and basal area (of canopy trees) were compared with estimated LAI indicator scores of corresponding strata.

Litter cover and depth were compared with each other and with litter volume to determine if they were significantly correlated. Snag density was also compared with snag basal area and the similarity of the results of density and basal area among the several field methods applied (point-quarter, counts in 10-m-radius plots, and plotless Bitterlich technique).

Results and Discussion

Natural microtopography in unaltered Bunchgrass/Pine Savannas ranged from 2-12 cm (mean = 7.7 cm) and was primarily a function of the height of graminoid tussocks. The tops of these tussocks presumably represented the approximate average height of standing water during wet periods. Many species are restricted to the higher (less wet) elevations provided by tussocks: various aster species (e.g., *Eupatorium* spp., *Carphephorus* spp., *Liatris* spp., *Erigeron vernus*, *Solidago* spp., *Coreopsis* spp., *Baduina* spp., *Marshallia* spp.), orchid species (e.g., *Habenaria* spp., *Cleistes divaricata*, *Spiranthes* spp., *Calopogon* spp.), and lily species (*Aletris* spp., *Tolfieldia* spp., *Zigadesus* spp., *Pleea tenuifolia*). Other, more flood-tolerant species grow in the substrate between tussocks: pitcher plants (*Sarracenia* spp.), yellow-eyed grasses (*Xyris* spp.), club mosses (*Lycopodium* spp.), sundews (*Drosera* spp.), and pipeworts (*Eriocaulon* spp.).

Common alterations to microtopography disrupt small-scale microtopographic variability and can affect surface water storage and the structure of the herbaceous community. Differences between natural microtopographic features and alterations (by type) are provided in Table D2. This table shows that some alterations cause a greater range in microtopographic elevation than others (some alterations, such as grading and paving, completely reduce any variation in microtopography). Interestingly, relatively intact herbaceous communities persist at some military installations at light artillery ranges. Artillery exercises maintain the frequent fire regime needed to maintain savannas and may partially compensate for the small-scale disruptions (approx. 30 cm) they cause to natural microtopography.

In each reference site, the range in elevation (highest elevation minus lowest elevation) associated with each type of alteration to microtopography was measured and compared with the range in elevation associated with natural topographic features in the site. A paired t-test was used to determine if the mean elevation of microtopographic alterations differed from the mean elevation of

Microtopographic Alteration Type	n	Mean Height of Unaltered Microtopography cm	Mean Height of Alteration cm	Mean Difference in Elevation, cm	Probability of Difference (paired t-test)
None, natural	55	7.2	7.2	0.0	N/A
Recent feral hog rooting	1	5.7	9.3	3.6	N/A
Ruts from off-road vehicles (< 20 cm deep)	8	8.5	12.7	4.2	P<<0.001
Firebreaks	5	7.1	20.5	13.4	P=0.001
Bedding for silviculture	3	7.1	22.2	15.1	P=0.06
Deep ruts (> 20 cm deep)	4	7.2	24.9	17.7	P=0.003
Light artillery	2	6.5	29.4	22.9	P=0.02
Compacted by grazing cattle	1	5.0	4.3	-0.7	N/A
Graded or excavated for pipeline	2	6.7	2.3	-4.4	P=0.02
Tilled cropland	0	No data	No data	No data	No data
Impervious	0	No data	No data	No data	No data

natural microtopography by type of alteration. The t-test results (Table D2) were used to rank the relative severity of microtopographic alterations (Table D3). Each type of microtopographic alteration was then assigned a subindex from 0.0 to 1.0 based on differences in mean elevation between the natural and altered condition provided in Table D2. This ranking agreed fairly closely to the ranking provided by workshop participants. Some types of alterations occurred in too few sites to test for differences: no tilled cropland or paved surfaces were sampled, and rooting by feral hogs and compaction by grazing cattle were each encountered in only one site.

Variations in soil bulk density of unaltered soils were compared (paired t-test) to bulk density of soils compacted or bedded (Table D4). Each type of soil alteration was assigned a subindex ranging from 0.0 to 1.0 based on initial input from workshop participants and results of bulk density comparisons (Table D5). Unfortunately, the sample size was too small to statistically test for differences between altered and unaltered soils for each of the 10 types of soil alterations identified in Table D2 and the 5 soil classes (Table D6) from which reference data were collected. Rather, ranking was determined by comparing the absolute difference in bulk density between altered and unaltered soils from the soil types from which there were sufficient data and types of alterations that occurred in the reference set. (Note: no bulk density data were obtained from either the “impervious” or the “tilled cropland” type of alteration categories.)

Site No.	Type of Microtopographic Alteration	Natural Range in Microtopography cm	Altered Range in Microtopography cm	Difference in Range, cm	Assigned Microtopographic Alteration Value
45	Gasline	6.3	2.3	-4.0	0.10
34a	Gasline	7.0	2.3	-4.7	0.10
61	Artillery	6.7	28.3	21.7	0.20
62a	Artillery	6.3	30.5	24.2	0.20
57	Bedded	7.0	11.5	4.5	0.30
72	Bedded	8.7	25.0	16.3	0.20
21	Bedded	5.7	30.0	24.3	0.20
43	Firebreak	5.3	15.0	9.7	0.30
52	Firebreak	8.3	20.0	11.7	0.30
44	Firebreak	6.3	18.5	12.2	0.30
62b	Firebreak	6.3	19.0	12.7	0.30
70b	Firebreak	9.0	30.0	21.0	0.30
5	Ruts from logging	11.0	24.5	13.5	0.10
37	Ruts from logging	9.3	25.0	15.7	0.10
1	Ruts from logging	5.0	30.0	25.0	0.30
29	Cattle trail	5.0	4.3	-0.7	0.40
13	Ruts from off-road vehicles	7.0	9.0	2.0	0.40
6	Ruts from off-road vehicles	9.0	11.0	2.0	0.40
70a	Ruts from off-road vehicles	9.0	12.5	3.5	0.40
53	Ruts from off-road vehicles	4.3	8.0	3.7	0.40
58	Ruts from off-road vehicles	9.0	14.2	5.2	0.40
34a	Ruts from off-road vehicles	7.0	12.3	5.3	0.40
3	Ruts from off-road vehicles	12.7	18.5	5.8	0.40
7	Ruts from off-road vehicles	10.0	16.0	6.0	0.40
71	Ruts from off-road vehicles	3.7	20.0	16.3	0.40
27	Hog rooting	5.7	9.3	3.6	0.40
56	Stump holes	7.5	14.0	6.5	0.40

Table D4
Bulk Densities of Soil in Reference Sites

Site	Soil Location	Bulk Density
SC1	INTACT	0.719
SC1	INTACT	0.719
SC1	RUT	1.012
SC2	INTACT	0.574
SC3	INTACT	0.524
SC3	INTACT	0.524
SC3	RUT	0.791
SC4	INTACT	0.804
SC5	INTACT	0.653
SC6	INTACT	0.719
SC7	INTACT	0.536
SC8	INTACT	0.488
SC9	INTACT	0.588
SC10	INTACT	0.678
SC11	INTACT	0.542
SC12	INTACT	0.447
SC13	INTACT	0.753
SC14	INTACT	0.558
SC15	INTACT	0.933
SC16	INTACT	1.238
SC17	INTACT	0.819
SC18	INTACT	0.804
SC19	INTACT	0.748
SC20	INTACT	0.768
SC21	INTACT	1.070
SC22	INTACT	0.468
SC22	INTACT	0.502
SC23	INTACT	0.661
SC24	INTACT	0.946
SC25	INTACT	0.427
LA26	INTACT	1.196
LA27	INTACT	0.982
LA28	INTACT	0.832
LA29	INTACT	1.060
LA30	INTACT	1.144
TX31	INTACT	0.841
TX32	INTACT	1.077
TX33	INTACT	1.012
TX34	INTACT	1.002
TX35	INTACT	1.140
LA36	INTACT	0.989

Site	Soil Location	Bulk Density
LA37	INTACT	0.923
LA38	INTACT	0.652
MS39	INTACT	0.970
MS40	INTACT	1.107
AL46	INTACT	0.981
MS41	INTACT	0.705
MS42	INTACT	0.910
MS43	INTACT	0.989
AL44	INTACT	0.749
AL45	INTACT	1.390
AL47	INTACT	0.741
AL48	INTACT	0.850
AL49	INTACT	1.181
AL50	INTACT	0.197
AL51	INTACT	1.061
FL52	INTACT	1.071
FL53	INTACT	0.960
FL54	INTACT	0.554
FL55	INTACT	0.701
FL55	INTACT	0.701
FL55	RUT	0.791
FL56	INTACT	1.102
SC57	INTACT	1.102
FL58	INTACT	1.017
FL58	INTACT	1.017
FL58	RUT	0.924
FL59	INTACT	0.636
GA60	INTACT	0.449
GA61	INTACT	1.137
GA62	INTACT	0.929
GA63	INTACT	1.406
SC64	INTACT	0.374
NC65	INTACT	0.849
NC66	INTACT	0.992
NC67	INTACT	1.110
NC68	INTACT	1.075
NC69	INTACT	0.686
NC70	INTACT	0.925
NC71	INTACT	0.921
NC72	SILVIC BED	1.168
NC72	TRENCH	0.916

Table D5
Ranking of Soil Alterations

Site No.	Type of Soil Alteration	Bulk Density, gm/cm ³	Soil Alteration Value
21	Artillery Shelling	0.449	0.60
45	Ruts from off-road vehicles	0.524	0.60
34a	Ruts from off-road vehicles	0.536	0.60
5	Ruts from logging	0.653	0.60
1	Ruts from off-road vehicles	0.686	0.60
37	Fire break	0.686	0.60
3	Stump holes	0.701	0.60
7	Ruts from logging	0.719	0.40
70a	Ruts from off-road vehicles	0.719	0.40
6	Gasline	0.749	0.10
13	Ruts from off-road vehicles	0.753	0.20
71	Cattle trail	0.832	0.20
34a	Fire break	0.910	0.30
53	Bedded	0.921	0.20
58	Ruts from off-road vehicles	0.925	0.10
72	Hog rooting	0.982	0.20
57	Fire break	0.989	0.30
27	Ruts from logging	0.989	0.10
70b	Gasline	1.012	0.10
43	Ruts from off-road vehicles	1.012	0.10
44	Fire break	1.061	0.30
52	Bedded	1.070	0.10
62b	Ruts from off-road vehicles	1.071	0.10
62a	Ruts from off-road vehicles	1.102	0.10
61	Bedded	1.102	0.20
29	Fire break	1.137	0.30
56	Artillery Shelling	1.137	0.40

Table D6
Hydric Soils in Reference Sites, by State

	NC	SC	GA	FL	AL	MS	LA	TX	Total
Ultisols	4	17	3	5	5	7	1	0	42
Alfisols	1	3	1	1	0	0	3	4	13
Spodosols	3	0	0	0	1	0	0	0	4
Inceptisols	0	1	0	3	0	0	0	0	4
Mollisols	0	3	0	0	0	0	0	0	3
Total	8	24	4	9	6	7	4	4	66

The appropriate indices for both soil and microtopography were multiplied by the midpoint cover value for each respective type of alteration present in the 50-m² plot. All type-of-alteration scores were then summed to obtain a plot score. For example, if 5-25 percent of a given 50-m² quadrat had been microtopographically altered by firebreaks running through the plot (subindex = 0.4) and this was the only type of microtopographic alteration present in the plot (midpoint of cover class = 0.15), then the plot score for both microtopography and soil would be $(0.15 \times 0.3) + (1.0 \times 0.85) = 0.895$. Plot scores for all three 50-m² plots were averaged to obtain a mean site score for both soil and microtopographic alterations. Site scores from reference sites were then used to establish reference standards and rescale scores based on reference data.

Thirty different soil series were represented, with bulk densities ranging from 0.19 to 1.39 g/cm³. Of the 66 mineral soil Wet Pine Flats sampled, 54 were associated with poorly drained Ultisols and Alfisols, 4 were located on Spodosols (in North Carolina), and 4 were located on Inceptisols (Table D6). Appendix E provides data (Table E1) collected from 69 Wet Pine Flats in the Reference Domain. These field data were used to model and calibrate variables and determine reference standards. Table E2 provides additional data collected in reference sites but not used to determine standards.

Gradients of wet flats had a mean slope of 0.18 percent, ranging from 0.005 to 0.88 percent (Table E2). Two seepage savannas (slope wetlands) sampled in Kitchasie National Forest, Louisiana, had slopes of 1.2 and 1.5 percent, suggesting a 1 percent gradient is a reasonable split between Wet Pine Flats and seepage pine savannas (slope wetlands). These two seepage savannas were also fire-maintained systems and were vegetationally similar to Wet Pine Flats. Similar functions and variables could be used to model such slope wetlands should there be a need to do so, except that the $V_{OUTFLOW}$ variable might have to be revised in the hydrologic function.

Snag density, CWD volume, and cover of fine woody debris were very low in the unaltered Wet Pine Flats sampled. The only exceptions were sites hit hard by Hurricane Hugo. In most wet flats, detrital biomass is concentrated in standing dead herbaceous vegetation (mostly in graminoids), not in detrital biomass originating from trees. Standing dead graminoid biomass increases with time until

burned during a ground fire. Burning releases nutrients stored in the standing dead vegetation, which are presumed to be assimilated quickly by rapid growth of groundcover following fire.

Only one wet flat could be located in which a damming effect was evident (Sites 40i, 40m, 40o). This flat had a road crossing it and no culvert or drainage ditches (Figure D2). Noticeable changes in vegetation were evident at 22 m and 83 m upgradient from the road (Table D7). At the 83-m point, ground elevation equaled that of the lowest point in the road. A reference site, located approximately 30 m upgradient from the reservoir boundary, had an herbaceous indicator score of 8.3. The herbaceous species indicator score for the area halfway between 22 and 86 m (reservoir boundary) scored 4.4, and the area halfway between the dam and 22 m scored 1.1. Based on species indicator scores and potential water storage, it appears that herbaceous indicator scores were related to distance upgradient from an impediment to flow. Fire had been excluded from the downgradient side, so the relationship between reduced length of saturation (due to reservoir shadow effect) and herb indicator score could not be determined.

Table D7
Relationship Between Distance from Dam on Reservoir Side and Herbaceous Indicator Scores

Reference Sites	Indicator Score	Indicator Score at site 40o	Proportion of Total Distance from Road
40o (Outer)	321	1.00	1.00
40m (Middle)	222	0.69	0.62
40i (Inner)	54	0.16	0.13

Roads are a common alteration that could potentially alter surface water flow in a Wet Pine Flat. However, almost all Wet Pine Flats with roads or other potential impediments to flow are associated with a ditch that drains the flat or have culverts at ground level. Both conditions prevent water from pooling upgradient. Water level monitoring should be conducted to test and calibrate the effect of damming should this alteration become a more common phenomenon in wet flats.

Vegetation

Bunchgrass/Pine Savannas constituted 55 sites (of which 30 were reference standard sites); 8 sites were Cypress/Pine Savannas, 2 sites were Switchcane/Pine

Savannas, and 1 wet flat could not be classified into any of these categories (Appendix E, Tables E1 and E2). In addition, 2 sites sampled were seepage savannas (slope wetlands), 1 site was a flatwoods pond (depressional wetland), and 2 sites did not have hydric soils.

Wet Pine Flats are open-canopied savannas with few, if any, hardwoods (Appendix E, Table E3). Where trees were present (canopy or midcanopy), they usually included pines (primarily longleaf pine) in the less wet sites and pond cypress in the wetter sites. Tree density in unaltered sites ranged between mostly treeless to sparsely canopied savannas: 0-233 stems/ha in Bunchgrass/Pine Savannas, 21-286 stems/ha in Switchcane/Pine Savannas, and 53-201 stems/ha in Cypress/Pine Savannas). Midcanopy was even more sparse than the canopy in unaltered reference sites: 0-133 in Bunchgrass/Pine Savannas, 0-48 in Switchcane/Pine Savannas, and 11-467 stems/ha in Cypress/Pine Savannas. However, even in fire-excluded sites, canopy and subcanopy density was low. Therefore, except for Switchcane/Pine Savannas, information on pines appeared to be of little use for differentiating altered from unaltered sites.

Although subcanopy density tended to be relatively low in unaltered reference sites (<6,500 stems/ha), fire exclusion tended to greatly increase density (Appendix E, Table E4). Most woody species invading the subcanopy were understory species such as hollies (*Ilex* spp.), myrtles (*Myrica* spp.), and sweetbay (*Magnolia virginiana*). However, some hardwoods also were found to invade, especially sweetgum (*Liquidambar styraciflua*), swamp blackgum (*Nyssa biflora*), loblolly pine (*Pinus taeda*), and slash pine (*Pinus elliottii*).

Herbaceous species were particularly indicative of alterations in reference sites (Appendix E, Table E5), especially the selected group of native bunchgrasses and forbs used to obtain herbaceous indicator scores in Bunchgrass/Pine and Cypress/Pine cover types. Bunchgrass/Pine Savannas were found to be exceptionally high in small-scale herbaceous species richness: a mean of 17 species per 1-m² plot, including 7-10 indicator species, and indicator species scores ranging from 4.3-10.9 for the smallest two nested plots.

Reference data showed that small-scale species richness declines with degree of alteration. Figure D3 shows a species-area curve derived from selected reference sites using only herbaceous indicator plants. FL56, a Reference Standard wetland, has an average of 8 indicator species per 1-m² plot and 11 species in a 150-m² plot (3- x 50-m² plots). In contrast, a clear-cut and chopped site (SC3) averaged only 2 species per 1 m² even though 11 indicator species occurred in 150 m². In more severe alterations, 6 or fewer indicator species were supported in 150 m²: bedded and fire-excluded pine plantation (FL57), a gas line right-of-way (AL45), and a reservoir of a dam behind a culvertless road (MS40i).

Cypress/Pine Savannas near the transition with a Bunchgrass/Pine Savanna tended to support a rich herb layer much like that of Bunchgrass/Pine Savannas in composition (sites FL54, FL58, and SC4: Appendix E, Table E5). However, in wetter sites, various sedge species displaced bunchgrass species and indicator species. Thus, a wide range in species richness was recorded in reference standard

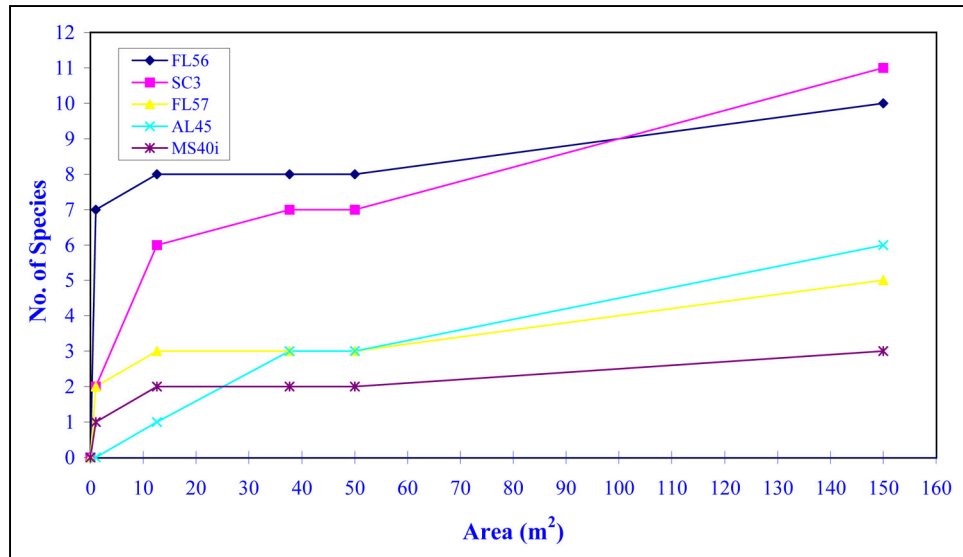

Figure D3. Species-area curve for indicator species among selected reference sites. FL56 is a reference standard wetland, SC3 has been without fire for 11 years, FL57 is a 27-year-old bedded pine plantation, AL45 is a gasoline right-of-way, MS40i is in a reservoir dammed by a road

Cypress/Pine Savanna: 2-20 species per 1-m² plot (including 0-8 indicator species) and indicator scores ranging from 0.5 to 11.2 (Table E1).

The four Switchcane/Pine Savannas sampled supported the few herbaceous indicator species and lower indicator scores (1.0 to 5.8) than unaltered Wet Pine Flats (Table E1); bunchgrass cover and herbaceous indicator scores were also low. Reduction in bunchgrass cover and indicator species in Switchcane/Pine Savannas may be due to a lower fire frequency since switchcane cover is positively correlated with two indicators of lower fire frequency: shrub LAI ($P < 0.05$) and midcanopy density ($P < 0.05$). Although switchcane can withstand fire, it appears that infrequent fire allows switchcane to become dense and tall (2-3 m); perhaps this allows switchcane to shade out bunchgrasses and typical savanna indicator species. Because only four Switchcane/Pine Savannas were located and sampled, it is unclear whether this was once a naturally occurring cover type or whether it is a type that develops after frequent fire is reintroduced following a prolonged period of fire exclusion.

Various measurements of vegetational structure and the results of correlation analyses support conventional wisdom that fire-maintained and otherwise unaltered wet flats are sparsely treed savannas with high herb cover, low detrital biomass, and few shrubs or trees. Therefore, frequent and recent fire would be expected to significantly correlate with various measurements of physiognomy (physical structure) and herbaceous indicator scores. As anticipated, presence of recent fire correlated positively with herb indicator scores ($P < 0.001$), total herb groundcover ($P < 0.001$), bunchgrass cover ($P < 0.01$), and herb LAI (both plot and site-scale measurements, $P < 0.001$) and negatively with subcanopy LAI indicator scores (both plot and site-scale measurements, $P < 0.05$), subcanopy

density ($P < 0.05$), canopy LAI score (both plot and site-scale measurements, $P < 0.05$), canopy density ($P < 0.05$), canopy basal area ($P < 0.05$), switchcane cover ($P < 0.05$), and litter volume ($P < 0.05$).

A number of field measurements were compared (using correlation analysis) with one another to determine if the various methods of measurements were equally precise. The same field variables were measured in a number of different ways to determine how closely more rapid site LAI indicator estimates would compare with more time-consuming plot measurements. The correlation analyses (Table D8) showed a consistently high correlation between most field measurements. LAI indicator estimates correlated with LAI plot estimates and with quantitative measures of cover, density, and basal area.

Midcanopy was the only stratum for which various measurement methods did not correlate consistently. Although midcanopy density correlated significantly ($P < 0.001$) with estimated midcanopy site LAI indicator score, the estimated plot LAI score did not correlate well with either of these measurements. This low correlation of plot LAI score was due to the fact that three 1-m² plots were inadequate to estimate midcanopy precisely. However, site LAI estimates and density measurements (in three 50-m² plots) provided equally precise results.

The sum of LAI for all strata (total LAI) showed a significant correlation ($P < 0.001$) between plot measurements and site measurements (Table D8). In both estimates, total LAI ranged from approximately 1 to 3 in unaltered Wet Pine Flats (Appendix E, Table E1). Total LAI was measured at approximately 3.5 in fire-suppressed Wet Pine Flats (a value similar to that of wet hardwood flats). Thus, it appears that LAI does not increase further after reaching 3.5.

Site LAI indicator scores for all strata were estimated very rapidly (<1 min/site). Since the plot LAI estimates and other indicators of biomass (cover, density, basal area) correlated significantly with site LAI scores, rapidly measurable site LAI scores provide a reliable check against quantitative measurements of strata.

Correlations of the various LAI estimates support the conventional wisdom that high herbaceous groundcover and indicator species scores are both associated with a sparse shrub, subcanopy, and canopy biomass: groundcover and indicator species scores are negatively correlated ($P < 0.05$) with measurements of shrub, subcanopy, and canopy strata (LAI estimates, density, basal area). However, midcanopy measurements did not correlate with any of the other measurements of strata, suggesting that measurements of the midcanopy stratum alone are not very useful in predicting physiognomy of Wet Pine Flats.

Searching for indicator species in the third and largest plot size (50 m²) of the nested plot was much more time-consuming than locating indicator species in the two smallest nested plots (1 m² and 12.6 m²). Fortunately, herbaceous indicator scores derived from only the two smallest nested plots correlated significantly ($P < 0.001$) with indicator scores derived from all three nested plots. This shows that only the two smallest nested plots are needed to obtain reliable herbaceous indicator scores. In addition, herbaceous indicator scores were significantly related

Table D8
Correlation Matrix¹ for Various Estimated Leaf Area Index (LAI) Values Among Reference Sites

	Herb ground-cover	Herb LAI-site	Herb LAI	Shrub LAI-site	Shrub LAI	Sub-canopy LAI-site	Sub-canopy LAI	Mid-canopy LAI-site	Mid-canopy LAI	Sub-canopy Density (stems/ha)	Mid-canopy Density (stems/ha)	Canopy LAI	Canopy LAI-site	Canopy LAI	Canopy Density (stems/ha)	Canopy BA (m ² /ha)	Total Site LAI	Total Plot LAI
Herb ground-cover	1.000																	
Herb LAI-site	<u>0.792</u>	1.000																
Herb LAI	0.887	0.847	1.000															
Shrub LAI-site	0.066	0.253	0.147	1.000														
Shrub LAI	-0.246	0.042	-0.082	0.603	1.000													
Sub-canopy LAI-site	-0.581	-0.464	-0.461	0.077	0.329	1.000												
Sub-canopy LAI	-0.553	-0.511	-0.442	-0.011	0.230	<u>0.793</u>	1.000											
Mid-canopy LAI-site	-0.044	0.103	-0.035	-0.133	-0.029	0.096	0.107	1.000										
Mid-canopy LAI	0.057	0.162	0.049	-0.119	0.126	-0.045	0.022	0.163	1.000									
Canopy LAI-site	-0.480	-0.381	-0.367	0.090	0.099	0.090	0.068	-0.119	-0.147	1.000								
Canopy LAI	-0.503	-0.405	-0.362	-0.103	-0.006	0.027	0.026	-0.086	-0.070	0.881	1.000							
Mid-canopy Density (stems/ha)	-0.076	0.066	-0.012	-0.116	-0.009	0.023	0.003	0.724	0.167	-0.069	1.000							
Sub-canopy Density (stems/ha)	-0.478	-0.428	-0.369	0.112	<u>0.424</u>	0.856	0.701	0.070	0.069	0.038	0.008	1.000						
Canopy Density (stems/ha)	-0.586	-0.448	-0.440	-0.007	0.030	0.174	0.132	-0.120	-0.089	0.809	0.845	1.000	1.000					
Canopy BA (m ² /ha)	-0.556	-0.528	-0.477	-0.017	0.064	0.265	0.219	-0.127	-0.164	0.752	0.738	0.043	0.157	1.000				
Total Site LAI	0.196	0.583	<u>0.387</u>	0.657	0.494	0.228	0.026	0.197	0.034	0.152	0.110	0.163	0.015	0.015	1.000		1.000	
Total Plot LAI	0.506	0.647	<u>0.776</u>	<u>0.396</u>	0.474	-0.078	-0.051	-0.035	0.143	-0.086	-0.002	0.022	-0.189	-0.196	0.022	1.000	0.647	1.000

¹For P<0.05 Confidence level (CL) = 0.268 and P < 0.01 (CL=0.348), correlations are underlined. For P<0.001, correlations are both underlined and emboldened. Degrees of freedom (df = 52).

($P \ll 0.001$) with the number of species in 1-m² plots, 2-m-radius plots, and 50-m² plots, and 150 m² (three 50-m² plots) (Table 9). Therefore, herbaceous indicator scores were considered to be a quick and reliable way to assess species richness at small scales.

Appendix E

Reference Field Data

Table E1. Data Used to Determine Reference Standards for FCI Models. RS# 1 = Reference Standard Sites, # 2 = Altered Site, # 3 = Non-jurisdictional

Wetland, BPS= Bunchgrass/Pine Savanna, CPS = Cypress/Pine Savanna, SPS = Switchcane/Pine Savanna, OUT = out of class.

Site No.	Site Name	Sub-class	RS#	Bunchgrass Cover	Herb Indicator Score	Switchcane Cover	LAI	Micro Alt Score	Soil Alt Score	Sub-canopy Density (stems/ha)	Sedge cover	Density of Cypress > 1 m tall, < 7.5 cm dbh (stems/ha)	Density of Cypress > 15 cm dbh (stems/ha)	Density of Longleaf and Pond Pine > 15 cm dbh (stems/ha)	Density of Pines > 15 cm dbh (trees/ha)
SC1	Mill Branch Savanna 211-C	BPS	2	0.330	8.5	0.250	1.2	0.88	0.84	318	N/A	NA	NA	NA	127
SC2	Mill Branch East Arundo	SPS	1	0.000	1.0	0.900	3.3	1.00	0.99	0	N/A	NA	NA	149	191
SC3	FR211 Clearcut	BPS	2	0.003	3.2	0.250	1.3	0.97	0.88	1,528	N/A	NA	NA	NA	11
SC4	FR212 Honey Hill	CPS	1	0.353	8.0	0.000	0.5	0.96	0.90	2,504	0.80	400	0	NA	74
SC5	Awendaw Savanna	BPS	1	0.737	9.3	0.100	1.3	0.99	0.99	8,105	N/A	NA	NA	NA	0
SC6	Friendfield Plantation	BPS	1	0.792	12.0	0.000	0.1	0.99	0.95	11	N/A	NA	NA	NA	64
SC7	Tibwin Rd	BPS	1	0.183	8.8	0.000	0.5	0.99	0.96	339	N/A	NA	NA	NA	0
SC9	(JD)	OUT	3	0.150	3.8	0.175	1.2	1.00	1.00	0	N/A	NA	NA	NA	170
SC10	Tiger Corner 1A	BPS	1	0.400	9.3	0.001	1.0	1.00	1.00	0	N/A	NA	NA	NA	85
SC11	Tiger Corner 2C	SPS	1	0.017	4.3	0.500	3.5	1.00	1.00	3,904	N/A	NA	NA	32	138
SC12	Tiger Corner No Burn	BPS	2	0.000	0.0	0.000	3.8	1.00	1.00	15,021	N/A	NA	NA	NA	170
SC13	336 Savanna	BPS	1	0.792	10.2	0.000	0.9	1.00	0.99	488	N/A	NA	NA	NA	0
SC14	Webb Center	BPS	2	0.000	0.5	0.050	2.5	1.00	1.00	7,400	N/A	NA	NA	NA	74
SC15	Hoover #1	BPS	1	0.875	6.7	0.000	0.4	1.00	1.00	0	N/A	NA	NA	NA	21
SC16	Hoover Ditch	BPS	2	0.000	1.8	0.000	?	1.00	1.00	0	N/A	NA	NA	NA	0
SC17	Hoover #2	BPS	1	0.675	5.7	0.000	0.6	1.00	1.00	267	N/A	NA	NA	NA	95
SC18	OKT Backwoods #1	BPS	1	0.933	10.0	0.000	0.5	1.00	1.00	9,133	N/A	NA	NA	NA	32
SC19	OKT Backwoods #2	BPS	1	0.942	7.2	0.000	0.9	1.00	1.00	1,533	N/A	NA	NA	NA	32
SC20	OKT Transition	BPS	1	0.975	8.0	0.008	1.0	1.00	1.00	267	N/A	NA	NA	NA	74
SC21	Hoover Silviculture	BPS	2	0.000	0.5	0.000	5.6	0.40	0.20	200	N/A	NA	NA	NA	85
SC22	OKT Powerline	CPS	2	0.000	0.7	0.000	0.4	0.83	0.59	0	0.80	0	0	NA	0
SC23	OKT Cypress Savanna	CPS	1	0.000	3.5	0.000	0.6	1.00	1.00	6,200	0.80	1,534	254	NA	0
SC24	OKT Aristida	BPS	1	0.975	5.7	0.000	0.7	1.00	1.00	200	N/A	NA	NA	NA	64
SC25	OKT dammed	BPS	2	0.008	2.0	0.000	0.1	1.00	1.00	3,600	N/A	NA	NA	NA	0
LA29	Pourteau Savanna	BPS	2	0.000	3.2	0.000	0.1	0.92	0.60	933	N/A	NA	NA	NA	0
LA30	Pourteau Pines	BPS	2	0.000	1.3	0.000	1.4	1.00	1.00	467	N/A	NA	NA	NA	11
TX31	Lance Rostler Savanna	BPS	2	0.000	5.7	0.000	0.7	1.00	1.00	3,200	N/A	NA	NA	NA	0
TX32	Pitcher Plant Savanna	BPS	2	0.000	5.0	0.000	2.6	1.00	1.00	8,867	N/A	NA	NA	NA	32
TX34	Desserter Baygall Gaselina	BPS	2	0.000	2.0	0.000	0.5	0.59	0.59	0	N/A	NA	NA	NA	117
TX35	Siviculture	BPS	2	0.175	6.5	0.000	0.4	1.00	0.90	1,467	N/A	NA	NA	NA	170
LA37	Lake Ramsey	BPS	1	0.417	8.0	0.000	0.1	1.00	0.99	267	N/A	NA	NA	NA	0
LA38	Abita Creek Cypress	CPS	2	0.000	7.3	0.000	5.2	1.00	1.00	6,733	0.54	67	32	NA	21
MS39	Sandhill Crane Windrow	BPS	1	0.175	9.5	0.000	0.1	1.00	1.00	133	N/A	NA	NA	NA	0
MS41	(No.)	BPS	1	0.267	11.5	0.000	0.0	1.00	1.00	1,600	N/A	NA	NA	NA	0
MS42	Fountainbleut Savanna (So.)	BPS	1	0.442	10.5	0.000	0.2	1.00	1.00	67	N/A	NA	NA	NA	0
MS43	Grand Bay Wiregrass	BPS	1	0.850	11.8	0.000	0.3	0.99	0.95	0	N/A	NA	NA	NA	11

Site No.	Site Name	Sub-class	RS#	Bunchgrass Cover	Herb Indicator Score	Switchcane Cover	LAI	Micro Alt Score	Soil Alt Score	Sub-canopy Density (stems/ha)	Sedge cover	Density of Cypress > 1 m tall, < 7.5 cm dbh (stems/ha)	Density of Cypress 7.5-15 cm dbh (stems/ha)	Density of Cypress > 15 cm dbh (stems/ha)	Density of Longleaf and Pond Pine > 15 cm dbh (stems/ha)	Density of Pines > 15 cm dbh (trees/ha)
AL44	Transco Ctenium	BPS	1	0.733	12.3	0.000	0.9	0.97	0.88	67	N/A	NA	NA	NA	NA	117
AL45	Transco Gasline	BPS	2	0.000	0.8	0.000	0.2	0.10	0.10	0	N/A	NA	NA	NA	NA	0
AL47	Transco Cypress Savanna	CPS	1	0.167	6.2	0.000	2.6	1.00	1.00	4,800	0.55	600	267	350	NA	0
AL48	Industrial Park Savanna	BPS	1	0.792	11.0	0.000	0.1	1.00	1.00	467	N/A	NA	NA	NA	NA	53
AL49	Gulf Park Savanna	BPS	1	0.125	10.0	0.000	0.8	1.00	1.00	2,200	N/A	NA	NA	NA	NA	95
AL50	Weeks Bay Savanna	BPS	1	0.283	8.2	0.000	0.1	1.00	1.00	1,067	N/A	NA	NA	NA	NA	0
AL51	Gulf Shores Savanna	BPS	1	0.675	9.2	0.000	0.4	1.00	1.00	333	N/A	NA	NA	NA	NA	32
FL52	Whitmer Island	BPS	1	0.975	7.8	0.000	0.5	0.99	0.97	400	N/A	NA	NA	NA	NA	95
FL53	Basin Bayou	BPS	2	0.167	1.5	0.000	3.0	0.98	0.89	29,067	N/A	NA	NA	NA	NA	127
FL54	A-20 Cypress Savanna	CPS	1	0.733	11.2	0.000	1.5	1.00	1.00	4,467	0.08	1,467	200	64	NA	21
FL55	Verbisina Savanna	BPS	1	0.933	10.8	0.000	0.0	1.00	1.00	133	N/A	NA	NA	NA	NA	21
FL56	(stumped)	BPS	1	0.850	8.3	0.000	0.1	1.00	1.00	467	N/A	NA	NA	NA	NA	0
FL57	Plummer Silviculture	BPS	2	0.000	2.2	0.000	3.6	0.73	0.20	0	N/A	NA	NA	NA	NA	689
FL58	Tate's Hell Plantation	BPS	2	0.150	9.0	0.000	0.7	0.60	0.39	600	N/A	NA	NA	NA	NA	0
FL59	Apalach Cypress Savanna	CPS	1	0.617	9.0	0.000	0.3	1.00	1.00	1,067	0.00	467	934	127	NA	21
GA60	Savanna	CPS	1	0.000	0.5	0.000	1.1	1.00	1.00	333	0.80	133	0	477	NA	0
GA61	RSPAC Savanna	BPS	2	0.342	8.8	0.000	0.2	0.73	0.77	67	N/A	NA	NA	NA	NA	0
GA62	Small Arms Range Savanna	BPS	2	0.617	10.8	0.017	1.0	0.86	0.86	0	N/A	NA	NA	NA	NA	53
GA63	Colony 210 Savanna	BPS	2	0.617	6.7	0.000	1.0	1.00	1.00	1,333	N/A	NA	NA	NA	NA	95
NC65	Green Swamp Savanna	BPS	1	0.775	10.8	0.038	0.4	1.00	1.00	0	N/A	NA	NA	NA	NA	170
NC66	Myrtlehead Savanna	BPS	1	0.792	9.5	0.000	1.7	1.00	1.00	2,133	N/A	NA	NA	NA	NA	21
NC67	Scenic Savanna	BPS	1	0.792	11.2	0.000	1.9	1.00	1.00	733	N/A	NA	NA	NA	NA	21
NC68	Holly Shelter Savanna	BPS	1	0.817	9.2	0.000	0.5	1.00	1.00	0	N/A	NA	NA	NA	NA	85
NC69	Holly Shelter Switchcane	SPS	2	0.300	5.8	0.100	2.7	1.00	1.00	1,933	N/A	NA	NA	NA	233	233
NC70	Lanier Quarry	BPS	1	0.608	9.2	0.000	0.8	0.95	0.90	1,867	N/A	NA	NA	NA	NA	53
NC71	Billfinger Road	BPS	2	0.058	1.7	0.292	1.9	1.00	0.99	333	N/A	NA	NA	NA	NA	85
NC72	Billfinger Plantation	SPS	2	0.050	4.3	0.183	0.4	0.40	0.20	1,867	N/A	NA	NA	NA	NA	0
MS40i	Sandhill Crane Dam (inner)	BPS	2	0.000	1.5	0.000	?	1.00	1.00	0	N/A	NA	NA	NA	NA	0
MS40m	Sandhill Crane Dam (mid)	BPS	2	0.000	5.5	0.000	?	1.00	1.00	1,267	N/A	NA	NA	NA	NA	0
MS40o	Sandhill Crane Dam (outer)	BPS	1	0.617	8.3	0.000	?	1.00	1.00	200	N/A	NA	NA	NA	NA	11

Table E2. Data collected at reference sites, but not used to model functions. BPS= Bunchgrass/Pine Savanna, CPS = Cypress/Pine Savanna, SPS = Switchcane/Pine Savanna, SSS = Seepage Slope/ Pine Savanna, WP = Flatwoods Pond, N/A=Not Applicable, OUT = outlier.

Site	Site Name	Sub-class	County	State	Latitude	Longitude	USGS Quadrangle	Soil Series	Soil Taxonomic Group
SC1	Mill Branch Savanna 211-C	BPS	Charleston	SC	33 10 22.7	79 29 22.5	Santee, SC	Myatt	Typic Ochraquult
SC2	Mill Branch East Arundo	SPS	Charleston	SC	33 10 17.9	79 29 19.6	Santee, SC	Wadmalaw	Umbrie Endoqualf
SC3	FR211 Clearcut	BPS	Charleston	SC	33 10 02.6	79 28 46.8	Santee, SC	Myatt	Typic Ochraqualf
SC4	FR212 Honey Hill	CPS	Berkeley	SC	33 09 46.7	79 32 02.7	Honey Hill, SC	Behera	Typic Paleaquult
SC5	Awendaw Savanna	BPS	Charleston	SC	33 02 35.5	79 35 33.8	Awendaw, SC	Stono	Typic Argiaquoll
SC6	Friendfield Plantation	BPS	Georgetown	SC	33 23 10.3	79 21 12.1	Georgetown N, SC	Grifton	Typic Ochraqualf
SC7	Tibwin Rd	BPS	Charleston	SC	33 06 10.1	79 30 14.2	Awendaw, SC	Rutledge	Typic Humaquapt
SC9	Tiger Corner annual burn (JD)	OUT	Berkeley	SC	33 15 16.6	79 41 28.4	Jamestown, SC	Rains	Typic Paleaquult
SC10	Tiger Corner 1A	BPS	Berkeley	SC	33 14 54.3	79 41 08.7	Schulerville, SC	Rains	Typic Paleaquult
SC11	Tiger Corner 2C	SPS	Berkeley	SC	33 15 08.5	79 41 28.3	Schulerville, SC	Rains	Typic Paleaquult
SC12	Tiger Corner No Burn	BPS	Berkeley	SC	33 15 18.9	79 41 27.1	Jamestown, SC	Behera	Typic Paleaquult
SC13	336 Savanna	BPS	Jasper	SC	32 28 33.2	81 04 09.4	Tillman, SC	Rains	Typic Paleaquult
SC14	Webb Center	BPS	Hampton	SC	32 36 44.9	81 17 47.8	Brighton, SC	Coxville	Typic Paleaquult
SC15	Hoover #1	BPS	Jasper	SC	32 29 47.7	81 06 34.8	Tillman, SC	Rains	Typic Paleaquult
SC16	Hoover Ditch	BPS	Jasper	SC	32 29 47.7	81 06 34.8	Tillman, SC	Rains	Typic Paleaquult
SC17	Hoover #2	BPS	Jasper	SC	32 29 28.8	81 06 17.2	Tillman, SC	Rains	Typic Paleaquult
SC18	OKT Backwoods #1	BPS	Jasper	SC	32 30 40.7	81 06 38.0	Calipen Bay, SC	Rains	Typic Paleaquult
SC19	OKT Backwoods #2	BPS	Jasper	SC	32 30 34.4	81 06 10.5	Calipen Bay, SC	Rains	Typic Paleaquult
SC20	OKT Transition	BPS	Jasper	SC	32 30 42.2	81 06 30.3	Calipen Bay, SC	Rains	Typic Paleaquult
SC21	Hoover Silviculture	BPS	Jasper	SC	32 30 22.7	81 06 19.7	Calipen Bay, SC	Rains	Typic Paleaquult
SC22	OKT Powerline	CPS	Jasper	SC	32 21 04.7	81 04 04.6	Hardeeville, SC	Argent	Typic Ochraqualf
SC23	OKT Cypress Savanna	CPS	Jasper	SC	32 21 04.4	81 04 12.0	Hardeeville, SC	Santee	Typic Argiaquoll
SC24	OKT Aristida	BPS	Jasper	SC	32 20 35.5	81 06 02.6	Hardeeville, SC	Bladen	Typic Albaquult
SC25	OKT dammed	BPS	Jasper	SC	32 20 21.6	81 05 04.6	Hardeeville, SC	Santee	Typic Argiaquoll
LA29	Pourteau Savanna	BPS	Allen	LA	30 29 14.0	92 59 27.3	Indian Village, LA	Caddo	Typic Glossaqualf
LA30	Pourteau Pines	BPS	Allen	LA	30 29 14.9	92 55 37.5	Indian Village, LA	Caddo	Typic Glossaqualf
TX31	Lance Roster Savanna	BPS	Hardin	TX	30 18 19.6	94 22 27.1	Kountze South, TX	Plank	Typic Vermaqualf
TX32	Picher Plant Savanna	BPS	Tyler	TX	30 35 06.6	94 20 10.8	Hicksbaugh, TX	Evadale	Typic Glossaqualf
TX34	Dessertier Baygall Gaseline	BPS	Hardin	TX	30 28 37.9	94 14 09.6	Desertier Baygall, TX	Nona	Natric Vermaqualf
TX35	Dessertier Baygall Siviculture	BPS	Hardin	TX	30 28 38.8	94 14 09.0	Desertier Baygall, TX	Nona	Natric Vermaqualf
LA37	Lake Ramsey	BPS	St. Tamany	LA	30 31 23.3	90 10 36.0	Martinville, LA	Guyton	Typic Glossaqualf
LA38	Abita Creek Cypress	CPS	St. Tamany	LA	30 30 38.3	89 57 49.1	Bush, LA	Myatt	Typic Ochraquult
MS39	Sandhill Crane Windrow	BPS	Jackson	MS	30 25 49.1	88 39 55.5	Gautier North, MS	Atmore	Plinthic Paleaquult
MS41	Fontainebleu Savanna (No.)	BPS	Jackson	MS	30 23 48.3	88 44 40.8	Gautier North, MS	Atmore	Plinthic Paleaquult
MS42	Fontainebleu Savanna (So.)	BPS	Jackson	MS	30 23 38.7	88 44 26.8	Gautier North, MS	Atmore	Plinthic Paleaquult

Site	Site Name	Sub-class	County	State	Latitude	Longitude	USGS Quadrangle	Soil Series	Soil Taxonomic Group
MS43	Grand Bay Wiregrass	BPS	Jackson	MS	30 28 05.5	88 24 19.5	Kreole, MS	Smithton	Typic Paleaquilt
AL44	Transco Ctenium	BPS	Mobile	AL	30 23 57.2	88 10 12.4	Coden, AL	Bayou	Typic Paleaquilt
AL45	Transco Gasline	BPS	Mobile	AL	30 23 56.2	88 10 05.4	Coden, AL	Bayou	Typic Paleaquilt
AL47	Transco Cypress Savanna	CPS	Mobile	AL	30 23 50.7	88 11 09.3	Coden, AL	Grady	Typic Paleaquilt
AL48	Industrial Park Savanna	BPS	Mobile	AL	30 34 10.3	88 08 43.0	Theodore, AL	Smithton	Typic Paleaquilt
AL49	Gulf Park Savanna	BPS	Baldwin	AL	30 16 55.2	87 36 13.0	Orange Beach, AL	Leon	Aeric Haplaquod
AL50	Weeks Bay Savanna	BPS	Baldwin	AL	30 24 57.2	87 49 08.4	Magnolia Springs, AL	Paxville	Typic Umbraquilt
AL51	Gulf Shores Savanna	BPS	Baldwin	AL	30 17 44.7	87 41 35.5	Gulf Shores, AL	Plummer	Grossarenic Paleaquilt
FL52	Whitmer Island	BPS	Santa Rosa	FL	30 35 22.0	86 51 52.1	Harold SE, FL	Rutledge	Typic Humaquept
FL53	Basin Bayou	BPS	Walton	FL	30 29 40.2	86 13 40.8	Freeport, FL	Rutledge	Typic Humaquept
FL54	A-20 Cypress Savanna	CPS	Okaloosa	FL	30 25 21.7	86 47 46.3	Navarre, FL	Rutledge	Typic Humaquept
FL55	Verbisina Savanna	BPS	Liberty	FL	30 07 06.0	85 01 44.4	Kennedy Creek, FL	Bladen	Typic Albaquilt
FL56	Plummer Savanna (stumped)	BPS	Liberty	FL	30 04 52.7	85 00 43.7	Kennedy Creek, FL	Plummer	Grossarenic Paleaquilt
FL57	Plummer Silviculture	BPS	Liberty	FL	30 04 58.0	85 00 42.7	Kennedy Creek, FL	Plummer	Grossarenic Paleaquilt
FL58	Tate's Hell Plantation	BPS	Franklin	FL	29 54 49.4	84 56 55.1	Fort Gadsden, FL	Plummer	Grossarenic Paleaquilt
FL59	Apalach Cypress Savanna	CPS	Liberty	FL	30 06 55.7	85 02 33.7	Kennedy Creek, FL	Surrency	Arenic Umbritic Paleaquilt
GA60	Ft. Stewart Cypress Savanna	CPS	Liberty	GA	31 55 00.3	81 45 15.6	Glenville NE, GA	Meggett	Typic Albaqualf
GA61	RSPAC Savanna	BPS	Long	GA	31 56 13.3	81 45 59.9	Glenville NE, GA	Pelham	Arenic Paleaquilt
GA62	Small Arms Range Savanna	BPS	Liberty	GA	31 55 36.1	81 34 11.1	Trinity, GA	Ellabelle	Arenic Umbritic Paleaquilt
GA63	Colony 210 Savanna	BPS	Liberty	GA	31 56 18.7	81 29 20.6	Limerick, GA	Pooler	Typic Ochraqquilt
NC65	Green Swamp Savanna	BPS	Brunswick	NC	34 05 14.6	78 18 15.5	Supply, NC	Woodington	Typic Paleaquilt
NC66	Myrtlehead Savanna	BPS	Brunswick	NC	34 08 17.2	78 29 58.1	Juniper Creek, NC	Woodington	Typic Paleaquilt
NC67	Scenic Savanna	BPS	Pender	NC	34 25 52.5	77 44 05.7	Topsail, NC	Leon	Aeric Haplaquod
NC68	Holly Shelter Savanna	BPS	Pender	NC	34 26 06.3	77 44 27.3	Topsail, NC	Leon	Aeric Haplaquod
NC69	Holly Shelter Switchcane	SPS	Pender	NC	34 26 07.4	77 44 24.9	Topsail, NC	Leon	Aeric Haplaquod
NC70	Lanier Quarry	CPS	Pender	NC	34 37 45.9	77 40 33.4	Maple Hill, NC	Grifton	Typic Ochraqqualf
NC71	Billfinger Road	BPS	Craven	NC	34 51 02.1	76 47 06.0	Newport, NC	Rains	Typic Paleaquilt
NC72	Billfinger Plantation	SPS	Craven	NC	34 51 11.9	76 47 15.7	Newport, NC	Rains	Typic Paleaquilt
MS40i	Sandhill Crane Dam (inner)	BPS	Jackson	MS	30 25 55.1	88 39 23.6	Gautier North, MS	Atmore	Plinthic Paleaquilt
MS40m	Sandhill Crane Dam (mid)	BPS	Jackson	MS	30 25 55.1	88 39 23.6	Gautier North, MS	Atmore	Plinthic Paleaquilt
MS40o	Sandhill Crane Dam (outer)	BPS	Jackson	MS	30 25 55.1	88 39 23.6	Gautier North, MS	Atmore	Plinthic Paleaquilt

Table E2.

Site	Horizon 1 (A) depth range	Hue	Value	Chroma	Texture	Horizon 2 depth range	Hue	Value	Chroma	Texture	Horizon 3 depth range	Hue	Value	Chroma	Texture
SC1	0 - 6 "	10YR	2	1	loamy sand	6 - 14 "	10YR	5	2	sand	14 - 26 "	10YR	5	2	sandy clay
SC2	0 - 5 "	10YR	2	1	loamy sand	5 - 7 "	10YR	3	1	sand	7 - 12 "	10YR	6	2	loamy sand
SC3	0 - 7 "	10YR	2	1	loamy sand	7 - 9 "	10YR	3	1	loamy sand	9 - 25 "	2.5YR	6	2	loamy sand
SC4	0 - 4 "	10YR	2	1	loam	4 - 7 "	10YR	3	1	loam	7 - 29 "	10YR	5	1	clay
SC5	0 - 11 "	10YR	2	1	loamy sand	11 - 20 "	10YR	3	1	sandy loam	20 - 30 "	10YR	5	3	sandy loam
SC6	0 - 7 "	10YR	2	1	loamy sand	7 - 11 "	10YR	5	2	loamy sand	11 - 24 "	10YR	6	1	sandy clay
SC7	0 - 6 "	10YR	2	1	loamy sand	6 - 21 "	10YR	4	2	sand	21 - 32 "	10YR	2	2	sand
SC9	0 - 6 "	10YR	2	1	sandy loam	6 - 9 "	10YR	3	1	sandy loam	9 - 13 "	2.5Y	5	2	sand
SC10	0 - 8 "	10YR	2	1	sandy loam	8 - 13 "	10YR	5	2	sand	13 - 28 "	10YR	6	1	sandy clay
SC11	0 - 11 "	10YR	2	1	sandy loam	11 - 17 "	10YR	4	2	sand	17 - 24 "	2.5YR	6	1	sandy clay loam
SC12	0 - 6 "	10YR	2	1	sandy loam	6 - 8 "	10YR	3	1	sandy loam	8 - 9 "	10YR	5	2	sandy loam
SC13	0 - 8 "	10YR	2	1	sandy loam	8 - 13 "	10YR	5	2	clay loam	13 - 25 "	2.5Y	6	1	sandy clay
SC14	0 - 10 "	10YR	2	1	sandy loam	10 - 18 "	10YR	4	1	loam	18 - 27 "	10YR	5	1	clay loam
SC15	0 - 11 "	10YR	2	1	loam	11 - 19 "	10YR	4	1	sandy loam	19 - 28 "	10YR	6	1	sandy clay
SC16	fill from ditch 6" thick														
SC17	0 - 7 "	10YR	2	1	loam	7 - 17 "	10YR	6	1	sandy loam	17 - 23 "	10YR	6	1	sandy clay
SC18	0 - 7 "	10YR	2	1	sandy loam	7 - 10 "	10YR	5	2	sandy loam	10 - 22 "	10YR	6	1	sandy clay loam
SC19	0 - 13 "	10YR	2	1	sandy loam	13 - 30 "	10YR	4	1	sand	30 - 33 "	10YR	6	1	sandy clay loam
SC20	0 - 7 "	10YR	2	1	sandy loam	7 - 9 "	10YR	5	1	sandy loam	9 - 22 "	10YR	6	1	sandy clay loam
SC21	0 - 3 "	10YR	2	1	loam	3 - 23 "	10YR	5	2	clay loam					
SC22	0 - 5 "	10YR	2	1	sandy loam	5 - 18 "	10YR	5	2	sandy clay loam	18 - 24 "	10YR	4	1	sandy clay
SC23	0 - 10 "	10YR	2	1	loam	10 - 12 "	10YR	3	1	clay	12 - 22 "	10YR	4	1	clay
SC24	0 - 5 "	10YR	3	1	sandy loam	5 - 10 "	10YR	7	2	sand	10 - 23 "	10YR	5	2	clay
SC25	0 - 9 "	10YR	2	1	loam	9 - 13 "	10YR	2	1	clay loam	13 - 20 "	10YR	3	1	sandy clay
LA29	0 - 2.5 "	10YR	5	2	silty clay loam	2.5 - 9 "	10YR	6	2	silt loam	9 - 21 "	10YR	6	2	silty clay loam
LA30	0 - 7 "	10YR	5	2	silt loam	7 - 18 "	10YR	6	2	silt loam					
TX31	0 - 5 "	10YR	6	2	silt loam	5 - 12 "	10YR	6	2	silt loam	12 - 20 "	10YR	6	2	silt loam
TX32	0 - 12 "	10YR	5	2	silt loam	at 12 "				impenetrable clay					
TX34	0 - 1 "	10YR	4	2	loam	1 - 5 "	10YR	5	2	silt loam	5 - 20 "	10YR	6	2	silt loam
TX35	0 - 20 "	10YR	5	2	silt loam										
LA37	0 - 5 "	10YR	3	1	loam	5 - 6 "	10YR	5	1	loam	6 - 20 "	10YR	6	1	silt loam
LA38	0 - 2 "	10YR	3	2	sandy loam	2 - 5 "	10YR	4	2	sandy loam	5 - 26 "	10YR	4	1	sandy loam
MS39	0 - 3 "	10YR	3	1	loam	3 - 7 "	10YR	5	1	loam	7 - 20 "	10YR	5	2	loam
MS41	0 - 4 "	10YR	4	1	sandy loam	4 - 13 "	10YR	5	1	loamy sand	13 - 20 "	10YR	5	2	sand
MS42	0 - 6 "	10YR	4	1	loamy sand	6 - 20 "	10YR	5	1	loamy sand					

Site	Horizon 1 (A) depth range	Hue	Value	Chroma	Texture	Horizon 2 depth range	Hue	Value	Chroma	Texture	Horizon 3 depth range	Hue	Value	Chroma	Texture
MS43	0 - 8 "	10YR	2	1	sandy loam	8 - 18 "	10YR	6	2	sandy loam	18 - 23 "	10YR	5	2	sandy clay loam
AL44	0 - 8 "	10YR	2	1	sandy loam	8 - 15 "	10YR	5	2	sand	- "	10YR			
AL45	0 - 6 "	10YR	3	1	clay loam	6 - 9 "	10YR	4	1	clay	9 - 20 "	10YR	6	1	clay
AL47	0 - 8 "	10YR	3	1	sandy loam	8 - 16 "	10YR	4	1	sandy clay loam	16 - 24 "	10YR	4	1	sandy clay
AL48	0 - 7 "	10YR	4	1	sandy loam	7 - 22 "	10YR	5	1	sandy loam					
AL49	0 - 8 "	10YR	2	1	sand	8 - 20 "	10YR	3	1	sand					
AL50	0 - 11 "	10YR	2	1	sandy loam	too wet to obtain additional info on profile									
AL51	0 - 11 "	10YR	4	1	sandy loam	11 - 21 "	10YR	4	1	sandy loam					
FL52	0 - 5 "	10YR	2	1	sand	5 - 14 "	10YR	3	1	sand	14 - 21 "	10YR	4	2	sand
FL53	0 - 2 "	10YR	4	2	sandy loam	2 - 7 "	10YR	4	1	sandy loam	7 - 9 "	10YR	4	2	sandy loam
FL54	0 - 15 "	10YR	2	1	loamy sand	15 - "	10YR	2	1	sand	too wet to obtain additional info on profile				
FL55	0 - 6 "	10YR	2	1	loam	6 - 8 "	10YR	3	1	loam	8 - 19 "	10YR	5	1	clay loam
FL56	0 - 7 "	10YR	3	1	loamy sand	7 - 18 "	10YR	4	1	loamy sand					
FL57	0 - 10 "	10YR	2	1	sand	10 - 15 "	10YR	3	1	loamy sand	15 - 20 "	10YR	3	2	sand
FL58	0 - 7 "	10YR	3	1	loamy sand	7 - 17 "	10YR	4	1	loam	17 - 24 "	10YR	5	1	sand
FL59	0 - 4 "	10YR	5	1	clay loam	4 - 16 "	10YR	5	1	silty clay loam	16 - 23 "	10YR	5	1	clay
GA60	0 - 5 "	10YR	2	1	loam	5 - 7 "	10YR	2	2	loamy sand	7 - 25 "	10YR	4	1	clay loam
GA61	0 - 15 "	10YR	3	1	loamy sand	15 - 22 "	10YR	4	1	loamy sand	- "	10YR			
GA62	0 - 9 "	10YR	3	2	loamy sand	9 - 24 "	10YR	5	2	loamy sand					
GA63	0 - 24 "	10YR	3	1	loamy sand										
NC65	0 - 7 "	10YR	2	1	sandy loam	7 - 15 "	10YR	5	1	sandy loam	15 - 19 "	10YR	6	2	sandy clay loam
NC66	0 - 6 "	10YR	4	1	fine sandy loam	6 - 11 "	10YR	4	1	fine sandy loam	11 - 20 "	10YR	6	2	fine sandy loam
NC67	0 - 8 "	10YR	2	1	sandy loam	8 - 20 "	10YR	4	1	fine sandy loam	- "	10YR			
NC68	0 - 2 "	10YR	2	1	loamy sand	2 - 5 "	10YR	3	1	loamy sand	5 - 7 "	10YR	7	1	sand
NC69	0 - 7 "	10YR	2	1	loamy sand	7 - 22 "	10YR	5	2	sand	- "	10YR			
NC70	0 - 8 "	10YR	2	1	loamy fine sand	8 - 17 "	10YR	2	1	loamy fine sand	17 - 21 "	2.5YR	3	1	loamy sand
NC71	0 - 6 "	10YR	2	1	sandy loam	6 - 13 "	10YR	5	1	sandy clay loam	13 - 24 "	10YR	5	1	clay
NC72	0 - 9 "	10YR	2	1	sandy loam	9 - 21 "	2.5YR	6	1	sandy clay loam	- "	10YR			
MS40i	0 - 5 "	10YR	4	1	sandy loam	5 - 9 "	10YR	5	1	sandy loam	9 - 20 "	10YR	5	2	sandy loam
MS40m															
MS40o	0 - 5 "	10YR	4	1	sandy loam	5 - 9 "	10YR	5	1	sandy loam	9 - 20 "	10YR	5	2	sandy loam

Table E2.

Site	Horizon 4 depth range	Hue	Value	Chroma	Texture	Depth range of mottles	Hue	Value	Chroma	Depth range of mottles	Hue	Value	Chroma	Depth to a Change in permeability
SC1						14 - 26 "	10YR	6	8					14 "
SC2	12 - 23 "	2.5YR	6	1	sandy clay loam	12 - 23 "	2.5YR	6	1					12 "
SC3	25 - 27 "	10YR	6	1	sandy clay	25 - 27 "	10YR	5	6					25 "
SC4						7 - 29 "	10YR	5	6					7 "
SC5	30 - 35 "	10YR	5	2	sandy clay	20 - 35 "	10YR	5	8					30 "
SC6						7 - 11 "	10YR	5	8	11 - 24 "	10YR	6	8	11 "
SC7														NA
SC9	13 - 23 "	10YR	6	1	sandy clay	13 - 23 "	10YR	6	8					13 "
SC10						13 - 28 "	10YR	6	6					13 "
SC11						17 - 24 "	2.5YR	5	6					17 "
SC12	9 - 23 "	2.5YR	6	1	clay loam	9 - 23 "	2.5YR	6	8					9 "
SC13						13 - 25 "	10YR	5	8					13 "
SC14						18 - 27 "	10YR	5	8					18 "
SC15						19 - 28 "	10YR	5	6					19 "
SC16														NA
SC17						17 - 23 "	10YR	5	8					17 "
SC18						7 - 10 "	10YR	5	6	10 - 22 "	10YR	6	8	10 "
SC19						30 - 33 "	10YR	6	8					30 "
SC20						9 - 22 "	10YR	6	8					9 "
SC21						2.5 - 23 "	10YR	6	8					NA
SC22						5 - 18 "	10YR	6	4					18 "
SC23						10 - 22 "	10YR	5	8					10 "
SC24						5 - 10 "	10YR	6	8	10 - 23 "	10YR	6	8	10 "
SC25						9 - 20 "	10YR	5	8					9 "
LA29						3 - 21 "	10YR	5	8					9 "
LA30						0 - 7 "	10YR	5	8					18 "
TX31						0 - 5 "	10YR	5	8					NA
TX32						0 - 12 "	10YR	5	8					NA
TX34						0 - 1 "	10YR	4	6	1 - 20 "	10YR	5	6	5 "
TX35						0 - 20 "	10YR	5	6					NA
LA37						6 - 20 "	10YR	6	8					6 "
LA38						5 - 26 "	10YR	4	6					NA
MS39	20 - 20+ "	10YR	6	1	silt loam	7 - 20 "	10YR	6	6					20 "
MS41						13 - 20 "	10YR	5	8					NA
MS42														NA

Site	Horizon 4 depth range	Hue	Value	Chroma	Texture	Depth range of mottles	Hue	Value	Chroma	Depth range of mottles	Hue	Value	Chroma	Depth to a Change in permeability
MS43						8 - 23 "	10YR	6	6					18 "
AL44						8 - 15 "	10YR	5	8					NA
AL45						0 - 6 "	10YR	5	8	6 - 20 "	10YR	6	8	6 "
AL47						8 - 24 "	10YR	5	6					16 "
AL48						0 - 22 "	10YR	5	8					NA
AL49														NA
AL50														NA
AL51						11 - 21 "	10YR	5	8					NA
FL52	22 - 24 "	10YR	6	4	sand									NA
FL53	9 - 20 "	10YR	3	1	loamy sand	2 - 9 "	10YR	4	6	9 - 25 "	10YR	5	6	NA
FL54														NA
FL55	19 - 24 "	10YR	6	1	clay	6 - 19 "	10YR	5	6	19 - 24 "	10YR	5	2	8 "
FL56														NA
FL57														NA
FL58														NA
FL59						0 - 4 "	10YR	5	8	4 - 23 "	10YR	5	8	NA
GA60														NA
GA61						0 - 15 "	10YR	3	6	15 - 22 "	10YR	5	8	NA
GA62														NA
GA63														NA
NC65	19 - 25 "	10YR	6	1	sandy clay loam	15 - 25 "	10YR	6	6					15 "
NC66						6 - 20 "	10YR	6	6					NA
NC67						8 - 20 "	10YR	6	6					NA
NC68	7 - 15 "	10YR	2	1	loamy sand	5 - 7 "	10YR	5	6	7 - 15 "	10YR	5	8	NA
NC69						7 - 22 "	10YR	5	6					NA
NC70						17 - 21 "	10YR	6	8					NA
NC71						6 - 24 "	10YR	5	6					6 "
NC72						9 - 21 "	2.5YR	7	6	9 - 21 "	10YR	5	8	9 "
MS40i						9 - 20 "	10YR	5	8					NA
MS40m														
MS40o						5 - 9 "	10YR	5	8					NA

Table E2.

Site	Bulk Density (g/cm ³)	Recent Fire	Herb Ground cover	Herb LAI-site	Shrub LAI-site	Sub-canopy LAI-site	Mid-canopy LAI-site	Canopy LAI-site	LAI Site	Shrub Cover	Snag Density >10 cm (stems/ha)	Snag BA >10 cm (m ² /ha)	Snag Density >20 cm (stems/ha)	Snag BA >20 cm (m ² /ha)	Snag Density (10 m radius)	Snag BA (Bitter-Lich)	CWD (m ³ /ha)
SC1	0.7187	N	0.792	0.850	0.025	0.025	0.150	0.110	11.73	1.16	6.63	0.71	0.00	0.00	1.00	7.43	
SC2	0.5738	Y	0.500	0.850	0.025	0.025	0.500	1.43	60.72	1.66	13.16	1.08	0.00	0.00	0.50	81.02	
SC3	0.5239	N	0.617	1.350	0.375	0.001	0.000	2.14	1.00	0.01	1.00	0.03	0.00	0.00	0.00	0.07	
SC4	0.8037	N	0.892	0.975	0.150	0.025	0.025	1.31	32.22	1.45	32.22	1.45	21.20	1.00	2.50	5.10	
SC5	0.6534	N	0.675	0.850	0.375	0.150	0.025	1.73	24.35	1.39	24.35	1.39	0.00	0.00	0.00	74.20	
SC6	0.7187	Y	0.892	0.850	0.001	0.025	0.150	1.05	3.90	0.38	3.90	0.38	0.00	0.00	0.00	6.55	
SC7	0.5358	Y	0.792	0.975	0.025	0.150	0.025	1.35	1.00	0.01	1.00	0.03	0.00	0.00	0.00	5.35	
SC9	0.5885	Y	0.792	0.975	0.150	0.000	0.025	0.500	12.49	1.01	12.49	1.01	10.60	1.00	1.00	74.37	
SC10	0.6781	Y	0.892	1.950	0.150	0.025	0.150	2.58	13.22	1.05	13.22	1.05	21.20	1.50	1.50	88.44	
SC11	0.5422	N	0.792	1.950	1.350	0.150	0.001	3.90	4.72	0.44	4.72	0.44	21.20	1.00	1.00	95.23	
SC12	0.4468	N	0.067	0.025	0.150	1.700	0.150	2.58	15.71	0.53	14.57	0.99	10.60	1.00	1.00	328.63	
SC13	0.7535	N	0.892	1.950	0.750	0.050	0.150	3.43	139.50	6.90	81.16	7.85	42.40	3.00	3.00	117.26	
SC14	0.5576	N	0.733	0.850	0.150	0.750	0.025	0.500	1.00	0.01	1.00	0.03	0.00	0.00	0.00	0.02	
SC15	0.9335	N	0.933	2.000	0.300	0.025	0.150	2.68	1.75	0.10	1.75	0.15	0.00	1.00	1.00	31.89	
SC16	1.2383	N	0.933	2.000	0.300	0.025	0.150	2.68	2.74	0.11	2.74	0.15	0.00	0.00	0.00	0.03	
SC17	0.8187	N	0.833	1.950	0.150	0.025	0.025	1.50	2.74	0.11	2.74	0.15	0.00	0.00	0.00	0.03	
SC18	0.8037	N	0.975	1.950	0.300	0.150	0.001	0.025	1.32	0.03	1.32	0.06	0.00	0.00	0.00	0.10	
SC19	0.7481	N	0.983	1.700	0.300	0.025	0.150	2.35	1.00	0.01	1.00	0.03	0.00	0.00	0.00	0.01	
SC20	0.7682	N	0.975	1.950	0.300	0.025	0.025	0.500	1.78	0.05	1.78	0.09	0.00	0.00	0.00	0.19	
SC21	1.0701	N	0.225	0.375	0.025	0.025	1.700	2.33	3.18	0.24	3.05	0.29	0.00	0.00	0.00	1.46	
SC22	0.4684	N	0.733	1.700	0.300	0.000	0.000	2.05	1.00	0.01	1.00	0.03	0.00	0.00	0.00	0.40	
SC23	0.5021	N	0.675	0.975	0.025	0.375	0.025	1.50	1.15	0.03	1.15	0.06	0.00	0.00	0.00	0.03	
SC24	0.6607	N	0.992	2.000	0.025	0.150	0.025	0.375	1.17	0.03	1.17	0.06	0.00	0.00	0.00	0.15	
SC25	0.9464	N	0.975	1.950	0.300	0.150	0.025	0.025	1.75	0.28	1.75	0.28	0.00	0.00	0.00	1.75	
LA29	0.8320	N	0.992	2.000	0.025	0.300	0.000	0.025	2.92	0.04	1.00	0.03	0.00	0.00	0.00	0.26	
LA30	1.0604	N	0.892	2.000	0.001	0.025	0.150	0.000	3.36	0.26	3.36	0.26	0.00	0.00	0.00	0.14	
TX31	1.1443	N	0.692	0.850	0.150	0.300	0.150	1.71	1.19	0.04	1.19	0.08	0.00	0.00	0.00	0.03	
TX32	0.8408	N	0.617	1.700	0.025	0.150	0.025	2.43	1.15	0.06	1.15	0.08	0.00	0.00	0.00	0.03	
TX34	1.0119	N	0.575	0.850	0.000	0.000	0.000	0.86	1.00	0.01	1.00	0.03	0.00	0.00	0.00	0.03	
TX35	1.0020	N	0.675	0.975	0.150	0.025	0.500	1.68	1.79	0.02	1.00	0.03	0.00	0.00	0.00	0.05	
LA37	0.9892	Y	0.983	1.950	0.050	0.025	0.025	2.09	3.32	0.05	2.72	0.11	21.20	0.50	0.50	0.88	
LA38	0.9226	N	0.558	0.975	0.150	0.850	0.150	2.43	1.56	0.05	1.23	0.06	0.00	0.00	0.00	0.05	
MS39	0.6517	N	0.892	1.950	0.300	0.000	0.000	2.28	2.44	0.10	2.44	0.13	0.00	0.00	0.00	0.47	
MS41	1.1070	N	0.975	1.950	0.050	0.025	0.025	2.08	2.64	0.16	2.64	0.20	0.00	0.00	0.00	0.13	
MS42	0.7048	N	0.850	1.950	0.300	0.150	0.025	1.50	1.57	0.02	1.00	0.03	0.00	0.00	0.00	0.05	

Site	Bulk Density (g/cm ³)	Recent Fire	Herb Ground cover	Herb LAI-site	Shrub LAI-site	Sub-canopy LAI-site	Mid-canopy LAI-site	Canopy LAI-site	LAI Site	Shrub Cover	Snag Density >10 cm (stems/ha)	Snag BA >10 cm (m ² /ha)	Snag Density >20 cm (stems/ha)	Snag BA >20 cm (m ² /ha)	Snag Density (10 m radius)	Snag BA (Bitterlich)	CWD (m ³ /ha)
MS43	0.9096	N	0.850	1.950	0.300	0.050	0.025	0.025	2.40	0.050	2.05	0.02	1.00	0.03	0.00	0.00	0.03
AL44	0.9888	Y	0.933	1.950	0.300	0.025	0.150	0.150	2.68	0.100	1.00	0.01	1.00	0.03	0.00	0.00	0.03
AL45	0.7491	Y	0.850	0.850	0.001	0.000	0.000	0.000	0.85	0.000	1.00	0.01	1.00	0.03	0.00	0.00	0.03
AL47	0.9805	N	0.792	1.950	0.050	0.150	0.150	0.150	2.83	0.375	3.23	0.19	1.78	0.14	0.00	0.00	2.44
AL48	0.7408	N	0.933	1.950	0.300	0.025	0.150	0.150	2.60	0.025	1.50	0.06	1.50	0.07	0.00	0.00	0.05
AL49	0.8502	N	0.833	1.950	0.150	0.750	0.150	0.025	3.13	0.100	1.85	0.05	1.85	0.07	0.00	0.00	0.64
AL50	1.1811	Y	1.000	1.950	0.300	0.150	0.001	0.025	2.48	0.058	2.41	0.07	2.36	0.14	0.00	0.00	0.03
AL51	0.1970	N	0.733	1.950	0.025	0.300	0.001	0.025	2.36	0.058	2.29	0.11	2.29	0.15	0.00	0.00	0.30
FL52	1.0609	N	1.000	1.950	0.750	0.025	0.001	0.150	3.13	0.250	1.98	0.10	1.98	0.13	0.00	0.00	0.03
FL53	1.0708	N	0.300	0.375	0.500	1.950	0.025	0.375	3.90	0.675	3.83	0.07	1.65	0.05	0.00	0.00	0.92
FL54	0.9601	Y	0.942	1.950	0.150	0.025	0.150	0.025	2.40	0.100	1.00	0.01	1.00	0.03	0.00	0.00	0.32
FL55	0.5539	Y	0.992	2.000	0.025	0.025	0.025	0.025	2.10	0.000	4.23	0.12	1.97	0.08	0.00	0.00	0.12
FL56	0.7013	Y	0.992	2.000	0.050	0.050	0.001	0.000	2.16	0.058	1.23	0.09	1.23	0.11	0.00	0.00	0.03
FL57	1.1016	Y	0.267	0.500	0.001	0.300	0.000	0.850	1.65	0.000	2.44	0.13	1.57	0.12	0.00	0.00	4.31
FL58	1.1016	N	0.942	2.000	0.050	0.150	0.150	0.000	2.36	0.009	5.12	0.24	5.12	0.16	0.00	0.50	6.87
FL59	1.0174	N	0.975	2.000	0.300	0.150	0.150	0.150	2.75	0.000	1.59	0.02	1.00	0.03	0.00	0.00	0.03
GA60	0.6361	N	0.842	2.000	0.025	0.025	0.025	0.150	2.23	0.009	1.78	0.06	1.78	0.08	0.00	0.00	0.07
GA61	0.4495	Y	0.833	2.000	0.300	0.025	0.025	0.001	2.38	0.025	1.00	0.01	1.00	0.03	0.00	0.00	0.03
GA62	1.1372	Y	0.892	1.950	0.300	0.001	0.000	0.150	2.55	0.150	90.70	0.93	1.00	0.03	0.00	0.00	5.01
GA63	0.9291	N	0.733	1.350	0.750	0.150	0.025	0.500	2.88	0.100	1.19	0.02	1.19	0.04	0.00	0.00	0.03
NC65	0.3739	Y	0.983	2.000	0.050	0.001	0.025	0.375	2.50	0.050	1.83	0.18	1.83	0.22	0.00	0.50	0.25
NC66	0.8491	N	1.000	2.000	0.300	0.150	0.025	0.025	2.80	0.300	6.60	0.29	6.30	0.36	0.00	0.50	10.57
NC67	0.9915	N	0.900	2.000	0.150	0.001	0.025	0.150	2.83	0.500	1.15	0.03	1.15	0.06	0.00	0.00	0.09
NC68	1.1102	N	0.983	2.000	0.300	0.025	0.001	0.150	2.70	0.225	1.00	0.01	1.00	0.03	0.00	0.00	0.26
NC69	1.0752	Y	0.833	1.950	1.000	0.150	0.025	0.375	3.84	0.342	1.47	0.01	1.40	0.06	0.00	0.00	1.07
NC70	0.6861	Y	0.892	2.000	0.750	0.150	0.025	0.150	3.42	0.342	2.40	0.05	1.38	0.05	10.60	0.00	2.09
NC71	0.9255	N	0.558	2.000	1.000	0.300	0.025	0.375	4.28	0.575	1.00	0.01	1.00	0.03	0.00	0.00	0.03
NC72	0.9208	N	0.792	2.000	0.025	0.150	0.675	0.000	2.92	0.067	1.68	0.04	1.07	0.05	0.00	0.00	1.44
MS40i	0.9704	N	0.417	0.675	0.025	0.150	0.000	0.000	0.85	0.000	4.10	0.12	2.46	0.15	0.00	0.00	1.53
MS40m	1.1070	N	0.833	0.850	0.150	0.025	0.000	0.000	1.03	0.000	4.19	0.20	3.02	0.24	0.00	0.00	22.21
MS40o	1.1070	N	0.992	2.000	0.375	0.150	0.000	0.025	2.68	0.133	1.33	0.01	1.00	0.03	0.00	0.00	0.10

Table E2.

Site	Mid-canopy Density (stems/ha)	Canopy Density (stems/ha)	Canopy BA (m ² /ha)	Cover Live and Dead	FWD Cover	Litter Cover	Litter Depth (cm)	Litter Volume (cm ³ /m ²)	Natural Elevation Range	Alt Height	Avg # indie spp/1m ²	Indicator spp/1m ²	Total # spp/150 m ²	Avg # Addl spp/1m ²	Avg # Addl spp/2 m rad	Avg # Addl spp/50m ²	# Addl spp/150 m ²	Total # of spp/150 m ²	Total # xtra spp. in site	Total spp/site
SC1	47.70	206.70	19.00	0.85	0.03	0.53	0.10	0.001	5.0	30.0	6	15	15	9	20	27	46	61	0	61
SC2	47.70	286.20	20.50	0.79	0.15	0.84	5.67	0.048	14.0	14.0	1	4	7	3	6	9	17	24	0	24
SC3	159.00	15.90	1.00	0.89	0.01	0.46	1.53	0.007	12.7	18.5	2	7	11	8	16	24	35	46	4	50
SC4	63.60	74.20	3.50	0.89	0.02	0.18	0.10	0.000	15.3	21.7	5	12	12	8	15	20	31	43	0	43
SC5	0.00	0.00	2.00	0.95	0.07	0.90	2.67	0.024	11.0	24.5	8	15	17	5	12	20	34	51	1	52
SC6	21.20	63.60	7.50	0.89	0.02	0.23	0.10	0.000	9.0	11.0	11	15	15	9	14	18	28	43	1	44
SC7	10.60	0.00	0.00	0.90	0.06	0.62	0.70	0.004	10.0	16.0	8	16	18	11	16	23	43	61	0	61
SC9	21.20	169.60	17.50	0.79	0.23	0.28	0.10	0.000	4.3	0.0	3	13	14	6	13	18	34	48	2	50
SC10	21.20	84.80	6.00	0.89	0.11	0.23	0.10	0.000	6.3	0.0	7	16	17	12	18	25	39	56	0	56
SC11	0.00	137.80	9.00	0.98	0.11	0.95	1.00	0.010	7.3	0.0	3	10	14	9	16	19	28	42	0	42
SC12	84.87	233.20	9.50	0.48	0.15	0.98	5.00	0.049	11.0	0.0	0	0	0	3	7	10	17	17	0	17
SC13	10.60	0.00	0.50	0.99	0.00	0.22	0.10	0.000	7.0	9.0	10	12	13	6	13	18	32	45	2	47
SC14	0.00	74.20	10.00	0.98	0.11	1.00	1.67	0.017	8.3	0.0	0	2	2	6	13	16	23	25	1	26
SC15	10.60	21.20	3.50	1.00	0.00	0.34	0.10	0.000	5.7	0.0	5	10	12	7	12	15	22	34	0	34
SC16	0.00	0.00	0.00	1.00	0.00	0.34	0.10	0.000	5.7	0.0	0	5	6	5	7	11	11	17	0	17
SC17	0.00	95.40	6.50	0.94	0.07	0.34	0.23	0.001	4.3	0.0	4	12	12	7	11	17	28	40	0	40
SC18	0.00	31.80	1.50	1.00	0.00	0.23	0.10	0.000	8.0	0.0	8	15	16	9	16	20	33	49	0	49
SC19	21.20	31.80	5.00	0.99	0.06	0.42	0.10	0.000	5.0	0.0	6	14	15	7	14	19	33	48	0	48
SC20	21.20	74.20	5.50	1.00	0.07	0.52	0.73	0.004	5.7	0.0	7	12	14	8	16	27	37	51	0	51
SC21	0.00	533.33	19.00	0.33	0.11	0.98	4.67	0.046	30.0	30.0	0	2	2	4	10	14	24	26	0	26
SC22	0.00	0.00	0.00	0.79	0.00	0.95	3.33	0.032	4.3	20.7	0	3	4	10	16	23	32	36	2	38
SC23	10.60	84.80	6.00	0.99	0.00	0.48	0.40	0.002	4.0	0.0	2	7	7	10	16	22	31	38	0	38
SC24	10.60	63.60	9.50	1.00	0.02	0.30	0.10	0.000	2.7	0.0	5	10	11	7	16	20	31	42	1	43
SC25	63.60	0.00	1.50	1.00	0.00	0.23	0.10	0.000	6.7	0.0	2	3	4	8	15	20	26	30	1	31
LA29	0.00	0.00	2.50	0.99	0.00	0.27	0.40	0.001	5.0	4.3	3	6	7	16	22	27	35	42	2	44
LA30	0.00	10.60	0.00	1.00	0.00	0.93	2.00	0.019	6.0	0.0	1	2	2	8	12	18	25	27	0	27
TX31	66.67	0.00	1.50	0.69	0.05	0.33	0.73	0.002	8.0	0.0	5	8	9	13	23	29	41	50	0	50
TX32	133.33	31.80	1.00	0.93	0.06	0.73	3.33	0.024	5.3	0.0	3	7	10	10	15	19	27	37	0	37
TX34	0.00	116.60	6.00	0.58	0.00	0.26	1.70	0.004	10.0	12.3	1	4	7	8	16	25	38	45	0	45
TX35	0.00	180.20	8.00	0.73	0.00	0.78	2.33	0.018	7.3	11.7	6	9	10	10	19	28	42	52	0	52
LA37	0.00	0.00	0.00	0.98	0.01	0.00	0.00	0.000	9.3	25.0	5	13	13	10	16	19	29	42	0	42
LA38	466.67	53.00	2.50	0.68	0.06	0.79	2.03	0.016	8.7	0.0	5	11	11	10	19	25	34	45	0	45
MS39	0.00	0.00	0.00	0.89	0.00	0.05	0.10	0.000	8.7	0.0	7	11	14	11	19	21	26	40	0	40
MS41	0.00	0.00	0.00	0.98	0.00	0.42	0.40	0.002	8.0	0.0	9	11	12	12	17	24	34	46	0	46
MS42	66.67	148.40	6.00	0.85	0.02	0.01	0.10	0.000	8.7	0.0	8	10	11	10	16	20	25	36	0	36

Site	Mid-canopy Density (stems/ha)	Canopy Density (stems/ha)	Canopy BA (m ² /ha)	Cover Live and Dead	FWD Cover	Litter Cover	Litter Depth (cm)	Litter Volume (cm ³ /m ²)	Natural Elevation Range	Alt Height	Avg # indic spp/1m ²	Total # Indicator spp/150 m ²	Avg # Addl spp/150 m ²	Avg # Addl spp/2 m rad	Avg # Addl spp/50m ²	# Addl spp/150 m ²	Total # of spp/150 m ²	Total # xtra spp. in site	Total spp./site	
MS43	0.00	42.40	0.50	1.00	0.00	0.56	0.10	0.001	5.3	15.0	10	13	14	11	15	21	31	45	0	45
AL44	66.67	116.60	5.50	0.93	0.00	0.27	0.10	0.000	6.3	18.5	10	14	15	18	23	28	40	55	0	55
AL45	0.00	0.00	0.00	0.85	0.00	0.53	0.10	0.001	2.3	20.7	0	3	6	4	14	22	33	39	0	39
AL47	333.33	127.20	4.50	0.94	0.06	0.46	0.10	0.000	9.3	0.0	5	9	9	20	28	32	45	54	0	54
AL48	0.00	53.00	1.50	0.98	0.00	0.38	0.10	0.000	7.7	0.0	9	12	13	11	20	24	31	44	0	44
AL49	0.00	95.40	4.50	0.98	0.01	0.68	1.37	0.009	8.0	0.0	8	12	13	9	18	23	35	48	0	48
AL50	0.00	0.00	0.00	1.00	0.00	0.51	1.40	0.007	10.0	0.0	7	13	14	15	27	32	47	61	1	62
AL51	0.00	31.80	0.00	1.00	0.00	0.38	0.40	0.002	8.3	0.0	7	12	15	11	19	23	36	51	1	52
FL52	0.00	95.40	4.00	1.00	0.01	0.07	0.10	0.000	8.3	20.0	7	12	12	7	13	18	24	36	3	39
FL53	10.60	127.20	10.50	0.84	0.03	1.00	2.33	0.023	4.3	8.0	1	3	4	2	5	9	12	16	1	17
FL54	333.33	31.80	1.00	0.94	0.02	0.58	0.10	0.001	8.7	0.0	8	13	13	11	17	22	35	48	0	48
FL55	0.00	21.20	0.50	0.99	0.00	0.02	0.10	0.000	10.0	0.0	8	12	13	11	16	18	23	36	1	37
FL56	0.00	0.00	0.00	0.99	0.00	0.00	0.10	0.000	7.7	14.0	7	9	10	9	15	19	26	36	0	36
FL57	200.00	689.00	25.00	0.27	0.15	0.95	7.00	0.067	7.0	11.5	3	5	5	2	4	8	12	17	1	18
FL58	600.00	0.00	0.00	0.94	0.06	0.05	0.10	0.000	9.0	14.2	6	12	13	11	20	23	33	46	0	46
FL59	266.67	63.60	5.50	0.98	0.00	0.00	0.03	0.000	12.3	0.0	7	10	11	11	21	27	34	45	0	45
GA60	0.00	201.40	9.00	0.99	0.05	1.00	2.00	0.020	1.0	0.0	0	1	2	2	3	4	6	8	1	9
GA61	0.00	0.00	0.00	0.83	0.00	0.00	0.10	0.000	6.7	28.3	8	13	13	11	20	28	45	58	2	60
GA62	0.00	53.00	3.50	0.89	0.00	0.01	0.10	0.000	6.3	28.6	10	14	15	7	15	20	33	48	0	48
GA63	66.67	148.40	6.00	0.94	0.10	0.95	4.00	0.038	12.3	0.0	5	11	12	7	16	21	36	48	0	48
NC65	0.00	169.60	8.50	0.98	0.02	0.01	0.10	0.000	3.7	0.0	10	16	17	15	24	32	44	61	1	62
NC66	66.67	63.60	1.50	1.00	0.01	0.63	1.67	0.011	10.7	0.0	8	15	16	14	23	30	46	62	0	62
NC67	66.67	42.40	2.00	1.00	0.01	0.46	0.10	0.000	6.3	0.0	8	16	17	15	27	32	45	62	0	62
NC68	0.00	84.80	1.50	1.00	0.00	0.52	0.10	0.001	12.0	0.0	8	13	16	14	23	30	42	58	0	58
NC69	66.67	233.20	8.00	0.95	0.06	0.00	0.10	0.000	12.3	0.0	4	12	12	8	19	23	34	46	0	46
NC70	133.33	106.00	4.50	1.00	0.00	0.15	0.10	0.000	9.0	18.3	7	13	14	19	34	41	63	77	0	77
NC71	0.00	84.80	6.50	0.90	0.11	0.74	0.40	0.003	3.7	20.0	1	4	8	6	12	18	29	37	1	38
NC72	733.33	0.00	0.00	1.00	0.00	0.95	0.10	0.001	8.7	25.0	3	8	9	16	25	30	43	52	3	55
MS40i	0.00	0.00	0.00	0.42	0.00	1.00	6.67	0.067	0.3	0.0	1	2	3	4	7	11	18	21	0	21
MS40m	0.00	0.00	0.00	0.83	0.00	0.99	5.00	0.050	0.0	0.0	4	9	12	8	15	20	31	43	0	43
MS40o	0.00	10.60	0.00	0.99	0.05	0.00	0.10	0.000	4.0	0.0	7	11	14	10	14	18	27	41	0	41

Table E2.

Site	% Slope
SC1	0.3100
SC2	0.0777
SC3	0.0500
SC4	0.0476
SC5	0.0076
SC6	0.0700
SC7	0.0309
SC9	0.0266
SC10	0.3000
SC11	0.4252
SC12	0.1143
SC13	0.0825
SC14	0.0781
SC15	0.0150
SC16	0.0150
SC17	0.1150
SC18	0.0200
SC19	0.1900
SC20	0.0254
SC21	0.0052
SC22	0.0900
SC23	0.0900
SC24	0.2725
SC25	0.0683
LA29	0.1394
LA30	0.0387
TX31	0.4342
TX32	0.0100
TX34	0.4894
TX35	0.8682
LA37	0.0300
LA38	0.0615
MS39	0.2485
MS41	0.0100
MS42	0.0236

Site	% Slope
MS43	0.2300
AL44	0.0550
AL45	0.1950
AL47	0.0141
AL48	0.2650
AL49	0.2960
AL50	0.8800
AL51	0.3800
FL52	0.4800
FL53	0.1543
FL54	0.4151
FL55	0.0050
FL56	0.0150
FL57	0.1150
FL58	0.2650
FL59	0.0403
GA60	0.1600
GA61	0.2857
GA62	0.2553
GA63	0.0100
NC65	0.0200
NC66	0.0997
NC67	0.4900
NC68	0.0900
NC69	0.1042
NC70	0.0330
NC71	0.0850
NC72	0.2231
MS40i	0.5212
MS40m	0.5212
MS40o	0.5212

Table E3

Table E3. Density of canopy and midcanopy strata for Wet Pine Flats on mineral soil. BPS=Bunchgrass/Pine Savanna, SPS= Switchcane/Pine Savanna, CPS= Cypress/Pine Savanna, SSS=Seepage Slope/Pine Savanna, WP=Flatwoods Pond, N/A=Not Applicable, OUT=outlier.

Site		SC5	SC6	SC7	SC10	SC13	SC15	SC17	SC18	SC19	SC20	SC24	LA37	MS40o	MS41	MS42	MS43	AL44	AL48	AL49
Subclass		BPS	BPS	BPS	BPS	BPS	BPS	BPS	BPS	BPS	BPS	BPS	BPS	BPS	BPS	BPS	BPS	BPS	BPS	BPS
Unaltered: Yes, No, Not Applicable (N/A)		Yes	Yes	Yes	Yes	Yes	Yes	Yes	Yes	Yes	Yes	Yes	Yes	Yes	Yes	Yes	Yes	Yes	Yes	Yes
<i>Pinus palustris</i>		0	64	0	42	0	21	95	32	32	74	64	0	0	0	0	42	21	53	11
<i>Pinus elliotii</i>		0	0	0	0	0	0	0	0	0	0	0	0	11	0	148	0	96	0	85
<i>Pinus taeda</i>		0	0	0	0	0	0	0	0	0	0	0	0	0	0	0	0	0	0	0
<i>Pinus serotina</i>		0	0	0	42	0	0	0	0	0	0	0	0	0	0	0	0	0	0	0
<i>Taxodium ascendens</i>		0	0	0	0	0	0	0	0	0	0	0	0	0	0	0	0	0	0	0
<i>Nyssa biflora</i>		0	0	0	0	0	0	0	0	0	0	0	0	0	0	0	0	0	0	0
<i>Acer rubrum</i>		0	0	0	0	0	0	0	0	0	0	0	0	0	0	0	0	0	0	0
<i>Quercus pumila</i>		0	0	0	0	0	0	0	0	0	0	0	0	0	0	0	0	0	0	0
<i>Ilex myrtifolia</i>		0	0	0	0	0	0	0	0	0	0	0	0	0	0	0	0	0	0	0
Total Density		0	64	0	84	0	21	95	32	32	74	64	0	11	0	148	42	117	53	95

MIDCANOPY

Site		SC5	SC6	SC7	SC10	SC13	SC15	SC17	SC18	SC19	SC20	SC24	LA37	MS40o	MS41	MS42	MS43	AL44	AL48	AL49
Subclass		BPS	BPS	BPS	BPS	BPS	BPS	BPS	BPS	BPS	BPS	BPS	BPS	BPS	BPS	BPS	BPS	BPS	BPS	BPS
Unaltered: Yes, No, Not Applicable (N/A)		Yes	Yes	Yes	Yes	Yes	Yes	Yes	Yes	Yes	Yes	Yes	Yes	Yes	Yes	Yes	Yes	Yes	Yes	Yes
<i>Pinus palustris</i>		0	21	11	0	11	11	0	0	21	21	11	0	0	0	67	0	0	0	0
<i>Pinus elliotii</i>		0	0	0	0	0	0	0	0	0	0	0	0	0	0	0	0	67	0	0
<i>Pinus taeda</i>		0	0	0	0	0	0	0	0	0	0	0	0	0	0	0	0	0	0	0
<i>Pinus serotina</i>		0	0	0	21	0	0	0	0	0	0	0	0	0	0	0	0	0	0	0
<i>Taxodium ascendens</i>		0	0	0	0	0	0	0	0	0	0	0	0	0	0	0	0	0	0	0
<i>Nyssa biflora</i>		0	0	0	0	0	0	0	0	0	0	0	0	0	0	0	0	0	0	0
<i>Acer rubrum</i>		0	0	0	0	0	0	0	0	0	0	0	0	0	0	0	0	0	0	0
<i>Quercus pumila</i>		0	0	0	0	0	0	0	0	0	0	0	0	0	0	0	0	0	0	0
<i>Cyrilla racemosa</i>		0	0	0	0	0	0	0	0	0	0	0	0	0	0	0	0	0	0	0
<i>Ilex myrtifolia</i>		0	0	0	0	0	0	0	0	0	0	0	0	0	0	0	0	0	0	0
<i>Persea borbonia</i>		0	0	0	0	0	0	0	0	0	0	0	0	0	0	0	0	0	0	0
Total Density		0	21	11	21	11	11	0	0	21	21	11	0	0	0	67	0	67	0	0

Table E3

Site		AL50	AL51	FL52	FL55	FL56	NC65	NC66	NC67	NC68	NC69	NC70	SC2	SC11	SC4	SC23	LA38	AL47	FL54	FL59	
Subclass		BPS	BPS	BPS	BPS	BPS	BPS	BPS	BPS	BPS	BPS	BPS	SPS	SPS	CPS	CPS	CPS	CPS	CPS	CPS	CPS
Unaltered: Yes, No, Not Applicable (N/A)		Yes	Yes	Yes	Yes	Yes	Yes	Yes	Yes	Yes	Yes	Yes	Yes	Yes	Yes	Yes	Yes	Yes	Yes	Yes	Yes
<i>Pinus palustris</i>		0	32	21	0	0	170	21	21	74	0	11	286	21	0	0	0	0	0	0	0
<i>Pinus elliotii</i>		0	0	74	21	0	0	0	21	0	0	0	0	0	0	0	21	0	21	42	42
<i>Pinus taeda</i>		0	0	0	0	0	0	0	0	0	0	0	0	117	42	0	0	0	0	0	0
<i>Pinus serotina</i>		0	0	0	0	0	0	11	0	11	233	43	0	0	32	0	0	0	0	0	0
<i>Taxodium ascendens</i>		0	0	0	0	0	0	32	0	0	0	53	0	0	0	85	11	116	11	22	22
<i>Nyssa biflora</i>		0	0	0	0	0	0	0	0	0	0	0	0	0	0	0	21	11	0	0	0
<i>Acer rubrum</i>		0	0	0	0	0	0	0	0	0	0	0	0	0	0	0	0	0	0	0	0
<i>Quercus pumila</i>		0	0	0	0	0	0	0	0	0	0	0	0	0	0	0	0	0	0	0	0
<i>Ilex myrtifolia</i>		0	0	0	0	0	0	0	0	0	0	0	0	0	0	0	0	0	0	0	0
Total Density		0	32	95	21	0	170	64	42	85	233	106	286	138	74	85	53	127	32	64	64

MIDCANOPY

Site		AL50	AL51	FL52	FL55	FL56	NC65	NC66	NC67	NC68	NC69	NC70	SC2	SC11	SC4	SC23	LA38	AL47	FL54	FL59	
Subclass		BPS	BPS	BPS	BPS	BPS	BPS	BPS	BPS	BPS	BPS	BPS	CPS	CPS	CPS	CPS	CPS	CPS	CPS	CPS	CPS
Unaltered: Yes, No, Not Applicable (N/A)		Yes	Yes	Yes	Yes	Yes	Yes	Yes	Yes	Yes	Yes	Yes	Yes	Yes	Yes	Yes	Yes	Yes	Yes	Yes	Yes
<i>Pinus palustris</i>		0	0	0	0	0	0	0	67	0	0	0	37	0	0	0	0	0	0	0	0
<i>Pinus elliotii</i>		0	0	0	0	0	0	0	0	0	0	0	0	0	0	0	133	0	200	0	0
<i>Pinus taeda</i>		0	0	0	0	0	0	0	0	0	0	0	11	0	0	0	0	0	0	0	0
<i>Pinus serotina</i>		0	0	0	0	0	0	67	0	0	67	133	0	0	64	0	0	0	0	0	0
<i>Taxodium ascendens</i>		0	0	0	0	0	0	0	0	0	0	0	0	0	0	11	67	266	67	267	267
<i>Nyssa biflora</i>		0	0	0	0	0	0	0	0	0	0	0	0	0	0	0	0	67	67	0	0
<i>Acer rubrum</i>		0	0	0	0	0	0	0	0	0	0	0	0	0	0	0	0	0	0	0	0
<i>Quercus pumila</i>		0	0	0	0	0	0	0	0	0	0	0	0	0	0	0	0	0	0	0	0
<i>Cyrilla racemosa</i>		0	0	0	0	0	0	0	0	0	0	0	0	0	0	0	267	0	0	0	0
<i>Ilex myrtifolia</i>		0	0	0	0	0	0	0	0	0	0	0	0	0	0	0	0	0	0	0	0
<i>Persea borbonia</i>		0	0	0	0	0	0	0	0	0	0	0	0	0	0	0	0	0	0	0	0
Total Density		0	0	0	0	0	0	67	67	0	67	133	48	64	11	467	333	334	267	267	267

Table E3

Site		GA60	SCI	SC3	SC12	SC14	SC16	SC21	SC25	LA29	LA30	TX31	TX32	TX34	TX35	MS39	MS40i	MS40m	AL45	FL53
Subclass	CPS	BPS	BPS	BPS	BPS	BPS	BPS	BPS	BPS	BPS	BPS	BPS	BPS	BPS	BPS	BPS	BPS	BPS	BPS	BPS
Unaltered: Yes, No, Not Applicable (N/A)		Yes	No	No	No	No	No	No	No	No	No	No	No	No	No	No	No	No	No	No
<i>Pinus palustris</i>	0	191	0	32	0	0	0	0	0	0	0	0	32	0	0	0	0	0	0	0
<i>Pinus elliotii</i>	0	0	0	74	0	533	0	11	0	117	169	0	0	0	0	0	0	0	0	127
<i>Pinus taeda</i>	0	0	16	95	0	0	0	0	0	0	0	0	0	0	0	0	0	0	0	0
<i>Pinus serotina</i>	0	0	0	0	0	0	0	0	0	0	0	0	0	0	0	0	0	0	0	0
<i>Taxodium ascendens</i>	158	0	0	0	0	0	0	0	0	0	0	0	0	0	0	0	0	0	0	0
<i>Nyssa biflora</i>	0	0	0	42	0	0	0	0	0	0	0	0	0	0	11	0	0	0	0	0
<i>Acer rubrum</i>	32	0	0	64	0	0	0	0	0	0	0	0	0	0	0	0	0	0	0	0
<i>Quercus pumila</i>	0	16	0	0	0	0	0	0	0	0	0	0	0	0	0	0	0	0	0	0
<i>Ilex myrtifolia</i>	11	0	0	0	0	0	0	0	0	0	0	0	0	0	0	0	0	0	0	0
Total Density	201	207	16	233	74	533	0	11	0	32	117	180	0	0	0	0	0	0	0	127

MIDCANOPY

Site		GA60	SCI	SC3	SC12	SC14	SC16	SC21	SC25	LA29	LA30	TX31	TX32	TX34	TX35	MS39	MS40i	MS40m	AL45	FL53
Subclass	CPS	BPS	BPS	BPS	BPS	BPS	BPS	BPS	BPS	BPS	BPS	BPS	BPS	BPS	BPS	BPS	BPS	BPS	BPS	BPS
Unaltered: Yes, No, Not Applicable (N/A)		Yes	No	No	No	No	No	No	No	No	No	No	No	No	No	No	No	No	No	No
<i>Pinus palustris</i>	0	48	64	0	0	0	0	0	0	0	0	0	67	0	0	0	0	0	0	0
<i>Pinus elliotii</i>	0	0	0	0	0	0	0	0	0	0	0	0	0	0	0	0	0	0	0	11
<i>Pinus taeda</i>	0	0	95	0	0	0	0	0	0	0	0	67	0	0	0	0	0	0	0	0
<i>Pinus serotina</i>	0	0	0	0	0	0	0	0	0	0	0	0	0	0	0	0	0	0	0	0
<i>Taxodium ascendens</i>	0	0	0	0	0	0	0	0	0	0	0	0	0	0	0	0	0	0	0	0
<i>Nyssa biflora</i>	0	0	0	85	0	0	11	0	0	0	0	0	0	0	0	0	0	0	0	0
<i>Acer rubrum</i>	0	0	0	0	0	0	32	0	0	0	0	0	0	0	0	0	0	0	0	0
<i>Quercus pumila</i>	0	0	0	0	0	0	0	0	21	0	0	0	0	0	0	0	0	0	0	0
<i>Cyrilla racemosa</i>	0	0	0	0	0	0	0	0	0	0	0	0	0	0	0	0	0	0	0	0
<i>Ilex myrtifolia</i>	0	0	0	0	0	0	0	0	0	0	0	0	0	0	0	0	0	0	0	0
<i>Persea borbonia</i>	0	0	0	0	0	0	0	0	0	0	0	0	67	0	0	0	0	0	0	0
Total Density	0	48	159	85	0	0	64	0	21	0	0	67	134	0	0	0	0	0	0	11

Table E3

Site		FL57	FL58	GA61	GA62	GA63	NC71	NC72	SC22	LA26	LA27	LA28	SC8	AL46	SC9
Subclass	BPS	BPS	BPS	BPS	BPS	BPS	SPS	BPS	SPS	SPS	SSS	FWP	N/A	N/A	OUT
Unaltered: Yes, No,		No	No	No	No	No	No	No	No	N/A	N/A	N/A	N/A	N/A	N/A
Not Applicable (N/A)		No	No	No	No	No	No	No	No	N/A	N/A	N/A	N/A	N/A	N/A
<i>Pinus palustris</i>	0	0	0	11	74	74	0	0	0	21	0	0	296	106	149
<i>Pinus elliotii</i>	689	0	0	42	21	0	0	0	0	127	11	0	1	11	0
<i>Pinus taeda</i>	0	0	0	0	0	0	0	0	0	0	0	0	0	0	21
<i>Pinus serotina</i>	0	0	0	0	0	11	0	0	0	0	0	0	0	0	0
<i>Taxodium ascendens</i>	0	0	0	0	42	0	0	0	0	0	0	0	0	0	0
<i>Nyssa biflora</i>	0	0	0	0	11	0	0	0	0	0	0	0	10	0	0
<i>Acer rubrum</i>	0	0	0	0	0	0	0	0	0	0	0	0	0	0	0
<i>Quercus pumila</i>	0	0	0	0	0	0	0	0	0	0	0	0	0	0	0
<i>Ilex myrtifolia</i>	0	0	0	0	0	0	0	0	0	0	0	0	0	0	0
Total Density	689	0	0	53	148	85	0	0	0	148	11	0	307	117	170

MIDCANOPY

Site		FL57	FL58	GA61	GA62	GA63	NC71	NC72	SC22	LA26	LA27	LA28	SC8	AL46	SC9
Subclass	BPS	BPS	BPS	BPS	BPS	BPS	SPS	BPS	CPS	SPS	SPS	FWP	NJD	NJD	OUT
Unaltered: Yes, No,		No	No	No	No	No	No	No	No	N/A	N/A	N/A	N/A	N/A	N/A
Not Applicable (N/A)		No	No	No	No	No	No	No	No	N/A	N/A	N/A	N/A	N/A	N/A
<i>Pinus palustris</i>	0	0	0	0	0	0	0	600	0	0	0	0	11	0	0
<i>Pinus elliotii</i>	200	600	0	0	0	0	0	0	0	0	0	0	0	0	0
<i>Pinus taeda</i>	0	0	0	0	0	0	133	0	0	0	0	0	0	0	21
<i>Pinus serotina</i>	0	0	0	0	0	0	0	0	0	0	0	0	0	0	0
<i>Taxodium ascendens</i>	0	0	0	0	67	0	0	0	0	0	0	0	0	0	0
<i>Nyssa biflora</i>	0	0	0	0	0	0	0	0	0	0	67	0	0	0	0
<i>Acer rubrum</i>	0	0	0	0	0	0	0	0	0	0	0	0	0	0	0
<i>Quercus pumila</i>	0	0	0	0	0	0	0	0	0	0	0	0	0	0	0
<i>Cyrilla racemosa</i>	0	0	0	0	0	0	0	0	0	0	0	0	0	0	0
<i>Ilex myrtifolia</i>	0	0	0	0	0	0	0	0	0	0	0	0	0	0	0
<i>Persea borbonia</i>	0	0	0	0	0	0	0	0	0	0	0	0	0	0	0
Total Density	200	600	0	0	67	0	733	0	0	0	67	0	11	0	21

Table E4

Table E4. Density of Subcanopy Strata for Wet Pine Flats on Mineral Soil. BPS = Bunchgrass/Pine Savanna, SCS = Switchcane/Pine Savanna, CPS = Cypress/Pine Savanna, SSS = Seepage Slope/Pine Savanna, FWP = Flatwoods Pond, N/A = Not Applicable, OUT = outlier.

Site	SC5		SC6		SC7		SC10		SC13		SC15		SC17		SC18		SC19		SC20		SC24		LA37		MS400		MS41		MS42		MS43		AL44		AL48					
	BPS	Yes	BPS	Yes	BPS	Yes	BPS	Yes	BPS	Yes	BPS	Yes	BPS	Yes	BPS	Yes	BPS	Yes	BPS	Yes	BPS	Yes	BPS	Yes	BPS	Yes	BPS	Yes	BPS	Yes	BPS	Yes	BPS	Yes	BPS	Yes				
<i>Ilex glabra</i>	1,528	0	0	0	0	0	0	0	0	0	0	0	0	0	0	0	0	0	0	0	0	0	0	0	0	0	0	0	0	0	0	0	0	0	0	0	0	0		
<i>Magnolia virginiana</i>	594	0	0	0	0	0	0	0	0	0	0	0	0	0	0	0	0	0	0	0	0	0	0	0	0	0	0	0	0	0	0	0	0	0	0	0	0	0	0	
<i>Myrica cerifera</i>	255	0	0	0	0	0	265	0	0	0	0	0	134	0	0	733	1,133	267	0	0	0	0	0	0	0	0	0	0	0	0	0	0	0	0	0	0	0	0	0	
<i>Ilex amelanchier</i>	0	0	0	0	0	0	0	0	0	0	0	0	0	0	0	0	0	0	0	0	0	0	0	0	0	0	0	0	0	0	0	0	0	0	0	0	0	0	0	
<i>Ilex coriata</i>	0	0	0	0	0	0	0	0	0	0	0	0	0	0	0	0	0	0	0	0	0	0	0	0	0	0	0	0	0	0	0	0	0	0	0	0	0	0	0	
<i>Ilex myrtifolia</i>	0	0	0	0	0	0	0	0	0	0	0	0	0	0	0	0	0	0	0	0	0	0	0	0	0	0	0	0	0	0	0	0	0	0	0	0	0	0	0	
<i>Ilex vomitoria</i>	0	0	0	0	0	0	0	0	0	0	0	0	0	0	0	0	0	0	0	0	0	0	0	0	0	0	0	0	0	0	0	0	0	0	0	0	0	0	0	
<i>Lyonia lucida</i>	0	0	0	0	0	0	0	0	0	0	0	0	0	0	0	0	0	0	0	0	0	0	0	0	0	0	0	0	0	0	0	0	0	0	0	0	0	0	0	
<i>Myrica heterophylla</i>	0	0	0	0	0	0	0	0	0	0	0	0	0	0	0	0	0	0	0	0	0	0	0	0	0	0	0	0	0	0	0	0	0	0	0	0	0	0	0	
<i>Cliftonia monophylla</i>	0	0	0	0	0	0	0	0	0	0	0	0	0	0	0	0	0	0	0	0	0	0	0	0	0	0	0	0	0	0	0	0	0	0	0	0	0	0	0	
<i>Cyrtilla racemosa</i>	0	0	0	0	0	0	0	0	0	0	0	0	0	0	0	0	0	0	0	0	0	0	0	0	0	0	0	0	0	0	0	0	0	0	0	0	0	0	0	
<i>Diospyros virginiana</i>	0	0	0	0	0	0	0	0	0	0	0	0	67	0	0	0	0	0	0	0	0	0	0	0	0	0	0	0	0	0	0	0	0	0	0	0	0	0	0	
<i>Hypericum fasciculatum</i>	0	0	0	0	0	0	0	0	0	0	0	0	0	0	0	0	0	0	0	0	0	0	0	0	0	0	0	0	0	0	0	0	0	0	0	0	0	0	0	
<i>Persea borbonia</i>	0	0	0	0	0	0	0	0	0	0	0	0	0	0	0	0	0	0	0	0	0	0	0	0	0	0	0	0	0	0	0	0	0	0	0	0	0	0	0	
<i>Clethra alnifolia</i>	0	0	0	0	0	0	0	0	0	0	0	0	0	0	0	0	0	0	0	0	0	0	0	0	0	0	0	0	0	0	0	0	0	0	0	0	0	0	0	
<i>Quercus pumila</i>	0	0	0	0	0	0	0	0	0	0	0	0	0	0	0	0	0	0	0	0	0	0	0	0	0	0	0	0	0	0	0	0	0	0	0	0	0	0	0	
<i>Quercus geminata</i>	0	0	0	0	0	0	53	0	0	0	0	0	0	0	0	67	133	0	0	0	0	0	0	0	0	0	0	0	0	0	0	0	0	0	0	0	0	0		
<i>Rhus copallina</i>	85	0	0	0	0	0	0	0	0	0	0	0	0	0	0	0	0	0	0	0	0	0	0	0	0	0	0	0	0	0	0	0	0	0	0	0	0	0	0	
<i>Rhus vernix</i>	0	0	0	0	0	0	0	0	0	0	0	0	0	0	0	0	0	0	0	0	0	0	0	0	0	0	0	0	0	0	0	0	0	0	0	0	0	0	0	
<i>Rubus sp.</i>	0	0	0	0	0	0	0	0	0	0	0	0	0	0	0	0	0	0	0	0	0	0	0	0	0	0	0	0	0	0	0	0	0	0	0	0	0	0	0	
<i>Sorbus arbutifolia</i>	85	0	0	0	0	0	0	0	0	0	0	0	0	0	0	0	0	0	0	0	0	0	0	0	0	0	0	0	0	0	0	0	0	0	0	0	0	0	0	
<i>Vaccinium arboreum</i>	0	0	0	0	0	0	0	0	0	0	0	0	0	0	0	0	0	0	0	0	0	0	0	0	0	0	0	0	0	0	0	0	0	0	0	0	0	0	0	
<i>Vaccinium corymbosum</i>	170	0	0	0	0	0	0	0	0	0	0	0	0	0	0	0	0	0	0	0	0	0	0	0	0	0	0	0	0	0	0	0	0	0	0	0	0	0	0	
<i>Vaccinium sp.</i>	0	0	0	0	0	0	0	0	0	0	0	0	0	0	0	0	0	0	0	0	0	0	0	0	0	0	0	0	0	0	0	0	0	0	0	0	0	0	0	
<i>Viburnum dentatum</i>	0	0	0	0	0	0	0	0	0	0	0	0	0	0	0	0	0	0	0	0	0	0	0	0	0	0	0	0	0	0	0	0	0	0	0	0	0	0	0	
<i>Viburnum nudum</i>	0	0	0	0	0	0	0	0	0	0	0	0	0	0	0	0	0	0	0	0	0	0	0	0	0	0	0	0	0	0	0	0	0	0	0	0	0	0	0	
<i>Acer rubrum</i>	339	0	0	0	0	0	0	0	0	0	0	0	0	0	0	67	0	0	0	0	0	0	0	0	0	0	0	0	0	0	0	0	0	0	0	0	0	0	0	
<i>Liquidambar styraciflua</i>	2,885	0	0	0	0	0	138	0	0	0	0	0	67	0	0	0	0	0	0	0	0	0	0	0	0	0	0	0	0	0	0	0	0	0	0	0	0	0	0	
<i>Nyssa biflora</i>	467	0	0	0	0	0	11	0	0	0	0	0	0	0	0	0	0	0	0	0	0	0	0	0	0	0	0	0	0	0	0	0	0	0	0	0	0	0	333	
<i>Pinus taeda</i>	1,655	0	0	0	0	0	0	0	0	0	0	0	0	0	0	0	0	0	0	0	0	0	0	0	0	0	0	0	0	0	0	0	0	0	0	0	0	0	0	
<i>Pinus elliotii</i>	0	0	0	0	0	0	0	0	0	0	0	0	0	0	0	0	0	0	0	0	0	0	0	0	0	0	0	0	0	0	0	0	0	0	0	0	0	0		
<i>Pinus palustris</i>	0	11	340	0	0	0	0	0	0	0	0	0	0	0	0	0	66	0	0	0	0	200	0	0	0	0	0	0	0	0	0	0	0	133	0	0	0	134		
<i>Pinus serotina</i>	0	0	0	0	0	0	0	0	0	0	0	0	0	0	0	0	0	0	0	0	0	0	0	0	0	0	0	0	0	0	0	0	0	0	0	0	0	0		
<i>Pinus enchinata</i>	0	0	0	0	0	0	0	0	0	0	0	0	0	0	0	0	0	0	0	0	0	0	0	0	0	0	0	0	0	0	0	0	0	0	0	0	0	0	0	
<i>Quercus laurifolia</i>	42	0	0	0	0	0	21	0	0	0	0	0	0	0	0	0	0	0	0	0	0	0	0	0	0	0	0	0	0	0	0	0	0	0	0	0	0	0		
<i>Quercus nigra</i>	0	0	0	0	0	0	0	0	0	0	0	0	0	0	0	0	0	0	0	0	0	0	0	0	0	0	0	0	0	0	0	0	0	0	0	0	0	0	0	
<i>Taxodium ascendens</i>	0	0	0	0	0	0	0	0	0	0	0	0	0	0	0	0	0	0	0	0	0	0	0	0	0	0	0	0	0	0	0	0	0	0	0	0	0	0		
Total Density	8,105	11	340	0	0	0	488	0	0	267	1,001	1,531	267	200	267	200	1,600	67	0	0	0	0	0	0	0	0	0	0	0	0	0	0	0	0	0	0	0	0	67	467

Table E4

Site Subclass	FL53		FL57		FL58		GA61		GA62		GA63		NC71		NC72		SC22		LA26	LA27	LA28	SC8	AL46	SC9
	BPS	No	BPS	No	BPS	No	BPS	No	BPS	No	BPS	No	BPS	No	BPS	No	SSS	SSS	FWP	N/A	N/A	N/A	N/A	OUT
Unaltered: Yes, No, Not Applicable (N/A)																								
<i>Ilex glabra</i>	27,992	0	0	0	0	0	200	0	0	0	0	866	0	0	0	0	0	0	0	0	0	0	0	0
<i>Magnolia virginiana</i>	66	0	0	0	0	0	200	0	0	0	0	0	0	0	0	0	333	599	0	0	0	0	0	0
<i>Myrica cerifera</i>	0	0	0	0	0	0	533	0	0	0	0	0	0	0	0	0	1,600	0	0	0	0	0	0	0
<i>Ilex amelancther</i>	0	0	0	0	0	0	0	0	0	0	0	0	0	0	0	0	0	0	0	0	0	0	0	0
<i>Ilex coriacea</i>	66	0	0	0	0	0	0	0	0	0	0	0	0	0	0	0	733	0	0	0	0	0	0	0
<i>Ilex myrtifolia</i>	0	0	0	0	0	0	0	0	0	0	0	0	0	0	0	0	0	0	0	0	0	0	0	0
<i>Ilex vomitoria</i>	0	0	0	0	0	0	0	0	0	0	0	0	0	0	0	0	0	0	0	0	0	0	0	0
<i>Lyonia lucida</i>	0	0	0	0	0	0	0	0	0	0	0	0	0	0	0	0	0	0	0	0	0	0	0	0
<i>Myrica heterophylla</i>	0	0	0	0	0	0	0	0	0	0	0	0	0	0	0	0	0	0	0	0	0	0	0	0
<i>Cliffortia monophylla</i>	145	0	0	0	0	0	0	0	0	0	0	0	0	0	0	0	0	0	0	0	0	0	0	0
<i>Cyrilla racemosa</i>	0	0	0	0	0	0	0	0	0	0	0	0	0	0	0	0	0	0	0	0	0	0	0	0
<i>Diospyros virginiana</i>	0	0	0	0	0	0	0	0	0	0	0	0	0	0	0	0	667	599	0	0	0	0	0	0
<i>Hypericum fasciculatum</i>	0	0	0	0	0	0	0	0	0	0	0	0	0	0	0	0	0	0	0	0	0	0	0	0
<i>Persea borbonia</i>	66	0	0	0	0	0	0	0	0	0	0	67	0	0	0	0	0	0	0	0	0	0	0	0
<i>Clethra alnifolia</i>	0	0	0	0	0	0	0	0	0	0	0	0	0	0	0	0	0	0	0	0	0	0	0	0
<i>Quercus pumila</i>	0	0	0	0	0	0	0	0	0	0	0	0	0	0	0	0	0	0	0	0	0	0	0	0
<i>Quercus geminata</i>	0	0	0	0	0	0	0	0	0	0	0	0	0	0	0	0	0	0	0	0	0	0	0	0
<i>Rhus copallina</i>	0	0	0	0	0	0	0	0	0	0	0	0	0	0	0	0	0	0	0	0	0	0	0	0
<i>Rhus vernix</i>	0	0	0	0	0	0	0	0	0	0	0	0	0	0	0	0	0	0	0	0	0	0	0	0
<i>Rubus sp.</i>	0	0	0	0	0	0	0	0	0	0	0	0	0	0	0	0	600	0	0	0	0	0	0	0
<i>Sorbus arbutifolia</i>	0	0	0	0	0	0	0	0	0	0	0	0	0	0	0	0	667	0	0	0	0	0	0	0
<i>Vaccinium arboreum</i>	66	0	0	0	0	0	0	0	0	0	0	0	0	0	0	0	0	0	0	0	0	0	0	0
<i>Vaccinium corymbosum</i>	533	0	0	0	0	0	0	0	0	0	200	0	0	0	0	0	0	0	0	0	0	0	0	0
<i>Vaccinium sp.</i>	0	0	0	0	0	0	0	0	0	0	0	0	0	0	0	0	0	0	0	0	0	0	0	0
<i>Viburnum dentatum</i>	0	0	0	0	0	0	0	0	0	0	0	0	0	0	0	0	0	0	0	0	0	0	0	0
<i>Viburnum nudum</i>	0	0	0	0	0	0	0	0	0	0	0	0	0	0	0	0	0	0	0	0	0	0	0	0
<i>Acer rubrum</i>	0	0	0	0	0	0	0	0	0	0	0	0	0	0	0	0	0	0	0	0	0	0	0	0
<i>Liquidambar styraciflua</i>	0	0	0	0	0	0	0	0	0	0	133	267	0	0	0	0	0	0	0	0	0	0	0	0
<i>Nyssa biflora</i>	66	0	0	0	0	0	0	0	0	0	0	0	0	0	0	0	667	1,201	0	0	0	0	0	0
<i>Pinus taeda</i>	0	0	0	0	0	0	0	0	0	0	0	133	0	0	0	0	0	0	0	0	0	0	0	0
<i>Pinus elliotii</i>	0	0	600	0	0	0	267	0	0	0	0	0	0	0	0	0	0	0	0	0	0	0	0	0
<i>Pinus palustris</i>	0	0	0	0	0	67	0	0	0	0	0	467	0	0	0	0	0	0	0	0	0	0	0	0
<i>Pinus serotina</i>	0	0	0	0	0	0	0	0	0	0	0	0	0	0	0	0	0	0	0	0	0	0	0	0
<i>Pinus enchinata</i>	0	0	0	0	0	0	0	0	0	0	0	0	0	0	0	0	0	0	0	0	0	0	0	0
<i>Quercus laurifolia</i>	0	0	0	0	0	0	0	0	0	0	0	0	0	0	0	0	0	0	0	0	0	0	0	0
<i>Quercus nigra</i>	66	0	0	0	0	0	0	0	0	0	0	0	0	0	0	0	0	0	0	0	0	0	0	0
<i>Taxodium ascendens</i>	0	0	0	0	0	0	0	133	0	0	0	0	0	0	0	0	0	0	0	0	0	0	0	0
Total Density	29,066	0	600	67	0	1,333	333	1,867	0	5,267	2,800	0	0	0	0	0	0	0	0	0	0	0	0	0

Indicator species	SC1	SC2	SC3	SC4	SC5	SC6	SC7	SC8	SC9	SC10	SC11	SC12	SC13	SC14	SC15	SC16	SC17	SC18	SC19	SC20	SC21
<i>Aster dumosus</i>	0.3	0.0	0.3	0.0	0.0	0.0	0.3	0.0	0.8	1.0	0.7	0.0	0.3	0.0	0.1	0.0	0.0	0.3	0.3	0.0	0.3
<i>Aster eryngifolius</i>	0.0	0.0	0.0	0.0	0.0	0.0	0.0	0.0	0.0	0.0	0.0	0.0	0.0	0.0	0.0	0.0	0.0	0.0	0.0	0.0	0.0
<i>Aster linariifolius</i>	0.2	0.0	0.0	0.0	0.0	0.0	0.0	0.0	0.8	0.0	0.0	0.0	0.0	0.0	0.0	0.0	0.0	0.0	0.0	0.0	0.0
<i>Aster paludosus</i>	0.0	0.0	0.0	0.0	0.0	0.0	0.0	0.0	0.0	0.0	0.0	0.0	0.0	0.0	0.0	0.0	0.0	0.0	0.0	0.0	0.0
<i>Aster sclerosus</i>	0.0	0.0	0.0	0.0	0.0	0.0	0.0	0.0	0.0	0.0	0.0	0.0	0.0	0.0	0.0	0.0	0.0	0.0	0.0	0.0	0.0
<i>Aster sp. 1</i>	0.2	0.0	0.0	0.4	0.0	0.4	0.8	0.3	0.0	0.0	0.0	0.0	0.0	0.0	0.0	0.0	0.0	0.0	0.0	0.0	0.0
<i>Aster sp. 2</i>	0.0	0.0	0.0	0.0	0.3	0.2	0.3	0.0	0.0	0.0	0.0	0.0	0.0	0.0	0.0	0.0	0.0	0.0	0.0	0.0	0.0
<i>Aster verticillata</i>	0.0	0.0	0.0	0.0	0.0	0.0	0.0	0.0	0.0	0.0	0.0	0.0	0.0	0.0	0.0	0.0	0.0	0.0	0.0	0.0	0.0
<i>Bacopa caroliniana</i>	0.0	0.0	0.0	0.0	0.0	0.0	0.0	0.0	0.0	0.0	0.0	0.0	0.0	0.0	0.0	0.0	0.0	0.0	0.0	0.0	0.0
<i>Balduna uniflora</i>	0.0	0.0	0.0	0.0	0.0	0.0	0.0	0.0	0.0	0.0	0.0	0.0	0.0	0.0	0.0	0.0	0.0	0.0	0.0	0.0	0.0
<i>Bartonia virginica</i>	0.0	0.0	0.0	0.0	0.0	0.0	0.0	0.0	0.0	0.0	0.0	0.0	0.0	0.0	0.0	0.0	0.0	0.0	0.0	0.0	0.0
<i>Berchemia scandens</i>	0.0	0.0	0.0	0.0	0.0	0.0	0.0	0.0	0.0	0.0	0.0	0.0	0.0	0.0	0.0	0.0	0.0	0.0	0.0	0.0	0.0
<i>Bidens bipinnata</i>	0.0	0.0	0.0	0.0	0.0	0.0	0.0	0.0	0.0	0.0	0.0	0.0	0.0	0.0	0.0	0.0	0.0	0.0	0.0	0.0	0.0
<i>Bidens mitis</i>	0.0	0.0	0.0	0.0	0.0	0.0	0.0	0.0	0.0	0.0	0.0	0.0	0.0	0.0	0.0	0.0	0.0	0.0	0.0	0.0	0.0
<i>Bidens sp.</i>	0.0	0.0	0.0	0.0	0.0	0.0	0.0	0.0	0.0	0.0	0.0	0.0	0.0	0.0	0.0	0.0	0.0	0.0	0.0	0.0	0.0
<i>Boltonia asteroides</i>	0.0	0.0	0.0	0.0	0.0	0.0	0.0	0.0	0.0	0.0	0.0	0.0	0.0	0.0	0.0	0.0	0.0	0.0	0.0	0.0	0.0
<i>Cacalia lanceolata</i>	0.3	0.0	0.0	0.0	0.0	0.0	0.0	0.0	0.0	0.0	0.0	0.0	0.0	0.0	0.0	0.0	0.0	0.0	0.0	0.0	0.0
<i>Calopogon sp.</i>	0.0	0.0	0.0	0.0	0.0	0.0	0.0	0.0	0.0	0.0	0.0	0.0	0.0	0.0	0.0	0.0	0.0	0.0	0.0	0.0	0.0
<i>Calopogon tuberosus</i>	0.0	0.0	0.0	0.0	0.0	0.0	0.0	0.0	0.0	0.0	0.0	0.0	0.0	0.0	0.0	0.0	0.0	0.0	0.0	0.0	0.0
<i>Carex crinita</i>	0.0	0.0	0.0	0.0	0.0	0.0	0.0	0.0	0.0	0.0	0.0	0.0	0.0	0.0	0.0	0.0	0.0	0.0	0.0	0.0	0.0
<i>Carex glaucescens</i>	0.0	0.0	0.0	0.0	0.0	0.0	0.0	0.0	0.0	0.0	0.0	0.0	0.0	0.0	0.0	0.0	0.0	0.0	0.0	0.0	0.0
<i>Carex sp.</i>	0.3	0.6	0.0	1.0	0.0	0.0	0.0	0.0	0.0	0.0	0.0	0.0	0.2	0.8	0.2	0.0	0.0	0.0	0.0	0.0	0.1
<i>Centella asiatica/erecta</i>	1.0	0.3	0.7	0.8	1.0	0.7	0.7	0.2	0.0	0.7	0.0	0.0	0.0	0.0	0.0	0.3	0.3	0.0	0.0	0.0	0.0
<i>Chrysopsis sp. (Heterotheca)</i>	0.0	0.0	0.0	0.0	0.0	0.0	0.0	0.0	0.0	0.0	0.0	0.0	0.0	0.0	0.0	0.0	0.0	0.0	0.0	0.0	0.0
<i>Cirsium lecontei</i>	0.0	0.0	0.0	0.0	0.0	0.0	0.0	0.0	0.0	0.0	0.0	0.0	0.0	0.0	0.0	0.0	0.0	0.0	0.0	0.0	0.0
<i>Cirsium sp.</i>	0.0	0.0	0.0	0.0	0.0	0.0	0.0	0.0	0.0	0.0	0.0	0.0	0.0	0.0	0.0	0.0	0.0	0.0	0.0	0.0	0.0
<i>Cleistes divaricata</i>	0.0	0.0	0.0	0.0	0.0	0.0	0.0	0.0	0.0	0.0	0.2	0.0	0.0	0.0	0.0	0.0	0.0	0.0	0.0	0.0	0.0
<i>Coreopsis falcata</i>	0.0	0.0	0.0	0.7	0.0	0.0	0.3	0.0	0.0	0.0	0.0	0.0	0.0	0.0	0.0	0.0	0.0	0.0	0.0	0.0	0.0
<i>Cuscuta sp.</i>	0.0	0.0	0.0	0.0	0.0	0.0	0.0	0.0	0.0	0.0	0.0	0.0	0.0	0.0	0.0	0.0	0.0	0.0	0.0	0.0	0.0
<i>Cynoclonium sessilifolium</i>	0.0	0.0	0.0	0.0	0.0	0.0	0.0	0.0	0.0	0.0	0.0	0.0	0.0	0.0	0.0	0.0	0.0	0.0	0.0	0.0	0.0
<i>Cyperus haspan</i>	0.0	0.0	0.0	0.0	0.0	0.0	0.0	0.0	0.0	0.0	0.0	0.0	0.0	0.0	0.0	0.0	0.0	0.0	0.0	0.0	0.0
<i>Cyperus pseudovegetus</i>	0.0	0.0	0.0	0.0	0.0	0.0	0.0	0.0	0.0	0.0	0.0	0.0	0.0	0.0	0.0	0.0	0.0	0.0	0.0	0.0	0.0
<i>Cyperus sp.</i>	0.0	0.0	0.0	0.0	0.0	0.0	0.0	0.0	0.0	0.0	0.0	0.0	0.0	0.0	0.0	0.0	0.0	0.0	0.0	0.0	0.0
<i>Dicanthellum aciculare</i>	0.0	0.0	0.0	0.0	0.0	0.0	0.0	0.0	0.0	0.0	0.0	0.0	0.2	0.0	0.0	0.0	0.0	0.0	0.0	0.0	0.0
<i>Dicanthellum acuminata</i>	0.3	0.0	0.4	0.4	0.0	0.2	0.4	0.0	0.0	0.0	0.0	0.2	0.2	0.3	0.1	0.7	0.0	0.4	0.2	0.7	0.3
<i>Dicanthellum consanguinum</i>	0.4	0.0	0.0	0.0	0.0	0.3	0.0	0.3	0.0	0.0	0.0	0.0	0.0	0.2	0.0	0.0	0.0	0.0	0.0	0.0	0.0
<i>Dicanthellum ensifolium</i>	0.0	0.3	0.0	0.0	0.0	0.0	0.0	0.0	0.0	0.0	0.0	0.0	0.0	0.0	0.0	0.0	0.0	0.0	0.0	0.0	0.0
<i>Dicanthellum scabrosiculum</i>	0.0	0.0	0.8	0.8	0.0	0.0	0.0	0.0	0.0	0.0	0.0	0.0	0.0	0.0	0.0	0.0	0.0	0.0	0.0	0.0	0.4
<i>Dicanthellum scoparium</i>	0.0	0.0	0.0	0.0	0.0	0.0	0.0	0.0	0.0	0.0	0.0	0.0	0.0	0.0	0.0	0.0	0.0	0.0	0.0	0.0	0.0
<i>Dicanthellum sp. 1</i>	0.0	0.0	0.0	0.0	0.0	0.0	0.0	0.0	0.0	0.0	0.0	0.0	0.0	0.0	0.0	0.0	0.0	0.0	0.0	0.0	0.0
<i>Dicanthellum sp. 2</i>	0.0	0.0	0.0	0.0	0.0	0.0	0.0	0.0	0.0	0.0	0.0	0.0	0.0	0.0	0.0	0.0	0.0	0.0	0.0	0.0	0.0
<i>Dicanthellum sp. 3</i>	0.0	0.0	0.0	0.0	0.0	0.0	0.0	0.0	0.0	0.0	0.0	0.0	0.0	0.0	0.0	0.0	0.0	0.0	0.0	0.0	0.0
<i>Dicanthellum strigosum</i>	0.0	0.0	0.0	0.0	0.0	0.4	0.2	0.8	0.3	0.7	0.0	0.0	1.0	0.2	0.3	0.0	0.0	0.0	0.2	0.3	0.0
<i>Dicanthellum tenue</i>	0.7	0.0	0.0	0.0	0.7	1.0	0.0	0.0	0.0	1.0	1.0	0.2	0.8	0.0	0.2	0.0	0.7	0.8	1.0	0.8	0.7

Indicator species	SC1	SC2	SC3	SC4	SC5	SC6	SC7	SC8	SC9	SC10	SC11	SC12	SC13	SC14	SC15	SC16	SC17	SC18	SC19	SC20	SC21
<i>Dichromena colorata</i>	0.0	0.0	0.0	0.0	0.0	0.0	0.0	0.0	0.0	0.0	0.0	0.0	0.0	0.0	0.0	0.0	0.0	0.0	0.0	0.0	0.0
<i>Dichromena latifolia</i>	0.0	0.0	0.0	0.0	0.0	0.0	0.0	0.0	0.0	0.0	0.0	0.0	0.0	0.0	0.0	0.0	0.0	0.0	0.0	0.0	0.0
<i>Dichromena</i> sp.	0.0	0.0	0.0	0.3	0.0	0.0	0.0	0.0	0.0	0.0	0.0	0.0	0.0	0.0	0.0	0.0	0.0	0.0	0.0	0.0	0.0
<i>Diodia virginiana</i>	0.0	0.0	0.0	0.0	0.0	0.0	0.0	0.0	0.0	0.0	0.0	0.0	0.0	0.0	0.0	0.0	0.0	0.0	0.0	0.0	0.0
<i>Dionaea muscipula</i>	0.0	0.0	0.0	0.0	0.0	0.0	0.0	0.0	0.0	0.0	0.0	0.0	0.0	0.0	0.0	0.0	0.0	0.0	0.0	0.0	0.0
<i>Drosera</i> sp.	0.6	0.0	0.4	0.0	0.4	0.8	0.8	0.2	0.3	0.7	0.7	0.0	0.7	0.0	0.2	0.0	0.7	0.8	1.0	0.3	0.0
<i>Eleocharis</i> sp.	0.0	0.0	0.0	0.0	0.0	0.0	0.0	0.0	0.0	0.0	0.0	0.0	0.0	0.3	0.1	0.0	0.0	0.0	0.0	0.0	0.0
<i>Elephantopus</i> sp.	0.0	0.0	0.0	0.0	0.0	0.0	0.0	0.3	0.3	0.0	0.0	0.0	0.0	0.0	0.0	0.0	0.0	0.0	0.0	0.0	0.0
<i>Eragrostis spectabilis</i>	0.0	0.0	0.0	0.0	0.0	0.0	0.0	0.0	0.0	0.0	0.0	0.0	0.0	0.0	0.0	0.0	0.0	0.0	0.0	0.0	0.0
<i>Erechtites hieracifolia</i>	0.0	0.0	0.0	0.0	0.0	0.0	0.0	0.0	0.0	0.0	0.0	0.0	0.0	0.0	0.0	0.0	0.0	0.0	0.0	0.0	0.0
<i>Erianthus contortus</i>	0.0	0.0	0.0	0.0	0.0	0.0	0.0	0.3	0.0	0.0	0.0	0.0	0.0	0.0	0.0	0.0	0.0	0.0	0.0	0.0	0.0
<i>Erianthus giganteus</i>	0.7	0.2	0.3	0.0	0.3	0.0	0.0	0.7	0.0	0.0	0.4	0.0	0.0	0.7	0.1	0.0	0.0	0.0	0.0	0.0	0.0
<i>Erianthus</i> sp.	0.0	0.0	0.0	0.0	0.0	0.0	0.0	0.0	0.0	0.0	0.3	0.3	0.0	0.8	0.2	0.0	0.3	0.3	0.0	0.0	0.3
<i>Eupatorium capillifolium</i>	0.0	0.0	0.0	0.0	0.0	0.0	0.0	0.0	0.0	0.0	0.0	0.0	0.0	0.0	0.0	0.0	0.0	0.0	0.0	0.0	0.0
<i>Eupatorium compositifolium</i>	0.0	0.0	0.0	0.0	0.0	0.0	0.0	0.0	0.0	0.0	0.0	0.0	0.0	0.0	0.0	0.0	0.0	0.0	0.2	0.0	0.0
<i>Eupatorium recurvans</i>	0.0	0.0	0.0	0.0	0.0	0.0	0.0	0.0	0.0	0.0	0.0	0.0	0.0	0.0	0.0	0.0	0.0	0.0	0.0	0.0	0.0
<i>Eupatorium pilosum</i>	0.0	0.0	0.0	0.0	0.0	0.3	0.3	0.7	0.4	0.7	0.3	0.0	0.0	0.0	0.0	0.0	0.0	0.0	0.3	0.0	0.0
<i>Eupatorium rotundifolium</i>	0.0	0.0	0.0	0.0	0.0	0.0	0.0	0.0	0.0	0.0	0.0	0.0	0.0	0.0	0.0	0.0	0.0	0.0	0.0	0.0	0.0
<i>Eupatorium semiserratum</i>	0.0	0.0	0.0	0.0	0.0	0.0	0.0	0.0	0.0	0.0	0.0	0.0	0.0	0.0	0.0	0.0	0.0	0.0	0.0	0.0	0.0
<i>Eupatorium</i> sp.	0.0	0.0	0.0	0.0	0.0	0.0	0.0	0.0	0.0	0.0	0.0	0.0	0.0	0.5	0.0	0.0	0.0	0.0	0.0	0.0	0.0
<i>Euphorbia inundata</i>	0.0	0.0	0.0	0.0	0.0	0.0	0.0	0.0	0.0	0.0	0.0	0.0	0.0	0.0	0.0	0.0	0.0	0.0	0.0	0.0	0.0
<i>Euthamia leptcephala</i>	0.0	0.0	0.0	0.0	0.0	0.0	0.0	0.0	0.0	0.0	0.0	0.0	0.0	0.0	0.0	0.0	0.0	0.0	0.0	0.0	0.0
<i>Euthamia minor</i>	0.0	0.0	0.0	0.0	0.0	0.0	0.0	0.0	0.0	0.0	0.0	0.0	0.0	0.0	0.0	0.0	0.0	0.0	0.0	0.0	0.0
<i>Euthamia</i> sp.	0.0	0.0	0.0	0.0	0.0	0.0	0.0	0.0	0.0	0.0	0.0	0.0	0.0	0.0	0.0	0.0	0.0	0.0	0.0	0.0	0.0
<i>Euthamia tenuifolia</i>	0.0	0.0	0.0	0.0	0.0	0.0	0.0	0.0	0.0	0.0	0.0	0.0	0.0	0.0	0.0	0.0	0.0	0.0	0.0	0.0	0.0
<i>Fimbristylis puberula</i>	0.0	0.0	0.0	0.0	0.0	0.8	0.0	0.0	0.0	0.0	0.0	0.0	0.0	0.0	0.0	0.0	0.0	0.0	0.0	0.0	0.0
<i>Fuirena pumila</i>	0.0	0.0	0.0	0.0	0.0	0.0	0.0	0.0	0.0	0.0	0.0	0.0	0.0	0.0	0.0	0.0	0.0	0.0	0.0	0.0	0.0
<i>Fuirena</i> sp.	0.0	0.0	0.0	0.0	0.0	0.0	0.0	0.0	0.0	0.0	0.0	0.0	0.0	0.0	0.0	0.0	0.0	0.0	0.0	0.0	0.0
<i>Fuirena squarrosa</i>	0.0	0.0	0.0	0.0	0.0	0.0	0.0	0.0	0.0	0.0	0.0	0.0	0.0	0.0	0.0	0.0	0.0	0.0	0.0	0.0	0.0
<i>Gelsemium sempervirens</i>	0.0	0.0	0.0	0.0	0.0	0.0	0.0	0.0	0.0	0.0	0.0	0.0	0.0	0.0	0.0	0.0	0.0	0.0	0.0	0.0	0.0
<i>Gratiola pilosa</i>	0.0	0.0	0.0	0.0	0.0	0.0	0.0	0.0	0.0	0.0	0.0	0.0	0.0	0.0	0.0	0.0	0.0	0.0	0.0	0.0	0.0
<i>Gymnopogon</i> sp.	0.0	0.0	0.0	0.0	0.0	0.0	0.2	0.0	0.0	0.0	0.0	0.0	0.0	0.0	0.0	0.0	0.0	0.0	0.0	0.0	0.0
<i>Habenaria</i> (esp. <i>ciliaris</i>)	0.2	0.0	0.0	0.0	0.0	0.0	0.0	0.0	0.3	0.6	0.6	0.0	0.0	0.0	0.0	0.0	0.0	0.0	0.0	0.0	0.0
<i>Habenaria</i> sp.	0.0	0.0	0.0	0.0	0.0	0.0	0.0	0.0	0.0	0.0	0.0	0.0	0.0	0.0	0.0	0.0	0.0	0.0	0.0	0.0	0.0
<i>Helenium</i> sp.	0.0	0.0	0.0	0.0	0.0	0.0	0.0	0.0	0.0	0.0	0.0	0.0	0.0	0.0	0.0	0.0	0.0	0.0	0.0	0.0	0.0
<i>Helenium vernale</i>	0.2	0.0	0.0	0.4	0.0	0.0	0.0	0.0	0.0	0.0	0.0	0.0	0.0	0.0	0.0	0.0	0.0	0.0	0.0	0.0	0.0
<i>Helianthus angustifolius</i>	0.0	0.0	0.0	0.0	0.0	0.0	0.0	0.0	0.4	0.8	0.0	0.0	0.0	0.0	0.0	0.0	0.0	0.3	0.7	0.0	0.0
<i>Hibiscus</i> sp.	0.0	0.0	0.0	0.0	0.0	0.0	0.0	0.0	0.0	0.0	0.0	0.0	0.0	0.0	0.0	0.0	0.0	0.0	0.0	0.0	0.0
<i>Hydrolea ovata</i>	0.0	0.0	0.0	0.0	0.0	0.0	0.0	0.0	0.0	0.0	0.0	0.0	0.0	0.0	0.0	0.0	0.0	0.0	0.0	0.0	0.0
<i>Hypericum brachyphyllum</i>	0.0	0.0	0.0	0.0	0.0	0.0	0.0	0.0	0.0	0.0	0.0	0.0	0.0	0.0	0.0	0.0	0.0	0.0	0.0	0.0	0.0
<i>Hypericum cistifolium</i>	0.0	0.0	0.0	0.0	0.0	0.0	0.0	0.0	0.0	0.0	0.0	0.0	0.0	0.0	0.0	0.0	0.0	0.0	0.0	0.0	0.0
<i>Hypericum setosum</i>	0.0	0.0	0.0	0.0	0.0	0.0	0.0	0.0	0.0	0.0	0.0	0.0	0.0	0.0	0.0	0.0	0.0	0.0	0.0	0.0	0.0
<i>Hypericum crux-andraee</i>	0.0	0.0	0.0	0.0	0.0	0.0	0.0	0.0	0.0	0.0	0.0	0.0	0.0	0.0	0.0	0.0	0.0	0.0	0.0	0.0	0.0
<i>Hypericum exile</i>	0.0	0.0	0.0	0.0	0.0	0.0	0.0	0.0	0.0	0.0	0.0	0.0	0.0	0.0	0.0	0.0	0.0	0.0	0.0	0.0	0.0

Indicator species	SC1	SC2	SC3	SC4	SC5	SC6	SC7	SC8	SC9	SC10	SC11	SC12	SC13	SC14	SC15	SC16	SC17	SC18	SC19	SC20	SC21
<i>Hypericum fasciculatum</i>	0.0	0.0	0.0	0.0	0.0	0.0	0.0	0.0	0.0	0.0	0.0	0.0	0.0	0.0	0.0	0.0	0.0	0.0	0.0	0.0	0.0
<i>Hypericum perforatum</i>	0.0	0.0	0.0	0.0	0.0	0.0	0.0	0.0	0.0	0.0	0.0	0.0	0.0	0.0	0.0	0.0	0.0	0.0	0.0	0.0	0.0
<i>Hypericum reductum</i>	0.0	0.0	0.0	0.0	0.0	0.0	0.0	0.0	0.0	0.0	0.0	0.0	0.0	0.0	0.0	0.0	0.0	0.0	0.0	0.0	0.0
<i>Hypericum sp.</i>	0.4	0.2	0.0	0.3	0.0	0.0	0.0	0.3	0.4	0.4	0.8	0.0	0.4	0.0	0.1	0.0	0.0	0.0	0.5	0.0	0.0
<i>Hypericum stans</i>	0.0	0.0	0.0	0.0	0.0	0.0	0.0	0.0	0.0	0.0	0.0	0.0	0.0	0.0	0.0	0.0	0.0	0.0	0.0	0.0	0.0
<i>Hypoxis micrantha</i>	0.7	0.0	0.0	0.0	0.0	0.4	0.0	0.3	0.4	0.4	0.0	0.0	0.0	0.0	0.0	0.0	0.0	0.0	0.0	0.0	0.0
<i>Hyptis alata</i>	0.0	0.0	0.0	0.0	0.0	0.0	0.0	0.0	0.0	0.0	0.0	0.0	0.0	0.0	0.0	0.0	0.0	0.0	0.0	0.0	0.0
<i>Iris sp.</i>	0.0	0.0	0.0	0.0	0.0	0.0	0.3	0.0	0.0	0.0	0.8	0.2	0.0	0.0	0.0	0.0	0.0	0.0	0.0	0.0	0.0
<i>Juncus biflorus</i>	0.0	0.0	0.0	0.0	0.0	0.0	0.0	0.0	0.0	0.0	0.0	0.0	0.0	0.0	0.0	0.0	0.0	0.0	0.0	0.0	0.0
<i>Juncus dichotomus</i>	0.0	0.0	0.0	0.0	0.0	0.0	0.0	0.0	0.0	0.0	0.0	0.0	0.0	0.0	0.0	0.0	0.0	0.0	0.0	0.0	0.0
<i>Juncus marginatus</i>	0.0	0.0	0.0	0.0	0.0	0.0	0.0	0.0	0.0	0.0	0.0	0.0	0.0	0.0	0.0	0.0	0.0	0.0	0.0	0.0	0.0
<i>Juncus polycephalus</i>	0.0	0.0	0.0	0.0	0.0	0.0	0.0	0.0	0.0	0.0	0.0	0.0	0.0	0.0	0.0	0.0	0.0	0.0	0.0	0.0	0.0
<i>Juncus sp. 1</i>	0.0	0.0	0.0	0.0	0.0	0.0	0.0	0.0	0.0	0.0	0.0	0.0	0.0	0.0	0.0	0.0	0.0	0.0	0.0	0.0	0.0
<i>Juncus sp. 2</i>	0.0	0.0	0.0	0.0	0.0	0.0	0.0	0.0	0.0	0.0	0.0	0.0	0.0	0.0	0.0	0.0	0.0	0.0	0.0	0.0	0.0
<i>Juncus sp. 3</i>	0.0	0.0	0.0	0.0	0.0	0.0	0.0	0.0	0.0	0.0	0.0	0.0	0.0	0.0	0.0	0.0	0.0	0.0	0.0	0.0	0.0
<i>Lachnanthes caroliniana</i>	0.0	0.3	0.3	0.0	0.7	0.3	0.8	0.0	0.0	0.3	0.3	0.0	0.4	0.0	0.1	1.0	0.7	1.0	0.4	0.8	0.4
<i>Lachnocaulon anceps</i>	0.0	0.0	0.0	0.0	0.0	0.0	0.0	0.0	0.0	0.0	0.0	0.0	0.0	0.0	0.0	0.0	0.0	0.0	0.0	0.0	0.0
<i>Lachnocaulon minus</i>	0.0	0.0	0.0	0.0	0.0	0.0	0.0	0.0	0.0	0.0	0.0	0.0	0.0	0.0	0.0	0.0	0.0	0.0	0.0	0.0	0.0
<i>Lachnocaulon sp.</i>	0.0	0.0	0.0	0.0	0.0	0.4	0.0	0.0	0.0	0.4	0.0	0.0	0.0	0.0	0.0	0.0	0.0	0.0	0.0	0.0	0.0
Lamiaceae sp.	0.0	0.0	0.0	0.0	0.2	0.0	0.0	0.0	0.0	0.0	0.0	0.0	0.0	0.0	0.0	0.0	0.0	0.0	0.0	0.0	0.0
<i>Lamium sp.</i>	0.0	0.0	0.0	0.2	0.0	0.0	0.0	0.0	0.0	0.0	0.0	0.0	0.0	0.0	0.0	0.0	0.0	0.0	0.0	0.0	0.0
<i>Leersia hexandra</i>	0.0	0.0	0.0	0.0	0.0	0.0	0.0	0.0	0.0	0.0	0.0	0.0	0.0	0.0	0.0	0.0	0.0	0.0	0.0	0.0	0.0
<i>Liatis acidota</i>	0.0	0.0	0.0	0.0	0.0	0.0	0.0	0.0	0.0	0.0	0.0	0.0	0.0	0.0	0.0	0.0	0.0	0.0	0.0	0.0	0.0
<i>Liatis gracilis</i>	0.0	0.0	0.0	0.0	0.0	0.0	0.0	0.0	0.0	0.0	0.0	0.0	0.0	0.0	0.0	0.0	0.0	0.0	0.0	0.0	0.0
<i>Liatis pycnostachya</i>	0.0	0.0	0.0	0.0	0.0	0.0	0.0	0.0	0.0	0.0	0.0	0.0	0.0	0.0	0.0	0.0	0.0	0.0	0.0	0.0	0.0
<i>Liatis spicata</i>	0.0	0.0	0.0	0.3	0.3	0.0	0.0	0.0	0.0	0.0	0.0	0.0	0.0	0.0	0.0	0.0	0.0	0.0	0.0	0.0	0.0
<i>Liatis sp.</i>	0.0	0.0	0.0	0.0	0.0	0.0	0.0	0.0	0.0	0.0	0.0	0.0	0.0	0.0	0.0	0.0	0.0	0.0	0.0	0.0	0.0
<i>Lilium catesbaei</i>	0.0	0.0	0.0	0.0	0.0	0.0	0.0	0.0	0.0	0.0	0.0	0.0	0.0	0.0	0.0	0.0	0.0	0.0	0.0	0.0	0.0
<i>Linum floridanum</i>	0.0	0.0	0.0	0.0	0.0	0.4	0.0	0.0	0.0	0.0	0.0	0.0	0.0	0.0	0.0	0.0	0.0	0.7	0.0	0.4	0.0
<i>Lobelia brevifolia</i>	0.0	0.0	0.0	0.0	0.0	0.0	0.0	0.0	0.0	0.0	0.0	0.0	0.0	0.0	0.0	0.0	0.0	0.0	0.0	0.0	0.0
<i>Lobelia floridana</i>	0.0	0.0	0.0	0.0	0.0	0.0	0.0	0.0	0.0	0.0	0.0	0.0	0.0	0.0	0.0	0.0	0.0	0.0	0.0	0.0	0.0
<i>Lobelia glandulosa</i>	0.0	0.0	0.0	0.0	0.0	0.0	0.3	0.0	0.0	0.0	0.0	0.0	0.0	0.3	0.1	0.0	0.0	0.4	0.0	0.0	0.0
<i>Lobelia nuttallii</i>	0.0	0.0	0.0	0.0	0.0	0.0	0.3	0.0	0.0	0.0	0.0	0.0	0.0	0.0	0.0	0.0	0.2	0.3	0.4	0.5	0.0
<i>Lobelia puberula</i>	0.0	0.0	0.0	0.0	0.0	0.0	0.0	0.0	0.0	0.0	0.0	0.0	0.0	0.0	0.0	0.0	0.0	0.0	0.0	0.0	0.0
<i>Lobelia (Gaura) sp.</i>	0.0	0.0	0.0	0.0	0.0	0.0	0.0	0.0	0.0	0.0	0.0	0.0	0.0	0.0	0.0	0.0	0.0	0.0	0.0	0.0	0.0
<i>Lophiola americana</i>	0.0	0.0	0.0	0.0	0.0	0.0	0.0	0.0	0.0	0.0	0.0	0.0	0.0	0.0	0.0	0.0	0.0	0.0	0.0	0.0	0.0
<i>Ludwigia hirtella</i>	0.0	0.0	0.0	0.0	0.0	0.0	0.0	0.0	0.0	0.0	0.0	0.0	0.0	0.0	0.0	0.0	0.0	0.0	0.0	0.0	0.0
<i>Ludwigia pilosa</i>	0.0	0.0	0.0	0.0	0.0	0.0	0.0	0.0	0.0	0.0	0.0	0.0	0.0	0.0	0.0	0.0	0.0	0.0	0.0	0.0	0.0
<i>Ludwigia sp.</i>	0.0	0.0	0.0	0.0	0.0	0.0	0.0	0.0	0.0	0.0	0.0	0.0	0.0	0.0	0.0	0.0	0.0	0.0	0.0	0.0	0.0
<i>Ludwigia virgata</i>	0.0	0.0	0.0	0.0	0.0	0.0	0.0	0.0	0.0	0.0	0.0	0.0	0.0	0.0	0.0	0.0	0.0	0.0	0.0	0.0	0.0
<i>Lycopodium alopecuroides</i>	0.0	0.0	0.0	0.0	0.0	0.0	0.0	0.0	0.0	0.0	0.0	0.0	0.0	0.0	0.0	0.0	0.0	0.0	0.0	0.0	0.0
<i>Lycopodium prostratum</i>	0.0	0.0	0.0	0.0	0.0	0.0	0.0	0.0	0.0	0.0	0.0	0.0	0.0	0.0	0.0	0.0	0.0	0.0	0.0	0.0	0.0
<i>Lycopodium sp.</i>	0.0	0.0	0.0	0.0	0.0	0.0	0.0	0.0	0.0	0.0	0.0	0.0	0.0	0.0	0.0	0.0	0.0	0.0	0.0	0.0	0.0

Indicator species	SC1	SC2	SC3	SC4	SC5	SC6	SC7	SC8	SC9	SC10	SC11	SC12	SC13	SC14	SC15	SC16	SC17	SC18	SC19	SC20	SC21
<i>Lycopus virginicus</i>	0.0	0.0	0.0	0.0	0.0	0.0	0.0	0.0	0.0	0.0	0.0	0.0	0.0	0.0	0.0	0.0	0.0	0.0	0.0	0.0	0.0
<i>Marshallia graminifolia</i>	0.0	0.0	0.3	0.0	0.0	0.0	0.0	0.0	0.0	0.7	0.0	0.0	0.2	0.0	0.0	0.0	0.0	0.7	0.0	0.8	0.0
<i>Marshallia tenuifolia</i>	0.0	0.0	0.0	0.0	0.0	0.0	0.0	0.0	0.0	0.0	0.0	0.0	0.0	0.0	0.0	0.0	0.0	0.0	0.0	0.0	0.0
<i>Mayaca aubletii</i>	0.0	0.0	0.0	0.0	0.0	0.0	0.0	0.0	0.0	0.0	0.0	0.0	0.0	0.0	0.0	0.0	0.0	0.0	0.0	0.0	0.0
<i>Mecardonia acuminata</i>	0.0	0.0	0.0	0.0	0.0	0.0	0.0	0.0	0.0	0.0	0.0	0.0	0.2	0.0	0.0	0.0	0.0	0.0	0.0	0.0	0.0
<i>Mecardonia marilandica</i>	0.0	0.0	0.0	0.0	0.0	0.0	0.0	0.0	0.0	0.0	0.0	0.0	0.0	0.0	0.0	0.0	0.0	0.0	0.0	0.0	0.0
<i>Onoclea sensibilis</i>	0.0	0.0	0.0	0.0	0.0	0.0	0.0	0.0	0.0	0.0	0.0	0.0	0.0	0.0	0.0	0.0	0.0	0.0	0.0	0.0	0.0
Orchidaceae sp.	0.0	0.0	0.0	0.0	0.0	0.0	0.0	0.0	0.0	0.0	0.0	0.0	0.0	0.0	0.0	0.0	0.0	0.2	0.0	0.0	0.0
<i>Osmunda cinnamomea</i>	0.0	0.0	0.0	0.0	0.2	0.0	0.3	0.0	0.0	0.0	0.5	0.0	0.0	0.0	0.0	0.0	0.0	0.0	0.0	0.0	0.0
<i>Osmunda regalis</i>	0.0	0.0	0.0	0.0	0.0	0.0	0.0	0.0	0.0	0.0	0.0	0.0	0.0	0.0	0.0	0.0	0.0	0.0	0.0	0.0	0.0
<i>Oxypolis filiformis</i>	0.0	0.0	0.0	0.4	0.3	0.0	0.0	0.0	0.0	0.0	0.0	0.0	0.0	0.0	0.0	0.0	0.0	0.0	0.0	0.0	0.0
<i>Oxypolis sp.</i>	0.0	0.0	0.0	0.0	0.0	0.0	0.0	0.0	0.0	0.0	0.0	0.0	0.0	0.0	0.0	0.0	0.0	0.0	0.0	0.0	0.0
<i>Oxypolis ternata</i>	0.0	0.0	0.0	0.0	0.0	0.0	0.0	0.0	0.0	0.0	0.0	0.0	0.0	0.0	0.0	0.0	0.0	0.0	0.0	0.0	0.0
<i>Panicum anceps</i>	0.0	0.0	0.0	0.0	0.0	0.0	0.0	0.0	0.7	0.0	0.0	0.0	0.0	0.0	0.0	0.0	0.0	0.0	0.0	0.0	0.0
<i>Panicum hians</i>	0.0	0.0	0.0	0.0	0.0	0.0	0.0	0.0	0.0	0.0	0.0	0.0	0.0	0.0	0.0	0.0	0.0	0.0	0.0	0.0	0.0
<i>Panicum sp.1</i>	0.2	0.0	0.0	0.0	0.0	0.0	0.0	0.0	0.0	0.0	0.0	0.2	0.0	0.0	0.0	1.0	0.0	0.0	0.0	0.0	0.0
<i>Panicum sp.2</i>	0.2	0.0	0.0	0.0	0.0	0.0	0.0	0.0	0.0	0.0	0.0	0.0	0.0	0.0	0.0	0.0	0.0	0.0	0.0	0.0	0.0
<i>Panicum virgatum</i>	0.0	0.0	0.3	0.2	0.0	0.0	1.0	0.0	0.7	0.7	0.3	0.0	0.2	0.0	0.0	0.0	0.8	0.4	0.3	0.5	0.2
<i>Paspalum sp.</i>	0.0	0.0	0.0	0.0	0.0	0.0	0.0	0.0	0.0	0.0	0.0	0.0	0.0	0.0	0.0	0.0	0.0	0.0	0.0	0.0	0.0
<i>Physotegia godfreyi</i>	0.0	0.0	0.0	0.0	0.0	0.0	0.0	0.0	0.0	0.0	0.0	0.0	0.0	0.0	0.0	0.0	0.0	0.0	0.0	0.0	0.0
<i>Pinguicula sp.</i>	0.0	0.0	0.0	0.0	0.0	0.0	0.0	0.0	0.2	0.0	0.0	0.0	0.0	0.0	0.0	0.0	0.0	0.4	0.3	0.0	0.0
<i>Pityopsis graminifolia</i>	0.3	0.0	0.0	0.0	0.0	0.0	0.3	0.4	0.3	0.7	0.0	0.0	0.2	0.0	0.0	0.0	0.0	0.0	0.4	0.4	0.0
<i>Pilea tenuifolia</i>	0.0	0.0	0.0	0.0	0.0	0.0	0.0	0.0	0.0	0.0	0.0	0.0	0.0	0.0	0.0	0.0	0.0	0.0	0.0	0.0	0.0
<i>Pluchea rosea</i>	0.0	0.0	0.0	0.0	0.0	0.0	0.0	0.0	0.0	0.0	0.0	0.0	0.0	0.0	0.0	0.0	0.0	0.0	0.0	0.0	0.0
<i>Pluchea sp.</i>	0.0	0.0	0.0	0.0	0.3	0.0	0.0	0.0	0.0	0.0	0.0	0.0	0.0	0.0	0.0	0.0	0.0	0.0	0.0	0.0	0.0
<i>Pogonia ophioglossoides</i>	0.0	0.0	0.0	0.0	0.0	0.0	0.0	0.0	0.0	0.0	0.0	0.0	0.0	0.0	0.0	0.0	0.0	0.0	0.0	0.0	0.0
<i>Pogonia sp.</i>	0.0	0.0	0.0	0.0	0.0	0.0	0.0	0.0	0.0	0.0	0.0	0.0	0.0	0.0	0.0	0.0	0.0	0.0	0.0	0.0	0.0
<i>Polygala cruciata</i>	0.0	0.0	0.0	0.0	0.0	0.0	0.0	0.0	0.0	0.0	0.0	0.0	0.0	0.0	0.0	0.0	0.0	0.0	0.0	0.0	0.0
<i>Polygala cymosa</i>	0.0	0.0	0.0	0.0	0.0	0.0	0.0	0.0	0.0	0.0	0.0	0.0	0.0	0.0	0.0	0.0	0.0	0.3	0.0	0.0	0.0
<i>Polygala hookeri</i>	0.0	0.0	0.0	0.0	0.0	0.0	0.0	0.0	0.0	0.0	0.0	0.0	0.0	0.0	0.0	0.0	0.0	0.0	0.0	0.0	0.0
<i>Polygala lutea</i>	0.0	0.0	0.4	0.0	0.2	0.0	0.3	0.0	0.3	0.5	0.1	0.0	0.0	0.0	0.0	0.0	0.0	0.2	0.0	0.0	0.0
<i>Polygala ramosa</i>	0.0	0.0	0.0	0.0	0.0	0.0	0.0	0.0	0.0	0.0	0.0	0.0	0.0	0.0	0.0	0.0	0.0	0.0	0.0	0.0	0.0
<i>Polygala sp.</i>	0.0	0.0	0.0	0.0	0.0	0.0	0.0	0.0	0.0	0.0	0.0	0.0	0.0	0.0	0.0	0.0	0.0	0.0	0.0	0.0	0.0
<i>Polygonum hydropter</i>	0.0	0.0	0.0	0.0	0.0	0.0	0.0	0.0	0.0	0.0	0.0	0.0	0.0	0.0	0.0	0.0	0.0	0.0	0.0	0.0	0.0
<i>Proserpinaca pectinata & serpent</i>	0.1	0.0	0.0	0.7	0.0	0.0	0.0	0.0	0.0	0.0	0.0	0.0	0.0	0.0	0.0	0.0	0.0	0.0	0.0	0.0	0.0
<i>Pteridium aquilinum</i>	0.1	0.4	0.2	0.0	0.0	0.0	0.3	0.0	0.0	0.0	0.0	0.0	0.0	0.0	0.0	0.0	0.0	0.2	0.0	0.0	0.0
<i>Ptilimnium nuttallii</i>	0.0	0.0	0.0	0.0	0.0	0.0	0.0	0.0	0.0	0.0	0.0	0.0	0.0	0.0	0.0	0.0	0.0	0.0	0.0	0.0	0.0
<i>Pycnanthemum nudum</i>	0.0	0.0	0.0	0.0	0.0	0.0	0.0	0.0	0.0	0.0	0.0	0.0	0.0	0.0	0.0	0.0	0.0	0.0	0.0	0.0	0.0
<i>Pycnanthemum tenuifolium</i>	0.0	0.0	0.0	0.0	0.0	0.0	0.0	0.0	0.0	0.0	0.0	0.0	0.0	0.0	0.0	0.0	0.0	0.0	0.0	0.0	0.0
<i>Rhexia virginica</i>	0.0	0.0	0.0	0.0	0.0	0.0	0.0	0.0	0.0	0.0	0.0	0.0	0.0	0.0	0.0	0.0	0.0	0.0	0.0	0.0	0.0
<i>Rhus radicans</i>	0.0	0.0	0.0	0.0	0.0	0.0	0.0	0.0	0.0	0.0	0.0	0.3	0.0	0.5	0.1	0.0	0.0	0.0	0.0	0.0	0.2
<i>Rhynchospora caduca</i>	0.0	0.0	0.0	0.0	0.0	0.0	0.0	0.0	0.0	0.0	0.0	0.0	0.0	0.0	0.0	0.0	0.0	0.0	0.0	0.0	0.0
<i>Rhynchospora chapmanii</i>	0.0	0.0	0.4	0.0	0.0	0.4	0.0	0.0	0.0	0.0	0.0	0.0	0.0	0.0	0.0	0.0	0.0	0.0	0.3	0.0	0.0

Indicator species	SC1	SC2	SC3	SC4	SC5	SC6	SC7	SC8	SC9	SC10	SC11	SC12	SC13	SC14	SC15	SC16	SC17	SC18	SC19	SC20	SC21	SC22
<i>Rhynchospora ciliaris</i>	0.0	0.0	0.0	0.0	0.0	0.0	0.0	0.0	0.0	0.0	0.0	0.0	0.0	0.0	0.0	0.0	0.0	0.0	0.0	0.0	0.0	0.0
<i>Rhynchospora compressa</i>	0.0	0.0	0.0	0.0	0.0	0.0	0.0	0.0	0.0	0.0	0.0	0.0	0.0	0.0	0.0	0.0	0.0	0.0	0.0	0.0	0.0	0.0
<i>Rhynchospora debilis</i>	0.4	0.0	0.4	0.0	0.0	0.0	0.0	0.0	0.0	0.0	0.0	0.0	0.0	0.0	0.0	0.0	0.0	0.0	0.0	0.0	0.0	0.0
<i>Rhynchospora eliottii</i>	0.0	0.0	0.0	0.0	0.0	0.0	0.0	0.0	0.0	0.0	0.0	0.0	0.0	0.0	0.0	0.0	0.0	0.0	0.0	0.0	0.0	0.0
<i>Rhynchospora glomerata</i>	0.0	0.0	0.0	0.0	0.0	0.0	0.0	0.0	0.0	0.0	0.0	0.0	0.0	0.0	0.0	0.0	0.0	0.0	0.0	0.0	0.0	0.0
<i>Rhynchospora gracilentia</i>	0.0	0.0	0.0	0.0	0.0	0.0	0.0	0.0	0.0	0.0	0.0	0.0	0.0	0.0	0.0	0.0	0.0	0.0	0.0	0.0	0.0	0.0
<i>Rhynchospora inexpansa</i>	0.0	0.0	0.0	0.0	0.0	0.0	0.0	0.0	0.0	0.0	0.0	0.0	0.0	0.0	0.0	0.0	0.0	0.0	0.0	0.0	0.0	0.0
<i>Rhynchospora macra</i>	0.0	0.0	0.0	0.0	0.0	0.0	0.0	0.0	0.0	0.0	0.0	0.0	0.0	0.0	0.0	0.0	0.0	0.0	0.0	0.0	0.0	0.0
<i>Rhynchospora microcarpa</i>	0.0	0.0	0.0	0.0	0.0	0.0	0.0	0.0	0.0	0.0	0.0	0.0	0.0	0.0	0.0	0.0	0.0	0.0	0.0	0.0	0.0	0.0
<i>Rhynchospora oligantha</i>	0.0	0.0	0.0	0.0	0.0	0.0	0.0	0.0	0.0	0.0	0.0	0.0	0.0	0.0	0.0	0.0	0.0	0.0	0.0	0.0	0.0	0.0
<i>Rhynchospora plumosa</i>	0.0	0.0	0.0	0.0	0.0	0.0	0.0	0.0	0.0	0.0	0.0	0.0	0.0	0.0	0.0	0.0	0.0	0.0	0.0	0.0	0.0	0.0
<i>Rhynchospora rariflora</i>	0.0	0.0	0.0	0.0	0.0	0.0	0.0	0.0	0.0	0.0	0.0	0.0	0.0	0.0	0.0	0.0	0.0	0.0	0.0	0.0	0.0	0.0
<i>Rhynchospora sp.1</i>	0.0	0.1	0.4	1.0	0.0	0.0	0.7	0.3	0.0	0.0	0.0	0.3	0.0	0.0	0.1	0.2	0.0	0.0	0.0	0.0	0.0	0.0
<i>Rhynchospora sp. 2</i>	0.3	0.2	0.7	0.0	0.3	0.0	0.0	0.0	0.0	0.0	0.0	0.4	0.0	0.0	0.1	0.0	0.0	0.0	0.0	0.0	0.0	0.0
<i>Rhynchospora sp. (large)</i>	0.0	0.0	0.0	0.0	0.0	0.0	0.0	0.0	0.0	0.0	0.0	0.0	0.0	0.0	0.0	0.0	0.0	0.0	0.0	0.0	0.0	0.0
<i>Rhynchospora sp. (medium)</i>	0.0	0.0	0.0	0.0	0.0	0.0	0.0	0.0	0.0	0.0	0.0	0.0	0.3	0.7	0.2	0.0	0.0	0.0	0.0	0.0	0.0	0.0
<i>Rhynchospora sp. (small)</i>	0.0	0.0	0.0	0.0	0.0	1.0	0.0	0.0	0.0	0.0	0.4	0.0	0.0	0.0	0.0	0.0	0.0	0.0	0.0	0.0	0.0	0.0
<i>Rhynchospora sp. (tiny)</i>	0.0	0.0	0.0	0.0	0.0	0.0	0.0	0.0	0.0	1.0	0.0	0.0	0.8	0.0	0.2	0.0	0.0	0.0	0.0	0.0	0.0	0.0
<i>Rhynchospora (tri-stemmed)</i>	0.0	0.0	0.0	0.0	0.0	0.0	0.0	0.0	0.0	0.0	0.0	0.0	0.0	0.0	0.0	0.0	0.0	0.0	0.0	0.0	0.0	0.0
<i>Rubus sp.</i>	0.2	0.0	0.3	0.0	0.0	0.0	0.0	0.0	0.0	0.0	0.0	0.0	0.0	0.0	0.0	0.0	0.0	0.0	0.0	0.0	0.0	0.0
<i>Rudbeckia graminifolia</i>	0.0	0.0	0.0	0.0	0.0	0.0	0.0	0.0	0.0	0.0	0.0	0.0	0.0	0.0	0.0	0.0	0.0	0.0	0.0	0.0	0.0	0.0
<i>Rudbeckia sp.</i>	0.0	0.0	0.0	0.0	0.0	0.0	0.0	0.0	0.0	0.0	0.0	0.0	0.0	0.0	0.0	0.0	0.0	0.0	0.0	0.0	0.0	0.0
<i>Ruellia humilis</i>	0.0	0.0	0.0	0.0	0.0	0.0	0.0	0.0	0.0	0.0	0.0	0.0	0.0	0.0	0.0	0.0	0.0	0.0	0.0	0.0	0.0	0.0
<i>Ruellia humilis var. longiflora</i>	0.0	0.0	0.0	0.0	0.0	0.0	0.0	0.0	0.0	0.0	0.0	0.0	0.0	0.0	0.0	0.0	0.0	0.0	0.0	0.0	0.0	0.0
<i>Sabal minor</i>	0.0	0.0	0.0	0.0	0.0	0.0	0.0	0.0	0.0	0.0	0.0	0.0	0.0	0.0	0.0	0.0	0.0	0.0	0.0	0.0	0.0	0.0
<i>Sabatia bartramii</i>	0.0	0.0	0.0	0.0	0.0	0.0	0.0	0.0	0.0	0.0	0.0	0.0	0.0	0.0	0.0	0.0	0.0	0.0	0.0	0.0	0.0	0.0
<i>Sabatia campanulata</i>	0.0	0.0	0.0	0.0	0.0	0.0	0.0	0.0	0.0	0.0	0.0	0.0	0.0	0.0	0.0	0.0	0.0	0.0	0.0	0.0	0.0	0.0
<i>Sabatia difformis</i>	0.0	0.0	0.0	0.0	0.0	0.0	0.0	0.0	0.0	0.0	0.0	0.0	0.0	0.0	0.0	0.0	0.0	0.0	0.0	0.0	0.0	0.0
<i>Sabatia dodecandra</i>	0.0	0.0	0.0	0.0	0.0	0.0	0.0	0.0	0.0	0.0	0.0	0.0	0.0	0.0	0.0	0.0	0.0	0.0	0.0	0.0	0.0	0.0
<i>Sabatia gentianoides</i>	0.0	0.0	0.0	0.0	0.0	0.0	0.0	0.0	0.0	0.0	0.0	0.0	0.0	0.0	0.0	0.0	0.0	0.0	0.0	0.0	0.0	0.0
<i>Sabatia macrophylla</i>	0.0	0.0	0.0	0.0	0.0	0.0	0.0	0.0	0.0	0.0	0.0	0.0	0.0	0.0	0.0	0.0	0.0	0.0	0.0	0.0	0.0	0.0
<i>Sabatia sp. 1</i>	0.0	0.0	0.0	0.0	0.2	0.0	0.4	0.0	0.0	0.2	0.0	0.0	0.0	0.0	0.0	0.0	0.3	0.0	0.2	0.0	0.0	0.0
<i>Sabatia sp. 2</i>	0.0	0.0	0.0	0.0	0.0	0.0	0.0	0.0	0.0	0.0	0.0	0.0	0.0	0.0	0.0	0.0	0.0	0.0	0.0	0.0	0.0	0.0
<i>Sagittaria lancifolia</i>	0.0	0.0	0.0	0.0	0.0	0.0	0.0	0.0	0.0	0.0	0.0	0.0	0.0	0.0	0.0	0.0	0.0	0.0	0.0	0.0	0.0	0.0
<i>Schizachyrium tenerum</i>	0.0	0.0	0.0	0.0	0.0	0.0	0.0	0.0	0.0	0.0	0.0	0.0	0.0	0.0	0.0	0.0	0.0	0.0	0.0	0.0	0.0	0.0
<i>Schoenolirion eliottii</i>	0.0	0.0	0.0	0.0	0.0	0.0	0.0	0.0	0.0	0.0	0.0	0.0	0.0	0.0	0.0	0.0	0.0	0.0	0.0	0.0	0.0	0.0
<i>Schrankia sp.</i>	0.0	0.0	0.0	0.0	0.0	0.0	0.0	0.0	0.0	0.0	0.0	0.0	0.0	0.0	0.0	0.0	0.0	0.0	0.0	0.0	0.0	0.0
<i>Scirpus cyperinus</i>	0.0	0.0	0.0	0.0	0.0	0.0	0.0	0.0	0.0	0.0	0.0	0.0	0.0	0.0	0.0	0.0	0.0	0.0	0.0	0.0	0.0	0.0
<i>Scleria baldwinii</i>	0.0	0.0	0.0	0.0	0.0	0.0	0.0	0.0	0.0	0.0	0.0	0.0	0.0	0.0	0.0	0.0	0.0	0.0	0.0	0.0	0.0	0.0
<i>Scleria pauciflora</i>	0.0	0.0	0.0	0.0	0.0	0.0	0.0	0.0	0.0	0.0	0.0	0.0	0.0	0.0	0.0	0.0	0.0	0.0	0.0	0.0	0.0	0.0
<i>Scleria pauciflora var. caroliniana</i>	0.0	0.0	0.0	0.0	0.0	0.0	0.0	0.0	0.0	0.0	0.0	0.0	0.0	0.0	0.0	0.0	0.0	0.0	0.0	0.0	0.0	0.0
<i>Scleria pauciflora var. pausiflora</i>	0.0	0.0	0.0	0.0	0.0	0.0	0.0	0.0	0.0	0.0	0.0	0.0	0.0	0.0	0.0	0.0	0.0	0.0	0.0	0.0	0.0	0.0
<i>Scleria sp. 1</i>	0.0	0.0	0.2	0.0	0.0	0.7	0.3	0.2	0.2	0.0	0.0	0.0	0.2	0.0	0.0	0.0	0.2	0.2	0.3	0.0	0.0	0.0

Indicator species	SC1	SC2	SC3	SC4	SC5	SC6	SC7	SC8	SC9	SC10	SC11	SC12	SC13	SC14	SC15	SC16	SC17	SC18	SC19	SC20	SC21
<i>Scleria</i> sp. 2	0.0	0.0	0.0	0.0	0.0	0.0	0.0	0.0	0.0	0.0	0.0	0.0	0.0	0.0	0.0	0.0	0.0	0.0	0.0	0.0	0.0
<i>Scutellaria integrifolia</i>	0.0	0.0	0.0	0.0	0.0	0.0	0.0	0.0	0.0	0.0	0.0	0.0	0.0	0.3	0.0	0.0	0.0	0.0	0.0	0.0	0.0
<i>Scutellaria</i> sp.	0.0	0.0	0.0	0.0	0.0	0.0	0.0	0.0	0.0	0.0	0.0	0.0	0.0	0.0	0.0	0.0	0.0	0.0	0.0	0.0	0.0
<i>Serenoa repens</i>	0.0	0.0	0.0	0.0	0.0	0.0	0.0	0.0	0.0	0.0	0.0	0.0	0.0	0.0	0.0	0.0	0.0	0.0	0.0	0.0	0.0
<i>Seymouria cassioides</i>	0.0	0.0	0.0	0.0	0.0	0.0	0.0	0.0	0.0	0.0	0.0	0.0	0.0	0.0	0.0	0.0	0.0	0.0	0.0	0.0	0.0
<i>Sisyrinchium</i> sp.	0.1	0.0	0.2	0.0	0.0	0.0	0.0	0.0	0.0	0.0	0.0	0.0	0.0	0.0	0.0	0.0	0.0	0.0	0.0	0.0	0.0
<i>Smilax bona-nox</i>	0.0	0.0	0.0	0.0	0.0	0.0	0.0	0.0	0.0	0.0	0.0	0.0	0.0	0.0	0.0	0.0	0.0	0.0	0.0	0.0	0.0
<i>Smilax laurifolia</i>	0.0	0.0	0.0	0.0	0.0	0.0	0.0	0.0	0.0	0.0	0.0	0.0	0.0	0.0	0.0	0.0	0.0	0.0	0.0	0.0	0.0
<i>Smilax rotundifolia</i>	0.0	0.0	0.0	0.0	0.0	0.0	0.0	0.0	0.0	0.0	0.0	0.0	0.0	0.0	0.0	0.0	0.0	0.0	0.0	0.0	0.0
<i>Smilax</i> sp.	0.0	0.0	0.0	0.0	0.0	0.0	0.0	0.0	0.0	0.0	0.0	0.0	0.0	0.0	0.0	0.0	0.0	0.0	0.0	0.0	0.0
<i>Solidago fistulosa</i>	0.6	0.0	0.0	0.0	0.0	0.0	0.0	0.0	0.0	0.2	0.0	0.0	0.2	0.8	0.2	0.0	0.2	0.0	0.0	0.0	0.0
<i>Solidago</i> sp. 1	0.2	0.0	0.3	0.0	0.0	0.4	0.0	0.4	0.0	0.2	0.0	0.0	0.0	0.0	0.0	0.7	0.3	0.0	0.4	0.7	0.4
<i>Solidago</i> sp. 2	0.2	0.0	0.4	0.0	0.0	0.0	0.0	0.3	0.0	0.0	0.0	0.0	0.0	0.0	0.0	0.0	0.0	0.0	0.0	0.0	0.0
<i>Solidago</i> sp. 3	0.4	0.0	0.0	0.0	0.0	0.0	0.0	0.0	0.0	0.0	0.0	0.0	0.0	0.0	0.0	0.0	0.0	0.0	0.0	0.0	0.0
<i>Solidago stricta</i>	0.6	0.0	0.0	0.8	0.5	0.0	0.4	0.0	0.0	1.0	1.0	0.0	0.7	0.0	0.1	0.0	0.3	0.3	0.4	0.7	0.0
<i>Sphagnum</i> spp.	0.0	0.0	0.0	0.0	0.0	0.0	0.8	0.0	0.7	1.0	0.8	1.0	1.0	0.0	0.7	0.0	1.0	1.0	0.4	0.7	0.4
<i>Spiranthes</i> sp.	0.0	0.0	0.0	0.0	0.0	0.0	0.0	0.0	0.0	0.0	0.0	0.0	0.0	0.0	0.0	0.0	0.0	0.0	0.0	0.0	0.0
<i>Sporobolus</i> sp.	0.0	0.0	0.0	0.0	0.0	0.0	0.0	0.0	0.0	0.0	0.0	0.0	0.0	0.0	0.0	0.0	0.0	0.0	0.0	0.0	0.0
<i>Sporobolus teretifolius</i>	0.0	0.0	0.0	0.0	0.0	0.0	0.0	0.0	0.0	0.0	0.0	0.0	0.0	0.0	0.0	0.0	0.0	0.0	0.0	0.0	0.0
<i>Stokesia laevis</i>	0.0	0.0	0.0	0.0	0.0	0.0	0.0	0.0	0.0	0.0	0.0	0.0	0.0	0.0	0.0	0.0	0.0	0.0	0.0	0.0	0.0
<i>Tephrosia onobrychooides</i>	0.0	0.0	0.0	0.0	0.0	0.0	0.0	0.0	0.0	0.0	0.0	0.0	0.0	0.0	0.0	0.0	0.0	0.0	0.0	0.0	0.0
<i>Tephrosia</i> sp.	0.0	0.0	0.0	0.0	0.0	0.0	0.0	0.0	0.0	0.0	0.0	0.0	0.0	0.0	0.0	0.0	0.0	0.0	0.3	0.2	0.0
<i>Tofieldia glabra</i>	0.0	0.0	0.0	0.0	0.0	0.0	0.0	0.0	0.0	0.0	0.0	0.0	0.0	0.0	0.0	0.0	0.0	0.0	0.0	0.0	0.0
<i>Tofieldia racemosa</i>	0.0	0.0	0.0	0.0	0.0	0.0	0.0	0.0	0.0	0.0	0.0	0.0	0.0	0.0	0.0	0.0	0.0	0.0	0.0	0.0	0.0
<i>Tridens</i> sp.	0.0	0.0	0.0	0.0	0.0	0.0	0.0	0.0	0.0	0.0	0.0	0.0	0.0	0.0	0.0	0.0	0.0	0.0	0.0	0.0	0.0
<i>Uniola laxa</i>	0.0	0.0	0.0	0.0	0.0	0.0	0.0	0.0	0.0	0.0	0.0	0.0	0.0	0.0	0.0	0.0	0.0	0.0	0.0	0.0	0.0
<i>Verbesina chapmannii</i>	0.0	0.0	0.0	0.0	0.0	0.0	0.0	0.0	0.0	0.0	0.0	0.0	0.0	0.0	0.0	0.0	0.0	0.0	0.0	0.0	0.0
<i>Vernonia</i> sp.	0.0	0.0	0.0	0.0	0.0	0.0	0.0	0.0	0.0	0.0	0.0	0.0	0.0	0.0	0.0	0.0	0.0	0.0	0.0	0.0	0.0
<i>Viola lanceolata</i>	0.0	0.0	0.0	0.0	0.0	0.0	0.0	0.0	0.0	0.0	0.0	0.0	0.0	0.7	0.0	0.2	0.0	0.3	0.0	0.0	0.0
<i>Viola</i> sp.	0.0	0.0	0.2	0.3	0.0	0.0	0.0	0.7	0.0	0.8	0.0	0.0	0.0	0.0	0.0	0.0	0.0	0.0	0.0	0.0	0.0
<i>Woodwardia areolata</i>	0.0	0.0	0.0	0.0	0.0	0.0	0.0	0.0	0.0	0.0	0.0	0.0	0.0	0.0	0.0	0.0	0.0	0.0	0.0	0.0	0.0
<i>Woodwardia virginica</i>	0.0	0.3	0.4	0.0	0.0	0.0	0.7	0.0	0.0	0.0	0.0	0.0	0.0	1.0	0.3	0.0	0.3	0.0	0.0	0.0	0.0
<i>Xyris scabriifolia</i>	0.0	0.0	0.0	0.0	0.0	0.0	0.0	0.0	0.0	0.0	0.0	0.0	0.0	0.0	0.0	0.0	0.0	0.0	0.0	0.0	0.0
<i>Zigadenus glaberrimus</i>	0.0	0.0	0.0	0.0	0.0	0.0	0.0	0.0	0.0	0.0	0.0	0.0	0.0	0.0	0.0	0.0	0.0	0.0	0.0	0.0	0.0
Unknown or unidentifiable vascular plants	0.3	0.0	0.2	0.2	0.0	0.3	0.0	1.1	0.3	0.0	0.0	0.0	0.0	0.7	0.1	0.3	0.0	0.0	0.5	1.5	0.4
Unk. bryophyte	0.0	0.0	0.0	0.0	0.0	0.0	0.0	0.0	0.0	0.0	0.0	0.0	0.0	0.0	0.0	0.0	0.0	0.0	0.0	0.0	0.0

Table E5.

Indicator species	SC22	SC23	SC24	SC25	LA26	LA27	LA28	LA29	LA30	TX31	TX32	TX34	TX35	LA37	LA38	MS39	MS40a	MS40b	MS40c
<i>Aletris</i> spp.	0.0	0.0	0.0	0.0	0.0	0.0	0.0	0.0	0.0	0.5	0.0	0.0	0.0	0.3	0.0	0.0	0.0	0.0	0.0
<i>Aristida</i> spp. & <i>Sporobolus</i> spp.	0.0	0.0	1.0	0.0	0.0	0.0	0.0	0.0	0.0	0.0	0.0	0.0	0.0	0.0	0.0	0.0	0.0	0.0	0.0
<i>Baldinia</i> spp.	0.0	0.0	0.0	0.0	0.0	0.0	0.0	0.0	0.0	0.0	0.0	0.0	0.0	0.0	0.5	0.8	0.0	0.5	0.5
<i>Bigelovia nudata</i>	0.0	0.0	0.8	0.0	0.0	0.0	0.0	0.0	0.0	0.0	0.0	0.0	0.0	0.3	0.5	1.0	0.0	0.0	0.7
<i>Carphephorus</i> spp.	0.0	0.0	0.0	0.0	0.0	0.0	0.0	0.0	0.0	0.0	0.0	0.0	0.0	0.0	0.0	0.0	0.0	0.0	0.0
<i>Chaptalia tomentosa</i>	0.0	0.2	0.3	0.0	0.2	0.2	0.0	0.0	0.0	0.0	0.0	0.0	0.0	0.2	0.7	0.3	0.3	0.0	0.3
<i>Coreopsis</i> sp.	0.0	0.3	1.0	0.0	0.0	1.0	1.0	0.3	0.0	1.0	0.8	0.0	0.5	0.3	0.8	1.0	0.0	0.7	0.2
<i>Ctenium aromaticum</i>	0.0	0.0	0.0	0.0	1.0	0.8	0.7	0.0	0.0	0.0	0.0	0.0	0.0	1.0	0.0	0.0	0.0	0.0	0.8
<i>Dichromena</i> sp.	0.0	0.0	0.0	0.0	0.7	0.8	0.5	0.0	0.0	0.0	0.0	0.0	0.0	0.7	0.0	0.5	0.0	0.0	0.0
<i>Erigeron vernus</i>	0.2	0.8	0.2	0.2	0.0	0.0	0.0	0.0	0.0	0.0	0.0	0.0	0.0	0.2	0.8	0.3	0.0	0.3	1.0
<i>Eriocalon</i> spp.	0.0	0.7	0.0	0.0	0.2	1.0	0.0	0.0	0.0	0.7	1.0	1.0	1.0	0.3	0.8	1.0	0.0	1.0	1.0
<i>Eryngium integrifolium</i>	0.0	0.0	0.0	0.0	0.0	0.0	0.0	0.0	0.0	0.0	0.0	0.0	0.0	0.0	0.0	0.0	0.0	0.2	0.0
<i>Eupatorium leucolepis</i>	0.2	0.5	1.0	0.8	0.8	0.8	1.0	0.7	0.0	0.3	0.5	0.0	0.7	0.8	0.5	0.0	0.0	0.0	0.3
<i>Helianthus</i> spp.	0.0	0.0	0.2	0.0	0.0	0.0	0.0	0.3	0.0	0.5	0.0	0.0	1.0	0.8	0.3	1.0	0.0	0.0	0.0
<i>Lycopodium</i> spp.	0.0	0.0	0.0	0.0	0.2	0.5	1.0	0.0	0.0	0.8	0.7	0.2	0.3	0.0	0.7	0.8	0.0	0.2	0.0
<i>Muhlenbergia expansa</i>	0.0	0.0	0.0	0.0	1.0	0.0	0.0	0.0	0.0	0.0	0.0	0.0	0.0	0.0	0.0	0.2	0.0	0.2	0.7
<i>Rhexia</i> spp.	0.3	0.8	0.3	1.0	1.0	1.0	0.8	1.0	0.5	1.0	0.8	0.2	1.0	1.0	0.8	0.8	0.0	0.5	0.8
<i>Sarracenia</i> spp.	0.0	0.0	0.0	0.0	0.7	1.0	0.0	0.0	0.0	0.0	0.8	0.0	0.0	0.5	0.7	0.7	0.5	1.0	1.0
<i>Schizachyrium scoparium</i>	0.0	0.0	0.8	0.0	0.2	0.0	1.0	0.0	0.0	0.0	0.0	0.0	0.8	0.3	0.0	0.0	0.0	0.0	0.0
<i>Xyris</i> spp.	0.0	0.2	0.0	0.0	0.3	1.0	0.5	0.8	0.8	0.8	0.7	0.7	1.0	0.7	0.5	1.0	1.0	1.0	1.0
Total Indic Score	0.7	3.5	5.7	2.0	6.2	8.2	6.5	3.2	1.3	5.7	5.0	2.0	6.5	8.0	7.3	9.5	1.5	5.5	8.3
Additional Species																			
<i>Agalinis aphylla</i>	0.0	0.0	0.0	0.0	0.0	0.0	0.0	0.0	0.0	0.0	0.0	0.0	0.0	0.0	0.0	0.0	0.0	0.0	0.0
<i>Agalinis purpurea</i>	0.0	0.0	0.0	0.0	0.0	0.0	0.0	0.0	0.0	0.0	0.0	0.0	0.0	0.0	0.0	0.0	0.0	0.0	0.0
<i>Agalinis</i> sp.	0.0	0.0	0.0	0.0	0.0	0.0	0.0	0.0	0.0	0.0	0.0	0.0	0.0	0.0	0.0	0.0	0.0	0.0	0.0
<i>Andropogon glaucopsis</i>	0.0	0.0	0.2	0.3	0.4	0.7	1.0	0.0	0.0	0.8	0.2	0.0	0.0	0.0	0.2	0.7	0.0	0.0	0.3
<i>Andropogon glomeratus</i>	0.0	0.0	0.0	0.0	0.0	0.0	0.0	0.0	0.0	0.0	0.0	0.0	0.0	0.0	0.0	0.0	0.0	0.0	0.0
<i>Andropogon mohrii</i>	0.0	0.0	0.0	0.0	0.0	0.7	0.0	0.0	0.0	0.8	0.8	0.0	0.0	0.7	0.0	0.8	0.0	0.0	0.0
<i>Andropogon</i> sp. 1	0.0	0.0	0.0	0.0	0.8	0.0	1.0	1.0	0.7	0.7	0.0	0.0	0.0	0.2	0.7	0.0	0.0	0.8	0.4
<i>Andropogon</i> sp. 2	0.0	0.0	0.0	0.0	0.0	0.0	0.0	0.0	0.0	0.0	0.0	0.0	0.0	0.0	0.0	0.7	0.0	0.2	0.0
<i>Andropogon</i> sp. 3	0.0	0.0	0.0	0.0	0.0	0.0	0.0	0.0	0.0	0.0	0.0	0.0	0.0	0.0	0.0	0.0	0.0	0.0	0.0
<i>Andropogon virginicus</i>	0.0	0.5	0.8	0.1	0.0	0.0	0.0	0.0	0.0	0.0	0.0	0.0	0.0	0.0	0.0	0.0	0.0	0.0	0.0
<i>Aristida affinis</i>	0.0	0.0	0.0	0.0	0.0	0.0	0.0	0.0	0.0	0.0	0.0	0.0	0.0	0.0	0.0	0.0	0.0	0.0	0.0
<i>Aristida virgata</i>	0.0	0.2	0.0	0.0	0.3	0.7	0.4	0.0	0.0	0.7	1.0	0.0	0.0	0.0	0.0	0.8	0.0	0.5	1.0
<i>Arnica acaulis</i>	0.0	0.0	0.3	0.0	0.0	0.0	0.0	0.0	0.0	0.0	0.0	0.0	0.0	0.0	0.0	0.0	0.0	0.0	0.0
<i>Arundinaria tecta</i>	0.0	0.0	0.0	0.0	0.0	0.0	0.0	0.0	0.0	0.0	0.0	0.0	0.0	0.0	0.0	0.0	0.0	0.0	0.0
<i>Asclepias longifolia</i>	0.0	0.0	0.0	0.0	0.0	0.0	0.0	0.0	0.0	0.0	0.0	0.0	0.0	0.0	0.0	0.0	0.0	0.0	0.0
<i>Asclepias</i> sp.	0.0	0.2	0.0	0.0	0.0	0.0	0.0	0.3	0.0	0.0	0.0	0.0	0.0	0.0	0.0	0.0	0.0	0.0	0.0
<i>Asclepias viridula</i>	0.0	0.0	0.0	0.0	0.0	0.0	0.0	0.0	0.0	0.0	0.0	0.0	0.0	0.0	0.0	0.0	0.0	0.0	0.0
<i>Aster adnatus</i>	0.0	0.0	0.0	0.0	0.0	0.0	0.0	0.0	0.0	0.0	0.0	0.0	0.0	0.0	0.0	0.0	0.0	0.0	0.0

Indicator species	SC22	SC23	SC24	SC25	LA26	LA27	LA28	LA29	LA30	TX31	TX32	TX34	TX35	LA37	LA38	MS39	MS40a	MS40b	MS40c
<i>Aster dumosus</i>	0.0	0.0	0.8	0.0	0.0	0.0	0.0	0.0	0.0	0.0	0.0	0.0	0.7	0.0	0.7	0.0	0.0	0.0	0.0
<i>Aster eringifolius</i>	0.0	0.0	0.0	0.0	0.0	0.0	0.0	0.0	0.0	0.0	0.0	0.0	0.0	0.0	0.0	0.0	0.0	0.0	0.0
<i>Aster linariifolius</i>	0.0	0.0	0.0	0.0	0.0	0.0	0.0	0.0	0.0	0.0	0.0	0.0	0.0	0.0	0.0	0.0	0.0	0.0	0.0
<i>Aster paludosus</i>	0.0	0.0	0.0	0.0	0.0	0.0	0.0	0.0	0.0	0.0	0.0	0.0	0.0	0.0	0.0	0.0	0.0	0.0	0.0
<i>Aster sclerosus</i>	0.0	0.0	0.0	0.0	0.0	0.0	0.0	0.0	0.0	0.0	0.0	0.0	0.0	0.0	0.0	0.0	0.0	0.0	0.0
<i>Aster sp. 1</i>	0.0	0.0	0.7	0.0	0.0	0.4	0.2	0.0	0.0	0.5	0.0	0.0	0.0	0.4	0.0	0.0	0.0	0.0	0.0
<i>Aster sp. 2</i>	0.0	0.0	0.0	0.0	0.0	0.0	0.0	0.0	0.0	0.0	0.0	0.0	0.0	0.0	0.0	0.0	0.0	0.0	0.0
<i>Aster verticillata</i>	0.0	0.0	0.0	0.0	0.0	0.0	0.0	0.0	0.0	0.0	0.0	0.0	0.0	0.0	0.0	0.0	0.0	0.0	0.0
<i>Bacopa caroliniana</i>	0.0	0.0	0.0	0.0	0.0	0.0	0.0	0.3	0.0	0.0	0.0	0.0	0.0	0.0	0.0	0.0	0.0	0.0	0.0
<i>Balduna uniflora</i>	0.0	0.0	0.0	0.0	0.0	0.0	0.0	0.0	0.0	0.0	0.0	0.0	0.0	0.0	0.4	0.8	0.0	0.4	0.8
<i>Bartonia virginica</i>	0.0	0.0	0.0	0.0	0.0	0.0	0.0	0.0	0.0	0.0	0.0	0.0	0.0	0.0	0.0	0.0	0.0	0.0	0.0
<i>Berchemia scandens</i>	0.0	0.0	0.0	0.0	0.0	0.0	0.0	0.0	0.0	0.0	0.0	0.0	0.3	0.0	0.0	0.0	0.0	0.0	0.0
<i>Bidens bipinnata</i>	0.0	0.0	0.0	0.0	0.0	0.0	0.0	0.2	0.0	0.0	0.0	0.0	0.0	0.0	0.0	0.0	0.0	0.0	0.0
<i>Bidens mitis</i>	0.0	0.0	0.0	0.0	0.0	0.0	0.0	0.0	0.0	0.0	0.0	0.0	0.0	0.0	0.0	0.0	0.8	1.0	0.0
<i>Bidens sp.</i>	0.0	0.0	0.0	0.0	0.0	0.0	0.0	0.0	0.0	0.0	0.0	0.0	0.2	0.0	0.5	0.0	0.0	0.0	0.0
<i>Boltonia asteroides</i>	0.0	0.0	0.0	0.0	0.0	0.0	0.0	0.7	0.0	0.0	0.0	0.0	0.0	0.0	0.0	0.0	0.0	0.0	0.0
<i>Cacalia lanceolata</i>	0.0	0.0	0.0	0.0	0.0	0.4	0.0	0.8	0.0	0.3	0.3	0.0	0.2	0.0	0.0	0.0	0.0	0.0	0.0
<i>Calopogon sp.</i>	0.0	0.0	0.0	0.0	0.0	0.0	0.0	0.0	0.0	0.0	0.0	0.0	0.0	0.0	0.0	0.0	0.0	0.0	0.0
<i>Calopogon tuberosus</i>	0.0	0.0	0.0	0.0	0.0	0.0	0.0	0.0	0.0	0.0	0.0	0.0	0.0	0.0	0.0	0.0	0.0	0.0	0.0
<i>Carex crinita</i>	0.0	0.0	0.0	0.0	0.0	0.0	0.0	0.0	0.0	0.0	0.0	0.0	0.0	0.0	0.0	0.0	0.0	0.0	0.0
<i>Carex glaucescens</i>	0.0	0.0	0.0	0.0	0.0	0.0	0.0	0.0	0.0	0.0	0.0	0.0	0.0	0.0	0.0	0.0	0.0	0.0	0.0
<i>Carex sp.</i>	1.0	1.0	0.0	0.3	0.0	0.0	0.0	0.0	0.0	0.0	0.2	0.0	0.0	0.0	0.3	0.0	0.0	0.0	0.0
<i>Centella asiatica/erecta</i>	0.0	0.0	0.0	0.0	0.0	1.0	0.7	0.0	0.3	0.0	0.8	0.7	0.7	0.0	0.4	0.7	0.2	0.0	0.0
<i>Chrysopsis sp. (Heterotheca)</i>	0.0	0.0	0.2	0.0	0.0	0.0	0.0	0.0	0.0	0.0	0.0	0.0	0.0	0.0	0.0	0.0	0.0	0.0	0.0
<i>Cirsium lecontei</i>	0.0	0.0	0.0	0.0	0.0	0.0	0.0	0.0	0.0	0.0	0.0	0.0	0.0	0.0	0.0	0.0	0.0	0.0	0.0
<i>Cirsium sp.</i>	0.0	0.0	0.0	0.0	0.0	0.0	0.0	0.0	0.0	0.0	0.0	0.0	0.0	0.0	0.0	0.0	0.0	0.0	0.0
<i>Cleistes divaricata</i>	0.0	0.0	0.0	0.0	0.0	0.0	0.0	0.0	0.0	0.0	0.0	0.0	0.0	0.0	0.0	0.0	0.0	0.0	0.0
<i>Coreopsis falcata</i>	0.0	0.0	0.0	0.0	0.0	0.0	0.0	0.0	0.0	0.0	0.0	0.0	0.0	0.0	0.0	0.0	0.0	0.0	0.0
<i>Cuscuta sp.</i>	0.0	0.0	0.0	0.0	0.0	0.0	0.0	0.0	0.0	0.0	0.0	0.0	0.0	0.0	0.0	0.0	0.0	0.0	0.0
<i>Cynoctonum sessilifolium</i>	0.0	0.0	0.0	0.0	0.0	0.4	0.0	0.0	0.0	0.0	0.0	0.0	0.0	0.0	0.0	0.0	0.0	0.0	0.0
<i>Cyperus haspan</i>	0.0	0.0	0.0	0.0	0.0	0.0	0.0	0.4	1.0	0.0	0.0	0.0	0.0	0.0	0.0	0.0	0.0	0.0	0.0
<i>Cyperus pseudovegetus</i>	0.0	0.0	0.0	0.0	0.0	0.0	0.0	0.0	0.0	0.0	0.0	0.0	0.0	0.0	0.0	0.0	0.0	0.0	0.0
<i>Cyperus sp.</i>	0.0	0.0	0.0	0.0	0.0	0.0	0.0	0.3	1.0	0.0	0.0	0.2	0.0	0.0	0.0	0.0	0.0	0.0	0.0
<i>Dicanthellum aciculare</i>	0.7	0.4	0.0	0.0	0.0	0.0	0.0	0.3	0.0	0.0	0.0	0.0	0.0	0.0	0.0	0.0	0.0	0.0	0.0
<i>Dicanthellum acuminata</i>	0.3	1.0	0.0	0.0	0.0	0.0	0.0	0.0	0.0	0.0	0.0	0.0	0.0	0.0	0.0	0.0	0.0	0.0	0.0
<i>Dicanthellum consanguinium</i>	0.0	0.0	0.0	0.0	0.0	0.0	0.0	0.0	0.0	0.0	0.0	0.0	0.0	0.0	0.0	0.0	0.0	0.0	0.0
<i>Dicanthellum ensifolium</i>	0.0	0.0	0.0	0.0	0.0	0.0	0.0	0.0	0.0	0.0	0.0	0.0	0.0	0.0	0.0	0.0	0.0	0.0	0.0
<i>Dicanthellum scabrosiculum</i>	0.0	0.0	0.0	0.8	0.2	0.8	0.7	0.7	0.0	0.2	0.0	0.0	0.0	0.2	0.8	0.3	0.0	0.5	0.0
<i>Dicanthellum scoparium</i>	0.0	0.0	0.0	0.0	0.0	0.0	0.0	0.0	0.0	0.0	0.0	0.0	0.0	0.0	0.0	0.0	0.0	0.0	0.0
<i>Dicanthellum sp. 1</i>	0.0	0.0	0.0	0.0	1.0	0.7	0.7	0.0	0.0	0.8	0.8	0.4	1.0	1.0	1.0	1.0	0.0	0.4	1.0
<i>Dicanthellum sp. 2</i>	0.0	0.0	0.0	0.0	0.2	0.0	0.0	0.0	0.0	0.0	0.0	0.0	0.0	0.7	0.0	0.0	0.0	0.0	0.0
<i>Dicanthellum sp. 3</i>	0.0	0.0	0.0	0.0	0.0	0.0	0.0	0.0	0.0	0.0	0.0	0.0	0.0	0.0	0.0	0.0	0.0	0.0	0.0
<i>Dicanthellum strigosum</i>	0.0	0.0	0.3	0.0	0.0	0.0	0.0	0.0	0.0	0.0	0.0	0.0	0.0	0.0	0.0	0.0	0.0	0.0	0.0
<i>Dicanthellum tenue</i>	0.0	0.0	0.8	0.0	0.0	0.0	0.0	0.0	0.0	0.0	0.0	0.0	0.0	0.0	0.0	0.0	0.0	0.0	0.0

Indicator species	SC22	SC23	SC24	SC25	LA26	LA27	LA28	LA29	LA30	TX31	TX32	TX34	TX35	LA37	LA38	MS39	MS40a	MS40b	MS40c
<i>Dichromena colorata</i>	0.0	0.0	0.0	0.0	0.0	0.0	0.0	0.0	0.0	0.0	0.0	0.0	0.0	0.4	0.0	0.4	0.0	0.0	0.0
<i>Dichromena latifolia</i>	0.0	0.0	0.0	0.0	0.0	0.7	0.8	0.0	0.0	0.0	0.0	0.0	0.0	0.0	0.0	0.0	0.0	0.0	0.0
<i>Dichromena</i> sp.	0.0	0.0	0.0	0.0	0.0	0.0	0.0	0.0	0.0	0.0	0.0	0.0	0.0	0.0	0.0	0.0	0.0	0.0	0.0
<i>Diodia virginiana</i>	0.0	0.0	0.0	0.0	0.0	0.3	0.0	0.0	0.0	0.0	0.0	0.8	0.0	0.0	0.0	0.0	0.0	0.0	0.0
<i>Dionea muscipula</i>	0.0	0.0	0.0	0.0	0.0	0.0	0.0	0.0	0.0	0.0	0.0	0.0	0.0	0.0	0.0	0.0	0.0	0.0	0.0
<i>Drosera</i> sp.	0.0	0.0	0.3	0.0	0.3	0.0	0.0	0.0	0.0	0.8	0.8	0.0	0.3	1.0	0.7	0.7	0.0	0.0	1.0
<i>Eleocharis</i> sp.	0.0	0.0	0.0	0.0	0.0	0.0	0.0	0.0	0.0	0.0	0.0	0.0	0.0	0.0	0.0	0.0	0.0	0.0	0.0
<i>Elephantopus</i> sp.	0.0	0.0	0.0	0.0	0.0	0.0	0.0	0.0	0.0	0.0	0.0	0.0	0.0	0.0	0.0	0.0	0.0	0.0	0.0
<i>Eragrostis spectabilis</i>	0.0	0.0	0.0	0.0	0.0	0.0	0.0	0.0	0.0	0.0	0.0	0.0	0.0	0.0	0.0	0.0	0.0	0.0	0.0
<i>Erechtites hieracifolia</i>	0.0	0.0	0.0	0.0	0.0	0.0	0.0	0.0	0.0	0.0	0.0	0.0	0.0	0.0	0.0	0.0	0.0	0.0	0.0
<i>Erianthus contortus</i>	0.0	0.0	0.0	0.0	0.0	0.0	0.0	0.0	0.0	0.0	0.0	0.0	0.0	0.0	0.0	0.0	0.0	0.0	0.0
<i>Erianthus giganteus</i>	0.0	0.0	0.0	0.0	0.0	0.0	0.0	0.0	0.0	0.0	0.0	0.0	0.0	0.0	0.0	0.0	0.0	0.0	0.0
<i>Erianthus</i> sp.	0.0	1.0	0.3	0.7	0.0	0.0	0.0	0.0	0.0	0.0	0.0	0.0	0.0	0.0	0.0	0.0	0.0	0.0	0.0
<i>Eupatorium capillifolium</i>	0.2	0.0	0.0	0.0	0.0	0.0	0.0	0.0	0.2	0.0	0.0	0.0	0.0	0.0	0.0	0.0	0.0	0.0	0.0
<i>Eupatorium compositifolium</i>	0.0	0.0	0.0	0.0	0.0	0.0	0.0	0.0	0.0	0.0	0.0	0.0	0.0	0.0	0.0	0.0	0.0	0.0	0.0
<i>Eupatorium recurvans</i>	0.0	0.0	0.0	0.0	0.0	0.0	0.0	0.0	0.0	0.0	0.0	0.0	0.0	0.0	0.0	0.0	0.0	0.0	0.0
<i>Eupatorium pilosum</i>	0.0	0.0	0.0	0.0	0.0	0.0	0.0	0.0	0.0	0.0	0.0	0.0	0.0	0.0	0.0	0.0	0.0	0.0	0.0
<i>Eupatorium rotundifolium</i>	0.0	0.0	0.0	0.0	0.2	0.0	0.0	0.0	0.0	0.0	0.0	0.0	0.0	0.0	0.0	0.0	0.0	0.0	0.0
<i>Eupatorium semiseratum</i>	0.0	0.0	0.0	0.0	0.0	0.0	0.1	0.0	0.0	0.0	0.0	0.0	0.0	0.0	0.0	0.0	0.0	0.0	0.0
<i>Eupatorium</i> sp.	0.0	0.0	0.0	0.0	0.0	0.0	0.0	0.0	0.0	0.0	0.0	0.0	0.0	0.0	0.0	0.0	0.0	0.0	0.0
<i>Euphorbia inundata</i>	0.0	0.0	0.0	0.0	0.0	0.0	0.0	0.0	0.0	0.0	0.0	0.0	0.0	0.0	0.0	0.0	0.0	0.0	0.0
<i>Euphorbia leptocephalala</i>	0.0	0.0	0.0	0.0	0.0	0.0	0.0	0.0	0.0	0.0	0.0	0.0	0.0	0.0	0.0	0.0	0.0	0.0	0.0
<i>Euthamia minor</i>	0.0	0.0	0.0	0.0	0.0	0.0	0.0	0.0	0.0	0.0	0.0	0.0	0.0	0.0	0.0	0.0	0.0	0.0	0.0
<i>Euthamia</i> sp.	0.0	0.0	0.0	0.0	0.0	0.0	0.0	1.0	0.0	0.7	0.3	0.3	0.0	0.0	0.0	0.0	0.4	1.0	0.0
<i>Euthamia tenuifolia</i>	0.0	0.0	0.0	0.0	0.0	0.0	0.0	0.0	0.0	0.0	0.0	0.0	0.0	0.0	0.0	0.0	0.0	0.0	0.0
<i>Fimbristylis puberula</i>	0.8	0.0	0.7	0.0	0.0	0.0	0.0	0.0	0.0	0.0	0.0	0.0	0.0	0.0	0.0	0.0	0.0	0.0	0.0
<i>Fuirena pumila</i>	0.0	0.0	0.0	0.0	0.0	0.0	0.7	0.5	0.0	0.8	0.0	0.0	0.0	0.0	0.0	0.0	0.0	0.3	0.0
<i>Fuirena</i> sp.	0.0	0.0	0.0	0.0	0.0	0.0	0.0	0.0	0.0	0.0	0.0	0.7	1.0	0.0	0.0	0.0	0.0	0.0	0.0
<i>Fuirena squarrosa</i>	0.0	0.0	0.0	0.0	0.0	0.0	0.0	0.0	0.0	0.0	0.0	0.0	0.0	0.0	0.0	0.0	0.0	0.0	0.0
<i>Gelsemium sempervirens</i>	0.0	0.0	0.0	0.0	0.0	0.0	0.0	0.0	0.0	0.0	0.0	0.0	0.8	0.0	0.0	0.0	0.0	0.0	0.0
<i>Gratiola pilosa</i>	0.0	0.0	0.0	0.0	0.0	0.0	0.0	0.0	0.0	0.0	0.0	0.0	0.0	0.0	0.0	0.0	0.0	0.0	0.0
<i>Gymnopogon</i> sp.	0.0	0.0	0.0	0.0	0.0	0.0	0.0	0.0	0.0	0.0	0.0	0.0	0.0	0.0	0.0	0.0	0.0	0.0	0.0
<i>Habenaria</i> (esp. <i>ciliaris</i>)	0.0	0.0	0.0	0.0	0.0	0.6	0.3	0.3	0.0	0.0	0.0	0.0	0.0	0.0	0.0	0.0	0.0	0.0	0.0
<i>Habenaria</i> sp.	0.0	0.0	0.0	0.0	0.0	0.0	0.0	0.0	0.0	0.0	0.0	0.0	0.0	0.0	0.0	0.0	0.0	0.0	0.0
<i>Helenium</i> sp.	0.0	0.0	0.0	0.0	0.0	0.0	1.0	0.5	0.0	0.2	0.0	0.4	0.3	0.0	0.0	0.0	0.0	0.0	0.0
<i>Helenium vernale</i>	0.0	0.0	0.0	0.0	0.0	0.0	0.0	0.0	0.0	0.0	0.0	0.0	0.0	0.0	0.0	0.0	0.0	0.0	0.0
<i>Helianthus angustifolius</i>	0.0	0.0	0.2	0.0	0.0	0.0	0.0	0.3	0.0	0.0	0.0	0.0	1.0	0.2	0.0	0.0	0.0	0.0	0.0
<i>Hibiscus</i> sp.	0.0	0.0	0.0	0.0	0.0	0.0	0.0	0.0	0.3	0.0	0.0	0.0	0.0	0.0	0.0	0.0	0.0	0.0	0.0
<i>Hydrolea ovata</i>	0.0	0.0	0.0	0.0	0.0	0.0	0.0	0.3	0.0	0.0	0.0	0.0	0.0	0.0	0.0	0.0	0.0	0.0	0.0
<i>Hypericum brachyphyllum</i>	0.0	0.0	0.0	0.0	0.0	0.0	0.0	0.7	0.0	0.0	0.0	0.0	0.0	0.0	0.0	0.0	0.8	0.0	0.0
<i>Hypericum cistifolium</i>	0.0	0.0	0.0	0.0	0.0	0.0	0.0	0.0	0.0	0.0	0.0	0.0	0.0	0.0	0.0	0.0	0.0	0.3	0.0
<i>Hypericum setosum</i>	0.0	0.0	0.0	0.0	0.0	0.0	0.0	0.0	0.0	0.0	0.0	0.0	0.0	0.0	0.0	0.0	0.0	0.0	0.0
<i>Hypericum crux-andreae</i>	0.0	0.0	0.0	0.0	0.0	0.0	0.0	0.0	0.0	0.0	0.0	0.0	0.0	0.0	0.0	0.0	0.0	0.0	0.0
<i>Hypericum exile</i>	0.0	0.0	0.0	0.0	0.0	0.0	0.0	0.0	0.0	0.0	0.0	0.0	0.0	0.0	0.0	0.0	0.0	0.0	0.0

Indicator species	SC22	SC23	SC24	SC25	LA26	LA27	LA28	LA29	LA30	TX31	TX32	TX34	TX35	LA37	LA38	MS39	MS40a	MS40b	MS40c
<i>Hypericum fasciculatum</i>	0.0	0.0	0.0	0.0	0.4	0.0	0.0	0.0	0.3	1.0	1.0	0.1	0.4	0.0	0.0	0.0	0.0	0.7	0.3
<i>Hypericum perforatum</i>	0.0	0.0	0.0	0.0	0.0	0.0	0.0	0.0	0.0	0.0	0.0	0.0	0.0	0.0	0.0	0.0	0.0	0.0	0.0
<i>Hypericum reductum</i>	0.0	0.0	0.0	0.0	0.0	0.0	0.0	0.0	0.0	0.0	0.0	0.0	0.0	0.0	0.0	0.0	0.0	0.0	0.0
<i>Hypericum sp.</i>	0.0	0.0	0.3	0.0	0.0	0.0	0.0	0.0	0.0	0.3	0.0	0.0	0.0	0.0	0.0	0.0	0.0	0.0	0.0
<i>Hypericum stans</i>	0.0	0.0	0.0	0.0	0.3	0.0	0.0	0.0	0.0	0.8	0.0	0.0	0.5	0.0	0.4	0.0	0.0	0.0	0.0
<i>Hypoxis micrantha</i>	0.0	0.0	0.0	0.0	0.0	0.0	0.0	0.0	0.0	0.0	0.0	0.0	0.0	0.0	0.0	0.0	0.0	0.0	0.0
<i>Hyptis alata</i>	0.0	0.0	0.0	0.0	0.0	0.0	0.4	1.0	0.0	0.7	0.0	0.0	0.3	0.0	0.3	0.0	0.0	0.0	0.0
<i>Iris sp.</i>	0.8	0.0	0.0	0.8	0.0	0.0	0.0	0.0	0.0	0.0	0.0	0.0	0.0	0.0	0.0	0.0	0.0	0.0	0.0
<i>Juncus biflorus</i>	0.0	0.0	0.0	0.0	0.0	0.0	0.0	0.0	0.0	0.0	0.0	0.0	0.0	0.0	0.0	0.0	0.0	0.0	0.0
<i>Juncus dichotomus</i>	0.0	0.0	0.0	0.0	0.0	0.0	0.0	0.0	0.0	0.0	0.0	0.0	0.0	0.0	0.0	0.0	0.0	0.0	0.0
<i>Juncus marginatus</i>	0.0	0.0	0.0	0.0	0.0	0.0	0.0	0.0	0.0	0.0	0.0	0.0	0.0	0.0	0.0	0.0	0.0	0.0	0.0
<i>Juncus polycephalus</i>	0.0	0.0	0.0	0.0	0.0	0.0	0.0	0.0	0.0	0.0	0.0	0.0	0.0	0.0	0.0	0.0	0.0	0.0	0.0
<i>Juncus sp. 1</i>	0.0	0.0	0.0	0.0	0.0	0.0	0.0	0.4	0.3	0.0	0.0	0.8	0.0	0.0	0.0	0.0	1.0	0.7	0.0
<i>Juncus sp. 2</i>	0.0	0.0	0.0	0.0	0.0	0.0	0.0	0.0	0.4	0.0	0.0	0.0	0.0	0.0	0.0	0.0	0.2	0.0	0.0
<i>Juncus sp. 3</i>	0.0	0.0	0.0	0.0	0.0	0.0	0.0	0.0	1.0	0.0	0.0	0.0	0.0	0.0	0.0	0.0	0.3	0.0	0.0
<i>Lachnanthes caroliniana</i>	0.0	0.0	0.0	0.0	0.0	0.0	0.0	0.0	0.0	0.0	0.0	0.0	0.0	0.2	0.3	0.0	0.0	0.0	0.0
<i>Lachnocaulon anceps</i>	0.0	0.0	0.0	0.0	0.0	0.0	0.0	0.0	0.0	0.0	0.0	0.0	0.0	0.0	0.0	0.0	0.0	0.0	0.0
<i>Lachnocaulon minus</i>	0.0	0.0	0.0	0.0	0.0	0.0	0.0	0.0	0.0	0.0	0.0	0.0	0.0	0.0	0.0	0.0	0.0	0.0	0.0
<i>Lachnocaulon sp.</i>	0.0	0.0	0.0	0.0	0.3	0.0	0.2	0.0	0.0	0.7	0.0	0.0	0.0	0.0	0.0	0.4	0.0	0.2	0.3
Lamiaceae sp.	0.0	0.3	0.0	0.5	0.0	0.0	0.0	0.0	0.0	0.0	0.0	0.0	0.0	0.0	0.0	0.0	0.0	0.0	0.0
<i>Lamium sp.</i>	0.0	0.0	0.0	0.0	0.0	0.0	0.0	0.0	0.0	0.0	0.0	0.0	0.0	0.0	0.0	0.0	0.0	0.0	0.0
<i>Leersia hexandra</i>	0.0	0.0	0.0	0.0	0.0	0.0	0.0	0.0	0.5	0.0	0.0	0.0	0.0	0.0	0.0	0.0	0.0	0.0	0.0
<i>Liatis acidota</i>	0.0	0.0	0.0	0.0	0.0	1.0	0.0	0.0	0.0	1.0	0.7	0.0	0.4	0.0	0.0	0.0	0.0	0.0	0.0
<i>Liatis gracilis</i>	0.0	0.0	0.0	0.0	0.0	0.0	0.0	0.0	0.0	0.0	0.0	0.0	0.0	0.0	0.0	0.0	0.0	0.0	0.0
<i>Liatis pycnostachya</i>	0.0	0.0	0.0	0.0	0.0	0.0	0.0	0.0	0.0	0.0	0.8	0.0	0.8	0.0	0.0	0.0	0.0	0.0	0.0
<i>Liatis spicata</i>	0.0	0.0	0.0	0.0	0.0	0.0	0.0	0.0	0.0	0.0	0.0	0.0	0.0	0.0	0.0	0.0	0.0	0.0	0.0
<i>Liatis sp.</i>	0.0	0.0	0.0	0.0	0.0	0.0	0.0	0.0	0.0	0.0	0.0	0.0	0.0	0.0	0.0	0.3	0.0	0.3	0.3
<i>Lilium catesbaei</i>	0.0	0.0	0.0	0.0	0.0	0.0	0.0	0.0	0.0	0.0	0.0	0.0	0.0	0.0	0.0	0.0	0.0	0.0	0.0
<i>Linum floridanum</i>	0.0	0.4	0.0	0.0	0.0	0.0	0.0	0.0	0.0	0.0	0.0	0.0	0.0	0.3	0.0	0.5	0.0	0.2	0.0
<i>Lobelia brevifolia</i>	0.0	0.0	0.0	0.0	0.0	0.0	0.0	0.0	0.0	0.0	0.0	0.0	0.0	1.0	0.3	0.0	0.0	0.0	0.0
<i>Lobelia floridana</i>	0.0	0.0	0.0	0.0	0.0	0.0	0.0	0.0	0.0	0.0	0.0	0.0	0.0	0.0	0.0	0.0	0.0	0.0	0.0
<i>Lobelia glandulosa</i>	0.0	0.0	0.0	0.7	0.0	0.0	0.0	0.0	0.0	0.0	0.0	0.0	0.0	0.0	0.0	0.0	0.0	0.0	0.0
<i>Lobelia nuttallii</i>	0.0	0.0	0.0	0.0	0.0	0.0	0.0	0.0	0.0	0.0	0.0	0.0	0.0	0.0	0.0	0.0	0.0	0.0	0.0
<i>Lobelia puberula</i>	0.0	0.0	0.0	0.0	0.3	0.0	0.0	0.0	0.0	0.0	0.0	0.0	0.0	0.0	0.0	0.0	0.0	0.0	0.0
<i>Lobelia (Gaura) sp.</i>	0.0	0.0	0.0	0.0	0.3	1.0	0.2	0.3	0.0	0.0	0.0	0.0	0.8	0.0	0.0	0.0	0.0	0.0	0.0
<i>Lophiola americana</i>	0.0	0.0	0.0	0.0	0.0	0.0	0.0	0.0	0.0	0.0	0.0	0.0	0.0	0.0	0.0	0.0	0.0	0.0	0.0
<i>Ludwigia hirtella</i>	0.0	0.0	0.0	0.0	0.3	0.0	0.0	0.7	0.2	0.0	0.0	0.0	0.3	0.0	0.0	0.0	0.0	0.0	0.0
<i>Ludwigia pilosa</i>	0.0	0.0	0.0	0.0	0.0	0.0	0.0	0.0	0.0	0.0	0.0	0.0	0.0	0.0	0.0	0.0	0.4	0.0	0.0
<i>Ludwigia sp.</i>	0.0	0.0	0.0	0.0	0.0	0.0	0.0	0.0	0.0	0.0	0.0	0.0	0.4	0.0	0.0	0.0	0.0	0.0	0.0
<i>Ludwigia virgata</i>	0.0	0.0	0.0	0.0	0.0	0.0	0.0	0.0	0.0	0.0	0.0	0.0	0.0	0.0	0.0	0.0	0.0	0.0	0.0
<i>Lycopodium alopecuroides</i>	0.0	0.0	0.0	0.0	0.0	0.0	0.0	0.0	0.0	0.0	0.0	0.0	0.0	0.0	0.0	0.0	0.0	0.0	0.0
<i>Lycopodium prostratum</i>	0.0	0.0	0.0	0.0	0.0	0.0	0.0	0.0	0.0	0.0	0.0	0.0	0.0	0.0	0.0	0.0	0.0	0.0	0.0
<i>Lycopodium sp.</i>	0.0	0.0	0.0	0.0	0.0	0.0	0.0	0.0	0.0	0.0	0.0	0.0	0.0	0.0	0.0	0.0	0.0	0.0	0.0
<i>Lycopus sp.</i>	0.0	0.0	0.0	0.0	0.0	0.0	0.0	0.0	0.0	0.0	0.0	0.0	0.0	0.0	0.0	0.0	0.0	0.0	0.0

Indicator species	SC22	SC23	SC24	SC25	LA26	LA27	LA28	LA29	LA30	TX31	TX32	TX34	TX35	LA37	LA38	MS39	MS40a	MS40b	MS40c
<i>Lycopus virginicus</i>	0.0	0.0	0.0	0.0	0.0	0.0	0.0	0.0	0.0	0.0	0.0	0.0	0.0	0.0	0.0	0.0	0.0	0.0	0.0
<i>Marshallia graminifolia</i>	0.0	0.0	0.0	0.4	0.0	0.0	0.0	0.0	0.0	0.0	0.0	0.0	0.0	0.0	0.0	0.0	0.0	0.0	0.0
<i>Marshallia tenuifolia</i>	0.0	0.0	0.0	0.0	1.0	1.0	0.3	0.0	1.0	0.8	0.0	0.8	0.0	0.2	0.0	0.0	0.0	0.0	0.3
<i>Mayaca aubletii</i>	0.0	0.0	0.0	0.0	0.0	0.0	0.0	0.0	0.0	0.0	0.0	0.0	0.0	0.0	0.0	0.0	0.0	0.0	0.0
<i>Mecardonia acuminata</i>	0.0	0.0	0.0	0.0	0.0	0.1	1.0	0.2	0.0	0.0	1.0	0.0	0.0	0.0	0.0	0.0	0.0	0.0	0.0
<i>Mecardonia marilandica</i>	0.0	0.0	0.0	0.0	0.0	0.0	0.0	0.0	0.0	0.0	0.0	0.0	0.0	0.0	0.0	0.0	0.0	0.0	0.0
<i>Onoclea sensibilis</i>	0.0	0.0	0.0	0.2	0.0	0.0	0.0	0.0	0.0	0.0	0.0	0.0	0.0	0.0	0.0	0.0	0.0	0.0	0.0
Orchidaceae sp.	0.0	0.0	0.0	0.0	0.0	0.0	0.0	0.0	0.0	0.0	0.0	0.0	0.0	0.0	0.0	0.0	0.0	0.0	0.0
<i>Osmunda cinnamomea</i>	0.0	0.0	0.0	0.0	0.0	0.0	0.0	0.0	0.0	0.0	0.0	0.0	0.0	0.0	0.0	0.0	0.0	0.0	0.0
<i>Osmunda regalis</i>	0.0	0.0	0.0	0.0	0.0	0.0	0.0	0.0	0.0	0.0	0.0	0.0	0.0	0.0	0.0	0.0	0.0	0.0	0.0
<i>Oxypolis filiformis</i>	0.0	0.0	0.0	0.0	0.7	0.7	0.0	0.0	0.0	0.0	0.0	0.0	0.0	0.0	0.0	0.0	0.0	0.0	0.3
<i>Oxypolis sp.</i>	0.0	0.0	0.0	0.0	0.0	0.0	0.0	0.0	0.0	0.0	0.0	0.3	0.0	0.0	0.0	0.0	0.0	0.0	0.0
<i>Oxypolis ternata</i>	0.0	0.0	0.0	0.0	0.0	0.0	0.0	0.0	0.0	0.0	0.0	0.0	0.0	0.0	0.0	0.0	0.0	0.0	0.0
<i>Panicum anceps</i>	0.0	0.0	0.0	0.0	0.0	0.0	0.0	0.0	0.0	0.0	0.0	0.0	0.0	0.0	0.0	0.0	0.0	0.0	0.0
<i>Panicum hians</i>	0.0	0.0	0.0	0.0	0.0	0.0	0.0	0.0	0.0	0.0	0.0	0.0	0.0	0.0	0.0	0.0	0.0	0.0	0.0
<i>Panicum sp.1</i>	0.0	0.0	0.0	0.0	0.0	0.0	0.0	0.0	0.0	0.0	0.0	0.0	0.0	0.0	0.0	0.0	0.0	0.0	0.0
<i>Panicum sp.2</i>	0.0	0.0	0.0	0.0	0.0	0.0	0.0	0.0	0.0	0.0	0.0	0.0	0.0	0.0	0.0	0.0	0.0	0.0	0.0
<i>Panicum virgatum</i>	0.0	0.3	0.0	0.4	0.0	0.0	0.3	1.0	0.0	0.0	0.0	0.0	0.2	0.0	0.8	0.8	0.0	0.0	0.0
<i>Paspalum sp.</i>	0.0	0.0	0.0	0.0	0.0	0.0	0.0	0.8	1.0	0.0	0.0	1.0	0.5	0.0	0.7	0.0	0.0	0.0	0.0
<i>Physotegia godfreyi</i>	0.0	0.0	0.0	0.0	0.0	0.0	0.0	0.0	0.0	0.0	0.0	0.0	0.0	0.0	0.0	0.0	0.0	0.0	0.0
<i>Pinguicula sp.</i>	0.0	0.0	0.0	0.0	0.0	0.0	0.0	0.0	0.0	0.0	0.0	0.0	0.0	0.0	0.0	0.0	0.0	0.0	0.0
<i>Pityopsis graminifolia</i>	0.0	0.0	0.7	0.0	0.0	0.0	0.0	0.0	0.0	0.0	0.0	0.0	0.0	0.3	0.0	0.0	0.0	0.0	0.0
<i>Pilea tenuifolia</i>	0.0	0.0	0.0	0.0	0.0	0.0	0.0	0.0	0.0	0.0	0.0	0.0	0.0	0.0	0.0	0.0	0.0	0.0	0.0
<i>Pluchea rosea</i>	0.0	0.0	0.0	0.0	0.0	0.0	0.0	0.0	0.0	0.0	0.0	0.0	0.0	0.0	0.0	0.0	0.0	0.0	0.0
<i>Pluchea sp.</i>	0.1	0.7	0.0	0.7	0.0	0.3	0.0	0.4	0.5	0.8	0.0	0.8	0.1	0.0	0.0	0.0	0.0	0.0	0.0
<i>Pogonia ophioglossoides</i>	0.0	0.0	0.0	0.0	0.0	0.0	0.0	0.0	0.0	0.0	0.0	0.0	0.0	0.0	0.0	0.0	0.0	0.0	0.0
<i>Pogonia sp.</i>	0.0	0.0	0.0	0.0	0.0	0.0	0.0	0.0	0.0	0.0	0.0	0.0	0.0	0.0	0.0	0.0	0.0	0.0	0.0
<i>Polygala cruciata</i>	0.0	0.0	0.0	0.0	0.0	0.0	0.0	0.0	0.0	0.0	0.0	0.0	0.0	0.4	0.0	0.1	0.0	0.0	0.0
<i>Polygala cymosa</i>	0.0	0.3	0.0	0.0	0.0	0.0	0.0	0.0	0.0	0.0	0.0	0.0	0.0	0.0	0.0	0.0	0.0	0.0	0.0
<i>Polygala hookeri</i>	0.0	0.0	0.0	0.0	0.0	0.0	0.0	0.0	0.0	0.0	0.0	0.0	0.0	0.0	0.0	0.0	0.0	0.0	0.0
<i>Polygala lutea</i>	0.0	0.0	0.0	0.0	0.0	0.0	0.0	0.0	0.0	0.0	0.0	0.0	0.0	0.0	0.0	0.0	0.0	0.0	0.2
<i>Polygala ramosa</i>	0.0	0.0	0.2	0.0	0.0	0.2	0.0	0.0	0.0	0.0	0.0	0.2	0.0	0.4	0.3	0.1	0.0	0.0	1.0
<i>Polygala sp.</i>	0.0	0.0	0.0	0.0	0.0	0.0	0.0	0.0	0.0	0.4	0.0	0.0	0.0	0.0	0.0	0.0	0.0	0.0	0.0
<i>Polygonum hydropiper</i>	0.7	0.0	0.0	0.0	0.0	0.0	0.0	0.2	0.0	0.0	0.0	0.0	0.0	0.0	0.0	0.0	0.0	0.0	0.0
<i>Proserpinaca pectinata & serpent</i>	0.3	0.0	0.0	0.0	0.0	0.3	0.7	1.0	0.0	0.0	0.0	0.4	0.0	0.0	0.0	0.0	0.0	0.0	0.0
<i>Pteridium aquilinum</i>	0.0	0.0	0.0	0.0	0.0	0.0	0.0	0.0	0.0	0.0	0.0	0.0	0.0	0.0	0.0	0.0	0.0	0.0	0.0
<i>Ptilimnium nuttallii</i>	0.0	0.0	0.0	0.0	0.0	0.7	0.0	0.0	0.0	0.0	0.0	0.0	0.0	0.0	0.0	0.0	0.0	0.0	0.0
<i>Pycnanthemum nudum</i>	0.0	0.0	0.0	0.0	0.0	0.0	0.0	0.0	0.0	0.0	0.0	0.0	0.0	0.0	0.0	0.0	0.0	0.0	0.0
<i>Pycnanthemum tenuifolium</i>	0.0	0.0	0.0	0.0	0.0	0.0	0.0	0.0	0.0	0.0	0.0	0.0	0.0	0.0	0.0	0.0	0.0	0.0	0.0
<i>Rhexia virginica</i>	0.0	0.0	0.0	0.0	0.0	0.0	0.0	0.0	0.0	0.0	0.0	0.0	0.0	0.0	0.0	0.0	0.0	0.0	0.0
<i>Rhus radicans</i>	0.0	0.0	0.0	0.0	0.2	0.0	0.0	0.0	0.0	0.0	0.0	0.0	0.0	0.0	0.0	0.0	0.0	0.0	0.0
<i>Rhynchospora caduca</i>	0.0	0.0	0.0	0.0	0.0	0.0	0.0	0.0	0.0	0.0	0.0	0.0	0.0	0.0	0.0	0.0	0.0	0.0	0.0
<i>Rhynchospora chapmanii</i>	0.0	0.0	0.0	0.0	0.0	0.0	0.0	0.0	0.0	0.0	0.0	0.0	0.0	0.7	0.0	1.0	0.0	0.0	0.7

Indicator species	SC22	SC23	SC24	SC25	LA26	LA27	LA28	LA29	LA30	TX31	TX32	TX34	TX35	LA37	LA38	MS39	MS40a	MS40b	MS40c
<i>Rhynchospora ciliaris</i>	0.0	0.0	0.0	0.0	0.0	0.0	0.0	0.0	0.0	0.0	0.0	0.0	0.0	0.0	0.0	0.0	0.0	0.0	0.0
<i>Rhynchospora compressa</i>	0.0	0.0	0.0	0.0	0.0	0.0	0.0	0.0	0.0	0.0	0.0	0.0	0.0	0.3	0.0	0.0	0.0	0.0	0.0
<i>Rhynchospora debilis</i>	0.0	0.0	0.0	0.0	0.0	0.0	0.0	0.0	0.0	0.0	0.0	0.0	0.0	0.0	0.0	0.0	0.0	0.0	0.0
<i>Rhynchospora elliotii</i>	0.0	0.0	0.0	0.0	0.0	0.5	0.0	0.5	0.0	0.0	0.4	0.3	0.2	0.0	0.0	0.0	0.0	0.0	0.0
<i>Rhynchospora glomerata</i>	0.0	0.0	0.0	0.0	0.0	0.0	0.8	1.0	0.0	0.0	1.0	0.0	0.0	0.3	0.0	0.0	0.0	0.0	0.0
<i>Rhynchospora gracilentia</i>	0.0	0.0	0.0	0.0	0.0	0.0	0.7	0.4	1.0	0.0	0.0	0.0	0.0	0.8	0.8	0.4	0.0	0.0	0.0
<i>Rhynchospora inexpansa</i>	0.0	0.0	0.0	0.0	0.0	0.0	0.0	0.0	0.0	0.7	0.0	0.3	0.0	0.0	0.0	0.2	0.0	0.0	0.0
<i>Rhynchospora macra</i>	0.0	0.0	0.0	0.0	0.0	1.0	0.0	0.0	0.0	0.0	0.0	0.0	0.0	0.0	0.0	0.0	0.0	0.0	0.0
<i>Rhynchospora microcarpa</i>	0.0	0.0	0.0	0.0	0.8	0.0	0.0	0.0	0.0	0.0	0.0	0.0	0.0	0.0	0.0	0.0	0.0	0.0	0.0
<i>Rhynchospora oligantha</i>	0.0	0.0	0.0	0.0	0.0	0.0	0.0	0.0	0.0	0.0	0.0	0.0	0.0	0.0	0.0	0.0	0.0	0.0	0.0
<i>Rhynchospora plumosa</i>	0.0	0.0	0.0	0.0	0.0	0.0	0.0	0.0	0.0	0.5	0.0	0.0	0.4	0.4	0.0	0.8	0.0	0.0	0.3
<i>Rhynchospora rariflora</i>	0.0	0.0	0.0	0.0	0.2	0.0	0.0	0.0	0.0	0.3	0.0	0.0	0.0	0.8	0.0	0.8	0.0	0.0	0.3
<i>Rhynchospora sp. 1</i>	0.0	0.7	0.0	0.7	0.0	0.0	1.0	0.0	1.0	0.0	0.4	0.0	0.0	0.0	1.0	0.0	0.3	0.7	0.4
<i>Rhynchospora sp. 2</i>	0.0	0.8	0.2	0.4	0.0	0.0	0.0	0.0	0.0	0.0	0.0	0.0	0.0	0.0	0.0	0.0	0.0	0.4	0.0
<i>Rhynchospora sp. (large)</i>	0.0	0.0	0.0	0.0	0.0	0.0	0.0	0.0	0.0	0.0	0.0	0.0	0.0	0.0	0.0	0.0	0.0	0.0	0.0
<i>Rhynchospora sp. (medium)</i>	0.1	0.2	0.0	0.0	0.0	0.0	0.0	0.0	0.0	0.0	0.0	0.0	0.0	0.0	0.0	0.0	0.0	0.0	0.0
<i>Rhynchospora sp. (small)</i>	0.0	0.0	0.0	0.0	0.0	0.0	0.0	0.0	0.0	0.0	0.0	0.0	0.0	0.0	0.0	0.7	0.0	0.0	0.0
<i>Rhynchospora sp. (tiny)</i>	0.0	0.0	0.7	0.0	0.0	0.0	0.0	0.0	0.0	0.0	0.0	0.0	0.0	0.0	0.0	0.0	0.0	0.0	0.0
<i>Rhynchospora (tri-stemmed)</i>	0.0	0.3	0.0	0.8	0.0	0.0	0.0	0.0	0.0	0.0	0.0	0.0	0.0	0.0	0.0	0.4	0.0	0.0	0.8
<i>Rubus sp.</i>	0.0	0.0	0.0	0.0	0.0	0.0	0.0	0.0	0.0	0.2	0.0	0.0	0.0	0.0	0.0	0.0	0.0	0.0	0.0
<i>Rudbeckia graminifolia</i>	0.0	0.0	0.0	0.0	0.0	0.0	0.0	0.0	0.0	0.0	0.0	0.0	0.0	0.0	0.0	0.0	0.0	0.0	0.0
<i>Rudbeckia sp.</i>	0.0	0.0	0.0	0.0	0.0	0.0	0.0	0.0	0.0	0.0	0.2	0.0	0.0	0.0	0.0	0.0	0.0	0.0	0.0
<i>Ruellia humilis</i>	0.0	0.0	0.0	0.0	0.0	0.0	0.0	0.0	0.0	0.0	0.0	0.0	0.2	0.0	0.0	0.0	0.0	0.0	0.0
<i>Ruellia humilis var. longiflora</i>	0.0	0.0	0.0	0.0	0.0	0.0	0.0	0.0	0.0	0.0	0.0	0.0	0.0	0.0	0.0	0.0	0.0	0.0	0.0
<i>Sabal minor</i>	0.0	0.0	0.0	0.0	0.0	0.0	0.0	0.0	0.0	0.0	0.0	0.0	0.0	0.0	0.0	0.0	0.0	0.0	0.0
<i>Sabatia bartramii</i>	0.0	0.0	0.0	0.0	0.0	0.0	0.0	0.0	0.0	0.0	0.0	0.0	0.0	0.0	0.0	0.0	0.0	0.0	0.0
<i>Sabatia campanulata</i>	0.0	0.0	0.0	0.0	0.0	0.0	1.0	0.7	0.0	0.0	0.0	0.0	0.0	0.5	0.0	0.0	0.0	0.0	0.0
<i>Sabatia difformis</i>	0.0	0.0	0.0	0.0	0.0	0.0	0.0	0.0	0.0	0.0	0.0	0.0	0.0	0.0	0.0	0.0	0.0	0.0	0.0
<i>Sabatia dodecandra</i>	0.0	0.0	0.0	0.0	0.0	0.0	0.0	0.0	0.0	0.0	0.0	0.0	0.0	0.0	0.0	0.0	0.0	0.0	0.0
<i>Sabatia gentianoides</i>	0.0	0.0	0.0	0.0	0.0	0.0	0.0	0.0	0.0	0.0	0.0	0.0	0.0	0.0	0.0	0.0	0.0	0.0	0.0
<i>Sabatia macrophylla</i>	0.0	0.0	0.0	0.0	0.0	0.0	0.0	0.0	0.0	0.0	0.0	0.0	0.0	0.0	0.0	0.0	0.0	0.0	0.0
<i>Sabatia sp. 1</i>	1.0	0.3	0.0	0.3	0.0	0.0	0.0	0.0	0.0	0.0	0.0	0.0	0.0	0.0	0.0	0.0	0.0	0.0	0.0
<i>Sabatia sp. 2</i>	0.0	0.0	0.0	0.0	0.0	0.0	0.0	0.0	0.0	0.0	0.0	0.0	0.0	0.0	0.0	0.0	0.0	0.0	0.0
<i>Sagittaria lancifolia</i>	0.0	0.0	0.0	0.0	0.0	0.0	0.0	0.0	0.0	0.0	0.0	0.0	0.0	0.0	0.0	0.0	0.0	0.0	0.0
<i>Schizachyrium tenerum</i>	0.0	0.0	0.0	0.0	0.0	0.0	0.0	0.0	0.0	0.0	0.0	0.0	0.0	0.0	0.0	0.0	0.0	0.0	0.0
<i>Schoenolirion elliotii</i>	0.0	0.0	0.0	0.0	0.0	0.0	0.0	0.0	0.0	0.0	0.0	0.0	0.0	0.0	0.0	0.0	0.0	0.0	0.0
<i>Schrankia sp.</i>	0.0	0.0	0.0	0.0	0.0	0.0	0.0	0.0	0.0	0.0	0.0	0.0	0.0	0.0	0.0	0.0	0.0	0.0	0.0
<i>Scirpus cyperinus</i>	0.0	0.0	0.0	0.0	0.0	0.0	0.0	0.0	0.0	0.0	0.0	0.0	0.0	0.0	0.0	0.0	0.0	0.0	0.0
<i>Scleria baldwinii</i>	0.0	0.0	0.0	0.0	0.0	0.4	0.0	0.0	0.0	0.0	0.0	0.0	0.0	0.3	0.4	0.0	0.0	0.0	0.0
<i>Scleria pauciflora</i>	0.0	0.0	0.0	0.0	0.0	0.0	0.0	0.0	0.0	0.0	0.0	0.0	0.0	0.0	0.0	0.0	0.0	0.0	0.0
<i>Scleria pauciflora var. caroliniana</i>	0.0	0.0	0.0	0.0	0.0	0.0	0.0	0.0	0.0	0.0	0.0	0.0	0.0	0.0	0.0	0.0	0.0	0.0	0.0
<i>Scleria pauciflora var. pausiflora</i>	0.0	0.0	0.0	0.0	0.0	0.0	0.0	0.0	0.0	0.0	0.0	0.0	0.0	0.0	0.0	0.0	0.0	0.0	0.0
<i>Scleria sp. 1</i>	0.0	0.0	0.3	0.0	0.3	0.0	1.0	0.0	0.0	0.0	0.0	0.0	0.0	0.4	0.0	0.0	0.0	0.0	0.0

Indicator species	SC22	SC23	SC24	SC25	LA26	LA27	LA28	LA29	LA30	TX31	TX32	TX34	TX35	LA37	LA38	MS39	MS40a	MS40b	MS40c
<i>Scleria</i> sp. 2	0.0	0.0	0.0	0.0	0.0	0.0	0.0	0.0	0.0	0.0	0.0	0.0	0.0	0.0	0.0	0.0	0.0	0.0	0.0
<i>Scutellaria integrifolia</i>	0.0	0.0	0.0	0.0	0.0	0.0	0.0	0.0	0.0	0.0	0.0	0.0	0.0	0.0	0.0	0.0	0.0	0.0	0.0
<i>Scutellaria</i> sp.	0.0	0.0	0.2	0.0	0.0	0.0	0.0	0.0	0.0	0.0	0.0	0.0	0.0	0.0	0.0	0.0	0.0	0.0	0.0
<i>Serenoa repens</i>	0.0	0.0	0.0	0.0	0.0	0.0	0.0	0.0	0.0	0.0	0.0	0.0	0.0	0.0	0.0	0.0	0.0	0.0	0.0
<i>Seymouria cassioides</i>	0.0	0.0	0.0	0.0	0.0	0.0	0.0	0.0	0.0	0.0	0.0	0.0	0.0	0.0	0.0	0.0	0.0	0.0	0.0
<i>Sisyrinchium</i> sp.	0.0	0.0	0.0	0.0	0.0	0.0	0.0	0.0	0.0	0.0	0.0	0.0	0.0	0.0	0.0	0.0	0.0	0.0	0.0
<i>Smilax bona-nox</i>	0.0	0.0	0.0	0.0	0.0	0.0	0.0	0.0	0.0	0.0	0.0	0.0	0.0	0.0	0.0	0.0	0.3	0.0	0.0
<i>Smilax laurifolia</i>	0.0	0.0	0.0	0.0	0.0	0.0	0.0	0.0	0.0	0.0	0.0	0.0	0.2	0.0	0.7	0.0	0.0	0.7	0.4
<i>Smilax rotundifolia</i>	0.0	0.0	0.0	0.0	0.0	0.0	0.0	0.0	0.0	0.0	0.0	0.0	0.0	0.0	0.0	0.0	0.0	0.0	0.0
<i>Smilax</i> sp.	0.0	0.0	0.0	0.0	0.0	0.0	0.0	0.0	0.0	0.0	0.0	0.0	0.0	0.0	0.0	0.0	0.0	0.0	0.0
<i>Solidago fistulosa</i>	0.0	0.2	0.0	0.0	0.0	0.0	0.0	0.0	0.0	0.0	0.0	0.0	0.0	0.0	0.0	0.0	0.0	0.0	0.0
<i>Solidago</i> sp. 1	0.8	0.3	0.0	0.0	0.0	0.0	0.0	0.0	0.0	0.0	0.0	0.0	0.0	0.0	0.0	0.0	0.0	0.0	0.0
<i>Solidago</i> sp. 2	0.4	0.4	0.0	0.0	0.0	0.0	0.0	0.0	0.0	0.0	0.0	0.0	0.0	0.0	0.0	0.0	0.0	0.0	0.0
<i>Solidago</i> sp. 3	0.0	0.0	0.0	0.0	0.0	0.0	0.0	0.0	0.0	0.0	0.0	0.0	0.0	0.0	0.0	0.0	0.0	0.0	0.0
<i>Solidago stricta</i>	0.7	0.4	1.0	0.0	0.0	0.0	0.0	0.0	0.0	0.0	0.0	0.0	0.0	0.0	0.0	0.0	0.0	0.0	0.0
<i>Sphagnum</i> spp.	0.0	1.0	0.4	0.0	0.7	0.3	0.7	0.0	0.0	0.2	0.7	0.0	0.3	0.3	0.8	0.0	0.0	0.0	0.3
<i>Spiranthes</i> sp.	0.0	0.0	0.0	0.0	0.0	0.0	0.0	0.0	0.0	0.0	0.0	0.0	0.0	0.0	0.0	0.0	0.0	0.0	0.0
<i>Sporobolus</i> sp.	0.0	0.0	0.0	0.0	0.0	0.0	0.0	0.0	0.0	0.0	0.0	0.0	0.0	0.0	0.0	0.0	0.0	0.0	0.0
<i>Sporobolus teretifolius</i>	0.0	0.0	0.0	0.0	0.0	0.0	0.0	0.0	0.0	0.0	0.0	0.0	0.0	0.0	0.0	0.0	0.0	0.0	0.0
<i>Stokesia laevis</i>	0.0	0.0	0.0	0.0	0.0	0.0	0.0	0.0	0.0	0.0	0.0	0.0	0.0	0.0	0.0	0.0	0.0	0.0	0.0
<i>Tephrosia onobrychooides</i>	0.0	0.0	0.0	0.0	0.0	0.0	0.0	0.0	0.0	0.0	0.0	0.0	0.0	0.0	0.0	0.0	0.0	0.0	0.0
<i>Tephrosia</i> sp.	0.0	0.0	0.3	0.0	0.0	0.0	0.0	0.0	0.0	0.0	0.0	0.0	0.0	0.0	0.0	0.0	0.0	0.0	0.0
<i>Tofieldia glabra</i>	0.0	0.0	0.0	0.0	0.0	0.0	0.0	0.0	0.0	0.0	0.0	0.0	0.0	0.0	0.0	0.0	0.0	0.0	0.0
<i>Tofieldia racemosa</i>	0.0	0.0	0.0	0.0	0.0	0.0	0.0	0.0	0.0	0.0	0.8	0.0	0.0	0.0	0.0	0.0	0.0	0.0	0.0
<i>Tridens</i> sp.	0.0	0.0	0.0	0.0	0.0	0.0	0.0	0.0	0.0	0.0	0.0	0.0	0.3	0.0	0.0	0.0	0.0	0.0	0.0
<i>Uniola laxa</i>	0.0	0.0	0.0	0.0	0.0	0.0	0.0	0.0	0.0	0.0	0.0	0.0	0.0	0.0	0.0	0.0	0.0	0.0	0.0
<i>Verbesina chapmanii</i>	0.0	0.0	0.0	0.0	0.0	0.0	0.0	0.0	0.0	0.0	0.0	0.0	0.0	0.0	0.0	0.0	0.0	0.0	0.0
<i>Vernonia</i> sp.	0.0	0.0	0.0	0.0	0.0	0.0	0.0	0.8	0.0	0.0	0.0	0.0	0.0	0.0	0.0	0.0	0.0	0.0	0.0
<i>Viola lanceolata</i>	0.2	0.8	0.0	0.7	0.0	0.0	0.0	0.0	0.0	0.2	0.3	0.0	0.2	0.0	0.2	0.0	0.0	0.0	0.0
<i>Viola</i> sp.	0.0	0.0	0.0	0.0	0.0	0.0	0.0	0.0	0.0	0.0	0.0	0.0	0.0	0.0	0.0	0.0	0.0	0.0	0.0
<i>Woodwardia areolata</i>	0.0	0.0	0.0	0.0	0.0	0.0	0.0	0.0	0.0	0.0	0.0	0.0	0.0	0.0	0.0	0.0	0.0	0.0	0.0
<i>Woodwardia virginica</i>	0.0	0.0	0.0	0.0	0.0	0.0	0.0	0.0	0.0	0.0	0.0	0.0	0.0	0.0	0.0	0.0	0.0	0.0	0.0
<i>Xyris scabriifolia</i>	0.0	0.0	0.0	0.0	0.0	0.0	0.0	0.0	0.0	0.0	0.0	0.0	0.0	0.0	0.0	0.0	0.0	0.0	0.0
<i>Zigadenus glaberrimus</i>	0.0	0.0	0.0	0.0	0.0	0.0	0.0	0.0	0.0	0.0	0.0	0.0	0.0	0.0	0.0	0.0	0.0	0.3	0.3
Unknown or unidentifiable vascular plants	2.4	0.3	0.4	1.7	0.0	0.0	0.0	0.0	0.0	0.0	0.0	0.0	0.0	0.0	0.3	0.0	0.0	0.0	0.0
Unk. bryophyte	0.0	0.0	0.0	0.0	0.2	0.0	0.0	0.0	0.0	0.3	0.0	0.0	0.0	0.0	0.0	0.0	0.0	0.0	0.0

Indicator species	MS41	MS42	MS43	AL44	AL45	AL46	AL47	AL48	AL49	AL50	AL51	FL52	FL53	FL54	FL55	FL56	FL57	FL58	FL59	GA60
<i>Aster dumosus</i>	0.0	0.0	0.3	0.8	0.0	0.0	0.0	0.0	0.0	1.0	0.0	0.0	0.0	0.0	0.0	0.0	0.0	0.0	0.0	0.0
<i>Aster eryngifolius</i>	0.0	0.0	0.0	0.0	0.0	0.0	0.0	0.0	0.0	0.0	0.0	0.0	0.0	0.0	0.0	0.0	0.0	0.2	0.0	0.0
<i>Aster linariifolius</i>	0.0	0.0	0.0	0.0	0.0	0.0	0.0	0.0	0.0	0.0	0.0	0.0	0.0	0.0	0.0	0.0	0.0	0.0	0.0	0.0
<i>Aster paludosus</i>	0.0	0.0	0.0	0.0	0.0	0.0	0.0	0.0	0.0	0.0	0.0	0.0	0.0	0.0	0.0	0.0	0.0	0.0	0.0	0.0
<i>Aster sclerosus</i>	0.0	0.0	0.0	0.0	0.0	0.0	0.0	0.0	0.0	0.0	0.0	0.0	0.0	0.0	0.0	0.0	0.0	0.0	0.0	0.0
<i>Aster sp. 1</i>	0.0	0.0	0.0	0.0	0.0	0.0	1.0	0.0	0.0	0.0	0.0	0.0	0.0	0.0	0.0	0.0	0.0	0.0	0.0	0.0
<i>Aster sp. 2</i>	0.0	0.0	0.0	0.0	0.0	0.0	0.5	0.0	0.0	0.0	0.0	0.0	0.0	0.0	0.0	0.0	0.0	0.0	0.0	0.0
<i>Aster verticillata</i>	0.0	0.0	0.0	0.0	0.0	0.0	0.0	0.0	0.0	0.0	0.0	0.0	0.0	0.0	0.0	0.0	0.0	0.0	0.0	0.0
<i>Bacopa caroliniana</i>	0.0	0.0	0.0	0.0	0.0	0.0	0.0	0.0	0.0	0.0	0.0	0.0	0.0	0.0	0.0	0.0	0.0	0.0	0.0	0.0
<i>Balduna uniflora</i>	0.7	1.0	0.0	0.3	0.0	0.8	0.0	0.7	0.4	0.0	0.8	0.0	0.0	0.8	0.0	0.0	0.0	0.0	0.0	0.0
<i>Bartonia virginica</i>	0.0	0.0	0.0	0.0	0.0	0.3	0.0	0.0	0.0	0.0	0.0	0.0	0.0	0.0	0.0	0.0	0.0	0.0	0.0	0.0
<i>Berchemia scandens</i>	0.0	0.0	0.0	0.0	0.0	0.0	0.0	0.0	0.0	0.0	0.0	0.0	0.0	0.0	0.0	0.0	0.0	0.0	0.0	0.0
<i>Bidens bipinnata</i>	0.0	0.0	0.0	0.0	0.0	0.0	0.0	0.0	0.0	0.0	0.0	0.0	0.0	0.0	0.0	0.0	0.0	0.0	0.0	0.0
<i>Bidens mitis</i>	0.0	0.0	0.0	0.0	0.0	0.0	0.0	0.0	0.0	0.8	0.0	0.0	0.0	0.0	0.0	0.0	0.0	0.0	0.0	0.0
<i>Bidens sp.</i>	0.0	0.0	0.0	0.0	0.0	0.0	1.0	0.0	0.0	1.0	0.0	0.0	0.0	0.0	0.0	0.0	0.0	0.0	0.0	0.0
<i>Boltonia asteroides</i>	0.0	0.0	0.0	0.0	0.0	0.0	0.0	0.0	0.0	0.0	0.0	0.0	0.0	0.0	0.0	0.0	0.0	0.0	0.0	0.0
<i>Cacalia lanceolata</i>	0.0	0.0	0.0	0.0	0.0	0.0	0.0	0.0	0.0	0.0	0.0	0.0	0.0	0.0	0.0	0.0	0.0	0.0	0.0	0.0
<i>Calopogon sp.</i>	0.0	0.0	0.0	0.0	0.0	0.0	0.0	0.0	0.0	0.0	0.0	0.0	0.0	0.0	0.0	0.0	0.0	0.0	0.0	0.0
<i>Calopogon tuberosus</i>	0.0	0.0	0.0	0.0	0.0	0.0	0.0	0.0	0.0	0.0	0.0	0.0	0.0	0.0	0.0	0.0	0.0	0.0	0.0	0.0
<i>Carex crinita</i>	0.0	0.0	0.0	0.0	0.0	0.0	0.8	0.0	0.0	0.0	0.0	0.0	0.0	0.0	0.0	0.0	0.0	0.0	0.0	0.0
<i>Carex glaucescens</i>	0.0	0.0	0.0	0.0	0.0	0.0	0.0	0.0	0.0	0.0	0.0	0.0	0.0	0.0	0.0	0.0	0.0	0.0	0.0	0.0
<i>Carex sp.</i>	0.0	0.0	0.0	0.0	0.2	0.0	0.0	0.0	0.0	0.0	0.0	0.0	0.4	0.0	0.0	0.3	0.0	0.0	0.0	1.0
<i>Centella asiatica/erecta</i>	0.3	0.0	0.0	0.2	0.0	0.0	0.7	0.0	0.2	0.7	0.0	0.0	0.0	0.0	0.0	0.0	0.0	0.0	0.0	0.0
<i>Chrysopsis sp. (Heterotheca)</i>	0.0	0.0	0.0	0.0	0.0	0.0	0.0	0.0	0.0	0.0	0.0	0.0	0.0	0.0	0.0	0.0	0.0	0.0	0.0	0.0
<i>Cirsium lecontei</i>	0.0	0.0	0.0	0.0	0.0	0.0	0.0	0.0	0.0	0.0	0.0	0.0	0.0	0.0	0.0	0.0	0.0	0.0	0.0	0.0
<i>Cirsium sp.</i>	0.0	0.0	0.0	0.0	0.0	0.2	0.0	0.0	0.0	0.0	0.0	0.0	0.0	0.0	0.0	0.0	0.0	0.0	0.0	0.0
<i>Cleistes divaricata</i>	0.0	0.0	0.0	0.0	0.0	0.0	0.0	0.0	0.0	0.3	0.0	0.0	0.0	0.0	0.0	0.0	0.0	0.0	0.0	0.0
<i>Coreopsis falcata</i>	0.0	0.0	0.0	0.0	0.0	0.0	0.0	0.0	0.0	0.0	0.0	0.0	0.0	0.0	0.0	0.0	0.0	0.0	0.0	0.0
<i>Cuscuta sp.</i>	0.0	0.0	0.0	0.3	0.0	0.0	0.0	0.2	0.0	1.0	0.0	0.0	0.0	0.0	0.0	0.0	0.0	0.0	0.0	0.0
<i>Cynoctonum sessilifolium</i>	0.0	0.0	0.0	0.0	0.0	0.0	0.0	0.0	0.0	0.0	0.0	0.0	0.0	0.0	0.0	0.0	0.0	0.0	0.0	0.0
<i>Cyperus haspan</i>	0.0	0.0	0.0	0.0	0.3	0.0	0.0	0.0	0.0	0.0	0.0	0.0	0.0	0.0	0.0	0.0	0.0	0.0	0.0	0.0
<i>Cyperus pseudovegetus</i>	0.0	0.0	0.0	0.0	0.5	0.0	0.0	0.0	0.0	0.0	0.0	0.0	0.0	0.0	0.0	0.0	0.0	0.0	0.0	0.0
<i>Cyperus sp.</i>	0.0	0.0	0.0	0.0	0.0	0.0	0.0	0.0	0.0	0.0	0.0	0.0	0.0	0.0	0.0	0.0	0.0	0.0	0.0	0.0
<i>Dicanthellum aciculare</i>	0.0	0.0	0.0	0.0	0.0	1.0	0.0	0.0	0.0	0.0	0.0	0.0	0.0	0.0	0.0	0.0	0.0	0.0	0.0	0.0
<i>Dicanthellum acuminata</i>	0.0	0.0	0.0	0.0	0.0	0.0	0.0	0.0	0.0	0.0	0.0	0.0	0.0	0.0	0.0	0.0	0.0	0.0	0.0	0.0
<i>Dicanthellum consanguinium</i>	0.0	0.0	0.0	0.0	0.0	0.0	0.0	0.0	0.0	0.0	0.0	0.0	0.0	0.0	0.0	0.0	0.0	0.0	0.0	0.0
<i>Dicanthellum ensifolium</i>	0.0	0.0	0.0	0.0	0.0	0.0	0.0	0.0	0.0	0.0	0.0	0.0	0.0	0.0	0.0	0.0	0.0	0.0	0.0	0.0
<i>Dicanthellum scabrosiculum</i>	0.0	0.0	0.0	0.0	0.0	0.0	0.8	0.0	0.0	0.2	0.0	0.0	0.0	0.0	0.0	0.0	0.0	0.0	0.0	0.0
<i>Dicanthellum scoparium</i>	0.0	0.0	0.0	0.0	0.0	0.0	0.0	0.0	0.0	0.0	0.0	0.0	0.0	0.0	0.0	0.0	0.0	0.0	0.0	0.0
<i>Dicanthellum sp. 1</i>	1.0	1.0	1.0	1.0	0.4	0.8	1.0	0.0	0.4	0.3	1.0	0.8	0.0	1.0	1.0	1.0	0.0	1.0	1.0	0.0
<i>Dicanthellum sp. 2</i>	0.0	0.0	0.0	0.0	0.4	0.0	0.0	0.0	0.0	0.0	0.0	0.0	0.0	0.0	0.0	0.0	0.0	0.4	0.0	0.0
<i>Dicanthellum sp. 3</i>	0.0	0.0	0.0	0.0	0.0	0.0	0.0	0.0	0.0	0.0	0.0	0.0	0.0	0.0	0.0	0.0	0.0	0.0	0.0	0.0
<i>Dicanthellum strigosum</i>	0.0	0.0	0.0	0.0	0.0	0.0	0.0	0.0	0.0	0.0	0.0	0.0	0.0	0.0	0.0	0.0	0.0	0.0	0.0	0.0
<i>Dicanthellum tenue</i>	0.0	0.0	0.0	0.0	0.0	0.0	0.0	1.0	1.0	0.0	0.0	0.0	0.0	0.0	0.0	0.0	0.0	0.0	0.0	0.0

Indicator species	MS41	MS42	MS43	AL44	AL45	AL46	AL47	AL48	AL49	AL50	AL51	FL52	FL53	FL54	FL55	FL56	FL57	FL58	FL59	GA60
<i>Dichromena colorata</i>	0.0	0.0	0.0	0.0	0.0	0.0	0.0	0.0	0.0	0.0	0.0	0.0	0.0	0.0	0.0	0.0	0.0	0.0	0.0	0.0
<i>Dichromena latifolia</i>	0.0	0.0	0.7	0.0	0.0	0.0	0.0	0.0	0.2	0.0	0.7	0.0	0.0	0.8	0.1	0.0	0.0	0.3	0.7	0.0
<i>Dichromena sp.</i>	0.7	0.7	0.0	0.2	0.0	0.0	0.0	0.0	0.0	0.3	0.0	0.0	0.0	0.0	0.0	0.0	0.0	0.0	0.0	0.0
<i>Diodia virginiana</i>	0.0	0.0	0.0	0.0	0.0	0.0	0.2	0.0	0.0	0.0	0.0	0.0	0.0	0.0	0.0	0.0	0.0	0.0	0.0	0.0
<i>Dionea muscipula</i>	0.0	0.0	0.0	0.0	0.0	0.0	0.0	0.0	0.0	0.0	0.0	0.0	0.0	0.0	0.0	0.0	0.0	0.0	0.0	0.0
<i>Drosera sp.</i>	1.0	1.0	1.0	1.0	1.0	1.0	1.0	1.0	0.8	0.8	0.8	1.0	0.0	0.8	1.0	1.0	0.0	1.0	0.7	0.0
<i>Eleocharis sp.</i>	0.0	0.0	0.0	0.0	0.2	0.0	0.0	0.0	0.8	0.4	0.0	0.0	0.0	0.0	0.0	0.0	0.0	0.0	0.0	0.0
<i>Elephantopus sp.</i>	0.0	0.0	0.0	0.0	0.0	0.0	0.0	0.0	0.0	0.0	0.0	0.0	0.0	0.0	0.0	0.0	0.0	0.0	0.0	0.0
<i>Eragrostis spectabilis</i>	0.0	0.0	0.0	0.0	0.0	0.0	0.0	0.0	0.0	0.0	0.0	0.0	0.0	0.0	0.0	0.0	0.0	0.0	0.0	0.0
<i>Erechtites hieracifolia</i>	0.0	0.0	0.0	0.0	0.0	0.0	0.0	0.0	0.0	0.0	0.0	0.0	0.0	0.0	0.0	0.0	0.0	0.0	0.0	0.0
<i>Erianthus contortus</i>	0.0	0.0	0.0	0.0	0.0	0.0	0.0	0.0	0.0	0.0	0.0	0.0	0.0	0.0	0.0	0.0	0.0	0.0	0.0	0.0
<i>Erianthus giganteus</i>	0.0	0.0	0.0	0.0	0.0	0.0	0.0	0.0	0.0	0.0	0.0	0.0	0.0	0.0	0.0	0.0	0.0	0.0	0.0	0.0
<i>Erianthus sp.</i>	0.0	0.0	0.0	0.0	0.0	0.0	0.0	0.0	0.0	0.0	0.0	0.0	0.0	0.0	0.0	0.0	0.0	0.0	0.0	0.0
<i>Eupatorium capillifolium</i>	0.0	0.0	0.0	0.0	0.0	0.0	0.0	0.0	0.0	0.0	0.0	0.0	0.0	0.0	0.0	0.0	0.0	0.0	0.0	0.0
<i>Eupatorium compositifolium</i>	0.0	0.0	0.0	0.0	0.0	0.0	0.0	0.0	0.0	0.0	0.0	0.0	0.0	0.0	0.0	0.0	0.0	0.0	0.0	0.0
<i>Eupatorium recurvans</i>	0.0	0.0	0.0	0.0	0.0	0.0	0.0	0.0	0.0	0.0	0.0	0.0	0.0	0.0	0.0	0.0	0.0	0.2	0.0	0.0
<i>Eupatorium pilosum</i>	0.0	0.0	0.0	0.0	0.0	0.0	0.0	0.0	0.0	0.0	0.0	0.0	0.0	0.0	0.0	0.0	0.0	0.0	0.0	0.0
<i>Eupatorium rotundifolium</i>	0.0	0.0	0.0	0.0	0.0	0.0	0.0	0.0	0.0	0.0	0.0	0.0	0.0	0.0	0.0	0.0	0.0	0.0	0.0	0.0
<i>Eupatorium semiseratum</i>	0.0	0.0	0.0	0.0	0.0	0.0	0.0	0.0	0.0	0.0	0.0	0.0	0.0	0.0	0.0	0.0	0.0	0.0	0.0	0.0
<i>Eupatorium sp.</i>	0.0	0.0	0.0	0.3	0.0	0.0	1.0	0.0	0.0	0.2	0.0	0.0	0.0	0.0	0.0	0.0	0.0	0.0	0.0	0.0
<i>Euphorbia inundata</i>	0.0	0.0	0.0	0.0	0.0	0.0	0.0	0.0	0.0	0.0	0.0	0.0	0.0	0.0	0.0	0.0	0.0	1.0	0.0	0.0
<i>Euthamia leptocephalala</i>	0.0	0.0	0.0	0.0	0.0	0.7	0.0	0.0	0.0	0.0	0.0	0.0	0.0	0.0	0.0	0.0	0.0	0.0	0.0	0.0
<i>Euthamia minor</i>	0.0	0.0	0.0	0.0	0.1	0.0	0.0	0.0	0.0	0.0	0.0	0.0	0.0	0.0	0.0	0.0	0.0	0.0	0.0	0.0
<i>Euthamia sp.</i>	0.0	0.0	0.0	0.7	0.0	0.0	1.0	0.0	0.3	0.0	0.3	0.0	0.0	0.0	0.0	0.0	0.0	0.0	0.0	0.0
<i>Euthamia tenuifolia</i>	0.0	0.0	0.0	0.0	0.0	0.0	0.0	0.0	0.0	0.3	0.0	0.0	0.0	0.0	0.0	0.0	0.0	0.0	0.0	0.0
<i>Fimbristylis puberula</i>	0.0	0.0	0.0	0.0	0.0	0.0	0.0	0.0	0.0	0.0	0.0	0.0	0.0	0.0	0.0	0.0	0.0	0.0	0.0	0.0
<i>Fuirena pumila</i>	0.0	0.0	0.0	0.0	0.0	0.0	0.0	0.3	0.0	0.0	0.0	0.0	0.0	0.0	0.0	0.0	0.0	0.0	0.0	0.0
<i>Fuirena sp.</i>	0.0	0.0	0.0	0.0	0.0	0.0	0.2	0.0	0.0	1.0	0.3	0.0	0.0	0.0	0.2	0.0	0.0	0.3	0.0	0.0
<i>Fuirena squarrosa</i>	0.0	0.0	0.0	0.0	0.0	0.0	0.0	0.0	0.0	0.0	0.0	0.0	0.0	0.0	0.0	0.0	0.0	0.0	0.0	0.0
<i>Gelsemium sempervirens</i>	0.0	0.0	0.0	0.0	0.0	0.0	0.0	0.0	0.0	0.0	0.0	0.0	0.0	0.0	0.0	0.0	0.0	0.0	0.0	0.0
<i>Gratiola pilosa</i>	0.0	0.0	0.0	0.0	0.0	0.0	0.0	0.0	0.0	0.0	0.0	0.0	0.0	0.0	0.0	0.0	0.0	0.0	0.0	0.0
<i>Gymnopogon sp.</i>	0.0	0.0	0.0	0.0	0.0	0.0	0.0	0.0	0.0	0.0	0.0	0.0	0.0	0.0	0.0	0.0	0.0	0.0	0.0	0.0
<i>Habenaria (esp. ciliaris)</i>	0.0	0.0	0.0	0.0	0.0	0.0	0.0	0.0	0.0	0.0	0.0	0.0	0.0	0.0	0.0	0.0	0.0	0.0	0.0	0.0
<i>Habenaria sp.</i>	0.0	0.0	0.0	0.0	0.0	0.0	0.0	0.0	0.0	0.0	0.0	0.0	0.0	0.0	0.0	0.0	0.0	0.0	0.0	0.0
<i>Helenium sp.</i>	0.0	0.0	0.0	0.0	0.0	0.0	0.2	0.7	0.0	0.0	1.0	0.0	0.0	0.0	0.0	0.0	0.0	0.0	0.0	0.0
<i>Helenium vernale</i>	0.0	0.0	0.0	0.0	0.0	0.0	0.0	0.0	0.0	0.0	0.0	0.0	0.0	0.0	0.0	0.0	0.0	0.0	0.0	0.0
<i>Helianthus angustifolius</i>	0.0	0.0	0.0	0.3	0.0	0.0	0.3	0.0	0.0	0.0	0.0	0.0	0.0	0.3	0.0	0.0	0.0	0.0	0.0	0.0
<i>Hibiscus sp.</i>	0.0	0.0	0.0	0.0	0.0	0.0	0.0	0.0	0.0	0.0	0.0	0.0	0.0	0.0	0.0	0.0	0.0	0.0	0.0	0.0
<i>Hydrolea ovata</i>	0.0	0.0	0.0	0.0	0.0	0.0	0.0	0.0	0.0	0.0	0.0	0.0	0.0	0.0	0.0	0.0	0.0	0.0	0.0	0.0
<i>Hypericum brachyphyllum</i>	0.0	0.0	0.0	0.0	0.0	0.0	0.3	0.0	0.0	0.0	0.0	0.0	0.0	0.0	0.0	0.0	0.0	0.0	0.0	0.0
<i>Hypericum cistifolium</i>	0.0	0.0	0.0	0.0	0.0	0.0	0.0	0.0	0.0	0.0	0.0	0.0	0.0	0.0	0.0	0.0	0.0	0.0	0.0	0.0
<i>Hypericum setosum</i>	0.0	0.0	0.0	0.0	0.0	0.0	0.0	0.0	0.0	0.0	0.0	0.0	0.0	0.0	0.0	0.0	0.0	0.0	0.0	0.0
<i>Hypericum crux-andreae</i>	0.0	0.0	0.0	0.3	0.0	0.3	0.3	0.0	0.0	0.3	0.8	0.0	0.0	0.0	0.0	0.0	0.0	0.0	0.0	0.0
<i>Hypericum exile</i>	0.0	0.0	0.0	0.0	0.0	0.0	0.0	0.0	0.0	0.0	0.0	0.0	0.0	0.0	0.0	0.0	0.0	1.0	1.0	0.0

Indicator species	MS41	MS42	MS43	AL44	AL45	AL46	AL47	AL48	AL49	AL50	AL51	FL52	FL53	FL54	FL55	FL56	FL57	FL58	FL59	GA60
<i>Hypericum fasciculatum</i>	0.7	1.0	0.3	0.0	0.0	0.0	0.0	0.0	0.0	0.7	0.0	0.0	0.0	0.0	0.0	0.0	0.0	0.0	0.0	0.0
<i>Hypericum perforatum</i>	0.0	0.0	0.0	0.0	0.0	0.0	0.0	0.1	0.0	0.0	0.0	0.0	0.0	0.0	0.0	0.0	0.0	0.0	0.0	0.0
<i>Hypericum reductum</i>	0.0	0.0	0.0	0.0	0.0	0.0	0.0	0.0	1.0	0.0	0.0	0.2	0.0	0.4	0.0	0.0	0.0	0.0	0.0	0.0
<i>Hypericum sp.</i>	0.0	0.0	0.0	0.0	0.0	0.0	0.0	0.0	0.0	0.0	0.0	0.0	0.0	0.0	0.0	0.0	0.0	0.0	0.0	0.0
<i>Hypericum stans</i>	0.0	0.0	0.0	0.0	0.0	0.0	0.0	0.0	0.3	0.0	0.0	0.0	0.0	0.0	0.0	0.0	0.0	0.0	0.0	0.0
<i>Hypoxis micrantha</i>	0.0	0.0	0.0	0.2	0.5	0.0	0.0	0.0	0.0	0.0	0.0	0.0	0.0	0.0	0.0	0.0	0.0	0.0	0.0	0.0
<i>Hyptis alata</i>	0.0	0.0	0.0	0.0	0.0	0.0	0.0	0.0	0.0	0.0	0.0	0.0	0.0	0.0	0.0	0.0	0.0	0.0	0.0	0.0
<i>Iris sp.</i>	0.0	0.0	0.0	0.0	0.0	0.0	0.0	0.0	0.0	0.0	0.0	0.0	0.0	0.0	0.0	0.0	0.0	0.0	0.0	0.0
<i>Juncus biflorus</i>	0.0	0.0	0.0	0.0	0.0	0.0	0.0	0.0	0.0	0.0	0.0	0.0	0.0	0.0	0.0	0.0	0.0	0.0	0.0	0.0
<i>Juncus dichotomus</i>	0.0	0.0	0.0	0.0	0.7	0.0	0.0	0.0	0.0	0.0	0.0	0.0	0.0	0.0	0.0	0.0	0.0	0.0	0.0	0.0
<i>Juncus marginatus</i>	0.0	0.0	0.0	0.0	0.0	0.0	0.0	0.0	0.0	0.0	0.0	0.0	0.0	0.0	0.0	0.0	0.0	0.0	0.0	0.0
<i>Juncus polycephalus</i>	0.0	0.0	0.0	0.0	0.4	0.0	0.0	0.0	0.0	0.0	0.0	0.0	0.0	0.0	0.0	0.0	0.0	0.0	0.0	0.0
<i>Juncus sp. 1</i>	0.0	0.0	0.0	0.0	0.0	0.0	0.2	0.0	0.0	0.0	0.0	0.0	0.0	0.0	0.0	0.0	0.0	0.0	0.0	0.0
<i>Juncus sp. 2</i>	0.0	0.0	0.0	0.0	0.0	0.0	0.0	0.4	0.0	0.0	0.0	0.0	0.0	0.0	0.0	0.0	0.0	0.0	0.0	0.0
<i>Juncus sp. 3</i>	0.0	0.0	0.0	0.0	0.0	0.0	0.0	0.0	0.0	0.0	0.0	0.0	0.0	0.0	0.0	0.0	0.0	0.0	0.0	0.0
<i>Lachnanthes caroliniana</i>	0.0	0.0	1.0	1.0	0.0	0.7	0.0	0.1	0.7	0.3	0.3	0.0	0.4	0.3	0.2	0.4	0.0	0.7	0.7	0.0
<i>Lachnocaulon anceps</i>	0.0	0.0	0.0	0.0	0.0	0.0	0.0	0.0	0.0	0.0	0.0	0.0	0.0	0.0	0.0	0.0	0.8	0.0	0.0	0.0
<i>Lachnocaulon minus</i>	0.0	0.0	0.0	0.0	0.0	0.0	0.0	0.0	0.0	0.0	0.0	0.0	0.0	0.0	0.0	0.0	0.4	0.0	0.0	0.0
<i>Lachnocaulon sp.</i>	1.0	1.0	0.0	0.4	0.0	0.0	1.0	1.0	0.0	0.0	0.0	0.2	0.0	0.3	1.0	0.0	0.0	0.8	1.0	0.0
Lamiaceae sp.	0.0	0.0	0.0	0.0	0.0	0.0	0.0	0.0	0.0	0.0	0.0	0.0	0.0	0.0	0.0	0.0	0.0	0.0	0.0	0.0
<i>Lamium sp.</i>	0.0	0.0	0.0	0.0	0.0	0.0	0.0	0.0	0.0	0.0	0.0	0.0	0.0	0.0	0.0	0.0	0.0	0.0	0.0	0.0
<i>Leersia hexandra</i>	0.0	0.0	0.0	0.0	0.0	0.0	0.0	0.0	0.0	0.0	0.0	0.0	0.0	0.0	0.0	0.0	0.0	0.0	0.0	0.0
<i>Liatis acidota</i>	0.0	0.0	0.0	0.0	0.0	0.0	0.0	0.0	0.0	0.0	0.0	0.0	0.0	0.0	0.0	0.0	0.0	0.0	0.0	0.0
<i>Liatis gracilis</i>	0.0	0.0	0.0	0.0	0.0	0.0	0.0	0.0	0.0	0.0	0.0	0.0	0.0	0.0	0.0	0.0	0.0	0.0	0.0	0.0
<i>Liatis pycnostachya</i>	0.0	0.0	0.0	0.0	0.0	0.0	0.0	0.0	0.0	0.0	0.0	0.0	0.0	0.0	0.0	0.0	0.0	0.0	0.0	0.0
<i>Liatis spicata</i>	0.0	0.0	0.0	1.0	0.0	0.0	0.0	0.7	0.0	1.0	0.0	0.0	0.0	0.3	0.0	0.0	0.0	0.0	0.8	0.0
<i>Liatis sp.</i>	0.0	1.0	0.0	0.0	0.0	0.0	0.0	0.0	0.0	0.0	0.0	0.0	0.0	0.0	0.0	0.0	0.0	0.0	0.0	0.0
<i>Lilium catesbaei</i>	0.0	0.0	0.0	0.0	0.0	0.0	0.0	0.0	0.0	0.0	0.0	0.0	0.0	0.0	0.0	0.0	0.0	0.0	0.0	0.0
<i>Linum floridanum</i>	0.0	0.2	0.7	0.3	0.0	0.8	0.3	0.7	0.2	0.0	0.2	0.0	0.0	0.0	0.7	0.7	0.0	0.5	0.4	0.0
<i>Lobelia brevifolia</i>	0.0	0.0	0.3	0.7	0.0	0.0	0.3	0.5	0.0	0.0	1.0	0.0	0.0	0.4	0.2	0.0	0.0	0.0	0.0	0.0
<i>Lobelia floridana</i>	0.0	0.0	0.0	0.0	0.0	0.0	0.0	0.0	0.0	0.0	0.0	0.0	0.0	0.0	0.0	0.0	0.0	0.0	0.4	0.0
<i>Lobelia glandulosa</i>	0.0	0.0	0.0	0.0	0.0	0.0	0.0	0.0	0.0	0.0	0.0	0.0	0.0	0.0	0.0	0.0	0.0	0.0	0.0	0.0
<i>Lobelia nuttallii</i>	0.0	0.0	0.0	0.0	0.0	0.0	0.0	0.0	0.0	0.0	0.0	0.4	0.0	0.0	0.0	0.0	0.0	0.0	0.0	0.0
<i>Lobelia puberula</i>	0.0	0.0	0.0	0.0	0.0	0.0	0.0	0.0	0.0	0.0	0.0	0.0	0.0	0.0	0.0	0.0	0.0	0.0	0.0	0.0
<i>Lobelia (Gaura) sp.</i>	0.0	0.0	0.0	0.0	0.0	0.0	0.0	0.0	0.0	0.0	0.0	0.0	0.0	0.0	0.0	0.0	0.0	0.0	0.0	0.0
<i>Lophiola americana</i>	0.0	0.7	0.0	0.0	0.0	0.0	0.0	0.0	0.0	0.0	0.0	0.0	0.0	0.0	0.0	0.3	0.0	0.0	0.0	0.0
<i>Ludwigia hirtella</i>	0.0	0.0	0.0	0.0	0.0	0.0	0.0	0.0	0.0	0.2	0.0	0.2	0.0	0.0	0.0	0.0	0.0	0.0	0.0	0.0
<i>Ludwigia pilosa</i>	0.0	0.0	0.0	0.0	0.0	0.0	0.3	0.0	0.0	0.0	0.0	0.0	0.0	0.0	0.0	0.0	0.0	0.0	0.0	0.3
<i>Ludwigia sp.</i>	0.0	0.0	0.0	0.3	0.0	0.0	0.0	0.0	0.0	0.2	0.0	0.0	0.0	0.0	0.0	0.0	0.0	0.0	0.0	0.0
<i>Ludwigia virgata</i>	0.0	0.0	0.0	0.0	0.0	0.0	0.0	0.0	0.0	0.0	0.0	0.0	0.0	0.0	0.0	0.0	0.0	0.0	0.0	0.0
<i>Lycopodium alopecuroides</i>	0.0	0.0	0.0	0.0	0.0	0.0	0.0	0.0	0.0	0.0	0.0	0.0	0.0	0.0	0.0	0.0	0.0	0.0	0.0	0.0
<i>Lycopodium prostratum</i>	0.0	0.0	0.0	0.0	0.0	0.3	0.0	0.0	0.0	0.0	0.0	0.0	0.0	0.0	0.0	0.0	0.0	0.0	0.0	0.0
<i>Lycopodium sp.</i>	0.0	0.0	0.8	0.0	0.0	0.0	0.0	0.0	0.0	0.0	0.0	0.0	0.0	0.0	0.0	0.0	0.0	0.0	0.0	0.0
<i>Lycopus sp.</i>	0.0	0.0	0.0	0.0	0.0	0.0	1.0	0.0	0.0	0.0	0.0	0.0	0.0	0.0	0.0	0.0	0.0	0.0	0.0	0.0

Indicator species	MS41	MS42	MS43	AL44	AL45	AL46	AL47	AL48	AL49	AL50	AL51	FL52	FL53	FL54	FL55	FL56	FL57	FL58	FL59	GA60
<i>Lycopus virginicus</i>	0.0	0.0	0.0	0.0	0.0	0.0	0.0	0.0	0.0	0.0	0.0	0.0	0.0	0.0	0.0	0.0	0.0	0.0	0.0	0.0
<i>Marshallia graminifolia</i>	0.0	0.0	0.0	0.0	0.0	0.0	0.0	0.0	0.0	0.0	0.0	0.0	0.0	0.0	0.0	0.0	0.0	0.0	0.0	0.0
<i>Marshallia tenuifolia</i>	0.0	0.4	0.4	1.0	0.0	0.0	0.3	0.0	0.5	0.7	0.2	0.7	0.0	0.8	0.0	0.0	0.0	0.0	0.7	0.0
<i>Mayaca aubletii</i>	0.0	0.0	0.0	0.0	0.0	0.0	0.0	0.0	0.0	0.0	0.0	0.0	0.0	0.0	0.0	0.0	0.0	0.0	0.0	0.0
<i>Mecardonia acuminata</i>	0.0	0.0	0.0	0.0	0.0	0.0	0.0	0.0	0.0	0.0	0.0	0.0	0.0	0.0	0.0	0.0	0.0	0.0	0.0	0.0
<i>Mecardonia marilandica</i>	0.0	0.0	0.0	0.0	0.0	0.0	0.0	0.0	0.0	0.0	0.0	0.0	0.0	0.0	0.0	0.0	0.0	0.0	0.0	0.0
<i>Onoclea sensibilis</i>	0.0	0.0	0.0	0.0	0.0	0.0	0.0	0.0	0.0	0.0	0.0	0.0	0.0	0.0	0.0	0.0	0.0	0.0	0.0	0.0
Orchidaceae sp.	0.0	0.0	0.0	0.0	0.0	0.0	0.0	0.0	0.0	0.0	0.0	0.0	0.0	0.0	0.0	0.0	0.0	0.0	0.0	0.0
<i>Osmunda cinnamomea</i>	0.0	0.0	0.0	0.0	0.0	0.0	0.0	0.0	0.0	0.0	0.0	0.0	0.0	0.0	0.0	0.0	0.0	0.0	0.0	0.0
<i>Osmunda regalis</i>	0.0	0.0	0.0	0.0	0.0	0.0	0.0	0.0	0.0	0.0	0.0	0.0	0.0	0.0	0.0	0.0	0.0	0.0	0.0	0.0
<i>Oxypolis filiformis</i>	0.2	0.2	0.0	0.0	0.0	0.0	0.3	0.0	0.0	0.0	0.0	0.0	0.0	0.2	0.0	0.0	0.0	0.0	0.4	0.0
<i>Oxypolis sp.</i>	0.0	0.0	0.0	0.0	0.0	0.0	0.0	0.0	0.0	0.0	0.0	0.0	0.0	0.0	0.0	0.0	0.0	0.0	0.0	0.0
<i>Oxypolis ternata</i>	0.0	0.0	0.0	0.0	0.0	0.0	0.0	0.0	0.0	0.0	0.0	0.0	0.0	0.0	0.0	0.0	0.0	0.0	0.0	0.0
<i>Panicum anceps</i>	0.0	0.0	0.0	0.0	0.0	0.0	0.0	0.0	0.0	0.0	0.0	0.0	0.0	0.0	0.0	0.0	0.0	0.0	0.0	0.0
<i>Panicum hians</i>	0.0	0.0	0.0	0.0	0.0	0.0	0.0	0.0	0.0	0.0	0.0	0.0	0.0	0.0	0.0	0.0	0.0	0.0	0.0	0.0
<i>Panicum sp.1</i>	0.0	0.0	0.0	0.0	0.0	0.0	0.0	0.0	0.0	0.0	0.0	0.0	0.0	0.0	0.0	0.0	0.0	0.0	0.0	0.0
<i>Panicum sp.2</i>	0.0	0.0	0.0	0.0	0.0	0.0	0.0	0.0	0.0	0.0	0.0	0.0	0.0	0.0	0.0	0.0	0.0	0.0	0.0	0.0
<i>Panicum virgatum</i>	0.0	0.0	0.0	0.7	0.0	0.0	0.8	0.0	0.0	0.3	0.0	0.0	0.0	0.0	0.0	0.0	0.0	0.0	0.0	0.0
<i>Paspalum sp.</i>	0.0	0.0	0.0	1.0	1.0	0.0	0.0	0.0	0.0	0.0	0.2	0.0	0.0	0.0	0.0	0.0	0.0	0.0	0.0	0.0
<i>Physotegia godfreyi</i>	0.0	0.0	0.0	0.0	0.0	0.0	0.0	0.0	0.0	0.0	0.0	0.0	0.0	0.0	0.3	0.0	0.0	0.0	0.3	0.0
<i>Pinguicula sp.</i>	0.0	0.0	0.0	0.0	0.0	0.0	0.0	0.0	0.0	0.0	0.0	0.0	0.0	0.0	0.0	0.0	0.0	0.0	0.0	0.0
<i>Pityopsis graminifolia</i>	0.0	0.0	0.0	0.7	0.5	0.4	0.0	0.0	0.0	0.0	0.0	0.0	0.0	0.0	0.0	0.0	0.0	0.0	0.0	0.0
<i>Pilea tenuifolia</i>	0.0	0.0	0.0	0.0	0.0	0.0	0.0	0.0	0.0	0.0	0.0	0.0	0.0	0.0	0.0	0.4	0.0	0.8	0.0	0.0
<i>Pluchea rosea</i>	0.0	0.0	0.0	0.0	0.0	0.0	0.0	0.0	0.0	0.0	0.0	0.0	0.0	0.0	0.0	0.0	0.0	0.0	0.0	0.0
<i>Pluchea sp.</i>	0.0	0.0	0.0	0.0	0.0	0.0	0.0	0.0	0.0	0.0	0.0	0.0	0.0	0.0	0.0	0.0	0.0	0.0	0.0	0.0
<i>Pogonia ophioglossoides</i>	0.0	0.0	0.0	0.0	0.0	0.0	0.0	0.0	0.0	0.3	0.0	0.0	0.0	0.0	0.0	0.0	0.0	0.0	0.0	0.0
<i>Pogonia sp.</i>	0.0	0.0	0.0	0.0	0.0	0.0	0.0	0.0	0.0	0.0	0.0	0.0	0.0	0.2	0.0	0.0	0.0	0.0	0.0	0.0
<i>Polygala cruciata</i>	1.0	0.8	0.8	1.0	0.0	0.8	0.0	0.0	0.7	0.3	0.2	0.0	0.0	0.4	1.0	1.0	0.0	0.7	0.8	0.0
<i>Polygala cymosa</i>	0.0	0.0	0.0	0.0	0.0	0.0	0.0	0.0	0.0	0.0	0.0	0.0	0.0	0.0	0.0	0.0	0.0	0.0	0.0	0.0
<i>Polygala hookeri</i>	0.0	0.0	0.0	0.0	0.0	0.0	0.0	0.0	0.0	0.0	0.0	0.5	0.0	0.3	0.0	0.2	0.0	0.0	0.0	0.0
<i>Polygala lutea</i>	0.0	0.0	0.0	0.3	0.0	0.7	0.0	0.0	0.0	0.0	0.0	1.0	0.0	0.3	0.0	0.2	0.0	0.0	0.0	0.0
<i>Polygala ramosa</i>	0.0	0.0	0.0	0.0	0.0	0.0	0.0	0.8	0.2	0.0	0.4	0.0	0.0	0.0	0.7	0.0	0.0	0.7	0.0	0.0
<i>Polygala sp.</i>	0.0	0.0	0.0	0.0	0.0	0.0	0.0	0.0	0.0	0.0	0.0	0.0	0.0	0.0	0.0	0.0	0.0	0.0	0.0	0.0
<i>Polygonum hydropper</i>	0.0	0.0	0.0	0.0	0.0	0.0	0.0	0.0	0.0	0.0	0.0	0.0	0.0	0.0	0.0	0.0	0.0	0.0	0.0	0.0
<i>Proserpinaca pectinata & serpent</i>	0.0	0.0	0.0	0.0	0.2	0.0	0.0	0.0	0.0	0.0	0.0	0.0	0.0	0.0	0.0	0.0	0.0	0.0	0.0	0.0
<i>Pteridium aquilinum</i>	0.0	0.0	0.0	0.0	0.0	0.0	0.0	0.0	0.0	0.0	0.0	0.0	0.0	0.0	0.0	0.0	0.0	0.0	0.0	0.0
<i>Ptilimnium nuttallii</i>	0.0	0.0	0.0	0.0	0.0	0.0	0.0	0.0	0.0	0.0	0.0	0.0	0.0	0.0	0.0	0.0	0.0	0.0	0.0	0.0
<i>Pycnanthemum nudum</i>	0.0	0.0	0.0	0.0	0.0	0.0	0.0	0.0	0.0	0.0	0.0	0.0	0.0	0.0	0.0	0.0	0.0	0.0	0.0	0.0
<i>Pycnanthemum tenuifolium</i>	0.0	0.0	0.0	0.0	0.0	0.0	0.0	0.0	0.0	0.0	0.0	0.0	0.0	0.0	0.0	0.0	0.0	0.0	0.0	0.0
<i>Rhexia virginica</i>	0.0	0.0	0.0	0.0	0.0	0.0	0.4	0.0	0.0	0.0	0.0	0.0	0.0	0.0	0.0	0.0	0.0	0.0	0.0	0.0
<i>Rhus radicans</i>	0.0	0.0	0.0	0.0	0.0	0.0	0.0	0.0	0.0	0.2	0.0	0.0	0.0	0.0	0.0	0.0	0.0	0.0	0.0	0.0
<i>Rhynchospora caduca</i>	0.0	0.0	0.0	0.0	0.0	0.0	0.0	0.0	0.0	0.0	0.0	0.0	0.0	0.0	0.0	0.0	0.0	0.0	0.0	0.0
<i>Rhynchospora chapmanii</i>	0.8	0.7	1.0	0.0	0.0	0.8	0.0	1.0	0.8	0.0	1.0	1.0	0.0	0.8	1.0	0.8	0.0	1.0	0.8	0.0

Indicator species	MS41	MS42	MS43	AL44	AL45	AL46	AL47	AL48	AL49	AL50	AL51	FL52	FL53	FL54	FL55	FL56	FL57	FL58	FL59	GA60
<i>Rhynchospora ciliaris</i>	0.0	0.0	0.0	0.0	0.0	0.0	0.0	0.0	0.0	0.0	0.0	0.0	0.0	0.0	0.0	0.0	0.0	0.0	0.0	0.0
<i>Rhynchospora compressa</i>	0.0	0.0	0.0	0.0	0.0	0.0	0.0	0.0	0.0	0.0	0.0	0.0	0.0	0.0	0.0	0.0	0.0	0.0	0.0	0.0
<i>Rhynchospora debilis</i>	0.0	0.0	0.0	0.0	0.0	0.0	0.0	0.0	0.0	0.0	0.0	0.0	0.0	0.0	0.0	0.0	0.0	0.0	0.0	0.0
<i>Rhynchospora elliotii</i>	0.0	0.0	0.0	0.0	0.5	0.0	0.5	0.0	0.0	0.0	0.0	0.0	0.0	0.0	0.0	0.0	0.0	0.0	0.0	0.0
<i>Rhynchospora glomerata</i>	0.0	0.0	0.0	0.0	0.0	0.0	0.0	0.0	0.0	0.0	0.0	0.0	0.0	0.0	0.0	0.0	0.0	0.0	0.0	0.0
<i>Rhynchospora gracilentia</i>	0.0	0.0	0.0	0.0	0.0	0.0	0.0	0.0	0.0	0.0	0.0	0.0	0.0	0.0	0.0	0.0	0.0	0.0	0.0	0.0
<i>Rhynchospora inexpansa</i>	0.0	0.0	0.0	0.0	0.0	0.0	0.0	0.0	0.0	0.0	0.0	0.0	0.0	0.0	0.0	0.0	0.0	0.0	0.0	0.0
<i>Rhynchospora macra</i>	0.0	0.0	0.0	0.0	0.0	0.0	0.0	0.0	0.0	0.0	0.0	0.0	0.0	0.0	0.0	0.0	0.0	0.0	0.0	0.0
<i>Rhynchospora microcarpa</i>	0.0	0.0	0.0	0.0	0.0	0.0	0.0	0.0	0.0	0.0	0.0	0.0	0.0	0.0	0.0	0.0	0.0	0.0	0.0	0.0
<i>Rhynchospora oligantha</i>	0.0	0.0	0.0	0.0	0.0	0.0	0.0	0.0	0.0	0.0	0.0	0.0	0.0	0.0	0.0	0.0	0.0	0.0	0.0	0.0
<i>Rhynchospora plumosa</i>	0.0	0.0	0.0	0.4	0.0	0.0	0.0	0.0	0.0	0.0	0.0	0.3	0.0	0.0	1.0	0.0	0.0	0.0	0.0	0.0
<i>Rhynchospora rariflora</i>	1.0	0.0	0.3	0.7	1.0	0.0	0.0	0.8	1.0	1.0	0.7	0.0	0.0	0.0	0.0	0.7	0.0	0.0	0.0	0.0
<i>Rhynchospora</i> sp. 1	0.0	0.3	0.0	0.4	0.0	1.0	1.0	0.4	0.0	0.0	0.0	0.0	0.0	0.0	0.0	0.0	0.4	0.0	0.0	0.3
<i>Rhynchospora</i> sp. 2	0.0	0.0	0.0	0.0	0.0	0.0	0.0	0.0	0.0	0.0	0.0	0.0	0.0	0.0	0.0	0.0	0.0	0.0	0.0	0.4
<i>Rhynchospora</i> sp. (large)	0.0	0.0	0.0	0.0	0.0	0.0	0.0	0.0	0.0	0.0	0.0	0.0	0.0	0.0	0.0	0.0	0.0	0.0	0.0	0.0
<i>Rhynchospora</i> sp. (medium)	0.0	0.0	0.0	0.0	0.0	0.0	0.0	0.0	0.0	0.0	0.0	0.0	0.0	0.0	0.0	0.0	0.0	0.0	0.0	0.0
<i>Rhynchospora</i> sp. (small)	0.0	0.0	0.0	0.0	0.0	0.0	0.7	0.0	0.0	0.0	0.0	0.0	0.0	0.0	0.0	0.0	0.0	0.0	0.4	0.0
<i>Rhynchospora</i> sp. (tiny)	0.0	0.0	0.0	0.0	0.0	0.0	0.0	0.0	0.0	0.0	0.0	0.0	0.0	0.0	0.0	0.0	0.0	0.0	0.0	0.0
<i>Rhynchospora</i> (tri-stemmed)	1.0	0.7	0.8	0.0	0.0	0.2	0.0	0.7	0.0	0.0	0.7	0.5	0.0	0.0	0.0	0.3	0.0	0.0	0.0	0.0
<i>Rubus</i> sp.	0.0	0.0	0.0	0.0	0.0	0.0	0.0	0.0	0.0	0.2	0.0	0.0	0.0	0.0	0.0	0.0	0.0	0.0	0.0	0.0
<i>Rudbeckia graminifolia</i>	0.0	0.0	0.0	0.0	0.0	0.0	0.0	0.0	0.0	0.0	0.0	0.0	0.0	0.0	0.7	0.7	0.0	0.3	0.8	0.0
<i>Rudbeckia</i> sp.	0.0	0.0	0.0	0.0	0.0	0.0	0.0	0.0	0.0	0.0	0.0	0.0	0.0	0.0	0.0	0.0	0.0	0.0	0.0	0.0
<i>Ruellia humilis</i>	0.0	0.0	0.0	0.0	0.0	0.0	0.0	0.0	0.0	0.0	0.0	0.0	0.0	0.0	0.0	0.0	0.0	0.0	0.0	0.0
<i>Ruellia humilis</i> var. <i>longiflora</i>	0.0	0.0	0.0	0.0	0.0	0.0	0.0	0.0	0.0	0.0	0.0	0.0	0.0	0.0	0.0	0.0	0.0	0.0	0.0	0.0
<i>Sabal minor</i>	0.0	0.0	0.0	0.0	0.0	0.0	0.0	0.0	0.0	0.0	0.0	0.0	0.0	0.0	0.0	0.2	0.0	0.0	0.0	0.0
<i>Sabatia bartramii</i>	0.0	0.0	0.0	0.0	0.0	0.0	0.0	0.0	0.0	0.0	0.0	0.0	0.0	0.0	0.0	0.0	0.0	0.0	0.0	0.0
<i>Sabatia campanulata</i>	0.2	0.0	0.0	0.0	0.3	0.0	0.0	0.0	0.0	0.0	0.0	0.0	0.0	0.0	0.0	0.0	0.0	0.0	0.0	0.0
<i>Sabatia difformis</i>	0.0	0.0	0.0	0.0	0.0	0.0	0.0	0.0	0.0	0.0	0.0	0.0	0.0	0.0	0.0	0.0	0.0	0.0	0.0	0.0
<i>Sabatia dodecandra</i>	0.0	0.0	0.0	0.0	0.0	0.0	0.0	0.0	0.0	0.0	0.0	0.0	0.0	0.0	0.0	0.0	0.0	0.0	0.0	0.0
<i>Sabatia gentianoides</i>	0.0	0.0	0.0	0.0	0.0	0.0	0.0	0.0	0.0	0.0	0.0	0.0	0.0	0.0	0.0	0.0	0.0	0.0	0.0	0.0
<i>Sabatia macrophylla</i>	0.0	0.0	0.0	0.0	0.0	0.0	0.2	0.0	0.0	0.3	0.3	0.0	0.0	0.0	0.0	0.0	0.0	0.0	0.0	0.0
<i>Sabatia</i> sp. 1	0.0	0.0	0.8	0.0	0.0	0.0	0.0	0.0	0.0	0.0	0.0	0.0	0.0	0.0	0.0	0.0	0.0	0.0	0.0	0.0
<i>Sabatia</i> sp. 2	0.0	0.0	0.0	0.0	0.0	0.0	0.0	0.0	0.0	0.0	0.0	0.0	0.0	0.0	0.0	0.0	0.0	0.0	0.0	0.0
<i>Sagittaria lancifolia</i>	0.0	0.0	0.0	0.0	0.0	0.0	0.0	0.0	0.0	0.0	0.0	0.0	0.0	0.0	0.0	0.0	0.0	0.0	0.0	0.0
<i>Schizachyrium tenerum</i>	0.0	0.0	0.0	0.0	0.0	0.0	0.0	0.0	0.0	0.0	0.0	0.0	0.0	0.0	0.0	0.0	0.0	0.0	0.0	0.0
<i>Schoenolirion elliotii</i>	0.0	0.0	0.0	0.0	0.0	0.0	0.0	0.0	0.0	0.0	0.0	0.0	0.0	0.0	0.0	0.0	0.0	0.0	0.0	0.0
<i>Schrankia</i> sp.	0.0	0.0	0.0	0.0	0.0	0.0	0.0	0.0	0.0	0.0	0.0	0.0	0.0	0.0	0.0	0.0	0.0	0.0	0.0	0.0
<i>Scirpus cyperinus</i>	0.0	0.0	0.0	0.0	0.0	0.0	0.0	0.0	0.0	0.0	0.0	0.0	0.0	0.0	0.0	0.0	0.0	0.0	0.0	0.0
<i>Scleria baldwinii</i>	0.0	0.0	0.0	0.0	0.0	0.0	1.0	0.0	0.4	0.0	0.0	0.0	0.0	0.0	0.0	0.0	0.0	0.0	1.0	0.0
<i>Scleria pauciflora</i>	0.0	0.0	0.0	0.0	0.0	0.0	0.0	0.0	0.0	0.0	0.0	0.0	0.0	0.0	0.0	0.0	0.0	0.0	0.0	0.0
<i>Scleria pauciflora</i> var. <i>caroliniana</i>	0.0	0.0	0.0	0.0	0.0	0.0	0.0	0.0	0.0	0.0	0.0	0.0	0.0	0.0	0.0	0.0	0.0	0.0	0.0	0.0
<i>Scleria pauciflora</i> var. <i>pausiflora</i>	0.0	0.0	0.0	0.0	0.0	0.0	0.0	0.0	0.0	0.0	0.0	0.0	0.0	0.0	0.0	0.0	0.0	0.0	0.0	0.0
<i>Scleria</i> sp. 1	0.0	1.0	0.3	0.8	0.0	1.0	0.0	0.0	0.0	1.0	0.2	0.7	0.0	0.0	0.7	0.0	0.0	0.3	0.0	0.0

Indicator species	MS41	MS42	MS43	AL44	AL45	AL46	AL47	AL48	AL49	AL50	AL51	FL52	FL53	FL54	FL55	FL56	FL57	FL58	FL59	GA60
<i>Scleria</i> sp. 2	0.0	0.0	0.0	0.0	0.0	0.0	0.0	0.0	0.0	0.0	0.7	0.5	0.0	0.0	0.7	0.0	0.0	0.0	0.0	0.0
<i>Scutellaria integrifolia</i>	0.0	0.0	0.0	0.0	0.0	0.0	0.0	0.0	0.0	0.0	0.0	0.0	0.0	0.0	0.0	0.0	0.0	0.0	0.0	0.0
<i>Scutellaria</i> sp.	0.0	0.0	0.0	0.0	0.0	0.0	0.3	0.0	0.0	0.0	0.0	0.0	0.0	0.0	0.0	0.0	0.0	0.0	0.0	0.0
<i>Serenoa repens</i>	0.0	0.0	0.0	0.0	0.0	0.0	0.0	0.0	0.0	0.0	0.0	0.0	0.0	0.0	0.0	0.0	0.0	0.0	0.0	0.0
<i>Seymouria cassioides</i>	0.0	0.0	0.2	0.0	0.0	0.0	0.0	0.0	0.0	0.0	0.0	0.0	0.0	0.0	0.0	0.0	0.0	0.4	0.0	0.0
<i>Sisyrinchium</i> sp.	0.0	0.0	0.0	0.0	0.0	0.0	0.0	0.0	0.0	0.0	0.0	0.0	0.0	0.0	0.0	0.0	0.0	0.0	0.0	0.0
<i>Smilax bona-nox</i>	0.0	0.0	0.0	0.0	0.0	0.0	0.0	0.0	0.0	0.0	0.0	0.0	0.0	0.0	0.0	0.0	0.0	0.0	0.0	0.0
<i>Smilax laurifolia</i>	0.7	0.0	0.0	0.0	0.0	0.0	0.7	0.4	0.4	0.8	0.2	0.5	0.7	0.8	0.0	0.0	0.0	0.7	0.3	0.0
<i>Smilax rotundifolia</i>	0.0	0.0	0.0	0.0	0.0	0.0	0.0	0.0	0.0	0.0	0.0	0.0	0.0	0.0	0.0	0.0	0.0	0.0	0.0	0.0
<i>Smilax</i> sp.	0.0	0.0	0.0	0.0	0.0	0.0	0.0	0.0	0.0	0.0	0.0	0.0	0.0	0.0	0.0	0.0	0.0	0.0	0.0	0.0
<i>Solidago fistulosa</i>	0.0	0.0	0.0	0.0	0.0	0.0	0.0	0.0	0.0	0.0	0.0	0.0	0.0	0.0	0.0	0.0	0.0	0.0	0.0	0.0
<i>Solidago</i> sp. 1	0.0	0.0	0.0	0.0	0.0	0.0	0.0	0.0	0.0	0.0	0.0	0.0	0.0	0.0	0.0	0.0	0.0	0.0	0.0	0.0
<i>Solidago</i> sp. 2	0.0	0.0	0.0	0.0	0.0	0.0	0.0	0.0	0.0	0.0	0.0	0.0	0.0	0.0	0.0	0.0	0.0	0.0	0.0	0.0
<i>Solidago</i> sp. 3	0.0	0.0	0.0	0.0	0.0	0.0	0.0	0.0	0.0	0.0	0.0	0.0	0.0	0.0	0.0	0.0	0.0	0.0	0.0	0.0
<i>Solidago stricta</i>	0.0	0.0	0.0	0.2	0.0	0.0	0.0	0.0	0.0	0.1	0.0	0.0	0.0	0.0	0.0	0.0	0.0	0.0	0.0	0.0
<i>Sphagnum</i> spp.	0.4	0.0	1.0	0.7	0.0	0.8	1.0	0.7	0.7	0.7	0.3	1.0	0.0	0.8	0.0	0.3	0.0	0.0	0.0	0.0
<i>Spiranthes</i> sp.	0.0	0.0	0.0	0.0	0.0	0.0	0.0	0.0	0.0	0.0	0.0	0.0	0.0	0.0	0.0	0.0	0.0	0.0	0.0	0.0
<i>Sporobolus</i> sp.	0.0	0.0	0.0	0.0	0.0	0.0	0.0	0.0	0.0	0.0	0.0	0.0	0.0	0.0	0.0	0.0	0.0	0.0	0.0	0.0
<i>Sporobolus teretifolius</i>	0.0	0.0	0.0	0.0	0.0	0.0	0.0	0.0	0.0	0.0	0.0	0.0	0.0	0.0	0.0	0.0	0.0	0.0	0.0	0.0
<i>Stokesia laevis</i>	0.0	0.0	0.0	0.0	0.0	0.0	0.0	0.0	0.0	0.0	0.0	0.0	0.0	0.2	0.0	0.0	0.0	0.0	0.0	0.0
<i>Tephrosia onobrychooides</i>	0.0	0.0	0.0	0.0	0.0	0.0	0.0	0.0	0.0	0.0	0.0	0.0	0.0	0.0	0.0	0.0	0.0	0.0	0.0	0.0
<i>Tephrosia</i> sp.	0.0	0.0	0.0	0.0	0.0	0.0	0.0	0.0	0.0	0.0	0.0	0.0	0.0	0.0	0.0	0.0	0.0	0.0	0.0	0.0
<i>Tofieldia glabra</i>	0.0	0.0	0.0	0.0	0.0	0.0	0.0	0.0	0.0	0.0	0.0	0.0	0.0	0.0	0.0	0.0	0.0	0.0	0.0	0.0
<i>Tofieldia racemosa</i>	0.0	0.0	0.0	0.3	0.0	0.2	0.0	0.7	0.5	0.0	0.3	0.4	0.0	0.0	0.0	0.0	0.0	0.0	0.0	0.0
<i>Tridens</i> sp.	0.0	0.0	0.0	0.0	0.0	0.0	0.0	0.0	0.0	0.0	0.0	0.0	0.0	0.0	0.0	0.0	0.0	0.0	0.0	0.0
<i>Uniola laxa</i>	0.0	0.0	0.0	0.0	0.0	0.0	0.0	0.0	0.0	0.0	0.0	0.0	0.0	0.0	0.0	0.0	0.0	0.0	0.0	0.0
<i>Verbesina chapmanii</i>	0.0	0.0	0.0	0.0	0.0	0.0	0.0	0.0	0.0	0.0	0.0	0.0	0.0	0.0	1.0	0.0	0.0	0.0	0.1	0.0
<i>Vernonia</i> sp.	0.0	0.0	0.0	0.0	0.0	0.0	0.0	0.0	0.0	0.0	0.0	0.0	0.0	0.0	0.0	0.0	0.0	0.0	0.0	0.0
<i>Viola lanceolata</i>	0.0	0.0	0.0	0.3	0.0	0.0	0.0	0.0	0.0	0.0	0.0	0.0	0.0	0.0	0.0	0.0	0.0	0.0	0.0	0.0
<i>Viola</i> sp.	0.0	0.0	0.0	0.0	0.0	0.0	0.0	0.0	0.0	0.0	0.0	0.0	0.0	0.0	0.0	0.0	0.0	0.0	0.0	0.0
<i>Woodwardia areolata</i>	0.0	0.0	0.0	0.0	0.0	0.0	0.0	0.0	0.0	0.0	0.0	0.0	0.0	0.0	0.0	0.0	0.0	0.0	0.0	0.0
<i>Woodwardia virginica</i>	0.0	0.0	0.0	0.0	0.0	0.0	0.3	0.0	0.0	0.0	0.0	0.0	0.0	0.0	0.0	0.0	0.0	0.0	0.0	0.0
<i>Xyris scabriifolia</i>	0.0	0.0	0.0	0.0	0.0	0.0	0.0	0.0	0.0	0.0	0.0	0.0	0.0	0.0	0.0	0.0	0.0	0.0	0.0	0.0
<i>Zigadenus glaberrimus</i>	0.3	0.0	0.3	0.0	0.0	0.0	0.0	0.4	0.0	0.0	0.4	0.0	0.0	0.0	0.0	0.0	0.0	0.0	0.0	0.0
Unknown or unidentifiable vascular plants	0.3	0.0	0.0	0.3	0.4	0.8	2.7	0.0	0.0	0.4	0.0	0.0	0.2	0.7	0.0	0.4	0.0	0.7	0.0	0.0
Unk. bryophyte	0.0	0.0	0.0	0.0	0.0	0.0	0.0	0.0	0.0	0.0	0.0	0.0	0.0	0.0	0.0	0.0	0.0	0.0	0.0	0.0

Table E5.

Indicator species	GA61	GA62	GA63	NC65	NC66	NC67	NC68	NC69	NC70	NC71	NC72
<i>Aletris</i> spp.	0.8	0.0	0.0	0.8	0.0	0.2	0.5	0.0	0.5	0.0	0.2
<i>Aristida</i> spp. & <i>Sporobolus</i> spp.	1.0	1.0	1.0	1.0	1.0	0.2	1.0	0.2	0.0	0.7	0.7
<i>Baldinia</i> spp.	0.7	0.0	0.0	0.0	0.0	0.0	0.0	0.0	0.0	0.0	0.0
<i>Bigelovia nudata</i>	1.0	1.0	0.5	1.0	0.7	0.7	0.8	0.3	1.0	0.0	0.0
<i>Carpophorus</i> spp.	0.0	0.8	0.0	0.0	0.0	0.0	0.0	0.0	0.0	0.0	0.0
<i>Chaptalia tomentosa</i>	0.0	0.2	0.2	0.2	0.5	0.3	0.2	0.0	0.0	0.0	0.0
<i>Coreopsis</i> sp.	0.7	0.8	0.7	1.0	0.8	0.8	1.0	0.2	0.5	0.0	1.0
<i>Ctenium aromaticum</i>	0.7	0.7	0.2	1.0	1.0	1.0	1.0	1.0	0.8	0.0	0.0
<i>Dichromena</i> sp.	0.3	0.0	0.0	0.0	0.0	0.0	0.0	0.0	0.0	0.0	0.0
<i>Erigeron vernus</i>	0.0	0.0	0.5	0.3	0.5	0.8	1.0	0.2	1.0	0.0	0.5
<i>Eriocaulon</i> spp.	0.0	0.7	1.0	0.2	0.3	0.5	0.0	0.2	0.0	0.0	0.0
<i>Eryngium integrifolium</i>	0.3	0.0	0.0	0.7	0.0	0.8	0.0	0.0	0.3	0.0	0.0
<i>Eupatorium leucolepis</i>	0.8	1.0	0.7	0.7	0.5	0.8	0.0	0.0	0.5	0.5	1.0
<i>Helianthus</i> spp.	0.3	0.3	0.0	1.0	0.8	0.8	0.0	0.0	0.8	0.0	0.3
<i>Lycopodium</i> spp.	0.2	0.8	0.0	0.2	0.3	1.0	0.7	0.5	0.7	0.0	0.0
<i>Muhlenbergia expansa</i>	0.0	1.0	0.3	0.8	1.0	0.8	0.7	0.2	0.8	0.2	0.2
<i>Rhexia</i> spp.	0.8	1.0	0.8	1.0	1.0	1.0	1.0	1.0	1.0	0.3	0.5
<i>Sarracenia</i> spp.	0.2	0.8	0.0	0.0	0.5	0.7	0.5	0.7	0.2	0.0	0.0
<i>Schizachyrium scoparium</i>	0.0	0.0	0.0	0.0	0.0	0.0	0.0	0.7	0.0	0.0	0.0
<i>Xyris</i> spp.	1.0	0.7	0.8	1.0	0.5	0.7	0.8	0.8	1.0	0.0	0.0
Total Indic Score	8.8	10.8	6.7	10.8	9.5	11.2	9.2	5.8	9.2	1.7	4.3
Additional Species											
<i>Agalinis aphylla</i>	0.0	0.0	0.0	0.0	0.0	0.4	0.5	0.0	0.0	0.0	0.0
<i>Agalinis purpurea</i>	0.0	0.0	0.0	0.0	0.0	0.0	0.0	0.0	0.0	0.0	0.0
<i>Agalinis</i> sp.	0.4	0.0	0.0	0.0	0.0	0.0	0.0	0.0	0.0	0.0	0.2
<i>Andropogon glaucopsis</i>	0.0	0.0	0.8	0.0	0.3	0.0	0.0	0.4	0.0	0.0	0.4
<i>Andropogon glomeratus</i>	0.0	0.0	0.0	0.0	0.0	0.0	0.0	0.0	0.7	0.5	0.0
<i>Andropogon mohrii</i>	0.0	0.0	0.0	0.0	0.0	0.0	0.0	0.0	0.0	0.0	0.0
<i>Andropogon</i> sp. 1	1.0	0.0	0.7	1.0	0.4	0.4	1.0	0.0	0.0	0.0	0.0
<i>Andropogon</i> sp. 2	0.0	0.0	0.0	0.8	0.0	0.8	0.0	0.0	0.0	0.0	0.0
<i>Andropogon</i> sp. 3	0.0	0.0	0.0	0.0	0.0	0.8	0.0	0.0	0.0	0.0	0.0
<i>Andropogon virginicus</i>	0.0	0.8	0.0	0.0	0.0	0.0	0.0	0.0	1.0	1.0	0.8
<i>Aristida affinis</i>	0.0	0.0	0.0	0.0	0.0	0.0	0.0	0.0	0.0	0.0	0.0
<i>Aristida virgata</i>	0.3	0.4	0.4	1.0	0.0	0.7	0.0	0.7	0.8	0.0	0.0
<i>Arnica acaulis</i>	0.0	0.0	0.0	0.0	0.0	0.0	0.0	0.0	0.0	0.0	0.0
<i>Arundinaria tecta</i>	0.0	0.7	0.0	0.7	0.0	0.0	0.0	0.8	0.5	0.7	1.0
<i>Asclepias longifolia</i>	0.0	0.0	0.0	0.0	0.0	0.0	0.0	0.0	0.0	0.0	0.0
<i>Asclepias</i> sp.	0.0	0.0	0.0	0.0	0.0	0.0	0.0	0.0	0.0	0.0	0.0
<i>Asclepias viridula</i>	0.0	0.0	0.0	0.0	0.0	0.0	0.0	0.0	0.0	0.0	0.0
<i>Aster adnatus</i>	0.0	0.0	0.0	0.0	0.0	0.0	0.0	0.0	0.0	0.0	0.0

Indicator species	GA61	GA62	GA63	NC65	NC66	NC67	NC68	NC69	NC70	NC71	NC72
<i>Aster dumosus</i>	0.3	0.0	0.0	0.4	0.4	0.0	0.0	0.0	0.7	0.0	1.0
<i>Aster eringifolius</i>	0.0	0.0	0.0	0.0	0.0	0.0	0.0	0.0	0.0	0.0	0.0
<i>Aster linariifolius</i>	0.0	0.0	0.0	0.0	0.0	0.0	0.0	0.0	0.0	0.0	0.0
<i>Aster paludosus</i>	0.0	0.7	0.0	0.0	0.4	0.0	0.0	0.0	1.0	0.0	0.0
<i>Aster sclerosus</i>	0.4	0.0	0.0	0.0	0.0	0.0	0.0	0.0	0.0	0.0	0.0
<i>Aster sp. 1</i>	0.0	0.0	0.0	0.0	0.0	1.0	0.0	0.1	0.0	0.0	0.0
<i>Aster sp. 2</i>	0.0	0.0	0.0	0.0	0.0	0.0	0.0	0.0	0.0	0.0	0.0
<i>Aster verticillata</i>	0.0	0.1	0.0	0.0	0.0	0.0	0.0	0.0	0.0	0.0	0.0
<i>Bacopa caroliniana</i>	0.0	0.0	0.0	0.0	0.0	0.0	0.0	0.0	0.0	0.0	0.0
<i>Balduna uniflora</i>	0.7	0.0	0.0	0.0	0.0	0.0	0.0	0.0	0.0	0.0	0.0
<i>Bartonia virginica</i>	0.0	0.0	0.0	0.0	0.0	0.2	0.0	0.0	0.0	0.0	0.0
<i>Berchemia scandens</i>	0.0	0.0	0.0	0.0	0.0	0.0	0.0	0.0	0.0	0.0	0.0
<i>Bidens bipinnata</i>	0.0	0.0	0.0	0.0	0.0	0.0	0.0	0.0	0.0	0.0	0.0
<i>Bidens mitis</i>	0.0	0.0	0.0	0.0	0.0	0.0	0.0	0.0	0.0	0.0	0.0
<i>Bidens sp.</i>	0.0	0.0	0.0	0.0	0.0	0.0	0.0	0.0	0.0	0.0	0.0
<i>Boltonia asteroides</i>	0.0	0.0	0.0	0.0	0.0	0.0	0.0	0.0	0.0	0.0	0.0
<i>Cacalia lanceolata</i>	0.0	0.0	0.0	0.0	0.0	0.0	0.0	0.0	0.0	0.0	0.0
<i>Calopogon sp.</i>	0.0	0.0	0.0	0.0	0.0	0.0	0.0	0.0	0.0	0.0	0.0
<i>Calopogon tuberosus</i>	0.0	0.0	0.0	0.0	0.0	0.0	0.0	0.0	0.0	0.0	0.0
<i>Carex crinita</i>	0.0	0.0	0.0	0.0	0.0	0.0	0.0	0.0	0.0	0.0	0.0
<i>Carex glaucescens</i>	0.0	0.0	0.0	0.0	0.8	0.0	0.0	0.0	0.0	0.0	0.0
<i>Carex sp.</i>	0.0	0.2	0.4	0.0	0.0	0.0	0.0	0.0	0.0	0.0	0.0
<i>Centella asiatica/erecta</i>	0.3	0.2	0.0	0.0	0.0	0.0	0.0	0.0	0.0	0.0	0.2
<i>Chrysopsis sp. (Heterotheca)</i>	0.0	0.0	0.0	0.0	0.0	0.0	0.0	0.0	0.0	0.0	0.0
<i>Cirsium lecontei</i>	0.0	0.0	0.0	0.0	0.0	0.0	0.0	0.0	0.0	0.0	0.0
<i>Cirsium sp.</i>	0.0	0.0	0.0	0.0	0.2	0.3	0.0	0.0	0.0	0.0	0.0
<i>Cleistes divaricata</i>	0.0	0.0	0.0	0.2	0.0	0.3	0.0	0.0	0.0	0.0	0.0
<i>Coreopsis falcata</i>	0.0	0.0	0.0	0.0	0.0	0.0	0.0	0.0	0.0	0.0	0.0
<i>Cuscuta sp.</i>	0.0	0.0	0.0	0.0	0.0	0.0	0.0	0.0	0.0	0.0	0.0
<i>Cynoctonum sessilifolium</i>	0.2	0.0	0.0	0.0	0.0	0.0	0.0	0.0	0.0	0.0	0.0
<i>Cyperus haspan</i>	0.0	0.0	0.0	0.0	0.0	0.0	0.0	0.0	0.0	0.0	0.0
<i>Cyperus pseudovegetus</i>	0.0	0.0	0.0	0.0	0.0	0.0	0.0	0.0	0.0	0.0	0.0
<i>Cyperus sp.</i>	0.0	0.0	0.0	0.0	0.0	0.0	0.0	0.0	0.0	0.0	0.0
<i>Dicanthellum aciculare</i>	0.0	0.0	0.0	0.0	0.0	0.0	0.0	0.0	0.0	0.0	0.0
<i>Dicanthellum acuminata</i>	0.0	0.0	0.8	0.0	0.0	0.0	0.0	0.0	0.0	0.0	0.0
<i>Dicanthellum consanguinium</i>	0.0	0.0	0.0	0.0	0.0	0.0	0.0	0.0	0.0	0.0	0.0
<i>Dicanthellum ensifolium</i>	0.0	0.0	0.0	0.0	0.0	0.0	0.0	0.0	0.0	0.0	0.0
<i>Dicanthellum scabrosculum</i>	0.0	0.0	0.0	0.0	0.0	0.0	0.0	0.0	0.0	0.0	0.0
<i>Dicanthellum scoparium</i>	0.0	0.0	0.0	0.0	0.0	0.0	0.0	0.0	0.0	0.0	0.0
<i>Dicanthellum sp. 1</i>	1.0	0.8	1.0	1.0	1.0	1.0	1.0	1.0	1.0	0.3	1.0
<i>Dicanthellum sp. 2</i>	0.5	0.0	0.0	0.4	0.7	0.0	0.0	0.0	0.0	0.0	0.4
<i>Dicanthellum sp. 3</i>	0.0	0.0	0.0	0.0	0.0	0.0	0.0	0.0	0.0	0.0	0.0
<i>Dicanthellum strigosum</i>	0.0	0.0	0.0	0.0	0.0	0.0	0.0	0.0	0.0	0.0	0.0
<i>Dicanthellum tenue</i>	0.0	0.0	0.0	0.0	0.0	0.0	0.0	0.0	0.0	0.0	0.0

Indicator species	GA61	GA62	GA63	NC65	NC66	NC67	NC68	NC69	NC70	NC71	NC72
<i>Dichromena colorata</i>	0.0	0.0	0.0	0.0	0.0	0.0	0.0	0.0	0.0	0.0	0.0
<i>Dichromena latifolia</i>	0.0	0.0	0.0	0.0	0.0	0.0	0.0	0.0	0.0	0.0	0.0
<i>Dichromena sp.</i>	0.3	0.0	0.0	0.0	0.0	0.0	0.0	0.0	0.0	0.0	0.0
<i>Diodia virginiana</i>	0.0	0.0	0.0	0.0	0.0	0.0	0.0	0.0	0.0	0.0	0.0
<i>Dionea muscipula</i>	0.0	0.0	0.0	0.4	0.0	0.0	0.0	0.0	0.0	0.0	0.0
<i>Drosera sp.</i>	0.7	0.0	0.0	0.7	1.0	0.7	0.8	0.0	1.0	0.0	0.0
<i>Eleocharis sp.</i>	0.0	0.0	0.0	0.0	0.0	0.0	0.0	0.0	0.0	0.0	0.0
<i>Elephantopus sp.</i>	0.0	0.0	0.0	0.0	0.0	0.0	0.0	0.0	0.0	0.0	0.0
<i>Eragrostis spectabilis</i>	0.2	0.0	0.0	0.0	0.0	0.0	0.0	0.0	0.0	0.0	0.0
<i>Erechtites hieracifolia</i>	0.0	0.0	0.0	0.0	0.0	0.0	0.0	0.0	0.0	0.0	0.0
<i>Erianthus contortus</i>	0.0	0.0	0.0	0.0	0.0	0.0	0.0	0.0	0.0	0.0	0.0
<i>Erianthus giganteus</i>	0.0	0.0	0.0	0.0	0.0	0.0	0.0	0.0	0.0	0.0	0.7
<i>Erianthus sp.</i>	0.0	0.0	0.3	0.0	0.0	0.0	0.0	0.0	0.0	0.0	0.0
<i>Eupatorium capillifolium</i>	0.0	0.0	0.0	0.0	0.0	0.0	0.0	0.0	0.4	0.0	0.0
<i>Eupatorium compositifolium</i>	0.0	0.0	0.0	0.0	0.0	0.0	0.0	0.0	0.0	0.0	0.0
<i>Eupatorium recurvans</i>	0.0	0.0	0.0	0.0	0.0	0.0	0.0	0.0	0.0	0.0	0.0
<i>Eupatorium pilosum</i>	0.0	0.3	0.0	0.0	0.0	0.0	0.2	0.0	0.0	0.2	0.2
<i>Eupatorium rotundifolium</i>	0.4	0.0	0.0	0.3	0.0	0.0	0.0	0.0	0.5	0.0	0.3
<i>Eupatorium semiserratatum</i>	0.0	0.0	0.0	0.0	0.0	0.0	0.0	0.0	0.0	0.0	0.0
<i>Eupatorium sp.</i>	0.0	0.0	0.0	0.0	0.0	0.0	0.0	0.2	0.0	0.0	0.0
<i>Euphorbia inundata</i>	0.0	0.0	0.0	0.0	0.0	0.0	0.0	0.0	0.0	0.0	0.0
<i>Euthamia leptocephalia</i>	0.0	0.0	0.0	0.0	0.0	0.0	0.0	0.0	0.0	0.0	0.0
<i>Euthamia minor</i>	0.0	0.0	0.0	0.0	0.0	0.0	0.0	0.0	0.0	0.0	0.0
<i>Euthamia sp.</i>	0.8	0.0	0.0	0.0	0.0	0.0	0.0	0.3	0.3	0.8	0.7
<i>Euthamia tenuifolia</i>	0.0	0.0	0.0	0.0	0.0	0.0	0.0	0.0	0.0	0.0	0.0
<i>Fimbristylis puberula</i>	0.0	0.0	0.0	0.4	0.0	0.0	0.0	0.0	0.0	0.0	0.0
<i>Fuirena pumila</i>	0.0	0.0	0.0	0.0	0.0	0.0	0.0	0.0	0.0	0.0	0.0
<i>Fuirena sp.</i>	0.0	0.0	0.0	0.0	0.0	0.0	0.0	0.0	0.2	0.0	0.0
<i>Fuirena squarrosa</i>	0.0	0.0	0.0	0.0	0.0	0.0	0.0	0.0	0.0	0.0	0.0
<i>Gelsemium sempervirens</i>	0.0	0.0	0.0	0.0	0.0	0.0	0.0	0.0	0.0	0.0	0.0
<i>Gratiola pilosa</i>	0.0	0.0	0.0	0.0	0.0	0.0	0.0	0.0	0.0	0.0	0.0
<i>Gymnopogon sp.</i>	0.0	0.0	0.0	0.0	0.0	0.0	0.0	0.0	0.0	0.0	0.0
<i>Habenaria (esp. ciliaris)</i>	0.0	0.0	0.0	0.0	0.0	0.0	0.0	0.0	0.0	0.0	0.0
<i>Habenaria sp.</i>	0.0	0.0	0.0	0.0	0.0	0.0	0.0	0.0	0.0	0.0	0.0
<i>Helenium sp.</i>	0.0	0.0	0.0	0.0	0.0	0.0	0.0	0.0	0.2	0.0	0.0
<i>Helenium vernale</i>	0.0	0.0	0.0	0.0	0.0	0.0	0.0	0.0	0.0	0.0	0.0
<i>Helianthus angustifolius</i>	0.0	0.0	0.0	0.0	0.0	0.0	0.0	0.0	0.0	0.0	0.0
<i>Hibiscus sp.</i>	0.0	0.0	0.0	0.0	0.0	0.0	0.0	0.0	0.0	0.0	0.0
<i>Hydrolea ovata</i>	0.0	0.0	0.0	0.0	0.0	0.0	0.0	0.0	0.0	0.0	0.0
<i>Hypericum brachyphyllum</i>	0.0	0.0	0.0	0.0	0.0	0.0	0.0	0.0	0.0	0.0	0.0
<i>Hypericum cistifolium</i>	0.0	0.0	0.0	0.0	0.0	0.0	0.0	0.0	0.0	0.0	0.0
<i>Hypericum setosum</i>	0.0	0.0	0.0	0.0	0.0	0.0	0.0	0.0	0.0	0.0	0.0
<i>Hypericum crux-andreae</i>	0.0	0.0	0.0	0.4	0.2	0.7	0.3	0.1	1.0	0.3	0.8
<i>Hypericum exile</i>	0.0	0.0	0.0	0.0	0.0	0.0	0.0	0.0	0.0	0.0	0.0

Indicator species	GA61	GA62	GA63	NC65	NC66	NC67	NC68	NC69	NC70	NC71	NC72
<i>Hypericum fasciculatum</i>	0.0	0.0	0.0	0.0	0.0	0.0	0.0	0.0	0.0	0.3	0.0
<i>Hypericum perforatum</i>	0.0	0.0	0.0	0.0	0.0	0.0	0.0	0.0	0.0	0.0	0.0
<i>Hypericum reductum</i>	0.0	0.0	0.0	0.0	0.0	0.0	0.0	0.0	0.0	0.0	0.0
<i>Hypericum sp.</i>	0.0	0.5	0.3	0.0	0.0	0.0	0.0	0.0	0.0	0.0	0.2
<i>Hypericum stans</i>	0.0	0.0	0.0	0.0	0.0	0.0	0.0	0.0	0.0	0.0	0.0
<i>Hypoxis micrantha</i>	0.0	0.0	0.0	0.0	0.0	0.0	0.0	0.0	0.0	0.0	0.0
<i>Hyptis alata</i>	0.0	0.0	0.0	0.0	0.0	0.0	0.0	0.0	0.0	0.0	0.0
<i>Iris sp.</i>	0.0	0.0	0.0	0.0	0.0	0.0	0.0	0.0	0.0	0.0	0.0
<i>Juncus biflorus</i>	0.0	0.0	0.0	0.0	0.0	0.0	0.0	0.0	0.0	0.0	0.0
<i>Juncus dichotomus</i>	0.0	0.0	0.0	0.0	0.0	0.0	0.0	0.0	0.0	0.0	0.0
<i>Juncus marginatus</i>	0.0	0.0	0.0	0.0	0.0	0.0	0.0	0.0	0.0	0.0	0.0
<i>Juncus polycephalus</i>	0.0	0.0	0.0	0.0	0.0	0.0	0.0	0.0	0.0	0.0	0.0
<i>Juncus sp. 1</i>	0.3	0.0	0.0	0.0	0.0	0.0	0.0	0.0	0.0	0.0	0.2
<i>Juncus sp. 2</i>	0.0	0.0	0.0	0.0	0.0	0.0	0.0	0.0	0.0	0.0	0.0
<i>Juncus sp. 3</i>	0.0	0.0	0.0	0.0	0.0	0.0	0.0	0.0	0.0	0.0	0.0
<i>Lachnanthes caroliniana</i>	0.2	0.0	0.0	0.0	0.7	0.8	0.7	0.4	1.0	0.0	0.0
<i>Lachnocaulon anceps</i>	0.0	0.0	0.0	0.0	0.0	0.0	0.0	0.0	0.0	0.0	0.0
<i>Lachnocaulon minus</i>	0.0	0.0	0.0	0.0	0.0	0.0	0.0	0.0	0.0	0.0	0.0
<i>Lachnocaulon sp.</i>	0.0	0.8	0.3	0.3	0.8	0.2	0.8	0.0	1.0	0.0	0.0
Lamiaceae sp.	0.0	0.0	0.0	0.0	0.0	0.0	0.7	0.0	0.0	0.0	0.0
<i>Lamium sp.</i>	0.0	0.0	0.0	0.0	0.0	0.0	0.0	0.0	0.0	0.0	0.0
<i>Leersia hexandra</i>	0.0	0.0	0.0	0.0	0.0	0.0	0.0	0.0	0.0	0.0	0.0
<i>Liatris acidota</i>	0.0	0.0	0.0	0.0	0.0	0.0	0.0	0.0	0.0	0.0	0.0
<i>Liatris gracilis</i>	0.0	0.0	0.0	0.0	0.0	0.0	0.0	0.0	0.0	0.0	0.0
<i>Liatris pycnostachya</i>	0.0	0.0	0.0	0.0	0.0	0.0	0.0	0.0	0.0	0.0	0.0
<i>Liatris spicata</i>	0.0	0.0	0.2	0.7	0.0	0.7	0.7	0.0	0.1	0.0	0.3
<i>Liatris sp.</i>	0.0	0.0	0.0	0.0	0.0	0.0	0.0	0.0	0.0	0.0	0.0
<i>Lilium catesbaei</i>	0.0	0.0	0.0	0.0	0.0	0.0	0.0	0.0	0.0	0.0	0.0
<i>Linum floridanum</i>	0.8	0.0	0.3	0.0	0.0	0.3	0.0	0.0	0.0	0.0	0.0
<i>Lobelia brevifolia</i>	0.0	0.0	0.0	0.0	0.0	0.0	0.0	0.0	0.0	0.0	0.0
<i>Lobelia floridana</i>	0.0	0.0	0.0	0.0	0.0	0.0	0.0	0.0	0.0	0.0	0.0
<i>Lobelia glandulosa</i>	0.2	0.0	0.2	0.0	0.0	0.0	0.0	0.0	0.0	0.0	0.0
<i>Lobelia nuttallii</i>	0.0	0.0	0.2	0.1	0.0	0.0	0.4	0.0	0.4	0.0	0.7
<i>Lobelia puberula</i>	0.0	0.0	0.0	0.0	0.0	0.0	0.0	0.0	0.0	0.0	0.0
<i>Lobelia (Gaura) sp.</i>	0.0	0.0	0.0	0.0	0.0	0.0	0.0	0.0	0.0	0.0	0.0
<i>Lophiola americana</i>	0.0	0.0	0.0	0.0	0.0	0.0	0.0	0.0	0.0	0.0	0.0
<i>Ludwigia hirtella</i>	0.0	0.0	0.0	0.0	0.0	0.0	0.0	0.0	0.0	0.0	0.0
<i>Ludwigia pilosa</i>	0.0	0.0	0.0	0.0	0.0	0.0	0.0	0.0	0.0	0.0	0.0
<i>Ludwigia sp.</i>	0.0	0.0	0.0	0.0	0.0	0.0	0.0	0.0	0.0	0.0	0.0
<i>Ludwigia virgata</i>	0.0	0.4	0.0	0.0	0.0	0.0	0.0	0.0	0.0	0.0	0.0
<i>Lycopodium alopecuroides</i>	0.0	0.0	0.0	0.0	0.0	0.0	0.0	0.0	0.0	0.0	0.0
<i>Lycopodium prostratum</i>	0.0	0.0	0.0	0.0	0.0	0.0	0.0	0.0	0.0	0.0	0.0
<i>Lycopodium sp.</i>	0.0	0.0	0.0	0.0	0.0	0.0	0.0	0.0	0.0	0.0	0.0
<i>Lycopus sp.</i>	0.0	0.0	0.0	0.0	0.0	0.0	0.0	0.0	0.0	0.0	0.0

Indicator species	GA61	GA62	GA63	NC65	NC66	NC67	NC68	NC69	NC70	NC71	NC72
<i>Lycopodium virginicum</i>	0.0	0.0	0.0	0.0	0.0	0.0	0.0	0.0	0.0	0.0	0.0
<i>Marshallia graminifolia</i>	0.7	0.0	0.2	0.8	0.7	0.4	0.8	0.2	1.0	0.0	0.2
<i>Marshallia tenuifolia</i>	0.0	0.0	0.0	0.0	0.0	0.0	0.0	0.0	0.0	0.0	0.0
<i>Mayaca eubleii</i>	0.0	0.0	0.0	0.0	0.0	0.0	0.0	0.0	0.0	0.0	0.0
<i>Mecardonia acuminata</i>	0.0	0.0	0.0	0.0	0.0	0.0	0.0	0.0	0.0	0.0	0.0
<i>Mecardonia marilandica</i>	0.0	0.0	0.0	0.0	0.0	0.0	0.0	0.0	0.0	0.0	0.0
<i>Onoclea sensibilis</i>	0.0	0.0	0.0	0.0	0.0	0.0	0.0	0.0	0.0	0.0	0.0
Orchidaceae sp.	0.2	0.0	0.0	0.0	0.0	0.5	0.0	0.0	0.2	0.0	0.0
<i>Osmunda cinnamomea</i>	0.0	0.0	0.0	0.0	0.0	0.0	0.0	0.0	0.0	0.0	0.0
<i>Osmunda regalis</i>	0.0	0.0	0.0	0.0	0.0	0.0	0.0	0.0	0.0	0.0	0.0
<i>Oxypolis filiformis</i>	0.0	0.2	0.0	0.0	0.0	0.0	0.0	0.0	0.0	0.0	0.0
<i>Oxypolis</i> sp.	0.0	0.0	0.0	0.0	0.7	0.0	0.0	0.0	0.0	0.0	0.0
<i>Oxypolis ternata</i>	0.0	0.0	0.0	0.0	0.0	0.0	0.3	0.0	0.7	0.2	0.0
<i>Panicum anceps</i>	0.0	0.0	0.0	0.0	0.0	0.0	0.0	0.0	0.0	0.0	0.0
<i>Panicum hians</i>	0.0	0.0	0.0	0.0	0.0	0.0	0.0	0.0	0.0	0.0	0.0
<i>Panicum</i> sp.1	0.0	0.0	0.0	0.0	0.0	0.0	0.0	0.0	0.0	0.0	0.0
<i>Panicum</i> sp.2	0.0	0.0	0.0	0.0	0.0	0.0	0.0	0.0	0.0	0.0	0.0
<i>Panicum virgatum</i>	0.0	0.0	0.7	0.0	0.0	0.0	0.0	0.0	0.0	0.0	0.3
<i>Paspalum</i> sp.	0.0	0.2	0.0	0.0	0.0	0.0	0.0	0.0	0.2	0.0	0.0
<i>Physotegia godfreyi</i>	0.0	0.0	0.0	0.0	0.0	0.0	0.0	0.0	0.0	0.0	0.0
<i>Pinguicula</i> sp.	0.0	0.0	0.0	0.0	0.0	0.2	0.0	0.0	0.2	0.0	0.0
<i>Pityopsis graminifolia</i>	0.4	0.4	0.0	0.2	0.0	0.3	0.0	0.0	0.1	0.2	0.0
<i>Pilea tenuifolia</i>	0.0	0.0	0.0	0.0	0.3	0.4	0.0	0.0	0.0	0.0	0.0
<i>Pluchea rosea</i>	0.2	0.0	0.0	0.0	0.0	0.0	0.0	0.0	0.0	0.0	0.0
<i>Pluchea</i> sp.	0.0	0.0	0.0	0.0	0.0	0.0	0.0	0.0	0.0	0.0	0.0
<i>Pogonia ophioglossoides</i>	0.0	0.0	0.0	0.0	0.0	0.0	0.0	0.0	0.0	0.0	0.0
<i>Pogonia</i> sp.	0.0	0.0	0.0	0.0	0.0	0.0	0.0	0.0	0.0	0.0	0.0
<i>Polygala cruciata</i>	0.0	0.0	0.4	0.0	0.0	0.5	0.0	0.0	0.4	0.2	0.0
<i>Polygala cymosa</i>	0.0	0.0	0.0	0.0	0.0	0.0	0.0	0.0	0.0	0.0	0.0
<i>Polygala hookeri</i>	0.0	0.0	0.0	0.8	0.2	0.2	0.7	0.0	0.3	0.0	0.0
<i>Polygala lutea</i>	0.7	0.0	0.0	0.4	0.2	0.2	0.4	0.0	0.0	0.4	0.3
<i>Polygala ramosa</i>	0.3	0.0	0.0	0.0	0.2	0.0	0.0	0.0	0.0	0.0	0.0
<i>Polygala</i> sp.	0.0	0.0	0.0	0.0	0.0	0.0	0.0	0.0	0.0	0.0	0.0
<i>Polygonum hydropter</i>	0.0	0.0	0.0	0.0	0.0	0.0	0.0	0.0	0.0	0.0	0.0
<i>Proserpinaca pectinata & serpent</i>	0.0	0.0	0.0	0.0	0.0	0.0	0.0	0.0	0.0	0.0	0.0
<i>Pteridium aquilinum</i>	0.0	0.0	0.0	0.0	0.0	0.0	0.7	0.3	0.2	0.8	0.8
<i>Ptilimnium nuttallii</i>	0.0	0.0	0.0	0.0	0.0	0.0	0.0	0.0	0.0	0.0	0.0
<i>Pycnanthemum nudum</i>	0.0	0.0	0.0	0.0	0.0	0.0	0.0	0.0	0.0	0.0	0.0
<i>Pycnanthemum tenuifolium</i>	0.0	0.0	0.0	0.0	0.0	0.0	0.0	0.0	0.0	0.0	0.0
<i>Rhexia virginica</i>	0.0	0.0	0.0	0.0	0.0	0.0	0.0	0.0	0.0	0.0	0.0
<i>Rhus radicans</i>	0.0	0.0	0.0	0.0	0.0	0.0	0.0	0.0	0.0	0.0	0.0
<i>Rhynchospora caduca</i>	0.0	0.0	0.0	0.0	0.0	0.0	0.0	0.0	0.0	0.0	0.7
<i>Rhynchospora chapmanii</i>	0.2	0.2	0.7	1.0	0.8	1.0	0.8	1.0	0.0	0.0	1.0

Indicator species	GA61	GA62	GA63	NC65	NC66	NC67	NC68	NC69	NC70	NC71	NC72
<i>Rhynchospora ciliaris</i>	0.0	0.0	0.0	0.0	0.0	0.0	0.8	0.3	0.2	0.0	0.0
<i>Rhynchospora compressa</i>	0.0	0.0	0.0	0.0	0.0	0.0	0.0	0.0	0.0	0.0	0.0
<i>Rhynchospora debilis</i>	0.0	0.0	0.0	0.0	0.0	0.0	0.0	0.0	0.0	0.0	0.0
<i>Rhynchospora elliotii</i>	0.0	0.0	0.0	0.0	0.0	0.0	0.0	0.0	0.0	0.0	0.0
<i>Rhynchospora glomerata</i>	0.0	0.0	0.0	0.0	0.3	0.0	0.0	0.0	0.3	0.0	0.0
<i>Rhynchospora gracilentia</i>	0.0	0.0	0.0	0.0	0.0	0.0	0.0	0.3	0.0	0.0	0.0
<i>Rhynchospora inexpansa</i>	0.2	0.0	0.2	0.0	0.0	0.0	0.0	0.0	0.0	0.0	0.0
<i>Rhynchospora macra</i>	0.0	0.0	0.0	0.0	0.0	0.0	0.0	0.0	0.0	0.0	0.0
<i>Rhynchospora microcarpa</i>	0.0	0.0	0.0	0.0	0.0	0.0	0.0	0.0	0.0	0.0	0.0
<i>Rhynchospora oligantha</i>	0.0	0.0	0.0	0.0	0.0	0.0	0.0	0.0	0.0	0.0	0.0
<i>Rhynchospora plumosa</i>	0.0	0.0	0.2	0.8	0.3	0.5	0.4	0.3	0.0	0.0	0.0
<i>Rhynchospora rariflora</i>	0.4	0.0	0.3	0.7	0.8	0.4	0.5	0.2	0.0	0.0	0.0
<i>Rhynchospora</i> sp. 1	0.2	0.0	0.0	0.0	0.0	0.3	0.3	0.8	0.0	0.0	0.0
<i>Rhynchospora</i> sp. 2	0.0	0.0	0.0	0.0	0.0	0.0	0.0	0.0	0.0	0.0	0.0
<i>Rhynchospora</i> sp. (large)	0.0	0.0	0.0	0.0	0.0	0.0	0.0	0.0	0.0	0.0	0.0
<i>Rhynchospora</i> sp. (medium)	0.0	0.0	0.0	0.0	0.0	0.0	0.0	0.0	0.0	0.0	0.0
<i>Rhynchospora</i> sp. (small)	0.0	0.0	0.0	0.0	0.0	0.0	0.0	0.0	0.0	0.0	0.0
<i>Rhynchospora</i> sp. (tiny)	0.0	0.0	0.0	0.0	0.0	0.0	0.0	0.0	0.0	0.0	0.0
<i>Rhynchospora</i> (tri-stemmed)	0.0	0.0	0.0	0.0	0.0	0.4	0.0	0.2	0.0	0.0	0.0
<i>Rubus</i> sp.	0.0	0.0	0.3	0.0	0.0	0.0	0.0	0.0	0.3	0.0	0.2
<i>Rudbeckia graminifolia</i>	0.0	0.0	0.0	0.0	0.0	0.0	0.0	0.0	0.0	0.0	0.0
<i>Rudbeckia</i> sp.	0.0	0.0	0.0	0.0	0.0	0.0	0.0	0.0	0.0	0.0	0.0
<i>Ruellia humilis</i>	0.0	0.0	0.0	0.0	0.0	0.0	0.0	0.0	0.0	0.0	0.0
<i>Ruellia humilis</i> var. <i>longiflora</i>	0.0	0.0	0.0	0.0	0.0	0.0	0.0	0.0	0.0	0.0	0.0
<i>Sabal minor</i>	0.0	0.0	0.0	0.0	0.0	0.0	0.0	0.0	0.0	0.0	0.0
<i>Sabatia bartramii</i>	0.0	0.0	0.0	0.0	0.0	0.0	0.0	0.0	0.0	0.0	0.0
<i>Sabatia campanulata</i>	0.0	0.0	0.0	0.0	0.0	0.0	0.0	0.0	0.0	0.0	0.0
<i>Sabatia difformis</i>	0.4	0.0	0.0	0.0	0.0	0.0	0.0	0.0	0.0	0.0	0.0
<i>Sabatia dodecandra</i>	0.0	0.0	0.0	0.0	0.0	0.0	0.0	0.0	0.0	0.0	0.0
<i>Sabatia genianoides</i>	0.0	0.0	0.0	0.0	0.0	0.0	0.0	0.0	0.0	0.0	0.0
<i>Sabatia macrophylla</i>	0.0	0.7	0.0	0.0	0.0	0.0	0.0	0.0	0.0	0.0	0.0
<i>Sabatia</i> sp. 1	0.0	0.0	0.0	0.4	0.3	1.0	0.0	0.0	0.0	0.0	0.0
<i>Sabatia</i> sp. 2	0.0	0.0	0.0	0.0	0.2	0.0	0.0	0.0	0.0	0.0	0.0
<i>Sagittaria lancifolia</i>	0.0	0.0	0.0	0.0	0.0	0.0	0.0	0.0	0.0	0.0	0.0
<i>Schizachyrium tenerum</i>	0.0	0.0	0.0	0.0	0.0	0.0	0.0	0.0	0.0	0.0	0.0
<i>Schoenolirion elliotii</i>	0.0	0.0	0.0	0.0	0.0	0.0	0.0	0.0	0.0	0.0	0.0
<i>Schrankia</i> sp.	0.0	0.0	0.0	0.0	0.0	0.0	0.0	0.0	0.0	0.0	0.0
<i>Scirpus cyperinus</i>	0.0	0.0	0.0	0.0	0.0	0.0	0.0	0.0	0.0	0.0	0.0
<i>Scleria baldwinii</i>	0.0	0.0	0.0	0.0	0.0	0.0	0.0	0.0	0.0	0.0	0.0
<i>Scleria pauciflora</i>	0.0	0.0	0.0	0.0	0.0	0.0	0.0	0.0	0.0	0.0	0.0
<i>Scleria pauciflora</i> var. <i>caroliniana</i>	0.0	0.3	0.0	0.0	0.0	0.0	0.0	0.0	0.0	0.0	0.0
<i>Scleria pauciflora</i> var. <i>pausiflora</i>	0.0	0.3	0.0	0.0	0.0	0.0	0.0	0.0	0.0	0.0	0.0
<i>Scleria</i> sp. 1	0.7	0.0	0.0	1.0	1.0	0.4	0.2	0.7	1.0	0.3	1.0

Indicator species	GA61	GA62	GA63	NC65	NC66	NC67	NC68	NC69	NC70	NC71	NC72
<i>Scleria</i> sp. 2	0.0	0.0	0.0	0.0	0.3	0.7	0.0	0.0	0.4	0.0	0.3
<i>Scutellaria integrifolia</i>	0.0	0.0	0.0	0.0	0.0	0.0	0.0	0.0	0.0	0.0	0.0
<i>Scutellaria</i> sp.	0.0	0.0	0.0	0.0	0.0	0.0	0.0	0.0	0.0	0.0	0.0
<i>Serenoa repens</i>	0.0	0.0	0.0	0.0	0.0	0.0	0.0	0.0	0.0	0.0	0.0
<i>Seymaria cassioides</i>	0.0	0.2	0.0	0.0	0.0	0.0	0.0	0.0	0.0	0.0	0.0
<i>Sisyrinchium</i> sp.	0.0	0.0	0.0	0.0	0.0	0.0	0.0	0.0	0.0	0.0	0.0
<i>Smilax bona-nox</i>	0.0	0.0	0.2	0.0	0.0	0.0	0.0	0.0	0.0	0.0	0.0
<i>Smilax laurifolia</i>	0.0	0.0	0.0	0.4	0.2	0.5	0.0	0.7	0.0	0.0	0.0
<i>Smilax rotundifolia</i>	0.0	0.0	0.0	0.0	0.0	0.0	0.0	0.0	0.2	0.0	0.4
<i>Smilax</i> sp.	0.0	0.0	0.0	0.0	0.0	0.0	0.0	0.0	0.0	0.4	0.0
<i>Solidago fistulosa</i>	0.0	0.0	0.0	0.0	0.0	0.0	0.0	0.0	0.0	0.2	0.4
<i>Solidago</i> sp. 1	0.0	0.0	0.3	0.3	0.0	0.8	1.0	0.3	0.7	0.8	0.7
<i>Solidago</i> sp. 2	0.0	0.0	0.0	0.0	0.0	0.0	0.0	0.0	0.0	0.0	0.0
<i>Solidago</i> sp. 3	0.0	0.0	0.0	0.0	0.0	0.0	0.0	0.0	0.0	0.0	0.0
<i>Solidago stricta</i>	0.3	0.3	0.0	0.1	0.8	0.7	0.0	0.0	0.1	0.0	0.7
<i>Sphagnum</i> spp.	0.0	0.0	0.0	1.0	0.7	1.0	1.0	0.2	0.0	0.0	1.0
<i>Spiranthes</i> sp.	0.0	0.0	0.0	0.0	0.0	0.0	0.0	0.0	0.0	0.0	0.0
<i>Sporobolus</i> sp.	0.0	0.0	0.0	0.0	0.0	0.0	0.0	0.0	0.0	0.0	0.0
<i>Sporobolus teretifolius</i>	0.0	0.0	0.0	0.0	0.0	0.2	0.0	0.0	0.0	0.0	0.0
<i>Stokesia laevis</i>	0.0	0.0	0.0	0.0	0.0	0.0	0.0	0.0	0.0	0.0	0.0
<i>Tephrosia onobrychooides</i>	0.0	0.0	0.0	0.0	0.0	0.0	0.0	0.0	0.0	0.0	0.0
<i>Tephrosia</i> sp.	0.0	0.0	0.0	0.0	0.0	0.0	0.0	0.0	0.0	0.0	0.0
<i>Tofieldia glabra</i>	0.0	0.0	0.0	0.0	0.0	0.0	0.0	0.0	0.0	0.0	0.0
<i>Tofieldia racemosa</i>	0.3	0.0	0.0	0.0	1.0	0.0	0.0	0.0	1.0	0.0	0.0
<i>Tridens</i> sp.	0.0	0.0	0.0	0.0	0.0	0.0	0.0	0.0	0.0	0.0	0.0
<i>Uniola laxa</i>	0.0	0.0	0.0	0.0	0.0	0.0	0.0	0.0	0.0	0.0	0.0
<i>Verbesina chapmannii</i>	0.0	0.0	0.0	0.0	0.0	0.0	0.0	0.0	0.0	0.0	0.0
<i>Vernonia</i> sp.	0.0	0.0	0.0	0.0	0.0	0.0	0.0	0.0	0.0	0.0	0.0
<i>Viola lanceolata</i>	0.3	0.3	0.3	0.0	0.0	0.0	0.0	0.0	0.0	0.0	0.0
<i>Viola</i> sp.	0.0	0.0	0.0	0.0	0.0	0.0	0.0	0.0	0.4	0.0	0.4
<i>Woodwardia areolata</i>	0.0	0.0	0.0	0.0	0.0	0.0	0.0	0.0	0.0	0.0	0.0
<i>Woodwardia virginica</i>	0.0	0.2	0.0	0.0	0.0	0.0	0.0	1.0	0.0	0.0	0.0
<i>Xyris scabriifolia</i>	0.0	0.0	0.0	0.0	0.0	0.0	0.0	0.0	0.0	0.0	0.0
<i>Zigadenus glaberrimus</i>	0.0	0.0	0.0	0.0	0.0	0.3	0.8	0.7	0.4	0.0	0.0
Unknown or unidentifiable vascular plants	0.0	0.0	0.0	0.4	1.3	0.3	1.1	0.0	2.8	1.6	0.9
Unk. bryophyte	0.0	0.0	0.0	0.0	0.0	0.0	0.0	0.0	0.0	0.0	0.0

Appendix F

Glossary

A Horizon: A mineral soil horizon at the soil surface or below an O (organic) horizon characterized by accumulation of humified organic matter intricately mixed with the mineral fraction.

Assessment Model: A simple model that defines the relationship between ecosystem and landscape-scale variables and functional capacity of a wetland. The model is developed and calibrated using reference wetlands from a Reference Domain.

Assessment Objective: The reason why an assessment of wetland functions is being conducted. Assessment objectives normally fall into one of three categories. These include: documenting existing conditions, comparing different wetlands at the same point in time (e.g., alternatives analysis), and comparing the same wetland at different points in time (e.g., impact analysis or mitigation success).

Assessment Team (A-Team): An interdisciplinary group of regional and local scientists responsible for classification of wetlands within a region, identification of reference wetlands, construction of assessment models, definition of reference standards, and calibration of assessment models.

Ecosystem: In a defined area, all populations of organisms and their nonliving environment that function together as an ecological system.

Evapotranspiration (ET): The loss of water to the atmosphere by evaporation from open water and soil surfaces and by transpiration from plants.

Functional Assessment: The process by which the capacity of a wetland to perform a function is measured relative to the unaltered condition. This approach measures capacity using an assessment model to determine a functional capacity index.

Functional Capacity: The rate or magnitude at which a wetland ecosystem performs a function relative to the unaltered condition. Functional capacity is dictated by the characteristics of the wetland ecosystem and the surrounding landscape and interaction between the two.

Functional Capacity Index (FCI): An index of the capacity of a wetland to perform a function relative to other wetlands from a Regional Wetland Subclass in a Reference Domain. Functional capacity indices are by definition scaled from 0.0

to 1.0. An index of 1.0 indicates a wetland performs a function at the characteristic and sustainable level of functioning for the regional subclass, the level equivalent to a wetland under reference standard conditions in a Reference Domain.

Hectare (ha): Metric unit of measurement equal to 10,000 m² (approx. 2.48 acres).

Hydrogeomorphic (HGM) Wetland Class: The highest level in the hydrogeomorphic wetland classification. There are seven basic hydrogeomorphic wetland classes, including estuarine and lacustrine fringe, depression, slope, riverine, and organic and mineral soil flat.

Indicator: Indicators are observable characteristics that correspond to identifiable variable conditions in a wetland or the surrounding landscape.

Jurisdictional Wetland: Areas that meet the soil, vegetation, and hydrologic criteria described in the “Corps of Engineers Wetlands Delineation Manual” (Environmental Laboratory 1987) or its successor.

Lateral Drainage Distance: Distance over which a drainage feature is expected to drain water from a WAA. An algorithm developed by van Schilfgaarde is used to determine lateral distance using constants based on characteristics of soils in Wet Pine Flats by the depth of the drainage feature and the soil series.

Leaf Area Index (LAI): The total leaf area (one surface only) per unit area of ground over which leaves occur.

Meter (m): Metric unit of length equal to approximately 39.37 inches or 1.09 feet.

Microtopographic Features: Variations of 5-20 cm in elevation that occur over small spatial scales (25-200 cm²). In Wet Pine Flats, these are mostly formed by graminoid tussocks.

Mitigation: Restoration or creation of a wetland to replace functional capacity that is lost as a result of project impacts.

Partial Wetland Assessment Area: A portion of a WAA that is identified *a priori*, or while applying the assessment procedure, because it is relatively homogeneous and different from the rest of the WAA with respect to one or more model variables. The difference may occur naturally or as a result of anthropogenic disturbance.

Pine Silviculture: The commercial production of pine trees as a crop for saw-wood or pulp. Intensive silviculture includes constructing raised beds on which pine seedlings are planted; bedding variables in all modeled functions in Wet Pine Flats.

Project Alternatives: Different ways in which a given project can be handled. Alternatives may vary in terms of project location, design, method of construction, amount of fill required, and other ways.

Project Area: The area that encompasses all activities related to an ongoing or proposed project.

Red Flag Features: Features of a wetland or the surrounding landscape to which special recognition or protection is assigned on the basis of objective criteria. The recognition or protection may occur at a federal, state, regional, or local level.

Reference Domain: The geographic area from which reference wetlands are selected. A Reference Domain may or may not include the entire geographic area in which a Regional Wetland Subclass occurs.

Reference Standards: Conditions exhibited by a group of reference wetlands that correspond to a level of functioning that is both characteristic for the reference subclass and is sustainable over the long term without human intervention. The characteristic level of functional capacity is assigned an index value of 1.0 by definition.

Reference Standard Wetlands: Wetlands within the reference wetland data set that represent the characteristic and sustainable level of functioning for the regional subclass. Generally, they are the least altered wetland sites in the least altered landscapes. By definition, the functional capacity index for all functions is 1.0 in reference standard wetlands.

Reference Wetlands: Wetland sites that encompass the variability (altered and unaltered) of a Regional Wetland Subclass in a Reference Domain. Reference wetlands are used to establish the range of conditions for construction and calibration of functional indices and establish reference standards.

Region: A geographic area that is relatively homogenous with respect to large-scale factors such as climate and geology that may influence how a specific subclass of wetlands function.

Regional Wetland Subclass: Wetlands within a region that are similar with respect to hydrogeomorphic (HGM) attributes by which the HGM subclass has been classified. There may be more than one Regional Wetland Subclass identified within each broad HGM wetland class.

Resources: Life-history requirements for maintaining a sustainable local population of an animal species, including food and suitable areas for shelter, nesting sites, resting areas, courtship and other reproductive activities, and movement among areas. (See Supplemental Resources.)

Savanna: Landscape of widely spaced trees on mineral soil with a graminoid-dominated ground layer and with sparse shrub and midstory cover. Some wet pine savannas in the Southeast support (at small spatial scales) an exceptionally rich herbaceous layer.

Silviculture: See Pine Silviculture.

Soil Porosity: The fraction as percent of total volume of soil occupied by channels and spaces.

Supplemental Resources: Resources available to animals for foraging, breeding, resting, or migration that are outside a defined area. In Wet Pine Flats, supplemental resources are largely determined by a frequent fire regime, which maintains savanna habitat. (See Resources.)

Variable: An attribute or characteristic of a wetland ecosystem or the surrounding landscape that influences the capacity of a wetland to perform a function.

Variable Condition: The condition of a variable as determined through quantitative or qualitative measure.

Variable Index: A measure of how an assessment model variable in a wetland compares to the reference standards of a Regional Wetland Subclass in a Reference Domain.

Wetlands: In Section 404 of the Clean Water Act: “.....areas that are inundated or saturated by surface or ground water at a frequency and duration sufficient to support, and that under normal circumstances do support, a prevalence of vegetation typically adapted for life in saturated soil conditions. Wetlands generally include swamps, marshes, bogs, and similar areas” (Corps Regulation 33 CFR 328.3 and EPA Regulations 40 CFR 230.3). In a more general sense, wetlands are three-dimensional segments of the natural world where the presence of water, at or near the surface, creates conditions leading to the development of redoximorphic soil conditions, and the presence of a flora and fauna adapted to the permanently or periodically flooded or saturated conditions. (See Jurisdictional Wetland.)

Wetland Assessment Area (WAA): The wetland area to which results of an assessment are applied.

Wetland Functions: The normal activities or actions that occur in wetland ecosystems or, simply, the things that wetlands do. Wetland functions result directly from the characteristics of a wetland ecosystem and the surrounding landscape and their interaction.

REPORT DOCUMENTATION PAGE

Form Approved
OMB No. 0704-0188

Public reporting burden for this collection of information is estimated to average 1 hour per response, including the time for reviewing instructions, searching existing data sources, gathering and maintaining the data needed, and completing and reviewing this collection of information. Send comments regarding this burden estimate or any other aspect of this collection of information, including suggestions for reducing this burden to Department of Defense, Washington Headquarters Services, Directorate for Information Operations and Reports (0704-0188), 1215 Jefferson Davis Highway, Suite 1204, Arlington, VA 22202-4302. Respondents should be aware that notwithstanding any other provision of law, no person shall be subject to any penalty for failing to comply with a collection of information if it does not display a currently valid OMB control number. **PLEASE DO NOT RETURN YOUR FORM TO THE ABOVE ADDRESS.**

1. REPORT DATE (DD-MM-YYYY) May 2002		2. REPORT TYPE Final report		3. DATES COVERED (From - To)	
4. TITLE AND SUBTITLE A Regional Guidebook for Applying the Hydrogeomorphic Approach to Assessing Wetland Functions of Wet Pine Flats on Mineral Soils in the Atlantic and Gulf Coastal Plains				5a. CONTRACT NUMBER	
				5b. GRANT NUMBER	
				5c. PROGRAM ELEMENT NUMBER	
6. AUTHOR(S) Richard D. Rheinhardt, Martha Craig Rheinhardt, Mark M. Brinson				5d. PROJECT NUMBER	
				5e. TASK NUMBER	
				5f. WORK UNIT NUMBER	
7. PERFORMING ORGANIZATION NAME(S) AND ADDRESS(ES) Department of Biology East Carolina University Greenville, NC 27858-4353				8. PERFORMING ORGANIZATION REPORT NUMBER ERDC/EL TR-02-9	
9. SPONSORING / MONITORING AGENCY NAME(S) AND ADDRESS(ES) U.S. Army Corps of Engineers Washington, DC 20314-1000				10. SPONSOR/MONITOR'S ACRONYM(S)	
				11. SPONSOR/MONITOR'S REPORT NUMBER(S)	
12. DISTRIBUTION / AVAILABILITY STATEMENT Approved for public release; distribution is unlimited.					
13. SUPPLEMENTARY NOTES					
14. ABSTRACT The Hydrogeomorphic (HGM) Approach is a collection of concepts and methods for developing functional indices and subsequently using them to assess the capacity of a wetland to perform functions relative to similar wetlands in a region. The Approach was initially designed to be used in the context of the Clean Water Act Section 404 Regulatory Program permit review sequence to consider alternatives, minimize impacts, assess unavoidable project impacts, determine mitigation requirements, and monitor the success of mitigation projects. However, a variety of other potential applications for the Approach have been identified including: determining minimal effects under the Food Security Act, designing mitigation projects, and managing wetlands. This report uses the HGM Approach to develop a Regional Guidebook for assessing the functions of wet pine flats wetlands on mineral soils in the southeastern United States. The report begins with a short introduction to the HGM Approach and a characterization of wet pine flats on mineral soils in the southeastern United States. It then discusses (a) the rationale used to select functions, (b) the rationale used to select model variables and metrics, (c) the rationale used to develop assessment models, and (d) the data from reference wetlands used to calibrate model variables and assessment models. Finally, it outlines an assessment protocol for using the model variables and functional indices to assess wet pine flats wetlands on mineral soils in the southeastern United States.					
15. SUBJECT TERMS		HGH Approach	Pine flatwoods	Wetlands	
Assessment		Hydrogeomorphic	Wetland assessment		
Functional assessment		Hydrogeomorphic Approach	Wetland functions		
16. SECURITY CLASSIFICATION OF:			17. LIMITATION OF ABSTRACT	18. NUMBER OF PAGES	19a. NAME OF RESPONSIBLE PERSON
a. REPORT	b. ABSTRACT	c. THIS PAGE			19b. TELEPHONE NUMBER (include area code)
UNCLASSIFIED	UNCLASSIFIED	UNCLASSIFIED		262	