

**IN-DEPTH STUDY REPORT
CONTROL TECHNOLOGY FOR CRYSTALLINE SILICA EXPOSURES IN
CONSTRUCTION: FIELD EVALUATION OF CONTROL MEASURES
FOR TUCK-POINTING**

The Farrell Building
Huntington West Virginia

REPORT WRITTEN BY
William A. Heitbrink, Ph.D., C.I.H.
Amber Rogers
Daniel S. Watkins
Alan Echt

REPORT DATE
August 2001

Report no ²⁰
EPHB NO 247-~~XXX~~

U.S. DEPARTMENT OF HEALTH AND HUMAN SERVICES
Public Health Service
Centers for Disease Control and Prevention
National Institute for Occupational Safety and Health
Division of Applied Research and Technology
4676 Columbia Parkway - R5
Cincinnati, Ohio 45226

STUDY SITE

The Farrell Building
914 Fifth Ave
Huntington West Virginia

Partner

Robert Pritchard
Risk Manager
The Western Group
1637 N. Warson Rd
St. Louis MO 63132

Interested Parties

Eileen Bettr
International Union of Bricklayers and Allied
Craftsman, Local 6
815 Fifteenth Street NW
Washington, DC 20005

D. Scott McConnell
Dustcontrol
6720 Amsterdam Way
Wilmington, DE 28405

STUDY DATES

May 21-25 , 2001

STUDY CONDUCTED BY

William A. Herbrink
Dan Watkins
Alan Echt
Paul Hentz
Amber Rogers
Ronald Kovein

DISCLAIMER

Mention of company names or products does not constitute endorsement by the Centers for Disease Control and Prevention

ABSTRACT

During masonry restoration of a building, 4 inch diameter grinders were used to remove mortar to a depth of 0.5 to 0.75 inches. This task was performed by two workers who stood on a swing stage. The workers used exhaust shrouds which were connected to vacuum cleaners to capture the dust. One of the grinders was partially enclosed by a Dustcontrol shroud. The exhaust volume for this shroud was 111 cubic feet per minute. The other grinder was partially enclosed by a Jec Duc shroud. The exhaust volume for this shroud was 76 cfm. The workers' respirable dust and respirable crystalline silica exposures were monitored during the mortar removal activities. The respirable dust and respirable crystalline silica exposures were, respectively, less than 0.17 and 0.03 mg/m³. This indicates that the workers' dust exposures were adequately controlled at this site. Because environmental and site-related conditions vary greatly in the construction industry, additional sampling should be done to confirm that an exhaust volume of 100 cfm adequately controls the respirable dust and crystalline silica exposures during the mortar removal tasks associated with tuck pointing.

Introduction

The National Institute for Occupational Safety and Health (NIOSH), a federal agency located in the Centers for Disease Control and Prevention under the Department of Health and Human Services, was established by the Occupational Safety and Health Act of 1970. This legislation mandated that NIOSH conduct research and education programs separate from the standard setting and enforcement functions conducted by the Occupational Safety and Health Administration (OSHA) in the Department of Labor. An important area of NIOSH research deals with methods for controlling occupational exposure to potential biological, chemical, and physical hazards.

The Engineering and Physical Hazards Branch (EPHB) of the Division of Applied Research and Technology has been given the lead within NIOSH to study the engineering aspects relevant to the control of hazards in the workplace. Since 1976, EPHB and its predecessors have assessed control technology found within selected industries or used for common industrial processes. The EPHB has also devised new control systems where current control technology is insufficient. The objective of these studies has been to document and evaluate effective control techniques (e.g., isolation or the use of local ventilation) that minimize risk of potential health hazards and to create an awareness of the usefulness and availability of effective hazard control measures.

The survey at this site was conducted as part of a larger effort to evaluate the technical

feasibility of controlling worker exposure to respirable crystalline silica. The silica exposure of construction workers is receiving some public and regulatory attention.^{1,2} In addition, EPHB investigates new technologies that reduce worker exposure to hazardous air contaminants such as respirable crystalline silica. EPHB is investigating control measures for respirable crystalline silica exposures that occur while a worker uses a grinder to remove mortar between the bricks on a building wall. During tuck pointing, the old mortar between the bricks is removed by grinding. Mortar and brick contain crystalline silica. Frequently, this task is performed without engineering control measures. This can result in exposures to respirable crystalline silica that are excessive. Shields reported on respirable crystalline silica exposures during tuck pointing. Of 37 exposure measurements, 38% of the samples exceeded 1 mg/m³ and 19% of the exposures exceeded 5 mg/m³ of respirable crystalline silica.³ These exposures are 20 to 100 times the NIOSH recommended exposure limit of 50 µg/m³.⁴ Such high exposures are associated with adverse health outcomes.

Excessive silica exposures in a sandblasting environment have caused premature deaths from silicosis. In 1998, the deaths of two sandblasters from silicosis were reported.⁵ In one case, a worker was diagnosed with progressive massive fibrosis after three years of experience as an abrasive blaster. He died of respiratory failure at age 36, 11 years after his initial exposure. In another case, a worker died of respiratory failure from silicosis at age 30. He worked as sandblaster from 1986 to 1990 and died in 1996. At autopsy, the lungs of both workers had an extremely high silica content. From 1968 to 1992, approximately 10 workers between the ages of 15 and 44 died of silicosis each year.⁵ These latter deaths

were attributed to inappropriate respirator usage and recent, intense exposure to crystalline silica that were 10 to 100 times the OSHA permissible exposure limit which is approximately 0.1 mg/m³ of respirable crystalline silica^{6,7}

Background

Existing control technology for reducing worker dust exposures during the grinding operations, conducted as part of tuck pointing, appears to be marginally effective. To control the dust generated by mortar grinding, a shroud is used to enclose the grinding wheel. Typically, a 4-inch diameter grinder, operated at 10,000-12,000 rpm, is used to remove mortar. A tool resembling a router can also be used to remove mortar. This tool has a diameter of about 0.4 inches.

A number of controls for the four-inch diameter grinders have been studied in the field and were found to be ineffective. In one control studied, a centrifugal impeller was mounted on the grinder's axle. The impeller was designed to move 40-50 cfm of air through an air-cleaning bag. The tools leaked so much dust that our view of the worker was obscured. However, some was collected in the filter collection bags. Based upon data collected by OSIIA and NIOSH while the control was used, the geometric mean and geometric standard deviation for the respirable crystalline silica exposures were 0.7 mg/m³ and 2.7 respectively⁸. These exposures were not very different from the exposures reported by Shields³. For uncontrolled grinding operations, Shield's data had a geometric mean concentration of 1.2 mg/m³ and a geometric standard deviation 6.1.

Grinder exhaust ventilation must exceed the air flow induced by the mechanical motion of the inertial particles generated by the grinding process¹⁵ In addition, the rotary motion of the grinding wheel also induces an air flow Most grinder exhaust ventilation design recommendations appear to be based upon undocumented experience The ACGIH manual, *Industrial Ventilation*, contains several specifications for the design of ventilation systems used for grinding operations⁹ In the manual's Figures VS-40-01 to VS40-03, 25-60 cfm per inch of grinding wheel diameter is recommended For a 5-inch grinding wheel operated at surface speeds between 6,500 and 12,000 fpm, Figure VS10-122 recommends 220 cfm for good enclosures and 390 cfm for poor enclosures Poor enclosures are those described as having more than 25% of the surface of the grinding wheel exposed Typically, the grinding wheels used for tuckpointing have a diameter of 4 to 6 inches and are operated at rotational speed as high 12,000 rpm with surface speeds of 12,000 to 15,000 fpm As a practical matter, Croteau observed that ventilation rates of 70 cfm provided an order of magnitude reduction in exposure over grinding with no ventilation¹⁰ There was no explanation for these results The Dustcontrol Company recommends exhaust flow rates of 180 m³/hr (106 cfm) based upon proprietary data¹¹

Effective engineering control measures for dust generated by grinders during tuckpointing are neither readily available or universally used Furthermore, the available literature indicates that 100-200 cfm are recommended exhaust volumes for a 4" diameter grinder However, the effectiveness of the shrouds to capture the dust generated by grinding mortar is unknown As a result, NIOSH EPHB, in partnership with the Brick and Allied Craftworkers, conducted a

laboratory evaluation of ventilated shrouds used to control worker exposure to mortar dust generated during tucking pointing¹² During laboratory study, the effect of exhaust flow rate upon respirable dust emissions was experimentally evaluated for four different shrouds that are used with 4-inch grinders To conduct this testing, a small brick wall was built and enclosed in a rectangular, hall-shaped ventilated test chamber The grinder was mounted on a mechanical trolley which moved the grinder horizontally across the wall at a constant velocity of approximately 1 m/min and the mortar was removed at a fixed cut depth of 0.5 or 0.75 inches A vacuum cleaner equipped with high efficiency filters (99.9% at 0.3 μm) exhausted air from the shrouds to a location outside the enclosure The vacuum cleaner's exhaust air flow was varied by controlling the voltage supplied the vacuum cleaner An air flow rate of 2794 cubic feet per minute was drawn through the test chamber and past mixing baffles and into an exhaust duct A time-of-flight aerosol spectrometer was used to measure the respirable dust concentration in the duct

Dust emissions per volume of mortar removed were plotted as a function of the exhaust flow rate For uncontrolled grinding, respirable dust emissions were about 20 mg/cm³ of mortar removed As flow rates increased, respirable dust emissions were reduced to under 0.2 mg/cm³ of mortar removed For the 4-inch diameter grinding wheel, 80 cubic feet per minute (cfm) was the minimum exhaust volumes which reduced respirable dust emissions to under 0.2 mg/cm³ of mortar removed Further flow rate increases did not provide useful emission reduction Thus, the laboratory study indicated that a minimum exhaust flow rate of at least 20 cfm/inch of blade or grinding wheel diameter is needed to control the dust emissions This is in agreement with

the ACGIH recommendation that 25 cfm/inch of blade or grinder diameter are needed for controlling emissions from a grinder⁹

Study Objective

NIOSH, in partnership with The Western Construction Group, collaborated to evaluate the utility of using 100 cfm as an exhaust volume to control the dust generated by grinder mortar. The Western Construction Group was doing some building restoration work at the Farrell Building in Huntington West Virginia. At this site, two workers were using four inch grinders to remove deteriorated mortar from the side of a building. The workers' grinders were outfitted with shrouds and exhaust ventilation. The study objective was addressed by monitoring worker respirable dust and crystalline silica exposures during tuckpointing at the this site.

Exposure Evaluation Criteria

As a guide to the evaluation of the hazards posed by workplace exposures, NIOSH field staff use exposure limits as evaluation criteria for assessment of a number of chemical and physical agents. These criteria are intended to suggest levels of exposure to which most workers may be exposed up to 10 hours per day, 40 hours per week, for a working lifetime without experiencing adverse health effects. Table 1 summarizes exposure limits for air contaminants which were sampled at this site. It is important to note that not all workers will be protected from adverse health effects if their exposures are maintained below these levels. A small percentage may

experience adverse health effects because of individual susceptibility, a preexisting medical condition, and/or a hypersensitivity (allergy)

The primary sources of environmental evaluation criteria in the United States that are used for the workplace are 1) NIOSH Recommended Exposure Limits (RELs), 2) the American Conference of Governmental Industrial Hygienists' (ACGIH) Threshold Limit Values (TLVs), and 3) the U.S. Department of Labor (OSHA) Permissible Exposure Limits (PELs). The OSHA PELs are required to consider the feasibility of controlling exposures in various industries where the agents are used, the NIOSH RELs, by contrast, are based primarily on concerns relating to the prevention of occupational disease. ACGIH Threshold Limit Values (TLVs) represent conditions under which it is believed that nearly all workers may be repeatedly exposed day after day without adverse health effects. ACGIH states that the TLVs are guidelines. It should be noted that ACGIH is a private, professional society, and that industry is legally required to meet only those levels specified by OSHA PELs.

Table 1 Relevant exposure limits (mg/m ³) as 8-hour time weighted averages			
air contaminant	NIOSH REL ¹³ mg/m ³	OSHA PEL ¹⁴ mg/m ³	ACGIH TLV ¹⁵ mg/m ³
respirable crystalline silica	0.05	varies with amount of quartz in dust See text following table	0.05
particulates, not otherwise classified - respirable		5	3

The current OSHA Permissible Exposure Limit (PEL) in mg/m³ for respirable dust containing

quartz is calculated from the following formula

$$PEL = \frac{10}{\% \text{ silica} + 2}$$

Procedures

This study was conducted to evaluate the exposure implications of using ventilated grinders to remove mortar. Two workers were using grinders to remove deteriorated mortar from the side of a building. These workers are named Worker S and Worker T. Worker S used a Dustcontrol

shroud exhausted by a vacuum cleaner (model 3700, Dustcontrol Norsborg Sweden) The grinder was used with a 0.25 inch thick, 4 inch diameter cutter blade The vacuum cleaner was operated with both vacuum cleaner motors **Figure 1**, which describes the design of the Dustcontrol shroud, was copied from a prior report ¹² Worker T used the Joe Due shroud shown in Figure 2 This shroud was exhausted by a vacuum cleaner (model 3700, Dustcontrol Norsborg Sweden) operated with one vacuum cleaner motor This shroud and grinder were used with 4" diameter, 0.093 inch thick grinder wheel This worker used the grinder to cut two slots in the mortar next to the bricks (top and bottom of the bed joints [horizontal joints]) A chisel was used to remove the mortar between the two slots The other worker simply used the grinder to remove all of the mortar between the joints The joints (or gaps between the bricks) had a width of about 0.4 inches

The Dustcontrol model 3700 vacuum cleaner (Figure 3) appears to be a very capable vacuum cleaner It uses two 1200 watt electrical motors to develop at least 80 inches of water vacuum when the inlet to the vacuum cleaner is blocked At zero static pressure loss, the air flow through the vacuum cleaner is 190 cfm (320 m³/hr) The vacuum cleaner filters are rated as being 99.9% efficient at 0.3µm and the surface area for the pleated filters is 19 ft² (1.8 square meters) This vacuum cleaner has provisions for pulsing the filter to remove dust collected on the filter When filters were pulsed, the dust fell through an open flapper valve into a plastic bag located under the vacuum cleaner Each vacuum cleaner motor required 10 amperes at 120 volts to obtain optimal performance Vacuums' bags were changed and weighed intermittently to determine the amount of dust collected during a sampling period Generally the bags were

weighed at lunch time and at the completion of the shift

In this study, two different blades and two different exhaust flow rates were used. The different exhaust flow rates were controlled by operating the vacuum cleaner with one or two motors.

Our partners were interested in simulating the performance of a model 2700 Dustcontrol vacuum cleaners which use one 1200 watt exhaust blower. The choice of blade thickness (0.25 or 0.093 inches) was made by the Mr. Pritchard and reflected his interest in considering two different blade thicknesses.

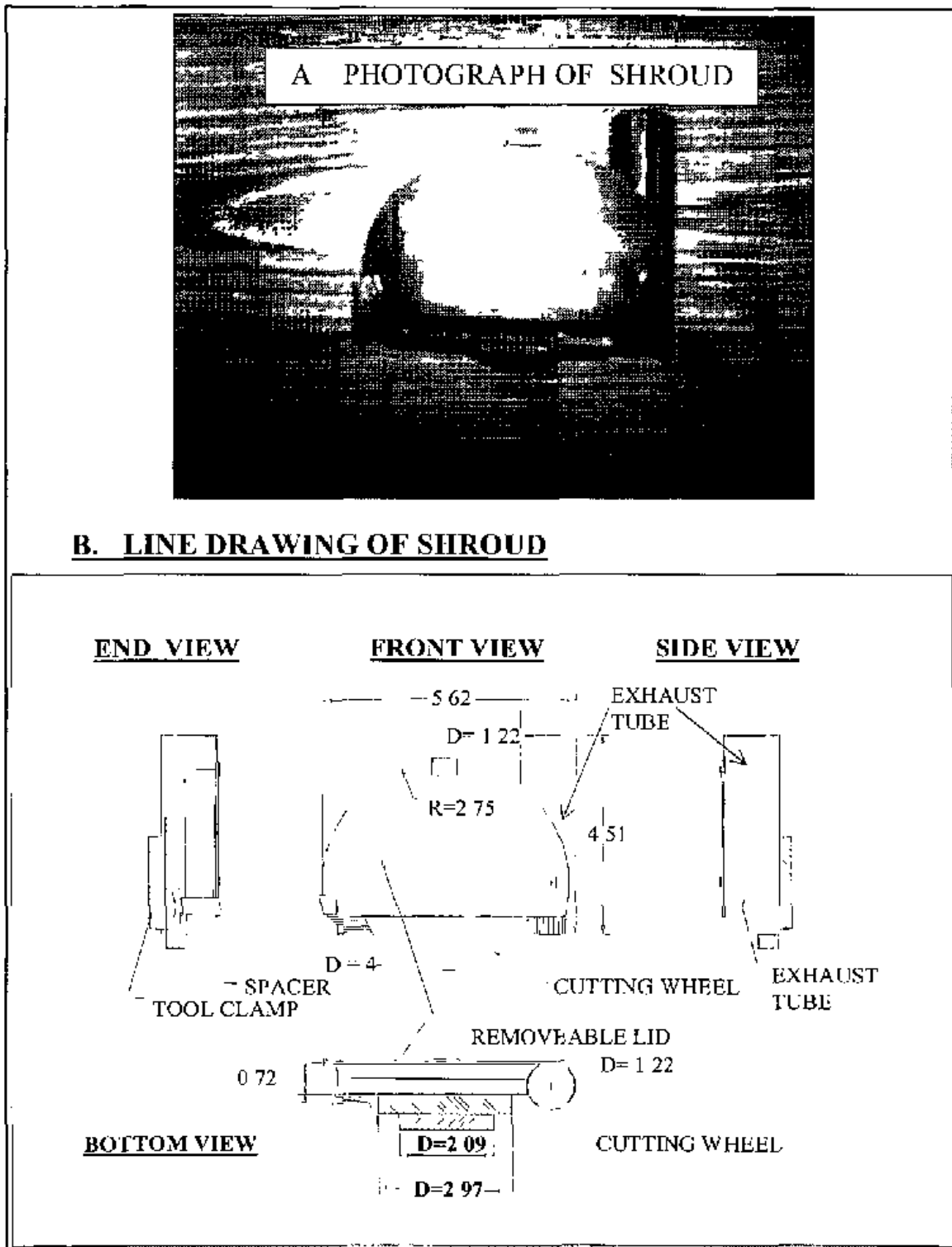

Figure 1 Photograph and detailed line drawing of Dustcontrol shroud. In this figure, all dimensions are in inches and "D=" indicates that the dimension is a diameter "R=" indicates that the dimension is a radius.

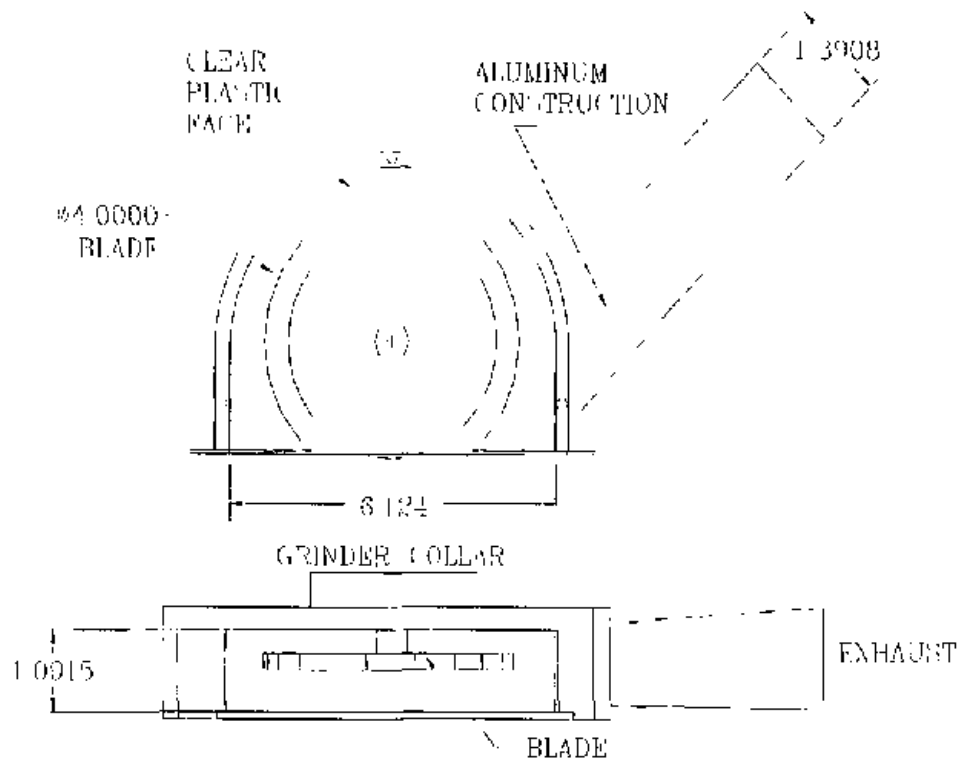

Figure 2 Schematic description of the Joe Due Shroud, dimensions are in inches

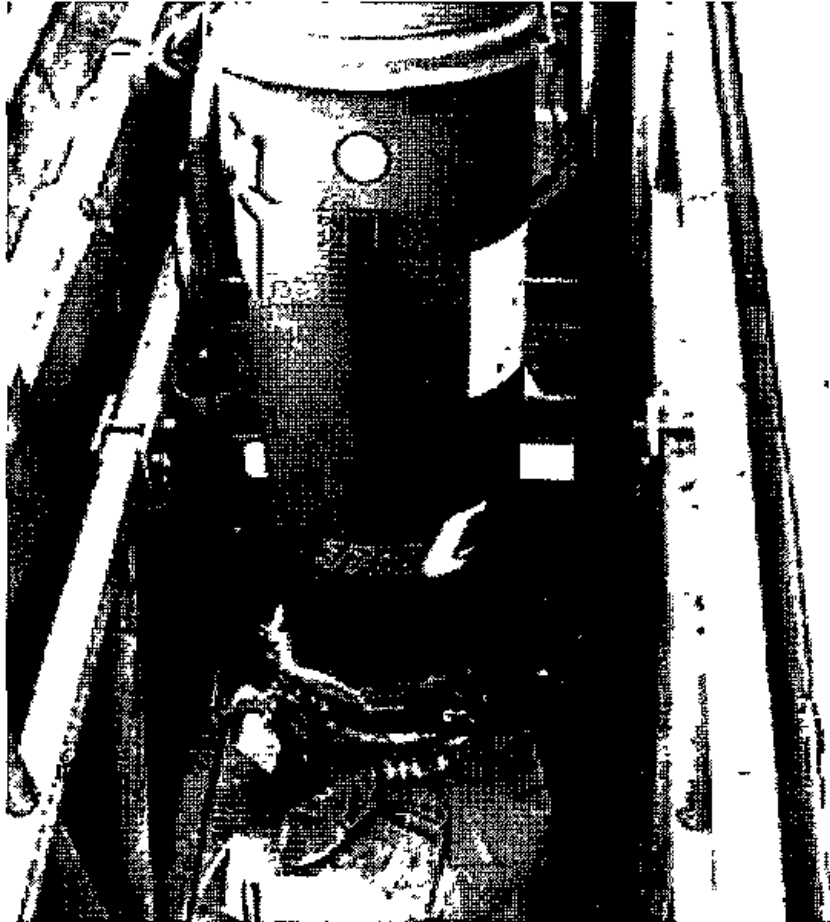

Figure 3 Dustcontrol vacuum cleaner with dust collected in bag. The vacuum cleaner barely fits into the swing stage. The plastic bag used for collecting dust is attached to the vacuum cleaner with a belt. To remove the bags, the worker went through the following motions: the belt is unbuckled, the bag is twisted shut to tie it off, and the bag is set aside. This approach appears to minimize dust exposure associated with handling the collected dust.

Site Description

The Western Group was repairing the mortar on the west side of the building (**Figure 4**). The west wall of the building faced a blind alley. The alley was about 12 feet wide, 50 feet long and enclosed on three sides. As part of this project, deteriorated mortar and bricks were removed. Grinders were run horizontally between the bricks and then vertically to a depth of 0.5 to 0.75 inches using a 0.093 or a 0.25 inch thick 4 inch diameter blades. Additional mortar was removed using a chisel and hammer (**Figure 5**). To reach the upper levels of the building, a 26 feet long, 2.5 feet wide swing stage was employed. The two vacuum cleaners were placed in the center of the scaffold (**Figure 6**) with one worker on each side of the scaffold. This created an obvious obstruction in the middle of the swing stage. The study was conducted to evaluate the effect of exhaust ventilation upon exposures. The authors and the collaborators from The Western Group concurred that the vacuum cleaners would need to be modified so that they could be hung from the side of the scaffolding at the end of the swing stage. This location is below the electric motors used to raise and lower the swing stage (**Figure 6**).

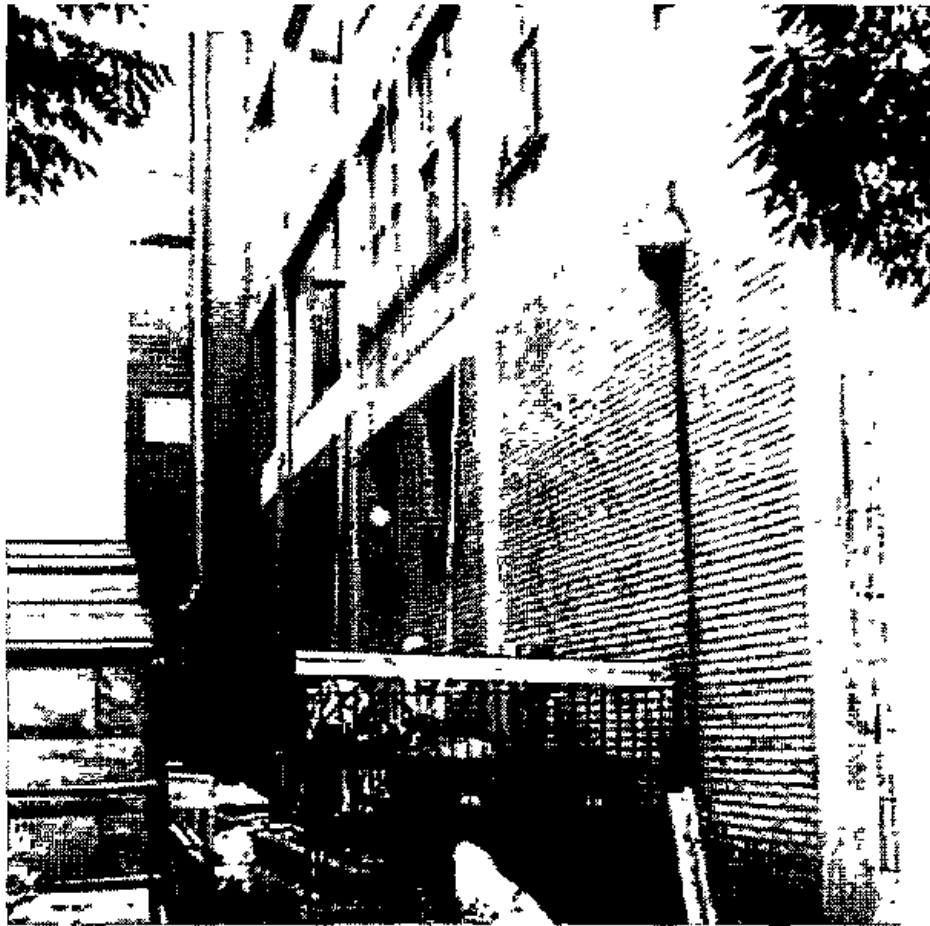

Figure 4 View of West side of Farrell Building This side of the building was being restored Deteriorated bricks and mortar were to be removed as part of a renovation project Note that this is a very enclosed area



Figure 5 A worker was chiseling the mortar to remove the deteriorated mortar. Note the use of the full face-piece respirator.

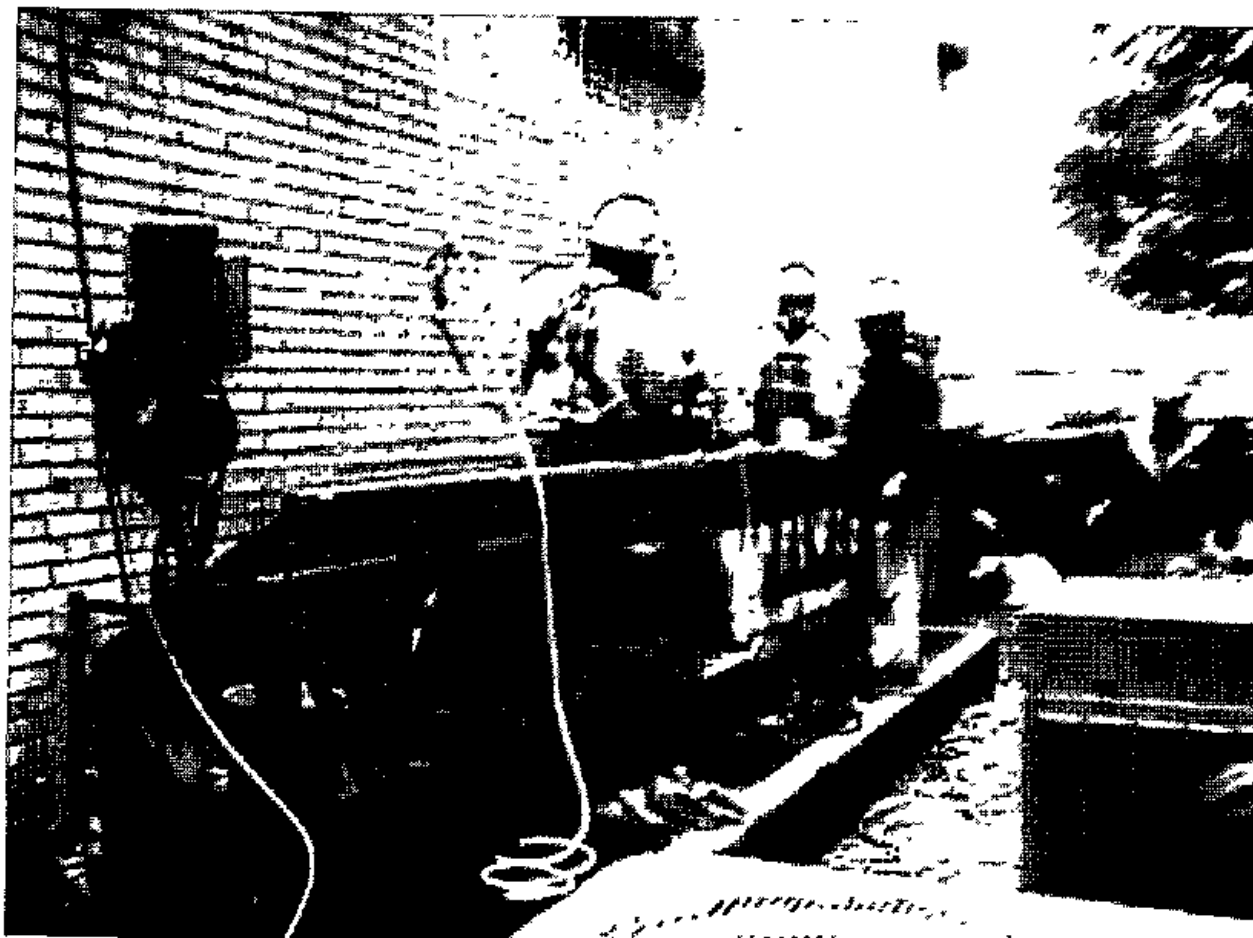

Figure 6 The Dustcontrol vacuum cleaners were set in the middle of this swing stage. Electric motors on the ends were used to raise and lower the swing stages up and down the cables. The workers wore harnesses for fall protection. Background air samples were collected under the electric motors used to raise and lower the swing stage.

Worker Job Description

Two workers used different grinders with different shrouds and flow rates to control the dust generated by removing the mortar. Worker T, used a Milwaukee right angle grinder equipped with 0.25 inch thick, 4 inch diameter cutter wheel to remove mortar. A Dustcontrol shroud (Figure 7) was used as a blade guard and exhaust shroud. The rotation of the blade is such that the dust is thrown into the exhaust take-off. When the worker grinds or cuts the mortar, the blade rotates out of the mortar discharging dust into the exhaust take-off on the shroud. To effectively capture the dust, the exhaust take-off must lead the grinder down the wall. When cutting the vertical joints, the worker placed the exhaust take-off on the wall and pivoted the cutting wheel into the mortar. The Dustcontrol vacuum cleaner was operated with both vacuum blowers.

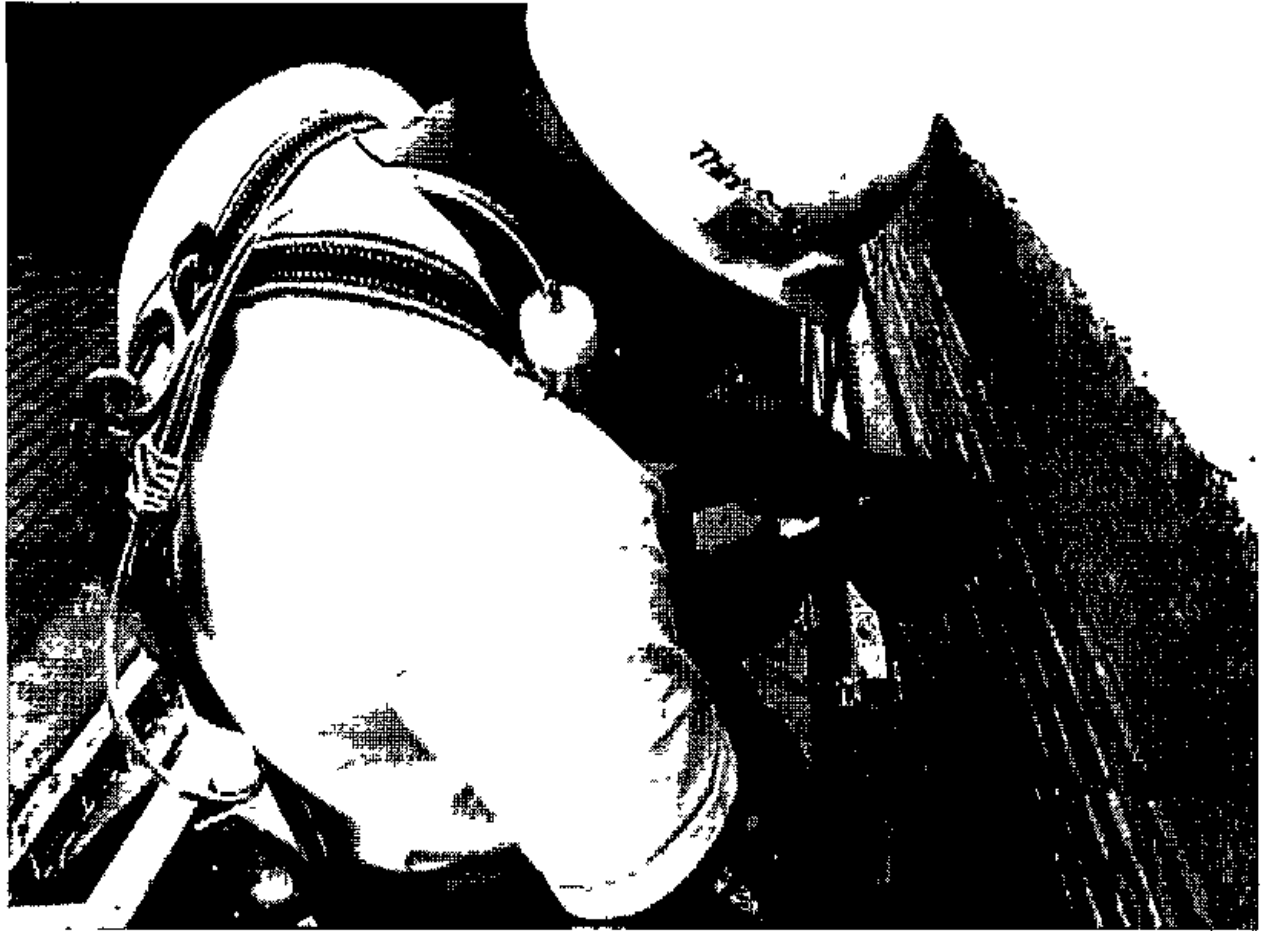

Figure 7 Worker using Dustcontrol! shroud to cut a vertical joint. Note, the worker places the exhaust take off on the wall and rotates the grinder wheel into the mortar.

Worker S (Figures 8-9) used a Metabo right angle grinder equipped with a 0.093 inch thick 4 inch diameter grinder wheel. A Joe Due shroud was used. The same basic work techniques were used with both tools. The Dustcontrol vacuum cleaner was operated with one vacuum blower in order to simulate the operation of the lower cost vacuum-cleaners which generate a lower exhaust volume.

In addition to removing mortar, the workers removed bricks and a lintel, by using a 10 inch diameter circular saw to cut through the brick wall. This tool had a shroud similar in design to the shrouds used for the 4 inch diameter grinders. Exhaust ventilation was supplied by one Dustcontrol 3700 vacuum cleaner operated with 2 motors. Worker S and T worked together to do this task.

The workers generally complied with our instructions on the proper use of the shrouds. Because these workers had not used ventilated shrouds for dust control, we instructed the workers to move the grinders along the horizontal joints such that the shroud's exhaust take-off was in front of the grinder. This was a change in that the workers usually ran the grinder in both directions to remove the mortar. On vertical joints, the workers placed the exhaust take-off on the wall and rotated the blade into the wall.

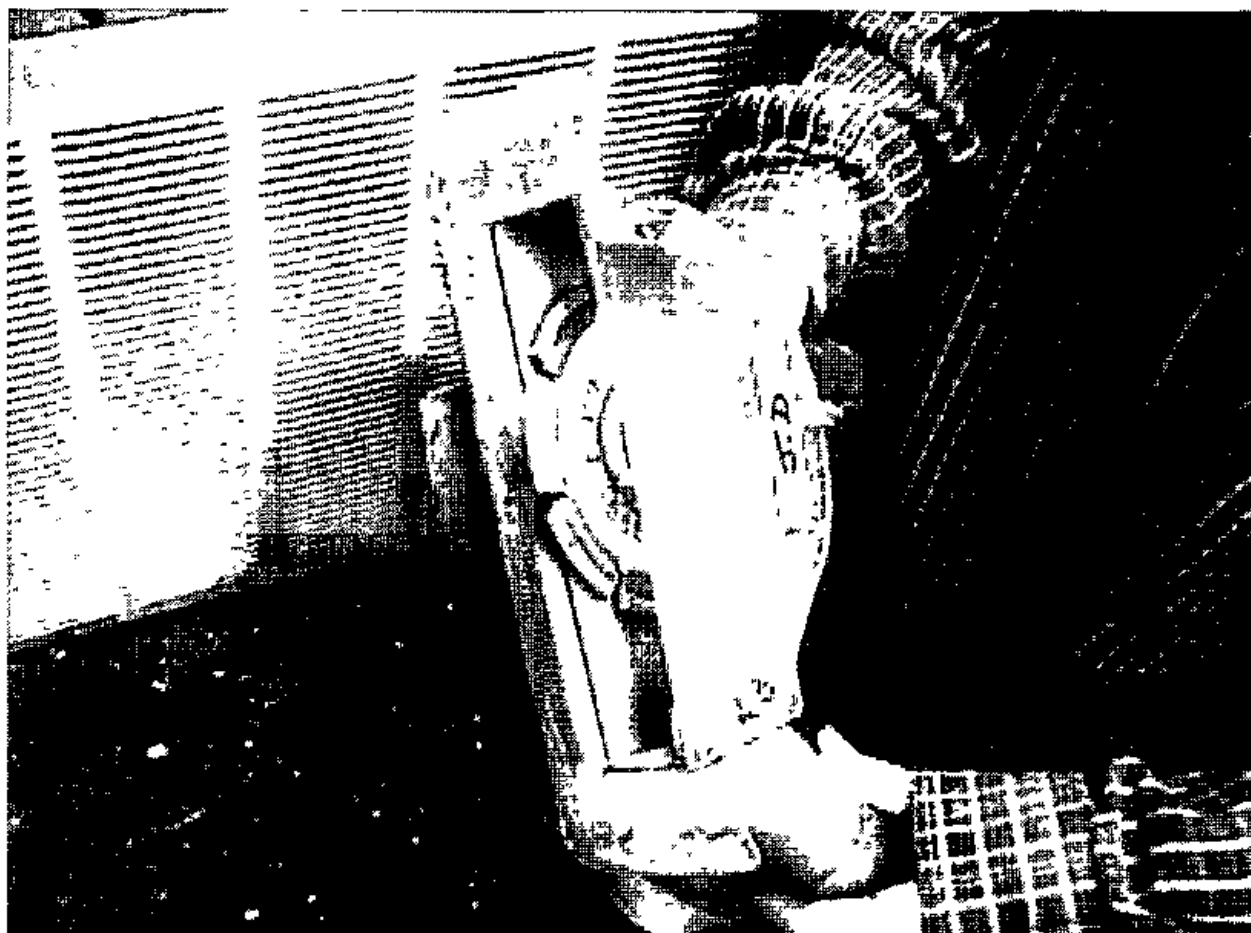

Figure 8 The Joe Due shroud with the 0.093 inch thick blade used by worker S

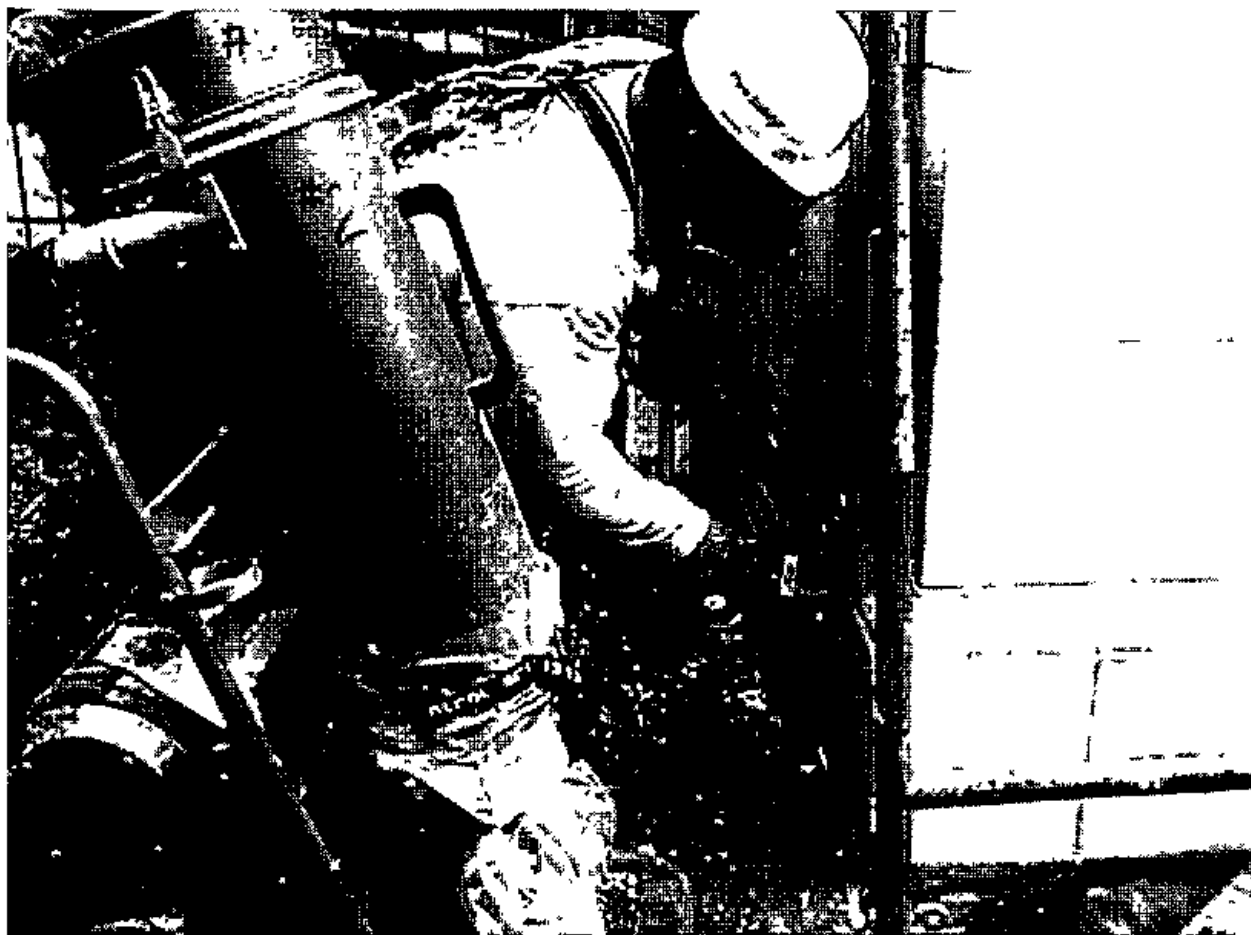

Figure 9 Worker cutting a vertical joint

Respirable Crystalline Silica and Dust Measurements

The concentration of respirable dust and crystalline silica were measured on the two workers on the swing stage, under the vacuum cleaners near the air discharge ports, and on the end of the swing stages. In this sampling procedure, a battery operated pump pulls 4.2 liters/minute through a pre-weighed 37-mm diameter, 5- μ m pore-size polyvinyl chloride filter supported by a backup pad in a three-piece filter cassette sealed with a cellulose shrink band. The top of the filter cassette was removed and the open cassette was mounted on a BGI GK2.69 cyclone, which was clipped to the worker's outer garment in their breathing zone (typically clipped to their lapel). This cyclone is used by the United Kingdom's Health and Safety Executive to measure respirable dust and crystalline silica exposure.¹⁶

Samples were analyzed for respirable dust and crystalline silica in accordance with NIOSH Methods 0600 and 7500 with modifications.¹⁷ Gravimetric analysis for respirable particulate was carried out with the following modifications to NIOSH Method 0600: 1) The filters and backup pads were stored in an environmentally controlled room (21 \pm 3 °C and 50 \pm 5% relative humidity) and were subjected to the room conditions for at least two hours for stabilization prior to tare and gross weighing, and, 2) Two weighings of the tare weight and gross weight were performed. The difference between the average gross weight and the average tare weight was the result of the analysis. The limit of detection for this method is 0.02 milligrams (mg).

After gravimetric analysis, the samples were analyzed for crystalline silica by x-ray diffraction

using NIOSH method 7500¹⁸. The following modifications were used in the sample analysis:

1. Filters were dissolved in tetrahydrofuran rather than being ashed in a furnace.
2. Standards and samples were run concurrently and an external calibration curve was prepared from integrated intensities.

These samples were analyzed for two forms of crystalline silica: quartz and cristobalite. The limits of detection for quartz and cristobalite on filters are 0.01 and 0.02 mg, respectively. The limit of quantitation is 0.03 mg for both quartz and cristobalite on filters. The limits of detection in bulk samples are 0.8% for quartz and 1% for cristobalite. The limit of quantitation is 2% for both forms of crystalline silica in bulk samples. In addition to the personal samples, bulk samples of the dust collected in the vacuum cleaners was analyzed for crystalline silica in accordance with NIOSH Method 7500.

Respirable dust and respirable crystalline silica concentration measurements were made during two days. Separate measurement periods were used for morning and afternoon sampling sessions. Personal samples were collected during mortar removal tasks. During other tasks, such as brick removal, personal air samples were not collected. Sometimes, separate short term samples were collected during these activities because of the potential for crystalline silica exposures. During this study, intermittent thunderstorms were present and these thunderstorms did interrupt the work. As a result, the sampling periods as documented in the data appendix were less than 4 hours and very intermittent. Sampling was stopped due to rain.

Ventilation Measurements

The grinders studied at the Farrel building all involved some form of ventilation. The air flow was estimated by using a velometer (Velocicalc, TSI St. Paul, Mn) to measure the air flow in a steel tube attached to the inlet of the vacuum cleaner. This tube had an inlet diameter of two inches. Air flow is computed as the product of the center line air velocity and the cross sectional area.

Video Exposure Monitoring

Video exposure monitoring was done to perform a quick evaluation of ventilated shrouds. Video exposure monitoring is typically done to evaluate how work activities affect exposure.¹⁹ An aerosol photometer (HAM, PPM Inc. Knoxville TN) was mounted on the worker's chest. Air is drawn through the sensing chamber of this instrument by a battery-operated pump at 2 lpm. The dust in the sensing chamber scatters light emitted from a light-emitting diode. The scattered light is detected by a photomultiplier tube. The analog output of the aerosol photometer is proportional to the amount of light detected by the photomultiplier tube. Because the amount of light scattered by the aerosol varies with the particle's size and optical properties, the analog output of the aerosol photometer is a measure of relative concentration. The HAM was used with a 1 second time constant and its analog output was recorded every second by a data logger (Metrologger dl 3200, Metrosonics, Rochester NY). While the output of the HAM was recorded on the data logger, the worker's activities were concurrently recorded on videotape. The videotapes and the analog output were reviewed to evaluate the extent to which work practices affected exposure.

A very senior foreman with over forty years experience in tuckpointing, performed mortar removal with a variety of ventilated shrouds mounted on a 4 inch grinder. He used the Joe Due Shroud and the Dust Control shrouds to remove mortar between the vertical and horizontal joints for a period of several minutes. He first cut the horizontal joints and then the vertical joints. For the Joe Due shroud, a Porter-Cable vacuum cleaner was used in addition to a Dustcontrol vacuum cleaner. Because Porter-Cable vacuum cleaner appeared to be a source of dust emissions, its use was terminated after use with one shroud. The Dustcontrol vacuum cleaner was used with one motor because two motors would trip circuit breakers. Other equipment was serviced by the 20 ampere circuit for the vacuum cleaner and the use of two motors would trip the circuit breakers.

Results

Air flow measurements

The air flows for the Dustcontrol vacuum cleaner operated with one and two motors respectively were 76 and 111 cubic feet per minute. The Porter-Cable vacuum cleaner was operated at 76 cfm. During the video exposure monitoring, the Dustcontrol vacuum cleaner was operated with one motor.

Respirable Dust and Crystalline Silica Exposure Measurements

Respirable dust concentrations are summarized in Table 2 and individual respirable dust concentrations and respirable quartz concentration values are listed in Appendix A. Statistical analyses were conducted on the respirable dust concentration measurements made during mortar grinding operations. This data analysis was conducted on the logarithms of the individual respirable dust concentrations. The computer printout for this analysis is in Appendix B. Analysis of variance was conducted using the SAS General Linear Models Procedures to assess whether sampling location, worker, or the interaction between sampling location and worker affected respirable dust concentration. In this study, the worker effect involves a different shroud, different exhaust flow rates, different work practices, and probably different rates of mortar removal. Sampling location significantly affected concentration ($p = 0.03$). Multiple comparison test results indicate that the concentration measured on the side of the swing stage

was less than the concentration measured under the vacuum cleaner discharge. The residuals from the analysis did not exhibit significant deviations from a normal distribution ($p = 0.3$).

From an occupational health perspective, the respirable dust concentrations measured on the worker during mortar removal were below 0.2 mg/m^3 and the respirable quartz exposures measured were below $30 \text{ } \mu\text{g/m}^3$. Most of the respirable crystalline silica exposures were below the detection limit and further analysis of the respirable crystalline silica exposure data is not useful. During mortar removal, the exposure measurements indicate that the workers' crystalline silica exposure measurements were adequately controlled.

Table 2. Respirable Dust Concentrations during Mortar Removal				
Worker	Location	Geometric Mean (mg/m^3)	Geometric Standard Deviation	N
S	background on side of swing stage	0.03	3.7	3
S	under vacuum cleaner	0.31	2.59	3
S	personal sample on worker	0.15	1.48	4
T	background on side of swing stage	0.057	1.65	3
T	under vacuum cleaner	0.13	1.63	3
T	personal sample on worker	0.07	1.79	4

Video Exposure Monitoring

Video exposure monitoring results are present in Figures 10 -2. In these figures, bed joints and head joints refer to the horizontal and vertical joints between the bricks. While using the tools, the test subject appeared to be struggling with the proper way to use some of the shrouds. For some shrouds, the worker appeared to find it easier to keep the exhaust take-off in contact with the wall. Because 1-4 minute sampling periods were used for each tool, the worker may not have become comfortable with each shroud. Inspection of Figures 10 -12 and the video tape shows that the control measure can capture the dust with nearly complete capture when the plume flows into the shroud. When there is a gap between the shroud and the bricks, visible dust emissions occurred. Because wind conditions were variable, these dust emission did not consistently flow into the worker's breathing zone. Thus exposure peaks appear to be a function of dust leakage and ambient air movement around the worker.

Observations

The Dustcontrol vacuum cleaners were awkward to use on the swing stage. These vacuum cleaners were located in the middle of the swing stages and the workers were not able to help one another. In the future, these vacuum cleaners should be hung from the ends of the swing stage. The workers seemed to stay markedly cleaner than other workers who perform the mortar removal tasks associated with tuckpointing. The workers were careful to routinely pulse the filters in order to maintain dust capture efficiency. The workers were pleased to use the control

measures which kept their clothes relatively clean during the operation. During the second day of air sampling, work was interrupted by sporadic thunderstorms.

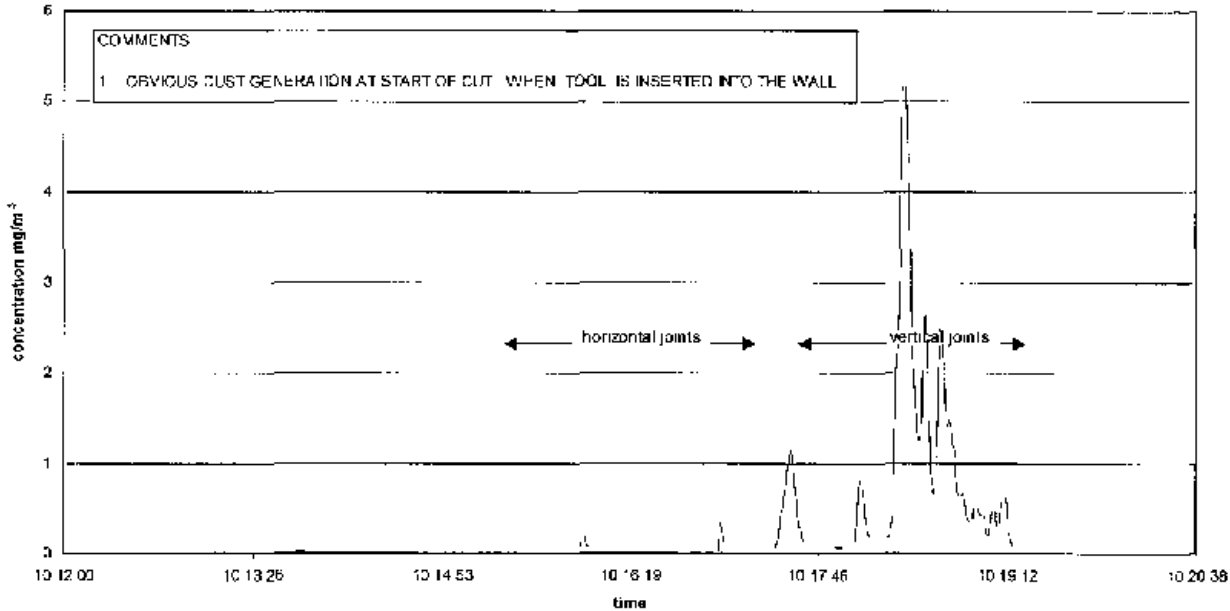

Figure 10 Video exposure monitoring results for Joe Due Shroud used with the Dustcontrol vacuum cleaner

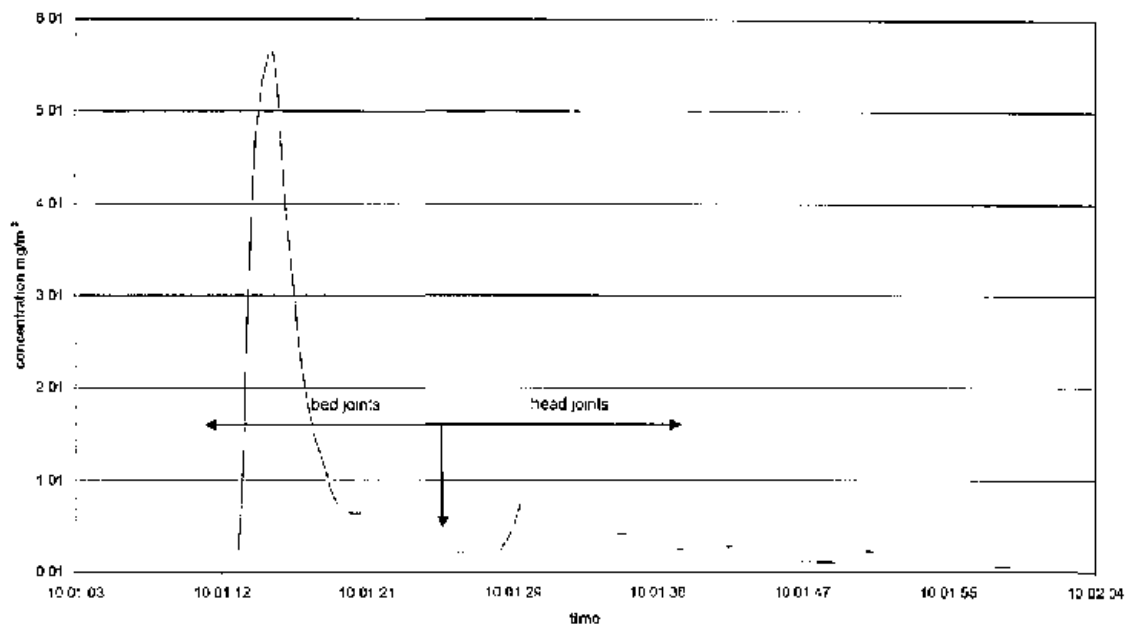

Figure 11 Video exposure monitoring results for Joe Due shroud used with the Portar-Cable vacuum cleaner

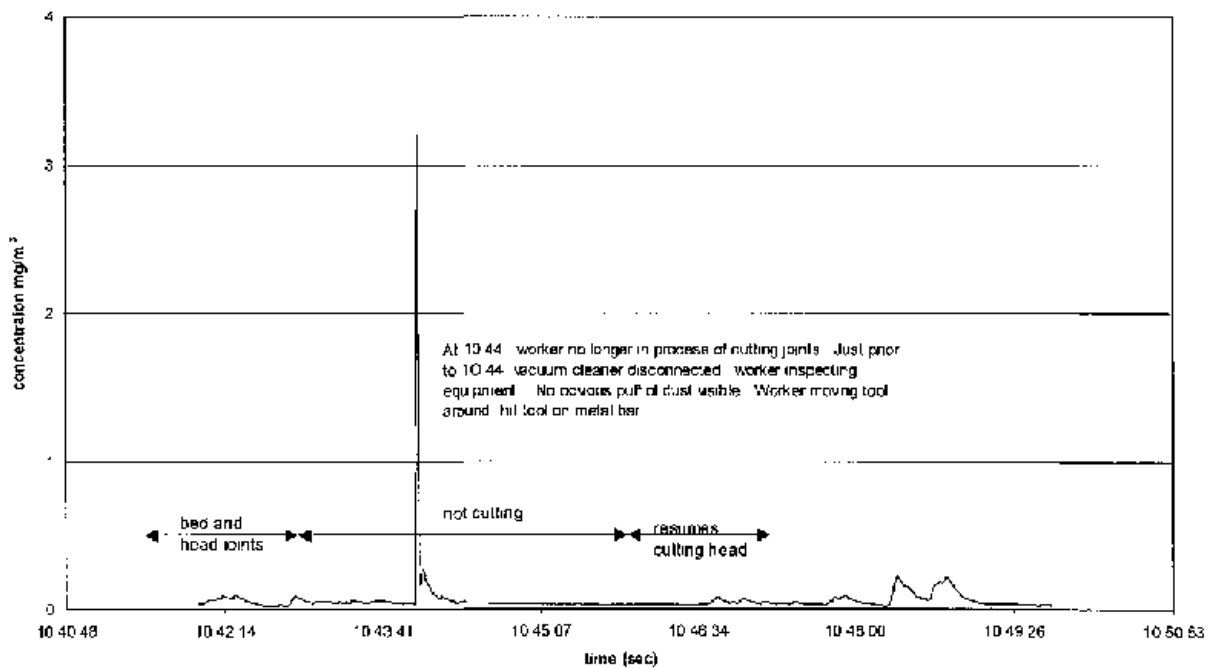

Figure 12 Video exposure monitoring results while worker was using the Dustcontrol shroud with the Dustcontrol vacuum cleaner

Discussion

Study Findings

Video exposure monitoring results are presented in Figures 10 -12. These results indicate that the ventilated shrouds do not provide complete dust control. In the video tape, highly visible dust plumes occurred when the shroud failed to capture the dust emitted by the grinding wheel. Shrouds used for capturing generated during grinding operation function as receiving hoods. Typically, visible dust plumes occur when the shroud's exhaust take-off does not make physical contact with the wall. This occurs at the start of a horizontal cut on the bed joints and during the cutting of vertical (head) joints. When the shroud's exhaust take-off is not touching the wall, the dust plume flows under the exhaust take-off. The presence of a visible exhaust plume, did not always cause an exposure peak. Sometimes, the dust plume moved away from the worker and at other times, the plume caused an exposure peak. Thus, worker exposure is a function of dust emissions, workpractices that cause dust emissions, and the dispersion of these emissions toward or away from the worker.

The respirable dust and respirable crystalline silica measurements were very encouraging. These exposures remained below 0.2 and 0.03 mg/m³ respectively. However, the workers were not continuously removing old mortar. During the first sampling session on May 23, 2001 the workers continuously removed mortar. The two respirable dust exposures were 0.17 and 0.12 mg/m³, respectively for workers S and T. The mass of respirable dust collected in the vacuum

cleaners were respectively 25 and 7 pounds in a time period of 160 minutes. During other sampling sessions, other work besides mortar removal by grinding was occurring and less material was collected in the vacuum cleaner bags.

A prior laboratory evaluation showed that exhaust ventilation rates in excess of 80-100 cfm did not result in further reduction of the respirable dust emissions generated by using a 4 inch grinder to remove mortar on a test wall¹². The field measurements presented here are consistent with the laboratory study finding that a minimum exhaust flow rate of 20 cfm per inch of blade diameter are needed to control respirable dust emissions. Because equipment deteriorates with age, vacuum cleaners and exhaust systems must involve a prudent amount of over design. Thus, a specification of 25 cfm per inch of blade diameter that is specified by ACGIH should be used as an exhaust volume criteria⁹.

The applicability of these results to other tuck pointing situations is unclear. The representative of The Western Group stated that this was a typical restoration job. Typically, restoration jobs involve removal of only the deteriorated mortar. Consequently, the fraction of the time spent grinding will vary from site to site. Thus, there is a need for additional exposure measurements to predict exposures for future jobs and to develop generic exposure control recommendations for this task.

Recommendations for Further NIOSH Work

During this study, two days of sampling on two workers were conducted. Because there may be tremendous exposure variability caused by production rates, the amount of mortar removed, wind conditions, the dust dispersal at the work site, and other site conditions, additional exposure data is needed to assess the exposure outcome of using exhaust shrouds with an exhaust volume of a minimum of 80 cfm for a four inch grinder. Additional data should be taken at a site where nearly all of the mortar is being removed. Such results would provide some exposure data for a worst case exposure scenario. Exposure data from several sites are needed to establish the exposure ranges for these exhaust volume recommendations. From such information an empirical control strategy involving engineering controls and respirators could be devised.

Research is needed on the performance of vacuum cleaners to control the dust collected by mortar removal. If a vacuum cleaner does not efficiently capture the dust, the vacuum cleaner could be a significant source of worker exposure to crystalline silica exposure. This research should address the efficiency of vacuum cleaners to remove dust, dust exposure sources associated with the operation of the vacuum cleaner, the durability of the vacuum cleaner, the filter's life, the ease of cleaning the vacuum cleaners filters, the ease of use of the vacuum cleaners, and the cost issues. The placement of the vacuum cleaner on the swing stage needs be reviewed for safety and practicality issues.

After completing the research described in the preceding paragraphs, NIOSH should prepare a hazard control document describing control recommendations for the use of grinders to remove mortar from buildings. These recommendations will need to address shroud design and exhaust ventilation specifications. Because the controls will not provide complete control of the dust exposures, respirator recommendations will probably need to be part of these recommendations. In addition, NIOSH should prepare a video tape describing the control measures capabilities and limitations. This video tape should emphasize that work practices are important and that the exhaust shroud is a receiving hood and needs to be appropriately placed in order for the dust to be captured.

Conclusions

Exposure measurements were obtained which were consistent with the laboratory finding that an exhaust flow rate of 100 cubic feet per minute can be used to reduce worker exposure to respirable crystalline silica during the mortar removal associated with tuckpointing. Because conditions at construction site vary tremendously, additional exposure measurements are needed to develop an empirical control strategy for the crystalline silica exposures during tuckpointing.

References

- 1 Krizam WG [2000] Deadly Dust Can Leave You Gasping at the Consequences Engineering News Record Nov 6, 2000 pp 64-68 V245(18)
- 2 Anon [2001] Silica Exposures Sets off \$176,620 in Fines Engineering News Record, Feb 5, 2001
- 3 Shields, C [1999] Massive Respirable Dust Exposure During Tuckpointing Presented at 1999 American Industrial Hygiene Conference, Toronto Canada June 5-11 1999
- 4 National Institute for Occupational Safety and Health (NIOSH) [1997] NIOSH Pocket Guide to Chemical Hazards DHHS(NIOSH) Publication 97-140 Cincinnati US Department of Health and Human Services, Public Health Service, Centers for Disease Control and Prevention, National Institute for Occupational Safety and Health
- 5 NIOSH [1998] Silicosis Deaths Among Young Adults in the United States 1964-1994 Morbidity and Mortality Weekly Report 47(16)331-333
- 6 A Mighozzi, MSN, K Gromen [1997] Silicosis Among Workers Involved in Abrasive Blasting -- Cleveland, Ohio, Morbidity and Mortality Weekly Report August 15, 1997 / 46(32),744-747
- 7 Glindmeyer HW, Hammad YY [1988] Contributing Factors to Sandblasters' Silicosis Inadequate Respiratory Protection Equipment and Standards Journal of Occupational Medicine 30(12) 917-921
- 8 Heitbrink WA [1999] Letter to Mr William Farmer, Lancel Arch Company September 28, 1999
- 9 American Conference of Governmental Industrial Hygienists [1995] Industrial Ventilation- A Manual of Recommended Practice 22nd edition Cincinnati Ohio
- 10 Croteau G [2000] The Effect of Local Exhaust Ventilation Controls on Dust Exposures During Masonry Activities Seattle University of Washington, Department of Environmental Health pp80
- 11 Soderberg G [1986] Handbook for Planning and Dimensioning of Spot Extraction Norsborg Sweden Dustcontrol
- 12 Heitbrink WA, Watkins, DS [2001] In-Depth Study Report Control Technology for Crystalline Silica Exposures in Construction The Effect OF Exhaust Flow Rate Upon The Respirable Dust Emissions For Tuck Pointing Operations and A Preliminary

- Evaluation of a Ventilated Tool For Brick Cutting U S DHHS, PHS, CDC, NIOSH (ECTB No 247-18)
- 13 NIOSH [1997] NIOSH Pocket Guide to Chemical Hazards DHHS (NIOSH) Publication 97-140 Cincinnati Ohio Department of Health and Human Services, Public Health Service, Centers for Disease Control and Prevention
 - 14 29CFR1910.1000
 - 15 American Conference of Governmental Industrial Hygienists [1999] 1999 TLV's and BEI's Cincinnati Ohio ACGIH
 - 16 Health and Safety Executive [1997] MDHS 14/2- General Methods for sampling and gravimetric analysis of respirable and inhalable dust HSU Books PO Box 1999 Sudbury, Suffolk, United Kingdom
 - 17 NIOSH [1994] Particles Not Otherwise Regulated, Respirable, Method 0600 In NIOSH Manual of Analytical Methods, 4th edition Editors Eller PM , Cassinelli ME Cincinnati Ohio Department of Health and Human Services, Public Health Service, Centers for Disease Control and Prevention
 - 18 NIOSH [1994] Silica, Crystalline by XRD In NIOSH Manual of Analytical Methods, 4th edition Editors Eller PM , Cassinelli ME Cincinnati Ohio Department of Health and Human Services, Public Health Service, Centers for Disease Control and Prevention
 - 19 NIOSH [1992] Analyzing Workplace Exposures Using Direct Reading Instruments and Video Exposure Monitoring Techniques Editors Gressel MG, Heitbrink WA DIIIS (NIOSH) Publication 92-104 Cincinnati Ohio Department of Health and Human Services, Public Health Service, Centers for Disease Control and Prevention

Appendix- Data listing and computer statistical analysis

Table A1 Respirable dust and quartz concentration data

date	worker	location	time (minutes)	start	stop	respirable dust concentration (mg/m ³)	respirable quartz concentration (µg/m ³)	comments
5/23/01	s	b	86	13 00	14 26	0 09	NA	
5/23/01	s	b	158	9 02	11 40	0 02	NA	
5/23/01	s	v	86	13 00	14 26	0 18	28	
5/23/01	s	y	158	9 02	11 40	0 93	151	
5/23/01	s	w	86	13 00	14 26	0 17	NA	
5/23/01	s	w	158	9 02	11 40	0 17	30	
5/23/01	t	b	86	13 00	14 26	0 09	ND	
5/23/01	t	b	158	9 02	11 40	0 03	NA	
5/23/01	t	v	86	13 00	14 26	0 20	28	
5/23/01	t	v	158	9 02	11 40	0 15	30	
5/23/01	t	w	86	13 00	14 26	0 12	ND	
5/23/01	t	w	158	9 02	11 40	0 04	15	
5/24/01	s	b	215	8 05	11 40	0 16	22	
5/24/01	s	v	215	8 05	11 40	0 18	22	
5/24/01	s	w	100	8 05	9 45	0 17	ND	
5/24/01	s	w	116	12 36	14 32	0 08	ND	
5/24/01	t	b	215	8 05	11 40	0 05	ND	
5/24/01	t	v	215	8 05	11 40	0 08	ND	
5/24/01	t	w	100	8 05	9 45	0 12	ND	
5/24/01	t	w	116	12 36	14 32	0 05	NA	
short term samples during brick and lentel removal								
5/23/01	s	w	25	14 40	15 05	0 82	ND	COMMENTS brick removal
5/23/01	t	w	25	14 40	15 05	0 10	95	brick removal
5/24/01	s	w	105	9 45	11 30	0 19	ND	lentil removal, grinding, cutting, prying, chiseling
5/24/01	t	w	105	9 45	11 30	0 50	77	cutting with 10 inch saw

abbreviations s - worker using Dustcontrol vacuum cleaner with one motor

t- worker using Dustcontrol vacuum cleaner with two motors

w- sample collected on worker

v- sample collected under discharge from vacuum cleaner

b- samples collected on sides of swing stage

ND - not detected, NA-not analyzed due to low mass collected on filter

Table A2 Mass of dust collected in the vacuum cleaner

Time period	mass collected in bag from vacuum cleaner for worker T (pounds)	mass collected in bag from vacuum cleaner for worker S (pounds)
5/23 - morning	25.4	7
5/23 - after noon	4.2	5
5/24 morning	4.0	3.4
5/25 afternoon		1.15

Table A2 %Silica in the dust collected in the vacuum cleaner

Time period	Vacuum cleaner for worker T	Vacuum cleaner for worker S
5/23 - morning	29	26
5/23 - after noon	26	32
5 /24 morning		49
5/25 afternoon	32	48

Appendix B

The SAS System 07 04 Friday, June 15, 2001 1

OBS	DATE	W	L	RD	LRD
1	37034	s	v	0.93430	-0.06796
2	37034	t	b	0.03466	-3.36219
3	37035	s	b	0.15504	-1.86408
4	37035	t	b	0.05316	-2.93452
5	37034	t	v	0.19934	-1.61277
6	37034	s	w	0.16576	-1.79720
7	37034	s	b	0.01507	-4.19509
8	37034	t	v	0.15069	-1.89251
9	37034	t	w	0.04219	-3.16548
10	37034	t	b	0.09413	-2.36307
11	37034	t	w	0.11628	-2.15176
12	37035	t	v	0.07641	-2.57162
13	37034	s	w	0.17165	-1.76230
14	37034	s	b	0.08583	-2.45544
15	37035	t	w	0.04516	-3.09763
16	37035	t	w	0.12381	-2.08901
17	37035	s	w	0.16667	-1.79176
18	37034	s	v	0.17996	-1.71504
19	37035	s	w	0.07594	-2.57776
20	37035	s	v	0.17719	-1.73055

Authors annotation

W - worker s= worker who used 1 motor
on vacuum cleaner, t = worker who
used 2 motors on vacuum cleaner

L -sampling location, v= under vacuum cleaner
w = worker
b = end of swing stage

RD = respirable dust
LRD = ln(RD)

The SAS System 07 04 Friday June 15, 2001 2

General Linear Models Procedure

Class Level Information

Class	Levels	Values
W	2	s t
L	3	b v w

Number of observations in data set = 20

The SAS System 07 04 Friday, June 15 2001 3

General Linear Models Procedure

Dependent Variable LRD

Source	DF	Sum of Squares	Mean Square	F Value	Pr > F
Model	5	6.74647786	1.34929557	2.61	0.0724
Error	14	7.25145594	0.51796114		
Corrected Total	19	13.99793380			

R-Square	C V	Root MSE	LRD Mean
0.481962	-31.84651	0.71969517	-2.25988676

Source	DF	Type I SS	Mean Square	F Value	Pr > F
W	1	1.39569695	1.39569695	2.69	0.1230
L	2	4.81910636	2.40955318	4.65	0.0282
W*L	2	0.53167455	0.26583728	0.51	0.6094

Source	DF	Type III SS	Mean Square	F Value	Pr > F
W	1	1.30462597	1.30462597	2.52	0.1348
L	2	4.81910636	2.40955318	4.65	0.0282
W*L	2	0.53167455	0.26583728	0.51	0.6094

The SAS System 07:04 Friday, June 15, 2001 7

General Linear Models Procedure

Tukey's Studentized Range (HSD) Test for variable LRD

NOTE: This test controls the type I experimentwise error rate, but generally has a higher type II error rate than REGWQ.

Alpha=0.05 df=14 MSE=0.517961
 Critical Value of Studentized Range=3.701
 Minimum Significant Difference=1.0412
 WARNING: Cell sizes are not equal
 Harmonic Mean of cell sizes=6.545455

Means with the same letter are not significantly different

Tukey Grouping	Mean	N	L
A	-1.5984	6	v
A			
B A	-2.3041	8	w
B			
B	-2.8624	6	b