

Section 4

NO_x Controls

Section 4.2

NO_x Post- Combustion

Introduction

Nitrogen oxides (NO_x) are gaseous pollutants that are primarily formed through combustion process. While flue gas is within the combustion unit, about 95% of the NO_x exists in the form of nitric oxide (NO). The balance is nitrogen dioxide (NO_2), which is unstable at high temperatures. Once the flue gas is emitted into the atmosphere, most of the NO_x is ultimately converted to NO_2 . NO_x in the atmosphere reacts in the presence of sunlight to form ozone (O_3), one of the criteria pollutants for which health-based National Ambient Air Quality Standards have been established. Since ozone formation requires sunlight and high temperatures, ozone formation is greatest in summer months.

NO_x is generated in one of three forms; fuel NO_x , thermal NO_x , and prompt NO_x . Fuel NO_x is produced by oxidation of nitrogen in the fuel source. Combustion of fuels with high nitrogen content such as coal and residual oils produces greater amounts of NO_x than those with low nitrogen content such as distillate oil and natural gas. Thermal NO_x is formed by the fixation of molecular nitrogen and oxygen at temperatures greater than 3600°F (2000°C). Prompt NO_x forms from the oxidation of hydrocarbon radicals near the combustion flame and produces an insignificant amount of NO_x .

Selective Noncatalytic Reduction (SNCR) and Selective Catalytic Reduction (SCR) are post-combustion control technologies based on the chemical reduction of nitrogen oxides (NO_x) into molecular nitrogen (N_2) and water vapor (H_2O). The primary difference between the two technologies is that SCR utilizes a catalyst to increase the NO_x removal efficiency, which allows the process to occur at lower temperatures. The technologies can be used separately or in combination with other NO_x combustion control technologies such as low NO_x burners (LNB) and natural gas reburn (NGR). SNCR and SCR can be designed to provide NO_x reductions year-round or only during summer months, when ozone concerns are greatest.

This section presents design specifications and a costing methodology for SNCR and SCR applications for large industrial boilers (greater than 250 MMBtu/hr). Its primary purpose is to provide study-level cost estimates. These estimates can be used to compare the approximate costs of SNCR, SCR, and alternative NO_x control technologies. The costing methodologies are based on cost estimations for SNCR and SCR applications to utility boilers, which were developed by the Office of Research and Development (ORD), U.S. Environmental Protection Agency (EPA), Research Triangle Park, NC.

As a prelude to the cost methodology, the section describes the process chemistry, performance parameters, and system components of SNCR and SCR. In addition, impacts to the boiler performance and facility operations resulting from the installation of SNCR and SCR are presented. The section also estimates important underlying design parameters including the normalized stoichiometric ratio, catalyst volume, and reagent consumption. Lastly, it presents

assumptions and equations for estimating capital costs, annual operation and maintenance costs, and annualized costs. SNCR and SCR are discussed in separate chapters, however, the chapter on SCR builds on the concepts discussed in the SNCR chapter.

Information on key aspects of the design of SNCR and SCR systems is considered proprietary by vendors, including methods for estimating certain design parameters and costs. This information is not available to develop cost methodologies for SNCR and SCR. In order to obtain estimates of the proprietary design parameters and costs, it is necessary to develop mathematical correlations from available data using regression and curve fitting techniques. These expressions are derived in EPA reports prepared by The Cadmus Group, Bechtel Power, Inc. and SAIC in SNCR and SCR References [1, 2 and 3] from documented comprehensive SNCR and SCR performance data and costs based on quotations provided by suppliers and facilities.

Chapter 2

Selective Catalytic Reduction

Daniel C. Mussatti
Innovative Strategies and Economics Group
Air Quality Strategies and Standards Division
Office of Air Quality Planning and Standards
U.S. Environmental Protection Agency
Research Triangle Park, NC 27711

Dr. Ravi Srivastava
Office of Research and Development
U.S. Environmental Protection Agency
Research Triangle Park, NC 27711

Paula M. Hemmer and
Randy Strait
E.H. Pechan & Associates, Inc.
Durham, NC 27707

October 2000

Contents

2.1 Introduction	2-3
2.2 Process Description	2-4
2.2.1 Sampling Systems	2-5
2.2.2 SCR Performance Parameters	2-9
2.2.3 SCR System Configurations	2-18
2.2.4 High Dust SCR System Equipment	2-23
2.2.5 SCR System Auxiliary Equipment	2-26
2.2.6 Other Considerations	2-28
2.3 Design Parameters	2-30
2.4 Cost Analysis	2-40
2.4.1 Total Capital Investment	2-41
2.4.2 Total Annual Costs	2-44
2.5 Example Problem	2-50
2.5.1 Design Parameter Example	2-51
2.5.2 Cost Estimation Example	2-54
References	2-59

2.1 Introduction

Selective Catalytic Reduction (SCR) has been applied to stationary source, fossil fuel-fired, combustion units for emission control since the early 1970s and is currently being used in Japan, Europe, and the United States. It has been applied to large (\$250 million British thermal units per hour (MMBtu/hr)) utility and industrial boilers, process heaters, and combined cycle gas turbines. There has been limited application of SCR to other combustion devices and processes such as simple cycle gas turbines, stationary reciprocating internal combustion engines, nitric acid plants, and steel mill annealing furnaces [4]. In the United States, SCR has mainly been applied to coal- and natural gas-fired electrical utility boilers ranging in size from 250 to 8,000 MMBtu/hr (25 to 800 megawatts (MW)). SCR can be applied as a stand-alone NO_x control or with other technologies such as combustion controls. SCR systems have experienced relatively few operational or maintenance problems [1].

SCR is typically implemented on stationary source combustion units requiring a higher level of NO_x reduction than achievable by SNCR or combustion controls. Theoretically, SCR systems can be designed for NO_x removal efficiencies up to 100 percent (%). Commercial coal-, oil- and natural gas-fired SCR systems are often designed to meet control targets of over 90%. However, maintaining this efficiency is not always practical from a cost standpoint. In practice, SCR systems operate at efficiencies in the range of 70% to 90%. [4]

SCR capital costs vary by the type of unit controlled and the fuel source. Capital costs for retrofit of coal-fired electric utility boilers range from 50¹ to 70² dollars per kilowatt (\$/kW) for wall- and tangential-fired boilers and 50¹ to 80¹ \$/kW for cyclone and wet bottom boilers. New utility boiler capital costs are generally less than 40¹ \$/kW. Retrofit of oil- and gas-fired utility boilers range from 25¹ to 30¹ \$/kW since they have lower NO_x and particulate emissions. Typical operation and maintenance costs are less than 0.1¹ cents per kilowatt-hour. Capital costs for installing SCR on new industrial boilers range from 4000¹ to 6000¹ \$/MMBtu/hr for small oil and gas-fired units to over 10,000¹ \$/MMBtu/hr for large coal-fired units. Gas turbines have capital costs of 30¹ to 100¹ \$/kW depending on the size of the turbine. The cost of retrofitting a gas-fired reciprocating internal combustion engine is approximately 125¹ \$/horsepower, which is less than retrofit of combustion control technology for this type of unit. [4]

Although the cost data used in this report are based on retrofit applications of SCR systems on existing utility coal-fired boilers, this report's costing procedure accounts for the major differences between a new and retrofit installation. Therefore, the costing procedure is suitable for retrofit or new boiler applications of SCR on all types of large (\$250 MMBtu/hr) coal-fired industrial boilers. The costing methodology incorporates certain approximations, consequently, it should be used to develop study-level ($\pm 30\%$) cost estimates of SCR applications.

¹ Cost are in 1997 dollars

2.2 Process Description

Like SNCR, the SCR process is based on the chemical reduction of the NO_x molecule. The primary difference between SNCR and SCR is that SCR employs a metal-based catalyst with activated sites to increase the rate of the reduction reaction. A nitrogen based reducing agent (reagent), such as ammonia or urea, is injected into the post combustion flue gas. The reagent reacts selectively with the flue gas NO_x within a specific temperature range and in the presence of the catalyst and oxygen to reduce the NO_x into molecular nitrogen (N_2) and water vapor (H_2O).

The use of a catalyst results in two primary advantages of the SCR process over SNCR. The main advantage is the higher NO_x reduction efficiency. In addition, SCR reactions occur within a lower and broader temperature range. However, the decrease in reaction temperature and increase in efficiency is accompanied by a significant increase in capital and operating costs. The cost increase is mainly due to the large volumes of catalyst required for the reduction reaction.

Figure 2.1 shows a simplified process flow schematic for SCR. Reagent is injected into the flue gas downstream of the combustion unit and economizer through an injection grid mounted in the ductwork. The reagent is generally diluted with compressed air or steam to aid in injection. The reagent mixes with the flue gas and both components enter a reactor chamber containing the catalyst. As the hot flue gas and reagent diffuse through the catalyst and contact activated catalyst sites, NO_x in the flue gas chemically reduces to nitrogen and water. The heat of the flue gas provides energy for the reaction. The nitrogen, water vapor, and any other flue gas constituents then flow out of the SCR reactor. More detail on the SCR process and equipment is provided in the following sections.

There are several different locations downstream of the combustion unit where SCR systems can be installed. Flue gas temperature and constituents vary with the location of the SCR reactor chamber. SCR reactors located upstream of the particulate control device and the air heater have higher temperatures and higher levels of particulate matter. An SCR reactor located downstream of the air heater, particulate control devices and flue gas desulfurization system is essentially dust- and sulfur-free but its temperature is generally below the acceptable range. In this case, reheating of the flue gas may be required which significantly increases the SCR operational costs. Section 2.2.3 discusses the various SCR system configurations.

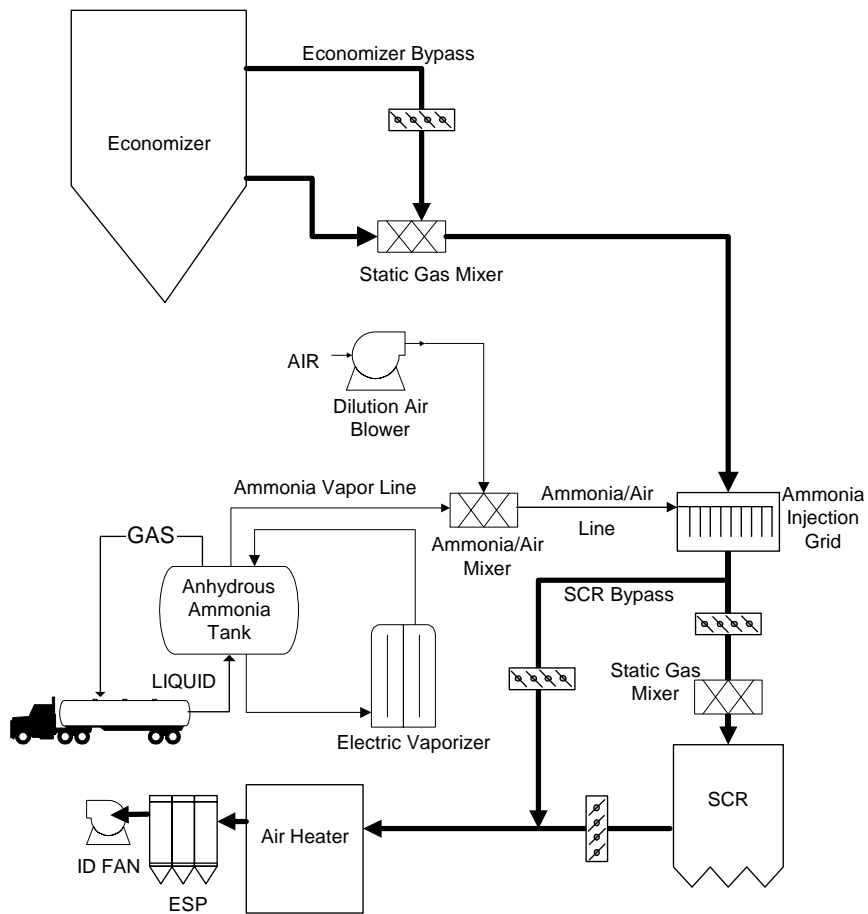
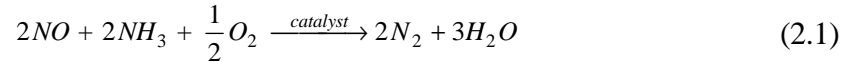

Figure 2.1: SCR Process Flow Diagram [6, 22]

2.2.1 Reduction Chemistry, Reagents and Catalyst

The reducing agent employed by the majority of SCR systems is gas-phase ammonia (NH_3) since it penetrates the catalyst pores more readily than aqueous urea. The ammonia, either in anhydrous or aqueous form, is vaporized before injection by a vaporizer. Within the appropriate temperature range, the gas-phase ammonia then decomposes into free radicals including NH_3 and NH_2 . After a series of reactions, the ammonia radicals come

into contact with the NO_x and reduce it to N_2 and H_2O . The global representation of these reactions is given below. Note that the NO_x is represented as nitrogen oxide (NO) since it is the predominant form of NO_x within the boiler. The ammonia reaction equation is represented by:



The equation indicates that 1 mole of NH_3 is required to remove one mole of NO_x . The catalyst lowers the required activation energy for the reduction reaction and increases the reaction rate. In the catalytic reaction, activated sites on the catalyst rapidly adsorb ammonia and gas phase nitric oxide to form an activated complex. The catalytic reaction, represented by Equation 2.1, occurs resulting in nitrogen and water, which are then desorbed to the flue gas. The site at which the reaction occurs is then reactivated via oxidation.

The high temperature of the flue gas converts the ammonia to free radicals and provides the activation energy for the reaction. The reaction also requires excess oxygen, typically 2 to 4 percent, to achieve completion. NO_x reduction with ammonia is exothermic, resulting in the release of heat. However, because the NO_x concentration in the flue gas at the inlet of the SCR is typically 0.02 to 0.01 percent by volume, the amount of heat released is correspondingly small. Thermodynamic equilibrium is not a limiting factor in NO_x reduction if the flue gas is within the required temperature range. [1]

Reagent

The SCR system can utilize either aqueous or anhydrous ammonia for the reduction reaction. Anhydrous ammonia is nearly 100% pure ammonia. It is a gas at normal atmospheric temperature, therefore, it must be transported and stored under pressure. Anhydrous ammonia often requires special permits for transportation and storage.

SCR applications using aqueous ammonia generally transport and store it at a concentration of 29.4% ammonia in water, though some recent applications utilize a 19% solution [1]. The use of aqueous ammonia reduces transport and storage problems. In addition, certain locations may not require permits for concentrations below 28%. Aqueous ammonia however, requires more storage capacity than anhydrous ammonia. While the 29.4% solution has substantial vapor pressure at normal air temperatures, to provide sufficient ammonia vapor to the SCR system generally requires a vaporizer.

The cost of the reagent impacts the annual costs of an SCR system. Depending on the local permitting requirements and on owner preference, either anhydrous or aqueous ammonia may be used in the SCR process. This presentation is valid for anhydrous or aqueous ammonia, however, the design parameters and cost analysis assume aqueous ammonia as a reagent since it is more commonly employed. Table 2.1 gives the properties of anhydrous ammonia and the properties of a 29.4% aqueous ammonia solution.

Table 2.1: Ammonia Reagent Properties

Property	Anhydrous Ammonia [15,16]	Aqueous Ammonia
Liquid or gas at normal air temperature	Liquid	Liquid
Concentration of reagent normally supplied	99.5 % (by weight)	29.4 % (by weight of NH ₃)
Molecular weight of reagent	17.03	17.03 (as NH ₃)
Ratio of ammonia to Solution	99.5% (by weight of NH ₃)	29.4 % (by weight of NH ₃)
Density of liquid at 60 °F	5.1 lb/gal	7.5 lb/gal
Vapor pressure @ 80 °F	153 psia	14.6 [15, p. 3]
Flammability limits in air	16-25 % NH ₃ (by volume)	16-25 % NH ₃ (by volume)
Short-term exposure limit	35 ppm	35 ppm
Odor	Pungent odor @ 5 ppm or more	Pungent odor @ 5 ppm or more
Acceptable materials for storage	Steel tank, rated for at least 250 psig pressure (no copper or copper-based alloys, etc.)	Steel tank, rated for at least 25 psig pressure (no copper or copper-based alloys, etc.)

Catalyst

SCR catalysts are composed of active metals or ceramics with a highly porous structure. Within the pores of the catalyst are activated sites. These sites have an acid group on the end of the compound structure where the reduction reaction occurs. As stated previously, after the reduction reaction occurs, the site reactivates via rehydration or oxidation. Over time, however, the catalyst activity decreases, requiring replacement of the catalyst. Catalyst designs and formulations are generally proprietary. Both the catalyst material and configuration determine the properties of the catalyst.

Originally, SCR catalysts were precious metals such as platinum (Pt). In the late 1970s, Japanese researchers used base metals consisting of vanadium (V), titanium (Ti), and tungsten (W), which significantly reduced catalyst cost. In the 1980's, metal oxides such as titanium oxide (TiO₂), zirconium oxide (ZrO₂), vanadium pentoxide (V₂O₅), and

silicon oxide (SiO_2) were employed to broaden the reaction temperature range. Zeolites, crystalline alumina silicates, were also introduced for high temperature (675°F to 1000°F) applications, however, zeolites tended to be cost prohibitive.

Improvements to the catalyst formulations decrease unwanted side reactions such as sulfur oxide conversions (SO_2 to SO_3) and increase the resistance to flue gas poisons. Newer catalyst designs also increase catalyst activity, surface area per unit volume, and the temperature range for the reduction reaction. As a consequence, there is a corresponding decrease in the required catalyst volumes and increase in the catalyst operating life. For coal-fired boiler applications, SCR catalyst vendors typically guarantee the catalyst for an operating life ranging between 10,000 hours to 30,000 hours [11]. Applications using oil and natural gas have a longer operating life, over 32,000 hours [19]. In addition, operating experience indicates that actual catalyst deactivation rates are lower than the design specifications [1].

Catalyst formulations include single component, multi-component, or active phase with a support structure. Most catalyst formulations contain additional compounds or supports to give thermal and structural stability or to increase surface area [4]. Catalysts configurations are generally ceramic honeycomb and pleated metal plate (monolith) designs in a fixed-bed reactor, which provide high surface area to volume ratio. Pellet catalyst in fluidized beds are also available. Pellets have greater surface area than honeycombs or pleated plates but are more susceptible to plugging. This limits the use of pellets to clean burning fuels such as natural gas.

Catalyst elements placed in a frame form a catalyst module. The modules stack together in multiple layers to create a reactor bed of the total required catalyst volume. A typical module is 3.3 ft to 6.6 ft in area (1 m x 2 m) and 3.3 ft (1 m) in height. A crane hoists the large catalyst modules into the reactor from either the interior or exterior of the reactor, depending on the reactor design.

Catalyst replacement is infrequent, generally less than one layer per year for fixed bed designs. Most SCR manufacturers offer a disposal service. The catalyst is either reactivated for reuse or its components are recycled for other uses [4]. If the catalyst cannot be recycled or reused, the facility operator must dispose of the spent catalyst in an approved landfill. In the United States, most catalyst formulations are not considered hazardous waste [4].

Catalysts greatly accelerate the NO_x reduction reaction rate, but some catalysts have more favorable properties for a given application. Performance requirements that drive the choice of catalyst include reaction temperature range, flue gas flow rate, fuel source, catalyst activity and selectivity, and catalyst operating life. In addition, the design must consider the cost of the catalyst, including disposal costs since catalyst costs can account for 20% or more of the capital costs for a SCR system [1].

2.2.2 SCR Performance Parameters

The rate of the reduction reaction determines the amount of NO_x removed from the flue gas. The major design and operational factors that affect the NO_x removal performance of SCR are similar to those presented in Chapter 1 SNCR. The factors discussed previously for SNCR include the following:

- Reaction temperature range;
- Residence time available in the optimum temperature range;
- Degree of mixing between the injected reagent and the combustion gases;
- Molar ratio of injected reagent to uncontrolled NO_x ;
- Uncontrolled NO_x concentration level; and
- Ammonia slip.

The majority of the discussion regarding SNCR design and operational factors is valid for the SCR process excepting small variations due to the use of a catalyst and the reaction chamber being separate from the combustion unit. Additional design and operational factors to consider, which are specific to the SCR process, include:

- Catalyst activity
- Catalyst selectivity
- Pressure drop across the catalyst
- Catalyst pitch
- Catalyst deactivation
- Catalyst management

The major differences between SNCR and SCR are discussed below.

Temperature

The NO_x reduction reaction is effective only within a given temperature range. The use of a catalyst in the SCR process lowers the temperature range required to maximize the NO_x reduction reaction. At temperatures below the specified range, the reaction kinetics decrease and ammonia passes through the boiler (ammonia slip). At temperatures above the specified range, nitrous oxide (N_2O) forms and catalyst sintering and deactivation occurs.

In an SCR system, the optimum temperature depends on both the type of catalyst utilized in the process and the flue gas composition. For the majority of commercial catalysts (metal oxides), the optimum temperatures for the SCR process range from 480 °F to 800 °F (250 °C to 427 °C) [11]. Figure 2.2 is a graph of the NO_x removal efficiency as a function of temperature for a typical metal oxide-type catalyst [11]. The figure shows the rate of

the NO_x removal increases with temperature up to a maximum between 700°F to 750°F (370°C to 400°C). As the temperature increases above 750°F, the reaction rate and resulting NO_x removal efficiency begin to decrease.

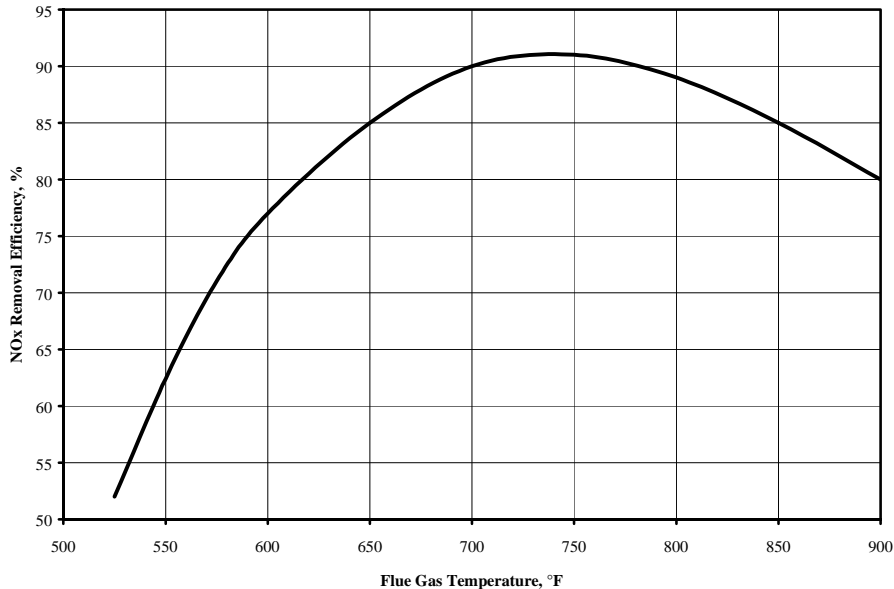

Figure 2.2: NO_x Removal versus Temperature [11]

As flue gas temperature approaches the optimum, the reaction rate increases and less catalyst volume achieves the same NO_x removal efficiency. Figure 2.3 shows the change in the required catalyst volume versus temperature [10]. There is approximately a 40% decrease in the required catalyst volume as flue gas temperature increases from 600 °F (320 °C) to the optimum range, 700 to 750 °F (370 °C to 400 °C). This decrease in catalyst volume also results in a significant decrease in capital cost for the SCR system.

The relationships between flue gas temperature, catalyst volume, and NO_x removal are complicated functions of the catalyst formulation and configuration. The physical and chemical properties of each catalyst are optimized for a different operating conditions. For a given catalyst formulation, the required catalyst volume and/or temperature range can even change from one manufacturer of the catalyst to another. The selection of catalyst, therefore, is critical to the operation and performance of the SCR system.

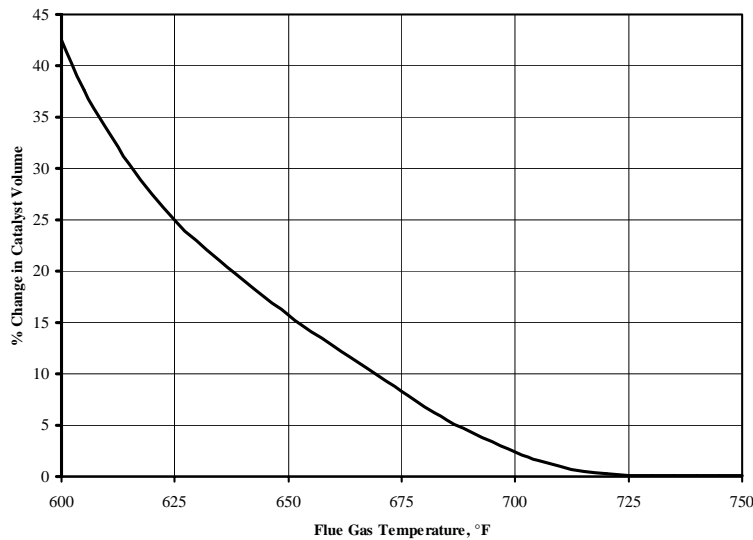

Figure 2.3: Change in Catalyst Volume vs. Temperature [10]

Since the optimum temperature window of the SCR process is lower than that of SNCR, the reagent injection into a reactor chamber occurs downstream of the combustion unit, rather than inside the combustion unit. As discussed previously, there are several options for the location of the SCR reactor. The flue gas temperature at each of these locations is different. Most designs install the reactor downstream of the economizer and prior to the air preheater, where the flue gas is at the appropriate temperature for metal oxide-based catalysts. Reheating of the flue gas may be required for reactors located downstream of the air pre-heater. Reheating significantly increases the SCR operational costs.

Boiler operation at reduced loads decreases the gas flow rate. At reduced gas flow rates, the economizer outlet gas temperature decreases because boiler heat transfer surfaces absorb more heat from the flue gas. Typical SCR systems tolerate temperature fluctuations of $\pm 200^{\circ}\text{F}$ ($\pm 93^{\circ}\text{C}$) [1]. At low boiler loads, however, the temperature can decrease below the optimum range. For example, a coal-fired utility boiler has an economizer exit flue gas temperature of 690°F (366°C) at 100% load, but only 570°F (300°C) at 50% load [1]. For low-load operations, an economizer bypass can be used to raise the flue gas temperature. An economizer bypass diverts part of the hot flue gas from within the economizer through a bypass duct and mixes it with the relatively cooler flue gas exiting the economizer. An economizer feedwater bypass also raises the flue gas temperature. The use of an economizer bypass results in less energy transfer to the feedwater for steam generation, consequently, there is a small reduction in boiler efficiency. Lower boiler efficiencies require more fuel to be burned to meet the required boiler steam output.

Residence Time and Space Velocity

Residence time is the time the reactants are within the reactor. Higher residence times generally result in higher NO_x removal rates. Temperature also affects the required residence time. The required residence time decreases as the temperature approaches the optimum temperature for the reduction reaction. Residence time is often expressed as space velocity, the inverse of residence time. The space velocity of a reactor is experimentally determined from the measured flue gas flow rate divided by the superficial volume of the catalytic reactor. The NO_x removal efficiency increases with decreasing space velocity, i.e. increasing catalyst volume, for a given flue gas flow rate.

The optimal residence time for an SCR system is a function of the number of active catalyst sites available for the reduction reaction and the gas flow rates within those active sites (interstitial flow rate). The “area velocity” is a parameter used by SCR vendors which relates the number of sites and the interstitial flow rate to residence time. The area velocity is defined as the space velocity divided by the catalyst pore surface area (specific surface area). For coal-fired boilers, typical specific surface areas range from 90 to 3,800 square feet per cubic feet (ft²/ft³) (300 to 1,200 square meters per cubic meters (m²/m³)) [1]. Increasing the catalyst specific surface area increases the NO_x removal for a given flue gas flow rate. This can be accomplished by either increasing the catalyst volume, which increases the reactor size, or increasing the pore space of the catalyst, which generally increases the catalyst cost.

Degree of Mixing

The reagent must be dispersed and mixed throughout the flue gas to ensure sufficient contact between the reactants. Mixing is performed by an injection system which injects pressurized gas-phase ammonia into the flue gas. The injection system controls the spray angle, velocity and direction of the injected reagent. Some systems inject the ammonia with a carrier fluid such as steam or air to increase penetration into the flue gas. Injection systems are application specific. Numeric modeling of the flue gas and reagent flow optimizes the design of the injection system. (See 2.2.6).

Mixing of the flue gas and ammonia occurs before entering the SCR reactor. If mixing is not adequate, the NO_x reduction is inefficient. SCR designs must incorporate adequate duct length between the ammonia injection and the reactor inlet to allow for mixing. Mixing patterns can be improved by:

- Installation of static mixers upstream of the reactor;
- Increase the energy imparted to the injected fluids;
- Increase the number of injectors and/or injection zones; and
- Modify the nozzle design to improve the reagent distribution, spray angle, and direction.

Actual Stoichiometric Ratio

The actual stoichiometric ratio (the moles of reagent injected per mole of uncontrolled NO_x) defines the quantity of reagent needed to achieve the targeted NO_x reduction. According to Equation 2.1, the theoretical stoichiometric ratio for the reduction reaction with ammonia is equal to 1. This assumption of a 1 to 1 linear relationship between the quantity of reagent and the NO_x removed is good up to about 85% NO_x reduction [11]. After 85%, the removal efficiency begins to level off and more than the theoretical amount of ammonia is required for additional NO_x removal. This is due to the portion of NO_x that is in the form of NO_2 rather than NO and reaction rate limitations. SCR systems typically employ a stoichiometric ratio 1.05 moles of ammonia per mole of NO_x [1]. Because capital and operating costs depend on the quantity of reagent consumed, the actual stoichiometric ratio is an important design parameter that is determined by the SCR designer.

Uncontrolled NO_x Concentration

The concentration of the reactants also affects the reaction rate of the NO_x reduction process. In general, higher uncontrolled NO_x inlet concentrations result in higher NO_x removal efficiencies [1] due to reaction kinetics. However, NO_x levels higher than approximately 150 parts per million (ppm), generally do not result in increased performance. Low NO_x inlet levels result in decreased NO_x removal efficiencies because the reaction rates are slower, particularly in the last layer of catalyst [1]. In general, though, SCR performs better than SNCR on sources with low uncontrolled NO_x levels such as natural gas-fired boilers.

For a given NO_x removal efficiency, higher NO_x levels at the SCR inlet require more catalyst volume. For example, to achieve 90% NO_x removal, requires 10% more catalyst at inlet NO_x level of 1.7 lb/MMBtu versus inlet levels of 0.8 lb/MMBtu [9]. SCR is generally more cost effective for sources which emit less NO_x , since the required catalyst volume is minimal.

Ammonia Slip

Ammonia slip refers to the excess reagent passing through the reactor. Ammonia in the flue gas causes a number of problems which were discussed in Chapter 1 SNCR, including health effects, visibility of the stack effluent, salability of the fly ash, and the formation of ammonium sulfates. Limits on acceptable ammonia slip, imposed by either regulatory limits or by design requirements, place constraints on SCR performance.

Ammonia slip does not remain constant as the SCR system operates but increases as the catalyst activity decreases. Properly designed SCR systems, which operate close to the theoretical stoichiometry and supply adequate catalyst volume, maintain low ammonia slip levels, approximately 2 to 5 ppm. Reliable instrumentation for monitoring ammonia slip is currently being

developed but not commercially available [11]. One method to quantify ammonia slip is to determine the ammonia concentration in collected fly ash [13].

Catalyst Activity

Catalyst activity is a measure of how much the catalyst accelerates the NO_x reduction reaction rate. A higher catalyst activity results in a faster reaction rate and more NO_x removal. Catalyst activity is a function of many variables including catalyst composition and structure, diffusion rates, mass transfer rates, gas temperature, and gas composition [14]. As the catalyst activity decreases, the NO_x reduction reaction rate also decreases. This results in lower NO_x removal and higher ammonia slip levels.

The following equation describes the deactivation of the catalyst activity, K , with time, t [8]:

$$K = K_o e^{-(t/\tau)} \quad (2.2)$$

where K_o is the original catalyst activity and τ is the catalyst operating life time constant. Figure 2.4 shows a typical catalyst deactivation curve based on Equation 2.2. As the catalyst activity decreases, the NO_x removal efficiency is usually kept constant by injecting more ammonia, thereby increasing the ammonia slip. When the ammonia slip reaches the maximum design or permitted level, new catalyst must be installed.

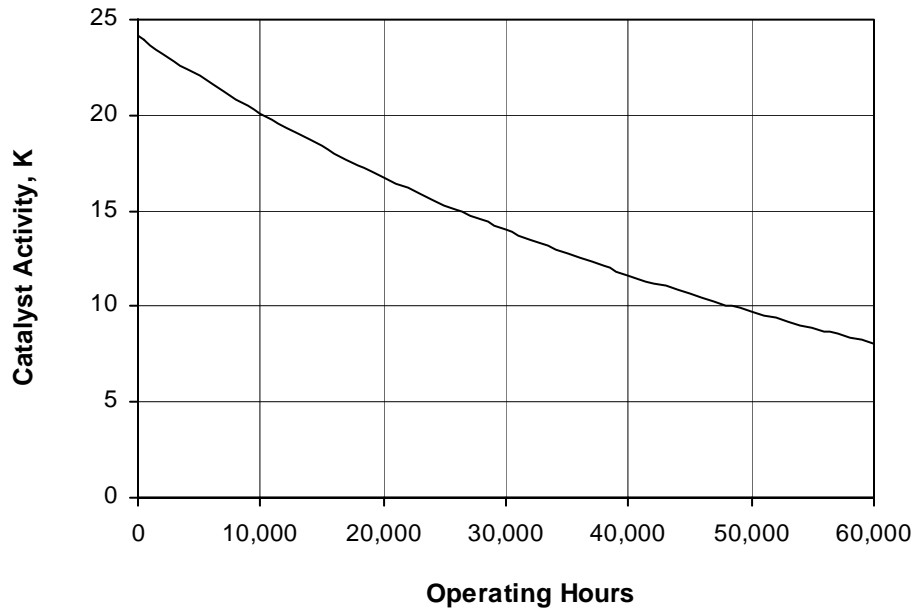

Figure 2.4: Typical Catalyst Deactivation per Equation 2.2 with $K_o = 24.12$; $\tau = 55,000$

Catalyst Reaction Selectivity

SCR favors the NO_x reduction reaction over competing reactions given the reactants are at the appropriate temperature and oxygen is present. However, competing reactions still occur and the catalyst accelerates these reactions as well. Each catalyst has different chemical reaction selectivity properties. In general, catalysts promote the formation of two undesirable compounds, sulfur trioxide (SO_3) and nitrous oxide (N_2O). SO_3 is formed by the oxidation of SO_2 to SO_3 . Sulfur oxides (SO_x) are regulated under the 1990 Clean Air Act. SO_3 reacts with ammonia in the flue gas to form ammonia sulfates. Ammonium sulfur salts deposit on the catalyst and on downstream equipment such as the air preheaters. N_2O is both an ozone depletor and a greenhouse gas but is currently not regulated.

Pressure Loss

The flue gas pressure decreases as the flue gas flows across the catalyst. The decrease in pressure is a function of the length of the catalyst and the catalyst configuration. Deposition of fly ash and other particulates on the catalyst over time increases this pressure drop across the catalyst. The flue gas pressure can be increased by installing new draft fans or by upgrading existing fans. To minimize the pressure loss across the catalyst, the SCR reactor ductwork can be expanded and flow rectifiers and turning vanes can be installed. Pressure loss is of greater concern in turbine applications which rely on air flow, rather than heat transfer, to generate power.

Catalyst Pitch

Catalyst pitch is a term used in association with honeycomb and metal plate catalyst and affects the flue gas velocity in interstitial spaces [1]. As shown in Figure 2.5 pitch, represented as p , is the width of the catalyst cell plus the cell wall thickness, a . For a given flow rate, wider pitch will result in lower interstitial gas velocities. Appropriate catalyst pitch is important to assure that ash will not deposit and bridge over catalyst cells and pores. Plugging of the catalyst reduces the effective surface area by decreasing the number of active sites available for the NO_x reduction reaction.

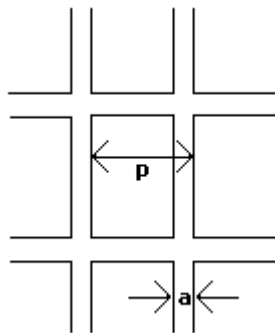

Figure 2.5: Pitch for a Honeycomb Catalyst Configuration

Catalyst Deactivation

Catalysts lose their activity over time for various reasons. The primary mechanisms for catalyst deactivation and surface area loss are discussed below.

Poisoning - Certain fuel constituents which are released during combustion act as catalyst poisons. Catalyst poisons include calcium oxide and magnesium oxide, potassium, sodium, arsenic, chlorine, fluorine, and lead. These constituents deactivate the catalyst by diffusing into active pore sites and occupying them irreversibly. Catalyst poisoning represents the main cause of catalyst deactivation.

Thermal Sintering - High flue gas temperatures within the SCR reactor cause sintering, a permanent loss of catalyst activity due to a change in the pore structure of the catalyst. Thermal sintering can occur at temperatures as low as 450°F (232°C). The amount of thermal sintering depends on the composition and structure of the catalyst. Newer catalyst materials are less susceptible to thermal sintering which increases their operating life.

Blinding/Plugging/Fouling - Ammonia-sulfur salts, fly ash, and other particulate matter in the flue gas cause blinding, plugging or fouling of the catalyst. The particulate matter deposits on the surface and in the active pore sites of the catalyst. This results in a decrease of the number of sites available for NO_x reduction and an increase in flue gas pressure loss across the catalyst.

Erosion - Impingement of particulate matter and high interstitial gas velocities erode the catalyst material. Catalysts with hardened leading edges or increased structural strength are less susceptible to erosion. Increasing catalyst strength through hardening, however, reduces the number of active pore sites.

Aging - Catalyst aging is a change in the physical and chemical properties of the catalyst pores that occurs over time.

There are a number of measures which can be taken to decrease the rate of deactivation and deterioration of the catalyst. These measures are discussed in the following section.

Catalyst Formulation - Each catalyst formulation has different physical and chemical properties. Catalyst formulations with the following properties will have decreased deactivation.

- Increased activity per unit volume
- Greater thermal resistance
- Chemical and physical resistance to poisons
- Wider thermal operating range
- Greater structural strength and hardened leading edges
- Lower interstitial velocities (i.e., wider catalyst pitch)

To obtain the optimum catalyst formulation and SCR design for an application, the catalyst supplier and SCR vendor should be informed of the fuel constituents, such as sulfur, chlorine, fluorine, alkali, and trace metals. These fuel and ash constituents can be determined by chemical analyses. The associated analytical data can then be used to modify the catalyst composition, to determine catalyst volume, and to design the SCR reactor components.

Soot Blowers - Deposits on the surface of the catalyst can be dislodged by soot blowers which are generally installed between each catalyst layer and operated on a periodic basis, such as once a week.

Turning Vanes and Rectifier Grids - Particulate matter can be removed from the flue gas by gas-flow turning vanes and flow rectifier grids near the front of the catalyst layer. Particles impact the surface of the vanes or grid and fall out of the flue gas stream. In addition to removing particles, turning vanes and flow rectifier grids decrease the linear velocity of the flue gas and align its vector with the flow path of the catalyst.

Catalyst Management Plan

Catalyst deactivation is an inherent part of the SCR process. As the catalyst activity decreases with time, the NO_x reduction reaction rate decreases and ammonia slip increases. When the ammonia slip level reaches the design limit, the catalyst must be replaced or new catalyst must be added. The catalyst life is the time the catalyst activity for a given catalyst volume (layer volume) maintains ammonia slip below the design limit. Currently, vendor-guaranteed life for a catalyst layer in coal-fired applications is approximately three years [10]. The actual catalyst layer lifetimes being experienced in such applications are in the 5 to 7 year range, depending on the condition of untreated flue gas [1]. Gas- and oil-fired applications experience even longer catalyst layer lifetimes.

A catalyst management plan, as shown in Figure 2.6, schedules periodic replacement of catalyst to maintain ammonia slip limits. Most catalyst management plans call for the SCR reactor design to provide two or more layers filled with catalyst and one or more empty or spare catalyst layers. When the initial catalyst layers deactivate to the point ammonia slip reaches the maximum design value, the facility adds catalyst to the empty layer. Catalyst addition is managed so that the total catalyst activity of all the layers (the two or three older catalyst layers plus new catalyst layers) is sufficient to meet the ammonia slip requirement for a relatively long period of time. As the catalyst continues to deactivate, ammonia slip begins to rise. When ammonia slip again reaches the maximum design value, one of the older catalyst layers is removed and replaced with new catalyst. Figure 2.6 shows a catalyst management plan for an application in which the maximum design value of ammonia slip is 2 ppm [7].

Catalyst cost is a significant portion of the annual cost of operating an SCR system. For SCR designs which utilize a catalyst management plan, only a fraction of the total catalyst inventory, rather than the entire volume, is replaced at any one time. This distributes the catalyst replacement costs more evenly over the lifetime of the system.

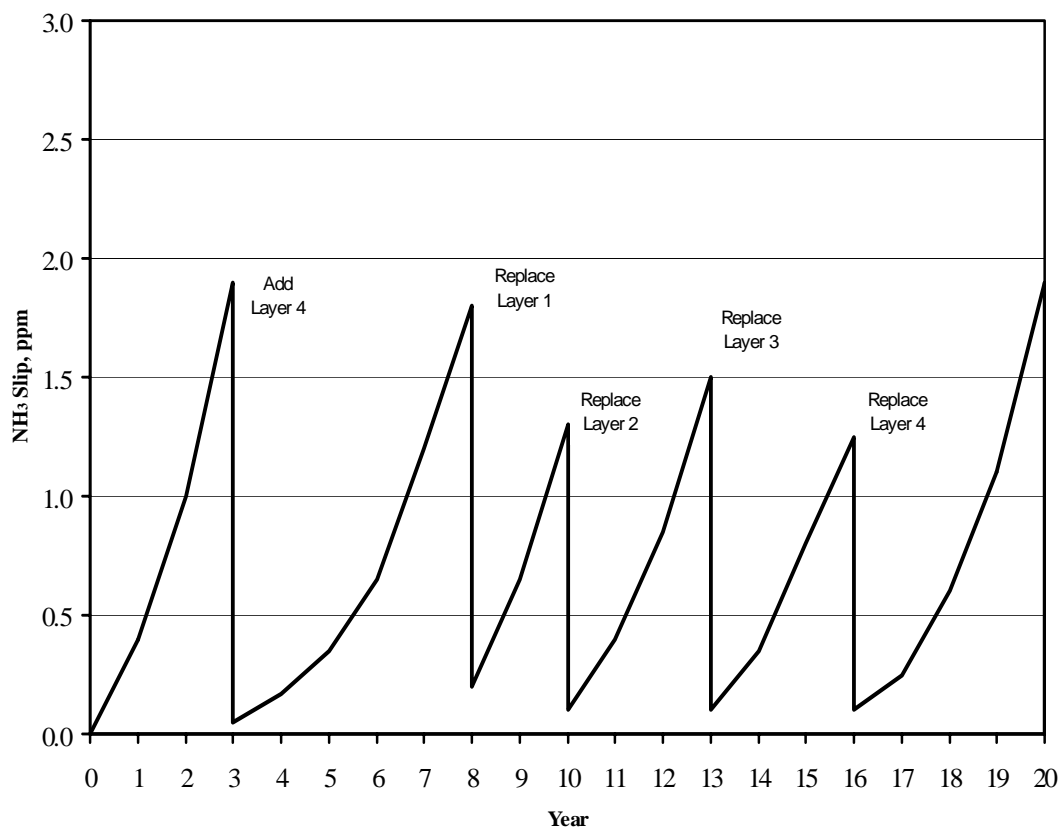

Figure 2.6: Typical Catalyst Management Plan [5]

2.2.3 SCR System Configurations

Electric utility and large industrial boiler applications implement several different SCR system configurations, including high-dust, low-dust, and tail-end arrangements. SCR configurations for gas turbine applications are dependant on the type of engine cycle, such as combined-cycle or simple cycle. The various configurations for boilers and gas-fired turbines are discussed below. In addition, there are two different SCR reactor designs; full SCR and in-duct SCR which are also discussed.

High-Dust SCR

Figure 2.7 shows a high-dust SCR system for coal-fired boiler applications. The SCR reactor location is downstream of the economizer and upstream of the air heater and particulate control devices. The flue gas temperature in this location is usually within the optimum temperature window for NO_x reduction reactions using metal oxide catalysts. In this configuration, however, the flue gas contains particulates when it enters the SCR reactor.

Coal-fired boilers generally use a vertical SCR reactor, where the flue gas flows downward through the catalyst. The reactor generally contains multiple layers of catalyst. The volume of catalyst required varies with each installation, as discussed previously. Sootblowers are installed to remove particulates from the catalyst surfaces. For design which utilize a honeycomb catalyst, the catalyst pitch is typically about 7 to 9 mm (compared with 3 or 4 mm for gas-fired boilers) to allow easy passage of ash particles without deposition and for ease of cleaning with sootblowers. To obtain uniform gas flow and remove particulates, high-dust SCR designs usually include turning vanes and a flow-rectifying grid in the ductwork prior to the reactor.

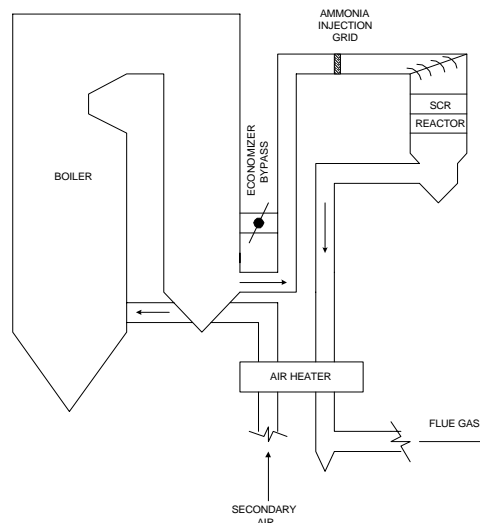

Figure 2.7: High Dust SCR Arrangement, [4]

A hopper at the bottom of the SCR reactor collects ash and particulates separated from the flue gas stream. The hopper outlet connects to the plant fly ash handling system for periodically removal of the accumulated ash. Flue gas exits the reactor via an opening at the top of the hopper and is directed to the air heater inlet. Some designs eliminate the need for hoppers by keeping flue gas velocities high enough in these areas so fly ash remains entrained in the flue gas.

Natural gas-fired and distillate oil-fired boilers generate flue gas that is relatively free of dust and SO_2 (for low-sulfur oil). Consequently, SCR systems for these boilers place the reactor upstream of the air heater, the high-dust SCR configuration.

Low-Dust SCR

Coal-fired units with an electrostatic precipitator (ESP) located upstream of the air heater (hot-side ESP), typically use a low-dust SCR configuration. Figure 2.8 shows a low dust configuration, which locates the SCR reactor downstream of the ESP. In this location, the flue gas is relatively dust free. The ash removed by the ESP typically contains arsenic, alkali metals, and other constituents that are detrimental to catalyst performance and life.

A low-dust SCR system increases catalyst life by reducing concentrations of particulates and catalyst poisons in the SCR reactor. In addition, low-dust SCR configurations do not need ash hoppers. For designs employing honeycomb catalyst, the catalyst pitch can be reduced to approximately 4 to 7 mm, resulting in lower catalyst volume. Longer catalyst life, lower catalyst volume and the elimination of the ash hopper mean lower costs for low-dust SCR compared to high-dust configurations. The only disadvantage of low dust SCR is the

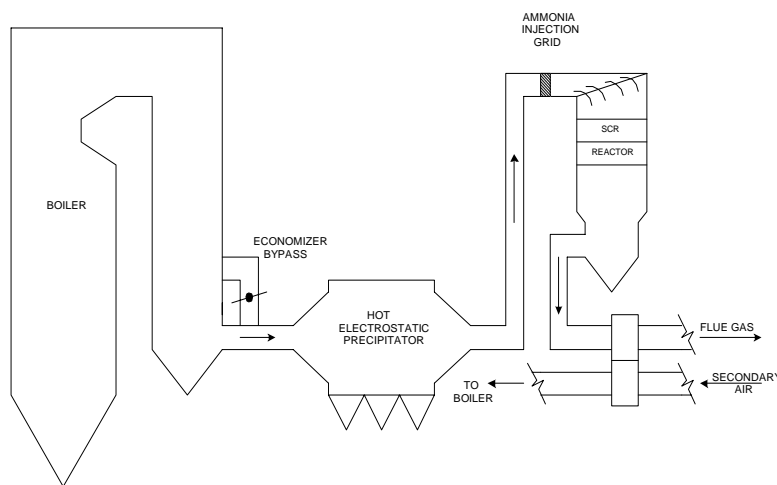

Figure 2.8: Low-Dust SCR Arrangement, [4]

temperature drop of the flue gas as it flows through the ESP. Flue gas temperatures generally do not decrease to the point where reheating is required. However, an increase in the size of the existing economizer bypass duct may be required to maintain the flue gas temperature within the optimum range.

Tail-end SCR

Early installations of coal-fired boilers in Europe and Japan employ tail-end SCR configurations. This configurations places the SCR reactor downstream of all air pollution control equipment installed on a unit Figure 2.9 depicts a tail-end system for a plant with a particulate control device and a wet flue gas desulfurization (FGD) system. The air pollution control equipment removes most flue gas constituents detrimental to SCR catalyst before it enters the SCR reactor. However, because the flue gas temperature at the tail-end is below the range required for the ammonia/ NO_x reaction, the flue gas needs to be reheated. Tail end SCR systems use oil- or natural gas-fired duct burners or steam coil gas heaters for reheating. Some of the energy used to reheat the gas is recovered in a recuperating gas-to-gas heater.

A tail-end system typically costs the most of the three SCR systems because of the additional equipment and operational costs required for flue gas reheating and heat recovery. Operating experience and the availability of improved catalysts for the high-dust SCR system makes the tail-end SCR system the least attractive of the three options. New low temperatures catalysts are currently being developed and may make tail end systems a more cost effective option in the future [25].

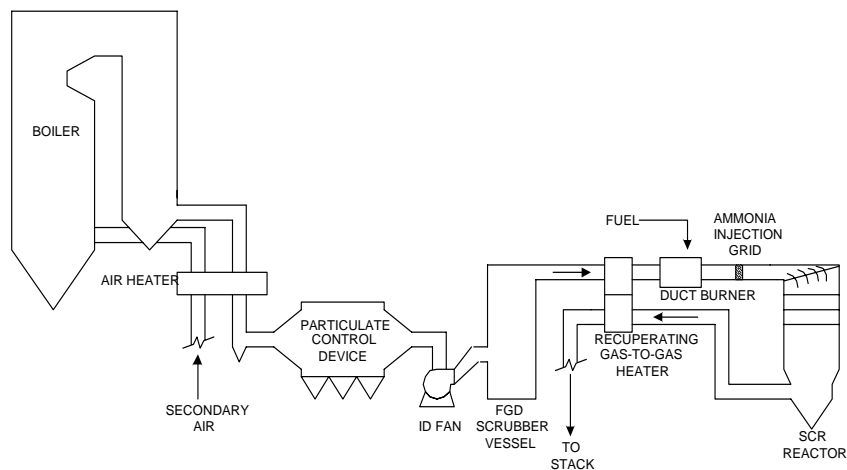

Figure 2.9: Tail-end SCR Arrangement, [4]

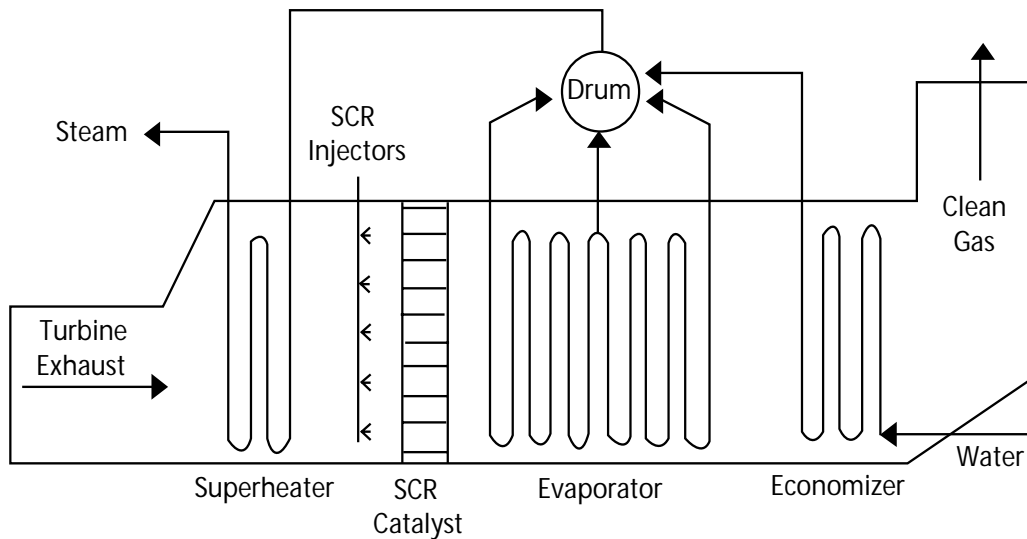

Figure 2.10: SCR Arrangement for a Combined Cycle Gas Turbine, [4]

Gas Turbines

Natural gas-fired turbine applications frequently use SCR technology for post-combustion NO_x control. There are two basic gas turbine configurations; combined cycle (co-generation cycle) and simple cycle. The majority of SCR systems are installed as combined cycle applications. A typical combined-cycle SCR design places the reactor chamber after the superheater within a cavity of the heat recovery steam generator system (HRSG) as shown in Figure 2.10. The flue gas temperature in this area is within the operating range for base metal-type catalysts. Some combined-cycle gas turbine designs locate the SCR reactor downstream of the HRSG and prior to the economizer at temperatures ranging from 350°F to 400°F. Simple cycle applications of SCR place the reactor chamber directly at the turbine exhaust where the flue gas temperature is in the range of 850°F to 1000°F (450°C to 540°C). This requires the use of a high temperature catalyst such as zeolite. [4]

SCR Reactor Designs

The reactor design affects capital and operating costs of the SCR system and the catalyst management plan. There are two different types of SCR reactors; full SCR and in-duct SCR. Full SCR designs house the catalyst in a separate reactor chamber. The boiler flue gas must be ducted from the economizer outlet, to the SCR reactor, then to the air heater inlet. A separate reactor allows a large volume of catalyst to be installed in layers, which increases NO_x reduction and catalyst lifetime. It also increases the duct length available for the mixing of reactants prior to entering the reactor chamber. A separate reactor,

however, requires a large amount of space adjacent the boiler to install the reactor and ductwork. The additional ductwork often necessitates upgrades to the draft fan system.

In-duct (in-line) SCR systems house the reactor within the plant's existing ductwork rather than in a separate reactor chamber. The ductwork is generally enlarged to provide sufficient room for the catalyst. In-duct systems save on costs for the ductwork, reactor chamber, and ID fan. In-duct designs limit catalyst volume and mixing length, therefore, they are commonly used in conjunction with other NO_x control technologies [19]. Catalyst erosion is generally higher for in-duct systems. Installation and maintenance of in-duct systems typically require more boiler outages. Natural gas-fired boilers, which have low catalyst volumes, frequently employ in-duct systems. Coal-fired boilers may apply in-duct SCR reactors where space limitations restrict the installation of a full reactor [19].

2.2.4 High Dust SCR System Equipment

The majority of SCR designs utilize Thermal DeNO_x®, which is an ammonia-based NO_x reduction system developed and patented by Exxon Research and Engineering Company in 1975. The SCR system has five basic steps to accomplish. These steps are:

- Receiving and storage of the ammonia;
- Vaporizing the ammonia and mixing with air;
- Injecting the ammonia/air mixture at appropriate locations;
- Mixing the ammonia/air with flue gas; and
- Diffusing the reactants into the catalyst and reducing the NO_x.

While the basic steps in an SCR system are similar for all configurations, the system design and equipment specifications are somewhat different. A discussion of the SCR system design and equipment is given below for an aqueous ammonia-based, high dust configuration, full reactor SCR for a large (\$2,500 MMBtu/hr) coal-burning industrial boiler. The SCR process steps, related auxiliary equipment, and the potential impacts of SCR operation on existing plant equipment are also discussed. A simplified system flow schematic is presented in Figure 2.1 and Figure 2.7 and a list of equipment is presented in Table 2.2.

Ammonia Storage and Vaporization

Aqueous ammonia is typically available as a 19% to 29.4% solution in water. Generally, a 29.4 percent solution is used in this application. Anhydrous ammonia is nearly 100% pure ammonia and stored as a liquid under pressure. Table 2.1 presents the properties of aqueous and anhydrous ammonia.

Table 2.2: Major Equipment List for an SCR Application

Item	Description/Size
SCR reactors (1 to 2)	Vertical flow type, 805,000 acfm capacity, 44 ft.x 44 ft.x 31 ft. high (excluding outlet duct and hoppers), equipped with 9,604 ft ³ of ceramic honeycomb catalyst, insulated casing, sootblowers, hoppers, and hoisting mechanism for catalyst replacement
Anhydrous ammonia tank (1 or more)	Horizontal tank, 250 psig design pressure, storage tanks 15,000 gal, 34-ton storage capacity
Air compressor (2)	Centrifugal type, rated at 3,200 acfm and 30 hp motor
Vaporizers (2)	Electrical type, rated at 80 kW
Mixing chamber	Carbon steel vessel for mixing of air and ammonia
Ammonia injection grid	Stainless steel construction, piping, valves and nozzles
Ammonia supply piping diameter, with valves and fittings	Piping for ammonia unloading and supply, carbon steel pipe: 1.0"
Sootblowing steam	Steam supply piping for the reactor soot-piping blowers, 2" diameter pipe with an on-off control valve and drain and vent valved connections
Air ductwork	Ductwork between air blowers, mixing chamber, and ammonia injection grid, carbon steel, 14 in. dia., with two isolation butterfly dampers and expansion joints
Flue gas ductwork	Ductwork modifications to install the SCR modifications reactors, consisting of insulated duct, static mixers, turning vanes, and expansion joints
Economizer bypass	Ductwork addition to increase flue gas temperature during low loads consisting of insulated duct, flow control dampers, static mixers, turning vanes, expansion joints, and an opening in the boiler casing
Ash handling	Extension of the existing fly ash handling modifications system: modifications consisting of twelve slide gate valves, twelve material handling valves, one segregating valve, and ash conveyor piping
Induced draft fans	Centrifugal type, 650,000 acfm at 34" wg and 4,000 hp motor
Controls and instrumentation	Stand-alone, microprocessor-based controls for the SCR system with feedback from the plant controls for the unit load, NO _x emissions, etc., including NO _x analyzers, air and ammonia flow monitoring devices, ammonia sensing and alarming devices at the tank area, and other miscellaneous instrumentation
Electrical supply	Electrical wiring, raceway, and conduit to connect the new equipment and controls to the existing plant supply systems
Electrical equipment	System service transformer OA/FA/-60 Hz, 1,000/1,250 kVA (65 °C)
Foundations	Foundations for the equipment and ductwork/piping, as required
Structural steel	Steel for access to and support of the SCR reactors and other equipment, ductwork, and piping

Facilities receive anhydrous or aqueous ammonia via a tank-truck or rail car and pump it into one or more storage tanks. Ammonia is typically stored as a liquid in horizontal cylindrical tanks. The aqueous ammonia tank is an enclosed tank rated for only slightly elevated pressure, while the anhydrous ammonia tank is a pressure vessel rated for at least 250 pounds per square inch gauge (psig). The anhydrous ammonia tank can be filled only to about 85% of its total volume to allow for a vapor space above the liquid level. The tanks are equipped with level and temperature indicators, a manway, vent, and access ladder, and other appurtenances. The applicability of heat tracing, insulation, and seismic design criteria are determined based on site-specific conditions. The tank should be mounted on a concrete pad and surrounded by a spill containment structure such as a dike.

SCR applications on large boilers generally require one to five tanks with volumes ranging from 10,000 to 20,000 gallons per tank to maintain sufficient volume for 1 to 3 weeks of SCR operations. The ammonia storage tank may be sized for 3 to 30 days of storage.

The high end of the range would be used in conservative design practice. Alternatively, if ammonia distributors are located nearby and considered reliable, the plant owner might opt for a smaller tank, sized for fewer days of ammonia storage.

Aqueous ammonia is vaporized by pumping it to a vessel where it mixes with hot air. The air from the dilution air fan is heated in an electric heater or other heat exchanger (e.g., steam). In most aqueous ammonia applications, the ammonia-air mixture leaves the vaporizer vessel at about 300 °F. The vaporization energy required for aqueous ammonia is much greater than that required for anhydrous ammonia because the water in the aqueous ammonia solution also must be vaporized.

If anhydrous ammonia is used, it is fed to the electrical vaporizer by gravity, and the vaporized gas is returned to the storage tank vapor space. Vapor is drawn from the vapor space and piped to the ammonia/air mixer. Alternatively, liquid anhydrous ammonia may be pumped to a vaporizer and piped to the ammonia/air mixer.

Ammonia (aqueous or anhydrous), diluted with air at a ratio of about 20:1 (air:NH₃), is transported to the ammonia injection grid. The high proportion of air helps ensure good mixing of air and ammonia and keeps the mixture below the flammable limit.

Ammonia Injection

For either aqueous or anhydrous ammonia, the ammonia-air mixture is directed through a flow-balancing skid to the ammonia injection grid (AIG) where it is injected under pressure. The flow-balancing skid consists of flow meters and manual valves to adjust the flow to each part of the AIG.

The AIG consists of a network of pipes or lances connected in parallel, and perforated with several holes or nozzles. The lances are placed in a grid formation across the width and height of the ductwork. The lances and holes are sized to distribute the ammonia uniformly into the flue gas. The spray angle and velocity of the injection control the trajectory of the ammonia. Injectors are subject to high-temperatures and to flue gas impingement which cause erosion, corrosion, and structural integrity degradation. Therefore, injectors are generally constructed of stainless steel and designed to be replaceable. Multiple injection zones may be utilized to increase the distribution of ammonia.

The ammonia can be injected with a low energy or high energy system. A low-energy system uses little or no pressurized air while a high-energy system uses large amounts of compressed air or steam to inject and vigorously mix the solution with the flue gas. AIG systems in large boilers typically use high-energy systems. High energy systems are more expensive to build and operate since they require a larger compressor, a more robust injection system, and consume more electric power.

Uniform distribution and mixing with flue gas is critical to maintain desired low levels of ammonia slip. Cold gas flow modeling and numerical flow modeling are generally performed for the AIG and SCR system to ensure uniform mixing and dispersion before the gases enter the SCR reactor. If duct length is inadequate to ensure thorough mixing, or results from the model study indicate poor gas mixing characteristics, devices such as turning vanes or static gas mixers may be added.

An essential part of an AIG system is the controller used to regulate ammonia injection. Boiler load, inlet NO_x , and inlet gas temperatures set the feed-forward signal to establish the base ammonia injection rate. A feedback signal measuring the SCR outlet NO_x concentration is used to trim the base ammonia injection rate.

Catalytic Reduction of NO_x

The catalytic reduction of NO_x in the SCR reactor occurs when the NO_x and ammonia in the flue gas contact the catalyst layers. The catalyst itself is the key component of the SCR system. The catalyst composition, type (honeycomb or plate), and physical properties affect performance, reliability, catalyst quantity required, and cost. However, because the SCR system supplier and catalyst supplier must guarantee catalyst life and performance, most catalyst characteristics are selected by the SCR system supplier.

2.2.5 SCR System Auxiliary Equipment

SCR Inlet and Outlet Ductwork

In retrofit installations, new ductwork is required to integrate the SCR system with the existing equipment. In high-dust SCR systems, the reactor is located between the econo-

mizer outlet, the air heater inlet. In the low-dust SCR, the SCR reactor is located between the outlet duct of the particulate control device and the the air heater inlet duct. In the tail-end SCR, the ductwork tie ins are downstream of the FGD system and also require the integration of the flue gas reheating equipment.

SCR Bypass Duct

Low load boiler operations can decrease the temperature at the SCR reactor inlet below the SCR operating range. In addition, startup and shutdown of the boiler causes drastic temperature fluctuations. For these operating conditions, an SCR bypass may be required to route the flue gas around the reactor chamber. The bypass prevents catalyst poisoning and fouling during periods when the SCR is not operating. This system must include zero-leakage dampers to protect the catalyst from flue gas leakage and deactivation during SCR shut down. A bypass system may also be considered for seasonal operation of the SCR system.

Sootblower

In coal-fired boilers, sootblowers are usually installed in the SCR reactor to remove particulates that may mask or block active catalyst surfaces and gas passages. Sootblowing helps maintain acceptable flue gas pressure drop in the SCR reactor by keeping the catalyst gas passages free of particulate. Sootblowers also keep the air heater gas passages open and thereby reduce system pressure drop. This is especially true for SCR retrofits where the air heater plate spacing is generally narrow, making it more susceptible to fouling or clogging by ammonia-sulfur salts.

Retractable rake-type sootblowers which use steam or air for blowing are utilized in SCR designs. The sootblowers are typically located above each catalyst layer. Sootblowing is usually performed on one catalyst layer or part of one catalyst layer at a time. Sootblowing of all the catalyst layers takes between 30 minutes to 2 hours, but it is usually done infrequently. In European SCR installations, sootblowing is done approximately once or twice a week [18].

Economizer Bypass Duct

Although the SCR reaction occurs within a temperature window of 600°F to 750°F (320°C to 400°C), the catalyst for a given application is designed for a somewhat narrower range, the economizer outlet temperature at normal boiler operating load. Maintaining the flue gas temperature within the required window is essential for optimizing the NO_x reduction reaction. When the economizer outlet flue gas temperature decreases because the plant is operating at reduced loads, the temperature can be raised using an economizer bypass.

The economizer bypass duct generally has a modulating damper to regulate the amount of hot bypass gas flow to be mixed with the cooler economizer outlet flue gas. The lower the boiler load, the more this damper opens, thus admitting more hot gas. The economizer outlet duct also needs a modulating damper to provide enough backpressure to allow the required volume of gas to flow through the bypass. The main design considerations for an economizer bypass involve maintaining the optimum gas temperature and ensuring uniform mixing of the two gas streams prior to entering the SCR reactor.

Upgraded or New Induced Draft (ID) Fan

The new ductwork and the SCR reactor's catalyst layers decrease the flue gas pressure. In order to maintain the same flow rate through the duct work, additional energy is required. The existing induced draft (ID) fan may be unable to provide the required increase in static pressure. In such cases, an upgraded or new ID fan is installed. The existing fan and motor foundation also may need modification. Replacement involves installation of a new fan or booster fan. In all cases, SCR systems require additional electric power for the ID fan equivalent to approximately 0.3 percent of the plant's electric output. Refer to Equation (2.49) for a more precise estimate of the additional electric power needs.

2.2.6 Other Considerations

Formation of SO_x

Sulfur trioxide (SO₃) forms during the combustion of fuels which contain sulfur. It reacts with ammonia in the flue gas downstream of the reactor (ammonia slip) to form ammonium bisulfate and ammonium sulfate. The amount formed depends on the sulfur content of the fuel and the amount of ammonia slip. Ammonium bisulfate condenses as the flue gas stream temperatures lowers. It then deposits on the SCR catalyst and downstream equipment such as the air heater, ducts, and fans. Ammonia slip limits are generally imposed as part of the SCR design requirements to avoid impacts on downstream equipment.

There are several methods for limiting the impact of ammonia-sulfur salt deposition. Soot blowers can be installed between catalyst layers to remove surface deposits by blowing air or steam across the catalyst. Increased acid washing of the air preheater and other equipment may be required to remove deposits. However, more frequent acid washing generates additional wastewater which must be disposed or treated by the plant. The sulfur content of the flue gas can be decreased by coal desulfurization processes or fuel switching. Lastly, the flue gas temperature may be raised to prevent condensation.

Elevated SO₃ concentrations raise the acid dew point of the flue gas. This phenomenon potentially leads to more corrosion on the air heater's cold-end surfaces if the flue gas temperature is below the acid dew point. To protect against this possibility, the cold-end baskets of the air heater can be replaced with enamel-coated baskets.

Ammonia sulfates also deposit on the fly ash. Ammonia content in the fly ash greater than 5 ppm can result in off-gassing which would impact the salability of the ash as a byproduct and the storage and disposal of the ash by landfill. [10] (See Chapter 1 SNCR)

Formation of Arsenic Oxide

Arsenic oxides (As_2O_3), formed during combustion of fuel containing arsenic, cause catalyst deactivation by occupying active pore sites. Coal burning boilers are particularly susceptible to arsenic poisoning. Limestone (CaCO_3) can be injected into the flue gas to generate the solid $\text{Ca}_3(\text{AsO}_4)_2$, which does not deposit on the catalyst and can be removed from the flue gas with a precipitator.

Retrofit Versus New Design

Retrofit of SCR on an existing boiler has higher capital costs than SCR installed on a new boiler system. The magnitude of the cost differential is a function of the difficulty of the retrofit. A large part of the capital costs are not impacted by retrofit including ammonia storage, vaporization, and injection equipment costs. The increase in cost is primarily due to modifications to existing ductwork, the cost of structural steel and reactor construction, auxiliary equipment costs, such as additional fans, and engineering costs. In addition, significant demolition and relocation of equipment may be required to provide space for the reactor. These costs can account for over 30% of the capital costs associated with SCR [9]. Retrofit costs for cyclone or wet bottom wall-fired boilers are somewhat higher than retrofit costs for dry bottom wall- or tangentially-fired boilers [4]. Differential retrofit cost for SCR in Germany is approximately \$200 per MMBtu/hr (20 \$/kW) [4].

Combustion Unit Design and Configuration

Boiler size is one of the primary factors that determines the SCR system capital costs. In addition, boiler configuration influences SCR costs. Boiler configurations that split the flue gas flow for two or more air preheaters and/or particulate removal systems require more than one SCR reactor. Additional reactors substantially increase capital costs. Boiler operations that have varying operating load, frequent startup/shutdowns, or seasonal operations require an SCR bypass. Additional ductwork, dampers, and control systems increase the SCR system capital costs. The SCR system may require modifications to draft fans and/or installation of additional fans. This increases both capital and operating costs of the SCR system. In addition, boiler and duct modifications may be required for implosion protection to accommodate increased draft requirements. [9]

Fuel Source

Industrial boilers use coal, distillate oil, residual oil, and natural gas. The fuel type and grade affects the SCR design and, therefore, the capital costs of the SCR system. Fuels

with high heating value have higher gas flow rates, which in turn results in an increase of the required SCR reactor size and catalyst volume. Coal-fueled applications are more costly than oil- and natural gas-fired boilers due to their higher flue gas flow rates. [9]

The quantity of nitrogen, fly ash and pollutants in the flue gas stream varies according to the type and grade of the fuel. This affects the volume of catalyst required as well as the catalyst design, composition and rate of deactivation. Coal flue gas contains a greater amount of fly ash, sulfur dioxide, sulfur trioxide, arsenic and other trace pollutants than oil and natural gas. Natural gas is the cleanest fuel and contains the least amount of nitrogen, therefore, burning natural gas results in the least amount of NO_x and pollutants in the flue gas stream. The amount of nitrogen and pollutants in oil-based fuels sources varies with the grade and type of oil, either refined or residual.

Modeling of the SCR System

Computational fluid dynamics (CFD) and chemical kinetic modeling are performed as part of the design process for SCR (See Chapter 1 SNCR). In addition to CFD and chemical kinetic modeling, three dimensional, physical flow modeling, also referred to as cold flow modeling, is generally required. Cold flow modeling ensures that the flow through the SCR reactor provides adequate residence time, achieves uniform mixing of flue gas and ammonia, minimizes linear velocities to prevent catalyst erosion, and minimizes pressure drop across the catalyst layers. It involves constructing a model of the ammonia injection system, mixing area and reactor chamber. In a high-dust configuration, this involves modeling from the economizer outlet to the inlet of the air heater. Typical model scales range from a 1:10 ratio to a 1:12 ratio for large electric utility boilers.

2.3 Design Parameters

SCR system design is a proprietary technology. Extensive details of the theory and correlations that can be used to estimate design parameters such as the required catalyst volume are not published in the technical literature [4]. Furthermore, the design is highly site-specific. In light of these complexities, SCR system design is generally undertaken by providing all of the plant- and boiler-specific data to the SCR system supplier, who specifies the required catalyst volume and other design parameters based on prior experience and computational fluid dynamics and chemical kinetic modeling. [1]

This section presents a step-by-step approach to estimate design parameters based on a procedure developed in the draft EPA report Selective Catalytic Reduction for NO_x Control on Coal-fired Boilers [1]. This procedure assumes SCR system size and cost are based on three main parameters: the boiler size or heat input, the required level of NO_x reduction, and the catalyst volume. The approach to SCR sizing described in this section is based on the catalyst volumes for a base case and several sensitivity cases developed to

support the cost estimating procedures in Reference [1]. Although this approach is based on SCR data for utility boilers, it provides sufficient accuracy and detail to develop the capital and annual cost estimates for SCR as applied to industrial boilers.

Boiler Heat Input

The primary cost estimation parameter in the methodology presented in Reference [1] is the maximum potential heat released by the boiler or heat input rate, Q_B , expressed as million British thermal units per hour (MMBtu/hr). It is obtained from the high heating value, HHV , of the fuel in Btu per pound (Btu/lb) multiplied by the maximum fuel consumption rate in pounds per hour (lb/hr), \dot{m}_{fuel} :

$$Q_B = HV \dot{m}_{fuel} \quad (2.3)$$

where Table 2.3 gives the HHV for various coals. A conversion of 10^{-6} MMBtu/Btu is required for HHV values.

Table 2.3: High Heating Values for Various Coals

T ype of Coal	Energy Content (Btu/ lb)
Lignite	5000-7500
Subbituminous	8000-10,000
Bituminous	11,000 - 15,000
Anthracite	14,000

If the boiler produces electricity, then its heat input can be estimated using the boiler net plant heat rate, in Btu per kilowatt-hr (Btu/kWh) $NPHR$:

$$Q_B = B_{MW} NPHR \quad (2.4)$$

where B_{MW} is the boiler megawatt (MW) rating at full load capacity. Note that if $NPHR$ is not known (e.g., a cogeneration unit), a value of 9,500 Btu/kWh can be used as a reasonable

estimate. Using this value, the heat input rate, Q_B , is:

$$Q_B \left(\frac{\text{MMBtu}}{\text{hr}} \right) = 9.5 \left(\frac{\text{MMBtu}}{\text{MWh}} \right) B_{MW} (\text{MW}) \quad (2.5)$$

System Capacity Factor

The total system capacity factor, CF_{total} , is a measure of the average annual use of the boiler in conjunction with the SCR system. CF_{total} is given by:

$$CF_{total} = CF_{plant} CF_{SNCR} \quad (2.6)$$

For industrial boilers, the capacity factor of the boiler, CF_{plant} , is the ratio of actual quantity of fuel burned annually to the potential maximum quantity of fuel burned annually in pounds. CF_{plant} is given by:

$$CF_{plant} = \frac{\text{actual } m_{fuel}}{\text{maximum } m_{fuel}} \quad (2.7)$$

SCR can be operated year-round or only during the specified ozone season. The capacity factor for the SCR system, CF_{SCR} , is the ratio of the actual number of SCR operating days, t_{SCR} , to the total number of days per year:

$$CF_{SCR} = \frac{t_{SCR}}{365 \text{ days}} \quad (2.8)$$

Uncontrolled NO_x and Stack NO_x

Uncontrolled NO_x, represented as NO_{xin} , is the NO_x concentration in the flue gas after any reductions provided by combustion controls, but prior to the SCR system. The uncontrolled NO_x concentration, obtained from analyzing the boiler flue gas stream, is generally given in pounds per MMBtu (lb/MMBtu) of NO₂ [1].

The stack NO_x, represented as NO_{xout} is the required NO_x emission limit at the stack outlet. It is generally set by the plant or regulatory limits and also given in pounds per MMBtu (lb/MMBtu) of NO₂ [1].

NO_x Removal Efficiency

The NO_x removal efficiency, represented as η_{NO_x} , is determined from the uncontrolled NO_x level of the boiler at maximum heat input rate, $CF_{plant} = 1.0$, and the required stack emission limit.

The equation for the NO_x removal efficiency is given by:

$$\eta_{NO_x} = \frac{NO_{x_{in}} - NO_{x_{out}}}{NO_{x_{in}}} \quad (2.9)$$

The required NO_x removal efficiency is one of the most influential parameters on the overall SCR system cost [9].

Actual Stoichiometric Ratios

The Actual Stoichiometric Ratio (*ASR*) indicates the actual amount of reagent needed to achieve the targeted NO_x reduction. Typical *ASR* values are higher than theoretical values due to the complexity of the reactions involving the catalyst and limited mixing. Higher *ASR* values generally result in increased NO_x reduction. The *ASR* is an important parameter in SCR system design because it establishes the reagent use of the SCR system. The *ASR* is defined as:

$$ASR = \frac{\text{moles of equivalent } NH_3 \text{ injected}}{\text{mole of uncontrolled } NO_x} \quad (2.10)$$

For estimating purposes, the moles of NO_x are equivalent to the moles of NO₂. Note that the moles of equivalent NH₃ in Equation 2.10 the moles of NH₃ that will be released from the reagent. When using ammonia as the reagent, the equivalent moles of NH₃ injected is equal to the moles of ammonia injected.

In a design developed by a system supplier, the *ASR* would be adjusted to account for temperature, residence time, degree of mixing, catalyst activity, and allowable ammonia slip for a specific boiler. No equation for estimating *ASR* was available for SCR. The value for *ASR* in a typical SCR system is approximately:

$$ASR = 1.05 \quad (2.11)$$

This value incorporates design margins for ammonia slip and the small amount of NO_2 in the boiler flue gas which requires two moles of NH_3 per mole of NO_2 instead of one mole of NH_3 per mole of NO as shown in Equation 2.1.

Flue Gas Flow Rate

The full-load flue gas flow rate, including the typical design margin of 5 to 15 percent, is used to size the SCR reactors and associated catalyst inventory. This flow rate should be obtained from test data or a combustion calculation.

If flow rate data are not available, an approximation of the flue gas flow rate to each of the SCR reactors can be calculated. The estimation of the volumetric flow rate in actual cubic ft. per minute (acfm) should be based on the expected operating gas temperature at the SCR inlet. The equation for the volumetric flow rate is:

$$q_{fluegas} = \frac{q_{fuel} Q_B (460 + T)}{(460 + 700^\circ F) n_{SCR}} \quad (2.12)$$

where n_{SCR} is the number of SCR reactors chambers and q_{fuel} is the fuel volumetric flow rate for the boiler in units of $ft^3/min - MMBtu/hr$ and Q_b is given in $MMBtu/lb$.

The fuel flow rate q_{fuel} is based on combustion calculations using typical fuels, typical boiler parameters (e.g., 20 % excess air), and typical SCR flue gas pressure (-10 in. w.g) [20]. Estimated values for q_{fuel} are given in Table 2.4 for various types of coal.

Table 2.4: Estimated Values of Volumetric Flow Rate for Various Coals

Coal Type	Estimate value of q_{fuel} ($ft^3/min - MMBtu/hr$)
Eastern Bituminous	484
Powder River Basin	516
Lignite	547

Note that, in general, the number of reactors, n_{SCR} , is site specific. One SCR reactor per boiler unit is typically required in high-dust system designs. However, two SCR reactors may be needed to treat flue gas from a boiler equipped with two air preheaters. The system designs developed for the base and sensitivity cases of this report use one reactor. Study-level costs of a two-reactor system are expected to be similar to the cost of a corresponding one-reactor system because the catalyst, ammonia, economizer bypass, and ID fan costs are essentially identical.

Space Velocity and Area Velocity

The space velocity is defined as the inverse of the residence time given by the equation:

$$V_{space} = \frac{1}{ResidenceTime} \quad (2.13)$$

Space velocity is calculated from the experimentally measured flue gas volumetric flow rate at the reactor inlet, represented as $q_{flue\ gas}$, and the reactor volume, represented as $Vol_{reactor}$, given by the equation:

$$V_{space} = \frac{q_{flue\ gas}}{Vol_{reactor}} \quad (2.14)$$

SCR system designers and vendors use the concept of area velocity, V_{area} , to account for the reaction being limited to active catalyst sites. The area velocity is calculated from the specific surface area of the catalyst per catalyst volume, $A_{specific}$, in the following equation:

$$V_{area} = \frac{V_{space}}{A_{specific}} \quad (2.15)$$

$A_{specific}$ is given in units of $length^2/length^3$ and must be provided by the catalyst manufacturer.

Theoretical NO_x Removal

Equation 2.9 defines the NO_x removal efficiency. However, in SCR NO_x removal efficiency changes with catalyst activation. The following theoretical equation allows for estimation of the NO_x removal efficiency, η_{NO_x} , based on the catalyst activity constant, $K_{catalyst}$, at a specified time, t [1]. The theoretical NO_x removal efficiency is:

$$\eta_{NO_x} = SR (1 - e^{-a}) \quad (2.16)$$

where

$$a = \left(\frac{-K_{catalyst} A_{specific}}{V_{space}} \right) \quad (2.16a)$$

Both $K_{catalyst}$ and $A_{specific}$ are generally provided by the catalyst manufacturer.

According to this equation, the NO_x removal efficiency increases with increasing NH_3/NO_x ratio and decreasing space velocity (i.e., increasing catalyst volume for a given gas flow rate). In addition, the equation shows that as the activity of the catalyst decreases over time, the NO_x removal also decreases.

The theoretical ammonia slip in parts per million by volume can be calculated from the value of η_{NO_x} , using the equation [14]:

$$\text{Slip} = \left(\text{ASR} - \eta_{\text{NO}_x} \right) \quad (2.17)$$

Catalyst Volume

The theoretical catalyst volume required for the SCR system is based on the factors discussed in Section 2.2 Process Description. Equation 2.17 can be rearranged to determine the theoretical catalyst volume [8]. Substituting the definition of space velocity into Equation 2.17, the volume of the catalyst is given by:

$$\text{Vol}_{\text{catalyst}} = \frac{- \left(q_{\text{fluegas}} \times \ln \left[1 - \left(\frac{\eta_{\text{NO}_x}}{\text{ASR}} \right) \right] \right)}{K_{\text{catalyst}} \times A_{\text{specific}}} \quad (2.18)$$

An empirical equation was developed in Reference [1] as a function of several sensitivity variables. The sensitivity variables were determined from catalyst volume estimates obtained from catalyst suppliers for base and sensitivity cases. Adjustment factors for these variables were then developed using regression techniques.

The empirical equation for catalyst volume is given below:

$$\text{Vol}_{\text{catalyst}} = 2.81 \times Q_B \times \eta_{\text{adj}} \times \text{Slip}_{\text{adj}} \times \text{NO}_{x,\text{adj}} \times S_{\text{adj}} \times \frac{T_{\text{adj}}}{N_{\text{SCR}}} \quad (2.19)$$

and the adjustment factors include:

- NO_x efficiency adjustment factor:

$$\eta_{\text{adj}} = 0.2869 + (1.058 \times \eta) \quad (2.20)$$

- NO_x adjustment factor for inlet NO_x :

$$NO_{x_{adj}} = 0.8524 + (0.3208 \times NO_{x_{in}}) \quad (2.21)$$

- Ammonia slip adjustment factor for ammonia slips between 2 and 5 ppm:

$$Slip_{adj} = 1.2835 - (0.0567 \times Slip) \quad (2.22)$$

- Sulfur in coal adjustment factor:

$$S_{adj} = 0.9636 + (0.0455 \times S) \quad (2.23)$$

where S is the sulfur content of the fuel by weight fraction.

- The temperature adjustment factor for gas temperatures other than 700°F:

$$T_{adj} = 15.16 - (0.03937 \times T) + (2.74 \times 10^{-5} \times T^2) \quad (2.24)$$

where T is the temperature of the flue gas at the reactor inlet in degrees Fahrenheit (°F).

SCR Reactor Dimensions

The cross sectional area of the SCR reactor is sized for the flow rate of the flue gas in acfm and the superficial velocity. A typical value for the superficial velocity is 16 feet per second (960 ft/min). Using this value for velocity the equation for the catalyst cross-sectional area is given by:

$$A_{catalyst} = \frac{q_{fluegas}}{16 \left(\frac{ft}{sec} \right) \times \left(\frac{60 sec}{min} \right)} \quad (2.25)$$

The SCR reactor cross-sectional area is approximately 15 percent greater than the catalyst cross-sectional area to account for the module geometry and hardware:

$$A_{SCR} = 1.15 \times A_{catalyst} \quad (2.26)$$

The actual dimensions of the SCR depend on the module arrangement in the catalyst layer. The typical cross-sectional dimensions of a module are 3.3 feet wide by 6.6 feet long. Therefore, the SCR plan dimensions are approximately multiples of these dimensions. Depending on the number of modules in width and in length, the SCR reactor may be square or rectangular.

For the purposes of this report, the SCR reactor can be treated as a square. The screening costs are valid for rectangular SCR reactors as long as the aspect ratio (length divided by width) is not too large. Industry standard aspect ratios are between 1.0 and 1.5. For a square reactor, the length, l , and width, w , are estimated by:

$$l = w = (A_{SCR})^{1/2} \quad (2.27)$$

An initial value for the number of catalyst layers is estimated first. This estimate is then checked by calculating the catalyst height for each layer. The initial estimate for the number of catalyst layers can be determined from the total catalyst volume, the cross sectional area of the catalyst, and estimating the height of the catalyst element. A nominal height for the catalyst, h'_{layer} , is 3.1 feet. A first estimate for the number of catalyst layers, n_{layer} , is:

$$n_{layer} = \frac{Vol_{catalyst}}{h'_{layer} \times A_{catalyst}} \quad (2.28)$$

This value of n_{layer} is then rounded to the nearest integer. In addition, there must be at least two catalyst layers.

The height of each catalyst layer is calculated using the estimated number of layers. This must result in the height of a catalyst layer, h_{layer} , to be within the standard industry range of 2.5 to 5.0 feet. The height of a catalyst layer is calculated from the following equation:

$$h_{layer} = \left[\frac{Vol_{catalyst}}{n_{layer} \times A_{catalyst}} \right] + 1 \quad (2.29)$$

where 1 foot is added to account for space required above and below the catalyst material for module assembly.

The number of catalyst layers calculated above does not include any empty catalyst layers for the future installation of catalyst. An empty catalyst layer is recommended for use with a catalyst management plan. The total number of catalyst layers includes all empty catalyst layers that will be installed:

$$n_{total} = n_{layer} + n_{empty} \quad (2.30)$$

The height of the SCR reactor, including the initial and future catalyst layers, the flow-rectifying layer, space for sootblowers and catalyst loading, but excluding the inlet and outlet ductwork and hoppers is determined from the equation:

$$h_{SCR} = n_{total} (c_1 + h_{layer}) + c_2 \quad (2.31)$$

where the constants are based on common industry practice of $c_1 = 7$ and $c_2 = 9$.

Estimating Reagent Consumption and Tank Size

The rate of reagent consumption or mass flow rate of the reagent, \dot{m} , generally expressed as pounds per hour (lb/hr), can be calculated using the inlet NO_x in lb/MMBtu and heat input rate in MMBtu/hr.

$$\dot{m}_{reagent} = \frac{NO_{x,in} Q_B NSR \eta_{NO_x} M_{reagent}}{M_{NO_x} SR_T} \quad (2.32)$$

where the $M_{reagent}$ is the molecular weight of ammonia (17.03 gram per mole) and M_{NO_x} is the molecular weight of NO₂ (46.01 gram per mole). The molecular weight of NO₂ is used because the NO_x emissions, $NO_{x,in}$, are given in lb/MMBtu of NO₂.

For ammonia, the mass flow rate of the aqueous reagent solution, is given by:

$$\dot{m}_{sol} = \frac{\dot{m}_{reagent}}{C_{sol}} \quad (2.33)$$

where C_{sol} is the percent concentration of the aqueous reagent solution by weight.

The solution volume flow rate, q_{sol} , generally expressed as gallons per hour (gph), is:

$$q_{sol} = \frac{\dot{m}_{sol}}{\rho_{sol}} v_{sol} \quad (2.34)$$

where ρ_{sol} is the density of the aqueous reagent solution in lbs per cubic foot, 56.0 lb/ft³ for a 29% solution ammonia at 60°F. The specific volume of a 29% solution ammonia at 60°F is 7.481 gal.ft³.

The total volume stored in the tank, or tanks, is based on the volume that the SCR system requires for operating a specified number of days. The volume stored on site for the number of operating days, t , is:

$$\text{Tank Volume} = q_{sol} t \quad (2.35)$$

Note that the tank volume is typically based on full-load operation, so the capacity factor is not included in Equation 2.36. A common on site storage requirement is for 14 days of SCR operation.

2.4 Cost Analysis

The cost-estimating methodology presented here provides a tool to estimate study-level costs for high-dust SCR systems. Actual selection of the most cost-effective option should be based on a detailed engineering study and cost quotations from the system suppliers. The costs presented here are expressed in 1998 dollars.

The cost estimating equations presented in this section are based on equations developed by The Cadmus Group, Bechtel Power, Inc. and SAIC in the draft EPA report, Selective Catalytic Reduction for NO_x Control on Coal-fired Boilers, [1]. These equations follow the costing methodology of Electric Power Research Institute (EPRI)[23]. In the EPRI method, both the purchased equipment cost (PEC) and direct installation cost are estimated together. This methodology is different from the EPA Air Pollution Control Cost Manual methodology, which estimates equipment costs and installation costs separately. Due to the limited availability of equipment cost data and installation cost data, the equations for SCR capital costs were not reformulated.

The capital and annual cost equations were developed for coal-fired wall and tangential utility and industrial boilers with heat input rates ranging from 250 MMBtu/hr to 6000 MMBtu/hr (25 MW to 600 MW). The SCR system design is a high-dust configuration with one SCR reactor per combustion unit. It utilizes anhydrous ammonia as the reagent with an allowed

ammonia slip in the range of 2 to 5 ppm.. The catalyst is a ceramic honeycomb with an operating life of 3 years at full load operations. The cost equations are sufficient for NO_x reduction efficiencies up to 90% . A correction factor for a new installation versus a retrofit installation is included to adjust the capital costs. [1]

The cost information presented in this report is based on using ceramic honeycomb catalyst for the base case. In general, more catalyst volume is required for an SCR system using plate catalyst, although the unit cost of plate catalyst is lower than honeycomb. Thus, any difference in capital cost is expected to be within the accuracy of a study-level cost estimate.

This report is based on the high-dust SCR system because it is the most common design. A low-dust configuration would cost somewhat less because the required catalyst volume is smaller and ash hoppers on the SCR reactor are not required. The cost methodology is valid for a low-dust SCR system because the cost reductions are expected to be within the range of uncertainty for study-level costs. The costs for the tail-end arrangement, however, cannot be estimated from this report because they are significantly higher than the high-dust SCR systems due to flue gas reheating requirements.

2.4.1 Total Capital Investment

Total Capital Investment (TCI) includes direct and indirect costs associated with purchasing and installing SCR equipment. Costs include the equipment cost (EC) for the SCR system itself, the cost of auxiliary equipment, direct and indirect installation costs, additional costs due to installation such as asbestos removal, costs for buildings and site preparation, offsite facilities, land, and working capital. In general, SCR does not require buildings, site preparation, offsite facilities, land, and working capital. A more detailed discussion of capital costs can be found in Section 1, Chapter 2 of this Manual.

Direct Capital Costs

Direct capital costs (DCC) include purchased equipment costs (PEC) such as SCR system equipment, instrumentation, sales tax and freight. This includes costs associated with field measurements, numerical modeling and system design. It also includes direct installation costs such as auxiliary equipment (e.g., ductwork, fans, compressor), foundations and supports, handling and erection, electrical, piping, insulation, painting, and asbestos removal. Table 2.2 presents a list of the equipment and installation requirements for an aqueous ammonia-based, high-dust SCR system.

The direct capital cost equation is based on data for one representative boiler and several

sensitivity cases [2]. The direct capital cost equation includes the affect of specific design parameters on the SCR cost through the use of adjustment factors. Adjustment factors are based on correlations of the sensitivity cases as functions of the catalyst volume, reactor height, and ammonia flow rate [2]. The design parameters and their affect on the capital cost equation are listed below:

- NO_x removal (catalyst volume);
- Inlet NO_x (catalyst volume);
- Ammonia slip (catalyst volume);
- Sulfur content in coal (catalyst volume);
- Flue gas temperature (catalyst volume);
- Catalyst management plan (cost of the SCR reactor);
- New plant versus retrofit (cost of the ductwork, structural steel, foundations); and
- With and without an SCR bypass, e.g., for seasonal operation (cost of ductwork)

The equation for direct capital cost (DCC) including the adjustment factors in dollars is:

$$DC = Q_B \left[\frac{\$3,380}{\left(\frac{MMBtu}{hr}\right)} + f(h_{SCR}) + f(NH_3 rate) + f(new) + f(bypass) \right] \left(\frac{3500}{Q_B} \right)^{0.35} + f(Vol_{catalyst}) \quad (2.36)$$

Note that in the capital cost equation only the catalyst volume factor is not multiplied by the boiler heat input scaling factor $(3500/Q_B)^{0.35}$. The catalyst cost in \$/ft³ is simply based on the volume of catalyst used and does not incorporate an economy of scale. The design parameter adjustment factors are given in the equations listed below.

Adjustment for the SCR reactor height:

$$f(h_{SCR}) = \left[\frac{\$6.12}{\frac{\$}{ft - MMBtu}} h_{SCR} \right] - \frac{\$187.9}{\left(\frac{MMBtu}{hr}\right)} \quad (2.37)$$

Adjustment for the ammonia flow rate:

$$f(NH_3 rate) = \left[\frac{\$411}{lb/hr} \frac{m_{reag}}{Q_B} \right] - \frac{\$47.3}{\left(\frac{MMBtu}{hr}\right)} \quad (2.38)$$

for a retrofit

$$f(new) = \frac{\$0}{\left(\frac{MMBtu}{hr}\right)} \quad (2.39)$$

for a new boiler

$$f(new) = \frac{-\$728}{\left(\frac{MMBtu}{hr}\right)} \quad (2.40)$$

Adjustment for installing an SCR bypass.
no bypass installed

$$f(bypass) = \frac{\$0}{\left(\frac{MMBtu}{hr}\right)} \quad (2.41)$$

bypass is installed

$$f(new) = \frac{\$127}{\left(\frac{MMBtu}{hr}\right)} \quad (2.42)$$

The capital cost for the initial charge of catalyst:

$$f(Vol_{catalyst}) = Vol_{catalyst} CC_{initial} \quad (2.43)$$

where $Vol_{catalyst}$ is in ft^3 and $CC_{initial}$ is the cost of the initial catalyst, currently estimated at 240 $\$/ft^3$ for a ceramic honeycomb catalyst.

Indirect Capital Costs

Indirect installation costs are those associated with installing and erecting the control system equipment but do not contribute directly to the physical capital of the installation. This generally includes general facilities and engineering costs such as construction and contractor fees, preproduction costs such as startup and testing, inventory capital and any process and project contingency costs. As explained in the Manual Section 1 Introduction, average values of indirect installation factors are applied to the direct capital cost estimate to obtain values for indirect installation costs. These costs are estimated as a percentage of the TCI. The equations for indirect installation costs are presented in Table 2.5.

Table 2.5: Capital Cost Factors for an SCR Application

Description	Data or Formula
Boiler Size (MMBtu/hr)	Q_B
NOx Removal Efficiency	η_{NOx}
Cost Year	December 1998
Total Direct Capital Costs (\$)	A (see eq. 2.37-2.44)
Indirect Installation Costs	
General Facilities (\$)	$0.05 \times A$
Engineering and Home Office Fees (\$)	$0.10 \times A$
Process Contingency (\$)	$0.05 \times A$
Total Indirect Installation Costs (\$)	$B = A \times (0.05 + 0.10 + 0.05)$
Project Contingency (\$)	$C = (A + B) \times 0.15$
Total Plant Cost (\$)	$D = A + B + C$
Allowance for Funds During Construction (\$)	$E = 0$ (Assumed for SCR)
Royalty Allowance (\$)	$F = 0$ (Assumed for SCR)
Preproduction Cost (\$)	$G = 0.02 \times (D + E)$
Inventory Capital* (\$)	$H = Vol_{reagent} \text{ (gal)} \times Cost_{reagent} \text{ (\$/gal)}$
Initial Catalyst and Chemicals (\$)	$I = 0$ (Assumed for SCR)
Total Capital Investment (TCI) (\$)	$TCI = D + E + F + G + H + I$

* Cost for ammonia stored at site, i.e., the first fill of the reagent tanks

The initial capital cost includes the cost of the initial reagent volume, where RC is the reagent cost in dollars per gallon, given by the equation:

$$Initial\ Capital\ Cost = Vol_{reagent} RC \quad (2.44)$$

2.4.1 Total Annual Costs

Total annual costs (TAC) consist of direct costs, indirect costs, and recovery credits. Direct annual costs are those proportional to the quantity of waste gas processed by the control system. Indirect (fixed) annual costs are independent of the operation of the control system and would be incurred even if it were shut down. No byproduct recovery credits are included because there are no salvageable byproducts generated from the SCR [2]. Each of these costs is discussed in the sections below. A more detailed discussion of annual costs can be found in Section 1, Chapter 2 of this Manual.

Design parameters are estimated using the maximum annual heat input rate of the boiler to ensure adequate sizing of the SCR system. Annual costs are calculated using the average heat input rate of the boiler and SCR system using CF_{total} . This ensures that annual costs are based on the actual operating conditions rather than the design case.

Direct Annual Costs

Direct annual costs (DAC) include variable and semivariable costs. Variable direct annual costs account for purchase of reagent and electrical power. Semivariable direct annual costs include operating and supervisory labor cost, maintenance cost, and catalyst replacement cost. These costs are discussed individually below. Equations for these variable cost items were derived in Reference [1].

Operating costs also result from small decreases in boiler efficiency due to operation of the economizer bypass. The economizer bypass operation depends on the flow rate of gas bypassed at full and partial loads and the boiler's capacity factor. Another operating cost is incurred for the steam or electric power used for compressed air, as required for the relatively infrequent operation of sootblowers. These operating costs are generally small and site-specific. Therefore, they are not discussed in this report.

$$DAC = \left(\begin{array}{c} \text{Annual} \\ \text{Maintenance} \\ \text{Cost} \end{array} \right) + \left(\begin{array}{c} \text{Annual} \\ \text{Reagent} \\ \text{Cost} \end{array} \right) + \left(\begin{array}{c} \text{Annual} \\ \text{Electricity} \\ \text{Cost} \end{array} \right) + \left(\begin{array}{c} \text{Annual} \\ \text{Water} \\ \text{Cost} \end{array} \right) + \left(\begin{array}{c} \text{Annual} \\ \text{Catalyst} \\ \text{Cost} \end{array} \right) \quad (2.45)$$

Operating and Supervisory Labor

The SCR reactor is a stationary device with no moving parts. Further, the SCR system incorporates only a few pieces of rotating equipment (e.g., pumps, motors, etc.). Therefore, the existing plant staff can operate the SCR from an existing control room. In general, operation of an SCR system does not require any additional operating or supervisory labor.

Maintenance

The annual maintenance labor and material cost in dollars per year (\$/yr), including nozzle tip replacement for the injectors, is assumed to be 1.5% of the Total Capital Investment (TCI) in dollars. The equation is given by:

$$\text{Annual Maintenance Cost} = 0.015 \text{ TCI} \quad (2.46)$$

Reagent Consumption

The annual cost of ammonia purchase in \$/yr is estimated using the ammonia volume flow rate, the capacity factor, and the cost of reagent in dollars per gallon, $Cost_{reag}$:

$$Annual\ Reagent\ Cost = q_{reagent} Cost_{reag} t_{op} \quad (2.47)$$

where

$$t_{ops} = CF_{plant} \frac{8760\ hr}{yr} \quad (2.47a)$$

Utilities

The electrical power consumption in kilowatts is estimated for SCR equipment, ammonia vaporization, and additional ID fan power [1]. It is based on linear regression of electrical power consumption data correlated to the uncontrolled NO_x concentration, NO_{xin} , ASR and the boiler heat input, Q_B .

$$Power = 0.105 Q_B \left[NO_{xin} \eta_{NO_x} + 0.5 \left(\Delta P_{duct} + n_{total} \Delta P_{catalyst} \right) \right] \quad (2.48)$$

The term, $(NO_{xin} \times \eta_{NO_x})$, accounts for the ammonia vaporization and dilution air blower. The terms $0.5 \times (\Delta P_{duct} + n_{total} \times \Delta P_{catalyst})$, account for the additional fan power required to overcome the additional pressure drop of the SCR and ductwork. Typical values of ΔP_{duct} range between 2 to 3 inches of water; $\Delta P_{catalyst}$ usually ranges from 0.75 to 1 inch of water per catalyst layer.

The annual cost of electricity is estimated from the equation:

$$Annual\ Electricity\ Cost = Power\ Cost_{elect} t_{op} \quad (2.49)$$

where $Cost_{elect}$ is the electricity cost in dollars per kilowatt-hour (\$/kWh).

Catalyst Replacement

The catalyst life is a function of the catalyst activity and ammonia slip. As the catalyst activity decreases with time, the ammonia slip increase until it reaches the design limit and new catalyst must be added. Catalyst life is usually specified when purchasing

the catalyst. A catalyst layer is typically guaranteed for 16,000 to 24,000 operating hours. This cost methodology assumes a guaranteed catalyst life of 24,000 hours or 3 years.

If the SCR does not have an empty catalyst layer, all of the catalyst layers must be replaced at the end of 24,000 operating hours. This very conservative assumption has been used in the SCR costs developed in the References [2] and [3]. If the SCR includes a spare catalyst layer, then only one catalyst layer is replaced at the end of 24,000 hours. Most SCR designs include a spare catalyst layer. The cost for catalyst replacement in all the SCR reactors for a given boiler, n_{SCR} , is given by:

$$Catalyst\ Replacement\ Cost = n_{SCR} Vol_{catalyst} \frac{CC_{replace}}{R_{layer}} \quad (2.50)$$

where $Vol_{catalyst}$ is in ft^3 , $CC_{replace}$ is the cost of catalyst in dollars per foot cubed ($\$/ft^3$) and R_{layer} is a factor for catalyst replacement. $R_{layer} = 1$ for full replacement and $R_{layer} = n_{layer}$ for replacing 1 layer per year.

Because the catalyst is replaced every few years, the annual catalyst cost for all reactors is a function of the future worth of the catalyst given by:

$$Annual\ Catalyst\ Replacement\ Cost = \left(\begin{array}{c} Catalyst \\ Replacement \\ Cost \end{array} \right) FWF \quad (2.51)$$

where FWF is the future worth factor. Future worth is used because the annual catalyst replacement cost is accrued starting in the first year of operation, while catalyst replacement purchases occur every few years. To account for the time value of money, the FWF amortizes the catalyst cost over the years preceding the actual catalyst purchase [21]. Because the money is allocated in advance of the purchase, the sum of the annual catalyst replacement costs is less than the purchase price of the catalyst. The future worth factor, FWF is given by:

$$FWF = i \left[\frac{1}{(1+i)^Y - 1} \right] \quad (2.52)$$

where i is the assumed interest rate and Y is the term in years.

The term, Y is given by the equation:

$$Y = \frac{h_{catalyst}}{h_{year}} \quad (2.53)$$

where $h_{catalyst}$ is the operating life of the catalyst in hours and h_{year} is the number of hours per year the SCR is operated. The value of Y estimated from the equation is then rounded to the nearest integer.

Indirect Annual Costs

In general, indirect annual costs (fixed costs) include the capital recovery cost, property taxes, insurance, administrative charges, and overhead. Capital recovery cost is based on the anticipated equipment lifetime and the annual interest rate employed. An economic lifetime of 20 years is assumed for the SCR system. The remaining life of the boiler may also be a determining factor for the system lifetime.

In many cases property taxes do not apply to capital improvements such as air pollution control equipment, therefore, for this analysis, taxes are assumed to be zero [19]. The cost of overhead for an SCR system is also considered to be zero. An SCR system is not viewed as risk-increasing hardware (e.g., a high energy device such as a boiler or a turbine). Consequently, insurance on an SCR system is on the order of a few pennies per thousand dollars annually [19]. The administrative charges, covering sales, research and development, accounting, and other home office expenses, incurred in operation of an SCR system are relatively insignificant for the cost estimation procedure presented here. Finally, there are two categories of overhead, payroll and plant. Payroll overhead includes expenses related to labor employed in operation and maintenance of hardware; whereas plant overhead accounts for items such as plant protection, control laboratories, and parking areas. Because this procedure assumes that no additional labor is needed in operation of an SCR system, payroll overhead is zero and plant overhead is considered to be negligible.

Using these assumptions, indirect annual costs in \$/yr, $IDAC$, can be expressed as:

$$IDAC = CRF TCI \quad (2.54)$$

where TCI is the total investment and CRF is the capital recovery factor and defined by:

$$CRF = \frac{i(1+i)^n}{(1+i)^n - 1} \quad (2.55)$$

where i is the interest rate, and n is the year the cost is incurred.

Total Annual Cost

The total annual cost (TAC) for owning and operating an SCR system is the sum of direct and indirect annual costs as given in the following equation:

$$Total\ Annual\ Cost = \left(\begin{array}{c} Direct \\ Annual \\ Cost \end{array} \right) + \left(\begin{array}{c} Indirect \\ Annual \\ Cost \end{array} \right) \quad (2.56)$$

The tons of NO_x removed annually are

$$NO_x\ removed = NO_{x,in} \eta_{NO_x} Q_B t_{op} \quad (2.57)$$

where NO_x is in lb/MMBtu, Q_B is in MMBtu/hr and t_{op} is in hours and a conversion of 2,000 lb/ton is required.

The cost in dollars per ton of NO_x removed per year is:

$$Cost\ Effectiveness = \frac{TAC}{NO_x\ Removed} \quad (2.58)$$

where TAC is in \$/yr and NO_x removed is tons/yr.

2.5 Example Problem

An example problem, which calculates both the design parameters and capital and annual costs, is presented below. The design basis is a retrofit SCR system being applied to a 1000 MMBtu/hr, wall-fired, industrial boiler firing subbituminous coal. The following assumptions are made to perform the calculations:

Fuel High Heating Value	10,000 Btu/lb
Maximum Fuel Consumption Rate	1.0×10^5 lb/hr
Average Annual Fuel Consumption	4.38×10^8 lb
Number of SCR operating days	155 days
Plant Capacity Factor	50%
Uncontrolled NO _x Concentration	0.86 lb/MMBtu
Required Controlled NO _x Concentration	0.13 lb/MMBtu
Acceptable Ammonia Slip	2.0 ppm
Fuel Volume Flow Rate, Eastern Bituminous	484 ft ³ /min per MMBtu/hr
Fuel Heating Value	12,696 Btu/lb
Fuel Sulfur Content	1.0% by weight
Fuel Ash Content	7.7% by weight
ASR	1.05
Stored Ammonia Concentration	29%
Number of Days of Storage for Ammonia	14 days
Pressure Drop for SCR Ductwork	3 inches w.g.
Pressure Drop for each Catalyst Layer	1 inch w.g.
Temperature at SCR Inlet	650°F

In addition to these assumptions, the estimated economic factors for the cost equations are:

Cost year	December, 1998
Equipment Life	20 years
Annual Interest Rate	7%
Catalyst Cost, Initial	240 \$/ft ³
Catalyst Cost, Replacement	290 \$/ft ³
Electrical Power Cost	0.05 \$/kWh
29% Ammonia Solution Cost	0.101 \$/lb
Operating Life of Catalyst	24,000 hours
Catalyst Layers	2 full, 1 empty

2.5.1 Design Parameter Example

Boiler Calculations

The boiler annual heat input rate, Q_B , is calculated from the High Heating Value for subbituminous coal given in Table 1.3 and the maximum fuel consumption rate, \dot{m}_{fuel} :

$$Q_B = \frac{10,000 \frac{Btu}{lb} \cdot 100,000 \frac{lb}{hr}}{10^6 \frac{Btu}{MMBtu}} = 1,000 \frac{MMBtu}{lb}$$

The plant capacity factor is calculated from the maximum and annual average fuel consumption:

$$CF_{plant} = \frac{4.38 \cdot 10^8 \text{ lb}}{1 \times 10^5 \left(\frac{lb}{hr}\right) \times 8760 \frac{hr}{yr}} = 0.5 = 50\%$$

The SCR system capacity factor is calculated from the months of SCR operation, 5 months:

$$CF_{SNCR} = \frac{155 \text{ days}}{365 \text{ days}} = 0.42 = 42\%$$

The total capacity factor including both plant and SCR capacity factors is given by:

$$CF_{total} = 0.5 \times 0.42 = 0.21 = 21\%$$

The flue gas flow rate using Equation (2.12) is:

$$q_{flue\ gas} = \frac{\frac{484 \text{ ft}^3}{\min\left(\frac{MMBtu}{hr}\right)} \times 1,000 \frac{MMBtu}{hr} \times (460 + 650^\circ F)}{(460 + 700^\circ F) \times 1} = 463,138 \text{ acfm}$$

The NO_x removal efficiency, η_{NO_x} , is calculated from the inlet NO_x concentration and the required

controlled NO_x concentration using Equation (2.16):

$$\eta_{NO_x} = \frac{0.86 \frac{lb}{MMBtu} - 0.13 MMBtu}{0.86 \frac{lb}{MMBtu}} = 0.85 = 85\%$$

SCR Reactor Calculations

The catalyst volume using Equation (2.20) and the equations for each adjustment factor is:

$$\begin{aligned} Vol_{catalyst} &= 2.81 \times 1,000 \text{ MBtu/hr} \\ &\times (0.2869 + (1.058 \times 0.85)) && (\eta_{NO_x}) \\ &\times (0.8524 + (0.3208 \times 0.86)) && (NO_{x,in}) \\ &\times (1.2835 - (0.0567 \times 2.0)) && (\text{Slip}) \\ &\times (0.9636 + (0.0455 \times 1.0)) && (\text{Sulfur}) \\ &\times (15.16 - (0.03937 \times 650) + (0.0000274 \times 650^2)) && (\text{Temperature}) \\ &= 5089 \text{ ft}^3 \end{aligned}$$

The catalyst and SCR cross-sectional areas using Equations (2.26) and (2.27) are:

$$A_{catalyst} = \frac{463,138 \text{ acfm}}{\left(16 \frac{ft}{s}\right) \left(\frac{60s}{min}\right)} = 482 \text{ ft}^2$$

$$A_{SCR} = 1.15 \times 482 \text{ ft}^2 = 554 \text{ ft}^2$$

The length and width of the reactor using Equation (2.28) is:

$$l = w = (554)^{1/2} = 23.5 \text{ ft}$$

The first estimate of the number of catalyst layers using Equation (2.29) is:

$$n_{layer} = \frac{5089}{3.1 \times 482} = 3.4$$

Rounding this value gives, $n_{layer} = 3$.

Checking the actual catalyst height using Equation (2.29):

$$h_{layer} = \frac{5089 \text{ ft}^3}{3 \times 482 \text{ ft}} + 1 = 4.5$$

This value is between the design height limits of 2.5 and 5 feet.

The total number of catalyst layers is determined by Equation (2.30) with 1 empty catalyst layer:

$$n_{total} = 3 + 1 = 4$$

The SCR height, excluding the outlet duct and hoppers using Equation (2.31) is:

$$h_{SCR} = 4 \times (7 + 4.5) + 9 = 55 \text{ ft}$$

Reagent Calculations

The mass flow rate of the reagent is calculated using the molecular weight of the reagent, 17.03 g/mole and NO_2 , 46.01g/mole. For an ASR of 1.05, the reagent mass flow rate is given by Equation (2.32):

$$\dot{m}_{reagent} = \frac{0.86 \frac{lb}{MMBtu} \times 1,000 \frac{MMBtu}{hr} \times 1.05 \times 17.03 \frac{g}{mole}}{46.01 \frac{g}{mole}} = 334 \frac{lb}{hr}$$

The mass flow rate of 29% aqueous ammonia solution is given by Equation (2.33):

$$\dot{m}_{sol} = \frac{334 \frac{lb}{hr}}{0.29} = 1,152 \frac{lb}{hr}$$

The solution volume flow rate can then be calculated from Equation (2.34) where ρ is the density of the 29% aqueous ammonia solution, 56.0 lb/ft³ at 60°F and the specific volume of the solution is 7.481 gal/ft³.

$$q_{sol} = \frac{1,152 \frac{lb}{hr} \times 7.481 \frac{gal}{ft^3}}{56.0 \frac{lb}{ft^3}} = 154 \text{ gph}$$

The total volume stored in the tank, or tanks, is based on the volume that the SCR system requires for 14 days of operation. The on site storage requirement is given by Equation (2.35):

$$\text{Tank Volume} = 154 \text{ gph} \times 14 \text{ (days)} \times \left(\frac{24 \text{ hr}}{\text{day}} \right) = 51,744 \text{ gal}$$

The on site storage requirement for ammonia is 51,744 gallons per 14 days of operation.

2.5.2 Cost Estimation Example

Once the SCR system is sized, the capital and annual costs for the SCR system can be estimated. The DCC are estimated using the Equation (2.36):

$$DC = 1,000 \frac{\text{MMBtu}}{\text{hr}} \times \left[3,380 + f(h_{SCR}) + f(NH_3) + f(\text{new}) + f(\text{bypass}) \right] \\ \times \left(\frac{3,500 \text{ MMBtu/hr}}{1,000 \text{ MMBtu/hr}} \right)^{0.35} + (\text{Vol}_{\text{catalyst}})$$

where the functions in units of dollars per MMBtu/hr are given by:

$$f(h_{SCR}) = [(6.12 \times 55) - 187.9] = \frac{\$ 149}{\text{MMBtu/hr}}$$

$$f(NH_3) = \left[\frac{334 \frac{\text{lb}}{\text{hr}}}{1000 \frac{\text{MMBtu}}{\text{hr}}} \times \frac{\$411}{\text{lb/hr}} \right] - \frac{\$47.3}{\text{MMBtu/hr}} = 90 \frac{\$}{\text{MMBtu/hr}}$$

$$f(\text{new}) = 0, \text{ for retrofit}$$

$$f(\text{bypass}) = 0, \text{ for no bypass}$$

The function $\text{Vol}_{\text{catalyst}}$ is the initial cost of the catalyst given by Equation (2.43):

$$f(\text{Vol}_{\text{catalyst}}) = 5089 \text{ ft}^3 \times \frac{\$ 240}{\text{ft}^3} = \$1,221,360$$

Substituting the value obtained for the factors gives:

$$DC = 1,000 \frac{MMBtu}{hr} \times [3,380 + 149 + 90 + 0 + 0] \frac{\$}{MMBtu} \times \left(\frac{3,500}{1,000} \right)^{0.35} + \$1,221,360 = \$6,832,000$$

Indirect capital costs are estimated from the direct capital costs using the following equations in Table 2.5:

Table 2.5: Indirect Capital Cost Estimations

Indirect Installation Costs	
General Facilities (\$)	$\$6,832,000 \times 0.05 = \$341,600$
Engineering and Home Office Fees (\$)	$\$6,832,000 \times 0.10 = \$683,200$
Process Contingency (\$)	$\$6,832,000 \times 0.05 = \$341,600$
Total Indirect Installation Costs (\$)	$\$341,600 + \$683,200 + \$341,600 = \$1,366,400$
Project Contingency (\$)	$(\$6,832,000 + 1,366,400) \times 0.15 = \$1,229,760$
Total Plant Cost (\$)	$\$6,832,000 + \$1,366,400 + \$1,229,760 = \$9,428,160$
Preproduction Cost (\$)	$\$9,428,160 \times 0.02 = \$188,562$
Inventory Capital (\$)	$\$0.101/\text{lb} \times 1,152 \text{ lb/hr} \times 24\text{hr/day} \times 14 \text{ days} = \$39,094$
Total Capital Investment (T CI) (\$)	$\$9,428,160 + \$188,562 + \$39,094 = \$9,655,816$

Annual costs are based on the economic factors listed above. In addition, the SCR system is assumed to operate for 5 months of the year with a boiler loading of 50%, resulting in a total capacity factor of 27%. The annual variable costs are given by:

$$\text{Maintenance Cost} = \frac{0.015}{\text{yr}} \times 9,601,261 = \frac{\$ 144,019}{\text{yr}}$$

An estimate for power consumption is given by:

$$Power = \frac{1000 \text{ MMBtu/hr}}{9.5 \frac{\text{MMBtu/hr}}{\text{kW}}} [(0.86 \times 0.85) + 0.5 (3 + 4 \times 1)] = 445 \text{ kW}$$

Electricity and reagent solution cost can then be estimated from Equation (2.49) and (2.47):

$$Electricity \text{ Cost} = 445 \text{ kW} \times \frac{8,760 \text{ hr}}{\text{yr}} \times 0.27 \times \frac{0.05 \text{ \$}}{\text{kWh}} = \frac{\$ 52,626}{\text{yr}}$$

$$Reagent \text{ Solution Cost} = 1152 \frac{\text{lb}}{\text{hr}} \times 8,760 \frac{\text{hr}}{\text{yr}} \times 0.27 \times 0.101 \frac{\text{\$}}{\text{lb}} = \frac{\$ 275,196}{\text{yr}}$$

The catalyst is replaced every few years, the annual catalyst cost for all reactors is a function of the future worth of the catalyst given by:

$$FWF = 0.07 \times \frac{1}{(1 + 0.07)^6 - 1} = 0.14$$

It is assumed that 1 layer of catalyst is replaced per year, therefore, $R_{\text{layer}} = 3$. The operating life of the catalyst is given as 24,000 hours and the estimated SCR operation hours per year is 3,720 hours which gives the value of Y in Equation (2.53) as:

$$Y = \frac{24000 \text{ hours}}{3720 \text{ hours}} = 6.4 = 6$$

The cost of the catalyst replacement, for one layer replaced per year, is given by Equation (2.50) and (2.51):

$$Annual \text{ Catalyst Replace Cost} = 0.14 \times \left[1 \times 5089 \text{ ft}^3 \times \frac{290 \frac{\text{\$}}{\text{ft}^3}}{3} \right] = \frac{\$68,871}{\text{yr}}$$

The total variable direct annual cost, the sum of the cost of the reagent, electricity, and catalyst replacement, is given by Equation (2.45):

$$\textit{Total Variable Direct Cost} = \frac{\$52,626}{\textit{yr}} + \frac{\$275,196}{\textit{yr}} + \frac{\$68,871}{\textit{yr}} = \frac{\$396,693}{\textit{yr}}$$

and the total direct annual cost is given by the sum of the maintenance and variable cost:

$$\textit{Total Direct Annual Cost} = \frac{\$144,837}{\textit{yr}} + \frac{\$396,693}{\textit{yr}} = \frac{\$541,530}{\textit{yr}}$$

In estimating total indirect annual costs, it is assumed that the property tax factor, F_{tax} , and the overhead factor, F_{ovhd} , are both zero. The capital recovery factor, CRF , is defined by:

$$CRF = \frac{0.07(1 + 0.07)^{20}}{(1 + 0.07)^{20} - 1} = 0.0944$$

and the indirect annual costs (IDAC) are calculated from Equation (2.55) and the TCI:

$$\textit{Indirect Annual Cost} = \frac{0.0944}{\textit{yr}} \times \$9,655,816 = \frac{\$911,412}{\textit{yr}}$$

The total annual cost is the sum of the direct annual and indirect annual costs given by Equation (2.56)

$$\textit{Total Annual Cost} = \frac{\$ 541,530}{\textit{yr}} + \frac{\$ 911,412}{\textit{yr}} = \frac{\$ 1,452,942}{\textit{yr}}$$

The annual cost in terms of NO_x removed can be calculated using the total annual cost and the tons of NO_x removed annually by Equation (2.58):

$$NO_x \text{ removed} = \frac{\frac{0.86 \text{ lb}}{MMBtu / hr} \times 0.85 \times 1,000 \frac{MMBtu}{hr} \times 0.27 \times 8,760 \frac{hr}{yr}}{2,000 \frac{lb}{ton}} = 864 \text{ tons}$$

and Equation (2.59)

$$Cost \text{ of } NO_x \text{ Removal} = \frac{\$ 1,452,492}{864 \text{ tons}} = \frac{\$1,682}{tons}$$

References

- [1] Selective Catalytic Reduction for NO_x Control on Coal-fired Boilers, Draft Report, prepared for the U.S. Environmental Protection Agency by The Cadmus Group, Inc., Bechtel Power Corporation, and Science Applications International Corporation. May 1998.
- [2] Investigation of Performance and Cost of NO_x Controls as Applied to Group 2 Boilers. Revised Draft Report, prepared for the U.S. Environmental Protection Agency by The Cadmus Group, Inc., Bechtel Power Corporation, and Science Applications International Corporation. August 1996.
- [3] Cost Estimates for Selected Applications of NO_x Control Technologies on Stationary Combustion Boilers, Draft Report and Responses to Comments on the Draft Report. prepared for the U.S. Environmental Protection Agency by The Cadmus Group, Inc., and Bechtel Power Corporation. June 1997.
- [4] Institute of Clean Air Companies (ICAC). Selective Catalytic Reduction (SCR) Control of NO_x Emissions, Prepared by the ICAC SCR Committee, November 1997.
- [5] U.S. EPA. Analyzing Electric Power Generation Under the CAAA. EPA Office of Air and Radiation, March 1998.
- [6] Rummenhohl, V., H. Weiler, and W. Ellison. Experience Sheds Light on SCR O&M Issues. Power Magazine, September 1992.
- [7] Pritchard, S., C. DiFrancesco, and T.R. von Alten. SCR Catalyst Performance Under Severe Operating Conditions. Presented at Power-Gen International '96 Conference and Exhibition, ASME, Orlando, FL. December 1996.
- [8] Harmgart, S., M. Meierer, and J. Fahlke. In-Service Assessment of DeNO_x Catalysts. Presented at the International Joint Power Generation Conference and Exposition '98, ASME, Baltimore, MD, 1998.
- [9] Cochran, J.R., M.G. Gregory, and V. Rummenhohl. The Effect of Various Parameters on SCR System Cost. Presented at Power-Gen '93, the Fourth International Power Generation Exhibition & Conference, ASME, Dallas, Texas, November 1993.
- [10] Electric Power research Institute. Technical Feasibility and Cost of Selective Catalytic Reduction (SCR) NO_x Control. EPRI GS-7266, Final Report, May 1991.

- [11] Rosenberg, H.S. and J. H. Oxley. Selective Catalytic Reduction for NO_x Control at Coal-fired Power Plants. ICAC Forum '93, Controlling Air Toxics and NO_x Emissions, Baltimore, MD, February 24-26, 1993.
- [12] Singer, J.G. (ed.) Combustion Fossil Power Systems. Third edition, Combustion Engineering, Inc., Windsor, CT, 1981.
- [13] Sigling, R. and R. Johnson. Current Practices for Monitoring Ammonia Slip from SCR Processes. Presented at the 1998 Conference on Selective Catalytic and Non-catalytic Reduction for NO_x Control, U.S. Department of Energy, Federal Energy Technology Center, Pittsburgh, PA, May 21-22, 1998.
- [14] Cho, S.M. and S. Z. Dubow. Design of a Selective Catalytic Reduction System for NO_x Abatement in a Coal-Fired Cogeneration Plant. Proceedings of the American Power Conference, Chicago, IL, pp. 717-722, April 1992.
- [15] ANSI K-61.1-1989. Safety Requirements for the Storage and Handling of Anhydrous Ammonia. Compressed Gas Association, Arlington, VA, March 1989.
- [16] Tanner Industries, Inc. Storage & Handling of Anhydrous Ammonia. Philadelphia, PA, Revision 5/96.
- [17] Tanner Industries, Inc. Storage & Handling of Ammonium Hydroxide. Philadelphia, PA, Revision 10/95.
- [18] Broske, D., G. Offen, and E. Cichanowicz. An Assessment of European Experience with Selective Catalytic Reduction for NO_x Control. Presented at the "NO_x Controls for Utility Boilers Workshop," Baltimore, MD, August 1998, ("Proceedings: 1998 NO_x Control Workshop," EPRI report number TR-1113561998.).
- [19] Staudt, J.E. Status Report on NO_x Control Technologies and Cost Effectiveness for Utility Boilers. Published by Northeast States for Coordinated Air Use Management (NESCAUM) and Mid-Atlantic Regional Air Management Association (MARAMA), June 1998.
- [20] S.C. Stultz and J. B. Kitto, eds. Steam, Its Generation and Use. 40th edition, Babcock & Wilcox, Inc., Barberton, Ohio, 1992.
- [21] Green, D.W. and R.H. Perry, eds. Perry's Chemical Engineers' Handbook. 6th edition, McGraw Hill, Inc., 1984.
- [22] Tonn, D.P. and T. A. Uysal. 2200 MW SCR Installation on New Coal-Fired

- Project. Presented at the Institute of Clean Air Companies ICAC Forum '98, Durham, North Carolina, March 18-20, 1998.
- [23] Electric Power Research Institute. Technical Assessment Guide. Vol. 1, Revision 7, 1993.
- [24] Babb, Bob, Ed Angelini and Scot Pritchard. Implementation of SCR System at TVA Paradise Unit 2, Presented at the Institute of Clean Air Companies ICAC Forum 2000, Washington D.C., March 23-24, 2000.
- [25] Stenger, H. G., et al, Low Temperature Selective Catalytic Reduction of NO, Presented at the Institute of Clean Air Companies ICAC Forum 2000, Washington D.C., March 23-24, 2000.

TECHNICAL REPORT DATA

(Please read Instructions on reverse before completing)

1. REPORT NO. 452/B-02-001	2.	3. RECIPIENT'S ACCESSION NO.
4. TITLE AND SUBTITLE The EPA Air Pollution Control Cost Manual	5. REPORT DATE January, 2002	
	6. PERFORMING ORGANIZATION CODE	
7. AUTHOR(S) Daniel Charles Mussatti	8. PERFORMING ORGANIZATION REPORT NO.	
9. PERFORMING ORGANIZATION NAME AND ADDRESS U.S. Environmental Protection Agency Office of Air Quality Planning and Standards Air Quality Standards and Strategies Division Innovative Strategies and Economics Group Research Triangle Park, NC 27711	10. PROGRAM ELEMENT NO.	
	11. CONTRACT/GRANT NO.	
12. SPONSORING AGENCY NAME AND ADDRESS Director Office of Air Quality Planning and Standards Office of Air and Radiation U.S. Environmental Protection Agency Research Triangle Park, NC 27711	13. TYPE OF REPORT AND PERIOD COVERED Final	
	14. SPONSORING AGENCY CODE EPA/200/04	
15. SUPPLEMENTARY NOTES Updates and revises EPA 453/b-96-001, OAQPS Control Cost Manual, fifth edition (in English only)		
16. ABSTRACT In Spanish, this document provides a detailed methodology for the proper sizing and costing of numerous air pollution control devices for planning and permitting purposes. Includes costing for volatile organic compounds (VOCs); particulate matter (PM); oxides of nitrogen (NOx); SO₂, SO₃, and other acid gasses; and hazardous air pollutants (HAPs).		
17. KEY WORDS AND DOCUMENT ANALYSIS		
a. DESCRIPTORS	b. IDENTIFIERS/OPEN ENDED TERMS	c. COSATI Field/Group
Economics Cost Engineering cost Sizing Estimation Design	Air Pollution control Incinerators Absorbers Adsorbers Filters Condensers Electrostatic Precipitators Scrubbers	
18. DISTRIBUTION STATEMENT Release Unlimited	19. SECURITY CLASS (<i>Report</i>) Unclassified	21. NO. OF PAGES 1,400
	20. SECURITY CLASS (<i>Page</i>) Unclassified	22. PRICE