

Int. Cls.: 9, 16 and 25

**Prior U.S. Cls.: 2, 5, 21, 22, 23, 26, 29, 36, 37, 38, 39
and 50**

Reg. No. 3,482,736

United States Patent and Trademark Office

Registered Aug. 12, 2008

**TRADEMARK
PRINCIPAL REGISTER**



NEW LIFE CINEMA, LLC (FLORIDA LTD LIAB
CO)
6109 OXBOW BEND LANE
PORT ORANGE, FL 32128

FOR: PRERECORDED VIDEOTAPES FEATUR-
ING PROGRAMS FOR CHILDREN; AND CD-ROM
COMPUTER GAMES, IN CLASS 9 (U.S. CLS. 21, 23,
26, 36 AND 38).

FIRST USE 1-15-1997; IN COMMERCE 1-15-1997.

FOR: SERIES OF CHILDREN'S BOOKS AND
COLORING BOOKS, IN CLASS 16 (U.S. CLS. 2, 5,
22, 23, 29, 37, 38 AND 50).

FIRST USE 2-25-1997; IN COMMERCE 2-25-1997.

FOR: CLOTHING, NAMELY, SHIRTS, SHORTS,
PANTS, JACKETS, CHILDREN'S SLEEPWEAR,
PLAYWEAR AND OVERALLS, IN CLASS 25 (U.S.
CLS. 22 AND 39).

FIRST USE 2-25-1997; IN COMMERCE 2-25-1997.

SER. NO. 75-254,207, FILED 3-10-1997.

JOHN E. MICHOS, EXAMINING ATTORNEY

Int. Cl.: 25

Prior U.S. Cls.: 22 and 39

United States Patent and Trademark Office

Reg. No. 3,482,737

Registered Aug. 12, 2008

**TRADEMARK
PRINCIPAL REGISTER**

SOS SPRING SAFARI

SOCIETY OF STRANDERS, INC. (SOUTH CAROLINA CORPORATION)
P.O. BOX 4688
COLUMBIA, SC 29204

FOR: CLOTHING, NAMELY, SHIRTS, T-SHIRTS, SWEATSHIRTS, GOLF SHIRTS, SHORTS, WIND RESISTANT JACKETS, SWEATERS, VESTS, SOCKS, CAPS, AND VISORS, IN CLASS 25 (U.S. CLS. 22 AND 39).

FIRST USE 1-0-1988; IN COMMERCE 1-0-1988.

NO CLAIM IS MADE TO THE EXCLUSIVE RIGHT TO USE "SPRING", APART FROM THE MARK AS SHOWN.

SER. NO. 75-698,873, FILED 5-6-1999.

REBECCA EISINGER, EXAMINING ATTORNEY

Int. Cl.: 36

Prior U.S. Cls.: 100, 101 and 102

United States Patent and Trademark Office

Reg. No. 3,482,738

Registered Aug. 12, 2008

**SERVICE MARK
PRINCIPAL REGISTER**

DUNDEE GLOBAL VALUE INVESTING

DUNDEE CORPORATION (CANADA CORPORATION)
1 ADELAIDE STREET EAST, 28TH FLOOR
TORONTO, ONTARIO, CANADA M5C 2V9

FOR: MANAGING MUTUAL FUNDS, IN CLASS
36 (U.S. CLS. 100, 101 AND 102).

PRIORITY CLAIMED UNDER SEC. 44(D) ON
CANADA APPLICATION NO. 1017248, FILED 5-31-

1999, REG. NO. TMA660096, DATED 3-3-2006, EX-
PIRES 3-3-2021.

NO CLAIM IS MADE TO THE EXCLUSIVE
RIGHT TO USE "GLOBAL VALUE INVESTING",
APART FROM THE MARK AS SHOWN.

SER. NO. 75-732,512, FILED 6-21-1999.

SHARON MEIER, EXAMINING ATTORNEY

Int. Cl.: 41

Prior U.S. Cls.: 100, 101 and 107

United States Patent and Trademark Office

Reg. No. 3,482,739

Registered Aug. 12, 2008

**SERVICE MARK
PRINCIPAL REGISTER**



XTRAVAGANZA

EXTRAVAGANCE MUSIC MANAGEMENT LTD
(UNITED KINGDOM LIMITED COMPANY
INCORPORATED)

SUITE 3D 36-37 WARPLE WAY
LONDON W3 0RG, ENGLAND

FOR: ENTERTAINMENT DISC JOCKEY SERVI-
CES; THEATRICAL AND MUSICAL FLOORSHOWS
PROVIDED IN NIGHTCLUBS AND DISCOTHE-
QUES; NIGHTCLUBS AND DISCOTHEQUES, IN
CLASS 41 (U.S. CLS. 100, 101 AND 107).

PRIORITY CLAIMED UNDER SEC. 44(D) ON
ERPNTY CMNTY TM OFC APPLICATION NO.

001757178, FILED 7-4-2000, REG. NO. 001757178,
DATED 8-2-2002, EXPIRES 7-4-2010.

PRIORITY CLAIMED UNDER SEC. 44(D) ON
JAPAN APPLICATION NO. 2000-58963, FILED 5-30-
2000.

THE LINING IN THE MARK IS A FEATURE OF
THE MARK AND NOT INTENDED TO INDICATE
COLOR.

SER. NO. 76-174,772, FILED 11-29-2000.

MARY BOAGNI, EXAMINING ATTORNEY

Int. Cl.: 5

Prior U.S. Cls.: 6, 18, 44, 46, 51 and 52

United States Patent and Trademark Office

Reg. No. 3,482,740

Registered Aug. 12, 2008

**TRADEMARK
PRINCIPAL REGISTER**

FLEXSOLUTIONS

NUTRASTAR INCORPORATED (CALIFORNIA
CORPORATION)
1261 HAWK'S FLIGHT COURT
EL DORADO HILLS, CA 95762

FIRST USE 11-16-2000; IN COMMERCE 11-16-2000.

SER. NO. 76-199,750, FILED 1-24-2001.

FOR: NUTRITIONAL SUPPLEMENTS, IN CLASS
5 (U.S. CLS. 6, 18, 44, 46, 51 AND 52).

CURTIS FRENCH, EXAMINING ATTORNEY

Int. Cls.: 35 and 36

Prior U.S. Cls.: 100, 101 and 102

United States Patent and Trademark Office

Reg. No. 3,482,741

Registered Aug. 12, 2008

**SERVICE MARK
PRINCIPAL REGISTER**



CFS FINANCIAL SERVICES, INC. (GEORGIA CORPORATION)
2785 LAWRENCEVILLE HIGHWAY
SUITE 207
DECATUR, GA 30033

FOR: CAR BUYING SERVICES, NAMELY, LOCATING, NEGOTIATING AND PURCHASING AUTOMOBILES FOR OTHERS, IN CLASS 35 (U.S. CLS. 100, 101 AND 102).

FIRST USE 1-0-1998; IN COMMERCE 1-0-1998.

FOR: UNDERWRITING EXTENDED MOTOR VEHICLE WARRANTY CONTRACTS, IN CLASS 36 (U.S. CLS. 100, 101 AND 102).

FIRST USE 1-0-1998; IN COMMERCE 1-0-1998.

NO CLAIM IS MADE TO THE EXCLUSIVE RIGHT TO USE "CAR", APART FROM THE MARK AS SHOWN.

SER. NO. 76-260,375, FILED 5-22-2001.

HOWARD B. LEVINE, EXAMINING ATTORNEY

Int. Cl.: 35

Prior U.S. Cls.: 100, 101 and 102

United States Patent and Trademark Office

Reg. No. 3,482,742

Registered Aug. 12, 2008

**SERVICE MARK
PRINCIPAL REGISTER**

THE OBSERVER

GUARDIAN NEWS & MEDIA LIMITED (UNITED
KINGDOM COMPANY)
119 FARRINGDON ROAD
LONDON, UNITED KINGDOM EC1R 3ER

FOR: BRINGING TOGETHER, FOR THE BENEFIT OF OTHERS, OF A VARIETY OF GOODS AND SERVICES ENABLING CUSTOMERS TO CONVENIENTLY VIEW AND PURCHASE THOSE GOODS AND/OR ORDER SUCH SERVICES; THE BRINGING TOGETHER, FOR THE BENEFIT OF OTHERS, OF A VARIETY OF GOODS AND SERVICES, THROUGH A GENERAL MERCHANDISE INTERNET WEB SITE, A GENERAL MERCHANDISE CATALOGUE, NEWSPAPER, MAGAZINE OR BROCHURE BY MAIL ORDER AND/OR A TELEVISION SHOPPING CHANNEL, ENABLING CUSTOMERS

TO CONVENIENTLY VIEW AND PURCHASE THOSE GOODS OR ORDER SUCH SERVICES, BY MEANS OF TELECOMMUNICATIONS, INCLUDING ORDERING SUCH GOODS/SERVICES BY AN INTERNET-ENABLED PHONE, IN CLASS 35 (U.S. CLS. 100, 101 AND 102).

PRIORITY CLAIMED UNDER SEC. 44(D) ON UNITED KINGDOM APPLICATION NO. 2257266, FILED 1-5-2001, REG. NO. 2257266, DATED 12-15-2006, EXPIRES 1-5-2011.

SER. NO. 76-280,641, FILED 7-5-2001.

MELVIN AXILBUND, EXAMINING ATTORNEY

Int. Cl.: 36

Prior U.S. Cls.: 100, 101 and 102

United States Patent and Trademark Office

Reg. No. 3,482,743

Registered Aug. 12, 2008

**SERVICE MARK
PRINCIPAL REGISTER**



PAYMENT SOLUTIONS (CALIFORNIA CORPORATION)
P.O. BOX 232220
SAN DIEGO, CA 921932220

FOR: CREDIT AND DEBIT CARD SERVICES; CHECK PROCESSING AND PAYMENT GUARANTEE SERVICES TO MERCHANTS; AND COLLECTION AGENCY SERVICES, IN CLASS 36 (U.S. CLS. 100, 101 AND 102).

FIRST USE 4-1-1995; IN COMMERCE 7-21-1995.

OWNER OF U.S. REG. NOS. 2,056,416 AND 2,117,091.

THE COLOR(S) GREEN AND WHITE IS/ARE CLAIMED AS A FEATURE OF THE MARK.

THE MARK CONSISTS OF THE COLOR GREEN APPEARS IN THE WORD "PAYMENT". THE WORD "SOLUTIONS" APPEARS IN WHITE REVERSED AGAINST A SOLID GREEN RECTANGULAR BACKGROUND..

SEC. 2(F).

SER. NO. 76-395,401, FILED 4-15-2002.

GEORGE LORENZO, EXAMINING ATTORNEY

Int. Cl.: 25

Prior U.S. Cls.: 22 and 39

United States Patent and Trademark Office

Reg. No. 3,482,744

Registered Aug. 12, 2008

**TRADEMARK
PRINCIPAL REGISTER**

OCEANIA

NOVUS, INC. (PUERTO RICO CORPORATION)
PARQUE INDUSTRIAL LOS NINOS 655 CUBITAS-
STREET
GUAYNABO, PUERTO RICO 00969

FIRST USE 5-0-2002; IN COMMERCE 5-0-2002.

SER. NO. 76-415,326, FILED 6-7-2002.

FOR: FOOTWEAR, AND CLOTHING, NAMELY,
BELTS, IN CLASS 25 (U.S. CLS. 22 AND 39).

GENE MACIOL, EXAMINING ATTORNEY

Int. Cls.: 35 and 42

Prior U.S. Cls.: 100, 101 and 102

United States Patent and Trademark Office

Reg. No. 3,482,745

Registered Aug. 12, 2008

**SERVICE MARK
PRINCIPAL REGISTER**

NET PAY PRO

RUSSOLI, HUMBERT A. (UNITED STATES IN-
DIVIDUAL)
3015 FAIRMONT STREET
ALLENTOWN, PA 18104

FOR: PAYROLL PREPARATION SERVICES FOR
OTHERS, NAMELY, PAYROLL PROCESSING AND
INVOICING SERVICES, IN CLASS 35 (U.S. CLS. 100,
101 AND 102).

FIRST USE 1-0-2001; IN COMMERCE 1-0-2001.

FOR: PROVIDING TEMPORARY USE OF ON-
LINE NON-DOWNLOADABLE SOFTWARE FOR

USE IN PAYROLL PROCESSING AND INVOICING,
IN CLASS 42 (U.S. CLS. 100 AND 101).

FIRST USE 1-0-2001; IN COMMERCE 1-0-2001.

NO CLAIM IS MADE TO THE EXCLUSIVE
RIGHT TO USE "NET PAY", APART FROM THE
MARK AS SHOWN.

SER. NO. 76-436,603, FILED 8-1-2002.

CURTIS FRENCH, EXAMINING ATTORNEY

Int. Cl.: 41

Prior U.S. Cls.: 100, 101 and 107

United States Patent and Trademark Office

Reg. No. 3,482,746

Registered Aug. 12, 2008

**SERVICE MARK
PRINCIPAL REGISTER**

GOTHAM GAZETTE

CITIZENS UNION FOUNDATION (NEW YORK
CORPORATION)
198 BROADWAY, 7TH FLOOR
NEW YORK, NY 10038

FOR: COMPUTER SERVICES, NAMELY, PRO-
VIDING AN ON-LINE NEWSPAPER FEATURING
GENERAL INTEREST NEWS, VIA GLOBAL COM-
PUTER NETWORK, IN CLASS 41 (U.S. CLS. 100, 101
AND 107).

FIRST USE 9-0-1999; IN COMMERCE 9-0-1999.

NO CLAIM IS MADE TO THE EXCLUSIVE
RIGHT TO USE "GAZETTE", APART FROM THE
MARK AS SHOWN.

SER. NO. 76-493,538, FILED 2-28-2003.

TEJBIR SINGH, EXAMINING ATTORNEY

Int. Cl.: 36

Prior U.S. Cls.: 100, 101 and 102

United States Patent and Trademark Office

Reg. No. 3,482,747

Registered Aug. 12, 2008

**SERVICE MARK
PRINCIPAL REGISTER**

VISTA INCOME PROVIDER

PHYSICIANS LIFE INSURANCE COMPANY (NE-
BRASKA CORPORATION)
2600 DODGE STREET
OMAHA, NE 681312671

NO CLAIM IS MADE TO THE EXCLUSIVE
RIGHT TO USE "INCOME PROVIDER", APART
FROM THE MARK AS SHOWN.

FOR: ANNUITY UNDERWRITING SERVICES, IN
CLASS 36 (U.S. CLS. 100, 101 AND 102).

SER. NO. 76-505,443, FILED 4-10-2003.

FIRST USE 1-1-2003; IN COMMERCE 1-1-2003.

CURTIS FRENCH, EXAMINING ATTORNEY

Int. Cl.: 26

Prior U.S. Cls.: 37, 39, 40, 42 and 50

United States Patent and Trademark Office

Reg. No. 3,482,748

Registered Aug. 12, 2008

**TRADEMARK
PRINCIPAL REGISTER**

TOE BOWS BY MAGGIE

LATIMER, MAGGIE L. (UNITED STATES INDIVIDUAL)
20 STURBRIDGE LANE
PITTSFORD, NY 14534

NO CLAIM IS MADE TO THE EXCLUSIVE RIGHT TO USE "TOE BOWS", APART FROM THE MARK AS SHOWN.

FOR: ACCESSORIES FOR THE FEET, NAMELY, ACCESSORIES FOR THE FEET MADE OF ARTIFICIAL FLOWERS, IN CLASS 26 (U.S. CLS. 37, 39, 40, 42 AND 50).

SER. NO. 76-509,859, FILED 4-28-2003.

FIRST USE 11-0-2002; IN COMMERCE 3-0-2003.

GEORGIA CARTY, EXAMINING ATTORNEY

Int. Cls.: 3, 21 and 26

**Prior U.S. Cls.: 1, 2, 4, 6, 13, 23, 29, 30, 33, 37, 39, 40,
42, 50, 51 and 52**

Reg. No. 3,482,749

United States Patent and Trademark Office

Registered Aug. 12, 2008

**TRADEMARK
PRINCIPAL REGISTER**

CARIBANA

HARGELL LIMITED (CANADA CORPORATION)
50 DON RIVER BLVD.
TORONTO, ONTARIO, CANADA M2N 2M9

FOR: HAIR LOTIONS, HAIR CONDITIONER,
SHAMPOO, SKIN CONDITIONERS, IN CLASS 3
(U.S. CLS. 1, 4, 6, 50, 51 AND 52).

FOR: HAIR BRUSHES AND COMBS, IN CLASS 21
(U.S. CLS. 2, 13, 23, 29, 30, 33, 40 AND 50).

FOR: HAIR ACCESSORIES, NAMELY, BEADS,
BARRETTES, RUBBER BANDS, BRAIDS, WEAVES,
IN CLASS 26 (U.S. CLS. 37, 39, 40, 42 AND 50).

PRIORITY CLAIMED UNDER SEC. 44(D) ON
CANADA APPLICATION NO. 1,162,016, FILED 12-
16-2002, REG. NO. TMA671244, DATED 8-25-2006,
EXPIRES 8-25-2021.

THE WORDING "CARIBANA" HAS NO MEAN-
ING IN A FOREIGN LANGUAGE.

SER. NO. 76-525,275, FILED 6-16-2003.

ZACHARY BELLO, EXAMINING ATTORNEY

Int. Cl.: 25

Prior U.S. Cls.: 22 and 39

United States Patent and Trademark Office

Reg. No. 3,482,750

Registered Aug. 12, 2008

**TRADEMARK
PRINCIPAL REGISTER**

BEACH HOUSE

SWIMWEAR ANYWHERE, INC. (NEW YORK
CORPORATION)
85 SHERWOOD AVENUE
FARMINGDALE, NY 11735

OWNER OF U.S. REG. NO. 1,309,135.

FOR: SWIMWEAR, SWIMWEAR COVER-UPS,
AND SARONGS, IN CLASS 25 (U.S. CLS. 22 AND 39).

SER. NO. 76-531,146, FILED 7-21-2003.

FIRST USE 5-27-1975; IN COMMERCE 5-27-1975.

JEFF DEFORD, EXAMINING ATTORNEY

Int. Cls.: 37 and 42

Prior U.S. Cls.: 100, 101, 103 and 106

United States Patent and Trademark Office

Reg. No. 3,482,751

Registered Aug. 12, 2008

**SERVICE MARK
PRINCIPAL REGISTER**

BECA

BECA GROUP LIMITED (NEW ZEALAND CORPORATION)
132 VINCENT STREET
AUCKLAND, NEW ZEALAND

FOR: BUILDING CONSTRUCTION SERVICES; CONSTRUCTION CONSULTANCY; CONSTRUCTION MANAGEMENT; CONSTRUCTION PROJECT MANAGEMENT SERVICES; CONSTRUCTION OF AIRPORTS, HARBORS, BRIDGES AND ROADWAYS; CONSTRUCTION PLANNING; CONSTRUCTION SUPERVISION, IN CLASS 37 (U.S. CLS. 100, 103 AND 106).

FOR: ENGINEERING; ENGINEERING SERVICES, NAMELY, CHEMICAL ENGINEERING, CIVIL ENGINEERING, EARTHQUAKE ENGINEERING, ELECTRICAL ENGINEERING, FIRE ENGINEERING, GEOTECHNICAL ENGINEERING, STRUCTURAL ENGINEERING, TRANSPORTATION ENGINEERING, WATER RESOURCES ENGINEER-

ING, COMPUTER ENGINEERING AND PROJECT MANAGEMENT SERVICES PROVIDED THEREWITH; CONSULTANCY SERVICES IN THE FIELDS OF CHEMICAL ENGINEERING, CIVIL ENGINEERING, EARTHQUAKE ENGINEERING, ELECTRICAL ENGINEERING, FIRE ENGINEERING, GEOTECHNICAL ENGINEERING, STRUCTURAL ENGINEERING, TRANSPORTATION ENGINEERING, WATER ENGINEERING, COMPUTER ENGINEERING AND PROJECT MANAGEMENT SERVICES PROVIDED THEREWITH, IN CLASS 42 (U.S. CLS. 100 AND 101).

OWNER OF NEW ZEALAND REG. NO. 608918, DATED 2-23-2000, EXPIRES 2-23-2017.

SER. NO. 76-544,270, FILED 9-12-2003.

STEPHANIE ALI, EXAMINING ATTORNEY

Int. Cl.: 19

Prior U.S. Cls.: 1, 12, 33 and 50

United States Patent and Trademark Office

Reg. No. 3,482,752

Registered Aug. 12, 2008

**TRADEMARK
PRINCIPAL REGISTER**

TREX ORIGINS

TREX COMPANY, INC. (DELAWARE CORPORATION)
160 EXETER DRIVE
WINCHESTER, VA 226038605

FOR: COMPOSITE BUILDING MATERIALS
COMPRISING WOOD FIBER AND POLYMER,
NAMELY, DECKING, RAILING, FENCING, AND
OTHER OUTDOOR PRODUCTS, IN CLASS 19 (U.S.
CLS. 1, 12, 33 AND 50).

FIRST USE 10-24-2003; IN COMMERCE 10-24-2003.

OWNER OF U.S. REG. NOS. 1,881,449, 1,938,516
AND OTHERS.

SER. NO. 76-545,504, FILED 9-17-2003.

JORDAN BAKER, EXAMINING ATTORNEY

Int. Cl.: 12

Prior U.S. Cls.: 19, 21, 23, 31, 35 and 44

Reg. No. 3,482,753

United States Patent and Trademark Office

Registered Aug. 12, 2008

**TRADEMARK
PRINCIPAL REGISTER**

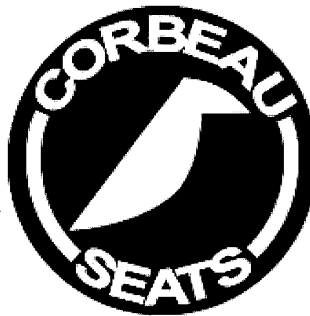

CORBEAU USA LLC (UTAH LTD LIAB CO)
727 WEST 14881 SOUTH
BLUFFDALE, UT 84065

FIRST USE 1-1-1996; IN COMMERCE 1-1-1996.

FOR: SEATS FOR AUTOMOBILES; SAFETY HAR-
NESSES FOR AUTOMOBILE SEATS; STRUCTURAL
PARTS OF VEHICLES, NAMELY, SEAT BRACKETS;
STRUCTURAL PARTS FOR SEATS FOR AUTOMO-
BILES AND STRUCTURAL PARTS FOR SAFETY
HARNESSES FOR AUTOMOBILE SEATS, IN CLASS
12 (U.S. CLS. 19, 21, 23, 31, 35 AND 44).

NO CLAIM IS MADE TO THE EXCLUSIVE
RIGHT TO USE "SEATS", APART FROM THE
MARK AS SHOWN.

SER. NO. 76-574,217, FILED 2-5-2004.

FRED MANDIR, EXAMINING ATTORNEY

Int. Cl.: 12

Prior U.S. Cls.: 19, 21, 23, 31, 35 and 44

United States Patent and Trademark Office

Reg. No. 3,482,754

Registered Aug. 12, 2008

**TRADEMARK
PRINCIPAL REGISTER**

CORBEAU

CORBEAU USA LLC (UTAH LTD LIAB CO)
727 WEST 14881 SOUTH
BLUFFDALE, UT 84065

FIRST USE 5-1-1983; IN COMMERCE 5-1-1983.

FOR: SEATS FOR AUTOMOBILES; SAFETY HAR-
NESSES FOR AUTOMOBILE SEATS; STRUCTURAL
PARTS OF VEHICLES, NAMELY, SEAT BRACKETS;
STRUCTURAL PARTS FOR SEATS FOR AUTOMO-
BILES AND STRUCTURAL PARTS FOR SAFETY
HARNESSES FOR AUTOMOBILE SEATS, IN CLASS
12 (U.S. CLS. 19, 21, 23, 31, 35 AND 44).

THE MARK CONSISTS OF STANDARD CHAR-
ACTERS WITHOUT CLAIM TO ANY PARTICULAR
FONT, STYLE, SIZE, OR COLOR.

SER. NO. 76-574,218, FILED 2-5-2004.

FRED MANDIR, EXAMINING ATTORNEY

Int. Cl.: 16

Prior U.S. Cls.: 2, 5, 22, 23, 29, 37, 38 and 50

Reg. No. 3,482,755

United States Patent and Trademark Office

Registered Aug. 12, 2008

**TRADEMARK
PRINCIPAL REGISTER**

CALIFORNIA NOTARY

NATIONAL NOTARY ASSOCIATION (CALIFORNIA
NONPROFIT MUTUAL BENEFIT CORPORATION)

9350 DE SOTO AVENUE
CHATSWORTH, CA 91311

FOR: PUBLICATIONS, NAMELY, PERIODICALS
RELATING TO NOTARY SERVICES, IN CLASS 16
(U.S. CLS. 2, 5, 22, 23, 29, 37, 38 AND 50).

FIRST USE 0-0-2003; IN COMMERCE 0-0-2003.

THE MARK CONSISTS OF STANDARD CHARACTERS
WITHOUT CLAIM TO ANY PARTICULAR FONT,
STYLE, SIZE, OR COLOR.

OWNER OF U.S. REG. NOS. 1,632,322, 1,633,170,
AND 2,315,926.

SEC. 2(F).

SER. NO. 76-577,282, FILED 2-17-2004.

HOWARD B. LEVINE, EXAMINING ATTORNEY

Int. Cl.: 9

Prior U.S. Cls.: 21, 23, 26, 36 and 38

Reg. No. 3,482,756

United States Patent and Trademark Office

Registered Aug. 12, 2008

**TRADEMARK
PRINCIPAL REGISTER**



UIJAE ELECTRICAL RESEARCH INSTITUTE
CO., LTD. (REPUBLIC OF KOREA CORPORATION)
DONGA BUILDING 4F, 156-1, YANGPYUNG-DONG
YEONGDEUNPO-GU, SEOUL, REPUBLIC OF KOREA
150040

FOR: LIGHTNING ARRESTERS; LIGHTNING
CONDUCTORS; ELECTRICAL FUSES, IN CLASS 9
(U.S. CLS. 21, 23, 26, 36 AND 38).

PRIORITY CLAIMED UNDER SEC. 44(D) ON
REPUBLIC OF KOREA APPLICATION NO. KR40-
2003-54, FILED 12-9-2003, REG. NO. 40-0605113, DA-
TED 1-6-2005, EXPIRES 1-6-2015.

NO CLAIM IS MADE TO THE EXCLUSIVE
RIGHT TO USE "LIGHTNING PROTECTION SYSTEM
CORP", APART FROM THE MARK AS SHOWN.

THE DESIGN ELEMENT IN THE MARK CON-
SISTS OF A WHITE LIGHTNING BOLT WITHIN AN
ORANGE SQUARE.

SER. NO. 76-578,147, FILED 2-27-2004.

CAROL SPILS, EXAMINING ATTORNEY

Int. Cl.: 9

Prior U.S. Cls.: 21, 23, 26, 36 and 38

United States Patent and Trademark Office

Reg. No. 3,482,757

Registered Aug. 12, 2008

**TRADEMARK
PRINCIPAL REGISTER**

WARRANT

THE DOWN BOYS, INC. (CALIFORNIA CORPORATION)
41117 OAK CREEK ROAD
MURRIETA, CA 92562

FOR: PHONOGRAPH RECORDS FEATURING MUSIC; PRERECORDED AUDIO CASSETTES AND COMPACT DISCS FEATURING MUSIC; DOWNLOADABLE MUSICAL SOUND RECORDINGS IN MP3 DIGITAL FORMAT; PRE-RECORDED VIDEO TAPES AND DVDS FEATURING MUSIC PERFORMANCES, IN CLASS 9 (U.S. CLS. 21, 23, 26, 36 AND 38).

FIRST USE 1-31-1989; IN COMMERCE 1-31-1989.

THE MARK CONSISTS OF STANDARD CHARACTERS WITHOUT CLAIM TO ANY PARTICULAR FONT, STYLE, SIZE, OR COLOR.

OWNER OF U.S. REG. NO. 1,543,001.

SER. NO. 76-580,238, FILED 3-10-2004.

DAWN HAN, EXAMINING ATTORNEY

Int. Cls.: 9, 36 and 38

Prior U.S. Cls.: 21, 23, 26, 36, 38, 100, 101, 102 and 104

Reg. No. 3,482,758

United States Patent and Trademark Office

Registered Aug. 12, 2008

**TRADEMARK
SERVICE MARK
PRINCIPAL REGISTER**



PLATINUMTEL COMMUNICATIONS, LLC (DE-
LAWARE LTD LIAB CO)
8106 SOUTH ROBERTS ROAD
JUSTICE, IL 60458

FOR: WIRELESS TELEPHONES, IN CLASS 9 (U.S.
CLS. 21, 23, 26, 36 AND 38).

FIRST USE 8-1-2002; IN COMMERCE 8-1-2002.

FOR: TELECOMMUNICATIONS RESELLER SER-
VICES, NAMELY, TELECOMMUNICATIONS AIR
TIME BROKERAGE SERVICES, IN CLASS 36 (U.S.
CLS. 100, 101 AND 102).

FIRST USE 8-1-2002; IN COMMERCE 8-1-2002.

FOR: TELECOMMUNICATION SERVICES,
NAMELY, PROVIDING LONG DISTANCE TELE-

COMMUNICATIONS SERVICES; PERSONAL COM-
MUNICATION SERVICES; LOCAL AND LONG
DISTANCE TRANSMISSION OF VOICE, DATA,
GRAPHICS BY MEANS OF TELEPHONE, TELE-
GRAPHIC, CABLE, SATELLITE, AND WIRELESS
ELECTRONIC TRANSMISSION OF VOICE SIG-
NALS, DATA, FACSIMILES, IMAGES, VIDEO,
GAMES AND INFORMATION, IN CLASS 38 (U.S.
CLS. 100, 101 AND 104).

FIRST USE 8-1-2002; IN COMMERCE 8-1-2002.

OWNER OF U.S. REG. NO. 3,078,436.

SER. NO. 76-609,417, FILED 8-30-2004.

TINA L. SNAPP, EXAMINING ATTORNEY

Int. Cl.: 39

Prior U.S. Cls.: 100 and 105

United States Patent and Trademark Office

Reg. No. 3,482,759

Registered Aug. 12, 2008

**SERVICE MARK
PRINCIPAL REGISTER**

DELTA VANLINES

DELTA VAN LINES, INC (FLORIDA CORPORATION)

211 NW 5TH AVE

HALLANDALE BROWARD, FL 33009

FOR: MOVING VAN SERVICES, IN CLASS 39 (U.S. CLS. 100 AND 105).

FIRST USE 8-8-2001; IN COMMERCE 8-8-2001.

THE MARK CONSISTS OF STANDARD CHARACTERS WITHOUT CLAIM TO ANY PARTICULAR FONT, STYLE, SIZE, OR COLOR.

NO CLAIM IS MADE TO THE EXCLUSIVE RIGHT TO USE "VANLINES", APART FROM THE MARK AS SHOWN.

SER. NO. 76-612,142, FILED 9-16-2004.

LINDA ESTRADA, EXAMINING ATTORNEY

Int. Cl.: 9

Prior U.S. Cls.: 21, 23, 26, 36 and 38

United States Patent and Trademark Office

Reg. No. 3,482,760

Registered Aug. 12, 2008

**TRADEMARK
PRINCIPAL REGISTER**

Advantage.

SURGE SUPPRESSION INCORPORATED (FLOR-
IDA CORPORATION)
109 MELVIN STREET
DESTIN, FL 32540

THE MARK CONSISTS OF STANDARD CHAR-
ACTERS WITHOUT CLAIM TO ANY PARTICULAR
FONT, STYLE, SIZE, OR COLOR.

FOR: VOLTAGE SURGE PROTECTORS FOR IN-
DUSTRIAL USE, IN CLASS 9 (U.S. CLS. 21, 23, 26, 36
AND 38).

SER. NO. 76-616,330, FILED 10-14-2004.

FIRST USE 3-1-2003; IN COMMERCE 3-1-2003.

ROBERT C. CLARK JR., EXAMINING ATTORNEY

Int. Cl.: 9

Prior U.S. Cls.: 21, 23, 26, 36 and 38

Reg. No. 3,482,761

United States Patent and Trademark Office

Registered Aug. 12, 2008

**TRADEMARK
PRINCIPAL REGISTER**



TOPOWER COMPUTER (USA) INC. (CALIFORNIA CORPORATION)
18529 E. GALE AVENUE
CITY OF INDUSTRY, CA 91748

NO CLAIM IS MADE TO THE EXCLUSIVE RIGHT TO USE "POWER TECHNOLOGY", APART FROM THE MARK AS SHOWN.

FOR: COMPUTER HOUSINGS, IN CLASS 9 (U.S. CLS. 21, 23, 26, 36 AND 38).

SER. NO. 76-623,640, FILED S.R. 12-8-2004 AM. P.R. 8-13-2007.

FIRST USE 8-29-2000; IN COMMERCE 8-29-2000.

JOHN DWYER, EXAMINING ATTORNEY

Int. Cl.: 5

Prior U.S. Cls.: 6, 18, 44, 46, 51 and 52

United States Patent and Trademark Office

Reg. No. 3,482,762

Registered Aug. 12, 2008

**TRADEMARK
PRINCIPAL REGISTER**

ATTEVIC

SOLVAY PHARMACEUTICALS MARKETING &
LICENSING AG (SWITZERLAND CORPORATION)
BINNINGERSTRASSE 94
ALLSCHWIL, SWITZERLAND

FOR: PHARMACEUTICALS TO TREAT DISEASES AND DISORDERS OF THE CARDIOVASCULAR SYSTEM, IN CLASS 5 (U.S. CLS. 6, 18, 44, 46, 51 AND 52).

THE MARK CONSISTS OF STANDARD CHARACTERS WITHOUT CLAIM TO ANY PARTICULAR FONT, STYLE, SIZE, OR COLOR.

OWNER OF SWITZERLAND REG. NO. P-454017,
DATED 8-20-1998, EXPIRES 2-11-2018.

OWNER OF U.S. REG. NO. 2,339,703.

SER. NO. 76-631,062, FILED 2-17-2005.

MARIA-VICTORIA SUAREZ, EXAMINING ATTORNEY

Int. Cls.: 9 and 42

Prior U.S. Cls.: 21, 23, 26, 36, 38, 100 and 101

United States Patent and Trademark Office

Reg. No. 3,482,763

Registered Aug. 12, 2008

**TRADEMARK
SERVICE MARK
PRINCIPAL REGISTER**

ID2PASS

CRYPTOMETRICS CANADA INCORPORATED
(CANADA INC. ASSOCIATION)
160 MICHAEL COWPLAND DRIVE
KANATA, ONTARIO K2M 1P6

FOR: (1) MACHINE-ASSISTED BIOMETRIC IDENTITY CONFIRMATION SYSTEMS COMPRISED OF CAMERAS, LIGHTING DEVICES FOR TAKING PICTURES, IMAGE SCANNERS, FINGERPRINT SCANNERS, IRIS SCANNERS, RANGE FINDERS, PRESENCE DETECTION SENSORS, COMPUTER HARDWARE, AND COMPUTER SOFTWARE FOR MONITORING, DETECTING, TRACKING, INSPECTING, IDENTIFYING AND AUTHENTICATING INDIVIDUALS; (2) SELF-SERVICE, USER CONTROLLED SECURE VALUE EXCHANGE SYSTEMS COMPRISED OF CAMERAS, LIGHTING DEVICES FOR TAKING PICTURES, IMAGE SCANNERS, FINGERPRINT SCANNERS, IRIS SCANNERS, PRESENCE DETECTION SENSORS, ELECTRONIC CARD READERS, OPTICAL DOCUMENT READERS, AND COMPUTER HARDWARE AND COMPUTER SOFTWARE FOR IDENTIFYING INDIVIDUALS; (3) AUTOMATED CAMERAS FOR USE IN MACHINE-ASSISTED BIOMETRIC IDENTITY CONFIRMATION SYSTEMS COMPRISED OF CAMERAS, LIGHTING DEVICES FOR TAKING PICTURES, IMAGE SCANNERS, FINGERPRINT SCANNERS, IRIS SCANNERS, RANGE FINDERS, PRESENCE DETECTION SENSORS, COMPUTER HARDWARE, AND COMPUTER SOFTWARE FOR MONITORING, DETECTING, TRACKING, INSPECTING, IDENTIFYING AND AUTHENTICATING INDIVIDUALS, AND FOR USE IN SELF-SERVICE, USER CONTROLLED SECURE VALUE EXCHANGE SYSTEMS COMPRISED OF CAMERAS, LIGHTING DEVICES FOR TAKING PICTURES, IMAGE SCANNERS, FINGERPRINT SCANNERS, IRIS SCANNERS, ELECTRONIC CARD READERS, OPTICAL DOCUMENT READERS, PRE-

SENCE DETECTION SENSORS, AND COMPUTER HARDWARE AND COMPUTER SOFTWARE FOR IDENTIFYING INDIVIDUALS; (4) COMPUTER HARDWARE, NAMELY, ELECTRONIC CARD READERS AND OPTICAL DOCUMENT READERS; (5) DOCUMENT AUTHENTICATION SYSTEMS COMPRISING ELECTRONIC CARD READERS, OPTICAL DOCUMENT READERS, AND COMPUTER HARDWARE AND SOFTWARE FOR AUTHENTICATING IDENTIFICATION CARDS AND/OR DOCUMENTS; (6) COMPUTERS AND COMPUTER SOFTWARE FOR CLEARING PASSENGERS CROSSING INTERNATIONAL BORDERS BY COMPARING BIOMETRIC IDENTITY INFORMATION OF THE PASSENGER WITH BIOMETRIC IDENTITY INFORMATION STORED IN A DATABASE OR ON AN IDENTIFICATION CARD OR DOCUMENT; (7) COMPUTERS AND COMPUTER SOFTWARE FOR ENROLLING BIOMETRIC DETAILS ON PERSONS; (8) COMPUTERS AND COMPUTER SOFTWARE FOR IDENTITY VERIFICATION, NAMELY, CONFIRMING A PERSON'S IDENTITY BY COMPARISON OF THE PERSON'S BIOMETRIC DATA TO BIOMETRIC DATA STORED ON AN IDENTIFICATION CARD OR DOCUMENT OR IN A DATABASE; (9) COMPUTERS AND COMPUTER SOFTWARE FOR IDENTITY FRAUD DETECTION, NAMELY, COMPARING A PERSON'S BIOMETRIC DATA TO BIOMETRIC DATA STORED IN A DATABASE TO DETERMINE IF THE BIOMETRIC DATA MATCHES MORE THAN ONE PERSON; (10) COMPUTERS AND COMPUTER SOFTWARE FOR WATCH LIST IDENTITY DETECTION, NAMELY, COMPARING A PERSON'S BIOMETRIC DATA TO BIOMETRIC DATA OF INDIVIDUALS STORED IN A WATCH-LIST DATABASE AND IDENTIFYING POTENTIAL MATCHES; (11) COMMUNICATION SOFTWARE FOR USE IN ELECTRONIC COMMUNICATION WITH AND BETWEEN SELF-SERVICE, USER CONTROLLED SECURE VALUE EX-

CHANGE SYSTEMS; (12) SECURITY/ACCESS CONTROL SYSTEMS AND COMPONENTS FOR PUBLIC, COMMERCIAL AND RESIDENTIAL PROPERTIES EMPLOYING MACHINE-ASSISTED BIOMETRIC IDENTIFICATION SYSTEMS COMPRISED OF CAMERAS, LIGHTING DEVICES FOR TAKING PICTURES, IMAGE SCANNERS, FINGERPRINT SCANNERS, IRIS SCANNERS, RANGE FINDERS, PRESENCE DETECTION SENSORS, COMPUTER HARDWARE, AND COMPUTER SOFTWARE FOR MONITORING, DETECTING, TRACKING, INSPECTING, IDENTIFYING AND/OR AUTHENTICATING INDIVIDUALS, IN CLASS 9 (U.S. CLS. 21, 23, 26, 36 AND 38).

FIRST USE 10-3-2004; IN COMMERCE 10-3-2004.

FOR: (1) TECHNICAL CONSULTING SERVICES, IN THE FIELD OF DESIGN, SELECTION, IMPLEMENTATION AND USE OF COMPUTER HARDWARE AND SOFTWARE SYSTEMS FOR OTHERS IN THE FIELD OF MACHINE ASSISTED IDENTITY CONFIRMATION SYSTEMS, IDENTIFICATION CARD AND DOCUMENT PERSONALIZATION SYSTEMS, IDENTIFICATION CARD AND DOCUMENT INSPECTION AND AUTHENTICATION SYSTEMS, SECURITY AND ACCESS CONTROL SYSTEMS, AND SELF-SERVICE, USER-CONTROLLED SECURE VALUE EXCHANGE SYSTEMS; (2) PRODUCT RESEARCH AND DEVELOPMENT SERVICES, IN THE FIELD OF MACHINE ASSISTED HUMAN BIOMETRIC IDENTITY CONFIRMATION SYSTEMS COMPRISED OF CAMERAS, LIGHTING DEVICES FOR TAKING PICTURES, IMAGE SCANNERS, FINGERPRINT SCANNERS, IRIS SCANNERS, RANGE FINDERS, PRESENCE DETECTION SENSORS, COMPUTER HARDWARE, AND COMPUTER SOFTWARE FOR MONITORING, DETECTING, TRACKING, INSPECTING, IDENTIFYING AND AUTHENTICATING INDIVIDUALS, AND IN THE FIELD OF SELF-SERVICE, USER-CONTROLLED SECURE VALUE EXCHANGE SYSTEMS COMPRISED OF CAMERAS, LIGHTING DEVICES FOR TAKING PICTURES, IMAGE SCANNERS, FINGERPRINT SCANNERS, IRIS SCANNERS; PRESENCE DETECTION SENSORS, ELECTRONIC CARD READERS, OPTICAL DOCUMENT READERS, AND COMPUTER HARDWARE AND COMPUTER SOFTWARE FOR IDENTIFYING INDIVIDUALS, AND IN THE FIELD OF IDENTIFICATION CARD AND DOCUMENT PERSONALIZATION SYSTEMS, FOR USE IN ENROLLING, BIOMETRIC DETAILS ON PERSONS, AND IN THE FIELD OF IDENTIFICATION CARD AND DOCUMENT INSPECTION AND AUTHENTICATION SYSTEMS FOR USE IN AUTHENTICATING IDENTIFICATION CARDS AND/OR DOCUMENTS, IDENTITY VERIFICATION OF INDIVIDUALS PRESENTING IDENTIFICATION CARDS AND/OR DOCUMENTS, IDENTITY FRAUD DETECTION, WATCH-LIST IDENTITY DETECTION, AND CLEARING PASSENGERS CROSSING INTERNATIONAL BORDERS, AND IN THE FIELD OF SECURITY/ACCESS CONTROL SYSTEMS FOR PUBLIC, COMMERCIAL AND RESIDENTIAL PROPERTIES EMPLOYING MACHINE ASSISTED HUMAN BIOMETRIC IDENTITY CONFIRMATION SYSTEMS COMPRISED OF CAMERAS, LIGHTING DEVICES FOR TAKING PICTURES, IMAGE SCANNERS, FINGERPRINT SCANNERS, IRIS SCANNERS, RANGE FINDERS, PRESENCE DETECTION SENSORS, COMPUTER HARDWARE, AND COMPUTER SOFTWARE FOR MONITORING, DETECTING, TRACKING, INSPECTING, IDENTIFYING AND AUTHENTICATING INDIVIDUALS, IN CLASS 42 (U.S. CLS. 100 AND 101).

DEVICES FOR TAKING PICTURES, IMAGE SCANNERS, FINGERPRINT SCANNERS, IRIS SCANNERS, RANGE FINDERS, PRESENCE DETECTION SENSORS, COMPUTER HARDWARE, AND COMPUTER SOFTWARE FOR MONITORING, DETECTING, TRACKING, INSPECTING, IDENTIFYING AND AUTHENTICATING INDIVIDUALS; (3) DESIGN SERVICES FOR OTHERS IN THE FIELD OF MACHINE ASSISTED HUMAN BIOMETRIC IDENTITY CONFIRMATION SYSTEMS COMPRISED OF CAMERAS, LIGHTING DEVICES FOR TAKING PICTURES, IMAGE SCANNERS, FINGERPRINT SCANNERS, IRIS SCANNERS, RANGE FINDERS, PRESENCE DETECTION SENSORS, COMPUTER HARDWARE, AND COMPUTER SOFTWARE FOR MONITORING, DETECTING, TRACKING, INSPECTING, IDENTIFYING AND AUTHENTICATING INDIVIDUALS; AND IN THE FIELD OF SELF-SERVICE, USER-CONTROLLED SECURE VALUE EXCHANGE SYSTEMS COMPRISED OF CAMERAS, LIGHTING DEVICES FOR TAKING PICTURES, IMAGE SCANNERS, FINGERPRINT SCANNERS, IRIS SCANNERS, PRESENCE DETECTION SENSORS, ELECTRONIC CARD READERS, OPTICAL DOCUMENT READERS, AND COMPUTER HARDWARE AND COMPUTER SOFTWARE FOR IDENTIFYING INDIVIDUALS, AND IN THE FIELD OF IDENTIFICATION CARD AND DOCUMENT PERSONALIZATION SYSTEMS, FOR USE IN ENROLLING BIOMETRIC DETAILS ON PERSONS, AND IN THE FIELD OF IDENTIFICATION CARD AND DOCUMENT INSPECTION AND AUTHENTICATION SYSTEMS FOR USE IN AUTHENTICATING IDENTIFICATION CARDS AND/OR DOCUMENTS, IDENTITY VERIFICATION OF INDIVIDUALS PRESENTING IDENTIFICATION CARDS AND/OR DOCUMENTS, IDENTITY FRAUD DETECTION, WATCH-LIST IDENTITY DETECTION, AND CLEARING PASSENGERS CROSSING INTERNATIONAL BORDERS, AND IN THE FIELD OF SECURITY/ACCESS CONTROL SYSTEMS FOR PUBLIC, COMMERCIAL AND RESIDENTIAL PROPERTIES EMPLOYING MACHINE ASSISTED HUMAN BIOMETRIC IDENTITY CONFIRMATION SYSTEMS COMPRISED OF CAMERAS, LIGHTING DEVICES FOR TAKING PICTURES, IMAGE SCANNERS, FINGERPRINT SCANNERS, IRIS SCANNERS, RANGE FINDERS, PRESENCE DETECTION SENSORS, COMPUTER HARDWARE, AND COMPUTER SOFTWARE FOR MONITORING, DETECTING, TRACKING, INSPECTING, IDENTIFYING AND AUTHENTICATING INDIVIDUALS, IN CLASS 42 (U.S. CLS. 100 AND 101).

FIRST USE 10-3-2004; IN COMMERCE 10-3-2004.

THE MARK CONSISTS OF STANDARD CHARACTERS WITHOUT CLAIM TO ANY PARTICULAR FONT, STYLE, SIZE, OR COLOR.

PRIORITY CLAIMED UNDER SEC. 44(D) ON CANADA APPLICATION NO. 1245904, FILED 2-3-2005, REG. NO. TMA708176, DATED 2-25-2008, EXPIRES 2-25-2023.

SER. NO. 76-635,903, FILED 4-15-2005.

MARK SPARACINO, EXAMINING ATTORNEY

Int. Cls.: 9 and 42

Prior U.S. Cls.: 21, 23, 26, 36, 38, 100 and 101

Reg. No. 3,482,764

United States Patent and Trademark Office

Registered Aug. 12, 2008

**TRADEMARK
SERVICE MARK
PRINCIPAL REGISTER**

BIODENTITY

CRYPTOMETRICS CANADA INCORPORATED
(CANADA INC. ASSOCIATION)

160 MICHAEL COWPLAND DRIVE
KANATA, ONTARIO K2M 1P6

FOR: (1) MACHINE ASSISTED FACE IDENTITY CONFIRMATION SYSTEMS COMPRISED OF CAMERAS, LIGHTING DEVICES FOR TAKING PICTURES, IMAGE SCANNERS, RANGE FINDERS, PRESENCE DETECTION SENSORS, COMPUTER HARDWARE, AND COMPUTER SOFTWARE FOR MONITORING, DETECTING, TRACKING AND CAPTURING FACE IMAGES AND FOR IDENTIFYING INDIVIDUALS USING FACE IMAGES; (2) SELF-SERVICE, USER CONTROLLED SECURE VALUE EXCHANGE SYSTEMS COMPRISED OF CAMERAS, LIGHTING DEVICES FOR TAKING PICTURES, IMAGE SCANNERS, PRESENCE DETECTION SENSORS, AND COMPUTER HARDWARE AND SOFTWARE FOR CAPTURING FACE IMAGES AND FOR IDENTIFYING INDIVIDUALS USING FACE IMAGES; (3) AUTOMATED CAMERAS FOR USE IN MACHINE ASSISTED FACE IDENTITY CONFIRMATION SYSTEMS COMPRISED OF CAMERAS, LIGHTING DEVICES FOR TAKING PICTURES, IMAGE SCANNERS, RANGE FINDERS, PRESENCE DETECTION SENSORS, COMPUTER HARDWARE, AND COMPUTER SOFTWARE FOR MONITORING, DETECTING, TRACKING AND CAPTURING FACE IMAGES AND FOR IDENTIFYING INDIVIDUALS USING FACE IMAGES, AND FOR USE IN SELF-SERVICE, USER CONTROLLED SECURE VALUE EXCHANGE SYSTEMS COMPRISED OF CAMERAS, LIGHTING DEVICES FOR TAKING PICTURES, IMAGE SCANNERS, PRESENCE DETECTION SENSORS, AND COMPUTER HARDWARE AND SOFTWARE FOR CAPTURING FACE IMAGES AND FOR IDENTIFYING INDIVIDUALS USING FACE IMAGES; (4) COMPUTERS AND COMPUTER SOFTWARE

FOR PROCESSING CAPTURED FACE IMAGES AND FOR COMPARING THE CAPTURED FACE IMAGES TO FACE IMAGES IN A DATABASE TO CONFIRM THE IDENTITY OF THE CAPTURED FACE IMAGE (5) COMPUTERS AND COMPUTER SOFTWARE FOR ENROLLING FACE IMAGE INFORMATION OF PERSONS FOR THE CREATION OF A FACE IMAGE DATABASE, IN CLASS 9 (U.S. CLS. 21, 23, 26, 36 AND 38).

FIRST USE 5-19-2004; IN COMMERCE 5-19-2004.

FOR: (1) TECHNICAL CONSULTING SERVICES, IN THE FIELD OF DESIGN, SELECTION, IMPLEMENTATION AND USE OF COMPUTER HARDWARE AND SOFTWARE SYSTEMS FOR OTHERS IN THE FIELD OF MACHINE ASSISTED FACE IDENTITY CONFIRMATION SYSTEMS AND SELF-SERVICE, USER-CONTROLLED SECURE VALUE EXCHANGE SYSTEMS; (2) PRODUCT RESEARCH AND DEVELOPMENT SERVICES, IN THE FIELD OF MACHINE ASSISTED FACE IDENTITY CONFIRMATION SYSTEMS COMPRISED OF CAMERAS, LIGHTING DEVICES FOR TAKING PICTURES, IMAGE SCANNERS, RANGE FINDERS, PRESENCE DETECTION SENSORS, COMPUTER HARDWARE, AND COMPUTER SOFTWARE FOR MONITORING, DETECTING, TRACKING AND CAPTURING FACE IMAGES AND FOR IDENTIFYING INDIVIDUALS USING FACE IMAGES, AND IN THE FIELD OF SELF-SERVICE, USER-CONTROLLED SECURE VALUE EXCHANGE SYSTEMS COMPRISED OF CAMERAS, LIGHTING DEVICES FOR TAKING PICTURES, IMAGE SCANNERS, PRESENCE DETECTION SENSORS, AND COMPUTER HARDWARE AND SOFTWARE FOR CAPTURING FACE IMAGES AND FOR IDENTIFYING INDIVIDUALS USING FACE IMAGES; (3) DESIGN SERVICES FOR OTHERS IN THE FIELD OF MACHINE ASSISTED FACE IDENTITY CONFIRMATION SYSTEMS

TEMS COMPRISED OF CAMERAS, LIGHTING DEVICES FOR TAKING PICTURES, IMAGE SCANNERS, RANGE FINDERS, PRESENCE DETECTION SENSORS, COMPUTER HARDWARE, AND COMPUTER SOFTWARE FOR MONITORING, DETECTING, TRACKING AND CAPTURING FACE IMAGES AND FOR IDENTIFYING INDIVIDUALS USING FACE IMAGES, AND IN THE FIELD OF SELF-SERVICE, USER-CONTROLLED SECURE VALUE EXCHANGE SYSTEMS COMPRISED OF CAMERAS, LIGHTING DEVICES FOR TAKING PICTURES, IMAGE SCANNERS, PRESENCE DETECTION SENSORS AND COMPUTER HARDWARE AND SOFTWARE FOR CAPTURING FACE IMAGES AND FOR IDENTIFYING INDIVIDUALS USING FACE IMAGES, IN CLASS 42 (U.S. CLS. 100 AND 101).

FIRST USE 5-19-2004; IN COMMERCE 5-19-2004.

THE MARK CONSISTS OF STANDARD CHARACTERS WITHOUT CLAIM TO ANY PARTICULAR FONT, STYLE, SIZE, OR COLOR.

PRIORITY CLAIMED UNDER SEC. 44(D) ON CANADA APPLICATION NO. 1245902, FILED 2-3-2005, REG. NO. TMA708781, DATED 3-4-2008, EXPIRES 3-4-2023.

SER. NO. 76-635,905, FILED 4-15-2005.

MARK SPARACINO, EXAMINING ATTORNEY

Int. Cls.: 9, 18, 21 and 28

Prior U.S. Cls.: 1, 2, 3, 13, 21, 22, 23, 26, 29, 30, 33, 36, 38, 40, 41 and 50

Reg. No. 3,482,765

United States Patent and Trademark Office

Registered Aug. 12, 2008

**TRADEMARK
PRINCIPAL REGISTER**

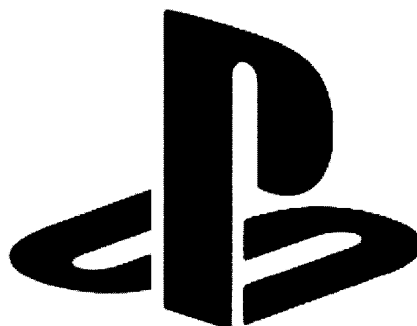

KABUSHIKI KAISHA SONY COMPUTER ENTERTAINMENT (JAPAN CORPORATION), TA SONY COMPUTER ENTERTAINMENT INC. 2-6-21, MINAMI-AOYAMA MINATO-KU, TOKYO 107-0062, JAPAN

FOR: EAR PLUGS, NOT FOR MEDICAL USE; OZONISERS; ELECTROLYSERS; EGG-CANDLERS; CASH REGISTERS; COIN COUNTING OR SORTING MACHINES; ELECTRIC SIGN BOARDS FOR DISPLAYING TARGET FIGURES, CURRENT OUTPUTS OR THE LIKE PROGRESS IN WORK; PHOTO-COPYING MACHINES; MANUALLY OPERATED COMPUTING APPARATUS; ELECTRONIC DRAWING OR DRAFTING MACHINES AND APPARATUS; TIME AND DATE STAMPING MACHINES; PUNCHED CARD OFFICE MACHINES; VOTING MACHINES; AUTOMATED BILLING MACHINES; POSTAGE STAMP CHECKING APPARATUS; VENDING MACHINES; GASOLINE STATION EQUIPMENT, NAMELY METERED GASOLINE DISTRIBUTION PUMPS FOR SERVICE STATIONS AND GASOLINE GAUGES; COIN-OPERATED GATES FOR CAR PARKS OR PARKING LOTS; LIFE JACKETS; FIRE EXTINGUISHER; FIRE HYDRANTS; FIRE HOSE NOZZLES; SPRINKLER SYSTEMS FOR FIRE PROTECTION; FIRE ALARMS; GAS ALARMS; ANTI-THEFT WARNING APPARATUS; PROTECTIVE HELMETS; RAILWAY SIGNALS; VEHICLE BREAKDOWN WARNING TRIANGLES; LUMINOUS OR MECHANICAL ROAD SIGNS; DIVERS' MASKS; DIVING SUITS; AMUSEMENT VIDEO GAME MACHINES ADAPTED FOR USE WITH TELEVISION RECEIVERS

ONLY; ELECTRIC DOOR OPENERS; SIMULATORS FOR THE STEERING AND CONTROL OF VEHICLES; SPORTS TRAINING SIMULATORS; CONSTANT TEMPERATURE INCUBATORS FOR LABORATORY; ONE-TIME USE CAMERA WITH UNEXPOSED FILMS; PHOTOGRAPHIC CAMERAS; LENS FOR PHOTOGRAPHIC CAMERAS; MOVIE PROJECTORS; CINEMATOGRAPHIC CAMERAS; BINOCULARS; TELESCOPES; SPEED INDICATORS; ALTIMETERS; VOLTMETERS; CURRENT RECTIFIERS; ELECTRIC TRANSFORMERS; ROTARY CONVERTERS; PHASE MODIFIERS; BATTERIES AND CELLS; AMMETERS; WATTMETERS; ELECTRIC FLAT IRONS FOR HOUSEHOLD USE; ELECTRIC HAIR-CURLERS FOR HOUSEHOLD USE; ELECTRIC BUZZERS; DIGITAL STILL CAMERAS; RECEIVING TUNERS FOR SATELLITE TELEVISION BROADCASTING; TELEVISION TUNERS; OPTICAL DISC PLAYERS AND THEIR ACCESSORIES INCLUDING PLAYER-OPERATED CONTROLLERS; OPTICAL DISC RECORDERS AND THEIR ACCESSORIES INCLUDING PLAYER-OPERATED CONTROLLERS; DVD-ROM PLAYERS AND THEIR ACCESSORIES INCLUDING PLAYER-OPERATED CONTROLLERS; CD RECORDERS AND THEIR ACCESSORIES INCLUDING PLAYER-OPERATED CONTROLLERS; RECHARGEABLE BATTERIES FOR USE WITH PORTABLE AUDIO-VISUAL PLAYERS ONLY; REMOTE CONTROLLERS FOR USE WITH PORTABLE AUDIO-VISUAL PLAYERS ONLY; BATTERY CHARGERS FOR USE WITH PORTABLE AUDIO-VISUAL PLAYERS ONLY; POUCHES, CASES AND BAGS ESPECIALLY DESIGNED

FOR PORTABLE AUDIO-VISUAL PLAYERS; HAND STRAPS, NECK STRAPS AND OTHER STRAPS ESPECIALLY DESIGNED FOR PORTABLE AUDIO-VISUAL PLAYERS; CAR ADAPTERS FOR USE WITH PORTABLE AUDIO-VISUAL PLAYERS ONLY; MEMORY CARDS FOR USE WITH PORTABLE AUDIO-VISUAL PLAYERS ONLY; LIQUID CRYSTAL MONITORS FOR USE WITH PORTABLE AUDIO-VISUAL PLAYERS ONLY; LIQUID CRYSTAL DISPLAYS FOR USE WITH PORTABLE AUDIO-VISUAL PLAYERS ONLY; KEYBOARDS FOR USE WITH PORTABLE AUDIO-VISUAL PLAYERS ONLY; MICROPHONES FOR USE WITH PORTABLE AUDIO-VISUAL PLAYERS ONLY; DIGITAL CAMERAS FOR USE WITH PORTABLE AUDIO-VISUAL PLAYERS ONLY; MODEMS FOR USE WITH PORTABLE AUDIO-VISUAL PLAYERS ONLY; SPEAKERS FOR USE WITH PORTABLE AUDIO-VISUAL PLAYERS ONLY; AMPLIFIERS FOR USE WITH PORTABLE AUDIO-VISUAL PLAYERS ONLY; HARD DISK DRIVES FOR USE WITH PORTABLE AUDIO-VISUAL PLAYERS ONLY; AV CABLES FOR USE WITH PORTABLE AUDIO-VISUAL PLAYERS ONLY; SUPPORTIVE STANDS ESPECIALLY DESIGNED FOR PORTABLE AUDIO-VISUAL PLAYERS; SATELLITE NAVIGATIONAL SYSTEM, NAMELY, A GLOBAL POSITIONING SYSTEM FOR USE WITH PORTABLE AUDIO-VISUAL PLAYERS ONLY; TOUCH PANELS FOR USE WITH PORTABLE AUDIO-VISUAL PLAYERS ONLY; ANGULAR VELOCITY AND/OR ACCELERATION SENSORS FOR USE WITH PORTABLE AUDIO-VISUAL PLAYERS ONLY; RECEIVING TUNERS FOR TERRESTRIAL DIGITAL BROADCASTING FOR USE WITH PORTABLE AUDIO-VISUAL PLAYERS ONLY; STRAPS FOR CASES ESPECIALLY DESIGNED FOR PORTABLE AUDIO-VISUAL PLAYERS; CASES ESPECIALLY DESIGNED FOR PORTABLE AUDIO-VISUAL PLAYERS; FM RADIO TRANSMITTERS FOR USE WITH PORTABLE AUDIO-VISUAL PLAYERS ONLY; RECHARGEABLE BATTERIES FOR USE WITH PORTABLE DIGITAL AUDIO PLAYERS ONLY; REMOTE CONTROLLERS FOR USE WITH PORTABLE DIGITAL AUDIO PLAYERS ONLY; BATTERY CHARGERS FOR USE WITH PORTABLE DIGITAL AUDIO PLAYERS ONLY; POUCHES, CASES AND BAGS ESPECIALLY DESIGNED FOR PORTABLE DIGITAL AUDIO PLAYERS; HAND STRAPS, NECK STRAPS AND OTHER STRAPS ESPECIALLY DESIGNED FOR PORTABLE DIGITAL AUDIO PLAYERS; CAR ADAPTERS ESPECIALLY DESIGNED FOR PORTABLE DIGITAL AUDIO PLAYERS; MEMORY CARDS FOR USE WITH PORTABLE DIGITAL AUDIO PLAYERS ONLY; KEYBOARDS FOR USE WITH PORTABLE DIGITAL AUDIO PLAYERS ONLY; PORTABLE DIGITAL AUDIO PLAYERS; MICROPHONES FOR USE WITH PORTABLE DIGITAL AUDIO PLAYERS ONLY; MODEMS FOR USE WITH PORTABLE DIGITAL AUDIO PLAYERS ONLY; SPEAKERS FOR USE WITH PORTABLE DIGITAL AUDIO PLAYERS ONLY; AMPLIFIERS FOR USE WITH PORTABLE DIGITAL AUDIO PLAYERS ONLY; HARD DISK DRIVES FOR USE WITH PORTABLE DIGITAL AUDIO PLAYERS ONLY; CABLES ESPECIALLY FOR USE WITH PORTABLE DIGITAL AUDIO

PLAYERS ONLY; SUPPORTIVE STANDS ESPECIALLY DESIGNED FOR PORTABLE DIGITAL AUDIO PLAYERS; TOUCH PANELS FOR USE WITH PORTABLE DIGITAL AUDIO PLAYERS ONLY; STRAPS FOR CASES ESPECIALLY DESIGNED FOR PORTABLE DIGITAL AUDIO PLAYERS; CASES ESPECIALLY DESIGNED FOR PORTABLE DIGITAL AUDIO PLAYERS; FM RADIO TRANSMITTERS FOR USE WITH PORTABLE DIGITAL AUDIO PLAYERS ONLY; STRAPS FOR CELLULAR PHONES; BLANK OPTICAL DISCS; OPTICAL SCANNERS; CONTROLLERS, JOYSTICKS, MEMORY CARDS AND VOLUME CONTROLLERS FOR PERSONAL COMPUTERS; HARD DISK DRIVES; HARD DISC RECORDERS; LIQUID CRYSTAL MONITORS FOR USE WITH COMPUTERS; LIQUID CRYSTAL DISPLAYS FOR USE WITH COMPUTERS; DISPLAYS FOR USE WITH COMPUTERS; KEYBOARDS FOR USE WITH COMPUTERS; MICROPHONES FOR USE WITH COMPUTERS; CAMERAS FOR USE WITH COMPUTERS; MODEMS FOR USE WITH COMPUTERS; SPEAKERS FOR USE WITH COMPUTERS; AMPLIFIER FOR USE WITH COMPUTERS; HARD DISK DRIVES FOR USE WITH COMPUTERS; CABLES FOR USE WITH COMPUTERS; SUPPORTIVE STANDS DESIGNED FOR COMPUTERS; REMOTE CONTROLLERS FOR USE WITH COMPUTERS; RECHARGEABLE BATTERIES FOR USE WITH COMPUTERS; HEADPHONES FOR USE WITH COMPUTERS; BATTERY CHARGERS FOR USE WITH COMPUTERS; POUCHES, CASES AND BAGS ESPECIALLY DESIGNED FOR COMPUTERS; HAND STRAPS, NECK STRAPS AND OTHER STRAPS ESPECIALLY DESIGNED FOR COMPUTERS; CAR ADAPTERS FOR USE WITH COMPUTERS; SATELLITE NAVIGATIONAL SYSTEM, NAMELY, GLOBAL POSITIONING SYSTEM FOR USE WITH COMPUTERS; TOUCH PANELS FOR USE WITH COMPUTERS; ANGULAR VELOCITY SENSORS AND/OR ACCELERATION SENSORS DESIGNED FOR COMPUTERS; RECEIVING TUNERS FOR TERRESTRIAL DIGITAL BROADCASTING FOR USE WITH COMPUTERS; STRAPS FOR CASES FOR USE WITH COMPUTERS; CASES ESPECIALLY DESIGNED FOR COMPUTERS; FM RADIO TRANSMITTERS FOR USE WITH COMPUTERS; MICE FOR COMPUTERS; ROUTERS FOR COMPUTERS; COMPUTER GAME PROGRAMS; RECORDED OPTICAL DISCS FEATURING COMPUTER GAME PROGRAMS; MAGNETIC CORES; RESISTANCE WIRES; ELECTRODES; FIRE BOATS; MOTOR FIRE ENGINES; CIGAR LIGHTERS FOR AUTOMOBILES; PROTECTIVE WORK GLOVES, NAMELY, GLOVES FOR PROTECTION AGAINST ACCIDENTS; DUST MASKS; GAS MASKS; WELDING MASKS; FIRE-PROOF GARMENTS; SPECTACLES; PROGRAMS FOR AMUSEMENT VIDEO GAME MACHINES; ELECTRONIC CIRCUITS RECORDING PROGRAMS FOR VIDEO GAMES WITH TELEVISION FOR PERSONAL USE; ELECTRONIC CIRCUITS RECORDING PROGRAMS FOR HAND-HELD GAMES WITH CRYSTAL LIQUID DISPLAYS; LIQUID CRYSTAL MONITORS FOR USE WITH VIDEO GAMES FOR USE WITH TELEVISIONS FOR PERSONAL USE ONLY; LIQUID CRYSTAL DISPLAYS FOR USE WITH VIDEO GAMES FOR USE

WITH TELEVISIONS FOR PERSONAL USE ONLY; KEYBOARDS FOR USE WITH VIDEO GAMES FOR USE WITH TELEVISION FOR PERSONAL USE ONLY; MICROPHONES FOR USE WITH VIDEO GAMES FOR USE WITH TELEVISION FOR PERSONAL USE ONLY; DIGITAL CAMERAS FOR USE WITH VIDEO GAMES FOR USE WITH TELEVISION FOR PERSONAL USE ONLY; MODEMS FOR USE WITH VIDEO GAMES FOR USE WITH TELEVISION FOR PERSONAL USE ONLY; SPEAKERS FOR USE WITH VIDEO GAMES FOR USE WITH TELEVISION FOR PERSONAL USE ONLY; AMPLIFIERS FOR USE WITH VIDEO GAMES FOR USE WITH TELEVISION FOR PERSONAL USE ONLY; HARD DISK DRIVES FOR USE WITH VIDEO GAMES FOR USE WITH TELEVISION FOR PERSONAL USE ONLY; CABLES FOR USE WITH VIDEO GAMES FOR USE WITH TELEVISION FOR PERSONAL USE ONLY; SUPPORTIVE STANDS ESPECIALLY DESIGNED FOR VIDEO GAMES FOR USE WITH TELEVISION FOR PERSONAL USE; REMOTE CONTROLLERS FOR USE WITH VIDEO GAMES FOR USE WITH TELEVISION FOR PERSONAL USE ONLY; RECHARGEABLE BATTERIES FOR USE WITH VIDEO GAMES FOR USE WITH TELEVISION FOR PERSONAL USE ONLY; HEADPHONES FOR USE WITH VIDEO GAMES FOR USE WITH TELEVISION FOR PERSONAL USE ONLY; BATTERY CHARGERS FOR USE WITH VIDEO GAMES FOR USE WITH TELEVISION FOR PERSONAL USE ONLY, POUCHES, CASES AND BAGS ESPECIALLY DESIGNED FOR VIDEO GAMES FOR USE WITH TELEVISION FOR PERSONAL USE ONLY; HAND STRAPS, NECK STRAPS AND OTHER STRAPS ESPECIALLY DESIGNED FOR VIDEO GAMES FOR USE WITH TELEVISION FOR PERSONAL USE ONLY; CAR ADAPTERS FOR USE WITH VIDEO GAMES FOR USE WITH TELEVISION FOR PERSONAL USE ONLY; SATELLITE NAVIGATIONAL SYSTEM, NAMELY, GLOBAL POSITIONING SYSTEM FOR USE WITH VIDEO GAMES FOR USE WITH TELEVISION FOR PERSONAL USE ONLY; TOUCH PANELS FOR USE WITH VIDEO GAMES FOR USE WITH TELEVISION FOR PERSONAL USE ONLY; ANGULAR VELOCITY SENSORS AND/OR ACCELERATION SENSORS FOR USE WITH VIDEO GAMES FOR USE WITH TELEVISION FOR PERSONAL USE ONLY; RECEIVING TUNERS FOR TERRESTRIAL DIGITAL BROADCASTING FOR USE WITH VIDEO GAMES FOR USE WITH TELEVISION FOR PERSONAL USE ONLY; STRAPS FOR CASES ESPECIALLY DESIGNED FOR VIDEO GAMES FOR USE WITH TELEVISION FOR PERSONAL USE ONLY; CASES ESPECIALLY DESIGNED FOR VIDEO GAMES FOR USE WITH TELEVISION FOR PERSONAL USE ONLY; FM RADIO TRANSMITTERS FOR USE WITH VIDEO GAMES FOR USE WITH TELEVISION FOR PERSONAL USE ONLY; RECHARGEABLE BATTERIES FOR USE WITH HAND-HELD GAMES WITH LIQUID CRYSTAL DISPLAYS ONLY; REMOTE CONTROLLERS FOR USE WITH HAND-HELD GAMES WITH LIQUID CRYSTAL DISPLAYS ONLY; BATTERY CHARGERS FOR USE WITH HAND-HELD GAMES WITH LIQUID CRYSTAL DISPLAYS ONLY; CAR ADAPTERS FOR USE WITH HAND-HELD GAMES WITH LIQUID CRYSTAL DISPLAYS ONLY; MEMORY

CARDS FOR USE WITH HAND-HELD GAMES WITH LIQUID CRYSTAL DISPLAYS ONLY; LIQUID CRYSTAL MONITORS FOR USE WITH HAND-HELD GAMES WITH LIQUID CRYSTAL DISPLAYS ONLY; LIQUID CRYSTAL DISPLAYS FOR USE WITH HAND-HELD GAMES WITH LIQUID CRYSTAL DISPLAYS ONLY; KEYBOARDS FOR USE WITH HAND-HELD GAMES WITH LIQUID CRYSTAL DISPLAYS ONLY; MICROPHONES FOR USE WITH HAND-HELD GAMES WITH LIQUID CRYSTAL DISPLAYS ONLY; DIGITAL CAMERAS FOR USE WITH HAND-HELD GAMES WITH LIQUID CRYSTAL DISPLAYS ONLY; MODEMS FOR USE WITH HAND-HELD GAMES WITH LIQUID CRYSTAL DISPLAYS ONLY; SPEAKERS FOR USE WITH HAND-HELD GAMES WITH LIQUID CRYSTAL DISPLAYS ONLY; AMPLIFIERS FOR USE WITH HAND-HELD GAMES WITH LIQUID CRYSTAL DISPLAYS ONLY; HARD DISK DRIVES FOR USE WITH HAND-HELD GAMES WITH LIQUID CRYSTAL DISPLAYS ONLY; AV CABLES FOR USE WITH HAND-HELD GAMES WITH LIQUID CRYSTAL DISPLAYS ONLY; SATELLITE NAVIGATIONAL SYSTEM, NAMELY, GLOBAL POSITIONING SYSTEM FOR USE WITH HAND-HELD GAMES WITH LIQUID CRYSTAL DISPLAYS ONLY; TOUCH PANELS FOR USE WITH HAND-HELD GAMES WITH LIQUID CRYSTAL DISPLAYS ONLY; ANGULAR VELOCITY SENSORS AND/OR ACCELERATION SENSORS FOR USE WITH HAND-HELD GAMES WITH LIQUID CRYSTAL DISPLAYS ONLY; RECEIVING TUNERS FOR TERRESTRIAL DIGITAL BROADCASTING FOR USE WITH HAND-HELD GAMES WITH LIQUID CRYSTAL DISPLAYS ONLY; FM RADIO TRANSMITTERS FOR USE WITH HAND-HELD GAMES WITH LIQUID CRYSTAL DISPLAYS ONLY; SLOT MACHINES; WEIGHT BELTS FOR SCUBA DIVING; PROTECTIVE HELMETS FOR SPORTS; AIR TANKS FOR SCUBA DIVING; REGULATORS FOR SCUBA DIVING; SOUND RECORDED MAGNETIC CARDS, MAGNETIC SHEETS, MAGNETIC DISCS, OPTICAL DISCS AND MAGNETIC TAPES; SOUND RECORDED COMPACT DISCS FEATURING MUSIC; CD-ROMS FEATURING RECORDED AUTOMATIC PERFORMANCE PROGRAMS FOR ELECTRONIC MUSICAL INSTRUMENTS; DOWNLOADABLE MUSICAL SOUND RECORDINGS; SLIDE-RULES; EXPOSED CINEMATOGRAPHIC FILMS; EXPOSED SLIDE FILMS; SLIDE FILM MOUNTS; PRE-RECORDED DVD-ROMS FEATURING CINEMA; PRE-RECORDED OPTICAL DISCS FEATURING CINEMA; PRE-RECORDED OPTICAL MAGNETIC DISCS FEATURING CINEMA; DOWNLOADABLE ELECTRONIC PUBLICATION IN THE NATURE OF MAGAZINES, BOOKS AND NEWSPAPERS IN THE FIELD OF MUSIC, VIDEO AND VIDEO GAME; DOWNLOADABLE MAPS, PICTURES AND DRAWINGS; DOWNLOADABLE VIDEO IMAGES; DOWNLOADABLE ELECTRONIC PUBLICATIONS IN THE NATURE OF MAGAZINES, BOOKS IN THE FIELD OF MUSIC, VIDEO AND VIDEO GAMES, IN CLASS 9 (U.S. CLS. 21, 23, 26, 36 AND 38).

FOR: METAL BAG CLASPS; PURSE CLASPS; INDUSTRIAL PACKAGING CONTAINERS OF LEATHER; CLOTHING FOR DOMESTIC PETS; FELT

POUCHES AND POUCHES OF LEATHER; DAY PACKS; FOLDING BRIEFCASES; SHOULDER BAGS; CARRY-ON BAGS; TRUNKS; HANDBAGS; BOSTON BAGS; BACKPACKS; NAME CARD CASES; CREDIT CARD CASES; KEY CASES; WALLET NOT OF PRECIOUS METAL; BUSINESS CARD CASES; FELT POUCHES; POUCHES OF LEATHER; TOOL POUCHES SOLD EMPTY; DRAWSTRING POUCHES; VANITY CASES, NOT FITTED SOLD EMPTY; UMBRELLAS; WALKING STICKS; CANES; METAL PARTS OF CANES AND WALKING-STICKS; HANDLES OF CANES OR WALKING-STICKS; SADDLERY; RAWHIDE CHEWS FOR DOGS; TOILET CASES, SOLD EMPTY; UNWORKED OR SEMI-WORKED LEATHER; VANITY CASES SOLD EMPTY, IN CLASS 18 (U.S. CLS. 1, 2, 3, 22 AND 41).

FOR: DENTAL FLOSS; UNWORKED OR SEMI-WORKED GLASS NOT FOR BUILDING; MANGERS FOR ANIMALS; POULTRY RINGS; COOKING SKEWERS; TUB BRUSHES; BRUSHES FOR PIPES; SHIP-SCRUBBING BRUSHES; HOUSEHOLD GLOVES FOR GENERAL PURPOSES; INDUSTRIAL PACKAGING CONTAINERS OF GLASS OR PORCELAIN FOR MEDICINES, FOODS, COSMETICS AND BEVERAGES; DRINKING GLASSES NOT OF PRECIOUS METAL; DISHES AND PLATES NOT OF PRECIOUS METAL; BEER MUGS NOT OF PRECIOUS METAL; HOUSEHOLD CANS FOR CONFECTIONERY NOT OF PRECIOUS METAL; KITCHEN URNS NOT OF PRECIOUS METAL; PORTABLE COLDBOXES, NON-ELECTRIC; RICE CHESTS; FOOD PRESERVING JARS OF GLASS; DRINKING FLASKS FOR TRAVELERS; VACUUM BOTTLES; CLOTHS FOR CLEANING VIDEO GAMES FOR USE WITH TELEVISION FOR PERSONAL USE; CLOTHS FOR CLEANING COMPUTERS; CLOTHS FOR CLEANING HAND-HELD GAMES WITH LIQUID CRYSTAL DISPLAYS; CLOTHS FOR CLEANING PORTABLE DIGITAL AUDIO PLAYERS; WASTE BASKETS; BUCKETS; IRONING BOARDS; STIRRERS FOR HOT BATHTUB WATER; BATHROOM STOOLS; BATHROOM PAILS; CANDLE EXTINGUISHERS AND CANDLE-STANDS NOT OF PRECIOUS METAL; FLY SWATTERS; MOUSE TRAPS; FLOWER POTS; WATERING CANS; FEEDING VESSELS FOR PETS; BRUSHES FOR

PETS; BIRD CAGES; BIRD BATHS; CLOTHES BRUSHES; CHAMBER POTS; TOILET PAPER HOLDERS; BOXES OF METAL FOR DISPENSING PAPER TOWELS; BOOT JACKS; SOAP DISPENSERS; FLOWER VASES AND BOWLS NOT OF PRECIOUS METAL; WIND CHIMES; UPRIGHT SIGNBOARDS OF GLASS OR CERAMICS; PERFUME BURNERS; COMBS; FITTED VANITY CASES; POWDER COMPACTS NOT OF PRECIOUS METAL, SOLD EMPTY; SOAP HOLDERS AND BOXES; TOOTHBRUSHES; SHOE BRUSHES; SHOE HORNS; SHOE SHINE CLOTHS; SHOE-TREES; PORTABLE COOKING KITS FOR OUTDOOR USE; PIG BRISTLES; INSECT COLLECTING IMPLEMENTS, NAMELY, INSECT TRAPS, IN CLASS 21 (U.S. CLS. 2, 13, 23, 29, 30, 33, 40 AND 50).

FOR: WAX FOR SKIS; AMUSEMENT MACHINES AND APPARATUS FOR USE IN AMUSEMENT PARKS OTHER THAN ARCADE VIDEO GAME MACHINES; TOYS FOR DOMESTIC PETS; POCKET-SIZED ELECTRONIC GAMES; PORTABLE GAMES WITH LIQUID CRYSTAL DISPLAYS INCLUDING EXCLUSIVE EARPHONES CONNECTED TO AND USED FOR SUCH GAMES AND OTHER ACCESSORIES THEREFOR; POUCHES, CASES AND BAGS ESPECIALLY DESIGNED FOR HAND-HELD GAMES WITH LIQUID CRYSTAL DISPLAYS; HAND STRAPS, NECK STRAPS AND OTHER STRAPS ESPECIALLY DESIGNED FOR HAND-HELD GAMES WITH LIQUID CRYSTAL DISPLAYS; SUPPORTIVE STANDS ESPECIALLY DESIGNED FOR HAND-HELD GAMES WITH LIQUID CRYSTAL DISPLAYS; STRAPS FOR CASES ESPECIALLY DESIGNED FOR HAND-HELD GAMES WITH LIQUID CRYSTAL DISPLAYS; CASES ESPECIALLY DESIGNED FOR HAND-HELD GAMES WITH LIQUID CRYSTAL DISPLAYS; GOLF BALLS; GOLF TEES; GOLF GLOVES; FISHING TACKLE , IN CLASS 28 (U.S. CLS. 22, 23, 38 AND 50).

OWNER OF AUSTRALIA REG. NO. 1060351, DATED 6-15-2005, EXPIRES 6-15-2015.

SER. NO. 76-641,547, FILED 6-24-2005.

PATRICIA EVANKO, EXAMINING ATTORNEY

Int. Cl.: 6

Prior U.S. Cls.: 2, 12, 13, 14, 23, 25 and 50

Reg. No. 3,482,766

United States Patent and Trademark Office

Registered Aug. 12, 2008

**TRADEMARK
PRINCIPAL REGISTER**

DU VERRE

DU VERRE GLASS LIMITED (CANADA CORPORATION)
188 STRACHAN AVENUE
TORONTO, ONTARIO, CANADA M6J 2S9

FOR: METAL DECORATIVE HARDWARE, NAMELY, DRAWER PULLS, KNOBS AND HANDLES FOR CABINETS AND DOORS; METAL DOOR HARDWARE, NAMELY, KNOBS AND HANDLES; METAL GATE HARDWARE, NAMELY, GATE LATCHES, KNOBS AND HANDLES; METAL BATHROOM HARDWARE, NAMELY, TOWEL BAR SUPPORTS AND HANDLES; METAL FURNITURE HARDWARE, NAMELY, KNOBS AND HANDLES, IN CLASS 6 (U.S. CLS. 2, 12, 13, 14, 23, 25 AND 50).

FIRST USE 12-31-1999; IN COMMERCE 12-31-1999.

THE MARK CONSISTS OF STANDARD CHARACTERS WITHOUT CLAIM TO ANY PARTICULAR FONT, STYLE, SIZE, OR COLOR.

THE WORDING "DUVERRE" APPEARING IN THE MARK HAS NO MEANING IN A FOREIGN LANGUAGE.

SER. NO. 76-648,454, FILED 10-14-2005.

GENE MACIOL, EXAMINING ATTORNEY

Int. Cl.: 5

Prior U.S. Cls.: 6, 18, 44, 46, 51 and 52

United States Patent and Trademark Office

Reg. No. 3,482,767

Registered Aug. 12, 2008

**TRADEMARK
PRINCIPAL REGISTER**

THE FUTURE OF BODYBUILDING

NXCARE, INC. (CANADA CORPORATION)
218 SILVERCREEK PKWY. N
SUITE 1163
GUELPH, ONTARIO N1H 8E8, CANADA

THE MARK CONSISTS OF STANDARD CHAR-
ACTERS WITHOUT CLAIM TO ANY PARTICULAR
FONT, STYLE, SIZE, OR COLOR.

FOR: DIETARY SUPPLEMENTS, IN CLASS 5 (U.S.
CLS. 6, 18, 44, 46, 51 AND 52).

SER. NO. 76-652,161, FILED 12-12-2005.

FIRST USE 9-25-2003; IN COMMERCE 9-25-2003.

LINDA E. BLOHM, EXAMINING ATTORNEY

Int. Cls.: 35 and 36

Prior U.S. Cls.: 100, 101 and 102

United States Patent and Trademark Office

Reg. No. 3,482,768

Registered Aug. 12, 2008

**SERVICE MARK
PRINCIPAL REGISTER**



BSG CLEARING SOLUTIONS NORTH AMERI-
CA, LLC (DELAWARE CORPORATION)
2700 PATRIOT BOULEVARD, SUITE 150
GLENVIEW, IL 60026

FOR: GENERAL INFORMATION CLEARING
HOUSE; NEGOTIATION AND SETTLEMENT OF
COMMERCIAL TRANSACTIONS FOR THIRD PAR-
TIES, IN CLASS 35 (U.S. CLS. 100, 101 AND 102).

FIRST USE 9-21-2005; IN COMMERCE 9-21-2005.

FOR: FINANCIAL CLEARING HOUSE, IN CLASS
36 (U.S. CLS. 100, 101 AND 102).

FIRST USE 9-21-2005; IN COMMERCE 9-21-2005.

SER. NO. 76-653,389, FILED 1-17-2006.

BRIDGETT SMITH, EXAMINING ATTORNEY

Int. Cl.: 41

Prior U.S. Cls.: 100, 101 and 107

United States Patent and Trademark Office

Reg. No. 3,482,769

Registered Aug. 12, 2008

**SERVICE MARK
PRINCIPAL REGISTER**



HARVEY, STEVE (UNITED STATES INDIVIDUAL)

10390 WILSHIRE BLVD., STE. 305

LOS ANGELES, CA 90024 AND

MCDONALD, RUSHION (UNITED STATES INDIVIDUAL)

1202 TUMBURY OAK LANE

HOUSTON, TX 77055 AND

ANDERSON, RICKY (UNITED STATES INDIVIDUAL)

7322 S. W. FRWY., STE. 2010

HOUSTON, TX 77074

FOR: ENTERTAINMENT SERVICES PROVIDED BY A NATIONAL RADIO NETWORK OF AFFILIATE STATIONS, NAMELY, RADIO PROGRAMS IN THE FIELDS OF BUSINESS, ENTERTAINMENT, NEWS, POLITICS, AND LIFE TOPICS AND HOSTED BY STEVE HARVEY, IN CLASS 41 (U.S. CLS. 100, 101 AND 107).

FIRST USE 9-19-2005; IN COMMERCE 9-19-2005.

NO CLAIM IS MADE TO THE EXCLUSIVE RIGHT TO USE "RADIO NETWORK", APART FROM THE MARK AS SHOWN.

THE NAME "STEVE HARVEY" IDENTIFIES A LIVING INDIVIDUAL WHOSE CONSENT IS OF RECORD.

THE COLOR(S) BLACK AND WHITE IS/ARE CLAIMED AS A FEATURE OF THE MARK.

THE MARK CONSISTS OF ALL TEXT APPEARS IN BLACK COLOR. SHADOWING ON THE HAT AND THE FABRIC TRIM APPEARS IN WHITE COLOR.

SER. NO. 76-654,277, FILED 1-31-2006.

MARY BOAGNI, EXAMINING ATTORNEY

Int. Cls.: 9, 37 and 42

Prior U.S. Cls.: 21, 23, 26, 36, 38, 100, 101, 103 and 106

United States Patent and Trademark Office

Reg. No. 3,482,770

Registered Aug. 12, 2008

TRADEMARK
SERVICE MARK
PRINCIPAL REGISTER

SOLAR
L I G H T

SOLAR LIGHT COMPANY, INC. (PENNSYLVANIA CORPORATION)
100 EAST GLENSIDE AVENUE
GLENSIDE, PA 19038

FOR: MEASURING EQUIPMENT FOR SCIENTIFIC, COMMERCIAL, INDUSTRIAL AND PERSONAL USE, NAMELY, ANALOG AND DIGITAL DETECTORS, MONITORS, METERS, AND INSTRUMENTATION FOR MEASURING LIGHT, UVA, UVB, UVC, VISIBLE, INFRARED, FULL SPECTRUM, GLOBAL RADIATION, ERYTHEMA, SAFETY, AND CUSTOM BANDWIDTHS, TEMPERATURE, AND HUMIDITY; RADIOMETERS; PHOTOMETERS; ATMOSPHERIC MONITORS; AND ACCESSORIES, NAMELY, POWER SUPPLIES, LAMPS, AND SOFTWARE FOR OPERATING THE FOREGOING; SUNPHOTOMETERS; OZONOMETERS; ELECTRONIC DATA LOGGERS FOR MEASURING LIGHT; SIMULATORS AND INSTRUMENTATION FOR REPRODUCING UVA, UVB, UVC, GLOBAL RADIATION EQUIVALENT OF SUNLIGHT, VISIBLE LIGHT, AND FULL SPECTRUM LIGHT FOR SCIENTIFIC, COMMERCIAL AND INDUSTRIAL USE, NAMELY, SIMULATORS FOR IRRADIATING BIOLOGICAL MATERIALS, PHOTOVOLTAIC CELL RESEARCH AND TESTING, SUNSCREEN PROTECTION FACTOR (SPF) DETERMINATION STUDIES, AND MATERIALS EXPOSURE TESTING, IN CLASS 9 (U.S. CLS. 21, 23, 26, 36 AND 38).

FIRST USE 0-0-1973; IN COMMERCE 0-0-1974.

FOR: REPAIR AND MAINTENANCE OF METERS, MONITORS, DETECTORS, INSTRUMENTATION AND LIGHT SOURCES FOR OTHERS, IN CLASS 37 (U.S. CLS. 100, 103 AND 106).

FIRST USE 0-0-1969; IN COMMERCE 0-0-1969.

FOR: MATERIALS TESTING SERVICES; TESTING AND RESEARCH ON MEASURING MACHINES, APPARATUS AND INSTRUMENTS; TESTING FOR OTHERS, NAMELY, UV EXPOSURE FOR MATERIALS TESTING, SPECTRAL RESPONSE, AND OUTPUT TESTING OF LIGHT SOURCES AND MEASURING DETECTORS; DESIGN MODIFICATION, CALIBRATION AND VALIDATION OF METERS, MONITORS, DETECTORS, INSTRUMENTATION AND LIGHT SOURCES FOR OTHERS, IN CLASS 42 (U.S. CLS. 100 AND 101).

FIRST USE 0-0-1989; IN COMMERCE 0-0-1991.

OWNER OF U.S. REG. NO. 2,528,783.

SEC. 2(F) AS TO "SOLAR LIGHT".

SER. NO. 76-654,584, FILED 2-3-2006.

CURTIS FRENCH, EXAMINING ATTORNEY

Int. Cl.: 42

Prior U.S. Cls.: 100 and 101

United States Patent and Trademark Office

Reg. No. 3,482,771

Registered Aug. 12, 2008

**SERVICE MARK
PRINCIPAL REGISTER**

Bee.Net

BEE ENTERPRISES, INC. (PENNSYLVANIA
CORPORATION)
56 EAST UWCHLAN AVENUE
EXTON, PA 19341

FOR: HOSTING THE WEB SITES OF OTHERS ON
A COMPUTER SERVER FOR GLOBAL COMPUTER
NETWORK, IN CLASS 42 (U.S. CLS. 100 AND 101).

FIRST USE 7-1-1996; IN COMMERCE 7-1-1996.

THE MARK CONSISTS OF STANDARD CHAR-
ACTERS WITHOUT CLAIM TO ANY PARTICULAR
FONT, STYLE, SIZE, OR COLOR.

SER. NO. 76-657,763, FILED 4-3-2006.

ARETHA SOMERVILLE, EXAMINING ATTORNEY

Int. Cl.: 35

Prior U.S. Cls.: 100, 101 and 102

United States Patent and Trademark Office

Reg. No. 3,482,772

Registered Aug. 12, 2008

**SERVICE MARK
PRINCIPAL REGISTER**

PACERS

FARLEY ENTERPRISES, INC. (VIRGINIA CORPORATION)
1301 KING STREET
ALEXANDRIA, VA 22314

FOR: RETAIL STORE SERVICES FEATURING RUNNING, WALKING, AND ATHLETIC FOOTWEAR, CLOTHING, SOCKS, HATS, GLOVES, SHOE INSERTS, WATCHES, HEART RATE MONITORS, ENERGY FOOD PRODUCTS, AND OTHER ACCESSORIES FOR RUNNERS, WALKERS, AND ATHLETES, IN CLASS 35 (U.S. CLS. 100, 101 AND 102).

FIRST USE 6-23-2003; IN COMMERCE 6-23-2003.

THE MARK CONSISTS OF STANDARD CHARACTERS WITHOUT CLAIM TO ANY PARTICULAR FONT, STYLE, SIZE, OR COLOR.

SER. NO. 76-659,065, FILED 4-24-2006.

BENJAMIN OKEKE, EXAMINING ATTORNEY

Int. Cl.: 28

Prior U.S. Cls.: 22, 23, 38 and 50

United States Patent and Trademark Office

Reg. No. 3,482,773

Registered Aug. 12, 2008

**TRADEMARK
PRINCIPAL REGISTER**

SCENT GUARD

STEICHEN, CRAIG (UNITED STATES INDIVIDUAL)
405 35TH AVENUE N.E.
GREAT FALLS, MT 59404

OWNER OF U.S. REG. NO. 1,487,288.

FOR: HUMAN SCENT ELIMINATOR, OR CAMOUFLAGE SCENT, FOR USE IN HUNTING AND FISHING, IN CLASS 28 (U.S. CLS. 22, 23, 38 AND 50).

NO CLAIM IS MADE TO THE EXCLUSIVE RIGHT TO USE "SCENT", APART FROM THE MARK AS SHOWN.

FIRST USE 3-29-1986; IN COMMERCE 3-29-1986.

SER. NO. 76-660,501, FILED 11-28-2005.

THE MARK CONSISTS OF STANDARD CHARACTERS WITHOUT CLAIM TO ANY PARTICULAR FONT, STYLE, SIZE, OR COLOR.

BENJAMIN OKEKE, EXAMINING ATTORNEY

Int. Cl.: 42

Prior U.S. Cls.: 100 and 101

United States Patent and Trademark Office

Reg. No. 3,482,774

Registered Aug. 12, 2008

**SERVICE MARK
PRINCIPAL REGISTER**



GOLF COURSE SUPERINTENDENTS ASSOCIATION OF AMERICA (DELAWARE ASSOCIATION)
1421 RESEARCH DRIVE
LAWRENCE, KS 660493859

FOR: SEARCH MECHANISM SERVICES IN THE NATURE OF PROVIDING SEARCH ENGINES FOR OBTAINING DATA ON A GLOBAL COMPUTER NETWORK ABOUT GOLF COURSE MANAGEMENT ON A GLOBAL COMPUTER NETWORK, IN CLASS 42 (U.S. CLS. 100 AND 101).

FIRST USE 2-4-2005; IN COMMERCE 2-4-2005.

THE COLOR(S) LIGHT YELLOW AND BLUE IS/ARE CLAIMED AS A FEATURE OF THE MARK.

THE LIGHT YELLOW-GREEN APPEARS IN THE MARK AS THE COLOR OF THE LETTERS "FORE" AND THE BLUE APPEARS AS THE OUTLINE FOR A STYLIZED QUOTE SYMBOL FROM WHICH THE MARK EXTENDS, AND IN THE EXCLAMATION POINT THAT APPEARS AT THE END OF THE MARK AFTER THE LETTER "E".

SER. NO. 76-661,228, FILED 6-8-2006.

SEAN CROWLEY, EXAMINING ATTORNEY

Int. Cls.: 7, 9, 11, 35, 41 and 42

**Prior U.S. Cls.: 13, 19, 21, 23, 26, 31, 34, 35, 36, 38,
100, 101, 102 and 107**

Reg. No. 3,482,775

United States Patent and Trademark Office

Registered Aug. 12, 2008

**TRADEMARK
SERVICE MARK
PRINCIPAL REGISTER**



KMT GROUP AB (SWEDEN PUBLIC LLC)
BOX 8 SE
STOCKHOLM, SWEDEN 101 20

FOR: BENDING MACHINES; CONTROL MECHANISMS BEING PARTS OF MACHINES FOR MACHINES, ENGINES AND MOTORS; CUTTING MACHINES; DRILLING MACHINES; MACHINE PARTS, NAMELY, FEEDERS FOR USE IN FEEDING PRODUCTS AND MATERIALS IN PROCESSING MACHINES; GRINDING MACHINES FOR USE IN GRINDING PISTON PINS, GEAR BOX COMPONENTS, PUMP GEARS, MOTOR AND PUMP GEARS, AND BEARING RINGS; MANIPULATORS, NAMELY, AUTOMATIC HANDLING MACHINES FOR HANDLING PRODUCTS AND MATERIALS FOR FURTHER MANIPULATION; MACHINE TOOL HOLDERS; LATHES; MACHINE TOOLS, NAMELY, METAL WORKING MACHINE TOOLS, BENDING MACHINE TOOLS, AND CUTTING MACHINE TOOLS; METALWORKING MACHINES, NAMELY, MACHINES USED FOR POLISHING METAL PARTS AND BEARING RINGS; POLISHING MACHINES FOR USE IN GRINDING AND POLISHING METAL; METAL EXTRUSION PRESSES; MACHINE PARTS, NAMELY, VACUUM PUMPS; TABLES SPECIALLY ADAPTED TO HOLD POWERED MACHINERY; TOOL BITS FOR MACHINES; TRIMMING MACHINES; PARTICLE BLAST CLEANING MACHINES AND STRUCTURAL PARTS THEREOF, IN CLASS 7 (U.S. CLS. 13, 19, 21, 23, 31, 34 AND 35).

FOR: MEASURING APPARATUS COMPRISED OF GAUGING INSTRUMENTS FOR USE IN MEASURING ANGLE CONTROL, TAPER, PARALLELISM, LENGTH, WIDTH, INSIDE AND OUTSIDE

DIAMETER OF SHEET STEEL PARTS, TUBES, CASTINGS, FORGED PARTS, COMPOSITE COMPONENTS, BEARING MATERIAL, FUEL INJECTION COMPONENTS, VALVE TRAIN COMPONENTS, PISTON PINS, GEAR BOX COMPONENTS, PUMP GEARS, MOTOR AND PUMP GEARS AND METAL PROCESSED; MEASURING JIGS FOR USE IN CONTROLLING SHEET STEEL PARTS, TUBES, CASTINGS, FORGED PARTS, COMPOSITE COMPONENTS, BEARING MATERIAL, FUEL INJECTION COMPONENTS, VALVE TRAIN COMPONENTS, PISTON PINS, GEAR BOX COMPONENTS, PUMP GEARS, MOTOR AND PUMP GEARS AND METAL PROCESSED; COMPUTER SOFTWARE PROGRAMS FOR CONTROLLING AND INTEGRATING INDUSTRIAL MACHINE OPERATIONS; ELECTRONIC MONITORING APPARATUS COMPRISED OF CONTROL PANELS FOR USE IN MONITORING THE STATUS OF INDUSTRIAL EQUIPMENT FOR FULFILLING COMPONENT REQUIREMENTS AND INDUSTRIAL MACHINE OPERATION REQUIREMENTS, IN CLASS 9 (U.S. CLS. 21, 23, 26, 36 AND 38).

FOR: AIR CONDITIONING APPARATUS; CENTRAL AIR CONDITIONING INSTALLATIONS; AIR COOLING APPARATUS, NAMELY, EVAPORATIVE AIR COOLING UNITS FOR DOMESTIC USE; AIR PURIFYING APPARATUS, NAMELY, AIR PURIFICATION UNITS; COOLING APPLIANCES AND COOLING INSTALLATIONS, NAMELY, ELECTRIC SPACE COOLING APPARATUS FOR INDUSTRIAL USE; ELECTRIC FANS; AIR CONDITIONING UNITS; REGULATING ACCESSORIES FOR WATER SUPPLY, NAMELY, METERED VALVES, IN CLASS 11 (U.S. CLS. 13, 21, 23, 31 AND 34).

FOR: ARRANGING AND CONDUCTING OF BUSINESS CONFERENCES, IN CLASS 35 (U.S. CLS. 100, 101 AND 102).

FOR: ARRANGING AND CONDUCTING EDUCATIONAL CONFERENCES IN THE FIELD OF TOOLS AND MACHINERY; ARRANGING PROFESSIONAL WORKSHOPS AND TRAINING COURSES IN THE FIELD OF TOOLS AND MACHINERY; CONDUCTING WORKSHOPS AND SEMINARS IN THE FIELD OF TOOLS AND MACHINERY; ORGANIZING EXHIBITIONS FOR CULTURAL OR EDUCATIONAL PURPOSES IN THE FIELD OF TOOLS AND MACHINERY; TEACHING IN THE FIELD OF TOOLS AND MACHINERY, IN CLASS 41 (U.S. CLS. 100, 101 AND 107).

FOR: COMPUTER PROGRAMMING; COMPUTER SOFTWARE DESIGN FOR OTHERS; MAINTENANCE OF COMPUTER SOFTWARE; UPDATING OF COMPUTER SOFTWARE FOR OTHERS; COMPUTER SYSTEM DESIGN FOR OTHERS; COMPUTER SYSTEM ANALYSIS; INDUSTRIAL DESIGN; ENGINEERING; INSTALLATION OF COMPUTER SOFTWARE; MATERIAL TESTING; QUALITY CONTROL FOR OTHERS; TECHNICAL RESEARCH

IN THE FIELD OF MECHANICAL ENGINEERING, IN CLASS 42 (U.S. CLS. 100 AND 101).

PRIORITY CLAIMED UNDER SEC. 44(D) ON ERPN CMNTY TM OFC APPLICATION NO. 005071774, FILED 4-21-2006, REG. NO. 005071774, DATED 3-8-2007, EXPIRES 4-21-2016.

OWNER OF U.S. REG. NO. 3,049,121.

THE COLOR(S) BLUE AND RED IS/ARE CLAIMED AS A FEATURE OF THE MARK.

THE MARK CONSISTS OF THE COLOR BLUE IN CONNECTION WITH THE STYLIZED LETTERING "KMT" WITH EXCEPTION TO THE UPPER RIGHT-HAND PORTION OF THE LETTER "K" AND THE COLOR RED IN CONNECTION WITH THE UPPER RIGHT-HAND PORTION OF THE LETTER "K" ALONG WITH THE STYLIZED LINE BELOW THE WORDING.

SER. NO. 76-662,074, FILED 6-19-2006.

AMY GEARIN, EXAMINING ATTORNEY

Int. Cl.: 24

Prior U.S. Cls.: 42 and 50

United States Patent and Trademark Office

Reg. No. 3,482,776

Registered Aug. 12, 2008

**TRADEMARK
PRINCIPAL REGISTER**

ENDURATEX

CHINA GENERAL PLASTICS CORPORATION
(TAIWAN CORPORATION)
11 FL., NO. 37, JI-HU ROAD
NEI-HU DISTRICT
TAIPEI, 114, TAIWAN

THE MARK CONSISTS OF STANDARD CHARACTERS WITHOUT CLAIM TO ANY PARTICULAR FONT, STYLE, SIZE, OR COLOR.

FOR: VINYL UPHOLSTERY FABRICS, IN CLASS 24 (U.S. CLS. 42 AND 50).

SER. NO. 76-664,502, FILED 8-11-2006.

FIRST USE 1-1-1996; IN COMMERCE 1-1-1996.

CHRISIE B. KING, EXAMINING ATTORNEY

Int. Cl.: 24

Prior U.S. Cls.: 42 and 50

United States Patent and Trademark Office

Reg. No. 3,482,777

Registered Aug. 12, 2008

**TRADEMARK
PRINCIPAL REGISTER**

PRODURATECT

CHINA GENERAL PLASTICS CORPORATION
(TAIWAN CORPORATION)
11 FL., NO. 37, JI-HU ROAD
NEI-HU DISTRICT
TAIPEI, 114, TAIWAN

THE MARK CONSISTS OF STANDARD CHAR-
ACTERS WITHOUT CLAIM TO ANY PARTICULAR
FONT, STYLE, SIZE, OR COLOR.

FOR: PROTECTIVE FINISH SOLD AS AN INTE-
GRAL COMPONENT OF VINYL UPHOLSTER FAB-
RICS, IN CLASS 24 (U.S. CLS. 42 AND 50).

SER. NO. 76-664,503, FILED 8-11-2006.

FIRST USE 1-1-1996; IN COMMERCE 1-1-1996.

CHRISIE B. KING, EXAMINING ATTORNEY

Int. Cl.: 25

Prior U.S. Cls.: 22 and 39

United States Patent and Trademark Office

Reg. No. 3,482,778

Registered Aug. 12, 2008

**TRADEMARK
PRINCIPAL REGISTER**

SCIENCE FRICTION

YOUNG CHU (UNITED STATES INDIVIDUAL)
12878 E. FLORENCE AVE.
SANTA FE SPRINGS, CA 90670

FIRST USE 3-1-2005; IN COMMERCE 3-1-2005.

FOR: CLOTHES AND FOOTWEAR FOR ROCK CLIMBING, NAMELY, SHOES, PANTS, JACKETS, SHIRTS, SHORTS, TANK TOPS, HATS, CAPS, SHOE SOLES; HIKING SHOES; FOOTWEAR FOR ICE CLIMBING, NAMELY, SHOES, IN CLASS 25 (U.S. CLS. 22 AND 39).

THE MARK CONSISTS OF STANDARD CHARACTERS WITHOUT CLAIM TO ANY PARTICULAR FONT, STYLE, SIZE, OR COLOR.

SER. NO. 76-665,347, FILED 8-29-2006.

SCOTT BIBB, EXAMINING ATTORNEY

Int. Cl.: 16

Prior U.S. Cls.: 2, 5, 22, 23, 29, 37, 38 and 50

United States Patent and Trademark Office

Reg. No. 3,482,779

Registered Aug. 12, 2008

**TRADEMARK
PRINCIPAL REGISTER**



ESCODA SABATES (SPAIN CORPORATION)
S.A., JOAQUIN COSTA, 47
08206 SABADELL, SPAIN

FOR: PAINT BRUSHES AND PAINT APPLICATOR ROLLERS, IN CLASS 16 (U.S. CLS. 2, 5, 22, 23, 29, 37, 38 AND 50).

FIRST USE 12-0-1993; IN COMMERCE 12-0-1993.

THE COLOR(S) RED AND WHITE IS/ARE CLAIMED AS A FEATURE OF THE MARK.

THE COLOR RED APPEARS AS A RECTANGULAR BACKGROUND, AND THE COLOR WHITE APPEARS AS WHITE LETTERS SPELLING "ESCODA" WITHIN THE BODY OF THE RECTANGULAR RED BACKGROUND.

SEC. 2(F).

SER. NO. 76-665,869, FILED 9-8-2006.

MARY MUNSON, EXAMINING ATTORNEY

Int. Cl.: 1

Prior U.S. Cls.: 1, 5, 6, 10, 26 and 46

Reg. No. 3,482,780

United States Patent and Trademark Office

Registered Aug. 12, 2008

**TRADEMARK
PRINCIPAL REGISTER**

SUMIFLEX

ADVANCED PLASTICS COMPOUNDS COMPAN-
NY (JAPAN CORPORATION)
1-23, SHIBA 4-CHOME, MINATO-KU
TOKYO, JAPAN

OWNER OF JAPAN REG. NO. 1736558, DATED 12-
20-1984, EXPIRES 12-20-2014.

FOR: UNPROCESSED PLASTICS, IN CLASS 1
(U.S. CLS. 1, 5, 6, 10, 26 AND 46).

SER. NO. 76-666,658, FILED 9-26-2006.

THE MARK CONSISTS OF STANDARD CHAR-
ACTERS WITHOUT CLAIM TO ANY PARTICULAR
FONT, STYLE, SIZE, OR COLOR.

GINA HAYES, EXAMINING ATTORNEY

Int. Cl.: 35

Prior U.S. Cls.: 100, 101 and 102

Reg. No. 3,482,781

United States Patent and Trademark Office

Registered Aug. 12, 2008

**SERVICE MARK
PRINCIPAL REGISTER**

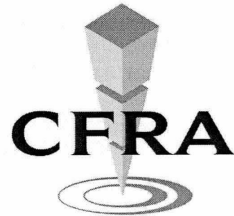

**CENTER FOR
FINANCIAL RESEARCH
& ANALYSIS**

CENTER FOR FINANCIAL RESEARCH & ANALYSIS LLC (DELAWARE LTD LIAB CO)
11140 ROCKVILLE PIKE
SUITE 640
ROCKVILLE, MD 20852

NO CLAIM IS MADE TO THE EXCLUSIVE RIGHT TO USE "CENTER FOR FINANCIAL RESEARCH & ANALYSIS", APART FROM THE MARK AS SHOWN.

FOR: FORENSIC ACCOUNTING RESEARCH SERVICES, IN CLASS 35 (U.S. CLS. 100, 101 AND 102).

SER. NO. 76-666,806, FILED 9-29-2006.

FIRST USE 0-0-2005; IN COMMERCE 0-0-2005.

TANYA AMOS, EXAMINING ATTORNEY

Int. Cl.: 7

Prior U.S. Cls.: 13, 19, 21, 23, 31, 34 and 35

United States Patent and Trademark Office

Reg. No. 3,482,782

Registered Aug. 12, 2008

**TRADEMARK
PRINCIPAL REGISTER**



RUTHMAN PUMP & ENGINEERING, INC.
(OHIO CORPORATION)
1212 STRENG STREET
CINCINNATI, OH 45223

FIRST USE 1-1-1954; IN COMMERCE 1-1-1954.

OWNER OF U.S. REG. NOS. 401,842 AND 770,708.

FOR: CENTRIFUGAL PUMPS, CLOSE-COUPLED PUMPS, END SUCTION PUMPS, IMMERSSED PUMPS, SELF-PRIMING PUMPS, VORTEX PUMPS, SLUDGE PUMPS, MULTI-STAGE PUMPS, AND FULL CANTILEVER PUMPS, IN CLASS 7 (U.S. CLS. 13, 19, 21, 23, 31, 34 AND 35).

SER. NO. 76-667,860, FILED 10-23-2006.

WANDA KAY PRICE, EXAMINING ATTORNEY

Int. Cl.: 14

Prior U.S. Cls.: 2, 27, 28 and 50

United States Patent and Trademark Office

Reg. No. 3,482,783

Registered Aug. 12, 2008

**TRADEMARK
PRINCIPAL REGISTER**



HOWARD COUNTY GENERAL HOSPITAL, INC.
(MARYLAND CORPORATION)
5755 CEDAR LANE
COLUMBIA, MD 21044

OWNER OF U.S. REG. NO. 2,415,859.

FOR: LAPEL PINS, IN CLASS 14 (U.S. CLS. 2, 27, 28
AND 50).

SER. NO. 76-670,243, FILED 12-11-2006.

FIRST USE 10-0-2005; IN COMMERCE 10-0-2005.

EMILY CARLSEN, EXAMINING ATTORNEY

Int. Cl.: 41

Prior U.S. Cls.: 100, 101 and 107

United States Patent and Trademark Office

Reg. No. 3,482,784

Registered Aug. 12, 2008

**SERVICE MARK
PRINCIPAL REGISTER**

RIDE YOUR BIKE

GETCHES, MICHAEL J. (UNITED STATES INDIVIDUAL)
912 HUNTINGTON HILLS DRIVE
FORT COLLINS, CO 80525

THE MARK CONSISTS OF STANDARD CHARACTERS WITHOUT CLAIM TO ANY PARTICULAR FONT, STYLE, SIZE, OR COLOR.

FOR: ENTERTAINMENT SERVICES IN THE NATURE OF LIVE MUSICAL PERFORMANCES, IN CLASS 41 (U.S. CLS. 100, 101 AND 107).

SER. NO. 76-673,512, FILED 3-2-2007.

FIRST USE 1-9-2005; IN COMMERCE 1-9-2005.

LINDA LAVACHE, EXAMINING ATTORNEY

Int. Cl.: 35

Prior U.S. Cls.: 100, 101 and 102

United States Patent and Trademark Office

Reg. No. 3,482,785

Registered Aug. 12, 2008

**SERVICE MARK
PRINCIPAL REGISTER**



CITY OF RANCHO MIRAGE (CALIFORNIA MUNICIPAL CORPORATION)

69-825 HIGHWAY 111

RANCHO MIRAGE, CA 92270

FOR: ADVERTISING, MARKETING, AND PROMOTION SERVICES TO PROMOTE LOCAL BUSINESS AND COMMERCE IN THE CITY OF RANCHO MIRAGE, IN CLASS 35 (U.S. CLS. 100, 101 AND 102).

FIRST USE 1-1-2007; IN COMMERCE 1-1-2007.

NO CLAIM IS MADE TO THE EXCLUSIVE RIGHT TO USE "SHOP RANCHO MIRAGE", APART FROM THE MARK AS SHOWN.

THE COLOR(S) BLACK, RED, WHITE, BROWN, AND GREY IS/ARE CLAIMED AS A FEATURE OF THE MARK.

THE COLOR BLACK APPEARS AS THE OUTLINE TO AN OCTAGON-SHAPED SYMBOL IN THE TOP PORTION OF THE MARK. THE COLOR RED APPEARS AS THE MAIN COLOR OF THE OCTAGON-SHAPED SYMBOL. THE COLOR WHITE APPEARS IN THE MARK TO BORDER THE EDGE OF THE OCTAGON-SHAPED SYMBOL AND APPEARS AS THE LETTERS "SHOP" IN THE CENTER OF THE OCTAGON-SHAPED SYMBOL. THE COLOR GREY APPEARS IN THE CENTER OF THE MARK DEPICTING A POLE. THE COLOR BROWN APPEARS IN THE RECTANGLE CENTERED ON THE MARK. THE COLOR WHITE APPEARS AS THE OUTLINE TO A RAM-SHAPED DESIGN AND THE LETTERS "RANCHO MIRAGE" WITHIN THE RECTANGLE CENTERED ON THE MARK.

SER. NO. 76-673,699, FILED 3-7-2007.

BERYL GARDNER, EXAMINING ATTORNEY

Int. Cl.: 40

Prior U.S. Cls.: 100, 103 and 106

United States Patent and Trademark Office

Reg. No. 3,482,786

Registered Aug. 12, 2008

**SERVICE MARK
PRINCIPAL REGISTER**



KE CELLARS, INC. (TEXAS CORPORATION)
3933 FM 344 E.
TYLER, TX 75703

FIRST USE 2-1-2007; IN COMMERCE 2-1-2007.

FOR: PROVIDING INFORMATION ABOUT
WINE-MAKING, IN CLASS 40 (U.S. CLS. 100, 103
AND 106).

SER. NO. 76-673,725, FILED 3-7-2007.

BRENDAN REGAN, EXAMINING ATTORNEY

Int. Cl.: 29

Prior U.S. Cl.: 46

United States Patent and Trademark Office

Reg. No. 3,482,787

Registered Aug. 12, 2008

**TRADEMARK
PRINCIPAL REGISTER**

ATLANTA DAIRIES

ATLANTA DAIRY LLC (DELAWARE LTD LIAB
CO)
777 MEMORIAL DRIVE S.E.
ATLANTA, GA 303161186

NO CLAIM IS MADE TO THE EXCLUSIVE
RIGHT TO USE "DAIRIES", APART FROM THE
MARK AS SHOWN.

FOR: MILK, CHOCOLATE MILK, FLAVORED
MILKS, CREAM, AND EGG NOG, IN CLASS 29 (U.S.
CL. 46).

SEC. 2(F).

FIRST USE 0-0-1941; IN COMMERCE 0-0-1941.

SER. NO. 76-674,067, FILED 3-14-2007.

THE MARK CONSISTS OF STANDARD CHAR-
ACTERS WITHOUT CLAIM TO ANY PARTICULAR
FONT, STYLE, SIZE, OR COLOR.

BERNICE MIDDLETON, EXAMINING ATTORNEY

Int. Cl.: 35

Prior U.S. Cls.: 100, 101 and 102

United States Patent and Trademark Office

Reg. No. 3,482,788

Registered Aug. 12, 2008

SERVICE MARK
PRINCIPAL REGISTER



VEGH, KATHY (UNITED STATES INDIVIDUAL)
12225 LORAIN AVE.
CLEVELAND, OH 44111

FOR: RETAIL STORE SERVICES FEATURING HOME RECREATION EQUIPMENT AND FURNITURE SUCH AS, BUT NOT LIMITED TO, BILLIARD TABLES, PING PONG, BAR STOOLS AND JUKE BOXES AND SUPPLIES ASSOCIATED WITH SUCH PRODUCTS, IN CLASS 35 (U.S. CLS. 100, 101 AND 102).

FIRST USE 1-1-2004; IN COMMERCE 1-1-2004.

NO CLAIM IS MADE TO THE EXCLUSIVE RIGHT TO USE "SINCE 1963" AND "BILLIARDS & HOME", APART FROM THE MARK AS SHOWN.

THE NAME "MR. DANNY VEGH" IDENTIFIES A LIVING INDIVIDUAL WHOSE CONSENT IS OF RECORD.

SER. NO. 76-674,277, FILED 3-19-2007.

MELVIN AXILBUND, EXAMINING ATTORNEY

Int. Cl.: 41

Prior U.S. Cls.: 100, 101 and 107

United States Patent and Trademark Office

Reg. No. 3,482,789

Registered Aug. 12, 2008

**SERVICE MARK
PRINCIPAL REGISTER**

Design for Living

DIABLO COUNTRY MAGAZINE, INC. (CALI-
FORNIA CORPORATION)
2520 CAMINO DIABLO
WALNUT CREEK, CA 94597

THE MARK CONSISTS OF STANDARD CHAR-
ACTERS WITHOUT CLAIM TO ANY PARTICULAR
FONT, STYLE, SIZE, OR COLOR.

FOR: PUBLISHING OF MAGAZINE, IN CLASS 41
(U.S. CLS. 100, 101 AND 107).

SER. NO. 76-674,309, FILED 3-19-2007.

FIRST USE 4-1-2005; IN COMMERCE 4-1-2005.

MICHAEL WIENER, EXAMINING ATTORNEY

Int. Cl.: 9

Prior U.S. Cls.: 21, 23, 26, 36 and 38

Reg. No. 3,482,790

United States Patent and Trademark Office

Registered Aug. 12, 2008

**TRADEMARK
PRINCIPAL REGISTER**

LOVE  BUGS

ALONSO-WOLFE, ALLISON ANN (UNITED STATES INDIVIDUAL)
8861 E. KALIL DR.
SCOTTSDALE, AZ 85260

FIRST USE 9-3-2006; IN COMMERCE 11-12-2006.

FOR: EDUCATIONAL DVDS, VHS TAPES AND CDS FEATURING READING, WRITING AND MATH FOR CHILDREN AND ADULTS, IN CLASS 9 (U.S. CLS. 21, 23, 26, 36 AND 38).

SER. NO. 76-674,326, FILED 3-20-2007.

CAROLYN CATALDO, EXAMINING ATTORNEY

Int. Cl.: 35

Prior U.S. Cls.: 100, 101 and 102

Reg. No. 3,482,791

United States Patent and Trademark Office

Registered Aug. 12, 2008

**SERVICE MARK
PRINCIPAL REGISTER**

QUALITY IS OUR STYLE

GOODING & COMPANY, INC. (CALIFORNIA
CORPORATION)
1528 6TH STREET, SUITE 120
SANTA MONICA, CA 90401

THE MARK CONSISTS OF STANDARD CHAR-
ACTERS WITHOUT CLAIM TO ANY PARTICULAR
FONT, STYLE, SIZE, OR COLOR.

FOR: AUCTIONING OF AUTOMOBILES, IN
CLASS 35 (U.S. CLS. 100, 101 AND 102).

SER. NO. 76-674,550, FILED 3-26-2007.

FIRST USE 5-0-2006; IN COMMERCE 5-0-2006.

TINA BROWN, EXAMINING ATTORNEY

Int. Cl.: 25

Prior U.S. Cls.: 22 and 39

United States Patent and Trademark Office

Reg. No. 3,482,792

Registered Aug. 12, 2008

**TRADEMARK
PRINCIPAL REGISTER**

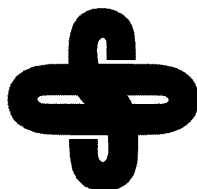

SQUEEZE OUT

BIG WILLIE JAPAN CO., LTD. (JAPAN CORPORATION)
2-11-20, NAGASAWA, TAMA-KU
KAWASAKI-SHI, KANAGAWA-KEN, JAPAN

FOR: NON-JAPANESE STYLE OUTER CLOTHING, NAMELY, EVENING DRESSES, JACKETS, JOGGING PANTS, SWEAT PANTS, SUITS, SKIRTS, TROUSERS; COATS, SWEATERS, SHIRTS, NIGHTWEAR, UNDERWEAR, SWIMSUITS, SWIMMING CAPS, JAPANESE TRADITIONAL CLOTHING, NAMELY, SASH BANDS FOR KIMONO ALSO KNOWN AS OBI, FULL-LENGTH KIMONOS ALSO KNOWN AS NAGAGI, SHORT OVERCOAT FOR KIMONO ALSO KNOWN AS HAORI, PLEATED SKIRTS FOR FORMAL KIMONOS ALSO KNOWN AS HAKAMA, JAPANESE SLEEPING ROBES ALSO KNOWN AS YUKATA, SLEEP MASKS, COLLAR PROTECTORS, SOCKS AND STOCKINGS, GAITERS, FUR STOLE, SHAWLS, SCARVES, GLOVES AND MITTENS, NECKTIES, NECKERCHIEVES,

BANDANAS NECKERCHIEFS, MUFFLERS, EAR MUFFS, HOODS, NIGHTCAPS, CAPS AND HATS, SUSPENDERS BRACES, WAISTBANDS, BELTS FOR CLOTHING, SHOES AND BOOTS, SHOE DOWELS, SHOE PEGS, HOBNAILS, SHOE PROTECTIVE METAL MEMBERS, CLOTHES FOR SPORTS, NAMELY, ANORAKS, SPORTS OVER-UNIFORMS, HEADBANDS, WIND-JACKETS, ATHLETIC UNIFORMS AND STOCKINGS, SPORTS SHIRTS, WRISTBANDS, BOOTS FOR SPORTS, HORSE-RIDING BOOTS, IN CLASS 25 (U.S. CLS. 22 AND 39).

PRIORITY CLAIMED UNDER SEC. 44(D) ON JAPAN APPLICATION NO. 2007-025413, FILED 3-23-2007, REG. NO. 5082613, DATED 10-5-2007, EXPIRES 10-5-2017.

SER. NO. 76-674,879, FILED 3-30-2007.

JENNIFER MARTIN, EXAMINING ATTORNEY

Int. Cl.: 35

Prior U.S. Cls.: 100, 101 and 102

United States Patent and Trademark Office

Reg. No. 3,482,793

Registered Aug. 12, 2008

SERVICE MARK
PRINCIPAL REGISTER

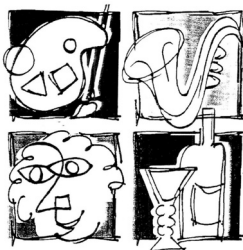

RANCHO MIRAGE
ART *Affaire*

CITY OF RANCHO MIRAGE (CALIFORNIA MUNICIPAL CORPORATION)
69-825 HIGHWAY 111
RANCHO MIRAGE, CA 92270

FOR: ADVERTISING, MARKETING, AND PROMOTION SERVICES TO PROMOTE LOCAL BUSINESS AND COMMERCE IN THE CITY OF RANCHO MIRAGE, IN CLASS 35 (U.S. CLS. 100, 101 AND 102).

FIRST USE 11-0-2004; IN COMMERCE 11-0-2004.

NO CLAIM IS MADE TO THE EXCLUSIVE RIGHT TO USE "RANCHO MIRAGE ART", APART FROM THE MARK AS SHOWN.

THE MARK CONSISTS OF THE FOLLOWING FOUR SQUARES: UPPER LEFT SQUARE WITH PAINT PALETTE AND BRUSH; UPPER RIGHT SQUARE WITH A SAXOPHONE; LOWER LEFT SQUARE WITH A FACE; LOWER RIGHT SQUARE WITH A WINE BOTTLE AND GLASS. THE WORDS "RANCHO MIRAGE" IN CAPITAL LETTERS ARE PLACED UNDER THE LOWER SQUARES. THE WORDS "ART AFFAIRE" (WITH "ART" IN CAPITAL LETTERS AND "AFFAIRE" WITH A SCRIPTED "A") ARE PLACED BELOW "RANCHO MIRAGE".

SER. NO. 76-675,117, FILED 4-5-2007.

BERYL GARDNER, EXAMINING ATTORNEY

Int. Cl.: 3

Prior U.S. Cls.: 1, 4, 6, 50, 51 and 52

Reg. No. 3,482,794

United States Patent and Trademark Office

Registered Aug. 12, 2008

TRADEMARK
PRINCIPAL REGISTER



NATURAL STONE CARE PRODUCTS, INC. (ARIZONA S CORPORATION)
2131 W. 7TH STREET
TEMPE, AZ 85281

FOR: MAINTENANCE PRODUCTS FOR USE ON NATURAL STONE, CERAMIC AND PORCELAIN, NAMELY, ALL PURPOSE CLEANING PREPARATIONS AND GENERAL PURPOSE ABRASIVE CLEANERS, IN CLASS 3 (U.S. CLS. 1, 4, 6, 50, 51 AND 52).

FIRST USE 2-10-1997; IN COMMERCE 2-10-1997.

NO CLAIM IS MADE TO THE EXCLUSIVE RIGHT TO USE "NATURAL STONE CARE PRODUCTS", APART FROM THE MARK AS SHOWN.

THE MARK CONSISTS OF A ROCK LIKE SURFACE CONTAINING THE LETTERS "NSC" WHICH ARE INTERCEPTED BY A RECTANGULAR TEXT BOX CONTAINING THE WORDS "NATURAL STONE CARE PRODUCTS".

SER. NO. 76-675,784, FILED 4-20-2007.

JEFF DEFORD, EXAMINING ATTORNEY

Int. Cl.: 9

Prior U.S. Cls.: 21, 23, 26, 36 and 38

Reg. No. 3,482,795

United States Patent and Trademark Office

Registered Aug. 12, 2008

**TRADEMARK
PRINCIPAL REGISTER**

MICROLINE

QUALITY VISION INTERNATIONAL, INC. (NEW
YORK CORPORATION)
850 HUDSON AVENUE
ROCHESTER, NY 14621

FOR: AN OPTICAL METROLOGY SYSTEM FOR
NANOMETROLOGY COMPRISED OF A LIGHT
SOURCE, A CAMERA AND SENSORS IN COMMU-
NICATION WITH COMPUTER SOFTWARE AND
HARDWARE, FOR NON-CONTACT DIMENSION-
AL MEASUREMENT OF SEMICONDUCTOR WA-
FERS, MICRO ELECTO-MECHANICAL SYSTEMS

AND MICRO-FABRICATED ELECTRONIC ASSEM-
BLIES, IN CLASS 9 (U.S. CLS. 21, 23, 26, 36 AND 38).

FIRST USE 10-31-1995; IN COMMERCE 10-31-1995.

THE MARK CONSISTS OF STANDARD CHAR-
ACTERS WITHOUT CLAIM TO ANY PARTICULAR
FONT, STYLE, SIZE, OR COLOR.

SER. NO. 76-675,858, FILED 4-23-2007.

TANYA AMOS, EXAMINING ATTORNEY

Int. Cl.: 40

Prior U.S. Cls.: 100, 103 and 106

United States Patent and Trademark Office

Reg. No. 3,482,796

Registered Aug. 12, 2008

**SERVICE MARK
PRINCIPAL REGISTER**



DMI AUTOMOTIVE, INC. (MICHIGAN CORPORATION)
1200 DURANT DRIVE
HOWELL, MI 48843

NO CLAIM IS MADE TO THE EXCLUSIVE RIGHT TO USE "AUTOMOTIVE", APART FROM THE MARK AS SHOWN.

FOR: MATERIAL TREATMENTS OF METALS, IN CLASS 40 (U.S. CLS. 100, 103 AND 106).

SER. NO. 76-675,859, FILED 4-23-2007.

FIRST USE 10-1-2006; IN COMMERCE 10-1-2006.

TANYA AMOS, EXAMINING ATTORNEY

Int. Cls.: 35, 37 and 42

Prior U.S. Cls.: 100, 101, 102, 103 and 106

United States Patent and Trademark Office

Reg. No. 3,482,797

Registered Aug. 12, 2008

**SERVICE MARK
PRINCIPAL REGISTER**

BUTLER

BUTLER INTERNATIONAL, INC. (MARYLAND CORPORATION)
110 SUMMIT AVENUE
MONTVALE, NJ 07645

FOR: PROJECT MANAGEMENT SERVICES, NAMELY, BUSINESS MANAGEMENT FOR OTHERS IN THE FIELDS OF ENGINEERING SUPPORT, NETWORK SERVICES AND INFORMATION TECHNOLOGY; EMPLOYMENT STAFFING SERVICES; OUTSOURCING SERVICES IN THE FIELDS OF ENGINEERING AND INFORMATION TECHNOLOGY; TRACKING, LOCATING AND MONITORING OF VEHICLES FOR COMMERCIAL PURPOSES, IN CLASS 35 (U.S. CLS. 100, 101 AND 102).

FIRST USE 2-0-1979; IN COMMERCE 2-0-1979.

FOR: AUTOMOBILE REPAIR AND MAINTENANCE; IMPLEMENTATION OF TELECOMMUNICATIONS NETWORK SYSTEMS FOR OTHERS, NAMELY, INSTALLATION OF TELECOMMUNICATION HARDWARE, IN CLASS 37 (U.S. CLS. 100, 103 AND 106).

FIRST USE 1-0-1991; IN COMMERCE 1-0-1991.

FOR: ENGINEERING; DESIGN FOR OTHERS IN THE FIELD OF ENGINEERING SUPPORT; DRAFTING; INTEGRATION OF COMPUTER SYSTEMS AND NETWORKS; IMPLEMENTATION OF TELECOMMUNICATIONS NETWORK SYSTEMS FOR OTHERS, NAMELY, DESIGN IN THE FIELD OF TELECOMMUNICATION NETWORK SYSTEMS; INFORMATION TECHNOLOGY CONSULTATION; COMPUTER SOFTWARE DEVELOPMENT SERVICES; DESIGN AND TESTING OF NEW COMPUTER SOFTWARE PRODUCTS FOR OTHERS; PROVIDING QUALITY ASSURANCE SERVICES IN THE FIELD OF COMPUTER SOFTWARE; DATA WAREHOUSING, IN CLASS 42 (U.S. CLS. 100 AND 101).

FIRST USE 2-0-1979; IN COMMERCE 2-0-1979.

THE MARK CONSISTS OF STANDARD CHARACTERS WITHOUT CLAIM TO ANY PARTICULAR FONT, STYLE, SIZE, OR COLOR.

OWNER OF U.S. REG. NOS. 2,078,380, 2,415,378 AND OTHERS.

SER. NO. 76-675,972, FILED 4-25-2007.

RUDY R. SINGLETON, EXAMINING ATTORNEY

Int. Cl.: 3

Prior U.S. Cls.: 1, 4, 6, 50, 51 and 52

Reg. No. 3,482,798

United States Patent and Trademark Office

Registered Aug. 12, 2008

**TRADEMARK
PRINCIPAL REGISTER**

AVICENNA'S GARDEN

TOTURGUL, DAVID (UNITED STATES INDIVIDUAL)
100 GALL COURT
ELMWOOD PARK, NJ 07407

FOR: BEAUTY PRODUCTS, NAMELY, BODY LOTIONS, COLD CREAMS, FACE CREAMS, SOAPS, AND COSMETICS, IN CLASS 3 (U.S. CLS. 1, 4, 6, 50, 51 AND 52).

FIRST USE 3-2-2007; IN COMMERCE 3-6-2007.

THE MARK CONSISTS OF STANDARD CHARACTERS WITHOUT CLAIM TO ANY PARTICULAR FONT, STYLE, SIZE, OR COLOR.

THE NAME(S), PORTRAIT(S), AND/OR SIGNATURE(S) SHOWN IN THE MARK DOES NOT IDENTIFY A PARTICULAR LIVING INDIVIDUAL.

SER. NO. 76-676,265, FILED 4-30-2007.

JENNIFER MARTIN, EXAMINING ATTORNEY

Int. Cl.: 35

Prior U.S. Cls.: 100, 101 and 102

United States Patent and Trademark Office

Reg. No. 3,482,799

Registered Aug. 12, 2008

**SERVICE MARK
PRINCIPAL REGISTER**

DILIGENCEREADY

COREFINO, INC. (DELAWARE CORPORATION)
530 LAKESIDE DRIVE, SUITE 140
SUNNYVALE, CA 940854055

THE MARK CONSISTS OF STANDARD CHAR-
ACTERS WITHOUT CLAIM TO ANY PARTICULAR
FONT, STYLE, SIZE, OR COLOR.

FOR: FINANCIAL ACCOUNTING SERVICES,
NAMELY, MAKING FINANCIAL RECORDS OF
BUSINESS TRANSACTIONS, IN CLASS 35 (U.S.
CLS. 100, 101 AND 102).

SER. NO. 76-676,847, FILED 5-14-2007.

FIRST USE 12-14-2005; IN COMMERCE 12-14-2005.

JIM RINGLE, EXAMINING ATTORNEY

Int. Cl.: 35

Prior U.S. Cls.: 100, 101 and 102

United States Patent and Trademark Office

Reg. No. 3,482,800

Registered Aug. 12, 2008

**SERVICE MARK
PRINCIPAL REGISTER**

BE A BRIT DIFFERENT

VISITBRITAIN (UNITED KINGDOM UNINCORPORATED INSTRUMENTALITY)
THAMES TOWER, BLACK'S ROAD
HAMMERSMITH, LONDON W6 9EL, ENGLAND

FOR: PROMOTING TRAVEL AND TOURISM TO THE UNITED KINGDOM, IN CLASS 35 (U.S. CLS. 100, 101 AND 102).

FIRST USE 2-15-2007; IN COMMERCE 2-15-2007.

THE MARK CONSISTS OF STANDARD CHARACTERS WITHOUT CLAIM TO ANY PARTICULAR FONT, STYLE, SIZE, OR COLOR.

NO CLAIM IS MADE TO THE EXCLUSIVE RIGHT TO USE "BRIT", APART FROM THE MARK AS SHOWN.

SER. NO. 76-676,975, FILED 5-17-2007.

TINA BROWN, EXAMINING ATTORNEY

Int. Cls.: 30 and 43

Prior U.S. Cls.: 46, 100 and 101

United States Patent and Trademark Office

Reg. No. 3,482,801

Registered Aug. 12, 2008

TRADEMARK
SERVICE MARK
PRINCIPAL REGISTER

World Cup of Tea

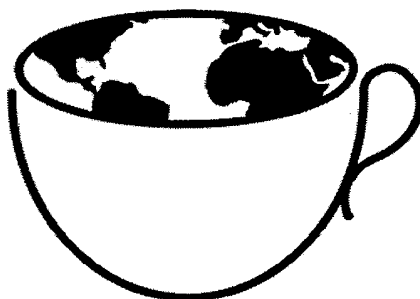

Discover the World in a Cup

WORLD CUP OF TEA, LLC (TENNESSEE LTD
LIAB CO)
439 AUTUMN LAKE TRAIL
FRANKLIN, TN 37067

FOR: LOOSE LEAF TEAS AND DRINKS MADE
OF TEA, IN CLASS 30 (U.S. CL. 46).

FIRST USE 9-27-2007; IN COMMERCE 9-27-2007.

FOR: CAFES SERVING TEAS AND DRINKS, IN
CLASS 43 (U.S. CLS. 100 AND 101).

FIRST USE 9-27-2007; IN COMMERCE 9-27-2007.

NO CLAIM IS MADE TO THE EXCLUSIVE
RIGHT TO USE "TEA", APART FROM THE MARK
AS SHOWN.

SER. NO. 76-677,061, FILED 5-18-2007.

LEIGH CAROLINE CASE, EXAMINING ATTOR-
NEY

Int. Cls.: 30 and 43

Prior U.S. Cls.: 46, 100 and 101

United States Patent and Trademark Office

Reg. No. 3,482,802

Registered Aug. 12, 2008

**TRADEMARK
SERVICE MARK
PRINCIPAL REGISTER**

WORLD CUP OF TEA

WORLD CUP OF TEA, LLC (TENNESSEE LTD
LIAB CO)
439 AUTUMN LAKE TRAIL
FRANKLIN, TN 37067

FOR: LOOSE LEAF TEAS AND DRINKS MADE
OF TEA, IN CLASS 30 (U.S. CL. 46).

FIRST USE 9-27-2007; IN COMMERCE 9-27-2007.

FOR: CAFES SERVING TEAS AND DRINKS, IN
CLASS 43 (U.S. CLS. 100 AND 101).

FIRST USE 9-27-2007; IN COMMERCE 9-27-2007.

THE MARK CONSISTS OF STANDARD CHAR-
ACTERS WITHOUT CLAIM TO ANY PARTICULAR
FONT, STYLE, SIZE, OR COLOR.

NO CLAIM IS MADE TO THE EXCLUSIVE
RIGHT TO USE "TEA", APART FROM THE MARK
AS SHOWN.

SER. NO. 76-677,063, FILED 5-18-2007.

LEIGH CAROLINE CASE, EXAMINING ATTOR-
NEY

Int. Cl.: 11

Prior U.S. Cls.: 13, 21, 23, 31 and 34

United States Patent and Trademark Office

Reg. No. 3,482,803

Registered Aug. 12, 2008

**TRADEMARK
PRINCIPAL REGISTER**

FIRE-FLY

SOURCE ONE DISTRIBUTORS, INC. (FLORIDA
CORPORATION)
3125 FORTUNE WAY, SUITE 1
WELLINGTON, FL 33414

FOR: FLASHLIGHTS, NAMELY, TACTICAL
TASK LIGHTING DEVICES FOR MILITARY AND
LAW ENFORCEMENT USE, IN CLASS 11 (U.S. CLS.
13, 21, 23, 31 AND 34).

FIRST USE 3-28-2007; IN COMMERCE 3-28-2007.

THE MARK CONSISTS OF STANDARD CHAR-
ACTERS WITHOUT CLAIM TO ANY PARTICULAR
FONT, STYLE, SIZE, OR COLOR.

SER. NO. 76-677,465, FILED 5-29-2007.

DAVID HOFFMAN, EXAMINING ATTORNEY

Int. Cls.: 41, 43 and 44

Prior U.S. Cls.: 100, 101 and 107

United States Patent and Trademark Office

Reg. No. 3,482,804

Registered Aug. 12, 2008

**SERVICE MARK
PRINCIPAL REGISTER**

TALISKER TOWER

TALISKER MOUNTAIN INCORPORATED
(UTAH CORPORATION)
340 MAIN STREET, SUITE 203
PARK CITY, UT 84060

FOR: MOUNTAIN AND SKI RESORT SERVICES, NAMELY, PROVIDING MID-MOUNTAIN SKI RESORT SERVICES FOR SKIERS, PROVIDING SKI INSTRUCTION; HEALTH CLUB SERVICES, NAMELY, PROVIDING INSTRUCTION AND EQUIPMENT IN THE FIELD OF PHYSICAL EXERCISE; PROVIDING FITNESS AND EXERCISE FACILITIES; PHYSICAL FITNESS CONSULTATION; PHYSICAL FITNESS CONDITIONING CLASSES; PHYSICAL FITNESS INSTRUCTION, IN CLASS 41 (U.S. CLS. 100, 101 AND 107).

FIRST USE 2-1-2007; IN COMMERCE 2-1-2007.

FOR: RESTAURANT AND BAR SERVICES; COFFEE-HOUSE AND SNACK-BAR SERVICES; COCKTAIL LOUNGES, IN CLASS 43 (U.S. CLS. 100 AND 101).

FIRST USE 2-1-2007; IN COMMERCE 2-1-2007.

FOR: HEALTH SPA SERVICES FOR HEALTH AND WELLNESS OF THE BODY AND SPIRIT OFFERED AT HEALTH RESORT; HEALTH SPA

SERVICES, NAMELY, COSMETIC BODY CARE SERVICES; NUTRITION COUNSELING; VITAMIN THERAPY; DERMATOLOGY SERVICES, NAMELY, COSMETIC DERMATOLOGY SERVICES IN THE NATURE OF TOPICAL SKIN TREATMENTS; HAIR IMPLANTATION, REPLACEMENT AND REMOVAL SERVICES; HAIR DRESSING SALONS; TANNING SALONS; NAIL CARE SALONS; SKIN CARE SALONS; MASSAGE SERVICES; MEDICAL TESTING SERVICES, NAMELY, FITNESS EVALUATION, IN CLASS 44 (U.S. CLS. 100 AND 101).

FIRST USE 2-1-2007; IN COMMERCE 2-1-2007.

THE MARK CONSISTS OF STANDARD CHARACTERS WITHOUT CLAIM TO ANY PARTICULAR FONT, STYLE, SIZE, OR COLOR.

OWNER OF U.S. REG. NOS. 3,195,527 AND 3,200,170.

NO CLAIM IS MADE TO THE EXCLUSIVE RIGHT TO USE "TOWER", APART FROM THE MARK AS SHOWN.

SER. NO. 76-677,761, FILED 6-4-2007.

ROBERT LAVACHE, EXAMINING ATTORNEY

Int. Cl.: 29

Prior U.S. Cl.: 46

United States Patent and Trademark Office

Reg. No. 3,482,805

Registered Aug. 12, 2008

**TRADEMARK
PRINCIPAL REGISTER**

hedoné

NEARER2U EXPORTS, S.L. (SPAIN SOCIEDAD
DE RESPONSABILIDAD LIMITADA)
FELIPE DE PAZ 4, ENTLO. 1
BARCELONA, SPAIN 08028

FOR: EDIBLE OILS AND EDIBLE FATS, IN
CLASS 29 (U.S. CL. 46).

OWNER OF ERPN CMNTY TM OFC REG. NO.
005155759, DATED 7-25-2007, EXPIRES 7-3-2016.

THE COLOR(S) GREEN, AS REPRESENTED ON
THE PANTONE MATCHING SYSTEM AS PAN-
TONE 5743 IS/ARE CLAIMED AS A FEATURE OF
THE MARK.

THE MARK CONSISTS OF THE WORDING "HE-
DONÉ" IN THE COLOR GREEN AS REPRESENTED
ON THE PANTONE MATCHING SYSTEM AS PAN-
TONE 5743.

THE FOREIGN WORDING IN THE MARK
TRANSLATES INTO ENGLISH AS "PLEASURE".

SER. NO. 76-677,807, FILED 6-4-2007.

KEVIN CORWIN, EXAMINING ATTORNEY

Int. Cl.: 9

Prior U.S. Cls.: 21, 23, 26, 36 and 38

Reg. No. 3,482,806

United States Patent and Trademark Office

Registered Aug. 12, 2008

**TRADEMARK
PRINCIPAL REGISTER**

REFLECT

GRIFFIN TECHNOLOGY, INC. (TENNESSEE
CORPORATION)
1930 AIR LANE DRIVE
NASHVILLE, TN 37210

THE MARK CONSISTS OF STANDARD CHAR-
ACTERS WITHOUT CLAIM TO ANY PARTICULAR
FONT, STYLE, SIZE, OR COLOR.

FOR: A MIRRORED, CHROME-FINISHED CASE
FOR AN MP3 PLAYER DEVICE, IN CLASS 9 (U.S.
CLS. 21, 23, 26, 36 AND 38).

SER. NO. 76-677,828, FILED 6-1-2007.

FIRST USE 2-20-2007; IN COMMERCE 2-20-2007.

ERNEST SHOSHO, EXAMINING ATTORNEY

Int. Cl.: 9

Prior U.S. Cls.: 21, 23, 26, 36 and 38

Reg. No. 3,482,807

United States Patent and Trademark Office

Registered Aug. 12, 2008

**TRADEMARK
PRINCIPAL REGISTER**

EVOLVE

GRIFFIN TECHNOLOGY, INC. (TENNESSEE
CORPORATION)
1930 AIR LANE DRIVE
NASHVILLE, TN 37210

THE MARK CONSISTS OF STANDARD CHAR-
ACTERS WITHOUT CLAIM TO ANY PARTICULAR
FONT, STYLE, SIZE, OR COLOR.

FOR: A WIRELESS SOUND SYSTEM FOR USE
WITH AN MP3 PLAYER DEVICE COMPRISING A
CHARGING BASE AND SPEAKERS, IN CLASS 9
(U.S. CLS. 21, 23, 26, 36 AND 38).

SER. NO. 76-677,835, FILED 6-1-2007.

FIRST USE 1-8-2007; IN COMMERCE 1-8-2007.

ERNEST SHOSHO, EXAMINING ATTORNEY

Int. Cl.: 9

Prior U.S. Cls.: 21, 23, 26, 36 and 38

United States Patent and Trademark Office

Reg. No. 3,482,808

Registered Aug. 12, 2008

**TRADEMARK
PRINCIPAL REGISTER**

GOAL TRACK

E&B EXERCISE, LLC (DELAWARE LTD LIAB
CO)
4 EXECUTIVE PLAZA
YONKERS, NY 10701

FOR: PEDOMETERS, IN CLASS 9 (U.S. CLS. 21, 23,
26, 36 AND 38).

FIRST USE 9-28-2007; IN COMMERCE 9-28-2007.

THE MARK CONSISTS OF STANDARD CHAR-
ACTERS WITHOUT CLAIM TO ANY PARTICULAR
FONT, STYLE, SIZE, OR COLOR.

NO CLAIM IS MADE TO THE EXCLUSIVE
RIGHT TO USE "TRACK", APART FROM THE
MARK AS SHOWN.

SER. NO. 76-678,059, FILED 6-11-2007.

SONYA STEPHENS, EXAMINING ATTORNEY

Int. Cl.: 5

Prior U.S. Cls.: 6, 18, 44, 46, 51 and 52

Reg. No. 3,482,809

United States Patent and Trademark Office

Registered Aug. 12, 2008

TRADEMARK
PRINCIPAL REGISTER



BIO3X LLC (UTAH LTD LIAB CO)
4802 N 400 W, SUITE 107
PARK CITY, UT 84098

FOR: BIO-SECURITY PRODUCTS, NAMELY, ANTIMICROBIAL SPRAY FOR SANITARY PURPOSES, FOR USE IN VETERINARY AND MEDICAL FIELDS, AS WELL AS COMMERCIAL USE, IN CLASS 5 (U.S. CLS. 6, 18, 44, 46, 51 AND 52).

FIRST USE 1-1-2007; IN COMMERCE 1-1-2007.

THE COLOR(S) RED, GRAY AND BLUE IS/ARE CLAIMED AS A FEATURE OF THE MARK.

THE COLOR RED APPEARS IN THE LETTERS "BI", THE NUMBER "3", THE LETTER "X", AND THE WORDING PHAZE CONTROL; THE COLORS GRAY AND BLUE APPEAR IN THE CURVED LINE DESIGNS SIGNIFYING THE CIRCLE, SEMI-CIRCLE AND LETTER "O".

SER. NO. 76-678,303, FILED 6-15-2007.

MICHAEL KAZAZIAN, EXAMINING ATTORNEY

Int. Cl.: 9

Prior U.S. Cls.: 21, 23, 26, 36 and 38

Reg. No. 3,482,810

United States Patent and Trademark Office

Registered Aug. 12, 2008

**TRADEMARK
PRINCIPAL REGISTER**

STAR★TRON

OPTICAL SYSTEMS TECHNOLOGY, INC.
(PENNSYLVANIA CORPORATION)
110 KOUNTZ LANE
FREEPORT, PA 16229

FIRST USE 1-7-1971; IN COMMERCE 1-7-1971.

OWNER OF U.S. REG. NO. 2,359,961.

FOR: ELECTRO-OPTICAL IMAGE AND LIGHT
INTENSIFYING DEVICES, NAMELY, LENSES,
NON-VISIBLE ILLUMINATORS, IMAGE STABILIZERS,
AND SENSORS FOR NIGHT VISION PRODUCTS,
IN CLASS 9 (U.S. CLS. 21, 23, 26, 36 AND 38).

SER. NO. 76-678,328, FILED 6-18-2007.

ESTHER BELENKER, EXAMINING ATTORNEY

Int. Cl.: 40

Prior U.S. Cls.: 100, 103 and 106

Reg. No. 3,482,811

United States Patent and Trademark Office

Registered Aug. 12, 2008

**SERVICE MARK
PRINCIPAL REGISTER**

BILCARE

BILCARE, INC. (DELAWARE CORPORATION)
300 KIMBERTON ROAD
PHOENIXVILLE, PA 19460

FIRST USE 9-0-2003; IN COMMERCE 9-0-2003.

FOR: MANUFACTURE OF PHARMACEUTICALS TO THE ORDER AND SPECIFICATIONS OF OTHERS; CUSTOM MANUFACTURE SERVICES, NAMELY, THE FORMULATION OF PHARMACEUTICALS FOR OTHERS; AND DESTRUCTION OF RETURNED SUPPLIES OF MEDICINES AND PHARMACEUTICALS IN CLINICAL STUDIES, IN CLASS 40 (U.S. CLS. 100, 103 AND 106).

THE MARK CONSISTS OF STANDARD CHARACTERS WITHOUT CLAIM TO ANY PARTICULAR FONT, STYLE, SIZE, OR COLOR.

SER. NO. 76-678,488, FILED 6-20-2007.

JOHN SCHUYLER YARD, EXAMINING ATTORNEY

Int. Cl.: 35

Prior U.S. Cls.: 100, 101 and 102

United States Patent and Trademark Office

Reg. No. 3,482,812

Registered Aug. 12, 2008

**SERVICE MARK
PRINCIPAL REGISTER**

BILCARE

BILCARE, INC. (DELAWARE CORPORATION)
300 KIMBERTON ROAD
PHOENIXVILLE, PA 19460

FIRST USE 9-0-2003; IN COMMERCE 9-0-2003.

FOR: PROFESSIONAL BUSINESS CONSULTING SERVICES IN THE FIELD OF PHARMACEUTICAL PACKAGING AND SOLUTIONS; BUSINESS ADVISORY SERVICES RELATING TO PRODUCT DEVELOPMENT AND MANUFACTURING; BUSINESS RESEARCH; AND COMPLICATION OF STATISTICAL DATA FOR BUSINESS PURPOSES RELATING TO MEDICAL RESEARCH, IN CLASS 35 (U.S. CLS. 100, 101 AND 102).

THE MARK CONSISTS OF STANDARD CHARACTERS WITHOUT CLAIM TO ANY PARTICULAR FONT, STYLE, SIZE, OR COLOR.

SER. NO. 76-678,489, FILED 6-20-2007.

JOHN SCHUYLER YARD, EXAMINING ATTORNEY

Int. Cls.: 36 and 43

Prior U.S. Cls.: 100, 101 and 102

United States Patent and Trademark Office

Reg. No. 3,482,813

Registered Aug. 12, 2008

**SERVICE MARK
PRINCIPAL REGISTER**

Global Pacific California

GLOBAL PACIFIC INTERNATIONAL INVEST-
MENT AND DEVELOPMENT CORPORATION
(DELAWARE CORPORATION)
POST OFFICE BOX 8702
WILLMINGTON, DE 19899

FOR: FINANCIAL INVESTMENT IN THE FIELD
OF REAL ESTATE; REAL ESTATE BROKERAGE;
REAL ESTATE ACQUISITION SERVICES; REAL
ESTATE INVESTMENT; REAL ESTATE VALUA-
TIONS, IN CLASS 36 (U.S. CLS. 100, 101 AND 102).

FIRST USE 6-1-2007; IN COMMERCE 6-1-2007.

FOR: PROVIDING SENIOR HOUSING MANAGE-
MENT, NAMELY, ASSISTED LIVING FACILITIES,
IN CLASS 43 (U.S. CLS. 100 AND 101).

FIRST USE 6-1-2007; IN COMMERCE 6-1-2007.

THE MARK CONSISTS OF STANDARD CHAR-
ACTERS WITHOUT CLAIM TO ANY PARTICULAR
FONT, STYLE, SIZE, OR COLOR.

NO CLAIM IS MADE TO THE EXCLUSIVE
RIGHT TO USE "GLOBAL" AND "CALIFORNIA",
APART FROM THE MARK AS SHOWN.

SER. NO. 76-678,509, FILED 6-21-2007.

KATHERINE M. DUBRAY, EXAMINING ATTOR-
NEY

Int. Cl.: 30

Prior U.S. Cl.: 46

United States Patent and Trademark Office

Reg. No. 3,482,814

Registered Aug. 12, 2008

TRADEMARK
PRINCIPAL REGISTER



QUALITY DAIRY CO. (MICHIGAN CORPORATION)
111 W. MT. HOPE AVE.
LANSING, MI 48910

FOR: BAKED DOUGHNUTS - FROZEN - PACKAGED, IN CLASS 30 (U.S. CL. 46).

FIRST USE 4-1-2000; IN COMMERCE 4-1-2000.

NO CLAIM IS MADE TO THE EXCLUSIVE RIGHT TO USE "BAKERY" , APART FROM THE MARK AS SHOWN.

THE COLOR(S) RED AND BLUE IS/ARE CLAIMED AS A FEATURE OF THE MARK.

THE COLOR BLUE APPEARS IN THE WORDING: "AUNTIE & BAKERY" AND THE OUTLINE OF THE CHEFS HAT; THE COLOR RED APPEARS IN THE WORDING "EM'S".

SER. NO. 76-678,542, FILED 6-21-2007.

SALLY SHIH, EXAMINING ATTORNEY

Int. Cl.: 10

Prior U.S. Cls.: 26, 39 and 44

United States Patent and Trademark Office

Reg. No. 3,482,815

Registered Aug. 12, 2008

**TRADEMARK
PRINCIPAL REGISTER**

U MASSAGE

SHIELDS, DAVID H. (UNITED STATES INDIVIDUAL)
15942 BLYTHE STREET
VANNUYS, CA 91406

FIRST USE 2-15-2005; IN COMMERCE 2-15-2005.

SER. NO. 76-678,591, FILED 6-22-2007.

FOR: HAND-PORTABLE MANUALLY OPERATED THERAPEUTIC MASSAGING IMPLEMENT, IN CLASS 10 (U.S. CLS. 26, 39 AND 44).

JILL PRATER, EXAMINING ATTORNEY

Int. Cl.: 9

Prior U.S. Cls.: 21, 23, 26, 36 and 38

United States Patent and Trademark Office

Reg. No. 3,482,816

Registered Aug. 12, 2008

**TRADEMARK
PRINCIPAL REGISTER**

ECLIPSE iEXTRACT

NEON ENTERPRISE SOFTWARE, INC. (DELA-
WARE CORPORATION)
14100 SOUTHWEST FREEWAY, SUITE 400
SUGAR LAND, TX 77478

FOR: SOFTWARE FOR MANAGING DATABASES,
IN CLASS 9 (U.S. CLS. 21, 23, 26, 36 AND 38).

FIRST USE 3-1-2005; IN COMMERCE 3-1-2005.

THE MARK CONSISTS OF STANDARD CHAR-
ACTERS WITHOUT CLAIM TO ANY PARTICULAR
FONT, STYLE, SIZE, OR COLOR.

SER. NO. 76-678,798, FILED 6-27-2007.

HOWARD SMIGA, EXAMINING ATTORNEY

Int. Cl.: 9

Prior U.S. Cls.: 21, 23, 26, 36 and 38

United States Patent and Trademark Office

Reg. No. 3,482,817

Registered Aug. 12, 2008

**TRADEMARK
PRINCIPAL REGISTER**

LIGHTNING EXTEND ONLINE

NEON ENTERPRISE SOFTWARE, INC. (DELA-
WARE CORPORATION)
14100 SOUTHWEST FREEWAY, SUITE 400
SUGAR LAND, TX 77478

FOR: SOFTWARE FOR MANAGING DATABASES,
IN CLASS 9 (U.S. CLS. 21, 23, 26, 36 AND 38).

FIRST USE 7-0-2006; IN COMMERCE 7-0-2006.

THE MARK CONSISTS OF STANDARD CHAR-
ACTERS WITHOUT CLAIM TO ANY PARTICULAR
FONT, STYLE, SIZE, OR COLOR.

NO CLAIM IS MADE TO THE EXCLUSIVE
RIGHT TO USE "ONLINE", APART FROM THE
MARK AS SHOWN.

SER. NO. 76-678,802, FILED 6-27-2007.

HOWARD SMIGA, EXAMINING ATTORNEY

Int. Cl.: 7

Prior U.S. Cls.: 13, 19, 21, 23, 31, 34 and 35

United States Patent and Trademark Office

Reg. No. 3,482,818

Registered Aug. 12, 2008

**TRADEMARK
PRINCIPAL REGISTER**

BMT

MORI SEIKI CO., LTD. (JAPAN CORPORATION)
106, KITAKORIYAMA-CHO
YAMATOKORIYAMA-SHI
NARA, JAPAN

FOR: METAL WORKING MACHINES, NAMELY,
LATHES, VERTICAL MACHINING CENTERS,
HORIZONTAL MACHINING CENTERS, AND
TURNING CENTERS, IN CLASS 7 (U.S. CLS. 13, 19,
21, 23, 31, 34 AND 35).

THE MARK CONSISTS OF STANDARD CHAR-
ACTERS WITHOUT CLAIM TO ANY PARTICULAR
FONT, STYLE, SIZE, OR COLOR.

PRIORITY CLAIMED UNDER SEC. 44(D) ON
JAPAN APPLICATION NO. 2007-005739, FILED 1-26-
2007, REG. NO. 5083114, DATED 10-12-2007, EXPIRES
10-12-2017.

SER. NO. 76-678,869, FILED 6-28-2007.

SIMON TENG, EXAMINING ATTORNEY

Int. Cl.: 9

Prior U.S. Cls.: 21, 23, 26, 36 and 38

Reg. No. 3,482,819

United States Patent and Trademark Office

Registered Aug. 12, 2008

**TRADEMARK
PRINCIPAL REGISTER**

**IBRIX Fusion Digital Bulk
Storage**

IBRIX, INC. (DELAWARE CORPORATION)
300 CONCORD ROAD
BILLERICA, MA 01821

FOR: COMPUTER SOFTWARE, NAMELY, FOR AGGREGATING STORAGE DEVICES INTO A REPOSITORY FOR STORING LARGE AMOUNTS OF DATA, THAT ASSISTS COMPUTERS IN SHARING THE DATA AMONG EACH OTHER , IN CLASS 9 (U.S. CLS. 21, 23, 26, 36 AND 38).

FIRST USE 10-0-2006; IN COMMERCE 5-15-2007.

THE MARK CONSISTS OF STANDARD CHARACTERS WITHOUT CLAIM TO ANY PARTICULAR FONT, STYLE, SIZE, OR COLOR.

OWNER OF U.S. REG. NOS. 2,860,510 AND 2,897,989.

NO CLAIM IS MADE TO THE EXCLUSIVE RIGHT TO USE "DIGITAL BULK STORAGE", APART FROM THE MARK AS SHOWN.

SER. NO. 76-678,895, FILED 6-29-2007.

ANDREA BUTLER, EXAMINING ATTORNEY

Int. Cl.: 14

Prior U.S. Cls.: 2, 27, 28 and 50

United States Patent and Trademark Office

Reg. No. 3,482,820

Registered Aug. 12, 2008

**TRADEMARK
PRINCIPAL REGISTER**

LIFE HAPPENS

LIFE AND HEALTH INSURANCE FOUNDATION FOR EDUCATION (D.C. CORPORATION)

1655 NORTH FORT MYER DRIVE
SUITE 610
ARLINGTON, VA 22209

FOR: RUBBER OR SILICON WRISTBANDS IN THE NATURE OF A BRACELET, IN CLASS 14 (U.S. CLS. 2, 27, 28 AND 50).

FIRST USE 6-1-2006; IN COMMERCE 6-20-2006.

THE MARK CONSISTS OF STANDARD CHARACTERS WITHOUT CLAIM TO ANY PARTICULAR FONT, STYLE, SIZE, OR COLOR.

OWNER OF U.S. REG. NOS. 3,247,314 AND 3,388,432.

SER. NO. 76-678,932, FILED 6-29-2007.

JANET LEE, EXAMINING ATTORNEY

Int. Cl.: 45

Prior U.S. Cls.: 100 and 101

United States Patent and Trademark Office

Reg. No. 3,482,821

Registered Aug. 12, 2008

**SERVICE MARK
PRINCIPAL REGISTER**

LAWGISTIC

LAWGISTIC, LTD. CO. (TEXAS LTD LIAB CO)
9595 SIX PINES, SUITE 8210
THE WOODLANDS, TX 77380

THE MARK CONSISTS OF STANDARD CHAR-
ACTERS WITHOUT CLAIM TO ANY PARTICULAR
FONT, STYLE, SIZE, OR COLOR.

FOR: LEGAL SERVICES, IN CLASS 45 (U.S. CLS.
100 AND 101).

SER. NO. 76-678,962, FILED 7-2-2007.

FIRST USE 6-1-2007; IN COMMERCE 6-10-2007.

FLORENTINA BLANDU, EXAMINING ATTORNEY

Int. Cl.: 43

Prior U.S. Cls.: 100 and 101

United States Patent and Trademark Office

Reg. No. 3,482,822

Registered Aug. 12, 2008

**SERVICE MARK
PRINCIPAL REGISTER**



K-9 GUARDIANS LLC (NEW JERSEY LTD LIAB
CO)
43 SOUTH AVENUE
FANWOOD, NJ 07023

NO CLAIM IS MADE TO THE EXCLUSIVE
RIGHT TO USE "K-9 RESORTS DAYCARE & LUX-
URY HOTELS", APART FROM THE MARK AS
SHOWN.

FOR: DAYCARE AND HOTEL SERVICES FOR
DOGS AND OTHER ANIMALS, IN CLASS 43 (U.S.
CLS. 100 AND 101).

SER. NO. 76-678,994, FILED 7-2-2007.

FIRST USE 10-0-2004; IN COMMERCE 10-0-2004.

OWNER OF U.S. REG. NO. 2,963,804.

CAROLINE WOOD, EXAMINING ATTORNEY

Int. Cls.: 9 and 16

Prior U.S. Cls.: 2, 5, 21, 22, 23, 26, 29, 36, 37, 38 and 50

Reg. No. 3,482,823

United States Patent and Trademark Office

Registered Aug. 12, 2008

**TRADEMARK
PRINCIPAL REGISTER**

The logo for Abingdon Youth. The word "Abingdon" is written in a bold, sans-serif font. Below it, the word "youth" is written in a stylized, lowercase font with a white outline, set against a solid black rectangular background.

THE UNITED METHODIST PUBLISHING
HOUSE (ILLINOIS CORPORATION)
201 EIGHTH AVENUE SOUTH
NASHVILLE, TN 37202

FOR: PRE-RECORDED DVDS AND CD-ROMS IN
THE FIELDS OF RELIGION, CHRISTIANITY, AND
FAMILY VALUES, IN CLASS 9 (U.S. CLS. 21, 23, 26, 36
AND 38).

FIRST USE 4-0-2007; IN COMMERCE 4-0-2007.

FOR: PUBLICATIONS, PRINTED CURRICULUM
AND EDUCATIONAL MATERIALS, NAMELY,
BOOKS, PAMPHLETS AND BROCHURES IN THE
FIELDS OF YOUTH GROUPS, SUNDAY SCHOOL
WORSHIP, BIBLE STUDY, MISSION YOUTH
WORKER DEVELOPMENT, COMMUNITY OUT-

REACH, YOUTH MINISTRIES, CHRISTIANITY,
FAMILY VALUES AND RELIGION, IN CLASS 16
(U.S. CLS. 2, 5, 22, 23, 29, 37, 38 AND 50).

FIRST USE 4-0-2007; IN COMMERCE 4-0-2007.

OWNER OF U.S. REG. NOS. 755,111, 1,251,646,
AND 1,762,823.

NO CLAIM IS MADE TO THE EXCLUSIVE
RIGHT TO USE "YOUTH", APART FROM THE
MARK AS SHOWN.

SER. NO. 76-679,074, FILED 7-3-2007.

CHRISTINE COOPER, EXAMINING ATTORNEY

Int. Cl.: 11

Prior U.S. Cls.: 13, 21, 23, 31 and 34

Reg. No. 3,482,824

United States Patent and Trademark Office

Registered Aug. 12, 2008

**TRADEMARK
PRINCIPAL REGISTER**



C G MOTOR SPORT, INC (CALIFORNIA CORPORATION)
14485 MONTE VISTA AVENUE
CHINO, CA 91710

FIRST USE 1-0-2003; IN COMMERCE 1-0-2003.

FOR: LIGHTS FOR VEHICLES; NAMELY, HEADLIGHTS, REAR LAMPS, CORNER LAMPS, DIRECTIONAL LIGHTS, FOG LIGHTS, SIDE MARKER LAMPS, BRAKE LAMPS, AUXILIARY BRAKE LAMPS, OFF-ROAD LIGHTS, IN CLASS 11 (U.S. CLS. 13, 21, 23, 31 AND 34).

NO CLAIM IS MADE TO THE EXCLUSIVE RIGHT TO USE "USA", APART FROM THE MARK AS SHOWN.

SER. NO. 76-679,075, FILED 6-25-2007.

KATHRYN COWARD, EXAMINING ATTORNEY

Int. Cls.: 9 and 16

Prior U.S. Cls.: 2, 5, 21, 22, 23, 26, 29, 36, 37, 38 and 50

Reg. No. 3,482,825

United States Patent and Trademark Office

Registered Aug. 12, 2008

**TRADEMARK
PRINCIPAL REGISTER**

ABINGDON YOUTH

THE UNITED METHODIST PUBLISHING
HOUSE (ILLINOIS CORPORATION)
201 EIGHTH AVENUE SOUTH
NASHVILLE, TN 37202

FOR: PRE-RECORDED DVDS AND CD-ROMS IN
THE FIELDS OF RELIGION, CHRISTIANITY, AND
FAMILY VALUES, IN CLASS 9 (U.S. CLS. 21, 23, 26, 36
AND 38).

FIRST USE 4-0-2007; IN COMMERCE 4-0-2007.

FOR: PUBLICATIONS, PRINTED CURRICULUM
AND EDUCATIONAL MATERIALS, NAMELY,
BOOKS, PAMPHLETS AND BROCHURES IN THE
FIELDS OF YOUTH GROUPS, SUNDAY SCHOOL
WORSHIP, BIBLE STUDY, MISSION YOUTH
WORKER DEVELOPMENT, COMMUNITY OUT-
REACH, YOUTH MINISTRIES, CHRISTIANITY,

FAMILY VALUES AND RELIGION, IN CLASS 16
(U.S. CLS. 2, 5, 22, 23, 29, 37, 38 AND 50).

FIRST USE 4-0-2007; IN COMMERCE 4-0-2007.

THE MARK CONSISTS OF STANDARD CHAR-
ACTERS WITHOUT CLAIM TO ANY PARTICULAR
FONT, STYLE, SIZE, OR COLOR.

OWNER OF U.S. REG. NOS. 755,111, 1,251,646,
AND 1,762,823.

NO CLAIM IS MADE TO THE EXCLUSIVE
RIGHT TO USE "YOUTH", APART FROM THE
MARK AS SHOWN.

SER. NO. 76-679,178, FILED 7-6-2007.

CHRISTINE COOPER, EXAMINING ATTORNEY

Int. Cl.: 35

Prior U.S. Cls.: 100, 101 and 102

United States Patent and Trademark Office

Reg. No. 3,482,826

Registered Aug. 12, 2008

**SERVICE MARK
PRINCIPAL REGISTER**

TOTAL TRAVEL EXPERIENCE

REARDEN COMMERCE, INC. (CALIFORNIA
CORPORATION)
SUITE 150
1400 FASHION ISLAND BOULEVARD
SAN MATEO, CA 94404

FIRST USE 8-16-2005; IN COMMERCE 8-16-2005.

NO CLAIM IS MADE TO THE EXCLUSIVE
RIGHT TO USE "TRAVEL", APART FROM THE
MARK AS SHOWN.

FOR: PROVIDING BUSINESS AND COMMER-
CIAL INFORMATION IN THE FIELD OF BUSINESS
TRAVEL MANAGEMENT AND THE BUSINESS
TRAVEL INDUSTRY , IN CLASS 35 (U.S. CLS. 100,
101 AND 102).

SER. NO. 76-679,204, FILED 7-9-2007.

JILL C. ALT, EXAMINING ATTORNEY

Int. Cl.: 3

Prior U.S. Cls.: 1, 4, 6, 50, 51 and 52

Reg. No. 3,482,827

United States Patent and Trademark Office

Registered Aug. 12, 2008

**TRADEMARK
PRINCIPAL REGISTER**

STUDIO GIRAULT

STUDIO GIRAULT, LLC (FLORIDA LTD LIAB
CO)
340 CIRCLE DRIVE
MAITLAND, FL 32751

FOR: HAIR CARE AND COSMETIC PRODUCTS
FOR THE HANDS AND BODY, NAMELY, SHAM-
POOS, CONDITIONERS, WAVING, STYLING AND
SETTING LOTIONS, GELS, FOAMS, SPRAYS,
MOISTURIZERS, AND RINSES; STYLING MOUS-
SES, HAIR STYLING WAX, HAIR DETANGLERS,
HAIR SPRITZES FOR STYLING, SUN SCREEN,
FACIAL SKIN TONERS, CREAMS FOR THE FACE
AND BODY, COSMETIC FACIAL PREPARATIONS

FOR FACE AND BODY CARE AND BODY POW-
DERS, IN CLASS 3 (U.S. CLS. 1, 4, 6, 50, 51 AND 52).

FIRST USE 6-24-2005; IN COMMERCE 6-24-2005.

THE MARK CONSISTS OF STANDARD CHAR-
ACTERS WITHOUT CLAIM TO ANY PARTICULAR
FONT, STYLE, SIZE, OR COLOR.

SER. NO. 76-679,230, FILED 7-9-2007.

ALYSSA PALADINO, EXAMINING ATTORNEY

Int. Cl.: 35

Prior U.S. Cls.: 100, 101 and 102

United States Patent and Trademark Office

Reg. No. 3,482,828

Registered Aug. 12, 2008

**SERVICE MARK
PRINCIPAL REGISTER**



ACERAY LLC (COLORADO LTD LIAB CO)
104 BROADWAY
SUITE 200
DENVER, CO 80203

FOR: DISTRIBUTORSHIPS IN THE FIELD OF
FURNITURE, IN CLASS 35 (U.S. CLS. 100, 101 AND
102).

FIRST USE 0-0-2003; IN COMMERCE 0-0-2003.

THE COLOR(S) BLACK AND GREEN IS/ARE
CLAIMED AS A FEATURE OF THE MARK.

THE MARK CONSISTS OF THE LETTER "A" IN A
TEAR DROP-LIKE SHAPE. THE COLOR GREEN
APPEARS IN THE PARTS OF THE SHAPE TO THE
LEFT OF THE LETTER "A" AND BELOW THE
LETTER "A". THE COLOR BLACK APPEARS IN
THE PART OF THE SHAPE TO THE RIGHT OF THE
COLOR "A" AND IN THE CENTER TRIANGLE OF
THE LETTER "A". THE WHITE IS NOT PART OF
THE MARK AND REPRESENTS TRANSPARENT
AREA.

SER. NO. 76-679,271, FILED 7-9-2007.

ELLEN B. AWRICH, EXAMINING ATTORNEY

Int. Cls.: 37 and 42

Prior U.S. Cls.: 100, 101, 103 and 106

United States Patent and Trademark Office

Reg. No. 3,482,829

Registered Aug. 12, 2008

**SERVICE MARK
PRINCIPAL REGISTER**

TAP THE SUN FOR POWER

ALTPOWER, INC. (NEW YORK CORPORATION)
125 MAIDEN LANE
SUITE 307
NEW YORK, NY 100384980

FOR: CONSTRUCTION OF RENEWABLE ENERGY SYSTEMS, NAMELY, SOLAR AND WIND ENERGY SYSTEMS, IN CLASS 37 (U.S. CLS. 100, 103 AND 106).

FIRST USE 8-1-1998; IN COMMERCE 8-1-1998.

FOR: DESIGN FOR OTHERS OF RENEWABLE ENERGY SYSTEMS, NAMELY, SOLAR AND WIND

ENERGY SYSTEMS, IN CLASS 42 (U.S. CLS. 100 AND 101).

FIRST USE 8-1-1998; IN COMMERCE 8-1-1998.

THE MARK CONSISTS OF STANDARD CHARACTERS WITHOUT CLAIM TO ANY PARTICULAR FONT, STYLE, SIZE, OR COLOR.

SER. NO. 76-679,290, FILED 7-9-2007.

CHRISTINA SOBRAL, EXAMINING ATTORNEY

Int. Cl.: 36

Prior U.S. Cls.: 100, 101 and 102

United States Patent and Trademark Office

Reg. No. 3,482,830

Registered Aug. 12, 2008

**SERVICE MARK
PRINCIPAL REGISTER**

e-BankPlus

BANKPLUS (MISSISSIPPI BANKING CORPORATION)
1068 HIGHLAND COLONY
400 CONCOURSE BUILDING, SUITE 100
RIDGELAND, MS 39157

OWNER OF U.S. REG. NO. 3,022,556.

SER. NO. 76-679,293, FILED 7-9-2007.

FOR: ON-LINE BANKING SERVICES, IN CLASS
36 (U.S. CLS. 100, 101 AND 102).

FIRST USE 12-31-1998; IN COMMERCE 12-31-1998.

KATHLEEN M. VANSTON, EXAMINING ATTORNEY

Int. Cls.: 37 and 42

Prior U.S. Cls.: 100, 101, 103 and 106

United States Patent and Trademark Office

Reg. No. 3,482,831

Registered Aug. 12, 2008

**SERVICE MARK
PRINCIPAL REGISTER**

SOLAR ENERGY - UTILIZE IT!

ALTPOWER, INC. (NEW YORK CORPORATION)
125 MAIDEN LANE
SUITE 307
NEW YORK, NY 100384980

FOR: CONSTRUCTION OF RENEWABLE ENERGY SYSTEMS, NAMELY, SOLAR AND WIND ENERGY SYSTEMS, IN CLASS 37 (U.S. CLS. 100, 103 AND 106).

FIRST USE 8-1-1998; IN COMMERCE 8-1-1998.

FOR: DESIGN FOR OTHERS OF RENEWAL ENERGY SYSTEMS, MAINLY SOLAR AND WIND ENERGY SYSTEMS, IN CLASS 42 (U.S. CLS. 100 AND 101).

FIRST USE 8-1-1998; IN COMMERCE 8-1-1998.

THE MARK CONSISTS OF STANDARD CHARACTERS WITHOUT CLAIM TO ANY PARTICULAR FONT, STYLE, SIZE, OR COLOR.

NO CLAIM IS MADE TO THE EXCLUSIVE RIGHT TO USE "SOLAR ENERGY", APART FROM THE MARK AS SHOWN.

SER. NO. 76-679,296, FILED 7-9-2007.

CHRISTINA SOBRAL, EXAMINING ATTORNEY

Int. Cl.: 36

Prior U.S. Cls.: 100, 101 and 102

United States Patent and Trademark Office

Reg. No. 3,482,832

Registered Aug. 12, 2008

SERVICE MARK
PRINCIPAL REGISTER



VILLAGE BANK AND TRUST FINANCIAL CORPORATION (VIRGINIA CORPORATION)
1231 ALVERSER DRIVE
MIDLOTHIAN, VA 23113

FIRST USE 5-1-2005; IN COMMERCE 5-1-2005.

OWNER OF U.S. REG. NO. 2,812,021.

FOR: MORTGAGE LENDING; MORTGAGE BANKING; MORTGAGE BANKING SERVICES, NAMELY, ORIGINATION, ACQUISITION, SERVICING, SECURITIZATION AND BROKERAGE OF MORTGAGE LOANS; MORTGAGE BROKERAGE; MORTGAGE PROCUREMENT FOR OTHERS; MORTGAGE SERVICES, NAMELY, BUYER PRE-QUALIFICATION OF MORTGAGES FOR MORTGAGE BROKERS AND BANKS, IN CLASS 36 (U.S. CLS. 100, 101 AND 102).

NO CLAIM IS MADE TO THE EXCLUSIVE RIGHT TO USE "BANK" AND "MORTGAGE CORPORATION", APART FROM THE MARK AS SHOWN.

SER. NO. 76-679,368, FILED 7-11-2007.

SIMON TENG, EXAMINING ATTORNEY

Int. Cls.: 36 and 37

Prior U.S. Cls.: 100, 101, 102, 103 and 106

United States Patent and Trademark Office

Reg. No. 3,482,833

Registered Aug. 12, 2008

**SERVICE MARK
PRINCIPAL REGISTER**

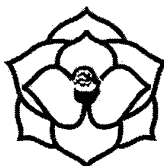

**MAGNOLIA
PARK**

MAGNOLIA PARK, LLC (DELAWARE LTD LIAB
CO)
C/O MENIN DEVELOPMENT COMPANIES, INC.
11701 LAKE VICTORIA GARDENS AVENUE
PALM BEACH GARDENS, FL 33410

FOR: SHOPPING CENTER SERVICES, NAMELY,
LEASING OF SHOPPING MALL SPACES, IN CLASS
36 (U.S. CLS. 100, 101 AND 102).

FIRST USE 3-21-2007; IN COMMERCE 3-21-2007.

FOR: MULTI-USE REAL ESTATE DEVELOP-
MENT, INCLUDING COMMERCIAL AND RETAIL

REAL ESTATE, IN CLASS 37 (U.S. CLS. 100, 103 AND
106).

FIRST USE 3-21-2007; IN COMMERCE 3-21-2007.

NO CLAIM IS MADE TO THE EXCLUSIVE
RIGHT TO USE "PARK", APART FROM THE MARK
AS SHOWN.

SER. NO. 76-679,387, FILED 7-11-2007.

BRIAN CALLAGHAN, EXAMINING ATTORNEY

Int. Cl.: 41

Prior U.S. Cls.: 100, 101 and 107

United States Patent and Trademark Office

Reg. No. 3,482,834

Registered Aug. 12, 2008

SERVICE MARK
PRINCIPAL REGISTER



L.D. PANKEY DENTAL FOUNDATION, INC.
(FLORIDA NON PROFIT CORPORATION),
DBA L.D. PANKEY INSTITUTE
ONE CRANDON BOULEVARD
KEY BISCAVNE, FL 33149

FOR: EDUCATIONAL SERVICES, NAMELY,
CONDUCTING POSTGRADUATE CLASSES, SEMI-
NARS, CONFERENCES AND WORKSHOPS IN THE
FIELD OF ADVANCED DENTISTRY, IN CLASS 41
(U.S. CLS. 100, 101 AND 107).

FIRST USE 11-1-1993; IN COMMERCE 11-1-1993.

NO CLAIM IS MADE TO THE EXCLUSIVE
RIGHT TO USE "INSTITUTE", APART FROM THE
MARK AS SHOWN.

SER. NO. 76-679,529, FILED 7-16-2007.

RENEE MCCRAY, EXAMINING ATTORNEY

Int. Cl.: 39

Prior U.S. Cls.: 100 and 105

United States Patent and Trademark Office

Reg. No. 3,482,835

Registered Aug. 12, 2008

**SERVICE MARK
PRINCIPAL REGISTER**

PPS CLUB

SINGAPORE AIRLINES LIMITED (SINGAPORE CORPORATION)
25 AIRLINE ROAD
AIRLINE HOUSE
SINGAPORE 819829

FOR: AIR TRANSPORTATION SERVICES; TRANSPORTATION OF PASSENGERS BY AIR; TRANSPORTATION OF GOODS BY AIR; TRAVEL ARRANGEMENT SERVICES FOR PACKAGE HOLIDAYS; BOOKING OF SEATS FOR AIR TRANSPORTATION; ESCORTING OF TRAVELERS ON TRAVEL TOURS; TRANSPORTATION OF PASSENGERS LUGGAGE, AND HANDLING OF BAGGAGE AND CARGO GOODS, IN CLASS 39 (U.S. CLS. 100 AND 105).

FIRST USE 12-0-1996; IN COMMERCE 1-0-1997.

THE MARK CONSISTS OF STANDARD CHARACTERS WITHOUT CLAIM TO ANY PARTICULAR FONT, STYLE, SIZE, OR COLOR.

NO CLAIM IS MADE TO THE EXCLUSIVE RIGHT TO USE "CLUB", APART FROM THE MARK AS SHOWN.

SER. NO. 76-679,570, FILED 7-16-2007.

JENNIFER VASQUEZ, EXAMINING ATTORNEY

Int. Cl.: 5

Prior U.S. Cls.: 6, 18, 44, 46, 51 and 52

Reg. No. 3,482,836

United States Patent and Trademark Office

Registered Aug. 12, 2008

**TRADEMARK
PRINCIPAL REGISTER**

SUPERTAB

WRIGHT ENRICHMENT, INC. (LOUISIANA CORPORATION)
6428 AIRPORT ROAD
CROWLEY, LA 70527

FOR: NUTRITIONAL DRINK DRY POWDER MIXES CONSISTING OF VARIOUS VITAMINS, MINERALS AND NUTRITIONAL COMPONENTS FOR USE AS A MEAL REPLACEMENT; VITAMIN AND MINERAL HOMOGENOUS PRE-MIXTURES FOR USE AS NUTRITIONAL INGREDIENTS IN BEVERAGES, JUICES, DAIRY PRODUCTS, INFANT FORMULA, NUTRITIONAL BARS, BAKED GOODS, BREADS, CEREAL, GRAIN PRODUCTS, MUFFINS, COOKIES, PASTRIES, CANDY, PHARMACEUTI-

CALS, DIETARY SUPPLEMENTS, NUTRACEUTICALS, SPORTS NUTRITION PRODUCTS, IN CLASS 5 (U.S. CLS. 6, 18, 44, 46, 51 AND 52).

FIRST USE 4-6-2007; IN COMMERCE 4-6-2007.

THE MARK CONSISTS OF STANDARD CHARACTERS WITHOUT CLAIM TO ANY PARTICULAR FONT, STYLE, SIZE, OR COLOR.

SER. NO. 76-679,671, FILED 7-19-2007.

MICHAEL SOUDERS, EXAMINING ATTORNEY

Int. Cl.: 21

Prior U.S. Cls.: 2, 13, 23, 29, 30, 33, 40 and 50

United States Patent and Trademark Office

Reg. No. 3,482,837

Registered Aug. 12, 2008

TRADEMARK
PRINCIPAL REGISTER



NJ SUPPLY LTD. (MISSOURI CORPORATION)

P.O. BOX 106

COTTLEVILLE, MO 63338

FOR: PLANT TUBS CAPABLE OF STACKING, IN
CLASS 21 (U.S. CLS. 2, 13, 23, 29, 30, 33, 40 AND 50).

FIRST USE 2-0-2006; IN COMMERCE 2-0-2006.

NO CLAIM IS MADE TO THE EXCLUSIVE
RIGHT TO USE "SUPPLY LTD." AND "GARDEN-
ING", APART FROM THE MARK AS SHOWN.

THE NAME "NANCY JANE" IDENTIFIES A LIV-
ING INDIVIDUAL WHOSE CONSENT IS OF RE-
CORD.

SER. NO. 76-679,795, FILED 7-23-2007.

SONYA STEPHENS, EXAMINING ATTORNEY

Int. Cls.: 38 and 41

Prior U.S. Cls.: 100, 101, 104 and 107

United States Patent and Trademark Office

Reg. No. 3,482,838

Registered Aug. 12, 2008

**SERVICE MARK
PRINCIPAL REGISTER**

THE OPTIMUM NETWORK

CSC HOLDINGS, INC. (DELAWARE CORPORATION)

1111 STEWART AVENUE
BETHPAGE, NY 11714

FOR: CABLE TELEVISION TRANSMISSION AND BROADCASTING SERVICES; TRANSMISSION AND BROADCASTING OF TELEVISION PROGRAMMING, DATA, SOUND, TEXT, IMAGES, VIDEO, AND VIDEO-ON-DEMAND, BY MEANS OF CABLE NETWORKS, SATELLITE, COMPUTER TERMINAL, THE GLOBAL COMPUTER NETWORK, FIBER OPTICS NETWORKS, AND MODEMS THAT ENABLE COMMUNICATIONS; PROVIDING MULTIPLE USE ACCESS TO THE INTERNET BY MEANS OF A CABLE NETWORK; TELECOMMUNICATIONS CONNECTIONS TO A GLOBAL COMPUTER NETWORK; PROVIDING TELECOMMUNICATIONS CONNECTIONS BETWEEN TELEPHONES AND COMPUTERS FOR TRANSFER OF VOICE AND DATA BY MEANS OF A GLOBAL COMPUTER NETWORK; AND TELECOMMUNICATIONS SERVICES, NAMELY, PERSONAL COMMUNICATION SERVICES AND LOCAL, REGIONAL AND LONG DISTANCE TELEPHONE SERVICES, IN CLASS 38 (U.S. CLS. 100, 101 AND 104).

FIRST USE 4-7-2007; IN COMMERCE 4-7-2007.

FOR: ENTERTAINMENT SERVICES, NAMELY, TELEVISION PROGRAMMING AND PRODUCTION SERVICES, DISTRIBUTION OF ENTERTAINMENT AND EDUCATIONAL PROGRAMMING AND VIDEO-ON-DEMAND TELEVISION PROGRAMMING, AND PROVIDING CABLE TELEVISION SCHEDULES AND CABLE TELEVISION PROGRAM REVIEWS; PROVIDING ON-LINE INTERACTIVE VIDEO GAMES VIA TELEVISION AND THE INTERNET, AND PROVIDING INFORMATION ON-LINE RELATING TO COMPUTER GAMES, IN CLASS 41 (U.S. CLS. 100, 101 AND 107).

FIRST USE 4-7-2007; IN COMMERCE 4-7-2007.

THE MARK CONSISTS OF STANDARD CHARACTERS WITHOUT CLAIM TO ANY PARTICULAR FONT, STYLE, SIZE, OR COLOR.

OWNER OF U.S. REG. NOS. 2,695,584, 3,021,926 AND OTHERS.

NO CLAIM IS MADE TO THE EXCLUSIVE RIGHT TO USE "NETWORK", APART FROM THE MARK AS SHOWN.

SER. NO. 76-679,836, FILED 7-23-2007.

GEORGIA CARTY, EXAMINING ATTORNEY

Int. Cl.: 44

Prior U.S. Cls.: 100 and 101

United States Patent and Trademark Office

Reg. No. 3,482,839

Registered Aug. 12, 2008

**SERVICE MARK
PRINCIPAL REGISTER**

MAGIC FOUNDATION

MAGIC FOUNDATION, INC. (ILLINOIS CORPORATION)
6645 W. NORTH AVENUE
OAK PARK, IL 60302

FOR: CHARITABLE SERVICES, NAMELY, PROVIDING MEDICAL INFORMATION TO SUPPORT FAMILIES WITH CHILDREN WITH POSSIBLE PHYSICAL GROWTH, AND RELATED DISORDERS, IN CLASS 44 (U.S. CLS. 100 AND 101).

FIRST USE 10-1-1989; IN COMMERCE 10-1-1989.

NO CLAIM IS MADE TO THE EXCLUSIVE RIGHT TO USE "FOUNDATION", APART FROM THE MARK AS SHOWN.

SER. NO. 76-680,785, FILED 8-17-2007.

INGRID C. EULIN, EXAMINING ATTORNEY

Int. Cl.: 43

Prior U.S. Cls.: 100 and 101

United States Patent and Trademark Office

Reg. No. 3,482,840

Registered Aug. 12, 2008

**SERVICE MARK
PRINCIPAL REGISTER**



AISLINN COFFEE ENTERPRISES LLC (OREGON
DOMESTIC LIMITED LIABILITY COMPANY)
P.O. BOX 67213
PORTLAND, OR 97268

FOR: RESTAURANT, CAFÉ, CAFETERIA,
SNACK BAR, COFFEE BAR, AND COFFEE HOUSE
SERVICES, IN CLASS 43 (U.S. CLS. 100 AND 101).

FIRST USE 4-5-2007; IN COMMERCE 4-19-2007.

THE MARK CONSISTS OF A CIRCLE ENCAPSULATING THE WORDS "SADIE'S HOT SPOT" AND A WOMAN SITTING ON TOP OF A CUP. THE CUP CREATES A SHADOW THAT SLIGHTLY PROTRUDES FROM BOTH SIDES OF THE CIRCLE.

SER. NO. 76-681,093, FILED 8-24-2007.

JEFF DEFORD, EXAMINING ATTORNEY

Int. Cl.: 28

Prior U.S. Cls.: 22, 23, 38 and 50

United States Patent and Trademark Office

Reg. No. 3,482,841

Registered Aug. 12, 2008

TRADEMARK
PRINCIPAL REGISTER



DUANE, GORDON P. (UNITED STATES INDIVIDUAL)
P.O. BOX 187
HUNTINGTON BEACH, CA 92648

OWNER OF U.S. REG. NO. 2,527,149.

FOR: SURFBOARDS, SKATEBOARDS, BODY BOARDS, KNEE BOARDS, AND AQUA BOARDING EQUIPMENT, NAMELY, PAIPO BOARDS, SKIM BOARDS, SURFBOARD WAX, SURFBOARD FINS, AND PADDLES FOR USE WITH SURFBOARDS, IN CLASS 28 (U.S. CLS. 22, 23, 38 AND 50).

NO CLAIM IS MADE TO THE EXCLUSIVE RIGHT TO USE "SURF BOARDS" AND "HUNTINGTON BEACH, CALIF.", APART FROM THE MARK AS SHOWN.

SER. NO. 76-681,325, FILED 8-30-2007.

FIRST USE 6-0-1956; IN COMMERCE 6-0-1956.

ANDREA K. NADELMAN, EXAMINING ATTORNEY

Int. Cls.: 9 and 41

Prior U.S. Cls.: 21, 23, 26, 36, 38, 100, 101 and 107

United States Patent and Trademark Office

Reg. No. 3,482,842

Registered Aug. 12, 2008

**TRADEMARK
SERVICE MARK
PRINCIPAL REGISTER**

CHICAGO MASS CHOIR

ECC MUSIC WORK SHOP (ILLINOIS NOT-FOR-PROFIT CORPORATION)
8000 S. SAWYER
CHICAGO, IL 60652

FOR: PRE-RECORDED COMPACT DISCS AND CASSETTE TAPES FEATURING MUSIC, IN CLASS 9 (U.S. CLS. 21, 23, 26, 36 AND 38).

FIRST USE 7-0-1990; IN COMMERCE 7-0-1990.

FOR: EDUCATIONAL SERVICES, NAMELY CONDUCTING EDUCATIONAL SEMINARS IN THE AREA OF GOSPEL MUSIC; ENTERTAINMENT SERVICES, NAMELY CHOIR PERFORMANCES, IN CLASS 41 (U.S. CLS. 100, 101 AND 107).

FIRST USE 7-0-1990; IN COMMERCE 7-0-1990.

THE MARK CONSISTS OF STANDARD CHARACTERS WITHOUT CLAIM TO ANY PARTICULAR FONT, STYLE, SIZE, OR COLOR.

NO CLAIM IS MADE TO THE EXCLUSIVE RIGHT TO USE "MASS CHOIR", APART FROM THE MARK AS SHOWN.

SEC. 2(F).

SER. NO. 76-681,416, FILED 8-31-2007.

ELI HELLMAN, EXAMINING ATTORNEY

Int. Cl.: 41

Prior U.S. Cls.: 100, 101 and 107

United States Patent and Trademark Office

Reg. No. 3,482,843

Registered Aug. 12, 2008

**SERVICE MARK
PRINCIPAL REGISTER**

THE MOPTOPS

STEFANELLI, JOSEPH (UNITED STATES INDIVIDUAL)
7721 SAINT BERNARD STREET, SUITE #6
PLAYA DEL REY, CA 90293

THE MARK CONSISTS OF STANDARD CHARACTERS WITHOUT CLAIM TO ANY PARTICULAR FONT, STYLE, SIZE, OR COLOR.

FOR: ENTERTAINMENT SERVICES IN THE NATURE OF A MUSICAL GROUP, IN CLASS 41 (U.S. CLS. 100, 101 AND 107).

SER. NO. 76-682,251, FILED 9-24-2007.

FIRST USE 10-0-1992; IN COMMERCE 10-0-1992.

JENNIFER VASQUEZ, EXAMINING ATTORNEY

Int. Cls.: 9 and 41

Prior U.S. Cls.: 21, 23, 26, 36, 38, 100, 101 and 107

United States Patent and Trademark Office

Reg. No. 3,482,844

Registered Aug. 12, 2008

**TRADEMARK
SERVICE MARK
PRINCIPAL REGISTER**

SYNAPSE FILMS

SYNAPSE FILMS, INC. (DELAWARE CORPORATION)
P.O. BOX 351
NOVI, MI 483760351

FOR: CINEMATOGRAPHIC FILMS AND MOTION-PICTURE FILMS FEATURING DRAMA, HORROR, ACTION ADVENTURE, ADULT SUBJECT MATTER, DOCUMENTARY, HISTORICAL AND CHILDREN'S ENTERTAINMENT; PRE-RECORDED DIGITAL VERSATILE DISKS, NAMELY, DVD'S FEATURING DRAMA, HORROR, ACTION ADVENTURE, ADULT SUBJECT MATTER, DOCUMENTARY, HISTORICAL AND CHILDREN'S ENTERTAINMENT, IN CLASS 9 (U.S. CLS. 21, 23, 26, 36 AND 38).

FIRST USE 1-1-1998; IN COMMERCE 1-1-1998.

FOR: ENTERTAINMENT SERVICES, NAMELY, PRODUCTION AND DISTRIBUTION OF CINEMA-

TOGRAPHIC FILMS AND MOTION-PICTURE FILMS FEATURING DRAMA, HORROR, ACTION-ADVENTURE, ADULT SUBJECT MATTER, DOCUMENTARY, HISTORICAL, AND CHILDREN'S ENTERTAINMENT, IN CLASS 41 (U.S. CLS. 100, 101 AND 107).

FIRST USE 1-1-1998; IN COMMERCE 1-1-1998.

THE MARK CONSISTS OF STANDARD CHARACTERS WITHOUT CLAIM TO ANY PARTICULAR FONT, STYLE, SIZE, OR COLOR.

NO CLAIM IS MADE TO THE EXCLUSIVE RIGHT TO USE "FILMS", APART FROM THE MARK AS SHOWN.

SER. NO. 76-682,263, FILED 9-24-2007.

JAY FLOWERS, EXAMINING ATTORNEY

Int. Cls.: 35 and 40

Prior U.S. Cls.: 100, 101, 102, 103 and 106

United States Patent and Trademark Office

Reg. No. 3,482,845

Registered Aug. 12, 2008

**SERVICE MARK
PRINCIPAL REGISTER**

**HOLLOW STRUCTURALS – SOLID
PERFORMANCE!**

SCHAEFFER INDUSTRIES (CALIFORNIA CORPORATION)
141 S. WESTERN COIL ROAD
LINDON, UT 84042

FOR: RETAIL STORE SERVICES AND WHOLESALE DISTRIBUTORSHIP SERVICES, BOTH FEATURING STRUCTURAL STEEL PIPE AND TUBE, IN CLASS 35 (U.S. CLS. 100, 101 AND 102).

FIRST USE 8-0-2005; IN COMMERCE 8-0-2005.

FOR: CUSTOM MANUFACTURE OF STRUCTURAL STEEL PIPE AND TUBE, IN CLASS 40 (U.S. CLS. 100, 103 AND 106).

FIRST USE 8-0-2005; IN COMMERCE 8-0-2005.

THE MARK CONSISTS OF STANDARD CHARACTERS WITHOUT CLAIM TO ANY PARTICULAR FONT, STYLE, SIZE, OR COLOR.

NO CLAIM IS MADE TO THE EXCLUSIVE RIGHT TO USE "HOLLOW STRUCTURALS" AND "PERFORMANCE", APART FROM THE MARK AS SHOWN.

SER. NO. 76-682,532, FILED 10-3-2007.

SIMON TENG, EXAMINING ATTORNEY

Int. Cls.: 24 and 26

Prior U.S. Cls.: 37, 39, 40, 42 and 50

Reg. No. 3,482,846

United States Patent and Trademark Office

Registered Aug. 12, 2008

TRADEMARK
PRINCIPAL REGISTER



SNAP DRAPE INTERNATIONAL, INC. (TEXAS CORPORATION)
2045 WESTGATE DR.
SUITE 100
CARROLLTON, TX 75006

FOR: SKIRTINGS FOR TABLES OR STAGES, IN CLASS 24 (U.S. CLS. 42 AND 50).

FIRST USE 6-0-2000; IN COMMERCE 6-0-2000.

FOR: SNAP FASTENERS FOR SECURING SKIRTINGS AND DRAPES TO TABLES OR STAGES, IN CLASS 26 (U.S. CLS. 37, 39, 40, 42 AND 50).

FIRST USE 6-0-2000; IN COMMERCE 6-0-2000.

OWNER OF U.S. REG. NO. 1,314,641.

NO CLAIM IS MADE TO THE EXCLUSIVE RIGHT TO USE "INTERNATIONAL", APART FROM THE MARK AS SHOWN.

THE MARK CONSISTS OF A STYLIZED "S" DESIGN DEPICTING A STYLIZED DESIGN OF A COVERED TABLE APPEARING CENTERED WITHIN SUCH "S" DESIGN, AND THE "S" DESIGN APPEARING IMMEDIATELY TO THE LEFT OF THE TERMS "SNAP DRAPE INTERNATIONAL," WITH THE TERMS "SNAP" AND "DRAPE" APPEARING IN A STYLIZED FONT AND SEPARATED BY A SMALL CIRCULAR DOT APPEARING BETWEEN SUCH TERMS, AND WITH SUCH TERMS FURTHER APPEARING DIRECTLY ABOVE THE TERM "INTERNATIONAL," WITH THE TERM "INTERNATIONAL" APPEARING IN A SMALL BLOCK FONT.

SEC. 2(F).

SER. NO. 76-682,658, FILED 10-5-2007.

KYLE PEETE, EXAMINING ATTORNEY

Int. Cl.: 35

Prior U.S. Cls.: 100, 101 and 102

United States Patent and Trademark Office

Reg. No. 3,482,847

Registered Aug. 12, 2008

**SERVICE MARK
PRINCIPAL REGISTER**

LAUNCH PR

SCHNEIDER & ASSOCIATES, INC. (MASSACHU-
SETTS CORPORATION)
2 OLIVER STREET, SUITE 901
BOSTON, MA 02109

FOR: PUBLIC RELATIONS AND BUSINESS CON-
SULTING SERVICES, IN CLASS 35 (U.S. CLS. 100, 101
AND 102).

FIRST USE 0-0-2004; IN COMMERCE 0-0-2004.

THE MARK CONSISTS OF STANDARD CHAR-
ACTERS WITHOUT CLAIM TO ANY PARTICULAR
FONT, STYLE, SIZE, OR COLOR.

OWNER OF U.S. REG. NOS. 2,082,068 AND
2,684,301.

NO CLAIM IS MADE TO THE EXCLUSIVE
RIGHT TO USE "PR", APART FROM THE MARK
AS SHOWN.

SER. NO. 76-682,874, FILED 10-12-2007.

INGRID C. EULIN, EXAMINING ATTORNEY

Int. Cl.: 20

Prior U.S. Cls.: 2, 13, 22, 25, 32 and 50

Reg. No. 3,482,848

United States Patent and Trademark Office

Registered Aug. 12, 2008

**TRADEMARK
PRINCIPAL REGISTER**

ESSEX MANOR

AMINI INNOVATION CORP. (CALIFORNIA CORPORATION)
8725 REX ROAD
PICO RIVERA, CA 90660

FOR: HIGH-END, HIGHLY ORNAMENTED BED HEADBOARDS, BED FOOTBOARDS, BED RAILS, BED SLATS, DRESSERS, DRESSER MIRRORS, CHESTS WITH DRAWERS, ARMOIRES, NIGHT-STANDS, DINING ROOM TABLES, DINING ROOM CHAIRS, SIDEBOARDS, SIDEBOARD MIRRORS, COCKTAIL TABLES, END TABLES, BARREL END TABLES, CONSOLE TABLES, CURIOS, SOFAS, HIGH BACK CHAIRS, CHAIRS-AND-A-HALF,

ARMS BENCHES, AND OTTOMAN, MADE PRIMARILY FROM HAND-CARVED WOOD, IN CLASS 20 (U.S. CLS. 2, 13, 22, 25, 32 AND 50).

FIRST USE 7-0-2007; IN COMMERCE 7-0-2007.

THE MARK CONSISTS OF STANDARD CHARACTERS WITHOUT CLAIM TO ANY PARTICULAR FONT, STYLE, SIZE, OR COLOR.

SER. NO. 76-682,940, FILED 10-15-2007.

JAY FLOWERS, EXAMINING ATTORNEY

Int. Cl.: 37

Prior U.S. Cls.: 100, 103 and 106

United States Patent and Trademark Office

Reg. No. 3,482,849

Registered Aug. 12, 2008

**SERVICE MARK
PRINCIPAL REGISTER**



GREENSLEEVES GARMENT CARE LLC (NEW YORK LTD LIAB CO)

87 FOREST AVENUE
GLEN COVE, NY 11542

FOR: ENVIRONMENTALLY SAFE DRY CLEANING SERVICES, IN CLASS 37 (U.S. CLS. 100, 103 AND 106).

FIRST USE 2-20-2007; IN COMMERCE 2-20-2007.

NO CLAIM IS MADE TO THE EXCLUSIVE RIGHT TO USE "GARMENT CARE", APART FROM THE MARK AS SHOWN.

THE COLOR(S) TURQUOISE, GREY AND WHITE IS/ARE CLAIMED AS A FEATURE OF THE MARK.

THE MARK CONSISTS OF "GREENSLEEVES GARMENT CARE" IN STYLIZED LETTERING SUPERIMPOSED ON AN OUTLINED DOUBLE BREASTED VEST, JACKET WITH TIE AND SHIRT WITH VICTORIAN COLLAR. THE WORD "GREENSLEEVES" IS IN A DRAGONFLY FONT AND THE WORDING "GARMENT CARE" IS IN LOWER CASE VERDANA FONT. THE COLOR TURQUOISE APPEARS IN THE WORDING "GREENSLEEVES GARMENT CARE"; THE COLOR GREY APPEARS IN THE DESIGN OUTLINE OF THE DOUBLE BREASTED VEST, JACKET WITH TIE AND SHIRT WITH VICTORIAN COLLAR. THE COLOR WHITE APPEARS IN THE DOUBLE BREASTED VEST, JACKET AND SHIRT WITH VICTORIAN COLLAR.

SER. NO. 76-683,071, FILED 10-18-2007.

GIANCARLO CASTRO, EXAMINING ATTORNEY

Int. Cl.: 12

Prior U.S. Cls.: 19, 21, 23, 31, 35 and 44

Reg. No. 3,482,850

United States Patent and Trademark Office

Registered Aug. 12, 2008

**TRADEMARK
PRINCIPAL REGISTER**

TUFF BOY

TUFF BOY SALES, INC. (CALIFORNIA CORPORATION)
5151 EAST ALMONDWOOD DRIVE
MANTECA, CA 95337

FOR: ALL TYPES AND KINDS OF TRAILERS FOR THE HAULING OF FRUIT, VEGETABLES AND OTHER AGRICULTURAL COMMODITIES, PRODUCE, FREIGHT AND CARGO , IN CLASS 12 (U.S. CLS. 19, 21, 23, 31, 35 AND 44).

FIRST USE 12-22-1959; IN COMMERCE 9-17-1980.

THE MARK CONSISTS OF STANDARD CHARACTERS WITHOUT CLAIM TO ANY PARTICULAR FONT, STYLE, SIZE, OR COLOR.

NO CLAIM IS MADE TO THE EXCLUSIVE RIGHT TO USE "TOUGH", APART FROM THE MARK AS SHOWN.

SER. NO. 76-683,187, FILED 10-22-2007.

MICHAEL WIENER, EXAMINING ATTORNEY

Int. Cl.: 12

Prior U.S. Cls.: 19, 21, 23, 31, 35 and 44

Reg. No. 3,482,851

United States Patent and Trademark Office

Registered Aug. 12, 2008

**TRADEMARK
PRINCIPAL REGISTER**

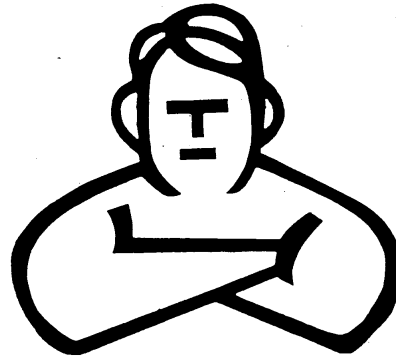

TUFF BOY SALES, INC. (CALIFORNIA CORPORATION)
5151 EAST ALMONDWOOD DRIVE
MANTECA, CA 95337

PRODUCE, FREIGHT AND CARGO , IN CLASS 12
(U.S. CLS. 19, 21, 23, 31, 35 AND 44).

FIRST USE 12-22-1959; IN COMMERCE 9-17-1980.

FOR: ALL TYPES AND KINDS OF TRAILERS
FOR THE HAULING OF FRUIT, VEGETABLES
AND OTHER AGRICULTURAL COMMODITIES,

SER. NO. 76-683,225, FILED 10-22-2007.

MICHAEL WIENER, EXAMINING ATTORNEY

Int. Cl.: 20

Prior U.S. Cls.: 2, 13, 22, 25, 32 and 50

Reg. No. 3,482,852

United States Patent and Trademark Office

Registered Aug. 12, 2008

**TRADEMARK
PRINCIPAL REGISTER**

ACASA

AMINI INNOVATION CORP. (CALIFORNIA
CORPORATION)
8725 REX ROAD
PICO RIVERA, CA 90660

FOR: FURNITURE, IN CLASS 20 (U.S. CLS. 2, 13,
22, 25, 32 AND 50).

FIRST USE 7-29-2007; IN COMMERCE 7-29-2007.

THE MARK CONSISTS OF STANDARD CHAR-
ACTERS WITHOUT CLAIM TO ANY PARTICULAR
FONT, STYLE, SIZE, OR COLOR.

THE WORDING "ACASA" HAS NO MEANING IN
A FOREIGN LANGUAGE.

SER. NO. 76-683,377, FILED 10-26-2007.

ANNE E. GUSTASON, EXAMINING ATTORNEY

Int. Cl.: 2

Prior U.S. Cls.: 6, 11 and 16

United States Patent and Trademark Office

Reg. No. 3,482,853

Registered Aug. 12, 2008

**TRADEMARK
PRINCIPAL REGISTER**

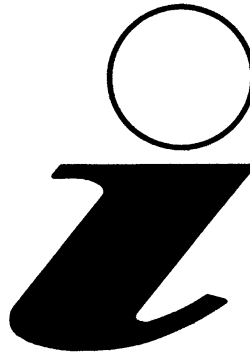

XSE GROUP, INC. (CONNECTICUT CORPORATION)
35 PHIL MACK DRIVE
MIDDLETOWN, CT 06457

FIRST USE 7-17-2007; IN COMMERCE 7-17-2007.

FOR: TONER CARTRIDGES, MAGNETIC INK CHARACTER RECOGNITION (MICR) TONER CARTRIDGES, INK CARTRIDGES, IN CLASS 2 (U.S. CLS. 6, 11 AND 16).

SER. NO. 76-683,491, FILED 10-29-2007.

JASON BLAIR, EXAMINING ATTORNEY

Int. Cl.: 2

Prior U.S. Cls.: 6, 11 and 16

United States Patent and Trademark Office

Reg. No. 3,482,854

Registered Aug. 12, 2008

**TRADEMARK
PRINCIPAL REGISTER**



XSE GROUP, INC. (CONNECTICUT CORPORATION)
35 PHIL MACK DRIVE
MIDDLETOWN, CT 06457

FIRST USE 5-1-2007; IN COMMERCE 5-1-2007.

FOR: TONER CARTRIDGES, MAGNETIC INK CHARACTER RECOGNITION (MICR) TONER CARTRIDGES, INK CARTRIDGES, IN CLASS 2 (U.S. CLS. 6, 11 AND 16).

SER. NO. 76-683,492, FILED 10-29-2007.

JASON BLAIR, EXAMINING ATTORNEY

Int. Cl.: 18

Prior U.S. Cls.: 1, 2, 3, 22 and 41

United States Patent and Trademark Office

Reg. No. 3,482,855

Registered Aug. 12, 2008

**TRADEMARK
PRINCIPAL REGISTER**

CASHIEL

CASHIEL PRODUCTS, INC. (DELAWARE C CORPORATION)

115 KLEIN ROAD

CHEHALLS, WA 98532

FOR: SADDLES, IN CLASS 18 (U.S. CLS. 1, 2, 3, 22 AND 41).

FIRST USE 3-0-2004; IN COMMERCE 3-0-2004.

THE MARK CONSISTS OF STANDARD CHARACTERS WITHOUT CLAIM TO ANY PARTICULAR FONT, STYLE, SIZE, OR COLOR.

OWNER OF U.S. REG. NO. 2,413,498.

SEC. 2(F).

SER. NO. 76-683,616, FILED 11-2-2007.

DOMINIC FATHY, EXAMINING ATTORNEY

Int. Cl.: 41

Prior U.S. Cls.: 100, 101 and 107

Reg. No. 3,482,856

United States Patent and Trademark Office

Registered Aug. 12, 2008

**SERVICE MARK
PRINCIPAL REGISTER**

Republic Free Press

MAITA, PHILLIP (UNITED STATES INDIVIDUAL)
1261 MYERS DR
GARDNERVILLE, NV 89410 AND
MAITA, MICHELLE (UNITED STATES INDIVIDUAL)
1261 MYERS DR
GARONERVILLE, NV 89410

THE MARK CONSISTS OF STANDARD CHARACTERS WITHOUT CLAIM TO ANY PARTICULAR FONT, STYLE, SIZE, OR COLOR.

NO CLAIM IS MADE TO THE EXCLUSIVE RIGHT TO USE "FREE PRESS", APART FROM THE MARK AS SHOWN.

FOR: ON-LINE PUBLICATION OF POLITICAL AND SOCIAL COMMENTARY, IN CLASS 41 (U.S. CLS. 100, 101 AND 107).

SER. NO. 76-683,645, FILED 11-5-2007.

FIRST USE 4-15-2007; IN COMMERCE 4-15-2008.

DAWN FELDMAN, EXAMINING ATTORNEY

Int. Cl.: 7

Prior U.S. Cls.: 13, 19, 21, 23, 31, 34 and 35

Reg. No. 3,482,857

United States Patent and Trademark Office

Registered Aug. 12, 2008

**TRADEMARK
PRINCIPAL REGISTER**

AXTREME

ALAMO GROUP INC. (DELAWARE CORPORATION)
1627 E. WALNUT
SEGUIN, TX 78155

THE MARK CONSISTS OF STANDARD CHARACTERS WITHOUT CLAIM TO ANY PARTICULAR FONT, STYLE, SIZE, OR COLOR.

FOR: MECHANICAL LANDSCAPE EQUIPMENT, NAMELY, BOOM MOWERS, IN CLASS 7 (U.S. CLS. 13, 19, 21, 23, 31, 34 AND 35).

SER. NO. 76-683,862, FILED 11-9-2007.

FIRST USE 11-0-2005; IN COMMERCE 11-0-2005.

TASHIA BUNCH, EXAMINING ATTORNEY

Int. Cl.: 40

Prior U.S. Cls.: 100, 103 and 106

United States Patent and Trademark Office

Reg. No. 3,482,858

Registered Aug. 12, 2008

**SERVICE MARK
PRINCIPAL REGISTER**



THE TAYLOR GROUP, INC. (MISSISSIPPI CORPORATION)
650 NORTH CHURCH AVENUE
LOUISVILLE, MS 393392017

FOR: CUSTOM STEEL FABRICATION SERVICES TO THE ORDER AND SPECIFICATION OF OTHERS, IN CLASS 40 (U.S. CLS. 100, 103 AND 106).

FIRST USE 12-31-1974; IN COMMERCE 12-31-1974.

NO CLAIM IS MADE TO THE EXCLUSIVE RIGHT TO USE "STEEL", APART FROM THE MARK AS SHOWN.

"THE COLOR(S) RED AND BLACK IS/ARE CLAIMED AS A FEATURE OF THE MARK."

THE MARK CONSISTS OF THE LITERAL ELEMENT "TEMTCO STEEL" AND A DESIGN ELEMENT COMPRISING A STYLIZED T ENCLOSED IN A CIRCLE INSIDE OF A SQUARE, LOCATED TO THE LEFT OF THE MARK'S LITERAL ELEMENT. THE LITERAL ELEMENT OF THE MARK APPEARS IN A RECTANGLE. THE COLOR RED APPEARS IN THE T AND THE CIRCLE AROUND THE T. THE COLOR BLACK APPEARS IN THE LITERAL ELEMENT OF THE MARK, IN THE SQUARE AROUND THE T AND CIRCLE, AND IN THE RECTANGLE. THE COLOR WHITE CONSTITUTES BACKGROUND OR TRANSPARENT AREAS AND IS NOT PART OF THE MARK.

SER. NO. 76-683,889, FILED 11-9-2007.

LAURIE KAUFMAN, EXAMINING ATTORNEY

Int. Cl.: 36

Prior U.S. Cls.: 100, 101 and 102

United States Patent and Trademark Office

Reg. No. 3,482,859

Registered Aug. 12, 2008

SERVICE MARK
PRINCIPAL REGISTER



CINTEL FINANCIAL (OHIO CREDIT UNION
(COOPERATIVE NOT-FOR-PROFIT FINAN-
CIAL INSTITUTION))
525 VINE-STREET
CINCINNATI, OH 45202

FOR: BANKING, NAMELY, CREDIT UNION, IN
CLASS 36 (U.S. CLS. 100, 101 AND 102).

FIRST USE 6-1-2007; IN COMMERCE 6-1-2007.

NO CLAIM IS MADE TO THE EXCLUSIVE
RIGHT TO USE "FINANCIAL", APART FROM
THE MARK AS SHOWN.

THE COLOR(S) BLUE AND GOLD IS/ARE
CLAIMED AS A FEATURE OF THE MARK.

THE COLOR BLUE APPEARS IN THE WORDING
"CINTEL" AND THE WORDS "PROUD OF OUR
PAST, COMMITTED TO YOUR FUTURE". THE
COLOR GOLD APPEARS IN THE WORD "FINAN-
CIAL". THE COLOR BLUE APPEARS IN THE DE-
SIGN AS THE OUTER SEMICIRCLE AND THE
COLOR GOLD APPEARS IN THE DESIGN AS THE
SMALLER SEMICIRCLE.

SER. NO. 76-684,077, FILED 11-16-2007.

KATHRYN COWARD, EXAMINING ATTORNEY

Int. Cl.: 34

Prior U.S. Cls.: 2, 8, 9 and 17

United States Patent and Trademark Office

Reg. No. 3,482,860

Registered Aug. 12, 2008

**TRADEMARK
PRINCIPAL REGISTER**



P.T. DJARUM (INDONESIA CORPORATION)
JL. JEND A. YANI NO. 28
KUDUS, 59317, INDONESIA

THE ENGLISH TRANSLATION OF "DIARUM" IN
THE MARK IS "NEEDLE."

FOR: CIGARS AND CIGARETTES BOTH CON-
TAINING TOBACCO AND CLOVES, IN CLASS 34
(U.S. CLS. 2, 8, 9 AND 17).

SER. NO. 76-684,120, FILED 11-16-2007.

FIRST USE 12-0-2002; IN COMMERCE 3-0-2003.

MIDGE BUTLER, EXAMINING ATTORNEY

Int. Cl.: 44

Prior U.S. Cls.: 100 and 101

United States Patent and Trademark Office

Reg. No. 3,482,861

Registered Aug. 12, 2008

**SERVICE MARK
PRINCIPAL REGISTER**

Z-Vision

CHARLOTTE OPHTHALMOLOGY CLINIC, P.A.
(NORTH CAROLINA CORPORATION)
4335 COLWICK ROAD
CHARLOTTE, NC 28211

FOR: LASER VISION SURGERY SERVICES
USING SECOND GENERATION FEMTO SECOND
LASER, CUSTOMIZED WAVE FRONT MEASURE-
MENTS, AND ADVANCED EXCIMER LASER
TREATMENT OF THE EYE TO PERFORM A RE-
FRACTIVE SURGICAL PROCEDURE WHICH RE-
DUCES OR ELIMINATES THE NEED FOR GLASSES

OR CONTACT LENSES, IN CLASS 44 (U.S. CLS. 100
AND 101).

FIRST USE 11-1-2007; IN COMMERCE 11-9-2007.

THE MARK CONSISTS OF STANDARD CHAR-
ACTERS WITHOUT CLAIM TO ANY PARTICULAR
FONT, STYLE, SIZE, OR COLOR.

SER. NO. 76-684,320, FILED 11-26-2007.

MARY MUNSON, EXAMINING ATTORNEY

Int. Cl.: 36

Prior U.S. Cls.: 100, 101 and 102

United States Patent and Trademark Office

Reg. No. 3,482,862

Registered Aug. 12, 2008

**SERVICE MARK
PRINCIPAL REGISTER**

Inverlad

REAL ESTATE INVERLAD DEVELOPMENT,
LLC (FLORIDA LTD LIAB CO)
205 S. EOLA DRIVE, SUITE B
ORLANDO, FL 32801

FOR: REAL ESTATE SERVICES, NAMELY, REAL ESTATE AGENCY SERVICES FEATURING THE SALE OF COMMERCIAL AND RESIDENTIAL PROPERTY, REAL ESTATE MANAGEMENT SERVICES, REAL ESTATE INVESTMENT SERVICES, REAL ESTATE BROKERAGE SERVICES, REAL ESTATE LEASING SERVICES AND REAL ESTATE

LENDING SERVICES, IN CLASS 36 (U.S. CLS. 100, 101 AND 102).

FIRST USE 4-11-2002; IN COMMERCE 4-11-2002.

THE MARK CONSISTS OF STANDARD CHARACTERS WITHOUT CLAIM TO ANY PARTICULAR FONT, STYLE, SIZE, OR COLOR.

SER. NO. 76-684,447, FILED 11-29-2007.

ANDREA SAUNDERS, EXAMINING ATTORNEY

Int. Cl.: 36

Prior U.S. Cls.: 100, 101 and 102

United States Patent and Trademark Office

Reg. No. 3,482,863

Registered Aug. 12, 2008

**SERVICE MARK
PRINCIPAL REGISTER**

Real Estate Inverlad

REAL ESTATE INVERLAD DEVELOPMENT,
LLC (FLORIDA LTD LIAB CO)
205 S. EOLA DRIVE, SUITE B
ORLANDO, FL 32801

FOR: REAL ESTATE SERVICES, NAMELY, REAL ESTATE AGENCY SERVICES FEATURING THE SALE OF COMMERCIAL AND RESIDENTIAL PROPERTY, REAL ESTATE MANAGEMENT SERVICES, REAL ESTATE INVESTMENT SERVICES, REAL ESTATE BROKERAGE SERVICES, REAL ESTATE LEASING SERVICES AND REAL ESTATE LENDING SERVICES, IN CLASS 36 (U.S. CLS. 100, 101 AND 102).

FIRST USE 4-11-2002; IN COMMERCE 4-11-2002.

THE MARK CONSISTS OF STANDARD CHARACTERS WITHOUT CLAIM TO ANY PARTICULAR FONT, STYLE, SIZE, OR COLOR.

NO CLAIM IS MADE TO THE EXCLUSIVE RIGHT TO USE "REAL ESTATE", APART FROM THE MARK AS SHOWN.

SER. NO. 76-684,449, FILED 11-29-2007.

ANDREA SAUNDERS, EXAMINING ATTORNEY

Int. Cl.: 9

Prior U.S. Cls.: 21, 23, 26, 36 and 38

Reg. No. 3,482,864

United States Patent and Trademark Office

Registered Aug. 12, 2008

**TRADEMARK
PRINCIPAL REGISTER**

EDI MADE SIMPLE

DATA MASONS SOFTWARE LLC (FLORIDA
LTD LIAB CO)
103 TRIPLE DIAMOND BLVD, UNIT 1
NORTH VENICE, FL 34275

THE MARK CONSISTS OF STANDARD CHAR-
ACTERS WITHOUT CLAIM TO ANY PARTICULAR
FONT, STYLE, SIZE, OR COLOR.

FOR: EDI (ELECTRONIC DATA INTERCHANGE)
SOFTWARE APPLICATIONS FOR USE BY BUSI-
NESSES TO TRANSLATE AND EXCHANGE BUSI-
NESS DOCUMENTS WITH CUSTOMERS AND
SUPPLIERS , IN CLASS 9 (U.S. CLS. 21, 23, 26, 36
AND 38).

NO CLAIM IS MADE TO THE EXCLUSIVE
RIGHT TO USE "EDI", APART FROM THE MARK
AS SHOWN.

SER. NO. 76-684,507, FILED 11-30-2007.

FIRST USE 6-1-2004; IN COMMERCE 6-1-2004.

BRIAN PINO, EXAMINING ATTORNEY

Int. Cl.: 33

Prior U.S. Cls.: 47 and 49

United States Patent and Trademark Office

Reg. No. 3,482,865

Registered Aug. 12, 2008

**TRADEMARK
PRINCIPAL REGISTER**

Happy Hour

REITER, ELIAS (UNITED STATES INDIVIDUAL)
10155 COLLINS AVENUE, SUITE 1003
BAL-HARBOR, FL 33154

FIRST USE 5-19-2006; IN COMMERCE 5-19-2006.

FOR: MALT BEVERAGES, NAMELY, ALCOHOL-
IC MALT BEVERAGE PRODUCED FROM A
BREWED MALT AND HOPS BASE, IN CLASS 33
(U.S. CLS. 47 AND 49).

SER. NO. 76-684,628, FILED 11-30-2007.

TINA BROWN, EXAMINING ATTORNEY

Int. Cl.: 9

Prior U.S. Cls.: 21, 23, 26, 36 and 38

Reg. No. 3,482,866

United States Patent and Trademark Office

Registered Aug. 12, 2008

**TRADEMARK
PRINCIPAL REGISTER**



GEOGENESIS, INC. (DELAWARE CORPORATION)
345 WEST MAIN STREET
DURHAM, NC 27701

FOR: COMPUTER SOFTWARE, NAMELY, PHOTOGRAMMETRIC, THREE-DIMENSIONAL MODELING AND/OR IMAGE PROCESSING SOFTWARE, IN CLASS 9 (U.S. CLS. 21, 23, 26, 36 AND 38).

FIRST USE 9-0-2007; IN COMMERCE 9-0-2007.

THE MARK CONSISTS, IN PART, OF THREE OVALS.

SER. NO. 76-684,765, FILED 12-10-2007.

PAUL E. FAHRENKOPF, EXAMINING ATTORNEY

Int. Cl.: 16

Prior U.S. Cls.: 2, 5, 22, 23, 29, 37, 38 and 50

United States Patent and Trademark Office

Reg. No. 3,482,867

Registered Aug. 12, 2008

**TRADEMARK
PRINCIPAL REGISTER**

THE DISCIPLINED INVESTOR

PERFORMANCE TRUST INVESTMENT ADVISORS, LLC (ILLINOIS LTD LIAB CO)
500 WEST MADISON STREET - SUITE 350
CHICAGO, IL 60661

FOR: FINANCIAL NEWSLETTERS FOR INVESTORS, IN CLASS 16 (U.S. CLS. 2, 5, 22, 23, 29, 37, 38 AND 50).

FIRST USE 7-27-2000; IN COMMERCE 7-27-2000.

THE MARK CONSISTS OF STANDARD CHARACTERS WITHOUT CLAIM TO ANY PARTICULAR FONT, STYLE, SIZE, OR COLOR.

OWNER OF U.S. REG. NO. 2,472,568.

SEC. 2(F).

SER. NO. 76-684,857, FILED 12-12-2007.

MARTHA FROMM, EXAMINING ATTORNEY

Int. Cl.: 17

Prior U.S. Cls.: 1, 5, 12, 13, 35 and 50

Reg. No. 3,482,868

United States Patent and Trademark Office

Registered Aug. 12, 2008

**TRADEMARK
PRINCIPAL REGISTER**

The Sidekick

PREMIER TAPE PRODUCTS, INC. (KENTUCKY
CORPORATION)
2424 LAKELAND ROAD
DALTON, GA 30721

THE MARK CONSISTS OF STANDARD CHAR-
ACTERS WITHOUT CLAIM TO ANY PARTICULAR
FONT, STYLE, SIZE, OR COLOR.

FOR: CARPET SEAM TAPE, IN CLASS 17 (U.S.
CLS. 1, 5, 12, 13, 35 AND 50).

SER. NO. 76-684,952, FILED 12-14-2007.

FIRST USE 12-6-2007; IN COMMERCE 12-6-2007.

TINA L. SNAPP, EXAMINING ATTORNEY

Int. Cl.: 5

Prior U.S. Cls.: 6, 18, 44, 46, 51 and 52

United States Patent and Trademark Office

Reg. No. 3,482,869

Registered Aug. 12, 2008

TRADEMARK
PRINCIPAL REGISTER



BELL, ROBERT D. (UNITED STATES INDIVIDUAL)
901 MASON
ROSWELL, NM 88201

FOR: PHARMACEUTICAL PREPARATIONS FOR THE TREATMENT OF DIAPER RASH, BED SORES, SUNBURNS, AND FIRST AND SECOND DEGREE BURNS, ECZEMA, SKIN ABRASIONS AND INSECT BITES, IN CLASS 5 (U.S. CLS. 6, 18, 44, 46, 51 AND 52).

FIRST USE 1-0-2005; IN COMMERCE 1-0-2005.

NO CLAIM IS MADE TO THE EXCLUSIVE RIGHT TO USE "OINTMENT", APART FROM THE MARK AS SHOWN.

THE COLOR(S) RED, BLUE, WHITE AND YELLOW IS/ARE CLAIMED AS A FEATURE OF THE MARK.

THE MARK CONSISTS OF A RECTANGLE AS A CARRIER APPEARING IN THE COLOR YELLOW. AN OVAL OUTLINED IN THE COLOR RED AND FILLED IN WITH THE COLOR WHITE EXISTS INSIDE THE RECTANGLE. WITHIN THE OVAL APPEARS THE WORD "TRIPLE" IN THE COLOR RED. BENEATH THE WORD "TRIPLE" APPEARS THE LETTER "B" IN THE COLOR BLUE AND OUTLINED IN THE COLOR WHITE. BENEATH THE LETTER "B" APPEARS THE WORD "OINTMENT" IN THE COLOR RED. BENEATH THE WORD "OINTMENT" APPEARS THE SLOGAN "THE ALL IN ONE OINTMENT" IN THE COLOR BLUE.

SER. NO. 76-685,024, FILED 12-17-2007.

MICHAEL WIENER, EXAMINING ATTORNEY

Int. Cl.: 43

Prior U.S. Cls.: 100 and 101

United States Patent and Trademark Office

Reg. No. 3,482,870

Registered Aug. 12, 2008

**SERVICE MARK
PRINCIPAL REGISTER**



SUGARMAN, EYTAN (UNITED STATES INDIVIDUAL)
134 WEST 18TH STREET
NEW YORK, NY 10011

FIRST USE 7-18-2007; IN COMMERCE 7-18-2007.

SER. NO. 76-685,147, FILED 12-21-2007.

FOR: RESTAURANT SERVICES, IN CLASS 43
(U.S. CLS. 100 AND 101).

MARILYN IZZI, EXAMINING ATTORNEY

Int. Cl.: 9

Prior U.S. Cls.: 21, 23, 26, 36 and 38

Reg. No. 3,482,871

United States Patent and Trademark Office

Registered Aug. 12, 2008

**TRADEMARK
PRINCIPAL REGISTER**

PROTECT-A-PAK

CHATSWORTH DATA CORPORATION (CALI-
FORNIA CORPORATION)
20710 LASSEN STREET
CHATSWORTH, CA 91311

FOR: IMPACT INDICATORS THAT ACCOMPANY
HIGH VALUE GOODS DURING SHIPMENT,
FOR INDICATING THE OCCURRENCE OF HIGH
LEVEL IMPACTS SUSTAINED BY THE GOODS, IN
CLASS 9 (U.S. CLS. 21, 23, 26, 36 AND 38).

FIRST USE 4-0-1973; IN COMMERCE 7-0-1973.

THE MARK CONSISTS OF STANDARD CHAR-
ACTERS WITHOUT CLAIM TO ANY PARTICULAR
FONT, STYLE, SIZE, OR COLOR.

SER. NO. 76-685,192, FILED 12-26-2007.

JORDAN BAKER, EXAMINING ATTORNEY

Int. Cl.: 9

Prior U.S. Cls.: 21, 23, 26, 36 and 38

Reg. No. 3,482,872

United States Patent and Trademark Office

Registered Aug. 12, 2008

**TRADEMARK
PRINCIPAL REGISTER**

IMPACT-O-GRAPH

CHATSWORTH DATA CORPORATION (CALI-
FORNIA CORPORATION)
20710 LASSEN STREET
CHATSWORTH, CA 91311

FOR: IMPACT INDICATORS AND RECORDERS
THAT ACCOMPANY HIGH VALUE GOODS DUR-
ING SHIPMENT, FOR MEASURING AND RE-
CORDING THE OCCURRENCE OF IMPACTS
SUSTAINED BY THE GOODS, IN CLASS 9 (U.S.
CLS. 21, 23, 26, 36 AND 38).

FIRST USE 10-8-1949; IN COMMERCE 10-8-1949.

THE MARK CONSISTS OF STANDARD CHAR-
ACTERS WITHOUT CLAIM TO ANY PARTICULAR
FONT, STYLE, SIZE, OR COLOR.

SER. NO. 76-685,193, FILED 12-26-2007.

LINDA LAVACHE, EXAMINING ATTORNEY

Int. Cl.: 35

Prior U.S. Cls.: 100, 101 and 102

United States Patent and Trademark Office

Reg. No. 3,482,873

Registered Aug. 12, 2008

SERVICE MARK
PRINCIPAL REGISTER



CIRCLE OF ONE MARKETING, INC. (FLORIDA CORPORATION)
2400 NE 2ND AVENUE, STUDIO C
MIAMI, FL 33137

FOR: ADVERTISING AGENCY SERVICES; DIRECT MARKETING ADVERTISING SERVICES; BUSINESS MARKETING CONSULTING SERVICES; BRAND CONSULTING, NAMELY, BRAND IMAGERY CONSULTING SERVICES; PUBLIC RELATIONS AND PUBLICITY SERVICES; MEDIA PLANNING AND MEDIA BUYING SERVICES, NAMELY, PROVIDING CONSULTING SERVICES IN THE FIELD OF FACILITATING THE PLANNING, BUYING, AND SELLING OF MEDIA; MARKET RESEARCH SERVICES; EVENT MARKETING SERVICES; AND PROMOTING THE SERVICES OF VARIOUS INDUSTRIES THROUGH THE DISTRIBUTION OF PRINTED, VIDEO AND AUDIO PROMOTIONAL MATERIALS AND BY RENDERING SALES PROMOTION ADVICE, IN CLASS 35 (U.S. CLS. 100, 101 AND 102).

FIRST USE 12-1-2001; IN COMMERCE 12-1-2001.

NO CLAIM IS MADE TO THE EXCLUSIVE RIGHT TO USE "MARKETING", APART FROM THE MARK AS SHOWN.

THE COLOR(S) GREY AND GREEN IS/ARE CLAIMED AS A FEATURE OF THE MARK.

THE MARK IS PRESENTED IN A SPECIAL DESIGN: A GREY CIRCLE FIGURE OVER THE WORDS, "CIRCLE OF" AND "MARKETING" IN GREY, THE WORD "ONE" IN GREEN, AND THE WORDS "CREATIVE—RESOURCEFUL— DIVERSE" IN GREEN.

SER. NO. 76-685,212, FILED 12-26-2007.

DAYNA BROWNE, EXAMINING ATTORNEY

Int. Cl.: 19

Prior U.S. Cls.: 1, 12, 33 and 50

United States Patent and Trademark Office

Reg. No. 3,482,874

Registered Aug. 12, 2008

**TRADEMARK
PRINCIPAL REGISTER**

FORT GREEN

WEEKS, BRUCE V. (UNITED STATES INDIVIDUAL)
201 SOUTH GIFT STREET
COLUMBUS, OH 43215

FOR: PRE-CAST NON-METAL BUILDING MATERIALS, NAMELY, INTERIOR WALL PANELS, EXTERIOR WALL PANELS, TRIM FOR DOORS, WINDOWS AND DECORATIVE BUILDING USE, ROOF COVERING PANELS, CORNER CAPS FOR SEALING CORNERS OF WALL PANELS, EXTERIOR WINDOW AND DOOR SHUTTERS; NON-METAL BUILDING PANELS INCORPORATING HEAT TRANSFER DUCTS; NON-METAL BUILDING PANELS INCORPORATING SOLAR ABSORPTION PANELS; NON-METAL BUILDING PANELS INCORPORATING PHOTO-VOLTAIC SILICON CELLS; NON-METAL BUILDING PANELS INCOR-

PORATING UTILITY CHASES AND WATER PASSAGES, IN CLASS 19 (U.S. CLS. 1, 12, 33 AND 50).

FIRST USE 12-19-2007; IN COMMERCE 12-19-2007.

THE MARK CONSISTS OF STANDARD CHARACTERS WITHOUT CLAIM TO ANY PARTICULAR FONT, STYLE, SIZE, OR COLOR.

NO CLAIM IS MADE TO THE EXCLUSIVE RIGHT TO USE "GREEN", APART FROM THE MARK AS SHOWN.

SER. NO. 76-685,229, FILED 12-26-2007.

PAUL CROWLEY, EXAMINING ATTORNEY

Int. Cl.: 16

Prior U.S. Cls.: 2, 5, 22, 23, 29, 37, 38 and 50

Reg. No. 3,482,875

United States Patent and Trademark Office

Registered Aug. 12, 2008

**TRADEMARK
PRINCIPAL REGISTER**

VIEW HIGHLIFE

MOJAHED, MOE (UNITED STATES INDIVIDUAL)
2520 EAST ENCINAS AVENUE
GILBERT, AZ 85234

FOR: PRINTED MATTER, NAMELY, A MAGAZINE OF FASHION, LIFESTYLE, EATING, HEALTH, CULTURE, AND INSPIRATION, IN CLASS 16 (U.S. CLS. 2, 5, 22, 23, 29, 37, 38 AND 50).

FIRST USE 5-0-2006; IN COMMERCE 5-0-2006.

THE MARK CONSISTS OF STANDARD CHARACTERS WITHOUT CLAIM TO ANY PARTICULAR FONT, STYLE, SIZE, OR COLOR.

NO CLAIM IS MADE TO THE EXCLUSIVE RIGHT TO USE "HIGHLIFE", APART FROM THE MARK AS SHOWN.

SER. NO. 76-685,364, FILED 12-28-2007.

RUDY R. SINGLETON, EXAMINING ATTORNEY

Int. Cl.: 15

Prior U.S. Cls.: 2, 21 and 36

United States Patent and Trademark Office

Reg. No. 3,482,876

Registered Aug. 12, 2008

**TRADEMARK
PRINCIPAL REGISTER**

MUSICMAIDE

LUEBCKE, KIMBERLY J. (UNITED STATES IN-
DIVIDUAL)
2340 CARA DRIVE
TROY, OH 45373

THE MARK CONSISTS OF STANDARD CHAR-
ACTERS WITHOUT CLAIM TO ANY PARTICULAR
FONT, STYLE, SIZE, OR COLOR.

FOR: TRANSPARENT PLASTIC SHEET MUSIC
HOLDER APPARATUS FOR USE ON A SHEET
MUSIC STAND, IN CLASS 15 (U.S. CLS. 2, 21 AND
36).

SER. NO. 76-685,484, FILED 1-2-2008.

FIRST USE 12-22-2007; IN COMMERCE 12-22-2007.

KRISTIN DAHLING, EXAMINING ATTORNEY

Int. Cls.: 25 and 28

Prior U.S. Cls.: 22, 23, 38, 39 and 50

United States Patent and Trademark Office

Reg. No. 3,482,877

Registered Aug. 12, 2008

TRADEMARK
PRINCIPAL REGISTER



SPEIRS, GREGORY (UNITED STATES INDIVIDUAL)
808 BRONX RIVER ROAD
BRONXVILLE, NY 10708

FOR: T-SHIRTS, BASEBALL CAPS, NECKTIES, BASEBALL JACKETS, BOXER SHORTS, HATS, SWEATSHIRTS, GOLF SHIRTS, SNEAKERS, HEADBANDS, WARM-UP UNIFORMS, SOCKS, SHORTS, BERETS, POLO SHIRTS, IN CLASS 25 (U.S. CLS. 22 AND 39).

FIRST USE 4-14-2005; IN COMMERCE 9-28-2006.

FOR: BASKETBALLS, GOLF BALLS, BASKETBALL NETS, BASKETBALL BACKBOARDS, SOCCER BALLS, BASEBALLS, GOLF BAGS, GOLF TEES, SPORT BOTTLES, GOLF GLOVES, SPORT PACK SACKS, SKI CARRYING CASE, SNOW-

BOARDS, SNOWBOARD CARRYING CASE, SKIS, PLUSH TOYS, TOY DIORAMAS, PLAYING CARDS, TOY FIGURINES, IN CLASS 28 (U.S. CLS. 22, 23, 38 AND 50).

FIRST USE 4-14-2005; IN COMMERCE 9-28-2006.

OWNER OF U.S. REG. NOS. 2,694,328, 2,833,965 AND OTHERS.

SKELETAL HANDS SLAM-DUNKING A FLAMING BASKETBALL SURROUNDED BY THE WORDS "LITHUANIA 2008".

SER. NO. 76-685,514, FILED 1-4-2008.

KARANENDRA S. CHHINA, EXAMINING ATTORNEY

Int. Cl.: 36

Prior U.S. Cls.: 100, 101 and 102

United States Patent and Trademark Office

Reg. No. 3,482,878

Registered Aug. 12, 2008

**SERVICE MARK
PRINCIPAL REGISTER**

LEGENDS RIDE

BUFFALO CHIP CAMPGROUND, LLC (SOUTH
DAKOTA LTD LIAB CO)
C/O.JACOBSON & COLFIN, P.C.
60 MADISON AVENUE, SUITE 1026
NEW YORK, NY 10010

THE MARK CONSISTS OF STANDARD CHAR-
ACTERS WITHOUT CLAIM TO ANY PARTICULAR
FONT, STYLE, SIZE, OR COLOR.

FOR: CHARITABLE FUND RAISING SERVICES,
IN CLASS 36 (U.S. CLS. 100, 101 AND 102).

SER. NO. 76-685,515, FILED 1-4-2008.

FIRST USE 11-20-2007; IN COMMERCE 11-20-2007.

NAAKWAMA ANKRAH, EXAMINING ATTORNEY

Int. Cl.: 43

Prior U.S. Cls.: 100 and 101

United States Patent and Trademark Office

Reg. No. 3,482,879

Registered Aug. 12, 2008

**SERVICE MARK
PRINCIPAL REGISTER**



FOEDERER, CHRIS (UNITED STATES INDIVIDUAL)
1130 ADAIR PARK PLACE
ORLANDO, FL 32804

FOR: SPORTS BAR AND RESTAURANT, IN CLASS 43 (U.S. CLS. 100 AND 101).

FIRST USE 1-24-2007; IN COMMERCE 1-24-2007.

THE COLOR(S) ORANGE AND BLACK IS/ARE CLAIMED AS A FEATURE OF THE MARK.

THE MARK CONSISTS OF A CIRCULAR ORANGE BALL, WITH BLACK OUTLINE AND LACING, WITH A LAZY "C" IN THE LOWER PORTION OF THE BALL.

SER. NO. 76-685,544, FILED 1-7-2008.

ODESSA BIBBINS, EXAMINING ATTORNEY

Int. Cl.: 12

Prior U.S. Cls.: 19, 21, 23, 31, 35 and 44

Reg. No. 3,482,880

United States Patent and Trademark Office

Registered Aug. 12, 2008

**TRADEMARK
PRINCIPAL REGISTER**

TRASH-POD

ANYUMBA, DAVID O. (UNITED STATES INDIVIDUAL)
4289 LEIDY AVENUE, STE 2.
PHILADELPHIA, PA 19104

FIRST USE 1-1-2008; IN COMMERCE 1-1-2008.

FOR: RESIDENTIAL AND COMMERCIAL GARBAGE HAULING TRAILER, NAMELY, CARGO TRAILER CONVERTED AND REDESIGNED TO BE USED AS A DUMPSTER FOR JUNK AND TRASH , IN CLASS 12 (U.S. CLS. 19, 21, 23, 31, 35 AND 44).

THE MARK CONSISTS OF STANDARD CHARACTERS WITHOUT CLAIM TO ANY PARTICULAR FONT, STYLE, SIZE, OR COLOR.

SER. NO. 76-685,561, FILED 1-7-2008.

LINDA M. KING, EXAMINING ATTORNEY

Int. Cl.: 10

Prior U.S. Cls.: 26, 39 and 44

United States Patent and Trademark Office

Reg. No. 3,482,881

Registered Aug. 12, 2008

**TRADEMARK
PRINCIPAL REGISTER**

PhysioLock

IMPLADENT LTD. (NEW YORK CORPORATION)
198-45 FOOTHILL AVENUE
HOLLISWOOD, NY 11423

THE MARK CONSISTS OF STANDARD CHARACTERS WITHOUT CLAIM TO ANY PARTICULAR FONT, STYLE, SIZE, OR COLOR.

FOR: DENTAL IMPLANTS, IN CLASS 10 (U.S. CLS. 26, 39 AND 44).

SER. NO. 76-685,562, FILED 1-7-2008.

FIRST USE 10-23-2007; IN COMMERCE 10-23-2007.

EDWARD NELSON, EXAMINING ATTORNEY

Int. Cl.: 7

Prior U.S. Cls.: 13, 19, 21, 23, 31, 34 and 35

Reg. No. 3,482,882

United States Patent and Trademark Office

Registered Aug. 12, 2008

**TRADEMARK
PRINCIPAL REGISTER**

KRYPTO KLAW

ENTEK MANUFACTURING, INC. (TEXAS CORPORATION)
6350 US HIGHWAY 90 EAST
SEGUIN, TX 78155

FOR: DEMOLITION, EXCAVATION, GRAPPLING, AND LOADING TOOL FOR USE WITH EARTH MOVING EQUIPMENT AND EXCAVATORS, NAMELY, HYDRAULICALLY ENERGIZED THUMB AND HYDRAULICALLY ENERGIZED BUCKET COMBINATION, IN CLASS 7 (U.S. CLS. 13, 19, 21, 23, 31, 34 AND 35).

FIRST USE 12-0-2006; IN COMMERCE 12-0-2006.

THE MARK CONSISTS OF STANDARD CHARACTERS WITHOUT CLAIM TO ANY PARTICULAR FONT, STYLE, SIZE, OR COLOR.

NO CLAIM IS MADE TO THE EXCLUSIVE RIGHT TO USE "CLAW", APART FROM THE MARK AS SHOWN.

SER. NO. 76-685,592, FILED 1-8-2008.

SARA THOMAS, EXAMINING ATTORNEY

Int. Cls.: 18 and 25

Prior U.S. Cls.: 1, 2, 3, 22, 39 and 41

United States Patent and Trademark Office

Reg. No. 3,482,883

Registered Aug. 12, 2008

**TRADEMARK
PRINCIPAL REGISTER**

CARLOS CAMPOS

VOS SAVANT, INC. (NEW YORK CORPORATION)
248 WEST 35TH STREET
NEW YORK, NY 10001

FOR: OVERNIGHT BAGS, GYM BAGS, CARRY-ON BAGS, IN CLASS 18 (U.S. CLS. 1, 2, 3, 22 AND 41).

FIRST USE 1-31-2003; IN COMMERCE 2-3-2005.

FOR: CLOTHING NAMELY, SHIRTS, BLOUSES, DRESSES, SUITS, COATS, PANTS, SHORTS, JEANS, JACKETS, JUMPERS, OVERALLS, RAINCOATS, SCARVES, SWEATERS, T-SHIRTS, TANK TOPS, TUXEDOS, BELTS AND BOOTS, IN CLASS 25 (U.S. CLS. 22 AND 39).

FIRST USE 1-31-2003; IN COMMERCE 7-27-2004.

THE MARK CONSISTS OF STANDARD CHARACTERS WITHOUT CLAIM TO ANY PARTICULAR FONT, STYLE, SIZE, OR COLOR.

THE NAME "CARLOS CAMPOS" IDENTIFIES A LIVING INDIVIDUAL WHOSE CONSENT IS OF RECORD.

SER. NO. 76-685,599, FILED 1-8-2008.

MARK PILARO, EXAMINING ATTORNEY

Int. Cl.: 33

Prior U.S. Cls.: 47 and 49

United States Patent and Trademark Office

Reg. No. 3,482,884

Registered Aug. 12, 2008

**TRADEMARK
PRINCIPAL REGISTER**

BUCKLIN

BUCKLIN LLC (CALIFORNIA LTD LIAB CO)
8 OLD HILL RANCH ROAD
GLEN ELLEN, CA 95442

OWNER OF U.S. REG. NO. 2,641,283.

FOR: WINE, IN CLASS 33 (U.S. CLS. 47 AND 49).

SEC. 2(F).

FIRST USE 5-22-2002; IN COMMERCE 5-22-2002.

SER. NO. 76-685,631, FILED 1-9-2008.

THE MARK CONSISTS OF STANDARD CHAR-
ACTERS WITHOUT CLAIM TO ANY PARTICULAR
FONT, STYLE, SIZE, OR COLOR.

PATRICIA EVANKO, EXAMINING ATTORNEY

Int. Cl.: 29

Prior U.S. Cl.: 46

United States Patent and Trademark Office

Reg. No. 3,482,885

Registered Aug. 12, 2008

**TRADEMARK
PRINCIPAL REGISTER**

ULTRACUBE

MASSEL PTY. LIMITED (AUSTRALIA CORPORATION)
12 MELISSA PLACE
KINGS PARK, 2148, NEW SOUTH WALES, AUSTRALIA

THE MARK CONSISTS OF STANDARD CHARACTERS WITHOUT CLAIM TO ANY PARTICULAR FONT, STYLE, SIZE, OR COLOR.

FOR: BOUILLON CUBES, IN CLASS 29 (U.S. CL. 46).

SER. NO. 76-685,633, FILED 1-9-2008.

FIRST USE 0-0-1987; IN COMMERCE 1-0-2001.

SARA THOMAS, EXAMINING ATTORNEY

Int. Cl.: 1

Prior U.S. Cls.: 1, 5, 6, 10, 26 and 46

United States Patent and Trademark Office

Reg. No. 3,482,886

Registered Aug. 12, 2008

**TRADEMARK
PRINCIPAL REGISTER**

PHOSPHOPLUS

CELL SIGNALING TECHNOLOGY, INC. (MAS-
SACHUSETTS CORPORATION)
3 TRASK LANE
DANVERS, MA 01915

FOR: REAGENTS FOR SCIENTIFIC AND CLINICAL RESEARCH USE, NAMELY, KITS CONTAINING ANTIBODIES AND/OR NUCLEIC ACIDS FOR THE DETECTION OF PROTEIN MODIFICATION, ACTIVITY, OR EXPRESSION, IN CLASS 1 (U.S. CLS. 1, 5, 6, 10, 26 AND 46).

FIRST USE 8-2-1995; IN COMMERCE 8-2-1995.

THE MARK CONSISTS OF STANDARD CHARACTERS WITHOUT CLAIM TO ANY PARTICULAR FONT, STYLE, SIZE, OR COLOR.

SER. NO. 76-685,645, FILED 1-10-2008.

SARA THOMAS, EXAMINING ATTORNEY

Int. Cl.: 9

Prior U.S. Cls.: 21, 23, 26, 36 and 38

Reg. No. 3,482,887

United States Patent and Trademark Office

Registered Aug. 12, 2008

**TRADEMARK
PRINCIPAL REGISTER**

FIREPRO

POINT GREY RESEARCH, INC. (CANADA CORPORATION)
8866 HUDSON ST.
VANCOUVER, BRITISH COLUMBIA V6P 4N2, CANADA

THE MARK CONSISTS OF STANDARD CHARACTERS WITHOUT CLAIM TO ANY PARTICULAR FONT, STYLE, SIZE, OR COLOR.

FOR: COMPUTER PERIPHERALS, IN CLASS 9 (U.S. CLS. 21, 23, 26, 36 AND 38).

SER. NO. 76-685,656, FILED 1-10-2008.

FIRST USE 10-30-2007; IN COMMERCE 10-30-2007.

SAIMA MAKHDOOM, EXAMINING ATTORNEY

Int. Cl.: 35

Prior U.S. Cls.: 100, 101 and 102

United States Patent and Trademark Office

Reg. No. 3,482,888

Registered Aug. 12, 2008

**SERVICE MARK
PRINCIPAL REGISTER**

FRESH CURRENT

SUMMIT COMMUNICATION DESIGN, INC.
(COLORADO CORPORATION)
143 UNION BLVD., SUITE 900
LAKEWOOD, CO 80228

THE MARK CONSISTS OF STANDARD CHARACTERS WITHOUT CLAIM TO ANY PARTICULAR FONT, STYLE, SIZE, OR COLOR.

FOR: INTERNET MARKETING AGENCY PROVIDING MARKETING SERVICES TO COMPANIES THAT RELY HEAVILY ON THE INTERNET, IN CLASS 35 (U.S. CLS. 100, 101 AND 102).

SER. NO. 76-685,679, FILED 1-11-2008.

FIRST USE 7-15-2007; IN COMMERCE 7-15-2007.

BRENDAN MCCAULEY, EXAMINING ATTORNEY

Int. Cl.: 25

Prior U.S. Cls.: 22 and 39

United States Patent and Trademark Office

Reg. No. 3,482,889

Registered Aug. 12, 2008

TRADEMARK
PRINCIPAL REGISTER



HARRIS SEAFOOD COMPANY, LLC (FLORIDA
LTD LIAB CO)
1260 CENTRAL FLORIDA PARKWAY
ORLANDO, FL 32837

THE MARK CONSISTS OF A STYLIZED SKELE-
TON OF A YELLOWFIN TUNA FISH DESIGN.

FOR: CLOTHING, NAMELY, T-SHIRTS, HATS,
SWEATSHIRTS AND POLO SHIRTS, IN CLASS 25
(U.S. CLS. 22 AND 39).

SER. NO. 76-685,705, FILED 1-14-2008.

FIRST USE 7-8-2005; IN COMMERCE 7-8-2005.

TINA BROWN, EXAMINING ATTORNEY

Int. Cl.: 29

Prior U.S. Cl.: 46

United States Patent and Trademark Office

Reg. No. 3,482,890

Registered Aug. 12, 2008

**TRADEMARK
PRINCIPAL REGISTER**



HARRIS SEAFOOD COMPANY, LLC (FLORIDA
LTD LIAB CO)
1260 CENTRAL FLORIDA PARKWAY
ORLANDO, FL 32837

THE MARK CONSISTS OF A STYLIZED SKELE-
TON OF A YELLOWFIN TUNA FISH DESIGN.

FOR: FRESH AND FROZEN SEAFOOD, IN CLASS
29 (U.S. CL. 46).

SER. NO. 76-685,706, FILED 1-14-2008.

FIRST USE 7-8-2005; IN COMMERCE 7-8-2005.

TINA BROWN, EXAMINING ATTORNEY

Int. Cl.: 35

Prior U.S. Cls.: 100, 101 and 102

United States Patent and Trademark Office

Reg. No. 3,482,891

Registered Aug. 12, 2008

SERVICE MARK
PRINCIPAL REGISTER



HARRIS SEAFOOD COMPANY, LLC (FLORIDA
LTD LIAB CO)
1260 CENTRAL FLORIDA PARKWAY
ORLANDO, FL 32837

THE MARK CONSISTS OF A STYLIZED SKELE-
TON OF A YELLOWFIN TUNA FISH DESIGN.

FOR: DISTRIBUTORSHIP SERVICES IN THE
FIELD OF FRESH AND FROZEN SEAFOOD, IN
CLASS 35 (U.S. CLS. 100, 101 AND 102).

SER. NO. 76-685,707, FILED 1-14-2008.

FIRST USE 7-8-2005; IN COMMERCE 7-8-2005.

TINA BROWN, EXAMINING ATTORNEY

Int. Cl.: 28

Prior U.S. Cls.: 22, 23, 38 and 50

United States Patent and Trademark Office

Reg. No. 3,482,892

Registered Aug. 12, 2008

**TRADEMARK
PRINCIPAL REGISTER**

LAND IT . . . WITH A BANDIT.

BANDIT LURES, INC. (MISSISSIPPI CORPORATION)
444 COLD SPRINGS ROAD
SARDIS, MS 38666

OWNER OF U.S. REG. NO. 1,946,468.

FOR: FISHING LURES, IN CLASS 28 (U.S. CLS. 22,
23, 38 AND 50).

SER. NO. 76-685,714, FILED 1-14-2008.

FIRST USE 4-12-2006; IN COMMERCE 4-12-2006.

JOHN WILKE, EXAMINING ATTORNEY

Int. Cl.: 5

Prior U.S. Cls.: 6, 18, 44, 46, 51 and 52

Reg. No. 3,482,893

United States Patent and Trademark Office

Registered Aug. 12, 2008

**TRADEMARK
PRINCIPAL REGISTER**

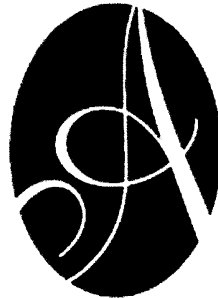

ALLATION

WALGREEN CO. (ILLINOIS CORPORATION)
200 WILMOT ROAD
DEERFIELD, IL 60015

FIRST USE 1-4-2008; IN COMMERCE 1-4-2008.

SER. NO. 76-685,739, FILED 1-14-2008.

FOR: PERSONAL LUBRICANTS, IN CLASS 5 (U.S.
CLS. 6, 18, 44, 46, 51 AND 52).

RICHARD WHITE, EXAMINING ATTORNEY

Int. Cl.: 37

Prior U.S. Cls.: 100, 103 and 106

Reg. No. 3,482,894

United States Patent and Trademark Office

Registered Aug. 12, 2008

**SERVICE MARK
PRINCIPAL REGISTER**

Build green. Live well.

3BY, LLC (COLORADO LTD LIAB CO)
1550 LARIMER ST, #282
DENVER, CO 80202

THE MARK CONSISTS OF STANDARD CHARACTERS WITHOUT CLAIM TO ANY PARTICULAR FONT, STYLE, SIZE, OR COLOR.

FOR: SINGLE-FAMILY HOME/MULTI-FAMILY HOME - RESIDENTIAL CONSTRUCTION, IN CLASS 37 (U.S. CLS. 100, 103 AND 106).

SER. NO. 76-685,749, FILED 1-14-2008.

FIRST USE 12-19-2007; IN COMMERCE 12-19-2007.

JOHN WILKE, EXAMINING ATTORNEY

Int. Cl.: 9

Prior U.S. Cls.: 21, 23, 26, 36 and 38

Reg. No. 3,482,895

United States Patent and Trademark Office

Registered Aug. 12, 2008

**TRADEMARK
PRINCIPAL REGISTER**

SETSIGHT

REP COMMERCE, INC. (MINNESOTA CORPORATION)
10500 E. BREN ROAD, SUITE 200
MINNETONKA, MN 55343

FOR: DOWNLOADABLE COMPUTER SOFTWARE FEATURING ONLINE RETAIL ANALYTICS FOR COLLECTING, PROCESSING AND STORING DETAILED SALES ANALYSIS, INVENTORY REPLENISHMENT, AND FORECASTING INFORMATION DESIGNED SPECIFICALLY FOR SUPPLIERS' AND MANUFACTURERS' REPRESENTATIVES IN

THE CONSUMER GOODS INDUSTRY, IN CLASS 9 (U.S. CLS. 21, 23, 26, 36 AND 38).

FIRST USE 5-1-2007; IN COMMERCE 5-1-2007.

THE MARK CONSISTS OF STANDARD CHARACTERS WITHOUT CLAIM TO ANY PARTICULAR FONT, STYLE, SIZE, OR COLOR.

SER. NO. 76-685,770, FILED 1-15-2008.

CYNTHIA TRIPI, EXAMINING ATTORNEY

Int. Cl.: 9

Prior U.S. Cls.: 21, 23, 26, 36 and 38

Reg. No. 3,482,896

United States Patent and Trademark Office

Registered Aug. 12, 2008

**TRADEMARK
PRINCIPAL REGISTER**

UDEA

AONEPRO ELECTRONICS, INC. (CALIFORNIA CORPORATION)
3346 WEST OLYMPIC BOULEVARD
LOS ANGELES, CA 90019

THE MARK CONSISTS OF STANDARD CHARACTERS WITHOUT CLAIM TO ANY PARTICULAR FONT, STYLE, SIZE, OR COLOR.

FOR: HAND HELD ELECTRONIC DICTIONARY AND TRANSLATION DEVICES AND COMPUTER SOFTWARE THAT SERVES AS A DICTIONARY AND TRANSLATOR, IN CLASS 9 (U.S. CLS. 21, 23, 26, 36 AND 38).

SER. NO. 76-685,772, FILED 1-15-2008.

FIRST USE 10-1-2007; IN COMMERCE 10-1-2007.

CHRISTOPHER BUONGIORNO, EXAMINING ATTORNEY

Int. Cl.: 5

Prior U.S. Cls.: 6, 18, 44, 46, 51 and 52

United States Patent and Trademark Office

Reg. No. 3,482,897

Registered Aug. 12, 2008

**TRADEMARK
PRINCIPAL REGISTER**

HIVEAID

FOX & LE SAUVAGE LLC (NEW MEXICO LTD
LIAB CO)
PO BOX 3512
SHAWNEE, OK 74801

THE MARK CONSISTS OF STANDARD CHAR-
ACTERS WITHOUT CLAIM TO ANY PARTICULAR
FONT, STYLE, SIZE, OR COLOR.

FOR: DIETARY SUPPLEMENTS FOR ANIMALS,
NAMELY, BEES, IN CLASS 5 (U.S. CLS. 6, 18, 44, 46, 51
AND 52).

SER. NO. 76-685,818, FILED 1-16-2008.

FIRST USE 3-31-2007; IN COMMERCE 3-31-2007.

LINDA ESTRADA, EXAMINING ATTORNEY

Int. Cl.: 35

Prior U.S. Cls.: 100, 101 and 102

United States Patent and Trademark Office

Reg. No. 3,482,898

Registered Aug. 12, 2008

**SERVICE MARK
PRINCIPAL REGISTER**



AIRCRAFT TECHNICAL PUBLISHERS (CALIFORNIA CORPORATION)
101 SOUTH HILL DRIVE
BRISBANE, CA 94306

FOR: PROVIDING WEB-BASED SERVICES FOR AIR CARRIERS TO ACTIVELY MANAGE DOCUMENTS AND INFORMATION RELATING TO THE FAA COMPLIANCE AND CONFORMANCE PROCESS, AS WELL AS AUDIT MANAGEMENT RE-

QUIRED BY EXTERNAL ORGANIZATIONS, IN CLASS 35 (U.S. CLS. 100, 101 AND 102).

FIRST USE 6-4-2007; IN COMMERCE 6-4-2007.

SER. NO. 76-685,849, FILED 1-16-2008.

JOHN WILKE, EXAMINING ATTORNEY

Int. Cl.: 35

Prior U.S. Cls.: 100, 101 and 102

United States Patent and Trademark Office

Reg. No. 3,482,899

Registered Aug. 12, 2008

**SERVICE MARK
PRINCIPAL REGISTER**

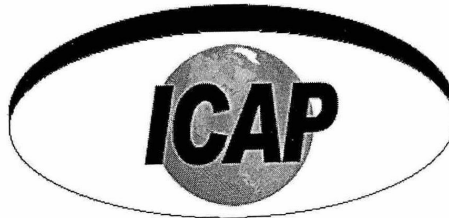

AIRCRAFT TECHNICAL PUBLISHERS (CALI-
FORNIA CORPORATION)
101 SOUTH HILL DRIVE
BRISBANE, CA 94306

FOR: PROVIDING WEB-BASED SERVICES FOR
AIR CARRIERS TO ACTIVELY MANAGE DOCU-
MENTS AND INFORMATION RELATING TO THE
FAA COMPLIANCE AND CONFORMANCE PRO-
CESS, AS WELL AS AUDIT MANAGEMENT RE-

QUIRED BY EXTERNAL ORGANIZATIONS, IN
CLASS 35 (U.S. CLS. 100, 101 AND 102).

FIRST USE 4-1-2005; IN COMMERCE 4-1-2005.

SER. NO. 76-685,851, FILED 1-16-2008.

JOHN WILKE, EXAMINING ATTORNEY

Int. Cls.: 9 and 42

Prior U.S. Cls.: 21, 23, 26, 36, 38, 100 and 101

United States Patent and Trademark Office

Reg. No. 3,482,900

Registered Aug. 12, 2008

**TRADEMARK
SERVICE MARK
PRINCIPAL REGISTER**

SUPERHEAT FGH

SUPERHEAT FGH TECHNOLOGIES INC. (CANADA CORPORATION)
R. R. #1, 1463 HIGHWAY 21
KINCARDINE, ONTARIO, CANADA N2Z 2X3

FOR: HEAT TREATMENT MONITORING AND CONTROLLING APPARATUS FOR INDUSTRIAL WELDING APPLICATIONS , IN CLASS 9 (U.S. CLS. 21, 23, 26, 36 AND 38).

FIRST USE 8-28-2003; IN COMMERCE 8-28-2003.

FOR: HEAT TREATMENT MONITORING SERVICES IN THE INDUSTRIAL WELDING INDUSTRY, IN CLASS 42 (U.S. CLS. 100 AND 101).

FIRST USE 8-28-2003; IN COMMERCE 8-28-2003.

SER. NO. 76-685,853, FILED 1-16-2008.

JOHN HWANG, EXAMINING ATTORNEY

Int. Cl.: 35

Prior U.S. Cls.: 100, 101 and 102

United States Patent and Trademark Office

Reg. No. 3,482,901

Registered Aug. 12, 2008

**SERVICE MARK
PRINCIPAL REGISTER**

YOUR COMPLIANCE AND SAFETY PARTNER

AIRCRAFT TECHNICAL PUBLISHERS (CALI-
FORNIA CORPORATION)
101 SOUTH HILL DRIVE
BRISBANE, CA 94306

FOR: PROVIDING WEB-BASED SERVICES FOR
AIR CARRIERS TO ACTIVELY MANAGE DOCU-
MENTS AND INFORMATION RELATING TO THE
FAA COMPLIANCE AND CONFORMANCE PRO-
CESS, AS WELL AS AUDIT MANAGEMENT RE-

QUIRED BY EXTERNAL ORGANIZATIONS, IN
CLASS 35 (U.S. CLS. 100, 101 AND 102).

FIRST USE 12-26-2007; IN COMMERCE 12-26-2007.

SER. NO. 76-686,913, FILED 2-19-2008.

JOHN WILKE, EXAMINING ATTORNEY

Int. Cls.: 6, 8, 14, 16, 18, 24, 25, 27, 28, 34, 36, 37, 39 and 41

Prior U.S. Cls.: 1, 2, 3, 5, 8, 9, 12, 13, 14, 17, 19, 20, 22, 23, 25, 27, 28, 29, 37, 38, 39, 41, 42, 44, 50, 100, 101, 102, 103, 105, 106 and 107

Reg. No. 3,482,902

United States Patent and Trademark Office

Registered Aug. 12, 2008

**TRADEMARK
SERVICE MARK
PRINCIPAL REGISTER**

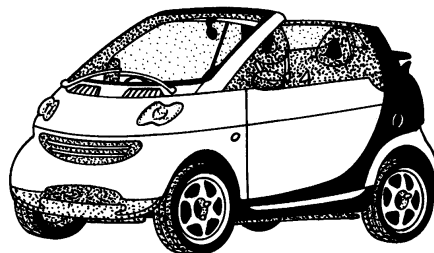

DAIMLER AG (FED REP GERMANY CORPORATION)

MERCEDESSTRASSE 137
STUTTGART, FED REP GERMANY 70327

FOR: METAL NAME BADGES, IN CLASS 6 (U.S. CLS. 2, 12, 13, 14, 23, 25 AND 50).

FOR: POCKET KNIVES, IN CLASS 8 (U.S. CLS. 23, 28 AND 44).

FOR: WATCHES AND WATCH CASES, COSTUME JEWELRY, JEWELRY, IN CLASS 14 (U.S. CLS. 2, 27, 28 AND 50).

FOR: MAGAZINES, NEWSPAPERS AND BROCHURES PERTAINING TO AUTOMOTIVE, TRAVEL AND RELATED MATTERS OF INTEREST TO OWNERS OF APPLICANT'S AUTOMOBILES, PAPER NAPKINS, PACKAGING CONTAINERS OF PAPER OR CARDBOARD, STATIONERY, PACKAGING MATERIALS OF PLASTIC, NAMELY, BAGS AND FOLIOS, IN CLASS 16 (U.S. CLS. 2, 5, 22, 23, 29, 37, 38 AND 50).

FOR: LEATHER AND IMITATION LEATHER GOODS AND GOODS MADE THEREFROM, NAMELY, HANDBAGS, BRIEFCASES AND SHOPPING BAGS, BACK PACKS, SMALL AND LARGE SUITCASES, WALLETTS AND PURSES; UMBRELLAS AND PARASOLS, IN CLASS 18 (U.S. CLS. 1, 2, 3, 22 AND 41).

FOR: TOWELS, IN CLASS 24 (U.S. CLS. 42 AND 50).

FOR: ARTICLES OF APPAREL, NAMELY, T-SHIRTS, SWEATSHIRTS, TIES, GLOVES, ANORAKS, PONCHOS, JACKETS, VESTS, SWEATERS, SPORTS SHIRTS, SCARVES, BELTS, FOOTWEAR; HEAD WEAR, NAMELY, HATS, CAPS, AVIATOR-TYPE CAPS, IN CLASS 25 (U.S. CLS. 22 AND 39).

FOR: CARPETS AND FLOOR MATS FOR AUTOMOBILES, IN CLASS 27 (U.S. CLS. 19, 20, 37, 42 AND 50).

FOR: TOY MODEL AUTOMOBILES, PLUSH STUFFED TOY ANIMALS, PLAYING CARDS, IN CLASS 28 (U.S. CLS. 22, 23, 38 AND 50).

FOR: ASHTRAYS, NOT OF PRECIOUS METAL; CIGARETTE CASES AND LIGHTERS, NOT OF PRECIOUS METAL; CIGARETTE LIGHTERS NOT FOR LAND VEHICLES; MATCHES, IN CLASS 34 (U.S. CLS. 2, 8, 9 AND 17).

FOR: CREDIT CARD SERVICES; INSURANCE ADMINISTRATION AND UNDERWRITING IN THE FIELDS OF AUTOMOBILE AND LIABILITY INSURANCE, IN CLASS 36 (U.S. CLS. 100, 101 AND 102).

FOR: REPAIR AND MAINTENANCE OF AUTOMOBILES; AUTOMOBILE CLEANING, DETAILING, GREASING, LUBRICATION, PAINTING, PINSTRIPE, POLISHING, REPAIR, AND WASHING; REPLACEMENT OF PARTS AND ACCESSORIES NEEDED TO PRESERVE THE AUTOMOBILE'S OPERATING CAPABILITY, IN CLASS 37 (U.S. CLS. 100, 103 AND 106).

FOR: LEASING AND RENTAL OF AUTOMOBILES; TRANSPORTATION OF PERSONS BY AUTOMOBILES OF ALL TYPES AND TRANSPORTATION OF GOODS AND AUTOMOBILES BY TRUCKS; ARRANGING TRAVEL TOURS; TRANSPORTATION RESERVATION SERVICES; AUTOMOBILE TOWING, IN CLASS 39 (U.S. CLS. 100 AND 105).

FOR: AUTOMOBILE DRIVING AND SAFETY TRAINING; TRAINING IN THE FIELD OF AUTOMOBILES THROUGH CLASSES, SEMINARS, CONFERENCES AND WORKSHOPS, IN CLASS 41 (U.S. CLS. 100, 101 AND 107).

PRIORITY CLAIMED UNDER SEC. 44(D) ON FED REP GERMANY APPLICATION NO. 001423482, FILED 12-15-1999, REG. NO. 001423482, DATED 6-8-2002, EXPIRES 6-8-2012.

THE STIPPLING IS FOR SHADING PURPOSES.

THE MARK CONSISTS OF A THREE-DIMENSIONAL DISTINCTIVE DESIGN OF A SUB-COMPACT AUTOMOBILE.

SER. NO. 76-978,380, FILED 6-15-2000.

TINA L. SNAPP, EXAMINING ATTORNEY

Int. Cls.: 6, 8, 14, 16, 18, 24, 25, 27, 28, 34, 36, 37, 39 and 41

Prior U.S. Cls.: 1, 2, 3, 5, 8, 9, 12, 13, 14, 17, 19, 20, 22, 23, 25, 27, 28, 29, 37, 38, 39, 41, 42, 44, 50, 100, 101, 102, 103, 105, 106 and 107

Reg. No. 3,482,903

United States Patent and Trademark Office

Registered Aug. 12, 2008

**TRADEMARK
SERVICE MARK
PRINCIPAL REGISTER**

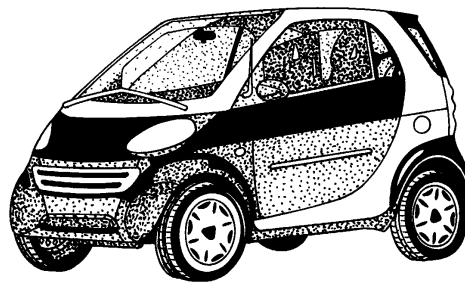

DAIMLER AG (FED REP GERMANY CORPORATION)
MERCEDÉSSTRASSE 137
STUTT GART, FED REP GERMANY 70327

FOR: METAL NAME BADGES AND METAL TRANSPORT BOXES, IN CLASS 6 (U.S. CLS. 2, 12, 13, 14, 23, 25 AND 50).

FOR: POCKET KNIVES, RAZORS, NAIL CLIPPERS, IN CLASS 8 (U.S. CLS. 23, 28 AND 44).

FOR: WATCHES AND WATCH CASES, CUFF LINKS, TIE PINS, COSTUME JEWELRY, JEWELRY, PRECIOUS STONES, IN CLASS 14 (U.S. CLS. 2, 27, 28 AND 50).

FOR: MAGAZINES, NEWSPAPERS AND BROCHURES PERTAINING TO AUTOMOTIVE, TRAVEL AND RELATED MATTERS OF INTEREST TO OWNERS OF APPLICANT'S AUTOMOBILES, PAPER NAPKINS, PACKAGING CONTAINERS OF PAPER OR CARDBOARD FOR INDUSTRIAL AND DOMESTIC USE, STATIONERY, PACKAGING MATERIALS OF PLASTIC, NAMELY, WRAPPINGS, BAGS, FOLIOS, IN CLASS 16 (U.S. CLS. 2, 5, 22, 23, 29, 37, 38 AND 50).

FOR: LEATHER AND IMITATION GOODS AND GOODS MADE THEREFROM, NAMELY, HANDBAGS, BRIEFCASES, BACKPACKS, SMALL AND LARGE SUITCASES, SHOPPING BAGS, WALLETS, PURSES, UMBRELLAS AND PARASOLS, IN CLASS 18 (U.S. CLS. 1, 2, 3, 22 AND 41).

FOR: FABRICS FOR MANUFACTURING USE IN THE AUTOMOTIVE INDUSTRY; NYLON FABRIC; TOWELS; UPHOLSTERY FABRIC; LAP ROBES, IN CLASS 24 (U.S. CLS. 42 AND 50).

FOR: ARTICLES OF APPAREL, NAMELY, T-SHIRTS, SWEATSHIRTS, TIES, GLOVES, ANORAKS, PONCHOS, JACKETS, VESTS, SWEATERS, SPORT SHIRTS, SCARVES, BELTS; FOOTWEAR; HEADWEAR, NAMELY, HATS, CAPS, AVIATOR-TYPE CAPS, IN CLASS 25 (U.S. CLS. 22 AND 39).

FOR: CARPETS AND FOOT MATS FOR AUTOMOBILES, IN CLASS 27 (U.S. CLS. 19, 20, 37, 42 AND 50).

FOR: TOY MODEL AUTOMOBILES, PLUSH STUFFED TOY ANIMALS; JIGSAW PUZZLES; DOMINOES; SPORTS BALLS FOR USE IN BADMINTON, TENNIS, TABLE TENNIS, PADDLE BALL, RACKET BALL AND SQUASH GAMES; YOYO'S; BOARD GAMES, NAMELY, CHESS, CHINESE CHECKERS, NINE MEN'S MORRIS; BALLOONS; WATER-SKI EQUIPMENT, NAMELY, METAL AND NYLON TOW ROPES; GYMNASTIC APPARATUS; PLAYING CARDS, IN CLASS 28 (U.S. CLS. 22, 23, 38 AND 50).

FOR: ASHTRAYS, NOT OF PRECIOUS METAL; CIGARETTE CASES, HOLDERS AND LIGHTERS NOT OF PRECIOUS METAL; CIGAR CUTTERS; CIGARETTE LIGHTERS NOT FOR LAND VEHICLES; MATCHES, IN CLASS 34 (U.S. CLS. 2, 8, 9 AND 17).

FOR: CREDIT CARD SERVICES; INSURANCE ADMINISTRATION AND UNDERWRITING IN THE FIELDS OF AUTOMOBILE AND LIABILITY INSURANCE, IN CLASS 36 (U.S. CLS. 100, 101 AND 102).

FOR: REPAIR AND MAINTENANCE OF AUTOMOBILES; AUTOMOBILE CLEANING, DETAILING, GREASING, LUBRICATION, PAINTING, PINSTRIPPING, POLISHING, REPAIR, AND WASHING; REPLACEMENT OF AUTOMOBILE PARTS AND ACCESSORIES, IN CLASS 37 (U.S. CLS. 100, 103 AND 106).

FOR: LEASING AND RENTAL OF AUTOMOBILES; PARKING LOT SERVICES; TRANSPORTATION OF PERSONS BY AUTOMOBILES OF ALL TYPES AND TRANSPORTATION OF GOODS AND AUTOMOBILES BY TRUCKS; ARRANGING TRAVEL TOURS; TRANSPORTATION RESERVATION SERVICES; AUTOMOBILE TOWING, IN CLASS 39 (U.S. CLS. 100 AND 105).

FOR: AUTOMOBILE DRIVING AND SAFETY TRAINING; TRAINING IN THE FIELD OF AUTOMOBILES THROUGH CLASSES, SEMINARS, CONFERENCES AND WORKSHOPS, IN CLASS 41 (U.S. CLS. 100, 101 AND 107).

PRIORITY CLAIMED UNDER SEC. 44(D) ON FED REP GERMANY APPLICATION NO. 001424399, FILED 12-15-1999, REG. NO. 001424399, DATED 12-15-1999, EXPIRES 12-15-2009.

THE STIPPLING SHOWN IN THE MARK IS FOR SHADING PURPOSES.

THE MARK CONSISTS OF A THREE-DIMENSIONAL DISTINCTIVE DESIGN OF A SUB-COMPACT AUTOMOBILE.

SER. NO. 76-978,544, FILED 6-15-2000.

TINA L. SNAPP, EXAMINING ATTORNEY

Int. Cl.: 9

Prior U.S. Cls.: 21, 23, 26, 36 and 38

Reg. No. 3,482,904

United States Patent and Trademark Office

Registered Aug. 12, 2008

**TRADEMARK
PRINCIPAL REGISTER**



NETSMART (CYPRUS) LTD (CYPRUS LIMITED CORPORATION)
CENTENNIAL BLDG., 1ST FLOOR, STE. 102
48 THEMISTOKLIS DERVIS ST.
NICOSIA, CYPRUS 1066

THE COLOR(S) YELLOW, RED, WHITE, GRAY AND BLUE IS/ARE CLAIMED AS A FEATURE OF THE MARK.

FOR: DOWNLOADABLE GAME SOFTWARE AND ENTERTAINMENT SOFTWARE, NAMELY, RING TONES, TRUE TONES, REAL TONES, SCREEN SAVERS, WALLPAPERS, IMAGES, THE LICENSED LOGOS OF OTHERS, SOUND CLIPS AND MUSIC VIA THE INTERNET AND WIRELESS DEVICES, IN CLASS 9 (U.S. CLS. 21, 23, 26, 36 AND 38).

THE MARK CONSISTS OF THE WORD "SMART" SET FORTH IN WHITE AND OUTLINED IN RED, THE WORD "LOGOS" SET FORTH IN YELLOW AND OUTLINED IN BLUE, AND SIX RAYS EXTENDING FROM THE LETTER "S" IN "SMART", THE RAYS BEING SET FORTH IN YELLOW OUTLINED IN GRAY.

FIRST USE 1-1-2003; IN COMMERCE 11-24-2006.

SER. NO. 77-000,452, FILED 9-15-2006.

NO CLAIM IS MADE TO THE EXCLUSIVE RIGHT TO USE "LOGOS", APART FROM THE MARK AS SHOWN.

PAUL MORENO, EXAMINING ATTORNEY

Int. Cl.: 33

Prior U.S. Cls.: 47 and 49

United States Patent and Trademark Office

Reg. No. 3,482,905

Registered Aug. 12, 2008

**TRADEMARK
PRINCIPAL REGISTER**



MOET HENNESSY USA, INC. (DELAWARE CORPORATION)
85 10TH AVENUE
NEW YORK, NY 10011

FOR: SPARKLING WINE, IN CLASS 33 (U.S. CLS. 47 AND 49).

FIRST USE 6-15-2006; IN COMMERCE 6-15-2006.

THE MARK CONSISTS OF TWO RIBBONS, WHICH ARE APPLIED AND ATTACHED TO, AND HANG VERTICALLY FROM, THE NECK AND CAP OF A BOTTLE, WITH THE RIBBON ENDS FALLING FREE. THE MATTER SHOWN IN BROKEN LINES IS NOT PART OF THE MARK.

SER. NO. 77-002,392, FILED 9-19-2006.

DAVID MILLER, EXAMINING ATTORNEY

Int. Cl.: 3

Prior U.S. Cls.: 1, 4, 6, 50, 51 and 52

Reg. No. 3,482,906

United States Patent and Trademark Office

Registered Aug. 12, 2008

**TRADEMARK
PRINCIPAL REGISTER**

JIFFY

ROCHESTER MIDLAND CORPORATION (NEW
YORK CORPORATION)
333 HOLLENBECK STREET
ROCHESTER, NY 14621

FIRST USE 12-31-1970; IN COMMERCE 12-31-1970.

FOR: CLEANING PREPARATION THAT IS WATER BASED AND IS USED FOR REMOVING MOST DETERGENT RESISTANT MARKS AND STAINS FROM SURFACES FOUND IN BUILDINGS IN THE NATURE OF PENCIL, CRAYON, BLACK HEEL MARKS, DRIED FLOOR FINISH, FINGERPRINTS, AND OTHER OIL AND GREASE STAINS, IN CLASS 3 (U.S. CLS. 1, 4, 6, 50, 51 AND 52).

THE MARK CONSISTS OF STANDARD CHARACTERS WITHOUT CLAIM TO ANY PARTICULAR FONT, STYLE, SIZE, OR COLOR.

SER. NO. 77-003,341, FILED 9-20-2006.

ZHALEH DELANEY, EXAMINING ATTORNEY

Int. Cls.: 11 and 21

Prior U.S. Cls.: 2, 13, 21, 23, 29, 30, 31, 33, 34, 40 and 50

Reg. No. 3,482,907

United States Patent and Trademark Office

Registered Aug. 12, 2008

**TRADEMARK
PRINCIPAL REGISTER**



TANGSHAN HUALIAN CO., LTD. (CHINA CORPORATION)
NO.7, XINHUAXI ROAD
TANGSHAN CITY, CHINA 063000

FOR: BATHTUBS, BIDETS, LAVATORIES, PLUMBING FITTINGS, NAMELY, DRAINS, FAUCETS, SHOWER HEADS; PLUMBING FIXTURES, NAMELY, TOILETS, TOILET BOWLS, TOILET SEATS, TOILET TANKS; URINALS, WHIRLPOOL BATHTUBS AND KITCHEN SINKS, IN CLASS 11 (U.S. CLS. 13, 21, 23, 31 AND 34).

FIRST USE 3-30-2006; IN COMMERCE 3-30-2006.

FOR: DINNERWARE, AND WASHBASINS, IN CLASS 21 (U.S. CLS. 2, 13, 23, 29, 30, 33, 40 AND 50).

FIRST USE 3-30-2006; IN COMMERCE 3-30-2006.

THE COLOR(S) LIGHT GREEN, DARK GREEN, AND BLACK IS/ARE CLAIMED AS A FEATURE OF THE MARK.

THE MARK CONSISTS OF A STYLIZED GREEN FLOWER WITH TWO CHINESE CHARACTERS, AND THEIR ENGLISH TRANSLITERATION "CUIWEI". THE COLOR LIGHT GREEN APPEARS IN THE FLOWER DESIGN, THE COLOR DARK GREEN APPEARS IN THE FLOWER DESIGN, AND THE COLOR BLACK APPEARS IN THE CHINESE CHARACTERS AND IN THE WORDING "CUIWEI".

THE FOREIGN WORDING IN THE MARK TRANSLATES INTO ENGLISH AS A SHADY RETREAT ON A GREEN HILL.

THE NON-LATIN CHARACTER(S) IN THE MARK TRANSLITERATES INTO "CUI WEI", AND THIS MEANS A SHADY RETREAT ON A GREEN HILL IN ENGLISH.

SER. NO. 77-003,475, FILED 9-20-2006.

CARRIE GENOVESE, EXAMINING ATTORNEY

Int. Cl.: 37

Prior U.S. Cls.: 100, 103 and 106

Reg. No. 3,482,908

United States Patent and Trademark Office

Registered Aug. 12, 2008

SERVICE MARK
PRINCIPAL REGISTER



PORTOFINO POOLS, INC. (FLORIDA CORPORATION)
SUITE 101
6005 POWERS AVENUE
JACKSONVILLE, FL 32217

NO CLAIM IS MADE TO THE EXCLUSIVE
RIGHT TO USE "POOLS", APART FROM THE
MARK AS SHOWN.

FOR: SWIMMING POOL CLEANING SERVICES,
IN CLASS 37 (U.S. CLS. 100, 103 AND 106).

SER. NO. 77-003,839, FILED 9-20-2006.

FIRST USE 0-0-1956; IN COMMERCE 0-0-1956.

COLLEEN DOMBROW, EXAMINING ATTORNEY

Int. Cl.: 17

Prior U.S. Cls.: 1, 5, 12, 13, 35 and 50

Reg. No. 3,482,909

United States Patent and Trademark Office

Registered Aug. 12, 2008

**TRADEMARK
PRINCIPAL REGISTER**

ARclad

ADHESIVES RESEARCH INC. (PENNSYLVANIA CORPORATION)
400 SEAKS RUN ROAD
GLEN ROCK, PA 17327

FOR: NON-METAL PROTECTIVE MASKING SHEETING FOR USE IN THE MANUFACTURE OF RIGID PLASTIC AND METAL PANELS; PRESSURE SENSITIVE ADHESIVE CLOSED CELL FOAM USED FOR BONDING AND ASSEMBLY; ADHESIVE TAPE FOR BONDING AND SPLICING; CUSTOM LAMINATING NON-METAL SHEETING FOR BONDING AND ASSEMBLY; PRESSURE SENSITIVE ADHESIVES, SPECIALTY PRESSURE SENSITIVE ADHESIVE TAPES, AND COATED NON-METAL

ADHESIVE COATED PLASTIC FILMS FOR BONDING AND ASSEMBLY; LAMINATES CONSISTING PRIMARILY OF PLASTIC WITH OR WITHOUT A METAL LAYER FOR APPLICATION TO A SUBSTRATE, IN CLASS 17 (U.S. CLS. 1, 5, 12, 13, 35 AND 50).

FIRST USE 2-5-1974; IN COMMERCE 2-5-1974.

OWNER OF U.S. REG. NO. 1,017,428.

SER. NO. 77-003,908, FILED 9-21-2006.

GINA HAYES, EXAMINING ATTORNEY

Int. Cl.: 35

Prior U.S. Cls.: 100, 101 and 102

United States Patent and Trademark Office

Reg. No. 3,482,910

Registered Aug. 12, 2008

**SERVICE MARK
PRINCIPAL REGISTER**

Finish Line

GRIFFITH HOLDINGS, INC. (OHIO CORPORATION)
3035 WEYMOUTH ROAD
MEDINA, OH 44256

FOR: ON-LINE SEARCH ENGINE MARKETING, NAMELY, PROVIDING A SERVICE FOR CONVERTING SEARCH ENGINE RANKINGS AND SITE TRAFFIC INTO NEW CUSTOMER OPPORTUNITIES BY FACILITATING WEB SITE VISITOR ACTIONS, IN CLASS 35 (U.S. CLS. 100, 101 AND 102).

FIRST USE 6-0-2005; IN COMMERCE 6-0-2005.

THE MARK CONSISTS OF STANDARD CHARACTERS WITHOUT CLAIM TO ANY PARTICULAR FONT, STYLE, SIZE, OR COLOR.

SER. NO. 77-004,358, FILED 9-21-2006.

LYDIA BELZER, EXAMINING ATTORNEY

Int. Cl.: 36

Prior U.S. Cls.: 100, 101 and 102

United States Patent and Trademark Office

Reg. No. 3,482,911

Registered Aug. 12, 2008

**SERVICE MARK
PRINCIPAL REGISTER**

*Villa*TAVIANA®

ARTIME, HENRY (UNITED STATES INDIVIDUAL)
SUITE 205
65 N. RAYMOND AVENUE
PASADENA, CA 91103

FOR: REAL ESTATE SERVICES, NAMELY, BROKERAGE OF CONDOMINIUM HOMES, IN CLASS 36 (U.S. CLS. 100, 101 AND 102).

FIRST USE 9-17-2005; IN COMMERCE 9-17-2005.

NO CLAIM IS MADE TO THE EXCLUSIVE RIGHT TO USE "VILLA", APART FROM THE MARK AS SHOWN.

THE MARK CONSISTS OF THE WORDS "VILLA TAVIANA" IN FANCIFUL FORM ALONG WITH A STARBURST-LIKE DESIGN.

THE WORDING "TAVIANA" HAS NO MEANING IN A FOREIGN LANGUAGE.

SER. NO. 77-005,707, FILED 9-22-2006.

JULIE WATSON, EXAMINING ATTORNEY

Int. Cl.: 5

Prior U.S. Cls.: 6, 18, 44, 46, 51 and 52

Reg. No. 3,482,912

United States Patent and Trademark Office

Registered Aug. 12, 2008

**TRADEMARK
PRINCIPAL REGISTER**

Bi-est

NICKELL, ROBERT P (UNITED STATES INDIVIDUAL)
SUITE 1507
381 VAN NESS AVE
TORRANCE, CA 90501

FIRST USE 1-1-1989; IN COMMERCE 1-1-1989.

THE MARK CONSISTS OF STANDARD CHARACTERS WITHOUT CLAIM TO ANY PARTICULAR FONT, STYLE, SIZE, OR COLOR.

FOR: TOPICAL GEL FOR MEDICAL AND THERAPEUTIC TREATMENT OF BIO IDENTICAL HORMONE REPLACEMENT THERAPY OF ESTRADIOL, ESTRONE, AND OR ESTRIOL , IN CLASS 5 (U.S. CLS. 6, 18, 44, 46, 51 AND 52).

SER. NO. 77-005,942, FILED 9-23-2006.

CYNTHIA SLOAN, EXAMINING ATTORNEY

Int. Cl.: 9

Prior U.S. Cls.: 21, 23, 26, 36 and 38

Reg. No. 3,482,913

United States Patent and Trademark Office

Registered Aug. 12, 2008

**TRADEMARK
PRINCIPAL REGISTER**

G - W A V E

ARUZE CORP. (JAPAN CORPORATION)
3-1-25 ARIAKE, KOTO-KU
TOKYO, JAPAN

FOR: SLOT MACHINES; CABINETS FOR SLOT MACHINES SOLD AS AN INTEGRAL COMPONENT THEREOF; VIDEO SLOT MACHINES; GAMING MACHINES; VIDEO GAMING MACHINES; MEDIA STORAGE COMPUTER SOFTWARE, NAMELY, COMPUTER SOFTWARE FOR CONTROLLING SLOT MACHINES AND GAMING MACHINES, IN CLASS 9 (U.S. CLS. 21, 23, 26, 36 AND 38).

PRIORITY CLAIMED UNDER SEC. 44(D) ON JAPAN APPLICATION NO. 2006-68403, FILED 7-21-2006, REG. NO. 5054549, DATED 6-15-2007, EXPIRES 6-15-2017.

THE MARK CONSISTS OF A STYLIZED FORM OF THE LETTERS "GWAVE".

SER. NO. 77-007,290, FILED 9-26-2006.

JAMES MACFARLANE, EXAMINING ATTORNEY

Int. Cl.: 9

Prior U.S. Cls.: 21, 23, 26, 36 and 38

Reg. No. 3,482,914

United States Patent and Trademark Office

Registered Aug. 12, 2008

**TRADEMARK
PRINCIPAL REGISTER**



ARUZE CORP. (JAPAN CORPORATION)
3-1-25 ARIAKE, KOTO-KU,
3-1-25 ARIAKE
TOKYO, JAPAN

PRIORITY CLAIMED UNDER SEC. 44(D) ON
JAPAN APPLICATION NO. 2006-68404, FILED 7-21-
2006, REG. NO. 5028407, DATED 2-23-2007, EXPIRES
2-23-2017.

FOR: SLOT MACHINES; CABINETS FOR SLOT
MACHINES SOLD AS AN INTEGRAL COMPO-
NENT THEREOF; VIDEO SLOT MACHINES; GAM-
ING MACHINES; VIDEO GAMING MACHINES;
MEDIA STORAGE COMPUTER SOFTWARE,
NAMELY, COMPUTER SOFTWARE FOR CON-
TROLLING SLOT MACHINES AND GAMING MA-
CHINES, IN CLASS 9 (U.S. CLS. 21, 23, 26, 36 AND 38).

THE MARK CONSISTS OF A STYLIZED LETTER
"G".

SER. NO. 77-007,307, FILED 9-26-2006.

JAMES MACFARLANE, EXAMINING ATTORNEY

Int. Cl.: 42

Prior U.S. Cls.: 100 and 101

United States Patent and Trademark Office

Reg. No. 3,482,915

Registered Aug. 12, 2008

SERVICE MARK
PRINCIPAL REGISTER



SUBSURFACE IMAGING CORPORATION (NEW YORK CORPORATION)
225 VALLEY ROAD
ROCHESTER, NY 14618

FOR: CONSULTING SERVICES IN THE FIELD OF POWER QUALITY ANALYSIS; POWER QUALITY ANALYSIS SERVICES, NAMELY, INFRARED SCANNING OF ELECTRICAL AND MECHANICAL EQUIPMENT, INFRARED SCANNING OF BUILDINGS FOR HEAT LOSS, INFRARED SCANNING OF BUILDINGS FOR QUALITY CONTROL, INFRARED SCANNING OF FLAT ROOF SYSTEMS FOR MOISTURE DAMAGED SUBSTRATE, INFRARED SCANNING OF RESIDENTIAL HOMES FOR HEAT LOSS AND INSULATION VALUES, POWER QUALITY ANALYSIS OF ELECTRICAL AND MECHANICAL SYSTEMS, UNDERGROUND FAULT LOCATION AND TRACKING USING RF SCANNING, UNDERGROUND UTILITY AND ASSET MANAGEMENT AND GIS/GPS MAPPING, AERIAL INFRARED SCANNING, AND AERIAL SCANNING FOR ARCHITECTS AND ENGINEERS, UTILITY POWER ANALYSIS, ANALYSIS OF ELECTRICAL CIRCUITS FOR DEGRADATION, ANALYSIS OF BOAT HULLS FOR DAMAGE, IN CLASS 42 (U.S. CLS. 100 AND 101).

FIRST USE 3-0-2006; IN COMMERCE 3-0-2006.

NO CLAIM IS MADE TO THE EXCLUSIVE RIGHT TO USE "SUBSURFACE IMAGING", APART FROM THE MARK AS SHOWN.

THE COLOR(S) GOLD AND BLUE IS/ARE CLAIMED AS A FEATURE OF THE MARK.

THE MARK CONSISTS OF THE WORDS "SUBSURFACE IMAGING" IN BLUE WITH A SHADED HALF CIRCLE IN GOLD OVERLAPPING THE UPPER LEFT PORTION OF THE "S", THE TOP OF THE "S" WITHIN THE GOLD HALF CIRCLE IS WHITE AND THE LOWER PORTION OF THE "S" OUTSIDE OF THE HALF CIRCLE IS OUTLINED IN BLUE; A LINE IN GOLD ANGLES DOWNWARD THROUGH THE "S" WITH A SCHEMATIC RESISTOR SYMBOL AND A GROUND SYMBOL AT THE END; THE WORD SUBSURFACE IS ABOVE THE WORD IMAGING SEPARATED BY A GOLD UNDERLINE.

SER. NO. 77-007,597, FILED 9-26-2006.

WILLIAM BRECKENFELD, EXAMINING ATTORNEY

Int. Cls.: 16, 39 and 43

Prior U.S. Cls.: 2, 5, 22, 23, 29, 37, 38, 50, 100, 101 and 105

Reg. No. 3,482,916

United States Patent and Trademark Office

Registered Aug. 12, 2008

**TRADEMARK
SERVICE MARK
PRINCIPAL REGISTER**



IBEROTRAVEL VACATIONS HOLDING, S.L.
(SPAIN CORPORATION)
AVENIDA GRAN VIA ASIMA, 23
PALMA DE MALLORCA, SPAIN 07009

FOR: PRINTED PUBLICATIONS, NAMELY,
TOURIST LEAFLETS AND BROCHURES, IN CLASS
16 (U.S. CLS. 2, 5, 22, 23, 29, 37, 38 AND 50).

FOR: PROVIDING TRAVEL ARRANGEMENTS,
AIRCRAFT TRANSPORT OF PASSENGERS,
GROUND TRANSPORT OF PASSENGERS, PACKA-
GING AND STORAGE OF GOODS, TICKET RESER-
VATION FOR THE AFORESAID MEANS OF
TRANSPORT, HIRING OF VEHICLES FOR PASSEN-
GERS, IN CLASS 39 (U.S. CLS. 100 AND 105).

FOR: PROVIDING RESERVATION OF TEMPOR-
ARY ACCOMMODATIONS, SERVICES FOR PRO-

VIDING FOOD, DRINK AND HOTEL TRADE
SERVICES, IN CLASS 43 (U.S. CLS. 100 AND 101).

OWNER OF ERPN CMNTY TM OFC REG. NO.
005337341, DATED 8-13-2007, EXPIRES 9-12-2016.

THE COLOR(S) DARK BLUE IS/ARE CLAIMED
AS A FEATURE OF THE MARK.

THE MARK IS ENTIRELY IN DARK BLUE.

SER. NO. 77-008,808, FILED 9-27-2006.

BRIAN NEVILLE, EXAMINING ATTORNEY

Int. Cl.: 36

Prior U.S. Cls.: 100, 101 and 102

United States Patent and Trademark Office

Reg. No. 3,482,917

Registered Aug. 12, 2008

**SERVICE MARK
PRINCIPAL REGISTER**

THE ANSWER IS YES. WHAT'S
YOUR QUESTION?

LYDIAN TRUST COMPANY (FLORIDA CORPORATION)
SUITE 700
3801 PGA BLVD.
PALM BEACH, FL 33410

FOR: BANKING AND FINANCIAL SERVICES, NAMELY, FINANCIAL MANAGEMENT, FINANCIAL PLANNING, FINANCIAL PORTFOLIO MANAGEMENT, FINANCIAL RESEARCH, DEPOSIT SERVICES, NAMELY, CHECKING, MONEY MARKET, SAVINGS AND CERTIFICATES OF DEPOSIT, MONEY LENDING SERVICES, INVESTMENT SERVICES, NAMELY, INVESTMENT ANALYSIS, ADVICE, CONSULTATION AND MANAGEMENT,

INVESTMENT BROKERAGE, FIDUCIARY SERVICES AND TRUST ADMINISTRATION, IN CLASS 36 (U.S. CLS. 100, 101 AND 102).

FIRST USE 12-8-2004; IN COMMERCE 12-8-2004.

THE MARK CONSISTS OF STANDARD CHARACTERS WITHOUT CLAIM TO ANY PARTICULAR FONT, STYLE, SIZE, OR COLOR.

SER. NO. 77-009,268, FILED 9-28-2006.

HENRY S. ZAK, EXAMINING ATTORNEY

Int. Cl.: 5

Prior U.S. Cls.: 6, 18, 44, 46, 51 and 52

Reg. No. 3,482,918

United States Patent and Trademark Office

Registered Aug. 12, 2008

**TRADEMARK
PRINCIPAL REGISTER**

SUPER LYSINE

QUANTUM, INC. (OREGON CORPORATION)
754 WASHINGTON STREET
EUGENE, OR 97401

FOR: DIETARY SUPPLEMENTS IN THE FORM A TABLET, MEDICATED TOPICAL OINTMENT FOR THE TREATMENT OF INFECTIONS SUCH AS VIRAL INFECTIONS THAT CAUSE COLD SORES AND SHINGLES, CUTS, BURNS, AND SENSITIVE SKIN, LIQUID DIETARY SUPPLEMENT, AND MEDICATED LIP BALM, ALL CONTAINING L-LYSINE AND OTHER INGREDIENTS, IN CLASS 5 (U.S. CLS. 6, 18, 44, 46, 51 AND 52).

FIRST USE 8-31-1999; IN COMMERCE 8-31-1999.

THE MARK CONSISTS OF STANDARD CHARACTERS WITHOUT CLAIM TO ANY PARTICULAR FONT, STYLE, SIZE, OR COLOR.

OWNER OF U.S. REG. NO. 2,474,768.

NO CLAIM IS MADE TO THE EXCLUSIVE RIGHT TO USE "LYSINE", APART FROM THE MARK AS SHOWN.

SEC. 2(F).

SER. NO. 77-009,942, FILED 9-28-2006.

COLLEEN DOMBROW, EXAMINING ATTORNEY

Int. Cl.: 35

Prior U.S. Cls.: 100, 101 and 102

United States Patent and Trademark Office

Reg. No. 3,482,919

Registered Aug. 12, 2008

**SERVICE MARK
PRINCIPAL REGISTER**



DEL MONTE & ASSOCIATES, INC. (MINNESOTA CORPORATION)

5509 EDEN PRAIRIE ROAD
MINNETONKA, MS 55345

FOR: ADVERTISING AND COMMERCIAL INFORMATION SERVICES, VIA THE INTERNET; ADVERTISING VIA ELECTRONIC MEDIA AND SPECIFICALLY THE INTERNET; ADVERTISING, MARKETING AND PROMOTION SERVICES; ADVICE AND INFORMATION ABOUT CUSTOMER SERVICES AND PRODUCT MANAGEMENT AND PRICES ON INTERNET SITES IN CONNECTION WITH PURCHASES MADE OVER THE INTERNET; BUSINESS CONSULTATION AND MANAGEMENT REGARDING MARKETING ACTIVITIES AND LAUNCHING OF NEW PRODUCTS; BUSINESS MARKETING CONSULTING SERVICES; DIRECT MARKETING ADVERTISING FOR OTHERS; DIRECT MARKETING SERVICES; DISSEMINATION OF ADVERTISING FOR OTHERS VIA THE INTERNET; INFORMATION, ADVISORY AND CONSULTANCY SERVICES RELATING TO BUSINESS AND MANAGEMENT OR BUSINESS ADMINISTRATION, INCLUDING SUCH SERVICES PROVIDED ON LINE OR VIA THE INTERNET; MARKET ANALYSIS; MARKET RESEARCH CONSULTATION; MARKET SEGMENTATION CONSULTATION; MARKETING CONSULTING; MARKETING PLAN DEVELOPMENT; MARKETING SERVICES, NAMELY, PROVIDING INFORMATIONAL WEB PAGES DESIGNED TO GENERATE SALES TRAFFIC VIA HYPERLINKS TO OTHER WEB SITES; MEDIA PLANNING, NAMELY, ADVISING THE CLIENT ON THE CORRECT TIMES AND STATIONS TO ADVERTISE BASED ON MEDIA ANALYSIS OF

THE MARKET FOR THAT MEDIA; ON-LINE ADVERTISING AND MARKETING SERVICES; PROMOTING, ADVERTISING AND MARKETING OF THE ON-LINE WEBSITES OF OTHERS; PROMOTION, ADVERTISING AND MARKETING OF ON-LINE WEBSITES, IN CLASS 35 (U.S. CLS. 100, 101 AND 102).

FIRST USE 9-15-2001; IN COMMERCE 9-29-2003.

NO CLAIM IS MADE TO THE EXCLUSIVE RIGHT TO USE "TMA E-MARKETING" AND "INTERNET MARKETING", APART FROM THE MARK AS SHOWN.

THE COLOR(S) BLACK AND WHITE, AND PURPLE/MAROON WITH RGB VALUES OF 79/21/43 IS/ARE CLAIMED AS A FEATURE OF THE MARK.

THE MARK CONSISTS OF A STYLIZED SHARPLY DISTINCT LARGE BLACK, SLANTED TO THE RIGHT, CAPITAL LETTER T, WITH THE RIGHT PORTION OF THE HORIZONTAL STROKE OF THE T LARGER THAN THE LEFT PORTION AND EXTENDING TO THE RIGHT AND INTERSECTING AND GOING PAST THE TOP OF THE INVERTED V OF THE FIRST SEGMENT OF THE FOLLOWING STYLIZED AND SLANTED LARGE BLACK LETTER M, WITH THE WHITE SPACE UNDER THE SECOND INVERTED V OF THE LETTER M ANNOTATED BY A SMALL BLACK TRIANGLE AND BELOW IT, A SMALL BLACK TRAPAZOID, SO THAT WITHIN THAT WHITE SPACE THE LETTER A APPEARS VISIBLE AS A WHITE LETTER WITHIN THE BLACK BACK-

GROUND OF THE SECOND INVERTED V OF THE LETTER M, FOLLOWED BY A SPACE, FOLLOWED BY THE BLACK CAPITAL LETTER E, FOLLOWED BY A BLACK DASH AND THE BLACK CAPITAL LETTERS OF THE WORD MARKETING; SET BELOW, AND STARTING DIRECTLY BELOW THE WHITE A AS ABOVE, ALL IN PURPLE/MAROON RGB COLOR 79/21/43, THE SLIGHTLY SLANTED TO THE RIGHT PRINTED PHRASE, WITH THE

FIRST LETTER OF EACH WORD IN CAPITAL LETTERS AND A SPACE BETWEEN EACH WORD, INTERNET MARKETING THAT MEANS BUSINESS, IMMEDIATELY FOLLOWED BY A SLIGHTLY SLANTED EXCLAMATION MARK.

SER. NO. 77-010,422, FILED 9-29-2006.

H. M. FISHER, EXAMINING ATTORNEY

Int. Cl.: 9

Prior U.S. Cls.: 21, 23, 26, 36 and 38

Reg. No. 3,482,920

United States Patent and Trademark Office

Registered Aug. 12, 2008

**TRADEMARK
PRINCIPAL REGISTER**

JAZZ ICONS

REELIN' IN THE YEARS PRODUCTIONS LLC
(DELAWARE LTD LIAB CO)

477 SKYVIEW STREET

EL CAJON, CA 92020

FOR: MUSICAL VIDEO RECORDINGS AND
DVDS FEATURING VARIOUS MUSICAL PERFOR-
MANCES, IN CLASS 9 (U.S. CLS. 21, 23, 26, 36 AND
38).

FIRST USE 7-0-2006; IN COMMERCE 9-26-2006.

THE MARK CONSISTS OF STANDARD CHAR-
ACTERS WITHOUT CLAIM TO ANY PARTICULAR
FONT, STYLE, SIZE, OR COLOR.

NO CLAIM IS MADE TO THE EXCLUSIVE
RIGHT TO USE "JAZZ", APART FROM THE MARK
AS SHOWN.

SEC. 2(F).

SER. NO. 77-011,848, FILED 10-2-2006.

KHANH LE, EXAMINING ATTORNEY

Int. Cl.: 26

Prior U.S. Cls.: 37, 39, 40, 42 and 50

Reg. No. 3,482,921

United States Patent and Trademark Office

Registered Aug. 12, 2008

**TRADEMARK
PRINCIPAL REGISTER**

EVERLASTING BOUQUET

LYNCH, PONGPUN (UNITED STATES INDIVIDUAL)
2231 TAYLOR DR.
CENTER VALLEY, PA 18034

FOR: ARTIFICIAL FLOWER ARRANGEMENTS; ARTIFICIAL FLOWERS; ARTIFICIAL FLOWERS OF PLASTICS; ARTIFICIAL FLOWERS OF TEXTILE, IN CLASS 26 (U.S. CLS. 37, 39, 40, 42 AND 50).

FIRST USE 9-14-2006; IN COMMERCE 9-14-2006.

THE MARK CONSISTS OF STANDARD CHARACTERS WITHOUT CLAIM TO ANY PARTICULAR FONT, STYLE, SIZE, OR COLOR.

NO CLAIM IS MADE TO THE EXCLUSIVE RIGHT TO USE "BOUQUET", APART FROM THE MARK AS SHOWN.

SER. NO. 77-014,414, FILED 10-5-2006.

GINA HAYES, EXAMINING ATTORNEY

Int. Cl.: 41

Prior U.S. Cls.: 100, 101 and 107

United States Patent and Trademark Office

Reg. No. 3,482,922

Registered Aug. 12, 2008

**SERVICE MARK
PRINCIPAL REGISTER**

TOUCHTIME

DR. ELAINE'S TOUCHTIME LLC (CALIFORNIA
LTD LIAB CO)
509 FAIRWAY DRIVE
PALMDALE, CA 93551

FOR: EDUCATIONAL SERVICES, NAMELY,
CONDUCTING SEMINARS AND TRAINING IN
THE FIELDS OF PARENTING, CHILD/PARENT
RELATIONSHIPS, CHILD DEVELOPMENT, IN-
FANT MENTAL HEALTH, INFANT MASSAGE
AND COMMUNICATION DEVELOPMENT FOR
FAMILY WELL-BEING, IN CLASS 41 (U.S. CLS.
100, 101 AND 107).

FIRST USE 1-26-2004; IN COMMERCE 1-26-2004.

THE MARK CONSISTS OF STANDARD CHAR-
ACTERS WITHOUT CLAIM TO ANY PARTICULAR
FONT, STYLE, SIZE, OR COLOR.

OWNER OF U.S. REG. NO. 2,963,300.

SER. NO. 77-016,182, FILED 10-6-2006.

ALICE BENMAMAN, EXAMINING ATTORNEY

Int. Cl.: 28

Prior U.S. Cls.: 22, 23, 38 and 50

United States Patent and Trademark Office

Reg. No. 3,482,923

Registered Aug. 12, 2008

**TRADEMARK
PRINCIPAL REGISTER**

BRITE VISTA

BRODART CO. (NEW YORK PARTNERSHIP)
500 ARCH STREET
WILLIAMSPORT, PA 17705

THE MARK CONSISTS OF STANDARD CHAR-
ACTERS WITHOUT CLAIM TO ANY PARTICULAR
FONT, STYLE, SIZE, OR COLOR.

FOR: TOYS, NAMELY, BUILDING BLOCKS, TOY
KITCHEN APPLIANCES, PUPPET THEATERS, IN
CLASS 28 (U.S. CLS. 22, 23, 38 AND 50).

SER. NO. 77-018,874, FILED 10-11-2006.

FIRST USE 9-12-2006; IN COMMERCE 9-12-2006.

AMEETA JORDAN, EXAMINING ATTORNEY

Int. Cl.: 45

Prior U.S. Cls.: 100 and 101

United States Patent and Trademark Office

Reg. No. 3,482,924

Registered Aug. 12, 2008

**SERVICE MARK
PRINCIPAL REGISTER**

Live Riders

LIVE RIDE CHRISTIAN CHURCH (CALIFORNIA
CORPORATION)
6245 SYLVAN DR
SIMI VALLEY, CA 93063

THE MARK CONSISTS OF STANDARD CHAR-
ACTERS WITHOUT CLAIM TO ANY PARTICULAR
FONT, STYLE, SIZE, OR COLOR.

FOR: ORGANIZING AND CONDUCTING SUP-
PORT GROUPS IN THE FIELD OF MOTORCYCLE
ENTHUSIASTS, IN CLASS 45 (U.S. CLS. 100 AND
101).

SER. NO. 77-019,255, FILED 10-11-2006.

FIRST USE 1-1-2000; IN COMMERCE 1-1-2000.

ROBIN MITTLER, EXAMINING ATTORNEY

Int. Cl.: 41

Prior U.S. Cls.: 100, 101 and 107

United States Patent and Trademark Office

Reg. No. 3,482,925

Registered Aug. 12, 2008

**SERVICE MARK
PRINCIPAL REGISTER**

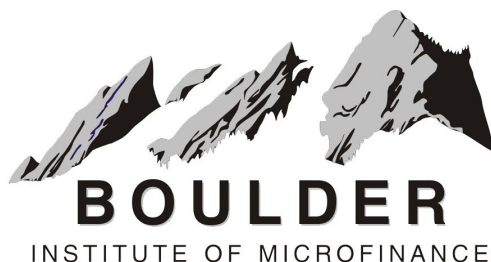

BOULDER INSTITUTE OF MICROFINANCE
(COLORADO CORPORATION)
1750 30TH STREET, NO. 163
BOULDER, CO 80301

FOR: EDUCATIONAL SERVICES, NAMELY, CONDUCTING CLASSES, SEMINARS, CONFERENCES, WORKSHOPS AND PROGRAMS IN PERSON AND OVER THE INTERNET FOR PROFESSIONALS AND IN GENERAL UNDERGRADUATE AND GRADUATE FIELDS WITH AN EMPHASIS IN MICROFINANCE; EDUCATIONAL SERVICES, NAMELY, THE OFFERING OF WEB BASED AND CLASSROOM TRAINING FOR CERTIFICATION OF AND CONTINUING EDUCATION FOR PROFESSIONALS AND IN GENERAL UNDERGRADUATE AND GRADUATE FIELDS WITH AN EMPHASIS IN MICROFINANCE; DISTRIBUTING COURSE MATERIALS IN CONNECTION WITH THE AFORESAID SERVICES, IN CLASS 41 (U.S. CLS. 100, 101 AND 107).

FIRST USE 2-15-2006; IN COMMERCE 2-15-2006.

NO CLAIM IS MADE TO THE EXCLUSIVE RIGHT TO USE "BOULDER INSTITUTE OF MICROFINANCE", APART FROM THE MARK AS SHOWN.

THE MARK CONSISTS OF THREE MOUNTAIN PEAKS WITH THE RIGHT SIDE SHADED IN BLACK AND THE LEFT SIDE LIGHTLY SHADED; THE WORD "BOULDER" IS LOCATED BELOW THE MOUNTAIN PEAKS IN BLOCK CAPITAL LETTERING THAT IS LIGHTLY SHADED; THE WORDS "INSTITUTE OF MICROFINANCE" ARE LOCATED BELOW THE WORD "BOULDER" IN BLACK CAPITAL LETTERS.

SER. NO. 77-019,347, FILED 10-12-2006.

MATTHEW MCDOWELL, EXAMINING ATTORNEY

Int. Cls.: 35, 37 and 42

Prior U.S. Cls.: 100, 101, 102, 103 and 106

United States Patent and Trademark Office

Reg. No. 3,482,926

Registered Aug. 12, 2008

**SERVICE MARK
PRINCIPAL REGISTER**



CURRENT LP (TEXAS LIMITED PARTNERSHIP)
5440 HARVEST HILL ROAD
SUITE 100
DALLAS, TX 75230

FOR: RETAIL STORE SERVICES AND ON-LINE RETAIL STORE SERVICES FEATURING ENERGY EFFICIENT PRODUCTS AND COST SAVING SERVICES FOR RESIDENTIAL, COMMERCIAL, AND INDUSTRIAL BUILDINGS FEATURING NEGOTIATING WITH AND SWITCHING RESIDENTIAL AND COMMERCIAL CUSTOMERS' ELECTRICITY PROVIDERS, PROVIDING HOME ENERGY AUDITS AND PROMOTING AND MARKETING ENERGY EFFICIENT LIGHTING, HEATING, VENTILATION, AND AIR CONDITIONING SYSTEMS, THERMOSTATS, WATER HEATERS, HOME AND BUSINESS LIGHTING AND LIGHTING CONTROLLING SYSTEMS, WINDOWS AND DOORS, RADIANT BARRIER PRODUCTS, INSULATION, SOLAR SCREENS, WINDOW FILMS, SURGE PROTECTION AND MODULATION, APPLIANCES, AND ALL OTHER ELECTRIC, GAS, SOLAR, WIND, AND WATER ENERGY TECHNOLOGY; ENERGY CONSULTING SERVICES, NAMELY IN THE FIELD OF ENERGY EFFICIENCY; BUSINESS MANAGEMENT SERVICES FOR PROMOTING ENERGY CONSERVATION AND SAVINGS, NAMELY, ELECTRICAL, GAS AND AIR CONDITIONING CONSERVATION AND SAVINGS; INFORMATION IN THE FIELD OF ENERGY EFFICIENCY, NAMELY, ELECTRICAL, GAS AND AIR CONDITIONING

CONSERVATION AND SAVINGS, IN CLASS 35 (U.S. CLS. 100, 101 AND 102).

FIRST USE 8-29-2006; IN COMMERCE 8-29-2006.

FOR: INSTALLING, MAINTAINING, AND SERVICING ENERGY EFFICIENT LIGHTING, HEATING, VENTILATION, AND AIR CONDITIONING CONTROL SYSTEMS, IN CLASS 37 (U.S. CLS. 100, 103 AND 106).

FIRST USE 8-29-2006; IN COMMERCE 8-29-2006.

FOR: DESIGNING AND MONITORING ENERGY EFFICIENT LIGHTING, HEATING, VENTILATION, AND AIR CONDITIONING CONTROL SYSTEMS, IN CLASS 42 (U.S. CLS. 100 AND 101).

FIRST USE 8-29-2006; IN COMMERCE 8-29-2006.

NO CLAIM IS MADE TO THE EXCLUSIVE RIGHT TO USE "ENERGY" , APART FROM THE MARK AS SHOWN.

THE MARK CONSISTS OF THE WORDS "CURRENT ENERGY" IN SANS SERIF TYPE, WITH "ENERGY" BELOW "CURRENT" AND THE "SMILING 'C' ELECTRICAL PLUG ICON IN THE ABOVE RIGHT CORNER.

SER. NO. 77-021,983, FILED 10-16-2006.

ANNE E. GUSTASON, EXAMINING ATTORNEY

Int. Cl.: 6

Prior U.S. Cls.: 2, 12, 13, 14, 23, 25 and 50

United States Patent and Trademark Office

Reg. No. 3,482,927

Registered Aug. 12, 2008

**TRADEMARK
PRINCIPAL REGISTER**

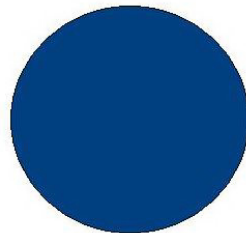

GBC METALS, LLC (DELAWARE LTD LIAB CO)
427 NORTH SHAMROCK STREET
EAST ALTON, IL 62024

FOR: BRASS ALLOYS IN SHEET, ROD, AND
OTHER FORMS FOR COMMERCIAL AND INDUS-
TRIAL USE, IN CLASS 6 (U.S. CLS. 2, 12, 13, 14, 23, 25
AND 50).

FIRST USE 3-0-1961; IN COMMERCE 3-0-1961.

THE COLOR(S) BLUE IS/ARE CLAIMED AS A
FEATURE OF THE MARK.

THE MARK CONSISTS OF A BLUE DOT.

SEC. 2(F).

SER. NO. 77-022,442, FILED 10-17-2006.

MATTHEW MCDOWELL, EXAMINING ATTOR-
NEY

Int. Cl.: 36

Prior U.S. Cls.: 100, 101 and 102

United States Patent and Trademark Office

Reg. No. 3,482,928

Registered Aug. 12, 2008

**SERVICE MARK
PRINCIPAL REGISTER**

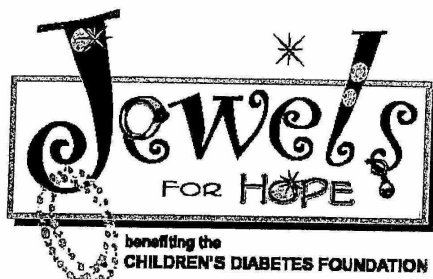

CHILDREN'S DIABETES FOUNDATION AT
DENVER, COLORADO (COLORADO COR-
PORATION)

777 GRANT STREET
SUITE 302
DENVER, CO 80203

FOR: CHARITABLE FUND RAISING SERVICES
BY MEANS OF COLLECTING AND RESELLING
JEWELRY, IN CLASS 36 (U.S. CLS. 100, 101 AND 102).

FIRST USE 11-5-2005; IN COMMERCE 11-5-2005.

NO CLAIM IS MADE TO THE EXCLUSIVE
RIGHT TO USE "JEWELS" AND "BENEFITING

THE CHILDREN'S DIABETES FOUNDATION",
APART FROM THE MARK AS SHOWN.

THE MARK CONSISTS OF THE WORDS "JEWELS
FOR HOPE" IN A RECTANGLE WITH DRAWINGS
OF JEWELRY, GEMSTONES, AND STARLIKE
DRAWINGS INTERSPERSED THROUGHOUT THE
WORDS "JEWELS FOR HOPE". THE WORDS "BEN-
EFITING THE CHILDREN'S DIABETES FOUNDA-
TION" APPEAR BELOW, AND OUTSIDE OF, THE
RECTANGLE.

SER. NO. 77-025,492, FILED 10-19-2006.

LOURDES AYALA, EXAMINING ATTORNEY

Int. Cl.: 21

Prior U.S. Cls.: 2, 13, 23, 29, 30, 33, 40 and 50

Reg. No. 3,482,929

United States Patent and Trademark Office

Registered Aug. 12, 2008

**TRADEMARK
PRINCIPAL REGISTER**

S-2 GLASS

AGY HOLDING CORP. (DELAWARE CORPORATION)
2558 WAGENER ROAD
AIKEN, SC 29801

THE MARK CONSISTS OF STANDARD CHARACTERS WITHOUT CLAIM TO ANY PARTICULAR FONT, STYLE, SIZE, OR COLOR.

FOR: GLASS FILAMENTS, ROVINGS AND YARN FOR NON-TEXTILE PURPOSES; SEMI-WORKED GLASS FOR FURTHER MANUFACTURE AND PROCESSING IN THE FORM OF GLASS FILAMENTS, STRANDS, ROVINGS AND YARNS FOR NON-TEXTILE PURPOSES, IN CLASS 21 (U.S. CLS. 2, 13, 23, 29, 30, 33, 40 AND 50).

NO CLAIM IS MADE TO THE EXCLUSIVE RIGHT TO USE "GLASS", APART FROM THE MARK AS SHOWN.

SER. NO. 77-026,141, FILED 10-20-2006.

FIRST USE 3-31-1970; IN COMMERCE 3-31-1970.

SUSAN RICHARDS, EXAMINING ATTORNEY

Int. Cls.: 11 and 21

Prior U.S. Cls.: 2, 13, 21, 23, 29, 30, 31, 33, 34, 40 and 50

Reg. No. 3,482,930

United States Patent and Trademark Office

Registered Aug. 12, 2008

**TRADEMARK
PRINCIPAL REGISTER**

CUCINA

HICO FLEX BRASS CO., INC. (ILLINOIS CORPORATION)
931 W. 19TH STREET
CHICAGO, IL 60608

FOR: WATER FAUCETS, HANDSPRAYS IN THE NATURE OF KITCHEN SINK SPRAYERS, PLUMBING FITTINGS, NAMELY, FAUCET FILTERS, BASKET SINK STRAINERS; AERATORS, NAMELY, FAUCET AERATORS, IN CLASS 11 (U.S. CLS. 13, 21, 23, 31 AND 34).

FIRST USE 1-11-2002; IN COMMERCE 1-11-2002.

FOR: SOAP DISPENSERS, IN CLASS 21 (U.S. CLS. 2, 13, 23, 29, 30, 33, 40 AND 50).

FIRST USE 1-11-2002; IN COMMERCE 1-11-2002.

THE MARK CONSISTS OF STANDARD CHARACTERS WITHOUT CLAIM TO ANY PARTICULAR FONT, STYLE, SIZE, OR COLOR.

THE FOREIGN WORDING IN THE MARK TRANSLATES INTO ENGLISH AS "KITCHEN".

SEC. 2(F).

SER. NO. 77-026,942, FILED 10-23-2006.

ANDREA K. NADELMAN, EXAMINING ATTORNEY

Int. Cls.: 14, 18, 24, 25 and 35

**Prior U.S. Cls.: 1, 2, 3, 22, 27, 28, 39, 41, 42, 50, 100,
101 and 102**

Reg. No. 3,482,931

United States Patent and Trademark Office

Registered Aug. 12, 2008

**TRADEMARK
SERVICE MARK
PRINCIPAL REGISTER**

Le Pêché Mignon

9165-6199 QUÉBEC INC. (CANADA CORPORATION)
N/A
8775 PASCAL GAGNON STREET
MONTREAL, CANADA H1P1Z4

WEAR, BATHING SUITS, SWIMWEAR, SHORTS, T-SHIRTS, PANTS, COVER-UPS, WARMERS, SANDALS, JOGGING SUITS, PRINTED PUBLICATIONS, NAMELY, MAGAZINES, CALENDARS AND POSTERS, IN CLASS 35 (U.S. CLS. 100, 101 AND 102).

FOR: JEWELRY; KEY RINGS OF PRECIOUS METAL, IN CLASS 14 (U.S. CLS. 2, 27, 28 AND 50).

THE MARK CONSISTS OF STANDARD CHARACTERS WITHOUT CLAIM TO ANY PARTICULAR FONT, STYLE, SIZE, OR COLOR.

FOR: BEACH BAGS, IN CLASS 18 (U.S. CLS. 1, 2, 3, 22 AND 41).

PRIORITY CLAIMED UNDER SEC. 44(D) ON CANADA APPLICATION NO. 1305018, FILED 6-9-2006, REG. NO. TMA708739, DATED 3-4-2008, EXPIRES 3-4-2023.

FOR: TOWELS, IN CLASS 24 (U.S. CLS. 42 AND 50).

FOR: BANDANAS; BATHING SUITS; BEACH COVERUPS; BEACHWEAR; CAFTANS; CAPS; HATS; JOGGING OUTFITS; LEG WARMERS; PANTS; SANDALS; SARONGS; SCARVES; SHORTS; SKIRTS; SOCKS; T-SHIRTS; TUNICS; WIND-JACKETS, IN CLASS 25 (U.S. CLS. 22 AND 39).

THE ENGLISH TRANSLATION OF "LE PÊCHÉ MIGNON" IS SINFUL DELIGHT.

FOR: PUBLICATION OF PUBLICITY TEXTS; RETAIL STORES FEATURING SALE OF BEACH

SER. NO. 77-027,683, FILED 10-24-2006.

ZACHARY BELLO, EXAMINING ATTORNEY

Int. Cls.: 37, 42 and 44

Prior U.S. Cls.: 100, 101, 103 and 106

United States Patent and Trademark Office

Reg. No. 3,482,932

Registered Aug. 12, 2008

**SERVICE MARK
PRINCIPAL REGISTER**

**ESTATE GARDENS BY
VALLEYCREST**

VALLYCREST COMPANIES LLC (CALIFORNIA
LTD LIAB CO)
24151 VENTURA BOULEVARD
CALABASAS, CA 91302

FOR: LANDSCAPE CONSTRUCTION AND
MAINTENANCE OF PROPERTY, NAMELY, GAR-
DENS AND LANDSCAPES, IN CLASS 37 (U.S. CLS.
100, 103 AND 106).

FIRST USE 10-3-2006; IN COMMERCE 10-3-2006.

FOR: LANDSCAPE ARCHITECTURAL DESIGN,
IN CLASS 42 (U.S. CLS. 100 AND 101).

FIRST USE 10-3-2006; IN COMMERCE 10-3-2006.

FOR: LANDSCAPE SERVICES, NAMELY, DE-
SIGN AND GARDENING, IN CLASS 44 (U.S. CLS.
100 AND 101).

FIRST USE 10-3-2006; IN COMMERCE 10-3-2006.

THE MARK CONSISTS OF STANDARD CHAR-
ACTERS WITHOUT CLAIM TO ANY PARTICULAR
FONT, STYLE, SIZE, OR COLOR.

OWNER OF U.S. REG. NOS. 2,282,997, 2,889,770
AND OTHERS.

NO CLAIM IS MADE TO THE EXCLUSIVE
RIGHT TO USE "ESTATE GARDENS", APART
FROM THE MARK AS SHOWN.

SER. NO. 77-028,129, FILED 10-24-2006.

DOMINIC FATHY, EXAMINING ATTORNEY

Int. Cls.: 9 and 41

Prior U.S. Cls.: 21, 23, 26, 36, 38, 100, 101 and 107

United States Patent and Trademark Office

Reg. No. 3,482,933

Registered Aug. 12, 2008

**TRADEMARK
SERVICE MARK
PRINCIPAL REGISTER**



ARTIST & IDEA MANAGEMENT, LTD. (NEW YORK CORPORATION)
5TH FLOOR
201 EAST 16TH STREET
NEW YORK, NY 10003

FOR: MUSICAL SOUND RECORDINGS; MUSICAL VIDEO RECORDINGS; PRE-RECORDED CD'S, VIDEO TAPES, LASER DISKS AND DVD'S FEATURING ENTERTAINMENT-RELATED PROGRAMMING IN THE NATURE OF PUNK MUSIC AND PUNK LIFESTYLES, IN CLASS 9 (U.S. CLS. 21, 23, 26, 36 AND 38).

FIRST USE 6-18-2006; IN COMMERCE 9-12-2007.

FOR: ENTERTAINMENT IN THE NATURE OF VISUAL AND AUDIO PERFORMANCES, AND MU-

SICAL, VARIETY, NEWS AND COMEDY SHOWS, IN CLASS 41 (U.S. CLS. 100, 101 AND 107).

FIRST USE 6-18-2006; IN COMMERCE 9-12-2007.

THE MARK CONSISTS OF STYLIZED LETTERS FOR "PUNK OUTLAW" AND THE DESIGN OF A FORWARD FACING HUMAN SKULL LACKING ITS MANDIBLE WITH A FIREY MOHAWK RISING FROM THE FRONT AND CENTER OF THE SKULL'S FOREHEAD, FLANKED BY MIRROR IMAGES OF LIGHTNING BOLTS FRAMING THE SKULL LIKE A LETTER "V".

SER. NO. 77-029,930, FILED 10-26-2006.

BRIDGETT SMITH, EXAMINING ATTORNEY

Int. Cl.: 42

Prior U.S. Cls.: 100 and 101

United States Patent and Trademark Office

Reg. No. 3,482,934

Registered Aug. 12, 2008

**SERVICE MARK
PRINCIPAL REGISTER**

SMB COLLABORATOR

NEXTCORP LTD. (TEXAS LIMITED PARTNER-
SHIP)
SUITE 100
7701 LAS COLINAS RIDGE
IRVING, TX 75063

FOR: BUSINESS APPLICATIONS SERVICES,
NAMELY, PROVIDING ON-LINE NON-DOWN-
LOADABLE BUSINESS PROCESS AUTOMATION
SOFTWARE APPLICATIONS FOR USE IN FIELDS
OF ELECTRONIC COMMERCE, BUSINESS, FI-
NANCE, PURCHASING, MARKETING, SALES, HU-
MAN RESOURCES, AND INFORMATION
TECHNOLOGY; COMPUTER SERVICES, NAMELY,
DESIGNING, CREATING, MAINTAINING, HOST-
ING, AND IMPLEMENTING THE WEB-ACCESSI-

BLE BUSINESS APPLICATIONS OF OTHERS, IN
CLASS 42 (U.S. CLS. 100 AND 101).

FIRST USE 6-25-2007; IN COMMERCE 6-25-2007.

THE MARK CONSISTS OF STANDARD CHAR-
ACTERS WITHOUT CLAIM TO ANY PARTICULAR
FONT, STYLE, SIZE, OR COLOR.

NO CLAIM IS MADE TO THE EXCLUSIVE
RIGHT TO USE "SMB" , APART FROM THE MARK
AS SHOWN.

SER. NO. 77-030,429, FILED 10-26-2006.

LINDA LAVACHE, EXAMINING ATTORNEY

Int. Cl.: 41

Prior U.S. Cls.: 100, 101 and 107

United States Patent and Trademark Office

Reg. No. 3,482,935

Registered Aug. 12, 2008

**SERVICE MARK
PRINCIPAL REGISTER**

DENALLIX

SOURCECODE TECHNOLOGY HOLDINGS, INC.
(DELAWARE CORPORATION)
4042 148TH AVENUE NE
REDMOND, WA 98052

FOR: EDUCATIONAL SERVICES IN THE NATURE OF EDUCATING CONSUMERS ABOUT BUSINESS PROCESS MANAGEMENT SOFTWARE, NAMELY, WORKFLOW SOLUTION AND PROCESS AUTOMATION SOFTWARE, THROUGH A TUTORIAL SOFTWARE PROGRAM THAT RECREATES A VIRTUAL BUSINESS WEB SITE, IN CLASS 41 (U.S. CLS. 100, 101 AND 107).

FIRST USE 5-1-2007; IN COMMERCE 5-1-2007.

THE MARK CONSISTS OF STANDARD CHARACTERS WITHOUT CLAIM TO ANY PARTICULAR FONT, STYLE, SIZE, OR COLOR.

SER. NO. 77-031,342, FILED 10-27-2006.

HEATHER SAPP, EXAMINING ATTORNEY

Int. Cl.: 41

Prior U.S. Cls.: 100, 101 and 107

United States Patent and Trademark Office

Reg. No. 3,482,936

Registered Aug. 12, 2008

**SERVICE MARK
PRINCIPAL REGISTER**

WORLD MINI GRAND PRIX

HENRICKSEN, RONALD J (UNITED STATES
INDIVIDUAL)

P.O. BOX 759

PERRIS, CA 92572

FOR: ENTERTAINMENT SERVICES, NAMELY,
PERFORMING AND COMPETING IN MOTOR
SPORTS EVENTS, IN CLASS 41 (U.S. CLS. 100, 101
AND 107).

FIRST USE 1-1-1973; IN COMMERCE 1-1-1973.

THE MARK CONSISTS OF STANDARD CHAR-
ACTERS WITHOUT CLAIM TO ANY PARTICULAR
FONT, STYLE, SIZE, OR COLOR.

NO CLAIM IS MADE TO THE EXCLUSIVE
RIGHT TO USE "MINI GRAND PRIX", APART
FROM THE MARK AS SHOWN.

SEC. 2(F) AS TO "WORLD".

SER. NO. 77-032,647, FILED 10-30-2006.

ROBIN CHOSID, EXAMINING ATTORNEY

Int. Cl.: 43

Prior U.S. Cls.: 100 and 101

United States Patent and Trademark Office

Reg. No. 3,482,937

Registered Aug. 12, 2008

**SERVICE MARK
PRINCIPAL REGISTER**

El Patio Mexican Restaurant

EL PATIO RESTAURANT & CLUB, LLC (TEXAS
LTD LIAB CO)
601 W. 6TH STREET
HOUSTON, TX 77007

FOR: RESTAURANT, BAR, AND PREPARED
TAKEOUT FOOD SERVICES, IN CLASS 43 (U.S.
CLS. 100 AND 101).

FIRST USE 12-28-1978; IN COMMERCE 12-28-1978.

THE MARK CONSISTS OF STANDARD CHAR-
ACTERS WITHOUT CLAIM TO ANY PARTICULAR
FONT, STYLE, SIZE, OR COLOR.

NO CLAIM IS MADE TO THE EXCLUSIVE
RIGHT TO USE "MEXICAN RESTAURANT",
APART FROM THE MARK AS SHOWN.

THE ENGLISH TRANSLATION OF THE WORD-
S"EL PATIO" IN THE MARK IS "THE PATIO."

SER. NO. 77-032,986, FILED 10-31-2006.

ERNEST SHOSHO, EXAMINING ATTORNEY

Int. Cl.: 42

Prior U.S. Cls.: 100 and 101

United States Patent and Trademark Office

Reg. No. 3,482,938

Registered Aug. 12, 2008

**SERVICE MARK
PRINCIPAL REGISTER**

FACETS

THE TRIZETTO GROUP, INC. (DELAWARE CORPORATION)
567 SAN NICOLAS DRIVE, SUITE 360
NEWPORT BEACH, CA 92660

FOR: APPLICATION SERVICE PROVIDER (ASP) FEATURING SOFTWARE FOR HEALTH CARE PLAN MANAGEMENT AND ADMINISTRATION; IMPLEMENTATION, MAINTENANCE AND SUPPORT OF COMPUTER SOFTWARE; APPLICATION SERVICE PROVIDER (ASP) FEATURING SOFTWARE FOR CLAIMS AND BENEFITS ADMINISTRATION FOR MEDICARE AND MEDICAID MANAGED CARE, IN CLASS 42 (U.S. CLS. 100 AND 101).

FIRST USE 7-12-1993; IN COMMERCE 7-12-1993.

THE MARK CONSISTS OF STANDARD CHARACTERS WITHOUT CLAIM TO ANY PARTICULAR FONT, STYLE, SIZE, OR COLOR.

OWNER OF U.S. REG. NOS. 3,019,804 AND 3,081,641.

SER. NO. 77-033,881, FILED 11-1-2006.

MIDGE BUTLER, EXAMINING ATTORNEY

Int. Cl.: 21

Prior U.S. Cls.: 2, 13, 23, 29, 30, 33, 40 and 50

United States Patent and Trademark Office

Reg. No. 3,482,939

Registered Aug. 12, 2008

**TRADEMARK
PRINCIPAL REGISTER**

CHUCK FISCHER

CHUCK FISCHER STUDIO, INC. (NEW YORK CORPORATION)
2715 NORTH OCEAN BLVD.
FORT LAUDERDALE, FL 33308

FOR: GLASSWARE, NAMELY, BEVERAGE GLASSWARE; CERAMIC ITEMS, NAMELY, COOKIE JARS, TEA POTS, TEACUPS AND SAUCERS, DECORATIVE FIGURINES, CREAM AND SUGAR HOLDERS, SALT AND PEPPER HOLDERS; FINE CHINA DINNERWARE; DINNERWARE, NAMELY, PLATES, BOWLS, PITCHERS, CREAM AND SUGAR HOLDERS, MUGS, CUPS, AND SAUCERS; PLATTERS, NAMELY, SERVING PLATTERS, IN CLASS 21 (U.S. CLS. 2, 13, 23, 29, 30, 33, 40 AND 50).

FIRST USE 0-0-2002; IN COMMERCE 0-0-2002.

THE MARK CONSISTS OF STANDARD CHARACTERS WITHOUT CLAIM TO ANY PARTICULAR FONT, STYLE, SIZE, OR COLOR.

THE NAME(S), PORTRAIT(S), AND/OR SIGNATURE(S) SHOWN IN THE MARK IDENTIFIES "CHUCK FISCHER", WHOSE CONSENT(S) TO REGISTER IS SUBMITTED.

SER. NO. 77-034,928, FILED 11-2-2006.

GEORGE LORENZO, EXAMINING ATTORNEY

Int. Cl.: 41

Prior U.S. Cls.: 100, 101 and 107

United States Patent and Trademark Office

Reg. No. 3,482,940

Registered Aug. 12, 2008

**SERVICE MARK
PRINCIPAL REGISTER**

Street Gangs

ALONSO, ALEX (UNITED STATES INDIVIDUAL)
BOX 18238
LOS ANGELES, CA 90018

FOR: ENTERTAINMENT SERVICES, NAMELY, PROVIDING A WEB SITE FEATURING MUSICAL PERFORMANCES, MUSICAL VIDEOS, RELATED FILM CLIPS, PHOTOGRAPHS, AND OTHER MULTIMEDIA MATERIALS, IN CLASS 41 (U.S. CLS. 100, 101 AND 107).

FIRST USE 10-31-1998; IN COMMERCE 11-1-1998.

THE MARK CONSISTS OF STANDARD CHARACTERS WITHOUT CLAIM TO ANY PARTICULAR FONT, STYLE, SIZE, OR COLOR.

SER. NO. 77-037,044, FILED 11-5-2006.

ANDREA K. NADELMAN, EXAMINING ATTORNEY

Int. Cls.: 5, 30 and 32

Prior U.S. Cls.: 6, 18, 44, 45, 46, 48, 51 and 52

United States Patent and Trademark Office

Reg. No. 3,482,941

Registered Aug. 12, 2008

**TRADEMARK
PRINCIPAL REGISTER**



PATRONYK, RYAN M (UNITED STATES INDIVIDUAL)

1448 CRESTLI NE DR.

SANTA BARBARA, CA 93105

FOR: NUTRITIONAL SUPPLEMENTS IN BEVERAGE FORM USED AS A MEAL SUPPLEMENT, NAMELY, WHEATGRASS JUICES, IN CLASS 5 (U.S. CLS. 6, 18, 44, 46, 51 AND 52).

FIRST USE 4-14-2005; IN COMMERCE 4-14-2005.

FOR: ORGANIC GOURMET COFFEE, ESPRESSO BASED DRINKS AND COFFEE BEANS, IN CLASS 30 (U.S. CL. 46).

FIRST USE 4-14-2005; IN COMMERCE 4-14-2005.

FOR: BEVERAGES, NAMELY, SMOOTHIES USING FRESH AND FROZEN FRUITS, JUICES, ICES, ICE CREAM, AND MILK; FRUIT JUICES; VEGETABLE JUICES, IN CLASS 32 (U.S. CLS. 45, 46 AND 48).

FIRST USE 4-14-2005; IN COMMERCE 4-14-2005.

"THE COLOR(S) YELLOW, BROWN, BLACK, WHITE AND GREEN IS/ARE CLAIMED AS A FEATURE OF THE MARK."

"THE MARK CONSISTS OF HALF A BROWN COFFEE BEAN WITH BROWN STEAM COMING OUT OF THE TOP, HALF A YELLOW PINEAPPLE WITH A GREEN LEAF COMING OUT OF THE TOP, WHITE ACCENTS, AND THE WORD CAJE IN BLACK UNDER THE DESIGN."

THE WORDING IN THE MARK HAS NO MEANING IN A FOREIGN LANGUAGE.

SER. NO. 77-037,109, FILED 11-5-2006.

HENRY S. ZAK, EXAMINING ATTORNEY

Int. Cl.: 35

Prior U.S. Cls.: 100, 101 and 102

United States Patent and Trademark Office

Reg. No. 3,482,942

Registered Aug. 12, 2008

**SERVICE MARK
PRINCIPAL REGISTER**

HomeStudioMusician

HOMESTUDIOMUSICIAN, LLC (KANSAS LTD
LIAB CO)
2135 E. 151ST ST.
#327
OLATHE, KS 66062

FOR: ON-LINE RETAIL STORE SERVICES FEATURING MUSICAL EQUIPMENT, NAMELY, COMPUTER RECORDING INTERFACES, MICROPHONES, SPEAKERS, SOFTWARE, BOOKS AND DVD'S FOR THE HOME RECORDING MUSICIAN, IN CLASS 35 (U.S. CLS. 100, 101 AND 102).

FIRST USE 7-2-2002; IN COMMERCE 10-2-2002.

THE MARK CONSISTS OF STANDARD CHARACTERS WITHOUT CLAIM TO ANY PARTICULAR FONT, STYLE, SIZE, OR COLOR.

SER. NO. 77-037,699, FILED 11-6-2006.

ANTHONY RINKER, EXAMINING ATTORNEY

Int. Cl.: 37

Prior U.S. Cls.: 100, 103 and 106

United States Patent and Trademark Office

Reg. No. 3,482,943

Registered Aug. 12, 2008

SERVICE MARK
PRINCIPAL REGISTER

NAVHOUSE
CORPORATION

NAVHOUSE CORPORATION (CANADA CORPORATION)
10 LORING DRIVE
BOLTON, CANADA L7E1J9

FOR: AVIONICS REPAIR AND OVERHAUL SERVICES; REPAIR AND OVERHAUL OF INERTIAL NAVIGATION UNITS (INU), SUBASSEMBLIES AND INSTRUMENTS INCLUDING SYSTEMS, PLATFORMS, GYROS, ACCELEROMETERS, CDUS, MSUS AND ELECTRONICS FOR CIVIL AVIATION INDUSTRY, INCLUDING COMMERCIAL AIRLINES, AND LARGE BUSINESS AIRCRAFT AS WELL AS FOR THE DEFENSE INDUSTRY INCLUDING MILITARY AIRCRAFT, NAVAL VESSELS, AND SURFACE VEHICLES; AVIONICS MAINTENANCE, IN CLASS 37 (U.S. CLS. 100, 103 AND 106).

FIRST USE 0-0-1997; IN COMMERCE 0-0-1997.

PRIORITY CLAIMED UNDER SEC. 44(D) ON CANADA APPLICATION NO. 1321853, FILED 10-27-2006, REG. NO. TMA698584, DATED 10-15-2007, EXPIRES 10-15-2022.

NO CLAIM IS MADE TO THE EXCLUSIVE RIGHT TO USE "CORPORATION", APART FROM THE MARK AS SHOWN.

SER. NO. 77-037,802, FILED 11-6-2006.

NATALIE POLZER, EXAMINING ATTORNEY

Int. Cls.: 9 and 42

Prior U.S. Cls.: 21, 23, 26, 36, 38, 100 and 101

Reg. No. 3,482,944

United States Patent and Trademark Office

Registered Aug. 12, 2008

**TRADEMARK
SERVICE MARK
PRINCIPAL REGISTER**



VIDEOB HOLDINGS LIMITED (BR.VIRGIN ISLANDS CORPORATION)
ST. GEORGE'S COURT, UPPER CHURCH STREET
DOUGLAS, ISLE OF MAN

FOR: COMPUTER SOFTWARE PLATFORM FOR INCORPORATING SINGLE OR MULTIPLE APPLICATIONS FEATURING FUNCTIONAL AND GRAPHICAL ELEMENTS IN THE GAMBLING FIELD; COMPUTER SOFTWARE FOR THE PROVISION OF MANAGEMENT, USE AND ACCESS OF PARTICIPANTS TO ON-LINE MULTIMEDIA ACTIVITIES IN THE ON-LINE GAMBLING FIELD; COMPUTER APPLICATION SOFTWARE FOR MOBILE PHONES IN THE ON-LINE GAMBLING FIELD; COMPUTER HARDWARE, ELECTRONIC COMPONENTS FOR COMPUTERS, ELECTRONIC COMPONENTS FOR GAMING MACHINES, COMPUTER PERIPHERAL EQUIPMENT, AND ELECTRONIC COMPONENTS FOR GAMBLING MACHINES DESIGNED AND ADAPTED FOR USE WITH COMPUTER AND ELECTRONIC GAMES APPARATUS, NAMELY, SLOT MACHINES AND JUKEBOXES AND GAMING MACHINES; ELECTRIC APPARATUS AND INSTRUMENTS, NAMELY, SLOT MACHINES, JUKEBOXES, GAMING MACHINE AND GAMBLING MACHINES; AUTOMATIC VENDING MACHINES AND MECHANISMS FOR COIN-OPERATED APPARATUS IN THE GAMBLING FIELD, IN CLASS 9 (U.S. CLS. 21, 23, 26, 36 AND 38).

FOR: COMPUTER SOFTWARE RESEARCH, DEVELOPMENT AND DESIGN OF A COMPUTER UNIFIED SOFTWARE PLATFORM INCORPORATING A SINGLE OR MULTIPLE APPLICATIONS

FEATURING FUNCTIONAL AND GRAPHICAL ELEMENTS IN THE GAMBLING FIELD; PROVIDING TEMPORARY USE OF NON-DOWNLOADABLE COMPUTER SOFTWARE FOR THE PROVISION OF MANAGEMENT, USE AND ACCESS OF PARTICIPANTS TO ON-LINE MULTIMEDIA ACTIVITIES IN THE ON-LINE GAMBLING FIELD; PROVIDING TEMPORARY USE OF NON-DOWNLOADABLE COMPUTER APPLICATION SOFTWARE FOR MOBILE PHONES IN THE ON-LINE GAMBLING FIELD, IN CLASS 42 (U.S. CLS. 100 AND 101).

OWNER OF ERPN CMNTY TM OFC REG. NO. 5448055, DATED 12-20-2007, EXPIRES 8-11-2016.

NO CLAIM IS MADE TO THE EXCLUSIVE RIGHT TO USE "VIDEO BET", APART FROM THE MARK AS SHOWN.

THE APPLICANT CLAIMS COLOR AS A FEATURE OF THE MARK, NAMELY, BLUE, RED, GREEN, LIGHT BLUE.

THE MARK CONSISTS OF AN OVAL LOGO COLORED RED, GREEN AND BLUE AND THE STYLIZED WORD "VIDEOBET" IN THE COLOR LIGHT BLUE.

SER. NO. 77-038,151, FILED 11-7-2006.

STEVEN JACKSON, EXAMINING ATTORNEY

Int. Cl.: 16

Prior U.S. Cls.: 2, 5, 22, 23, 29, 37, 38 and 50

Reg. No. 3,482,945

United States Patent and Trademark Office

Registered Aug. 12, 2008

**TRADEMARK
PRINCIPAL REGISTER**

The Dibble Company

THE DIBBLE COMPANY, LLC (MICHIGAN LTD
LIAB CO)
656 LYNNDALE CT.
ROCHESTER HILLS, MI 48309

FOR: BLANK JOURNAL BOOKS; GREETING
CARDS; PRINTED CALENDARS, IN CLASS 16
(U.S. CLS. 2, 5, 22, 23, 29, 37, 38 AND 50).

FIRST USE 12-15-2005; IN COMMERCE 12-15-2005.

THE MARK CONSISTS OF STANDARD CHAR-
ACTERS WITHOUT CLAIM TO ANY PARTICULAR
FONT, STYLE, SIZE, OR COLOR.

NO CLAIM IS MADE TO THE EXCLUSIVE
RIGHT TO USE "COMPANY", APART FROM THE
MARK AS SHOWN.

SER. NO. 77-038,290, FILED 11-7-2006.

STEVEN PEREZ, EXAMINING ATTORNEY

Int. Cls.: 37 and 40

Prior U.S. Cls.: 100, 103 and 106

United States Patent and Trademark Office

Reg. No. 3,482,946

Registered Aug. 12, 2008

**SERVICE MARK
PRINCIPAL REGISTER**

HEMMA

HEMMA CONCRETE, INC. (GEORGIA CORPORATION)
SUITE A
1691 SANDS PLACE
MARIETTA, GA 30067

FOR: DECORATIVE CONCRETE AND PAVER SOLUTIONS SERVICES, NAMELY, BROOM FINISH CONCRETE WORK, EXPOSED AGGREGATE SERVICES, IN THE NATURE OF CONCRETE LAYING, CONCRETE RESURFACING SERVICES, OVERLAYMENTS, AND COLORED CONCRETE WORK FOR DRIVEWAYS, PATIOS, POOL DECKS, WALKWAYS, SLABS, PARKING LOTS AND WALLS CONSTRUCTION SERVICES, IN CLASS 37 (U.S. CLS. 100, 103 AND 106).

FIRST USE 1-1-2002; IN COMMERCE 4-1-2003.

FOR: CONCRETE AND ASPHALT STAMPING SERVICES; CHEMICAL STAINING FOR DRIVEWAYS, PATIOS, POOL DECKS, WALKWAYS, SLABS, PARKING LOTS AND WALLS, IN CLASS 40 (U.S. CLS. 100, 103 AND 106).

FIRST USE 1-1-2002; IN COMMERCE 4-1-2003.

THE MARK CONSISTS OF STANDARD CHARACTERS WITHOUT CLAIM TO ANY PARTICULAR FONT, STYLE, SIZE, OR COLOR.

SER. NO. 77-038,308, FILED 11-7-2006.

ZACHARY BELLO, EXAMINING ATTORNEY

Int. Cl.: 26

Prior U.S. Cls.: 37, 39, 40, 42 and 50

Reg. No. 3,482,947

United States Patent and Trademark Office

Registered Aug. 12, 2008

**TRADEMARK
PRINCIPAL REGISTER**



KILBRIDE, TIM (MICHIGAN PARTNERSHIP)
51081 MOUND RD.
SHELBY TOWNSHIP, MI 48316 AND
KILBRIDE, GEORGINA (MICHIGAN PARTNER-
SHIP)
51081 MOUND RD.
SHELBY TOWNSHIP, MI 48316

FOR: EMBROIDERED EMBLEMS, IN CLASS 26
(U.S. CLS. 37, 39, 40, 42 AND 50).

FIRST USE 5-15-2006; IN COMMERCE 6-1-2006.

NO CLAIM IS MADE TO THE EXCLUSIVE
RIGHT TO USE "PATCHES", APART FROM THE
MARK AS SHOWN.

THE COLOR(S) KELLY GREEN, ORANGE, RED,
BLACK, WHITE AND PINK IS/ARE CLAIMED AS A
FEATURE OF THE MARK.

THE MARK CONSISTS OF A MOUTH WITH RED
LIPS, WHITE TEETH, PINK GUMS AND A BLACK
OPENING. THE WORDS "PATCHES" AND "LOUD"
IN ORANGE. THE WORD "OUT" IN KELLY GREEN
AND THE WORD ".COM" IN WHITE.

SER. NO. 77-038,870, FILED 11-7-2006.

KATHERINE CONNOLLY, EXAMINING ATTOR-
NEY

Int. Cl.: 35

Prior U.S. Cls.: 100, 101 and 102

Reg. No. 3,482,948

United States Patent and Trademark Office

Registered Aug. 12, 2008

**SERVICE MARK
PRINCIPAL REGISTER**

NPU

NIPPON PAINT (USA) INC. (DELAWARE COR-
PORATION)
GLENPOINTE CENTRE EAST
300 FRANK W. BURR BLVD.
TEANECK, NJ 076666895

THE MARK CONSISTS OF STANDARD CHAR-
ACTERS WITHOUT CLAIM TO ANY PARTICULAR
FONT, STYLE, SIZE, OR COLOR.

FOR: BUSINESS OPERATION, BUSINESS AD-
MINISTRATION AND OFFICE FUNCTIONS, IN
CLASS 35 (U.S. CLS. 100, 101 AND 102).

SER. NO. 77-039,719, FILED 11-8-2006.

FIRST USE 12-31-1990; IN COMMERCE 12-31-1990.

KELLY BOULTON, EXAMINING ATTORNEY

Int. Cl.: 36

Prior U.S. Cls.: 100, 101 and 102

United States Patent and Trademark Office

Reg. No. 3,482,949

Registered Aug. 12, 2008

SERVICE MARK
PRINCIPAL REGISTER



MASRAF AL-RAYAN (QATAR CORPORATION)
P.O. BOX 28888
DOHA, QATAR

FOR: BANKING; INSURANCE UNDERWRITING SERVICES FOR ALL TYPES OF INSURANCE; FINANCIAL ANALYSIS; MONETARY EXCHANGE; ASSESSMENT AND MANAGEMENT OF REAL ESTATE; REAL ESTATE AGENCIES, IN CLASS 36 (U.S. CLS. 100, 101 AND 102).

OWNER OF QATAR REG. NO. 41142, DATED 6-12-2007, EXPIRES 9-5-2016.

NO CLAIM IS MADE TO THE EXCLUSIVE RIGHT TO USE "MASRAF", APART FROM THE MARK AS SHOWN.

THE NAME MASRAF AL RAYAN DOES NOT IDENTIFY A LIVING INDIVIDUAL.

THE MARK CONSISTS OF THE WORDS MASRAF AL RAYAN AND ITS ARABIC EQUIVALENT WITH A SEMI CIRCLES DESIGN.

"THE FOREIGN WORDING IN THE MARK TRANSLATES INTO ENGLISH AS AL RAYAN BANK."

SER. NO. 77-040,855, FILED 11-9-2006.

ALEXANDER L. POWERS, EXAMINING ATTORNEY

Int. Cl.: 9

Prior U.S. Cls.: 21, 23, 26, 36 and 38

Reg. No. 3,482,950

United States Patent and Trademark Office

Registered Aug. 12, 2008

**TRADEMARK
PRINCIPAL REGISTER**

LANDNOVA

NOVATRON OY (FINLAND LIMITED COMPANY)
JUVANKATU 6
FL-33710 TAMPERE, FINLAND

FOR: SURVEYING MACHINES AND INSTRUMENTS; ELECTRONIC, OPTICAL AND LASER MEASUREMENT DEVICES IN THE FIELD OF CIVIL ENGINEERING AND SURVEYING; SENSORS FOR THE DETERMINATION OF POSITIONS, SENSORS FOR THE DETERMINATION OF DISTANCES, TILT SENSORS, INSTRUMENTS FOR MEASURING LENGTH, INSTRUMENTS FOR DETERMINATION OF COORDINATES, POSITION FINDING AND LOCATING DEVICES IN THE FORM OF COMPUTERS, ALL TO BE USED IN THE FIELD OF CIVIL ENGINEERING AND SURVEYING; FIELD COMPUTERS AND GRAPHIC DISPLAY DEVICES TO BE USED IN CIVIL ENGINEERING AND SURVEYING; APPARATUS FOR RECORDING, TRANSMISSION OR REPRODUCTION OF IMAGES IN THE FIELD OF CIVIL ENGINEERING AND SURVEYING; COMPUTER SOFTWARE, PROGRAMS AND APPLICATIONS FOR HANDLING, SORTING AND STORING INFORMATION NEEDED IN SURVEYING AND CIVIL ENGINEERING, COMPUTER PROGRAMS FOR MONITORING, LOGGING AND VIEWING DIFFERENT FUNCTIONS, SETTINGS AND PARAMETERS OF CIVIL ENGINEERING MACHINES; COMPUTER SOFTWARE FOR PROCESSING IMAGES, GRAPHICS AND TEXT; COMPUTER PROGRAMS RECORDED ON DATA MEDIA (SOFTWARE), COMPUTER PROGRAMS FOR USE

IN HANDLING GEOGRAPHIC INFORMATION; ALL AFORESAID PROGRAMS TO BE USED IN THE FIELD OF CIVIL ENGINEERING AND SURVEYING; SENSORS FOR THE DETERMINATION OF POSITIONS, SENSORS FOR THE DETERMINATION OF DISTANCES, TILT SENSORS, INSTRUMENTS FOR MEASURING LENGTH, INSTRUMENTS FOR DETERMINATION OF COORDINATES, POSITION FINDING AND LOCATING DEVICES IN THE FORM OF COMPUTERS, ALL TO BE USED IN CIVIL ENGINEERING MACHINES; NAVIGATION APPARATUS FOR CIVIL ENGINEERING MACHINES IN THE FORM OF ON-BOARD COMPUTERS, ON-BOARD GRAPHIC DISPLAY DEVICES FOR CIVIL ENGINEERING MACHINES; SIGNAL TRANSMITTERS AND RECEIVERS FOR REMOTE CONTROL TO BE USED IN CIVIL ENGINEERING MACHINES, IN CLASS 9 (U.S. CLS. 21, 23, 26, 36 AND 38).

THE MARK CONSISTS OF STANDARD CHARACTERS WITHOUT CLAIM TO ANY PARTICULAR FONT, STYLE, SIZE, OR COLOR.

PRIORITY CLAIMED UNDER SEC. 44(D) ON ERPN CMNTY TM OFC APPLICATION NO. 5070198, FILED 5-11-2006, REG. NO. 005070198, DATED 5-4-2007, EXPIRES 5-11-2016.

SER. NO. 77-041,212, FILED 11-10-2006.

STEVEN JACKSON, EXAMINING ATTORNEY

Int. Cl.: 28

Prior U.S. Cls.: 22, 23, 38 and 50

United States Patent and Trademark Office

Reg. No. 3,482,951

Registered Aug. 12, 2008

**TRADEMARK
PRINCIPAL REGISTER**

HUVRBLIND

BANDED MALLARD CO. (ARKANSAS CORPORATION)
310 ORANGE STREET
AUSTIN, AR 72007

THE MARK CONSISTS OF STANDARD CHARACTERS WITHOUT CLAIM TO ANY PARTICULAR FONT, STYLE, SIZE, OR COLOR.

FOR: DUCK BLINDS; FIELD BLINDS USED IN HUNTING; FISHING FLOATS; HUNTING BLINDS; INFLATABLE FLOAT TUBES FOR FISHING, IN CLASS 28 (U.S. CLS. 22, 23, 38 AND 50).

SER. NO. 77-042,032, FILED 11-11-2006.

FIRST USE 7-15-2006; IN COMMERCE 11-10-2006.

STEVEN PEREZ, EXAMINING ATTORNEY

Int. Cl.: 9

Prior U.S. Cls.: 21, 23, 26, 36 and 38

United States Patent and Trademark Office

Reg. No. 3,482,952

Registered Aug. 12, 2008

**TRADEMARK
PRINCIPAL REGISTER**

OLIVE OPUS

OLIVE MEDIA PRODUCTS INC. (CALIFORNIA CORPORATION)
555 HOWARD STREET
SAN FRANCISCO, CA 94105

FOR: COMPACT DISC PLAYERS; COMPUTER SOFTWARE FOR PROCESSING DIGITAL MUSIC FILES; DOWNLOADABLE MP3 FILES, MP3 RECORDINGS, ONLINE DISCUSSION BOARDS, WEB CASTS, POD CASTS, WEBINARS FEATURING MUSIC, AUDIO BOOKS AND NEWS BROADCASTS; JUKE BOXES; NETWORK ACCESS SERVER HARDWARE, IN CLASS 9 (U.S. CLS. 21, 23, 26, 36 AND 38).

FIRST USE 1-6-2006; IN COMMERCE 1-6-2006.

THE MARK CONSISTS OF STANDARD CHARACTERS WITHOUT CLAIM TO ANY PARTICULAR FONT, STYLE, SIZE, OR COLOR.

OWNER OF U.S. REG. NOS. 3,032,935, 3,151,000, AND 3,151,002.

SER. NO. 77-042,524, FILED 11-13-2006.

STEVEN PEREZ, EXAMINING ATTORNEY

Int. Cls.: 43, 44 and 45

Prior U.S. Cls.: 100 and 101

United States Patent and Trademark Office

Reg. No. 3,482,953

Registered Aug. 12, 2008

**SERVICE MARK
PRINCIPAL REGISTER**



THE VILLAGE FOR FAMILIES & CHILDREN,
INC. (CONNECTICUT CHARITABLE, NON-
PROFIT CORPORATION)
1680 ALBANY AVENUE
HARTFORD, CT 06105

FOR: RESIDENTIAL SERVICES FOR CHILDREN
AND FAMILIES IN THE NATURE OF INTERMEDI-
ATE CARE FACILITIES, NAMELY, COMMUNITY
RESIDENCES AND OFFERING SHELTER FOR
TROUBLED CHILDREN AND YOUTH, AND FA-
MILY HOUSING ALTERNATIVES, IN CLASS 43
(U.S. CLS. 100 AND 101).

FIRST USE 2-1-2004; IN COMMERCE 4-1-2004.

FOR: PROVIDING SCHOOL-BASED YOUTH
AND FAMILY DEVELOPMENT CENTERS, NAME-
LY, NON-RESIDENTIAL OUT-PATIENT MENTAL
HEALTH SERVICES FOR CHILDREN AND
ADULTS; FAMILY SUPPORT AND PREVENTION

SERVICES, NAMELY, MENTAL HEALTH SERVI-
CES AND COUNSELING IN THE FIELD OF DRUG
REHABILITATION AND PREVENTION , IN CLASS
44 (U.S. CLS. 100 AND 101).

FIRST USE 2-1-2004; IN COMMERCE 4-1-2004.

FOR: CHILD WELFARE AGENCY SERVICES,
NAMELY, SPECIALIZED FOSTER CARE AND
ADOPTION PLACEMENT SERVICES, IN CLASS 45
(U.S. CLS. 100 AND 101).

FIRST USE 2-1-2004; IN COMMERCE 4-1-2004.

THE MARK CONSISTS OF A SKETCH OF A
FAMILY UNDER A HOUSE ROOF.

SER. NO. 77-042,684, FILED 11-13-2006.

RENEE MCCRAY, EXAMINING ATTORNEY

Int. Cls.: 43, 44 and 45

Prior U.S. Cls.: 100 and 101

United States Patent and Trademark Office

Reg. No. 3,482,954

Registered Aug. 12, 2008

SERVICE MARK
PRINCIPAL REGISTER



THE VILLAGE FOR FAMILIES & CHILDREN,
INC. (CONNECTICUT CHARITABLE, NON-
PROFIT CORPORATION)

1680 ALBANY AVENUE
HARTFORD, CT 06105

FOR: RESIDENTIAL SERVICES FOR CHILDREN
AND FAMILIES IN THE NATURE OF INTERMEDI-
ATE CARE FACILITIES, NAMELY, COMMUNITY
RESIDENCES AND OFFERING SHELTER FOR
TROUBLED CHILDREN AND YOUTH, AND FA-
MILY HOUSING ALTERNATIVES, IN CLASS 43
(U.S. CLS. 100 AND 101).

FIRST USE 2-1-2004; IN COMMERCE 4-1-2004.

FOR: PROVIDING SCHOOL-BASED YOUTH
AND FAMILY DEVELOPMENT CENTERS, NAME-
LY, NON-RESIDENTIAL OUT-PATIENT MENTAL
HEALTH SERVICES FOR CHILDREN AND
ADULTS; FAMILY SUPPORT AND PREVENTION
SERVICES, NAMELY, MENTAL HEALTH SERVI-
CES AND COUNSELING IN THE FIELD OF DRUG

REHABILITATION AND PREVENTION , IN CLASS
44 (U.S. CLS. 100 AND 101).

FIRST USE 2-1-2004; IN COMMERCE 4-1-2004.

FOR: CHILD WELFARE AGENCY SERVICES,
NAMELY, SPECIALIZED FOSTER CARE AND
ADOPTION PLACEMENT SERVICES, IN CLASS 45
(U.S. CLS. 100 AND 101).

FIRST USE 2-1-2004; IN COMMERCE 4-1-2004.

OWNER OF U.S. REG. NO. 2,485,806.

NO CLAIM IS MADE TO THE EXCLUSIVE
RIGHT TO USE "VILLAGE" AND "FAMILIES &
CHILDREN SINCE 1809", APART FROM THE
MARK AS SHOWN.

SER. NO. 77-043,225, FILED 11-14-2006.

RENEE MCCRAY, EXAMINING ATTORNEY

Int. Cl.: 42

Prior U.S. Cls.: 100 and 101

United States Patent and Trademark Office

Reg. No. 3,482,955

Registered Aug. 12, 2008

**SERVICE MARK
PRINCIPAL REGISTER**

MetaLogic Solutions

METALOGIC SOLUTIONS, INC. (ILLINOIS CORPORATION)
32ND FLOOR
131 SOUTH DEARBORN STREET
CHICAGO, IL 60603

FOR: BUSINESS INTELLIGENCE SOLUTIONS DEVELOPMENT, NAMELY, DEVELOPING BUSINESS INTELLIGENCE COMPUTER SOFTWARE FOR DATA ANALYSIS, REPORTING AND DATA MANAGEMENT; DESIGN OF BUSINESS INTELLIGENCE SOLUTIONS COMPUTER SOFTWARE BY USING UTILITY PROGRAMS THAT ARE INTENDED TO FACILITATE BUSINESS AND CONSUMER USER ACCESS TO LIVE AND STORED DATA AND TO SIMPLIFY E-COMMERCE PLATFORMS; MAINTENANCE OF BUSINESS INTELLIGENCE SOFTWARE; TECHNICAL SUPPORT SERVICES, NAMELY, TROUBLESHOOTING OF BUSINESS INTELLIGENCE SOFTWARE PROBLEMS VIA TELEPHONE, GLOBAL COMPUTER NETWORK, LOCAL

AREA NETWORK OR ON-SITE EXAMINATION OR A COMBINATION OF ANY OF THE ABOVE; COMPUTER CONSULTATION ON HOW TO SIMPLIFY ACCESS TO DATA AND IMPROVE PERFORMANCE OF BUSINESS INTELLIGENCE COMPUTER SOFTWARE, IN CLASS 42 (U.S. CLS. 100 AND 101).

FIRST USE 5-8-2000; IN COMMERCE 5-8-2000.

THE MARK CONSISTS OF STANDARD CHARACTERS WITHOUT CLAIM TO ANY PARTICULAR FONT, STYLE, SIZE, OR COLOR.

OWNER OF U.S. REG. NO. 2,801,280.

SER. NO. 77-043,335, FILED 11-14-2006.

TINA BROWN, EXAMINING ATTORNEY

Int. Cls.: 3, 5 and 30

Prior U.S. Cls.: 1, 4, 6, 18, 44, 46, 50, 51 and 52

United States Patent and Trademark Office

Reg. No. 3,482,956

Registered Aug. 12, 2008

TRADEMARK
PRINCIPAL REGISTER



YUNNAN BAIYAO GROUP CO., LTD. (CHINA CORPORATION)

STATE HIGH & NEW TECHNOLOGY ZONE
KUNMING, CHINA

FOR: HAIR LOTIONS; DISINFECTANT SOAP; SHAMPOOS; CAKES OF TOILET SOAP; BATH SALTS, NOT FOR MEDICAL PURPOSES; HAND CLEANERS; FACIAL CLEANSING LOTION; BATH LOTION; NON-MEDICATED MICROORGANISM-SUPPRESSING HAND WASH, NAMELY, ANTIBACTERIAL HANDWASH; WASHING PREPARATIONS, NAMELY, WASHING POWDER AND WASHING-UP LIQUIDS; STAIN REMOVERS; POLISHING PREPARATIONS; SHINING PREPARATIONS, NAMELY, POLISH FOR FURNITURE, FLOORS AND LEATHER; GRINDING PREPARATIONS, NAMELY, GENERAL PURPOSE POLISHING AND ABRASIVE LIQUIDS AND POWDERS; ESSENTIAL OILS; ROSE OIL FOR COSMETIC PURPOSES; INDUSTRIAL PERFUMES; COSMETIC AROMATIC INGREDIENTS, NAMELY, PERFUMERY AND PERFUME OILS; BEAUTY MASKS; SKIN WHITENING CREAMS; MAKE-UP PREPARATIONS; COSMETICS; MAKE-UP REMOVING PREPARATIONS; TOILET WATER; OILS FOR COSMETIC PURPOSES, NAMELY, COSMETIC OILS; LOTIONS FOR COSMETIC PURPOSES, NAMELY, FACE, BODY AND HAND LOTIONS; COSMETIC PREPARATIONS FOR SLIMMING PURPOSES, NAMELY, CREAMS FOR CELLULITE REDUCTION AND LOTIONS FOR CELLULITE REDUCTION; SUN-TANNING PREPARATIONS; ANTI-WRINKLE CREAMS; FRECKLE REMOVING CREAMS; MOUTH WASHES, NOT FOR MEDICAL PURPOSES; DENTIFRICES; PREPARATIONS FOR CLEANING DENTURES; DENTURE POLISHES; BREATH FRESHENING SPRAYS; INCENSE; POTPOURRIS; COSMETICS FOR ANIMALS, IN CLASS 3 (U.S. CLS. 1, 4, 6, 50, 51 AND 52).

FOR: MEDICINES FOR HUMAN PURPOSES, NAMELY, MEDICINES FOR USE IN THE TREATMENT OF TRAUMATIC INJURIES, BLEEDING WOUNDS, GYNECOLOGICAL DISEASES, EPISTAXIS, BRONCHIAL DILATING, PULMONARY TUBERCULOSIS, PNEUMONIA, GASTROINTESTINAL TRACT HEMORRHAGE, ARREST BLEEDING, ANTI-INFLAMMATION, HEALING OF A WOUND, CHILBLAIN, HELP HEALING OF FRACTURE, MOTOR IMPAIRMENT, PAIN FROM RHEUMATISM, INJURY OF BONES, JOINTS AND SOFT TISSUE, MOSQUITO AND INSECT BITES, SWELLING AND PAIN DUE TO BLOOD STASIS, AND LUMBAR MUSCLE STRAIN; CAPSULES FOR PHARMACEUTICAL PURPOSES, NAMELY, CAPSULES CONTAINING MEDICINES AND PHARMACEUTICAL PREPARATIONS FOR USE IN THE TREATMENT OF TRAUMATIC INJURIES, BLEEDING WOUNDS, GYNECOLOGICAL DISEASES, EPISTAXIS, BRONCHIAL DILATING, PULMONARY TUBERCULOSIS, PNEUMONIA, GASTROINTESTINAL TRACT HEMORRHAGE, ARREST BLEEDING, ANTI-INFLAMMATION, HEALING OF A WOUND, CHILBLAIN, HELP HEALING OF FRACTURE, MOTOR IMPAIRMENT, PAIN FROM RHEUMATISM, INJURY OF BONES, JOINTS AND SOFT TISSUE, MOSQUITO AND INSECT BITES, SWELLING AND PAIN DUE TO BLOOD STASIS, AND LUMBAR MUSCLE STRAIN; PHARMACEUTICAL PREPARATIONS FOR USE IN THE TREATMENT OF TRAUMATIC INJURIES, BLEEDING WOUNDS, GYNECOLOGICAL DISEASES, EPISTAXIS, BRONCHIAL DILATING, PULMONARY TUBERCULOSIS, PNEUMONIA, GASTROINTESTINAL TRACT HEMORRHAGE, ARREST BLEEDING, ANTI-INFLAMMATION, HEALING OF A WOUND, CHILBLAIN, HELP HEALING OF FRACTURE, MOTOR IMPAIRMENT, PAIN FROM RHEUMATISM, INJURY OF BONES, JOINTS AND SOFT TISSUE, MOSQUITO AND INSECT BITES, SWELLING AND PAIN DUE TO BLOOD STASIS, AND LUMBAR MUSCLE STRAIN; NERVINES, NAMELY,

FIRST USE 7-1-2003; IN COMMERCE 3-15-2006.

NERVE CALMING PREPARATION AND PHARMACEUTICAL PREPARATIONS ACTING ON THE CENTRAL NERVOUS SYSTEM; GERMICIDES; MEDICINAL HERBS IN DRIED OR PRESERVED FORM; STYPTIC PREPARATIONS; BIOLOGICAL PREPARATIONS FOR MEDICAL PURPOSES; MEDICAL PREPARATIONS FOR SLIMMING PURPOSES; MEDICINES FOR DENTAL PURPOSES, NAMELY, MEDICINES FOR USE IN TREATMENT OF PAIN IN THE GUMS AND PERIODONTIA; EDIBLE PLANT FIBRES, NAMELY, PLANT EXTRACTS FOR MEDICAL AND PHARMACEUTICAL PURPOSES; RAW MEDICINES, NAMELY, RAW MATERIALS PHARMACEUTICALS, NAMELY, MEDICINAL HERBAL EXTRACTS FOR MEDICAL PURPOSES, VITAMIN AND MINERAL PREPARATIONS FOR USE AS INGREDIENTS IN THE PHARMACEUTICAL INDUSTRY; CHINESE PATENT MEDICINES FOR USE IN THE TREATMENT OF TRAUMATIC INJURIES, BLEEDING WOUNDS, GYNECOLOGICAL DISEASES, EPISTAXIS, BRONCHIAL DILATING, PULMONARY TUBERCULOSIS, PNEUMONIA, GASTROINTESTINAL TRACT HEMORRHAGE, ARREST BLEEDING, ANTI-INFLAMMATION, HEALING OF A WOUND, CHILBLAIN, HELP HEALING OF FRACTURE, MOTOR IMPAIRMENT, PAIN FROM RHEUMATISM, INJURY OF BONES, JOINTS AND SOFT TISSUE, MOSQUITO AND INSECT BITES, SWELLING AND PAIN DUE TO BLOOD STASIS, AND LUMBAR MUSCLE STRAIN; PHARMACEUTICAL PREPARATIONS FOR SKIN CARE; PHARMACEUTICAL PREPARATIONS FOR TREATING DANDRUFF; HERBAL OINTMENTS USED FOR STOPPING BLEEDING, RELIEVING PAIN AND ANTI-INFLAMMATORY PURPOSES; POULTICES; RADIOACTIVE MEDICINES, NAMELY, RADIOACTIVE SUBSTANCES FOR USE IN NUCLEAR MEDICINE; GASES FOR MEDICAL PURPOSES; CHEMICAL CONDUCTORS FOR ELECTROCARDIOGRAPH ELECTRODES; SEMEN FOR ARTIFICIAL INSEMINATION; SANITARY STERILIZING PREPARATIONS; SOLUTIONS FOR CONTACT LENSES; CULTURES OF MICROORGANISMS FOR MEDICAL AND VETERINARY USE; DIETETIC FOODS ADAPTED FOR MEDICAL PURPOSES; DIETETIC FOOD PREPARATIONS ADAPTED FOR MEDICAL PURPOSES, NAMELY, DIETETIC BEVERAGES FOR TREATMENT OF TRACE ELEMENTS, NAMELY, IRON, ZINC, AND CALCIUM DEFICIENCY DISEASES; NUTRITIONAL ADDITIVES FOR USE IN FOODS AND DIETARY SUPPLEMENTS FOR HUMAN CONSUMPTION FOR MEDICAL PURPOSES; INFANT MILK POWDER; AIR PURIFYING PREPARATIONS, NAMELY, AIR DEODORIZER AND AIR FRESHENING PREPARATIONS; MEDICINES FOR VETERINARY PURPOSES, NAMELY, VETERINARY MEDICINES FOR TREATMENT OF INTESTINAL BACTERIA, RELIEVING PAIN, ANTI-INFECTIVE AND VETERINARY VACCINES; PESTICIDES; HERBICIDES; SANITARY TOWELS, NAMELY, SANITARY NAPKINS AND SANITARY PADS; STERILE PAPER TOWEL, NAMELY, MEDICATED PRE-MOISTENED TOWLETTES; ADHE-

SIVE PLASTER FOR MEDICAL PURPOSES; GUMMED MEDICAL PLASTERS; MEDICAL DRESSINGS, NAMELY, GAUZE AND COTTON FOR MEDICAL PURPOSES; SURGICAL DRESSINGS; SURGICAL TISSUES, NAMELY, SURGICAL DRESSINGS AND SURGICAL BANDAGES; FIRST-AID KITS; TEETH FILLING MATERIAL, NAMELY, FILLINGS FOR TEETH; AN EXTERNAL ANALGESIC AEROSOL USED FOR RELIEVING PAIN AND ANTI-INFLAMMATORY PURPOSES; DIET CAPSULES; DIET CAPSULES IN THE NATURE OF PROCESSED GINSENG, PANAX NOTOGINSENG, BEE POLLEN AND BIRD'S NEST USED AS AN HERBAL SUPPLEMENT, IN CLASS 5 (U.S. CLS. 6, 18, 44, 46, 51 AND 52).

FIRST USE 1-31-1999; IN COMMERCE 8-31-2000.

FOR: COFFEE; COCOA; COFFEE SUBSTITUTES; TEA; TEA SUBSTITUTES; SUGAR; CANDY; CHEWING GUM, NOT FOR MEDICAL PURPOSES; HONEY; ALIMENTARY LIQUIDS IN THE NATURE OF HERBAL FOOD BEVERAGES; ALIMENTARY PASTES; ALIMENTARY POWDER, NAMELY, PROCESSED GINSENG IN THE NATURE OF A POWDER FOR USE AS AN HERB, SPICE OR FLAVORING, AND PROCESSED PANAX NOTOGINSENG IN THE NATURE OF A POWDER FOR USE AS AN HERB, SPICE OR FLAVORING; ROYAL JELLY FOR FOOD PURPOSES AND HUMAN CONSUMPTION, NOT FOR MEDICAL PURPOSES; ALIMENTARY PASTES MADE OF BEE POLLEN, NOT FOR MEDICAL PURPOSES; BREAD; CAKES; PASTRIES; CEREAL PREPARATIONS, NAMELY, BREAKFAST CEREALS, CEREAL-BASED SNACK FOODS, AND PROCESSED CEREALS; NOODLES; POPCORN; SOYA FLOUR; STARCH PRODUCTS FOR FOOD, NAMELY, FOOD STARCH, CORN STARCH, RICE STARCH FLOUR; ICE CREAM; COOKING SALT; VINEGAR; SOYA SAUCE; SEASONINGS; YEAST; ESSENCES FOR FOODSTUFFS, EXCLUDING ETHERIC ESSENCES AND ESSENTIAL OILS, NAMELY, EXTRACTS FOR USE AS FOOD FLAVORING; MEAT TENDERIZERS FOR HOUSEHOLD PURPOSES, IN CLASS 30 (U.S. CL. 46).

FIRST USE 1-31-1999; IN COMMERCE 8-31-2000.

OWNER OF U.S. REG. NO. 2,929,102.

NO CLAIM IS MADE TO THE EXCLUSIVE RIGHT TO USE "YUNNAN" AND "YAO" , APART FROM THE MARK AS SHOWN.

THE NON-LATIN CHARACTER(S) IN THE MARK transliterates into YUN NAN BAI YAO, AND THIS MEANS YUNNAN WHITE MEDICINE IN ENGLISH.

SER. NO. 77-044,341, FILED 11-15-2006.

JAY BESCH, EXAMINING ATTORNEY

Int. Cl.: 28

Prior U.S. Cls.: 22, 23, 38 and 50

Reg. No. 3,482,957

United States Patent and Trademark Office

Registered Aug. 12, 2008

**TRADEMARK
PRINCIPAL REGISTER**



ALMOSTGOLF LLC (CALIFORNIA LTD LIAB
CO)
5855 A UPLANDER WAY
CULVER CITY, CA 90230

FOR: GOLF BALLS, IN CLASS 28 (U.S. CLS. 22, 23,
38 AND 50).

FIRST USE 11-1-2004; IN COMMERCE 11-1-2004.

THE COLOR(S) YELLOW, GREEN, BLACK AND
WHITE IS/ARE CLAIMED AS A FEATURE OF THE
MARK.

THE MARK CONSISTS OF A BLACK UPPER-
CASE LETTER "P" FOLLOWED BY THE SUPRA-
SCRIPT NUMBER "3", BOTH OUTLINED IN
YELLOW AND FURTHER OUTLINED IN GREEN.
THE LOWER PORTION OF THE CURVE OF THE
LETTER P WRAPS AROUND THE VERTICAL LINE
AND TERMINATES WITH A CIRCLE FILLED IN
WHITE AND OUTINGED IN BLACK AND YEL-
LOW.

SER. NO. 77-044,983, FILED 11-15-2006.

JANICE KIM, EXAMINING ATTORNEY

Int. Cl.: 41

Prior U.S. Cls.: 100, 101 and 107

United States Patent and Trademark Office

Reg. No. 3,482,958

Registered Aug. 12, 2008

**SERVICE MARK
PRINCIPAL REGISTER**

THE LOVE

MURPHY, JESSIE (UNITED STATES INDIVIDUAL)
24-06 31ST STREET, #1
ASTORIA, NY 11102 AND
STELLINI, JAMIE (UNITED STATES INDIVIDUAL)
24-06 31ST STREET, #1
ASTORIA, NY 11102

FOR: ENTERTAINMENT SERVICES, NAMELY,
LIVE PERFORMANCES BY A MUSICAL GROUP,
IN CLASS 41 (U.S. CLS. 100, 101 AND 107).

FIRST USE 2-1-2006; IN COMMERCE 2-1-2006.

THE MARK CONSISTS OF STANDARD CHARACTERS WITHOUT CLAIM TO ANY PARTICULAR FONT, STYLE, SIZE, OR COLOR.

SER. NO. 77-046,663, FILED 11-17-2006.

JOHN DWYER, EXAMINING ATTORNEY

Int. Cl.: 25

Prior U.S. Cls.: 22 and 39

United States Patent and Trademark Office

Reg. No. 3,482,959

Registered Aug. 12, 2008

**TRADEMARK
PRINCIPAL REGISTER**

SCHLEPRECHAUN

MEMBRAIN, LLC (CALIFORNIA LTD LIAB CO)
C/O GOLDRING HERTZ & LICHTENSTEIN, LLP
450 N. ROXBURY DR., 8TH FL
BEVERLY HILLS, CA 90210

THE MARK CONSISTS OF STANDARD CHAR-
ACTERS WITHOUT CLAIM TO ANY PARTICULAR
FONT, STYLE, SIZE, OR COLOR.

FOR: CLOTHING, NAMELY, SWEATSHIRTS, T-
SHIRTS, IN CLASS 25 (U.S. CLS. 22 AND 39).

SER. NO. 77-047,100, FILED S.R. 11-17-2006 AM.
P.R. 4-21-2008.

FIRST USE 11-12-2006; IN COMMERCE 11-12-2006.

ANNE E. GUSTASON, EXAMINING ATTORNEY

Int. Cls.: 5 and 44

Prior U.S. Cls.: 6, 18, 44, 46, 51, 52, 100 and 101

United States Patent and Trademark Office

Reg. No. 3,482,960

Registered Aug. 12, 2008

**TRADEMARK
SERVICE MARK
PRINCIPAL REGISTER**

EVASLIM

EVASLIM, INC. (CALIFORNIA CORPORATION)
41555 CHERRY ST., SUITE A
MURRIETA, CA 92562

FOR: NUTRITIONAL AND WEIGHT LOSS SUPPLEMENTS; PHARMACEUTICAL PRODUCTS AND PREPARATIONS TO PREVENT AND REDUCE STRETCH MARKS, IN CLASS 5 (U.S. CLS. 6, 18, 44, 46, 51 AND 52).

FIRST USE 1-1-2005; IN COMMERCE 1-1-2005.

FOR: NON-SURGICAL WEIGHT LOSS TREATMENT USING MICRO CURRENT WAVE FORM

TECHNOLOGY, IN CLASS 44 (U.S. CLS. 100 AND 101).

FIRST USE 1-1-2005; IN COMMERCE 1-1-2005.

THE MARK CONSISTS OF STANDARD CHARACTERS WITHOUT CLAIM TO ANY PARTICULAR FONT, STYLE, SIZE, OR COLOR.

SER. NO. 77-048,455, FILED 11-21-2006.

PAULA MAHONEY, EXAMINING ATTORNEY

Int. Cls.: 35 and 36

Prior U.S. Cls.: 100, 101 and 102

United States Patent and Trademark Office

Reg. No. 3,482,961

Registered Aug. 12, 2008

**SERVICE MARK
PRINCIPAL REGISTER**



AIRPROJECTS, INC. (VIRGINIA CORPORATION)
905 DUKE STREET., SUITE A
ALEXANDRIA, VA 22314

FOR: BUSINESS PLANNING, DEVELOPING AND MANAGEMENT OF COMMERCIAL FACILITIES FOR OTHERS; PROVIDING BUSINESS PLANNING, ASSISTANCE, ADVISORY AND CONSULTANCY SERVICES WITH REGARD TO DEMAND FORECASTING; PROVIDING ASSISTANCE, ADVISORY AND CONSULTANCY SERVICES WITH REGARD TO THE ANALYSIS OF BUSINESS MARKETS, FINANCING AND OPERATION OF COMMERCIAL FACILITIES; CONCEPT DEVELOPMENT IN THE FIELD OF COMMERCIAL BUSINESS; PROVIDING ASSISTANCE, ADVISORY AND CONSULTANCY SERVICES IN THE FIELD OF DELIVERY AND DISTRIBUTION SYSTEMS FOR COMMERCIAL FACILITIES, NAMELY, AIRPORTS; ASSISTANCE WITH BUSINESS MANAGEMENT AND PLAN-

NING, BUSINESS CONSULTING AND BUSINESS INFORMATION FOR ENTERPRISES, IN CLASS 35 (U.S. CLS. 100, 101 AND 102).

FIRST USE 2-0-2006; IN COMMERCE 2-0-2006.

FOR: REAL ESTATE CONSULTATION; REAL ESTATE MANAGEMENT; LEASING OF REAL ESTATE; FINANCIAL ANALYSIS AND CONSULTATION, IN CLASS 36 (U.S. CLS. 100, 101 AND 102).

FIRST USE 2-0-2006; IN COMMERCE 2-0-2006.

THE MARK CONSISTS OF THE WORD "AIRPROJECTS" AND DESIGN.

SER. NO. 77-051,162, FILED 11-27-2006.

SUZANNE BLANE, EXAMINING ATTORNEY

Int. Cl.: 36

Prior U.S. Cls.: 100, 101 and 102

United States Patent and Trademark Office

Reg. No. 3,482,962

Registered Aug. 12, 2008

**SERVICE MARK
PRINCIPAL REGISTER**

SYMBILITY

SYMBILITY SOLUTIONS, INC. (CANADA CORPORATION)

SUITE 304

72 VICTORIA STREET SOUTH

ONTARIO, CANADA N2G4Y9

FOR: INSURANCE CARRIER SERVICES; INSURANCE CLAIMS ADMINISTRATION; CLAIMS ADJUSTMENT IN THE FIELD OF INSURANCE; INSURANCE CLAIMS PROCESSING , IN CLASS 36 (U.S. CLS. 100, 101 AND 102).

FIRST USE 4-1-2005; IN COMMERCE 4-30-2005.

THE MARK CONSISTS OF STANDARD CHARACTERS WITHOUT CLAIM TO ANY PARTICULAR FONT, STYLE, SIZE, OR COLOR.

PRIORITY CLAIMED UNDER SEC. 44(D) ON CANADA APPLICATION NO. 1316059, FILED 9-11-2006, REG. NO. TMA695778, DATED 9-6-2007, EXPIRES 9-6-2022.

THE WORDING "SYMBILITY" HAS NO MEANING IN A FOREIGN LANGUAGE.

SER. NO. 77-052,207, FILED 11-28-2006.

DORITT L. CARROLL, EXAMINING ATTORNEY

Int. Cl.: 36

Prior U.S. Cls.: 100, 101 and 102

United States Patent and Trademark Office

Reg. No. 3,482,963

Registered Aug. 12, 2008

**SERVICE MARK
PRINCIPAL REGISTER**



SYMBILITY SOLUTIONS, INC. (CANADA CORPORATION)
SUITE 304
72 VICTORIA STREET SOUTH
KITCHENER, CANADA N2G4Y9

FOR: INSURANCE CARRIER SERVICES; INSURANCE CLAIMS ADMINISTRATION; CLAIMS ADJUSTMENT IN THE FIELD OF INSURANCE; INSURANCE CLAIMS PROCESSING, IN CLASS 36 (U.S. CLS. 100, 101 AND 102).

FIRST USE 4-1-2005; IN COMMERCE 4-30-2005.

PRIORITY CLAIMED UNDER SEC. 44(D) ON CANADA APPLICATION NO. 1316070, FILED 9-26-2006, REG. NO. TMA705289, DATED 1-22-2008, EXPIRES 1-22-2023.

THE COLOR(S) BLUE AND ORANGE IS/ARE CLAIMED AS A FEATURE OF THE MARK.

THE MARK CONSISTS OF THE WORD "SYMBILITY" IN LOWER CASE FONT AT THE BASE OF THE MARK, WITH THREE ROWS OF DOTS, PROGRESSING FROM LIGHT TO DARK BLUE, FROM THE LEFT SIDE OF THE MARK MOVING HORIZONTALLY TOWARD A ROUNDED RECTANGLE SHAPE ON THE RIGHT, WHICH HAS AN INNER ORANGE COLOR; AND A CURVED BLUE LINE BISECTS THE ROUNDED RECTANGLE FROM ABOVE.

THE WORDING "SYMBILITY" HAS NO MEANING IN A FOREIGN LANGUAGE.

SER. NO. 77-052,251, FILED 11-28-2006.

DORITT L. CARROLL, EXAMINING ATTORNEY

Int. Cl.: 9

Prior U.S. Cls.: 21, 23, 26, 36 and 38

Reg. No. 3,482,964

United States Patent and Trademark Office

Registered Aug. 12, 2008

**TRADEMARK
PRINCIPAL REGISTER**

SYMBILITY.NET

SYMBILITY SOLUTIONS, INC. (CANADA CORPORATION)
SUITE 304
72 VICTORIA ST. SOUTH
KITCHENER, CANADA N2G4Y9

FOR: COMPUTER SOFTWARE FOR INSURANCE CLAIMS ADJUDICATION AND INSURANCE CLAIMS ADJUSTMENT, IN CLASS 9 (U.S. CLS. 21, 23, 26, 36 AND 38).

FIRST USE 4-1-2005; IN COMMERCE 4-30-2005.

THE MARK CONSISTS OF STANDARD CHARACTERS WITHOUT CLAIM TO ANY PARTICULAR FONT, STYLE, SIZE, OR COLOR.

PRIORITY CLAIMED UNDER SEC. 44(D) ON CANADA APPLICATION NO. 1316060, FILED 9-11-2006, REG. NO. TMA705,291, DATED 1-22-2008, EXPIRES 1-22-2023.

SER. NO. 77-052,281, FILED 11-28-2006.

DORITT L. CARROLL, EXAMINING ATTORNEY

Int. Cls.: 25, 35 and 41

Prior U.S. Cls.: 22, 39, 100, 101, 102 and 107

United States Patent and Trademark Office

Reg. No. 3,482,965

Registered Aug. 12, 2008

**TRADEMARK
SERVICE MARK
PRINCIPAL REGISTER**



BEY, AZIZ (UNITED STATES INDIVIDUAL)
C/O NY PERKS, LLC, 193 SMITH STREET
BROOKLYN, NY 11201

FOR: CLOTHING, NAMELY, T-SHIRTS, HATS,
SWEATSHIRTS, TANK-TOPS, SNEAKERS, SOCKS,
UNDERWEAR, SHORTS, PANTS, SCARVES, IN
CLASS 25 (U.S. CLS. 22 AND 39).

FIRST USE 8-22-2003; IN COMMERCE 8-22-2003.

FOR: ENTERTAINMENT MARKETING SERVI-
CES, NAMELY, PROMOTING THE MUSICAL EX-
HIBITIONS OF OTHERS THROUGH THE
DISTRIBUTION OF PRINTED AND AUDIO PRO-
MOTIONAL MATERIALS, IN CLASS 35 (U.S. CLS.
100, 101 AND 102).

FIRST USE 8-22-2003; IN COMMERCE 8-22-2003.

FOR: NIGHT CLUBS; LIVE MUSICAL PERFOR-
MANCES BY RECORDING ARTISTS; LIVE MUSI-
CAL PERFORMANCES BY RECORDING ARTISTS,
FEATURING PRERECORDED VOCAL, INSTRU-

MENTAL AND VISUAL ELEMENTS , IN CLASS 41
(U.S. CLS. 100, 101 AND 107).

FIRST USE 8-22-2003; IN COMMERCE 8-22-2003.

NO CLAIM IS MADE TO THE EXCLUSIVE
RIGHT TO USE "NY", APART FROM THE MARK
AS SHOWN.

THE COLOR(S) CRIMSON, BLACK AND WHITE
IS/ARE CLAIMED AS A FEATURE OF THE MARK.

THE MARK CONSISTS OF THE WORDING "NY
PERKS" APPEARING WITHIN AN OVAL. THE
COLOR WHITE APPEARS IN THE WORDING
"NY" AND THE COLOR BLACK APPEARS IN THE
WORDING "PERKS." THE OVAL IS OUTLINED IN
BLACK AND THE INNER PORTION OF THE OVAL
IS HALF WHITE HALF CRIMSON.

SER. NO. 77-052,290, FILED 11-28-2006.

ROBERT LAVACHE, EXAMINING ATTORNEY

Int. Cl.: 9

Prior U.S. Cls.: 21, 23, 26, 36 and 38

United States Patent and Trademark Office

Reg. No. 3,482,966

Registered Aug. 12, 2008

**TRADEMARK
PRINCIPAL REGISTER**

SYMBILITY

SYMBILITY SOLUTIONS, INC. (CANADA CORPORATION)
SUITE 304
72 VICTORIA STREET SOUTH
KITCHENER, CANADA N2G4Y9

FOR: COMPUTER SOFTWARE FOR INSURANCE CLAIMS ADJUDICATION AND INSURANCE CLAIMS ADJUSTMENT, IN CLASS 9 (U.S. CLS. 21, 23, 26, 36 AND 38).

FIRST USE 4-1-2005; IN COMMERCE 4-30-2005.

THE MARK CONSISTS OF STANDARD CHARACTERS WITHOUT CLAIM TO ANY PARTICULAR FONT, STYLE, SIZE, OR COLOR.

PRIORITY CLAIMED UNDER SEC. 44(D) ON CANADA APPLICATION NO. 1316059, FILED 9-11-2006, REG. NO. TMA695,778, DATED 9-6-2007, EXPIRES 9-6-2022.

SER. NO. 77-052,418, FILED 11-28-2006.

DORITT L. CARROLL, EXAMINING ATTORNEY

Int. Cl.: 7

Prior U.S. Cls.: 13, 19, 21, 23, 31, 34 and 35

United States Patent and Trademark Office

Reg. No. 3,482,967

Registered Aug. 12, 2008

**TRADEMARK
PRINCIPAL REGISTER**



ELLIS CORPORATION (ILLINOIS CORPORATION)
1400 WEST BRYN MAWR
ITASCA, IL 60143

FOR: INDUSTRIAL LAUNDRY EQUIPMENT,
NAMELY WASHERS, IN CLASS 7 (U.S. CLS. 13, 19,
21, 23, 31, 34 AND 35).

FIRST USE 1-1-2005; IN COMMERCE 1-1-2005.

OWNER OF U.S. REG. NO. 2,479,226.

NO CLAIM IS MADE TO THE EXCLUSIVE
RIGHT TO USE "SEQUENTIAL WASHING SYSTEM",
APART FROM THE MARK AS SHOWN.

SER. NO. 77-052,649, FILED 11-29-2006.

JENNY PARK, EXAMINING ATTORNEY

Int. Cl.: 9

Prior U.S. Cls.: 21, 23, 26, 36 and 38

Reg. No. 3,482,968

United States Patent and Trademark Office

Registered Aug. 12, 2008

**TRADEMARK
PRINCIPAL REGISTER**



ROOMCONX, INC (NEVADA CORPORATION)
4340 VON KARMAN AVE
SUITE 137
NEWPORT BEACH, CA 92660

FOR: TELEVISION MONITORS; TELEVISION RECEIVERS; TELEVISION SETS, IN CLASS 9 (U.S. CLS. 21, 23, 26, 36 AND 38).

FIRST USE 9-29-2003; IN COMMERCE 4-12-2005.

THE COLOR(S) DARK BLUE, LIGHT BLUE AND LIGHTER BLUE IS/ARE CLAIMED AS A FEATURE OF THE MARK.

THE MARK CONSISTS OF DARK BLUE WORDING OF "ROOMCONX", WITH CAPITAL "R", CAPITAL "C" AND CAPITAL "X", AS STYLIZED IN THE NAME, COMPASS IN DARK BLUE, SURROUNDED BY DARK BLUE DOTS, LIGHT BLUE DOTS AND LIGHTER BLUE DOTS.

SER. NO. 77-055,188, FILED 12-1-2006.

JENNIFER VASQUEZ, EXAMINING ATTORNEY

Int. Cls.: 16 and 41

Prior U.S. Cls.: 2, 5, 22, 23, 29, 37, 38, 50, 100, 101 and 107

Reg. No. 3,482,969

United States Patent and Trademark Office

Registered Aug. 12, 2008

**TRADEMARK
SERVICE MARK
PRINCIPAL REGISTER**



SECURITIES TRAINING CORPORATION (NEW YORK CORPORATION)
17 BATTERY PLACE
NEW YORK, NY 10004

FOR: PRINTED EDUCATIONAL BROCHURES, EDUCATIONAL NEWSLETTERS, AND PRINTED STUDY GUIDES RELATING TO THE LAWS, RULES AND REGULATIONS DIRECTED TO THE FINANCIAL, INVESTMENT, INSURANCE AND BANKING INDUSTRIES, IN CLASS 16 (U.S. CLS. 2, 5, 22, 23, 29, 37, 38 AND 50).

FIRST USE 8-13-2004; IN COMMERCE 8-13-2004.

FOR: PROVIDING ONLINE, NON-DOWNLOADABLE INTERACTIVE ELECTRONIC PUBLICATIONS IN THE NATURE OF STUDY GUIDES AND

TRAINING MATERIALS FROM THE INTERNET IN THE FIELD OF LAWS, RULES AND REGULATIONS DIRECTED TO THE FINANCIAL, INVESTMENT, INSURANCE AND BANKING INDUSTRIES, IN CLASS 41 (U.S. CLS. 100, 101 AND 107).

FIRST USE 8-13-2004; IN COMMERCE 8-13-2004.

OWNER OF U.S. REG. NOS. 1,808,055, 3,164,648 AND OTHERS.

THE MARK CONSISTS OF STC AND A HEAD OF A HORSE DESIGN.

SER. NO. 77-055,387, FILED 12-1-2006.

RON FAIRBANKS, EXAMINING ATTORNEY

Int. Cls.: 9, 16 and 41

**Prior U.S. Cls.: 2, 5, 21, 22, 23, 26, 29, 36, 37, 38, 50,
100, 101 and 107**

Reg. No. 3,482,970

United States Patent and Trademark Office

Registered Aug. 12, 2008

**TRADEMARK
SERVICE MARK
PRINCIPAL REGISTER**

The logo for UL University, featuring the letters 'UL' in a large, bold, black font, with the 'U' and 'L' overlapping. Below the 'UL' is the word 'UNIVERSITY' in a smaller, bold, black font.

UNDERWRITERS LABORATORIES INC. (DELA-
WARE CORPORATION)
333 PFINGSTEN ROAD
NORTHBROOK, IL 600622096

FOR: PRE-RECORDED CD'S, VIDEO TAPES, LA-
SER DISKS AND DVDS FEATURING SAFETY
TRAINING AND FIRE SAFETY; DOWNLOADABLE
ELECTRONIC PUBLICATIONS IN THE NATURE
OF INSTRUCTIONAL MATERIALS IN THE FIELD
OF QUALITY MANAGEMENT FOR SAFETY COM-
PLIANCE, QUALITY MANAGEMENT SYSTEMS,
NAMELY, ISO 9000, ISO 13485, TL9000 AND SA8800,
AND MANUFACTURING IMPROVEMENT PRO-
CESSES, NAMELY, LEAN AND SIX SIGMA, IN
CLASS 9 (U.S. CLS. 21, 23, 26, 36 AND 38).

FIRST USE 5-0-2004; IN COMMERCE 5-0-2004.

FOR: PRINTED INSTRUCTIONAL MATERIALS
IN THE FIELDS OF SAFETY COMPLIANCE, QUAL-
ITY MANAGEMENT SYSTEMS, NAMELY, ISO 9000,
ISO 13485, TL 9000 AND SA 8800 AND MANUFAC-
TURING IMPROVEMENT PROCESSES, NAMELY,
LEAN AND SIX SIGMA, IN CLASS 16 (U.S. CLS. 2, 5,
22, 23, 29, 37, 38 AND 50).

FIRST USE 5-0-2004; IN COMMERCE 5-0-2004.

FOR: EDUCATIONAL AND TRAINING SERVI-
CES, NAMELY, PROVIDING SEMINARS, ONE-ON-
ONE TRAINING, ONLINE COURSES AND TEST-
ING FOR COMPETENCY INCLUDING VIA INTER-
NET, PRIMARILY IN THE FIELDS OF SAFETY
COMPLIANCE, QUALITY MANAGEMENT SYS-
TEMS AND MANUFACTURING IMPROVEMENT
PROCESSES, IN CLASS 41 (U.S. CLS. 100, 101 AND
107).

FIRST USE 5-0-2004; IN COMMERCE 5-0-2004.

OWNER OF U.S. REG. NOS. 782,589, 2,391,083,
AND 2,391,140.

THE MARK CONSISTS OF THE LETTERS UL
STAGGERED OVER THE WORD UNIVERSITY.

SER. NO. 77-057,794, FILED 12-6-2006.

DAVID I, EXAMINING ATTORNEY

Int. Cls.: 9, 10, 16, 25, 35, 38 and 41

Prior U.S. Cls.: 2, 5, 21, 22, 23, 26, 29, 36, 37, 38, 39, 44, 50, 100, 101, 102, 104 and 107

Reg. No. 3,482,971

United States Patent and Trademark Office

Registered Aug. 12, 2008

**TRADEMARK
SERVICE MARK
PRINCIPAL REGISTER**

GIRL WITH A ONE TRACK MIND

MARGOLIS, ZOE (UNITED KINGDOM INDIVIDUAL)
SWISS COTTAGE
5-7 BROADHURST GARDENS
LONDON, ENGLAND NW63RZ

FOR: VIDEO RECORDINGS AND VIDEO DISCS FEATURING DRAMATIC AND DOCUMENTARY FILMS WITH ADULT CONTENT; FEATURE-LENGTH MOTION PICTURE FILMS WITH ADULT CONTENT, FEATURING COMEDIC AND DRAMATIC PERFORMANCES; DOWNLOADABLE AUDIO AND VIDEO RECORDINGS FEATURING COMEDIC, DRAMATIC AND DOCUMENTARY MOVIES WITH ADULT CONTENT, IN CLASS 9 (U.S. CLS. 21, 23, 26, 36 AND 38).

FOR: ADULT SEXUAL AIDS, NAMELY, CONDOMS, VIBRATORS AND MASSAGE APPARATUS, IN CLASS 10 (U.S. CLS. 26, 39 AND 44).

FOR: BOOKS AND MAGAZINES FEATURING ADULT CONTENT; MAGAZINE AND NEWSPAPER COLUMNS FEATURING ADULT CONTENT; PHOTOGRAPHS, IN CLASS 16 (U.S. CLS. 2, 5, 22, 23, 29, 37, 38 AND 50).

FOR: CLOTHING, NAMELY, DRESSES, TROUSERS, GLOVES, SCARVES, NIGHTWEAR AND UNDERWEAR, IN CLASS 25 (U.S. CLS. 22 AND 39).

FOR: PROVIDING AN ONLINE RETAIL SHOP AND MAIL ORDER RETAIL SERVICE IN THE FIELDS OF ADULT-CONTENT BOOKS AND MAGAZINES, PHOTOGRAPHS, FILMS, ADULT SEX AIDS AND SEX TOYS, CLOTHING, CLOTHING ACCESSORIES AND GIFTWARE; ADVERTISING THE GOODS AND SERVICES OF OTHER VIA WEB

PAGES ON THE INTERNET, IN CLASS 35 (U.S. CLS. 100, 101 AND 102).

FOR: BROADCASTING AND STREAMING OF VIDEO AND AUDIO MATERIAL ON THE INTERNET; PROVIDING CONDUCTING AND OPERATING INTERNET BULLETIN BOARDS AND MESSAGES BOARDS FOR TRANSMISSION OF MESSAGES AMONG COMPUTER USERS CONCERNING ADULT SEXUAL CONTENT, IN CLASS 38 (U.S. CLS. 100, 101 AND 104).

FOR: ENTERTAINMENT SERVICES IN THE NATURE OF AN INTERNET WEB SITE FEATURING ADULT CONTENT AND A WEB LOG; PUBLISHING OF BOOKS AND OTHER PRINTED MATTER FOR OTHERS; MOTION PICTURE FILM AND TELEVISION PRODUCTION; SCRIPT WRITING SERVICES; AND CUSTOM WRITING SERVICES ON A FREELANCE BASIS, IN CLASS 41 (U.S. CLS. 100, 101 AND 107).

THE MARK CONSISTS OF STANDARD CHARACTERS WITHOUT CLAIM TO ANY PARTICULAR FONT, STYLE, SIZE, OR COLOR.

PRIORITY CLAIMED UNDER SEC. 44(D) ON UNITED KINGDOM APPLICATION NO. 2,438,204, FILED 11-10-2006, REG. NO. 2438204, DATED 10-5-2007, EXPIRES 11-10-2016.

OWNER OF UNITED KINGDOM REG. NO. 2,414,067, DATED 2-16-2006, EXPIRES 2-16-2016.

SER. NO. 77-058,430, FILED 12-6-2006.

STEVEN R. FINE, EXAMINING ATTORNEY

Int. Cls.: 25, 35 and 42

Prior U.S. Cls.: 22, 39, 100, 101 and 102

Reg. No. 3,482,972

United States Patent and Trademark Office

Registered Aug. 12, 2008

**TRADEMARK
SERVICE MARK
PRINCIPAL REGISTER**

preg-a-licious

RAN GHOMAN DESIGNS INC. (CANADA CORPORATION)
100 - 215 NIAGARA STREET
TORONTO, ONTARIO, CANADA M6J2L2

FOR: MATERNITY CLOTHING, NAMELY, SLEEPWEAR, TOPS, PANTS, BLOUSES, SWEAT SUITS, IN CLASS 25 (U.S. CLS. 22 AND 39).

FOR: RETAIL STORE SERVICES FEATURING MATERNITY CLOTHES; MAIL ORDER SERVICES FEATURING MATERNITY CLOTHES; ON-LINE RETAIL STORE SERVICES FEATURING MATERNITY CLOTHES, IN CLASS 35 (U.S. CLS. 100, 101 AND 102).

FOR: DESIGN FOR OTHERS IN THE FIELD OF MATERNITY CLOTHES, IN CLASS 42 (U.S. CLS. 100 AND 101).

THE MARK CONSISTS OF STANDARD CHARACTERS WITHOUT CLAIM TO ANY PARTICULAR FONT, STYLE, SIZE, OR COLOR.

OWNER OF CANADA REG. NO. TMA709464, DATED 3-14-2008, EXPIRES 3-14-2023.

SER. NO. 77-059,494, FILED 12-7-2006.

BARBARA RUTLAND, EXAMINING ATTORNEY

Int. Cl.: 12

Prior U.S. Cls.: 19, 21, 23, 31, 35 and 44

Reg. No. 3,482,973

United States Patent and Trademark Office

Registered Aug. 12, 2008

**TRADEMARK
PRINCIPAL REGISTER**

SV

AUTOMOBILI LAMBORGHINI HOLDING S.P.A.
(ITALY CORPORATION)
VIA MODENA, 12
SANT'AGATA
BOLOGNESE (BO), ITALY 40019

PRIORITY CLAIMED UNDER SEC. 44(D) ON
ERPN CMNTY TM OFC APPLICATION NO.
005134663, FILED 6-14-2006, REG. NO. 005134663,
DATED 4-25-2007, EXPIRES 6-14-2016.

FOR: MOTOR VEHICLES, NAMELY, AUTOMO-
BILES, IN CLASS 12 (U.S. CLS. 19, 21, 23, 31, 35 AND
44).

SER. NO. 77-059,549, FILED 12-7-2006.

THE MARK CONSISTS OF STANDARD CHAR-
ACTERS WITHOUT CLAIM TO ANY PARTICULAR
FONT, STYLE, SIZE, OR COLOR.

JAMES GRIFFIN, EXAMINING ATTORNEY

Int. Cl.: 36

Prior U.S. Cls.: 100, 101 and 102

United States Patent and Trademark Office

Reg. No. 3,482,974

Registered Aug. 12, 2008

**SERVICE MARK
PRINCIPAL REGISTER**

BAIL NOW, PAY LATER

VAN NUYS BAIL BONDS (CALIFORNIA CORPORATION)
14419 SYLVAN STREET
VAN NUYS, CA 91401

NO CLAIM IS MADE TO THE EXCLUSIVE RIGHT TO USE "BAIL", APART FROM THE MARK AS SHOWN.

FOR: BAIL BONDING SERVICES, IN CLASS 36 (U.S. CLS. 100, 101 AND 102).

SEC. 2(F).

FIRST USE 0-0-1998; IN COMMERCE 0-0-1998.

SER. NO. 77-059,599, FILED 12-7-2006.

THE MARK CONSISTS OF STANDARD CHARACTERS WITHOUT CLAIM TO ANY PARTICULAR FONT, STYLE, SIZE, OR COLOR.

MATTHEW MCDOWELL, EXAMINING ATTORNEY

Int. Cl.: 41

Prior U.S. Cls.: 100, 101 and 107

United States Patent and Trademark Office

Reg. No. 3,482,975

Registered Aug. 12, 2008

**SERVICE MARK
PRINCIPAL REGISTER**

StyleFixx

STYLEFIXX, LLC (NEW YORK LTD LIAB CO)
160 FRONT STREET, SUITE PHA
NEW YORK, NY 10038

THE MARK CONSISTS OF STANDARD CHAR-
ACTERS WITHOUT CLAIM TO ANY PARTICULAR
FONT, STYLE, SIZE, OR COLOR.

FOR: ENTERTAINMENT IN THE NATURE OF
NON-TELEVISED FASHION SHOWS, IN CLASS 41
(U.S. CLS. 100, 101 AND 107).

SER. NO. 77-063,423, FILED 12-13-2006.

FIRST USE 6-1-2003; IN COMMERCE 6-1-2003.

WON TEAK OH, EXAMINING ATTORNEY

Int. Cl.: 42

Prior U.S. Cls.: 100 and 101

United States Patent and Trademark Office

Reg. No. 3,482,976

Registered Aug. 12, 2008

**SERVICE MARK
PRINCIPAL REGISTER**

IMATRIX

IMATRIX SOFTWARE, INC. (WISCONSIN CORPORATION)
27068 LA PAZ ROAD
NO. 617
ALISO VIEJO, CA 92656

FOR: APPLICATION SERVICE PROVIDER (ASP)
FEATURING SOFTWARE IN THE FIELD OF MULTI-LEVEL MARKETING AND DIRECT SALES, IN CLASS 42 (U.S. CLS. 100 AND 101).

FIRST USE 6-30-2003; IN COMMERCE 6-30-2003.

THE MARK CONSISTS OF STANDARD CHARACTERS WITHOUT CLAIM TO ANY PARTICULAR FONT, STYLE, SIZE, OR COLOR.

SEC. 2(F).

SER. NO. 77-068,104, FILED 12-20-2006.

KATHY DE JONGE, EXAMINING ATTORNEY

Int. Cls.: 25 and 41

Prior U.S. Cls.: 22, 39, 100, 101 and 107

Reg. No. 3,482,977

United States Patent and Trademark Office

Registered Aug. 12, 2008

**TRADEMARK
SERVICE MARK
PRINCIPAL REGISTER**

PILLSBURY BAKERY INSTITUTE

THE PILLSBURY COMPANY (DELAWARE CORPORATION)
NUMBER ONE GENERAL MILLS BLVD.
MINNEAPOLIS, MN 55426

FOR: T-SHIRTS, IN CLASS 25 (U.S. CLS. 22 AND 39).

FIRST USE 9-18-2006; IN COMMERCE 2-28-2007.

FOR: EDUCATIONAL SERVICES, NAMELY, CONDUCTING SEMINARS IN THE FIELDS OF BUSINESS MANAGEMENT FOR BAKERY OPERATORS AND DISTRIBUTION OF COURSE MATERIAL IN CONNECTION THEREWITH, IN CLASS 41 (U.S. CLS. 100, 101 AND 107).

FIRST USE 9-18-2006; IN COMMERCE 2-28-2007.

THE MARK CONSISTS OF STANDARD CHARACTERS WITHOUT CLAIM TO ANY PARTICULAR FONT, STYLE, SIZE, OR COLOR.

OWNER OF U.S. REG. NOS. 45,179, 563,259, AND 698,691.

NO CLAIM IS MADE TO THE EXCLUSIVE RIGHT TO USE "BAKERY INSTITUTE", APART FROM THE MARK AS SHOWN.

SER. NO. 77-068,540, FILED 12-20-2006.

ANTHONY RINKER, EXAMINING ATTORNEY

Int. Cl.: 37

Prior U.S. Cls.: 100, 103 and 106

United States Patent and Trademark Office

Reg. No. 3,482,978

Registered Aug. 12, 2008

**SERVICE MARK
PRINCIPAL REGISTER**

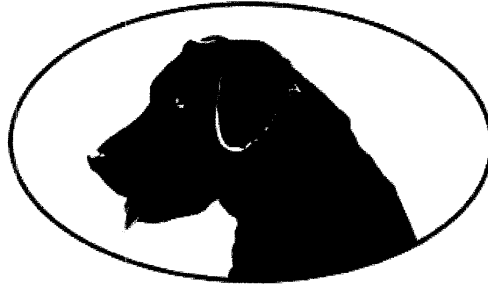

CHILD, JOHN S. (UNITED STATES INDIVIDUAL)
65 CHRISTIAN HILL ROAD
AMHERST, NH 03031

FIRST USE 8-15-2005; IN COMMERCE 8-15-2005.

FOR: ASPHALT REPAIR, MAINTENANCE, SEALING, PARKING LOT STRIPING AND FLOOR RESURFACING, IN CLASS 37 (U.S. CLS. 100, 103 AND 106).

SER. NO. 77-068,660, FILED 12-20-2006.

RAMONA ORTIGA, EXAMINING ATTORNEY

Int. Cls.: 9 and 42

Prior U.S. Cls.: 21, 23, 26, 36, 38, 100 and 101

United States Patent and Trademark Office

Reg. No. 3,482,979

Registered Aug. 12, 2008

**TRADEMARK
SERVICE MARK
PRINCIPAL REGISTER**

SCITEC

SCITEC, INC. (NEW JERSEY CORPORATION)
100 WALL STREET
PRINCETON, NJ 08540

FOR: ELECTRO-OPTIC SENSORS, NAMELY, ELECTRONIC SENSORS FOR DETECTION AND MEASUREMENT OF LIGHT; RADIOMETERS; SCINTILLOMETERS / TRANSMISSOMETERS; WIDE BAND RADIO-FREQUENCY DETECTION SYSTEMS COMPRISED OF ELECTRONICS IN THE NATURE OF COMMERCIAL ANTENNAS, TRANSFORMERS, AMPLIFIERS, AND ELECTRONIC DATA ACQUISITION UNITS CONSISTING OF PROXIMITY SENSORS, COMPUTER HARDWARE AND COMPUTER SOFTWARE FOR USE IN THE IDENTIFICATION AND LOCATION OF COMMUNICATION AND RADAR TRANSMITTERS; LASER THREAT AND MISSILE PLUME IR/UV SIMULATORS; COMPUTER SOFTWARE FOR USE WITH ELECTRO-OPTIC SENSOR SYSTEMS FOR SIGNAL PROCESSING; COMPUTER HARDWARE FOR USE WITH ELECTRO-OPTIC SENSOR SYSTEMS; ELECTRONIC TEST AND MEASUREMENT DEVICES FOR USE WITH INSTRUMENTATION USED TO RESEARCH, DEVELOP, ACQUIRE, INTEGRATE, TEST AND CERTIFY NEW AND EXISTING ELECTRO-OPTIC SENSOR SYSTEMS, NAMELY, MISSILE AND EXPLOSIVE DETECTORS, LASER COMMUNICATORS, AND COMMUNICATION AND RADAR TRANSMITTERS, IN CLASS 9 (U.S. CLS. 21, 23, 26, 36 AND 38).

FIRST USE 6-13-1979; IN COMMERCE 6-13-1979.

FOR: COMPUTER SOFTWARE DESIGN AND DEVELOPMENT FOR OTHERS; COMPUTER HARDWARE DEVELOPMENT; SCIENTIFIC RESEARCH AND DEVELOPMENT; DEVELOPMENT OF COMPUTER HARDWARE AND SOFTWARE FOR OTHERS FOR DOMESTIC AND MILITARY DEFENSE PURPOSES, NAMELY, FOR MODELING AND SIMULATION OF INTELLIGENT SENSOR AND PROCESSING SYSTEMS; ENGINEERING; TECHNOLOGY CONSULTING SERVICES IN THE FIELD OF ELECTRO-OPTICS AND RADIO-FREQUENCY SENSOR SYSTEMS; TEST AND EVALUATION PROCEDURES, NAMELY, DETECTION AND MEASUREMENTS OF ULTRAVIOLET, INFRARED AND RADIO FREQUENCY TO US AND INTERNATIONAL RADIATION STANDARDS; CALIBRATION, IN CLASS 42 (U.S. CLS. 100 AND 101).

FIRST USE 6-13-1979; IN COMMERCE 6-13-1979.

THE MARK CONSISTS OF STANDARD CHARACTERS WITHOUT CLAIM TO ANY PARTICULAR FONT, STYLE, SIZE, OR COLOR.

SER. NO. 77-069,630, FILED 12-21-2006.

COLLEEN DOMBROW, EXAMINING ATTORNEY

Int. Cl.: 9

Prior U.S. Cls.: 21, 23, 26, 36 and 38

Reg. No. 3,482,980

United States Patent and Trademark Office

Registered Aug. 12, 2008

**TRADEMARK
PRINCIPAL REGISTER**

EESIFLO

EESIFLO INTERNATIONAL PTE LTD (SINGAPORE CORPORATION)
#02-19 EUNOS TECHPARK
NO. 60 KAKI BUKIT PLACE
SINGAPORE, SINGAPORE 415979

FOR: FLOWMETERS; AND ELECTRONIC MONITORS FOR MEASURING WATER IN OIL, IN CLASS 9 (U.S. CLS. 21, 23, 26, 36 AND 38).

FIRST USE 4-1-2001; IN COMMERCE 8-23-2001.

THE MARK CONSISTS OF STANDARD CHARACTERS WITHOUT CLAIM TO ANY PARTICULAR FONT, STYLE, SIZE, OR COLOR.

OWNER OF FED REP GERMANY REG. NO. T0421572C, DATED 12-8-2004, EXPIRES 12-8-2014.

SER. NO. 77-071,229, FILED 12-26-2006.

STEVEN JACKSON, EXAMINING ATTORNEY

Int. Cl.: 9

Prior U.S. Cls.: 21, 23, 26, 36 and 38

United States Patent and Trademark Office

Reg. No. 3,482,981

Registered Aug. 12, 2008

**TRADEMARK
PRINCIPAL REGISTER**

ELVA

CARL ZEISS VISION GMBH (FED REP GERMA-
NY LTD LIAB CO)
TURNSTRASSE 27
73430 AALEN, FED REP GERMANY

FOR: ELECTRONIC VISION AIDS, NAMELY,
VIDEO SPECTACLES FOR VISUALLY DISABLED
PERSONS; LOUPES, IN CLASS 9 (U.S. CLS. 21, 23, 26,
36 AND 38).

THE MARK CONSISTS OF STANDARD CHAR-
ACTERS WITHOUT CLAIM TO ANY PARTICULAR
FONT, STYLE, SIZE, OR COLOR.

OWNER OF FED REP GERMANY REG. NO.
30644435, DATED 12-5-2006, EXPIRES 7-31-2016.

THE WORDING IN THE MARK HAS NO MEAN-
ING IN A FOREIGN LANGUAGE.

SER. NO. 77-071,772, FILED 12-27-2006.

LINDA LAVACHE, EXAMINING ATTORNEY

Int. Cl.: 35

Prior U.S. Cls.: 100, 101 and 102

United States Patent and Trademark Office

Reg. No. 3,482,982

Registered Aug. 12, 2008

**SERVICE MARK
PRINCIPAL REGISTER**

GRAPE COMMUNICATIONS

DIGITAL GRAPE, LLC (UNITED KINGDOM
LTD LIAB CO)
36 NEW ROAD
LOVEDEAN, UNITED KINGDOM PO89RU

FOR: GPS AND GSM CELLULAR TRACKING SERVICES, NAMELY, LOCATING AND MONITORING OF LAND-BASED VEHICLES, MARITIME VESSELS, AIRCRAFT, AND INDIVIDUALS FOR COMMERCIAL AND PERSONAL PURPOSES; MONITORING OF LAND-BASED VEHICLES, MARITIME VESSELS, AIRCRAFT, AND INDIVIDUALS FOR COMMERCIAL AND PERSONAL PURPOSES; CONSULTING SERVICES IN THE FIELD GPS AND GSM CELLULAR TRACKING AND MONITORING SERVICES, IN CLASS 35 (U.S. CLS. 100, 101 AND 102).

FIRST USE 12-0-2005; IN COMMERCE 12-0-2005.

THE MARK CONSISTS OF STANDARD CHARACTERS WITHOUT CLAIM TO ANY PARTICULAR FONT, STYLE, SIZE, OR COLOR.

NO CLAIM IS MADE TO THE EXCLUSIVE RIGHT TO USE "COMMUNICATIONS" , APART FROM THE MARK AS SHOWN.

SER. NO. 77-071,796, FILED 12-27-2006.

BRIDGETT SMITH, EXAMINING ATTORNEY

Int. Cl.: 9

Prior U.S. Cls.: 21, 23, 26, 36 and 38

United States Patent and Trademark Office

Reg. No. 3,482,983

Registered Aug. 12, 2008

TRADEMARK
PRINCIPAL REGISTER



ARUZE CORPORATION (JAPAN CORPORATION)
1-25, ARIAKE 3-CHOME, KOTOKU
TOKYO, JAPAN

FOR: VIDEO POKER MACHINES AND REPLACEMENT PARTS THEREFOR; SLOT MACHINES AND REPLACEMENT PARTS THEREFOR; VIDEO SLOT MACHINES AND REPLACEMENT PARTS THEREFOR; GAMING MACHINES WITH A LIQUID CRYSTAL DISPLAY AND REPLACEMENT PARTS THEREFOR; MECHANICAL REEL TYPE SLOT MACHINES WITH A LIQUID CRYSTAL DISPLAY AND REPLACEMENT PARTS THEREFOR; VIDEO GAMING MACHINES AND REPLACEMENT PARTS THEREFOR; MEDIA STORAGE COMPUTER SOFTWARE AND COMPUTER SOFTWARE FOR CONTROLLING SLOT MACHINES OR

GAME MACHINES, AND COMPUTER GAME SOFTWARE FOR GAME MACHINES OR SLOT MACHINES, IN CLASS 9 (U.S. CLS. 21, 23, 26, 36 AND 38).

PRIORITY CLAIMED UNDER SEC. 44(D) ON JAPAN APPLICATION NO. 2006-112300, FILED 12-5-2006, REG. NO. 5075413, DATED 9-7-2007, EXPIRES 9-7-2017.

THE MARK CONSISTS OF STYLIZED WORDS WITH WINGS AND FLOWERS.

SER. NO. 77-072,174, FILED 12-27-2006.

BRIAN PINO, EXAMINING ATTORNEY

Int. Cl.: 1

Prior U.S. Cls.: 1, 5, 6, 10, 26 and 46

Reg. No. 3,482,984

United States Patent and Trademark Office

Registered Aug. 12, 2008

**TRADEMARK
PRINCIPAL REGISTER**

LEAP START FEEDER PAKS

SIERRA REFORESTATION COMPANY (CALIFORNIA CORPORATION), DBA REFORESTATION TECHNOLOGIES INTERNATIONAL
1341 DAYTON STREET UNIT G
SALINAS, CA 93901

FOR: FERTILIZERS, IN CLASS 1 (U.S. CLS. 1, 5, 6, 10, 26 AND 46).

FIRST USE 12-29-2006; IN COMMERCE 12-29-2006.

THE MARK CONSISTS OF STANDARD CHARACTERS WITHOUT CLAIM TO ANY PARTICULAR FONT, STYLE, SIZE, OR COLOR.

NO CLAIM IS MADE TO THE EXCLUSIVE RIGHT TO USE "FEEDER PAKS", APART FROM THE MARK AS SHOWN.

SER. NO. 77-073,534, FILED 12-29-2006.

BILL DAWE, EXAMINING ATTORNEY

Int. Cl.: 9

Prior U.S. Cls.: 21, 23, 26, 36 and 38

Reg. No. 3,482,985

United States Patent and Trademark Office

Registered Aug. 12, 2008

**TRADEMARK
PRINCIPAL REGISTER**

FMDESKTOP

AUTODESK, INC. (DELAWARE CORPORATION)
111 MCINNIS PARKWAY
SAN RAFAEL, CA 94903

FIRST USE 9-1-2002; IN COMMERCE 9-1-2002.

FOR: COMPUTER GRAPHICS SOFTWARE; COMPUTER SOFTWARE FOR ORGANIZING AND VIEWING DIGITAL IMAGES AND PHOTOGRAPHS; COMPUTER SOFTWARE FOR THE COLLECTION, EDITING, ORGANIZING, MODIFYING, BOOK MARKING, TRANSMISSION, STORAGE AND SHARING OF DATA AND INFORMATION; COMPUTER SOFTWARE TO AUTOMATE DATA WAREHOUSING, IN CLASS 9 (U.S. CLS. 21, 23, 26, 36 AND 38).

THE MARK CONSISTS OF STANDARD CHARACTERS WITHOUT CLAIM TO ANY PARTICULAR FONT, STYLE, SIZE, OR COLOR.

SEC. 2(F).

SER. NO. 77-074,599, FILED 1-2-2007.

DOMINIC J. FERRAIUOLO, EXAMINING ATTORNEY

Int. Cl.: 16

Prior U.S. Cls.: 2, 5, 22, 23, 29, 37, 38 and 50

Reg. No. 3,482,986

United States Patent and Trademark Office

Registered Aug. 12, 2008

**TRADEMARK
PRINCIPAL REGISTER**

RELATOS DE LA HISTORIA

HMH PUBLISHERS LLC (DELAWARE LTD LIAB
CO)
2711 CENTREVILLE ROAD, SUITE 4000
WILMINGTON, DE 19808

FOR: PRINTED MATERIALS, NAMELY, A SERIES OF BOOKS, TEACHERS' GUIDES, WORKBOOKS AND TESTS FOR TEACHING SOCIAL STUDIES TO ELEMENTARY AND MIDDLE SCHOOL STUDENTS, IN CLASS 16 (U.S. CLS. 2, 5, 22, 23, 29, 37, 38 AND 50).

FIRST USE 7-0-1996; IN COMMERCE 7-0-1996.

THE MARK CONSISTS OF STANDARD CHARACTERS WITHOUT CLAIM TO ANY PARTICULAR FONT, STYLE, SIZE, OR COLOR.

THE ENGLISH TRANSLATION OF "RELATOS DE LA HISTORIA" IS "STORIES OF HISTORY".

SEC. 2(F).

SER. NO. 77-074,802, FILED 1-3-2007.

ELISSA GARBER KON, EXAMINING ATTORNEY

Int. Cl.: 10

Prior U.S. Cls.: 26, 39 and 44

United States Patent and Trademark Office

Reg. No. 3,482,987

Registered Aug. 12, 2008

**TRADEMARK
PRINCIPAL REGISTER**

GO PRO

OTICON A/S (DENMARK CORPORATION)

KONGEBAKKEN 9

SMORUM, DENMARK 2765

FOR: APPARATUS AND INSTRUMENTS FOR
OR IN CONNECTION WITH PEOPLE WITH IM-
PAIRED HEARING, NAMELY, HEARING AIDS
AND PARTS AND FITTINGS THEREFOR, IN
CLASS 10 (U.S. CLS. 26, 39 AND 44).

THE MARK CONSISTS OF STANDARD CHAR-
ACTERS WITHOUT CLAIM TO ANY PARTICULAR
FONT, STYLE, SIZE, OR COLOR.

OWNER OF ERPN CMNTY TM OFC REG. NO.
005305354, DATED 11-15-2007, EXPIRES 9-11-2016.

OWNER OF U.S. REG. NO. 3,026,719.

SER. NO. 77-075,015, FILED 1-3-2007.

KAREN SEVERSON, EXAMINING ATTORNEY

Int. Cl.: 16

Prior U.S. Cls.: 2, 5, 22, 23, 29, 37, 38 and 50

Reg. No. 3,482,988

United States Patent and Trademark Office

Registered Aug. 12, 2008

**TRADEMARK
PRINCIPAL REGISTER**

QUINTESSENTIAL PEOPLE

QUINTESSENTIAL MEDIA GROUP, INC. (ILLINOIS CORPORATION)
211 FOX STREET
CARY, IL 60013

FOR: PRINTED PUBLICATIONS SPECIFICALLY MAGAZINES IN THE FIELD OF LIFESTYLE, BOOK REVIEWS, FASHION, PROFILES OF INDIVIDUALS, COMMUNITY EVENTS, CURRENT EVENTS, HOME DECOR, TRAVEL AND ENTERTAINMENT, IN CLASS 16 (U.S. CLS. 2, 5, 22, 23, 29, 37, 38 AND 50).

FIRST USE 1-1-2006; IN COMMERCE 1-1-2006.

THE MARK CONSISTS OF STANDARD CHARACTERS WITHOUT CLAIM TO ANY PARTICULAR FONT, STYLE, SIZE, OR COLOR.

NO CLAIM IS MADE TO THE EXCLUSIVE RIGHT TO USE "PEOPLE", APART FROM THE MARK AS SHOWN.

SER. NO. 77-075,497, FILED 1-3-2007.

ZHALEH DELANEY, EXAMINING ATTORNEY

Int. Cls.: 9 and 42

Prior U.S. Cls.: 21, 23, 26, 36, 38, 100 and 101

United States Patent and Trademark Office

Reg. No. 3,482,989

Registered Aug. 12, 2008

**TRADEMARK
SERVICE MARK
PRINCIPAL REGISTER**

Connectware

METAVANTE CORPORATION (WISCONSIN CORPORATION)
MAIL STOP BD 2111
4900 W BROWN DEER RD
MILWAUKEE, WI 53223

FOR: COMPUTER SOFTWARE, NAMELY, GENERAL LEDGER ACCOUNTING AND ACCOUNT RECONCILIATION SOFTWARE; COMPUTER SOFTWARE FOR USE IN CUSTOMER RELATIONSHIP MANAGEMENT (CRM); COMPUTER COMMUNICATIONS SOFTWARE TO ALLOW CUSTOMERS TO ACCESS BANK ACCOUNT INFORMATION AND TRANSACT BANK BUSINESS; COMPUTER SOFTWARE FOR CONDUCTING ELECTRONIC BANKING, ELECTRONIC FUNDS TRANSFERS, BILL PAYMENT, CHECK IMAGING AND PROCESSING, CREDIT CARD ACCOUNT PROCESSING, DEBIT CARD ACCOUNT PROCESSING, PREPAID DEBIT CARD PROCESSING, AND SAFE DEPOSIT ACCOUNT ACCESS; LOAN MANAGEMENT SOFTWARE; COMPUTER SOFTWARE FOR CREATING CUSTOMIZED BANK STATEMENTS; COMPUTER SOFTWARE FOR USE IN TELEPHONIC ACCOUNT ACCESS, NAMELY, VOICE-RECOGNITION SOFTWARE TO ACCESS AND CHANGE ACCOUNT INFORMATION AND TRANSFER FUNDS; COMPUTER SOFTWARE FOR APPLICATION AND DATABASE INTEGRATION IN THE FIELD OF FINANCIAL SERVICE PROVIDERS, HEALTH CARE ADMINISTRATION, AND TELECOMMUNICATIONS; COMPUTER SOFTWARE PLATFORMS FOR MANAGEMENT OF PREPAID DEBIT, ATM AND CREDIT CARD ACCOUNTS; COMPUTER SOFTWARE FOR ELECTRONIC BILL PRESENTMENT AND PAYMENT; COMPUTER SOFTWARE FOR PROVIDING AN ONLINE DATABASE IN THE FIELD OF TRANSACTION PROCES-

SING TO UPLOAD TRANSACTIONAL DATA, PROVIDE STATISTICAL ANALYSIS, AND PRODUCE NOTIFICATIONS AND REPORTS; COMPUTER SOFTWARE FOR CUSTOM GENERATION OF REPORTS AND STATEMENTS; COMPUTER SOFTWARE FOR CHECK PROCESSING, FOR DOCUMENT GENERATION AND MANAGEMENT; COMPUTER SOFTWARE FOR USE IN POINT-OF-SALE TRANSACTIONS; COMPUTER SOFTWARE FOR TAX PREPARATION AND SUBMISSION; COMPUTER SOFTWARE FOR RISK ASSESSMENT, TRACKING, AND MANAGING IN THE FIELD OF FINANCIAL INSTITUTIONS, IN CLASS 9 (U.S. CLS. 21, 23, 26, 36 AND 38).

FIRST USE 6-1-1997; IN COMMERCE 6-1-1997.

FOR: CONSULTING SERVICES IN THE FIELD OF DESIGN, SELECTION, IMPLEMENTATION AND USE OF COMPUTER HARDWARE AND SOFTWARE SYSTEMS FOR OTHERS; CONVERSION OF DOCUMENTS FROM A PHYSICAL MEDIUM TO AN ELECTRONIC MEDIUM; DATA CONVERSION OF COMPUTER PROGRAMS AND DATA, BUT NOT A PHYSICAL CONVERSION; COMPUTER PROGRAMMING FOR OTHERS, IN CLASS 42 (U.S. CLS. 100 AND 101).

FIRST USE 6-1-1997; IN COMMERCE 6-1-1997.

THE MARK CONSISTS OF STANDARD CHARACTERS WITHOUT CLAIM TO ANY PARTICULAR FONT, STYLE, SIZE, OR COLOR.

SER. NO. 77-077,755, FILED 1-8-2007.

MARY ROSSMAN, EXAMINING ATTORNEY

Int. Cl.: 35

Prior U.S. Cls.: 100, 101 and 102

United States Patent and Trademark Office

Reg. No. 3,482,990

Registered Aug. 12, 2008

**SERVICE MARK
PRINCIPAL REGISTER**

ENTERTAINMENTCAREERS.NET

ENTERTAINMENTCAREERS.NET, INC. (CALI-
FORNIA CORPORATION)
914 S. BARRINGTON AVE.
LOS ANGELES, CA 90049

FOR: PROVIDING AN ONLINE DIRECTORY
INFORMATION SERVICE FEATURING INFORMA-
TION REGARDING JOB LISTINGS AND EMPLOY-
MENT RESOURCES, IN CLASS 35 (U.S. CLS. 100, 101
AND 102).

FIRST USE 3-1-2000; IN COMMERCE 3-1-2000.

THE MARK CONSISTS OF STANDARD CHAR-
ACTERS WITHOUT CLAIM TO ANY PARTICULAR
FONT, STYLE, SIZE, OR COLOR.

OWNER OF U.S. REG. NO. 3,390,873.

SEC. 2(F).

SER. NO. 77-078,160, FILED 1-8-2007.

CORY BOONE, EXAMINING ATTORNEY

Int. Cl.: 35

Prior U.S. Cls.: 100, 101 and 102

United States Patent and Trademark Office

Reg. No. 3,482,991

Registered Aug. 12, 2008

**SERVICE MARK
PRINCIPAL REGISTER**

**NO REJECTIONS JUST 100%
CREDIT ACCEPTIONS!**

A&H MOTORS, INC. (VIRGINIA CORPORATION)
8710 LIBERIA AVE.
MANASSAS, VA 20110

THE MARK CONSISTS OF STANDARD CHARACTERS WITHOUT CLAIM TO ANY PARTICULAR FONT, STYLE, SIZE, OR COLOR.

FOR: AUTOMOTIVE DEALERSHIPS, IN CLASS 35
(U.S. CLS. 100, 101 AND 102).

SER. NO. 77-078,576, FILED 1-9-2007.

FIRST USE 1-1-2005; IN COMMERCE 1-1-2005.

DAVID C. REIHNER, EXAMINING ATTORNEY

Int. Cl.: 9

Prior U.S. Cls.: 21, 23, 26, 36 and 38

Reg. No. 3,482,992

United States Patent and Trademark Office

Registered Aug. 12, 2008

**TRADEMARK
PRINCIPAL REGISTER**

RC1

METTLER-TOLEDO AG (SWITZERLAND CORPORATION)
IM LANGACHER
GREIFENSEE, SWITZERLAND 8606

FOR: LABORATORY, MEASURING AND CONTROL APPARATUS AND INSTRUMENTS, NAMELY LABORATORY REACTORS, LABORATORY ROBOTS, TRUE MODELS OF REACTORS FOR MEASURING OF PHYSICAL, CHEMICAL AND ANALYTICAL PROPERTIES FOR ENSURING SAFETY OF PRODUCTION PROCESSES, QUALITY OF PRODUCTS, PROFITABILITY OF THE PRODUCTION, OPTIMIZATION OF THE PRODUCTION PROCESS AND ENVIRONMENTAL COMPATIBILITY OF INDUSTRIAL PROCESS, ALSO AS DEVICE COMBINATIONS AND PARTS THEREOF, NAMELY, COMPUTER PROGRAMMES FOR THE DATA HANDLING OF MEASURED PHYSICAL, CHEMICAL AND ANALYTICAL PROPERTIES, ESPECIALLY FOR CALORIMETRY, DATA PROCESSING DEVICES, NAMELY, INTERFACES IN THE FORM OF PRINTED CIRCUITS, ELECTRONIC CONTROLS NAMELY FOR DIRECTING SEQUENCES OF

WORKING PROCESSES, NAMELY, GUIDING THE USER STEP-BY-STEP THROUGH EXPERIMENTS, MAIN AND SECONDARY DISPLAYS WITH EXTERNAL SCREENS OR MONITORS AND SENSORS, FOR MEASURING OF PHYSICAL, CHEMICAL AND ANALYTICAL PROPERTIES, ESPECIALLY FOR CALORIMETRY, IN CLASS 9 (U.S. CLS. 21, 23, 26, 36 AND 38).

FIRST USE 1-1-1990; IN COMMERCE 1-1-1990.

THE MARK CONSISTS OF STANDARD CHARACTERS WITHOUT CLAIM TO ANY PARTICULAR FONT, STYLE, SIZE, OR COLOR.

PRIORITY CLAIMED UNDER SEC. 44(D) ON SWITZERLAND APPLICATION NO. 56224/2006, FILED 7-14-2006, REG. NO. 551316, DATED 10-20-2006, EXPIRES 7-14-2016.

SER. NO. 77-079,588, FILED 1-10-2007.

KATHLEEN LORENZO, EXAMINING ATTORNEY

Int. Cl.: 44

Prior U.S. Cls.: 100 and 101

United States Patent and Trademark Office

Reg. No. 3,482,993

Registered Aug. 12, 2008

**SERVICE MARK
PRINCIPAL REGISTER**

Smile In The City

SMILE IN THE CITY DENTAL GROUP, P.L.L.C.
(NEW YORK LTD LIAB CO)
SUITE 105
30 EAST 40TH STREET
NEW YORK, NY 10016

THE MARK CONSISTS OF STANDARD CHAR-
ACTERS WITHOUT CLAIM TO ANY PARTICULAR
FONT, STYLE, SIZE, OR COLOR.

FOR: DENTIST SERVICES, IN CLASS 44 (U.S. CLS.
100 AND 101).

SER. NO. 77-079,641, FILED 1-10-2007.

FIRST USE 2-1-2005; IN COMMERCE 2-1-2005.

EUGENIA MARTIN, EXAMINING ATTORNEY

Int. Cl.: 45

Prior U.S. Cls.: 100 and 101

United States Patent and Trademark Office

Reg. No. 3,482,994

Registered Aug. 12, 2008

SERVICE MARK
PRINCIPAL REGISTER



SHOE4AFRICA INC. (NEW YORK NON-PROFIT CORPORATION)
1752 FIRST AVENUE, #3A
NEW YORK, NY 10128

FOR: CHARITABLE SERVICES, NAMELY, COLLECTING IN THE UNITED STATES AND DISTRIBUTING RUNNING SHOES TO THE NEEDY IN AFRICA, IN CLASS 45 (U.S. CLS. 100 AND 101).

FIRST USE 7-0-2004; IN COMMERCE 7-0-2004.

NO CLAIM IS MADE TO THE EXCLUSIVE RIGHT TO USE "SHOE 4 AFRICA . ORG", APART FROM THE MARK AS SHOWN.

THE MARK CONSISTS OF THE WORDS "SHOE4AFRICA" SUPERIMPOSED ON TOP OF A SHIELD DESIGN WITH TWO SPEARS WHICH CROSS IN THE MIDDLE LOWER PORTION OF THE DESIGN.

SER. NO. 77-081,256, FILED 1-11-2007.

LESLIE RICHARDS, EXAMINING ATTORNEY

Int. Cl.: 41

Prior U.S. Cls.: 100, 101 and 107

United States Patent and Trademark Office

Reg. No. 3,482,995

Registered Aug. 12, 2008

**SERVICE MARK
PRINCIPAL REGISTER**



LINDA VEGA (UNITED STATES INDIVIDUAL)
215 WEST VICTORIA ST.
SANTA BARBARA, CA 93101

THE MARK CONSISTS OF THE SILHOUETTE
IMAGE OF A FEMALE DANCER IN A FLAMENCO
POSE.

FOR: DANCE INSTRUCTION; ENTERTAIN-
MENT IN THE NATURE OF DANCE PERFORMAN-
CES; ORGANIZATION OF DANCING EVENTS, IN
CLASS 41 (U.S. CLS. 100, 101 AND 107).

SER. NO. 77-081,480, FILED 1-11-2007.

FIRST USE 6-1-1986; IN COMMERCE 6-1-1986.

ANDREA BUTLER, EXAMINING ATTORNEY

Int. Cls.: 10 and 25

Prior U.S. Cls.: 22, 26, 39 and 44

United States Patent and Trademark Office

Reg. No. 3,482,996

Registered Aug. 12, 2008

**TRADEMARK
PRINCIPAL REGISTER**

CB-6000

A.L. ENTERPRISES, INC. (NEVADA CORPORATION)
396 SOUTH CARBON AVENUE
PRICE, UT 84501

FOR: ADULT SEXUAL AIDS CONDUCTIVE TO MALE CHASTITY, NAMELY, CHASTITY RESTRAINTS FOR MEN, IN CLASS 10 (U.S. CLS. 26, 39 AND 44).

FIRST USE 5-14-2007; IN COMMERCE 6-22-2007.

FOR: DEVICES CONDUCTIVE TO MALE CHASTITY, NAMELY, CHASTITY BELTS FOR MEN, IN CLASS 25 (U.S. CLS. 22 AND 39).

FIRST USE 5-14-2007; IN COMMERCE 6-22-2007.

THE MARK CONSISTS OF STANDARD CHARACTERS WITHOUT CLAIM TO ANY PARTICULAR FONT, STYLE, SIZE, OR COLOR.

OWNER OF U.S. REG. NO. 3,150,789.

SER. NO. 77-082,358, FILED 1-12-2007.

JOHN DWYER, EXAMINING ATTORNEY

Int. Cl.: 40

Prior U.S. Cls.: 100, 103 and 106

United States Patent and Trademark Office

Reg. No. 3,482,997

Registered Aug. 12, 2008

**SERVICE MARK
PRINCIPAL REGISTER**

Endura!

CONCEPT SEATING, INC. (WISCONSIN CORPORATION)
N227 W752 WESTMOUND DRIVE, UNIT L-1
WAUKESHA, WI 53186

FOR: MANUFACTURE OF OFFICE CHAIRS, OFFICE SEATS, OFFICE FURNITURE, AND OFFICE ARMCHAIRS TO ORDER AND/OR SPECIFICATION OF OTHERS , IN CLASS 40 (U.S. CLS. 100, 103 AND 106).

FIRST USE 2-1-2006; IN COMMERCE 2-1-2006.

THE MARK CONSISTS OF STANDARD CHARACTERS WITHOUT CLAIM TO ANY PARTICULAR FONT, STYLE, SIZE, OR COLOR.

SER. NO. 77-082,769, FILED 1-15-2007.

ANN E. SAPPENFIELD, EXAMINING ATTORNEY

Int. Cls.: 16 and 35

Prior U.S. Cls.: 2, 5, 22, 23, 29, 37, 38, 50, 100, 101 and 102

Reg. No. 3,482,998

United States Patent and Trademark Office

Registered Aug. 12, 2008

**TRADEMARK
SERVICE MARK
PRINCIPAL REGISTER**

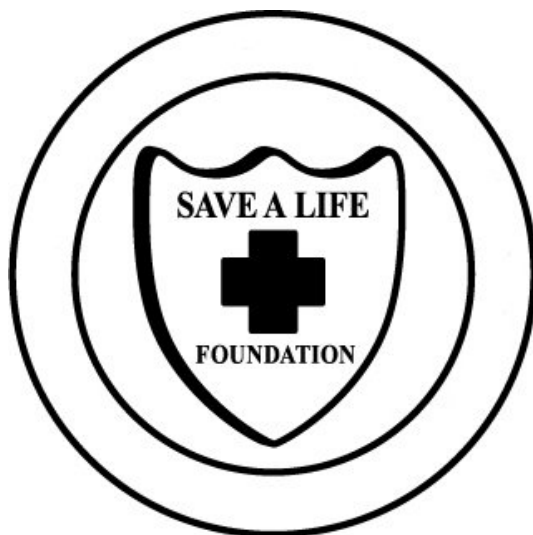

SAVE A LIFE FOUNDATION, INC. (ILLINOIS CORPORATION)
9950 W. LAWRENCE AVE. STE. 300
SCHILLER PARK, IL 60176

PROMOTING PUBLIC AWARENESS OF LIFE SAVING TECHNIQUES, FIRST AID TECHNIQUES OR CPR TECHNIQUES, IN CLASS 35 (U.S. CLS. 100, 101 AND 102).

FOR: EDUCATIONAL PUBLICATIONS, NAME-
LY, TRAINING MANUALS IN THE FIELD OF
EMERGENCY PREPAREDNESS, LIFE SAVING
TECHNIQUES, FIRST AID TECHNIQUES OR CPR
TECHNIQUES; MANUALS IN THE FIELD OF
EMERGENCY PREPAREDNESS, LIFE SAVING
TECHNIQUES, FIRST AID TECHNIQUES OR CPR
TECHNIQUES; PUBLICATIONS, NAMELY, BRO-
CHURES, BOOKLETS, AND TEACHING MATERI-
ALS IN THE FIELD OF EMERGENCY
PREPAREDNESS, LIFE SAVING TECHNIQUES,
FIRST AID TECHNIQUES OR CPR TECHNIQUES,
IN CLASS 16 (U.S. CLS. 2, 5, 22, 23, 29, 37, 38 AND 50).

FIRST USE 12-31-1993; IN COMMERCE 12-31-1993.

NO CLAIM IS MADE TO THE EXCLUSIVE
RIGHT TO USE "FOUNDATION", APART FROM
THE MARK AS SHOWN.

THE MARK CONSISTS OF A SHIELD GRAPHIC
ELEMENT FEATURING A CROSS AND "SAVE A
LIFE FOUNDATION" SURROUNDED BY A CIR-
CULAR GRAPHIC ELEMENT. THE CROSS WILL
NOT BE DISPLAYED IN ANY SHADE OF THE
COLOR RED.

FIRST USE 12-31-1993; IN COMMERCE 12-31-1993.

SER. NO. 77-083,251, FILED 1-15-2007.

FOR: PROMOTING PUBLIC AWARENESS OF
THE NEED FOR EMERGENCY PREPAREDNESS;

CYNTHIA SLOAN, EXAMINING ATTORNEY

Int. Cls.: 9, 16 and 42

**Prior U.S. Cls.: 2, 5, 21, 22, 23, 26, 29, 36, 37, 38, 50,
100 and 101**

Reg. No. 3,482,999

United States Patent and Trademark Office

Registered Aug. 12, 2008

**TRADEMARK
SERVICE MARK
PRINCIPAL REGISTER**

addVANTAGE Pro

ADCON TELEMETRY GMBH (AUSTRIA LTD
LIAB CO)
INKUSTRASSE 24
KLOSTERNEUBURG, AUSTRIA A-3400

FOR: COMPUTER PROGRAMS FOR VISUALIZ-
ING MEASURED DATA, IN CLASS 9 (U.S. CLS. 21,
23, 26, 36 AND 38).

FIRST USE 1-28-2002; IN COMMERCE 1-28-2002.

FOR: MANUALS AND TEXTBOOKS RELATING
TO COMPUTER PROGRAMS, IN CLASS 16 (U.S.
CLS. 2, 5, 22, 23, 29, 37, 38 AND 50).

FIRST USE 1-28-2002; IN COMMERCE 1-28-2002.

FOR: DEVELOPMENT OF COMPUTER PRO-
GRAMS FOR VISUALIZING, PROCESSING AND

DISTRIBUTING MEASURED DATA, AND PROVID-
ING TECHNICAL ADVICE TO OTHERS FOR AS-
SESSING THE MEASURED DATA, IN CLASS 42
(U.S. CLS. 100 AND 101).

FIRST USE 1-28-2002; IN COMMERCE 1-28-2002.

THE MARK CONSISTS OF STANDARD CHAR-
ACTERS WITHOUT CLAIM TO ANY PARTICULAR
FONT, STYLE, SIZE, OR COLOR.

NO CLAIM IS MADE TO THE EXCLUSIVE
RIGHT TO USE "PRO"(INTERNATIONAL CLASS
042 ONLY), APART FROM THE MARK AS SHOWN.

SER. NO. 77-083,700, FILED 1-16-2007.

ODESSA BIBBINS, EXAMINING ATTORNEY

Int. Cl.: 3

Prior U.S. Cls.: 1, 4, 6, 50, 51 and 52

Reg. No. 3,483,000

United States Patent and Trademark Office

Registered Aug. 12, 2008

**TRADEMARK
PRINCIPAL REGISTER**

AQUOLINA

SELECTIVA S.P.A. (ITALY JOINT STOCK COMPANY)
STRADA STATALE PER GENOVA KM. 98
15100 ALESSANDRIA, ITALY

FOR: PERFUMERY, NAMELY, PERFUMES, EAU DE TOILETTE, ESSENTIAL OILS FOR PERSONAL USE, SCENTED BODY WATER, NAMELY, TONIC WATER FOR THE BODY; PERSONAL DEODORANTS AND ANTIPERSPIRANTS; HAIR PERFUMES; PERFUMED COMPACT BODY POWDER; SOAPS, NAMELY, FOR HANDS, SKIN, FACE; LIQUID SOAPS, DEODORANT SOAPS; SHOWER GELS, BODY SCRUBS, SHOWER AND BATH FOAMS; LOTIONS, MILKS, OILS, MOUSSE, AND POWDERS

FOR THE CARE AND CLEANSING OF THE SKIN, BODY, HANDS AND FEET; AFTER-SHAVE GELS, IN CLASS 3 (U.S. CLS. 1, 4, 6, 50, 51 AND 52).

FIRST USE 9-0-2003; IN COMMERCE 9-0-2003.

THE MARK CONSISTS OF STANDARD CHARACTERS WITHOUT CLAIM TO ANY PARTICULAR FONT, STYLE, SIZE, OR COLOR.

SER. NO. 77-084,125, FILED 1-16-2007.

FRANK LATTUCA, EXAMINING ATTORNEY

Int. Cls.: 7, 11 and 20

**Prior U.S. Cls.: 2, 13, 19, 21, 22, 23, 25, 31, 32, 34, 35
and 50**

Reg. No. 3,483,001

United States Patent and Trademark Office

Registered Aug. 12, 2008

**TRADEMARK
PRINCIPAL REGISTER**



AERO MANUFACTURING COMPANY, INC.
(NEW JERSEY CORPORATION)
310 ALLWOOD RD.
CLIFTON, NJ 07012

FOR: STAINLESS STEEL PRODUCTS, NAMELY,
MACHINE STANDS FOR USE IN THE COMMERCIAL,
PLUMBING, INDUSTRIAL, MEDICAL, MATERIAL
HANDLING AND FOOD MANUFACTURING AND FOOD
PROCESSING INDUSTRIES, IN CLASS 7 (U.S. CLS. 13,
19, 21, 23, 31, 34 AND 35).

FIRST USE 0-0-1965; IN COMMERCE 0-0-1965.

FOR: STAINLESS STEEL PRODUCTS, NAMELY,
METAL SINKS FOR USE IN THE COMMERCIAL,
PLUMBING, INDUSTRIAL, MEDICAL, MATERIAL
HANDLING AND FOOD MANUFACTURING AND

FOOD PROCESSING INDUSTRIES, IN CLASS 11
(U.S. CLS. 13, 21, 23, 31 AND 34).

FIRST USE 0-0-1965; IN COMMERCE 0-0-1965.

FOR: STAINLESS STEEL PRODUCTS, NAMELY,
WORK TABLES, SHELVING, DISHTABLES AND
CABINETS FOR USE IN THE COMMERCIAL,
PLUMBING, INDUSTRIAL, MEDICAL, MATERIAL
HANDLING AND FOOD MANUFACTURING AND
FOOD PROCESSING INDUSTRIES, IN CLASS 20
(U.S. CLS. 2, 13, 22, 25, 32 AND 50).

FIRST USE 0-0-1965; IN COMMERCE 0-0-1965.

SER. NO. 77-084,738, FILED 1-17-2007.

COLLEEN DOMBROW, EXAMINING ATTORNEY

Int. Cls.: 16 and 41

Prior U.S. Cls.: 2, 5, 22, 23, 29, 37, 38, 50, 100, 101 and 107

Reg. No. 3,483,002

United States Patent and Trademark Office

Registered Aug. 12, 2008

**TRADEMARK
SERVICE MARK
PRINCIPAL REGISTER**

SCOUTPARENTS

BOY SCOUTS OF AMERICA (UNITED STATES A
UNITED STATES CORPORATION CHAR-
TERED BY THE ACT OF CONGRESS, 36
U.S.C. SECTION 21)

P.O. BOX 152079
1325 WEST WALNUT HILL LANE
IRVING, TX 750152079

FOR: BUMPER STICKERS, BROCHURES AND
ORIENTATION GUIDES RELATED TO AN ORGA-
NIZATION FOR YOUNG MEN AND BOYS. IN
CLASS 16 (U.S. CLS. 2, 5, 22, 23, 29, 37, 38 AND 50).

FIRST USE 5-24-2006; IN COMMERCE 5-24-2006.

FOR: PROVIDING A WEBSITE THAT OFFERS
PARENTS RECREATIONAL-CLUB INFORMATION
NECESSARY TO BECOME MORE INVOLVED IN A

SERVICE ORGANIZATION FOR YOUNG MEN
AND BOYS, IN CLASS 41 (U.S. CLS. 100, 101 AND
107).

FIRST USE 5-24-2006; IN COMMERCE 5-24-2006.

THE MARK CONSISTS OF STANDARD CHAR-
ACTERS WITHOUT CLAIM TO ANY PARTICULAR
FONT, STYLE, SIZE, OR COLOR.

OWNER OF U.S. REG. NOS. 1,213,650, 1,215,939
AND OTHERS.

SER. NO. 77-085,901, FILED 1-18-2007.

BRENDAN REGAN, EXAMINING ATTORNEY

Int. Cls.: 16 and 41

Prior U.S. Cls.: 2, 5, 22, 23, 29, 37, 38, 50, 100, 101 and 107

Reg. No. 3,483,003

United States Patent and Trademark Office

Registered Aug. 12, 2008

**TRADEMARK
SERVICE MARK
PRINCIPAL REGISTER**

**SCOUTING MAKES GREAT
PARENTS, TOO!**

BOY SCOUTS OF AMERICA (UNITED STATES A
UNITED STATES CORPORATION CHAR-
TERED BY ACT OF CONGRESS, 36 U.S.C.
SECTION 21.)

P.O. BOX 152079
1325 WEST WALNUT HILL LANE
IRVING, TX 750152079

FOR: BUMPER STICKERS, BROCHURES AND
ORIENTATION GUIDES RELATED TO AN ORGA-
NIZATION FOR YOUNG MEN AND BOYS, IN
CLASS 16 (U.S. CLS. 2, 5, 22, 23, 29, 37, 38 AND 50).

FIRST USE 5-24-2006; IN COMMERCE 5-24-2006.

FOR: PROVIDING A WEBSITE THAT OFFERS
PARENTS RECREATIONAL-CLUB INFORMATION
NECESSARY TO BECOME MORE INVOLVED IN A

SERVICE ORGANIZATION FOR YOUNG MEN
AND BOYS, IN CLASS 41 (U.S. CLS. 100, 101 AND
107).

FIRST USE 5-24-2006; IN COMMERCE 5-24-2006.

THE MARK CONSISTS OF STANDARD CHAR-
ACTERS WITHOUT CLAIM TO ANY PARTICULAR
FONT, STYLE, SIZE, OR COLOR.

OWNER OF U.S. REG. NOS. 1,213,650, 1,215,939
AND OTHERS.

SER. NO. 77-085,911, FILED 1-18-2007.

BRENDAN REGAN, EXAMINING ATTORNEY

Int. Cl.: 41

Prior U.S. Cls.: 100, 101 and 107

United States Patent and Trademark Office

Reg. No. 3,483,004

Registered Aug. 12, 2008

**SERVICE MARK
PRINCIPAL REGISTER**

NUTTIEST PLAY OF THE WEEK

BLUE DIAMOND GROWERS (CALIFORNIA
CORPORATION)
1802 "C" STREET
SACRAMENTO, CA 95814

FOR: ENTERTAINMENT SERVICES, NAMELY,
CONDUCTING A CONTEST DURING SPORTING
EVENTS VIA PRINT, BROADCAST MEDIA, OUT-
DOOR MEDIA, OR THE INTERNET, IN CLASS 41
(U.S. CLS. 100, 101 AND 107).

FIRST USE 9-0-2004; IN COMMERCE 9-0-2004.

THE MARK CONSISTS OF STANDARD CHAR-
ACTERS WITHOUT CLAIM TO ANY PARTICULAR
FONT, STYLE, SIZE, OR COLOR.

OWNER OF U.S. REG. NOS. 3,083,293 AND
3,296,875.

SER. NO. 77-086,523, FILED 1-19-2007.

TINA BROWN, EXAMINING ATTORNEY

Int. Cl.: 35

Prior U.S. Cls.: 100, 101 and 102

United States Patent and Trademark Office

Reg. No. 3,483,005

Registered Aug. 12, 2008

**SERVICE MARK
PRINCIPAL REGISTER**



CAROLINA LOGISTICS SERVICES INC. (NORTH
CAROLINA CORPORATION)
2601 PILGRIM COURT
WINSTON-SALEM, NC 27106

FOR: COORDINATING THE COLLECTION OF
EXPIRED AND RECALLED PHARMACEUTICALS
FOR THIRD-PARTY PHARMACIES, HEALTHCARE
FACILITIES, PHYSICIAN OFFICES, AND CLINICS
AND THEIR RETURN FOR CREDIT TO THEIR
RESPECTIVE MANUFACTURERS OR THEIR DE-
STRUCTION, IN CLASS 35 (U.S. CLS. 100, 101 AND
102).

FIRST USE 1-9-2006; IN COMMERCE 3-1-2006.

THE COLOR(S) BLUE, BLACK, AND WHITE IS/
ARE CLAIMED AS A FEATURE OF THE MARK.

THE MARK CONSISTS OF "MED" MATED WITH
"TURN", WITH THE "R" AND THE "N" IN "TURN"
JOINING AT THEIR RESPECTIVE RIGHT AND
LEFT LOWER ASPECTS. THE WORD "MEDTURN"
IS UNDERLINED IN BLUE, WITH THE LINE COM-
ING OFF OF A BLUE ARC OVER THE LOWERCASE
LETTERS "CLS".

SER. NO. 77-086,792, FILED 1-19-2007.

ELI HELLMAN, EXAMINING ATTORNEY

Int. Cl.: 25

Prior U.S. Cls.: 22 and 39

United States Patent and Trademark Office

Reg. No. 3,483,006

Registered Aug. 12, 2008

**TRADEMARK
PRINCIPAL REGISTER**

DIAPER VEST

DADGEAR LLC (COLORADO LTD LIAB CO)
2121 S. ONEIDA STREET, SUITE 175
DENVER, CO 80224

FOR: CLOTHING, NAMELY, VESTS, IN CLASS 25
(U.S. CLS. 22 AND 39).

FIRST USE 5-25-2005; IN COMMERCE 5-25-2005.

THE MARK CONSISTS OF STANDARD CHAR-
ACTERS WITHOUT CLAIM TO ANY PARTICULAR
FONT, STYLE, SIZE, OR COLOR.

NO CLAIM IS MADE TO THE EXCLUSIVE
RIGHT TO USE "VEST", APART FROM THE MARK
AS SHOWN.

SER. NO. 77-087,170, FILED 1-19-2007.

DOMINICK J. SALEMI, EXAMINING ATTORNEY

Int. Cl.: 10

Prior U.S. Cls.: 26, 39 and 44

United States Patent and Trademark Office

Reg. No. 3,483,007

Registered Aug. 12, 2008

**TRADEMARK
PRINCIPAL REGISTER**

TRABECULAR METAL

ZIMMER, INC. (DELAWARE CORPORATION)
345 EAST MAIN STREET
WARSAW, IN 46580

FOR: ORTHOPEDIC HIP, KNEE AND SHOULD-
ER JOINT PROSTHESES AND PARTS THEREFOR;
ARTIFICIAL OSTEONECROSIS INTERVENTION
IMPLANTS; AND ARTIFICIAL SPINAL IMPLANTS,
NAMELY, CERVICAL, LUMBAR AND THORACIC
DEVICES FOR THE FUSION, STABILIZATION AND
REGENERATION OF THE SPINE, IN CLASS 10 (U.S.
CLS. 26, 39 AND 44).

FIRST USE 0-0-2001; IN COMMERCE 0-0-2001.

THE MARK CONSISTS OF STANDARD CHAR-
ACTERS WITHOUT CLAIM TO ANY PARTICULAR
FONT, STYLE, SIZE, OR COLOR.

NO CLAIM IS MADE TO THE EXCLUSIVE
RIGHT TO USE "METAL", APART FROM THE
MARK AS SHOWN.

SEC. 2(F) AS TO "TRABECULAR".

SER. NO. 77-087,660, FILED 1-22-2007.

BENJAMIN OKEKE, EXAMINING ATTORNEY

Int. Cl.: 43

Prior U.S. Cls.: 100 and 101

United States Patent and Trademark Office

Reg. No. 3,483,008

Registered Aug. 12, 2008

SERVICE MARK
PRINCIPAL REGISTER



Fresh Life Restaurant

CJ FOODVILLE CORP. (REPUBLIC OF KOREA CORPORATION)
1026-28, BANGBAE-DONG, SEOCHO-KU
SEOUL, REPUBLIC OF KOREA

FOR: RESTAURANTS, KOREAN RESTAURANTS, CAFES, BUFFET-STYLE RESTAURANTS, IN CLASS 43 (U.S. CLS. 100 AND 101).

PRIORITY CLAIMED UNDER SEC. 44(D) ON REPUBLIC OF KOREA APPLICATION NO. 41-2007-0001, FILED 1-15-2007, REG. NO. 0158987, DATED 1-3-2008, EXPIRES 1-3-2018.

NO CLAIM IS MADE TO THE EXCLUSIVE RIGHT TO USE "RESTAURANT", APART FROM THE MARK AS SHOWN.

THE MARK CONSISTS OF THE LETTERS "VIPS" WITHIN AN OVAL. THERE IS ONE ADDITIONAL OVAL SURROUNDING THIS AND THE WORDS "FRESH LIFE RESTAURANT" ARE CENTERED UNDERNEATH.

SER. NO. 77-087,672, FILED 1-22-2007.

BRENDAN REGAN, EXAMINING ATTORNEY

Int. Cl.: 25

Prior U.S. Cls.: 22 and 39

United States Patent and Trademark Office

Reg. No. 3,483,009

Registered Aug. 12, 2008

**TRADEMARK
PRINCIPAL REGISTER**

gnarlē

GNARLE PARTNERSHIP (CALIFORNIA PART-
NERSHIP)
16907 FONTHILL AVE
TORRANCE, CA 90504

FOR: CAPS; COATS; GLOVES; HATS; JACKETS;
LINGERIE; LOUNGEWEAR; PANTS; SHIRTS;
SHORTS; SLEEPWEAR; SUITS; SWEAT PANTS;
SWEAT SHIRTS; SWEATERS; SWIM WEAR; UN-
DERWEAR; VESTS , IN CLASS 25 (U.S. CLS. 22 AND
39).

FIRST USE 7-21-2005; IN COMMERCE 7-21-2005.

THE MARK CONSISTS OF STANDARD CHAR-
ACTERS WITHOUT CLAIM TO ANY PARTICULAR
FONT, STYLE, SIZE, OR COLOR.

SER. NO. 77-090,885, FILED 1-25-2007.

JORDAN BAKER, EXAMINING ATTORNEY

Int. Cl.: 30

Prior U.S. Cl.: 46

United States Patent and Trademark Office

Reg. No. 3,483,010

Registered Aug. 12, 2008

TRADEMARK
PRINCIPAL REGISTER



GOURMET CAKES & PASTRIES

CALJOR INC (FLORIDA CORPORATION)
PO BOX 352411
PALM COAST, FL 32135

FOR: BAKERY PRODUCTS AND DESSERTS, NAMELY, PASTRIES, CAKES, CHEESECAKES, COOKIES, BITE SIZED PASTRIES, MINI CAKES AND INDIVIDUAL SIZED CAKES AND PASTRIES, IN CLASS 30 (U.S. CL. 46).

FIRST USE 1-29-2007; IN COMMERCE 1-29-2007.

NO CLAIM IS MADE TO THE EXCLUSIVE RIGHT TO USE "CARAMEL" AND "GOURMET CAKES AND PASTRIES", APART FROM THE MARK AS SHOWN.

THE COLOR(S) ORANGE AND BLACK IS/ARE CLAIMED AS A FEATURE OF THE MARK.

THE MARK CONSISTS OF AN ORANGE SWIRLING CURVED DESIGN WITH THE WORDING "CARAMEL SWIRLS" IN STYLIZED BLACK LETTERING ON TOP OF THE DESIGN AND FOLLOWING THE CONTOUR OF THE CURVED OF THE DESIGN. THE WORDING "GOURMET CAKES & PASTRIES" IS DISPLAYED BELOW THE DESIGN IN STYLIZED BLACK LETTERING AND IS UNDERLINED WITH A BLACK HORIZONTAL LINE.

SER. NO. 77-093,589, FILED 1-29-2007.

RENEE SERVANCE, EXAMINING ATTORNEY

Int. Cl.: 25

Prior U.S. Cls.: 22 and 39

United States Patent and Trademark Office

Reg. No. 3,483,011

Registered Aug. 12, 2008

**TRADEMARK
PRINCIPAL REGISTER**



TAMARA IMPORTS, INC. (FLORIDA CORPORATION)
SUITE 1
2854 STIRLING ROAD
HOLLYWOOD, FL 33020

FOR: WOMEN'S CLOTHING, NAMELY, TOPS
AND BOTTOMS, IN CLASS 25 (U.S. CLS. 22 AND 39).

FIRST USE 2-13-2006; IN COMMERCE 2-13-2006.

THE COLOR(S) BLACK, BLUE, AND WHITE IS/
ARE CLAIMED AS A FEATURE OF THE MARK.

THE COLOR BLACK APPEARS IN THE WORDING "TAMARAUS" AND IN THE LEFT HALF OF THE CIRCLE DESIGN. THE COLOR BLUE APPEARS IN THE RIGHT HALF OF THE CIRCLE DESIGN. THE COLOR WHITE APPEARS IN THE STYLIZED LETTER "T" CONTAINED IN THE CIRCLE DESIGN.

SER. NO. 77-094,186, FILED 1-30-2007.

JENNY PARK, EXAMINING ATTORNEY

Int. Cl.: 33

Prior U.S. Cls.: 47 and 49

United States Patent and Trademark Office

Reg. No. 3,483,012

Registered Aug. 12, 2008

TRADEMARK
PRINCIPAL REGISTER



DESTILADORA SANTA VIRGINIA S.A. DE C.V.
(MEXICO CORPORATION)
SIERRA ORIENTAL 251 FRACC SIERRA HERMOSA
TEPATITLAN DE MORELOS, MEXICO

FOR: TEQUILA, IN CLASS 33 (U.S. CLS. 47 AND 49).

FIRST USE 4-20-2006; IN COMMERCE 4-20-2006.

NO CLAIM IS MADE TO THE EXCLUSIVE RIGHT TO USE "ALTEÑA", APART FROM THE MARK AS SHOWN.

THE COLOR(S) RED, GREEN AND GOLD IS/ARE CLAIMED AS A FEATURE OF THE MARK.

THE MARK CONSISTS OF THE COLOR RED APPEARS IN THE WORDING "SANGRE ALTEÑA" AND GREEN APPEARS IN THE DESIGN OF THE AGAVE PLANT AND RED APPEARS IN THE MISCELLANEOUS DESIGNS.

THE FOREIGN WORDING IN THE MARK TRANSLATES INTO ENGLISH AS "BLOOD PURE OF AGAVE".

SER. NO. 77-094,596, FILED 1-30-2007.

AMOS T. MATTHEWS, JR., EXAMINING ATTORNEY

Int. Cl.: 7

Prior U.S. Cls.: 13, 19, 21, 23, 31, 34 and 35

United States Patent and Trademark Office

Reg. No. 3,483,013

Registered Aug. 12, 2008

**TRADEMARK
PRINCIPAL REGISTER**

VarioRobot

EISENMANN LACKTECHNIK GMBH & CO. KG.
(FED REP GERMANY CORPORATION)
TÜBINGER STR. 81
BÖBLINGEN, FED REP GERMANY D-71032

PRIORITY CLAIMED UNDER SEC. 44(D) ON
ERPN CMNTY TM OFC APPLICATION NO.
005270517, FILED 8-1-2006, REG. NO. 005270517,
DATED 8-2-2007, EXPIRES 8-1-2016.

FOR: INDUSTRIAL ROBOTS, NAMELY, ROBOTS
FOR COATING WORKPIECES, IN CLASS 7 (U.S.
CLS. 13, 19, 21, 23, 31, 34 AND 35).

SER. NO. 77-094,825, FILED 1-30-2007.

THE MARK CONSISTS OF STANDARD CHAR-
ACTERS WITHOUT CLAIM TO ANY PARTICULAR
FONT, STYLE, SIZE, OR COLOR.

KELLY BOULTON, EXAMINING ATTORNEY

Int. Cl.: 12

Prior U.S. Cls.: 19, 21, 23, 31, 35 and 44

Reg. No. 3,483,014

United States Patent and Trademark Office

Registered Aug. 12, 2008

**TRADEMARK
PRINCIPAL REGISTER**

BALANCE MASTERS

SUN-TECH INNOVATIONS, LLC (CALIFORNIA
LTD LIAB CO)
P.O. BOX 9154
CANOGA PARK, CA 91309

FOR: BALANCING DEVICES FOR MOTOR VE-
HICLES, NAMELY, BALANCERS FOR ATTACH-
MENT TO ENGINES, MOTORS, CLUTCHES, DRIVE
SHAFTS, AND WHEELS, IN CLASS 12 (U.S. CLS. 19,
21, 23, 31, 35 AND 44).

FIRST USE 0-0-1984; IN COMMERCE 0-0-1984.

THE MARK CONSISTS OF STANDARD CHAR-
ACTERS WITHOUT CLAIM TO ANY PARTICULAR
FONT, STYLE, SIZE, OR COLOR.

OWNER OF U.S. REG. NO. 3,072,913.

NO CLAIM IS MADE TO THE EXCLUSIVE
RIGHT TO USE "BALANCE", APART FROM THE
MARK AS SHOWN.

SER. NO. 77-094,859, FILED 1-30-2007.

SUE LAWRENCE, EXAMINING ATTORNEY

Int. Cl.: 36

Prior U.S. Cls.: 100, 101 and 102

United States Patent and Trademark Office

Reg. No. 3,483,015

Registered Aug. 12, 2008

**SERVICE MARK
PRINCIPAL REGISTER**

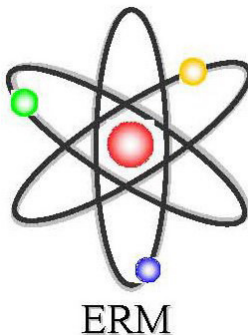

ENERGY RESOURCE MANAGEMENT, COR-
PORATION (MICHIGAN CORPORATION)
24768 LAHSER RD., SUITE 302
SOUTHFIELD, MI 48034

FOR: BROKERAGE OF ENERGY, NAMELY, GAS
AND ELECTRICITY, IN CLASS 36 (U.S. CLS. 100, 101
AND 102).

FIRST USE 10-10-1991; IN COMMERCE 10-10-1991.

NO CLAIM IS MADE TO THE EXCLUSIVE
RIGHT TO USE "THE ATOMIC SYMBOL", APART
FROM THE MARK AS SHOWN.

THE COLOR(S) BLACK, ORANGE, YELLOW,
GREEN AND BLUE IS/ARE CLAIMED AS A FEAT-
URE OF THE MARK.

THE MARK CONSISTS OF AN ATOMIC SYMBOL
WITH BLACK OVULAR ORBITS. THE COLOR
ORANGE APPEARS IN THE LARGE CIRCLE IN
THE MIDDLE OF THE ATOMIC SYMBOL. THE
COLOR YELLOW APPEARS IN THE SMALL CIR-
CLE ON THE TOP OF THE UPPER RIGHT ORBIT
OF THE ATOMIC SYMBOL. THE COLOR GREEN
APPEARS IN THE SMALL CIRCLE ON THE BOT-
TOM OF THE UPPER LEFT ORBIT OF THE ATOM-
IC SYMBOL. THE COLOR BLUE APPEARS IN THE
SMALL CIRCLE ON THE BOTTOM RIGHT OF THE
VERTICAL ORBIT OF THE ATOMIC SYMBOL.

SER. NO. 77-095,021, FILED 1-30-2007.

ANDREA BUTLER, EXAMINING ATTORNEY

Int. Cl.: 14

Prior U.S. Cls.: 2, 27, 28 and 50

United States Patent and Trademark Office

Reg. No. 3,483,016

Registered Aug. 12, 2008

**TRADEMARK
PRINCIPAL REGISTER**

MARGO MANHATTAN

MARGO MANHATTAN, LTD. (NEW YORK CORPORATION)

SUITE 211

1636 THIRD AVENUE

NEW YORK, NY 10128

FOR: JEWELRY, NAMELY, BRACELETS, EARRINGS, RINGS, PENDANTS AND PINS, IN CLASS 14 (U.S. CLS. 2, 27, 28 AND 50).

FIRST USE 2-15-1988; IN COMMERCE 2-15-1988.

THE MARK CONSISTS OF STANDARD CHARACTERS WITHOUT CLAIM TO ANY PARTICULAR FONT, STYLE, SIZE, OR COLOR.

NO CLAIM IS MADE TO THE EXCLUSIVE RIGHT TO USE "MANHATTAN", APART FROM THE MARK AS SHOWN.

SEC. 2(F).

SER. NO. 77-095,578, FILED 1-31-2007.

DAWN HAN, EXAMINING ATTORNEY

Int. Cl.: 5

Prior U.S. Cls.: 6, 18, 44, 46, 51 and 52

United States Patent and Trademark Office

Reg. No. 3,483,017

Registered Aug. 12, 2008

**TRADEMARK
PRINCIPAL REGISTER**

ALALIFE

BIOGIN BIOCHEMICALS CO., LTD. (CHINA CORPORATION)
NO. 9, SECTION 4, RENMIN NAN ROAD
CHENGDU, CHINA 610041

FOR: FOOD PREPARATIONS CONTAINING FLAXSEED EXTRACT, OMEGA-3 (ALFA LINOLENIC ACID), FLAX OIL, FLAX LIGNANS, FLAX GUM, AND FLAX POWDER ADAPTED FOR MEDICAL PURPOSES, NAMELY, DIETARY SUPPLEMENTS; PREPARATIONS CONTAINING FLOWER, SEED AND PLANT EXTRACTS FOR MEDICINAL PURPOSES, NAMELY, DIETARY SUPPLEMENTS; FOOD SUPPLEMENTS; PHARMACEUTICAL PREPARATIONS FOR THE TREATMENT OF CARDIOVASCULAR DISORDERS CONTAINING FLAXSEED EXTRACT INCLUDING OMEGA-3 (ALFA LINOLENIC ACID), FLAX OIL, FLAX LIG-

NANS, FLAX GUM, AND FLAX POWDER; FOOD FOR INFANTS; VITAMIN AND MINERAL SUPPLEMENTS INCLUDING OMEGA-3 (ALFA LINOLENIC ACID), FLAX OIL, FLAX LIGNANS, FLAX GUM, AND FLAX POWDER, IN CLASS 5 (U.S. CLS. 6, 18, 44, 46, 51 AND 52).

FIRST USE 8-18-2004; IN COMMERCE 12-31-2004.

THE MARK CONSISTS OF STANDARD CHARACTERS WITHOUT CLAIM TO ANY PARTICULAR FONT, STYLE, SIZE, OR COLOR.

SER. NO. 77-095,613, FILED 1-31-2007.

BRIDGETT SMITH, EXAMINING ATTORNEY

Int. Cl.: 41

Prior U.S. Cls.: 100, 101 and 107

United States Patent and Trademark Office

Reg. No. 3,483,018

Registered Aug. 12, 2008

**SERVICE MARK
PRINCIPAL REGISTER**

Third Street Productions

THIRD STREET PRODUCTIONS (TEXAS SOLE
PROPRIETORSHIP)

12012 WICKCHESTER LANE SUITE 600

HOUSTON, TX 77079

FOR: FILM STUDIOS, IN CLASS 41 (U.S. CLS. 100,
101 AND 107).

FIRST USE 1-1-2007; IN COMMERCE 1-1-2007.

THE MARK CONSISTS OF STANDARD CHAR-
ACTERS WITHOUT CLAIM TO ANY PARTICULAR
FONT, STYLE, SIZE, OR COLOR.

NO CLAIM IS MADE TO THE EXCLUSIVE
RIGHT TO USE "PRODUCTIONS", APART FROM
THE MARK AS SHOWN.

SER. NO. 77-097,635, FILED 2-2-2007.

SEAN CROWLEY, EXAMINING ATTORNEY

Int. Cls.: 36 and 37

Prior U.S. Cls.: 100, 101, 102, 103 and 106

United States Patent and Trademark Office

Reg. No. 3,483,019

Registered Aug. 12, 2008

**SERVICE MARK
PRINCIPAL REGISTER**

**CREATING VALUE IN REAL
ESTATE**

NORTHLAND INVESTMENT CORPORATION
(MASSACHUSETTS CORPORATION)
2150 WASHINGTON STREET
NEWTON, MA 02462

FOR: REAL ESTATE ACQUISITION, MANAGE-
MENT, BROKERAGE, LEASING, APPRAISAL,
CONSULTING, FINANCING AND INVESTMENT
SERVICES, IN CLASS 36 (U.S. CLS. 100, 101 AND 102).

FIRST USE 11-0-2002; IN COMMERCE 11-0-2002.

FOR: REAL ESTATE DEVELOPMENT SERVICES,
IN CLASS 37 (U.S. CLS. 100, 103 AND 106).

FIRST USE 11-0-2002; IN COMMERCE 11-0-2002.

THE MARK CONSISTS OF STANDARD CHAR-
ACTERS WITHOUT CLAIM TO ANY PARTICULAR
FONT, STYLE, SIZE, OR COLOR.

SER. NO. 77-098,333, FILED 2-2-2007.

JASON LOTT, EXAMINING ATTORNEY

Int. Cls.: 7 and 9

Prior U.S. Cls.: 13, 19, 21, 23, 26, 31, 34, 35, 36 and 38

Reg. No. 3,483,020

United States Patent and Trademark Office

Registered Aug. 12, 2008

**TRADEMARK
PRINCIPAL REGISTER**

AMPLE POWER

AMPLE POWER COMPANY, LLC (WASHINGTON LTD LIAB CO)
6315 SEAVIEW AVENUE NW
SEATTLE, WA 98107

FOR: DC POWER AND CONTROL EQUIPMENT, NAMELY, GENERATOR SETS AND ALTERNATORS, IN CLASS 7 (U.S. CLS. 13, 19, 21, 23, 31, 34 AND 35).

FIRST USE 11-10-1987; IN COMMERCE 11-10-1987.

FOR: DC POWER AND CONTROL EQUIPMENT, NAMELY, BATTERIES, VOLTAGE REGULATORS FOR ELECTRIC POWER, CONTROLLERS, AND MONITORS FOR DISPLAYING VARIOUS POWER

AND CONTROL FUNCTIONS, IN CLASS 9 (U.S. CLS. 21, 23, 26, 36 AND 38).

FIRST USE 11-10-1987; IN COMMERCE 11-10-1987.

THE MARK CONSISTS OF STANDARD CHARACTERS WITHOUT CLAIM TO ANY PARTICULAR FONT, STYLE, SIZE, OR COLOR.

NO CLAIM IS MADE TO THE EXCLUSIVE RIGHT TO USE "POWER" , APART FROM THE MARK AS SHOWN.

SER. NO. 77-098,459, FILED 2-2-2007.

DEIRDRE ROBERTSON, EXAMINING ATTORNEY

Int. Cls.: 29 and 30

Prior U.S. Cl.: 46

United States Patent and Trademark Office

Reg. No. 3,483,021

Registered Aug. 12, 2008

TRADEMARK
PRINCIPAL REGISTER



GOLDEN WEST TRADING CO. (CALIFORNIA CORPORATION)
3420 E. VERNON AVE.
VERNON, CA 900581812

FOR: MEATS; NAMELY, BEEF, CHICKEN, TURKEY, DUCK, PORK AND LAMB; CHEESE; LUNCHEON MEATS; MEATBALLS; TACO MEAT; JERKY; SEAFOOD; FISH; CHICKEN, BEEF, PORK AND/OR POULTRY IN A SAUCE; PRESERVED, PREPACKAGED, PREPARED OR FROZEN MEALS CONSISTING PRIMARILY OF MEAT, POULTRY, VEGETABLES, OR CHEESE AS WELL AS STARCHES; PRESERVED, PREPACKAGED, PREPARED OR FROZEN ENTREES CONSISTING PRIMARILY OF MEAT, POULTRY, VEGETABLES, FRUITS, OR CHEESE AS WELL AS STARCHES; PREPARED FOODS, NAMELY, MEALS READY TO HEAT CONSISTING PRIMARILY OF BEEF, POULTRY, PORK OR VEGETABLES, AS WELL AS STARCHES, VEGETABLES AND SALADS, IN CLASS 29 (U.S. CL. 46).

FIRST USE 9-15-2006; IN COMMERCE 1-3-2007.

FOR: FROZEN ENTREES AND SIDE DISHES CONSISTING PRIMARILY OF PASTA, RICE, OR CORN MEAL AND CONTAINING A COMBINATION OF CHEESE OR VEGETABLES AND/OR MEAT OR SEAFOOD; LATIN FOOD, NAMELY, TAMALES, ENCHILADAS, BURRITOS, TAQUITOS, TACOS AND QUESADILLAS; DUMPLINGS; APPETIZERS CONSISTING PRIMARILY OF BLENDS OF MEAT AND CHEESE AS WELL AS SALSA CON-

TAINED WITHIN AN EDIBLE WRAPPER, IN CLASS 30 (U.S. CL. 46).

FIRST USE 9-15-2006; IN COMMERCE 1-3-2007.

NO CLAIM IS MADE TO THE EXCLUSIVE RIGHT TO USE "COMPLETELY FRESH FOODS COOKED & PREPARED", APART FROM THE MARK AS SHOWN.

THE COLOR(S) WHITE, RED, GOLD, LIGHT BROWN, DARK BROWN, LIGHT GREEN, MEDIUM GREEN, DARK GREEN, PURPLE, ORANGE, BLACK IS/ARE CLAIMED AS A FEATURE OF THE MARK.

THE WORDING IS BLACK, THE FORK IS GOLD, THE CHEF'S HAT IS WHITE, THE BANNER IS LIGHT GREEN, THE GRAPES BELOW THE HAM ARE MEDIUM GREEN, THE LETTUCE IS DARK GREEN, THE GRAPES ABOVE THE ROAST BEEF ARE PURPLE, THE ROAST AND THE HAM ARE DARK BROWN ON THE OUTSIDE AND RED ON THE INSIDE, THE TURKEY IS LIGHT BROWN AND GOLD, THE TOMATOES ARE RED AND THE ORANGE IS ORANGE.

SER. NO. 77-100,244, FILED 2-6-2007.

RONALD MCMORROW, EXAMINING ATTORNEY

Int. Cl.: 18

Prior U.S. Cls.: 1, 2, 3, 22 and 41

Reg. No. 3,483,022

United States Patent and Trademark Office

Registered Aug. 12, 2008

TRADEMARK
PRINCIPAL REGISTER



RELIANCE LEATHER GROUP, INC. (NEW
YORK CORPORATION)
21 TEC STREET
HICKSVILLE, NY 11801

FOR: HANDBAGS; KEY WALLETS; WALLETS,
IN CLASS 18 (U.S. CLS. 1, 2, 3, 22 AND 41).

FIRST USE 12-1-2006; IN COMMERCE 12-1-2006.

THE NAME(S), PORTRAIT(S), AND/OR SIGNA-
TURE(S) SHOWN IN THE MARK DOES NOT IDEN-
TIFY A PARTICULAR LIVING INDIVIDUAL.

THE MARK CONSISTS OF A DEER HEAD.

SER. NO. 77-101,255, FILED 2-7-2007.

JILL C. ALT, EXAMINING ATTORNEY

Int. Cl.: 40

Prior U.S. Cls.: 100, 103 and 106

United States Patent and Trademark Office

Reg. No. 3,483,023

Registered Aug. 12, 2008

**SERVICE MARK
PRINCIPAL REGISTER**

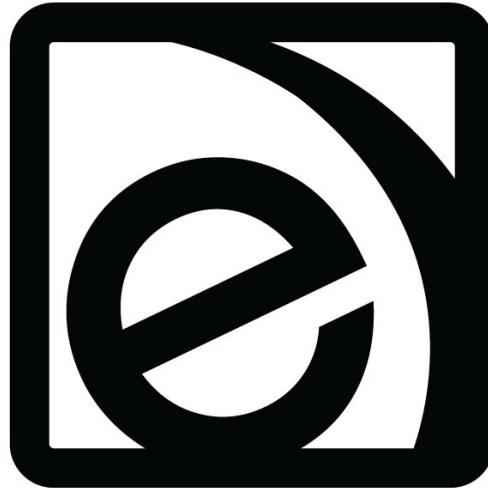

**E-WORLD RECYCLERS, LLC (CALIFORNIA
LTD LIAB CO)
2480 ASH STREET
VISTA, CA 92081**

**THE MARK CONSISTS OF THE LETTER "E" AND
BORDER INSIDE A RECTANGLE.**

**FOR: RECYCLING OF ELECTRONIC EQUIP-
MENT, IN CLASS 40 (U.S. CLS. 100, 103 AND 106).**

SER. NO. 77-101,673, FILED 2-7-2007.

FIRST USE 1-9-2007; IN COMMERCE 1-9-2007.

MONIQUE MILLER, EXAMINING ATTORNEY

Int. Cl.: 43

Prior U.S. Cls.: 100 and 101

United States Patent and Trademark Office

Reg. No. 3,483,024

Registered Aug. 12, 2008

SERVICE MARK
PRINCIPAL REGISTER



RANDALL, LARA J (UNITED STATES INDIVIDUAL)
1913 GRANT LANE
WOODSTOCK, GA 30188

FOR: COFFEE SHOPS, IN CLASS 43 (U.S. CLS. 100 AND 101).

FIRST USE 12-24-2003; IN COMMERCE 4-1-2004.

NO CLAIM IS MADE TO THE EXCLUSIVE RIGHT TO USE "BEAN" AND THE PICTORIAL REPRESENTATION OF THE COFFEE BEAN, APART FROM THE MARK AS SHOWN.

THE MARK CONSISTS OF A STYLIZED RING WHICH RESEMBLES THE MARK LEFT ON A TABLE BY A COFFEE CUP. CENTERED IN THE RING AND EXTENDING THROUGH A BREAK IN THE RIGHT SIDE OF THE RING ARE THE WORDS "THE SERENE BEAN". ALSO IN THE RING, TO THE LEFT OF THE NAME IS A COFFEE BEAN.

SER. NO. 77-102,137, FILED 2-7-2007.

CARYN GLASSER, EXAMINING ATTORNEY

Int. Cl.: 45

Prior U.S. Cls.: 100 and 101

United States Patent and Trademark Office

Reg. No. 3,483,025

Registered Aug. 12, 2008

**SERVICE MARK
PRINCIPAL REGISTER**

EURO27

IQS AVANTIQ AG (SWITZERLAND CORPORATION)

BAARERSTR. 98

6302 ZUG, SWITZERLAND

FOR: SEARCHING AND CLEARANCE OF TRADEMARKS AND OTHER DISTINCTIVE SYMBOLS IN THE NATURE OF TRADE NAMES AND DOMAIN NAMES FOR OTHERS, IN CLASS 45 (U.S. CLS. 100 AND 101).

THE MARK CONSISTS OF STANDARD CHARACTERS WITHOUT CLAIM TO ANY PARTICULAR FONT, STYLE, SIZE, OR COLOR.

PRIORITY CLAIMED UNDER SEC. 44(D) ON ERPN CMNTY TM OFC APPLICATION NO. 5549407, FILED 12-13-2006, REG. NO. 005549407, DATED 11-22-2007, EXPIRES 12-13-2016.

SER. NO. 77-102,598, FILED 2-8-2007.

KRISTINA MORRIS, EXAMINING ATTORNEY

Int. Cls.: 9 and 41

Prior U.S. Cls.: 21, 23, 26, 36, 38, 100, 101 and 107

Reg. No. 3,483,026

United States Patent and Trademark Office

Registered Aug. 12, 2008

**TRADEMARK
SERVICE MARK
PRINCIPAL REGISTER**

SSRN

SOCIAL SCIENCE ELECTRONIC PUBLISHING,
INC. (DELAWARE CORPORATION)
SUITE 3
2171 MONROE AVENUE
ROCHESTER, NY 14618

FOR: DOWNLOADABLE ELECTRONIC PUBLICATIONS IN THE NATURE OF SCHOLARLY RESEARCH PAPERS AND WRITINGS IN THE FIELD OF ACCOUNTING, ECONOMICS, LAW, ENTREPRENEURSHIP, EDUCATION, FINANCIAL ECONOMICS, HEALTH ECONOMICS, INFORMATION SYSTEMS AND TECHNOLOGY, BUSINESS MANAGEMENT, POLITICAL SCIENCE, CORPORATE GOVERNANCE, SOCIAL INSURANCE AND HUMANITIES, IN CLASS 9 (U.S. CLS. 21, 23, 26, 36 AND 38).

FIRST USE 4-1-1996; IN COMMERCE 4-1-1996.

FOR: PROVIDING AN ONLINE SEARCHABLE DATABASE FEATURING SCHOLARLY RESEARCH PAPERS AND WRITINGS, IN CLASS 41 (U.S. CLS. 100, 101 AND 107).

FIRST USE 4-1-1996; IN COMMERCE 4-1-1996.

THE MARK CONSISTS OF STANDARD CHARACTERS WITHOUT CLAIM TO ANY PARTICULAR FONT, STYLE, SIZE, OR COLOR.

SER. NO. 77-102,880, FILED 2-8-2007.

JENNIFER DIXON, EXAMINING ATTORNEY

Int. Cls.: 9 and 41

Prior U.S. Cls.: 21, 23, 26, 36, 38, 100, 101 and 107

Reg. No. 3,483,027

United States Patent and Trademark Office

Registered Aug. 12, 2008

**TRADEMARK
SERVICE MARK
PRINCIPAL REGISTER**

**SOCIAL SCIENCE RESEARCH
NETWORK**

SOCIAL SCIENCE ELECTRONIC PUBLISHING,
INC. (DELAWARE CORPORATION)
SUITE 3
2171 MONROE AVENUE
ROCHESTER, NY 14618

FOR: DOWNLOADABLE ELECTRONIC PUBLICATIONS IN THE NATURE OF SCHOLARLY RESEARCH PAPERS AND WRITINGS IN THE FIELD OF ACCOUNTING, ECONOMICS, LAW, ENTREPRENEURSHIP, EDUCATION, FINANCIAL ECONOMICS, HEALTH ECONOMICS, INFORMATION SYSTEMS AND TECHNOLOGY, BUSINESS MANAGEMENT, POLITICAL SCIENCE, CORPORATE GOVERNANCE, SOCIAL INSURANCE AND HUMANITIES, IN CLASS 9 (U.S. CLS. 21, 23, 26, 36 AND 38).

FIRST USE 4-1-1996; IN COMMERCE 4-1-1996.

FOR: PROVIDING AN ONLINE SEARCHABLE DATABASE FEATURING SCHOLARLY RESEARCH PAPERS AND WRITINGS, IN CLASS 41 (U.S. CLS. 100, 101 AND 107).

FIRST USE 4-1-1996; IN COMMERCE 4-1-1996.

THE MARK CONSISTS OF STANDARD CHARACTERS WITHOUT CLAIM TO ANY PARTICULAR FONT, STYLE, SIZE, OR COLOR.

SEC. 2(F).

SER. NO. 77-102,891, FILED 2-8-2007.

JENNIFER DIXON, EXAMINING ATTORNEY

Int. Cls.: 9 and 41

Prior U.S. Cls.: 21, 23, 26, 36, 38, 100, 101 and 107

Reg. No. 3,483,028

United States Patent and Trademark Office

Registered Aug. 12, 2008

**TRADEMARK
SERVICE MARK
PRINCIPAL REGISTER**

TOMORROW'S RESEARCH TODAY

SOCIAL SCIENCE ELECTRONIC PUBLISHING,
INC. (DELAWARE CORPORATION)
SUITE 3
2171 MONROE AVENUE
ROCHESTER, NY 14618

FOR: DOWNLOADABLE ELECTRONIC PUBLICATIONS IN THE NATURE OF SCHOLARLY RESEARCH PAPERS AND WRITINGS IN THE FIELD OF ACCOUNTING, ECONOMICS, LAW, ENTREPRENEURSHIP, EDUCATION, FINANCIAL ECONOMICS, HEALTH ECONOMICS, INFORMATION SYSTEMS AND TECHNOLOGY, BUSINESS MANAGEMENT, POLITICAL SCIENCE, CORPORATE GOVERNANCE, SOCIAL INSURANCE AND HUMANITIES, IN CLASS 9 (U.S. CLS. 21, 23, 26, 36 AND 38).

FIRST USE 12-31-1999; IN COMMERCE 12-31-1999.

FOR: PROVIDING AN ONLINE SEARCHABLE DATABASE FEATURING SCHOLARLY RESEARCH PAPERS AND WRITINGS, IN CLASS 41 (U.S. CLS. 100, 101 AND 107).

FIRST USE 12-31-1999; IN COMMERCE 12-31-1999.

THE MARK CONSISTS OF STANDARD CHARACTERS WITHOUT CLAIM TO ANY PARTICULAR FONT, STYLE, SIZE, OR COLOR.

SER. NO. 77-102,896, FILED 2-8-2007.

JENNIFER DIXON, EXAMINING ATTORNEY

Int. Cls.: 9 and 36

Prior U.S. Cls.: 21, 23, 26, 36, 38, 100, 101 and 102

United States Patent and Trademark Office

Reg. No. 3,483,029

Registered Aug. 12, 2008

**TRADEMARK
SERVICE MARK
PRINCIPAL REGISTER**



MILLENNIUM CORPORATE SOLUTIONS (CALIFORNIA CORPORATION)
5530 TRABUCO ROAD
IRVINE, CA 92620

FOR: DOWNLOADABLE PUBLICATIONS IN ELECTRONIC FORMAT, NAMELY, NEWSLETTERS, BROCHURES, ELECTRONIC ADVERTISING FLYERS PROVIDED ON-LINE VIA THE INTERNET AND OTHER INTERACTIVE ELECTRONIC PLATFORMS FOR USE IN PROFESSIONAL MANAGEMENT CONSULTING, PROPERTY MANAGEMENT, FINANCE, INVESTMENTS, ACCOUNTING, LAW, REAL ESTATE AND INSURANCE AND SOFTWARE FOR DATABASE CREATION, SPREADSHEET CREATION, CREATING EDUCATIONAL MATERIALS, WORD PROCESSING, DATA MANAGEMENT, DOCUMENT MANAGEMENT, NETWORKING RELATING TO PROFESSIONAL MANAGEMENT CONSULTING, PROPERTY MANAGEMENT, FINANCE, INVEST-

MENTS, ACCOUNTING, LEGAL, REAL ESTATE AND INSURANCE, IN CLASS 9 (U.S. CLS. 21, 23, 26, 36 AND 38).

FIRST USE 12-1-1997; IN COMMERCE 12-1-1997.

FOR: BROKERAGE IN THE FIELD OF GROUP MEDICAL INSURANCE, DENTAL INSURANCE, LIFE INSURANCE, LTD (LONG TERM DISABILITY) INSURANCE, VISION INSURANCE, LEGAL SERVICES, LONG TERM CARE INSURANCE, COBRA AND HIPAA INSURANCE COMPLIANCE, PROPERTY INSURANCE, CASUALTY INSURANCE, AND EMPLOYEE BENEFITS, IN CLASS 36 (U.S. CLS. 100, 101 AND 102).

FIRST USE 12-1-1997; IN COMMERCE 12-1-1997.

SER. NO. 77-103,246, FILED 2-8-2007.

FRED CARL, EXAMINING ATTORNEY

Int. Cl.: 44

Prior U.S. Cls.: 100 and 101

United States Patent and Trademark Office

Reg. No. 3,483,030

Registered Aug. 12, 2008

**SERVICE MARK
PRINCIPAL REGISTER**

GO ON... SMILE!

NORTHERN VIRGINIA ORAL AND MAXILLO-
FACIAL SURGERY ASSOCIATES (VIRGINIA
CORPORATION)
SUITE 101E
7611 LITTLE RIVER TURNPIKE
ANNANDALE, VA 22003

FOR: ORAL AND MAXILLOFACIAL CONSULT-
ING AND SURGERY SERVICES, IN CLASS 44 (U.S.
CLS. 100 AND 101).

FIRST USE 1-19-2007; IN COMMERCE 1-19-2007.

THE MARK CONSISTS OF STANDARD CHAR-
ACTERS WITHOUT CLAIM TO ANY PARTICULAR
FONT, STYLE, SIZE, OR COLOR.

SER. NO. 77-103,938, FILED 2-9-2007.

ALICE SUE CARRUTHERS, EXAMINING ATTOR-
NEY

Int. Cl.: 1

Prior U.S. Cls.: 1, 5, 6, 10, 26 and 46

Reg. No. 3,483,031

United States Patent and Trademark Office

Registered Aug. 12, 2008

**TRADEMARK
PRINCIPAL REGISTER**



INTERCAT, INC. (DELAWARE CORPORATION)
2399 HIGHWAY 34, BUILDING C1
MANASQUAN, NJ 08736

FOR: CHEMICAL ADDITIVES FOR CATALYTIC
CRACKING IN THE PETROLEUM INDUSTRY, IN
CLASS 1 (U.S. CLS. 1, 5, 6, 10, 26 AND 46).

FIRST USE 10-1-2006; IN COMMERCE 10-1-2006.

NO CLAIM IS MADE TO THE EXCLUSIVE
RIGHT TO USE "CLEAN AIR TECHNOLOGY",
APART FROM THE MARK AS SHOWN.

THE MARK CONSISTS OF STYLIZED FONT OF
THE WORDS "CAT CLEAN AIR TECHNOLOGY"
WITHIN A SQUARE OUTLINE.

SER. NO. 77-104,931, FILED 2-12-2007.

KHANH LE, EXAMINING ATTORNEY

Int. Cl.: 41

Prior U.S. Cls.: 100, 101 and 107

United States Patent and Trademark Office

Reg. No. 3,483,032

Registered Aug. 12, 2008

**SERVICE MARK
PRINCIPAL REGISTER**

Mopar Magic

MONSTER TRUCKS UNLIMITED (VIRGINIA
LTD LIAB CO)
1468 N WOODHOUSE RD
VIRGINIA BEACH, VA 23454

FOR: ENTERTAINMENT IN THE NATURE OF
AUTOMOBILE RACES; ENTERTAINMENT IN THE
NATURE OF MONSTER TRUCK RACES; ENTER-
TAINMENT SERVICES, NAMELY, PARTICIPA-
TION IN MONSTER TRUCK RACING, IN CLASS
41 (U.S. CLS. 100, 101 AND 107).

FIRST USE 1-1-1980; IN COMMERCE 1-1-2007.

THE MARK CONSISTS OF STANDARD CHAR-
ACTERS WITHOUT CLAIM TO ANY PARTICULAR
FONT, STYLE, SIZE, OR COLOR.

SER. NO. 77-105,013, FILED 2-12-2007.

DEZMONA MIZELLE, EXAMINING ATTORNEY

Int. Cl.: 9

Prior U.S. Cls.: 21, 23, 26, 36 and 38

Reg. No. 3,483,033

United States Patent and Trademark Office

Registered Aug. 12, 2008

**TRADEMARK
PRINCIPAL REGISTER**



MIRANDA, DAVID R. (UNITED STATES INDIVIDUAL)
2401 E. 6TH STREET
#5068
AUSTIN, TX 78702

FOR: MICROPHONES; PORTABLE MEDIA PLAYERS; VIDEO DISK PLAYERS, IN CLASS 9 (U.S. CLS. 21, 23, 26, 36 AND 38).

FIRST USE 6-22-2004; IN COMMERCE 6-22-2004.

THE COLOR(S) BLACK AND WHITE IS/ARE CLAIMED AS A FEATURE OF THE MARK.

THE MARK CONSISTS OF BLACK OUTLINE, BLACK & WHITE INSIDE MARK.

SER. NO. 77-105,680, FILED 2-12-2007.

DEZMONA MIZELLE, EXAMINING ATTORNEY

Int. Cl.: 41

Prior U.S. Cls.: 100, 101 and 107

United States Patent and Trademark Office

Reg. No. 3,483,034

Registered Aug. 12, 2008

**SERVICE MARK
PRINCIPAL REGISTER**

JUNKYARD PROPHET

JUNKYARD RECORDS, LLC (MINNESOTA LTD
LIAB CO)
125 OAK NORTH
ANNANDALE, MN 55302

FOR: ENTERTAINMENT, NAMELY, LIVE PER-
FORMANCES BY MUSICAL BANDS, IN CLASS 41
(U.S. CLS. 100, 101 AND 107).

FIRST USE 10-31-1998; IN COMMERCE 10-31-2001.

THE MARK CONSISTS OF STANDARD CHAR-
ACTERS WITHOUT CLAIM TO ANY PARTICULAR
FONT, STYLE, SIZE, OR COLOR.

SER. NO. 77-106,184, FILED 2-13-2007.

LEIGH CAROLINE CASE, EXAMINING ATTOR-
NEY

Int. Cl.: 30

Prior U.S. Cl.: 46

United States Patent and Trademark Office

Reg. No. 3,483,035

Registered Aug. 12, 2008

**TRADEMARK
PRINCIPAL REGISTER**

PIEDMONT CANDY

PIEDMONT CANDY COMPANY (NORTH CAROLINA CORPORATION)
404 MARKET STREET
LEXINGTON, NC 27292

NO CLAIM IS MADE TO THE EXCLUSIVE RIGHT TO USE "CANDY", APART FROM THE MARK AS SHOWN.

FOR: CANDY, IN CLASS 30 (U.S. CL. 46).

FIRST USE 1-1-1934; IN COMMERCE 1-1-1950.

SER. NO. 77-106,690, FILED 2-13-2007.

THE MARK CONSISTS OF STANDARD CHARACTERS WITHOUT CLAIM TO ANY PARTICULAR FONT, STYLE, SIZE, OR COLOR.

ANNE E. GUSTASON, EXAMINING ATTORNEY

Int. Cl.: 3

Prior U.S. Cls.: 1, 4, 6, 50, 51 and 52

United States Patent and Trademark Office

Reg. No. 3,483,036

Registered Aug. 12, 2008

**TRADEMARK
PRINCIPAL REGISTER**

DR. BRANDT

COSMETIC DERMATOLOGY, INC. (FLORIDA CORPORATION)
8798 NW 15TH STREET
MIAMI, FL 33172

FOR: SKIN CREAM, SKIN LOTION, SKIN MOISTURIZER, SKIN EMOLLIENT, SKIN MASK, FACIAL EXFOLIATE, SKIN CLEANSER, SKIN TONER, SKIN GEL, SHAVE GEL, SUN SCREEN AND SUN BLOCK PREPARATION, IN CLASS 3 (U.S. CLS. 1, 4, 6, 50, 51 AND 52).

FIRST USE 8-31-2001; IN COMMERCE 8-31-2001.

THE MARK CONSISTS OF STANDARD CHARACTERS WITHOUT CLAIM TO ANY PARTICULAR FONT, STYLE, SIZE, OR COLOR.

OWNER OF U.S. REG. NOS. 2,285,902, 3,115,694 AND OTHERS.

THE NAME(S), PORTRAIT(S), AND/OR SIGNATURE(S) SHOWN IN THE MARK IDENTIFIES "DR. BRANDT" , WHOSE CONSENT(S) TO REGISTER IS MADE OF RECORD.

SEC. 2(F).

SER. NO. 77-108,484, FILED 2-15-2007.

KATHERINE E. HALMEN, EXAMINING ATTORNEY

Int. Cls.: 17 and 19

Prior U.S. Cls.: 1, 5, 12, 13, 33, 35 and 50

Reg. No. 3,483,037

United States Patent and Trademark Office

Registered Aug. 12, 2008

**TRADEMARK
PRINCIPAL REGISTER**

HD

PREMARK RWP HOLDINGS, INC. (DELAWARE CORPORATION)
1300 MARKET STREET, SUITE 504
WILMINGTON, DE 19801

FOR: PLASTIC LAMINATE IN THE FORM OF SHEETS, PLATES AND PANELS FOR USE IN THE MANUFACTURE OF COUNTERTOPS, WORK SURFACES, VANITY TOPS, DECORATIVE EDGE MOLDINGS, AND OTHER INTERIOR HOME AND COMMERCIAL FIXTURES; PLASTIC LAMINATE IN THE FORM OF SHEETS, PLATES AND PANELS FOR USE AS A SURFACE MATERIAL IN INTERIOR HOME AND COMMERCIAL FIXTURES, IN CLASS 17 (U.S. CLS. 1, 5, 12, 13, 35 AND 50).

FIRST USE 6-0-2005; IN COMMERCE 6-0-2005.

FOR: ARTIFICIAL STONE FOR USE IN THE MANUFACTURE OF COUNTERTOPS, WORK SUR-

FACES, VANITY TOPS, DECORATIVE EDGE MOLDINGS, AND OTHER INTERIOR HOME AND COMMERCIAL FIXTURES; ARTIFICIAL STONE IN THE FORM OF SHEETS, PLATES AND PANELS FOR USE AS A SURFACE MATERIAL IN INTERIOR HOME AND COMMERCIAL FIXTURES, IN CLASS 19 (U.S. CLS. 1, 12, 33 AND 50).

FIRST USE 6-0-2005; IN COMMERCE 6-0-2005.

THE MARK CONSISTS OF STANDARD CHARACTERS WITHOUT CLAIM TO ANY PARTICULAR FONT, STYLE, SIZE, OR COLOR.

SER. NO. 77-108,824, FILED 2-15-2007.

SARA THOMAS, EXAMINING ATTORNEY

Int. Cls.: 17 and 19

Prior U.S. Cls.: 1, 5, 12, 13, 33, 35 and 50

Reg. No. 3,483,038

United States Patent and Trademark Office

Registered Aug. 12, 2008

**TRADEMARK
PRINCIPAL REGISTER**



PREMARK RWP HOLDINGS, INC. (DELAWARE CORPORATION)
SUITE 504
1300 MARKET STREET
WILMINGTON, DE 19801

FOR: PLASTIC LAMINATE IN THE FORM OF SHEETS, PLATES AND PANELS FOR USE IN THE MANUFACTURE OF COUNTERTOPS, WORK SURFACES, VANITY TOPS, DECORATIVE EDGE MOLDINGS, BACKSPLASHES AND TABLE TOPS, IN CLASS 17 (U.S. CLS. 1, 5, 12, 13, 35 AND 50).

FIRST USE 6-0-2005; IN COMMERCE 6-0-2005.

FOR: ARTIFICIAL STONE FOR USE IN THE MANUFACTURE OF COUNTERTOPS, WORK SUR-

FACES, VANITY TOPS, DECORATIVE EDGE MOLDINGS, AND OTHER INTERIOR HOME AND COMMERCIAL FIXTURES; ARTIFICIAL STONE IN THE FORM OF SHEETS, PLATES AND PANELS FOR USE AS A SURFACE MATERIAL IN INTERIOR HOME AND COMMERCIAL FIXTURES, IN CLASS 19 (U.S. CLS. 1, 12, 33 AND 50).

FIRST USE 6-0-2005; IN COMMERCE 6-0-2005.

THE MARK CONSISTS OF "HD" WITH INTERLOCKING CIRCLES.

SER. NO. 77-108,862, FILED 2-15-2007.

SARA THOMAS, EXAMINING ATTORNEY

Int. Cls.: 17 and 19

Prior U.S. Cls.: 1, 5, 12, 13, 33, 35 and 50

United States Patent and Trademark Office

Reg. No. 3,483,039

Registered Aug. 12, 2008

**TRADEMARK
PRINCIPAL REGISTER**

HIGH DEFINITION

PREMARK RWP HOLDINGS, INC. (DELAWARE CORPORATION)
1300 MARKET STREET
SUITE 504
WILMINGTON, DE 19801

FOR: PLASTIC LAMINATE IN THE FORM OF SHEETS, PLATES AND PANELS FOR USE IN THE MANUFACTURE OF COUNTERTOPS, WORK SURFACES, VANITY TOPS, DECORATIVE EDGE MOLDINGS, BACKSPASHES AND TABLE TOPS, IN CLASS 17 (U.S. CLS. 1, 5, 12, 13, 35 AND 50).

FIRST USE 6-0-2005; IN COMMERCE 6-0-2005.

FOR: ARTIFICIAL STONE FOR USE IN THE MANUFACTURE OF COUNTERTOPS, TABLE TOPS, DESK TOPS, WORK SURFACES, VANITY TOPS, DECORATIVE EDGE MOLDINGS, FURNI-

TURE AND OTHER INTERIOR HOME AND COMMERCIAL FURNISHINGS AND FIXTURES; ARTIFICIAL STONE IN THE FORM OF SHEETS, PLATES AND PANELS FOR USE AS A SURFACE MATERIAL IN INTERIOR HOME AND COMMERCIAL FURNISHINGS AND FIXTURES, IN CLASS 19 (U.S. CLS. 1, 12, 33 AND 50).

FIRST USE 6-0-2005; IN COMMERCE 6-0-2005.

THE MARK CONSISTS OF STANDARD CHARACTERS WITHOUT CLAIM TO ANY PARTICULAR FONT, STYLE, SIZE, OR COLOR.

SER. NO. 77-108,889, FILED 2-15-2007.

SARA THOMAS, EXAMINING ATTORNEY

Int. Cl.: 2

Prior U.S. Cls.: 6, 11 and 16

United States Patent and Trademark Office

Reg. No. 3,483,040

Registered Aug. 12, 2008

**TRADEMARK
PRINCIPAL REGISTER**



CUSTOM AGGREGATES & GRINDING, INC
(LOUISIANA CORPORATION)
130 HUEY STOCKSTILL ROAD
PICAYUNE, MS 39466

THE COLOR GRAY APPEARS IN THE LETTERING OF THE WORD "FLEX-C-MENT" OVER STYLIZED STONES CONTAINING SHADES OF BROWN AND BEIGE.

FOR: POLYMER MODIFIED DECORATIVE CONCRETE COATING, IN CLASS 2 (U.S. CLS. 6, 11 AND 16).

SER. NO. 77-109,310, FILED 2-16-2007.

FIRST USE 1-1-2001; IN COMMERCE 1-1-2001.

THE COLOR(S) GRAY, BROWN, AND BEIGE IS/ARE CLAIMED AS A FEATURE OF THE MARK.

KRISTINA MORRIS, EXAMINING ATTORNEY

Int. Cl.: 9

Prior U.S. Cls.: 21, 23, 26, 36 and 38

Reg. No. 3,483,041

United States Patent and Trademark Office

Registered Aug. 12, 2008

**TRADEMARK
PRINCIPAL REGISTER**

REMOTE-D

TOSHIBA INTERNATIONAL CORPORATION
(CALIFORNIA CORPORATION)
13131 WEST LITTLE YORK ROAD
HOUSTON, TX 77041

FOR: ELECTRICAL POWER DISTRIBUTION
UNITS FOR USE IN MONITORING, MANAGING
AND CONTROLLING POWER TO MULTIPLE
ELECTRONIC DEVICES, IN CLASS 9 (U.S. CLS. 21,
23, 26, 36 AND 38).

FIRST USE 8-1-2006; IN COMMERCE 8-1-2006.

THE MARK CONSISTS OF STANDARD CHAR-
ACTERS WITHOUT CLAIM TO ANY PARTICULAR
FONT, STYLE, SIZE, OR COLOR.

SER. NO. 77-109,331, FILED 2-16-2007.

STEVEN PEREZ, EXAMINING ATTORNEY

Int. Cl.: 9

Prior U.S. Cls.: 21, 23, 26, 36 and 38

Reg. No. 3,483,042

United States Patent and Trademark Office

Registered Aug. 12, 2008

**TRADEMARK
PRINCIPAL REGISTER**



ASPHALT ENTERTAINMENT

ASPHALT ENTERTAINMENT, LLC (CALIFORNIA LTD LIAB CO)
23127 CHEYENNE DRIVE
VALENCIA, CA 91354

NO CLAIM IS MADE TO THE EXCLUSIVE RIGHT TO USE "ENTERTAINMENT", APART FROM THE MARK AS SHOWN.

FOR: PRE-RECORDED CDS, VIDEO TAPES, LASER DISKS AND DVDS FEATURING MUSIC, IN CLASS 9 (U.S. CLS. 21, 23, 26, 36 AND 38).

SER. NO. 77-109,360, FILED 2-16-2007.

FIRST USE 1-9-2006; IN COMMERCE 2-10-2006.

LINDA MICKLEBURGH, EXAMINING ATTORNEY

Int. Cl.: 3

Prior U.S. Cls.: 1, 4, 6, 50, 51 and 52

United States Patent and Trademark Office

Reg. No. 3,483,043

Registered Aug. 12, 2008

**TRADEMARK
PRINCIPAL REGISTER**

REINERA

FABRICA DE JABON LA REINERA, S.A. (MEX-
ICO CORPORATION)
COL. INDUSTRIAL
PEDRO CELESTINO NEGRETE # 1212 PTE.,
MONTERREY, N:L., MEXICO 64440

FOR: LAUNDRY DETERGENT; SOAPS AND
DETERGENTS; WASHING POWDER, IN CLASS 3
(U.S. CLS. 1, 4, 6, 50, 51 AND 52).

THE MARK CONSISTS OF STANDARD CHAR-
ACTERS WITHOUT CLAIM TO ANY PARTICULAR
FONT, STYLE, SIZE, OR COLOR.

OWNER OF MEXICO REG. NO. 147338, DATED
10-18-1968, EXPIRES 10-18-2013.

THE WORDING "REINERA" HAS NO MEANING
IN A FOREIGN LANGUAGE.

SER. NO. 77-110,844, FILED 2-19-2007.

LINDA LAVACHE, EXAMINING ATTORNEY

Int. Cls.: 35 and 41

Prior U.S. Cls.: 100, 101, 102 and 107

United States Patent and Trademark Office

Reg. No. 3,483,044

Registered Aug. 12, 2008

**SERVICE MARK
PRINCIPAL REGISTER**

**MORE BUSINESS, MORE MONEY,
MORE LIFE**

ONECOACH, INC. (CALIFORNIA CORPORATION)
512 VIA DE LA VALLE, SUITE 201
SAN DIEGO, CA 92075

FOR: RECRUITMENT FOR BUSINESS NETWORKING OF ENTREPRENEURS, BUSINESSES, SELF-EMPLOYED INDIVIDUALS, PROFESSIONALS, HOME-BASED BUSINESSES AND DIRECT SALE BUSINESSES AND OTHERS WHO WANT TO INCREASE THEIR SMALL BUSINESS REVENUES SO THAT THEY CAN ACHIEVE FINANCIAL FREEDOM AND LIVE EXTRAORDINARY LIVES ON THE SUBJECT OF BUSINESS MANAGEMENT AND BUSINESS STRATEGIES AND BUSINESS ADVISORY SERVICES AND HOW TO INCREASE REVENUES AND PROFITS; RECRUITMENT FOR OFFERING TECHNICAL AND BUSINESS MANAGEMENT ASSISTANCE IN THE ESTABLISHMENT AND OPERATION OF A GROUP OF ENTREPRENEURS, BUSINESSES, SELF-EMPLOYED INDIVIDUALS, PROFESSIONALS, HOME-BASED BUSINESSES AND DIRECT SALE BUSINESSES AND OTHERS WHO WANT TO INCREASE THEIR SMALL BUSINESS REVENUES SO THAT THEY CAN ACHIEVE FINANCIAL FREEDOM AND LIVE EXTRAORDINARY LIVES ON THE SUBJECT OF BUSINESS MANAGEMENT AND BUSINESS STRATEGIES AND BUSINESS ADVISORY SERVICES AND HOW TO INCREASE REVENUES AND PROFITS, IN CLASS 35 (U.S. CLS. 100, 101 AND 102).

FIRST USE 8-14-2006; IN COMMERCE 8-14-2006.

FOR: CONDUCTING EDUCATIONAL EXHIBITIONS IN THE NATURE OF LIVE EVENTS TO INSTRUCT, ENTERTAIN, INFORM AND EDU-

CATE A GROUP OF ENTREPRENEURS, BUSINESSES, SELF-EMPLOYED INDIVIDUALS, PROFESSIONALS, HOME-BASED BUSINESSES AND DIRECT SALE BUSINESSES AND OTHERS WHO WANT TO INCREASE THEIR SMALL BUSINESS REVENUES SO THAT THEY CAN ACHIEVE FINANCIAL FREEDOM AND LIVE EXTRAORDINARY LIVES ON THE SUBJECT OF BUSINESS MANAGEMENT AND BUSINESS STRATEGIES AND BUSINESS ADVISORY SERVICES AND HOW TO INCREASE REVENUES AND PROFITS; CONDUCTING ENTERTAINMENT EXHIBITIONS IN THE NATURE OF LIVE EVENTS TO INSTRUCT, ENTERTAIN, INFORM AND EDUCATE A GROUP OF ENTREPRENEURS, BUSINESSES, SELF-EMPLOYED INDIVIDUALS, PROFESSIONALS, HOME-BASED BUSINESSES AND DIRECT SALE BUSINESSES AND OTHERS WHO WANT TO INCREASE THEIR SMALL BUSINESS REVENUES SO THAT THEY CAN ACHIEVE FINANCIAL FREEDOM AND LIVE EXTRAORDINARY LIVES ON THE SUBJECT OF BUSINESS MANAGEMENT AND BUSINESS STRATEGIES AND BUSINESS ADVISORY SERVICES AND HOW TO INCREASE REVENUES AND PROFITS, IN CLASS 41 (U.S. CLS. 100, 101 AND 107).

FIRST USE 8-14-2006; IN COMMERCE 8-14-2006.

THE MARK CONSISTS OF STANDARD CHARACTERS WITHOUT CLAIM TO ANY PARTICULAR FONT, STYLE, SIZE, OR COLOR.

SER. NO. 77-110,972, FILED 2-19-2007.

CHARISMA HAMPTON, EXAMINING ATTORNEY

Int. Cl.: 35

Prior U.S. Cls.: 100, 101 and 102

United States Patent and Trademark Office

Reg. No. 3,483,045

Registered Aug. 12, 2008

**SERVICE MARK
PRINCIPAL REGISTER**



ASSOCIATION FOR DRESSINGS AND SAUCES
(NEW YORK NON-PROFIT CORPORATION)
1100 JOHNSON FERRY ROAD NE
SUITE 300, CENTER POINTE 1
ATLANTA, GA 30342

FOR: ASSOCIATION SERVICES, NAMELY, PROMOTING THE INTERESTS OF SALAD DRESSING AND CONDIMENT SAUCE MANUFACTURERS AND SUPPLIERS TO THE INDUSTRY AND CREATING PUBLIC AWARENESS OF THE NEED FOR HEALTHY EATING HABITS AND BALANCED DIETS THROUGH SPONSORSHIP OF A CONTEST AMONG SCHOOLS TO CREATE SCULPTURES FROM FRUITS, VEGETABLES, SALAD DRESSING AND OTHER CONDIMENT SAUCES, IN CLASS 35 (U.S. CLS. 100, 101 AND 102).

FIRST USE 0-0-1997; IN COMMERCE 0-0-1997.

NO CLAIM IS MADE TO THE EXCLUSIVE RIGHT TO USE "NATIONAL" AND "COMPETITION", APART FROM THE MARK AS SHOWN.

THE COLOR(S) WHITE, BLUE AND RED IS/ARE CLAIMED AS A FEATURE OF THE MARK.

THE MARK CONSISTS OF THE OUTLINE OF A TRIANGLE IN RED WITH A SOLID BLUE TRIANGLE AT THE TOP OF THE RED TRIANGLE, WITH ALL THE WORDING IN BLUE AND THE BACKGROUND IN WHITE.

SER. NO. 77-111,076, FILED 2-20-2007.

SUE LAWRENCE, EXAMINING ATTORNEY

Int. Cl.: 41

Prior U.S. Cls.: 100, 101 and 107

United States Patent and Trademark Office

Reg. No. 3,483,046

Registered Aug. 12, 2008

**SERVICE MARK
PRINCIPAL REGISTER**

New Creation Body Prayer

YORK, ANNA S (UNITED STATES INDIVIDUAL)
5201 S. CORNELL AVENUE, 28D
CHICAGO, IL 60615

FOR: EDUCATIONAL SERVICES, NAMELY,
CONDUCTING DEMONSTRATIONS AND TRAIN-
ING SESSIONS IN THE FIELD OF EXERCISE,
STRESS RELIEF AND HEALTH, IN CLASS 41 (U.S.
CLS. 100, 101 AND 107).

FIRST USE 2-10-2007; IN COMMERCE 2-17-2007.

THE MARK CONSISTS OF STANDARD CHAR-
ACTERS WITHOUT CLAIM TO ANY PARTICULAR
FONT, STYLE, SIZE, OR COLOR.

NO CLAIM IS MADE TO THE EXCLUSIVE
RIGHT TO USE "BODY PRAYER", APART FROM
THE MARK AS SHOWN.

SER. NO. 77-112,015, FILED 2-20-2007.

MICHAEL WIENER, EXAMINING ATTORNEY

Int. Cl.: 25

Prior U.S. Cls.: 22 and 39

United States Patent and Trademark Office

Reg. No. 3,483,047

Registered Aug. 12, 2008

**TRADEMARK
PRINCIPAL REGISTER**

LeLuxe Clothing

BURROUGHS, SHANE (UNITED STATES INDIVIDUAL)
8058 KYLES STREET
SUNLAND, CA 91040

FOR: COATS; DRESS SHIRTS; DRESS SUITS; EVENING DRESSES; PANTS; SHIRTS; SHORT-SLEEVED OR LONG-SLEEVED T-SHIRTS; SHORT-SLEEVED SHIRTS; SKIRTS AND DRESSES; WOMEN'S CEREMONIAL DRESSES, IN CLASS 25 (U.S. CLS. 22 AND 39).

FIRST USE 9-18-1999; IN COMMERCE 9-18-1999.

THE MARK CONSISTS OF STANDARD CHARACTERS WITHOUT CLAIM TO ANY PARTICULAR FONT, STYLE, SIZE, OR COLOR.

NO CLAIM IS MADE TO THE EXCLUSIVE RIGHT TO USE "CLOTHING", APART FROM THE MARK AS SHOWN.

SER. NO. 77-112,029, FILED 2-21-2007.

DOMINIC J. FERRAIUOLO, EXAMINING ATTORNEY

Int. Cl.: 35

Prior U.S. Cls.: 100, 101 and 102

United States Patent and Trademark Office

Reg. No. 3,483,048

Registered Aug. 12, 2008

**SERVICE MARK
PRINCIPAL REGISTER**



DOUBLE EDGE SWORD RECORDS INC (COLORADO CORPORATION)

P.O. BOX 12691

COLORADO SPRINGS, CO 80902

FOR: ON-LINE RETAIL STORE SERVICES FEATURING CDS, DVDS, AND MP3S; STREET VENDOR SERVICES FEATURING CDS, DVDS, AND MP3S, IN CLASS 35 (U.S. CLS. 100, 101 AND 102).

FIRST USE 6-1-2004; IN COMMERCE 8-1-2004.

NO CLAIM IS MADE TO THE EXCLUSIVE RIGHT TO USE "RECORDS", APART FROM THE MARK AS SHOWN.

THE STIPLING IS FOR SHADING PURPOSES ONLY.

THE MARK CONSISTS OF STYLIZED WORDING "DOUBLE EDGE SWORD RECORDS".

SER. NO. 77-112,352, FILED 2-21-2007.

ARETHA SOMERVILLE, EXAMINING ATTORNEY

Int. Cl.: 31

Prior U.S. Cls.: 1 and 46

United States Patent and Trademark Office

Reg. No. 3,483,049

Registered Aug. 12, 2008

TRADEMARK
PRINCIPAL REGISTER

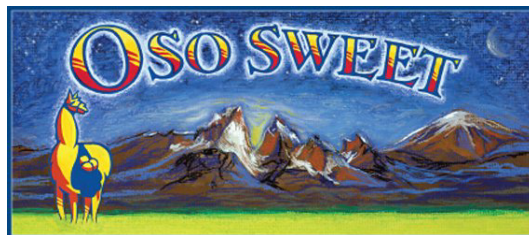

SAVEN CORPORATION (MICHIGAN CORPORATION)
1410 LEWIS STREET
CHARLESTON, WV 25301

FOR: FRESH ONIONS, IN CLASS 31 (U.S. CLS. 1 AND 46).

FIRST USE 1-10-2007; IN COMMERCE 1-10-2007.

OWNER OF U.S. REG. NOS. 1,636,261, 2,186,268 AND OTHERS.

THE COLOR(S) BLUE, RED, YELLOW, GREEN, BROWN, BLACK, WHITE AND PURPLE IS/ARE CLAIMED AS A FEATURE OF THE MARK.

THE MARK CONSISTS OF "OSO SWEET" (STY- LIZED, YELLOW AND RED INTERIOR COLORING

AND OUTLINED IN BLUE) WITH A LLAMA (YEL- LOW AND RED INTERIOR COLORING AND OUT- LINED IN BLUE, WITH A BLUE SADDLE BAG CONTAINING ROUND OBJECTS IN YELLOW AND RED SHAPED LIKE ONIONS) STANDING TO THE LEFT OF A GRASSY FIELD (IN GREEN) WITH A SNOW-CAPPED MOUNTAIN RANGE (PRINCIPAL COLOR OF BROWN, WITH HIGHLIGHTS AND ACCENTS IN BLUE, PURPLE, BLACK, WHITE AND RED) IN THE BACKGROUND WITH A STAR- RY NIGHT SKY (BLUE AND BLACK WITH WHITE STARS THROUGHOUT AND A WHITE CRESCENT MOON ON THE RIGHT).

SEC. 2(F).

SER. NO. 77-112,683, FILED 2-21-2007.

STEVEN R. FINE, EXAMINING ATTORNEY

Int. Cls.: 38 and 41

Prior U.S. Cls.: 100, 101, 104 and 107

United States Patent and Trademark Office

Reg. No. 3,483,050

Registered Aug. 12, 2008

**SERVICE MARK
PRINCIPAL REGISTER**

ROADCAST

ROADCAST GROUP LLC (MICHIGAN LTD LIAB
CO)
171 MONROE AVENUE, SUITE 400
GRAND RAPIDS, MI 49503

FOR: PROVIDING WEB CONFERENCING SERVICES FOR COMPANIES TO ALLOW INVESTORS TO REVIEW FINANCES, MANAGEMENT AND CORPORATE INFORMATION RELATED TO SUCH COMPANIES; PROVIDING WEB CONFERENCING SERVICES FOR COMPANIES WHICH ALLOW INVESTORS TO ACCESS ONLINE VIDEO PRESENTATIONS IN ORDER TO REVIEW FINANCES, MANAGEMENT AND CORPORATE INFORMATION RELATED TO SUCH COMPLAINTS, IN CLASS 38 (U.S. CLS. 100, 101 AND 104).

FIRST USE 11-1-2006; IN COMMERCE 12-6-2006.

FOR: PROVIDING VIDEO PRESENTATIONS FOR COMPANIES TO ALLOW INVESTORS TO REVIEW FINANCES, MANAGEMENT AND CORPORATE INFORMATION RELATED TO SUCH COMPANIES, IN CLASS 41 (U.S. CLS. 100, 101 AND 107).

FIRST USE 11-1-2006; IN COMMERCE 12-6-2006.

THE MARK CONSISTS OF STANDARD CHARACTERS WITHOUT CLAIM TO ANY PARTICULAR FONT, STYLE, SIZE, OR COLOR.

SER. NO. 77-113,356, FILED 2-22-2007.

PAULA MAHONEY, EXAMINING ATTORNEY

Int. Cl.: 25

Prior U.S. Cls.: 22 and 39

United States Patent and Trademark Office

Reg. No. 3,483,051

Registered Aug. 12, 2008

**TRADEMARK
PRINCIPAL REGISTER**

GOT AIR FORCE?

EAGLE CREST, INC. (FLORIDA CORPORATION)
5353-1 RAMONA BOULEVARD
JACKSONVILLE, FL 32205

FIRST USE 2-1-2007; IN COMMERCE 2-1-2007.

FOR: CLOTHING IN CLASS 025, NAMELY HATS, SHIRTS, UNDERGARMENTS, SWIMSUITS, SWEATSHIRTS, SWEATERS, JACKETS, COATS, GLOVES, SCARVES, BELTS, HEADBANDS, WRISTBANDS, PANTS, SHORTS, SKIRTS, DRESSES, OVERALLS, SOCKS, STOCKINGS, AND LEGGINGS, IN CLASS 25 (U.S. CLS. 22 AND 39).

THE MARK CONSISTS OF STANDARD CHARACTERS WITHOUT CLAIM TO ANY PARTICULAR FONT, STYLE, SIZE, OR COLOR.

SER. NO. 77-114,612, FILED 2-23-2007.

CHRIS WELLS, EXAMINING ATTORNEY

Int. Cls.: 24 and 25

Prior U.S. Cls.: 22, 39, 42 and 50

United States Patent and Trademark Office

Reg. No. 3,483,052

Registered Aug. 12, 2008

TRADEMARK
PRINCIPAL REGISTER



SOUTH DAKOTA STATE UNIVERSITY (SOUTH
DAKOTA EDUCATIONAL INSTITUTION)

CMC 105, ROTUNDA LANE, BOX 2230

BROOKINGS, SD 57007

FOR: BLANKETS, TOWELS, CLOTH PENNANTS,
BANNERS, FLAGS, IN CLASS 24 (U.S. CLS. 42 AND
50).

FIRST USE 0-0-1976; IN COMMERCE 0-0-1976.

FOR: CLOTHING, NAMELY, SHIRTS, SWEAT-
SHIRTS, JACKETS, HEADWEAR, INFANTWEAR,
PANTS, SHORTS, GLOVES, SOCKS, AND SCARVES,
IN CLASS 25 (U.S. CLS. 22 AND 39).

FIRST USE 0-0-1976; IN COMMERCE 0-0-1976.

THE MARK CONSISTS OF A RUNNING RABBIT.

SER. NO. 77-115,402, FILED 2-24-2007.

GEORGE LORENZO, EXAMINING ATTORNEY

Int. Cl.: 5

Prior U.S. Cls.: 6, 18, 44, 46, 51 and 52

Reg. No. 3,483,053

United States Patent and Trademark Office

Registered Aug. 12, 2008

**TRADEMARK
PRINCIPAL REGISTER**

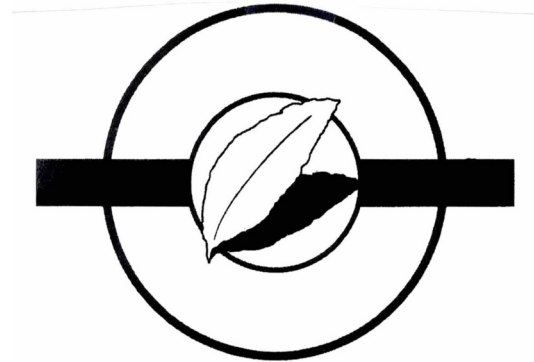

BREYNER (FRANCE SOCIETE A RESPONSABILITE LIMITEE)
CHEMIN DE LONESE LONES
VIENNE, FRANCE 38200

FOR: DISINFECTING PRODUCTS AGAINST MITES, BEDBUGS, SURGICAL CLOTH TREATED AGAINST MITES, BEDBUGS, AND MOSQUITOES, NAMELY, DISINFECTANT SPRAYS; INSECT REPELLING PRODUCTS, NAMELY, ACARICIDES; INSECT AND MITE REPELLENTS; MEDICAL OR SANITARY DISINFECTANTS OTHER THAN SOAPS TO SANITIZE MEDICAL EQUIPMENT; DETERGENTS FOR MEDICAL USE IN THE NATURE OF ANTIBACTERIAL HANDWASH; PRODUCTS FOR

DESTROYING VERMIN, NAMELY, RODENTICIDES; FUNGICIDES; HERBICIDES, IN CLASS 5 (U.S. CLS. 6, 18, 44, 46, 51 AND 52).

OWNER OF FRANCE REG. NO. 053385185, DATED 10-11-2005, EXPIRES 10-10-2015.

THE MARK CONSISTS OF A CIRCLE BISECTED BY A BAR WITH A LEAF.

SER. NO. 77-115,833, FILED 2-26-2007.

ANNE FARRELL, EXAMINING ATTORNEY

Int. Cls.: 43, 44 and 45

Prior U.S. Cls.: 100 and 101

United States Patent and Trademark Office

Reg. No. 3,483,054

Registered Aug. 12, 2008

**SERVICE MARK
PRINCIPAL REGISTER**



AIDS PROJECT LOS ANGELES (CALIFORNIA
NON-PROFIT CORPORATION)
THE DAVID GEFFEN CENTER
611 SOUTH KINGSLEY DRIVE
LOS ANGELES, CA 90005

FOR: CHARITABLE SERVICES, NAME-
LY, PROVIDING FOOD TO PEOPLE LIVING WITH HIV AND
AIDS, IN CLASS 43 (U.S. CLS. 100 AND 101).

FIRST USE 1-0-2003; IN COMMERCE 1-0-2003.

FOR: CHARITABLE SOCIAL SERVICES, NAME-
LY, PROVIDING COUNSELING ON FOOD AND
NUTRITION, MENTAL HEALTH SERVICES, AND
DENTAL CARE FOR PEOPLE LIVING WITH HIV
AND AIDS, IN CLASS 44 (U.S. CLS. 100 AND 101).

FIRST USE 1-0-2003; IN COMMERCE 1-0-2003.

FOR: CHARITABLE SOCIAL SERVICES, NAME-
LY, CASE MANAGEMENT SERVICES, THE COOR-
DINATION OF SOCIAL AND PSYCHOLOGICAL
SERVICES, NECESSARY DENTAL SERVICES,
AND EDUCATIONAL SERVICES FOR PERSONS
LIVING WITH HIV AND AIDS, IN CLASS 45 (U.S.
CLS. 100 AND 101).

FIRST USE 1-0-2003; IN COMMERCE 1-0-2003.

OWNER OF U.S. REG. NO. 2,197,182.

NO CLAIM IS MADE TO THE EXCLUSIVE
RIGHT TO USE "AIDS PROJECT LOS ANGELES",
APART FROM THE MARK AS SHOWN.

SER. NO. 77-116,512, FILED 2-26-2007.

TARAH HARDY, EXAMINING ATTORNEY

Int. Cl.: 1

Prior U.S. Cls.: 1, 5, 6, 10, 26 and 46

Reg. No. 3,483,055

United States Patent and Trademark Office

Registered Aug. 12, 2008

**TRADEMARK
PRINCIPAL REGISTER**

GEL-PAC-FRAC

TRICAN WELL SERVICE LTD. (CANADA CORPORATION)
SUITE 2900
645 - 7TH AVENUE S.W.
CALGARY, ALBERTA, CANADA T2P4G8

FOR: HIGH VISCOSITY POLYMER WATER PLUG USED TO DIVERT FRACTURING TREATMENTS IN SUBTERRANEAN FORMATIONS, FOR USE IN FRACTURING AND COMPLETION OF OIL AND GAS WELLS, IN CLASS 1 (U.S. CLS. 1, 5, 6, 10, 26 AND 46).

THE MARK CONSISTS OF STANDARD CHARACTERS WITHOUT CLAIM TO ANY PARTICULAR FONT, STYLE, SIZE, OR COLOR.

PRIORITY CLAIMED UNDER SEC. 44(D) ON CANADA APPLICATION NO. 1336162, FILED 2-20-2007, REG. NO. TMA708,921, DATED 3-5-2008, EXPIRES 3-5-2023.

SER. NO. 77-117,358, FILED 2-27-2007.

REBECCA EISINGER, EXAMINING ATTORNEY

Int. Cl.: 5

Prior U.S. Cls.: 6, 18, 44, 46, 51 and 52

Reg. No. 3,483,056

United States Patent and Trademark Office

Registered Aug. 12, 2008

**TRADEMARK
PRINCIPAL REGISTER**

NERVOBION

MERCK KGAA (FED REP GERMANY PART-
NERSHIP)
FRANKFURTER STRASSE 250
DARMSTADT, FED REP GERMANY D-64293

FOR: CHEMICAL PREPARATIONS FOR MEDI-
CAL USE, FOR HEALING PURPOSES AND
HEALTH CARE FOR THE TREATMENT OF PAIN,
VITAMIN DEFICIENCIES, AND RELATED OR SI-
MILAR CONDITIONS IN THE NATURE OF NEU-
ROPATHY, RETINOPATHY, NEPHROPATHY,
DIABETES AND VASCULAR DYSFUNCTION;
PHARMACEUTICAL DRUGS FOR TREATING
PAIN, VITAMIN DEFICIENCIES, AND RELATED
OR SIMILAR CONDITIONS IN THE NATURE OF

NEUROPATHY, RETINOPATHY, NEPHROPATHY,
DIABETES AND VASCULAR DYSFUNCTION, IN
CLASS 5 (U.S. CLS. 6, 18, 44, 46, 51 AND 52).

THE MARK CONSISTS OF STANDARD CHAR-
ACTERS WITHOUT CLAIM TO ANY PARTICULAR
FONT, STYLE, SIZE, OR COLOR.

OWNER OF FED REP GERMANY REG. NO.
690686, DATED 5-14-1956, EXPIRES 10-31-2015.

SER. NO. 77-117,806, FILED 2-27-2007.

ANN E. SAPPENFIELD, EXAMINING ATTORNEY

Int. Cl.: 36

Prior U.S. Cls.: 100, 101 and 102

United States Patent and Trademark Office

Reg. No. 3,483,057

Registered Aug. 12, 2008

**SERVICE MARK
PRINCIPAL REGISTER**

AIG E-SOLUTIONS

AMERICAN INTERNATIONAL GROUP, INC.
(DELAWARE CORPORATION)
70 PINE STREET
NEW YORK, NY 10270

OWNER OF U.S. REG. NOS. 1,172,557, 3,105,291
AND OTHERS.

FOR: ADMINISTRATION OF EMPLOYEE BENEFIT PLANS, IN CLASS 36 (U.S. CLS. 100, 101 AND 102).

NO CLAIM IS MADE TO THE EXCLUSIVE RIGHT TO USE "E-SOLUTIONS", APART FROM THE MARK AS SHOWN.

FIRST USE 10-1-2006; IN COMMERCE 10-1-2006.

SER. NO. 77-118,717, FILED 2-28-2007.

THE MARK CONSISTS OF STANDARD CHARACTERS WITHOUT CLAIM TO ANY PARTICULAR FONT, STYLE, SIZE, OR COLOR.

KELLY MCCOY, EXAMINING ATTORNEY

Int. Cls.: 18, 25 and 41

Prior U.S. Cls.: 1, 2, 3, 22, 39, 41, 100, 101 and 107

United States Patent and Trademark Office

Reg. No. 3,483,058

Registered Aug. 12, 2008

**TRADEMARK
SERVICE MARK
PRINCIPAL REGISTER**

FIVE DAYS IN JULY

VACCARO, JOHN (UNITED STATES INDIVIDUAL)
5314 COLLINGWOOD CIRCLE
CALABASAS, CA 91302

FOR: ALL PURPOSE SPORT BAGS; ALL-PURPOSE ATHLETIC BAGS; ALL-PURPOSE CARRYING BAGS; ATHLETIC BAGS; BAGS AND HOLDALLS FOR SPORTS CLOTHING; BAGS FOR SPORTS; BEACH BAGS; CARRY-ALL BAGS; CARRY-ON BAGS; DUFFEL BAGS; GYM BAGS; MESSENGER BAGS; OVERNIGHT BAGS; SCHOOL BAGS; TOTE BAGS; WAIST BAGS, IN CLASS 18 (U.S. CLS. 1, 2, 3, 22 AND 41).

FIRST USE 5-1-2005; IN COMMERCE 5-1-2005.

FOR: ATHLETIC FOOTWEAR; BOXER SHORTS; CAMP SHIRTS; FOOTWEAR; GOLF SHIRTS; GYM SHORTS; HATS; JACKETS; OPEN-NECKED SHIRTS; PANTS; PIQUE SHIRTS; POLO SHIRTS; SHIRTS; SHORT-SLEEVED OR LONG-SLEEVED T-SHIRTS; SHORTS; SOCKS; SPORT SHIRTS; SWEAT PANTS;

SWEAT SHIRTS; TRACK PANTS; WATERPROOF JACKETS AND PANTS, IN CLASS 25 (U.S. CLS. 22 AND 39).

FIRST USE 5-1-2005; IN COMMERCE 5-1-2005.

FOR: ARRANGING AND CONDUCTING ATHLETIC COMPETITIONS; BASKETBALL CAMPS; ENTERTAINMENT IN THE NATURE OF BASKETBALL TOURNAMENTS; RECREATIONAL CAMPS; SPORT CAMPS, IN CLASS 41 (U.S. CLS. 100, 101 AND 107).

FIRST USE 5-1-2005; IN COMMERCE 5-1-2005.

THE MARK CONSISTS OF STANDARD CHARACTERS WITHOUT CLAIM TO ANY PARTICULAR FONT, STYLE, SIZE, OR COLOR.

SER. NO. 77-118,986, FILED 2-28-2007.

ANDREA SAUNDERS, EXAMINING ATTORNEY

Int. Cl.: 42

Prior U.S. Cls.: 100 and 101

United States Patent and Trademark Office

Reg. No. 3,483,059

Registered Aug. 12, 2008

**SERVICE MARK
PRINCIPAL REGISTER**

THE NEW RESEARCH

CONNOTATE TECHNOLOGIES, INC. (DELAWARE CORPORATION)
100 ALBANY STREET
NEW BRUNSWICK, NJ 08901

FOR: COMPUTER SERVICE, NAMELY, ACTING AS AN APPLICATION SERVICE PROVIDER IN THE FIELD OF KNOWLEDGE MANAGEMENT TO HOST COMPUTER APPLICATION SOFTWARE FOR CREATING SEARCHABLE DATABASES OF INFORMATION AND DATA; COMPUTER SERVICE, NAMELY, ACTING AS AN APPLICATION SERVICE PROVIDER IN THE FIELD OF KNOWLEDGE MANAGEMENT TO HOST COMPUTER APPLICATION SOFTWARE FOR SEARCHING AND RETRIEVING INFORMATION FROM DATABASES AND COMPUTER NETWORKS; COMPUTER SERVICE, NAMELY, ACTING AS AN APPLICATION SERVICE PROVIDER IN THE FIELD OF KNOWLEDGE MANAGEMENT TO HOST COMPUTER APPLICATION SOFTWARE FOR THE COLLECTION, EDITING, ORGANIZING, MODIFYING, BOOK MARKING, TRANSMISSION, STORAGE AND SHARING OF DATA AND INFORMATION; COMPUTER SERVICES, NAMELY, CREATING INDEXES

OF INFORMATION, SITES AND OTHER RESOURCES AVAILABLE ON COMPUTER NETWORKS; COMPUTER SOFTWARE CONSULTATION; DATA AUTOMATION AND COLLECTION SERVICE USING PROPRIETARY SOFTWARE TO EVALUATE, ANALYZE AND COLLECT SERVICE DATA; AND DATA CONVERSION OF COMPUTER PROGRAM DATA OR INFORMATION, IN CLASS 42 (U.S. CLS. 100 AND 101).

FIRST USE 2-0-2003; IN COMMERCE 2-0-2003.

THE MARK CONSISTS OF STANDARD CHARACTERS WITHOUT CLAIM TO ANY PARTICULAR FONT, STYLE, SIZE, OR COLOR.

NO CLAIM IS MADE TO THE EXCLUSIVE RIGHT TO USE "RESEARCH", APART FROM THE MARK AS SHOWN.

SER. NO. 77-119,556, FILED 3-1-2007.

DEZMONA MIZELLE, EXAMINING ATTORNEY

Int. Cl.: 42

Prior U.S. Cls.: 100 and 101

United States Patent and Trademark Office

Reg. No. 3,483,060

Registered Aug. 12, 2008

**SERVICE MARK
PRINCIPAL REGISTER**

CELLUMEN

CELLUMEN, INC. (DELAWARE CORPORATION)
3180 WILLIAM PITT WAY
PITTSBURGH, PA 15238

FOR: CHEMICAL, BIOCHEMICAL, BIOLOGICAL AND BACTERIOLOGICAL RESEARCH AND ANALYSIS; CONDUCTING OF FEASIBILITY STUDIES; CONSULTANCY PERTAINING TO PHARMACOLOGY; DESIGN FOR OTHERS IN THE FIELD OF BIOTECHNOLOGY; DEVELOPMENT OF NEW TECHNOLOGY FOR OTHERS IN THE FIELD OF CELLULAR BIOLOGY; DIAGNOSTIC SERVICES IN THE FIELD OF CELL AND TISSUE ANALYSIS; ENGINEERING SERVICES, NAMELY, ENGINEERING FOR THE PHARMACEUTICAL AND BIOTECHNOLOGY INDUSTRIES; LABORATORY RESEARCH IN THE FIELD OF CELLULAR BIOLOGY; MEDICAL AND SCIENTIFIC RESEARCH IN THE FIELD OF DRUG DISCOVERY AND DRUG DEVELOPMENT; MEDICAL AND SCIENTIFIC RESEARCH SERVICES IN THE FIELD OF CANCER TREATMENT AND DIAGNOSIS; MEDICAL RE-

SEARCH; PHARMACEUTICAL DRUG DEVELOPMENT SERVICES; PHARMACEUTICAL RESEARCH AND DEVELOPMENT; PHARMACEUTICAL RESEARCH SERVICES; PRODUCT RESEARCH & DEVELOPMENT; PRODUCT SAFETY TESTING; RESEARCH AND DEVELOPMENT AND CONSULTATION RELATED THERETO IN THE FIELD OF BIOMEDICINE; RESEARCH IN THE FIELD OF ENVIRONMENTAL PROTECTION; SCIENTIFIC RESEARCH; SCIENTIFIC RESEARCH AND DEVELOPMENT, IN CLASS 42 (U.S. CLS. 100 AND 101).

FIRST USE 2-9-2004; IN COMMERCE 6-12-2004.

THE MARK CONSISTS OF STANDARD CHARACTERS WITHOUT CLAIM TO ANY PARTICULAR FONT, STYLE, SIZE, OR COLOR.

SER. NO. 77-119,974, FILED 3-1-2007.

PAULA MAHONEY, EXAMINING ATTORNEY

Int. Cl.: 42

Prior U.S. Cls.: 100 and 101

United States Patent and Trademark Office

Reg. No. 3,483,061

Registered Aug. 12, 2008

**SERVICE MARK
PRINCIPAL REGISTER**

Celsius[°] designs

SCHAUMBERG, ERICA B (UNITED STATES IN-
DIVIDUAL)
6513 76TH PLACE
CABIN JOHN, MD 20818

FOR: GRAPHIC DESIGN SERVICES, IN CLASS 42
(U.S. CLS. 100 AND 101).

FIRST USE 1-1-1999; IN COMMERCE 8-28-2003.

OWNER OF U.S. REG. NO. 3,054,718.

NO CLAIM IS MADE TO THE EXCLUSIVE
RIGHT TO USE "DESIGNS", APART FROM THE
MARK AS SHOWN.

THE MARK CONSISTS OF THE WORDS "CEL-
SIUS DESIGNS"; THERE IS A DEGREE SYMBOL
AFTER THE WORD "CELSIUS".

SER. NO. 77-121,105, FILED 3-2-2007.

CARYN GLASSER, EXAMINING ATTORNEY

Int. Cl.: 11

Prior U.S. Cls.: 13, 21, 23, 31 and 34

United States Patent and Trademark Office

Reg. No. 3,483,062

Registered Aug. 12, 2008

**TRADEMARK
PRINCIPAL REGISTER**

MATCHED PERFORMANCE

CAROMA INDUSTRIES LTD (AUSTRALIA COMPANY)
10 MARKET STREET
BRISBANE, QUEENSLAND, AUSTRALIA 4000

FOR: PLUMBING FITTINGS AND FIXTURES IN THIS CLASS, NAMELY, BIBBS, COCKS, TRAPS, VALVES, SINK SPRAYERS AND SHOWER SPRAYERS; SINKS; BATHTUBS; WHIRLPOOL BATHTUBS; BATHTUB COMPONENTS, NAMELY, PANS AND RESERVOIRS FOR INSTALLATION BENEATH BATHTUBS; SHOWERS; SHOWER BASES; SHOWER DOORS; SHOWER ENCLOSURES; SHOWER PANELS; TOILETS; TOILET BOWLS; TOILET SEATS; TOILET TANKS; TOILET TANK BALLS; BIDETS; URINALS; TAPWARE, NAMELY, TAP WATER FAUCETS; FAUCETS; TOILET CISTERNS AND BUTTONS FOR THE OPERATION THEREOF; TOILET PANS FOR WATER COLLECTION AND DIS-

TRIBUTION; AND REPLACEMENT PARTS FOR THE AFOREMENTIONED PRODUCTS, IN CLASS 11 (U.S. CLS. 13, 21, 23, 31 AND 34).

THE MARK CONSISTS OF STANDARD CHARACTERS WITHOUT CLAIM TO ANY PARTICULAR FONT, STYLE, SIZE, OR COLOR.

OWNER OF AUSTRALIA REG. NO. 1001704, DATED 5-12-2004, EXPIRES 5-12-2014.

NO CLAIM IS MADE TO THE EXCLUSIVE RIGHT TO USE "PERFORMANCE", APART FROM THE MARK AS SHOWN.

SER. NO. 77-122,187, FILED 3-5-2007.

BRIAN CALLAGHAN, EXAMINING ATTORNEY

Int. Cl.: 36

Prior U.S. Cls.: 100, 101 and 102

United States Patent and Trademark Office

Reg. No. 3,483,063

Registered Aug. 12, 2008

**SERVICE MARK
PRINCIPAL REGISTER**

Bandwidth Advisors, Inc

AARON LOEHR (WASHINGTON COMPANY)
2401 N. NORTHLAKE WAY #5
SEATTLE, WA 98103

FOR: FINANCIAL CONSULTATION IN THE
FIELD OF TELECOMMUNICATIONS, IN CLASS 36
(U.S. CLS. 100, 101 AND 102).

FIRST USE 1-1-2003; IN COMMERCE 1-1-2003.

THE MARK CONSISTS OF STANDARD CHAR-
ACTERS WITHOUT CLAIM TO ANY PARTICULAR
FONT, STYLE, SIZE, OR COLOR.

NO CLAIM IS MADE TO THE EXCLUSIVE
RIGHT TO USE "ADVISORS INC", APART FROM
THE MARK AS SHOWN.

SER. NO. 77-124,583, FILED 3-7-2007.

ROBIN CHOSID, EXAMINING ATTORNEY

Int. Cl.: 3

Prior U.S. Cls.: 1, 4, 6, 50, 51 and 52

United States Patent and Trademark Office

Reg. No. 3,483,064

Registered Aug. 12, 2008

**TRADEMARK
PRINCIPAL REGISTER**

BOIS 1920

SIRETA S.R.L. (ITALY SOCIETA A RESPONSABILITA LIMITATA)
VIA STAGNACCIO BASSO 46A
BADIA A SETTIMO Z.I.
SCANDICCI FI, ITALY 50018

FOR: PERFUMES, EAU DE COLOGNE, TOILETTE WATER, OILS FOR TOILETRY PURPOSES, SCENTED BODY SPRAYS, AFTER SHAVE, DEODORANT FOR PERSONAL USE, PERFUMED CREAMS, ESSENTIAL OILS FOR PERSONAL USE, TOILET SOAP, BAR SOAP, DEODORANT SOAP, HAIR SHAMPOO, HAIR LOTION, BATH SALTS, SHAVING PREPARATIONS, COSMETIC MILKS, BEAUTY LOTIONS, BEAUTY MASKS, COSMETIC CREAMS, COSMETIC PREPARATIONS FOR BODY CARE, TALCUM POWDER FOR PERSONAL USE, IN CLASS 3 (U.S. CLS. 1, 4, 6, 50, 51 AND 52).

THE MARK CONSISTS OF STANDARD CHARACTERS WITHOUT CLAIM TO ANY PARTICULAR FONT, STYLE, SIZE, OR COLOR.

OWNER OF ERPN CMNTY TM OFC REG. NO. 005077921, DATED 4-27-2007, EXPIRES 4-27-2017.

NO CLAIM IS MADE TO THE EXCLUSIVE RIGHT TO USE "1920", APART FROM THE MARK AS SHOWN.

THE FOREIGN WORDING IN THE MARK TRANSLATES INTO ENGLISH AS WOOD.

SER. NO. 77-125,048, FILED 3-7-2007.

NELSON SNYDER, EXAMINING ATTORNEY

Int. Cl.: 9

Prior U.S. Cls.: 21, 23, 26, 36 and 38

Reg. No. 3,483,065

United States Patent and Trademark Office

Registered Aug. 12, 2008

**TRADEMARK
PRINCIPAL REGISTER**

NET 7 TECHNOLOGIES

NET 7 TECHNOLOGIES INC. (WASHINGTON CORPORATION)

23829 S.E. 208TH STREET

MAPLE VALLEY, WA 98038

FOR: COMPUTER NETWORKING HARDWARE,
IN CLASS 9 (U.S. CLS. 21, 23, 26, 36 AND 38).

FIRST USE 11-1-2005; IN COMMERCE 11-1-2005.

THE MARK CONSISTS OF STANDARD CHARACTERS WITHOUT CLAIM TO ANY PARTICULAR FONT, STYLE, SIZE, OR COLOR.

NO CLAIM IS MADE TO THE EXCLUSIVE RIGHT TO USE "NET" AND "TECHNOLOGIES", APART FROM THE MARK AS SHOWN.

SER. NO. 77-125,094, FILED 3-7-2007.

MARY BOAGNI, EXAMINING ATTORNEY

Int. Cl.: 19

Prior U.S. Cls.: 1, 12, 33 and 50

United States Patent and Trademark Office

Reg. No. 3,483,066

Registered Aug. 12, 2008

**TRADEMARK
PRINCIPAL REGISTER**



ADVANCED ROCK TECHNOLOGIES, LLC (COL-
ORADO LTD LIAB CO)
UNIT B-9
879 BRICKYARD CIRCLE
GOLDEN, CO 80403

FOR: LIGHTWEIGHT POLYURETHANE WALL
PANEL SIDING MOLDED TO GIVE THE APPEAR-
ANCE OF MASONRY, SUCH AS BRICK, ROCK,
SLATE, STUCCO AND STONE , IN CLASS 19 (U.S.
CLS. 1, 12, 33 AND 50).

FIRST USE 8-25-2005; IN COMMERCE 8-25-2005.

NO CLAIM IS MADE TO THE EXCLUSIVE
RIGHT TO USE "ROCK", APART FROM THE
MARK AS SHOWN.

THE COLOR(S) WHITE, BLUE, PURPLE, BROWN
AND ORANGE IS/ARE CLAIMED AS A FEATURE
OF THE MARK.

THE MARK CONSISTS OF THE LETTERS "ART",
SLIGHTLY OVERLAPPING, CENTERED IN THE
FOREGROUND OF A GEOMETRIC PATTERN. THE
WORDS "ADVANCED ROCK TECHNOLOGIES"
BELOW THE LETTERS "ART". THE COLOR(S)
WHITE APPEAR IN THE WORDING "ART" AND
THE WORDING "ADVANCED ROCK TECHNOLO-
GIES". IN THE DESIGN THE COLOR BLUE AP-
PEARS AS BACKGROUND FOR THE WORDING
"ADVANCED ROCK TECHNOLOGIES" AND A
BLEND OF THE COLORS BLUE, PURPLE, BROWN
AND ORANGE APPEAR AS BACKGROUND FOR
THE WORDING "ART".

SER. NO. 77-125,705, FILED 3-8-2007.

GIANCARLO CASTRO, EXAMINING ATTORNEY

Int. Cl.: 5

Prior U.S. Cls.: 6, 18, 44, 46, 51 and 52

United States Patent and Trademark Office

Reg. No. 3,483,067

Registered Aug. 12, 2008

**TRADEMARK
PRINCIPAL REGISTER**

Ionic-Cal

LONGEVITY LINE, INC. (CALIFORNIA CORPORATION)
23852 PACIFIC COAST HIGHWAY #286
MALIBU, CA 90265

FOR: ACTIVATED IONIZED CALCIUM PLUS MAGNESIUM IN A PERFECTLY BALANCED 2 TO 1 RATION ALONG WITH OTHER INGREDIENTS THAT CONVERTS CALCIUM FROM NATURAL OYSTER SHELLS INTO HIGHLY ABSORBABLE IONIC FORMS THROUGH A PATENTED ELECTRONIC PROCESS, NAMELY, CALCIUM SUPPLE-

MENTS, IN CLASS 5 (U.S. CLS. 6, 18, 44, 46, 51 AND 52).

FIRST USE 2-28-2006; IN COMMERCE 2-28-2006.

THE MARK CONSISTS OF STANDARD CHARACTERS WITHOUT CLAIM TO ANY PARTICULAR FONT, STYLE, SIZE, OR COLOR.

SER. NO. 77-126,668, FILED 3-9-2007.

ROBERT STRUCK, EXAMINING ATTORNEY

Int. Cl.: 41

Prior U.S. Cls.: 100, 101 and 107

United States Patent and Trademark Office

Reg. No. 3,483,068

Registered Aug. 12, 2008

**SERVICE MARK
PRINCIPAL REGISTER**

SHANTA

ENHANCA LLC (MARYLAND LTD LIAB CO)
SUITE 704
601 N. EUTAW STREET
BALTIMORE, MD 21201

FOR: ENTERTAINMENT SERVICES, NAMELY,
ORGANIZING, CONDUCTING AND PROMOTING
AND SPONSORING THE PRODUCTION OF MUL-
TICULTURAL EVENTS AND DANCE PARTIES, IN
CLASS 41 (U.S. CLS. 100, 101 AND 107).

FIRST USE 9-13-2002; IN COMMERCE 9-13-2002.

THE MARK CONSISTS OF STANDARD CHAR-
ACTERS WITHOUT CLAIM TO ANY PARTICULAR
FONT, STYLE, SIZE, OR COLOR.

THE FOREIGN WORDING IN THE MARK
TRANSLATES INTO ENGLISH AS SERENITY.

SER. NO. 77-127,261, FILED 3-9-2007.

ALEXANDER L. POWERS, EXAMINING ATTOR-
NEY

Int. Cl.: 33

Prior U.S. Cls.: 47 and 49

United States Patent and Trademark Office

Reg. No. 3,483,069

Registered Aug. 12, 2008

**TRADEMARK
PRINCIPAL REGISTER**

ACORDE

VIÑA UNDURRAGA S.A. (CHILE CORPORATION)
VITACURA 2939, PISO 21, LAS CONDES
SANTIAGO, CHILE

FOR: WINES, IN CLASS 33 (U.S. CLS. 47 AND 49).

THE MARK CONSISTS OF STANDARD CHARACTERS WITHOUT CLAIM TO ANY PARTICULAR FONT, STYLE, SIZE, OR COLOR.

PRIORITY CLAIMED UNDER SEC. 44(D) ON CHILE APPLICATION NO. 765035, FILED 3-7-2007, REG. NO. 794857, DATED 8-21-2007, EXPIRES 8-21-2017.

THE FOREIGN WORDING IN THE MARK TRANSLATES INTO ENGLISH AS CHORD.

SER. NO. 77-128,843, FILED 3-12-2007.

JORDAN BAKER, EXAMINING ATTORNEY

Int. Cl.: 35

Prior U.S. Cls.: 100, 101 and 102

United States Patent and Trademark Office

Reg. No. 3,483,070

Registered Aug. 12, 2008

**SERVICE MARK
PRINCIPAL REGISTER**

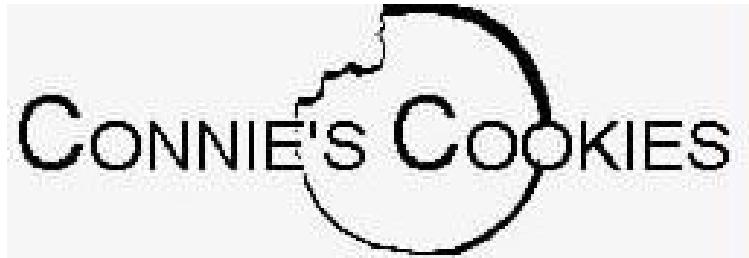

HAMILTON, CONNIE S. (UNITED STATES IN-
DIVIDUAL)

CONNIESCOOKIES.COM

2339 N. AMIDON

WICHITA, KS 67204

FOR: RETAIL BAKERY SHOPS, IN CLASS 35 (U.S.
CLS. 100, 101 AND 102).

FIRST USE 9-1-1993; IN COMMERCE 9-1-1993.

NO CLAIM IS MADE TO THE EXCLUSIVE
RIGHT TO USE "COOKIES", APART FROM THE
MARK AS SHOWN.

THE MARK CONSISTS OF THE WORDS "CON-
NIE'S COOKIES" SUPERIMPOSED OVER THE OUT-
LINE OF A COOKIE FROM WHICH A BITE HAS
BEEN TAKEN.

SER. NO. 77-129,323, FILED 3-13-2007.

ELLEN PERKINS, EXAMINING ATTORNEY

Int. Cl.: 35

Prior U.S. Cls.: 100, 101 and 102

United States Patent and Trademark Office

Reg. No. 3,483,071

Registered Aug. 12, 2008

**SERVICE MARK
PRINCIPAL REGISTER**

ALASKA WILDERNESS LEAGUE

ALASKA WILDERNESS LEAGUE (D.C. CORPORATION)

122 C STREET, N.W.

WASHINGTON, DC 20001

FOR: PROMOTING PUBLIC AWARENESS OF THE NEED FOR CONSERVATION OF ALASKA'S NATURAL RESOURCES, IN CLASS 35 (U.S. CLS. 100, 101 AND 102).

FIRST USE 3-3-1993; IN COMMERCE 3-3-1993.

THE MARK CONSISTS OF STANDARD CHARACTERS WITHOUT CLAIM TO ANY PARTICULAR FONT, STYLE, SIZE, OR COLOR.

NO CLAIM IS MADE TO THE EXCLUSIVE RIGHT TO USE "LEAGUE", APART FROM THE MARK AS SHOWN.

SEC. 2(F).

SER. NO. 77-129,517, FILED 3-13-2007.

SHANNON TWOHIG, EXAMINING ATTORNEY

Int. Cl.: 19

Prior U.S. Cls.: 1, 12, 33 and 50

United States Patent and Trademark Office

Reg. No. 3,483,072

Registered Aug. 12, 2008

**TRADEMARK
PRINCIPAL REGISTER**

OPTIONLOCK

PRIVACYLINK, LLC (UTAH LTD LIAB CO)
PO BOX 295
HYDE PARK, UT 84318

THE MARK CONSISTS OF STANDARD CHAR-
ACTERS WITHOUT CLAIM TO ANY PARTICULAR
FONT, STYLE, SIZE, OR COLOR.

FOR: NON-METAL FENCING COMPONENTS,
NAMELY, PLASTIC SLAT INSERTS FOR CHAIN-
LINK FENCES, IN CLASS 19 (U.S. CLS. 1, 12, 33 AND
50).

SER. NO. 77-129,980, FILED 3-13-2007.

FIRST USE 5-10-2006; IN COMMERCE 5-10-2006.

CHRISIE B. KING, EXAMINING ATTORNEY

Int. Cl.: 30

Prior U.S. Cl.: 46

United States Patent and Trademark Office

Reg. No. 3,483,073

Registered Aug. 12, 2008

TRADEMARK
PRINCIPAL REGISTER



POLLET, JEREMY (UNITED STATES INDIVIDUAL), DBA MIX MASTERS ITALIAN ICE
205 WEST ELIZABETH STREET
AUSTIN, TX 78704

FOR: FLAVORED ICES, IN CLASS 30 (U.S. CL. 46).

FIRST USE 2-26-2007; IN COMMERCE 3-1-2007.

NO CLAIM IS MADE TO THE EXCLUSIVE RIGHT TO USE "ITALIAN ICE" , APART FROM THE MARK AS SHOWN.

THE COLOR(S) RED, GREEN, BLACK, AND WHITE. IS/ARE CLAIMED AS A FEATURE OF THE MARK.

THE MARK CONSISTS OF THE WORDS "MIX MASTERS" IN RED SCRIPT AND OUTLINED IN BLACK, A RED STAR WITH BLACK OUTLINE ON TOP OF THE "I" IN "MIX"; THE COLOR GREEN IN AN OVAL WHICH CONTAINS A BRIDGE AND SKYLINE WITH BUILDING SILHOUETTES WHICH ARE IN THE COLORS GREEN AND WHITE; AND THE WORDS "ITALIAN ICE" IN WHITE LETTERS ENCLOSED IN ALTERNATING RED AND GREEN OVALS.

SER. NO. 77-130,032, FILED 3-13-2007.

BILL DAWE, EXAMINING ATTORNEY

Int. Cl.: 28

Prior U.S. Cls.: 22, 23, 38 and 50

Reg. No. 3,483,074

United States Patent and Trademark Office

Registered Aug. 12, 2008

**TRADEMARK
PRINCIPAL REGISTER**

HIDE-A-SCENT

BC OUTDOORS D/B/A CHEMIC PACKAGING
INC. (GEORGIA CORPORATION)
72 RIVERSIDE DRIVE S.W.
CARTERSVILLE, GA 30120

THE MARK CONSISTS OF STANDARD CHAR-
ACTERS WITHOUT CLAIM TO ANY PARTICULAR
FONT, STYLE, SIZE, OR COLOR.

FOR: SCENT ELIMINATOR FOR USE IN HUNT-
ING, IN CLASS 28 (U.S. CLS. 22, 23, 38 AND 50).

SER. NO. 77-130,765, FILED 3-14-2007.

FIRST USE 6-0-2006; IN COMMERCE 6-0-2006.

JILL PRATER, EXAMINING ATTORNEY

Int. Cl.: 29

Prior U.S. Cl.: 46

United States Patent and Trademark Office

Reg. No. 3,483,075

Registered Aug. 12, 2008

**TRADEMARK
PRINCIPAL REGISTER**

HEALTH SMART

WELLS' DAIRY, INC. (IOWA CORPORATION)
ONE BLUE BUNNY DRIVE, P.O. BOX 1310
LE MARS, IA 51031

FOR: COTTAGE CHEESE AND SOUR CREAM, IN
CLASS 29 (U.S. CL. 46).

FIRST USE 11-3-2003; IN COMMERCE 11-3-2003.

THE MARK CONSISTS OF STANDARD CHAR-
ACTERS WITHOUT CLAIM TO ANY PARTICULAR
FONT, STYLE, SIZE, OR COLOR.

OWNER OF U.S. REG. NO. 2,075,920.

SER. NO. 77-131,164, FILED 3-14-2007.

MICHAEL SOUDERS, EXAMINING ATTORNEY

Int. Cls.: 16, 35 and 36

Prior U.S. Cls.: 2, 5, 22, 23, 29, 37, 38, 50, 100, 101 and 102

United States Patent and Trademark Office

Reg. No. 3,483,076

Registered Aug. 12, 2008

**TRADEMARK
SERVICE MARK
PRINCIPAL REGISTER**

GRAIL PARTNERS

GRAIL PARTNERS LLC (DELAWARE LTD LIAB
CO)
41ST FLOOR
ONE POST OFFICE SQUARE
BOSTON, MA 02109

FOR: PRINTED PUBLICATIONS, NAMELY, RE-
SEARCH PAPERS IN THE FIELD OF FINANCIAL
SERVICES AND CORPORATE TRANSACTIONS, IN
CLASS 16 (U.S. CLS. 2, 5, 22, 23, 29, 37, 38 AND 50).

FIRST USE 7-1-2005; IN COMMERCE 7-1-2005.

FOR: BUSINESS CONSULTING AND BUSINESS
ADVISORY SERVICES REGARDING BUSINESS
AND FINANCIAL STRATEGIES IN THE FIELD OF
CORPORATE TRANSACTIONS, IN CLASS 35 (U.S.
CLS. 100, 101 AND 102).

FIRST USE 2-1-2005; IN COMMERCE 2-1-2005.

FOR: CAPITAL FINANCING SERVICES FOR
EMERGING AND START-UP COMPANIES; FINAN-
CIAL CONSULTATION SERVICES IN THE FIELD
OF CORPORATE TRANSACTIONS , IN CLASS 36
(U.S. CLS. 100, 101 AND 102).

FIRST USE 2-1-2005; IN COMMERCE 2-1-2005.

THE MARK CONSISTS OF STANDARD CHAR-
ACTERS WITHOUT CLAIM TO ANY PARTICULAR
FONT, STYLE, SIZE, OR COLOR.

NO CLAIM IS MADE TO THE EXCLUSIVE
RIGHT TO USE "PARTNERS", APART FROM THE
MARK AS SHOWN.

SER. NO. 77-131,589, FILED 3-15-2007.

JENNIFER MARTIN, EXAMINING ATTORNEY

Int. Cls.: 35 and 42

Prior U.S. Cls.: 100, 101 and 102

United States Patent and Trademark Office

Reg. No. 3,483,077

Registered Aug. 12, 2008

**SERVICE MARK
PRINCIPAL REGISTER**

ALAVEN

ALAVEN PHARMACEUTICAL LLC (DELAWARE
LTD LIAB CO)
SUITE A
2260 NORTHWEST PARKWAY
MARIETTA, GA 30067

FOR: DISTRIBUTORSHIP SERVICES FEATUR-
ING PHARMACEUTICAL PREPARATIONS AND
MEDICINES, BOTH PRESCRIPTION AND OVER-
THE-COUNTER, IN CLASS 35 (U.S. CLS. 100, 101
AND 102).

FIRST USE 3-1-2003; IN COMMERCE 10-28-2003.

FOR: DEVELOPMENT OF PHARMACEUTICAL
PREPARATIONS AND MEDICINES, BOTH PRE-

SCRIPTION AND OVER-THE-COUNTER, IN CLASS
42 (U.S. CLS. 100 AND 101).

FIRST USE 3-1-2003; IN COMMERCE 10-28-2003.

THE MARK CONSISTS OF STANDARD CHAR-
ACTERS WITHOUT CLAIM TO ANY PARTICULAR
FONT, STYLE, SIZE, OR COLOR.

"ALAVEN" APPEARING IN THE MARK HAS NO
MEANING IN A FOREIGN LANGUAGE.

SER. NO. 77-131,654, FILED 3-15-2007.

JANICE L. MCMORROW, EXAMINING ATTOR-
NEY

Int. Cl.: 35

Prior U.S. Cls.: 100, 101 and 102

United States Patent and Trademark Office

Reg. No. 3,483,078

Registered Aug. 12, 2008

**SERVICE MARK
PRINCIPAL REGISTER**

ART RAW

L ABRAHIM (UNITED STATES INDIVIDUAL)
10E
90 DAYTON AVE
PASSAIC, NJ 07055 AND
F IBRAHIM (UNITED STATES INDIVIDUAL)
10E
90 DAYTON AVE
PASSAIC, NJ 07055

THE MARK CONSISTS OF STANDARD CHAR-
ACTERS WITHOUT CLAIM TO ANY PARTICULAR
FONT, STYLE, SIZE, OR COLOR.

NO CLAIM IS MADE TO THE EXCLUSIVE
RIGHT TO USE "ART", APART FROM THE MARK
AS SHOWN.

FOR: ART GALLERIES, IN CLASS 35 (U.S. CLS.
100, 101 AND 102).

SER. NO. 77-132,920, FILED 3-16-2007.

FIRST USE 3-15-2007; IN COMMERCE 3-15-2007.

JOHN KELLY, EXAMINING ATTORNEY

Int. Cl.: 41

Prior U.S. Cls.: 100, 101 and 107

United States Patent and Trademark Office

Reg. No. 3,483,079

Registered Aug. 12, 2008

**SERVICE MARK
PRINCIPAL REGISTER**

Argentina Wild Wings

LINDSAY, GEORGE D. (UNITED STATES INDIVIDUAL)
327 KELLY VIEW DRIVE
BURNSVILLE, NC 28714

FOR: HUNTING GUIDE SERVICES, IN CLASS 41
(U.S. CLS. 100, 101 AND 107).

FIRST USE 4-1-2002; IN COMMERCE 4-1-2002.

THE MARK CONSISTS OF STANDARD CHARACTERS WITHOUT CLAIM TO ANY PARTICULAR FONT, STYLE, SIZE, OR COLOR.

NO CLAIM IS MADE TO THE EXCLUSIVE RIGHT TO USE "ARGENTINA" OR "WINGS", APART FROM THE MARK AS SHOWN.

SER. NO. 77-132,991, FILED 3-16-2007.

TRACY WHITTAKER-BROWN, EXAMINING ATTORNEY

Int. Cl.: 41

Prior U.S. Cls.: 100, 101 and 107

United States Patent and Trademark Office

Reg. No. 3,483,080

Registered Aug. 12, 2008

**SERVICE MARK
PRINCIPAL REGISTER**

Buzz Carlton

BUZZ CARLTON, LLC (VIRGINIA LTD LIAB CO)
P.O. BOX 8382
RICHMOND, VA 23226

FOR: ENTERTAINMENT, NAMELY, PRESENTATION OF MUSICAL PERFORMANCES; LIVE MUSIC CONCERTS; PUBLIC APPEARANCES AND PERSONAL APPEARANCES BY A PERFORMER; NON-DOWNLOADABLE RINGTONES AND PRE-RECORDED MUSIC PRESENTED TO COMMUNICATION DEVICES VIA THE INTERNET AND WIRELESS NETWORKS, IN CLASS 41 (U.S. CLS. 100, 101 AND 107).

FIRST USE 7-1-1984; IN COMMERCE 7-1-1984.

THE MARK CONSISTS OF STANDARD CHARACTERS WITHOUT CLAIM TO ANY PARTICULAR FONT, STYLE, SIZE, OR COLOR.

THE NAME "BUZZ CARLTON" IDENTIFIES A LIVING INDIVIDUAL WHOSE CONSENT IS OF RECORD.

SER. NO. 77-133,568, FILED 3-16-2007.

KAREN K. BUSH, EXAMINING ATTORNEY

Int. Cl.: 41

Prior U.S. Cls.: 100, 101 and 107

United States Patent and Trademark Office

Reg. No. 3,483,081

Registered Aug. 12, 2008

**SERVICE MARK
PRINCIPAL REGISTER**



GAME ALMIGHTY, LLC (DELAWARE LTD
LIAB CO)
STE. 100
23265 SOUTH POINTE DRIVE
LAGUNA HILLS, CA 92653

FOR: ENTERTAINMENT SERVICES, NAMELY,
PROVIDING ONLINE NON-DOWNLOADABLE RE-
VIEWS, MAGAZINE ARTICLES AND MAGAZINE
EDITORIALS IN THE FIELD OF VIDEO GAMES
AND COMPUTER GAMES, COMPUTER TECHNOL-
OGY AND MOVIES; PROVIDING ON-LINE NON-
DOWNLOADABLE COMPUTER GAMES; PROVID-
ING ONLINE NON-DOWNLOADABLE PREVIEW
FILM CLIPS OF MOTION PICTURES, IN CLASS 41
(U.S. CLS. 100, 101 AND 107).

FIRST USE 12-20-2006; IN COMMERCE 12-20-2006.

THE MARK CONSISTS OF A SUPERHERO IN A
BODYSUIT WITH A MASK COVERING TWO-
THIRDS OF THE FACE, WITH A LIGHTNING BOLT
ON THE FRONT FOREHEAD AREA OF THE MASK,
A CAPE HANGING OFF THE BACK, A LIGHTNING
BOLT ON THE FRONT TORSO OF THE SUPER-
HERO, WITH A BELT AND GLOVES.

SER. NO. 77-134,405, FILED 3-19-2007.

REGINA DRUMMOND, EXAMINING ATTORNEY

Int. Cl.: 41

Prior U.S. Cls.: 100, 101 and 107

United States Patent and Trademark Office

Reg. No. 3,483,082

Registered Aug. 12, 2008

SERVICE MARK
PRINCIPAL REGISTER



NAPLES CHILDREN & EDUCATION FOUNDATION (FLORIDA NON-PROFIT CORPORATION)
6200 SHIRLEY STREET, SUITE 206
NAPLES, FL 34109

FOR: ARRANGING AND CONDUCTING EXHIBITIONS IN THE NATURE OF WINE FESTIVALS, IN CLASS 41 (U.S. CLS. 100, 101 AND 107).

FIRST USE 8-0-2003; IN COMMERCE 8-0-2003.

NO CLAIM IS MADE TO THE EXCLUSIVE RIGHT TO USE "NAPLES WINTER WINE FESTIVAL EST. 2000", APART FROM THE MARK AS SHOWN.

THE COLOR(S) RED, BROWN, BEIGE, BLUE, WHITE, LIGHT GREEN, DARK GREEN, AND YELLOW IS/ARE CLAIMED AS A FEATURE OF THE MARK.

THE COLOR RED APPEARS IN THE WORDING "NAPLES WINTER WINE FESTIVAL EST. 2000", IN THE DESIGN OF WINE INSIDE OF A WINE GLASS AND IN THE DESIGN OF AN OVAL; THE COLOR BROWN APPEARS IN THE DESIGN OF AN SECOND INTERIOR OVAL AND IN THE STYLIZED DESIGN OF TWO PALM TREE TRUNKS; THE COLOR BEIGE APPEARS IN THE FORM OF TWO STYLIZED SUNS; THE COLOR BLUE APPEARS IN THE FORM OF A WINE GLASS; THE COLOR WHITE APPEARS IN THE FORM OF A LIGHT REFLECTION IN THE WINE GLASS AND IN THE BACKGROUND OF THE MARK; THE COLORS LIGHT GREEN AND DARK GREEN APPEAR IN THE STYLIZED DESIGN OF THE LEAVES OF TWO PALM TREES; THE COLOR YELLOW APPEARS IN THE FORM OF A STYLIZED SUN.

SER. NO. 77-135,050, FILED 3-20-2007.

SEAN CROWLEY, EXAMINING ATTORNEY

Int. Cls.: 9, 16, 36 and 41

**Prior U.S. Cls.: 2, 5, 21, 22, 23, 26, 29, 36, 37, 38, 50,
100, 101, 102 and 107**

Reg. No. 3,483,083

United States Patent and Trademark Office

Registered Aug. 12, 2008

**TRADEMARK
SERVICE MARK
PRINCIPAL REGISTER**

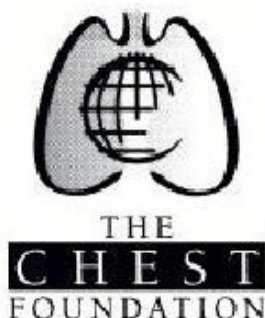

THE CHEST FOUNDATION (ILLINOIS NON-PROFIT CORPORATION)
3300 DUNDEE ROAD
NORTHBROOK, IL 60062

FOR: DIGITAL MEDIA, NAMELY, CDS, DVDS, AND DOWNLOADABLE AUDIO FILES, CONTAINING EDUCATIONAL MATERIALS IN THE FIELD OF HEALTH EDUCATION, NAMELY, MATERIALS RELATED TO LUNG HEALTH AWARENESS, TOBACCO PREVENTION, CARDIOPULMONARY MEDICINE, CRITICAL CARE, AND END OF LIFE CARE, IN CLASS 9 (U.S. CLS. 21, 23, 26, 36 AND 38).

FIRST USE 1-1-2001; IN COMMERCE 1-1-2001.

FOR: PRINTED MEDIA, NAMELY, BOOKS AND MAGAZINES, CONTAINING EDUCATIONAL MATERIALS IN THE FIELD OF HEALTH EDUCATION, NAMELY, MATERIALS RELATED TO LUNG HEALTH AWARENESS, TOBACCO PREVENTION, CARDIOPULMONARY MEDICINE, CRITICAL CARE, AND END OF LIFE CARE, IN CLASS 16 (U.S. CLS. 2, 5, 22, 23, 29, 37, 38 AND 50).

FIRST USE 1-1-2001; IN COMMERCE 1-1-2001.

FOR: CHARITABLE FUND RAISING SERVICES, PROVIDING GRANTS AND FUNDING, IN THE FIELDS OF MEDICINE AND HEALTH AWARENESS, NAMELY, FOR LUNG HEALTH AWARENESS, TOBACCO PREVENTION,

CARDIOPULMONARY MEDICINE, CRITICAL CARE, AND END OF LIFE CARE, IN CLASS 36 (U.S. CLS. 100, 101 AND 102).

FIRST USE 1-1-2001; IN COMMERCE 1-1-2001.

FOR: EDUCATIONAL SERVICES, NAMELY, SEMINARS, CONFERENCES, AND WORKSHOPS IN THE FIELDS OF HEALTH AND MEDICINE, NAMELY, MATERIALS RELATED TO LUNG HEALTH AWARENESS, TOBACCO PREVENTION, CARDIOPULMONARY MEDICINE, CRITICAL CARE, AND END OF LIFE CARE; SPONSORING HUMANITARIAN AND RESEARCH AWARDS IN THE FIELDS OF MEDICINE AND HEALTH AWARENESS, NAMELY, FOR LUNG HEALTH AWARENESS, TOBACCO PREVENTION, CARDIOPULMONARY MEDICINE, CRITICAL CARE, AND END OF LIFE CARE, IN CLASS 41 (U.S. CLS. 100, 101 AND 107).

FIRST USE 1-1-2001; IN COMMERCE 1-1-2001.

NO CLAIM IS MADE TO THE EXCLUSIVE RIGHT TO USE "CHEST FOUNDATION", APART FROM THE MARK AS SHOWN.

THE MARK CONSISTS OF A STYLIZED REPRESENTATION OF A GLOBE WITHIN HUMAN LUNGS AND INCLUDING THE WORDS "THE CHEST FOUNDATION".

SER. NO. 77-136,199, FILED 3-21-2007.

BRIAN NEVILLE, EXAMINING ATTORNEY

Int. Cl.: 25

Prior U.S. Cls.: 22 and 39

United States Patent and Trademark Office

Reg. No. 3,483,084

Registered Aug. 12, 2008

**TRADEMARK
PRINCIPAL REGISTER**

LORD JOHN

LORD JOHN U.K. LIMITED (UNITED KING-
DOM CORPORATION)
MAYFAIR
15A HANOVER STREET
LONDON, UNITED KINGDOM W1S1YG

FOR: CLOTHING, NAMELY, SUITS, JACKETS,
PANTS, SHIRTS, T-SHIRTS, SKIRTS, SWEATERS,
SWEAT SHIRTS, UNDERWEAR, SOCKS, GLOVES;
SPORTS WEAR, NAMELY, SPORTS JERSEYS,
SPORTS PANTS, SHORTS, LEGGINGS, SPORTS
JACKETS; FOOTWEAR, NAMELY, SPORTS SHOES,
TRAINERS, BOOTS, WALKING BOOTS, FOOTBALL
BOOTS, SHOES, CYCLING SHOES; HEAD GEAR,
NAMELY, DRESS HATS, SPORTS CAPS, HATS,
CAPS, WOOLLEN HATS; COATS; OUTERWEAR,
NAMELY, JACKETS, ANORAKS, PULLOVERS,
CARDIGANS, TROUSERS, SMOCKS, SALOPETTES,
NAMELY, SKI PANTS, WINTER SUITS, NAMELY,
SKI SUITS, GLOVES, SOCKS, SCARVES, GAITERS,

WET SUITS, SPORTS UNIFORMS, FISHING JACK-
ETS, BOOTS AND VESTS, IN CLASS 25 (U.S. CLS. 22
AND 39).

THE MARK CONSISTS OF STANDARD CHAR-
ACTERS WITHOUT CLAIM TO ANY PARTICULAR
FONT, STYLE, SIZE, OR COLOR.

OWNER OF UNITED KINGDOM REG. NO.
2149689, DATED 10-2-1998, RENEWED AS REG. NO.
2149689, DATED 8-30-2007, EXPIRES 10-24-2017.

"LORD JOHN" DOES NOT IDENTIFY A LIVING
INDIVIDUAL.

SER. NO. 77-136,301, FILED 3-21-2007.

KATHRYN COWARD, EXAMINING ATTORNEY

Int. Cl.: 20

Prior U.S. Cls.: 2, 13, 22, 25, 32 and 50

United States Patent and Trademark Office

Reg. No. 3,483,085

Registered Aug. 12, 2008

**TRADEMARK
PRINCIPAL REGISTER**



ROBBINS, RUNELL SUE (UNITED STATES INDIVIDUAL)

933 KETTLE ROCK CT.

COLORADO SPRINGS, CO 80921

FOR: NON-METAL LAWN EDGING, IN CLASS 20 (U.S. CLS. 2, 13, 22, 25, 32 AND 50).

FIRST USE 3-20-2007; IN COMMERCE 3-20-2007.

NO CLAIM IS MADE TO THE EXCLUSIVE RIGHT TO USE "MACHINE LAID LANDSCAPE BORDERS, CURBS & PATHWAYS", APART FROM THE MARK AS SHOWN.

THE COLOR(S) PINK, YELLOW, GREEN, GREY, RED, ORANGE, BLACK IS/ARE CLAIMED AS A FEATURE OF THE MARK.

THE MARK CONSISTS OF GREEN "EDGEIT", LEAVES, AND UNDERLINE; YELLOW SUN OUTLINED IN ORANGE; FIRST FLOWER RED AND SECOND FLOWER PINK, BOTH WITH YELLOW CENTERS; GREY SHADOW ON FLOWERS AND THE UNDERLINING; AND ALL OTHER WORDS IN BLACK.

SER. NO. 77-136,428, FILED 3-21-2007.

KIMBERLY FRYE, EXAMINING ATTORNEY

Int. Cl.: 6

Prior U.S. Cls.: 2, 12, 13, 14, 23, 25 and 50

Reg. No. 3,483,086

United States Patent and Trademark Office

Registered Aug. 12, 2008

**TRADEMARK
PRINCIPAL REGISTER**

MULTIPHASE

SPS TECHNOLOGIES, LLC (PENNSYLVANIA
LTD LIAB CO)
301 HIGHLAND AVENUE
JENKINTOWN, PA 19046

THE MARK CONSISTS OF STANDARD CHAR-
ACTERS WITHOUT CLAIM TO ANY PARTICULAR
FONT, STYLE, SIZE, OR COLOR.

FOR: METAL ALLOYS FOR FURTHER MANU-
FACTURING, IN CLASS 6 (U.S. CLS. 2, 12, 13, 14, 23,
25 AND 50).

SER. NO. 77-137,741, FILED 3-22-2007.

FIRST USE 10-0-1968; IN COMMERCE 10-0-1968.

ZACHARY BELLO, EXAMINING ATTORNEY

Int. Cls.: 35 and 36

Prior U.S. Cls.: 100, 101 and 102

United States Patent and Trademark Office

Reg. No. 3,483,087

Registered Aug. 12, 2008

**SERVICE MARK
PRINCIPAL REGISTER**

EQUICARE CAPITAL

EQUICARE CAPITAL, LLC (DELAWARE LTD
LIAB CO)
1050 LOS VALLECITOS BLVD., SUITE 104-105
SAN MARCOS, CA 92069

FOR: ACCOUNTS RECEIVABLE SERVICES, IN
CLASS 35 (U.S. CLS. 100, 101 AND 102).

FIRST USE 6-22-2005; IN COMMERCE 10-7-2005.

FOR: DEBT RECOVERY AND COLLECTIONS
SERVICES; ACCOUNTS RECEIVABLE FINAN-
CING, IN CLASS 36 (U.S. CLS. 100, 101 AND 102).

FIRST USE 6-22-2005; IN COMMERCE 10-7-2005.

THE MARK CONSISTS OF STANDARD CHAR-
ACTERS WITHOUT CLAIM TO ANY PARTICULAR
FONT, STYLE, SIZE, OR COLOR.

NO CLAIM IS MADE TO THE EXCLUSIVE
RIGHT TO USE "CAPITAL", APART FROM THE
MARK AS SHOWN.

SER. NO. 77-137,887, FILED 3-22-2007.

DAVID TAYLOR, EXAMINING ATTORNEY

Int. Cls.: 35 and 36

Prior U.S. Cls.: 100, 101 and 102

United States Patent and Trademark Office

Reg. No. 3,483,088

Registered Aug. 12, 2008

**SERVICE MARK
PRINCIPAL REGISTER**



EQUICARE CAPITAL, LLC (DELAWARE LTD
LIAB CO)
1050 LOS VALLECITOS BLVD., SUITE 104-105
SAN MARCOS, CA 92069

FOR: ACCOUNTS RECEIVABLE SERVICES, IN
CLASS 35 (U.S. CLS. 100, 101 AND 102).

FIRST USE 9-20-2006; IN COMMERCE 9-20-2006.

FOR: DEBT RECOVERY AND COLLECTIONS
SERVICES; ACCOUNTS RECEIVABLE FINAN-
CING, IN CLASS 36 (U.S. CLS. 100, 101 AND 102).

FIRST USE 9-20-2006; IN COMMERCE 9-20-2006.

NO CLAIM IS MADE TO THE EXCLUSIVE
RIGHT TO USE "CAPITAL", APART FROM THE
MARK AS SHOWN.

THE MARK CONSISTS OF THE WORD "EQUI-
CARE" ABOVE THE WORD "CAPITAL" AND PRE-
CEDED BY A STYLIZED TOP WITH A SWIRL TO
REPRESENT A SPINNING ACTION.

SER. NO. 77-137,907, FILED 3-22-2007.

DAVID TAYLOR, EXAMINING ATTORNEY

Int. Cl.: 35

Prior U.S. Cls.: 100, 101 and 102

United States Patent and Trademark Office

Reg. No. 3,483,089

Registered Aug. 12, 2008

**SERVICE MARK
PRINCIPAL REGISTER**



cribs
to
Campus

CINDY DYCE (NEW JERSEY SOLE PROPRIETORSHIP)
3171 ROUTE 9 NORTH, #328
OLD BRIDGE, NJ 088572690

FOR: RETAIL STORE SERVICES FEATURING CHILDREN'S BEDDING, BOOKS AND CHILDREN'S ROOM ACCESSORIES, NAMELY, NIGHT LIGHTS, IN CLASS 35 (U.S. CLS. 100, 101 AND 102).

FIRST USE 2-1-2007; IN COMMERCE 2-1-2007.

THE MARK CONSISTS OF HAND DRAWN CRIB WITH A GRADUATION CAP PERCHED ON THE

UPPER RIGHT CORNER OF THE CRIB(IF LOOKING AT THE CRIB). THE WORDS "CRIBS TO CAMPUS" ALSO APPEAR IN CLOSE PROXIMITY TO THE CRIB. IN REGARDS TO FONT THE WORD "CRIB" IS IN BRADLEY HAND ITC, THE "TO" WORD TO IS IN ARIAL AND "CAMPUS" IS IN TIME NEW ROMAN.

SER. NO. 77-138,112, FILED 3-22-2007.

SHANNON TWOHIG, EXAMINING ATTORNEY

Int. Cls.: 21 and 24

Prior U.S. Cls.: 2, 13, 23, 29, 30, 33, 40, 42 and 50

United States Patent and Trademark Office

Reg. No. 3,483,090

Registered Aug. 12, 2008

**TRADEMARK
PRINCIPAL REGISTER**



CLEAN-RITE PRODUCTS, L.L.C. (ILLINOIS LTD
LIAB CO)
625 BARCLAY BOULEVARD
LINCOLNSHIRE, IL 60069

FOR: AUTOMOTIVE CLEANING BRUSHES AND
CHAMOIS CLEANING CLOTHS, IN CLASS 21 (U.S.
CLS. 2, 13, 23, 29, 30, 33, 40 AND 50).

FIRST USE 8-1-2006; IN COMMERCE 8-1-2006.

FOR: TOWELS, IN CLASS 24 (U.S. CLS. 42 AND 50).

FIRST USE 8-1-2006; IN COMMERCE 8-1-2006.

OWNER OF U.S. REG. NOS. 1,835,476 AND
2,963,153.

NO CLAIM IS MADE TO THE EXCLUSIVE
RIGHT TO USE "DETAILER'S CHOICE", APART
FROM THE MARK AS SHOWN.

THE COLOR(S) RED, GOLD, AND WHITE IS/ARE
CLAIMED AS A FEATURE OF THE MARK.

THE MARK CONSISTS OF AN OVAL RED
SHIELD WITH A GOLD, DIMPLED BORDER IN-
CLUDING THE WORDS "DETAILER'S CHOICE" IN
GOLD AND A STYLIZED ROAD IN GOLD. THE
SHIELD IS COVERED WITH WHITE, HORIZONTAL
STRIPES THAT ARE SHADED GRAY ON THE
ENDS WITHIN THE GOLD BORDER WITH A RED
BORDER OUTSIDE THE BOTTOM HALF OF THE
GOLD BORDER. THERE IS GRAY SHADING BE-
NEATH A LOWER MARGIN OF THE SHIELD. THE
SHIELD IS PLACED UPON A WHITE BACK-
GROUND THAT IS BORDERED BY TWO RED
CURVED LINES THAT RUN OUTSIDE THE
SHIELD AND GRAY SHADING.

SER. NO. 77-138,916, FILED 3-23-2007.

TINA KUAN, EXAMINING ATTORNEY

Int. Cl.: 41

Prior U.S. Cls.: 100, 101 and 107

United States Patent and Trademark Office

Reg. No. 3,483,091

Registered Aug. 12, 2008

**SERVICE MARK
PRINCIPAL REGISTER**



ENHANCA LLC (MARYLAND LTD LIAB CO)
SUITE 704
601 N. EUTAW STREET
BALTIMORE, MD 21201

FOR: ENTERTAINMENT SERVICES, NAMELY,
ORGANIZING, CONDUCTING AND PROMOTING
AND SPONSORING THE PRODUCTION OF MUL-
TICULTURAL EVENTS AND DANCE PARTIES, IN
CLASS 41 (U.S. CLS. 100, 101 AND 107).

FIRST USE 9-13-2002; IN COMMERCE 9-13-2002.

THE MARK CONSISTS OF A STYLIZED "S" WITH
A DIAMOND SHAPE ABOVE IT.

SER. NO. 77-139,007, FILED 3-23-2007.

ALEXANDER L. POWERS, EXAMINING ATTOR-
NEY

Int. Cls.: 6, 16, 20, 40 and 42

**Prior U.S. Cls.: 2, 5, 12, 13, 14, 22, 23, 25, 29, 32, 37,
38, 50, 100, 101, 103 and 106**

Reg. No. 3,483,092

United States Patent and Trademark Office

Registered Aug. 12, 2008

**TRADEMARK
SERVICE MARK
PRINCIPAL REGISTER**

MAVERICKLABEL.COM

MAVERICK MULTIMEDIA, INC. (WASHINGTON CORPORATION)
SUITE A-7
120 W. DAYTON AVE.
EDMONDS, WA 980204180

FOR: LABELS AND TAGS MADE OF FOIL, ANODIZED ALUMINUM AND OTHER METALS, IN CLASS 6 (U.S. CLS. 2, 12, 13, 14, 23, 25 AND 50).

FIRST USE 1-0-2000; IN COMMERCE 1-0-2000.

FOR: LABELS, STICKERS AND TAGS, NAMELY, PRE-PRINTED, CUSTOM PRINTED, ROLL, FAN-FOLD, SHEET, DIGITAL AND STOCK LABELS, STICKERS AND TAGS, ALL MADE OF COATED AND UNCOATED PAPER, PRESSURE OR TEMPERATURE-SENSITIVE PAPER OR ADHESIVE-BACKED PAPER, IN CLASS 16 (U.S. CLS. 2, 5, 22, 23, 29, 37, 38 AND 50).

FIRST USE 1-0-2000; IN COMMERCE 1-0-2000.

FOR: LABELS AND IDENTIFICATION TAGS MADE OF PLASTIC, VINYL, POLY-VINYL CHLORIDE, POLYCARBONATE, POLYESTER, OR POLY-

PROPYLENE, IN CLASS 20 (U.S. CLS. 2, 13, 22, 25, 32 AND 50).

FIRST USE 1-0-2000; IN COMMERCE 1-0-2000.

FOR: PRINTING OF LABELS, TAGS AND STICKERS FOR OTHERS, IN CLASS 40 (U.S. CLS. 100, 103 AND 106).

FIRST USE 1-0-2000; IN COMMERCE 1-0-2000.

FOR: DESIGNING OF LABELS, TAGS AND STICKERS FOR OTHERS, IN CLASS 42 (U.S. CLS. 100 AND 101).

FIRST USE 1-0-2000; IN COMMERCE 1-0-2000.

THE MARK CONSISTS OF STANDARD CHARACTERS WITHOUT CLAIM TO ANY PARTICULAR FONT, STYLE, SIZE, OR COLOR.

SER. NO. 77-139,326, FILED 3-23-2007.

KHANH LE, EXAMINING ATTORNEY

Int. Cls.: 35 and 44

Prior U.S. Cls.: 100, 101 and 102

United States Patent and Trademark Office

Reg. No. 3,483,093

Registered Aug. 12, 2008

**SERVICE MARK
PRINCIPAL REGISTER**



HEALTH CARE EXCEL, INCORPORATED (IN-
DIANA NON-PROFIT CORPORATION)
2629 WATERFRONT PARKWAY EAST DR.,STE 200
INDIANAPOLIS, IN 46214

FOR: MEDICAL REVIEW AND UTILIZATION
SERVICES, IN CLASS 35 (U.S. CLS. 100, 101 AND 102).

FIRST USE 10-0-2003; IN COMMERCE 10-0-2003.

FOR: CONSULTING SERVICES IN THE FIELD
OF HEALTH AND HEALTHCARE; PROVIDING
INFORMATION ON HEALTH AND HEALTHCARE,
IN CLASS 44 (U.S. CLS. 100 AND 101).

FIRST USE 10-0-2003; IN COMMERCE 10-0-2003.

SER. NO. 77-140,536, FILED 3-26-2007.

JEFF DEFORD, EXAMINING ATTORNEY

Int. Cl.: 44

Prior U.S. Cls.: 100 and 101

United States Patent and Trademark Office

Reg. No. 3,483,094

Registered Aug. 12, 2008

**SERVICE MARK
PRINCIPAL REGISTER**

Biodesix

BIODESIX, INCORPORATED (DELAWARE CORPORATION)
1370 BOB ADAMS DRIVE, P.O. BOX 774872
STEAMBOAT SPRINGS, CO 80477

FOR: DEGENERATIVE DISEASE DIAGNOSTICS
MEDICAL TESTING BASED ON MASS SPECTRAL
ANALYSIS OF CLINICAL SPECIMENS, IN CLASS 44
(U.S. CLS. 100 AND 101).

FIRST USE 5-15-2006; IN COMMERCE 5-15-2006.

THE MARK CONSISTS OF STANDARD CHARACTERS WITHOUT CLAIM TO ANY PARTICULAR FONT, STYLE, SIZE, OR COLOR.

SER. NO. 77-141,889, FILED 3-27-2007.

WILLIAM VERHOSEK, EXAMINING ATTORNEY

Int. Cl.: 9

Prior U.S. Cls.: 21, 23, 26, 36 and 38

Reg. No. 3,483,095

United States Patent and Trademark Office

Registered Aug. 12, 2008

**TRADEMARK
PRINCIPAL REGISTER**

ARKONA

ARKONA, INC. (UTAH CORPORATION)
10757 SOUTH RIVER FRONT PARKWAY
SUITE 400
SOUTH JORDAN, UT 840953907

FIRST USE 9-1-1996; IN COMMERCE 9-1-1996.

FOR: COMPUTER SOFTWARE FOR USE IN
DATABASE MANAGEMENT AND SYNCHRONI-
ZATION APPLICATIONS BY AUTOMOBILE DEAL-
ERSHIPS, IN CLASS 9 (U.S. CLS. 21, 23, 26, 36 AND
38).

THE MARK CONSISTS OF STANDARD CHAR-
ACTERS WITHOUT CLAIM TO ANY PARTICULAR
FONT, STYLE, SIZE, OR COLOR.

SER. NO. 77-142,033, FILED 3-27-2007.

RONALD MCMORROW, EXAMINING ATTORNEY

Int. Cl.: 14

Prior U.S. Cls.: 2, 27, 28 and 50

United States Patent and Trademark Office

Reg. No. 3,483,096

Registered Aug. 12, 2008

**TRADEMARK
PRINCIPAL REGISTER**

RI

COLOR JEWELS, INC. (NEW YORK CORPORATION)
36 WEST 44 STREET SUITE 900
NEW YORK, NY 10036

THE MARK CONSISTS OF STANDARD CHARACTERS WITHOUT CLAIM TO ANY PARTICULAR FONT, STYLE, SIZE, OR COLOR.

FOR: COLORED GEMSTONE JEWELRY SOLD ON A WHOLESALE BASIS ONLY AT TRADE SHOWS AND TO MAJOR DEPARTMENT STORES, IN CLASS 14 (U.S. CLS. 2, 27, 28 AND 50).

SER. NO. 77-143,191, FILED 3-28-2007.

FIRST USE 3-23-2007; IN COMMERCE 3-23-2007.

SIMON TENG, EXAMINING ATTORNEY

Int. Cl.: 40

Prior U.S. Cls.: 100, 103 and 106

Reg. No. 3,483,097

United States Patent and Trademark Office

Registered Aug. 12, 2008

**SERVICE MARK
PRINCIPAL REGISTER**

MIKRON

MIKRON INDUSTRIES, INC. (WASHINGTON CORPORATION)
1034 SIXTH AVENUE NORTH
KENT, WA 98032

THE MARK CONSISTS OF STANDARD CHARACTERS WITHOUT CLAIM TO ANY PARTICULAR FONT, STYLE, SIZE, OR COLOR.

FOR: CUSTOM MANUFACTURE OF NON-METALLIC BUILDING MATERIALS, NAMELY, WINDOW AND DOOR SYSTEMS COMPRISED OF WINDOWS, DOORS AND ASSOCIATED FRAMING AND HARDWARE ALL SOLD AS UNITS , IN CLASS 40 (U.S. CLS. 100, 103 AND 106).

OWNER OF U.S. REG. NOS. 2,466,189, 2,652,417 AND OTHERS.

SER. NO. 77-143,279, FILED 3-29-2007.

FIRST USE 8-0-1979; IN COMMERCE 8-0-1979.

BRIAN CALLAGHAN, EXAMINING ATTORNEY

Int. Cl.: 45

Prior U.S. Cls.: 100 and 101

United States Patent and Trademark Office

Reg. No. 3,483,098

Registered Aug. 12, 2008

**SERVICE MARK
PRINCIPAL REGISTER**

FaithDates

100% PRODUCTIONS, INC. (CALIFORNIA CORPORATION)
BUILDING 2, 1ST FLOOR
808 EAST CARLISLE ROAD
WESTLAKE VILLAGE, CA 91361

THE MARK CONSISTS OF STANDARD CHARACTERS WITHOUT CLAIM TO ANY PARTICULAR FONT, STYLE, SIZE, OR COLOR.

FOR: INTERNET BASED SOCIAL NETWORKING, INTRODUCTION AND DATING SERVICES, IN CLASS 45 (U.S. CLS. 100 AND 101).

SER. NO. 77-144,302, FILED 3-29-2007.

FIRST USE 3-8-2007; IN COMMERCE 3-8-2007.

CARYN GLASSER, EXAMINING ATTORNEY

Int. Cl.: 36

Prior U.S. Cls.: 100, 101 and 102

United States Patent and Trademark Office

Reg. No. 3,483,099

Registered Aug. 12, 2008

**SERVICE MARK
PRINCIPAL REGISTER**

EJH ENTERPRISES, LLC

EJH ENTERPRISES, LLC (CALIFORNIA LTD
LIAB CO)
#903
2889 PLAZA DEL AMO
TORRANCE, CA 90503

FOR: MORTGAGE BANKING SERVICES, NAME-
LY, ORIGINATION OF MORTGAGE LOANS; REAL
ESTATE ACQUISITION; REAL ESTATE BROKER-
AGE AND REAL ESTATE AGENCIES; PROVIDING
INFORMATION IN THE FIELD OF REAL ESTATE;
AND REAL ESTATE MANAGEMENT, IN CLASS 36
(U.S. CLS. 100, 101 AND 102).

FIRST USE 4-27-2006; IN COMMERCE 4-27-2006.

THE MARK CONSISTS OF STANDARD CHAR-
ACTERS WITHOUT CLAIM TO ANY PARTICULAR
FONT, STYLE, SIZE, OR COLOR.

NO CLAIM IS MADE TO THE EXCLUSIVE
RIGHT TO USE "ENTERPRISES, LLC", APART
FROM THE MARK AS SHOWN.

SER. NO. 77-146,206, FILED 4-2-2007.

STEVEN R. FINE, EXAMINING ATTORNEY

Int. Cl.: 36

Prior U.S. Cls.: 100, 101 and 102

United States Patent and Trademark Office

Reg. No. 3,483,100

Registered Aug. 12, 2008

**SERVICE MARK
PRINCIPAL REGISTER**



EJH ENTERPRISES, LLC (CALIFORNIA LTD
LIAB CO)
#903
2889 PLAZA DEL AMO
TORRANCE, CA 90503

FOR: MORTGAGE BANKING SERVICES, NAME-
LY, ORIGINATION OF MORTGAGE LOANS; REAL
ESTATE ACQUISITION; REAL ESTATE BROKER-
AGE AND REAL ESTATE AGENCIES; PROVIDING
INFORMATION IN THE FIELD OF REAL ESTATE;
AND REAL ESTATE MANAGEMENT, IN CLASS 36
(U.S. CLS. 100, 101 AND 102).

FIRST USE 4-27-2006; IN COMMERCE 4-27-2006.

NO CLAIM IS MADE TO THE EXCLUSIVE
RIGHT TO USE "ENTERPRISES, LLC", APART
FROM THE MARK AS SHOWN.

THE MARK CONSISTS OF "EJH ENTERPRISES,
LLC" WITH THE LETTERS "E", "J" AND "H" IN A
SCHEMATIC OF A HOUSE WITH A ROOF.

SER. NO. 77-146,236, FILED 4-2-2007.

STEVEN R. FINE, EXAMINING ATTORNEY

Int. Cl.: 35

Prior U.S. Cls.: 100, 101 and 102

United States Patent and Trademark Office

Reg. No. 3,483,101

Registered Aug. 12, 2008

**SERVICE MARK
PRINCIPAL REGISTER**

WOODSIDE CAPITAL PARTNERS

WOODSIDE CAPITAL PARTNERS, LLC (DELA-
WARE LTD LIAB CO)
2460 SAND HILL ROAD, SUITE 202
MENLO PARK, CA 94025

FOR: BUSINESS SERVICES, NAMELY, ADVIS-
ING BUSINESSES ON BUSINESS STRATEGY,
NAMELY, CAPITAL FORMATION, CORPORATE
MERGERS AND ACQUISITIONS, DISPOSITION OR
SALE OF CORPORATE ASSETS, IN CLASS 35 (U.S.
CLS. 100, 101 AND 102).

FIRST USE 1-30-2002; IN COMMERCE 1-30-2002.

THE MARK CONSISTS OF STANDARD CHAR-
ACTERS WITHOUT CLAIM TO ANY PARTICULAR
FONT, STYLE, SIZE, OR COLOR.

NO CLAIM IS MADE TO THE EXCLUSIVE
RIGHT TO USE "CAPITAL PARTNERS", APART
FROM THE MARK AS SHOWN.

SER. NO. 77-148,004, FILED 4-3-2007.

BRIDGETT SMITH, EXAMINING ATTORNEY

Int. Cl.: 44

Prior U.S. Cls.: 100 and 101

United States Patent and Trademark Office

Reg. No. 3,483,102

Registered Aug. 12, 2008

**SERVICE MARK
PRINCIPAL REGISTER**



LANDIS
L I F E S T Y L E S A L O N

MATTHEW JAMES LANDIS (UNITED STATES
INDIVIDUAL)
686 WALL STREET
SALT LAKE CITY, UT 84103

FOR: BEAUTY SALONS; HAIRDRESSING SAL-
ONS, IN CLASS 44 (U.S. CLS. 100 AND 101).

FIRST USE 10-1-2005; IN COMMERCE 11-10-2005.

NO CLAIM IS MADE TO THE EXCLUSIVE
RIGHT TO USE "SALON", APART FROM THE
MARK AS SHOWN.

THE MARK CONSISTS OF THE LOGO IS A
REPRESENTATION OF A SEGO LILY, THE STATE
FLOWER OF UTAH. LANDIS LIFESTYLE SALON IS
THE NAME OF A HAIR SALON.

SER. NO. 77-148,017, FILED 4-4-2007.

DOMINICK J. SALEMI, EXAMINING ATTORNEY

Int. Cl.: 7

Prior U.S. Cls.: 13, 19, 21, 23, 31, 34 and 35

Reg. No. 3,483,103

United States Patent and Trademark Office

Registered Aug. 12, 2008

**TRADEMARK
PRINCIPAL REGISTER**

Scribble

HENLINE ADHESIVE EQUIPMENT CO., INC.
(OHIO CORPORATION)
6504 SNIDER RD
LOVELAND, OH 45140

FIRST USE 11-10-2006; IN COMMERCE 11-10-2006.

FOR: CORRUGATED PAPERBOARD MAKING
MACHINES; MACHINES FOR NON-CONTACT
GLUE APPLICATION; MACHINES IN THE NAT-
URE OF EQUIPMENT TO APPLY COLD GLUE
NON-CONTACT TO CORRUGATED MATERIAL,
IN CLASS 7 (U.S. CLS. 13, 19, 21, 23, 31, 34 AND 35).

THE MARK CONSISTS OF STANDARD CHAR-
ACTERS WITHOUT CLAIM TO ANY PARTICULAR
FONT, STYLE, SIZE, OR COLOR.

SER. NO. 77-148,651, FILED 4-4-2007.

THOMAS MANOR, EXAMINING ATTORNEY

Int. Cl.: 41

Prior U.S. Cls.: 100, 101 and 107

United States Patent and Trademark Office

Reg. No. 3,483,104

Registered Aug. 12, 2008

**SERVICE MARK
PRINCIPAL REGISTER**

Rock-a-Baby

TRACHTENBERG, MARC (UNITED STATES IN-
DIVIDUAL)
2026 28TH ST.
ASTORIA, NY 11105

FOR: EDUCATION IN THE FIELD OF MUSIC
RENDERED THROUGH CORRESPONDENCE
COURSES; INSTRUCTION IN THE FIELD OF MU-
SIC; TEACHING IN THE FIELD OF MUSIC, IN
CLASS 41 (U.S. CLS. 100, 101 AND 107).

FIRST USE 9-1-2007; IN COMMERCE 9-1-2007.

THE MARK CONSISTS OF STANDARD CHAR-
ACTERS WITHOUT CLAIM TO ANY PARTICULAR
FONT, STYLE, SIZE, OR COLOR.

SER. NO. 77-149,108, FILED 4-5-2007.

CAROLINE WOOD, EXAMINING ATTORNEY

Int. Cl.: 25

Prior U.S. Cls.: 22 and 39

United States Patent and Trademark Office

Reg. No. 3,483,105

Registered Aug. 12, 2008

**TRADEMARK
PRINCIPAL REGISTER**

HANDSOME DEVIL 

DUVARNEY, TORY (UNITED STATES INDIVIDUAL)
891 PORTOLA ROAD
VENTURA, CA 93003

FOR: SHIRTS, T-SHIRTS, HOODS, JERSEYS, MEN'S AND WOMEN'S JACKETS, COATS, TROUSERS, AND VESTS, MEN'S SOCKS, MEN'S SUITS, MEN'S BATHING SUITS, BELTS, CAPS, MEN'S SUSPENDER BELTS, TIES, TOPS, SWEATERS, SWEAT SHIRTS, HEADGEAR, NAMELY, BEANIES, BASEBALL CAPS, MEN'S DRESS HATS, PANTS, DRESS SHIRTS, KNIT SHIRTS, AND JACKETS, IN CLASS 25 (U.S. CLS. 22 AND 39).

FIRST USE 8-15-2000; IN COMMERCE 9-15-2000.

THE MARK CONSISTS OF A STYLIZED SPADE WITH "DEVIL" HORNS EXTENDING UPWARD FROM THE UPPER RIGHT AND LEFT SIDES OF THE SPADE AND THE WORDS "HANDSOME DEVIL".

SER. NO. 77-149,749, FILED 4-5-2007.

DAVID C. REIHNER, EXAMINING ATTORNEY

Int. Cls.: 36 and 44

Prior U.S. Cls.: 100, 101 and 102

United States Patent and Trademark Office

Reg. No. 3,483,106

Registered Aug. 12, 2008

**SERVICE MARK
PRINCIPAL REGISTER**

AID VILLAGE CLINICS

AFRICA INFECTIOUS DISEASE VILLAGE CLINICS, INC. (DELAWARE NON-PROFIT CORPORATION)
440 W. ONTARIO STREET
CHICAGO, IL 60610

FOR: ACCEPTING AND ADMINISTERING MONETARY CHARITABLE CONTRIBUTIONS; CHARITABLE FUND RAISING, IN CLASS 36 (U.S. CLS. 100, 101 AND 102).

FIRST USE 1-1-2003; IN COMMERCE 1-1-2003.

FOR: CHARITABLE SERVICES, NAMELY, PROVIDING MEDICAL SERVICES TO UNDERDEVELOPED COUNTRIES, IN CLASS 44 (U.S. CLS. 100 AND 101).

FIRST USE 1-1-2003; IN COMMERCE 1-1-2003.

THE MARK CONSISTS OF STANDARD CHARACTERS WITHOUT CLAIM TO ANY PARTICULAR FONT, STYLE, SIZE, OR COLOR.

NO CLAIM IS MADE TO THE EXCLUSIVE RIGHT TO USE "VILLAGE CLINICS" FOR INTERNATIONAL CLASS 44, APART FROM THE MARK AS SHOWN.

SEC. 2(F).

SER. NO. 77-149,875, FILED 4-5-2007.

MARTHA FROMM, EXAMINING ATTORNEY

Int. Cls.: 36 and 44

Prior U.S. Cls.: 100, 101 and 102

United States Patent and Trademark Office

Reg. No. 3,483,107

Registered Aug. 12, 2008

**SERVICE MARK
PRINCIPAL REGISTER**



AFRICA INFECTIOUS DISEASE VILLAGE CLINICS, INC. (DELAWARE NON-PROFIT CORPORATION)

440 W. ONTARIO STREET
CHICAGO, IL 60610

FOR: ACCEPTING AND ADMINISTERING MONETARY CHARITABLE CONTRIBUTIONS; CHARITABLE FUND RAISING, IN CLASS 36 (U.S. CLS. 100, 101 AND 102).

FIRST USE 1-1-2003; IN COMMERCE 1-1-2003.

FOR: CHARITABLE SERVICES, NAMELY, PROVIDING MEDICAL SERVICES TO UNDERDEVELOPED COUNTRIES, IN CLASS 44 (U.S. CLS. 100 AND 101).

FIRST USE 1-1-2003; IN COMMERCE 1-1-2003.

NO CLAIM IS MADE TO THE EXCLUSIVE RIGHT TO USE "VILLAGE CLINICS" FOR INTER-

NATIONAL CLASS 44, APART FROM THE MARK AS SHOWN.

THE COLOR(S) GREEN, DARK ORANGE AND BLACK IS/ARE CLAIMED AS A FEATURE OF THE MARK.

THE MARK CONSISTS OF TWO HANDS, OUTLINED IN BLACK, ON GREEN AND DARK ORANGE BACKGROUNDS, THE WORD "AID" IN DARK ORANGE, AND THE WORDING "VILLAGE CLINICS" IN BLACK.

SEC. 2(F) AS TO "AID VILLAGE CLINICS".

SER. NO. 77-149,877, FILED 4-5-2007.

MARTHA FROMM, EXAMINING ATTORNEY

Int. Cls.: 20 and 24

Prior U.S. Cls.: 2, 13, 22, 25, 32, 42 and 50

United States Patent and Trademark Office

Reg. No. 3,483,108

Registered Aug. 12, 2008

**TRADEMARK
PRINCIPAL REGISTER**

COOSHEE

BABYSMART, LLC (NEW JERSEY LTD LIAB CO)
P.O. BOX 26
BERNARDSVILLE, NJ 07924

FIRST USE 10-0-2006; IN COMMERCE 10-0-2006.

FOR: BOOSTER SEATS; NON-METAL BUMPER
GUARDS FOR TUBS, IN CLASS 20 (U.S. CLS. 2, 13,
22, 25, 32 AND 50).

THE MARK CONSISTS OF STANDARD CHAR-
ACTERS WITHOUT CLAIM TO ANY PARTICULAR
FONT, STYLE, SIZE, OR COLOR.

FIRST USE 10-0-2006; IN COMMERCE 10-0-2006.

SER. NO. 77-151,979, FILED 4-9-2007.

FOR: DIAPER CHANGING PADS NOT OF PA-
PER, NAMELY, MOLDED FOAM DIAPER CHAN-
GING PADS, IN CLASS 24 (U.S. CLS. 42 AND 50).

REBECCA SMITH, EXAMINING ATTORNEY

Int. Cl.: 33

Prior U.S. Cls.: 47 and 49

United States Patent and Trademark Office

Reg. No. 3,483,109

Registered Aug. 12, 2008

TRADEMARK
PRINCIPAL REGISTER



CHATAM INTERNATIONAL INCORPORATED
(DELAWARE CORPORATION)
103 SPRINGER BUILDING
3411 SILVERSIDE ROAD
WILMINGTON, DE 19810

FOR: LIQUEURS, IN CLASS 33 (U.S. CLS. 47 AND 49).

FIRST USE 10-3-1983; IN COMMERCE 10-3-1983.

THE MARK CONSISTS OF A BOTTLE FEATURING A PEDESTAL-SHAPED BOTTOM SURROUNDED BY A CONVEX RADIUS AND EMBOSSED WITH A DISTINCT THREE-DIMENSIONAL FLEUR DE LIS DESIGN.

SEC. 2(F).

SER. NO. 77-152,615, FILED 4-10-2007.

CARRIE GENOVESE, EXAMINING ATTORNEY

Int. Cls.: 7 and 11

Prior U.S. Cls.: 13, 19, 21, 23, 31, 34 and 35

United States Patent and Trademark Office

Reg. No. 3,483,110

Registered Aug. 12, 2008

**TRADEMARK
PRINCIPAL REGISTER**



KUMSUNG USA, LLC (VIRGINIA LTD LIAB CO)
477 SOUTH DEAN STREET
ENGLEWOOD, NJ 07631

FIRST USE 6-2-2005; IN COMMERCE 6-2-2005.

FOR: ELECTRIC CLOTHING PRESSING MACHINES FOR COMMERCIAL DRY CLEANING AND LAUNDRY PURPOSES INCLUDING SHIRTS PRESS, COLLAR AND CUFF PRESS, UTILITY PRESS, LEGGER PRESS, DRAPERIE PRESS, PANTS TOPPER, MUSHROOM TOPPER, PUFF IRON, AND LAUNDRY WASHER, IN CLASS 7 (U.S. CLS. 13, 19, 21, 23, 31, 34 AND 35).

THE MARK CONSISTS OF AN "IRONCLAD SHIP" WITH BODY RESEMBLING A TURTLE WITH TWELVE ROWS, ELEVEN SHARP PIERCING EDGES AT THE ROOFTOP AND DOUBLE POINTED TAIL.

FIRST USE 6-2-2005; IN COMMERCE 6-2-2005.

THE FOREIGN WORDING IN THE MARK TRANSLATES INTO ENGLISH AS "TURTLE SHIP".

FOR: CLOTHES DRYERS FOR COMMERCIAL DRY CLEANING AND LAUNDRY PURPOSES, IN CLASS 11 (U.S. CLS. 13, 21, 23, 31 AND 34).

SER. NO. 77-152,637, FILED 4-10-2007.

BENJAMIN ALLEN, EXAMINING ATTORNEY

Int. Cl.: 25

Prior U.S. Cls.: 22 and 39

United States Patent and Trademark Office

Reg. No. 3,483,111

Registered Aug. 12, 2008

**TRADEMARK
PRINCIPAL REGISTER**

BITCHSPIT

INTERNET SUPPORT & SERVICES CORPORATION (CALIFORNIA CORPORATION)
5730 N. FIRST ST., STE 105-219
FRESNO, CA 93710

FOR: BANDANAS; BEACHWEAR; BEANIES; BELTS; BOOTS; BOTTOMS; BRAS; BRIEFS; CAPS; DO RAGS; FOOTWEAR; GLOVES; HEADWEAR; JACKETS; JERSEYS; KERCHIEFS; JEANS; LOUNGEWEAR; MINISKIRTS; MOTORCYCLE GLOVES; NECKWEAR; PANTS; RAINWEAR; SHIRTS; SHOES; SHORTS; SKIRTS AND DRESSES; SLIPPERS; SOCKS; SPORTS BRA; SWEAT BANDS; SWEAT PANTS; SWEAT SHIRTS; SWEAT SHORTS; SWEAT

SUITS; TANK TOPS; TENNIS SHOES; THONGS; TOPS; UNDERWEAR; VISORS; WRISTBANDS; T-SHIRTS, IN CLASS 25 (U.S. CLS. 22 AND 39).

FIRST USE 4-5-2007; IN COMMERCE 4-5-2007.

THE MARK CONSISTS OF STANDARD CHARACTERS WITHOUT CLAIM TO ANY PARTICULAR FONT, STYLE, SIZE, OR COLOR.

SER. NO. 77-153,321, FILED 4-10-2007.

HANNO RITTNER, EXAMINING ATTORNEY

Int. Cls.: 35, 39 and 43

Prior U.S. Cls.: 100, 101, 102 and 105

United States Patent and Trademark Office

Reg. No. 3,483,112

Registered Aug. 12, 2008

**SERVICE MARK
PRINCIPAL REGISTER**

TOTALTRAVEL

TOTALTRAVEL.COM OF INTERNATIONAL LIMITED (UNITED KINGDOM LTD LIAB CO) ST BRIDE'S HOUSE 10 SALISBURY SQUARE LONDON, ENGLAND EC4Y 8EH

FOR: ADVERTISING SERVICES FOR ACCOMMODATION AND TRANSPORT PROVIDERS SEEKING TO ATTRACT TOURISTS AND TRAVELERS, IN CLASS 35 (U.S. CLS. 100, 101 AND 102).

FOR: TRAVEL SERVICES, NAMELY, ORGANIZATION OF EXCURSIONS, SIGHTSEEING TOURS, HOLIDAYS, TOURS AND TRAVEL, PROVIDING INFORMATION, NEWS AND COMMENTARY IN THE FIELD OF TRAVEL, PROVIDING LINKS TO WEB SITES OF OTHERS FEATURING TRAVEL, AND PROVIDING REVIEWS OF TRAVEL SERVICES PROVIDERS; TRAVEL AGENCY SERVICES, NAMELY, MAKING RESERVATIONS AND BOOKINGS FOR TRANSPORTATION; TRANSPORT SERVICES, NAMELY, TRANSPORT BY FERRY, BOAT, RAIL AND AIR; PROVIDING INFORMATION IN THE FIELD OF TRANSPORTATION FOR TOUR-

ISTS AND TRAVELERS, IN CLASS 39 (U.S. CLS. 100 AND 105).

FOR: PROVIDING INFORMATION IN THE FIELD OF LODGING FOR TOURISTS AND TRAVELERS; TRAVEL AGENCY SERVICES, NAMELY, MAKING RESERVATIONS AND BOOKING FOR TEMPORARY LODGING AND FOR RESTAURANTS AND MEALS, IN CLASS 43 (U.S. CLS. 100 AND 101).

THE MARK CONSISTS OF STANDARD CHARACTERS WITHOUT CLAIM TO ANY PARTICULAR FONT, STYLE, SIZE, OR COLOR.

PRIORITY CLAIMED UNDER SEC. 44(D) ON ERPN CMNTY TM OFC APPLICATION NO. 005642641, FILED 1-25-2007, REG. NO. 005642641, DATED 2-18-2008, EXPIRES 1-25-2017.

SER. NO. 77-153,804, FILED 4-11-2007.

MICHAEL KEATING, EXAMINING ATTORNEY

Int. Cl.: 25

Prior U.S. Cls.: 22 and 39

United States Patent and Trademark Office

Reg. No. 3,483,113

Registered Aug. 12, 2008

**TRADEMARK
PRINCIPAL REGISTER**

HERMOSO NEW YORK

SM SIGNATURE, INC. (NEW YORK CORPORATION)
390 FIFTH AVE. SUITE 802
NEW YORK, NY 10018

FOR: NECKTIES; MEN'S SUITS; PANTS; SLACKS;
SWEATERS; FOOTWEAR; HEADWEAR; BELTS;
DRESS SHIRTS, IN CLASS 25 (U.S. CLS. 22 AND 39).

FIRST USE 1-5-2007; IN COMMERCE 2-1-2007.

THE MARK CONSISTS OF STANDARD CHARACTERS WITHOUT CLAIM TO ANY PARTICULAR FONT, STYLE, SIZE, OR COLOR.

NO CLAIM IS MADE TO THE EXCLUSIVE RIGHT TO USE "NEW YORK", APART FROM THE MARK AS SHOWN.

THE FOREIGN WORDING IN THE MARK TRANSLATES INTO ENGLISH AS GOOD LOOKING, BEAUTIFUL.

SER. NO. 77-154,233, FILED 4-11-2007.

KAELIE KUNG, EXAMINING ATTORNEY

Int. Cl.: 41

Prior U.S. Cls.: 100, 101 and 107

United States Patent and Trademark Office

Reg. No. 3,483,114

Registered Aug. 12, 2008

**SERVICE MARK
PRINCIPAL REGISTER**

YOUR LIFE... YOUR WAY...

GRIFFIN TELEVISION OKC, L.L.C. (OKLAHOMA LTD LIAB CO)
PO BOX 14159
OKLAHOMA CITY, OK 731130159

THE MARK CONSISTS OF STANDARD CHARACTERS WITHOUT CLAIM TO ANY PARTICULAR FONT, STYLE, SIZE, OR COLOR.

FOR: ENTERTAINMENT, NAMELY, TELEVISION NEWS SHOWS, IN CLASS 41 (U.S. CLS. 100, 101 AND 107).

SER. NO. 77-154,410, FILED 4-11-2007.

FIRST USE 1-1-2007; IN COMMERCE 1-1-2007.

SIMON TENG, EXAMINING ATTORNEY

Int. Cl.: 16

Prior U.S. Cls.: 2, 5, 22, 23, 29, 37, 38 and 50

Reg. No. 3,483,115

United States Patent and Trademark Office

Registered Aug. 12, 2008

**TRADEMARK
PRINCIPAL REGISTER**

Vero Beach Magazine

MOULTON PUBLICATIONS, INC. (FLORIDA
CORPORATION)
956 20TH STREET
VERO BEACH, FL 32960

NO CLAIM IS MADE TO THE EXCLUSIVE
RIGHT TO USE "MAGAZINE", APART FROM THE
MARK AS SHOWN.

FOR: MAGAZINES FEATURING LIFE IN THE
INDIAN RIVER COUNTY, FLORIDA AREA, IN
CLASS 16 (U.S. CLS. 2, 5, 22, 23, 29, 37, 38 AND 50).

SEC. 2(F).

FIRST USE 11-1-1997; IN COMMERCE 1-1-1998.

SER. NO. 77-154,985, FILED 4-12-2007.

THE MARK CONSISTS OF STANDARD CHAR-
ACTERS WITHOUT CLAIM TO ANY PARTICULAR
FONT, STYLE, SIZE, OR COLOR.

FRANK LATTUCA, EXAMINING ATTORNEY

Int. Cl.: 9

Prior U.S. Cls.: 21, 23, 26, 36 and 38

Reg. No. 3,483,116

United States Patent and Trademark Office

Registered Aug. 12, 2008

**TRADEMARK
PRINCIPAL REGISTER**

SOUND ALIBI

H32 DESIGN & DEVELOPMENT, LLC (NEW HAMPSHIRE LTD LIAB CO)
39 MOUNTAIN VIEW ACRES RD.
WILMOT, NH 03287

FOR: COMPUTER SOFTWARE TO CONTROL ELECTRONIC EQUIPMENT WHICH ALLOWS ACCESS TO VARIOUS TYPES OF PRE-RECORDED AUDIO RECORDINGS, NAMELY, COMPUTER SOFTWARE WHICH ALLOWS ELECTRONIC EQUIPMENT TO ACCESS VOICE, MUSIC, AND EFFECTS; COMPUTER SOFTWARE FOR THE INTEGRATION OF TEXT, AUDIO, GRAPHICS, AND STILL IMAGES INTO AN INTERACTIVE DELIVERY FOR MULTIMEDIA APPLICATIONS; COMPUTER SOFTWARE FOR CONTROLLING SELF-

SERVICE TERMINALS; COMPUTER SOFTWARE FOR PROCESSING, MODIFICATION, TRANSMISSION, RECEPTION, AND MODULATION OF AUDIO CONTENT, IN CLASS 9 (U.S. CLS. 21, 23, 26, 36 AND 38).

FIRST USE 12-15-2006; IN COMMERCE 12-15-2006.

THE MARK CONSISTS OF STANDARD CHARACTERS WITHOUT CLAIM TO ANY PARTICULAR FONT, STYLE, SIZE, OR COLOR.

SER. NO. 77-155,017, FILED 4-12-2007.

MARLENE BELL, EXAMINING ATTORNEY

Int. Cls.: 35 and 41

Prior U.S. Cls.: 100, 101, 102 and 107

United States Patent and Trademark Office

Reg. No. 3,483,117

Registered Aug. 12, 2008

**SERVICE MARK
PRINCIPAL REGISTER**



SCHEFREN PUBLISHING, LLC (FLORIDA LTD
LIAB CO)
100 NE 5 AVENUE, SUITE B2
DELRAY BEACH, FL 33483

FOR: MANAGEMENT AND BUSINESS CON-
SULTING SERVICES IN THE FIELD OF BUSINESS
ORGANIZATION, BUSINESS MANAGEMENT,
BUSINESS PLANNING, STRATEGIC PLANNING,
MARKETING BY MEANS OF THE INTERNET AND
TRADITIONAL MARKETING, IN CLASS 35 (U.S.
CLS. 100, 101 AND 102).

FIRST USE 0-0-2004; IN COMMERCE 0-0-2004.

FOR: EDUCATIONAL SERVICES, NAMELY,
CONDUCTING SEMINARS AND PROFESSIONAL

COACHING IN THE FIELD OF BUSINESS DEVEL-
OPMENT, BUSINESS MANAGEMENT, STRATEGIC
PLANNING, MARKETING BY MEANS OF THE
INTERNET AND TRADITIONAL MARKETING;
AND ON-LINE TRAINING AND EDUCATIONAL
EVALUATIONS IN THE FIELD OF BUSINESS DE-
VELOPMENT, BUSINESS MANAGEMENT, STRA-
TEGIC PLANNING AND MARKETING BY MEANS
OF THE INTERNET, IN CLASS 41 (U.S. CLS. 100, 101
AND 107).

FIRST USE 0-0-2004; IN COMMERCE 0-0-2004.

SER. NO. 77-156,295, FILED 4-13-2007.

LINDA POWELL, EXAMINING ATTORNEY

Int. Cls.: 29 and 30

Prior U.S. Cl.: 46

United States Patent and Trademark Office

Reg. No. 3,483,118

Registered Aug. 12, 2008

**TRADEMARK
PRINCIPAL REGISTER**

PINOY FIESTA

C.N. TRADING CORP. (CALIFORNIA CORPORATION)
903 S. AZUSA AVENUE, SUITE #B
CITY OF INDUSTRY, CA 91748

FOR: CANNED VEGETABLES; FROZEN VEGETABLES; FRUIT-BASED AND POTATO-BASED SNACK FOODS; FRUIT, VEGETABLE, AND POTATO CHIPS; CANNED SEAFOOD; FROZEN SEAFOOD; PRESERVED FRUITS , IN CLASS 29 (U.S. CL. 46).

FIRST USE 8-17-2003; IN COMMERCE 8-17-2003.

FOR: CEREAL-BASED AND CORN-BASED SNACK FOODS; CORN AND TORTILLA CHIPS; AND SWEETS, NAMELY CANDIES AND CHOCOLATE, IN CLASS 30 (U.S. CL. 46).

FIRST USE 8-17-2003; IN COMMERCE 8-17-2003.

THE MARK CONSISTS OF STANDARD CHARACTERS WITHOUT CLAIM TO ANY PARTICULAR FONT, STYLE, SIZE, OR COLOR.

NO CLAIM IS MADE TO THE EXCLUSIVE RIGHT TO USE "PINOY", APART FROM THE MARK AS SHOWN.

THE FOREIGN WORDING IN THE MARK TRANSLATES INTO ENGLISH AS "FILIPINO."

SER. NO. 77-156,572, FILED 4-13-2007.

ROBERT STRUCK, EXAMINING ATTORNEY

Int. Cl.: 19

Prior U.S. Cls.: 1, 12, 33 and 50

United States Patent and Trademark Office

Reg. No. 3,483,119

Registered Aug. 12, 2008

**TRADEMARK
PRINCIPAL REGISTER**

A PAVING SYSTEM WE CAN ALL
LIVE WITH

ABBOTSFORD CONCRETE PRODUCTS LIM-
ITED PARTNERSHIP (CANADA LIMITED
PARTNERSHIP)
3422 MCCALLUM ROAD
ABBOTSFORD, CANADA V2S7W8

PRIORITY CLAIMED UNDER SEC. 44(D) ON
CANADA APPLICATION NO. 1342941, FILED 4-11-
2007, REG. NO. TMA710,291, DATED 3-27-2008, EX-
PIRES 3-27-2023.

FOR: INTERLOCKING CONCRETE PAVERS, IN
CLASS 19 (U.S. CLS. 1, 12, 33 AND 50).

SER. NO. 77-156,679, FILED 4-13-2007.

THE MARK CONSISTS OF STANDARD CHAR-
ACTERS WITHOUT CLAIM TO ANY PARTICULAR
FONT, STYLE, SIZE, OR COLOR.

KATHERINE E. HALMEN, EXAMINING ATTOR-
NEY

Int. Cl.: 36

Prior U.S. Cls.: 100, 101 and 102

United States Patent and Trademark Office

Reg. No. 3,483,120

Registered Aug. 12, 2008

**SERVICE MARK
PRINCIPAL REGISTER**

FundMD

THE WILLIS GROUP (COLORADO CORPORATION)
128 SOUTH TEJON #150
COLORADO SPRINGS, CO 80903

FOR: FINANCIAL INFORMATION PROCESSING; FINANCIAL INFORMATION PROVIDED BY ELECTRONIC MEANS, IN CLASS 36 (U.S. CLS. 100, 101 AND 102).

FIRST USE 2-1-2007; IN COMMERCE 2-22-2007.

THE MARK CONSISTS OF STANDARD CHARACTERS WITHOUT CLAIM TO ANY PARTICULAR FONT, STYLE, SIZE, OR COLOR.

SER. NO. 77-157,365, FILED 4-16-2007.

FRED MANDIR, EXAMINING ATTORNEY

Int. Cls.: 16, 35 and 41

**Prior U.S. Cls.: 2, 5, 22, 23, 29, 37, 38, 50, 100, 101, 102
and 107**

Reg. No. 3,483,121

United States Patent and Trademark Office

Registered Aug. 12, 2008

**TRADEMARK
SERVICE MARK
PRINCIPAL REGISTER**

ILLINOIS CPA SOCIETY

ILLINOIS CPA SOCIETY (ILLINOIS NON-PROFIT CORPORATION)
550 W. JACKSON, SUITE 900
CHICAGO, IL 606615716

FOR: PUBLICATIONS, NAMELY, MAGAZINES AND NEWSLETTERS IN THE FIELD OF ACCOUNTING AND FINANCIAL SERVICES AND BUSINESS TOPICS OF INTEREST TO PROFESSIONALS IN THE ACCOUNTING AND FINANCIAL SERVICES FIELDS, IN CLASS 16 (U.S. CLS. 2, 5, 22, 23, 29, 37, 38 AND 50).

FIRST USE 6-0-1974; IN COMMERCE 6-0-1974.

FOR: ASSOCIATION SERVICES, NAMELY, PROMOTING THE INTERESTS OF CERTIFIED PUBLIC ACCOUNTANTS AND OTHER PROFESSIONALS IN THE FIELD OF ACCOUNTING AND FINANCIAL SERVICES, IN CLASS 35 (U.S. CLS. 100, 101 AND 102).

FIRST USE 6-0-1974; IN COMMERCE 6-0-1974.

FOR: EDUCATIONAL SERVICES, NAMELY, PROVIDING COURSES, CLASSES, CONFERENCES AND FORUMS IN THE FIELDS OF ACCOUNTING AND FINANCIAL SERVICES AND BUSINESS TOPICS OF INTEREST TO PROFESSIONALS IN THE ACCOUNTING AND FINANCIAL SERVICES FIELDS, IN CLASS 41 (U.S. CLS. 100, 101 AND 107).

FIRST USE 6-0-1974; IN COMMERCE 6-0-1974.

THE MARK CONSISTS OF STANDARD CHARACTERS WITHOUT CLAIM TO ANY PARTICULAR FONT, STYLE, SIZE, OR COLOR.

NO CLAIM IS MADE TO THE EXCLUSIVE RIGHT TO USE "CPA SOCIETY", APART FROM THE MARK AS SHOWN.

SEC. 2(F).

SER. NO. 77-157,762, FILED 4-16-2007.

LINDSEY RUBIN, EXAMINING ATTORNEY

Int. Cl.: 5

Prior U.S. Cls.: 6, 18, 44, 46, 51 and 52

Reg. No. 3,483,122

United States Patent and Trademark Office

Registered Aug. 12, 2008

**TRADEMARK
PRINCIPAL REGISTER**

LABSAN

SANITATION STRATEGIES, LLC (MICHIGAN
LTD LIAB CO)
2104 JOLLY ROAD
OKEMOS, MI 48864

FIRST USE 9-0-2003; IN COMMERCE 9-0-2003.

FOR: CHEMICAL PREPARATIONS FOR SANI-
TARY PURPOSES USED SPECIFICALLY IN THE
ANIMAL LIFE SCIENCE INDUSTRY; DISINFEC-
TANTS FOR SANITARY PURPOSES USED IN THE
ANIMAL LIFE SCIENCE INDUSTRY, IN CLASS 5
(U.S. CLS. 6, 18, 44, 46, 51 AND 52).

THE MARK CONSISTS OF STANDARD CHAR-
ACTERS WITHOUT CLAIM TO ANY PARTICULAR
FONT, STYLE, SIZE, OR COLOR.

SER. NO. 77-158,270, FILED 4-17-2007.

PAM WILLIS, EXAMINING ATTORNEY

Int. Cl.: 9

Prior U.S. Cls.: 21, 23, 26, 36 and 38

Reg. No. 3,483,123

United States Patent and Trademark Office

Registered Aug. 12, 2008

**TRADEMARK
PRINCIPAL REGISTER**

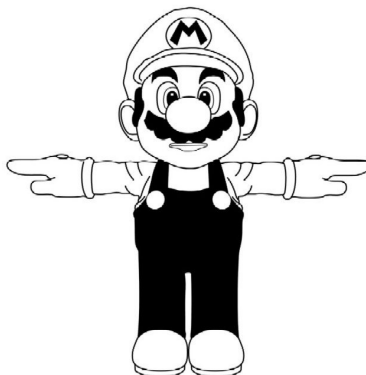

NINTENDO CO., LTD. (JAPAN CORPORATION)
11-1 HOKOTATE-CHO KAMITOBA, MINAMI-KU
KYOTO-SHI, KYOTO, JAPAN 601-8501

FOR: ADAPTERS FOR USE IN CONNECTING COMPUTER AND VIDEO GAME MACHINES WITH COMMUNICATION DEVICES, NAMELY, TELEPHONES, CELLULAR TELEPHONES, PCS TELEPHONES, WIRELESS TELEPHONES AND PAGERS; CARTRIDGES, COMPACT DISCS AND OPTICAL DISCS FEATURING ENTERTAINMENT CONTENT, NAMELY, CHILDREN'S ENTERTAINMENT CONTENT, NAMELY, STORIES, MUSIC, AND GAMES; COMPUTER GAME CARTRIDGES; COMPUTER GAME DISCS; COMPUTER GAME EQUIPMENT CONTAINING MEMORY DEVICES, NAMELY, DISCS; COMPUTER GAME MEMORY CARDS; COMPUTER GAME PERIPHERALS; COMPUTER GAME PROGRAMS; COMPUTER GAME SOFTWARE; COMPUTER SOFTWARE FOR USE IN CONNECTING COMPUTER AND VIDEO GAME MACHINES WITH COMMUNICATION DEVICES, NAMELY, TELEPHONES, CELLULAR TELEPHONES, PCS TELEPHONES, WIRELESS TELEPHONES AND PAGERS; ELECTRONIC GAME CARTRIDGES; ELECTRONIC GAME DISCS; ELECTRONIC GAME MACHINES FOR USE WITH EXTERNAL SCREENS OR MONITORS; ELECTRONIC GAME PROGRAMS; ELECTRONIC GAME SOFTWARE; ELECTRONIC VIDEO GAME MACHINES FOR USE WITH A MONITOR OR TELEVISION; EYEGLASS CASES; EYEGLASSES; INTERACTIVE ELECTRONIC GAME MACHINES FOR USE WITH EXTERNAL SCREENS OR MONITORS; INTERACTIVE GAME MEMORY CARDS; INTERACTIVE VIDEO GAME CARTRIDGES; INTERACTIVE VI-

DEO GAME DISCS; INTERACTIVE VIDEO GAME PROGRAMS; INTERACTIVE VIDEO GAME SOFTWARE; MAGNETIC TRADING CARDS AND DISCS FEATURING GAME PROGRAM AND DATA CONTENT; MUSICAL SOUND RECORDINGS; SPECTACLES; SUNGLASSES; VIDEO GAME CARTRIDGES; VIDEO GAME DISCS; VIDEO GAME EQUIPMENT CONNECTABLE TO COMMUNICATIONS DEVICES, NAMELY, TELEPHONES, CELLULAR TELEPHONES, PCS TELEPHONES, WIRELESS TELEPHONES AND PAGERS; VIDEO GAME MACHINE ACCESSORIES, NAMELY, CARRY CASES, BATTERY CHARGERS, AUXILIARY LIGHTS, SCREEN MAGNIFIERS, DIGITAL CAMERAS, PRINTERS; VIDEO GAME CONTROLLERS AND VIDEO GAME JOYSTICKS; VIDEO GAME MACHINES FOR USE WITH A MONITOR OR TELEVISION; VIDEO GAME MACHINES WITH MEMORY DEVICES, NAMELY, FLASH MEMORY; VIDEO GAME MEMORY CARDS; VIDEO GAME PROGRAMS; VIDEO GAME SOFTWARE; WRITING INSTRUMENTS FOR USE WITH COMPUTER/VIDEO GAME MACHINE TOUCH SCREEN DISPLAYS, NAMELY, COMPUTER STYLUS, IN CLASS 9 (U.S. CLS. 21, 23, 26, 36 AND 38).

PRIORITY CLAIMED UNDER SEC. 44(D) ON JAPAN APPLICATION NO. 2006-119736, FILED 12-26-2006, REG. NO. 5088766, DATED 11-2-2007, EXPIRES 11-2-2017.

THE MARK CONSISTS OF A FRONT VIEW DEPICTION OF A MAN STANDING UP WITH ARMS STRETCHED OUT TO THE SIDES. THE MAN IS DEPICTED WEARING A HAT, THE HAT BEARING THE LETTER M, AND ALSO WEARING

COVERALLS. THE MARK IS BLACK AND WHITE
AND DOES NOT CONTAIN COLOR.

SER. NO. 77-158,281, FILED 4-17-2007.

JILL C. ALT, EXAMINING ATTORNEY

Int. Cl.: 36

Prior U.S. Cls.: 100, 101 and 102

United States Patent and Trademark Office

Reg. No. 3,483,124

Registered Aug. 12, 2008

**SERVICE MARK
PRINCIPAL REGISTER**

BRAISHFIELD

BRAISHFIELD ASSOCIATES, INC. (FLORIDA CORPORATION)
SUITE 200
5955 T.G. LEE BLVD.
ORLANDO, FL 32822

FOR: INSURANCE BROKERAGE, INSURANCE ADMINISTRATION; PROGRAM MANAGEMENT SERVICES, NAMELY PERFORMING CLAIMS MANAGEMENT SERVICES AND ADMINISTRATION SERVICES, NAMELY, CLAIMS ADMINISTRATION IN THE FIELD OF PROPERTY AND

CASUALTY INSURANCE, IN CLASS 36 (U.S. CLS. 100, 101 AND 102).

FIRST USE 0-0-1984; IN COMMERCE 0-0-1984.

THE MARK CONSISTS OF STANDARD CHARACTERS WITHOUT CLAIM TO ANY PARTICULAR FONT, STYLE, SIZE, OR COLOR.

SER. NO. 77-159,416, FILED 4-18-2007.

CARYN GLASSER, EXAMINING ATTORNEY

Int. Cl.: 36

Prior U.S. Cls.: 100, 101 and 102

United States Patent and Trademark Office

Reg. No. 3,483,125

Registered Aug. 12, 2008

**SERVICE MARK
PRINCIPAL REGISTER**



BRAISHFIELD ASSOCIATES, INC. (FLORIDA CORPORATION)
SUITE 200
5955 T.G. LEE BLVD.
ORLANDO, FL 32822

FOR: INSURANCE BROKERAGE, INSURANCE ADMINISTRATION; PROGRAM MANAGEMENT SERVICES, NAMELY, PERFORMING CLAIMS MANAGEMENT SERVICES AND ADMINISTRATION SERVICES, NAMELY, CLAIMS ADMINISTRATION IN THE FIELD OF PROPERTY AND

CASUALTY INSURANCE, IN CLASS 36 (U.S. CLS. 100, 101 AND 102).

FIRST USE 0-0-1984; IN COMMERCE 0-0-1984.

THE MARK CONSISTS OF AN IMAGE OF A HORSE.

SER. NO. 77-159,461, FILED 4-18-2007.

CARYN GLASSER, EXAMINING ATTORNEY

Int. Cls.: 36 and 41

Prior U.S. Cls.: 100, 101, 102 and 107

United States Patent and Trademark Office

Reg. No. 3,483,126

Registered Aug. 12, 2008

**SERVICE MARK
PRINCIPAL REGISTER**



COMMUNITY FOUNDATION OF JACKSON
HOLE (WYOMING CORPORATION)
PO BOX 574, 255 E. SIMPSON STREET
JACKSON, WY 83001

FOR: ACCEPTING AND ADMINISTERING
MONETARY CHARITABLE CONTRIBUTIONS;
CHARITABLE FUND RAISING, IN CLASS 36 (U.S.
CLS. 100, 101 AND 102).

FIRST USE 9-11-1997; IN COMMERCE 9-11-1997.

FOR: ORGANIZING COMMUNITY SPORTING
AND CULTURAL EVENTS, IN CLASS 41 (U.S. CLS.
100, 101 AND 107).

FIRST USE 9-11-1997; IN COMMERCE 9-11-1997.

NO CLAIM IS MADE TO THE EXCLUSIVE
RIGHT TO USE "FUN RUN", APART FROM THE
MARK AS SHOWN.

THE MARK CONSISTS OF A RUNNER IN
FRONT OF MOUNTAINS WITH A SUN IN THE
TOP, LEFT CORNER.

SER. NO. 77-159,845, FILED 4-18-2007.

BARBARA BROWN, EXAMINING ATTORNEY

Int. Cl.: 9

Prior U.S. Cls.: 21, 23, 26, 36 and 38

Reg. No. 3,483,127

United States Patent and Trademark Office

Registered Aug. 12, 2008

**TRADEMARK
PRINCIPAL REGISTER**

DISNEY MIX MICRO

DISNEY ENTERPRISES, INC. (DELAWARE CORPORATION)
500 SOUTH BUENA VISTA STREET
BURBANK, CA 91521

FOR: MP3 PLAYERS AND MUSICAL AUDIO RECORDINGS, IN CLASS 9 (U.S. CLS. 21, 23, 26, 36 AND 38).

FIRST USE 8-1-2006; IN COMMERCE 8-1-2006.

THE MARK CONSISTS OF STANDARD CHARACTERS WITHOUT CLAIM TO ANY PARTICULAR FONT, STYLE, SIZE, OR COLOR.

OWNER OF U.S. REG. NOS. 2,573,544, 3,235,413, AND 3,242,910.

SER. NO. 77-160,174, FILED 4-18-2007.

BRIDGETT SMITH, EXAMINING ATTORNEY

Int. Cls.: 35 and 42

Prior U.S. Cls.: 100, 101 and 102

United States Patent and Trademark Office

Reg. No. 3,483,128

Registered Aug. 12, 2008

**SERVICE MARK
PRINCIPAL REGISTER**

ALUMINIUM VALLEY

SOCIÉTÉ DE LA VALLÉE DE L'ALUMINIUM
(CANADA CORPORATION)
100, ST-JOSEPH SUD, SUITE 205
ALMA, QUEBEC, CANADA G8B7A6

FOR: PROMOTING ECONOMIC DEVELOPMENT
IN THE ALUMINIUM INDUSTRY IN THE SAGUE-
NAY-LAC-ST-JEAN REGION OF CANADA; BUSI-
NESS CONSULTATION SERVICES, NAMELY,
PROVIDING TECHNOLOGY TRANSFER ASSIS-
TANCE AND RELATED BUSINESS ASSISTANCE
IN THE NATURE OF ASSESSMENT AND VALUA-
TION OF TECHNOLOGY IN THE AREAS OF TECH-
NOLOGY COMMERCIALIZATION, IN CLASS 35
(U.S. CLS. 100, 101 AND 102).

FOR: TECHNOLOGY CONSULTATION AND RE-
SEARCH IN THE FIELD OF ALUMINIUM MANU-
FACTURING, IN CLASS 42 (U.S. CLS. 100 AND 101).

THE MARK CONSISTS OF STANDARD CHAR-
ACTERS WITHOUT CLAIM TO ANY PARTICULAR
FONT, STYLE, SIZE, OR COLOR.

PRIORITY CLAIMED UNDER SEC. 44(D) ON
CANADA APPLICATION NO. 1321463, FILED 10-24-
2006, REG. NO. TMA708449, DATED 2-28-2008, EX-
PIRES 2-28-2023.

NO CLAIM IS MADE TO THE EXCLUSIVE
RIGHT TO USE "ALUMINIUM", APART FROM
THE MARK AS SHOWN.

SER. NO. 77-160,540, FILED 4-19-2007.

MORGAN WYNNE, EXAMINING ATTORNEY

Int. Cl.: 9

Prior U.S. Cls.: 21, 23, 26, 36 and 38

Reg. No. 3,483,129

United States Patent and Trademark Office

Registered Aug. 12, 2008

**TRADEMARK
PRINCIPAL REGISTER**

VITESSE

CARL ZEISS AG (FED REP GERMANY CORPORATION)

CARL-ZEISS-STRASSE 22

73447 OBERKOCHEN, FED REP GERMANY

FOR: COORDINATE MEASURING MACHINES AND PARTS THEREOF, IN CLASS 9 (U.S. CLS. 21, 23, 26, 36 AND 38).

THE MARK CONSISTS OF STANDARD CHARACTERS WITHOUT CLAIM TO ANY PARTICULAR FONT, STYLE, SIZE, OR COLOR.

OWNER OF FED REP GERMANY REG. NO. 39707187, DATED 5-21-1997, EXPIRES 2-28-2017.

SER. NO. 77-160,805, FILED 4-19-2007.

DORITT L. CARROLL, EXAMINING ATTORNEY

Int. Cl.: 9

Prior U.S. Cls.: 21, 23, 26, 36 and 38

United States Patent and Trademark Office

Reg. No. 3,483,130

Registered Aug. 12, 2008

**TRADEMARK
PRINCIPAL REGISTER**

CARMET

CARL ZEISS AG (FED REP GERMANY CORPORATION)

CARL-ZEISS-STRASSE 22

73447 OBERKOCHEN, FED REP GERMANY

FOR: COORDINATE MEASURING MACHINES AND PARTS THEREOF, IN CLASS 9 (U.S. CLS. 21, 23, 26, 36 AND 38).

THE MARK CONSISTS OF STANDARD CHARACTERS WITHOUT CLAIM TO ANY PARTICULAR FONT, STYLE, SIZE, OR COLOR.

OWNER OF FED REP GERMANY REG. NO. 397 07 184, DATED 6-6-1997, EXPIRES 2-28-2017.

SER. NO. 77-160,813, FILED 4-19-2007.

DORITT L. CARROLL, EXAMINING ATTORNEY

Int. Cl.: 41

Prior U.S. Cls.: 100, 101 and 107

United States Patent and Trademark Office

Reg. No. 3,483,131

Registered Aug. 12, 2008

SERVICE MARK
PRINCIPAL REGISTER

**MyPet
Story**

MAKING EVERLASTING MEMORIES, L.L.C
(DELAWARE LTD LIAB CO)
11475 NORTHLAKE DRIVE
CINCINNATI, OH 45249

FOR: ENTERTAINMENT SERVICES, NAMELY,
PROVIDING AN INTERACTIVE WEBSITE ALLOW-
ING USERS TO UPLOAD AND DOWNLOAD PHO-
TOGRAPHIC, AUDIO, VIDEO AND PROSE
PRESENTATIONS FEATURING LIFE STORIES OF
PETS, VIA A GLOBAL COMPUTER NETWORK,
LOCAL AREA NETWORK OR STAND-ALONE

COMPUTER, IN CLASS 41 (U.S. CLS. 100, 101 AND
107).

FIRST USE 9-27-2005; IN COMMERCE 9-27-2005.

NO CLAIM IS MADE TO THE EXCLUSIVE
RIGHT TO USE "PET STORY", APART FROM THE
MARK AS SHOWN.

SER. NO. 77-161,183, FILED 4-19-2007.

KATHRYN COWARD, EXAMINING ATTORNEY

Int. Cl.: 33

Prior U.S. Cls.: 47 and 49

United States Patent and Trademark Office

Reg. No. 3,483,132

Registered Aug. 12, 2008

**TRADEMARK
PRINCIPAL REGISTER**

CREMA DE ORO

ISIDRO BORDAS, C. POR A. (DOMINICAN REP
CORPORATION)
AVENIDA INDEPENDENCIA NO. 55
SANTIAGO, DOMINICAN REP

FOR: ALCOHOLIC PUNCH, IN CLASS 33 (U.S.
CLS. 47 AND 49).

THE MARK CONSISTS OF STANDARD CHAR-
ACTERS WITHOUT CLAIM TO ANY PARTICULAR
FONT, STYLE, SIZE, OR COLOR.

PRIORITY CLAIMED UNDER SEC. 44(D) ON
DOMINICAN REP APPLICATION NO. 2007-22279,

FILED 3-30-2007, REG. NO. 161450, DATED 6-29-2007,
EXPIRES 6-29-2017.

OWNER OF U.S. REG. NO. 2,046,214.

THE FOREIGN WORDING IN THE MARK
TRANSLATES INTO ENGLISH AS "CREME OF
GOLD".

SER. NO. 77-162,635, FILED 4-22-2007.

CHRISIE B. KING, EXAMINING ATTORNEY

Int. Cls.: 18 and 25

Prior U.S. Cls.: 1, 2, 3, 22, 39 and 41

United States Patent and Trademark Office

Reg. No. 3,483,133

Registered Aug. 12, 2008

**TRADEMARK
PRINCIPAL REGISTER**

BABY'S LANGUAGE

BABY'S LANGUAGE, LLC (CONNECTICUT LTD
LIAB CO)
P.O. BOX 3606
MILFORD, CT 06460

FOR: BEACH BAGS; BEACH UMBRELLAS; DIA-
PER BAGS; INFANT CARRIERS WORN ON THE
BODY; SLINGS FOR CARRYING INFANTS; ALL-
PURPOSE CARRYING BAGS; BAGS FOR CARRY-
ING BABIES' ACCESSORIES; CARRY-ALL BAGS;
TOTE BAGS; BABY BACKPACKS, IN CLASS 18 (U.S.
CLS. 1, 2, 3, 22 AND 41).

FIRST USE 3-16-2006; IN COMMERCE 1-1-2007.

FOR: BASEBALL CAPS; BATHING SUITS; BATH-
ROBES; BEACHWEAR; BIB OVERALLS; CHIL-
DREN'S AND INFANTS' CLOTH BIBS; BLOUSES;
BOOTIES; BOOTS; CAPS; CHILDREN'S HEAD-
WEAR; CLOTH DIAPERS; COATS; COVERALLS;
CREEPERS; DRESSES; BOTTOMS; FLEECE PULL-
OVERS; PULLOVERS; FOOTWEAR; GLOVES; GYM
SHORTS; SHORTS; HALLOWEEN COSTUMES;
HATS; HEADWEAR; INFANT AND TODDLER
ONE PIECE CLOTHING; INFANT DIAPER COVERS;
INFANT SLEEPERS; INFANTS' SHOES AND

BOOTS; INFANTWEAR; JACKETS; JEANS; JOG-
GING SUITS; JUMPSUITS; LAYETTES; MITTENS;
PAJAMAS; PANTS; SWEAT PANTS; RAINCOATS;
ROBES; SHIRTS; SWEAT SHIRTS; T-SHIRTS;
SHOES; SKORTS; SLEEPWEAR; SLEEVELESS JER-
SEYS; SLIPPERS; SNOW PANTS; SNOW SUITS;
SOCKS AND STOCKINGS; SWEATERS; SWIM
WEAR; SWIMSUITS; TANK TOPS; TRACKSUITS;
TROUSERS; UNDERWEAR; WIND RESISTANT
JACKETS; BABY BUNTING; SKIRTS, IN CLASS 25
(U.S. CLS. 22 AND 39).

FIRST USE 3-16-2006; IN COMMERCE 1-1-2007.

THE MARK CONSISTS OF STANDARD CHAR-
ACTERS WITHOUT CLAIM TO ANY PARTICULAR
FONT, STYLE, SIZE, OR COLOR.

NO CLAIM IS MADE TO THE EXCLUSIVE
RIGHT TO USE "BABY", APART FROM THE MARK
AS SHOWN.

SER. NO. 77-163,681, FILED 4-23-2007.

JEFF DEFORD, EXAMINING ATTORNEY

Int. Cl.: 36

Prior U.S. Cls.: 100, 101 and 102

United States Patent and Trademark Office

Reg. No. 3,483,134

Registered Aug. 12, 2008

**SERVICE MARK
PRINCIPAL REGISTER**



PI FINANCIAL CORP (CANADA CORPORATION)
19TH FLOOR STE 1900 - 666 BURRARD STREET
VANCOUVER, CANADA V6C3N1

FOR: FINANCIAL SERVICES, NAMELY, BROKERAGE ACCOUNT INVESTMENT AND INVESTMENT MANAGEMENT SERVICES INCLUDING PORTFOLIO MANAGEMENT SERVICES; INVESTMENT, SECURITIES AND MUTUAL FUND INVESTMENT SERVICES; RETAIL AND INSTITUTIONAL SECURITIES INVESTMENT SERVICES; INSTITUTIONAL INVESTMENT AND UNDERWRITING SERVICES, NAMELY, UNDERWRITING NEW SECURITIES ISSUES AND PRIVATE PLACEMENTS OF SECURITIES; WEALTH MANAGEMENT, RETIREMENT, AND ESTATE PLANNING SERVICES; SECURITIES RESEARCH AND ADVISORY SERVICES; AND SECURITIES LENDING AND BORROWING SERVICES; MARKET MAKING SERVICES, NAMELY, ACTING AS MARKET MAKER IN PUBLICLY TRADED SECURITIES; BROKERAGE OF LIFE AND HEALTH INSURANCE POLICIES, ANNUITIES, AND SEGREGATED FUNDS; ESTATE AND TRUST PORTFOLIO MAN-

AGEMENT SERVICES; PENSION SERVICES, NAMELY, ADMINISTRATION OF EMPLOYEE PENSION PLANS; FINANCIAL CLEARING HOUSE; FUTURES AND DERIVATIVES TRADING SERVICES; AND PROPRIETARY INVESTMENT, NAMELY, INVENTORY TRADING AND MUTUAL FUND INVESTMENT SERVICES, IN CLASS 36 (U.S. CLS. 100, 101 AND 102).

FIRST USE 7-1-2007; IN COMMERCE 7-1-2007.

PRIORITY CLAIMED UNDER SEC. 44(D) ON CANADA APPLICATION NO. 1343623, FILED 4-17-2007.

THE MARK CONSISTS OF THREE SEMI-TRANSPARENT CURVED SCALENE TRIANGLES ARRANGED END-TO-END, CREATING AN EQUILATERAL TRIANGLE IN THE CENTER.

SER. NO. 77-163,755, FILED 4-24-2007.

DAVID TOOLEY, EXAMINING ATTORNEY

Int. Cl.: 36

Prior U.S. Cls.: 100, 101 and 102

United States Patent and Trademark Office

Reg. No. 3,483,135

Registered Aug. 12, 2008

**SERVICE MARK
PRINCIPAL REGISTER**

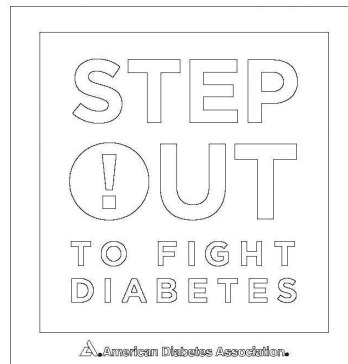

AMERICAN DIABETES ASSOCIATION, INC.
(OHIO CORPORATION)
1701 N. BEAUREGARD STREET
ALEXANDRIA, VA 22311

FOR: CHARITABLE FUND RAISING, IN CLASS
36 (U.S. CLS. 100, 101 AND 102).

FIRST USE 4-2-2007; IN COMMERCE 4-2-2007.

OWNER OF U.S. REG. NOS. 1,218,650, 2,531,757,
AND 2,667,016.

NO CLAIM IS MADE TO THE EXCLUSIVE
RIGHT TO USE "DIABETES", APART FROM THE
MARK AS SHOWN.

THE MARK CONSISTS OF "STEP OUT TO FIGHT
DIABETES" AND DESIGN.

SEC. 2(F) AS TO "AMERICAN DIABETES ASSO-
CIATION".

SER. NO. 77-164,284, FILED 4-24-2007.

CAROLINE WOOD, EXAMINING ATTORNEY

Int. Cls.: 36 and 45

Prior U.S. Cls.: 100, 101 and 102

United States Patent and Trademark Office

Reg. No. 3,483,136

Registered Aug. 12, 2008

**SERVICE MARK
PRINCIPAL REGISTER**

**Cardinal Intellectual
Property**

CARDINAL INTELLECTUAL PROPERTY, INC.
(ILLINOIS CORPORATION)
SUITE 2000
1603 ORRINGTON AVENUE
EVANSTON, IL 60201

FOR: INTELLECTUAL PROPERTY VALUATION
ANALYSIS, IN CLASS 36 (U.S. CLS. 100, 101 AND
102).

FIRST USE 3-21-2007; IN COMMERCE 3-21-2007.

FOR: INTELLECTUAL PROPERTY SEARCH
ANALYSIS AND INTELLECTUAL PROPERTY
SEARCHING, IN CLASS 45 (U.S. CLS. 100 AND 101).

FIRST USE 3-21-2007; IN COMMERCE 3-21-2007.

THE MARK CONSISTS OF STANDARD CHAR-
ACTERS WITHOUT CLAIM TO ANY PARTICULAR
FONT, STYLE, SIZE, OR COLOR.

OWNER OF U.S. REG. NO. 2,622,102.

NO CLAIM IS MADE TO THE EXCLUSIVE
RIGHT TO USE "INTELLECTUAL PROPERTY",
APART FROM THE MARK AS SHOWN.

SER. NO. 77-165,148, FILED 4-25-2007.

CARYN GLASSER, EXAMINING ATTORNEY

Int. Cl.: 36

Prior U.S. Cls.: 100, 101 and 102

United States Patent and Trademark Office

Reg. No. 3,483,137

Registered Aug. 12, 2008

**SERVICE MARK
PRINCIPAL REGISTER**

**AMERICANS FOR FAIRNESS IN
LENDING**

AMERICANS FOR FAIRNESS IN LENDING,
INC. (MASSACHUSETTS CORPORATION)
10TH FLOOR
77 SUMMER STREET
BOSTON, MA 02110

FOR: PROVIDING INFORMATION IN THE
FIELD OF CONSUMER CREDIT; PROVIDING IN-
FORMATION IN THE FIELD OF CONSUMER
CREDIT ACTIVISM, IN CLASS 36 (U.S. CLS. 100,
101 AND 102).

FIRST USE 10-2-2006; IN COMMERCE 10-2-2006.

THE MARK CONSISTS OF STANDARD CHAR-
ACTERS WITHOUT CLAIM TO ANY PARTICULAR
FONT, STYLE, SIZE, OR COLOR.

NO CLAIM IS MADE TO THE EXCLUSIVE
RIGHT TO USE "AMERICANS" AND "LENDING",
APART FROM THE MARK AS SHOWN.

SER. NO. 77-166,352, FILED 4-26-2007.

JOHN E. MICHOS, EXAMINING ATTORNEY

Int. Cls.: 9, 10, 35 and 44

Prior U.S. Cls.: 21, 23, 26, 36, 38, 39, 44, 100, 101 and 102

Reg. No. 3,483,138

United States Patent and Trademark Office

Registered Aug. 12, 2008

**TRADEMARK
SERVICE MARK
PRINCIPAL REGISTER**

MEDICPEN

MEDICPEN AB (SWEDEN STOCK COMPANY)
STORGATAN 44
HALMSTAD, SWEDEN 30243

FOR: DOSAGE DISPENSING APPARATUS, NAMELY, DEVICES FOR DISPENSING PRE-DETERMINED DOSAGES OF MEDICATION; DATA-PROCESSING APPARATUS, NAMELY, DATA PROCESSORS, IN CLASS 9 (U.S. CLS. 21, 23, 26, 36 AND 38).

FOR: MEDICAL APPARATUS AND INSTRUMENTS, NAMELY, APPARATUS FOR CONTROLLING INTAKE OF MEDICATION, IN CLASS 10 (U.S. CLS. 26, 39 AND 44).

FOR: ADVERTISING; RETAIL STORE SERVICES FEATURING MEASURING, SIGNALING, CHECKING AND SUPERVISORY APPARATUS AND INSTRUMENTS, DOSAGE DISPENSERS, DATA PROCESSING EQUIPMENT AND MEDICAL APPA-

RATUS AND INSTRUMENTS, IN CLASS 35 (U.S. CLS. 100, 101 AND 102).

FOR: MEDICAL SERVICES; INFORMATION RELATING TO THE CARE OF PERSONS, NAMELY, PROVIDING HEALTH CARE INFORMATION, IN CLASS 44 (U.S. CLS. 100 AND 101).

THE MARK CONSISTS OF STANDARD CHARACTERS WITHOUT CLAIM TO ANY PARTICULAR FONT, STYLE, SIZE, OR COLOR.

PRIORITY CLAIMED UNDER SEC. 44(D) ON ERPN CMNTY TM OFC APPLICATION NO. 5453246, FILED 10-27-2006, REG. NO. 5453246, DATED 11-12-2007, EXPIRES 10-27-2016.

SER. NO. 77-166,520, FILED 4-26-2007.

RON FAIRBANKS, EXAMINING ATTORNEY

Int. Cl.: 36

Prior U.S. Cls.: 100, 101 and 102

United States Patent and Trademark Office

Reg. No. 3,483,139

Registered Aug. 12, 2008

**SERVICE MARK
PRINCIPAL REGISTER**

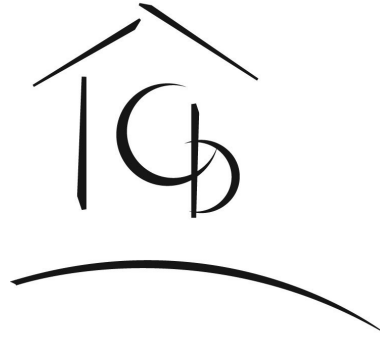

CITYWIDE BROKERS, INC. (COLORADO CORPORATION)
1717 E. 39TH AVE.
DENVER, CO 80205

FOR: REAL ESTATE BROKERAGE, IN CLASS 36
(U.S. CLS. 100, 101 AND 102).

FIRST USE 2-28-2007; IN COMMERCE 2-28-2007.

THE MARK CONSISTS OF A HOME STRUCTURE
WITH AN ARTISTIC "C" AND "B". THE "C" SITS IN

THE MIDDLE OF THE HOME STRUCTURE WITH
THE "B" PLACED OVER BOTTOM-RIGHT CURVE
OF "C". BENEATH THE HOME STRUCTURE, THE
"C" AND "B" AND EXTENDING PAST THE LEFT
AND RIGHT SIDES OF THE HOME STRUCTURE IS
A SLIGHTLY CURVED HILL STRUCTURE.

SER. NO. 77-166,916, FILED 4-26-2007.

SHARON MEIER, EXAMINING ATTORNEY

Int. Cls.: 7 and 37

Prior U.S. Cls.: 13, 19, 21, 23, 31, 34, 35, 100, 103 and 106

Reg. No. 3,483,140

United States Patent and Trademark Office

Registered Aug. 12, 2008

**TRADEMARK
SERVICE MARK
PRINCIPAL REGISTER**

SMITH INTERNATIONAL, INC.

SMITH INTERNATIONAL, INC. (DELAWARE CORPORATION)
16740 HARDY STREET
HOUSTON, TX 77032

FOR: DRILLING MACHINES AND PARTS THEREFORE FOR DRILLING AND COMPLETING OIL AND GAS WELLS, COMPRISED OF DRILLING MACHINES, TURBODRILLS, DOWNHOLE MOTORS, TUBING, DRILL PIPE, CASING, PACKERS AND PACKER ACCESSORIES SOLD AS A UNIT, DRILL BITS, REAMERS, MILLS AND MILLING ACCESSORIES SOLD AS A UNIT, VALVES, SUBMERSIBLE PUMPS, WIRELINE ACTUATED TOOLS AND SUBS, IN CLASS 7 (U.S. CLS. 13, 19, 21, 23, 31, 34 AND 35).

FIRST USE 1-18-1937; IN COMMERCE 1-18-1937.

FOR: OIL AND GAS WELL CONSTRUCTION AND DRILLING SERVICES, WELLBORE WASTE DISPOSAL SERVICES, CASING, TUBING AND

DRILL PIPE INSTALLATION AND COMPLETION SERVICES AND TOOL RENTAL SERVICES, IN CLASS 37 (U.S. CLS. 100, 103 AND 106).

FIRST USE 1-18-1937; IN COMMERCE 1-18-1937.

THE MARK CONSISTS OF STANDARD CHARACTERS WITHOUT CLAIM TO ANY PARTICULAR FONT, STYLE, SIZE, OR COLOR.

OWNER OF U.S. REG. NOS. 1,252,730, 3,124,352 AND OTHERS.

NO CLAIM IS MADE TO THE EXCLUSIVE RIGHT TO USE "INTERNATIONAL, INC.", APART FROM THE MARK AS SHOWN.

SER. NO. 77-167,201, FILED 4-27-2007.

JULIE WATSON, EXAMINING ATTORNEY

Prior U.S. Cl.: A

United States Patent and Trademark Office

Reg. No. 3,483,141

Registered Aug. 12, 2008

CERTIFICATION MARK
PRINCIPAL REGISTER



FLORIDA DEPARTMENT OF AGRICULTURE
AND CONSUMER SERVICES (FLORIDA
STATE AGENCY)

407 S. CALHOUN STREET
TALLAHASSEE, FL 323990800

FOR: NATURAL FRESH AGRICULTURAL
FOOD PRODUCTS FROM A FLORIDA PRODUCER,
PROCESSOR, SHIPPER, PACKER, WHOLESALER
OR RETAILER, IN CLASS A (U.S. CL. A).

FIRST USE 8-31-1991; IN COMMERCE 8-31-1991.

NO CLAIM IS MADE TO THE EXCLUSIVE
RIGHT TO USE "FRESH", APART FROM THE
MARK AS SHOWN.

THE CERTIFICATION MARK, AS USED BY
AUTHORIZED PERSONS, CERTIFIES THE PRO-
DUCT IS A FRESH AGRICULTURAL PRODUCT
FROM A FLORIDA PRODUCER, PROCESSOR,
SHIPPER, PACKER, WHOLESALER, OR RETAILER.

SER. NO. 77-168,050, FILED 4-27-2007.

STEPHEN AQUILA, EXAMINING ATTORNEY

Int. Cl.: 45

Prior U.S. Cls.: 100 and 101

United States Patent and Trademark Office

Reg. No. 3,483,142

Registered Aug. 12, 2008

**SERVICE MARK
PRINCIPAL REGISTER**

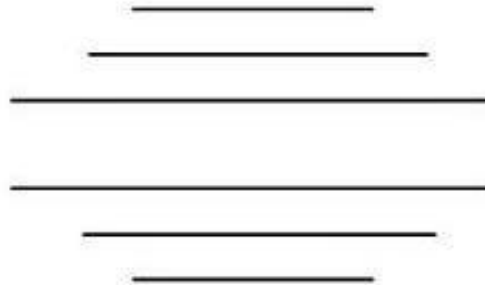

JOHNSTON, MICHAEL W. (UNITED STATES
INDIVIDUAL)
4200 AIRPORT FREEWAY
DISPUTE MANAGEMENT CENTER
FORT WORTH, TX 76117

FOR: ATTORNEY SERVICES; MEDIATION; LITI-
GATION SERVICES; ARBITRATION SERVICES, IN
CLASS 45 (U.S. CLS. 100 AND 101).

FIRST USE 1-1-1997; IN COMMERCE 1-1-1997.

THE MARK CONSISTS OF SIX PARALLEL HOR-
IZONTAL LINES. LINES 3 AND 4 ARE THE SAME

LENGTH. LINES 2 AND 5 ARE THE SAME LENGTH
AND SHORTER THAN LINES 3 AND 4. LINES 1
AND 6 ARE THE SAME LENGTH AND ARE THE
SHORTEST OF ALL OF THE LINES. THERE IS AN
EQUAL SPACE BETWEEN ALL LINES EXCEPT
FOR BETWEEN LINES 3 AND 4, THERE IS ADDI-
TIONAL SPACE BETWEEN THOSE.

SER. NO. 77-168,675, FILED 4-30-2007.

LESLIE RICHARDS, EXAMINING ATTORNEY

Int. Cl.: 43

Prior U.S. Cls.: 100 and 101

United States Patent and Trademark Office

Reg. No. 3,483,143

Registered Aug. 12, 2008

SERVICE MARK
PRINCIPAL REGISTER



TAQUERIA EL SABOR LLC (WASHINGTON LTD
LIAB CO)
401 SW 153RD ST., SUITE F
BURIEN, WA 98166

THE COLOR(S) GREEN, RED, WHITE, YELLOW,
AND ORANGE IS/ARE CLAIMED AS A FEATURE
OF THE MARK.

FOR: RESTAURANTS; RESTAURANTS FEATUR-
ING HOME DELIVERY; SELF SERVICE RESTAU-
RANTS; SELF-SERVICE RESTAURANTS; TAKE-
OUT RESTAURANT SERVICES; CAFE-RESTAU-
RANTS; CARRY-OUT RESTAURANTS; DELICA-
TESSENS; FAST FOOD AND NON-STOP
RESTAURANT SERVICES; FAST-FOOD RESTAU-
RANTS; FAST-FOOD RESTAURANTS AND SNACK
BARS; RESERVATION OF RESTAURANTS; RES-
TAURANT AND BAR SERVICES; RESTAURANT
SERVICES, IN CLASS 43 (U.S. CLS. 100 AND 101).

THE MARK CONSISTS OF THE WORD TAQUER-
IA IN GREEN ABOVE A STYLIZED LETTER BOX
WITHIN WHICH APPEAR THE WORDS EL SABOR
IN YELLOW WITH THE WORD AUNTENTICO IN
WHITE ABOVE IT AND THE WORD MEXICANO IN
WHITE BELOW IT. THE LETTER BOX HAS TWO
SWISH LINE DESIGN ELEMENTS IN ORANGE
ABOVE AND BELOW THE WORDING, ALONG
WITH A WHITE BORDER APPEARING AROUND
THE PERIMETER OF THE LETTER BOX. .

FIRST USE 4-1-2007; IN COMMERCE 4-1-2007.

THE FOREIGN WORDING IN THE MARK
TRANSLATES INTO ENGLISH AS TACO SHOP
THE FLAVOR AUTHENTIC MEXICAN.

NO CLAIM IS MADE TO THE EXCLUSIVE
RIGHT TO USE "TAQUERIA" AND "AUTENTICO
MEXICANO", APART FROM THE MARK AS
SHOWN.

SER. NO. 77-168,951, FILED 4-30-2007.

ESTHER A. BORSUK, EXAMINING ATTORNEY

Int. Cls.: 37, 39 and 42

Prior U.S. Cls.: 100, 101, 103, 105 and 106

United States Patent and Trademark Office

Reg. No. 3,483,144

Registered Aug. 12, 2008

**SERVICE MARK
PRINCIPAL REGISTER**

UBQ

UBQ (SWEDEN CORPORATION)
KVARNBYSVÄGEN 18
MALMO, SWEDEN

FOR: BUILDING CONSTRUCTION SERVICES, IN
CLASS 37 (U.S. CLS. 100, 103 AND 106).

FOR: TRANSPORT OF GOODS, IN CLASS 39 (U.S.
CLS. 100 AND 105).

FOR: COMPUTER SOFTWARE CONSULTANCY,
IN CLASS 42 (U.S. CLS. 100 AND 101).

THE MARK CONSISTS OF STANDARD CHAR-
ACTERS WITHOUT CLAIM TO ANY PARTICULAR
FONT, STYLE, SIZE, OR COLOR.

PRIORITY CLAIMED UNDER SEC. 44(D) ON
ERPN CMNTY TM OFC APPLICATION NO.
005737127, FILED 3-6-2007, REG. NO. 005737127,
DATED 1-7-2008, EXPIRES 3-6-2017.

SER. NO. 77-169,696, FILED 5-1-2007.

ANDREA SAUNDERS, EXAMINING ATTORNEY

Int. Cl.: 41

Prior U.S. Cls.: 100, 101 and 107

United States Patent and Trademark Office

Reg. No. 3,483,145

Registered Aug. 12, 2008

**SERVICE MARK
PRINCIPAL REGISTER**



MOMMYDOCS, LLC (MARYLAND LTD LIAB
CO)

8408 PITTSFIELD COURT

POTOMAC, MD 20854

FOR: EDUCATIONAL AND ENTERTAINMENT
SERVICES, NAMELY PROVIDING PROGRAMS IN
THE FIELD OF CHILDREN HEALTH ISSUES; PRO-
VIDING A WEBSITE FEATURING INFORMATION
IN THE FIELD OF CHILDREN'S EDUCATION
ISSUES, IN CLASS 41 (U.S. CLS. 100, 101 AND 107).

FIRST USE 1-7-2007; IN COMMERCE 1-7-2007.

THE COLOR(S) PINK, WHITE, BLACK AND
GREY IS/ARE CLAIMED AS A FEATURE OF THE
MARK.

THE MARK CONSISTS OF A PINK BAND-AID
WITH WHITE DOTS WITH THE WORDING "MOM-
MYDOCS" SHADED IN BLACK AND LOCATED IN
THE CENTER OF THE BAND-AID WITH A GREY
TELESCOPE SHADED WITH BLACK AND WHITE
WRAPPED AROUND THE BAND-AID.

SER. NO. 77-170,016, FILED 5-1-2007.

MICHAEL LEWIS, EXAMINING ATTORNEY

Int. Cl.: 3

Prior U.S. Cls.: 1, 4, 6, 50, 51 and 52

Reg. No. 3,483,146

United States Patent and Trademark Office

Registered Aug. 12, 2008

**TRADEMARK
PRINCIPAL REGISTER**

SKIN FIX TATTOO OINTMENT

NGUYEN, DA VAN (UNITED STATES INDIVIDUAL)
3024 N. CICERO AVE.
CHICAGO, IL 60641

FOR: SKIN AND BODY TOPICAL LOTIONS, CREAMS AND OILS FOR THE LONGEVITY OF YOUR TATTOO, IN CLASS 3 (U.S. CLS. 1, 4, 6, 50, 51 AND 52).

FIRST USE 4-20-2006; IN COMMERCE 5-1-2006.

THE MARK CONSISTS OF STANDARD CHARACTERS WITHOUT CLAIM TO ANY PARTICULAR FONT, STYLE, SIZE, OR COLOR.

NO CLAIM IS MADE TO THE EXCLUSIVE RIGHT TO USE "SKIN" AND "TATTOO OINTMENT", APART FROM THE MARK AS SHOWN.

SER. NO. 77-170,150, FILED 5-1-2007.

LINDA POWELL, EXAMINING ATTORNEY

Int. Cl.: 11

Prior U.S. Cls.: 13, 21, 23, 31 and 34

United States Patent and Trademark Office

Reg. No. 3,483,147

Registered Aug. 12, 2008

TRADEMARK
PRINCIPAL REGISTER

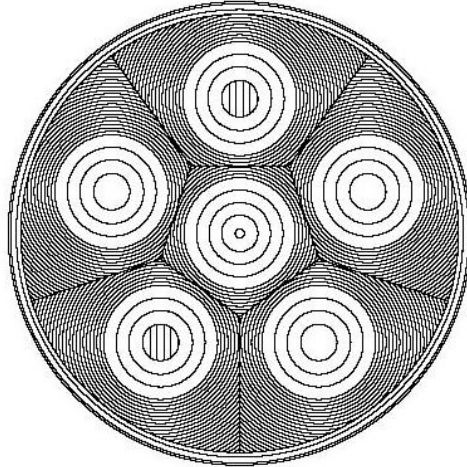

TRUCK-LITE CO., INC. (NEW YORK CORPORATION)
310 EAST ELMWOOD AVENUE
FALCONER, NY 14733

FOR: LIGHTING PRODUCTS FOR VEHICLES, NAMELY, A COMBINED STOP-TURN-TAIL LAMP, IN CLASS 11 (U.S. CLS. 13, 21, 23, 31 AND 34).

FIRST USE 10-31-2000; IN COMMERCE 10-31-2000.

THE MARK CONSISTS OF THE CONFIGURATION OF A STOP/TURN/TAIL LIGHT, WHICH CONSISTS OF A CIRCULAR BASE AND A CIRCULAR COVER PORTION. THE CIRCULAR COVER PORTION OF THE STOP/TURN/TAIL LIGHT CONSISTS OF AN ARRANGEMENT OF CIRCULAR PATTERNS INTEGRALLY FORMED WITHIN THE COVER. THE CIRCULAR PATTERNS FORM INDIVIDUAL LENS PORTIONS ARRANGED ABOVE LIGHT EMITTING DIODE (LED) LIGHTS LOCA-

TED WITHIN THE INTERIOR OF THE STOP/TURN/TAIL LIGHT. THERE ARE SIX LENSES AND SIX CORRESPONDING LED'S. A CENTER LENS PORTION, WHICH HAS A PENTAGONAL PERIMETER, IS LOCATED IN THE CENTER OF THE COVER. EACH OF THE FIVE ADDITIONAL LENS PORTIONS ARE ARRANGED AROUND THE PENTAGONAL PERIMETER OF THE CENTER LENS PORTION. A CORRESPONDING LED IS POSITIONED BELOW EACH LENS PORTION. WHEN ILLUMINATED, THE LIGHT EMITTED FROM THE SIX LED'S SHINES THROUGH THE CORRESPONDING LENS PORTIONS AND THE AFOREMENTIONED PATTERN OF THE LED'S AND LENS PORTIONS IS VISIBLE.

SEC. 2(F).

SER. NO. 77-171,113, FILED 5-2-2007.

DAWN HAN, EXAMINING ATTORNEY

Int. Cl.: 28

Prior U.S. Cls.: 22, 23, 38 and 50

Reg. No. 3,483,148

United States Patent and Trademark Office

Registered Aug. 12, 2008

**TRADEMARK
PRINCIPAL REGISTER**



T&L PERFECT USA, INC. (CALIFORNIA CORPORATION)

14452 CHESTNUT STREET

WESTMINSTER, CA 92683

FOR: EXERCISE MACHINE, IN CLASS 28 (U.S. CLS. 22, 23, 38 AND 50).

FIRST USE 11-22-2006; IN COMMERCE 11-22-2006.

NO CLAIM IS MADE TO THE EXCLUSIVE RIGHT TO USE "CHAIR", APART FROM THE MARK AS SHOWN.

THE MARK CONSISTS OF THE WORDS "HAWAII" AND "CHAIR" SEPARATED BY A STYLIZED "H".

SER. NO. 77-172,080, FILED 5-3-2007.

JESSICA FATHY, EXAMINING ATTORNEY

Int. Cls.: 9, 18 and 25

Prior U.S. Cls.: 1, 2, 3, 21, 22, 23, 26, 36, 38, 39 and 41

United States Patent and Trademark Office

Reg. No. 3,483,149

Registered Aug. 12, 2008

**TRADEMARK
PRINCIPAL REGISTER**

BODY FADERS

WICKEDGLOW INDUSTRIES, INC. (MICHIGAN CORPORATION)
11456 FRANCIS DRIVE
STERLING HEIGHTS, MI 48312

FOR: CARRYING CASES FOR ELECTRICAL EQUIPMENT, NAMELY, CELL PHONES, IN CLASS 9 (U.S. CLS. 21, 23, 26, 36 AND 38).

FIRST USE 4-30-2007; IN COMMERCE 4-30-2007.

FOR: HAND BAGS; PET SWEATERS; PET COATS, IN CLASS 18 (U.S. CLS. 1, 2, 3, 22 AND 41).

FIRST USE 2-12-2007; IN COMMERCE 2-12-2007.

FOR: T-SHIRTS, TANK TOPS, HALTER TOPS, LONG AND SHORT SLEEVE POLO SHIRTS, SPORTS SHIRTS, HENLEYS, SWEATSHIRTS, HOODED SHIRTS, CARDIGANS, SWEAT PANTS, ROBES, SWIM COVER-UPS, FLAT CAPS, KNIT

CAPS, HEAD BANDS, BANDANNAS, PONCHOS, TUBE TOPS, SKIRTS, BLOUSES, SHORTS, IN CLASS 25 (U.S. CLS. 22 AND 39).

FIRST USE 5-28-2005; IN COMMERCE 5-28-2005.

THE MARK CONSISTS OF STANDARD CHARACTERS WITHOUT CLAIM TO ANY PARTICULAR FONT, STYLE, SIZE, OR COLOR.

OWNER OF U.S. REG. NO. 2,947,824.

NO CLAIM IS MADE TO THE EXCLUSIVE RIGHT TO USE "BODY", APART FROM THE MARK AS SHOWN.

SER. NO. 77-172,893, FILED 5-4-2007.

WENDY GOODMAN, EXAMINING ATTORNEY

Int. Cl.: 35

Prior U.S. Cls.: 100, 101 and 102

United States Patent and Trademark Office

Reg. No. 3,483,150

Registered Aug. 12, 2008

**SERVICE MARK
PRINCIPAL REGISTER**

LONGS DRUGS HAWAII CARE

LONGS DRUG STORES CALIFORNIA, INC. (CALIFORNIA CORPORATION)

141 N. CIVIC

WALNUT CREEK, CA 94596

FOR: ADMINISTRATION OF A DISCOUNT AND REBATE PROGRAM FOR ENABLING PARTICIPANTS TO OBTAIN DISCOUNTS AND REBATES ON GOODS AND SERVICES THROUGH USE OF A DISCOUNT MEMBERSHIP CARD AT COMPANY OWNED STORES, IN CLASS 35 (U.S. CLS. 100, 101 AND 102).

FIRST USE 3-0-2007; IN COMMERCE 4-0-2007.

THE MARK CONSISTS OF STANDARD CHARACTERS WITHOUT CLAIM TO ANY PARTICULAR FONT, STYLE, SIZE, OR COLOR.

OWNER OF U.S. REG. NOS. 2,838,531 AND 3,065,272.

NO CLAIM IS MADE TO THE EXCLUSIVE RIGHT TO USE "HAWAII" AND "CARE", APART FROM THE MARK AS SHOWN.

SEC. 2(F) AS TO "LONGS DRUGS".

SER. NO. 77-173,190, FILED 5-4-2007.

JOHN WILKE, EXAMINING ATTORNEY

Int. Cl.: 9

Prior U.S. Cls.: 21, 23, 26, 36 and 38

Reg. No. 3,483,151

United States Patent and Trademark Office

Registered Aug. 12, 2008

**TRADEMARK
PRINCIPAL REGISTER**

PriceNav

RESOLUTE SOLUTIONS, INC. (MARYLAND CORPORATION)
931 DEEP CREEK AVENUE
ARNOLD, MD 21012

FOR: COMPUTER DATABASE MANAGEMENT SOFTWARE FOR USE IN PERSONALIZING THE CONTENT OF EMAIL COMMUNICATIONS; COMPUTER SOFTWARE THAT PROVIDES REAL-TIME, INTEGRATED BUSINESS MANAGEMENT INTELLIGENCE BY COMBINING INFORMATION FROM VARIOUS DATABASES AND PRESENTING IT IN AN EASY-TO-UNDERSTAND USER INTERFACE; COMPUTER SOFTWARE, NAMELY, AN APPLICATION ALLOWING SALES AND FIELD SERVICE EMPLOYEES TO UPDATE AND RECEIVE DATA STORED IN AN ENTERPRISE'S COMPUTER DATABASES IN REAL TIME, USING A MOBILE DE-

VICE, WITH FULL TELEPHONY INTEGRATION WITH THE TELEPHONE AND/OR SOFTWARE FEATURES OF THE MOBILE DEVICE; DATABASE MANAGEMENT SOFTWARE FOR MORTGAGE RATE PRICING, IN CLASS 9 (U.S. CLS. 21, 23, 26, 36 AND 38).

FIRST USE 8-23-2005; IN COMMERCE 8-23-2005.

THE MARK CONSISTS OF STANDARD CHARACTERS WITHOUT CLAIM TO ANY PARTICULAR FONT, STYLE, SIZE, OR COLOR.

SER. NO. 77-173,559, FILED 5-4-2007.

TINA BROWN, EXAMINING ATTORNEY

Int. Cls.: 16, 20 and 27

Prior U.S. Cls.: 2, 5, 13, 19, 20, 22, 23, 25, 29, 32, 37, 38, 42 and 50

Reg. No. 3,483,152

United States Patent and Trademark Office

Registered Aug. 12, 2008

**TRADEMARK
PRINCIPAL REGISTER**



KITTRICH CORPORATION (CALIFORNIA CORPORATION)
14555 ALONDRA BLVD.
LA MIRADA, CA 90638

FOR: SHELF LINING MATERIAL, NAMELY, PLASTIC AND VINYL SHELF LINING, IN CLASS 16 (U.S. CLS. 2, 5, 22, 23, 29, 37, 38 AND 50).

FIRST USE 6-5-1999; IN COMMERCE 6-5-1999.

FOR: SINK MATS, RUBBER DISH MATS AND PLASTIC REFRIGERATOR BIN MATS, IN CLASS 20 (U.S. CLS. 2, 13, 22, 25, 32 AND 50).

FIRST USE 6-5-1999; IN COMMERCE 6-5-1999.

FOR: FLOOR COVERINGS, NAMELY, SAFETY MATTING AND ANTI-SLIP MATTING; CARPETS, RUGS, MATS AND MATTING; CARPET RUNNERS; FLOOR MATS; WALLCOVERINGS; FLOOR COV-

ERINGS, IN CLASS 27 (U.S. CLS. 19, 20, 37, 42 AND 50).

FIRST USE 12-31-2005; IN COMMERCE 12-31-2005.

OWNER OF U.S. REG. NOS. 1,479,570, 2,810,711 AND OTHERS.

NO CLAIM IS MADE TO THE EXCLUSIVE RIGHT TO USE "COVER", APART FROM THE MARK AS SHOWN.

THE MARK CONSISTS OF THE WORDS "MAGIC COVER" WITH A NARROW INVERTED ARC ABOVE THE WORDS.

SER. NO. 77-173,574, FILED 5-4-2007.

G. MAYERSCHOFF, EXAMINING ATTORNEY

Int. Cl.: 9

Prior U.S. Cls.: 21, 23, 26, 36 and 38

United States Patent and Trademark Office

Reg. No. 3,483,153

Registered Aug. 12, 2008

TRADEMARK
PRINCIPAL REGISTER

PipeNav

RESOLUTE SOLUTIONS, INC. (MARYLAND CORPORATION)
931 DEEP CREEK AVENUE
ARNOLD, MD 21012

FOR: COMPUTER SOFTWARE FOR APPLICATION AND DATABASE INTEGRATION; COMPUTER SOFTWARE THAT PROVIDES REAL-TIME, INTEGRATED BUSINESS MANAGEMENT INTELLIGENCE BY COMBINING INFORMATION FROM VARIOUS DATABASES AND PRESENTING IT IN AN EASY-TO-UNDERSTAND USER INTERFACE; DATABASE MANAGEMENT SOFTWARE FOR IN-

TEGRATED MORTGAGE PIPELINE MANAGEMENT, IN CLASS 9 (U.S. CLS. 21, 23, 26, 36 AND 38).

FIRST USE 11-18-2003; IN COMMERCE 11-18-2003.

THE MARK CONSISTS OF STANDARD CHARACTERS WITHOUT CLAIM TO ANY PARTICULAR FONT, STYLE, SIZE, OR COLOR.

SER. NO. 77-173,590, FILED 5-4-2007.

TINA BROWN, EXAMINING ATTORNEY

Int. Cl.: 40

Prior U.S. Cls.: 100, 103 and 106

United States Patent and Trademark Office

Reg. No. 3,483,154

Registered Aug. 12, 2008

**SERVICE MARK
PRINCIPAL REGISTER**

I AM AMERICAN MADE

TAUNTON, KEN (UNITED STATES INDIVIDUAL)
813 DEERWOOD DRIVE, SUITE 100
STOCKBRIDGE, GA 30281

FOR: IMPRINTING MESSAGES ON WEARING APPAREL, ACCESSORIES AND MUGS, IN CLASS 40 (U.S. CLS. 100, 103 AND 106).

FIRST USE 10-5-2006; IN COMMERCE 10-5-2006.

THE MARK CONSISTS OF STANDARD CHARACTERS WITHOUT CLAIM TO ANY PARTICULAR FONT, STYLE, SIZE, OR COLOR.

NO CLAIM IS MADE TO THE EXCLUSIVE RIGHT TO USE "AMERICAN MADE", APART FROM THE MARK AS SHOWN.

SER. NO. 77-173,857, FILED 5-6-2007.

FLORENTINA BLANDU, EXAMINING ATTORNEY

Int. Cl.: 9

Prior U.S. Cls.: 21, 23, 26, 36 and 38

United States Patent and Trademark Office

Reg. No. 3,483,155

Registered Aug. 12, 2008

**TRADEMARK
PRINCIPAL REGISTER**

X-act

DRÄGER SAFETY AG & CO. KGAA (FED REP
GERMANY CORPORATION)
REVALSTR. 1
LÜBECK, FED REP GERMANY 23560

FOR: FEED PUMPS FOR DETECTING GASEOUS
OR LIQUID COMPONENTS IN GASES OR LIQUIDS
BY MEANS OF SENSORS OR TEST TUBES, IN
CLASS 9 (U.S. CLS. 21, 23, 26, 36 AND 38).

THE MARK CONSISTS OF STANDARD CHAR-
ACTERS WITHOUT CLAIM TO ANY PARTICULAR
FONT, STYLE, SIZE, OR COLOR.

PRIORITY CLAIMED UNDER SEC. 44(D) ON
ERPN CMNTY TM OFC APPLICATION NO.
005856943, FILED 4-25-2007, REG. NO. 005856943,
DATED 3-6-2008, EXPIRES 4-25-2017.

SER. NO. 77-175,079, FILED 5-8-2007.

JOHN WILKE, EXAMINING ATTORNEY

Int. Cl.: 37

Prior U.S. Cls.: 100, 103 and 106

United States Patent and Trademark Office

Reg. No. 3,483,156

Registered Aug. 12, 2008

**SERVICE MARK
PRINCIPAL REGISTER**

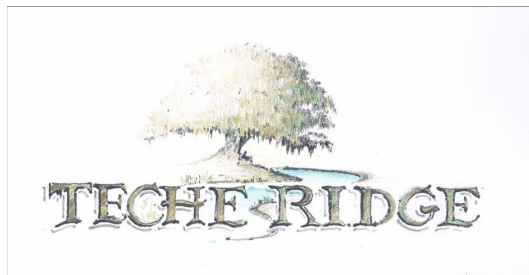

SOUTHERN MUTUAL HELP ASSOCIATION,
INC. (LOUISIANA CORPORATION)

3602 OLD JEANERETTE ROAD

NEW IBERIA, LA 70563

FOR: REAL ESTATE DEVELOPMENT, NAMELY,
TRADITIONAL RESIDENTIAL NEIGHBORHOOD
COMMUNITIES, IN CLASS 37 (U.S. CLS. 100, 103
AND 106).

FIRST USE 4-27-2007; IN COMMERCE 4-27-2007.

NO CLAIM IS MADE TO THE EXCLUSIVE
RIGHT TO USE "TECHE RIDGE", APART FROM
THE MARK AS SHOWN.

THE COLOR(S) BROWN, GREEN, BLUE, WHITE,
BLACK, TAN AND OLIVE IS/ARE CLAIMED AS A
FEATURE OF THE MARK.

THE MARK CONSISTS OF A TREE WITH A
BLACK OUTLINE, GREEN, TAN, AND WHITE
LEAVES AND TRUNK, GRASS WITH GREEN,
TAN AND WHITE COLORS, BLUE WATER OUT-
LINED IN BLACK, AND THE LITERAL ELEMENT
"TECHE RIDGE" IN BROWN, TAN, GREEN, OLIVE
AND WHITE AND OUTLINED IN BLACK.

SER. NO. 77-175,171, FILED S.R. 5-8-2007 AM. P.R.
2-29-2008.

ANGELA GAW, EXAMINING ATTORNEY

Int. Cls.: 16, 36 and 41

**Prior U.S. Cls.: 2, 5, 22, 23, 29, 37, 38, 50, 100, 101, 102
and 107**

Reg. No. 3,483,157

United States Patent and Trademark Office

Registered Aug. 12, 2008

**TRADEMARK
SERVICE MARK
PRINCIPAL REGISTER**

MONEY MOTTO

ROPER HOUSE PUBLISHING LTD. (CANADA
CORPORATION)
WHITE ROCK
14862 ROPER AVENUE
BRITISH COLUMBIA, CANADA V4B2E2

FOR: BOOKS IN THE FIELD OF FINANCIAL
AND LIFE PLANNING, NAMELY, LIFE PLANNING
RELATING TO FINANCE AND WEALTH MAN-
AGEMENT, IN CLASS 16 (U.S. CLS. 2, 5, 22, 23, 29, 37,
38 AND 50).

FOR: FINANCIAL CONSULTATION, NAMELY,
MOTIVATIONAL CONSULTING IN THE FIELD OF
FINANCIAL AND LIFE PLANNING, IN CLASS 36
(U.S. CLS. 100, 101 AND 102).

FOR: EDUCATIONAL SERVICES, NAMELY,
CONDUCTING LECTURES IN THE FIELD OF
FINANCIAL LIFE PLANNING AND CONDUCTING

SEMINARS IN THE FIELD OF FINANCIAL AND
LIFE PLANNING, IN CLASS 41 (U.S. CLS. 100, 101
AND 107).

THE MARK CONSISTS OF STANDARD CHAR-
ACTERS WITHOUT CLAIM TO ANY PARTICULAR
FONT, STYLE, SIZE, OR COLOR.

OWNER OF CANADA REG. NO. TMA694022,
DATED 8-14-2007, EXPIRES 8-14-2022.

NO CLAIM IS MADE TO THE EXCLUSIVE
RIGHT TO USE "MONEY", APART FROM THE
MARK AS SHOWN.

SER. NO. 77-175,394, FILED 5-8-2007.

LESLIE RICHARDS, EXAMINING ATTORNEY

Int. Cl.: 35

Prior U.S. Cls.: 100, 101 and 102

United States Patent and Trademark Office

Reg. No. 3,483,158

Registered Aug. 12, 2008

**SERVICE MARK
PRINCIPAL REGISTER**

“Get Your Pipes Checked”

PIPETECH PLUMBING AND ROOTER, LLC.
(ARIZONA LTD LIAB CO)
1742 S. FRASER DRIVE
MESA, AZ 85204

THE COLOR(S) BLUE IS/ARE CLAIMED AS A
FEATURE OF THE MARK.

FOR: ADVERTISING AND BUSINESS SERVICES,
NAMELY, SECURING AIRTIME ON ALL FORMS
OF MEDIA COMMUNICATIONS STATIONS, SYS-
TEMS, NETWORKS, AND SERVICES FOR THE
PURPOSE OF PROMOTING THE GOODS AND
SERVICES OF OTHERS, IN CLASS 35 (U.S. CLS.
100, 101 AND 102).

THE MARK CONSISTS OF THE WORDS "GET
YOUR PIPES CHECKED" IN THE FONT OF BLUE
HIGHWAY.

SER. NO. 77-175,563, FILED 5-8-2007.

FIRST USE 8-1-2003; IN COMMERCE 8-1-2003.

DEZMONA MIZELLE, EXAMINING ATTORNEY

Int. Cl.: 21

Prior U.S. Cls.: 2, 13, 23, 29, 30, 33, 40 and 50

Reg. No. 3,483,159

United States Patent and Trademark Office

Registered Aug. 12, 2008

**TRADEMARK
PRINCIPAL REGISTER**

**ISLAND CRAFT
ORIGINALS**

CRAFT PEDLARS, INC., THE (CALIFORNIA
CORPORATION)
1035 SHARY CT
CONCORD, CA 94518

NO CLAIM IS MADE TO THE EXCLUSIVE
RIGHT TO USE "CRAFT ORIGINALS", APART
FROM THE MARK AS SHOWN.

FOR: BASKETS OF WICKER, IN CLASS 21 (U.S.
CLS. 2, 13, 23, 29, 30, 33, 40 AND 50).

SER. NO. 77-175,846, FILED 5-8-2007.

FIRST USE 5-1-2007; IN COMMERCE 5-1-2007.

HOWARD FRIEDMAN, EXAMINING ATTORNEY

Int. Cl.: 10

Prior U.S. Cls.: 26, 39 and 44

United States Patent and Trademark Office

Reg. No. 3,483,160

Registered Aug. 12, 2008

**TRADEMARK
PRINCIPAL REGISTER**

TRI SPHERE

TRI-SPHERE HOLDINGS, L.L.C. (ILLINOIS LTD
LIAB CO)
2122 YORK ROAD, SUITE 180
OAK BROOK, IL 60523

FOR: ELECTRONIC COMPONENTS AND MICRO-CONTROLLED DEVICES FOR MEDICAL USE, NAMELY, BLOOD PRESSURE MONITORS, INTRA-CRANIAL PRESSURE MONITORS, INTRA-COMPARTMENTAL PRESSURE MONITORS, ABDOMINAL CAVITY PRESSURE MONITORS, PRESSURE SENSORS AND SURGICAL DRILLS AND SAWS, IN CLASS 10 (U.S. CLS. 26, 39 AND 44).

FIRST USE 5-8-2007; IN COMMERCE 5-8-2007.

THE MARK CONSISTS OF STANDARD CHARACTERS WITHOUT CLAIM TO ANY PARTICULAR FONT, STYLE, SIZE, OR COLOR.

SER. NO. 77-176,050, FILED 5-9-2007.

HEATHER BIDDULPH, EXAMINING ATTORNEY

Int. Cl.: 9

Prior U.S. Cls.: 21, 23, 26, 36 and 38

Reg. No. 3,483,161

United States Patent and Trademark Office

Registered Aug. 12, 2008

**TRADEMARK
PRINCIPAL REGISTER**



UNCORK PTY LTD (AUSTRALIA CORPORATION)
8 SHAND COURT
BERWICK, 3806, VIC, AUSTRALIA

FOR: COMPUTER SOFTWARE FOR WINE CELLAR INVENTORY MANAGEMENT; COMPUTER HARDWARE, NAMELY, HAND HELD DEVICES FOR WINE CELLAR INVENTORY MANAGEMENT; BARCODE SCANNERS, BARCODE READERS; HY-GRO-THERMOMETERS, IN CLASS 9 (U.S. CLS. 21, 23, 26, 36 AND 38).

PRIORITY CLAIMED UNDER SEC. 44(D) ON AUSTRALIA APPLICATION NO. 1173220, FILED 4-27-2007, REG. NO. 1173220, DATED 4-27-2007, EXPIRES 4-27-2017.

NO CLAIM IS MADE TO THE EXCLUSIVE RIGHT TO USE "CELLAR", APART FROM THE MARK AS SHOWN.

THE COLOR(S) DARK RED AND WHITE IS/ARE CLAIMED AS A FEATURE OF THE MARK.

THE MARK CONSISTS OF CIRCLES, PARTIAL CIRCLES AND WORDING IN WHITE; BACKGROUND IN DARK RED.

SER. NO. 77-176,067, FILED 5-9-2007.

MARK SPARACINO, EXAMINING ATTORNEY

Int. Cl.: 14

Prior U.S. Cls.: 2, 27, 28 and 50

United States Patent and Trademark Office

Reg. No. 3,483,162

Registered Aug. 12, 2008

**TRADEMARK
PRINCIPAL REGISTER**

mode^{rn}

GLENN MILLER (CALIFORNIA SOLE PROPRIETORSHIP)
4909 LAKEWOOD BLVD. STE. 501
LAKEWOOD, CA 90712

FIRST USE 3-1-2007; IN COMMERCE 3-1-2007.

SER. NO. 77-177,687, FILED 5-10-2007.

FOR: JEWELRY, IN CLASS 14 (U.S. CLS. 2, 27, 28 AND 50).

DEIRDRE ROBERTSON, EXAMINING ATTORNEY

Int. Cl.: 12

Prior U.S. Cls.: 19, 21, 23, 31, 35 and 44

United States Patent and Trademark Office

Reg. No. 3,483,163

Registered Aug. 12, 2008

**TRADEMARK
PRINCIPAL REGISTER**

ECO-START

DAIMLER AG (FED REP GERMANY CORPORATION)
MERCEDESSTRASSE 137
STUTTGART, FED REP GERMANY 70327

FOR: ENGINES FOR MOTOR VEHICLES, IN CLASS 12 (U.S. CLS. 19, 21, 23, 31, 35 AND 44).

THE MARK CONSISTS OF STANDARD CHARACTERS WITHOUT CLAIM TO ANY PARTICULAR FONT, STYLE, SIZE, OR COLOR.

PRIORITY CLAIMED UNDER SEC. 44(D) ON ERPN CMNTY TM OFC APPLICATION NO. 005471487, FILED 11-15-2006, REG. NO. 005471487, DATED 9-17-2007, EXPIRES 11-15-2016.

SER. NO. 77-178,721, FILED 5-11-2007.

AISHA CLARKE, EXAMINING ATTORNEY

Int. Cl.: 9

Prior U.S. Cls.: 21, 23, 26, 36 and 38

Reg. No. 3,483,164

United States Patent and Trademark Office

Registered Aug. 12, 2008

**TRADEMARK
PRINCIPAL REGISTER**

CUB

RED LION CONTROLS, INC. (PENNSYLVANIA
CORPORATION)
20 WILLOW SPRINGS CIRCLE
YORK, PA 17402

FOR: (BASED ON USE IN COMMERCE) INDUS-
TRIAL CONTROL DEVICES, NAMELY, PANEL
METERS, IN CLASS 9 (U.S. CLS. 21, 23, 26, 36 AND
38).

FIRST USE 1-1-1982; IN COMMERCE 1-1-1982.

THE MARK CONSISTS OF STANDARD CHAR-
ACTERS WITHOUT CLAIM TO ANY PARTICULAR
FONT, STYLE, SIZE, OR COLOR.

THE WORDING "CUB" HAS NO MEANING IN A
FOREIGN LANGUAGE.

SER. NO. 77-178,736, FILED 5-11-2007.

FRANK LATTUCA, EXAMINING ATTORNEY

Int. Cl.: 42

Prior U.S. Cls.: 100 and 101

United States Patent and Trademark Office

Reg. No. 3,483,165

Registered Aug. 12, 2008

**SERVICE MARK
PRINCIPAL REGISTER**

URBI NET

URBI DESARROLLOS URBANOS, S.A.B. DE C.V.
(MEXICO CORPORATION)

RÍO DANUBIO NO. 169, COL. CUAUHTÉMOC

MÉXICO, DF, MEXICO 06500

FOR: ARCHITECTURAL DESIGN; CONSULTING SERVICES IN THE FIELD OF ARCHITECTURAL DESIGN; CONSTRUCTION DRAFTING; INTERIOR DESIGN SERVICES; ENGINEERING; MATERIAL TESTING; CONDUCTING ENGINEERING SURVEYS; URBAN PLANNING, IN CLASS 42 (U.S. CLS. 100 AND 101).

THE MARK CONSISTS OF STANDARD CHARACTERS WITHOUT CLAIM TO ANY PARTICULAR FONT, STYLE, SIZE, OR COLOR.

PRIORITY CLAIMED UNDER SEC. 44(D) ON MEXICO APPLICATION NO. 851426, FILED 4-27-2007, REG. NO. 1008518, DATED 10-26-2007, EXPIRES 4-27-2017.

OWNER OF U.S. REG. NO. 3,125,830.

SER. NO. 77-178,959, FILED 5-11-2007.

KELLEY WELLS, EXAMINING ATTORNEY

Int. Cl.: 9

Prior U.S. Cls.: 21, 23, 26, 36 and 38

Reg. No. 3,483,166

United States Patent and Trademark Office

Registered Aug. 12, 2008

**TRADEMARK
PRINCIPAL REGISTER**



DYNAMODE LTD. (UNITED KINGDOM COMPANY)
132A ALBANS ROAD, HILLE BUSINESS CENTRE
WATFORD, UNITED KINGDOM WD244AE

FOR: COMPUTER PERIPHERALS; COMPUTER NETWORKING PRODUCTS, NAMELY, MODEMS, MEDIA CONVERTERS, ROUTERS, SWITCHES, KVM SWITCH, NETWORK CARDS, NAMELY, LAN (LOCAL AREA NETWORK) COMPUTER CARDS FOR CONNECTING PORTABLE COMPUTER DEVICES TO COMPUTER NETWORKS; PRINT SERVERS, COMPUTER SERVERS, COMMUNICATION SERVERS, TERMINAL SERVERS, GATEWAYS, NAMELY, GATEWAY ROUTERS, WIRELESS LAN CARDS FOR CONNECTING PORTABLE COMPUTER DEVICES TO COMPUTER NETWORKS, HUBS, FIBER OPTIC COUPLERS, COMPUTER NETWORK MANAGEMENT HARDWARE AND COMPUTER NETWORK MANAGEMENT SOFTWARE AND ASSOCIATED NETWORKING SOFTWARE USED TO MANAGE VIRTUAL OR PHYSICAL SERVERS; PCMCIA CARDS; USB CARDS; USB DISK DRIVES, USB CONVERTERS; STEREO AND VOIP HEADSETS; WIRELESS HEADSETS, NAMELY, WIRELESS HEADSETS FOR TELEPHONES, MOBILE PHONES, MP3 PLAYERS, CD PLAYERS, PORTABLE MULTI-

MEDIA PLAYERS AND PERSONAL COMPUTERS; VOIP USB PHONES; ELECTRICAL POWER SUPPLIES; PRINTED CIRCUIT BOARDS; INTEGRATED CIRCUITS; COMPUTER CHIPS; COMPUTER HARDWARE, NAMELY, MULTI PORT MICROCHIP CARDS FOR CONTROLLING SERIAL DEVICES SUCH AS MODEMS AND OTHER INDUSTRIAL MACHINES; VIDEO SPLITTERS FOR USE IN DISPLAYING THE OUTPUT FROM A SINGLE COMPUTER OR VIDEO EQUIPMENT ON MULTIPLE MONITORS; TELECOMMUNICATIONS AND DATA NETWORKING HARDWARE, NAMELY, DEVICES FOR TRANSPORTING AND AGGREGATING VOICE, DATA AND VIDEO COMMUNICATIONS ACROSS MULTIPLE NETWORK INFRASTRUCTURES AND COMMUNICATIONS PROTOCOLS; DVD RECORDERS; CD RECORDERS; DIGITAL PHOTO FRAMES FOR DISPLAYING DIGITAL PICTURES, VIDEO CLIPS AND MUSIC, IN CLASS 9 (U.S. CLS. 21, 23, 26, 36 AND 38).

FIRST USE 12-1-1995; IN COMMERCE 1-1-1998.

SER. NO. 77-179,242, FILED 5-11-2007.

TINA BROWN, EXAMINING ATTORNEY

Int. Cl.: 42

Prior U.S. Cls.: 100 and 101

United States Patent and Trademark Office

Reg. No. 3,483,167

Registered Aug. 12, 2008

**SERVICE MARK
PRINCIPAL REGISTER**

Escape To Everywhere

BOOMERSCAPE, INC. (DELAWARE CORPORATION)
1445 NE 17TH AVENUE
FT. LAUDERDALE, FL 33304

FOR: COMPUTER SERVICES, NAMELY, PROVIDING SEARCH ENGINES FOR OBTAINING DATA AND INFORMATION ABOUT REAL ESTATE PROPERTIES ON A GLOBAL COMPUTER NETWORK; COMPUTER SERVICES, NAMELY, PROVIDING AN INTERNET SEARCH ENGINE TO ASSIST TRAVELERS WITH CUSTOMIZED ITINERARIES; COMPUTER SERVICES, NAMELY, SEARCHING, EXTRACTING AND AGGREGATING DATA AND INFORMATION FROM ONLINE SOURCES FOR RESEARCH PURPOSES IN THE FIELD OF CULTURES AND COUNTRY-SPECIFIC

INFORMATION ; COMPUTER SERVICES, NAMELY, HOSTING AN ONLINE WEB COMMUNITY THAT PROVIDES INFORMATION AND INTERACTIVE DATABASES IN THE FIELD OF TRAVEL AND LIVING ABROAD, IN CLASS 42 (U.S. CLS. 100 AND 101).

FIRST USE 2-19-2007; IN COMMERCE 2-19-2007.

THE MARK CONSISTS OF STANDARD CHARACTERS WITHOUT CLAIM TO ANY PARTICULAR FONT, STYLE, SIZE, OR COLOR.

SER. NO. 77-179,721, FILED 5-13-2007.

JEFF DEFORD, EXAMINING ATTORNEY

Int. Cl.: 9

Prior U.S. Cls.: 21, 23, 26, 36 and 38

Reg. No. 3,483,168

United States Patent and Trademark Office

Registered Aug. 12, 2008

**TRADEMARK
PRINCIPAL REGISTER**



PLUTOLIFE A/S (SWITZERLAND LTD LIAB CO)
PLUTOLIFE
DRAMMENSVEIEN 167
OSLO, NORWAY N0277

THE MARK CONSISTS OF WORD "MOBILOVE"
WHERE BOTH LETTERS "O" ARE HEART-
SHAPED.

FOR: COMPUTER APPLICATION SOFTWARE
FOR MOBILE PHONES, IN CLASS 9 (U.S. CLS. 21,
23, 26, 36 AND 38).

SER. NO. 77-179,794, FILED 5-14-2007.

FIRST USE 1-1-2002; IN COMMERCE 1-1-2007.

HEATHER SAPP, EXAMINING ATTORNEY

Int. Cls.: 35, 36 and 37

Prior U.S. Cls.: 100, 101, 102, 103 and 106

United States Patent and Trademark Office

Reg. No. 3,483,169

Registered Aug. 12, 2008

**SERVICE MARK
PRINCIPAL REGISTER**



ZELNIK & COMPANY LLC (NEW YORK LTD
LIAB CO)
424 MADISON AVENUE
5TH FLOOR
NEW YORK, NY 10017

FOR: NEGOTIATION AND RENEGOTIATION OF
REAL ESTATE LEASES AND SUBLEASES AND THE
PURCHASE AND SALE OF BUILDINGS; AND
MARKET ANALYSIS IN THE FIELD OF REAL
ESTATE, IN CLASS 35 (U.S. CLS. 100, 101 AND 102).

FIRST USE 10-0-2006; IN COMMERCE 10-0-2006.

FOR: REAL ESTATE SERVICES, NAMELY, LEAS-
ING STORE SPACE; REAL ESTATE AGENCIES IN
THE FIELD OF SELLING AND BUYING BUILD-
INGS; REAL ESTATE CONSULTATION FOR IN-
VESTORS; REAL ESTATE CONSULTATION IN THE
FIELD OF LEASE ANALYSIS AND REVIEW OF
FLOOR PLANS, IN CLASS 36 (U.S. CLS. 100, 101 AND
102).

FIRST USE 10-0-2006; IN COMMERCE 10-0-2006.

FOR: REAL ESTATE SITE SELECTION, IN CLASS
37 (U.S. CLS. 100, 103 AND 106).

FIRST USE 10-0-2006; IN COMMERCE 10-0-2006.

NO CLAIM IS MADE TO THE EXCLUSIVE
RIGHT TO USE "COMPANY LLC", APART FROM
THE MARK AS SHOWN.

THE MARK CONSISTS OF A STYLIZED LETTER
"Z" FOLLOWED BY THE WORDS "ZELNIK &
COMPANY LLC".

SER. NO. 77-179,989, FILED 5-14-2007.

ELLEN B. AWRICH, EXAMINING ATTORNEY

Int. Cls.: 9, 35, 36, 44 and 45

Prior U.S. Cls.: 21, 23, 26, 36, 38, 100, 101 and 102

Reg. No. 3,483,170

United States Patent and Trademark Office

Registered Aug. 12, 2008

**TRADEMARK
SERVICE MARK
PRINCIPAL REGISTER**



WORKPLACE BENEFITS, LLC (DELAWARE LTD
LIAB CO)
4020 CAPITOL BOULEVARD, SUITE 100
RALEIGH, NC 27604

FOR: DOWNLOADABLE ELECTRONIC PUBLICATIONS IN THE NATURE OF NEWSLETTERS, ARTICLES AND INFORMATION SHEETS IN THE FIELD OF HEALTH, EDUCATION, FINANCE, FAMILY ISSUES, DEPENDENT CARE, NAMELY, FAMILY DAYCARE CENTERS, CHILD CARE CENTERS, AND IN-HOME CHILD AND ELDER CARE, AND LEGAL ISSUES, IN CLASS 9 (U.S. CLS. 21, 23, 26, 36 AND 38).

FIRST USE 4-28-2006; IN COMMERCE 4-28-2006.

FOR: PROVIDING REFERRALS IN THE FIELD OF DEPENDENT CARE, NAMELY, CHILD CARE, ELDER CARE, SICK CARE AND INVALID CARE, PHYSICAL AND MENTAL HEALTH, MEDICAL CARE, FINANCE, LEGAL MATTERS, TAXES, RETIREMENT, ESTATE PLANNING, REAL ESTATE, HOME MAINTENANCE, HOME CLEANING AND SAFETY, CAREER SERVICES, RELOCATION OF EMPLOYEES AND EMPLOYEES' FAMILIES AND HOUSEHOLDS, TRANSPORTATION, AUTO REPAIR, TRAVEL, EDUCATION, NUTRITION, FITNESS, SHOPPING, ENTERTAINMENT, DINING, RECREATION AND LODGING; PROVIDING INFORMATION AND CONSULTING IN THE FIELD OF RELOCATION OF EMPLOYEES AND EMPLOYEES' FAMILIES AND HOUSEHOLDS VIA THIRD PARTY PROVIDERS; PROVIDING INFORMATION AND CONSULTING IN THE FIELD OF TAX MATTERS, NAMELY, CONSULTATION AND ADVISORY SERVICES VIA THIRD-PARTY PROVIDERS, IN CLASS 35 (U.S. CLS. 100, 101 AND 102).

FIRST USE 4-28-2006; IN COMMERCE 4-28-2006.

FOR: ADMINISTRATION OF EMPLOYEE WELFARE BENEFITS PLANS, NAMELY, SUBSIDIES IN THE NATURE OF DEPENDENT CARE, NAMELY, CHILD CARE, ELDER CARE, AND DEPENDENT ADULT CARE, ADOPTIONS, INFERTILITY, AND SICK CHILD CARE; PROVIDING INFORMATION AND CONSULTING IN THE FIELD OF FINANCE, REAL ESTATE AND INSURANCE, IN CLASS 36 (U.S. CLS. 100, 101 AND 102).

FIRST USE 4-28-2006; IN COMMERCE 4-28-2006.

FOR: PROVIDING HEALTH INFORMATION FOR EMPLOYEES CONSULTING SERVICES IN THE FIELD OF MENTAL FITNESS, NAMELY, STRESS MANAGEMENT INFORMATION AND MENTAL WELLNESS INFORMATION FOR EMPLOYEES, IN CLASS 44 (U.S. CLS. 100 AND 101).

FIRST USE 4-28-2006; IN COMMERCE 4-28-2006.

FOR: PROVIDING INFORMATION AND CONSULTING SERVICES IN THE FIELD OF LEGAL SERVICES VIA THIRD-PARTY PROVIDERS, IN CLASS 45 (U.S. CLS. 100 AND 101).

FIRST USE 4-28-2006; IN COMMERCE 4-28-2006.

NO CLAIM IS MADE TO THE EXCLUSIVE RIGHT TO USE "WORKPLACE OPTIONS", APART FROM THE MARK AS SHOWN.

THE MARK CONSISTS OF A CIRCLE ABOVE A CURVED LINE WITH THE WORDS "WORKPLACE OPTIONS" BELOW.

SER. NO. 77-179,997, FILED 5-14-2007.

LOURDES AYALA, EXAMINING ATTORNEY

Int. Cl.: 35

Prior U.S. Cls.: 100, 101 and 102

United States Patent and Trademark Office

Reg. No. 3,483,171

Registered Aug. 12, 2008

**SERVICE MARK
PRINCIPAL REGISTER**



TADEO GARCIA (UNITED STATES INDIVIDUAL)
6154 BELMONT SHORES STREET
LAS VEGAS, NV 891156005

FOR: PROMOTING THE SALE OF GOODS AND SERVICES OF OTHERS BY PROVIDING A WEBSITE WHICH FEATURES INFORMATION ABOUT EVENTS, NEWS AND ENTERTAINMENT OFFERINGS AT TARGETED GEOGRAPHIC LOCATIONS, WHICH PROVIDES HYPERTEXT LINKS TO THE WEBSITES OF OTHERS, AND WHICH HAS INTERACTIVE FEATURES PERMITTING INDIVIDUALS WITH SIMILAR INTERESTS TO PARTICIPATE IN

CREATING AN ON-LINE COMMUNITY, IN CLASS 35 (U.S. CLS. 100, 101 AND 102).

FIRST USE 4-1-2006; IN COMMERCE 4-1-2006.

THE MARK CONSISTS OF STANDARD CHARACTERS WITHOUT CLAIM TO ANY PARTICULAR FONT, STYLE, SIZE, OR COLOR.

SER. NO. 77-181,621, FILED 5-15-2007.

WENDY GOODMAN, EXAMINING ATTORNEY

Int. Cl.: 41

Prior U.S. Cls.: 100, 101 and 107

United States Patent and Trademark Office

Reg. No. 3,483,172

Registered Aug. 12, 2008

**SERVICE MARK
PRINCIPAL REGISTER**

CENTRAL ARIZONA COLLEGE

PINAL COUNTY COMMUNITY COLLEGE DISTRICT (ARIZONA POLITICAL SUBDIVISION OF THE STATE OF ARIZONA)
8470 NORTH OVERFIELD ROAD
COOLIDGE, AZ 85228

FOR: EDUCATIONAL SERVICES, NAMELY, PROVIDING COURSES OF INSTRUCTION AT THE COLLEGE LEVEL AND DISTRIBUTING COURSE MATERIALS IN CONNECTION THEREWITH; EDUCATIONAL SERVICES, NAMELY, PROVIDING COURSES OF INSTRUCTION AT THE COMMUNITY EDUCATION LEVEL TO THE PUBLIC AND DISTRIBUTING COURSE MATERIALS IN CONNECTION THEREWITH; EDUCATIONAL SERVICES, NAMELY, CONDUCTING DISTANCE LEARNING INSTRUCTION AT THE COLLEGE LEVEL; ENTERTAINMENT IN THE NATURE OF DANCE PERFORMANCES, THEATER PRODUCTIONS, LIVE MUSIC CONCERTS, ART EXHIBI-

TIONS AND COMPETITIONS IN THE FIELD OF ATHLETICS, IN CLASS 41 (U.S. CLS. 100, 101 AND 107).

FIRST USE 12-31-1967; IN COMMERCE 12-31-1967.

THE MARK CONSISTS OF STANDARD CHARACTERS WITHOUT CLAIM TO ANY PARTICULAR FONT, STYLE, SIZE, OR COLOR.

NO CLAIM IS MADE TO THE EXCLUSIVE RIGHT TO USE "COLLEGE", APART FROM THE MARK AS SHOWN.

SEC. 2(F).

SER. NO. 77-181,779, FILED 5-15-2007.

SONYA STEPHENS, EXAMINING ATTORNEY

Int. Cl.: 41

Prior U.S. Cls.: 100, 101 and 107

United States Patent and Trademark Office

Reg. No. 3,483,173

Registered Aug. 12, 2008

**SERVICE MARK
PRINCIPAL REGISTER**

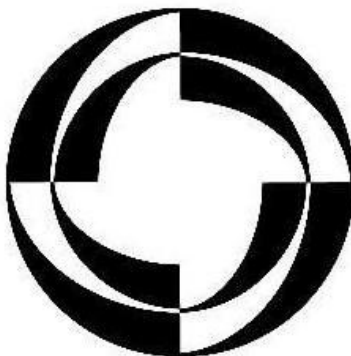

PINAL COUNTY COMMUNITY COLLEGE DISTRICT (ARIZONA POLITICAL SUBDIVISION OF THE STATE OF ARIZONA)
8470 NORTH OVERFIELD ROAD
COOLIDGE, AZ 85228

FOR: EDUCATIONAL SERVICES, NAMELY, PROVIDING COURSES OF INSTRUCTION AT THE COLLEGE LEVEL AND DISTRIBUTING COURSE MATERIALS IN CONNECTION THEREWITH; EDUCATIONAL SERVICES, NAMELY, PROVIDING COURSES OF INSTRUCTION AT THE COMMUNITY EDUCATION LEVEL TO THE PUBLIC AND DISTRIBUTING COURSE MATERIALS IN CONNECTION THEREWITH; EDUCATIONAL SERVICES, NAMELY, CONDUCTING DISTANCE LEARNING INSTRUCTION AT THE COLLEGE

LEVEL; ENTERTAINMENT IN THE NATURE OF DANCE PERFORMANCES, THEATER PRODUCTIONS, LIVE MUSIC CONCERTS, ART EXHIBITIONS AND COMPETITIONS IN THE FIELD OF ATHLETICS, IN CLASS 41 (U.S. CLS. 100, 101 AND 107).

FIRST USE 9-30-2006; IN COMMERCE 9-30-2006.

THE MARK CONSISTS OF A STYLIZED CIRCLE WITHIN A SYTLIZED CIRCLE.

SER. NO. 77-181,782, FILED 5-15-2007.

SONYA STEPHENS, EXAMINING ATTORNEY

Int. Cl.: 35

Prior U.S. Cls.: 100, 101 and 102

United States Patent and Trademark Office

Reg. No. 3,483,174

Registered Aug. 12, 2008

**SERVICE MARK
PRINCIPAL REGISTER**

TPS-Lean Six Sigma

TPS-LEAN SIX SIGMA LLC (DELAWARE LTD
LIAB CO)

#303

144 VILLAGE LANDING
FAIRPORT, NY 14450

FOR: BUSINESS CONSULTATION SERVICES, IN
CLASS 35 (U.S. CLS. 100, 101 AND 102).

FIRST USE 4-27-2007; IN COMMERCE 5-11-2007.

THE MARK CONSISTS OF STANDARD CHAR-
ACTERS WITHOUT CLAIM TO ANY PARTICULAR
FONT, STYLE, SIZE, OR COLOR.

OWNER OF U.S. REG. NO. 3,194,643.

NO CLAIM IS MADE TO THE EXCLUSIVE
RIGHT TO USE "SIX SIGMA", APART FROM THE
MARK AS SHOWN.

SER. NO. 77-181,898, FILED 5-15-2007.

JENNIFER VASQUEZ, EXAMINING ATTORNEY

Int. Cl.: 41

Prior U.S. Cls.: 100, 101 and 107

United States Patent and Trademark Office

Reg. No. 3,483,175

Registered Aug. 12, 2008

**SERVICE MARK
PRINCIPAL REGISTER**

**AMERICAN COLLEGE OF
VETERINARY RADIOLOGY**

AMERICAN COLLEGE OF VETERINARY RADIOLOGY (ILLINOIS EDUCATIONAL NON-PROFIT CORPORATION)
109 OGDEN AVENUE
SWARTHMORE, PA 19081

FOR: EDUCATIONAL SERVICES, NAMELY, CONDUCTING SEMINARS, MEETINGS, AND CONFERENCES ON VETERINARY IMAGING AND RADIATION ONCOLOGY, IN CLASS 41 (U.S. CLS. 100, 101 AND 107).

FIRST USE 0-0-1969; IN COMMERCE 0-0-1969.

THE MARK CONSISTS OF STANDARD CHARACTERS WITHOUT CLAIM TO ANY PARTICULAR FONT, STYLE, SIZE, OR COLOR.

NO CLAIM IS MADE TO THE EXCLUSIVE RIGHT TO USE "COLLEGE", APART FROM THE MARK AS SHOWN.

SEC. 2(F).

SER. NO. 77-182,427, FILED 5-16-2007.

CURTIS FRENCH, EXAMINING ATTORNEY

Int. Cl.: 41

Prior U.S. Cls.: 100, 101 and 107

United States Patent and Trademark Office

Reg. No. 3,483,176

Registered Aug. 12, 2008

**SERVICE MARK
PRINCIPAL REGISTER**



AMERICAN COLLEGE OF VETERINARY RADIOLOGY (ILLINOIS EDUCATIONAL NON-PROFIT CORPORATION)
109 OGDEN AVENUE
SWARTHMORE, PA 19081

FOR: EDUCATIONAL SERVICES, NAMELY, CONDUCTING SEMINARS, MEETINGS, AND CONFERENCES ON VETERINARY IMAGING AND RADIATION ONCOLOGY, IN CLASS 41 (U.S. CLS. 100, 101 AND 107).

FIRST USE 7-0-1975; IN COMMERCE 7-0-1975.

NO CLAIM IS MADE TO THE EXCLUSIVE RIGHT TO USE "COLLEGE" AND "1961", APART FROM THE MARK AS SHOWN.

SEC. 2(F) "AMERICAN COLLEGE OF VETERINARY RADIOLOGY".

SER. NO. 77-182,438, FILED 5-16-2007.

CURTIS FRENCH, EXAMINING ATTORNEY

Int. Cl.: 29

Prior U.S. Cl.: 46

United States Patent and Trademark Office

Reg. No. 3,483,177

Registered Aug. 12, 2008

**TRADEMARK
PRINCIPAL REGISTER**

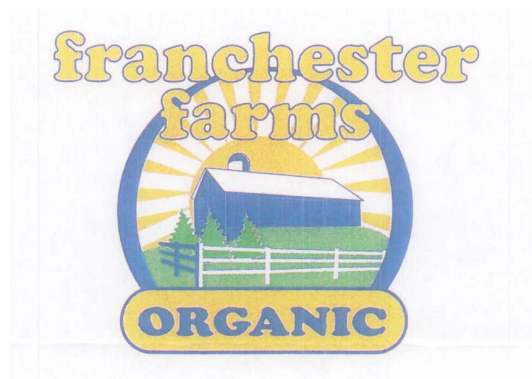

MICELI DAIRY PRODUCTS COMPANY, INC.
(OHIO CORPORATION)
2721 EAST 90TH STREET
CLEVELAND, OH 44104

FOR: DAIRY PRODUCTS EXCLUDING ICE CREAM, ICE MILK AND FROZEN YOGURT, IN CLASS 29 (U.S. CL. 46).

FIRST USE 12-1-2006; IN COMMERCE 12-1-2006.

NO CLAIM IS MADE TO THE EXCLUSIVE RIGHT TO USE "FARMS" OR "ORGANIC", APART FROM THE MARK AS SHOWN.

THE COLOR(S) YELLOW, BLUE, GREEN AND WHITE IS/ARE CLAIMED AS A FEATURE OF THE MARK.

THE MARK CONSISTS OF "FRANCHESTER FARMS" IN YELLOW LETTERS OUTLINED IN BLUE, A YELLOW SUN WITH YELLOW RAYS ON A WHITE SKY IS IN THE BACKGROUND BEHIND A BLUE BARN WITH WHITE ROOF, GREEN GRASS AND GREEN TREES AND A FENCE THAT IS PART WHITE AND PART BLUE ARE IN FRONT OF THE BLUE BARN. THE DESIGN IS BORDERED BY A BLUE BAND AND A YELLOW BAR OUTLINED IN BLUE BENEATH IT WITH THE WORD "ORGANIC" IN BLUE LETTERING.

SER. NO. 77-182,670, FILED 5-16-2007.

SUSAN LESLIE DUBOIS, EXAMINING ATTORNEY

Int. Cls.: 36 and 44

Prior U.S. Cls.: 100, 101 and 102

United States Patent and Trademark Office

Reg. No. 3,483,178

Registered Aug. 12, 2008

**SERVICE MARK
PRINCIPAL REGISTER**



HEALTHNOW NEW YORK INC. (NEW YORK CORPORATION)
1901 MAIN STREET
BUFFALO, NY 14208

FOR: ORGANIZATION AND ADMINISTRATION OF PREPAID HEALTH CARE PLANS AND INDEMNITY PLANS, INSURANCE UNDERWRITING IN THE FIELD OF HEALTH CARE AND INSURANCE CLAIMS PROCESSING SERVICES, IN CLASS 36 (U.S. CLS. 100, 101 AND 102).

FIRST USE 5-1-1999; IN COMMERCE 5-1-1999.

FOR: HEALTH CARE SERVICES IN THE NATURE OF HEALTH MAINTENANCE ORGANIZATIONS, PREFERRED PROVIDER ORGANIZATIONS AND MANAGED HEALTH

CARE SERVICES, IN CLASS 44 (U.S. CLS. 100 AND 101).

FIRST USE 5-1-1999; IN COMMERCE 5-1-1999.

NO CLAIM IS MADE TO THE EXCLUSIVE RIGHT TO USE "NEW YORK INC.", APART FROM THE MARK AS SHOWN.

THE MARK CONSISTS OF WORD "HEALTHNOW" WITH THREE CURVED LINES FORMING A FLAG/BANNER CONNECTED TO THE "W" ON ONE LINE, AND THE WORDS "HEALTHNOW NEW YORK INC." UNDERNEATH.

SER. NO. 77-182,809, FILED 5-16-2007.

GEORGIA CARTY, EXAMINING ATTORNEY

Int. Cl.: 12

Prior U.S. Cls.: 19, 21, 23, 31, 35 and 44

Reg. No. 3,483,179

United States Patent and Trademark Office

Registered Aug. 12, 2008

**TRADEMARK
PRINCIPAL REGISTER**

ITALIKA

ELEKTRA TRADING & CONSULTING GROUP,
S.A. DE C.V. (MEXICO CORPORATION)
COL. TLALPAN LA JOYA
AV. INSURGENTES SUR #3570, PISO 8
MEXICO, D.F., MEXICO 14000

FOR: MOTORCYCLES, CONNECTING RODS FOR LAND VEHICLES, OTHER THAN PARTS OF MOTORS AND ENGINES, USED IN CONNECTION WITH TERRESTRIAL AND AQUATIC VEHICLES; AERONAUTICAL VEHICLES USED FOR TRANSPORTING GOODS, AERIAL VEHICLES; GLIDERS; AIRSHIPS; AIRPLANES; AEROSTATICS BALLOONS; AIRBAGS FOR VEHICLES; AIR PUMPS FOR AUTOMOBILES, MOTORCYCLES, TWO-WHEELED MOTOR VEHICLES, BICYCLES; ACOUSTIC REVERSE ALARMS FOR VEHICLES; ANTI THEFT ALARMS FOR VEHICLES; SHOCK ABSORBER SPRINGS FOR VEHICLES, SHOCK ABSORBERS FOR VEHICLES SUSPENSION, SHOCK ABSORBERS FOR VEHICLES; AMPHIBIOUS AIRPLANES; ANTI-SKID CHAINS FOR VEHICLES; ANTI-SKID DEVICES FOR VEHICLE TIRES FOR VEHICLE WHEELS, NAMELY, TIRE CHAINS, TIRE SNOW CHAINS, ANTI-SKID TIRES FOR BICYCLES, MOTORCYCLES, AND TIRES SOLID, FOR VEHICLE WHEELS; ANTI-GLARE DEVICES FOR VEHICLES; NAMELY, WINDSHIELDS, REAR VIEW MIRRORS, VANITY MIRRORS, SIDE-VIEW MIRRORS; ANTI-THEFT DEVICES FOR VEHICLES; PARTS FOR TRUCKS AND WAGONS, NAMELY, STRUCTURAL PARTS; APPARATUS AND INSTALLATION OF CABLE TRANSPORT CARS, NAMELY, SUSPENSION ARMS FOR CABLE CARS; DRIVE SHAFTS FOR TERRESTRIAL VEHICLES; SAFETY HARNESSES FOR VEHICLE SEATS; SEATS COVERS FOR BICYCLES OR MOTORCYCLES; SAFETY SEATS FOR CHILDREN FOR VEHICLES; HEAD RESTS OR SUPPORTS FOR THE HEAD FOR VEHICLE SEATS; SAFETY BELTS FOR VEHICLE SEATS; VEHICLE SEAT COVERS; EJECTOR SEATS FOR AIRPLANES; SEATS FOR BICYCLES OR MOTOR-

CYCLES; SEATS FOR VEHICLES, MOTOR BUSES, MOTOR COACHES, AUTOMOBILES; CHAINS FOR AUTOMOBILES; AUTOMOBILE HOODS; AUTOMOBILE BODIES; AUTOMOBILE CHASSIS; AUTOMOBILE BUMPERS OR TOW BARS; AUTOMOBILE TIRES; SUN BLINDS ADAPTED FOR AUTOMOBILES; SPORTS VEHICLES; AIRPLANES; BALANCING WEIGHTS FOR VEHICLE WHEELS; BRAKE PADS FOR VEHICLES; TREADS FOR RE-TREADING TIRES; BARGES; SHIP HULLS; RIBS OF SHIPS; SHIP FUNNELS; SHIP BUMPERS; SHIP GAFFS; SHIP CRANES; SHIP DAVITS; MASTS FOR SHIPS; BABY CARRIAGES; BICYCLES; BICYCLE BELLS; BICYCLE PUMPS; BICYCLE CHAINS; INNER TUBES FOR BICYCLES; SPEAKERS, HORNS OR ACOUSTIC WARNING SYSTEMS FOR BICYCLES; BASKETS ADAPTED FOR BICYCLES; BICYCLE CRANKS AND PEDALS; BICYCLE GEAR ASSEMBLIES; BICYCLE BRAKES; TUBELESS TIRES FOR BICYCLES; HANDLEBARS FOR BICYCLES; BRAKE HANDLES FOR BICYCLES; MOTORS FOR BICYCLES; TIRES FOR BICYCLES; PEDALS FOR BICYCLES; BICYCLE FRAMES; RIMS FOR BICYCLE WHEELS; BICYCLE SADDLES; BICYCLE STANDS; CONNECTING RODS FOR TERRESTRIAL VEHICLES OTHER THAN PARTS OF MOTORS AND ENGINES; SPEAKERS FOR VEHICLES; RAILWAY BOGIES OR WHEELS TRUCKS FOR TRAINS CARRIAGES; BRIDLES FOR TIRES FOR TRAIN WHEELS; CABINS FOR CABLE TRANSPORT INSTALLATIONS, NAMELY, CABLE CARS; DRIVE BELTS FOR TERRESTRIAL VEHICLES; DRIVE TRAINS FOR TERRESTRIAL VEHICLES; BOXES ADAPTED FOR BICYCLES; GEARBOXES FOR TERRESTRIAL VEHICLES; HOODS FOR VEHICLES; CARRIAGES, NAMELY, PASSENGER CARRIAGES, RAILWAY CARRIAGES; PUSH-CARTS; FORK LIFT TRUCKS; WHEELS FOR CARTS; TWO WHEELED SACK TRUCKS; MOTORIZED GOLF CARTS; SUPERMARKET CARTS; CARTS FOR HANDLING MERCHANDISE; SHOPPING CARTS; CLEANING CARTS; GARDEN HOSE

REEL CARTS; CARTS; BODIES FOR VEHICLES; CARS; FORK LIFT CARS; CARTS FOR CRANK-SHAFTS OF TERRESTRIAL VEHICLES; HYDRAULIC CIRCUITS FOR VEHICLES; HORNS FOR VEHICLES; SPOKE CLIPS FOR RIMS FOR BICYCLE WHEELS; CLUTCHES FOR TERRESTRIAL VEHICLES; SIDECARS FOR MOTORCYCLES; AUTOMOBILES; BICYCLE AND SKI RACKS FOR AUTOMOBILES; MOTOR CARS; SPORTS CARTS; PNEUMATIC TIRES AND INNER TUBES FOR VEHICLES; AXLE BEARING FOR LAND VEHICLES; TORQUE CONVERTERS FOR TERRESTRIAL VEHICLES; GLASS WINDOWS FOR VEHICLES; COVERS FOR BABY CARRIAGES; COVERS FOR TIRES; BRAKE COVERS FOR LAND VEHICLES; CANOES; VEHICLE CHASSIS; BUMPERS FOR VEHICLES; DIRIGIBLE BALLOON AIRSHIPS; AXLES FOR VEHICLES; ELECTRIC MOTORS FOR TERRESTRIAL VEHICLES; ELECTRIC VEHICLES; WINDOW MECHANISM PARTS FOR TERRESTRIAL VEHICLES; BOATS; CLUTCHES FOR TERRESTRIAL VEHICLES; RAILCAR OR WAGON COUPLINGS; TRAILER HITCHES FOR VEHICLES; LOW RATION GEAR ASSEMBLIES FOR TERRESTRIAL VEHICLES, NAMELY GEARS, GEARBOXES, GEAR LEVER KNOBS, REVERSING GEARS; LUGGAGE NETS FOR VEHICLES; ROLLING STOCK BUFFERS FOR RAILWAYS; ROLLING STOCK FOR RAILROADS; ROLLING STOCK FOR FUNICULAR RAILWAYS; THOLEPINS; SPACE VEHICLES; SCULLS; OARS; SKI LIFTS; RUNNING BOARDS FOR VEHICLES; FERRY BOATS; BRAKE LININGS FOR VEHICLES; BRAKE SEGMENTS FOR VEHICLES; BRAKES FOR VEHICLES; REFRIGERATED TRAILERS; CAR COVERS MADE TO MEASURE; FUNICULAR RAILCARS; SEAPLANES; HYDROPLANES, LAUNCHES; WINDSCREEN WIPERS FOR VEHICLES; PIVOT PINS FOR TIRES; TIRE VALVES FOR VEHICLE; VEHICLE TIRES; CARTS FOR GARDEN HOSES; SPOKES FOR BICYCLE WHEELS BRAKES; PROPULSION MECHANISMS FOR TERRESTRIAL VEHICLES; MEDALLIONS FOR VEHICLES; WHEELS FOR MINE CARTS;

LUGGAGE RACKS FOR MOTOR CARS, MOTORCYCLES, VEHICLES; MOTORCYCLES; JET ENGINES FOR TERRESTRIAL VEHICLES; TRACTION ENGINES FOR MOTOR CARS, MOTORCYCLES, AUTOMOBILES, LAND VEHICLES; IMPULSE ENGINES FOR TERRESTRIAL VEHICLES; MOTORS FOR TERRESTRIAL VEHICLES; SCOOTERS; OMNIBUSES; CATERPILLAR TRACKS FOR VEHICLES; RAFTS; WINDSCREENS FOR MOTOR CARS; PARACHUTES; BUMPER BARS FOR VEHICLES; PONTOON BOATS; LUGGAGE RACKS FOR VEHICLES; PORTHOLES; DOORS FOR VEHICLES; SPOKES FOR VEHICLE WHEEL RIMS; REFRIGERATED VEHICLES; SUSPENSION SPRING FOR VEHICLES; REAR VIEW MIRRORS FOR VEHICLES; CENTERS FOR VEHICLE WHEEL RIMS; WHEEL RIMS FOR VEHICLES; WHEELCHAIRS; SPARE WHEELS FOR TERRESTRIAL VEHICLES; BOAT FENDERS, LAND VEHICLE FENDERS; CHAIRS FOR CHAIR LIFTS; GAS CAPS FOR LAND VEHICLES; CABLE RAILWAYS; CHAIR LIFTS; RUDDERS FOR VESSELS; TRACTORS, SPACE SHUTTLES; TRANSMISSIONS FOR TERRESTRIAL VEHICLES; STREETCARS; TRICYCLES; DELIVERY TRICYCLES; SLEIGHS; MOTORIZED SNOW SLEDS; TROLLEY LOADER; UPHOLSTERY FOR VEHICLES; STEERING WHEELS FOR VEHICLES; VEHICLES FOR TERRESTRIAL, AERIAL, MARITIME OR RAIL LOCOMOTIVES; AIR TURBINES FOR TERRESTRIAL VEHICLES; YACHTS; BRAKE SHOES FOR VEHICLES, IN CLASS 12 (U.S. CLS. 19, 21, 23, 31, 35 AND 44).

THE MARK CONSISTS OF STANDARD CHARACTERS WITHOUT CLAIM TO ANY PARTICULAR FONT, STYLE, SIZE, OR COLOR.

OWNER OF MEXICO REG. NO. 861001, DATED 10-8-2006, EXPIRES 10-8-2016.

SER. NO. 77-183,603, FILED 5-17-2007.

SANDRA MANIOS, EXAMINING ATTORNEY

Int. Cl.: 25

Prior U.S. Cls.: 22 and 39

United States Patent and Trademark Office

Reg. No. 3,483,180

Registered Aug. 12, 2008

**TRADEMARK
PRINCIPAL REGISTER**

INTIMATE ESSENTIALS

CARSON PIRIE SCOTT II, INC. (MISSISSIPPI
CORPORATION)

2801 EAST MARKET STREET

YORK, PA 17402

FOR: CLOTHING, NAMELY, SLEEPWEAR AND
ROBES, IN CLASS 25 (U.S. CLS. 22 AND 39).

FIRST USE 10-1-1998; IN COMMERCE 10-1-1998.

THE MARK CONSISTS OF STANDARD CHAR-
ACTERS WITHOUT CLAIM TO ANY PARTICULAR
FONT, STYLE, SIZE, OR COLOR.

NO CLAIM IS MADE TO THE EXCLUSIVE
RIGHT TO USE "INTIMATE", APART FROM THE
MARK AS SHOWN.

SER. NO. 77-183,901, FILED 5-17-2007.

MARK SPARACINO, EXAMINING ATTORNEY

Int. Cl.: 35

Prior U.S. Cls.: 100, 101 and 102

United States Patent and Trademark Office

Reg. No. 3,483,181

Registered Aug. 12, 2008

**SERVICE MARK
PRINCIPAL REGISTER**

Bizgifts

ACCLAIM MARKETING (WASHINGTON LTD
LIAB CO)
14667 SE 173RD ST
RENTON, WA 98058

FOR: DISTRIBUTION OF PRODUCTS FOR AD-
VERTISING PURPOSES; PRODUCT MERCHANDIS-
ING, IN CLASS 35 (U.S. CLS. 100, 101 AND 102).

FIRST USE 5-8-1996; IN COMMERCE 2-1-1997.

THE MARK CONSISTS OF STANDARD CHAR-
ACTERS WITHOUT CLAIM TO ANY PARTICULAR
FONT, STYLE, SIZE, OR COLOR.

SEC. 2(F).

SER. NO. 77-184,191, FILED 5-17-2007.

BERYL GARDNER, EXAMINING ATTORNEY

Int. Cl.: 35

Prior U.S. Cls.: 100, 101 and 102

United States Patent and Trademark Office

Reg. No. 3,483,182

Registered Aug. 12, 2008

**SERVICE MARK
PRINCIPAL REGISTER**

GARDNER

GARDNER, INC. (OHIO CORPORATION)
3641 INTERCHANGE ROAD
COLUMBUS, OH 43204

FOR: WHOLESALE DISTRIBUTORSHIP SERVICES IN THE FIELD OF SMALL ENGINES AND PARTS FOR LAWN AND GARDEN PRODUCTS AND EQUIPMENT, IN CLASS 35 (U.S. CLS. 100, 101 AND 102).

FIRST USE 6-1-1947; IN COMMERCE 6-1-1947.

THE MARK CONSISTS OF STANDARD CHARACTERS WITHOUT CLAIM TO ANY PARTICULAR FONT, STYLE, SIZE, OR COLOR.

SEC. 2(F).

SER. NO. 77-184,272, FILED 5-18-2007.

ERIN FALK, EXAMINING ATTORNEY

Int. Cl.: 35

Prior U.S. Cls.: 100, 101 and 102

United States Patent and Trademark Office

Reg. No. 3,483,183

Registered Aug. 12, 2008

**SERVICE MARK
PRINCIPAL REGISTER**



GARDNER, INC. (OHIO CORPORATION)
3641 INTERCHANGE ROAD
COLUMBUS, OH 43204

THE MARK CONSISTS OF THE WORD "GARDNER" IN STYLIZED LETTERS.

FOR: WHOLESALE DISTRIBUTORSHIP SERVICES IN THE FIELD OF SMALL ENGINES AND PARTS FOR LAWN AND GARDEN PRODUCTS AND EQUIPMENT, IN CLASS 35 (U.S. CLS. 100, 101 AND 102).

SEC. 2(F).

SER. NO. 77-184,273, FILED 5-18-2007.

FIRST USE 6-1-1984; IN COMMERCE 6-1-1984.

ERIN FALK, EXAMINING ATTORNEY

Int. Cl.: 12

Prior U.S. Cls.: 19, 21, 23, 31, 35 and 44

United States Patent and Trademark Office

Reg. No. 3,483,184

Registered Aug. 12, 2008

**TRADEMARK
PRINCIPAL REGISTER**

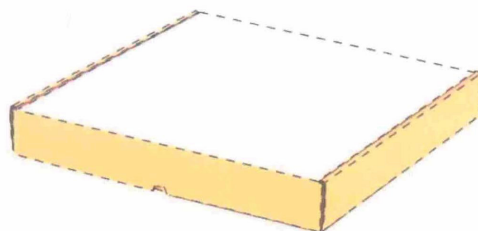

LUK LAMELLEN UND KUPPLUNGSBAU BE-
TEILIGUNGS KG (FED REP GERMANY COR-
PORATION)

INDUSTRIESTRASSE 3, 77815
BUHL, FED REP GERMANY

FOR: CLUTCHES FOR LAND VEHICLES AND
STRUCTURAL PARTS THEREFORE AND CLUTCH
RELEASE SYSTEMS FOR LAND VEHICLES COM-
PRISING RELEASE BEARINGS, RELEASE LEVERS,
RELEASE HYDRAULIC UNITS AND RELEASE
TOOLS SOLD AS A COMPLETE UNIT; DAMPERS
IN THE DRIVE TRAIN OF LAND VEHICLES;
CLUTCH REPSETS FOR LAND VEHICLES COM-
PRISING CLUTCHES, DISCS, RELEASE BEARINGS,
PILOT BEARING BUSHING; FLYWHEELS FOR
LAND VEHICLES; DUAL MASS FLYWHEELS FOR
LAND VEHICLES; CLUTCH RELEASE CABLES
FOR LAND VEHICLES; CLUTCHES FOR AGRI-
CULTURAL LAND VEHICLES AND REPSETS
COMPRISING CLUTCHES, DISCS, RELEASE BEAR-
INGS, PILOT BEARING BUSHING, IN CLASS 12
(U.S. CLS. 19, 21, 23, 31, 35 AND 44).

FIRST USE 0-0-1990; IN COMMERCE 0-0-1990.

OWNER OF U.S. REG. NO. 2,675,776.

THE COLOR(S) YELLOW IS/ARE CLAIMED AS A
FEATURE OF THE MARK.

THE MARK CONSISTS OF THE COLOR YELLOW
ON ALL SIDES OF THE BOX. THE DOTTED OUT-
LINE OF THE BOX IS INTENDED TO SHOW THE
POSITION OF THE MARK AND IS NOT PART OF
THE TRADEMARK AS SHOWN.

SEC. 2(F).

SER. NO. 77-184,506, FILED 5-18-2007.

WILLIAM VERHOSEK, EXAMINING ATTORNEY

Int. Cl.: 12

Prior U.S. Cls.: 19, 21, 23, 31, 35 and 44

United States Patent and Trademark Office

Reg. No. 3,483,185

Registered Aug. 12, 2008

**TRADEMARK
PRINCIPAL REGISTER**

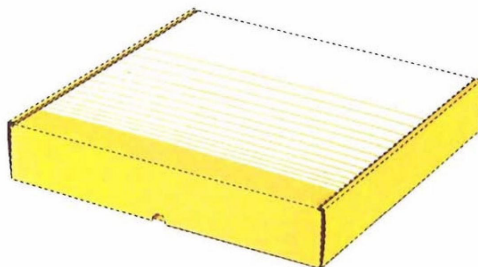

LUK LAMELLEN UND KUPPLUNGSBAU BE-
TEILIGUNGS KG (FED REP GERMANY COR-
PORATION)
INDUSTRIESTRASSE 3, 77815
BUHL, FED REP GERMANY

FOR: CLUTCHES FOR LAND VEHICLES AND STRUCTURAL PARTS THEREFORE AND CLUTCH RELEASE SYSTEMS FOR LAND VEHICLES COMPRISING RELEASE BEARINGS, RELEASE LEVERS, RELEASE HYDRAULIC UNITS AND RELEASE TOOLS SOLD AS A COMPLETE UNIT; DAMPERS IN THE DRIVE TRAIN OF LAND VEHICLES; CLUTCH REPSETS FOR LAND VEHICLES COMPRISING CLUTCHES, DISCS, RELEASE BEARINGS, PILOT BEARING BUSHING; FLYWHEELS FOR LAND VEHICLES; DUAL MASS FLYWHEELS FOR LAND VEHICLES; CLUTCH RELEASE CABLES FOR LAND VEHICLES; SLAVE BRAKE CYLINDERS AND MASTER BRAKE CYLINDERS FOR LAND VEHICLES; CLUTCHES FOR AGRICULTURAL LAND VEHICLES AND REPSETS COMPRISING CLUTCHES, DISCS, RELEASE BEARINGS, PILOT BEARING BUSHING, IN CLASS 12 (U.S. CLS. 19, 21, 23, 31, 35 AND 44).

FIRST USE 0-0-1990; IN COMMERCE 0-0-1990.

OWNER OF FED REP GERMANY REG. NO. 30720585, DATED 6-1-2007, EXPIRES 6-1-2017.

OWNER OF U.S. REG. NO. 2,675,776.

THE COLOR(S) WHITE AND YELLOW IS/ARE CLAIMED AS A FEATURE OF THE MARK.

THE MARK CONSISTS OF THE COLORS WHITE ON THE TOP OF THE BOX WITH YELLOW STRIPES SOLID YELLOW BAR AT THE BOTTOM ON TOP OF THE BOX AND YELLOW ON ALL SIDES. THE DOTTED OUTLINE OF THE BOX IS INTENDED TO SHOW THE POSITION OF THE MARK AND IS NOT PART OF THE MARK AS SHOWN.

SEC. 2(F).

SER. NO. 77-184,536, FILED 5-18-2007.

WILLIAM VERHOSEK, EXAMINING ATTORNEY

Int. Cl.: 12

Prior U.S. Cls.: 19, 21, 23, 31, 35 and 44

United States Patent and Trademark Office

Reg. No. 3,483,186

Registered Aug. 12, 2008

**TRADEMARK
PRINCIPAL REGISTER**

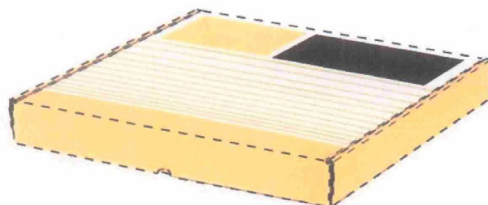

LUK LAMELLEN UND KUPPLUNGSBAU BE-
TEILIGUNGS KG (FED REP GERMANY COR-
PORATION)
INDUSTRIESTRASSE 3, 77815
BUHL, FED REP GERMANY

FOR: CLUTCHES FOR LAND VEHICLES AND STRUCTURAL PARTS THEREFORE AND CLUTCH RELEASE SYSTEMS FOR LAND VEHICLES COMPRISING RELEASE BEARINGS, RELEASE LEVERS, RELEASE HYDRAULIC UNITS AND RELEASE TOOLS SOLD AS A COMPLETE UNIT; DAMPERS IN THE DRIVE TRAIN OF LAND VEHICLES; CLUTCH REPSETS FOR LAND VEHICLES COMPRISING CLUTCHES, DISCS, RELEASE BEARINGS, PILOT BEARING BUSHING; FLYWHEELS FOR LAND VEHICLES; DUAL MASS FLYWHEELS FOR LAND VEHICLES; CLUTCH RELEASE CABLES FOR LAND VEHICLES; SLAVE BRAKE CYLINDERS AND MASTER BRAKE CYLINDERS FOR LAND VEHICLES; CLUTCHES FOR AGRICULTURAL LAND VEHICLES AND REPSETS COMPRISING CLUTCHES, DISCS, RELEASE BEARINGS, PILOT BEARING BUSHING, IN CLASS 12 (U.S. CLS. 19, 21, 23, 31, 35 AND 44).

FIRST USE 0-0-1990; IN COMMERCE 0-0-1990.

OWNER OF U.S. REG. NO. 2,675,776.

THE COLOR(S) WHITE, YELLOW AND BLACK IS/ARE CLAIMED AS A FEATURE OF THE MARK.

THE MARK CONSISTS OF THE COLORS WHITE ON THE TOP OF THE BOX WITH YELLOW STRIPES, A YELLOW RECTANGLE ON THE LEFT AND A BLACK RECTANGLE ON THE RIGHT ALSO ON TOP AND YELLOW ON ALL SIDES. THE DOTTED OUTLINE OF THE BOX IS INTENDED TO SHOW THE POSITION OF THE MARK AND IS NOT PART OF THE MARK AS SHOWN.

SEC. 2(F).

SER. NO. 77-184,550, FILED 5-18-2007.

WILLIAM VERHOSEK, EXAMINING ATTORNEY

Int. Cl.: 30

Prior U.S. Cl.: 46

United States Patent and Trademark Office

Reg. No. 3,483,187

Registered Aug. 12, 2008

**TRADEMARK
PRINCIPAL REGISTER**

VANILLA VANILLA NUT
AMERICA'S FAVORITE FLAVOR,
WITH NUTTY ACCENT

BABY'S COFFEE LLC (FLORIDA LTD LIAB CO)
3180 US1 AND MM15
KEY WEST, FL 33040

FOR: COFFEE; READY TO DRINK COFFEE;
WHOLE COFFEE BEANS; DARK ROASTED COFFEE BEANS; GROUND COFFEE, IN CLASS 30 (U.S. CL. 46).

FIRST USE 1-4-2000; IN COMMERCE 1-4-2000.

THE MARK CONSISTS OF STANDARD CHARACTERS WITHOUT CLAIM TO ANY PARTICULAR FONT, STYLE, SIZE, OR COLOR.

NO CLAIM IS MADE TO THE EXCLUSIVE RIGHT TO USE "VANILLA" AND "VANILLA NUT", APART FROM THE MARK AS SHOWN.

SER. NO. 77-185,207, FILED 5-18-2007.

RICHARD WHITE, EXAMINING ATTORNEY

Int. Cl.: 42

Prior U.S. Cls.: 100 and 101

United States Patent and Trademark Office

Reg. No. 3,483,188

Registered Aug. 12, 2008

**SERVICE MARK
PRINCIPAL REGISTER**

KJV

KJV CORPORATION (DELAWARE CORPORATION)
5675 ROSWELL RD SUITE 3E
ATLANTA, GA 30342

FOR: DEVELOPMENT OF NEW TECHNOLOGY FOR OTHERS IN THE FIELD OF ROBOTICS, ELECTRONICS AND COMPUTERS; DEVELOPMENT OF TECHNOLOGIES FOR THE FABRICATION OF CIRCUITS FOR WIRELESS COMMUNICATION, ELECTRONIC DATA PROCESSING, CONSUMER ELECTRONIC, AUTOMOTIVE ELECTRONICS; INFORMATION TECHNOLOGY CONSULTATION; PROVIDING A WEBSITE THAT FEATURES INFORMATION ON COMPUTER TECHNOLOGY AND

PROGRAMMING; TECHNOLOGY CONSULTATION AND RESEARCH IN THE FIELD OF ROBOTICS, ELECTRONICS AND COMPUTERS, IN CLASS 42 (U.S. CLS. 100 AND 101).

FIRST USE 0-0-1992; IN COMMERCE 1-30-2006.

THE MARK CONSISTS OF STANDARD CHARACTERS WITHOUT CLAIM TO ANY PARTICULAR FONT, STYLE, SIZE, OR COLOR.

SER. NO. 77-185,320, FILED 5-19-2007.

MICHAEL LEWIS, EXAMINING ATTORNEY

Int. Cls.: 9 and 41

Prior U.S. Cls.: 21, 23, 26, 36, 38, 100, 101 and 107

Reg. No. 3,483,189

United States Patent and Trademark Office

Registered Aug. 12, 2008

**TRADEMARK
SERVICE MARK
PRINCIPAL REGISTER**

ANAMI JORDAN

ADEOKUN, COMFORT O (UNITED STATES INDIVIDUAL)

7400 BUCHANAN STREET, STE. 2334

LANDOVER HILLS, MD 207842334

FOR: DOWNLOADABLE MUSICAL SOUND RECORDINGS; MUSICAL SOUND RECORDINGS; AUDIO CASSETTES FEATURING MUSIC AND ENTERTAINMENT IN THE NATURE OF PRE-RECORDED MUSICAL PERFORMANCES; PRERECORDED AUDIO CASSETTES FEATURING MUSIC AND ENTERTAINMENT IN THE NATURE OF PRE-RECORDED MUSICAL PERFORMANCES; PRERECORDED VIDEO CASSETTES FEATURING MUSIC AND ENTERTAINMENT IN THE NATURE OF PRE-RECORDED MUSICAL PERFORMANCES; COMPACT DISCS FEATURING MUSIC AND ENTERTAINMENT IN THE NATURE OF PRE-RECORDED MUSICAL PERFORMANCES; PHONOGRAPH RECORDS FEATURING MUSIC AND ENTERTAINMENT IN THE NATURE OF PRE-RECORDED MUSICAL PERFORMANCES; DOWNLOADABLE VIDEO RECORDINGS FEATURING MUSIC AND ENTERTAINMENT IN THE NATURE OF PRE-RECORDED MUSICAL PERFORMANCES; VIDEO RECORDINGS FEATURING MUSIC AND ENTERTAINMENT IN THE NATURE OF PRE-RECORDED MUSICAL PERFORMANCES; AUDIO AND VIDEO RECORDINGS FEATURING MUSIC AND ENTERTAINMENT IN THE NATURE OF PRE-RECORDED MUSICAL PERFORMANCES; DOWNLOADABLE RING TONES, GRAPHICS AND MUSIC VIA A GLOBAL COMPUTER NETWORK AND WIRELESS DEVICES, IN CLASS 9 (U.S. CLS. 21, 23, 26, 36 AND 38).

FIRST USE 12-1-2002; IN COMMERCE 1-1-2003.

FOR: MULTIMEDIA ENTERTAINMENT SERVICES IN THE NATURE OF RECORDING, PRODUCTION AND POST-PRODUCTION SERVICES IN THE FIELDS OF MUSIC, VIDEO, AND FILMS; ENTERTAINMENT IN THE NATURE OF LIVE PERFORMANCES BY A MUSICAL PERFORMER, SONGWRITER, PRODUCER AND DANCER; ENTERTAINMENT SERVICES, NAMELY, PROVIDING A WEBSITE FEATURING, PHOTOGRAPHIC, AUDIO, VIDEO AND PROSE PRESENTATIONS FEATURING MUSIC AND ENTERTAINMENT IN THE NATURE OF MUSICAL PERFORMANCES; ENTERTAINMENT SERVICES, NAMELY, LIVE, TELEVISED AND MOVIE APPEARANCES BY A PROFESSIONAL ENTERTAINER; ENTERTAINMENT SERVICES, NAMELY, PERSONAL APPEARANCES BY A MUSICAL PERFORMER, SONGWRITER, PRODUCER AND DANCER; ENTERTAINMENT, NAMELY LIVE MUSIC CONCERTS; PRODUCTION OF SOUND AND MUSIC VIDEO RECORDINGS, IN CLASS 41 (U.S. CLS. 100, 101 AND 107).

FIRST USE 12-1-2002; IN COMMERCE 1-1-2003.

THE MARK CONSISTS OF STANDARD CHARACTERS WITHOUT CLAIM TO ANY PARTICULAR FONT, STYLE, SIZE, OR COLOR.

THE NAME "ANAMI JORDAN" IDENTIFIES A LIVING INDIVIDUAL WHOSE CONSENT IS OF RECORD.

SEC. 2(F).

SER. NO. 77-185,471, FILED 5-20-2007.

JIM RINGLE, EXAMINING ATTORNEY

Int. Cl.: 37

Prior U.S. Cls.: 100, 103 and 106

United States Patent and Trademark Office

Reg. No. 3,483,190

Registered Aug. 12, 2008

**SERVICE MARK
PRINCIPAL REGISTER**

HEATH CONSTRUCTION

HEATH CONSTRUCTION (COLORADO CORPORATION)
141 RACQUETTE DR.
P.O. DRAWER H
FORT COLLINS, CO 80522

FOR: GENERAL CONSTRUCTION CONTRACTING; CONSTRUCTION OF COMMERCIAL, INDUSTRIAL, GOVERNMENT, EDUCATIONAL, RECREATIONAL AND SPORTS FACILITY BUILDINGS, IN CLASS 37 (U.S. CLS. 100, 103 AND 106).

FIRST USE 7-1-1977; IN COMMERCE 7-1-1977.

THE MARK CONSISTS OF STANDARD CHARACTERS WITHOUT CLAIM TO ANY PARTICULAR FONT, STYLE, SIZE, OR COLOR.

NO CLAIM IS MADE TO THE EXCLUSIVE RIGHT TO USE "CONSTRUCTION", APART FROM THE MARK AS SHOWN.

SER. NO. 77-185,785, FILED 5-21-2007.

MONIQUE MILLER, EXAMINING ATTORNEY

Int. Cl.: 41

Prior U.S. Cls.: 100, 101 and 107

United States Patent and Trademark Office

Reg. No. 3,483,191

Registered Aug. 12, 2008

**SERVICE MARK
PRINCIPAL REGISTER**

COAST RECORDERS

PAUL STUBBLEBINE (UNITED STATES INDIVIDUAL)
1340 MISSION ST.
SAN FRANCISCO, CA 94103

FOR: PROVIDING AUDIO OR VIDEO STUDIOS; RECORDING STUDIOS; SOUND RECORDING STUDIOS; RECORD MASTER PRODUCTION; RECORD PRODUCTION; AUDIO RECORDING AND PRODUCTION; MUSIC PRODUCTION SERVICES, IN CLASS 41 (U.S. CLS. 100, 101 AND 107).

FIRST USE 12-31-2003; IN COMMERCE 12-31-2003.

THE MARK CONSISTS OF STANDARD CHARACTERS WITHOUT CLAIM TO ANY PARTICULAR FONT, STYLE, SIZE, OR COLOR.

NO CLAIM IS MADE TO THE EXCLUSIVE RIGHT TO USE "RECORDERS", APART FROM THE MARK AS SHOWN.

SER. NO. 77-185,860, FILED 5-21-2007.

REBECCA EISINGER, EXAMINING ATTORNEY

Int. Cl.: 35

Prior U.S. Cls.: 100, 101 and 102

United States Patent and Trademark Office

Reg. No. 3,483,192

Registered Aug. 12, 2008

**SERVICE MARK
PRINCIPAL REGISTER**



UNITED FARMERS COOPERATIVE (MINNESOTA COOPERATIVE ASSOCIATION)
705 EAST FOURTH STREET
WINTHROP, MN 55396

FOR: RETAIL STORE SERVICES FEATURING GASOLINE; RETAIL STORE SERVICES FEATURING AGRICULTURAL PRODUCTS CONSISTING OF FERTILIZER, ANIMAL FEED, CROP SEED, GRAIN, AND FARM MACHINERY, IN CLASS 35 (U.S. CLS. 100, 101 AND 102).

FIRST USE 1-1-2007; IN COMMERCE 1-1-2007.

THE COLOR(S) GREEN AND WHITE IS/ARE CLAIMED AS A FEATURE OF THE MARK.

THE MARK CONSISTS OF THE LETTERS "UFC" IN THE COLOR GREEN WITH A GREEN CIRCLE AROUND THE LETTERS, A WHITE BACKGROUND, AND A WHITE CORN STALK INSIDE THE LETTER "U".

SER. NO. 77-186,076, FILED 5-21-2007.

WILLIAM ROSSMAN, EXAMINING ATTORNEY

Int. Cl.: 37

Prior U.S. Cls.: 100, 103 and 106

United States Patent and Trademark Office

Reg. No. 3,483,193

Registered Aug. 12, 2008

**SERVICE MARK
PRINCIPAL REGISTER**

AMRIT

BAROT, DILIP (UNITED STATES INDIVIDUAL)
4243 D NORTHLAKE BLVD.
PALM BEACH GARDENS, FL 33410

FOR: REAL ESTATE DEVELOPMENT, PLAN-
NING AND LAYING OUT OF LUXURY RESIDEN-
TIAL CONDOMINIUMS, CONSTRUCTION OF
RESIDENTIAL REAL PROPERTY, AND MAINTEN-
ANCE SERVICES IN THE FIELD OF LUXURY
RESIDENTIAL CONDOMINIUM HOMES, IN CLASS
37 (U.S. CLS. 100, 103 AND 106).

FIRST USE 11-1-2004; IN COMMERCE 12-8-2004.

THE MARK CONSISTS OF STANDARD CHAR-
ACTERS WITHOUT CLAIM TO ANY PARTICULAR
FONT, STYLE, SIZE, OR COLOR.

THE ENGLISH TRANSLATION OF THE WORD
"AMRIT" IN THE MARK IS THE ELIXIR OR
ESSENCE OF LIFE.

SER. NO. 77-186,087, FILED 5-21-2007.

LANA PHAM, EXAMINING ATTORNEY

Int. Cl.: 37

Prior U.S. Cls.: 100, 103 and 106

United States Patent and Trademark Office

Reg. No. 3,483,194

Registered Aug. 12, 2008

**SERVICE MARK
PRINCIPAL REGISTER**

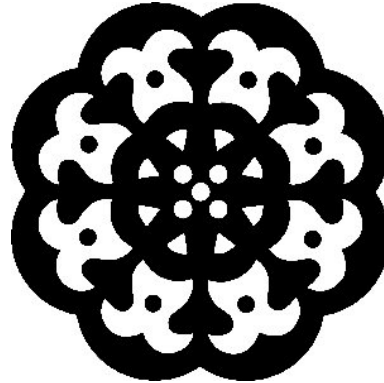

BAROT, DILIP (UNITED STATES INDIVIDUAL)
4243 D NORTHLAKE BLVD.
PALM BEACH GARDENS, FL 33410

FIRST USE 11-1-2004; IN COMMERCE 12-8-2004.

FOR: REAL ESTATE DEVELOPMENT, PLAN-
NING AND LAYING OUT OF LUXURY RESIDEN-
TIAL CONDOMINIUMS, CONSTRUCTION OF
RESIDENTIAL REAL PROPERTY, AND MAINTEN-
ANCE SERVICES IN THE FIELD OF LUXURY
RESIDENTIAL CONDOMINIUM HOMES, IN CLASS
37 (U.S. CLS. 100, 103 AND 106).

THE MARK CONSISTS OF A TWO-DIMENSION-
AL STYLIZED FANCIFUL DESIGN INCLUDING
SYMMETRICAL GRAPHIC ELEMENTS.

SER. NO. 77-186,168, FILED 5-21-2007.

LANA PHAM, EXAMINING ATTORNEY

Int. Cl.: 3

Prior U.S. Cls.: 1, 4, 6, 50, 51 and 52

United States Patent and Trademark Office

Reg. No. 3,483,195

Registered Aug. 12, 2008

**TRADEMARK
PRINCIPAL REGISTER**

EASY-CLEAN FOREVER

PAULINE SUAREZ (UNITED STATES INDIVIDUAL)
275 SOUTH PERALTA HILLS DR.
ANAHEIM, CA 92807

FOR: GENERAL PURPOSE CLEANING AND POLISHING LIQUIDS AND POWDERS FOR USE ON HARD SURFACES; AND POLYMER SEALANT FOR CLEANING, SHINING AND PROTECTING HARD AUTOMOBILE EXTERIOR SURFACES AND HOUSEHOLD INTERIOR AND EXTERIOR SURFACES, IN CLASS 3 (U.S. CLS. 1, 4, 6, 50, 51 AND 52).

FIRST USE 2-0-2003; IN COMMERCE 2-0-2003.

THE MARK CONSISTS OF STANDARD CHARACTERS WITHOUT CLAIM TO ANY PARTICULAR FONT, STYLE, SIZE, OR COLOR.

SEC. 2(F) AS TO "EASY-CLEAN".

SER. NO. 77-186,273, FILED 5-21-2007.

TIMOTHY FINNEGAN, EXAMINING ATTORNEY

Int. Cl.: 9

Prior U.S. Cls.: 21, 23, 26, 36 and 38

United States Patent and Trademark Office

Reg. No. 3,483,196

Registered Aug. 12, 2008

**TRADEMARK
PRINCIPAL REGISTER**

ACTIVEXPRESSION

PROMETHEAN LIMITED (UNITED KINGDOM
COMPANY)
PROMETHEAN HOUSE, LOWER PHILIPS ROAD
BLACKBURN, LANCASHIRE, UNITED KINGDOM
BB15TH

FOR: HANDHELD EDUCATIONAL DEVICES
AND VOTING DEVICES, NAMELY, RADIO AND
WIRELESS TRANSMITTERS AND RECEIVERS OF
DATA, IN CLASS 9 (U.S. CLS. 21, 23, 26, 36 AND 38).

PRIORITY CLAIMED UNDER SEC. 44(D) ON
UNITED KINGDOM APPLICATION NO. 2456331,
FILED 5-22-2007, REG. NO. 2456331, DATED 5-22-
2007, EXPIRES 5-22-2017.

SER. NO. 77-187,001, FILED 5-22-2007.

RENEE MCCRAY, EXAMINING ATTORNEY

Int. Cls.: 41 and 45

Prior U.S. Cls.: 100, 101 and 107

United States Patent and Trademark Office

Reg. No. 3,483,197

Registered Aug. 12, 2008

**SERVICE MARK
PRINCIPAL REGISTER**

YOUNG PEOPLE FOR

PEOPLE FOR THE AMERICAN WAY FOUNDATION (DELAWARE NON-PROFIT CORPORATION)

2000 M STREET, NW
WASHINGTON, DC 20036

FOR: PROVIDING TRAINING IN THE FIELD OF NONPROFIT PROJECT MANAGEMENT AND THE PLANNING AND RUNNING OF SOCIAL JUSTICE ISSUE CAMPAIGNS, IN CLASS 41 (U.S. CLS. 100, 101 AND 107).

FIRST USE 4-0-2005; IN COMMERCE 4-0-2005.

FOR: PROVIDING INFORMATION REGARDING SOCIAL JUSTICE ISSUES TO COLLEGE-AGE INDIVIDUALS, IN CLASS 45 (U.S. CLS. 100 AND 101).

FIRST USE 1-13-2005; IN COMMERCE 1-13-2005.

THE MARK CONSISTS OF THE REPRESENTATION OF THE WORDS "YOUNG PEOPLE FOR" ALIGNED HORIZONTALLY WITH EACH WORD PRESSED INTO A SEPARATE RECTANGULAR STRIP.

SER. NO. 77-187,346, FILED 5-22-2007.

HOWARD B. LEVINE, EXAMINING ATTORNEY

Int. Cl.: 10

Prior U.S. Cls.: 26, 39 and 44

United States Patent and Trademark Office

Reg. No. 3,483,198

Registered Aug. 12, 2008

**TRADEMARK
PRINCIPAL REGISTER**

The FaceTrainer

ROONEY, BRYAN RUSSELL (UNITED STATES
INDIVIDUAL)
7245 HILLSIDE AVENUE, #422
LOS ANGELES, CA 90046

FOR: FACIAL TONING MACHINES FOR COS-
METIC USE; MOUTH EXERCISER FOR USE IN
EXERCISING AND STRENGTHENING MOUTH
AND FACIAL MUSCLES FOR MEDICAL AND
BEAUTY BENEFITS, IN CLASS 10 (U.S. CLS. 26, 39
AND 44).

FIRST USE 8-8-2005; IN COMMERCE 11-15-2005.

THE MARK CONSISTS OF STANDARD CHAR-
ACTERS WITHOUT CLAIM TO ANY PARTICULAR
FONT, STYLE, SIZE, OR COLOR.

SER. NO. 77-187,472, FILED 5-22-2007.

PAUL E. FAHRENKOPF, EXAMINING ATTORNEY

Int. Cl.: 12

Prior U.S. Cls.: 19, 21, 23, 31, 35 and 44

Reg. No. 3,483,199

United States Patent and Trademark Office

Registered Aug. 12, 2008

**TRADEMARK
PRINCIPAL REGISTER**



ELEKTRA TRADING & CONSULTING GROUP,
S.A. DE C.V. (MEXICO CORPORATION)
COL. TLALPAN LA JOYA
AV. INSURGENTES SUR #3570, PISO 8
MEXICO, D.F., MEXICO 14000

FOR: MOTORCYCLES, CONNECTING RODS FOR LAND VEHICLES, OTHER THAN PARTS OF MOTORS AND ENGINES, USED IN CONNECTION WITH TERRESTRIAL AND AQUATIC VEHICLES; AERONAUTICAL VEHICLES USED FOR TRANSPORTING GOODS, AERIAL VEHICLES; GLIDERS; AIRSHIPS; AIRPLANES; AEROSTATICS BALLOONS; AIRBAGS FOR VEHICLES; AIR PUMPS FOR AUTOMOBILES, MOTORCYCLES, TWO-WHEELED MOTOR VEHICLES, BICYCLES; ACOUSTIC REVERSE ALARMS FOR VEHICLES; ANTI THEFT ALARMS FOR VEHICLES; SHOCK ABSORBER SPRINGS FOR VEHICLES, SHOCK ABSORBERS FOR VEHICLES SUSPENSION, SHOCK ABSORBERS FOR VEHICLES; AMPHIBIOUS AIRPLANES; ANTI-SKID CHAINS FOR VEHICLES; ANTI-SKID DEVICES FOR VEHICLE TIRES FOR VEHICLE WHEELS, NAMELY, TIRE CHAINS, TIRE SNOW CHAINS, ANTI-SKID TIRES FOR BICYCLES, MOTORCYCLES, AND TIRES SOLID, FOR VEHICLE WHEELS; ANTI-GLARE DEVICES FOR VEHICLES; NAMELY, WINDSHIELDS, REAR VIEW MIRRORS, VANITY MIRRORS, SIDE-VIEW MIRRORS; ANTI-THEFT DEVICES FOR VEHICLES; PARTS FOR TRUCKS AND WAGONS, NAMELY, STRUCTURAL PARTS; APPARATUS AND INSTALLATION OF CABLE TRANSPORT CARS, NAMELY, SUSPENSION ARMS FOR CABLE CARS; DRIVE SHAFTS FOR TERRESTRIAL VEHICLES; SAFETY HARNESSES FOR VEHICLE SEATS; SEATS COVERS FOR BICYCLES OR MOTORCYCLES; SAFETY SEATS FOR CHILDREN FOR VEHICLES; HEAD RESTS OR SUPPORTS FOR THE HEAD FOR VEHICLE SEATS; SAFETY BELTS FOR VEHICLE SEATS; VEHICLE SEAT COVERS; EJECTOR SEATS FOR AIRPLANES; SEATS FOR BICYCLES OR MOTOR-

CYCLES; SEATS FOR VEHICLES, MOTOR BUSES, MOTOR COACHES, AUTOMOBILES; CHAINS FOR AUTOMOBILES; AUTOMOBILE HOODS; AUTOMOBILE BODIES; AUTOMOBILE CHASSIS; AUTOMOBILE BUMPERS OR TOW BARS; AUTOMOBILE TIRES; SUN BLINDS ADAPTED FOR AUTOMOBILES; SPORTS VEHICLES; AIRPLANES; BALANCING WEIGHTS FOR VEHICLE WHEELS; BRAKE PADS FOR VEHICLES; TREADS FOR RE-TREADING TIRES; BARGES; SHIP HULLS; RIBS OF SHIPS; SHIP FUNNELS; SHIP BUMPERS; SHIP GAFFS; SHIP CRANES; SHIP DAVITS; MASTS FOR SHIPS; BABY CARRIAGES; BICYCLES; BICYCLE BELLS; BICYCLE PUMPS; BICYCLE CHAINS; INNER TUBES FOR BICYCLES; SPEAKERS, HORNS OR ACOUSTIC WARNING SYSTEMS FOR BICYCLES; BASKETS ADAPTED FOR BICYCLES; BICYCLE CRANKS AND PEDALS; BICYCLE GEAR ASSEMBLIES; BICYCLE BRAKES; TUBELESS TIRES FOR BICYCLES; HANDLEBARS FOR BICYCLES; BRAKE HANDLES FOR BICYCLES; MOTORS FOR BICYCLES; TIRES FOR BICYCLES; PEDALS FOR BICYCLES; BICYCLE FRAMES; RIMS FOR BICYCLE WHEELS; BICYCLE SADDLES; BICYCLE STANDS; CONNECTING RODS FOR TERRESTRIAL VEHICLES OTHER THAN PARTS OF MOTORS AND ENGINES; SPEAKERS FOR VEHICLES; RAILWAY BOGIES OR WHEELS TRUCKS FOR TRAINS CARRIAGES; BRIDLES FOR TIRES FOR TRAIN WHEELS; CABINS FOR CABLE TRANSPORT INSTALLATIONS, NAMELY, CABLE CARS; DRIVE BELTS FOR TERRESTRIAL VEHICLES; DRIVE TRAINS FOR TERRESTRIAL VEHICLES; BOXES ADAPTED FOR BICYCLES; GEARBOXES FOR TERRESTRIAL VEHICLES; HOODS FOR VEHICLES; CARRIAGES, NAMELY PASSENGER CARRIAGES, RAILWAY CARRIAGES; PUSHCARTS; FORK LIFT TRUCKS; WHEELS FOR CARTS; TWO WHEELED SACK TRUCKS; MOTORIZED GOLF CARTS; SUPERMARKET CARTS; CARTS FOR HANDLING MERCHANDISE; SHOPPING CARTS; CLEANING CARTS; GARDEN HOSE REEL CARTS;

CARTS; BODIES FOR VEHICLES; CARS; FORK LIFT CARS; CARTS FOR CRANKSHAFTS OF TERRESTRIAL VEHICLES; HYDRAULIC CIRCUITS FOR VEHICLES; HORNS FOR VEHICLES; SPOKE CLIPS FOR RIMS FOR BICYCLE WHEELS; CLUTCHES FOR TERRESTRIAL VEHICLES; SIDECARS FOR MOTORCYCLES; AUTOMOBILES; BICYCLE AND SKI RACKS FOR AUTOMOBILES; MOTOR CARS; SPORTS CARTS; PNEUMATIC TIRES AND INNER TUBES FOR VEHICLES; AXLE BEARING FOR LAND VEHICLES; TORQUE CONVERTERS FOR TERRESTRIAL VEHICLES; GLASS WINDOWS FOR VEHICLES; COVERS FOR BABY CARRIAGES; COVERS FOR TIRES; BRAKE COVERS FOR LAND VEHICLES; CANOES; VEHICLE CHASSIS; BUMPERS FOR VEHICLES; DIRIGIBLE BALLOON AIRSHIPS; AXLES FOR VEHICLES; ELECTRIC MOTORS FOR TERRESTRIAL VEHICLES; ELECTRIC VEHICLES; WINDOW MECHANISM PARTS FOR TERRESTRIAL VEHICLES; BOATS; CLUTCHES FOR TERRESTRIAL VEHICLES; RAILCAR OR WAGON COUPLINGS; TRAILER HITCHES FOR VEHICLES; LOW RATION GEAR ASSEMBLIES FOR TERRESTRIAL VEHICLES, NAMELY, GEARS, GEARBOXES, GEAR LEVER KNOBS, REVERSING GEARS; LUGGAGE NETS FOR VEHICLES; ROLLING STOCK BUFFERS FOR RAILWAYS; ROLLING STOCK FOR RAILROADS; ROLLING STOCK FOR FUNICULAR RAILWAYS; THOLEPINS; SPACE VEHICLES; SCULLS; OARS; SKI LIFTS; RUNNING BOARDS FOR VEHICLES; FERRY BOATS; BRAKE LININGS FOR VEHICLES; BRAKE SEGMENTS FOR VEHICLES; BRAKES FOR VEHICLES; REFRIGERATED TRAILERS; CAR COVERS MADE TO MEASURE; FUNICULAR RAILCARS; SEAPLANES; HYDROPLANES, LAUNCHES; WINDSCREEN WIPERS FOR VEHICLES; PIVOT PINS FOR TIRES; TIRE VALVES FOR VEHICLE; VEHICLE TIRES; CARTS FOR GARDEN HOSES; SPOKES FOR BICYCLE WHEELS BRAKES; PROPULSION MECHANISMS FOR TERRESTRIAL VEHICLES; MEDALLIONS FOR VEHICLES; WHEELS FOR MINE CARTS; LUGGAGE RACKS FOR MOTOR

CARS, MOTORCYCLES, VEHICLES; MOTORCYCLES; JET ENGINES FOR TERRESTRIAL VEHICLES; TRACTION ENGINES FOR MOTOR CARS, MOTORCYCLES, AUTOMOBILES, LAND VEHICLES; IMPULSE ENGINES FOR TERRESTRIAL VEHICLES; MOTORS FOR TERRESTRIAL VEHICLES; SCOOTERS; OMNIBUSES; CATERPILLAR TRACKS FOR VEHICLES; RAFTS; WINDSCREENS FOR MOTOR CARS; PARACHUTES; BUMPER BARS FOR VEHICLES; PONTOON BOATS; LUGGAGE RACKS FOR VEHICLES; PORTHOLES; DOORS FOR VEHICLES; SPOKES FOR VEHICLE WHEEL RIMS; REFRIGERATED VEHICLES; SUSPENSION SPRING FOR VEHICLES; REAR VIEW MIRRORS FOR VEHICLES; CENTERS FOR VEHICLE WHEEL RIMS; WHEEL RIMS FOR VEHICLES; WHEELCHAIRS; SPARE WHEELS FOR TERRESTRIAL VEHICLES; BOAT FENDERS, LAND VEHICLE FENDERS; CHAIRS FOR CHAIR LIFTS; GAS CAPS FOR LAND VEHICLES; CABLE RAILWAYS; CHAIR LIFTS; RUDDERS FOR VESSELS; TRACTORS, SPACE SHUTTLES; TRANSMISSIONS FOR TERRESTRIAL VEHICLES; STREETCARS; TRICYCLES; DELIVERY TRICYCLES; SLEIGHS; MOTORIZED SNOW SLEDS; TROLLEY LOADER; UPHOLSTERY FOR VEHICLES; STEERING WHEELS FOR VEHICLES; VEHICLES FOR TERRESTRIAL, AERIAL, MARITIME OR RAIL LOCOMOTIVES; AIR TURBINES FOR TERRESTRIAL VEHICLES; YACHTS; BRAKE SHOES FOR VEHICLES, IN CLASS 12 (U.S. CLS. 19, 21, 23, 31, 35 AND 44).

OWNER OF MEXICO REG. NO. 953823, DATED 8-9-2006, EXPIRES 8-9-2016.

THE MARK CONSISTS OF WORD MARK "ITALIKA" AND INSIGNIA DESIGN.

SER. NO. 77-187,969, FILED 5-23-2007.

SANDRA MANIOS, EXAMINING ATTORNEY

Int. Cl.: 36

Prior U.S. Cls.: 100, 101 and 102

United States Patent and Trademark Office

Reg. No. 3,483,200

Registered Aug. 12, 2008

**SERVICE MARK
PRINCIPAL REGISTER**

FC HELP

GREGORY FUNDING LLC (OREGON LTD LIAB
CO)
425 NW 10TH AVE #307
PORTLAND, OR 97209

FOR: MORTGAGE LENDING; LEASE-PUR-
CHASE LOANS; LEASE-PURCHASE FINANCING;
LEASING OF REAL PROPERTY; FINANCIAL
LOAN CONSULTATION; LOAN REFINANCING,
IN CLASS 36 (U.S. CLS. 100, 101 AND 102).

FIRST USE 7-28-2004; IN COMMERCE 9-0-2004.

THE MARK CONSISTS OF STANDARD CHAR-
ACTERS WITHOUT CLAIM TO ANY PARTICULAR
FONT, STYLE, SIZE, OR COLOR.

NO CLAIM IS MADE TO THE EXCLUSIVE
RIGHT TO USE "FC", APART FROM THE MARK
AS SHOWN.

SER. NO. 77-187,970, FILED 5-23-2007.

JAMES LOVELACE, EXAMINING ATTORNEY

Int. Cls.: 42 and 45

Prior U.S. Cls.: 100 and 101

United States Patent and Trademark Office

Reg. No. 3,483,201

Registered Aug. 12, 2008

**SERVICE MARK
PRINCIPAL REGISTER**

OPTIMIZED CASCADE

CONOCOPHILLIPS COMPANY (DELAWARE
CORPORATION)
ML 1106
600 NORTH DAIRY ASHFORD
HOUSTON, TX 770791175

FOR: TECHNOLOGY CONSULTATION AND RE-
SEARCH; ENGINEERING; PRODUCT DEVELOP-
MENT CONSULTATION; INDUSTRIAL DESIGN;
PREPARATION OF ENGINEERING DRAWINGS,
TECHNICAL DOCUMENTATION AND REPORTS;
ALL OF THESE SERVICES BEING IN THE FIELD
OF LIQUEFIED NATURAL GAS PROCESSING, IN
CLASS 42 (U.S. CLS. 100 AND 101).

FIRST USE 12-31-1969; IN COMMERCE 12-31-1996.

FOR: LICENSING OF TECHNOLOGY AND IN-
TELLECTUAL PROPERTY IN THE FIELD OF LI-
QUEFIED NATURAL GAS PROCESSING, IN CLASS
45 (U.S. CLS. 100 AND 101).

FIRST USE 12-31-1969; IN COMMERCE 12-31-1996.

THE MARK CONSISTS OF STANDARD CHAR-
ACTERS WITHOUT CLAIM TO ANY PARTICULAR
FONT, STYLE, SIZE, OR COLOR.

SER. NO. 77-188,398, FILED 5-23-2007.

MARY CRAWFORD, EXAMINING ATTORNEY

Int. Cl.: 9

Prior U.S. Cls.: 21, 23, 26, 36 and 38

Reg. No. 3,483,202

United States Patent and Trademark Office

Registered Aug. 12, 2008

**TRADEMARK
PRINCIPAL REGISTER**

INCIDE

PABLO, LESLIE (UNITED STATES INDIVIDUAL)
PO BOX 1018
KIRTLAND, NM 87417

THE MARK CONSISTS OF STANDARD CHAR-
ACTERS WITHOUT CLAIM TO ANY PARTICULAR
FONT, STYLE, SIZE, OR COLOR.

FOR: AUDIO RECORDINGS FEATURING MU-
SIC, IN CLASS 9 (U.S. CLS. 21, 23, 26, 36 AND 38).

SER. NO. 77-188,988, FILED 5-23-2007.

FIRST USE 7-23-2006; IN COMMERCE 7-23-2006.

EDWARD NELSON, EXAMINING ATTORNEY

Int. Cls.: 9 and 35

Prior U.S. Cls.: 21, 23, 26, 36, 38, 100, 101 and 102

Reg. No. 3,483,203

United States Patent and Trademark Office

Registered Aug. 12, 2008

**TRADEMARK
SERVICE MARK
PRINCIPAL REGISTER**

**THE RENEGADE NETWORK
MARKETER**

80/20 MARKETING, INC. (MINNESOTA CORPORATION)
1074 S. ROBERT STREET
WEST ST. PAUL, MN 55118

FIRST USE 3-27-2007; IN COMMERCE 3-27-2007.

FOR: DOWNLOADABLE COMPUTER SOFTWARE FOR USE IN GENERATING DIRECTLY READABLE TEXT AND IMAGES, IN THE FIELD OF BUSINESS MANAGEMENT AND SALES TECHNIQUES, IN CLASS 9 (U.S. CLS. 21, 23, 26, 36 AND 38).

THE MARK CONSISTS OF STANDARD CHARACTERS WITHOUT CLAIM TO ANY PARTICULAR FONT, STYLE, SIZE, OR COLOR.

FIRST USE 3-27-2007; IN COMMERCE 3-27-2007.

NO CLAIM IS MADE TO THE EXCLUSIVE RIGHT TO USE "NETWORK MARKETER", APART FROM THE MARK AS SHOWN.

FOR: PROVIDING INFORMATION IN THE FIELD OF BUSINESS MANAGEMENT AND SALES TECHNIQUES, IN CLASS 35 (U.S. CLS. 100, 101 AND 102).

SER. NO. 77-189,288, FILED 5-24-2007.

SANJEEV VOHRA, EXAMINING ATTORNEY

Int. Cl.: 30

Prior U.S. Cl.: 46

United States Patent and Trademark Office

Reg. No. 3,483,204

Registered Aug. 12, 2008

TRADEMARK
PRINCIPAL REGISTER



AOI TEA COMPANY (CALIFORNIA CORPORATION)
PMB438
18685-101 MAIN STREET
HUNTINGTON BEACH, CA 92648

FOR: GREEN TEA, IN CLASS 30 (U.S. CL. 46).

FIRST USE 5-15-2007; IN COMMERCE 5-15-2007.

THE MARK CONSISTS OF THE LETTERS "A" "O"
AND "I", PRESENTED IN A VERTICAL ORDER,

WITH THE LETTER "A" AT THE TOP, AND LETTER
"I" AT THE BOTTOM. THERE IS AN IMAGE OF A
TREE IN THE MIDDLE OF THE "O".

THE FOREIGN WORDING IN THE MARK
TRANSLATES INTO ENGLISH AS "HOLLYHOCK".

SER. NO. 77-189,560, FILED 5-24-2007.

SUSAN RICHARDS, EXAMINING ATTORNEY

Int. Cl.: 42

Prior U.S. Cls.: 100 and 101

United States Patent and Trademark Office

Reg. No. 3,483,205

Registered Aug. 12, 2008

**SERVICE MARK
PRINCIPAL REGISTER**

THE LOAN POST

THE LOAN POST, INC. (FLORIDA CORPORATION)
17645 S.W. 84TH AVENUE
MIAMI, FL 33157

FOR: COMPUTER SERVICE, NAMELY, ACTING AS AN APPLICATION SERVICE PROVIDER IN THE FIELD OF MORTGAGE FINANCING TO HOST COMPUTER APPLICATION SOFTWARE FOR COLLECTION, EDITING, ORGANIZING, MODIFYING, BOOKMARKING, TRANSMISSION, STORAGE AND SHARING OF DATA AND INFORMATION FOR USE IN THE ONLINE FACILITATION OF LOAN TRANSACTIONS, NAMELY, ELECTRONIC DOCUMENT, IMAGE, AND DATE COLLECTION FROM THE PARTIES TO THE TRANSACTION, STORAGE AND MANAGEMENT OF LOAN RELATED DOCUMENTS, AND THE DELIVERY AND SHARING OF LOAN RELATED DOCUMENTS TO THE PARTIES OF THE TRANSACTION; PROVIDING TEMPORARY USE OF ON-LINE NON-DOWN-

LOADABLE SOFTWARE FOR USE IN GUIDING LOANS THROUGH THE LOAN PROCESS BY ASSISTING IN DATA ENTRY, CALCULATIONS, REPORT GENERATION, AND INTERACTION WITH THIRD PARTY APPLICATIONS FOR LOANS, IN CLASS 42 (U.S. CLS. 100 AND 101).

FIRST USE 10-1-2006; IN COMMERCE 11-16-2006.

THE MARK CONSISTS OF STANDARD CHARACTERS WITHOUT CLAIM TO ANY PARTICULAR FONT, STYLE, SIZE, OR COLOR.

NO CLAIM IS MADE TO THE EXCLUSIVE RIGHT TO USE "LOAN", APART FROM THE MARK AS SHOWN.

SER. NO. 77-189,578, FILED 5-24-2007.

SUSAN RICHARDS, EXAMINING ATTORNEY

Int. Cls.: 28 and 41

Prior U.S. Cls.: 22, 23, 38, 50, 100, 101 and 107

United States Patent and Trademark Office

Reg. No. 3,483,206

Registered Aug. 12, 2008

**TRADEMARK
SERVICE MARK
PRINCIPAL REGISTER**

TORIBASH

NABI STUDIOS (PTE.LTD.) (SINGAPORE CORPORATION)

#06-02, RESIDENCES AT 338A
338A RIVER VALLEY ROAD
SINGAPORE, SINGAPORE 238381

FOR: TOYS, NAMELY, PLUSH TOYS; ACTION FIGURES; MODELED PLASTIC TOY FIGURINES; PLASTIC TOYS, NAMELY, PLASTIC CHARACTER TOYS; STUFFED PLUSH TOYS, IN CLASS 28 (U.S. CLS. 22, 23, 38 AND 50).

FOR: ENTERTAINMENT SERVICES, NAMELY, PROVIDING ENTERTAINMENT IN THE FIELD OF INTERACTIVE GAMES BY MEANS OF A GLOBAL COMPUTER NETWORK; PRODUCTION OF ANIMATED CARTOON MOTION PICTURES AND/OR TELEVISION SHOWS; PRODUCTION OF VIDEO RECORDINGS; MULTIMEDIA ENTERTAINMENT SERVICES IN THE NATURE OF RECORDING, PRODUCTION AND POST-PRODUCTION SERVI-

CES IN THE FIELDS OF MUSIC, VIDEO AND FILMS; MOVIE STUDIO SERVICES , IN CLASS 41 (U.S. CLS. 100, 101 AND 107).

THE MARK CONSISTS OF STANDARD CHARACTERS WITHOUT CLAIM TO ANY PARTICULAR FONT, STYLE, SIZE, OR COLOR.

OWNER OF SINGAPORE REG. NO. T0711616E, DATED 5-25-2007, EXPIRES 5-25-2017.

OWNER OF SINGAPORE REG. NO. T0711615G, DATED 5-25-2007, EXPIRES 5-25-2017.

"TORIBASH" HAS NO MEANING IN A FOREIGN LANGUAGE.

SER. NO. 77-190,261, FILED 5-25-2007.

HOWARD B. LEVINE, EXAMINING ATTORNEY

Int. Cls.: 35, 41 and 42

Prior U.S. Cls.: 100, 101, 102 and 107

United States Patent and Trademark Office

Reg. No. 3,483,207

Registered Aug. 12, 2008

**SERVICE MARK
PRINCIPAL REGISTER**

EXPRESS KCS

EXPRESS KCS, INC. (DELAWARE CORPORATION)
435 SIXTH AVENUE
PITTSBURGH, PA 15276

FOR: GRAPHIC ART DESIGN FOR MAGAZINES, NEWSPAPERS, CATALOGUES, MANUALS AND BROCHURES, IN CLASS 42 (U.S. CLS. 100 AND 101).

FOR: ADVERTISING SERVICES; DESIGN OF ADVERTISING MATERIAL FOR OTHERS, IN CLASS 35 (U.S. CLS. 100, 101 AND 102).

FIRST USE 6-30-2004; IN COMMERCE 6-30-2004.

FIRST USE 6-30-2004; IN COMMERCE 6-30-2004.

THE MARK CONSISTS OF STANDARD CHARACTERS WITHOUT CLAIM TO ANY PARTICULAR FONT, STYLE, SIZE, OR COLOR.

FOR: LAYOUT SERVICES OF MAGAZINES, NEWSPAPERS, CATALOGS AND BROCHURES NOT FOR ADVERTISING SERVICES, IN CLASS 41 (U.S. CLS. 100, 101 AND 107).

SER. NO. 77-191,934, FILED 5-29-2007.

FIRST USE 6-30-2004; IN COMMERCE 6-30-2004.

TANYA AMOS, EXAMINING ATTORNEY

Int. Cl.: 38

Prior U.S. Cls.: 100, 101 and 104

United States Patent and Trademark Office

Reg. No. 3,483,208

Registered Aug. 12, 2008

**SERVICE MARK
PRINCIPAL REGISTER**

WINTEGRATOR

WINTEGRATOR (CALIFORNIA LTD LIAB CO)
5405 ALTON PKWY, STE 5A-288
IRVINE, CA 92604

THE MARK CONSISTS OF STANDARD CHAR-
ACTERS WITHOUT CLAIM TO ANY PARTICULAR
FONT, STYLE, SIZE, OR COLOR.

FOR: WIRELESS ELECTRONIC TRANSMISSION
OF VOICE SIGNALS, DATA, FACSIMILES, IMAGES
AND INFORMATIONS, IN CLASS 38 (U.S. CLS. 100,
101 AND 104).

SER. NO. 77-192,036, FILED 5-29-2007.

FIRST USE 3-13-2007; IN COMMERCE 3-13-2007.

MICHAEL ENGEL, EXAMINING ATTORNEY

Int. Cl.: 36

Prior U.S. Cls.: 100, 101 and 102

United States Patent and Trademark Office

Reg. No. 3,483,209

Registered Aug. 12, 2008

**SERVICE MARK
PRINCIPAL REGISTER**

TCW LIFEPLAN FUNDS

THE TCW GROUP, INC. (NEVADA CORPORATION)
SUITE 1800
865 FIGUEROA STREET
LOS ANGELES, CA 90017

FOR: INVESTMENT MANAGEMENT SERVICES,
IN CLASS 36 (U.S. CLS. 100, 101 AND 102).

FIRST USE 1-16-2007; IN COMMERCE 2-28-2007.

THE MARK CONSISTS OF STANDARD CHARACTERS WITHOUT CLAIM TO ANY PARTICULAR FONT, STYLE, SIZE, OR COLOR.

OWNER OF U.S. REG. NOS. 1,731,608, 2,492,345
AND OTHERS.

NO CLAIM IS MADE TO THE EXCLUSIVE
RIGHT TO USE "FUNDS", APART FROM THE
MARK AS SHOWN.

SER. NO. 77-192,154, FILED 5-29-2007.

MARILYN IZZI, EXAMINING ATTORNEY

Int. Cl.: 44

Prior U.S. Cls.: 100 and 101

United States Patent and Trademark Office

Reg. No. 3,483,210

Registered Aug. 12, 2008

SERVICE MARK
PRINCIPAL REGISTER



KID FIXER WORKSHOP, LLC (TEXAS LTD LIAB
CO)
3616 BURTS DRIVE
KELLER, TX 76248

FOR: HEALTH CARE AND MEDICAL SERVICES
FOR CHILDREN, IN CLASS 44 (U.S. CLS. 100 AND
101).

FIRST USE 6-15-2001; IN COMMERCE 6-15-2001.

OWNER OF U.S. REG. NO. 3,113,271.

NO CLAIM IS MADE TO THE EXCLUSIVE
RIGHT TO USE "KID CARE PEDIATRICS", APART
FROM THE MARK AS SHOWN.

"THE COLOR(S) BLUE, RED, AND YELLOW IS/
ARE CLAIMED AS A FEATURE OF THE MARK."

"THE MARK CONSISTS OF THE WORDS "KID"
AND "CARE" IN RED WITH A YELLOW SMILEY
FACE AS THE DOT ON THE LETTER "I" AND A BIG
YELLOW SMILEY FACE BETWEEN THE WORDS
"KID" AND "CARE." THE WORD "PEDIATRICS" IS
IN BLUE WITH A YELLOW SMILEY FACE FOR
EACH DOT OVER THE LETTERS "I"; THE COLOR
BLUE ALSO OUTLINES EACH SMILEY FACE AND
IS USED TO HIGHLIGHT THE FACIAL FEATURES
ON EACH SMILEY FACE, INCLUDING A HAT AND
A BOW; THE COLOR RED APPEARS INSIDE THE
BASEBALL CAP ON TOP OF THE LOWER LEF-
MOST SMILEY FACE, AND IS IN THE BOW WORN
BY THE SMILEY FACE IN THE LOWER RIGHT-
MOST PORTION OF THE MARK."

SER. NO. 77-192,361, FILED 5-29-2007.

JORDAN BAKER, EXAMINING ATTORNEY

Int. Cl.: 1

Prior U.S. Cls.: 1, 5, 6, 10, 26 and 46

Reg. No. 3,483,211

United States Patent and Trademark Office

Registered Aug. 12, 2008

**TRADEMARK
PRINCIPAL REGISTER**

ASTAREAL

FUJI CHEMICAL INDUSTRY CO., LTD. (JAPAN CORPORATION)
NO. 55, YOKOHOONJI, KAMIICHI-MACHI
NAKANIKAWA-GUN
TOYAMA-KEN, JAPAN

FOR: CHEMICAL ADDITIVES, NAMELY, OIL CONTAINING CAROTENOIDS FOR USE IN THE MANUFACTURE OF PHARMACEUTICALS, MEDICINES, HEALTH FOODS, DIETARY SUPPLEMENTS, NUTRITIONAL SUPPLEMENTS, FOOD SUPPLEMENTS, FOODSTUFF, COSMETICS, PERSONAL CARE PRODUCTS, AND TOILETRIES; CHEMICAL ADDITIVES, NAMELY, POWDERS WHICH CONSIST OF OIL CONTAINING CAROTENOIDS FOR USE IN THE MANUFACTURE OF PHARMACEUTICALS, MEDICINES, HEALTH FOODS, DIETARY SUPPLEMENTS, NUTRITIONAL SUPPLEMENTS, FOOD SUPPLEMENTS, FOODSTUFF, COSMETICS, PERSONAL CARE PRODUCTS, AND TOILETRIES; CHEMICAL ADDITIVES, NAMELY, SOLUTIONS WHICH CONSIST OF OIL CONTAINING CAROTENOIDS FOR USE IN THE MANUFACTURE OF PHARMACEUTICALS, MEDICINES, HEALTH FOODS, DIETARY

SUPPLEMENTS, NUTRITIONAL SUPPLEMENTS, FOOD SUPPLEMENTS, FOODSTUFF, COSMETICS, PERSONAL CARE PRODUCTS, AND TOILETRIES; CHEMICAL ADDITIVES, NAMELY, BIOMASS CONTAINING CAROTENOIDS FOR USE IN THE MANUFACTURE OF PHARMACEUTICALS, MEDICINES, HEALTH FOODS, DIETARY SUPPLEMENTS, NUTRITIONAL SUPPLEMENTS, FOOD SUPPLEMENTS, FOODSTUFF, COSMETICS, PERSONAL CARE PRODUCTS, AND TOILETRIES, IN CLASS 1 (U.S. CLS. 1, 5, 6, 10, 26 AND 46).

FIRST USE 3-1-2001; IN COMMERCE 3-1-2001.

THE MARK CONSISTS OF STANDARD CHARACTERS WITHOUT CLAIM TO ANY PARTICULAR FONT, STYLE, SIZE, OR COLOR.

OWNER OF U.S. REG. NO. 2,640,546.

SER. NO. 77-193,023, FILED 5-30-2007.

FLORENTINA BLANDU, EXAMINING ATTORNEY

Int. Cl.: 29

Prior U.S. Cl.: 46

United States Patent and Trademark Office

Reg. No. 3,483,212

Registered Aug. 12, 2008

**TRADEMARK
PRINCIPAL REGISTER**

PIT-TATOES

NELSON'S, INC. (INDIANA CORPORATION)
607 NELSON PARKWAY
WAKARUSA, IN 46573

THE MARK CONSISTS OF STANDARD CHAR-
ACTERS WITHOUT CLAIM TO ANY PARTICULAR
FONT, STYLE, SIZE, OR COLOR.

FOR: FOOD PRODUCTS, NAMELY, BARBE-
CUED POTATOES, IN CLASS 29 (U.S. CL. 46).

SER. NO. 77-193,269, FILED 5-30-2007.

FIRST USE 4-20-2007; IN COMMERCE 4-20-2007.

GEORGIA CARTY, EXAMINING ATTORNEY

Int. Cls.: 16 and 41

Prior U.S. Cls.: 2, 5, 22, 23, 29, 37, 38, 50, 100, 101 and 107

Reg. No. 3,483,213

United States Patent and Trademark Office

Registered Aug. 12, 2008

**TRADEMARK
SERVICE MARK
PRINCIPAL REGISTER**

VAIL DAILY

COLORADO MOUNTAIN NEWS MEDIA CO.
(NEVADA CORPORATION)
500 DOUBLE EAGLE COURT
RENO, NV 89521

FOR: DAILY NEWSPAPER, IN CLASS 16 (U.S. CLS. 2, 5, 22, 23, 29, 37, 38 AND 50).

FIRST USE 6-15-1981; IN COMMERCE 6-15-1981.

FOR: PROVIDING ON-LINE PUBLICATIONS IN THE NATURE OF NEWSPAPERS FEATURING CURRENT EVENTS, POLITICS, POLICY, SPORTS, BUSINESS, TECHNOLOGY, ENTERTAINMENT, ARTS, LEISURE, AND TRAVEL; PROVIDING ON-LINE PUBLICATIONS IN THE NATURE OF NEWSPAPERS FEATURING INFORMATION IN THE FIELDS OF CURRENT EVENTS, POLITICS, POLICY, SPORTS, BUSINESS, TECHNOLOGY, ENTERTAINMENT, ARTS, LEISURE AND TRAVEL VIA

ELECTRONIC MAIL, IN CLASS 41 (U.S. CLS. 100, 101 AND 107).

FIRST USE 3-0-2002; IN COMMERCE 3-0-2002.

THE MARK CONSISTS OF STANDARD CHARACTERS WITHOUT CLAIM TO ANY PARTICULAR FONT, STYLE, SIZE, OR COLOR.

NO CLAIM IS MADE TO THE EXCLUSIVE RIGHT TO USE "DAILY", APART FROM THE MARK AS SHOWN.

SEC. 2(F).

SER. NO. 77-193,618, FILED 5-30-2007.

STEPHANIE ALI, EXAMINING ATTORNEY

Int. Cls.: 36 and 41

Prior U.S. Cls.: 100, 101, 102 and 107

United States Patent and Trademark Office

Reg. No. 3,483,214

Registered Aug. 12, 2008

**SERVICE MARK
PRINCIPAL REGISTER**

TREAT ASIA

THE FOUNDATION FOR AIDS RESEARCH (AM-
FAR) (NEW YORK NON-PROFIT CORPORA-
TION)
13TH FLOOR
120 WALL STREET
NEW YORK, NY 10005

FOR: CHARITABLE FUND RAISING, IN CLASS
36 (U.S. CLS. 100, 101 AND 102).

FIRST USE 12-1-2001; IN COMMERCE 12-1-2001.

FOR: CONDUCTING WORKSHOPS AND SEMI-
NARS IN THE FIELDS OF AIDS RESEARCH AND
TREATMENT AND DISTRIBUTING EDUCATION-
AL MATERIAL IN CONNECTION THEREWITH
AND EDUCATIONAL RESEARCH; EDUCATIONAL
SERVICES, NAMELY, CONDUCTING CLASSES,
SEMINARS, CONFERENCES, WORKSHOPS AND

TRAINING IN THE FIELD OF AIDS RESEARCH
AND TREATMENT, IN CLASS 41 (U.S. CLS. 100, 101
AND 107).

FIRST USE 12-1-2001; IN COMMERCE 12-1-2001.

THE MARK CONSISTS OF STANDARD CHAR-
ACTERS WITHOUT CLAIM TO ANY PARTICULAR
FONT, STYLE, SIZE, OR COLOR.

NO CLAIM IS MADE TO THE EXCLUSIVE
RIGHT TO USE "ASIA", APART FROM THE MARK
AS SHOWN.

SER. NO. 77-194,514, FILED 5-31-2007.

KATHRYN COWARD, EXAMINING ATTORNEY

Int. Cl.: 5

Prior U.S. Cls.: 6, 18, 44, 46, 51 and 52

Reg. No. 3,483,215

United States Patent and Trademark Office

Registered Aug. 12, 2008

**TRADEMARK
PRINCIPAL REGISTER**

XETHAZAT

SANOFI-AVENTIS (FRANCE CORPORATION)
174, AVENUE DE FRANCE
PARIS, FRANCE 75013

FOR: PHARMACEUTICAL PREPARATIONS IN
THE NATURE OF CYTOTOXIC COMPOUNDS
USED TO TREAT CANCER, IN CLASS 5 (U.S. CLS.
6, 18, 44, 46, 51 AND 52).

THE MARK CONSISTS OF STANDARD CHAR-
ACTERS WITHOUT CLAIM TO ANY PARTICULAR
FONT, STYLE, SIZE, OR COLOR.

PRIORITY CLAIMED UNDER SEC. 44(D) ON
FRANCE APPLICATION NO. 063468148, FILED 12-
6-2006, REG. NO. 063468148, DATED 12-6-2006, EX-
PIRES 12-6-2016.

SER. NO. 77-195,875, FILED 6-1-2007.

VERNA BETH RIRIE, EXAMINING ATTORNEY

Int. Cl.: 44

Prior U.S. Cls.: 100 and 101

United States Patent and Trademark Office

Reg. No. 3,483,216

Registered Aug. 12, 2008

**SERVICE MARK
PRINCIPAL REGISTER**

EASYLIFT

MCBRIDE, KEVIN L. (UNITED STATES INDIVIDUAL)
C-212
7777 FOREST LANE
DALLAS, TX 75230

THE MARK CONSISTS OF STANDARD CHARACTERS WITHOUT CLAIM TO ANY PARTICULAR FONT, STYLE, SIZE, OR COLOR.

FOR: COSMETIC AND PLASTIC SURGERY, IN CLASS 44 (U.S. CLS. 100 AND 101).

SER. NO. 77-196,312, FILED 6-3-2007.

FIRST USE 11-1-2004; IN COMMERCE 11-1-2004.

FLORENTINA BLANDU, EXAMINING ATTORNEY

Int. Cls.: 20 and 24

Prior U.S. Cls.: 2, 13, 22, 25, 32, 42 and 50

Reg. No. 3,483,217

United States Patent and Trademark Office

Registered Aug. 12, 2008

TRADEMARK
PRINCIPAL REGISTER



ACG GREEN GROUP, INC. (CALIFORNIA CORPORATION)
12772 MONARCH STREET
GARDEN GROVE, CA 92841

FOR: FURNITURE, IN CLASS 20 (U.S. CLS. 2, 13, 22, 25, 32 AND 50).

FIRST USE 1-12-2001; IN COMMERCE 1-12-2001.

FOR: TEXTILE FABRICS FOR HOME AND COMMERCIAL INTERIORS, COMFORTER AND DUVET COVERS, PILLOW COVERS, TEXTILE TABLE RUNNERS, IN CLASS 24 (U.S. CLS. 42 AND 50).

FIRST USE 1-12-2001; IN COMMERCE 1-12-2001.

"THE NAME(S), PORTRAIT(S), AND/OR SIGNATURE(S) SHOWN IN THE MARK DOES NOT IDENTIFY A PARTICULAR LIVING INDIVIDUAL."

THE MARK CONSISTS OF THE WORDINGS "JENNIFER" AND "TAYLOR". BETWEEN THESE TWO WORDING IS A SHIELD DESIGN COMPRISED OF FLOURISHES, SUPERIMPOSED ON TOP OF WHICH IS THE WORDING "JT".

SER. NO. 77-196,421, FILED 6-4-2007.

RICHARD A. STRASER, EXAMINING ATTORNEY

Int. Cl.: 36

Prior U.S. Cls.: 100, 101 and 102

United States Patent and Trademark Office

Reg. No. 3,483,218

Registered Aug. 12, 2008

**SERVICE MARK
PRINCIPAL REGISTER**



UPLIFTING ATHLETES (SOUTH CAROLINA CORPORATION)
122 LASCH FOOTBALL BUILDING
UNIVERSITY PARK, PA 16802

FOR: CHARITABLE FUND RAISING, IN CLASS 36 (U.S. CLS. 100, 101 AND 102).

FIRST USE 5-14-2006; IN COMMERCE 5-14-2006.

NO CLAIM IS MADE TO THE EXCLUSIVE RIGHT TO USE "ATHLETES", APART FROM THE MARK AS SHOWN.

THE COLOR(S) DARK BLUE AND LIGHT BLUE IS/ARE CLAIMED AS A FEATURE OF THE MARK.

THE MARK CONSISTS OF THE LETTER "A" IN DARK BLUE OVER TOP THE LETTER "U" IN LIGHT BLUE AND BORDERED IN DARK BLUE. THE LETTER "A" IS REPRESENTED BY A DARK BLUE TRIANGLE WITH A FOOTBALL SHAPE CUT OUT OF THE MIDDLE. THE FOOTBALL SHAPE HAS A LIGHT BLUE SWISH LOCATED NEAR THE CENTER WHICH IS REPRESENTATIVE OF THE LACES ON AN ACTUAL FOOTBALL. THE FOOTBALL SHAPE IS TRANSPARENT. TO THE RIGHT OF THE LETTERS AFOREMENTIONED ARE THE WORDS "UPLIFTING" IN LIGHT BLUE AND "ATHLETES" IN DARK BLUE.

SER. NO. 77-196,911, FILED 6-4-2007.

MICHELLE DUBOIS, EXAMINING ATTORNEY

Int. Cls.: 35, 37, 42 and 44

Prior U.S. Cls.: 100, 101, 102, 103 and 106

United States Patent and Trademark Office

Reg. No. 3,483,219

Registered Aug. 12, 2008

**SERVICE MARK
PRINCIPAL REGISTER**

PLACE CREATION

BRAD SMITH ASSOCIATES, INC. (FLORIDA CORPORATION)
2090 W. EAU GALLIE BOULEVARD
SUITE B
MELBOURNE, FL 32935

FOR: BUSINESS MANAGEMENT, IN CLASS 35 (U.S. CLS. 100, 101 AND 102).

FIRST USE 12-13-2006; IN COMMERCE 12-13-2006.

FOR: LAND DEVELOPMENT SERVICES, NAME-
LY, PLANNING AND LAYING OUT OF RESIDEN-
TIAL AND/OR COMMERCIAL COMMUNITIES;
REAL ESTATE DEVELOPMENT SERVICES, NAME-
LY, REDEVELOPMENT PLANNING AND LAYING
OUT SERVICES FOR RESIDENTIAL AND COM-
MERCIAL COMMUNITIES; MASTER PLAN COM-
MUNITY SERVICES, NAMELY, PLANNING AND
DEVELOPING MASTER PLAN COMMUNITIES;
CONSTRUCTION MANAGEMENT; CONSTRUC-
TION MANAGEMENT OF JURISDICTIONAL AP-
PROVALS AND ENTITLEMENTS; LAND
DEVELOPMENT SERVICES, NAMELY, PLANNING
AND LAYING OUT OF RESIDENTIAL AND/OR
COMMERCIAL COMMUNITIES INCLUDING PLA-
CEMENT OF SIGNAGE; REAL ESTATE DEVELOP-
MENT SERVICES, NAMELY, CONCEPT
DEVELOPMENT IN THE FIELD OF LAND DEVEL-
OPMENT SERVICES, IN CLASS 37 (U.S. CLS. 100, 103
AND 106).

FIRST USE 12-13-2006; IN COMMERCE 12-13-2006.

FOR: ARCHITECTURAL DESIGN FOR URBAN
STRUCTURES; ARCHITECTURAL DESIGN SERVI-
CES FOR OTHERS IN THE FIELD OF SUSTAIN-
ABLE DESIGN; EXTERIOR LANDSCAPE
ARCHITECTURAL DESIGN SERVICES IN THE
NATURE OF HARDSCAPES, NAMELY, DESIGN-
ING EXTERIOR LANDSCAPES USING ROCKS,
CONCRETE, PAVING STONES; LANDSCAPE
LIGHTING DESIGN; CIVIL ENGINEERING DE-
SIGN OF WATER IRRIGATION SYSTEMS AND
RECREATIONAL AREAS, IN CLASS 42 (U.S. CLS.
100 AND 101).

FIRST USE 12-13-2006; IN COMMERCE 12-13-2006.

FOR: LANDSCAPE DESIGN; LANDSCAPE GAR-
DENING DESIGN FOR OTHERS, IN CLASS 44 (U.S.
CLS. 100 AND 101).

FIRST USE 12-13-2006; IN COMMERCE 12-13-2006.

THE MARK CONSISTS OF STANDARD CHAR-
ACTERS WITHOUT CLAIM TO ANY PARTICULAR
FONT, STYLE, SIZE, OR COLOR.

SER. NO. 77-197,248, FILED 6-4-2007.

JUSTINE D. PARKER, EXAMINING ATTORNEY

Int. Cl.: 16

Prior U.S. Cls.: 2, 5, 22, 23, 29, 37, 38 and 50

Reg. No. 3,483,220

United States Patent and Trademark Office

Registered Aug. 12, 2008

**TRADEMARK
PRINCIPAL REGISTER**



DYI, INC. (KANSAS CORPORATION)
4706 W. 64 TERRACE
PRAIRIE VILLAGE, KS 66208

NO CLAIM IS MADE TO THE EXCLUSIVE
RIGHT TO USE "BABY SPACES", APART FROM
THE MARK AS SHOWN.

FOR: LIFE-SIZE PAPER TEMPLATES OF FURNI-
TURE FOOTPRINTS TO FACILITATE THE AR-
RANGEMENT OF FURNITURE IN A ROOM, IN
CLASS 16 (U.S. CLS. 2, 5, 22, 23, 29, 37, 38 AND 50).

SER. NO. 77-197,609, FILED 6-5-2007.

FIRST USE 6-1-2007; IN COMMERCE 6-1-2007.

DAVID MILLER, EXAMINING ATTORNEY

Int. Cl.: 5

Prior U.S. Cls.: 6, 18, 44, 46, 51 and 52

United States Patent and Trademark Office

Reg. No. 3,483,221

Registered Aug. 12, 2008

**TRADEMARK
PRINCIPAL REGISTER**

CalComp Nutrition

CALCOMP NUTRITION, INC. (PENNSYLVANIA CORPORATION)
2021 CLAY PIKE, SUITE 1
IRWIN, PA 15642

FOR: DIETARY AND NUTRITIONAL SUPPLEMENTS; MINERAL NUTRITIONAL SUPPLEMENTS; NUTRITIONAL DRINK MIX FOR USE AS A MEAL REPLACEMENT; NUTRITIONAL OILS NOT FOR COSMETIC PURPOSES; NUTRITIONAL OILS NOT FOR FOOD OR COSMETIC PURPOSES; NUTRITIONAL SHAKES FOR USE AS A MEAL SUBSTITUTE; NUTRITIONAL SUPPLEMENTS; NUTRITIONAL SUPPLEMENTS IN LOTION FORM SOLD AS A COMPONENT OF NUTRITIONAL SKIN CARE PRODUCTS; POWDERED NUTRITIONAL

SUPPLEMENT DRINK MIX, IN CLASS 5 (U.S. CLS. 6, 18, 44, 46, 51 AND 52).

FIRST USE 8-2-2002; IN COMMERCE 8-2-2002.

THE MARK CONSISTS OF STANDARD CHARACTERS WITHOUT CLAIM TO ANY PARTICULAR FONT, STYLE, SIZE, OR COLOR.

NO CLAIM IS MADE TO THE EXCLUSIVE RIGHT TO USE "NUTRITION", APART FROM THE MARK AS SHOWN.

SER. NO. 77-197,863, FILED 6-5-2007.

SUSAN RICHARDS, EXAMINING ATTORNEY

Int. Cl.: 35

Prior U.S. Cls.: 100, 101 and 102

United States Patent and Trademark Office

Reg. No. 3,483,222

Registered Aug. 12, 2008

**SERVICE MARK
PRINCIPAL REGISTER**

The Daily Do It

ABEL, EDWARD (UNITED STATES INDIVIDUAL)
1345 AVENUE OF THE AMERICAS, 31ST FLOOR
C/O MARSHALL J. GLUCK, ESQ.
NEW YORK, NY 10105

FOR: PROVIDING ORGANIZING SERVICES FOR INDIVIDUALS AT HOME, IN HOME OFFICES AND IN BUSINESS OFFICES, THAT PROVIDES HELP WITH TIME AND PAPER MANAGEMENT, IN CLASS 35 (U.S. CLS. 100, 101 AND 102).

FIRST USE 1-8-2006; IN COMMERCE 1-8-2006.

THE MARK CONSISTS OF STANDARD CHARACTERS WITHOUT CLAIM TO ANY PARTICULAR FONT, STYLE, SIZE, OR COLOR.

SER. NO. 77-198,501, FILED 6-5-2007.

NAAKWAMA ANKRAH, EXAMINING ATTORNEY

Int. Cls.: 37 and 42

Prior U.S. Cls.: 100, 101, 103 and 106

United States Patent and Trademark Office

Reg. No. 3,483,223

Registered Aug. 12, 2008

**SERVICE MARK
PRINCIPAL REGISTER**

AVS

ADVANCED VEHICLE SYSTEMS, INC. (DELA-
WARE CORPORATION)

SUITE 2000

11710 PLAZA AMERICA DRIVE

RESTON, VA 20190

FOR: AUTOMOTIVE MAINTENANCE AND RE-
PAIR OF MILITARY VEHICLES, IN CLASS 37 (U.S.
CLS. 100, 103 AND 106).

FIRST USE 7-1-1999; IN COMMERCE 7-1-1999.

FOR: CUSTOM DESIGN OF MACHINES AND
VEHICLES BASED ON CUSTOMER SPECIFICA-
TIONS, IN CLASS 42 (U.S. CLS. 100 AND 101).

FIRST USE 7-1-1999; IN COMMERCE 7-1-1999.

THE MARK CONSISTS OF STANDARD CHAR-
ACTERS WITHOUT CLAIM TO ANY PARTICULAR
FONT, STYLE, SIZE, OR COLOR.

SER. NO. 77-198,733, FILED 6-6-2007.

CYNTHIA SLOAN, EXAMINING ATTORNEY

Int. Cl.: 41

Prior U.S. Cls.: 100, 101 and 107

United States Patent and Trademark Office

Reg. No. 3,483,224

Registered Aug. 12, 2008

**SERVICE MARK
PRINCIPAL REGISTER**

**America's #1 Power &
Success Diva**

SUPERNOVA COACHING ENTERPRISES (CALIFORNIA SOLE PROPRIETORSHIP)
SUITE 102-796
14622 VENTURA BLVD.
SHERMAN OAKS, CA 91403

FOR: TELEPROMPTING SERVICES PROVIDED TO FILM AND TELEVISION AND CORPORATE PUBLIC SPEAKING; EDUCATIONAL AND ENTERTAINMENT SERVICES, NAMELY, PROVIDING MOTIVATIONAL AND EDUCATIONAL SPEAKERS; BUSINESS TRAINING; PROVIDING ON-LINE TRAINING IN THE FORM OF E-COURSES, SEMINARS AND WORKSHOPS IN THE FIELD OF COLLEGE PLANNING AND CAREER PLANNING; TRAINING SERVICES IN THE FIELD OF COLLEGE

PLANNING AND CAREER PLANNING, IN CLASS 41 (U.S. CLS. 100, 101 AND 107).

FIRST USE 5-1-2007; IN COMMERCE 5-25-2007.

THE MARK CONSISTS OF STANDARD CHARACTERS WITHOUT CLAIM TO ANY PARTICULAR FONT, STYLE, SIZE, OR COLOR.

NO CLAIM IS MADE TO THE EXCLUSIVE RIGHT TO USE "AMERICA'S #1", APART FROM THE MARK AS SHOWN.

SER. NO. 77-198,997, FILED 6-6-2007.

PAULA MAHONEY, EXAMINING ATTORNEY

Int. Cl.: 36

Prior U.S. Cls.: 100, 101 and 102

United States Patent and Trademark Office

Reg. No. 3,483,225

Registered Aug. 12, 2008

SERVICE MARK
PRINCIPAL REGISTER

PRO FED

PROFESSIONAL FEDERAL CREDIT UNION (INDIANA FEDERALLY CHARTERED CREDIT UNION)
1710 ST. JOE RIVER DR
FORT WAYNE, IN 46895

FOR: BANKING SERVICES, NAMELY, SAVINGS AND CHECKING ACCOUNTS SERVICES; FINANCIAL SERVICES, NAMELY, PROVIDING BANK CHECKING CARDS, SHARE CERTIFICATES AND MONEY MARKET SHARE ACCOUNTS, INDIVIDUAL RETIREMENT ACCOUNTS; FINANCIAL MANAGEMENT OF HEALTH SAVINGS ACCOUNTS, "NAME YOUR OWN" VACATION AND CLUB ACCOUNTS, CHRISTMAS CLUB ACCOUNTS; DIRECT DEPOSIT OF FUNDS INTO CUSTOMER BANK ACCOUNTS AND PAYROLL DEDUCTION SERVICES; ORIGINATING, PURCHASING AND SERVICING AUTO LOANS; MORTGAGES BANKING, LENDING AND BROKERAGE; HOME EQUITY LOANS AND LINES OF CREDIT; PERSONAL LOANS; BUSINESS LOANS; EDUCA-

TION LOANS; FINANCIAL ADVISING; CREDIT CARD SERVICES; YOUTH SAVINGS PROGRAMS; GROUP SAVINGS PROGRAMS; ISSUING OF CASHIER'S CHECKS AND MONEY ORDERS; SAFE DEPOSIT BOXES SERVICES; WIRE TRANSFER SERVICES; ATM SERVICES; ONLINE AND TELEPHONE BANKING SERVICES; BILL PAYMENT SERVICES; PROVIDING ONLINE LOAN APPLICATION SERVICES; AFTER HOURS LOAN-BY-PHONE APPLICATION SERVICES, IN CLASS 36 (U.S. CLS. 100, 101 AND 102).

FIRST USE 6-1-1987; IN COMMERCE 6-1-1987.

THE MARK CONSISTS OF STANDARD CHARACTERS WITHOUT CLAIM TO ANY PARTICULAR FONT, STYLE, SIZE, OR COLOR.

SER. NO. 77-199,286, FILED 6-6-2007.

NAAKWAMA ANKRAH, EXAMINING ATTORNEY

Int. Cl.: 34

Prior U.S. Cls.: 2, 8, 9 and 17

United States Patent and Trademark Office

Reg. No. 3,483,226

Registered Aug. 12, 2008

**TRADEMARK
PRINCIPAL REGISTER**

VPAPERS

SUSTAINABLE TRADING LIMITED (ENGLAND
LIMITED COMPANY)
MAIDSTONE
ARNOLD YOKE BACK STREET
KENT, ENGLAND ME171TF

FOR: TOBACCO; MATCHES; CIGARETTES; CIGARETTE FILTERS; CIGARETTE TIPS; CIGARETTE PAPER; CIGARETTE PAPERS; BOOKS OF CIGARETTE PAPERS; PACKS OF CIGARETTE PAPERS; PADS OF CIGARETTE PAPERS; POCKET MACHINES FOR ROLLING CIGARETTES, IN CLASS 34 (U.S. CLS. 2, 8, 9 AND 17).

THE MARK CONSISTS OF STANDARD CHARACTERS WITHOUT CLAIM TO ANY PARTICULAR FONT, STYLE, SIZE, OR COLOR.

OWNER OF UNITED KINGDOM REG. NO. 2422841, DATED 5-25-2006, EXPIRES 5-25-2016.

SER. NO. 77-199,435, FILED 6-6-2007.

STEPHEN AQUILA, EXAMINING ATTORNEY

Int. Cls.: 35 and 36

Prior U.S. Cls.: 100, 101 and 102

United States Patent and Trademark Office

Reg. No. 3,483,227

Registered Aug. 12, 2008

**SERVICE MARK
PRINCIPAL REGISTER**



MICHAEL & SUSAN DELL FOUNDATION
(TEXAS CORPORATION)
3600 CAPITAL OF TEXAS HIGHWAY NORTH
SUITE A-200
AUSTIN, TX 78746

FOR: PROMOTING PUBLIC AWARENESS OF PUBLIC EDUCATION AND HEALTH ISSUES; CHARITABLE DONATION OF BUSINESS CONSULTING SERVICES AND PERFORMANCE MANAGEMENT CONSULTING SERVICES TO CHARITABLE AND PUBLIC BENEFIT PROGRAMS AND ORGANIZATIONS; CHARITABLE DONATION OF SERVICES, NAMELY, PERFORMANCE MANAGEMENT AND OUTCOMES MEASUREMENT ADVICE AND CONSULTING SERVICES TO CHARITABLE AND PUBLIC BENEFIT PROGRAMS AND ORGANIZATIONS, IN CLASS 35 (U.S. CLS. 100, 101 AND 102).

FIRST USE 8-28-2003; IN COMMERCE 8-28-2003.

FOR: PHILANTHROPIC AND CHARITABLE SERVICES, NAMELY, PROVIDING GRANTS, LOANS, AND MONETARY DONATIONS TO CHARITABLE AND PUBLIC BENEFIT PROGRAMS AND ORGANIZATIONS; PROGRAM-RELATED INVESTMENTS

FOR CHARITABLE PURPOSES; PROVIDING EDUCATIONAL SCHOLARSHIPS AND ADMINISTERING A SCHOLARSHIP PROGRAM; ELEEMOSYNARY SERVICES IN THE FIELD OF MONETARY DONATIONS; CHARITABLE DONATION OF SERVICES, NAMELY, FINANCIAL ADVICE AND CONSULTING SERVICES TO CHARITABLE AND PUBLIC BENEFIT PROGRAMS AND ORGANIZATIONS, IN CLASS 36 (U.S. CLS. 100, 101 AND 102).

FIRST USE 8-28-2003; IN COMMERCE 8-28-2003.

THE COLOR(S) PURPLE AND WHITE IS/ARE CLAIMED AS A FEATURE OF THE MARK.

THE MARK CONSISTS OF THE LETTERS "MSDF" IN STYLIZED FORM, WITH THE LETTERS APPEARING IN WHITE AGAINST A PURPLE BACKGROUND.

SER. NO. 77-199,964, FILED 6-7-2007.

HOWARD B. LEVINE, EXAMINING ATTORNEY

Int. Cl.: 36

Prior U.S. Cls.: 100, 101 and 102

United States Patent and Trademark Office

Reg. No. 3,483,228

Registered Aug. 12, 2008

**SERVICE MARK
PRINCIPAL REGISTER**

FRONTENAC BANK

FRONTENAC BANK (MISSOURI CHARTERED
BANK)
3330 RIDER TRAIL SOUTH DRIVE
EARTH CITY, MO 63045

FOR: BANKING SERVICES, IN CLASS 36 (U.S.
CLS. 100, 101 AND 102).

FIRST USE 1-29-1999; IN COMMERCE 1-29-1999.

THE MARK CONSISTS OF STANDARD CHAR-
ACTERS WITHOUT CLAIM TO ANY PARTICULAR
FONT, STYLE, SIZE, OR COLOR.

NO CLAIM IS MADE TO THE EXCLUSIVE
RIGHT TO USE "BANK", APART FROM THE
MARK AS SHOWN.

SEC. 2(F).

SER. NO. 77-199,968, FILED 6-7-2007.

SUSAN LESLIE DUBOIS, EXAMINING ATTORNEY

Int. Cls.: 35 and 36

Prior U.S. Cls.: 100, 101 and 102

United States Patent and Trademark Office

Reg. No. 3,483,229

Registered Aug. 12, 2008

**SERVICE MARK
PRINCIPAL REGISTER**

MSDF

MICHAEL & SUSAN DELL FOUNDATION
(TEXAS CORPORATION)
3600 CAPITAL OF TEXAS HIGHWAY NORTH
SUITE A-200
AUSTIN, TX 78746

FOR: PROMOTING PUBLIC AWARENESS OF PUBLIC EDUCATION AND HEALTH ISSUES; CHARITABLE DONATION OF BUSINESS CONSULTING SERVICES AND PERFORMANCE MANAGEMENT CONSULTING SERVICES TO CHARITABLE AND PUBLIC BENEFIT PROGRAMS AND ORGANIZATIONS; CHARITABLE DONATION OF SERVICES, NAMELY, PERFORMANCE MANAGEMENT AND OUTCOMES MEASUREMENT ADVICE AND CONSULTING SERVICES TO CHARITABLE AND PUBLIC BENEFIT PROGRAMS AND ORGANIZATIONS, IN CLASS 35 (U.S. CLS. 100, 101 AND 102).

FIRST USE 8-28-2003; IN COMMERCE 8-28-2003.

FOR: PHILANTHROPIC AND CHARITABLE SERVICES, NAMELY, PROVIDING GRANTS, LOANS,

AND MONETARY DONATIONS TO CHARITABLE AND PUBLIC BENEFIT PROGRAMS AND ORGANIZATIONS; PROGRAM-RELATED INVESTMENTS FOR CHARITABLE PURPOSES; PROVIDING EDUCATIONAL SCHOLARSHIPS AND ADMINISTERING A SCHOLARSHIP PROGRAM; ELEEMOSYNARY SERVICES IN THE FIELD OF MONETARY DONATIONS; CHARITABLE DONATION OF SERVICES, NAMELY, FINANCIAL ADVICE AND CONSULTING SERVICES TO CHARITABLE AND PUBLIC BENEFIT PROGRAMS AND ORGANIZATIONS, IN CLASS 36 (U.S. CLS. 100, 101 AND 102).

FIRST USE 8-28-2003; IN COMMERCE 8-28-2003.

THE MARK CONSISTS OF STANDARD CHARACTERS WITHOUT CLAIM TO ANY PARTICULAR FONT, STYLE, SIZE, OR COLOR.

SER. NO. 77-199,978, FILED 6-7-2007.

HOWARD B. LEVINE, EXAMINING ATTORNEY

Int. Cls.: 35 and 36

Prior U.S. Cls.: 100, 101 and 102

United States Patent and Trademark Office

Reg. No. 3,483,230

Registered Aug. 12, 2008

**SERVICE MARK
PRINCIPAL REGISTER**

**Michael & Susan Dell
Foundation**

MICHAEL & SUSAN DELL FOUNDATION
(TEXAS CORPORATION)
3600 CAPITAL OF TEXAS HIGHWAY NORTH
SUITE A-200
AUSTIN, TX 78746

FOR: PROMOTING PUBLIC AWARENESS OF PUBLIC EDUCATION AND HEALTH ISSUES; CHARITABLE DONATION OF BUSINESS CONSULTING SERVICES AND PERFORMANCE MANAGEMENT CONSULTING SERVICES TO CHARITABLE AND PUBLIC BENEFIT PROGRAMS AND ORGANIZATIONS; CHARITABLE DONATION OF SERVICES, NAMELY, PERFORMANCE MANAGEMENT AND OUTCOMES MEASUREMENT ADVICE AND CONSULTING SERVICES TO CHARITABLE AND PUBLIC BENEFIT PROGRAMS AND ORGANIZATIONS, IN CLASS 35 (U.S. CLS. 100, 101 AND 102).

FIRST USE 12-20-1999; IN COMMERCE 12-20-1999.

FOR: PHILANTHROPIC AND CHARITABLE SERVICES, NAMELY, PROVIDING GRANTS, LOANS, AND MONETARY DONATIONS TO CHARITABLE AND PUBLIC BENEFIT PROGRAMS AND ORGANIZATIONS; PROGRAM-RELATED INVESTMENTS

FOR CHARITABLE PURPOSES; PROVIDING EDUCATIONAL SCHOLARSHIPS AND ADMINISTERING A SCHOLARSHIP PROGRAM; ELEEMOSYNARY SERVICES IN THE FIELD OF MONETARY DONATIONS; CHARITABLE DONATION OF SERVICES, NAMELY, FINANCIAL ADVICE AND CONSULTING SERVICES TO CHARITABLE AND PUBLIC BENEFIT PROGRAMS AND ORGANIZATIONS, IN CLASS 36 (U.S. CLS. 100, 101 AND 102).

FIRST USE 12-20-1999; IN COMMERCE 12-20-1999.

THE MARK CONSISTS OF STANDARD CHARACTERS WITHOUT CLAIM TO ANY PARTICULAR FONT, STYLE, SIZE, OR COLOR.

THE NAME(S), PORTRAIT(S), AND/OR SIGNATURE(S) SHOWN IN THE MARK IDENTIFIES "MICHAEL S. DELL" & "SUSAN L. DELL", WHOSE CONSENT(S) TO REGISTER IS SUBMITTED.

SER. NO. 77-199,982, FILED 6-7-2007.

HOWARD B. LEVINE, EXAMINING ATTORNEY

Int. Cls.: 5, 30, 35, 41 and 44

Prior U.S. Cls.: 6, 18, 44, 46, 51, 52, 100, 101, 102 and 107

Reg. No. 3,483,231

United States Patent and Trademark Office

Registered Aug. 12, 2008

**TRADEMARK
SERVICE MARK
PRINCIPAL REGISTER**

VIVA WORKS

CARR, LISA A. (UNITED STATES INDIVIDUAL)
107 OSPREY COURT
SECAUCUS, NJ 07094

FOR: NUTRITIONAL SUPPLEMENTS; DIETARY SUPPLEMENTS; NUTRITIONAL BEVERAGES, SHAKES, JUICES, DRINK MIXES AND SHAKE MIXES FOR USE AS DIETARY SUPPLEMENTS AND MEAL REPLACEMENTS; READY-TO-EAT NUTRITIONAL FOOD BARS AND COOKIES FOR USE AS DIETARY SUPPLEMENTS AND MEAL REPLACEMENTS; ANTIOXIDANTS, BOTANICAL EXTRACTS, DETOXERS, HERBS AND HERBAL EXTRACTS, METABOLIC ACTIVATORS, MINERALS, RELAXERS, VITALIZERS AND VITAMINS, ALL FOR USE AS DIETARY SUPPLEMENTS; NUTRITIONAL AND PROTEIN SHAKES FOR USE AS A MEAL SUBSTITUTE, IN CLASS 5 (U.S. CLS. 6, 18, 44, 46, 51 AND 52).

FIRST USE 1-1-2007; IN COMMERCE 3-1-2007.

FOR: CEREAL BASED READY TO EAT FOOD BARS AND SNACK FOODS; NUTRITIONAL CANDY BARS; FROZEN CONFECTIONS; PROTEIN SHAKES; SUGAR-FREE BAKERY DESSERTS, SOUFFLES, MOUSSE AND PUDDINGS, IN CLASS 30 (U.S. CL. 46).

FIRST USE 1-1-2007; IN COMMERCE 3-1-2007.

FOR: RETAIL STORE SERVICES, MAIL ORDER SERVICES AND ONLINE RETAIL STORE SERVICES FEATURING AUDIO/VIDEO RECORDINGS, BOOKS, CLOTHING, EXERCISE EQUIPMENT, VITAMINS AND FOOD SUPPLEMENTS IN THE FIELD OF HEALTHCARE, NUTRITION, PHYSICAL FITNESS AND WELLNESS, IN CLASS 35 (U.S. CLS. 100, 101 AND 102).

FIRST USE 1-1-2007; IN COMMERCE 3-1-2007.

FOR: EDUCATIONAL SERVICES, NAMELY CONDUCTING PROGRAMS, SEMINARS AND WORKSHOPS IN THE FIELD OF HEALTHCARE, NUTRITION, PHYSICAL FITNESS AND WELLNESS AND DISTRIBUTING COURSE MATERIALS IN CONNECTION THEREWITH; ENTERTAINMENT SERVICES, NAMELY, ARRANGING AND CONDUCTING LIVE SPEAKING ENGAGEMENTS IN THE FIELD OF ALTERNATIVE HEALTH CARE, NUTRITION, PHYSICAL FITNESS AND WELLNESS AND DISTRIBUTING COURSE MATERIALS IN CONNECTION THEREWITH; PROVIDING PERSONAL COACHING AND CONSULTATION SERVICES IN THE FIELD OF PHYSICAL FITNESS; PROVIDING ON-LINE INFORMATION IN THE FIELD OF PHYSICAL FITNESS, IN CLASS 41 (U.S. CLS. 100, 101 AND 107).

FIRST USE 1-1-2007; IN COMMERCE 3-1-2007.

FOR: HEALTHCARE SERVICES, NAMELY, PROVIDING INFORMATION, ADVICE, COUNSELING AND CONSULTATION IN THE FIELD OF HEALTHCARE, NUTRITION AND WELLNESS; PROVIDING CONSULTATION SERVICES IN THE FIELD OF HEALTHCARE, NUTRITION AND WELLNESS; PROVIDING ON-LINE INFORMATION IN THE FIELD OF HEALTHCARE, NUTRITION, AND WELLNESS, IN CLASS 44 (U.S. CLS. 100 AND 101).

FIRST USE 1-1-2007; IN COMMERCE 3-1-2007.

THE MARK CONSISTS OF STANDARD CHARACTERS WITHOUT CLAIM TO ANY PARTICULAR FONT, STYLE, SIZE, OR COLOR.

SER. NO. 77-200,067, FILED 6-7-2007.

PAULA MAHONEY, EXAMINING ATTORNEY

Int. Cls.: 39, 41 and 43

Prior U.S. Cls.: 100, 101, 105 and 107

United States Patent and Trademark Office

Reg. No. 3,483,232

Registered Aug. 12, 2008

SERVICE MARK
PRINCIPAL REGISTER



FUHRMANN, JENS (FED REP GERMANY INDIVIDUAL)
REBENWEG 38
39118 MAGDEBURG, FED REP GERMANY

FOR: TRAVEL AGENCY SERVICES, NAMELY, MAKING BOOKINGS AND RESERVATIONS FOR TRANSPORTATION, IN CLASS 39 (U.S. CLS. 100 AND 105).

FOR: OPERATING DISCOTHEQUES, IN CLASS 41 (U.S. CLS. 100, 101 AND 107).

FOR: CATERING SERVICES AND PROVIDING TEMPORARY ACCOMMODATIONS FOR GUESTS;

TRAVEL AGENCY SERVICES, NAMELY, MAKING BOOKINGS AND RESERVATIONS FOR ACCOMMODATIONS, IN CLASS 43 (U.S. CLS. 100 AND 101).

OWNER OF FED REP GERMANY REG. NO. 30631304.9, DATED 11-23-2006, EXPIRES 5-17-2016.

NO CLAIM IS MADE TO THE EXCLUSIVE RIGHT TO USE "VILLAGE", APART FROM THE MARK AS SHOWN.

SER. NO. 77-200,364, FILED 6-7-2007.

SHAILA SETTLES, EXAMINING ATTORNEY

Int. Cl.: 36

Prior U.S. Cls.: 100, 101 and 102

United States Patent and Trademark Office

Reg. No. 3,483,233

Registered Aug. 12, 2008

**SERVICE MARK
PRINCIPAL REGISTER**

**BOND SAFEGUARD INSURANCE
CO.**

BOND SAFEGUARD INSURANCE COMPANY
(ILLINOIS CORPORATION)

SUITE 100

10002 SHELBYVILLE ROAD

LOUISVILLE, KY 40223

FOR: INSURANCE SERVICES, NAMELY, UN-
DERWRITING SURETY BONDS, IN CLASS 36 (U.S.
CLS. 100, 101 AND 102).

FIRST USE 6-18-1973; IN COMMERCE 6-18-1973.

THE MARK CONSISTS OF STANDARD CHAR-
ACTERS WITHOUT CLAIM TO ANY PARTICULAR
FONT, STYLE, SIZE, OR COLOR.

NO CLAIM IS MADE TO THE EXCLUSIVE
RIGHT TO USE "INSURANCE CO.", APART FROM
THE MARK AS SHOWN.

SEC. 2(F).

SER. NO. 77-200,431, FILED 6-7-2007.

VERNA BETH RIRIE, EXAMINING ATTORNEY

Int. Cl.: 9

Prior U.S. Cls.: 21, 23, 26, 36 and 38

Reg. No. 3,483,234

United States Patent and Trademark Office

Registered Aug. 12, 2008

**TRADEMARK
PRINCIPAL REGISTER**

EDGEIRON

FOUNDRY NETWORKS, INC. (DELAWARE
CORPORATION)
4980 GREAT AMERICA PARKWAY
SANTA CLARA, CA 95054

FOR: COMPUTER HARDWARE FOR USE IN
NETWORKING, NAMELY, SWITCHES, IN CLASS 9
(U.S. CLS. 21, 23, 26, 36 AND 38).

FIRST USE 12-14-2001; IN COMMERCE 12-14-2001.

THE MARK CONSISTS OF STANDARD CHAR-
ACTERS WITHOUT CLAIM TO ANY PARTICULAR
FONT, STYLE, SIZE, OR COLOR.

OWNER OF U.S. REG. NOS. 2,212,298, 2,312,393
AND OTHERS.

SER. NO. 77-200,471, FILED 6-7-2007.

TANYA AMOS, EXAMINING ATTORNEY

Int. Cl.: 36

Prior U.S. Cls.: 100, 101 and 102

United States Patent and Trademark Office

Reg. No. 3,483,235

Registered Aug. 12, 2008

**SERVICE MARK
PRINCIPAL REGISTER**

BANCO FUERZA

APPALACHIAN BANCSHARES, INC. (GEORGIA CORPORATION)
P.O. BOX G
829 INDUSTRIAL BOULEVARD
EILIJAY, GA 305403705

FOR: BANKING AND FINANCIAL SERVICES, NAMELY, COMMERCIAL LENDING SERVICES; CONSUMER LENDING SERVICES, INCLUDING HOME EQUITY LOANS AND CREDIT CARD SERVICES; PERSONAL PROPERTY LENDING SERVICES, NAMELY, LEASE-PURCHASE FINANCING FOR EQUIPMENT; COMMERCIAL AND RESIDENTIAL REAL ESTATE LENDING SERVICES; ACCOUNTS-RECEIVABLE LENDING SERVICES; UNSECURED LENDING SERVICES; SAVINGS ACCOUNT SERVICES, INCLUDING CERTIFICATES OF DEPOSIT AND MONEY MARKET SAVINGS; DEMAND-DEPOSIT ACCOUNT SERVICES, NAMELY, CHECKING ACCOUNT SERVICES AND MONEY-MARKET CHECKING ACCOUNT SERVICES; RETIREMENT ACCOUNT SERVICES; ELECTRONIC FUNDS TRANSFER SERVICES; SAFE-DEPOSIT BOX SERVICES; ON-LINE BANKING SERVICES,

CORPORATE AND SMALL BUSINESS FINANCIAL SERVICES, NAMELY, PROVIDING WORKING CAPITAL; AND ASSET, CASH, AND INVESTMENT MANAGEMENT SERVICES, IN CLASS 36 (U.S. CLS. 100, 101 AND 102).

FIRST USE 8-20-2007; IN COMMERCE 8-20-2007.

THE MARK CONSISTS OF STANDARD CHARACTERS WITHOUT CLAIM TO ANY PARTICULAR FONT, STYLE, SIZE, OR COLOR.

NO CLAIM IS MADE TO THE EXCLUSIVE RIGHT TO USE "BANCO", APART FROM THE MARK AS SHOWN.

THE FOREIGN WORDING IN THE MARK TRANSLATES INTO ENGLISH AS STRENGTH BANK.

SER. NO. 77-200,555, FILED 6-7-2007.

KELLEY WELLS, EXAMINING ATTORNEY

Int. Cl.: 37

Prior U.S. Cls.: 100, 103 and 106

United States Patent and Trademark Office

Reg. No. 3,483,236

Registered Aug. 12, 2008

**SERVICE MARK
PRINCIPAL REGISTER**

ARIENCE BUILDERS, INC.

HOLLOWAY, DANIEL L. (UNITED STATES IN-
DIVIDUAL)
5 S. 202 DRENDEL RD.
DOWNERS GROVE, IL 60515

FOR: CUSTOM CONSTRUCTION AND BUILD-
ING RENOVATION, IN CLASS 37 (U.S. CLS. 100, 103
AND 106).

FIRST USE 4-1-2006; IN COMMERCE 4-1-2006.

THE MARK CONSISTS OF STANDARD CHAR-
ACTERS WITHOUT CLAIM TO ANY PARTICULAR
FONT, STYLE, SIZE, OR COLOR.

NO CLAIM IS MADE TO THE EXCLUSIVE
RIGHT TO USE "BUILDERS, INC.", APART FROM
THE MARK AS SHOWN.

THE WORDING "ARIENCE" HAS NO MEANING
IN A FOREIGN LANGUAGE.

SER. NO. 77-200,603, FILED 6-7-2007.

JENNIFER VASQUEZ, EXAMINING ATTORNEY

Int. Cl.: 16

Prior U.S. Cls.: 2, 5, 22, 23, 29, 37, 38 and 50

United States Patent and Trademark Office

Reg. No. 3,483,237

Registered Aug. 12, 2008

**TRADEMARK
PRINCIPAL REGISTER**

EUKARYOTIC CELL

AMERICAN SOCIETY FOR MICROBIOLOGY
(D.C. CORPORATION)
1752 N STREET, N.W.
WASHINGTON, DC 20036

FOR: PERIODIC SCIENTIFIC JOURNAL IN THE
FIELD OF MICROORGANISMS, IN CLASS 16 (U.S.
CLS. 2, 5, 22, 23, 29, 37, 38 AND 50).

FIRST USE 2-28-2002; IN COMMERCE 2-28-2002.

THE MARK CONSISTS OF STANDARD CHAR-
ACTERS WITHOUT CLAIM TO ANY PARTICULAR
FONT, STYLE, SIZE, OR COLOR.

SEC. 2(F).

SER. NO. 77-200,613, FILED 6-7-2007.

TINA BROWN, EXAMINING ATTORNEY

Int. Cl.: 9

Prior U.S. Cls.: 21, 23, 26, 36 and 38

Reg. No. 3,483,238

United States Patent and Trademark Office

Registered Aug. 12, 2008

**TRADEMARK
PRINCIPAL REGISTER**

IRONPOINT

FOUNDRY NETWORKS, INC. (DELAWARE
CORPORATION)
4980 GREAT AMERICA PARKWAY
SANTA CLARA, CA 95054

FOR: COMPUTER HARDWARE AND SOFTWARE FOR USE IN WIRELESS NETWORKING, NAMELY, WIRELESS CONTROLLERS TO MONITOR AND CONTROL THE FUNCTION OF OTHER ELECTRONIC DEVICES, COMPUTER HARDWARE IN THE NATURE OF WIRELESS ACCESS POINT DEVICES, AND WIRELESS ACCESS MANAGEMENT SOFTWARE, IN CLASS 9 (U.S. CLS. 21, 23, 26, 36 AND 38).

FIRST USE 11-14-2003; IN COMMERCE 11-14-2003.

THE MARK CONSISTS OF STANDARD CHARACTERS WITHOUT CLAIM TO ANY PARTICULAR FONT, STYLE, SIZE, OR COLOR.

OWNER OF U.S. REG. NOS. 2,174,495, 2,312,393 AND OTHERS.

SER. NO. 77-200,812, FILED 6-7-2007.

TANYA AMOS, EXAMINING ATTORNEY

Int. Cl.: 9

Prior U.S. Cls.: 21, 23, 26, 36 and 38

Reg. No. 3,483,239

United States Patent and Trademark Office

Registered Aug. 12, 2008

**TRADEMARK
PRINCIPAL REGISTER**

FIREPATH

BROADCOM CORPORATION (CALIFORNIA
CORPORATION)
5300 CALIFORNIA AVENUE
IRVINE, CA 92617

FOR: MICROPROCESSORS; MICROPROCESSOR
CORES; SOFTWARE FOR CONTROLLING AND
USING MICROPROCESSORS AND MICROPROCES-
SOR CORES, IN CLASS 9 (U.S. CLS. 21, 23, 26, 36 AND
38).

FIRST USE 7-0-1999; IN COMMERCE 7-0-1999.

THE MARK CONSISTS OF STANDARD CHAR-
ACTERS WITHOUT CLAIM TO ANY PARTICULAR
FONT, STYLE, SIZE, OR COLOR.

SER. NO. 77-200,896, FILED 6-7-2007.

JENNIFER DIXON, EXAMINING ATTORNEY

Int. Cls.: 9 and 41

Prior U.S. Cls.: 21, 23, 26, 36, 38, 100, 101 and 107

Reg. No. 3,483,240

United States Patent and Trademark Office

Registered Aug. 12, 2008

**TRADEMARK
SERVICE MARK
PRINCIPAL REGISTER**

J. L. FISHER

J. L. FISHER, INC. (CALIFORNIA CORPORATION)
1000 ISABEL STREET
BURBANK, CA 91506

FOR: MOTION PICTURE AND TELEVISION EQUIPMENT, NAMELY, CAMERA DOLLIES, JIB ARMS, CAMERA RISERS, DOLLY TRACKS, AND CAMERA MOUNTS; LIGHTING EQUIPMENT, NAMELY, SUPPORTS FOR MOTION PICTURE OR TELEVISION LIGHTING; GRIP EQUIPMENT, NAMELY, SUPPORTS FOR HOLDING AND SUPPORTING MOTION PICTURE OR TELEVISION CAMERA AND CAMERA RELATED EQUIPMENT; AND AUDIO EQUIPMENT, NAMELY, SUPPORTS FOR HOLDING AND SUPPORTING MICROPHONES OR SOUND CONVERSION AND SOUND CONVERSION RELATED EQUIPMENT, IN CLASS 9 (U.S. CLS. 21, 23, 26, 36 AND 38).

FIRST USE 1-1-1971; IN COMMERCE 1-1-1971.

FOR: RENTAL SERVICES IN THE NATURE OF MOTION PICTURE AND TELEVISION EQUIPMENT, NAMELY, CAMERA DOLLIES, JIB ARMS, CAMERA RISERS, DOLLY TRACKS, AND CAMERA MOUNTS; RENTAL SERVICES IN THE NATURE OF

LIGHTING EQUIPMENT, NAMELY, SUPPORTS FOR MOTION PICTURE OR TELEVISION LIGHTING; RENTAL SERVICES IN THE NATURE OF GRIP EQUIPMENT, NAMELY, SUPPORTS FOR HOLDING AND SUPPORTING MOTION PICTURE OR TELEVISION CAMERAS AND CAMERA RELATED EQUIPMENT; AND RENTAL SERVICES IN THE NATURE OF AUDIO EQUIPMENT, NAMELY, SUPPORTS FOR HOLDING AND SUPPORTING MICROPHONES OR SOUND CONVERSION AND SOUND CONVERSION RELATED EQUIPMENT, IN CLASS 41 (U.S. CLS. 100, 101 AND 107).

FIRST USE 1-1-1971; IN COMMERCE 1-1-1971.

THE MARK CONSISTS OF STANDARD CHARACTERS WITHOUT CLAIM TO ANY PARTICULAR FONT, STYLE, SIZE, OR COLOR.

THE NAME "J. L. FISHER" IDENTIFIES A LIVING INDIVIDUAL WHOSE CONSENT IS OF RECORD.

SER. NO. 77-200,912, FILED 6-7-2007.

CHARLOTTE CORWIN, EXAMINING ATTORNEY

Int. Cls.: 35 and 44

Prior U.S. Cls.: 100, 101 and 102

United States Patent and Trademark Office

Reg. No. 3,483,241

Registered Aug. 12, 2008

**SERVICE MARK
PRINCIPAL REGISTER**

Medquest
ASSOCIATES

MEDQUEST, INC. (DELAWARE CORPORATION)
3480 PRESTON RIDGE ROAD, SUITE 600
ALPHARETTA, GA 30005

FOR: OPERATING AND MANAGING MEDICAL
IMAGING AND MRI FACILITIES, IN CLASS 35 (U.S.
CLS. 100, 101 AND 102).

FIRST USE 8-2-2006; IN COMMERCE 8-2-2006.

FOR: MEDICAL IMAGING SERVICES AND MRI
MEDICAL IMAGING SERVICES, IN CLASS 44 (U.S.
CLS. 100 AND 101).

FIRST USE 8-2-2006; IN COMMERCE 8-2-2006.

OWNER OF U.S. REG. NO. 3,023,466.

NO CLAIM IS MADE TO THE EXCLUSIVE
RIGHT TO USE "ASSOCIATES", APART FROM
THE MARK AS SHOWN.

THE MARK CONSISTS OF THE WORDS "MED-
QUEST" AND "ASSOCIATES", WITH THE LETTERS
"M" AND "Q" IN UPPER CASE AND THE LETTER
"Q" IN STYLIZED FORM INCORPORATING A
SWIRL DESIGN.

SER. NO. 77-201,020, FILED 6-8-2007.

HOWARD SMIGA, EXAMINING ATTORNEY

Int. Cl.: 35

Prior U.S. Cls.: 100, 101 and 102

United States Patent and Trademark Office

Reg. No. 3,483,242

Registered Aug. 12, 2008

**SERVICE MARK
PRINCIPAL REGISTER**

The logo for Travelmart features the word "Travel" in a large, bold, blue sans-serif font. To its right, the word "mart" is written in a smaller, white, sans-serif font inside a black rectangular box that is shaped like a suitcase with a handle on top.

OMEGA WORLD TRAVEL, INC. (VIRGINIA CORPORATION)
3102 OMEGA OFFICE PARK
FAIRFAX, VA 22031

FOR: ADVERTISING AND PUBLICITY SERVICES, NAMELY, PROMOTING THE GOODS, SERVICES, BRAND IDENTITY AND COMMERCIAL INFORMATION AND NEWS OF THIRD PARTIES THROUGH PRINT, AUDIO, VIDEO, DIGITAL AND ON-LINE MEDIUM, IN CLASS 35 (U.S. CLS. 100, 101 AND 102).

FIRST USE 1-1-2007; IN COMMERCE 1-1-2007.

NO CLAIM IS MADE TO THE EXCLUSIVE RIGHT TO USE "TRAVEL MART", APART FROM THE MARK AS SHOWN.

THE COLOR(S) BLUE, WHITE AND BLACK IS/ ARE CLAIMED AS A FEATURE OF THE MARK.

THE MARK CONSISTS OF A STYLIZED CAPITAL "T", IN BLUE, FOLLOWED BY A STYLIZED SMALL "R", "A", "V", "E" AND "L", ALL IN BLUE, IMMEDIATELY FOLLOWED BY BLACK BOX SHAPED LIKE A SUITCASE SURROUNDING THE SMALL LETTERS OF "M", "A", "R" AND "T", ALL OF WHICH ARE WHITE.

SER. NO. 77-201,087, FILED 6-8-2007.

AISHA SALEM, EXAMINING ATTORNEY

Int. Cl.: 41

Prior U.S. Cls.: 100, 101 and 107

United States Patent and Trademark Office

Reg. No. 3,483,243

Registered Aug. 12, 2008

**SERVICE MARK
PRINCIPAL REGISTER**

SERVING U

NORTH TEXAS FOOD BANK (TEXAS NON-
PROFIT ORGANIZATION)
4306 SHILLING WAY
DALLAS, TX 75237

FOR: ORGANIZING AND CONDUCTING EDU-
CATIONAL WORKSHOPS TO TEACH AND EN-
COURAGE TEAMBUILDING WITHIN
ORGANIZATIONS FOR CHARITABLE PROGRAMS
WHICH BENEFIT THE NEEDY AND THE COMMU-
NITY, IN CLASS 41 (U.S. CLS. 100, 101 AND 107).

FIRST USE 6-1-2007; IN COMMERCE 6-1-2007.

THE MARK CONSISTS OF STANDARD CHAR-
ACTERS WITHOUT CLAIM TO ANY PARTICULAR
FONT, STYLE, SIZE, OR COLOR.

SER. NO. 77-201,119, FILED 6-8-2007.

PAULA MAHONEY, EXAMINING ATTORNEY

Int. Cl.: 41

Prior U.S. Cls.: 100, 101 and 107

United States Patent and Trademark Office

Reg. No. 3,483,244

Registered Aug. 12, 2008

**SERVICE MARK
PRINCIPAL REGISTER**

**CORPORATE TEAMBUILDING
FROM NORTH TEXAS FOOD BANK**

NORTH TEXAS FOOD BANK (TEXAS NON-
PROFIT ORGANIZATION)
4306 SHILLING WAY
DALLAS, TX 75237

FOR: ORGANIZING AND CONDUCTING EDU-
CATIONAL WORKSHOPS TO TEACH AND EN-
COURAGE TEAMBUILDING WITHIN
ORGANIZATIONS FOR CHARITABLE PROGRAMS
WHICH BENEFIT THE NEEDY AND THE COMMU-
NITY, IN CLASS 41 (U.S. CLS. 100, 101 AND 107).

FIRST USE 5-2-2007; IN COMMERCE 5-2-2007.

THE MARK CONSISTS OF STANDARD CHAR-
ACTERS WITHOUT CLAIM TO ANY PARTICULAR
FONT, STYLE, SIZE, OR COLOR.

OWNER OF U.S. REG. NO. 2,937,308.

SEC. 2(F).

SER. NO. 77-201,130, FILED 6-8-2007.

PAULA MAHONEY, EXAMINING ATTORNEY

Int. Cl.: 35

Prior U.S. Cls.: 100, 101 and 102

United States Patent and Trademark Office

Reg. No. 3,483,245

Registered Aug. 12, 2008

**SERVICE MARK
PRINCIPAL REGISTER**

ZARGO

ZELBY, LLC (RHODE ISLAND LTD LIAB CO)
100 MAIN STREET
PAWTUCKET, RI 02860

FOR: PROMOTING THE GOODS AND SERVICES OF OTHERS BY PREPARING AND PLACING ADVERTISEMENTS IN AN ELECTRONIC MAGAZINE ACCESSED THROUGH A GLOBAL COMPUTER NETWORK; PROMOTING THE GOODS AND SERVICES OF OTHERS THROUGH ON-LINE ORDERING AND CATALOGING OF THOSE GOODS AND SERVICES; PROMOTING THE GOODS AND SERVICES OF OTHERS VIA A GLOBAL COMPUTER NETWORK; PROMOTING THE GOODS AND SERVICES OF OTHERS BY MEANS OF OPERATING AN ON-LINE SHOPPING MALL WITH LINKS TO THE RETAIL WEB SITES OF OTHERS; PROVIDING A WEB SITE WHICH FEATURES ADVERTISEMENTS FOR THE GOODS AND SERVICES OF OTHERS ON A GLOBAL COMPUTER NETWORK; PROVIDING INFORMATION ABOUT THE GOODS AND SERVICES OF OTHERS VIA THE GLOBAL COMPUTER

NETWORK; ON-LINE RETAIL STORE SERVICES FEATURING A WIDE VARIETY CONSUMER GOODS AND GENERAL MERCHANDISE OF OTHERS; COMPUTERIZED ON-LINE ORDERING FEATURING GENERAL MERCHANDISE AND GENERAL CONSUMER GOODS; BUSINESS SERVICES, NAMELY, PROVIDING COMPUTER DATABASES REGARDING THE PURCHASE AND SALE OF A WIDE VARIETY OF PRODUCTS AND SERVICES OF OTHERS, IN CLASS 35 (U.S. CLS. 100, 101 AND 102).

FIRST USE 7-3-2006; IN COMMERCE 7-3-2006.

THE MARK CONSISTS OF STANDARD CHARACTERS WITHOUT CLAIM TO ANY PARTICULAR FONT, STYLE, SIZE, OR COLOR.

SER. NO. 77-201,301, FILED 6-8-2007.

SCOTT BIBB, EXAMINING ATTORNEY

Int. Cls.: 9 and 41

Prior U.S. Cls.: 21, 23, 26, 36, 38, 100, 101 and 107

United States Patent and Trademark Office

Reg. No. 3,483,246

Registered Aug. 12, 2008

**TRADEMARK
SERVICE MARK
PRINCIPAL REGISTER**

BK MULTIMEDIAS

GILL, HARJINDER S. (UNITED STATES INDIVIDUAL)
2443 18TH ST.
SANTA MONICA, CA 90405

FOR: PRERECORDED VIDEO TAPES FEATURING EDUCATIONAL INFORMATION IN THE FIELD OF AGRICULTURE AND ECONOMICS, IN CLASS 9 (U.S. CLS. 21, 23, 26, 36 AND 38).

FIRST USE 12-4-2007; IN COMMERCE 12-8-2007.

FOR: PUBLISHING OF BOOKS AND EDUCATIONAL PRINTED MATERIAL FOR THE PRIMARY, SECONDARY AND COLLEGE LEVELS, IN CLASS 41 (U.S. CLS. 100, 101 AND 107).

FIRST USE 12-1-2007; IN COMMERCE 12-1-2007.

THE MARK CONSISTS OF STANDARD CHARACTERS WITHOUT CLAIM TO ANY PARTICULAR FONT, STYLE, SIZE, OR COLOR.

NO CLAIM IS MADE TO THE EXCLUSIVE RIGHT TO USE "MULTIMEDIAS", APART FROM THE MARK AS SHOWN.

SER. NO. 77-201,371, FILED 6-8-2007.

JASON TURNER, EXAMINING ATTORNEY

Int. Cls.: 35 and 41

Prior U.S. Cls.: 100, 101, 102 and 107

United States Patent and Trademark Office

Reg. No. 3,483,247

Registered Aug. 12, 2008

**SERVICE MARK
PRINCIPAL REGISTER**

**american
business
media** 

The Association of Business Information Companies

AMERICAN BUSINESS MEDIA, INC. (NEW YORK CORPORATION)
675 THIRD AVENUE
NEW YORK, NY 100175704

FOR: ASSOCIATION SERVICES, NAMELY, PROMOTING THE INTERESTS OF BUSINESS PUBLISHERS, IN CLASS 35 (U.S. CLS. 100, 101 AND 102).

FIRST USE 3-22-2007; IN COMMERCE 3-22-2007.

FOR: EDUCATIONAL SERVICES, NAMELY, CONDUCTING CONFERENCES, SEMINARS, COURSES AND WORKSHOPS IN THE FIELD OF BUSINESS PUBLISHING, IN CLASS 41 (U.S. CLS. 100, 101 AND 107).

FIRST USE 3-22-2007; IN COMMERCE 3-22-2007.

OWNER OF U.S. REG. NO. 2,939,116.

NO CLAIM IS MADE TO THE EXCLUSIVE RIGHT TO USE "THE ASSOCIATION OF BUSINESS INFORMATION COMPANIES", APART FROM THE MARK AS SHOWN.

THE MARK CONSISTS OF "AMERICAN BUSINESS MEDIA, THE ASSOCIATION OF BUSINESS INFORMATION COMPANIES", GLOBE DESIGN CONTAINING THE LETTER "I".

SEC. 2(F) "AMERICAN BUSINESS MEDIA".

SER. NO. 77-201,445, FILED 6-8-2007.

LESLEY LAMOTHE, EXAMINING ATTORNEY

Int. Cl.: 7

Prior U.S. Cls.: 13, 19, 21, 23, 31, 34 and 35

Reg. No. 3,483,248

United States Patent and Trademark Office

Registered Aug. 12, 2008

**TRADEMARK
PRINCIPAL REGISTER**

BREEZE

MOLINS PLC (UNITED KINGDOM PUBLIC LIMITED COMPANY (PLC))
11 TANNERS DRIVE, BLAKELANDS
MILTON KEYNES, BUCKS, UNITED KINGDOM
MK145LU

FOR: PACKAGING MACHINERY, INCLUDING MACHINERY FOR PACKING, CARTOONING, AND CASE PACKING; MACHINERY FOR THE PACKAGING INDUSTRY, NAMELY, ARTICLE HANDLING, CONVEYING EQUIPMENT, AND ROBOTIC MACHINERY; EQUIPMENT IN THE NATURE OF MACHINERY USED FOR SUPPLYING PRODUCTS OR PACKAGING MATERIAL TO AND FOR DELIVERING PRODUCTS FROM PACKAGING MACHINERY, NAMELY, CONVEY-

OR BELTS; EQUIPMENT IN THE NATURE OF MACHINERY FOR USE HANDLING AND PROCESSING PACKAGING; PARTS AND FITTINGS FOR ALL THE AFORESAID GOODS, IN CLASS 7 (U.S. CLS. 13, 19, 21, 23, 31, 34 AND 35).

FIRST USE 0-0-2006; IN COMMERCE 0-0-2007.

THE MARK CONSISTS OF STANDARD CHARACTERS WITHOUT CLAIM TO ANY PARTICULAR FONT, STYLE, SIZE, OR COLOR.

SER. NO. 77-201,498, FILED 6-8-2007.

DANNAN HETZEL, EXAMINING ATTORNEY

Int. Cl.: 7

Prior U.S. Cls.: 13, 19, 21, 23, 31, 34 and 35

Reg. No. 3,483,249

United States Patent and Trademark Office

Registered Aug. 12, 2008

**TRADEMARK
PRINCIPAL REGISTER**

VENTO

MOLINS PLC (UNITED KINGDOM PUBLIC LIMITED COMPANY (PLC))
11 TANNERS DRIVE, BLAKELANDS
MILTON KEYNES, BUCKS, UNITED KINGDOM
MK145LU

FOR: PACKAGING MACHINERY, INCLUDING MACHINERY FOR PACKING, CARTOONING, AND CASE PACKING; MACHINERY FOR THE PACKAGING INDUSTRY, NAMELY, ARTICLE HANDLING, CONVEYING EQUIPMENT, AND ROBOTIC MACHINERY; EQUIPMENT IN THE NATURE OF MACHINERY USED FOR SUPPLYING PRODUCTS OR PACKAGING MATERIAL TO AND FOR DELIVERING PRODUCTS FROM PACKAGING MACHINERY, NAMELY, CONVEY-

OR BELTS; EQUIPMENT IN THE NATURE OF MACHINERY FOR USE HANDLING AND PROCESSING PACKAGING; PARTS AND FITTINGS FOR ALL THE AFORESAID GOODS, IN CLASS 7 (U.S. CLS. 13, 19, 21, 23, 31, 34 AND 35).

FIRST USE 0-0-2006; IN COMMERCE 0-0-2007.

THE MARK CONSISTS OF STANDARD CHARACTERS WITHOUT CLAIM TO ANY PARTICULAR FONT, STYLE, SIZE, OR COLOR.

SER. NO. 77-201,508, FILED 6-8-2007.

DANNEAN HETZEL, EXAMINING ATTORNEY

Int. Cls.: 7, 11 and 20

**Prior U.S. Cls.: 2, 13, 19, 21, 22, 23, 25, 31, 32, 34, 35
and 50**

Reg. No. 3,483,250

United States Patent and Trademark Office

Registered Aug. 12, 2008

**TRADEMARK
PRINCIPAL REGISTER**

UniqFresh

OY HYDROCELL LTD (FINLAND CORPORATION)
MINKKIKATU 1-3
JÄRVENPÄÄ, FINLAND FI-04430

FOR: MOTORS FOR FANS FOR AIR FILTERING AND VENTILATING APPARATUS, IN CLASS 7 (U.S. CLS. 13, 19, 21, 23, 31, 34 AND 35).

FOR: APPARATUS FOR VENTILATING OF AIR; APPARATUS FOR FILTERING OF AIR AND AIR PURIFICATION; AND MACHINES, NAMELY, DEVICES FOR AIR FILTERING AND VENTILATING, IN CLASS 11 (U.S. CLS. 13, 21, 23, 31 AND 34).

FOR: FURNITURE FOR COVERING AND ENCLOSING AIR FILTERING AND VENTILATION

DEVICES, IN CLASS 20 (U.S. CLS. 2, 13, 22, 25, 32 AND 50).

THE MARK CONSISTS OF STANDARD CHARACTERS WITHOUT CLAIM TO ANY PARTICULAR FONT, STYLE, SIZE, OR COLOR.

PRIORITY CLAIMED UNDER SEC. 44(D) ON FINLAND APPLICATION NO. T200603635, FILED 12-11-2006, REG. NO. 239670, DATED 6-15-2007, EXPIRES 6-15-2017.

SER. NO. 77-201,571, FILED 6-8-2007.

THOMAS MANOR, EXAMINING ATTORNEY

Int. Cl.: 5

Prior U.S. Cls.: 6, 18, 44, 46, 51 and 52

United States Patent and Trademark Office

Reg. No. 3,483,251

Registered Aug. 12, 2008

**TRADEMARK
PRINCIPAL REGISTER**



PAN CHUNG PAT WO TONG (HONG KONG)
LIMITED (HONG KONG LTD LIAB CO)
FLAT A, 15F, CHIAP LUEN INDUSTRIAL BLDG
30-32 KUNG YIP STREET, KWAI CHUNG
NEW TERRITORIES, HONG KONG

FOR: MEDICINAL OIL; MEDICINES FOR THE
TREATMENT OF GASTROINTESTINAL DISEASES;
COUGH TREATMENT PREPARATIONS; ACNE
TREATMENT PREPARATIONS; HEADACHE
TREATMENT PREPARATIONS; DIAGNOSTIC PRE-
PARATIONS FOR MEDICAL AND VETERINARY
USE; DIETETIC FOODS ADAPTED FOR MEDICAL
USE; DIETETIC SUGAR FOR MEDICAL USE; BABY
FOOD; MEDICAL PLASTERS; DRESSINGS FOR
WOUNDS, BURNS, SURGERY; FILLINGS FOR
TEETH; DENTAL WAXES; DISINFECTANTS FOR
HYGIENIC PURPOSES; PREPARATIONS FOR DE-

STROYING VERMIN; FUNGICIDES FOR AGRICUL-
TURAL, DOMESTIC, OR MEDICAL USE;
HERBICIDES FOR AGRICULTURAL OR DOMES-
TIC USE, IN CLASS 5 (U.S. CLS. 6, 18, 44, 46, 51 AND
52).

FIRST USE 8-28-1962; IN COMMERCE 6-20-1995.

THE MARK CONSISTS OF AN OVAL CARRIER
CONTAINING THREE MEN DRESSING IN TRADI-
TIONAL CHINESE COSTUME AND PLAYING
CHESSES AT A TABLE, AND SOME CLOUDS AND
PLANTS AS BACKGROUND.

SER. NO. 77-202,352, FILED 6-11-2007.

JEFF DEFORD, EXAMINING ATTORNEY

Int. Cl.: 41

Prior U.S. Cls.: 100, 101 and 107

United States Patent and Trademark Office

Reg. No. 3,483,252

Registered Aug. 12, 2008

**SERVICE MARK
PRINCIPAL REGISTER**

**Oh Baby Photography
Bellies. Babies.
Beautiful.**

VANCE, ELIZABETH ANNE (UNITED STATES
INDIVIDUAL)
211 N. PARK DRIVE
ARLINGTON, VA 22203

FOR: PHOTOGRAPHY SERVICES; PORTRAIT
PHOTOGRAPHY, IN CLASS 41 (U.S. CLS. 100, 101
AND 107).

FIRST USE 1-1-2002; IN COMMERCE 1-1-2002.

THE MARK CONSISTS OF STANDARD CHAR-
ACTERS WITHOUT CLAIM TO ANY PARTICULAR
FONT, STYLE, SIZE, OR COLOR.

NO CLAIM IS MADE TO THE EXCLUSIVE
RIGHT TO USE "BABY PHOTOGRAPHY", APART
FROM THE MARK AS SHOWN.

SER. NO. 77-202,539, FILED 6-11-2007.

KEVON CHISOLM, EXAMINING ATTORNEY

Int. Cl.: 42

Prior U.S. Cls.: 100 and 101

United States Patent and Trademark Office

Reg. No. 3,483,253

Registered Aug. 12, 2008

**SERVICE MARK
PRINCIPAL REGISTER**

SexGen

EROS, LLC (FLORIDA LTD LIAB CO)
16207 SEPTEMBER DRIVE
LUTZ, FL 33549

THE MARK CONSISTS OF STANDARD CHAR-
ACTERS WITHOUT CLAIM TO ANY PARTICULAR
FONT, STYLE, SIZE, OR COLOR.

FOR: PROVIDING TEMPORARY USE OF NON-
DOWNLOADABLE SOFTWARE FOR ANIMATING
THREE-DIMENSIONAL VIRTUAL CHARACTERS,
IN CLASS 42 (U.S. CLS. 100 AND 101).

SER. NO. 77-202,601, FILED 6-11-2007.

FIRST USE 1-1-2005; IN COMMERCE 1-1-2005.

EVELYN BRADLEY, EXAMINING ATTORNEY

Int. Cl.: 35

Prior U.S. Cls.: 100, 101 and 102

United States Patent and Trademark Office

Reg. No. 3,483,254

Registered Aug. 12, 2008

**SERVICE MARK
PRINCIPAL REGISTER**

vNetwork

JOHN ZUBAK (UNITED STATES INDIVIDUAL)
4695 BURNT HOUSE HILL ROAD
DOYLESTOWN, PA 18902 AND
HARVEY MITGANG (UNITED STATES INDIVIDUAL)
14 DICKENS DRIVE
PRINCETON JUNCTION, NJ 08550

FIRST USE 7-0-2007; IN COMMERCE 7-0-2007.

THE MARK CONSISTS OF STANDARD CHARACTERS WITHOUT CLAIM TO ANY PARTICULAR FONT, STYLE, SIZE, OR COLOR.

FOR: HEALTHCARE ADMINISTRATION SERVICES, NAMELY, ELECTRONIC PROCESSING OF HEALTH CARE INFORMATION FOR OTHERS, IN CLASS 35 (U.S. CLS. 100, 101 AND 102).

SER. NO. 77-202,876, FILED 6-11-2007.

FLORENTINA BLANDU, EXAMINING ATTORNEY

Int. Cl.: 35

Prior U.S. Cls.: 100, 101 and 102

United States Patent and Trademark Office

Reg. No. 3,483,255

Registered Aug. 12, 2008

**SERVICE MARK
PRINCIPAL REGISTER**

Health Ticket

JOHN ZUBAK (UNITED STATES INDIVIDUAL)
4695 BURNT HOUSE HILL ROAD
DOYLESTOWN, PA 18902 AND
HARVEY MITGANG (UNITED STATES INDIVIDUAL)
14 DICKENS DRIVE
PRINCETON JUNCTION, NJ 08550

FOR: HEALTHCARE ADMINISTRATION SERVICES, NAMELY, ELECTRONIC PROCESSING OF HEALTH CARE INFORMATION FOR OTHERS, IN CLASS 35 (U.S. CLS. 100, 101 AND 102).

FIRST USE 7-0-2007; IN COMMERCE 7-0-2007.

THE MARK CONSISTS OF STANDARD CHARACTERS WITHOUT CLAIM TO ANY PARTICULAR FONT, STYLE, SIZE, OR COLOR.

NO CLAIM IS MADE TO THE EXCLUSIVE RIGHT TO USE "HEALTH", APART FROM THE MARK AS SHOWN.

SER. NO. 77-202,900, FILED 6-11-2007.

FLORENTINA BLANDU, EXAMINING ATTORNEY

Int. Cl.: 44

Prior U.S. Cls.: 100 and 101

United States Patent and Trademark Office

Reg. No. 3,483,256

Registered Aug. 12, 2008

**SERVICE MARK
PRINCIPAL REGISTER**



GLOBAL MEDICAL RESPONSE, INC. (DELA-
WARE CORPORATION)

SUITE 200

6200 SOUTH SYRACUSE WAY

GREENWOOD VILLAGE, CO 80111

FOR: EMERGENCY MEDICAL ASSISTANCE, IN
CLASS 44 (U.S. CLS. 100 AND 101).

FIRST USE 9-13-2005; IN COMMERCE 9-13-2005.

NO CLAIM IS MADE TO THE EXCLUSIVE
RIGHT TO USE "GLOBAL MEDICAL RESPONSE"
AND THE REPRESENTATIONS OF THE CADU-
CEUS AND MEDICAL EMERGENCY CROSS,
APART FROM THE MARK AS SHOWN.

THE COLOR(S) BLUE AND WHITE IS/ARE
CLAIMED AS A FEATURE OF THE MARK.

THE MARK CONSISTS OF A GLOBE OUTLINED
IN WHITE WITH THE LETTERS "GMR" IN WHITE
SUPERIMPOSED OVER THE GLOBE; A WHITE
CADUCEUS ON A BLUE BACKGROUND PLACED
BETWEEN THE "M" AND "R" OF "GMR"; AND
"GLOBAL MEDICAL RESPONSE" IN BLUE LET-
TERS LOCATED IN THE MIDDLE OF A WHITE
RECTANGULAR BOX LOCATED AT THE BOTTOM
OF THE GLOBE.

SER. NO. 77-202,991, FILED 6-11-2007.

CORY BOONE, EXAMINING ATTORNEY

Int. Cl.: 39

Prior U.S. Cls.: 100 and 105

United States Patent and Trademark Office

Reg. No. 3,483,257

Registered Aug. 12, 2008

**SERVICE MARK
PRINCIPAL REGISTER**



GLOBAL MEDICAL RESPONSE, INC. (DELA-
WARE CORPORATION)
SUITE 200
6200 SOUTH SYRACUSE WAY
GREENWOOD VILLAGE, CO 80111

FOR: MEDICAL TRANSPORTATION, NAMELY,
AMBULANCE AND WHEELCHAIR TRANSPORTA-
TION; AMBULANCE TRANSPORT, IN CLASS 39
(U.S. CLS. 100 AND 105).

FIRST USE 9-13-2005; IN COMMERCE 9-13-2005.

NO CLAIM IS MADE TO THE EXCLUSIVE
RIGHT TO USE "GLOBAL MEDICAL RESPONSE"
AND THE REPRESENTATIONS OF THE CADU-
CEUS AND MEDICAL EMERGENCY CROSS,
APART FROM THE MARK AS SHOWN.

THE COLOR(S) BLUE AND WHITE IS/ARE
CLAIMED AS A FEATURE OF THE MARK.

THE MARK CONSISTS OF A GLOBE OUTLINED
IN WHITE WITH THE LETTERS "GMR" IN WHITE
SUPERIMPOSED OVER THE GLOBE; A WHITE
CADUCEUS ON A BLUE BACKGROUND PLACED
BETWEEN THE "M" AND "R" OF "GMR"; AND
"GLOBAL MEDICAL RESPONSE" IN BLUE LET-
TERS LOCATED IN THE MIDDLE OF A WHITE
RECTANGULAR BOX LOCATED AT THE BOTTOM
OF THE GLOBE.

SER. NO. 77-202,998, FILED 6-11-2007.

CORY BOONE, EXAMINING ATTORNEY

Int. Cl.: 36

Prior U.S. Cls.: 100, 101 and 102

United States Patent and Trademark Office

Reg. No. 3,483,258

Registered Aug. 12, 2008

**SERVICE MARK
PRINCIPAL REGISTER**

CCS

CONSUMER CREDIT SERVICES, INC. (FLORIDA CORPORATION)
SUITE 304
4417 BEACH BLVD.
JACKSONVILLE, FL 322079408

FOR: FINANCIAL SERVICES, NAMELY, MORTGAGE BROKERING AND MORTGAGE LENDING, IN CLASS 36 (U.S. CLS. 100, 101 AND 102).

FIRST USE 9-12-1998; IN COMMERCE 9-12-1998.

THE MARK CONSISTS OF STANDARD CHARACTERS WITHOUT CLAIM TO ANY PARTICULAR FONT, STYLE, SIZE, OR COLOR.

OWNER OF U.S. REG. NO. 2,838,019.

SER. NO. 77-203,463, FILED 6-11-2007.

VERNA BETH RIRIE, EXAMINING ATTORNEY

Int. Cl.: 1

Prior U.S. Cls.: 1, 5, 6, 10, 26 and 46

United States Patent and Trademark Office

Reg. No. 3,483,259

Registered Aug. 12, 2008

**TRADEMARK
PRINCIPAL REGISTER**

HYALO-OLIGO

KEWPIE KABUSHIKI KAISHA (JAPAN CORPORATION), DBA Q.P. CORPORATION
4-13, SHIBUYA 1-CHOME
SHIBUYA-KU, TOKYO, JAPAN

FOR: HYALURONIC ACID AND OTHER CHEMICALS FOR USE IN THE MANUFACTURE OF PHARMACEUTICALS, COSMETICS AND/OR FOOD, IN CLASS 1 (U.S. CLS. 1, 5, 6, 10, 26 AND 46).

THE MARK CONSISTS OF STANDARD CHARACTERS WITHOUT CLAIM TO ANY PARTICULAR FONT, STYLE, SIZE, OR COLOR.

PRIORITY CLAIMED UNDER SEC. 44(D) ON JAPAN APPLICATION NO. 2007-055854, FILED 6-4-2007, REG. NO. 5098401, DATED 12-14-2007, EXPIRES 12-14-2017.

SER. NO. 77-203,675, FILED 6-12-2007.

DORITT L. CARROLL, EXAMINING ATTORNEY

Int. Cl.: 8

Prior U.S. Cls.: 23, 28 and 44

United States Patent and Trademark Office

Reg. No. 3,483,260

Registered Aug. 12, 2008

**TRADEMARK
PRINCIPAL REGISTER**



THE C.H. HANSON COMPANY (ILLINOIS CORPORATION)
2000 NORTH AURORA ROAD
NAPERVILLE, IL 60563

FOR: HAND TOOLS, NAMELY, LAYOUT TOOLS IN THE NATURE OF SQUARES, IN CLASS 8 (U.S. CLS. 23, 28 AND 44).

FIRST USE 1-22-2007; IN COMMERCE 1-22-2007.

NO CLAIM IS MADE TO THE EXCLUSIVE RIGHT TO USE "PIVOT", APART FROM THE MARK AS SHOWN.

THE COLOR(S) RED, WHITE, AND BLUE IS/ARE CLAIMED AS A FEATURE OF THE MARK.

THE MARK CONSISTS OF THE WORDING "PIVOT SQUARE", IN WHICH THE LETTERING IS WHITE, OUTLINED IN BLUE, WITH A SURROUNDING OUTLINE OF RED, AND IN WHICH THE LETTER "A" IS COMPRISED OF A STYLIZED DESIGN OF A CARPENTER'S SQUARE.

SER. NO. 77-203,685, FILED 6-12-2007.

JASON LOTT, EXAMINING ATTORNEY

Int. Cl.: 29

Prior U.S. Cl.: 46

United States Patent and Trademark Office

Reg. No. 3,483,261

Registered Aug. 12, 2008

**TRADEMARK
PRINCIPAL REGISTER**



DUTCH AND DELICIOUS (FLORIDA CORPORATION)
6575 NOVA DRIVE
DAVIE, FL 33317

FOR: FROZEN, PREPARED ENTREES CONSISTING PRIMARILY OF MEAT, FISH, POULTRY OR VEGETABLES; FROZEN, PREPARED MEALS CONSISTING PRIMARILY OF MEAT, FISH, POULTRY OR VEGETABLES, IN CLASS 29 (U.S. CL. 46).

FIRST USE 12-1-2004; IN COMMERCE 2-1-2005.

NO CLAIM IS MADE TO THE EXCLUSIVE RIGHT TO USE "SABOR LATINO", APART FROM THE MARK AS SHOWN.

THE COLOR(S) BURGUNDY RED AND BRIGHT ORANGE IS/ARE CLAIMED AS A FEATURE OF THE MARK.

THE MARK CONSISTS OF WORDING IN BURGUNDY RED WITH A BRIGHT ORANGE SWIRL IN THE MIDDLE.

THE FOREIGN WORDING IN THE MARK TRANSLATES INTO ENGLISH AS "LATIN FLAVOR".

SER. NO. 77-203,918, FILED 6-12-2007.

SUSAN RICHARDS, EXAMINING ATTORNEY

Int. Cl.: 20

Prior U.S. Cls.: 2, 13, 22, 25, 32 and 50

Reg. No. 3,483,262

United States Patent and Trademark Office

Registered Aug. 12, 2008

**TRADEMARK
PRINCIPAL REGISTER**

**EVERY BABY SHOULD BE A
HOUNDSTOOTH BABY.**

ROOT, MATTHEW F. (UNITED STATES INDIVIDUAL)
40 ETON COURT
BEDMINSTER, NJ 07921

FOR: FURNITURE, NAMELY, DRESSERS; FURNITURE, NAMELY, WARDROBES; LIVING ROOM FURNITURE; MIRRORS; OUTDOOR FURNITURE; RECLINERS; SEATING FURNITURE; SEATS; TABLES; TOY BOXES; BEDROOM FURNITURE; CABINETS; COMPUTER FURNITURE; FURNITURE; FURNITURE CHESTS; FURNITURE FOR HOUSE, OFFICE AND GARDEN; FURNITURE PARTS; FURNITURE PARTS, NAMELY, TABLE LEAVES; FURNITURE ACCESSORIES, NAMELY, PICTURE FRAMES, MIRRORS AND PILLOWS; CHAIR CUSHIONS; CUSHIONS; MATTRESS CUSHIONS; FITTED

COVERS FOR HIGH CHAIRS; FITTED FABRIC FURNITURE COVERS, IN CLASS 20 (U.S. CLS. 2, 13, 22, 25, 32 AND 50).

FIRST USE 2-0-2007; IN COMMERCE 2-0-2007.

THE MARK CONSISTS OF STANDARD CHARACTERS WITHOUT CLAIM TO ANY PARTICULAR FONT, STYLE, SIZE, OR COLOR.

OWNER OF U.S. REG. NO. 2,889,823.

SER. NO. 77-204,089, FILED 6-12-2007.

ANDREA BUTLER, EXAMINING ATTORNEY

Int. Cl.: 35

Prior U.S. Cls.: 100, 101 and 102

United States Patent and Trademark Office

Reg. No. 3,483,263

Registered Aug. 12, 2008

**SERVICE MARK
PRINCIPAL REGISTER**

KEEP APOPTOSIS ALIVE.

GENTA INCORPORATED (DELAWARE CORPORATION)
200 CONNELL DRIVE
BERKELEY HEIGHTS, NJ 07922

FOR: DISSEMINATION OF MEDICAL INFORMATION FOR OTHERS VIA PRINTED PUBLICATIONS, NAMELY, MEDICAL AND SCIENTIFIC JOURNALS, MAGAZINES AND POSTERS, IN CLASS 35 (U.S. CLS. 100, 101 AND 102).

FIRST USE 3-1-2006; IN COMMERCE 3-1-2006.

THE MARK CONSISTS OF STANDARD CHARACTERS WITHOUT CLAIM TO ANY PARTICULAR FONT, STYLE, SIZE, OR COLOR.

SER. NO. 77-204,137, FILED 6-12-2007.

HEATHER SAPP, EXAMINING ATTORNEY

Int. Cls.: 3 and 21

**Prior U.S. Cls.: 1, 2, 4, 6, 13, 23, 29, 30, 33, 40, 50, 51
and 52**

Reg. No. 3,483,264

United States Patent and Trademark Office

Registered Aug. 12, 2008

**TRADEMARK
PRINCIPAL REGISTER**

MAKE-UP DESIGNORY

LOS ANGELES SCHOOL OF MAKE-UP, INC.
(CALIFORNIA CORPORATION)
129 S. SAN FERNANDO BLVD.
BURBANK, CA 91502

FOR: COSMETICS, NAMELY, FOUNDATIONS,
CONCEALERS, HIGHLIGHTS, SHADOWS, CHEEK
COLORS, LIPSTICK, LIP PENCILS, LIP GLOSS, EYE
COLORS, EYE PENCILS, MASCARA, LOOSE POW-
DER, BLUSH, IN CLASS 3 (U.S. CLS. 1, 4, 6, 50, 51
AND 52).

FIRST USE 2-19-1999; IN COMMERCE 4-15-1999.

FOR: MAKE-UP BRUSHES AND SPONGES, IN
CLASS 21 (U.S. CLS. 2, 13, 23, 29, 30, 33, 40 AND 50).

FIRST USE 2-19-1999; IN COMMERCE 4-15-1999.

THE MARK CONSISTS OF STANDARD CHAR-
ACTERS WITHOUT CLAIM TO ANY PARTICULAR
FONT, STYLE, SIZE, OR COLOR.

OWNER OF U.S. REG. NOS. 2,262,575, 2,395,785,
AND 2,908,190.

NO CLAIM IS MADE TO THE EXCLUSIVE
RIGHT TO USE "MAKE-UP", APART FROM THE
MARK AS SHOWN.

SER. NO. 77-204,141, FILED 6-12-2007.

MICHELLE DUBOIS, EXAMINING ATTORNEY

Int. Cl.: 40

Prior U.S. Cls.: 100, 103 and 106

United States Patent and Trademark Office

Reg. No. 3,483,265

Registered Aug. 12, 2008

**SERVICE MARK
PRINCIPAL REGISTER**



DEMPSEY, PATRICK (UNITED STATES INDIVIDUAL)

10116 ORO VISTA AVE.

SUNLAND, CA 91040

FOR: CUSTOM CONSTRUCTION OF GOLF CLUBS, IN CLASS 40 (U.S. CLS. 100, 103 AND 106).

FIRST USE 1-6-2000; IN COMMERCE 1-6-2000.

NO CLAIM IS MADE TO THE EXCLUSIVE RIGHT TO USE "GOLF", APART FROM THE MARK AS SHOWN.

THE MARK CONSISTS OF A HORSE'S HEAD DRAWN ABOVE THE NAME "HORSEPOWER GOLF".

SER. NO. 77-204,472, FILED 6-12-2007.

RON FAIRBANKS, EXAMINING ATTORNEY

Int. Cl.: 32

Prior U.S. Cls.: 45, 46 and 48

United States Patent and Trademark Office

Reg. No. 3,483,266

Registered Aug. 12, 2008

**TRADEMARK
PRINCIPAL REGISTER**

wine country soda

VIGNETTE SODA LLC (CALIFORNIA LTD LIAB
CO)

2625 ALCATRAZ AVENUE #274

BERKELEY, CA 94705

FOR: SOFT DRINKS, IN CLASS 32 (U.S. CLS. 45, 46
AND 48).

FIRST USE 7-17-2006; IN COMMERCE 7-17-2006.

THE MARK CONSISTS OF STANDARD CHAR-
ACTERS WITHOUT CLAIM TO ANY PARTICULAR
FONT, STYLE, SIZE, OR COLOR.

NO CLAIM IS MADE TO THE EXCLUSIVE
RIGHT TO USE "SODA", APART FROM THE MARK
AS SHOWN.

SER. NO. 77-204,583, FILED 6-13-2007.

INGRID C. EULIN, EXAMINING ATTORNEY

Int. Cls.: 41 and 44

Prior U.S. Cls.: 100, 101 and 107

United States Patent and Trademark Office

Reg. No. 3,483,267

Registered Aug. 12, 2008

SERVICE MARK
PRINCIPAL REGISTER

MAC
Achieve Wellness

MARYLAND ATHLETIC CLUB & WELLNESS
CENTER (MARYLAND LTD LIAB CO)
110 W. TIMONIUM ROAD
TIMONIUM, MD 21093

FOR: PHYSICAL FITNESS CONSULTATION AND
INSTRUCTION FOR DEVELOPING PHYSICAL
HEALTH FOR INDIVIDUALS USING STRENGTH
AND BALANCE TRAINING, FLEXIBILITY TRAIN-
ING, ENDURANCE TRAINING, AND REST AND
REJUVENATION, IN CLASS 41 (U.S. CLS. 100, 101
AND 107).

FIRST USE 1-31-2007; IN COMMERCE 1-31-2007.

FOR: PROVIDING ASSISTANCE, FITNESS EVA-
LUATION AND CONSULTATION TO HELP IM-

PROVE EMOTIONAL AND PHYSICAL HEALTH;
NUTRITION COUNSELING, IN CLASS 44 (U.S. CLS.
100 AND 101).

FIRST USE 1-31-2007; IN COMMERCE 1-31-2007.

OWNER OF U.S. REG. NOS. 3,109,372 AND
3,270,647.

THE MARK CONSISTS OF THE BLOCK LETTERS
"MAC" OVER THE STYLIZED CURSIVE WORDING
"ACHIEVE WELLNESS" UNDERLINED.

SER. NO. 77-205,091, FILED 6-13-2007.

KYLE PEETE, EXAMINING ATTORNEY

Int. Cl.: 9

Prior U.S. Cls.: 21, 23, 26, 36 and 38

Reg. No. 3,483,268

United States Patent and Trademark Office

Registered Aug. 12, 2008

TRADEMARK
PRINCIPAL REGISTER



BLOODHOUND
TRACKER SYSTEMS

VARLEY, M. RICHARD (UNITED STATES INDIVIDUAL)

#2

111-2 TALSMAN DR.

CANFIELD, OH 44406 AND

GARDINER JR., ALFRED W. (UNITED STATES INDIVIDUAL)

22590 BRETMAR CT.

LEONARDTOWN, MD 20653

FOR: ELECTRONIC DEVICES FOR VEHICLES INCORPORATING GPS TECHNOLOGY, NAMELY, DEVICES ATTACHED TO VEHICLES FOR THE PURPOSES OF RECEIVING ALERTS WHEN A VEHICLE PAYMENT IS DUE OR OVERDUE, ALLOWING A REMOTE SOURCE TO DISABLE A VEHICLE WHEN A PAYMENT IS OVERDUE, AND ALLOWING A REMOTE SOURCE TO LOCATE A VEHICLE WHOSE PAYMENT IS OVERDUE FOR

RECOVERY PURPOSES; NOT INTENDED FOR USE IN LAW ENFORCEMENT APPLICATIONS, IN CLASS 9 (U.S. CLS. 21, 23, 26, 36 AND 38).

FIRST USE 3-5-2007; IN COMMERCE 3-5-2007.

NO CLAIM IS MADE TO THE EXCLUSIVE RIGHT TO USE "TRACKER SYSTEMS", APART FROM THE MARK AS SHOWN.

THE MARK CONSISTS OF THE WORDS "BLOODHOUND TRACKER SYSTEMS" AND A CROSSHAIR SITE WITH DOG TRACKS OVER THE IMAGE.

SER. NO. 77-205,354, FILED 6-13-2007.

LYDIA BELZER, EXAMINING ATTORNEY

Int. Cl.: 36

Prior U.S. Cls.: 100, 101 and 102

United States Patent and Trademark Office

Reg. No. 3,483,269

Registered Aug. 12, 2008

**SERVICE MARK
PRINCIPAL REGISTER**

TOWNEBANK MORTGAGE

TOWNEBANK (VIRGINIA CORPORATION)
5716 HIGH STREET
PORTSMOUTH, VA 23703

FOR: MORTGAGE LENDING SERVICES, IN
CLASS 36 (U.S. CLS. 100, 101 AND 102).

FIRST USE 10-1-2000; IN COMMERCE 10-1-2000.

THE MARK CONSISTS OF STANDARD CHAR-
ACTERS WITHOUT CLAIM TO ANY PARTICULAR
FONT, STYLE, SIZE, OR COLOR.

NO CLAIM IS MADE TO THE EXCLUSIVE
RIGHT TO USE "MORTGAGE", APART FROM
THE MARK AS SHOWN.

SER. NO. 77-205,414, FILED 6-13-2007.

ANDREA K. NADELMAN, EXAMINING ATTOR-
NEY

Int. Cl.: 9

Prior U.S. Cls.: 21, 23, 26, 36 and 38

Reg. No. 3,483,270

United States Patent and Trademark Office

Registered Aug. 12, 2008

**TRADEMARK
PRINCIPAL REGISTER**

vGuardian

ISECURITECH COMPANY LIMITED (HONG
KONG LTD LIAB CO)
BLK 1, 16A, THE BELCHER'S, POKFULAM ROAD
HONG KONG, HONG KONG

FOR: BUILDING SECURITY SYSTEMS COM-
PRISING SOFTWARE AND HARDWARE FOR PRO-
VIDING PICTURE, VIDEO, ALARM STATUS,
BUILDING PLANS, AND OTHER INFORMATION
TO A REMOTE STATION; ENTRY/EXIT SECURITY
PORTAL COMPRISED OF AN ELECTRONIC PAS-
SAGEWAY EQUIPPED WITH BIOMETRIC DEVI-
CES FOR IDENTIFICATION VERIFICATION AND
DETECTION OF IMPERMISSIBLE ITEMS BEING

CARRIED THROUGH, IN CLASS 9 (U.S. CLS. 21, 23,
26, 36 AND 38).

FIRST USE 12-15-2006; IN COMMERCE 12-15-2006.

THE MARK CONSISTS OF STANDARD CHAR-
ACTERS WITHOUT CLAIM TO ANY PARTICULAR
FONT, STYLE, SIZE, OR COLOR.

SER. NO. 77-205,727, FILED 6-14-2007.

ALEXANDER L. POWERS, EXAMINING ATTOR-
NEY

Int. Cl.: 38

Prior U.S. Cls.: 100, 101 and 104

United States Patent and Trademark Office

Reg. No. 3,483,271

Registered Aug. 12, 2008

**SERVICE MARK
PRINCIPAL REGISTER**

**RXHUB NATIONAL PATIENT
HEALTH INFORMATION NETWORK**

RXHUB LLC (DELAWARE LTD LIAB CO)
380 ST. PETER STREET, SUITE 530
ST. PAUL, MN 55102

FOR: TRANSMISSION OF PRESCRIPTION AND PRESCRIPTION-RELATED INFORMATION AMONG PHARMACY BENEFITS MANAGERS, HEALTH PLANS, POINT OF CARE VENDORS, PRESCRIBING PHYSICIANS, PHARMACIES, PHARMACY NETWORKS AND OTHERS BY ELECTRONIC COMMUNICATIONS NETWORKS TO FACILITATE PRESCRIPTION AND PHARMACY BENEFIT COMMUNICATIONS AND OTHER HEALTHCARE-RELATED TRANSACTIONS, AND OTHER RELATED BUSINESSES, IN CLASS 38 (U.S. CLS. 100, 101 AND 104).

FIRST USE 5-3-2007; IN COMMERCE 5-3-2007.

THE MARK CONSISTS OF STANDARD CHARACTERS WITHOUT CLAIM TO ANY PARTICULAR FONT, STYLE, SIZE, OR COLOR.

OWNER OF U.S. REG. NO. 2,783,075.

NO CLAIM IS MADE TO THE EXCLUSIVE RIGHT TO USE "NATIONAL PATIENT HEALTH INFORMATION NETWORK", APART FROM THE MARK AS SHOWN.

SER. NO. 77-205,893, FILED 6-14-2007.

JUSTINE D. PARKER, EXAMINING ATTORNEY

Int. Cl.: 42

Prior U.S. Cls.: 100 and 101

United States Patent and Trademark Office

Reg. No. 3,483,272

Registered Aug. 12, 2008

**SERVICE MARK
PRINCIPAL REGISTER**

**RXHUB NATIONAL PATIENT
HEALTH INFORMATION NETWORK**

RXHUB LLC (DELAWARE LTD LIAB CO)
380 ST. PETER STREET, SUITE 530
ST. PAUL, MN 55102

FOR: PROVIDING AND MANAGING AN ELECTRONIC PRESCRIPTION AND INFORMATION ROUTING NETWORK LINKING PHARMACY BENEFITS MANAGERS, HEALTH PLANS, POINT OF CARE VENDORS, PRESCRIBING PHYSICIANS, PHARMACIES, PHARMACY NETWORKS AND OTHERS BY MEANS OF GLOBAL COMPUTER NETWORKS TO FACILITATE PRESCRIPTION AND PHARMACY BENEFIT COMMUNICATIONS AND OTHER HEALTHCARE-RELATED TRANSACTIONS, AND OTHER RELATED BUSINESSES, IN CLASS 42 (U.S. CLS. 100 AND 101).

FIRST USE 5-3-2007; IN COMMERCE 5-3-2007.

THE MARK CONSISTS OF STANDARD CHARACTERS WITHOUT CLAIM TO ANY PARTICULAR FONT, STYLE, SIZE, OR COLOR.

OWNER OF U.S. REG. NO. 2,783,075.

NO CLAIM IS MADE TO THE EXCLUSIVE RIGHT TO USE "NATIONAL PATIENT HEALTH INFORMATION NETWORK", APART FROM THE MARK AS SHOWN.

SER. NO. 77-205,913, FILED 6-14-2007.

JUSTINE D. PARKER, EXAMINING ATTORNEY

Int. Cl.: 35

Prior U.S. Cls.: 100, 101 and 102

United States Patent and Trademark Office

Reg. No. 3,483,273

Registered Aug. 12, 2008

**SERVICE MARK
PRINCIPAL REGISTER**



PATRIOT HEALTH, INC. (DELAWARE CORPORATION)

998C OLD COUNTRY ROAD, #335

PLAINVIEW, NY 11803

FOR: ADMINISTRATION OF A DISCOUNT PROGRAM FOR ENABLING PARTICIPANTS TO OBTAIN DISCOUNTS ON MEDICAL, PHARMACEUTICAL, DENTAL, VISION AND HEALTH CARE GOODS AND SERVICES THROUGH USE OF A DISCOUNT MEMBERSHIP CARD, IN CLASS 35 (U.S. CLS. 100, 101 AND 102).

FIRST USE 6-21-2001; IN COMMERCE 6-21-2001.

OWNER OF U.S. REG. NO. 2,999,151.

NO CLAIM IS MADE TO THE EXCLUSIVE RIGHT TO USE "HEALTH", APART FROM THE MARK AS SHOWN.

THE COLOR(S) DARK BLUE, LIGHT BLUE AND RED IS/ARE CLAIMED AS A FEATURE OF THE MARK.

THE MARK CONSISTS OF THE WORDS "PATRIOT HEALTH" IN DARK BLUE, WITH A RED HORIZONTAL LINE ABOVE AND BELOW THE WORDS, ALL SUPERIMPOSED OVER A STYLIZED "P" IN LIGHT BLUE.

SER. NO. 77-206,232, FILED 6-14-2007.

CHRIS WELLS, EXAMINING ATTORNEY

Int. Cl.: 9

Prior U.S. Cls.: 21, 23, 26, 36 and 38

Reg. No. 3,483,274

United States Patent and Trademark Office

Registered Aug. 12, 2008

**TRADEMARK
PRINCIPAL REGISTER**

ARRAYPRO

ADTRON CORPORATION (ARIZONA CORPORATION)
4415 E. COTTON CENTER BLVD., SUITE 100
PHOENIX, AZ 85040

FOR: HARDWARE WITH EMBEDDED FIRMWARE FOR READING AND WRITING TO STORAGE DEVICES, NAMELY, TO HARD DISKS AND SOLID-STATE DISKS, IN CLASS 9 (U.S. CLS. 21, 23, 26, 36 AND 38).

FIRST USE 2-0-2005; IN COMMERCE 2-0-2005.

THE MARK CONSISTS OF STANDARD CHARACTERS WITHOUT CLAIM TO ANY PARTICULAR FONT, STYLE, SIZE, OR COLOR.

SER. NO. 77-206,348, FILED 6-14-2007.

KIMBERLY PERRY, EXAMINING ATTORNEY

Int. Cls.: 35, 41, 43 and 44

Prior U.S. Cls.: 100, 101, 102 and 107

United States Patent and Trademark Office

Reg. No. 3,483,275

Registered Aug. 12, 2008

**SERVICE MARK
PRINCIPAL REGISTER**

IT'S DEEPER HERE

YMCA OF CENTRAL MARYLAND, INC.
(MARYLAND NON-PROFIT CORPORATION)
20 S. CHARLES STREET, STE. 600
BALTIMORE, MD 21201

FOR: HUMAN RESOURCES CONSULTATION;
EMPLOYMENT COUNSELING; JOB AND PERSON-
NEL PLACEMENT; ORGANIZING AND CON-
DUCTING JOB FAIRS, IN CLASS 35 (U.S. CLS. 100,
101 AND 102).

FIRST USE 7-0-2007; IN COMMERCE 7-0-2007.

FOR: EDUCATIONAL SERVICES FOR CHIL-
DREN, NAMELY, PRE-SCHOOLS; ORGANIZING
AND CONDUCTING SPORTING AND CULTURAL
ACTIVITIES FOR CHILDREN; SUMMER CAMPS;
RESIDENTIAL CAMPS, NAMELY, OVERNIGHT
CAMPS; SPORTS PROGRAMS FOR CHILDREN,
NAMELY, PROVIDING VARIOUS FACILITIES
FOR AN ARRAY OF SPORTING ACTIVITIES,
SPORTS, AND ATHLETIC COMPETITIONS; TEEN
LEADERSHIP PROGRAMS, NAMELY, CAREER
SKILLS TRAINING AND GED AND PRE-GED
EDUCATIONAL CLASSES; FITNESS INSTRU-
CTION; FITNESS PROGRAMS, NAMELY, INSTRU-
CTION IN YOGA, PILATES, CYCLING, MARTIAL

ARTS, DANCE, AND AQUATICS, IN CLASS 41 (U.S.
CLS. 100, 101 AND 107).

FIRST USE 7-0-2007; IN COMMERCE 7-0-2007.

FOR: CHILD CARE SERVICES; DAY CARE SER-
VICES; PROVIDING TEMPORARY HOUSING AC-
COMMODATIONS AND OPERATION OF
HOMELESS SHELTERS, IN CLASS 43 (U.S. CLS. 100
AND 101).

FIRST USE 7-0-2007; IN COMMERCE 7-0-2007.

FOR: HEALTH CARE SERVICES, NAMELY,
WELLNESS PROGRAMS , IN CLASS 44 (U.S. CLS.
100 AND 101).

FIRST USE 7-0-2007; IN COMMERCE 7-0-2007.

THE MARK CONSISTS OF STANDARD CHAR-
ACTERS WITHOUT CLAIM TO ANY PARTICULAR
FONT, STYLE, SIZE, OR COLOR.

SER. NO. 77-206,397, FILED 6-14-2007.

DORITT L. CARROLL, EXAMINING ATTORNEY

Int. Cl.: 44

Prior U.S. Cls.: 100 and 101

United States Patent and Trademark Office

Reg. No. 3,483,276

Registered Aug. 12, 2008

**SERVICE MARK
PRINCIPAL REGISTER**



**THE
INSTITUTE
OF LIVING**



HARTFORD HOSPITAL

HARTFORD HOSPITAL (CONNECTICUT CORPORATION)
80 SEYMOUR STREET, P.O. BOX 5037
HARTFORD, CT 061025037

FOR: INPATIENT AND OUTPATIENT MENTAL HEALTH SERVICES, IN CLASS 44 (U.S. CLS. 100 AND 101).

FIRST USE 8-31-2003; IN COMMERCE 8-31-2003.

OWNER OF U.S. REG. NOS. 2,018,768, 2,118,156 AND OTHERS.

NO CLAIM IS MADE TO THE EXCLUSIVE RIGHT TO USE "INSTITUTE" AND "HOSPITAL", APART FROM THE MARK AS SHOWN.

THE MARK CONSISTS OF THE WORDING "THE INSTITUTE OF LIVING" AND "H HARTFORD HOSPITAL" SEPARATED BY A LINE, AND A DEPICTION OF A TREE ENCLOSED IN A RECTANGLE.

SEC. 2(F) AS TO "HARTFORD HOSPITAL".

SER. NO. 77-206,450, FILED 6-14-2007.

EVELYN BRADLEY, EXAMINING ATTORNEY

Int. Cl.: 9

Prior U.S. Cls.: 21, 23, 26, 36 and 38

United States Patent and Trademark Office

Reg. No. 3,483,277

Registered Aug. 12, 2008

**TRADEMARK
PRINCIPAL REGISTER**

HYPERVU

HYPERMED, INC. (DELAWARE CORPORATION)
305 SECOND AVENUE
WALTHAM, MA 02451

FOR: MEDICAL SOFTWARE IN THE FIELD OF SPECTRAL IMAGING FOR PROCESSING AND DISPLAYING INFORMATION AND FOR SENDING AND RECEIVING INFORMATION THROUGH THE INTERNET OR ANOTHER NETWORKED COMPUTER INCLUDING ACCOMPANYING PRINTED OR DOWNLOADABLE TECHNICAL AND INSTRUCTIONAL MATERIALS AND DOCUMENTATION SOLD THEREWITH AS UNIT, IN CLASS 9 (U.S. CLS. 21, 23, 26, 36 AND 38).

FIRST USE 3-31-2007; IN COMMERCE 3-31-2007.

THE MARK CONSISTS OF STANDARD CHARACTERS WITHOUT CLAIM TO ANY PARTICULAR FONT, STYLE, SIZE, OR COLOR.

OWNER OF U.S. REG. NO. 2,617,713.

SER. NO. 77-206,537, FILED 6-14-2007.

CHRISTINA SOBRAL, EXAMINING ATTORNEY

Int. Cl.: 9

Prior U.S. Cls.: 21, 23, 26, 36 and 38

Reg. No. 3,483,278

United States Patent and Trademark Office

Registered Aug. 12, 2008

**TRADEMARK
PRINCIPAL REGISTER**

NEUROPHONICS

GILL, MEL (UNITED STATES INDIVIDUAL)
2416 PINECREST LANE
WESTCHESTER, IL 60154

FIRST USE 3-1-2007; IN COMMERCE 3-1-2007.

FOR: PRE-RECORDED AUDIO CD'S AND TAPES
FEATURING EDUCATIONAL MATERIAL IN THE
FIELD OF PSYCHOLOGICAL SELF-HELP AND
SELF-AWARENESS, IN CLASS 9 (U.S. CLS. 21, 23,
26, 36 AND 38).

THE MARK CONSISTS OF STANDARD CHAR-
ACTERS WITHOUT CLAIM TO ANY PARTICULAR
FONT, STYLE, SIZE, OR COLOR.

SER. NO. 77-206,696, FILED 6-14-2007.

FRANK LATTUCA, EXAMINING ATTORNEY

Int. Cls.: 16 and 43

Prior U.S. Cls.: 2, 5, 22, 23, 29, 37, 38, 50, 100 and 101

United States Patent and Trademark Office

Reg. No. 3,483,279

Registered Aug. 12, 2008

**TRADEMARK
SERVICE MARK
PRINCIPAL REGISTER**



HOTELS & RESORTS

DORPAN, S.L. (SPAIN CORPORATION)
GREMIO TONELEROS, 24
POLIGONO SON CASTELLO
PALMA DE MALLORCA, BALEARES, SPAIN 07009

FOR: POSTCARDS, STATIONERY; BOOKS, BROCHURES, MAGAZINES AND CATALOGS ON THE SUBJECT OF TRAVEL, TRAVEL DESTINATIONS AND INFORMATION OF INTEREST TO TRAVELERS; POSTERS, IN CLASS 16 (U.S. CLS. 2, 5, 22, 23, 29, 37, 38 AND 50).

FOR: HOTEL SERVICES, RESTAURANT SERVICES, IN CLASS 43 (U.S. CLS. 100 AND 101).

PRIORITY CLAIMED UNDER SEC. 44(D) ON SPAIN APPLICATION NO. 2.768.238, FILED 4-23-2007, REG. NO. 2768238, DATED 10-4-2007, EXPIRES 4-23-2017.

NO CLAIM IS MADE TO THE EXCLUSIVE RIGHT TO USE "HOTELS & RESORTS", APART FROM THE MARK AS SHOWN.

THE MARK CONSISTS OF THE WORDS "ME HOTELS & RESORTS" IN A STYLIZED FONT.

SER. NO. 77-206,997, FILED 6-15-2007.

REBECCA EISINGER, EXAMINING ATTORNEY

Int. Cl.: 28

Prior U.S. Cls.: 22, 23, 38 and 50

Reg. No. 3,483,280

United States Patent and Trademark Office

Registered Aug. 12, 2008

**TRADEMARK
PRINCIPAL REGISTER**

TRIGGER FIRE

BLIP, LLC (MINNESOTA LTD LIAB CO)
15255 MINNETONKA BOULEVARD
MINNETONKA, MN 55345

THE MARK CONSISTS OF STANDARD CHAR-
ACTERS WITHOUT CLAIM TO ANY PARTICULAR
FONT, STYLE, SIZE, OR COLOR.

FOR: TOY GUNS FOR SHOOTING BALLS, IN
CLASS 28 (U.S. CLS. 22, 23, 38 AND 50).

SER. NO. 77-207,106, FILED 6-15-2007.

FIRST USE 6-1-2007; IN COMMERCE 6-1-2007.

KAREN K. BUSH, EXAMINING ATTORNEY

Int. Cl.: 38

Prior U.S. Cls.: 100, 101 and 104

United States Patent and Trademark Office

Reg. No. 3,483,281

Registered Aug. 12, 2008

**SERVICE MARK
PRINCIPAL REGISTER**

**B2 NETWORKS BROADBAND
BROADCASTS**

B2 NETWORKS, INC. (TEXAS CORPORATION)
SUITE 308
13330 NOEL ROAD
DALLAS, TX 75240

FOR: BROADCASTING PROGRAMS VIA A GLOBAL COMPUTER NETWORK, BROADBAND, WIRED AND WIRELESS NETWORKS; INTERNET, TELEVISION, VIDEO AND AUDIO BROADCASTING SERVICES; BROADCASTING SERVICES AND PROVISION OF TELECOMMUNICATION ACCESS TO VIDEO AND AUDIO CONTENT, FILMS AND TV PROGRAMS, PROVIDED VIA A VIDEO-ON-DEMAND SERVICE VIA THE INTERNET; AUDIO AND VIDEO BROADCASTING SERVICES OVER THE INTERNET; BROADCASTING SERVICES AND PROVISION OF BROADBAND ACCESS TO LIVE AND DELAYED PROGRAMS VIA PAY-PER-VIEW, SUBSCRIPTION OR FREE VIA BROADBAND ENABLED FIXED OR MOBILE, WIRED OR WIRELESS

VIDEO DISPLAY DEVICES; CABLE AND SATELLITE TELEVISION BROADCASTING; SUBSCRIPTION TELEVISION BROADCASTING , IN CLASS 38 (U.S. CLS. 100, 101 AND 104).

FIRST USE 10-1-2005; IN COMMERCE 10-1-2005.

THE MARK CONSISTS OF STANDARD CHARACTERS WITHOUT CLAIM TO ANY PARTICULAR FONT, STYLE, SIZE, OR COLOR.

NO CLAIM IS MADE TO THE EXCLUSIVE RIGHT TO USE "NETWORKS BROADBAND BROADCASTS", APART FROM THE MARK AS SHOWN.

SER. NO. 77-207,205, FILED 6-15-2007.

ARETHA SOMERVILLE, EXAMINING ATTORNEY

Int. Cl.: 38

Prior U.S. Cls.: 100, 101 and 104

United States Patent and Trademark Office

Reg. No. 3,483,282

Registered Aug. 12, 2008

**SERVICE MARK
PRINCIPAL REGISTER**

**CLICK HERE TO WATCH THE
GAME "LIVE" B2 NETWORKS**

B2 NETWORKS, INC. (TEXAS CORPORATION)
SUITE 308
13330 NOEL ROAD
DALLAS, TX 75240

FOR: BROADCASTING PROGRAMS VIA A GLOBAL COMPUTER NETWORK, BROADBAND, WIRED AND WIRELESS NETWORKS; INTERNET, TELEVISION, VIDEO AND AUDIO BROADCASTING SERVICES; BROADCASTING SERVICES AND PROVISION OF TELECOMMUNICATION ACCESS TO VIDEO AND AUDIO CONTENT, FILMS AND TV PROGRAMS, PROVIDED VIA A VIDEO-ON-DEMAND SERVICE VIA THE INTERNET; AUDIO AND VIDEO BROADCASTING SERVICES OVER THE INTERNET; BROADCASTING SERVICES AND PROVISION OF BROADBAND ACCESS TO LIVE AND DELAYED PROGRAMS VIA PAY-PER-VIEW, SUBSCRIPTION OR FREE VIA BROADBAND ENABLED FIXED OR MOBILE, WIRED OR WIRELESS

VIDEO DISPLAY DEVICES; CABLE AND SATELLITE TELEVISION BROADCASTING; SUBSCRIPTION TELEVISION BROADCASTING , IN CLASS 38 (U.S. CLS. 100, 101 AND 104).

FIRST USE 9-1-2004; IN COMMERCE 9-1-2004.

THE MARK CONSISTS OF STANDARD CHARACTERS WITHOUT CLAIM TO ANY PARTICULAR FONT, STYLE, SIZE, OR COLOR.

NO CLAIM IS MADE TO THE EXCLUSIVE RIGHT TO USE "CLICK HERE TO WATCH THE GAME LIVE AND NETWORKS", APART FROM THE MARK AS SHOWN.

SER. NO. 77-207,222, FILED 6-15-2007.

ARETHA SOMERVILLE, EXAMINING ATTORNEY

Int. Cl.: 9

Prior U.S. Cls.: 21, 23, 26, 36 and 38

Reg. No. 3,483,283

United States Patent and Trademark Office

Registered Aug. 12, 2008

**TRADEMARK
PRINCIPAL REGISTER**

WiRanger

ICRON TECHNOLOGIES CORP. (CANADA CORPORATION)
SUITE #221
4664 LOUGHEED HWY
BURNABY, B.C., CANADA V5C5T5

FOR: COMPUTER DATA COMMUNICATION HARDWARE FOR USE IN THE FIELD OF COMPUTER COMMUNICATION TO ENABLE DATA COMMUNICATION BETWEEN COMPUTERS AND COMPUTER RELATED PERIPHERAL DEVICES, IN CLASS 9 (U.S. CLS. 21, 23, 26, 36 AND 38).

FIRST USE 6-4-2007; IN COMMERCE 6-4-2007.

THE MARK CONSISTS OF STANDARD CHARACTERS WITHOUT CLAIM TO ANY PARTICULAR FONT, STYLE, SIZE, OR COLOR.

OWNER OF U.S. REG. NO. 2,772,917.

SER. NO. 77-207,379, FILED 6-15-2007.

SARA THOMAS, EXAMINING ATTORNEY

Int. Cl.: 38

Prior U.S. Cls.: 100, 101 and 104

United States Patent and Trademark Office

Reg. No. 3,483,284

Registered Aug. 12, 2008

**SERVICE MARK
PRINCIPAL REGISTER**



B2 NETWORKS, INC. (TEXAS CORPORATION)
SUITE 308
13330 NOEL ROAD
DALLAS, TX 75240

FOR: BROADCASTING PROGRAMS VIA A GLOBAL COMPUTER NETWORK, BROADBAND, WIRED AND WIRELESS NETWORKS; INTERNET, TELEVISION, VIDEO AND AUDIO BROADCASTING SERVICES; BROADCASTING SERVICES AND PROVISION OF TELECOMMUNICATION ACCESS TO VIDEO AND AUDIO CONTENT, FILMS AND TV PROGRAMS, PROVIDED VIA A VIDEO-ON-DEMAND SERVICE VIA THE INTERNET; AUDIO AND VIDEO BROADCASTING SERVICES OVER THE INTERNET; BROADCASTING SERVICES AND PROVISION OF BROADBAND ACCESS TO LIVE AND DELAYED PROGRAMS VIA PAY-PER-VIEW, SUBSCRIPTION OR FREE VIA BROADBAND ENABLED FIXED OR MOBILE, WIRED OR WIRELESS VIDEO DISPLAY DEVICES; CABLE AND SATELLITE TELEVISION BROADCASTING; SUBSCRIPTION TELEVISION BROADCASTING, IN CLASS 38 (U.S. CLS. 100, 101 AND 104).

FIRST USE 9-1-2004; IN COMMERCE 9-1-2004.

NO CLAIM IS MADE TO THE EXCLUSIVE RIGHT TO USE "CLICK HERE TO WATCH THE GAME LIVE AND NETWORKS", APART FROM THE MARK AS SHOWN.

THE COLOR(S) RED, BLUE, BLACK AND GREY IS/ARE CLAIMED AS A FEATURE OF THE MARK.

THE MARK CONSISTS OF THE WORDS "CLICK HERE TO WATCH THE GAME" WRITTEN IN RED, ABOVE THE WORD "LIVE" WRITTEN IN BLUE, ABOVE "B2" WRITTEN IN BLUE, ABOVE "NETWORKS" WRITTEN IN BLACK AND "B2 NETWORKS" IS SUPERIMPOSED OVER A GREY PYRAMID.

SER. NO. 77-207,394, FILED 6-15-2007.

ARETHA SOMERVILLE, EXAMINING ATTORNEY

Int. Cl.: 38

Prior U.S. Cls.: 100, 101 and 104

United States Patent and Trademark Office

Reg. No. 3,483,285

Registered Aug. 12, 2008

**SERVICE MARK
PRINCIPAL REGISTER**



B2 NETWORKS, INC. (TEXAS CORPORATION)
SUITE 308
13330 NOEL ROAD
DALLAS, TX 75240

FOR: BROADCASTING PROGRAMS VIA A GLOBAL COMPUTER NETWORK, BROADBAND, WIRED AND WIRELESS NETWORKS; INTERNET, TELEVISION, VIDEO AND AUDIO BROADCASTING SERVICES; BROADCASTING SERVICES AND PROVISION OF TELECOMMUNICATION ACCESS TO VIDEO AND AUDIO CONTENT, FILMS AND TV PROGRAMS, PROVIDED VIA A VIDEO-ON-DEMAND SERVICE VIA THE INTERNET; AUDIO AND VIDEO BROADCASTING SERVICES OVER THE INTERNET; BROADCASTING SERVICES AND PROVISION OF BROADBAND ACCESS TO LIVE AND DELAYED PROGRAMS VIA PAY-PER-VIEW, SUBSCRIPTION OR FREE VIA BROADBAND ENABLED FIXED OR MOBILE, WIRED OR WIRELESS VIDEO DISPLAY DEVICES; CABLE AND SATELLITE TELEVISION BROADCASTING; SUBSCRIP-

TION TELEVISION BROADCASTING , IN CLASS 38 (U.S. CLS. 100, 101 AND 104).

FIRST USE 4-1-2007; IN COMMERCE 4-1-2007.

NO CLAIM IS MADE TO THE EXCLUSIVE RIGHT TO USE "CLICK HERE TO WATCH EVENTS NOW", APART FROM THE MARK AS SHOWN.

THE COLOR(S) BLACK, GREY, WHITE AND BLUE IS/ARE CLAIMED AS A FEATURE OF THE MARK.

THE MARK CONSISTS OF A GREY AND WHITE SHADED PYRAMID POSITIONED ABOVE THE BLUE WORDS "CLICK HERE TO WATCH EVENTS NOW", SUPERIMPOSED ON A BLACK RECTANGLE.

SER. NO. 77-207,679, FILED 6-15-2007.

ARETHA SOMERVILLE, EXAMINING ATTORNEY

Int. Cl.: 9

Prior U.S. Cls.: 21, 23, 26, 36 and 38

Reg. No. 3,483,286

United States Patent and Trademark Office

Registered Aug. 12, 2008

**TRADEMARK
PRINCIPAL REGISTER**

Ray Dragon

DRAGONAJTYS RAYMOND (UNITED STATES
INDIVIDUAL)
271 WEST 11TH STREET 4A
NEW YORK, NY 10014

FOR: PRE-RECORDED CDS, VIDEO TAPES, LA-
SER DISKS AND DVDS FEATURING ORIGINAL
FICTIONAL WORKS, CONSISTING OF ADULT
MALE SEXUAL AND ROMANTIC CONTENT, IN
CLASS 9 (U.S. CLS. 21, 23, 26, 36 AND 38).

FIRST USE 6-1-2000; IN COMMERCE 8-25-2002.

THE MARK CONSISTS OF STANDARD CHAR-
ACTERS WITHOUT CLAIM TO ANY PARTICULAR
FONT, STYLE, SIZE, OR COLOR.

THE NAME " RAYMOND DRAGONAJTYS"
IDENTIFIES A LIVING INDIVIDUAL WHOSE CON-
SENT IS OF RECORD.

SER. NO. 77-207,854, FILED 6-15-2007.

ARETHA SOMERVILLE, EXAMINING ATTORNEY

Int. Cls.: 35 and 40

Prior U.S. Cls.: 100, 101, 102, 103 and 106

United States Patent and Trademark Office

Reg. No. 3,483,287

Registered Aug. 12, 2008

**SERVICE MARK
PRINCIPAL REGISTER**



MONA LISA GALLERY & FRAMING, INC. (NEW
JERSEY CORPORATION)
168 MAPLEWOOD AVE.,
MAPLEWOOD, NJ 07040

FOR: ARRANGING AND CONDUCTING TRADE
SHOWS IN THE FIELD OF ART; ART GALLERIES,
IN CLASS 35 (U.S. CLS. 100, 101 AND 102).

FIRST USE 5-1-2007; IN COMMERCE 5-1-2007.

FOR: FRAMING OF WORKS OF ART, IN CLASS
40 (U.S. CLS. 100, 103 AND 106).

FIRST USE 5-1-2007; IN COMMERCE 5-1-2007.

THE MARK CONSISTS OF THE MONA LISA
HOLDING A FRAME.

SER. NO. 77-208,162, FILED 6-18-2007.

DOMINICK J. SALEMI, EXAMINING ATTORNEY

Int. Cls.: 3, 5 and 16

**Prior U.S. Cls.: 1, 2, 4, 5, 6, 18, 22, 23, 29, 37, 38, 44,
46, 50, 51 and 52**

Reg. No. 3,483,288

United States Patent and Trademark Office

Registered Aug. 12, 2008

**TRADEMARK
PRINCIPAL REGISTER**



KRUGER PRODUCTS LIMITED (CANADA COR-
PORATION)
SUITE 200
1900 MINNESOTA COURT
MISSISSAUGA, CANADA L5N5R5

FOR: FEMININE HYGIENE DEODORANT
SPRAYS, IN CLASS 3 (U.S. CLS. 1, 4, 6, 50, 51 AND 52).

FOR: INCONTINENCE PADS AND DIAPERS;
FEMININE HYGIENE CLEANSING TOWELETTES
AND PADS, IN CLASS 5 (U.S. CLS. 6, 18, 44, 46, 51
AND 52).

FOR: PAPER PRODUCTS, NAMELY, PAPER TO-
WELS, BATHROOM AND FACIAL TISSUES, NAP-

KINS AND WIPES NOT IMPREGNATED WITH
CHEMICALS OR CHEMICAL COMPOUNDS, IN
CLASS 16 (U.S. CLS. 2, 5, 22, 23, 29, 37, 38 AND 50).

OWNER OF CANADA REG. NO. TMA683844,
DATED 3-16-2007, EXPIRES 3-16-2022.

THE STIPPLING IS A FEATURE OF THE MARK.

THE MARK CONSISTS OF SILHOUTTE OF A
WOMAN WITH A RIBBON DESIGN.

SER. NO. 77-208,209, FILED 6-18-2007.

ANDREA HACK, EXAMINING ATTORNEY

Int. Cls.: 9 and 38

Prior U.S. Cls.: 21, 23, 26, 36, 38, 100, 101 and 104

United States Patent and Trademark Office

Reg. No. 3,483,289

Registered Aug. 12, 2008

**TRADEMARK
SERVICE MARK
PRINCIPAL REGISTER**



KMEDIA, INC. (FLORIDA CORPORATION), DBA
VIVOPHONE
10435 NW 29 TERRACE, BAY #2
MIAMI, FL 33172

FOR: TELECOMMUNICATIONS AND DATA
NETWORKING HARDWARE, NAMELY, DEVICES
FOR TRANSPORTING VOICE COMMUNICATIONS
VIA A GLOBAL COMMUNICATIONS NETWORK,
IN CLASS 9 (U.S. CLS. 21, 23, 26, 36 AND 38).

FIRST USE 6-0-2004; IN COMMERCE 6-0-2004.

FOR: TELEPHONY COMMUNICATION SERVI-
CES, IN CLASS 38 (U.S. CLS. 100, 101 AND 104).

FIRST USE 6-0-2004; IN COMMERCE 6-0-2004.

THE COLOR(S) ORANGE AND BLACK IS/ARE
CLAIMED AS A FEATURE OF THE MARK.

THE MARK CONSISTS OF A SOLID "V" SHAPE
IN THE COLOR ORANGE, A SOLID DOT IN THE
COLOR BLACK IN THE CENTER OF THE "V"
SHAPE, AND A SOLID TELEPHONE HAND-PIECE
SHAPE IN THE COLOR BLACK ON AN ANGLE
AND TO THE TOP RIGHT SIDE OF THE "V".

SER. NO. 77-208,212, FILED 6-18-2007.

MICHAEL KAZAZIAN, EXAMINING ATTORNEY

Int. Cl.: 25

Prior U.S. Cls.: 22 and 39

United States Patent and Trademark Office

Reg. No. 3,483,290

Registered Aug. 12, 2008

**TRADEMARK
PRINCIPAL REGISTER**

RED HEAD CANVASBACK

BASS PRO TRADEMARKS, L.L.C. (MISSOURI
LTD LIAB CO)
2500 EAST KEARNEY
SPRINGFIELD, MO 65898

FOR: HUNTING CLOTHING, NAMELY, JACK-
ETS, PARKAS, OVERALLS AND PANTS, IN CLASS
25 (U.S. CLS. 22 AND 39).

FIRST USE 6-0-2004; IN COMMERCE 6-0-2004.

THE MARK CONSISTS OF STANDARD CHAR-
ACTERS WITHOUT CLAIM TO ANY PARTICULAR
FONT, STYLE, SIZE, OR COLOR.

OWNER OF U.S. REG. NOS. 157,633, 1,264,756,
AND 2,207,956.

SER. NO. 77-208,272, FILED 6-18-2007.

KATHY DE JONGE, EXAMINING ATTORNEY

Int. Cl.: 17

Prior U.S. Cls.: 1, 5, 12, 13, 35 and 50

Reg. No. 3,483,291

United States Patent and Trademark Office

Registered Aug. 12, 2008

**TRADEMARK
PRINCIPAL REGISTER**

EZ FLOW

RING INDUSTRIAL GROUP, L.P. (TENNESSEE
LIMITED PARTNERSHIP)
65 INDUSTRIAL PARK
OAKLAND, TN 38060

FOR: DRAIN FIELD PRODUCTS, NAMELY, PRE-
ASSEMBLED, PLASTIC CONDUITS SURROUNDED
BY A GEO-SYNTHETIC AGGREGATE FOR A WIDE
VARIETY OF IN-GROUND INSTALLATION, SEP-
TIC AND DRAINAGE APPLICATIONS, IN CLASS 17
(U.S. CLS. 1, 5, 12, 13, 35 AND 50).

FIRST USE 2-0-2000; IN COMMERCE 2-0-2000.

THE MARK CONSISTS OF STANDARD CHAR-
ACTERS WITHOUT CLAIM TO ANY PARTICULAR
FONT, STYLE, SIZE, OR COLOR.

OWNER OF U.S. REG. NOS. 2,647,481 AND
2,785,112.

SEC. 2(F).

SER. NO. 77-208,289, FILED 6-18-2007.

STEVEN JACKSON, EXAMINING ATTORNEY

Int. Cls.: 9 and 38

Prior U.S. Cls.: 21, 23, 26, 36, 38, 100, 101 and 104

United States Patent and Trademark Office

Reg. No. 3,483,292

Registered Aug. 12, 2008

**TRADEMARK
SERVICE MARK
PRINCIPAL REGISTER**



KMEDIA, INC. (FLORIDA CORPORATION), DBA
VIVOPHONE
10435 NW 29 TERRACE, BAY #2
MIAMI, FL 33172

FOR: TELECOMMUNICATIONS AND DATA
NETWORKING HARDWARE, NAMELY, DEVICES
FOR TRANSPORTING VOICE COMMUNICATIONS
VIA A GLOBAL COMMUNICATIONS NETWORK,
IN CLASS 9 (U.S. CLS. 21, 23, 26, 36 AND 38).

FIRST USE 6-0-2004; IN COMMERCE 6-0-2004.

FOR: TELEPHONY COMMUNICATION SERVI-
CES, IN CLASS 38 (U.S. CLS. 100, 101 AND 104).

FIRST USE 6-0-2004; IN COMMERCE 6-0-2004.

SER. NO. 77-208,313, FILED 6-18-2007.

MICHAEL KAZAZIAN, EXAMINING ATTORNEY

Int. Cl.: 9

Prior U.S. Cls.: 21, 23, 26, 36 and 38

Reg. No. 3,483,293

United States Patent and Trademark Office

Registered Aug. 12, 2008

**TRADEMARK
PRINCIPAL REGISTER**

UNLIMITED MAILBOX

COMPUTER GENERATED SOLUTIONS CANADA, LTD. (CANADA CORPORATION)
P.O. BOX 1324 - SUITE 1500
ONE GERMAIN STREET
SAINT JOHN, CANADA E2L4H8

FOR: SOFTWARE FOR EMAIL STORAGE AND ARCHIVING, IN CLASS 9 (U.S. CLS. 21, 23, 26, 36 AND 38).

FIRST USE 10-30-2001; IN COMMERCE 6-30-2004.

THE MARK CONSISTS OF STANDARD CHARACTERS WITHOUT CLAIM TO ANY PARTICULAR FONT, STYLE, SIZE, OR COLOR.

NO CLAIM IS MADE TO THE EXCLUSIVE RIGHT TO USE "MAILBOX", APART FROM THE MARK AS SHOWN.

SER. NO. 77-209,083, FILED 6-18-2007.

DOMINIC J. FERRAIUOLO, EXAMINING ATTORNEY

Int. Cl.: 6

Prior U.S. Cls.: 2, 12, 13, 14, 23, 25 and 50

Reg. No. 3,483,294

United States Patent and Trademark Office

Registered Aug. 12, 2008

TRADEMARK
PRINCIPAL REGISTER

KWICKER  **KICKER**

BRUNO BRACING-ALIGNING-SHORING (CALIFORNIA PARTNERSHIP)
5809 CASCABEL RD.
ATASCADERO, CA 93422

FOR: RETRACTABLE FORM ALIGNMENT BRACES MADE OF METAL, NAMELY, USED IN THE CONSTRUCTION INDUSTRY FOR BRACING AND ALIGNING CAST IN PLACE CONCRETE FORMS, WOOD AND STEEL FRAMED WALLS AND BRACING AND ALIGNING APPLICATIONS, IN CLASS 6 (U.S. CLS. 2, 12, 13, 14, 23, 25 AND 50).

FIRST USE 1-0-2000; IN COMMERCE 2-1-2003.

THE MARK CONSISTS OF ONE CAPITAL "K" FACING FORWARD AS SHOWN HERE "K", AND ONE CAPITAL "K" FACING THE OPPOSITE DIRECTION. SO THAT THE VERTICAL PART OF THE LETTERS ARE TOUCHING. THE CAPITAL "K'S" WOULD BE AGAINST EACH OTHER WITH UPPER AND LOWER DIAGONAL PARTS POINTING AWAY FROM THE CENTER. THE WORD "KWICKER" IS ON THE LEFT SIDE AND IS CENTERED IN BETWEEN THE UPPER AND LOWER DIAGONAL PARTS OF THE CAPITAL "K" WHICH ARE POINTING LEFT. CENTERED MEANING ELEVATION,

THE CAPITAL "R" FROM "KWICKER" IS ACTUALLY LOCATED BETWEEN THE UPPER AND LOWER DIAGONAL PART OF THE BACKWARDS FACING CAPITAL "K". ON THE RIGHT HAND SIDE THE WORD "KICKER" IS CENTERED IN ELEVATION BETWEEN THE UPPER AND LOWER DIAGONAL PARTS OF THE CAPITAL "K". THE CAPITAL LETTER "K" FROM THE WORD "KICKER" IS LOCATED BETWEEN THE UPPER AND LOWER DIAGONAL PARTS OF THE CAPITAL "K" ON THE RIGHT HAND SIDE. THE BACK TO BACK CAPITAL "K'S" ARE LARGER THAN THE OTHER TEXT. WHEN PLACED NEXT TO EACH OTHER THE VERTICAL PART OF THE "K'S" BECOMES THICK AND REPRESENTS THE CONCRETE FORMS THAT "KWICKER-KICKER" PATENT PENDING RETRACTABLE FORM ALIGNMENT BRACES ARE USED ON. THE UPPER AND LOWER DIAGONAL PARTS OF THE "K'S" POINTING AWAY FROM EACH OTHER REPRESENT BRACES IN USE.

SER. NO. 77-209,098, FILED 6-18-2007.

DOMINIC J. FERRAIUOLO, EXAMINING ATTORNEY

Int. Cl.: 35

Prior U.S. Cls.: 100, 101 and 102

United States Patent and Trademark Office

Reg. No. 3,483,295

Registered Aug. 12, 2008

**SERVICE MARK
PRINCIPAL REGISTER**

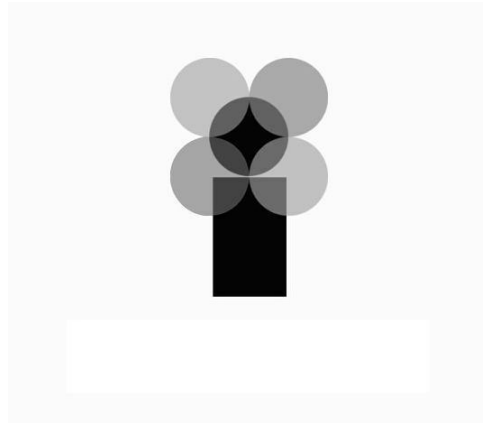

DURHAM ENTERPRISES CORPORATION
(UTAH CORPORATION)
SUITE B
1837 SOUTH 4130 WEST
SALT LAKE CITY, UT 84104

FOR: WHOLESALE DISTRIBUTORSHIPS FEATURING JEWELRY AND SCRAPBOOKING PRODUCTS, NAMELY, RUBBER STAMPS, PRINTING BLOCKS, STICKERS, CHARMS, BRADS, RIBBON SLIDERS AND DECORATIVE EMBELLISHMENTS

FOR SCRAPBOOKING PURPOSES, IN CLASS 35 (U.S. CLS. 100, 101 AND 102).

FIRST USE 8-22-2006; IN COMMERCE 8-22-2006.

THE MARK CONSISTS OF THE LETTER "I" WITH FOUR CIRCLES INTERSECTING IT.

SER. NO. 77-209,384, FILED 6-19-2007.

KYLE PEETE, EXAMINING ATTORNEY

Int. Cl.: 32

Prior U.S. Cls.: 45, 46 and 48

United States Patent and Trademark Office

Reg. No. 3,483,296

Registered Aug. 12, 2008

**TRADEMARK
PRINCIPAL REGISTER**

GLACEAU FRUITWATER

ENERGY BRANDS, INC. (NEW YORK COR-
PORATION)

17-20 WHITESTONE EXPRESSWAY

WHITESTONE, NY 11357

FOR: NON-ALCOHOLIC BEVERAGES, NAMELY,
WATERS AND FLAVORED WATERS, IN CLASS 32
(U.S. CLS. 45, 46 AND 48).

FIRST USE 2-0-1998; IN COMMERCE 2-0-1998.

THE MARK CONSISTS OF STANDARD CHAR-
ACTERS WITHOUT CLAIM TO ANY PARTICULAR
FONT, STYLE, SIZE, OR COLOR.

OWNER OF U.S. REG. NOS. 2,265,015, 2,708,123,
AND 3,279,708.

SEC. 2(F) AS TO "FRUITWATER".

SER. NO. 77-209,603, FILED 6-19-2007.

MARILYN IZZI, EXAMINING ATTORNEY

Int. Cl.: 16

Prior U.S. Cls.: 2, 5, 22, 23, 29, 37, 38 and 50

United States Patent and Trademark Office

Reg. No. 3,483,297

Registered Aug. 12, 2008

**TRADEMARK
PRINCIPAL REGISTER**

GREAT LEAPS

DIARMUID, INC. (FLORIDA CORPORATION)
2630 NW 41ST STREET D-1
GAINESVILLE, FL 32606

THE MARK CONSISTS OF STANDARD CHAR-
ACTERS WITHOUT CLAIM TO ANY PARTICULAR
FONT, STYLE, SIZE, OR COLOR.

FOR: PRINTED INSTRUCTIONAL, EDUCATION-
AL, AND TEACHING MATERIALS IN THE FIELD
OF READING AND MATHEMATICS, IN CLASS 16
(U.S. CLS. 2, 5, 22, 23, 29, 37, 38 AND 50).

SER. NO. 77-209,673, FILED 6-19-2007.

FIRST USE 11-30-1995; IN COMMERCE 3-1-1996.

PAUL CROWLEY, EXAMINING ATTORNEY

Int. Cls.: 36 and 37

Prior U.S. Cls.: 100, 101, 102, 103 and 106

United States Patent and Trademark Office

Reg. No. 3,483,298

Registered Aug. 12, 2008

**SERVICE MARK
PRINCIPAL REGISTER**

CAMPBELL CORPORATION

CAMPBELL FARMING CORPORATION (MONTANA CORPORATION)
SUITE 1020
6501 AMERICAS PARKWAY NORTHEAST
ALBUQUERQUE, NM 87110

FOR: REAL ESTATE ACQUISITION SERVICES; REAL ESTATE MANAGEMENT; MANAGEMENT OF MASTER PLANNED RESIDENTIAL AND MIXED-USE COMMUNITIES AND RESORTS, IN CLASS 36 (U.S. CLS. 100, 101 AND 102).

FIRST USE 11-1-2002; IN COMMERCE 11-1-2002.

FOR: REAL ESTATE DEVELOPMENT SERVICES; DEVELOPMENT OF MASTER PLANNED RESI-

DENTIAL AND MIXED-USE COMMUNITIES AND RESORTS, IN CLASS 37 (U.S. CLS. 100, 103 AND 106).

FIRST USE 9-4-2002; IN COMMERCE 9-4-2002.

THE MARK CONSISTS OF STANDARD CHARACTERS WITHOUT CLAIM TO ANY PARTICULAR FONT, STYLE, SIZE, OR COLOR.

SEC. 2(F).

SER. NO. 77-210,045, FILED 6-19-2007.

AISHA CLARKE, EXAMINING ATTORNEY

Int. Cl.: 3

Prior U.S. Cls.: 1, 4, 6, 50, 51 and 52

United States Patent and Trademark Office

Reg. No. 3,483,299

Registered Aug. 12, 2008

TRADEMARK
PRINCIPAL REGISTER

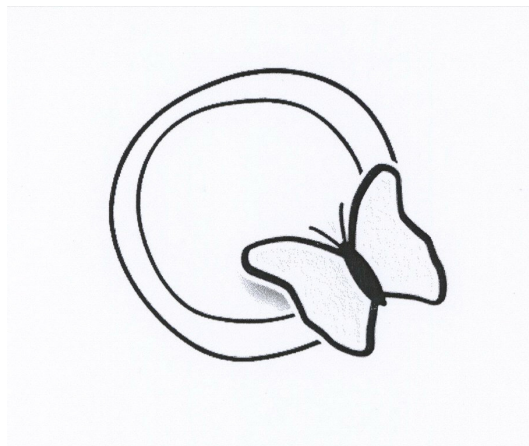

ZIELSKI, DAVID (UNITED STATES INDIVIDUAL)
15 GREY LEDGE ROAD
BRANFORD, CT 06405 AND
ZIELSKI, LINDA (UNITED STATES INDIVIDUAL)
15 GREY LEDGE ROAD
BRANFORD, CT 06405

FOR: NATURAL CLEANING PRODUCTS, NAMELY, CLEANING SWABS FOR HOUSEHOLD PURPOSES, ALL PURPOSE CLEANING PREPARATIONS, CARPET SHAMPOOS, AMMONIA FOR CLEANING PURPOSES, ALCOHOL FOR CLEANING PURPOSES, CARPET CLEANING PREPARATIONS, DRY CLEANING FLUIDS, SOAPS, HOUSEHOLD CLEANING PREPARATIONS, GLASS CLEANING PREPARATIONS, FOAM CLEANING PREPARATIONS, GENERAL PURPOSE CLEANING AND POLISHING AND ABRASIVE LIQUIDS AND CLEANING PREPARATIONS FOR HOUSEHOLD PURPOSES, BATHROOM CLEANERS, FLOOR STRIPPING/CLEANING PREPARATIONS FOR HARDWOODS, DUSTING POWDER, FABRIC SOFTENER, ESSENTIAL OILS AS PERFUME FOR LAUNDRY PURPOSES, LAUNDRY BLEACH ALTERNATIVES IN THE NATURE OF LAUNDRY BLEACH, LAUNDRY PRE-SOAK, SCOURING AND GENERAL PURPOSE ABRASIVE POWDERS; PERSONAL CARE PRODUCTS, NAMELY, LIP BALMS, BODY LOTIONS, SOAPS, HAND CLEANING PREPARATIONS, HAIR CLEANING PRE-

PARATIONS, TOOTH CLEANING PREPARATIONS, PERFUMES, PERFUME OILS, DENTURE CLEANING PREPARATIONS, SKIN AND TOOTH WHITENING PREPARATIONS, SHAMPOOS, HAIR CONDITIONERS, HAND LOTIONS, AND AROMATHERAPY BODY CARE PRODUCTS, NAMELY, BODY LOTION, SHOWER GEL, CUTICLE CREAM, SHAMPOO, CONDITIONER, NON-MEDICATED LIP BALM, SOAP, EAU DE PERFUME, BODY POLISH, BODY AND FOOT SCRUB AND NON-MEDICATED FOOT CREAM; AND BABY CARE PRODUCTS, NAMELY, NON-MEDICATED DIAPER RASH OINTMENTS, PERFUMES, OILS AND LOTIONS, ALL PURPOSE CLEANERS FOR USE WITH HARD SURFACES AND ESSENTIAL OILS FOR USE FOR TOYS AND OTHER HARD SURFACES, BABY HAIR CONDITIONERS, BABY LOTION, BABY SOAPS, BABY SHAMPOO, BABY OILS, BABY POWDER, AND BABY WIPES, IN CLASS 3 (U.S. CLS. 1, 4, 6, 50, 51 AND 52).

FIRST USE 1-1-2005; IN COMMERCE 1-1-2005.

THE MARK CONSISTS OF BUTTERFLY.

SER. NO. 77-210,305, FILED 6-20-2007.

DAVID TAYLOR, EXAMINING ATTORNEY

Int. Cls.: 9 and 42

Prior U.S. Cls.: 21, 23, 26, 36, 38, 100 and 101

United States Patent and Trademark Office

Reg. No. 3,483,300

Registered Aug. 12, 2008

**TRADEMARK
SERVICE MARK
PRINCIPAL REGISTER**

INTERNET & COMPUTING BENCHMARK

CERTIPORT, INC. (DELAWARE CORPORATION)
1276 SOUTH 820 EAST
SUITE 200
AMERICAN FORK, UT 84003

FOR: EDUCATIONAL SOFTWARE FEATURING
INSTRUCTION AND TRAINING IN THE FIELD OF
COMPUTER SKILLS AND KNOWLEDGE, IN CLASS
9 (U.S. CLS. 21, 23, 26, 36 AND 38).

FIRST USE 6-30-2005; IN COMMERCE 6-30-2005.

FOR: PROVIDING USE OF ON-LINE NON-
DOWNLOADABLE EDUCATIONAL SOFTWARE
FEATURING INSTRUCTION AND TRAINING IN

THE FIELD OF COMPUTER SKILLS AND KNOWL-
EDGE, IN CLASS 42 (U.S. CLS. 100 AND 101).

FIRST USE 6-30-2005; IN COMMERCE 6-30-2005.

THE MARK CONSISTS OF STANDARD CHAR-
ACTERS WITHOUT CLAIM TO ANY PARTICULAR
FONT, STYLE, SIZE, OR COLOR.

NO CLAIM IS MADE TO THE EXCLUSIVE
RIGHT TO USE "INTERNET & COMPUTING" ,
APART FROM THE MARK AS SHOWN.

SER. NO. 77-210,734, FILED 6-20-2007.

RENEE MCCRAY, EXAMINING ATTORNEY

Int. Cls.: 9 and 16

Prior U.S. Cls.: 2, 5, 21, 22, 23, 26, 29, 36, 37, 38 and 50

United States Patent and Trademark Office

Reg. No. 3,483,301

Registered Aug. 12, 2008

**TRADEMARK
PRINCIPAL REGISTER**



ITI HOLDINGS, INC. (MAINE CORPORATION)
18 ELM STREET
TOPSHAM, ME 04086

FOR: INSTRUCTIONAL AND ILLUSTRATIVE
COMPUTER SOFTWARE, AUDIO TAPES, VIDEO
TAPES, CDS, CD-ROMS, AND DVDS IN THE FIELD
OF SCUBA DIVING, OPEN WATER DIVING, AND
DIVER TRAINING, IN CLASS 9 (U.S. CLS. 21, 23, 26,
36 AND 38).

FIRST USE 8-0-1998; IN COMMERCE 8-0-1998.

FOR: PRINTED MATTER, NAMELY, BOOKS,
STUDENT MANUALS, INSTRUCTOR MANUALS,
BOOKLETS, CHECKLISTS, TESTING MATERIALS,
CARDS, NAMELY, CARDS BEARING INSTRUC-

TIONS AND CHECKLISTS, POSTERS, STICKERS,
SAFETY STICKERS, AND PAPERS ALL IN THE
FIELD OF SCUBA DIVING, OPEN WATER DIVING,
AND DIVER TRAINING, IN CLASS 16 (U.S. CLS. 2, 5,
22, 23, 29, 37, 38 AND 50).

FIRST USE 8-0-1998; IN COMMERCE 8-0-1998.

OWNER OF U.S. REG. NO. 2,615,626.

SEC. 2(F) AS TO "SCUBA DIVING INTERNA-
TIONAL".

SER. NO. 77-210,737, FILED 6-20-2007.

ELLEN PERKINS, EXAMINING ATTORNEY

Int. Cls.: 35 and 44

Prior U.S. Cls.: 100, 101 and 102

United States Patent and Trademark Office

Reg. No. 3,483,302

Registered Aug. 12, 2008

**SERVICE MARK
PRINCIPAL REGISTER**



FLORIDA'S BLOOD CENTERS, INC. (FLORIDA
NON-PROFIT CORPORATION)
8669 COMMODITY CIRCLE
ORLANDO, FL 32819

FOR: PROMOTING PUBLIC AWARENESS OF
THE NEED FOR BLOOD DONORS, BLOOD PRO-
DUCTS AND COMMUNITY BLOOD BANK SERVI-
CES, IN CLASS 35 (U.S. CLS. 100, 101 AND 102).

FIRST USE 1-5-2003; IN COMMERCE 1-5-2003.

FOR: COLLECTION AND PRESERVATION OF
HUMAN BLOOD, IN CLASS 44 (U.S. CLS. 100 AND
101).

FIRST USE 1-5-2003; IN COMMERCE 1-5-2003.

NO CLAIM IS MADE TO THE EXCLUSIVE
RIGHT TO USE "BLOOD CENTERS", APART FROM
THE MARK AS SHOWN.

THE COLOR(S) RED, BLUE AND WHITE IS/ARE
CLAIMED AS A FEATURE OF THE MARK.

THE COLOR RED APPEARS IN THE DESIGN OF
THE DROPLET FORMING THE LETTER "C" AND
IN THE LINE APPEARING BELOW THE WORD
"FLORIDA'S", THE COLOR BLUE APPEARS IN THE
WORDING "FLORIDA'S BLOOD CENTERS", AND
THE COLOR WHITE APPEARS IN THE SPACE
INSIDE THE DROPLET.

SEC. 2(F).

SER. NO. 77-210,883, FILED 6-20-2007.

SUSAN RICHARDS, EXAMINING ATTORNEY

Int. Cl.: 35

Prior U.S. Cls.: 100, 101 and 102

United States Patent and Trademark Office

Reg. No. 3,483,303

Registered Aug. 12, 2008

**SERVICE MARK
PRINCIPAL REGISTER**



ADVERPLEX, INC. (DELAWARE CORPORATION)
SUITE 212
100 QUANNAPOWITT PARKWAY
WAKEFIELD, MA 01880

FOR: GENERAL BUSINESS NETWORKING REFERRAL SERVICES, NAMELY, PROMOTING THE GOODS AND SERVICES OF OTHERS BY GENERATING AND PROVIDING MARKETING LEADS TO GROUP MEMBERS THAT ARE AUTOMOBILE DEALERSHIPS AND MANUFACTURERS; MATCHING CONSUMERS WITH POTENTIAL SELLERS OF

AUTOMOBILES, IN CLASS 35 (U.S. CLS. 100, 101 AND 102).

FIRST USE 4-25-2007; IN COMMERCE 4-25-2007.

THE MARK CONSISTS OF THE OUTLINE OF THE TOP OF AN AUTOMOBILE WITH THE WORDS "SMARTAUTOSAVINGS DRIVE A GREAT DEAL." BELOW.

SER. NO. 77-211,696, FILED 6-21-2007.

SEAN CROWLEY, EXAMINING ATTORNEY

Int. Cl.: 25

Prior U.S. Cls.: 22 and 39

United States Patent and Trademark Office

Reg. No. 3,483,304

Registered Aug. 12, 2008

**TRADEMARK
PRINCIPAL REGISTER**



LEWIS & CLARK OUTDOORS, INC. (ARKANSAS CORPORATION)
8980 WEST MILLER
SPRINGDALE, AR 72762

FOR: SOCKS MADE PRIMARILY OF WOOL FOR MULTIPURPOSE AND MULTISEASONAL USAGE, IN CLASS 25 (U.S. CLS. 22 AND 39).

FIRST USE 2-3-2007; IN COMMERCE 2-3-2007.

NO CLAIM IS MADE TO THE EXCLUSIVE RIGHT TO USE THE DESIGN OF THE HEAD OF A

SHEEP AND WORD "WOOL", APART FROM THE MARK AS SHOWN.

THE MARK CONSISTS OF THE HEAD OF A SHEEP AND SIGN WITH THE WORDS "OMNI" AND "WOOL".

SER. NO. 77-211,804, FILED 6-21-2007.

DAVID C. REIHNER, EXAMINING ATTORNEY

Int. Cls.: 7 and 9

Prior U.S. Cls.: 13, 19, 21, 23, 26, 31, 34, 35, 36 and 38

United States Patent and Trademark Office

Reg. No. 3,483,305

Registered Aug. 12, 2008

**TRADEMARK
PRINCIPAL REGISTER**

START INTERNATIONAL

START MANUFACTURING, INC. (TEXAS CORPORATION)
4270 AIRBORN
ADDISON, TX 75001

FOR: TAPE DISPENSERS, NAMELY, ADHESIVE TAPE DISPENSING MACHINES; LABELING MACHINES IN THE NATURE OF LABEL DISPENSERS, IN CLASS 7 (U.S. CLS. 13, 19, 21, 23, 31, 34 AND 35).

FIRST USE 2-28-1998; IN COMMERCE 2-28-1998.

FOR: OPTICAL INSPECTION DEVICES FOR INDUSTRIAL USE; OPTICAL INSPECTION DEVICES FOR COMMERCIAL USE, NAMELY, MAGNIFIERS, LOUPES, AND MICROSCOPES, IN CLASS 9 (U.S. CLS. 21, 23, 26, 36 AND 38).

FIRST USE 2-28-1998; IN COMMERCE 2-28-1998.

THE MARK CONSISTS OF STANDARD CHARACTERS WITHOUT CLAIM TO ANY PARTICULAR FONT, STYLE, SIZE, OR COLOR.

NO CLAIM IS MADE TO THE EXCLUSIVE RIGHT TO USE "INTERNATIONAL" , APART FROM THE MARK AS SHOWN.

SER. NO. 77-211,868, FILED 6-21-2007.

ANDREA K. NADELMAN, EXAMINING ATTORNEY

Int. Cls.: 20 and 21

Prior U.S. Cls.: 2, 13, 22, 23, 25, 29, 30, 32, 33, 40 and 50

United States Patent and Trademark Office

Reg. No. 3,483,306

Registered Aug. 12, 2008

**TRADEMARK
PRINCIPAL REGISTER**



PROTREND CO., LTD. (TAIWAN CORPORATION)
10F, NO. 458, SEC. 4, HSIN-YI ROAD
TAIPEI, TAIWAN

FOR: WIRE SHELVING; STORAGE RACKS; CABINETS; ENTERTAINMENT CENTERS; FURNITURE; FURNITURE HARDWARE, NAMELY, DRAWER SLIDES; WOOD CONTAINERS AND PLASTIC CONTAINERS FOR COMMERCIAL AND INDUSTRIAL USE, IN CLASS 20 (U.S. CLS. 2, 13, 22, 25, 32 AND 50).

FIRST USE 7-31-2005; IN COMMERCE 2-18-2007.

FOR: WOOD CONTAINERS AND PLASTIC CONTAINERS FOR RESIDENTIAL USE, IN CLASS 21 (U.S. CLS. 2, 13, 23, 29, 30, 33, 40 AND 50).

FIRST USE 7-31-2005; IN COMMERCE 2-18-2007.

NO CLAIM IS MADE TO THE EXCLUSIVE RIGHT TO USE "HOME", APART FROM THE MARK AS SHOWN.

THE COLOR(S) GREEN, WHITE, YELLOW IS/ ARE CLAIMED AS A FEATURE OF THE MARK.

THE MARK CONSISTS OF THE WORDS "HOME PLUS" IN WHITE EXCEPT FOR THE "M," WHICH IS IN YELLOW. THE WORDS ARE UNDERLINED IN YELLOW AND ON A GREEN BACKGROUND.

SER. NO. 77-211,950, FILED 6-21-2007.

WILLIAM BRECKENFELD, EXAMINING ATTORNEY

Int. Cls.: 7 and 9

Prior U.S. Cls.: 13, 19, 21, 23, 26, 31, 34, 35, 36 and 38

United States Patent and Trademark Office

Reg. No. 3,483,307

Registered Aug. 12, 2008

**TRADEMARK
PRINCIPAL REGISTER**



START MANUFACTURING, INC. (TEXAS CORPORATION)
4270 AIRBORN DRIVE
ADDISON, TX 75001

FOR: TAPE DISPENSERS, NAMELY, ADHESIVE TAPE DISPENSING MACHINES; LABELING MACHINES IN THE NATURE OF LABEL DISPENSERS, IN CLASS 7 (U.S. CLS. 13, 19, 21, 23, 31, 34 AND 35).

FIRST USE 2-28-1998; IN COMMERCE 2-28-1998.

FOR: OPTICAL INSPECTION DEVICES FOR INDUSTRIAL USE; OPTICAL INSPECTION DEVICES

FOR COMMERCIAL USE, NAMELY, MAGNIFIERS, LOUPES, AND MICROSCOPES, IN CLASS 9 (U.S. CLS. 21, 23, 26, 36 AND 38).

FIRST USE 2-28-1998; IN COMMERCE 2-28-1998.

THE MARK CONSISTS OF OPPOSING SWOOSHES.

SER. NO. 77-212,032, FILED 6-21-2007.

ANDREA K. NADELMAN, EXAMINING ATTORNEY

Int. Cls.: 16, 35 and 41

**Prior U.S. Cls.: 2, 5, 22, 23, 29, 37, 38, 50, 100, 101, 102
and 107**

Reg. No. 3,483,308

United States Patent and Trademark Office

Registered Aug. 12, 2008

**TRADEMARK
SERVICE MARK
PRINCIPAL REGISTER**

seasons
HyVee

HY-VEE, INC. (IOWA CORPORATION)
5820 WESTOWN PARKWAY
WEST DES MOINES, IA 50266

FOR: PRINTED CATALOG IN THE FIELD OF FAMILY LIFESTYLES FEATURING TIPS ON THE USE OF AND OFFERING PRODUCTS FOR SEASONAL INDOOR AND OUTDOOR FURNITURE AND FURNISHINGS, SEASONAL RECIPES AND TIPS ON PREPARATION OF THE RECIPES, SEASONAL GROCERY ITEMS FOR INDOOR AND OUTDOOR COOKING AND OFFERING TIPS FOR USE OF THE GROCERY ITEMS IN INDOOR AND OUTDOOR COOKING, TIPS ON THE USE OF AND OFFERING PRODUCTS FOR SEASONAL FLORAL AND DECORATING IDEAS FOR THE HOME BOTH INDOORS AND OUTDOORS, TIPS ON THE USE OF AND OFFERING PRODUCTS FOR SEASONAL LAWN AND GARDEN CARE, TIPS ON THE USE OF AND OFFERING PRODUCTS FOR SEASONAL CLEANING FOR BOTH THE INDOORS AND THE OUTDOORS, TIPS ON THE USE OF AND OFFERING PRODUCTS FOR SEASONAL HOME ENTERTAINING FOR USE BOTH INDOORS AND OUTDOORS, SEASONAL TIPS ON THE USE OF AND OFFERING PRODUCTS FOR PLANNING VACATION ROAD TRIPS, AND SEASONAL TIPS ON THE USE OF AND OFFERING PRODUCT FOR LIVING A HEALTHIER LIFESTYLE, IN CLASS 16 (U.S. CLS. 2, 5, 22, 23, 29, 37, 38 AND 50).

FIRST USE 11-24-2006; IN COMMERCE 11-24-2006.

FOR: ONLINE CATALOG IN THE FIELD OF FAMILY LIFESTYLES FEATURING TIPS ON THE USE OF AND OFFERING PRODUCTS FOR SEASONAL INDOOR AND OUTDOOR FURNITURE AND FURNISHINGS, SEASONAL RECIPES AND TIPS ON PREPARATION OF THE RECIPES, SEASONAL GROCERY ITEMS FOR INDOOR AND OUTDOOR COOKING AND OFFERING TIPS FOR USE OF THE

GROCERY ITEMS IN INDOOR AND OUTDOOR COOKING, TIPS ON THE USE OF AND OFFERING PRODUCTS FOR SEASONAL FLORAL AND DECORATING IDEAS FOR THE HOME BOTH INDOORS AND OUTDOORS, TIPS ON THE USE OF AND OFFERING PRODUCTS FOR SEASONAL LAWN AND GARDEN CARE, TIPS ON THE USE OF AND OFFERING PRODUCTS FOR SEASONAL CLEANING FOR BOTH THE INDOORS AND THE OUTDOORS, TIPS ON THE USE OF AND OFFERING PRODUCTS FOR SEASONAL HOME ENTERTAINING FOR USE BOTH INDOORS AND OUTDOORS, SEASONAL TIPS ON THE USE OF AND OFFERING PRODUCTS FOR PLANNING VACATION ROAD TRIPS, AND SEASONAL TIPS ON THE USE OF AND OFFERING PRODUCT FOR LIVING A HEALTHIER LIFESTYLE, IN CLASS 35 (U.S. CLS. 100, 101 AND 102).

FIRST USE 11-24-2006; IN COMMERCE 11-24-2006.

FOR: ONLINE MAGAZINE IN THE FIELD OF FAMILY LIFESTYLES FEATURING TIPS ON THE USE OF AND OFFERING PRODUCTS FOR SEASONAL INDOOR AND OUTDOOR FURNITURE AND FURNISHINGS, SEASONAL RECIPES AND TIPS ON PREPARATION OF THE RECIPES, SEASONAL GROCERY ITEMS FOR INDOOR AND OUTDOOR COOKING AND OFFERING TIPS FOR USE OF THE GROCERY ITEMS IN INDOOR AND OUTDOOR COOKING, TIPS ON THE USE OF AND OFFERING PRODUCTS FOR SEASONAL FLORAL AND DECORATING IDEAS FOR THE HOME BOTH INDOORS AND OUTDOORS, TIPS ON THE USE OF AND OFFERING PRODUCTS FOR SEASONAL LAWN AND GARDEN CARE, TIPS ON THE USE OF AND OFFERING PRODUCTS FOR SEASONAL CLEANING FOR BOTH THE INDOORS AND THE OUTDOORS, TIPS ON THE USE OF AND OFFERING PRODUCTS FOR SEASONAL HOME ENTERTAINING FOR USE BOTH INDOORS AND OUTDOORS,

SEASONAL TIPS ON THE USE OF AND OFFERING PRODUCTS FOR PLANNING VACATION ROAD TRIPS, AND SEASONAL TIPS ON THE USE OF AND OFFERING PRODUCT FOR LIVING A HEALTHIER LIFESTYLE, IN CLASS 41 (U.S. CLS. 100, 101 AND 107).

FIRST USE 11-24-2006; IN COMMERCE 11-24-2006.

OWNER OF U.S. REG. NOS. 3,231,652, 3,231,653 AND OTHERS.

THE MARK CONSISTS OF THE WORD "HY-VEE" IN SYLIZED FONT APPEARING WITHIN THE "O" OF THE WORD "SEASONS".

SER. NO. 77-212,404, FILED 6-21-2007.

JUSTINE D. PARKER, EXAMINING ATTORNEY

Int. Cls.: 7 and 8

Prior U.S. Cls.: 13, 19, 21, 23, 28, 31, 34, 35 and 44

Reg. No. 3,483,309

United States Patent and Trademark Office

Registered Aug. 12, 2008

**TRADEMARK
PRINCIPAL REGISTER**



BURCHETT QUALITY TOOL, LTD. (MICHIGAN CORPORATION)
5271 WYNN RD.
KALAMAZOO, MI 49048

FOR: MACHINES AND MACHINE TOOLS FOR THE CUTTING AND FORMING OF MATERIALS; POWER TOOLS, NAMELY, END MILLS, IN CLASS 7 (U.S. CLS. 13, 19, 21, 23, 31, 34 AND 35).

FIRST USE 5-1-2001; IN COMMERCE 5-1-2001.

FOR: HAND HELD CUTTING TOOLS; BITS FOR HAND DRILLS, IN CLASS 8 (U.S. CLS. 23, 28 AND 44).

FIRST USE 5-1-2001; IN COMMERCE 5-1-2001.

NO CLAIM IS MADE TO THE EXCLUSIVE RIGHT TO USE "QUALITY TOOL LTD.", APART FROM THE MARK AS SHOWN.

THE MARK CONSISTS OF STYLIZED LETTER "B" USED IN "BURCHETT" AND "BQT" WITH THE ARM COMPLETING THE LETTER "Q" BEING THE TIP OF A CUTTING TOOL.

SER. NO. 77-212,557, FILED 6-21-2007.

ANNE MADDEN, EXAMINING ATTORNEY

Int. Cl.: 42

Prior U.S. Cls.: 100 and 101

United States Patent and Trademark Office

Reg. No. 3,483,310

Registered Aug. 12, 2008

**SERVICE MARK
PRINCIPAL REGISTER**

ADT Always There

ADT SERVICES AG (SWITZERLAND CORPORATION)
BAHNHOFSTRASSE 29
SCHAFFHAUSEN, SWITZERLAND 8200

FOR: COMPUTER CONSULTATION SERVICES TO ASSIST IN THE MANAGEMENT OF BUSINESS IN THE FIELDS OF RETAIL LOSS PREVENTION, INVENTORY AND OPERATIONS MANAGEMENT AND EXCEPTION REPORTING, IN CLASS 42 (U.S. CLS. 100 AND 101).

FIRST USE 4-17-2007; IN COMMERCE 4-17-2007.

THE MARK CONSISTS OF STANDARD CHARACTERS WITHOUT CLAIM TO ANY PARTICULAR FONT, STYLE, SIZE, OR COLOR.

SER. NO. 77-212,883, FILED 6-22-2007.

RENEE SERVANCE, EXAMINING ATTORNEY

Int. Cls.: 18, 25, 26 and 35

**Prior U.S. Cls.: 1, 2, 3, 22, 37, 39, 40, 41, 42, 50, 100,
101 and 102**

Reg. No. 3,483,311

United States Patent and Trademark Office

Registered Aug. 12, 2008

**TRADEMARK
SERVICE MARK
PRINCIPAL REGISTER**

BM COLLECTION

THE PEACOCK GROUP PLC (UNITED KINGDOM PUBLIC LIMITED COMPANY (PLC))
ATLANTIC HOUSE, TYNDALL STREET
CARDIFF, UNITED KINGDOM CF104PS

FOR: BAGS, NAMELY, BEACH BAGS, CLUTCH BAGS, DUFFLE BAGS, LEATHER SHOPPING BAGS, MESH SHOPPING BAGS, TEXTILE SHOPPING BAGS, AND TOTE BAGS; GOODS MADE OF LEATHER AND IMITATION OF LEATHER, NAMELY, HANDBAGS, PURSES AND WALLETS; UMBRELLAS, IN CLASS 18 (U.S. CLS. 1, 2, 3, 22 AND 41).

FOR: CLOTHING, NAMELY, BLOUSES, SKIRTS, TROUSERS, DRESSES, T-SHIRTS, SLEEVELESS T-SHIRTS, CAMISOLES, SWEATSHIRTS, JOGGING BOTTOMS, YOGA PANTS, SOCKS, HOSIERY, SWEATERS, COATS, JACKETS, CARDIGANS, WAISTCOATS, JEANS, SHORTS, LEGGINGS, SHIRTS, LINGERIE, BRAS, BRIEFS, SLIPS, VESTS; NIGHTWEAR, PAJAMAS, NIGHTDRESSES, ROBES AND CHEMISES; HEADWEAR; UNDERWEAR; SWIMWEAR, IN CLASS 25 (U.S. CLS. 22 AND 39).

FOR: BEADS OTHER THAN FOR MAKING JEWELRY; BUTTONS FOR CLOTHING, BUCKLES FOR CLOTHING, EMBROIDERY, ARTIFICIAL FLOWERS, KNITTING NEEDLES, LACE, RIBBONS, THIMBLES, SEWING BOXES, ZIPPER FASTENERS, ORNAMENTAL NOVELTY BADGES; HAIR BANDS AND HAIR ORNAMENTS, IN CLASS 26 (U.S. CLS. 37, 39, 40, 42 AND 50).

FOR: THE BRINGING TOGETHER FOR THE BENEFIT OF OTHERS, OF A VARIETY OF GOODS ENABLING CUSTOMERS TO CONVENIENTLY VIEW AND PURCHASE THOSE GOODS IN THE FIELD OF BAGS, NAMELY, BEACH BAGS, CLUTCH BAGS, DUFFLE BAGS, LEATHER SHOPPING BAGS, MESH SHOPPING BAGS, TEXTILE

SHOPPING BAGS, AND TOTE BAGS; GOODS MADE OF LEATHER AND IMITATION OF LEATHER, NAMELY, HANDBAGS, PURSES AND WALLETS; UMBRELLAS, CLOTHING, NAMELY, BLOUSES, SKIRTS, TROUSERS, DRESSES, T-SHIRTS, SLEEVELESS T-SHIRTS, CAMISOLES, SWEATSHIRTS, JOGGING BOTTOMS, YOGA PANTS, SOCKS, HOSIERY, SWEATERS, COATS, JACKETS, CARDIGANS, WAISTCOATS, JEANS, SHORTS, LEGGINGS, SHIRTS, LINGERIE, BRAS, BRIEFS, SLIPS, VESTS; NIGHTWEAR, PAJAMAS, NIGHTDRESSES, ROBES AND CHEMISES; HEADWEAR; UNDERWEAR; SWIMWEAR, BEADS OTHER THAN FOR MAKING JEWELRY; BUTTONS FOR CLOTHING, BUCKLES FOR CLOTHING, EMBROIDERY, ARTIFICIAL FLOWERS, KNITTING NEEDLES, LACE, RIBBONS, THIMBLES, SEWING BOXES, ZIPPER FASTENERS, ORNAMENTAL NOVELTY BADGES; HAIR BANDS AND HAIR ORNAMENTS; MAIL ORDER RETAIL STORE SERVICES CONNECTED WITH A VARIETY OF BAGS, NAMELY, BEACH BAGS, CLUTCH BAGS, DUFFLE BAGS, LEATHER SHOPPING BAGS, MESH SHOPPING BAGS, TEXTILE SHOPPING BAGS, AND TOTE BAGS; GOODS MADE OF LEATHER AND IMITATION OF LEATHER, NAMELY, HANDBAGS, PURSES AND WALLETS; UMBRELLAS, CLOTHING, NAMELY, BLOUSES, SKIRTS, TROUSERS, DRESSES, T-SHIRTS, SLEEVELESS T-SHIRTS, CAMISOLES, SWEATSHIRTS, JOGGING BOTTOMS, YOGA PANTS, SOCKS, HOSIERY, SWEATERS, COATS, JACKETS, CARDIGANS, WAISTCOATS, JEANS, SHORTS, LEGGINGS, SHIRTS, LINGERIE, BRAS, BRIEFS, SLIPS, VESTS; NIGHTWEAR, PAJAMAS, NIGHTDRESSES, ROBES AND CHEMISES; HEADWEAR; UNDERWEAR; SWIMWEAR, BEADS OTHER THAN FOR MAKING JEWELRY; BUTTONS FOR CLOTHING, BUCKLES FOR CLOTHING, EMBROIDERY, ARTIFICIAL FLOWERS, KNITTING

NEEDLES, LACE, RIBBONS, THIMBLES, SEWING BOXES, ZIPPER FASTENERS, ORNAMENTAL NOVELTY BADGES; HAIR BANDS AND HAIR ORNAMENTS; ELECTRONIC SHOPPING RETAIL STORE SERVICES CONNECTED WITH A VARIETY OF BAGS, NAMELY, BEACH BAGS, CLUTCH BAGS, DUFFLE BAGS, LEATHER SHOPPING BAGS, MESH SHOPPING BAGS, TEXTILE SHOPPING BAGS, AND TOTE BAGS; GOODS MADE OF LEATHER AND IMITATION OF LEATHER, NAMELY, HANDBAGS, PURSES AND WALLETS; UMBRELLAS, CLOTHING, NAMELY, BLOUSES, SKIRTS, TROUSERS, DRESSES, T-SHIRTS, SLEEVELESS T-SHIRTS, CAMISOLES, SWEATSHIRTS, JOGGING BOTTOMS, YOGA PANTS, SOCKS, HOSIERY, SWEATERS, COATS, JACKETS, CARDIGANS, WAISTCOATS, JEANS, SHORTS, LEGGINGS, SHIRTS, LINGERIE, BRAS, BRIEFS, SLIPS, VESTS; NIGHTWEAR, PAJAMAS, NIGHTDRESSES, ROBES AND CHEMISES; HEADWEAR; UNDERWEAR; SWIMWEAR, BEADS OTHER THAN FOR MAKING JEWELRY; BUTTONS FOR CLOTHING, BUCKLES FOR CLOTHING, EMBROIDERY, ARTIFICIAL

FLOWERS, KNITTING NEEDLES, LACE, RIBBONS, THIMBLES, SEWING BOXES, ZIPPER FASTENERS, ORNAMENTAL NOVELTY BADGES; HAIR BANDS AND HAIR ORNAMENTS, IN CLASS 35 (U.S. CLS. 100, 101 AND 102).

THE MARK CONSISTS OF STANDARD CHARACTERS WITHOUT CLAIM TO ANY PARTICULAR FONT, STYLE, SIZE, OR COLOR.

PRIORITY CLAIMED UNDER SEC. 44(D) ON UNITED KINGDOM APPLICATION NO. 2455749, FILED 5-16-2007, REG. NO. 2455749, DATED 5-16-2007, EXPIRES 5-16-2017.

NO CLAIM IS MADE TO THE EXCLUSIVE RIGHT TO USE "COLLECTION", APART FROM THE MARK AS SHOWN.

SER. NO. 77-212,980, FILED 6-22-2007.

BRENDAN REGAN, EXAMINING ATTORNEY

Int. Cl.: 14

Prior U.S. Cls.: 2, 27, 28 and 50

United States Patent and Trademark Office

Reg. No. 3,483,312

Registered Aug. 12, 2008

**TRADEMARK
PRINCIPAL REGISTER**

JULIE BAKER

JULIE BAKER DESIGN, INC. (NEW YORK CORPORATION)

STE 715

BROADWAY

NEW YORK, NY 10012

FOR: JEWELRY, IN CLASS 14 (U.S. CLS. 2, 27, 28 AND 50).

FIRST USE 6-0-2000; IN COMMERCE 6-0-2000.

THE MARK CONSISTS OF STANDARD CHARACTERS WITHOUT CLAIM TO ANY PARTICULAR FONT, STYLE, SIZE, OR COLOR.

THE NAME(S), PORTRAIT(S), AND/OR SIGNATURE(S) SHOWN IN THE MARK IDENTIFIES "JULIE BAKER", WHOSE CONSENT(S) TO REGISTER IS MADE OF RECORD.

SER. NO. 77-212,985, FILED 6-22-2007.

JENNIFER VASQUEZ, EXAMINING ATTORNEY

Int. Cl.: 9

Prior U.S. Cls.: 21, 23, 26, 36 and 38

Reg. No. 3,483,313

United States Patent and Trademark Office

Registered Aug. 12, 2008

**TRADEMARK
PRINCIPAL REGISTER**

IVC

PHOENIX WORLDWIDE INDUSTRIES, INC.
(FLORIDA CORPORATION)
10780 S.W. 190TH ST.
MIAMI, FL 33157

FIRST USE 8-1-2006; IN COMMERCE 8-1-2006.

FOR: BUILDING SECURITY SYSTEMS COM-
PRISING SOFTWARE AND HARDWARE FOR PRO-
VIDING PICTURE, VIDEO, ALARM STATUS,
BUILDING PLANS, AND OTHER INFORMATION
TO A REMOTE STATION, IN CLASS 9 (U.S. CLS. 21,
23, 26, 36 AND 38).

THE MARK CONSISTS OF STANDARD CHAR-
ACTERS WITHOUT CLAIM TO ANY PARTICULAR
FONT, STYLE, SIZE, OR COLOR.

SER. NO. 77-213,156, FILED 6-22-2007.

ALICIA COLLINS, EXAMINING ATTORNEY

Int. Cl.: 41

Prior U.S. Cls.: 100, 101 and 107

United States Patent and Trademark Office

Reg. No. 3,483,314

Registered Aug. 12, 2008

**SERVICE MARK
PRINCIPAL REGISTER**

ALLEGRO PHOTOGRAPHY

ALLEGRO PHOTOGRAPHY, INC. (CALIFORNIA CORPORATION)
5513 TILDEN PLACE
FREMONT, CA 94538

FOR: PHOTOGRAPHY SERVICES FOR WEDDINGS, EVENTS, AND PORTRAITS, IN CLASS 41 (U.S. CLS. 100, 101 AND 107).

FIRST USE 2-23-2005; IN COMMERCE 2-23-2005.

THE MARK CONSISTS OF STANDARD CHARACTERS WITHOUT CLAIM TO ANY PARTICULAR FONT, STYLE, SIZE, OR COLOR.

NO CLAIM IS MADE TO THE EXCLUSIVE RIGHT TO USE "PHOTOGRAPHY", APART FROM THE MARK AS SHOWN.

THE FOREIGN WORDING IN THE MARK TRANSLATES INTO ENGLISH AS CHEERFUL.

SER. NO. 77-213,288, FILED 6-22-2007.

JESSICA A. POWERS, EXAMINING ATTORNEY

Int. Cl.: 25

Prior U.S. Cls.: 22 and 39

United States Patent and Trademark Office

Reg. No. 3,483,315

Registered Aug. 12, 2008

TRADEMARK
PRINCIPAL REGISTER



REGENTS OF THE UNIVERSITY OF MINNESOTA (MINNESOTA CORPORATION)
600 MCNAMARA ALUMNI CENTER
200 OAK ST. SE
MINNEAPOLIS, MN 55455

FOR: CLOTHING FOR MEN, WOMEN AND CHILDREN, NAMELY, SHIRTS, SWEATSHIRTS, JACKETS, YOUTH APPAREL, NAMELY, ROMPERS, CAPS, IN CLASS 25 (U.S. CLS. 22 AND 39).

FIRST USE 0-0-1994; IN COMMERCE 0-0-1994.

OWNER OF U.S. REG. NOS. 1,224,605 AND 2,788,911.

THE COLOR(S) BLACK (PANTONE PROCESS BLACK), TAN (PANTONE 465), WHITE, BROWN (PANTONE 464), GOLD (PANTONE 116 (UNCOATED)) AND MAROON (PANTONE 201(UNCOATED)) IS/ARE CLAIMED AS A FEATURE OF THE MARK.

THE MARK CONSISTS OF AN IMAGE OF A GOPHER WEARING A UNIVERSITY OF MINNESOTA LETTER SWEATER, LEANING WITH AN ARM AGAINST A MAROON, BLOCK LETTER "M", OTHER HAND ON HIP, FACING THE VIEWER, HIS STRIPED TAIL RISING BEHIND HIM AND SHOWING TWO, LARGE FRONT TEETH. SHADES OF THE COLOR MAROON APPEAR IN THE IMAGE OF THE SWEATER AND BLOCK "M"; THE COLOR GOLD APPEARS IN THE LETTER "M" AND STRIPES ON THE SWEATER; THE COLOR TAN APPEARS AS THE COLOR OF THE GOPHER; THE COLORS BROWN AND WHITE APPEAR AS STRIPES ON THE TAIL; AND THE COLORS BLACK AND WHITE APPEAR THROUGHOUT THE MARK FOR HIGHLIGHTING PURPOSES.

SEC. 2(F).

SER. NO. 77-213,291, FILED 6-22-2007.

ANNE E. GUSTASON, EXAMINING ATTORNEY

Int. Cl.: 35

Prior U.S. Cls.: 100, 101 and 102

United States Patent and Trademark Office

Reg. No. 3,483,316

Registered Aug. 12, 2008

**SERVICE MARK
PRINCIPAL REGISTER**

memstech

MEMS TECHNOLOGY BERHAD (MALAYSIA
CORPORATION)
810 BLOCK A, PHILEO DAMANSARA II
15 JALAN 16/11, SELANGOR DARUL EHSAN
PETALING JAYA, MALAYSIA 46350

FOR: PACKAGING ARTICLES TO THE ORDER
AND SPECIFICATION OF OTHERS, IN CLASS 35
(U.S. CLS. 100, 101 AND 102).

FIRST USE 12-1-2001; IN COMMERCE 9-24-2002.

THE MARK CONSISTS OF STANDARD CHAR-
ACTERS WITHOUT CLAIM TO ANY PARTICULAR
FONT, STYLE, SIZE, OR COLOR.

SEC. 2(F).

SER. NO. 77-213,340, FILED 6-22-2007.

KATHLEEN LORENZO, EXAMINING ATTORNEY

Int. Cl.: 35

Prior U.S. Cls.: 100, 101 and 102

United States Patent and Trademark Office

Reg. No. 3,483,317

Registered Aug. 12, 2008

**SERVICE MARK
PRINCIPAL REGISTER**



THE FAMILY MEDIATION INSTITUTE, INC.
(FLORIDA CORPORATION)
44 WEST FLAGLER STREET, SUITE 1500
MIAMI, FL 33130

NO CLAIM IS MADE TO THE EXCLUSIVE
RIGHT TO USE "FAMILY MEDIATION", APART
FROM THE MARK AS SHOWN.

FOR: MEDIATION SERVICES, IN CLASS 35 (U.S.
CLS. 100, 101 AND 102).

SER. NO. 77-213,346, FILED 6-22-2007.

FIRST USE 6-0-2000; IN COMMERCE 6-0-2000.

ANN E. SAPPENFIELD, EXAMINING ATTORNEY

Int. Cls.: 9, 36 and 42

Prior U.S. Cls.: 21, 23, 26, 36, 38, 100, 101 and 102

Reg. No. 3,483,318

United States Patent and Trademark Office

Registered Aug. 12, 2008

**TRADEMARK
SERVICE MARK
PRINCIPAL REGISTER**

MARKET IMPACT MODEL

MORGAN STANLEY CAPITAL INTERNATIONAL INC. (DELAWARE CORPORATION)
88 PINE STREET
NEW YORK, NY 10036

FOR: COMPUTER SOFTWARE, NAMELY, SOFTWARE FOR USE IN ANALYZING TRANSACTION COSTS OF SECURITIES TRADES, INCLUDING FORECASTING AND ANALYZING THE DIRECT AND INDIRECT COST OF TRADES, ANALYZING THE LIQUIDITY PROPERTIES OF INDIVIDUAL SECURITIES, CHARACTERIZING THE LIQUIDITY OF SECURITIES PORTFOLIOS, ASSESSING THE COST OF INVESTMENT STYLES, AND ANALYZING COST, RISK AND RETURN TO CREATE OPTIMAL PORTFOLIOS; AND INSTRUCTIONAL MANUALS SOLD AS A UNIT THEREWITH, IN CLASS 9 (U.S. CLS. 21, 23, 26, 36 AND 38).

FIRST USE 9-15-1997; IN COMMERCE 9-15-1997.

FOR: PROVIDING FINANCIAL DATA FOR USE IN SECURITIES ANALYSIS, IN CLASS 36 (U.S. CLS. 100, 101 AND 102).

FIRST USE 9-15-1997; IN COMMERCE 9-15-1997.

FOR: TECHNICAL SERVICES IN SUPPORT OF SOFTWARE AND DATA USED IN SECURITIES ANALYSIS, NAMELY, PROVIDING TECHNICAL INFORMATION ABOUT COMPUTER SOFTWARE AND COMPUTER PRODUCT USE, IN CLASS 42 (U.S. CLS. 100 AND 101).

FIRST USE 9-15-1997; IN COMMERCE 9-15-1997.

THE MARK CONSISTS OF STANDARD CHARACTERS WITHOUT CLAIM TO ANY PARTICULAR FONT, STYLE, SIZE, OR COLOR.

OWNER OF U.S. REG. NO. 2,304,936.

SEC. 2(F).

SER. NO. 77-213,360, FILED 6-22-2007.

JOHN GARTNER, EXAMINING ATTORNEY

Int. Cl.: 36

Prior U.S. Cls.: 100, 101 and 102

United States Patent and Trademark Office

Reg. No. 3,483,319

Registered Aug. 12, 2008

**SERVICE MARK
PRINCIPAL REGISTER**



HON, MICHAEL (UNITED STATES INDIVIDUAL)
1159 E. IRON EAGLE DRIVE, SUITE 170
EAGLE, ID 83616

FOR: LEASING OF REAL ESTATE; FINANCIAL INVESTMENT IN THE FIELD OF REAL ESTATE; REAL ESTATE INVESTMENT; REAL ESTATE INVESTMENT SERVICES IN THE NATURE OF PURCHASING AND SELLING OF REAL ESTATE FOR OTHERS; PROVIDING INFORMATION IN THE FIELD OF REAL ESTATE BY MEANS OF LINKING THE WEB SITE TO OTHER WEB SITES FEATURING REAL ESTATE INFORMATION; PROVIDING INFORMATION IN THE FIELD OF REAL ESTATE VIA THE INTERNET; PROVIDING REAL ESTATE LISTINGS AND REAL ESTATE INFORMATION VIA THE INTERNET; REAL ESTATE ACQUISITION

SERVICES; REAL ESTATE AGENCIES; REAL ESTATE APPRAISAL; REAL ESTATE BROKERAGE; REAL ESTATE CONSULTATION; REAL ESTATE LISTING; REAL ESTATE MANAGEMENT; REAL ESTATE PROCUREMENT FOR OTHERS, IN CLASS 36 (U.S. CLS. 100, 101 AND 102).

FIRST USE 12-1-2006; IN COMMERCE 12-1-2006.

THE MARK CONSISTS OF AN EAGLE OVERLAYING A REPRESENTATION OF THE LETTER "I".

SER. NO. 77-213,620, FILED 6-22-2007.

KYLE PEETE, EXAMINING ATTORNEY

Int. Cl.: 15

Prior U.S. Cls.: 2, 21 and 36

United States Patent and Trademark Office

Reg. No. 3,483,320

Registered Aug. 12, 2008

**TRADEMARK
PRINCIPAL REGISTER**

VIOMARK

POFF, STEPHEN WALTER (UNITED STATES
INDIVIDUAL)
6409 THOROUGHBRED LOOP
ODESSA, FL 33556

FOR: STRAP FOR STRINGED MUSICAL IN-
STRUMENTS, IN CLASS 15 (U.S. CLS. 2, 21 AND 36).

FIRST USE 1-2-2005; IN COMMERCE 1-7-2005.

THE MARK CONSISTS OF STANDARD CHAR-
ACTERS WITHOUT CLAIM TO ANY PARTICULAR
FONT, STYLE, SIZE, OR COLOR.

SER. NO. 77-213,863, FILED S.R. 6-23-2007 AM. P.R.
3-31-2008.

CIMMERIAN COLEMAN, EXAMINING ATTOR-
NEY

Int. Cl.: 36

Prior U.S. Cls.: 100, 101 and 102

United States Patent and Trademark Office

Reg. No. 3,483,321

Registered Aug. 12, 2008

**SERVICE MARK
PRINCIPAL REGISTER**

**LA FORMA INTELIGENTE DE
INVERTIR**

EDWARD D. JONES & CO. LP (MISSOURI LIMITED PARTNERSHIP)
12555 MANCHESTER ROAD
ST. LOUIS, MO 63131

FOR: STOCK BROKERAGE SERVICES, INVESTMENT BANKING SERVICES, FINANCIAL INVESTMENT SERVICES IN THE FIELD OF SECURITIES, FINANCIAL PLANNING SERVICES, AND INSURANCE AGENCY SERVICES IN THE FIELD OF LIFE INSURANCE AND ANNUITIES, IN CLASS 36 (U.S. CLS. 100, 101 AND 102).

FIRST USE 1-0-2007; IN COMMERCE 1-0-2007.

THE MARK CONSISTS OF STANDARD CHARACTERS WITHOUT CLAIM TO ANY PARTICULAR FONT, STYLE, SIZE, OR COLOR.

THE FOREIGN WORDING IN THE MARK TRANSLATES INTO ENGLISH AS MAKING SENSE OF INVESTING.

SER. NO. 77-213,870, FILED 6-23-2007.

CAROLINE WOOD, EXAMINING ATTORNEY

Int. Cl.: 41

Prior U.S. Cls.: 100, 101 and 107

United States Patent and Trademark Office

Reg. No. 3,483,322

Registered Aug. 12, 2008

**SERVICE MARK
PRINCIPAL REGISTER**

Domino Villino

VILLINO, DOMINO (UNITED STATES INDIVIDUAL)
SUITE 928
4100 CENTRAL SARASOTA PKWY
SARASOTA, FL 34238

THE MARK CONSISTS OF STANDARD CHARACTERS WITHOUT CLAIM TO ANY PARTICULAR FONT, STYLE, SIZE, OR COLOR.

FOR: MULTIMEDIA ENTERTAINMENT SOFTWARE PRODUCTION SERVICES, IN CLASS 41 (U.S. CLS. 100, 101 AND 107).

SER. NO. 77-214,008, FILED 6-24-2007.

FIRST USE 6-1-2007; IN COMMERCE 6-1-2007.

KRISTINA MORRIS, EXAMINING ATTORNEY

Int. Cl.: 42

Prior U.S. Cls.: 100 and 101

United States Patent and Trademark Office

Reg. No. 3,483,323

Registered Aug. 12, 2008

**SERVICE MARK
PRINCIPAL REGISTER**

GlobalTrak

GLOBALOPTIONS GROUP, INC. (NEVADA CORPORATION)
27TH FLOOR 75 ROCKEFELLER PLAZA
NEW YORK, NY 10019

FOR: PROVIDING TEMPORARY USE OF ON-LINE, NON-DOWNLOADABLE SOFTWARE THAT ALLOWS USERS TO MANAGE RISK MANAGEMENT OPERATIONS AND STRATEGIES, AS WELL AS PERSONAL AND CORPORATE SECURITY AND INVESTIGATION SERVICES, IN CLASS 42 (U.S. CLS. 100 AND 101).

FIRST USE 12-31-2006; IN COMMERCE 12-31-2006.

THE MARK CONSISTS OF STANDARD CHARACTERS WITHOUT CLAIM TO ANY PARTICULAR FONT, STYLE, SIZE, OR COLOR.

SER. NO. 77-214,091, FILED 6-25-2007.

JASON LOTT, EXAMINING ATTORNEY

Int. Cl.: 25

Prior U.S. Cls.: 22 and 39

United States Patent and Trademark Office

Reg. No. 3,483,324

Registered Aug. 12, 2008

**TRADEMARK
PRINCIPAL REGISTER**

DUNNING GOLF

2055488 ONTARIO INC. (CANADA CORPORATION)
16 ESNA PARK DRIVE, UNIT 6
MARKHAM, CANADA L3R5X1

FOR: CLOTHING PRODUCTS AND ACCESSORIES, NAMELY, SHIRTS, HEADWEAR, RAIN-WEAR, SHORTS, PANTS, BELTS AND UNDERWEAR, IN CLASS 25 (U.S. CLS. 22 AND 39).

FIRST USE 11-30-1998; IN COMMERCE 1-3-2003.

THE MARK CONSISTS OF STANDARD CHARACTERS WITHOUT CLAIM TO ANY PARTICULAR FONT, STYLE, SIZE, OR COLOR.

OWNER OF CANADA REG. NO. TMA610416,
DATED 5-14-2004, EXPIRES 5-14-2019.

NO CLAIM IS MADE TO THE EXCLUSIVE RIGHT TO USE "GOLF", APART FROM THE MARK AS SHOWN.

SEC. 2(F).

SER. NO. 77-214,250, FILED 6-25-2007.

INGRID C. EULIN, EXAMINING ATTORNEY

Int. Cl.: 41

Prior U.S. Cls.: 100, 101 and 107

United States Patent and Trademark Office

Reg. No. 3,483,325

Registered Aug. 12, 2008

**SERVICE MARK
PRINCIPAL REGISTER**

**A WORLD-CLASS EDUCATION
FOR EVERY CHILD**

EDISON SCHOOLS INC. (DELAWARE CORPORATION)
521 FIFTH AVENUE
NEW YORK, NY 10175

FOR: EDUCATIONAL SERVICES FOR CHARTER SCHOOLS, NAMELY, DEVELOPMENT AND DISSEMINATION OF EDUCATIONAL MATERIALS IN THE FIELD OF ELEMENTARY, MIDDLE AND HIGH SCHOOL EDUCATION; CURRICULUM DEVELOPMENT, IN THE FIELD OF ELEMENTARY, MIDDLE AND HIGH SCHOOL EDUCATION; OPERATION AND MANAGEMENT OF REGULAR DAY, AFTER-SCHOOL, WEEKEND AND SUMMER RECREATIONAL AND TUTORING PROGRAMS FOR ELEMENTARY, MIDDLE AND HIGH SCHOOL STUDENTS; DEVELOPMENT AND DISSEMINATION OF RESEARCH-BASED STUDENT ACHIEVEMENT DIAGNOSTIC TOOLS IN THE FIELD OF ELEMENTARY, MIDDLE AND HIGH SCHOOL EDUCATION; PROFESSIONAL DEVELOPMENT, NAMELY, CONTINUING EDUCATION COURSES FOR TEACHERS AND SCHOOL LEA-

TERS IN THE FIELD OF ELEMENTARY, MIDDLE AND HIGH SCHOOL EDUCATION; EDUCATIONAL CONSULTATION IN THE NATURE OF SCHOOL PARTNERING WITH FAMILY, EDUCATORS, AND OTHERS IN THE COMMUNITY FOR ENRICHING EDUCATIONAL SERVICES AND IMPROVING STUDENT LEARNING PERFORMANCE FOR PUBLIC SCHOOL STUDENTS AT THE ELEMENTARY, MIDDLE AND HIGH SCHOOL LEVELS, IN CLASS 41 (U.S. CLS. 100, 101 AND 107).

FIRST USE 12-31-1992; IN COMMERCE 12-31-1992.

THE MARK CONSISTS OF STANDARD CHARACTERS WITHOUT CLAIM TO ANY PARTICULAR FONT, STYLE, SIZE, OR COLOR.

SEC. 2(F).

SER. NO. 77-214,315, FILED 6-25-2007.

SUSAN RICHARDS, EXAMINING ATTORNEY

Int. Cl.: 14

Prior U.S. Cls.: 2, 27, 28 and 50

United States Patent and Trademark Office

Reg. No. 3,483,326

Registered Aug. 12, 2008

**TRADEMARK
PRINCIPAL REGISTER**

Silver Parrot

SILVER PARROT OF ALEXANDRIA, LLC (VIRGINIA LTD LIAB CO)

11510 HAVENNER ROAD

FAIRFAX STATION, VA 22039

FOR: SILVER JEWELRY, IN CLASS 14 (U.S. CLS. 2, 27, 28 AND 50).

FIRST USE 0-0-1977; IN COMMERCE 0-0-1977.

THE MARK CONSISTS OF STANDARD CHARACTERS WITHOUT CLAIM TO ANY PARTICULAR FONT, STYLE, SIZE, OR COLOR.

NO CLAIM IS MADE TO THE EXCLUSIVE RIGHT TO USE "SILVER", APART FROM THE MARK AS SHOWN.

SER. NO. 77-214,884, FILED 6-25-2007.

PAM WILLIS, EXAMINING ATTORNEY

Int. Cls.: 37 and 42

Prior U.S. Cls.: 100, 101, 103 and 106

United States Patent and Trademark Office

Reg. No. 3,483,327

Registered Aug. 12, 2008

**SERVICE MARK
PRINCIPAL REGISTER**

MOORE TWINING

MOORE TWINING ASSOCIATES, INC. (CALIFORNIA CORPORATION)
2527 FRESNO STREET
FRESNO, CA 93721

FOR: CONSTRUCTION INSPECTION TO ENSURE COMPLIANCE WITH DESIGN PLANS AND SPECIFICATIONS, IN CLASS 37 (U.S. CLS. 100, 103 AND 106).

FIRST USE 1-31-2007; IN COMMERCE 1-31-2007.

FOR: TECHNICAL CONSULTATION IN THE FIELDS OF ENGINEERING, GEOTECHNICAL ENGINEERING AND ENVIRONMENTAL ENGINEERING; TECHNICAL EVALUATION OF SOIL MECHANICS AND FOUNDATION, ENVIRONMENTAL TRANSACTION SCREENS, GROUNDWATER EVALUATIONS AND MONITORING, UNDERGROUND STORAGE TANKS, LANDFILL AND SOLID WASTE, EARTHWORK OBSERVATIONS AND COMPACTION TESTING IN THE FIELDS OF ENGINEERING, GEOTECHNICAL ENGINEERING AND ENVIRONMENTAL ENGINEERING; TECH-

NICAL REPORTING SERVICES IN THE FIELDS OF ENGINEERING, GEOTECHNICAL ENGINEERING AND ENVIRONMENTAL ENGINEERING, NAMELY, SOIL MECHANICS AND FOUNDATION, ENVIRONMENTAL TRANSACTION SCREENS, GROUNDWATER EVALUATIONS AND MONITORING, UNDERGROUND STORAGE TANKS, LANDFILL AND SOLID WASTE, EARTHWORK OBSERVATIONS AND COMPACTION TESTING; ANALYTICAL CHEMISTRY TESTING; AND MATERIALS TESTING, IN CLASS 42 (U.S. CLS. 100 AND 101).

FIRST USE 1-31-2007; IN COMMERCE 1-31-2007.

THE MARK CONSISTS OF STANDARD CHARACTERS WITHOUT CLAIM TO ANY PARTICULAR FONT, STYLE, SIZE, OR COLOR.

SER. NO. 77-215,094, FILED 6-25-2007.

HEATHER BIDDULPH, EXAMINING ATTORNEY

Int. Cls.: 8, 26 and 44

Prior U.S. Cls.: 23, 28, 37, 39, 40, 42, 44, 50, 100 and 101

Reg. No. 3,483,328

United States Patent and Trademark Office

Registered Aug. 12, 2008

**TRADEMARK
SERVICE MARK
PRINCIPAL REGISTER**

TEASE

BREUL, KRISTEN (UNITED STATES INDIVIDUAL)
PO BOX 5276
HUNTINGTON BEACH, CA 92615

FOR: MANUALLY OPERATED HAND TOOL FOR INSTALLING HAIR EXTENSIONS, IN CLASS 8 (U.S. CLS. 23, 28 AND 44).

FIRST USE 1-1-2007; IN COMMERCE 1-1-2007.

FOR: HAIR EXTENSIONS, IN CLASS 26 (U.S. CLS. 37, 39, 40, 42 AND 50).

FIRST USE 1-1-2007; IN COMMERCE 1-1-2007.

FOR: HAIR REPLACEMENT, HAIR ADDITION, AND HAIR EXTENSION SERVICES, IN CLASS 44 (U.S. CLS. 100 AND 101).

FIRST USE 1-1-2007; IN COMMERCE 1-1-2007.

THE MARK CONSISTS OF STANDARD CHARACTERS WITHOUT CLAIM TO ANY PARTICULAR FONT, STYLE, SIZE, OR COLOR.

SER. NO. 77-215,183, FILED 6-26-2007.

WON TEAK OH, EXAMINING ATTORNEY

Int. Cl.: 25

Prior U.S. Cls.: 22 and 39

United States Patent and Trademark Office

Reg. No. 3,483,329

Registered Aug. 12, 2008

TRADEMARK
PRINCIPAL REGISTER

The image shows the trademark 'MommyMilk' written in a cursive, handwritten style. The word 'Mommy' is in a standard cursive font, while 'Milk' is also cursive but features a rattle as the letter 'I'. The rattle is a small, circular object with a handle and a textured surface, positioned vertically within the letter 'I'.

A Shapelier Nursing Tank

MOGAVERO, ALLICIA (UNITED STATES INDIVIDUAL)
14 PLEASANT ST.
WESTERLY, RI 02891

FOR: NURSING SHIRTS, NURSING BRAS, NURSING DRESSES, PANTS, BABY'S ONE PIECE CLOTHING, BIBS, ROMPERS, OVERALLS, PANTS, SHIRTS, IN CLASS 25 (U.S. CLS. 22 AND 39).

FIRST USE 6-11-2007; IN COMMERCE 6-11-2007.

OWNER OF U.S. REG. NO. 3,385,259.

NO CLAIM IS MADE TO THE EXCLUSIVE RIGHT TO USE "NURSING TANK", APART FROM THE MARK AS SHOWN.

THE MARK CONSISTS OF THE WORD "MOMMYMILK" WRITTEN OUT AS ONE WORD IN A SPECIAL FONT AND HAS A RATTLE AS THE LETTER "I" IN THE WORD "MILK". IT STATES "A SHAPELIER NURSING TANK" UNDERNEATH IT.

SER. NO. 77-215,308, FILED 6-26-2007.

TERESA M. RUPP, EXAMINING ATTORNEY

Int. Cl.: 25

Prior U.S. Cls.: 22 and 39

United States Patent and Trademark Office

Reg. No. 3,483,330

Registered Aug. 12, 2008

**TRADEMARK
PRINCIPAL REGISTER**



FABULUS PLAYERS INC. (MINNESOTA CORPORATION)
818 OCEAN
SAINT PAUL, MN 55106

FIRST USE 1-23-2006; IN COMMERCE 1-23-2006.

SER. NO. 77-215,459, FILED 6-26-2007.

FOR: LINGERIE, IN CLASS 25 (U.S. CLS. 22 AND 39).

ALICE SUE CARRUTHERS, EXAMINING ATTORNEY

Int. Cl.: 35

Prior U.S. Cls.: 100, 101 and 102

United States Patent and Trademark Office

Reg. No. 3,483,331

Registered Aug. 12, 2008

**SERVICE MARK
PRINCIPAL REGISTER**

A Job Near Home

A JOB NEAR HOME, INC. (OHIO CORPORATION)
13201 GRANGER ROAD
SUITE 6
GARFIELD HEIGHTS, OH 44125

FOR: EMPLOYMENT AGENCY SERVICES RELATING TO TEMPORARY AND PERMANENT PLACEMENT OF PERSONNEL; CONSULTATION IN THE FIELD OF PERSONNEL MANAGEMENT, SELECTION, RECRUITING AND EMPLOYMENT AGENCY SERVICES FOR TEMPORARY, SHORT-TERM AND PERMANENT PERSONNEL; PROVIDING QUALIFIED PERSONNEL ON A TEMPORARY,

CONTRACT OR PERMANENT BASIS, IN CLASS 35 (U.S. CLS. 100, 101 AND 102).

FIRST USE 8-20-2000; IN COMMERCE 8-20-2000.

THE MARK CONSISTS OF STANDARD CHARACTERS WITHOUT CLAIM TO ANY PARTICULAR FONT, STYLE, SIZE, OR COLOR.

SER. NO. 77-215,689, FILED 6-26-2007.

ANGELA GAW, EXAMINING ATTORNEY

Int. Cl.: 29

Prior U.S. Cl.: 46

United States Patent and Trademark Office

Reg. No. 3,483,332

Registered Aug. 12, 2008

TRADEMARK
PRINCIPAL REGISTER



WHOLESOME & HEARTY FOODS, INC. (DELA-
WARE CORPORATION)
SUITE 350
15615 ALTON PARKWAY
IRVINE, CA 92618

FOR: UNFORMED AND FORMED TEXTURED
MEAT SUBSTITUTES AND MEAT EXTENDERS
CONSISTING PRIMARILY OF VEGETABLES,
GRAINS OR SOY, IN CLASS 29 (U.S. CL. 46).

FIRST USE 6-25-2007; IN COMMERCE 6-25-2007.

THE COLOR(S) RED, WHITE, BLACK AND YEL-
LOW IS/ARE CLAIMED AS A FEATURE OF THE
MARK.

THE MARK CONSISTS OF A STAMP-LIKE
SHAPE BORDERED IN AN OUTER BORDER OF
BLACK AND AN INNER BORDER OF RED, WITH
THE PHRASE "FIRE DRAGON" IN WHITE
AGAINST A BLACK BANNER DISPOSED BE-
NEATH A BLACK DRAGON AGAINST A RED
AND YELLOW BACKGROUND.

SER. NO. 77-215,720, FILED 6-26-2007.

GEORGIA CARTY, EXAMINING ATTORNEY

Int. Cls.: 35 and 41

Prior U.S. Cls.: 100, 101, 102 and 107

United States Patent and Trademark Office

Reg. No. 3,483,333

Registered Aug. 12, 2008

SERVICE MARK
PRINCIPAL REGISTER



ERKKIBLUM, LLC (NEW YORK LTD LIAB CO)
616 LORIMER ST
BROOKLYN, NY 11211

FOR: RETAIL STORE SERVICES, MAIL ORDER CATALOG SERVICES, AND INTERNET CATALOG ORDERING SERVICES, ALL FEATURING FOODS, SPICES, VINTAGE COOKWARE, AND VINTAGE KITCHENWARE, CUTLERY, KITCHEN GADGETS, KITCHEN APPLIANCES, KITCHEN UTENSILS, KITCHENWARE, DINNERWARE, TABLEWARE, COOKWARE, BAKEWARE, GIFTWARE, GLASSWARE, FLATWARE, BARWARE, HOUSEWARES, TABLE LINENS, KITCHEN TOWELS, VASES, STORAGE CONTAINERS, SOAPS AND CLEANING PRODUCTS, COOKBOOKS, AND HOUSEHOLD FURNISHINGS, IN CLASS 35 (U.S. CLS. 100, 101 AND 102).

FIRST USE 9-1-2006; IN COMMERCE 9-1-2006.

FOR: EDUCATIONAL SERVICES, NAMELY, PROVIDING CLASSES, SEMINARS, DEMONSTRATIONS IN THE FIELDS OF COOKING, BAKING, PRESERVING, CULINARY TECHNIQUE, IN CLASS 41 (U.S. CLS. 100, 101 AND 107).

FIRST USE 9-1-2006; IN COMMERCE 11-1-2006.

NO CLAIM IS MADE TO THE EXCLUSIVE RIGHT TO USE "THE BROOKLYN KITCHEN", APART FROM THE MARK AS SHOWN.

THE MARK CONSISTS OF TEXT "THE BROOKLYN KITCHEN" AND A STYLIZED IMAGE OF POTS AND PANS.

SER. NO. 77-215,862, FILED 6-26-2007.

NELSON SNYDER, EXAMINING ATTORNEY

Int. Cl.: 9

Prior U.S. Cls.: 21, 23, 26, 36 and 38

Reg. No. 3,483,334

United States Patent and Trademark Office

Registered Aug. 12, 2008

**TRADEMARK
PRINCIPAL REGISTER**

SUPER FLY THUG TOOL KIT

WORLD PREMEAR ENTERTAINMENT, LLC
(DELAWARE LTD LIAB CO)
2175 HUDSON TERRACE #1-D
FORT LEE, NJ 07024

FIRST USE 11-10-2006; IN COMMERCE 2-26-2007.

FOR: AUDIO AND VIDEO RECORDINGS IN A PORTABLE KIT FEATURING EDUCATIONAL MOTIVATIONAL AND ENTERTAINMENT WORKS IN THE NATURE OF SELF-IMPROVEMENT TECHNIQUES PERFORMED BY RECORDING ARTISTS ENTERTAINERS, IN CLASS 9 (U.S. CLS. 21, 23, 26, 36 AND 38).

THE MARK CONSISTS OF STANDARD CHARACTERS WITHOUT CLAIM TO ANY PARTICULAR FONT, STYLE, SIZE, OR COLOR.

SER. NO. 77-216,041, FILED 6-26-2007.

DAVID HOFFMAN, EXAMINING ATTORNEY

Int. Cl.: 35

Prior U.S. Cls.: 100, 101 and 102

United States Patent and Trademark Office

Reg. No. 3,483,335

Registered Aug. 12, 2008

**SERVICE MARK
PRINCIPAL REGISTER**

FAX SUPERSTORE

TCG BUSINESS SYSTEMS, INC., A CALIFORNIA
CORPORATION (CALIFORNIA CORPORA-
TION), DBA PACIFIC COAST OFFICE PRO-
DUCTS
BUILDING K
3440 W. WARNER AVENUE
SANTA ANA, CA 92704

FOR: PROVIDING INFORMATION ABOUT OF-
FICE PRODUCTS FOR SALE BY MEANS OF THE
INTERNET, IN CLASS 35 (U.S. CLS. 100, 101 AND
102).

FIRST USE 6-3-1996; IN COMMERCE 6-3-1996.

THE MARK CONSISTS OF STANDARD CHAR-
ACTERS WITHOUT CLAIM TO ANY PARTICULAR
FONT, STYLE, SIZE, OR COLOR.

SEC. 2(F).

SER. NO. 77-216,107, FILED 6-26-2007.

TINA KUAN, EXAMINING ATTORNEY

Int. Cls.: 7 and 9

Prior U.S. Cls.: 13, 19, 21, 23, 26, 31, 34, 35, 36 and 38

United States Patent and Trademark Office

Reg. No. 3,483,336

Registered Aug. 12, 2008

**TRADEMARK
PRINCIPAL REGISTER**



START MANUFACTURING, INC. (TEXAS CORPORATION)
4270 AIRBORN DRIVE
ADDISON, TX 75001

FOR: TAPE DISPENSERS, NAMELY, ADHESIVE TAPE DISPENSING MACHINES; LABELING MACHINES IN THE NATURE OF LABEL DISPENSERS, IN CLASS 7 (U.S. CLS. 13, 19, 21, 23, 31, 34 AND 35).

FIRST USE 2-28-1998; IN COMMERCE 2-28-1998.

FOR: OPTICAL INSPECTION DEVICES FOR INDUSTRIAL USE; OPTICAL INSPECTION DEVICES FOR COMMERCIAL USE, NAMELY, MAGNIFIERS, LOUPES, AND MICROSCOPES, IN CLASS 9 (U.S. CLS. 21, 23, 26, 36 AND 38).

FIRST USE 2-28-1998; IN COMMERCE 2-28-1998.

NO CLAIM IS MADE TO THE EXCLUSIVE RIGHT TO USE "INTERNATIONAL", APART FROM THE MARK AS SHOWN.

THE MARK CONSISTS OF AN OPPOSING SWOOSH LOGO PLUS THE WORDING "START INTERNATIONAL" WITH A HORIZONTAL LINE BETWEEN THE TWO WORDS.

SER. NO. 77-216,111, FILED 6-26-2007.

ANDREA K. NADELMAN, EXAMINING ATTORNEY

Int. Cl.: 35

Prior U.S. Cls.: 100, 101 and 102

United States Patent and Trademark Office

Reg. No. 3,483,337

Registered Aug. 12, 2008

**SERVICE MARK
PRINCIPAL REGISTER**

COPIER SUPERSTORE

TCG BUSINESS SYSTEMS, INC. (CALIFORNIA CORPORATION), DBA PACIFIC COAST OFFICE PRODUCTS
BUILDING K
3440 W. WARNER AVENUE
SANTA ANA, CA 92704

FOR: PROVIDING INFORMATION ABOUT OFFICE PRODUCTS FOR SALE BY MEANS OF THE INTERNET, IN CLASS 35 (U.S. CLS. 100, 101 AND 102).

FIRST USE 7-6-1998; IN COMMERCE 7-6-1998.

THE MARK CONSISTS OF STANDARD CHARACTERS WITHOUT CLAIM TO ANY PARTICULAR FONT, STYLE, SIZE, OR COLOR.

SEC. 2(F).

SER. NO. 77-216,130, FILED 6-26-2007.

TINA KUAN, EXAMINING ATTORNEY

Int. Cls.: 7 and 9

Prior U.S. Cls.: 13, 19, 21, 23, 26, 31, 34, 35, 36 and 38

Reg. No. 3,483,338

United States Patent and Trademark Office

Registered Aug. 12, 2008

**TRADEMARK
PRINCIPAL REGISTER**



START MANUFACTURING, INC. (TEXAS CORPORATION)
4270 AIRBORN DRIVE
ADDISON, TX 75001

FOR: TAPE DISPENSERS, NAMELY, ADHESIVE TAPE DISPENSING MACHINES; LABELING MACHINES IN THE NATURE OF LABEL DISPENSERS, IN CLASS 7 (U.S. CLS. 13, 19, 21, 23, 31, 34 AND 35).

FIRST USE 2-28-1998; IN COMMERCE 2-28-1998.

FOR: OPTICAL INSPECTION DEVICES FOR INDUSTRIAL USE; OPTICAL INSPECTION DEVICES FOR COMMERCIAL USE, NAMELY, MAGNIFIERS, LOUPES, AND MICROSCOPES, IN CLASS 9 (U.S. CLS. 21, 23, 26, 36 AND 38).

FIRST USE 2-28-1998; IN COMMERCE 2-28-1998.

NO CLAIM IS MADE TO THE EXCLUSIVE RIGHT TO USE "INTERNATIONAL", APART FROM THE MARK AS SHOWN.

THE MARK CONSISTS OF AN OPPOSING SWOOSH LOGO PLUS THE WORDING "START INTERNATIONAL" WITH A HORIZONTAL LINE BETWEEN THE TWO WORDS.

SER. NO. 77-216,138, FILED 6-26-2007.

ANDREA K. NADELMAN, EXAMINING ATTORNEY

Int. Cl.: 25

Prior U.S. Cls.: 22 and 39

United States Patent and Trademark Office

Reg. No. 3,483,339

Registered Aug. 12, 2008

**TRADEMARK
PRINCIPAL REGISTER**

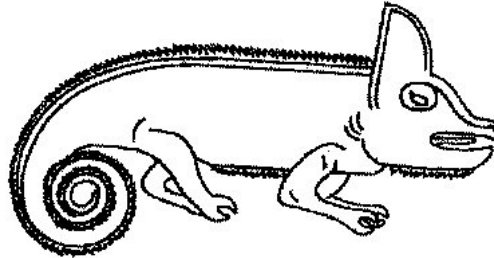

MAILLOECHII, LLC (ALABAMA LTD LIAB CO)
211 W LONGLEAF DR APT 704
AUBURN, AL 36832

THE MARK CONSISTS OF THE IMAGE OF A
CHAMELEON WITH A CURLED TAIL.

FOR: SHIRTS; JACKETS; JEANS; BELTS, IN
CLASS 25 (U.S. CLS. 22 AND 39).

SER. NO. 77-216,324, FILED 6-27-2007.

FIRST USE 0-0-2001; IN COMMERCE 0-0-2001.

JENNIFER VASQUEZ, EXAMINING ATTORNEY

Int. Cl.: 36

Prior U.S. Cls.: 100, 101 and 102

United States Patent and Trademark Office

Reg. No. 3,483,340

Registered Aug. 12, 2008

**SERVICE MARK
PRINCIPAL REGISTER**



UNION MUTUAL FIRE INSURANCE COMPANY
(VERMONT CORPORATION)
139 STATE STREET
MONTPELIER, VT 05602

OWNER OF U.S. REG. NO. 3,348,612.

FOR: INSURANCE SERVICES, NAMELY, WRITING PROPERTY AND CASUALTY INSURANCE TO THE PUBLIC; SERVICES RELATED TO PROPERTY AND CASUALTY INSURANCE, NAMELY, CLAIM ADJUSTMENT SERVICES, INSURANCE CONSULTATION SERVICES, AND INSURANCE UNDERWRITING SERVICES FOR PROPERTY AND CASUALTY INSURANCE, IN CLASS 36 (U.S. CLS. 100, 101 AND 102).

THE MARK CONSISTS OF A STYLIZED ANTIQUE LANTERN ATOP A POLE. THE NUMBERS "1874" ARE POSITIONED INSIDE THE LANTERN. STYLIZED RAYS OF LIGHT EMANATE FROM BEHIND THE NUMBERS AND EXTEND BEYOND THE LANTERN.

SEC. 2(F) AS TO "1874" .

SER. NO. 77-216,582, FILED 6-27-2007.

FIRST USE 5-15-2007; IN COMMERCE 5-15-2007.

CHARLES L. JENKINS, EXAMINING ATTORNEY

Int. Cl.: 41

Prior U.S. Cls.: 100, 101 and 107

United States Patent and Trademark Office

Reg. No. 3,483,341

Registered Aug. 12, 2008

**SERVICE MARK
PRINCIPAL REGISTER**

Oregon Dental Conference

OREGON DENTAL ASSOCIATION (OREGON
NON-PROFIT ASSOCIATION)
PO BOX 3710
WILSONVILLE, OR 97070

FOR: ARRANGING OF EXHIBITIONS, SEMI-
NARS AND CONFERENCES; EDUCATIONAL SER-
VICES, NAMELY, CONDUCTING A CONFERENCE
IN THE FIELD OF DENTISTRY AND DISTRIBUTION
OF COURSE MATERIAL IN CONNECTION
THEREWITH; EDUCATIONAL SERVICES, NAME-
LY, DEVELOPING, ARRANGING, AND CONDUCT-
ING EDUCATIONAL CONFERENCES AND
PROGRAMS AND PROVIDING COURSES OF IN-
STRUCTION IN THE FIELD OF DENTISTRY; EDU-
CATIONAL SERVICES, NAMELY, CONDUCTING A
CONFERENCE IN THE FIELD OF DENTISTRY, IN
CLASS 41 (U.S. CLS. 100, 101 AND 107).

FIRST USE 1-1-1998; IN COMMERCE 1-1-1998.

THE MARK CONSISTS OF STANDARD CHAR-
ACTERS WITHOUT CLAIM TO ANY PARTICULAR
FONT, STYLE, SIZE, OR COLOR.

NO CLAIM IS MADE TO THE EXCLUSIVE
RIGHT TO USE "DENTAL CONFERENCE", APART
FROM THE MARK AS SHOWN.

SEC. 2(F).

SER. NO. 77-216,598, FILED 6-27-2007.

TINA BROWN, EXAMINING ATTORNEY

Int. Cl.: 9

Prior U.S. Cls.: 21, 23, 26, 36 and 38

Reg. No. 3,483,342

United States Patent and Trademark Office

Registered Aug. 12, 2008

**TRADEMARK
PRINCIPAL REGISTER**

GREEN ARMOR

GREEN ARMOR SOLUTIONS, INC. (NEW JERSEY CORPORATION)
SUITE 404
39 HUDSON STREET
HACKENSACK, NJ 076016918

THE MARK CONSISTS OF STANDARD CHARACTERS WITHOUT CLAIM TO ANY PARTICULAR FONT, STYLE, SIZE, OR COLOR.

FOR: INFORMATION TECHNOLOGY SECURITY SOFTWARE, IN CLASS 9 (U.S. CLS. 21, 23, 26, 36 AND 38).

SER. NO. 77-217,052, FILED 6-27-2007.

FIRST USE 4-12-2005; IN COMMERCE 4-12-2005.

DAVID MILLER, EXAMINING ATTORNEY

Int. Cl.: 42

Prior U.S. Cls.: 100 and 101

United States Patent and Trademark Office

Reg. No. 3,483,343

Registered Aug. 12, 2008

**SERVICE MARK
PRINCIPAL REGISTER**

GREEN ARMOR

GREEN ARMOR SOLUTIONS, INC. (NEW JERSEY CORPORATION)
SUITE 404
39 HUDSON STREET
HACKENSACK, NJ 076016918

FOR: COMPUTER CONSULTING SERVICES IN THE FIELDS OF COMPUTER INFORMATION SECURITY, PRODUCT TECHNICAL SUPPORT, AND PRODUCT INTEGRATION FOR INFORMATION TECHNOLOGY SECURITY SOFTWARE, IN CLASS 42 (U.S. CLS. 100 AND 101).

FIRST USE 4-12-2005; IN COMMERCE 4-12-2005.

THE MARK CONSISTS OF STANDARD CHARACTERS WITHOUT CLAIM TO ANY PARTICULAR FONT, STYLE, SIZE, OR COLOR.

SER. NO. 77-217,080, FILED 6-27-2007.

DAVID MILLER, EXAMINING ATTORNEY

Int. Cl.: 9

Prior U.S. Cls.: 21, 23, 26, 36 and 38

Reg. No. 3,483,344

United States Patent and Trademark Office

Registered Aug. 12, 2008

**TRADEMARK
PRINCIPAL REGISTER**

SCOPECOAT

DANIEL D. EVANS (UNITED STATES INDIVIDUAL), DBA DEVTRON
3001 EAST CHOLLA STREET
PHOENIX, AZ 85028

FIRST USE 2-28-1994; IN COMMERCE 2-28-1994.

FOR: PROTECTIVE COVERS FOR OPTICAL EQUIPMENT, NAMELY, OPTICAL LENSES, FIRE-ARM SCOPES AND SIGHTS, OPTICS, RANGE FINDERS, NIGHT VISION, LASERS, BINOCULARS, AND TELESCOPES, IN CLASS 9 (U.S. CLS. 21, 23, 26, 36 AND 38).

THE MARK CONSISTS OF STANDARD CHARACTERS WITHOUT CLAIM TO ANY PARTICULAR FONT, STYLE, SIZE, OR COLOR.

SER. NO. 77-217,287, FILED 6-27-2007.

MICHAEL LITZAU, EXAMINING ATTORNEY

Int. Cl.: 9

Prior U.S. Cls.: 21, 23, 26, 36 and 38

Reg. No. 3,483,345

United States Patent and Trademark Office

Registered Aug. 12, 2008

**TRADEMARK
PRINCIPAL REGISTER**

D2R

WORLD PREMEAR ENTERTAINMENT, LLC
(NEW JERSEY LTD LIAB CO)
2175 HUDSON TERRACE #1-D
FORT LEE, NJ 07024

FIRST USE 11-10-2006; IN COMMERCE 2-26-2007.

FOR: AUDIO AND VIDEO RECORDINGS FEATURING EDUCATIONAL MOTIVATIONAL AND ENTERTAINMENT WORKS IN THE NATURE OF SELF-IMPROVEMENT TECHNIQUES PERFORMED BY RECORDING ARTISTS ENTERTAINERS, IN CLASS 9 (U.S. CLS. 21, 23, 26, 36 AND 38).

THE MARK CONSISTS OF STANDARD CHARACTERS WITHOUT CLAIM TO ANY PARTICULAR FONT, STYLE, SIZE, OR COLOR.

SER. NO. 77-217,970, FILED 6-28-2007.

DAVID HOFFMAN, EXAMINING ATTORNEY

Int. Cls.: 9 and 41

Prior U.S. Cls.: 21, 23, 26, 36, 38, 100, 101 and 107

United States Patent and Trademark Office

Reg. No. 3,483,346

Registered Aug. 12, 2008

**TRADEMARK
SERVICE MARK
PRINCIPAL REGISTER**

OPIATE FOR THE MASSES

OFTM SERVICES LLC (CALIFORNIA LTD LIAB
CO)
C/O MITCHELL SILBERBERG & KNUPP
11377 WEST OLYMPIC BOULEVARD
LOS ANGELES, CA 900641683

FOR: MUSICAL SOUND RECORDINGS, MUSICAL VIDEO RECORDINGS, PRE-RECORDED AUDIO CASSETTES FEATURING MUSICAL SOUND RECORDINGS, PRE-RECORDED COMPACT DISCS FEATURING MUSICAL SOUND RECORDINGS, PRE-RECORDED VIDEO TAPE CASSETTES FEATURING MUSICAL VIDEO RECORDINGS, IN CLASS 9 (U.S. CLS. 21, 23, 26, 36 AND 38).

FIRST USE 0-0-1999; IN COMMERCE 0-0-1999.

FOR: ENTERTAINMENT, NAMELY, LIVE PERFORMANCES BY A MUSICAL BAND; ENTERTAINMENT, NAMELY, LIVE MUSIC CONCERTS; ENTERTAINMENT IN THE NATURE OF LIVE PERFORMANCES BY A MUSICAL GROUP, IN CLASS 41 (U.S. CLS. 100, 101 AND 107).

FIRST USE 0-0-1999; IN COMMERCE 0-0-1999.

THE MARK CONSISTS OF STANDARD CHARACTERS WITHOUT CLAIM TO ANY PARTICULAR FONT, STYLE, SIZE, OR COLOR.

SER. NO. 77-218,395, FILED 6-28-2007.

SEAN CROWLEY, EXAMINING ATTORNEY

Int. Cl.: 9

Prior U.S. Cls.: 21, 23, 26, 36 and 38

United States Patent and Trademark Office

Reg. No. 3,483,347

Registered Aug. 12, 2008

**TRADEMARK
PRINCIPAL REGISTER**

CHART NAVIGATOR PRO

MAPTECH, INC. (DELAWARE CORPORATION)
10 INDUSTRIAL WAY
AMESBURY, MA 01913

FOR: NAUTICAL NAVIGATION SOFTWARE, IN
CLASS 9 (U.S. CLS. 21, 23, 26, 36 AND 38).

FIRST USE 9-30-2004; IN COMMERCE 9-30-2004.

THE MARK CONSISTS OF STANDARD CHAR-
ACTERS WITHOUT CLAIM TO ANY PARTICULAR
FONT, STYLE, SIZE, OR COLOR.

SEC. 2(F) AS TO "CHART NAVIGATOR".

SER. NO. 77-218,681, FILED 6-29-2007.

HOWARD B. LEVINE, EXAMINING ATTORNEY

Int. Cl.: 9

Prior U.S. Cls.: 21, 23, 26, 36 and 38

Reg. No. 3,483,348

United States Patent and Trademark Office

Registered Aug. 12, 2008

**TRADEMARK
PRINCIPAL REGISTER**

CHART NAVIGATOR

MAPTECH, INC. (DELAWARE CORPORATION)
10 INDUSTRIAL WAY
AMESBURY, MA 01913

THE MARK CONSISTS OF STANDARD CHARACTERS WITHOUT CLAIM TO ANY PARTICULAR FONT, STYLE, SIZE, OR COLOR.

FOR: NAUTICAL NAVIGATION SOFTWARE, IN CLASS 9 (U.S. CLS. 21, 23, 26, 36 AND 38).

SEC. 2(F).

SER. NO. 77-218,685, FILED 6-29-2007.

FIRST USE 12-0-1997; IN COMMERCE 12-0-1997.

HOWARD B. LEVINE, EXAMINING ATTORNEY

Int. Cl.: 41

Prior U.S. Cls.: 100, 101 and 107

United States Patent and Trademark Office

Reg. No. 3,483,349

Registered Aug. 12, 2008

**SERVICE MARK
PRINCIPAL REGISTER**

The Talent Edge

BEVERLY KAYE & ASSOCIATES, INC. (CALI-
FORNIA CORPORATION)
2300 STAFFORD AVENUE
SUITE 500
SCRANTON, PA 18505

FOR: EDUCATIONAL SERVICES, NAMELY,
CONDUCTING CLASSES, SEMINARS AND WORK-
SHOPS IN THE FIELD OF EMPLOYEE RETENTION,
IN CLASS 41 (U.S. CLS. 100, 101 AND 107).

FIRST USE 6-1-2006; IN COMMERCE 6-1-2006.

THE MARK CONSISTS OF STANDARD CHAR-
ACTERS WITHOUT CLAIM TO ANY PARTICULAR
FONT, STYLE, SIZE, OR COLOR.

SER. NO. 77-218,745, FILED 6-29-2007.

AMOS T. MATTHEWS, JR., EXAMINING ATTOR-
NEY

Int. Cl.: 43

Prior U.S. Cls.: 100 and 101

United States Patent and Trademark Office

Reg. No. 3,483,350

Registered Aug. 12, 2008

**SERVICE MARK
PRINCIPAL REGISTER**

FUEL UP AND POWER ON

DOCTOR'S ASSOCIATES INC. (FLORIDA COR-
PORATION)
300 SOUTH PINE ISLAND ROAD
SUITE 306
PLANTATION, FL 33324

FOR: RESTAURANT SERVICES, IN CLASS 43
(U.S. CLS. 100 AND 101).

FIRST USE 3-1-2007; IN COMMERCE 3-1-2007.

THE MARK CONSISTS OF STANDARD CHAR-
ACTERS WITHOUT CLAIM TO ANY PARTICULAR
FONT, STYLE, SIZE, OR COLOR.

SER. NO. 77-218,817, FILED 6-29-2007.

ELISSA GARBER KON, EXAMINING ATTORNEY

Int. Cl.: 9

Prior U.S. Cls.: 21, 23, 26, 36 and 38

United States Patent and Trademark Office

Reg. No. 3,483,351

Registered Aug. 12, 2008

**TRADEMARK
PRINCIPAL REGISTER**

ALCOGUARD

VOLVO CAR CORPORATION (ALSO KNOWN AS
VOLVO PERSONVAGNAR AB) (SWEDEN
CORPORATION)
S-405 31
GOTEBORG, SWEDEN

FOR: APPARATUS AND INSTRUMENTS FOR
DETECTING AND MEASURING ALCOHOL IN
BREATH AND PARTS AND FITTINGS THEREFOR;
A BREATH ALCOHOL IGNITION INTERLOCK
DEVICE; ELECTRONIC AUTOMOTIVE IGNITION
INTERLOCKS INCORPORATING A BREATH AL-
COHOL TESTER, IN CLASS 9 (U.S. CLS. 21, 23, 26, 36
AND 38).

THE MARK CONSISTS OF STANDARD CHAR-
ACTERS WITHOUT CLAIM TO ANY PARTICULAR
FONT, STYLE, SIZE, OR COLOR.

OWNER OF SWEDEN REG. NO. 388652, DATED
11-13-2006, EXPIRES 4-27-2017.

SER. NO. 77-219,019, FILED 6-29-2007.

SHAUNIA CARLYLE, EXAMINING ATTORNEY

Int. Cl.: 44

Prior U.S. Cls.: 100 and 101

United States Patent and Trademark Office

Reg. No. 3,483,352

Registered Aug. 12, 2008

**SERVICE MARK
PRINCIPAL REGISTER**

UNITED MEDICAL RECORDS

QUIXAM LLC (PENNSYLVANIA LTD LIAB CO)
P.O. BOX 377
CHELTENHAM, PA 190120377

FOR: MAINTAINING FILES AND RECORDS CONCERNING THE MEDICAL CONDITION OF INDIVIDUALS; MAINTAINING FILES AND RECORDS CONCERNING THE MEDICAL CONDITION OF PATIENTS FOR USE BY MEDICAL PROFESSIONALS AND INSURERS; SELECTIVELY SHARING FILES AND RECORDS CONCERNING THE MEDICAL CONDITION OF PATIENTS AMONG MEDICAL PROFESSIONALS, IN CLASS 44 (U.S. CLS. 100 AND 101).

FIRST USE 6-29-2007; IN COMMERCE 6-29-2007.

THE MARK CONSISTS OF STANDARD CHARACTERS WITHOUT CLAIM TO ANY PARTICULAR FONT, STYLE, SIZE, OR COLOR.

NO CLAIM IS MADE TO THE EXCLUSIVE RIGHT TO USE "MEDICAL RECORDS", APART FROM THE MARK AS SHOWN.

SER. NO. 77-219,176, FILED 6-29-2007.

CAROLYN CATALDO, EXAMINING ATTORNEY

Int. Cl.: 41

Prior U.S. Cls.: 100, 101 and 107

United States Patent and Trademark Office

Reg. No. 3,483,353

Registered Aug. 12, 2008

**SERVICE MARK
PRINCIPAL REGISTER**

SESAC

SESAC, INC. (NEW YORK CORPORATION)
55 MUSIC SQUARE EAST
NASHVILLE, TN 37203

FOR: ENTERTAINMENT AND EDUCATIONAL SERVICES, NAMELY, PROVIDING WORKSHOPS AND SEMINARS IN THE FIELD OF SONGWRITING, COMPOSING AND MUSIC PRODUCTION; LIVE MUSICAL PERFORMANCES BY SOLO ARTISTS AND MUSICAL BANDS; ARTIST DEVELOPMENT PROGRAMS, NAMELY, SEMINARS AND WORKSHOPS FOR, AND MENTORING NEW ARTISTS IN THE FIELDS OF, SONGWRITING, MUSICAL COMPOSITION AND LEGAL ISSUES PERTAINING TO THE MUSIC BUSINESS, NAME-

LY, MUSIC PUBLISHING AND RECORDING CONTRACTS, IN CLASS 41 (U.S. CLS. 100, 101 AND 107).

FIRST USE 12-1-1985; IN COMMERCE 12-1-1985.

THE MARK CONSISTS OF STANDARD CHARACTERS WITHOUT CLAIM TO ANY PARTICULAR FONT, STYLE, SIZE, OR COLOR.

OWNER OF U.S. REG. NOS. 2,888,403 AND 2,930,093.

SER. NO. 77-219,293, FILED 6-29-2007.

LINDA ESTRADA, EXAMINING ATTORNEY

Int. Cl.: 13

Prior U.S. Cls.: 2 and 9

United States Patent and Trademark Office

Reg. No. 3,483,354

Registered Aug. 12, 2008

**TRADEMARK
PRINCIPAL REGISTER**

Little Sharps

LITTLE SHARPS RIFLE MANUFACTURING LLP
(MONTANA LIMITED PARTNERSHIP)
159 2ND AVE.
BIG SANDY, MT 59520

NO CLAIM IS MADE TO THE EXCLUSIVE
RIGHT TO USE "SHARPS", APART FROM THE
MARK AS SHOWN.

FOR: FIREARMS, IN CLASS 13 (U.S. CLS. 2 AND
9).

SEC. 2(F).

FIRST USE 6-1-1996; IN COMMERCE 11-1-1996.

SER. NO. 77-219,876, FILED 6-30-2007.

THE MARK CONSISTS OF STANDARD CHAR-
ACTERS WITHOUT CLAIM TO ANY PARTICULAR
FONT, STYLE, SIZE, OR COLOR.

KELLY MCCOY, EXAMINING ATTORNEY

Int. Cl.: 32

Prior U.S. Cls.: 45, 46 and 48

Reg. No. 3,483,355

United States Patent and Trademark Office

Registered Aug. 12, 2008

**TRADEMARK
PRINCIPAL REGISTER**

#10

LAGUNITAS BREWING COMPANY (CALIFORNIA CORPORATION)
1280 N. MCDOWELL BLVD
PETALUMA, CA 94954

THE MARK CONSISTS OF STANDARD CHARACTERS WITHOUT CLAIM TO ANY PARTICULAR FONT, STYLE, SIZE, OR COLOR.

FOR: ALE, IN CLASS 32 (U.S. CLS. 45, 46 AND 48).

SER. NO. 77-219,945, FILED 7-1-2007.

FIRST USE 2-28-2003; IN COMMERCE 2-28-2003.

LINDA E. BLOHM, EXAMINING ATTORNEY

Int. Cls.: 35, 40 and 42

Prior U.S. Cls.: 100, 101, 102, 103 and 106

United States Patent and Trademark Office

Reg. No. 3,483,356

Registered Aug. 12, 2008

**SERVICE MARK
PRINCIPAL REGISTER**

SCHAWK

SCHAWK, INC. (DELAWARE CORPORATION)
1695 RIVER ROAD
DES PLAINES, IL 60018

FOR: BUSINESS MANAGEMENT AND CONSULTATION SERVICES, NAMELY, PROVIDING OUTSOURCING SERVICES TO CLIENTS IN THE FIELD OF DIGITAL IMAGING; MANAGEMENT OF DIGITAL IMAGING FACILITIES FOR OTHERS, INCLUDING PRODUCTION MANAGEMENT; DATABASE MANAGEMENT OF COMPUTER SYSTEMS, IN CLASS 35 (U.S. CLS. 100, 101 AND 102).

FIRST USE 1-1-1953; IN COMMERCE 1-1-1953.

FOR: PROVIDING ELECTRONIC DIGITIZED COLOR IMAGING SERVICES; ELECTRONIC IMAGING, SCANNING, DIGITIZING, ALTERATION AND/OR RETOUCHING OF PHOTOGRAPHIC IMAGES OR ARTWORK INCLUDING DIGITAL OR ELECTRONIC IMAGES OR ARTWORK; CONSULTATION IN THE FIELD OF DIGITAL IMAGING; DIGITAL PHOTOGRAPHY SERVICES, IN CLASS 40 (U.S. CLS. 100, 103 AND 106).

FIRST USE 1-1-1953; IN COMMERCE 1-1-1953.

FOR: GRAPHIC ART DESIGN, LAYOUT AND PRODUCTION SERVICES; ENGINEERING SERVICES IN THE CONSUMER PRODUCTS AND PACKAGING INDUSTRY, IN CLASS 42 (U.S. CLS. 100 AND 101).

FIRST USE 1-1-1953; IN COMMERCE 1-1-1953.

THE MARK CONSISTS OF STANDARD CHARACTERS WITHOUT CLAIM TO ANY PARTICULAR FONT, STYLE, SIZE, OR COLOR.

OWNER OF U.S. REG. NOS. 905,671 AND 3,068,598.

SEC. 2(F).

SER. NO. 77-220,094, FILED 7-2-2007.

ELLEN BURNS, EXAMINING ATTORNEY

Int. Cls.: 9, 11 and 44

Prior U.S. Cls.: 13, 21, 23, 26, 31, 34, 36, 38, 100 and 101

Reg. No. 3,483,357

United States Patent and Trademark Office

Registered Aug. 12, 2008

**TRADEMARK
SERVICE MARK
PRINCIPAL REGISTER**

SWISSWAVER

SWISS WAVE AG (SWITZERLAND CORPORATION)

GOTTHARDSTRASSE 3

ZUG, SWITZERLAND 6304

FOR: ELECTRO-THERMAL CURLER; APPARATUS FOR BRUSHING, DRYING, MODELING AND SHAPING HAIR, NAMELY, ELECTRO-THERMAL HAIR BRUSHES, ELECTRO-THERMAL HAIR ROLLERS, ELECTRO-THERMAL HAIR STRAIGHTENERS; APPARATUS FOR SHAPING AND MODELING HAIR BY MEANS OF HOT AIR, VAPOR OR SPRAYED LOTION, NAMELY, WARM AIR HAIR BRUSHES, VAPOR HAIR BRUSHES, SPRAYED LOTION HAIR BRUSHES, WARM AIR HAIR ROLLERS, VAPOR HAIR ROLLERS, SPRAYED LOTION HAIR ROLLERS, WARM AIR HAIR STRAIGHTENERS, VAPOR HAIR STRAIGHTENERS, SPRAYED LOTION HAIR STRAIGHTENERS, IN CLASS 9 (U.S. CLS. 21, 23, 26, 36 AND 38).

FOR: HAIR DRYING APPARATUS, NAMELY, HAIR DRYERS, IN CLASS 11 (U.S. CLS. 13, 21, 23, 31 AND 34).

FOR: HAIR DRESSING SERVICES, IN CLASS 44 (U.S. CLS. 100 AND 101).

THE MARK CONSISTS OF STANDARD CHARACTERS WITHOUT CLAIM TO ANY PARTICULAR FONT, STYLE, SIZE, OR COLOR.

PRIORITY CLAIMED UNDER SEC. 44(D) ON SWITZERLAND APPLICATION NO. 51256/2007, FILED 2-2-2007, REG. NO. 558858, DATED 5-30-2007, EXPIRES 2-2-2017.

OWNER OF U.S. REG. NO. 3,171,687.

SER. NO. 77-220,189, FILED 7-2-2007.

EMILY CHUO, EXAMINING ATTORNEY

Int. Cl.: 35

Prior U.S. Cls.: 100, 101 and 102

Reg. No. 3,483,358

United States Patent and Trademark Office

Registered Aug. 12, 2008

**SERVICE MARK
PRINCIPAL REGISTER**

AMERICLEAN

AMERICLEAN DRY CLEANING CENTERS, INCORPORATED (FLORIDA CORPORATION)
SUITE 105
600 FAIRWAY DRIVE
DEERFIELD BEACH, FL 33441

FOR: BUSINESS CONSULTATION AND TECHNICAL ASSISTANCE IN THE ESTABLISHMENT, OPERATION, AND MARKETING OF RETAIL AND WHOLESALE DRY CLEANING AND LAUNDRY ESTABLISHMENTS; BUSINESS CONSULTATION IN THE ACQUISITION OF PHYSICAL FACILITIES FOR RETAIL AND WHOLESALE DRY CLEANING AND LAUNDRY ESTABLISHMENTS AND IN THE NEGOTIATION OF LEASEHOLD INTERESTS IN SAME; PROCUREMENT SERVICES FOR OTHERS, NAMELY, PURCHASING EQUIPMENT AND SUPPLIES FOR RETAIL AND WHOLESALE DRY

CLEANING AND LAUNDRY ESTABLISHMENTS; ADVERTISING, MARKETING AND PROMOTIONAL SERVICES FOR OTHERS IN THE FIELD OF CLOTHES DRY CLEANING AND LAUNDRY SERVICE ESTABLISHMENTS, IN CLASS 35 (U.S. CLS. 100, 101 AND 102).

FIRST USE 3-0-1996; IN COMMERCE 3-0-1996.

THE MARK CONSISTS OF STANDARD CHARACTERS WITHOUT CLAIM TO ANY PARTICULAR FONT, STYLE, SIZE, OR COLOR.

SER. NO. 77-220,194, FILED 7-2-2007.

EDWARD NELSON, EXAMINING ATTORNEY

Int. Cl.: 43

Prior U.S. Cls.: 100 and 101

United States Patent and Trademark Office

Reg. No. 3,483,359

Registered Aug. 12, 2008

**SERVICE MARK
PRINCIPAL REGISTER**

DILLINGER'S

DILLINGER, LLC (INDIANA LTD LIAB CO)
PO BOX 500
MOORESVILLE, IN 46158

OWNER OF U.S. REG. NOS. 2,809,305 AND
2,944,205.

FOR: RESTAURANTS, IN CLASS 43 (U.S. CLS. 100
AND 101).

SEC. 2(F).

FIRST USE 12-11-2002; IN COMMERCE 12-11-2002.

SER. NO. 77-220,236, FILED 7-2-2007.

THE MARK CONSISTS OF STANDARD CHAR-
ACTERS WITHOUT CLAIM TO ANY PARTICULAR
FONT, STYLE, SIZE, OR COLOR.

CAROLINE WOOD, EXAMINING ATTORNEY

Int. Cls.: 42 and 44

Prior U.S. Cls.: 100 and 101

United States Patent and Trademark Office

Reg. No. 3,483,360

Registered Aug. 12, 2008

**SERVICE MARK
PRINCIPAL REGISTER**

CLOSE TO HOME

NATIONWIDE CHILDREN'S HOSPITAL (OHIO
NON-PROFIT CORPORATION)
700 CHILDREN'S DRIVE
COLUMBUS, OH 43205

FOR: MEDICAL LABORATORY SERVICES, IN
CLASS 42 (U.S. CLS. 100 AND 101).

FIRST USE 1-12-1998; IN COMMERCE 1-12-1998.

FOR: HOSPITAL AND HEALTH CARE SERVI-
CES; PSYCHIATRIC SERVICES; HOSPICE AND

MANAGED HEALTH CARE, IN CLASS 44 (U.S.
CLS. 100 AND 101).

FIRST USE 1-12-1998; IN COMMERCE 1-12-1998.

THE MARK CONSISTS OF STANDARD CHAR-
ACTERS WITHOUT CLAIM TO ANY PARTICULAR
FONT, STYLE, SIZE, OR COLOR.

SER. NO. 77-220,293, FILED 7-2-2007.

MICHAEL WEBSTER, EXAMINING ATTORNEY

Int. Cl.: 25

Prior U.S. Cls.: 22 and 39

United States Patent and Trademark Office

Reg. No. 3,483,361

Registered Aug. 12, 2008

TRADEMARK
PRINCIPAL REGISTER

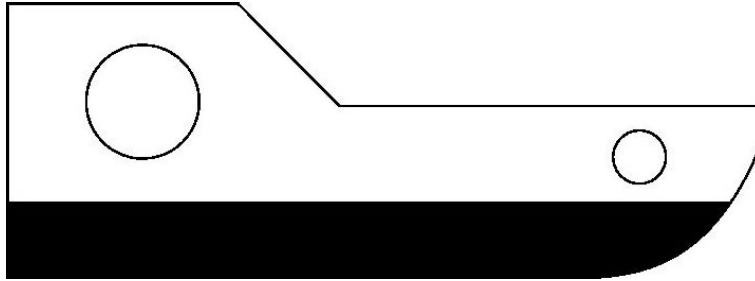

CHATFIELD, MALCOLM F. (UNITED STATES
INDIVIDUAL)
4127 N. MANITOU TRAIL
PO BOX 88
LELAND, MI 49654

FOR: CAMP SHIRTS; DRESS SHIRTS; KNIT SHIRTS; NIGHT SHIRTS; OPEN-NECKED SHIRTS; POLO SHIRTS; SHIRTS; SHORT-SLEEVED OR LONG-SLEEVED T-SHIRTS; SHORT-SLEEVED SHIRTS; SLEEP SHIRTS; SPORT SHIRTS; SPORTS SHIRTS; SPORTS SHIRTS WITH SHORT SLEEVES; SWEAT SHIRTS; T-SHIRTS; CAPRI PANTS; CARGO PANTS; DENIMS; JOGGING PANTS; LOUNGE PANTS; PANTS; SKI PANTS; SNOW PANTS; SNOWBOARD PANTS; SWEAT PANTS; TRACK PANTS; WATERPROOF JACKETS AND PANTS; WIND PANTS; YOGA PANTS; GOLF SHIRTS; HAT BANDS; HATS; WOOLLY HATS; BABY BIBS NOT OF PAPER; BABY BODYSUITS; BABY BOTTOMS; BABY BUNTING; BABY TOPS; BELTS; CAPS; CHILDREN'S AND INFANTS' CLOTH BIBS; CHILDREN'S CLOTH EATING BIBS; CLOTH BIBS; CLOTHING, NAMELY, KNEE WARMERS; CLOTHING, NAMELY, NECK TUBES; CLOTHING, NAMELY, WRAP-AROUNDS; HOODS; INFANT AND TODDLER ONE PIECE CLOTHING; INFANT CLOTH DIAPERS; JERSEYS; LEATHER BELTS; MANTLES; MUFFLERS; SHIRTS; SHORT SETS; SHOULDER WRAPS; SWADDLING CLOTHES; TIES; TOPS; WRAPS; BELTS MADE OF LEATHER; BELTS OF TEXTILE; FABRIC BELTS; GARTER BELTS; MONEY BELTS; SUSPENDER BELTS FOR MEN; SUSPENDER BELTS FOR WOMEN; WAIST BELTS; ATHLETIC SHOES; BEACH SHOES; CANVAS SHOES; DECK-SHOES; INFANTS' SHOES AND BOOTS; SHOES; TENNIS SHOES; WOMEN'S SHOES; BOLO TIES; BOW TIES; SANDALS; CLOTH DIAPERS; CLOTHING, NAMELY, ARM WARMERS; CLOTHING, NAMELY, HAND-WARMERS; PAJAMA BOTTOMS; PAJAMAS; BATH SLIP-

PERS; BATHING CAPS; BATHING COSTUMES; BATHING COSTUMES FOR WOMEN; BATHING SUITS; BATHING SUITS FOR MEN; BATHING TRUNKS; BATHROBES; ROBES; SWIMMING CAPS; HEAD SCARVES; SCARVES; SHOULDER SCARVES; SILK SCARVES; BASEBALL CAPS; CAP VISORS; CAPS WITH VISORS; GOLF CAPS; KNITTED CAPS; SHOWER CAPS; SKULL CAPS; SWIM CAPS; SWIMMING CAPS; BUTTON-FRONT ALOHA SHIRTS; STOCKINGS; SWEAT BANDS; SWEAT SHORTS; SWEAT SUITS; TROUSERS FOR SWEATING; BERMUDA SHORTS; BOARD SHORTS; BOXER SHORTS; FLEECE SHORTS; GYM SHORTS; PANTIES, SHORTS AND BRIEFS; RUGBY SHORTS; SHORT TROUSERS; SHORTS; UNDERWEAR, NAMELY, BOY SHORTS; WALKING SHORTS; BRIEFS; LADIES' UNDERWEAR; UNDERWEAR; WOMEN'S UNDERWEAR; WOVEN OR KNITTED UNDERWEAR; DRESSES; SKIRTS AND DRESSES; SKIRTS; MEN AND WOMEN JACKETS, COATS, TROUSERS, VESTS; QUILTED VESTS; VESTS; JACKETS; RAIN JACKETS; SKI JACKETS; SLEEVED OR SLEEVELESS JACKETS; SPORTS JACKETS; SUEDE JACKETS; WIND RESISTANT JACKETS; WIND-JACKETS; COATS; COATS FOR MEN AND WOMEN; COATS MADE OF COTTON; COATS OF DENIM; FUR COATS AND JACKETS; LEATHER COATS; LIGHT-REFLECTING COATS; OVER COATS; RAIN COATS; SPORT COATS; SUIT COATS; TOP COATS; TRENCH COATS; WIND COATS; CROP TOPS; HALTER TOPS; MUSCLE TOPS; RUGBY TOPS; TANK TOPS; TANK-TOPS; TUBE TOPS; BLOUSES; HEADBANDS; HEADBANDS AGAINST SWEATING; BANDANAS; GLOVES; MITTENS; OUTDOOR MITTENS, IN CLASS 25 (U.S. CLS. 22 AND 39).

FIRST USE 1-1-1996; IN COMMERCE 1-1-1996.

SER. NO. 77-220,510, FILED 7-2-2007.

COLLEEN DOMBROW, EXAMINING ATTORNEY

Int. Cl.: 9

Prior U.S. Cls.: 21, 23, 26, 36 and 38

Reg. No. 3,483,362

United States Patent and Trademark Office

Registered Aug. 12, 2008

**TRADEMARK
PRINCIPAL REGISTER**

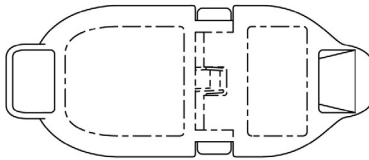

STONERIDGE CONTROL DEVICES, INC. (MAS-
SACHUSETTS CORPORATION)
300 DAN ROAD
CANTON, MA 02021

FOR: ELECTRICAL CONNECTORS AND ADAP-
TERS, IN CLASS 9 (U.S. CLS. 21, 23, 26, 36 AND 38).

FIRST USE 5-11-2005; IN COMMERCE 5-11-2005.

THE MARK CONSISTS OF A THREE DIMEN-
SIONAL CONFIGURATION OF AN ELECTRICAL
CONNECTOR FEATURING A CURVED ELONGA-
TED SHAPE, DIVIDED AT SLIGHTLY OFF CENTER
BY INDENTS WHERE AN OFF-CENTER HINGE IS

LOCATED, AND HAVING PROTRUSIONS AT EI-
THER END WHICH PROTRUSIONS ARE OF A
ROUNDED SQUARE SHAPE WITH INDENTA-
TIONS WITHIN THE SAID PROTRUSIONS. THE
DOTTED LINES SHOW THE LOCATION OF SPACE
INTENDED FOR INSTRUCTIONS ON THE GOODS
AND A HINGE AND ARE NOT CLAIMED AS
FEATURES OF THE MARK.

SEC. 2(F).

SER. NO. 77-220,584, FILED 7-2-2007.

DAVID MURRAY, EXAMINING ATTORNEY

Int. Cl.: 42

Prior U.S. Cls.: 100 and 101

United States Patent and Trademark Office

Reg. No. 3,483,363

Registered Aug. 12, 2008

SERVICE MARK
PRINCIPAL REGISTER



FEDERATION OF CHIROPRACTIC LICENSING
BOARDS (WYOMING NON-PROFIT COR-
PORATION)
5401 W. 10TH STREET, STE 101
GREELEY, CO 80634

FOR: ACCREDITATION SERVICES, NAMELY,
EVALUATING CONTINUING EDUCATION PRO-
GRAMS TO DETERMINE WHETHER THE ORGA-
NIZATIONS MEET ESTABLISHED STANDARDS
FOR RENEWAL OF CHIROPRACTIC LICENSES,
IN CLASS 42 (U.S. CLS. 100 AND 101).

FIRST USE 1-20-2006; IN COMMERCE 8-21-2006.

NO CLAIM IS MADE TO THE EXCLUSIVE
RIGHT TO USE "CHIROPRACTIC RECOGNIZED
CE PROVIDER", APART FROM THE MARK AS
SHOWN.

THE MARK CONSISTS OF A SEAL BEARING A
SET OF BALANCING SCALES WOUND WITH A
RIBBON. THE PERIPHERY OF THE SEAL CON-
TAINS THE WORDS "PACE - CHIROPRACTIC
RECOGNIZED CE PROVIDER".

SER. NO. 77-220,686, FILED 7-2-2007.

G. MAYERSCHOFF, EXAMINING ATTORNEY

Int. Cl.: 1

Prior U.S. Cls.: 1, 5, 6, 10, 26 and 46

Reg. No. 3,483,364

United States Patent and Trademark Office

Registered Aug. 12, 2008

**TRADEMARK
PRINCIPAL REGISTER**

KQ-XRN

KUGLER OIL COMPANY (NEBRASKA CORPORATION)
P.O. BOX 1748
MCCOOK, NE 690011748

THE MARK CONSISTS OF STANDARD CHARACTERS WITHOUT CLAIM TO ANY PARTICULAR FONT, STYLE, SIZE, OR COLOR.

FOR: FERTILIZERS, IN CLASS 1 (U.S. CLS. 1, 5, 6, 10, 26 AND 46).

SER. NO. 77-220,759, FILED 7-2-2007.

FIRST USE 2-0-2004; IN COMMERCE 2-0-2004.

DAVID C. REIHNER, EXAMINING ATTORNEY

Int. Cl.: 15

Prior U.S. Cls.: 2, 21 and 36

United States Patent and Trademark Office

Reg. No. 3,483,365

Registered Aug. 12, 2008

**TRADEMARK
PRINCIPAL REGISTER**

PRECIOUS REBELS

KENNETH BRIAN DUNBAR (UNITED STATES
INDIVIDUAL)
902 CARNEGIE CT.
ALLEN, TX 75002

THE MARK CONSISTS OF STANDARD CHAR-
ACTERS WITHOUT CLAIM TO ANY PARTICULAR
FONT, STYLE, SIZE, OR COLOR.

FOR: GUITARS, NAMELY, GUITARS SOLD AS
FUNCTIONING WORKS OF ART AND MUSICAL
INSTRUMENTS SOLD AS FUNCTIONING WORKS
OF ART, IN CLASS 15 (U.S. CLS. 2, 21 AND 36).

SER. NO. 77-220,893, FILED 7-2-2007.

FIRST USE 5-19-2007; IN COMMERCE 5-19-2007.

MICHAEL WEBSTER, EXAMINING ATTORNEY

Int. Cls.: 12 and 35

Prior U.S. Cls.: 19, 21, 23, 31, 35, 44, 100, 101 and 102

United States Patent and Trademark Office

Reg. No. 3,483,366

Registered Aug. 12, 2008

**TRADEMARK
SERVICE MARK
PRINCIPAL REGISTER**



AMERICAN RACING EQUIPMENT, INC. (DELA-
WARE CORPORATION)
19067 SOUTH REYES AVENUE
RANCHO DOMINGUEZ, CA 90221

FOR: AUTOMOTIVE VEHICLE WHEELS, IN
CLASS 12 (U.S. CLS. 19, 21, 23, 31, 35 AND 44).

FIRST USE 11-30-1999; IN COMMERCE 10-31-2000.

FOR: PROVIDING CONSUMER INFORMATION
ON-LINE IN THE FIELD OF MOTOR VEHICLE

WHEELS AND MOTOR VEHICLES, IN CLASS 35
(U.S. CLS. 100, 101 AND 102).

FIRST USE 12-31-2006; IN COMMERCE 12-31-2006.

THE MARK CONSISTS OF A STYLIZED LETTER
"M".

SER. NO. 77-220,994, FILED 7-2-2007.

PAUL CROWLEY, EXAMINING ATTORNEY

Int. Cl.: 5

Prior U.S. Cls.: 6, 18, 44, 46, 51 and 52

Reg. No. 3,483,367

United States Patent and Trademark Office

Registered Aug. 12, 2008

**TRADEMARK
PRINCIPAL REGISTER**

OTICIN-HC

TERAL INC. (PUERTO RICO CORPORATION)
4405 GUACAMAYO ST. URB. VILLA DELICIAS
PONCE, PUERTO RICO 007283714

THE MARK CONSISTS OF STANDARD CHAR-
ACTERS WITHOUT CLAIM TO ANY PARTICULAR
FONT, STYLE, SIZE, OR COLOR.

FOR: OTIC SOLUTION FOR THE TREATMENT
OF SUPERFICIAL BACTERIAL INFECTIONS OF
THE EXTERNAL AUDITORY CANAL, IN CLASS 5
(U.S. CLS. 6, 18, 44, 46, 51 AND 52).

SER. NO. 77-221,190, FILED 7-3-2007.

FIRST USE 2-10-1984; IN COMMERCE 2-10-1984.

TINA KUAN, EXAMINING ATTORNEY

Int. Cl.: 6

Prior U.S. Cls.: 2, 12, 13, 14, 23, 25 and 50

Reg. No. 3,483,368

United States Patent and Trademark Office

Registered Aug. 12, 2008

**TRADEMARK
PRINCIPAL REGISTER**

NEXgeneration

NEXUS CORPORATION (COLORADO CORPORATION)
10983 LEROY DRIVE
NORTHGLENN, CO 80233

THE MARK CONSISTS OF STANDARD CHARACTERS WITHOUT CLAIM TO ANY PARTICULAR FONT, STYLE, SIZE, OR COLOR.

FOR: METAL FRAMED ENCLOSURES, NAME-
LY, GREENHOUSE STRUCTURES, POOL HOUSES
AND SMOKING SHELTERS, IN CLASS 6 (U.S. CLS.
2, 12, 13, 14, 23, 25 AND 50).

SER. NO. 77-221,358, FILED 7-3-2007.

FIRST USE 6-1-2007; IN COMMERCE 6-30-2007.

NAAKWAMA ANKRAH, EXAMINING ATTORNEY

Int. Cl.: 14

Prior U.S. Cls.: 2, 27, 28 and 50

United States Patent and Trademark Office

Reg. No. 3,483,369

Registered Aug. 12, 2008

TRADEMARK
PRINCIPAL REGISTER



HEATHER ELIZABETH DESIGNS (LOUISIANA
SOLE PROPRIETORSHIP)
2416 ROYAL STREET
NEW ORLEANS, LA 70117

FOR: BRACELETS; JEWELRY; NECKLACES;
CUFF-LINKS; EARRINGS; RINGS BEING JEWEL-
RY, IN CLASS 14 (U.S. CLS. 2, 27, 28 AND 50).

FIRST USE 5-23-2002; IN COMMERCE 5-23-2002.

NO CLAIM IS MADE TO THE EXCLUSIVE
RIGHT TO USE "DESIGNS", APART FROM THE
MARK AS SHOWN.

THE NAME(S), PORTRAIT(S), AND/OR SIGNA-
TURE(S) SHOWN IN THE MARK DOES NOT IDEN-
TIFY A PARTICULAR LIVING INDIVIDUAL.

SER. NO. 77-221,384, FILED 7-3-2007.

NICHOLAS ALTREE, EXAMINING ATTORNEY

Int. Cl.: 19

Prior U.S. Cls.: 1, 12, 33 and 50

United States Patent and Trademark Office

Reg. No. 3,483,370

Registered Aug. 12, 2008

**TRADEMARK
PRINCIPAL REGISTER**

BAKER

SUMMIT-USA, INC. (WASHINGTON CORPORATION)
700 COLORADO STREET
KELSO, WA 98626

THE MARK CONSISTS OF STANDARD CHARACTERS WITHOUT CLAIM TO ANY PARTICULAR FONT, STYLE, SIZE, OR COLOR.

FOR: NON-METAL SWIMMING POOL SLIDES,
IN CLASS 19 (U.S. CLS. 1, 12, 33 AND 50).

SER. NO. 77-221,666, FILED 7-3-2007.

FIRST USE 5-1-1999; IN COMMERCE 5-1-1999.

LESLIE RICHARDS, EXAMINING ATTORNEY

Int. Cl.: 5

Prior U.S. Cls.: 6, 18, 44, 46, 51 and 52

Reg. No. 3,483,371

United States Patent and Trademark Office

Registered Aug. 12, 2008

**TRADEMARK
PRINCIPAL REGISTER**

Sniper

GLOBAL ENVIRONMENTAL RESTORATION,
LLC (LOUISIANA LTD LIAB CO)
108 MAPLE RIDGE DRIVE
LAFAYETTE, LA 70507

THE MARK CONSISTS OF STANDARD CHAR-
ACTERS WITHOUT CLAIM TO ANY PARTICULAR
FONT, STYLE, SIZE, OR COLOR.

FOR: NON-TOXIC DISINFECTANT, IN CLASS 5
(U.S. CLS. 6, 18, 44, 46, 51 AND 52).

SER. NO. 77-221,817, FILED 7-3-2007.

FIRST USE 5-2-2005; IN COMMERCE 5-2-2005.

BARBARA BROWN, EXAMINING ATTORNEY

Int. Cls.: 5, 10, 29 and 30

Prior U.S. Cls.: 6, 18, 26, 39, 44, 46, 51 and 52

Reg. No. 3,483,372

United States Patent and Trademark Office

Registered Aug. 12, 2008

**TRADEMARK
PRINCIPAL REGISTER**

NEURATE

N.V. NUTRICIA (NETHERLANDS PUBLIC LIMITED COMPANY (PLC))
EERSTE STATIONSSTRAAT 186,
2712 HM ZOETERMEER, NETHERLANDS

FOR: PHARMACEUTICAL PRODUCTS FOR USE IN THE TREATMENT OF ALZHEIMER'S DISEASE; DIETETIC SUBSTANCES ADAPTED FOR MEDICAL USE, NAMELY, DIETETIC FOODS; FOOD FOR BABIES, INFANTS AND INVALIDS; FOOD SUPPLEMENTS ADAPTED FOR MEDICAL USE; DIETARY NUTRITIONAL SUPPLEMENTS, IN CLASS 5 (U.S. CLS. 6, 18, 44, 46, 51 AND 52).

FOR: MEDICAL APPARATUS AND INSTRUMENTS FOR ADMINISTERING FOOD, NAMELY, FOOD DISPENSER PUMPS, ENTERAL FEEDING TUBES, CATETHERS, AND PARTS AND FITTINGS THEREOF, IN CLASS 10 (U.S. CLS. 26, 39 AND 44).

FOR: MEAT, FISH, POULTRY AND GAME; MEAT EXTRACTS; PRESERVED, DRIED AND COOKED FRUITS AND VEGETABLES; JELLIES, JAMS; FRUIT SAUCES, NAMELY, CRANBERRY SAUCE AND APPLE SAUCE; EGGS; MILK; MILK PRODUCTS, EXCLUDING ICE CREAM, ICE MILK AND FROZEN YOGURT; EDIBLE OILS AND FATS, IN CLASS 29 (U.S. CL. 46).

FOR: FRUIT SAUCES EXCLUDING CRANBERRY SAUCE AND APPLESAUCE; MILK PRODUCTS,

NAMELY, ICE MILK, ICE CREAM AND FROZEN YOGURT; NUTRITIONAL ADDITIVES, NOT FOR MEDICAL USE, NAMELY, FOOD ADDITIVES FOR FLAVOR, INGREDIENT OR FILLER; COFFEE, TEA, COCOA, SUGAR, RICE, TAPIOCA, SAGO, COFFEE SUBSTITUTES, NAMELY, ARTIFICIAL COFFEE; FLOUR; PREPARATIONS MADE FROM CEREALS, NAMELY, CEREAL-BASED SNACK FOODS; BREAD; PASTRIES; CONFECTIONERY, NAMELY, CAKES, COOKIES; ICES, NAMELY, FRUIT ICES, FLAVORED ICES; HONEY, TREACLE; YEAST, BAKING POWDER; SALT, MUSTARD; VINEGAR, SAUCES; CONDIMENTS, NAMELY, KETCHUP, MAYONNAISE; SPICES; ICE, IN CLASS 30 (U.S. CL. 46).

THE MARK CONSISTS OF STANDARD CHARACTERS WITHOUT CLAIM TO ANY PARTICULAR FONT, STYLE, SIZE, OR COLOR.

OWNER OF BENELUX REG. NO. 0819691, DATED 3-20-2007, EXPIRES 3-6-2017.

THE WORDING "NEURATE" HAS NO MEANING IN A FOREIGN LANGUAGE.

SER. NO. 77-222,096, FILED 7-4-2007.

PAULA MAHONEY, EXAMINING ATTORNEY

Int. Cl.: 16

Prior U.S. Cls.: 2, 5, 22, 23, 29, 37, 38 and 50

United States Patent and Trademark Office

Reg. No. 3,483,373

Registered Aug. 12, 2008

TRADEMARK
PRINCIPAL REGISTER



MARVIN, DORIS MOORE (UNITED STATES INDIVIDUAL)
409 MARILU STREET
RICHARDSON, TX 75080

BLUE IS/ARE CLAIMED AS A FEATURE OF THE MARK.

FOR: CHILDREN'S ACTIVITY BOOKS; CHILDREN'S BOOKS; CHILDREN'S INTERACTIVE EDUCATIONAL BOOKS; CHILDREN'S STORYBOOKS, IN CLASS 16 (U.S. CLS. 2, 5, 22, 23, 29, 37, 38 AND 50).

THE MARK CONSISTS OF A LIGHT GRAY SQUIRREL WITH DARKER GRAY SHADING AND BLACK EYES WITH A BROWN NOSE WEARING A BLUE SHIRT.

FIRST USE 2-1-2007; IN COMMERCE 3-3-2007.

SER. NO. 77-222,137, FILED 7-5-2007.

THE COLOR(S) LIGHT GRAY, DARK GRAY, BLACK, LIGHT BROWN, DARK BROWN AND

ESTHER A. BORSUK, EXAMINING ATTORNEY

Int. Cl.: 20

Prior U.S. Cls.: 2, 13, 22, 25, 32 and 50

Reg. No. 3,483,374

United States Patent and Trademark Office

Registered Aug. 12, 2008

**TRADEMARK
PRINCIPAL REGISTER**

Sailshade

SAILSHADE, INC. (MASSACHUSETTS CORPORATION)
P.O. BOX 3935
WESTPORT, MA 02790

FOR: FABRIC WINDOW COVERINGS AND TREATMENTS, NAMELY, SHADES CONSTRUCTED OF LAYERS OF TEXTILE FABRIC, METALLIZED FABRIC AND POLYETHYLENE, IN CLASS 20 (U.S. CLS. 2, 13, 22, 25, 32 AND 50).

FIRST USE 2-14-1981; IN COMMERCE 2-14-1981.

THE MARK CONSISTS OF STANDARD CHARACTERS WITHOUT CLAIM TO ANY PARTICULAR FONT, STYLE, SIZE, OR COLOR.

SER. NO. 77-222,319, FILED 7-5-2007.

MARK RADEMACHER, EXAMINING ATTORNEY

Int. Cl.: 9

Prior U.S. Cls.: 21, 23, 26, 36 and 38

Reg. No. 3,483,375

United States Patent and Trademark Office

Registered Aug. 12, 2008

**TRADEMARK
PRINCIPAL REGISTER**



ONE WORLD ARTISTS, LLC (NEW JERSEY LTD
LIAB CO)
45 RIVER DRIVE SOUTH PENTHOUSE SUITE 340
PENTHOUSE SUITE 3503
JERSEY CITY, NJ 07310

FOR: AUDIO AND VIDEO RECORDINGS FEATURING EDUCATIONAL PROACTIVE POSITIVE THEMES; AUDIO RECORDINGS FEATURING EDUCATIONAL PROACTIVE POSITIVE THEMES;

CHILDREN'S EDUCATIONAL MUSIC CDS AND DVDS; CHILDREN'S VIDEO TAPES, IN CLASS 9 (U.S. CLS. 21, 23, 26, 36 AND 38).

FIRST USE 1-3-2003; IN COMMERCE 1-23-2003.

SER. NO. 77-222,452, FILED 7-5-2007.

KAREN SEVERSON, EXAMINING ATTORNEY

Int. Cl.: 36

Prior U.S. Cls.: 100, 101 and 102

United States Patent and Trademark Office

Reg. No. 3,483,376

Registered Aug. 12, 2008

**SERVICE MARK
PRINCIPAL REGISTER**

DVM

DREMAN, DAVID N. (UNITED STATES INDIVIDUAL)
0698 EPPLEY DRIVE
ASPEN, CO 81611

THE MARK CONSISTS OF STANDARD CHARACTERS WITHOUT CLAIM TO ANY PARTICULAR FONT, STYLE, SIZE, OR COLOR.

FOR: FINANCIAL INVESTMENT AND MANAGEMENT SERVICES; FINANCIAL ADVISORY SERVICES, IN CLASS 36 (U.S. CLS. 100, 101 AND 102).

SER. NO. 77-222,570, FILED 7-5-2007.

FIRST USE 12-31-1977; IN COMMERCE 12-31-1977.

EDWARD FENNESSY, EXAMINING ATTORNEY

Int. Cls.: 14, 25 and 28

Prior U.S. Cls.: 2, 22, 23, 27, 28, 38, 39 and 50

Reg. No. 3,483,377

United States Patent and Trademark Office

Registered Aug. 12, 2008

**TRADEMARK
PRINCIPAL REGISTER**



SUPREME BEING LIMITED (ENGLAND LIMITED COMPANY)
ERMINE WAY, ARRINGTON, ROYSTON
UNIT 8, ROAD FARM WENDY
HERTFORDSHIRE, UNITED KINGDOM SG80AA

FOR: JEWELRY, GOODS OF PRECIOUS METAL, NAMELY, EARRINGS, RINGS, BRACELETS, NECKLACES CUFFLINKS AND BADGES; WATCHES AND CLOCKS, IN CLASS 14 (U.S. CLS. 2, 27, 28 AND 50).

FOR: CASUAL WEAR, STREET WEAR AND LEISUREWEAR, NAMELY, T-SHIRTS, VESTS, SWEATSHIRTS, HOODED SWEATSHIRTS, JACKETS, BELTS OF CANVAS, NYLON OR WEBBING, JEANS AND TROUSERS; UNDERWEAR; HATS AND BASEBALL HATS; SHOES, OUTERWEAR, NAMELY, COATS, GLOVES, SCARVES, SNOWBOARD WEAR, NAMELY, JACKETS AND TROUSERS, IN CLASS 25 (U.S. CLS. 22 AND 39).

FOR: TOYS AND PLAYTHINGS, NAMELY, KITES, MOLDED PLASTIC CHARACTERS, CARD GAMES, SKATEBOARDS, SNOWBOARDS, MECHANICAL ACTION TOYS, CONSTRUCTION TOYS, PULL TOYS, STUFFED TOYS, PLASTIC CHARACTER TOYS AND PLASTIC ANIMAL TOY FIGURES, PLUSH TOYS, AND OTHER SPORTING ARTICLES, NAMELY, SKIS, SLEDGES, SLEDS, IN-LINE SKATES, ROLLER SKIS, SKI BINDINGS AND SNOWBOARD BINDING, WAKE BOARDS, FOOTBALLS, SOCCER BALLS, AND BASKETBALLS, IN CLASS 28 (U.S. CLS. 22, 23, 38 AND 50).

OWNER OF ERPN CMNTY TM OFC REG. NO. 004925764, DATED 4-10-2007, EXPIRES 2-22-2016.

SER. NO. 77-222,577, FILED 7-5-2007.

THEODORE MCBRIDE, EXAMINING ATTORNEY

Int. Cl.: 36

Prior U.S. Cls.: 100, 101 and 102

United States Patent and Trademark Office

Reg. No. 3,483,378

Registered Aug. 12, 2008

**SERVICE MARK
PRINCIPAL REGISTER**

DREMAN

DREMAN, DAVID N. (UNITED STATES INDIVIDUAL)
0698 EPPLEY DRIVE
ASPEN, CO 81611

FOR: FINANCIAL INVESTMENT AND MANAGEMENT SERVICES; FINANCIAL ADVISORY SERVICES, IN CLASS 36 (U.S. CLS. 100, 101 AND 102).

FIRST USE 12-31-1977; IN COMMERCE 12-31-1977.

THE MARK CONSISTS OF STANDARD CHARACTERS WITHOUT CLAIM TO ANY PARTICULAR FONT, STYLE, SIZE, OR COLOR.

SEC. 2(F).

SER. NO. 77-222,596, FILED 7-5-2007.

EDWARD FENNESSY, EXAMINING ATTORNEY

Int. Cls.: 9 and 42

Prior U.S. Cls.: 21, 23, 26, 36, 38, 100 and 101

United States Patent and Trademark Office

Reg. No. 3,483,379

Registered Aug. 12, 2008

**TRADEMARK
SERVICE MARK
PRINCIPAL REGISTER**

RPATH APPLIANCE PLATFORM

RPATH, INC. (DELAWARE CORPORATION)
701 CORPORATE CENTER DRIVE, SUITE 395
RALEIGH, NC 27607

FOR: DOWNLOADABLE SOFTWARE OFFERED
OVER THE INTERNET TO ENABLE USERS TO
COMBINE THEIR OWN SOFTWARE WITH OTHER
SOFTWARE COMPONENTS AND APPLIANCES
SOURCED FROM MULTIPLE POINTS OF ORIGIN,
IN CLASS 9 (U.S. CLS. 21, 23, 26, 36 AND 38).

FIRST USE 1-2-2007; IN COMMERCE 1-2-2007.

FOR: APPLICATION SERVICE PROVIDER FEATURING
SOFTWARE TO ENABLE USERS TO COMBINE
THEIR OWN SOFTWARE WITH OTHER
SOFTWARE COMPONENTS SOURCED FROM

MULTIPLE POINTS OF ORIGIN, IN CLASS 42 (U.S.
CLS. 100 AND 101).

FIRST USE 1-2-2007; IN COMMERCE 1-2-2007.

THE MARK CONSISTS OF STANDARD CHARACTERS
WITHOUT CLAIM TO ANY PARTICULAR
FONT, STYLE, SIZE, OR COLOR.

NO CLAIM IS MADE TO THE EXCLUSIVE
RIGHT TO USE "APPLIANCE PLATFORM", APART
FROM THE MARK AS SHOWN.

SER. NO. 77-222,714, FILED 7-5-2007.

MARIAM MAHMOUDI, EXAMINING ATTORNEY

Int. Cl.: 42

Prior U.S. Cls.: 100 and 101

United States Patent and Trademark Office

Reg. No. 3,483,380

Registered Aug. 12, 2008

**SERVICE MARK
PRINCIPAL REGISTER**



HERZOG VENEERS INC. (NORTH CAROLINA CORPORATION)
2100 DUNMORE COURT
HIGH POINT, NC 27263

FOR: PROVIDING ON-LINE NON-DOWNLOADABLE INTERACTIVE SOFTWARE FOR CREATING VIRTUAL WOOD VENEER PANELS, IN CLASS 42 (U.S. CLS. 100 AND 101).

FIRST USE 7-2-2007; IN COMMERCE 7-2-2007.

THE COLOR(S) BLACK, BLUE, GOLD, WHITE. IS/ARE CLAIMED AS A FEATURE OF THE MARK.

THE WORDS "PANEL" AND "YOUR VISION AND OUR VENEER CAN WORK MAGIC" ARE IN BLACK; A WAND IS BLACK AND WHITE; STARS ARE GOLD; THE WORDING "WIZARD" IS IN BLUE.

SER. NO. 77-222,738, FILED 7-5-2007.

BRIAN NEVILLE, EXAMINING ATTORNEY

Int. Cl.: 18

Prior U.S. Cls.: 1, 2, 3, 22 and 41

United States Patent and Trademark Office

Reg. No. 3,483,381

Registered Aug. 12, 2008

**TRADEMARK
PRINCIPAL REGISTER**

TYSON

TYSON FOODS, INC. (DELAWARE CORPORATION)
2210 W. OAKLAWN DRIVE
SPRINGDALE, AR 72762

OWNER OF U.S. REG. NOS. 1,205,623, 2,810,231
AND OTHERS.

FOR: ANIMAL SKINS AND HIDES, IN CLASS 18
(U.S. CLS. 1, 2, 3, 22 AND 41).

SEC. 2(F).

FIRST USE 6-11-2003; IN COMMERCE 6-11-2003.

SER. NO. 77-222,784, FILED 7-5-2007.

THE MARK CONSISTS OF STANDARD CHARACTERS WITHOUT CLAIM TO ANY PARTICULAR FONT, STYLE, SIZE, OR COLOR.

LINDA ORNDORFF, EXAMINING ATTORNEY

Int. Cl.: 9

Prior U.S. Cls.: 21, 23, 26, 36 and 38

Reg. No. 3,483,382

United States Patent and Trademark Office

Registered Aug. 12, 2008

**TRADEMARK
PRINCIPAL REGISTER**

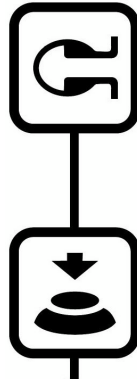

EIKON DEVICE INC. (CANADA CORPORATION)
692 MCKAY STREET
KINGSTON, ONTARIO, CANADA K7M7G2

FOR: TATTOO MACHINE POWER SUPPLIES
AND DIAGNOSTIC METERS FOR ANALYZING
VOLTAGE, TATTOO MACHINE SPEED AND PER-
FORMANCE, IN CLASS 9 (U.S. CLS. 21, 23, 26, 36
AND 38).

FIRST USE 7-0-2003; IN COMMERCE 7-0-2003.

PRIORITY CLAIMED UNDER SEC. 44(D) ON
CANADA APPLICATION NO. 1350526, FILED 6-6-
2007.

SER. NO. 77-222,903, FILED 7-5-2007.

JENNIFER VASQUEZ, EXAMINING ATTORNEY

Int. Cl.: 9

Prior U.S. Cls.: 21, 23, 26, 36 and 38

Reg. No. 3,483,383

United States Patent and Trademark Office

Registered Aug. 12, 2008

**TRADEMARK
PRINCIPAL REGISTER**



VIRTUAL LUXURY

GMW DIGITAL, LLC. (ARIZONA LTD LIAB CO)
2425 E. CAMELBACK RD. SUITE 950
PHOENIX, AZ 85016

THE COLOR(S) NAVY BLUE IS/ARE CLAIMED
AS A FEATURE OF THE MARK.

FOR: COMPUTER SOFTWARE FOR COMPUTER
SYSTEM AND APPLICATION DEVELOPMENT, DE-
PLOYMENT AND MANAGEMENT, IN CLASS 9
(U.S. CLS. 21, 23, 26, 36 AND 38).

THE MARK CONSISTS OF "VL" AND "VIRTUAL
LUXURY", NAVY BLUE COLOR "VL", NAVY BLUE
COLOR "VIRTUAL LUXURY".

FIRST USE 1-1-2000; IN COMMERCE 1-1-2000.

SER. NO. 77-222,920, FILED 7-5-2007.

NO CLAIM IS MADE TO THE EXCLUSIVE
RIGHT TO USE "VIRTUAL", APART FROM THE
MARK AS SHOWN.

AMY MCMENAMIN, EXAMINING ATTORNEY

Int. Cl.: 25

Prior U.S. Cls.: 22 and 39

United States Patent and Trademark Office

Reg. No. 3,483,384

Registered Aug. 12, 2008

**TRADEMARK
PRINCIPAL REGISTER**

VIPER

DEI HEADQUARTERS, INC. (FLORIDA CORPORATION)
ONE VIPER WAY
VISTA, CA 92081

FOR: KNITTED CAPS; JACKETS; HATS; SUN VISORS; GOLF SHIRTS, IN CLASS 25 (U.S. CLS. 22 AND 39).

FIRST USE 2-21-1990; IN COMMERCE 2-21-1990.

THE MARK CONSISTS OF STANDARD CHARACTERS WITHOUT CLAIM TO ANY PARTICULAR FONT, STYLE, SIZE, OR COLOR.

OWNER OF U.S. REG. NO. 1,755,228.

SER. NO. 77-222,952, FILED 7-5-2007.

ALYSSA PALADINO, EXAMINING ATTORNEY

Int. Cl.: 7

Prior U.S. Cls.: 13, 19, 21, 23, 31, 34 and 35

United States Patent and Trademark Office

Reg. No. 3,483,385

Registered Aug. 12, 2008

**TRADEMARK
PRINCIPAL REGISTER**

TURBO DRYWALL SANDER

DUST COLLECTION PRODUCTS, LLC (UTAH
LTD LIAB CO)
1285 EAST 650 SOUTH
PRICE, UT 84501

FOR: MACHINERY, NAMELY, AIR POWERED
SANDERS, IN CLASS 7 (U.S. CLS. 13, 19, 21, 23, 31, 34
AND 35).

FIRST USE 7-1-2007; IN COMMERCE 7-1-2007.

THE MARK CONSISTS OF STANDARD CHAR-
ACTERS WITHOUT CLAIM TO ANY PARTICULAR
FONT, STYLE, SIZE, OR COLOR.

NO CLAIM IS MADE TO THE EXCLUSIVE
RIGHT TO USE "DRYWALL SANDER", APART
FROM THE MARK AS SHOWN.

SER. NO. 77-222,998, FILED 7-5-2007.

LINDA MICKLEBURGH, EXAMINING ATTORNEY

Int. Cl.: 19

Prior U.S. Cls.: 1, 12, 33 and 50

United States Patent and Trademark Office

Reg. No. 3,483,386

Registered Aug. 12, 2008

**TRADEMARK
PRINCIPAL REGISTER**

MACK

HANSEN, DANIEL R. (UNITED STATES INDIVIDUAL)
616 VETERAN AVENUE, SUITE 201
LOS ANGELES, CA 90024

THE MARK CONSISTS OF STANDARD CHARACTERS WITHOUT CLAIM TO ANY PARTICULAR FONT, STYLE, SIZE, OR COLOR.

FOR: SELF-STICKING AND PLASTER COATED MESH FOR REPAIRING HOLES IN WALLS, IN CLASS 19 (U.S. CLS. 1, 12, 33 AND 50).

SER. NO. 77-223,008, FILED 7-5-2007.

FIRST USE 4-30-2007; IN COMMERCE 4-30-2007.

ZACHARY BELLO, EXAMINING ATTORNEY

Int. Cl.: 35

Prior U.S. Cls.: 100, 101 and 102

United States Patent and Trademark Office

Reg. No. 3,483,387

Registered Aug. 12, 2008

**SERVICE MARK
PRINCIPAL REGISTER**

1-800-NO-AGENT

800 NO AGENT, LLC (CALIFORNIA LTD LIAB
CO)
#324
8939 SEPULVEDA BLVD
LOS ANGELES, CA 90045

FOR: REAL ESTATE MARKETING SERVICES,
NAMELY, PROVIDING REAL ESTATE LEADS FOR
PROSPECTIVE PURCHASERS, IN CLASS 35 (U.S.
CLS. 100, 101 AND 102).

FIRST USE 8-1-2001; IN COMMERCE 8-1-2001.

THE MARK CONSISTS OF STANDARD CHAR-
ACTERS WITHOUT CLAIM TO ANY PARTICULAR
FONT, STYLE, SIZE, OR COLOR.

SEC. 2(F).

SER. NO. 77-223,009, FILED 7-5-2007.

SIMON TENG, EXAMINING ATTORNEY

Int. Cl.: 21

Prior U.S. Cls.: 2, 13, 23, 29, 30, 33, 40 and 50

Reg. No. 3,483,388

United States Patent and Trademark Office

Registered Aug. 12, 2008

**TRADEMARK
PRINCIPAL REGISTER**

GLOBAL MARKET

FITZ AND FLOYD, INC. (DELAWARE CORPORATION)
501 CORPORATE DRIVE
LEWISVILLE, TX 75057

FOR: HOUSEWARES, NOT OF PRECIOUS METAL, NAMELY, DINNERWARE, DINNER PLATES, SALAD PLATES, PARTY PLATES, SOUP BOWLS, CEREAL BOWLS, RIM SOUP BOWLS, MUGS, INDIVIDUAL FOOTED BOWLS, INDIVIDUAL SERVING DISHES, SALT AND PEPPER SHAKERS, SEASONING SALT CANISTERS, RAMEKINS, APPETIZER TRAYS, DEEP OVAL BOWLS, SERVING BOWLS, PITCHERS, LIDDED BAKERS, BREAD TRAYS, PLATTERS, SOAP AND LOTION DISPEN-

SERS, FOOD CANISTERS AND FIGURINES OF CERAMIC, CHINA, CRYSTAL, EARTHENWARE, GLASS, PORCELAIN, AND TERRA COTTA, IN CLASS 21 (U.S. CLS. 2, 13, 23, 29, 30, 33, 40 AND 50).

FIRST USE 7-16-2007; IN COMMERCE 7-16-2007.

THE MARK CONSISTS OF STANDARD CHARACTERS WITHOUT CLAIM TO ANY PARTICULAR FONT, STYLE, SIZE, OR COLOR.

SER. NO. 77-223,015, FILED 7-5-2007.

HEATHER BIDDULPH, EXAMINING ATTORNEY

Int. Cl.: 38

Prior U.S. Cls.: 100, 101 and 104

United States Patent and Trademark Office

Reg. No. 3,483,389

Registered Aug. 12, 2008

**SERVICE MARK
PRINCIPAL REGISTER**

**BE IN THE MIDDLE OF
NOWHERE. AND AT THE
CENTER OF EVERYTHING.**

SEAMOBILE, INC. (WASHINGTON CORPORATION)
1200 WESTLAKE AVENUE NORTH, SUITE 600
SEATTLE, WA 98109

FOR: TELECOMMUNICATIONS SERVICES, NAMELY, TRANSMISSION OF VOICE, DATA, GRAPHICS, PHOTOS, VIDEO, MUSIC, NEWS, AND INFORMATION BY MEANS OF SATELLITE OR WIRELESS NETWORKS, PROVIDING WIRELESS INTERNET ACCESS, WIRELESS TELEPHONE SERVICES, LOCAL AND LONG DISTANCE WIRELESS TELEPHONE SERVICES, LOCAL AND LONG DISTANCE WIRELESS TELEPHONE SERVICES PROVIDING

DED VIA PRE-PAID TELEPHONE CALLING CARDS, IN CLASS 38 (U.S. CLS. 100, 101 AND 104).

FIRST USE 3-13-2007; IN COMMERCE 3-13-2007.

THE MARK CONSISTS OF STANDARD CHARACTERS WITHOUT CLAIM TO ANY PARTICULAR FONT, STYLE, SIZE, OR COLOR.

SER. NO. 77-223,197, FILED 7-6-2007.

SANI KHOURI, EXAMINING ATTORNEY

Int. Cl.: 9

Prior U.S. Cls.: 21, 23, 26, 36 and 38

United States Patent and Trademark Office

Reg. No. 3,483,390

Registered Aug. 12, 2008

**TRADEMARK
PRINCIPAL REGISTER**



ECLIPSE MICROWAVE, INC. (CALIFORNIA CORPORATION)
780 MONTAGUE EXPRESSWAY; SUITE 606
SAN JOSE, CA 95131

FOR: MICROWAVE AND RADIO FREQUENCY MIXERS, DETECTORS, LIMITERS AND EQUALIZERS, IN CLASS 9 (U.S. CLS. 21, 23, 26, 36 AND 38).

FIRST USE 3-1-2006; IN COMMERCE 6-6-2006.

THE COLOR(S) DARK BROWN, BURGUNDY AND LIGHT ORANGE IS/ARE CLAIMED AS A FEATURE OF THE MARK.

THE MARK CONSISTS OF THE LETTER "E", THE COLOR BURGUNDY APPEARS IN THE LETTER E, AND DARK BROWN IN THE DESIGN OF A CIRCLE WITH A LIGHT ORANGE IN THE SQUARE BACKGROUND.

SER. NO. 77-223,336, FILED 7-6-2007.

ZACHARY BELLO, EXAMINING ATTORNEY

Int. Cl.: 25

Prior U.S. Cls.: 22 and 39

United States Patent and Trademark Office

Reg. No. 3,483,391

Registered Aug. 12, 2008

**TRADEMARK
PRINCIPAL REGISTER**



UTAX CO., LTD. (JAPAN CORPORATION)
201-1 NOMURA-CHO, NISHIWAKI-CITY
HYOGO, JAPAN

FOR: BRAS AND UNDERWEAR, NAMELY, PANTIES, IN CLASS 25 (U.S. CLS. 22 AND 39).

FIRST USE 9-30-2003; IN COMMERCE 2-1-2006.

NO CLAIM IS MADE TO THE EXCLUSIVE RIGHT TO USE "INTERNATIONAL", APART FROM THE MARK AS SHOWN.

THE MARK CONSISTS OF A FIGURE AGAINST A SQUARE BACKGROUND, POSITIONED IN THE SHAPE OF THE LETTERS "L" AND "A", TO THE LEFT OF THE WORDS "LA CLE INTERNATIONAL".

THE FOREIGN WORDING IN THE MARK TRANSLATES INTO ENGLISH AS THE "KEY".

SER. NO. 77-223,352, FILED 7-6-2007.

TEJBIR SINGH, EXAMINING ATTORNEY

Int. Cl.: 21

Prior U.S. Cls.: 2, 13, 23, 29, 30, 33, 40 and 50

United States Patent and Trademark Office

Reg. No. 3,483,392

Registered Aug. 12, 2008

**TRADEMARK
PRINCIPAL REGISTER**



THE PORCELAIN AND FINE CHINA COMPANIES LIMITED (UNITED KINGDOM COMPANY)
STOKE ON TRENT
118 CHURCH STREET
STAFFORDSHIRE, UNITED KINGDOM ST41BX

FOR: EARTHENWARE, NAMELY, PLATES, CUPS, SAUCERS, NON-ELECTRIC TEAPOTS, DINNER SERVICES, TEA SERVICES, COFFEE SERVICES, JUGS, BOWLS, DISHES, SALT AND PEPPER SHAKERS, EGG CUPS AND SERVING TRAYS, SOUP PLATES, LITHOPHANES IN THE NATURE OF PORCELAIN CASTINGS, TEA LIGHT HOLDERS, SALAD BOWLS, TRAYS, NAMELY, SERVICE TRAYS AND DINNER TRAYS, SAUCE BOATS AND STANDS, TRIPLE DISHES, FLUTED DISHES, NAPKIN RINGS NOT OF PRECIOUS METALS, FOOTED

BASINS, SERVING PLATTERS, MUGS, COASTERS NOT OF PAPER AND NOT BEING TABLE LINEN, VEGETABLE DISHES AND SUGAR BOXES, IN CLASS 21 (U.S. CLS. 2, 13, 23, 29, 30, 33, 40 AND 50).

FIRST USE 0-0-1939; IN COMMERCE 0-0-1939.

THE MARK CONSISTS OF A STYLIZED REPRESENTATION OF A CHRISTMAS TREE WITH PRESENTS AND HOLLY AROUND ITS BASE.

SEC. 2(F).

SER. NO. 77-223,826, FILED 7-6-2007.

STEVEN JACKSON, EXAMINING ATTORNEY

Int. Cl.: 25

Prior U.S. Cls.: 22 and 39

United States Patent and Trademark Office

Reg. No. 3,483,393

Registered Aug. 12, 2008

**TRADEMARK
PRINCIPAL REGISTER**

TERUO ARTISTRY

TERUO, INC. (CALIFORNIA CORPORATION)
P.O. BOX 3759
SANTA ROSA, CA 954023759

FOR: BELTS; BLOUSES; BOOTS; BOW TIES;
BRAS; CAPS; COATS; DRESSES; HATS; HEAD-
BANDS; JACKETS; JEANS; JERSEYS; NECKTIES;
PANTIES; PARKAS; SANDALS; SARONGS;
SCARVES; SHIRTS; SHOES; SHORT-SLEEVED OR
LONG-SLEEVED T-SHIRTS; SHORT-SLEEVED
SHIRTS; SHORTS; SKIRTS; SLACKS; SOCKS; SUS-
PENDERS; SWEAT PANTS; SWEAT SHIRTS; SWEA-
TERS; SWIM WEAR FOR GENTLEMEN AND
LADIES; SWIMSUITS, TANK-TOPS, T-SHIRTS;
TURTLENECK SWEATERS; UNDERWEAR; VESTS;

VISORS; WIND RESISTANT JACKETS; WRIST
BANDS, IN CLASS 25 (U.S. CLS. 22 AND 39).

FIRST USE 4-5-2007; IN COMMERCE 4-5-2007.

THE MARK CONSISTS OF STANDARD CHAR-
ACTERS WITHOUT CLAIM TO ANY PARTICULAR
FONT, STYLE, SIZE, OR COLOR.

OWNER OF U.S. REG. NOS. 2,574,280 AND
3,195,580.

SER. NO. 77-223,865, FILED 7-6-2007.

ELLEN B. AWRICH, EXAMINING ATTORNEY

Int. Cl.: 16

Prior U.S. Cls.: 2, 5, 22, 23, 29, 37, 38 and 50

Reg. No. 3,483,394

United States Patent and Trademark Office

Registered Aug. 12, 2008

**TRADEMARK
PRINCIPAL REGISTER**

CHARTEDCOURSE

CHARTEDCOURSE, LLC (UTAH LTD LIAB CO)
3601 NORTH UNIVERSITY AVENUE, SUITE 250
PROVO, UT 84604

FIRST USE 6-30-2007; IN COMMERCE 6-30-2007.

FOR: PUBLICATIONS, NAMELY, BOOKS,
WORKBOOKS, MANUALS, HANDOUTS ALL IN
THE FIELD OF REVIEWING, ANALYZING, AND
IMPROVING PERSONAL FINANCES AND DEBT
PAYMENT STRATEGIES AND PROCESSES, IN
CLASS 16 (U.S. CLS. 2, 5, 22, 23, 29, 37, 38 AND 50).

THE MARK CONSISTS OF STANDARD CHAR-
ACTERS WITHOUT CLAIM TO ANY PARTICULAR
FONT, STYLE, SIZE, OR COLOR.

SER. NO. 77-223,908, FILED 7-6-2007.

KIMBERLY PERRY, EXAMINING ATTORNEY

Int. Cl.: 41

Prior U.S. Cls.: 100, 101 and 107

United States Patent and Trademark Office

Reg. No. 3,483,395

Registered Aug. 12, 2008

**SERVICE MARK
PRINCIPAL REGISTER**

CHARTEDCOURSE

CHARTEDCOURSE, LLC (UTAH LTD LIAB CO)
3601 NORTH UNIVERSITY AVENUE, SUITE 250
PROVO, UT 84604

FOR: EDUCATIONAL SERVICES, NAMELY,
WORKSHOPS, SEMINARS, CONFERENCES, CLAS-
SES, SPEECHES AND SYMPOSIUMS, ALL IN THE
FIELD OF REVIEWING, ANALYZING, AND IM-
PROVING PERSONAL FINANCES AND DEBT PAY-
MENT STRATEGIES AND PROCESSES, IN CLASS 41
(U.S. CLS. 100, 101 AND 107).

FIRST USE 6-30-2007; IN COMMERCE 6-30-2007.

THE MARK CONSISTS OF STANDARD CHAR-
ACTERS WITHOUT CLAIM TO ANY PARTICULAR
FONT, STYLE, SIZE, OR COLOR.

SER. NO. 77-223,916, FILED 7-6-2007.

KIMBERLY PERRY, EXAMINING ATTORNEY

Int. Cl.: 42

Prior U.S. Cls.: 100 and 101

United States Patent and Trademark Office

Reg. No. 3,483,396

Registered Aug. 12, 2008

**SERVICE MARK
PRINCIPAL REGISTER**

CHARTEDCOURSE

CHARTEDCOURSE, LLC (UTAH LTD LIAB CO)
3601 NORTH UNIVERSITY AVENUE, SUITE 250
PROVO, UT 84604

FOR: PROVIDING TEMPORARY USE OF ON-
LINE SOFTWARE FOR REVIEWING, ANALYZING,
AND IMPROVING PERSONAL FINANCES AND
DEBT PAYMENT STRATEGIES AND PROCESSES,
IN CLASS 42 (U.S. CLS. 100 AND 101).

FIRST USE 6-30-2007; IN COMMERCE 6-30-2007.

THE MARK CONSISTS OF STANDARD CHAR-
ACTERS WITHOUT CLAIM TO ANY PARTICULAR
FONT, STYLE, SIZE, OR COLOR.

SER. NO. 77-223,928, FILED 7-6-2007.

KIMBERLY PERRY, EXAMINING ATTORNEY

Int. Cl.: 9

Prior U.S. Cls.: 21, 23, 26, 36 and 38

Reg. No. 3,483,397

United States Patent and Trademark Office

Registered Aug. 12, 2008

**TRADEMARK
PRINCIPAL REGISTER**

Punch In & Out

PRATT, JOHN ROBINSON (UNITED STATES
INDIVIDUAL)
501 HAHAIONE STREET #9H
HONOLULU, HI 96825

THE MARK CONSISTS OF STANDARD CHAR-
ACTERS WITHOUT CLAIM TO ANY PARTICULAR
FONT, STYLE, SIZE, OR COLOR.

FOR: COMPUTER SOFTWARE FOR CREATING
SEARCHABLE DATABASES OF INFORMATION
AND DATA, IN CLASS 9 (U.S. CLS. 21, 23, 26, 36
AND 38).

SER. NO. 77-224,114, FILED 7-7-2007.

FIRST USE 6-1-2006; IN COMMERCE 6-21-2006.

HANNO RITTNER, EXAMINING ATTORNEY

Int. Cl.: 41

Prior U.S. Cls.: 100, 101 and 107

United States Patent and Trademark Office

Reg. No. 3,483,398

Registered Aug. 12, 2008

**SERVICE MARK
PRINCIPAL REGISTER**



ANDREW K. STEELE (HAWAII INDIVIDUAL)
RR 2 BOX 3896
PAHOA, HI 96778 AND
DENNIS DRAGON (CALIFORNIA INDIVIDUAL)
P.O. BOX 1253
CARPINTERIA, CA 93014

FOR: ENTERTAINMENT IN THE NATURE OF
LIVE PERFORMANCES BY MUSICAL SINGING
GROUP, IN CLASS 41 (U.S. CLS. 100, 101 AND 107).

FIRST USE 8-1-1977; IN COMMERCE 8-1-1977.

OWNER OF U.S. REG. NO. 2,986,153.

THE COLOR(S) BLACK AND WHITE IS/ARE
CLAIMED AS A FEATURE OF THE MARK.

THE MARK CONSISTS OF STYLIZED LETTERS
"SURF PUNKS" WITH PAINT SPLASH DESIGN IN
BACKGROUND AND NO OTHER COLORS BUT
BLACK OR WHITE.

SER. NO. 77-224,122, FILED 7-7-2007.

REBECCA SMITH, EXAMINING ATTORNEY

Int. Cl.: 28

Prior U.S. Cls.: 22, 23, 38 and 50

Reg. No. 3,483,399

United States Patent and Trademark Office

Registered Aug. 12, 2008

**TRADEMARK
PRINCIPAL REGISTER**



SAUNDERS, DANIEL AUSTIN (UNITED STATES
INDIVIDUAL)
2457 HUNTING HORN WAY
VIRGINIA BEACH, VA 23456

FOR: SURFBOARDS, IN CLASS 28 (U.S. CLS. 22,
23, 38 AND 50).

FIRST USE 1-1-2006; IN COMMERCE 1-1-2006.

NO CLAIM IS MADE TO THE EXCLUSIVE
RIGHT TO USE "CUSTOM SURF BOARDS", APART
FROM THE MARK AS SHOWN.

THE COLOR(S) BLACK, WHITE AND ORANGE
IS/ARE CLAIMED AS A FEATURE OF THE MARK.

THE MARK CONSISTS OF THE WORDING
"AUSTIN" IN THE COLOR ORANGE WITH AN
OUTLINE OF THE LETTERING IN THE COLOR
BLACK. THE WORDING "CUSTOM SURF
BOARDS" IS IN THE COLOR BLACK. ALL OF THE
WORDING IS INSIDE A HEXAGON WHICH IS IN
THE COLORS BLACK AND ORANGE.

SER. NO. 77-224,195, FILED 7-8-2007.

EMILY CHUO, EXAMINING ATTORNEY

Int. Cl.: 41

Prior U.S. Cls.: 100, 101 and 107

United States Patent and Trademark Office

Reg. No. 3,483,400

Registered Aug. 12, 2008

**SERVICE MARK
PRINCIPAL REGISTER**

The logo for Broadway Living.com features the word "BROADWAY" in a large, bold, black, sans-serif font. Below it, the words "LIVING.COM" are displayed in a white, bold, sans-serif font, set against a solid black rectangular background.

LEONARD, JAME CHIP (UNITED STATES INDIVIDUAL)
18 ANITA WAY
WARREN, CT 06754

FOR: ENTERTAINMENT SERVICES, NAMELY, PRODUCTION OF VIDEO POD CASTS, DVDS AND CD-ROMS FEATURING ARTICLES IN THE FIELD OF THE THEATER AND ENTERTAINMENT INDUSTRY, IN CLASS 41 (U.S. CLS. 100, 101 AND 107).

FIRST USE 7-12-2006; IN COMMERCE 7-1-2007.

NO CLAIM IS MADE TO THE EXCLUSIVE RIGHT TO USE "BROADWAY", APART FROM THE MARK AS SHOWN.

SER. NO. 77-224,213, FILED 7-8-2007.

JOHN WILKE, EXAMINING ATTORNEY

Int. Cl.: 35

Prior U.S. Cls.: 100, 101 and 102

United States Patent and Trademark Office

Reg. No. 3,483,401

Registered Aug. 12, 2008

SERVICE MARK
PRINCIPAL REGISTER



CENTRAL STATES NUMISMATIC SOCIETY (ILLINOIS CORPORATION)
103 POWDER MILL ROAD
BELLEVILLE, IL 62223

FOR: ASSOCIATION SERVICES, NAMELY, PROMOTING THE INTERESTS OF THE NUMISMATIC COMMUNITY, IN CLASS 35 (U.S. CLS. 100, 101 AND 102).

FIRST USE 11-1-1965; IN COMMERCE 11-1-1965.

NO CLAIM IS MADE TO THE EXCLUSIVE RIGHT TO USE "SOCIETY", APART FROM THE MARK AS SHOWN.

THE MARK CONSISTS OF TWO CONCENTRIC OVALS BOUNDING PUNCTUATION AND THE WORDS "CENTRAL STATES NUMISMATIC SOCIETY" AND ENCOMPASSING A PARTIAL MAP OF THE MIDWEST UNITED STATES.

SEC. 2(F).

SER. NO. 77-224,258, FILED 7-8-2007.

MICHAEL KAZAZIAN, EXAMINING ATTORNEY

Int. Cl.: 16

Prior U.S. Cls.: 2, 5, 22, 23, 29, 37, 38 and 50

Reg. No. 3,483,402

United States Patent and Trademark Office

Registered Aug. 12, 2008

**TRADEMARK
PRINCIPAL REGISTER**

The Centinel

CENTRAL STATES NUMISMATIC SOCIETY (IL-
LINOIS CORPORATION)
103 POWDER MILL ROAD
BELLEVILLE, IL 62223

THE MARK CONSISTS OF STANDARD CHAR-
ACTERS WITHOUT CLAIM TO ANY PARTICULAR
FONT, STYLE, SIZE, OR COLOR.

FOR: JOURNALS CONCERNING NUMISMAT-
ICS, NUMISMATIC SOCIETIES AND/OR NUMIS-
MATIC ACTIVITIES, IN CLASS 16 (U.S. CLS. 2, 5, 22,
23, 29, 37, 38 AND 50).

SER. NO. 77-224,291, FILED 7-8-2007.

FIRST USE 10-1-1953; IN COMMERCE 10-1-1953.

MICHAEL KAZAZIAN, EXAMINING ATTORNEY

Int. Cl.: 9

Prior U.S. Cls.: 21, 23, 26, 36 and 38

United States Patent and Trademark Office

Reg. No. 3,483,403

Registered Aug. 12, 2008

**TRADEMARK
PRINCIPAL REGISTER**

Cooler Master

COOLER MASTER CO., LTD. (TAIWAN CORPORATION)
TAIPEI HSIEN
9F, NO. 782, CHUNG CHEN RD.
CHUNG HO CITY, TAIWAN

FOR: NOTEBOOK COMPUTERS; INTERNAL COOLING FANS FOR COMPUTERS; COOLERS FOR USE IN COMPUTERS; CENTRAL PROCESSING UNIT (CPU) COOLERS; COOLERS FOR USE IN ELECTRONIC COMPONENTS; COMPUTER CARRYING CASES; COMPUTERS; CASES FOR DISKETTES AND COMPACT DISKS; COMPUTER KEYBOARDS; COMPUTER MONITORS; COMPUTER MOUSE; ELECTRIC CORDS; ELECTRICAL CONTROLLING DEVICES; ELECTRICAL POWER SUPPLIES; UNINTERRUPTED POWER SUPPLIES; COMPUTER CABLES; COMPUTER HARDWARE;

ELECTRIC METERS, IN CLASS 9 (U.S. CLS. 21, 23, 26, 36 AND 38).

FIRST USE 5-1-1995; IN COMMERCE 5-1-1995.

THE MARK CONSISTS OF STANDARD CHARACTERS WITHOUT CLAIM TO ANY PARTICULAR FONT, STYLE, SIZE, OR COLOR.

OWNER OF U.S. REG. NO. 2,106,330.

NO CLAIM IS MADE TO THE EXCLUSIVE RIGHT TO USE "COOLER", APART FROM THE MARK AS SHOWN.

SER. NO. 77-224,369, FILED 7-9-2007.

TARAH HARDY, EXAMINING ATTORNEY

Int. Cl.: 9

Prior U.S. Cls.: 21, 23, 26, 36 and 38

United States Patent and Trademark Office

Reg. No. 3,483,404

Registered Aug. 12, 2008

**TRADEMARK
PRINCIPAL REGISTER**



COOLER MASTER CO., LTD. (TAIWAN CORPORATION)
TAIPEI HSIEN
9 F, NO. 782, CHUNG CHENG RD.
CHUNG HO CITY, TAIWAN

FOR: NOTEBOOK COMPUTERS; INTERNAL COOLING FANS FOR COMPUTERS; COOLERS FOR USE IN COMPUTERS; CENTRAL PROCESSING UNIT (CPU) COOLERS; COOLERS FOR USE IN ELECTRONIC COMPONENTS; COMPUTER CARRYING CASES; COMPUTERS; CASES FOR DISKETTES AND COMPACT DISKS; COMPUTER KEYBOARDS; COMPUTER MONITORS; COMPUTER MOUSE; ELECTRIC CORDS; ELECTRICAL CONTROLLING DEVICES; ELECTRICAL POWER SUPPLIES; UNINTERRUPTED POWER SUPPLIES; COMPUTER CABLES; COMPUTER HARDWARE;

ELECTRIC METERS, IN CLASS 9 (U.S. CLS. 21, 23, 26, 36 AND 38).

FIRST USE 5-1-1995; IN COMMERCE 5-1-1995.

OWNER OF U.S. REG. NO. 2,106,330.

NO CLAIM IS MADE TO THE EXCLUSIVE RIGHT TO USE "COOLER", APART FROM THE MARK AS SHOWN.

THE MARK CONSISTS OF THE WORDS "COOLER" OVER THE WORD "MASTER." A THICK LINE SURROUNDS THE WORDING.

SER. NO. 77-224,370, FILED 7-9-2007.

TARAH HARDY, EXAMINING ATTORNEY

Int. Cls.: 36 and 41

Prior U.S. Cls.: 100, 101, 102 and 107

United States Patent and Trademark Office

Reg. No. 3,483,405

Registered Aug. 12, 2008

**SERVICE MARK
PRINCIPAL REGISTER**



EQUITYKEY LLC (DELAWARE LTD LIAB CO)
4TH FLOOR
8880 RIO SAN DIEGO
SAN DIEGO, CA 92018

FOR: FINANCIAL SERVICES, NAMELY, REAL ESTATE INVESTMENT, IN CLASS 36 (U.S. CLS. 100, 101 AND 102).

FIRST USE 11-1-2006; IN COMMERCE 11-1-2006.

FOR: TRAINING OF LICENSED REAL ESTATE BROKERS IN REAL ESTATE INVESTMENT, IN CLASS 41 (U.S. CLS. 100, 101 AND 107).

FIRST USE 5-15-2007; IN COMMERCE 5-15-2007.

NO CLAIM IS MADE TO THE EXCLUSIVE RIGHT TO USE "EQUITY" AND "CERTIFIED BROKER", APART FROM THE MARK AS SHOWN.

SER. NO. 77-224,392, FILED 7-9-2007.

GEOFFREY FOSDICK, EXAMINING ATTORNEY

Int. Cl.: 33

Prior U.S. Cls.: 47 and 49

United States Patent and Trademark Office

Reg. No. 3,483,406

Registered Aug. 12, 2008

**TRADEMARK
PRINCIPAL REGISTER**

MARQUÉS DE VIDIAGO

INTERTRADE BEVERAGES, LLC (FLORIDA
LTD LIAB CO)
8105 N.W. 77 STREET
MIAMI, FL 33166

FOR: WINES, IN CLASS 33 (U.S. CLS. 47 AND 49).

FIRST USE 4-0-2006; IN COMMERCE 11-0-2006.

THE MARK CONSISTS OF STANDARD CHAR-
ACTERS WITHOUT CLAIM TO ANY PARTICULAR
FONT, STYLE, SIZE, OR COLOR.

THE NAME "MARQUES DE VIDIAGO" DOES
NOT IDENTIFY A LIVING INDIVIDUAL.

THE ENGLISH TRANSLATION OF THE WORD
"MARQUES DE VIDIAGO" IN THE MARK IS
MARQUIS OF VIDIAGO.

SER. NO. 77-224,394, FILED 7-9-2007.

COLLEEN DOMBROW, EXAMINING ATTORNEY

Int. Cl.: 35

Prior U.S. Cls.: 100, 101 and 102

United States Patent and Trademark Office

Reg. No. 3,483,407

Registered Aug. 12, 2008

SERVICE MARK
PRINCIPAL REGISTER



CITY OF NEW BERN (NORTH CAROLINA MUNICIPAL CORPORATION)

ATTN. CITY MANAGER

300 POLLOCK STREET

NEW BERN, NC 28560

FOR: PROMOTING PUBLIC AWARENESS OF THE CELEBRATION OF THE 300TH ANNIVERSARY OF THE FOUNDING OF NEW BERN, NORTH CAROLINA, IN CLASS 35 (U.S. CLS. 100, 101 AND 102).

FIRST USE 11-1-2005; IN COMMERCE 11-1-2005.

NO CLAIM IS MADE TO THE EXCLUSIVE RIGHT TO USE "300TH ANNIVERSARY", "1710" AND "2010" AND "NEW BERN NORTH CAROLINA", APART FROM THE MARK AS SHOWN.

THE COLOR(S) RED, WHITE, BLACK, AND YELLOW IS/ARE CLAIMED AS A FEATURE OF THE MARK.

THE MARK CONSISTS OF A BLACK BEAR ON A RED AND YELLOW CREST WITH THE DATES "1710" AND "2010" IN BLACK ON A WHITE BACKGROUND AND "ANNIVERSARY" APPEARS IN RED ON A WHITE BACKGROUND OVERTOP THE BEAR; THE WORDING "300TH" APPEARS IN WHITE ON A RED BANNER ABOVE THE BEAR DESIGN; "NEW BERN NORTH CAROLINA" APPEARS IN WHITE BELOW THE DESIGN; THE BACKGROUND IS BLACK WITH AN INSIDE YELLOW BORDER.

SER. NO. 77-224,513, FILED 7-9-2007.

KAREN K. BUSH, EXAMINING ATTORNEY

Int. Cl.: 44

Prior U.S. Cls.: 100 and 101

United States Patent and Trademark Office

Reg. No. 3,483,408

Registered Aug. 12, 2008

**SERVICE MARK
PRINCIPAL REGISTER**

PAWSATIVELY PURRFECT

PAWSATIVELY PURRFECT, INC. (GEORGIA CORPORATION)

#130

7380 SPOUT SPRINGS ROAD
FLOWERY BRANCH, GA 30542

FOR: ANIMAL GROOMING; PET CARE SERVICES, NAMELY, DOG WALKING, DOG BATHING AND NON-MEDICATED PET GROOMING, IN CLASS 44 (U.S. CLS. 100 AND 101).

FIRST USE 1-2-2000; IN COMMERCE 1-2-2000.

THE MARK CONSISTS OF STANDARD CHARACTERS WITHOUT CLAIM TO ANY PARTICULAR FONT, STYLE, SIZE, OR COLOR.

SER. NO. 77-224,559, FILED 7-9-2007.

TARAH HARDY, EXAMINING ATTORNEY

Int. Cl.: 35

Prior U.S. Cls.: 100, 101 and 102

United States Patent and Trademark Office

Reg. No. 3,483,409

Registered Aug. 12, 2008

**SERVICE MARK
PRINCIPAL REGISTER**



IMPINJ, INC. (DELAWARE CORPORATION)
701 NORTH 34TH STREET, SUITE 300
SEATTLE, WA 98103

FOR: ARRANGING AND CONDUCTING TRADE
SHOWS FOR THE SEMI-CONDUCTOR INDUSTRY
ON DESIGNING NEW ELECTRONICS PRODUCTS,
IN CLASS 35 (U.S. CLS. 100, 101 AND 102).

FIRST USE 3-0-2007; IN COMMERCE 3-0-2007.

NO CLAIM IS MADE TO THE EXCLUSIVE
RIGHT TO USE "LOGIC NVM", APART FROM
THE MARK AS SHOWN.

THE MARK CONSISTS OF THE WORDS "LOGIC
NVM" WITH FOUR ROWS OF BLOCKS TO THE
LEFT OF THE WORDS.

SER. NO. 77-224,575, FILED 7-9-2007.

DAVID C. REIHNER, EXAMINING ATTORNEY

Int. Cl.: 21

Prior U.S. Cls.: 2, 13, 23, 29, 30, 33, 40 and 50

Reg. No. 3,483,410

United States Patent and Trademark Office

Registered Aug. 12, 2008

**TRADEMARK
PRINCIPAL REGISTER**

NEXSTEP

NEXSTEP COMMERCIAL PRODUCTS, LLC
(OHIO LTD LIAB CO)
625 BURT STREET
SPRINGFIELD, OH 45505

FOR: WASHING BRUSHES; FINGERNAIL BRUSHES; WIRE BRUSHES NOT BEING PARTS OF MACHINES; GROUT BRUSHES; BRUSHES FOR CLEANING COFFEE DECANTERS AND FRYERS USED FOR COOKING; PASTRY BRUSHES; BRUSHES FOR BASTING FOOD; HOLDERS FOR THE FOREGOING BRUSHES; BUCKETS; WRINGER ATTACHMENTS FOR BUCKETS; BROOMS AND PARTS THEREOF, NAMELY, METAL AND NON-METAL BROOM HANDLES SOLD AS A UNIT; CLOTHS FOR WIPING OR DUSTING; DUST PANS; MOPS AND PARTS THEREOF, NAMELY, METAL AND NON-METAL MOP HANDLES SOLD AS A UNIT; MOP HEADS; SQUEEGEES; CLEANING SPONGES; NON-ELECTRICAL CARPET AND

HARDWOOD FLOOR SWEEPERS; CLEANING PADS FOR NON-ELECTRICAL CARPET AND HARDWOOD FLOOR SWEEPERS; COBWEB DUSTERS; NON-ELECTRICAL ELECTROSTATIC CLEANING DUSTERS; FEATHER DUSTERS FOR CLEANING; LAMB'S WOOL DUSTERS FOR CLEANING; PLUNGERS FOR CLEARING BLOCKED DRAINS; SCOURING PADS, IN CLASS 21 (U.S. CLS. 2, 13, 23, 29, 30, 33, 40 AND 50).

FIRST USE 7-9-2007; IN COMMERCE 8-26-2007.

THE MARK CONSISTS OF STANDARD CHARACTERS WITHOUT CLAIM TO ANY PARTICULAR FONT, STYLE, SIZE, OR COLOR.

SER. NO. 77-224,598, FILED 7-9-2007.

JENNIFER MARTIN, EXAMINING ATTORNEY

Int. Cl.: 41

Prior U.S. Cls.: 100, 101 and 107

United States Patent and Trademark Office

Reg. No. 3,483,411

Registered Aug. 12, 2008

**SERVICE MARK
PRINCIPAL REGISTER**

HEALTHWAYS

HEALTHWAYS, INC. (DELAWARE CORPORATION)
SUITE 300
3841 GREEN HILLS VILLAGE DRIVE
NASHVILLE, TN 37215

FOR: EDUCATIONAL SERVICES, NAMELY, PROVIDING COURSES OF INSTRUCTION IN THE HEALTH CARE FIELD FEATURING DISEASE MANAGEMENT, IN CLASS 41 (U.S. CLS. 100, 101 AND 107).

FIRST USE 9-0-2005; IN COMMERCE 9-0-2005.

THE MARK CONSISTS OF STANDARD CHARACTERS WITHOUT CLAIM TO ANY PARTICULAR FONT, STYLE, SIZE, OR COLOR.

OWNER OF U.S. REG. NOS. 3,226,699 AND 3,294,917.

SER. NO. 77-224,784, FILED 7-9-2007.

DEZMONA MIZELLE, EXAMINING ATTORNEY

Int. Cl.: 44

Prior U.S. Cls.: 100 and 101

United States Patent and Trademark Office

Reg. No. 3,483,412

Registered Aug. 12, 2008

**SERVICE MARK
PRINCIPAL REGISTER**

HEALTHWAYS

HEALTHWAYS, INC. (DELAWARE CORPORATION)
SUITE 300
3841 GREEN HILLS VILLAGE DRIVE
NASHVILLE, TN 37215

FOR: PROVIDING INFORMATION AND ADVICE
ON HEALTH AND HEALTH-RELATED ISSUES VIA
A GLOBAL COMMUNICATION NETWORK AND
TELEPHONE, IN CLASS 44 (U.S. CLS. 100 AND 101).

FIRST USE 9-0-2005; IN COMMERCE 9-0-2005.

THE MARK CONSISTS OF STANDARD CHARACTERS WITHOUT CLAIM TO ANY PARTICULAR FONT, STYLE, SIZE, OR COLOR.

OWNER OF U.S. REG. NOS. 3,226,699 AND 3,294,917.

SER. NO. 77-224,787, FILED 7-9-2007.

DEZMONA MIZELLE, EXAMINING ATTORNEY

Int. Cl.: 44

Prior U.S. Cls.: 100 and 101

United States Patent and Trademark Office

Reg. No. 3,483,413

Registered Aug. 12, 2008

**SERVICE MARK
PRINCIPAL REGISTER**

HEALTHWAYS

HEALTHWAYS, INC. (DELAWARE CORPORATION)
SUITE 300
3841 GREEN HILLS VILLAGE DRIVE
NASHVILLE, TN 37215

FOR: HEALTH INFORMATION SERVICES, NAMELY, GENERATING AND MAINTAINING FILES AND PERSONAL MEDICAL HISTORY RECORDS FOR PATIENTS AND HEALTHCARE PROVIDERS; HEALTH MONITORING SERVICES BY WHICH HEALTH CARE PROFESSIONALS CAN MONITOR AND TRACK THROUGH REMOTE AND NON-REMOTE MEANS THE CURRENT HEALTH STATUS OF PATIENTS; PROVIDING CONSULTATION AND INFORMATION SERVICES FOR PATIENTS, PHYSICIANS AND CAREGIVERS IN THE FIELDS OF HEALTHCARE, NUTRITION,

DISEASE PROCESSES, SELF-GUIDED HEALTH CARE TREATMENT AND SELF-GUIDED DISEASE MANAGEMENT, IN CLASS 44 (U.S. CLS. 100 AND 101).

FIRST USE 9-0-2005; IN COMMERCE 9-0-2005.

THE MARK CONSISTS OF STANDARD CHARACTERS WITHOUT CLAIM TO ANY PARTICULAR FONT, STYLE, SIZE, OR COLOR.

OWNER OF U.S. REG. NOS. 3,226,699 AND 3,294,917.

SER. NO. 77-224,788, FILED 7-9-2007.

DEZMONA MIZELLE, EXAMINING ATTORNEY

Int. Cl.: 9

Prior U.S. Cls.: 21, 23, 26, 36 and 38

United States Patent and Trademark Office

Reg. No. 3,483,414

Registered Aug. 12, 2008

**TRADEMARK
PRINCIPAL REGISTER**

WIMBERLEY

WIMBERLEY, INC. (VIRGINIA CORPORATION)
974 BAKER LANE
WINCHESTER, VA 22603

FOR: PHOTOGRAPHIC EQUIPMENT AND ACCESSORIES, NAMELY, TRIPOD HEADS, TRIPODS, QUICK RELEASE SYSTEMS FOR MOUNTING CAMERAS AND LENSES, FLASH BRACKETS AND FLASH SUPPORTS, STABILIZING ADAPTERS AND CONNECTORS FOR CAMERA LENSES AND CAMERA BODIES, REPLACEMENT PARTS FOR CAMERA LENSES AND CAMERA BODIES, AND DEVICES FOR HOLDING THE SUBJECTS OF PHOTOGRAPHS AND ACCESSORIES USED DURING PHOTO SESSIONS, NAMELY, GRAY CARDS, RE-

FLECTORS AND BACKGROUND SHEETS, IN CLASS 9 (U.S. CLS. 21, 23, 26, 36 AND 38).

FIRST USE 12-31-1991; IN COMMERCE 12-31-1991.

THE MARK CONSISTS OF STANDARD CHARACTERS WITHOUT CLAIM TO ANY PARTICULAR FONT, STYLE, SIZE, OR COLOR.

OWNER OF U.S. REG. NO. 3,081,797.

SEC. 2(F).

SER. NO. 77-224,911, FILED 7-9-2007.

DAVID C. REIHNER, EXAMINING ATTORNEY

Int. Cl.: 22

Prior U.S. Cls.: 1, 2, 7, 19, 22, 42 and 50

United States Patent and Trademark Office

Reg. No. 3,483,415

Registered Aug. 12, 2008

**TRADEMARK
PRINCIPAL REGISTER**



REAVES & COMPANY, INC. (NORTH CAROLINA CORPORATION)
4527 HILLSBOROUGH ROAD
DURHAM, NC 277052341

NO CLAIM IS MADE TO THE EXCLUSIVE RIGHT TO USE "BUTYL", APART FROM THE MARK AS SHOWN.

FOR: DROP CLOTHS, IN CLASS 22 (U.S. CLS. 1, 2, 7, 19, 22, 42 AND 50).

SER. NO. 77-224,990, FILED 7-9-2007.

FIRST USE 0-0-2003; IN COMMERCE 0-0-2003.

OWNER OF U.S. REG. NO. 3,385,161.

JACLYN KIDWELL, EXAMINING ATTORNEY

Int. Cl.: 9

Prior U.S. Cls.: 21, 23, 26, 36 and 38

United States Patent and Trademark Office

Reg. No. 3,483,416

Registered Aug. 12, 2008

**TRADEMARK
PRINCIPAL REGISTER**

SIDEKICK

WIMBERLEY, INC. (VIRGINIA CORPORATION)
974 BAKER LANE
WINCHESTER, VA 22603

THE MARK CONSISTS OF STANDARD CHAR-
ACTERS WITHOUT CLAIM TO ANY PARTICULAR
FONT, STYLE, SIZE, OR COLOR.

FOR: PHOTOGRAPHIC EQUIPMENT AND AC-
CESSORIES, NAMELY, TRIPOD HEAD CONVER-
TERS, IN CLASS 9 (U.S. CLS. 21, 23, 26, 36 AND 38).

SER. NO. 77-224,992, FILED 7-9-2007.

FIRST USE 1-31-1998; IN COMMERCE 1-31-1998.

DAVID C. REIHNER, EXAMINING ATTORNEY

Int. Cls.: 35 and 39

Prior U.S. Cls.: 100, 101, 102 and 105

United States Patent and Trademark Office

Reg. No. 3,483,417

Registered Aug. 12, 2008

**SERVICE MARK
PRINCIPAL REGISTER**

JC MOTORS

JC MOTORS (CALIFORNIA CORPORATION)
16591 NOYES AVENUE
IRVINE, CA 92606

FOR: ONLINE RETAIL STORE SERVICES AND
RETAIL STORE SERVICES FEATURING MOTOR-
CYCLES, MOTORCYCLE PARTS, MOTORCYCLE
ACCESSORIES, IN CLASS 35 (U.S. CLS. 100, 101 AND
102).

FIRST USE 7-0-1994; IN COMMERCE 7-0-1994.

FOR: MOTORCYCLE TRANSPORTATION SER-
VICES, NAMELY, TRANSPORTING MOTOR-
CYCLES VIA TRUCK, BOAT AND AIR, IN CLASS
39 (U.S. CLS. 100 AND 105).

FIRST USE 7-0-1994; IN COMMERCE 7-0-1994.

THE MARK CONSISTS OF STANDARD CHAR-
ACTERS WITHOUT CLAIM TO ANY PARTICULAR
FONT, STYLE, SIZE, OR COLOR.

NO CLAIM IS MADE TO THE EXCLUSIVE
RIGHT TO USE "MOTORS", APART FROM THE
MARK AS SHOWN.

SER. NO. 77-224,996, FILED 7-9-2007.

HENRY S. ZAK, EXAMINING ATTORNEY

Int. Cls.: 35 and 39

Prior U.S. Cls.: 100, 101, 102 and 105

United States Patent and Trademark Office

Reg. No. 3,483,418

Registered Aug. 12, 2008

**SERVICE MARK
PRINCIPAL REGISTER**

WHERE RIDERS GET DEALS

JC MOTORS (CALIFORNIA CORPORATION)
16591 NOYES AVENUE
IRVINE, CA 92606

FOR: ONLINE RETAIL STORE SERVICES AND
RETAIL STORE SERVICES FEATURING MOTOR-
CYCLES, MOTORCYCLE PARTS, MOTORCYCLE
ACCESSORIES, IN CLASS 35 (U.S. CLS. 100, 101 AND
102).

FIRST USE 6-0-2006; IN COMMERCE 6-0-2006.

FOR: MOTORCYCLE TRANSPORTATION SER-
VICES, NAMELY, TRANSPORTING MOTOR-

CYCLES VIA TRUCK, BOAT AND AIR, IN CLASS
39 (U.S. CLS. 100 AND 105).

FIRST USE 6-0-2006; IN COMMERCE 6-0-2006.

THE MARK CONSISTS OF STANDARD CHAR-
ACTERS WITHOUT CLAIM TO ANY PARTICULAR
FONT, STYLE, SIZE, OR COLOR.

SER. NO. 77-225,008, FILED 7-9-2007.

HENRY S. ZAK, EXAMINING ATTORNEY

Int. Cl.: 18

Prior U.S. Cls.: 1, 2, 3, 22 and 41

United States Patent and Trademark Office

Reg. No. 3,483,419

Registered Aug. 12, 2008

**TRADEMARK
PRINCIPAL REGISTER**



AZAR TRADING INC. (CANADA CORPORATION)
125 RIVER ST
TORONTO, CANADA M5A3P5

FOR: DOG CLOTHING, NAMELY, FOOTWEAR,
JACKETS, VESTS, RAIN COATS, SADDLE BAGS;
DOG AND CAT COLLARS AND LEASHES, NAME-

LY, GLOW IN THE DARK LEASHES, IN CLASS 18
(U.S. CLS. 1, 2, 3, 22 AND 41).

FIRST USE 10-15-1995; IN COMMERCE 11-15-1995.

SER. NO. 77-225,193, FILED 7-9-2007.

ANDREA HACK, EXAMINING ATTORNEY

Int. Cl.: 35

Prior U.S. Cls.: 100, 101 and 102

United States Patent and Trademark Office

Reg. No. 3,483,420

Registered Aug. 12, 2008

**SERVICE MARK
PRINCIPAL REGISTER**

Coastal Behring

COASTAL BEHRING INTERNATIONAL, LLC
(DELAWARE LTD LIAB CO)
3318 FOSTER AVENUE
BALTIMORE, MD 21224

FOR: BUSINESS ADMINISTRATION AND MANAGEMENT; BUSINESS MANAGEMENT; MANAGEMENT AND BUSINESS CONSULTING SERVICES IN THE FIELD OF INDUSTRIAL MANUFACTURING, IN CLASS 35 (U.S. CLS. 100, 101 AND 102).

FIRST USE 7-1-2007; IN COMMERCE 7-1-2007.

THE MARK CONSISTS OF STANDARD CHARACTERS WITHOUT CLAIM TO ANY PARTICULAR FONT, STYLE, SIZE, OR COLOR.

SER. NO. 77-225,357, FILED 7-9-2007.

LYDIA BELZER, EXAMINING ATTORNEY

Int. Cl.: 36

Prior U.S. Cls.: 100, 101 and 102

United States Patent and Trademark Office

Reg. No. 3,483,421

Registered Aug. 12, 2008

**SERVICE MARK
PRINCIPAL REGISTER**

EAGLES LANDING

EAGLES LANDING VENTURES LLC (TENNESSEE LTD LIAB CO)
SUITE 115
7901 STRICKLAND ROAD
RALEIGH, NC 27615

FOR: APARTMENT HOUSE MANAGEMENT;
LEASING OF APARTMENTS; RENTAL OF APARTMENTS, IN CLASS 36 (U.S. CLS. 100, 101 AND 102).

FIRST USE 12-31-2005; IN COMMERCE 12-31-2005.

THE MARK CONSISTS OF STANDARD CHARACTERS WITHOUT CLAIM TO ANY PARTICULAR FONT, STYLE, SIZE, OR COLOR.

SER. NO. 77-225,382, FILED 7-10-2007.

WARREN L. OLANDRIA, EXAMINING ATTORNEY

Int. Cl.: 41

Prior U.S. Cls.: 100, 101 and 107

United States Patent and Trademark Office

Reg. No. 3,483,422

Registered Aug. 12, 2008

SERVICE MARK
PRINCIPAL REGISTER



RED HOUSE STUDIOS, INC. (CALIFORNIA CORPORATION)
1667 BOTELHO DRIVE
WALNUT CREEK, CA 94596

FOR: ENTERTAINMENT IN THE NATURE OF VISUAL AND AUDIO PERFORMANCES, NAMELY, MUSICAL ENSEMBLES AND SOLOISTS; ENTERTAINMENT, NAMELY, LIVE PERFORMANCES BY A MUSICAL ENSEMBLES AND SOLOISTS; ENTERTAINMENT, NAMELY, LIVE MUSIC CONCERTS; MUSIC PRODUCTION SERVICES; PRESENTATION OF MUSICAL PERFORMANCE; PRODUCTION OF SOUND AND MUSIC VIDEO RECORDINGS; PROVIDING FACILITIES FOR MOVIES, SHOWS, PLAYS, MUSIC OR EDUCATIONAL TRAINING; TEACHING IN THE FIELD OF MODERN MUSIC, NAMELY, GUITAR, BASS, DRUMS, VOCALS, PIANO/KEYBOARDS, FOLK INSTRUMENTS, NAMELY, BANJO, MANDOLIN, FIDDLE AND HORNS; PROVIDING AUDIO OR VIDEO STUDIOS; RECORDING STUDIOS; SOUND RECORDING STUDIOS; EDUCATION SERVICES, NAMELY,

PROVIDING TUTORIAL SESSIONS IN THE FIELD OF MUSIC, IN CLASS 41 (U.S. CLS. 100, 101 AND 107).

FIRST USE 9-17-2005; IN COMMERCE 9-17-2005.

THE COLOR(S) RED AND BLACK IS/ARE CLAIMED AS A FEATURE OF THE MARK.

THE MARK CONSISTS OF THE WORDS "RED HOUSE" IN SCRIPT WRITING AT A SLIGHT UPWARD SLOPE. THE LIKENESS OF A GUITAR CABLE EXTENDS FROM THE BASE OF THE LETTER "H". THE COLOR RED APPEARS IN THE WORDING "RED", AND THE COLOR BLACK APPEARS IN THE WORDING "HOUSE" AND IN THE DESIGN OF THE IMAGE OF A GUITAR CABLE.

SER. NO. 77-225,416, FILED 7-10-2007.

NAKWAMA ANKRAH, EXAMINING ATTORNEY

Int. Cl.: 9

Prior U.S. Cls.: 21, 23, 26, 36 and 38

Reg. No. 3,483,423

United States Patent and Trademark Office

Registered Aug. 12, 2008

**TRADEMARK
PRINCIPAL REGISTER**

InSync

MACRO 4, PLC (ENGLAND CORPORATION)
THE ORANGERY, TURNERSHILL ROAD
CRAWLEY, WEST SUSSEX, UNITED KINGDOM
RH104SS

FOR: COMPUTER SOFTWARE FOR DEBUG-
GING AND ANALYZING MAINFRAME APPLICA-
TIONS BY MANIPULATING, BROWSING,
COMPARING, AND FORMATTING DATA AND
FILES WHICH ARE USED BY SUCH MAINFRAME
APPLICATIONS, IN CLASS 9 (U.S. CLS. 21, 23, 26, 36
AND 38).

FIRST USE 6-21-1983; IN COMMERCE 6-21-1983.

THE MARK CONSISTS OF STANDARD CHAR-
ACTERS WITHOUT CLAIM TO ANY PARTICULAR
FONT, STYLE, SIZE, OR COLOR.

SER. NO. 77-225,488, FILED 7-10-2007.

KAPIL BHANOT, EXAMINING ATTORNEY

Int. Cl.: 20

Prior U.S. Cls.: 2, 13, 22, 25, 32 and 50

Reg. No. 3,483,424

United States Patent and Trademark Office

Registered Aug. 12, 2008

**TRADEMARK
PRINCIPAL REGISTER**

COMFY K9

COMFY K9, LLC (OHIO LTD LIAB CO)
7105 SHERWOOD COURT
CIRCLEVILLE, OH 43113

FOR: DOG BEDS, IN CLASS 20 (U.S. CLS. 2, 13, 22,
25, 32 AND 50).

FIRST USE 3-27-2006; IN COMMERCE 5-1-2006.

THE MARK CONSISTS OF STANDARD CHAR-
ACTERS WITHOUT CLAIM TO ANY PARTICULAR
FONT, STYLE, SIZE, OR COLOR.

NO CLAIM IS MADE TO THE EXCLUSIVE
RIGHT TO USE "K9", APART FROM THE MARK
AS SHOWN.

SER. NO. 77-225,669, FILED 7-10-2007.

BARBARA GAYNOR, EXAMINING ATTORNEY

Int. Cl.: 3

Prior U.S. Cls.: 1, 4, 6, 50, 51 and 52

United States Patent and Trademark Office

Reg. No. 3,483,425

Registered Aug. 12, 2008

**TRADEMARK
PRINCIPAL REGISTER**

NEVADO

FABRICA DE JABON LA REINERA, S.A. (MEX-
ICO CORPORATION)
COL. INDUSTRIAL
PEDRO CELESTINO NEGRETE 31212 PTE.
MONTERREY, N:L., MEXICO

FOR: BLEACHING PREPARATIONS, LAUNDRY
DETERGENT, FABRIC SOFTENERS, WASHING
POWDER FOR LAUNDRY USE; CLEANING PRE-
PARATIONS, NAMELY, ABRASIVE, POLISHING
AND WASHING PREPARATIONS IN THE NATURE
OF LIQUIDS AND POWDERS; SOAPS, NAMELY,
SOAPS FOR HOUSEHOLD USE; PERFUMERY, ES-
SENTIAL OILS, HAIR LOTIONS; TOOTHPASTE,
AND CHEMICAL CLEANERS FOR DOMESTIC
USE, NAMELY, GLASS CLEANERS, HOUSEHOLD
CLEANING PREPARATIONS AND ALL PURPOSE
CLEANERS, IN CLASS 3 (U.S. CLS. 1, 4, 6, 50, 51 AND
52).

THE MARK CONSISTS OF STANDARD CHAR-
ACTERS WITHOUT CLAIM TO ANY PARTICULAR
FONT, STYLE, SIZE, OR COLOR.

OWNER OF MEXICO REG. NO. 287031, DATED 5-
3-1983, RENEWED AS REG. NO. 287031, DATED 2-27-
1986, EXPIRES 2-27-2011.

THE FOREIGN WORDING IN THE MARK
TRANSLATES INTO ENGLISH AS SNOW COV-
ERED MOUNTAIN.

SER. NO. 77-225,960, FILED 7-10-2007.

C. DIONNE CLYBURN, EXAMINING ATTORNEY

Int. Cl.: 45

Prior U.S. Cls.: 100 and 101

United States Patent and Trademark Office

Reg. No. 3,483,426

Registered Aug. 12, 2008

**SERVICE MARK
PRINCIPAL REGISTER**

Roughneck Security System

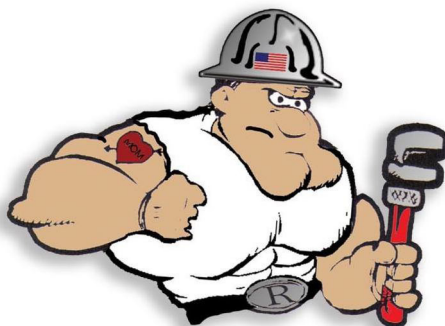

RANCHERS PIPE & STEEL CORPORATION (OK-LAHOMA CORPORATION)
7105 E. ADMIRAL PLACE
TULSA, OK 74115

FOR: MONITORING BURGLAR AND SECURITY ALARMS, IN CLASS 45 (U.S. CLS. 100 AND 101).

FIRST USE 6-1-2007; IN COMMERCE 6-1-2007.

NO CLAIM IS MADE TO THE EXCLUSIVE RIGHT TO USE "SECURITY SYSTEM", APART FROM THE MARK AS SHOWN.

THE COLOR(S) BEIGE, WHITE, GRAY, RED BLUE, BLACK IS/ARE CLAIMED AS A FEATURE OF THE MARK.

THE MARK CONSISTS OF CARTOON HEAVY-WEIGHT MALE FIGURE APPEARING IN BEIGE COLOR TONE FROM WAIST UP WEARING A WHITE SLEEVELESS SHIRT. ALSO WEARING A GRAY HARD HAT WITH THE AMERICAN FLAG APPEARING IN RED, WHITE, AND BLUE SHOWN UPON THE HAT. THE FIGURE IS WEARING A BLACK STRAPPED BELT WITH A GRAY BELT BUCKLE DISPLAYING THE LETTER "R" IN BLACK PRINT. THE FIGURE IS HOLDING A GRAY AND RED WRENCH. THERE IS A RED HEART SHAPED TATTOO WITH THE WORD, "MOM" ON THE RIGHT ARM.

SER. NO. 77-225,968, FILED 7-10-2007.

C. DIONNE CLYBURN, EXAMINING ATTORNEY

Int. Cl.: 9

Prior U.S. Cls.: 21, 23, 26, 36 and 38

Reg. No. 3,483,427

United States Patent and Trademark Office

Registered Aug. 12, 2008

**TRADEMARK
PRINCIPAL REGISTER**



EDMUND OPTICS, INC. (NEW JERSEY CORPORATION)
101 E. GLOUCESTER PIKE
BARRINGTON, NJ 080071380

FOR: OPTICAL COMPONENTS AND ASSEMBLIES FOR USE IN INDUSTRIAL APPLICATIONS, NAMELY, CAMERAS; SPECTROMETERS; MICROSCOPES; EYEPIECE ADAPTERS; POLARIZERS; FILTERS; MIRRORS; LENSES; LENS ASSEMBLIES; LENS KITS; ACHROMATS; OPTICAL MOUNTS; ILLUMINATION SOURCES, NAMELY ILLUMINATORS, ACCESSORY LENSES/FILTERS, LIGHT GUIDES, RING LIGHTS, DARK FIELD ATTACHMENTS, DIFFUSE AXIAL ADAPTERS, BACK LIGHTS, LED ILLUMINATION/STROBES AND FLUORESCENT SOURCES; MAGNIFICATION SYSTEMS CONSISTING OF OPTICAL INSPECTION OR IMAGING SYSTEMS, COMPRISED OF OPTICS, A CAMERA AND RELATED SOFTWARE, FOR THE

PURPOSE OF IMAGE MAGNIFICATION, CALIBRATION, RESOLUTION, FIELD OR VIEW, DISTORTION, OR RELATED INSPECTION; AND OPTICS TEST EQUIPMENT, NAMELY, LENSES, CAMERAS, SOFTWARE, TARGETS, RONCHI RULINGS, AND MICROMETERS, IN CLASS 9 (U.S. CLS. 21, 23, 26, 36 AND 38).

FIRST USE 12-31-2003; IN COMMERCE 12-31-2003.

OWNER OF U.S. REG. NO. 2,549,839.

THE MARK CONSISTS OF THE LETTERS EO STYLIZED.

SER. NO. 77-226,111, FILED 7-10-2007.

STEVEN R. FINE, EXAMINING ATTORNEY

Int. Cl.: 9

Prior U.S. Cls.: 21, 23, 26, 36 and 38

United States Patent and Trademark Office

Reg. No. 3,483,428

Registered Aug. 12, 2008

**TRADEMARK
PRINCIPAL REGISTER**

EDMUND OPTICS

EDMUND OPTICS, INC. (NEW JERSEY CORPORATION)
101 E. GLOUCESTER PIKE
BARRINGTON, NJ 080071380

FOR: OPTICAL COMPONENTS AND ASSEMBLIES FOR USE IN INDUSTRIAL APPLICATIONS, NAMELY, CAMERAS; SPECTROMETERS; MICROSCOPES; EYEPIECE ADAPTERS; POLARIZERS; FILTERS; MIRRORS; LENSES; LENS ASSEMBLIES; LENS KITS; ACHROMATS; OPTICAL MOUNTS; ILLUMINATION SOURCES, NAMELY, ILLUMINATORS, ACCESSORY LENSES/FILTERS, LIGHT GUIDES, RING LIGHTS, DARK FIELD ATTACHMENTS, DIFFUSE AXIAL ADAPTERS, BACK LIGHTS, LED ILLUMINATION/STROBES AND FLUORESCENT SOURCES; MAGNIFICATION SYSTEMS CONSISTING OF OPTICAL INSPECTION OR IMAGING SYSTEMS, COMPRISED OF OPTICS, A CAMERA AND RELATED SOFTWARE, FOR THE PURPOSE OF IMAGE MAGNIFICATION, CALIBRATION, RESOLUTION, FIELD OR VIEW, DISTORTION, OR RELATED INSPECTION; AND

OPTICS TEST EQUIPMENT, NAMELY, LENSES, CAMERAS, SOFTWARE, TARGETS, RONCHI RULINGS, AND MICROMETERS, IN CLASS 9 (U.S. CLS. 21, 23, 26, 36 AND 38).

FIRST USE 12-31-2003; IN COMMERCE 12-31-2003.

THE MARK CONSISTS OF STANDARD CHARACTERS WITHOUT CLAIM TO ANY PARTICULAR FONT, STYLE, SIZE, OR COLOR.

OWNER OF U.S. REG. NOS. 2,558,597, 3,090,170, AND 3,095,767.

NO CLAIM IS MADE TO THE EXCLUSIVE RIGHT TO USE "OPTICS", APART FROM THE MARK AS SHOWN.

SER. NO. 77-226,120, FILED 7-10-2007.

STEVEN R. FINE, EXAMINING ATTORNEY

Int. Cls.: 35 and 44

Prior U.S. Cls.: 100, 101 and 102

United States Patent and Trademark Office

Reg. No. 3,483,429

Registered Aug. 12, 2008

**SERVICE MARK
PRINCIPAL REGISTER**

MATERNITYMALL.COM

CAVE SPRINGS, INC. (DELAWARE CORPORATION)
2751 CENTERVILLE ROAD
WILMINGTON, DE 19808

FOR: COMPUTERIZED ON-LINE RETAIL STORE SERVICES FEATURING MATERNITY PRODUCTS, INFANT WEAR, INFANT PRODUCTS, AND PROMOTING THE SERVICES OF OTHERS BY MEANS OF OPERATING AN ON-LINE SHOPPING MALL WITH LINKS TO THE RETAIL WEB SITES OF OTHERS, IN CLASS 35 (U.S. CLS. 100, 101 AND 102).

FIRST USE 1-1-1999; IN COMMERCE 1-1-1999.

FOR: PROVIDING HEALTH CARE INFORMATION FOR WOMEN, CHILDREN AND FAMILIES

VIA A GLOBAL COMPUTER NETWORK, IN CLASS 44 (U.S. CLS. 100 AND 101).

FIRST USE 1-1-1999; IN COMMERCE 1-1-1999.

THE MARK CONSISTS OF STANDARD CHARACTERS WITHOUT CLAIM TO ANY PARTICULAR FONT, STYLE, SIZE, OR COLOR.

OWNER OF U.S. REG. NOS. 2,474,594 AND 2,551,236.

SEC. 2(F).

SER. NO. 77-226,169, FILED 7-10-2007.

LINDA E. BLOHM, EXAMINING ATTORNEY

Int. Cl.: 35

Prior U.S. Cls.: 100, 101 and 102

United States Patent and Trademark Office

Reg. No. 3,483,430

Registered Aug. 12, 2008

**SERVICE MARK
PRINCIPAL REGISTER**

**Making Media Part of the
Solution**

MASCOMM ASSOCIATES, LLC (WISCONSIN
LTD LIAB CO)
4510 REGENT STREET
MADISON, WI 53705

THE MARK CONSISTS OF STANDARD CHAR-
ACTERS WITHOUT CLAIM TO ANY PARTICULAR
FONT, STYLE, SIZE, OR COLOR.

FOR: BUSINESS CONSULTATION, IN CLASS 35
(U.S. CLS. 100, 101 AND 102).

SER. NO. 77-226,261, FILED 7-10-2007.

FIRST USE 9-1-1996; IN COMMERCE 9-1-1996.

WENDY JUN, EXAMINING ATTORNEY

Int. Cl.: 28

Prior U.S. Cls.: 22, 23, 38 and 50

United States Patent and Trademark Office

Reg. No. 3,483,431

Registered Aug. 12, 2008

**TRADEMARK
PRINCIPAL REGISTER**

SNAKE ESCAPE

MATTEL, INC. (DELAWARE CORPORATION)
M1-1518
333 CONTINENTAL BLVD.
EL SEGUNDO, CA 90245

FOR: TOYS, GAMES AND PLAYTHINGS, NAME-
LY, TOY VEHICLE PLAYSETS AND ACCESSORIES
THEREFOR, IN CLASS 28 (U.S. CLS. 22, 23, 38 AND
50).

FIRST USE 3-20-2008; IN COMMERCE 3-20-2008.

THE MARK CONSISTS OF STANDARD CHAR-
ACTERS WITHOUT CLAIM TO ANY PARTICULAR
FONT, STYLE, SIZE, OR COLOR.

OWNER OF U.S. REG. NO. 3,262,628.

NO CLAIM IS MADE TO THE EXCLUSIVE
RIGHT TO USE "SNAKE", APART FROM THE
MARK AS SHOWN.

SER. NO. 77-226,672, FILED 7-11-2007.

JUSTINE D. PARKER, EXAMINING ATTORNEY

Int. Cl.: 10

Prior U.S. Cls.: 26, 39 and 44

United States Patent and Trademark Office

Reg. No. 3,483,432

Registered Aug. 12, 2008

**TRADEMARK
PRINCIPAL REGISTER**

AUTOPLEX

STRYKER CORPORATION (MICHIGAN CORPORATION)
OFFICE OF THE GENERAL COUNSEL
2825 AIRVIEW BLVD.
KALAMAZOO, MI 49002

FOR: MEDICAL AND SURGICAL GOODS, NAMELY, MIXERS-AND-INJECTORS SOLD AS COMBINED UNITS FOR MIXING BONE CEMENT FOR INJECTION INTO LIVING TISSUE AND INJECTING THE BONE CEMENT INTO LIVING TISSUE AND REPLACEMENT PARTS THEREFOR, IN CLASS 10 (U.S. CLS. 26, 39 AND 44).

FIRST USE 4-7-2008; IN COMMERCE 4-7-2008.

THE MARK CONSISTS OF STANDARD CHARACTERS WITHOUT CLAIM TO ANY PARTICULAR FONT, STYLE, SIZE, OR COLOR.

OWNER OF U.S. REG. NO. 2,851,972.

SER. NO. 77-226,860, FILED 7-11-2007.

GEOFFREY FOSDICK, EXAMINING ATTORNEY

Int. Cls.: 41 and 42

Prior U.S. Cls.: 100, 101 and 107

United States Patent and Trademark Office

Reg. No. 3,483,433

Registered Aug. 12, 2008

**SERVICE MARK
PRINCIPAL REGISTER**



APOGEE INTERACTIVE, INC. (GEORGIA CORPORATION)
2100 EAST EXCHANGE PLACE, SUITE 100
TUCKER, GA 30084

FOR: PROVIDING ENERGY-RELATED TRAINING COURSES VIA THE INTERNET; PROVIDING A WEBSITE FEATURING TRAINING AND REFERENCE MATERIALS IN THE NATURE OF ONLINE NEWSLETTERS AND ENCYCLOPEDIAS IN THE FIELD OF ENERGY, IN CLASS 41 (U.S. CLS. 100, 101 AND 107).

FIRST USE 5-0-2006; IN COMMERCE 5-0-2006.

FOR: PROVIDING TEMPORARY USE OF ONLINE NON-DOWNLOADABLE SOFTWARE FOR ENERGY USE ANALYSIS AND MANAGEMENT, ENERGY BILLING QUESTION MANAGEMENT, CUSTOMER CONTACT MANAGEMENT REGARDING ENERGY CONSUMPTION, ENERGY FIELD AUDITS, AND CALCULATING ENERGY USAGE; DESIGN, CREATION, HOSTING, AND MAINTENANCE OF WEBSITES AND HOME PAGES FOR UTILITY COMPANIES; DESIGN, DEVELOPMENT AND IMPLEMENTATION OF SOFTWARE APPLICATIONS FOR UTILITY COMPANIES, IN CLASS 42 (U.S. CLS. 100 AND 101).

FIRST USE 5-0-2006; IN COMMERCE 5-0-2006.

OWNER OF U.S. REG. NO. 1,985,193.

NO CLAIM IS MADE TO THE EXCLUSIVE RIGHT TO USE "INTERACTIVE", APART FROM THE MARK AS SHOWN.

THE MARK CONSISTS OF THE WORD "APOGEE" WITH A GLOBE DESIGN FOR THE "O" ABOVE THE WORD "INTERACTIVE".

SER. NO. 77-227,086, FILED 7-11-2007.

MELISSA VALLILLO, EXAMINING ATTORNEY

Int. Cl.: 25

Prior U.S. Cls.: 22 and 39

United States Patent and Trademark Office

Reg. No. 3,483,434

Registered Aug. 12, 2008

**TRADEMARK
PRINCIPAL REGISTER**

RUGGED SHARK

GORDON BROTHERS WHOLESALE LLC (DELA-
WARE LTD LIAB CO)
101 HUNTINGTON AVENUE, 10TH FLOOR
BOSTON, MA 02199

OWNER OF U.S. REG. NOS. 2,526,161 AND
2,795,678.

FOR: FOOTWEAR, NAMELY, HIKING BOOTS
AND MOUNTAINEERING BOOTS, IN CLASS 25
(U.S. CLS. 22 AND 39).

NO CLAIM IS MADE TO THE EXCLUSIVE
RIGHT TO USE "RUGGED", APART FROM THE
MARK AS SHOWN.

FIRST USE 8-1-1996; IN COMMERCE 8-1-1996.

SER. NO. 77-227,168, FILED 7-11-2007.

THE MARK CONSISTS OF STANDARD CHAR-
ACTERS WITHOUT CLAIM TO ANY PARTICULAR
FONT, STYLE, SIZE, OR COLOR.

DANNEAN HETZEL, EXAMINING ATTORNEY

Int. Cl.: 35

Prior U.S. Cls.: 100, 101 and 102

United States Patent and Trademark Office

Reg. No. 3,483,435

Registered Aug. 12, 2008

**SERVICE MARK
PRINCIPAL REGISTER**

Prospect Technologies

PROSPECT TECHNOLOGIES INC. (D.C. CORPORATION)
2346 PROSPECT STREET, N.W.
WASHINGTON, DC 20007

FOR: PROVIDING A SECURED ACCESS DATABASE VIA THE INTERNET THROUGH WHICH DOCUMENTS AND IMAGES CAN BE VIEWED, ORGANIZED, COPIED AND PRINTED, IN CLASS 35 (U.S. CLS. 100, 101 AND 102).

FIRST USE 11-1-1995; IN COMMERCE 11-1-1995.

THE MARK CONSISTS OF STANDARD CHARACTERS WITHOUT CLAIM TO ANY PARTICULAR FONT, STYLE, SIZE, OR COLOR.

NO CLAIM IS MADE TO THE EXCLUSIVE RIGHT TO USE "TECHNOLOGIES", APART FROM THE MARK AS SHOWN.

SER. NO. 77-227,175, FILED 7-11-2007.

LINDA ORNDORFF, EXAMINING ATTORNEY

Int. Cls.: 1, 5, 42 and 45

**Prior U.S. Cls.: 1, 5, 6, 10, 18, 26, 44, 46, 51, 52, 100
and 101**

Reg. No. 3,483,436

United States Patent and Trademark Office

Registered Aug. 12, 2008

**TRADEMARK
SERVICE MARK
PRINCIPAL REGISTER**



SIGNA CHEMISTRY, INC. (DELAWARE CORPORATION)
SUITE 9E
530 EAST 76TH STREET
NEW YORK, NY 10021

FOR: CHEMICALS, NAMELY, ALKALI METALS IN COMBINATION WITH POROUS MATERIALS FOR USE AS CHEMICAL REAGENTS AND IN HYDROGEN GENERATION; CHEMICAL REAGENTS FOR NON-MEDICAL USE IN CHEMICAL RESEARCH, CHEMICAL SYNTHESIS, CHEMICAL REACTIONS, AND INDUSTRIAL PROCESSES; CHEMICAL PREPARATIONS FOR USE IN THE DESIGN AND DEVELOPMENT OF HYDROGEN FUELS; CHEMICALS FOR USE IN ENVIRONMENTAL REMEDIATION; CHEMICAL PRODUCTS FOR THE DESULFURIZATION OF PETROLEUM, IN CLASS 1 (U.S. CLS. 1, 5, 6, 10, 26 AND 46).

FIRST USE 3-0-2005; IN COMMERCE 3-0-2005.

FOR: CHEMICAL REAGENTS FOR MEDICAL OR VETERINARY USE IN CHEMICAL SYNTHESIS AND CHEMICAL REACTIONS, IN CLASS 5 (U.S. CLS. 6, 18, 44, 46, 51 AND 52).

FIRST USE 3-0-2005; IN COMMERCE 3-0-2005.

FOR: PRODUCT RESEARCH AND DEVELOPMENT; PRODUCT RESEARCH AND DEVELOPMENT CONSULTATION; CONSULTATION SERVICES IN THE FIELD OF CHEMISTRY, IN CLASS 42 (U.S. CLS. 100 AND 101).

FIRST USE 1-0-2005; IN COMMERCE 1-0-2005.

FOR: INTELLECTUAL PROPERTY CONSULTATION, IN CLASS 45 (U.S. CLS. 100 AND 101).

FIRST USE 3-0-2005; IN COMMERCE 3-0-2005.

THE COLOR(S) BLUE, LIGHT BLUE AND DARK BLUE IS/ARE CLAIMED AS A FEATURE OF THE MARK.

THE MARK CONSISTS OF A BLUE CUBE WITH LIGHT BLUE AND DARK BLUE INSERTS.

SER. NO. 77-227,187, FILED 7-11-2007.

ERIN FALK, EXAMINING ATTORNEY

Int. Cl.: 41

Prior U.S. Cls.: 100, 101 and 107

United States Patent and Trademark Office

Reg. No. 3,483,437

Registered Aug. 12, 2008

**SERVICE MARK
PRINCIPAL REGISTER**

WILD CATS

GRAHAM BROTHERS PARTNERSHIP (TEXAS
PARTNERSHIP)
6999 EAST HIGHWAY 90
ODESSA, TX 79762

THE MARK CONSISTS OF STANDARD CHAR-
ACTERS WITHOUT CLAIM TO ANY PARTICULAR
FONT, STYLE, SIZE, OR COLOR.

FOR: NIGHTCLUB SERVICES, IN CLASS 41 (U.S.
CLS. 100, 101 AND 107).

SER. NO. 77-227,459, FILED 7-11-2007.

FIRST USE 1-1-2004; IN COMMERCE 1-1-2004.

RON FAIRBANKS, EXAMINING ATTORNEY

Int. Cl.: 41

Prior U.S. Cls.: 100, 101 and 107

United States Patent and Trademark Office

Reg. No. 3,483,438

Registered Aug. 12, 2008

**SERVICE MARK
PRINCIPAL REGISTER**



GRAHAM BROTHERS PARTNERSHIP (TEXAS
PARTNERSHIP)
6999 EAST HIGHWAY 90
ODESSA, TX 79762

THE MARK CONSISTS OF A PAIR OF EYES SET
ABOVE THE WORDS "WILD CATS".

FOR: NIGHTCLUB SERVICES, IN CLASS 41 (U.S.
CLS. 100, 101 AND 107).

SER. NO. 77-227,470, FILED 7-11-2007.

FIRST USE 1-1-2004; IN COMMERCE 1-1-2004.

RON FAIRBANKS, EXAMINING ATTORNEY

Int. Cl.: 9

Prior U.S. Cls.: 21, 23, 26, 36 and 38

Reg. No. 3,483,439

United States Patent and Trademark Office

Registered Aug. 12, 2008

**TRADEMARK
PRINCIPAL REGISTER**

LEATT-BRACE

LEATT BRACE HOLDINGS (PTY) LTD. (SOUTH
AFRICA PRIVATE LIMITED COMPANY)
UNIT 1 KYALAMI PLAZA
KYALAMI DRIVE
KILLARNEY GARDENS, SOUTH AFRICA 7441

FOR: SAFETY EQUIPMENT, NAMELY, A PRO-
TECTIVE NECK BRACE FOR USE IN CONJUNC-
TION WITH A FULL FACE OR OPEN FACE
PROTECTIVE HELMET TO PREVENT CERVICAL
DISK OR CERVICAL SPINE INJURY, TO OPERA-
TORS OF MOTORIZED VEHICLES INCLUDING
MOTORCYCLES, SUPER BIKES, MOTORCROSS,
GO-KARTS, ATVS, PERSONAL WATERCRAFTS,

SNOW MOBILES, MOUNTAIN BIKES, CARS,
TRUCKS, BOATS, AND MILITARY VEHICLES, IN
CLASS 9 (U.S. CLS. 21, 23, 26, 36 AND 38).

FIRST USE 2-14-2006; IN COMMERCE 12-1-2006.

THE MARK CONSISTS OF STANDARD CHAR-
ACTERS WITHOUT CLAIM TO ANY PARTICULAR
FONT, STYLE, SIZE, OR COLOR.

SER. NO. 77-227,507, FILED 7-11-2007.

SALLY SHIH, EXAMINING ATTORNEY

Int. Cl.: 35

Prior U.S. Cls.: 100, 101 and 102

United States Patent and Trademark Office

Reg. No. 3,483,440

Registered Aug. 12, 2008

**SERVICE MARK
PRINCIPAL REGISTER**

Style Scene

STYLE SCENE (TEXAS SOLE PROPRIETORSHIP)
3614 GALENA HILLS LOOP
ROUND ROCK, TX 78681

FOR: ADVERTISING, MARKETING AND PROMOTION SERVICES; ON-LINE RETAIL STORE SERVICES FEATURING CLOTHING, CLOTHING ACCESSORIES, HANDBAGS, JEWELRY, AND HOUSEWARES, IN CLASS 35 (U.S. CLS. 100, 101 AND 102).

FIRST USE 11-29-2006; IN COMMERCE 11-29-2006.

THE MARK CONSISTS OF STANDARD CHARACTERS WITHOUT CLAIM TO ANY PARTICULAR FONT, STYLE, SIZE, OR COLOR.

SER. NO. 77-227,560, FILED 7-11-2007.

MORGAN WYNNE, EXAMINING ATTORNEY

Int. Cl.: 36

Prior U.S. Cls.: 100, 101 and 102

United States Patent and Trademark Office

Reg. No. 3,483,441

Registered Aug. 12, 2008

**SERVICE MARK
PRINCIPAL REGISTER**



UNITED STATES EQUESTRIAN TEAM FOUNDATION, INC. (NEW JERSEY CORPORATION)
1040 POTTERSVILLE ROAD
P.O. BOX 355
GLADSTONE, NJ 079340355

FOR: CHARITABLE FUNDRAISING SERVICES BY MEANS OF COLLECTING DONATED TAX-DEDUCTIBLE CONTRIBUTIONS IN ORDER TO PROVIDE FUNDING FOR COMPETITION, TRAINING, COACHING, TRAVEL AND EDUCATION NEEDS OF UNITED STATES EQUESTRIANS, IN CLASS 36 (U.S. CLS. 100, 101 AND 102).

FIRST USE 2-10-2007; IN COMMERCE 2-10-2007.

OWNER OF U.S. REG. NOS. 2,605,119, 3,186,701 AND OTHERS.

NO CLAIM IS MADE TO THE EXCLUSIVE RIGHT TO USE "FOUNDATION" AND "CAMPAIGN TO ACHIEVE COMPETITIVE EXCELLENCE", APART FROM THE MARK AS SHOWN.

THE MARK CONSISTS OF THE WORDS "USET FOUNDATION CAMPAIGN TO ACHIEVE COMPETITIVE EXCELLENCE" IN CONJUNCTION WITH A MEDAL DESIGN.

SER. NO. 77-227,697, FILED 7-12-2007.

ALICIA COLLINS, EXAMINING ATTORNEY

Int. Cl.: 10

Prior U.S. Cls.: 26, 39 and 44

United States Patent and Trademark Office

Reg. No. 3,483,442

Registered Aug. 12, 2008

**TRADEMARK
PRINCIPAL REGISTER**



MEDICAL COMPONENTS, INC. (PENNSYLVANIA CORPORATION)
1499 DELP DRIVE
HARLEYSVILLE, PA 19438

THE MARK CONSISTS OF THE STYLIZED LETTERS "PRO.FUSE CT".

FOR: IMPLANTABLE PORTS; IMPLANTABLE PORT KITS; DIALYSIS TREATMENT EQUIPMENT, IN CLASS 10 (U.S. CLS. 26, 39 AND 44).

SER. NO. 77-228,048, FILED 7-12-2007.

FIRST USE 4-1-2007; IN COMMERCE 4-1-2007.

LINDA MICKLEBURGH, EXAMINING ATTORNEY

Int. Cl.: 35

Prior U.S. Cls.: 100, 101 and 102

United States Patent and Trademark Office

Reg. No. 3,483,443

Registered Aug. 12, 2008

**SERVICE MARK
PRINCIPAL REGISTER**

a¢¢ountnet

Accounting solutions that won't become extinct.

ACCOUNTNET, INC. (NEW YORK CORPORATION)
1333 BROADWAY, SUITE 1008
NEW YORK, NY 10018

FOR: DISTRIBUTORSHIPS IN THE FIELD OF
ACCOUNTING SOFTWARE, IN CLASS 35 (U.S. CLS.
100, 101 AND 102).

FIRST USE 12-2-1996; IN COMMERCE 12-2-1996.

NO CLAIM IS MADE TO THE EXCLUSIVE
RIGHT TO USE "ACCOUNTING", APART FROM
THE MARK AS SHOWN.

THE MARK CONSISTS OF "THE TWO LETTER
C'S IN ACCOUNTNET ARE CENT SIGNS".

SER. NO. 77-228,281, FILED 7-12-2007.

JIM RINGLE, EXAMINING ATTORNEY

Int. Cl.: 41

Prior U.S. Cls.: 100, 101 and 107

United States Patent and Trademark Office

Reg. No. 3,483,444

Registered Aug. 12, 2008

**SERVICE MARK
PRINCIPAL REGISTER**

The Bandit Run

RESTORE A MUSCLE CAR LLC (NEBRASKA
LTD LIAB CO)
11850 NO 56TH
LINCOLN, NE 68514

FOR: ENTERTAINMENT SERVICES, NAMELY,
CONDUCTING AUTOMOBILE RALLYS, IN CLASS
41 (U.S. CLS. 100, 101 AND 107).

FIRST USE 1-1-2006; IN COMMERCE 1-1-2006.

THE MARK CONSISTS OF STANDARD CHAR-
ACTERS WITHOUT CLAIM TO ANY PARTICULAR
FONT, STYLE, SIZE, OR COLOR.

NO CLAIM IS MADE TO THE EXCLUSIVE
RIGHT TO USE "RUN", APART FROM THE MARK
AS SHOWN.

SER. NO. 77-228,285, FILED 7-12-2007.

JIM RINGLE, EXAMINING ATTORNEY

Int. Cls.: 3 and 44

Prior U.S. Cls.: 1, 4, 6, 50, 51, 52, 100 and 101

United States Patent and Trademark Office

Reg. No. 3,483,445

Registered Aug. 12, 2008

**TRADEMARK
SERVICE MARK
PRINCIPAL REGISTER**

RODIAL

RODIAL LIMITED (UNITED KINGDOM PRIVATE LIMITED COMPANY)
SUITE 1.24, THE PLAZA
535 KINGS ROAD
LONDON, UNITED KINGDOM SW100SZ

FOR: PERFUMES; NON-MEDICATED BATH PREPARATIONS; NON-MEDICATED TOILET PREPARATIONS, NAMELY, TOILET WATER AND SOAPS; COSMETIC PREPARATIONS FOR EYELASHES, BODY CARE, THE PREVENTION OF SUNBURN, SKIN RENEWAL AND SLIMMING PURPOSES; LOTIONS AND CREAMS FOR USE ON THE SKIN; POWDERS FOR USE ON THE SKIN, NAMELY, BODY POWDERS, DUSTING POWDERS, BABY POWDERS AND FOOT POWDERS; SCRUBBING PREPARATIONS FOR USE ON THE SKIN, NAMELY, BODY SCRUBS, FACIAL SCRUBS; FACE MOISTURIZERS AND TONERS; DEPILATORY PREPARATIONS; DEODORANT FOR PERSONAL USE; TOILET ARTICLES, NAMELY, SOAPS AND TOILET WATER; LIP BALM; SKIN AND HAIR MASKS; PREPARATIONS FOR CARE OF THE HAIR; SHAMPOOS AND HAIR CONDITIONERS; SOAPS; ESSENTIAL OILS FOR PERSONAL USE; MASSAGE PREPARATIONS, NAMELY, OILS AND CREAMS; PREPARATIONS FOR THE CARE OF NAILS; COSMETICS FOR SUN SCREENING, NAMELY, FOAMS CONTAINING COSMETICS AND SUNSCREEN; COTTON WOOL AND COTTON WOOL BUDS FOR COSMETICS AND TOILET USE; EMERY BOARDS, IN CLASS 3 (U.S. CLS. 1, 4, 6, 50, 51 AND 52).

FIRST USE 9-0-2005; IN COMMERCE 9-0-2005.

FOR: BEAUTY SALON SERVICES; BEAUTY TREATMENT SERVICES; BEAUTY DEMONSTRATIONS, NAMELY, PROVIDING COSMETIC MAKEOVERS; AROMATHERAPY SERVICES; SKIN CARE SERVICES; MASSAGE SERVICES; BEAUTY TREATMENTS; COSMETIC TREATMENTS; COUNSELING, ADVISORY AND INFORMATION SERVICES, ALL RELATING TO THE AFORESAID, IN CLASS 44 (U.S. CLS. 100 AND 101).

FIRST USE 9-0-2005; IN COMMERCE 9-0-2005.

THE MARK CONSISTS OF STANDARD CHARACTERS WITHOUT CLAIM TO ANY PARTICULAR FONT, STYLE, SIZE, OR COLOR.

PRIORITY CLAIMED UNDER SEC. 44(D) ON UNITED KINGDOM APPLICATION NO. 2459678, FILED 6-27-2007, REG. NO. 2459678, DATED 6-27-2007, EXPIRES 6-27-2017.

OWNER OF UNITED KINGDOM REG. NO. 2244943, DATED 2-9-2001, EXPIRES 9-7-2010.

SER. NO. 77-228,298, FILED 7-12-2007.

AMY MCMENAMIN, EXAMINING ATTORNEY

Int. Cl.: 37

Prior U.S. Cls.: 100, 103 and 106

United States Patent and Trademark Office

Reg. No. 3,483,446

Registered Aug. 12, 2008

SERVICE MARK
PRINCIPAL REGISTER



LEGASUS

Properties of Generations

LEGASUS OF NORTH CAROLINA LLC (NORTH
CAROLINA LTD LIAB CO)
22 SOUTH PACK SQUARE, SUITE 700
ASHEVILLE, NC 28801

FOR: REAL ESTATE DEVELOPMENT, IN CLASS
37 (U.S. CLS. 100, 103 AND 106).

FIRST USE 2-1-2006; IN COMMERCE 1-1-2007.

THE MARK CONSISTS OF "LEGASUS PROPER-
TIES OF GENERATIONS" AND DESIGN OF

SHIELD WITH UPPER-LEFT AND LOWER-RIGHT
QUADRANT OF SHIELD FILLED WITH JAGGED
STRIPED LINES AND BOTTOM PORTION OF
SHIELD FILLED WITH RAYS OF SUNSHINE IN
ADDITION TO THE PICTURE OF BEAR IN UPPER-
RIGHT QUADRANT OF SHIELD AND PICTURE OF
TREE IN LOWER-LEFT QUADRANT OF SHIELD.

SER. NO. 77-228,440, FILED 7-12-2007.

AMY GEARIN, EXAMINING ATTORNEY

Int. Cl.: 25

Prior U.S. Cls.: 22 and 39

United States Patent and Trademark Office

Reg. No. 3,483,447

Registered Aug. 12, 2008

**TRADEMARK
PRINCIPAL REGISTER**

AQUA SHARK

GORDON BROTHERS WHOLESale, LLC (DE-
LAWARE LTD LIAB CO)
101 HUNTINGTON AVENUE, 10TH FLOOR
BOSTON, MA 01608

THE MARK CONSISTS OF STANDARD CHAR-
ACTERS WITHOUT CLAIM TO ANY PARTICULAR
FONT, STYLE, SIZE, OR COLOR.

FOR: FOOTWEAR, IN CLASS 25 (U.S. CLS. 22 AND
39).

SER. NO. 77-228,446, FILED 7-12-2007.

FIRST USE 6-1-1999; IN COMMERCE 9-1-1999.

CARRIE GENOVESE, EXAMINING ATTORNEY

Int. Cl.: 41

Prior U.S. Cls.: 100, 101 and 107

United States Patent and Trademark Office

Reg. No. 3,483,448

Registered Aug. 12, 2008

**SERVICE MARK
PRINCIPAL REGISTER**

make workshop

MAKE WORKSHOP INC. (NEW YORK CORPORATION)
SUITE 502
195 CHRYSTIE ST
NEW YORK, NY 10002

FOR: EDUCATION SERVICES, NAMELY, PROVIDING CLASSES IN THE FIELD OF KNITTING, CROCHETING, EMBROIDERY, JEWELRY DESIGN, QUILTING, AND SEWING, IN CLASS 41 (U.S. CLS. 100, 101 AND 107).

FIRST USE 3-1-2002; IN COMMERCE 3-1-2002.

THE MARK CONSISTS OF STANDARD CHARACTERS WITHOUT CLAIM TO ANY PARTICULAR FONT, STYLE, SIZE, OR COLOR.

NO CLAIM IS MADE TO THE EXCLUSIVE RIGHT TO USE "WORKSHOP", APART FROM THE MARK AS SHOWN.

SER. NO. 77-228,470, FILED 7-12-2007.

WON TEAK OH, EXAMINING ATTORNEY

Int. Cls.: 35 and 41

Prior U.S. Cls.: 100, 101, 102 and 107

United States Patent and Trademark Office

Reg. No. 3,483,449

Registered Aug. 12, 2008

**SERVICE MARK
PRINCIPAL REGISTER**

PARTNERS IN MUSIC EDUCATION

PERIPOLE-BERGERAULT, INC. (OREGON CORPORATION)
1270 WILBUR STREET, S.E.
SALEM, OR 97302

FOR: RETAIL STORE SERVICES FEATURING MUSICAL INSTRUMENTS AND RELATED MUSIC ACCESSORIES, IN CLASS 35 (U.S. CLS. 100, 101 AND 102).

FIRST USE 10-1-2005; IN COMMERCE 10-1-2005.

FOR: EDUCATIONAL SERVICES, NAMELY, CONDUCTING WORKSHOPS AND SEMINARS TO ESTABLISH, PROMOTE, AND MAINTAIN STANDARDS IN ARTS EDUCATION, IN CLASS 41 (U.S. CLS. 100, 101 AND 107).

FIRST USE 10-1-2005; IN COMMERCE 10-1-2005.

THE MARK CONSISTS OF STANDARD CHARACTERS WITHOUT CLAIM TO ANY PARTICULAR FONT, STYLE, SIZE, OR COLOR.

NO CLAIM IS MADE TO THE EXCLUSIVE RIGHT TO USE "MUSIC EDUCATION", APART FROM THE MARK AS SHOWN.

SER. NO. 77-228,571, FILED 7-12-2007.

KATHLEEN M. VANSTON, EXAMINING ATTORNEY

Int. Cl.: 45

Prior U.S. Cls.: 100 and 101

United States Patent and Trademark Office

Reg. No. 3,483,450

Registered Aug. 12, 2008

**SERVICE MARK
PRINCIPAL REGISTER**

SHATWANEE

HOSKET, SHATWANEE (UNITED STATES INDIVIDUAL)
9200 YAAK RIVER RD
TROY, MT 59935

FOR: PSYCHIC READING SERVICES; RELIGIOUS AND SPIRITUAL SERVICES, NAMELY, PROVIDING GATHERINGS AND RETREATS TO DEVELOP AND ENHANCE THE SPIRITUAL LIVES OF INDIVIDUALS, IN CLASS 45 (U.S. CLS. 100 AND 101).

FIRST USE 4-24-1996; IN COMMERCE 7-4-1996.

THE MARK CONSISTS OF STANDARD CHARACTERS WITHOUT CLAIM TO ANY PARTICULAR FONT, STYLE, SIZE, OR COLOR.

THE NAME "SHATWANEE" IDENTIFIES A LIVING INDIVIDUAL WHOSE CONSENT IS OF RECORD.

SER. NO. 77-228,645, FILED 7-12-2007.

ESTHER A. BORSUK, EXAMINING ATTORNEY

Int. Cls.: 36 and 37

Prior U.S. Cls.: 100, 101, 102, 103 and 106

United States Patent and Trademark Office

Reg. No. 3,483,451

Registered Aug. 12, 2008

**SERVICE MARK
PRINCIPAL REGISTER**

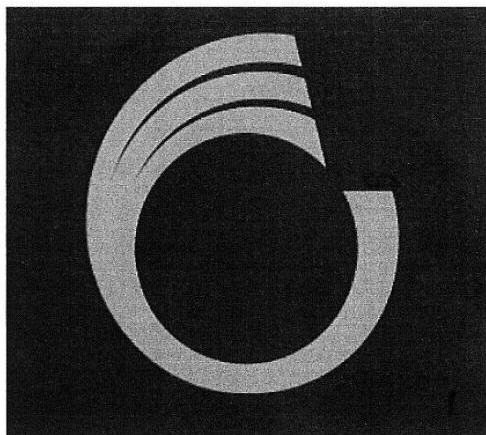

WORLD CAPITAL PARTNERS LIMITED (UNI-
TED KINGDOM LTD LIAB CO)
3 SHELDON SQUARE
LONDON, UNITED KINGDOM W26PS

FOR: REAL ESTATE AND PROPERTY CONSULTATION; REAL ESTATE AGENCIES; REAL ESTATE APPRAISAL; REAL ESTATE AND PROPERTY BROKERAGE SERVICES; FINANCIAL EVALUATION OF REAL ESTATE; REAL ESTATE MANAGEMENT; REAL ESTATE INVESTMENT; APARTMENT MANAGEMENT; LEASING OF REAL ESTATE; RENTAL OF OFFICES, APARTMENTS AND HOUSES, IN CLASS 36 (U.S. CLS. 100, 101 AND 102).

FOR: REAL ESTATE AND PROPERTY DEVELOPMENT, IN CLASS 37 (U.S. CLS. 100, 103 AND 106).

OWNER OF UNITED KINGDOM REG. NO. 2409641, DATED 8-11-2006, EXPIRES 6-21-2016.

THE MARK CONSISTS OF A STYLIZED REPRESENTATION OF A WAVE.

SER. NO. 77-228,697, FILED 7-12-2007.

ESTHER A. BORSUK, EXAMINING ATTORNEY

Int. Cl.: 35

Prior U.S. Cls.: 100, 101 and 102

United States Patent and Trademark Office

Reg. No. 3,483,452

Registered Aug. 12, 2008

**SERVICE MARK
PRINCIPAL REGISTER**

HOMEOFSHOES

EUROSTAR BRANDS, INC. (CALIFORNIA CORPORATION)
13425 SOUTH FIGUEROA ST.
LOS ANGELES, CA 90061

THE MARK CONSISTS OF STANDARD CHARACTERS WITHOUT CLAIM TO ANY PARTICULAR FONT, STYLE, SIZE, OR COLOR.

FOR: ONLINE WHOLESALE STORE SERVICES FEATURING FOOTWEAR AND FOOTWEAR ACCESSORIES, IN CLASS 35 (U.S. CLS. 100, 101 AND 102).

SER. NO. 77-228,708, FILED 7-12-2007.

FIRST USE 11-30-2006; IN COMMERCE 11-30-2006.

LOURDES AYALA, EXAMINING ATTORNEY

Int. Cl.: 40

Prior U.S. Cls.: 100, 103 and 106

United States Patent and Trademark Office

Reg. No. 3,483,453

Registered Aug. 12, 2008

**SERVICE MARK
PRINCIPAL REGISTER**



GOLDEN APPLIXX CO., INC. (CALIFORNIA CORPORATION)
128 BRENT CIRCLE
INDUSTRY, CA 91789

FOR: CUSTOMIZED PRINTING OF COMPANY NAMES AND LOGOS FOR PROMOTIONAL AND ADVERTISING PURPOSES ON THE GOODS OF OTHERS, IN CLASS 40 (U.S. CLS. 100, 103 AND 106).

FIRST USE 1-1-2002; IN COMMERCE 1-1-2002.

THE COLOR(S) BLUE, RED, WHITE AND BLACK IS/ARE CLAIMED AS A FEATURE OF THE MARK.

THE MARK CONSISTS OF A STYLIZED DESIGN OF A WORKING STEAM ENGINE FEATURED IN BLUE AND WHITE AND OUTLINED IN BLACK, A WHITE CLOUD STEAM OUTLINED IN BLACK

APPEARS TO BE COMING OUT OF THE TOP OF THE STEAM ENGINE, THE WORDING "STOP GO" FEATURED IN WHITE APPEARS IN A RED, WHITE, AND BLACK OVAL FEATURED BELOW THE STEAM ENGINE, IN THE CENTER OF THE OVAL IS A CIRCLE IN RED, WHITE AND BLACK WITH A WHITE STAR AND A BLACK LETTER "N" FEATURED IN THE CENTER, THE TERM "LINE" APPEARS BELOW THE OVAL WHICH IS IN WHITE SURROUNDED BY A CYLINDER FEATURED IN RED, WHITE AND BLACK, TO THE LEFT AND RIGHT OF THE CYLINDER DESIGN ARE TWO STARS FEATURED IN WHITE AND OUTLINED IN BLACK.

SER. NO. 77-228,770, FILED 7-13-2007.

DEIRDRE ROBERTSON, EXAMINING ATTORNEY

Int. Cl.: 35

Prior U.S. Cls.: 100, 101 and 102

United States Patent and Trademark Office

Reg. No. 3,483,454

Registered Aug. 12, 2008

**SERVICE MARK
PRINCIPAL REGISTER**

DISTINCTLY ELEGANT

DISTINCTLY ELEGANT (CALIFORNIA LTD
LIAB CO)
271 WALNUT COURT
AZUSA, CA 91702

FOR: COMPUTERIZED ON-LINE RETAIL STORE
SERVICES, MAIL ORDER CATALOG SERVICES,
AND TELEPHONE ORDER SERVICES IN THE
FIELD OF GIFTWARE, IN CLASS 35 (U.S. CLS. 100,
101 AND 102).

FIRST USE 0-0-2004; IN COMMERCE 0-0-2004.

THE MARK CONSISTS OF STANDARD CHAR-
ACTERS WITHOUT CLAIM TO ANY PARTICULAR
FONT, STYLE, SIZE, OR COLOR.

SER. NO. 77-228,781, FILED 7-13-2007.

JENNY PARK, EXAMINING ATTORNEY

Int. Cls.: 1 and 31

Prior U.S. Cls.: 1, 5, 6, 10, 26 and 46

United States Patent and Trademark Office

Reg. No. 3,483,455

Registered Aug. 12, 2008

**TRADEMARK
PRINCIPAL REGISTER**

Margo's Natural Helper

MARGO GARDEN PRODUCTS, INC. (FLORIDA CORPORATION)
PO BOX 68
FOLKSTON, GA 315370068

FOR: ORGANIC SOIL CONDITIONERS FOR AGRICULTURAL, DOMESTIC OR HORTICULTURAL USE, NAMELY, COMPOST, PLANTING SOIL, AND AGGREGATES, IN CLASS 1 (U.S. CLS. 1, 5, 6, 10, 26 AND 46).

FIRST USE 12-6-2006; IN COMMERCE 12-6-2006.

FOR: MULCH, IN CLASS 31 (U.S. CLS. 1 AND 46).

FIRST USE 12-6-2006; IN COMMERCE 12-6-2006.

THE MARK CONSISTS OF STANDARD CHARACTERS WITHOUT CLAIM TO ANY PARTICULAR FONT, STYLE, SIZE, OR COLOR.

NO CLAIM IS MADE TO THE EXCLUSIVE RIGHT TO USE "NATURAL HELPER", APART FROM THE MARK AS SHOWN.

SER. NO. 77-229,081, FILED 7-13-2007.

MICHAEL LITZAU, EXAMINING ATTORNEY

Int. Cl.: 41

Prior U.S. Cls.: 100, 101 and 107

United States Patent and Trademark Office

Reg. No. 3,483,456

Registered Aug. 12, 2008

**SERVICE MARK
PRINCIPAL REGISTER**



SHIFT INTO GEAR, INC. (DELAWARE CORPORATION)
2450 PHILADELPHIA STREET
INDIANA, PA 15701

FOR: DRIVER SAFETY TRAINING; TRAINING IN MOTOR VEHICLE RACING, MOTOR VEHICLE LAW ENFORCEMENT AND SECURITY DRIVING, AND TRAINING IN MOTOR VEHICLE STUNT DRIVING, IN CLASS 41 (U.S. CLS. 100, 101 AND 107).

FIRST USE 1-11-2006; IN COMMERCE 1-11-2006.

THE COLOR(S) BLACK, WHITE, RED, SCARLET, METALLIC SILVER AND GRAY IS/ARE CLAIMED AS A FEATURE OF THE MARK.

THE MARK CONSISTS OF A FANCIFUL OVAL OUTLINED IN RED, WHITE AND BLACK; THE WORDS "SHIFT INTO GEAR" IN WHITE, BLACK, GRAY AND RED; A CENTER WITH THE DESIGN OF FLAMES IN RED AND SCARLET; AND A GEAR SHIFTING LEVER IN BLACK, GRAY AND METALLIC SILVER.

SER. NO. 77-229,102, FILED 7-13-2007.

DAVID C. REIHNER, EXAMINING ATTORNEY

Int. Cls.: 7, 9 and 39

**Prior U.S. Cls.: 13, 19, 21, 23, 26, 31, 34, 35, 36, 38, 100
and 105**

Reg. No. 3,483,457

United States Patent and Trademark Office

Registered Aug. 12, 2008

**TRADEMARK
SERVICE MARK
PRINCIPAL REGISTER**

JIVARO

SAVOYE (FRANCE SOCIETE ANONYME)
18 BD DES GORGETS
DIJON, FRANCE 21000

FOR: PACKAGING MACHINES; ASSEMBLY CONVEYOR LINES UTILIZING PACKAGING MACHINES AND COMPONENT PARTS THEREOF; PACKAGING AND WRAPPING MACHINES; ASSEMBLY CONVEYOR LINES UTILIZING PACKAGING AND WRAPPING MACHINES AND COMPONENT PARTS THEREOF; BOXING MACHINES AND COMPONENT PARTS THEREOF, NAMELY ROTARY DIES FOR CUTTING BOXES FOR PACKAGING INDUSTRY; MACHINES AND EQUIPMENT FOR CLOSING PACKAGES, NAMELY, POWER STAPLERS, GLUING MACHINES, HOOP CASING MACHINES, BUNDLE TYING MACHINES; CONVEYORS, PNEUMATIC TRANSPORTERS; MACHINE-TOOLS FOR THE CUTTING AND FORMING OF MATERIALS, NAMELY, TOOLS FOR ADJUSTING THE SIZE OF A CARDBOARD BOX AND PACKAGE TO THE VOLUME OF THE PACKED GOOD, IN CLASS 7 (U.S. CLS. 13, 19, 21, 23, 31, 34 AND 35).

FOR: ELECTRIC INSTALLATIONS FOR THE REMOTE CONTROL OF INDUSTRIAL OPERA-

TIONS OTHER THAN THOSE RELATED TO THE VARIOUS PROCESS STEPS FOR BOXING, SHAPING, PACKAGING, PACKING, DISTRIBUTING AND STORING GOODS; MEASURING APPARATUS FOR ADJUSTING THE SIZE OF A CARDBOARD BOX OR PACKAGE TO THE VOLUME OF THE PACKED GOOD, IN CLASS 9 (U.S. CLS. 21, 23, 26, 36 AND 38).

FOR: TRANSPORT, PACKAGING AND STORAGE OF GOODS FOR TRANSPORTATION, IN CLASS 39 (U.S. CLS. 100 AND 105).

THE MARK CONSISTS OF STANDARD CHARACTERS WITHOUT CLAIM TO ANY PARTICULAR FONT, STYLE, SIZE, OR COLOR.

OWNER OF FRANCE REG. NO. 043331059, DATED 12-22-2004, EXPIRES 12-21-2014.

THE WORDING "JIVARO" HAS NO MEANING IN A FOREIGN LANGUAGE.

SER. NO. 77-229,193, FILED 7-13-2007.

DAVID HOFFMAN, EXAMINING ATTORNEY

Int. Cl.: 25

Prior U.S. Cls.: 22 and 39

United States Patent and Trademark Office

Reg. No. 3,483,458

Registered Aug. 12, 2008

**TRADEMARK
PRINCIPAL REGISTER**

RUGGED SHARK

GORDON BROTHERS LLC (DELAWARE LTD
LIAB CO)
101 HUNTINGTON AVENUE, 10TH FLOOR
BOSTON, MA 02199

OWNER OF U.S. REG. NOS. 2,526,161 AND
2,795,678.

FOR: CLOTHING, NAMELY, T-SHIRTS, POLO
SHIRTS, CASUAL SHIRTS, CAPS, SOCKS, AND
SHORTS, IN CLASS 25 (U.S. CLS. 22 AND 39).

NO CLAIM IS MADE TO THE EXCLUSIVE
RIGHT TO USE "RUGGED", APART FROM THE
MARK AS SHOWN.

FIRST USE 5-1-1996; IN COMMERCE 5-1-1996.

SER. NO. 77-229,227, FILED 7-13-2007.

THE MARK CONSISTS OF STANDARD CHAR-
ACTERS WITHOUT CLAIM TO ANY PARTICULAR
FONT, STYLE, SIZE, OR COLOR.

DANNEAN HETZEL, EXAMINING ATTORNEY

Int. Cl.: 7

Prior U.S. Cls.: 13, 19, 21, 23, 31, 34 and 35

United States Patent and Trademark Office

Reg. No. 3,483,459

Registered Aug. 12, 2008

**TRADEMARK
PRINCIPAL REGISTER**

PAC 600

SAVOYE (FRANCE SOCIETE ANONYME)
18 BD DES GORGETS
DIJON, FRANCE 21000

FOR: MACHINES AND MACHINE TOOLS FOR PACKAGING INDUSTRY, NAMELY, AUTOMATIC LIDDER MACHINES FOR BOXES WITHOUT FLAPS, CASE ERECTORS AND AUTOMATIC SHRINK TUNNEL FOR BOXES; GOODS HANDLING MACHINES, NAMELY, PALLETIZERS, CASE ELEVATORS, AUTOMATIC PALLET DISPENSING MACHINES AND AUTOMATIC SLIP SHEET DISPENSING MACHINES; WRAPPING MACHINES; PACKAGING MACHINES; ASSEMBLY CONVEYOR LINES UTILIZING PACKAGING MACHINES AND COMPONENT PARTS THEREOF; PACKAGING AND WRAPPING MACHINES; ASSEMBLY CONVEYOR LINES UTILIZING PACKAGING AND WRAPPING MACHINES AND COMPONENT PARTS THEREOF; MACHINES AND EQUIPMENT FOR MAKING PACKAGING, NAMELY, VACUUM PACKAGING MACHINES AND COMPONENT PARTS THEREOF; MACHINES AND COMPONENT PARTS THEREOF FOR FORMING OF MATERIALS BY WAY OF HEAT SEALING, THERMOFORMING

AND FOLDING; FILLING MACHINES AND COMPONENT PARTS THEREOF; BOXING MACHINES AND COMPONENT PARTS THEREOF, NAMELY, ROTARY DIES FOR CUTTING BOXES FOR PACKAGING INDUSTRY; MACHINES AND EQUIPMENT FOR CLOSING PACKAGES, NAMELY, POWER STAPLERS, GLUING MACHINES, HOOP CASING MACHINES, BUNDLE TYING MACHINES, IN CLASS 7 (U.S. CLS. 13, 19, 21, 23, 31, 34 AND 35).

THE MARK CONSISTS OF STANDARD CHARACTERS WITHOUT CLAIM TO ANY PARTICULAR FONT, STYLE, SIZE, OR COLOR.

OWNER OF ERPN CMNTY TM OFC REG. NO. 001068196, DATED 6-6-2000, EXPIRES 2-12-2009.

NO CLAIM IS MADE TO THE EXCLUSIVE RIGHT TO USE "PACK", APART FROM THE MARK AS SHOWN.

SER. NO. 77-229,239, FILED 7-13-2007.

DAVID HOFFMAN, EXAMINING ATTORNEY

Int. Cl.: 41

Prior U.S. Cls.: 100, 101 and 107

United States Patent and Trademark Office

Reg. No. 3,483,460

Registered Aug. 12, 2008

**SERVICE MARK
PRINCIPAL REGISTER**

SHIFT INTO GEAR

SHIFT INTO GEAR, INC. (DELAWARE CORPORATION)
2450 PHILADELPHIA STREET
INDIANA, PA 15701

FOR: DRIVER SAFETY TRAINING; TRAINING IN MOTOR VEHICLE RACING, MOTOR VEHICLE LAW ENFORCEMENT AND SECURITY DRIVING, AND TRAINING IN MOTOR VEHICLE STUNT DRIVING, IN CLASS 41 (U.S. CLS. 100, 101 AND 107).

FIRST USE 1-11-2006; IN COMMERCE 1-11-2006.

THE MARK CONSISTS OF STANDARD CHARACTERS WITHOUT CLAIM TO ANY PARTICULAR FONT, STYLE, SIZE, OR COLOR.

SER. NO. 77-229,291, FILED 7-13-2007.

DAVID C. REIHNER, EXAMINING ATTORNEY

Int. Cl.: 39

Prior U.S. Cls.: 100 and 105

United States Patent and Trademark Office

Reg. No. 3,483,461

Registered Aug. 12, 2008

**SERVICE MARK
PRINCIPAL REGISTER**



COOPERATIVE ENERGY COMPANY (OHIO CORPORATION)
125 BALES RD.
KENTON, OH 433268909

FOR: HOME AND FARM DELIVERY OF HEATING OIL, DIESEL FUEL, GASOLINE, KEROSENE, LIQUEFIED PETROLEUM GAS, PROPANE, AND OILS, IN CLASS 39 (U.S. CLS. 100 AND 105).

FIRST USE 7-1-2007; IN COMMERCE 7-1-2007.

NO CLAIM IS MADE TO THE EXCLUSIVE RIGHT TO USE "COOPERATIVE ENERGY", APART FROM THE MARK AS SHOWN.

THE COLOR(S) BLACK, WHITE, GREEN AND RED IS/ARE CLAIMED AS A FEATURE OF THE MARK.

THE MARK CONSISTS OF THE WORDING "COOPERATIVE ENERGY" IN BLACK SUPERIMPOSED OVER THE DESIGN OF A FLAME, WITH THE LEFT PORTION OF THE FLAME DISPLAYED IN GREEN, A THIN CURVED MIDDLE SECTION OF THE FLAME DISPLAYED IN WHITE, AND THE RIGHT PORTION OF THE FLAME DISPLAYED IN RED. THE PORTION OF THE WORDING "COOPERATIVE ENERGY" THAT IS SUPERIMPOSED ON THE FLAME DESIGN, CONSISTING OF ALL OR PART OF ALL LETTERS OF SUCH WORDING EXCEPT FOR THE FIRST TWO AND LAST TWO LETTERS, IS OUTLINED IN WHITE. THE ENTIRE MARK APPEARS ON A WHITE BACKGROUND.

SER. NO. 77-229,334, FILED 7-13-2007.

ZACHARY BELLO, EXAMINING ATTORNEY

Int. Cl.: 41

Prior U.S. Cls.: 100, 101 and 107

United States Patent and Trademark Office

Reg. No. 3,483,462

Registered Aug. 12, 2008

**SERVICE MARK
PRINCIPAL REGISTER**

**SPEED IS NOTHING WITHOUT
CONTROL**

SHIFT INTO GEAR, INC. (DELAWARE CORPORATION)
2450 PHILADELPHIA STREET
INDIANA, PA 15701

FOR: DRIVER SAFETY TRAINING; TRAINING IN MOTOR VEHICLE RACING, MOTOR VEHICLE LAW ENFORCEMENT AND SECURITY DRIVING, AND TRAINING IN MOTOR VEHICLE STUNT DRIVING, IN CLASS 41 (U.S. CLS. 100, 101 AND 107).

FIRST USE 1-11-2006; IN COMMERCE 1-11-2006.

THE MARK CONSISTS OF STANDARD CHARACTERS WITHOUT CLAIM TO ANY PARTICULAR FONT, STYLE, SIZE, OR COLOR.

SER. NO. 77-229,362, FILED 7-13-2007.

DAVID C. REIHNER, EXAMINING ATTORNEY

Int. Cl.: 37

Prior U.S. Cls.: 100, 103 and 106

United States Patent and Trademark Office

Reg. No. 3,483,463

Registered Aug. 12, 2008

**SERVICE MARK
PRINCIPAL REGISTER**

WE HELP YOU BUILD A BETTER
HOME

MARK MAGRANN ASSOCIATES, INC. (NEW
JERSEY CORPORATION)
240 WEST ROUTE 38
MOORESTOWN, NJ 08057

THE MARK CONSISTS OF STANDARD CHAR-
ACTERS WITHOUT CLAIM TO ANY PARTICULAR
FONT, STYLE, SIZE, OR COLOR.

FOR: CONSULTING IN THE FIELD OF BUILD-
ING CONSTRUCTION, IN CLASS 37 (U.S. CLS. 100,
103 AND 106).

SER. NO. 77-229,426, FILED 7-13-2007.

FIRST USE 5-0-2007; IN COMMERCE 5-0-2007.

ELLEN B. AWRICH, EXAMINING ATTORNEY

Int. Cl.: 42

Prior U.S. Cls.: 100 and 101

United States Patent and Trademark Office

Reg. No. 3,483,464

Registered Aug. 12, 2008

**SERVICE MARK
PRINCIPAL REGISTER**

WE HELP YOU BUILD A BETTER
HOME

MARK MAGRANN ASSOCIATES, INC. (NEW
JERSEY CORPORATION)
240 WEST ROUTE 38
MOORESTOWN, NJ 08057

FOR: CONSULTING IN THE FIELDS OF ENGI-
NEERING AND ARCHITECTURE; DESIGN FOR
OTHERS IN THE FIELD OF ENGINEERING, AR-
CHITECTURE AND BUILDING CONSTRUCTION,
IN CLASS 42 (U.S. CLS. 100 AND 101).

FIRST USE 5-0-2007; IN COMMERCE 5-0-2007.

THE MARK CONSISTS OF STANDARD CHAR-
ACTERS WITHOUT CLAIM TO ANY PARTICULAR
FONT, STYLE, SIZE, OR COLOR.

SER. NO. 77-229,443, FILED 7-13-2007.

ELLEN B. AWRICH, EXAMINING ATTORNEY

Int. Cls.: 7 and 8

Prior U.S. Cls.: 13, 19, 21, 23, 28, 31, 34, 35 and 44

United States Patent and Trademark Office

Reg. No. 3,483,465

Registered Aug. 12, 2008

**TRADEMARK
PRINCIPAL REGISTER**



ATD TOOLS, INC. (MISSOURI CORPORATION)
160 ENTERPRISE DRIVE
WENTZVILLE, MO 63385

FOR: POWER TOOLS AND ACCESSORIES, NAMELY, IMPACT DRIVER, TOOL BITS, CARBIDE INSERTS, DRILL PRESS AND WORKPIECE HOLDER THEREFOR, HYDRAULIC PRESS, SAWS, GRINDERS, AIR HAMMERS, AIR WRENCHES, AIR RATCHETS, AIR COMPRESSORS, SANDERS, POLISHERS, ABRASIVE BLASTERS, LIFTING EQUIPMENT, NAMELY, HYDRAULIC JACKS AND HOISTS, CHAIN BLOCKS, POWER PULLS, PARTS WASHERS, STEAM AND VACUUM TYPE POWER CLEANERS, VACUUM PUMPS, POWER SPRAY GUNS, IN CLASS 7 (U.S. CLS. 13, 19, 21, 23, 31, 34 AND 35).

FIRST USE 5-1-2007; IN COMMERCE 5-1-2007.

FOR: HAND TOOLS, NAMELY, NUTCRACKER, ROCKER ARM, OIL DEFLECTOR, SCREW EXTRACTOR, SOCKET HOLDER, SCREW STARTER, SCREW DRIVER, PLIERS, BLADE SHARPENER, SNIPS, TUBE BENDING TOOL, TUBE CUTTING TOOL, SOCKETS, RATCHETS, WIRE STRIPPERS,

BRAKE TOOLS, NAMELY, BRAKE SPRING COMPRESSOR, BRAKE SPRING TOOL, BRAKE ADJUSTING TOOL, BRAKE BLEEDER WRENCH, BRAKE SPRING PLIERS AND BRAKE CYLINDER HONE, VALVE SPRING COMPRESSORS, SAWS, LUBRICATION TOOL, NAMELY, GREASE GUN, IN CLASS 8 (U.S. CLS. 23, 28 AND 44).

FIRST USE 5-1-2007; IN COMMERCE 5-1-2007.

OWNER OF U.S. REG. NOS. 1,468,800 AND 1,468,826.

NO CLAIM IS MADE TO THE EXCLUSIVE RIGHT TO USE "TOOL DESIGN", APART FROM THE MARK AS SHOWN.

THE MARK CONSISTS OF THE CAPITAL LETTERS "ATD" IN SHADOW FORM ON THE LONG SIDE OF A TRIANGLE WITH THE WORDS "ADVANCED TOOL DESIGN" UNDER THE TRIANGLE.

SER. NO. 77-229,474, FILED 7-13-2007.

JAY FLOWERS, EXAMINING ATTORNEY

Int. Cls.: 7 and 8

Prior U.S. Cls.: 13, 19, 21, 23, 28, 31, 34, 35 and 44

Reg. No. 3,483,466

United States Patent and Trademark Office

Registered Aug. 12, 2008

**TRADEMARK
PRINCIPAL REGISTER**

ATD

ATD TOOLS, INC. (MISSOURI CORPORATION)
160 ENTERPRISE DRIVE
WENTZVILLE, MO 63385

FOR: POWER TOOLS AND ACCESSORIES, NAMELY, IMPACT DRIVER, TOOL BITS, CARBIDE INSERTS, DRILL PRESS AND WORKPIECE HOLDER THEREFOR, HYDRAULIC PRESS, SAWS, GRINDERS, AIR HAMMERS, AIR WRENCHES, AIR RATCHETS, AIR COMPRESSORS, SANDERS, POLISHERS, ABRASIVE BLASTERS, LIFTING EQUIPMENT, NAMELY, HYDRAULIC JACKS AND HOISTS, CHAIN BLOCKS, POWER PULLS, PARTS WASHERS, STEAM AND VACUUM TYPE POWER CLEANERS, VACUUM PUMPS, POWER SPRAY GUNS, IN CLASS 7 (U.S. CLS. 13, 19, 21, 23, 31, 34 AND 35).

FIRST USE 3-1-1977; IN COMMERCE 3-1-1977.

FOR: HAND TOOLS, NAMELY, NUTCRACKER, ROCKER ARM, OIL DEFLECTOR, SCREW EXTRACTOR, SOCKET HOLDER, SCREW STARTER,

SCREW DRIVER, PLIERS, BLADE SHARPENER, SNIPS, TUBE BENDING TOOL, TUBE CUTTING TOOL, SOCKETS, RATCHETS, WIRE STRIPPERS, BRAKE TOOLS, NAMELY, BRAKE SPRING COMPRESSOR, BRAKE SPRING TOOL, BRAKE ADJUSTING TOOL, BRAKE BLEEDER WRENCH, BRAKE SPRING PLIERS AND BRAKE CYLINDER HONE, VALVE SPRING COMPRESSORS, SAWS, LUBRICATION TOOL, NAMELY, GREASE GUN, IN CLASS 8 (U.S. CLS. 23, 28 AND 44).

FIRST USE 3-1-1977; IN COMMERCE 3-1-1977.

THE MARK CONSISTS OF STANDARD CHARACTERS WITHOUT CLAIM TO ANY PARTICULAR FONT, STYLE, SIZE, OR COLOR.

OWNER OF U.S. REG. NOS. 1,468,800 AND 1,468,826.

SER. NO. 77-229,499, FILED 7-13-2007.

JAY FLOWERS, EXAMINING ATTORNEY

Int. Cls.: 16 and 25

Prior U.S. Cls.: 2, 5, 22, 23, 29, 37, 38, 39 and 50

Reg. No. 3,483,467

United States Patent and Trademark Office

Registered Aug. 12, 2008

**TRADEMARK
PRINCIPAL REGISTER**

MERRIEBERRIE

CHRISTIE, WILLIAM JAMES & JACQUELINE
CHRISTIE (CANADA PARTNERSHIP), DBA
THE BERRY FARM (AT CHRISTIE'S COR-
NER)

52002 RANGE ROAD 232
SHERWOOD PARK, CANADA T8B1B3

FOR: STORY BOOKS, IN CLASS 16 (U.S. CLS. 2, 5,
22, 23, 29, 37, 38 AND 50).

FOR: CLOTHING, NAMELY, HATS, T-SHIRTS
AND VESTS, IN CLASS 25 (U.S. CLS. 22 AND 39).

THE MARK CONSISTS OF STANDARD CHAR-
ACTERS WITHOUT CLAIM TO ANY PARTICULAR
FONT, STYLE, SIZE, OR COLOR.

OWNER OF CANADA REG. NO. TMA691,171,
DATED 6-29-2007, EXPIRES 6-29-2022.

SER. NO. 77-229,669, FILED 7-13-2007.

SHANNON TWOHIG, EXAMINING ATTORNEY

Int. Cl.: 41

Prior U.S. Cls.: 100, 101 and 107

United States Patent and Trademark Office

Reg. No. 3,483,468

Registered Aug. 12, 2008

**SERVICE MARK
PRINCIPAL REGISTER**

**"How To Think Like a
Professional Trader"**

DOUGLAS, MARK (UNITED STATES INDIVIDUAL)
10190 N 106TH STREET
SCOTTSDALE, AZ 85258

FOR: EDUCATION SERVICES, NAMELY, PROVIDING LIVE AND ON-LINE CLASSES, SEMINARS, AND WORKSHOPS IN THE FIELD OF PROFESSIONAL TRADING; EDUCATION SERVICES, NAMELY, PROVIDING CLASSES, SEMINARS, AND WORKSHOPS IN THE FIELD OF PROFESSIONAL TRADING, IN CLASS 41 (U.S. CLS. 100, 101 AND 107).

FIRST USE 11-17-2006; IN COMMERCE 11-17-2006.

THE MARK CONSISTS OF STANDARD CHARACTERS WITHOUT CLAIM TO ANY PARTICULAR FONT, STYLE, SIZE, OR COLOR.

SER. NO. 77-229,671, FILED 7-13-2007.

BILL DAWE, EXAMINING ATTORNEY

Int. Cl.: 16

Prior U.S. Cls.: 2, 5, 22, 23, 29, 37, 38 and 50

Reg. No. 3,483,469

United States Patent and Trademark Office

Registered Aug. 12, 2008

**TRADEMARK
PRINCIPAL REGISTER**



ELEANOR ACADEMIA-MAGDA (UNITED STATES INDIVIDUAL)
17043 MIDWOOD DRIVE
GRANADA HILLS, CA 91344

FOR: PUBLICATIONS, NAMELY, POSTERS, CALENDARS AND PHOTOGRAPHS, IN CLASS 16 (U.S. CLS. 2, 5, 22, 23, 29, 37, 38 AND 50).

FIRST USE 1-1-1998; IN COMMERCE 1-1-1998.

"THE NAME(S), PORTRAIT(S), AND/OR SIGNATURE(S) SHOWN IN THE MARK IDENTIFIES

ELEANOR ACADEMIA, WHOSE CONSENT(S) TO REGISTER IS SUBMITTED".

THE MARK CONSISTS OF THE DRAWING OF A SWAN OVER A CIRCLE, WITH THE WORDS "ELEANOR ACADEMIA" AROUND THE RIGHT PERIMETER OF THE CIRCLE, AND THE WORDS "BLACK SWAN" INSIDE THE CIRCLE BELOW THE DRAWING OF THE SWAN.

SER. NO. 77-229,695, FILED 7-13-2007.

MICHAEL WEBSTER, EXAMINING ATTORNEY

Int. Cl.: 41

Prior U.S. Cls.: 100, 101 and 107

United States Patent and Trademark Office

Reg. No. 3,483,470

Registered Aug. 12, 2008

**SERVICE MARK
PRINCIPAL REGISTER**

ELEANOR ACADEMIA THE BLACK
SWAN

ACADEMIA-MAGDA, ELEANOR (UNITED STATES INDIVIDUAL)
17043 MIDWOOD DRIVE
GRANADA HILLS, CA 91344

FOR: ENTERTAINMENT SERVICES IN THE NATURE OF LIVE CONCERTS AND LIVE PERFORMANCES BY MUSICAL GROUPS; WORKSHOPS AND SEMINARS IN THE FIELD OF MUSIC; PROVIDING ONLINE INFORMATION REGARDING ENTERTAINMENT CONCERTS AND LIVE PERFORMANCES; ONLINE WORKSHOPS AND SEMINARS BY RECORDING ARTISTS AND MUSICAL GROUPS; EDUCATION IN THE FIELD OF MUSIC RENDERED THROUGH CORRESPONDENCE COURSES; ENTERTAINMENT SERVICES, NAMELY, PROVIDING ONLINE REVIEWS OF MUSIC, PRERECORDED MUSIC, INFORMATION IN THE FIELD OF MUSIC, COMMENTARY AND ARTICLES ABOUT MUSIC; INSTRUCTION IN THE FIELD OF MUSIC; MUSIC COMPOSITION AND TRANSCRIPTION FOR OTHERS; MUSIC PRODUCTION SERVICES; MUSIC PUBLISHING SERVICES;

RENTAL OF PHONOGRAPHIC AND MUSICAL RECORDINGS AND TEACHINGS IN THE FIELD OF MUSIC; ENTERTAINMENT SERVICES, NAMELY, PROVIDING A RADIO PROGRAM IN THE FIELD OF MUSIC; PROVIDING AN ONLINE RADIO PROGRAM IN THE FIELD OF MUSIC, IN CLASS 41 (U.S. CLS. 100, 101 AND 107).

FIRST USE 1-1-1998; IN COMMERCE 1-1-1998.

THE MARK CONSISTS OF STANDARD CHARACTERS WITHOUT CLAIM TO ANY PARTICULAR FONT, STYLE, SIZE, OR COLOR.

THE NAME(S), PORTRAIT(S), AND/OR SIGNATURE(S) SHOWN IN THE MARK IDENTIFIES "ELEANOR ACADEMIA", WHOSE CONSENT(S) TO REGISTER IS SUBMITTED.

SER. NO. 77-229,716, FILED 7-13-2007.

MICHAEL WEBSTER, EXAMINING ATTORNEY

Int. Cl.: 9

Prior U.S. Cls.: 21, 23, 26, 36 and 38

Reg. No. 3,483,471

United States Patent and Trademark Office

Registered Aug. 12, 2008

**TRADEMARK
PRINCIPAL REGISTER**

PROJECT BLUE

PROPAGANDA HEADQUARTERS, INC. (CALIFORNIA CORPORATION)
SUITE 1
31014 SOUTH COAST HIGHWAY
LAGUNA BEACH, CA 92651

FOR: COMPUTER SOFTWARE FOR THE DISTRIBUTION OF INFORMATION AND INTERACTIVE MULTIMEDIA CONTENT CONTAINING TEXT, IMAGES, VIDEO AND SOUND TO USERS IN THE FIELD OF COMMUNICATIONS; MUSICAL SOUND RECORDINGS, AUDIOVISUAL RECORDINGS FEATURING ADVERTISEMENTS AND/OR COMMERCIALS; DOWNLOADABLE MUSICAL SOUND RECORDINGS; DOWNLOADABLE RINGTONES, GRAPHICS AND MUSIC VIA A GLOBAL COMPUTER NETWORK, AND WIRELESS DEVICES; TELECOMMUNICATIONS AND TELEPHONE DEVICES, NAMELY, TELEPHONES, CELLULAR TELEPHONES, RADIO TELEPHONES, PAGERS, TWO-WAY RADIOS, RADIO TRANSMITTERS, RADIO RECEIVERS AND RADIO TRANSCEIVERS; COMPUTER GAME PROGRAMS AND SOFTWARE; WIRELESS TELECOMMUNICATIONS DEVICES AND EQUIPMENT, NAMELY, TELEPHONES;

ELECTRONIC DEVICES AND EQUIPMENT, NAMELY, ANALOG AND DIGITAL RADIO TRANSCEIVERS OR RECEIVERS FOR DATA, VOICE, IMAGE AND VIDEO COMMUNICATION; ELECTRONIC PUBLICATIONS DOWNLOADABLE FROM THE INTERNET IN THE NATURE OF NEWSLETTERS AND ARTICLES IN THE FIELD OF MUSIC, SPORTS AND ENTERTAINMENT; DIGITAL MUSIC DOWNLOADABLE FROM THE INTERNET AND FROM MP3 INTERNET WEB SITES; EYEWEAR, NAMELY, SUNGLASSES, EYEGASSES, SPORT GOGGLES, AND OTHER TYPES OF EYEWEAR , IN CLASS 9 (U.S. CLS. 21, 23, 26, 36 AND 38).

FIRST USE 1-23-2007; IN COMMERCE 1-23-2007.

THE MARK CONSISTS OF STANDARD CHARACTERS WITHOUT CLAIM TO ANY PARTICULAR FONT, STYLE, SIZE, OR COLOR.

SER. NO. 77-229,726, FILED 7-13-2007.

MICHAEL WEBSTER, EXAMINING ATTORNEY

Int. Cl.: 41

Prior U.S. Cls.: 100, 101 and 107

United States Patent and Trademark Office

Reg. No. 3,483,472

Registered Aug. 12, 2008

**SERVICE MARK
PRINCIPAL REGISTER**



ACADEMIA-MAGDA, ELEANOR (UNITED STATES INDIVIDUAL)
17043 MIDWOOD DRIVE
GRANADA HILLS, CA 91344

FOR: ENTERTAINMENT SERVICES IN THE NATURE OF LIVE CONCERTS AND LIVE PERFORMANCES BY MUSICAL GROUPS; WORKSHOPS AND SEMINARS IN THE FIELD OF MUSIC; PROVIDING ONLINE INFORMATION REGARDING ENTERTAINMENT CONCERTS AND LIVE PERFORMANCES; ONLINE WORKSHOPS AND SEMINARS BY RECORDING ARTISTS AND MUSICAL GROUPS; EDUCATION IN THE FIELD OF MUSIC RENDERED THROUGH CORRESPONDENCE COURSES; ENTERTAINMENT SERVICES, NAMELY, PROVIDING ONLINE REVIEWS OF MUSIC, PRERECORDED MUSIC, INFORMATION IN THE FIELD OF MUSIC, COMMENTARY AND ARTICLES ABOUT MUSIC; INSTRUCTION IN THE FIELD OF MUSIC; MUSIC COMPOSITION AND TRANSCRIPTION FOR OTHERS; MUSIC PRODUCTION SERVICES; MUSIC PUBLISHING SERVICES; RENTAL OF PHONOGRAPHIC AND MUSICAL RECORDINGS AND TEACHINGS IN THE FIELD

OF MUSIC; ENTERTAINMENT SERVICES, NAMELY, PROVIDING A RADIO PROGRAM IN THE FIELD OF MUSIC; PROVIDING AN ONLINE RADIO PROGRAM IN THE FIELD OF MUSIC, IN CLASS 41 (U.S. CLS. 100, 101 AND 107).

FIRST USE 1-1-1998; IN COMMERCE 1-1-1998.

THE NAME(S), PORTRAIT(S), AND/OR SIGNATURE(S) SHOWN IN THE MARK IDENTIFIES "ELEANOR ACADEMIA", WHOSE CONSENT(S) TO REGISTER IS SUBMITTED.

THE MARK CONSISTS OF THE DRAWING OF A SWAN OVER A CIRCLE, WITH THE WORDS "ELEANOR ACADEMIA" AROUND THE RIGHT PERIMETER OF THE CIRCLE, AND THE WORDS "BLACK SWAN" INSIDE THE CIRCLE BELOW THE DRAWING OF THE SWAN.

SER. NO. 77-229,729, FILED 7-13-2007.

MICHAEL WEBSTER, EXAMINING ATTORNEY

Int. Cl.: 14

Prior U.S. Cls.: 2, 27, 28 and 50

United States Patent and Trademark Office

Reg. No. 3,483,473

Registered Aug. 12, 2008

**TRADEMARK
PRINCIPAL REGISTER**

PROJECT BLUE

PROPAGANDA HEADQUARTERS, INC. (CALI-
FORNIA CORPORATION)
SUITE 1
31014 SOUTH COAST HIGHWAY
LAGUNA BEACH, CA 92651

FOR: WATCHES, POCKET WATCHES, WATCH
BANDS, JEWELRY, BRACELETS, CHARITY BRA-
CELETS, NECKLACES AND JEWELRY CASES, IN
CLASS 14 (U.S. CLS. 2, 27, 28 AND 50).

FIRST USE 1-23-2007; IN COMMERCE 1-23-2007.

THE MARK CONSISTS OF STANDARD CHAR-
ACTERS WITHOUT CLAIM TO ANY PARTICULAR
FONT, STYLE, SIZE, OR COLOR.

SER. NO. 77-229,736, FILED 7-13-2007.

MICHAEL WEBSTER, EXAMINING ATTORNEY

Int. Cl.: 29

Prior U.S. Cl.: 46

United States Patent and Trademark Office

Reg. No. 3,483,474

Registered Aug. 12, 2008

**TRADEMARK
PRINCIPAL REGISTER**

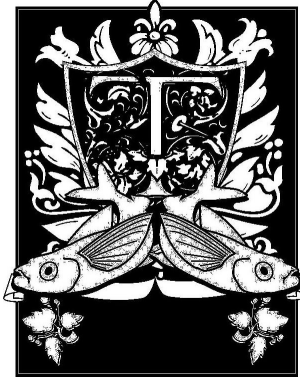

AZUMA FOODS INTERNATIONAL INC., U.S.A.
(CALIFORNIA CORPORATION)
1787 SABRE STREET
HAYWARD, CA 94545

THE MARK CONSISTS OF LEAVES BELOW
SYMMETRICAL TWO FISH AND A SHIELD DE-
SIGN SURROUNDING THE "T".

FOR: SEASONED FLYING FISH ROE, ALSO
KNOWN AS TOBIKKO, IN CLASS 29 (U.S. CL. 46).

SER. NO. 77-229,737, FILED 7-13-2007.

FIRST USE 0-0-1992; IN COMMERCE 0-0-1992.

THE APPLICANT CLAIMS COLOR AS A FEAT-
URE OF THE MARK, NAMELY, ORANGE, YEL-
LOW, AND BLACK.

MICHAEL WEBSTER, EXAMINING ATTORNEY

Int. Cl.: 16

Prior U.S. Cls.: 2, 5, 22, 23, 29, 37, 38 and 50

Reg. No. 3,483,475

United States Patent and Trademark Office

Registered Aug. 12, 2008

**TRADEMARK
PRINCIPAL REGISTER**

New Leaf

NEW LEAF PAPER, LLC (NEW YORK LTD LIAB
CO)
116 NEW MONTGOMERY ST., SUITE 830
SAN FRANCISCO, CA 941053607

FOR: COPIER PAPER; COPY PAPER; OFFICE
PAPER STATIONERY; OPAQUE PAPER; PAPER;
PAPER STATIONERY; PAPER STOCK, IN CLASS
16 (U.S. CLS. 2, 5, 22, 23, 29, 37, 38 AND 50).

FIRST USE 6-1-2007; IN COMMERCE 6-1-2007.

THE MARK CONSISTS OF STANDARD CHAR-
ACTERS WITHOUT CLAIM TO ANY PARTICULAR
FONT, STYLE, SIZE, OR COLOR.

OWNER OF U.S. REG. NOS. 3,244,700, 3,244,702,
AND 3,392,438.

SER. NO. 77-229,820, FILED 7-14-2007.

STEVEN R. FOSTER, EXAMINING ATTORNEY

Int. Cl.: 16

Prior U.S. Cls.: 2, 5, 22, 23, 29, 37, 38 and 50

Reg. No. 3,483,476

United States Patent and Trademark Office

Registered Aug. 12, 2008

**TRADEMARK
PRINCIPAL REGISTER**

NICK

VIACOM INTERNATIONAL INC. (DELAWARE
CORPORATION)
1515 BROADWAY
NEW YORK, NY 10036

FOR: PRINTED MATTER, NAMELY, PAPER
NAPKINS, DECALS, BOOK COVERS, POSTERS,
PAPER BANNERS, PENCILS, IN CLASS 16 (U.S.
CLS. 2, 5, 22, 23, 29, 37, 38 AND 50).

FIRST USE 7-1-1980; IN COMMERCE 5-1-1984.

THE MARK CONSISTS OF STANDARD CHAR-
ACTERS WITHOUT CLAIM TO ANY PARTICULAR
FONT, STYLE, SIZE, OR COLOR.

OWNER OF U.S. REG. NOS. 2,989,800, 3,312,123
AND OTHERS.

SER. NO. 77-230,122, FILED 7-16-2007.

COLLEEN DOMBROW, EXAMINING ATTORNEY

Int. Cl.: 16

Prior U.S. Cls.: 2, 5, 22, 23, 29, 37, 38 and 50

Reg. No. 3,483,477

United States Patent and Trademark Office

Registered Aug. 12, 2008

**TRADEMARK
PRINCIPAL REGISTER**

NICKELODEON

VIACOM INTERNATIONAL INC. (DELAWARE
CORPORATION)
1515 BROADWAY
NEW YORK, NY 10036

FOR: PRINTED MATTER, NAMELY, PAPER
NAPKINS, DECALS, BOOK COVERS, POSTERS,
PAPER BANNERS, PENCILS, IN CLASS 16 (U.S.
CLS. 2, 5, 22, 23, 29, 37, 38 AND 50).

FIRST USE 12-1-1980; IN COMMERCE 12-1-1980.

THE MARK CONSISTS OF STANDARD CHAR-
ACTERS WITHOUT CLAIM TO ANY PARTICULAR
FONT, STYLE, SIZE, OR COLOR.

OWNER OF U.S. REG. NOS. 1,907,159, 2,589,358,
AND 2,872,457.

SER. NO. 77-230,124, FILED 7-16-2007.

COLLEEN DOMBROW, EXAMINING ATTORNEY

Int. Cl.: 35

Prior U.S. Cls.: 100, 101 and 102

United States Patent and Trademark Office

Reg. No. 3,483,478

Registered Aug. 12, 2008

**SERVICE MARK
PRINCIPAL REGISTER**

Habitat For Hounds

HABITAT FOR HOUNDS, LLC (NEW MEXICO
LTD LIAB CO)
1295 VALLECITA DR.
SANTE FE, NM 87501

FOR: ONLINE RETAIL STORE SERVICES FEATURING DOG HOUSES, DOG HOUSE PLANS, PET SUPPLIES AND ACCESSORIES, GIFT ITEMS, CALENDARS, CLOTHING, VIDEOS, DVD'S, BOOKS; PROMOTING GOODS AND SERVICES OF OTHERS BY DISTRIBUTING DISCOUNT COUPONS VIA GLOBAL COMPUTER NETWORKS; PROVIDING ONLINE LISTING OF INTERNET SHOPPING DIRECTORIES FEATURING, PET SUPPLIES AND ACCESSORIES, GIFT ITEMS, CALENDARS, CLOTHING, VIDEOS, DVD'S, BOOKS, IN CLASS 35 (U.S. CLS. 100, 101 AND 102).

FIRST USE 7-7-2007; IN COMMERCE 7-7-2007.

THE MARK CONSISTS OF STANDARD CHARACTERS WITHOUT CLAIM TO ANY PARTICULAR FONT, STYLE, SIZE, OR COLOR.

NO CLAIM IS MADE TO THE EXCLUSIVE RIGHT TO USE "HOUNDS" , APART FROM THE MARK AS SHOWN.

SER. NO. 77-230,221, FILED 7-16-2007.

ZACHARY BELLO, EXAMINING ATTORNEY

Int. Cl.: 5

Prior U.S. Cls.: 6, 18, 44, 46, 51 and 52

United States Patent and Trademark Office

Reg. No. 3,483,479

Registered Aug. 12, 2008

**TRADEMARK
PRINCIPAL REGISTER**

OSPARIX

GLAXOSMITHKLINE BIOLOGICALS, S.A. (BEL-
GIUM CORPORATION)
RUE DE L'INSTITUT 89
RIXENSART, BELGIUM B-1330

OWNER OF BENELUX REG. NO. 622652, DATED
2-17-1997, EXPIRES 2-17-2017.

FOR: HUMAN VACCINES, IN CLASS 5 (U.S. CLS.
6, 18, 44, 46, 51 AND 52).

SER. NO. 77-230,299, FILED 7-16-2007.

THE MARK CONSISTS OF STANDARD CHAR-
ACTERS WITHOUT CLAIM TO ANY PARTICULAR
FONT, STYLE, SIZE, OR COLOR.

KARANENDRA S. CHHINA, EXAMINING ATTOR-
NEY

Int. Cl.: 6

Prior U.S. Cls.: 2, 12, 13, 14, 23, 25 and 50

Reg. No. 3,483,480

United States Patent and Trademark Office

Registered Aug. 12, 2008

**TRADEMARK
PRINCIPAL REGISTER**

ELK RIVER

R.G. APPLGATE STEEL COMPANY, INC. (IN-
DIANA CORPORATION)
201 OWENS STREET
SARATOGA, IN 47382

FOR: METAL LIVESTOCK HANDLING EQUIP-
MENT, NAMELY, GATES AND FENCING PANELS,
CORRALS, CORRAL GUIDES AND SQUEEZE
CHUTES, IN CLASS 6 (U.S. CLS. 2, 12, 13, 14, 23, 25
AND 50).

FIRST USE 3-31-1997; IN COMMERCE 3-31-1997.

THE MARK CONSISTS OF STANDARD CHAR-
ACTERS WITHOUT CLAIM TO ANY PARTICULAR
FONT, STYLE, SIZE, OR COLOR.

SER. NO. 77-230,430, FILED 7-16-2007.

DANIEL BRODY, EXAMINING ATTORNEY

Int. Cls.: 6, 7 and 21

**Prior U.S. Cls.: 2, 12, 13, 14, 19, 21, 23, 25, 29, 30, 31,
33, 34, 35, 40 and 50**

Reg. No. 3,483,481

United States Patent and Trademark Office

Registered Aug. 12, 2008

**TRADEMARK
PRINCIPAL REGISTER**

INDIAN CREEK

R.G. APPLGATE STEEL COMPANY, INC. (IN-
DIANA CORPORATION)
201 OWENS STREET
SARATOGA, IN 47382

FOR: METAL LIVESTOCK HANDLING EQUIP-
MENT, NAMELY, GATES AND FENCING PANELS,
SQUEEZE CHUTES, BOW GATES, BOW GATE
PANELS, ALLEY BOW GATE SLIDE-UPS, AND
HEADGATES, IN CLASS 6 (U.S. CLS. 2, 12, 13, 14,
23, 25 AND 50).

FIRST USE 7-6-1995; IN COMMERCE 7-6-1995.

FOR: METAL LIVESTOCK HANDLING EQUIP-
MENT, NAMELY, MECHANIZED LIVESTOCK
BALE FEEDERS AND FEED BUNKS, IN CLASS 7
(U.S. CLS. 13, 19, 21, 23, 31, 34 AND 35).

FIRST USE 7-6-1995; IN COMMERCE 7-6-1995.

FOR: METAL ANIMAL ACTIVATED LIVESTOCK
FEEDERS, NAMELY, BALE FEEDERS AND FEED
BUNKS, IN CLASS 21 (U.S. CLS. 2, 13, 23, 29, 30, 33, 40
AND 50).

FIRST USE 7-6-1995; IN COMMERCE 7-6-1995.

THE MARK CONSISTS OF STANDARD CHAR-
ACTERS WITHOUT CLAIM TO ANY PARTICULAR
FONT, STYLE, SIZE, OR COLOR.

SER. NO. 77-230,442, FILED 7-16-2007.

DANIEL BRODY, EXAMINING ATTORNEY

Int. Cls.: 6, 9, 16, 20 and 21

Prior U.S. Cls.: 2, 5, 12, 13, 14, 21, 22, 23, 25, 26, 29, 30, 32, 33, 36, 37, 38, 40 and 50

Reg. No. 3,483,483

United States Patent and Trademark Office

Registered Aug. 12, 2008

**TRADEMARK
PRINCIPAL REGISTER**



SPECTRUM DIVERSIFIED DESIGNS, INC. (OHIO CORPORATION)
675 MONDIAL PARKWAY
STREETSBORO, OH 44241

FOR: HOUSEHOLD ORGANIZATION ACCESSORIES, NAMELY, METAL HOOKS, METAL CLOTHES HOOKS, METAL UTILITY HOOKS, METAL WIRE BASKETS, STORAGE AND ORGANIZATION BASKETS OF METAL, METAL OVER-THE-DOOR HOOKS AND ORGANIZERS IN THE NATURE OF BASKETS OF COMMON METALS; METAL BATH HOOKS, IN CLASS 6 (U.S. CLS. 2, 12, 13, 14, 23, 25 AND 50).

FIRST USE 6-5-2007; IN COMMERCE 6-5-2007.

FOR: OFFICE AND HOUSEHOLD ORGANIZATION ACCESSORIES, NAMELY, COMPACT DISC HOLDERS AND STORAGE RACKS, MAGNETS IN THE NATURE OF MAGNET MOUNTED SUPPORTS, STRIPS AND BOARDS, DECORATIVE MAGNETS, REFRIGERATOR MAGNETS , IN CLASS 9 (U.S. CLS. 21, 23, 26, 36 AND 38).

FIRST USE 6-13-2007; IN COMMERCE 6-13-2007.

FOR: DESK AND HOUSEHOLD ORGANIZATION ACCESSORIES, NAMELY, BOOKENDS, DESKTOP ORGANIZERS, SELF-ADHESIVE AND MAGNETIC BACKED CLIPS TO HOLD PAPERS, MESSAGE PAD HOLDERS, BULLETIN BOARDS, MAGNETIC BOARDS, HOLDERS FOR DESK ACCESSORIES, DESK BASKETS, HOLDERS FOR NOTEPADS, HOLDERS FOR CLIPS, DOCUMENT FILE RACKS, CORRESPONDENCE RACKS, LETTER RACKS, PAPER RACKS, PEN AND PENCIL HOLDERS, COOK-

BOOK HOLDERS , IN CLASS 16 (U.S. CLS. 2, 5, 22, 23, 29, 37, 38 AND 50).

FIRST USE 6-13-2007; IN COMMERCE 6-13-2007.

FOR: HOUSEHOLD ORGANIZATION ACCESSORIES, NAMELY, SELF-ADHESIVE AND MAGNETIC-BACKED UTILITY HOOKS NOT OF METAL, PLATE RACKS, MAGAZINE RACK, COAT RACKS, HAT AND COAT RACKS, WINE RACKS, CLOTHES HANGERS, DISPLAY BOARDS, PLASTIC HOOKS, NON-METAL OVER-THE-DOOR HOOKS; NON-METAL BATH HOOKS; BATH-TOWEL RACKS; METAL HOOK RACKS FOR HOUSEHOLD ITEMS, CLOTHING AND PERSONAL ACCESSORIES; METAL SHELF ORGANIZERS IN THE NATURE OF SHELF DIVIDERS, IN CLASS 20 (U.S. CLS. 2, 13, 22, 25, 32 AND 50).

FIRST USE 6-18-2007; IN COMMERCE 6-18-2007.

FOR: STORAGE AND ORGANIZATION BASKETS OF PLASTIC, KITCHEN AND HOUSEHOLD ORGANIZATION ACCESSORIES, NAMELY, RACKS FOR DISPENSING PAPER TOWELS, MOP OR BROOM HOLDERS, IRON AND IRONING BOARD HOLDERS, DRINK COASTERS OF PLASTIC, COASTER HOLDERS, SPOON RESTS, BANANA RACKS AND FRUIT HOLDERS, MUG AND CUP TREES, TRIVETS, NAPKIN HOLDERS, UTENSIL HOLDERS, STEM WARE AND GLASS HOLDERS, BOTTLE HOLDERS, SPICE RACKS, BATH ORGANIZATION ACCESSORIES, NAMELY, TOWEL HOLDERS, BATH ACCESSORIES IN THE NATURE OF TOOTHBRUSH HOLDERS, SPONGE HOLDERS, TOILET BRUSH HOLDERS, SHAMPOO BOTTLE HOLDERS, SQUEEGEE HOLDERS, RAZOR HOLDERS, OVER-THE-TANK MAGAZINE

HOLDERS, OVER-THE-TANK TISSUE HOLDERS, PLASTIC BATH RACKS AND PLASTIC BATHROOM BASKETS, TOILET PAPER HOLDERS, TISSUE HOLDERS, TOWEL BARS, SQUEEGEES, BAR SOAP HOLDERS, SHOWER CADDIES, AND WASTEBASKETS, IN CLASS 21 (U.S. CLS. 2, 13, 23, 29, 30, 33, 40 AND 50).

FIRST USE 6-18-2007; IN COMMERCE 6-18-2007.

OWNER OF U.S. REG. NO. 1,508,057.

THE MARK CONSISTS OF THE WORD "SPECTRUM" UNDER A ROOF LINE DESIGN.

SER. NO. 77-230,507, FILED 7-16-2007.

BRENDAN REGAN, EXAMINING ATTORNEY

Int. Cl.: 38

Prior U.S. Cls.: 100, 101 and 104

United States Patent and Trademark Office

Reg. No. 3,483,484

Registered Aug. 12, 2008

**SERVICE MARK
PRINCIPAL REGISTER**

**BLUE CARPET CONCIERGE
SERVICES**

QWEST COMMUNICATIONS INTERNATIONAL
INC. (DELAWARE CORPORATION)
1801 CALIFORNIA ST.
DENVER, CO 80202

FOR: ELECTRONIC, ELECTRIC, AND DIGITAL
TRANSMISSION OF VOICE, DATA, IMAGES, SIG-
NALS, AND MESSAGES, IN CLASS 38 (U.S. CLS. 100,
101 AND 104).

FIRST USE 8-31-2007; IN COMMERCE 8-31-2007.

THE MARK CONSISTS OF STANDARD CHAR-
ACTERS WITHOUT CLAIM TO ANY PARTICULAR
FONT, STYLE, SIZE, OR COLOR.

NO CLAIM IS MADE TO THE EXCLUSIVE
RIGHT TO USE "CONCIERGE SERVICES", APART
FROM THE MARK AS SHOWN.

SER. NO. 77-230,660, FILED 7-16-2007.

TRACY WHITTAKER-BROWN, EXAMINING AT-
TORNEY

Int. Cl.: 37

Prior U.S. Cls.: 100, 103 and 106

United States Patent and Trademark Office

Reg. No. 3,483,485

Registered Aug. 12, 2008

SERVICE MARK
PRINCIPAL REGISTER



GROUND ZERO SERVICES, LLC (MINNESOTA
LTD LIAB CO)
312 FOURTH STREET
COURTLAND, MN 56021

FOR: MAINTENANCE AND/OR REPAIR OF
PARKING LOTS, IN CLASS 37 (U.S. CLS. 100, 103
AND 106).

FIRST USE 1-1-1999; IN COMMERCE 1-1-1999.

NO CLAIM IS MADE TO THE EXCLUSIVE
RIGHT TO USE "COMMERCIAL AND RETAIL
PARKING AREA MAINTENANCE", "SERVICES",
OR "COURTLAND, MINNESOTA", APART FROM
THE MARK AS SHOWN.

THE COLOR(S) WHITE, BLACK AND RED IS/
ARE CLAIMED AS A FEATURE OF THE MARK.

THE MARK CONSISTS OF A WHITE OVAL WITH
A DOUBLE OUTLINE IN BLACK. THE WORDS
"GROUND", "COMMERCIAL & RETAIL PARKING
AREA MAINTENANCE", AND "COURTLAND,
MINNESOTA" ARE ALL IN BLACK. THE WORD
"SERVICES" IS IN WHITE ON A BLACK BACK-
GROUND WITH WHITE LINING. THE WORD
"ZERO" IS IN RED.

SER. NO. 77-231,263, FILED 7-17-2007.

KATHLEEN M. VANSTON, EXAMINING ATTOR-
NEY

Int. Cl.: 9

Prior U.S. Cls.: 21, 23, 26, 36 and 38

Reg. No. 3,483,486

United States Patent and Trademark Office

Registered Aug. 12, 2008

**TRADEMARK
PRINCIPAL REGISTER**

ALL FLEX

ALL FLEX ACQUISITIONS, LLC (DELAWARE
LTD LIAB CO)
#325
301 CARLSON PKWY
MINNETONKA, MN 55305

FOR: FLEXIBLE PRINTED CIRCUITS FOR THE
MEDICAL, AEROSPACE, AUTOMOTIVE, MILI-
TARY, INSTRUMENTATION, AND INDUSTRIAL
MARKETS, IN CLASS 9 (U.S. CLS. 21, 23, 26, 36 AND
38).

FIRST USE 8-19-1991; IN COMMERCE 9-16-1991.

THE MARK CONSISTS OF STANDARD CHAR-
ACTERS WITHOUT CLAIM TO ANY PARTICULAR
FONT, STYLE, SIZE, OR COLOR.

NO CLAIM IS MADE TO THE EXCLUSIVE
RIGHT TO USE "FLEX", APART FROM THE MARK
AS SHOWN.

SER. NO. 77-231,347, FILED 7-17-2007.

LINDA LAVACHE, EXAMINING ATTORNEY

Int. Cl.: 42

Prior U.S. Cls.: 100 and 101

United States Patent and Trademark Office

Reg. No. 3,483,487

Registered Aug. 12, 2008

**SERVICE MARK
PRINCIPAL REGISTER**

ALL FLEX

ALL FLEX ACQUISITIONS, LLC (DELAWARE
LTD LIAB CO)

#325

301 CARLSON PKWY

MINNETONKA, MN 55305

FOR: CUSTOM DESIGN OF FLEXIBLE CIR-
CUITS, IN CLASS 42 (U.S. CLS. 100 AND 101).

FIRST USE 8-19-1991; IN COMMERCE 9-16-1991.

THE MARK CONSISTS OF STANDARD CHAR-
ACTERS WITHOUT CLAIM TO ANY PARTICULAR
FONT, STYLE, SIZE, OR COLOR.

NO CLAIM IS MADE TO THE EXCLUSIVE
RIGHT TO USE "FLEX", APART FROM THE MARK
AS SHOWN.

SER. NO. 77-231,353, FILED 7-17-2007.

LINDA LAVACHE, EXAMINING ATTORNEY

Int. Cl.: 40

Prior U.S. Cls.: 100, 103 and 106

United States Patent and Trademark Office

Reg. No. 3,483,488

Registered Aug. 12, 2008

**SERVICE MARK
PRINCIPAL REGISTER**

ALL FLEX

ALL FLEX ACQUISITIONS, LLC (DELAWARE
LTD LIAB CO)
#325
301 CARLSON PKWY
MINNETONKA, MN 55305

FOR: ASSEMBLY OF FLEXIBLE CIRCUITS TO
THE ORDER AND SPECIFICATION OF OTHERS;
CUSTOM MANUFACTURE OF FLEXIBLE CIR-
CUITS, IN CLASS 40 (U.S. CLS. 100, 103 AND 106).

FIRST USE 8-19-1991; IN COMMERCE 9-16-1991.

THE MARK CONSISTS OF STANDARD CHAR-
ACTERS WITHOUT CLAIM TO ANY PARTICULAR
FONT, STYLE, SIZE, OR COLOR.

NO CLAIM IS MADE TO THE EXCLUSIVE
RIGHT TO USE "FLEX", APART FROM THE MARK
AS SHOWN.

SER. NO. 77-231,359, FILED 7-17-2007.

LINDA LAVACHE, EXAMINING ATTORNEY

Int. Cl.: 3

Prior U.S. Cls.: 1, 4, 6, 50, 51 and 52

United States Patent and Trademark Office

Reg. No. 3,483,489

Registered Aug. 12, 2008

**TRADEMARK
PRINCIPAL REGISTER**

**JUICY TUBES
ORGANIC**

LANCOME PARFUMS ET BEAUTE & CIE
(FRANCE SOCIETE EN NOM COLLECTIF)

29, RUE DU FAUBOURG SAINT-HONORE

PARIS, FRANCE 75008

FOR: COSMETICS MADE IN WHOLE OR SIGNIFICANT PART FROM ORGANIC INGREDIENTS, NAMELY, CREAMS, GELS, MILKS, POWDERS AND LOTIONS FOR THE FACE, THE BODY AND THE HANDS; MAKEUP PRODUCTS, MADE IN WHOLE OR SIGNIFICANT PART FROM ORGANIC INGREDIENTS, NAMELY, MASCARA, EYE LINER, EYE SHADOW, EYEBROW PENCIL, LIPSTICKS, NAIL POLISH, BLUSH, FOUNDATIONS CREAMS AND POWDER, AND BODY DEODORANTS, IN CLASS 3 (U.S. CLS. 1, 4, 6, 50, 51 AND 52).

THE MARK CONSISTS OF STANDARD CHARACTERS WITHOUT CLAIM TO ANY PARTICULAR FONT, STYLE, SIZE, OR COLOR.

PRIORITY CLAIMED UNDER SEC. 44(D) ON FRANCE APPLICATION NO. 073498508, FILED 5-3-2007, REG. NO. 073498508, DATED 5-3-2007, EXPIRES 5-3-2017.

OWNER OF U.S. REG. NO. 2,442,440.

NO CLAIM IS MADE TO THE EXCLUSIVE RIGHT TO USE "ORGANIC", APART FROM THE MARK AS SHOWN.

SER. NO. 77-231,437, FILED 7-17-2007.

JENNIFER VASQUEZ, EXAMINING ATTORNEY

Int. Cls.: 37 and 42

Prior U.S. Cls.: 100, 101, 103 and 106

United States Patent and Trademark Office

Reg. No. 3,483,490

Registered Aug. 12, 2008

**SERVICE MARK
PRINCIPAL REGISTER**

**INNOVATIVE BUILDING AND
ARCHITECTURE CONSULTANTS**

IBA CONSULTANTS, INC. (FLORIDA CORPORATION)
SUITE A301
6909 S W 18TH STREET
BOCA RATON, FL 33433

FOR: BUILDING INSPECTION SERVICES, IN CLASS 37 (U.S. CLS. 100, 103 AND 106).

FIRST USE 12-6-2006; IN COMMERCE 12-6-2006.

FOR: INSPECTIONS OF BUILDINGS; BUILDING CONSTRUCTION TESTING; DESIGN OF COMMERCIAL AND RESIDENTIAL BUILDINGS, IN CLASS 42 (U.S. CLS. 100 AND 101).

FIRST USE 12-6-2006; IN COMMERCE 12-6-2006.

THE MARK CONSISTS OF STANDARD CHARACTERS WITHOUT CLAIM TO ANY PARTICULAR FONT, STYLE, SIZE, OR COLOR.

NO CLAIM IS MADE TO THE EXCLUSIVE RIGHT TO USE "BUILDING AND ARCHITECTURE CONSULTANTS", APART FROM THE MARK AS SHOWN.

SER. NO. 77-231,635, FILED 7-17-2007.

DAVID COLLIER, EXAMINING ATTORNEY

Int. Cl.: 16

Prior U.S. Cls.: 2, 5, 22, 23, 29, 37, 38 and 50

United States Patent and Trademark Office

Reg. No. 3,483,491

Registered Aug. 12, 2008

**TRADEMARK
PRINCIPAL REGISTER**



SCHOLASTIC INC. (NEW YORK CORPORATION)
557 BROADWAY
NEW YORK, NY 10012

FOR: A SERIES OF NONFICTION BOOKS FOR TEENS AND YOUNG ADULTS IN THE FIELD OF SOCIAL AND CULTURAL ISSUES, IN CLASS 16 (U.S. CLS. 2, 5, 22, 23, 29, 37, 38 AND 50).

FIRST USE 1-1-2007; IN COMMERCE 1-1-2007.

OWNER OF U.S. REG. NOS. 273,405, 1,567,119 AND OTHERS.

SEC. 2(F) AS TO "SCHOLASTIC".

SER. NO. 77-231,715, FILED 7-17-2007.

EVELYN BRADLEY, EXAMINING ATTORNEY

Int. Cl.: 36

Prior U.S. Cls.: 100, 101 and 102

United States Patent and Trademark Office

Reg. No. 3,483,492

Registered Aug. 12, 2008

**SERVICE MARK
PRINCIPAL REGISTER**

ICAN

IOWA STUDENT LOAN LIQUIDITY CORPORATION (IOWA CORPORATION)
6805 VISTA DRIVE, ASHFORD 1 BLDG.
WEST DES MOINES, IA 502669307

THE MARK CONSISTS OF STANDARD CHARACTERS WITHOUT CLAIM TO ANY PARTICULAR FONT, STYLE, SIZE, OR COLOR.

FOR: PROVIDING FINANCIAL AID INFORMATION, PROVIDING INFORMATION REGARDING FINANCIAL AID COMPLETION AND FILING, IN CLASS 36 (U.S. CLS. 100, 101 AND 102).

SER. NO. 77-231,753, FILED 7-17-2007.

FIRST USE 6-1-2007; IN COMMERCE 6-1-2007.

KAREN K. BUSH, EXAMINING ATTORNEY

Int. Cls.: 36 and 41

Prior U.S. Cls.: 100, 101, 102 and 107

United States Patent and Trademark Office

Reg. No. 3,483,493

Registered Aug. 12, 2008

**SERVICE MARK
PRINCIPAL REGISTER**

IOWA COLLEGE ACCESS NETWORK

IOWA STUDENT LOAN LIQUIDITY CORPORATION (IOWA CORPORATION)
6805 VISTA DRIVE, ASHFORD 1 BLDG.
WEST DES MOINES, IA 502669307

FOR: PROVIDING FINANCIAL AID INFORMATION, PROVIDING INFORMATION REGARDING FINANCIAL AID COMPLETION AND FILING, IN CLASS 36 (U.S. CLS. 100, 101 AND 102).

FIRST USE 6-1-2007; IN COMMERCE 6-1-2007.

FOR: ASSISTANCE WITH EDUCATIONAL AND CAREER GOALS, NAMELY, CAREER COUNSELING; COLLEGE PLANNING; COLLEGE SEARCHING AND SELECTION; ACADEMIC PLANNING; ONLINE TEST PREPARATION AND ASSISTANCE

WITH ADMISSION APPLICATIONS, IN CLASS 41 (U.S. CLS. 100, 101 AND 107).

FIRST USE 6-1-2007; IN COMMERCE 6-1-2007.

THE MARK CONSISTS OF STANDARD CHARACTERS WITHOUT CLAIM TO ANY PARTICULAR FONT, STYLE, SIZE, OR COLOR.

NO CLAIM IS MADE TO THE EXCLUSIVE RIGHT TO USE "IOWA COLLEGE" AND "NETWORK", APART FROM THE MARK AS SHOWN.

SER. NO. 77-231,819, FILED 7-17-2007.

KAREN K. BUSH, EXAMINING ATTORNEY

Int. Cl.: 28

Prior U.S. Cls.: 22, 23, 38 and 50

United States Patent and Trademark Office

Reg. No. 3,483,494

Registered Aug. 12, 2008

**TRADEMARK
PRINCIPAL REGISTER**

**POLLY WHEELS COLORS
COLLECTION**

ORIGIN PRODUCTS LIMITED (UNITED KING-
DOM LIMITED COMPANY)
VANWALL ROAD
MATTEL HOUSE, VANWALL BUSINESS PARK
MAIDENHEAD, UNITED KINGDOM SL64UB

FOR: TOYS, GAMES AND PLAYTHINGS, NAME-
LY, TOY FIGURES, TOY VEHICLES AND ACCES-
SORIES FOR ALL OF THE FOREGOING , IN CLASS
28 (U.S. CLS. 22, 23, 38 AND 50).

FIRST USE 11-9-2007; IN COMMERCE 11-9-2007.

THE MARK CONSISTS OF STANDARD CHAR-
ACTERS WITHOUT CLAIM TO ANY PARTICULAR
FONT, STYLE, SIZE, OR COLOR.

OWNER OF U.S. REG. NOS. 2,112,633, 3,311,932
AND OTHERS.

NO CLAIM IS MADE TO THE EXCLUSIVE
RIGHT TO USE "COLORS COLLECTION", APART
FROM THE MARK AS SHOWN.

SER. NO. 77-231,843, FILED 7-17-2007.

ANDREA K. NADELMAN, EXAMINING ATTOR-
NEY

Int. Cls.: 36 and 41

Prior U.S. Cls.: 100, 101, 102 and 107

United States Patent and Trademark Office

Reg. No. 3,483,495

Registered Aug. 12, 2008

**SERVICE MARK
PRINCIPAL REGISTER**



IOWA STUDENT LOAN LIQUIDITY CORPORATION (IOWA CORPORATION)
6805 VISTA DRIVE, ASHFORD 1 BUILDING
WEST DES MOINES, IA 502669307

FOR: PROVIDING FINANCIAL AID INFORMATION, PROVIDING INFORMATION REGARDING FINANCIAL AID COMPLETION AND FILING , IN CLASS 36 (U.S. CLS. 100, 101 AND 102).

FIRST USE 6-1-2007; IN COMMERCE 6-1-2007.

FOR: ASSISTANCE WITH EDUCATIONAL AND CAREER GOALS, NAMELY, CAREER COUNSELING; COLLEGE PLANNING; COLLEGE SEARCHING AND SELECTION; ACADEMIC PLANNING;

ONLINE TEST PREPARATION AND ASSISTANCE WITH ADMISSION APPLICATIONS, IN CLASS 41 (U.S. CLS. 100, 101 AND 107).

FIRST USE 6-1-2007; IN COMMERCE 6-1-2007.

NO CLAIM IS MADE TO THE EXCLUSIVE RIGHT TO USE "IOWA STUDENT LOAN COLLEGE" AND "NETWORK" , APART FROM THE MARK AS SHOWN.

SER. NO. 77-231,876, FILED 7-17-2007.

KAREN K. BUSH, EXAMINING ATTORNEY

Int. Cl.: 30

Prior U.S. Cl.: 46

United States Patent and Trademark Office

Reg. No. 3,483,496

Registered Aug. 12, 2008

TRADEMARK
PRINCIPAL REGISTER



SIMPLICITY DESSERTS LLC (NEW JERSEY LTD
LIAB CO)
476 CENTENNIAL BLVD #17
VOORHEES, NJ 08043

FOR: BAKERY DESSERTS; BAKERY PRODUCTS,
NAMELY, SWEET BAKERY GOODS; CAKES; CUP
CAKES, IN CLASS 30 (U.S. CL. 46).

FIRST USE 3-15-2007; IN COMMERCE 3-15-2007.

NO CLAIM IS MADE TO THE EXCLUSIVE
RIGHT TO USE "DESSERTS", APART FROM THE
MARK AS SHOWN.

THE COLOR(S) BLUE, BLACK, AND RED IS/ARE
CLAIMED AS A FEATURE OF THE MARK.

THE MARK CONSISTS OF A STYLIZED BLACK
COLORED WORD "SIMPLICITY" WITH THE LET-
TER "Y" FORMING A CUPCAKE WITH A RED
CHERRY ON TOP. A BLUE BAR SEPARATES THE
BLACK "SIMPLICITY" FROM A BLUE PRINT
"DESSERTS".

SER. NO. 77-231,906, FILED 7-17-2007.

KATHRYN COWARD, EXAMINING ATTORNEY

Int. Cl.: 35

Prior U.S. Cls.: 100, 101 and 102

United States Patent and Trademark Office

Reg. No. 3,483,497

Registered Aug. 12, 2008

SERVICE MARK
PRINCIPAL REGISTER



EVANTAGE CONSULTING, LLC (MINNESOTA
LTD LIAB CO)
212 3RD AVENUE NORTH #400
MINNEAPOLIS, MN 55401

FOR: ADVERTISING AND MARKETING; ADVERTISING SERVICES, NAMELY, PROMOTING AND MARKETING THE GOODS AND SERVICES OF OTHERS THROUGH ALL PUBLIC COMMUNICATION MEANS; ADVERTISING SERVICES, PUBLIC RELATIONS AND MARKETING SERVICES, NAMELY, PROMOTING AND MARKETING THE GOODS AND SERVICES OF OTHERS THROUGH ALL PUBLIC COMMUNICATION MEANS; ADVERTISING, MARKETING AND PROMOTION SERVICES; BUSINESS MARKETING CONSULTING SERVICES; CREATION OF MARKETING TOOLS DESIGNED TO INCREASE A CLIENT COMPANY'S KNOWLEDGE OF CUSTOMER NEEDS, AND ITS COMPETITORS' PRODUCTS AND SERVICES, PRICING, ADVERTISING STRATEGY AND SALES STRATEGY; CREATIVE MARKETING DESIGN SERVICES; DEVELOPMENT OF MARKETING STRATEGIES AND CONCEPTS; MARKETING CONSULTING; MARKETING PLAN DEVELOPMENT; ON-LINE ADVERTISING AND MARKETING SERVICES; PROMOTION AND MARKETING

SERVICES AND RELATED CONSULTING; PROVIDING BUSINESS MARKETING INFORMATION; PROVIDING INFORMATION IN THE FIELD OF MARKETING AND ON-LINE MARKETING MEDIA VIA THE INTERNET; STATISTICAL EVALUATIONS OF MARKETING DATA, IN CLASS 35 (U.S. CLS. 100, 101 AND 102).

FIRST USE 1-1-2007; IN COMMERCE 7-16-2007.

NO CLAIM IS MADE TO THE EXCLUSIVE RIGHT TO USE "MARKETING", APART FROM THE MARK AS SHOWN.

THE COLOR(S) RED, WHITE AND BLACK IS/ ARE CLAIMED AS A FEATURE OF THE MARK.

THE MARK CONSISTS OF A RED CIRCLE WITH A DIAGONAL RED LINE THROUGH IT (SIGNIFYING THE WORD "NO") AND THE WORDS "RANDOM ACTS OF MARKETING" IN BLACK ON A WHITE BACKGROUND.

SER. NO. 77-232,568, FILED 7-18-2007.

RONALD MCMORROW, EXAMINING ATTORNEY

Int. Cls.: 35 and 42

Prior U.S. Cls.: 100, 101 and 102

United States Patent and Trademark Office

Reg. No. 3,483,498

Registered Aug. 12, 2008

**SERVICE MARK
PRINCIPAL REGISTER**

TEKNISION

TEKNISION INC. (CANADA CORPORATION)
UNIT 308
311 RICHMOND RD.
ONTARIO, CANADA K1Z6X3

FOR: BUSINESS MARKETING SERVICES, IN
CLASS 35 (U.S. CLS. 100, 101 AND 102).

FIRST USE 8-0-2001; IN COMMERCE 8-0-2001.

FOR: DESIGNING AND DEVELOPING WEBSITES FOR THE ADVERTISING AND/OR MARKETING PURPOSES OF OTHERS; DESIGNING AND DEVELOPING COMPUTER APPLICATIONS, NAMELY, HOME PAGES AND COMPUTER SOFTWARE FOR THE ADVERTISING AND/OR MARKETING PURPOSES OF OTHERS; DESIGNING AND DEVELOPING MULTI-MEDIA PRODUCTS IN THE FORM OF INTERACTIVE CD-ROMS; GRAPHIC ART DESIGN SERVICES, NAMELY, THE

DESIGN, CREATION AND IMPLEMENTATION OF COMPUTER GRAPHICS FOR WEBSITES AND COMPUTER APPLICATIONS FOR OTHERS; COMPUTER SERVICES, NAMELY, DESIGNING AND DEVELOPING INTERNET WEBSITES FOR OTHERS, DESIGNING AND DEVELOPING CUSTOM COMPUTER APPLICATIONS AND PROGRAMS, NAMELY, HOME PAGES, COMPUTER SOFTWARE AND WEB SITES AS REQUESTED BY OTHERS, IN CLASS 42 (U.S. CLS. 100 AND 101).

FIRST USE 8-0-2001; IN COMMERCE 8-0-2001.

THE MARK CONSISTS OF STANDARD CHARACTERS WITHOUT CLAIM TO ANY PARTICULAR FONT, STYLE, SIZE, OR COLOR.

SER. NO. 77-232,597, FILED 7-18-2007.

LOURDES AYALA, EXAMINING ATTORNEY

Int. Cl.: 38

Prior U.S. Cls.: 100, 101 and 104

United States Patent and Trademark Office

Reg. No. 3,483,499

Registered Aug. 12, 2008

**SERVICE MARK
PRINCIPAL REGISTER**

PHONE NUMBER BANK

RNK, INC. (MASSACHUSETTS CORPORATION),
DBA RNK COMMUNICATIONS
333 ELM STREET, SUITE 310
DEDHAM, MA 02026

FOR: TELECOMMUNICATIONS SERVICES,
NAMELY, PERSONAL COMMUNICATION AND
CALL FORWARDING SERVICES, IN CLASS 38
(U.S. CLS. 100, 101 AND 104).

FIRST USE 7-16-2007; IN COMMERCE 7-16-2007.

THE MARK CONSISTS OF STANDARD CHAR-
ACTERS WITHOUT CLAIM TO ANY PARTICULAR
FONT, STYLE, SIZE, OR COLOR.

NO CLAIM IS MADE TO THE EXCLUSIVE
RIGHT TO USE "PHONE NUMBER", APART FROM
THE MARK AS SHOWN.

SER. NO. 77-232,627, FILED 7-18-2007.

G. MAYERSCHOFF, EXAMINING ATTORNEY

Int. Cl.: 38

Prior U.S. Cls.: 100, 101 and 104

United States Patent and Trademark Office

Reg. No. 3,483,500

Registered Aug. 12, 2008

**SERVICE MARK
PRINCIPAL REGISTER**



**PHONE
NUMBER
BANK**

RNK, INC. (MASSACHUSETTS CORPORATION),
DBA RNK COMMUNICATIONS
333 ELM STREET, SUITE 310
DEDHAM, MA 02026

FOR: TELECOMMUNICATIONS SERVICES,
NAMELY, PERSONAL COMMUNICATION AND
CALL FORWARDING SERVICES, IN CLASS 38
(U.S. CLS. 100, 101 AND 104).

FIRST USE 7-16-2007; IN COMMERCE 7-16-2007.

NO CLAIM IS MADE TO THE EXCLUSIVE
RIGHT TO USE "PHONE NUMBER", APART FROM
THE MARK AS SHOWN.

THE MARK CONSISTS OF IN PART, A COMBI-
NATION OF A STYLIZED TELEPHONE AND A
STYLIZED KEYHOLE.

SER. NO. 77-232,731, FILED 7-18-2007.

G. MAYERSCHOFF, EXAMINING ATTORNEY

Int. Cl.: 12

Prior U.S. Cls.: 19, 21, 23, 31, 35 and 44

Reg. No. 3,483,501

United States Patent and Trademark Office

Registered Aug. 12, 2008

**TRADEMARK
PRINCIPAL REGISTER**

The logo for 'Duffy' is rendered in a bold, italicized, sans-serif typeface. The letters are thick and slanted to the right. A thick, solid black horizontal bar runs beneath the entire word, extending slightly beyond the left and right edges of the letters.

DUFFIELD MARINE, INC. (CALIFORNIA CORPORATION)
17260 MUSKRAT AVENUE
ADELANTO, CA 92301

FIRST USE 0-0-1996; IN COMMERCE 0-0-1996.

OWNER OF U.S. REG. NO. 2,313,510.

FOR: ELECTRIC BOATS AND STRUCTURAL PARTS THEREFOR, IN CLASS 12 (U.S. CLS. 19, 21, 23, 31, 35 AND 44).

SER. NO. 77-232,965, FILED 7-18-2007.

ROBIN CHOSID, EXAMINING ATTORNEY

Int. Cl.: 35

Prior U.S. Cls.: 100, 101 and 102

United States Patent and Trademark Office

Reg. No. 3,483,502

Registered Aug. 12, 2008

**SERVICE MARK
PRINCIPAL REGISTER**



ETECH SURPLUS (NEW YORK LTD LIAB CO)
184 BROOKLEA DRIVE
ROCHESTER, NY 14624

FIRST USE 3-1-2005; IN COMMERCE 4-1-2005.

FOR: DISTRIBUTORSHIP SERVICES FEATURING USED INDUSTRIAL, COMMERCIAL AND LABORATORY EQUIPMENT, NAMELY, METAL WORKING EQUIPMENT, ELECTRONIC TEST AND MEASUREMENT EQUIPMENT, INSPECTION EQUIPMENT, MANUFACTURING EQUIPMENT, RESTAURANT EQUIPMENT, STORE FIXTURES AND EQUIPMENT, VENDING EQUIPMENT, LABORATORY EQUIPMENT, IN CLASS 35 (U.S. CLS. 100, 101 AND 102).

NO CLAIM IS MADE TO THE EXCLUSIVE RIGHT TO USE "ETECH SURPLUS", APART FROM THE MARK AS SHOWN.

THE MARK CONSISTS OF THE WORDING "ETECH SURPLUS" AND DIAMOND DESIGN.

SER. NO. 77-232,992, FILED 7-18-2007.

DAVID C. REIHNER, EXAMINING ATTORNEY

Int. Cls.: 44 and 45

Prior U.S. Cls.: 100 and 101

United States Patent and Trademark Office

Reg. No. 3,483,503

Registered Aug. 12, 2008

**SERVICE MARK
PRINCIPAL REGISTER**

EHARMONY LABS

EHARMONY.COM (CALIFORNIA CORPORATION)
2ND FLOOR
888 EAST WALNUT STREET
PASADENA, CA 91101

FOR: PROVIDING A WEBSITE FEATURING INFORMATION IN THE AREA OF PSYCHOLOGICAL RESEARCH, IN CLASS 44 (U.S. CLS. 100 AND 101).

FIRST USE 2-28-2007; IN COMMERCE 2-28-2007.

FOR: PROVIDING A WEBSITE FEATURING INFORMATION IN THE AREA OF PERSONAL RELATIONSHIP WELLNESS; PROVIDING INFORMATION IN THE FIELD OF PERSONAL

RELATIONSHIP WELLNESS; PROVIDING INFORMATION IN THE FIELD OF SOCIAL INTRODUCTION, IN CLASS 45 (U.S. CLS. 100 AND 101).

FIRST USE 2-28-2007; IN COMMERCE 2-28-2007.

THE MARK CONSISTS OF STANDARD CHARACTERS WITHOUT CLAIM TO ANY PARTICULAR FONT, STYLE, SIZE, OR COLOR.

OWNER OF U.S. REG. NO. 2,764,705.

SER. NO. 77-233,006, FILED 7-18-2007.

HOWARD SMIGA, EXAMINING ATTORNEY

Int. Cls.: 35, 38, 39, 42 and 45

Prior U.S. Cls.: 100, 101, 102, 104 and 105

United States Patent and Trademark Office

Reg. No. 3,483,504

Registered Aug. 12, 2008

**SERVICE MARK
PRINCIPAL REGISTER**

mytrip

MYTRIP, LLC (TEXAS LTD LIAB CO)
P.O. BOX 155217
FT. WORTH, TX 76155

FOR: DISSEMINATION OF ADVERTISING FOR OTHERS VIA THE INTERNET, IN CLASS 35 (U.S. CLS. 100, 101 AND 102).

FIRST USE 10-1-2004; IN COMMERCE 10-1-2004.

FOR: PROVIDING ON-LINE CHAT ROOMS FOR TRANSMISSION OF MESSAGES AMONG COMPUTER USERS CONCERNING TRAVEL AND GENERAL INTEREST, IN CLASS 38 (U.S. CLS. 100, 101 AND 104).

FIRST USE 10-1-2004; IN COMMERCE 10-1-2004.

FOR: TRAVEL AGENCY SERVICES, NAMELY, MAKING RESERVATIONS AND BOOKINGS FOR TRANSPORTATION, IN CLASS 39 (U.S. CLS. 100 AND 105).

FIRST USE 10-1-2004; IN COMMERCE 10-1-2004.

FOR: COMPUTER SERVICES, NAMELY, HOSTING ON-LINE WEB FACILITIES FOR OTHERS FOR ORGANIZING AND CONDUCTING ONLINE MEETINGS, GATHERINGS, AND INTERACTIVE DISCUSSIONS, IN CLASS 42 (U.S. CLS. 100 AND 101).

FIRST USE 10-1-2004; IN COMMERCE 10-1-2004.

FOR: ONLINE SOCIAL NETWORKING SERVICES, IN CLASS 45 (U.S. CLS. 100 AND 101).

FIRST USE 10-1-2004; IN COMMERCE 10-1-2004.

THE MARK CONSISTS OF STANDARD CHARACTERS WITHOUT CLAIM TO ANY PARTICULAR FONT, STYLE, SIZE, OR COLOR.

SER. NO. 77-233,543, FILED 7-19-2007.

MIDGE BUTLER, EXAMINING ATTORNEY

Int. Cl.: 7

Prior U.S. Cls.: 13, 19, 21, 23, 31, 34 and 35

United States Patent and Trademark Office

Reg. No. 3,483,505

Registered Aug. 12, 2008

**TRADEMARK
PRINCIPAL REGISTER**

iVAC INTERVAC DESIGN CORP

SCHLAPKOHL, PETER (UNITED STATES INDIVIDUAL)
2939 SW 42ND AVENUE
PALM CITY, FL 34990

FOR: CLEANING SYSTEMS WHICH COMPRISE A WALL-MOUNTED CENTRAL VACUUM UNIT AND CLEANING NOZZLES AND PARTS THEREFOR, IN CLASS 7 (U.S. CLS. 13, 19, 21, 23, 31, 34 AND 35).

FIRST USE 7-18-2007; IN COMMERCE 7-18-2007.

THE MARK CONSISTS OF STANDARD CHARACTERS WITHOUT CLAIM TO ANY PARTICULAR FONT, STYLE, SIZE, OR COLOR.

OWNER OF U.S. REG. NO. 2,537,634.

NO CLAIM IS MADE TO THE EXCLUSIVE RIGHT TO USE "DESIGN CORP", APART FROM THE MARK AS SHOWN.

SER. NO. 77-233,724, FILED 7-19-2007.

SCOTT BIBB, EXAMINING ATTORNEY

Int. Cl.: 38

Prior U.S. Cls.: 100, 101 and 104

United States Patent and Trademark Office

Reg. No. 3,483,506

Registered Aug. 12, 2008

**SERVICE MARK
PRINCIPAL REGISTER**

TREASURE HD FIND YOURSELF

TREASURE HD COMPANY LLC (DELAWARE
LTD LIAB CO)
1111 STEWART AVENUE
BETHPAGE, NY 11714

FOR: TELEVISION BROADCASTING AND TELEVISION TRANSMISSION SERVICES; SATELLITE TELEVISION BROADCASTING AND SATELLITE TELEVISION TRANSMISSION SERVICES; HIGH DEFINITION TELEVISION BROADCASTING AND HIGH DEFINITION TELEVISION TRANSMISSION SERVICES, IN CLASS 38 (U.S. CLS. 100, 101 AND 104).

FIRST USE 7-4-2007; IN COMMERCE 7-4-2007.

THE MARK CONSISTS OF STANDARD CHARACTERS WITHOUT CLAIM TO ANY PARTICULAR FONT, STYLE, SIZE, OR COLOR.

OWNER OF U.S. REG. NOS. 3,239,118 AND 3,239,133.

SER. NO. 77-233,792, FILED 7-19-2007.

TRACY CROSS, EXAMINING ATTORNEY

Int. Cl.: 29

Prior U.S. Cl.: 46

United States Patent and Trademark Office

Reg. No. 3,483,507

Registered Aug. 12, 2008

**TRADEMARK
PRINCIPAL REGISTER**



MORGAN DAVID M. (UNITED STATES INDIVIDUAL)
755 ALBANY ST.
DAYTON, OH 45408

FOR: COMBINATION MEAL CONSISTING PRIMARILY OF A MEAT OR VEGETABLE-BASED ENTREE AND A SOUP OR SALAD FOR CONSUMPTION ON OR OFF THE PREMISES, IN CLASS 29 (U.S. CL. 46).

FIRST USE 6-29-2007; IN COMMERCE 6-29-2007.

NO CLAIM IS MADE TO THE EXCLUSIVE RIGHT TO USE "QUALITY" AND "FOODS", APART FROM THE MARK AS SHOWN.

THE COLOR(S) DARK GREEN AND LIGHT GREEN IS/ARE CLAIMED AS A FEATURE OF THE MARK.

THE MARK CONSIST OF "QUALITY CHOICE" IS LIGHT GREEN, WITH A DARK GREEN BORDER, THE TAIL OF THE "Q" IS DARK GREEN; THE PLANT IS DARK GREEN; "FOODS" IS DARK GREEN.

SER. NO. 77-233,826, FILED 7-19-2007.

PAUL E. FAHRENKOPF, EXAMINING ATTORNEY

Int. Cl.: 35

Prior U.S. Cls.: 100, 101 and 102

United States Patent and Trademark Office

Reg. No. 3,483,508

Registered Aug. 12, 2008

**SERVICE MARK
PRINCIPAL REGISTER**

TRANQUILTEENS

TRANQUIL SPACE FOUNDATION (D.C. NON-
PROFIT ORGANIZATION)
1820 T STREET, NW, #2
WASHINGTON, DC 20009

FOR: CHARITABLE SERVICES, NAMELY, OR-
GANIZING AND CONDUCTING VOLUNTEER
PROGRAMS AND COMMUNITY SERVICE PRO-
JECTS, IN CLASS 35 (U.S. CLS. 100, 101 AND 102).

FIRST USE 2-0-2007; IN COMMERCE 2-0-2007.

THE MARK CONSISTS OF STANDARD CHAR-
ACTERS WITHOUT CLAIM TO ANY PARTICULAR
FONT, STYLE, SIZE, OR COLOR.

SER. NO. 77-233,978, FILED 7-19-2007.

ANN E. SAPPENFIELD, EXAMINING ATTORNEY

Int. Cl.: 33

Prior U.S. Cls.: 47 and 49

United States Patent and Trademark Office

Reg. No. 3,483,509

Registered Aug. 12, 2008

**TRADEMARK
PRINCIPAL REGISTER**

Olsen Hills

OLSEN ESTATES L.L.C. (WASHINGTON LTD
LIAB CO), DBA OLSEN HILLS
500 MERLOT DRIVE
PROSSER, WA 99350

THE MARK CONSISTS OF STANDARD CHAR-
ACTERS WITHOUT CLAIM TO ANY PARTICULAR
FONT, STYLE, SIZE, OR COLOR.

FOR: WINES, IN CLASS 33 (U.S. CLS. 47 AND 49).

SER. NO. 77-233,992, FILED 7-19-2007.

FIRST USE 6-16-2007; IN COMMERCE 6-16-2007.

NELSON SNYDER, EXAMINING ATTORNEY

Int. Cl.: 26

Prior U.S. Cls.: 37, 39, 40, 42 and 50

United States Patent and Trademark Office

Reg. No. 3,483,510

Registered Aug. 12, 2008

TRADEMARK
PRINCIPAL REGISTER



KATHERINE M BLACK (GEORGIA SOLE PROPRIETORSHIP)
810 CROFT COURT
ALPHARETTA, GA 30022

FOR: HAIR BOWS, IN CLASS 26 (U.S. CLS. 37, 39, 40, 42 AND 50).

FIRST USE 8-7-2006; IN COMMERCE 3-2-2007.

THE COLOR(S) PINK, RED, BLACK, WHITE AND GREEN IS/ARE CLAIMED AS A FEATURE OF THE MARK.

THE COLOR PINK APPEARS IN THE CHERRY AND IN THE LANGUAGE "SWEET TOPPINGS FOR YOUR LITTLE CUPCAKE"; THE COLOR RED APPEARS IN THE CHERRY; THE COLOR BLACK APPEARS IN THE OUTLINE OF THE CUPCAKE, CHERRY, STEM, LEAF AND IN THE LANGUAGE "CHERRY ON TOP"; THE COLOR WHITE APPEARS IN THE CUPCAKE'S ICING; THE COLOR GREEN APPEARS IN THE LEAF AND IN THE CUPCAKE WRAPPER.

SER. NO. 77-234,002, FILED 7-19-2007.

JUSTINE D. PARKER, EXAMINING ATTORNEY

Int. Cl.: 9

Prior U.S. Cls.: 21, 23, 26, 36 and 38

Reg. No. 3,483,511

United States Patent and Trademark Office

Registered Aug. 12, 2008

**TRADEMARK
PRINCIPAL REGISTER**

MY WISE GUIDES

EILEEN BREWER EVENT PRODUCTION, INC.
(WASHINGTON CORPORATION)
7742 21ST AVENUE NE
SEATTLE, WA 98115

FOR: DIGITAL MEDIA, NAMELY, DOWNLOAD-
ABLE GUIDES, SPREADSHEETS, FORMS, AND
CDS USED TO STORE HEALTH AND PERSONAL
INFORMATION; PRE-RECORDED CDS USED TO
STORE HEALTH AND PERSONAL INFORMATION,
IN CLASS 9 (U.S. CLS. 21, 23, 26, 36 AND 38).

FIRST USE 7-19-2007; IN COMMERCE 7-19-2007.

THE MARK CONSISTS OF STANDARD CHAR-
ACTERS WITHOUT CLAIM TO ANY PARTICULAR
FONT, STYLE, SIZE, OR COLOR.

NO CLAIM IS MADE TO THE EXCLUSIVE
RIGHT TO USE "GUIDES", APART FROM THE
MARK AS SHOWN.

SER. NO. 77-234,280, FILED 7-19-2007.

RICHARD A. STRASER, EXAMINING ATTORNEY

Int. Cl.: 9

Prior U.S. Cls.: 21, 23, 26, 36 and 38

Reg. No. 3,483,512

United States Patent and Trademark Office

Registered Aug. 12, 2008

**TRADEMARK
PRINCIPAL REGISTER**

MY WISE GUIDES HEALTH FILE

EILEEN BREWER EVENT PRODUCTION, INC.
(WASHINGTON CORPORATION)
7742 21ST AVENUE NE
SEATTLE, WA 98115

FOR: DIGITAL MEDIA, NAMELY, DOWNLOAD-
ABLE GUIDES, SPREADSHEETS, FORMS, AND
CDS USED TO STORE HEALTH AND PERSONAL
INFORMATION; PRE-RECORDED CDS USED TO
STORE HEALTH AND PERSONAL INFORMATION,
IN CLASS 9 (U.S. CLS. 21, 23, 26, 36 AND 38).

FIRST USE 7-19-2007; IN COMMERCE 7-19-2007.

THE MARK CONSISTS OF STANDARD CHAR-
ACTERS WITHOUT CLAIM TO ANY PARTICULAR
FONT, STYLE, SIZE, OR COLOR.

NO CLAIM IS MADE TO THE EXCLUSIVE
RIGHT TO USE "GUIDES HEALTH FILE", APART
FROM THE MARK AS SHOWN.

SER. NO. 77-234,290, FILED 7-19-2007.

RICHARD A. STRASER, EXAMINING ATTORNEY

Int. Cl.: 9

Prior U.S. Cls.: 21, 23, 26, 36 and 38

Reg. No. 3,483,513

United States Patent and Trademark Office

Registered Aug. 12, 2008

**TRADEMARK
PRINCIPAL REGISTER**

MY WISE GUIDES LIFE FILE

EILEEN BREWER EVENT PRODUCTION, INC.
(WASHINGTON CORPORATION)
7742 21ST AVENUE NE
SEATTLE, WA 98115

THE MARK CONSISTS OF STANDARD CHARACTERS WITHOUT CLAIM TO ANY PARTICULAR FONT, STYLE, SIZE, OR COLOR.

FOR: DIGITAL MEDIA, NAMELY, DOWNLOADABLE GUIDES, SPREADSHEETS, FORMS, AND CDS USED TO STORE HEALTH AND PERSONAL INFORMATION; PRE-RECORDED CDS USED TO STORE HEALTH AND PERSONAL INFORMATION, IN CLASS 9 (U.S. CLS. 21, 23, 26, 36 AND 38).

NO CLAIM IS MADE TO THE EXCLUSIVE RIGHT TO USE "GUIDES", APART FROM THE MARK AS SHOWN.

SER. NO. 77-234,291, FILED 7-19-2007.

FIRST USE 7-19-2007; IN COMMERCE 7-19-2007.

RICHARD A. STRASER, EXAMINING ATTORNEY

Int. Cls.: 16 and 41

Prior U.S. Cls.: 2, 5, 22, 23, 29, 37, 38, 50, 100, 101 and 107

Reg. No. 3,483,514

United States Patent and Trademark Office

Registered Aug. 12, 2008

**TRADEMARK
SERVICE MARK
PRINCIPAL REGISTER**



JUMP STREET (PENNSYLVANIA NON-PROFIT CORPORATION)
1703 N. FRONT STREET
HARRISBURG, PA 17102

FOR: PRINTED PERIODICALS FOR TEENAGERS FEATURING THE ARTS AND HEALTHY LIFESTYLES, IN CLASS 16 (U.S. CLS. 2, 5, 22, 23, 29, 37, 38 AND 50).

FIRST USE 8-12-2005; IN COMMERCE 8-12-2005.

FOR: PROVIDING A WEBSITE FOR TEENAGERS CONCERNING THE ARTS; ONLINE MAGAZINE FEATURING THE ARTS AND HEALTHY LIFESTYLES FOR TEENAGERS; EDUCATIONAL SER-

VICES, NAMELY, CONDUCTING PROGRAMS FEATURING JOURNALISM AND MEDIA TECHNOLOGIES FOR TEENAGERS FOCUSING ON THE ARTS AND HEALTHY LIFESTYLES, IN CLASS 41 (U.S. CLS. 100, 101 AND 107).

FIRST USE 8-12-2005; IN COMMERCE 8-12-2005.

THE MARK CONSISTS OF THE STYLIZED WORDS "AND & A NEW DIVERSION".

SER. NO. 77-234,450, FILED 7-20-2007.

CHRISIE B. KING, EXAMINING ATTORNEY

Int. Cl.: 20

Prior U.S. Cls.: 2, 13, 22, 25, 32 and 50

United States Patent and Trademark Office

Reg. No. 3,483,515

Registered Aug. 12, 2008

**TRADEMARK
PRINCIPAL REGISTER**



PLASTICOS ERUM, S.L. (SPAIN CORPORATION)
CARRETERA DE BANERES, KM. 1,500
ALCOY (ALICANTE), SPAIN 03802

FOR: HANGERS FOR CLOTHING, IN CLASS 20
(U.S. CLS. 2, 13, 22, 25, 32 AND 50).

OWNER OF SPAIN REG. NO. 2.744.804, DATED 6-
15-2007, EXPIRES 12-12-2016.

OWNER OF U.S. REG. NO. 2,619,809.

THE MARK CONSISTS OF THE DESIGN OF A
HANGER; THE LOWER PART OF IT IS FORMED
BY THE WORD "ERUM" IN PLAIN BLOCK LET-
TERS.

"ERUM" HAS NO MEANING IN A FOREIGN
LANGUAGE.

SER. NO. 77-234,837, FILED 7-20-2007.

ELLEN B. AWRICH, EXAMINING ATTORNEY

Int. Cl.: 3

Prior U.S. Cls.: 1, 4, 6, 50, 51 and 52

United States Patent and Trademark Office

Reg. No. 3,483,516

Registered Aug. 12, 2008

**TRADEMARK
PRINCIPAL REGISTER**

optionsforlife

CODDINGTON ENVIRONMENTAL, INC. (NEW
YORK CORPORATION)
150 BEEKMAN STREET
NEW YORK, NY 10038

FOR: COMMERCIAL AND HOUSEHOLD
CLEANING PRODUCTS, NAMELY, GLASS CLEANERS,
ALL-PURPOSE CLEANERS, FLOOR CLEANING
AND STRIPPING PREPARATIONS, FLOOR
WAX, FLOOR POLISH, FLOOR FINISHING
PREPARATIONS, LAUNDRY DETERGENT, AND
HAND, DISH AND LAUNDRY SOAPS, IN CLASS 3
(U.S. CLS. 1, 4, 6, 50, 51 AND 52).

FIRST USE 9-0-2006; IN COMMERCE 9-0-2006.

THE MARK CONSISTS OF STANDARD CHARACTERS
WITHOUT CLAIM TO ANY PARTICULAR
FONT, STYLE, SIZE, OR COLOR.

SER. NO. 77-235,012, FILED 7-20-2007.

KIMBERLY FRYE, EXAMINING ATTORNEY

Int. Cl.: 11

Prior U.S. Cls.: 13, 21, 23, 31 and 34

United States Patent and Trademark Office

Reg. No. 3,483,517

Registered Aug. 12, 2008

**TRADEMARK
PRINCIPAL REGISTER**

CABINET COOLER

EXAIR CORPORATION (OHIO CORPORATION)
11510 GOLDCOAST DRIVE
CINCINNATI, OH 45249

FOR: VORTEX TUBE FOR COOLING, AND PUR-
GING DIRT AND DUST FROM, ELECTRONIC
CONTROL PANELS, IN CLASS 11 (U.S. CLS. 13, 21,
23, 31 AND 34).

FIRST USE 12-31-1985; IN COMMERCE 12-31-1985.

THE MARK CONSISTS OF STANDARD CHAR-
ACTERS WITHOUT CLAIM TO ANY PARTICULAR
FONT, STYLE, SIZE, OR COLOR.

NO CLAIM IS MADE TO THE EXCLUSIVE
RIGHT TO USE "COOLER", APART FROM THE
MARK AS SHOWN.

SEC. 2(F) AS TO "CABINET".

SER. NO. 77-235,167, FILED 7-20-2007.

EDWARD NELSON, EXAMINING ATTORNEY

Int. Cl.: 5

Prior U.S. Cls.: 6, 18, 44, 46, 51 and 52

Reg. No. 3,483,518

United States Patent and Trademark Office

Registered Aug. 12, 2008

**TRADEMARK
PRINCIPAL REGISTER**

FEEL THE GOOD

ALACER CORPORATION (CALIFORNIA CORPORATION)
80 ICON
FOOTHILL RANCH, CA 92610

THE MARK CONSISTS OF STANDARD CHARACTERS WITHOUT CLAIM TO ANY PARTICULAR FONT, STYLE, SIZE, OR COLOR.

FOR: VITAMINS, MINERAL SUPPLEMENTS AND FOOD SUPPLEMENTS, IN CLASS 5 (U.S. CLS. 6, 18, 44, 46, 51 AND 52).

SER. NO. 77-235,199, FILED 7-20-2007.

FIRST USE 10-1-2006; IN COMMERCE 10-1-2006.

H. M. FISHER, EXAMINING ATTORNEY

Int. Cls.: 35 and 45

Prior U.S. Cls.: 100, 101 and 102

United States Patent and Trademark Office

Reg. No. 3,483,519

Registered Aug. 12, 2008

**SERVICE MARK
PRINCIPAL REGISTER**

THE PATH TO PROGRESS

SZD WHITEBOARD, LLC (OHIO LTD LIAB CO)
250 WEST STREET
COLUMBUS, OH 43215

FOR: BUSINESS ACQUISITION AND MERGER CONSULTATION; BUSINESS CONSULTING SERVICES, NAMELY, CONSULTING RELATED TO THE IMPORT AND EXPORT OF PRODUCTS AND SERVICES; BUSINESS CONSULTING SERVICES RELATED TO CUSTOMS REGULATION AND COMPLIANCE; BUSINESS CONSULTING SERVICES, NAMELY, BUSINESS EMPLOYEE IMMIGRATION CONSULTING; BUSINESS CONSULTING SERVICES, NAMELY, PROVIDING BUSINESS CONSULTING IN THE HEALTH CARE INDUSTRY; NEW BUSINESS VENTURE DEVELOPMENT AND FORMATION CONSULTING SERVICES; BUSINESS CONSULTING, NAMELY, BUSINESS CONSULTING IN THE FIELDS OF ECONOMIC DEVELOPMENT, ECONOMIC INCENTIVES, PUBLIC-PRIVATE INCENTIVE-BASED PARTNERSHIPS, WORKFORCE DEVELOPMENT, COMMUNITY PLANNING, CITY PLANNING, COMMUNITY RELATIONS, MARKETING AND CORPORATE SITE LOCATION; BUSINESS CONSULTING, NAMELY, PROVIDING BUSINESS ADVICE IN THE FIELDS OF STRATEGIC PLANNING, ECONOMIC DEVELOPMENT AND IMPLEMENTATION OF ECONOMIC DEVELOPMENT STRATEGIES, MARKET ENTRY STRATEGY PLANNING, MANAGEMENT, ECONOMIC ANALYSIS AND COMPETITIVENESS ANALYSIS; LOBBYING SERVICES, NAMELY, PROMOTING THE INTERESTS OF CORPORATIONS, COMMUNITIES, AND ORGANIZATIONS IN THE FIELDS OF POLITICS, LEGISLATION, REGULATION; BUSINESS CONSULTING AND BUSINESS PLANNING SERVICES IN THE BROADBAND AND TELECOMMUNICATIONS INDUSTRIES, IN CLASS 35 (U.S. CLS. 100, 101 AND 102).

OPMENT AND IMPLEMENTATION OF ECONOMIC DEVELOPMENT STRATEGIES, MARKET ENTRY STRATEGY PLANNING, MANAGEMENT, ECONOMIC ANALYSIS AND COMPETITIVENESS ANALYSIS; LOBBYING SERVICES, NAMELY, PROMOTING THE INTERESTS OF CORPORATIONS, COMMUNITIES, AND ORGANIZATIONS IN THE FIELDS OF POLITICS, LEGISLATION, REGULATION; BUSINESS CONSULTING AND BUSINESS PLANNING SERVICES IN THE BROADBAND AND TELECOMMUNICATIONS INDUSTRIES, IN CLASS 35 (U.S. CLS. 100, 101 AND 102).

FIRST USE 7-20-2007; IN COMMERCE 7-20-2007.

FOR: LEGAL SERVICES AND ARBITRATION SERVICES, IN CLASS 45 (U.S. CLS. 100 AND 101).

FIRST USE 7-20-2007; IN COMMERCE 7-20-2007.

THE MARK CONSISTS OF STANDARD CHARACTERS WITHOUT CLAIM TO ANY PARTICULAR FONT, STYLE, SIZE, OR COLOR.

SER. NO. 77-236,029, FILED 7-23-2007.

PAUL CROWLEY, EXAMINING ATTORNEY

Int. Cls.: 36 and 37

Prior U.S. Cls.: 100, 101, 102, 103 and 106

United States Patent and Trademark Office

Reg. No. 3,483,520

Registered Aug. 12, 2008

**SERVICE MARK
PRINCIPAL REGISTER**

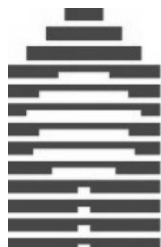

**Bentall
CAPITAL**

**BENTALL CAPITAL LIMITED PARTNERSHIP
(CANADA LIMITED PARTNERSHIP)
1055 DUNSMUIR STREET, SUITE 1800
VANCOUVER, B.C., CANADA V7X1B1**

**FOR: COMMERCIAL REAL ESTATE MANAGE-
MENT AND LEASING SERVICES, IN CLASS 36 (U.S.
CLS. 100, 101 AND 102).**

FIRST USE 7-0-2001; IN COMMERCE 7-0-2001.

**FOR: COMMERCIAL REAL ESTATE DEVELOP-
MENT, IN CLASS 37 (U.S. CLS. 100, 103 AND 106).**

FIRST USE 7-0-2001; IN COMMERCE 7-0-2001.

**OWNER OF U.S. REG. NOS. 1,649,676 AND
1,649,698.**

**NO CLAIM IS MADE TO THE EXCLUSIVE
RIGHT TO USE "CAPTIAL", APART FROM THE
MARK AS SHOWN.**

SER. NO. 77-236,159, FILED 7-23-2007.

ROBERT C. CLARK JR., EXAMINING ATTORNEY

Int. Cl.: 35

Prior U.S. Cls.: 100, 101 and 102

United States Patent and Trademark Office

Reg. No. 3,483,521

Registered Aug. 12, 2008

**SERVICE MARK
PRINCIPAL REGISTER**



NEW JERSEY RESOURCES CORPORATION
(NEW JERSEY CORPORATION)
1415 WYCKOFF ROAD
WALL, NJ 07719

THE MARK CONSISTS OF "CONSERVE TO PRESERVE SAVINGS SEAL" & LEAF DESIGN.

FOR: ENERGY USAGE MANAGEMENT INFORMATION SERVICES, IN CLASS 35 (U.S. CLS. 100, 101 AND 102).

SER. NO. 77-236,349, FILED 7-23-2007.

FIRST USE 10-12-2006; IN COMMERCE 10-12-2006.

ERNEST SHOSHO, EXAMINING ATTORNEY

Int. Cl.: 9

Prior U.S. Cls.: 21, 23, 26, 36 and 38

Reg. No. 3,483,522

United States Patent and Trademark Office

Registered Aug. 12, 2008

TRADEMARK
PRINCIPAL REGISTER



HOWAYECK, LORRAINE A. (UNITED STATES
INDIVIDUAL)
P.O. BOX 17634
TUCSON, AZ 857317634

FOR: PRE-RECORDED AUDIOVISUAL PRESEN-
TATION RELATING TO FINGERNAIL ORNAMEN-
TATION ENCODED IN A DISK, IN CLASS 9 (U.S.
CLS. 21, 23, 26, 36 AND 38).

FIRST USE 2-1-1989; IN COMMERCE 2-1-1989.

NO CLAIM IS MADE TO THE EXCLUSIVE
RIGHT TO USE "SALON NAILS", APART FROM
THE MARK AS SHOWN.

THE MARK CONSISTS OF NAIL WITH A BRUSH
NEXT TO IT - "SALON NAILS".

SER. NO. 77-236,503, FILED 7-23-2007.

DANIEL CAPSHAW, EXAMINING ATTORNEY

Int. Cl.: 9

Prior U.S. Cls.: 21, 23, 26, 36 and 38

Reg. No. 3,483,523

United States Patent and Trademark Office

Registered Aug. 12, 2008

**TRADEMARK
PRINCIPAL REGISTER**



LEATT BRACE HOLDINGS (PTY) LTD. (SOUTH
AFRICA PRIVATE LIMITED COMPANY)
UNIT 1 KYALAMI PLAZA
KYALAMI DRIVE
KILLARNEY GARDENS, SOUTH AFRICA 7441

FOR: SAFETY EQUIPMENT, NAMELY, A PRO-
TECTIVE NECK BRACE FOR USE IN CONJUNC-
TION WITH A FULL FACE OR OPEN FACE
PROTECTIVE HELMET TO PREVENT CERVICAL
DISK OR CERVICAL SPINE INJURY, TO OPERA-
TORS OF MOTORIZED VEHICLES INCLUDING
MOTORCYCLES, SUPER BIKES, MOTORCROSS,

GO-KARTS, ATVS, PERSONAL WATERCRAFTS,
SNOW MOBILES, MOUNTAIN BIKES, CARS,
TRUCKS, BOATS, AND MILITARY VEHICLES, IN
CLASS 9 (U.S. CLS. 21, 23, 26, 36 AND 38).

FIRST USE 2-14-2006; IN COMMERCE 2-14-2006.

THE MARK CONSISTS OF HELMET FOR YOUR
HEAD PROFILE.

SER. NO. 77-236,512, FILED 7-23-2007.

SALLY SHIH, EXAMINING ATTORNEY

Int. Cl.: 16

Prior U.S. Cls.: 2, 5, 22, 23, 29, 37, 38 and 50

Reg. No. 3,483,524

United States Patent and Trademark Office

Registered Aug. 12, 2008

**TRADEMARK
PRINCIPAL REGISTER**

LA GUATEMALTECA NEGRA

TOUCH-TEL USA, LLC (TEXAS LTD LIAB CO)
5444 WESTHEIMER, SUITE 1535
HOUSTON, TX 77056

FOR: PRE-PAID TELEPHONE CALLING CARDS,
NOT MAGNETICALLY ENCODED, IN CLASS 16
(U.S. CLS. 2, 5, 22, 23, 29, 37, 38 AND 50).

FIRST USE 7-11-2007; IN COMMERCE 7-11-2007.

THE MARK CONSISTS OF STANDARD CHAR-
ACTERS WITHOUT CLAIM TO ANY PARTICULAR
FONT, STYLE, SIZE, OR COLOR.

NO CLAIM IS MADE TO THE EXCLUSIVE
RIGHT TO USE "NEGRA", APART FROM THE
MARK AS SHOWN.

THE FOREIGN WORDING "LA GUATEMALTE-
CA" TRANSLATES INTO ENGLISH AS THE GUA-
TEMALAN. THE FOREIGN WORDING "NEGRA"
TRANSLATES INTO ENGLISH AS BLACK.

SER. NO. 77-236,813, FILED 7-24-2007.

CHRISTOPHER BUONGIORNO, EXAMINING AT-
TORNEY

Int. Cl.: 16

Prior U.S. Cls.: 2, 5, 22, 23, 29, 37, 38 and 50

Reg. No. 3,483,525

United States Patent and Trademark Office

Registered Aug. 12, 2008

**TRADEMARK
PRINCIPAL REGISTER**

LA SALVADOREÑA NEGRA

TOUCH-TEL USA, LLC (TEXAS LTD LIAB CO)
5444 WESTHEIMER, SUITE 1535
HOUSTON, TX 77056

FOR: PRE-PAID TELEPHONE CALLING CARDS,
NOT MAGNETICALLY ENCODED, IN CLASS 16
(U.S. CLS. 2, 5, 22, 23, 29, 37, 38 AND 50).

FIRST USE 7-11-2007; IN COMMERCE 7-11-2007.

THE MARK CONSISTS OF STANDARD CHAR-
ACTERS WITHOUT CLAIM TO ANY PARTICULAR
FONT, STYLE, SIZE, OR COLOR.

NO CLAIM IS MADE TO THE EXCLUSIVE
RIGHT TO USE "NEGRA", APART FROM THE
MARK AS SHOWN.

THE FOREIGN WORDING "LA SALVADOREÑA"
TRANSLATES INTO ENGLISH AS "THE SALVA-
DORIAN". THE FOREIGN WORDING "NEGRA"
TRANSLATES INTO ENGLISH AS "BLACK".

SER. NO. 77-236,841, FILED 7-24-2007.

CHRISTOPHER BUONGIORNO, EXAMINING AT-
TORNEY

Int. Cl.: 3

Prior U.S. Cls.: 1, 4, 6, 50, 51 and 52

Reg. No. 3,483,526

United States Patent and Trademark Office

Registered Aug. 12, 2008

TRADEMARK
PRINCIPAL REGISTER

ENERGIZER
TOTAL

LANCOME PARFUMS ET BEAUTE & CIE
(FRANCE SOCIETE EN NOM COLLECTIF)
29, RUE DU FAUBOURG SAINT-HONORE
PARIS, FRANCE 75008

FOR: PERFUMERY PRODUCTS, NAMELY, PERFUMES, EAU DE COLOGNE, PERFUMED WATER, SKIN LOTIONS, SOAPS, BATH AND SHOWER FOAMING COMPOSITIONS AND GELS; COSMETICS, NAMELY, CREAMS, GELS, MILKS, POWDERS AND LOTIONS FOR THE FACE, THE BODY AND THE HANDS; MAKEUP PRODUCTS, NAMELY, MASCARA, EYE LINER, EYE SHADOW, EYEBROW PENCIL, LIPSTICKS, NAIL POLISH, BLUSH, FOUNDATION CREAMS AND POWDER, BODY DEODORANTS; NON-MEDICATED SUN CARE PREPARATIONS, NAMELY, TANNING AND AFTER-SUN MILKS, GELS AND OILS; ESSENTIAL OILS FOR PERSONAL USE; GELS, SPRAYS AND BALMS FOR THE HAIR STYLING AND HAIR

CARE; HAIR LACQUERS; SHAMPOOS, CONDITIONERS, SERUMS, MASQUES AND MOUSSE FOR THE HAIR; NON-MEDICATED HAIR TREATMENT PREPARATIONS, IN CLASS 3 (U.S. CLS. 1, 4, 6, 50, 51 AND 52).

PRIORITY CLAIMED UNDER SEC. 44(D) ON FRANCE APPLICATION NO. 073512968, FILED 7-11-2007, REG. NO. 073512968, DATED 7-11-2007, EXPIRES 7-11-2017.

OWNER OF U.S. REG. NO. 3,217,132.

THE MARK CONSISTS OF RIGHT JUSTIFIED "ENERGIZER TOTAL" DESIGN.

SER. NO. 77-236,922, FILED 7-24-2007.

DAVID MURRAY, EXAMINING ATTORNEY

Int. Cl.: 43

Prior U.S. Cls.: 100 and 101

United States Patent and Trademark Office

Reg. No. 3,483,527

Registered Aug. 12, 2008

SERVICE MARK
PRINCIPAL REGISTER



ODUTOLA, ADEREMI O (MARYLAND CORPORATION)
8205 BROOKTREE STREET
LAUREL, MD 20724

FOR: CHILD CARE; CHILD CARE CENTERS; CHILD CARE SERVICES; DAY CARE CENTERS; NURSERIES AND DAY CARE CENTERS; PRE-SCHOOLER AND INFANT CARE AT DAYCARE CENTERS, IN CLASS 43 (U.S. CLS. 100 AND 101).

FIRST USE 6-2-2005; IN COMMERCE 6-2-2005.

NO CLAIM IS MADE TO THE EXCLUSIVE RIGHT TO USE "CHILDREN LEARNING CENTERS", APART FROM THE MARK AS SHOWN.

THE MARK CONSISTS OF THE WORD "KINDER" WITH FIRST LETTER "E" IN THE WORD "EXPLORERS" INSCRIBED IN THE HAND OF A CHILD, ABOVE THE WORDS "CHILDREN LEARNING CENTERS".

SER. NO. 77-237,169, FILED 7-24-2007.

FRANK LATTUCA, EXAMINING ATTORNEY

Int. Cl.: 25

Prior U.S. Cls.: 22 and 39

United States Patent and Trademark Office

Reg. No. 3,483,528

Registered Aug. 12, 2008

**TRADEMARK
PRINCIPAL REGISTER**

COMPASSION TEE

THE TALBOTS GROUP, LIMITED PARTNER-
SHIP (MASSACHUSETTS LIMITED PART-
NERSHIP)

ONE TALBOTS DRIVE
HINGHAM, MA 02043

FOR: CLOTHING, NAMELY, TEE SHIRTS, IN
CLASS 25 (U.S. CLS. 22 AND 39).

FIRST USE 4-30-2005; IN COMMERCE 4-30-2005.

THE MARK CONSISTS OF STANDARD CHAR-
ACTERS WITHOUT CLAIM TO ANY PARTICULAR
FONT, STYLE, SIZE, OR COLOR.

NO CLAIM IS MADE TO THE EXCLUSIVE
RIGHT TO USE "TEE", APART FROM THE MARK
AS SHOWN.

SER. NO. 77-237,391, FILED 7-24-2007.

TEJBIR SINGH, EXAMINING ATTORNEY

Int. Cl.: 16

Prior U.S. Cls.: 2, 5, 22, 23, 29, 37, 38 and 50

United States Patent and Trademark Office

Reg. No. 3,483,529

Registered Aug. 12, 2008

**TRADEMARK
PRINCIPAL REGISTER**

CASABELLA

CASABELLA HOLDINGS LLC (DELAWARE LTD
LIAB CO)
400 CORPORATEDRIVE
BLAUVELT, NY 10913

OWNER OF U.S. REG. NOS. 1,976,718 AND
2,651,483.

FOR: CATALOGS IN THE FIELD OF CLEANING
TOOLS AND KITCHEN AND BATH ACCESSORIES,
IN CLASS 16 (U.S. CLS. 2, 5, 22, 23, 29, 37, 38 AND 50).

THE FOREIGN WORDING IN THE MARK
TRANSLATES INTO ENGLISH AS BEAUTIFUL
HOUSE.

FIRST USE 1-15-1997; IN COMMERCE 1-15-1997.

SER. NO. 77-237,612, FILED 7-24-2007.

THE MARK CONSISTS OF STANDARD CHAR-
ACTERS WITHOUT CLAIM TO ANY PARTICULAR
FONT, STYLE, SIZE, OR COLOR.

MARK PILARO, EXAMINING ATTORNEY

Int. Cl.: 35

Prior U.S. Cls.: 100, 101 and 102

United States Patent and Trademark Office

Reg. No. 3,483,530

Registered Aug. 12, 2008

**SERVICE MARK
PRINCIPAL REGISTER**

TRADE A FAVOR

FRICK, STEPHEN AND BARILE, AMANDA
(UNITED STATES INDIVIDUAL)
912 HILDALE AVENUE #4
WEST HOLLYWOOD, CA 90069

FOR: PROVIDING A WEB SITE AT WHICH
USERS CAN OFFER SKILLS, GOODS AND SER-
VICES IN EXCHANGE FOR SKILLS, GOODS AND
SERVICES OFFERED BY OTHERS, INCLUDING
REAL-TIME BARTERING CAPABILITIES; PROVID-
ING AN ON-LINE SEARCHABLE DATABASE FEAT-
URING LISTINGS FOR SKILLS, GOODS AND
SERVICES OFFERED IN EXCHANGE FOR SKILLS,
GOODS AND SERVICES OF OTHERS; EXCHANGE

SERVICES, NAMELY, BARTERING OF SKILLS,
GOODS AND SERVICES FOR OTHERS, IN CLASS
35 (U.S. CLS. 100, 101 AND 102).

FIRST USE 4-2-2008; IN COMMERCE 4-2-2008.

THE MARK CONSISTS OF STANDARD CHAR-
ACTERS WITHOUT CLAIM TO ANY PARTICULAR
FONT, STYLE, SIZE, OR COLOR.

SER. NO. 77-237,646, FILED 7-24-2007.

JOHN GARTNER, EXAMINING ATTORNEY

Int. Cl.: 35

Prior U.S. Cls.: 100, 101 and 102

United States Patent and Trademark Office

Reg. No. 3,483,531

Registered Aug. 12, 2008

**SERVICE MARK
PRINCIPAL REGISTER**

MarketVision

C.I.K. ENTERPRISES, LLC (INDIANA LTD LIAB
CO)
7225 GEORGETOWN ROAD
INDIANAPOLIS, IN 46268

FOR: ADVERTISING, MARKETING AND PRO-
MOTION SERVICES, MARKET ANALYSIS SERVI-
CES, NAMELY, AN AUTOMOTIVE MARKETING
AND DATA COLLECTION PROGRAM WHEREBY
CUSTOMER DATA AND MAIL PROMOTION DATA
IS COLLECTED THROUGH ELECTRONIC KIOSKS,
PERSONAL UNIFORM RESOURCE LOCATORS
AND OTHER MEANS FOR THE PURPOSE OF
ALLOWING DEALERSHIPS AND EVENT TEAMS

TO ANALYZE AND IMPROVE CUSTOMER RE-
SPONSE RATE AND PROMOTIONAL MAIL RELIA-
BILITY, IN CLASS 35 (U.S. CLS. 100, 101 AND 102).

FIRST USE 1-15-2008; IN COMMERCE 1-15-2008.

THE MARK CONSISTS OF STANDARD CHAR-
ACTERS WITHOUT CLAIM TO ANY PARTICULAR
FONT, STYLE, SIZE, OR COLOR.

SER. NO. 77-237,977, FILED 7-25-2007.

FRANK LATTUCA, EXAMINING ATTORNEY

Int. Cl.: 35

Prior U.S. Cls.: 100, 101 and 102

United States Patent and Trademark Office

Reg. No. 3,483,532

Registered Aug. 12, 2008

**SERVICE MARK
PRINCIPAL REGISTER**

Business@Lightning Speed

TECHNODYNE, LLC (NEW JERSEY LTD LIAB
CO)
SUITE 302
22 RIVERVIEW DRIVE
WAYNE, NJ 07470

FOR: EMPLOYMENT AGENCY SERVICES FOR CONTRACT AND PERMANENT STAFF; PERSONNEL MANAGEMENT; SELECTION, RECRUITMENT AND PLACEMENT OF TEMPORARY AND PERMANENT PERSONNEL; REPLACEMENT OF EMPLOYEES, NAMELY, PERSONNEL PLACEMENT AND RECRUITMENT; MANAGEMENT CONSULTING IN THE BUSINESS ORGANIZATION AND MANAGEMENT FIELD; EMPLOYMENT AGENCY SERVICES, NAMELY, ONLINE PROVISION OF EMPLOYMENT ADVERTISEMENTS AND EMPLOYMENT DESCRIPTIONS; OUTSOURCING SERVICES; OUTSOURCING SERVICES, NAMELY, BUSINESS ASSISTANCE, NAMELY, OUTSOURCING SERVICES IN THE FIELDS OF INFORMA-

TION TECHNOLOGY, SERVICES OF ENGINEERS AND FINANCIAL SERVICES; DATA MANAGEMENT SERVICES BY MEANS OF COMPUTERS FOR USE IN BUSINESS MANAGEMENT; BUSINESS AND ORGANIZATION CONSULTING; BUSINESS CONSULTING SERVICES IN THE FIELDS OF UTILITIES, HEALTH CARE, TRANSPORTATION, RETAIL AND DISTRIBUTION, IN CLASS 35 (U.S. CLS. 100, 101 AND 102).

FIRST USE 8-0-1998; IN COMMERCE 9-28-1998.

THE MARK CONSISTS OF STANDARD CHARACTERS WITHOUT CLAIM TO ANY PARTICULAR FONT, STYLE, SIZE, OR COLOR.

SER. NO. 77-238,025, FILED 7-25-2007.

RICHARD A. STRASER, EXAMINING ATTORNEY

Int. Cl.: 42

Prior U.S. Cls.: 100 and 101

United States Patent and Trademark Office

Reg. No. 3,483,533

Registered Aug. 12, 2008

**SERVICE MARK
PRINCIPAL REGISTER**

Business@Lightning Speed

TECHNODYNE, LLC (NEW JERSEY LTD LIAB
CO)
SUITE 302
22 RIVERVIEW DRIVE
WAYNE, NJ 07470

FOR: DATABASE DEVELOPMENT SERVICES,
NAMELY, INFORMATION TECHNOLOGY INFRA-
STRUCTURE DEVELOPMENT; COMPUTER PRO-
JECT MANAGEMENT SERVICES FEATURING
THE DEVELOPMENT OF INFORMATION TECH-
NOLOGY INFRASTRUCTURES; COMPUTER NET-
WORK DESIGN FOR OTHERS; COMPUTER
TECHNOLOGY CONSULTATION; COMPUTER
PROGRAMMING FOR OTHERS; COMPUTER
SOFTWARE DESIGN FOR OTHERS; TECHNOLO-

GICAL CONSULTING IN THE TECHNOLOGY
FIELD OF INFORMATION TECHNOLOGY AND
COMPUTER TECHNOLOGY CONSULTING, IN
CLASS 42 (U.S. CLS. 100 AND 101).

FIRST USE 8-0-1998; IN COMMERCE 9-25-1998.

THE MARK CONSISTS OF STANDARD CHAR-
ACTERS WITHOUT CLAIM TO ANY PARTICULAR
FONT, STYLE, SIZE, OR COLOR.

SER. NO. 77-238,034, FILED 7-25-2007.

RICHARD A. STRASER, EXAMINING ATTORNEY

Int. Cl.: 45

Prior U.S. Cls.: 100 and 101

United States Patent and Trademark Office

Reg. No. 3,483,534

Registered Aug. 12, 2008

**SERVICE MARK
PRINCIPAL REGISTER**

INFINI

GLOBAL CORPORATE SERVICES LTD (SEY-
CHELLES LTD LIAB CO)
PO BOX 1312 FRANCIS RACHEL ST
MAHE, SEYCHELLES 1312

FOR: ANALYSIS OF DATA, POLICY AND PROCESS, AND PROVISION OF BUSINESS MANAGEMENT ADVICE AND ASSISTANCE TO ENSURE COMPLIANCE WITH PUBLIC SECTOR PROCUREMENT LAWS AND REGULATIONS; ARBITRATION SERVICES; ATTORNEY SERVICES; AUTHENTICATION, ISSUANCE AND VALIDATION OF DIGITAL CERTIFICATES; COMPUTER DATING SERVICES; COMPUTER SECURITY SERVICES IN THE NATURE OF PROVIDING AN INTERNET TRUST CENTER, NAMELY, COMPUTER SECURITY ASSURANCE AND ADMINISTRATION OF DIGITAL KEYS AND DIGITAL CERTIFICATES; CONSULTATION SERVICES CONCERNING HOMELAND SAFETY AND SECURITY ISSUES; CONSULTATION SERVICES IN THE FIELD OF THE SAFETY NEEDS OF COMMERCIAL AND INDUSTRIAL COMPANIES; CONSULTING AND LEGAL SERVICES IN THE FIELD OF PRIVACY AND SECURITY LAWS, REGULATIONS, AND REQUIREMENTS; CONSULTING IN THE FIELD OF WORKPLACE SAFETY; CONSULTING SERVICES IN THE FIELD OF MAINTAINING THE SECURITY AND INTEGRITY OF DATABASES; COPYRIGHT MANAGEMENT; DATING SERVICES; FASHION INFORMATION; FASHION TREND CONSULTING FOR THE FASHION INDUSTRY; FINANCIAL IDENTITY MONITORING SERVICE; HOME SECURITY MONITORING USING WIRELESS AND WIRED SENSORS FOR GLASS BREAKAGE, MOTION DETECTORS, CAMERAS, POOL ALARMS, WATER ALARMS AND SHUTOFF VALVES, GATE, DOOR AND WINDOW CONTACT SENSORS, SEVERE WEATHER ALARMS; INTELLECTUAL PROPERTY CONSULTATION; INTELLECTUAL PROPERTY WATCH SERVICES; INTERNET BASED SOCIAL NETWORKING, INTRODUCTION, AND

DATING SERVICES; INVESTIGATION OR SURVEILLANCE ON BACKGROUND PROFILES; LEGAL DOCUMENT PREPARATION AND RESEARCH SERVICES FOR ATTORNEYS; LEGAL RESEARCH; LEGAL SERVICES; LEGAL SERVICES, NAMELY, TRADEMARK MAINTENANCE SERVICES; LEGAL SERVICES, NAMELY, TRADEMARK SEARCHING AND CLEARANCE SERVICES; LICENSING OF ADVERTISING SLOGANS AND CARTOON CHARACTERS; LICENSING OF ARCHITECTURAL DRAWINGS TO OTHERS; LICENSING OF COMPUTER SOFTWARE; LICENSING OF INTELLECTUAL PROPERTY; LITIGATION CONSULTANCY; LITIGATION SERVICES; LITIGATION SUPPORT SERVICES; MEDIATION; MONITORING SECURITY SYSTEMS; MONITORING TELEPHONE CALLS FROM SUBSCRIBERS AND NOTIFYING EMERGENCY FACILITIES; ON-LINE IDENTITY RELIABILITY INVESTIGATION IN THE FIELD OF ON-LINE DATING AND CLAIMS MADE ABOUT AGE, GENDER; ON-LINE MONITORING, NAMELY, VIDEO MONITORING OF FACILITIES, VIEWABLE THROUGH A GLOBAL COMPUTER NETWORK; ONLINE MONITORING TO PREVENT ILLEGAL FILE SHARING AND PROVIDING ELECTRONIC REPORTS REGARDING ATTEMPTS AT ILLEGAL FILE SHARING IN CONNECTION THEREWITH ON NETWORKS WORLDWIDE; ONLINE SOCIAL NETWORKING SERVICES; PATENT AGENT SERVICES; PATENT AND INDUSTRIAL PROPERTY CONSULTATION; PATENT LICENSING; PERMITTING, NAMELY, OBTAINING ENVIRONMENTAL, DESIGN, ZONING AND OTHER GOVERNMENTAL PERMITS FOR DEVELOPMENT PROJECTS; PERSONAL BACKGROUND INVESTIGATIONS; PERSONAL SECURITY CONSULTATION; PRE-EMPLOYMENT BACKGROUND SCREENING; PROVIDING INFORMATION RELATING TO LEGAL AFFAIRS; TRADEMARK WATCH SERVICES; WEB SITE SERVICES FEATURING ON-LINE DATING CLUB, IN CLASS 45 (U.S. CLS. 100 AND 101).

FIRST USE 1-1-2004; IN COMMERCE 1-1-2004.

THE MARK CONSISTS OF STANDARD CHARACTERS WITHOUT CLAIM TO ANY PARTICULAR FONT, STYLE, SIZE, OR COLOR.

THE FOREIGN WORDING IN THE MARK TRANSLATES INTO ENGLISH AS INFINITE.

SER. NO. 77-238,481, FILED 7-25-2007.

RONALD MCMORROW, EXAMINING ATTORNEY

Int. Cl.: 9

Prior U.S. Cls.: 21, 23, 26, 36 and 38

Reg. No. 3,483,535

United States Patent and Trademark Office

Registered Aug. 12, 2008

TRADEMARK
PRINCIPAL REGISTER

The logo features the word "echo" in a black, lowercase, cursive script font. Below it, the word "DRIVE" is written in a bold, black, uppercase, sans-serif font. The entire logo is centered within a light gray rectangular background.

ROVER TECHNOLOGY FUSIONS (FLORIDA
LTD LIAB CO)
5115 JOANNE KEARNEY BLVD.
TAMPA, FL 33619

NO CLAIM IS MADE TO THE EXCLUSIVE
RIGHT TO USE "DRIVE", APART FROM THE
MARK AS SHOWN.

FOR: PORTABLE HARD DRIVES FOR COMPU-
TERS FEATURING CONTINUOUS DATA PROTEC-
TION SOFTWARE, IN CLASS 9 (U.S. CLS. 21, 23, 26,
36 AND 38).

SER. NO. 77-238,606, FILED 7-25-2007.

FIRST USE 6-24-2007; IN COMMERCE 6-24-2007.

AISHA SALEM, EXAMINING ATTORNEY

Int. Cl.: 35

Prior U.S. Cls.: 100, 101 and 102

United States Patent and Trademark Office

Reg. No. 3,483,536

Registered Aug. 12, 2008

**SERVICE MARK
PRINCIPAL REGISTER**

**GOOD PEOPLE AREN'T LOOKING
FOR WORK ... THEY'RE
LISTENING FOR IT!!!**

FKM/RAS, LLP (TEXAS LTD LIAB LTD PART),
DBA MITTON MEDIA
846 MERRICK
SUGAR LAND, TX 77478

FOR: ADVERTISING SERVICES, NAMELY, PERSONNEL RECRUITMENT ADVERTISING FOR OTHERS; BUSINESS SERVICES, NAMELY, BUSINESS PLANNING, BUSINESS MANAGEMENT; ADVERTISING AND BUSINESS SERVICES, NAMELY, SECURING AIRTIME ON ALL FORMS OF MEDIA COMMUNICATIONS STATIONS, SYSTEMS, NETWORKS, AND SERVICES FOR THE PURPOSE OF PROMOTING THE GOODS AND SERVICES OF OTHERS; ADVERTISING VIA ELECTRONIC MEDIA AND SPECIFICALLY THE INTERNET; PREPARATION AND REALIZATION OF MEDIA AND ADVERTISING PLANS AND CONCEPTS; MEDIA PLANNING, NAMELY, ADVISING THE CLIENT ON THE CORRECT TIMES AND STATIONS TO

ADVERTISE BASED ON MEDIA ANALYSIS OF THE MARKET FOR THAT MEDIA; EMPLOYMENT COUNSELING AND RECRUITING; CONSULTING FOR THE PROMOTION OF EMPLOYEE RETENTION; PERSONNEL PLACEMENT AND RECRUITMENT; JOB PLACEMENT; AND BUSINESS CONSULTATION, IN CLASS 35 (U.S. CLS. 100, 101 AND 102).

FIRST USE 1-20-2003; IN COMMERCE 1-20-2003.

THE MARK CONSISTS OF STANDARD CHARACTERS WITHOUT CLAIM TO ANY PARTICULAR FONT, STYLE, SIZE, OR COLOR.

SER. NO. 77-238,617, FILED 7-25-2007.

G. MAYERSCHOFF, EXAMINING ATTORNEY

Int. Cl.: 35

Prior U.S. Cls.: 100, 101 and 102

United States Patent and Trademark Office

Reg. No. 3,483,537

Registered Aug. 12, 2008

**SERVICE MARK
PRINCIPAL REGISTER**



4STAFF, LLC (DELAWARE LTD LIAB CO)
SUITE 425 WEST
1001 G STREET NW
WASHINGTON, DC 20001

FOR: TEMPORARY EMPLOYMENT AGENCIES;
EMPLOYMENT HIRING, RECRUITING, PLACE-
MENT, STAFFING AND CAREER NETWORKING
SERVICES; EMPLOYMENT AGENCIES, IN CLASS
35 (U.S. CLS. 100, 101 AND 102).

FIRST USE 12-11-2005; IN COMMERCE 12-11-2005.

NO CLAIM IS MADE TO THE EXCLUSIVE
RIGHT TO USE "STAFF", APART FROM THE
MARK AS SHOWN.

THE COLOR(S) WHITE, RED AND BLACK IS/
ARE CLAIMED AS A FEATURE OF THE MARK.

THE COLOR RED APPEARS IN THE CIRCLE
SURROUNDING THE NUMBER "4" AT THE TOP
OF THE MARK AND IN THE PARALLEL LINES
RUNNING PARALLEL BOTH ABOVE AND BELOW
THE WORD "STAFF". THE NUMBER "4" AT THE
TOP OF THE MARK IS FRAMED ON EITHER SIDE
BY CRESCENTS ENCIRLING THE NUMBER "4",
AND ALL 3 OF THESE CHARACTERS ARE WHITE.
THE WORD "STAFF" WITHIN THE MARK IS
BLACK.

SER. NO. 77-238,756, FILED 7-25-2007.

ALICE BENMAMAN, EXAMINING ATTORNEY

Int. Cl.: 40

Prior U.S. Cls.: 100, 103 and 106

United States Patent and Trademark Office

Reg. No. 3,483,538

Registered Aug. 12, 2008

SERVICE MARK
PRINCIPAL REGISTER



FLOWERS INTO PAINTINGS LLC (LOUISIANA
LTD LIAB CO)
SUITE E
201 WESTMARK BOULEVARD
LAFAYETTE, LA 70506

FOR: CUSTOM CONSTRUCTION OF PAINTING
CONTAINING ACTUAL PRESSED FLOWERS,
NAMELY, COMBINING FLOWER PRESERVATION
WITH FINE ART BY PRESSING AND DRYING THE
FLOWERS AND THEN APPLYING THE FLOWERS
TO A CUSTOM PAINTING CONSTRUCTION OF
BUILDINGS AND OTHER STRUCTURES, IN CLASS
40 (U.S. CLS. 100, 103 AND 106).

FIRST USE 1-0-2004; IN COMMERCE 1-0-2004.

NO CLAIM IS MADE TO THE EXCLUSIVE
RIGHT TO USE "FLOWERS INTO PAINTINGS",
APART FROM THE MARK AS SHOWN.

THE MARK CONSISTS OF THE STYLIZED TEXT
"FLOWERS INTO PAINTINGS" WITH A LONG
STEM ROSE THAT IS PLACED AFTER THE WORD
FLOWERS.

SER. NO. 77-238,875, FILED 7-25-2007.

GEORGIA CARTY, EXAMINING ATTORNEY

Int. Cl.: 43

Prior U.S. Cls.: 100 and 101

United States Patent and Trademark Office

Reg. No. 3,483,539

Registered Aug. 12, 2008

**SERVICE MARK
PRINCIPAL REGISTER**

**Scotto's Italian
Restaurant & Pizzeria**

SCOTTO LAVINA, TOMAS (TOMMY), A. (UNI-
TED STATES INDIVIDUAL)
1412 WEST BROAD STREET
WAYNESBORO, VA 22980

FOR: RESTAURANTS, IN CLASS 43 (U.S. CLS. 100
AND 101).

FIRST USE 5-2-1989; IN COMMERCE 5-2-1989.

THE MARK CONSISTS OF STANDARD CHAR-
ACTERS WITHOUT CLAIM TO ANY PARTICULAR
FONT, STYLE, SIZE, OR COLOR.

NO CLAIM IS MADE TO THE EXCLUSIVE
RIGHT TO USE "ITALIAN RESTAURANT & PIZ-
ZERIA", APART FROM THE MARK AS SHOWN.

SEC. 2(F).

SER. NO. 77-239,738, FILED 7-26-2007.

ELLEN B. AWRICH, EXAMINING ATTORNEY

Int. Cl.: 28

Prior U.S. Cls.: 22, 23, 38 and 50

United States Patent and Trademark Office

Reg. No. 3,483,540

Registered Aug. 12, 2008

**TRADEMARK
PRINCIPAL REGISTER**

TOTALLY HAIR

MATTEL, INC. (DELAWARE CORPORATION)
M1-1518
333 CONTINENTAL BLVD.
EL SEGUNDO, CA 90245

FOR: TOYS, GAMES AND PLAYTHINGS, NAME-
LY, DOLL HAIR STYLING HEADS AND ACCES-
SORIES THEREFOR, IN CLASS 28 (U.S. CLS. 22, 23,
38 AND 50).

FIRST USE 9-13-2007; IN COMMERCE 9-13-2007.

THE MARK CONSISTS OF STANDARD CHAR-
ACTERS WITHOUT CLAIM TO ANY PARTICULAR
FONT, STYLE, SIZE, OR COLOR.

NO CLAIM IS MADE TO THE EXCLUSIVE
RIGHT TO USE "HAIR", APART FROM THE MARK
AS SHOWN.

SER. NO. 77-239,986, FILED 7-26-2007.

CYNTHIA SLOAN, EXAMINING ATTORNEY

Int. Cl.: 28

Prior U.S. Cls.: 22, 23, 38 and 50

Reg. No. 3,483,541

United States Patent and Trademark Office

Registered Aug. 12, 2008

**TRADEMARK
PRINCIPAL REGISTER**

DAY 2 NITE

MATTEL, INC. (DELAWARE CORPORATION)
M1-1518
333 CONTINENTAL BLVD.
EL SEGUNDO, CA 90245

FIRST USE 10-18-2007; IN COMMERCE 10-18-2007.

FOR: TOYS, GAMES AND PLAYTHINGS, NAME-
LY, DOLLS, DOLL CLOTHING AND DOLL ACCES-
SORIES, TOY FIGURES AND ACCESSORIES
THEREFOR, IN CLASS 28 (U.S. CLS. 22, 23, 38 AND
50).

THE MARK CONSISTS OF STANDARD CHAR-
ACTERS WITHOUT CLAIM TO ANY PARTICULAR
FONT, STYLE, SIZE, OR COLOR.

SER. NO. 77-240,001, FILED 7-26-2007.

CYNTHIA SLOAN, EXAMINING ATTORNEY

Int. Cl.: 28

Prior U.S. Cls.: 22, 23, 38 and 50

Reg. No. 3,483,542

United States Patent and Trademark Office

Registered Aug. 12, 2008

**TRADEMARK
PRINCIPAL REGISTER**

SURF'S UP

MATTEL, INC. (DELAWARE CORPORATION)
M1-1518
333 CONTINENTAL BLVD.
EL SEGUNDO, CA 90245

THE MARK CONSISTS OF STANDARD CHARACTERS WITHOUT CLAIM TO ANY PARTICULAR FONT, STYLE, SIZE, OR COLOR.

FOR: TOYS, GAMES AND PLAYTHINGS, NAME-
LY, DOLLS, DOLL CLOTHING AND DOLL ACCES-
SORIES, DOLL PLAYSETS, TOY FIGURES, AND
ACCESSORIES FOR ALL OF THE FOREGOING, IN
CLASS 28 (U.S. CLS. 22, 23, 38 AND 50).

OWNER OF U.S. REG. NO. 3,009,390.

SER. NO. 77-240,003, FILED 7-26-2007.

FIRST USE 8-9-2007; IN COMMERCE 8-9-2007.

CYNTHIA SLOAN, EXAMINING ATTORNEY

Int. Cl.: 42

Prior U.S. Cls.: 100 and 101

United States Patent and Trademark Office

Reg. No. 3,483,543

Registered Aug. 12, 2008

**SERVICE MARK
PRINCIPAL REGISTER**

JUSTICEMAX

MAXIMUS, INC. (VIRGINIA CORPORATION)
11419 SUNSET HILLS ROAD
RESTON, VA 20190

THE MARK CONSISTS OF STANDARD CHAR-
ACTERS WITHOUT CLAIM TO ANY PARTICULAR
FONT, STYLE, SIZE, OR COLOR.

FOR: PROVIDING ON-LINE, NON-DOWNLOAD-
ABLE SOFTWARE FOR MANAGING COURT OP-
ERATIONS AND COURT CASE RELATED DATA,
IN CLASS 42 (U.S. CLS. 100 AND 101).

SER. NO. 77-240,444, FILED 7-27-2007.

FIRST USE 1-0-2007; IN COMMERCE 1-0-2007.

JAY BESCH, EXAMINING ATTORNEY

Int. Cl.: 44

Prior U.S. Cls.: 100 and 101

United States Patent and Trademark Office

Reg. No. 3,483,544

Registered Aug. 12, 2008

**SERVICE MARK
PRINCIPAL REGISTER**

**LASER VAGINAL REJUVENATION
INSTITUTE**

ENTREPRENEURIAL MEDICAL CONSULTING,
LLC (ST.CHRIST-NEVIS LTD LIAB CO)
SUITE 404
9201 SUNSET BLVD.
LOS ANGELES, CA 90069

FOR: MEDICAL SERVICES, NAMELY, GYNECO-
LOGIC SURGERY, IN CLASS 44 (U.S. CLS. 100 AND
101).

FIRST USE 5-0-2001; IN COMMERCE 5-0-2001.

THE MARK CONSISTS OF STANDARD CHAR-
ACTERS WITHOUT CLAIM TO ANY PARTICULAR
FONT, STYLE, SIZE, OR COLOR.

OWNER OF U.S. REG. NOS. 2,885,439 AND
2,888,004.

NO CLAIM IS MADE TO THE EXCLUSIVE
RIGHT TO USE "INSTITUTE", APART FROM THE
MARK AS SHOWN.

SEC. 2(F).

SER. NO. 77-240,693, FILED 7-27-2007.

DAVID COLLIER, EXAMINING ATTORNEY

Int. Cl.: 38

Prior U.S. Cls.: 100, 101 and 104

United States Patent and Trademark Office

Reg. No. 3,483,545

Registered Aug. 12, 2008

**SERVICE MARK
PRINCIPAL REGISTER**

YOUR BEST WEBFRIEND

ZALETTEL, MICHAEL E. (UNITED STATES INDIVIDUAL)
378 E. CLIFTON COURT
GILBERT, AZ 85296

FOR: PROVIDING ON-LINE COMMUNICATIONS LINKS WHICH TRANSFER THE WEBSITE USER TO OTHER LOCAL AND GLOBAL WEB PAGES, IN CLASS 38 (U.S. CLS. 100, 101 AND 104).

FIRST USE 7-0-1999; IN COMMERCE 7-0-1999.

THE MARK CONSISTS OF STANDARD CHARACTERS WITHOUT CLAIM TO ANY PARTICULAR FONT, STYLE, SIZE, OR COLOR.

OWNER OF U.S. REG. NO. 2,445,114.

SER. NO. 77-240,729, FILED 7-27-2007.

ANN E. SAPPENFIELD, EXAMINING ATTORNEY

Int. Cls.: 10, 41 and 44

Prior U.S. Cls.: 26, 39, 44, 100, 101 and 107

United States Patent and Trademark Office

Reg. No. 3,483,546

Registered Aug. 12, 2008

**TRADEMARK
SERVICE MARK
PRINCIPAL REGISTER**

LYMPHEASE

CYPRO-SSAGE PTY LTD (AUSTRALIA LTD
LIAB CO)
1-5 NESTOR DRIVE
MEADOWBROOK, QUEENSLAND, AUSTRALIA
4131

FOR: THERAPY APPARATUS, NAMELY, MEDICAL THERAPY APPARATUS FOR HOME USE OR SELF ADMINISTRATION; MASSAGE APPARATUS INCLUDING THERAPEUTIC MASSAGE APPARATUS; MANUAL VIBRATORY MASSAGERS INCLUDING HAND HELD MANUAL MASSAGERS, IN CLASS 10 (U.S. CLS. 26, 39 AND 44).

FOR: EDUCATION AND TRAINING, NAMELY, CONDUCTING CLASSES AND TRAINING COURSES IN THE FIELD OF PHYSICAL THERAPY, NAMELY, VIBRATION THERAPY, IN CLASS 41 (U.S. CLS. 100, 101 AND 107).

FOR: PHYSICAL THERAPY, NAMELY, VIBRATION THERAPY, IN CLASS 44 (U.S. CLS. 100 AND 101).

THE MARK CONSISTS OF STANDARD CHARACTERS WITHOUT CLAIM TO ANY PARTICULAR FONT, STYLE, SIZE, OR COLOR.

PRIORITY CLAIMED UNDER SEC. 44(D) ON AUSTRALIA APPLICATION NO. 1169654, FILED 4-2-2007, REG. NO. 1169654, DATED 4-2-2007, EXPIRES 4-2-2017.

SER. NO. 77-240,868, FILED 7-27-2007.

KAREN K. BUSH, EXAMINING ATTORNEY

Int. Cls.: 9 and 42

Prior U.S. Cls.: 21, 23, 26, 36, 38, 100 and 101

United States Patent and Trademark Office

Reg. No. 3,483,547

Registered Aug. 12, 2008

**TRADEMARK
SERVICE MARK
PRINCIPAL REGISTER**

The image shows the letters 'ZK' in a large, bold, black, serif font. The letters are centered and have a slight shadow effect behind them, giving them a three-dimensional appearance. The 'Z' and 'K' are connected at the top.

POTIX CORPORATION (CAYMAN ISLANDS CORPORATION)
GEORGE TOWN
GRAND CAYMAN, CAYMAN ISLANDS KY1-1203

FOR: COMPUTER PROGRAMS FOR DEVELOPING SOFTWARE IN THE FIELD OF COMPUTER APPLICATIONS AND COMPUTER OPERATING SYSTEMS; COMPUTER SOFTWARE FOR APPLICATIONS AND DATABASE INTEGRATION; WEB SITE DEVELOPMENT SOFTWARE; COMPUTER SOFTWARE FOR USE IN APPLICATIONS DEVELOPMENT BY COMPUTER PROGRAMMERS; COMPUTER SOFTWARE USED IN THE DEVELOPMENT OF SOFTWARE APPLICATIONS; COMPUTER SOFTWARE FOR COMPUTER SYSTEM AND APPLICATION DEVELOPMENT, IN CLASS 9 (U.S. CLS. 21, 23, 26, 36 AND 38).

FIRST USE 11-15-2005; IN COMMERCE 11-15-2005.

FOR: TECHNICAL SUPPORT SERVICES FOR TROUBLE-SHOOTING OF COMPUTER HARD-

WARE AND SOFTWARE PROBLEMS; CONSULTING SERVICES RELATING TO ENTERPRISE SERVER SOFTWARE; CONSULTING SERVICES IN THE FIELD OF COMPUTER PROGRAMMING; TECHNICAL ANALYSIS AND CONSULTATION IN THE FIELD OF DATA PROCESSING AND DATA MANAGEMENT; PROVIDING INFORMATION IN THE FIELDS OF COMPUTER SOFTWARE AND INFORMATION TECHNOLOGY BY MEANS OF A WEBSITE ACCESSIBLE VIA A GLOBAL COMPUTER NETWORK, IN CLASS 42 (U.S. CLS. 100 AND 101).

FIRST USE 11-15-2005; IN COMMERCE 11-15-2005.

THE MARK CONSISTS OF STANDARD CHARACTERS WITHOUT CLAIM TO ANY PARTICULAR FONT, STYLE, SIZE, OR COLOR.

SER. NO. 77-240,876, FILED 7-27-2007.

BRIDGETT SMITH, EXAMINING ATTORNEY

Int. Cl.: 2

Prior U.S. Cls.: 6, 11 and 16

United States Patent and Trademark Office

Reg. No. 3,483,548

Registered Aug. 12, 2008

**TRADEMARK
PRINCIPAL REGISTER**

FINNAREN & HALEY PAINT

HALEY PAINT COMPANY (PENNSYLVANIA
CORPORATION)

901 WASHINGTON STREET

CONSHOHOCKEN, PA 194282390

FOR: INTERIOR AND EXTERIOR PAINT, IN
CLASS 2 (U.S. CLS. 6, 11 AND 16).

FIRST USE 0-0-1907; IN COMMERCE 0-0-1907.

THE MARK CONSISTS OF STANDARD CHAR-
ACTERS WITHOUT CLAIM TO ANY PARTICULAR
FONT, STYLE, SIZE, OR COLOR.

NO CLAIM IS MADE TO THE EXCLUSIVE
RIGHT TO USE "PAINT", APART FROM THE
MARK AS SHOWN.

SER. NO. 77-240,963, FILED 7-27-2007.

JULIE WATSON, EXAMINING ATTORNEY

Int. Cls.: 35 and 41

Prior U.S. Cls.: 100, 101, 102 and 107

United States Patent and Trademark Office

Reg. No. 3,483,549

Registered Aug. 12, 2008

**SERVICE MARK
PRINCIPAL REGISTER**



GREEN BLUE INSTITUTE (DELAWARE TAX EXEMPT CORPORATION), DBA GREENBLUE
600 E. WATER STREET, SUITE C
CHARLOTTESVILLE, VA 22901

FOR: INFORMATION SERVICES IN THE FIELD OF SUSTAINABLE BUSINESS SOLUTIONS, IN CLASS 35 (U.S. CLS. 100, 101 AND 102).

FIRST USE 10-16-2005; IN COMMERCE 10-16-2005.

FOR: EDUCATION SERVICES, NAMELY, PROVIDING LIVE AND ON-LINE CONFERENCES AND SEMINARS IN THE FIELD OF SUSTAINABLE BUSINESS SOLUTIONS, AND PRINTED AND PRINTABLE MATERIALS DISTRIBUTED THEREWITH, IN CLASS 41 (U.S. CLS. 100, 101 AND 107).

FIRST USE 10-16-2005; IN COMMERCE 10-16-2005.

THE COLOR(S) GREEN, BLUE, AND WHITE IS/ ARE CLAIMED AS A FEATURE OF THE MARK.

THE MARK CONSISTS OF A FILLED CIRCLE WITH THE LETTERS S, P, AND C ARRANGED THEREIN SO THAT THE THE LETTER S IS TO THE LEFT OF THE LETTER C WITH THE LETTER P BELOW AND BETWEEN THEM. ALL THREE LETTERS ARE THE COLOR WHITE. THE SPACE BETWEEN THE LETTERS S AND C AND THE CIRCULAR SPACE WITHIN THE LETTER P ARE THE COLOR GREEN. THE REMAINDER OF THE SPACE IN THE CIRCLE IS THE COLOR BLUE.

SER. NO. 77-241,051, FILED 7-27-2007.

ANNE E. GUSTASON, EXAMINING ATTORNEY

Int. Cls.: 35 and 41

Prior U.S. Cls.: 100, 101, 102 and 107

United States Patent and Trademark Office

Reg. No. 3,483,550

Registered Aug. 12, 2008

**SERVICE MARK
PRINCIPAL REGISTER**

GreenBlue 

GREEN BLUE INSTITUTE (DELAWARE TAX EXEMPT CORPORATION), DBA GREENBLUE
600 E. WATER STREET, SUITE C
CHARLOTTESVILLE, VA 22901

FOR: CONSULTING SERVICES IN THE AREA OF SUSTAINABLE BUSINESS SOLUTIONS, AND INFORMATION SERVICES IN THE FIELD OF SUSTAINABLE BUSINESS SOLUTIONS, IN CLASS 35 (U.S. CLS. 100, 101 AND 102).

FIRST USE 4-30-2003; IN COMMERCE 4-30-2003.

FOR: EDUCATION SERVICES, NAMELY, PROVIDING LIVE AND ON-LINE CONFERENCES AND SEMINARS IN THE FIELD OF SUSTAINABLE BUSINESS SOLUTIONS, AND PRINTED AND PRINTABLE MATERIAL DISTRIBUTED THEREWITH, IN CLASS 41 (U.S. CLS. 100, 101 AND 107).

FIRST USE 4-30-2003; IN COMMERCE 4-30-2003.

THE COLOR(S) GREEN, BLUE, AND BLACK IS/ ARE CLAIMED AS A FEATURE OF THE MARK.

THE MARK CONSISTS OF THE WORD GREEN-BLUE IN BLACK LETTERING, WITH THE LETTERS G AND B BEING CAPITALIZED, FOLLOWED BY A CIRCLE COMPOSED OF NINE WATER DROPLETS, SOME JOINED AND OTHERS UNJOINED. THE WATER DROPLET APPEARING AT APPROXIMATELY THE THREE O'CLOCK POSITION IS BLUE AND THE DROPLET AT APPROXIMATELY THE ELEVEN O'CLOCK POSITION IS GREEN. PROCEEDING IN A CLOCKWISE FASHION AFTER THE BLUE DROPLET, THE REMAINING DROPLETS SHADE FROM BLUE TO GREEN AND BACK AGAIN TO BLUE.

SER. NO. 77-241,095, FILED 7-27-2007.

ANNE E. GUSTASON, EXAMINING ATTORNEY

Int. Cl.: 39

Prior U.S. Cls.: 100 and 105

Reg. No. 3,483,551

United States Patent and Trademark Office

Registered Aug. 12, 2008

**SERVICE MARK
PRINCIPAL REGISTER**

INFINI

GLOBAL CORPORATE SERVICES LTD (SEY-
CHELLES LTD LIAB CO)
PO BOX 1312 FRANCIS RACHEL STREET
MAHE, SEYCHELLES 1312

FOR: AERONAUTICAL RADIO NAVIGATION SERVICES; AIR TRAFFIC CONTROL SERVICES; AIR TRANSPORT; AIRPLANE CHARTERING; AIRPORT SERVICES; ARRANGING EXCURSIONS FOR TOURISTS; ARRANGING FOR TRAVEL VISAS, PASSPORTS AND TRAVEL DOCUMENTS FOR PERSONS TRAVELING ABROAD; ARRANGING OF CRUISES; ARRANGING TRAVEL TOURS; BIOMEDICAL SERVICES, NAMELY, THE STORAGE OF HUMAN CELLS FOR MEDICAL USE; BOAT CHARTERING; BOAT CRUISES; CARGO HANDLING; COURIER SERVICES; CRUISE SHIP SERVICES; ELECTRONIC STORAGE OF FILES AND DOCUMENTS; FREIGHT BROKERAGE; GLOBAL TRANSPORTATION OF FREIGHT FOR OTHERS BY ALL AVAILABLE MEANS; GOODS WAREHOUSING; HELICOPTER TRANSPORT; LAUNCH AND PLACEMENT IN PRESCRIBED ORBIT OF SATELLITES OF OTHERS; MAIL BOX RENTAL; MARINE TRANSPORT; MOBILE MEDIA SERVICES IN THE NATURE OF STORAGE OF ENTERTAINMENT MEDIA CONTENT; ON-LINE COMPUTER SERVICES FOR STORING CONTENT ITEMS SELECTED BY USERS FROM INTERNET WEB PAGES; ORGANISATION OF TRAVEL; PHYSICAL STORAGE OF ELECTRONICALLY-STORED DATA OR DOCUMENTS; PROVIDING A WEBSITE AND WEBSITE LINKS TO GEOGRAPHIC INFORMATION, MAP IMAGES, AND TRIP ROUTING; PROVIDING A WEBSITE FEATURING INFORMATION IN THE FIELD OF POSTAL CODES; PROVIDING AN INTERACTIVE COMPUTER DATABASE IN THE FIELD OF TOURISM VIA A GLOBAL COMPUTER NETWORK; PROVIDING AN ON-LINE COMPUTER DATABASE IN THE FIELD OF TRAVEL INFORMATION SERVICES; PROVIDING FLIGHT ARRIVAL AND DEPARTURE INFORMATION;

PROVIDING INFORMATION, NEWS AND COMMENTARY IN THE FIELD OF TRAVEL; PROVIDING LINKS TO WEB SITES OF OTHERS FEATURING TRAVEL; PROVIDING OCEAN TRANSPORTATION, STORAGE AND DELIVERY SERVICES; PROVIDING REVIEWS OF TRAVEL SERVICE PROVIDERS; PROVIDING ROAD AND TRAFFIC INFORMATION; PROVIDING SELF-STORAGE FACILITIES FOR OTHERS; RAILWAY TRANSPORT; RENTAL OF MAIL BOXES; RENTAL OF SAILBOATS; RENTAL OF VEHICLES; RENTAL OF WAREHOUSE SPACE; SHIP BROKERAGE; STORAGE OF ELECTRONIC MEDIA, NAMELY, IMAGES, TEXT AND AUDIO DATA; STORAGE SERVICES FOR ARCHIVING DATABASES, IMAGES AND OTHER ELECTRONIC DATA; SUPPLY CHAIN, LOGISTICS AND REVERSE LOGISTICS SERVICES, NAMELY, STORAGE, TRANSPORTATION AND DELIVERY OF DOCUMENTS, PACKAGES, RAW MATERIALS, AND OTHER FREIGHT FOR OTHERS BY AIR, RAIL, SHIP OR TRUCK; TRAFFIC INFORMATION SERVICES; TRAVEL AND TOUR INFORMATION SERVICE; TRAVEL BOOKING AGENCIES; WAREHOUSING INFORMATION; WAREHOUSING SERVICES; YACHT CHARTERING, IN CLASS 39 (U.S. CLS. 100 AND 105).

FIRST USE 1-1-2004; IN COMMERCE 1-1-2004.

THE MARK CONSISTS OF STANDARD CHARACTERS WITHOUT CLAIM TO ANY PARTICULAR FONT, STYLE, SIZE, OR COLOR.

THE FOREIGN WORDING IN THE MARK TRANSLATES INTO ENGLISH AS INFINITE.

SER. NO. 77-241,423, FILED 7-29-2007.

RONALD MCMORROW, EXAMINING ATTORNEY

Int. Cl.: 41

Prior U.S. Cls.: 100, 101 and 107

Reg. No. 3,483,552

United States Patent and Trademark Office

Registered Aug. 12, 2008

**SERVICE MARK
PRINCIPAL REGISTER**

INFINI

GLOBAL CORPORATE SERVICES LTD (SEY-
CHELLES LTD LIAB CO)
PO BOX 1312 FRANCIS RACHEL STREET
MAHE, SEYCHELLES W1G9QR

FOR: ADMINISTRATION OF LOTTERIES FOR OTHERS; AERIAL PHOTOGRAPHY; AIRPLANE FLIGHT INSTRUCTION; ANALYZING EDUCATIONAL TESTS SCORES AND DATA FOR OTHERS; ANIMATION PRODUCTION SERVICES; ARRANGING FOR TICKET RESERVATIONS FOR SHOWS AND OTHER ENTERTAINMENT EVENTS; ARRANGING OF CONTESTS; ARRANGING OF SEMINARS AND CONFERENCES; ARRANGING PROFESSIONAL WORKSHOP AND TRAINING COURSES; AUDIO RECORDING AND PRODUCTION; BETTING SERVICES; BOOK AND REVIEW PUBLISHING; BOOKKEEPING INSTRUCTION; BUSINESS TRAINING; CASINOS; COMPOSITION OF MUSIC FOR OTHERS; COMPUTER EDUCATION TRAINING; COMPUTER EDUCATION TRAINING SERVICES; CUSTOM WRITING SERVICES; DESKTOP PUBLISHING FOR OTHERS; DIGITAL IMAGING SERVICES; DISTRIBUTION OF RADIO PROGRAMS FOR OTHERS; EDITING OR RECORDING OF SOUNDS AND IMAGES; EDUCATION COURSES RELATING TO THE TRAVEL INDUSTRY; EDUCATION SERVICES IN THE NATURE OF COURSES AT THE UNIVERSITY LEVEL; EDUCATIONAL AND ENTERTAINMENT SERVICES, NAMELY, PROVIDING MOTIVATIONAL AND EDUCATIONAL SPEAKERS; EDUCATIONAL ASSESSMENT; EDUCATIONAL COURSE MONITORING, NAMELY, TRACKING STUDENT PERFORMANCE; EDUCATIONAL PROGRAMS, NAMELY, PRE-SCHOOLS; EDUCATIONAL RESEARCH; ENTERTAINMENT IN THE NATURE OF BASEBALL GAMES; ENTERTAINMENT IN THE NATURE OF BASKETBALL GAMES; ENTERTAINMENT IN THE NATURE OF BOXING CONTESTS; ENTERTAINMENT IN THE NATURE OF FOOTBALL GAMES; ENTERTAINMENT IN THE NAT-

URE OF SOCCER GAMES; ENTERTAINMENT IN THE NATURE OF TELEVISION NEWS SHOWS; ENTERTAINMENT IN THE NATURE OF TENNIS TOURNAMENTS; ENTERTAINMENT SERVICES, NAMELY, AN ONLINE ACTIVITY WHERE YOU CREATE YOUR OWN MUSIC VIDEOS; ENTERTAINMENT SERVICES, NAMELY, PROVIDING A WEB SITE FEATURING MUSICAL PERFORMANCES, MUSICAL VIDEOS, RELATED FILM CLIPS, PHOTOGRAPHS, AND OTHER MULTIMEDIA MATERIALS; ENTERTAINMENT SERVICES, NAMELY, PROVIDING AN ON-LINE COMPUTER GAME; ENTERTAINMENT SERVICES, NAMELY, PROVIDING PRERECORDED MUSIC, INFORMATION IN THE FIELD OF MUSIC, AND COMMENTARY AND ARTICLES ABOUT MUSIC, ALL ON-LINE VIA A GLOBAL COMPUTER NETWORK; ENTERTAINMENT, NAMELY, LIVE PERFORMANCES BY ROCK GROUPS; FAN CLUBS; FILM EDITING; FILM MASTERING SERVICES; GAMBLING SERVICES; GOLF INSTRUCTION; HAIRDRESSING INSTRUCTION; INFORMATION ABOUT EDUCATION; JUDO INSTRUCTION; KARATE INSTRUCTION; LANGUAGE TRANSLATION; LOTTERY SERVICES; MARTIAL ARTS INSTRUCTION; MEDICAL TRAINING AND TEACHING; MEDITATION TRAINING; MOBILE MEDIA AND ENTERTAINMENT SERVICES IN THE NATURE OF CONTENT PREPARATION; MOTION PICTURE FILM PRODUCTION; MOVIE STUDIOS; MULTIMEDIA ENTERTAINMENT SERVICES IN THE NATURE OF RECORDING, PRODUCTION AND POST-PRODUCTION SERVICES IN THE FIELDS OF MUSIC, VIDEO, AND FILMS; MULTIMEDIA PUBLISHING OF BOOKS, MAGAZINES, JOURNALS, SOFTWARE, GAMES, MUSIC, AND ELECTRONIC PUBLICATIONS; MUSEUMS; MUSIC COMPOSITION FOR OTHERS; MUSIC PRODUCTION SERVICES; MUSIC PUBLISHING SERVICES; ON-LINE EDUCATION CREDIT AND DEGREE EVALUATION AND COMPARISON SERVICES; ON-LINE LIBRARY SERVICES, NAMELY, PROVIDING

ELECTRONIC LIBRARY SERVICES WHICH FEATURE NEWSPAPERS, MAGAZINES, PHOTOGRAPHS AND PICTURES VIA AN ON-LINE COMPUTER NETWORK; ONLINE ENTERTAINMENT TICKET AGENCY SERVICES; PARTY PLANNING; PARTY PLANNING CONSULTATION; PERSONAL TRAINER SERVICES; PHOTOGRAPHIC AND VIDEO SERVICES, NAMELY, PHOTOGRAPHY AND VIDEO CAPTURE; PHOTOGRAPHY SERVICES; PHYSICAL FITNESS INSTRUCTION; POST-PRODUCTION EDITING SERVICES IN THE FIELD OF MUSIC, VIDEOS AND FILMS; PRODUCTION AND DISTRIBUTION OF MOTION PICTURES; PRODUCTION AND DISTRIBUTION OF RADIO PROGRAMS; PRODUCTION AND DISTRIBUTION OF TELEVISION SHOWS AND MOVIES; PRODUCTION OF VIDEO AND COMPUTER GAME SOFTWARE; PRODUCTION OF VISUAL EFFECTS FOR VIDEOS, DVDS, TELEVISION AND FOR INTERNET WEBSITES; PROGRAMMING ON A GLOBAL COMPUTER NETWORK; PROVIDING A COMPUTER GAME THAT MAY BE ACCESSED NETWORK-WIDE BY NETWORK USERS; PROVIDING A WEB SITE WHERE USERS CAN POST RATINGS, REVIEWS AND RECOMMENDATIONS ON EVENTS AND ACTIVITIES IN THE FIELD OF ENTERTAINMENT AND EDUCATION; PROVIDING A WEBSITE FEATURING SPORTING INFORMATION; PROVIDING ADVICE AND INFORMATION IN THE FIELD OF EDUCATIONAL AND ENTERTAINMENT ACTIVITIES AND EVENTS FOR CHILDREN; PROVIDING CONTINUING BUSINESS EDUCATION COURSES; PROVIDING CONTINUING LEGAL EDUCATION COURSES; PROVIDING CONTINUING MEDICAL

EDUCATION COURSES; PROVIDING INFORMATION IN THE FIELD OF ENTERTAINMENT, FEATURING ANIMATION RENDERED BY MEANS OF A GLOBAL COMPUTER NETWORK; PROVIDING INFORMATION IN THE FIELD OF EXERCISE TRAINING; PROVIDING INFORMATION, NEWS AND COMMENTARY IN THE FIELD OF ENTERTAINMENT; PROVIDING NEWS AND INFORMATION IN THE FIELD OF SPORTS; PROVIDING ON-LINE CARD GAMES; PROVIDING ON-LINE INFORMATION AND NEWS IN THE FIELD OF EMPLOYMENT TRAINING; PUBLICATION OF BOOKS, OF MAGAZINES, OF JOURNALS, OF NEWSPAPERS, OF PERIODICALS, OF CATALOGS, OF BROCHURES; PUBLICATION OF ELECTRONIC MAGAZINES; PUBLICATION OF ELECTRONIC NEWSPAPERS ACCESSIBLE VIA A GLOBAL COMPUTER NETWORK; TRANSLATION; TRANSLATION SERVICES; VIDEO EDITING; YOGA INSTRUCTION; ZOOS; LANGUAGE INSTRUCTION, IN CLASS 41 (U.S. CLS. 100, 101 AND 107).

FIRST USE 1-1-2004; IN COMMERCE 1-1-2004.

THE MARK CONSISTS OF STANDARD CHARACTERS WITHOUT CLAIM TO ANY PARTICULAR FONT, STYLE, SIZE, OR COLOR.

THE FOREIGN WORDING IN THE MARK TRANSLATES INTO ENGLISH AS INFINITE.

SER. NO. 77-241,428, FILED 7-29-2007.

RONALD MCMORROW, EXAMINING ATTORNEY

Int. Cl.: 35

Prior U.S. Cls.: 100, 101 and 102

United States Patent and Trademark Office

Reg. No. 3,483,553

Registered Aug. 12, 2008

**SERVICE MARK
PRINCIPAL REGISTER**



I.I. FUELS, INC. (CALIFORNIA CORPORATION)
7436 PALOMA DRIVE
HUNTINGTON BEACH, CA 92648

FOR: ON-LINE SERVICES, NAMELY, ORDERING AND INVENTORY MONITORING FOR FUEL TANKS, IN CLASS 35 (U.S. CLS. 100, 101 AND 102).

FIRST USE 1-1-2006; IN COMMERCE 1-1-2006.

THE COLOR(S) DARK BLUE, LIGHT BLUE AND BLACK ARE CLAIMED AS A FEATURE OF THE MARK. IS/ARE CLAIMED AS A FEATURE OF THE MARK.

THE COLOR DARK BLUE APPEARS IN THE UPPER PORTIONS OF THE WORDING "FUELCAS-TER"; THE COLOR LIGHT BLUE APPEARS IN THE LOWER PORTIONS OF THE WORDING "FUEL-CASTER"; THE COLOR BLACK APPEARS IN THE OUTLINING OF THE WORDING "FUELCASTER", THE WORDING "PRECISION IS NOT IMPOSSIBLE" AND THE FUEL HOSE AND NOZZLE.

SER. NO. 77-241,446, FILED 7-29-2007.

CYNTHIA SLOAN, EXAMINING ATTORNEY

Int. Cl.: 9

Prior U.S. Cls.: 21, 23, 26, 36 and 38

Reg. No. 3,483,554

United States Patent and Trademark Office

Registered Aug. 12, 2008

**TRADEMARK
PRINCIPAL REGISTER**

RLM Records

RLM RECORDS, INC. (ILLINOIS CORPORATION)
2452 WEST CHICAGO AVENUE
CHICAGO, IL 60622

FOR: PRE-RECORDED COMPACT DISCS, AUDIOTAPES, VIDEOTAPES, DVDS, AND AUDIO-VISUAL DISCS, ALL FEATURING MUSIC, IN CLASS 9 (U.S. CLS. 21, 23, 26, 36 AND 38).

FIRST USE 12-1-2006; IN COMMERCE 12-1-2006.

THE MARK CONSISTS OF STANDARD CHARACTERS WITHOUT CLAIM TO ANY PARTICULAR FONT, STYLE, SIZE, OR COLOR.

NO CLAIM IS MADE TO THE EXCLUSIVE RIGHT TO USE "RECORDS", APART FROM THE MARK AS SHOWN.

SER. NO. 77-241,474, FILED 7-29-2007.

JILL C. ALT, EXAMINING ATTORNEY

Int. Cl.: 41

Prior U.S. Cls.: 100, 101 and 107

United States Patent and Trademark Office

Reg. No. 3,483,555

Registered Aug. 12, 2008

**SERVICE MARK
PRINCIPAL REGISTER**



BLACK UMBRELLA BOOKS

WOOLVERTON, JEFFREY T. (MINNESOTA
SOLE PROPRIETORSHIP)

P.O. BOX 241

DULUTH, MN 558010241

FOR: PUBLISHING OF BOOKS, MAGAZINES, IN
CLASS 41 (U.S. CLS. 100, 101 AND 107).

FIRST USE 7-26-2007; IN COMMERCE 7-26-2007.

NO CLAIM IS MADE TO THE EXCLUSIVE
RIGHT TO USE "BOOKS", APART FROM THE
MARK AS SHOWN.

THE MARK CONSISTS OF THE WORDING
"BLACK UMBRELLA BOOKS" WITH A DEPICTION
OF AN UMBRELLA.

SER. NO. 77-241,586, FILED 7-29-2007.

EVELYN BRADLEY, EXAMINING ATTORNEY

Int. Cl.: 19

Prior U.S. Cls.: 1, 12, 33 and 50

United States Patent and Trademark Office

Reg. No. 3,483,556

Registered Aug. 12, 2008

**TRADEMARK
PRINCIPAL REGISTER**

MACERAMIK

METROPOLITAN RENOVATORS, INC.. (TEXAS CORPORATION)
10707 CORPORATE DRIVE STE 106
STAFFORD, TX 77477

FOR: (BASED ON USE IN COMMERCE) CLAY ROOFING TILES; EARTHENWARE TILES; NON-METAL ROOF COVERINGS; NON-METAL ROOFING; NON-METAL ROOFING TILES; NON-METAL TILES , IN CLASS 19 (U.S. CLS. 1, 12, 33 AND 50).

FIRST USE 5-1-2007; IN COMMERCE 5-1-2007.

THE MARK CONSISTS OF STANDARD CHARACTERS WITHOUT CLAIM TO ANY PARTICULAR FONT, STYLE, SIZE, OR COLOR.

THE MARK IS A COINED TERM AND HAS NO MEANING OTHER THAN TRADEMARK SIGNIFICANCE

SEC. 2(F).

SER. NO. 77-242,126, FILED 7-30-2007.

REBECCA SMITH, EXAMINING ATTORNEY

Int. Cl.: 41

Prior U.S. Cls.: 100, 101 and 107

United States Patent and Trademark Office

Reg. No. 3,483,557

Registered Aug. 12, 2008

**SERVICE MARK
PRINCIPAL REGISTER**



HEALTHY INSPIRATIONS, LLC (DELAWARE
LTD LIAB CO)
SUITE 107
1001 B AVENUE
CORONADO, CA 92118

FOR: HEALTH CLUB SERVICES, NAMELY, PRO-
VIDING INSTRUCTION, EQUIPMENT AND CON-
SULTATION SERVICES IN THE FIELD OF
PHYSICAL EXERCISE; CONDUCTING SEMINARS,
CONFERENCES AND WORKSHOPS IN THE
FIELDS OF WEIGHT-LOSS, STRESS REDUCTION
AND PHYSICAL FITNESS, IN CLASS 41 (U.S. CLS.
100, 101 AND 107).

FIRST USE 2-20-2007; IN COMMERCE 2-20-2007.

OWNER OF U.S. REG. NOS. 2,812,866 AND
2,929,590.

THE COLOR(S) PINK AND PURPLE IS/ARE
CLAIMED AS A FEATURE OF THE MARK.

THE MARK CONSISTS OF A LIGHT PURPLE
HEART OUTLINED IN DARK PINK TO THE LEFT
OF THE WORDS "HEALTHY INSPIRATIONS",
WHICH ARE DARKER PURPLE IN COLOR. THE
COLOR WHITE APPEARS ON THE LEFT SIDE OF
THE HEART AND CONSTITUTES SHADING, AND
IS NOT A PART OF THE MARK.

SER. NO. 77-242,336, FILED 7-30-2007.

PAUL MORENO, EXAMINING ATTORNEY

Int. Cl.: 35

Prior U.S. Cls.: 100, 101 and 102

United States Patent and Trademark Office

Reg. No. 3,483,558

Registered Aug. 12, 2008

**SERVICE MARK
PRINCIPAL REGISTER**

ARMORLINE

ARMORLINE CORPORATION (CALIFORNIA
CORPORATION)
10541 ASHDALE STREET
STANTON, CA 906802621

THE MARK CONSISTS OF STANDARD CHAR-
ACTERS WITHOUT CLAIM TO ANY PARTICULAR
FONT, STYLE, SIZE, OR COLOR.

FOR: DISTRIBUTORSHIPS IN THE FIELD OF
ARMOR, FORCE PROTECTION AND SPECIA-
LIZED SECURITY PRODUCTS, IN CLASS 35 (U.S.
CLS. 100, 101 AND 102).

SER. NO. 77-242,453, FILED 7-30-2007.

FIRST USE 4-0-2006; IN COMMERCE 4-0-2006.

HOWARD B. LEVINE, EXAMINING ATTORNEY

Int. Cl.: 36

Prior U.S. Cls.: 100, 101 and 102

United States Patent and Trademark Office

Reg. No. 3,483,559

Registered Aug. 12, 2008

**SERVICE MARK
PRINCIPAL REGISTER**

plus⁺energy
students fighting cancer

PLUS ENERGY (VIRGINIA CORPORATION),
DBA + ENERGY
1524 LINCOLN WAY, #102
MCLEAN, VA 22102

FOR: CHARITABLE FUNDRAISING SERVICES
FOR MEDICAL AND SCIENTIFIC RESEARCH IN
THE FIELD OF CANCER TREATMENT AND DI-
AGNOSIS, IN CLASS 36 (U.S. CLS. 100, 101 AND 102).

FIRST USE 9-6-2007; IN COMMERCE 9-6-2007.

NO CLAIM IS MADE TO THE EXCLUSIVE
RIGHT TO USE "STUDENTS FIGHTING CANCER",
APART FROM THE MARK AS SHOWN.

THE MARK CONSISTS OF THE WORDS "PLUS
ENERGY STUDENTS FIGHTING CANCER" WITH
A PLUS SYMBOL IN A CIRCLE BETWEEN THE
WORDS "PLUS" AND "ENERGY".

SER. NO. 77-242,693, FILED 7-31-2007.

MAUREEN DALL, EXAMINING ATTORNEY

Int. Cl.: 41

Prior U.S. Cls.: 100, 101 and 107

United States Patent and Trademark Office

Reg. No. 3,483,560

Registered Aug. 12, 2008

**SERVICE MARK
PRINCIPAL REGISTER**

POP-IN PLAYTIME

PIU MANAGEMENT, LLC (CALIFORNIA LTD
LIAB CO)
1249 QUARRY LANE, SUITE 150
PLEASANTON, CA 94566

FOR: ENTERTAINMENT AND RECREATION
SERVICES, NAMELY, PROVIDING FACILITIES
WITH LARGE INFLATABLE PLAY STRUCTURES
FOR CHILDREN'S PARTIES, IN CLASS 41 (U.S. CLS.
100, 101 AND 107).

FIRST USE 3-0-2004; IN COMMERCE 3-0-2004.

THE MARK CONSISTS OF STANDARD CHAR-
ACTERS WITHOUT CLAIM TO ANY PARTICULAR
FONT, STYLE, SIZE, OR COLOR.

SER. NO. 77-242,755, FILED 7-31-2007.

KELLY MCCOY, EXAMINING ATTORNEY

Int. Cl.: 41

Prior U.S. Cls.: 100, 101 and 107

United States Patent and Trademark Office

Reg. No. 3,483,561

Registered Aug. 12, 2008

**SERVICE MARK
PRINCIPAL REGISTER**

POKEROLOGY

RYERSON, TIM (UNITED KINGDOM INDIVIDUAL)
KIDLEY, ACTON BEAUCHAMP
WORCESTER, UNITED KINGDOM WR65AE

THE MARK CONSISTS OF STANDARD CHARACTERS WITHOUT CLAIM TO ANY PARTICULAR FONT, STYLE, SIZE, OR COLOR.

FOR: EDUCATION SERVICES, NAMELY, PROVIDING LESSONS, TUTORIALS, ADVICE, AND INFORMATION IN THE FIELD OF POKER, IN CLASS 41 (U.S. CLS. 100, 101 AND 107).

SER. NO. 77-242,880, FILED 7-31-2007.

FIRST USE 2-15-2005; IN COMMERCE 2-15-2005.

RICHARD A. STRASER, EXAMINING ATTORNEY

Int. Cl.: 7

Prior U.S. Cls.: 13, 19, 21, 23, 31, 34 and 35

Reg. No. 3,483,562

United States Patent and Trademark Office

Registered Aug. 12, 2008

**TRADEMARK
PRINCIPAL REGISTER**

TRUNKPUMP

TRUNK PUMP, INC. (NORTH CAROLINA CORPORATION)
980 NORTHWEST AVE.
BURGAW, NC 28425

THE MARK CONSISTS OF STANDARD CHARACTERS WITHOUT CLAIM TO ANY PARTICULAR FONT, STYLE, SIZE, OR COLOR.

FOR: VEHICLE MOUNTED PUMPS FOR MOVING BODIES OF WATER, IN CLASS 7 (U.S. CLS. 13, 19, 21, 23, 31, 34 AND 35).

SER. NO. 77-243,141, FILED 7-31-2007.

FIRST USE 4-11-2006; IN COMMERCE 4-11-2006.

BRENDAN REGAN, EXAMINING ATTORNEY

Int. Cl.: 9

Prior U.S. Cls.: 21, 23, 26, 36 and 38

Reg. No. 3,483,563

United States Patent and Trademark Office

Registered Aug. 12, 2008

**TRADEMARK
PRINCIPAL REGISTER**

Damn!Sexy Living

SHUFFIELD ENTERPRISES LLC (WASHINGTON
LTD LIAB CO)
1250 N WENATCHEE, SUITE H131
WENATCHEE, WA 98801

FOR: ELECTRONIC PUBLICATIONS, NAMELY,
MAGAZINES FEATURING MEN'S LIFESTYLE, RE-
CIPES AND POPULAR CULTURE RECORDED ON
COMPUTER MEDIA , IN CLASS 9 (U.S. CLS. 21, 23,
26, 36 AND 38).

FIRST USE 7-8-2007; IN COMMERCE 7-8-2007.

THE MARK CONSISTS OF STANDARD CHAR-
ACTERS WITHOUT CLAIM TO ANY PARTICULAR
FONT, STYLE, SIZE, OR COLOR.

SER. NO. 77-243,504, FILED 7-31-2007.

HEATHER BIDDULPH, EXAMINING ATTORNEY

Int. Cl.: 35

Prior U.S. Cls.: 100, 101 and 102

United States Patent and Trademark Office

Reg. No. 3,483,564

Registered Aug. 12, 2008

**SERVICE MARK
PRINCIPAL REGISTER**

TireTrends

TIRETRENDS.COM ENTERPRISES LTD (CANADA CORPORATION)
10-20295 113B AVENUE
MAPLE RIDGE, B.C., CANADA V2X6E9

FOR: ON-LINE RETAIL STORE SERVICES FEATURING AUTOMOTIVE PRODUCTS; RETAIL STORE SERVICES FEATURING AUTOMOTIVE PRODUCTS; RETAIL TIRE STORES; MAIL ORDER SERVICES FEATURING AUTOMOTIVE PRODUCTS; WHOLESALE DISTRIBUTORSHIPS FEATURING AUTOMOTIVE PRODUCTS, IN CLASS 35 (U.S. CLS. 100, 101 AND 102).

FIRST USE 8-11-2000; IN COMMERCE 8-11-2000.

THE MARK CONSISTS OF STANDARD CHARACTERS WITHOUT CLAIM TO ANY PARTICULAR FONT, STYLE, SIZE, OR COLOR.

SER. NO. 77-244,782, FILED 8-1-2007.

JILL C. ALT, EXAMINING ATTORNEY

Int. Cl.: 45

Prior U.S. Cls.: 100 and 101

United States Patent and Trademark Office

Reg. No. 3,483,565

Registered Aug. 12, 2008

**SERVICE MARK
PRINCIPAL REGISTER**

CORE IDENTITY PROTECTION

IDENTITY FRAUD, INC. (CALIFORNIA CORPORATION)
6160 CENTER STREET
CLAYTON, CA 94517

FOR: CONSULTATION IN THE FIELD OF DATA THEFT AND IDENTITY THEFT; FINANCIAL IDENTITY MONITORING SERVICE, IN CLASS 45 (U.S. CLS. 100 AND 101).

FIRST USE 7-24-2007; IN COMMERCE 7-24-2007.

THE MARK CONSISTS OF STANDARD CHARACTERS WITHOUT CLAIM TO ANY PARTICULAR FONT, STYLE, SIZE, OR COLOR.

NO CLAIM IS MADE TO THE EXCLUSIVE RIGHT TO USE "IDENTITY PROTECTION", APART FROM THE MARK AS SHOWN.

SER. NO. 77-245,150, FILED 8-2-2007.

LINDA ORNDORFF, EXAMINING ATTORNEY

Int. Cl.: 7

Prior U.S. Cls.: 13, 19, 21, 23, 31, 34 and 35

Reg. No. 3,483,566

United States Patent and Trademark Office

Registered Aug. 12, 2008

**TRADEMARK
PRINCIPAL REGISTER**

APS3000

LANGENBACH, MICHAEL (AUSTRALIA INDIVIDUAL)
47 LALINA AVENUE
TWEED HEADS, AUSTRALIA 2485,NSW

FOR: SHAPING, CUTTING, MILLING, GRINDING, DRILLING, FINISHING, AND POLISHING MACHINES FOR SHAPING OR FORMING BLANKS AND CORES FOR WATERCRAFT, IN PARTICULAR, BOARDS SUCH AS SURFBOARDS WINDSURFING BOARDS AND OTHER SIMILAR RECREATIONAL BOARDS HAVING A FLOTATION CORE OR BLANK THAT IS SHAPED DURING FABRICATION AND COMPONENTS AND ACCESSORIES THEREFOR, NAMELY, MACHINE TOOLS, NAMELY, BLADES, SAW BLADES, KNIVES, AND OTHER MATERIAL REMOVING TOOLS AND HOLDING AND HANDLING DEVICES FOR SUCH APPARATUS AND MACHINES, NAMELY, POWER OPERATED TOOLS FOR SHAPING OR FORMING BLANKS AND CORES FOR WATERCRAFT, IN

PARTICULAR, BOARDS SUCH AS SURFBOARDS WINDSURFING BOARDS AND OTHER SIMILAR RECREATIONAL BOARDS HAVING A FLOTATION CORE OR BLANK THAT IS SHAPED DURING FABRICATION, IN CLASS 7 (U.S. CLS. 13, 19, 21, 23, 31, 34 AND 35).

THE MARK CONSISTS OF STANDARD CHARACTERS WITHOUT CLAIM TO ANY PARTICULAR FONT, STYLE, SIZE, OR COLOR.

PRIORITY CLAIMED UNDER SEC. 44(D) ON AUSTRALIA APPLICATION NO. 1161465, FILED 2-14-2007, REG. NO. 1161465, DATED 2-14-2007, EXPIRES 2-14-2017.

SER. NO. 77-245,278, FILED 8-2-2007.

ALEX KEAM, EXAMINING ATTORNEY

Int. Cls.: 35, 36 and 44

Prior U.S. Cls.: 100, 101 and 102

United States Patent and Trademark Office

Reg. No. 3,483,567

Registered Aug. 12, 2008

**SERVICE MARK
PRINCIPAL REGISTER**

**MEDCO, THE WORLD'S MOST
ADVANCED PHARMACY**

MEDCO HEALTH SOLUTIONS, INC. (DELA-
WARE CORPORATION)
100 PARSONS POND DRIVE
FRANKLIN LAKES, NJ 07417

FOR: PHARMACEUTICAL COST MANAGE-
MENT REVIEW SERVICES; PROVIDING INFOR-
MATION IN THE FIELD OF PHARMACEUTICAL
COST MANAGEMENT TO PHARMACY BENEFIT
MANAGEMENT SERVICES MEMBERS AND MEM-
BERS' PHYSICIANS AND HEALTHCARE PROVI-
DERS, CLIENTS, CONSULTANTS, BROKERS; MAIL
ORDER AND ON-LINE PHARMACY SERVICES, IN
CLASS 35 (U.S. CLS. 100, 101 AND 102).

FIRST USE 9-24-2007; IN COMMERCE 9-24-2007.

FOR: PHARMACY BENEFIT MANAGEMENT
SERVICES; ADMINISTRATION OF PHARMACY
BENEFIT MANAGEMENT PLANS; PROVIDING IN-
FORMATION IN THE FIELD OF PHARMACY
BENEFIT MANAGEMENT TO PHARMACY BENE-
FIT MANAGEMENT SERVICES MEMBERS, MEM-
BERS' PHYSICIANS AND HEALTHCARE
PROVIDERS, CLIENTS, CONSULTANTS, AND
BROKERS, IN CLASS 36 (U.S. CLS. 100, 101 AND 102).

FIRST USE 9-24-2007; IN COMMERCE 9-24-2007.

FOR: PROVIDING INFORMATION IN THE
FIELD OF HEALTHCARE AS PROVIDED TO PHAR-
MACY BENEFIT MANAGEMENT SERVICES MEM-
BERS, MEMBERS' PHYSICIANS AND
HEALTHCARE PROVIDERS, CLIENTS, CONSUL-
TANTS, AND BROKERS, IN CLASS 44 (U.S. CLS. 100
AND 101).

FIRST USE 9-24-2007; IN COMMERCE 9-24-2007.

THE MARK CONSISTS OF STANDARD CHAR-
ACTERS WITHOUT CLAIM TO ANY PARTICULAR
FONT, STYLE, SIZE, OR COLOR.

OWNER OF U.S. REG. NOS. 2,755,838, 2,894,558,
AND 3,061,048.

NO CLAIM IS MADE TO THE EXCLUSIVE
RIGHT TO USE "THE WORLD'S MOST ADVANCED
PHARMACY", APART FROM THE MARK AS
SHOWN.

SER. NO. 77-245,282, FILED 8-2-2007.

ZACHARY BELLO, EXAMINING ATTORNEY

Int. Cl.: 44

Prior U.S. Cls.: 100 and 101

United States Patent and Trademark Office

Reg. No. 3,483,568

Registered Aug. 12, 2008

**SERVICE MARK
PRINCIPAL REGISTER**

TEXAS HAND THERAPY CENTER

TEXAS HAND THERAPY CENTER, INC. (TEXAS
CORPORATION)
4131 DIRECTORS ROW
HOUSTON, TX 77092

NO CLAIM IS MADE TO THE EXCLUSIVE
RIGHT TO USE "HAND THERAPY CENTER",
APART FROM THE MARK AS SHOWN.

FOR: HAND THERAPY SERVICES, IN CLASS 44
(U.S. CLS. 100 AND 101).

SEC. 2(F).

FIRST USE 6-21-1996; IN COMMERCE 6-21-1996.

SER. NO. 77-245,421, FILED 8-2-2007.

THE MARK CONSISTS OF STANDARD CHAR-
ACTERS WITHOUT CLAIM TO ANY PARTICULAR
FONT, STYLE, SIZE, OR COLOR.

RENEE SERVANCE, EXAMINING ATTORNEY

Int. Cl.: 35

Prior U.S. Cls.: 100, 101 and 102

United States Patent and Trademark Office

Reg. No. 3,483,569

Registered Aug. 12, 2008

**SERVICE MARK
PRINCIPAL REGISTER**



DIVERSIFIED CLINICAL SERVICES, INC. (DE-
LAWARE CORPORATION)
4500 SALISBURY ROAD, SUITE 490
JACKSONVILLE, FL 32216

FOR: BUSINESS MANAGEMENT AND CONSUL-
TATION IN THE FIELD OF WOUND CARE PRO-
GRAMS, IN CLASS 35 (U.S. CLS. 100, 101 AND 102).

FIRST USE 7-15-2006; IN COMMERCE 7-15-2006.

NO CLAIM IS MADE TO THE EXCLUSIVE
RIGHT TO USE "DIVERSIFIED CLINICAL SERVI-

CES AND HEALING WOUNDS", APART FROM
THE MARK AS SHOWN.

THE MARK CONSISTS OF THE WORD "DIVER-
SIFIED" ABOVE THE WORDS "CLINICAL SERVI-
CES" ABOVE THE WORDS "HEALING WOUNDS.
CHANGING LIVES.", ALL TO THE RIGHT OF A
DESIGN COMPRISING A SILHOUETTE AND A
CURVE.

SER. NO. 77-245,595, FILED 8-2-2007.

THOMAS MANOR, EXAMINING ATTORNEY

Int. Cl.: 17

Prior U.S. Cls.: 1, 5, 12, 13, 35 and 50

United States Patent and Trademark Office

Reg. No. 3,483,570

Registered Aug. 12, 2008

**TRADEMARK
PRINCIPAL REGISTER**



SBAR'S INC. (NEW JERSEY CORPORATION)
14 SBAR BLVD
MOORESTOWN, NJ 08057

FOR: PLASTIC FOAM USED FOR ARTS AND CRAFTS, IN CLASS 17 (U.S. CLS. 1, 5, 12, 13, 35 AND 50).

FIRST USE 8-2-2007; IN COMMERCE 8-2-2007.

NO CLAIM IS MADE TO THE EXCLUSIVE RIGHT TO USE "KIDS" AND "FOAM", APART FROM THE MARK AS SHOWN.

THE NAME(S), PORTRAIT(S), AND/OR SIGNATURE(S) SHOWN IN THE MARK DOES NOT IDENTIFY A PARTICULAR LIVING INDIVIDUAL.

THE COLOR(S) WHITE, BLACK, BLUE, YELLOW IS/ARE CLAIMED AS A FEATURE OF THE MARK.

THE MARK CONSISTS OF WHITE IS USED IN THE WORDING "FOAM ZONE" AND "NICOLE". BLACK IS USED IN THE "KIDS" WORDING AND THE FOAM DESIGN. BLUE IS USED FOR THE SQUIGGLY LINE TRIM. YELLOW APPEARS IN THE BACKGROUND OUTSIDE THE FOAM DESIGN AND THE DIAMOND SHAPE BEHIND "NICOLE KIDS".

SER. NO. 77-246,157, FILED 8-3-2007.

JENNIFER VASQUEZ, EXAMINING ATTORNEY

Int. Cl.: 9

Prior U.S. Cls.: 21, 23, 26, 36 and 38

Reg. No. 3,483,571

United States Patent and Trademark Office

Registered Aug. 12, 2008

**TRADEMARK
PRINCIPAL REGISTER**



RPATH, INC. (DELAWARE CORPORATION)
701 CORPORATE CENTER DRIVE, SUITE 450
RALEIGH, NC 27607

FIRST USE 9-15-2005; IN COMMERCE 9-15-2005.

FOR: DOWNLOADABLE SOFTWARE OFFERED
OVER THE INTERNET TO ENABLE USERS TO
COMBINE THEIR OWN SOFTWARE WITH OTHER
SOFTWARE COMPONENTS AND APPLIANCE
SOURCES FROM MULTIPLE POINTS OF ORIGIN,
IN CLASS 9 (U.S. CLS. 21, 23, 26, 36 AND 38).

THE MARK CONSISTS OF LOWERCASE LET-
TERS "R" AND "P" WITHIN A CIRCLE.

SER. NO. 77-246,161, FILED 8-3-2007.

MARIAM MAHMOUDI, EXAMINING ATTORNEY

Int. Cl.: 9

Prior U.S. Cls.: 21, 23, 26, 36 and 38

Reg. No. 3,483,572

United States Patent and Trademark Office

Registered Aug. 12, 2008

**TRADEMARK
PRINCIPAL REGISTER**

rBuilder

RPATH, INC. (DELAWARE CORPORATION)
701 CORPORATE CENTER DRIVE, SUITE 450
RALEIGH, NC 27607

FIRST USE 9-15-2005; IN COMMERCE 9-15-2005.

FOR: DOWNLOADABLE SOFTWARE OFFERED
OVER THE INTERNET TO ENABLE USERS TO
COMBINE THEIR OWN SOFTWARE WITH OTHER
SOFTWARE COMPONENTS AND APPLIANCE
SOURCES FROM MULTIPLE POINTS OF ORIGIN,
IN CLASS 9 (U.S. CLS. 21, 23, 26, 36 AND 38).

THE MARK CONSISTS OF LOWERCASE "R"
AND CAPITAL "B" AND LOWER CASE "UILDER".

SER. NO. 77-246,177, FILED 8-3-2007.

MARIAM MAHMOUDI, EXAMINING ATTORNEY

Int. Cl.: 9

Prior U.S. Cls.: 21, 23, 26, 36 and 38

Reg. No. 3,483,573

United States Patent and Trademark Office

Registered Aug. 12, 2008

**TRADEMARK
PRINCIPAL REGISTER**

CONARY

RPATH, INC. (DELAWARE CORPORATION)
701 CORPORATE CENTER DRIVE, SUITE 450
RALEIGH, NC 27607

THE MARK CONSISTS OF STANDARD CHAR-
ACTERS WITHOUT CLAIM TO ANY PARTICULAR
FONT, STYLE, SIZE, OR COLOR.

FOR: DOWNLOADABLE SOFTWARE OFFERED
OVER THE INTERNET TO ENABLE USERS TO
COMBINE THEIR OWN SOFTWARE WITH OTHER
SOFTWARE COMPONENTS AND APPLIANCE
SOURCES FROM MULTIPLE POINTS OF ORIGIN,
IN CLASS 9 (U.S. CLS. 21, 23, 26, 36 AND 38).

OWNER OF U.S. REG. NO. 3,308,827.

SER. NO. 77-246,189, FILED 8-3-2007.

FIRST USE 4-15-2005; IN COMMERCE 4-15-2005.

MARIAM MAHMOUDI, EXAMINING ATTORNEY

Int. Cl.: 41

Prior U.S. Cls.: 100, 101 and 107

United States Patent and Trademark Office

Reg. No. 3,483,574

Registered Aug. 12, 2008

**SERVICE MARK
PRINCIPAL REGISTER**

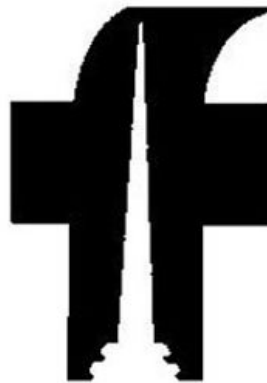

FAULKNER UNIVERSITY (ALABAMA CORPORATION)
5345 ATLANTA HIGHWAY
MONTGOMERY, AL 36109

FOR: EDUCATIONAL SERVICES, NAMELY, PROVIDING INSTRUCTION AND TRAINING AT THE UNDERGRADUATE, GRADUATE, POST-GRADUATE AND PROFESSIONAL LEVELS; ARRANGING AND CONDUCTING OF CONFERENCES, SEMINARS, WORKSHOPS, PUBLIC LECTURES AND EXHIBITIONS FOR CULTURAL OR EDUCATIONAL PURPOSES; ENTERTAINMENT SERVICES, NAMELY, CONDUCTING ATHLETIC CONTESTS; ARRANGING AND

CONDUCTING OF CONCERTS; AND ENTERTAINMENT SERVICES IN THE NATURE OF THEATRE PRODUCTIONS, IN CLASS 41 (U.S. CLS. 100, 101 AND 107).

FIRST USE 7-18-1985; IN COMMERCE 7-18-1985.

THE MARK CONSISTS OF THE LETTER "F" IN THICK BLOCK LETTERING WITH THE FORM OF A SPIRE EMBEDDED IN THE "F".

SER. NO. 77-246,854, FILED 8-3-2007.

WON TEAK OH, EXAMINING ATTORNEY

Int. Cls.: 9, 35 and 41

Prior U.S. Cls.: 21, 23, 26, 36, 38, 100, 101, 102 and 107

United States Patent and Trademark Office

Reg. No. 3,483,575

Registered Aug. 12, 2008

**TRADEMARK
SERVICE MARK
PRINCIPAL REGISTER**

HARPCO

HARPCO SYSTEMS INC. (MICHIGAN CORPORATION)
28056 OAKLAND OAKS CT.
WIXOM, MI 48393

FOR: COMPUTER SOFTWARE FOR IMPLEMENTING INTEGRATED BUSINESS MANAGEMENT SYSTEM THAT COVERS ENTIRE PRODUCT LIFE CYCLE FROM DEFINITION OF CUSTOMER NEEDS THROUGH DELIVERY AND MAINTENANCE OF THE PRODUCT OR SERVICE, IN CLASS 9 (U.S. CLS. 21, 23, 26, 36 AND 38).

FIRST USE 4-0-1987; IN COMMERCE 9-0-1990.

FOR: BUSINESS MANAGEMENT CONSULTING, IN CLASS 35 (U.S. CLS. 100, 101 AND 102).

FIRST USE 4-0-1987; IN COMMERCE 9-0-1990.

FOR: TRAINING SERVICES IN THE FIELD OF BUSINESS, IN CLASS 41 (U.S. CLS. 100, 101 AND 107).

FIRST USE 4-0-1987; IN COMMERCE 9-0-1990.

THE MARK CONSISTS OF STANDARD CHARACTERS WITHOUT CLAIM TO ANY PARTICULAR FONT, STYLE, SIZE, OR COLOR.

SER. NO. 77-247,195, FILED 8-3-2007.

LYDIA BELZER, EXAMINING ATTORNEY

Int. Cl.: 41

Prior U.S. Cls.: 100, 101 and 107

United States Patent and Trademark Office

Reg. No. 3,483,576

Registered Aug. 12, 2008

**SERVICE MARK
PRINCIPAL REGISTER**

ONE DAY UNIVERSITY

EDUCATIONAL MEDIA GROUP (DELAWARE
LTD LIAB CO), DBA ONE DAY UNIVERSITY
1285 AVE OF AMERICAS, SUITE 3545
NEW YORK, NY 10019

FOR: EDUCATION SERVICES, NAMELY, PRO-
VIDING SEMINARS IN THE FIELD OF GENERAL
EDUCATION AT THE COLLEGE LEVEL FOR IN-
DIVIDUALS OF ALL AGES AND EDUCATIONAL
BACKGROUNDS, IN CLASS 41 (U.S. CLS. 100, 101
AND 107).

FIRST USE 3-1-2006; IN COMMERCE 6-19-2006.

THE MARK CONSISTS OF STANDARD CHAR-
ACTERS WITHOUT CLAIM TO ANY PARTICULAR
FONT, STYLE, SIZE, OR COLOR.

NO CLAIM IS MADE TO THE EXCLUSIVE
RIGHT TO USE "ONE DAY", APART FROM THE
MARK AS SHOWN.

SER. NO. 77-247,535, FILED 8-6-2007.

MICHELLE DUBOIS, EXAMINING ATTORNEY

Int. Cl.: 3

Prior U.S. Cls.: 1, 4, 6, 50, 51 and 52

Reg. No. 3,483,577

United States Patent and Trademark Office

Registered Aug. 12, 2008

**TRADEMARK
PRINCIPAL REGISTER**

LUMINOX

LUMINOX INTERNATIONAL CORP. (FLORIDA
CORPORATION)
P.O. BOX 242
PALM BEACH, FL 33480

THE MARK CONSISTS OF STANDARD CHAR-
ACTERS WITHOUT CLAIM TO ANY PARTICULAR
FONT, STYLE, SIZE, OR COLOR.

FOR: COSMETIC PREPARATIONS FOR BODY
CARE, IN CLASS 3 (U.S. CLS. 1, 4, 6, 50, 51 AND 52).

SER. NO. 77-247,584, FILED 8-6-2007.

FIRST USE 5-15-2007; IN COMMERCE 5-15-2007.

JOHN E. MICHOS, EXAMINING ATTORNEY

Int. Cl.: 21

Prior U.S. Cls.: 2, 13, 23, 29, 30, 33, 40 and 50

Reg. No. 3,483,578

United States Patent and Trademark Office

Registered Aug. 12, 2008

**TRADEMARK
PRINCIPAL REGISTER**

BonnyBleu

BALDWIN, BONNY C. (UNITED STATES INDIVIDUAL)

111 CLYDE FREELS RD

SUNBRIGHT, TN 37872

FOR: MEAL AND SERVING TRAYS, IN CLASS 21
(U.S. CLS. 2, 13, 23, 29, 30, 33, 40 AND 50).

FIRST USE 6-15-2006; IN COMMERCE 6-15-2006.

THE MARK CONSISTS OF STANDARD CHARACTERS WITHOUT CLAIM TO ANY PARTICULAR FONT, STYLE, SIZE, OR COLOR.

THE NAME(S), PORTRAIT(S), AND/OR SIGNATURE(S) SHOWN IN THE MARK DOES NOT IDENTIFY A PARTICULAR LIVING INDIVIDUAL.

SER. NO. 77-247,593, FILED 8-6-2007.

GISELLE AGOSTO, EXAMINING ATTORNEY

Int. Cl.: 9

Prior U.S. Cls.: 21, 23, 26, 36 and 38

Reg. No. 3,483,579

United States Patent and Trademark Office

Registered Aug. 12, 2008

**TRADEMARK
PRINCIPAL REGISTER**

ECHO CENTRAL

ROVER TECHNOLOGY FUSIONS (FLORIDA
LTD LIAB CO)
5115 JOANNE KEARNEY BLVD.
TAMPA, FL 33619

FOR: SOFTWARE FOR MANAGING THE CON-
FIGURATION OF USER PROFILE BACKUPS WITH-
IN A NETWORK, IN CLASS 9 (U.S. CLS. 21, 23, 26, 36
AND 38).

FIRST USE 6-24-2007; IN COMMERCE 6-24-2007.

THE MARK CONSISTS OF STANDARD CHAR-
ACTERS WITHOUT CLAIM TO ANY PARTICULAR
FONT, STYLE, SIZE, OR COLOR.

NO CLAIM IS MADE TO THE EXCLUSIVE
RIGHT TO USE "CENTRAL", APART FROM THE
MARK AS SHOWN.

SER. NO. 77-247,714, FILED 8-6-2007.

AISHA SALEM, EXAMINING ATTORNEY

Int. Cl.: 36

Prior U.S. Cls.: 100, 101 and 102

United States Patent and Trademark Office

Reg. No. 3,483,580

Registered Aug. 12, 2008

SERVICE MARK
PRINCIPAL REGISTER



COMPLETE ENROLLMENT AGENCY, LLC (DE-
LAWARE LTD LIAB CO)
SUITE 510
TWO LOGAN SQUARE
PHILADELPHIA, PA 19103

FOR: INSURANCE BROKERAGE IN THE FIELD OF HEALTH, LIFE, AND PRESCRIPTION DRUG INSURANCE; CONSULTING SERVICES, NAMELY, PROVIDING INFORMATION AND ADVICE TO SENIOR CITIZENS ABOUT HEALTH, LIFE, AND PRESCRIPTION DRUG INSURANCE AND ABOUT ENROLLMENT IN SAID INSURANCE PLANS; PROVIDING INFORMATION AND ADVICE TO SENIOR CITIZENS ABOUT GOVERNMENT SPONSORED INSURANCE PROGRAMS, NAMELY, SOCIAL SECURITY, MEDICARE AND MEDICAID, IN CLASS 36 (U.S. CLS. 100, 101 AND 102).

FIRST USE 5-21-2007; IN COMMERCE 5-21-2007.

NO CLAIM IS MADE TO THE EXCLUSIVE RIGHT TO USE "ENROLLMENT", APART FROM THE MARK AS SHOWN.

THE COLOR(S) DARK BLUE, LIGHT BLUE AND ORANGE IS/ARE CLAIMED AS A FEATURE OF THE MARK.

THE MARK CONSISTS OF THE WORDING "COMPLETE ENROLLMENT" AND A TRIANGLE DESIGN. THE WORD "COMPLETE", IN UPPER CASE LETTERS, IS DARK BLUE AND THE WORD "ENROLLMENT", IN LOWER CASE LETTERS, IS LIGHT BLUE. THE TRIANGLE DESIGN IS ORANGE.

SER. NO. 77-247,891, FILED 8-6-2007.

WENDY GOODMAN, EXAMINING ATTORNEY

Int. Cl.: 35

Prior U.S. Cls.: 100, 101 and 102

United States Patent and Trademark Office

Reg. No. 3,483,581

Registered Aug. 12, 2008

**SERVICE MARK
PRINCIPAL REGISTER**

Lions Roar Gear

ALLISON SR., HUGH (UNITED STATES INDIVIDUAL)

7601 KIMBERLY

NORTH LAUDERDALE, FL 33068

FOR: RETAIL STORE SERVICES FEATURING APPAREL, IN CLASS 35 (U.S. CLS. 100, 101 AND 102).

FIRST USE 9-1-1997; IN COMMERCE 9-1-1997.

THE MARK CONSISTS OF STANDARD CHARACTERS WITHOUT CLAIM TO ANY PARTICULAR FONT, STYLE, SIZE, OR COLOR.

NO CLAIM IS MADE TO THE EXCLUSIVE RIGHT TO USE "GEAR", APART FROM THE MARK AS SHOWN.

SER. NO. 77-248,099, FILED 8-6-2007.

RONALD MCMORROW, EXAMINING ATTORNEY

Int. Cl.: 35

Prior U.S. Cls.: 100, 101 and 102

United States Patent and Trademark Office

Reg. No. 3,483,582

Registered Aug. 12, 2008

**SERVICE MARK
PRINCIPAL REGISTER**

SECOND LIFE

LINDEN RESEARCH, INC. (DELAWARE CORPORATION)
945 BATTERY STREET
SAN FRANCISCO, CA 94111

FOR: ADVERTISING AND MARKETING SERVICES, NAMELY, DEVELOPING AND DISTRIBUTING ELECTRONIC MARKETING MATERIALS, IN CLASS 35 (U.S. CLS. 100, 101 AND 102).

FIRST USE 5-1-2002; IN COMMERCE 12-31-2002.

THE MARK CONSISTS OF STANDARD CHARACTERS WITHOUT CLAIM TO ANY PARTICULAR FONT, STYLE, SIZE, OR COLOR.

OWNER OF U.S. REG. NOS. 2,813,096 AND 2,832,935.

SER. NO. 77-248,248, FILED 8-6-2007.

DAVID ELTON, EXAMINING ATTORNEY

Int. Cl.: 24

Prior U.S. Cls.: 42 and 50

United States Patent and Trademark Office

Reg. No. 3,483,583

Registered Aug. 12, 2008

**TRADEMARK
PRINCIPAL REGISTER**

EarthenSilk

RISING PHOENIX, INC. (CALIFORNIA CORPORATION)
44317 ARAPAHO AVENUE
FREMONT, CA 94539

THE MARK CONSISTS OF STANDARD CHARACTERS WITHOUT CLAIM TO ANY PARTICULAR FONT, STYLE, SIZE, OR COLOR.

FOR: SILK CLOTH; TEXTILE FABRICS FOR THE MANUFACTURE OF CLOTHING; TEXTILE USED AS LINING FOR CLOTHING, IN CLASS 24 (U.S. CLS. 42 AND 50).

SER. NO. 77-248,524, FILED 8-6-2007.

FIRST USE 3-1-2007; IN COMMERCE 3-1-2007.

SUZANNE BLANE, EXAMINING ATTORNEY

Int. Cl.: 9

Prior U.S. Cls.: 21, 23, 26, 36 and 38

Reg. No. 3,483,584

United States Patent and Trademark Office

Registered Aug. 12, 2008

**TRADEMARK
PRINCIPAL REGISTER**

The logo for XCORE Technology features the word "XCORE" in a large, bold, serif font. The letter "X" is significantly larger than the other letters. Above the "O" in "CORE", there are seven small, five-pointed stars arranged in a slight arc. Below the word "XCORE", the word "Technology" is written in a smaller, spaced-out, sans-serif font.

X-CORE TECHNOLOGY CO., LTD. (TAIWAN
LIMITED PARTNERSHIP)
P.O. BOX NO. 6-57
JUNGHE CITY, TAIWAN

FOR: CHARGE-COUPLED DEVICES (CCD); DI-
GITAL CAMERAS; DIGITAL VIDEO RECORDERS,
IN CLASS 9 (U.S. CLS. 21, 23, 26, 36 AND 38).

FIRST USE 4-2-2007; IN COMMERCE 4-2-2007.

NO CLAIM IS MADE TO THE EXCLUSIVE
RIGHT TO USE "TECHNOLOGY", APART FROM
THE MARK AS SHOWN.

THE MARK CONSISTS OF LETTERS "XCORE
TECHNOLOGY" WITH STARS GROUPED IN SEMI-
CIRCLES.

SER. NO. 77-248,589, FILED 8-7-2007.

JOHN WILKE, EXAMINING ATTORNEY

Int. Cl.: 19

Prior U.S. Cls.: 1, 12, 33 and 50

United States Patent and Trademark Office

Reg. No. 3,483,585

Registered Aug. 12, 2008

**TRADEMARK
PRINCIPAL REGISTER**

PANFLOR

SCHNELLER, INC. (OHIO CORPORATION)
6019 POWDERMILL ROAD
KENT, OH 44240

THE MARK CONSISTS OF STANDARD CHAR-
ACTERS WITHOUT CLAIM TO ANY PARTICULAR
FONT, STYLE, SIZE, OR COLOR.

FOR: NON-METAL FLOORS FOR AIRCRAFT
INTERIORS; RUBBER FLOORING FOR AIRCRAFT
INTERIORS, IN CLASS 19 (U.S. CLS. 1, 12, 33 AND
50).

SER. NO. 77-248,629, FILED 8-7-2007.

FIRST USE 5-7-1962; IN COMMERCE 5-7-1962.

G. MAYERSCHOFF, EXAMINING ATTORNEY

Int. Cl.: 3

Prior U.S. Cls.: 1, 4, 6, 50, 51 and 52

United States Patent and Trademark Office

Reg. No. 3,483,586

Registered Aug. 12, 2008

**TRADEMARK
PRINCIPAL REGISTER**



IVORRA, TERESA CRESPO (SPAIN INDIVIDUAL)
CALLE INGENIEROS CANALES 31-33
ALICANTE 03013, SPAIN

FOR: CLEANING PREPARATIONS, CHEMICAL CLEANERS FOR USE IN THE COSMETICS INDUSTRY, BLEACHING PREPARATIONS FOR HOUSEHOLD USE, DEGREASING PREPARATIONS FOR STOVES AND FLOORS, SOAPS, PERFUMES, ESSENTIALS AND PERFUMES OILS, COSMETICS, BODY LOTIONS, HAIR LOTIONS, TOOTH PASTE, PERSONAL DEODORANTS, FLOOR WAX, IN CLASS 3 (U.S. CLS. 1, 4, 6, 50, 51 AND 52).

OWNER OF SPAIN REG. NO. 950615, DATED 8-19-1980, EXPIRES 8-19-2010.

THE COLOR(S) RED IS/ARE CLAIMED AS A FEATURE OF THE MARK.

THE MARK CONSISTS OF THE WORDING "VITRICRIS" IN RED.

SER. NO. 77-248,685, FILED 8-7-2007.

TARAH HARDY, EXAMINING ATTORNEY

Int. Cls.: 35 and 36

Prior U.S. Cls.: 100, 101 and 102

United States Patent and Trademark Office

Reg. No. 3,483,587

Registered Aug. 12, 2008

**SERVICE MARK
PRINCIPAL REGISTER**

LIBERTAS CAPITAL

LIBERTAS CAPITAL GROUP PLC (ENGLAND
PUBLIC LIMITED COMPANY (PLC))
16 BERKELEY STREET
LONDON, UNITED KINGDOM W1J8DZ

FOR: BUSINESS SERVICES, NAMELY, BUSINESS
CONSULTATION SERVICES; BUSINESS RE-
SEARCH; MERGER AND ACQUISITION CONSULT-
ING; BUSINESS RESEARCH RELATING TO
BUSINESS MERGERS AND ACQUISITIONS, IN
CLASS 35 (U.S. CLS. 100, 101 AND 102).

FOR: CORPORATE FINANCE SERVICES, NAME-
LY, THE PROVISION OF FINANCE TO CORPO-
RATE ENTITIES AND FUND RAISING FOR
OTHERS FOR THE PURPOSE OF PURCHASING
COMPANIES; FINANCIAL RESEARCH SERVICES
RELATING TO ASSET MANAGEMENT, PRIVATE
EQUITY INVESTING, FUNDRAISING, MANAGE-
MENT BUY-OUTS, MANAGEMENT BUY-INS,
DEBT MANAGEMENT CONSULTATION AND AD-
VISORY SERVICES RELATED THERETO, IN CLASS
36 (U.S. CLS. 100, 101 AND 102).

THE MARK CONSISTS OF STANDARD CHAR-
ACTERS WITHOUT CLAIM TO ANY PARTICULAR
FONT, STYLE, SIZE, OR COLOR.

PRIORITY CLAIMED UNDER SEC. 44(D) ON
GREAT BRITAIN APPLICATION NO. 2455211,
FILED 5-11-2007, REG. NO. 2455211, DATED 5-11-
2007, EXPIRES 5-11-2017.

NO CLAIM IS MADE TO THE EXCLUSIVE
RIGHT TO USE "CAPITAL", APART FROM THE
MARK AS SHOWN.

THE ENGLISH TRANSLATION OF "LIBERTAS"
IS LIBERTY.

SER. NO. 77-249,007, FILED 8-7-2007.

TRICIA SONNEBORN, EXAMINING ATTORNEY

Int. Cls.: 35 and 36

Prior U.S. Cls.: 100, 101 and 102

United States Patent and Trademark Office

Reg. No. 3,483,588

Registered Aug. 12, 2008

**SERVICE MARK
PRINCIPAL REGISTER**

Libertas Capital 

LIBERTAS CAPITAL GROUP PLC (ENGLAND
PUBLIC LIMITED COMPANY (PLC))
16 BERKELEY STREET
LONDON, UNITED KINGDOM W1J8DZ

FOR: BUSINESS SERVICES, NAMELY, BUSINESS
CONSULTATION SERVICES; BUSINESS RE-
SEARCH; MERGER AND ACQUISITION CONSULT-
ING; BUSINESS RESEARCH RELATING TO
BUSINESS MERGERS AND ACQUISITIONS, IN
CLASS 35 (U.S. CLS. 100, 101 AND 102).

FOR: CORPORATE FINANCE SERVICES, NAME-
LY, THE PROVISION OF FINANCE TO CORPO-
RATE ENTITIES AND FUND RAISING FOR
OTHERS FOR THE PURPOSE OF PURCHASING
COMPANIES; FINANCIAL RESEARCH SERVICES
RELATING TO ASSET MANAGEMENT, PRIVATE
EQUITY INVESTING, FUNDRAISING, MANAGE-
MENT BUY-OUTS, MANAGEMENT BUY-INS,

DEBT MANAGEMENT CONSULTATION AND AD-
VISORY SERVICES RELATED THERETO, IN CLASS
36 (U.S. CLS. 100, 101 AND 102).

PRIORITY CLAIMED UNDER SEC. 44(D) ON
GREAT BRITAIN APPLICATION NO. 2455213,
FILED 5-11-2007, REG. NO. 2455213, DATED 5-11-
2007, EXPIRES 5-11-2017.

NO CLAIM IS MADE TO THE EXCLUSIVE
RIGHT TO USE "CAPITAL", APART FROM THE
MARK AS SHOWN.

THE ENGLISH TRANSLATION OF "LIBERTAS"
IS LIBERTY.

SER. NO. 77-249,019, FILED 8-7-2007.

TRICIA SONNEBORN, EXAMINING ATTORNEY

Int. Cl.: 28

Prior U.S. Cls.: 22, 23, 38 and 50

United States Patent and Trademark Office

Reg. No. 3,483,589

Registered Aug. 12, 2008

**TRADEMARK
PRINCIPAL REGISTER**



EMUSE MEDIA LIMITED (IRELAND COMPAN-
NY)
UNIT 24 ENTERPRISE CENTRE
TRINITY COLLEGE, PEARSE STREET
DUBLIN, IRELAND 2

FOR: GAMES AND PLAYTHINGS, NAMELY,
HAND-HELD UNITS FOR PLAYING VIDEO
GAMES, IN CLASS 28 (U.S. CLS. 22, 23, 38 AND 50).

PRIORITY CLAIMED UNDER SEC. 44(D) ON
ERPNTY CMNTY TM OFC APPLICATION NO.
5887013, FILED 5-9-2007, REG. NO. 005887013, DATED
2-27-2008, EXPIRES 5-9-2017.

SER. NO. 77-249,149, FILED 8-7-2007.

MARK T. MULLEN, EXAMINING ATTORNEY

Int. Cl.: 40

Prior U.S. Cls.: 100, 103 and 106

United States Patent and Trademark Office

Reg. No. 3,483,590

Registered Aug. 12, 2008

**SERVICE MARK
PRINCIPAL REGISTER**



EMUSE MEDIA LIMITED (IRELAND COMPANY)
UNIT 24 ENTERPRISE CENTRE
TRINITY COLLEGE, PEARSE STREET
DUBLIN, IRELAND 2

FOR: DIGITAL ENHANCEMENT OF MEDIA OBJECTS AND DIGITAL CONTENT INCLUDING TEXT, DOCUMENTS, PHOTOGRAPHS, IMAGES, VIDEO AND AUDIO; PROVIDING ON-LINE COMPUTER DATABASES AND ON-LINE SEARCHABLE DATABASES REGARDING DIGITAL ENHANCEMENT OF MEDIA OBJECTS AND DIGITAL CONTENT; PROVIDING ON-LINE COMPUTER DATABASES AND ON-LINE SEARCHABLE DATA-

BASES REGARDING THE MANIPULATION, EMBEDDING AND CONTEXTUALISATION OF VIDEO; PROVISION OF CONSULTATION REGARDING THE FOREGOING, IN CLASS 40 (U.S. CLS. 100, 103 AND 106).

PRIORITY CLAIMED UNDER SEC. 44(D) ON ERPN CMNTY TM OFC APPLICATION NO. 5887013, FILED 5-9-2007, REG. NO. 005887013, DATED 2-27-2008, EXPIRES 5-9-2017.

SER. NO. 77-249,172, FILED 8-7-2007.

MARK T. MULLEN, EXAMINING ATTORNEY

Int. Cl.: 35

Prior U.S. Cls.: 100, 101 and 102

United States Patent and Trademark Office

Reg. No. 3,483,591

Registered Aug. 12, 2008

**SERVICE MARK
PRINCIPAL REGISTER**



QUANTUM LEADERS (CALIFORNIA CORPORATION)
7 SHASTA
IRVINE, CA 92612

FOR: BUSINESS MANAGEMENT CONSULTING,
IN CLASS 35 (U.S. CLS. 100, 101 AND 102).

FIRST USE 3-1-2007; IN COMMERCE 3-1-2007.

NO CLAIM IS MADE TO THE EXCLUSIVE
RIGHT TO USE "STRATEGY" , APART FROM
THE MARK AS SHOWN.

THE COLOR(S) MAROON AND GRAY IS/ARE
CLAIMED AS A FEATURE OF THE MARK.

THE COLOR MAROON APPEARS IN THE WORD
"QUANTUM" AND THE COLOR GRAY APPEARS
IN THE WORDS "LEADERS EXECUTING STRAT-
EGY".

SER. NO. 77-249,247, FILED 8-7-2007.

CARYN GLASSER, EXAMINING ATTORNEY

Int. Cls.: 19 and 37

Prior U.S. Cls.: 1, 12, 33, 50, 100, 103 and 106

United States Patent and Trademark Office

Reg. No. 3,483,592

Registered Aug. 12, 2008

**TRADEMARK
SERVICE MARK
PRINCIPAL REGISTER**

INNOVA TILE

METROPOLITAN RENOVATORS, INC.. (TEXAS CORPORATION)
10707 CORPORATE DRIVE STE 106
STAFFORD, TX 77477

FOR: CLAY ROOFING TILES; EARTHENWARE TILES; NON-METAL ROOF COVERINGS; NON-METAL ROOFING; NON-METAL ROOFING TILES; NON-METAL TILES, IN CLASS 19 (U.S. CLS. 1, 12, 33 AND 50).

FIRST USE 5-1-2007; IN COMMERCE 5-1-2007.

FOR: ROOFING CONSULTATION; ROOFING CONTRACTING; ROOFING INSTALLATION; ROOFING REPAIR; ROOFING SERVICES, IN CLASS 37 (U.S. CLS. 100, 103 AND 106).

FIRST USE 5-1-2007; IN COMMERCE 5-1-2007.

THE MARK CONSISTS OF STANDARD CHARACTERS WITHOUT CLAIM TO ANY PARTICULAR FONT, STYLE, SIZE, OR COLOR.

NO CLAIM IS MADE TO THE EXCLUSIVE RIGHT TO USE "TILE", APART FROM THE MARK AS SHOWN.

SER. NO. 77-249,906, FILED 8-8-2007.

REBECCA SMITH, EXAMINING ATTORNEY

Int. Cl.: 37

Prior U.S. Cls.: 100, 103 and 106

United States Patent and Trademark Office

Reg. No. 3,483,593

Registered Aug. 12, 2008

**SERVICE MARK
PRINCIPAL REGISTER**



TINT WORLD, LLC (FLORIDA LTD LIAB CO)
2375 NW 49TH LANE
BOCA RATON, FL 33431

FOR: INSTALLATION SERVICES, NAMELY, INSTALLATION OF TINTED PLASTIC FILMS ON THE WINDOWS OF AUTOMOBILES, RESIDENTIAL BUILDINGS, COMMERCIAL BUILDINGS AND MARINE VESSELS; VEHICLE AUTOMOBILE DETAILING, WASHING AND POLISHING SERVICES; VEHICLE RESTORATION SERVICES, NAMELY, PAINT TOUCH UPS, DENT REPAIR, INTERIOR TRIM REPAIR AND INSTALLING AUTO ACCESSORIES; INSTALLING RESIDENTIAL AND COMMERCIAL SHUTTERS, INSTALLING SECURITY

FILM AND INSTALLING AUTO ALARMS, IN CLASS 37 (U.S. CLS. 100, 103 AND 106).

FIRST USE 1-1-1983; IN COMMERCE 1-1-1983.

NO CLAIM IS MADE TO THE EXCLUSIVE RIGHT TO USE "TINT", APART FROM THE MARK AS SHOWN.

THE MARK CONSISTS OF "TINT WORLD" SUPERIMPOSED ON A SPHERE WITH A STYLIZED AUTOMOBILE.

SER. NO. 77-250,129, FILED 8-8-2007.

MICHAEL SOUDERS, EXAMINING ATTORNEY

Int. Cl.: 37

Prior U.S. Cls.: 100, 103 and 106

United States Patent and Trademark Office

Reg. No. 3,483,594

Registered Aug. 12, 2008

**SERVICE MARK
PRINCIPAL REGISTER**

TINT WORLD

TINT WORLD, LLC (FLORIDA LTD LIAB CO)
2375 NW 49TH LANE
BOCA RATON, FL 33431

FOR: INSTALLATION SERVICES, NAMELY, INSTALLATION OF TINTED PLASTIC FILMS ON THE WINDOWS OF AUTOMOBILES, RESIDENTIAL BUILDINGS, COMMERCIAL BUILDINGS AND MARINE VESSELS; VEHICLE AUTOMOBILE DETAILING, WASHING AND POLISHING SERVICES; VEHICLE RESTORATION SERVICES, NAMELY, PAINT TOUCH UPS, DENT REPAIR, INTERIOR TRIM REPAIR AND INSTALLING AUTO ACCESSORIES; INSTALLING RESIDENTIAL AND COMMERCIAL SHUTTERS, INSTALLING SECURITY

FILM AND INSTALLING AUTO ALARMS, IN CLASS 37 (U.S. CLS. 100, 103 AND 106).

FIRST USE 7-7-2007; IN COMMERCE 7-7-2007.

NO CLAIM IS MADE TO THE EXCLUSIVE RIGHT TO USE "TINT", APART FROM THE MARK AS SHOWN.

THE MARK CONSISTS OF "TINT WORLD" WITH A GLOBE INSIDE THE LETTER "O".

SER. NO. 77-250,167, FILED 8-8-2007.

MICHAEL SOUDERS, EXAMINING ATTORNEY

Int. Cl.: 37

Prior U.S. Cls.: 100, 103 and 106

United States Patent and Trademark Office

Reg. No. 3,483,595

Registered Aug. 12, 2008

**SERVICE MARK
PRINCIPAL REGISTER**



TINT WORLD, LLC (FLORIDA LTD LIAB CO)
2375 NW 49TH LANE
BOCA RATON, FL 33431

FIRST USE 1-31-2002; IN COMMERCE 1-31-2002.

FOR: INSTALLATION SERVICES, NAMELY, INSTALLATION OF TINTED PLASTIC FILMS ON THE WINDOWS OF AUTOMOBILES, RESIDENTIAL BUILDINGS, COMMERCIAL BUILDINGS AND MARINE VESSELS; VEHICLE AUTOMOBILE DETAILING, WASHING AND POLISHING SERVICES; VEHICLE RESTORATION SERVICES, NAMELY, PAINT TOUCH UPS, DENT REPAIR, INTERIOR TRIM REPAIR AND INSTALLING AUTO ACCESSORIES; INSTALLING RESIDENTIAL AND COMMERCIAL SHUTTERS, INSTALLING SECURITY FILM AND INSTALLING AUTO ALARMS, IN CLASS 37 (U.S. CLS. 100, 103 AND 106).

NO CLAIM IS MADE TO THE EXCLUSIVE RIGHT TO USE "TINT", APART FROM THE MARK AS SHOWN.

THE MARK CONSISTS OF "TINT WORLD" SUPERIMPOSED ON A SPHERE SURROUNDED BY REPRESENTATIONS OF A BOAT, AUTOMOBILE AND BUILDINGS.

SER. NO. 77-250,206, FILED 8-8-2007.

MICHAEL SOUDERS, EXAMINING ATTORNEY

Int. Cl.: 29

Prior U.S. Cl.: 46

United States Patent and Trademark Office

Reg. No. 3,483,596

Registered Aug. 12, 2008

TRADEMARK
PRINCIPAL REGISTER

GREAT VALUE

WAL-MART STORES, INC. (DELAWARE CORPORATION)
702 S.W. 8TH ST.
BENTONVILLE, AR 727160520

FOR: EDIBLE OILS, NAMELY, COOKING OIL, COOKING SPRAY, SHORTENING, OLIVE OIL; VEGETABLE OIL SPREAD, BUTTER, MARGARINE; BROTH; MEAT; PROCESSED MEAT, FISH, AND POULTRY; FROZEN MEAT, FISH, AND POULTRY; FROZEN PRE-COOKED BREADED MEAT, FISH, AND POULTRY; CANNED MEAT, FISH, AND POULTRY; SAUSAGES; BRATWURSTS; LUNCHMEATS; BACON; BACON BITS; IMITATION BACON BITS; CHILI WITH OR WITHOUT BEANS; CHICKEN AND DUMPLINGS; SOUPS AND FROZEN, PREPARED, AND PACKAGED ENTREES CONSISTING PRIMARILY OF VEGETABLES AND/OR MEAT; BEEF STEW; SOUPS AND SOUP MIXES; PREPARED ENTREES CONSISTING PRIMARILY OF BEEF OR PORK OR POULTRY OR FISH AND/OR VEGETABLES; PICKLES; PROCESSED PEPPERS; PROCESSED OLIVES; PROCESSED MUSHROOMS; STIR FRY VEGETABLES, NAMELY, FROZEN OR PROCESSED VEGETABLES; FROZEN VEGETABLES; CANNED CUT VEGETABLES; CANNED SLICED VEGETABLES; TOMATO PUREE; TOMATO PASTE; PROCESSED BEETS; PROCESSED BEANS; REFRIED BEANS; CANNED PORK AND BEANS; BAKED BEANS; CANNED FRANKFURTERS AND BEANS; DRIED BEANS; PROCESSED CACTUS FOR FOOD PURPOSES; DRIED POTATO MIXES; DEHYDRATED POTATO PRODUCTS, NAMELY, SCALLOPED POTATOES, AU GRATIN POTATOES; FRENCH FRIED ONIONS; FORTIFIED AND FLAVORED INSTANT MILK DRINK, NAMELY, MILK POWDER; SOY MILK; FLAVORED SOY MILK; SOY SPREAD, NAMELY, SOYBEAN OIL; DAIRY PRODUCTS, NAMELY, MILK, POWDERED MILK FOR FOOD CONSUMPTION, EVAPORATED MILK, CONDENSED MILK, ORGANIC MILK, YOGURT, HALF AND HALF, WHIPPING CREAM,

BUTTERMILK, SOUR CREAM, CHEESES, CREAM CHEESE, COTTAGE CHEESE AND CHEESE SPREADS; DAIRY AND NON-DAIRY WHIPPED TOPPINGS; DAIRY-BASED DIPS; NON-DAIRY CREAMER; FRUIT-BASED FILLING FOR CAKES AND PIES; PROCESSED, CANNED, FROZEN AND DRIED FRUIT; CRANBERRY SAUCE; APPLE SAUCE; FRUIT-BASED SNACK FOODS; JAMS, JELLIES AND FRUIT PRESERVES; FRUIT BUTTERS; PEANUT BUTTER; FLAKED COCONUT; PROCESSED EDIBLE SEEDS; ROASTED OR PROCESSED PEANUTS, ALMONDS, CASHEWS; DRIED BEEF JERKY; POTATO CHIPS, SNACK MIX CONSISTING PRIMARILY OF PROCESSED FRUITS, PROCESSED NUTS AND/OR RAISINS; CHEESE AND CRACKER COMBINATIONS; FROZEN PREPARED ENTREES CONSISTING OF MEAT, FISH, OR POULTRY; FROZEN PREPARED MEALS CONSISTING PRIMARILY OF MEAT, FISH, OR POULTRY; FROZEN ONION RINGS; FROZEN FRENCH FRIES AND OTHER FROZEN POTATO PRODUCTS, NAMELY, BATTERED POTATOES, POTATO PATTIES, POTATO NUGGETS, POTATO LOGS, AND HASH BROWNS; FROZEN FRENCH FRIED SWEET POTATOES; READY-TO-EAT NUT-BASED FOOD BARS; PACKAGED MEALS CONSISTING PRIMARILY OF POTATOES WITH SPICES AND SAUCE MIXES, IN CLASS 29 (U.S. CL. 46).

FIRST USE 4-2-1993; IN COMMERCE 4-2-1993.

THE MARK CONSISTS OF STANDARD CHARACTERS WITHOUT CLAIM TO ANY PARTICULAR FONT, STYLE, SIZE, OR COLOR.

OWNER OF U.S. REG. NOS. 2,129,655, 2,603,144 AND OTHERS.

^I2

SER. NO. 77-250,280, FILED 8-8-2007.

SOPHIA S. KIM, EXAMINING ATTORNEY

Int. Cl.: 1

Prior U.S. Cls.: 1, 5, 6, 10, 26 and 46

Reg. No. 3,483,597

United States Patent and Trademark Office

Registered Aug. 12, 2008

**TRADEMARK
PRINCIPAL REGISTER**

ACT

FRANSSEN ENTERPRISES, INC. (COLORADO CORPORATION), DBA AMERICAN CLEANING TECHNOLOGIES, INC.
P.O. BOX 386
DACONO, CO 805140386

FOR: BIOREMEDIATION CLEANING PRODUCTS, NAMELY, A BLEND OF NATURAL MICROORGANISMS; DRY BIOREMEDIATION CLEANING PRODUCTS, NAMELY, A BLEND OF NATURAL MICROORGANISMS; BIOREMEDIATION CLEANING PRODUCTS, NAMELY, A BLEND OF NATURAL MICROORGANISMS FOR CLEANING CONCRETE, ASPHALT, SOIL, TRASH CONTAINERS, DUMPSTERS, CORRALS, GREASE BINS

AND ANIMAL WASTE; BIOREMEDIATION ABSORBENT PRODUCTS, NAMELY, A BLEND OF NATURAL MICROORGANISMS, IN CLASS 1 (U.S. CLS. 1, 5, 6, 10, 26 AND 46).

FIRST USE 0-0-1997; IN COMMERCE 0-0-1997.

THE MARK CONSISTS OF STANDARD CHARACTERS WITHOUT CLAIM TO ANY PARTICULAR FONT, STYLE, SIZE, OR COLOR.

SER. NO. 77-250,293, FILED 8-8-2007.

KEVON CHISOLM, EXAMINING ATTORNEY

Int. Cl.: 42

Prior U.S. Cls.: 100 and 101

United States Patent and Trademark Office

Reg. No. 3,483,598

Registered Aug. 12, 2008

**SERVICE MARK
PRINCIPAL REGISTER**

ISSIS

TECH S2, INC. (NEW YORK CORPORATION)
6 SUNSET DRIVE
LANSING, NY 14850

THE MARK CONSISTS OF STANDARD CHAR-
ACTERS WITHOUT CLAIM TO ANY PARTICULAR
FONT, STYLE, SIZE, OR COLOR.

FOR: PROVIDING ON-LINE NON-DOWNLOAD-
ABLE SOFTWARE FOR USE IN INTEGRATED
CASE MANAGEMENT, IN CLASS 42 (U.S. CLS. 100
AND 101).

SER. NO. 77-251,208, FILED 8-9-2007.

FIRST USE 4-12-2006; IN COMMERCE 6-2-2006.

KAPIL BHANOT, EXAMINING ATTORNEY

Int. Cls.: 9 and 11

Prior U.S. Cls.: 13, 21, 23, 26, 31, 34, 36 and 38

United States Patent and Trademark Office

Reg. No. 3,483,599

Registered Aug. 12, 2008

**TRADEMARK
PRINCIPAL REGISTER**

HORIBASTEC

HORIBA, LTD. (JAPAN CORPORATION)
2, MIYANOHIGASHI, KISSHOIN, MINAMI-KU
KYOTO, JAPAN 601-8510

FOR: ELECTRICAL MASS FLOW CONTROLLERS COMPRISING FLOW METERS AND VALVES; MASS FLOW METERS; ELECTRICAL LIQUID SOURCE CONTROLLERS; ELECTRONIC DEVICES FOR SUPPLYING LIQUID TO LIQUID SOURCE VAPORIZATION CONTROL SYSTEMS; PRESSURE REGULATOR FOR FLUIDS; ELECTRONIC VALVES FOR CONTROLLING FLUIDS; ELECTRICAL EXHAUST CONTROLLERS; PRECISION FILM FLOW METERS; ELECTRONIC CONTROLLERS USED TO CHECK POWER SOURCE, POWER VOLTAGE, SIGNAL, DISPLAY UNIT, SETTING UNIT, CABLES, AND OTHER PARTS OF MASS FLOW CONTROLLERS, FLOW METER OR VALVES; INFRARED RAY GAS CONCENTRATION MONITORS; RESI-

DUAL GAS ANALYZER; VACUUM GAUGE USED TO MEASURE GAS PRESSURE, IN CLASS 9 (U.S. CLS. 21, 23, 26, 36 AND 38).

FIRST USE 7-1-2004; IN COMMERCE 7-2-2004.

FOR: LIQUID VAPORIZER FOR MIXING LIQUID AND GASES; GAS PURIFYING INSTALLATIONS; DIRECT INJECTION LIQUID SOURCE VAPORIZER, IN CLASS 11 (U.S. CLS. 13, 21, 23, 31 AND 34).

FIRST USE 7-1-2004; IN COMMERCE 7-2-2004.

THE MARK CONSISTS OF THE WORD "HORBASTEC" IN STYLIZED LETTERING.

SER. NO. 77-251,682, FILED 8-9-2007.

ANGELA M. MICHELI, EXAMINING ATTORNEY

Int. Cl.: 35

Prior U.S. Cls.: 100, 101 and 102

United States Patent and Trademark Office

Reg. No. 3,483,600

Registered Aug. 12, 2008

**SERVICE MARK
PRINCIPAL REGISTER**



STRATEGY ARCHITECTS, LLC, THE (DELA-
WARE LTD LIAB CO)
4157 BRITTS GATE LANE
TUCKER, GA 30084

FOR: PROVIDING A WEBSITE FEATURING AN
INTERNATIONAL INTERNET-BASED PORTAL
PROMOTING THE GOODS AND SERVICES OF
OTHERS; PREPARING CUSTOM PROMOTIONAL
AND MERCHANDISING MATERIAL FOR OTH-
ERS; MAIL ORDER SERVICES FEATURING BRAN-
DED PROMOTIONAL AND MARKETING ITEMS;
ONLINE RETAIL STORE SERVICES FEATURING
BRANDED PROMOTIONAL AND MARKETING
ITEMS; AND BUSINESS CONSULTATION RELAT-
ING TO ALL OF THE ABOVE, IN CLASS 35 (U.S.
CLS. 100, 101 AND 102).

FIRST USE 8-1-2007; IN COMMERCE 8-1-2007.

THE COLOR(S) BLUE AND GREEN IS/ARE
CLAIMED AS A FEATURE OF THE MARK.

THE COLOR BLUE APPEARS IN THE WORDING
"PROMO", "COM" AND THE LOWER PART OF THE
EXCLAMATION POINT, NAMELY, THE PERIOD,
AND THE COLOR GREEN APPEARS IN THE
LETTERS "MOMMA" AND IN THE TOP PART OF
THE EXCLAMATION POINT.

SER. NO. 77-252,015, FILED 8-10-2007.

JASON BLAIR, EXAMINING ATTORNEY

Int. Cl.: 42

Prior U.S. Cls.: 100 and 101

United States Patent and Trademark Office

Reg. No. 3,483,601

Registered Aug. 12, 2008

**SERVICE MARK
PRINCIPAL REGISTER**

MorrisSwitzer

MORRISSWITZER~ENVIRONMENTS FOR
HEALTH (VERMONT LTD LIAB CO)
185 TALCOTT ROAD
WILLISTON, VT 05495

FOR: ARCHITECTURAL DESIGN AND PLAN-
NING OF HEALTH CARE FACILITIES, IN CLASS 42
(U.S. CLS. 100 AND 101).

FIRST USE 6-4-2002; IN COMMERCE 6-4-2002.

THE MARK CONSISTS OF STANDARD CHAR-
ACTERS WITHOUT CLAIM TO ANY PARTICULAR
FONT, STYLE, SIZE, OR COLOR.

THE NAME "MORRIS SWITZER" DOES NOT
IDENTIFY A LIVING INDIVIDUAL.

SER. NO. 77-252,017, FILED 8-10-2007.

JASON BLAIR, EXAMINING ATTORNEY

Int. Cl.: 10

Prior U.S. Cls.: 26, 39 and 44

United States Patent and Trademark Office

Reg. No. 3,483,602

Registered Aug. 12, 2008

TRADEMARK
PRINCIPAL REGISTER



FAUBEL, KRISTINA E. (UNITED STATES INDIVIDUAL)
1209 SW 51ST TERRACE
CAPE CORAL, FL 33914

FOR: WEARING APPAREL FOR THE HEALTH-CARE INDUSTRY, NAMELY, MEDICAL GOWNS AND SMOCKS, AND PATIENT EXAMINATION GOWNS, IN CLASS 10 (U.S. CLS. 26, 39 AND 44).

FIRST USE 2-1-2007; IN COMMERCE 7-28-2007.

NO CLAIM IS MADE TO THE EXCLUSIVE RIGHT TO USE "GOWNS", APART FROM THE MARK AS SHOWN.

THE COLOR(S) TEAL AND FUCHSIA IS/ARE CLAIMED AS A FEATURE OF THE MARK.

THE MARK CONSISTS OF THE WORDS "GIGGLE GOWNS" WHEREIN THE INITIAL "G" IN "GIGGLE" FORMS THE FANCIFUL DESIGN OF A SMILING FACE HAVING A FUCHSIA DOT THAT REPRESENTS AN EYE. THE LETTERS OF "GIGGLE" ARE TEAL AND PRINTED IN A SERIF FONT. THE LETTERS OF "GOWN" ARE FUCHSIA, PRINTED IN A SANS SERIF FONT AND SEPARATED BY TEAL DOTS.

SER. NO. 77-252,649, FILED 8-10-2007.

ANN E. SAPPENFIELD, EXAMINING ATTORNEY

Int. Cl.: 41

Prior U.S. Cls.: 100, 101 and 107

United States Patent and Trademark Office

Reg. No. 3,483,603

Registered Aug. 12, 2008

**SERVICE MARK
PRINCIPAL REGISTER**

CANADIANDRIVER

CANADIANDRIVER COMMUNICATIONS INC.
(CANADA CORPORATION)
709 LARCASTLE CIRCLE
ORLEANS, CANADA

FOR: ON-LINE PUBLICATIONS IN THE NATURE
OF A MAGAZINE IN THE FIELD OF AUTOMO-
BILES, IN CLASS 41 (U.S. CLS. 100, 101 AND 107).

FIRST USE 0-0-1998; IN COMMERCE 0-0-1998.

THE MARK CONSISTS OF STANDARD CHAR-
ACTERS WITHOUT CLAIM TO ANY PARTICULAR
FONT, STYLE, SIZE, OR COLOR.

SEC. 2(F).

SER. NO. 77-252,838, FILED 8-10-2007.

BRENDAN MCCAULEY, EXAMINING ATTORNEY

Int. Cls.: 25 and 41

Prior U.S. Cls.: 22, 39, 100, 101 and 107

United States Patent and Trademark Office

Reg. No. 3,483,604

Registered Aug. 12, 2008

**TRADEMARK
SERVICE MARK
PRINCIPAL REGISTER**



TENNIS AND FRIENDS S.L. (SPAIN SOCIEDAD LIMITADA)
08820 - EL PRAT DE LLOBREGAT
AUTOVIA CASTELLDEFELS C-31 KM. 191
BARCELONA, SPAIN

FOR: CLOTHING, NAMELY, JACKETS, SHIRTS, PANTS, SOCKS, BELTS, SHORTS, UNDERWEAR, HOODS, JERSEYS, TIES, TOPS, TENNIS CLOTHING, NAMELY, TENNIS WEAR, TENNIS WARM UP SUITS, TENNIS TOPS, TENNIS SHORTS, TENNIS SINGLETs, TENNIS SUITS; CLOTHING FOR WEAR IN TENNIS PRACTICES, NAMELY, TENNIS WEAR; CLOTHING FOR WEAR IN TENNIS MATCHES, NAMELY, TENNIS WEAR; FOOTWEAR; AND HEADGEAR, NAMELY, HATS, CAPS, AND VISORS, IN CLASS 25 (U.S. CLS. 22 AND 39).

FIRST USE 1-1-1999; IN COMMERCE 4-1-2007.

FOR: TENNIS INSTRUCTION SERVICES, NAMELY, PROVIDING TENNIS TECHNICAL AND TACTICAL TRAINING AT THE BEGINNER, INTERMEDIATE, AND PROFESSIONAL LEVELS; PROVIDING COACHING TRAINING SERVICES IN THE FIELD OF TENNIS; BOARDING SCHOOLS;

EDUCATIONAL SERVICES, NAMELY, PROVIDING COURSES OF INSTRUCTION AT THE SECONDARY LEVEL; PROVIDING ENTERTAINMENT IN THE NATURE OF COMPETITIONS IN THE FIELD OF ATHLETIC TENNIS; ORGANIZING COMMUNITY SPORTING AND CULTURAL EVENTS, IN CLASS 41 (U.S. CLS. 100, 101 AND 107).

FIRST USE 1-1-1999; IN COMMERCE 4-1-2007.

NO CLAIM IS MADE TO THE EXCLUSIVE RIGHT TO USE "ACADEMIA" , APART FROM THE MARK AS SHOWN.

THE MARK CONSISTS OF THE LETTERS "A", "S", AND "C" IN A DESIGN FOLLOWED BY THE PHRASE "ACADEMIA SANCHEZ-CASAL".

THE FOREIGN WORDING "ACADEMIA" IN THE MARK TRANSLATES INTO ENGLISH AS ACADEMY.

SER. NO. 77-252,839, FILED 8-10-2007.

BRENDAN MCCAULEY, EXAMINING ATTORNEY

Int. Cl.: 25

Prior U.S. Cls.: 22 and 39

United States Patent and Trademark Office

Reg. No. 3,483,605

Registered Aug. 12, 2008

**TRADEMARK
PRINCIPAL REGISTER**

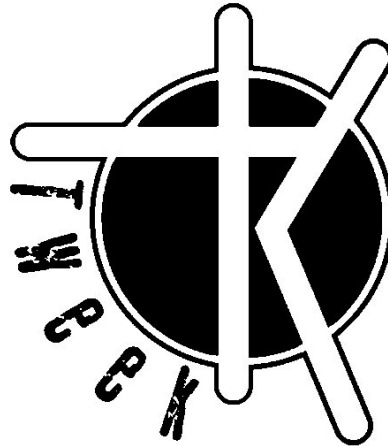

TWEEK APPAREL LLC (CALIFORNIA LTD LIAB
CO)
21371 SILVERTREE LANE
TRABUCO CANYON, CA 92679

FOR: BOARD SHORTS; HATS; JACKETS; PANTS;
POLO SHIRTS; SHORT-SLEEVED OR LONG-
SLEEVED T-SHIRTS; SHORTS; SOCKS; SWEAT
SHIRTS, IN CLASS 25 (U.S. CLS. 22 AND 39).

FIRST USE 3-30-2007; IN COMMERCE 4-30-2007.

THE MARK CONSISTS OF THE LETTERS (TK)
INCLUDED IN A CIRCLE WITH THE WORD
TWEEK, ON THE OUTSIDE. TWEEK FONT IS
CARPEDIEMEFOP-REGULAR.

SER. NO. 77-253,557, FILED 8-13-2007.

CAROLYN GRAY, EXAMINING ATTORNEY

Int. Cls.: 25 and 28

Prior U.S. Cls.: 22, 23, 38, 39 and 50

United States Patent and Trademark Office

Reg. No. 3,483,606

Registered Aug. 12, 2008

**TRADEMARK
PRINCIPAL REGISTER**

365 NO OFF-SEASON

DIAMOND BASEBALL COMPANY, INC. (CALI-
FORNIA CORPORATION)
11130 WARLAND DR.
CYPRESS, CA 90630

FOR: CLOTHING, NAMELY, T-SHIRTS AND
SWEATSHIRTS, IN CLASS 25 (U.S. CLS. 22 AND 39).

FIRST USE 5-17-2007; IN COMMERCE 5-17-2007.

FOR: BASEBALLS , IN CLASS 28 (U.S. CLS. 22, 23,
38 AND 50).

FIRST USE 8-6-2007; IN COMMERCE 8-6-2007.

THE MARK CONSISTS OF STANDARD CHAR-
ACTERS WITHOUT CLAIM TO ANY PARTICULAR
FONT, STYLE, SIZE, OR COLOR.

SER. NO. 77-253,861, FILED 8-13-2007.

CHRISTINE COOPER, EXAMINING ATTORNEY

Int. Cl.: 42

Prior U.S. Cls.: 100 and 101

United States Patent and Trademark Office

Reg. No. 3,483,607

Registered Aug. 12, 2008

**SERVICE MARK
PRINCIPAL REGISTER**

MEDACTIONPLAN

MEDACTIONPLAN.COM, LLC (NEW JERSEY
LTD LIAB CO)
P.O. BOX 430
PEAPACK, NJ 07977

FOR: APPLICATION SERVICE PROVIDER FEATURING SOFTWARE FOR USE IN THE CREATION OF PERSONALIZED MEDICAL TREATMENT PLANS FOR USE BY PATIENTS AND THEIR HEALTHCARE PROFESSIONALS , IN CLASS 42 (U.S. CLS. 100 AND 101).

FIRST USE 10-0-2004; IN COMMERCE 10-0-2004.

THE MARK CONSISTS OF STANDARD CHARACTERS WITHOUT CLAIM TO ANY PARTICULAR FONT, STYLE, SIZE, OR COLOR.

SER. NO. 77-253,905, FILED 8-13-2007.

SEAN CROWLEY, EXAMINING ATTORNEY

Int. Cl.: 9

Prior U.S. Cls.: 21, 23, 26, 36 and 38

Reg. No. 3,483,608

United States Patent and Trademark Office

Registered Aug. 12, 2008

**TRADEMARK
PRINCIPAL REGISTER**

Armormax

INTERNATIONAL ARMORING CORPORATION
(UTAH CORPORATION)
2335 LINCOLN AVE
OGDEN, UT 84401

FOR: BULLET RESISTANT DOOR PANELS, COLUMN PANELS, ROOF LINERS AND SIDEWALL PANELS MADE OF ARAMID FIBERS FOR LAND VEHICLES; BLAST RESISTANT FLOOR LINERS MADE OF NYLON AND ARAMID FIBERS FOR LAND VEHICLES, IN CLASS 9 (U.S. CLS. 21, 23, 26, 36 AND 38).

FIRST USE 11-15-1994; IN COMMERCE 11-15-1994.

THE MARK CONSISTS OF STANDARD CHARACTERS WITHOUT CLAIM TO ANY PARTICULAR FONT, STYLE, SIZE, OR COLOR.

SER. NO. 77-253,912, FILED 8-13-2007.

MORGAN WYNNE, EXAMINING ATTORNEY

Int. Cl.: 35

Prior U.S. Cls.: 100, 101 and 102

United States Patent and Trademark Office

Reg. No. 3,483,609

Registered Aug. 12, 2008

**SERVICE MARK
PRINCIPAL REGISTER**

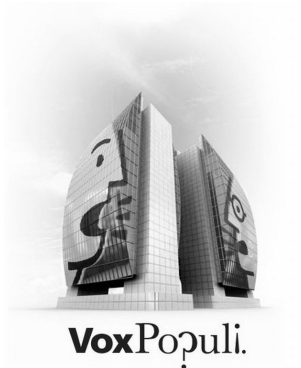

GARNET, WILLIAM (UNITED STATES INDIVIDUAL)
4513 COMBER AVENUE
ENCINO, CA 91316

FOR: PROVIDING AN INTERACTIVE WEB SITE IN THE FIELD OF PUBLIC OPINION POLLING RESULTS; PROVIDING INFORMATION ABOUT PUBLIC OPINION POLLING RESULTS VIA A GLOBAL COMPUTER NETWORK , IN CLASS 35 (U.S. CLS. 100, 101 AND 102).

FIRST USE 7-7-2007; IN COMMERCE 7-7-2007.

THE MARK CONSISTS OF THE WORDS "VOX POPULI" AND DESIGNS OF FACES.

THE FOREIGN WORDING IN THE MARK TRANSLATES INTO ENGLISH AS VOICE OF THE PEOPLE.

SER. NO. 77-254,315, FILED 8-13-2007.

CARRIE GENOVESE, EXAMINING ATTORNEY

Int. Cls.: 11 and 35

Prior U.S. Cls.: 13, 21, 23, 31, 34, 100, 101 and 102

Reg. No. 3,483,610

United States Patent and Trademark Office

Registered Aug. 12, 2008

**TRADEMARK
SERVICE MARK
PRINCIPAL REGISTER**



QUALITY ENCLOSURES, INC. (FLORIDA CORPORATION)
UNIT E
2025 PORTER LAKE DR
SARASOTA, FL 34240

FOR: SHOWER ENCLOSURES, SHOWER DOORS AND HARDWARE ACCESSORIES FOR USE WITH SHOWER ENCLOSURES, SHOWER DOORS, NAMELY, HINGES, SHOWER DOOR HANDLES, SHOWER DOOR TOWEL BARS, SHOWER DOOR BRACKETS, SHOWER DOOR ALUMINUM CHANNELS, SHOWER DOOR POLYCARBONATE WATER SEALS, IN CLASS 11 (U.S. CLS. 13, 21, 23, 31 AND 34).

FIRST USE 8-1-2005; IN COMMERCE 8-1-2005.

FOR: WHOLESALE ORDERING SERVICES IN THE FIELD OF SHOWER ENCLOSURES, SHOWER DOORS, MIRRORED WARDROBE DOORS AND

HARDWARE ACCESSORIES FOR USE WITH SHOWER ENCLOSURES, SHOWER DOORS, AND MIRRORED WARDROBE DOORS, IN CLASS 35 (U.S. CLS. 100, 101 AND 102).

FIRST USE 8-1-2005; IN COMMERCE 8-1-2005.

NO CLAIM IS MADE TO THE EXCLUSIVE RIGHT TO USE "INC" AND "ENCLOSURES", APART FROM THE MARK AS SHOWN.

THE MARK CONSISTS OF AN IMAGE OF A SPLASH, TO THE RIGHT OF WHICH APPEAR THE WORDS "QUALITY ENCLOSURES INC."

SER. NO. 77-254,552, FILED 8-14-2007.

GINA HAYES, EXAMINING ATTORNEY

Int. Cl.: 37

Prior U.S. Cls.: 100, 103 and 106

United States Patent and Trademark Office

Reg. No. 3,483,611

Registered Aug. 12, 2008

**SERVICE MARK
PRINCIPAL REGISTER**



SIMKO, DOUG (UNITED STATES INDIVIDUAL)
27388 LAKEVIEW DR.
P.O. BOX 1149
HELENDALE, CA 92342

FOR: PLUMBING CONTRACTOR SERVICES, IN
CLASS 37 (U.S. CLS. 100, 103 AND 106).

FIRST USE 7-25-2007; IN COMMERCE 7-25-2007.

THE COLOR(S) GRAY, WHITE, YELLOW,
BLACK, BLUE, AND RED IS/ARE CLAIMED AS A
FEATURE OF THE MARK.

THE MARK CONSISTS OF A LOGO SHAPED
LIKE PILOT WINGS WITH A CIRCLE IN THE
MIDDLE. STARTING FROM THE CENTER, THERE
IS A CIRCLE WITH GRAY BRICKS OUTLINED IN
WHITE. A YELLOW PIPE SURROUNDS THE
BRICKS WITH FOUR PIPES COMING OUT OF
EACH SIDE STARTING THE FORMATION OF

THE WINGS. THE TOP PIPE IS THE LONGEST
AND EACH PIPE FOLLOWING IT GRADUALLY
GETS SMALLER. THERE IS A SMALL SPACE
BETWEEN EACH PIPE. AT THE END OF EACH
PIPE THERE IS A BLACK CIRCLE WITH A WHITE
OUTLINE WHICH GIVE THE PIPES A THREE
DIMENSIONAL LOOK. ON THE BOTTOM LEFT
HAND SIDE OF THE CIRCLE PIPE, A YELLOW
FAUCET COMES OUT FACING RIGHT. THE
SPOUT OVERLAPS THE CIRCLE PIPE AND TWO
BLUE WATER DROPS COME DOWN. AS STATED
BEFORE, THE FORMATION OF THE WINGS
START WITH THE THREE DIMENSIONAL PIPES
THEN END WITH FEATHERS. FROM THE PIPES,
THE FEATHERS CHANGE COLORS FROM RED TO
WHITE TO BLUE TO BLACK TO WHITE AND THE
TIP OF THE FEATHERS END IN BLACK. EACH
SIDE IS A MIRROR IMAGE OF ONE ANOTHER.

SER. NO. 77-254,665, FILED 8-14-2007.

CURTIS FRENCH, EXAMINING ATTORNEY

Int. Cl.: 25

Prior U.S. Cls.: 22 and 39

United States Patent and Trademark Office

Reg. No. 3,483,612

Registered Aug. 12, 2008

**TRADEMARK
PRINCIPAL REGISTER**

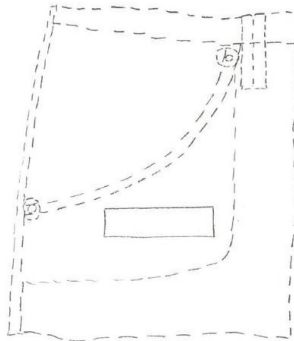

LUCKY BRAND DUNGAREES, INC. (DELA-
WARE CORPORATION)
5233 ALCOA AVENUE
VERNON, CA 90058

FOR: DENIMS; JEANS; PANTS, IN CLASS 25 (U.S.
CLS. 22 AND 39).

FIRST USE 1-0-2000; IN COMMERCE 1-0-2000.

THE MARK CONSISTS OF A "RECTANGULAR
STRIP OF PAPER" MADE TO APPEAR SIMILAR TO

A FORTUNE COOKIE FORTUNE, PLACED INSIDE
A PANT POCKET.

SEC. 2(F).

SER. NO. 77-254,756, FILED 8-14-2007.

ALEXANDER L. POWERS, EXAMINING ATTOR-
NEY

Int. Cl.: 38

Prior U.S. Cls.: 100, 101 and 104

United States Patent and Trademark Office

Reg. No. 3,483,613

Registered Aug. 12, 2008

**SERVICE MARK
PRINCIPAL REGISTER**

HUEVOCARTOON MOBILE

COMUNIDAD HUEVO S.A. DE C.V. (MEXICO CORPORATION)
COLONIA DEL VALLE
LUZ SAVIÑON 513, PISO 2
MEXICO, D.F., MEXICO 03100

FOR: DATA TRANSMISSION AND RECEPTION SERVICES VIA TELECOMMUNICATION MEANS; PROVIDING ON-LINE COMMUNICATIONS LINKS WHICH TRANSFER THE WEBSITE USER TO OTHER LOCAL AND GLOBAL WEB PAGES; TRANSMISSION OF INFORMATION ON OPTICAL TELECOMMUNICATION NETWORKS; TRANSMISSION OF DATABASE INFORMATION VIA TELECOMMUNICATIONS NETWORKS; ELECTRONIC EXCHANGE OF DATA STORED IN DATABASES ACCESSIBLE VIA TELECOMMUNICATION NETWORKS; BROADCAST OF CABLE TELEVISION PROGRAMMES, IN CLASS 38 (U.S. CLS. 100, 101 AND 104).

THE MARK CONSISTS OF STANDARD CHARACTERS WITHOUT CLAIM TO ANY PARTICULAR FONT, STYLE, SIZE, OR COLOR.

PRIORITY CLAIMED UNDER SEC. 44(D) ON MEXICO APPLICATION NO. 874120, FILED 8-9-2007, REG. NO. 1005077, DATED 9-28-2007, EXPIRES 8-9-2017.

OWNER OF U.S. REG. NO. 3,161,984.

NO CLAIM IS MADE TO THE EXCLUSIVE RIGHT TO USE "MOBILE", APART FROM THE MARK AS SHOWN.

THE WORDING "HUEVOCARTOON" HAS NO MEANING IN A FOREIGN LANGUAGE.

SER. NO. 77-255,024, FILED 8-14-2007.

GEOFFREY FOSDICK, EXAMINING ATTORNEY

Int. Cl.: 16

Prior U.S. Cls.: 2, 5, 22, 23, 29, 37, 38 and 50

United States Patent and Trademark Office

Reg. No. 3,483,614

Registered Aug. 12, 2008

**TRADEMARK
PRINCIPAL REGISTER**

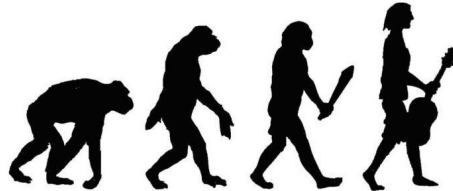

The Evolving Guitarist

RICHARD, GEOFFREY T. (UNITED STATES INDIVIDUAL)
1147 OAKRIDGE ROAD
PETERSBURG, VA 23805

FOR: PRINTED INSTRUCTIONAL, EDUCATIONAL, AND TEACHING MATERIALS IN THE FIELD OF MUSIC, IN CLASS 16 (U.S. CLS. 2, 5, 22, 23, 29, 37, 38 AND 50).

FIRST USE 12-31-2006; IN COMMERCE 12-31-2006.

NO CLAIM IS MADE TO THE EXCLUSIVE RIGHT TO USE "GUITARIST", APART FROM THE MARK AS SHOWN.

THE MARK CONSISTS OF MAMMALS WITH TEXT "THE EVOLVING GUITARIST".

SER. NO. 77-255,077, FILED 8-14-2007.

HEATHER THOMPSON, EXAMINING ATTORNEY

Int. Cl.: 30

Prior U.S. Cl.: 46

United States Patent and Trademark Office

Reg. No. 3,483,615

Registered Aug. 12, 2008

**TRADEMARK
PRINCIPAL REGISTER**



MOLINO GUADALAJARA SA DE CV (MEXICO CORPORATION)
CALLE 3 #690
GUADALAJARA, MEXICO 44940

THE MARK CONSISTS OF A CROSS WITH THE NAME "LORENA" IN THE BOTTOM.

FOR: FLOUR, IN CLASS 30 (U.S. CL. 46).

SER. NO. 77-255,188, FILED 8-14-2007.

FIRST USE 3-31-2004; IN COMMERCE 3-31-2004.

JENNIFER DIXON, EXAMINING ATTORNEY

Int. Cls.: 3 and 4

Prior U.S. Cls.: 1, 4, 6, 15, 50, 51 and 52

United States Patent and Trademark Office

Reg. No. 3,483,616

Registered Aug. 12, 2008

**TRADEMARK
PRINCIPAL REGISTER**

SPIEGEL SIGNATURE

SPIEGEL CATALOG HOLDINGS CORPORATION
(DELAWARE CORPORATION)
4TH FLOOR
711 THIRD AVENUE
NEW YORK, NY 10017

FOR: EAU DE TOILETTE, COLOGNE, PERFUME
AND PERFUME OILS, IN CLASS 3 (U.S. CLS. 1, 4, 6,
50, 51 AND 52).

FIRST USE 11-17-2007; IN COMMERCE 11-17-2007.

FOR: SCENTED CANDLES, IN CLASS 4 (U.S. CLS.
1, 6 AND 15).

FIRST USE 11-17-2007; IN COMMERCE 11-17-2007.

THE MARK CONSISTS OF STANDARD CHAR-
ACTERS WITHOUT CLAIM TO ANY PARTICULAR
FONT, STYLE, SIZE, OR COLOR.

OWNER OF U.S. REG. NOS. 1,339,154, 1,840,600
AND OTHERS.

SER. NO. 77-255,689, FILED 8-15-2007.

ANN E. SAPPENFIELD, EXAMINING ATTORNEY

Int. Cls.: 9, 16, 41 and 44

**Prior U.S. Cls.: 2, 5, 21, 22, 23, 26, 29, 36, 37, 38, 50,
100, 101 and 107**

Reg. No. 3,483,617

United States Patent and Trademark Office

Registered Aug. 12, 2008

**TRADEMARK
SERVICE MARK
PRINCIPAL REGISTER**

THE BACK TRACK

UNITEDHEALTH GROUP INCORPORATED
(MINNESOTA CORPORATION)
9900 BREN ROAD EAST, MN008-T202
MINNETONKA, MN 55343

FOR: PRE-RECORDED DVDS FEATURING INFORMATION IN THE FIELDS OF HEALTH, WELLNESS AND BACK INJURY CARE AND PREVENTION, IN CLASS 9 (U.S. CLS. 21, 23, 26, 36 AND 38).

FIRST USE 5-1-2007; IN COMMERCE 5-1-2007.

FOR: PRINTED PUBLICATIONS, NAMELY, MANUALS, BOOKLETS, PAMPHLETS AND BROCHURES REGARDING ISSUES RELATED TO HEALTH AND WELLNESS, AND BACK INJURY CARE AND PREVENTION, IN CLASS 16 (U.S. CLS. 2, 5, 22, 23, 29, 37, 38 AND 50).

FIRST USE 5-1-2007; IN COMMERCE 5-1-2007.

FOR: PROVIDING TRAINING TO OTHERS IN THE FIELD OF BACK INJURY CARE AND PREVENTION, IN CLASS 41 (U.S. CLS. 100, 101 AND 107).

FIRST USE 5-1-2007; IN COMMERCE 5-1-2007.

FOR: PROVIDING INFORMATION IN THE FIELDS OF HEALTH AND WELLNESS; PROVIDING HEALTH CARE INFORMATION AND CONSULTATION IN THE FIELD OF LOW BACK INJURY CARE AND PREVENTION, IN CLASS 44 (U.S. CLS. 100 AND 101).

FIRST USE 5-1-2007; IN COMMERCE 5-1-2007.

THE MARK CONSISTS OF STANDARD CHARACTERS WITHOUT CLAIM TO ANY PARTICULAR FONT, STYLE, SIZE, OR COLOR.

SER. NO. 77-255,946, FILED 8-15-2007.

Alice Benmaman, Examining Attorney

Int. Cls.: 9, 16, 41 and 44

**Prior U.S. Cls.: 2, 5, 21, 22, 23, 26, 29, 36, 37, 38, 50,
100, 101 and 107**

Reg. No. 3,483,618

United States Patent and Trademark Office

Registered Aug. 12, 2008

**TRADEMARK
SERVICE MARK
PRINCIPAL REGISTER**

**YOUR PATH TO REDUCING BACK
PAIN**

UNITEDHEALTH GROUP INCORPORATED
(MINNESOTA CORPORATION)
9900 BREN ROAD EAST, MN008-T202
MINNETONKA, MN 55343

FOR: PRE-RECORDED DVDS FEATURING INFORMATION IN THE FIELDS OF HEALTH, WELLNESS AND BACK INJURY CARE AND PREVENTION, IN CLASS 9 (U.S. CLS. 21, 23, 26, 36 AND 38).

FIRST USE 5-1-2007; IN COMMERCE 5-1-2007.

FOR: PRINTED PUBLICATIONS, NAMELY, MANUALS, BOOKLETS, PAMPHLETS AND BROCHURES REGARDING ISSUES RELATED TO HEALTH AND WELLNESS, AND BACK INJURY CARE AND PREVENTION, IN CLASS 16 (U.S. CLS. 2, 5, 22, 23, 29, 37, 38 AND 50).

FIRST USE 5-1-2007; IN COMMERCE 5-1-2007.

FOR: PROVIDING TRAINING TO OTHERS IN THE FIELD OF BACK INJURY CARE AND PREVENTION, IN CLASS 41 (U.S. CLS. 100, 101 AND 107).

FIRST USE 5-1-2007; IN COMMERCE 5-1-2007.

FOR: PROVIDING INFORMATION IN THE FIELDS OF HEALTH AND WELLNESS; PROVIDING HEALTH CARE INFORMATION AND CONSULTATION IN THE FIELD OF LOW BACK INJURY CARE AND PREVENTION, IN CLASS 44 (U.S. CLS. 100 AND 101).

FIRST USE 5-1-2007; IN COMMERCE 5-1-2007.

THE MARK CONSISTS OF STANDARD CHARACTERS WITHOUT CLAIM TO ANY PARTICULAR FONT, STYLE, SIZE, OR COLOR.

NO CLAIM IS MADE TO THE EXCLUSIVE RIGHT TO USE "REDUCING BACK PAIN", APART FROM THE MARK AS SHOWN.

SER. NO. 77-255,992, FILED 8-15-2007.

ALICE BENMAMAN, EXAMINING ATTORNEY

Int. Cl.: 41

Prior U.S. Cls.: 100, 101 and 107

United States Patent and Trademark Office

Reg. No. 3,483,619

Registered Aug. 12, 2008

**SERVICE MARK
PRINCIPAL REGISTER**

BRAINSTUFF

HOWSTUFFWORKS, INC. (DELAWARE CORPORATION)
SUITE 1500
ONE CAPITAL CITY PLZA; 3350 PEACHTREE RD
ATLANTA, GA 30326

FOR: ENTERTAINMENT SERVICES, NAMELY, PROVIDING PODCASTS IN THE FIELD OF SCIENCE, TECHNOLOGY, HEALTH, MEDICINE, NATURE, AND TRAVEL; ON-LINE JOURNALS, NAMELY, BLOGS FEATURING INFORMATION IN THE FIELDS OF SCIENCE, TECHNOLOGY, HEALTH, MEDICINE, NATURE, AND TRAVEL; PROVIDING INFORMATION, NEWS AND COM-

MENTARY IN THE FIELD OF ENTERTAINMENT, IN CLASS 41 (U.S. CLS. 100, 101 AND 107).

FIRST USE 7-19-2007; IN COMMERCE 7-19-2007.

THE MARK CONSISTS OF STANDARD CHARACTERS WITHOUT CLAIM TO ANY PARTICULAR FONT, STYLE, SIZE, OR COLOR.

SER. NO. 77-256,003, FILED 8-15-2007.

STEVEN JACKSON, EXAMINING ATTORNEY

Int. Cls.: 9, 16, 41 and 44

**Prior U.S. Cls.: 2, 5, 21, 22, 23, 26, 29, 36, 37, 38, 50,
100, 101 and 107**

Reg. No. 3,483,620

United States Patent and Trademark Office

Registered Aug. 12, 2008

**TRADEMARK
SERVICE MARK
PRINCIPAL REGISTER**



UNITEDHEALTH GROUP INCORPORATED
(MINNESOTA CORPORATION)
9900 BREN ROAD EAST, MN008-T202
MINNETONKA, MN 55343

FOR: PRE-RECORDED DVDS FEATURING INFORMATION IN THE FIELDS OF HEALTH, WELLNESS AND BACK INJURY CARE AND PREVENTION, IN CLASS 9 (U.S. CLS. 21, 23, 26, 36 AND 38).

FIRST USE 5-1-2007; IN COMMERCE 5-1-2007.

FOR: PRINTED PUBLICATIONS, NAMELY, MANUALS, BOOKLETS, PAMPHLETS AND BROCHURES REGARDING ISSUES RELATED TO HEALTH AND WELLNESS, AND BACK INJURY CARE AND PREVENTION, IN CLASS 16 (U.S. CLS. 2, 5, 22, 23, 29, 37, 38 AND 50).

FIRST USE 5-1-2007; IN COMMERCE 5-1-2007.

FOR: PROVIDING TRAINING TO OTHERS IN THE FIELD OF BACK INJURY CARE AND PREVENTION, IN CLASS 41 (U.S. CLS. 100, 101 AND 107).

FIRST USE 5-1-2007; IN COMMERCE 5-1-2007.

FOR: PROVIDING INFORMATION IN THE FIELDS OF HEALTH AND WELLNESS; PROVIDING HEALTH CARE INFORMATION AND CONSULTATION IN THE FIELD OF LOW BACK INJURY CARE AND PREVENTION, IN CLASS 44 (U.S. CLS. 100 AND 101).

FIRST USE 5-1-2007; IN COMMERCE 5-1-2007.

SER. NO. 77-256,027, FILED 8-15-2007.

ALICE BENMAMAN, EXAMINING ATTORNEY

Int. Cl.: 10

Prior U.S. Cls.: 26, 39 and 44

United States Patent and Trademark Office

Reg. No. 3,483,621

Registered Aug. 12, 2008

**TRADEMARK
PRINCIPAL REGISTER**

TRIDENT

MEDICAL COMPONENTS, INC. (PENNSYLVANIA CORPORATION)
1499 DELP DRIVE
HARLEYSVILLE, PA 19438

FOR: CATHETERS; CATHETER-EQUIPPED NURSING TRAYS; CATHETER EQUIPPED TRAYS FOR USE BY PHYSICIANS AND OTHER HEALTH CARE PROFESSIONALS DURING PLACEMENT IN PATIENTS OF CATHETERS BY RADIOLOGICALLY GUIDED AND OTHER MEANS, IN CLASS 10 (U.S. CLS. 26, 39 AND 44).

FIRST USE 9-15-2004; IN COMMERCE 9-15-2004.

THE MARK CONSISTS OF STANDARD CHARACTERS WITHOUT CLAIM TO ANY PARTICULAR FONT, STYLE, SIZE, OR COLOR.

SER. NO. 77-256,148, FILED 8-15-2007.

LINDA MICKLEBURGH, EXAMINING ATTORNEY

Int. Cls.: 5, 9 and 16

Prior U.S. Cls.: 2, 5, 6, 18, 21, 22, 23, 26, 29, 36, 37, 38, 44, 46, 50, 51 and 52

Reg. No. 3,483,622

United States Patent and Trademark Office

Registered Aug. 12, 2008

**TRADEMARK
PRINCIPAL REGISTER**

BODYTRIM

IGIA PACIFIC PTY LTD (AUSTRALIA CORPORATION)
SUITE 1605, 33 BLIGH STREET
SYDNEY, AUSTRALIA 2000

FOR: DIETARY SUPPLEMENTS FOR WEIGHT REDUCTION; DIETARY FOOD SUPPLEMENTS FOR MEDICAL USE; DIETARY NUTRITIONAL SUPPLEMENTS FOR MEDICAL USE; MINERAL DIETARY SUPPLEMENTS FOR HUMANS; NUTRITIONAL SUPPLEMENTS; VITAMIN AND MINERAL SUPPLEMENTS; MULTIVITAMINS; DIETARY ENZYME SUPPLEMENTS FOR MEDICAL PURPOSES; FOOD SUPPLEMENTS FOR MEDICAL PURPOSES; NUTRITIONAL ADDITIVES FOR MEDICAL PURPOSES FOR USE IN FOODS AND DIETARY SUPPLEMENTS FOR HUMAN CONSUMPTION; VITAMIN PREPARATIONS IN THE NATURE OF FOOD SUPPLEMENTS; DIETETIC FOODS ADAPTED FOR MEDICAL USE FOR WEIGHT CONTROL; POWDERED DIETARY FOOD SUPPLEMENT CONCENTRATES FOR USE IN A WEIGHT REDUCTION PROGRAM FOR MEDICAL PURPOSES; APPETITE STIMULANT PREPARATIONS; APPETITE SUPPRESSANTS FOR MEDICAL PURPOSES; PHARMACEUTICAL APPETITE SUPPRESSANTS; CENTRAL NERVOUS SYSTEM STIMULANTS FOR MEDICAL PURPOSES; PHARMACEUTICALS FOR THE PURPOSE OF WEIGHT CONTROL; INSTRUCTION MANUALS SOLD WITH THE AFORESAID GOODS AS A UNIT, IN CLASS 5 (U.S. CLS. 6, 18, 44, 46, 51 AND 52).

FOR: PRE-RECORDED DVD'S FEATURING PROGRAMS ABOUT WEIGHT CONTROL; PRE-RECORDED CD'S FEATURING AUDIO PROGRAMS ABOUT WEIGHT CONTROL; DOWNLOADABLE ELECTRONIC PUBLICATIONS IN THE NATURE OF NEWSLETTERS, MAGAZINES, BOOKS AND INSTRUCTION MANUALS IN THE FIELD OF

WEIGHT CONTROL; PRE-RECORDED INSTRUCTIONAL CDS AND DVDS FEATURING PROGRAMS ABOUT WEIGHT CONTROL; INSTRUCTION MANUALS SOLD WITH THE AFORESAID GOODS AS A UNIT, IN CLASS 9 (U.S. CLS. 21, 23, 26, 36 AND 38).

FOR: PRINTED PUBLICATIONS, NAMELY, NEWSLETTERS, MAGAZINES, HANDBOOKS, GUIDE BOOKS, TRAINING GUIDES, INSTRUCTION BOOKS, USER'S GUIDES, INSTRUCTION MANUALS, PAMPHLETS, BROCHURES, CATALOGUES, AND BOOKS IN THE FIELD OF WEIGHT CONTROL; INSTRUCTIONAL CHARTS FOR USE IN RELATION TO EXERCISE, IN CLASS 16 (U.S. CLS. 2, 5, 22, 23, 29, 37, 38 AND 50).

THE MARK CONSISTS OF STANDARD CHARACTERS WITHOUT CLAIM TO ANY PARTICULAR FONT, STYLE, SIZE, OR COLOR.

PRIORITY CLAIMED UNDER SEC. 44(D) ON AUSTRALIA APPLICATION NO. 1169572, FILED 4-3-2007, REG. NO. 1169572, DATED 4-3-2007, EXPIRES 4-3-2017.

PRIORITY CLAIMED UNDER SEC. 44(D) ON AUSTRALIA APPLICATION NO. 1169575, FILED 4-3-2007, REG. NO. 1169575, DATED 4-3-2007, EXPIRES 4-3-2017.

PRIORITY CLAIMED UNDER SEC. 44(D) ON AUSTRALIA APPLICATION NO. 1169577, FILED 4-3-2007, REG. NO. 1169577, DATED 4-3-2007, EXPIRES 4-3-2017.

SER. NO. 77-256,529, FILED 8-16-2007.

DAVID TOOLEY, EXAMINING ATTORNEY

Int. Cl.: 16

Prior U.S. Cls.: 2, 5, 22, 23, 29, 37, 38 and 50

United States Patent and Trademark Office

Reg. No. 3,483,623

Registered Aug. 12, 2008

**TRADEMARK
PRINCIPAL REGISTER**

Utah's premier information source for people 50 and better!

ACTION MARKETING LLC (UTAH LTD LIAB
CO)
7835 SOUTH 2000 EAST
SOUTH WEBER, UT 84405

FOR: NEWSPAPERS, IN CLASS 16 (U.S. CLS. 2, 5,
22, 23, 29, 37, 38 AND 50).

FIRST USE 3-12-2007; IN COMMERCE 5-1-2007.

NO CLAIM IS MADE TO THE EXCLUSIVE
RIGHT TO USE "SENIORS" AND "UTAH'S PRE-
MIER INFORMATION SOURCE FOR PEOPLE 50",
APART FROM THE MARK AS SHOWN.

THE COLOR(S) BLACK AND BLUE IS/ARE
CLAIMED AS A FEATURE OF THE MARK.

THE COLOR BLUE APPEARS IN THE TEXT OF
THE WORDING "SIMPLY SENIORS", WHILE THE
COLOR BLACK APPEARS IN THE TEXT OF THE
WORDING "UTAH'S PREMIER INFORMATION
SOURCE FOR PEOPLE 50 AND BETTER".

SER. NO. 77-256,630, FILED 8-16-2007.

ELI HELLMAN, EXAMINING ATTORNEY

Int. Cl.: 9

Prior U.S. Cls.: 21, 23, 26, 36 and 38

United States Patent and Trademark Office

Reg. No. 3,483,624

Registered Aug. 12, 2008

**TRADEMARK
PRINCIPAL REGISTER**



STONEWARE, INC. (INDIANA CORPORATION)
14300 CLAY TERRACE BOULEVARD, SUITE 240
CARMEL, IN 46032

FOR: COMPUTER SOFTWARE THAT PROVIDES
WEB-BASED ACCESS TO APPLICATIONS AND
SERVICES THROUGH A WEB OPERATING SYS-
TEM OR PORTAL INTERFACE, IN CLASS 9 (U.S.
CLS. 21, 23, 26, 36 AND 38).

FIRST USE 6-0-2005; IN COMMERCE 6-0-2005.

NO CLAIM IS MADE TO THE EXCLUSIVE
RIGHT TO USE "SW", APART FROM THE MARK
AS SHOWN.

SER. NO. 77-257,678, FILED 8-17-2007.

KELLEY WELLS, EXAMINING ATTORNEY

Int. Cls.: 9 and 11

Prior U.S. Cls.: 13, 21, 23, 26, 31, 34, 36 and 38

United States Patent and Trademark Office

Reg. No. 3,483,625

Registered Aug. 12, 2008

**TRADEMARK
PRINCIPAL REGISTER**

KUNNE

JOKINEN, TEPPU K (UNITED STATES INDIVIDUAL)
4300 10TH AVE N.
LAKE WORTH, FL 33461

FOR: CLIMATE CONTROL SYSTEMS CONSISTING OF DIGITAL THERMOSTATS, AIR CONDITIONING, HEATING, VENTILATION AND DRYING CONTROL DEVICES , IN CLASS 9 (U.S. CLS. 21, 23, 26, 36 AND 38).

FIRST USE 7-19-1997; IN COMMERCE 12-22-1998.

FOR: AIR CONDITIONING UNITS, IN CLASS 11 (U.S. CLS. 13, 21, 23, 31 AND 34).

FIRST USE 7-14-1997; IN COMMERCE 12-22-1998.

THE MARK CONSISTS OF A STYLIZED LETTERS "K", "U", "N", "N", "E" FORMING THE WORD "KUNNE".

SER. NO. 77-258,164, FILED 8-17-2007.

DOMINICK J. SALEMI, EXAMINING ATTORNEY

Int. Cl.: 3

Prior U.S. Cls.: 1, 4, 6, 50, 51 and 52

United States Patent and Trademark Office

Reg. No. 3,483,626

Registered Aug. 12, 2008

**TRADEMARK
PRINCIPAL REGISTER**



THE WILLIAM M. YARBROUGH FOUNDATION
(ILLINOIS CORPORATION)
7800 SEARS TOWER
C/O MICHALE LEGAMARO, 233 S. WACKER DR.
CHICAGO, IL 60606

FOR: NON-MEDICATED TOPICAL WASH FOR
USE IN POISON IVY, OAK AND LIKE REACTIONS,
IN CLASS 3 (U.S. CLS. 1, 4, 6, 50, 51 AND 52).

FIRST USE 2-1-2003; IN COMMERCE 2-1-2003.

OWNER OF U.S. REG. NOS. 2,859,827, 2,980,463
AND OTHERS.

NO CLAIM IS MADE TO THE EXCLUSIVE
RIGHT TO USE FOR POISON IVY, OAK & SUMAC,
APART FROM THE MARK AS SHOWN.

THE COLOR(S) GREY, LIGHT GREEN, DARK
GREEN, BLACK AND WHITE IS/ARE CLAIMED AS
A FEATURE OF THE MARK.

THE MARK CONSISTS OF THE PRODUCT
NAME "ZANFEL" IN CAPITAL LETTERS IN
BLACK WITH WHITE OUTLINING, WITH A
SMALL BRANCH IN GREEN OUTLINED IN
BLACK, WITH THREE LEAVES ATTACHED IN
LIGHT GREEN WITH FIRST BLACK OUTLINING,
THEN SURROUNDED BY WHITE TO THE RIGHT
OF THE WORD "ZANFEL", WITH THE WORDS
"FOR POISON IVY, OAK & SUMAC" IN BLACK
LETTERS DIRECTLY BELOW THE WORD "ZAN-
FEL", WITH 4 DARKER GREEN LINES WHICH
ARE THE SAME SIZE AND ONE DARK GREEN
LINE WHICH IS THICKER AT THE BOTTOM OF
THE DESIGN ALL RUNNING HORIZONTALLY
THROUGH A GREY BACKGROUND, AND TWO
OF THE LINES ALSO RUN THROUGH THE WORD
"ZANFEL" AND THE THREE LEAVES.

SER. NO. 77-258,860, FILED 8-19-2007.

SUNG IN, EXAMINING ATTORNEY

Int. Cl.: 33

Prior U.S. Cls.: 47 and 49

United States Patent and Trademark Office

Reg. No. 3,483,627

Registered Aug. 12, 2008

**TRADEMARK
PRINCIPAL REGISTER**

FALSE BAY

BOUTINOT LIMITED (UNITED KINGDOM COR-
PORATION)

BROOK HOUSE

4 NORTHENDON ROAD

GATLEY, UNITED KINGDOM 5484DN

FOR: WINES, IN CLASS 33 (U.S. CLS. 47 AND 49).

FIRST USE 3-16-2001; IN COMMERCE 3-16-2001.

THE MARK CONSISTS OF STANDARD CHAR-
ACTERS WITHOUT CLAIM TO ANY PARTICULAR
FONT, STYLE, SIZE, OR COLOR.

OWNER OF U.S. REG. NO. 2,551,313.

SEC. 2(F).

SER. NO. 77-259,393, FILED 8-20-2007.

STEPHEN AQUILA, EXAMINING ATTORNEY

Int. Cls.: 9 and 41

Prior U.S. Cls.: 21, 23, 26, 36, 38, 100, 101 and 107

Reg. No. 3,483,628

United States Patent and Trademark Office

Registered Aug. 12, 2008

**TRADEMARK
SERVICE MARK
PRINCIPAL REGISTER**

**ILL COMMISSION
ENTERTAINMENT**

ROBINSON, JEVON (UNITED STATES INDIVIDUAL)

7602#234 FONTAINBLUEI DR.

NEW CARROLLTON, MD 20784 AND

HEMPHILL, KORTEZ V. SR. (UNITED STATES INDIVIDUAL)

7602#234 FONTAINBLUEI DR.

NEW CARROLLTON, MD 20784 AND

BRYANT, TERMAINE D. (UNITED STATES INDIVIDUAL)

7602#234 FONTAINBLUEI DR.

NEW CARROLLTON, MD 20784

FOR: MUSICAL SOUND RECORDINGS; COMPACT DISCS, DVDS, AND AUDIOTAPES, ALL FEATURING MUSIC, IN CLASS 9 (U.S. CLS. 21, 23, 26, 36 AND 38).

FIRST USE 2-1-2003; IN COMMERCE 8-20-2007.

FOR: ENTERTAINMENT IN THE NATURE OF LIVE PERFORMANCES BY RAPPERS, SINGERS AND MUSICAL BANDS, IN CLASS 41 (U.S. CLS. 100, 101 AND 107).

FIRST USE 2-1-2003; IN COMMERCE 8-20-2007.

THE MARK CONSISTS OF STANDARD CHARACTERS WITHOUT CLAIM TO ANY PARTICULAR FONT, STYLE, SIZE, OR COLOR.

NO CLAIM IS MADE TO THE EXCLUSIVE RIGHT TO USE "ENTERTAINMENT", APART FROM THE MARK AS SHOWN.

SER. NO. 77-259,509, FILED 8-20-2007.

BRENDAN REGAN, EXAMINING ATTORNEY

Int. Cl.: 43

Prior U.S. Cls.: 100 and 101

United States Patent and Trademark Office

Reg. No. 3,483,629

Registered Aug. 12, 2008

**SERVICE MARK
PRINCIPAL REGISTER**

YOGIS GRILL
TERIYAKI & ROLL

YOGIS GRILL FRANCHISE MANAGEMENT,
INC. (ARIZONA CORPORATION)
2189 E. LYNX PLACE
CHANDLER, AZ 85249

FOR: FAST-FOOD RESTAURANTS; FOOD PREPARATION SERVICES; PREPARATION OF FOOD AND BEVERAGES; PROVIDING OF FOOD AND DRINK; SERVING FOOD AND DRINKS; SERVING OF FOOD AND DRINK/BEVERAGES, IN CLASS 43 (U.S. CLS. 100 AND 101).

FIRST USE 3-16-2005; IN COMMERCE 3-16-2005.

NO CLAIM IS MADE TO THE EXCLUSIVE RIGHT TO USE "GRILL", APART FROM THE MARK AS SHOWN.

THE COLOR(S) RED, BLACK AND WHITE IS/ ARE CLAIMED AS A FEATURE OF THE MARK.

THE MARK CONSISTS OF THE WORDS "YOGIS GRILL" ARE IN RED AND OUTLINED IN BLACK. THERE IS A BLACK LONG OVAL BOX THAT CONTAINS THE WORDS "TERIYAKI ROLL" WHICH ARE IN WHITE AND AN AMPERSAM IS RED.

SER. NO. 77-259,722, FILED 8-20-2007.

THOMAS MANOR, EXAMINING ATTORNEY

Int. Cl.: 9

Prior U.S. Cls.: 21, 23, 26, 36 and 38

Reg. No. 3,483,630

United States Patent and Trademark Office

Registered Aug. 12, 2008

**TRADEMARK
PRINCIPAL REGISTER**

BLACKMALE

BAUGH, LAVAR R (UNITED STATES INDIVIDUAL)
2299 PRIMROSE LANE #1405
CLEARWATER, FL 33763

THE MARK CONSISTS OF STANDARD CHARACTERS WITHOUT CLAIM TO ANY PARTICULAR FONT, STYLE, SIZE, OR COLOR.

FOR: SOUND RECORDINGS FEATURING MUSIC, IN CLASS 9 (U.S. CLS. 21, 23, 26, 36 AND 38).

SER. NO. 77-260,311, FILED 8-21-2007.

FIRST USE 12-25-2006; IN COMMERCE 3-10-2007.

MORGAN WYNNE, EXAMINING ATTORNEY

Int. Cl.: 35

Prior U.S. Cls.: 100, 101 and 102

United States Patent and Trademark Office

Reg. No. 3,483,631

Registered Aug. 12, 2008

**SERVICE MARK
PRINCIPAL REGISTER**

CLIENTIZE

CLIENTIZE.COM INC. (FLORIDA CORPORATION)
408 COTTONWOOD PLACE
BOCA RATON, FL 33431

FOR: BUSINESS MARKETING SERVICES; DISSEMINATION OF MARKETING AND ADVERTISING FOR OTHERS VIA THE INTERNET; DESIGN OF ADVERTISING AND MARKETING MATERIALS FOR OTHERS; DESIGN AND ONLINE DISSEMINATION OF MARKETING AND ADVERTISING MATERIALS FOR OTHERS, NAMELY, PROMOTIONAL NEWSLETTERS AND MARKETING NEWSLETTERS TO SUPPORT CUSTOMER BUSINESS, IN CLASS 35 (U.S. CLS. 100, 101 AND 102).

FIRST USE 10-17-2000; IN COMMERCE 10-17-2000.

THE MARK CONSISTS OF STANDARD CHARACTERS WITHOUT CLAIM TO ANY PARTICULAR FONT, STYLE, SIZE, OR COLOR.

OWNER OF U.S. REG. NOS. 2,474,461 AND 2,493,461.

SER. NO. 77-260,450, FILED 8-21-2007.

CHARLOTTE CORWIN, EXAMINING ATTORNEY

Int. Cl.: 9

Prior U.S. Cls.: 21, 23, 26, 36 and 38

Reg. No. 3,483,632

United States Patent and Trademark Office

Registered Aug. 12, 2008

**TRADEMARK
PRINCIPAL REGISTER**

MAPSTER

VIRTUALTOURIST.COM, INC. (CALIFORNIA
CORPORATION)
BUILDING 6-B
1600 ROSECRANS AVENUE
MANHATTAN BEACH, CA 90266

THE MARK CONSISTS OF STANDARD CHAR-
ACTERS WITHOUT CLAIM TO ANY PARTICULAR
FONT, STYLE, SIZE, OR COLOR.

FOR: COMPUTER SOFTWARE FOR SOCIAL
NETWORKING AND TRAVEL MANAGEMENT,
IN CLASS 9 (U.S. CLS. 21, 23, 26, 36 AND 38).

SER. NO. 77-260,479, FILED 8-21-2007.

FIRST USE 7-0-2007; IN COMMERCE 7-0-2007.

SOPHIA S. KIM, EXAMINING ATTORNEY

Int. Cls.: 24 and 25

Prior U.S. Cls.: 22, 39, 42 and 50

United States Patent and Trademark Office

Reg. No. 3,483,633

Registered Aug. 12, 2008

**TRADEMARK
PRINCIPAL REGISTER**

bubbaloo babies

MONTLACK, LAINI (UNITED STATES INDIVIDUAL)
2847 SEDGEWICK ROAD
SHAKER HEIGHTS, OH 44120

FOR: (BASED ON USE IN COMMERCE) CHILDREN'S BLANKETS; BURP CLOTHS, IN CLASS 24 (U.S. CLS. 42 AND 50).

FIRST USE 4-30-2007; IN COMMERCE 4-30-2007.

FOR: (BASED ON USE IN COMMERCE) CHILDREN'S AND INFANTS' CLOTH BIBS; CLOTH BIBS; CLOTH DIAPERS; CHILDREN'S CLOTH EATING BIBS; INFANT CLOTH DIAPERS, IN CLASS 25 (U.S. CLS. 22 AND 39).

FIRST USE 4-30-2007; IN COMMERCE 4-30-2007.

THE COLOR(S) BROWN AND BLUE AND WHITE IS/ARE CLAIMED AS A FEATURE OF THE MARK.

THE MARK CONSISTS OF ONE WORD BUBBALOOBABIES WITH BROWN LETTERS FOR BUABLOO AND BLUE LETTERS FOR BABIES WITH A WHITE BACKGROUND WITH BLUE DOTS AND BROWN EYEBROWS.

SER. NO. 77-260,517, FILED 8-21-2007.

SOPHIA S. KIM, EXAMINING ATTORNEY

Int. Cl.: 3

Prior U.S. Cls.: 1, 4, 6, 50, 51 and 52

United States Patent and Trademark Office

Reg. No. 3,483,634

Registered Aug. 12, 2008

**TRADEMARK
PRINCIPAL REGISTER**



THE WILLIAM M. YARBROUGH FOUNDATION
(ILLINOIS CORPORATION)
7800 SEARS TOWER
C/O MICHAEL LEGAMARO, 233 S. WACKER DR.
CHICAGO, IL 60606

FOR: NON-MEDICATED TOPICAL WASH FOR
USE IN POISON IVY, OAK AND LIKE REACTIONS,
IN CLASS 3 (U.S. CLS. 1, 4, 6, 50, 51 AND 52).

FIRST USE 2-1-2003; IN COMMERCE 2-1-2003.

OWNER OF U.S. REG. NOS. 2,859,827, 2,980,463
AND OTHERS.

NO CLAIM IS MADE TO THE EXCLUSIVE
RIGHT TO USE "FOR POISON IVY, OAK & SU-
MAC", APART FROM THE MARK AS SHOWN.

THE COLOR(S) BLUISH-GREEN, BLACK,
WHITE, LIGHTER GREEN, SILVER-GREY IS/ARE
CLAIMED AS A FEATURE OF THE MARK.

THE MARK CONSISTS OF THE WORD "ZAN-
FEL" IN BLACK WITH WHITE OUTLINING, WITH
THE WORDS "FOR POISON IVY, OAK & SUMAC"
UNDER THE WORD "ZANFEL" IN WHITE IM-
POSED ON A BLUISH-GREEN BACKGROUND
WITH WITH A THREE LEAF DESIGN TO THE
RIGHT OF THE LETTER "L" IN "ZANFEL" IN A
LIGHTER GREEN OUTLINED IN BLACK ALL ON
A SILVER-GREY BACKGROUND WITH BLUISH-
GREEN LINES RUNNING HORIZONTALLY BE-
HIND THE LOGO AND DESIGN.

SER. NO. 77-261,285, FILED 8-22-2007.

SUNG IN, EXAMINING ATTORNEY

Int. Cl.: 5

Prior U.S. Cls.: 6, 18, 44, 46, 51 and 52

United States Patent and Trademark Office

Reg. No. 3,483,635

Registered Aug. 12, 2008

**TRADEMARK
PRINCIPAL REGISTER**

CYCLADOL

BARRY J. LEON (UNITED STATES INDIVIDUAL)
326 LINDEN PLACE
WEST HEMPSTEAD, NY 11552

THE MARK CONSISTS OF STANDARD CHARACTERS WITHOUT CLAIM TO ANY PARTICULAR FONT, STYLE, SIZE, OR COLOR.

FOR: DIETARY SUPPLEMENTS FOR HUMAN CONSUMPTION, IN CLASS 5 (U.S. CLS. 6, 18, 44, 46, 51 AND 52).

SER. NO. 77-261,368, FILED 8-22-2007.

FIRST USE 1-15-1998; IN COMMERCE 1-15-1998.

JUSTINE D. PARKER, EXAMINING ATTORNEY

Int. Cl.: 9

Prior U.S. Cls.: 21, 23, 26, 36 and 38

Reg. No. 3,483,636

United States Patent and Trademark Office

Registered Aug. 12, 2008

**TRADEMARK
PRINCIPAL REGISTER**

UNIVISION MÓVIL

UNIVISION COMMUNICATIONS INC. (DELA-
WARE CORPORATION)
5999 CENTER DRIVE
LOS ANGELES, CA 90045

FOR: DOWNLOADABLE RINGTONES, MUSIC,
PHOTOGRAPHS, IMAGES, ELECTRONIC GAMES,
AUDIO FILES, VIDEO FILES, FILM CLIPS, AND
OTHER MULTIMEDIA MATERIALS VIA MOBILE
PHONES AND OTHER HAND-HELD OR WIRELESS
DEVICES; DOWNLOADABLE PODCASTS TO MO-
BILE PHONES AND OTHER HAND-HELD OR
WIRELESS DEVICES IN THE FIELD OF NEWS
AND ENTERTAINMENT PROGRAMS, IN CLASS 9
(U.S. CLS. 21, 23, 26, 36 AND 38).

FIRST USE 10-26-2004; IN COMMERCE 10-26-2004.

THE MARK CONSISTS OF STANDARD CHAR-
ACTERS WITHOUT CLAIM TO ANY PARTICULAR
FONT, STYLE, SIZE, OR COLOR.

NO CLAIM IS MADE TO THE EXCLUSIVE
RIGHT TO USE "MOVIL", APART FROM THE
MARK AS SHOWN.

THE ENGLISH TRANSLATION OF THE WORD
"UNIVISION MÓVIL" IN THE MARK IS UNIVISION
MOBILE.

SER. NO. 77-261,538, FILED 8-22-2007.

DAVID C. REIHNER, EXAMINING ATTORNEY

Int. Cl.: 10

Prior U.S. Cls.: 26, 39 and 44

United States Patent and Trademark Office

Reg. No. 3,483,637

Registered Aug. 12, 2008

**TRADEMARK
PRINCIPAL REGISTER**

VIRILITY STRING

COMEAU, JEAN (CANADA INDIVIDUAL)
1021 HYMAN, SUITE 103
DOLLARD DES ORMEAUX, CANADA H9B2L4

FOR: PENILE ERECTION ASSISTING CINTURE,
NAMELY, ELASTOMERIC TUBE FOR USE IN
REACHING AND MAINTAINING PENILE EREC-
TION IN MEN WITH ERECTILE DYSFUNCTION,
IN CLASS 10 (U.S. CLS. 26, 39 AND 44).

FIRST USE 12-1-2006; IN COMMERCE 7-1-2007.

THE MARK CONSISTS OF STANDARD CHAR-
ACTERS WITHOUT CLAIM TO ANY PARTICULAR
FONT, STYLE, SIZE, OR COLOR.

PRIORITY CLAIMED UNDER SEC. 44(D) ON
CANADA APPLICATION NO. 1,336,628, FILED 2-23-
2007, REG. NO. TMA710203, DATED 3-26-2008, EX-
PIRES 3-26-2023.

SER. NO. 77-261,612, FILED 8-22-2007.

ANGELA GAW, EXAMINING ATTORNEY

Int. Cl.: 35

Prior U.S. Cls.: 100, 101 and 102

United States Patent and Trademark Office

Reg. No. 3,483,638

Registered Aug. 12, 2008

**SERVICE MARK
PRINCIPAL REGISTER**



ECO-BELLA, LLC (GEORGIA LTD LIAB CO)
1281 DURAND MILL DRIVE
ATLANTA, GA 30307

FOR: RETAIL CLOTHING STORES, IN CLASS 35
(U.S. CLS. 100, 101 AND 102).

FIRST USE 4-17-2006; IN COMMERCE 4-17-2006.

THE MARK CONSISTS OF LETTERS "C", "B",
TWO "E'S", AND TWO "L'S" AS STANDARD LET-
TERS OF THE ALPHABET. THE "O" IS REPRESENTED

BY A GLOBE WITH OUTLINES OF
CONTINENTS. ABOVE THE "O" IS A COAT HANG-
ER. THE "A" IS REPRESENTED BY A GEOMETRIC
FIGURE..

THE FOREIGN WORDING IN THE MARK
TRANSLATES INTO ENGLISH AS BEAUTIFUL
FOR THE ITALIAN WORD "BELLA".

SER. NO. 77-261,837, FILED 8-22-2007.

INGA ERVIN, EXAMINING ATTORNEY

Int. Cl.: 19

Prior U.S. Cls.: 1, 12, 33 and 50

United States Patent and Trademark Office

Reg. No. 3,483,639

Registered Aug. 12, 2008

**TRADEMARK
PRINCIPAL REGISTER**

 **FOLDADOOOR**

LA CANTINA DOORS, INC. (CALIFORNIA CORPORATION)
3720 CORPORATE VIEW, STE D
VISTA, CA 92081

FOR: DOOR PANELS, NOT OF METAL; NON-METAL DOOR UNITS; NON-METAL PATIO DOORS; DOOR FRAMES, NOT OF METAL, IN CLASS 19 (U.S. CLS. 1, 12, 33 AND 50).

FIRST USE 3-22-2007; IN COMMERCE 4-28-2007.

THE MARK CONSISTS OF THREE RECTANGLES PRECEDING THE WORD "FOLDADOOOR".

SER. NO. 77-262,194, FILED 8-22-2007.

ELISSA GARBER KON, EXAMINING ATTORNEY

Int. Cl.: 40

Prior U.S. Cls.: 100, 103 and 106

United States Patent and Trademark Office

Reg. No. 3,483,640

Registered Aug. 12, 2008

**SERVICE MARK
PRINCIPAL REGISTER**

SOS MOLD

ANTHRACITE RADON MITIGATION, INC
(PENNSYLVANIA CORPORATION), DBA SOS
MOLD

768 STATE ROUTE 307
MOSCOW, PA 18444

FOR: MOLD REMEDIATION SERVICES, IN
CLASS 40 (U.S. CLS. 100, 103 AND 106).

FIRST USE 0-0-2002; IN COMMERCE 0-0-2002.

THE MARK CONSISTS OF STANDARD CHAR-
ACTERS WITHOUT CLAIM TO ANY PARTICULAR
FONT, STYLE, SIZE, OR COLOR.

NO CLAIM IS MADE TO THE EXCLUSIVE
RIGHT TO USE "MOLD", APART FROM THE
MARK AS SHOWN.

SER. NO. 77-262,369, FILED 8-23-2007.

DAVID ELTON, EXAMINING ATTORNEY

Int. Cl.: 29

Prior U.S. Cl.: 46

Reg. No. 3,483,641

United States Patent and Trademark Office

Registered Aug. 12, 2008

**TRADEMARK
PRINCIPAL REGISTER**

PHIL'S FRESH FOODS

PHIL'S FRESH FOODS, INC. (DELAWARE COR-
PORATION)
UNIT A
1845 RANGE STREET
BOULDER, CO 80301

FOR: GREEN AND FRUIT SALADS, ANTIPASTO
SALADS, DIPS, DOLMATHES, CHEESE SPREADS,
AND VEGETABLE BASED SPREADS, IN CLASS 29
(U.S. CL. 46).

FIRST USE 12-23-2000; IN COMMERCE 1-1-2001.

THE MARK CONSISTS OF STANDARD CHAR-
ACTERS WITHOUT CLAIM TO ANY PARTICULAR
FONT, STYLE, SIZE, OR COLOR.

NO CLAIM IS MADE TO THE EXCLUSIVE
RIGHT TO USE "FRESH FOODS", APART FROM
THE MARK AS SHOWN.

SER. NO. 77-262,556, FILED 8-23-2007.

DAVID TOOLEY, EXAMINING ATTORNEY

Int. Cls.: 7 and 9

Prior U.S. Cls.: 13, 19, 21, 23, 26, 31, 34, 35, 36 and 38

Reg. No. 3,483,642

United States Patent and Trademark Office

Registered Aug. 12, 2008

**TRADEMARK
PRINCIPAL REGISTER**

Intellihelp

HEIDELBERGER DRUCKMASCHINEN AG (FED
REP GERMANY CORPORATION)
KURFÜRSTEN-ANLAGE 52-60
HEIDEBERG, FED REP GERMANY 69115

FOR: PRINT SHOP MACHINES FOR THE GRAPHICS INDUSTRY, NAMELY, PRINTING MACHINES, AND MACHINES AND DEVICES FOR THE FURTHER PROCESSING OF PRINT SHOP PRODUCTS IN BINDERIES AND MAIL ROOMS, NAMELY, BINDING MACHINES, CUTTING MACHINES, PACKAGING MACHINES, WRAPPING MACHINES, STITCHING MACHINES, FOLDING MACHINES; MACHINERY CONTROL DEVICES AND PARTS FOR THE AFOREMENTIONED GOODS SOLD AS COMPONENT PARTS OF THE MACHINERY, IN CLASS 7 (U.S. CLS. 13, 19, 21, 23, 31, 34 AND 35).

FOR: ELECTRONIC CONTROL DEVICES, NAMELY, CONTROLLERS FOR CONTROLLING, REGULATING, SUPPLYING AND NETWORKING THE PRINTING PROCESS OF PRINTING MACHINES, AND FOR RECORDING, TRANSMITTING AND REPRODUCING IMAGES AND INFORMATION; COMPUTER SOFTWARE FOR OPERATING PRINT SHOP MACHINES, FOR CONTROLLING AND REGULATING THE PRINTING PROCESS IN A PRINT SHOP, FOR CREATING DIGITAL PRINT COPIES, FOR COLOR CALIBRATION, FOR PROCESSING IMAGES AND GRAPHICS, AND FOR CONTROL-

LING WORK PROCESSES IN CONNECTION WITH THE PRODUCTION OF PRINT JOB PRODUCTS; DIGITAL DATA CARRIERS FEATURING SOFTWARE FOR USE IN OPERATING PRINT MACHINES AND FOR USE IN MACHINES FOR THE FURTHER PROCESSING OF PRINT JOB PRODUCTS AND IN PREPRESS EQUIPMENT, NAMELY, IMAGE SETTERS AND COMPUTERS CONTROLLING THE PREPRESS PROCESS; CONTROL CONSOLES AND ELECTRONIC CONTROL DEVICES FOR OPERATING PRINT SHOP MACHINES, FOR CONTROLLING, REGULATING, AND NETWORKING THE PRINTING PROCESS; SCREENS, NAMELY, PROJECTION SCREENS, FLAT PANEL DISPLAY SCREENS, AND CRT DISPLAYS, IN CLASS 9 (U.S. CLS. 21, 23, 26, 36 AND 38).

THE MARK CONSISTS OF STANDARD CHARACTERS WITHOUT CLAIM TO ANY PARTICULAR FONT, STYLE, SIZE, OR COLOR.

PRIORITY CLAIMED UNDER SEC. 44(D) ON ERPNTY TM OFC APPLICATION NO. 005785373, FILED 3-26-2007, REG. NO. 005785373, DATED 2-28-2008, EXPIRES 3-26-2017.

SER. NO. 77-263,743, FILED 8-24-2007.

ESTHER BELENKER, EXAMINING ATTORNEY

Int. Cl.: 25

Prior U.S. Cls.: 22 and 39

United States Patent and Trademark Office

Reg. No. 3,483,643

Registered Aug. 12, 2008

**TRADEMARK
PRINCIPAL REGISTER**

EMBYRS

DRAKE, CHRISTOPHER M. (UNITED STATES
INDIVIDUAL)
PO BOX 2156
COEUR D ALENE, ID 83816

FOR: BELTS; BELTS MADE OF LEATHER; BELTS
OF TEXTILE; CAPS; COATS; FOOTWEAR; GLOVES;
HATS; HEADBANDS; HEADWEAR; HEAD
SCARVES; HOODS; JACKETS; LOUNGEWEAR;
NECKWEAR; PAJAMAS; PANTS; SHIRTS; SHOES;
SHORTS; SKIRTS; SOCKS; SWEAT PANTS; SWEAT
SHIRTS; SWIM WEAR; T-SHIRTS; TANK TOPS;

UNDERWEAR; VESTS; WRAPS, IN CLASS 25 (U.S.
CLS. 22 AND 39).

FIRST USE 12-1-2006; IN COMMERCE 12-1-2006.

THE MARK CONSISTS OF STANDARD CHAR-
ACTERS WITHOUT CLAIM TO ANY PARTICULAR
FONT, STYLE, SIZE, OR COLOR.

SER. NO. 77-264,164, FILED 8-24-2007.

CHRISTINE COOPER, EXAMINING ATTORNEY

Int. Cl.: 9

Prior U.S. Cls.: 21, 23, 26, 36 and 38

Reg. No. 3,483,644

United States Patent and Trademark Office

Registered Aug. 12, 2008

**TRADEMARK
PRINCIPAL REGISTER**

THE HELMET FOR YOUR NECK

LEATT BRACE HOLDINGS (PTY) LTD. (SOUTH
AFRICA PRIVATE LIMITED COMPANY)
UNIT 1
KYALAMI PLAZA, KYALAMI DRIVE
KILLARNEY GARDENS, SOUTH AFRICA 7441

FOR: SAFETY EQUIPMENT, NAMELY, A PRO-
TECTIVE NECK BRACE FOR USE IN CONJUNC-
TION WITH A FULL FACE OR OPEN FACE
PROTECTIVE HELMET TO PREVENT CERVICAL
DISK OR CERVICAL SPINE INJURY, TO OPERA-
TORS OF MOTORIZED VEHICLES INCLUDING
MOTORCYCLES, SUPER BIKES, MOTORCROSS,
GO-KARTS, ATVS, PERSONAL WATERCRAFTS,

SNOW MOBILES, MOUNTAIN BIKES, CARS,
TRUCKS, BOATS AND MILITARY VEHICLES, IN
CLASS 9 (U.S. CLS. 21, 23, 26, 36 AND 38).

FIRST USE 2-14-2006; IN COMMERCE 2-14-2006.

THE MARK CONSISTS OF STANDARD CHAR-
ACTERS WITHOUT CLAIM TO ANY PARTICULAR
FONT, STYLE, SIZE, OR COLOR.

SER. NO. 77-264,171, FILED 8-24-2007.

SALLY SHIH, EXAMINING ATTORNEY

Int. Cl.: 35

Prior U.S. Cls.: 100, 101 and 102

United States Patent and Trademark Office

Reg. No. 3,483,645

Registered Aug. 12, 2008

SERVICE MARK
PRINCIPAL REGISTER

The logo for 'Embryes' is rendered in a highly decorative, black gothic script. The letters are thick and feature intricate flourishes, particularly on the 'E' and 'y'. The 'E' has a large, sweeping top curve and a vertical stem. The 'y' has a long, elegant tail that curves back up. The overall style is reminiscent of traditional blackletter or gothic typefaces.

DRAKE, CHRISTOPHER M. (UNITED STATES
INDIVIDUAL)
PO BOX 2156
COEUR D ALENE, ID 83816

FOR: RETAIL APPAREL STORES; RETAIL
STORE SERVICES FEATURING CLOTHING,
NAMELY, BELTS, CAPS, COATS, FOOTWEAR,
GLOVES, HATS, HEAD BANDS, HEADWEAR,
HEAD SCARVES, HOODS, JACKETS, NECKWEAR,
PAJAMAS, PANTS, SHIRTS, SHOES, SHORTS,

SKIRTS, SOCKS, SWEAT PANTS, SWEAT SHIRTS,
SWIM WEAR, T-SHIRTS, TANK TOPS, UNDER-
WEAR, VESTS, WRAPS, IN CLASS 35 (U.S. CLS.
100, 101 AND 102).

FIRST USE 12-1-2006; IN COMMERCE 12-1-2006.

SER. NO. 77-264,177, FILED 8-24-2007.

CHRISTINE COOPER, EXAMINING ATTORNEY

Int. Cl.: 9

Prior U.S. Cls.: 21, 23, 26, 36 and 38

Reg. No. 3,483,646

United States Patent and Trademark Office

Registered Aug. 12, 2008

**TRADEMARK
PRINCIPAL REGISTER**

LEATT

LEATT BRACE HOLDINGS (PTY) LTD. (SOUTH
AFRICA PRIVATE LIMITED COMPANY)
UNIT 1
KYALAMI PLAZA, KYALAMI DRIVE
KILLARNEY GARDENS, SOUTH AFRICA 7441

FOR: SAFETY EQUIPMENT, NAMELY, A PRO-
TECTIVE NECK BRACE FOR USE IN CONJUNC-
TION WITH A FULL FACE OR OPEN FACE
PROTECTIVE HELMET TO PREVENT CERVICAL
DISK OR CERVICAL SPINE INJURY, TO OPERA-
TORS OF MOTORIZED VEHICLES INCLUDING
MOTORCYCLES, SUPER BIKES, MOTORCROSS,
GO-KARTS, ATVS, PERSONAL WATERCRAFTS,

SNOW MOBILES, MOUNTAIN BIKES, CARS,
TRUCKS, BOATS AND MILITARY VEHICLES, IN
CLASS 9 (U.S. CLS. 21, 23, 26, 36 AND 38).

FIRST USE 2-14-2006; IN COMMERCE 2-14-2006.

THE MARK CONSISTS OF STANDARD CHAR-
ACTERS WITHOUT CLAIM TO ANY PARTICULAR
FONT, STYLE, SIZE, OR COLOR.

SER. NO. 77-264,178, FILED 8-24-2007.

SALLY SHIH, EXAMINING ATTORNEY

Int. Cl.: 5

Prior U.S. Cls.: 6, 18, 44, 46, 51 and 52

Reg. No. 3,483,647

United States Patent and Trademark Office

Registered Aug. 12, 2008

**TRADEMARK
PRINCIPAL REGISTER**

COLOSTRUM 80/40

PROPER NUTRITION, INC. (DELAWARE CORPORATION)
P.O. BOX 13905
READING, PA 19612

NO CLAIM IS MADE TO THE EXCLUSIVE RIGHT TO USE "COLOSTRUM", APART FROM THE MARK AS SHOWN.

FOR: DIETARY SUPPLEMENTS CONTAINING COLOSTRUM, IN CLASS 5 (U.S. CLS. 6, 18, 44, 46, 51 AND 52).

SEC. 2(F).

FIRST USE 8-5-2002; IN COMMERCE 8-19-2002.

SER. NO. 77-264,651, FILED 8-27-2007.

THE MARK CONSISTS OF STANDARD CHARACTERS WITHOUT CLAIM TO ANY PARTICULAR FONT, STYLE, SIZE, OR COLOR.

WILLIAM P. SHANAHAN, EXAMINING ATTORNEY

Int. Cl.: 41

Prior U.S. Cls.: 100, 101 and 107

United States Patent and Trademark Office

Reg. No. 3,483,648

Registered Aug. 12, 2008

**SERVICE MARK
PRINCIPAL REGISTER**

MY BEST FIEND

COLDWELL, FRED (UNITED STATES INDIVIDUAL)

13 JUDGE STREET, THIRD FLOOR

BROOKLYN, NY 11211 AND

TEDDER, GARY (UNITED STATES INDIVIDUAL)

13 JUDGE STREET, THIRD FLOOR

BROOKLYN, NY 11211 AND

NOLL, JOSEPH (UNITED STATES INDIVIDUAL)

140A JACKSON STREET

BROOKLYN, NY 11211 AND

LINDBLADE, KRIS (UNITED STATES INDIVIDUAL)

75 ROEBLING STREET, #1L

BROOKLYN, NY 11211

FOR: MUSICAL ENTERTAINMENT SERVICES, NAMELY, LIVE PERFORMANCES BY A MUSICAL BAND, LIVE MUSIC CONCERTS, IN CLASS 41 (U.S. CLS. 100, 101 AND 107).

FIRST USE 7-30-2002; IN COMMERCE 7-30-2002.

THE MARK CONSISTS OF STANDARD CHARACTERS WITHOUT CLAIM TO ANY PARTICULAR FONT, STYLE, SIZE, OR COLOR.

SER. NO. 77-264,657, FILED 8-27-2007.

LAURIE KAUFMAN, EXAMINING ATTORNEY

Int. Cl.: 32

Prior U.S. Cls.: 45, 46 and 48

Reg. No. 3,483,649

United States Patent and Trademark Office

Registered Aug. 12, 2008

**TRADEMARK
PRINCIPAL REGISTER**

FLAVOURTECH (OFFSHORE) S.A.L. (TURKEY
CORPORATION)
EGE SERBEST BOLGESI, AKCAY CADDESI 144/1
AYFER SOK. NO:16
GAZIEMIR-IZMIR, TURKEY

DRINKS AND FRUIT JUICES, IN CLASS 32 (U.S.
CLS. 45, 46 AND 48).

FIRST USE 5-24-2004; IN COMMERCE 5-24-2004.

FOR: POWDERED JUICES, POWDERED FRUIT
AND VEGETABLE DRINK MIXES, POWDERS AND
SYRUPS FOR MAKING SOFT DRINKS, FRUIT

SER. NO. 77-265,553, FILED 8-27-2007.

REBECCA EISINGER, EXAMINING ATTORNEY

Int. Cl.: 32

Prior U.S. Cls.: 45, 46 and 48

Reg. No. 3,483,650

United States Patent and Trademark Office

Registered Aug. 12, 2008

**TRADEMARK
PRINCIPAL REGISTER**



FLAVOURTECH (OFFSHORE) S.A.L. (TURKEY
CORPORATION)
EGE SERBEST BOLGESI, AKCAY CADDESI 144/1
AYFER SOK. NO:16
GAZIEMIR-IZMIR, TURKEY

FOR: POWDERED JUICES, POWDERED FRUIT
AND VEGETABLE DRINK MIXES, POWDERS AND
SYRUPS FOR MAKING SOFT DRINKS, FRUIT

DRINKS AND FRUIT JUICES, IN CLASS 32 (U.S.
CLS. 45, 46 AND 48).

FIRST USE 12-15-2004; IN COMMERCE 12-15-2004.

SER. NO. 77-265,557, FILED 8-27-2007.

REBECCA EISINGER, EXAMINING ATTORNEY

Int. Cl.: 9

Prior U.S. Cls.: 21, 23, 26, 36 and 38

Reg. No. 3,483,651

United States Patent and Trademark Office

Registered Aug. 12, 2008

**TRADEMARK
PRINCIPAL REGISTER**

DARWIN

SOUTHWEST RESEARCH INSTITUTE (TEXAS
CORPORATION)
6220 CULEBRA ROAD
SAN ANTONIO, TX 782280510

FOR: SOFTWARE PROGRAMS TO PREDICT THE
PROBABILITY OF STRUCTURAL FAILURE IN
MECHANICAL COMPONENTS, IN CLASS 9 (U.S.
CLS. 21, 23, 26, 36 AND 38).

FIRST USE 12-4-1998; IN COMMERCE 12-4-1998.

THE MARK CONSISTS OF STANDARD CHAR-
ACTERS WITHOUT CLAIM TO ANY PARTICULAR
FONT, STYLE, SIZE, OR COLOR.

OWNER OF U.S. REG. NOS. 2,459,747 AND
2,725,665.

SER. NO. 77-265,858, FILED 8-28-2007.

DAVID H. STINE, EXAMINING ATTORNEY

Int. Cls.: 19 and 20

Prior U.S. Cls.: 1, 2, 12, 13, 22, 25, 32, 33 and 50

United States Patent and Trademark Office

Reg. No. 3,483,652

Registered Aug. 12, 2008

TRADEMARK
PRINCIPAL REGISTER



EASTERN WHOLESALE FENCE CO., INC. (NEW
YORK CORPORATION)
274 MIDDLE ISLAND ROAD
MEDFORD, NY 11763

FOR: NON-METAL FENCING PANELS, POSTS,
GATES, IN CLASS 19 (U.S. CLS. 1, 12, 33 AND 50).

FIRST USE 1-0-1998; IN COMMERCE 1-0-1998.

FOR: NON-METAL HINGES, IN CLASS 20 (U.S.
CLS. 2, 13, 22, 25, 32 AND 50).

FIRST USE 1-0-1998; IN COMMERCE 1-0-1998.

OWNER OF U.S. REG. NO. 1,587,437.

NO CLAIM IS MADE TO THE EXCLUSIVE
RIGHT TO USE "VINYL FENCE", APART FROM
THE MARK AS SHOWN.

SER. NO. 77-266,414, FILED 8-28-2007.

TARAH HARDY, EXAMINING ATTORNEY

Int. Cls.: 35, 41 and 42

Prior U.S. Cls.: 100, 101, 102 and 107

United States Patent and Trademark Office

Reg. No. 3,483,653

Registered Aug. 12, 2008

**SERVICE MARK
PRINCIPAL REGISTER**

GARFUM

HOMEVIDEOCHALLENGE.COM, LLC (NEW
JERSEY LTD LIAB CO)
6 DICKENS COURT
HOWELL, NJ 07731

FOR: ON-LINE RETAIL STORE SERVICES FEATURING ELECTRONICS, APPAREL AND CLOTHING, IN CLASS 35 (U.S. CLS. 100, 101 AND 102).

FIRST USE 8-27-2007; IN COMMERCE 8-27-2007.

FOR: ENTERTAINMENT SERVICES, NAMELY, PROVIDING A WEB SITE FEATURING MUSICAL PERFORMANCES, MUSICAL VIDEOS, RELATED FILM CLIPS, PHOTOGRAPHS, AND OTHER MULTIMEDIA MATERIALS; ENTERTAINMENT INFORMATION IN THE FIELD OF AUDIO CLIPS, VIDEO CLIPS, MUSICAL PERFORMANCES, MUSICAL VIDEOS, FILM CLIPS, PHOTOGRAPHS, AND OTHER MULTIMEDIA MATERIALS; ON-LINE JOURNALS, NAMELY, BLOGS FEATURING INFORMATION IN THE FIELD OF AUDIO CLIPS, VIDEO CLIPS, MUSICAL PERFORMANCES, MUSICAL VIDEOS, FILM CLIPS, PHOTOGRAPHS, AND OTHER MULTIMEDIA MATERIALS; INTERACTIVE MULTIMEDIA COMPETITIONS FEATURING

MUSICAL PERFORMANCES, MUSICAL VIDEOS, RELATED FILM CLIPS, PHOTOGRAPHS, AND OTHER MULTIMEDIA MATERIALS, IN CLASS 41 (U.S. CLS. 100, 101 AND 107).

FIRST USE 8-27-2007; IN COMMERCE 8-27-2007.

FOR: APPLICATION SERVICE PROVIDER (ASP) FEATURING SOFTWARE TO ENABLE UPLOADING, POSTING, SHOWING, DISPLAYING, TAGGING, BLOGGING, SHARING OR OTHERWISE PROVIDING ELECTRONIC MULTIMEDIA OR INFORMATION OVER GLOBAL COMPUTER NETWORK, IN CLASS 42 (U.S. CLS. 100 AND 101).

FIRST USE 8-27-2007; IN COMMERCE 8-27-2007.

THE MARK CONSISTS OF STANDARD CHARACTERS WITHOUT CLAIM TO ANY PARTICULAR FONT, STYLE, SIZE, OR COLOR.

SER. NO. 77-266,532, FILED 8-28-2007.

SARA THOMAS, EXAMINING ATTORNEY

Int. Cl.: 41

Prior U.S. Cls.: 100, 101 and 107

United States Patent and Trademark Office

Reg. No. 3,483,654

Registered Aug. 12, 2008

**SERVICE MARK
PRINCIPAL REGISTER**

HOWSTUFFWORKS

HOWSTUFFWORKS, INC. (DELAWARE CORPORATION)
SUITE 1500
ONE CAPITAL CITY PLZA; 3350 PEACHTREE RD
ATLANTA, GA 30326

FOR: EDUCATION SERVICES, NAMELY, PROVIDING CLASSES, TUTORIAL SESSIONS, AND EDUCATIONAL TESTING IN THE FIELDS OF HEALTH, MEDICINE, LAW, ETHICS, REGULATIONS, COMPLIANCE, AND PRODUCTS, AND DISTRIBUTION OF COURSE MATERIAL IN CON-

NECTION THEREWITH, IN CLASS 41 (U.S. CLS. 100, 101 AND 107).

FIRST USE 7-0-1998; IN COMMERCE 7-0-1998.

THE MARK CONSISTS OF STANDARD CHARACTERS WITHOUT CLAIM TO ANY PARTICULAR FONT, STYLE, SIZE, OR COLOR.

SER. NO. 77-266,711, FILED 8-28-2007.

STEVEN JACKSON, EXAMINING ATTORNEY

Int. Cl.: 42

Prior U.S. Cls.: 100 and 101

United States Patent and Trademark Office

Reg. No. 3,483,655

Registered Aug. 12, 2008

**SERVICE MARK
PRINCIPAL REGISTER**

GoRoundTown

NAJERA DESIGN, INC. (GEORGIA CORPORATION), DBA GOROUND MULTIMEDIA
348 COTTON AVENUE, SUITE 200
MACON, GA 31201

THE MARK CONSISTS OF STANDARD CHARACTERS WITHOUT CLAIM TO ANY PARTICULAR FONT, STYLE, SIZE, OR COLOR.

FOR: DESIGN AND DEVELOPMENT OF MULTIMEDIA PRODUCTS, IN CLASS 42 (U.S. CLS. 100 AND 101).

SER. NO. 77-266,901, FILED 8-29-2007.

FIRST USE 5-1-2007; IN COMMERCE 5-1-2007.

ANDREA BUTLER, EXAMINING ATTORNEY

Int. Cl.: 29

Prior U.S. Cl.: 46

United States Patent and Trademark Office

Reg. No. 3,483,656

Registered Aug. 12, 2008

**TRADEMARK
PRINCIPAL REGISTER**

LEGENDARY SPREADABLE FRUIT

SARABETH'S KITCHEN, INC. (NEW YORK CORPORATION)
1161 EAST 156TH STREET
BRONX, NY 10474

FOR: FRUIT PRESERVES, IN CLASS 29 (U.S. CL. 46).

FIRST USE 6-1-1998; IN COMMERCE 6-1-1998.

THE MARK CONSISTS OF STANDARD CHARACTERS WITHOUT CLAIM TO ANY PARTICULAR FONT, STYLE, SIZE, OR COLOR.

OWNER OF U.S. REG. NO. 2,295,517.

NO CLAIM IS MADE TO THE EXCLUSIVE RIGHT TO USE "SPREADABLE FRUIT", APART FROM THE MARK AS SHOWN.

SER. NO. 77-267,267, FILED 8-29-2007.

JESSICA FATHY, EXAMINING ATTORNEY

Int. Cl.: 11

Prior U.S. Cls.: 13, 21, 23, 31 and 34

United States Patent and Trademark Office

Reg. No. 3,483,657

Registered Aug. 12, 2008

TRADEMARK
PRINCIPAL REGISTER



ENTROPY SOLUTIONS, INC. (MINNESOTA CORPORATION)
9827 VALLEY VIEW ROAD
EDEN PRAIRIE, MN 55344

FOR: MEDICAL THERMAL MANAGEMENT SYSTEM FOR TRANSPORTING TRANSPLANT ORGANS, MEDICATIONS, BLOOD AND OTHER MEDICAL ITEMS REQUIRING STABLE TEMPERATURES DURING TRANSPORT; MEDICAL CONTAINER FOR STORAGE, TRANSPORTATION AND MAINTENANCE OF STANDARD TEMPERATURE DURING TRANSPORT FOR MEDICATIONS, TRANSPLANT ORGANS, BLOOD AND OTHER MEDICAL ITEMS, IN CLASS 11 (U.S. CLS. 13, 21, 23, 31 AND 34).

FIRST USE 8-23-2007; IN COMMERCE 8-23-2007.

NO CLAIM IS MADE TO THE EXCLUSIVE RIGHT TO USE "THERMAL MANAGEMENT SYSTEM", APART FROM THE MARK AS SHOWN.

THE COLOR(S) GREEN, LIME GREEN, RED, WHITE, BLUE, BLACK AND WHITE IS/ARE CLAIMED AS A FEATURE OF THE MARK.

THE MARK CONSISTS OF A RECTANGLE BACKGROUND IN LIME GREEN, THE WORDING "GREENBOX" IS IN BLACK, THE WORDING "THERMAL MANAGEMENT SYSTEM" IS IN WHITE AND A GREEN HEXAGON CONTAINING THREE ARROWS IN BLUE, WHITE AND RED.

SER. NO. 77-267,401, FILED 8-29-2007.

EDWARD NELSON, EXAMINING ATTORNEY

Int. Cl.: 45

Prior U.S. Cls.: 100 and 101

United States Patent and Trademark Office

Reg. No. 3,483,658

Registered Aug. 12, 2008

**SERVICE MARK
PRINCIPAL REGISTER**

43 THINGS

THE ROBOT CO-OP, INC. (DELAWARE CORPORATION)
ATTN: TRADEMARKS
PMB 1461 1122 E PIKE STREET
SEATTLE, WA 98122

FOR: PROVIDING INFORMATION REGARDING, AND IN THE NATURE OF, SOCIAL NETWORKING SERVICES; ONLINE SOCIAL NETWORKING SERVICES DESIGNED FOR PEOPLE WITH A COMMON DESIRE TO MEET OTHER PEOPLE WITH SIMILAR INTERESTS, IN CLASS 45 (U.S. CLS. 100 AND 101).

FIRST USE 12-31-2004; IN COMMERCE 12-31-2004.

THE MARK CONSISTS OF STANDARD CHARACTERS WITHOUT CLAIM TO ANY PARTICULAR FONT, STYLE, SIZE, OR COLOR.

NO CLAIM IS MADE TO THE EXCLUSIVE RIGHT TO USE "THINGS", APART FROM THE MARK AS SHOWN.

SER. NO. 77-267,409, FILED 8-29-2007.

AMOS T. MATTHEWS, JR., EXAMINING ATTORNEY

Int. Cl.: 19

Prior U.S. Cls.: 1, 12, 33 and 50

United States Patent and Trademark Office

Reg. No. 3,483,659

Registered Aug. 12, 2008

TRADEMARK
PRINCIPAL REGISTER



EASTERN WHOLESALE FENCE CO., INC. (NEW YORK CORPORATION)
274 MIDDLE ISLAND ROAD
MEDFORD, NY 11763

FOR: FABRICATED WOOD PANELS, IN CLASS 19 (U.S. CLS. 1, 12, 33 AND 50).

FIRST USE 1-0-2003; IN COMMERCE 1-0-2003.

OWNER OF U.S. REG. NO. 1,587,437.

NO CLAIM IS MADE TO THE EXCLUSIVE RIGHT TO USE "WHITE CEDAR," "STOCKADE," "CUSTOM WOOD," "TONGUE & GROOVE," AND "FENCE", APART FROM THE MARK AS SHOWN.

THE COLOR(S) GREEN AND WHITE IS/ARE CLAIMED AS A FEATURE OF THE MARK.

THE MARK CONSISTS OF THE WORD "EASTERN" WRITTEN IN GREEN IN A SEMI-CIRCLE AND THE WORDS "WHITE CEDAR" IN GREEN IN A SEMI-CIRCLE BELOW IT, SEPARATED BY A GREEN STAR ON EITHER SIDE, SURROUNDED BY A SOLID GREEN BORDER WITH GREEN SPIKED EDGING, AND A SOLID GREEN INNER CIRCLE WITH A PICTURE OF A WHITE PINE TREE IN THE MIDDLE, WITH THE WORDS EASTERN FENCE WRITTEN ACROSS IT IN GREEN SCRIPT LETTERS, SURROUNDED IN A CIRCLE BY THE WORDS "STOCKADE, CUSTOM WOOD", AND "TONGUE & GROOVE" IN WHITE CAPITAL LETTERS, SEPARATED BY WHITE BULLETS.

SER. NO. 77-267,467, FILED 8-29-2007.

TARAH HARDY, EXAMINING ATTORNEY

Int. Cl.: 35

Prior U.S. Cls.: 100, 101 and 102

United States Patent and Trademark Office

Reg. No. 3,483,660

Registered Aug. 12, 2008

**SERVICE MARK
PRINCIPAL REGISTER**



HOST ASSOCIATES, INC (TEXAS CORPORATION), DBA BUDGET HOST OR BUDGET HOST INTERNATIONAL

2307-B ROOSEVELT DRIVE
ARLINGTON, TX 76016

FOR: ADVERTISING AND PUBLICITY SERVICES, NAMELY, PROMOTING THE GOODS, SERVICES, BRAND IDENTITY AND COMMERCIAL INFORMATION AND NEWS OF THIRD PARTIES THROUGH PRINT, AUDIO, VIDEO, DIGITAL AND ON-LINE MEDIUM, IN CLASS 35 (U.S. CLS. 100, 101 AND 102).

FIRST USE 12-0-1984; IN COMMERCE 12-0-1984.

OWNER OF U.S. REG. NOS. 1,172,220 AND 1,544,937.

NO CLAIM IS MADE TO THE EXCLUSIVE RIGHT TO USE "BUDGET", APART FROM THE MARK AS SHOWN.

THE COLOR(S) GOLD, BROWN AND WHITE IS/ ARE CLAIMED AS A FEATURE OF THE MARK.

THE MARK CONSISTS OF BROWN LANTERN WITH WHITE INSIDE, AND BROWN LETTERS; GOLD LARGE LETTERS ON A BROWN BACKGROUND; GOLD INNER BORDER AND BROWN OUTER BORDER.

SEC. 2(F).

SER. NO. 77-267,506, FILED 8-29-2007.

PAULA MAHONEY, EXAMINING ATTORNEY

Int. Cls.: 6 and 35

Prior U.S. Cls.: 2, 12, 13, 14, 23, 25, 50, 100, 101 and 102

Reg. No. 3,483,661

United States Patent and Trademark Office

Registered Aug. 12, 2008

TRADEMARK
SERVICE MARK
PRINCIPAL REGISTER

EASTERN WHOLESALE FENCE CO., INC. (NEW YORK CORPORATION)
274 MIDDLE ISLAND ROAD
MEDFORD, NY 11763

FOR: METAL HINGES, LATCHES, CAPS AND FENCING HARDWARE, NAMELY, TENSION BANDS, BRACE BANDS, RAIL END CUPS , IN CLASS 6 (U.S. CLS. 2, 12, 13, 14, 23, 25 AND 50).

FIRST USE 0-0-1996; IN COMMERCE 0-0-1996.

FOR: WHOLESALE DISTRIBUTORSHIPS FEATURING FENCES, FENCING PRODUCTS AND

FENCING RELATED HARDWARE, IN CLASS 35 (U.S. CLS. 100, 101 AND 102).

FIRST USE 0-0-1996; IN COMMERCE 0-0-1996.

OWNER OF U.S. REG. NO. 1,587,437.

NO CLAIM IS MADE TO THE EXCLUSIVE RIGHT TO USE FENCE, APART FROM THE MARK AS SHOWN.

SER. NO. 77-267,516, FILED 8-29-2007.

TARAH HARDY, EXAMINING ATTORNEY

Int. Cl.: 43

Prior U.S. Cls.: 100 and 101

United States Patent and Trademark Office

Reg. No. 3,483,662

Registered Aug. 12, 2008

**SERVICE MARK
PRINCIPAL REGISTER**

JFK JUST FOR KINGS

LES DÉVELOPPEMENTS HORLOGERS (LDH)
(SWITZERLAND CORPORATION)
C/O TVA CONSEILS STÉPHANE GMÜNDER
8, BOULEVARD PÉROLLES
FRIBOURG, SWITZERLAND 1700

FOR: HOSTELS; TOURIST INNS; FOOD PREPARATION SERVICES; TRAVEL AGENCY SERVICES, NAMELY, MAKING RESERVATIONS AND BOOKING FOR TEMPORARY LODGING; HOTELS; RESTAURANT SERVICES, IN CLASS 43 (U.S. CLS. 100 AND 101).

THE MARK CONSISTS OF STANDARD CHARACTERS WITHOUT CLAIM TO ANY PARTICULAR FONT, STYLE, SIZE, OR COLOR.

PRIORITY CLAIMED UNDER SEC. 44(D) ON SWITZERLAND APPLICATION NO. 56284/2007, FILED 6-13-2007, REG. NO. 563043, DATED 10-3-2007, EXPIRES 6-13-2017.

SER. NO. 77-267,547, FILED 8-29-2007.

JIM RINGLE, EXAMINING ATTORNEY

Int. Cls.: 35 and 41

Prior U.S. Cls.: 100, 101, 102 and 107

United States Patent and Trademark Office

Reg. No. 3,483,663

Registered Aug. 12, 2008

**SERVICE MARK
PRINCIPAL REGISTER**



BASCIANO, RICHARD (UNITED STATES INDIVIDUAL), DBA 303 WEST 42ND STREET REALTY COMPANY
303 WEST 42ND STREET
NEW YORK, NY 10036

FOR: ART GALLERIES, IN CLASS 35 (U.S. CLS. 100, 101 AND 102).

FIRST USE 7-6-2005; IN COMMERCE 7-6-2005.

FOR: RADIO ENTERTAINMENT PRODUCTION; ENTERTAINMENT, NAMELY, A CONTINUING COMEDY SHOW BROADCAST OVER TELEVISION, SATELLITE, AUDIO AND VIDEO MEDIA; LIVE PERFORMANCES BY MUSICAL BANDS; CONDUCTING ENTERTAINMENT EXHIBITIONS OF COMEDY SHOWS AND MOTIVATIONAL SPEAKING, IN CLASS 41 (U.S. CLS. 100, 101 AND 107).

FIRST USE 7-6-2005; IN COMMERCE 7-6-2005.

NO CLAIM IS MADE TO THE EXCLUSIVE RIGHT TO USE "TIMES SQUARE ARTS CENTER", APART FROM THE MARK AS SHOWN.

THE COLOR(S) BLUE, WHITE, GREEN, PINK, YELLOW, RED AND BLACK IS/ARE CLAIMED AS A FEATURE OF THE MARK.

THE MARK CONSISTS OF THE COLORS BLUE, WHITE, GREEN, PINK, YELLOW, RED AND BLACK, WITH THE COLORS BLUE, WHITE, GREEN, PINK, YELLOW, RED AND BLACK APPEARING IN THE DESIGN AND THE COLOR WHITE APPEARING IN THE WORDING "TIMES SQUARE" AND THE COLOR BLUE APPEARING IN THE WORDING "ARTS CENTER".

SER. NO. 77-268,077, FILED 8-30-2007.

JAY FLOWERS, EXAMINING ATTORNEY

Int. Cl.: 41

Prior U.S. Cls.: 100, 101 and 107

United States Patent and Trademark Office

Reg. No. 3,483,664

Registered Aug. 12, 2008

**SERVICE MARK
PRINCIPAL REGISTER**

Yoga Today

YOGA TODAY (WYOMING LTD LIAB CO)
PO BOX 9880
JACKSON, WY 83002

THE MARK CONSISTS OF STANDARD CHARACTERS WITHOUT CLAIM TO ANY PARTICULAR FONT, STYLE, SIZE, OR COLOR.

FOR: EDUCATIONAL AND ENTERTAINMENT SERVICES, NAMELY, PROVIDING INFORMATIONAL AND INSTRUCTIONAL PROGRAMS CONCERNING THE SUBJECTS OF FITNESS, CONDITIONING EXERCISES AND YOGA DISTRIBUTED VIA GLOBAL AND LOCAL COMMUNICATION NETWORKS AND TELEVISION, IN CLASS 41 (U.S. CLS. 100, 101 AND 107).

NO CLAIM IS MADE TO THE EXCLUSIVE RIGHT TO USE "YOGA", APART FROM THE MARK AS SHOWN.

SER. NO. 77-268,270, FILED 8-30-2007.

FIRST USE 5-5-2006; IN COMMERCE 6-5-2006.

CHRIS WELLS, EXAMINING ATTORNEY

Int. Cl.: 41

Prior U.S. Cls.: 100, 101 and 107

United States Patent and Trademark Office

Reg. No. 3,483,665

Registered Aug. 12, 2008

**SERVICE MARK
PRINCIPAL REGISTER**



YOGA TODAY (WYOMING LTD LIAB CO)
PO BOX 9880
JACKSON, WY 83002

NO CLAIM IS MADE TO THE EXCLUSIVE
RIGHT TO USE "YOGA", APART FROM THE
MARK AS SHOWN.

FOR: EDUCATIONAL AND ENTERTAINMENT
SERVICES, NAMELY, PROVIDING INFORMA-
TIONAL AND INSTRUCTIONAL PROGRAMS CON-
CERNING THE SUBJECTS OF FITNESS,
CONDITIONING EXERCISES AND YOGA DISTRIB-
UTED VIA GLOBAL AND LOCAL COMMUNICA-
TION NETWORKS AND TELEVISION, IN CLASS 41
(U.S. CLS. 100, 101 AND 107).

THE MARK CONSISTS OF BLOCK LETTERS OF
THE WORDS "YOGA TODAY" AND A MALE
FIGURE ABOVE THE WORDS IN A YOGA POSE.

SER. NO. 77-268,274, FILED 8-30-2007.

FIRST USE 5-5-2006; IN COMMERCE 6-5-2006.

CHRIS WELLS, EXAMINING ATTORNEY

Int. Cl.: 30

Prior U.S. Cl.: 46

United States Patent and Trademark Office

Reg. No. 3,483,666

Registered Aug. 12, 2008

**TRADEMARK
PRINCIPAL REGISTER**

ALLAN WINE GUMS

THE ALLAN CANDY COMPANY LIMITED (CANADA CORPORATION)
356 EMERALD STREET NORTH
HAMILTON, ONTARIO L8L8K6

FOR: CANDY, IN CLASS 30 (U.S. CL. 46).

THE MARK CONSISTS OF STANDARD CHARACTERS WITHOUT CLAIM TO ANY PARTICULAR FONT, STYLE, SIZE, OR COLOR.

OWNER OF CANADA REG. NO. TMA706337,
DATED 2-1-2008, EXPIRES 2-1-2023.

OWNER OF U.S. REG. NOS. 1,708,471 AND 1,718,452.

NO CLAIM IS MADE TO THE EXCLUSIVE RIGHT TO USE "WINE GUMS", APART FROM THE MARK AS SHOWN.

SER. NO. 77-268,508, FILED 8-30-2007.

G. MAYERSCHOFF, EXAMINING ATTORNEY

Int. Cl.: 38

Prior U.S. Cls.: 100, 101 and 104

United States Patent and Trademark Office

Reg. No. 3,483,667

Registered Aug. 12, 2008

**SERVICE MARK
PRINCIPAL REGISTER**

SAFE TV CHANNEL

TOTAL LIFE COMMUNITY EDUCATIONAL
FOUNDATION, INC (ARKANSAS CORPORATION)
3556 LIBERTY AVENUE
SPRINGDALE, AR 72762

FOR: SATELLITE TELEVISION BROADCASTING;
TELEVISION BROADCASTING, IN CLASS 38
(U.S. CLS. 100, 101 AND 104).

FIRST USE 9-22-1997; IN COMMERCE 9-22-1998.

THE MARK CONSISTS OF STANDARD CHARACTERS
WITHOUT CLAIM TO ANY PARTICULAR FONT,
STYLE, SIZE, OR COLOR.

OWNER OF U.S. REG. NOS. 2,190,728, 2,568,525
AND OTHERS.

NO CLAIM IS MADE TO THE EXCLUSIVE
RIGHT TO USE "TV CHANNEL", APART FROM
THE MARK AS SHOWN.

SEC. 2(F).

SER. NO. 77-268,631, FILED 8-30-2007.

KATINA MISTER, EXAMINING ATTORNEY

Int. Cl.: 37

Prior U.S. Cls.: 100, 103 and 106

United States Patent and Trademark Office

Reg. No. 3,483,668

Registered Aug. 12, 2008

**SERVICE MARK
PRINCIPAL REGISTER**

REGAL AUTO WASH EXPRESS

TDI TERRAPLAN DEVELOPMENT, INC. (ARIZONA CORPORATION)
8698 EAST SAN ALBERTO DRIVE
SCOTTSDALE, AZ 85258

FOR: CAR WASHING; AUTOMOBILE CLEANING AND CAR WASHING; AUTOMOBILE DETAILING; VEHICLE DETAILING, IN CLASS 37 (U.S. CLS. 100, 103 AND 106).

FIRST USE 5-15-2007; IN COMMERCE 5-15-2007.

THE MARK CONSISTS OF STANDARD CHARACTERS WITHOUT CLAIM TO ANY PARTICULAR FONT, STYLE, SIZE, OR COLOR.

OWNER OF U.S. REG. NO. 2,988,848.

NO CLAIM IS MADE TO THE EXCLUSIVE RIGHT TO USE "AUTO WASH EXPRESS", APART FROM THE MARK AS SHOWN.

SER. NO. 77-268,777, FILED 8-30-2007.

LEIGH CAROLINE CASE, EXAMINING ATTORNEY

Int. Cls.: 6 and 35

Prior U.S. Cls.: 2, 12, 13, 14, 23, 25, 50, 100, 101 and 102

United States Patent and Trademark Office

Reg. No. 3,483,669

Registered Aug. 12, 2008

**TRADEMARK
SERVICE MARK
PRINCIPAL REGISTER**

EASTERN FENCE

EASTERN WHOLESALE FENCE CO., INC. (NEW YORK CORPORATION)
274 MIDDLE ISLAND ROAD
MEDFORD, NY 11763

FOR: METAL HINGES, LATCHES, CAPS AND FENCING HARDWARE, NAMELY, TENSION BANDS, BRACE BANDS, RAIL END CUPS , IN CLASS 6 (U.S. CLS. 2, 12, 13, 14, 23, 25 AND 50).

FIRST USE 0-0-1996; IN COMMERCE 0-0-1996.

FOR: WHOLESALE DISTRIBUTORSHIPS FEATURING FENCES, FENCING PRODUCTS AND FENCING RELATED HARDWARE, IN CLASS 35 (U.S. CLS. 100, 101 AND 102).

FIRST USE 0-0-1996; IN COMMERCE 0-0-1996.

THE MARK CONSISTS OF STANDARD CHARACTERS WITHOUT CLAIM TO ANY PARTICULAR FONT, STYLE, SIZE, OR COLOR.

OWNER OF U.S. REG. NO. 1,587,437.

NO CLAIM IS MADE TO THE EXCLUSIVE RIGHT TO USE "FENCE" , APART FROM THE MARK AS SHOWN.

SER. NO. 77-269,473, FILED 8-31-2007.

TARAH HARDY, EXAMINING ATTORNEY

Int. Cl.: 35

Prior U.S. Cls.: 100, 101 and 102

United States Patent and Trademark Office

Reg. No. 3,483,670

Registered Aug. 12, 2008

**SERVICE MARK
PRINCIPAL REGISTER**

CREBIT

ROSENBERGER RONALD J (UNITED STATES
INDIVIDUAL)
506 STERLING ST
NEWTOWN, PA 18940

FOR: PROVIDING INTELLECTUAL PROPERTY
SERVICES IN THE NATURE OF CREATING AND
DEVELOPING BUSINESS METHODS AND TRADE-
MARKS FOR OTHERS RELATING TO CREDIT
CARD SERVICES AND DEBIT CARD SERVICES,
IN CLASS 35 (U.S. CLS. 100, 101 AND 102).

FIRST USE 2-2-2007; IN COMMERCE 2-2-2007.

THE MARK CONSISTS OF STANDARD CHAR-
ACTERS WITHOUT CLAIM TO ANY PARTICULAR
FONT, STYLE, SIZE, OR COLOR.

OWNER OF U.S. REG. NOS. 3,330,403 AND
3,406,550.

SER. NO. 77-271,038, FILED 9-4-2007.

AMY GEARIN, EXAMINING ATTORNEY

Int. Cl.: 36

Prior U.S. Cls.: 100, 101 and 102

United States Patent and Trademark Office

Reg. No. 3,483,671

Registered Aug. 12, 2008

**SERVICE MARK
PRINCIPAL REGISTER**

TOOTHFAIRY CAMPAIGN

NATIONAL CHILDREN'S ORAL HEALTH
FOUNDATION (DELAWARE NON-PROFIT
CORPORATION)
1610 EAST MOREHEAD STREET, SUITE 203
CHARLOTTE, NC 28207

FOR: CHARITABLE FUND RAISING; CHARITABLE FUNDRAISING SERVICES IN THE FIELD OF DENTAL HEALTH; PROVIDING FINANCIAL GRANTS TO LOCAL ORGANIZATIONS AND CLINICS TO ENABLE THEM TO PROVIDE DIRECT TREATMENT AND PREVENTIVE SERVICES IN SUPPORT OF ORAL HEALTH FOR UNDERSERVED GROUPS AND AREAS; PROVIDING FINANCIAL GRANTS TO PROGRAMS WHICH FURTHER ORAL HEALTH THROUGH ACCESS TO CARE, INTERVENTION, PREVENTIVE EDUCATION AND PROGRAMS CONCERNED WITH ORAL

HEALTH POLICY AND RESEARCH, IN CLASS 36 (U.S. CLS. 100, 101 AND 102).

FIRST USE 5-21-2007; IN COMMERCE 5-21-2007.

THE MARK CONSISTS OF STANDARD CHARACTERS WITHOUT CLAIM TO ANY PARTICULAR FONT, STYLE, SIZE, OR COLOR.

NO CLAIM IS MADE TO THE EXCLUSIVE RIGHT TO USE "CAMPAIGN", APART FROM THE MARK AS SHOWN.

SER. NO. 77-271,321, FILED 9-4-2007.

DAVID TOOLEY, EXAMINING ATTORNEY

Int. Cls.: 9 and 35

Prior U.S. Cls.: 21, 23, 26, 36, 38, 100, 101 and 102

Reg. No. 3,483,672

United States Patent and Trademark Office

Registered Aug. 12, 2008

**TRADEMARK
SERVICE MARK
PRINCIPAL REGISTER**



BUSINESS INFORMATION SYSTEMS, INC.
(FLORIDA CORPORATION)
1350 NE 56TH STREET, SUITE 300
FORT LAUDERDALE, FL 33334

FOR: COMPUTER SOFTWARE FOR RECORDING AND REPLAYING SPEECH; COMPUTER SOFTWARE FOR RECORDING AND REPLAYING SPEECH, USED BY COURT REPORTERS AND CLERKS TO TRANSCRIBE TESTIMONY, IN CLASS 9 (U.S. CLS. 21, 23, 26, 36 AND 38).

FIRST USE 8-0-2007; IN COMMERCE 8-0-2007.

FOR: DISTRIBUTORSHIPS IN THE FIELD OF DIGITAL RECORDING EQUIPMENT AND SOFTWARE, IN CLASS 35 (U.S. CLS. 100, 101 AND 102).

FIRST USE 5-0-2005; IN COMMERCE 5-0-2005.

THE MARK CONSISTS OF THE LETTERS "DCR" ON A CIRCULAR BACKGROUND.

SER. NO. 77-273,142, FILED 9-6-2007.

SANJEEV VOHRA, EXAMINING ATTORNEY

Int. Cl.: 35

Prior U.S. Cls.: 100, 101 and 102

United States Patent and Trademark Office

Reg. No. 3,483,673

Registered Aug. 12, 2008

**SERVICE MARK
PRINCIPAL REGISTER**

HYPOTISEMENT

NOBLE COMMUNICATIONS COMPANY (MISSOURI CORPORATION)
2155 WEST CHESTERFIELD BOULEVARD
SPRINGFIELD, MO 65807

FOR: BUSINESS MARKETING AND BUSINESS CONSULTING SERVICES; MARKET RESEARCH; MARKET SERVICES, NAMELY, CONDUCTING CONSUMER TRACKING BEHAVIOR RESEARCH AND CONSUMER TREND ANALYSIS; COMMERCIALIZATION STRATEGY SERVICES, NAMELY, CREATING CORPORATE AND BRANDING IDENTITY FOR OTHERS; MARKETING, ADVERTISING AND PROMOTION OF THE GOODS AND SERVICES OF OTHERS; BUSINESS CONSULTATION AND

MANAGEMENT REGARDING MARKETING ACTIVITIES AND LAUNCHING OF NEW PRODUCTS, IN CLASS 35 (U.S. CLS. 100, 101 AND 102).

FIRST USE 7-31-2006; IN COMMERCE 7-31-2006.

THE MARK CONSISTS OF STANDARD CHARACTERS WITHOUT CLAIM TO ANY PARTICULAR FONT, STYLE, SIZE, OR COLOR.

SER. NO. 77-273,916, FILED 9-7-2007.

TIMOTHY FINNEGAN, EXAMINING ATTORNEY

Int. Cl.: 2

Prior U.S. Cls.: 6, 11 and 16

United States Patent and Trademark Office

Reg. No. 3,483,674

Registered Aug. 12, 2008

**TRADEMARK
PRINCIPAL REGISTER**

POLYUROXY

BASF CORPORATION (DELAWARE CORPORATION)
100 CAMPUS DRIVE
FLORHAM PARK, NJ 07932

FOR: CHEMICAL ACTIVATOR SOLD AS AN INTEGRAL COMPONENT OF LIQUID PRIMER/SEALERS USED TO COAT BARE METAL IN THE AUTOMOTIVE INDUSTRY, IN CLASS 2 (U.S. CLS. 6, 11 AND 16).

FIRST USE 7-1-1997; IN COMMERCE 7-1-1997.

THE MARK CONSISTS OF STANDARD CHARACTERS WITHOUT CLAIM TO ANY PARTICULAR FONT, STYLE, SIZE, OR COLOR.

SER. NO. 77-274,671, FILED 9-7-2007.

KAPIL BHANOT, EXAMINING ATTORNEY

Int. Cl.: 16

Prior U.S. Cls.: 2, 5, 22, 23, 29, 37, 38 and 50

Reg. No. 3,483,675

United States Patent and Trademark Office

Registered Aug. 12, 2008

**TRADEMARK
PRINCIPAL REGISTER**

EGBOK

DE LORRELL, WALTER J., JR. (UNITED STATES
INDIVIDUAL)
10876 MARIETTA AVENUE
CULVER CITY, CA 90232

FOR: ADHESIVE-BACKED LETTERS AND NUMBERS FOR USE IN MAKING SIGNS AND POSTERS; PRINTED PAPER SIGNS; VINYL LETTERS AND NUMBER FOR USE IN MAKING SIGNS AND POSTERS; ADHESIVE LABELS; PAPER LABELS; PRINTED PAPER LABELS; MOTIVATIONAL CARDS; POSTERS; POSTERS MADE OF PAPER; UNMOUNTED POSTERS; ADHESIVE NOTE PADS; CALENDAR DESK PADS; LOOSE-LEAF PADS; MEMO PADS; NOTE PADS; SCRATCH PADS; STAMP PADS; WRITING PADS; WRITING PAPER PADS; BALL PENS; BALL POINT PENS; BALL-

POINT PENS; COLOURED PENS; DESK STANDS AND HOLDERS FOR PENS, PENCILS, AND INK; FELT MARKING PENS; FELT WRITING PENS; FELT-TIP PENS; FIBERTIP PENS; BUMPER STICKERS; STICKERS, IN CLASS 16 (U.S. CLS. 2, 5, 22, 23, 29, 37, 38 AND 50).

FIRST USE 1-1-2002; IN COMMERCE 9-18-2007.

THE MARK CONSISTS OF STANDARD CHARACTERS WITHOUT CLAIM TO ANY PARTICULAR FONT, STYLE, SIZE, OR COLOR.

SER. NO. 77-274,928, FILED 9-8-2007.

TINA BROWN, EXAMINING ATTORNEY

Int. Cl.: 41

Prior U.S. Cls.: 100, 101 and 107

United States Patent and Trademark Office

Reg. No. 3,483,676

Registered Aug. 12, 2008

**SERVICE MARK
PRINCIPAL REGISTER**

**GREEN CLEAN INSTITUTE
CERTIFIED**

GREEN CLEAN INSTITUTE TRUST (ILLINOIS
TRUST)
2227 WHITE EAGLE DR
PLAINFIELD, IL 60586

FOR: EDUCATIONAL SERVICES, NAMELY,
PROVIDING CLASSES, SEMINARS, WORKSHOPS
IN THE FIELDS OF JANITORIAL SERVICES, FA-
CILITIES MAINTENANCE AND DISTRIBUTION
OF COURSE MATERIAL IN CONNECTION THERE-
WITH, IN CLASS 41 (U.S. CLS. 100, 101 AND 107).

FIRST USE 9-25-2005; IN COMMERCE 10-15-2006.

THE MARK CONSISTS OF STANDARD CHAR-
ACTERS WITHOUT CLAIM TO ANY PARTICULAR
FONT, STYLE, SIZE, OR COLOR.

NO CLAIM IS MADE TO THE EXCLUSIVE
RIGHT TO USE "INSTITUTE AND CERTIFIED",
APART FROM THE MARK AS SHOWN.

SER. NO. 77-274,951, FILED 9-8-2007.

HOWARD B. LEVINE, EXAMINING ATTORNEY

Int. Cls.: 37 and 44

Prior U.S. Cls.: 100, 101, 103 and 106

United States Patent and Trademark Office

Reg. No. 3,483,677

Registered Aug. 12, 2008

**SERVICE MARK
PRINCIPAL REGISTER**

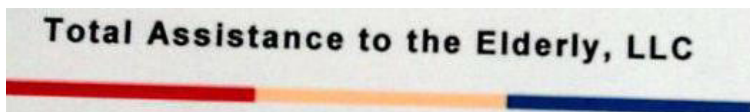

TOTAL ASSISTANCE TO THE ELDERLY, LLC
(MISSOURI LTD LIAB CO)
634 MEDITERRANEAN DR.
FLORISSANT, MO 63031

FOR: CLEANING OF RESIDENTIAL HOUSES, IN
CLASS 37 (U.S. CLS. 100, 103 AND 106).

FIRST USE 4-0-2006; IN COMMERCE 4-0-2006.

FOR: LAWN MOWING SERVICES, IN CLASS 44
(U.S. CLS. 100 AND 101).

FIRST USE 4-0-2006; IN COMMERCE 4-0-2006.

NO CLAIM IS MADE TO THE EXCLUSIVE
RIGHT TO USE "TOTAL ASSISTANCE TO THE
ELDERLY, LLC", APART FROM THE MARK AS
SHOWN.

THE COLOR(S) BLACK, RED, TAN, AND TEAL
IS/ARE CLAIMED AS A FEATURE OF THE MARK.

THE MARK CONSISTS OF THE WORDING "TO-
TAL ASSISTANCE TO THE ELDERLY, LLC", IN
THE COLOR BLACK. BELOW THE WORDING A
LINE CONTAINING THREE SECTIONS, THE FIRST
IN THE COLOR RED, THE SECOND SECTION IN
THE COLOR TAN, AND THE THIRD SECTION IN
THE COLOR TEAL.

SER. NO. 77-275,115, FILED 9-9-2007.

LINDA E. BLOHM, EXAMINING ATTORNEY

Int. Cl.: 45

Prior U.S. Cls.: 100 and 101

United States Patent and Trademark Office

Reg. No. 3,483,678

Registered Aug. 12, 2008

**SERVICE MARK
PRINCIPAL REGISTER**

**Helping People Solve
Problems**

JAMES, VERNON & WEEKS, P.A. (IDAHO CORPORATION)
1626 LINCOLN WAY
COEUR D' ALENE, ID 83814

THE MARK CONSISTS OF STANDARD CHARACTERS WITHOUT CLAIM TO ANY PARTICULAR FONT, STYLE, SIZE, OR COLOR.

FOR: LEGAL SERVICES; PROVIDING INFORMATION RELATING TO LEGAL AFFAIRS, IN CLASS 45 (U.S. CLS. 100 AND 101).

SER. NO. 77-275,149, FILED 9-10-2007.

FIRST USE 0-0-2003; IN COMMERCE 10-0-2003.

DANNEAN HETZEL, EXAMINING ATTORNEY

Int. Cl.: 29

Prior U.S. Cl.: 46

United States Patent and Trademark Office

Reg. No. 3,483,679

Registered Aug. 12, 2008

**TRADEMARK
PRINCIPAL REGISTER**



OF COURSE FOODS, LLC (NEW JERSEY LTD
LIAB CO)
723 WASHINGTON STREET, SUITE 7
HOBOKEN, NJ 07030

FOR: CHEESE, IN CLASS 29 (U.S. CL. 46).

FIRST USE 6-26-2007; IN COMMERCE 8-29-2007.

NO CLAIM IS MADE TO THE EXCLUSIVE
RIGHT TO USE "FINE CHEESE" AND "CHEESE",
APART FROM THE MARK AS SHOWN.

THE COLOR(S) BROWN, GREEN AND LIGHT
BROWN IS/ARE CLAIMED AS A FEATURE OF THE
MARK.

THE MARK CONSISTS OF A SQUARE WHEREIN
THE BACKGROUND DESIGN CONSISTS OF AN
ANTIQUE MAP APPEARS IN THE COLOR BROWN.
THE TOP PORTION OF THIS SQUARE CONSISTS
OF THE PHRASE "WELCOME TO THE WORLD OF
FINE CHEESE" IN THE COLOR LIGHT BROWN.
TOWARD THE BOTTOM OF THE MARK, IN STY-
LIZED LETTERING "THE CHEESE AMBASSA-
DOR", APPEARS IN THE COLOR GREEN. THE
LINES ON EACH SIDE OF THE WORD "THE", AND
BENEATH THE LETTERING "AMBASSADOR" ALL
APPEAR IN THE COLOR GREEN.

SER. NO. 77-275,299, FILED 9-10-2007.

GEORGIA CARTY, EXAMINING ATTORNEY

Int. Cl.: 34

Prior U.S. Cls.: 2, 8, 9 and 17

United States Patent and Trademark Office

Reg. No. 3,483,680

Registered Aug. 12, 2008

TRADEMARK
PRINCIPAL REGISTER

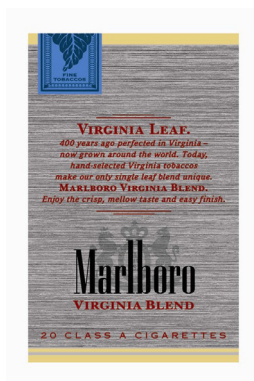

PHILIP MORRIS USA INC. (VIRGINIA CORPORATION)
6601 WEST BROAD STREET
RICHMOND, VA 23230

FOR: TOBACCO PRODUCTS, NAMELY, CIGARETTES, IN CLASS 34 (U.S. CLS. 2, 8, 9 AND 17).

FIRST USE 9-10-2007; IN COMMERCE 9-10-2007.

OWNER OF U.S. REG. NOS. 68,502, 938,510 AND OTHERS.

NO CLAIM IS MADE TO THE EXCLUSIVE RIGHT TO USE "FINE TOBACCOS", "VIRGINIA LEAF", "VIRGINIA TOBACCOS", "VIRGINIA BLEND" AND "20 CLASS A CIGARETTES", APART FROM THE MARK AS SHOWN.

THE COLOR(S) SILVER, GOLD, GRAY, RED, BLUE, DARK BLUE, AND BLACK IS/ARE CLAIMED AS A FEATURE OF THE MARK.

THE MARK CONSISTS OF A STRIATED SILVER RECTANGLE WITH ONE HORIZONTAL GOLD LINE ALONG THE TOP EDGE AND TWO HORIZONTAL GOLD LINES ALONG THE BOTTOM EDGE. THERE IS A BLUE RECTANGLE LOCATED IN THE UPPER LEFT HAND CORNER OF THE STRIATED SILVER RECTANGLE WITH A DARK BLUE BORDER ON THREE SIDES AND A DARK

BLUE CIRCULAR PATTERN, A DARK BLUE LEAF DESIGN, AND THE WORDS "FINE TOBACCOS" IN DARK BLUE LOCATED WITHIN THE DARK BLUE BORDER. THE WORDS "VIRGINIA LEAF." "400 YEARS AGO PERFECTED IN VIRGINIA - NOW GROWN AROUND THE WORLD." "TODAY, HAND-SELECTED VIRGINIA TOBACCOS MAKE OUR ONLY SINGLE LEAF BLEND UNIQUE." "MARLBORO VIRGINIA BLEND." "ENJOY THE CRISP, MELLOW TASTE AND EASY FINISH." IN RED ARE LOCATED IN THE UPPER HALF OF THE STRIATED SILVER RECTANGLE. THERE ARE TWO HORIZONTAL RED LINES ABOVE THE WORDS "VIRGINIA LEAF." AND TWO HORIZONTAL RED LINES BELOW THE WORDS "ENJOY THE CRISP, MELLOW TASTE AND EASY FINISH." THERE IS A GRAY CREST LOCATED IN THE LOWER HALF OF THE STRIATED SILVER RECTANGLE, PARTIALLY COVERED BY THE WORD "MARLBORO" IN BLACK. THE WORDS "VIRGINIA BLEND" APPEAR IN RED BELOW THE WORD "MARLBORO". THE WORDS "20 CLASS A CIGARETTES" APPEAR IN RED ABOVE THE TWO HORIZONTAL GOLD LINES LOCATED ALONG THE BOTTOM EDGE OF THE STRIATED SILVER RECTANGLE.

SER. NO. 77-275,704, FILED 9-10-2007.

CYNTHIA SLOAN, EXAMINING ATTORNEY

Int. Cl.: 43

Prior U.S. Cls.: 100 and 101

United States Patent and Trademark Office

Reg. No. 3,483,681

Registered Aug. 12, 2008

**SERVICE MARK
PRINCIPAL REGISTER**

MCSHARRY'S IRISH PUB

LOUELDA LLC (ALABAMA LTD LIAB CO)
68 NORTH BANCROFT ST.
FAIRHOPE, AL 36532

FOR: RESTAURANT AND BAR SERVICES, IN
CLASS 43 (U.S. CLS. 100 AND 101).

FIRST USE 9-8-2006; IN COMMERCE 9-8-2006.

THE MARK CONSISTS OF STANDARD CHAR-
ACTERS WITHOUT CLAIM TO ANY PARTICULAR
FONT, STYLE, SIZE, OR COLOR.

NO CLAIM IS MADE TO THE EXCLUSIVE
RIGHT TO USE "IRISH PUB", APART FROM THE
MARK AS SHOWN.

THE NAME(S), PORTRAIT(S), AND/OR SIGNA-
TURE(S) SHOWN IN THE MARK DOES NOT IDEN-
TIFY A PARTICULAR LIVING INDIVIDUAL.

SER. NO. 77-275,706, FILED 9-10-2007.

JENNIFER VASQUEZ, EXAMINING ATTORNEY

Int. Cl.: 34

Prior U.S. Cls.: 2, 8, 9 and 17

United States Patent and Trademark Office

Reg. No. 3,483,682

Registered Aug. 12, 2008

TRADEMARK
PRINCIPAL REGISTER

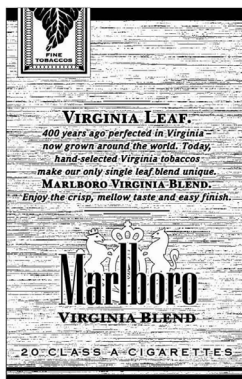

PHILIP MORRIS USA INC. (VIRGINIA CORPORATION)
6601 WEST BROAD STREET
RICHMOND, VA 23230

FOR: TOBACCO PRODUCTS, NAMELY, CIGARETTES, IN CLASS 34 (U.S. CLS. 2, 8, 9 AND 17).

FIRST USE 9-10-2007; IN COMMERCE 9-10-2007.

OWNER OF U.S. REG. NOS. 68,502, 938,510 AND OTHERS.

NO CLAIM IS MADE TO THE EXCLUSIVE RIGHT TO USE "FINE TOBACCOS", "VIRGINIA LEAF", "VIRGINIA TOBACCOS," "VIRGINIA BLEND" AND "20 CLASS A CIGARETTES", APART FROM THE MARK AS SHOWN.

THE MARK CONSISTS OF A STRIATED RECTANGLE WITH ONE HORIZONTAL LINE ALONG THE TOP EDGE AND TWO HORIZONTAL LINES ALONG THE BOTTOM EDGE. THERE IS A RECTANGLE LOCATED IN THE UPPER LEFT HAND CORNER OF THE STRIATED RECTANGLE WITH A BORDER ON THREE SIDES AND A CIRCULAR PATTERN, A LEAF DESIGN, AND THE WORDS

"FINE TOBACCOS" LOCATED WITHIN THE BORDER. THE WORDS "VIRGINIA LEAF," "400 YEARS AGO PERFECTED IN VIRGINIA - NOW GROWN AROUND THE WORLD." "TODAY, HAND-SELECTED VIRGINIA TOBACCOS MAKE OUR ONLY SINGLE LEAF BLEND UNIQUE." "MARLBORO VIRGINIA BLEND." "ENJOY THE CRISP, MELLOW TASTE AND EASY FINISH." ARE LOCATED IN THE UPPER HALF OF THE STRIATED RECTANGLE. THERE ARE TWO HORIZONTAL LINES ABOVE THE WORDS "VIRGINIA LEAF," AND TWO HORIZONTAL LINES BELOW THE WORDS "ENJOY THE CRISP, MELLOW TASTE AND EASY FINISH." THERE IS A CREST LOCATED IN THE LOWER HALF OF THE STRIATED RECTANGLE, PARTIALLY COVERED BY THE WORD "MARLBORO." THE WORDS "VIRGINIA BLEND" APPEAR BELOW THE WORD "MARLBORO". THE WORDS "20 CLASS A CIGARETTES" APPEAR ABOVE THE TWO HORIZONTAL LINES LOCATED ALONG THE BOTTOM EDGE OF THE STRIATED RECTANGLE.

SER. NO. 77-275,730, FILED 9-10-2007.

CYNTHIA SLOAN, EXAMINING ATTORNEY

Int. Cl.: 9

Prior U.S. Cls.: 21, 23, 26, 36 and 38

Reg. No. 3,483,683

United States Patent and Trademark Office

Registered Aug. 12, 2008

**TRADEMARK
PRINCIPAL REGISTER**

Tune Trapper

ELECTRONIC CONTROL SERVICES CORP.
(FLORIDA CORPORATION)

10721 KIM LANE

HUDSON, FL 34669

FOR: ANTENNAS, IN CLASS 9 (U.S. CLS. 21, 23, 26,
36 AND 38).

FIRST USE 9-0-2003; IN COMMERCE 12-6-2003.

THE MARK CONSISTS OF STANDARD CHAR-
ACTERS WITHOUT CLAIM TO ANY PARTICULAR
FONT, STYLE, SIZE, OR COLOR.

NO CLAIM IS MADE TO THE EXCLUSIVE
RIGHT TO USE "TUNE", APART FROM THE MARK
AS SHOWN.

SER. NO. 77-276,338, FILED 9-11-2007.

SEAN CROWLEY, EXAMINING ATTORNEY

Int. Cl.: 9

Prior U.S. Cls.: 21, 23, 26, 36 and 38

United States Patent and Trademark Office

Reg. No. 3,483,684

Registered Aug. 12, 2008

**TRADEMARK
PRINCIPAL REGISTER**

PICTURE MASTER

KABUSHIKI KAISHA HITACHI SEISAKUSHO
(JAPAN CORPORATION), DBA HITACHI,
LTD.
6-6, MARUNOUCHI 1-CHOME, CHIYODA-KU
TOKYO, JAPAN

FOR: TELEVISION SETS, CAMCORDERS AND
DIGITAL IMAGE VIDEO PROCESSORS FOR CAM-
CORDERS AND TELEVISIONS, IN CLASS 9 (U.S.
CLS. 21, 23, 26, 36 AND 38).

THE MARK CONSISTS OF STANDARD CHAR-
ACTERS WITHOUT CLAIM TO ANY PARTICULAR
FONT, STYLE, SIZE, OR COLOR.

OWNER OF JAPAN REG. NO. 4855698, DATED 4-
8-2005, EXPIRES 4-8-2015.

NO CLAIM IS MADE TO THE EXCLUSIVE
RIGHT TO USE "PICTURE", APART FROM THE
MARK AS SHOWN.

SER. NO. 77-276,367, FILED 9-11-2007.

PAUL CROWLEY, EXAMINING ATTORNEY

Int. Cl.: 28

Prior U.S. Cls.: 22, 23, 38 and 50

United States Patent and Trademark Office

Reg. No. 3,483,685

Registered Aug. 12, 2008

**TRADEMARK
PRINCIPAL REGISTER**

RATTLE SHAD

BASS PRO TRADEMARKS, L.L.C. (MISSOURI
LTD LIAB CO)
2500 EAST KEARNEY
SPRINGFIELD, MO 65898

FOR: FISHING LURES, IN CLASS 28 (U.S. CLS. 22,
23, 38 AND 50).

FIRST USE 12-21-1999; IN COMMERCE 12-21-1999.

THE MARK CONSISTS OF STANDARD CHAR-
ACTERS WITHOUT CLAIM TO ANY PARTICULAR
FONT, STYLE, SIZE, OR COLOR.

SEC. 2(F).

SER. NO. 77-276,850, FILED 9-11-2007.

DAVID C. REIHNER, EXAMINING ATTORNEY

Int. Cl.: 9

Prior U.S. Cls.: 21, 23, 26, 36 and 38

Reg. No. 3,483,686

United States Patent and Trademark Office

Registered Aug. 12, 2008

**TRADEMARK
PRINCIPAL REGISTER**

ROMATIC

AUTOKONTROL LIMITED (UNITED KINGDOM
CORPORATION)
QUANTUM HOUSE
SALMON FIELDS
ROYTON, ENGLAND

FOR: ELECTRONIC SPEED CONTROLLERS FOR
VEHICLES AND PARTS THEREOF AND FITTINGS
THEREFOR SOLD AS A UNIT, IN CLASS 9 (U.S. CLS.
21, 23, 26, 36 AND 38).

THE MARK CONSISTS OF STANDARD CHAR-
ACTERS WITHOUT CLAIM TO ANY PARTICULAR
FONT, STYLE, SIZE, OR COLOR.

OWNER OF UNITED KINGDOM REG. NO.
1424714, DATED 5-10-1990, EXPIRES 5-10-2017.

SER. NO. 77-276,898, FILED 9-11-2007.

CIMMERIAN COLEMAN, EXAMINING ATTOR-
NEY

Int. Cl.: 37

Prior U.S. Cls.: 100, 103 and 106

United States Patent and Trademark Office

Reg. No. 3,483,687

Registered Aug. 12, 2008

SERVICE MARK
PRINCIPAL REGISTER



MOLOGOUSIS, WILLIAM A. (UNITED STATES
INDIVIDUAL)
1615 S. 55TH AVENUE
CICERO, IL 60804

FOR: PRESSURE WASHING SERVICES, IN
CLASS 37 (U.S. CLS. 100, 103 AND 106).

FIRST USE 6-3-1991; IN COMMERCE 6-3-1991.

NO CLAIM IS MADE TO THE EXCLUSIVE
RIGHT TO USE "PRESSURE WASHING" AND
"INC.", APART FROM THE MARK AS SHOWN.

THE COLOR(S) RED AND BLUE IS/ARE
CLAIMED AS A FEATURE OF THE MARK.

THE MARK CONSISTS OF THE WORDS "PRES-
SURE WASHING" IN RED ALL UPPER CASE
LETTERS, THE WORD "SYSTEMS" IN BLUE WITH
A DIFFERENT DESIGN FONT WITH A BLUE
HORIZONTAL LINE EXTENDING TO THE RIGHT
AFTER THE LAST S IN THE WORD, THE PHRASE
"ENVIRONMENTAL, INC." IN BLUE IN ALL UP-
PER CASE LETTERS WITH A BLUE HORIZONTAL
LINE BEFORE AND AFTER THE PHRASE.

SEC. 2(F) AS TO "PRESSURE WASHING SYS-
TEMS".

SER. NO. 77-277,277, FILED 9-12-2007.

TINA BROWN, EXAMINING ATTORNEY

Int. Cls.: 1, 9 and 42

**Prior U.S. Cls.: 1, 5, 6, 10, 21, 23, 26, 36, 38, 46, 100
and 101**

Reg. No. 3,483,688

United States Patent and Trademark Office

Registered Aug. 12, 2008

**TRADEMARK
SERVICE MARK
PRINCIPAL REGISTER**



ANTHILL TECHNOLOGIES, INC. (MASSACHUSETTS CORPORATION)
63 COLONY ROAD
LEXINGTON, MA 02420

FOR: CUSTOM CHEMICAL COMPOUNDS FOR USE BY CHEMISTS AND BIOLOGISTS TO PERFORM RESEARCH AND DEVELOPMENT IN LABORATORIES, IN CLASS 1 (U.S. CLS. 1, 5, 6, 10, 26 AND 46).

FIRST USE 10-1-2006; IN COMMERCE 10-1-2006.

FOR: LABORATORY EQUIPMENT FOR USE BY CHEMISTS AND BIOLOGISTS TO PERFORM RESEARCH AND DEVELOPMENT IN LABORATORIES, NAMELY, HEATER-SHAKERS, CUSTOM BLOCKS, CUSTOM ENCLOSURES AND VIALS, IN CLASS 9 (U.S. CLS. 21, 23, 26, 36 AND 38).

FIRST USE 10-1-2006; IN COMMERCE 10-1-2006.

FOR: PRODUCT RESEARCH AND DEVELOPMENT IN THE FIELDS OF PHARMACEUTICAL AND BIOTECHNOLOGY; CUSTOM DESIGN AND DEVELOPMENT OF CHEMICAL COMPOUNDS

FOR USE IN THE PHARMACEUTICAL AND BIOTECHNOLOGY FIELDS; WORKING ON AND EVALUATION OF CHEMICAL SYNTHESSES IN THE PHARMACEUTICAL AND BIOTECHNOLOGY FIELDS; CHEMICAL LABORATORIES IN THE FIELDS OF PHARMACEUTICAL AND BIOTECHNOLOGY, IN CLASS 42 (U.S. CLS. 100 AND 101).

FIRST USE 10-1-2006; IN COMMERCE 10-1-2006.

NO CLAIM IS MADE TO THE EXCLUSIVE RIGHT TO USE "TECHNOLOGIES", APART FROM THE MARK AS SHOWN.

THE MARK CONSISTS OF AN IMAGE OF AN ANT WEARING GLASSES WITH LEFT ARM RAISED IN THE AIR AND RIGHT ARM DOWN STANDING NEXT TO THE TEXT "ANTHILL TECHNOLOGIES."

SER. NO. 77-277,420, FILED 9-12-2007.

KATHERINE M. DUBRAY, EXAMINING ATTORNEY

Int. Cl.: 14

Prior U.S. Cls.: 2, 27, 28 and 50

United States Patent and Trademark Office

Reg. No. 3,483,689

Registered Aug. 12, 2008

**TRADEMARK
PRINCIPAL REGISTER**

CEDRICK

CEDRICK JEWELERS (CALIFORNIA CORPORATION)
611 WILSHIRE BOULEVARD, SUITE 1010
LOS ANGELES, CA 90017

THE MARK CONSISTS OF STANDARD CHARACTERS WITHOUT CLAIM TO ANY PARTICULAR FONT, STYLE, SIZE, OR COLOR.

FOR: JEWELRY, IN CLASS 14 (U.S. CLS. 2, 27, 28 AND 50).

SER. NO. 77-277,500, FILED 9-12-2007.

FIRST USE 1-5-1998; IN COMMERCE 1-5-1998.

GEORGE LORENZO, EXAMINING ATTORNEY

Int. Cl.: 16

Prior U.S. Cls.: 2, 5, 22, 23, 29, 37, 38 and 50

Reg. No. 3,483,690

United States Patent and Trademark Office

Registered Aug. 12, 2008

**TRADEMARK
PRINCIPAL REGISTER**

BK

THE BERRETT-KOEHLER GROUP, INC. (CALI-
FORNIA CORPORATION)
235 MONTGOMERY STREET
SUITE 650
SAN FRANCISCO, CA 94104

FOR: NON-FICTION BOOKS, BOOKLETS AND
PAMPHLETS ON A WIDE VARIETY OF TOPICS;
POSTERS, CATALOGS FEATURING NON-FICTION
BOOKS; POSTER PAPER DESIGNED FOR USE AS
BILLBOARDS, IN CLASS 16 (U.S. CLS. 2, 5, 22, 23, 29,
37, 38 AND 50).

FIRST USE 5-20-1992; IN COMMERCE 5-20-1992.

THE MARK CONSISTS OF STANDARD CHAR-
ACTERS WITHOUT CLAIM TO ANY PARTICULAR
FONT, STYLE, SIZE, OR COLOR.

OWNER OF U.S. REG. NO. 2,481,963.

SER. NO. 77-277,524, FILED 9-12-2007.

PAM WILLIS, EXAMINING ATTORNEY

Int. Cl.: 39

Prior U.S. Cls.: 100 and 105

United States Patent and Trademark Office

Reg. No. 3,483,691

Registered Aug. 12, 2008

**SERVICE MARK
PRINCIPAL REGISTER**

EVERYTHING, HANDLED WITH
CARE

CADOGAN TATE GROUP LIMITED (UNITED
KINGDOM LIMITED COMPANY (LTD.))
CADOGAN HOUSE
239 ACTON LANE
LONDON, UNITED KINGDOM NW107NP

FOR: TRANSPORT AND STORAGE OF GOODS;
PACKAGING ARTICLES FOR TRANSPORTATION;
JUNK REMOVAL SERVICES; FREIGHT FOR-
WARDING SERVICES, PACKING OR WRAPPING
OF GOODS TO BE STORED OR TRANSPORTED;
RENTAL OF TRUCKS, VANS OR VEHICLES FOR
TRANSPORTING GOODS; RENTAL OF STORAGE
CONTAINERS; STORAGE OF GOODS; STORAGE
OF GOODS USING CONTROLLED ENVIRON-
MENTS; STORAGE, PACKING AND SHIPPING OF
FINE ART; RESIDENTIAL FURNITURE MOVING,
MOVING VAN AND STORAGE SERVICES; WARE-
HOUSING AND STORAGE OF GOODS AND PER-
SONAL BELONGINGS; PROVIDING SELF-

STORAGE FACILITIES FOR OTHERS, AND REN-
TAL OF WAREHOUSE AND STORAGE SPACE, IN
CLASS 39 (U.S. CLS. 100 AND 105).

FIRST USE 7-31-2007; IN COMMERCE 7-31-2007.

THE MARK CONSISTS OF STANDARD CHAR-
ACTERS WITHOUT CLAIM TO ANY PARTICULAR
FONT, STYLE, SIZE, OR COLOR.

PRIORITY CLAIMED UNDER SEC. 44(D) ON
ERPNTY TM OFC APPLICATION NO.
005760665, FILED 3-15-2007.

SER. NO. 77-278,383, FILED 9-12-2007.

JOHN SCHUYLER YARD, EXAMINING ATTOR-
NEY

Int. Cl.: 38

Prior U.S. Cls.: 100, 101 and 104

United States Patent and Trademark Office

Reg. No. 3,483,692

Registered Aug. 12, 2008

**SERVICE MARK
PRINCIPAL REGISTER**

**RadioMankato
The Sound of Southern
Minnesota**

MINNESOTA VALLEY BROADCASTING COM-
PANY (MINNESOTA CORPORATION)
59346 MADISON AVE.
MANKATO, MN 560021420

NO CLAIM IS MADE TO THE EXCLUSIVE
RIGHT TO USE "RADIOMANKATO" AND "SOUTH-
ERN MINNESOTA", APART FROM THE MARK AS
SHOWN.

FOR: RADIO BROADCASTING, IN CLASS 38 (U.S.
CLS. 100, 101 AND 104).

FIRST USE 9-1-2007; IN COMMERCE 9-1-2007.

SER. NO. 77-278,490, FILED 9-13-2007.

THE MARK CONSISTS OF STANDARD CHAR-
ACTERS WITHOUT CLAIM TO ANY PARTICULAR
FONT, STYLE, SIZE, OR COLOR.

REBECCA SMITH, EXAMINING ATTORNEY

Int. Cl.: 28

Prior U.S. Cls.: 22, 23, 38 and 50

Reg. No. 3,483,693

United States Patent and Trademark Office

Registered Aug. 12, 2008

**TRADEMARK
PRINCIPAL REGISTER**

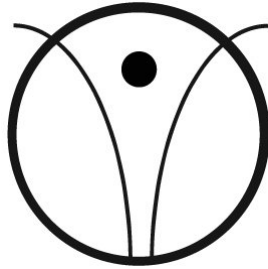

SOLO

STRENGTH

SOLOSTRENGTH LIFESTYLE PRODUCTS
CORP. (CANADA CORPORATION)
2815 COLWOOD DR.
NORTH VANCOUVER, CANADA V7R-2R2

PRIORITY CLAIMED UNDER SEC. 44(D) ON
CANADA APPLICATION NO. 1303090, FILED 6-1-
2007, REG. NO. TMA703323, DATED 12-18-2007, EX-
PIRES 12-18-2022.

FOR: MANUALLY-OPERATED EXERCISE
EQUIPMENT, IN CLASS 28 (U.S. CLS. 22, 23, 38
AND 50).

SER. NO. 77-278,798, FILED 9-13-2007.

FIRST USE 2-1-2006; IN COMMERCE 1-4-2007.

HEATHER THOMPSON, EXAMINING ATTORNEY

Int. Cl.: 25

Prior U.S. Cls.: 22 and 39

United States Patent and Trademark Office

Reg. No. 3,483,694

Registered Aug. 12, 2008

**TRADEMARK
PRINCIPAL REGISTER**

TRANSITIONS

BROWNING (UTAH CORPORATION)
ONE BROWNING PLACE
MORGAN, UT 84050

THE MARK CONSISTS OF STANDARD CHAR-
ACTERS WITHOUT CLAIM TO ANY PARTICULAR
FONT, STYLE, SIZE, OR COLOR.

FOR: JACKETS; PANTS; VESTS; PARKAS, IN
CLASS 25 (U.S. CLS. 22 AND 39).

SER. NO. 77-279,053, FILED 9-13-2007.

FIRST USE 8-1-2007; IN COMMERCE 9-1-2007.

STEVEN R. FINE, EXAMINING ATTORNEY

Int. Cl.: 9

Prior U.S. Cls.: 21, 23, 26, 36 and 38

Reg. No. 3,483,695

United States Patent and Trademark Office

Registered Aug. 12, 2008

**TRADEMARK
PRINCIPAL REGISTER**



AWARENESS TECHNOLOGIES, INC. (DELAWARE CORPORATION)
4640 ADMIRALTY WAY
MARINA DEL REY, CA 90292

FOR: COMPUTER SOFTWARE FOR COMPREHENSIVE END POINT MONITORING, PROTECTION, ACCESS RESTRICTION, INTERNET RESTRICTION AND REMOTE CONTROL , IN CLASS 9 (U.S. CLS. 21, 23, 26, 36 AND 38).

FIRST USE 7-10-2007; IN COMMERCE 7-10-2007.

THE MARK CONSISTS OF THE WORD "SONAR" IN ALL CAPITAL LETTERS. INSTEAD OF THE LETTER "O", THE IMAGE USES A CIRCLE CON-

TAINING TWO INTERNAL CONCENTRIC CIRCLES, BOTH OF WHICH ARE BISECTED VERTICALLY AND HORIZONTALLY, AS MAY APPEAR ON A RADAR OR SONAR SCREEN. A LINE PULLING A SHADOW EMANATES FROM THE CENTER OF THE "O" AND EXTENDS OUTSIDE THE "O" AS THE SWEEP HAND ON A RADAR/SONAR SCREEN. THE SWEEP HAND APPEARS TO PULL A SHADOW IMAGE BEHIND THE SWEEP.

SER. NO. 77-279,083, FILED 9-13-2007.

SUSAN RICHARDS, EXAMINING ATTORNEY

Int. Cl.: 42

Prior U.S. Cls.: 100 and 101

United States Patent and Trademark Office

Reg. No. 3,483,696

Registered Aug. 12, 2008

**SERVICE MARK
PRINCIPAL REGISTER**

ManageForce

MANAGEFORCE CORPORATION (ILLINOIS
CORPORATION)
4137 FRANKLIN AVE.
WESTERN SPRINGS, IL 60558

FOR: SOFTWARE CONSULTATION; COMPUTER
SERVICES, NAMELY, SYSTEM ADMINISTRATION
FOR OTHERS; COMPUTER PROJECT MANAGE-
MENT SERVICES IN CLASS 42, IN CLASS 42 (U.S.
CLS. 100 AND 101).

FIRST USE 1-1-2006; IN COMMERCE 4-1-2006.

THE MARK CONSISTS OF STANDARD CHAR-
ACTERS WITHOUT CLAIM TO ANY PARTICULAR
FONT, STYLE, SIZE, OR COLOR.

SER. NO. 77-279,567, FILED 9-14-2007.

MARK RADEMACHER, EXAMINING ATTORNEY

Int. Cl.: 41

Prior U.S. Cls.: 100, 101 and 107

United States Patent and Trademark Office

Reg. No. 3,483,697

Registered Aug. 12, 2008

**SERVICE MARK
PRINCIPAL REGISTER**

WORLD CUISINES UNCOVERED

EDUCATION MANAGEMENT LLC (DELAWARE
LTD LIAB CO)
210 SIXTH AVENUE
PITTSBURGH, PA 15222

FOR: EDUCATIONAL SERVICES, NAMELY,
PROVIDING COURSES OF INSTRUCTION AT
THE POSTSECONDARY LEVEL, IN CLASS 41 (U.S.
CLS. 100, 101 AND 107).

FIRST USE 11-5-2007; IN COMMERCE 11-5-2007.

THE MARK CONSISTS OF STANDARD CHAR-
ACTERS WITHOUT CLAIM TO ANY PARTICULAR
FONT, STYLE, SIZE, OR COLOR.

NO CLAIM IS MADE TO THE EXCLUSIVE
RIGHT TO USE "WORLD CUISINES", APART
FROM THE MARK AS SHOWN.

SER. NO. 77-279,724, FILED 9-14-2007.

KELLEY WELLS, EXAMINING ATTORNEY

Int. Cl.: 45

Prior U.S. Cls.: 100 and 101

United States Patent and Trademark Office

Reg. No. 3,483,698

Registered Aug. 12, 2008

**SERVICE MARK
PRINCIPAL REGISTER**



AWARENESS TECHNOLOGIES, INC. (DELAWARE CORPORATION)
4640 ADMIRALTY WAY, SUITE 1140
MARINA DEL REY, CA 90292

FOR: LICENSING OF COMPUTER SOFTWARE,
IN CLASS 45 (U.S. CLS. 100 AND 101).

FIRST USE 7-20-2007; IN COMMERCE 7-20-2007.

NO CLAIM IS MADE TO THE EXCLUSIVE
RIGHT TO USE "AWARENESS TECHNOLOGIES",
APART FROM THE MARK AS SHOWN.

THE MARK CONSISTS OF THE WORDS "AWARENESS" AND "TECHNOLOGIES" STACKED IN A SINGLE COLUMN. TO THE LEFT OF THE TEXT IS AN OPAQUE CIRCLE, SURROUNDED BY TWO ELONGATED CRESCENTS. ONE CRESCENT BEGINS AT 11 O'CLOCK, CIRCLING DOWN AND UNDER THE CIRCLE TO THE RIGHT. THE SECOND CRESCENT BEGINS AT 5 O'CLOCK, CIRCLING UP AND OVER THE CIRCLE TO THE LEFT.

SER. NO. 77-279,910, FILED 9-14-2007.

SUSAN RICHARDS, EXAMINING ATTORNEY

Int. Cls.: 9, 37 and 42

Prior U.S. Cls.: 21, 23, 26, 36, 38, 100, 101, 103 and 106

United States Patent and Trademark Office

Reg. No. 3,483,699

Registered Aug. 12, 2008

**TRADEMARK
SERVICE MARK
PRINCIPAL REGISTER**

SPARC ENTERPRISE

SPARC INTERNATIONAL, INC. (CALIFORNIA CORPORATION)
SUITE 204
1671 DELL AVENUE
CAMPBELL, CA 95008

FOR: COMPUTERS, COMPUTER HARDWARE, COMPUTER SERVERS, COMPUTER PERIPHERAL DEVICES, AND MANUALS SOLD THEREWITH, IN CLASS 9 (U.S. CLS. 21, 23, 26, 36 AND 38).

FIRST USE 4-17-2007; IN COMMERCE 4-17-2007.

FOR: COMPUTER SERVICES, NAMELY, INSTALLATION, MAINTENANCE AND REPAIR OF COMPUTER HARDWARE, COMPUTER PERIPHERALS, COMPUTER SYSTEMS, AND COMPUTER NETWORKS, IN CLASS 37 (U.S. CLS. 100, 103 AND 106).

FIRST USE 4-17-2007; IN COMMERCE 4-17-2007.

FOR: COMPUTER CONSULTATION SERVICES; PROVIDING ONLINE INFORMATION AND NEWS IN THE FIELD OF COMPUTERS, COMPUTER

HARDWARE, COMPUTER SOFTWARE, COMPUTER SERVERS, PROCESSORS, SEMICONDUCTORS, INTEGRATED CIRCUITS, AND INFORMATION TECHNOLOGY, IN CLASS 42 (U.S. CLS. 100 AND 101).

FIRST USE 4-17-2007; IN COMMERCE 4-17-2007.

THE MARK CONSISTS OF STANDARD CHARACTERS WITHOUT CLAIM TO ANY PARTICULAR FONT, STYLE, SIZE, OR COLOR.

OWNER OF U.S. REG. NOS. 1,591,728, 1,684,099 AND OTHERS.

NO CLAIM IS MADE TO THE EXCLUSIVE RIGHT TO USE "ENTERPRISE", APART FROM THE MARK AS SHOWN.

SER. NO. 77-279,973, FILED 9-14-2007.

TINA BROWN, EXAMINING ATTORNEY

Int. Cls.: 35 and 41

Prior U.S. Cls.: 100, 101, 102 and 107

United States Patent and Trademark Office

Reg. No. 3,483,700

Registered Aug. 12, 2008

**SERVICE MARK
PRINCIPAL REGISTER**

AFM

AMERICAN FEDERATION OF MOTORCYCLISTS, INCORPORATED (CALIFORNIA CORPORATION)
6167 JARVIS AVENUE, SUITE 333
NEWARK, CA 94560

FOR: PROMOTION OF THE SPORT AND PASTIME OF MOTORCYCLING, IN CLASS 35 (U.S. CLS. 100, 101 AND 102).

FIRST USE 12-1-1956; IN COMMERCE 12-1-1956.

FOR: ORGANIZATION, ARRANGEMENT AND REGULATION OF CLOSED-CIRCUIT ROAD RA-

CING AND OTHER FORMS OF MOTORCYCLE COMPETITION, IN CLASS 41 (U.S. CLS. 100, 101 AND 107).

FIRST USE 12-1-1956; IN COMMERCE 12-1-1956.

THE MARK CONSISTS OF STANDARD CHARACTERS WITHOUT CLAIM TO ANY PARTICULAR FONT, STYLE, SIZE, OR COLOR.

SER. NO. 77-280,331, FILED 9-14-2007.

EMILY CHUO, EXAMINING ATTORNEY

Int. Cl.: 30

Prior U.S. Cl.: 46

United States Patent and Trademark Office

Reg. No. 3,483,701

Registered Aug. 12, 2008

**TRADEMARK
PRINCIPAL REGISTER**

BLACKBERRY FIELDS

BLACKBERRY PATCH, INC. (GEORGIA CORPORATION)
92 GENESIS PARKWAY
THOMASVILLE, GA 31799

FOR: TABLE SYRUP, TOPPING SYRUP, MAPLE SYRUP, MAPLE-BLEND SYRUP, FRUIT SYRUP, AND PANCAKE SYRUP; SAUCES, NAMELY, FRUIT SAUCES EXCLUDING CRANBERRY SAUCE AND APPLESAUCE, IN CLASS 30 (U.S. CL. 46).

FIRST USE 11-14-2007; IN COMMERCE 11-14-2007.

THE MARK CONSISTS OF STANDARD CHARACTERS WITHOUT CLAIM TO ANY PARTICULAR FONT, STYLE, SIZE, OR COLOR.

NO CLAIM IS MADE TO THE EXCLUSIVE RIGHT TO USE "BLACKBERRY", APART FROM THE MARK AS SHOWN.

SER. NO. 77-280,566, FILED 9-16-2007.

KATHRYN COWARD, EXAMINING ATTORNEY

Prior U.S. Cl.: B

United States Patent and Trademark Office

Reg. No. 3,483,702

Registered Aug. 12, 2008

**CERTIFICATION MARK
PRINCIPAL REGISTER**



ALABAMA TREASURE FOREST ASSOCIATION
(ALABAMA 501 (C)3 NON-PROFIT, EDUCATIONAL CORPORATION)
C/O UNIVERSITY OF MOBILE
5735 COLLEGE PARKWAY
MOBILE, AL 366132842

FOR: FORESTRY AND LAND MANAGEMENT SERVICES, IN CLASS B (U.S. CL. B).

FIRST USE 12-31-1999; IN COMMERCE 12-31-1999.

NO CLAIM IS MADE TO THE EXCLUSIVE RIGHT TO USE "FOREST", APART FROM THE MARK AS SHOWN.

THE MARK CONSISTS OF A RECTANGLE THAT IS LONGER IN THE VERTICAL, WITH THE WORD

"TREASURE", ATOP AN ACORN DESIGN WITH STARS FOR THE TOP OF THE ACORN AND STRIPES FOR THE BOTTOM OF THE ACORN, ALL ATOP THE WORD "FOREST".

THE CERTIFICATION MARK, AS USED BY AUTHORIZED PERSONS, CERTIFIES THAT INDIVIDUALS HAVE ACHIEVED A SPECIFIC LEVEL OF PROFESSIONAL KNOWLEDGE, TRAINING AND EXPERIENCE IN THE FIELD OF ENVIRONMENTALLY FRIENDLY TECHNIQUES AND APPROACHES TO LAND AND FOREST MANAGEMENT PRACTICES.

SER. NO. 77-280,869, FILED 9-17-2007.

DORITT L. CARROLL, EXAMINING ATTORNEY

Int. Cl.: 33

Prior U.S. Cls.: 47 and 49

United States Patent and Trademark Office

Reg. No. 3,483,703

Registered Aug. 12, 2008

**TRADEMARK
PRINCIPAL REGISTER**

MUTINY

WHYTE AND MACKAY LIMITED (UNITED
KINGDOM CORPORATION)
DALMORE HOUSE
310 ST VINCENT STREET
GLASGOW, UNITED KINGDOM G25RG

FOR: ALCOHOLIC BEVERAGES EXCEPT BEERS;
RUM AND RUM BASED LIQUEURS, IN CLASS 33
(U.S. CLS. 47 AND 49).

THE MARK CONSISTS OF STANDARD CHAR-
ACTERS WITHOUT CLAIM TO ANY PARTICULAR
FONT, STYLE, SIZE, OR COLOR.

PRIORITY CLAIMED UNDER SEC. 44(D) ON
UNITED KINGDOM APPLICATION NO. 2464108,
FILED 8-14-2007.

OWNER OF UNITED KINGDOM REG. NO.
2464108, DATED 3-14-2008, EXPIRES 8-14-2017.

SER. NO. 77-280,936, FILED 9-17-2007.

KATHY DE JONGE, EXAMINING ATTORNEY

Int. Cl.: 33

Prior U.S. Cls.: 47 and 49

United States Patent and Trademark Office

Reg. No. 3,483,704

Registered Aug. 12, 2008

**TRADEMARK
PRINCIPAL REGISTER**

INDIAN MUTINY

WHYTE AND MACKAY LIMITED (UNITED
KINGDOM CORPORATION)
DALMORE HOUSE
310 ST VINCENT STREET
GLASGOW, UNITED KINGDOM G25RG

FOR: ALCOHOLIC BEVERAGES EXCEPT BEERS;
RUM AND RUM BASED LIQUEURS, IN CLASS 33
(U.S. CLS. 47 AND 49).

THE MARK CONSISTS OF STANDARD CHAR-
ACTERS WITHOUT CLAIM TO ANY PARTICULAR
FONT, STYLE, SIZE, OR COLOR.

PRIORITY CLAIMED UNDER SEC. 44(D) ON
UNITED KINGDOM APPLICATION NO. 2464106,
FILED 8-14-2007.

OWNER OF UNITED KINGDOM REG. NO.
2464106, DATED 1-25-2008, EXPIRES 8-14-2017.

SER. NO. 77-280,957, FILED 9-17-2007.

KATHY DE JONGE, EXAMINING ATTORNEY

Int. Cl.: 41

Prior U.S. Cls.: 100, 101 and 107

United States Patent and Trademark Office

Reg. No. 3,483,705

Registered Aug. 12, 2008

**SERVICE MARK
PRINCIPAL REGISTER**

Pre-Inheritance Experience

HERITAGE INSTITUTE, THE (OREGON LTD
LIAB CO)
SUITE 202
7724 SE APEN SUMMIT DR.
PORTLAND, OR 97266

FOR: EDUCATIONAL SERVICES, NAMELY,
CONDUCTING CONTINUING EDUCATION CLAS-
SES, WORKSHOPS AND SEMINARS IN WRITTEN
AND COMPUTERIZED FORM IN THE FIELD OF
ESTATE, FINANCIAL, RETIREMENT AND TAX
PLANNING RELATING TO SPECIFIC ISSUES OF
INDIVIDUALS AND FAMILIES, IN CLASS 41 (U.S.
CLS. 100, 101 AND 107).

FIRST USE 9-1-2005; IN COMMERCE 9-1-2005.

THE MARK CONSISTS OF STANDARD CHAR-
ACTERS WITHOUT CLAIM TO ANY PARTICULAR
FONT, STYLE, SIZE, OR COLOR.

NO CLAIM IS MADE TO THE EXCLUSIVE
RIGHT TO USE "PRE-INHERITANCE", APART
FROM THE MARK AS SHOWN.

SER. NO. 77-281,032, FILED 9-17-2007.

ALICE SUE CARRUTHERS, EXAMINING ATTOR-
NEY

Int. Cl.: 35

Prior U.S. Cls.: 100, 101 and 102

United States Patent and Trademark Office

Reg. No. 3,483,706

Registered Aug. 12, 2008

**SERVICE MARK
PRINCIPAL REGISTER**

GT4H

GT4H, INC. (MARYLAND CORPORATION)
SUITE 120
12138 CENTRAL AVENUE
BOWIE, MD 20721

FIRST USE 7-25-2007; IN COMMERCE 7-25-2007.

FOR: BUSINESS MANAGEMENT CONSULTANCY AS WELL AS DEVELOPMENT OF PROCESSES FOR THE ANALYSIS AND THE IMPLEMENTATION OF STRATEGIC PLANS AND MANAGEMENT OF PROJECTS, IN CLASS 35 (U.S. CLS. 100, 101 AND 102).

THE MARK CONSISTS OF STANDARD CHARACTERS WITHOUT CLAIM TO ANY PARTICULAR FONT, STYLE, SIZE, OR COLOR.

SER. NO. 77-281,069, FILED 9-17-2007.

JIM RINGLE, EXAMINING ATTORNEY

Int. Cl.: 36

Prior U.S. Cls.: 100, 101 and 102

United States Patent and Trademark Office

Reg. No. 3,483,707

Registered Aug. 12, 2008

**SERVICE MARK
PRINCIPAL REGISTER**



CONVENIENCE SALES NETWORK INC. (DELA-
WARE CORPORATION)
SUITE 5
41419 PEAR ST.
MURRIETA, CA 92562

FOR: BROKERAGE IN THE FIELD OF FOOD,
BEVERAGES, HEALTH AND BEAUTY CARE, AND
GENERAL CONSUMER MERCHANDISE, IN CLASS
36 (U.S. CLS. 100, 101 AND 102).

FIRST USE 1-1-2000; IN COMMERCE 1-1-2000.

OWNER OF U.S. REG. NO. 2,553,937.

NO CLAIM IS MADE TO THE EXCLUSIVE
RIGHT TO USE "CONVENIENCE SALES NET-
WORK", APART FROM THE MARK AS SHOWN.

THE COLOR(S) BURGUNDY AND BLACK IS/
ARE CLAIMED AS A FEATURE OF THE MARK.

THE MARK CONSISTS OF A GEOMETRIC FIG-
URE RESEMBLING THE LETTER "C" IN BURGUN-
DY FOLLOWED BY THE WORDS "CONVENIENCE
SALES NETWORK" IN BLACK LETTERING.

SER. NO. 77-281,092, FILED 9-17-2007.

MARIA-VICTORIA SUAREZ, EXAMINING ATTOR-
NEY

Int. Cl.: 41

Prior U.S. Cls.: 100, 101 and 107

United States Patent and Trademark Office

Reg. No. 3,483,708

Registered Aug. 12, 2008

**SERVICE MARK
PRINCIPAL REGISTER**



STRENGTH & GRACE FITNESS, LLC (VIRGINIA
LTD LIAB CO)
P.O. BOX 90441
ALEXANDRIA, VA 22309

FOR: PERSONAL TRAINER, IN CLASS 41 (U.S.
CLS. 100, 101 AND 107).

FIRST USE 8-1-2007; IN COMMERCE 8-15-2007.

OWNER OF U.S. REG. NO. 3,304,844.

NO CLAIM IS MADE TO THE EXCLUSIVE
RIGHT TO USE "FITNESS FOR TWO", APART
FROM THE MARK AS SHOWN.

THE MARK CONSISTS OF A SHADED SWOOSH
IN THE FORM OF A WOMAN WITH A SMALLER
SHADED SWOOSH ABOVE IT IN THE SHAPE OF A
BABY. THE WORDING "STRENGTH & GRACE" IS
UNDERNEATH THE TWO SWOOSHES. UNDER
"STRENGTH & GRACE" IS "FITNESS", AND UN-
DER "FITNESS" IS "FOR TWO", ALL IN STYLIZED
TEXT.

SER. NO. 77-281,334, FILED 9-17-2007.

MICHAEL WIENER, EXAMINING ATTORNEY

Int. Cl.: 35

Prior U.S. Cls.: 100, 101 and 102

United States Patent and Trademark Office

Reg. No. 3,483,709

Registered Aug. 12, 2008

**SERVICE MARK
PRINCIPAL REGISTER**

TMC

TEXAS MIGRANT COUNCIL, INC. (TEXAS
NON-PROFIT CORPORATION)
5215 MCPHERSON ROAD
LAREDO, TX 78041

FOR: JOB PLACEMENT; SKILLS ASSESSMENT, NAMELY, TESTING TO DETERMINE EMPLOYMENT SKILLS; PROMOTING PUBLIC AWARENESS OF THE NEED TO PROVIDE TRAINING AND ENHANCEMENT OF JOB SKILLS IN THE WORKFORCE AND PROGRAMS PERTAINING TO WORKFORCE TRAINING; PROMOTING AWARENESS IN THE BUSINESS COMMUNITY OF THE NEED TO PROVIDE TRAINING AND ENHANCEMENT OF JOB SKILLS IN THE WORKFORCE AND PROGRAMS PERTAINING TO WORKFORCE TRAINING; CHARITABLE SERVICES, NAMELY, PROMOTING PUBLIC AWARENESS ABOUT MIGRANT FAMILIES; CHARITABLE SERVICES,

NAMELY, PROVIDING BUSINESS ADMINISTRATION AND MANAGEMENT OF CHILD CARE FACILITIES AND ORGANIZING AND CONDUCTING VOLUNTEER PROGRAMS AND COMMUNITY SERVICE PROJECTS; ASSOCIATION SERVICES, NAMELY, PROMOTING THE INTEREST OF MIGRANT WORKERS, IN CLASS 35 (U.S. CLS. 100, 101 AND 102).

FIRST USE 6-25-1971; IN COMMERCE 6-25-1971.

THE MARK CONSISTS OF STANDARD CHARACTERS WITHOUT CLAIM TO ANY PARTICULAR FONT, STYLE, SIZE, OR COLOR.

SER. NO. 77-281,401, FILED 9-17-2007.

PAUL CROWLEY, EXAMINING ATTORNEY

Int. Cl.: 37

Prior U.S. Cls.: 100, 103 and 106

United States Patent and Trademark Office

Reg. No. 3,483,710

Registered Aug. 12, 2008

**SERVICE MARK
PRINCIPAL REGISTER**



KEVIN MARK BARNETT (UNITED STATES IN-
DIVIDUAL)
3605 ALHAMBRA LANE
PERRIS, CA 92571

FOR: TERMITE AND PEST CONTROL, IN CLASS
37 (U.S. CLS. 100, 103 AND 106).

FIRST USE 9-17-2007; IN COMMERCE 9-17-2007.

NO CLAIM IS MADE TO THE EXCLUSIVE
RIGHT TO USE "TERMITE AND PEST CONTROL",
APART FROM THE MARK AS SHOWN.

THE COLOR(S) SILVER, RED AND ORANGE IS/
ARE CLAIMED AS A FEATURE OF THE MARK.

THE MARK CONSISTS OF THE COLOR SILVER
APPEARS IN THE WORDING IN THE MARK; THE
COLOR RED APPEARS AS A BACKGROUND OF
THE WORDING IN THE MARK AND IN THE
CENTER FLAME DESIGN; THE COLOR ORANGE
APPEARS IN THE FLAMES ABOVE AND BELOW
THE RED FLAME.

SER. NO. 77-281,761, FILED 9-18-2007.

CYNTHIA SLOAN, EXAMINING ATTORNEY

Int. Cl.: 39

Prior U.S. Cls.: 100 and 105

United States Patent and Trademark Office

Reg. No. 3,483,711

Registered Aug. 12, 2008

**SERVICE MARK
PRINCIPAL REGISTER**



ATTIC PLUS, A GENERAL PARTNERSHIP (ALABAMA PARTNERSHIP), DBA ATTIC PLUS STORAGE

4748 CAHABA RIVER ROAD
BIRMINGHAM, AL 35243

FOR: PROVIDING SELF-STORAGE FACILITIES FOR OTHERS, IN CLASS 39 (U.S. CLS. 100 AND 105).

FIRST USE 9-1-1995; IN COMMERCE 9-1-1995.

THE COLOR(S) BLUE, YELLOW, ORANGE IS/ARE CLAIMED AS A FEATURE OF THE MARK.

THE MARK CONSISTS OF LOGO FEATURES "ATTIC PLUS" WORDS WITH ROOF AND WINDOW.

SER. NO. 77-282,539, FILED 9-18-2007.

JUSTINE D. PARKER, EXAMINING ATTORNEY

Int. Cl.: 5

Prior U.S. Cls.: 6, 18, 44, 46, 51 and 52

United States Patent and Trademark Office

Reg. No. 3,483,712

Registered Aug. 12, 2008

**TRADEMARK
PRINCIPAL REGISTER**

NATURALLY PURE

NEXGEN PHARMA, INC. (CALIFORNIA CORPORATION)
46 CORPORATE PARK, SUITE 100
IRVINE, CA 92606

FOR: NUTRITIONAL AND DIETARY SUPPLEMENTS, IN CLASS 5 (U.S. CLS. 6, 18, 44, 46, 51 AND 52).

FIRST USE 3-29-2002; IN COMMERCE 3-29-2002.

THE MARK CONSISTS OF STANDARD CHARACTERS WITHOUT CLAIM TO ANY PARTICULAR FONT, STYLE, SIZE, OR COLOR.

OWNER OF U.S. REG. NO. 2,603,097.

SEC. 2(F).

SER. NO. 77-282,772, FILED 9-18-2007.

RICHARD A. STRASER, EXAMINING ATTORNEY

Int. Cl.: 3

Prior U.S. Cls.: 1, 4, 6, 50, 51 and 52

Reg. No. 3,483,713

United States Patent and Trademark Office

Registered Aug. 12, 2008

**TRADEMARK
PRINCIPAL REGISTER**

CURLING CUSTARD

SHELLEY DAVIS (DELAWARE LTD LIAB CO),
DBA KINKY-CURLY HAIR CARE
SUITE #374
289 SOUTH ROBERTSON
BEVERLY HILLS, CA 90211

FOR: HAIR CARE PRODUCTS, NAMELY, HAIR
CARE PREPARATIONS, HAIR CLEANING PRE-
PARATIONS, HAIR STYLING PREPARATIONS,
HAIR DRESSINGS, SHAMPOO, CONDITIONERS,
HAIR SPRAY, HAIR GEL AND MOUSSE, IN CLASS
3 (U.S. CLS. 1, 4, 6, 50, 51 AND 52).

FIRST USE 2-4-2005; IN COMMERCE 2-14-2005.

THE MARK CONSISTS OF STANDARD CHAR-
ACTERS WITHOUT CLAIM TO ANY PARTICULAR
FONT, STYLE, SIZE, OR COLOR.

NO CLAIM IS MADE TO THE EXCLUSIVE
RIGHT TO USE "CURLING", APART FROM THE
MARK AS SHOWN.

SER. NO. 77-282,813, FILED 9-18-2007.

JESSICA FATHY, EXAMINING ATTORNEY

Int. Cl.: 33

Prior U.S. Cls.: 47 and 49

United States Patent and Trademark Office

Reg. No. 3,483,714

Registered Aug. 12, 2008

TRADEMARK
PRINCIPAL REGISTER



BARGER WINE HUNGRAY, LLC (GEORGIA
LTD LIAB CO)
425 WITTENRIDGE CT
ALPHARETTA, GA 30022

FOR: WINE, IN CLASS 33 (U.S. CLS. 47 AND 49).

FIRST USE 1-1-2006; IN COMMERCE 8-1-2007.

NO CLAIM IS MADE TO THE EXCLUSIVE
RIGHT TO USE "MATRAI" AND "QUALITY DRY
RED WINE 2005 ALC. 12,5% BY VOL. 750 ML
HUNGARIAN WINE FAMILY", APART FROM
THE MARK AS SHOWN.

THE COLOR(S) BURGUNDY AND WHITE IS/
ARE CLAIMED AS A FEATURE OF THE MARK.

THE MARK CONSISTS OF THE BURGUNDY
WORDING "MATRAI STAG'S BLOOD SZARVAS-
VER" CENTERED ON THE TOP, A BURGUNDY

HEAD OF STAG IN THE MIDDLE, THE BURGUN-
DY WORDING "QUALITY DRY RED WINE 2005"
CENTERED BELOW THE STAG, THE BURGUNDY
WORDING "ALC. 12,5% BY VOL." ON THE BOT-
TOM LEFT, THE BURGUNDY WORDING "750 ML"
ON THE BOTTOM RIGHT, AND THE BURGUNDY
WORDING "HUNGARIAN WINE FAMILY" CEN-
TERED ON THE VERY BOTTOM. THE ENTIRE
DESIGN IS SET AGAINST A WHITE BACK-
GROUND, FRAMED WITHIN A THIN BURGUNDY
RECTANGLE, SOME WHITE SPACE, AND THEN A
THICKER BURGUNDY RECTANGLE.

THE ENGLISH TRANSLATION OF "MATRAI"
REFERS TO THE MATRA MOUNTAIN RANGE IN
HUNGARY; THE ENGLISH TRANSLATION OF
"SZARVASVER" IS STAG'S BLOOD.

SER. NO. 77-282,944, FILED 9-18-2007.

TOBY BULLOFF, EXAMINING ATTORNEY

Int. Cl.: 16

Prior U.S. Cls.: 2, 5, 22, 23, 29, 37, 38 and 50

United States Patent and Trademark Office

Reg. No. 3,483,715

Registered Aug. 12, 2008

**TRADEMARK
PRINCIPAL REGISTER**

For better dentistry

DENTSPLY

DENTSPLY INTERNATIONAL INC. (DELA-
WARE CORPORATION)
221 WEST PHILADELPHIA STREET
YORK, PA 174050872

FOR: BROCHURES ABOUT DENTAL EDUCA-
TION AND DENTAL HEALTH AND DENTAL HY-
GIENE; PUBLICATIONS, NAMELY, BROCHURES,
BOOKLETS, AND TEACHING MATERIALS IN THE
FIELD OF DENTISTRY, IN CLASS 16 (U.S. CLS. 2, 5,
22, 23, 29, 37, 38 AND 50).

FIRST USE 3-30-2007; IN COMMERCE 3-30-2007.

OWNER OF U.S. REG. NOS. 42,060, 745,903 AND
OTHERS.

THE MARK CONSISTS OF THE WORDS "FOR
BETTER DENTISTRY" ABOVE THE STYLIZED
WORD "DENTSPLY".

SER. NO. 77-283,584, FILED 9-19-2007.

JAY FLOWERS, EXAMINING ATTORNEY

Int. Cl.: 42

Prior U.S. Cls.: 100 and 101

United States Patent and Trademark Office

Reg. No. 3,483,716

Registered Aug. 12, 2008

**SERVICE MARK
PRINCIPAL REGISTER**



COUPONS, INC. (CALIFORNIA CORPORATION)
400 LOGUE DR.
MOUNTAIN VIEW, CA 94043

FOR: PROVIDING ONLINE, NON-DOWNLOAD-
ABLE SOFTWARE FOR USE IN DISPLAYING IN-
FORMATION AND ADVERTISEMENTS OF
OTHERS THAT ARE LINKED TO KEYWORDS,
PHRASES OR ICONS, IN CLASS 42 (U.S. CLS. 100
AND 101).

FIRST USE 3-19-2007; IN COMMERCE 3-19-2007.

OWNER OF U.S. REG. NO. 2,992,533.

NO CLAIM IS MADE TO THE EXCLUSIVE
RIGHT TO USE "COUPONS.COM", APART FROM
THE MARK AS SHOWN.

THE COLOR(S) WHITE, GREEN, BLUE, YELLOW
AND RED IS/ARE CLAIMED AS A FEATURE OF
THE MARK.

THE MARK CONSISTS OF THE WORDS "COU-
PONS.COM" IN WHITE LETTERS WITH A GREEN
BLOCK BEHIND THE LETTERS CO, A BLUE
BLOCK BEHIND THE LETTERS UP, A YELLOW
BLOCK BEHIND THE LETTER O AND HALF OF
THE LETTER N, AND A RED BLOCK BEHIND
HALF OF THE LETTER N AND THE LETTER S.

SER. NO. 77-283,645, FILED 9-19-2007.

JACQUELINE A. LAVINE, EXAMINING ATTOR-
NEY

Int. Cl.: 34

Prior U.S. Cls.: 2, 8, 9 and 17

United States Patent and Trademark Office

Reg. No. 3,483,717

Registered Aug. 12, 2008

**TRADEMARK
PRINCIPAL REGISTER**

DOUBLE-UP

NEW IMAGE GLOBAL, INC. (CALIFORNIA
CORPORATION)
1672 RAIL ROAD
CORONA, CA 92882

FOR: CHEWING TOBACCO; CIGARETTE PAPERS; CIGARETTE ROLLING PAPERS; CIGARETTE TUBES; CIGARETTES; CIGARILLOS; CIGARS; FILTER-TIPPED CIGARETTES; HAND-ROLLING TOBACCO; FLAVORED ROLLING TOBACCO SHEETS, PIPE TOBACCO; ROLL YOUR OWN TOBACCO; ROLLING TOBACCO; TOBACCO;

TOBACCO PIPES, IN CLASS 34 (U.S. CLS. 2, 8, 9 AND 17).

FIRST USE 6-1-2007; IN COMMERCE 6-1-2007.

THE MARK CONSISTS OF STANDARD CHARACTERS WITHOUT CLAIM TO ANY PARTICULAR FONT, STYLE, SIZE, OR COLOR.

SER. NO. 77-283,925, FILED 9-19-2007.

JUSTINE D. PARKER, EXAMINING ATTORNEY

Int. Cls.: 35 and 42

Prior U.S. Cls.: 100, 101 and 102

United States Patent and Trademark Office

Reg. No. 3,483,718

Registered Aug. 12, 2008

**SERVICE MARK
PRINCIPAL REGISTER**



LAS VEGAS SANDS CORP. (NEVADA CORPORATION)
3355 LAS VEGAS BOULEVARD SOUTH
LAS VEGAS, NV 89109

FOR: RETAIL FLORIST SHOP FEATURING E-MAIL OR PHONE-IN ORDERS FOR WEDDINGS AND SPECIAL EVENTS, IN CLASS 35 (U.S. CLS. 100, 101 AND 102).

FIRST USE 3-31-1999; IN COMMERCE 3-31-1999.

FOR: FLORAL DECORATION SERVICES AND FLORAL DESIGN SERVICES FOR WEDDINGS

AND SPECIAL EVENTS, IN CLASS 42 (U.S. CLS. 100 AND 101).

FIRST USE 3-31-1999; IN COMMERCE 3-31-1999.

THE MARK CONSISTS OF A WINGED LION WITH A CREST CONTAINING THE LETTER "V".

SER. NO. 77-284,156, FILED 9-20-2007.

MELISSA VALLILLO, EXAMINING ATTORNEY

Int. Cls.: 39 and 41

Prior U.S. Cls.: 100, 101, 105 and 107

United States Patent and Trademark Office

Reg. No. 3,483,719

Registered Aug. 12, 2008

**SERVICE MARK
PRINCIPAL REGISTER**

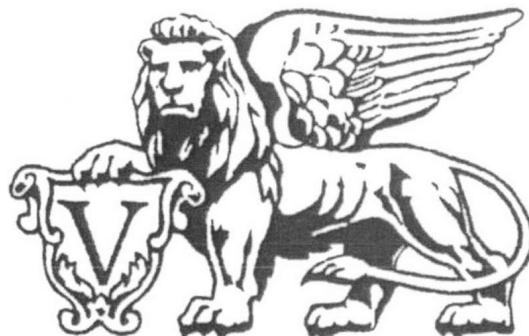

LAS VEGAS SANDS CORP. (NEVADA CORPORATION)
3355 LAS VEGAS BOULEVARD SOUTH
LAS VEGAS, NV 89109

FOR: SHIPPING AND DELIVERY SERVICES, NAMELY, PICKUP, TRANSPORTATION, AND DELIVERY OF PACKAGES AND LETTERS BY VARIOUS MODES OF TRANSPORTATION; COORDINATING TRAVEL ARRANGEMENTS FOR INDIVIDUALS AND FOR GROUPS; ORGANIZATION OF EXCURSIONS, SIGHTSEEING TOURS, HOLIDAYS, TOURS AND TRAVEL; ORGANIZATION, BOOKING AND ARRANGEMENT OF EXCURSIONS, DAY TRIPS AND SIGHTSEEING TOURS; TRAVEL AGENCY SERVICES, NAMELY, MAKING RESERVATIONS AND BOOKINGS FOR EXCURSIONS; TRANSPORT OF PASSENGERS; CAR TRANSPORT; HIRED CAR TRANSPORT; CHAUFFEUR SERVICES; LIMOUSINE SERVICES; BUS TRANSPORT SERVICES; CAR PARKING; VA-

LET PARKING; AIRPORT BAGGAGE CHECK-IN SERVICES; DELIVERY OF GIFT BASKETS WITH SELECTED ITEMS REGARDING A PARTICULAR OCCASION OR THEME, IN CLASS 39 (U.S. CLS. 100 AND 105).

FIRST USE 3-31-1999; IN COMMERCE 3-31-1999.

FOR: BOAT RIDES FOR ENTERTAINMENT AND RECREATIONAL PURPOSES, IN CLASS 41 (U.S. CLS. 100, 101 AND 107).

FIRST USE 3-31-1999; IN COMMERCE 3-31-1999.

THE MARK CONSISTS OF A WINGED LION WITH A CREST CONTAINING THE LETTER "V".

SER. NO. 77-284,160, FILED 9-20-2007.

MELISSA VALLILLO, EXAMINING ATTORNEY

Int. Cls.: 35 and 42

Prior U.S. Cls.: 100, 101 and 102

United States Patent and Trademark Office

Reg. No. 3,483,720

Registered Aug. 12, 2008

**SERVICE MARK
PRINCIPAL REGISTER**

VENETIAN

LAS VEGAS SANDS CORP. (NEVADA CORPORATION)
3355 LAS VEGAS BOULEVARD SOUTH
LAS VEGAS, NV 89109

FOR: RETAIL FLORIST SHOP FEATURING E-MAIL OR PHONE-IN ORDERS, IN CLASS 35 (U.S. CLS. 100, 101 AND 102).

FIRST USE 3-31-1999; IN COMMERCE 3-31-1999.

FOR: FLORAL DECORATION SERVICES AND FLORAL DESIGN SERVICES FOR WEDDINGS

AND SPECIAL EVENTS, IN CLASS 42 (U.S. CLS. 100 AND 101).

FIRST USE 3-31-1999; IN COMMERCE 3-31-1999.

THE MARK CONSISTS OF STANDARD CHARACTERS WITHOUT CLAIM TO ANY PARTICULAR FONT, STYLE, SIZE, OR COLOR.

SER. NO. 77-284,162, FILED 9-20-2007.

MELISSA VALLILLO, EXAMINING ATTORNEY

Int. Cls.: 35 and 42

Prior U.S. Cls.: 100, 101 and 102

United States Patent and Trademark Office

Reg. No. 3,483,721

Registered Aug. 12, 2008

**SERVICE MARK
PRINCIPAL REGISTER**

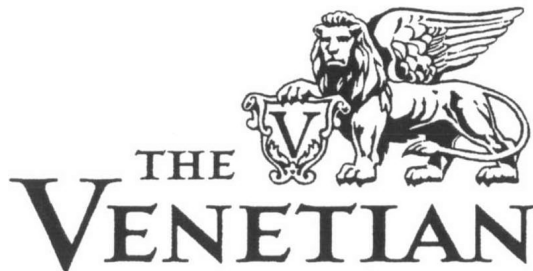

LAS VEGAS SANDS CORP. (NEVADA CORPORATION)
3355 LAS VEGAS BOULEVARD SOUTH
LAS VEGAS, NV 89109

FOR: RETAIL FLORIST SHOP FEATURING E-MAIL OR PHONE-IN ORDERS FOR WEDDINGS AND SPECIAL EVENTS, IN CLASS 35 (U.S. CLS. 100, 101 AND 102).

FIRST USE 3-31-1999; IN COMMERCE 3-31-1999.

FOR: FLORAL DECORATION SERVICES AND FLORAL DESIGN SERVICES FOR WEDDINGS

AND SPECIAL EVENTS, IN CLASS 42 (U.S. CLS. 100 AND 101).

FIRST USE 3-31-1999; IN COMMERCE 3-31-1999.

THE MARK CONSISTS OF A WINGED LION WITH A CREST CONTAINING THE LETTER "V", ACCOMPANIED BY THE TERM "THE VENETIAN".

SER. NO. 77-284,167, FILED 9-20-2007.

MELISSA VALLILLO, EXAMINING ATTORNEY

Int. Cls.: 35 and 42

Prior U.S. Cls.: 100, 101 and 102

United States Patent and Trademark Office

Reg. No. 3,483,722

Registered Aug. 12, 2008

**SERVICE MARK
PRINCIPAL REGISTER**



LAS VEGAS SANDS CORP. (NEVADA CORPORATION)
3355 LAS VEGAS BOULEVARD SOUTH
LAS VEGAS, NV 89109

FOR: RETAIL FLORIST SHOP FEATURING E-MAIL OR PHONE-IN ORDERS FOR WEDDINGS AND SPECIAL EVENTS, IN CLASS 35 (U.S. CLS. 100, 101 AND 102).

FIRST USE 3-31-1999; IN COMMERCE 3-31-1999.

FOR: FLORAL DECORATION SERVICES AND FLORAL DESIGN SERVICES FOR WEDDINGS

AND SPECIAL EVENTS, IN CLASS 42 (U.S. CLS. 100 AND 101).

FIRST USE 3-31-1999; IN COMMERCE 3-31-1999.

THE MARK CONSISTS OF A CREST CONTAINING THE LETTER "V".

SER. NO. 77-284,176, FILED 9-20-2007.

MELISSA VALLILLO, EXAMINING ATTORNEY

Int. Cls.: 39 and 41

Prior U.S. Cls.: 100, 101, 105 and 107

United States Patent and Trademark Office

Reg. No. 3,483,723

Registered Aug. 12, 2008

**SERVICE MARK
PRINCIPAL REGISTER**



LAS VEGAS SANDS CORP. (NEVADA CORPORATION)
3355 LAS VEGAS BOULEVARD SOUTH
LAS VEGAS, NV 89109

FOR: SHIPPING AND DELIVERY SERVICES, NAMELY, PICKUP, TRANSPORTATION, AND DELIVERY OF PACKAGES AND LETTERS BY VARIOUS MODES OF TRANSPORTATION; COORDINATING TRAVEL ARRANGEMENTS FOR INDIVIDUALS AND FOR GROUPS; ORGANIZATION OF EXCURSIONS, SIGHTSEEING TOURS, HOLIDAYS, TOURS AND TRAVEL; ORGANIZATION, BOOKING AND ARRANGEMENT OF EXCURSIONS, DAY TRIPS AND SIGHTSEEING TOURS; TRAVEL AGENCY SERVICES, NAMELY, MAKING RESERVATIONS AND BOOKINGS FOR EXCURSIONS; TRANSPORT OF PASSENGERS; CAR TRANSPORT; HIRED CAR TRANSPORT; CHAUFFEUR SERVICES; LIMOUSINE SERVICES; BUS TRANSPORT SERVICES; CAR PARKING; VA-

LET PARKING; AIRPORT BAGGAGE CHECK-IN SERVICES; DELIVERY OF GIFT BASKETS WITH SELECTED ITEMS REGARDING A PARTICULAR OCCASION OR THEME, IN CLASS 39 (U.S. CLS. 100 AND 105).

FIRST USE 3-31-1999; IN COMMERCE 3-31-1999.

FOR: BOAT RIDES FOR ENTERTAINMENT AND RECREATIONAL PURPOSES, IN CLASS 41 (U.S. CLS. 100, 101 AND 107).

FIRST USE 3-31-1999; IN COMMERCE 3-31-1999.

THE MARK CONSISTS OF A CREST CONTAINING THE LETTER "V".

SER. NO. 77-284,187, FILED 9-20-2007.

MELISSA VALLILLO, EXAMINING ATTORNEY

Int. Cl.: 41

Prior U.S. Cls.: 100, 101 and 107

United States Patent and Trademark Office

Reg. No. 3,483,724

Registered Aug. 12, 2008

SERVICE MARK
PRINCIPAL REGISTER



THE TRAVELERS PROTECTIVE ASSOCIATION
OF AMERICA (MISSOURI CORPORATION)
3755 LINDELL BLVD.
ST. LOUIS, MO 631083476

FOR: EDUCATIONAL SERVICES, NAMELY, DEVELOPING AND CONDUCTING SEMINARS, CLASSES, WORKSHOPS, AND DEMONSTRATIONS IN THE FIELD OF CHILD AND ADULT SAFETY AND DISTRIBUTING COURSE MATERIALS IN CON-

SECTION THEREWITH, IN CLASS 41 (U.S. CLS. 100, 101 AND 107).

FIRST USE 0-0-1996; IN COMMERCE 0-0-1996.

OWNER OF U.S. REG. NO. 2,186,285.

SER. NO. 77-284,444, FILED 9-20-2007.

DAWN FELDMAN, EXAMINING ATTORNEY

Int. Cl.: 35

Prior U.S. Cls.: 100, 101 and 102

United States Patent and Trademark Office

Reg. No. 3,483,725

Registered Aug. 12, 2008

SERVICE MARK
PRINCIPAL REGISTER



CITY OF NEW BERN (NORTH CAROLINA MUNICIPAL CORPORATION)
300 POLLOCK STREET
NEW BERN, NC 28560

FOR: PROMOTING PUBLIC AWARENESS OF THE CELEBRATION OF THE 300TH ANNIVERSARY OF THE FOUNDING OF NEW BERN, NORTH CAROLINA, IN CLASS 35 (U.S. CLS. 100, 101 AND 102).

FIRST USE 1-1-2007; IN COMMERCE 1-1-2007.

NO CLAIM IS MADE TO THE EXCLUSIVE RIGHT TO USE "NEW BERN", "300 YEARS", "1710", "2010" AND "NORTH CAROLINA", APART FROM THE MARK AS SHOWN.

THE COLOR(S) RED, WHITE, BLACK, AND YELLOW IS/ARE CLAIMED AS A FEATURE OF THE MARK.

THE MARK CONSISTS OF A BLACK BEAR ON A RED AND YELLOW CREST ON A BLACK BACKGROUND WITH AN INSIDE YELLOW BORDER; THE WORDING "300 YEARS" APPEARS IN RED ON A WHITE BANNER; "NEW BERN" AND "NORTH CAROLINA" APPEARS IN WHITE, THE DATES "1710" AND "2010" APPEAR IN BLACK ON A WHITE BACKGROUND.

SER. NO. 77-285,288, FILED 9-21-2007.

KAREN K. BUSH, EXAMINING ATTORNEY

Int. Cl.: 35

Prior U.S. Cls.: 100, 101 and 102

United States Patent and Trademark Office

Reg. No. 3,483,726

Registered Aug. 12, 2008

**SERVICE MARK
PRINCIPAL REGISTER**



MISSOURI DIVISION OF TOURISM (MISSOURI
UNINCORPORATED STATE AGENCY)
301 W. HIGH STREET
TRUMAN STATE OFFICE BUILDING
JEFFERSON CITY, MO 65101

FOR: TOURISM SERVICES, NAMELY, PROMOT-
ING TOURISM IN THE STATE OF MISSOURI, IN
CLASS 35 (U.S. CLS. 100, 101 AND 102).

FIRST USE 8-25-2007; IN COMMERCE 8-25-2007.

OWNER OF U.S. REG. NO. 2,238,921.

NO CLAIM IS MADE TO THE EXCLUSIVE
RIGHT TO USE "MISSOURI" OR THE MAP OF
MISSOURI, APART FROM THE MARK AS SHOWN.

THE MARK CONSISTS OF OUTLINE OF STATE
OF MISSOURI WITH "MISSOURI" IN MIDDLE
WHERE "SS" IS STYLIZED TO FORM A ROAD
WITH SUN AT TOP AND MARK BELOW.

SER. NO. 77-285,587, FILED 9-21-2007.

MARK RADEMACHER, EXAMINING ATTORNEY

Int. Cls.: 37 and 40

Prior U.S. Cls.: 100, 103 and 106

United States Patent and Trademark Office

Reg. No. 3,483,727

Registered Aug. 12, 2008

**SERVICE MARK
PRINCIPAL REGISTER**

COLD SPRING GRANITE

COLD SPRING GRANITE COMPANY (MINNESOTA CORPORATION)
202 SOUTH THIRD STREET
COLD SPRING, MN 56320

FOR: QUARRY SERVICES, IN CLASS 37 (U.S. CLS. 100, 103 AND 106).

FIRST USE 0-0-1920; IN COMMERCE 0-0-1920.

FOR: CUSTOM FABRICATION SERVICES IN THE FIELD OF STONE GRANITE; MANUFACTURE OF ARCHITECTURAL BUILDING AND RESIDENTIAL STONE, AND MEMORIAL PRODUCTS IN THE NATURE OF MONUMENT STONE TO THE ORDER AND SPECIFICATION OF OTHERS, IN CLASS 40 (U.S. CLS. 100, 103 AND 106).

FIRST USE 0-0-1920; IN COMMERCE 0-0-1920.

THE MARK CONSISTS OF STANDARD CHARACTERS WITHOUT CLAIM TO ANY PARTICULAR FONT, STYLE, SIZE, OR COLOR.

NO CLAIM IS MADE TO THE EXCLUSIVE RIGHT TO USE "GRANITE", APART FROM THE MARK AS SHOWN.

SEC. 2(F).

SER. NO. 77-286,017, FILED 9-21-2007.

MARLENE BELL, EXAMINING ATTORNEY

Int. Cl.: 9

Prior U.S. Cls.: 21, 23, 26, 36 and 38

Reg. No. 3,483,728

United States Patent and Trademark Office

Registered Aug. 12, 2008

**TRADEMARK
PRINCIPAL REGISTER**

Fusion-io

FUSION-IO INC (NEVADA CORPORATION)
1011 E. MURRAY HOLLADAY ROAD., SUITE 210
SALT LAKE CITY, UT 84117

FIRST USE 3-14-2007; IN COMMERCE 7-27-2007.

FOR: COMPUTER ACCELERATOR BOARD;
COMPUTER EXPANSION BOARDS; COMPUTER
CARD ADAPTER; COMPUTER MEMORY HARD-
WARE; COMPUTER STORAGE DEVICES, NAME-
LY, FLASH DRIVES, IN CLASS 9 (U.S. CLS. 21, 23, 26,
36 AND 38).

THE MARK CONSISTS OF STANDARD CHAR-
ACTERS WITHOUT CLAIM TO ANY PARTICULAR
FONT, STYLE, SIZE, OR COLOR.

SER. NO. 77-286,096, FILED 9-21-2007.

ALEX KEAM, EXAMINING ATTORNEY

Int. Cl.: 30

Prior U.S. Cl.: 46

United States Patent and Trademark Office

Reg. No. 3,483,729

Registered Aug. 12, 2008

**TRADEMARK
PRINCIPAL REGISTER**

VANDERBILT

ASSOCIATED WHOLESALE GROCERS, INC.
(KANSAS CORPORATION)
5000 KANSAS AVE
KANSAS CITY, KS 66106

OWNER OF U.S. REG. NO. 2,497,304.

SEC. 2(F).

FOR: MUSTARD, IN CLASS 30 (U.S. CL. 46).

FIRST USE 1-10-2001; IN COMMERCE 1-10-2001.

SER. NO. 77-286,140, FILED 9-21-2007.

THE MARK CONSISTS OF STANDARD CHAR-
ACTERS WITHOUT CLAIM TO ANY PARTICULAR
FONT, STYLE, SIZE, OR COLOR.

BRIAN PINO, EXAMINING ATTORNEY

Prior U.S. Cl.: A

United States Patent and Trademark Office

Reg. No. 3,483,730

Registered Aug. 12, 2008

CERTIFICATION MARK
PRINCIPAL REGISTER



NATIONAL CONFERENCE ON WEIGHTS AND MEASURES (VIRGINIA CORPORATION)
15245 SHADY GROVE ROAD, SUITE 130
ROCKVILLE, MD 20850

FOR: WEIGHING AND MEASURING APPARATUS INTENDED FOR COMMERCIAL USE, SUCH AS DIGITAL ELECTRONIC SCALES, AUTOMATIC WEIGHING SYSTEMS, BELT CONVEYOR SCALES, AUTOMATIC, LIVESTOCK WEIGHING SYSTEMS, LOAD CELLS, GRAIN MOISTURE MACHINES, NEAR INFRARED GRAIN ANALYZERS, ELECTRONIC CASH REGISTERS INTERFACED WITH SCALES, ELECTRONIC CASH REGISTERS INTERFACED WITH RETAIL MOTOR FUEL DISPENSERS, LIQUID MEASURING DEVICES AND TAXI METERS, IN CLASS A (U.S. CL. A).

FIRST USE 8-12-1985; IN COMMERCE 8-12-1985.

NO CLAIM IS MADE TO THE EXCLUSIVE RIGHT TO USE "WEIGHTS AND MEASURES", APART FROM THE MARK AS SHOWN.

THE MARK CONSISTS OF AN OUTER CIRCLE, WITH ANOTHER CIRCLE INSIDE (INNER CIRCLE). THE OUTER CIRCLE HAS THE WORDS "NATIONAL CONFERENCE ON WEIGHTS AND

MEASURES" WRITTEN AROUND THE INSIDE PERIMETER OF THE OUTER CIRCLE. THE INNER CIRCLE HAS THE LETTERS "NTEP" IN THE MIDDLE OF IT.

THE CERTIFICATION MARK, AS USED BY AUTHORIZED PERSONS, CERTIFIES THAT THE APPARATUS HAS BEEN FOUND THROUGH THE NATIONAL TYPE EVALUATION PROGRAM (NTEP) TO CONFORM TO THE DESIGN REQUIREMENTS AND BE CAPABLE OF MEETING THE PERFORMANCE REQUIREMENTS FOR GOODS, OF THE PARTICULAR TYPE AS SET FORTH IN HANDBOOK 44: SPECIFICATIONS, TOLERANCE AND OTHER TECHNICAL REQUIREMENTS FOR WEIGHING AND MEASURING DEVICES, OF THE NATIONAL INSTITUTE OF STANDARDS AND TECHNOLOGY AND THE NATIONAL CONFERENCE ON WEIGHTS AND MEASURES.

SEC. 2(F) "NATIONAL CONFERENCE ON WEIGHTS AND MEASURES".

SER. NO. 77-286,258, FILED 9-21-2007.

DOMINIC FATHY, EXAMINING ATTORNEY

Int. Cls.: 16 and 41

Prior U.S. Cls.: 2, 5, 22, 23, 29, 37, 38, 50, 100, 101 and 107

Reg. No. 3,483,731

United States Patent and Trademark Office

Registered Aug. 12, 2008

**TRADEMARK
SERVICE MARK
PRINCIPAL REGISTER**

**YOU DON'T NEED A TITLE TO
BE A LEADER**

SANBORN & ASSOCIATES, INC. (COLORADO CORPORATION)
818 SUMMER DRIVE
HIGHLANDS RANCH, CA 80126

FOR: BOOKS IN THE FIELDS OF LEADERSHIP, TEAM BUILDING, CHANGE MANAGEMENT AND CUSTOMER SERVICE , IN CLASS 16 (U.S. CLS. 2, 5, 22, 23, 29, 37, 38 AND 50).

FIRST USE 0-0-2004; IN COMMERCE 0-0-2004.

FOR: EDUCATIONAL SERVICES, NAMELY, PROVIDING KEYNOTE PRESENTATIONS AND PROFESSIONAL SEMINARS IN THE FIELDS OF LEADERSHIP, TEAM BUILDING, CHANGE MAN-

AGEMENT AND CUSTOMER SERVICES, AND PROVIDING COURSE MATERIALS IN CONNECTION THEREWITH, IN CLASS 41 (U.S. CLS. 100, 101 AND 107).

FIRST USE 0-0-2004; IN COMMERCE 0-0-2004.

THE MARK CONSISTS OF STANDARD CHARACTERS WITHOUT CLAIM TO ANY PARTICULAR FONT, STYLE, SIZE, OR COLOR.

SER. NO. 77-286,416, FILED 9-22-2007.

LINDA M. KING, EXAMINING ATTORNEY

Int. Cl.: 20

Prior U.S. Cls.: 2, 13, 22, 25, 32 and 50

Reg. No. 3,483,732

United States Patent and Trademark Office

Registered Aug. 12, 2008

TRADEMARK
PRINCIPAL REGISTER



WILLIAMS, JENNIFER (UNITED STATES INDIVIDUAL)
C/O E. HANSCOM, 7395 PORTAGE WAY
CARLSBAD, CA 92011

FOR: TOY BOXES AND CHESTS; WOOD BOXES; WOODEN BOXES WITH A LOCKED STORAGE AREA FOR PERSONAL ITEMS; TOY BOXES; FURNITURE CHESTS; NON-METAL CHESTS; TOY CHESTS, IN CLASS 20 (U.S. CLS. 2, 13, 22, 25, 32 AND 50).

FIRST USE 9-15-2007; IN COMMERCE 9-15-2007.

NO CLAIM IS MADE TO THE EXCLUSIVE RIGHT TO USE "DESIGNS", APART FROM THE MARK AS SHOWN.

THE NAME SHOWN IN THE MARK IDENTIFIES "JENNIFER WILLIAMS", WHOSE CONSENT IS OF RECORD.

SER. NO. 77-286,535, FILED 9-23-2007.

PAUL MORENO, EXAMINING ATTORNEY

Int. Cl.: 16

Prior U.S. Cls.: 2, 5, 22, 23, 29, 37, 38 and 50

Reg. No. 3,483,733

United States Patent and Trademark Office

Registered Aug. 12, 2008

TRADEMARK
PRINCIPAL REGISTER



WILLIAMS, JENNIFER (UNITED STATES INDIVIDUAL)
C/O E. HANSCOM, 7395 PORTAGE WAY
CARLSBAD, CA 92011

FOR: CHILDREN'S ACTIVITY BOOKS; CHILDREN'S BOOKS; TRAVEL BOOKS; LOG BOOKS, IN CLASS 16 (U.S. CLS. 2, 5, 22, 23, 29, 37, 38 AND 50).

FIRST USE 9-15-2007; IN COMMERCE 9-15-2007.

NO CLAIM IS MADE TO THE EXCLUSIVE RIGHT TO USE "DESIGNS", APART FROM THE MARK AS SHOWN.

THE NAME SHOWN IN THE MARK IDENTIFIES "JENNIFER WILLIAMS", WHOSE CONSENT IS OF RECORD.

SER. NO. 77-286,538, FILED 9-23-2007.

PAUL MORENO, EXAMINING ATTORNEY

Int. Cl.: 20

Prior U.S. Cls.: 2, 13, 22, 25, 32 and 50

United States Patent and Trademark Office

Reg. No. 3,483,734

Registered Aug. 12, 2008

**TRADEMARK
PRINCIPAL REGISTER**

MEMORIES THAT WILL LAST A
LIFETIME CELEBRATION
TRUNKS BY JENNIFER
WILLIAMS DESIGNS

WILLIAMS, JENNIFER (UNITED STATES INDIVIDUAL)
C/O E. HANSCOM, 7395 PORTAGE WAY
CARLSBAD, CA 92011

FOR: TOY BOXES; TOY BOXES AND CHESTS;
TOY CHESTS; WOOD BOXES, IN CLASS 20 (U.S.
CLS. 2, 13, 22, 25, 32 AND 50).

FIRST USE 9-15-2007; IN COMMERCE 9-15-2007.

THE MARK CONSISTS OF STANDARD CHARACTERS WITHOUT CLAIM TO ANY PARTICULAR FONT, STYLE, SIZE, OR COLOR.

NO CLAIM IS MADE TO THE EXCLUSIVE RIGHT TO USE "CELEBRATION TRUNKS" AND "DESIGNS", APART FROM THE MARK AS SHOWN.

THE NAME SHOWN IN THE MARK IDENTIFIES "JENNIFER WILLIAMS", WHOSE CONSENT IS OF RECORD.

SER. NO. 77-286,539, FILED 9-23-2007.

PAUL MORENO, EXAMINING ATTORNEY

Int. Cl.: 9

Prior U.S. Cls.: 21, 23, 26, 36 and 38

Reg. No. 3,483,735

United States Patent and Trademark Office

Registered Aug. 12, 2008

TRADEMARK
PRINCIPAL REGISTER



ASSOCIATED POWER TECHNOLOGIES, INC.
(DELAWARE CORPORATION)
13860 WEST LAUREL DRIVE
LAKE FOREST, IL 60045

FOR: ELECTRICAL AND ELECTRONIC MEASURING AND TESTING PRODUCTS, NAMELY, AC POWER SOURCES, FREQUENCY CONVERTERS, AC POWER SUPPLIES, DC POWER SUPPLIES, DC POWER SOURCES, DC ELECTRONIC LOAD MEASURERS AND TESTERS, AC ELECTRONIC LOAD MEASURERS AND TESTERS, AC SOURCE MEASURERS AND TESTERS, AND DC SOURCE MEASURERS AND TESTERS, IN CLASS 9 (U.S. CLS. 21, 23, 26, 36 AND 38).

FIRST USE 1-2-2008; IN COMMERCE 1-2-2008.

NO CLAIM IS MADE TO THE EXCLUSIVE RIGHT TO USE "POWER TECHNOLOGIES", APART FROM THE MARK AS SHOWN.

THE COLOR(S) BLUE AND BLACK IS/ARE CLAIMED AS A FEATURE OF THE MARK.

THE MARK CONSISTS OF THE COLOR BLUE IS APPLIED TO A STYLIZED WAVE, AND THE COLOR BLACK IS APPLIED TO THE LETTERS.

SER. NO. 77-286,986, FILED 9-24-2007.

ARETHA SOMERVILLE, EXAMINING ATTORNEY

Int. Cl.: 3

Prior U.S. Cls.: 1, 4, 6, 50, 51 and 52

United States Patent and Trademark Office

Reg. No. 3,483,736

Registered Aug. 12, 2008

**TRADEMARK
PRINCIPAL REGISTER**

BUMP BRIGADE

JGF PRO , LLC (TEXAS LTD LIAB CO)
P.O. BOX 181922
ARLINGTON, TX 76096

FOR: SKIN CONDITIONERS; AFTER SHAVE
CONDITIONERS, IN CLASS 3 (U.S. CLS. 1, 4, 6, 50,
51 AND 52).

FIRST USE 4-25-2007; IN COMMERCE 4-25-2007.

THE MARK CONSISTS OF STANDARD CHAR-
ACTERS WITHOUT CLAIM TO ANY PARTICULAR
FONT, STYLE, SIZE, OR COLOR.

NO CLAIM IS MADE TO THE EXCLUSIVE
RIGHT TO USE "BUMP", APART FROM THE
MARK AS SHOWN.

SER. NO. 77-286,993, FILED 9-24-2007.

MATTHEW PAPPAS, EXAMINING ATTORNEY

Int. Cl.: 32

Prior U.S. Cls.: 45, 46 and 48

United States Patent and Trademark Office

Reg. No. 3,483,737

Registered Aug. 12, 2008

**TRADEMARK
PRINCIPAL REGISTER**

Uncle Matt's Organic

UNCLE MATT'S ORGANIC, INC. (FLORIDA
CORPORATION)
2ND FLOOR, SUITE B
1000 E. HIGHWAY 50
CLERMONT, FL 34711

FOR: ORGANIC FRUIT JUICES AND FRUIT
DRINKS, IN CLASS 32 (U.S. CLS. 45, 46 AND 48).

FIRST USE 3-1-2004; IN COMMERCE 3-1-2004.

THE MARK CONSISTS OF STANDARD CHAR-
ACTERS WITHOUT CLAIM TO ANY PARTICULAR
FONT, STYLE, SIZE, OR COLOR.

OWNER OF U.S. REG. NOS. 2,579,746, 2,632,179,
AND 2,795,105.

NO CLAIM IS MADE TO THE EXCLUSIVE
RIGHT TO USE "ORGANIC", APART FROM THE
MARK AS SHOWN.

SER. NO. 77-287,209, FILED 9-24-2007.

DAVID TAYLOR, EXAMINING ATTORNEY

Int. Cl.: 3

Prior U.S. Cls.: 1, 4, 6, 50, 51 and 52

United States Patent and Trademark Office

Reg. No. 3,483,738

Registered Aug. 12, 2008

**TRADEMARK
PRINCIPAL REGISTER**

Pure Rx

SUMMERS, ADAM N (UNITED STATES INDIVIDUAL)
7704 QUARTERFIELD RD, PLASTIC SURGERY
GLEN BURNIE, MD 21061

THE MARK CONSISTS OF STANDARD CHARACTERS WITHOUT CLAIM TO ANY PARTICULAR FONT, STYLE, SIZE, OR COLOR.

FOR: SKIN CREAMS, IN CLASS 3 (U.S. CLS. 1, 4, 6, 50, 51 AND 52).

SER. NO. 77-287,756, FILED 9-25-2007.

FIRST USE 8-1-2004; IN COMMERCE 1-1-2005.

JASON TURNER, EXAMINING ATTORNEY

Int. Cls.: 1 and 2

Prior U.S. Cls.: 1, 5, 6, 10, 11, 16, 26 and 46

United States Patent and Trademark Office

Reg. No. 3,483,739

Registered Aug. 12, 2008

**TRADEMARK
PRINCIPAL REGISTER**

CREATUS WOOD PRODUCTS

CREATUS, INC. (DELAWARE CORPORATION)
4501 BRICKEL PRIVADO
ONTARIO, CA 91761

FOR: FIRE RETARDENT CHEMICALS, IN CLASS
1 (U.S. CLS. 1, 5, 6, 10, 26 AND 46).

FIRST USE 9-26-2007; IN COMMERCE 9-26-2007.

FOR: FIRE RETARDANT PAINTS , IN CLASS 2
(U.S. CLS. 6, 11 AND 16).

FIRST USE 9-26-2007; IN COMMERCE 9-26-2007.

THE MARK CONSISTS OF STANDARD CHAR-
ACTERS WITHOUT CLAIM TO ANY PARTICULAR
FONT, STYLE, SIZE, OR COLOR.

NO CLAIM IS MADE TO THE EXCLUSIVE
RIGHT TO USE "WOOD PRODUCTS", APART
FROM THE MARK AS SHOWN.

SER. NO. 77-289,212, FILED 9-26-2007.

ALEXANDER L. POWERS, EXAMINING ATTOR-
NEY

Int. Cl.: 7

Prior U.S. Cls.: 13, 19, 21, 23, 31, 34 and 35

Reg. No. 3,483,740

United States Patent and Trademark Office

Registered Aug. 12, 2008

**TRADEMARK
PRINCIPAL REGISTER**



SHANGHAI TOP MOTOR CO., LTD (CHINA CORPORATION)
303 KANGLIU RD. KANGQIAO INDUSTRIAL ZONE
PUDONG, SHANGHAI, CHINA 201315

FIRST USE 1-30-2006; IN COMMERCE 1-30-2006.

THE MARK CONSISTS OF THE STYLIZED WORD TECHTOP.

FOR: ELECTRIC MOTORS FOR MACHINES; AC ALTERNATOR AND GENERATOR SET; ELECTRIC PUMPS FOR USE IN WATER AND WATER BORNE SLURRY TRANSFER , IN CLASS 7 (U.S. CLS. 13, 19, 21, 23, 31, 34 AND 35).

SER. NO. 77-289,243, FILED 9-26-2007.

RON FAIRBANKS, EXAMINING ATTORNEY

Int. Cl.: 1

Prior U.S. Cls.: 1, 5, 6, 10, 26 and 46

United States Patent and Trademark Office

Reg. No. 3,483,741

Registered Aug. 12, 2008

**TRADEMARK
PRINCIPAL REGISTER**

PANOMICS

PANOMICS, INC. (CALIFORNIA CORPORATION)
6519 DUMBARTON CIRCLE
FREMONT, CA 94555

FOR: REAGENTS FOR SCIENTIFIC OR MEDICAL RESEARCH USE, IN CLASS 1 (U.S. CLS. 1, 5, 6, 10, 26 AND 46).

FIRST USE 7-30-2001; IN COMMERCE 7-30-2001.

THE MARK CONSISTS OF STANDARD CHARACTERS WITHOUT CLAIM TO ANY PARTICULAR FONT, STYLE, SIZE, OR COLOR.

OWNER OF U.S. REG. NO. 2,685,955.

SER. NO. 77-289,472, FILED 9-26-2007.

JEFF DEFORD, EXAMINING ATTORNEY

Int. Cl.: 41

Prior U.S. Cls.: 100, 101 and 107

United States Patent and Trademark Office

Reg. No. 3,483,742

Registered Aug. 12, 2008

SERVICE MARK
PRINCIPAL REGISTER



KUCHAR, RACHEL, R (SOUTH CAROLINA
SOLE PROPRIETORSHIP), DBA BLUE NALU
PHOTOGRAPHY

PO BOX 5381

NORTH CHARLESTON, SC 29405

FOR: PHOTOGRAPHY SERVICES; PORTRAIT
PHOTOGRAPHY, IN CLASS 41 (U.S. CLS. 100, 101
AND 107).

FIRST USE 5-0-2006; IN COMMERCE 6-1-2006.

NO CLAIM IS MADE TO THE EXCLUSIVE
RIGHT TO USE "PHOTOGRAPHY", APART FROM
THE MARK AS SHOWN.

THE COLOR(S) BLUE (PMS 311C) IS/ARE
CLAIMED AS A FEATURE OF THE MARK.

"THE MARK CONSISTS OF THE WORDS "BLUE
NALU" ABOVE A WAVE GRAPHIC WITH THE
WORD "PHOTOGRAPHY" BELOW. LOGO IS USED
ON A BLACK FIELD. THE ENTIRE LOGO IS BLUE
(PANTONE COLOR 311C)."

"THE FOREIGN WORDING IN THE MARK
TRANSLATES INTO ENGLISH AS WAVE."

SER. NO. 77-289,698, FILED 9-26-2007.

SANJEEV VOHRA, EXAMINING ATTORNEY

Int. Cl.: 35

Prior U.S. Cls.: 100, 101 and 102

United States Patent and Trademark Office

Reg. No. 3,483,743

Registered Aug. 12, 2008

**SERVICE MARK
PRINCIPAL REGISTER**

IDEAFACTORY

SUCCESSFACTORS, INC. (DELAWARE CORPORATION)
1500 FASHION ISLAND BLVD. SUITE 300
SAN MATEO, CA 94404

FOR: PROVIDING A WEB SITE WHERE USERS CAN POST RATINGS, REVIEWS AND RECOMMENDATIONS ON PRODUCTS AND SERVICES, NAMELY, PROVIDING AN ONLINE INTERACTIVE WEBSITE ALLOWING USERS TO SUBMIT AND COMMENT ON IDEAS FOR NEW PRODUCTS, NEW SOFTWARE APPLICATIONS AND NEW FEATURES FOR SOFTWARE APPLICATIONS AND FOR ONLINE WEBSITES IN THE FIELD OF HUMAN RESOURCES, PERFORMANCE AND TALENT MANAGEMENT, EMPLOYMENT TRAINING, WORKFORCE PLANNING AND DEVELOPMENT,

MANAGEMENT OF CHANGES IN THE WORKFORCE, EMPLOYEE CAREER DEVELOPMENT AND PLANNING, COMPENSATION PLANNING, WORKFORCE RECRUITING, EVALUATION OF PERSONNEL, DATA ANALYSIS AND REPORTING, IN CLASS 35 (U.S. CLS. 100, 101 AND 102).

FIRST USE 6-7-2007; IN COMMERCE 6-7-2007.

THE MARK CONSISTS OF STANDARD CHARACTERS WITHOUT CLAIM TO ANY PARTICULAR FONT, STYLE, SIZE, OR COLOR.

SER. NO. 77-289,701, FILED 9-26-2007.

JENNIFER VASQUEZ, EXAMINING ATTORNEY

Int. Cls.: 9, 14 and 18

**Prior U.S. Cls.: 1, 2, 3, 21, 22, 23, 26, 27, 28, 36, 38, 41
and 50**

Reg. No. 3,483,744

United States Patent and Trademark Office

Registered Aug. 12, 2008

**TRADEMARK
PRINCIPAL REGISTER**

SHASA

ARMANDO ERNESTO DOLLERO FIGUEROA
AND CARLO DOLLERO FIGUEROA (MEXI-
CO INDIVIDUAL)
COL. RANCHO EL ROSARIO
BOULEVARD AEROPUERTO NO. 154 NAVE 11
LERMA ESTADO DE MEXICO, MEXICO 520000

FOR: SUNGLASSES , IN CLASS 9 (U.S. CLS. 21, 23,
26, 36 AND 38).

FOR: PRECIOUS METALS AND THE ALLOYS
THEREOF, ITEMS MADE FROM PRECIOUS ME-
TALS OR PLATED THEREWITH, NAMELY, BRA-
CELETS, EARRINGS, CUFF LINKS, FIGURINES,
SCULPTURES, JEWELRY BOXES; JEWELRY; PRE-
CIOUS STONES; CLOCKS, WATCHES AND
CHRONOMETRIC INSTRUMENTS, IN CLASS 14
(U.S. CLS. 2, 27, 28 AND 50).

FOR: LEATHER AND IMITATION LEATHER,
BAGS, NAMELY, ALL-PURPOSE ATHLETIC BAGS,
TRAVELING BAGS; LADIES' BAGS, NAMELY,
PURSES, CLUTCH BAGS, BEACH BAGS, ALL-PUR-
POSE ATHLETIC BAGS, SCHOOL BAGS, TRAVEL-
ING BAGS; PRODUCTS MADE FROM LEATHER
AND IMITATION LEATHER, NAMELY, HAND-

BAGS, BRIEFCASES, WALLETS, SUITCASES, ANI-
MAL FURS, CHESTS AND SUITCASES, PARASOLS
AND WALKING STICKS, RIDING CROPS AND
SADDLERY, IN CLASS 18 (U.S. CLS. 1, 2, 3, 22 AND
41).

THE MARK CONSISTS OF STANDARD CHAR-
ACTERS WITHOUT CLAIM TO ANY PARTICULAR
FONT, STYLE, SIZE, OR COLOR.

OWNER OF MEXICO REG. NO. 686251, DATED
10-19-2000, EXPIRES 10-19-2010.

OWNER OF MEXICO REG. NO. 918632, DATED 1-
9-2006, EXPIRES 1-9-2016.

OWNER OF U.S. REG. NOS. 2,226,033 AND
2,763,116.

THE WORDING "SHASA" HAS NO MEANING IN
A FOREIGN LANGUAGE.

SER. NO. 77-290,147, FILED 9-27-2007.

RON FAIRBANKS, EXAMINING ATTORNEY

Int. Cl.: 42

Prior U.S. Cls.: 100 and 101

United States Patent and Trademark Office

Reg. No. 3,483,745

Registered Aug. 12, 2008

**SERVICE MARK
PRINCIPAL REGISTER**

TEAMPAYER

SEATTLE SPORTS LEAGUES, INC. (WASHINGTON CORPORATION)
2013 4TH AVENUE, SUITE 201
SEATTLE, WA 98121

FOR: PROVIDING ON-LINE NON-DOWNLOADABLE SOFTWARE FOR USE IN THE MANAGEMENT, COLLECTION, AND PAYMENT OF TEAM AND/OR SPORT LEAGUE FEES, IN CLASS 42 (U.S. CLS. 100 AND 101).

FIRST USE 1-20-2007; IN COMMERCE 1-20-2007.

THE MARK CONSISTS OF STANDARD CHARACTERS WITHOUT CLAIM TO ANY PARTICULAR FONT, STYLE, SIZE, OR COLOR.

SER. NO. 77-290,418, FILED 9-27-2007.

DARRYL SPRUILL, EXAMINING ATTORNEY

Int. Cl.: 20

Prior U.S. Cls.: 2, 13, 22, 25, 32 and 50

United States Patent and Trademark Office

Reg. No. 3,483,746

Registered Aug. 12, 2008

**TRADEMARK
PRINCIPAL REGISTER**

architek

DAVID KEIGLEY (UNITED STATES INDIVIDUAL)
3325 ALTON ROAD
MIAMI BEACH, FL 33140

FOR: BEDROOM FURNITURE; FURNITURE;
LAWN FURNITURE; LIVING ROOM FURNITURE;
MIRRORS; OFFICE FURNITURE; OUTDOOR FURNITURE;
TABLES; MIRROR FRAMES; PICTURE

FRAMES, IN CLASS 20 (U.S. CLS. 2, 13, 22, 25, 32 AND 50).

FIRST USE 9-24-2007; IN COMMERCE 9-24-2007.

SER. NO. 77-290,863, FILED 9-27-2007.

BARNEY CHARLON, EXAMINING ATTORNEY

Int. Cls.: 9, 16 and 25

**Prior U.S. Cls.: 2, 5, 21, 22, 23, 26, 29, 36, 37, 38, 39
and 50**

Reg. No. 3,483,747

United States Patent and Trademark Office

Registered Aug. 12, 2008

**TRADEMARK
PRINCIPAL REGISTER**

THE DEVIL IN MISS JONES

ARROW PRODUCTIONS, LTD. (NEVADA CORPORATION)
631 LAS VEGAS BOULEVARD SOUTH
LAS VEGAS, NV 89101

FOR: PRE-RECORDED VIDEOTAPES AND DIGITAL VIDEO DISKS FEATURING ADULT ENTERTAINMENT, IN CLASS 9 (U.S. CLS. 21, 23, 26, 36 AND 38).

FIRST USE 0-0-1975; IN COMMERCE 2-14-2008.

FOR: POSTERS, IN CLASS 16 (U.S. CLS. 2, 5, 22, 23, 29, 37, 38 AND 50).

FIRST USE 0-0-1975; IN COMMERCE 2-14-2008.

FOR: CLOTHING, NAMELY, T-SHIRTS AND MASQUERADE COSTUMES, IN CLASS 25 (U.S. CLS. 22 AND 39).

FIRST USE 6-0-2006; IN COMMERCE 6-0-2006.

THE MARK CONSISTS OF STANDARD CHARACTERS WITHOUT CLAIM TO ANY PARTICULAR FONT, STYLE, SIZE, OR COLOR.

SER. NO. 77-290,898, FILED 9-27-2007.

JOHN E. MICHOS, EXAMINING ATTORNEY

Int. Cls.: 6 and 35

Prior U.S. Cls.: 2, 12, 13, 14, 23, 25, 50, 100, 101 and 102

United States Patent and Trademark Office

Reg. No. 3,483,748

Registered Aug. 12, 2008

**TRADEMARK
SERVICE MARK
PRINCIPAL REGISTER**

DAN-LOC EXPRESS

DAN-LOC, LLC (DELAWARE LTD LIAB CO)
725 N. DRENNAN
HOUSTON, TX 770031320

FOR: METAL NUTS AND BOLTS, IN CLASS 6
(U.S. CLS. 2, 12, 13, 14, 23, 25 AND 50).

FIRST USE 11-0-2007; IN COMMERCE 12-28-2007.

FOR: RETAIL STORE SERVICES IN THE FIELD
OF NUTS AND BOLTS, IN CLASS 35 (U.S. CLS. 100,
101 AND 102).

FIRST USE 11-0-2007; IN COMMERCE 11-0-2007.

THE MARK CONSISTS OF STANDARD CHAR-
ACTERS WITHOUT CLAIM TO ANY PARTICULAR
FONT, STYLE, SIZE, OR COLOR.

OWNER OF U.S. REG. NOS. 2,015,702, 2,026,929,
AND 2,771,798.

NO CLAIM IS MADE TO THE EXCLUSIVE
RIGHT TO USE EXPRESS (IC 035 ONLY), APART
FROM THE MARK AS SHOWN.

SER. NO. 77-291,249, FILED 9-28-2007.

ODESSA BIBBINS, EXAMINING ATTORNEY

Int. Cl.: 25

Prior U.S. Cls.: 22 and 39

United States Patent and Trademark Office

Reg. No. 3,483,749

Registered Aug. 12, 2008

TRADEMARK
PRINCIPAL REGISTER



PERSONAL TOUCH SIGNATURE SERIES, LLC
(ALABAMA LTD LIAB CO)
208 GARVIN DRIVE
ALBERTVILLE, AL 35950

FOR: CLOTHING, NAMELY, SOCKS, IN CLASS 25
(U.S. CLS. 22 AND 39).

FIRST USE 4-17-2007; IN COMMERCE 4-17-2007.

NO CLAIM IS MADE TO THE EXCLUSIVE
RIGHT TO USE "FOOTWEAR", APART FROM
THE MARK AS SHOWN.

THE MARK CONSISTS OF A CIRCLE WITH AN
IMAGE OF A COWBOY ON A BUCKING HORSE,
THE MAJORITY OF WHICH IS ENCLOSED WITHIN
THE CIRCLE, WITH THE WORDS "THE ULTIMATE

COWBOY FOOTWEAR" IMPOSED OVER THE IM-
AGE. THE WORD "THE" IS IN THE UPPER LEFT
CORNER OF THE MARK OUTSIDE THE CIRCLE
AND IS IN SCRIPT. THE WORD "ULTIMATE" IS
ALSO IN SCRIPT BUT IN LARGER FONT AND
BELOW AND TO THE RIGHT OF THE WORD
"THE." THE "U" IN "ULTIMATE" RESEMBLES A
HORSESHOE. THE WORD "COWBOY" IS IN SCRIPT
AND FONT SIMILAR TO "ULTIMATE" AND IS
BELOW AND TO THE RIGHT OF THE WORD
"ULTIMATE." THE WORD "FOOTWEAR" IS BE-
LOW THE WORD "COWBOY" AND IS IN SMALLER
FONT AND NOT IN SCRIPT.

SER. NO. 77-292,400, FILED 9-30-2007.

DAVID H. STINE, EXAMINING ATTORNEY

Int. Cls.: 35, 36 and 45

Prior U.S. Cls.: 100, 101 and 102

United States Patent and Trademark Office

Reg. No. 3,483,750

Registered Aug. 12, 2008

**SERVICE MARK
PRINCIPAL REGISTER**

TSYS DEBT MANAGEMENT

TOTAL SYSTEM SERVICES, INC. (GEORGIA CORPORATION)
1600 FIRST AVENUE
COLUMBUS, GA 319022567

FOR: DATA MANAGEMENT SERVICES FOR USE IN DEBT COLLECTION, NAMELY, ELECTRONIC DATA COLLECTION AND ONLINE CLAIMS MANAGEMENT, IN CLASS 35 (U.S. CLS. 100, 101 AND 102).

FIRST USE 3-0-2003; IN COMMERCE 3-0-2003.

FOR: DEBT RECOVERY AND COLLECTION AGENCY SERVICES; BANKRUPTCY AND PROBATE CASE MANAGEMENT SERVICES, NAMELY, BANKRUPTCY AND PROBATE CLAIMS ADMINISTRATION, IN CLASS 36 (U.S. CLS. 100, 101 AND 102).

FIRST USE 3-0-2003; IN COMMERCE 3-0-2003.

FOR: SKIP TRACING SERVICES; LITIGATION MANAGEMENT AND SUPPORT SERVICES; LE-

GAL SERVICES, NAMELY, BANKRUPTCY CASE MANAGEMENT SERVICES AND PROBATE CASE MANAGEMENT SERVICES, IN CLASS 45 (U.S. CLS. 100 AND 101).

FIRST USE 3-0-2003; IN COMMERCE 3-0-2003.

THE MARK CONSISTS OF STANDARD CHARACTERS WITHOUT CLAIM TO ANY PARTICULAR FONT, STYLE, SIZE, OR COLOR.

OWNER OF U.S. REG. NOS. 2,599,320, 3,195,413 AND OTHERS.

NO CLAIM IS MADE TO THE EXCLUSIVE RIGHT TO USE "DEBT MANAGEMENT", APART FROM THE MARK AS SHOWN.

SER. NO. 77-292,672, FILED 10-1-2007.

SANI KHOURI, EXAMINING ATTORNEY

Int. Cl.: 41

Prior U.S. Cls.: 100, 101 and 107

United States Patent and Trademark Office

Reg. No. 3,483,751

Registered Aug. 12, 2008

**SERVICE MARK
PRINCIPAL REGISTER**



BRAINSTORM TUTORING, LLC (NEW JERSEY LTD LIAB CO)
141 WEST OAK STREET
RAMSEY, NJ 07446

FOR: EDUCATIONAL SERVICES, NAMELY, ACADEMIC TUTORING SERVICES MATCHED TO CUSTOMER NEEDS AND DELIVERED BY TRAINED PROFESSIONAL TUTORS IN ONE-ON-ONE SESSIONS BETWEEN TUTOR AND CUSTOMER WITHIN THE CUSTOMER'S HOME OR AT ANOTHER LOCATION OF THE CUSTOMER'S CHOICE, TREATING SUBJECT AREAS OF THE CUSTOMER'S CHOICE AT THE PRE-K THROUGH GRADE 12 LEVELS, AND THE DISTRIBUTION OF TRAINING COURSE MATERIALS PROVIDED IN CONNECTION THEREWITH; EDUCATION SERVICES, NAMELY, PROVIDING TUTORING AND CLASSES TO IMPROVE ACADEMIC PERFORMANCE OF STUDENTS AND FOR PROFESSIONAL DEVELOPMENT OF TEACHERS; EDUCATION SERVICES, NAMELY, PROVIDING INFORMATION ON COLLEGES, GRADUATE SCHOOLS AND PROFESSIONAL SCHOOLS AND ADMISSIONS INFORMATION VIA THE INTERNET; EDUCATIONAL SERVICES, NAMELY, PERSONALIZED IN-HOME AND SMALL GROUP TUTORING IN MATHEMAT-

ICS, SCIENCE, READING, WRITING, LANGUAGES, MUSIC, STUDY SKILLS, ORGANIZATION, INTERVIEW SKILLS, APPLICATION PREPARATION, AND STANDARDIZED TEST PREPARATION, IN CLASS 41 (U.S. CLS. 100, 101 AND 107).

FIRST USE 4-0-2006; IN COMMERCE 10-0-2006.

THE COLOR(S) BLACK, ORANGE, LIGHT ORANGE AND WHITE IS/ARE CLAIMED AS A FEATURE OF THE MARK.

THE MARK CONSISTS OF TWO OVERLAPPING SILHOUETTES OF A HUMAN HEAD, CREATING THREE DISTINCT PORTIONS, WITH A LIGHTNING BOLT DESCENDING AMIDST THE OVERLAPPING MIDDLE PORTION. THE LEFT-HAND PORTION IS ORANGE, THE MIDDLE PORTION IS LIGHT ORANGE, AND THE RIGHT-HAND PORTION IS WHITE. THE LIGHTNING BOLT AND THE OUTLINE OF THE HEADS IS IN BLACK.

SER. NO. 77-293,088, FILED 10-1-2007.

SANI KHOURI, EXAMINING ATTORNEY

Int. Cl.: 44

Prior U.S. Cls.: 100 and 101

United States Patent and Trademark Office

Reg. No. 3,483,752

Registered Aug. 12, 2008

**SERVICE MARK
PRINCIPAL REGISTER**



TENET HEALTHSYSTEM MEDICAL, INC. (DE-
LAWARE CORPORATION)
13737 NOEL RD., STE. 100
DALLAS, TX 75240

FOR: HEALTH CARE, IN CLASS 44 (U.S. CLS. 100
AND 101).

FIRST USE 8-31-2007; IN COMMERCE 8-31-2007.

NO CLAIM IS MADE TO THE EXCLUSIVE
RIGHT TO USE "30 MINUTE ER" , APART FROM
THE MARK AS SHOWN.

THE MARK CONSISTS OF THE WORDS "30
MINUTE ER" WITHIN A CIRCLE.

SER. NO. 77-293,145, FILED 10-1-2007.

RICHARD A. STRASER, EXAMINING ATTORNEY

Int. Cl.: 42

Prior U.S. Cls.: 100 and 101

United States Patent and Trademark Office

Reg. No. 3,483,753

Registered Aug. 12, 2008

**SERVICE MARK
PRINCIPAL REGISTER**

IGNITECAST.COM

SCATE TECHNOLOGIES, INC. (MICHIGAN CORPORATION)
SUITE B
40 ENGELWOOD DR.
ORION, MI 48359

FOR: APPLICATION SERVICE PROVIDER (ASP) FEATURING SOFTWARE TO ENABLE UPLOADING, POSTING, SHOWING, DISPLAYING, TAGGING, BLOGGING, SHARING OF ELECTRONIC MEDIA AND INFORMATION OVER THE INTERNET AND OTHER COMMUNICATIONS NETWORK, IN CLASS 42 (U.S. CLS. 100 AND 101).

FIRST USE 9-17-2007; IN COMMERCE 9-17-2007.

THE MARK CONSISTS OF STANDARD CHARACTERS WITHOUT CLAIM TO ANY PARTICULAR FONT, STYLE, SIZE, OR COLOR.

SER. NO. 77-293,264, FILED 10-1-2007.

CURTIS FRENCH, EXAMINING ATTORNEY

Int. Cl.: 42

Prior U.S. Cls.: 100 and 101

United States Patent and Trademark Office

Reg. No. 3,483,754

Registered Aug. 12, 2008

**SERVICE MARK
PRINCIPAL REGISTER**

YOU KNOW - YOU SHOW

SCATE TECHNOLOGIES, INC. (MICHIGAN CORPORATION)
SUITE B
40 ENGELWOOD DR.
ORION, MI 48359

FOR: APPLICATION SERVICE PROVIDER (ASP) FEATURING SOFTWARE TO ENABLE UPLOADING, POSTING, SHOWING, DISPLAYING, TAGGING, BLOGGING, SHARING OF ELECTRONIC MEDIA AND INFORMATION OVER THE INTERNET AND OTHER COMMUNICATIONS NETWORK, IN CLASS 42 (U.S. CLS. 100 AND 101).

FIRST USE 9-17-2007; IN COMMERCE 9-17-2007.

THE MARK CONSISTS OF STANDARD CHARACTERS WITHOUT CLAIM TO ANY PARTICULAR FONT, STYLE, SIZE, OR COLOR.

SER. NO. 77-293,275, FILED 10-1-2007.

CURTIS FRENCH, EXAMINING ATTORNEY

Int. Cl.: 36

Prior U.S. Cls.: 100, 101 and 102

United States Patent and Trademark Office

Reg. No. 3,483,755

Registered Aug. 12, 2008

**SERVICE MARK
PRINCIPAL REGISTER**

BIRDIES FOR THE BRAVE

PGA TOUR, INC. (MARYLAND CORPORATION)
LEGAL DEPT.
112 PGA TOUR, BLVD.
PONTE VEDRA BEACH, FL 32082

FOR: CHARITABLE FUNDRAISING SERVICES
IN THE NATURE OF GENERATING FUNDS TO
SUPPORT OTHER QUALIFIED CHARITABLE OR-
GANIZATIONS FOCUSED ON ASSISTING MILI-
TARY PERSONNEL AND THEIR FAMILIES BOTH
DOMESTICALLY AND ABROAD, IN CLASS 36 (U.S.
CLS. 100, 101 AND 102).

FIRST USE 7-4-2005; IN COMMERCE 7-4-2005.

THE MARK CONSISTS OF STANDARD CHAR-
ACTERS WITHOUT CLAIM TO ANY PARTICULAR
FONT, STYLE, SIZE, OR COLOR.

SER. NO. 77-293,993, FILED 10-2-2007.

MICHELLE DUBOIS, EXAMINING ATTORNEY

Int. Cl.: 9

Prior U.S. Cls.: 21, 23, 26, 36 and 38

Reg. No. 3,483,756

United States Patent and Trademark Office

Registered Aug. 12, 2008

**TRADEMARK
PRINCIPAL REGISTER**



PLUMB, JONATHAN JAMES CURTIS (UNITED STATES INDIVIDUAL)
5691 N. ACADEMY BLVD.
COLORADO SPRINGS, CO 80918 AND
HOUSTON, ROBERT II (UNITED STATES INDIVIDUAL)
5691 N. ACADEMY BLVD.
COLORADO SPRINGS, CO 80918

FOR: DIGITAL MATERIALS, NAMELY, CDS, DVDS, AND DOWNLOADABLE AUDIO FILES FEATURING MUSIC. DIGITAL MEDIA, NAMELY, CDS, DVDS, AND DOWNLOADABLE AUDIO FILES FEATURING MUSIC. PRE-RECORDED CDS, VIDEO TAPES, LASER DISKS AND DVDS FEATURING MUSIC. AUDIO RECORDINGS FEATURING MUSIC. DOWNLOADABLE RING TONES AND MUSIC VIA THE INTERNET AND WIRELESS DEVICES. DOWNLOADABLE MP3 FILES, MP3 RECORDINGS, ONLINE DISCUSSION BOARDS, WEBCASTS AND PODCASTS FEATURING MUSIC. DOWNLOADABLE RING TONES, GRAPHICS AND MUSIC VIA

A GLOBAL COMPUTER NETWORK AND WIRELESS DEVICES. DOWNLOADABLE VIDEO RECORDINGS FEATURING MUSIC. SOUND RECORDINGS FEATURING MUSIC. VIDEO RECORDINGS FEATURING MUSIC, IN CLASS 9 (U.S. CLS. 21, 23, 26, 36 AND 38).

FIRST USE 1-1-2002; IN COMMERCE 1-1-2003.

NO CLAIM IS MADE TO THE EXCLUSIVE RIGHT TO USE "ENTERTAINMENT", APART FROM THE MARK AS SHOWN.

THE MARK CONSISTS OF THE IMAGE OF SPIKED BRASS KNUCKLES WITH THE WORDS "BRASS KNUCKLE ENTERTAINMENT" INCLUDED IN THE MARK.

SER. NO. 77-294,648, FILED 10-3-2007.

LINDA E. BLOHM, EXAMINING ATTORNEY

Int. Cl.: 9

Prior U.S. Cls.: 21, 23, 26, 36 and 38

Reg. No. 3,483,757

United States Patent and Trademark Office

Registered Aug. 12, 2008

**TRADEMARK
PRINCIPAL REGISTER**

Black Pegasus

PLUMB, JONATHAN JAMES CURTIS (UNITED STATES INDIVIDUAL)
5691 N. ACADEMY BLVD.
COLORADO SPRINGS, CO 80918 AND
HOUSTON, ROBERT II (UNITED STATES INDIVIDUAL)
5691 N. ACADEMY BLVD.
COLORADO SPRINGS, CO 80918

FOR: AUDIO RECORDINGS FEATURING MUSIC. DOWNLOADABLE RING TONES AND MUSIC VIA THE INTERNET AND WIRELESS DEVICES. DOWNLOADABLE MP3 FILES, MP3 RECORDINGS, ONLINE DISCUSSION BOARDS, WEBCASTS AND PODCASTS FEATURING MUSIC. DOWNLOADABLE RING TONES, GRAPHICS AND MUSIC VIA A GLOBAL COMPUTER NETWORK AND WIRELESS DEVICES. DOWNLOADABLE VIDEO RECORDINGS FEATURING MUSIC. SOUND RECORDINGS FEATURING MUSIC. VIDEO RE-

CORDINGS FEATURING MUSIC. DIGITAL MATERIALS, NAMELY, CDS, DVDS, AND DOWNLOADABLE AUDIO FILES FEATURING MUSIC. DIGITAL MEDIA, NAMELY, CDS, DVDS, AND DOWNLOADABLE AUDIO FILES FEATURING MUSIC. PRE-RECORDED CDS, VIDEO TAPES, LASER DISKS AND DVDS FEATURING MUSIC, IN CLASS 9 (U.S. CLS. 21, 23, 26, 36 AND 38).

FIRST USE 1-1-2002; IN COMMERCE 1-1-2003.

THE MARK CONSISTS OF STANDARD CHARACTERS WITHOUT CLAIM TO ANY PARTICULAR FONT, STYLE, SIZE, OR COLOR.

SER. NO. 77-294,651, FILED 10-3-2007.

LINDA E. BLOHM, EXAMINING ATTORNEY

Int. Cl.: 33

Prior U.S. Cls.: 47 and 49

United States Patent and Trademark Office

Reg. No. 3,483,758

Registered Aug. 12, 2008

**TRADEMARK
PRINCIPAL REGISTER**

FADO

TERRAS DE ALTER - COMPANHIA DE VINHOS
LDA. (PORTUGAL LTD LIAB CO)
RUA FELICIANO CASTILHO - 3
ALTER DO CHAO, PORTUGAL 7440-022

FOR: ALCOHOLIC DRINKS, NAMELY, WINES,
IN CLASS 33 (U.S. CLS. 47 AND 49).

THE MARK CONSISTS OF STANDARD CHAR-
ACTERS WITHOUT CLAIM TO ANY PARTICULAR
FONT, STYLE, SIZE, OR COLOR.

OWNER OF PORTUGAL REG. NO. 290221MNA,
DATED 2-17-1995, EXPIRES 2-17-2015.

THE FOREIGN WORDING IN THE MARK
TRANSLATES INTO ENGLISH AS "DESTINY".

SER. NO. 77-295,010, FILED 10-3-2007.

ODESSA BIBBINS, EXAMINING ATTORNEY

Int. Cls.: 35, 37 and 42

Prior U.S. Cls.: 100, 101, 102, 103 and 106

United States Patent and Trademark Office

Reg. No. 3,483,759

Registered Aug. 12, 2008

**SERVICE MARK
PRINCIPAL REGISTER**

**HOLISTIC ORGANIZATIONAL
DESIGN**

CLOS-ETTE LLC (NEW YORK LTD LIAB CO)
SUITE 820
41 UNION SQUARE WEST
NEW YORK, NY 10003

FOR: RETAIL STORE SERVICES FEATURING CLOTHES HANGERS, JEWELRY CASES, HOUSEHOLD DÉCOR AND STORAGE ITEMS, CONTAINERS FOR STORING CLOTHING AND SHOES, SHOE TREES, SACHETS, AND HOUSEHOLD STORAGE CONTAINERS; ONLINE RETAIL STORE SERVICES FEATURING CLOTHES HANGERS, JEWELRY CASES, HOUSEHOLD DÉCOR AND STORAGE ITEMS, CONTAINERS FOR STORING CLOTHING AND SHOES, SHOE TREES, SACHETS, AND HOUSEHOLD STORAGE CONTAINERS, IN CLASS 35 (U.S. CLS. 100, 101 AND 102).

FIRST USE 12-31-2004; IN COMMERCE 12-31-2004.

FOR: CUSTOM INSTALLATION OF FURNITURE AND CONTAINERS, IN CLASS 37 (U.S. CLS. 100, 103 AND 106).

FIRST USE 12-31-2004; IN COMMERCE 12-31-2004.

FOR: INTERIOR DESIGN, HOME DESIGN, APARTMENT DESIGN, STYLING SERVICES IN THE NATURE OF INTERIOR DECORATING SERVICES, IN CLASS 42 (U.S. CLS. 100 AND 101).

FIRST USE 12-31-2004; IN COMMERCE 12-31-2004.

THE MARK CONSISTS OF STANDARD CHARACTERS WITHOUT CLAIM TO ANY PARTICULAR FONT, STYLE, SIZE, OR COLOR.

NO CLAIM IS MADE TO THE EXCLUSIVE RIGHT TO USE "DESIGN", APART FROM THE MARK AS SHOWN.

SER. NO. 77-295,908, FILED 10-4-2007.

GRETТА YAO, EXAMINING ATTORNEY

Int. Cl.: 43

Prior U.S. Cls.: 100 and 101

United States Patent and Trademark Office

Reg. No. 3,483,760

Registered Aug. 12, 2008

**SERVICE MARK
PRINCIPAL REGISTER**

TRUMP

TRUMP, DONALD J. (UNITED STATES INDIVIDUAL)
725 FIFTH AVENUE
NEW YORK, NY 10022

FOR: RESTAURANT SERVICES, IN CLASS 43
(U.S. CLS. 100 AND 101).

FIRST USE 11-0-2003; IN COMMERCE 11-0-2003.

THE MARK CONSISTS OF STANDARD CHARACTERS WITHOUT CLAIM TO ANY PARTICULAR FONT, STYLE, SIZE, OR COLOR.

OWNER OF U.S. REG. NOS. 2,226,174, 2,577,243 AND OTHERS.

SER. NO. 77-295,919, FILED 10-4-2007.

STEVEN R. FOSTER, EXAMINING ATTORNEY

Int. Cl.: 35

Prior U.S. Cls.: 100, 101 and 102

United States Patent and Trademark Office

Reg. No. 3,483,761

Registered Aug. 12, 2008

**SERVICE MARK
PRINCIPAL REGISTER**

**THE ABUNDANT LIFE MODEL
FOR ADVISORS**

HORIZON FINANCIAL & INSURANCE GROUP,
INC. (UTAH CORPORATION)
1376 GOLDEN CIRCLE DRIVE
FRUIT HEIGHTS, UT 84037

THE MARK CONSISTS OF STANDARD CHAR-
ACTERS WITHOUT CLAIM TO ANY PARTICULAR
FONT, STYLE, SIZE, OR COLOR.

FOR: RECRUITING AGENTS FOR PROMOTING
INSURANCE AND FINANCIAL PLANNING SER-
VICES, IN CLASS 35 (U.S. CLS. 100, 101 AND 102).

SER. NO. 77-296,209, FILED 10-4-2007.

FIRST USE 12-15-2006; IN COMMERCE 12-15-2006.

ERNEST SHOSHO, EXAMINING ATTORNEY

Int. Cl.: 9

Prior U.S. Cls.: 21, 23, 26, 36 and 38

United States Patent and Trademark Office

Reg. No. 3,483,762

Registered Aug. 12, 2008

**TRADEMARK
PRINCIPAL REGISTER**

PARTY MUSICAL

TUTM ENTERTAINMENT, INC. (NEW JERSEY CORPORATION)
45 FERNWOOD AVENUE
RARITAN CENTER
EDISON, NJ 08837

FOR: PRE-RECORDED CDS FEATURING MUSICAL PERFORMANCES, IN CLASS 9 (U.S. CLS. 21, 23, 26, 36 AND 38).

FIRST USE 1-28-2008; IN COMMERCE 1-28-2008.

THE MARK CONSISTS OF STANDARD CHARACTERS WITHOUT CLAIM TO ANY PARTICULAR FONT, STYLE, SIZE, OR COLOR.

OWNER OF U.S. REG. NOS. 2,195,254, 2,477,111, AND 2,491,671.

NO CLAIM IS MADE TO THE EXCLUSIVE RIGHT TO USE "MUSICAL", APART FROM THE MARK AS SHOWN.

THE WORDING "PARTY" HAS NO MEANING IN A FOREIGN LANGUAGE.

SER. NO. 77-296,691, FILED 10-4-2007.

DAVID ELTON, EXAMINING ATTORNEY

Int. Cl.: 24

Prior U.S. Cls.: 42 and 50

United States Patent and Trademark Office

Reg. No. 3,483,763

Registered Aug. 12, 2008

**TRADEMARK
PRINCIPAL REGISTER**

LOUNGEWISE

BLUE BELL (MICHIGAN LTD LIAB CO)
2011 HILL CT.
MIDLAND, MI 48640

THE MARK CONSISTS OF STANDARD CHAR-
ACTERS WITHOUT CLAIM TO ANY PARTICULAR
FONT, STYLE, SIZE, OR COLOR.

FOR: BED BLANKETS; BLANKET THROWS;
BLANKETS FOR OUTDOOR USE; CHILDREN'S
BLANKETS, IN CLASS 24 (U.S. CLS. 42 AND 50).

SER. NO. 77-297,663, FILED 10-5-2007.

FIRST USE 7-19-2007; IN COMMERCE 9-8-2007.

TINA BROWN, EXAMINING ATTORNEY

Int. Cl.: 7

Prior U.S. Cls.: 13, 19, 21, 23, 31, 34 and 35

Reg. No. 3,483,764

United States Patent and Trademark Office

Registered Aug. 12, 2008

**TRADEMARK
PRINCIPAL REGISTER**

KANSAS TOOLS

FERNANDEZ, JOAQUIN (MEXICO INDIVIDUAL)
APARTMENT 1101
432 RED RIVER TRIAL
IRVING, TX 75062

FOR: CEMENTED CARBIDE CUTTING TOOLS; MILLING CUTTERS; MACHINES AND MACHINE TOOLS FOR THE CUTTING AND FORMING OF MATERIALS, IN CLASS 7 (U.S. CLS. 13, 19, 21, 23, 31, 34 AND 35).

FIRST USE 1-1-2003; IN COMMERCE 1-1-2003.

THE MARK CONSISTS OF STANDARD CHARACTERS WITHOUT CLAIM TO ANY PARTICULAR FONT, STYLE, SIZE, OR COLOR.

NO CLAIM IS MADE TO THE EXCLUSIVE RIGHT TO USE "TOOLS", APART FROM THE MARK AS SHOWN.

SER. NO. 77-297,875, FILED 10-5-2007.

EDWARD NELSON, EXAMINING ATTORNEY

Int. Cl.: 42

Prior U.S. Cls.: 100 and 101

United States Patent and Trademark Office

Reg. No. 3,483,765

Registered Aug. 12, 2008

**SERVICE MARK
PRINCIPAL REGISTER**



SEAL OF SUSTAINABILITY, LLC (ARKANSAS
LTD LIAB CO)
SUITE 500
5417 PINNACLE POINT DRIVE
ROGERS, AR 72758

FOR: ENVIRONMENTAL SERVICES, NAMELY,
TECHNICAL CONSULTATION IN THE FIELD OF
ENGINEERING SERVICES; TECHNICAL ANALY-
SIS OF A PRODUCT OR PROCESS TO DETERMINE
HOW TO MAKE IT MORE ENVIRONMENTALLY
SOUND; CONSULTING SERVICES IN THE FIELD
OF ENVIRONMENTAL ASSESSMENT, COMPLI-
ANCE AND PLANNING, IN CLASS 42 (U.S. CLS.
100 AND 101).

FIRST USE 6-1-2007; IN COMMERCE 6-1-2007.

NO CLAIM IS MADE TO THE EXCLUSIVE
RIGHT TO USE "SEAL OF SUSTAINABILITY",
APART FROM THE MARK AS SHOWN.

THE COLOR(S) GREEN, GRAY AND WHITE IS/
ARE CLAIMED AS A FEATURE OF THE MARK.

THE MARK CONSISTS OF THE WORDS "SEAL
OF SUSTAINABILITY" IN WHITE SUPERIMPOSED
OVER A GREEN LEAF ON A CIRCLE COMPOSED
OF VARYING SHADES OF GRAY AND BOR-
DERED BY TWO GRAY COCENTRIC LINES.

SER. NO. 77-298,143, FILED 10-7-2007.

HANNO RITTNER, EXAMINING ATTORNEY

Int. Cl.: 5

Prior U.S. Cls.: 6, 18, 44, 46, 51 and 52

United States Patent and Trademark Office

Reg. No. 3,483,766

Registered Aug. 12, 2008

**TRADEMARK
PRINCIPAL REGISTER**

JACK'S HARVEST

JACK'S HARVEST, LLC (GEORGIA LTD LIAB
CO)
3967 ST. GEORGE'S COURT
DULUTH, GA 30096

THE MARK CONSISTS OF STANDARD CHAR-
ACTERS WITHOUT CLAIM TO ANY PARTICULAR
FONT, STYLE, SIZE, OR COLOR.

FOR: FOOD FOR INFANTS, IN CLASS 5 (U.S. CLS.
6, 18, 44, 46, 51 AND 52).

SER. NO. 77-298,220, FILED 10-8-2007.

FIRST USE 10-30-2006; IN COMMERCE 2-12-2007.

ALYSSA PALADINO, EXAMINING ATTORNEY

Int. Cl.: 5

Prior U.S. Cls.: 6, 18, 44, 46, 51 and 52

Reg. No. 3,483,767

United States Patent and Trademark Office

Registered Aug. 12, 2008

**TRADEMARK
PRINCIPAL REGISTER**

**BECAUSE YOUR BABY HAS
GOOD TASTE**

JACK'S HARVEST, LLC (GEORGIA LTD LIAB
CO)
3967 ST. GEORGE'S COURT
DULUTH, GA 30096

THE MARK CONSISTS OF STANDARD CHAR-
ACTERS WITHOUT CLAIM TO ANY PARTICULAR
FONT, STYLE, SIZE, OR COLOR.

FOR: FOOD FOR INFANTS, IN CLASS 5 (U.S. CLS.
6, 18, 44, 46, 51 AND 52).

SER. NO. 77-298,231, FILED 10-8-2007.

FIRST USE 10-30-2006; IN COMMERCE 2-12-2007.

ALYSSA PALADINO, EXAMINING ATTORNEY

Int. Cl.: 44

Prior U.S. Cls.: 100 and 101

United States Patent and Trademark Office

Reg. No. 3,483,768

Registered Aug. 12, 2008

**SERVICE MARK
PRINCIPAL REGISTER**

L.A.  TEETH WHITENING

L.A. TAN ENTERPRISES, INC. (ILLINOIS CORPORATION)
3775 W. ARTHUR STREET
LINCOLNWOOD, IL 60712

FOR: TEETH WHITENING SERVICES, IN CLASS 44 (U.S. CLS. 100 AND 101).

FIRST USE 10-5-2007; IN COMMERCE 10-5-2007.

NO CLAIM IS MADE TO THE EXCLUSIVE RIGHT TO USE "TEETH WHITENING", APART FROM THE MARK AS SHOWN.

THE MARK CONSISTS OF THE LITERAL ELEMENT "L.A." BESIDE THE LITERAL ELEMENT "TEETH" BESIDE THE LITERAL ELEMENT "WHITENING" WITH A STYLIZED LETTER "A" IN THE LITERAL ELEMENT "L.A.", SAID LETTER "A" CONTAINING A PALM TREE.

SER. NO. 77-298,256, FILED 10-8-2007.

KAREN K. BUSH, EXAMINING ATTORNEY

Int. Cl.: 35

Prior U.S. Cls.: 100, 101 and 102

United States Patent and Trademark Office

Reg. No. 3,483,769

Registered Aug. 12, 2008

**SERVICE MARK
PRINCIPAL REGISTER**

eventsense

AMIANDO AG (FED REP GERMANY COR-
PORATION)
BLUMENSTR. 28
MUNICH, FED REP GERMANY 80331

PRIORITY CLAIMED UNDER SEC. 44(D) ON FED
REP GERMANY APPLICATION NO. 30765470.2/3,
FILED 10-8-2007, REG. NO. 30765470, DATED 2-4-
2008, EXPIRES 10-31-2017.

FOR: PROMOTING THE PARTIES AND SPECIAL
EVENTS OF OTHERS, IN CLASS 35 (U.S. CLS. 100,
101 AND 102).

SER. NO. 77-298,270, FILED 10-8-2007.

THE MARK CONSISTS OF STANDARD CHAR-
ACTERS WITHOUT CLAIM TO ANY PARTICULAR
FONT, STYLE, SIZE, OR COLOR.

JENNIFER HETU, EXAMINING ATTORNEY

Int. Cl.: 35

Prior U.S. Cls.: 100, 101 and 102

United States Patent and Trademark Office

Reg. No. 3,483,770

Registered Aug. 12, 2008

**SERVICE MARK
PRINCIPAL REGISTER**

Grandevity

GRANDEIVTY, LLC (DELAWARE LTD LIAB CO)
PO BOX 381589
CAMBRIDGE, MA 02238

FOR: BUSINESS CONSULTATION AND MANAGEMENT REGARDING MARKETING ACTIVITIES AND LAUNCHING OF NEW PRODUCTS, IN CLASS 35 (U.S. CLS. 100, 101 AND 102).

FIRST USE 4-13-2005; IN COMMERCE 2-5-2007.

THE MARK CONSISTS OF STANDARD CHARACTERS WITHOUT CLAIM TO ANY PARTICULAR FONT, STYLE, SIZE, OR COLOR.

SER. NO. 77-298,380, FILED 10-8-2007.

VIVIAN MICZNIK FIRST, EXAMINING ATTORNEY

Int. Cls.: 35, 41 and 42

Prior U.S. Cls.: 100, 101, 102 and 107

United States Patent and Trademark Office

Reg. No. 3,483,771

Registered Aug. 12, 2008

**SERVICE MARK
PRINCIPAL REGISTER**

PICTURE

ALGERMISSEN, LARS (FED REP GERMANY
INDIVIDUAL)
MUHLENSTR. 1
MUNSTER, FED REP GERMANY 48143 AND
FALK, THORSTEN (FED REP GERMANY INDIVI-
DUAL)
SPIEKERHOF 1
MUNSTER, FED REP GERMANY 48143

FOR: BUSINESS MANAGEMENT SERVICES;
BUSINESS ADMINISTRATION CONSULTANCY;
BUSINESS CONSULTATION, CONSULTANCY
WITH REGARD TO THE ORGANIZATION OF
PUBLIC INSTITUTIONS AND ENTERPRISES, BUSI-
NESS PROCESS MANAGEMENT AND CONSUL-
TANCY, IN CLASS 35 (U.S. CLS. 100, 101 AND 102).

FOR: THE PROVIDING OF TRAINING IS IN THE
FIELD OF ORGANIZATIONAL COMPOSITION OF
PUBLIC INSTITUTIONS AND ENTERPRISES, IN
CLASS 41 (U.S. CLS. 100, 101 AND 107).

FOR: DESIGN AND DEVELOPMENT OF COM-
PUTER SOFTWARE FOR BUSINESS PROCESS
MANAGEMENT; INSTALLATION, CUSTOM
ADAPTATION, MAINTENANCE AND UPDATING
OF COMPUTER SOFTWARE FOR BUSINESS PRO-
CESS MANAGEMENT; RENTAL OF COMPUTER
SOFTWARE FOR BUSINESS PROCESS MANAGE-
MENT, IN CLASS 42 (U.S. CLS. 100 AND 101).

THE MARK CONSISTS OF STANDARD CHAR-
ACTERS WITHOUT CLAIM TO ANY PARTICULAR
FONT, STYLE, SIZE, OR COLOR.

PRIORITY CLAIMED UNDER SEC. 44(D) ON
ERPNTY TM OFC APPLICATION NO.
005828165, FILED 4-12-2007, REG. NO. 005828165,
DATED 1-4-2008, EXPIRES 4-12-2017.

SER. NO. 77-298,559, FILED 10-8-2007.

AMY HELLA, EXAMINING ATTORNEY

Int. Cl.: 41

Prior U.S. Cls.: 100, 101 and 107

United States Patent and Trademark Office

Reg. No. 3,483,772

Registered Aug. 12, 2008

**SERVICE MARK
PRINCIPAL REGISTER**

CAMP TEEN ANGEL

ANGEL ON MY SHOULDER, LTD. (WISCONSIN
CORPORATION)
1611 PINE TREE LANE
ST. GERMAIN, WI 51558

OWNER OF U.S. REG. NOS. 2,473,746 AND
2,519,887.

FOR: CHARITABLE SERVICES, NAMELY, PRO-
VIDING CAMPS FOR CHILDREN AFFECTED BY
CANCER, IN CLASS 41 (U.S. CLS. 100, 101 AND 107).

NO CLAIM IS MADE TO THE EXCLUSIVE
RIGHT TO USE "CAMP", APART FROM THE
MARK AS SHOWN.

FIRST USE 1-19-2001; IN COMMERCE 1-19-2001.

SER. NO. 77-298,799, FILED 10-8-2007.

THE MARK CONSISTS OF STANDARD CHAR-
ACTERS WITHOUT CLAIM TO ANY PARTICULAR
FONT, STYLE, SIZE, OR COLOR.

LINDA ORNDORFF, EXAMINING ATTORNEY

Int. Cl.: 9

Prior U.S. Cls.: 21, 23, 26, 36 and 38

Reg. No. 3,483,773

United States Patent and Trademark Office

Registered Aug. 12, 2008

**TRADEMARK
PRINCIPAL REGISTER**

CarterKone

CARTER CONTACT LENS, INC. (CALIFORNIA
CORPORATION)
SUITE 109
105 W. DAKOTA AVE.
CLOVIS, CA 93612

THE MARK CONSISTS OF STANDARD CHAR-
ACTERS WITHOUT CLAIM TO ANY PARTICULAR
FONT, STYLE, SIZE, OR COLOR.

FOR: CONTACT LENSES, IN CLASS 9 (U.S. CLS.
21, 23, 26, 36 AND 38).

SER. NO. 77-298,954, FILED 10-8-2007.

FIRST USE 3-1-2007; IN COMMERCE 3-1-2007.

ELI HELLMAN, EXAMINING ATTORNEY

Int. Cl.: 43

Prior U.S. Cls.: 100 and 101

United States Patent and Trademark Office

Reg. No. 3,483,774

Registered Aug. 12, 2008

SERVICE MARK
PRINCIPAL REGISTER



CAROLINA SPICE COMPANY, LLC (SOUTH
CAROLINA LTD LIAB CO)
130 WHITEFORD WAY, SUITE D
LEXINGTON, SC 29072

FOR: CARRY-OUT RESTAURANTS; RESTAU-
RANT AND BAR SERVICES; TAKE-OUT RESTAU-
RANT SERVICES; PREPARATION OF FOOD AND
BEVERAGES; SERVING OF FOOD AND DRINK/
BEVERAGES , IN CLASS 43 (U.S. CLS. 100 AND 101).

FIRST USE 8-31-2007; IN COMMERCE 8-31-2007.

NO CLAIM IS MADE TO THE EXCLUSIVE
RIGHT TO USE "CAROLINA SMOKEHOUSE",
APART FROM THE MARK AS SHOWN.

THE COLOR(S) BLACK, ORANGE, RED, GAR-
NET, WHITE, AND PINK IS/ARE CLAIMED AS A
FEATURE OF THE MARK.

THE MARK CONSISTS OF THE STYLIZED
WORDING "CAROLINA SMOKEHOUSE" WITH
"CAROLINA" WRITTEN IN BLACK AND OUT-
LINED IN RED IN AN UPWARDS ARC AROUND
A PINK PIG OUTLINED IN BLACK WITH A RED
MOUTH AND WEARING BLACK SUNGLASSES
WITH A WHITE REFLECTION IN THE SUNGLAS-
SES' LENS. AN ORANGE SUN IS BEHIND THE PIG.
THE WORD "SMOKEHOUSE" IS WRITTEN IN
ORANGE WITH A GARNET AND BLACK OUT-
LINE UNDERNEATH THE PIG AND THE SUN. THE
PIG'S HOOF IS DISPLAYED IN BLACK AND
WHITE.

SER. NO. 77-299,004, FILED 10-9-2007.

STEVEN R. FOSTER, EXAMINING ATTORNEY

Int. Cl.: 36

Prior U.S. Cls.: 100, 101 and 102

United States Patent and Trademark Office

Reg. No. 3,483,775

Registered Aug. 12, 2008

**SERVICE MARK
PRINCIPAL REGISTER**



LOGIC LOANS, INC. (CALIFORNIA CORPORATION)
1235 VIA BLAIRO CIRCLE
CORONA, CA 92879

FOR: MORTGAGE BROKERAGE, IN CLASS 36
(U.S. CLS. 100, 101 AND 102).

FIRST USE 6-20-2007; IN COMMERCE 6-20-2007.

NO CLAIM IS MADE TO THE EXCLUSIVE
RIGHT TO USE "LOANS INC." , APART FROM
THE MARK AS SHOWN.

THE MARK CONSISTS OF A BUTTON DESIGN
WITH A HOUSE IN THE CENTER OF IT WITH THE
STYLIZED WORDS "LOGIC LOANS, INC." NEXT
TO IT, ABOVE PARTIAL MIRROR IMAGES OF THE
WORDS IN THE MARK.

SER. NO. 77-299,238, FILED 10-9-2007.

KATHERINE M. DUBRAY, EXAMINING ATTORNEY

Int. Cl.: 9

Prior U.S. Cls.: 21, 23, 26, 36 and 38

Reg. No. 3,483,776

United States Patent and Trademark Office

Registered Aug. 12, 2008

**TRADEMARK
PRINCIPAL REGISTER**

**DYNAMIC APPLICATION
DISCOVERY**

SYNTELLECT, INC. (DELAWARE CORPORATION)
SUITE 100
16610 N. BLACK CANYON HIGHWAY
PHOENIX, AZ 85053

FOR: DOWNLOADABLE COMPUTER SOFTWARE AND COMPUTER SOFTWARE USED TO IMPROVE TAG-BASED EXTENSIBLE MARKUP LANGUAGE (XML) APPLICATIONS , IN CLASS 9 (U.S. CLS. 21, 23, 26, 36 AND 38).

FIRST USE 8-20-2007; IN COMMERCE 8-20-2007.

THE MARK CONSISTS OF STANDARD CHARACTERS WITHOUT CLAIM TO ANY PARTICULAR FONT, STYLE, SIZE, OR COLOR.

SER. NO. 77-299,458, FILED 10-9-2007.

LINDA MICKLEBURGH, EXAMINING ATTORNEY

Int. Cl.: 42

Prior U.S. Cls.: 100 and 101

United States Patent and Trademark Office

Reg. No. 3,483,777

Registered Aug. 12, 2008

**SERVICE MARK
PRINCIPAL REGISTER**



AIMSBIO, INC. (IOWA CORPORATION), DBA
AIMSBIO
2612 ASPEN #4
AMES, IA 50010

FOR: DEVELOPMENT OF NEW TECHNOLOGY
FOR OTHERS IN THE FIELD OF AGRICULTURE
AND BIOTECHNOLOGY, IN CLASS 42 (U.S. CLS. 100
AND 101).

FIRST USE 10-6-2006; IN COMMERCE 6-1-2007.

THE COLOR(S) BLUE GREEN WHITE IS/ARE
CLAIMED AS A FEATURE OF THE MARK.

THE MARK CONSISTS OF THE WORDING
"AIMSBIO" TO THE RIGHT OF A DEPICTION OF
A HALF WATER DROPLET WITH PLANT LEAVES
WITHIN THE DROPLET. THE LETTERS AIMS ARE
IN BLUE, THE LETTERS BIO ARE IN GREEN. THE
WATER DROPLET APPEARS IN GREEN AND THE
LEAVES ARE IN BLUE ALL ON A WHITE BACK-
GROUND.

SER. NO. 77-299,612, FILED 10-9-2007.

REBECCA SMITH, EXAMINING ATTORNEY

Int. Cls.: 37, 40, 42 and 45

Prior U.S. Cls.: 100, 101, 103 and 106

United States Patent and Trademark Office

Reg. No. 3,483,778

Registered Aug. 12, 2008

**SERVICE MARK
PRINCIPAL REGISTER**



KESTREL HORIZONS, LLC (SOUTH CAROLINA
LTD LIAB CO)
20-B CREEKVIEW COURT
GREENVILLE, SC 29615

FOR: CONSTRUCTION MANAGEMENT, IN
CLASS 37 (U.S. CLS. 100, 103 AND 106).

FIRST USE 9-1-2007; IN COMMERCE 9-1-2007.

FOR: HAZARDOUS WASTE MANAGEMENT;
WASTE MANAGEMENT; ENVIRONMENTAL RE-
MEDIATION SERVICES, NAMELY, SOIL TREAT-
MENT SERVICES; ENVIRONMENTAL
REMEDICATION SERVICES, NAMELY, SOIL,
WASTE AND/OR WATER TREATMENT SERVICES,
IN CLASS 40 (U.S. CLS. 100, 103 AND 106).

FIRST USE 9-1-2007; IN COMMERCE 9-1-2007.

FOR: PREPARING ENVIRONMENTAL COMPLI-
ANCE REPORTS; CONSULTING SERVICES IN THE
FIELD OF ENVIRONMENTAL ASSESSMENT, COM-
PLIANCE AND PLANNING; ENGINEERING SER-
VICES FOR BUILDING AND PROPERTY
CONDITION ASSESSMENT, FACILITY MANAGE-
MENT, REPAIR AND RESTORATION, BUILDING
INSTRUMENTATION AND MONITORING, AND
ENVIRONMENTAL CONSULTING; TECHNICAL
ANALYSIS OF A PRODUCT OR PROCESS TO

DETERMINE HOW TO MAKE IT MORE ENVIR-
ONMENTALLY SOUND; ENVIRONMENTAL SER-
VICES, NAMELY, DETECTION OF
CONTAMINANTS IN WATER, IN CLASS 42 (U.S.
CLS. 100 AND 101).

FIRST USE 9-1-2007; IN COMMERCE 9-1-2007.

FOR: PERMITTING, NAMELY, OBTAINING EN-
VIRONMENTAL, DESIGN, ZONING AND OTHER
GOVERNMENTAL PERMITS FOR DEVELOPMENT
PROJECTS; REVIEWING STANDARDS AND PRAC-
TICES TO ASSURE COMPLIANCE WITH ENVIR-
ONMENTAL LAWS AND REGULATIONS, IN
CLASS 45 (U.S. CLS. 100 AND 101).

FIRST USE 9-1-2007; IN COMMERCE 9-1-2007.

THE COLOR(S) GOLD, BLUE, AND BLACK IS/
ARE CLAIMED AS A FEATURE OF THE MARK.

THE MARK CONSISTS OF GOLD CRESCENT
WITH BLUE BIRD, BLACK TEXT, AND GOLD
UNDERLINE.

SER. NO. 77-300,423, FILED 10-10-2007.

JERI J. FICKES, EXAMINING ATTORNEY

Int. Cl.: 2

Prior U.S. Cls.: 6, 11 and 16

United States Patent and Trademark Office

Reg. No. 3,483,779

Registered Aug. 12, 2008

TRADEMARK
PRINCIPAL REGISTER



HOWELL, RANDY, SCOTT (UNITED STATES
INDIVIDUAL)
4869 FOUNTAIN AVENUE
LOS ANGELES, CA 90029

FOR: TATTOO INKS, IN CLASS 2 (U.S. CLS. 6, 11
AND 16).

FIRST USE 10-1-2005; IN COMMERCE 10-1-2005.

NO CLAIM IS MADE TO THE EXCLUSIVE
RIGHT TO USE "INK, MADE IN USA AND THE
ORIGINAL GREY WASH SERIES", APART FROM
THE MARK AS SHOWN.

THE MARK CONSISTS OF A BLACK BACK-
GROUND WITH THE STYLIZED WORDS "SILVER-

BACK INK" APPEARING AT THE TOP WRITTEN
IN BLACK AGAINST A WHITE, BELOW WHICH
THE WORDS "MADE IN USA" APPEAR IN WHITE
AGAINST THE BLACK BACKGROUND, IN THE
CENTER OF THE MARK THERE IS A DRAWING
OF A SILVERBACK GORILLA HEAD WITH BLACK
AND WHITE DETAILING, BELOW WHICH IT
STATES "THE ORIGINAL" IN WHITE STYLIZED
LETTERS WITH BLACK FILLING, AND "GREY
WASH SERIES" IN WHITE.

SER. NO. 77-300,700, FILED 10-10-2007.

CAROLYN CATALDO, EXAMINING ATTORNEY

Int. Cl.: 30

Prior U.S. Cl.: 46

United States Patent and Trademark Office

Reg. No. 3,483,780

Registered Aug. 12, 2008

**TRADEMARK
PRINCIPAL REGISTER**

PITA RITAS

REGCO CORPORATION (MASSACHUSETTS CORPORATION), DBA REGENIE'S ALL NATURAL SNACKS
46 ROGERS ROAD
HAVERHILL, MA 01835

FOR: PITA CHIPS; TORTILLA CHIPS; WHEAT-BASED SNACK FOODS; FLOUR-BASED CHIPS; TORTILLAS, IN CLASS 30 (U.S. CL. 46).

FIRST USE 10-9-2007; IN COMMERCE 10-9-2007.

THE MARK CONSISTS OF STANDARD CHARACTERS WITHOUT CLAIM TO ANY PARTICULAR FONT, STYLE, SIZE, OR COLOR.

NO CLAIM IS MADE TO THE EXCLUSIVE RIGHT TO USE "PITA", APART FROM THE MARK AS SHOWN.

SER. NO. 77-301,038, FILED 10-10-2007.

TINA BROWN, EXAMINING ATTORNEY

Int. Cl.: 35

Prior U.S. Cls.: 100, 101 and 102

United States Patent and Trademark Office

Reg. No. 3,483,781

Registered Aug. 12, 2008

**SERVICE MARK
PRINCIPAL REGISTER**

TRITONIC

TRITONIC, LLC (NEW JERSEY LTD LIAB CO)
421HALSEY STREET
NEWARK, NJ 07102

FOR: (BASED ON USE IN COMMERCE) CREA-
TIVE MARKETING DESIGN SERVICES; ADVER-
TISING AND PUBLICITY SERVICES, NAMELY,
PROMOTING THE GOODS, SERVICES, BRAND
IDENTITY AND COMMERCIAL INFORMATION
AND NEWS OF THIRD PARTIES THROUGH
PRINT, AUDIO, VIDEO, DIGITAL AND ON-LINE
MEDIUM; ADVERTISING SERVICES, NAMELY,
CREATING CORPORATE AND BRAND IDENTITY

FOR OTHERS; ADVERTISING AGENCIES, NAME-
LY, PROMOTING THE GOODS AND SERVICES OF
OTHERS, IN CLASS 35 (U.S. CLS. 100, 101 AND 102).

FIRST USE 1-31-2003; IN COMMERCE 1-31-2003.

THE MARK CONSISTS OF STANDARD CHAR-
ACTERS WITHOUT CLAIM TO ANY PARTICULAR
FONT, STYLE, SIZE, OR COLOR.

SER. NO. 77-301,375, FILED 10-11-2007.

KIMBERLY PERRY, EXAMINING ATTORNEY

Int. Cl.: 42

Prior U.S. Cls.: 100 and 101

United States Patent and Trademark Office

Reg. No. 3,483,782

Registered Aug. 12, 2008

**SERVICE MARK
PRINCIPAL REGISTER**

RAINDANCE TECHNOLOGIES

RAINDANCE TECHNOLOGIES, INC. (DELA-
WARE CORPORATION)
530 WHITFIELD STREET
GUILFORD, CT 06437

FOR: RESEARCH AND DEVELOPMENT OF NEW
PRODUCTS FOR ANALYZING AND MANIPULAT-
ING FLUIDS FOR USE IN THE FIELD OF LIFE
SCIENCE RESEARCH, CANCER DIAGNOSIS AND
THE DETECTION OF RESIDUAL DISEASE, IN
CLASS 42 (U.S. CLS. 100 AND 101).

FIRST USE 9-0-2004; IN COMMERCE 9-0-2004.

THE MARK CONSISTS OF STANDARD CHAR-
ACTERS WITHOUT CLAIM TO ANY PARTICULAR
FONT, STYLE, SIZE, OR COLOR.

NO CLAIM IS MADE TO THE EXCLUSIVE
RIGHT TO USE "TECHNOLOGIES", APART FROM
THE MARK AS SHOWN.

SER. NO. 77-302,048, FILED 10-11-2007.

DAVID ELTON, EXAMINING ATTORNEY

Int. Cl.: 9

Prior U.S. Cls.: 21, 23, 26, 36 and 38

Reg. No. 3,483,783

United States Patent and Trademark Office

Registered Aug. 12, 2008

TRADEMARK
PRINCIPAL REGISTER

CentralStaffer

VASTECH, INC. (MARYLAND CORPORATION)
888 BESTGATE ROAD, SUITE 310
ANNAPOLIS, MD 21401

FOR: COMPUTER SOFTWARE FOR VIEWING
AND MAKING REAL-TIME CHANGES TO STAFF-
ING LEVELS ACROSS AN ENTIRE ENTERPRISE,
IN CLASS 9 (U.S. CLS. 21, 23, 26, 36 AND 38).

FIRST USE 3-31-2002; IN COMMERCE 10-31-2002.

THE MARK CONSISTS OF A STYLIZED RENDI-
TION OF THE WORD "CENTRALSTAFFER".

SER. NO. 77-302,547, FILED 10-12-2007.

REBECCA GILBERT, EXAMINING ATTORNEY

Int. Cl.: 31

Prior U.S. Cls.: 1 and 46

United States Patent and Trademark Office

Reg. No. 3,483,784

Registered Aug. 12, 2008

**TRADEMARK
PRINCIPAL REGISTER**

ANABEL

DANZIGER-DAN FLOWER FARM (ISRAEL
CORPORATION)
MOSHAV MISHMAR HASHIVA 50297
P.O. BOX 24
BEIT DAGAN, ISRAEL

THE MARK CONSISTS OF STANDARD CHAR-
ACTERS WITHOUT CLAIM TO ANY PARTICULAR
FONT, STYLE, SIZE, OR COLOR.

FOR: FLOWER SEEDS, LIVE PLANTS AND
FLOWERS, EACH OF THE LOBELIA GENUS, IN
CLASS 31 (U.S. CLS. 1 AND 46).

SER. NO. 77-302,813, FILED 10-12-2007.

FIRST USE 4-1-2006; IN COMMERCE 4-1-2006.

MARK T. MULLEN, EXAMINING ATTORNEY

Int. Cl.: 41

Prior U.S. Cls.: 100, 101 and 107

United States Patent and Trademark Office

Reg. No. 3,483,785

Registered Aug. 12, 2008

**SERVICE MARK
PRINCIPAL REGISTER**



EDUCATION MANAGEMENT LLC (DELAWARE
LTD LIAB CO)
210 SIXTH AVENUE
PITTSBURGH, PA 15222

FOR: EDUCATIONAL SERVICES, NAMELY,
PROVIDING COURSES OF INSTRUCTION AT
THE POSTSECONDARY LEVEL, IN CLASS 41 (U.S.
CLS. 100, 101 AND 107).

FIRST USE 11-5-2007; IN COMMERCE 11-5-2007.

OWNER OF U.S. REG. NOS. 1,652,020, 2,262,221,
AND 2,371,036.

THE COLOR(S) RED, BLACK, AND WHITE IS/
ARE CLAIMED AS A FEATURE OF THE MARK.

THE MARK CONSISTS OF A SHIELD DESIGN,
WITH THE LEFT HALF OF THE SHIELD IN RED
WITH A WHITE HALF-GLOBE DESIGN, AND THE
RIGHT HALF OF THE SHIELD IN BLACK WITH
THE LETTERS "AI" IN RED AND CONCENTRIC
HALF-CIRCLES IN WHITE.

SER. NO. 77-303,616, FILED 10-14-2007.

KELLEY WELLS, EXAMINING ATTORNEY

Int. Cl.: 41

Prior U.S. Cls.: 100, 101 and 107

United States Patent and Trademark Office

Reg. No. 3,483,786

Registered Aug. 12, 2008

**SERVICE MARK
PRINCIPAL REGISTER**



EDUCATION MANAGEMENT LLC (DELAWARE
LTD LIAB CO)
210 SIXTH AVENUE
PITTSBURGH, PA 15222

FOR: EDUCATIONAL SERVICES, NAMELY,
PROVIDING COURSES OF INSTRUCTION AT
THE POSTSECONDARY LEVEL, IN CLASS 41 (U.S.
CLS. 100, 101 AND 107).

FIRST USE 11-5-2007; IN COMMERCE 11-5-2007.

OWNER OF U.S. REG. NOS. 1,652,020, 2,262,221,
AND 2,371,036.

THE MARK CONSISTS OF A SHIELD CONTAIN-
ING THE DESIGN OF A GLOBE AND THE LET-
TERS "AI".

SER. NO. 77-303,623, FILED 10-14-2007.

KELLEY WELLS, EXAMINING ATTORNEY

Int. Cl.: 21

Prior U.S. Cls.: 2, 13, 23, 29, 30, 33, 40 and 50

United States Patent and Trademark Office

Reg. No. 3,483,787

Registered Aug. 12, 2008

**TRADEMARK
PRINCIPAL REGISTER**

CREATED FOR A GREEN WORLD

LENTRADE, INC. (TEXAS CORPORATION), DBA
CHANTAL COOKWARE CORP.
5425 NORTH SAM HOUSTON PARKWAY W.
HOUSTON, TX 77086

FOR: HOUSEHOLD OR KITCHEN UTENSILS
AND CONTAINERS, NAMELY, BAKEWARE,
NAMELY, PIE DISHES AND SQUARE OR RECTAN-
GULAR BAKING DISHES, CASSEROLE DISHES
NOT OF PRECIOUS METALS; TABLEWARE,
NAMELY, PLATES, SAUCERS AND OTHER
DISHES, SERVING TRAYS NOT OF PRECIOUS
METAL, CERAMIC PITCHERS, BOWLS, TEA POTS,
MUGS, TEA INFUSERS NOT OF PRECIOUS ME-

TALS, SUGAR BOWLS NOT OF PRECIOUS ME-
TALS, IN CLASS 21 (U.S. CLS. 2, 13, 23, 29, 30, 33, 40
AND 50).

FIRST USE 11-19-2007; IN COMMERCE 12-5-2007.

THE MARK CONSISTS OF STANDARD CHAR-
ACTERS WITHOUT CLAIM TO ANY PARTICULAR
FONT, STYLE, SIZE, OR COLOR.

SER. NO. 77-304,385, FILED 10-15-2007.

LYDIA BELZER, EXAMINING ATTORNEY

Int. Cl.: 35

Prior U.S. Cls.: 100, 101 and 102

United States Patent and Trademark Office

Reg. No. 3,483,788

Registered Aug. 12, 2008

SERVICE MARK
PRINCIPAL REGISTER



MATEJKA, LARRY (UNITED STATES INDIVIDUAL)
8559 E. WASHINGTON ST.
CHAGRIN FALLS, OH 44023

FOR: BUSINESS CONSULTATION SERVICES, IN CLASS 35 (U.S. CLS. 100, 101 AND 102).

FIRST USE 11-30-2006; IN COMMERCE 11-30-2006.

NO CLAIM IS MADE TO THE EXCLUSIVE RIGHT TO USE "LEADERSHIP LESSONS", APART FROM THE MARK AS SHOWN.

THE MARK CONSISTS OF A BOX WITH A BIG CURSIVE "L" WITH THE STYLIZED WORDS "LIFE LEADERSHIP LESSONS" NEXT TO THE BOX. UNDER THE BOX ARE THE STYLIZED WORDS "UNFOLDING THE BETTER YOU".

SER. NO. 77-305,108, FILED 10-16-2007.

JILL C. ALT, EXAMINING ATTORNEY

Int. Cl.: 9

Prior U.S. Cls.: 21, 23, 26, 36 and 38

United States Patent and Trademark Office

Reg. No. 3,483,789

Registered Aug. 12, 2008

**TRADEMARK
PRINCIPAL REGISTER**

OCEAN FRIENDS

EIDOS INTERACTIVE LIMITED (ENGLAND
CORPORATION)
WIMBLEDON BRIDGE HOUSE 1 HARTFIELD
ROAD
WIMBLEDON, LONDON, UNITED KINGDOM
SW193RU

FOR: COMPUTER GAME SOFTWARE; VIDEO
GAME SOFTWARE; COMPUTER GAMES AND
VIDEO GAMES DOWNLOADABLE FROM A RE-
MOTE COMPUTER LOCATION OR RECORDED
ON CD-ROMS, COMPACT DISCS, AND GAME
CARTRIDGES, IN CLASS 9 (U.S. CLS. 21, 23, 26, 36
AND 38).

THE MARK CONSISTS OF STANDARD CHAR-
ACTERS WITHOUT CLAIM TO ANY PARTICULAR
FONT, STYLE, SIZE, OR COLOR.

PRIORITY CLAIMED UNDER SEC. 44(D) ON
UNITED KINGDOM APPLICATION NO. 2464754,
FILED 8-20-2007, REG. NO. 2464754, DATED 1-18-
2008, EXPIRES 8-20-2017.

SER. NO. 77-305,508, FILED 10-16-2007.

BILL DAWE, EXAMINING ATTORNEY

Int. Cl.: 42

Prior U.S. Cls.: 100 and 101

United States Patent and Trademark Office

Reg. No. 3,483,790

Registered Aug. 12, 2008

**SERVICE MARK
PRINCIPAL REGISTER**

Work 2.0

COLLABOR INC (DELAWARE CORPORATION)
ONE APPLE HILL DRIVE, SUITE #316
NATICK, MA 01760

FOR: COMPUTER SERVICES, NAMELY, CREAT-
ING AN ONLINE COMMUNITY FOR REGISTERED
USERS TO PARTICIPATE IN COMPETITIONS,
SHOWCASE THEIR SKILLS, GET FEEDBACK
FROM THEIR PEERS, FORM VIRTUAL COMMU-
NITIES, ENGAGE IN SOCIAL NETWORKING AND
IMPROVE THEIR TALENT, IN CLASS 42 (U.S. CLS.
100 AND 101).

FIRST USE 12-6-2006; IN COMMERCE 4-14-2007.

THE MARK CONSISTS OF STANDARD CHAR-
ACTERS WITHOUT CLAIM TO ANY PARTICULAR
FONT, STYLE, SIZE, OR COLOR.

NO CLAIM IS MADE TO THE EXCLUSIVE
RIGHT TO USE "2.0", APART FROM THE MARK
AS SHOWN.

SER. NO. 77-305,753, FILED 10-17-2007.

KATHRYN COWARD, EXAMINING ATTORNEY

Int. Cl.: 41

Prior U.S. Cls.: 100, 101 and 107

United States Patent and Trademark Office

Reg. No. 3,483,791

Registered Aug. 12, 2008

**SERVICE MARK
PRINCIPAL REGISTER**

Peaches & Herb

FEEMSTER, HERBERT (UNITED STATES INDIVIDUAL)
7734 ROTHERHAM DRIVE
HANOVER, MD 21076

FOR: ENTERTAINMENT SERVICES, NAMELY, LIVE PERFORMANCES RENDERED BY A MUSICAL GROUP, IN CLASS 41 (U.S. CLS. 100, 101 AND 107).

FIRST USE 6-1-1964; IN COMMERCE 6-1-1964.

THE MARK CONSISTS OF STANDARD CHARACTERS WITHOUT CLAIM TO ANY PARTICULAR FONT, STYLE, SIZE, OR COLOR.

SER. NO. 77-306,619, FILED 10-17-2007.

LINDA E. BLOHM, EXAMINING ATTORNEY

Int. Cls.: 35, 41 and 42

Prior U.S. Cls.: 100, 101, 102 and 107

United States Patent and Trademark Office

Reg. No. 3,483,792

Registered Aug. 12, 2008

**SERVICE MARK
PRINCIPAL REGISTER**



ISKY FOUNDATION (D.C. NON-PROFIT CORPORATION)
1522 CERRO GORDO ROAD
SANTA FE, NM 87501

FOR: PROMOTING THE PUBLIC AWARENESS OF THE NEED FOR ENVIRONMENTAL PRESERVATION, NAMELY, USING NON-VIOLENT, CREATIVE CONFRONTATION TO EXPOSE GLOBAL ENVIRONMENTAL ISSUES ESPECIALLY AS RELATED TO ENERGY AND GLOBAL WARMING, IN CLASS 35 (U.S. CLS. 100, 101 AND 102).

FIRST USE 9-5-2007; IN COMMERCE 9-5-2007.

FOR: ONLINE JOURNALS, NAMELY, BLOGS ON THE SUBJECTS OF ENERGY, ENERGY EFFICIENCY, GLOBAL WARMING IMPACTS AND SOLUTIONS, IN CLASS 41 (U.S. CLS. 100, 101 AND 107).

FIRST USE 9-5-2007; IN COMMERCE 9-5-2007.

FOR: PROVIDING A WEBSITE FEATURING INFORMATION ABOUT GLOBAL WARMING AND

ITS EFFECT ON NATURE AND THE ENVIRONMENT; SCIENTIFIC AND NEW PRODUCT RESEARCH AND DEVELOPMENT OF DURABLE USE OF NATURE AND THE ENVIRONMENT; PROVIDING INFORMATION AND ADVICE WITH REGARD TO ENVIRONMENTAL PROTECTION IN THE FIELD OF ENVIRONMENTAL ASSESSMENT, COMPLIANCE AND PLANNING, AS WELL AS CONDUCTING RESEARCH AND DRAWING UP EXPERT REPORTS IN THE AFOREMENTIONED FIELDS, IN CLASS 42 (U.S. CLS. 100 AND 101).

FIRST USE 9-5-2007; IN COMMERCE 9-5-2007.

THE MARK CONSISTS OF TWO SQUARES; ONE CONTAINING THE NUMBER "1" AND THE OTHER CONTAINING THE WORD "SKY" AGAINST A BACKGROUND OF CLOUDS.

SER. NO. 77-307,041, FILED 10-18-2007.

DARRYL SPRUILL, EXAMINING ATTORNEY

Int. Cl.: 41

Prior U.S. Cls.: 100, 101 and 107

United States Patent and Trademark Office

Reg. No. 3,483,793

Registered Aug. 12, 2008

**SERVICE MARK
PRINCIPAL REGISTER**

GoddessBody

RADDEN, KRISTEN A. (UNITED STATES INDIVIDUAL)
118 N. DENISON ST. #2
BALTIMORE, MD 21229

FOR: PHYSICAL FITNESS INSTRUCTION; PROVIDING ASSISTANCE, PERSONAL TRAINING AND PHYSICAL FITNESS CONSULTATION TO INDIVIDUALS TO HELP THEM MAKE PHYSICAL FITNESS, STRENGTH, CONDITIONING, AND EXERCISE IMPROVEMENT IN THEIR DAILY LIVING; EDUCATION SERVICES, NAMELY, PROVIDING CLASSES, WORKSHOPS, WORKSHOP CLINICS, SEMINARS, AND ONE-ON-ONE TRAINING IN THE FIELDS OF GROUP EXERCISE; EDUCATIONAL SERVICES, NAMELY, DEVELOPING CURRICU-

LUM FOR OTHERS IN THE FIELD OF GROUP EXERCISE, BODY AWARENESS AND MINDFUL MOVEMENT, IN CLASS 41 (U.S. CLS. 100, 101 AND 107).

FIRST USE 8-12-2007; IN COMMERCE 9-8-2007.

THE MARK CONSISTS OF STANDARD CHARACTERS WITHOUT CLAIM TO ANY PARTICULAR FONT, STYLE, SIZE, OR COLOR.

SER. NO. 77-308,188, FILED 10-19-2007.

SETH A. RAPPAPORT, EXAMINING ATTORNEY

Int. Cl.: 9

Prior U.S. Cls.: 21, 23, 26, 36 and 38

Reg. No. 3,483,794

United States Patent and Trademark Office

Registered Aug. 12, 2008

**TRADEMARK
PRINCIPAL REGISTER**

ActiveShareFS

9STAR RESEARCH, INC (DELAWARE CORPORATION)

E 240

3801 N. CAPITAL OF TEXAS HWY
AUSTIN, TX 78746

FOR: COMPUTER SOFTWARE FOR ENABLING
FEDERATED AUTHENTICATION AND ACCESS
CONTROL, IN CLASS 9 (U.S. CLS. 21, 23, 26, 36
AND 38).

FIRST USE 4-1-2006; IN COMMERCE 4-1-2006.

THE MARK CONSISTS OF STANDARD CHARACTERS WITHOUT CLAIM TO ANY PARTICULAR FONT, STYLE, SIZE, OR COLOR.

SER. NO. 77-308,976, FILED 10-19-2007.

RENEE MCCRAY, EXAMINING ATTORNEY

Int. Cl.: 16

Prior U.S. Cls.: 2, 5, 22, 23, 29, 37, 38 and 50

United States Patent and Trademark Office

Reg. No. 3,483,795

Registered Aug. 12, 2008

**TRADEMARK
PRINCIPAL REGISTER**

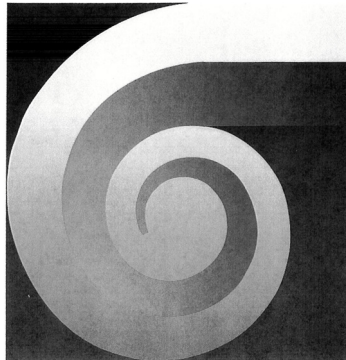

ARIES INSTITUTE OF TECHNOLOGY, INC. (ARIZONA CORPORATION)
1445 WEST 12TH PLACE
TEMPE, AZ 85281

FOR: MANUALS FOR EDUCATION AND TRAINING IN THE FIELDS OF COMPUTER HARDWARE AND SOFTWARE, IN CLASS 16 (U.S. CLS. 2, 5, 22, 23, 29, 37, 38 AND 50).

FIRST USE 8-30-2007; IN COMMERCE 8-30-2007.

THE MARK CONSISTS OF A SPIRAL WITH STRAIGHT TAIL.

SER. NO. 77-309,008, FILED 10-19-2007.

LINDA E. BLOHM, EXAMINING ATTORNEY

Int. Cl.: 25

Prior U.S. Cls.: 22 and 39

United States Patent and Trademark Office

Reg. No. 3,483,796

Registered Aug. 12, 2008

**TRADEMARK
PRINCIPAL REGISTER**

Sub 32 Apparel

GUINNESS, B MICHAEL (UNITED STATES INDIVIDUAL)

33 PEREGRINE RD.

NEWTON, MA 02459

FOR: SHIRTS, HATS, JACKETS, TIES, IN CLASS 25 (U.S. CLS. 22 AND 39).

FIRST USE 10-5-2007; IN COMMERCE 10-5-2007.

THE MARK CONSISTS OF STANDARD CHARACTERS WITHOUT CLAIM TO ANY PARTICULAR FONT, STYLE, SIZE, OR COLOR.

NO CLAIM IS MADE TO THE EXCLUSIVE RIGHT TO USE "APPAREL", APART FROM THE MARK AS SHOWN.

SER. NO. 77-309,183, FILED S.R. 10-20-2007 AM. P.R. 4-13-2008.

KIMBERLY FRYE, EXAMINING ATTORNEY

Int. Cl.: 41

Prior U.S. Cls.: 100, 101 and 107

United States Patent and Trademark Office

Reg. No. 3,483,797

Registered Aug. 12, 2008

**SERVICE MARK
PRINCIPAL REGISTER**

Scotty Beats

DANIELLE STEELE BROWN (UNITED STATES
INDIVIDUAL)
P.O. BOX 6855
LARGO, MD 20792

FOR: MUSIC PRODUCTION SERVICES; MULTI-
MEDIA ENTERTAINMENT SERVICES IN THE
NATURE OF RECORDING, PRODUCTION AND
POST-PRODUCTION SERVICES IN THE FIELDS OF
MUSIC, VIDEO, AND FILMS; AUDIO RECORDING
AND PRODUCTION, IN CLASS 41 (U.S. CLS. 100, 101
AND 107).

FIRST USE 1-1-1998; IN COMMERCE 1-1-2003.

THE MARK CONSISTS OF STANDARD CHAR-
ACTERS WITHOUT CLAIM TO ANY PARTICULAR
FONT, STYLE, SIZE, OR COLOR.

"THE NAME(S), PORTRAIT(S), AND/OR SIGNA-
TURE(S) SHOWN IN THE MARK DOES NOT IDENTI-
FY A PARTICULAR LIVING INDIVIDUAL."

SER. NO. 77-309,302, FILED 10-20-2007.

MICHAEL GAAFAR, EXAMINING ATTORNEY

Int. Cl.: 35

Prior U.S. Cls.: 100, 101 and 102

United States Patent and Trademark Office

Reg. No. 3,483,798

Registered Aug. 12, 2008

**SERVICE MARK
PRINCIPAL REGISTER**

DIAMOND DOLLARS

COLUMBIA INSURANCE COMPANY (NEBRASKA CORPORATION)

3024 HARNEY STREET

OMAHA, NE 68131

FOR: RETAIL JEWELRY STORE SERVICES, IN CLASS 35 (U.S. CLS. 100, 101 AND 102).

FIRST USE 4-9-2007; IN COMMERCE 4-9-2007.

THE MARK CONSISTS OF STANDARD CHARACTERS WITHOUT CLAIM TO ANY PARTICULAR FONT, STYLE, SIZE, OR COLOR.

NO CLAIM IS MADE TO THE EXCLUSIVE RIGHT TO USE "DIAMOND", APART FROM THE MARK AS SHOWN.

SER. NO. 77-309,603, FILED 10-22-2007.

KAREN BRACEY, EXAMINING ATTORNEY

Int. Cl.: 9

Prior U.S. Cls.: 21, 23, 26, 36 and 38

Reg. No. 3,483,799

United States Patent and Trademark Office

Registered Aug. 12, 2008

**TRADEMARK
PRINCIPAL REGISTER**

MACHTRAK

TAB COMPUTER SYSTEMS, INC. (CONNECTI-
CUT CORPORATION)
29-31 BISSELL STREET
EAST HARTFORD, CT 061082286

FOR: COMPUTER SOFTWARE FOR ASSISTING
OTHERS IN THE MAINTENANCE REQUIRE-
MENTS OF THEIR MACHINE TOOLS, AND RELA-
TED EQUIPMENT AND RELATED OFFSITE
SERVICES, NAMELY, MONITORING COMPLI-
ANCE WITH PROGRAMMABLE PARAMETERS
PROVIDED IN SAID SOFTWARE, IN CLASS 9 (U.S.
CLS. 21, 23, 26, 36 AND 38).

FIRST USE 2-1-2007; IN COMMERCE 2-1-2007.

THE MARK CONSISTS OF STANDARD CHAR-
ACTERS WITHOUT CLAIM TO ANY PARTICULAR
FONT, STYLE, SIZE, OR COLOR.

SER. NO. 77-310,611, FILED 10-23-2007.

TINA L. SNAPP, EXAMINING ATTORNEY

Int. Cl.: 39

Prior U.S. Cls.: 100 and 105

United States Patent and Trademark Office

Reg. No. 3,483,800

Registered Aug. 12, 2008

**SERVICE MARK
PRINCIPAL REGISTER**



BEAUDOIN, JAMES G (UNITED STATES INDIVIDUAL)
22 DOUGLAS WAY
FARMINGTON, CT 06032

FOR: TRUCK TRANSPORT, IN CLASS 39 (U.S. CLS. 100 AND 105).

FIRST USE 3-0-2001; IN COMMERCE 3-0-2001.

THE MARK CONSISTS OF STYLIZED LETTERS "SRS" FLANKED ON EACH SIDE BY 5 THICK ARCS THAT BEGIN AND END AT POINTS WHICH ARE JOINED TOGETHER TO FORM THE DESIGN OF THE MARK.

SER. NO. 77-310,702, FILED 10-23-2007.

PAUL F. GAST, EXAMINING ATTORNEY

Int. Cl.: 25

Prior U.S. Cls.: 22 and 39

United States Patent and Trademark Office

Reg. No. 3,483,801

Registered Aug. 12, 2008

**TRADEMARK
PRINCIPAL REGISTER**

Power Band

INNOVATIVE GLOVES & SAFETY, LLC (TEXAS
LTD LIAB CO)

11906 BRITTMOORE PARK DRIVE

HOUSTON, TX 77041

FOR: WRIST BANDS, IN CLASS 25 (U.S. CLS. 22
AND 39).

FIRST USE 9-15-2007; IN COMMERCE 10-15-2007.

THE MARK CONSISTS OF STANDARD CHAR-
ACTERS WITHOUT CLAIM TO ANY PARTICULAR
FONT, STYLE, SIZE, OR COLOR.

NO CLAIM IS MADE TO THE EXCLUSIVE
RIGHT TO USE "BAND", APART FROM THE
MARK AS SHOWN.

SER. NO. 77-310,861, FILED 10-23-2007.

KIMBERLY PERRY, EXAMINING ATTORNEY

Int. Cl.: 39

Prior U.S. Cls.: 100 and 105

United States Patent and Trademark Office

Reg. No. 3,483,802

Registered Aug. 12, 2008

**SERVICE MARK
PRINCIPAL REGISTER**

WILDLIFE AID BRIGADE

FARINATO, SUE LUNSON (UNITED STATES
INDIVIDUAL)
28309 KEMPTOWN ROAD
DAMASCUS, MD 20872

FOR: WILDLIFE ANIMAL RESCUE SERVICES
BY TRAINED VOLUNTEERS, IN CLASS 39 (U.S.
CLS. 100 AND 105).

FIRST USE 10-23-2007; IN COMMERCE 10-23-2007.

THE MARK CONSISTS OF STANDARD CHAR-
ACTERS WITHOUT CLAIM TO ANY PARTICULAR
FONT, STYLE, SIZE, OR COLOR.

NO CLAIM IS MADE TO THE EXCLUSIVE
RIGHT TO USE "WILDLIFE AID", APART FROM
THE MARK AS SHOWN.

SER. NO. 77-310,980, FILED 10-23-2007.

KEVIN DINALLO, EXAMINING ATTORNEY

Int. Cl.: 9

Prior U.S. Cls.: 21, 23, 26, 36 and 38

Reg. No. 3,483,803

United States Patent and Trademark Office

Registered Aug. 12, 2008

**TRADEMARK
PRINCIPAL REGISTER**



AFCO, INC. (TENNESSEE CORPORATION)
122 GAYOSO
MEMPHIS, TN 38103

FOR: AUDIO SPEAKERS, AMPLIFIERS AND
SIGNAL PROCESSORS FOR CUSTOM AUTOMO-
TIVE AUDIO SYSTEMS, IN CLASS 9 (U.S. CLS. 21, 23,
26, 36 AND 38).

FIRST USE 1-1-1998; IN COMMERCE 1-1-1998.

THE MARK CONSISTS OF THE CAPITAL LET-
TER "M", HALF BLACK ON A WHITE BACK-
GROUND, HALF WHITE ON A BLACK
BACKGROUND, ENCIRCLED IN A HALF WHITE,
HALF BLACK CIRCLE.

SER. NO. 77-311,033, FILED 10-23-2007.

JANET LEE, EXAMINING ATTORNEY

Int. Cl.: 42

Prior U.S. Cls.: 100 and 101

United States Patent and Trademark Office

Reg. No. 3,483,804

Registered Aug. 12, 2008

**SERVICE MARK
PRINCIPAL REGISTER**



APPLIED COMPUTER SOLUTIONS (CALIFORNIA CORPORATION)
15461 SPRINGDALE STREET
HUNTINGTON BEACH, CA 92649

FOR: CONSULTATION SERVICES IN THE FIELDS OF SELECTION, IMPLEMENTATION AND USE OF COMPUTER HARDWARE AND SOFTWARE SYSTEMS FOR OTHERS; CONSULTING SERVICES IN THE FIELD OF ARCHITECTURAL DESIGN; CONSULTING SERVICES IN THE FIELD OF DESIGN, SELECTION, IMPLEMENTATION AND USE OF COMPUTER HARDWARE AND SOFTWARE SYSTEMS FOR OTHERS; COMPUTER PROJECT MANAGEMENT SERVICES; TECHNICAL SUPPORT SERVICES, NAMELY, TROUBLESHOOTING OF COMPUTER HARDWARE AND SOFTWARE PROBLEMS; DATABASE DEVELOPMENT SERVICES, IN CLASS 42 (U.S. CLS. 100 AND 101).

FIRST USE 1-2-1991; IN COMMERCE 1-2-1991.

NO CLAIM IS MADE TO THE EXCLUSIVE RIGHT TO USE "COMPUTER SOLUTIONS", APART FROM THE MARK AS SHOWN.

THE MARK CONSISTS OF THE WORDS "APPLIED COMPUTER SOLUTIONS" AND THE LETTERS "ACS" IN AN INTEGRATED DESIGN WITH THE WORDS SURROUNDING THE LETTERS ON THREE SIDES.

SER. NO. 77-311,360, FILED 10-23-2007.

CYNTHIA SLOAN, EXAMINING ATTORNEY

Int. Cl.: 25

Prior U.S. Cls.: 22 and 39

United States Patent and Trademark Office

Reg. No. 3,483,805

Registered Aug. 12, 2008

TRADEMARK
PRINCIPAL REGISTER

JD4U

SAWA AMANA & JAHA, INC. (CALIFORNIA CORPORATION)
921 GOLD COAST COURT
FAIRFIELD, CA 94533

FOR: MEN'S, WOMEN'S, AND CHILDREN'S CLOTHING, NAMELY, THE FOLLOWING, T-SHIRTS, SWEATPANTS, SWEATSHIRTS, SHIRTS, CLOTH BIBS, BIB OVERALLS, JACKETS, COATS, VESTS, SWEATERS, CARDIGANS, FUR COATS, LAB COATS, LEATHER COATS, SKI JACKETS, SKI LEGGINGS, SKI PANTS, SKI MASKS, SKI HATS, SCARVES, OVERCOATS, RAINCOATS, SLICKERS, SPORT COATS, TOP COATS, SUIT JACKETS, SPORT JACKETS, LEATHER JACKETS, BOMBER JACKETS, PARKAS, WIND RESISTANT JACKETS, JEANS, BIB JEANS, OVERALLS, ATHLETIC WEAR, NAMELY, SHIRTS, JACKETS, JERSEYS, SKIRTS, SHORTS, AND BOOTIES, SLACKS, KNIT SLACKS, LEATHER SLACKS, DRESS SLACKS, CAPRIS, JOGGING SUITS, JUMPSUITS, SKIRT SETS, DRESSES, DUNGAREES, PROFESSIONAL UNIFORMS, SKORTS, NON-SURGICAL SCRUBS, NAMELY, JACKETS, PANTS, LAB COATS, AND SHIRTS, DUSTERS, BRAS, BLOUSES, SLIPS, NIGHTGOWNS, DRESSES, NAMELY, GOWNS, DINNER, SUMMER, AND PARTY, BRIDAL WEAR, NAMELY, PANTS, SHIRTS, CUMMERBUNDS, SLACKS, TIES, GOWNS, DRESSES, AND STOCKINGS, HALTER TOPS, HEADBANDS, NECKBANDS, WRISTBANDS, SWEATBANDS, MUSCLE SHIRTS, COLLARED SHIRTS, HEADWEAR, NAMELY, HATS, CAPS, VISORS, BEANIES, SCARVES, AND BANDANAS, SWIM WEAR, NAMELY, SWIM CAPS, SWIM SUITS,

FLIP FLOPS, SANDALS, AND WATER SHOES, SLEEP WEAR, NAMELY, PAJAMAS, ROBES, NIGHTGOWNS, SLEEPERS, SLIPPERS, BOXERS, BRIEFS, PANTIES, AND SLEEP MASKS, ACCESSORIES, NAMELY, BELTS, SOCKS, GLOVES, EARMUFFS, MITTENS, ANKLETS, TIES, STOCKINGS, KNEE HIGHS, AND BOOTIES, UNDER GARMENTS, NAMELY, SLIPS, BOXERS, SHORTS, TANKS, BRIEFS, PANTIES, BRAS, AND HOSIERY, FOOTWEAR, NAMELY, BOOTS, SHOES, SANDALS, CLOGS, SNEAKERS, SKI BOOTS, LOAFERS, AND MOCCASINS, RAINWEAR, NAMELY, GALOSHES, COATS, HOODS, PONCHOS, AND APRONS, ONE PIECE GARMENT FOR INFANTS AND TODDLERS, ONE-PIECE PLAY SUITS, SHAWLS, TRACKSUITS, SWADDLING CLOTHES, TANK-TOPS, TEDDIES, THONGS, VEILS, MEN'S AND WOMEN'S SUITS, SUSPENDERS, THERMAL UNDERWEAR, UNITARD, SPORTS JERSEYS AND BREECHES, PANTS, JUDO SUITS, KIMONOS, KERICHS, NEGLIGEES, HOUSECOATS, IN CLASS 25 (U.S. CLS. 22 AND 39).

FIRST USE 6-10-2005; IN COMMERCE 6-17-2006.

THE MARK CONSISTS OF STANDARD CHARACTERS WITHOUT CLAIM TO ANY PARTICULAR FONT, STYLE, SIZE, OR COLOR.

SER. NO. 77-311,691, FILED 10-23-2007.

GEORGIA CARTY, EXAMINING ATTORNEY

Int. Cl.: 35

Prior U.S. Cls.: 100, 101 and 102

Reg. No. 3,483,806

United States Patent and Trademark Office

Registered Aug. 12, 2008

**SERVICE MARK
PRINCIPAL REGISTER**

KOUNTRY MART

MAYFIELD OIL COMPANY, INC. (ALABAMA
CORPORATION)
176 WALNUT STREET
CENTREVILLE, AL 35042

FOR: RETAIL STORES FEATURING PETRO-
LEUM PRODUCTS, NAMELY, GASOLINE, DIESEL
FUEL, AND FUEL OIL, IN CLASS 35 (U.S. CLS. 100,
101 AND 102).

FIRST USE 8-31-2003; IN COMMERCE 8-31-2003.

THE MARK CONSISTS OF STANDARD CHAR-
ACTERS WITHOUT CLAIM TO ANY PARTICULAR
FONT, STYLE, SIZE, OR COLOR.

NO CLAIM IS MADE TO THE EXCLUSIVE
RIGHT TO USE "MART", APART FROM THE
MARK AS SHOWN.

SER. NO. 77-312,393, FILED 10-24-2007.

SIMON TENG, EXAMINING ATTORNEY

Int. Cls.: 35 and 40

Prior U.S. Cls.: 100, 101, 102, 103 and 106

United States Patent and Trademark Office

Reg. No. 3,483,807

Registered Aug. 12, 2008

**SERVICE MARK
PRINCIPAL REGISTER**

Promo Deli

RIVALDI JEAN M (CALIFORNIA SOLE PROPRIETORSHIP), DBA PROMO DELI
1512 FERN STREET
SAN DIEGO, CA 92102

FOR: ADVERTISING, MARKETING AND PROMOTION SERVICES, IN CLASS 35 (U.S. CLS. 100, 101 AND 102).

FIRST USE 5-15-2007; IN COMMERCE 5-15-2007.

FOR: CUSTOMIZED PRINTING OF COMPANY NAMES AND LOGOS FOR PROMOTIONAL AND ADVERTISING PURPOSES ON THE GOODS OF OTHERS, IN CLASS 40 (U.S. CLS. 100, 103 AND 106).

FIRST USE 5-15-2007; IN COMMERCE 5-15-2007.

THE MARK CONSISTS OF STANDARD CHARACTERS WITHOUT CLAIM TO ANY PARTICULAR FONT, STYLE, SIZE, OR COLOR.

NO CLAIM IS MADE TO THE EXCLUSIVE RIGHT TO USE "PROMO", APART FROM THE MARK AS SHOWN.

SER. NO. 77-312,480, FILED 10-24-2007.

SUSAN STIGLITZ, EXAMINING ATTORNEY

Int. Cl.: 42

Prior U.S. Cls.: 100 and 101

United States Patent and Trademark Office

Reg. No. 3,483,808

Registered Aug. 12, 2008

SERVICE MARK
PRINCIPAL REGISTER



EARTHEN VESSELS, INC (NEVADA CORPORATION)

937 FEATHER SKY ST. NW

SALEM, OR 97304

FOR: COMPUTER SOFTWARE CONSULTATION;
TECHNOLOGICAL CONSULTATION IN THE
TECHNOLOGY FIELD OF COMPUTER SOFTWARE,
IN CLASS 42 (U.S. CLS. 100 AND 101).

FIRST USE 1-1-2004; IN COMMERCE 1-1-2004.

NO CLAIM IS MADE TO THE EXCLUSIVE
RIGHT TO USE "INC", APART FROM THE MARK
AS SHOWN.

THE MARK CONSISTS OF THE STYLIZED
WORDS "EARTHEN VESSELS, INC.". THE WORD
"EARTHEN" IS ABOVE THE WORDS "VESSELS,
INC." AND ARE BEING SEPERATED BY A HOR-
IZONTAL LINE WITH A TARGET AT THE END.

SER. NO. 77-312,739, FILED 10-24-2007.

TIMOTHY FINNEGAN, EXAMINING ATTORNEY

Int. Cl.: 44

Prior U.S. Cls.: 100 and 101

United States Patent and Trademark Office

Reg. No. 3,483,809

Registered Aug. 12, 2008

**SERVICE MARK
PRINCIPAL REGISTER**

PATTON PROTOCOL

ASIA BIOTECH CORPORATION (CAYMAN ISLANDS CORPORATION)

24 E. 64TH ST., 5TH FLOOR

NEW YORK, NY 10021

FOR: HEALTH AND WELLNESS COUNSELING,
IN CLASS 44 (U.S. CLS. 100 AND 101).

FIRST USE 3-19-2007; IN COMMERCE 3-19-2007.

THE MARK CONSISTS OF STANDARD CHARACTERS WITHOUT CLAIM TO ANY PARTICULAR FONT, STYLE, SIZE, OR COLOR.

NO CLAIM IS MADE TO THE EXCLUSIVE RIGHT TO USE "PROTOCOL", APART FROM THE MARK AS SHOWN.

SER. NO. 77-313,031, FILED 10-25-2007.

CHRISTINE COOPER, EXAMINING ATTORNEY

Int. Cl.: 27

Prior U.S. Cls.: 19, 20, 37, 42 and 50

Reg. No. 3,483,810

United States Patent and Trademark Office

Registered Aug. 12, 2008

**TRADEMARK
PRINCIPAL REGISTER**

WELLNESS MAT

DANIEL BOUZIDE (UNITED STATES INDIVIDUAL)
3918 ROCHESTER ROAD
TROY, MI 48083

FOR: FLOOR MATS FOR USE IN REDUCING FATIGUE WHILE STANDING, IN CLASS 27 (U.S. CLS. 19, 20, 37, 42 AND 50).

FIRST USE 3-12-2006; IN COMMERCE 3-12-2006.

THE MARK CONSISTS OF STANDARD CHARACTERS WITHOUT CLAIM TO ANY PARTICULAR FONT, STYLE, SIZE, OR COLOR.

NO CLAIM IS MADE TO THE EXCLUSIVE RIGHT TO USE "MAT", APART FROM THE MARK AS SHOWN.

SER. NO. 77-313,265, FILED 10-25-2007.

ALICIA COLLINS, EXAMINING ATTORNEY

Int. Cls.: 35 and 38

Prior U.S. Cls.: 100, 101, 102 and 104

United States Patent and Trademark Office

Reg. No. 3,483,811

Registered Aug. 12, 2008

**SERVICE MARK
PRINCIPAL REGISTER**



POLYGROUP, LTD (DELAWARE CORPORATION)
P O BOX 4806
DILLON, CO 80435

FOR: PROVIDING INFORMATION ABOUT THE TRADING OF PRECIOUS STONES, IN CLASS 35 (U.S. CLS. 100, 101 AND 102).

FIRST USE 9-26-2001; IN COMMERCE 9-26-2001.

FOR: PROVIDING ON-LINE ELECTRONIC BULLETIN BOARDS FOR TRANSMISSION OF MESSAGES AMONG COMPUTER USERS CONCERNING TRADING OF PRECIOUS STONES, IN CLASS 38 (U.S. CLS. 100, 101 AND 104).

FIRST USE 9-26-2001; IN COMMERCE 9-26-2001.

THE COLOR(S) RED AND WHITE IS/ARE CLAIMED AS A FEATURE OF THE MARK.

THE MARK CONSISTS OF A DESIGN RESEMBLING A STARBURST AND RADIAL LINES APPEARING WITHIN A CIRCLE. THE COLOR RED APPEARS ON THE CIRCULAR MARK BACKGROUND; THE COLOR WHITE APPEARS ON THE DESIGNS RESEMBLING A STARBURST AND RADIAL LINES.

SER. NO. 77-313,608, FILED 10-25-2007.

KALIE KUNG, EXAMINING ATTORNEY

Int. Cl.: 9

Prior U.S. Cls.: 21, 23, 26, 36 and 38

United States Patent and Trademark Office

Reg. No. 3,483,812

Registered Aug. 12, 2008

**TRADEMARK
PRINCIPAL REGISTER**

DATADIRECT XML CONVERTERS

PROGRESS SOFTWARE CORPORATION (MAS-
SACHUSETTS CORPORATION)
14 OAK PARK
BEDFORD, MA 01730

FOR: COMPUTER SOFTWARE IN THE FIELD OF
INFORMATION TECHNOLOGY FOR USE IN DE-
VELOPMENT, DEPLOYMENT, INTEGRATION,
AND MANAGEMENT OF BUSINESS APPLICA-
TIONS OVER LOCAL AREA, WIDE AREA, AND
GLOBAL COMPUTER NETWORKS AND MAN-
UALS SOLD TOGETHER THEREWITH, IN CLASS
9 (U.S. CLS. 21, 23, 26, 36 AND 38).

FIRST USE 4-25-2007; IN COMMERCE 4-25-2007.

THE MARK CONSISTS OF STANDARD CHAR-
ACTERS WITHOUT CLAIM TO ANY PARTICULAR
FONT, STYLE, SIZE, OR COLOR.

OWNER OF U.S. REG. NOS. 2,000,319, 3,081,113
AND OTHERS.

NO CLAIM IS MADE TO THE EXCLUSIVE
RIGHT TO USE "XML CONVERTERS", APART
FROM THE MARK AS SHOWN.

SER. NO. 77-313,737, FILED 10-25-2007.

SANI KHOURI, EXAMINING ATTORNEY

Int. Cl.: 38

Prior U.S. Cls.: 100, 101 and 104

United States Patent and Trademark Office

Reg. No. 3,483,813

Registered Aug. 12, 2008

SERVICE MARK
PRINCIPAL REGISTER



NORTH CAROLINA ANGLER, INC. (NORTH
CAROLINA CORPORATION)
4232 LANDSBURG DRIVE
RALEIGH, NC 27603

FOR: PROVIDING ON-LINE FORUMS FOR
TRANSMISSION OF MESSAGES AMONG COMPU-
TER USERS CONCERNING FISHING, IN CLASS 38
(U.S. CLS. 100, 101 AND 104).

FIRST USE 12-31-2004; IN COMMERCE 4-2-2005.

NO CLAIM IS MADE TO THE EXCLUSIVE
RIGHT TO USE "NC ANGLER.COM", APART
FROM THE MARK AS SHOWN.

THE MARK CONSISTS OF AN OUTLINE OF A
RED DRUM FISH WITH THE STYLIZED WORDS
"NCANGLER.COM" ENCLOSED WITHIN THE
OUTLINE OF THE FISH. THE LETTER "G" IS IN
THE SHAPE OF A CIRCLE FISHING HOOK.

SER. NO. 77-313,807, FILED 10-25-2007.

STEVEN R. FOSTER, EXAMINING ATTORNEY

Int. Cl.: 37

Prior U.S. Cls.: 100, 103 and 106

United States Patent and Trademark Office

Reg. No. 3,483,814

Registered Aug. 12, 2008

SERVICE MARK
PRINCIPAL REGISTER



PRIVATE ISLAND HOMES, INC. (CALIFORNIA CORPORATION)
1499 DANVILLE BLVD. #200
ALAMO, CA 94507

FOR: CUSTOM CONSTRUCTION OF HOMES, IN CLASS 37 (U.S. CLS. 100, 103 AND 106).

FIRST USE 5-24-2002; IN COMMERCE 5-24-2002.

NO CLAIM IS MADE TO THE EXCLUSIVE RIGHT TO USE "PRIVATE ISLAND HOMES", APART FROM THE MARK AS SHOWN.

THE COLOR(S) BLACK, WHITE, GOLD, GREEN, RED, BLUE IS/ARE CLAIMED AS A FEATURE OF THE MARK.

THE MARK CONSISTS OF BLACK = LETTERING, ROOF TOPS (TRIANGLES), BOTTOM OF HOUSE SHAPES, GOLD = PINEAPPLE GRAPHIC/1ST HOUSE SHAPE, GREEN = FLOWER GRAPHIC/2ND HOUSE SHAPE, RED = PALM GRAPHIC/3RD HOUSE SHAPE, BLUE = BAMBOO GRAPHIC/4TH HOUSE SHAPE, WHITE = BACKGROUND FILL FOR ALL GRAPHICS.

SER. NO. 77-313,833, FILED 10-25-2007.

LINDA M. KING, EXAMINING ATTORNEY

Int. Cl.: 41

Prior U.S. Cls.: 100, 101 and 107

United States Patent and Trademark Office

Reg. No. 3,483,815

Registered Aug. 12, 2008

SERVICE MARK
PRINCIPAL REGISTER

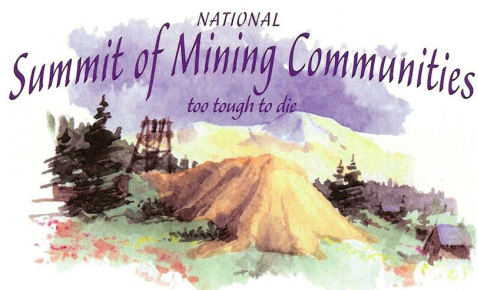

COLORADO MOUNTAIN JUNIOR COLLEGE
DISTRICT (COLORADO EDUCATIONAL IN-
STITUTION)
931 GRAND AVENUE
GLENWOOD SPRINGS, CO 81601

FOR: EDUCATION SERVICES, NAMELY, PRO-
VIDING AND CONDUCTING CLASSES AND SEMI-
NARS IN THE FIELD OF NATURAL RESOURCE
MANAGEMENT, MINING, AND RELATED ECO-
NOMIC, NATURAL, SOCIAL AND CULTURAL IM-
PACTS, IN CLASS 41 (U.S. CLS. 100, 101 AND 107).

FIRST USE 9-15-2005; IN COMMERCE 9-15-2005.

NO CLAIM IS MADE TO THE EXCLUSIVE
RIGHT TO USE "NATIONAL SUMMIT OF MINING
COMMUNITIES", APART FROM THE MARK AS
SHOWN.

"THE COLOR(S) RED, YELLOW, GREEN,
BROWN, BLUE, PURPLE AND WHITE IS/ARE
CLAIMED AS A FEATURE OF THE MARK."

"THE MARK CONSISTS OF A WATERCOLOR
DEPICTION OF A BLUE SKY ABOVE TWO ROUN-

DED SNOW-COVERED GOLD MOUNTAINS. THE
WORD "NATIONAL" IS ON TOP AND "SUMMIT OF
MINING COMMUNITIES" IS ON A SLIGHT CURVE
ON THE NEXT LINE, WITH THE WORDS "TOO
TOUGH TO DIE" BELOW THIS LINE, ALL ARE
PURPLE AND ALL WITHIN THE BLUE SKY.
BELOW THAT ARE YELLOW MOUNTAINS WITH
WHITE CAPS AND NEXT TO THEM ARE TWO
EVERGREEN TREES IN THE SEMI-FOREGROUND
WITH A BROWN WOODEN MINING STRUCTURE ;
SLIGHTLY BEHIND AND TO THE RIGHT ARE
GREEN AND BLACK TREES. THE HEAD FRAME
IS BEHIND A LARGE YELLOW AND BROWN
MOUND ; TWO MORE GREEN-BLACK EVER-
GREENS ARE ON THE RIGHT; AND TWO
BROWN-BLACK MINER'S SHACKS, WITH ONE IN
THE FOREGROUND, ONE TOWARDS THE BACK-
GROUND. THE BOTTOM OF THE MARK IS A
GREEN GRASS WITH , WITH SOME RED AND
YELLOW FLOWERS. ALL OF THIS APPEARS ON A
WHITE BACKGROUND."

SER. NO. 77-314,344, FILED 10-26-2007.

LINDA MICKLEBURGH, EXAMINING ATTORNEY

Int. Cl.: 41

Prior U.S. Cls.: 100, 101 and 107

United States Patent and Trademark Office

Reg. No. 3,483,816

Registered Aug. 12, 2008

**SERVICE MARK
PRINCIPAL REGISTER**

THE RED THREAD PROJECT

OBERMEYER, LINDSAY B. (UNITED STATES
INDIVIDUAL)
4253 WEST MELROSE STREET
CHICAGO, IL 60641

FOR: ORGANIZING COMMUNITY FESTIVALS
FEATURING A VARIETY OF ACTIVITIES, NAME-
LY, ART EXHIBITIONS, HERITAGE MARKETS,
ETHNIC DANCES, AND THE LIKE, IN CLASS 41
(U.S. CLS. 100, 101 AND 107).

FIRST USE 10-0-2005; IN COMMERCE 10-0-2005.

THE MARK CONSISTS OF STANDARD CHAR-
ACTERS WITHOUT CLAIM TO ANY PARTICULAR
FONT, STYLE, SIZE, OR COLOR.

NO CLAIM IS MADE TO THE EXCLUSIVE
RIGHT TO USE "PROJECT", APART FROM THE
MARK AS SHOWN.

SER. NO. 77-314,369, FILED 10-26-2007.

REBECCA GILBERT, EXAMINING ATTORNEY

Int. Cl.: 38

Prior U.S. Cls.: 100, 101 and 104

United States Patent and Trademark Office

Reg. No. 3,483,817

Registered Aug. 12, 2008

**SERVICE MARK
PRINCIPAL REGISTER**



NOISY PLANET, INC. (NEVADA CORPORATION)
507 CASAZZA STREET SUITE A
RENO, NV 89509

THE MARK CONSISTS OF THE WORDS "NOISY PLANET" IN STYLIZED TEXT. THERE IS A SPHERE BEHIND THE TEXT.

FOR: STREAMING OF AUDIO MATERIAL ON THE INTERNET, IN CLASS 38 (U.S. CLS. 100, 101 AND 104).

SER. NO. 77-314,899, FILED 10-26-2007.

FIRST USE 8-27-2007; IN COMMERCE 8-27-2007.

CYNTHIA SLOAN, EXAMINING ATTORNEY

Int. Cl.: 41

Prior U.S. Cls.: 100, 101 and 107

Reg. No. 3,483,818

United States Patent and Trademark Office

Registered Aug. 12, 2008

**SERVICE MARK
PRINCIPAL REGISTER**

Green Your Spirit

HOLZER, CARRIE M. (UNITED STATES INDIVIDUAL)
20 SUNNYSIDE AVE., SUITE A # 113
MILL VALLEY, CA 94941 AND
LEONARDI, RUDOLPH A. (UNITED STATES INDIVIDUAL)
POBOX 1714
SAUSALITO, CA 94966

FOR: EDUCATION SERVICES, NAMELY, PROVIDING WORKSHOPS, SEMINARS, EXHIBITIONS, CONFERENCES, CONTESTS, ONLINE COURSES, CLASSES, TUTORING, MENTORING, LIFE-COACHING, FESTIVALS, CAMPAIGNS, IN THE FIELD OF HEALTH, SPIRITUAL DEVELOPMENT, ENVIRONMENT, PHYSICS, GEOMETRY, BIOLOGY, ECOLOGY, ARCHITECTURE, INTERIOR DESIGN, PARENTING, CHILDRENS EDUCATION, NUTRITION, CLEANSING, SUSTAINABILITY, FENG SHUI, PERMACULTURE, GREEN BUSINESS PRACTICES; ARRANGING PROFESSIONAL WORKSHOP AND TRAINING COURSES; CONDUCTING WORKSHOPS AND SEMINARS IN PERSONAL AWARENESS; CONDUCTING WORKSHOPS AND SEMINARS IN SELF AWARENESS; CHARITABLE SERVICES, NAMELY, PROVIDING TRAINING IN THE FIELD OF HEALTH, SPIRITUAL DEVELOPMENT, ENVIRONMENT, PHYSICS, GEOMETRY, BIOLOGY, ECOLOGY, ARCHITECTURE, INTERIOR DESIGN, PARENTING, CHILDRENS EDUCATION, NUTRITION, CLEANSING, SUSTAINABILITY, FENG SHUI, PERMACULTURE, GREEN BUSINESS PRACTICES; BOOKING OF ENTERTAINMENT HALLS; CHILDREN'S ENTERTAINMENT AND AMUSEMENT CENTERS, NAMELY, INTERACTIVE PLAY AREAS; CONDUCTING ENTERTAINMENT EXHIBITIONS FOR CULTURAL AND EDUCATIONAL PURPOSES IN THE FIELD OF HEALTH, SPIRITUAL DEVELOPMENT, ENVIRONMENT, PHYSICS, GEOMETRY, BIOLOGY, ECOLOGY, ARCHITECTURE, INTERIOR DESIGN, PARENTING, CHILDRENS EDUCA-

TION, NUTRITION, CLEANSING, SUSTAINABILITY, FENG SHUI, PERMACULTURE, GREEN BUSINESS PRACTICES; EDUCATIONAL AND ENTERTAINMENT SERVICES, NAMELY, A CONTINUING PROGRAM ABOUT HEALTH, SPIRITUAL DEVELOPMENT, ENVIRONMENT, PHYSICS, GEOMETRY, BIOLOGY, ECOLOGY, ARCHITECTURE, INTERIOR DESIGN, PARENTING, CHILDRENS EDUCATION, NUTRITION, CLEANSING, SUSTAINABILITY, FENG SHUI, PERMACULTURE, GREEN BUSINESS PRACTICES, ACCESSIBLE BY RADIO, TELEVISION, SATELLITE, AUDIO, VIDEO AND COMPUTER NETWORKS; EDUCATIONAL AND ENTERTAINMENT SERVICES, NAMELY, PROVIDING MOTIVATIONAL AND EDUCATIONAL SPEAKERS; ENTERTAINMENT SERVICES, NAMELY, PROVIDING A WEBSITE FEATURING PHOTOGRAPHIC, AUDIO, VIDEO AND PROSE PRESENTATIONS FEATURING HEALTH, SPIRITUAL DEVELOPMENT, ENVIRONMENT, PHYSICS, GEOMETRY, BIOLOGY, ECOLOGY, ARCHITECTURE, INTERIOR DESIGN, PARENTING, CHILDRENS EDUCATION, NUTRITION, CLEANSING, SUSTAINABILITY, FENG SHUI, PERMACULTURE, GREEN BUSINESS PRACTICES; ENTERTAINMENT IN THE NATURE OF AN ON-GOING SPECIAL VARIETY, NEWS, MUSIC OR COMEDY SHOW FEATURING HEALTH, SPIRITUAL DEVELOPMENT, ENVIRONMENT, PHYSICS, GEOMETRY, BIOLOGY, ECOLOGY, ARCHITECTURE, INTERIOR DESIGN, PARENTING, CHILDRENS EDUCATION, NUTRITION, CLEANSING, SUSTAINABILITY, FENG SHUI, PERMACULTURE, GREEN BUSINESS PRACTICES BROADCAST OVER TELEVISION, SATELLITE, AUDIO, AND VIDEO MEDIA; ENTERTAINMENT IN THE NATURE OF DANCE PERFORMANCES; ENTERTAINMENT IN THE NATURE OF FASHION SHOWS; ENTERTAINMENT IN THE NATURE OF FOOTBALL GAMES; ENTERTAINMENT IN THE NATURE OF LIGHT SHOWS; ENTERTAINMENT IN THE NATURE OF ON-GOING TELEVISION

PROGRAMS IN THE FIELD OF HEALTH, SPIRITUAL DEVELOPMENT, ENVIRONMENT, PHYSICS, GEOMETRY, BIOLOGY, ECOLOGY, ARCHITECTURE, INTERIOR DESIGN, PARENTING, CHILDRENS EDUCATION, NUTRITION, CLEANSING, SUSTAINABILITY, FENG SHUI, PERMACULTURE, GREEN BUSINESS PRACTICES; ENTERTAINMENT IN THE NATURE OF TELEVISION NEWS SHOWS; ENTERTAINMENT IN THE NATURE OF VISUAL AND AUDIO PERFORMANCES, AND MUSICAL, VARIETY, NEWS AND COMEDY SHOWS; ENTERTAINMENT IN THE NATURE OF VISUAL AND AUDIO PERFORMANCES, NAMELY, MUSICAL BAND, ROCK GROUP, GYMNASTIC, DANCE, AND BALLET PERFORMANCES; ENTERTAINMENT SERVICES, NAMELY, AN ONLINE ACTIVITY WHERE YOU CREATE YOUR OWN MUSIC VIDEOS; ENTERTAINMENT SERVICES, NAMELY, CONDUCTING CONTESTS; ENTERTAINMENT SERVICES, NAMELY, CONDUCTING PARTIES FOR THE PURPOSE OF DATING AND SOCIAL INTRODUCTION FOR ADULTS; ENTERTAINMENT SERVICES, NAMELY, CONTEST AND INCENTIVE AWARD PROGRAMS DESIGNED TO REWARD PROGRAM PARTICIPANTS WHO EXERCISE, MAKE HEALTHY EATING CHOICES, AND ENGAGING IN OTHER HEALTH-PROMOTING ACTIVITIES; ENTERTAINMENT SERVICES, NAMELY, NON-DOWNLOADABLE RINGTONES, PRE-RECORDED MUSIC, VIDEO AND GRAPHICS PRESENTED TO MOBILE COMMUNICATIONS DEVICES VIA A GLOBAL COMPUTER NETWORK AND WIRELESS NETWORKS; ENTERTAINMENT SERVICES, NAMELY, PROVIDING A RADIO PROGRAM IN THE FIELD OF HEALTH, SPIRITUAL DEVELOPMENT, ENVIRONMENT, PHYSICS, GEOMETRY, BIOLOGY, ECOLOGY, ARCHITECTURE, INTERIOR DESIGN, PARENTING, CHILDRENS EDUCATION, NUTRITION, CLEANSING, SUSTAINABILITY, FENG SHUI, PERMACULTURE, GREEN BUSINESS PRACTICES VIA A GLOBAL COMPUTER NETWORK; ENTERTAINMENT SERVICES, NAMELY, PROVIDING A WEB SITE FEATURING MUSICAL PERFORMANCES, MUSICAL VIDEOS, RELATED FILM CLIPS, PHOTOGRAPHS, AND OTHER MULTIMEDIA MATERIALS; ENTERTAINMENT, NAMELY, LIVE MUSIC CONCERTS; ORGANIZING EXHIBITIONS FOR CULTURAL AND EDUCATIONAL PURPOSES IN THE FIELD OF HEALTH, SPIRITUAL DEVELOPMENT, ENVIRONMENT, PHYSICS, GEOMETRY, BIOLOGY, ECOLOGY, ARCHITECTURE, INTERIOR DESIGN, PARENTING, CHILDRENS EDUCATION, NUTRITION, CLEANSING, SUSTAINABILITY, FENG SHUI, PERMACULTURE, GREEN BUSINESS PRACTICES; ORGANIZING COMMUNITY FESTIVALS FEATURING A VARIETY OF ACTIVITIES, NAMELY SPORTING EVENTS, ART EXHIBITIONS, FLEA MARKETS, ETHNIC DANCES AND THE LIKE;

ORGANIZING COMMUNITY FESTIVALS FEATURING A VARIETY OF ACTIVITIES, NAMELY, ART EXHIBITIONS, HERITAGE MARKETS, ETHNIC DANCES, AND THE LIKE; ORGANIZING COMMUNITY SPORTING AND CULTURAL EVENTS; PROVIDING INFORMATION, NEWS AND COMMENTARY IN THE FIELD OF CURRENT EVENTS RELATING TO THE GAY COMMUNITY; PROVIDING INFORMATION, NEWS AND COMMENTARY IN THE FIELD OF ENTERTAINMENT RELATING TO THE GAY COMMUNITY; TRAINING IN THE FIELD OF DESIGN, ADVERTISING AND COMMUNICATION TECHNOLOGIES; ENTERTAINMENT SERVICES IN THE NATURE OF ORGANIZING, ARRANGING AND CONDUCTING MOTORCYCLE RIDING EXCURSIONS; EDUCATION SERVICES IN THE NATURE OF COURSES AT THE UNIVERSITY LEVEL; HEALTH CLUB SERVICES, NAMELY, PROVIDING INSTRUCTION AND EQUIPMENT IN THE FIELD OF PHYSICAL EXERCISE; GARDENS FOR PUBLIC ADMISSION; PUBLICATION OF BOOKS, OF MAGAZINES, OF JOURNALS, OF NEWSPAPERS, OF PERIODICALS, OF CATALOGS, OF BROCHURES; PUBLICATION OF ELECTRONIC MAGAZINES; PUBLICATION OF ELECTRONIC NEWSPAPERS ACCESSIBLE VIA A GLOBAL COMPUTER NETWORK; PUBLICATION OF LEAFLETS; PUBLICATION OF MANUALS; PUBLICATION OF MUSICAL TEXTS; PUBLICATION OF PRINTED MATTER; PUBLICATION OF TEXT BOOKS; PUBLICATION OF TEXTS, BOOKS, JOURNALS; PUBLICATION OF TEXTS, BOOKS, MAGAZINES AND OTHER PRINTED MATTER; SOCIAL CLUB SERVICES, NAMELY, ARRANGING, ORGANIZING, AND HOSTING SOCIAL EVENTS, GET-TOGETHERS, AND PARTIES FOR CLUB MEMBERS; WRITING OF ARTICLES FOR JOURNALS OTHER THAN FOR ADVERTISING OR PUBLICITY; WRITING OF ARTICLES FOR PERIODICALS OTHER THAN FOR ADVERTISING OR PUBLICITY; WRITING OF ARTICLES FOR PROFESSIONAL JOURNALS OTHER THAN FOR ADVERTISING OR PUBLICITY; WRITING OF TEXTS; WRITING OF TEXTS OTHER THAN PUBLICITY TEXTS, IN CLASS 41 (U.S. CLS. 100, 101 AND 107).

FIRST USE 2-11-2007; IN COMMERCE 2-19-2007.

THE MARK CONSISTS OF STANDARD CHARACTERS WITHOUT CLAIM TO ANY PARTICULAR FONT, STYLE, SIZE, OR COLOR.

NO CLAIM IS MADE TO THE EXCLUSIVE RIGHT TO USE "GREEN", APART FROM THE MARK AS SHOWN.

SER. NO. 77-315,163, FILED 10-27-2007.

TINA BROWN, EXAMINING ATTORNEY

Int. Cl.: 38

Prior U.S. Cls.: 100, 101 and 104

United States Patent and Trademark Office

Reg. No. 3,483,819

Registered Aug. 12, 2008

**SERVICE MARK
PRINCIPAL REGISTER**

STARTS LOW AND STAYS LOW

VONAGE MARKETING INC. (DELAWARE COR-
PORATION)
23 MAIN STREET
HOLMDEL, NJ 07733

THE MARK CONSISTS OF STANDARD CHAR-
ACTERS WITHOUT CLAIM TO ANY PARTICULAR
FONT, STYLE, SIZE, OR COLOR.

FOR: TELEPHONY COMMUNICATION SERVI-
CES, IN CLASS 38 (U.S. CLS. 100, 101 AND 104).

SER. NO. 77-315,551, FILED 10-29-2007.

FIRST USE 6-4-2007; IN COMMERCE 6-4-2007.

MAUREEN DALL, EXAMINING ATTORNEY

Int. Cl.: 35

Prior U.S. Cls.: 100, 101 and 102

United States Patent and Trademark Office

Reg. No. 3,483,820

Registered Aug. 12, 2008

**SERVICE MARK
PRINCIPAL REGISTER**

ADSCOPE MEDIA

ADSCOPE MEDIA, LLC (MICHIGAN LTD LIAB
CO)
SUITE F
1407 ALLEN DRIVE
TROY, MI 48083

FOR: MOBILE ADVERTISING SERVICES, IN
CLASS 35 (U.S. CLS. 100, 101 AND 102).

FIRST USE 10-1-2007; IN COMMERCE 10-1-2007.

THE MARK CONSISTS OF STANDARD CHAR-
ACTERS WITHOUT CLAIM TO ANY PARTICULAR
FONT, STYLE, SIZE, OR COLOR.

NO CLAIM IS MADE TO THE EXCLUSIVE
RIGHT TO USE "MEDIA", APART FROM THE
MARK AS SHOWN.

SER. NO. 77-315,845, FILED 10-29-2007.

AMOS T. MATTHEWS, JR., EXAMINING ATTOR-
NEY

Int. Cl.: 31

Prior U.S. Cls.: 1 and 46

United States Patent and Trademark Office

Reg. No. 3,483,821

Registered Aug. 12, 2008

TRADEMARK
PRINCIPAL REGISTER



HAY USA, INC. (TEXAS CORPORATION)
1714 BLAIR DRIVE
WEATHERFORD, TX 76086

FOR: HAY FOR USE AS FEED BY HORSES AND
OTHER ANIMALS, IN CLASS 31 (U.S. CLS. 1 AND
46).

FIRST USE 1-1-1995; IN COMMERCE 1-1-1995.

NO CLAIM IS MADE TO THE EXCLUSIVE
RIGHT TO USE "HAY" AND "INC.", APART FROM
THE MARK AS SHOWN.

THE COLOR(S) NAVY BLUE IS/ARE CLAIMED
AS A FEATURE OF THE MARK.

THE MARK CONSISTS OF OUTLINE OF THE
UNITED STATES WITH A STAR AND RECTANGLE
CONTAINING THE WORDS, "HAY USA, INC.
WEATHERFORD TEXAS". THE COLOR NAVY
BLUE APPEARS IN THE OUTLINE OF THE UNI-
TED STATES, AND THE STAR, IN THE RECTAN-
GLE AND IN ALL THE WORDING.

SEC. 2(F).

SER. NO. 77-315,891, FILED 10-29-2007.

DAYNA BROWNE, EXAMINING ATTORNEY

Int. Cls.: 35 and 36

Prior U.S. Cls.: 100, 101 and 102

United States Patent and Trademark Office

Reg. No. 3,483,822

Registered Aug. 12, 2008

**SERVICE MARK
PRINCIPAL REGISTER**



MONT PAC
OUTSOURCING

MONTGOMERY PACIFIC OUTSOURCING LLC
(HAWAII LTD LIAB CO), DBA MONT PAC
OUTSOURCING

500 ALA MOANA BLVD., STE 7-411
HONOLULU, HI 96813

FOR: ACCOUNTANCY SERVICES; ACCOUNTING CONSULTATION; ACCOUNTING SERVICES; ACCOUNTS RECEIVABLE SERVICES; ADMINISTRATION, BILLING AND RECONCILIATION OF ACCOUNTS ON BEHALF OF OTHERS; ADMINISTRATIVE ACCOUNTING; COST ACCOUNTING; BOOKKEEPING; BOOKKEEPING FOR ELECTRONIC FUNDS TRANSFER; BUSINESS PROCESS OUTSOURCING SERVICES IN THE FIELD OF ACCOUNTING AND BOOKKEEPING; OUTSOURCING IN THE FIELD OF ACCOUNTING AND BOOKKEEPING; OUTSOURCING SERVICES; PREPARING FINANCIAL REPORTS FOR OTHERS; FINANCIAL STATEMENT PREPARATION AND ANALYSIS FOR BUSINESSES; FINANCIAL RECORDS MANAGEMENT; INCOME TAX CONSULTATION; INCOME TAX PREPARATION; MANAGEMENT OF TAX FILES; TAX AND TAXATION PLANNING, ADVICE, INFORMATION AND CONSULTANCY SERVICES; TAX CONSULTATION; TAX PREPARATION, IN CLASS 35 (U.S. CLS. 100, 101 AND 102).

FIRST USE 5-22-2006; IN COMMERCE 6-1-2006.

FOR: FINANCIAL FORECASTING; FINANCIAL INFORMATION PROCESSING; CASH MANAGEMENT; FINANCIAL ANALYSIS AND CONSULTATION, IN CLASS 36 (U.S. CLS. 100, 101 AND 102).

FIRST USE 5-22-2006; IN COMMERCE 6-1-2006.

NO CLAIM IS MADE TO THE EXCLUSIVE RIGHT TO USE "OUTSOURCING" , APART FROM THE MARK AS SHOWN.

THE COLOR(S) BLUE, WHITE AND BLACK IS/ ARE CLAIMED AS A FEATURE OF THE MARK.

THE MARK CONSISTS OF A BLUE (PANTONE 5415 C) COLORED SQUARE WITH ROUNDED CORNERS FEATURING A WHITE ARROW INSIDE THE SQUARE. THE WHITE ARROW IS COMPOSED OF EIGHT WHITE SQUARES AND THE ARROW SYMBOL IS POINTING TOWARDS THE UPPER-RIGHT HAND CORNER OF THE BLUE SQUARE. THE TEXT "MONT PAC" APPEARS IN THE COLOR BLACK, IN UPPER-CASE DIRECTLY BENEATH THE BLUE SQUARE. THE TEXT "OUTSOURCING" APPEARS IN THE COLOR BLUE (PANTONE 5415 C) DIRECTLY BENEATH THE "MONT PAC" TEXT.

SER. NO. 77-316,393, FILED 10-29-2007.

TINA BROWN, EXAMINING ATTORNEY

Int. Cl.: 21

Prior U.S. Cls.: 2, 13, 23, 29, 30, 33, 40 and 50

Reg. No. 3,483,823

United States Patent and Trademark Office

Registered Aug. 12, 2008

**TRADEMARK
PRINCIPAL REGISTER**



LIBERTY GLOVE & SAFETY, INC. (CALIFORNIA CORPORATION)
433 CHERYL LANE
CITY OF INDUSTRY, CA 91789

THE MARK CONSISTS OF THE WORDS "X-GRIP" WITH A HAND GRASPING THE INTERSECTION OF THE "X".

FOR: WORK GLOVES, IN CLASS 21 (U.S. CLS. 2, 13, 23, 29, 30, 33, 40 AND 50).

SER. NO. 77-316,435, FILED 10-29-2007.

FIRST USE 7-23-2007; IN COMMERCE 7-23-2007.

JOHN E. MICHOS, EXAMINING ATTORNEY

Int. Cl.: 12

Prior U.S. Cls.: 19, 21, 23, 31, 35 and 44

Reg. No. 3,483,824

United States Patent and Trademark Office

Registered Aug. 12, 2008

**TRADEMARK
PRINCIPAL REGISTER**

VEURO

SUMITOMO RUBBER INDUSTRIES, LTD. (JAPAN CORPORATION)
6-9, 3-CHOME, WAKINOHAMA-CHO, CHUO-KU,
KOBE 651-0072, JAPAN

THE MARK CONSISTS OF THE WORD "VEURO"
IN STYLIZED FORM.

FOR: TIRES FOR AUTOMOBILES, IN CLASS 12
(U.S. CLS. 19, 21, 23, 31, 35 AND 44).

SER. NO. 77-316,480, FILED 10-29-2007.

OWNER OF JAPAN REG. NO. 5026099, DATED 2-16-2007, EXPIRES 2-16-2017.

SKYE YOUNG, EXAMINING ATTORNEY

Int. Cls.: 6, 19 and 20

Prior U.S. Cls.: 1, 2, 12, 13, 14, 22, 23, 25, 32, 33 and 50

Reg. No. 3,483,825

United States Patent and Trademark Office

Registered Aug. 12, 2008

**TRADEMARK
PRINCIPAL REGISTER**



VOSS SIGNS, LLC (NEW YORK LTD LIAB CO)
P.O. BOX 553
MANLIUS, NY 13104

FOR: NONMETAL HOLDERS FOR SIGNS; DISPLAY BOARDS; PLASTIC BANNERS, IN CLASS 20 (U.S. CLS. 2, 13, 22, 25, 32 AND 50).

FOR: METAL HOLDERS FOR SIGNS; NON-LUMINOUS AND NON-MECHANICAL METAL SIGNS; ROAD SIGNS OF METAL; PORTABLE TRADE SHOW DISPLAY BOOTH MADE PRIMARILY OF METAL, IN CLASS 6 (U.S. CLS. 2, 12, 13, 14, 23, 25 AND 50).

FIRST USE 1-2-2004; IN COMMERCE 1-2-2004.

FIRST USE 1-2-2004; IN COMMERCE 1-2-2004.

NO CLAIM IS MADE TO THE EXCLUSIVE RIGHT TO USE "SIGNS", APART FROM THE MARK AS SHOWN.

FOR: NON-LUMINOUS, NON-MECHANICAL SIGNS NOT OF METAL; NON-METAL ROAD SIGNS; PORTABLE TRADE SHOW DISPLAY BOOTH NOT MADE PRIMARILY OF METAL, IN CLASS 19 (U.S. CLS. 1, 12, 33 AND 50).

THE MARK CONSISTS OF A STYLIZED LETTER "V" BETWEEN THE WORDS "VOSS" AND "SIGNS" WITH THE WORD "SIGNS" UNDERLINED.

SER. NO. 77-316,601, FILED 10-30-2007.

FIRST USE 1-2-2004; IN COMMERCE 1-2-2004.

TRICIA SONNEBORN, EXAMINING ATTORNEY

Int. Cl.: 35

Prior U.S. Cls.: 100, 101 and 102

United States Patent and Trademark Office

Reg. No. 3,483,826

Registered Aug. 12, 2008

**SERVICE MARK
PRINCIPAL REGISTER**

Don's Crabs

DON'S CRABS, INC. (MARYLAND CORPORATION)
1764 EAST JOPPA ROAD
BALTIMORE, MD 21234

FOR: RETAIL STORE SERVICES; NAMELY, A SMALL CHAIN OF SEAFOOD MARKETS FEATURING STEAMED CRABS, CRAB CAKES, SHRIMP, FISH AND OTHER ASSORTED FRESH AND PREPARED SEAFOOD, IN CLASS 35 (U.S. CLS. 100, 101 AND 102).

FIRST USE 6-15-1985; IN COMMERCE 6-15-1985.

THE MARK CONSISTS OF STANDARD CHARACTERS WITHOUT CLAIM TO ANY PARTICULAR FONT, STYLE, SIZE, OR COLOR.

NO CLAIM IS MADE TO THE EXCLUSIVE RIGHT TO USE "CRABS", APART FROM THE MARK AS SHOWN.

SER. NO. 77-316,665, FILED 10-30-2007.

CHRISTINA SOBRAL, EXAMINING ATTORNEY

Int. Cl.: 11

Prior U.S. Cls.: 13, 21, 23, 31 and 34

Reg. No. 3,483,827

United States Patent and Trademark Office

Registered Aug. 12, 2008

**TRADEMARK
PRINCIPAL REGISTER**

INTELLIGENT WATER

JAPIN INTERNATIONAL, INC. (TAIWAN CORPORATION)
57, SEC. 2, JIAO-TAN RD.
FONG YUAN, TAICHUNG, TAIWAN

FOR: WATER PURIFYING APPARATUS; WATER PURIFYING MACHINES; WATER FILTERING APPARATUS, NAMELY, WATER FILTERS AND WATER FILTERING UNITS FOR DOMESTIC AND COMMERCIAL USE; WATER FILTER REPLACEMENTS FOR WATER FILTERING UNITS TO BE SOLD THROUGH A DIRECT SELLING OR PERSON-TO-PERSON SELLING FORMAT, IN CLASS 11 (U.S. CLS. 13, 21, 23, 31 AND 34).

FIRST USE 5-8-2006; IN COMMERCE 7-6-2006.

THE MARK CONSISTS OF STANDARD CHARACTERS WITHOUT CLAIM TO ANY PARTICULAR FONT, STYLE, SIZE, OR COLOR.

NO CLAIM IS MADE TO THE EXCLUSIVE RIGHT TO USE "WATER", APART FROM THE MARK AS SHOWN.

SER. NO. 77-316,977, FILED 10-30-2007.

KELLEY WELLS, EXAMINING ATTORNEY

Int. Cl.: 5

Prior U.S. Cls.: 6, 18, 44, 46, 51 and 52

Reg. No. 3,483,828

United States Patent and Trademark Office

Registered Aug. 12, 2008

**TRADEMARK
PRINCIPAL REGISTER**

PUSH 'N SCENT

BATH SOLUTIONS, INC. (ILLINOIS CORPORATION)

1120 THORNDALE AVENUE

BENSENVILLE, IL 60106

FOR: AIR FRESHENERS, IN CLASS 5 (U.S. CLS. 6, 18, 44, 46, 51 AND 52).

FIRST USE 8-31-2007; IN COMMERCE 8-31-2007.

THE MARK CONSISTS OF STANDARD CHARACTERS WITHOUT CLAIM TO ANY PARTICULAR FONT, STYLE, SIZE, OR COLOR.

NO CLAIM IS MADE TO THE EXCLUSIVE RIGHT TO USE "SCENT", APART FROM THE MARK AS SHOWN.

SER. NO. 77-317,044, FILED 10-30-2007.

CHRIS WELLS, EXAMINING ATTORNEY

Int. Cl.: 11

Prior U.S. Cls.: 13, 21, 23, 31 and 34

Reg. No. 3,483,829

United States Patent and Trademark Office

Registered Aug. 12, 2008

**TRADEMARK
PRINCIPAL REGISTER**

FAN FUSION

BATH SOLUTIONS, INC. (ILLINOIS CORPORATION)

1120 THORNDALE AVENUE

BENSENVILLE, IL 60106

FOR: PORTABLE ELECTRIC FANS, IN CLASS 11
(U.S. CLS. 13, 21, 23, 31 AND 34).

FIRST USE 3-11-2007; IN COMMERCE 3-11-2007.

THE MARK CONSISTS OF STANDARD CHARACTERS WITHOUT CLAIM TO ANY PARTICULAR FONT, STYLE, SIZE, OR COLOR.

NO CLAIM IS MADE TO THE EXCLUSIVE RIGHT TO USE "FAN", APART FROM THE MARK AS SHOWN.

SER. NO. 77-317,074, FILED 10-30-2007.

CHRIS WELLS, EXAMINING ATTORNEY

Int. Cl.: 21

Prior U.S. Cls.: 2, 13, 23, 29, 30, 33, 40 and 50

Reg. No. 3,483,830

United States Patent and Trademark Office

Registered Aug. 12, 2008

**TRADEMARK
PRINCIPAL REGISTER**

GRIPPER SCENTS

BATH SOLUTIONS, INC. (ILLINOIS CORPORATION)

1120 THORNDALE AVENUE

BENSENVILLE, IL 60106

FOR: TOWEL HOLDERS, IN CLASS 21 (U.S. CLS. 2, 13, 23, 29, 30, 33, 40 AND 50).

FIRST USE 3-11-2007; IN COMMERCE 3-11-2007.

THE MARK CONSISTS OF STANDARD CHARACTERS WITHOUT CLAIM TO ANY PARTICULAR FONT, STYLE, SIZE, OR COLOR.

NO CLAIM IS MADE TO THE EXCLUSIVE RIGHT TO USE "SCENTS", APART FROM THE MARK AS SHOWN.

SER. NO. 77-317,096, FILED 10-30-2007.

CHRIS WELLS, EXAMINING ATTORNEY

Int. Cl.: 16

Prior U.S. Cls.: 2, 5, 22, 23, 29, 37, 38 and 50

Reg. No. 3,483,831

United States Patent and Trademark Office

Registered Aug. 12, 2008

**TRADEMARK
PRINCIPAL REGISTER**

ABT

BALLET THEATRE FOUNDATION, INC. (NEW
YORK NON-PROFIT CORPORATION)
LAWRENCE WEIN CENTER FOR DANCE & THEA-
TER
890 BROADWAY, THIRD FLOOR
NEW YORK, NY 10003

FOR: EDUCATIONAL PUBLICATIONS, NAME-
LY, MANUALS CONSISTING OF A DANCE-RELA-
TED TRAINING CURRICULUM AND HEALTH
GUIDELINES FOR DANCERS, STUDENTS OF
DANCE AND DANCE TEACHERS, IN CLASS 16
(U.S. CLS. 2, 5, 22, 23, 29, 37, 38 AND 50).

FIRST USE 2-17-2008; IN COMMERCE 2-17-2008.

THE MARK CONSISTS OF STANDARD CHAR-
ACTERS WITHOUT CLAIM TO ANY PARTICULAR
FONT, STYLE, SIZE, OR COLOR.

OWNER OF U.S. REG. NO. 2,511,720.

SER. NO. 77-317,223, FILED 10-30-2007.

MIDGE BUTLER, EXAMINING ATTORNEY

Int. Cl.: 16

Prior U.S. Cls.: 2, 5, 22, 23, 29, 37, 38 and 50

Reg. No. 3,483,832

United States Patent and Trademark Office

Registered Aug. 12, 2008

**TRADEMARK
PRINCIPAL REGISTER**

AMERICAN BALLET THEATRE

BALLET THEATRE FOUNDATION, INC. (NEW
YORK NON-PROFIT CORPORATION)
LAWRENCE WEIN CENTER FOR DANCE & THEA-
TER
890 BROADWAY, THIRD FLOOR
NEW YORK, NY 10003

FOR: EDUCATIONAL PUBLICATIONS, NAME-
LY, MANUALS CONSISTING OF A DANCE-RELA-
TED TRAINING CURRICULUM AND HEALTH
GUIDELINES FOR DANCERS, STUDENTS OF
DANCE AND DANCE TEACHERS, IN CLASS 16
(U.S. CLS. 2, 5, 22, 23, 29, 37, 38 AND 50).

FIRST USE 2-17-2008; IN COMMERCE 2-17-2008.

THE MARK CONSISTS OF STANDARD CHAR-
ACTERS WITHOUT CLAIM TO ANY PARTICULAR
FONT, STYLE, SIZE, OR COLOR.

OWNER OF U.S. REG. NO. 2,511,719.

NO CLAIM IS MADE TO THE EXCLUSIVE
RIGHT TO USE "BALLET", APART FROM THE
MARK AS SHOWN.

SEC. 2(F).

SER. NO. 77-317,268, FILED 10-30-2007.

MIDGE BUTLER, EXAMINING ATTORNEY

Int. Cl.: 45

Prior U.S. Cls.: 100 and 101

United States Patent and Trademark Office

Reg. No. 3,483,833

Registered Aug. 12, 2008

**SERVICE MARK
PRINCIPAL REGISTER**

SMILE ON SENIORS

LUBAVITCH CENTER OF ESSEX COUNTY
(NEW JERSEY LTD LIAB CO)
456 PLEASANT VALLEY WAY
WEST ORANGE, NJ 07052

FOR: SOCIAL SERVICE, NAMELY, COMPANIONSHIP SERVICES FOR THE ELDERLY, IN CLASS 45 (U.S. CLS. 100 AND 101).

FIRST USE 7-4-2007; IN COMMERCE 7-4-2007.

THE MARK CONSISTS OF STANDARD CHARACTERS WITHOUT CLAIM TO ANY PARTICULAR FONT, STYLE, SIZE, OR COLOR.

NO CLAIM IS MADE TO THE EXCLUSIVE RIGHT TO USE "SENIORS", APART FROM THE MARK AS SHOWN.

SER. NO. 77-317,307, FILED 10-30-2007.

DAWN FELDMAN, EXAMINING ATTORNEY

Int. Cl.: 9

Prior U.S. Cls.: 21, 23, 26, 36 and 38

Reg. No. 3,483,834

United States Patent and Trademark Office

Registered Aug. 12, 2008

**TRADEMARK
PRINCIPAL REGISTER**

ELECTRO-JOY

PYO, HENRY J. (REPUBLIC OF KOREA INDIVIDUAL)
619 E. FAIRMOUNT RD.
BURBANK, CA 91501

FIRST USE 5-31-1998; IN COMMERCE 5-31-1998.

FOR: AUDIO SPEAKERS, AUDIO AMPLIFIERS, INCLUDING MICROPHONES, AND SECURITY MONITORING DEVICES, NAMELY, METAL DETECTORS, SECURITY VIDEO MONITORS, AND SECURITY VIDEO CAMERAS , IN CLASS 9 (U.S. CLS. 21, 23, 26, 36 AND 38).

THE MARK CONSISTS OF STANDARD CHARACTERS WITHOUT CLAIM TO ANY PARTICULAR FONT, STYLE, SIZE, OR COLOR.

SER. NO. 77-317,414, FILED 10-30-2007.

GEORGE LORENZO, EXAMINING ATTORNEY

Int. Cl.: 41

Prior U.S. Cls.: 100, 101 and 107

United States Patent and Trademark Office

Reg. No. 3,483,835

Registered Aug. 12, 2008

**SERVICE MARK
PRINCIPAL REGISTER**

PARTNERS

PARTNERS IN MEDICAL EDUCATION, INC.
(PENNSYLVANIA CORPORATION)
109 BRUSH CREEK ROAD
IRWIN, PA 15642

FOR: CONSULTING SERVICES IN THE FIELD
OF MEDICAL EDUCATION PROGRAMS DIREC-
TED TO MEDICAL PROFESSIONALS FOR AC-
CREDITATION, PROFESSIONAL DEVELOPMENT
AND OPERATIONS CONSULTING, IN CLASS 41
(U.S. CLS. 100, 101 AND 107).

FIRST USE 4-1-1994; IN COMMERCE 4-1-1994.

THE MARK CONSISTS OF STANDARD CHAR-
ACTERS WITHOUT CLAIM TO ANY PARTICULAR
FONT, STYLE, SIZE, OR COLOR.

SER. NO. 77-317,652, FILED 10-31-2007.

PATRICIA EVANKO, EXAMINING ATTORNEY

Int. Cl.: 19

Prior U.S. Cls.: 1, 12, 33 and 50

United States Patent and Trademark Office

Reg. No. 3,483,836

Registered Aug. 12, 2008

**TRADEMARK
PRINCIPAL REGISTER**

ARMOR

GUARDIAN BUILDING PRODUCTS DISTRIBUTION, INC. (GEORGIA CORPORATION)
P.O. BOX 528
GREENVILLE, SC 29602

FOR: PROTECTIVE NON-METAL COMPOSITE SHEETING FOR ROOFS; NON-METAL BUILDING FLASHING, NAMELY, PROTECTIVE COMPOSITE MEMBRANE FOR DOORS AND WINDOWS , IN CLASS 19 (U.S. CLS. 1, 12, 33 AND 50).

FIRST USE 1-0-2006; IN COMMERCE 1-0-2006.

THE MARK CONSISTS OF STANDARD CHARACTERS WITHOUT CLAIM TO ANY PARTICULAR FONT, STYLE, SIZE, OR COLOR.

SER. NO. 77-318,005, FILED 10-31-2007.

JENNIFER VASQUEZ, EXAMINING ATTORNEY

Int. Cl.: 41

Prior U.S. Cls.: 100, 101 and 107

United States Patent and Trademark Office

Reg. No. 3,483,837

Registered Aug. 12, 2008

SERVICE MARK
PRINCIPAL REGISTER



THE NEW YORK TIMES COMPANY (NEW YORK CORPORATION)
620 EIGHTH AVENUE
NEW YORK, NY 10018

FOR: PROVIDING RATINGS OF THEATRICAL FILMS, MOVIES, AND TELEVISION; ENTERTAINMENT AND EDUCATIONAL SERVICES, NAMELY, PROVIDING INCENTIVES TO PEOPLE TO DEMONSTRATE EXCELLENCE IN THE FIELD OF THEATRICAL FILM AND TELEVISION PRODUCTION AND RELEASES BY PROVIDING RECOGNITION OF DISTINGUISHED ACHIEVEMENT BY THE WAY OF BEING IDENTIFIED IN PRINT AND ONLINE PUBLICATIONS IN THE FIELD OF THEATRICAL FILM AND TELEVISION PRODUCTION AND RELEASES; PROVIDING RECOGNITION OF DISTINGUISHED ACHIEVEMENT IN THE FIELD OF THEATRICAL FILM AND TELEVISION PRODUCTION AND RELEASES BY MEANS OF A SEAL USED TO IDENTIFY NOMINEES AND WINNERS OF AN AWARD FOR EXCELLENCE; PROVIDING RECOGNITION OF DISTINGUISHED ACHIEVEMENT AND EXCELLENCE BY THE WAY OF BEING IDENTIFIED IN PRINT AND ONLINE PUBLICATIONS IN THE FIELD OF THEATRICAL FILM

AND TELEVISION PRODUCTION AND RELEASES FOR USE IN THE FILM AND TELEVISION INDUSTRY, IN CLASS 41 (U.S. CLS. 100, 101 AND 107).

FIRST USE 9-21-2007; IN COMMERCE 9-21-2007.

OWNER OF U.S. REG. NOS. 227,904, 3,251,615 AND OTHERS.

NO CLAIM IS MADE TO THE EXCLUSIVE RIGHT TO USE "CRITICS'PICKS", APART FROM THE MARK AS SHOWN.

THE MARK CONSISTS OF THE WORDS THE NEW YORK TIMES WITH THE WORDS CRITICS' PICKS UNDERNEATH WITH A CHECK MARK WITHIN A CIRCLE BESIDE THE WORDING ON THE LEFT.

SEC. 2(F) AS TO "THE NEW YORK TIMES".

SER. NO. 77-318,118, FILED 10-31-2007.

DEIRDRE ROBERTSON, EXAMINING ATTORNEY

Int. Cl.: 41

Prior U.S. Cls.: 100, 101 and 107

United States Patent and Trademark Office

Reg. No. 3,483,838

Registered Aug. 12, 2008

SERVICE MARK
PRINCIPAL REGISTER



THE NEW YORK TIMES COMPANY (NEW YORK CORPORATION)
620 EIGHTH AVENUE
NEW YORK, NY 10018

FOR: PROVIDING RATINGS OF THEATRICAL FILMS, MOVIES, AND TELEVISION; ENTERTAINMENT AND EDUCATIONAL SERVICES, NAMELY, PROVIDING INCENTIVES TO PEOPLE TO DEMONSTRATE EXCELLENCE IN THE FIELD OF THEATRICAL FILM AND TELEVISION PRODUCTION AND RELEASES BY PROVIDING RECOGNITION OF DISTINGUISHED ACHIEVEMENT BY THE WAY OF BEING IDENTIFIED IN PRINT AND ONLINE PUBLICATIONS IN THE FIELD OF THEATRICAL FILM AND TELEVISION PRODUCTION AND RELEASES; PROVIDING RECOGNITION OF DISTINGUISHED ACHIEVEMENT IN THE FIELD OF THEATRICAL FILM AND TELEVISION PRODUCTION AND RELEASES BY MEANS OF A SEAL USED TO IDENTIFY NOMINEES AND WINNERS OF AN AWARD FOR EXCELLENCE; PROVIDING RECOGNITION OF DISTINGUISHED ACHIEVEMENT AND EXCELLENCE BY THE WAY OF BEING IDENTIFIED IN PRINT AND ONLINE PUBLICATIONS IN THE FIELD OF THEATRICAL FILM

AND TELEVISION PRODUCTION AND RELEASES FOR USE IN THE FILM AND TELEVISION INDUSTRY, IN CLASS 41 (U.S. CLS. 100, 101 AND 107).

FIRST USE 9-21-2007; IN COMMERCE 9-21-2007.

OWNER OF U.S. REG. NOS. 227,904, 3,251,615 AND OTHERS.

NO CLAIM IS MADE TO THE EXCLUSIVE RIGHT TO USE "CRITIC'S PICK", APART FROM THE MARK AS SHOWN.

THE MARK CONSISTS OF THE WORDS THE NEW YORK TIMES WITH THE WORDS CRITIC'S PICK UNDERNEATH WITH A CHECK MARK WITHIN A CIRCLE BESIDE THE WORDING ON THE LEFT.

SEC. 2(F) AS TO "THE NEW YORK TIMES".

SER. NO. 77-318,126, FILED 10-31-2007.

DEIRDRE ROBERTSON, EXAMINING ATTORNEY

Int. Cl.: 24

Prior U.S. Cls.: 42 and 50

United States Patent and Trademark Office

Reg. No. 3,483,839

Registered Aug. 12, 2008

**TRADEMARK
PRINCIPAL REGISTER**



SWEATRAG, INC. (NORTH CAROLINA CORPORATION)
5131 ORIOLE DRIVE
WILMINGTON, NC 28403

THE MARK CONSISTS OF A SPLAT WITH THE STYLIZED WORDS "SWEATRAG.COM" UNDERNEATH.

FOR: TOWELS, IN CLASS 24 (U.S. CLS. 42 AND 50).

FIRST USE 1-18-2006; IN COMMERCE 1-18-2006.

SER. NO. 77-318,416, FILED 10-31-2007.

NO CLAIM IS MADE TO THE EXCLUSIVE RIGHT TO USE "SWEAT RAG.COM", APART FROM THE MARK AS SHOWN.

CHRISTINA SOBRAL, EXAMINING ATTORNEY

Int. Cl.: 35

Prior U.S. Cls.: 100, 101 and 102

United States Patent and Trademark Office

Reg. No. 3,483,840

Registered Aug. 12, 2008

**SERVICE MARK
PRINCIPAL REGISTER**

Freer Consulting

FREER CONSULTING CO. (WASHINGTON CORPORATION)
3213 W. WHEELER ST.
SUITE 219
SEATTLE, WA 98199

FOR: MANAGEMENT AND BUSINESS CONSULTING SERVICES IN THE FIELD OF RISK MANAGEMENT, REGULATORY SUPPORT, LITIGATION SUPPORT, IMPLEMENTATION OF INTERNATIONAL STANDARDS AND GENERAL PROGRAM MANAGEMENT CONSULTING, IN CLASS 35 (U.S. CLS. 100, 101 AND 102).

FIRST USE 0-0-1998; IN COMMERCE 0-0-1998.

THE MARK CONSISTS OF STANDARD CHARACTERS WITHOUT CLAIM TO ANY PARTICULAR FONT, STYLE, SIZE, OR COLOR.

NO CLAIM IS MADE TO THE EXCLUSIVE RIGHT TO USE "CONSULTING", APART FROM THE MARK AS SHOWN.

SER. NO. 77-318,491, FILED 10-31-2007.

ELI HELLMAN, EXAMINING ATTORNEY

Int. Cl.: 42

Prior U.S. Cls.: 100 and 101

United States Patent and Trademark Office

Reg. No. 3,483,841

Registered Aug. 12, 2008

**SERVICE MARK
PRINCIPAL REGISTER**

Hiperos

HIPEROS, LLC (DELAWARE LTD LIAB CO)
304 TURNPIKE ROAD
SOUTHBOROUGH, MA 01772

FOR: PROVIDING ON-LINE NON-DOWNLOAD-
ABLE SOFTWARE FOR SUPPLIER-RELATIONSHIP
MANAGEMENT, NAMELY, FOR DATA COMPILA-
TION, CALCULATION AND SCORING OF PER-
FORMANCES AND COMPLIANCE OF SUPPLIERS
AND CORPORATIONS AND FOR DATABASE
MANAGEMENT, IN CLASS 42 (U.S. CLS. 100 AND
101).

FIRST USE 1-2-2007; IN COMMERCE 1-2-2007.

THE MARK CONSISTS OF STANDARD CHAR-
ACTERS WITHOUT CLAIM TO ANY PARTICULAR
FONT, STYLE, SIZE, OR COLOR.

THE WORDING "HIPEROS" HAS NO MEANING
OTHER THAN TRADEMARK SIGNIFICANCE.

SER. NO. 77-318,937, FILED 11-1-2007.

ANDREA K. NADELMAN, EXAMINING ATTOR-
NEY

Int. Cls.: 25, 36 and 41

Prior U.S. Cls.: 22, 39, 100, 101, 102 and 107

United States Patent and Trademark Office

Reg. No. 3,483,842

Registered Aug. 12, 2008

**TRADEMARK
SERVICE MARK
PRINCIPAL REGISTER**



100 MILE MAN LLC (DELAWARE LTD LIAB CO)
C/O ROTHESTEIN KASS
1350 AVENUE OF THE AMERICAS
NEW YORK, NY 10019

FOR: CLOTHING, NAMELY, HATS, CAPS, T-SHIRTS, AND SWEATSHIRTS, IN CLASS 25 (U.S. CLS. 22 AND 39).

FIRST USE 11-0-2006; IN COMMERCE 11-0-2006.

FOR: CHARITABLE FUNDRAISING SERVICES; PROVIDING INFORMATION REGARDING CHARITABLE FUNDRAISING VIA A WEB SITE, IN CLASS 36 (U.S. CLS. 100, 101 AND 102).

FIRST USE 9-0-2006; IN COMMERCE 9-0-2006.

FOR: EDUCATION AND ENTERTAINMENT SERVICES, NAMELY, PROVIDING INFORMATION REGARDING ATHLETIC TRAINING VIA A WEB SITE, IN CLASS 41 (U.S. CLS. 100, 101 AND 107).

FIRST USE 9-0-2006; IN COMMERCE 9-0-2006.

THE MARK CONSISTS OF THE SILHOUETTE OF A RUNNER HOLDING AN UNFURLED FLAG IN HIS LEFT HAND WITH THE TERMS "THE 100 MILE MAN" SHOWN HORIZONTALLY IN LOWER-CASE LETTERS ACROSS THE MIDDLE OF THE RUNNER'S IMAGE.

SER. NO. 77-319,432, FILED 11-1-2007.

ZACHARY BELLO, EXAMINING ATTORNEY

Int. Cl.: 11

Prior U.S. Cls.: 13, 21, 23, 31 and 34

United States Patent and Trademark Office

Reg. No. 3,483,843

Registered Aug. 12, 2008

**TRADEMARK
PRINCIPAL REGISTER**

HURRICONE

ASAP DESIGN, INC. (OHIO CORPORATION)
655 W. MARKET STREET
AKRON, OH 44303

THE MARK CONSISTS OF STANDARD CHAR-
ACTERS WITHOUT CLAIM TO ANY PARTICULAR
FONT, STYLE, SIZE, OR COLOR.

FOR: VENTILATION APPARATUS, NAMELY,
CORDLESS FLOOR DRYING CONE DOLLY, IN
CLASS 11 (U.S. CLS. 13, 21, 23, 31 AND 34).

SER. NO. 77-319,439, FILED 11-1-2007.

FIRST USE 9-26-2005; IN COMMERCE 9-26-2005.

MICHAEL TANNER, EXAMINING ATTORNEY

Int. Cl.: 36

Prior U.S. Cls.: 100, 101 and 102

United States Patent and Trademark Office

Reg. No. 3,483,844

Registered Aug. 12, 2008

**SERVICE MARK
PRINCIPAL REGISTER**

ROC-KIT

KEYSOURCE COMMERCIAL BANK (NORTH
CAROLINA CORPORATION)
SUITE 60
410 BLACKWELL STREET
DURHAM, NC 27701

FOR: BANKING SERVICES, NAMELY, REMOTE
CAPTURE AND DIRECT DEPOSIT SERVICES FOR
CHECKING AND OTHER DEPOSIT ACCOUNTS, IN
CLASS 36 (U.S. CLS. 100, 101 AND 102).

FIRST USE 3-19-2007; IN COMMERCE 4-0-2007.

THE MARK CONSISTS OF STANDARD CHAR-
ACTERS WITHOUT CLAIM TO ANY PARTICULAR
FONT, STYLE, SIZE, OR COLOR.

SER. NO. 77-319,698, FILED 11-2-2007.

AMOS T. MATTHEWS, JR., EXAMINING ATTOR-
NEY

Int. Cl.: 41

Prior U.S. Cls.: 100, 101 and 107

United States Patent and Trademark Office

Reg. No. 3,483,845

Registered Aug. 12, 2008

**SERVICE MARK
PRINCIPAL REGISTER**

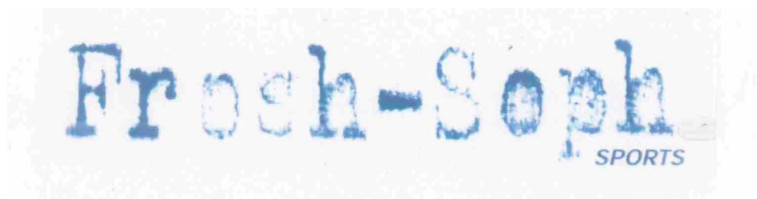

COASTAL BREEZE PUBLICATIONS, INC. (CALIFORNIA CORPORATION)
2558 WHITE AVE.
CHICO, CA 95973

FOR: PUBLISHING OF ELECTRONIC PUBLICATIONS, IN CLASS 41 (U.S. CLS. 100, 101 AND 107).

FIRST USE 8-15-2007; IN COMMERCE 8-25-2007.

NO CLAIM IS MADE TO THE EXCLUSIVE RIGHT TO USE "SPORTS", APART FROM THE MARK AS SHOWN.

THE COLOR(S) BLUE IS/ARE CLAIMED AS A FEATURE OF THE MARK.

THE MARK CONSISTS OF THE WORDS "FRESH-SOPH" IN OLD-FASHIONED AMERICAN TYPEWRITER FONT, IN COLOR; THE WORD "SPORTS" PARTLY BENEATH THE "P", ENTIRELY BENEATH THE "H" AND PARTLY EXTENDING BEYOND THE END OF THE "H".

SER. NO. 77-320,214, FILED 11-2-2007.

JOHN HWANG, EXAMINING ATTORNEY

Int. Cl.: 9

Prior U.S. Cls.: 21, 23, 26, 36 and 38

Reg. No. 3,483,846

United States Patent and Trademark Office

Registered Aug. 12, 2008

**TRADEMARK
PRINCIPAL REGISTER**



HENZHEN MELE DIGITAL TECHNOLOGY LTD.
(CHINA CORPORATION)
#1803 18F LEADER TOWER, #98 1ST FUHUA RD
SHENZHEN, CHINA

FOR: ELECTRONIC, DIGITAL, OPTICAL, COMPUTER, AND TELECOMMUNICATION PRODUCTS, NAMELY, PORTABLE MULTI-MEDIA PLAYERS, DIGITAL HOME ENTERTAINMENT SYSTEMS COMPRISING TELEVISIONS, COMPUTERS AND SPEAKERS, AUDIO-VIDEO RECEIVERS AND RECORDERS, FLASH MEMORY CARDS, LCD DISPLAYS, GLOBAL POSITIONING SYSTEMS, COMPUTER GAME SOFTWARE, APPARATUS

FOR TRANSMISSION OF COMMUNICATION, BATTERIES, POWER ADAPTORS, CABLES, NAMELY, ELECTRIC CABLES AND COAXIAL CABLES, IN CLASS 9 (U.S. CLS. 21, 23, 26, 36 AND 38).

FIRST USE 11-1-2006; IN COMMERCE 11-1-2006.

THE MARK CONSISTS OF STYLIZED LETTERS.

SER. NO. 77-320,434, FILED 11-2-2007.

RICHARD WHITE, EXAMINING ATTORNEY

Int. Cl.: 44

Prior U.S. Cls.: 100 and 101

United States Patent and Trademark Office

Reg. No. 3,483,847

Registered Aug. 12, 2008

**SERVICE MARK
PRINCIPAL REGISTER**

Sunshine Wellness

MARKLE, SARA E. (CALIFORNIA SOLE PROPRIETORSHIP), DBA SUNSHINE WELLNESS
5257 CALLE MORELIA
SANTA BARBARA, CA 93111

FOR: COUNSELING SERVICES IN THE FIELDS OF HEALTH, NUTRITION AND LIFESTYLE WELLNESS; NUTRITION COUNSELING; PROVIDING ASSISTANCE, FITNESS EVALUATION AND CONSULTATION TO INDIVIDUALS TO HELP THEM MAKE HEALTH, WELLNESS AND NUTRITIONAL CHANGES IN THEIR DAILY LIVING TO IMPROVE HEALTH; PROVIDING INFORMATION ABOUT DIETARY SUPPLEMENTS AND NUTRITION, IN CLASS 44 (U.S. CLS. 100 AND 101).

FIRST USE 1-1-2004; IN COMMERCE 1-1-2004.

THE MARK CONSISTS OF STANDARD CHARACTERS WITHOUT CLAIM TO ANY PARTICULAR FONT, STYLE, SIZE, OR COLOR.

NO CLAIM IS MADE TO THE EXCLUSIVE RIGHT TO USE "WELLNESS", APART FROM THE MARK AS SHOWN.

SER. NO. 77-320,660, FILED 11-2-2007.

CARYN GLASSER, EXAMINING ATTORNEY

Int. Cl.: 41

Prior U.S. Cls.: 100, 101 and 107

United States Patent and Trademark Office

Reg. No. 3,483,848

Registered Aug. 12, 2008

**SERVICE MARK
PRINCIPAL REGISTER**

Elliot in the Morning

SEGAL, JACQUIE LYNN (UNITED STATES IN-
DIVIDUAL)
3120 BEECHWOOD LANE
FALLS CHURCH, VA 22042

FOR: RADIO ENTERTAINMENT SERVICES,
NAMELY, RADIO PROGRAMS FEATURING PER-
FORMANCES BY AN INDIVIDUAL NAMED EL-
LIOT SEGAL, IN CLASS 41 (U.S. CLS. 100, 101 AND
107).

FIRST USE 8-30-1999; IN COMMERCE 8-30-1999.

THE MARK CONSISTS OF STANDARD CHAR-
ACTERS WITHOUT CLAIM TO ANY PARTICULAR
FONT, STYLE, SIZE, OR COLOR.

THE NAME(S), PORTRAIT(S), AND/OR SIGNA-
TURE(S) SHOWN IN THE MARK IDENTIFIES
"ELLIOT" SEGAL, WHOSE CONSENT(S) TO REGIS-
TER IS SUBMITTED.

SER. NO. 77-320,712, FILED 11-3-2007.

LINDA LAVACHE, EXAMINING ATTORNEY

Int. Cl.: 36

Prior U.S. Cls.: 100, 101 and 102

United States Patent and Trademark Office

Reg. No. 3,483,849

Registered Aug. 12, 2008

**SERVICE MARK
PRINCIPAL REGISTER**

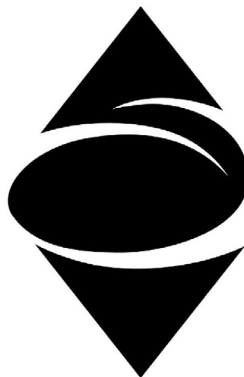

OTTER TAIL CORPORATION (MINNESOTA CORPORATION)
P.O. BOX 496
215 SOUTH CASCADE STREET
FERGUS FALLS, MN 565380496

FOR: HOLDING COMPANY SERVICES PROVIDED TO OTHER THAN THE APPLICANT'S OWN HELD COMPANIES, NAMELY, ACQUISITION, MANAGEMENT, AND TRANSFER OF COMPANY STAKES AS WELL AS THE INTERMEDIATION OF EQUITY CAPITAL FINANCING OF COMPANIES, NAMELY, ASSET ACQUISITION, CONSULTATION, DEVELOPMENT AND MANAGEMENT SERVICES; FINANCIAL SERVICES, NAMELY FINANCIAL

ANALYSIS AND CONSULTATION; FINANCIAL PLANNING; FINANCIAL RISK MANAGEMENT, IN CLASS 36 (U.S. CLS. 100, 101 AND 102).

FIRST USE 6-30-2001; IN COMMERCE 6-30-2001.

THE MARK CONSISTS OF A VERTICAL DIAMOND SHAPE INTERSECTED HORIZONTALLY BY AN OVAL-SHAPED SWIRL.

SER. NO. 77-321,102, FILED 11-5-2007.

BRENDAN REGAN, EXAMINING ATTORNEY

Int. Cl.: 7

Prior U.S. Cls.: 13, 19, 21, 23, 31, 34 and 35

Reg. No. 3,483,850

United States Patent and Trademark Office

Registered Aug. 12, 2008

**TRADEMARK
PRINCIPAL REGISTER**

Baoda

SUNSHINE ENTERPRISE, INC. (DELAWARE CORPORATION)
2005 FLETCHER CREEK DR.
MEMPHIS, TN 38133

FOR: HOISTS; STORAGE MACHINERY, NAME-
LY, A VERTICAL HOIST FOR RAISING AND
STORING RECREATIONAL EQUIPMENT, SPORT-
ING GOODS AND HOUSEHOLD ITEMS ELEVATED
FROM GROUND LEVEL, IN CLASS 7 (U.S. CLS. 13,
19, 21, 23, 31, 34 AND 35).

FIRST USE 5-1-2007; IN COMMERCE 5-1-2007.

THE MARK CONSISTS OF STANDARD CHAR-
ACTERS WITHOUT CLAIM TO ANY PARTICULAR
FONT, STYLE, SIZE, OR COLOR.

THE FOREIGN WORDING IN THE MARK
TRANSLATES INTO ENGLISH AS "TREASURE
OBTAINED".

SER. NO. 77-321,113, FILED 11-5-2007.

ERNEST SHOSHO, EXAMINING ATTORNEY

Int. Cl.: 35

Prior U.S. Cls.: 100, 101 and 102

United States Patent and Trademark Office

Reg. No. 3,483,851

Registered Aug. 12, 2008

**SERVICE MARK
PRINCIPAL REGISTER**

V-CARD

VC CONCIERGE SERVICES, LLC (NEBRASKA
LTD LIAB CO)
13227 "B" STREET
OMAHA, NE 68144

FOR: PROMOTING THE GOODS AND SERVICES
OF OTHERS, NAMELY, RESTAURANT, RETAIL
STORE, ENTERTAINMENT VENUE, RETAIL PRO-
DUCTS, AND SERVICES THROUGH THE DISTRI-
BUTION OF DISCOUNT CARDS AND CUSTOMER
REWARD CARD PROGRAM, IN CLASS 35 (U.S.
CLS. 100, 101 AND 102).

FIRST USE 6-15-2006; IN COMMERCE 9-17-2006.

THE MARK CONSISTS OF STANDARD CHAR-
ACTERS WITHOUT CLAIM TO ANY PARTICULAR
FONT, STYLE, SIZE, OR COLOR.

SER. NO. 77-321,154, FILED S.R. 11-5-2007 AM. P.R.
2-21-2008.

LINDA E. BLOHM, EXAMINING ATTORNEY

Int. Cls.: 11 and 42

Prior U.S. Cls.: 13, 21, 23, 31, 34, 100 and 101

United States Patent and Trademark Office

Reg. No. 3,483,852

Registered Aug. 12, 2008

**TRADEMARK
SERVICE MARK
PRINCIPAL REGISTER**

OpenCEL 

OPENCEL LLC (ILLINOIS LTD LIAB CO)
315 PARK AVENUE
GLENCOE, IL 60022

FOR: WASTE AND WASTEWATER TREATMENT
UNITS, IN CLASS 11 (U.S. CLS. 13, 21, 23, 31 AND 34).

FIRST USE 3-31-2007; IN COMMERCE 3-31-2007.

FOR: ENGINEERING AND DESIGN SERVICES
RELATING TO THE CONSTRUCTION OF WATER
TREATMENT AND PURIFICATION PLANTS,

WASTE TREATMENT PLANTS AND MUNICIPAL
AND COMMERCIAL INFRASTRUCTURE FACIL-
ITIES, IN CLASS 42 (U.S. CLS. 100 AND 101).

FIRST USE 1-31-2007; IN COMMERCE 1-31-2007.

THE WORDING "OPENCEL" HAS NO MEANING
IN A FOREIGN LANGUAGE.

SER. NO. 77-321,583, FILED 11-5-2007.

ZACHARY BELLO, EXAMINING ATTORNEY

Int. Cls.: 11 and 42

Prior U.S. Cls.: 13, 21, 23, 31, 34, 100 and 101

United States Patent and Trademark Office

Reg. No. 3,483,853

Registered Aug. 12, 2008

**TRADEMARK
SERVICE MARK
PRINCIPAL REGISTER**

OpenCEL

OPENCEL LLC (ILLINOIS LTD LIAB CO)
315 PARK AVENUE
GLENCOE, IL 60022

FOR: WASTE AND WASTEWATER TREATMENT
UNITS, IN CLASS 11 (U.S. CLS. 13, 21, 23, 31 AND 34).

FIRST USE 3-31-2007; IN COMMERCE 3-31-2007.

FOR: ENGINEERING AND DESIGN SERVICES
RELATING TO THE CONSTRUCTION OF WATER
TREATMENT AND PURIFICATION PLANTS,
WASTE TREATMENT PLANTS AND MUNICIPAL
AND COMMERCIAL INFRASTRUCTURE FACIL-
ITIES, IN CLASS 42 (U.S. CLS. 100 AND 101).

FIRST USE 1-31-2007; IN COMMERCE 1-31-2007.

THE MARK CONSISTS OF STANDARD CHAR-
ACTERS WITHOUT CLAIM TO ANY PARTICULAR
FONT, STYLE, SIZE, OR COLOR.

THE WORDING "OPENCEL" HAS NO MEANING
IN A FOREIGN LANGUAGE.

SER. NO. 77-321,585, FILED 11-5-2007.

ZACHARY BELLO, EXAMINING ATTORNEY

Int. Cl.: 36

Prior U.S. Cls.: 100, 101 and 102

United States Patent and Trademark Office

Reg. No. 3,483,854

Registered Aug. 12, 2008

**SERVICE MARK
PRINCIPAL REGISTER**

LINCOLN STATE BANK

MERCHANTS & MANUFACTURERS BANCORPORATION, INC. (WISCONSIN CORPORATION)
5445 S. WESTRIDGE DRIVE
NEW BERLIN, WI 53151

FOR: BANKING; BANKING SERVICES, IN CLASS 36 (U.S. CLS. 100, 101 AND 102).

FIRST USE 1-2-1919; IN COMMERCE 1-2-1919.

THE MARK CONSISTS OF STANDARD CHARACTERS WITHOUT CLAIM TO ANY PARTICULAR FONT, STYLE, SIZE, OR COLOR.

NO CLAIM IS MADE TO THE EXCLUSIVE RIGHT TO USE "STATE BANK", APART FROM THE MARK AS SHOWN.

THE NAME(S), PORTRAIT(S), AND/OR SIGNATURE(S) SHOWN IN THE MARK DOES NOT IDENTIFY A PARTICULAR LIVING INDIVIDUAL.

SEC. 2(F).

SER. NO. 77-321,879, FILED 11-5-2007.

ALICIA COLLINS, EXAMINING ATTORNEY

Int. Cl.: 36

Prior U.S. Cls.: 100, 101 and 102

United States Patent and Trademark Office

Reg. No. 3,483,855

Registered Aug. 12, 2008

**SERVICE MARK
PRINCIPAL REGISTER**

FRANKLIN STATE BANK

MERCHANTS & MANUFACTURERS BANCORPORATION, INC. (WISCONSIN CORPORATION)
5445 S. WESTRIDGE DRIVE
NEW BERLIN, WI 53151

FOR: BANKING; BANKING SERVICES, IN CLASS 36 (U.S. CLS. 100, 101 AND 102).

FIRST USE 11-15-1982; IN COMMERCE 11-15-1982.

THE MARK CONSISTS OF STANDARD CHARACTERS WITHOUT CLAIM TO ANY PARTICULAR FONT, STYLE, SIZE, OR COLOR.

NO CLAIM IS MADE TO THE EXCLUSIVE RIGHT TO USE "STATE BANK", APART FROM THE MARK AS SHOWN.

THE NAME(S), PORTRAIT(S), AND/OR SIGNATURE(S) SHOWN IN THE MARK DOES NOT IDENTIFY A PARTICULAR LIVING INDIVIDUAL.

SEC. 2(F).

SER. NO. 77-321,889, FILED 11-5-2007.

ALICIA COLLINS, EXAMINING ATTORNEY

Int. Cl.: 36

Prior U.S. Cls.: 100, 101 and 102

United States Patent and Trademark Office

Reg. No. 3,483,856

Registered Aug. 12, 2008

**SERVICE MARK
PRINCIPAL REGISTER**

GRAFTON STATE BANK

MERCHANTS & MANUFACTURERS BANCORPORATION, INC. (WISCONSIN CORPORATION)
5445 S. WESTRIDGE DRIVE
NEW BERLIN, WI 53151

NO CLAIM IS MADE TO THE EXCLUSIVE RIGHT TO USE "STATE BANK", APART FROM THE MARK AS SHOWN.

FOR: BANKING; BANKING SERVICES, IN CLASS 36 (U.S. CLS. 100, 101 AND 102).

SEC. 2(F).

FIRST USE 1-15-1907; IN COMMERCE 1-15-1907.

SER. NO. 77-321,898, FILED 11-5-2007.

THE MARK CONSISTS OF STANDARD CHARACTERS WITHOUT CLAIM TO ANY PARTICULAR FONT, STYLE, SIZE, OR COLOR.

ALICIA COLLINS, EXAMINING ATTORNEY

Int. Cl.: 36

Prior U.S. Cls.: 100, 101 and 102

United States Patent and Trademark Office

Reg. No. 3,483,857

Registered Aug. 12, 2008

**SERVICE MARK
PRINCIPAL REGISTER**

WISCONSIN STATE BANK

MERCHANTS & MANUFACTURERS BANCORPORATION, INC. (WISCONSIN CORPORATION)
5445 S. WESTRIDGE DRIVE
NEW BERLIN, WI 53151

NO CLAIM IS MADE TO THE EXCLUSIVE RIGHT TO USE "STATE BANK", APART FROM THE MARK AS SHOWN.

FOR: BANKING; BANKING SERVICES, IN CLASS 36 (U.S. CLS. 100, 101 AND 102).

SEC. 2(F).

FIRST USE 1-12-2000; IN COMMERCE 1-12-2000.

SER. NO. 77-321,916, FILED 11-5-2007.

THE MARK CONSISTS OF STANDARD CHARACTERS WITHOUT CLAIM TO ANY PARTICULAR FONT, STYLE, SIZE, OR COLOR.

ALICIA COLLINS, EXAMINING ATTORNEY

Int. Cl.: 36

Prior U.S. Cls.: 100, 101 and 102

United States Patent and Trademark Office

Reg. No. 3,483,858

Registered Aug. 12, 2008

**SERVICE MARK
PRINCIPAL REGISTER**

THE REEDSBURG BANK

MERCHANTS & MANUFACTURERS BANCORPORATION, INC. (WISCONSIN CORPORATION)
5445 S. WESTRIDGE DRIVE
NEW BERLIN, WI 53151

NO CLAIM IS MADE TO THE EXCLUSIVE RIGHT TO USE "BANK", APART FROM THE MARK AS SHOWN.

FOR: BANKING; BANKING SERVICES, IN CLASS 36 (U.S. CLS. 100, 101 AND 102).

SEC. 2(F).

FIRST USE 1-2-1865; IN COMMERCE 1-2-1865.

SER. NO. 77-321,925, FILED 11-5-2007.

THE MARK CONSISTS OF STANDARD CHARACTERS WITHOUT CLAIM TO ANY PARTICULAR FONT, STYLE, SIZE, OR COLOR.

ALICIA COLLINS, EXAMINING ATTORNEY

Int. Cl.: 36

Prior U.S. Cls.: 100, 101 and 102

United States Patent and Trademark Office

Reg. No. 3,483,859

Registered Aug. 12, 2008

**SERVICE MARK
PRINCIPAL REGISTER**

FORTRESS BANK

MERCHANTS & MANUFACTURERS BANCORPORATION, INC. (WISCONSIN CORPORATION)
5445 S. WESTRIDGE DRIVE
NEW BERLIN, WI 53151

FOR: BANKING; BANKING SERVICES, IN CLASS 36 (U.S. CLS. 100, 101 AND 102).

FIRST USE 1-2-1919; IN COMMERCE 1-2-1919.

THE MARK CONSISTS OF STANDARD CHARACTERS WITHOUT CLAIM TO ANY PARTICULAR FONT, STYLE, SIZE, OR COLOR.

OWNER OF U.S. REG. NOS. 2,147,194 AND 2,147,196.

NO CLAIM IS MADE TO THE EXCLUSIVE RIGHT TO USE "BANK", APART FROM THE MARK AS SHOWN.

SER. NO. 77-321,930, FILED 11-5-2007.

ALICIA COLLINS, EXAMINING ATTORNEY

Int. Cl.: 29

Prior U.S. Cl.: 46

United States Patent and Trademark Office

Reg. No. 3,483,860

Registered Aug. 12, 2008

**TRADEMARK
PRINCIPAL REGISTER**



OSKALOOSA FOOD PRODUCTS CORPORATION
(IOWA CORPORATION)
546 NINTH AVE EAST
OSKALOOSA, IA 52577

FOR: DRIED EGGS; EGG WHITES; EGG YOLKS;
EGGS; FROZEN EGGS, IN CLASS 29 (U.S. CL. 46).

FIRST USE 11-1-2001; IN COMMERCE 11-1-2001.

OWNER OF U.S. REG. NOS. 2,309,298, 2,680,380
AND OTHERS.

THE COLOR(S) BLUE, WHITE, GREEN, BLACK
IS/ARE CLAIMED AS A FEATURE OF THE MARK.

THE MARK CONSISTS OF A DEPICTION OF THE
EARTH IN AN EGG SHAPE. OCEAN AREAS ARE
SHOWN IN BLUE AND BLACK, CLOUDS AND
MOUNTAINS ARE WHITE, LAND AREAS ARE
GREEN AND BLACK..

SER. NO. 77-321,938, FILED 11-5-2007.

WARREN L. OLANDRIA, EXAMINING ATTOR-
NEY

Int. Cl.: 36

Prior U.S. Cls.: 100, 101 and 102

United States Patent and Trademark Office

Reg. No. 3,483,861

Registered Aug. 12, 2008

**SERVICE MARK
PRINCIPAL REGISTER**

SVEDKA

SPIRITS MARQUE ONE LLC (DELAWARE LTD
LIAB CO)
598 MADISON AVENUE, SUITE 4R
NEW YORK, NY 10022

FOR: FINANCIAL SPONSORSHIP OF ENTERTAINMENT EVENTS, FASHION SHOWS, NIGHT-LIFE AND LIFESTYLE EVENTS, CULTURAL EVENTS AND MUSICAL PERFORMANCES, IN CLASS 36 (U.S. CLS. 100, 101 AND 102).

FIRST USE 0-0-2004; IN COMMERCE 0-0-2004.

THE MARK CONSISTS OF STANDARD CHARACTERS WITHOUT CLAIM TO ANY PARTICULAR FONT, STYLE, SIZE, OR COLOR.

OWNER OF U.S. REG. NO. 2,126,196.

SER. NO. 77-321,953, FILED 11-5-2007.

SOPHIA S. KIM, EXAMINING ATTORNEY

Int. Cl.: 37

Prior U.S. Cls.: 100, 103 and 106

United States Patent and Trademark Office

Reg. No. 3,483,862

Registered Aug. 12, 2008

**SERVICE MARK
PRINCIPAL REGISTER**



LIBERTY
EXTERIORS^{INC}

LIBERTY EXTERIORS, INC. (WISCONSIN CORPORATION), DBA LIBERTY SIDING
855 INDUSTRIAL DR
MONDOVI, WI 54755

THE COLOR(S) WHITE, BLACK, ORANGE, BLUE AND GRAY IS/ARE CLAIMED AS A FEATURE OF THE MARK.

FOR: CONSTRUCTING DECKS; CONSTRUCTING PORCHES; CONSTRUCTING SUNROOMS; CONSTRUCTION AND RENOVATION OF BUILDINGS; CONSTRUCTION AND REPAIR OF BUILDINGS; INSTALLING SIDING; ROOFING INSTALLATION; ROOFING REPAIR; ROOFING SERVICES; INSTALLATION OF DOORS AND WINDOWS; INSTALLATION OF RAIN GUTTERS AND DOWNSPOUTS, IN CLASS 37 (U.S. CLS. 100, 103 AND 106).

THE COLOR WHITE APPEARS IN THE TORCH. THE COLOR BLACK APPEARS IN THE TORCH AND THE OUTLINING OF THE FLAME. THE COLOR BLUE APPEARS IN THE WORDING "LIBERTY EXTERIORS INC". THE COLOR ORANGE APPEARS IN THE FLAME OF THE TORCH. THE COLOR GRAY APPEARS IN THE SHADOWING OF THE WORDING "LIBERTY EXTERIORS INC".

FIRST USE 6-1-2004; IN COMMERCE 6-1-2004.

SER. NO. 77-322,113, FILED 11-6-2007.

NO CLAIM IS MADE TO THE EXCLUSIVE RIGHT TO USE "EXTERIORS INC", APART FROM THE MARK AS SHOWN.

BRENDAN MCCAULEY, EXAMINING ATTORNEY

Int. Cl.: 16

Prior U.S. Cls.: 2, 5, 22, 23, 29, 37, 38 and 50

Reg. No. 3,483,863

United States Patent and Trademark Office

Registered Aug. 12, 2008

**TRADEMARK
PRINCIPAL REGISTER**



BARG-N-FINDERS, INC. (VIRGINIA CORPORATION)
P.O. BOX 947
TAZEWELL, VA 24651

FOR: CLASSIFIED DIRECTORIES, IN CLASS 16
(U.S. CLS. 2, 5, 22, 23, 29, 37, 38 AND 50).

FIRST USE 10-1-2007; IN COMMERCE 10-1-2007.

THE COLOR(S) BLACK, WHITE, YELLOW, BLUE,
GRAY, AND RED IS/ARE CLAIMED AS A FEATURE
OF THE MARK.

THE MARK CONSISTS OF THE WORDING
"RIDE-FINDERS" APPEARING IN THE COLOR
YELLOW OUTLINED WITH BLACK AND THEN
WHITE LINES; THE WORDING APPEARS IN A
BLACK RECTANGULAR DESIGN THAT IS OUT-
LINED WITH BLUE, THEN RED, THEN BLACK
LINES; BLACK TIRES WITH GRAY WHEELS OUT-
LINED IN BLACK APPEAR IN THE TWO LETTER
"D'S" IN THE WORDING "RIDE-FINDERS."

SER. NO. 77-322,225, FILED 11-6-2007.

LAURA HAMMEL, EXAMINING ATTORNEY

Int. Cl.: 37

Prior U.S. Cls.: 100, 103 and 106

United States Patent and Trademark Office

Reg. No. 3,483,864

Registered Aug. 12, 2008

**SERVICE MARK
PRINCIPAL REGISTER**

"Let us clean your home so
that you don't have to"

MY TRAVELING HOUSEKEEPER, LLC (UTAH
LTD LIAB CO)
110 W 13775 SO #3
138 EAST 12300 SOUTH
DRAPER, UT 84020

FOR: CLEANING SERVICES, NAMELY, INTER-
IOR AND EXTERIOR CLEANING OF RESIDEN-
TIAL AND COMMERCIAL PROPERTIES, IN CLASS
37 (U.S. CLS. 100, 103 AND 106).

FIRST USE 7-5-2005; IN COMMERCE 7-5-2005.

THE MARK CONSISTS OF STANDARD CHAR-
ACTERS WITHOUT CLAIM TO ANY PARTICULAR
FONT, STYLE, SIZE, OR COLOR.

SER. NO. 77-322,345, FILED 11-6-2007.

NAAKWAMA ANKRAH, EXAMINING ATTORNEY

Int. Cl.: 41

Prior U.S. Cls.: 100, 101 and 107

United States Patent and Trademark Office

Reg. No. 3,483,865

Registered Aug. 12, 2008

SERVICE MARK
PRINCIPAL REGISTER



NATIONAL INFORMATION SOLUTIONS COOP-
ERATIVE, INC. (COLORADO CORPORATION)
ONE INNOVATION CIRCLE
LAKE ST. LOUIS, MO 63367

FOR: COMPUTER EDUCATION TRAINING;
EDUCATION IN THE FIELD OF TECHNOLOGY
RENDERED THROUGH CORRESPONDENCE
COURSES; EDUCATION IN THE FIELD OF TECH-
NOLOGY RENDERED THROUGH VIDEO CON-
FERENCE; EDUCATION SERVICES, NAMELY,
MENTORING IN THE FIELD OF TECHNOLOGY;
EDUCATION SERVICES, NAMELY, PROVIDING
LIVE AND ON-LINE CLASSES, SEMINARS, WORK-
SHIPS IN THE FIELD OF TECHNOLOGY; EDU-
CATION SERVICES, NAMELY, PROVIDING
TUTORING IN THE FIELD OF TECHNOLOGY;
EDUCATIONAL ASSESSMENT; EDUCATIONAL
COURSE MONITORING, NAMELY, TRACKING
STUDENT PERFORMANCE; EDUCATIONAL DE-
MONSTRATIONS; EDUCATIONAL SERVICES,
NAMELY, CONDUCTING INFORMAL PROGRAMS
IN THE FIELDS OF TECHNOLOGY, USING ON-
LINE ACTIVITIES AND INTERACTIVE EXHIBITS,
AND PRINTABLE MATERIALS DISTRIBUTED
THEREWITH; EDUCATIONAL SERVICES, NAME-
LY, DEVELOPING, ARRANGING, AND CONDUCT-
ING EDUCATIONAL CONFERENCES AND
PROGRAMS AND PROVIDING COURSES OF IN-
STRUCTION IN THE FIELD OF TECHNOLOGY;
EDUCATIONAL SERVICES, NAMELY, PROVIDING
INCENTIVES TO EMPLOYEES AND USERS TO

DEMONSTRATE EXCELLENCE IN THE FIELD OF
TECHNOLOGY; EDUCATIONAL SERVICES,
NAMELY, PROVIDING INTERNSHIPS AND AP-
PRENTICESHIPS IN THE FIELD OF TECHNOLOGY
, IN CLASS 41 (U.S. CLS. 100, 101 AND 107).

FIRST USE 1-1-2006; IN COMMERCE 1-1-2006.

OWNER OF U.S. REG. NO. 3,025,203.

NO CLAIM IS MADE TO THE EXCLUSIVE
RIGHT TO USE "IT NATIONAL LEARNING Cen-
TER", APART FROM THE MARK AS SHOWN.

THE COLOR(S) RED, BLUE, GREY IS/ARE
CLAIMED AS A FEATURE OF THE MARK.

THE MARK CONSISTS OF A STYLIZED RED "I"
NEXT TO THE ACRONYM "NISC," IN BLUE, AND
THE WORDS NATIONAL LEARNING CENTER, IN
BLUE, ABOVE A STYLIZED RED "T," AND THE
PREVIOUSLY-REGISTERED NISC SWOOSH LOGO,
WHICH CONSISTS OF THE LETTERS "NISC" IN
GREY, SURROUNDED ABOVE AND BELOW BY
TWO RED SWOOSHES, ALL ON A WHITE BACK-
GROUND.

SER. NO. 77-322,606, FILED 11-6-2007.

BARBARA BROWN, EXAMINING ATTORNEY

Int. Cl.: 36

Prior U.S. Cls.: 100, 101 and 102

United States Patent and Trademark Office

Reg. No. 3,483,866

Registered Aug. 12, 2008

**SERVICE MARK
PRINCIPAL REGISTER**



FLEETWOOD BANK (PENNSYLVANIA CORPORATION)
MAIN AND FRANKLIN STREETS
FLEETWOOD, PA 19522

FOR: BANKING, IN CLASS 36 (U.S. CLS. 100, 101 AND 102).

FIRST USE 4-3-2006; IN COMMERCE 4-3-2006.

NO CLAIM IS MADE TO THE EXCLUSIVE RIGHT TO USE "BANK" , APART FROM THE MARK AS SHOWN.

THE COLOR(S) BLUE, GREE AND WHITE IS/ARE CLAIMED AS A FEATURE OF THE MARK.

THE MARK CONSISTS OF AGAINST A WHITE BACKGROUND, THE WORDS "FLEETWOOD BANK" APPEAR IN BLUE, WITH A BLUE SWOOSH ABOVE THE WORD "FLEETWOOD", AND BELOW THE WORD "FLEETWOOD" AND TO THE RIGHT OF THE WORD "BANK" APPEAR THREE SWOOSHES IN GREEN.

SER. NO. 77-322,616, FILED 11-6-2007.

MARGERY A. TIERNEY, EXAMINING ATTORNEY

Int. Cls.: 36 and 39

Prior U.S. Cls.: 100, 101, 102 and 105

United States Patent and Trademark Office

Reg. No. 3,483,867

Registered Aug. 12, 2008

**SERVICE MARK
PRINCIPAL REGISTER**

ISLAND GARDENS

FLAGSTONE ISLAND GARDENS, LLC (DELA-
WARE LTD LIAB CO)
1674 MERIDIAN AVENUE, 3RD FLOOR
MIAMI BEACH, FL 33139

FOR: LEASING AND MANAGEMENT OF REAL
ESTATE; LEASING OF RETAIL, RESTAURANT
AND HOTEL SPACE, IN CLASS 36 (U.S. CLS. 100,
101 AND 102).

FIRST USE 7-16-2001; IN COMMERCE 0-0-2002.

FOR: MARINA SERVICES, IN CLASS 39 (U.S. CLS.
100 AND 105).

FIRST USE 7-16-2001; IN COMMERCE 0-0-2002.

THE MARK CONSISTS OF STANDARD CHAR-
ACTERS WITHOUT CLAIM TO ANY PARTICULAR
FONT, STYLE, SIZE, OR COLOR.

SER. NO. 77-322,643, FILED 11-6-2007.

KIMBERLY PERRY, EXAMINING ATTORNEY

Int. Cl.: 37

Prior U.S. Cls.: 100, 103 and 106

United States Patent and Trademark Office

Reg. No. 3,483,868

Registered Aug. 12, 2008

**SERVICE MARK
PRINCIPAL REGISTER**

My Traveling Housekeeper
"We do it for you."

MY TRAVELING HOUSEKEEPER, LLC (UTAH
LTD LIAB CO)
110 W 13775 SO #3
138 EAST 12300 SOUTH
DRAPER, UT 84020

FOR: CLEANING SERVICES FOR RESIDENTIAL
AND COMMERCIAL PROPERTIES, NAMELY, IN-
TERIOR AND EXTERIOR CLEANING OF BUILD-
INGS, IN CLASS 37 (U.S. CLS. 100, 103 AND 106).

FIRST USE 10-29-2007; IN COMMERCE 10-29-2007.

THE MARK CONSISTS OF STANDARD CHAR-
ACTERS WITHOUT CLAIM TO ANY PARTICULAR
FONT, STYLE, SIZE, OR COLOR.

NO CLAIM IS MADE TO THE EXCLUSIVE
RIGHT TO USE "HOUSEKEEPER", APART FROM
THE MARK AS SHOWN.

SER. NO. 77-322,877, FILED 11-6-2007.

NAAKWAMA ANKRAH, EXAMINING ATTORNEY

Int. Cl.: 21

Prior U.S. Cls.: 2, 13, 23, 29, 30, 33, 40 and 50

Reg. No. 3,483,869

United States Patent and Trademark Office

Registered Aug. 12, 2008

**TRADEMARK
PRINCIPAL REGISTER**

COLOR CAST KINETIC

PATHWAY INVESTMENT CORP. (NEW JERSEY CORPORATION), DBA KINETIC, A DIVISION OF PATHWAY
401 NEW YORK AVENUE
WYCKOFF, NJ 07481

FOR: POTS, PANS, NON-ELECTRIC GRILLS, NON-ELECTRIC FRYING PANS, BOWLS, SAUTE PANS, MULTI-USE POTS, CLAM POTS, LASAGNA PANS, PAELLA PANS, TEAKETTLES, GRIDDLES, STOCKPOTS, ROASTERS, SAUCEPANS, NON-ELECTRIC CHICKEN FRYERS, NON-ELECTRIC PRESSURE COOKERS, MIXING SPOONS, SERVING

SPOONS, AND BASTING SPOONS, IN CLASS 21 (U.S. CLS. 2, 13, 23, 29, 30, 33, 40 AND 50).

FIRST USE 12-1-2006; IN COMMERCE 8-1-2007.

THE MARK CONSISTS OF STANDARD CHARACTERS WITHOUT CLAIM TO ANY PARTICULAR FONT, STYLE, SIZE, OR COLOR.

SER. NO. 77-323,273, FILED 11-7-2007.

DAWN FELDMAN, EXAMINING ATTORNEY

Int. Cl.: 19

Prior U.S. Cls.: 1, 12, 33 and 50

United States Patent and Trademark Office

Reg. No. 3,483,870

Registered Aug. 12, 2008

**TRADEMARK
PRINCIPAL REGISTER**

Trash Guard

TRASH GUARD, INC. (NORTH CAROLINA CORPORATION)

6320 GAINSBOROUGH DRIVE

RALEIGH, NC 27612

FOR: NON-METAL STORM WATER SCREENS,
IN CLASS 19 (U.S. CLS. 1, 12, 33 AND 50).

FIRST USE 8-31-2005; IN COMMERCE 8-31-2005.

THE MARK CONSISTS OF STANDARD CHARACTERS WITHOUT CLAIM TO ANY PARTICULAR FONT, STYLE, SIZE, OR COLOR.

NO CLAIM IS MADE TO THE EXCLUSIVE RIGHT TO USE "TRASH", APART FROM THE MARK AS SHOWN.

SER. NO. 77-323,616, FILED 11-7-2007.

LINDA M. KING, EXAMINING ATTORNEY

Int. Cl.: 9

Prior U.S. Cls.: 21, 23, 26, 36 and 38

Reg. No. 3,483,871

United States Patent and Trademark Office

Registered Aug. 12, 2008

**TRADEMARK
PRINCIPAL REGISTER**

CheeseCrafter

PAGE & PEDERSEN, INC. (DELAWARE CORPORATION)
158 WEST MAIN STREET
HOPKINTON, MA 01748

THE MARK CONSISTS OF STANDARD CHARACTERS WITHOUT CLAIM TO ANY PARTICULAR FONT, STYLE, SIZE, OR COLOR.

FOR: COMPUTER SOFTWARE USED TO IMPROVE CHEESE-MAKING PROCESS BY USE OF MILK COMPOSITION DATA, IN CLASS 9 (U.S. CLS. 21, 23, 26, 36 AND 38).

SER. NO. 77-323,695, FILED 11-7-2007.

FIRST USE 2-12-2007; IN COMMERCE 5-16-2007.

SUSAN LESLIE DUBOIS, EXAMINING ATTORNEY

Int. Cls.: 41, 44 and 45

Prior U.S. Cls.: 100, 101 and 107

United States Patent and Trademark Office

Reg. No. 3,483,872

Registered Aug. 12, 2008

**SERVICE MARK
PRINCIPAL REGISTER**

MODERN MOM

MODERN MOM, INC. (DELAWARE CORPORATION)
8335 W SUNSET BLVD
LOS ANGELES, CA 90069

FOR: PROVIDING A WEBSITE FEATURING INFORMATION AND CONTENT IN THE FIELD OF PARENTING CONCERNING EDUCATION AND ENTERTAINMENT OF CHILDREN; PROVIDING A WEBSITE FEATURING INFORMATION AND CONTENT IN THE FIELD OF ENTERTAINMENT, IN CLASS 41 (U.S. CLS. 100, 101 AND 107).

FIRST USE 12-1-2002; IN COMMERCE 11-1-2003.

FOR: PROVIDING A WEBSITE FEATURING INFORMATION AND CONTENT IN THE FIELD OF PARENTING CONCERNING THE HEALTH OF CHILDREN; PROVIDING A WEBSITE FEATURING INFORMATION AND CONTENT IN THE FIELD OF HUMAN HEALTH, IN CLASS 44 (U.S. CLS. 100 AND 101).

FIRST USE 12-1-2002; IN COMMERCE 11-1-2003.

FOR: PROVIDING A WEBSITE FEATURING INFORMATION AND CONTENT IN THE FIELD OF PARENTING CONCERNING INTRAFAMILY RELATIONSHIPS, PROVIDING A WEBSITE FEATURING INFORMATION AND CONTENT IN THE FIELDS OF PERSONAL RELATIONSHIPS AND FASHION, PROVIDING A WEBSITE FEATURING INFORMATION AND CONTENT ON LIFESTYLES, IN CLASS 45 (U.S. CLS. 100 AND 101).

FIRST USE 12-1-2002; IN COMMERCE 11-1-2003.

THE MARK CONSISTS OF STANDARD CHARACTERS WITHOUT CLAIM TO ANY PARTICULAR FONT, STYLE, SIZE, OR COLOR.

NO CLAIM IS MADE TO THE EXCLUSIVE RIGHT TO USE "MOM", APART FROM THE MARK AS SHOWN.

SER. NO. 77-323,778, FILED 11-7-2007.

JENNIFER MARTIN, EXAMINING ATTORNEY

Int. Cl.: 3

Prior U.S. Cls.: 1, 4, 6, 50, 51 and 52

United States Patent and Trademark Office

Reg. No. 3,483,873

Registered Aug. 12, 2008

**TRADEMARK
PRINCIPAL REGISTER**

**THE SCIENCE OF SKINCARE
FOR HAIR**

ALTERNA HOLDINGS CORPORATION (DELA-
WARE CORPORATION)
2029 CENTURY PARK EAST, #1300
CENTURY CITY, CA 90067

FOR: HAIR CARE PREPARATIONS; HAIR
SHAMPOOS; HAIR CONDITIONERS; HAIR STY-
LING PREPARATIONS; BODY WASHES, IN CLASS
3 (U.S. CLS. 1, 4, 6, 50, 51 AND 52).

FIRST USE 9-4-2007; IN COMMERCE 9-4-2007.

THE MARK CONSISTS OF STANDARD CHAR-
ACTERS WITHOUT CLAIM TO ANY PARTICULAR
FONT, STYLE, SIZE, OR COLOR.

SER. NO. 77-324,146, FILED 11-7-2007.

MYRIAH HABEEB, EXAMINING ATTORNEY

Int. Cl.: 33

Prior U.S. Cls.: 47 and 49

United States Patent and Trademark Office

Reg. No. 3,483,874

Registered Aug. 12, 2008

**TRADEMARK
PRINCIPAL REGISTER**

YPSILON

SOCIEDADE AGRICOLA DA QUINTA DE
MATA-MOUROS, S.A. (PORTUGAL SOCIE-
DADE ANÓNIMA)

17TH FLOOR

AMOREIRAS, TORRE 2

LISBOA, PORTUGAL 1070-102

FOR: ALCOHOLIC BEVERAGES EXCEPT BEERS,
IN CLASS 33 (U.S. CLS. 47 AND 49).

THE MARK CONSISTS OF STANDARD CHAR-
ACTERS WITHOUT CLAIM TO ANY PARTICULAR
FONT, STYLE, SIZE, OR COLOR.

OWNER OF PORTUGAL REG. NO. 386937, DA-
TED 8-11-2005, EXPIRES 8-11-2015.

SER. NO. 77-324,561, FILED 11-8-2007.

SANDRA MANIOS, EXAMINING ATTORNEY

Int. Cl.: 41

Prior U.S. Cls.: 100, 101 and 107

United States Patent and Trademark Office

Reg. No. 3,483,875

Registered Aug. 12, 2008

**SERVICE MARK
PRINCIPAL REGISTER**

AFMI

AMERICAN FEDERATION OF MUSLIMS OF
INDIAN ORIGIN (MICHIGAN CORPORATION)

29008 W. EIGHT MILE ROAD
FARMINGTON, MI 48302

FOR: CHARITABLE AND EDUCATIONAL SERVICES, NAMELY, CONDUCTING EDUCATIONAL PROGRAMS THAT TEACH AND ENCOURAGE THE DEVELOPMENT OF READING SKILLS IN DISADVANTAGED GROUPS, IN CLASS 41 (U.S. CLS. 100, 101 AND 107).

FIRST USE 12-28-1989; IN COMMERCE 12-28-1989.

THE MARK CONSISTS OF STANDARD CHARACTERS WITHOUT CLAIM TO ANY PARTICULAR FONT, STYLE, SIZE, OR COLOR.

SER. NO. 77-324,694, FILED 11-8-2007.

ANDREW RHIM, EXAMINING ATTORNEY

Int. Cl.: 35

Prior U.S. Cls.: 100, 101 and 102

United States Patent and Trademark Office

Reg. No. 3,483,876

Registered Aug. 12, 2008

**SERVICE MARK
PRINCIPAL REGISTER**

ADOPT A PILOT

SOUTHWEST AIRLINES CO. (TEXAS CORPORATION)
2702 LOVE FIELD DRIVE
DALLAS, TX 752351611

FOR: PROMOTING PUBLIC INTEREST IN MATH, SCIENCE AND AVIATION TO SCHOOL AGED CHILDREN, IN CLASS 35 (U.S. CLS. 100, 101 AND 102).

FIRST USE 3-0-1997; IN COMMERCE 9-0-1997.

THE MARK CONSISTS OF STANDARD CHARACTERS WITHOUT CLAIM TO ANY PARTICULAR FONT, STYLE, SIZE, OR COLOR.

SER. NO. 77-324,737, FILED 11-8-2007.

FRANK LATTUCA, EXAMINING ATTORNEY

Int. Cls.: 7 and 9

Prior U.S. Cls.: 13, 19, 21, 23, 26, 31, 34, 35, 36 and 38

Reg. No. 3,483,877

United States Patent and Trademark Office

Registered Aug. 12, 2008

**TRADEMARK
PRINCIPAL REGISTER**

PRESTEL

PRESTOLITE WIRE CORPORATION (DELA-
WARE CORPORATION)
SUITE 212
200 GALLERIA OFFICENTRE
SOUTHFIELD, MI 48034

FOR: IGNITION WIRES; SPARK PLUG BOOTS, IN
CLASS 7 (U.S. CLS. 13, 19, 21, 23, 31, 34 AND 35).

FIRST USE 0-0-1981; IN COMMERCE 0-0-1981.

FOR: BATTERY CABLES, IN CLASS 9 (U.S. CLS.
21, 23, 26, 36 AND 38).

FIRST USE 0-0-1989; IN COMMERCE 0-0-1989.

THE MARK CONSISTS OF STANDARD CHAR-
ACTERS WITHOUT CLAIM TO ANY PARTICULAR
FONT, STYLE, SIZE, OR COLOR.

SER. NO. 77-324,975, FILED 11-8-2007.

TARAH HARDY, EXAMINING ATTORNEY

Int. Cl.: 43

Prior U.S. Cls.: 100 and 101

United States Patent and Trademark Office

Reg. No. 3,483,878

Registered Aug. 12, 2008

**SERVICE MARK
PRINCIPAL REGISTER**



VIPER ROOM DEVELOPMENT, LLC (DELA-
WARE LTD LIAB CO)
510 N. ROBERTSON BLVD.
LOS ANGELES, CA 90048

FOR: RESTAURANT AND BAR SERVICES, IN
CLASS 43 (U.S. CLS. 100 AND 101).

FIRST USE 8-14-1993; IN COMMERCE 8-14-1993.

THE MARK CONSISTS OF AN IMAGE OF A
PERSON WITH A VIPER TAIL CLAD IN TOP HAT
SMOKING, WITH THE WORDS "THE VIPER
ROOM".

SER. NO. 77-325,063, FILED 11-8-2007.

WON TEAK OH, EXAMINING ATTORNEY

Int. Cl.: 35

Prior U.S. Cls.: 100, 101 and 102

United States Patent and Trademark Office

Reg. No. 3,483,879

Registered Aug. 12, 2008

**SERVICE MARK
PRINCIPAL REGISTER**

EAT. SLEEP. 3D.

NET WORTH MEDIA LLC (FLORIDA LTD LIAB
CO), DBA READY HELI
354 CYPRESS DR #8
TEQUESTA, FL 33469

FOR: RETAIL STORE AND MAIL ORDER AND
ON-LINE RETAIL STORE AND MAIL ORDER
SERVICES IN THE FIELD OF RADIO CONTROL-
LED MODELS, IN CLASS 35 (U.S. CLS. 100, 101 AND
102).

FIRST USE 11-8-2007; IN COMMERCE 11-8-2007.

THE MARK CONSISTS OF STANDARD CHAR-
ACTERS WITHOUT CLAIM TO ANY PARTICULAR
FONT, STYLE, SIZE, OR COLOR.

NO CLAIM IS MADE TO THE EXCLUSIVE
RIGHT TO USE "3D", APART FROM THE MARK
AS SHOWN.

SER. NO. 77-325,375, FILED 11-8-2007.

JUSTINE D. PARKER, EXAMINING ATTORNEY

Int. Cl.: 36

Prior U.S. Cls.: 100, 101 and 102

United States Patent and Trademark Office

Reg. No. 3,483,880

Registered Aug. 12, 2008

**SERVICE MARK
PRINCIPAL REGISTER**

**DISCREET. SECURE.
CONVENIENT.**

NET CASH, LLC (DELAWARE LTD LIAB CO)
SUITE 214
600 NORTH BROADWAY
NORTH WHITE PLAINS, NY 10603

FOR: ELECTRONIC PAYMENT, NAMELY, ELECTRONIC PROCESSING AND TRANSMISSION OF PAYMENT DATA THAT ALLOWS BUYERS TO REMAIN ANONYMOUS, AND PROVIDING FINANCIAL INFORMATION IN THE FORM OF STATUS REPORTS FOR MERCHANTS REGARDING

ON-LINE SALE TRANSACTIONS, IN CLASS 36 (U.S. CLS. 100, 101 AND 102).

FIRST USE 10-8-2007; IN COMMERCE 10-8-2007.

THE MARK CONSISTS OF STANDARD CHARACTERS WITHOUT CLAIM TO ANY PARTICULAR FONT, STYLE, SIZE, OR COLOR.

SER. NO. 77-325,581, FILED 11-9-2007.

BARBARA BROWN, EXAMINING ATTORNEY

Int. Cls.: 35 and 40

Prior U.S. Cls.: 100, 101, 102, 103 and 106

United States Patent and Trademark Office

Reg. No. 3,483,881

Registered Aug. 12, 2008

**SERVICE MARK
PRINCIPAL REGISTER**

**Southern Aluminum
Finishing Co.**

SOUTHERN ALUMINUM FINISHING COMP-
NY, INC. (GEORGIA CORPORATION)
1581 HUBER STREET, N.W.
ATLANTA, GA 303183725

FOR: DISTRIBUTORSHIP SERVICES IN THE
FIELD OF ALUMINUM AND STAINLESS STEEL
SHEETS AND COILS, IN CLASS 35 (U.S. CLS. 100, 101
AND 102).

FIRST USE 0-0-1946; IN COMMERCE 0-0-1946.

FOR: METAL FABRICATION AND FINISHING
SERVICES, IN CLASS 40 (U.S. CLS. 100, 103 AND 106).

FIRST USE 0-0-1946; IN COMMERCE 0-0-1946.

THE MARK CONSISTS OF STANDARD CHAR-
ACTERS WITHOUT CLAIM TO ANY PARTICULAR
FONT, STYLE, SIZE, OR COLOR.

NO CLAIM IS MADE TO THE EXCLUSIVE
RIGHT TO USE "ALUMINUM FINISHING CO.",
APART FROM THE MARK AS SHOWN.

SER. NO. 77-325,586, FILED 11-9-2007.

JAY FLOWERS, EXAMINING ATTORNEY

Int. Cl.: 35

Prior U.S. Cls.: 100, 101 and 102

United States Patent and Trademark Office

Reg. No. 3,483,882

Registered Aug. 12, 2008

SERVICE MARK
PRINCIPAL REGISTER



CITY OF SPARTA, TENNESSEE (TENNESSEE
MUNICIPAL CORPORATION)
6 LIBERTY SQUARE
SPARTA, TN 38583

FOR: MUNICIPAL SERVICES, NAMELY, PROMOTING THE BUSINESS, COMMUNITY, CULTURAL, HISTORIC, MUNICIPAL AND CIVIC INTERESTS IN THE CITY OF SPARTA, AND PROMOTING TOURISM, EDUCATION, RESIDENTIAL AND COMMERCIAL GROWTH, ECONOMIC DEVELOPMENT AND GOVERNMENT SERVICES IN THE CITY OF SPARTA, IN CLASS 35 (U.S. CLS. 100, 101 AND 102).

FIRST USE 5-31-2007; IN COMMERCE 9-13-2007.

NO CLAIM IS MADE TO THE EXCLUSIVE RIGHT TO USE "SPARTA TENNESSEE" AND

"BLUEGRASS USA", APART FROM THE MARK AS SHOWN.

THE MARK CONSISTS OF A BUILDING WITH THE WORDS "OLDHAM" ON IT, THE WORDS "SPARTA TENNESSEE" WITH AN UPSIDE DOWN GUITAR MAKING THE LETTER "P" ALL ENCLOSED WITHIN A RECTANGULAR BOX, THE WORDS "BLUEGRASS USA" BELOW THE BOX, A STAR BETWEEN THE WORDS "BLUEGRASS AND "USA", AND MUSIC NOTES MAKING THE LETTER "R".

SER. NO. 77-326,019, FILED 11-9-2007.

PAUL E. FAHRENKOPF, EXAMINING ATTORNEY

Int. Cl.: 35

Prior U.S. Cls.: 100, 101 and 102

United States Patent and Trademark Office

Reg. No. 3,483,883

Registered Aug. 12, 2008

**SERVICE MARK
PRINCIPAL REGISTER**

**Quality People Quality
Products**

GARTON TRACTOR, INC. (DELAWARE CORPORATION)
2400 N. GOLDEN STATE BLVD
TURLOCK, CA 95382

FOR: DEALERSHIPS IN THE FIELD OF TRACTORS, TRACTOR IMPLEMENTS, MATERIAL HANDLING EQUIPMENT, COMMERCIAL AND RESIDENTIAL MOWERS, HARVEST EQUIPMENT, AND ATV UTILITY VEHICLES , IN CLASS 35 (U.S. CLS. 100, 101 AND 102).

FIRST USE 1-1-1992; IN COMMERCE 1-1-1992.

THE MARK CONSISTS OF STANDARD CHARACTERS WITHOUT CLAIM TO ANY PARTICULAR FONT, STYLE, SIZE, OR COLOR.

NO CLAIM IS MADE TO THE EXCLUSIVE RIGHT TO USE "QUALITY PRODUCTS", APART FROM THE MARK AS SHOWN.

SER. NO. 77-326,338, FILED 11-9-2007.

KELLEY WELLS, EXAMINING ATTORNEY

Int. Cl.: 18

Prior U.S. Cls.: 1, 2, 3, 22 and 41

United States Patent and Trademark Office

Reg. No. 3,483,884

Registered Aug. 12, 2008

**TRADEMARK
PRINCIPAL REGISTER**

CAMERON GREENE DESIGNS

KILBERG, CAMERON A. (UNITED STATES INDIVIDUAL)

1170 N. VERNON STREET

ARLINGTON, VA 22201

FOR: HANDBAGS, CLUTCH PURSES, TOTE BAGS, CARRYING BAGS, TRAVEL BAGS, SHOULDER BAGS, ATHLETIC BAGS, BACKPACKS, WALLETS, COIN PURSES, AND COSMETIC BAGS SOLD EMPTY, IN CLASS 18 (U.S. CLS. 1, 2, 3, 22 AND 41).

FIRST USE 10-25-2004; IN COMMERCE 1-5-2005.

THE MARK CONSISTS OF STANDARD CHARACTERS WITHOUT CLAIM TO ANY PARTICULAR FONT, STYLE, SIZE, OR COLOR.

NO CLAIM IS MADE TO THE EXCLUSIVE RIGHT TO USE "DESIGNS", APART FROM THE MARK AS SHOWN.

THE NAME(S), PORTRAIT(S), AND/OR SIGNATURE(S) SHOWN IN THE MARK DOES NOT IDENTIFY A PARTICULAR LIVING INDIVIDUAL.

SER. NO. 77-326,555, FILED 11-10-2007.

LAURIE KAUFMAN, EXAMINING ATTORNEY

Int. Cl.: 9

Prior U.S. Cls.: 21, 23, 26, 36 and 38

United States Patent and Trademark Office

Reg. No. 3,483,885

Registered Aug. 12, 2008

**TRADEMARK
PRINCIPAL REGISTER**

ConciseStaff

CONCISEWARE, LLC (FLORIDA LTD LIAB CO)
10859 EMERALD COAST PKWY W # 4123
DESTIN, FL 32550

FOR: COMPUTER SOFTWARE FOR CREATING
SEARCHABLE DATABASES OF INFORMATION
AND DATA, IN CLASS 9 (U.S. CLS. 21, 23, 26, 36
AND 38).

FIRST USE 7-4-2007; IN COMMERCE 7-4-2007.

THE MARK CONSISTS OF STANDARD CHAR-
ACTERS WITHOUT CLAIM TO ANY PARTICULAR
FONT, STYLE, SIZE, OR COLOR.

OWNER OF U.S. REG. NO. 3,295,507.

SER. NO. 77-326,640, FILED 11-11-2007.

ELLEN BURNS, EXAMINING ATTORNEY

Int. Cl.: 41

Prior U.S. Cls.: 100, 101 and 107

United States Patent and Trademark Office

Reg. No. 3,483,886

Registered Aug. 12, 2008

SERVICE MARK
PRINCIPAL REGISTER



THE NATIONAL D-DAY MEMORIAL FOUNDATION, LTD. (VIRGINIA CORPORATION)
PO BOX 77
BEDFORD, VA 24523

FOR: OPERATION OF A MEMORIAL THAT REMEMBERS THE VALOR, FIDELITY, AND SACRIFICE OF THE ALLIED FORCES ON D-DAY AND RELATED EDUCATIONAL FACILITIES, IN CLASS 41 (U.S. CLS. 100, 101 AND 107).

FIRST USE 6-6-2001; IN COMMERCE 6-6-2001.

OWNER OF U.S. REG. NO. 2,632,012.

NO CLAIM IS MADE TO THE EXCLUSIVE RIGHT TO USE "NATIONAL D-DAY MEMORIAL", APART FROM THE MARK AS SHOWN.

THE MARK CONSISTS OF TWO CIRCLES, ONE SMALLER THAN THE OTHER, AROUND A CREST WITH DESIGNS OF A LION, DOG AND PELICAN ON THE LOWER PORTION OF THE CREST AND DESIGNS OF BOMB BLASTS AND A CASTLE ON THE UPPER PORTION OF THE CREST AND THE WORDS "NATIONAL D-DAY MEMORIAL" "AD COMMORANDAM, FORTITUDINEM, FIDELITATEM, SACRIFICIUM EORUM" BETWEEN THE TWO CIRCLES.

SER. NO. 77-326,686, FILED 11-11-2007.

KEVIN DINALLO, EXAMINING ATTORNEY

Int. Cls.: 41, 42 and 44

Prior U.S. Cls.: 100, 101 and 107

United States Patent and Trademark Office

Reg. No. 3,483,887

Registered Aug. 12, 2008

**SERVICE MARK
PRINCIPAL REGISTER**



ASHLAND HOSPITAL CORPORATION (KENTUCKY CORPORATION), DBA KING'S DAUGHTERS MEDICAL CENTER
P.O. BOX 151
ASHLAND, KY 41101

FOR: EDUCATIONAL SERVICES, NAMELY, PROVIDING TRAINING FOR HEALTHCARE PROFESSIONALS AND THE PUBLIC ON MEDICAL AND HEALTHCARE ISSUES, IN CLASS 41 (U.S. CLS. 100, 101 AND 107).

FIRST USE 5-19-2007; IN COMMERCE 5-19-2007.

FOR: MEDICAL AND SCIENTIFIC RESEARCH; CONDUCTING CLINICAL TRIALS RELATING TO MEDICAL DEVICES, MEDICAL PROCEDURES, AND MEDICATIONS, IN CLASS 42 (U.S. CLS. 100 AND 101).

FIRST USE 5-19-2007; IN COMMERCE 5-19-2007.

FOR: HEALTHCARE SERVICES, IN CLASS 44 (U.S. CLS. 100 AND 101).

FIRST USE 5-19-2007; IN COMMERCE 5-19-2007.

NO CLAIM IS MADE TO THE EXCLUSIVE RIGHT TO USE "KENTUCKY HEART INSTITUTE", APART FROM THE MARK AS SHOWN.

THE MARK CONSISTS OF A STYLIZED DRAWING OF THREE HEARTS TO THE LEFT OF A VERTICAL LINE TO THE LEFT OF THE WORDS "KENTUCKY HEART INSTITUTE".

SER. NO. 77-326,743, FILED 11-11-2007.

DAVID ELTON, EXAMINING ATTORNEY

Int. Cl.: 35

Prior U.S. Cls.: 100, 101 and 102

United States Patent and Trademark Office

Reg. No. 3,483,888

Registered Aug. 12, 2008

**SERVICE MARK
PRINCIPAL REGISTER**

Mama Healthy

YEGG, INC. (NEVADA CORPORATION)
1924 RUHLAND AVENUE #A
REDONDO BEACH, CA 90278

FOR: WHOLESALE DISTRIBUTORSHIPS FOR FOODS AND BEVERAGES INCLUDING NATURAL SWEETENERS, ORGANIC SWEETENERS, FLAVORINGS FOR BEVERAGES AND FOODS, HONEY CRYSTALS, EVAPORATED CANE JUICE, HONEY AND MOLASSES FOR FOODS AND BEVERAGES, IN CLASS 35 (U.S. CLS. 100, 101 AND 102).

FIRST USE 10-7-2007; IN COMMERCE 11-7-2007.

THE MARK CONSISTS OF STANDARD CHARACTERS WITHOUT CLAIM TO ANY PARTICULAR FONT, STYLE, SIZE, OR COLOR.

NO CLAIM IS MADE TO THE EXCLUSIVE RIGHT TO USE "HEALTHY", APART FROM THE MARK AS SHOWN.

SER. NO. 77-326,779, FILED 11-12-2007.

HANNO RITTNER, EXAMINING ATTORNEY

Int. Cls.: 9, 38 and 42

Prior U.S. Cls.: 21, 23, 26, 36, 38, 100, 101 and 104

United States Patent and Trademark Office

Reg. No. 3,483,889

Registered Aug. 12, 2008

**TRADEMARK
SERVICE MARK
PRINCIPAL REGISTER**

PSYCHNOTESEMR

AMERICAN PSYCHIATRIC MANAGEMENT SERVICES, LLC (CALIFORNIA LTD LIAB CO)
16450 LOS GATOS BLVD., SUITE 112
LOS GATOS, CA 95032

FOR: SOFTWARE FACILITATING THE STORING AND PROCESSING OF DATA; THE FOREGOING GOODS FOR USE IN THE MEDICAL FIELD; THE FOREGOING GOODS FOR USE IN THE MENTAL HEALTH FIELD; THE FOREGOING GOODS FOR USE IN KEEPING RECORDS AND CHARTS, SCHEDULING APPOINTMENTS, WRITING PRESCRIPTIONS, REPORTING CLAIMS, AND PROCESSING ACCOUNTS AND BILLING STATEMENTS, IN CLASS 9 (U.S. CLS. 21, 23, 26, 36 AND 38).

FIRST USE 5-21-2007; IN COMMERCE 5-23-2007.

FOR: PROVIDING ACCESS FOR OTHERS TO A SERVER FOR COMMUNICATION OF DATA, FOR ACCESSING DATA, AND FOR INTERACTING WITH DATA; PROVIDING ACCESS FOR OTHERS FOR STORING AND PROCESSING OF DATA; THE FOREGOING SERVICES FOR USE IN KEEPING RECORDS AND CHARTS, SCHEDULING APPOINTMENTS, WRITING PRESCRIPTIONS, REPORTING CLAIMS, AND PROCESSING ACCOUNTS AND BILLING STATEMENTS; THE FOREGOING SERVICES IN THE MEDICAL FIELD; THE FOREGOING SERVICES IN THE MENTAL

HEALTH FIELD, IN CLASS 38 (U.S. CLS. 100, 101 AND 104).

FIRST USE 4-23-2007; IN COMMERCE 4-23-2007.

FOR: MAINTAINING DATA FOR OTHERS ON A SERVER; PROVIDING TEMPORARY USE BY OTHERS OF ONLINE, NON-DOWNLOADABLE SOFTWARE FOR KEEPING RECORDS AND CHARTS, SCHEDULING APPOINTMENTS, WRITING PRESCRIPTIONS, REPORTING CLAIMS, AND PROCESSING ACCOUNTS AND BILLING STATEMENTS; THE FOREGOING SERVICES IN THE MEDICAL FIELD; THE FOREGOING SERVICES IN THE MENTAL HEALTH FIELD; PROVIDING TECHNICAL CUSTOMER SUPPORT SERVICES CONCERNING ANY OF THE FOREGOING SERVICES, NAMELY, TROUBLESHOOTING COMPUTER SOFTWARE PROBLEMS AND MONITORING NETWORK SYSTEMS, IN CLASS 42 (U.S. CLS. 100 AND 101).

FIRST USE 4-23-2007; IN COMMERCE 4-23-2007.

THE MARK CONSISTS OF STANDARD CHARACTERS WITHOUT CLAIM TO ANY PARTICULAR FONT, STYLE, SIZE, OR COLOR.

SER. NO. 77-327,008, FILED 11-12-2007.

JASON BLAIR, EXAMINING ATTORNEY

Int. Cl.: 36

Prior U.S. Cls.: 100, 101 and 102

United States Patent and Trademark Office

Reg. No. 3,483,890

Registered Aug. 12, 2008

**SERVICE MARK
PRINCIPAL REGISTER**

WEST GATE

FIRC MANAGEMENT, INC. (FLORIDA CORPORATION)
SUITE 302
2665 SOUTH BAYSHORE DRIVE
COCONUT GROVE, FL 33133

FOR: SHOPPING CENTER SERVICES, NAMELY,
RENTAL OF SHOPPING CENTER SPACE; AND
LEASING OFFICE SPACE, IN CLASS 36 (U.S. CLS.
100, 101 AND 102).

FIRST USE 0-0-1955; IN COMMERCE 0-0-1955.

THE MARK CONSISTS OF STANDARD CHARACTERS WITHOUT CLAIM TO ANY PARTICULAR FONT, STYLE, SIZE, OR COLOR.

SER. NO. 77-327,186, FILED 11-12-2007.

SEAN CROWLEY, EXAMINING ATTORNEY

Int. Cl.: 30

Prior U.S. Cl.: 46

United States Patent and Trademark Office

Reg. No. 3,483,891

Registered Aug. 12, 2008

**TRADEMARK
PRINCIPAL REGISTER**

SABOR DE LA ABUELA LIGHT

MOLINO CENTRAL SA DE CV (MEXICO CORPORATION)
AV. MEXICO 3777
GUADALAJARA, MEXICO 47150

FOR: PANCAKES, IN CLASS 30 (U.S. CL. 46).

FIRST USE 10-18-2007; IN COMMERCE 10-18-2007.

THE MARK CONSISTS OF STANDARD CHARACTERS WITHOUT CLAIM TO ANY PARTICULAR FONT, STYLE, SIZE, OR COLOR.

NO CLAIM IS MADE TO THE EXCLUSIVE RIGHT TO USE "LIGHT", APART FROM THE MARK AS SHOWN.

THE FOREIGN WORDING IN THE MARK TRANSLATES INTO ENGLISH AS "GRANNY'S FLAVOR LIGHT".

SER. NO. 77-327,841, FILED 11-13-2007.

WILLIAM P. SHANAHAN, EXAMINING ATTORNEY

Int. Cl.: 5

Prior U.S. Cls.: 6, 18, 44, 46, 51 and 52

Reg. No. 3,483,892

United States Patent and Trademark Office

Registered Aug. 12, 2008

**TRADEMARK
PRINCIPAL REGISTER**

LONCOR

BAYER AKTIENGESELLSCHAFT (FED REP
GERMANY AKTIENGESELLSCHAFT)
D-51368
LEVERKUSEN-BAYERWERK, FED REP GERMA-
NY

FOR: PHARMACEUTICAL PREPARATIONS FOR
VETERINARY USE TO TREAT CHRONIC DISEA-
SES, NAMELY, CONGESTIVE HEART FAILURE,
ARTHRITIS, AND PAIN , IN CLASS 5 (U.S. CLS. 6, 18,
44, 46, 51 AND 52).

THE MARK CONSISTS OF STANDARD CHAR-
ACTERS WITHOUT CLAIM TO ANY PARTICULAR
FONT, STYLE, SIZE, OR COLOR.

OWNER OF FED REP GERMANY REG. NO.
30700544, DATED 2-23-2007, EXPIRES 1-31-2017.

SER. NO. 77-327,853, FILED 11-13-2007.

KAREN K. BUSH, EXAMINING ATTORNEY

Int. Cl.: 8

Prior U.S. Cls.: 23, 28 and 44

Reg. No. 3,483,893

United States Patent and Trademark Office

Registered Aug. 12, 2008

**TRADEMARK
PRINCIPAL REGISTER**

TATTOO

WAHL CLIPPER CORPORATION (ILLINOIS
CORPORATION)
P.O. BOX 578
STERLING, IL 610810578

THE MARK CONSISTS OF STANDARD CHAR-
ACTERS WITHOUT CLAIM TO ANY PARTICULAR
FONT, STYLE, SIZE, OR COLOR.

FOR: ELECTRIC HAIR TRIMMERS, IN CLASS 8
(U.S. CLS. 23, 28 AND 44).

SER. NO. 77-327,990, FILED 11-13-2007.

FIRST USE 10-0-2007; IN COMMERCE 10-0-2007.

CHRISTINE COOPER, EXAMINING ATTORNEY

Int. Cl.: 12

Prior U.S. Cls.: 19, 21, 23, 31, 35 and 44

Reg. No. 3,483,894

United States Patent and Trademark Office

Registered Aug. 12, 2008

**TRADEMARK
PRINCIPAL REGISTER**



PRAIRIE SEATING CORPORATION (ILLINOIS CORPORATION)
7515 LINDER AVE.
SKOKIE, IL 60077

"THE MARK CONSISTS OF A LIGHTNING BOLT DESIGN FORMING THE LETTERS "L" AND "T" IN THE WORDS "LITE-NING" AND "TILT-IN-SPACE"."

FOR: WHEELCHAIR ACCESSORIES, NAMELY, MANUALLY-OPERATED APPARATUS FOR TILTING WHEEL CHAIR SEAT, IN CLASS 12 (U.S. CLS. 19, 21, 23, 31, 35 AND 44).

SER. NO. 77-328,053, FILED 11-13-2007.

FIRST USE 6-6-1995; IN COMMERCE 6-6-1995.

DAVID C. REIHNER, EXAMINING ATTORNEY

Int. Cl.: 41

Prior U.S. Cls.: 100, 101 and 107

United States Patent and Trademark Office

Reg. No. 3,483,895

Registered Aug. 12, 2008

**SERVICE MARK
PRINCIPAL REGISTER**

ARTISTIC REFLECT

MARKEVE EXUM (UNITED STATES INDIVIDUAL)
1320 DIVISION AVE
PLAINFIELD, NJ 07063

FOR: MULTIMEDIA ENTERTAINMENT SERVICES IN THE NATURE OF RECORDING, PRODUCTION AND POST-PRODUCTION SERVICES IN THE FIELDS OF MUSIC, VIDEO, AND FILMS; MUSIC PRODUCTION SERVICES; MUSIC PUBLISHING SERVICES, IN CLASS 41 (U.S. CLS. 100, 101 AND 107).

FIRST USE 10-3-2007; IN COMMERCE 10-3-2007.

THE MARK CONSISTS OF STANDARD CHARACTERS WITHOUT CLAIM TO ANY PARTICULAR FONT, STYLE, SIZE, OR COLOR.

SER. NO. 77-328,457, FILED 11-13-2007.

JENNIFER MARTIN, EXAMINING ATTORNEY

Int. Cl.: 41

Prior U.S. Cls.: 100, 101 and 107

United States Patent and Trademark Office

Reg. No. 3,483,896

Registered Aug. 12, 2008

**SERVICE MARK
PRINCIPAL REGISTER**

Singing To Read

THE VISIONS GROUP, LLC (NORTH CAROLINA
LTD LIAB CO)
405 COMMONS WALK CIRCLE
CARY, NC 27519

FOR: EDUCATIONAL SERVICES, NAMELY,
CONDUCTING LIVE CLASSES AND ACCESSIBLE
BY RADIO, TELEVISION, SATELLITE, AUDIO, VI-
DEO AND COMPUTER NETWORKS IN THE FIELD
OF LITERACY AND DISTRIBUTION OF COURSE
MATERIAL IN CONNECTION THEREWITH;
TEACHING AT ELEMENTARY SCHOOLS; TEACH-

ING IN THE FIELD OF LITERACY, IN CLASS 41
(U.S. CLS. 100, 101 AND 107).

FIRST USE 7-1-1992; IN COMMERCE 7-1-1992.

THE MARK CONSISTS OF STANDARD CHAR-
ACTERS WITHOUT CLAIM TO ANY PARTICULAR
FONT, STYLE, SIZE, OR COLOR.

SER. NO. 77-328,561, FILED 11-13-2007.

DEIRDRE ROBERTSON, EXAMINING ATTORNEY

Int. Cl.: 41

Prior U.S. Cls.: 100, 101 and 107

United States Patent and Trademark Office

Reg. No. 3,483,897

Registered Aug. 12, 2008

**SERVICE MARK
PRINCIPAL REGISTER**

**STRAIGHT TALK BY THE
EXPERTS**

GRABARITS, MICHAEL J. (UNITED STATES
INDIVIDUAL)
3207 BRYNWOOD DRIVE
WHITEHALL, PA 18052

FOR: EDUCATIONAL SERVICES, NAMELY, DE-
VELOPING, ARRANGING, AND CONDUCTING
EDUCATIONAL CONFERENCES AND PROGRAMS
AND PROVIDING COURSES OF INSTRUCTION IN
THE FIELD OF LITERACY AND READING, IN
CLASS 41 (U.S. CLS. 100, 101 AND 107).

FIRST USE 3-1-2007; IN COMMERCE 3-1-2007.

THE MARK CONSISTS OF STANDARD CHAR-
ACTERS WITHOUT CLAIM TO ANY PARTICULAR
FONT, STYLE, SIZE, OR COLOR.

SER. NO. 77-328,911, FILED 11-14-2007.

CORY BOONE, EXAMINING ATTORNEY

Int. Cl.: 10

Prior U.S. Cls.: 26, 39 and 44

United States Patent and Trademark Office

Reg. No. 3,483,898

Registered Aug. 12, 2008

**TRADEMARK
PRINCIPAL REGISTER**

Flexoject

TERRILL, MATTHEW (UNITED STATES INDIVIDUAL)
151 CARLO DRIVE
GOLETA, CA 93117

FOR: SOFT, FLEXIBLE SYRINGE TIPS FOR APPLYING EXTERNAL MEDICINE TO ANIMALS AND FOR USE WITH SYRINGES FOR FEEDING AND DISPENSING FORMULAS TO ANIMALS, IN CLASS 10 (U.S. CLS. 26, 39 AND 44).

FIRST USE 6-1-2007; IN COMMERCE 7-21-2007.

THE MARK CONSISTS OF STANDARD CHARACTERS WITHOUT CLAIM TO ANY PARTICULAR FONT, STYLE, SIZE, OR COLOR.

SER. NO. 77-328,968, FILED 11-14-2007.

DANNEAN HETZEL, EXAMINING ATTORNEY

Int. Cls.: 7 and 9

Prior U.S. Cls.: 13, 19, 21, 23, 26, 31, 34, 35, 36 and 38

Reg. No. 3,483,899

United States Patent and Trademark Office

Registered Aug. 12, 2008

**TRADEMARK
PRINCIPAL REGISTER**

YZ

MILTON ROY COMPANY (PENNSYLVANIA CORPORATION)
201 IVYLAND ROAD
IVYLAND, PA 18974

FOR: MACHINERY IN THE NATURE OF AN ODORIZATION AND CHEMICAL INJECTION SYSTEMS FOR INTRODUCING A MATERIAL INTO A STORED MATERIAL CONSISTING OF TANKS, PUMPS, FILTERS, GAUGES, VALVES FOR PUMPS, CONTROLLERS, DRYERS, POWER SUPPLY, REGULATORS, CABINETS AND MONITORS; LUBRICATION SYSTEMS, NAMELY, A LUBRICANT INJECTION SYSTEM FOR LUBRICATING A METER CONSISTING OF TANKS, PUMPS, MANIFOLDS, VALVES, GAUGES AND CABINETS, IN CLASS 7 (U.S. CLS. 13, 19, 21, 23, 31, 34 AND 35).

FIRST USE 2-4-1968; IN COMMERCE 2-4-1968.

FOR: ELECTRICAL AND SCIENTIFIC APPARATUS TESTING EQUIPMENT, NAMELY, ODORANT DETECTION SYSTEMS AND SAMPLING SYSTEMS FOR OBTAINING SAMPLES AND ANALYZING

CONSTITUENTS OF A STORED MATERIAL CONSISTING OF PUMPS, FILTER, GAUGES, VALVES, REGULATORS AND CABINETS; ACCESSORIES FOR THE TESTING EQUIPMENT, NAMELY, VESSELS FOR STORING CHEMICAL SAMPLES; ACCESSORIES FOR THE INJECTION SYSTEMS, NAMELY, TESTING AND MONITORING PROBES, VIBRATION ISOLATORS, AND ELECTRIC POWER SCRUBBERS; ACCESSORIES FOR THE LUBRICATION SYSTEM, NAMELY, DIFFERENTIAL ELECTRIC PRESSURE SWITCHES, IN CLASS 9 (U.S. CLS. 21, 23, 26, 36 AND 38).

FIRST USE 2-4-1968; IN COMMERCE 2-4-1968.

THE MARK CONSISTS OF STANDARD CHARACTERS WITHOUT CLAIM TO ANY PARTICULAR FONT, STYLE, SIZE, OR COLOR.

SER. NO. 77-329,011, FILED 11-14-2007.

MIDGE BUTLER, EXAMINING ATTORNEY

Int. Cl.: 41

Prior U.S. Cls.: 100, 101 and 107

Reg. No. 3,483,900

United States Patent and Trademark Office

Registered Aug. 12, 2008

**SERVICE MARK
PRINCIPAL REGISTER**

YOUR LIFE. YOUR WAY.

LADY OF AMERICA FRANCHISE CORPORATION (FLORIDA CORPORATION)
500 E. BROWARD BLVD, SUITE 1650
FT. LAUDERDALE, FL 33394

THE MARK CONSISTS OF STANDARD CHARACTERS WITHOUT CLAIM TO ANY PARTICULAR FONT, STYLE, SIZE, OR COLOR.

FOR: HEALTH CLUB SERVICES, NAMELY, PROVIDING FACILITIES FOR PHYSICAL EXERCISE, AND PHYSICAL FITNESS INSTRUCTION, IN CLASS 41 (U.S. CLS. 100, 101 AND 107).

SER. NO. 77-329,082, FILED 11-14-2007.

FIRST USE 9-19-2006; IN COMMERCE 9-19-2006.

DAVID C. REIHNER, EXAMINING ATTORNEY

Int. Cl.: 21

Prior U.S. Cls.: 2, 13, 23, 29, 30, 33, 40 and 50

Reg. No. 3,483,901

United States Patent and Trademark Office

Registered Aug. 12, 2008

**TRADEMARK
PRINCIPAL REGISTER**



Meal Measure

MEAL MEASURE, INC. (MINNESOTA CORPORATION)
12633 SABLE DRIVE
BURNSVILLE, MN 55337

FOR: SERVING DISHES, IN CLASS 21 (U.S. CLS. 2, 13, 23, 29, 30, 33, 40 AND 50).

FIRST USE 9-30-2007; IN COMMERCE 9-30-2007.

NO CLAIM IS MADE TO THE EXCLUSIVE RIGHT TO USE "MEAL MEASURE", APART FROM THE MARK AS SHOWN.

THE MARK CONSISTS OF THE SYMBOL IS A CIRCULAR FIGURE WITH THE BOTTOM PORTION REMOVED AND SCALE MARKS INCLUDED IN THE REMOVED PORTION. THE MARK ALSO INCLUDES TEXT STATING "MEAL MEASURE".

SER. NO. 77-329,325, FILED 11-14-2007.

SALLY SHIH, EXAMINING ATTORNEY

Int. Cls.: 35 and 41

Prior U.S. Cls.: 100, 101, 102 and 107

United States Patent and Trademark Office

Reg. No. 3,483,902

Registered Aug. 12, 2008

**SERVICE MARK
PRINCIPAL REGISTER**

WRITE IT WELL

ADVANCED COMMUNICATION DESIGNS INC.
(CALIFORNIA CORPORATION)
5626 ESTATES DRIVE
OAKLAND, CA 94618

FOR: ON-LINE RETAIL STORE SERVICES FEATURING BOOKS AND GUIDES, IN CLASS 35 (U.S. CLS. 100, 101 AND 102).

FIRST USE 10-0-2007; IN COMMERCE 10-0-2007.

FOR: EDUCATIONAL SERVICES, NAMELY, CONDUCTING WORKSHOPS, CLASSES AND SEMINARS IN THE FIELD OF COMMUNICATION SKILLS AND WRITING SKILLS AND DISTRIBUTION OF COURSE MATERIAL IN CONNECTION THEREWITH, IN CLASS 41 (U.S. CLS. 100, 101 AND 107).

TION OF COURSE MATERIAL IN CONNECTION THEREWITH, IN CLASS 41 (U.S. CLS. 100, 101 AND 107).

FIRST USE 12-0-1997; IN COMMERCE 12-0-1997.

THE MARK CONSISTS OF STANDARD CHARACTERS WITHOUT CLAIM TO ANY PARTICULAR FONT, STYLE, SIZE, OR COLOR.

SER. NO. 77-329,433, FILED 11-14-2007.

KHANH LE, EXAMINING ATTORNEY

Int. Cl.: 9

Prior U.S. Cls.: 21, 23, 26, 36 and 38

Reg. No. 3,483,903

United States Patent and Trademark Office

Registered Aug. 12, 2008

**TRADEMARK
PRINCIPAL REGISTER**

SPEC MANAGER

DETROIT DIESEL CORPORATION (DELAWARE CORPORATION)
13400 OUTER DRIVE WEST
DETROIT, MI 482394001

THE MARK CONSISTS OF STANDARD CHARACTERS WITHOUT CLAIM TO ANY PARTICULAR FONT, STYLE, SIZE, OR COLOR.

FOR: SOFTWARE FOR AIDING IN THE SPECIFICATION OF DIESEL ENGINES, IN PARTICULAR, TO ALLOW AN OPERATOR TO SELECT ENGINE OPERATING CONDITIONS FOR MAXIMUM FUEL ECONOMY OR PERFORMANCE, IN CLASS 9 (U.S. CLS. 21, 23, 26, 36 AND 38).

SEC. 2(F).

SER. NO. 77-329,523, FILED 11-14-2007.

FIRST USE 1-1-1996; IN COMMERCE 1-1-1996.

LINDA ORNDORFF, EXAMINING ATTORNEY

Int. Cl.: 16

Prior U.S. Cls.: 2, 5, 22, 23, 29, 37, 38 and 50

Reg. No. 3,483,904

United States Patent and Trademark Office

Registered Aug. 12, 2008

**TRADEMARK
PRINCIPAL REGISTER**

GETORGANIZEDHERE

GBS CORP. (OHIO CORPORATION)
7233 FREEDOM AVENUE, NW
NORTH CANTON, OH 44720

THE MARK CONSISTS OF STANDARD CHAR-
ACTERS WITHOUT CLAIM TO ANY PARTICULAR
FONT, STYLE, SIZE, OR COLOR.

FOR: EXPANDABLE FOLDERS FOR THE ORGA-
NIZATION AND FILING OF PERSONAL AND
BUSINESS DOCUMENTS, IN CLASS 16 (U.S. CLS. 2,
5, 22, 23, 29, 37, 38 AND 50).

SER. NO. 77-329,585, FILED 11-14-2007.

FIRST USE 10-31-2007; IN COMMERCE 10-31-2007.

SKYE YOUNG, EXAMINING ATTORNEY

Int. Cl.: 41

Prior U.S. Cls.: 100, 101 and 107

United States Patent and Trademark Office

Reg. No. 3,483,905

Registered Aug. 12, 2008

**SERVICE MARK
PRINCIPAL REGISTER**



CAP & GOWN WEDDINGS, LLC. (NEW YORK
LTD LIAB CO)
372 CENTRAL PARK WEST, SUITE 8K
NEW YORK, NY 10025

FOR: SPECIAL EVENT, PARTY AND WEDDING
PLANNING, COORDINATION AND CONSULTA-
TION SERVICES, IN CLASS 41 (U.S. CLS. 100, 101
AND 107).

FIRST USE 6-0-2007; IN COMMERCE 6-0-2007.

THE COLOR(S) GOLD AND WHITE IS/ARE
CLAIMED AS A FEATURE OF THE MARK.

THE MARK CONSISTS OF THE WHITE LETTERS
"C & G" WITHIN A GOLD DIAMOND SHAPE, WITH
THE HIGHLY STYLIZED LETTERS "C & G" IN
DARK AND LIGHT GOLD AS BACKGROUND
THROUGHOUT AND BEHIND THE GOLD DIA-
MOND SHAPE.

SER. NO. 77-329,742, FILED 11-14-2007.

BARBARA GAYNOR, EXAMINING ATTORNEY

Int. Cl.: 19

Prior U.S. Cls.: 1, 12, 33 and 50

Reg. No. 3,483,906

United States Patent and Trademark Office

Registered Aug. 12, 2008

**TRADEMARK
PRINCIPAL REGISTER**

BRIZIA

SAROYAN LUMBER COMPANY, INC. (CALI-
FORNIA CORPORATION)
6230 SO. ALAMEDA ST.
HUNTINGTON PARK, CA 90255

FOR: FLOOR BOARDS, WOODEN FLOORING,
HARDWOOD FLOORING; NON-METAL ARCHI-
TECTURAL MOULDINGS AND FINISH TRIM, IN
CLASS 19 (U.S. CLS. 1, 12, 33 AND 50).

FIRST USE 4-18-2006; IN COMMERCE 4-18-2006.

THE MARK CONSISTS OF STANDARD CHAR-
ACTERS WITHOUT CLAIM TO ANY PARTICULAR
FONT, STYLE, SIZE, OR COLOR.

THE WORDING "BRIZIA" HAS NO MEANING IN
A FOREIGN LANGUAGE.

SER. NO. 77-329,873, FILED 11-14-2007.

JEAN IM, EXAMINING ATTORNEY

Int. Cls.: 20 and 24

Prior U.S. Cls.: 2, 13, 22, 25, 32, 42 and 50

United States Patent and Trademark Office

Reg. No. 3,483,907

Registered Aug. 12, 2008

TRADEMARK
PRINCIPAL REGISTER



O.W. LEE CO., INC. (CALIFORNIA CORPORATION)
1822 E. FRANCIS STREET
ONTARIO, CA 91761

FOR: OUTDOOR FURNITURE; PILLOWS, IN CLASS 20 (U.S. CLS. 2, 13, 22, 25, 32 AND 50).

FIRST USE 5-1-2007; IN COMMERCE 5-1-2007.

FOR: DRAPERIES; THROWS, IN CLASS 24 (U.S. CLS. 42 AND 50).

FIRST USE 5-1-2007; IN COMMERCE 5-1-2007.

THE NAME(S), PORTRAIT(S), AND/OR SIGNATURE(S) SHOWN IN THE MARK DOES NOT IDENTIFY A PARTICULAR LIVING INDIVIDUAL.

THE MARK CONSISTS OF SCRIPT WORDS, "OW LEE", IN A SQUARE BOX.

SER. NO. 77-329,880, FILED 11-14-2007.

ROBERT STRUCK, EXAMINING ATTORNEY

Int. Cl.: 35

Prior U.S. Cls.: 100, 101 and 102

United States Patent and Trademark Office

Reg. No. 3,483,908

Registered Aug. 12, 2008

**SERVICE MARK
PRINCIPAL REGISTER**

TREAT YOURSELF

BRUSTER'S, INC. (PENNSYLVANIA CORPORATION)
730 MULBERRY STREET
BRIDGEWATER, PA 15009

THE MARK CONSISTS OF STANDARD CHARACTERS WITHOUT CLAIM TO ANY PARTICULAR FONT, STYLE, SIZE, OR COLOR.

FOR: RETAIL SHOPS FEATURING ICE CREAM, FROZEN YOGURT, SHERBET AND FROZEN CONFECTIONS, IN CLASS 35 (U.S. CLS. 100, 101 AND 102).

SER. NO. 77-330,380, FILED 11-15-2007.

FIRST USE 4-30-2006; IN COMMERCE 4-30-2006.

LAURIE KAUFMAN, EXAMINING ATTORNEY

Int. Cls.: 35, 39 and 43

Prior U.S. Cls.: 100, 101, 102 and 105

United States Patent and Trademark Office

Reg. No. 3,483,909

Registered Aug. 12, 2008

**SERVICE MARK
PRINCIPAL REGISTER**

YTB

YTB INTERNATIONAL, INC. (DELAWARE CORPORATION)
1901 EAST EDWARDSVILLE ROAD
WOOD RIVER, IL 62095

FOR: PROMOTION OF OPPORTUNITIES FOR BUSINESS IN THE FIELD OF TRAVEL; MULTI-LEVEL MARKETING BUSINESS SERVICES, IN CLASS 35 (U.S. CLS. 100, 101 AND 102).

FIRST USE 8-5-2001; IN COMMERCE 8-5-2001.

FOR: ONLINE TRAVEL AGENCY SERVICES, NAMELY, RESERVATIONS AND BOOKINGS FOR TRANSPORTATION OF AIR TRAVEL, VACATIONS, GROUP TRAVEL, RESORTS, CRUISES, TOUR PACKAGES, CAR RENTALS, RAIL TICKETS, AND GOLF PACKAGES VIA A GLOBAL COMPUTER NETWORK, IN CLASS 39 (U.S. CLS. 100 AND 105).

FIRST USE 8-5-2001; IN COMMERCE 8-5-2001.

FOR: ONLINE TRAVEL AGENCY SERVICES, NAMELY, MAKING RESERVATIONS AND BOOKINGS FOR TEMPORARY LODGING, HOTEL ROOMS, RESTAURANTS AND MEALS, IN CLASS 43 (U.S. CLS. 100 AND 101).

FIRST USE 8-5-2001; IN COMMERCE 8-5-2001.

THE MARK CONSISTS OF STANDARD CHARACTERS WITHOUT CLAIM TO ANY PARTICULAR FONT, STYLE, SIZE, OR COLOR.

SER. NO. 77-330,905, FILED 11-15-2007.

KEVON CHISOLM, EXAMINING ATTORNEY

Int. Cl.: 35

Prior U.S. Cls.: 100, 101 and 102

United States Patent and Trademark Office

Reg. No. 3,483,910

Registered Aug. 12, 2008

**SERVICE MARK
PRINCIPAL REGISTER**

SCOUT'S HONOR CARD

ACCESS VG, LLC (UTAH LTD LIAB CO)
1012 W. BEARDSLEY
SALT LAKE CITY, UT 84119

FOR: ADMINISTRATION OF A CUSTOMER DISCOUNT AND REWARDS CARD SOLD BY ORGANIZATIONS TO RAISE MONEY FOR YOUTH PROGRAMS, IN CLASS 35 (U.S. CLS. 100, 101 AND 102).

FIRST USE 1-31-2007; IN COMMERCE 1-31-2007.

THE MARK CONSISTS OF STANDARD CHARACTERS WITHOUT CLAIM TO ANY PARTICULAR FONT, STYLE, SIZE, OR COLOR.

NO CLAIM IS MADE TO THE EXCLUSIVE RIGHT TO USE "SCOUTS AND CARD", APART FROM THE MARK AS SHOWN.

SER. NO. 77-330,985, FILED 11-15-2007.

NAAKWAMA ANKRAH, EXAMINING ATTORNEY

Int. Cl.: 35

Prior U.S. Cls.: 100, 101 and 102

United States Patent and Trademark Office

Reg. No. 3,483,911

Registered Aug. 12, 2008

**SERVICE MARK
PRINCIPAL REGISTER**

DISCOUNT CONNECTION

ACCESS VG, LLC (UTAH LTD LIAB CO)
1012 W. BEARDSLEY
SALT LAKE CITY, UT 84119

FOR: ADMINISTRATION OF A CONSUMER DISCOUNT PROGRAM PROVIDED BY AN ORGANIZATION AS A BENEFIT TO MEMBERS AFFILIATED WITH THE ORGANIZATION, IN CLASS 35 (U.S. CLS. 100, 101 AND 102).

FIRST USE 10-1-2007; IN COMMERCE 10-1-2007.

THE MARK CONSISTS OF STANDARD CHARACTERS WITHOUT CLAIM TO ANY PARTICULAR FONT, STYLE, SIZE, OR COLOR.

NO CLAIM IS MADE TO THE EXCLUSIVE RIGHT TO USE "DISCOUNT", APART FROM THE MARK AS SHOWN.

SER. NO. 77-330,986, FILED 11-15-2007.

NAAKWAMA ANKRAH, EXAMINING ATTORNEY

Int. Cl.: 35

Prior U.S. Cls.: 100, 101 and 102

United States Patent and Trademark Office

Reg. No. 3,483,912

Registered Aug. 12, 2008

**SERVICE MARK
PRINCIPAL REGISTER**

SAVINGS CONNECTION

ACCESS VG, LLC (UTAH LTD LIAB CO)
1012 W. BEARDSLEY
SALT LAKE CITY, UT 84119

FOR: ADMINISTRATION OF A CONSUMER DISCOUNT PROGRAM PROVIDED BY AN ORGANIZATION AS A BENEFIT TO MEMBERS AFFILIATED WITH THE ORGANIZATION, IN CLASS 35 (U.S. CLS. 100, 101 AND 102).

FIRST USE 10-1-2007; IN COMMERCE 10-1-2007.

THE MARK CONSISTS OF STANDARD CHARACTERS WITHOUT CLAIM TO ANY PARTICULAR FONT, STYLE, SIZE, OR COLOR.

NO CLAIM IS MADE TO THE EXCLUSIVE RIGHT TO USE "SAVINGS", APART FROM THE MARK AS SHOWN.

SER. NO. 77-330,987, FILED 11-15-2007.

NAAKWAMA ANKRAH, EXAMINING ATTORNEY

Int. Cl.: 36

Prior U.S. Cls.: 100, 101 and 102

United States Patent and Trademark Office

Reg. No. 3,483,913

Registered Aug. 12, 2008

**SERVICE MARK
PRINCIPAL REGISTER**



GRAYSTONE BANK (PENNSYLVANIA CORPORATION)
112 MARKET STREET
HARRISBURG, PA 17101

FOR: BANKING SERVICES, NAMELY, RETAIL BANKING SERVICES, COMMERCIAL BANKING SERVICES, MORTGAGE BANKING SERVICES AND ONLINE BANKING SERVICES, IN CLASS 36 (U.S. CLS. 100, 101 AND 102).

FIRST USE 11-0-2005; IN COMMERCE 11-0-2005.

THE COLOR(S) BLUE AND GRAY IS/ARE CLAIMED AS A FEATURE OF THE MARK.

THE MARK CONSISTS OF THE LETTER "G" IN BLUE IN A GRAY DIAMOND WITH GRAY STONE SHAPED BACKGROUND.

SER. NO. 77-331,144, FILED 11-16-2007.

ALICE BENMAMAN, EXAMINING ATTORNEY

Int. Cl.: 45

Prior U.S. Cls.: 100 and 101

United States Patent and Trademark Office

Reg. No. 3,483,914

Registered Aug. 12, 2008

**SERVICE MARK
PRINCIPAL REGISTER**

CIMIP

UTICA COLLEGE (NEW YORK NON-PROFIT
CORPORATION)
1600 BURRSTONE ROAD
UTICA, NY 13502

FOR: RESEARCH AND DEVELOPMENT FOR
SECURITY PROTECTION AND/OR PURPOSES,
AND CONSULTATION RELATED THERETO, IN
THE FIELDS OF IDENTITY MANAGEMENT, IN-
FORMATION SHARING, AND DATA PROTEC-
TION , IN CLASS 45 (U.S. CLS. 100 AND 101).

FIRST USE 7-1-2006; IN COMMERCE 7-1-2006.

THE MARK CONSISTS OF STANDARD CHAR-
ACTERS WITHOUT CLAIM TO ANY PARTICULAR
FONT, STYLE, SIZE, OR COLOR.

SER. NO. 77-331,224, FILED 11-16-2007.

KIMBERLY PERRY, EXAMINING ATTORNEY

Int. Cl.: 35

Prior U.S. Cls.: 100, 101 and 102

United States Patent and Trademark Office

Reg. No. 3,483,915

Registered Aug. 12, 2008

**SERVICE MARK
PRINCIPAL REGISTER**



THE DOUGHERTY CONSULTING GROUP, LLC
(ARKANSAS LTD LIAB CO)
P.O. BOX 7816
1708 N MONROE STREET
LITTLE ROCK, AR 72207

FOR: PROVIDING A WEBSITE FEATURING INFORMATION ON SHOPPING AND PROMOTING THE GOODS AND SERVICES OF OTHERS THROUGH A DAILY E-NEWSLETTER , IN CLASS 35 (U.S. CLS. 100, 101 AND 102).

FIRST USE 11-15-2007; IN COMMERCE 11-15-2007.

NO CLAIM IS MADE TO THE EXCLUSIVE RIGHT TO USE "LITTLE ROCK", APART FROM THE MARK AS SHOWN.

THE COLOR(S) WHITE, DARK PINK, PINK, LIGHT PINK, GREEN, AND BLACK IS/ARE CLAIMED AS A FEATURE OF THE MARK.

THE MARK CONSISTS OF THREE DARK PINK AND WHITE FLAMES WITH A GREEN CIRCLE CENTER ON TOP OF THE WORDS "LITTLE ROCK" IN WHITE IN A BLACK RECTANGULAR BOX AND THE WORDS "HOT IN" IN BLACK, ALL IN FRONT OF A LIGHT PINK AND PINK FLORAL WATER-MARK BACKGROUND WITH A LIGHT PINK VERTICAL LINE AND A WHITE CURVED BORDER ON THE LEFT.

SER. NO. 77-331,258, FILED 11-16-2007.

TINA KUAN, EXAMINING ATTORNEY

Int. Cl.: 37

Prior U.S. Cls.: 100, 103 and 106

United States Patent and Trademark Office

Reg. No. 3,483,916

Registered Aug. 12, 2008

**SERVICE MARK
PRINCIPAL REGISTER**



KUMKANG SHOE CO., LTD. (REPUBLIC OF
KOREA CORPORATION)
406-3 HYOSEONG-DONG, KYEYANG-GU
INCHEON, REPUBLIC OF KOREA

FOR: LEATHER REPAIR, SHOE REPAIR, REPAIR
OF HATS, FUR PELT REPAIR, CLOCK REPAIR,
FOOTWEAR REPAIR, REPAIR OF SPECTACLES,
UMBRELLA REPAIR, CLOTHING REPAIR, RE-
PAIR OF SHOE MAKING MACHINES AND IN-
STRUMENTS, IN CLASS 37 (U.S. CLS. 100, 103 AND
106).

OWNER OF REPUBLIC OF KOREA REG. NO.
0067119, DATED 3-22-2001, EXPIRES 3-22-2011.

OWNER OF U.S. REG. NOS. 1,670,922, 2,285,956,
AND 2,401,213.

NO CLAIM IS MADE TO THE EXCLUSIVE
RIGHT TO USE "VIGEVANO", APART FROM THE
MARK AS SHOWN.

THE MARK CONSISTS OF THE WORD "VIGE-
VANO" FOLLOWING A DESIGN OF A FANCIFUL
POT INSIDE A CIRCLE.

SER. NO. 77-331,727, FILED 11-16-2007.

DARRYL SPRUILL, EXAMINING ATTORNEY

Int. Cl.: 1

Prior U.S. Cls.: 1, 5, 6, 10, 26 and 46

Reg. No. 3,483,917

United States Patent and Trademark Office

Registered Aug. 12, 2008

**TRADEMARK
PRINCIPAL REGISTER**

PROTECTACLEAR

EVERBRITE, INC. (NEVADA CORPORATION)
SUITE 116, 955 S. VIRGINIA ST.
RENO, NV 89502

THE MARK CONSISTS OF STANDARD CHAR-
ACTERS WITHOUT CLAIM TO ANY PARTICULAR
FONT, STYLE, SIZE, OR COLOR.

FOR: SYNTHETIC TRANSPARENT POLYMER
RESIN FOR PROTECTING METAL SURFACES, IN
CLASS 1 (U.S. CLS. 1, 5, 6, 10, 26 AND 46).

SER. NO. 77-332,119, FILED 11-16-2007.

FIRST USE 4-19-2007; IN COMMERCE 4-19-2007.

FRANK LATTUCA, EXAMINING ATTORNEY

Int. Cl.: 40

Prior U.S. Cls.: 100, 103 and 106

United States Patent and Trademark Office

Reg. No. 3,483,918

Registered Aug. 12, 2008

**SERVICE MARK
PRINCIPAL REGISTER**



INTERMOUNTAIN COLOR, INC. (COLORADO CORPORATION)
4900 PEARL STREET, SUITE 300 EAST
BOULDER, CO 80301

THE MARK CONSISTS OF TWO ARROWS AND A LEAF ARRANGED IN A TRIANGULAR PATTERN.

FOR: PRINTING SERVICES; OFFSET PRINTING SERVICES; LITHOGRAPHIC PRINTING SERVICES, IN CLASS 40 (U.S. CLS. 100, 103 AND 106).

SER. NO. 77-332,270, FILED 11-17-2007.

FIRST USE 11-15-2007; IN COMMERCE 11-15-2007.

CAROLINE WOOD, EXAMINING ATTORNEY

Int. Cl.: 40

Prior U.S. Cls.: 100, 103 and 106

United States Patent and Trademark Office

Reg. No. 3,483,919

Registered Aug. 12, 2008

**SERVICE MARK
PRINCIPAL REGISTER**

**DEFINING SUSTAINABLE
PRINTING**

INTERMOUNTAIN COLOR, INC. (COLORADO
CORPORATION)
4900 PEARL STREET, SUITE 300 EAST
BOULDER, CO 80301

FOR: PRINTING SERVICES; OFFSET PRINTING
SERVICES; LITHOGRAPHIC PRINTING SERVICES,
IN CLASS 40 (U.S. CLS. 100, 103 AND 106).

FIRST USE 10-31-2007; IN COMMERCE 10-31-2007.

THE MARK CONSISTS OF STANDARD CHAR-
ACTERS WITHOUT CLAIM TO ANY PARTICULAR
FONT, STYLE, SIZE, OR COLOR.

NO CLAIM IS MADE TO THE EXCLUSIVE
RIGHT TO USE "SUSTAINABLE PRINTING",
APART FROM THE MARK AS SHOWN.

SER. NO. 77-332,271, FILED 11-17-2007.

CAROLINE WOOD, EXAMINING ATTORNEY

Int. Cls.: 5 and 32

Prior U.S. Cls.: 6, 18, 44, 45, 46, 48, 51 and 52

United States Patent and Trademark Office

Reg. No. 3,483,920

Registered Aug. 12, 2008

**TRADEMARK
PRINCIPAL REGISTER**



MD DRINKS, INC. (CALIFORNIA CORPORATION)
2639A MANHATTAN BEACH BLVD.
REDONDO BEACH, CA 90278

FOR: DIETARY SUPPLEMENTAL DRINKS, IN CLASS 5 (U.S. CLS. 6, 18, 44, 46, 51 AND 52).

FIRST USE 8-0-2007; IN COMMERCE 8-0-2007.

FOR: BEVERAGES, NAMELY, FRUIT FLAVORED AND FRUIT-BASED ENERGY DRINKS, SOFT DRINKS, AND SPORTS DRINKS ALL ENHANCED WITH VITAMINS, MINERALS, NUTRIENTS, AMINO ACIDS AND/OR HERBS, IN CLASS 32 (U.S. CLS. 45, 46 AND 48).

FIRST USE 8-0-2007; IN COMMERCE 8-0-2007.

NO CLAIM IS MADE TO THE EXCLUSIVE RIGHT TO USE "CREATED BY PHYSICIANS", APART FROM THE MARK AS SHOWN.

THE MARK CONSISTS OF THE WORDS, "CREATED BY PHYSICIANS" AND A SNAKE WRAPPED AROUND A VERTICAL LINE.

SER. NO. 77-332,292, FILED 11-17-2007.

MIDGE BUTLER, EXAMINING ATTORNEY

Int. Cl.: 9

Prior U.S. Cls.: 21, 23, 26, 36 and 38

Reg. No. 3,483,921

United States Patent and Trademark Office

Registered Aug. 12, 2008

**TRADEMARK
PRINCIPAL REGISTER**

LEARN-ED HANDS

FRAZIER, JEFFERY D. (UNITED STATES INDIVIDUAL)
14 ARASTRADERO ROAD
PORTOLA VALLEY, CA 94028

THE MARK CONSISTS OF STANDARD CHARACTERS WITHOUT CLAIM TO ANY PARTICULAR FONT, STYLE, SIZE, OR COLOR.

FOR: AUDIO RECORDINGS FEATURING MUSIC; DOWNLOADABLE MUSICAL SOUND RECORDINGS, IN CLASS 9 (U.S. CLS. 21, 23, 26, 36 AND 38).

SER. NO. 77-332,448, FILED 11-18-2007.

FIRST USE 1-1-1988; IN COMMERCE 1-1-1988.

COLLEEN DOMBROW, EXAMINING ATTORNEY

Int. Cls.: 9, 16 and 41

Prior U.S. Cls.: 2, 5, 21, 22, 23, 26, 29, 36, 37, 38, 50,
100, 101 and 107

Reg. No. 3,483,922

United States Patent and Trademark Office

Registered Aug. 12, 2008

TRADEMARK
SERVICE MARK
PRINCIPAL REGISTER



STORPER, BARBARA F. (UNITED STATES IN-
DIVIDUAL)
1 SUNSET AVENUE
HATFIELD, MA 01038

FOR: PRE-RECORDED VIDEO CASSETTES, CD-
ROM, DVDS, AND AUDIO CASSETTES FEATUR-
ING INFORMATION ON FOOD, NUTRITION,
HEALTH, FITNESS, CONSUMER SKILLS, TOBAC-
CO PREVENTION, OSTEOPOROSIS PREVENTION,
MEDIA LITERACY, BODY IMAGE, EATING DIS-
ORDERS, AND OTHER HEALTH TOPICS, IN CLASS
9 (U.S. CLS. 21, 23, 26, 36 AND 38).

FIRST USE 10-14-2004; IN COMMERCE 10-14-2004.

FOR: ACTIVITY BOOKS FOR CHILDREN AND
ADULTS, COOKBOOKS, CHILDREN'S BOOKS,
COLORING BOOKS, SERIES OF FICTION BOOKS;
AND SERIES OF NON-FICTION BOOKS, FACT
SHEETS, NEWSLETTERS, BOOKLETS, CATALOGS
AND BROCHURES ALL IN THE FIELD OF NUTRI-
TION, HEALTH, FITNESS, CONSUMER SKILLS,
TOBACCO PREVENTION, OSTEOPOROSIS PRE-
VENTION, MEDIA LITERACY, BODY IMAGE, EAT-
ING DISORDERS, AND OTHER HEALTH TOPICS,
IN CLASS 16 (U.S. CLS. 2, 5, 22, 23, 29, 37, 38 AND 50).

FIRST USE 10-14-2004; IN COMMERCE 10-14-2004.

FOR: EDUCATION AND ENTERTAINMENT
SERVICES, NAMELY, PRESENTATION OF LIVE
SHOWS, AND WORKSHOPS IN THE FIELD OF
NUTRITION AND FITNESS FOR CHILDREN AND
ADULTS, IN CLASS 41 (U.S. CLS. 100, 101 AND 107).

FIRST USE 10-14-2004; IN COMMERCE 10-14-2004.

OWNER OF U.S. REG. NOS. 2,460,782, 3,065,683
AND OTHERS.

NO CLAIM IS MADE TO THE EXCLUSIVE
RIGHT TO USE "PRODUCTIONS", APART FROM
THE MARK AS SHOWN.

THE MARK CONSISTS OF THE WORDS "FOOD-
PLAY PRODUCTIONS TURNING KIDS ON TO
HEALTHY HABITS". BELOW THE "FOOD" POR-
TION OF THE WORD "FOODPLAY" IS AN OVAL
DESIGN. THERE ARE THREE "O'S IN "FOODPLAY"
AND ONE HAS A LEAF AT THE TOP TO RESEM-
BLE AN APPLE. TO THE LEFT OF THE WORDS IS A
SQUARE INSIDE OF WHICH IS A PICTURE OF A
CHILD WITH A STRIPED SHIRT JUGGLING AP-
PLES.

SER. NO. 77-332,679, FILED 11-19-2007.

AHSEN KHAN, EXAMINING ATTORNEY

Int. Cl.: 16

Prior U.S. Cls.: 2, 5, 22, 23, 29, 37, 38 and 50

Reg. No. 3,483,923

United States Patent and Trademark Office

Registered Aug. 12, 2008

TRADEMARK
PRINCIPAL REGISTER



CALPINE CONTAINERS, INC. (CALIFORNIA CORPORATION)
3478 BUSKIRK AVENUE, SUITE 336
PLEASANT HILL, CA 94523

FOR: CARDBOARD CONTAINERS; CORRUGATED CARDBOARD BOXES, IN CLASS 16 (U.S. CLS. 2, 5, 22, 23, 29, 37, 38 AND 50).

FIRST USE 8-28-2006; IN COMMERCE 8-28-2006.

OWNER OF U.S. REG. NOS. 841,442 AND 847,796.

NO CLAIM IS MADE TO THE EXCLUSIVE RIGHT TO USE "SINCE 1895", APART FROM THE MARK AS SHOWN.

THE MARK CONSISTS OF THE WORD "CALPINE" NEXT TO A PINE TREE AND WITH THE ADDITIONAL WORDS "SINCE 1895" BELOW.

SER. NO. 77-333,003, FILED 11-19-2007.

JACQUELINE A. LAVINE, EXAMINING ATTORNEY

Int. Cl.: 41

Prior U.S. Cls.: 100, 101 and 107

United States Patent and Trademark Office

Reg. No. 3,483,924

Registered Aug. 12, 2008

**SERVICE MARK
PRINCIPAL REGISTER**

IPBL

JEFFREY H. ROSEN (UNITED STATES INDIVIDUAL)
BELLE MARE UNIT 1401, WILLIAMS ISLAND
6000 ISLAND BOULEVARD
AVENTURA, FL 33160

FOR: ENTERTAINMENT SERVICES IN THE NATURE OF BASEBALL GAMES AND EXHIBITIONS, IN CLASS 41 (U.S. CLS. 100, 101 AND 107).

FIRST USE 11-16-2007; IN COMMERCE 11-16-2007.

THE MARK CONSISTS OF STANDARD CHARACTERS WITHOUT CLAIM TO ANY PARTICULAR FONT, STYLE, SIZE, OR COLOR.

SER. NO. 77-333,194, FILED 11-19-2007.

CHRISTOPHER BUONGIORNO, EXAMINING ATTORNEY

Int. Cl.: 41

Prior U.S. Cls.: 100, 101 and 107

United States Patent and Trademark Office

Reg. No. 3,483,925

Registered Aug. 12, 2008

**SERVICE MARK
PRINCIPAL REGISTER**

Equal Opportunity School

SAARIS, REID DEVIN (UNITED STATES INDIVIDUAL)
1250 H STREET, NW, SUITE 700
WASHINGTON, DC 20005

FOR: CONSULTATION IN THE FIELD OF K-12 EDUCATIONAL SYSTEMS, IN CLASS 41 (U.S. CLS. 100, 101 AND 107).

FIRST USE 8-7-2007; IN COMMERCE 8-31-2007.

THE MARK CONSISTS OF STANDARD CHARACTERS WITHOUT CLAIM TO ANY PARTICULAR FONT, STYLE, SIZE, OR COLOR.

NO CLAIM IS MADE TO THE EXCLUSIVE RIGHT TO USE "SCHOOL", APART FROM THE MARK AS SHOWN.

SER. NO. 77-333,438, FILED 11-19-2007.

JORDAN BAKER, EXAMINING ATTORNEY

Int. Cl.: 45

Prior U.S. Cls.: 100 and 101

United States Patent and Trademark Office

Reg. No. 3,483,926

Registered Aug. 12, 2008

**SERVICE MARK
PRINCIPAL REGISTER**



MAC PRIVATE INVESTIGATOR FIRM (FLORIDA CORPORATION)
496 W. 45 PLACE
HIALEAH, FL 33012

FOR: PRIVATE INVESTIGATION, IN CLASS 45
(U.S. CLS. 100 AND 101).

FIRST USE 12-1-2006; IN COMMERCE 12-1-2006.

NO CLAIM IS MADE TO THE EXCLUSIVE
RIGHT TO USE "PRIVATE INVESTIGATOR FIRM",
APART FROM THE MARK AS SHOWN.

THE LIKENESS (OR, "PORTRAIT") IN THE
MARK DOES NOT IDENTIFY A LIVING INDIVIDUAL.

THE MARK CONSISTS OF NAME OF COMPANY,
MAN WITH PIPE AND MAGNIFYING GLASS.

SER. NO. 77-333,643, FILED 11-19-2007.

ELLEN PERKINS, EXAMINING ATTORNEY

Int. Cl.: 9

Prior U.S. Cls.: 21, 23, 26, 36 and 38

Reg. No. 3,483,927

United States Patent and Trademark Office

Registered Aug. 12, 2008

TRADEMARK
PRINCIPAL REGISTER



M - **GLIDE**

SUN K. OH (UNITED STATES INDIVIDUAL)
219 MUSKET CIRCLE
LANSDALE, PA 19446 AND
BYUNG KIM (UNITED STATES INDIVIDUAL)
219 MUSKET CIRCLE
LANSDALE, PA 19446

THE MARK CONSISTS OF THE STYLIZED PRESENTATION OF THE CAPITAL LETTER "M" ITALICIZED, FOLLOWED BY A DASH AND THE WORD "GLIDE" IN CAPITAL LETTERS, UNDERSCORED WITH THREE WAVE LINES.

FOR: MOVABLE WRIST RESTS FOR COMPUTER MOUSE USERS, IN CLASS 9 (U.S. CLS. 21, 23, 26, 36 AND 38).

SER. NO. 77-334,194, FILED 11-20-2007.

FIRST USE 10-28-2007; IN COMMERCE 10-28-2007.

CURTIS FRENCH, EXAMINING ATTORNEY

Int. Cl.: 42

Prior U.S. Cls.: 100 and 101

United States Patent and Trademark Office

Reg. No. 3,483,928

Registered Aug. 12, 2008

**SERVICE MARK
PRINCIPAL REGISTER**

MajorTom

AQUENT LLC (DELAWARE LTD LIAB CO)
711 BOYLSTON STREET
BOSTON, MA 02116

FIRST USE 4-30-2007; IN COMMERCE 4-30-2007.

FOR: PROVIDING TEMPORARY USE OF ON-LINE NON-DOWNLOADABLE SOFTWARE FOR MANAGING DIGITAL MEDIA ASSETS FOR INFORMATION-ORIENTED ORGANIZATIONS TO CAPTURE, MANAGE AND RE-EXPRESS AND DISTRIBUTE CONTENT, INCLUDING TEXT, IMAGES, AUDIO AND VIDEO ACROSS INTERACTIVE MEDIA, IN CLASS 42 (U.S. CLS. 100 AND 101).

THE MARK CONSISTS OF STANDARD CHARACTERS WITHOUT CLAIM TO ANY PARTICULAR FONT, STYLE, SIZE, OR COLOR.

SER. NO. 77-334,227, FILED 11-20-2007.

ROBIN MITTLER, EXAMINING ATTORNEY

Int. Cls.: 39 and 42

Prior U.S. Cls.: 100, 101 and 105

United States Patent and Trademark Office

Reg. No. 3,483,929

Registered Aug. 12, 2008

**SERVICE MARK
PRINCIPAL REGISTER**

DIGISHIELD

DATA AGE BUSINESS SYSTEMS, INC. (FLOR-
IDA CORPORATION)
10225 ULMERTON RD., SUITE 10A
LARGO, FL 33771

FOR: CONSULTING IN THE FIELD OF ELEC-
TRONIC STORAGE OF DATA, IN CLASS 39 (U.S.
CLS. 100 AND 105).

FIRST USE 10-15-2007; IN COMMERCE 10-15-2007.

FOR: TECHNICAL SUPPORT SERVICES, NAME-
LY, PROVIDING TECHNICAL ADVICE AND
TROUBLESHOOTING COMPUTER SOFTWARE
PROBLEMS, ALL IN THE FIELD OF COMPUTER

SOFTWARE FOR USE IN THE ELECTRONIC STO-
RAGE OF DATA, IN CLASS 42 (U.S. CLS. 100 AND
101).

FIRST USE 10-15-2007; IN COMMERCE 10-15-2007.

THE MARK CONSISTS OF STANDARD CHAR-
ACTERS WITHOUT CLAIM TO ANY PARTICULAR
FONT, STYLE, SIZE, OR COLOR.

SER. NO. 77-334,286, FILED 11-20-2007.

ERNEST SHOSHO, EXAMINING ATTORNEY

Int. Cl.: 16

Prior U.S. Cls.: 2, 5, 22, 23, 29, 37, 38 and 50

Reg. No. 3,483,930

United States Patent and Trademark Office

Registered Aug. 12, 2008

**TRADEMARK
PRINCIPAL REGISTER**

ALL KIDS CAN LEARN

CVS PHARMACY, INC. (RHODE ISLAND CORPORATION)
ONE CVS DRIVE
WOONSOCKET, RI 02895

FOR: EDUCATIONAL MATERIALS, NAMELY, WORKBOOKS AND ACTIVITY BOOKS FOR USE IN LEARNING PROGRAMS FOR CHILDREN; AND PRINTED INSTRUCTIONAL, EDUCATIONAL AND TEACHING MATERIALS IN THE FIELD OF LEARNING STYLES, CHILDREN WITH LEARNING DISABILITIES AND INCLUSIVE CURRICULA, IN CLASS 16 (U.S. CLS. 2, 5, 22, 23, 29, 37, 38 AND 50).

FIRST USE 10-31-2007; IN COMMERCE 10-31-2007.

THE MARK CONSISTS OF STANDARD CHARACTERS WITHOUT CLAIM TO ANY PARTICULAR FONT, STYLE, SIZE, OR COLOR.

OWNER OF U.S. REG. NOS. 3,303,944 AND 3,313,617.

SER. NO. 77-334,316, FILED 11-20-2007.

ZACHARY BELLO, EXAMINING ATTORNEY

Int. Cl.: 18

Prior U.S. Cls.: 1, 2, 3, 22 and 41

United States Patent and Trademark Office

Reg. No. 3,483,931

Registered Aug. 12, 2008

TRADEMARK
PRINCIPAL REGISTER



ANIT ACCESSORIES (CALIFORNIA CORPORATION)
19030 HICKORY HILL LANE
WALNUT, CA 91789

PRIORITY CLAIMED UNDER SEC. 44(D) ON
TAIWAN APPLICATION NO. 096023970, FILED 5-
23-2007.

FOR: (BASED ON USE IN COMMERCE) CLOTHING FOR DOMESTIC PETS; GARMENTS FOR PETS; PET CLOTHING; DOG APPAREL; DOG CLOTHING; DOG COATS; DOG PARKAS(BASED ON 44(D) PRIORITY APPLICATION) CLOTHING FOR DOMESTIC PETS; GARMENTS FOR PETS; PET CLOTHING; DOG APPAREL; DOG CLOTHING; DOG COATS; DOG PARKAS, IN CLASS 18 (U.S. CLS. 1, 2, 3, 22 AND 41).

THE MARK CONSISTS OF STYLIZED WORD "ANIT" IN HARRINGTON FONT. THE WORD IS SET IN BETWEEN A SET OF OUTLINED WINGS, EACH CONSISTING OF THREE BUBBLE LIKE SHAPES AND A SHARP POINT AT THE END.

SER. NO. 77-334,376, FILED 11-20-2007.

FIRST USE 5-0-2007; IN COMMERCE 9-17-2007.

CHRIS WELLS, EXAMINING ATTORNEY

Int. Cl.: 36

Prior U.S. Cls.: 100, 101 and 102

United States Patent and Trademark Office

Reg. No. 3,483,932

Registered Aug. 12, 2008

**SERVICE MARK
PRINCIPAL REGISTER**

**BREATHESY SMOKE-FREE
ENVIRONMENT**

AMLI RESIDENTIAL PROPERTIES, L.P. (DELA-
WARE LIMITED PARTNERSHIP)
SUITE 2200
200 W. MONROE ST.
CHICAGO, IL 60606

FOR: LEASING OF APARTMENTS; RENTAL OF
APARTMENTS, IN CLASS 36 (U.S. CLS. 100, 101 AND
102).

FIRST USE 3-15-2007; IN COMMERCE 3-15-2007.

THE MARK CONSISTS OF STANDARD CHAR-
ACTERS WITHOUT CLAIM TO ANY PARTICULAR
FONT, STYLE, SIZE, OR COLOR.

NO CLAIM IS MADE TO THE EXCLUSIVE
RIGHT TO USE "SMOKE-FREE ENVIRONMENT",
APART FROM THE MARK AS SHOWN.

SER. NO. 77-334,387, FILED 11-20-2007.

KEVON CHISOLM, EXAMINING ATTORNEY

Int. Cl.: 36

Prior U.S. Cls.: 100, 101 and 102

United States Patent and Trademark Office

Reg. No. 3,483,933

Registered Aug. 12, 2008

SERVICE MARK
PRINCIPAL REGISTER



AMLI RESIDENTIAL PROPERTIES, L.P. (DELA-
WARE LIMITED PARTNERSHIP)
SUITE 2200
200 W. MONROE ST.
CHICAGO, IL 60606

FOR: LEASING OF APARTMENTS; RENTAL OF
APARTMENTS, IN CLASS 36 (U.S. CLS. 100, 101 AND
102).

FIRST USE 3-15-2007; IN COMMERCE 3-15-2007.

NO CLAIM IS MADE TO THE EXCLUSIVE
RIGHT TO USE "SMOKE-FREE ENVIRONMENT",
APART FROM THE MARK AS SHOWN.

THE COLOR(S) BLUE, GREEN AND GREY IS/
ARE CLAIMED AS A FEATURE OF THE MARK.

THE MARK CONSISTS OF THE WORD
"BREATHEASY" IS IN BLUE SHADOW FONT, EX-
CEPT THE SECOND "E" IS FORMED IN DOUBLE
LINE GREEN SHADOW FONT, AND THERE IS A
GREEN LEAF, WITH A GREY SHADOW AND THE
WORDS SMOKE-FREE ENVIRONMENT IN GREEN
BELOW THE WORD "BREATHEASY".

SER. NO. 77-334,434, FILED 11-20-2007.

KEVON CHISOLM, EXAMINING ATTORNEY

Int. Cl.: 25

Prior U.S. Cls.: 22 and 39

United States Patent and Trademark Office

Reg. No. 3,483,934

Registered Aug. 12, 2008

**TRADEMARK
PRINCIPAL REGISTER**



UNIVERSITY OF CENTRAL MISSOURI BOARD
OF GOVERNORS (MISSOURI STATE UNI-
VERSITY)
ADMINISTRATION 101
WARRENSBURG, MO 64093

FOR: CAPS; SHIRTS; SWEAT SHIRTS; T-SHIRTS,
IN CLASS 25 (U.S. CLS. 22 AND 39).

FIRST USE 9-1-1996; IN COMMERCE 9-1-1996.

NO CLAIM IS MADE TO THE EXCLUSIVE
RIGHT TO USE "CENTRAL MO", APART FROM
THE MARK AS SHOWN.

THE MARK CONSISTS OF WALKING MULE
WEARING A SHIRT CONTAINING THE WORDS
"CENTRAL MO".

SER. NO. 77-334,868, FILED 11-21-2007.

JASON BLAIR, EXAMINING ATTORNEY

Int. Cls.: 21 and 25

Prior U.S. Cls.: 2, 13, 22, 23, 29, 30, 33, 39, 40 and 50

Reg. No. 3,483,935

United States Patent and Trademark Office

Registered Aug. 12, 2008

**TRADEMARK
PRINCIPAL REGISTER**

UCM

UNIVERSITY OF CENTRAL MISSOURI BOARD
OF GOVERNORS (MISSOURI STATE UNI-
VERSITY)
ADMINISTRATION 101
WARRENSBURG, MO 64093

FOR: CUPS AND MUGS, IN CLASS 21 (U.S. CLS. 2,
13, 23, 29, 30, 33, 40 AND 50).

FIRST USE 9-20-2006; IN COMMERCE 9-20-2006.

FOR: SHIRTS; SWEAT SHIRTS; T-SHIRTS; CAPS,
IN CLASS 25 (U.S. CLS. 22 AND 39).

FIRST USE 9-20-2006; IN COMMERCE 9-20-2006.

THE MARK CONSISTS OF STANDARD CHAR-
ACTERS WITHOUT CLAIM TO ANY PARTICULAR
FONT, STYLE, SIZE, OR COLOR.

SER. NO. 77-334,873, FILED 11-21-2007.

JASON BLAIR, EXAMINING ATTORNEY

Int. Cl.: 10

Prior U.S. Cls.: 26, 39 and 44

United States Patent and Trademark Office

Reg. No. 3,483,936

Registered Aug. 12, 2008

**TRADEMARK
PRINCIPAL REGISTER**

DRINK & DREAM BOTTLE

Q-PIT INDUSTRIES, INC. (DELAWARE CORPORATION)
418 CENTRAL PARK WEST
NEW YORK, NY 10025

FOR: MUSICAL BABY BOTTLES, IN CLASS 10
(U.S. CLS. 26, 39 AND 44).

FIRST USE 1-1-1996; IN COMMERCE 1-1-1996.

THE MARK CONSISTS OF STANDARD CHARACTERS WITHOUT CLAIM TO ANY PARTICULAR FONT, STYLE, SIZE, OR COLOR.

NO CLAIM IS MADE TO THE EXCLUSIVE RIGHT TO USE "BOTTLE", APART FROM THE MARK AS SHOWN.

SER. NO. 77-335,037, FILED 11-21-2007.

VIVIAN MICZNIK FIRST, EXAMINING ATTORNEY

Int. Cl.: 41

Prior U.S. Cls.: 100, 101 and 107

United States Patent and Trademark Office

Reg. No. 3,483,937

Registered Aug. 12, 2008

**SERVICE MARK
PRINCIPAL REGISTER**

PhotoTudes

PHOTOTUDES, LLC (CALIFORNIA LTD LIAB
CO)
641 17TH STREET
SAN DIEGO, CA 92101

THE MARK CONSISTS OF STANDARD CHAR-
ACTERS WITHOUT CLAIM TO ANY PARTICULAR
FONT, STYLE, SIZE, OR COLOR.

FOR: PHOTOGRAPHY SERVICES, IN CLASS 41
(U.S. CLS. 100, 101 AND 107).

SER. NO. 77-335,200, FILED 11-21-2007.

FIRST USE 4-10-2007; IN COMMERCE 4-10-2007.

BRIAN CALLAGHAN, EXAMINING ATTORNEY

Int. Cl.: 20

Prior U.S. Cls.: 2, 13, 22, 25, 32 and 50

United States Patent and Trademark Office

Reg. No. 3,483,938

Registered Aug. 12, 2008

**TRADEMARK
PRINCIPAL REGISTER**

Miracle Cone

WEYTS, PIETER A. (BELGIUM INDIVIDUAL)
DAVIS POLK & WARDWELL
450 LEXINGTON AVENUE
NEW YORK, NY 10017

FOR: PACKAGING CONTAINERS OF PLASTIC,
IN CLASS 20 (U.S. CLS. 2, 13, 22, 25, 32 AND 50).

FIRST USE 3-1-2008; IN COMMERCE 3-1-2008.

THE MARK CONSISTS OF STANDARD CHAR-
ACTERS WITHOUT CLAIM TO ANY PARTICULAR
FONT, STYLE, SIZE, OR COLOR.

NO CLAIM IS MADE TO THE EXCLUSIVE
RIGHT TO USE "CONE", APART FROM THE MARK
AS SHOWN.

SER. NO. 77-335,310, FILED 11-21-2007.

SONYA STEPHENS, EXAMINING ATTORNEY

Int. Cl.: 11

Prior U.S. Cls.: 13, 21, 23, 31 and 34

Reg. No. 3,483,939

United States Patent and Trademark Office

Registered Aug. 12, 2008

**TRADEMARK
PRINCIPAL REGISTER**

EMERY THOMPSON

EMERY THOMPSON MACHINE & SUPPLY, CO.
(NEW YORK CORPORATION)
15350 FLIGHT PATH DR
BROOKSVILLE, FL, FL 34604

FOR: ELECTRICAL ICE CREAM, ITALIAN ICE,
AND FROZEN CUSTARD MAKERS, IN CLASS 11
(U.S. CLS. 13, 21, 23, 31 AND 34).

FIRST USE 0-0-1905; IN COMMERCE 0-0-1905.

THE MARK CONSISTS OF STANDARD CHAR-
ACTERS WITHOUT CLAIM TO ANY PARTICULAR
FONT, STYLE, SIZE, OR COLOR.

EMERY THOMPSON DOES NOT IDENTIFY A
LIVING INDIVIDUAL.

SER. NO. 77-335,489, FILED 11-21-2007.

STEVEN R. FOSTER, EXAMINING ATTORNEY

Int. Cl.: 25

Prior U.S. Cls.: 22 and 39

United States Patent and Trademark Office

Reg. No. 3,483,940

Registered Aug. 12, 2008

**TRADEMARK
PRINCIPAL REGISTER**

IZZA B

ANANDA SOLUTIONS, LLC (UTAH LTD LIAB
CO), DBA IZZA B
1105 EAST 1000 NORTH
OGDEN, UT 84404

THE MARK CONSISTS OF STANDARD CHAR-
ACTERS WITHOUT CLAIM TO ANY PARTICULAR
FONT, STYLE, SIZE, OR COLOR.

FOR: CLOTHING, NAMELY, VESTS, PANTS,
SOCKS, UNDERGARMENTS, SHIRTS, HATS, JACK-
ETS, COATS AND GLOVES, IN CLASS 25 (U.S. CLS.
22 AND 39).

SER. NO. 77-335,529, FILED 11-21-2007.

FIRST USE 10-25-2007; IN COMMERCE 10-25-2007.

JOHN DALIER, EXAMINING ATTORNEY

Int. Cl.: 41

Prior U.S. Cls.: 100, 101 and 107

United States Patent and Trademark Office

Reg. No. 3,483,941

Registered Aug. 12, 2008

**SERVICE MARK
PRINCIPAL REGISTER**

REFLEXOLOGY-PLUS

BARRANCE, PATRICIA M. (UNITED STATES
INDIVIDUAL)
1590 17TH AVENUE
MARION, IA 52302

FOR: EDUCATIONAL SERVICES, NAMELY,
CONDUCTING CLASSES AND WORKSHOPS IN
THE FIELD OF REFLEXOLOGY AND DISTRIBUTION
OF COURSE MATERIAL IN CONNECTION
THEREWITH, IN CLASS 41 (U.S. CLS. 100, 101 AND
107).

FIRST USE 4-24-2002; IN COMMERCE 4-24-2002.

THE COLOR(S) BLACK AND LIGHT PURPLE IS/
ARE CLAIMED AS A FEATURE OF THE MARK.

THE MARK CONSISTS OF THE STYLIZED
WORDING "REFLEXOLOGY-PLUS" UNDER-
LINED WITHIN A RECTANGLE. THE COLOR
BLACK APPEARS IN THE STYLIZED WORDING
"REFLEXOLOGY-PLUS" AND IN THE UNDER-
LINE. THE COLOR LIGHT PURPLE APPEARS IN
THE RECTANGULAR CARRIER.

SER. NO. 77-336,107, FILED 11-23-2007.

JAY BESCH, EXAMINING ATTORNEY

Int. Cl.: 24

Prior U.S. Cls.: 42 and 50

United States Patent and Trademark Office

Reg. No. 3,483,942

Registered Aug. 12, 2008

TRADEMARK
PRINCIPAL REGISTER

MONICA'S HOUSE

ARANA ART, LLC (FLORIDA LTD LIAB CO),
DBA MONICA'S HOUSE
825 SOUTH WYMORE RD APT 3B
ALTAMONTE SPRINGS, FL 32714

FOR: BARBECUE MITTS; BATH GLOVES; BATH LINEN; BATH MITTS; BATH SHEETS; BATH TOWELS; BEACH TOWELS; BED AND TABLE LINEN; BED AND TABLE LINEN, WALL HANGINGS OF TEXTILE; BED BLANKETS; BED CANOPIES; BED LINEN; BED LINEN AND TABLE LINEN; BED PADS; BED SHEETS; BED SKIRTS; BED SPREADS; BEDSHEETS; BLANKET THROWS; BLANKETS FOR OUTDOOR USE; BROCADE; BURP CLOTHS; CHILDREN'S BLANKETS; CHILDREN'S TOWELS; CLOTH BUNTING; CLOTH COASTERS; CLOTH DOILIES; CLOTH FLAGS; CLOTH LABELS; CLOTHS USED FOR WRAPPING GOODS; COMFORTERS; CONTOUR SHEETS; COVERINGS OF PLASTIC FOR FURNITURE; COVERLETS; COVERS FOR CUSHIONS; CRIB BUMPERS; CRIB CANOPIES; CURTAIN TIE-BACKS; CURTAINS; CURTAINS AND TOWELS; CURTAINS MADE OF TEXTILE FABRICS; CURTAINS OF TEXTILE OR PLASTIC; CUSHION COVERS; DIAPER CHANGING MATS; DIAPER CHANGING PADS NOT OF PAPER; DINING LINENS; DISH CLOTHS; DRAPERIES; DRAPERIES; DRAPERY; DUST RUFFLES; DUVET COVERS; EIDERDOWN COVERS; EIDERDOWNS; FABRIC COVERS FOR USE ON VARIOUS STRAPS; FABRIC DIAPER STACKERS; FABRIC DRAPES DESIGNED TO CONCEAL THE ACT OF BREAST-FEEDING IN PUBLIC; FABRIC FLAGS; FABRIC TABLE RUNNERS; FABRIC TABLE TOPPERS; FABRIC VALANCES; FABRIC WINDOW COVERINGS AND TREATMENTS, NAMELY, CURTAINS, DRAPERIES, SHEERS, SWAGS AND VALANCES; FACE CLOTHS; FACE TOWELS; GIFT WRAP OF FABRIC; GIFT WRAP OF TEXTILE; HAND TOWELS; HAND TOWELS OF TEXTILE; HAND-TOWELS MADE OF TEXTILE FABRICS; HANDKERCHIEFS; HANDKERCHIEFS OF TEXTILE; HANDKERCHIEFS OF

TEXTILES; HOODED TOWELS; HOUSEHOLD LINEN; KITCHEN LINENS; KITCHEN TOWELS; LABELS OF CLOTH; LAP ROBES; LARGE BATH TOWELS; LINEN; LINEN CLOTH; MATTRESS COVERS; NON-PAPER DOILIES; OVEN MITTS; PET BLANKETS; PILLOW CASES; PILLOW COVERS; PILLOW SHAMS; PILLOWCASES; PLACE MATS NOT OF PAPER; PLACE MATS OF TEXTILE MATERIAL; POCKET HANDKERCHIEFS; POT HOLDERS; PRINTED TEXTILE LABELS; PUFFS; QUILTS; QUILTS OF TEXTILE; RECEIVING BLANKETS; SHAMS; SHOWER CURTAINS; SHOWER ROOM CURTAINS; SHROUDS; SILK BED BLANKETS; SILK BLANKETS; SWAGS; TABLE AND BED LINEN; TABLE CLOTHS NOT OF PAPER; TABLE LINEN; TABLE LINEN OF TEXTILE; TABLE LINEN, NAMELY, COASTERS; TABLE MATS NOT OF PAPER; TABLE NAPKINS OF TEXTILE; TABLE PADS; TABLECLOTHS OF TEXTILES; TABLECLOTHS, NOT OF PAPER; TEA TOWELS; TERRY TOWELS; TEXTILE HANDKERCHIEFS; TEXTILE HANG TAGS; TEXTILE LABELS; TEXTILE NAPKINS; TEXTILE NAPKINS FOR REMOVING MAKE-UP; TEXTILE PLACE MATS; TEXTILE SERVIETTES; TEXTILE TABLECLOTHS; TEXTILE TISSUES FOR REMOVING MAKE-UP; TEXTILE WALL HANGINGS; TEXTILE WALL HANGINGS, NAMELY, CLOTH POSTERS; THROWS; THROWS DESIGNED TO ALSO BE WRAPPED AROUND A PERSON; TOILET TANK COVERS MADE OF FABRIC OR FABRIC SUBSTITUTES; TOWEL SETS; TOWELING COVERLETS; TOWELS; TOWELS; TRAVELLING RUGS; TRAVELLING RUGS; TRICOT QUILTS; UNFITTED FABRIC FURNITURE COVERS; UNFITTED FURNITURE COVERS NOT OF PAPER; UNFITTED FUTON COVERS NOT OF PAPER; WALL HANGINGS OF TEXTILE; WASH CLOTHS; WASHCLOTHS; WINDOW CURTAINS; WINDOW TREATMENTS IN THE NATURE OF WINDOW PANELS OF POLYESTER, COTTON AND WOOL; WOOLLEN BLANKETS, IN CLASS 24 (U.S. CLS. 42 AND 50).

FIRST USE 10-1-2006; IN COMMERCE 11-1-2006.

NO CLAIM IS MADE TO THE EXCLUSIVE RIGHT TO USE "HOUSE", APART FROM THE MARK AS SHOWN.

THE MARK CONSISTS OF STANDARD CHARACTERS WITHOUT CLAIM TO ANY PARTICULAR FONT, STYLE, SIZE, OR COLOR.

SER. NO. 77-336,389, FILED 11-26-2007.

ELISSA GARBER KON, EXAMINING ATTORNEY

Int. Cls.: 25 and 41

Prior U.S. Cls.: 22, 39, 100, 101 and 107

United States Patent and Trademark Office

Reg. No. 3,483,943

Registered Aug. 12, 2008

**TRADEMARK
SERVICE MARK
PRINCIPAL REGISTER**

KINGS ROYAL

ELDORA SPEEDWAY, INC. (INDIANA CORPORATION)
13929 STATE ROUTE 118
NEW WESTON, OH 45348

FOR: T-SHIRTS, IN CLASS 25 (U.S. CLS. 22 AND 39).

FIRST USE 7-0-2005; IN COMMERCE 7-0-2005.

FOR: ENTERTAINMENT IN THE NATURE OF AUTOMOBILERACES, IN CLASS 41 (U.S. CLS. 100, 101 AND 107).

FIRST USE 5-0-1984; IN COMMERCE 5-0-1984.

THE MARK CONSISTS OF STANDARD CHARACTERS WITHOUT CLAIM TO ANY PARTICULAR FONT, STYLE, SIZE, OR COLOR.

SER. NO. 77-336,481, FILED 11-26-2007.

CURTIS FRENCH, EXAMINING ATTORNEY

Int. Cl.: 36

Prior U.S. Cls.: 100, 101 and 102

United States Patent and Trademark Office

Reg. No. 3,483,944

Registered Aug. 12, 2008

**SERVICE MARK
PRINCIPAL REGISTER**

Entrex
An exchange for the better.

UBIQUE HOLDINGS LP (NEVADA LIMITED
PARTNERSHIP)

#158

2436 NORTH FEDERAL

LIGHTHOUSE POINT, FL 33064

FOR: FINANCIAL EXCHANGE; FINANCIAL IN-
FORMATION AND EVALUATIONS; FINANCIAL
INFORMATION PROCESSING, IN CLASS 36 (U.S.
CLS. 100, 101 AND 102).

FIRST USE 5-22-2002; IN COMMERCE 5-22-2002.

THE COLOR(S) BLUE AND GRAY IS/ARE
CLAIMED AS A FEATURE OF THE MARK.

THE COLOR BLUE APPEARS ON THE WORD-
ING 'ENTREX'; THE COLOR GRAY APPEARS ON
WORDING "AN EXCHANGE FOR THE BETTER."
AS WELL AS ON THE SHADING APPEARING IN
THE WORD "ENTREX".

SER. NO. 77-336,482, FILED S.R. 11-26-2007 AM.
P.R. 3-10-2008.

MICHAEL TANNER, EXAMINING ATTORNEY

Int. Cls.: 25 and 41

Prior U.S. Cls.: 22, 39, 100, 101 and 107

Reg. No. 3,483,945

United States Patent and Trademark Office

Registered Aug. 12, 2008

**TRADEMARK
SERVICE MARK
PRINCIPAL REGISTER**

WORLD 100

ELDORA SPEEDWAY, INC. (INDIANA CORPORATION)
13929 STATE ROUTE 118
NEW WESTON, OH 45348

THE MARK CONSISTS OF STANDARD CHARACTERS WITHOUT CLAIM TO ANY PARTICULAR FONT, STYLE, SIZE, OR COLOR.

FOR: T-SHIRTS, IN CLASS 25 (U.S. CLS. 22 AND 39).

NO CLAIM IS MADE TO THE EXCLUSIVE RIGHT TO USE "100", APART FROM THE MARK AS SHOWN.

FIRST USE 9-0-2005; IN COMMERCE 9-0-2005.

FOR: ENTERTAINMENT IN THE NATURE OF AUTOMOBILE RACES, IN CLASS 41 (U.S. CLS. 100, 101 AND 107).

SER. NO. 77-336,485, FILED 11-26-2007.

FIRST USE 8-0-1971; IN COMMERCE 8-0-1971.

CURTIS FRENCH, EXAMINING ATTORNEY

Int. Cls.: 25 and 41

Prior U.S. Cls.: 22, 39, 100, 101 and 107

United States Patent and Trademark Office

Reg. No. 3,483,946

Registered Aug. 12, 2008

**TRADEMARK
SERVICE MARK
PRINCIPAL REGISTER**

PRELUDE TO THE DREAM

ELDORA SPEEDWAY, INC. (INDIANA CORPORATION)
13929 STATE ROUTE 118
NEW WESTON, OH 45348

FOR: T-SHIRTS, IN CLASS 25 (U.S. CLS. 22 AND 39).

FIRST USE 6-0-2005; IN COMMERCE 6-0-2005.

FOR: ENTERTAINMENT IN THE NATURE OF AUTOMOBILERACES, IN CLASS 41 (U.S. CLS. 100, 101 AND 107).

FIRST USE 6-0-2005; IN COMMERCE 6-0-2005.

THE MARK CONSISTS OF STANDARD CHARACTERS WITHOUT CLAIM TO ANY PARTICULAR FONT, STYLE, SIZE, OR COLOR.

SER. NO. 77-336,488, FILED 11-26-2007.

CURTIS FRENCH, EXAMINING ATTORNEY

Int. Cl.: 37

Prior U.S. Cls.: 100, 103 and 106

United States Patent and Trademark Office

Reg. No. 3,483,947

Registered Aug. 12, 2008

**SERVICE MARK
PRINCIPAL REGISTER**

We Cover Your Aft

OZARK VILLAGE DOCKS & SLIPS LLC (MISSOURI LTD LIAB CO)
1002 SUSAN RD.
LAKE OZARK, MO 65049

THE MARK CONSISTS OF STANDARD CHARACTERS WITHOUT CLAIM TO ANY PARTICULAR FONT, STYLE, SIZE, OR COLOR.

FOR: INSTALLATION OF DOCKS, IN CLASS 37 (U.S. CLS. 100, 103 AND 106).

SER. NO. 77-336,573, FILED 11-26-2007.

FIRST USE 2-20-2007; IN COMMERCE 2-20-2007.

HEATHER THOMPSON, EXAMINING ATTORNEY

Int. Cl.: 45

Prior U.S. Cls.: 100 and 101

United States Patent and Trademark Office

Reg. No. 3,483,948

Registered Aug. 12, 2008

**SERVICE MARK
PRINCIPAL REGISTER**

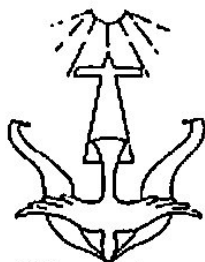

**Wings of Love
Church and Ministries
"Where Faith Works By Love"
Gal 5:6**

FRANKE, ALBERT (UNITED STATES INDIVIDUAL)
24928 CRYSLER DRIVE
CALCIUM, NY 13616

FOR: MINISTERIAL SERVICES AND MINISTERIAL COUNSELING, IN CLASS 45 (U.S. CLS. 100 AND 101).

FIRST USE 1-1-1988; IN COMMERCE 1-1-1988.

NO CLAIM IS MADE TO THE EXCLUSIVE RIGHT TO USE "CHURCH AND MINISTRIES AND GAL 5:6", APART FROM THE MARK AS SHOWN.

THE MARK CONSISTS OF ONE HALF OF A LINE DRAWING OF THE SUN WITH SEVEN RAYS EMITTING DOWNWARD; THREE OF THE RAYS INTERSECT THE TOP OF A CROSS; WHICH INTERSECTS THE OUTSPREAD TAIL OF A DOVE WITH EXTENDED WINGS WHICH CARRIES A BI-PART RIBBON STREAMING FROM ITS MOUTH. THE RIBBON FLOWS UPWARD ON TWO SIDES OF THE DOVE UNDER IT'S WINGS. THE STYLIZED WORDS "WINGS OF LOVE CHURCH AND MINISTRIES "WHERE FAITH WORKS BY LOVE" GAL 5:6" ARE LOCATED BELOW THE DOVE.

SER. NO. 77-336,578, FILED 11-26-2007.

HEATHER THOMPSON, EXAMINING ATTORNEY

Int. Cl.: 19

Prior U.S. Cls.: 1, 12, 33 and 50

United States Patent and Trademark Office

Reg. No. 3,483,949

Registered Aug. 12, 2008

**TRADEMARK
PRINCIPAL REGISTER**

Hein Post-Frame Structures

HEIN, JIM (UNITED STATES INDIVIDUAL)
9130 N. INDUSTRIAL RD.
PEORIA, IL 61615

NO CLAIM IS MADE TO THE EXCLUSIVE
RIGHT TO USE "POST-FRAME STRUCTURES",
APART FROM THE MARK AS SHOWN.

FOR: PRE-ENGINEERED WOOD FRAME BUILD-
ING, IN CLASS 19 (U.S. CLS. 1, 12, 33 AND 50).

SEC. 2(F).

FIRST USE 12-0-1994; IN COMMERCE 12-0-1994.

SER. NO. 77-336,727, FILED 11-26-2007.

THE MARK CONSISTS OF STANDARD CHAR-
ACTERS WITHOUT CLAIM TO ANY PARTICULAR
FONT, STYLE, SIZE, OR COLOR.

BRIAN NEVILLE, EXAMINING ATTORNEY

Int. Cl.: 35

Prior U.S. Cls.: 100, 101 and 102

United States Patent and Trademark Office

Reg. No. 3,483,950

Registered Aug. 12, 2008

**SERVICE MARK
PRINCIPAL REGISTER**



DISTRIMAX, S.A. DE C.V. (MEXICO CORPORATION)
GOBERNADOR IGNACIO ESTEVA NUM. 70
SAN MIGUEL CHAPULTEPEC, MEXICO 11850

FOR: ON-LINE RETAIL STORE SERVICES FEATURING PRE-RECORDED VIDEOS, IN CLASS 35 (U.S. CLS. 100, 101 AND 102).

FIRST USE 9-0-2005; IN COMMERCE 9-0-2005.

NO CLAIM IS MADE TO THE EXCLUSIVE RIGHT TO USE "ONLY DVD" AND "LATINO", APART FROM THE MARK AS SHOWN.

THE COLOR(S) GREEN, BLACK, YELLOW, WHITE, SILVER AND BLUE IS/ARE CLAIMED AS A FEATURE OF THE MARK.

THE COLOR GREEN APPEARS ON THE WORDING "ONLY DVD". THE COLOR YELLOW APPEARS ON THE WORDING "LATINO". THE COLORS SILVER AND WHITE APPEAR ON THE STYLIZED DESIGN OF A DVD. THE COLOR BLUE APPEARS ON THE RECTANGLE BEHIND THE WORDING AND THE DESIGN ELEMENT. THE COLOR BLACK SHADOWS THE WORDING "ONLY DVD" AND APPEARS AS A HORIZONTAL LINE ABOVE AND BELOW THE WORDING "ONLY DVD".

SER. NO. 77-336,909, FILED 11-26-2007.

COLLEEN DOMBROW, EXAMINING ATTORNEY

Int. Cl.: 20

Prior U.S. Cls.: 2, 13, 22, 25, 32 and 50

Reg. No. 3,483,951

United States Patent and Trademark Office

Registered Aug. 12, 2008

**TRADEMARK
PRINCIPAL REGISTER**

SERENI SLEEP

NOAH'S MANUFACTURING, INC. (TEXAS CORPORATION)
4619 NAVIGATION BLVD.
HOUSTON, TX 77011

FOR: SLEEP PRODUCTS, NAMELY, MATTRESSES, SPRING MATTRESSES, BOX SPRINGS AND MATTRESS FOUNDATIONS, IN CLASS 20 (U.S. CLS. 2, 13, 22, 25, 32 AND 50).

FIRST USE 6-7-2007; IN COMMERCE 6-7-2007.

THE MARK CONSISTS OF STANDARD CHARACTERS WITHOUT CLAIM TO ANY PARTICULAR FONT, STYLE, SIZE, OR COLOR.

NO CLAIM IS MADE TO THE EXCLUSIVE RIGHT TO USE "SLEEP", APART FROM THE MARK AS SHOWN.

SER. NO. 77-336,979, FILED 11-26-2007.

KELLY MCCOY, EXAMINING ATTORNEY

Int. Cl.: 20

Prior U.S. Cls.: 2, 13, 22, 25, 32 and 50

Reg. No. 3,483,952

United States Patent and Trademark Office

Registered Aug. 12, 2008

TRADEMARK
PRINCIPAL REGISTER



REGENCY HOUSE, INC. (NORTH CAROLINA CORPORATION)
PO BOX 2544, 97 FAIRGROVE CHURCH RD
HICKORY, NC 28603

FOR: BEDROOM FURNITURE; ENTERTAINMENT CENTERS; FURNITURE; FURNITURE CHESTS; FURNITURE FOR HOUSE, OFFICE AND GARDEN; FURNITURE MADE FROM STEEL TUBING; FURNITURE MADE FROM WOOD OR SUBSTITUTES OF WOOD; FURNITURE, MIRRORS, PICTURE FRAMES; FURNITURE, NAMELY, DRESSERS; LIVING ROOM FURNITURE; METAL FURNITURE; MIRRORS; SEATING FURNITURE; TABLES; UPHOLSTERED FURNITURE; CHAIRS; DECK CHAIRS; DINING CHAIRS; LOUNGE CHAIRS; SOFAS; DINING ROOM TABLES; DINING

TABLES; CHAISE LOUNGES; OTTOMANS, IN CLASS 20 (U.S. CLS. 2, 13, 22, 25, 32 AND 50).

FIRST USE 8-15-1970; IN COMMERCE 11-1-1970.

NO CLAIM IS MADE TO THE EXCLUSIVE RIGHT TO USE "INC." OR "HICKORY NORTH CAROLINA USA", APART FROM THE MARK AS SHOWN.

SEC. 2(F).

SER. NO. 77-337,068, FILED 11-26-2007.

JENNIFER HETU, EXAMINING ATTORNEY

Int. Cl.: 25

Prior U.S. Cls.: 22 and 39

United States Patent and Trademark Office

Reg. No. 3,483,953

Registered Aug. 12, 2008

**TRADEMARK
PRINCIPAL REGISTER**

NIC STRUAN

GRUPO EMYCO, S.A. DE C.V. (MEXICO SOCIE-
DAD ANONIMA (SA DE CV)))
MONTE ELBRUZ 124, 1ER PISO, EDIF. PRISMA
COL. PALMITAS CHAPULTEPEC
MÉXICO, DF, MEXICO 11560

FOR: FOOTWEAR, IN CLASS 25 (U.S. CLS. 22 AND
39).

THE MARK CONSISTS OF STANDARD CHAR-
ACTERS WITHOUT CLAIM TO ANY PARTICULAR
FONT, STYLE, SIZE, OR COLOR.

PRIORITY CLAIMED UNDER SEC. 44(D) ON
MEXICO APPLICATION NO. 898055, FILED 11-23-
2007, REG. NO. 1023875, DATED 2-18-2008, EXPIRES
11-23-2017.

THE NAME(S), PORTRAIT(S), AND/OR SIGNA-
TURE(S) SHOWN IN THE MARK DOES NOT IDEN-
TIFY A PARTICULAR LIVING INDIVIDUAL.

SER. NO. 77-337,137, FILED 11-26-2007.

PAUL CROWLEY, EXAMINING ATTORNEY

Int. Cl.: 41

Prior U.S. Cls.: 100, 101 and 107

United States Patent and Trademark Office

Reg. No. 3,483,954

Registered Aug. 12, 2008

SERVICE MARK
PRINCIPAL REGISTER



MUELLER, MARK R. (UNITED STATES INDIVIDUAL)
404 W. 7TH STREET
AUSTIN, TX 787012710

FOR: ENTERTAINMENT SERVICES, NAMELY, PRODUCTION AND DISTRIBUTION OF MOTION PICTURES AND PRODUCTION OF MUSICAL VIDEOS; ENTERTAINMENT SERVICES IN THE NATURE OF LIVE MUSICAL PERFORMANCES; ENTERTAINMENT SERVICES, NAMELY, PROVIDING A WEB SITE FEATURING MUSICAL PERFORMANCES, MUSICAL VIDEOS, RELATED FILM CLIPS, PHOTOGRAPHS, AND OTHER MULTIMEDIA MATERIALS; ENTERTAINMENT SERVICES, NAMELY, PROVIDING PRERECORDED MUSIC AND VIDEO, INFORMATION IN THE FIELD OF MUSIC, ENTERTAINMENT AND FILM, AND COMMENTARY AND ARTICLES ABOUT MUSIC, ENTERTAINMENT AND FILM, ALL ON-LINE VIA A GLOBAL COMPUTER NETWORK, IN CLASS 41 (U.S. CLS. 100, 101 AND 107).

FIRST USE 0-0-2006; IN COMMERCE 0-0-2006.

NO CLAIM IS MADE TO THE EXCLUSIVE RIGHT TO USE "ENTERTAINMENT", APART FROM THE MARK AS SHOWN.

THE COLOR(S) RED, BLACK AND WHITE IS/ARE CLAIMED AS A FEATURE OF THE MARK.

THE MARK CONSISTS OF A BLACK RECTANGLE CONTAINING A RED SNAKE WRAPPED AROUND A WHITE POLE SHAPE AND CONTAINING FOUR WHITE STAR SHAPES AND TWO WHITE DOUBLE "X" DESIGNS, AND THE TERMS "VOODOO COWBOY ENTERTAINMENT" IN STYLIZED BLACK FONT.

SER. NO. 77-337,150, FILED 11-26-2007.

JAMES LOVELACE, EXAMINING ATTORNEY

Int. Cl.: 43

Prior U.S. Cls.: 100 and 101

United States Patent and Trademark Office

Reg. No. 3,483,955

Registered Aug. 12, 2008

**SERVICE MARK
PRINCIPAL REGISTER**

BURN WEEKS

HOLIDAY SYSTEMS INTERNATIONAL OF NE-
VADA (NEVADA CORPORATION)
7690 WEST CHEYENNE AVE., SUITE 200
LAS VEGAS, NV 89129

FOR: TRAVEL AGENCY SERVICES, NAMELY,
MAKING RESERVATIONS AND BOOKING FOR
TEMPORARY LODGING, IN CLASS 43 (U.S. CLS.
100 AND 101).

FIRST USE 8-0-1993; IN COMMERCE 8-0-1993.

THE MARK CONSISTS OF STANDARD CHAR-
ACTERS WITHOUT CLAIM TO ANY PARTICULAR
FONT, STYLE, SIZE, OR COLOR.

OWNER OF U.S. REG. NO. 2,459,164.

NO CLAIM IS MADE TO THE EXCLUSIVE
RIGHT TO USE "WEEKS", APART FROM THE
MARK AS SHOWN.

SER. NO. 77-337,176, FILED 11-26-2007.

KATHERINE E. HALMEN, EXAMINING ATTOR-
NEY

Int. Cls.: 35, 39 and 43

Prior U.S. Cls.: 100, 101, 102 and 105

United States Patent and Trademark Office

Reg. No. 3,483,956

Registered Aug. 12, 2008

**SERVICE MARK
PRINCIPAL REGISTER**

The image shows a stylized, handwritten-style script logo for the letters 'ytb'. The letters are lowercase and connected, with a fluid, cursive appearance. The 'y' has a long, sweeping tail that loops under the 't' and 'b'. The 't' and 'b' are also connected to each other.

YTB INTERNATIONAL, INC. (DELAWARE CORPORATION)
1901 EAST EDWARDSVILLE ROAD
WOOD RIVER, IL 62095

FOR: PROMOTION OF OPPORTUNITIES FOR BUSINESS IN THE FIELD OF TRAVEL; MULTI-LEVEL MARKETING BUSINESS SERVICES, IN CLASS 35 (U.S. CLS. 100, 101 AND 102).

FIRST USE 8-5-2001; IN COMMERCE 8-5-2001.

FOR: ONLINE TRAVEL AGENCY SERVICES, NAMELY, RESERVATIONS AND BOOKINGS FOR TRANSPORTATION OF AIR TRAVEL, VACATIONS, GROUP TRAVEL, RESORT, CRUISES, TOUR PACKAGES, CAR RENTAL, RAIL TICKETS, AND GOLF PACKAGES VIA A GLOBAL COMPUTER NETWORK, IN CLASS 39 (U.S. CLS. 100 AND 105).

FIRST USE 8-5-2001; IN COMMERCE 8-5-2001.

FOR: ONLINE TRAVEL AGENCY SERVICES, NAMELY, MAKING RESERVATIONS AND BOOKINGS FOR TEMPORARY LODGING, HOTEL ROOMS, RESTAURANTS AND MEALS, IN CLASS 43 (U.S. CLS. 100 AND 101).

FIRST USE 8-5-2001; IN COMMERCE 8-5-2001.

THE MARK CONSISTS OF THE STYLIZED LETTERS "YTB" IN LOWER-CASE AND SCRIPT FONT.

SER. NO. 77-337,573, FILED 11-27-2007.

KEVON CHISOLM, EXAMINING ATTORNEY

Int. Cls.: 16 and 35

Prior U.S. Cls.: 2, 5, 22, 23, 29, 37, 38, 50, 100, 101 and 102

Reg. No. 3,483,957

United States Patent and Trademark Office

Registered Aug. 12, 2008

**TRADEMARK
SERVICE MARK
PRINCIPAL REGISTER**

DAVID'S BRIDAL
wedding

DBD, INC. (DELAWARE CORPORATION)
1001 WASHINGTON STREET
CONSHOHOCKEN, PA 19428

FOR: PRINT CATALOGUES FEATURING DRESSES AND ACCESSORIES, IN CLASS 16 (U.S. CLS. 2, 5, 22, 23, 29, 37, 38 AND 50).

FIRST USE 8-1-2007; IN COMMERCE 11-20-2007.

FOR: ELECTRONIC CATALOG SERVICES FEATURING DRESSES AND ACCESSORIES, IN CLASS 35 (U.S. CLS. 100, 101 AND 102).

FIRST USE 8-1-2007; IN COMMERCE 11-20-2007.

OWNER OF U.S. REG. NOS. 2,708,959, 3,017,372 AND OTHERS.

NO CLAIM IS MADE TO THE EXCLUSIVE RIGHT TO USE "BRIDAL WEDDING", APART FROM THE MARK AS SHOWN.

THE MARK CONSISTS OF "DAVID'S BRIDAL" WRITTEN IN CAPITAL BLOCK LETTERS WITH A HEART APOSTROPHE AND WEDDING WRITTEN IN SCRIPT IN A SMALLER FONT BENEATH "BRIDAL".

SER. NO. 77-337,650, FILED 11-27-2007.

BENJAMIN ALLEN, EXAMINING ATTORNEY

Int. Cl.: 35

Prior U.S. Cls.: 100, 101 and 102

United States Patent and Trademark Office

Reg. No. 3,483,958

Registered Aug. 12, 2008

**SERVICE MARK
PRINCIPAL REGISTER**

GREENSITE

HANLEY-WOOD, LLC (DELAWARE LTD LIAB
CO)
SUITE 600
ONE THOMAS CIRCLE, N.W.
WASHINGTON, DC 20005

FOR: ORGANIZING AND CONDUCTING
TRADE SHOW EXHIBITIONS IN THE FIELD OF
SUSTAINABLE CONSTRUCTION, IN CLASS 35 (U.S.
CLS. 100, 101 AND 102).

FIRST USE 1-22-2008; IN COMMERCE 1-22-2008.

THE MARK CONSISTS OF STANDARD CHAR-
ACTERS WITHOUT CLAIM TO ANY PARTICULAR
FONT, STYLE, SIZE, OR COLOR.

SER. NO. 77-337,723, FILED 11-27-2007.

JASON BLAIR, EXAMINING ATTORNEY

Int. Cl.: 35

Prior U.S. Cls.: 100, 101 and 102

United States Patent and Trademark Office

Reg. No. 3,483,959

Registered Aug. 12, 2008

**SERVICE MARK
PRINCIPAL REGISTER**



HANLEY-WOOD, LLC (DELAWARE LTD LIAB
CO)
SUITE 600
ONE THOMAS CIRCLE, N.W.
WASHINGTON, DC 20005

FOR: ORGANIZING AND CONDUCTING
TRADE SHOW EXHIBITIONS IN THE FIELD OF
SUSTAINABLE CONSTRUCTION, IN CLASS 35 (U.S.
CLS. 100, 101 AND 102).

FIRST USE 1-22-2008; IN COMMERCE 1-22-2008.

THE MARK CONSISTS OF A REPRESENTATION
OF A BUILDING UNDER CONSTRUCTION
ALONG WITH THE TERM "GREENSITE".

SER. NO. 77-337,742, FILED 11-27-2007.

JASON BLAIR, EXAMINING ATTORNEY

Int. Cl.: 9

Prior U.S. Cls.: 21, 23, 26, 36 and 38

United States Patent and Trademark Office

Reg. No. 3,483,960

Registered Aug. 12, 2008

**TRADEMARK
PRINCIPAL REGISTER**

**JABBER EXTENSIBLE
COMMUNICATIONS PLATFORM**

JABBER, INC. (DELAWARE CORPORATION)
1899 WYNKOOP, SUITE 600
DENVER, CO 80202

FOR: COMPUTER SERVER SOFTWARE FOR
ENABLING REAL-TIME COMMUNICATION AND
PRESENCE IDENTIFICATION OVER COMPUTER
NETWORKS, IN CLASS 9 (U.S. CLS. 21, 23, 26, 36
AND 38).

FIRST USE 12-31-2002; IN COMMERCE 12-31-2002.

THE MARK CONSISTS OF STANDARD CHAR-
ACTERS WITHOUT CLAIM TO ANY PARTICULAR
FONT, STYLE, SIZE, OR COLOR.

OWNER OF U.S. REG. NO. 2,623,241.

NO CLAIM IS MADE TO THE EXCLUSIVE
RIGHT TO USE "EXTENSIBLE COMMUNICA-
TIONS PLATFORM", APART FROM THE MARK
AS SHOWN.

SER. NO. 77-337,965, FILED 11-27-2007.

TINA BROWN, EXAMINING ATTORNEY

Int. Cl.: 9

Prior U.S. Cls.: 21, 23, 26, 36 and 38

United States Patent and Trademark Office

Reg. No. 3,483,961

Registered Aug. 12, 2008

**TRADEMARK
PRINCIPAL REGISTER**

JABBER XCP

JABBER, INC. (DELAWARE CORPORATION)
1899 WYNKOOP, SUITE 600
DENVER, CO 80202

FOR: COMPUTER SERVER SOFTWARE FOR
ENABLING REAL-TIME COMMUNICATION AND
PRESENCE IDENTIFICATION OVER COMPUTER
NETWORKS, IN CLASS 9 (U.S. CLS. 21, 23, 26, 36
AND 38).

FIRST USE 12-31-2002; IN COMMERCE 12-31-2002.

THE MARK CONSISTS OF STANDARD CHAR-
ACTERS WITHOUT CLAIM TO ANY PARTICULAR
FONT, STYLE, SIZE, OR COLOR.

OWNER OF U.S. REG. NO. 2,623,241.

SER. NO. 77-337,968, FILED 11-27-2007.

TINA BROWN, EXAMINING ATTORNEY

Int. Cl.: 44

Prior U.S. Cls.: 100 and 101

United States Patent and Trademark Office

Reg. No. 3,483,962

Registered Aug. 12, 2008

**SERVICE MARK
PRINCIPAL REGISTER**

PHYTEL

PHYTEL, INC. (TEXAS CORPORATION)
SUITE 240
14900 LANDMARK BOULEVARD
DALLAS, TX 75254

FOR: HEALTH CARE SERVICES, NAMELY, PROVIDING SERVICES THAT IDENTIFY, NOTIFY, TRACK AND MEASURE PATIENT COMPLIANCE IN THE FIELD OF HEALTH AND DISEASE MANAGEMENT, IN CLASS 44 (U.S. CLS. 100 AND 101).

FIRST USE 7-1-2002; IN COMMERCE 7-1-2002.

THE MARK CONSISTS OF STANDARD CHARACTERS WITHOUT CLAIM TO ANY PARTICULAR FONT, STYLE, SIZE, OR COLOR.

OWNER OF U.S. REG. NO. 2,241,255.

SER. NO. 77-338,092, FILED 11-27-2007.

LINDA ORNDORFF, EXAMINING ATTORNEY

Int. Cl.: 35

Prior U.S. Cls.: 100, 101 and 102

United States Patent and Trademark Office

Reg. No. 3,483,963

Registered Aug. 12, 2008

**SERVICE MARK
PRINCIPAL REGISTER**

MarketingCrazy

SALSACRAZY, INC. (CALIFORNIA CORPORATION)

#416

3701 SACRAMENTO STREET

SAN FRANCISCO, CA 94118

THE MARK CONSISTS OF STANDARD CHARACTERS WITHOUT CLAIM TO ANY PARTICULAR FONT, STYLE, SIZE, OR COLOR.

FOR: MARKETING AND INTERNET MARKETING CONSULTING SERVICES, IN CLASS 35 (U.S. CLS. 100, 101 AND 102).

SER. NO. 77-338,308, FILED 11-27-2007.

FIRST USE 6-1-2007; IN COMMERCE 7-1-2007.

CHRISTINE COOPER, EXAMINING ATTORNEY

Int. Cl.: 38

Prior U.S. Cls.: 100, 101 and 104

United States Patent and Trademark Office

Reg. No. 3,483,964

Registered Aug. 12, 2008

**SERVICE MARK
PRINCIPAL REGISTER**



PAKISTAN TELEVISION CORPORATION LIM-
ITED (PAKISTAN CORPORATION)
CONSTITUTION AVENUE
ISLAMABAD, PAKISTAN 44000

FOR: TELEVISION BROADCASTING, IN CLASS
38 (U.S. CLS. 100, 101 AND 104).

FIRST USE 4-22-2006; IN COMMERCE 4-22-2006.

NO CLAIM IS MADE TO THE EXCLUSIVE
RIGHT TO USE "GLOBAL", APART FROM THE
MARK AS SHOWN.

THE MARK CONSISTS OF "PTV" IN SPECIAL
LETTERING FOLLOWED BY "GLOBAL" IN LIGHT
LETTERING AGAINST A DARKER BACK-
GROUND.

SER. NO. 77-338,620, FILED 11-28-2007.

JENNY PARK, EXAMINING ATTORNEY

Int. Cl.: 35

Prior U.S. Cls.: 100, 101 and 102

United States Patent and Trademark Office

Reg. No. 3,483,965

Registered Aug. 12, 2008

SERVICE MARK
PRINCIPAL REGISTER



GARAGE STORAGE CABINETS OF AUSTIN,
LLC (TEXAS LTD LIAB CO), DBA TEXAS
GARAGES
6105 GRASS HOLW
AUSTIN, TX 78750

FOR: ON-LINE RETAIL STORE SERVICES FEATURING COMMERCIAL AND RESIDENTIAL GARAGE ACCESSORIES, NAMELY, STORAGE CABINETS, WORK BENCHES, FLOORING AND STORAGE RACKS; RETAIL STORES FEATURING COMMERCIAL AND RESIDENTIAL GARAGE ACCESSORIES, NAMELY, STORAGE CABINETS, WORK BENCHES, FLOORING AND STORAGE RACKS, IN CLASS 35 (U.S. CLS. 100, 101 AND 102).

FIRST USE 8-13-2003; IN COMMERCE 11-1-2003.

NO CLAIM IS MADE TO THE EXCLUSIVE RIGHT TO USE "TEXAS GARAGES", APART FROM THE MARK AS SHOWN.

THE MARK CONSISTS OF THE TEXT "TEXAS" IN FRUTIGER ULTRA BLACK FONT, "GARAGES" IN RAPIER FONT, AND "MAKING GARAGES GREAT!" IN FRUTIGER CONDENSED FONT.

SER. NO. 77-338,679, FILED 11-28-2007.

HOWARD B. LEVINE, EXAMINING ATTORNEY

Int. Cl.: 42

Prior U.S. Cls.: 100 and 101

United States Patent and Trademark Office

Reg. No. 3,483,966

Registered Aug. 12, 2008

**SERVICE MARK
PRINCIPAL REGISTER**



LITTLE BIT VENTURE COMPANY, LLC (PENNSYLVANIA LTD LIAB CO), DBA S & H SOLUTIONS
911 MAIN STREET
AVOCA, PA 18641

FOR: COMPUTER SOFTWARE DESIGN FOR OTHERS; CONSULTING SERVICES IN THE FIELD OF DESIGN, SELECTION, IMPLEMENTATION AND USE OF COMPUTER HARDWARE AND SOFTWARE SYSTEMS FOR OTHERS, IN CLASS 42 (U.S. CLS. 100 AND 101).

FIRST USE 1-0-2007; IN COMMERCE 1-0-2007.

NO CLAIM IS MADE TO THE EXCLUSIVE RIGHT TO USE "SOLUTIONS", APART FROM THE MARK AS SHOWN.

THE STIPPLING IS FOR SHADING PURPOSES ONLY.

THE MARK CONSISTS OF LEFT SIDE OF MARK CONSISTS OF A CIRCLE "S" AND "H" INSIDE THIS CIRCLE. THIS CIRCLE HAS AN ORBIT RING WHICH IS ENCIRCLING IT. THE RIGHT SIDE OF MARK CONSISTS OF A "S", FOLLOWED BY A AMPERSAND (&), FOLLOWED BY A "H" AND THE WORD "SOLUTIONS" BELOW THESE LETTERS.

SER. NO. 77-338,690, FILED 11-28-2007.

CHRISTINE COOPER, EXAMINING ATTORNEY

Int. Cl.: 9

Prior U.S. Cls.: 21, 23, 26, 36 and 38

Reg. No. 3,483,967

United States Patent and Trademark Office

Registered Aug. 12, 2008

**TRADEMARK
PRINCIPAL REGISTER**

DISASTER BRIDGE

DISASTER BLASTER, INC. (PENNSYLVANIA
CORPORATION)
911 MAIN STREET
AVOCA, PA 18641

FIRST USE 9-0-2007; IN COMMERCE 9-0-2007.

THE STIPLING IS FOR SHADING PURPOSES
ONLY.

FOR: COMPUTER SOFTWARE FOR THE COL-
LECTION, EDITING, ORGANIZING, TRANSMIS-
SION, STORAGE AND SHARING OF DATA AND
INFORMATION, IN CLASS 9 (U.S. CLS. 21, 23, 26, 36
AND 38).

SER. NO. 77-338,698, FILED 11-28-2007.

CHRISTINE COOPER, EXAMINING ATTORNEY

Int. Cl.: 25

Prior U.S. Cls.: 22 and 39

United States Patent and Trademark Office

Reg. No. 3,483,968

Registered Aug. 12, 2008

**TRADEMARK
PRINCIPAL REGISTER**

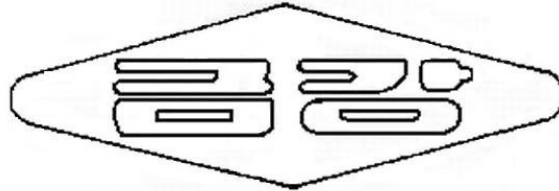

KUMKANG SHOE CO., LTD. (REPUBLIC OF KOREA CORPORATION)
406-3 HYOSEONG-DONG, KYEYANG-GU
INCHEON, REPUBLIC OF KOREA

FOR: SHOES, IN CLASS 25 (U.S. CLS. 22 AND 39).

FIRST USE 1-3-1954; IN COMMERCE 8-24-2006.

OWNER OF U.S. REG. NOS. 2,349,311 AND 2,411,905.

THE MARK CONSISTS OF VARIOUS KOREAN LETTERS INSIDE OF A DIAMOND.

THE NON-LATIN CHARACTER(S) IN THE MARK TRANSLITERATES INTO KUMKANG, AND THIS MEANS GOLDEN RIVER IN ENGLISH.

SER. NO. 77-338,812, FILED 11-28-2007.

DARRYL SPRUILL, EXAMINING ATTORNEY

Int. Cl.: 9

Prior U.S. Cls.: 21, 23, 26, 36 and 38

Reg. No. 3,483,969

United States Patent and Trademark Office

Registered Aug. 12, 2008

**TRADEMARK
PRINCIPAL REGISTER**

CARMA

CENTER FOR GLOBAL DEVELOPMENT (D.C.
CORPORATION)
1776 MASSACHUSETTS AVE., NW, 3RD FLOOR
WASHINGTON, DC 20036

FOR: DOWNLOADABLE EDUCATIONAL PUBLICATIONS IN THE NATURE OF BROCHURES, BOOKLETS, AND TEACHING MATERIALS IN THE FIELD OF GREENHOUSE EMISSIONS REDUCTION, IN CLASS 9 (U.S. CLS. 21, 23, 26, 36 AND 38).

FIRST USE 11-14-2007; IN COMMERCE 11-14-2007.

THE MARK CONSISTS OF STANDARD CHARACTERS WITHOUT CLAIM TO ANY PARTICULAR FONT, STYLE, SIZE, OR COLOR.

SER. NO. 77-338,954, FILED 11-28-2007.

LOURDES AYALA, EXAMINING ATTORNEY

Int. Cls.: 42 and 45

Prior U.S. Cls.: 100 and 101

United States Patent and Trademark Office

Reg. No. 3,483,970

Registered Aug. 12, 2008

**SERVICE MARK
PRINCIPAL REGISTER**

DANK APPS

DANK APPS INC (NEW YORK CORPORATION)
SECOND FLOOR
2250 35TH ST
ASTORIA, NY 11105

FOR: COMPUTER SOFTWARE DEVELOPMENT SERVICES, NAMELY, DEVELOPING, DESIGNING AND IMPLEMENTING SOFTWARE THAT USES THE SOCIAL NETWORK OF INTERNET BASED SOCIAL NETWORKING PLATFORMS TO PROVIDE SWEEPSTAKES AND INSTANT WIN APPLICATIONS, IN CLASS 42 (U.S. CLS. 100 AND 101).

FIRST USE 4-0-2007; IN COMMERCE 4-0-2007.

FOR: ONLINE SOCIAL NETWORKING SERVICES, IN CLASS 45 (U.S. CLS. 100 AND 101).

FIRST USE 4-0-2007; IN COMMERCE 4-0-2007.

THE MARK CONSISTS OF STANDARD CHARACTERS WITHOUT CLAIM TO ANY PARTICULAR FONT, STYLE, SIZE, OR COLOR.

NO CLAIM IS MADE TO THE EXCLUSIVE RIGHT TO USE "APPS", APART FROM THE MARK AS SHOWN.

"APPS" APPEARING IN THE MARK MEANS OR SIGNIFIES APPLICATIONS. "DANK" APPEARING IN THE MARK HAS NO MEANING IN A FOREIGN LANGUAGE.

SER. NO. 77-338,987, FILED 11-28-2007.

SHARON MEIER, EXAMINING ATTORNEY

Int. Cls.: 42 and 45

Prior U.S. Cls.: 100 and 101

United States Patent and Trademark Office

Reg. No. 3,483,971

Registered Aug. 12, 2008

**SERVICE MARK
PRINCIPAL REGISTER**



DANK APPS INC (NEW YORK CORPORATION)
SECOND FLOOR
2250 35TH ST
ASTORIA, NY 11105

FOR: COMPUTER SOFTWARE DEVELOPMENT SERVICES, NAMELY, DEVELOPING, DESIGNING AND IMPLEMENTING SOFTWARE THAT USES THE SOCIAL NETWORK OF INTERNET BASED SOCIAL NETWORKING PLATFORMS TO PROVIDE SWEEPSTAKES AND INSTANT WIN APPLICATIONS, IN CLASS 42 (U.S. CLS. 100 AND 101).

FIRST USE 4-0-2007; IN COMMERCE 4-0-2007.

FOR: ONLINE SOCIAL NETWORKING SERVICES, IN CLASS 45 (U.S. CLS. 100 AND 101).

FIRST USE 4-0-2007; IN COMMERCE 4-0-2007.

NO CLAIM IS MADE TO THE EXCLUSIVE RIGHT TO USE "APPS", APART FROM THE MARK AS SHOWN.

THE MARK CONSISTS OF A STYLIZED AT SYMBOL FOLLOWED BY THE WORDS "DANK APPS".

"APPS" APPEARING IN THE MARK MEANS OR SIGNIFIES APPLICATIONS. "DANK" APPEARING IN THE MARK HAS NO MEANING IN A FOREIGN LANGUAGE.

SER. NO. 77-339,233, FILED 11-28-2007.

SHARON MEIER, EXAMINING ATTORNEY

Int. Cls.: 9, 35, 41 and 42

Prior U.S. Cls.: 21, 23, 26, 36, 38, 100, 101, 102 and 107

United States Patent and Trademark Office

Reg. No. 3,483,972

Registered Aug. 12, 2008

**TRADEMARK
SERVICE MARK
PRINCIPAL REGISTER**

PAAS

ISO SERVICES, INC. (DELAWARE CORPORATION)
545 WASHINGTON BOULEVARD
JERSEY CITY, NJ 07310

FOR: COMPUTER SOFTWARE, NAMELY, SOFTWARE STORED ON MAGNETIC MEDIA AND DOWNLOADABLE SOFTWARE USED TO CONDUCT INSURANCE PREMIUM AUDITS, IN CLASS 9 (U.S. CLS. 21, 23, 26, 36 AND 38).

FIRST USE 0-0-1979; IN COMMERCE 0-0-1979.

FOR: PROVIDING DATA USED IN INSURANCE PREMIUM AUDITS TO OTHERS, NAMELY, DATA USED BY INSURANCE AUDITORS IN CONDUCTING INSURANCE AUDITS; BUSINESS INFORMATION IN THE FIELD OF INSURANCE PREMIUM AUDITS, IN CLASS 35 (U.S. CLS. 100, 101 AND 102).

FIRST USE 0-0-1979; IN COMMERCE 0-0-1979.

FOR: PROVIDING ONLINE PUBLICATIONS IN THE NATURE OF BULLETINS AND NEWSLETTERS IN THE FIELD OF INSURANCE PREMIUM AUDITS; EDUCATIONAL AND TRAINING SERVI-

CES, NAMELY, LIVE AND ONLINE TRAINING, SEMINARS AND FORUMS IN THE FIELD OF INSURANCE PREMIUM AUDITS, AND DISTRIBUTING TRAINING MANUALS IN CONNECTION THEREWITH, IN CLASS 41 (U.S. CLS. 100, 101 AND 107).

FIRST USE 0-0-1979; IN COMMERCE 0-0-1979.

FOR: PROVIDING ONLINE NON-DOWNLOADABLE SOFTWARE FOR USE IN CONDUCTING INSURANCE PREMIUM AUDITS, IN CLASS 42 (U.S. CLS. 100 AND 101).

FIRST USE 0-0-1979; IN COMMERCE 0-0-1979.

THE MARK CONSISTS OF STANDARD CHARACTERS WITHOUT CLAIM TO ANY PARTICULAR FONT, STYLE, SIZE, OR COLOR.

SER. NO. 77-339,399, FILED 11-28-2007.

KATHERINE M. DUBRAY, EXAMINING ATTORNEY

Int. Cl.: 9

Prior U.S. Cls.: 21, 23, 26, 36 and 38

Reg. No. 3,483,973

United States Patent and Trademark Office

Registered Aug. 12, 2008

**TRADEMARK
PRINCIPAL REGISTER**

LSH LIGHTS

KENCO OR, LLC (OREGON LTD LIAB CO), DBA
LSH LIGHTS
5289 NE ELAM YOUNG PARKWAY
SUITE F500
HILLSBORO, OR 97124

FOR: EMERGENCY WARNING LIGHTS; SIRENS
FOR VEHICLES; FLASHING SAFETY LIGHTS;
SAFETY EQUIPMENT, NAMELY, BEACON
LIGHTS; SAFETY MARKERS , IN CLASS 9 (U.S.
CLS. 21, 23, 26, 36 AND 38).

FIRST USE 6-1-2001; IN COMMERCE 6-1-2001.

THE MARK CONSISTS OF STANDARD CHAR-
ACTERS WITHOUT CLAIM TO ANY PARTICULAR
FONT, STYLE, SIZE, OR COLOR.

NO CLAIM IS MADE TO THE EXCLUSIVE
RIGHT TO USE "LIGHTS", APART FROM THE
MARK AS SHOWN.

SER. NO. 77-339,527, FILED 11-28-2007.

STEVEN JACKSON, EXAMINING ATTORNEY

Int. Cl.: 19

Prior U.S. Cls.: 1, 12, 33 and 50

United States Patent and Trademark Office

Reg. No. 3,483,974

Registered Aug. 12, 2008

TRADEMARK
PRINCIPAL REGISTER



PIAZZA STONE, LLC (GEORGIA LTD LIAB CO)
3817 MARTINEZ BLVD SUITE A
AUGUSTA, GA 30907

FOR: DECORATIVE FOAM CORE ARCHITECTURAL ELEMENTS THAT ARE COATED TO RESEMBLE STONE; NON-METAL DECORATIVE MOLDINGS AND DECORATIVE TRIM FOR USE IN BUILDING CONSTRUCTION, IN CLASS 19 (U.S. CLS. 1, 12, 33 AND 50).

FIRST USE 1-1-2006; IN COMMERCE 1-1-2006.

THE STIPPLING IS A FEATURE OF THE MARK AND DOES NOT INDICATE COLOR.

THE COLOR(S) RED AND GRAY IS/ARE CLAIMED AS A FEATURE OF THE MARK.

THE MARK CONSISTS OF THE WORD "PIAZZA" IN GRAY, THE WORD "STONWORKS" IN RED, THE INITIAL LETTER "S" IN "STONWORKS" WRAPPING AROUND A GRAY COLUMN, AND AN INCOMPLETE RED SEMI-CIRCLE THAT COMBINES WITH THE COLUMN TO REPRESENT THE LETTER "P".

THE FOREIGN WORDING IN THE MARK TRANSLATES INTO ENGLISH AS "PLAZA".

SER. NO. 77-339,866, FILED 11-29-2007.

REBECCA EISINGER, EXAMINING ATTORNEY

Int. Cl.: 42

Prior U.S. Cls.: 100 and 101

United States Patent and Trademark Office

Reg. No. 3,483,975

Registered Aug. 12, 2008

**SERVICE MARK
PRINCIPAL REGISTER**

ELECTROGEEK

ELECTROGEEK INC. (ILLINOIS CORPORATION)
1820 GEORGE COURT
GLENVIEW, IL 60025

FOR: TECHNICAL SUPPORT SERVICES, NAME-
LY, TROUBLESHOOTING OF COMPUTER HARD-
WARE AND SOFTWARE PROBLEMS AND
INFORMATION TECHNOLOGY (IT) CONSULTING
FOR OTHERS, IN CLASS 42 (U.S. CLS. 100 AND 101).

FIRST USE 11-26-2003; IN COMMERCE 11-26-2003.

THE MARK CONSISTS OF STANDARD CHAR-
ACTERS WITHOUT CLAIM TO ANY PARTICULAR
FONT, STYLE, SIZE, OR COLOR.

SER. NO. 77-340,254, FILED 11-29-2007.

AMOS T. MATTHEWS, JR., EXAMINING ATTOR-
NEY

Int. Cl.: 41

Prior U.S. Cls.: 100, 101 and 107

United States Patent and Trademark Office

Reg. No. 3,483,976

Registered Aug. 12, 2008

**SERVICE MARK
PRINCIPAL REGISTER**



WINGS
helping kids soar

WINGS FOR KIDS (SOUTH CAROLINA NON-
PROFIT CORPORATION)
P. O. BOX 369
SULLIVAN'S ISLAND, SC 29482

FOR: EDUCATIONAL SERVICES, NAMELY,
PROVIDING AFTER SCHOOL PROGRAMS FOR
CHILDREN AND THEIR CARETAKERS IN THE
FIELD OF EMOTIONAL AND SOCIAL SKILLS,
AND DISTRIBUTING COURSE MATERIALS
THEREWITH, IN CLASS 41 (U.S. CLS. 100, 101 AND
107).

FIRST USE 11-0-2005; IN COMMERCE 11-0-2005.

OWNER OF U.S. REG. NOS. 2,585,079 AND
2,971,081.

SER. NO. 77-340,776, FILED 11-30-2007.

KAREN SEVERSON, EXAMINING ATTORNEY

Int. Cl.: 25

Prior U.S. Cls.: 22 and 39

United States Patent and Trademark Office

Reg. No. 3,483,977

Registered Aug. 12, 2008

**TRADEMARK
PRINCIPAL REGISTER**

CLIMAPLUS

KABUSHIKI KAISHA MONTBELL (JAPAN CORPORATION)
NISHI-KU, OSAKA-SHI
33-20 SHINMACHI 1-CHOME
OSAKA, JAPAN

FOR: BOOTS FOR SPORTS OTHER THAN JUMPING BOOTS FOR HORSES; GARTERS; SOCK SUSPENDERS; SUSPENDERS; WAISTBANDS; BELTS FOR CLOTHING; CLOTHING, NAMELY, JACKETS, INSULATED JACKETS, COATS, RAINWEAR, SHIRTS, SLEEVELESS SHIRTS, T-SHIRTS, POLO SHIRTS, LONG-SLEEVED SHIRTS, SWEAT SHIRTS, PULLOVERS, SWEATERS, VESTS, PARKAS, PANTS, SHORT PANTS, KNICKERS, LONG PANTS, SPATS, INSULATED PANTS, OVERALLS, TIGHTS, SHORTS, ONE-PIECE EXPEDITION SUITS, ONE-PIECE SUITS FOR OUTERWEAR, UNDERWEAR,

MANTLES, PONCHOS, GLOVES, SOCKS, TURTLE-NECKS, ANORAK; HEADWEAR, BALACLAVAS, HEADBANDS, WRISTBANDS, FLEECE JACKETS, FLEECE VESTS, FLEECE PANTS, FLEECE PULLOVERS, FLEECE CAPS, FLEECE HATS, FLEECE GLOVES, FLEECE MUFFLERS, FLEECE SOCKS; FOOTWEAR, IN CLASS 25 (U.S. CLS. 22 AND 39).

FIRST USE 11-0-1997; IN COMMERCE 11-0-2002.

THE MARK CONSISTS OF STANDARD CHARACTERS WITHOUT CLAIM TO ANY PARTICULAR FONT, STYLE, SIZE, OR COLOR.

SER. NO. 77-341,298, FILED 11-30-2007.

DAWN FELDMAN, EXAMINING ATTORNEY

Int. Cl.: 35

Prior U.S. Cls.: 100, 101 and 102

United States Patent and Trademark Office

Reg. No. 3,483,978

Registered Aug. 12, 2008

**SERVICE MARK
PRINCIPAL REGISTER**

our business is holding
your business together.

ACTIVE SCREW & FASTENER COMPANY (A
LIMITED PARTNERSHIP) (ILLINOIS LIM-
ITED PARTNERSHIP), DBA ACTIVE SCREW
5215 OLD ORCHARD ROAD, SUITE 700
SKOKIE, IL 60077

FOR: INVENTORY MANAGEMENT IN THE
FIELD OF SMALL HARDWARE PRODUCTS, IN
CLASS 35 (U.S. CLS. 100, 101 AND 102).

FIRST USE 6-1-2005; IN COMMERCE 6-1-2005.

THE MARK CONSISTS OF STANDARD CHAR-
ACTERS WITHOUT CLAIM TO ANY PARTICULAR
FONT, STYLE, SIZE, OR COLOR.

SER. NO. 77-341,646, FILED 11-30-2007.

ALICE BENMAMAN, EXAMINING ATTORNEY

Int. Cl.: 35

Prior U.S. Cls.: 100, 101 and 102

United States Patent and Trademark Office

Reg. No. 3,483,979

Registered Aug. 12, 2008

**SERVICE MARK
PRINCIPAL REGISTER**



WILLIAM CHARLES HARRIS III (NORTH CAROLINA SOLE PROPRIETORSHIP)
290 GROWERS WAY COURT
FAYETTEVILLE, NC 28314

FOR: INFORMATION SERVICES RELATING TO BUSINESS MATTERS, IN CLASS 35 (U.S. CLS. 100, 101 AND 102).

FIRST USE 10-10-2007; IN COMMERCE 11-30-2007.

NO CLAIM IS MADE TO THE EXCLUSIVE RIGHT TO USE "STOCK CONSULTANTS", APART FROM THE MARK AS SHOWN.

"THE COLOR(S) GREEN AND WHITE IS/ARE CLAIMED AS A FEATURE OF THE MARK."

THE COLOR WHITE APPEARS IN THE BACKGROUND OF THE MARK AND THE COLOR GREEN APPEARS IN THE WORDING "JADE DRAGON STOCK CONSULTANTS" IN THE STYLIZED DESIGN OF A DRAGON, AND IN THE FORM OF A BORDER LINE SURROUNDING THE MARK.

SER. NO. 77-341,955, FILED 12-2-2007.

SEAN CROWLEY, EXAMINING ATTORNEY

Int. Cl.: 3

Prior U.S. Cls.: 1, 4, 6, 50, 51 and 52

Reg. No. 3,483,980

United States Patent and Trademark Office

Registered Aug. 12, 2008

**TRADEMARK
PRINCIPAL REGISTER**



PERIANNE SKIN CARE LLC (NEW YORK LTD
LIAB CO)
171 WYCKOFF STREET, #1
BROOKLYN, NY 11217

FOR: NON-MEDICATED SKIN CARE PREPARA-
TIONS; SKIN CLEANSERS; SKIN CREAM; SKIN
MOISTURIZER; SKIN TONERS, IN CLASS 3 (U.S.
CLS. 1, 4, 6, 50, 51 AND 52).

FIRST USE 11-26-2007; IN COMMERCE 11-26-2007.

THE COLOR(S) CHOCOLATE BROWN IS/ARE
CLAIMED AS A FEATURE OF THE MARK.

THE MARK CONSISTS OF THE WORD "PERI-
ANNE" IN STYLIZED CHOCOLATE BROWN LET-
TERS, WITH THE UPPER CASE "P" FEATURING A
SWIRLING DESIGN.

SER. NO. 77-342,020, FILED 12-2-2007.

SEAN CROWLEY, EXAMINING ATTORNEY

Int. Cls.: 29 and 30

Prior U.S. Cl.: 46

United States Patent and Trademark Office

Reg. No. 3,483,981

Registered Aug. 12, 2008

**TRADEMARK
PRINCIPAL REGISTER**

BETTER THAN BAKERY

BETTER THAN BAKERY, LLC (CONNECTICUT
LTD LIAB CO)
100 STAGE COACH ROAD
WINDSOR, CT 06095

FOR: BUTTER AND FLAVORED BUTTERS, IN
CLASS 29 (U.S. CL. 46).

FIRST USE 8-21-2006; IN COMMERCE 8-21-2006.

FOR: BREADS, FROZEN BREADS, FLAVORED
BREADS, AND PASTRIES, IN CLASS 30 (U.S. CL. 46).

FIRST USE 12-1-1984; IN COMMERCE 12-1-1984.

THE MARK CONSISTS OF STANDARD CHAR-
ACTERS WITHOUT CLAIM TO ANY PARTICULAR
FONT, STYLE, SIZE, OR COLOR.

NO CLAIM IS MADE TO THE EXCLUSIVE
RIGHT TO USE "BAKERY", APART FROM THE
MARK AS SHOWN.

SER. NO. 77-342,205, FILED 12-3-2007.

ADA HAN, EXAMINING ATTORNEY

Int. Cl.: 45

Prior U.S. Cls.: 100 and 101

United States Patent and Trademark Office

Reg. No. 3,483,982

Registered Aug. 12, 2008

SERVICE MARK
PRINCIPAL REGISTER



AVA INVESTIGATIONS, LLC (PENNSYLVANIA
LTD LIAB CO)

3645 BROADHEAD RD.

MONACA, PA 15061

THE COLOR(S) BLUE, LIGHT GREY AND
BLACK IS/ARE CLAIMED AS A FEATURE OF
THE MARK.

FOR: LEGAL SERVICES, NAMELY, PROCESS
SERVING; LITIGATION SUPPORT SERVICES; AC-
CIDENT INVESTIGATIONS; BACKGROUND IN-
VESTIGATION AND RESEARCH SERVICES;
INVESTIGATION OR SURVEILLANCE ON BACK-
GROUND PROFILES; INVESTIGATION SERVICES
RELATED TO INSURANCE CLAIMS; PRE-EM-
PLOYMENT BACKGROUND INVESTIGATION
SERVICES; PRIVATE INVESTIGATION; FRAUD
DETECTION SERVICES IN THE FIELD OF WORK-
ERS COMPENSATION FRAUD; SURVEILLANCE
SERVICES, IN CLASS 45 (U.S. CLS. 100 AND 101).

FIRST USE 10-15-2007; IN COMMERCE 10-15-2007.

NO CLAIM IS MADE TO THE EXCLUSIVE
RIGHT TO USE "CORPORATE SECURITY AND
INVESTIGATIONS, LLC", APART FROM THE
MARK AS SHOWN.

THE MARK CONSISTS OF A BOTTOM LAYER
WHICH CONSISTS OF THE LETTERS CSI IN BLUE;
A MIDDLE LAYER WHICH CONSISTS OF THE
FOLLOWING SEQUENCE OF NUMERALS IN
LIGHT GREY: 01000011 01101111 01110010 0111
01110010 01101001 01110100 0111 01101001 01100111
01100001 0111 01110000 01101111 01110010 0110
01111001 01100001 01101110 0110 01110100 01101001
01101111 0110 01100001 01110100 01100101 0101
01100100 01001001 01101110 0111 01101110 01110011
01001100 0100 01010011 01100101 01100011 0111
01110110 01100101 01110011 0111; AND A TOP LAYER
CONSISTING OF A BLUE THUMBPRINT DESIGN
WITH THE LETTERS CSI FORMING PART OF THE
THUMBPRINT, THE WORDS CORPORATE SECUR-
ITY AND IN BLACK LETTERS, AND THE WORDS
INVESTIGATIONS, LLC IN BLUE LETTERS.

SER. NO. 77-342,214, FILED 12-3-2007.

BRENDAN MCCAULEY, EXAMINING ATTORNEY

Int. Cls.: 38 and 41

Prior U.S. Cls.: 100, 101, 104 and 107

United States Patent and Trademark Office

Reg. No. 3,483,983

Registered Aug. 12, 2008

**SERVICE MARK
PRINCIPAL REGISTER**



MEDIA WORLD LLC (FLORIDA LTD LIAB CO)
7395 WEST 19TH COURT
HIALEAH, FL 33014

FOR: TELECOMMUNICATION SERVICES, NAMELY, ELECTRONIC TRANSMISSION OF VIDEO, IMAGE, VOICE, SOUND AND DATA VIA TELEVISION, SATELLITE, CABLE, WIRELESS, FIBER OPTICS, AUDIO AND VIDEO MEDIA AND GLOBAL COMPUTER NETWORKS; PROVIDING TELEVISION BROADCASTING SERVICES VIA COMMUNICATION SATELLITE, IN CLASS 38 (U.S. CLS. 100, 101 AND 104).

FIRST USE 9-11-2004; IN COMMERCE 9-11-2004.

FOR: ENTERTAINMENT IN THE NATURE OF ON-GOING TELEVISION AND RADIO SPANISH-LANGUAGE PROGRAMS FEATURING NEWS, SPORTS, DRAMA, COMEDY, CHILDREN'S TOPICS, ENTERTAINMENT, DOCUMENTARY, TOURISM, BIOGRAPHY, GAME SHOW AND MUSIC PROGRAMMING BROADCAST OVER TELEVISION, SATELLITE, WIRELESS, AUDIO AND VIDEO MEDIA, FIBER OPTICS, CABLE AND GLOBAL COMPUTER NETWORKS, IN CLASS 41 (U.S. CLS. 100, 101 AND 107).

FIRST USE 9-11-2004; IN COMMERCE 9-11-2004.

NO CLAIM IS MADE TO THE EXCLUSIVE RIGHT TO USE "CENTRO AMÉRICA TV", APART FROM THE MARK AS SHOWN.

THE COLOR(S) LIGHT BLUE AND DARK BLUE IS/ARE CLAIMED AS A FEATURE OF THE MARK.

THE MARK CONSISTS OF THE COLOR DARK BLUE APPEARS IN THE WORDING "CENTROAMÉRICA" AND THE COLOR LIGHT BLUE APPEARS IN THE WORDING "TV" OF THE MARK. THE DESIGN ELEMENT OF THE MARK IS IN THE COLORS LIGHT AND DARK BLUE.

THE ENGLISH TRANSLATION OF THE WORDING "CENTRO AMÉRICA TV" IS "CENTRAL AMERICA TV."

SER. NO. 77-342,572, FILED 12-3-2007.

DAWN HAN, EXAMINING ATTORNEY

Int. Cl.: 41

Prior U.S. Cls.: 100, 101 and 107

United States Patent and Trademark Office

Reg. No. 3,483,984

Registered Aug. 12, 2008

**SERVICE MARK
PRINCIPAL REGISTER**



MEDIA WORLD LLC (FLORIDA LTD LIAB CO)
7395 WEST 19TH COURT
HIALEAH, FL 33014

FOR: ENTERTAINMENT IN THE NATURE OF ON-GOING TELEVISION AND RADIO SPANISH-LANGUAGE PROGRAMS FEATURING NEWS, SPORTS, DRAMA, COMEDY, CHILDREN'S TOPICS, ENTERTAINMENT, DOCUMENTARY, TOURISM, BIOGRAPHY, GAME SHOW AND MUSIC PROGRAMMING BROADCAST OVER TELEVISION, SATELLITE, WIRELESS, AUDIO AND VIDEO MEDIA, FIBER OPTICS, CABLE AND GLOBAL COMPUTER NETWORKS, IN CLASS 41 (U.S. CLS. 100, 101 AND 107).

FIRST USE 4-18-2007; IN COMMERCE 4-18-2007.

OWNER OF U.S. REG. NO. 3,331,670.

NO CLAIM IS MADE TO THE EXCLUSIVE RIGHT TO USE "TELEVISIÓN DOMINICANA", APART FROM THE MARK AS SHOWN.

THE COLOR(S) BLUE AND RED IS/ARE CLAIMED AS A FEATURE OF THE MARK.

THE MARK CONSISTS OF THE COLOR BLUE APPEARS IN THE WORDING "TELEVISIÓN DOMINICANA" OF THE MARK. THE DESIGN ELEMENT OF THE MARK IS IN THE COLORS RED AND BLUE.

THE ENGLISH TRANSLATION OF THE WORDING "TELEVISIÓN DOMINICANA" IS "DOMINICAN TELEVISION."

SER. NO. 77-342,604, FILED 12-3-2007.

DAWN HAN, EXAMINING ATTORNEY

Int. Cl.: 41

Prior U.S. Cls.: 100, 101 and 107

United States Patent and Trademark Office

Reg. No. 3,483,985

Registered Aug. 12, 2008

**SERVICE MARK
PRINCIPAL REGISTER**

**A New Science of Human
Relationships**

PATRICK JOHN MCNALLY (UNITED STATES
INDIVIDUAL)
2210 SPINNAKER COURT
RESTON, VA 20191

FOR: LIFE COACHING SERVICES IN GROUP
AND PRIVATE SESSION WORKSHOPS IN THE
FIELDS OF PERSONAL HEALTH, HAPPINESS
AND SUCCESS UTILIZING VISUALIZATION AND
MEDITATIVE TECHNIQUES , IN CLASS 41 (U.S.
CLS. 100, 101 AND 107).

FIRST USE 11-17-1007; IN COMMERCE 12-1-2007.

THE MARK CONSISTS OF STANDARD CHAR-
ACTERS WITHOUT CLAIM TO ANY PARTICULAR
FONT, STYLE, SIZE, OR COLOR.

SER. NO. 77-342,705, FILED S.R. 12-3-2007 AM. P.R.
4-23-2008.

PAULA MAHONEY, EXAMINING ATTORNEY

Int. Cl.: 11

Prior U.S. Cls.: 13, 21, 23, 31 and 34

United States Patent and Trademark Office

Reg. No. 3,483,986

Registered Aug. 12, 2008

**TRADEMARK
PRINCIPAL REGISTER**

**EXPERIENCE THE NATURAL
CLEANSING POWER OF WATER**

M.F.B. INTERNATIONAL, INC. (FLORIDA CORPORATION)
10773 N.W. 58TH STREET # 335
DORAL, FL 33178

THE MARK CONSISTS OF STANDARD CHARACTERS WITHOUT CLAIM TO ANY PARTICULAR FONT, STYLE, SIZE, OR COLOR.

FOR: ACCESSORIES FOR TOILETS OR WC, NAMELY, BIDETS, IN CLASS 11 (U.S. CLS. 13, 21, 23, 31 AND 34).

SER. NO. 77-342,737, FILED 12-3-2007.

FIRST USE 5-1-2004; IN COMMERCE 5-1-2004.

AMEETA JORDAN, EXAMINING ATTORNEY

Int. Cl.: 41

Prior U.S. Cls.: 100, 101 and 107

United States Patent and Trademark Office

Reg. No. 3,483,987

Registered Aug. 12, 2008

**SERVICE MARK
PRINCIPAL REGISTER**

UFC WIRED

ZUFFA LLC (NEVADA LTD LIAB CO)
2960 W. SAHARA AVENUE
LAS VEGAS, NV 89102

FOR: ENTERTAINMENT IN THE NATURE OF
TELEVISION PROGRAMS FEATURING COMPETITION
IN THE FIELD OF SPORTS AND MIXED
MARTIAL ARTS, IN CLASS 41 (U.S. CLS. 100, 101
AND 107).

FIRST USE 10-6-2007; IN COMMERCE 10-6-2007.

THE MARK CONSISTS OF STANDARD CHAR-
ACTERS WITHOUT CLAIM TO ANY PARTICULAR
FONT, STYLE, SIZE, OR COLOR.

OWNER OF U.S. REG. NOS. 2,645,312, 2,941,044
AND OTHERS.

SER. NO. 77-342,768, FILED 12-3-2007.

BILL DAWE, EXAMINING ATTORNEY

Int. Cl.: 35

Prior U.S. Cls.: 100, 101 and 102

United States Patent and Trademark Office

Reg. No. 3,483,988

Registered Aug. 12, 2008

**SERVICE MARK
PRINCIPAL REGISTER**

Kate's Caring Gifts

AMON, KATE (UNITED STATES INDIVIDUAL),
DBA KATE'S CARING GIFTS
45953 WARM SPRINGS BLVD. STE 2
FREMONT, CA 94539

FOR: RETAIL GIFT SHOPS, IN CLASS 35 (U.S.
CLS. 100, 101 AND 102).

FIRST USE 8-1-2004; IN COMMERCE 8-1-2004.

THE MARK CONSISTS OF STANDARD CHAR-
ACTERS WITHOUT CLAIM TO ANY PARTICULAR
FONT, STYLE, SIZE, OR COLOR.

NO CLAIM IS MADE TO THE EXCLUSIVE
RIGHT TO USE "GIFTS", APART FROM THE
MARK AS SHOWN.

THE NAME SHOWN IN THE MARK IDENTIFIES
"KATE AMON" WHOSE CONSENT IS OF RECORD.

SER. NO. 77-342,998, FILED 12-3-2007.

MICHELE SWAIN, EXAMINING ATTORNEY

Int. Cl.: 42

Prior U.S. Cls.: 100 and 101

United States Patent and Trademark Office

Reg. No. 3,483,989

Registered Aug. 12, 2008

**SERVICE MARK
PRINCIPAL REGISTER**

PLANET CYBER

CYBER GAMING LLC. (CALIFORNIA LTD LIAB
CO), DBA PLANET CYBER

5188 MECCA AVE

TARZANA, CA 91356

FOR: COMPUTER RENTALS, REPAIRS, WEB
DESIGN, IN CLASS 42 (U.S. CLS. 100 AND 101).

FIRST USE 11-1-2001; IN COMMERCE 11-1-2001.

THE MARK CONSISTS OF STANDARD CHAR-
ACTERS WITHOUT CLAIM TO ANY PARTICULAR
FONT, STYLE, SIZE, OR COLOR.

NO CLAIM IS MADE TO THE EXCLUSIVE
RIGHT TO USE "CYBER", APART FROM THE
MARK AS SHOWN.

SER. NO. 77-343,022, FILED 12-3-2007.

EMILY CHUO, EXAMINING ATTORNEY

Int. Cl.: 35

Prior U.S. Cls.: 100, 101 and 102

United States Patent and Trademark Office

Reg. No. 3,483,990

Registered Aug. 12, 2008

**SERVICE MARK
PRINCIPAL REGISTER**

Prime Interactive

PRIME INTERACTIVE, INC. (NORTH CAROLINA CORPORATION)
4304 JOHN H RENCHER WYND
RALEIGH, NC 27612

FOR: PROMOTING THE GOODS AND SERVICES OF OTHERS THROUGH SEARCH ENGINE REFERRAL TRAFFIC ANALYSIS AND REPORTING; PROMOTING THE GOODS AND SERVICES OF OTHERS BY PROVIDING HYPERTEXT LINKS TO THE WEBSITES OF OTHERS; ADVERTISING AND COMMERCIAL INFORMATION SERVICES, VIA THE INTERNET; ADVERTISING AND MARKETING; ADVERTISING AND PROMOTION SERVICES AND RELATED CONSULTING; ADVERTISING AND PROMOTIONAL SERVICES; ADVERTISING AND PUBLICITY SERVICES, NAMELY, PROMOTING THE GOODS, SERVICES, BRAND IDENTITY AND COMMERCIAL INFORMATION AND NEWS OF THIRD PARTIES THROUGH PRINT, AUDIO, VIDEO, DIGITAL AND ON-LINE MEDIUM; ADVERTISING SERVICES; ADVERTISING SERVICES, NAMELY, CREATING CORPORATE LOGOS FOR OTHERS; CREATING AND UPDATING ADVERTISING MATERIAL; DESIGN OF ADVERTISING MATERIALS FOR OTHERS; DESIGN OF INTERNET ADVERTISING; DISSEMINATION OF ADVERTISING FOR OTHERS VIA AN ON-LINE COMMUNICATIONS NETWORK ON THE INTERNET; DISSEMINATION OF ADVERTISING MATTER; ELECTRONIC COMMERCE SERVICES, NAMELY, PROVIDING INFORMATION ABOUT PRODUCTS VIA TELECOMMUNICATION NETWORKS FOR ADVERTISING AND SALES PURPOSES; INTERNET ADVERTISING SERVICES; ON-LINE ADVERTISING AND MARKETING SERVICES; ON-LINE AD-

VERTISING ON COMPUTER COMMUNICATION NETWORKS; PREPARING AND PLACING ADVERTISEMENTS FOR OTHERS; PROMOTING, ADVERTISING AND MARKETING OF THE ON-LINE WEBSITES OF OTHERS; PROMOTION, ADVERTISING AND MARKETING OF ON-LINE WEBSITES; ADVERTISING, MARKETING AND PROMOTION SERVICES; BUSINESS MARKETING CONSULTING SERVICES; BUSINESS MARKETING SERVICES; CONDUCTING BUSINESS AND MARKET RESEARCH SURVEYS; CREATIVE MARKETING DESIGN SERVICES; DIRECT MARKETING CONSULTING SERVICES; DIRECT MARKETING SERVICES; MARKET ANALYSIS; MARKET RESEARCH; MARKETING CONSULTING; DISSEMINATION OF ADVERTISING FOR OTHERS VIA THE INTERNET; BUSINESS MONITORING SERVICES, NAMELY, TRACKING WEBSITES OF OTHERS TO PROVIDE DETAILS ABOUT USER CLICK TRAFFIC OR VISITS TO THE WEBSITE, IN CLASS 35 (U.S. CLS. 100, 101 AND 102).

FIRST USE 12-19-2006; IN COMMERCE 12-19-2006.

THE MARK CONSISTS OF STANDARD CHARACTERS WITHOUT CLAIM TO ANY PARTICULAR FONT, STYLE, SIZE, OR COLOR.

NO CLAIM IS MADE TO THE EXCLUSIVE RIGHT TO USE INTERACTIVE, APART FROM THE MARK AS SHOWN.

SER. NO. 77-343,764, FILED 12-4-2007.

DANIEL CAPSHAW, EXAMINING ATTORNEY

Int. Cl.: 6

Prior U.S. Cls.: 2, 12, 13, 14, 23, 25 and 50

Reg. No. 3,483,991

United States Patent and Trademark Office

Registered Aug. 12, 2008

**TRADEMARK
PRINCIPAL REGISTER**

SPENAX

STANLEY LOGISTICS, INC. (DELAWARE CORPORATION)
1000 STANLEY DRIVE
NEW BRITAIN, CT 06053

FOR: METAL FASTENERS, NAMELY, FASTENING RINGS, IN CLASS 6 (U.S. CLS. 2, 12, 13, 14, 23, 25 AND 50).

FIRST USE 12-0-1988; IN COMMERCE 12-0-1988.

THE MARK CONSISTS OF STANDARD CHARACTERS WITHOUT CLAIM TO ANY PARTICULAR FONT, STYLE, SIZE, OR COLOR.

THE WORDING "SPENAX" HAS NO MEANING IN A FOREIGN LANGUAGE.

SER. NO. 77-343,805, FILED 12-4-2007.

KATHY DE JONGE, EXAMINING ATTORNEY

Int. Cl.: 25

Prior U.S. Cls.: 22 and 39

United States Patent and Trademark Office

Reg. No. 3,483,992

Registered Aug. 12, 2008

TRADEMARK
PRINCIPAL REGISTER



HUANG, SHUNZHEN (CHINA INDIVIDUAL)
43-17 UNION STREET, APT#3B
FLUSHING, NY 11354

FOR: CHILDREN'S CLOTHING, NAMELY, HATS
AND CAPS, SHOES, COATS, SWEATERS, SHIRTS,
PANTS, AND SKIRTS, IN CLASS 25 (U.S. CLS. 22
AND 39).

FIRST USE 8-1-2007; IN COMMERCE 10-1-2007.

NO CLAIM IS MADE TO THE EXCLUSIVE
RIGHT TO USE "KIDSWEAR", APART FROM THE
MARK AS SHOWN.

THE MARK CONSISTS OF A CARTOONIZED
CHICKEN COMING OUT FROM A SHELL;
"AWILL" ABOVE A BAR; AND "KIDSWEAR" BE-
LOW THE BAR.

SER. NO. 77-343,841, FILED 12-4-2007.

VERNA BETH RIRIE, EXAMINING ATTORNEY

Int. Cls.: 1 and 5

Prior U.S. Cls.: 1, 5, 6, 10, 18, 26, 44, 46, 51 and 52

United States Patent and Trademark Office

Reg. No. 3,483,993

Registered Aug. 12, 2008

**TRADEMARK
PRINCIPAL REGISTER**

REATIS

BAYER AKTIENGESELLSCHAFT (FED REP
GERMANY AKTIENGESELLSCHAFT)
D-51368
LEVERKUSEN-BAYERWERK, FED REP GERMA-
NY

FOR: CHEMICAL PREPARATIONS FOR USE IN
AGRICULTURE, HORTICULTURE AND FOREST-
RY, NAMELY, PREPARATIONS FOR THE TREAT-
MENT OF SEEDS; FERTILIZERS, IN CLASS 1 (U.S.
CLS. 1, 5, 6, 10, 26 AND 46).

FOR: PREPARATIONS FOR KILLING WEEDS
AND DESTROYING VERMIN, INSECTICIDES,

HERBICIDES, FUNGICIDES, IN CLASS 5 (U.S. CLS.
6, 18, 44, 46, 51 AND 52).

THE MARK CONSISTS OF STANDARD CHAR-
ACTERS WITHOUT CLAIM TO ANY PARTICULAR
FONT, STYLE, SIZE, OR COLOR.

OWNER OF FED REP GERMANY REG. NO.
30705565, DATED 5-10-2007, EXPIRES 1-31-2017.

SER. NO. 77-343,844, FILED 12-4-2007.

KAREN K. BUSH, EXAMINING ATTORNEY

Int. Cl.: 30

Prior U.S. Cl.: 46

United States Patent and Trademark Office

Reg. No. 3,483,994

Registered Aug. 12, 2008

**TRADEMARK
PRINCIPAL REGISTER**



KUPPA INTERNATIONAL (CALIFORNIA CORPORATION)
17400 VON KARMAN AVE.
IRVINE, CA 92614

FOR: A DISPOSABLE CUP WITH A TEA-FILLED POUCH ULTRASONICALLY WELDED TO ONE SIDE OF THE BOTTOM OF THE CUP, WHICH ALLOWS THE NATURAL FIBER POUCH TO FLOAT NEAR THE BOTTOM , IN CLASS 30 (U.S. CL. 46).

FIRST USE 9-1-2006; IN COMMERCE 10-1-2006.

THE MARK CONSISTS OF THE STYLIZED MARK INCLUDES THE LETTERS "K U P P A", AND THE WORD "INTERNATIONAL". THE LETTER "U" IN THE WORD "KUPPA" DESIGNED TO APPEAR AS THE SHAPE OF A "CUP".

SER. NO. 77-344,093, FILED 12-4-2007.

PAULA MAHONEY, EXAMINING ATTORNEY

Int. Cl.: 36

Prior U.S. Cls.: 100, 101 and 102

United States Patent and Trademark Office

Reg. No. 3,483,995

Registered Aug. 12, 2008

**SERVICE MARK
PRINCIPAL REGISTER**



DEBORDIEU COLONY REAL ESTATE, INC.
(SOUTH CAROLINA CORPORATION)
129 LUVAN BLVD
GEORGETOWN, SC 29440

THE MARK CONSISTS OF A HERON IN AN
OVAL.

FOR: REAL ESTATE BROKERAGE; REAL ES-
TATE MANAGEMENT; LEASING OF REAL ES-
TATE, IN CLASS 36 (U.S. CLS. 100, 101 AND 102).

SER. NO. 77-344,300, FILED 12-5-2007.

FIRST USE 3-27-1995; IN COMMERCE 3-27-1995.

ANNE FARRELL, EXAMINING ATTORNEY

Int. Cl.: 41

Prior U.S. Cls.: 100, 101 and 107

United States Patent and Trademark Office

Reg. No. 3,483,996

Registered Aug. 12, 2008

**SERVICE MARK
PRINCIPAL REGISTER**



WAYNE FOSTER ENTERTAINMENT PRODUCTIONS (CALIFORNIA CORPORATION)
1940 KELLOGG AVENUE
CARLSBAD, CA 92008

FIRST USE 1-12-2006; IN COMMERCE 3-24-2006.

OWNER OF U.S. REG. NO. 1,994,378.

FOR: ENTERTAINMENT IN THE NATURE OF CUSTOMIZED LIVE MUSICAL AND DANCE PERFORMANCES AND SPECIAL EVENT PLANNING, IN CLASS 41 (U.S. CLS. 100, 101 AND 107).

SER. NO. 77-344,651, FILED 12-5-2007.

DAWN HAN, EXAMINING ATTORNEY

Int. Cl.: 6

Prior U.S. Cls.: 2, 12, 13, 14, 23, 25 and 50

Reg. No. 3,483,997

United States Patent and Trademark Office

Registered Aug. 12, 2008

**TRADEMARK
PRINCIPAL REGISTER**

PICTURE FIXER

BELLEHUMEUR, ALEX R. (UNITED STATES
INDIVIDUAL)
6242 NAPOLI COURT
LONG BEACH, CA 90803

FOR: METAL BRACKETS WITH ADHESIVE FOR
ATTACHMENT TO THE BASE OF A PICTURE
FRAME TO SECURE THE FRAME WITH A HOR-
IZONTAL OR DESIRED POSITION, IN CLASS 6 (U.S.
CLS. 2, 12, 13, 14, 23, 25 AND 50).

FIRST USE 11-18-1996; IN COMMERCE 11-18-1996.

THE MARK CONSISTS OF STANDARD CHAR-
ACTERS WITHOUT CLAIM TO ANY PARTICULAR
FONT, STYLE, SIZE, OR COLOR.

NO CLAIM IS MADE TO THE EXCLUSIVE
RIGHT TO USE "PICTURE", APART FROM THE
MARK AS SHOWN.

SER. NO. 77-344,845, FILED 12-5-2007.

CHARLES L. JENKINS, EXAMINING ATTORNEY

Int. Cl.: 9

Prior U.S. Cls.: 21, 23, 26, 36 and 38

Reg. No. 3,483,998

United States Patent and Trademark Office

Registered Aug. 12, 2008

**TRADEMARK
PRINCIPAL REGISTER**

WEBWORK

UNIVERSITY OF ROCHESTER (NEW YORK
EDUCATIONAL INSTITUTION CHARTERED
BY THE STATE OF NEW YORK)

BOX OTT
601 ELMWOOD AVENUE
ROCHESTER, NY 14642

FOR: SOFTWARE FOR PROVIDING STUDENTS
WITH INTERACTIVE MATH AND SCIENCE
HOMEWORK PROBLEMS OVER THE INTERNET
WITH IMMEDIATE FEEDBACK AS TO THE COR-
RECTNESS OF THE ANSWERS ENTREED BY THE

STUDENT, IN CLASS 9 (U.S. CLS. 21, 23, 26, 36 AND
38).

FIRST USE 9-30-1996; IN COMMERCE 9-30-1996.

THE MARK CONSISTS OF STANDARD CHAR-
ACTERS WITHOUT CLAIM TO ANY PARTICULAR
FONT, STYLE, SIZE, OR COLOR.

SER. NO. 77-344,918, FILED 12-5-2007.

SOPHIA S. KIM, EXAMINING ATTORNEY

Int. Cl.: 45

Prior U.S. Cls.: 100 and 101

United States Patent and Trademark Office

Reg. No. 3,483,999

Registered Aug. 12, 2008

**SERVICE MARK
PRINCIPAL REGISTER**

You Can't Beat A Woman

HAUBER, HANNAH K. (UNITED STATES INDIVIDUAL)
12405 KNOX
OVERLAND PARK, KS 66213

FOR: PROVIDING INFORMATION AND CONSULTATION IN THE FIELD OF DATING VIOLENCE AND ABUSIVE RELATIONSHIPS, IN CLASS 45 (U.S. CLS. 100 AND 101).

FIRST USE 9-1-2007; IN COMMERCE 9-25-2007.

THE MARK CONSISTS OF STANDARD CHARACTERS WITHOUT CLAIM TO ANY PARTICULAR FONT, STYLE, SIZE, OR COLOR.

SER. NO. 77-345,085, FILED 12-5-2007.

JASON TURNER, EXAMINING ATTORNEY

Int. Cls.: 7 and 12

Prior U.S. Cls.: 13, 19, 21, 23, 31, 34, 35 and 44

United States Patent and Trademark Office

Reg. No. 3,484,000

Registered Aug. 12, 2008

**TRADEMARK
PRINCIPAL REGISTER**

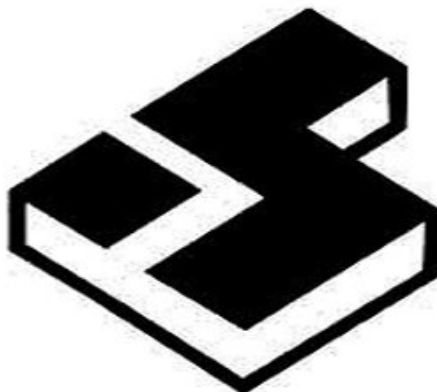

HUNAN SUNWARD INTELLIGENT MACHIN-
ERY CO., LTD. (CHINA CORPORATION)
NO.2 , LIXIANG ROAD, ECONOMIC DEV.ZONE
CHANGSHA, CHINA 410100

FOR: EARTH COMPACTING MACHINES;
EARTH MOVING MACHINES, NAMELY, EXCAVA-
TORS; EARTH MOVING MACHINES, NAMELY,
SCRAPERS; DRILLING MACHINES; DRILLS FOR
THE MINING INDUSTRY; HOISTS; FLUID POWER
COMPONENT KIT FOR MACHINE CONTROL
COMPRISING PUMPS AND VALVES; GAS COM-
PRESSORS; BULLDOZERS; PILE DRIVERS; EARTH
MOVING MACHINES; AGRICULTURAL MACHIN-
ERY AND ATTACHMENTS THEREFORE, NAME-
LY, ROTARY MOWERS, BOX SCRAPERS, AND
THREE-POINT ATTACHMENTS; LOADING AND
UNLOADING MACHINES; MINE BORERS; CAR
LIFTS, IN CLASS 7 (U.S. CLS. 13, 19, 21, 23, 31, 34 AND
35).

FIRST USE 12-16-2004; IN COMMERCE 4-15-2005.

FOR: FORK LIFT TRUCKS; TRACTORS; CON-
CRETE MIXING TRUCKS; MOTORS FOR LAND
VEHICLES; TRANSMISSION CASES FOR LAND
VEHICLES; AEROPLANES; AIRCRAFT; BOATS;
BOAT HULLS, IN CLASS 12 (U.S. CLS. 19, 21, 23, 31,
35 AND 44).

FIRST USE 10-12-2004; IN COMMERCE 5-25-2005.

OWNER OF U.S. REG. NO. 3,194,425.

THE MARK CONSISTS OF A THREE-DIMEN-
SIONAL GEOMETRIC SHAPE.

SER. NO. 77-345,254, FILED 12-5-2007.

KHANH LE, EXAMINING ATTORNEY

Int. Cl.: 9

Prior U.S. Cls.: 21, 23, 26, 36 and 38

Reg. No. 3,484,001

United States Patent and Trademark Office

Registered Aug. 12, 2008

**TRADEMARK
PRINCIPAL REGISTER**

Codeworks

COOPER, THEODORE B. (UNITED STATES IN-
DIVIDUAL)
12319 SKYLINE BLVD.
OAKLAND, CA 94619

THE MARK CONSISTS OF STANDARD CHAR-
ACTERS WITHOUT CLAIM TO ANY PARTICULAR
FONT, STYLE, SIZE, OR COLOR.

FOR: COMPUTER SOFTWARE FOR APPLICA-
TION AND DATABASE INTEGRATION, IN CLASS 9
(U.S. CLS. 21, 23, 26, 36 AND 38).

SER. NO. 77-345,270, FILED 12-6-2007.

FIRST USE 12-5-2007; IN COMMERCE 12-5-2007.

LAURIE KAUFMAN, EXAMINING ATTORNEY

Int. Cl.: 19

Prior U.S. Cls.: 1, 12, 33 and 50

United States Patent and Trademark Office

Reg. No. 3,484,002

Registered Aug. 12, 2008

**TRADEMARK
PRINCIPAL REGISTER**

HYDROSHIELD TECHNOLOGY

PLASTPRO 2000, INC. (NEW JERSEY CORPORATION)
9 PEACHTREE ROAD
LIVINGSTON, NJ 07039

FOR: NON-METAL DOOR UNITS; PLASTIC AND PLASTIC COMPOSITE PARTS OF ENTRY DOORS, NAMELY, DOOR STILES, DOOR RAILS, DOOR JAMBS, AND DOOR SILLS, IN CLASS 19 (U.S. CLS. 1, 12, 33 AND 50).

FIRST USE 11-0-2006; IN COMMERCE 11-0-2006.

THE MARK CONSISTS OF STANDARD CHARACTERS WITHOUT CLAIM TO ANY PARTICULAR FONT, STYLE, SIZE, OR COLOR.

NO CLAIM IS MADE TO THE EXCLUSIVE RIGHT TO USE "TECHNOLOGY", APART FROM THE MARK AS SHOWN.

SER. NO. 77-345,467, FILED 12-6-2007.

JANICE L. MCMORROW, EXAMINING ATTORNEY

Int. Cl.: 19

Prior U.S. Cls.: 1, 12, 33 and 50

Reg. No. 3,484,003

United States Patent and Trademark Office

Registered Aug. 12, 2008

**TRADEMARK
PRINCIPAL REGISTER**

Power Over Water

JM SALES ASSOCIATES INC. (MICHIGAN CORPORATION), DBA TRITON STORMWATER SOLUTIONS
SUITE 110 #176
9864 EAST GRAND RIVER
BRIGHTON, MI 48116

FIRST USE 8-10-2007; IN COMMERCE 8-10-2007.

THE MARK CONSISTS OF STANDARD CHARACTERS WITHOUT CLAIM TO ANY PARTICULAR FONT, STYLE, SIZE, OR COLOR.

FOR: STORMWATER SYSTEM NON-METAL COMPONENTS, NAMELY, CHAMBERS, DUMPSTERS, SEDIMENT FLOORS AND SUMP BASINS , IN CLASS 19 (U.S. CLS. 1, 12, 33 AND 50).

SER. NO. 77-345,470, FILED 12-6-2007.

JANICE L. MCMORROW, EXAMINING ATTORNEY

Int. Cl.: 36

Prior U.S. Cls.: 100, 101 and 102

United States Patent and Trademark Office

Reg. No. 3,484,004

Registered Aug. 12, 2008

**SERVICE MARK
PRINCIPAL REGISTER**

BGI

BARCLAYS GLOBAL INVESTORS, N.A. (UNITED STATES FEDERALLY CHARTERED BANKING INSTITUTION ORGANIZED UNDER THE LAWS OF THE UNITED STATES)
45 FREMONT STREET
SAN FRANCISCO, CA 94105

FOR: BANKING SERVICES; MUTUAL FUND INVESTMENT ADVISORY SERVICES; HEDGE FUND SERVICES; INVESTMENT SERVICES, NAMELY, INVESTMENT ADVISORY SERVICES; INVESTMENT MANAGEMENT SERVICES AND FINANCIAL SERVICES IN THE NATURE OF POOLED INVESTMENT FUNDS; PROVIDING FINANCIAL INFORMATION VIA A GLOBAL COMPUTER INFORMATION NETWORK; FINANCIAL

MANAGEMENT INVESTMENT ANALYSIS AND CONSULTATION IN THE FIELD OF SECURITIES, REAL ESTATE, FUNDS, MUTUAL FUNDS, HEDGE FUNDS, IN CLASS 36 (U.S. CLS. 100, 101 AND 102).

FIRST USE 1-1-1996; IN COMMERCE 1-1-1996.

THE MARK CONSISTS OF STANDARD CHARACTERS WITHOUT CLAIM TO ANY PARTICULAR FONT, STYLE, SIZE, OR COLOR.

SER. NO. 77-345,558, FILED 12-6-2007.

JAY FLOWERS, EXAMINING ATTORNEY

Int. Cls.: 35 and 42

Prior U.S. Cls.: 100, 101 and 102

United States Patent and Trademark Office

Reg. No. 3,484,005

Registered Aug. 12, 2008

**SERVICE MARK
PRINCIPAL REGISTER**



THINK NOCTURNAL, LLC (NEW HAMPSHIRE
LTD LIAB CO)
8 CONTINENTAL DRIVE, UNIT E
EXETER, NH 03833

FOR: MARKETING CONSULTING SERVICES;
MARKETING RESEARCH; BRANDING CONSUL-
TATION, NAMELY, BRAND PLANNING AND
BRAND DEVELOPMENT FOR OTHERS , IN CLASS
35 (U.S. CLS. 100, 101 AND 102).

FIRST USE 4-30-2006; IN COMMERCE 4-30-2006.

FOR: GRAPHIC DESIGN, ILLUSTRATION AND
WEB SITE DESIGN SERVICES FOR OTHERS; COM-

PUTER SERVICES, NAMELY, DESIGNING CUSTO-
MIZED SOFTWARE APPLICATIONS FOR OTHERS,
IN CLASS 42 (U.S. CLS. 100 AND 101).

FIRST USE 4-30-2006; IN COMMERCE 4-30-2006.

THE MARK CONSISTS OF A STYLIZED LETTER
"N".

SER. NO. 77-345,608, FILED 12-6-2007.

CURTIS FRENCH, EXAMINING ATTORNEY

Int. Cl.: 12

Prior U.S. Cls.: 19, 21, 23, 31, 35 and 44

Reg. No. 3,484,006

United States Patent and Trademark Office

Registered Aug. 12, 2008

**TRADEMARK
PRINCIPAL REGISTER**

EXKATE

CHASE BOARDS, LLC (CALIFORNIA LTD LIAB
CO)
A259
31441 SANTA MARGARITA PARKWAY
RANCHO SANTA MARGARITA, CA 92688

FOR: VEHICLES, NAMELY, ELECTRONICALLY
MOTORIZED SKATEBOARDS, AND SKATE-
BOARD ACCESSORIES, NAMELY, SKATEBOARD
DRIVE MOTORS, IN CLASS 12 (U.S. CLS. 19, 21, 23,
31, 35 AND 44).

FIRST USE 1-0-1997; IN COMMERCE 1-0-1997.

THE MARK CONSISTS OF STANDARD CHAR-
ACTERS WITHOUT CLAIM TO ANY PARTICULAR
FONT, STYLE, SIZE, OR COLOR.

OWNER OF U.S. REG. NO. 2,267,219.

SER. NO. 77-345,630, FILED 12-6-2007.

JAMES LOVELACE, EXAMINING ATTORNEY

Int. Cl.: 5

Prior U.S. Cls.: 6, 18, 44, 46, 51 and 52

Reg. No. 3,484,007

United States Patent and Trademark Office

Registered Aug. 12, 2008

**TRADEMARK
PRINCIPAL REGISTER**

ARTHOCIN

LEMEROND, TERRENCE J. (UNITED STATES
INDIVIDUAL)
SUITE 40
2625 DEVELOPMENT DRIVE
GREEN BAY, WI 54305

FOR: DIETARY SUPPLEMENTS AND NUTRI-
TIONAL SUPPLEMENTS, IN CLASS 5 (U.S. CLS. 6,
18, 44, 46, 51 AND 52).

FIRST USE 10-31-2006; IN COMMERCE 10-31-2006.

THE MARK CONSISTS OF STANDARD CHAR-
ACTERS WITHOUT CLAIM TO ANY PARTICULAR
FONT, STYLE, SIZE, OR COLOR.

THE TERM "ARTHOCIN" HAS NO MEANING IN
A FOREIGN LANGUAGE.

SER. NO. 77-345,732, FILED 12-6-2007.

JAY BESCH, EXAMINING ATTORNEY

Int. Cls.: 16 and 41

Prior U.S. Cls.: 2, 5, 22, 23, 29, 37, 38, 50, 100, 101 and 107

Reg. No. 3,484,008

United States Patent and Trademark Office

Registered Aug. 12, 2008

TRADEMARK
SERVICE MARK
PRINCIPAL REGISTER



NANCY D. DOERING, LLC (MISSOURI LTD
LIAB CO)
P.O. BOX 220133
KIRKWOOD, MO 63122

FOR: PRINTED EDUCATIONAL PUBLICA-
TIONS, NAMELY, BOOKS, PAMPHLETS, AND
HANDOUTS IN THE FIELD OF HEALTH CARE
AND THE RELATIONSHIP BETWEEN DOCTORS
AND PATIENTS; PERSONAL ORGANIZERS FOR
MEDICAL AND HEALTH CARE INFORMATION,
IN CLASS 16 (U.S. CLS. 2, 5, 22, 23, 29, 37, 38 AND 50).

FIRST USE 7-19-2007; IN COMMERCE 7-19-2007.

FOR: CONDUCTING SEMINARS AND WORK-
SHOPS IN THE FIELD OF HEALTH CARE AND
THE RELATIONSHIP BETWEEN DOCTORS AND
PATIENTS, IN CLASS 41 (U.S. CLS. 100, 101 AND 107).

FIRST USE 7-19-2007; IN COMMERCE 7-19-2007.

THE MARK CONSISTS OF THE WORD "REALI-
TY" IN THE MIDDLE OF A CHECK MARK.

SER. NO. 77-345,734, FILED 12-6-2007.

JAY BESCH, EXAMINING ATTORNEY

Int. Cl.: 10

Prior U.S. Cls.: 26, 39 and 44

Reg. No. 3,484,009

United States Patent and Trademark Office

Registered Aug. 12, 2008

**TRADEMARK
PRINCIPAL REGISTER**

EPIC

MARCO OPHTHALMIC, INC. (FLORIDA CORPORATION)
11825 CENTRAL PARKWAY
JACKSONVILLE, FL 32225

THE MARK CONSISTS OF STANDARD CHARACTERS WITHOUT CLAIM TO ANY PARTICULAR FONT, STYLE, SIZE, OR COLOR.

FOR: OPHTHALMOLOGICAL DIAGNOSTIC EQUIPMENT, NAMELY, AUTOREFRACTORS, IN CLASS 10 (U.S. CLS. 26, 39 AND 44).

SER. NO. 77-345,801, FILED 12-6-2007.

FIRST USE 1-15-1997; IN COMMERCE 1-15-1997.

MARK RADEMACHER, EXAMINING ATTORNEY

Int. Cls.: 36 and 38

Prior U.S. Cls.: 100, 101, 102 and 104

United States Patent and Trademark Office

Reg. No. 3,484,010

Registered Aug. 12, 2008

**SERVICE MARK
PRINCIPAL REGISTER**

ALPINEREMOTE

ALPINE BANKS OF COLORADO (COLORADO CORPORATION)
P.O. BOX 10000
2200 GRAND AVENUE
GLENWOOD SPRINGS, CO 81602

FOR: BANKING SERVICES; ONLINE-BANKING SERVICES; CHECKING ACCOUNT SERVICES IN THE NATURE OF REMOTE CHECKING DEPOSIT SERVICES; CHECKING ACCOUNT SERVICES IN THE NATURE OF PROVIDING ELECTRONIC CHECK DEPOSITING SERVICES, IN CLASS 36 (U.S. CLS. 100, 101 AND 102).

FIRST USE 11-0-2007; IN COMMERCE 11-0-2007.

FOR: REMOTE DEPOSIT CAPTURE SERVICES IN THE NATURE OF COMPUTER AIDED TRANS-

MISSION OF INFORMATION AND IMAGES APPEARING ON CHECKS THAT ARE REMOTELY DEPOSITED, IN CLASS 38 (U.S. CLS. 100, 101 AND 104).

FIRST USE 11-0-2007; IN COMMERCE 11-0-2007.

THE MARK CONSISTS OF STANDARD CHARACTERS WITHOUT CLAIM TO ANY PARTICULAR FONT, STYLE, SIZE, OR COLOR.

OWNER OF U.S. REG. NOS. 2,600,606, 3,055,289 AND OTHERS.

SER. NO. 77-345,831, FILED 12-6-2007.

COLLEEN KEARNEY, EXAMINING ATTORNEY

Int. Cl.: 33

Prior U.S. Cls.: 47 and 49

United States Patent and Trademark Office

Reg. No. 3,484,011

Registered Aug. 12, 2008

**TRADEMARK
PRINCIPAL REGISTER**

Piattelli

ALFREDO KOCH (ARGENTINA INDIVIDUAL)
905 EL CAPITAN WAY
SAN LUIS OBISPO, CA 93401

FOR: GRAPE WINE, IN CLASS 33 (U.S. CLS. 47
AND 49).

FIRST USE 2-10-2002; IN COMMERCE 2-10-2002.

THE MARK CONSISTS OF STANDARD CHAR-
ACTERS WITHOUT CLAIM TO ANY PARTICULAR
FONT, STYLE, SIZE, OR COLOR.

SEC. 2(F).

SER. NO. 77-346,308, FILED 12-7-2007.

CHRISTINE COOPER, EXAMINING ATTORNEY

Int. Cl.: 9

Prior U.S. Cls.: 21, 23, 26, 36 and 38

United States Patent and Trademark Office

Reg. No. 3,484,012

Registered Aug. 12, 2008

**TRADEMARK
PRINCIPAL REGISTER**

OMNI XLT

CELESTRON ACQUISITION, LLC (DELAWARE
LTD LIAB CO)
2835 COLUMBIA ST.
TORRANCE, CA 90503

OWNER OF U.S. REG. NO. 3,385,832.

FOR: TELESCOPES, IN CLASS 9 (U.S. CLS. 21, 23,
26, 36 AND 38).

NO CLAIM IS MADE TO THE EXCLUSIVE
RIGHT TO USE "XLT", APART FROM THE MARK
AS SHOWN.

FIRST USE 2-8-2007; IN COMMERCE 2-8-2007.

SER. NO. 77-347,182, FILED 12-7-2007.

THE MARK CONSISTS OF STANDARD CHAR-
ACTERS WITHOUT CLAIM TO ANY PARTICULAR
FONT, STYLE, SIZE, OR COLOR.

JAY FLOWERS, EXAMINING ATTORNEY

Int. Cl.: 41

Prior U.S. Cls.: 100, 101 and 107

United States Patent and Trademark Office

Reg. No. 3,484,013

Registered Aug. 12, 2008

**SERVICE MARK
PRINCIPAL REGISTER**

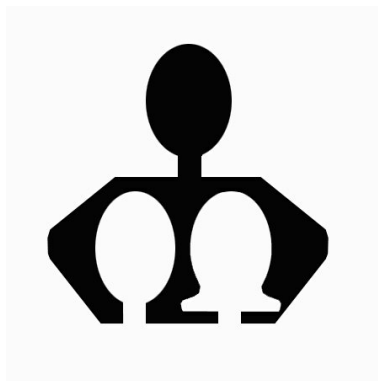

FATHER'S TIME, UNLIMITED (CALIFORNIA CORPORATION)
SUITE 107376
39252 WINCHESTER RD.
MURRIETA, CA 92563

FOR: INFORMATION IN THE FIELD OF PARENTING CONCERNING EDUCATION OF CHILDREN; EDUCATION SERVICES, NAMELY, PROVIDING CLASSES, SEMINARS, AND WORKSHOPS IN THE FIELDS OF PARENTING AND INTRAFAMILY RELATIONSHIPS; EDUCATIONAL SERVICES, NAMELY, A CONTINUING PROGRAM ABOUT PARENTING AND INTRAFAMILY RELATIONSHIPS ACCESSIBLE BY VIDEO; EDUCATIONAL AND ENTERTAINMENT SERVICES, NAMELY, A CONTINUING PROGRAM ABOUT SOCIAL, SPIRITUAL, EMOTIONAL AND FINANCIAL ISSUES RELATED TO FATHERHOOD AND PARENTING ACCESSIBLE BY RADIO, TELEVISION, SATELLITE, AUDIO, VIDEO AND COMPUTER NETWORKS; EDUCATIONAL SERVICES, NAMELY, CONDUCTING CLASSES, SEMINARS, AND WORKSHOPS IN THE FIELD OF PARENTING AND INTRAFAMILY RELATIONSHIPS AND DIS-

TRIBUTION OF COURSE MATERIAL IN CONNECTION THEREWITH; EDUCATIONAL SERVICES, NAMELY, CONDUCTING INFORMAL PROGRAMS IN THE FIELDS OF PARENTING AND INTRAFAMILY RELATIONSHIPS, USING ON-LINE ACTIVITIES AND INTERACTIVE EXHIBITS, AND PRINTABLE MATERIALS DISTRIBUTED THEREWITH; PROVIDING EDUCATIONAL MENTORING SERVICES AND PROGRAMS IN THE FIELD OF PARENTING, IN CLASS 41 (U.S. CLS. 100, 101 AND 107).

FIRST USE 7-7-1998; IN COMMERCE 7-7-1998.

THE MARK CONSISTS OF THE STYLIZED IMAGE OF A SILHOUETTED MAN IN A STICK FIGURE FORM WITH HIS ARMS AROUND TWO CHILDREN, A BOY AND A GIRL, WHOSE IMAGES ARE SHADOWED AGAINST THE MAN IN REVERSE.

SER. NO. 77-347,192, FILED 12-7-2007.

LANA PHAM, EXAMINING ATTORNEY

Int. Cl.: 35

Prior U.S. Cls.: 100, 101 and 102

United States Patent and Trademark Office

Reg. No. 3,484,014

Registered Aug. 12, 2008

**SERVICE MARK
PRINCIPAL REGISTER**

TixCap

TIXCAP, INC. (NEBRASKA CORPORATION)
SUITE 300
17445 ARBOR STREET
OMAHA, NE 68130

FOR: BUSINESS MANAGEMENT CONSULTANCY AS WELL AS DEVELOPMENT OF PROCESSES FOR THE ANALYSIS AND THE IMPLEMENTATION OF STRATEGY PLANS AND MANAGEMENT PROJECTS; DEVELOPMENT OF MARKETING STRATEGIES AND CONCEPTS; ENTERTAINMENT ADMISSION VENUE CONTROL SERVICES, NAMELY, THE REMOTE VERIFICATION OF TICKET

VALIDITY UPON PRESENTATION OF TICKETS AT AN ENTERTAINMENT VENUE, IN CLASS 35 (U.S. CLS. 100, 101 AND 102).

FIRST USE 10-18-2007; IN COMMERCE 10-18-2007.

THE MARK CONSISTS OF STANDARD CHARACTERS WITHOUT CLAIM TO ANY PARTICULAR FONT, STYLE, SIZE, OR COLOR.

SER. NO. 77-347,194, FILED 12-7-2007.

REBECCA GILBERT, EXAMINING ATTORNEY

Int. Cl.: 35

Prior U.S. Cls.: 100, 101 and 102

United States Patent and Trademark Office

Reg. No. 3,484,015

Registered Aug. 12, 2008

**SERVICE MARK
PRINCIPAL REGISTER**

MARKET READER PRO

TONAL POEM'S MULTIMEDIA INCORPORATED (PENNSYLVANIA CORPORATION)
5741 MEMORIAL ROAD
GERMANSVILLE, PA 18053

FOR: BUSINESS ADVICE AND ANALYSIS OF MARKETS; MARKET RESEARCH SERVICES; MARKETING CONSULTING, IN CLASS 35 (U.S. CLS. 100, 101 AND 102).

FIRST USE 7-0-2001; IN COMMERCE 7-0-2001.

THE MARK CONSISTS OF STANDARD CHARACTERS WITHOUT CLAIM TO ANY PARTICULAR FONT, STYLE, SIZE, OR COLOR.

NO CLAIM IS MADE TO THE EXCLUSIVE RIGHT TO USE "MARKET", APART FROM THE MARK AS SHOWN.

SER. NO. 77-347,315, FILED 12-7-2007.

TINA BROWN, EXAMINING ATTORNEY

Int. Cls.: 16 and 41

Prior U.S. Cls.: 2, 5, 22, 23, 29, 37, 38, 50, 100, 101 and 107

Reg. No. 3,484,016

United States Patent and Trademark Office

Registered Aug. 12, 2008

**TRADEMARK
SERVICE MARK
PRINCIPAL REGISTER**

FULL-TILT LEADERSHIP

ELI GROUP, LLC (TEXAS LTD LIAB CO)
2612 SURREY WOODS ROAD
FLOWER MOUND, TX 75028

FOR: PRINTED TEACHING MATERIALS IN THE FIELD OF BUSINESS, PERSONAL MANAGEMENT AND LEADERSHIP DEVELOPMENT, IN CLASS 16 (U.S. CLS. 2, 5, 22, 23, 29, 37, 38 AND 50).

FIRST USE 8-7-2006; IN COMMERCE 8-7-2006.

FOR: EDUCATIONAL SERVICES, NAMELY, CONDUCTING SEMINARS, COACHING, WORKSHOPS AND CLASSES IN THE FIELD OF BUSINESS, PERSONAL MANAGEMENT AND LEADERSHIP

DEVELOPMENT, IN CLASS 41 (U.S. CLS. 100, 101 AND 107).

FIRST USE 10-16-2006; IN COMMERCE 10-16-2006.

THE MARK CONSISTS OF STANDARD CHARACTERS WITHOUT CLAIM TO ANY PARTICULAR FONT, STYLE, SIZE, OR COLOR.

NO CLAIM IS MADE TO THE EXCLUSIVE RIGHT TO USE "LEADERSHIP", APART FROM THE MARK AS SHOWN.

SER. NO. 77-347,686, FILED 12-10-2007.

KAREN K. BUSH, EXAMINING ATTORNEY

Int. Cl.: 42

Prior U.S. Cls.: 100 and 101

United States Patent and Trademark Office

Reg. No. 3,484,017

Registered Aug. 12, 2008

**SERVICE MARK
PRINCIPAL REGISTER**

GEMS

SYSTEM WIDE SOLUTIONS, INC. (SOUTH CAROLINA CORPORATION)
P.O. BOX 11391
COLUMBIA, SC 29211

FOR: COMPUTER SERVICES, PROVIDING TEMPORARY USE OF NON-DOWNLOADABLE COMPUTER SOFTWARE THAT GATHERS, STORES, TRANSMITS, AND REPORTS ON THE MANAGEMENT, OUTCOME, AND EVALUATION DATA REQUIREMENTS OF SPECIFIC FEDERAL GRANTS FOR CHILDREN AND YOUTH SERVICES, IN CLASS 42 (U.S. CLS. 100 AND 101).

FIRST USE 9-1-2006; IN COMMERCE 9-1-2006.

THE MARK CONSISTS OF STANDARD CHARACTERS WITHOUT CLAIM TO ANY PARTICULAR FONT, STYLE, SIZE, OR COLOR.

SER. NO. 77-347,730, FILED 12-10-2007.

HOWARD SMIGA, EXAMINING ATTORNEY

Int. Cl.: 40

Prior U.S. Cls.: 100, 103 and 106

United States Patent and Trademark Office

Reg. No. 3,484,018

Registered Aug. 12, 2008

**SERVICE MARK
PRINCIPAL REGISTER**



ANATECH, LTD. (NORTH CAROLINA CORPORATION)
771 CROSSPOINT DRIVE
DENVER, NC 28037

FOR: APPLICATION OF PROTECTIVE COATINGS, IN CLASS 40 (U.S. CLS. 100, 103 AND 106).

FIRST USE 12-5-2005; IN COMMERCE 12-5-2005.

THE MARK CONSISTS OF THE GRAPHIC REPRESENTATION OF A REPTILIAN EYE APPEARING ABOVE THE STYLIZED WORDING "EXTREMEION" APPEARING ABOVE THE STYLIZED WORDING "EXTREME, PROVEN, PERFORMANCE."

SER. NO. 77-347,866, FILED 12-10-2007.

MARY ROSSMAN, EXAMINING ATTORNEY

Int. Cl.: 9

Prior U.S. Cls.: 21, 23, 26, 36 and 38

United States Patent and Trademark Office

Reg. No. 3,484,019

Registered Aug. 12, 2008

**TRADEMARK
PRINCIPAL REGISTER**



OWL COMPUTING TECHNOLOGIES, INC. (NEW YORK CORPORATION)
38A GROVE STREET
RIDGEFIELD, CT 06877

FOR: COMPUTER PERIPHERALS AND SOFTWARE THAT PERMIT SECURE UNIDIRECTIONAL TRANSFER OF DATA FROM A SOURCE COMPUTER TO A DESTINATION COMPUTER, IN CLASS 9 (U.S. CLS. 21, 23, 26, 36 AND 38).

FIRST USE 1-31-2007; IN COMMERCE 1-31-2007.

OWNER OF U.S. REG. NO. 2,473,097.

THE MARK CONSISTS OF THE WORDS "SECURED BY OWL" WITHIN A BOX WHICH IS MADE TO LOOK LIKE A RUBBER STAMP WITH AN OWL REPRESENTATION WITHIN THE LETTER "O".

SER. NO. 77-347,965, FILED 12-10-2007.

BRENDAN MCCAULEY, EXAMINING ATTORNEY

Int. Cl.: 25

Prior U.S. Cls.: 22 and 39

United States Patent and Trademark Office

Reg. No. 3,484,020

Registered Aug. 12, 2008

**TRADEMARK
PRINCIPAL REGISTER**

Gender Bias

GENDER BIAS, INC (NEW YORK CORPORATION)
2 FIFTH AVENUE # 19
NEW YORK, NY 10011

THE MARK CONSISTS OF STANDARD CHARACTERS WITHOUT CLAIM TO ANY PARTICULAR FONT, STYLE, SIZE, OR COLOR.

FOR: CLOTHING, NAMELY, TOPS, KNIT TOPS, DRESSES, PANTS, BLOUSES, SKIRTS, SHIRTS, JACKETS, BELTS AND LEATHER BELTS, IN CLASS 25 (U.S. CLS. 22 AND 39).

SER. NO. 77-348,078, FILED 12-10-2007.

FIRST USE 1-0-2007; IN COMMERCE 1-0-2007.

CAROLINE WOOD, EXAMINING ATTORNEY

Int. Cl.: 44

Prior U.S. Cls.: 100 and 101

United States Patent and Trademark Office

Reg. No. 3,484,021

Registered Aug. 12, 2008

**SERVICE MARK
PRINCIPAL REGISTER**



HEALTHY PROGRESS, LLC (ILLINOIS LTD LIAB
CO)
222 HARLEM AVE.
GLENVIEW, IL 60025

FOR: ON-LINE PUBLICATION OF INFORMATION AND IMAGES RELATED TO HEALTH AND MEDICINE; EDUCATIONAL SERVICES, NAMELY, CONDUCTING INFORMAL ON-LINE PROGRAMS IN THE FIELDS OF HEALTH AND MEDICINE ALONG WITH FORMAL INSTRUCTION FOR THE SAME, AND PRINTABLE MATERIALS DISTRIBUTED THEREWITH; PROVIDING A WEBSITE THAT FEATURES INFORMAL INSTRUCTION ON HEALTH AND MEDICINE ALONG WITH FORMAL

INSTRUCTION FOR THE SAME, IN CLASS 44 (U.S. CLS. 100 AND 101).

FIRST USE 12-10-2007; IN COMMERCE 12-10-2007.

NO CLAIM IS MADE TO THE EXCLUSIVE RIGHT TO USE "HEALTHY", APART FROM THE MARK AS SHOWN.

THE MARK CONSISTS OF THE WORDS" HEALTHY PROGRESS" NEXT TO A MAN.

SER. NO. 77-348,145, FILED 12-10-2007.

PAUL E. FAHRENKOPF, EXAMINING ATTORNEY

Int. Cl.: 41

Prior U.S. Cls.: 100, 101 and 107

United States Patent and Trademark Office

Reg. No. 3,484,022

Registered Aug. 12, 2008

**SERVICE MARK
PRINCIPAL REGISTER**



COUNCIL ON AMERICAN-ISLAMIC RELATIONS (D.C. CORPORATION)
453 NEW JERSEY AVE., SE
WASHINGTON, DC 20003

FOR: EDUCATION SERVICES, NAMELY, PROVIDING CLASSES, SEMINARS, WORKSHOPS, PUBLIC DISCUSSIONS IN THE FIELD OF PROMOTING THE UNDERSTANDING OF ISLAM AND THE CIVIL RIGHTS OF MUSLIMS LIVING IN AMERICA, IN CLASS 41 (U.S. CLS. 100, 101 AND 107).

FIRST USE 9-1-2006; IN COMMERCE 9-1-2006.

OWNER OF U.S. REG. NOS. 3,205,355 AND 3,243,789.

THE COLOR(S) LIGHT BLUE, ORANGE, DARK BLUE IS/ARE CLAIMED AS A FEATURE OF THE MARK.

THE MARK CONSISTS OF A GEOMETRIC DESIGN IN LIGHT AND DARK BLUE WITH ORANGE DIAMOND-LIKE SHAPES AND THE ACRONYM "CAIR" IN DARK BLUE. THE COLOR WHITE IS NOT A FEATURE OF THE MARK AND REPRESENTS THE TRANSPARENT AREAS OF THE MARK.

SER. NO. 77-348,316, FILED 12-10-2007.

MELISSA VALLILLO, EXAMINING ATTORNEY

Int. Cl.: 45

Prior U.S. Cls.: 100 and 101

United States Patent and Trademark Office

Reg. No. 3,484,023

Registered Aug. 12, 2008

**SERVICE MARK
PRINCIPAL REGISTER**

ARONSONLAW

ARONSON, STANLEY (UNITED STATES INDIVIDUAL)

#130

3085 W. MARKET ST.

AKRON, OH 44333

FOR: LEGAL SERVICES, IN CLASS 45 (U.S. CLS. 100 AND 101).

FIRST USE 4-0-1970; IN COMMERCE 4-0-1970.

THE MARK CONSISTS OF STANDARD CHARACTERS WITHOUT CLAIM TO ANY PARTICULAR FONT, STYLE, SIZE, OR COLOR.

SEC. 2(F).

SER. NO. 77-348,358, FILED 12-10-2007.

MARY CRAWFORD, EXAMINING ATTORNEY

Int. Cls.: 35 and 41

Prior U.S. Cls.: 100, 101, 102 and 107

United States Patent and Trademark Office

Reg. No. 3,484,024

Registered Aug. 12, 2008

**SERVICE MARK
PRINCIPAL REGISTER**

ROBIN'S RESUMES

SCHLINGER, ROBIN (UNITED STATES INDIVIDUAL)
SUITE 2206
860 PEACHTREE STREET, NE
ATLANTA, GA 30308

FOR: RESUME PREPARATION SERVICES, IN CLASS 35 (U.S. CLS. 100, 101 AND 102).

FIRST USE 7-15-2006; IN COMMERCE 10-0-2006.

FOR: CAREER COUNSELING SERVICES, IN CLASS 41 (U.S. CLS. 100, 101 AND 107).

FIRST USE 7-15-2006; IN COMMERCE 10-0-2006.

THE MARK CONSISTS OF STANDARD CHARACTERS WITHOUT CLAIM TO ANY PARTICULAR FONT, STYLE, SIZE, OR COLOR.

NO CLAIM IS MADE TO THE EXCLUSIVE RIGHT TO USE "RESUMES", APART FROM THE MARK AS SHOWN.

THE NAME "ROBIN" IDENTIFIES A LIVING INDIVIDUAL WHOSE CONSENT IS OF RECORD.

SER. NO. 77-348,689, FILED 12-11-2007.

MELVIN AXILBUND, EXAMINING ATTORNEY

Int. Cl.: 7

Prior U.S. Cls.: 13, 19, 21, 23, 31, 34 and 35

Reg. No. 3,484,025

United States Patent and Trademark Office

Registered Aug. 12, 2008

**TRADEMARK
PRINCIPAL REGISTER**

GYROMIXER

FLUID MANAGEMENT, INC. (DELAWARE
CORPORATION)
1023 WHEELING ROAD
WHEELING, IL 60090

FOR: MACHINES FOR MIXING FLUIDS SUCH
AS PAINTS, STAINS, DYES AND THE LIKE, IN
CLASS 7 (U.S. CLS. 13, 19, 21, 23, 31, 34 AND 35).

FIRST USE 1-1-1977; IN COMMERCE 1-1-1977.

THE MARK CONSISTS OF STANDARD CHAR-
ACTERS WITHOUT CLAIM TO ANY PARTICULAR
FONT, STYLE, SIZE, OR COLOR.

OWNER OF U.S. REG. NOS. 1,506,823 AND
1,507,818.

SER. NO. 77-348,699, FILED 12-11-2007.

MARY BOAGNI, EXAMINING ATTORNEY

Int. Cl.: 41

Prior U.S. Cls.: 100, 101 and 107

United States Patent and Trademark Office

Reg. No. 3,484,026

Registered Aug. 12, 2008

**SERVICE MARK
PRINCIPAL REGISTER**

Step By Step Learning

STEP BY STEP LEARNING, LLC (PENNSYLVANIA LTD LIAB CO)
P.O. BOX 230
WHITEHALL, PA 18052

FOR: CONSULTATION IN THE FIELD OF K-12 EDUCATIONAL SYSTEMS, IN CLASS 41 (U.S. CLS. 100, 101 AND 107).

FIRST USE 3-7-2002; IN COMMERCE 3-7-2002.

THE MARK CONSISTS OF STANDARD CHARACTERS WITHOUT CLAIM TO ANY PARTICULAR FONT, STYLE, SIZE, OR COLOR.

NO CLAIM IS MADE TO THE EXCLUSIVE RIGHT TO USE "LEARNING", APART FROM THE MARK AS SHOWN.

SER. NO. 77-348,739, FILED 12-11-2007.

ALLISON SCHRODY, EXAMINING ATTORNEY

Int. Cl.: 41

Prior U.S. Cls.: 100, 101 and 107

United States Patent and Trademark Office

Reg. No. 3,484,027

Registered Aug. 12, 2008

**SERVICE MARK
PRINCIPAL REGISTER**

**Step By Step
Learning...learning one
step at a time**

STEP BY STEP LEARNING, LLC (PENNSYLVANIA LTD LIAB CO)
P.O. BOX 230
WHITEHALL, PA 18052

FOR: CONSULTATION IN THE FIELD OF K-12 EDUCATIONAL SYSTEMS, IN CLASS 41 (U.S. CLS. 100, 101 AND 107).

FIRST USE 6-29-2004; IN COMMERCE 6-29-2004.

THE MARK CONSISTS OF STANDARD CHARACTERS WITHOUT CLAIM TO ANY PARTICULAR FONT, STYLE, SIZE, OR COLOR.

NO CLAIM IS MADE TO THE EXCLUSIVE RIGHT TO USE "LEARNING", APART FROM THE MARK AS SHOWN.

SER. NO. 77-348,755, FILED 12-11-2007.

ALLISON SCHRODY, EXAMINING ATTORNEY

Int. Cl.: 35

Prior U.S. Cls.: 100, 101 and 102

United States Patent and Trademark Office

Reg. No. 3,484,028

Registered Aug. 12, 2008

**SERVICE MARK
PRINCIPAL REGISTER**

THE START MY COMPANY

BARDOM.COM, LLC (FLORIDA LTD LIAB CO)
1309 ELIZA ST
KEY WEST, FL 33040

FOR: PROVIDING A WEBSITE FEATURING RE-
FERRALS IN THE FIELDS OF BUSINESS, IN CLASS
35 (U.S. CLS. 100, 101 AND 102).

FIRST USE 8-21-2007; IN COMMERCE 10-1-2007.

THE MARK CONSISTS OF STANDARD CHAR-
ACTERS WITHOUT CLAIM TO ANY PARTICULAR
FONT, STYLE, SIZE, OR COLOR.

NO CLAIM IS MADE TO THE EXCLUSIVE
RIGHT TO USE "COMPANY", APART FROM THE
MARK AS SHOWN.

SER. NO. 77-348,792, FILED 12-11-2007.

FLORENTINA BLANDU, EXAMINING ATTORNEY

Int. Cl.: 41

Prior U.S. Cls.: 100, 101 and 107

United States Patent and Trademark Office

Reg. No. 3,484,029

Registered Aug. 12, 2008

**SERVICE MARK
PRINCIPAL REGISTER**

Step By Step Learning
...learning one step at a time

STEP BY STEP LEARNING, LLC (PENNSYLVANIA LTD LIAB CO)
P.O. BOX 230
WHITEHALL, PA 18052

FOR: CONSULTATION IN THE FIELD OF K-12 EDUCATIONAL SYSTEMS, IN CLASS 41 (U.S. CLS. 100, 101 AND 107).

FIRST USE 6-29-2004; IN COMMERCE 6-29-2004.

NO CLAIM IS MADE TO THE EXCLUSIVE RIGHT TO USE "LEARNING", APART FROM THE MARK AS SHOWN.

THE COLOR(S) BLUE IS/ARE CLAIMED AS A FEATURE OF THE MARK.

THE COLOR BLUE APPEARS IN THE WORDING "STEP BY STEP LEARNING...LEARNING ONE STEP AT A TIME".

SER. NO. 77-348,961, FILED 12-11-2007.

ALLISON SCHRODY, EXAMINING ATTORNEY

Int. Cl.: 38

Prior U.S. Cls.: 100, 101 and 104

United States Patent and Trademark Office

Reg. No. 3,484,030

Registered Aug. 12, 2008

**SERVICE MARK
PRINCIPAL REGISTER**



CENTURYTEL, INC. (LOUISIANA CORPORATION)
100 CENTURYTEL DRIVE
MONROE, LA 71203

FOR: PROVIDING MULTIPLE USER ACCESS TO A GLOBAL COMPUTER INFORMATION NETWORK; BROADBAND INTERNET ACCESS SERVICES, NAMELY, PROVIDING HIGH-SPEED INTERNET ACCESS FOR THE TRANSFER AND DISSEMINATION OF A WIDE RANGE OF INFORMATION AND PRODUCT FEATURE ENHANCEMENTS, NAMELY, E-MAIL, TELEVISION BROADCASTING, DIGITAL MUSIC BROADCASTING AND VIDEO-ON-DEMAND BROADCASTING SERVICES THAT ARE DELIVERED OVER THE SAME INTERNET ACCESS, IN CLASS 38 (U.S. CLS. 100, 101 AND 104).

FIRST USE 8-8-2007; IN COMMERCE 8-8-2007.

OWNER OF U.S. REG. NOS. 2,228,120, 2,461,492, AND 2,516,851.

NO CLAIM IS MADE TO THE EXCLUSIVE RIGHT TO USE "BROADBAND", APART FROM THE MARK AS SHOWN.

THE MARK CONSISTS OF THE WORD "PURE" IN WHITE LETTERS BEGINNING WITH A CAPITAL "P" AND LOWER CASE LETTERS "U", "R", "E" ON A DARK BACKGROUND WITHIN A BOX WITH THE WORD "BROADBAND" IN WHITE LETTERS UNDERNEATH THE BOX AND THE PHRASE "FROM CENTURYTEL" IN GRAY LETTERS TO THE RIGHT OF THE WORD "BROADBAND".

SER. NO. 77-348,964, FILED 12-11-2007.

MELVIN AXILBUND, EXAMINING ATTORNEY

Int. Cl.: 37

Prior U.S. Cls.: 100, 103 and 106

United States Patent and Trademark Office

Reg. No. 3,484,031

Registered Aug. 12, 2008

**SERVICE MARK
PRINCIPAL REGISTER**



CITADEL RESTORATION AND REPAIR, INC.
(MINNESOTA CORPORATION)
3001 103RD LANE NE
BLAINE, MN 55449

FOR: COMMERCIAL FLOOR FINISHING SERVICES; FLOOR FINISHING SERVICES FOR RESIDENTIAL GARAGES, IN CLASS 37 (U.S. CLS. 100, 103 AND 106).

FIRST USE 8-0-2006; IN COMMERCE 12-0-2006.

OWNER OF U.S. REG. NO. 3,333,731.

NO CLAIM IS MADE TO THE EXCLUSIVE RIGHT TO USE "FLOOR FINISHING SYSTEMS", APART FROM THE MARK AS SHOWN.

THE COLOR(S) GRAY, WHITE AND BLUE IS/ARE CLAIMED AS A FEATURE OF THE MARK.

THE MARK CONSISTS OF A GRAPHICAL DEPICTION OF A CASTLE IN THE COLORS WHITE AND GRAY ABOVE THE TERM "CITADEL" IN THE COLOR BLUE ABOVE THE TERM "FLOOR FINISHING SYSTEMS" IN THE COLOR BLUE.

SER. NO. 77-349,028, FILED 12-11-2007.

TINA BROWN, EXAMINING ATTORNEY

Int. Cl.: 9

Prior U.S. Cls.: 21, 23, 26, 36 and 38

Reg. No. 3,484,032

United States Patent and Trademark Office

Registered Aug. 12, 2008

**TRADEMARK
PRINCIPAL REGISTER**

Retail Connect

VOICERITE INC (FLORIDA CORPORATION)
2501 DAVIE RD SUITE 230
FORT LAUDERDALE, FL 33317

THE MARK CONSISTS OF STANDARD CHAR-
ACTERS WITHOUT CLAIM TO ANY PARTICULAR
FONT, STYLE, SIZE, OR COLOR.

FOR: COMPUTER TELEPHONY SOFTWARE, IN
CLASS 9 (U.S. CLS. 21, 23, 26, 36 AND 38).

SER. NO. 77-349,057, FILED 12-11-2007.

FIRST USE 8-1-2007; IN COMMERCE 10-22-2007.

JORDAN BAKER, EXAMINING ATTORNEY

Int. Cl.: 41

Prior U.S. Cls.: 100, 101 and 107

United States Patent and Trademark Office

Reg. No. 3,484,033

Registered Aug. 12, 2008

**SERVICE MARK
PRINCIPAL REGISTER**

PREDICT THE PLAY

NTN BUZZTIME, INC. (DELAWARE CORPORATION)
SUITE 100
5966 LA PLACE COURT
CARLSBAD, CA 92008

FOR: PRODUCTION OF CABLE AND NETWORK TELEVISION PROGRAMS FEATURING INTERACTIVE GAMES; DISTRIBUTION OF CABLE AND NETWORK TELEVISION PROGRAMS FEATURING INTERACTIVE GAMES FOR OTHERS; ENTERTAINMENT SERVICES, NAMELY, PROVIDING ON-LINE INTERACTIVE COMPUTER GAMES; ENTERTAINMENT SERVICES, NAMELY, PROVIDING INTERACTIVE GAMES PLAYED VIA TELEPHONE, IN CLASS 41 (U.S. CLS. 100, 101 AND 107).

FIRST USE 7-19-2000; IN COMMERCE 7-19-2000.

THE MARK CONSISTS OF STANDARD CHARACTERS WITHOUT CLAIM TO ANY PARTICULAR FONT, STYLE, SIZE, OR COLOR.

OWNER OF U.S. REG. NO. 2,513,578.

SEC. 2(F).

SER. NO. 77-349,324, FILED 12-11-2007.

JANICE L. MCMORROW, EXAMINING ATTORNEY

Int. Cl.: 10

Prior U.S. Cls.: 26, 39 and 44

Reg. No. 3,484,034

United States Patent and Trademark Office

Registered Aug. 12, 2008

**TRADEMARK
PRINCIPAL REGISTER**

Eyecubed

ELLEX, INC. (MINNESOTA CORPORATION),
DBA FKA INNOVATIVE IMAGING, INC.
1793 UNION STREET
SAN FRANCISCO, CA 94123

THE MARK CONSISTS OF STANDARD CHAR-
ACTERS WITHOUT CLAIM TO ANY PARTICULAR
FONT, STYLE, SIZE, OR COLOR.

FOR: ULTRASOUND DIAGNOSTIC APPARA-
TUS, IN CLASS 10 (U.S. CLS. 26, 39 AND 44).

SER. NO. 77-349,511, FILED 12-11-2007.

FIRST USE 4-1-2007; IN COMMERCE 4-1-2007.

DANIEL CAPSHAW, EXAMINING ATTORNEY

Int. Cl.: 37

Prior U.S. Cls.: 100, 103 and 106

United States Patent and Trademark Office

Reg. No. 3,484,035

Registered Aug. 12, 2008

**SERVICE MARK
PRINCIPAL REGISTER**

scorpio autoglass

MONTERO, LEONARDO (UNITED STATES IN-
DIVIDUAL)

2802 CARTWRIGHT ST.

DALLAS, TX 75212

FOR: INSTALLATION OF CAR WINDOWS, IN
CLASS 37 (U.S. CLS. 100, 103 AND 106).

FIRST USE 1-9-2006; IN COMMERCE 1-9-2006.

THE MARK CONSISTS OF STANDARD CHAR-
ACTERS WITHOUT CLAIM TO ANY PARTICULAR
FONT, STYLE, SIZE, OR COLOR.

NO CLAIM IS MADE TO THE EXCLUSIVE
RIGHT TO USE "AUTO GLASS", APART FROM
THE MARK AS SHOWN.

SER. NO. 77-349,536, FILED 12-11-2007.

SUE LAWRENCE, EXAMINING ATTORNEY

Int. Cl.: 42

Prior U.S. Cls.: 100 and 101

United States Patent and Trademark Office

Reg. No. 3,484,036

Registered Aug. 12, 2008

SERVICE MARK
PRINCIPAL REGISTER

Sustainable Places

SUSTAINABLE PLACES, INC. (ILLINOIS CORPORATION)
9822 KEDVALE AVENUE
SKOKIE, IL 60076

FOR: ENVIRONMENTAL SERVICES, NAMELY, TECHNICAL CONSULTATION IN THE FIELD OF ENVIRONMENTAL SCIENCE, ENGINEERING SERVICES, DESIGN FOR OTHERS IN THE FIELD OF ENVIRONMENTAL ENGINEERING, DESIGNING AND TESTING OF NEW ENVIRONMENTALLY FRIENDLY PRODUCTS FOR OTHERS; LANDSCAPE ARCHITECTURAL DESIGN INCLUDING RESEARCH, DEVELOPMENT AND CONSUL-

TATION RELATED THERETO IN THE FIELD OF LANDSCAPE ARCHITECTURE AND ARCHITECTURE; LANDSCAPE LIGHTING DESIGN; CONSULTING SERVICES IN THE FIELD OF ARCHITECTURAL DESIGN; ARCHITECTURAL DESIGN INCLUDING URBAN PLANNING, IN CLASS 42 (U.S. CLS. 100 AND 101).

FIRST USE 4-14-1995; IN COMMERCE 4-14-1995.

SER. NO. 77-349,676, FILED S.R. 12-12-2007 AM.
P.R. 4-11-2008.

DAVID HOFFMAN, EXAMINING ATTORNEY

Int. Cls.: 41 and 43

Prior U.S. Cls.: 100, 101 and 107

United States Patent and Trademark Office

Reg. No. 3,484,037

Registered Aug. 12, 2008

**SERVICE MARK
PRINCIPAL REGISTER**



ALAMO DRAFTHOUSE CINEMAS, LTD. (TEXAS
LIMITED PARTNERSHIP)
13809 RESEARCH BLVD., SUITE 735
AUSTIN, TX 78750

FOR: ENTERTAINMENT SERVICES, NAMELY,
CINEMA THEATER SERVICES, IN CLASS 41 (U.S.
CLS. 100, 101 AND 107).

FIRST USE 5-1-2003; IN COMMERCE 5-1-2003.

FOR: RESTAURANT SERVICES, IN CLASS 43
(U.S. CLS. 100 AND 101).

FIRST USE 5-1-2003; IN COMMERCE 5-1-2003.

NO CLAIM IS MADE TO THE EXCLUSIVE
RIGHT TO USE "DRAFTHOUSE CINEMA", APART
FROM THE MARK AS SHOWN.

THE MARK CONSISTS OF THE WORD "ALAMO"
WITH THE WORDS "DRAFTHOUSE CINEMA" BE-
LOW IT AND THREE HORIZONTAL LINES TO THE
LEFT OF THE WORD "ALAMO" AND THREE
HORIZONTAL LINE TO RIGHT OF THE WORD
"ALAMO".

SER. NO. 77-349,734, FILED 12-12-2007.

RICHARD WHITE, EXAMINING ATTORNEY

Int. Cl.: 16

Prior U.S. Cls.: 2, 5, 22, 23, 29, 37, 38 and 50

United States Patent and Trademark Office

Reg. No. 3,484,038

Registered Aug. 12, 2008

**TRADEMARK
PRINCIPAL REGISTER**

METRO CHICAGO REAL ESTATE

LAW BULLETIN PUBLISHING COMPANY (DE-
LAWARE CORPORATION)
415 NORTH STATE STREET
CHICAGO, IL 60610

FOR: MAGAZINE FEATURING THE PROMO-
TION OF RESIDENTIAL NEW CONSTRUCTION
AND REAL ESTATE NEWS, IN CLASS 16 (U.S.
CLS. 2, 5, 22, 23, 29, 37, 38 AND 50).

FIRST USE 2-20-1987; IN COMMERCE 2-20-1987.

THE MARK CONSISTS OF STANDARD CHAR-
ACTERS WITHOUT CLAIM TO ANY PARTICULAR
FONT, STYLE, SIZE, OR COLOR.

OWNER OF U.S. REG. NO. 1,495,558.

NO CLAIM IS MADE TO THE EXCLUSIVE
RIGHT TO USE "REAL ESTATE", APART FROM
THE MARK AS SHOWN.

SEC. 2(F).

SER. NO. 77-349,745, FILED 12-12-2007.

HOWARD FRIEDMAN, EXAMINING ATTORNEY

Int. Cl.: 41

Prior U.S. Cls.: 100, 101 and 107

United States Patent and Trademark Office

Reg. No. 3,484,039

Registered Aug. 12, 2008

**SERVICE MARK
PRINCIPAL REGISTER**



MEMPHIS IN MAY INTERNATIONAL FESTIVAL, INC. (TENNESSEE CORPORATION)
88 UNION AVENUE, SUITE 301
MEMPHIS, TN 38103

FOR: ENTERTAINMENT IN THE NATURE OF AN INTERNATIONAL FESTIVAL COMPRISING CULTURAL EVENTS, SPORTING EVENTS, ART EXHIBITIONS, COOKING CONTESTS, LIVE MUSIC PROGRAMS AND PERFORMANCES AND EDUCATIONAL PROGRAMS, IN CLASS 41 (U.S. CLS. 100, 101 AND 107).

FIRST USE 12-1-1976; IN COMMERCE 12-1-1976.

OWNER OF U.S. REG. NO. 3,293,860.

NO CLAIM IS MADE TO THE EXCLUSIVE RIGHT TO USE "INTERNATIONAL FESTIVAL, INC.", APART FROM THE MARK AS SHOWN.

THE COLOR(S) ORANGE, YELLOW, PURPLE AND BLACK IS/ARE CLAIMED AS A FEATURE OF THE MARK.

THE MARK CONSISTS OF THE COLOR ORANGE, YELLOW AND PURPLE APPEARS IN THE TRIANGULAR DESIGN AND THE COLOR BLACK APPEARS IN THE WORDING "MEMPHIS IN MAY INTERNATIONAL FESTIVAL, INC."

SEC. 2(F) AS TO MEMPHIS IN MAY.

SER. NO. 77-349,912, FILED 12-12-2007.

AMOS T. MATTHEWS, JR., EXAMINING ATTORNEY

Int. Cls.: 16, 35, 36 and 41

**Prior U.S. Cls.: 2, 5, 22, 23, 29, 37, 38, 50, 100, 101, 102
and 107**

Reg. No. 3,484,040

United States Patent and Trademark Office

Registered Aug. 12, 2008

**TRADEMARK
SERVICE MARK
PRINCIPAL REGISTER**

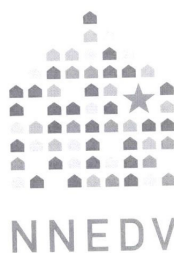

NATIONAL NETWORK TO END DOMESTIC
VIOLENCE (D.C. CORPORATION)
2001 S STREET, N.W., SUITE 400
WASHINGTON, DC 20009

FOR: PRINTED REPORTS, FLYERS, FACT
SHEETS, AND NEWSLETTERS IN THE FIELD OF
DOMESTIC VIOLENCE; PAPER BANNERS AND
POSTERS, IN CLASS 16 (U.S. CLS. 2, 5, 22, 23, 29, 37,
38 AND 50).

FIRST USE 3-12-2007; IN COMMERCE 3-12-2007.

FOR: LOBBYING SERVICES, NAMELY, PRO-
MOTING THE INTERESTS OF DOMESTIC VIO-
LENCE VICTIMS IN THE FIELDS OF
LEGISLATION AND REGULATION; PUBLIC SER-
VICE ANNOUNCEMENTS, NAMELY, PROMOTING
PUBLIC AWARENESS OF DOMESTIC VIOLENCE
PROGRAMS, IN CLASS 35 (U.S. CLS. 100, 101 AND
102).

FIRST USE 3-12-2007; IN COMMERCE 3-12-2007.

FOR: CHARITABLE FUNDRAISING SERVICES
IN THE FIELD OF DOMESTIC VIOLENCE; CHARI-
TABLE SERVICES, NAMELY, PROVIDING FINAN-
CIAL SUPPORT TO HELP DOMESTIC VIOLENCE
VICTIMS, IN CLASS 36 (U.S. CLS. 100, 101 AND 102).

FIRST USE 3-12-2007; IN COMMERCE 3-12-2007.

FOR: EDUCATIONAL SERVICES, NAMELY,
CONDUCTING EDUCATIONAL PROGRAMS,
WORKSHOPS, CONFERENCES AND SEMINARS
IN THE FIELD OF DOMESTIC VIOLENCE, IN
CLASS 41 (U.S. CLS. 100, 101 AND 107).

FIRST USE 3-12-2007; IN COMMERCE 3-12-2007.

THE MARK CONSISTS OF A SERIES OF SMALL
HOUSES AND A STAR IN THE SHAPE OF A HOUSE
DESIGN WITH THE ACRONYM "NNEDV" BELOW.

SER. NO. 77-350,057, FILED 12-12-2007.

MICHAEL TANNER, EXAMINING ATTORNEY

Int. Cls.: 16, 35, 36 and 41

**Prior U.S. Cls.: 2, 5, 22, 23, 29, 37, 38, 50, 100, 101, 102
and 107**

Reg. No. 3,484,041

United States Patent and Trademark Office

Registered Aug. 12, 2008

**TRADEMARK
SERVICE MARK
PRINCIPAL REGISTER**

**NATIONAL NETWORK TO END
DOMESTIC VIOLENCE**

NATIONAL NETWORK TO END DOMESTIC
VIOLENCE (D.C. CORPORATION)
2001 S STREET, N.W, SUITE 400
WASHINGTON, DC 20009

FOR: PRINTED REPORTS, FLYERS, FACT
SHEETS, AND NEWSLETTERS IN THE FIELD OF
DOMESTIC VIOLENCE; PAPER BANNERS AND
POSTERS, IN CLASS 16 (U.S. CLS. 2, 5, 22, 23, 29, 37,
38 AND 50).

FIRST USE 7-26-1995; IN COMMERCE 7-26-1995.

FOR: LOBBYING SERVICES, NAMELY, PRO-
MOTING THE INTERESTS OF DOMESTIC VIO-
LENCE VICTIMS IN THE FIELDS OF
LEGISLATION AND REGULATION; PUBLIC SER-
VICE ANNOUNCEMENTS, NAMELY, PROMOTING
PUBLIC AWARENESS OF DOMESTIC VIOLENCE
PROGRAMS, IN CLASS 35 (U.S. CLS. 100, 101 AND
102).

FIRST USE 7-26-1995; IN COMMERCE 7-26-1995.

FOR: CHARITABLE FUNDRAISING SERVICES
IN THE FIELD OF DOMESTIC VIOLENCE; CHARI-

TABLE SERVICES, NAMELY, PROVIDING FINAN-
CIAL SUPPORT TO HELP DOMESTIC VIOLENCE
VICTIMS, IN CLASS 36 (U.S. CLS. 100, 101 AND 102).

FIRST USE 7-26-1995; IN COMMERCE 7-26-1995.

FOR: EDUCATIONAL SERVICES, NAMELY,
CONDUCTING EDUCATIONAL PROGRAMS,
WORKSHOPS, CONFERENCES AND SEMINARS
IN THE FIELD OF DOMESTIC VIOLENCE, IN
CLASS 41 (U.S. CLS. 100, 101 AND 107).

FIRST USE 7-26-1995; IN COMMERCE 7-26-1995.

THE MARK CONSISTS OF STANDARD CHAR-
ACTERS WITHOUT CLAIM TO ANY PARTICULAR
FONT, STYLE, SIZE, OR COLOR.

SEC. 2(F).

SER. NO. 77-350,071, FILED 12-12-2007.

MICHAEL TANNER, EXAMINING ATTORNEY

Int. Cl.: 36

Prior U.S. Cls.: 100, 101 and 102

United States Patent and Trademark Office

Reg. No. 3,484,042

Registered Aug. 12, 2008

**SERVICE MARK
PRINCIPAL REGISTER**



JEANIE C. LINDERS FUND

JEANIE C. LINDERS FUND, INC. (FLORIDA CORPORATION)
SUITE 1
1069 WEST MORSE BOULEVARD
WINTER PARK, FL 32789

FOR: CHARITABLE FUND RAISING SERVICES; PROVIDING GRANTS TO WOMEN'S CHARITABLE ORGANIZATIONS, IN CLASS 36 (U.S. CLS. 100, 101 AND 102).

FIRST USE 9-10-2007; IN COMMERCE 9-10-2007.

NO CLAIM IS MADE TO THE EXCLUSIVE RIGHT TO USE "FUND", APART FROM THE MARK AS SHOWN.

THE NAME(S), PORTRAIT(S), AND/OR SIGNATURE(S) SHOWN IN THE MARK IDENTIFIES

"JEANIE C. LINDERS", WHOSE CONSENT(S) TO REGISTER IS MADE OF RECORD.

THE MARK CONSISTS OF A LARGE SQUARE DIVIDED INTO FOUR SMALLER SQUARES AND SET ON END TO MAKE A LARGE DIAMOND WITH A STYLIZED LETTER "J" ON THE CENTER LEFT SMALLER SQUARE, A STYLIZED "C" ON THE TOP SMALLER SQUARE, A STYLIZED "L" ON THE BOTTOM SQUARE, AND A STYLIZED "F" ON THE CENTER RIGHT SQUARE, WITH A SHADOW OF THE LARGER DIAMOND TO THE LOWER RIGHT OF THE LARGER DIAMOND, ALL ABOVE THE TERM "JEANIE C. LINDERS FUND" IN STYLIZED LETTERS.

SER. NO. 77-350,089, FILED 12-12-2007.

EUGENIA MARTIN, EXAMINING ATTORNEY

Int. Cl.: 35

Prior U.S. Cls.: 100, 101 and 102

United States Patent and Trademark Office

Reg. No. 3,484,043

Registered Aug. 12, 2008

**SERVICE MARK
PRINCIPAL REGISTER**

**ASSOCIATE SAFETY
PROFESSIONAL**

BOARD OF CERTIFIED SAFETY PROFESSIONALS, INC. (ILLINOIS CORPORATION)
208 BURWASH AVENUE
SAVOY, IL 61874

FOR: TESTING, ANALYSIS AND EVALUATION OF INDIVIDUALS WORKING IN THE FIELD OF SAFETY TO DETERMINE PROFESSIONAL COMPETENCY, IN CLASS 35 (U.S. CLS. 100, 101 AND 102).

FIRST USE 9-1-1978; IN COMMERCE 9-1-1978.

THE MARK CONSISTS OF STANDARD CHARACTERS WITHOUT CLAIM TO ANY PARTICULAR FONT, STYLE, SIZE, OR COLOR.

SEC. 2(F).

SER. NO. 77-350,122, FILED 12-12-2007.

PAUL F. GAST, EXAMINING ATTORNEY

Int. Cls.: 16, 35, 36 and 41

**Prior U.S. Cls.: 2, 5, 22, 23, 29, 37, 38, 50, 100, 101, 102
and 107**

Reg. No. 3,484,044

United States Patent and Trademark Office

Registered Aug. 12, 2008

**TRADEMARK
SERVICE MARK
PRINCIPAL REGISTER**

**NATIONAL NETWORK TO END
DOMESTIC VIOLENCE FUND**

NATIONAL NETWORK TO END DOMESTIC
VIOLENCE (D.C. CORPORATION)
2001 S STREET, N.W, SUITE 400
WASHINGTON, DC 20009

FOR: PRINTED REPORTS, FLYERS, FACT
SHEETS, AND NEWSLETTERS IN THE FIELD OF
DOMESTIC VIOLENCE; PAPER BANNERS AND
POSTERS, IN CLASS 16 (U.S. CLS. 2, 5, 22, 23, 29, 37,
38 AND 50).

FIRST USE 4-22-1996; IN COMMERCE 4-22-1996.

FOR: PUBLIC ADVOCACY, NAMELY, PROMOT-
ING THE INTERESTS OF DOMESTIC VIOLENCE
VICTIMS; PUBLIC SERVICE ANNOUNCEMENTS,
NAMELY, PROMOTING PUBLIC AWARENESS OF
DOMESTIC VIOLENCE PROGRAMS, IN CLASS 35
(U.S. CLS. 100, 101 AND 102).

FIRST USE 4-22-1996; IN COMMERCE 4-22-1996.

FOR: CHARITABLE FUNDRAISING SERVICES
IN THE FIELD OF DOMESTIC VIOLENCE; CHARI-
TABLE SERVICES, NAMELY, PROVIDING FINAN-
CIAL SUPPORT TO HELP DOMESTIC VIOLENCE
VICTIMS, IN CLASS 36 (U.S. CLS. 100, 101 AND 102).

FIRST USE 4-22-1996; IN COMMERCE 4-22-1996.

FOR: EDUCATIONAL SERVICES, NAMELY,
CONDUCTING EDUCATIONAL PROGRAMS,
WORKSHOPS, CONFERENCES AND SEMINARS
IN THE FIELD OF DOMESTIC VIOLENCE, IN
CLASS 41 (U.S. CLS. 100, 101 AND 107).

FIRST USE 4-22-1996; IN COMMERCE 4-22-1996.

THE MARK CONSISTS OF STANDARD CHAR-
ACTERS WITHOUT CLAIM TO ANY PARTICULAR
FONT, STYLE, SIZE, OR COLOR.

NO CLAIM IS MADE TO THE EXCLUSIVE
RIGHT TO USE "FUND" AS TO INTERNATIONAL
CLASS 036, APART FROM THE MARK AS SHOWN.

SEC. 2(F).

SER. NO. 77-350,141, FILED 12-12-2007.

MICHAEL TANNER, EXAMINING ATTORNEY

Int. Cls.: 16, 35, 36 and 41

**Prior U.S. Cls.: 2, 5, 22, 23, 29, 37, 38, 50, 100, 101, 102
and 107**

Reg. No. 3,484,045

United States Patent and Trademark Office

Registered Aug. 12, 2008

**TRADEMARK
SERVICE MARK
PRINCIPAL REGISTER**

NNEDV FUND

NATIONAL NETWORK TO END DOMESTIC
VIOLENCE (D.C. CORPORATION)
2001 S STREET, N.W, SUITE 400
WASHINGTON, DC 20009

FOR: PRINTED REPORTS, FLYERS, FACT
SHEETS, AND NEWSLETTERS IN THE FIELD OF
DOMESTIC VIOLENCE; PAPER BANNERS AND
POSTERS, IN CLASS 16 (U.S. CLS. 2, 5, 22, 23, 29, 37,
38 AND 50).

FIRST USE 4-22-1996; IN COMMERCE 4-22-1996.

FOR: PUBLIC ADVOCACY, NAMELY, PROMOT-
ING THE INTERESTS OF DOMESTIC VIOLENCE
VICTIMS; PUBLIC SERVICE ANNOUNCEMENTS,
NAMELY, PROMOTING PUBLIC AWARENESS OF
DOMESTIC VIOLENCE PROGRAMS, IN CLASS 35
(U.S. CLS. 100, 101 AND 102).

FIRST USE 4-22-1996; IN COMMERCE 4-22-1996.

FOR: CHARITABLE FUNDRAISING SERVICES
IN THE FIELD OF DOMESTIC VIOLENCE; CHARI-
TABLE SERVICES, NAMELY, PROVIDING FINAN-

CIAL SUPPORT TO HELP DOMESTIC VIOLENCE
VICTIMS, IN CLASS 36 (U.S. CLS. 100, 101 AND 102).

FIRST USE 4-22-1996; IN COMMERCE 4-22-1996.

FOR: EDUCATIONAL SERVICES, NAMELY,
CONDUCTING EDUCATIONAL PROGRAMS,
WORKSHOPS, CONFERENCES AND SEMINARS
IN THE FIELD OF DOMESTIC VIOLENCE, IN
CLASS 41 (U.S. CLS. 100, 101 AND 107).

FIRST USE 4-22-1996; IN COMMERCE 4-22-1996.

THE MARK CONSISTS OF STANDARD CHAR-
ACTERS WITHOUT CLAIM TO ANY PARTICULAR
FONT, STYLE, SIZE, OR COLOR.

NO CLAIM IS MADE TO THE EXCLUSIVE
RIGHT TO USE "FUND" AS TO INTERNATIONAL
CLASS 036, APART FROM THE MARK AS SHOWN.

SER. NO. 77-350,145, FILED 12-12-2007.

MICHAEL TANNER, EXAMINING ATTORNEY

Int. Cl.: 41

Prior U.S. Cls.: 100, 101 and 107

United States Patent and Trademark Office

Reg. No. 3,484,046

Registered Aug. 12, 2008

SERVICE MARK
PRINCIPAL REGISTER

STRAIGHT TALK
An SBRR Institute *by the Experts*

GRABARITS, MICHAEL J. (UNITED STATES
INDIVIDUAL)
3207 BRYNWOOD DRIVE
WHITEHALL, PA 18052

FOR: EDUCATIONAL SERVICES, NAMELY, DE-
VELOPING, ARRANGING, AND CONDUCTING
EDUCATIONAL CONFERENCES AND PROGRAMS
AND PROVIDING COURSES OF INSTRUCTION IN
THE FIELD OF READING, LITERACY, AND
LEARNING, IN CLASS 41 (U.S. CLS. 100, 101 AND
107).

FIRST USE 5-1-2007; IN COMMERCE 5-1-2007.

NO CLAIM IS MADE TO THE EXCLUSIVE
RIGHT TO USE "BY THE EXPERTS" OR "INSTI-
TUTE", APART FROM THE MARK AS SHOWN.

THE COLOR(S) BLACK, BLUE IS/ARE CLAIMED
AS A FEATURE OF THE MARK.

THE MARK CONSISTS OF THE STYLIZED
WORDING "STRAIGHT TALK", "BY THE EX-
PERTS", AND "AN SBRR INSTITUTE". THE WORD-
ING IS ALL IN BLACK, EXCEPT FOR THE PHRASE
"BY THE EXPERTS", WHICH IS IN BLUE.

SER. NO. 77-350,182, FILED 12-12-2007.

CORY BOONE, EXAMINING ATTORNEY

Int. Cl.: 41

Prior U.S. Cls.: 100, 101 and 107

United States Patent and Trademark Office

Reg. No. 3,484,047

Registered Aug. 12, 2008

**SERVICE MARK
PRINCIPAL REGISTER**

Manners in Motion

CYNTHIA GLINKA (CALIFORNIA SOLE PROPRIETORSHIP)
POB 122
LARKSPUR, CA 94977

FOR: EDUCATIONAL, INSTRUCTIONAL, AND ENTERTAINMENT SERVICES, NAMELY, AUDIENCE PARTICIPATION EVENTS, ORGANIZING COMPETITIONS, CONTESTS, GAMES, SHOWS, STAGE EVENTS, THEATRICAL PERFORMANCES, AND LIVE PERFORMANCES OF MUSIC AND DANCE, PERTAINING TO OR FEATURING INSTRUCTION, ENTERTAINMENT, AND INFORMATION RELATING TO MUSIC AND DANCE AS THEY RELATE TO ETIQUETTE; PRODUCTION AND RENTAL OF SOUND AND VIDEO RECORDINGS, MOTION PICTURE FILMS, TELEVISION AND RADIO PROGRAMS, AUDIO AND VIDEO

MATERIAL FOR BROADCAST ON THE INTERNET, AND DOWNLOADABLE MUSICAL OR SPOKEN SOUND RECORDINGS; PROVIDING INFORMATION RELATING TO MUSIC AND DANCE AS THEY RELATE TO ETIQUETTE, IN CLASS 41 (U.S. CLS. 100, 101 AND 107).

FIRST USE 2-2-2007; IN COMMERCE 2-2-2007.

THE MARK CONSISTS OF STANDARD CHARACTERS WITHOUT CLAIM TO ANY PARTICULAR FONT, STYLE, SIZE, OR COLOR.

SER. NO. 77-350,209, FILED 12-12-2007.

CHARLES L. JENKINS, EXAMINING ATTORNEY

Int. Cls.: 16, 35, 36 and 41

**Prior U.S. Cls.: 2, 5, 22, 23, 29, 37, 38, 50, 100, 101, 102
and 107**

Reg. No. 3,484,048

United States Patent and Trademark Office

Registered Aug. 12, 2008

**TRADEMARK
SERVICE MARK
PRINCIPAL REGISTER**

NNEDV

NATIONAL NETWORK TO END DOMESTIC
VIOLENCE (D.C. CORPORATION)
2001 S STREET, N.W, SUITE 400
WASHINGTON, DC 20009

FOR: PRINTED REPORTS, FLYERS, FACT
SHEETS, AND NEWSLETTERS IN THE FIELD OF
DOMESTIC VIOLENCE; PAPER BANNERS AND
POSTERS, IN CLASS 16 (U.S. CLS. 2, 5, 22, 23, 29, 37,
38 AND 50).

FIRST USE 7-26-1995; IN COMMERCE 7-26-1995.

FOR: LOBBYING SERVICES, NAMELY, PRO-
MOTING THE INTERESTS OF DOMESTIC VIO-
LENCE VICTIMS IN THE FIELDS OF
LEGISLATION AND REGULATION; PUBLIC SER-
VICE ANNOUNCEMENTS, NAMELY, PROMOTING
PUBLIC AWARENESS OF DOMESTIC VIOLENCE
PROGRAMS, IN CLASS 35 (U.S. CLS. 100, 101 AND
102).

FIRST USE 7-26-1995; IN COMMERCE 7-26-1995.

FOR: CHARITABLE FUNDRAISING SERVICES
IN THE FIELD OF DOMESTIC VIOLENCE; CHARI-
TABLE SERVICES, NAMELY, PROVIDING FINAN-
CIAL SUPPORT TO HELP DOMESTIC VIOLENCE
VICTIMS, IN CLASS 36 (U.S. CLS. 100, 101 AND 102).

FIRST USE 7-26-1995; IN COMMERCE 7-26-1995.

FOR: EDUCATIONAL SERVICES, NAMELY,
CONDUCTING EDUCATIONAL PROGRAMS,
WORKSHOPS, CONFERENCES AND SEMINARS
IN THE FIELD OF DOMESTIC VIOLENCE, IN
CLASS 41 (U.S. CLS. 100, 101 AND 107).

FIRST USE 7-26-1995; IN COMMERCE 7-26-1995.

THE MARK CONSISTS OF STANDARD CHAR-
ACTERS WITHOUT CLAIM TO ANY PARTICULAR
FONT, STYLE, SIZE, OR COLOR.

SER. NO. 77-350,213, FILED 12-12-2007.

MICHAEL TANNER, EXAMINING ATTORNEY

Int. Cls.: 16, 35, 36 and 41

**Prior U.S. Cls.: 2, 5, 22, 23, 29, 37, 38, 50, 100, 101, 102
and 107**

Reg. No. 3,484,049

United States Patent and Trademark Office

Registered Aug. 12, 2008

**TRADEMARK
SERVICE MARK
PRINCIPAL REGISTER**

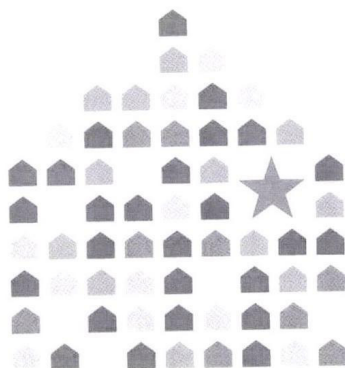

NATIONAL NETWORK TO END DOMESTIC
VIOLENCE (D.C. CORPORATION)
SUITE 400
2001 S STREET, N.W
WASHINGTON, DC 20009

FOR: PRINTED REPORTS, FLYERS, FACT
SHEETS, AND NEWSLETTERS IN THE FIELD OF
DOMESTIC VIOLENCE; PAPER BANNERS AND
POSTERS, IN CLASS 16 (U.S. CLS. 2, 5, 22, 23, 29, 37,
38 AND 50).

FIRST USE 4-22-1996; IN COMMERCE 4-22-1996.

FOR: LOBBYING SERVICES, NAMELY, PRO-
MOTING THE INTERESTS OF DOMESTIC VIO-
LENCE VICTIMS IN THE FIELDS OF
LEGISLATION AND REGULATION; PUBLIC SER-
VICE ANNOUNCEMENTS, NAMELY, PROMOTING
PUBLIC AWARENESS OF DOMESTIC VIOLENCE
PROGRAMS, IN CLASS 35 (U.S. CLS. 100, 101 AND
102).

FIRST USE 4-22-1996; IN COMMERCE 4-22-1996.

FOR: CHARITABLE FUNDRAISING SERVICES
IN THE FIELD OF DOMESTIC VIOLENCE; CHARI-
TABLE SERVICES, NAMELY, PROVIDING FINAN-
CIAL SUPPORT TO HELP DOMESTIC VIOLENCE
VICTIMS, IN CLASS 36 (U.S. CLS. 100, 101 AND 102).

FIRST USE 4-22-1996; IN COMMERCE 4-22-1996.

FOR: EDUCATIONAL SERVICES, NAMELY,
CONDUCTING EDUCATIONAL PROGRAMS,
WORKSHOPS, CONFERENCES AND SEMINARS
IN THE FIELD OF DOMESTIC VIOLENCE, IN
CLASS 41 (U.S. CLS. 100, 101 AND 107).

FIRST USE 4-22-1996; IN COMMERCE 4-22-1996.

THE MARK CONSISTS OF A SERIES OF SMALL
HOUSES AND A STAR IN THE SHAPE OF A HOUSE
DESIGN.

SER. NO. 77-350,242, FILED 12-12-2007.

MICHAEL TANNER, EXAMINING ATTORNEY

Int. Cl.: 16

Prior U.S. Cls.: 2, 5, 22, 23, 29, 37, 38 and 50

Reg. No. 3,484,050

United States Patent and Trademark Office

Registered Aug. 12, 2008

**TRADEMARK
PRINCIPAL REGISTER**

CHICAGO LAW JOURNAL

LAW BULLETIN PUBLISHING COMPANY (DE-
LAWARE CORPORATION)
415 NORTH STATE STREET
CHICAGO, IL 60610

FOR: PRINTED PERIODICALS PROVIDING DAI-
LY COURT DOCKETS, IN CLASS 16 (U.S. CLS. 2, 5,
22, 23, 29, 37, 38 AND 50).

FIRST USE 7-1-1999; IN COMMERCE 7-1-1999.

THE MARK CONSISTS OF STANDARD CHAR-
ACTERS WITHOUT CLAIM TO ANY PARTICULAR
FONT, STYLE, SIZE, OR COLOR.

OWNER OF U.S. REG. NO. 2,521,326.

NO CLAIM IS MADE TO THE EXCLUSIVE
RIGHT TO USE "JOURNAL", APART FROM THE
MARK AS SHOWN.

SEC. 2(F).

SER. NO. 77-351,077, FILED 12-13-2007.

HOWARD FRIEDMAN, EXAMINING ATTORNEY

Int. Cl.: 11

Prior U.S. Cls.: 13, 21, 23, 31 and 34

United States Patent and Trademark Office

Reg. No. 3,484,051

Registered Aug. 12, 2008

**TRADEMARK
PRINCIPAL REGISTER**

PYTHON SQUEEZE

PYTHON PRODUCTS, INC. (WISCONSIN CORPORATION)
7000 WEST MARCIA ROAD
MILWAUKEE, WI 53223

FOR: AQUARIUM FILTRATION APPARATUS, NAMELY, SIPHON STARTERS, IN CLASS 11 (U.S. CLS. 13, 21, 23, 31 AND 34).

FIRST USE 4-21-2007; IN COMMERCE 4-21-2007.

THE MARK CONSISTS OF STANDARD CHARACTERS WITHOUT CLAIM TO ANY PARTICULAR FONT, STYLE, SIZE, OR COLOR.

OWNER OF U.S. REG. NO. 1,564,377.

SER. NO. 77-351,093, FILED 12-13-2007.

BARBARA RUTLAND, EXAMINING ATTORNEY

Int. Cl.: 14

Prior U.S. Cls.: 2, 27, 28 and 50

United States Patent and Trademark Office

Reg. No. 3,484,052

Registered Aug. 12, 2008

**TRADEMARK
PRINCIPAL REGISTER**

**ANYTHING GOES SO LONG AS
IT'S GLAM**

YANAGI CORPORATION (JAPAN CORPORATION)
SHIBUYA-KU, JINNAN 1-13-8
PARK AVENUE JINNAN #1302
TOKYO, JAPAN 150-0041

THE MARK CONSISTS OF STANDARD CHARACTERS WITHOUT CLAIM TO ANY PARTICULAR FONT, STYLE, SIZE, OR COLOR.

FOR: JEWELRY, IN CLASS 14 (U.S. CLS. 2, 27, 28 AND 50).

SER. NO. 77-351,256, FILED 12-13-2007.

FIRST USE 11-0-2006; IN COMMERCE 11-0-2006.

JAMES A. RAUEN, EXAMINING ATTORNEY

Int. Cl.: 3

Prior U.S. Cls.: 1, 4, 6, 50, 51 and 52

United States Patent and Trademark Office

Reg. No. 3,484,053

Registered Aug. 12, 2008

TRADEMARK
PRINCIPAL REGISTER



HARDOUIN-FINEZ, ANNE (FRANCE INDIVIDUAL)
66, RUE DE CAUMARTIN
PARIS, FRANCE 75009 AND
HARDOUIN-FINEZ, ALEXIS (FRANCE INDIVIDUAL)
66, RUE DE CAUMARTIN
PARIS, FRANCE 75009

FOR: PERFUME; EAU DE COLOGNE; TOILET WATERS; PERFUMED BODY MILKS, BODY LOTIONS, BODY GELS, BODY OILS, AND BODY POWDERS; PERFUMED BATH AND SHOWER FOAMS AND GELS; PERFUMED SOAPS; PERFUMED MOISTURIZING CREAMS; PERFUMED TALCUM POWDER; PERSONAL DEODORANTS, IN CLASS 3 (U.S. CLS. 1, 4, 6, 50, 51 AND 52).

FIRST USE 5-1-2007; IN COMMERCE 6-30-2007.

NO CLAIM IS MADE TO THE EXCLUSIVE RIGHT TO USE "DEPUIS", "1952", "LES PARFUMS", "PARIS" AND "FRAGRANCE COLLECTION", APART FROM THE MARK AS SHOWN.

ENGLISH TRANSLATION OF THE WORDS "DEPUIS" IS SINCE, THE TRANSLATION OF "LES PARFUMS" IS THE PERFUME, AND THE TRANSLATION OF "FILLES DES ILES" IS GIRLS OF THE ISLE.

SER. NO. 77-351,274, FILED 12-13-2007.

KAPIL BHANOT, EXAMINING ATTORNEY

Int. Cl.: 35

Prior U.S. Cls.: 100, 101 and 102

United States Patent and Trademark Office

Reg. No. 3,484,054

Registered Aug. 12, 2008

**SERVICE MARK
PRINCIPAL REGISTER**

**CALLED TO PROTECT THE
ANOINTED**

LEGACY CONSULTANTS, INC. (GEORGIA CORPORATION)
SUITE B
3117 WOODCHUCK WAY
CONYERS, GA 30094

FOR: BUSINESS MANAGEMENT AND CONSULTING SERVICES, NAMELY, GENERAL BUSINESS MANAGEMENT SERVICES, ACCOUNTING SERVICES AND TAX-RELATED SERVICES IN THE NATURE OF TAX CONSULTATION, TAX PREPARATION AND TAX FILING, IN CLASS 35 (U.S. CLS. 100, 101 AND 102).

FIRST USE 11-30-2006; IN COMMERCE 11-30-2006.

THE MARK CONSISTS OF STANDARD CHARACTERS WITHOUT CLAIM TO ANY PARTICULAR FONT, STYLE, SIZE, OR COLOR.

SER. NO. 77-351,357, FILED 12-13-2007.

CARRIE GENOVESE, EXAMINING ATTORNEY

Int. Cl.: 33

Prior U.S. Cls.: 47 and 49

United States Patent and Trademark Office

Reg. No. 3,484,055

Registered Aug. 12, 2008

**TRADEMARK
PRINCIPAL REGISTER**

CUVÉE CARLOTTA

ROBERT TALBOTT, INC. (CALIFORNIA CORPORATION)
TALBOTT STUDIO
CARMEL VALLEY, CA 939240996

NO CLAIM IS MADE TO THE EXCLUSIVE RIGHT TO USE "CUVÉE", APART FROM THE MARK AS SHOWN.

FOR: WINE, IN CLASS 33 (U.S. CLS. 47 AND 49).

FIRST USE 10-1-2007; IN COMMERCE 10-1-2007.

THE FOREIGN WORDING IN THE MARK TRANSLATES INTO ENGLISH AS VINTAGE.

THE MARK CONSISTS OF STANDARD CHARACTERS WITHOUT CLAIM TO ANY PARTICULAR FONT, STYLE, SIZE, OR COLOR.

SER. NO. 77-351,380, FILED 12-13-2007.

OWNER OF U.S. REG. NOS. 2,755,899 AND 2,755,900.

JACQUELINE A. LAVINE, EXAMINING ATTORNEY

Int. Cls.: 3 and 11

Prior U.S. Cls.: 1, 4, 6, 13, 21, 23, 31, 34, 50, 51 and 52

United States Patent and Trademark Office

Reg. No. 3,484,056

Registered Aug. 12, 2008

**TRADEMARK
PRINCIPAL REGISTER**

OCEANS

MANAGING TRUSTEE OF PIER 1 SERVICES
COMPANY (DELAWARE STATUTORY
TRUST)
100 PIER 1 PLACE
FORT WORTH, TX 76102

FOR: SCENTED ROOM SPRAYS, IN CLASS 3 (U.S.
CLS. 1, 4, 6, 50, 51 AND 52).

FIRST USE 7-1-2007; IN COMMERCE 7-1-2007.

FOR: NON-ELECTRIC AIR DIFFUSERS COM-
PRISED OF REEDS AND OIL USED TO EMIT
SCENT, IN CLASS 11 (U.S. CLS. 13, 21, 23, 31 AND 34).

FIRST USE 7-1-2007; IN COMMERCE 7-1-2007.

THE MARK CONSISTS OF STANDARD CHAR-
ACTERS WITHOUT CLAIM TO ANY PARTICULAR
FONT, STYLE, SIZE, OR COLOR.

OWNER OF U.S. REG. NO. 2,448,618.

SER. NO. 77-351,676, FILED 12-13-2007.

ANNE FARRELL, EXAMINING ATTORNEY

Int. Cl.: 7

Prior U.S. Cls.: 13, 19, 21, 23, 31, 34 and 35

United States Patent and Trademark Office

Reg. No. 3,484,057

Registered Aug. 12, 2008

**TRADEMARK
PRINCIPAL REGISTER**



BEZIC, VIVIAN T. (UNITED STATES INDIVIDUAL)
P.O. BOX 5328
CARSON, CA 907495328

FOR: LATHES; MILLING CUTTERS; MILLING MACHINES; MILLING-DRILLING MACHINES, IN CLASS 7 (U.S. CLS. 13, 19, 21, 23, 31, 34 AND 35).

FIRST USE 11-0-1969; IN COMMERCE 11-0-1969.

THE MARK CONSISTS OF "R LAGUN".

THE ENGLISH TRANSLATION OF THE WORD "LAGUN" IN THE MARK IS "FRIENDS".

SER. NO. 77-351,774, FILED 12-13-2007.

JIM RINGLE, EXAMINING ATTORNEY

Int. Cl.: 44

Prior U.S. Cls.: 100 and 101

United States Patent and Trademark Office

Reg. No. 3,484,058

Registered Aug. 12, 2008

**SERVICE MARK
PRINCIPAL REGISTER**



DIAGNOSTIC IMAGING NW, P.C. (OREGON
PROFESSIONAL CORPORATION)
PO BOX 10768
PORTLAND, OR 97296

FOR: MEDICAL RADIOLOGY SERVICES; MEDICAL CLINICS; MEDICAL SERVICES, IN CLASS 44 (U.S. CLS. 100 AND 101).

FIRST USE 7-1-2007; IN COMMERCE 7-1-2007.

NO CLAIM IS MADE TO THE EXCLUSIVE RIGHT TO USE "IMAGING" AND "INTERVENTIONAL CONSULTANTS", APART FROM THE MARK AS SHOWN.

SER. NO. 77-351,801, FILED 12-13-2007.

AISHA SALEM, EXAMINING ATTORNEY

Int. Cl.: 36

Prior U.S. Cls.: 100, 101 and 102

United States Patent and Trademark Office

Reg. No. 3,484,059

Registered Aug. 12, 2008

**SERVICE MARK
PRINCIPAL REGISTER**

Building on a Vision

MERK, ELIZABETH T. (HAWAII SOLE PROPRIETORSHIP), DBA ELIZABETH MERK / INVESTMENTS

65-1231 OPELO ROAD #3
KAMUELA, HI 96743

FOR: ADVICE RELATING TO INVESTMENTS; FINANCIAL INVESTMENT IN THE FIELD OF SECURITIES; FINANCIAL PLANNING AND INVESTMENT ADVISORY SERVICES; FINANCIAL SERVICES, NAMELY, A TOTAL PORTFOLIO OFFERING FOR HIGH NET WORTH CLIENTS CONSISTING OF BOTH SEPARATE ACCOUNTS AND MUTUAL FUNDS FOR EQUITY AND FIXED INCOME INVESTMENTS; FUND INVESTMENT CONSULTATION; FUNDS INVESTMENT; INVESTMENT ADVICE; INVESTMENT BY ELECTRONIC MEANS; INVESTMENT CONSULTATION; MUTUAL FUND

INVESTMENT; PROVIDING INFORMATION AND ADVICE IN THE FIELD OF FINANCE, FINANCIAL INVESTMENTS, FINANCIAL VALUATIONS, AND THE FINANCIAL ASPECTS OF RETIREMENT; TRUST SERVICES, NAMELY, INVESTMENT AND TRUST COMPANY SERVICES, IN CLASS 36 (U.S. CLS. 100, 101 AND 102).

FIRST USE 1-1-1997; IN COMMERCE 1-1-1997.

THE MARK CONSISTS OF STANDARD CHARACTERS WITHOUT CLAIM TO ANY PARTICULAR FONT, STYLE, SIZE, OR COLOR.

SER. NO. 77-351,842, FILED 12-13-2007.

SUE LAWRENCE, EXAMINING ATTORNEY

Int. Cl.: 36

Prior U.S. Cls.: 100, 101 and 102

United States Patent and Trademark Office

Reg. No. 3,484,060

Registered Aug. 12, 2008

**SERVICE MARK
PRINCIPAL REGISTER**

Living Beyond 100

MERK, ELIZABETH T. (HAWAII SOLE PROPRIETORSHIP), DBA ELIZABETH MERK / INVESTMENTS
65-1231 OPELO ROAD #3
KAMUELA, HI 96743

FOR: ADVICE RELATING TO INVESTMENTS; FINANCIAL SERVICES, NAMELY, A TOTAL PORTFOLIO OFFERING FOR HIGH NET WORTH CLIENTS CONSISTING OF BOTH SEPARATE ACCOUNTS AND MUTUAL FUNDS FOR EQUITY AND FIXED INCOME INVESTMENTS; FUND INVESTMENT CONSULTATION; FUNDS INVESTMENT; INVESTMENT ADVICE; INVESTMENT ADVISORY SERVICES; INVESTMENT BY ELECTRONIC MEANS; INVESTMENT CONSULTATION; MUTUAL FUND INVESTMENT; PROVIDING IN-

FORMATION AND ADVICE IN THE FIELD OF FINANCE, FINANCIAL INVESTMENTS, FINANCIAL VALUATIONS, AND THE FINANCIAL ASPECTS OF RETIREMENT; TRUST SERVICES, NAMELY, INVESTMENT AND TRUST COMPANY SERVICES, IN CLASS 36 (U.S. CLS. 100, 101 AND 102).

FIRST USE 3-1-2004; IN COMMERCE 3-1-2004.

THE MARK CONSISTS OF STANDARD CHARACTERS WITHOUT CLAIM TO ANY PARTICULAR FONT, STYLE, SIZE, OR COLOR.

SER. NO. 77-351,868, FILED 12-13-2007.

SUE LAWRENCE, EXAMINING ATTORNEY

Int. Cl.: 41

Prior U.S. Cls.: 100, 101 and 107

United States Patent and Trademark Office

Reg. No. 3,484,061

Registered Aug. 12, 2008

**SERVICE MARK
PRINCIPAL REGISTER**

Character Ovations

SPOTLIGHT OVATIONS (CALIFORNIA PART-
NERSHIP)
P.O. BOX 99775
SAN DIEGO, CA 92169

FOR: EDUCATIONAL SERVICES, NAMELY,
CONDUCTING PROGRAMS IN THE FIELD OF
TEACHING CHILDREN TO WRITE AND PER-
FORM PLAYS, IN CLASS 41 (U.S. CLS. 100, 101
AND 107).

FIRST USE 5-15-2007; IN COMMERCE 5-15-2007.

THE MARK CONSISTS OF STANDARD CHAR-
ACTERS WITHOUT CLAIM TO ANY PARTICULAR
FONT, STYLE, SIZE, OR COLOR.

NO CLAIM IS MADE TO THE EXCLUSIVE
RIGHT TO USE "CHARACTER", APART FROM
THE MARK AS SHOWN.

SER. NO. 77-352,249, FILED 12-14-2007.

ANN E. SAPPENFIELD, EXAMINING ATTORNEY

Int. Cls.: 37 and 42

Prior U.S. Cls.: 100, 101, 103 and 106

United States Patent and Trademark Office

Reg. No. 3,484,062

Registered Aug. 12, 2008

**SERVICE MARK
PRINCIPAL REGISTER**

CareCyte

CARECYTE, LLC (WASHINGTON LTD LIAB CO)
15721 SE 45TH STREET
BELLEVUE, WA 98006

FOR: BUILDING CONSTRUCTION SERVICES,
NAMELY, THE ASSEMBLY OF MODULAR UNITS
TO BE USED AS UNIFIED HEALTH CARE SYSTEM
FACILITIES, IN CLASS 37 (U.S. CLS. 100, 103 AND
106).

FIRST USE 9-18-2007; IN COMMERCE 9-18-2007.

FOR: BUILDING DESIGN SERVICES, NAMELY,
THE DESIGN OF MODULAR UNITS TO BE USED

AS UNIFIED HEALTH CARE SYSTEM FACILITIES,
IN CLASS 42 (U.S. CLS. 100 AND 101).

FIRST USE 9-18-2007; IN COMMERCE 9-18-2007.

THE MARK CONSISTS OF STANDARD CHAR-
ACTERS WITHOUT CLAIM TO ANY PARTICULAR
FONT, STYLE, SIZE, OR COLOR.

SER. NO. 77-352,259, FILED 12-14-2007.

GRETТА YAO, EXAMINING ATTORNEY

Int. Cls.: 37 and 42

Prior U.S. Cls.: 100, 101, 103 and 106

United States Patent and Trademark Office

Reg. No. 3,484,063

Registered Aug. 12, 2008

**SERVICE MARK
PRINCIPAL REGISTER**



CARECYTE, LLC (WASHINGTON LTD LIAB CO)
15721 SE 45TH STREET
BELLEVUE, WA 98006

FOR: BUILDING CONSTRUCTION SERVICES,
NAMELY, THE ASSEMBLY OF MODULAR UNITS
TO BE USED AS UNIFIED HEALTH CARE SYSTEM
FACILITIES, IN CLASS 37 (U.S. CLS. 100, 103 AND
106).

FIRST USE 9-18-2007; IN COMMERCE 9-18-2007.

FOR: BUILDING DESIGN SERVICES, NAMELY,
THE DESIGN OF MODULAR UNITS TO BE USED
AS UNIFIED HEALTH CARE SYSTEM FACILITIES,
IN CLASS 42 (U.S. CLS. 100 AND 101).

FIRST USE 9-18-2007; IN COMMERCE 9-18-2007.

THE COLOR(S) GREEN IS/ARE CLAIMED AS A
FEATURE OF THE MARK.

THE MARK CONSISTS OF A SILHOUETTE OF A
MALE FIGURE WITH ARMS AND LEGS EXTEN-
DED, INSIDE A CIRCLE OVERLAPPING A BOX,
ALL IN GREEN.

SER. NO. 77-352,274, FILED 12-14-2007.

GRETТА YAO, EXAMINING ATTORNEY

Int. Cl.: 36

Prior U.S. Cls.: 100, 101 and 102

United States Patent and Trademark Office

Reg. No. 3,484,064

Registered Aug. 12, 2008

**SERVICE MARK
PRINCIPAL REGISTER**

Oxford Cove

CELLUZZI, PAUL R. (UNITED STATES INDIVIDUAL)
1211 BISHOPSGATE WAY
RESTON, VA 20194 AND
CELLUZZI, LORI A. (UNITED STATES INDIVIDUAL)
1211 BISHOPSGATE WAY
RESTON, VA 20194

FOR: REAL ESTATE SERVICES, NAMELY, RENTAL OF VACATION HOMES, CONDOMINIUMS, CABINS, AND VILLAS USING PAY PER CLICK

ADVERTISING ON A GLOBAL COMPUTER NETWORK, IN CLASS 36 (U.S. CLS. 100, 101 AND 102).

FIRST USE 5-1-2006; IN COMMERCE 5-1-2006.

THE MARK CONSISTS OF STANDARD CHARACTERS WITHOUT CLAIM TO ANY PARTICULAR FONT, STYLE, SIZE, OR COLOR.

SER. NO. 77-352,663, FILED 12-14-2007.

MICHAEL WIENER, EXAMINING ATTORNEY

Int. Cl.: 41

Prior U.S. Cls.: 100, 101 and 107

United States Patent and Trademark Office

Reg. No. 3,484,065

Registered Aug. 12, 2008

**SERVICE MARK
PRINCIPAL REGISTER**

CELTIC WOMAN

CELTIC WOMAN, LTD. (IRELAND CORPORATION)
32 LOWER LESSON STREET
DUBLIN 2, IRELAND

FOR: ENTERTAINMENT, EDUCATION, CULTURAL ACTIVITIES AND RADIO AND TELEVISION ENTERTAINMENT SERVICES, NAMELY, ENTERTAINMENT IN THE NATURE OF LIVE PERFORMANCES BY A MUSICAL OR DANCE GROUP OR PERFORMER, LIVE MUSIC CONCERTS AND DANCE PERFORMANCES, AND PROVIDING TELEVISION PROGRAMS IN THE FIELDS OF MUSIC AND DANCE; ENTERTAINMENT AND EDUCATIONAL SERVICES, NAMELY, PRODUCTION OF MUSICAL AND DANCE SHOWS, VIDEOTAPE, AUDIOTAPE, RADIO AND TELEVISION PROGRAMS, ORGANIZING EXHIBITIONS AND EVENTS FOR ENTERTAINMENT, EDUCATIONAL AND CULTURAL PURPOSES IN THE FIELDS OF MUSIC AND DANCE; PROVIDING A WEB SITE

FEATURING MUSICAL AND DANCE PERFORMANCES, MUSICAL AND DANCE VIDEOS, AND RELATED FILM CLIPS, PHOTOGRAPHS AND OTHER MULTIMEDIA MATERIALS IN THE FIELDS OF MUSIC AND DANCE, IN CLASS 41 (U.S. CLS. 100, 101 AND 107).

FIRST USE 3-17-2005; IN COMMERCE 3-17-2005.

THE MARK CONSISTS OF STANDARD CHARACTERS WITHOUT CLAIM TO ANY PARTICULAR FONT, STYLE, SIZE, OR COLOR.

OWNER OF U.S. REG. NOS. 3,263,503, 3,290,299, AND 3,290,300.

SER. NO. 77-352,672, FILED 12-14-2007.

REGINA DRUMMOND, EXAMINING ATTORNEY

Int. Cl.: 41

Prior U.S. Cls.: 100, 101 and 107

United States Patent and Trademark Office

Reg. No. 3,484,066

Registered Aug. 12, 2008

**SERVICE MARK
PRINCIPAL REGISTER**

The Essence of *I.C.E.D.*
(Impress, Connect, Engage, Declare)

TAMARA JACOBS COMMUNICATIONS, INC.
(NEW YORK CORPORATION)
107 LIBRARY PLACE
PRINCETON, NJ 08540

FOR: ARRANGING OF SEMINARS; CONDUCTING WORKSHOPS AND SEMINARS IN THE FIELDS OF PERSONAL MARKETING; EDUCATIONAL SERVICES, NAMELY, PROVIDING LIVE AND ON-LINE CONFERENCES, SEMINARS AND WORKSHOPS IN THE FIELDS OF COMMUNICATIONS, PERSONAL BRANDING, PERSONAL PACKAGING IN THE NATURE OF PERSONAL APPEARANCE, PUBLIC SPEAKING, PRESENTER SKILLS TRAINING, FACILITATION SKILLS IN THE NATURE OF GROUP MANAGEMENT AND GUIDANCE, EXECUTIVE PRESENCE IN THE NATURE OF LEADERSHIP VISIBILITY AND STATURE, GENDER COMMUNICATION, NETWORKING, BUSINESS ETIQUETTE, MEDIA PREPARATION IN THE NATURE OF READYING PERSONS AND/OR CORPORATIONS FOR MEDIA PUBLICITY; EDUCATIONAL SERVICES, NAMELY, CONDUCTING SEMINARS WORKSHOPS, AND CONFERENCES IN THE FIELDS OF COMMUNICATIONS, PERSONAL BRANDING, PERSONAL PACKAGING IN THE NATURE OF PERSONAL APPEARANCE, PUBLIC SPEAKING, PRESENTER SKILLS TRAINING, FACILITATION SKILLS IN THE NATURE OF GROUP MANAGEMENT AND GUIDANCE, EXECUTIVE PRESENCE IN THE NATURE OF LEADERSHIP VISIBILITY AND STATURE, GENDER COMMUNICATION, NETWORKING, BUSINESS

ETIQUETTE, MEDIA PREPARATION IN THE NATURE OF READYING PERSONS AND/OR CORPORATIONS FOR MEDIA PUBLICITY, AND THE DISTRIBUTION OF COURSE MATERIAL IN CONNECTION THEREWITH; MEETING AND SEMINAR ARRANGING; WORKSHOPS AND SEMINARS IN THE FIELDS OF COMMUNICATIONS, PERSONAL BRANDING, PERSONAL PACKAGING IN THE NATURE OF PERSONAL APPEARANCE, PUBLIC SPEAKING, PRESENTER SKILLS TRAINING, FACILITATION SKILLS IN THE NATURE OF GROUP MANAGEMENT AND GUIDANCE, EXECUTIVE PRESENCE IN THE NATURE OF LEADERSHIP VISIBILITY AND STATURE, GENDER COMMUNICATION, NETWORKING, BUSINESS ETIQUETTE, MEDIA PREPARATION IN THE NATURE OF READYING PERSONS AND/OR CORPORATIONS FOR MEDIA PUBLICITY, IN CLASS 41 (U.S. CLS. 100, 101 AND 107).

FIRST USE 12-10-2007; IN COMMERCE 12-10-2007.

THE MARK CONSISTS OF THE PHRASE "THE ESSENCE OF I.C.E.D.", WITH "I.C.E.D." IN ITALIC LETTERING, IS ABOVE THE PHRASE "(IMPRESS, CONNECT, ENGAGE, DECLARE)" WHICH IS ALSO IN ITALIC LETTERING AND PLACED INSIDE A PARENTHETICAL AS SHOWN HEREIN.

SER. NO. 77-352,720, FILED 12-14-2007.

MARIAM MAHMOUDI, EXAMINING ATTORNEY

Int. Cl.: 41

Prior U.S. Cls.: 100, 101 and 107

United States Patent and Trademark Office

Reg. No. 3,484,067

Registered Aug. 12, 2008

**SERVICE MARK
PRINCIPAL REGISTER**

Define it. Design it. Deliver it.

TAMARA JACOBS COMMUNICATIONS, INC.
(NEW YORK CORPORATION)
107 LIBRARY PLACE
PRINCETON, NJ 08540

FOR: ARRANGING OF SEMINARS; CONDUCTING WORKSHOPS AND SEMINARS IN THE FIELDS OF PERSONAL MARKETING; EDUCATION SERVICES, NAMELY, PROVIDING LIVE AND ON-LINE CONFERENCES, SEMINARS AND WORKSHOPS IN THE FIELDS OF COMMUNICATIONS, PERSONAL BRANDING, PERSONAL PACKAGING IN THE NATURE OF PERSONAL APPEARANCE, PUBLIC SPEAKING, PRESENTER SKILLS TRAINING, FACILITATION SKILLS IN THE NATURE OF GROUP MANAGEMENT AND GUIDANCE, EXECUTIVE PRESENCE IN THE NATURE OF LEADERSHIP VISIBILITY AND STATURE, GENDER COMMUNICATION, NETWORKING, BUSINESS ETIQUETTE, MEDIA PREPARATION IN THE NATURE OF READYING PERSONS AND/OR CORPORATIONS FOR MEDIA PUBLICITY; EDUCATIONAL SERVICES, NAMELY, CONDUCTING SEMINARS WORKSHOPS, AND CONFERENCES IN THE FIELDS OF COMMUNICATIONS, PERSONAL BRANDING, PERSONAL PACKAGING IN THE NATURE OF PERSONAL APPEARANCE, PUBLIC SPEAKING, PRESENTER SKILLS TRAINING, FACILITATION SKILLS IN THE NATURE OF GROUP MANAGEMENT AND GUIDANCE, EXECUTIVE PRESENCE IN THE NATURE OF LEA-

DERSHIP VISIBILITY AND STATURE, GENDER COMMUNICATION, NETWORKING, BUSINESS ETIQUETTE, MEDIA PREPARATION IN THE NATURE OF READYING PERSONS AND/OR CORPORATIONS FOR MEDIA PUBLICITY; WORKSHOPS AND SEMINARS IN THE FIELDS OF COMMUNICATIONS, PERSONAL BRANDING, PERSONAL PACKAGING IN THE NATURE OF PERSONAL APPEARANCE, PUBLIC SPEAKING, PRESENTER SKILLS TRAINING, FACILITATION SKILLS IN THE NATURE OF GROUP MANAGEMENT AND GUIDANCE, EXECUTIVE PRESENCE IN THE NATURE OF LEADERSHIP VISIBILITY AND STATURE, GENDER COMMUNICATION, NETWORKING, BUSINESS ETIQUETTE, MEDIA PREPARATION IN THE NATURE OF READYING PERSONS AND/OR CORPORATIONS FOR MEDIA PUBLICITY, IN CLASS 41 (U.S. CLS. 100, 101 AND 107).

FIRST USE 11-16-2007; IN COMMERCE 11-16-2007.

THE MARK CONSISTS OF THE WORDS "DEFINE IT" FOLLOWED BY A PERIOD, "DESIGN IT" FOLLOWED BY A PERIOD AND "DELIVER IT" FOLLOWED BY A PERIOD ARE ALL IN ITALICS.

SER. NO. 77-352,818, FILED 12-14-2007.

MARIAM MAHMOUDI, EXAMINING ATTORNEY

Int. Cl.: 3

Prior U.S. Cls.: 1, 4, 6, 50, 51 and 52

Reg. No. 3,484,068

United States Patent and Trademark Office

Registered Aug. 12, 2008

**TRADEMARK
PRINCIPAL REGISTER**

SKIN APPÉTIT

WOODRIDGE LABS, INC. (DELAWARE CORPORATION)
16217 KITTRIDGE STREET
VAN NUYS, CA 91406

NO CLAIM IS MADE TO THE EXCLUSIVE RIGHT TO USE "SKIN", APART FROM THE MARK AS SHOWN.

FOR: NON-MEDICATED SKIN CARE PREPARATIONS, IN CLASS 3 (U.S. CLS. 1, 4, 6, 50, 51 AND 52).

THE FOREIGN WORDING IN THE MARK TRANSLATES INTO ENGLISH AS "APPETITE".

FIRST USE 6-1-2007; IN COMMERCE 6-1-2007.

SER. NO. 77-353,000, FILED 12-14-2007.

THE MARK CONSISTS OF STANDARD CHARACTERS WITHOUT CLAIM TO ANY PARTICULAR FONT, STYLE, SIZE, OR COLOR.

ARETHA SOMERVILLE, EXAMINING ATTORNEY

Int. Cl.: 16

Prior U.S. Cls.: 2, 5, 22, 23, 29, 37, 38 and 50

United States Patent and Trademark Office

Reg. No. 3,484,069

Registered Aug. 12, 2008

**TRADEMARK
PRINCIPAL REGISTER**

Daisy's Great Adventures

SAY WHAT ENTERPRISES, INC (NEW JERSEY
CORPORATION)
PO BOX 79
PO BOX 79
MIDDLETOWN, NJ 07748

FOR: ACTIVITY BOOKS FOR CHILDREN, IN
CLASS 16 (U.S. CLS. 2, 5, 22, 23, 29, 37, 38 AND 50).

FIRST USE 2-17-2008; IN COMMERCE 3-5-2008.

THE MARK CONSISTS OF STANDARD CHAR-
ACTERS WITHOUT CLAIM TO ANY PARTICULAR
FONT, STYLE, SIZE, OR COLOR.

SER. NO. 77-353,070, FILED 12-15-2007.

LINDA E. BLOHM, EXAMINING ATTORNEY

Int. Cl.: 35

Prior U.S. Cls.: 100, 101 and 102

United States Patent and Trademark Office

Reg. No. 3,484,070

Registered Aug. 12, 2008

**SERVICE MARK
PRINCIPAL REGISTER**

WORLDWIDE AMBASSADOR

HORNING, EFFIE (UNITED STATES INDIVIDUAL)
3888 CAMEO DRIVE
OCEANSIDE, CA 92056

FOR: CHARITABLE SERVICES, NAMELY, PROMOTING PUBLIC AWARENESS ABOUT MENTAL HEALTH, MEDICAL SERVICES AND COMMUNITY EDUCATION, IN CLASS 35 (U.S. CLS. 100, 101 AND 102).

FIRST USE 8-1-1999; IN COMMERCE 8-1-1999.

THE MARK CONSISTS OF STANDARD CHARACTERS WITHOUT CLAIM TO ANY PARTICULAR FONT, STYLE, SIZE, OR COLOR.

NO CLAIM IS MADE TO THE EXCLUSIVE RIGHT TO USE "WORLDWIDE", APART FROM THE MARK AS SHOWN.

SER. NO. 77-353,163, FILED 12-16-2007.

SKYE YOUNG, EXAMINING ATTORNEY

Int. Cl.: 31

Prior U.S. Cls.: 1 and 46

United States Patent and Trademark Office

Reg. No. 3,484,071

Registered Aug. 12, 2008

**TRADEMARK
PRINCIPAL REGISTER**

PETUNIA BLANKET

JOHN BODGER & SONS COMPANY (CALIFORNIA CORPORATION)
1800 NORTH TYLER AVENUE
SOUTH EL MONTE, CA 91733

FOR: LIVE PETUNIA PLANTS, IN CLASS 31 (U.S. CLS. 1 AND 46).

FIRST USE 7-1-2005; IN COMMERCE 7-1-2005.

THE MARK CONSISTS OF STANDARD CHARACTERS WITHOUT CLAIM TO ANY PARTICULAR FONT, STYLE, SIZE, OR COLOR.

NO CLAIM IS MADE TO THE EXCLUSIVE RIGHT TO USE "PETUNIA", APART FROM THE MARK AS SHOWN.

SER. NO. 77-353,251, FILED 12-16-2007.

JOHN SCHUYLER YARD, EXAMINING ATTORNEY

Int. Cl.: 45

Prior U.S. Cls.: 100 and 101

United States Patent and Trademark Office

Reg. No. 3,484,072

Registered Aug. 12, 2008

**SERVICE MARK
PRINCIPAL REGISTER**

Visceral Truth

KING, MARC (UNITED STATES INDIVIDUAL)
800 W. RENNER RD., # 2028
RICHARDSON, TX 75080

THE MARK CONSISTS OF STANDARD CHAR-
ACTERS WITHOUT CLAIM TO ANY PARTICULAR
FONT, STYLE, SIZE, OR COLOR.

FOR: LITIGATION CONSULTANCY, IN CLASS 45
(U.S. CLS. 100 AND 101).

SER. NO. 77-353,302, FILED 12-16-2007.

FIRST USE 11-8-2007; IN COMMERCE 11-8-2007.

JENNIFER VASQUEZ, EXAMINING ATTORNEY

Int. Cl.: 35

Prior U.S. Cls.: 100, 101 and 102

United States Patent and Trademark Office

Reg. No. 3,484,073

Registered Aug. 12, 2008

**SERVICE MARK
PRINCIPAL REGISTER**



POPULATION SERVICES INTERNATIONAL
(NORTH CAROLINA CORPORATION)
SUITE 600
1120 19TH STREET, NW
WASHINGTON, DC 20036

FOR: PROMOTING PUBLIC AWARENESS OF THE CRITICAL ISSUES AFFECTING THE SURVIVAL OF CHILDREN YOUNGER THAN FIVE WORLDWIDE AND OF HOW INDIVIDUALS AND CORPORATIONS MAY PROVIDE SUPPORT TO SAVE CHILDREN'S LIVES AND IMPROVE THEIR HEALTH, IN CLASS 35 (U.S. CLS. 100, 101 AND 102).

FIRST USE 6-30-2007; IN COMMERCE 6-30-2007.

OWNER OF U.S. REG. NO. 3,364,981.

THE MARK CONSISTS OF A GLOBE CONTAINING REPRESENTATIONS OF THE CONTINENTS WITH A CHILD'S HAND OUTSTRETCHED TOWARDS THE CENTER, WITH THE WORDS "FIVE & ALIVE" PRINTED UNDER THE GLOBE.

SER. NO. 77-353,730, FILED 12-17-2007.

ELISSA GARBER KON, EXAMINING ATTORNEY

Int. Cls.: 35 and 42

Prior U.S. Cls.: 100, 101 and 102

United States Patent and Trademark Office

Reg. No. 3,484,074

Registered Aug. 12, 2008

**SERVICE MARK
PRINCIPAL REGISTER**



NATIONAL BOARD FOR PROFESSIONAL
TEACHING STANDARDS, INC. (DELAWARE
NON-PROFIT CORPORATION)
1525 WILSON BOULEVARD, SUITE 500
ARLINGTON, VA 22209

FOR: ASSOCIATION SERVICES, NAMELY, PROMOTING THE INTERESTS OF TEACHERS THROUGH THE ESTABLISHMENT OF STANDARDS FOR CERTIFICATION AND ASSESSMENT AND THE TESTING OF TEACHING SERVICES, IN CLASS 35 (U.S. CLS. 100, 101 AND 102).

FIRST USE 12-4-2007; IN COMMERCE 12-4-2007.

FOR: PROVIDING INFORMATION VIA THE INTERNET IN THE FIELD OF CERTIFICATION OF TEACHING SERVICES, NAMELY, PROVIDING INFORMATION RELATING TO THE CERTIFICATION OF ACCOMPLISHED TEACHERS, VIA THE INTERNET, IN CLASS 42 (U.S. CLS. 100 AND 101).

FIRST USE 12-4-2007; IN COMMERCE 12-4-2007.

OWNER OF U.S. REG. NOS. 1,893,850 AND 3,073,349.

NO CLAIM IS MADE TO THE EXCLUSIVE RIGHT TO USE "BOARD CERTIFICATION DAY", APART FROM THE MARK AS SHOWN.

THE COLOR(S) ORANGE, LIGHT BLUE, DARK BLUE, AND WHITE IS/ARE CLAIMED AS A FEATURE OF THE MARK.

THE MARK CONSISTS OF THE WORDING "NATIONAL BOARD CERTIFICATION DAY" AND "ADVANCING EXCELLENCE IN TEACHING," WHICH IS UNDERLINED AND APPEARS TO THE RIGHT OF A CIRCULAR DESIGN ELEMENT FEATURING A HUMAN FIGURE. THE COLOR LIGHT BLUE APPEARS IN THE WORDING "NATIONAL BOARD" AND "ADVANCING EXCELLENCE IN TEACHING." THE COLOR DARK BLUE APPEARS IN THE WORDING "CERTIFICATION DAY" AND IN PART OF THE OUTLINE OF THE HUMAN FIGURE. THE COLOR ORANGE APPEARS IN THE CIRCULAR DESIGN ELEMENT AND IN THE LINE THAT UNDERLINES THE LITERAL ELEMENT OF THE MARK. THE COLOR WHITE APPEARS IN THE DEPICTION OF THE HUMAN FIGURE FEATURED IN THE DESIGN ELEMENT.

SEC. 2(F) AS TO "NATIONAL".

SER. NO. 77-353,732, FILED 12-17-2007.

ROBERT LAVACHE, EXAMINING ATTORNEY

Int. Cl.: 35

Prior U.S. Cls.: 100, 101 and 102

United States Patent and Trademark Office

Reg. No. 3,484,075

Registered Aug. 12, 2008

**SERVICE MARK
PRINCIPAL REGISTER**

AskForensics

ASKFORENSICS, LLC (GEORGIA LTD LIAB CO)
SUITE 125
2100 POWERS FERRY ROAD
ATLANTA, GA 30339

FOR: BUSINESS MANAGEMENT CONSULTING WITH RELATION TO STRATEGY, MARKETING, PRODUCTION, PERSONNEL AND RETAIL SALE MATTERS; CREATION OF MARKETING TOOLS DESIGNED TO INCREASE A CLIENT COMPANY'S KNOWLEDGE OF CUSTOMER NEEDS, AND ITS COMPETITORS' PRODUCTS AND SERVICES, PRICING, ADVERTISING STRATEGY AND SALES STRATEGY; PROVIDING INTERACTIVE SALES ASSESSMENT SERVICES VIA THE TELEPHONE

FOR MEASURING THE SKILLS AND KNOWLEDGE OF FIELD SALES FORCES IN REAL WORLD SELLING SITUATIONS, IN CLASS 35 (U.S. CLS. 100, 101 AND 102).

FIRST USE 4-24-2005; IN COMMERCE 4-24-2005.

THE MARK CONSISTS OF STANDARD CHARACTERS WITHOUT CLAIM TO ANY PARTICULAR FONT, STYLE, SIZE, OR COLOR.

SER. NO. 77-353,780, FILED 12-17-2007.

MICHAEL GAAFAR, EXAMINING ATTORNEY

Int. Cl.: 41

Prior U.S. Cls.: 100, 101 and 107

United States Patent and Trademark Office

Reg. No. 3,484,076

Registered Aug. 12, 2008

**SERVICE MARK
PRINCIPAL REGISTER**

Mental Nutrition

MITZI DULAN, LLC (KANSAS LTD LIAB CO)
14330 JUNIPER
LEAWOOD, KS 66224

FOR: EDUCATION SERVICES, NAMELY, PROVIDING SEMINARS, WORKSHOPS, AND CONFERENCES IN THE FIELD OF IMPROVEMENT OF PERSONAL AND PROFESSIONAL HUMAN PERFORMANCE, IN CLASS 41 (U.S. CLS. 100, 101 AND 107).

FIRST USE 7-8-2007; IN COMMERCE 9-25-2007.

THE MARK CONSISTS OF STANDARD CHARACTERS WITHOUT CLAIM TO ANY PARTICULAR FONT, STYLE, SIZE, OR COLOR.

NO CLAIM IS MADE TO THE EXCLUSIVE RIGHT TO USE "NUTRITION", APART FROM THE MARK AS SHOWN.

SER. NO. 77-353,897, FILED 12-17-2007.

PAUL CROWLEY, EXAMINING ATTORNEY

Int. Cl.: 42

Prior U.S. Cls.: 100 and 101

United States Patent and Trademark Office

Reg. No. 3,484,077

Registered Aug. 12, 2008

**SERVICE MARK
PRINCIPAL REGISTER**



THE WINE COMPANY (MINNESOTA CORPORATION)
425 WEST MINNEHAHA AVENUE
ST. PAUL, MN 55103

FOR: HOSTING AN ONLINE COMMUNITY WEBSITE FEATURING INFORMATION ABOUT WINE, WINE AND FOOD PAIRINGS, WINE SERVICE AND SALES OF WINE THROUGH LOCAL RETAILERS, IN CLASS 42 (U.S. CLS. 100 AND 101).

FIRST USE 7-1-2007; IN COMMERCE 9-24-2007.

THE COLOR(S) GREEN, BROWN, WHITE AND GREY IS/ARE CLAIMED AS A FEATURE OF THE MARK.

THE MARK CONSISTS OF GREEN LEAF ON BROWN CIRCULAR BACKGROUND WITH THE WORDS "ARTISAN VINEYARDS" IN WHITE CIRCLING ABOVE AND BELOW THE LEAF, RESPECTIVELY; THERE IS A GREY CIRCULAR SHADOW UNDERNEATH THE CIRCULAR BACKGROUND; AND THE GREEN STEM OF THE LEAF CURLS UP TO THE RIGHT BETWEEN THE LETTERS "S" AND "A" OF THE WORD "ARTISAN".

SER. NO. 77-353,994, FILED 12-17-2007.

TINA L. SNAPP, EXAMINING ATTORNEY

Int. Cl.: 42

Prior U.S. Cls.: 100 and 101

United States Patent and Trademark Office

Reg. No. 3,484,078

Registered Aug. 12, 2008

**SERVICE MARK
PRINCIPAL REGISTER**



BALKCOM, ANDREW (UNITED STATES INDIVIDUAL)
353 MAC ARTHUR BLVD
OAKLAND, CA 94610

THE MARK CONSISTS OF THE WORDING "AFLEEXO" BELOW A MISCELLANEOUS DESIGN WITH OVERALL TRIANGULAR SHAPE.

FOR: CUSTOM DESIGN OF WEARABLE APPAREL AND CAR WHEELS BASED ON PERSONAL SELECTIONS MADE BY THE CUSTOMER, IN CLASS 42 (U.S. CLS. 100 AND 101).

SER. NO. 77-354,032, FILED 12-17-2007.

FIRST USE 11-3-2003; IN COMMERCE 11-12-2003.

BARBARA RUTLAND, EXAMINING ATTORNEY

Int. Cl.: 28

Prior U.S. Cls.: 22, 23, 38 and 50

Reg. No. 3,484,079

United States Patent and Trademark Office

Registered Aug. 12, 2008

**TRADEMARK
PRINCIPAL REGISTER**

CROSS-BOLA

MATTEL, INC. (DELAWARE CORPORATION)
M1-1518
333 CONTINENTAL BLVD.
EL SEGUNDO, CA 90245

FOR: TOYS, GAMES AND PLAYTHINGS, NAME-
LY, TOY ACTION FIGURES, TOY FIGURES, AND
ACCESSORIES FOR ALL OF THE FOREGOING, IN
CLASS 28 (U.S. CLS. 22, 23, 38 AND 50).

FIRST USE 4-9-2008; IN COMMERCE 4-9-2008.

THE MARK CONSISTS OF STANDARD CHAR-
ACTERS WITHOUT CLAIM TO ANY PARTICULAR
FONT, STYLE, SIZE, OR COLOR.

OWNER OF U.S. REG. NO. 1,549,313.

SER. NO. 77-354,098, FILED 12-17-2007.

BARBARA GAYNOR, EXAMINING ATTORNEY

Int. Cl.: 28

Prior U.S. Cls.: 22, 23, 38 and 50

United States Patent and Trademark Office

Reg. No. 3,484,080

Registered Aug. 12, 2008

**TRADEMARK
PRINCIPAL REGISTER**

STEALTH LAUNCH

MATTEL, INC. (DELAWARE CORPORATION)
M1-1518
333 CONTINENTAL BLVD.
EL SEGUNDO, CA 90245

FOR: TOYS, GAMES AND PLAYTHINGS, NAME-
LY, TOY VEHICLES AND ACCESSORIES THERE-
FOR, IN CLASS 28 (U.S. CLS. 22, 23, 38 AND 50).

FIRST USE 4-9-2008; IN COMMERCE 4-9-2008.

THE MARK CONSISTS OF STANDARD CHAR-
ACTERS WITHOUT CLAIM TO ANY PARTICULAR
FONT, STYLE, SIZE, OR COLOR.

OWNER OF U.S. REG. NOS. 3,113,979 AND
3,271,686.

SER. NO. 77-354,102, FILED 12-17-2007.

BARBARA GAYNOR, EXAMINING ATTORNEY

Int. Cl.: 35

Prior U.S. Cls.: 100, 101 and 102

United States Patent and Trademark Office

Reg. No. 3,484,081

Registered Aug. 12, 2008

**SERVICE MARK
PRINCIPAL REGISTER**

ALPHA & LEADER U.S.

USA CHINA LAW GROUP, INC. (DELAWARE CORPORATION), DBA ALPHA & LEADER US
22917 PACIFIC COAST HIGHWAY, SUITE 350
MALIBU, CA 90265

FOR: PROVIDING MARKETING AND PROMOTIONAL SERVICES, NAMELY, PROVIDING SERVICES TO INVESTORS, BUSINESSES AND LAW FIRMS TO ESTABLISH OR EXPAND THEIR PRESENCE IN THE PEOPLE'S REPUBLIC OF CHINA, IN CLASS 35 (U.S. CLS. 100, 101 AND 102).

FIRST USE 9-24-2007; IN COMMERCE 9-24-2007.

THE MARK CONSISTS OF STANDARD CHARACTERS WITHOUT CLAIM TO ANY PARTICULAR FONT, STYLE, SIZE, OR COLOR.

NO CLAIM IS MADE TO THE EXCLUSIVE RIGHT TO USE "U.S.", APART FROM THE MARK AS SHOWN.

SER. NO. 77-354,159, FILED 12-17-2007.

NAAKWAMA ANKRAH, EXAMINING ATTORNEY

Int. Cl.: 35

Prior U.S. Cls.: 100, 101 and 102

United States Patent and Trademark Office

Reg. No. 3,484,082

Registered Aug. 12, 2008

**SERVICE MARK
PRINCIPAL REGISTER**

Compr@mericA

COMPRAMERICA PANAMA, INC. (PANAMA CORPORATION)
EDIF DE LA CLIN. ODON. ARANGO ORILLAC
MARBELLA CALLE 54
PANAMA CITY, PANAMA

FOR: ON-LINE RETAIL STORE SERVICES FEATURING A WIDE RANGE OF CONSUMER GOODS OF OTHERS, IN CLASS 35 (U.S. CLS. 100, 101 AND 102).

FIRST USE 12-0-1999; IN COMMERCE 12-0-1999.

THE MARK CONSISTS OF THE MARK CONSISTS OF THE WORD "COMPRAMERICA" WITH THE INITIAL "A" STYLIZED AS AN "@".

THE FOREIGN WORDING IN THE MARK TRANSLATES INTO ENGLISH AS PURCHASE.

SER. NO. 77-354,273, FILED 12-18-2007.

MICHAEL TANNER, EXAMINING ATTORNEY

Int. Cl.: 35

Prior U.S. Cls.: 100, 101 and 102

United States Patent and Trademark Office

Reg. No. 3,484,083

Registered Aug. 12, 2008

SERVICE MARK
PRINCIPAL REGISTER

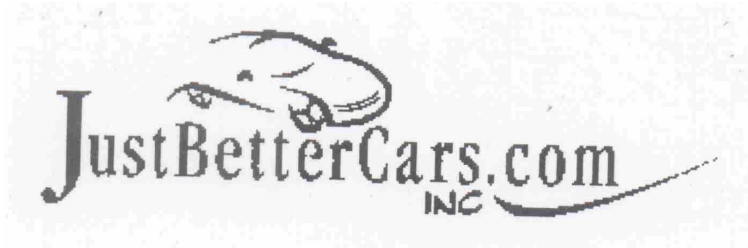

JUSTBETTERCARS.COM (CALIFORNIA CORPORATION)
403 RIVERSIDE AVE.
ROSEVILLE, CA 95678

FOR: DEALERSHIPS IN THE FIELD OF AUTOMOBILES, IN CLASS 35 (U.S. CLS. 100, 101 AND 102).

FIRST USE 10-1-2005; IN COMMERCE 10-1-2005.

NO CLAIM IS MADE TO THE EXCLUSIVE RIGHT TO USE "INC", APART FROM THE MARK AS SHOWN.

THE MARK CONSISTS OF A STYLIZED IMAGE OF A CAR ON TOP OF THE COMPANY NAME "JUSTBETTERCARS.COM" WITH "INC" UNDERNEATH AND A CURVED LINE DESIGN.

SER. NO. 77-354,476, FILED 12-18-2007.

SUNG IN, EXAMINING ATTORNEY

Int. Cl.: 35

Prior U.S. Cls.: 100, 101 and 102

United States Patent and Trademark Office

Reg. No. 3,484,084

Registered Aug. 12, 2008

**SERVICE MARK
PRINCIPAL REGISTER**

WEAR ART

JEWELRY BY S.A. GAUTHIER, INC. (ARIZONA
CORPORATION)
4211 NORTH MARSHALL WAY
SCOTTSDALE, AZ 85251

THE MARK CONSISTS OF STANDARD CHAR-
ACTERS WITHOUT CLAIM TO ANY PARTICULAR
FONT, STYLE, SIZE, OR COLOR.

FOR: RETAIL STORE SERVICES FEATURING
JEWELRY, IN CLASS 35 (U.S. CLS. 100, 101 AND 102).

SER. NO. 77-354,498, FILED 12-18-2007.

FIRST USE 3-17-1994; IN COMMERCE 3-17-1994.

MARY MUNSON, EXAMINING ATTORNEY

Int. Cl.: 42

Prior U.S. Cls.: 100 and 101

United States Patent and Trademark Office

Reg. No. 3,484,085

Registered Aug. 12, 2008

**SERVICE MARK
PRINCIPAL REGISTER**

VERITOCRACY

VERITOCRACY LLC (NEW YORK LTD LIAB CO)
111 E. 85TH ST, SUITE 21D
NEW YORK, NY 10028

FOR: COMPUTER SERVICES, NAMELY, HOST-
ING AND MAINTAINING AN ONLINE WEBSITE
FOR OTHERS TO WRITE ARTICLES ABOUT MO-
VIES, STOCKS, AND POLITICS, IN CLASS 42 (U.S.
CLS. 100 AND 101).

FIRST USE 12-1-2006; IN COMMERCE 11-22-2007.

THE MARK CONSISTS OF STANDARD CHAR-
ACTERS WITHOUT CLAIM TO ANY PARTICULAR
FONT, STYLE, SIZE, OR COLOR.

SER. NO. 77-354,554, FILED 12-18-2007.

JAMES A. RAUEN, EXAMINING ATTORNEY

Int. Cl.: 9

Prior U.S. Cls.: 21, 23, 26, 36 and 38

Reg. No. 3,484,086

United States Patent and Trademark Office

Registered Aug. 12, 2008

**TRADEMARK
PRINCIPAL REGISTER**

CONTROLKOM

ATLAS SOUND LP (TEXAS LIMITED PARTNER-
SHIP)
4545 EAST BASELINE ROAD
PHOENIX, AZ 85040

FOR: CONTROL SOFTWARE FOR PAGING,
MESSAGING AND CLOCK/BELL CONTROL FOR
PRIMARY AND SECONDARY EDUCATIONAL FA-
CILITIES, IN CLASS 9 (U.S. CLS. 21, 23, 26, 36 AND
38).

FIRST USE 6-0-2007; IN COMMERCE 6-0-2007.

THE MARK CONSISTS OF STANDARD CHAR-
ACTERS WITHOUT CLAIM TO ANY PARTICULAR
FONT, STYLE, SIZE, OR COLOR.

SER. NO. 77-354,577, FILED 12-18-2007.

CURTIS FRENCH, EXAMINING ATTORNEY

Int. Cl.: 33

Prior U.S. Cls.: 47 and 49

United States Patent and Trademark Office

Reg. No. 3,484,087

Registered Aug. 12, 2008

**TRADEMARK
PRINCIPAL REGISTER**

LA CANCION DE JONATA

COOL HAND VINEYARDS, LLC (CALIFORNIA
LTD LIAB CO)
123 EL PASEO
SANTA BARBARA, CA 93101

THE FOREIGN WORDING IN THE MARK
TRANSLATES INTO ENGLISH AS "THE SONG OF
JONATA".

FOR: WINE, IN CLASS 33 (U.S. CLS. 47 AND 49).

FIRST USE 7-18-2007; IN COMMERCE 7-18-2007.

SER. NO. 77-354,600, FILED 12-18-2007.

THE MARK CONSISTS OF STANDARD CHAR-
ACTERS WITHOUT CLAIM TO ANY PARTICULAR
FONT, STYLE, SIZE, OR COLOR.

JORDAN BAKER, EXAMINING ATTORNEY

Int. Cl.: 33

Prior U.S. Cls.: 47 and 49

United States Patent and Trademark Office

Reg. No. 3,484,088

Registered Aug. 12, 2008

**TRADEMARK
PRINCIPAL REGISTER**

LA POESIA DE JONATA

COOL HAND VINEYARDS, LLC (CALIFORNIA
LTD LIAB CO)
123 EL PASEO
SANTA BARBARA, CA 93101

THE FOREIGN WORDING IN THE MARK
TRANSLATES INTO ENGLISH AS "THE POETRY
OF JONATA".

FOR: WINE, IN CLASS 33 (U.S. CLS. 47 AND 49).

FIRST USE 10-0-2007; IN COMMERCE 10-0-2007.

SER. NO. 77-354,608, FILED 12-18-2007.

THE MARK CONSISTS OF STANDARD CHAR-
ACTERS WITHOUT CLAIM TO ANY PARTICULAR
FONT, STYLE, SIZE, OR COLOR.

JORDAN BAKER, EXAMINING ATTORNEY

Int. Cls.: 13 and 41

Prior U.S. Cls.: 2, 9, 100, 101 and 107

United States Patent and Trademark Office

Reg. No. 3,484,089

Registered Aug. 12, 2008

**TRADEMARK
SERVICE MARK
PRINCIPAL REGISTER**



SECURITY WITH ADVANCED TECHNOLOGY,
INC. (COLORADO CORPORATION)
SUITE 1000
10855 DOVER STREET
WESTMINSTER, CO 80021

FOR: NON-LETHAL WEAPONS, NAMELY, SEMI-AUTOMATIC PISTOL AND RIFLE LAUNCHERS FOR FRANGIBLE PROJECTILES; PROJECTILES; FIREARM CONVERSION KITS COMPOSED OF A REPLACEMENT BARREL AND REPLACEMENT MAGAZINE; MUNITIONS, GUNS, AND FIREARMS USED FOR SIMULATION PURPOSES, IN CLASS 13 (U.S. CLS. 2 AND 9).

FIRST USE 4-30-2007; IN COMMERCE 4-30-2007.

FOR: TRAINING CLASSES FEATURING EXERCISES IN THE AREAS OF WEAPON USE AND FIREARM CONVERSION, IN CLASS 41 (U.S. CLS. 100, 101 AND 107).

FIRST USE 10-31-2006; IN COMMERCE 10-31-2006.

THE MARK CONSISTS OF A STYLIZED HAWK.

SER. NO. 77-354,634, FILED 12-18-2007.

MICHELE SWAIN, EXAMINING ATTORNEY

Int. Cl.: 33

Prior U.S. Cls.: 47 and 49

United States Patent and Trademark Office

Reg. No. 3,484,090

Registered Aug. 12, 2008

**TRADEMARK
PRINCIPAL REGISTER**

LA MIEL DE JONATA

COOL HAND VINEYARDS, LLC (CALIFORNIA
LTD LIAB CO)
123 EL PASEO
SANTA BARBARA, CA 93101

THE FOREIGN WORDING IN THE MARK
TRANSLATES INTO ENGLISH AS "THE HONEY
OF JONATA".

FOR: WINE, IN CLASS 33 (U.S. CLS. 47 AND 49).

FIRST USE 5-21-2007; IN COMMERCE 5-21-2007.

SER. NO. 77-354,650, FILED 12-18-2007.

THE MARK CONSISTS OF STANDARD CHAR-
ACTERS WITHOUT CLAIM TO ANY PARTICULAR
FONT, STYLE, SIZE, OR COLOR.

JORDAN BAKER, EXAMINING ATTORNEY

Int. Cl.: 33

Prior U.S. Cls.: 47 and 49

United States Patent and Trademark Office

Reg. No. 3,484,091

Registered Aug. 12, 2008

**TRADEMARK
PRINCIPAL REGISTER**

LA SANGRE DE JONATA

COOL HAND VINEYARDS, LLC (CALIFORNIA
LTD LIAB CO)
123 EL PASEO
SANTA BARBARA, CA 93101

THE FOREIGN WORDING IN THE MARK
TRANSLATES INTO ENGLISH AS "THE BLOOD
OF JONATA".

FOR: WINE, IN CLASS 33 (U.S. CLS. 47 AND 49).

FIRST USE 8-0-2007; IN COMMERCE 8-0-2007.

SER. NO. 77-354,653, FILED 12-18-2007.

THE MARK CONSISTS OF STANDARD CHAR-
ACTERS WITHOUT CLAIM TO ANY PARTICULAR
FONT, STYLE, SIZE, OR COLOR.

JORDAN BAKER, EXAMINING ATTORNEY

Int. Cl.: 33

Prior U.S. Cls.: 47 and 49

United States Patent and Trademark Office

Reg. No. 3,484,092

Registered Aug. 12, 2008

**TRADEMARK
PRINCIPAL REGISTER**

LA FLOR DE JONATA

COOL HAND VINEYARDS, LLC (CALIFORNIA
LTD LIAB CO)
123 EL PASEO
SANTA BARBARA, CA 93101

THE FOREIGN WORDING IN THE MARK
TRANSLATES INTO ENGLISH AS "THE FLOWER
OF JONATA".

FOR: WINE, IN CLASS 33 (U.S. CLS. 47 AND 49).

FIRST USE 5-21-2007; IN COMMERCE 5-21-2007.

SER. NO. 77-354,657, FILED 12-18-2007.

THE MARK CONSISTS OF STANDARD CHAR-
ACTERS WITHOUT CLAIM TO ANY PARTICULAR
FONT, STYLE, SIZE, OR COLOR.

JORDAN BAKER, EXAMINING ATTORNEY

Int. Cl.: 33

Prior U.S. Cls.: 47 and 49

United States Patent and Trademark Office

Reg. No. 3,484,093

Registered Aug. 12, 2008

**TRADEMARK
PRINCIPAL REGISTER**

EL ALMA DE JONATA

COOL HAND VINEYARDS, LLC (CALIFORNIA
LTD LIAB CO)
123 EL PASEO
SANTA BARBARA, CA 93101

THE FOREIGN WORDING IN THE MARK
TRANSLATES INTO ENGLISH AS "THE SOUL OF
JONATA".

FOR: WINE, IN CLASS 33 (U.S. CLS. 47 AND 49).

FIRST USE 5-21-2007; IN COMMERCE 5-21-2007.

SER. NO. 77-354,660, FILED 12-18-2007.

THE MARK CONSISTS OF STANDARD CHAR-
ACTERS WITHOUT CLAIM TO ANY PARTICULAR
FONT, STYLE, SIZE, OR COLOR.

JORDAN BAKER, EXAMINING ATTORNEY

Int. Cl.: 33

Prior U.S. Cls.: 47 and 49

United States Patent and Trademark Office

Reg. No. 3,484,094

Registered Aug. 12, 2008

**TRADEMARK
PRINCIPAL REGISTER**

LA FUERZA DE JONATA

COOL HAND VINEYARDS, LLC (CALIFORNIA
LTD LIAB CO)
123 EL PASEO
SANTA BARBARA, CA 93101

THE FOREIGN WORDING IN THE MARK
TRANSLATES INTO ENGLISH AS "THE
STRENGTH OF JONATA".

FOR: WINE, IN CLASS 33 (U.S. CLS. 47 AND 49).

FIRST USE 8-0-2007; IN COMMERCE 8-0-2007.

SER. NO. 77-354,661, FILED 12-18-2007.

THE MARK CONSISTS OF STANDARD CHAR-
ACTERS WITHOUT CLAIM TO ANY PARTICULAR
FONT, STYLE, SIZE, OR COLOR.

JORDAN BAKER, EXAMINING ATTORNEY

Int. Cl.: 33

Prior U.S. Cls.: 47 and 49

United States Patent and Trademark Office

Reg. No. 3,484,095

Registered Aug. 12, 2008

**TRADEMARK
PRINCIPAL REGISTER**

EL CORAZON DE JONATA

COOL HAND VINEYARDS, LLC (CALIFORNIA
LTD LIAB CO)
123 EL PASEO
SANTA BARBARA, CA 93101

THE FOREIGN WORDING IN THE MARK
TRANSLATES INTO ENGLISH AS "THE HEART
OF JONATA".

FOR: WINE, IN CLASS 33 (U.S. CLS. 47 AND 49).

FIRST USE 5-21-2007; IN COMMERCE 5-21-2007.

SER. NO. 77-354,662, FILED 12-18-2007.

THE MARK CONSISTS OF STANDARD CHAR-
ACTERS WITHOUT CLAIM TO ANY PARTICULAR
FONT, STYLE, SIZE, OR COLOR.

JORDAN BAKER, EXAMINING ATTORNEY

Int. Cl.: 33

Prior U.S. Cls.: 47 and 49

United States Patent and Trademark Office

Reg. No. 3,484,096

Registered Aug. 12, 2008

**TRADEMARK
PRINCIPAL REGISTER**

EL DESAFIO DE JONATA

COOL HAND VINEYARDS, LLC (CALIFORNIA
LTD LIAB CO)
123 EL PASEO
SANTA BARBARA, CA 93101

THE FOREIGN WORDING IN THE MARK
TRANSLATES INTO ENGLISH AS "THE CHAL-
LENGE OF JONATA".

FOR: WINE, IN CLASS 33 (U.S. CLS. 47 AND 49).

FIRST USE 5-21-2007; IN COMMERCE 5-21-2007.

SER. NO. 77-354,666, FILED 12-18-2007.

THE MARK CONSISTS OF STANDARD CHAR-
ACTERS WITHOUT CLAIM TO ANY PARTICULAR
FONT, STYLE, SIZE, OR COLOR.

JORDAN BAKER, EXAMINING ATTORNEY

Int. Cl.: 33

Prior U.S. Cls.: 47 and 49

United States Patent and Trademark Office

Reg. No. 3,484,097

Registered Aug. 12, 2008

**TRADEMARK
PRINCIPAL REGISTER**

LA TIERRA DE JONATA

COOL HAND VINEYARDS, LLC (CALIFORNIA
LTD LIAB CO)
123 EL PASEO
SANTA BARBARA, CA 93101

THE FOREIGN WORDING IN THE MARK
TRANSLATES INTO ENGLISH AS "THE LAND OF
JONATA" OR "THE EARTH OF JONATA".

FOR: WINE, IN CLASS 33 (U.S. CLS. 47 AND 49).

FIRST USE 8-0-2007; IN COMMERCE 8-0-2007.

SER. NO. 77-354,668, FILED 12-18-2007.

THE MARK CONSISTS OF STANDARD CHAR-
ACTERS WITHOUT CLAIM TO ANY PARTICULAR
FONT, STYLE, SIZE, OR COLOR.

JORDAN BAKER, EXAMINING ATTORNEY

Int. Cl.: 35

Prior U.S. Cls.: 100, 101 and 102

United States Patent and Trademark Office

Reg. No. 3,484,098

Registered Aug. 12, 2008

**SERVICE MARK
PRINCIPAL REGISTER**

ESSENTIALS PLUS

ESSENTIALS PLUS CORP. (NEW YORK CORPORATION)
2259 BROADWAY
NEW YORK, NY 10024

THE MARK CONSISTS OF THE WORDS "ESSENTIALS PLUS" WITH THE WORD "PLUS" FACING IN AN UP AND DOWN DIRECTION.

FOR: RETAIL STORES FEATURING HEALTH AND BEAUTY AIDS, PERSONAL CARE APPLIANCES AND ACCESSORIES, IN CLASS 35 (U.S. CLS. 100, 101 AND 102).

SER. NO. 77-354,694, FILED 12-18-2007.

FIRST USE 8-31-1991; IN COMMERCE 8-31-1991.

BRIAN NEVILLE, EXAMINING ATTORNEY

Int. Cl.: 36

Prior U.S. Cls.: 100, 101 and 102

United States Patent and Trademark Office

Reg. No. 3,484,099

Registered Aug. 12, 2008

**SERVICE MARK
PRINCIPAL REGISTER**

GREGORY FUNDING

GREGORY FUNDING LLC (OREGON LTD LIAB
CO)
SUITE 306
425 NW 10TH AVENUE
PORTLAND, OR 97209

FOR: MORTGAGE LENDING, LEASE-PUR-
CHASE LOANS, LEASE-PURCHASE FINANCING,
LEASING OF REAL PROPERTY, FINANCIAL
LOAN CONSULTATION, LOAN REFINANCING,
IN CLASS 36 (U.S. CLS. 100, 101 AND 102).

FIRST USE 4-1-2004; IN COMMERCE 4-1-2004.

THE MARK CONSISTS OF STANDARD CHAR-
ACTERS WITHOUT CLAIM TO ANY PARTICULAR
FONT, STYLE, SIZE, OR COLOR.

NO CLAIM IS MADE TO THE EXCLUSIVE
RIGHT TO USE "FUNDING", APART FROM THE
MARK AS SHOWN.

SER. NO. 77-355,246, FILED 12-18-2007.

REBECCA EISINGER, EXAMINING ATTORNEY

Int. Cl.: 25

Prior U.S. Cls.: 22 and 39

United States Patent and Trademark Office

Reg. No. 3,484,100

Registered Aug. 12, 2008

**TRADEMARK
PRINCIPAL REGISTER**



THE MARITEX GROUP, INC. (PENNSYLVANIA CORPORATION), DBA KEYSTONE WORKWEAR
57 S COMMERCE WAY
BETHLEHEM, PA 18017

NO CLAIM IS MADE TO THE EXCLUSIVE RIGHT TO USE "TRADEMARK," "KEYSTONE WORKWEAR" AND "GUARANTEED", APART FROM THE MARK AS SHOWN.

FOR: WORKING OVERALLS, IN CLASS 25 (U.S. CLS. 22 AND 39).

SER. NO. 77-355,304, FILED 12-19-2007.

FIRST USE 9-1-2003; IN COMMERCE 9-1-2003.

JORDAN BAKER, EXAMINING ATTORNEY

Int. Cl.: 1

Prior U.S. Cls.: 1, 5, 6, 10, 26 and 46

Reg. No. 3,484,101

United States Patent and Trademark Office

Registered Aug. 12, 2008

**TRADEMARK
PRINCIPAL REGISTER**

AQUA FINESSE

SPECIAL WATER HOLDING B.V. (NETHERLANDS LTD LIAB CO)
PLESMANSTRAAT 50
VEENENDAAL, NETHERLANDS 3905KZ

FOR: WATER TREATMENT CHEMICALS FOR USE IN HOT TUBS, POOLS AND COOLING SYSTEMS FOR MANUFACTURING PROCESSES, IN CLASS 1 (U.S. CLS. 1, 5, 6, 10, 26 AND 46).

FIRST USE 10-1-2005; IN COMMERCE 10-1-2005.

THE MARK CONSISTS OF STANDARD CHARACTERS WITHOUT CLAIM TO ANY PARTICULAR FONT, STYLE, SIZE, OR COLOR.

NO CLAIM IS MADE TO THE EXCLUSIVE RIGHT TO USE "AQUA", APART FROM THE MARK AS SHOWN.

SER. NO. 77-355,482, FILED 12-19-2007.

WARREN L. OLANDRIA, EXAMINING ATTORNEY

Int. Cl.: 42

Prior U.S. Cls.: 100 and 101

United States Patent and Trademark Office

Reg. No. 3,484,102

Registered Aug. 12, 2008

**SERVICE MARK
PRINCIPAL REGISTER**



GNOSTECH INC. (PENNSYLVANIA CORPORATION)
SUITE 190
650 LOUIS DRIVE
WARMINSTER, PA 18974

FOR: COMPUTER CONSULTATION IN THE
FIELD OF COMPUTER SECURITY, IN CLASS 42
(U.S. CLS. 100 AND 101).

FIRST USE 9-20-1999; IN COMMERCE 9-20-1999.

THE COLOR(S) RED, BLUE, WHITE AND BLACK
IS/ARE CLAIMED AS A FEATURE OF THE MARK.

THE MARK CONSISTS OF THE STYLIZED LET-
TERS "GI". THE LETTER "G" IS BLUE WITH A
THIN STRIP OF WHITE THROUGH THE CENTER

AT THE TOP AND BOTTOM AND BLACK SHAD-
ING ON THE EDGES. THE LETTER "I" IS PART OF
THE LETTER "G", THE ARM OF THE "G" CREATES
THE BODY OF THE LETTER "I." THE "DOT" OF
THE "I" IS RED WITH A SMALL WHITE CIRCLE IN
THE CENTER AND BLACK SHADING ON THE
EDGES. THERE IS A SWOOP STARTING AT THE
"DOT" OF THE "I" WHICH EXTENDS AROUND TO
THE BACK OF THE LETTER "G" AS IF TO CREATE
AN OVAL SHAPE. THE SWOOP DESIGN IS RED
WITH A WHITE STRIPE THROUGH THE CENTER
AT THE TOP AND BOTTOM OF THE SWOOP AND
BLACK SHADING ALONG THE EDGES.

SER. NO. 77-355,580, FILED 12-19-2007.

WENDY GOODMAN, EXAMINING ATTORNEY

Int. Cls.: 36, 41 and 42

Prior U.S. Cls.: 100, 101, 102 and 107

United States Patent and Trademark Office

Reg. No. 3,484,103

Registered Aug. 12, 2008

**SERVICE MARK
PRINCIPAL REGISTER**

VAN ANDEL INSTITUTE

VAN ANDEL INSTITUTE (MICHIGAN CHARITABLE TRUST)
333 BOSTWICK AVENUE NE
GRAND RAPIDS, MI 49503

FOR: PROVIDING EDUCATIONAL SCHOLARSHIPS, IN CLASS 36 (U.S. CLS. 100, 101 AND 102).

FIRST USE 5-31-2000; IN COMMERCE 5-31-2000.

FOR: EDUCATIONAL SERVICES, NAMELY, PROVIDING A GRADUATE PROGRAM, AN ACADEMY, CLASSES, AND SEMINARS IN THE FIELDS OF EDUCATION, MOLECULAR BIOLOGY AND MEDICINE; PROVIDING INTERNSHIPS IN THE FIELD OF MOLECULAR BIOLOGY AND MEDICINE; AND ORGANIZATION OF SYMPOSIA IN THE FIELDS OF EDUCATION, MOLECULAR BIOLOGY AND MEDICINE, IN CLASS 41 (U.S. CLS. 100, 101 AND 107).

FIRST USE 12-2-1996; IN COMMERCE 12-2-1996.

FOR: MEDICAL AND SCIENTIFIC RESEARCH AND CONSULTING IN THE FIELDS OF CANCER, HEMATOLOGY, OPTICAL DISORDERS, NEURODEGENERATIVE DISORDERS, CARDIOVASCULAR DISORDERS, AND BONE AND JOINT

DISORDERS; PROVIDING SCIENTIFIC INFORMATION IN THE FIELDS OF CANCER, HEMATOLOGY, OPTICAL DISORDERS, NEURODEGENERATIVE DISORDERS, CARDIOVASCULAR DISORDERS, AND BONE AND JOINT DISORDERS; RESEARCH AND DEVELOPMENT OF PHARMACEUTICAL PREPARATIONS, IN CLASS 42 (U.S. CLS. 100 AND 101).

FIRST USE 7-2-1996; IN COMMERCE 7-2-1996.

THE MARK CONSISTS OF STANDARD CHARACTERS WITHOUT CLAIM TO ANY PARTICULAR FONT, STYLE, SIZE, OR COLOR.

OWNER OF U.S. REG. NOS. 2,333,684, 2,814,138, AND 3,120,704.

NO CLAIM IS MADE TO THE EXCLUSIVE RIGHT TO USE "INSTITUTE", APART FROM THE MARK AS SHOWN.

SEC. 2(F).

SER. NO. 77-356,130, FILED 12-19-2007.

KATHRYN COWARD, EXAMINING ATTORNEY

Int. Cl.: 38

Prior U.S. Cls.: 100, 101 and 104

United States Patent and Trademark Office

Reg. No. 3,484,104

Registered Aug. 12, 2008

**SERVICE MARK
PRINCIPAL REGISTER**

**DAN
Display & Alert Network**

UNIVERSITY OF UTAH RESEARCH FOUNDATION (UTAH CORPORATION)
TECHNOLOGY COMMERCIALIZATION OFFICE
615 ARAPEEN DRIVE, SUITE 310
SALT LAKE CITY, UT 84108

FOR: INFORMATION TRANSMISSION VIA ELECTRONIC COMMUNICATIONS NETWORKS, IN CLASS 38 (U.S. CLS. 100, 101 AND 104).

FIRST USE 12-18-2007; IN COMMERCE 12-18-2007.

THE MARK CONSISTS OF STANDARD CHARACTERS WITHOUT CLAIM TO ANY PARTICULAR FONT, STYLE, SIZE, OR COLOR.

NO CLAIM IS MADE TO THE EXCLUSIVE RIGHT TO USE "DISPLAY & ALERT NETWORK", APART FROM THE MARK AS SHOWN.

SER. NO. 77-356,145, FILED 12-19-2007.

HENRY S. ZAK, EXAMINING ATTORNEY

Int. Cl.: 20

Prior U.S. Cls.: 2, 13, 22, 25, 32 and 50

Reg. No. 3,484,105

United States Patent and Trademark Office

Registered Aug. 12, 2008

**TRADEMARK
PRINCIPAL REGISTER**

CRATER-MAX

GLOBAL ENVIRONMENTAL SOLUTIONS, INC.
(NEVADA CORPORATION)
36717 OAK GLEN ROAD
YUCAIPA, CA 92399

FOR: INORGANIC PACKING MATERIAL,
NAMELY, SELECTED POROUS IGNEOUS ROCK
FOR THE PACKING OF BIOLOGICAL SCRUBBERS
USED IN WASTEWATER TREATMENT AND ODOR
CONTROL , IN CLASS 20 (U.S. CLS. 2, 13, 22, 25, 32
AND 50).

FIRST USE 11-1-2007; IN COMMERCE 11-1-2007.

THE MARK CONSISTS OF STANDARD CHAR-
ACTERS WITHOUT CLAIM TO ANY PARTICULAR
FONT, STYLE, SIZE, OR COLOR.

SER. NO. 77-356,233, FILED 12-19-2007.

JAY FLOWERS, EXAMINING ATTORNEY

Int. Cl.: 33

Prior U.S. Cls.: 47 and 49

United States Patent and Trademark Office

Reg. No. 3,484,106

Registered Aug. 12, 2008

**TRADEMARK
PRINCIPAL REGISTER**



TOWNSHEND CELLAR (WASHINGTON SOLE
PROPRIETORSHIP)
16112 N. GREENBLUFF ROAD
COLBERT, WA 99005

FOR: WINE, IN CLASS 33 (U.S. CLS. 47 AND 49).

FIRST USE 9-9-2007; IN COMMERCE 10-1-2007.

THE MARK CONSISTS OF AN IMAGE OF A
TABLE.

SER. NO. 77-356,777, FILED 12-20-2007.

JILL C. ALT, EXAMINING ATTORNEY

Int. Cl.: 35

Prior U.S. Cls.: 100, 101 and 102

United States Patent and Trademark Office

Reg. No. 3,484,107

Registered Aug. 12, 2008

**SERVICE MARK
PRINCIPAL REGISTER**

IPA

INTERNATIONAL PRESS ASSOCIATION, LLC
(NEW JERSEY LTD LIAB CO)
15 CARLOW WAY
HAZLET, NJ 07730

FOR: PROVIDING A WEBSITE AT WHICH PROFESSIONAL PHOTOGRAPHERS, VIDEOGRAPHERS, JOURNALISTS AND NEWS REPORTERS CAN POST PROMOTIONAL PROFILES AND RESPOND TO INQUIRIES FOR THEIR SERVICES, IN CLASS 35 (U.S. CLS. 100, 101 AND 102).

FIRST USE 2-0-1987; IN COMMERCE 8-0-1987.

THE MARK CONSISTS OF STANDARD CHARACTERS WITHOUT CLAIM TO ANY PARTICULAR FONT, STYLE, SIZE, OR COLOR.

SER. NO. 77-356,785, FILED 12-20-2007.

NELSON SNYDER, EXAMINING ATTORNEY

Int. Cls.: 31 and 35

Prior U.S. Cls.: 1, 46, 100, 101 and 102

Reg. No. 3,484,108

United States Patent and Trademark Office

Registered Aug. 12, 2008

**TRADEMARK
SERVICE MARK
PRINCIPAL REGISTER**

GIFT OF GREEN

GREEN MOUNTAIN ENERGY COMPANY (DE-
LAWARE CORPORATION)
300 WEST 6TH STREET, SUITE 900
AUSTIN, TX 78701

FOR: PLANTABLE SEED PAPER COMPRISED OF
AGRICULTURAL SEEDS FOR PLANTING PURPO-
SES, IN CLASS 31 (U.S. CLS. 1 AND 46).

FIRST USE 11-0-2006; IN COMMERCE 11-0-2006.

FOR: CARBON OFFSET PURCHASING AND
PROCUREMENT SERVICES, NAMELY, PURCHAS-
ING AND PROCUREMENT OF CARBON OFFSETS

THROUGH INVESTMENT IN FOREST SEQUES-
TRATION FOR OTHERS, IN CLASS 35 (U.S. CLS.
100, 101 AND 102).

FIRST USE 11-0-2006; IN COMMERCE 11-0-2006.

THE MARK CONSISTS OF STANDARD CHAR-
ACTERS WITHOUT CLAIM TO ANY PARTICULAR
FONT, STYLE, SIZE, OR COLOR.

SER. NO. 77-356,838, FILED 12-20-2007.

JAMES STEIN, EXAMINING ATTORNEY

Int. Cl.: 35

Prior U.S. Cls.: 100, 101 and 102

United States Patent and Trademark Office

Reg. No. 3,484,109

Registered Aug. 12, 2008

**SERVICE MARK
PRINCIPAL REGISTER**

AEE

MICRON METALS, INC. (NEW JERSEY CORPORATION)
13 FOSTER STREET
BERGENFIELD, NJ 07621

FOR: DISTRIBUTORSHIP SERVICES IN THE FIELD OF HIGH PURITY METAL POWDERS AND COMPOUNDS, SPRAY POWDERS, CHEMICALS, AND EXOTIC METALS, IN CLASS 35 (U.S. CLS. 100, 101 AND 102).

FIRST USE 1-1-1978; IN COMMERCE 1-1-1978.

THE MARK CONSISTS OF STANDARD CHARACTERS WITHOUT CLAIM TO ANY PARTICULAR FONT, STYLE, SIZE, OR COLOR.

SER. NO. 77-356,869, FILED 12-20-2007.

KEVON CHISOLM, EXAMINING ATTORNEY

Int. Cl.: 33

Prior U.S. Cls.: 47 and 49

United States Patent and Trademark Office

Reg. No. 3,484,110

Registered Aug. 12, 2008

**TRADEMARK
PRINCIPAL REGISTER**

EXCELEGANCE

LEŞ VINS GEORGES DUBOEUF (FRANCE SOCI-
ETE ANONYME (SA))
ROMANECHÉ-THORINS
LA CHAPELLE DE GUINCHAY, FRANCE 71570

OWNER OF FRANCE REG. NO. 073505021, DA-
TED 6-6-2007, EXPIRES 6-5-2017.

FOR: WINES, IN CLASS 33 (U.S. CLS. 47 AND 49).

SER. NO. 77-356,905, FILED 12-20-2007.

THE MARK CONSISTS OF STANDARD CHAR-
ACTERS WITHOUT CLAIM TO ANY PARTICULAR
FONT, STYLE, SIZE, OR COLOR.

COLLEEN DOMBROW, EXAMINING ATTORNEY

Int. Cls.: 31 and 35

Prior U.S. Cls.: 1, 46, 100, 101 and 102

United States Patent and Trademark Office

Reg. No. 3,484,111

Registered Aug. 12, 2008

**TRADEMARK
SERVICE MARK
PRINCIPAL REGISTER**



GREEN MOUNTAIN ENERGY COMPANY (DE-
LAWARE CORPORATION)
300 WEST 6TH STREET, SUITE 900
AUSTIN, TX 78701

FOR: PLANTABLE SEED PAPER COMPRISED OF
AGRICULTURAL SEEDS FOR PLANTING PURPO-
SES, IN CLASS 31 (U.S. CLS. 1 AND 46).

FIRST USE 11-0-2006; IN COMMERCE 11-0-2006.

FOR: CARBON OFFSET PURCHASING AND
PROCUREMENT SERVICES, NAMELY, PURCHAS-
ING AND PROCUREMENT OF CARBON OFFSETS
THROUGH INVESTMENT IN FOREST SEQUES-

TRATION FOR OTHERS, IN CLASS 35 (U.S. CLS.
100, 101 AND 102).

FIRST USE 11-0-2006; IN COMMERCE 11-0-2006.

THE MARK CONSISTS OF A SPROUTING PLANT
WITH THE WORDS "GIFT OF GREEN", WITH A
STYLIZED "G" AT THE BEGINNING OF THE
WORD "GREEN".

SER. NO. 77-357,099, FILED 12-20-2007.

JAMES STEIN, EXAMINING ATTORNEY

Int. Cl.: 42

Prior U.S. Cls.: 100 and 101

United States Patent and Trademark Office

Reg. No. 3,484,112

Registered Aug. 12, 2008

**SERVICE MARK
PRINCIPAL REGISTER**

WINWEB

WINWEB INTERNATIONAL LIMITED (UNITED
KINGDOM LIMITED COMPANY (LTD.))
10 DOVER STREET
LONDON, UNITED KINGDOM W1S4LQ

FOR: COMPUTER PROGRAMMING FOR OTHERS;
RENTAL OF A DATABASE SERVER (TO THIRD PARTIES);
WEBSITE DESIGN; GRAPHIC DESIGN; DESIGN OF
HOMEPAGES AND WEBSITES; COMPUTER NETWORK
DESIGN FOR OTHERS; COMPUTER CONSULTATIONS
RELATING TO THE AFORESAID SERVICES, IN CLASS 42
(U.S. CLS. 100 AND 101).

THE MARK CONSISTS OF STANDARD CHARACTERS
WITHOUT CLAIM TO ANY PARTICULAR FONT, STYLE,
SIZE, OR COLOR.

OWNER OF UNITED KINGDOM REG. NO. 2301736,
DATED 5-29-2002, EXPIRES 5-29-2012.

SER. NO. 77-357,171, FILED 12-20-2007.

LINDSEY RUBIN, EXAMINING ATTORNEY

Int. Cl.: 40

Prior U.S. Cls.: 100, 103 and 106

United States Patent and Trademark Office

Reg. No. 3,484,113

Registered Aug. 12, 2008

**SERVICE MARK
PRINCIPAL REGISTER**

Portrait Fusion

BEST SOLUTIONS, INC. (NEVADA CORPORATION)
2023 CEDARBROOK COURT
COLUMBIA, SC 29212

FOR: CREATION OF CUSTOM OIL PAINTED
PORTRAITS ON CANVAS BASED ON PHOTO-
GRAPHS, SNAPSHOTS OR IMAGES, IN CLASS 40
(U.S. CLS. 100, 103 AND 106).

FIRST USE 10-1-2006; IN COMMERCE 10-1-2006.

THE MARK CONSISTS OF STANDARD CHAR-
ACTERS WITHOUT CLAIM TO ANY PARTICULAR
FONT, STYLE, SIZE, OR COLOR.

NO CLAIM IS MADE TO THE EXCLUSIVE
RIGHT TO USE "PORTRAIT", APART FROM THE
MARK AS SHOWN.

SER. NO. 77-357,484, FILED 12-20-2007.

KHANH LE, EXAMINING ATTORNEY

Int. Cl.: 41

Prior U.S. Cls.: 100, 101 and 107

United States Patent and Trademark Office

Reg. No. 3,484,114

Registered Aug. 12, 2008

**SERVICE MARK
PRINCIPAL REGISTER**

UNDERGROUND STRENGTH COACH

ZACH EVEN-ESH (UNITED STATES INDIVIDUAL)
11 WILK ROAD
EDISON, NJ 08837

FOR: PROVIDING ASSISTANCE, PERSONAL TRAINING AND PHYSICAL FITNESS CONSULTATION TO INDIVIDUALS TO HELP THEM MAKE PHYSICAL FITNESS, STRENGTH, CONDITIONING, AND EXERCISE IMPROVEMENT IN THEIR DAILY LIVING; PROVIDING FITNESS AND EXERCISE FACILITIES, IN CLASS 41 (U.S. CLS. 100, 101 AND 107).

FIRST USE 8-26-2005; IN COMMERCE 8-26-2005.

THE MARK CONSISTS OF STANDARD CHARACTERS WITHOUT CLAIM TO ANY PARTICULAR FONT, STYLE, SIZE, OR COLOR.

NO CLAIM IS MADE TO THE EXCLUSIVE RIGHT TO USE STRENGTH COACH, APART FROM THE MARK AS SHOWN.

SER. NO. 77-357,501, FILED 12-20-2007.

REGINA DRUMMOND, EXAMINING ATTORNEY

Int. Cl.: 35

Prior U.S. Cls.: 100, 101 and 102

United States Patent and Trademark Office

Reg. No. 3,484,115

Registered Aug. 12, 2008

**SERVICE MARK
PRINCIPAL REGISTER**

About Frixxxon

CRUM ENTERPRISES, INC. (FLORIDA CORPORATION), DBA ABOUT FRIXXXON
P.O. BOX 24543
FORT LAUDERDALE, FL 33307

FOR: ON-LINE RETAIL STORE SERVICES FEATURING ADULT GOODS, NAMELY, ADULT SEXUAL AIDS, WOMEN'S AND MEN'S CLOTHING, LINGERIE, SWIMWEAR, AND DVDS , IN CLASS 35 (U.S. CLS. 100, 101 AND 102).

FIRST USE 12-9-2006; IN COMMERCE 12-9-2006.

THE MARK CONSISTS OF STANDARD CHARACTERS WITHOUT CLAIM TO ANY PARTICULAR FONT, STYLE, SIZE, OR COLOR.

SER. NO. 77-357,563, FILED 12-20-2007.

KATHRYN COWARD, EXAMINING ATTORNEY

Int. Cl.: 7

Prior U.S. Cls.: 13, 19, 21, 23, 31, 34 and 35

Reg. No. 3,484,116

United States Patent and Trademark Office

Registered Aug. 12, 2008

**TRADEMARK
PRINCIPAL REGISTER**

MAGNUM

OCEANEERING INTERNATIONAL, INC. (DELA-
WARE CORPORATION)
11911 FM 529
HOUSTON, TX 77041

THE MARK CONSISTS OF STANDARD CHAR-
ACTERS WITHOUT CLAIM TO ANY PARTICULAR
FONT, STYLE, SIZE, OR COLOR.

FOR: INDUSTRIAL ROBOT, NAMELY, REMOTE-
CONTROLLED SUBMERSIBLE ROBOT FOR UN-
DERWATER EXPLORATION, IN CLASS 7 (U.S. CLS.
13, 19, 21, 23, 31, 34 AND 35).

SER. NO. 77-357,732, FILED 12-21-2007.

FIRST USE 7-1-1994; IN COMMERCE 7-1-1994.

LINDSEY RUBIN, EXAMINING ATTORNEY

Int. Cl.: 7

Prior U.S. Cls.: 13, 19, 21, 23, 31, 34 and 35

Reg. No. 3,484,117

United States Patent and Trademark Office

Registered Aug. 12, 2008

**TRADEMARK
PRINCIPAL REGISTER**

MILLENNIUM

OCEANEERING INTERNATIONAL, INC. (DELA-
WARE CORPORATION)
11911 FM 529
HOUSTON, TX 77041

THE MARK CONSISTS OF STANDARD CHAR-
ACTERS WITHOUT CLAIM TO ANY PARTICULAR
FONT, STYLE, SIZE, OR COLOR.

FOR: INDUSTRIAL ROBOTS, NAMELY, RE-
MOTE-CONTROLLED SUBMERSIBLE ROBOT
FOR UNDERWATER EXPLORATION, IN CLASS 7
(U.S. CLS. 13, 19, 21, 23, 31, 34 AND 35).

SER. NO. 77-357,781, FILED 12-21-2007.

FIRST USE 10-15-1997; IN COMMERCE 10-15-1997.

LINDSEY RUBIN, EXAMINING ATTORNEY

Int. Cl.: 3

Prior U.S. Cls.: 1, 4, 6, 50, 51 and 52

United States Patent and Trademark Office

Reg. No. 3,484,118

Registered Aug. 12, 2008

**TRADEMARK
PRINCIPAL REGISTER**



STIPOT TRADING CO., LTD. (TAIWAN CORPORATION)
8F., NO. 10, RUICHENG ST.
KAOHSIUNG, TAIWAN R.O.C.

FOR: COSMETICS; BODY DETERGENTS; HAIR STYLING GELS; FACE CREAMS; SKIN MOISTURIZING CREAMS; HAND CREAMS; FACE MASKS; FACIAL CLEANING CREAMS; BATH LOTIONS; SHAMPOOS; HAIR CONDITIONERS; BODY SOAPS; FRAGRANCES; ESSENTIAL OILS; BATH TEA BAGS; AND BREATH MINTS; NON-MEDICATED SKIN CARE PREPARATIONS; PERMANENT WAVE

LOTIONS, HAIR DYES, SKIN WHITENING CREAMS; HAIR CARE CREAMS, IN CLASS 3 (U.S. CLS. 1, 4, 6, 50, 51 AND 52).

FIRST USE 11-15-2007; IN COMMERCE 11-15-2007.

THE MARK CONSISTS OF 2 LETTERS "T" SEPARATED BY A SERPENTINE.

SER. NO. 77-357,792, FILED 12-21-2007.

KELLEY WELLS, EXAMINING ATTORNEY

Int. Cl.: 16

Prior U.S. Cls.: 2, 5, 22, 23, 29, 37, 38 and 50

Reg. No. 3,484,119

United States Patent and Trademark Office

Registered Aug. 12, 2008

**TRADEMARK
PRINCIPAL REGISTER**

FINALLY, A MONEY CLIP THAT
WORKS.

GERAGHTY, LLC (GEORGIA LTD LIAB CO)
508 LAS BRASIS COURT
PEACHTREE CITY, GA 30269

THE MARK CONSISTS OF STANDARD CHAR-
ACTERS WITHOUT CLAIM TO ANY PARTICULAR
FONT, STYLE, SIZE, OR COLOR.

FOR: MONEY CLIPS, IN CLASS 16 (U.S. CLS. 2, 5,
22, 23, 29, 37, 38 AND 50).

SER. NO. 77-357,799, FILED 12-21-2007.

FIRST USE 3-0-2006; IN COMMERCE 3-0-2006.

AISHA SALEM, EXAMINING ATTORNEY

Int. Cl.: 24

Prior U.S. Cls.: 42 and 50

United States Patent and Trademark Office

Reg. No. 3,484,120

Registered Aug. 12, 2008

**TRADEMARK
PRINCIPAL REGISTER**

THE GIGI BLANKI CO.

GASTON, HEATHER (UNITED STATES INDIVIDUAL)
359 BAY LANE
NORTH MUSKEGON, MI 49445

FOR: CHILDREN'S BLANKETS, IN CLASS 24
(U.S. CLS. 42 AND 50).

FIRST USE 1-1-2005; IN COMMERCE 9-1-2006.

THE MARK CONSISTS OF STANDARD CHARACTERS WITHOUT CLAIM TO ANY PARTICULAR FONT, STYLE, SIZE, OR COLOR.

NO CLAIM IS MADE TO THE EXCLUSIVE RIGHT TO USE "BLANKIE CO.", APART FROM THE MARK AS SHOWN.

THE NAME "GIGI BLANKI" DOES NOT IDENTIFY A LIVING INDIVIDUAL.

SER. NO. 77-357,924, FILED 12-21-2007.

SEAN CROWLEY, EXAMINING ATTORNEY

Int. Cls.: 2, 3, 4 and 5

Prior U.S. Cls.: 1, 4, 6, 11, 15, 16, 18, 44, 46, 50, 51 and 52

United States Patent and Trademark Office

Reg. No. 3,484,121

Registered Aug. 12, 2008

**TRADEMARK
PRINCIPAL REGISTER**

ECAN

CHASE PRODUCTS COMPANY (ILLINOIS CORPORATION)
19TH STREET AND GARDNER ROAD
BROADVIEW, IL 60155

FOR: PAINTS AND ANTI-CORROSIVE COATINGS, NAMELY, RUST INHIBITORS, IN CLASS 2 (U.S. CLS. 6, 11 AND 16).

FIRST USE 1-0-2001; IN COMMERCE 1-0-2001.

FOR: METAL CLEANERS AND POLISHERS, IN CLASS 3 (U.S. CLS. 1, 4, 6, 50, 51 AND 52).

FIRST USE 10-0-2003; IN COMMERCE 10-0-2003.

FOR: ALL-PURPOSE LUBRICANTS, IN CLASS 4 (U.S. CLS. 1, 6 AND 15).

FIRST USE 1-0-2004; IN COMMERCE 1-0-2004.

FOR: INSECTICIDES, IN CLASS 5 (U.S. CLS. 6, 18, 44, 46, 51 AND 52).

FIRST USE 8-0-2003; IN COMMERCE 8-0-2003.

THE MARK CONSISTS OF STANDARD CHARACTERS WITHOUT CLAIM TO ANY PARTICULAR FONT, STYLE, SIZE, OR COLOR.

OWNER OF U.S. REG. NO. 2,523,153.

SER. NO. 77-357,949, FILED 12-21-2007.

JORDAN BAKER, EXAMINING ATTORNEY

Int. Cl.: 35

Prior U.S. Cls.: 100, 101 and 102

United States Patent and Trademark Office

Reg. No. 3,484,122

Registered Aug. 12, 2008

**SERVICE MARK
PRINCIPAL REGISTER**

NBC Textbooks

NEBRASKA BOOK COMPANY, INC. (KANSAS
CORPORATION)
4700 S. 19TH
LINCOLN, NE 68512

OWNER OF U.S. REG. NOS. 1,312,759, 2,530,469,
AND 2,568,157.

FOR: DISTRIBUTORSHIP SERVICES IN THE
FIELD OF TEXTBOOKS; AND RETAIL COLLEGE
TEXTBOOK AND SCHOOL SUPPLY STORE SERVI-
CES, IN CLASS 35 (U.S. CLS. 100, 101 AND 102).

NO CLAIM IS MADE TO THE EXCLUSIVE
RIGHT TO USE "TEXTBOOKS", APART FROM
THE MARK AS SHOWN.

FIRST USE 1-0-2003; IN COMMERCE 1-0-2003.

SER. NO. 77-358,077, FILED 12-21-2007.

THE MARK CONSISTS OF STANDARD CHAR-
ACTERS WITHOUT CLAIM TO ANY PARTICULAR
FONT, STYLE, SIZE, OR COLOR.

CHRISTOPHER BUONGIORNO, EXAMINING AT-
TORNEY

Int. Cl.: 42

Prior U.S. Cls.: 100 and 101

United States Patent and Trademark Office

Reg. No. 3,484,123

Registered Aug. 12, 2008

**SERVICE MARK
PRINCIPAL REGISTER**



NEBRASKA BOOK COMPANY, INC. (KANSAS CORPORATION)
4700 S. 19TH
LINCOLN, NE 68512

THE MARK CONSISTS OF A SKETCH OF A STORE FRONT AND THE WORDS "COLLEGE STORE DESIGN".

FOR: DESIGN AND PLANNING OF COLLEGE BOOKSTORES, IN CLASS 42 (U.S. CLS. 100 AND 101).

SER. NO. 77-358,131, FILED 12-21-2007.

FIRST USE 1-17-2003; IN COMMERCE 1-17-2003.

NO CLAIM IS MADE TO THE EXCLUSIVE RIGHT TO USE "COLLEGE STORE DESIGN", APART FROM THE MARK AS SHOWN.

CHRISTOPHER BUONGIORNO, EXAMINING ATTORNEY

Int. Cl.: 36

Prior U.S. Cls.: 100, 101 and 102

United States Patent and Trademark Office

Reg. No. 3,484,124

Registered Aug. 12, 2008

**SERVICE MARK
PRINCIPAL REGISTER**

INSTITUTIONAL IN PLAY

BRIEFING.COM, INC. (DELAWARE CORPORATION)
SUITE 1780
401 N. MICHIGAN AVENUE
CHICAGO, IL 60611

FOR: FINANCIAL INFORMATION PROVIDED
BY ELECTRONIC MEANS, IN CLASS 36 (U.S. CLS.
100, 101 AND 102).

FIRST USE 2-25-2008; IN COMMERCE 2-25-2008.

THE MARK CONSISTS OF STANDARD CHARACTERS
WITHOUT CLAIM TO ANY PARTICULAR FONT,
STYLE, SIZE, OR COLOR.

OWNER OF U.S. REG. NOS. 2,279,165, 3,022,737,
AND 3,170,085.

NO CLAIM IS MADE TO THE EXCLUSIVE
RIGHT TO USE "INSTITUTIONAL", APART FROM
THE MARK AS SHOWN.

SER. NO. 77-358,172, FILED 12-21-2007.

YONG KIM, EXAMINING ATTORNEY

Int. Cl.: 41

Prior U.S. Cls.: 100, 101 and 107

United States Patent and Trademark Office

Reg. No. 3,484,125

Registered Aug. 12, 2008

**SERVICE MARK
PRINCIPAL REGISTER**

THE PJ LIBRARY

THE HAROLD GRINSPOON FOUNDATION
(MASSACHUSETTS NON-PROFIT ORGANI-
ZATION)
380 UNION STREET
WEST SPRINGFIELD, MA 01089

FOR: CHARITABLE SERVICES, NAMELY, PRO-
VIDING NEWSLETTERS IN THE FIELD OF CHAR-
ITY IN ELECTRONIC FORM VIA EMAIL, AND
PROVIDING BOOKS, CDS AND DVDS, TO PEOPLE,
IN CLASS 41 (U.S. CLS. 100, 101 AND 107).

FIRST USE 12-6-2007; IN COMMERCE 12-6-2007.

THE MARK CONSISTS OF STANDARD CHAR-
ACTERS WITHOUT CLAIM TO ANY PARTICULAR
FONT, STYLE, SIZE, OR COLOR.

SER. NO. 77-358,213, FILED 12-21-2007.

TEJBIR SINGH, EXAMINING ATTORNEY

Int. Cl.: 9

Prior U.S. Cls.: 21, 23, 26, 36 and 38

United States Patent and Trademark Office

Reg. No. 3,484,126

Registered Aug. 12, 2008

**TRADEMARK
PRINCIPAL REGISTER**

WinPRISM

NEBRASKA BOOK COMPANY, INC. (KANSAS
CORPORATION)
4700 S. 19TH
LINCOLN, NE 68512

FOR: SOFTWARE THAT PROVIDES ACCOUNTING FUNCTIONS, ADMINISTRATION FUNCTIONS AND MANAGEMENT OF INVENTORY AND THE POINT OF SALE OF GOODS FOR COLLEGE BOOKSTORES, IN CLASS 9 (U.S. CLS. 21, 23, 26, 36 AND 38).

FIRST USE 1-0-2001; IN COMMERCE 1-0-2001.

THE MARK CONSISTS OF STANDARD CHARACTERS WITHOUT CLAIM TO ANY PARTICULAR FONT, STYLE, SIZE, OR COLOR.

OWNER OF U.S. REG. NOS. 2,568,157 AND 2,817,707.

SER. NO. 77-358,228, FILED 12-21-2007.

CHRISTOPHER BUONGIORNO, EXAMINING ATTORNEY

Int. Cl.: 7

Prior U.S. Cls.: 13, 19, 21, 23, 31, 34 and 35

United States Patent and Trademark Office

Reg. No. 3,484,127

Registered Aug. 12, 2008

**TRADEMARK
PRINCIPAL REGISTER**

FROGWIRE

STREAMLINE AUTOMATION LTD. (CANADA
CORPORATION)
9192 - 52ND STREET S.E.
CALGARY, CANADA T2C5A9

FOR: MILLING CUTTERS, NAMELY, CUTTING
MACHINES FOR MILLING OPERATIONS, IN
CLASS 7 (U.S. CLS. 13, 19, 21, 23, 31, 34 AND 35).

FIRST USE 9-30-2006; IN COMMERCE 9-30-2006.

THE MARK CONSISTS OF STANDARD CHAR-
ACTERS WITHOUT CLAIM TO ANY PARTICULAR
FONT, STYLE, SIZE, OR COLOR.

OWNER OF U.S. REG. NO. 3,372,483.

SER. NO. 77-358,297, FILED 12-21-2007.

PAUL CROWLEY, EXAMINING ATTORNEY

Int. Cl.: 37

Prior U.S. Cls.: 100, 103 and 106

United States Patent and Trademark Office

Reg. No. 3,484,128

Registered Aug. 12, 2008

**SERVICE MARK
PRINCIPAL REGISTER**



MANHEIM AUCTIONS, INC. (DELAWARE CORPORATION)
6205 PEACHTREE DUNWOODY ROAD
ATLANTA, GA 30328

FOR: VEHICLE RESTORATION SERVICES, IN CLASS 37 (U.S. CLS. 100, 103 AND 106).

FIRST USE 5-20-2007; IN COMMERCE 5-20-2007.

THE COLOR(S) BROWN, GOLD, PURPLE, PEACH, TAN, GREY, BLACK AND WHITE IS/ARE CLAIMED AS A FEATURE OF THE MARK.

THE MARK CONSISTS OF A CHARACTER DESIGN OF A MAN STANDING HOLDING A SCEPTER IN HIS RIGHT HAND AND HIS LEFT HAND DOWN BY HIS SIDE HOLDING HIS CAPE. THE MAN IS WEARING A GOLD AND BROWN CAPE WITH BLACK SHADING AND OUTLINING, A PURPLE HAT WITH A GOLD HEAD PIECE, A

GOLD NECKLACE WITH A GOLD CAPITAL LETTER "M" WITH BLACK SHADING INSIDE CONSECUTIVE BLACK AND GOLD CIRCLES, A PURPLE CHEST PLATE WITH GOLD SIDES, BLACK DETAIL AND OUTLINING, A GOLD BELT WITH A GOLD CAPITAL LETTER "M" WITH BLACK SHADING INSIDE CONSECUTIVE BLACK AND GOLD CIRCLES, PURPLE PANTS WITH BLACK DETAIL AND OUTLINING, PURPLE GLOVES WITH GOLD DETAIL AND BLACK OUTLINING, GOLD BOOTS WITH GREY KNEE PADS AND BLACK DETAIL AND OUTLINING. THE MAN'S HAIR IS BROWN WITH BLACK OUTLINING, HIS FACE, CHEST AND ARMS ARE THE COLOR PEACH WITH TAN SHADING AND BLACK OUTLINING, AND HIS EYES AND MOUTH ARE WHITE.

SER. NO. 77-358,410, FILED 12-21-2007.

DAVID TAYLOR, EXAMINING ATTORNEY

Int. Cl.: 10

Prior U.S. Cls.: 26, 39 and 44

Reg. No. 3,484,129

United States Patent and Trademark Office

Registered Aug. 12, 2008

TRADEMARK
PRINCIPAL REGISTER



BLACK AND BLACK SURGICAL, INC. (GEORGIA CORPORATION)
4896 N. ROYAL ATLANTA DRIVE
TUCKER, GA 30084

FOR: SURGICAL INSTRUMENTS AND APPARATUS, IN CLASS 10 (U.S. CLS. 26, 39 AND 44).

FIRST USE 10-0-2007; IN COMMERCE 10-0-2007.

NO CLAIM IS MADE TO THE EXCLUSIVE RIGHT TO USE "SURGICAL", APART FROM THE MARK AS SHOWN.

THE MARK CONSISTS OF THE WORDS "BLACK & BLACK SURGICAL" AND DESIGN.

SER. NO. 77-358,442, FILED 12-21-2007.

LINDSEY RUBIN, EXAMINING ATTORNEY

Int. Cl.: 28

Prior U.S. Cls.: 22, 23, 38 and 50

United States Patent and Trademark Office

Reg. No. 3,484,130

Registered Aug. 12, 2008

TRADEMARK
PRINCIPAL REGISTER

· i n d o o r ·
BoHo
Bocce

OUTSIDE IN GAMES (COLORADO LTD LIAB
CO)
411 KALAMATH STREET
DENVER, CO 80204

FOR: ACTION SKILL GAMES; ACTION TARGET
GAMES; ACTION-TYPE TARGET GAMES; BALLS
FOR GAMES; EQUIPMENT SOLD AS A UNIT FOR
PLAYING ACTION TYPE TARGET GAMES; GO
GAMES; OUTDOOR ACTIVITY GAMES IN THE
NATURE OF BOCCE BALL; TARGET GAMES, IN
CLASS 28 (U.S. CLS. 22, 23, 38 AND 50).

FIRST USE 6-1-2007; IN COMMERCE 9-1-2007.

NO CLAIM IS MADE TO THE EXCLUSIVE
RIGHT TO USE "INDOOR" AND "BOCCE", APART
FROM THE MARK AS SHOWN.

THE MARK CONSISTS OF THE WORDS "IN-
DOOR BOHO BOCCE". EACH A DIFFERENT TYPE
STYLE. THE WORD "INDOOR" HAS A BULLET
BEFORE AND AFTER IT.

SER. NO. 77-358,563, FILED 12-21-2007.

TIMOTHY FINNEGAN, EXAMINING ATTORNEY

Int. Cl.: 5

Prior U.S. Cls.: 6, 18, 44, 46, 51 and 52

Reg. No. 3,484,131

United States Patent and Trademark Office

Registered Aug. 12, 2008

TRADEMARK
PRINCIPAL REGISTER

Anesidora's Jar
Taking the lid off all
good formulations

THOMPSON, SHARON G. (UNITED STATES INDIVIDUAL)
11 POTTER LANE
HALESITE, NY 117432142

FOR: ALMOND OIL FOR PHARMACEUTICAL PURPOSES; ALMOND OILS FOR PHARMACEUTICAL PURPOSES; ANTI-DIABETIC PHARMACEUTICALS; ANTIBACTERIAL PHARMACEUTICALS; ANTIMICROBIAL PREPARATIONS FOR INHIBITING MICROBIOLOGICAL DECOMPOSITION IN FOOD, BEVERAGES, ANIMAL FEED AND PHARMACEUTICALS; ANTIMICROBIAL PRESERVATIVES FOR COSMETICS AND PHARMACEUTICALS; ASTRINGENTS; BISMUTH PREPARATIONS FOR PHARMACEUTICAL PURPOSES; CARDIOVASCULAR PHARMACEUTICALS; DERMATOLOGICAL PHARMACEUTICAL PRODUCTS; DRUG DELIVERY AGENTS CONSISTING OF COMPOUNDS THAT FACILITATE DELIVERY OF A WIDE RANGE OF PHARMACEUTICALS; GELATIN CAPSULES SOLD EMPTY FOR PHARMACEUTICALS; HOMEOPATHIC PHARMACEUTICALS FOR USE IN THE TREATMENT OF MUSCLE SORENESS; INHALED PHARMACEUTICAL PREPARATIONS FOR THE TREATMENT OF RESPIRATORY DISEASES AND DISORDERS; INJECTABLE PHARMACEUTICALS FOR TREATMENT OF ANAPHYLACTIC REACTIONS; INTRAVENOUS FLUIDS USED FOR REHYDRATION, NUTRITION AND THE DELIVERY OF PHARMACEUTICAL PREPARATIONS; OCULAR PHARMACEUTICALS; PHARMACEUTICAL ANTI-ALLERGIC PREPARATIONS AND SUBSTANCES; PHARMACEUTICAL ANTITUSSIVE-COLD PREPARATIONS; PHARMACEUTICAL FOR THE TREATMENT OF ERECTILE DYSFUNCTION; PHARMACEUTICAL PREPARATION FOR THE TREATMENT OF GOUT; PHARMACEUTICAL PREPARATIONS ACTING ON THE CENTRAL NERVOUS SYSTEM; PHARMACEUTICAL PREPARATIONS AND SUBSTANCES FOR THE TREATMENT OF GASTRO-INTESTINAL DIS-

EASES; PHARMACEUTICAL PREPARATIONS FOR ANIMAL SKINCARE; PHARMACEUTICAL PREPARATIONS FOR INHALATION FOR THE TREATMENT OF PULMONARY HYPERTENSION; PHARMACEUTICAL PREPARATIONS FOR OCULAR OR INTRAOCULAR SURGERY; PHARMACEUTICAL PREPARATIONS FOR SKIN CARE; PHARMACEUTICAL PREPARATIONS FOR THE PREVENTION AND TREATMENT OF DISORDERS OF THE NERVOUS SYSTEM, THE IMMUNE SYSTEM, THE CARDIO-VASCULAR SYSTEM, THE METABOLIC SYSTEM, THE RESPIRATORY SYSTEM, THE MUSCULO-SKELETAL SYSTEM, THE GENITOURINARY SYSTEM; FOR THE TREATMENT OF INFLAMMATORY DISORDERS; FOR USE IN DERMATOLOGY, ONCOLOGY, HEMATOLOGY AND IN TISSUE AND ORGAN TRANSPLANTATION, IN OPHTHALMOLOGY AND FOR GASTROENTEROLOGICAL DISORDERS; PHARMACEUTICAL PREPARATIONS FOR THE PREVENTION AND TREATMENT OF OCULAR DISORDERS OR DISEASES, FOR THE TREATMENT OF BACTERIA-BASED DISEASES, AND FOR THE TREATMENT OF DIABETES, AND ANTI-INFECTIVE PREPARATIONS, ANTIVIRAL PREPARATIONS, ANTIBIOTICS, ANTIFUNGAL PREPARATIONS AND VACCINES; PHARMACEUTICAL PREPARATIONS FOR THE TREATMENT OF EYE DISEASES AND CONDITIONS; PHARMACEUTICAL PREPARATIONS FOR THE TREATMENT OF HEART RHYTHM DISORDERS; PHARMACEUTICAL PREPARATIONS FOR THE TREATMENT OF HORMONAL DISORDERS AND THE PREVENTION OF OSTEOPOROSIS; PHARMACEUTICAL PREPARATIONS FOR THE TREATMENT OF INFECTIOUS DISEASES; PHARMACEUTICAL PREPARATIONS FOR THE TREATMENT OF HORMONE REPLACEMENT; PHARMACEUTICAL PREPARATIONS FOR TREATING ALLERGIC RHINITIS AND ASTHMA; PHARMACEUTICAL PREPARATIONS FOR TREATING DIABETES; PHARMACEUTICAL PRE-

PARATIONS FOR TREATING SKIN DISORDERS; PHARMACEUTICAL PREPARATIONS FOR USE IN CHEMOTHERAPY; PHARMACEUTICAL PREPARATIONS FOR USE IN DERMATOLOGY; PHARMACEUTICAL PREPARATIONS FOR USE IN UROLOGY; PHARMACEUTICAL PREPARATIONS FOR WOUNDS; PHARMACEUTICAL PREPARATIONS, NAMELY, ANTIDEPRESSANTS; PHARMACEUTICAL PREPARATIONS, NAMELY, APPETITE SUPPRESSANTS; PHARMACEUTICAL PREPARATIONS, NAMELY, A BLOOD CLOTTING AID AND DELIVERY SYSTEM FOR USE IN HUMAN AND VETERINARY MEDICINE; PHARMACEUTICAL PREPARATIONS, NAMELY, A DRUG DELIVERY SYSTEM COMPRISING POLYMER-BASED ORAL TABLETS FOR THE CONTINUOUS RELEASE OF A WIDE VARIETY OF THERAPEUTIC AGENTS; PHARMACEUTICAL PREPARATIONS, NAMELY, ANTICOAGULANTS; PHARMACEUTICAL PRODUCTS AND PREPARATIONS AGAINST DRY SKIN CAUSED BY PREGNANCY; PHARMACEUTICAL PRODUCTS AND PREPARATIONS FOR CHLOASMA; PHARMACEUTICAL PRODUCTS AND PREPARATIONS FOR HYDRATING THE SKIN DURING PREGNANCY; PHARMACEUTICAL PRODUCTS AND PREPARATIONS FOR PREGNANCY BLEMISHES; PHARMACEUTICAL PRODUCTS AND PREPARATIONS FOR PREVENTING SKIN BLEMISHES DURING PREGNANCY; PHARMACEUTICAL PRODUCTS AND PREPARATIONS TO PREVENT STRETCH MARKS; PHARMACEUTICAL PRODUCTS AND PREPARATIONS TO PREVENT SWELLING IN THE LEGS; PHARMACEUTICAL PRODUCTS FOR OPHTHALMOLOGICAL USE; PHARMACEUTICAL PRODUCTS FOR SKIN CARE FOR ANIMALS; PHARMACEUTICAL PRODUCTS FOR THE TREATMENT OF BONE DISEASES; PHARMACEUTICAL PRODUCTS FOR THE TREATMENT OF VIRAL AND INFECTIOUS DISEASES, FOR THE TREATMENT OF CANCER; PHARMACEUTICAL

PRODUCTS FOR TREATING RESPIRATORY DISEASES AND ASTHMA; PHARMACEUTICAL SKIN LOTIONS; PHARMACEUTICAL SOLUTIONS USED IN DIALYSIS; PHARMACEUTICALS FOR THE TREATMENT OF ERECTILE DYSFUNCTION; PHARMACEUTICALS, NAMELY, ANTI-INFECTIVES; PHARMACEUTICALS, NAMELY, ANTIHELMINTICS; PHARMACEUTICALS, NAMELY, INDUCERS OF ERECTIONS; PHARMACEUTICALS, NAMELY, LIPID LOWERING AGENTS; PHARMACEUTICALS, NAMELY, PSYCHOTROPICS; PLANT EXTRACTS FOR MEDICAL, VETERINARY AND PHARMACEUTICAL PURPOSES; POTASSIUM PREPARATIONS FOR PHARMACEUTICAL PURPOSES; RADIOACTIVE PHARMACEUTICAL PREPARATIONS FOR USE IN VIVO DIAGNOSTIC OR THERAPEUTIC USE; SYNTHETIC PEPTIDES FOR PHARMACEUTICAL PURPOSES; SYRINGES SOLD FILLED WITH HORMONE REPLACEMENT THERAPY; UNIT DOSE CAPSULES SOLD EMPTY FOR PHARMACEUTICAL USE; VITAMIN AND MINERAL PREPARATIONS FOR USE AS INGREDIENTS IN THE FOOD AND PHARMACEUTICAL INDUSTRY; YEAST OR YEAST EXTRACTS FOR MEDICAL, VETERINARY OR PHARMACEUTICAL PURPOSES, IN CLASS 5 (U.S. CLS. 6, 18, 44, 46, 51 AND 52).

FIRST USE 8-1-2007; IN COMMERCE 12-1-2007.

THE MARK CONSISTS OF STANDARD CHARACTERS WITHOUT CLAIM TO ANY PARTICULAR FONT, STYLE, SIZE, OR COLOR.

NO CLAIM IS MADE TO THE EXCLUSIVE RIGHT TO USE "JAR", APART FROM THE MARK AS SHOWN.

SER. NO. 77-358,724, FILED 12-21-2007.

HEATHER THOMPSON, EXAMINING ATTORNEY

Int. Cl.: 41

Prior U.S. Cls.: 100, 101 and 107

Reg. No. 3,484,132

United States Patent and Trademark Office

Registered Aug. 12, 2008

**SERVICE MARK
PRINCIPAL REGISTER**

DJ4U

PARKINSON, JASON M (UNITED STATES INDIVIDUAL), DBA DJ4U MOBILE ENTERTAINMENT
2219 W. FORREST HILL AVE
PEORIA, IL 61604

FOR: ENTERTAINMENT IN THE NATURE OF LIGHT SHOWS; ENTERTAINMENT SERVICES, NAMELY, CONDUCTING PARTIES; RADIO ENTERTAINMENT PRODUCTION; RADIO ENTERTAINMENT SERVICES, NAMELY, RADIO PROGRAMS FEATURING PERFORMANCES BY A RADIO PERSONALITY - JASON PARKINSON; BOOKING OF ENTERTAINMENT HALLS; CON-

DUCTING ENTERTAINMENT EXHIBITIONS IN THE NATURE OF MOBILE DJ SERVICES, IN CLASS 41 (U.S. CLS. 100, 101 AND 107).

FIRST USE 1-1-1999; IN COMMERCE 1-1-2007.

THE MARK CONSISTS OF STANDARD CHARACTERS WITHOUT CLAIM TO ANY PARTICULAR FONT, STYLE, SIZE, OR COLOR.

SER. NO. 77-358,758, FILED 12-22-2007.

JANET LEE, EXAMINING ATTORNEY

Int. Cl.: 25

Prior U.S. Cls.: 22 and 39

United States Patent and Trademark Office

Reg. No. 3,484,133

Registered Aug. 12, 2008

TRADEMARK
PRINCIPAL REGISTER



DEVIN E HAJEK (CALIFORNIA SOLE PROPRIETORSHIP)
2904 ESPLANADE CIR.
FOLSOM, CA 95630 AND
ASHLEY E HAJEK (CALIFORNIA SOLE PROPRIETORSHIP)
2904 ESPLANADE CIR.
FOLSOM, CA 95630

FIRST USE 6-15-2007; IN COMMERCE 6-21-2007.

THE MARK CONSISTS OF A CROWN ABOVE THE LETTER "T" AND THE LETTER "S" IN A CALIGRAPHIC SCRIPT WITH THE LETTER "T" SLIGHTLY HIGHER THAN THE LETTER "S".

FOR: CLOTHING, NAMELY, SHIRTS, T-SHIRTS, TANK TOPS, JACKETS, SWEATSHIRTS, SHORTS, PANTS, SWEATPANTS, HATS, CAPS AND FOOTWEAR, IN CLASS 25 (U.S. CLS. 22 AND 39).

SER. NO. 77-358,830, FILED 12-22-2007.

MELVIN AXILBUND, EXAMINING ATTORNEY

Int. Cl.: 10

Prior U.S. Cls.: 26, 39 and 44

United States Patent and Trademark Office

Reg. No. 3,484,134

Registered Aug. 12, 2008

**TRADEMARK
PRINCIPAL REGISTER**

LYNX

LIFE SPINE, INC. (DELAWARE CORPORATION)
SUITE 1535
2401 W. HASSELL ROAD
HOFFMAN ESTATES, IL 60169

THE MARK CONSISTS OF STANDARD CHAR-
ACTERS WITHOUT CLAIM TO ANY PARTICULAR
FONT, STYLE, SIZE, OR COLOR.

FOR: SPINAL IMPLANTS COMPOSED OF ARTI-
FICIAL MATERIAL, NAMELY, SPINE CROSS-CON-
NECTORS, IN CLASS 10 (U.S. CLS. 26, 39 AND 44).

SER. NO. 77-358,914, FILED 12-23-2007.

FIRST USE 12-14-2007; IN COMMERCE 12-14-2007.

WENDY GOODMAN, EXAMINING ATTORNEY

Int. Cl.: 36

Prior U.S. Cls.: 100, 101 and 102

United States Patent and Trademark Office

Reg. No. 3,484,135

Registered Aug. 12, 2008

**SERVICE MARK
PRINCIPAL REGISTER**

EMBASSY

EMBASSY BANK FOR THE LEHIGH VALLEY
(PENNSYLVANIA CORPORATION)
100 GATEWAY DRIVE
BETHLEHEM, PA 18017

FOR: BANKING SERVICES, IN CLASS 36 (U.S.
CLS. 100, 101 AND 102).

FIRST USE 11-6-2001; IN COMMERCE 11-6-2001.

THE MARK CONSISTS OF STANDARD CHAR-
ACTERS WITHOUT CLAIM TO ANY PARTICULAR
FONT, STYLE, SIZE, OR COLOR.

OWNER OF U.S. REG. NO. 2,666,336.

SER. NO. 77-358,980, FILED 12-24-2007.

JASON TURNER, EXAMINING ATTORNEY

Int. Cl.: 41

Prior U.S. Cls.: 100, 101 and 107

United States Patent and Trademark Office

Reg. No. 3,484,136

Registered Aug. 12, 2008

**SERVICE MARK
PRINCIPAL REGISTER**



OREGON TILTH, INC. (OREGON CORPORATION)
470 LANCASTER DRIVE NE
SALEM, OR 97301

FOR: EDUCATION SERVICES, NAMELY, PROVIDING WORKSHOPS, DEMONSTRATIONS, AND CLASSES AND PUBLICATION OF NEWSLETTERS, ALL IN THE FIELDS OF ORGANIC AND ECOLOGICAL GARDENING AND FARMING, FOOD CHOICES AND NUTRITION PLANNING, IN CLASS 41 (U.S. CLS. 100, 101 AND 107).

FIRST USE 4-30-2007; IN COMMERCE 4-30-2007.

OWNER OF U.S. REG. NOS. 2,962,194 AND 3,019,048.

NO CLAIM IS MADE TO THE EXCLUSIVE RIGHT TO USE "OREGON", APART FROM THE MARK AS SHOWN.

THE MARK CONSISTS OF THE WORDS "OREGON TILTH" ABOVE A REPRESENTATION OF ROWS OF CROPS ALL WITHIN A CIRCLE, WITH TWO LEAVES AT THE TOP OF THE CIRCLE.

SER. NO. 77-359,068, FILED 12-24-2007.

BARBARA BROWN, EXAMINING ATTORNEY

Int. Cls.: 9 and 11

Prior U.S. Cls.: 13, 21, 23, 26, 31, 34, 36 and 38

United States Patent and Trademark Office

Reg. No. 3,484,137

Registered Aug. 12, 2008

**TRADEMARK
PRINCIPAL REGISTER**



LUNA OPTICS, INC (DELAWARE CORPORATION)

54 COLUMBUS AVENUE
STATEN ISLAND, NY 10304

FOR: NIGHT VISION GOGGLES; BINOCULARS;
HUNTING BINOCULARS; RIFLESCOPES; SPOT-
TING SCOPES; GUN SCOPES; INFRARED CAM-
ERAS, IN CLASS 9 (U.S. CLS. 21, 23, 26, 36 AND 38).

FIRST USE 1-20-2006; IN COMMERCE 3-1-2006.

FOR: INFRARED ILLUMINATORS, IN CLASS 11
(U.S. CLS. 13, 21, 23, 31 AND 34).

FIRST USE 1-20-2006; IN COMMERCE 3-1-2006.

NO CLAIM IS MADE TO THE EXCLUSIVE
RIGHT TO USE "OPTICS", APART FROM THE
MARK AS SHOWN.

THE COLOR(S) GREEN, BLACK IS/ARE
CLAIMED AS A FEATURE OF THE MARK.

THE MARK CONSISTS OF STYLIZED WORDS:
"LUNA OPTICS" IN DARK GREEN COLOR WITH
LIGHT GREEN IMAGE OF THE MOON OVERLAP-
PING LETTERS "L, U, O, P, T". UNDER THE WORD
"OPTICS", PHRASE: "QUALITY YOU CAN SEE...E-
VEN IN THE DARK."

SER. NO. 77-359,086, FILED 12-24-2007.

KEVON CHISOLM, EXAMINING ATTORNEY

Int. Cl.: 9

Prior U.S. Cls.: 21, 23, 26, 36 and 38

Reg. No. 3,484,138

United States Patent and Trademark Office

Registered Aug. 12, 2008

**TRADEMARK
PRINCIPAL REGISTER**

STARNOMENON

AURIGEMA, ANDREW (UNITED STATES INDIVIDUAL)
1685 MAYTOWN ROAD
OAK HILL, FL 32759

THE MARK CONSISTS OF STANDARD CHARACTERS WITHOUT CLAIM TO ANY PARTICULAR FONT, STYLE, SIZE, OR COLOR.

FOR: SINGLE MIRROR TELESCOPE, IN CLASS 9 (U.S. CLS. 21, 23, 26, 36 AND 38).

SER. NO. 77-359,337, FILED 12-26-2007.

FIRST USE 4-1-2007; IN COMMERCE 10-1-2007.

DAVID TOOLEY, EXAMINING ATTORNEY

Int. Cl.: 5

Prior U.S. Cls.: 6, 18, 44, 46, 51 and 52

Reg. No. 3,484,139

United States Patent and Trademark Office

Registered Aug. 12, 2008

**TRADEMARK
PRINCIPAL REGISTER**

Flush 24

HAMIDA PHARMA, INC. (CALIFORNIA CORPORATION)
25441 ARCTIC OCEAN DRIVE
LAKE FOREST, CA 92630

FOR: DIETARY AND NUTRITIONAL SUPPLEMENTS; DIETARY SUPPLEMENTS FOR HUMAN CONSUMPTION; HERBAL SUPPLEMENTS, IN CLASS 5 (U.S. CLS. 6, 18, 44, 46, 51 AND 52).

FIRST USE 1-1-2006; IN COMMERCE 1-1-2006.

THE MARK CONSISTS OF STANDARD CHARACTERS WITHOUT CLAIM TO ANY PARTICULAR FONT, STYLE, SIZE, OR COLOR.

NO CLAIM IS MADE TO THE EXCLUSIVE RIGHT TO USE "24", APART FROM THE MARK AS SHOWN.

SER. NO. 77-359,377, FILED 12-26-2007.

DAVID I, EXAMINING ATTORNEY

Int. Cl.: 5

Prior U.S. Cls.: 6, 18, 44, 46, 51 and 52

Reg. No. 3,484,140

United States Patent and Trademark Office

Registered Aug. 12, 2008

**TRADEMARK
PRINCIPAL REGISTER**

smart molecule technology

BIOPHARMACA (CALIFORNIA SOLE PROPRIETORSHIP)
335 COUNTYVIEW DR
MILL VALLEY, CA 94941

FOR: DIETARY SUPPLEMENTS FOR HUMAN CONSUMPTION; HERBAL SUPPLEMENTS; NUTRACEUTICALS FOR USE AS A DIETARY SUPPLEMENT; NUTRITIONAL SUPPLEMENTS; VITAMIN SUPPLEMENT IN TABLET FORM FOR USE IN MAKING AN EFFERVESCENT BEVERAGE WHEN ADDED TO WATER, IN CLASS 5 (U.S. CLS. 6, 18, 44, 46, 51 AND 52).

FIRST USE 12-3-2007; IN COMMERCE 12-3-2007.

THE MARK CONSISTS OF STANDARD CHARACTERS WITHOUT CLAIM TO ANY PARTICULAR FONT, STYLE, SIZE, OR COLOR.

NO CLAIM IS MADE TO THE EXCLUSIVE RIGHT TO USE "MOLECULE TECHNOLOGY", APART FROM THE MARK AS SHOWN.

SER. NO. 77-359,472, FILED 12-26-2007.

STEPHEN AQUILA, EXAMINING ATTORNEY

Int. Cl.: 24

Prior U.S. Cls.: 42 and 50

United States Patent and Trademark Office

Reg. No. 3,484,141

Registered Aug. 12, 2008

**TRADEMARK
PRINCIPAL REGISTER**

QUIET CURTAINS

SCOTT SOMIT - ESP (CALIFORNIA CORPORATION)

#3

3750 RIVIERA DRIVE
SAN DIEGO, CA 92109

FOR: FABRIC WINDOW COVERINGS AND TREATMENTS, NAMELY, CURTAINS, DRAPERIES, SHEERS, SWAGS, VALANCES, IN CLASS 24 (U.S. CLS. 42 AND 50).

FIRST USE 10-1-2007; IN COMMERCE 10-1-2007.

THE MARK CONSISTS OF STANDARD CHARACTERS WITHOUT CLAIM TO ANY PARTICULAR FONT, STYLE, SIZE, OR COLOR.

NO CLAIM IS MADE TO THE EXCLUSIVE RIGHT TO USE "CURTAINS", APART FROM THE MARK AS SHOWN.

SER. NO. 77-359,478, FILED 12-26-2007.

ANN E. SAPPENFIELD, EXAMINING ATTORNEY

Int. Cls.: 9 and 36

Prior U.S. Cls.: 21, 23, 26, 36, 38, 100, 101 and 102

United States Patent and Trademark Office

Reg. No. 3,484,142

Registered Aug. 12, 2008

**TRADEMARK
SERVICE MARK
PRINCIPAL REGISTER**



MONEY TREE SOFTWARE, LTD. (OREGON CORPORATION)
1600 SW WESTERN BLVD. SUITE 110
CORVALLIS, OR 97333

FOR: COMPUTER SOFTWARE AND HARDWARE FOR RETIREMENT PLANNING AND ANALYSIS ILLUSTRATIONS; DOWNLOADABLE COMPUTER SOFTWARE FOR RETIREMENT PLANNING AND ANALYSIS ILLUSTRATIONS, IN CLASS 9 (U.S. CLS. 21, 23, 26, 36 AND 38).

FIRST USE 12-19-2007; IN COMMERCE 12-24-2007.

FOR: FINANCIAL PLANNING AND INVESTMENT ADVISORY SERVICES; ONLINE FINANCIAL PLANNING SERVICES; PROVIDING ONLINE FINANCIAL CALCULATORS; FINANCIAL PLANNING FOR RETIREMENT; FINANCIAL IN-

FORMATION AND EVALUATIONS, IN CLASS 36 (U.S. CLS. 100, 101 AND 102).

FIRST USE 12-19-2007; IN COMMERCE 12-24-2007.

THE COLOR(S) GREEN, GREY IS/ARE CLAIMED AS A FEATURE OF THE MARK.

THE MARK CONSISTS OF GREEN ITALIC LETTERS AND QUESTION MARK SPELLING OUT "WHEN-IF?" WITH AN INVERTED AND REFLECTED GREY SHADOW OF THE LETTERS BELOW THE GREEN TEXT.

SER. NO. 77-359,483, FILED 12-26-2007.

JANET LEE, EXAMINING ATTORNEY

Int. Cl.: 24

Prior U.S. Cls.: 42 and 50

United States Patent and Trademark Office

Reg. No. 3,484,143

Registered Aug. 12, 2008

**TRADEMARK
PRINCIPAL REGISTER**

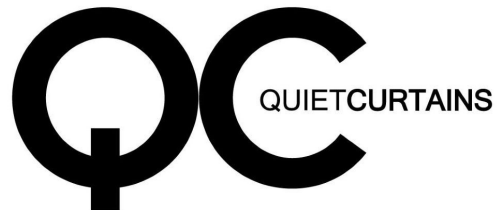

SCOTT SOMIT-ESP (CALIFORNIA CORPORATION)

#3
3750 RIVIERA DRIVE
SAN DIEGO, CA 92109

FOR: FABRIC WINDOW COVERINGS AND TREATMENTS, NAMELY, CURTAINS, DRAPERIES, SHEERS, SWAGS, VALANCES, IN CLASS 24 (U.S. CLS. 42 AND 50).

FIRST USE 10-1-2007; IN COMMERCE 10-1-2007.

NO CLAIM IS MADE TO THE EXCLUSIVE RIGHT TO USE "CURTAINS", APART FROM THE MARK AS SHOWN.

SER. NO. 77-359,486, FILED 12-26-2007.

ANN E. SAPPENFIELD, EXAMINING ATTORNEY

Int. Cl.: 5

Prior U.S. Cls.: 6, 18, 44, 46, 51 and 52

Reg. No. 3,484,144

United States Patent and Trademark Office

Registered Aug. 12, 2008

**TRADEMARK
PRINCIPAL REGISTER**

DAILY MOVEMENT

TANGO ADVANCED NUTRITION, INC. (CALI-
FORNIA CORPORATION)
515 EUREKA STREET
SAN FRANCISCO, CA 94114

FOR: DIETARY, HERBAL AND NUTRITIONAL
SUPPLEMENTS, IN CLASS 5 (U.S. CLS. 6, 18, 44, 46, 51
AND 52).

FIRST USE 12-11-2007; IN COMMERCE 12-12-2007.

THE MARK CONSISTS OF STANDARD CHAR-
ACTERS WITHOUT CLAIM TO ANY PARTICULAR
FONT, STYLE, SIZE, OR COLOR.

NO CLAIM IS MADE TO THE EXCLUSIVE
RIGHT TO USE "DAILY", APART FROM THE
MARK AS SHOWN.

SER. NO. 77-359,559, FILED 12-26-2007.

EDWARD NELSON, EXAMINING ATTORNEY

Int. Cl.: 2

Prior U.S. Cls.: 6, 11 and 16

United States Patent and Trademark Office

Reg. No. 3,484,145

Registered Aug. 12, 2008

**TRADEMARK
PRINCIPAL REGISTER**

**XTREME ORIGINAL SPEED
KLEARKOTE**

INTERNATIONAL AUTOBODY MARKETING
GROUP, INC. (ARIZONA CORPORATION)

9419 E. SAN SALVADOR DRIVE, SUITE 104

SCOTTSDALE, AZ 85258

FOR: CLEAR COATING PROTECTANT FOR AU-
TOMOTIVE PAINTS AND PRIMERS FOR USE IN
THE AUTOMOTIVE REFINISHING AND RE-
STORATION INDUSTRY , IN CLASS 2 (U.S. CLS. 6,
11 AND 16).

FIRST USE 11-12-2007; IN COMMERCE 11-12-2007.

THE MARK CONSISTS OF STANDARD CHAR-
ACTERS WITHOUT CLAIM TO ANY PARTICULAR
FONT, STYLE, SIZE, OR COLOR.

OWNER OF U.S. REG. NOS. 2,965,817, 3,006,978
AND OTHERS.

NO CLAIM IS MADE TO THE EXCLUSIVE
RIGHT TO USE "ORIGINAL SPEED CLEAR COAT",
APART FROM THE MARK AS SHOWN.

SER. NO. 77-359,598, FILED 12-26-2007.

MARCIE MILONE, EXAMINING ATTORNEY

Int. Cl.: 35

Prior U.S. Cls.: 100, 101 and 102

United States Patent and Trademark Office

Reg. No. 3,484,146

Registered Aug. 12, 2008

**SERVICE MARK
PRINCIPAL REGISTER**



CREA CONSULTING GROUP, LLC (VIRGINIA
LTD LIAB CO)
3848 9TH ROAD SOUTH
ARLINGTON, VA 22204

FOR: INFORMATION IN THE FIELD OF GOV-
ERNMENT AFFAIRS, IN CLASS 35 (U.S. CLS. 100,
101 AND 102).

FIRST USE 2-1-2006; IN COMMERCE 2-23-2006.

NO CLAIM IS MADE TO THE EXCLUSIVE
RIGHT TO USE "CONSULTING GROUP", APART
FROM THE MARK AS SHOWN.

THE MARK CONSISTS OF A SWOOSH SYMBOL
BEHIND THE WORDING "CREA CONSULTING
GROUP".

SER. NO. 77-359,760, FILED 12-26-2007.

TOBY BULLOFF, EXAMINING ATTORNEY

Int. Cl.: 44

Prior U.S. Cls.: 100 and 101

United States Patent and Trademark Office

Reg. No. 3,484,147

Registered Aug. 12, 2008

**SERVICE MARK
PRINCIPAL REGISTER**

Trisoma

SVACINA, PAUL (UNITED STATES INDIVIDUAL), DBA TRISOMA
452 LINFIELD PLACE, STE. B
GOLETA, CA 93117

THE MARK CONSISTS OF STANDARD CHARACTERS WITHOUT CLAIM TO ANY PARTICULAR FONT, STYLE, SIZE, OR COLOR.

FOR: BODYWORK THERAPY, IN CLASS 44 (U.S. CLS. 100 AND 101).

SER. NO. 77-359,815, FILED 12-26-2007.

FIRST USE 2-19-2007; IN COMMERCE 2-19-2007.

CURTIS FRENCH, EXAMINING ATTORNEY

Int. Cl.: 41

Prior U.S. Cls.: 100, 101 and 107

United States Patent and Trademark Office

Reg. No. 3,484,148

Registered Aug. 12, 2008

**SERVICE MARK
PRINCIPAL REGISTER**



**Hooray
for
Books**

Creative classes where kids look,
cook & devour good books!

MURPHY, MARY (UNITED STATES INDIVIDUAL)
31 ELIZABETH RD.
HOPKINTON, MA 01748

FOR: EDUCATIONAL SERVICES, NAMELY, CONDUCTING CLASSES IN THE FIELD OF READING AND SCIENCE AND DISTRIBUTION OF COURSE MATERIAL IN CONNECTION THEREWITH, IN CLASS 41 (U.S. CLS. 100, 101 AND 107).

FIRST USE 12-1-2000; IN COMMERCE 12-1-2000.

THE MARK CONSISTS OF A WORM WITH A CHEF'S HAT AND GLASSES HOLDING A BOOK SITTING ON A FISH HOOK WITH THE STYLIZED WORDS "HOORAY FOR BOOKS CREATIVE CLASSES WHERE KIDS LOOK, COOK & DEVOUR GOOD BOOKS!" BELOW IT.

SER. NO. 77-360,004, FILED 12-27-2007.

ANNE MADDEN, EXAMINING ATTORNEY

Int. Cl.: 5

Prior U.S. Cls.: 6, 18, 44, 46, 51 and 52

United States Patent and Trademark Office

Reg. No. 3,484,149

Registered Aug. 12, 2008

**TRADEMARK
PRINCIPAL REGISTER**



HORSETECH, INC. (IOWA CORPORATION)
112 WALNUT ST.
LAURENS, IA 50554

FOR: ANIMAL FEED SUPPLEMENTS; FEED SUPPLEMENTS FOR HORSES; NON-MEDICATED ADDITIVES FOR ANIMAL FEED FOR USE AS NUTRITIONAL SUPPLEMENTS, IN CLASS 5 (U.S. CLS. 6, 18, 44, 46, 51 AND 52).

FIRST USE 12-26-2007; IN COMMERCE 12-26-2007.

THE COLOR(S) RED AND BLACK IS/ARE CLAIMED AS A FEATURE OF THE MARK.

THE MARK CONSISTS OF THE STYLIZED ELEMENT "BUGGZO!" IN THE COLOR RED; THE LETTERING AND EXCLAMATION POINT ARE OUTLINED IN BLACK; THERE ARE EIGHT BLACK SLASH MARKS EXTENDING FROM THE TOP OF THE LETTER "B"; THE COLOR WHITE SERVES AS BACKGROUND COLOR ONLY.

SER. NO. 77-360,140, FILED 12-27-2007.

CHRISTOPHER BUONGIORNO, EXAMINING ATTORNEY

Int. Cl.: 41

Prior U.S. Cls.: 100, 101 and 107

United States Patent and Trademark Office

Reg. No. 3,484,150

Registered Aug. 12, 2008

**SERVICE MARK
PRINCIPAL REGISTER**

COLLEGE CHALKTALK

DISANO, CHRISTOPHER (UNITED STATES IN-
DIVIDUAL)
7727 SEDGEBROOK DRIVE EAST
STANLEY, NC 28164

FOR: PROVIDING NEWS AND INFORMATION
IN THE FIELD OF SPORTS, IN CLASS 41 (U.S. CLS.
100, 101 AND 107).

FIRST USE 11-27-2007; IN COMMERCE 12-13-2007.

THE MARK CONSISTS OF STANDARD CHAR-
ACTERS WITHOUT CLAIM TO ANY PARTICULAR
FONT, STYLE, SIZE, OR COLOR.

NO CLAIM IS MADE TO THE EXCLUSIVE
RIGHT TO USE "COLLEGE", APART FROM THE
MARK AS SHOWN.

SER. NO. 77-360,204, FILED 12-27-2007.

MARCIE MILONE, EXAMINING ATTORNEY

Int. Cl.: 29

Prior U.S. Cl.: 46

United States Patent and Trademark Office

Reg. No. 3,484,151

Registered Aug. 12, 2008

**TRADEMARK
PRINCIPAL REGISTER**

WIDMER'S CHEESE CELLARS

WIDMER'S CHEESE CELLARS, INC. (WISCONSIN CORPORATION)
214 W. HENNI ST.
THERESA, WI 530910127

NO CLAIM IS MADE TO THE EXCLUSIVE RIGHT TO USE "CHEESE", APART FROM THE MARK AS SHOWN.

FOR: CHEESE, IN CLASS 29 (U.S. CL. 46).

SER. NO. 77-360,320, FILED 12-27-2007.

FIRST USE 7-31-1974; IN COMMERCE 7-31-1974.

THE MARK CONSISTS OF STANDARD CHARACTERS WITHOUT CLAIM TO ANY PARTICULAR FONT, STYLE, SIZE, OR COLOR.

KARANENDRA S. CHHINA, EXAMINING ATTORNEY

Int. Cl.: 41

Prior U.S. Cls.: 100, 101 and 107

United States Patent and Trademark Office

Reg. No. 3,484,152

Registered Aug. 12, 2008

**SERVICE MARK
PRINCIPAL REGISTER**

DONOR-CENTERED FUNDRAISING

CYGNUS APPLIED RESEARCH, INC. (DELA-
WARE CORPORATION)
12TH FLOOR
444 N MICHIGAN AVE.
CHICAGO, IL 60611

FOR: EDUCATIONAL SERVICES, NAMELY,
CONDUCTING CLASSES, SEMINARS AND TRAIN-
ING IN THE FIELD OF CHARITABLE FUNDRAIS-
ING FOR CHARITIES, FUNDRAISING
PROFESSIONALS AND FUNDRAISING ORGANI-
ZATIONS, IN CLASS 41 (U.S. CLS. 100, 101 AND 107).

FIRST USE 12-22-2002; IN COMMERCE 12-22-2002.

THE MARK CONSISTS OF STANDARD CHAR-
ACTERS WITHOUT CLAIM TO ANY PARTICULAR
FONT, STYLE, SIZE, OR COLOR.

NO CLAIM IS MADE TO THE EXCLUSIVE
RIGHT TO USE "FUNDRAISING", APART FROM
THE MARK AS SHOWN.

SEC. 2(F).

SER. NO. 77-360,372, FILED 12-27-2007.

CHERYL CLAYTON, EXAMINING ATTORNEY

Int. Cl.: 41

Prior U.S. Cls.: 100, 101 and 107

United States Patent and Trademark Office

Reg. No. 3,484,153

Registered Aug. 12, 2008

**SERVICE MARK
PRINCIPAL REGISTER**

HOTBED

HOTBED MEDIA INC. (CALIFORNIA CORPORATION)
120 SECOND STREET, 3RD FLOOR
SAN FRANCISCO, CA 94105

FOR: MULTIMEDIA ENTERTAINMENT SERVICES, NAMELY, SCRIPTWRITING FEATURING STORY DEVELOPMENT, PRODUCTION, POST-PRODUCTION AND DISTRIBUTION OF VIDEOS, MUSIC VIDEOS, FEATURE FILMS, DOCUMENTARIES AND COMMERCIALS, IN CLASS 41 (U.S. CLS. 100, 101 AND 107).

FIRST USE 9-1-2002; IN COMMERCE 9-1-2002.

THE MARK CONSISTS OF STANDARD CHARACTERS WITHOUT CLAIM TO ANY PARTICULAR FONT, STYLE, SIZE, OR COLOR.

OWNER OF U.S. REG. NO. 2,452,660.

SER. NO. 77-360,397, FILED 12-27-2007.

NORA BUCHANAN WILL, EXAMINING ATTORNEY

Int. Cl.: 25

Prior U.S. Cls.: 22 and 39

United States Patent and Trademark Office

Reg. No. 3,484,154

Registered Aug. 12, 2008

**TRADEMARK
PRINCIPAL REGISTER**



SHILINSKI, MICHAEL (UNITED STATES INDIVIDUAL)
33 ROSELLE AVENUE
PLEASANTVILLE, NY 10570

FOR: BASEBALL CAPS; DRESS SHIRTS; PANTS; PULLOVERS; SHIRTS; SHORTS; SWEAT PANTS; SWEAT SHIRTS; T-SHIRTS, IN CLASS 25 (U.S. CLS. 22 AND 39).

FIRST USE 11-21-2007; IN COMMERCE 11-21-2007.

THE MARK CONSISTS OF AN ABSTRACT DESIGN.

SER. NO. 77-360,408, FILED 12-27-2007.

LESLEY LAMOTHE, EXAMINING ATTORNEY

Int. Cl.: 35

Prior U.S. Cls.: 100, 101 and 102

United States Patent and Trademark Office

Reg. No. 3,484,155

Registered Aug. 12, 2008

**SERVICE MARK
PRINCIPAL REGISTER**



LEVANTE MARKETING (FLORIDA LTD LIAB
CO)
7186 REGINA WAY
ORLANDO, FL 32819

FOR: PROVIDING A WEBSITE THAT ALLOWS
USERS TO LOCATE BUSINESSES, SERVICES,
EVENTS, JOBS AND WORKERS THAT ARE BRA-
ZILIAN IN NATURE LOCATED IN COUNTRIES
AROUND THE WORLD INCLUDING THE UNITED
STATES AND BRAZIL, IN CLASS 35 (U.S. CLS. 100,
101 AND 102).

FIRST USE 11-27-2007; IN COMMERCE 11-27-2007.

THE MARK CONSISTS OF THE STYLIZED
WORD "BRASILICANO" BEING UNDERLINED
WITH A TOUCAN PERCHED ON THE RIGHT SIDE
OF THE LINE.

SER. NO. 77-360,889, FILED 12-28-2007.

ANNE MADDEN, EXAMINING ATTORNEY

Int. Cl.: 36

Prior U.S. Cls.: 100, 101 and 102

United States Patent and Trademark Office

Reg. No. 3,484,156

Registered Aug. 12, 2008

**SERVICE MARK
PRINCIPAL REGISTER**

Allen and Sloan

GRAHAM ENTERPRISES, INC. (MISSISSIPPI
CORPORATION)
2107 4TH STREET
MERIDIAN, MS 39301

THE MARK CONSISTS OF STANDARD CHAR-
ACTERS WITHOUT CLAIM TO ANY PARTICULAR
FONT, STYLE, SIZE, OR COLOR.

FOR: COLLECTION AGENCIES, IN CLASS 36
(U.S. CLS. 100, 101 AND 102).

SER. NO. 77-360,994, FILED 12-28-2007.

FIRST USE 1-25-2006; IN COMMERCE 1-25-2006.

ANNE MADDEN, EXAMINING ATTORNEY

Int. Cl.: 41

Prior U.S. Cls.: 100, 101 and 107

United States Patent and Trademark Office

Reg. No. 3,484,157

Registered Aug. 12, 2008

**SERVICE MARK
PRINCIPAL REGISTER**

KAI CHI DO

ROBINSON, CHARLES (UNITED STATES INDIVIDUAL)
1400 VERMONT AVE.
TARPON SPRINGS, FL 34689

FOR: EDUCATION SERVICES, NAMELY, CONDUCTING CLASSES, SEMINARS AND WORKSHOPS IN THE FIELD OF PERSONAL GROWTH AND FITNESS THROUGH A SYSTEM OF MOVEMENTS, MUSIC, MEDITATION, AND BREATHWORK, IN CLASS 41 (U.S. CLS. 100, 101 AND 107).

FIRST USE 4-0-1971; IN COMMERCE 3-3-2007.

THE MARK CONSISTS OF STANDARD CHARACTERS WITHOUT CLAIM TO ANY PARTICULAR FONT, STYLE, SIZE, OR COLOR.

THE ENGLISH TRANSLATION OF "KAI" IS OPEN OR LOOSEN, "CHI" IS SPIRIT, LIFE, ENERGY, AND "DO" IS WAY OR FORM.

SER. NO. 77-360,996, FILED 12-28-2007.

ANDREA SAUNDERS, EXAMINING ATTORNEY

Int. Cl.: 6

Prior U.S. Cls.: 2, 12, 13, 14, 23, 25 and 50

Reg. No. 3,484,158

United States Patent and Trademark Office

Registered Aug. 12, 2008

**TRADEMARK
PRINCIPAL REGISTER**

AXS

WATERLOO INDUSTRIES, INC. (DELAWARE
CORPORATION)
100 EAST 4TH STREET
WATERLOO, IA 507034714

THE MARK CONSISTS OF STANDARD CHAR-
ACTERS WITHOUT CLAIM TO ANY PARTICULAR
FONT, STYLE, SIZE, OR COLOR.

FOR: METAL TOOL CHESTS, METAL TOOL
CABINETS, AND WHEELED METAL TOOL CHEST
AND TOOL CABINET UNITS, IN CLASS 6 (U.S. CLS.
2, 12, 13, 14, 23, 25 AND 50).

SER. NO. 77-361,082, FILED 12-28-2007.

FIRST USE 9-11-2007; IN COMMERCE 9-11-2007.

JULIE GUTTADAURO, EXAMINING ATTORNEY

Int. Cl.: 6

Prior U.S. Cls.: 2, 12, 13, 14, 23, 25 and 50

Reg. No. 3,484,159

United States Patent and Trademark Office

Registered Aug. 12, 2008

**TRADEMARK
PRINCIPAL REGISTER**

T-POST GRABBER

ADVANCED EDGE PRODUCTS, LLC (TEXAS
LTD LIAB CO)
P.O. BOX 53237
AMARILLO, TX 791593237

FOR: METAL CLEVIS, CHAIN AND HOOK SOLD
AS A UNIT FOR REMOVING STEEL FARMING
POSTS FOR USE WITH A TRACTOR, IN CLASS 6
(U.S. CLS. 2, 12, 13, 14, 23, 25 AND 50).

FIRST USE 11-27-2007; IN COMMERCE 11-27-2007.

THE MARK CONSISTS OF STANDARD CHAR-
ACTERS WITHOUT CLAIM TO ANY PARTICULAR
FONT, STYLE, SIZE, OR COLOR.

NO CLAIM IS MADE TO THE EXCLUSIVE
RIGHT TO USE "T-POST", APART FROM THE
MARK AS SHOWN.

SER. NO. 77-361,135, FILED 12-28-2007.

GRETTA YAO, EXAMINING ATTORNEY

Int. Cl.: 36

Prior U.S. Cls.: 100, 101 and 102

United States Patent and Trademark Office

Reg. No. 3,484,160

Registered Aug. 12, 2008

**SERVICE MARK
PRINCIPAL REGISTER**

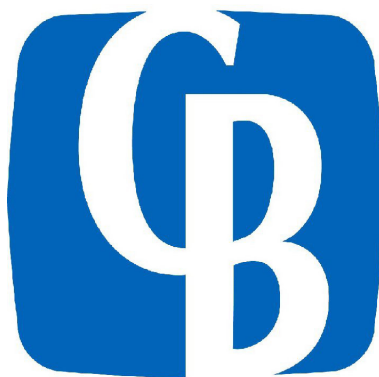

COLUMBIA STATE BANK (WASHINGTON CORPORATION)
1301 A STREET
TACOMA, WA 98402

FOR: BANKING AND FINANCING SERVICES; CHECKING ACCOUNT SERVICES; SAVINGS ACCOUNT SERVICES; ONLINE CASH ACCOUNT SERVICES; BANKING SERVICES; PROVIDING BANK ACCOUNT INFORMATION BY TELEPHONE; INVESTMENT BANKING SERVICES; MORTGAGE BANKING; COMMERCIAL LENDING SERVICES; CONSUMER LENDING SERVICES; FINANCIAL PLANNING; SAFE DEPOSIT BOX SERVICES; CREDIT AND DEBIT CARD SERVICES, IN CLASS 36 (U.S. CLS. 100, 101 AND 102).

FIRST USE 8-17-1993; IN COMMERCE 8-17-1993.

THE COLOR(S) BLUE AND WHITE IS/ARE CLAIMED AS A FEATURE OF THE MARK.

THE MARK CONSISTS OF A BLUE SQUARE WITH ROUNDED EDGES CONTAINING THE WHITE INTERLOCKING STYLIZED LETTERS "CB". THE OUTER PORTION OF THE DESIGN IS BLUE, WHILE THE "CB" LETTERS INSIDE THE DESIGN ARE WHITE.

SER. NO. 77-361,141, FILED 12-28-2007.

CHERYL CLAYTON, EXAMINING ATTORNEY

Int. Cl.: 36

Prior U.S. Cls.: 100, 101 and 102

United States Patent and Trademark Office

Reg. No. 3,484,161

Registered Aug. 12, 2008

SERVICE MARK
PRINCIPAL REGISTER



PACIFIC REALTY & FINANCIAL SERVICES,
INC. (CALIFORNIA CORPORATION), DBA
NOVA REALTY GROUP

SUITE 690

3200 BRISTOLL STREET

COSTA MESA, CA 92626

FOR: REAL ESTATE BROKERAGE, IN CLASS 36
(U.S. CLS. 100, 101 AND 102).

FIRST USE 11-16-2006; IN COMMERCE 12-13-2006.

NO CLAIM IS MADE TO THE EXCLUSIVE
RIGHT TO USE "REALTY GROUP", APART FROM
THE MARK AS SHOWN.

THE MARK CONSISTS OF A HOUSE SHAPE
WITH A STYLIZED LETTER "N" WITH THE STY-
LIZED WORDS "NOVA REALTY GROUP" TO THE
RIGHT OF IT.

SER. NO. 77-361,304, FILED 12-28-2007.

SONYA STEPHENS, EXAMINING ATTORNEY

Int. Cl.: 36

Prior U.S. Cls.: 100, 101 and 102

United States Patent and Trademark Office

Reg. No. 3,484,162

Registered Aug. 12, 2008

**SERVICE MARK
PRINCIPAL REGISTER**

**I don't just sell property,
I understand it**

WOOD, SARAH (UNITED STATES INDIVIDUAL)
7047 E. MADERO AVE.
MESA, AZ 85209

THE MARK CONSISTS OF STANDARD CHAR-
ACTERS WITHOUT CLAIM TO ANY PARTICULAR
FONT, STYLE, SIZE, OR COLOR.

FOR: REAL ESTATE BROKERAGE IN THE
FIELD OF RESIDENTIAL AND COMMERCIAL
PROPERTIES, BUILDINGS AND LAND, IN CLASS
36 (U.S. CLS. 100, 101 AND 102).

SER. NO. 77-361,317, FILED 12-28-2007.

FIRST USE 1-1-2007; IN COMMERCE 3-15-2007.

ZHALEH DELANEY, EXAMINING ATTORNEY

Int. Cl.: 35

Prior U.S. Cls.: 100, 101 and 102

United States Patent and Trademark Office

Reg. No. 3,484,163

Registered Aug. 12, 2008

**SERVICE MARK
PRINCIPAL REGISTER**

PUMPED

PUMPED, INC. (FLORIDA CORPORATION)
40 NE 1ST AVE STE 603
MIAMI, FL 33132

FIRST USE 12-29-2007; IN COMMERCE 12-29-2007.

FOR: ADVERTISING SERVICES, PUBLIC RELATIONS AND MARKETING SERVICES, NAMELY, PROMOTING AND MARKETING THE GOODS AND SERVICES OF OTHERS THROUGH ALL PUBLIC COMMUNICATION MEANS, IN CLASS 35 (U.S. CLS. 100, 101 AND 102).

THE MARK CONSISTS OF STANDARD CHARACTERS WITHOUT CLAIM TO ANY PARTICULAR FONT, STYLE, SIZE, OR COLOR.

SER. NO. 77-361,554, FILED 12-30-2007.

MAUREEN DALL, EXAMINING ATTORNEY

Int. Cl.: 16

Prior U.S. Cls.: 2, 5, 22, 23, 29, 37, 38 and 50

United States Patent and Trademark Office

Reg. No. 3,484,164

Registered Aug. 12, 2008

**TRADEMARK
PRINCIPAL REGISTER**

Storm Tactical

STORM TACTICAL, INC (NEVADA CORPORATION)
PO BOX 27115
LAS VEGAS, NV 89126

THE MARK CONSISTS OF STANDARD CHARACTERS WITHOUT CLAIM TO ANY PARTICULAR FONT, STYLE, SIZE, OR COLOR.

FOR: EDUCATIONAL PUBLICATIONS, NAME-
LY, TRAINING MANUALS IN THE FIELD OF
FIREARMS, IN CLASS 16 (U.S. CLS. 2, 5, 22, 23, 29,
37, 38 AND 50).

SER. NO. 77-361,652, FILED 12-30-2007.

FIRST USE 11-14-2007; IN COMMERCE 11-14-2007.

REGINA DRUMMOND, EXAMINING ATTORNEY

Int. Cl.: 37

Prior U.S. Cls.: 100, 103 and 106

United States Patent and Trademark Office

Reg. No. 3,484,165

Registered Aug. 12, 2008

**SERVICE MARK
PRINCIPAL REGISTER**

Strober Roofing Metal Works

STROBER ROOFING METAL WORKS LLC (NEW
JERSEY LTD LIAB CO)
47 FAIRVIEW ROAD
FRENCHTOWN, NJ 08825

FOR: ROOFING CONSULTATION; ROOFING
CONTRACTING; ROOFING INSTALLATION;
ROOFING REPAIR; ROOFING SERVICES, IN
CLASS 37 (U.S. CLS. 100, 103 AND 106).

FIRST USE 1-2-2000; IN COMMERCE 1-2-2000.

THE MARK CONSISTS OF STANDARD CHAR-
ACTERS WITHOUT CLAIM TO ANY PARTICULAR
FONT, STYLE, SIZE, OR COLOR.

NO CLAIM IS MADE TO THE EXCLUSIVE
RIGHT TO USE "ROOFING", APART FROM THE
MARK AS SHOWN.

SER. NO. 77-361,789, FILED 12-31-2007.

TEJBIR SINGH, EXAMINING ATTORNEY

Int. Cl.: 28

Prior U.S. Cls.: 22, 23, 38 and 50

United States Patent and Trademark Office

Reg. No. 3,484,166

Registered Aug. 12, 2008

**TRADEMARK
PRINCIPAL REGISTER**

Tony Maja

E-Z OUTRODDER LLC (NEW JERSEY LTD LIAB
CO)
117 CEDAR RUN ROAD
BAYVILLE, NJ 08721

FOR: FISHING LURES, IN CLASS 28 (U.S. CLS. 22,
23, 38 AND 50).

FIRST USE 11-1-2007; IN COMMERCE 11-1-2007.

THE MARK CONSISTS OF STANDARD CHAR-
ACTERS WITHOUT CLAIM TO ANY PARTICULAR
FONT, STYLE, SIZE, OR COLOR.

THE NAME "TONY MAJA" DOES NOT IDENTI-
FY A LIVING INDIVIDUAL.

SER. NO. 77-361,794, FILED 12-31-2007.

ALLISON SCHRODY, EXAMINING ATTORNEY

Int. Cl.: 1

Prior U.S. Cls.: 1, 5, 6, 10, 26 and 46

Reg. No. 3,484,167

United States Patent and Trademark Office

Registered Aug. 12, 2008

**TRADEMARK
PRINCIPAL REGISTER**

Dolphin Skin USA

MAULDIN, BOBBY L. (CALIFORNIA INDIVIDUAL), DBA DOLPHIN SKIN USA
4162 THOMAS ST.
OCEANSIDE, CA 920564222 AND
MAULDIN, DOROTHY A. (CALIFORNIA INDIVIDUAL), DBA DOLPHIN SKIN USA
4162 THOMAS ST.
OCEANSIDE, CA 920564222

THE MARK CONSISTS OF STANDARD CHARACTERS WITHOUT CLAIM TO ANY PARTICULAR FONT, STYLE, SIZE, OR COLOR.

NO CLAIM IS MADE TO THE EXCLUSIVE RIGHT TO USE "USA", APART FROM THE MARK AS SHOWN.

FOR: ACRYLIC RESINS , IN CLASS 1 (U.S. CLS. 1, 5, 6, 10, 26 AND 46).

SER. NO. 77-362,080, FILED 12-31-2007.

FIRST USE 9-11-2007; IN COMMERCE 9-11-2007.

JENNIFER MARTIN, EXAMINING ATTORNEY

Int. Cl.: 11

Prior U.S. Cls.: 13, 21, 23, 31 and 34

United States Patent and Trademark Office

Reg. No. 3,484,168

Registered Aug. 12, 2008

TRADEMARK
PRINCIPAL REGISTER

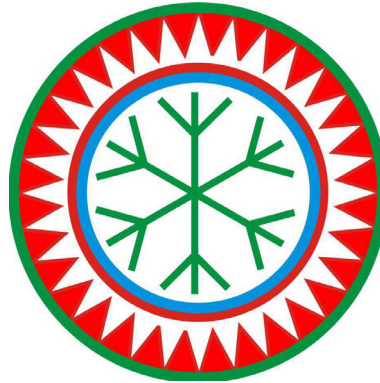

GAMLIEL, JOSEPH (ISRAEL INDIVIDUAL)

3 SITVANIT ST.

AHUZAT BARAK, ISRAEL 19323

FOR: AIR CONDITIONERS, IN CLASS 11 (U.S. CLS. 13, 21, 23, 31 AND 34).

FIRST USE 7-1-2007; IN COMMERCE 7-1-2007.

THE COLOR(S) GREEN, RED, WHITE, DARK RED AND BLUE IS/ARE CLAIMED AS A FEATURE OF THE MARK.

THE MARK CONSISTS OF THE COLOR GREEN APPEARING AS THE OUTER MOST CIRCLE AND THE SNOWFLAKE DESIGN; THE COLOR RED APPEARS AS THE OUTER TRIANGLE DESIGNS; THE COLOR WHITE APPEARS AS THE INNER TRIANGLE DESIGNS AND AS THE CENTER CIRCLE CONTAINING THE SNOWFLAKE; THE WHITE CIRCLE CONTAINING THE SNOWFLAKE IS SURROUNDED BY A BLUE CIRCLE WHICH IS SURROUNDED BY A DARK RED CIRCLE.

SER. NO. 77-362,190, FILED 1-1-2008.

KATHERINE E. HALMEN, EXAMINING ATTORNEY

Int. Cl.: 41

Prior U.S. Cls.: 100, 101 and 107

United States Patent and Trademark Office

Reg. No. 3,484,169

Registered Aug. 12, 2008

**SERVICE MARK
PRINCIPAL REGISTER**



COACHING FOR THE FUTURE, INC. (ARIZONA CORPORATION)
2712 EAST MOUNTAIN VIEW ROAD
PHOENIX, AZ 85028

OWNER OF U.S. REG. NO. 2,963,716.

FOR: EDUCATIONAL SERVICES, NAMELY, CONDUCTING TRAINING COURSES IN THE FIELD OF GOLF AND DISTRIBUTION OF COURSE MATERIAL IN CONNECTION THEREWITH; PROFESSIONAL COACHING SERVICES IN THE FIELD OF GOLF, IN CLASS 41 (U.S. CLS. 100, 101 AND 107).

THE MARK CONSISTS OF A FIGURE SYMBOL WITH OUTSTRETCHED ARMS AND LEGS, AND THE STYLIZED TEXT "VISION54 BRING POSSIBILITY TO LIFE".

SER. NO. 77-362,453, FILED 1-2-2008.

FIRST USE 7-10-2007; IN COMMERCE 7-10-2007.

REBECCA SMITH, EXAMINING ATTORNEY

Int. Cl.: 9

Prior U.S. Cls.: 21, 23, 26, 36 and 38

United States Patent and Trademark Office

Reg. No. 3,484,170

Registered Aug. 12, 2008

**TRADEMARK
PRINCIPAL REGISTER**

FORBIDDEN DOWNLOADS

GEMS PUBLISHING USA, INC. (MASSACHUSETTS CORPORATION)
12 WALNUT STREET
FRAMINGHAM, MA 01702

FOR: DOWNLOADABLE ELECTRONIC PUBLICATIONS, NAMELY, NEWSLETTERS, ARTICLE REPRINTS, BROCHURES, INFORMATIONAL PAMPHLETS, SPECIAL PRINTED REPORTS, BROCHURES, OFFICE FORM TEMPLATES, AND PRINTED SEMINAR TRANSCRIPTS OF AUDIO PRESENTATIONS; DOWNLOADABLE ELECTRONIC AUDIO AND VIDEO FILES; DOWNLOADABLE GRAPHIC IMAGE FILES; AND DOWNLOADABLE ELECTRONIC SPREADSHEETS, ALL IN THE FIELDS OF DENTISTRY, DENTAL PRACTICE MANAGEMENT, AND DENTAL PRACTICE PRO-

MOTION, IN CLASS 9 (U.S. CLS. 21, 23, 26, 36 AND 38).

FIRST USE 12-0-2007; IN COMMERCE 12-0-2007.

THE MARK CONSISTS OF STANDARD CHARACTERS WITHOUT CLAIM TO ANY PARTICULAR FONT, STYLE, SIZE, OR COLOR.

NO CLAIM IS MADE TO THE EXCLUSIVE RIGHT TO USE "DOWNLOADS", APART FROM THE MARK AS SHOWN.

SER. NO. 77-362,477, FILED 1-2-2008.

ELISSA GARBER KON, EXAMINING ATTORNEY

Int. Cl.: 9

Prior U.S. Cls.: 21, 23, 26, 36 and 38

United States Patent and Trademark Office

Reg. No. 3,484,171

Registered Aug. 12, 2008

**TRADEMARK
PRINCIPAL REGISTER**

think-cell

THINK-CELL SOFTWARE GMBH (FED REP
GERMANY LTD LIAB CO)
INVALIDENSTR. 34
BERLIN, FED REP GERMANY 10115

FOR: (BASED ON USE IN COMMERCE) COMPU-
TER GRAPHICS SOFTWARE(BASED ON 44(E))
COMPUTER GRAPHICS SOFTWARE, IN CLASS 9
(U.S. CLS. 21, 23, 26, 36 AND 38).

FIRST USE 7-1-2002; IN COMMERCE 7-1-2002.

THE MARK CONSISTS OF STANDARD CHAR-
ACTERS WITHOUT CLAIM TO ANY PARTICULAR
FONT, STYLE, SIZE, OR COLOR.

OWNER OF FED REP GERMANY REG. NO.
30233668.0, DATED 9-10-2002, EXPIRES 9-10-2012.

SER. NO. 77-362,509, FILED 1-2-2008.

MONIQUE MILLER, EXAMINING ATTORNEY

Int. Cl.: 35

Prior U.S. Cls.: 100, 101 and 102

United States Patent and Trademark Office

Reg. No. 3,484,172

Registered Aug. 12, 2008

**SERVICE MARK
PRINCIPAL REGISTER**

JEWELBASKET.COM

JEWELBASKET.COM, LLC (NEW JERSEY LTD
LIAB CO)
19-03 MAPLE AVENUE, UNIT 1
FAIR LAWN, NJ 07410

FOR: ON-LINE RETAIL STORE SPECIALIZING
IN JEWELRY VIA THE INTERNET; PROVIDING
CONSUMER PRODUCT INFORMATION IN THE
FIELD OF JEWELRY BY MEANS OF THE INTER-
NET, IN CLASS 35 (U.S. CLS. 100, 101 AND 102).

FIRST USE 3-1-2003; IN COMMERCE 3-1-2003.

THE MARK CONSISTS OF STANDARD CHAR-
ACTERS WITHOUT CLAIM TO ANY PARTICULAR
FONT, STYLE, SIZE, OR COLOR.

SER. NO. 77-362,652, FILED 1-2-2008.

MONIQUE MILLER, EXAMINING ATTORNEY

Int. Cl.: 35

Prior U.S. Cls.: 100, 101 and 102

United States Patent and Trademark Office

Reg. No. 3,484,173

Registered Aug. 12, 2008

**SERVICE MARK
PRINCIPAL REGISTER**



EQUITY CONSULTING, LLC (SOUTH DAKOTA
LTD LIAB CO)
1315 LAQUINTA STREET
SIOUX FALLS, SD 571083308

FOR: ACCOUNTING SERVICES; ACCOUNTS RECEIVABLE SERVICES; ACQUISITION AND MERGER CONSULTATION; ADMINISTRATION OF BUSINESS PAYROLL FOR OTHERS; ANALYSES AND APPRAISALS OF ENTERPRISES; ASSISTANCE IN MANAGEMENT OF BUSINESS ACTIVITIES; ASSISTANCE, ADVISORY SERVICES AND CONSULTANCY WITH REGARD TO BUSINESS PLANNING, BUSINESS ANALYSIS, BUSINESS MANAGEMENT, AND BUSINESS ORGANIZATION; BOOKKEEPING; BUSINESS APPRAISAL CONSULTATION; BUSINESS CONSULTATION SERVICES; BUSINESS DEVELOPMENT SERVICES, NAMELY, PROVIDING START-UP SUPPORT FOR BUSINESSES OF OTHERS; COMPTROLLER SERVICES; CONSULTANCY SERVICES REGARDING BUSINESS STRATEGIES; CORPORATE MANAGEMENT ASSISTANCE; COST ACCOUNTING; COST ANALYSES; FINANCIAL STATEMENT PREPARA-

TION AND ANALYSIS FOR BUSINESSES; NEW BUSINESS VENTURE DEVELOPMENT AND FORMATION CONSULTING SERVICES; PAYROLL PROCESSING SERVICES; PREPARATION OF WAGE SLIPS; PREPARING BUSINESS REPORTS; PREPARING FINANCIAL REPORTS FOR OTHERS; PROFESSIONAL BUSINESS CONSULTING; TAX AND TAXATION PLANNING, ADVICE, INFORMATION AND CONSULTANCY SERVICES; TAX FILING SERVICES, IN CLASS 35 (U.S. CLS. 100, 101 AND 102).

FIRST USE 4-1-2007; IN COMMERCE 4-1-2007.

THE MARK CONSISTS OF "A" CIRCLE CIRCUMSCRIBING A STYLIZED LETTER "E" AND A STYLIZED LETTER "C" NESTED WITHIN THE STYLIZED LETTER "E".

SER. NO. 77-362,684, FILED 1-2-2008.

NORA BUCHANAN WILL, EXAMINING ATTORNEY

Int. Cl.: 44

Prior U.S. Cls.: 100 and 101

United States Patent and Trademark Office

Reg. No. 3,484,174

Registered Aug. 12, 2008

**SERVICE MARK
PRINCIPAL REGISTER**

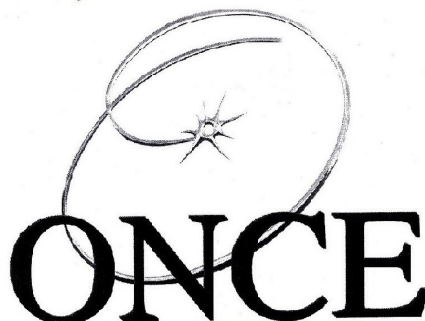

KLOS, KEVIN J. (UNITED STATES INDIVIDUAL)
8110 SOUTH YALE
TULSA, OK 74137

FOR: MEDICAL SERVICES IN THE FIELD OF NEUROLOGY, NAMELY, EXAMINATION, DIAGNOSIS, TREATMENT, PHYSICAL THERAPY, BALANCE AND HEARING TESTING, AND SPEECH AND SWALLOWING EVALUATION THERAPY, IN CLASS 44 (U.S. CLS. 100 AND 101).

FIRST USE 5-1-2007; IN COMMERCE 5-1-2007.

OWNER OF U.S. REG. NO. 3,391,485.

THE MARK CONSISTS OF THE TERM "ONCE" APPEARING UNDERNEATH OF A STYLIZED CAPITAL LETTER "O" WITH A FANCIFUL DEPICTION OF A BRAIN NEURON APPEARING INSIDE OF THE STYLIZED LETTER.

SER. NO. 77-362,703, FILED 1-2-2008.

AMY MCMENAMIN, EXAMINING ATTORNEY

Int. Cl.: 19

Prior U.S. Cls.: 1, 12, 33 and 50

United States Patent and Trademark Office

Reg. No. 3,484,175

Registered Aug. 12, 2008

**TRADEMARK
PRINCIPAL REGISTER**

BARRICOAT

CARLISLE INTANGIBLE COMPANY (DELA-
WARE CORPORATION)
SUITE 201
250 SOUTH CLINTON STREET
SYRACUSE, NY 13202

FOR: ASPHALT EMULSION COATING FOR
FOUNDATIONS, IN CLASS 19 (U.S. CLS. 1, 12, 33
AND 50).

FIRST USE 4-30-2002; IN COMMERCE 4-30-2002.

THE MARK CONSISTS OF STANDARD CHAR-
ACTERS WITHOUT CLAIM TO ANY PARTICULAR
FONT, STYLE, SIZE, OR COLOR.

SER. NO. 77-362,726, FILED 1-2-2008.

JOHN SCHUYLER YARD, EXAMINING ATTOR-
NEY

Int. Cl.: 44

Prior U.S. Cls.: 100 and 101

United States Patent and Trademark Office

Reg. No. 3,484,176

Registered Aug. 12, 2008

**SERVICE MARK
PRINCIPAL REGISTER**



Pain PACT

PURDUE PHARMA L.P. (DELAWARE LIMITED
PARTNERSHIP)
ONE STAMFORD FORUM
STAMFORD, CT 06901

FOR: INFORMATIONAL SERVICES, NAMELY,
PROVIDING INFORMATION IN THE FIELD OF
PAIN MANAGEMENT TO HEALTH CARE PROFES-
SIONALS, IN CLASS 44 (U.S. CLS. 100 AND 101).

FIRST USE 1-27-2008; IN COMMERCE 1-27-2008.

NO CLAIM IS MADE TO THE EXCLUSIVE
RIGHT TO USE "PAIN", APART FROM THE MARK
AS SHOWN.

THE MARK CONSISTS OF THE WORDS "PAIN
PACT" UNDERNEATH A LOGO DEPICTING A
ROAD LEADING TO TWO MOUNTAINS WITH A
SUN BEHIND THEM.

SER. NO. 77-362,727, FILED 1-2-2008.

EUGENIA MARTIN, EXAMINING ATTORNEY

Int. Cl.: 35

Prior U.S. Cls.: 100, 101 and 102

United States Patent and Trademark Office

Reg. No. 3,484,177

Registered Aug. 12, 2008

SERVICE MARK
PRINCIPAL REGISTER



WE
— *are* —
TEACHERS
The Knowledge Marketplace.

WEARETEACHERS (TEXAS LTD LIAB CO)
SUITE 100
8015 SHOAL CREEK BLVD.
AUSTIN, TX 78757

FOR: ADVERTISING AND PUBLICITY SERVICES, NAMELY, PROMOTING THE GOODS, SERVICES, BRAND IDENTITY AND COMMERCIAL INFORMATION AND NEWS OF THIRD PARTIES THROUGH PRINT, AUDIO, VIDEO, DIGITAL AND ON-LINE MEDIUM, IN CLASS 35 (U.S. CLS. 100, 101 AND 102).

FIRST USE 5-1-2007; IN COMMERCE 11-15-2007.

THE MARK CONSISTS OF A CUBE WITH THREE SIDES VISIBLE THE SQUARE ON THE LEFT SIDE WITH A YIN YANG SYMBOL INSIDE, THE TOP SQUARE HAS A BOOK ITS PAGES OPENING SLIGHTLY INSIDE, THE RIGHT SQUARE HAS A MUSIC NOTE INSIDE, THE CUBE IS CENTER ALIGNED ABOVE THE TEXT "WE", THE 'ARE' IS LOCATED BELOW 'WE' IN SMALLER FONT IN THE MIDDLE OF A HORIZONTAL LINE, BELOW THE HORIZONTAL LINE CENTER ALIGNED IS THE TEXT "TEACHERS", BELOW "TEACHERS" IS THE TEXT "THE KNOWLEDGE MARKETPLACE".

SER. NO. 77-362,804, FILED 1-2-2008.

AISHA CLARKE, EXAMINING ATTORNEY

Int. Cl.: 36

Prior U.S. Cls.: 100, 101 and 102

United States Patent and Trademark Office

Reg. No. 3,484,178

Registered Aug. 12, 2008

**SERVICE MARK
PRINCIPAL REGISTER**



AMERICASBANK CORP. (MARYLAND CORPORATION)
500 YORK ROAD
TOWSON, MD 212045103

FOR: BANKING SERVICES, IN CLASS 36 (U.S. CLS. 100, 101 AND 102).

FIRST USE 8-1-2007; IN COMMERCE 8-1-2007.

OWNER OF U.S. REG. NOS. 2,246,780, 2,427,771, AND 3,207,470.

NO CLAIM IS MADE TO THE EXCLUSIVE RIGHT TO USE "TOWSON COMMUNITY BANK" AND "DIVISION", APART FROM THE MARK AS SHOWN.

THE MARK CONSISTS OF A LAMP POST WITH A HANGING FLAG CONTAINING THE CAPITAL LETTER "T" IN STYLIZED TEXT. IMMEDIATELY TO THE RIGHT OF THE LAMP POST ARE THE WORDS "TOWSON COMMUNITY BANK," (EACH WORD APPEARING ON A SEPARATE LINE) WITH THE WORD "TOWSON" APPEARING IN BOLD STYLIZED TEXT. DIRECTLY BENEATH THE WORD "BANK" ARE THE WORDS "A DIVISION OF AMERICASBANK" IN SMALLER LETTERS.

SER. NO. 77-362,853, FILED 1-2-2008.

ROBIN CHOSID, EXAMINING ATTORNEY

Int. Cl.: 3

Prior U.S. Cls.: 1, 4, 6, 50, 51 and 52

United States Patent and Trademark Office

Reg. No. 3,484,179

Registered Aug. 12, 2008

**TRADEMARK
PRINCIPAL REGISTER**



SANITIZE GLOBAL WARMING, LLC. (NEW
JERSEY LTD LIAB CO)
APT D
324 DAWSON STREET
MOORESTOWN, NJ 08057

FOR: LIQUID SOAPS FOR HANDS, FACE AND
BODY, IN CLASS 3 (U.S. CLS. 1, 4, 6, 50, 51 AND 52).

FIRST USE 12-20-2007; IN COMMERCE 12-20-2007.

NO CLAIM IS MADE TO THE EXCLUSIVE
RIGHT TO USE "ECO-SOAP", APART FROM THE
MARK AS SHOWN.

THE MARK CONSISTS OF LETTERING TYPED
IN A LOWER-CASE CENTURY GOTHIC FONT,
SPELLING OUT ECO-SOAP. UNDERNEATH THE
"A" IN SOAP ARE 4 DOTS LINED UP HORIZON-
TALLY.

SER. NO. 77-362,921, FILED 1-2-2008.

DAVID ELTON, EXAMINING ATTORNEY

Int. Cl.: 41

Prior U.S. Cls.: 100, 101 and 107

United States Patent and Trademark Office

Reg. No. 3,484,180

Registered Aug. 12, 2008

**SERVICE MARK
PRINCIPAL REGISTER**

Rock the Slopes

ROCK FUEL, LLC (CALIFORNIA LTD LIAB CO)
10521 CLEARWOOD CT.
LOS ANGELES, CA 90077

FOR: ENTERTAINMENT SERVICES, NAMELY, ORGANIZING, PRODUCING, AND CONDUCTING SPORTS COMPETITIONS FEATURING SNOW BOARDING, ORGANIZING EXHIBITIONS FEATURING SNOW BOARDING COMPETITIONS, PROVIDING AN ON-GOING TELEVISION SERIES FEATURING SNOW BOARDING COMPETITIONS, PROVIDING A MULTIMEDIA PROGRAM SERIES FEATURING SNOW BOARDING COMPETITIONS AND LIVE MUSIC PERFORMANCES DISTRIBUTED VIA VARIOUS PLATFORMS ACROSS MULTI-

PLE FORMS OF TRANSMISSION MEDIA, IN CLASS 41 (U.S. CLS. 100, 101 AND 107).

FIRST USE 2-26-2007; IN COMMERCE 2-26-2007.

THE MARK CONSISTS OF STANDARD CHARACTERS WITHOUT CLAIM TO ANY PARTICULAR FONT, STYLE, SIZE, OR COLOR.

NO CLAIM IS MADE TO THE EXCLUSIVE RIGHT TO USE "SLOPES", APART FROM THE MARK AS SHOWN.

SER. NO. 77-362,938, FILED 1-2-2008.

MARGARET POWER, EXAMINING ATTORNEY

Int. Cl.: 42

Prior U.S. Cls.: 100 and 101

United States Patent and Trademark Office

Reg. No. 3,484,181

Registered Aug. 12, 2008

**SERVICE MARK
PRINCIPAL REGISTER**

SpellStore

SPELL SPACE INCORPORATED (CALIFORNIA CORPORATION)
PO BOX 1106
LAKE ARROWHEAD, CA 923521106

FOR: COMPUTER SERVICES, NAMELY, HOSTING AND MAINTAINING AN ONLINE WEBSITE FOR OTHERS TO PURCHASE NEW AGE PRODUCTS SUCH AS TAROT CARDS AND SPELLS AND POTIONS, IN CLASS 42 (U.S. CLS. 100 AND 101).

FIRST USE 4-1-2007; IN COMMERCE 9-5-2007.

THE MARK CONSISTS OF STANDARD CHARACTERS WITHOUT CLAIM TO ANY PARTICULAR FONT, STYLE, SIZE, OR COLOR.

SER. NO. 77-362,942, FILED 1-2-2008.

TRACY WHITTAKER-BROWN, EXAMINING ATTORNEY

Int. Cl.: 1

Prior U.S. Cls.: 1, 5, 6, 10, 26 and 46

Reg. No. 3,484,182

United States Patent and Trademark Office

Registered Aug. 12, 2008

**TRADEMARK
PRINCIPAL REGISTER**

SYNTHETICS ON STEROIDS

PX3 LUBRICANTS LLC (KANSAS LTD LIAB CO)
12080 CHERRY LANE
OLATHE, KS 66061

FOR: CHEMICAL ADDITIVES FOR ENHANCING THE PERFORMANCE OF LUBRICATING OILS, GREASES AND INTERNAL COMBUSTION ENGINE FUELS; CHEMICAL ENGINE TREATMENTS AND ADDITIVES FOR ENGINE OILS, GASOLINE AND DIESEL FUELS, TRANSMISSION FLUIDS AND COOLING SYSTEMS, IN CLASS 1 (U.S. CLS. 1, 5, 6, 10, 26 AND 46).

FIRST USE 1-2-2008; IN COMMERCE 1-2-2008.

THE MARK CONSISTS OF STANDARD CHARACTERS WITHOUT CLAIM TO ANY PARTICULAR FONT, STYLE, SIZE, OR COLOR.

NO CLAIM IS MADE TO THE EXCLUSIVE RIGHT TO USE "SYNTHETICS", APART FROM THE MARK AS SHOWN.

SER. NO. 77-362,950, FILED 1-2-2008.

KATHERINE E. HALMEN, EXAMINING ATTORNEY

Int. Cl.: 5

Prior U.S. Cls.: 6, 18, 44, 46, 51 and 52

Reg. No. 3,484,183

United States Patent and Trademark Office

Registered Aug. 12, 2008

**TRADEMARK
PRINCIPAL REGISTER**

SaniCap

HILL, BRYAN (UNITED STATES INDIVIDUAL)
1901 BROOKCLIFF DRIVE
GREENSBORO, NC 27410

THE MARK CONSISTS OF STANDARD CHAR-
ACTERS WITHOUT CLAIM TO ANY PARTICULAR
FONT, STYLE, SIZE, OR COLOR.

FOR: DISINFECTANT FOR NEEDLES USED FOR
PRICE TAG TAGGING GUNS, IN CLASS 5 (U.S. CLS.
6, 18, 44, 46, 51 AND 52).

SER. NO. 77-362,955, FILED 1-2-2008.

FIRST USE 1-1-1996; IN COMMERCE 1-1-1996.

EDWARD NELSON, EXAMINING ATTORNEY

Int. Cl.: 41

Prior U.S. Cls.: 100, 101 and 107

United States Patent and Trademark Office

Reg. No. 3,484,184

Registered Aug. 12, 2008

**SERVICE MARK
PRINCIPAL REGISTER**



ADDRESS ONE

ADDRESS ONE LLC (NEVADA LTD LIAB CO)
SUITE 301
662 N. VAN NESS AVE.
LOS ANGELES, CA 90004

THE MARK CONSISTS IN PART OF A STYLIZED
PIECE OF DIGITAL FILM LOOP THAT FORMS THE
LETTERS "A" AND "O".

FOR: TELEVISION SHOW PRODUCTION, IN
CLASS 41 (U.S. CLS. 100, 101 AND 107).

SER. NO. 77-362,971, FILED 1-2-2008.

FIRST USE 6-14-1995; IN COMMERCE 6-14-1995.

EDWARD NELSON, EXAMINING ATTORNEY

Int. Cl.: 35

Prior U.S. Cls.: 100, 101 and 102

United States Patent and Trademark Office

Reg. No. 3,484,185

Registered Aug. 12, 2008

**SERVICE MARK
PRINCIPAL REGISTER**



WILLIAMS III, EDWARD R. (UNITED STATES
INDIVIDUAL)
1391 DUBLIN ROAD
COLUMBUS, OH 43215

FOR: TRANSPORTATION LOGISTICS SERVICES,
NAMELY, ARRANGING THE TRANSPORTATION
OF GOODS FOR OTHERS, IN CLASS 35 (U.S. CLS.
100, 101 AND 102).

FIRST USE 6-6-2007; IN COMMERCE 6-6-2007.

THE MARK CONSISTS OF A SILHOUETTE ON A
ZIPLINE.

SER. NO. 77-363,073, FILED 1-3-2008.

NATALIE POLZER, EXAMINING ATTORNEY

Int. Cl.: 27

Prior U.S. Cls.: 19, 20, 37, 42 and 50

United States Patent and Trademark Office

Reg. No. 3,484,186

Registered Aug. 12, 2008

**TRADEMARK
PRINCIPAL REGISTER**

POLYBAC

PROPEX INC. (DELAWARE CORPORATION)
6025 LEE HIGHWAY
CHATTANOOGA, TN 37422

FOR: WOVEN BACKINGS FOR RUGS AND CAR-
PETS, IN CLASS 27 (U.S. CLS. 19, 20, 37, 42 AND 50).

FIRST USE 8-1-2006; IN COMMERCE 8-1-2006.

THE MARK CONSISTS OF STANDARD CHAR-
ACTERS WITHOUT CLAIM TO ANY PARTICULAR
FONT, STYLE, SIZE, OR COLOR.

OWNER OF U.S. REG. NO. 793,425.

SER. NO. 77-363,090, FILED 1-3-2008.

ANGELA GAW, EXAMINING ATTORNEY

Int. Cl.: 42

Prior U.S. Cls.: 100 and 101

United States Patent and Trademark Office

Reg. No. 3,484,187

Registered Aug. 12, 2008

**SERVICE MARK
PRINCIPAL REGISTER**



LUNAWEB.COM (UTAH CORPORATION)
SUITE 701
10 WEST BROADWAY
SALT LAKE CITY, UT 84101

FOR: DESIGN OF HOMEPAGES AND WEBSITES, IN CLASS 42 (U.S. CLS. 100 AND 101).

FIRST USE 10-10-2004; IN COMMERCE 1-0-2005.

NO CLAIM IS MADE TO THE EXCLUSIVE RIGHT TO USE "WEBS.COM", APART FROM THE MARK AS SHOWN.

THE MARK CONSISTS OF A LOGO OF A CRESCENT MOON AND THE WORDS "LUNAWEB.COM".

SER. NO. 77-363,208, FILED 1-3-2008.

CAROLINE WOOD, EXAMINING ATTORNEY

Int. Cl.: 37

Prior U.S. Cls.: 100, 103 and 106

United States Patent and Trademark Office

Reg. No. 3,484,188

Registered Aug. 12, 2008

**SERVICE MARK
PRINCIPAL REGISTER**



BURKE, JOHN (UNITED STATES INDIVIDUAL)
4812 JOELLE DR.
CONCORD, CA 94521

FOR: PAINTING CONTRACTOR SERVICES, IN
CLASS 37 (U.S. CLS. 100, 103 AND 106).

FIRST USE 11-11-2001; IN COMMERCE 11-11-2001.

THE MARK CONSISTS OF TWO PAINT BRUSHES
CROSSED LEAVING A TRAIL; THE RIGHT BRUSH
HAS SMALL TRAILING STARS ON THE RIGHT
SIDE.

SER. NO. 77-363,213, FILED 1-3-2008.

SCOTT BIBB, EXAMINING ATTORNEY

Int. Cls.: 35 and 39

Prior U.S. Cls.: 100, 101, 102 and 105

United States Patent and Trademark Office

Reg. No. 3,484,189

Registered Aug. 12, 2008

SERVICE MARK
PRINCIPAL REGISTER



WORLD BRIDGE LOGISTICS, INC. (TENNESSEE CORPORATION)
SUITE 510
6555 QUINCE ROAD
MEMPHIS, TN 38119

FOR: LOGISTICS MANAGEMENT IN THE FIELD OF TRANSPORTATION; TRANSPORTATION LOGISTICS SERVICES, NAMELY, ARRANGING THE TRANSPORTATION OF GOODS FOR OTHERS; TRANSPORTATION LOGISTICS SERVICES, NAMELY, PLANNING AND SCHEDULING SHIPMENTS FOR USERS OF TRANSPORTATION SERVICES, IN CLASS 35 (U.S. CLS. 100, 101 AND 102).

FIRST USE 3-3-2006; IN COMMERCE 3-3-2006.

FOR: FREIGHT FORWARDING; SUPPLY CHAIN, LOGISTICS AND REVERSE LOGISTICS SERVICES, NAMELY, STORAGE, TRANSPORTATION AND DELIVERY OF PACKAGES, RAW MATERIALS, AND OTHER FREIGHT FOR OTHERS BY AIR, RAIL, SHIP OR TRUCK, IN CLASS 39 (U.S. CLS. 100 AND 105).

FIRST USE 3-3-2006; IN COMMERCE 3-3-2006.

NO CLAIM IS MADE TO THE EXCLUSIVE RIGHT TO USE "LOGISTICS, INC.", APART FROM THE MARK AS SHOWN.

THE MARK CONSISTS OF TWO INVERTED SWOOPS. THEY ARE A STRETCHED TEAR DROP SHAPE WITH THE POINTED SIDE TO THE LEFT EXTENDING TO LARGER ROUNDED SIDE ON THE RIGHT. THE SWOOPS ARE POSITIONED OVER THE NAME "WORLD BRIDGE" WITH THE THIN PART OF THE SWOOP APPROXIMATELY OVER THE "L" AND THE WIDER PART APPROXIMATELY OVER THE "I" AND "D"; UNDERNEATH "WORLD BRIDGE" IS THE TEXT "LOGISTICS, INC."

SER. NO. 77-363,226, FILED 1-3-2008.

JAY BESCH, EXAMINING ATTORNEY

Int. Cl.: 9

Prior U.S. Cls.: 21, 23, 26, 36 and 38

Reg. No. 3,484,190

United States Patent and Trademark Office

Registered Aug. 12, 2008

TRADEMARK
PRINCIPAL REGISTER



NAIL ARTIST USA INC (NEVADA CORPORATION), DBA PRINTAPETAL
3501 SHADY TIMBER ST, SHADOW HILLS #1050
LAS VEGAS, NV 89129

FOR: PRINTERS FOR USE WITH COMPUTERS,
IN CLASS 9 (U.S. CLS. 21, 23, 26, 36 AND 38).

FIRST USE 1-1-2007; IN COMMERCE 1-1-2007.

THE COLOR(S) RED, BLACK, GREEN IS/ARE
CLAIMED AS A FEATURE OF THE MARK.

THE MARK CONSISTS OF "PRINTAPETAL"
SCRIPT WITH ROSE MOTIF. THE COLOR RED
APPEARS IN THE DESIGN OF THE ROSE, THE
COLOR GREEN APPEARS IN THE STEM OF THE
ROSE, THE COLOR BLACK APPEARS IN THE
LETTERS "PRINTAPETAL".

SER. NO. 77-363,330, FILED 1-3-2008.

MARGERY A. TIERNEY, EXAMINING ATTORNEY

Int. Cl.: 35

Prior U.S. Cls.: 100, 101 and 102

United States Patent and Trademark Office

Reg. No. 3,484,191

Registered Aug. 12, 2008

**SERVICE MARK
PRINCIPAL REGISTER**

TRANSFORMING PASSION INTO
ACTION TO ADVANCE HUMAN
HEALTH

HEALTH ADVOCACY STRATEGIES LLC (WA-
SHINGTON LTD LIAB CO)
4126 EAST MADISON STREET, SUITE 200
SEATTLE, WA 98112

FOR: PUBLIC ADVOCACY TO PROMOTE
AWARENESS OF THE NEED FOR VOLUNTARY
ADVOCATES TO WORK WITH HEALTH-RELATED
COMPANIES AND ORGANIZATIONS TO AD-
VANCE HUMAN HEALTH AND HEALTHCARE;
PROMOTING PUBLIC AWARENESS OF THE NEED
FOR VOLUNTARY ADVOCATES TO WORK WITH
HEALTH-RELATED COMPANIES AND ORGANI-
ZATIONS TO ADVANCE HUMAN HEALTH AND

HEALTHCARE; PUBLIC RELATIONS; CONSULT-
ING SERVICES RELATING TO PUBLICITY, IN
CLASS 35 (U.S. CLS. 100, 101 AND 102).

FIRST USE 7-31-2006; IN COMMERCE 7-31-2006.

THE MARK CONSISTS OF STANDARD CHAR-
ACTERS WITHOUT CLAIM TO ANY PARTICULAR
FONT, STYLE, SIZE, OR COLOR.

SER. NO. 77-363,387, FILED 1-3-2008.

TASHIA BUNCH, EXAMINING ATTORNEY

Int. Cls.: 36 and 45

Prior U.S. Cls.: 100, 101 and 102

United States Patent and Trademark Office

Reg. No. 3,484,192

Registered Aug. 12, 2008

**SERVICE MARK
PRINCIPAL REGISTER**



THE LAW OFFICES OF MARC J. LANE, A
PROFESSIONAL CORPORATION (ILLINOIS
CORPORATION)
SUITE 2100
180 NORTH LASALLE STREET
CHICAGO, IL 60601

FOR: INVESTMENT MANAGEMENT; INVEST-
MENT ADVISORY SERVICES; FINANCIAL RE-
SEARCH; FINANCIAL PORTFOLIO
MANAGEMENT; FINANCIAL ANALYSIS AND
CONSULTATION; FINANCIAL PLANNING;
BROKERAGE IN THE FIELD OF SECURITIES;
FINANCIAL INVESTMENT IN THE FIELD OF
SECURITIES; ESTATE PLANNING; INSURANCE
CONSULTATION; INSURANCE PREMIUM RATE
COMPUTING; PROVIDING INFORMATION IN IN-
SURANCE MATTERS, IN CLASS 36 (U.S. CLS. 100,
101 AND 102).

FIRST USE 1-2-2008; IN COMMERCE 1-2-2008.

FOR: LEGAL SERVICES, IN CLASS 45 (U.S. CLS.
100 AND 101).

FIRST USE 1-2-2008; IN COMMERCE 1-2-2008.

OWNER OF U.S. REG. NO. 2,715,461.

NO CLAIM IS MADE TO THE EXCLUSIVE
RIGHT TO USE "WEALTH GROUP", APART FROM
THE MARK AS SHOWN.

THE NAME "MARC J. LANE" IDENTIFIES A
LIVING INDIVIDUAL WHOSE CONSENT IS OF
RECORD.

THE MARK CONSISTS OF A RECTANGLE CON-
TAINING THE WORDS "MARC J. LANE WEALTH
GROUP" WITH A SMALLER SHADED RECTAN-
GLE BELOW IT CONTAINING THE WORDS "PRO-
TECTING TODAY'S WEALTH. BUILDING
TOMORROW'S."

SER. NO. 77-363,400, FILED 1-3-2008.

JIM RINGLE, EXAMINING ATTORNEY

Int. Cl.: 43

Prior U.S. Cls.: 100 and 101

United States Patent and Trademark Office

Reg. No. 3,484,193

Registered Aug. 12, 2008

**SERVICE MARK
PRINCIPAL REGISTER**

**INTOWN
SUITES**

EXTENDED-STAY LIVING

INTOWN SUITES MANAGEMENT, INC. (GEORGIA CORPORATION)
2727 PACES FERRY ROAD, SUITE 2-1200
ATLANTA, GA 30339

FOR: HOTEL AND MOTEL SERVICES; EXTENDED-STAY HOTELS, IN CLASS 43 (U.S. CLS. 100 AND 101).

FIRST USE 12-0-2007; IN COMMERCE 12-0-2007.

NO CLAIM IS MADE TO THE EXCLUSIVE RIGHT TO USE "SUITES" AND "EXTENDED-STAY LIVING", APART FROM THE MARK AS SHOWN.

THE MARK CONSISTS OF THE WORDS "INTOWN" CENTERED OVER "SUITES" IN A STYLIZED TYPE AND THE WORDS "EXTENDED-STAY-LIVING" IN A SECOND TYPE AND SMALLER FONT CENTERED BELOW "SUITES".

SER. NO. 77-363,422, FILED 1-3-2008.

EMILY CHUO, EXAMINING ATTORNEY

Int. Cl.: 41

Prior U.S. Cls.: 100, 101 and 107

United States Patent and Trademark Office

Reg. No. 3,484,194

Registered Aug. 12, 2008

**SERVICE MARK
PRINCIPAL REGISTER**

THE WASHINGTON INDEPENDENT

THE CENTER FOR INDEPENDENT MEDIA (D.C.
NON-PROFIT CORPORATION)
SUITE 625
1825 CONNECTICUT AVENUE NW
WASHINGTON, DC 20009

FOR: GATHERING AND DISSEMINATING
NEWS, COMMENTARY, CRITICISM AND OPI-
NIONS ON A VARIETY OF CURRENT EVENTS
VIA THE INTERNET, IN CLASS 41 (U.S. CLS. 100, 101
AND 107).

FIRST USE 12-10-2007; IN COMMERCE 12-10-2007.

THE MARK CONSISTS OF STANDARD CHAR-
ACTERS WITHOUT CLAIM TO ANY PARTICULAR
FONT, STYLE, SIZE, OR COLOR.

NO CLAIM IS MADE TO THE EXCLUSIVE
RIGHT TO USE "WASHINGTON", APART FROM
THE MARK AS SHOWN.

SER. NO. 77-363,539, FILED 1-3-2008.

CURTIS FRENCH, EXAMINING ATTORNEY

Int. Cl.: 43

Prior U.S. Cls.: 100 and 101

United States Patent and Trademark Office

Reg. No. 3,484,195

Registered Aug. 12, 2008

SERVICE MARK
PRINCIPAL REGISTER



JERRY'S SYSTEMS, INC. (MARYLAND CORPORATION)
15942 SHADY GROVE ROAD
GAITHERSBURG, MD 208771315

FOR: RESTAURANT SERVICES, IN CLASS 43
(U.S. CLS. 100 AND 101).

FIRST USE 12-6-1999; IN COMMERCE 12-6-1999.

NO CLAIM IS MADE TO THE EXCLUSIVE
RIGHT TO USE "SUBS PIZZA", APART FROM
THE MARK AS SHOWN.

THE COLOR(S) RED, YELLOW, BLUE AND
WHITE IS/ARE CLAIMED AS A FEATURE OF
THE MARK.

THE MARK CONSISTS OF A RED OVAL WITH A
YELLOW OVAL CIRCUMSCRIBING THE RED
OVAL AND A BLUE OVAL CIRCUMSCRIBING
THE YELLOW OVAL WITH THE WORD "JERRY'S"
IN WHITE LETTERS OUTLINED WITH BLUE IN-
SCRIBED INSIDE THE RED OVAL AND THE
WORDS "SUBS PIZZA" IN WHITE LETTERS UN-
DERNEATH THE WORD "JERRY'S" INSIDE THE
RED OVAL.

SER. NO. 77-363,641, FILED 1-3-2008.

NAAKWAMA ANKRAH, EXAMINING ATTORNEY

Int. Cl.: 38

Prior U.S. Cls.: 100, 101 and 104

United States Patent and Trademark Office

Reg. No. 3,484,196

Registered Aug. 12, 2008

**SERVICE MARK
PRINCIPAL REGISTER**

C2 GLOBAL TECHNOLOGIES

C2 GLOBAL TECHNOLOGIES, INC. (FLORIDA CORPORATION)
SUITE 3200, SCOTIA PLAZA
40 KING STREET WEST
TORONTO, CANADA

FOR: TELECOMMUNICATION SERVICES UTILIZING INTERNET PROTOCOL, NAMELY, ELECTRONIC TRANSMISSION OF VOICE, DATA AND DOCUMENTS VIA THE INTERNET , IN CLASS 38 (U.S. CLS. 100, 101 AND 104).

FIRST USE 8-0-2005; IN COMMERCE 8-0-2005.

THE MARK CONSISTS OF STANDARD CHARACTERS WITHOUT CLAIM TO ANY PARTICULAR FONT, STYLE, SIZE, OR COLOR.

NO CLAIM IS MADE TO THE EXCLUSIVE RIGHT TO USE "GLOBAL TECHNOLOGIES", APART FROM THE MARK AS SHOWN.

SER. NO. 77-363,646, FILED 1-3-2008.

NAAKWAMA ANKRAH, EXAMINING ATTORNEY

Int. Cl.: 35

Prior U.S. Cls.: 100, 101 and 102

United States Patent and Trademark Office

Reg. No. 3,484,197

Registered Aug. 12, 2008

**SERVICE MARK
PRINCIPAL REGISTER**

Exclusive Wireless

EXCLUSIVE WIRELESS, INC. (CALIFORNIA CORPORATION), DBA T-MOBILE
5151 NORTH PALM AVENUE
FRESNO, CA 93704

FOR: RETAIL STORES, KIOSKS AND MALL CARTS FEATURING SERVICE ACTIVATIONS FOR PERSONAL COMMUNICATION PRODUCTS, NAMELY, CELLULAR PHONES, WIRELESS INTERNET AIRCARDS, DATA INPUT DEVICES, SMART PHONES, HANDHELD E-MAIL DEVICES AND CELLULAR PHONE ACCESSORIES AND PARTS, NAMELY, BATTERIES, TRAVEL CHARGERS, CAR CHARGERS, HANDSFREE HEADSETS AND DEVICES, WIRELESS PERSONAL AREA NETWORK DEVICES, PROTECTOR CASES, PREPAID CARDS, FITTED CASES, CELLULAR SKINS, FACE PLATES, POUCHES, SPEAKERS, AND BACK COV-

ERS NOT MADE OF PAPER, IN CLASS 35 (U.S. CLS. 100, 101 AND 102).

FIRST USE 9-1-2006; IN COMMERCE 9-1-2006.

THE MARK CONSISTS OF STANDARD CHARACTERS WITHOUT CLAIM TO ANY PARTICULAR FONT, STYLE, SIZE, OR COLOR.

NO CLAIM IS MADE TO THE EXCLUSIVE RIGHT TO USE "WIRELESS", APART FROM THE MARK AS SHOWN.

SER. NO. 77-363,663, FILED 1-3-2008.

BRENDAN MCCAULEY, EXAMINING ATTORNEY

Int. Cl.: 35

Prior U.S. Cls.: 100, 101 and 102

United States Patent and Trademark Office

Reg. No. 3,484,198

Registered Aug. 12, 2008

**SERVICE MARK
PRINCIPAL REGISTER**



WIDE WORLD OF MAPS, INC. (ARIZONA CORPORATION)
2626 WEST INDIAN SCHOOL ROAD
PHOENIX, AZ 85017

FOR: RETAIL STORE SERVICES AND WHOLESALE DISTRIBUTORSHIPS FEATURING MAPS AND MAP ACCESSORY ITEMS, NAMELY, MAP PINS, TACKS, TAPE, STICKERS, TEMPLATES, CARRIERS, AND TUBES; MAP AND GEOGRAPHIC THEMED GIFT ITEMS, NAMELY, CALENDARS, NOVELTIES, PENS, BALLS, STATIONERY, ORNAMENTS AND APPAREL; MAP SOFTWARE FOR COMPUTERS AND PDAS, GPS DEVICES, GPS ACCESSORIES, NAMELY, CABLES, MOUNTS, MEMORY CARDS AND CHIPS, AND MAPPING AND GPS SOFTWARE, AND INSTRUCTIONAL BOOKS AND VIDEOS, POSTERS, BOARD AND SOFTWARE MAP-BASED GAMES AND PUZZLES; OPTICAL DEVICES, NAMELY, TELESCOPES, BINOCULARS, MICROSCOPES, MAGNIFIERS, AND LOUPES, AND ACCESSORIES THEREFOR, TRAVEL, DUFFEL, AND TOTE BAGS AND TRAVEL AND TOTE CASES, TOILETRIES KITS, PILLOWS, NECK RESTS, AND SLEEP MASKS, TRAVEL ORGANIZERS, WALLETS, MONEY BELTS, WALKING STICKS, FLAGS, FIRE

STARTERS, MEDICINE KITS, ELECTRIC CONVERTERS, WATER PURIFYING FILTERS, DROPS, AND TABLETS, FLASH LIGHTS, CAMPING LIGHTS, FLEX LIGHTS, AND LOUPE LIGHTS, AND TRAVEL BOOKS, MAP BOOKS, ATLASES AND GLOBES, IN CLASS 35 (U.S. CLS. 100, 101 AND 102).

FIRST USE 10-21-2007; IN COMMERCE 10-21-2007.

THE COLOR(S) BLUE AND RED IS/ARE CLAIMED AS A FEATURE OF THE MARK.

THE COLOR RED APPEARS IN THE WORDS "WIDE WORLD", THE COLOR BLUE APPEARS IN THE PARALLEL AND MERIDIAN LINES AND IN THE OUTLINE OF THE GLOBE DESIGN; THE SPACE BETWEEN THE PARALLEL AND MERIDIAN LINES IS TRANSPARENT, AND TAKES ON THE COLOR OF THE BACKGROUND ON WHICH THE MARK IS PLACED.

SER. NO. 77-363,710, FILED 1-3-2008.

LINDA POWELL, EXAMINING ATTORNEY

Int. Cl.: 35

Prior U.S. Cls.: 100, 101 and 102

United States Patent and Trademark Office

Reg. No. 3,484,199

Registered Aug. 12, 2008

**SERVICE MARK
PRINCIPAL REGISTER**

DRINKERSONLY.COM

DRINKERSONLY.COM LLC (FLORIDA LTD
LIAB CO)
950 S PINE ISLAND RD
PLANTATION, FL 33324

FOR: MEMBERSHIP CLUB SERVICES PROVID-
ING DISCOUNTS, EXCLUSIVE OFFERS, AND SPE-
CIAL INVITATIONS TO EVENTS AND SOCIAL
FUNCTIONS; ADMINISTRATION OF A DISCOUNT
PROGRAM FOR ENABLING PARTICIPANTS TO
OBTAIN DISCOUNTS ON GOODS AND SERVICES
THROUGH USE OF A DISCOUNT MEMBERSHIP
CARD, IN CLASS 35 (U.S. CLS. 100, 101 AND 102).

FIRST USE 8-0-2007; IN COMMERCE 9-0-2007.

THE MARK CONSISTS OF STANDARD CHAR-
ACTERS WITHOUT CLAIM TO ANY PARTICULAR
FONT, STYLE, SIZE, OR COLOR.

SER. NO. 77-363,747, FILED 1-3-2008.

BRENDAN MCCAULEY, EXAMINING ATTORNEY

Int. Cl.: 39

Prior U.S. Cls.: 100 and 105

United States Patent and Trademark Office

Reg. No. 3,484,200

Registered Aug. 12, 2008

**SERVICE MARK
PRINCIPAL REGISTER**



AIT WORLDWIDE LOGISTICS, INC. (ILLINOIS CORPORATION)
701 N. ROHLWING ROAD
ITASCA, IL 60143

FIRST USE 11-1-1991; IN COMMERCE 11-1-1991.

OWNER OF U.S. REG. NOS. 1,641,570, 3,200,736, AND 3,200,737.

FOR: FREIGHT FORWARDING SERVICES; GLOBAL TRANSPORTATION OF FREIGHT FOR OTHERS BY ALL AVAILABLE MEANS; SUPPLY CHAIN, LOGISTICS AND REVERSE LOGISTICS SERVICES, NAMELY, STORAGE, TRANSPORTATION AND DELIVERY OF DOCUMENTS, PACKAGES, RAW MATERIALS, AND OTHER FREIGHT FOR OTHERS BY AIR, RAIL, SHIP OR TRUCK, IN CLASS 39 (U.S. CLS. 100 AND 105).

NO CLAIM IS MADE TO THE EXCLUSIVE RIGHT TO USE "WORLDWIDE LOGISTICS", APART FROM THE MARK AS SHOWN.

SER. NO. 77-363,751, FILED 1-3-2008.

SIMON TENG, EXAMINING ATTORNEY

Int. Cl.: 33

Prior U.S. Cls.: 47 and 49

United States Patent and Trademark Office

Reg. No. 3,484,201

Registered Aug. 12, 2008

**TRADEMARK
PRINCIPAL REGISTER**

WINDFALL VINEYARD

FLORA SPRINGS WINE COMPANY (CALIFORNIA CORPORATION)
677 SOUTH ST. HELENA HIGHWAY
ST. HELENA, CA 94574

FOR: WINE, IN CLASS 33 (U.S. CLS. 47 AND 49).

FIRST USE 9-0-1997; IN COMMERCE 9-0-1997.

THE MARK CONSISTS OF STANDARD CHARACTERS WITHOUT CLAIM TO ANY PARTICULAR FONT, STYLE, SIZE, OR COLOR.

NO CLAIM IS MADE TO THE EXCLUSIVE RIGHT TO USE "VINEYARD", APART FROM THE MARK AS SHOWN.

SER. NO. 77-363,754, FILED 1-3-2008.

BRENDAN MCCAULEY, EXAMINING ATTORNEY

Int. Cl.: 35

Prior U.S. Cls.: 100, 101 and 102

United States Patent and Trademark Office

Reg. No. 3,484,202

Registered Aug. 12, 2008

SERVICE MARK
PRINCIPAL REGISTER



STATER BROS. MARKETS (CALIFORNIA CORPORATION)
301 S. TIPPECANOE AVENUE
SAN BERNARDINO, CA 92408

FOR: RETAIL PHARMACY SERVICES, IN CLASS 35 (U.S. CLS. 100, 101 AND 102).

FIRST USE 12-1-2005; IN COMMERCE 12-1-2005.

OWNER OF U.S. REG. NOS. 1,291,536 AND 1,979,818.

NO CLAIM IS MADE TO THE EXCLUSIVE RIGHT TO USE "SUPER RX" AND "BROS. PHARMACY" AND "BROS. MARKET", APART FROM THE MARK AS SHOWN.

THE COLOR(S) RED, BLUE, ORANGE AND WHITE IS/ARE CLAIMED AS A FEATURE OF THE MARK.

THE MARK CONSISTS OF THE WORDING "SUPER RX" IN RED LETTERS WITH A WHITE AND BLUE OUTLINE WITHIN A BLUE AND WHITE RIBBON WITH AN ORANGE AND RED CENTER, FOLLOWED BY THE WORD "PHARMACY" IN RED. THE WORDS "STATER BROS." APPEAR IN RED ABOVE THE WORD "PHARMACY." HOWEVER, THE LETTER "O" IN "STATER BROS" IS THE IMAGE OF A BLUE AND WHITE RIBBON WITH THE WORDS "STATER BROS. MARKETS" IN THE CENTER IN WHITE. BELOW THE RED WORD "PHARMACY" SITS A BLUE RECTANGLE WITH THE WORDS "HOME OF HEARTLAND HEALTHCARE" IN WHITE.

SER. NO. 77-363,756, FILED 1-3-2008.

BRENDAN MCCAULEY, EXAMINING ATTORNEY

Int. Cl.: 43

Prior U.S. Cls.: 100 and 101

United States Patent and Trademark Office

Reg. No. 3,484,203

Registered Aug. 12, 2008

**SERVICE MARK
PRINCIPAL REGISTER**

MULTITOODLES

NOODLES & COMPANY (DELAWARE COR-
PORATION)
520 ZANG STREET, SUITE D
BROOMFIELD, CO 80021

THE MARK CONSISTS OF STANDARD CHAR-
ACTERS WITHOUT CLAIM TO ANY PARTICULAR
FONT, STYLE, SIZE, OR COLOR.

FOR: RESTAURANT SERVICES, IN CLASS 43
(U.S. CLS. 100 AND 101).

SER. NO. 77-363,812, FILED 1-3-2008.

FIRST USE 1-2-2008; IN COMMERCE 1-2-2008.

FRANK LATTUCA, EXAMINING ATTORNEY

Int. Cl.: 9

Prior U.S. Cls.: 21, 23, 26, 36 and 38

United States Patent and Trademark Office

Reg. No. 3,484,204

Registered Aug. 12, 2008

TRADEMARK
PRINCIPAL REGISTER



OPALTONE AUSTRALASIA PTY. LTD. (AUSTRALIA CORPORATION)
UNIT 2
7 HINDE STREET
ASHMORE, AUSTRALIA

FOR: INK-JET COLOR PRINTERS; LASER COLOR PRINTERS; SOFTWARE FOR PROCESSING IMAGES, GRAPHICS AND TEXT; DESKTOP PUBLISHING SOFTWARE, IN CLASS 9 (U.S. CLS. 21, 23, 26, 36 AND 38).

FIRST USE 12-1-2007; IN COMMERCE 12-1-2007.

OWNER OF U.S. REG. NOS. 2,446,657, 2,750,358, AND 3,361,405.

THE COLOR(S) AQUA, MAGENTA, YELLOW, RED, GREEN, BLUE AND BLACK IS/ARE CLAIMED AS A FEATURE OF THE MARK.

THE MARK CONSISTS OF A BLACK OVAL BAND AND BLACK TEXT, "OPALTONE", SURROUNDING INNER OVAL SHAPE SEPARATED

BY A WHITE KEY LINE. THE INNER OVAL SHAPE IS DISSECTED WITH TWO PARALLEL LINES INTO SIX TRIANGULAR SECTIONS. THE TOP SECTION IS SHADED RED. THE LEFT SECTION IS SHADED GREEN. THE RIGHT SECTION IS SHADED BLUE. THE BOTTOM SECTION IS SHADED AQUA. THE UPPER MIDDLE SECTION IS SHADED YELLOW. THE LOWER MIDDLE SECTION IS SHADED MAGENTA. THE CHARACTERS "VK" APPEAR IN BLACK TO THE IMMEDIATE RIGHT OF THE OVAL SHAPE. WITHIN THE CHARACTER "V" IS AN INVERTED EQUILATERAL TRIANGLE SHADED RED. BETWEEN THE CHARACTERS "V" AND "K" IS A RIGHT ANGLED TRIANGLE SHADED GREEN. WITHIN THE RIGHT SIDE OF THE CHARACTER "K" IS AN EQUILATERAL TRIANGLE ROTATED 90° AND SHADED BLUE. THE "VK" CHARACTERS AND SHADED TRIANGLES ARE SEPARATED BY A WHITE KEY LINE.

SER. NO. 77-363,849, FILED 1-3-2008.

ANDREA BUTLER, EXAMINING ATTORNEY

Int. Cl.: 13

Prior U.S. Cls.: 2 and 9

United States Patent and Trademark Office

Reg. No. 3,484,205

Registered Aug. 12, 2008

TRADEMARK
PRINCIPAL REGISTER



ADVANCED ARMAMENT CORP. (GEORGIA CORPORATION)
1434 HILLCREST RD
NORCROSS, GA 30093

FOR: SILENCERS FOR FIREARMS, IN CLASS 13 (U.S. CLS. 2 AND 9).

FIRST USE 8-1-2003; IN COMMERCE 8-1-2003.

NO CLAIM IS MADE TO THE EXCLUSIVE RIGHT TO USE "ARMAMENT" , APART FROM THE MARK AS SHOWN.

THE MARK CONSISTS OF A MALE RESTROOM LOGO WHERE MALE IS HOLDING A SILENCED PISTOL, ON A ROUNDED RECTANGULAR BACKGROUND, THE WORDING "ADVANCED ARMAMENT" APPEARING BELOW THE MALE, WHERE ALL ELEMENTS ARE ENCLOSED IN A ROUNDED RECTANGLE.

SER. NO. 77-363,867, FILED 1-3-2008.

ADA HAN, EXAMINING ATTORNEY

Int. Cl.: 13

Prior U.S. Cls.: 2 and 9

United States Patent and Trademark Office

Reg. No. 3,484,206

Registered Aug. 12, 2008

**TRADEMARK
PRINCIPAL REGISTER**



ADVANCED ARMAMENT CORP. (GEORGIA
CORPORATION)
1434 HILLCREST RD
NORCROSS, GA 30093

FOR: SILENCERS FOR FIREARMS, IN CLASS 13
(U.S. CLS. 2 AND 9).

FIRST USE 6-2-1997; IN COMMERCE 6-2-1997.

THE MARK CONSISTS OF STYLIZED "AAC".

SER. NO. 77-363,870, FILED 1-3-2008.

ADA HAN, EXAMINING ATTORNEY

Int. Cl.: 9

Prior U.S. Cls.: 21, 23, 26, 36 and 38

United States Patent and Trademark Office

Reg. No. 3,484,207

Registered Aug. 12, 2008

**TRADEMARK
PRINCIPAL REGISTER**



TRANSPANT GPS, INC. (MINNESOTA CORPORATION)
5050 75TH AVE NW
BYRON, MN 55920

FOR: SATELLITE NAVIGATIONAL SYSTEM, NAMELY, A GLOBAL POSITIONING SYSTEM (GPS), IN CLASS 9 (U.S. CLS. 21, 23, 26, 36 AND 38).

FIRST USE 8-27-2007; IN COMMERCE 12-10-2007.

THE COLOR(S) BLACK AND RED IS/ARE CLAIMED AS A FEATURE OF THE MARK.

THE MARK CONSISTS OF THE LETTERS "R" AND "GHT" IN BLACK AND THE LETTERS "WAY" IN RED. THE LETTER "I" IN THE WORD "RIGHT" IS A RED CHECK MARK WITH A RED ARROW AT THE END AND A BLACK DOT WITH THREE BLACK SEMI CIRCLES ABOVE IT. THE COLOR WHITE REPRESENTS BACKGROUND AND IS NOT INTENDED AS PART OF THE MARK

SER. NO. 77-363,880, FILED 1-3-2008.

AMY ALFIERI, EXAMINING ATTORNEY

Int. Cl.: 5

Prior U.S. Cls.: 6, 18, 44, 46, 51 and 52

Reg. No. 3,484,208

United States Patent and Trademark Office

Registered Aug. 12, 2008

**TRADEMARK
PRINCIPAL REGISTER**

Phyto Feed

SONORAN AQUACULTURE LLC (ARIZONA
LTD LIAB CO)
6109 E. CALLE SILVOSA
TUCSON, AZ 85711

FOR: VITAMINS AND DIETARY FOOD SUPPLE-
MENTS FOR ANIMALS, IN CLASS 5 (U.S. CLS. 6, 18,
44, 46, 51 AND 52).

FIRST USE 10-1-2007; IN COMMERCE 10-1-2007.

NO CLAIM IS MADE TO THE EXCLUSIVE
RIGHT TO USE "FEED", APART FROM THE MARK
AS SHOWN.

THE MARK CONSISTS OF TEXT ONLY IN THE
PAPYRUS FONT.

SER. NO. 77-363,890, FILED 1-3-2008.

BRENDAN MCCAULEY, EXAMINING ATTORNEY

Int. Cl.: 39

Prior U.S. Cls.: 100 and 105

United States Patent and Trademark Office

Reg. No. 3,484,209

Registered Aug. 12, 2008

**SERVICE MARK
PRINCIPAL REGISTER**

SKI THE WEST

COLLECTIVE TRAVEL HOLDINGS (PENNSYLVANIA CORPORATION)
110 ROESSLER ROAD, SUITE 300A
PITTSBURGH, PA 15220

FOR: ORGANIZATION, BOOKING AND ARRANGEMENT OF SKI EXCURSIONS, IN CLASS 39 (U.S. CLS. 100 AND 105).

FIRST USE 8-31-1984; IN COMMERCE 8-31-1984.

THE MARK CONSISTS OF STANDARD CHARACTERS WITHOUT CLAIM TO ANY PARTICULAR FONT, STYLE, SIZE, OR COLOR.

NO CLAIM IS MADE TO THE EXCLUSIVE RIGHT TO USE "SKI", APART FROM THE MARK AS SHOWN.

SER. NO. 77-363,947, FILED 1-4-2008.

TARAH HARDY, EXAMINING ATTORNEY

Int. Cl.: 36

Prior U.S. Cls.: 100, 101 and 102

United States Patent and Trademark Office

Reg. No. 3,484,210

Registered Aug. 12, 2008

**SERVICE MARK
PRINCIPAL REGISTER**

Hidden Wealth Workshop

CHARLES D. OLIVER (UNITED STATES INDIVIDUAL)
1611 SUMMERLAND AVENUE
WINTER PARK, FL 32789

FOR: CONSULTING SERVICES RELATING TO MORTGAGE BANKING; MORTGAGE BANKING SERVICES; LOAN FINANCING SERVICES; REAL ESTATE TRANSACTIONS, NAMELY, FINANCIAL INVESTMENT IN THE FIELD OF REAL ESTATE; PROVIDING SECURITIES BROKERAGE SERVICES IN CONNECTION WITH REAL ESTATE TRANSACTIONS; BUYER AND SELLER REPRESENTATION IN REAL ESTATE TRANSACTIONS; SERVICES FOR ORIGINATING, CLOSING AND SERVICING REAL ESTATE TRANSACTIONS FOR OTHERS, NAMELY, REAL ESTATE VALUATION, CASH DISBURSEMENT PROCESSING SERVICES, REAL ESTATE ESCROW AND IMPOUNDING SERVICES, PROPERTY VALUATION AND APPRAISAL SERVICES AND BROKER-PRICED OPINION SERVICES, LOAN PORTFOLIO SERVICES FEATURING DOCUMENT PREPARATION AND RECORDING, MORTGAGE LENDING SERVICES, MORTGAGE ASSIGNMENT

AND RELEASE PREPARATION SERVICES, SERVICES RELATING TO ADVISORY AND MANAGEMENT SERVICES FOR COORDINATION OF REAL ESTATE OWNED "REO" TRANSACTIONS FOR LENDERS AND SERVICERS, SERVICES IN THE NATURE OF ACTING AS A QUALIFIED INTERMEDIARY FOR TAX-DEFERRED EXCHANGES FOR REAL AND PERSONAL PROPERTY, IN CLASS 36 (U.S. CLS. 100, 101 AND 102).

FIRST USE 10-1-2006; IN COMMERCE 10-1-2006.

THE MARK CONSISTS OF STANDARD CHARACTERS WITHOUT CLAIM TO ANY PARTICULAR FONT, STYLE, SIZE, OR COLOR.

NO CLAIM IS MADE TO THE EXCLUSIVE RIGHT TO USE "WORKSHOP", APART FROM THE MARK AS SHOWN.

SER. NO. 77-364,052, FILED 1-4-2008.

GIANCARLO CASTRO, EXAMINING ATTORNEY

Int. Cl.: 11

Prior U.S. Cls.: 13, 21, 23, 31 and 34

Reg. No. 3,484,211

United States Patent and Trademark Office

Registered Aug. 12, 2008

**TRADEMARK
PRINCIPAL REGISTER**

Powered Aire Inc.

POWERED AIRE INC. (PENNSYLVANIA CORPORATION)
109 MORTENSEN ROAD
GREENVILLE, PA 16125

FOR: AIR CURTAIN OR AIR DOOR CONSISTING OF A BLOWER FOR DIRECTING A FLOW OF AIR ACROSS AN OPEN DOORWAY, IN CLASS 11 (U.S. CLS. 13, 21, 23, 31 AND 34).

FIRST USE 11-1-1997; IN COMMERCE 11-1-1997.

THE MARK CONSISTS OF STANDARD CHARACTERS WITHOUT CLAIM TO ANY PARTICULAR FONT, STYLE, SIZE, OR COLOR.

NO CLAIM IS MADE TO THE EXCLUSIVE RIGHT TO USE "AIRE INC.", APART FROM THE MARK AS SHOWN.

SER. NO. 77-364,222, FILED 1-4-2008.

MICHAEL SOUDERS, EXAMINING ATTORNEY

Int. Cl.: 39

Prior U.S. Cls.: 100 and 105

United States Patent and Trademark Office

Reg. No. 3,484,212

Registered Aug. 12, 2008

**SERVICE MARK
PRINCIPAL REGISTER**



PARKING COMPANY OF AMERICA, INC.
(GEORGIA CORPORATION)
250 W. COURT STREET, SUITE 200E
CINCINNATI, OH 45202

FOR: PARKING LOT SERVICES; TRANSPORTATION OF PASSENGERS AND/OR GOODS BY SHUTTLE BUS BETWEEN A PARKING FACILITY AND AN AIRPORT, IN CLASS 39 (U.S. CLS. 100 AND 105).

FIRST USE 6-0-1995; IN COMMERCE 6-0-1995.

OWNER OF U.S. REG. NO. 2,205,535.

THE MARK CONSISTS OF A SLANTED BOX WITH PORTIONS OF AN AIRPLANE AND AUTOMOBILE THEREIN.

SER. NO. 77-364,250, FILED 1-4-2008.

ALEX KEAM, EXAMINING ATTORNEY

Int. Cl.: 35

Prior U.S. Cls.: 100, 101 and 102

United States Patent and Trademark Office

Reg. No. 3,484,213

Registered Aug. 12, 2008

**SERVICE MARK
PRINCIPAL REGISTER**

VisionPerks

VISIONBANK OF IOWA (IOWA CORPORATION)
925 GATEWAY DRIVE
GRIMES, IA 50111

FOR: PROVIDING INCENTIVE REWARD PROGRAMS FOR CUSTOMERS THROUGH THE DISTRIBUTION OF POINTS THAT MAY BE USED TO PURCHASE SERVICES AND MERCHANDISE FROM THIRD PARTIES FOR THE PURPOSE OF PROMOTING AND REWARDING CUSTOMER LOYALTY, IN CLASS 35 (U.S. CLS. 100, 101 AND 102).

FIRST USE 8-1-2007; IN COMMERCE 12-14-2007.

THE MARK CONSISTS OF STANDARD CHARACTERS WITHOUT CLAIM TO ANY PARTICULAR FONT, STYLE, SIZE, OR COLOR.

SER. NO. 77-364,257, FILED 1-4-2008.

KATHERINE M. DUBRAY, EXAMINING ATTORNEY

Int. Cl.: 16

Prior U.S. Cls.: 2, 5, 22, 23, 29, 37, 38 and 50

Reg. No. 3,484,214

United States Patent and Trademark Office

Registered Aug. 12, 2008

**TRADEMARK
PRINCIPAL REGISTER**

GARNISH

GARNISH, INC. (MASSACHUSETTS CORPORATION)
432 SOUTH STREET
AUBURN, MA 01501

FOR: PAPER, CARDBOARD, TISSUE PAPER, PAPER CHIPBOARD AND CELLOPHANE PAPER PACKAGING CONTAINERS USED FOR ENTERTAINING AND GIFT GIVING; PAPER, CARDBOARD, TISSUE PAPER, PAPER CHIPBOARD AND CELLOPHANE PAPER PACKAGING MATERIALS USED FOR ENTERTAINING AND GIFT

GIVING, IN CLASS 16 (U.S. CLS. 2, 5, 22, 23, 29, 37, 38 AND 50).

FIRST USE 11-17-2007; IN COMMERCE 11-17-2007.

THE MARK CONSISTS OF STANDARD CHARACTERS WITHOUT CLAIM TO ANY PARTICULAR FONT, STYLE, SIZE, OR COLOR.

SER. NO. 77-364,292, FILED 1-4-2008.

TRICIA SONNEBORN, EXAMINING ATTORNEY

Int. Cl.: 25

Prior U.S. Cls.: 22 and 39

United States Patent and Trademark Office

Reg. No. 3,484,215

Registered Aug. 12, 2008

**TRADEMARK
PRINCIPAL REGISTER**

Stella Formals

ZHANG, JUNXIANG (CHINA INDIVIDUAL)
21315 COTTONWOOD LN.
WALNUT, CA 91789

FOR: DRESSES; DRESSING GOWNS; EVENING
DRESSES; EVENING GOWNS; WEDDING DRESSES;
WEDDING GOWNS, IN CLASS 25 (U.S. CLS. 22
AND 39).

FIRST USE 2-1-2002; IN COMMERCE 2-1-2002.

THE MARK CONSISTS OF STANDARD CHARACTERS
WITHOUT CLAIM TO ANY PARTICULAR
FONT, STYLE, SIZE, OR COLOR.

NO CLAIM IS MADE TO THE EXCLUSIVE
RIGHT TO USE "FORMALS", APART FROM THE
MARK AS SHOWN.

SER. NO. 77-364,325, FILED 1-4-2008.

LINDA MICKLEBURGH, EXAMINING ATTORNEY

Int. Cl.: 12

Prior U.S. Cls.: 19, 21, 23, 31, 35 and 44

Reg. No. 3,484,216

United States Patent and Trademark Office

Registered Aug. 12, 2008

TRADEMARK
PRINCIPAL REGISTER



TEKTRO TECHNOLOGY CORPORATION (TAI-
WAN CORPORATION)
101, SEC 1, KUANGMING ROAD, PUYEN
CHANGHUA, TAIWAN

FOR: BICYCLE BRAKES, BRAKE LEVERS FOR
BICYCLES, DISC BRAKES FOR BICYCLES, AND
HYDRAULIC BRAKES FOR BICYCLES, IN CLASS
12 (U.S. CLS. 19, 21, 23, 31, 35 AND 44).

THE MARK CONSISTS OF STYLIZED TEXT OF
WORDS, "TRP" AND A BLACK RECTANGLE WITH
THE WORDS "INPLACE" IN THE COLOR WHITE IN
THE RECTANGLE.

SER. NO. 77-364,350, FILED 1-4-2008.

FIRST USE 12-12-2007; IN COMMERCE 12-12-2007.

LINDA M. KING, EXAMINING ATTORNEY

Int. Cl.: 41

Prior U.S. Cls.: 100, 101 and 107

United States Patent and Trademark Office

Reg. No. 3,484,217

Registered Aug. 12, 2008

**SERVICE MARK
PRINCIPAL REGISTER**

Fitness Maven

MORANT, FELICIA DAWN (SOUTH CAROLINA
SOLE PROPRIETORSHIP), DBA FITNESS MA-
VEN
P.O. BOX 290416
COLUMBIA, SC 29229

FOR: PROVIDING ASSISTANCE, PERSONAL
TRAINING AND PHYSICAL FITNESS CONSULTA-
TION TO INDIVIDUALS TO HELP THEM MAKE
PHYSICAL FITNESS, STRENGTH, CONDITION-
ING, AND EXERCISE IMPROVEMENT IN THEIR
DAILY LIVING; PROVIDING A WEBSITE FEATUR-
ING INFORMATION ON EXERCISE AND FITNESS;
PROVIDING AN ON-LINE COMPUTER DATABASE
FEATURING INFORMATION REGARDING EXER-
CISE AND FITNESS; PROVIDING ASSISTANCE,
PERSONAL TRAINING AND PHYSICAL FITNESS
CONSULTATION TO CORPORATE CLIENTS TO
HELP THEIR EMPLOYEES MAKE PHYSICAL FIT-

NESS, STRENGTH, CONDITIONING, AND EXER-
CISE ALTERATIONS IN THEIR DAILY LIVING, IN
CLASS 41 (U.S. CLS. 100, 101 AND 107).

FIRST USE 10-11-2007; IN COMMERCE 10-12-2007.

THE MARK CONSISTS OF STANDARD CHAR-
ACTERS WITHOUT CLAIM TO ANY PARTICULAR
FONT, STYLE, SIZE, OR COLOR.

NO CLAIM IS MADE TO THE EXCLUSIVE
RIGHT TO USE "FITNESS", APART FROM THE
MARK AS SHOWN.

SER. NO. 77-364,353, FILED 1-4-2008.

TARAH HARDY, EXAMINING ATTORNEY

Int. Cl.: 41

Prior U.S. Cls.: 100, 101 and 107

United States Patent and Trademark Office

Reg. No. 3,484,218

Registered Aug. 12, 2008

SERVICE MARK
PRINCIPAL REGISTER



TYSON FOODS, INC. (DELAWARE CORPORATION)
2210 W. OAKLAWN DRIVE
SPRINGDALE, AR 72762

FOR: PROVIDING TRAINING SERVICES IN THE FIELD OF FOOD SERVICE PROFESSIONALS, IN CLASS 41 (U.S. CLS. 100, 101 AND 107).

FIRST USE 10-0-2006; IN COMMERCE 10-0-2006.

NO CLAIM IS MADE TO THE EXCLUSIVE RIGHT TO USE "UNIVERSITY" AND "1986", APART FROM THE MARK AS SHOWN.

THE MARK CONSISTS OF WORDING AND A SEAL DESIGN. THE SEAL CONSISTS OF CONCEN-

TRIC CIRCLES AROUND THE DESIGN OF A GREEK TEMPLE. THE WORDING "TYSON UNIVERSITY" APPEARS AT THE TOP OF THE SEAL. THE WORDING "MEDIA PARS CATILLI" APPEARS AT THE BOTTOM OF THE SEAL. THE GREEK TEMPLE DESIGN APPEARS ABOVE THE WORDING "1986" IN THE CENTER OF THE MARK. A FORK AND KNIFE APPEAR TO THE LEFT AND RIGHT OF THE GREEK TEMPLE.

THE ENGLISH TRANSLATION OF "MEDIA PARS CATILLI" IN THE MARK IS "CENTER OF THE PLATE."

SER. NO. 77-364,369, FILED 1-4-2008.

CORY BOONE, EXAMINING ATTORNEY

Int. Cl.: 35

Prior U.S. Cls.: 100, 101 and 102

United States Patent and Trademark Office

Reg. No. 3,484,219

Registered Aug. 12, 2008

**SERVICE MARK
PRINCIPAL REGISTER**

GREENHOUSE MALL

THE GREENHOUSE MALL, INC. (TEXAS CORPORATION)
9900 RR 620 NORTH
AUSTIN, TX 78726

FOR: RETAIL STORE SERVICES IN THE FIELD OF GREENHOUSES AND GREENHOUSE ACCESSORIES, IN CLASS 35 (U.S. CLS. 100, 101 AND 102).

FIRST USE 3-0-1977; IN COMMERCE 3-0-1977.

THE MARK CONSISTS OF STANDARD CHARACTERS WITHOUT CLAIM TO ANY PARTICULAR FONT, STYLE, SIZE, OR COLOR.

OWNER OF U.S. REG. NO. 2,876,659.

NO CLAIM IS MADE TO THE EXCLUSIVE RIGHT TO USE "GREENHOUSE", APART FROM THE MARK AS SHOWN.

SEC. 2(F).

SER. NO. 77-364,371, FILED 1-4-2008.

JOHN GARTNER, EXAMINING ATTORNEY

Int. Cl.: 41

Prior U.S. Cls.: 100, 101 and 107

United States Patent and Trademark Office

Reg. No. 3,484,220

Registered Aug. 12, 2008

**SERVICE MARK
PRINCIPAL REGISTER**

CHARMANDHAPPY

TELLEZ, CARMEN (UNITED STATES INDIVIDUAL)
9358 CLAYMORE ST.
PICO RIVERA, CA 90660

THE MARK CONSISTS OF STANDARD CHARACTERS WITHOUT CLAIM TO ANY PARTICULAR FONT, STYLE, SIZE, OR COLOR.

FOR: ENTERTAINMENT SERVICES, NAMELY, CONDUCTING PARTIES, IN CLASS 41 (U.S. CLS. 100, 101 AND 107).

SER. NO. 77-364,382, FILED 1-4-2008.

FIRST USE 4-0-1994; IN COMMERCE 4-0-1994.

TINA KUAN, EXAMINING ATTORNEY

Int. Cl.: 41

Prior U.S. Cls.: 100, 101 and 107

United States Patent and Trademark Office

Reg. No. 3,484,221

Registered Aug. 12, 2008

**SERVICE MARK
PRINCIPAL REGISTER**

THE EXERCISE COACH

STRENGTH FOR LIFE LLC (ILLINOIS LTD LIAB
CO)
775 S. BUFFALO GROVE ROAD
BUFFALO GROVE, IL 60089

FOR: EDUCATIONAL SERVICES, NAMELY, IN-
STRUCTION AND CONSULTATION IN THE FIELD
OF PHYSICAL FITNESS AND PROVIDING COURSE
MATERIALS THEREWITH, IN CLASS 41 (U.S. CLS.
100, 101 AND 107).

FIRST USE 7-0-2002; IN COMMERCE 7-0-2002.

THE MARK CONSISTS OF STANDARD CHAR-
ACTERS WITHOUT CLAIM TO ANY PARTICULAR
FONT, STYLE, SIZE, OR COLOR.

OWNER OF U.S. REG. NO. 2,799,490.

SEC. 2(F).

SER. NO. 77-364,513, FILED 1-4-2008.

MICHAEL TANNER, EXAMINING ATTORNEY

Int. Cl.: 36

Prior U.S. Cls.: 100, 101 and 102

United States Patent and Trademark Office

Reg. No. 3,484,222

Registered Aug. 12, 2008

**SERVICE MARK
PRINCIPAL REGISTER**

**OUR CUSTOMERS KNOW THE
DIFFERENCE**

TRIANGLE INSURANCE COMPANY, INC (OK-
LAHOMA CORPORATION)
2821 N. VAN BUREN
ENID, OK 73703

THE MARK CONSISTS OF STANDARD CHAR-
ACTERS WITHOUT CLAIM TO ANY PARTICULAR
FONT, STYLE, SIZE, OR COLOR.

FOR: INSURANCE SERVICES, NAMELY, WRIT-
ING PROPERTY AND CASUALTY INSURANCE, IN
CLASS 36 (U.S. CLS. 100, 101 AND 102).

SER. NO. 77-364,545, FILED 1-4-2008.

FIRST USE 12-1-2007; IN COMMERCE 12-1-2007.

DAVID COLLIER, EXAMINING ATTORNEY

Int. Cls.: 36 and 38

Prior U.S. Cls.: 100, 101, 102 and 104

United States Patent and Trademark Office

Reg. No. 3,484,223

Registered Aug. 12, 2008

**SERVICE MARK
PRINCIPAL REGISTER**

**THE LOGICAL SOLUTIONS
PROVIDER.**

THE DEPOSITORY TRUST & CLEARING COR-
PORATION (NEW YORK CORPORATION)
55 WATER STREET
NEW YORK, NY 100410099

FOR: PROVIDING FINANCIAL INFORMATION
FOR INVESTMENT PORTFOLIO MANAGEMENT,
AND COMMUNICATING INFORMATION RELAT-
ING TO CLIENT ACCOUNTS, TRADES, PURCHAS-
ES, REDEMPTION, AND EXCHANGE ORDERS;
FINANCIAL TRADE PROCESSING SERVICES,
NAMELY, TRADE COMPARISON, CONFIRMA-
TION, CLEARANCE, AND SETTLEMENT; FINAN-
CIAL PRODUCTS CUSTODY; ASSET SERVICING,
NAMELY, PRINCIPAL AND INCOME DISTRIBU-
TION, PROCESSING OF CORPORATE ACTION
FINANCIAL TRANSACTIONS, WITHHOLDING
TAX DEBITING SERVICES, PROCESSING AND
CUSTODY OF COLLATERAL LOANS AND RE-
PURCHASE AGREEMENTS; AND PROVIDING IN-
FORMATION AND DATABASES FEATURING
INFORMATION WITH RESPECT TO SECURITIES
AND FINANCIAL PRODUCTS, IN CLASS 36 (U.S.
CLS. 100, 101 AND 102).

FIRST USE 11-0-2004; IN COMMERCE 11-0-2004.

FOR: ELECTRONIC MESSAGING SERVICES,
NAMELY, PROVIDING MESSAGES CONCERNING
CLIENT ACCOUNT INFORMATION, TRADES,
PURCHASES, REDEMPTIONS, AND EXCHANGE
ORDERS OF SECURITIES, AND CONFIRMATIONS,
ALL PERTAINING TO FINANCIAL TRANSAC-
TIONS, VIA A GLOBAL COMPUTER NETWORK,
IN CLASS 38 (U.S. CLS. 100, 101 AND 104).

FIRST USE 11-0-2004; IN COMMERCE 11-0-2004.

THE MARK CONSISTS OF STANDARD CHAR-
ACTERS WITHOUT CLAIM TO ANY PARTICULAR
FONT, STYLE, SIZE, OR COLOR.

NO CLAIM IS MADE TO THE EXCLUSIVE
RIGHT TO USE "PROVIDER", APART FROM THE
MARK AS SHOWN.

SER. NO. 77-364,554, FILED 1-4-2008.

DAVID COLLIER, EXAMINING ATTORNEY

Int. Cl.: 36

Prior U.S. Cls.: 100, 101 and 102

United States Patent and Trademark Office

Reg. No. 3,484,224

Registered Aug. 12, 2008

**SERVICE MARK
PRINCIPAL REGISTER**



AMERICAN INTERNATIONAL GROUP, INC.
(DELAWARE CORPORATION)
70 PINE STREET
NEW YORK, NY 10270

FOR: INSURANCE UNDERWRITING IN THE
FIELD OF MORTGAGE GUARANTY INSURANCE,
IN CLASS 36 (U.S. CLS. 100, 101 AND 102).

FIRST USE 6-1-2001; IN COMMERCE 6-1-2001.

OWNER OF U.S. REG. NOS. 2,520,656, 2,714,346
AND OTHERS.

THE MARK CONSISTS OF THE WORD "DIREC-
TAIM" WITH A VERTICAL LINE BETWEEN THE
WORDING IN AN OVAL DESIGN; A CIRCLE IS
DIRECTLY ABOVE AND CONNECTED TO THE
OVAL DESIGN; WITHIN THE CIRCLE IS A LINE
FORMING AN ARC NEAR THE BOTTOM RIGHT
HAND OF THE CIRCLE; UNDER THE ARC IN THE
CIRCLE, THERE IS A SEMICIRCLE IN THE BOT-
TOM RIGHT HAND SIDE.

SER. NO. 77-364,581, FILED 1-4-2008.

THOMAS MANOR, EXAMINING ATTORNEY

Int. Cl.: 35

Prior U.S. Cls.: 100, 101 and 102

United States Patent and Trademark Office

Reg. No. 3,484,225

Registered Aug. 12, 2008

**SERVICE MARK
PRINCIPAL REGISTER**

BEHMANGELS

BEHM, MATTHEW M. (UNITED STATES INDIVIDUAL)

7112 SEMINOLE RD. NE
ALBUQUERQUE, NM 87110

FOR: BUSINESS ADVICE AND INFORMATION ABOUT A CORPORATE EXECUTIVE WHOSE WEALTH AMOUNTS TO AT LEAST A BILLION DOLLARS, POUNDS, OR THE EQUIVALENT IN OTHER CURRENCY; BUSINESS ADVICE AND INFORMATION ABOUT A CORPORATE EXECUTIVE WHOSE WEALTH AMOUNTS TO AT LEAST A MILLION DOLLARS, POUNDS, OR THE EQUIVALENT IN OTHER CURRENCY; BUSINESS ADVICE AND INFORMATION ABOUT CORPORATE EXECUTIVES WHOSE WEALTH AMOUNTS TO AT LEAST A BILLION DOLLARS, POUNDS, OR THE EQUIVALENT IN OTHER CURRENCY; BUSINESS ADVICE AND INFORMATION ABOUT CORPORATE EXECUTIVES WHOSE WEALTH AMOUNTS TO AT LEAST A MILLION DOLLARS, POUNDS, OR THE EQUIVALENT IN OTHER CURRENCY; BUSINESS CONSULTATION; BUSINESS CONSULTATION SERVICES; BUSINESS DEVELOPMENT SERVICES, NAMELY, PROVIDING START-UP SUPPORT FOR BUSINESSES OF OTHERS; BUSINESS INFORMATION SERVICES IN THE NATURE OF PROVIDING INFORMATION ON BUSINESS OPPORTUNITIES; BUSINESS MANAGEMENT SERVICES, NAMELY, PURCHASING OF AND SELLING OF COMPANIES FOR OTHERS; BUSINESS NETWORKING; BUSINESS NETWORKING OF PEER TO PEER LEARNING GROUPS OF HIGH NET WORTH INDIVIDUALS; BUSINESS OPERATION, BUSINESS ADMINISTRATION AND OFFICE FUNCTIONS; BUSINESS ORGANISATION AND MANAGEMENT CONSULTING SERVICES; BUSINESS ORGANISATION CONSULTING; BUSINESS ORGANIZATION ADVICE; BUSINESS ORGANIZATION AND MANAGEMENT CONSULTING; BUSINESS ORGANIZATION AND OPERATION CONSULTANCY; BUSINESS ORGANIZATION CONSULTING; BUSINESS ORGANIZATIONAL CONSULTATION; BUSINESS PLANNING; BUSINESS SERVICES, NAMELY, MATCHING POTENTIAL PRIVATE INVESTORS WITH ENTREPRENEURS NEEDING FUNDING; BUSINESS SUPERVISION; CINEMA ADVERTISING; COMMERCIAL ADMINISTRATION OF THE LICENSING OF THE GOODS AND SERVICES OF

OTHERS; CONSULTANCY SERVICES REGARDING BUSINESS STRATEGIES; CONSULTATION SERVICES IN THE FIELD OF COMPANY, BUSINESS SECTOR AND INDUSTRY DATA AND RESEARCH; CONSULTING SERVICES IN BUSINESS ORGANIZATION AND MANAGEMENT; CREATIVE MARKETING DESIGN SERVICES; DEVELOPMENT OF MARKETING STRATEGIES AND CONCEPTS; GENERAL BUSINESS NETWORKING REFERRAL SERVICES, NAMELY, PROMOTING THE GOODS AND SERVICES OF OTHERS BY PASSING BUSINESS LEADS AND REFERRALS AMONG GROUP MEMBERS; INFORMATION AND EXPERT OPINIONS RELATING TO COMPANIES AND BUSINESS; INFORMATION IN BUSINESS MATTERS; INFORMATION, ADVISORY AND CONSULTANCY SERVICES RELATING TO BUSINESS AND MANAGEMENT OR BUSINESS ADMINISTRATION, INCLUDING SUCH SERVICES PROVIDED ON LINE OR VIA THE INTERNET; ISSUING GIFT CERTIFICATES WHICH MAY THEN BE REDEEMED FOR GOODS OR SERVICES; LAWYER REFERRALS; MARKET RESEARCH; MARKET RESEARCH CONSULTATION; MARKET RESEARCH SERVICES; MARKET SEGMENTATION CONSULTATION; MARKET STUDY AND ANALYSIS OF MARKET STUDIES; MARKETING PLAN DEVELOPMENT; NEGOTIATION AND SETTLEMENT OF COMMERCIAL TRANSACTIONS FOR THIRD PARTIES; NEW BUSINESS VENTURE DEVELOPMENT AND FORMATION CONSULTING SERVICES; ONLINE BUSINESS NETWORKING SERVICES; OPERATING ON-LINE MARKETPLACES FOR SELLERS OF GOODS AND/OR SERVICES; OPERATION AND ADMINISTRATION OF TELECOMMUNICATION SYSTEMS AND NETWORKS FOR OTHERS; ORGANIZATIONAL SERVICES FOR BUSINESS PURPOSES; ORGANIZING OF BUSINESS COMPETITIONS; PLANNING CONCERNING BUSINESS MANAGEMENT, NAMELY, SEARCHING FOR PARTNERS FOR AMALGAMATIONS AND BUSINESS TAKE-OVERS AS WELL AS FOR BUSINESS ESTABLISHMENTS; PREPARATION AND REALIZATION OF MEDIA AND ADVERTISING PLANS AND CONCEPTS; PREPARING BUSINESS REPORTS; PROFESSIONAL BUSINESS CONSULTATION; PROFESSIONAL BUSINESS CONSULTING; PROMOTION OF BUSINESS OPPORTUNITIES; PROVIDING BUSINESS MANAGE-

MENT INFORMATION IN CONNECTION WITH CONSULTING AND ADVISORY SERVICES IN THE FIELD OF STRATEGIC PLANNING; PROVIDING INFORMATION PERTAINING TO INVESTORS WHO QUALIFY TO PURCHASE CERTAIN TYPES OF SECURITIES; PROVIDING LISTINGS OF BUSINESSES FOR SALE; PROVIDING ORGANIZATIONAL DEVELOPMENT CONSULTING SERVICES, IN CLASS 35 (U.S. CLS. 100, 101 AND 102).

FIRST USE 1-16-2007; IN COMMERCE 1-16-2007.

OWNER OF U.S. REG. NO. 3,278,111.

THE MARK CONSISTS OF THE WORDS "BEHM ANGELS" WITH "BEHM" BEING IN THE COLOR GREY AND "ANGELS" BEING IN THE COLOR WHITE AND WITHOUT A SPACE BETWEEN THE WORDS "BEHM" AND "ANGELS" SUCH THAT IT READS "BEHMANGELS" RATHER THAN "BEHM ANGELS". ALL THE ABOVE OF WHICH IS PRESENTED WITH A BLACK BACKGROUND.

SER. NO. 77-364,999, FILED 1-6-2008.

EDWARD NELSON, EXAMINING ATTORNEY

Int. Cl.: 41

Prior U.S. Cls.: 100, 101 and 107

United States Patent and Trademark Office

Reg. No. 3,484,226

Registered Aug. 12, 2008

**SERVICE MARK
PRINCIPAL REGISTER**

LOADTRAINING.COM

QT INVESTMENTS, INC. (ARIZONA CORPORATION)
SUITE J
11116 CALIFORNIA AVENUE
YOUNGTOWN, AZ 85363

FOR: EDUCATIONAL SERVICES IN THE NATURE OF PROFESSIONAL DEVELOPMENT PROGRAMS, NAMELY, LIVE OR ONLINE TRAINING SERVICES IN THE FIELD OF FREIGHT BROKERING FOR FREIGHT AGENTS AND PROVIDING COURSE MATERIALS IN CONNECTION THEREWITH, IN CLASS 41 (U.S. CLS. 100, 101 AND 107).

FIRST USE 5-19-2004; IN COMMERCE 5-19-2004.

THE MARK CONSISTS OF STANDARD CHARACTERS WITHOUT CLAIM TO ANY PARTICULAR FONT, STYLE, SIZE, OR COLOR.

SER. NO. 77-365,071, FILED 1-6-2008.

JESSICA A. POWERS, EXAMINING ATTORNEY

Int. Cl.: 6

Prior U.S. Cls.: 2, 12, 13, 14, 23, 25 and 50

Reg. No. 3,484,227

United States Patent and Trademark Office

Registered Aug. 12, 2008

**TRADEMARK
PRINCIPAL REGISTER**

MERCURY VAPORLOK

VAPORLOK TECHNOLOGY, LLC (DELAWARE
LTD LIAB CO)
302 N. RIVERFRONT DR.
MANKATO, MN 56001

OWNER OF U.S. REG. NO. 3,345,388.

FOR: FOIL BAG FOR STORING AND SHIPPING
WASTE MATERIAL, IN CLASS 6 (U.S. CLS. 2, 12, 13,
14, 23, 25 AND 50).

NO CLAIM IS MADE TO THE EXCLUSIVE
RIGHT TO USE "MERCURY", APART FROM THE
MARK AS SHOWN.

FIRST USE 6-1-2005; IN COMMERCE 6-1-2005.

SER. NO. 77-365,154, FILED 1-7-2008.

THE MARK CONSISTS OF STANDARD CHAR-
ACTERS WITHOUT CLAIM TO ANY PARTICULAR
FONT, STYLE, SIZE, OR COLOR.

LOURDES AYALA, EXAMINING ATTORNEY

Int. Cl.: 35

Prior U.S. Cls.: 100, 101 and 102

Reg. No. 3,484,228

United States Patent and Trademark Office

Registered Aug. 12, 2008

**SERVICE MARK
PRINCIPAL REGISTER**

Solaris

INTELLIGENT LIGHTING DISTRIBUTIONS,
INC. (GEORGIA CORPORATION), DBA SO-
LARIS
SUITE K
1409 N. HIGHLAND AVE. N.E.
ATLANTA, GA 30306

FIRST USE 1-12-2003; IN COMMERCE 1-12-2003.

THE MARK CONSISTS OF STANDARD CHAR-
ACTERS WITHOUT CLAIM TO ANY PARTICULAR
FONT, STYLE, SIZE, OR COLOR.

FOR: PROVIDING A WEBSITE WHERE USERS
ADVERTISE NEW AND USED PRODUCTION AND
STAGE EQUIPMENT FOR SALE; ON-LINE RETAIL
STORE OFFERING NEW AND USED PRODUC-
TION AND STAGE EQUIPMENT, IN CLASS 35 (U.S.
CLS. 100, 101 AND 102).

SER. NO. 77-365,193, FILED 1-7-2008.

JAY BESCH, EXAMINING ATTORNEY

Int. Cl.: 35

Prior U.S. Cls.: 100, 101 and 102

United States Patent and Trademark Office

Reg. No. 3,484,229

Registered Aug. 12, 2008

**SERVICE MARK
PRINCIPAL REGISTER**

THE MOP BUCKET

ADAMS, KAREN (UNITED STATES INDIVIDUAL)
P.O. BOX 14072
KANSAS CITY, MO 64152

FOR: RETAIL AND WHOLESALE STORES FEATURING JANITORIAL PRODUCTS AND CLEANING SUPPLIES, IN CLASS 35 (U.S. CLS. 100, 101 AND 102).

FIRST USE 12-31-1998; IN COMMERCE 12-31-1998.

THE MARK CONSISTS OF STANDARD CHARACTERS WITHOUT CLAIM TO ANY PARTICULAR FONT, STYLE, SIZE, OR COLOR.

OWNER OF U.S. REG. NO. 2,633,650.

SEC. 2(F).

SER. NO. 77-365,287, FILED 1-7-2008.

TARA PATE, EXAMINING ATTORNEY

Int. Cl.: 35

Prior U.S. Cls.: 100, 101 and 102

United States Patent and Trademark Office

Reg. No. 3,484,230

Registered Aug. 12, 2008

**SERVICE MARK
PRINCIPAL REGISTER**



POM ENERGY CONCEPTS INC. (VERMONT CORPORATION)

1554 ELMORE MOUNTAIN ROAD

MORRISVILLE, VT 05661

FOR: MANUFACTURER REPRESENTATIVES IN THE FIELD OF ENERGY CONSERVATION, IN CLASS 35 (U.S. CLS. 100, 101 AND 102).

FIRST USE 8-17-2006; IN COMMERCE 8-17-2006.

NO CLAIM IS MADE TO THE EXCLUSIVE RIGHT TO USE "ENERGY" AND "INC", APART FROM THE MARK AS SHOWN.

THE MARK CONSISTS OF STYLIZED TEXT OF "POM ENERGY CONCEPTS INC" WITH TWO STYLIZED SWIRLS IN THE YIN AND YANG FASHION.

SER. NO. 77-365,302, FILED 1-7-2008.

SAMUEL E. SHARPER JR., EXAMINING ATTORNEY

Int. Cl.: 35

Prior U.S. Cls.: 100, 101 and 102

United States Patent and Trademark Office

Reg. No. 3,484,231

Registered Aug. 12, 2008

**SERVICE MARK
PRINCIPAL REGISTER**

SBIZC

SMART BUSINESS CONCEPTS, INC. (GEORGIA
CORPORATION)

#700

ONE GLENLAKE PARKWAY
ATLANTA, GA 30328

FOR: BUSINESS CONSULTATION SERVICES, IN
CLASS 35 (U.S. CLS. 100, 101 AND 102).

FIRST USE 11-1-2003; IN COMMERCE 11-1-2003.

THE MARK CONSISTS OF STANDARD CHAR-
ACTERS WITHOUT CLAIM TO ANY PARTICULAR
FONT, STYLE, SIZE, OR COLOR.

SER. NO. 77-365,323, FILED 1-7-2008.

TINA KUAN, EXAMINING ATTORNEY

Int. Cl.: 31

Prior U.S. Cls.: 1 and 46

United States Patent and Trademark Office

Reg. No. 3,484,232

Registered Aug. 12, 2008

**TRADEMARK
PRINCIPAL REGISTER**

sunlet

KISTER, JOHN (UNITED STATES INDIVIDUAL)
3636 LUNETTA LANE
FALLBROOK, CA 92028 AND
KISTER, JANET (UNITED STATES INDIVIDUAL)
3636 LUNETTA LANE
FALLBROOK, CA 92028

FIRST USE 1-2-1985; IN COMMERCE 3-15-1985.

THE MARK CONSISTS OF STANDARD CHARACTERS WITHOUT CLAIM TO ANY PARTICULAR FONT, STYLE, SIZE, OR COLOR.

SER. NO. 77-365,345, FILED 1-7-2008.

FOR: LIVE PLANTS, IN CLASS 31 (U.S. CLS. 1 AND 46).

THEODORE MCBRIDE, EXAMINING ATTORNEY

Int. Cl.: 3

Prior U.S. Cls.: 1, 4, 6, 50, 51 and 52

Reg. No. 3,484,233

United States Patent and Trademark Office

Registered Aug. 12, 2008

**TRADEMARK
PRINCIPAL REGISTER**

FRESH BOUQUET

TRANSMACRO, INC. (TEXAS CORPORATION)
14511 FALLING CREEK DR. SUITE 409
HOUSTON, TX 77014

THE MARK CONSISTS OF STANDARD CHAR-
ACTERS WITHOUT CLAIM TO ANY PARTICULAR
FONT, STYLE, SIZE, OR COLOR.

FOR: TOILET SOAPS, IN CLASS 3 (U.S. CLS. 1, 4, 6,
50, 51 AND 52).

SER. NO. 77-365,397, FILED 1-7-2008.

FIRST USE 6-14-2007; IN COMMERCE 6-14-2007.

TINA KUAN, EXAMINING ATTORNEY

Int. Cl.: 10

Prior U.S. Cls.: 26, 39 and 44

Reg. No. 3,484,234

United States Patent and Trademark Office

Registered Aug. 12, 2008

**TRADEMARK
PRINCIPAL REGISTER**

BIG BAD WOLF

SANETTI, JAMES (UNITED STATES INDIVIDUAL)
3405 RICHMOND COURT
HILLSBOROUGH, NJ 08844

THE MARK CONSISTS OF STANDARD CHARACTERS WITHOUT CLAIM TO ANY PARTICULAR FONT, STYLE, SIZE, OR COLOR.

FOR: CONDOMS; DENTAL DAMS, IN CLASS 10 (U.S. CLS. 26, 39 AND 44).

SER. NO. 77-365,400, FILED 1-7-2008.

FIRST USE 8-1-2007; IN COMMERCE 1-4-2008.

TINA KUAN, EXAMINING ATTORNEY

Int. Cl.: 35

Prior U.S. Cls.: 100, 101 and 102

United States Patent and Trademark Office

Reg. No. 3,484,235

Registered Aug. 12, 2008

**SERVICE MARK
PRINCIPAL REGISTER**

SMART BUSINESS CONCEPTS

SMART BUSINESS CONCEPTS, INC. (GEORGIA CORPORATION)

#700

ONE GLENLAKE PARKWAY

ATLANTA, GA 30328

FOR: BUSINESS CONSULTATION SERVICES, IN CLASS 35 (U.S. CLS. 100, 101 AND 102).

FIRST USE 11-1-2003; IN COMMERCE 11-1-2003.

THE MARK CONSISTS OF STANDARD CHARACTERS WITHOUT CLAIM TO ANY PARTICULAR FONT, STYLE, SIZE, OR COLOR.

NO CLAIM IS MADE TO THE EXCLUSIVE RIGHT TO USE "BUSINESS", APART FROM THE MARK AS SHOWN.

SER. NO. 77-365,401, FILED 1-7-2008.

TINA KUAN, EXAMINING ATTORNEY

Int. Cl.: 35

Prior U.S. Cls.: 100, 101 and 102

United States Patent and Trademark Office

Reg. No. 3,484,236

Registered Aug. 12, 2008

**SERVICE MARK
PRINCIPAL REGISTER**

Feel Good Fueling Up

RTC FUELS, LLC (CALIFORNIA LTD LIAB CO)
#201
4001 EL CAJON BLVD.
SAN DIEGO, CA 92105

FOR: RETAIL AND WHOLESALE GASOLINE
SUPPLY SERVICES FEATURING ALTERNATIVE
FUELS, NAMELY, ETHANOL, BIO-DIESEL, NAT-
URAL GAS, PROPANE AND HYDROGEN, IN
CLASS 35 (U.S. CLS. 100, 101 AND 102).

FIRST USE 6-1-2007; IN COMMERCE 6-1-2007.

THE MARK CONSISTS OF STANDARD CHAR-
ACTERS WITHOUT CLAIM TO ANY PARTICULAR
FONT, STYLE, SIZE, OR COLOR.

SER. NO. 77-365,436, FILED 1-7-2008.

EMILY CHUO, EXAMINING ATTORNEY

Int. Cl.: 44

Prior U.S. Cls.: 100 and 101

United States Patent and Trademark Office

Reg. No. 3,484,237

Registered Aug. 12, 2008

**SERVICE MARK
PRINCIPAL REGISTER**

AURORA DENTAL SPECIALISTS

MCGOUGH, JAMES W (UNITED STATES INDIVIDUAL)
345 W SULLIVAN RD.
AURORA, IL 60506 AND
BARNES, ELLEN M (UNITED STATES INDIVIDUAL)
345 W SULLIVAN RD.
AURORA, IL 60506

THE MARK CONSISTS OF STANDARD CHARACTERS WITHOUT CLAIM TO ANY PARTICULAR FONT, STYLE, SIZE, OR COLOR.

NO CLAIM IS MADE TO THE EXCLUSIVE RIGHT TO USE "DENTAL SPECIALISTS", APART FROM THE MARK AS SHOWN.

FOR: DENTISTRY, IN CLASS 44 (U.S. CLS. 100 AND 101).

SER. NO. 77-365,440, FILED 1-7-2008.

FIRST USE 1-15-1994; IN COMMERCE 1-15-1994.

EMILY CHUO, EXAMINING ATTORNEY

Int. Cl.: 41

Prior U.S. Cls.: 100, 101 and 107

United States Patent and Trademark Office

Reg. No. 3,484,238

Registered Aug. 12, 2008

**SERVICE MARK
PRINCIPAL REGISTER**

SkirtChaser

SKIRTSPORTS, INC. (COLORADO CORPORATION)
SUITE J
6235 LOOKOUT ROAD
BOULDER, CO 80301

FOR: ENTERTAINMENT SERVICES, NAMELY, ORGANIZING AND CONDUCTING RUNNING EVENTS AND FITNESS-ASSOCIATED EVENTS; EDUCATIONAL AND ENTERTAINMENT SERVICES, NAMELY, PROVIDING MOTIVATIONAL AND EDUCATIONAL SPEAKERS; ENTERTAINMENT IN THE NATURE OF FASHION SHOWS; ENTERTAINMENT SERVICES, NAMELY, PERSONAL APPEARANCES BY A MOTIVATIONAL SPEAKER, IN CLASS 41 (U.S. CLS. 100, 101 AND 107).

NAL APPEARANCES BY A MOTIVATIONAL SPEAKER, IN CLASS 41 (U.S. CLS. 100, 101 AND 107).

FIRST USE 10-1-2007; IN COMMERCE 10-1-2007.

THE MARK CONSISTS OF STANDARD CHARACTERS WITHOUT CLAIM TO ANY PARTICULAR FONT, STYLE, SIZE, OR COLOR.

SER. NO. 77-365,481, FILED 1-7-2008.

KHANH LE, EXAMINING ATTORNEY

Int. Cls.: 14, 16 and 25

Prior U.S. Cls.: 2, 5, 22, 23, 27, 28, 29, 37, 38, 39 and 50

United States Patent and Trademark Office

Reg. No. 3,484,239

Registered Aug. 12, 2008

TRADEMARK
PRINCIPAL REGISTER



EWER, REGINA M. (UNITED STATES INDIVIDUAL), DBA REGINA MARIE DESIGNS
P.O. BOX 177
SCHWENKSVILLE, PA 19473

FOR: JEWELRY, NAMELY, EARRINGS, PENDANTS, BRACELETS, PINS, RINGS, ANKLETS, IN CLASS 14 (U.S. CLS. 2, 27, 28 AND 50).

FIRST USE 10-0-2007; IN COMMERCE 10-0-2007.

FOR: GREETING CARDS, POST CARDS, CALENDARS, IN CLASS 16 (U.S. CLS. 2, 5, 22, 23, 29, 37, 38 AND 50).

FIRST USE 10-0-2007; IN COMMERCE 10-0-2007.

FOR: CLOTHING, NAMELY, T-SHIRTS, POLO SHIRTS, SWEAT SHIRTS, SWEAT PANTS, SWEAT

JACKETS, HOODED JACKETS, WIND RESISTANT JACKETS, BANDANAS, SHORTS, RUNNING SHORTS, TANK TOPS, SOCKS, BIKE SHORTS, HEADWEAR AND LEOTARDS, IN CLASS 25 (U.S. CLS. 22 AND 39).

FIRST USE 6-0-2006; IN COMMERCE 10-0-2007.

OWNER OF U.S. REG. NO. 3,106,675.

THE MARK CONSISTS OF THE WORDS "EMPOWERED ZONE" ON EITHER SIDE OF A GEOMETRICALLY SHAPED HUMAN FORM WITH ARMS UPRAISED.

SER. NO. 77-365,487, FILED 1-7-2008.

SANJEEV VOHRA, EXAMINING ATTORNEY

Int. Cl.: 33

Prior U.S. Cls.: 47 and 49

United States Patent and Trademark Office

Reg. No. 3,484,240

Registered Aug. 12, 2008

TRADEMARK
PRINCIPAL REGISTER



JUAN M. CANTU (MEXICO INDIVIDUAL)
SUITE 114-15
55 LYERLY
HOUSTON, TX 77022

FOR: DISTILLED SPIRITS, IN CLASS 33 (U.S. CLS.
47 AND 49).

FIRST USE 1-2-2008; IN COMMERCE 1-2-2008.

NO CLAIM IS MADE TO THE EXCLUSIVE
RIGHT TO USE "PREMIUM" AND "BLENDS" ,
APART FROM THE MARK AS SHOWN.

THE COLOR(S) YELLOW, WHITE, RED, LIGHT
BROWN IS/ARE CLAIMED AS A FEATURE OF THE
MARK.

THE MARK CONSISTS OF RED CIRCLE WITH A
WHITE CROWN INSIDE. THE WORD "PREMIUM"
IS IN CAPITAL, BOLD, YELLOW WITH LIGHT
BROWN OUTLINE, IT IS ON TOP OF THE
"CROWN" WORD IN CURSIVE, YELLOW WITH A
LIGHT BROWN OUTLINE. THE WORD "BLENDS"
IN BOLD YELLOW, IS LOCATED ON THE BOTTOM
PART OF THE LOGO.

SER. NO. 77-365,498, FILED 1-7-2008.

RENEE MCCRAY, EXAMINING ATTORNEY

Int. Cl.: 42

Prior U.S. Cls.: 100 and 101

United States Patent and Trademark Office

Reg. No. 3,484,241

Registered Aug. 12, 2008

**SERVICE MARK
PRINCIPAL REGISTER**

4cast

MEDICAL EDUCATION DEVELOPMENT SERVICES, INC. (MARYLAND CORPORATION)
SUITE 203
7901 SANDY SPRING ROAD
LAUREL, MD 20707

FOR: PROVIDING TEMPORARY USE OF ON-LINE NONDOWNLOADABLE SOFTWARE DEVELOPMENT TOOLS FOR USE IN ASSESSMENT AND REMEDIATION OF TEST RESPONSES IN THE FIELD OF NURSING EDUCATION, IN CLASS 42 (U.S. CLS. 100 AND 101).

FIRST USE 1-1-2008; IN COMMERCE 1-1-2008.

THE MARK CONSISTS OF STANDARD CHARACTERS WITHOUT CLAIM TO ANY PARTICULAR FONT, STYLE, SIZE, OR COLOR.

SER. NO. 77-365,519, FILED 1-7-2008.

CORY BOONE, EXAMINING ATTORNEY

Int. Cl.: 36

Prior U.S. Cls.: 100, 101 and 102

United States Patent and Trademark Office

Reg. No. 3,484,242

Registered Aug. 12, 2008

**SERVICE MARK
PRINCIPAL REGISTER**

BANK CAROLINE

THE SOUTH FINANCIAL GROUP, INC. (SOUTH
CAROLINA CORPORATION)
P.O. BOX 1029
GREENVILLE, SC 29602

FOR: BANKING; MORTGAGE BANKING; SAV-
INGS BANKING; PROVIDING BANK ACCOUNT
INFORMATION BY COMPUTER AND BY TELE-
PHONE, INTERNET, BROADBAND, AND WIRE-
LESS SYSTEMS; BANKING AND FINANCIAL
MANAGEMENT SERVICES; CREDIT CARD AND
DEBIT CARD SERVICES; ELECTRONIC FUNDS
TRANSFER SERVICES; FINANCING SERVICES;
LOAN FINANCING SERVICES; MORTGAGE
LENDING SERVICES, IN CLASS 36 (U.S. CLS. 100,
101 AND 102).

FIRST USE 0-0-1999; IN COMMERCE 0-0-1999.

THE MARK CONSISTS OF STANDARD CHAR-
ACTERS WITHOUT CLAIM TO ANY PARTICULAR
FONT, STYLE, SIZE, OR COLOR.

OWNER OF U.S. REG. NOS. 2,441,572 AND
2,441,573.

NO CLAIM IS MADE TO THE EXCLUSIVE
RIGHT TO USE "BANK" , APART FROM THE
MARK AS SHOWN.

SER. NO. 77-365,521, FILED 1-7-2008.

NICHOLAS COLEMAN, EXAMINING ATTORNEY

Int. Cl.: 41

Prior U.S. Cls.: 100, 101 and 107

United States Patent and Trademark Office

Reg. No. 3,484,243

Registered Aug. 12, 2008

**SERVICE MARK
PRINCIPAL REGISTER**

THE CORPORATE CITIZEN

THE CHAMBER OF COMMERCE OF THE UNITED STATES OF AMERICA (D.C. CORPORATION)
1615 H STREET, NW
WASHINGTON, DC 20062

FOR: PROVIDING NON-DOWNLOADABLE ONLINE PUBLICATIONS IN THE NATURE OF A NEWSLETTER RELATING TO BUSINESS PRACTICES AND BUSINESS ISSUES VIA EMAIL , IN CLASS 41 (U.S. CLS. 100, 101 AND 107).

FIRST USE 11-0-2002; IN COMMERCE 11-0-2002.

THE MARK CONSISTS OF STANDARD CHARACTERS WITHOUT CLAIM TO ANY PARTICULAR FONT, STYLE, SIZE, OR COLOR.

OWNER OF U.S. REG. NO. 3,125,110.

SER. NO. 77-365,603, FILED 1-7-2008.

REBECCA EISINGER, EXAMINING ATTORNEY

Int. Cl.: 35

Prior U.S. Cls.: 100, 101 and 102

United States Patent and Trademark Office

Reg. No. 3,484,244

Registered Aug. 12, 2008

**SERVICE MARK
PRINCIPAL REGISTER**

Makeitmove

L&H TECHNOLOGIES, INC. (NORTH CAROLINA CORPORATION)
11616 WILMAR BLVD.
CHARLOTTE, NC 28273

THE MARK CONSISTS OF STANDARD CHARACTERS WITHOUT CLAIM TO ANY PARTICULAR FONT, STYLE, SIZE, OR COLOR.

FOR: BUSINESS INTERMEDIARY AND ADVISORY SERVICES IN THE FIELD OF SELLING PRODUCTS AND RENDERING SERVICES, IN CLASS 35 (U.S. CLS. 100, 101 AND 102).

SER. NO. 77-365,668, FILED 1-7-2008.

FIRST USE 11-1-1998; IN COMMERCE 7-1-1999.

MEGHAN REINHART, EXAMINING ATTORNEY

Int. Cl.: 42

Prior U.S. Cls.: 100 and 101

United States Patent and Trademark Office

Reg. No. 3,484,245

Registered Aug. 12, 2008

**SERVICE MARK
PRINCIPAL REGISTER**

INCLOSED

PETERSON, LESLEY A. (UNITED STATES INDIVIDUAL)
4535 HICKORY STREET
OMAHA, NE 68106

FOR: DESIGN OF PERSONALIZED STATIONERY, WEDDING INVITATIONS, THANK YOU CARDS, RSVP CARDS, AND GREETING CARDS FOR OTHERS, IN CLASS 42 (U.S. CLS. 100 AND 101).

FIRST USE 10-1-2007; IN COMMERCE 10-1-2007.

THE MARK CONSISTS OF STANDARD CHARACTERS WITHOUT CLAIM TO ANY PARTICULAR FONT, STYLE, SIZE, OR COLOR.

SER. NO. 77-365,695, FILED 1-7-2008.

JENNIFER VASQUEZ, EXAMINING ATTORNEY

Int. Cl.: 28

Prior U.S. Cls.: 22, 23, 38 and 50

United States Patent and Trademark Office

Reg. No. 3,484,246

Registered Aug. 12, 2008

**TRADEMARK
PRINCIPAL REGISTER**

BICYCLE PRO

THE UNITED STATES PLAYING CARD COM-
PANY (DELAWARE CORPORATION)
4590 BEECH STREET
CINCINNATI, OH 45212

FOR: PLAYING CARDS AND PLAYING CARD
CASES, IN CLASS 28 (U.S. CLS. 22, 23, 38 AND 50).

FIRST USE 1-22-2007; IN COMMERCE 4-15-2007.

THE MARK CONSISTS OF STANDARD CHAR-
ACTERS WITHOUT CLAIM TO ANY PARTICULAR
FONT, STYLE, SIZE, OR COLOR.

OWNER OF U.S. REG. NOS. 48,891, 3,085,786 AND
OTHERS.

SER. NO. 77-365,747, FILED 1-7-2008.

GINA FINK, EXAMINING ATTORNEY

Int. Cl.: 25

Prior U.S. Cls.: 22 and 39

United States Patent and Trademark Office

Reg. No. 3,484,247

Registered Aug. 12, 2008

TRADEMARK
PRINCIPAL REGISTER

EDDEN
CLOTHING CO.



EDDEN CLOTHING COMPANY, INC. (FLORIDA CORPORATION)
4201 WESTGATE AVENUE
SUITE B-10
WEST PALM BEACH, FL 33409

FOR: CLOTHING AND CLOTHING ACCESSORIES, NAMELY, SHIRTS, POLO SHIRTS, COLLARED SHIRTS, T-SHIRTS, JERSEYS, SWEAT SHIRTS, SWEAT PANTS, SWEAT SHORTS, TRACK SUITS, JOGGING SUITS, WARM-UP SUITS, TROUSERS, PANTS, SHORTS, JACKETS, COATS, HEADWEAR, HATS, CAPS, VISORS, BLAZERS, CARDIGANS, PULLOVERS, SWEATERS, VESTS, SLEEPWEAR, RAINWEAR, WIND-RESISTANT JACKETS, COMBINATIONS, TENNIS WEAR, HOODED PULLOVERS

AND SWEAT SHIRTS, IN CLASS 25 (U.S. CLS. 22 AND 39).

FIRST USE 8-0-2002; IN COMMERCE 7-0-2003.

NO CLAIM IS MADE TO THE EXCLUSIVE RIGHT TO USE "CLOTHING CO.", APART FROM THE MARK AS SHOWN.

THE MARK CONSISTS OF THE LITERAL ELEMENTS OF THE MARK ARE CENTERED ABOVE A DEPICTION OF A LION.

SER. NO. 77-365,753, FILED 1-7-2008.

GINA FINK, EXAMINING ATTORNEY

Int. Cl.: 37

Prior U.S. Cls.: 100, 103 and 106

United States Patent and Trademark Office

Reg. No. 3,484,248

Registered Aug. 12, 2008

**SERVICE MARK
PRINCIPAL REGISTER**

**Burke Painting "A Brush
Above the Rest"**

BURKE, JOHN (UNITED STATES INDIVIDUAL)
4812 JOELLE DR.
CONCORD, CA 94521

FOR: PAINTING CONTRACTOR SERVICES, IN
CLASS 37 (U.S. CLS. 100, 103 AND 106).

FIRST USE 11-11-2001; IN COMMERCE 11-11-2001.

THE MARK CONSISTS OF STANDARD CHAR-
ACTERS WITHOUT CLAIM TO ANY PARTICULAR
FONT, STYLE, SIZE, OR COLOR.

NO CLAIM IS MADE TO THE EXCLUSIVE
RIGHT TO USE "PAINTING", APART FROM THE
MARK AS SHOWN.

SER. NO. 77-365,809, FILED 1-7-2008.

SCOTT BIBB, EXAMINING ATTORNEY

Int. Cl.: 36

Prior U.S. Cls.: 100, 101 and 102

United States Patent and Trademark Office

Reg. No. 3,484,249

Registered Aug. 12, 2008

SERVICE MARK
PRINCIPAL REGISTER



CHOOSEACHARITY.NET (NEW JERSEY CORPORATION)
22 OLCOTT SQ.
BERNARDSVILLE, NJ 07924

FOR: CHARITABLE FUND RAISING SERVICES, NAMELY, ASSISTING IN FUND RAISING NEEDS FOR NON-PROFIT ORGANIZATIONS, SMALL BUSINESS SECTOR AND LOCAL MERCHANT COMMUNITIES, IN CLASS 36 (U.S. CLS. 100, 101 AND 102).

FIRST USE 4-20-2007; IN COMMERCE 4-20-2007.

THE MARK CONSISTS OF THE TEXT "CHOOSE A CHARITY.NET" INSIDE AN OVAL; THERE ARE TWO SUNFLOWERS IN THE OPENING OF THE LETTER "A". THE FONT USED IS HARLOW SOLID ITALIC. "CHOOSE A" IS THE FIRST LINE AND "CHARITY.NET" IS THE SECOND LINE.

SER. NO. 77-365,872, FILED 1-7-2008.

LIEF MARTIN, EXAMINING ATTORNEY

Int. Cl.: 36

Prior U.S. Cls.: 100, 101 and 102

United States Patent and Trademark Office

Reg. No. 3,484,250

Registered Aug. 12, 2008

**SERVICE MARK
PRINCIPAL REGISTER**



CHILDREN'S MIRACLE NETWORK (UTAH
NON-PROFIT CORPORATION)
4525 SOUTH 2300 EAST
SALT LAKE CITY, UT 84117

FOR: CHARITABLE FUND RAISING AND ELEE-
MOSYNARY SERVICES IN THE FIELD OF MONE-
TARY DONATIONS, IN CLASS 36 (U.S. CLS. 100, 101
AND 102).

FIRST USE 4-0-2007; IN COMMERCE 4-0-2007.

THE MARK CONSISTS OF A PINWHEEL DESIGN
WITH DOTS.

SER. NO. 77-365,888, FILED 1-7-2008.

MICHAEL ENGEL, EXAMINING ATTORNEY

Int. Cl.: 41

Prior U.S. Cls.: 100, 101 and 107

United States Patent and Trademark Office

Reg. No. 3,484,251

Registered Aug. 12, 2008

**SERVICE MARK
PRINCIPAL REGISTER**



CHILDREN'S MIRACLE NETWORK (UTAH
NON-PROFIT CORPORATION)
4525 SOUTH 2300 EAST
SALT LAKE CITY, UT 84117

FOR: RADIO AND TELEVISION PROGRAM-
MING AND PRODUCTION OF RADIO AND TELE-
VISION PROGRAMS IN THE FIELD OF CHILDREN
AND CHILDREN'S ISSUES , IN CLASS 41 (U.S. CLS.
100, 101 AND 107).

FIRST USE 12-0-2007; IN COMMERCE 12-0-2007.

THE MARK CONSISTS OF A PINWHEEL DESIGN
WITH DOTS.

SER. NO. 77-365,898, FILED 1-7-2008.

MICHAEL ENGEL, EXAMINING ATTORNEY

Int. Cl.: 30

Prior U.S. Cl.: 46

United States Patent and Trademark Office

Reg. No. 3,484,252

Registered Aug. 12, 2008

**TRADEMARK
PRINCIPAL REGISTER**

**RUSSELL STOVER AMERICAN
CLASSICS**

RUSSELL STOVER CANDIES, INC. (MISSOURI
CORPORATION)
4900 OAK STREET
KANSAS CITY, MO 641122702

FOR: CHOCOLATE CANDY, IN CLASS 30 (U.S.
CL. 46).

FIRST USE 3-3-2008; IN COMMERCE 3-3-2008.

THE MARK CONSISTS OF STANDARD CHAR-
ACTERS WITHOUT CLAIM TO ANY PARTICULAR
FONT, STYLE, SIZE, OR COLOR.

OWNER OF U.S. REG. NOS. 739,454 AND 1,243,031.

NO CLAIM IS MADE TO THE EXCLUSIVE
RIGHT TO USE "AMERICAN", APART FROM THE
MARK AS SHOWN.

THE NAME SHOWN IN THE MARK DOES NOT
IDENTIFY A PARTICULAR LIVING INDIVIDUAL.

SER. NO. 77-365,900, FILED 1-7-2008.

MICHAEL ENGEL, EXAMINING ATTORNEY

Int. Cl.: 44

Prior U.S. Cls.: 100 and 101

United States Patent and Trademark Office

Reg. No. 3,484,253

Registered Aug. 12, 2008

**SERVICE MARK
PRINCIPAL REGISTER**



CHILDREN'S MIRACLE NETWORK (UTAH
NON-PROFIT CORPORATION)
4525 SOUTH 2300 EAST
SALT LAKE CITY, UT 84117

FOR: PROVIDING HEALTH CARE INFORMA-
TION, IN CLASS 44 (U.S. CLS. 100 AND 101).

FIRST USE 4-0-2007; IN COMMERCE 4-0-2007.

THE MARK CONSISTS OF A PINWHEEL DESIGN
WITH DOTS.

SER. NO. 77-365,903, FILED 1-7-2008.

GENE MACIOL, EXAMINING ATTORNEY

Int. Cl.: 42

Prior U.S. Cls.: 100 and 101

United States Patent and Trademark Office

Reg. No. 3,484,254

Registered Aug. 12, 2008

**SERVICE MARK
PRINCIPAL REGISTER**



ONX, INC. (OKLAHOMA CORPORATION)
8155A E. 46TH ST.
TULSA, OK 74145

FOR: COMPUTER COLOCATION SERVICES, NAMELY, PROVIDING FACILITIES FOR THE LOCATION OF COMPUTER SERVERS WITH THE EQUIPMENT OF OTHERS; COMPUTER CONSULTATION; COMPUTER MONITORING SERVICE WHICH TRACKS HARDWARE PERFORMANCE AND PROCESSES AND SENDS OUT HISTORICAL REPORTS AND ALERTS; COMPUTER NETWORK DESIGN FOR OTHERS; COMPUTER PROJECT MANAGEMENT SERVICES; COMPUTER SERVICES, NAMELY, MONITORING AND REPORTING ON THE PERFORMANCE, AVAILABILITY, AND ERRORS OF WEBSITES OF OTHERS; COMPUTER SERVICES, NAMELY, COMPUTER SYSTEM ADMINISTRATION FOR OTHERS; COMPUTER SERVICES, NAMELY, DATA RECOVERY SERVICES; COMPUTER SERVICES, NAMELY, FILTERING OF UNWANTED E-MAILS; COMPUTER SERVICES, NAMELY, HOSTING AND MAINTAINING AN ONLINE WEBSITE FOR OTHERS TO MANAGE AND MAINTAIN COMPUTER NETWORKS; COMPUTER SERVICES, NAMELY, REMOTE AND ON-SITE MANAGEMENT OF ELECTRONIC MESSAGING SYSTEMS AND APPLICATIONS FOR OTHERS; COMPUTER SITE DESIGN; COMPUTER SOFTWARE CONSULTATION; CONSULTATION SERVICES IN THE FIELDS OF SELECTION, IMPLEMENTATION AND USE OF COMPUTER HARDWARE AND SOFTWARE SYSTEMS FOR OTHERS; CONSULTING SERVICES IN THE FIELD OF COMPUTER-BASED INFORMATION SYSTEMS FOR BUSINESSES; CONSULTING SERVICES IN

THE FIELD OF DESIGN, SELECTION, IMPLEMENTATION AND USE OF COMPUTER HARDWARE AND SOFTWARE SYSTEMS FOR OTHERS; CONSULTING SERVICES IN THE FIELD OF IDENTIFICATION, SUPPORT, AND IMPLEMENTATION OF COMPUTER-BASED INFORMATION SYSTEMS FOR BUSINESSES; CUSTOMIZATION OF COMPUTER HARDWARE AND SOFTWARE; DESIGN OF COMPUTER NETWORKS AND SOFTWARE FOR OTHERS FOR THE SMALL AND MEDIUM BUSINESS MARKET; INSTALLATION OF COMPUTER SOFTWARE; INTEGRATION OF COMPUTER SYSTEMS AND NETWORKS; MAINTENANCE OF COMPUTER SOFTWARE; MONITORING THE COMPUTER SYSTEMS OF OTHERS FOR TECHNICAL PURPOSES AND PROVIDING BACK-UP COMPUTER PROGRAMS AND FACILITIES; PERIODIC UPGRADING OF COMPUTER SOFTWARE FOR OTHERS; TECHNICAL SUPPORT, NAMELY, PROVIDING BACK-UP COMPUTER PROGRAMS AND FACILITIES; TECHNICAL SUPPORT SERVICES, NAMELY, TROUBLESHOOTING OF COMPUTER HARDWARE AND SOFTWARE PROBLEMS; TECHNOLOGICAL CONSULTATION IN THE TECHNOLOGY FIELD OF COMPUTER NETWORK AND SYSTEMS INTEGRATION; UP-DATING OF COMPUTER SOFTWARE; UPDATING OF COMPUTER SOFTWARE FOR OTHERS, IN CLASS 42 (U.S. CLS. 100 AND 101).

FIRST USE 10-26-2007; IN COMMERCE 10-26-2007.

NO CLAIM IS MADE TO THE EXCLUSIVE RIGHT TO USE "VIRTUAL NETWORK ADMINISTRATOR", APART FROM THE MARK AS SHOWN.

THE COLOR(S) BLACK, RED, AND GRAY IS/ ARE CLAIMED AS A FEATURE OF THE MARK.

THE MARK CONSISTS OF THE LETTER "V" COLORED BLACK, FOLLOWED BY A STYLIZED FORM OF THE LETTER "N" IN WHICH THE CROSS-MEMBER OF THE LETTER EXTENDS BACKWARD AND PARTIALLY OVER THE TOP OF THE LETTER "V"; THE STYLIZED "N" IS COLORED RED AND FOLLOWED BY THE LETTER

"A" COLORED BLACK; CENTERED BELOW THE LETTERS "VNA" APPEARS THE PHRASE "VIRTUAL NETWORK ADMINISTRATOR" IN SMALLER PRINT AND COLORED BLACK. ALL CHARACTERS OF THE MARK ARE IMPOSED IN FRONT OF AND SLIGHTLY ABOVE A SHADOWING EFFECT THAT IS GRAY IN COLOR.

SER. NO. 77-365,908, FILED 1-7-2008.

LYDIA BELZER, EXAMINING ATTORNEY

Int. Cl.: 9

Prior U.S. Cls.: 21, 23, 26, 36 and 38

Reg. No. 3,484,255

United States Patent and Trademark Office

Registered Aug. 12, 2008

**TRADEMARK
PRINCIPAL REGISTER**

BROADX

BROAD-CONNECT LLC (NEW YORK LTD LIAB
CO)
221 COMMERCE DRIVE
AMHERST, NY 14228

FOR: CORDLESS TELEPHONES; DIGITAL TELEPHONE PLATFORMS AND SOFTWARE; TELEPHONE APPARATUS AND RECEIVERS; TELEPHONE TERMINALS; TELEPHONES; VIDEO TELEPHONES; TELECOMMUNICATIONS AND DATA NETWORKING HARDWARE, NAMELY DEVICES FOR TRANSPORTING AND AGGREGATING VOICE, DATA, AND VIDEO COMMUNICATIONS ACROSS MULTIPLE NET-

WORK INFRASTRUCTURES AND COMMUNICATIONS PROTOCOLS, IN CLASS 9 (U.S. CLS. 21, 23, 26, 36 AND 38).

FIRST USE 1-1-2008; IN COMMERCE 1-1-2008.

THE MARK CONSISTS OF STANDARD CHARACTERS WITHOUT CLAIM TO ANY PARTICULAR FONT, STYLE, SIZE, OR COLOR.

SER. NO. 77-365,911, FILED 1-7-2008.

ALYSSA PALADINO, EXAMINING ATTORNEY

Int. Cl.: 41

Prior U.S. Cls.: 100, 101 and 107

United States Patent and Trademark Office

Reg. No. 3,484,256

Registered Aug. 12, 2008

**SERVICE MARK
PRINCIPAL REGISTER**

CHROME BUMPER FILMS

CHROME BUMPER FILMS LLC (MICHIGAN
LTD LIAB CO)
10815 KINGSTON AVE.
HUNTINGTON WOODS, MI 48070

FOR: FILM AND VIDEO FILM PRODUCTION;
FILM AND VIDEO PRODUCTION; FILM AND
VIDEO TAPE FILM PRODUCTION; FILM DISTRI-
BUTION; FILM EDITING; FILM MASTERING SER-
VICES; FILM PRODUCTION; FILM STUDIOS;
MEDIA PRODUCTION SERVICES, NAMELY, VI-
DEO AND FILM PRODUCTION; MOTION PICTURE
FILM PRODUCTION; MULTIMEDIA ENTERTAIN-
MENT SERVICES IN THE NATURE OF RECORD-
ING, PRODUCTION AND POST-PRODUCTION
SERVICES IN THE FIELDS OF MUSIC, VIDEO,
AND FILMS; POST-PRODUCTION EDITING SER-
VICES IN THE FIELD OF MUSIC, VIDEOS AND
FILMS; ENTERTAINMENT SERVICES, NAMELY,
PROVIDING A WEB SITE FEATURING MUSICAL

PERFORMANCES, MUSICAL VIDEOS, RELATED
FILM CLIPS, PHOTOGRAPHS, AND OTHER MUL-
TIMEDIA MATERIALS, IN CLASS 41 (U.S. CLS. 100,
101 AND 107).

FIRST USE 1-1-1990; IN COMMERCE 1-1-1990.

THE MARK CONSISTS OF STANDARD CHAR-
ACTERS WITHOUT CLAIM TO ANY PARTICULAR
FONT, STYLE, SIZE, OR COLOR.

NO CLAIM IS MADE TO THE EXCLUSIVE
RIGHT TO USE "FILMS", APART FROM THE
MARK AS SHOWN.

SER. NO. 77-365,981, FILED 1-7-2008.

MEGHAN REINHART, EXAMINING ATTORNEY

Int. Cl.: 28

Prior U.S. Cls.: 22, 23, 38 and 50

United States Patent and Trademark Office

Reg. No. 3,484,257

Registered Aug. 12, 2008

**TRADEMARK
PRINCIPAL REGISTER**



SPRENGER, MARK, W (UNITED STATES INDIVIDUAL)
P.O. BOX 455
ELK GROVE VILLAGE, IL 600090455

FOR: AMUSEMENT GAME MACHINES; COIN-OPERATED AMUSEMENT MACHINES, IN CLASS 28 (U.S. CLS. 22, 23, 38 AND 50).

FIRST USE 7-1-2007; IN COMMERCE 9-15-2007.

THE COLOR(S) BLACK, WHITE, RED, YELLOW, BLUE, AND ORANGE IS/ARE CLAIMED AS A FEATURE OF THE MARK.

THE MARK CONSISTS OF STYLIZED LETTERS IN YELLOW HAVING AN ORANGE HIGHLIGHT, A BLUE OUTLINE, A BLACK SHADOW LINE AND WHITE HIGHLIGHTS AGAINST A RED ECLIPSE, WITH A GRAPHIC IMAGE OF A BASKETBALL IN THE CENTER OF THE "O" IN "TOT".

SER. NO. 77-366,002, FILED 1-7-2008.

JAY FLOWERS, EXAMINING ATTORNEY

Int. Cl.: 42

Prior U.S. Cls.: 100 and 101

United States Patent and Trademark Office

Reg. No. 3,484,258

Registered Aug. 12, 2008

**SERVICE MARK
PRINCIPAL REGISTER**

ASKBIGMOMMA.COM

CARSON IFILL (UNITED STATES INDIVIDUAL)
REAR HOUSE
11 ELM STREET
BLOOMFIELD, NY 07042

FOR: COMPUTER SERVICES, NAMELY, PROVIDING SEARCH ENGINES FOR OBTAINING DATA ON A GLOBAL COMPUTER NETWORK; SEARCHING AND RETRIEVING INFORMATION, SITES, AND OTHER RESOURCES AVAILABLE ON COMPUTER NETWORKS FOR OTHERS; DEVELOPING COMPUTER SOFTWARE; DEVELOPMENT, MAINTENANCE AND UPDATING OF A TELECOMMUNICATION NETWORK SEARCH ENGINE; PROVIDING CUSTOMIZED ON-LINE WEB PAGES FEATURING USER-DEFINED INFORMATION,

WHICH INCLUDES SEARCH ENGINES AND ON-LINE WEB LINKS TO OTHER WEB SITES; PROVIDING SPECIFIC INFORMATION AS REQUESTED BY CUSTOMERS VIA THE INTERNET, IN CLASS 42 (U.S. CLS. 100 AND 101).

FIRST USE 1-1-2003; IN COMMERCE 1-1-2003.

THE MARK CONSISTS OF STANDARD CHARACTERS WITHOUT CLAIM TO ANY PARTICULAR FONT, STYLE, SIZE, OR COLOR.

SER. NO. 77-366,098, FILED 1-8-2008.

CARYN GLASSER, EXAMINING ATTORNEY

Int. Cl.: 30

Prior U.S. Cl.: 46

United States Patent and Trademark Office

Reg. No. 3,484,259

Registered Aug. 12, 2008

**TRADEMARK
PRINCIPAL REGISTER**

Moofy

LACAYO, KASSANDRA (UNITED STATES INDIVIDUAL)
4126 NE 22ND STREET
HOMESTEAD, FL 33033

THE MARK CONSISTS OF STANDARD CHARACTERS WITHOUT CLAIM TO ANY PARTICULAR FONT, STYLE, SIZE, OR COLOR.

FOR: PRE-PACKAGED BAKERY GOODS, IN CLASS 30 (U.S. CL. 46).

SER. NO. 77-366,137, FILED 1-8-2008.

FIRST USE 10-27-2007; IN COMMERCE 10-27-2007.

DAWN FELDMAN, EXAMINING ATTORNEY

Int. Cl.: 18

Prior U.S. Cls.: 1, 2, 3, 22 and 41

Reg. No. 3,484,260

United States Patent and Trademark Office

Registered Aug. 12, 2008

**TRADEMARK
PRINCIPAL REGISTER**

LANE

ABERCROMBIE & FITCH TRADING CO. (OHIO
CORPORATION)
6301 FITCH PATH
NEW ALBANY, OH 43054

THE MARK CONSISTS OF STANDARD CHAR-
ACTERS WITHOUT CLAIM TO ANY PARTICULAR
FONT, STYLE, SIZE, OR COLOR.

FOR: LEATHER AND IMITATION LEATHER
BAGS; LEATHER PURSES; PURSES; HANDBAGS;
LEATHER HANDBAGS, IN CLASS 18 (U.S. CLS. 1, 2,
3, 22 AND 41).

SER. NO. 77-366,163, FILED 1-8-2008.

FIRST USE 12-31-2007; IN COMMERCE 12-31-2007.

STEVEN PEREZ, EXAMINING ATTORNEY

Int. Cl.: 18

Prior U.S. Cls.: 1, 2, 3, 22 and 41

Reg. No. 3,484,261

United States Patent and Trademark Office

Registered Aug. 12, 2008

**TRADEMARK
PRINCIPAL REGISTER**

RYAH

ABERCROMBIE & FITCH TRADING CO. (OHIO
CORPORATION)
6301 FITCH PATH
NEW ALBANY, OH 43054

THE MARK CONSISTS OF STANDARD CHAR-
ACTERS WITHOUT CLAIM TO ANY PARTICULAR
FONT, STYLE, SIZE, OR COLOR.

FOR: LEATHER AND IMITATION LEATHER
BAGS; LEATHER PURSES; PURSES; HANDBAGS;
LEATHER HANDBAGS, IN CLASS 18 (U.S. CLS. 1, 2,
3, 22 AND 41).

SER. NO. 77-366,165, FILED 1-8-2008.

FIRST USE 12-31-2007; IN COMMERCE 12-31-2007.

STEVEN PEREZ, EXAMINING ATTORNEY

Int. Cl.: 7

Prior U.S. Cls.: 13, 19, 21, 23, 31, 34 and 35

Reg. No. 3,484,262

United States Patent and Trademark Office

Registered Aug. 12, 2008

**TRADEMARK
PRINCIPAL REGISTER**

MAGNATRAX

MANNA MARKETING & DEVELOPMENT
GROUP, INC. (TEXAS CORPORATION)
9140 PREMIER ROW ROAD
DALLAS, TX 75247

THE MARK CONSISTS OF STANDARD CHAR-
ACTERS WITHOUT CLAIM TO ANY PARTICULAR
FONT, STYLE, SIZE, OR COLOR.

FOR: EXTENSION GUIDE RAILS TO HOLD
CLOTH SPREADER MACHINE ON INDUSTRIAL
TABLES, IN CLASS 7 (U.S. CLS. 13, 19, 21, 23, 31, 34
AND 35).

SER. NO. 77-366,169, FILED 1-8-2008.

FIRST USE 11-5-1964; IN COMMERCE 11-5-1964.

ALICE BENMAMAN, EXAMINING ATTORNEY

Int. Cl.: 42

Prior U.S. Cls.: 100 and 101

United States Patent and Trademark Office

Reg. No. 3,484,263

Registered Aug. 12, 2008

**SERVICE MARK
PRINCIPAL REGISTER**

TICKERBOY

POINT ROLL, INC. (DELAWARE CORPORATION)
951 EAST HECTOR STREET
CONSHOHOCKEN, PA 19428

THE MARK CONSISTS OF STANDARD CHARACTERS WITHOUT CLAIM TO ANY PARTICULAR FONT, STYLE, SIZE, OR COLOR.

FOR: PROVIDING TEMPORARY USE OF NON-DOWNLOADABLE COMPUTER SOFTWARE FOR USE IN CREATING WEB-BASED ADVERTISEMENTS, IN CLASS 42 (U.S. CLS. 100 AND 101).

SER. NO. 77-366,231, FILED 1-8-2008.

FIRST USE 11-19-2007; IN COMMERCE 11-19-2007.

CHRIS WELLS, EXAMINING ATTORNEY

Int. Cl.: 4

Prior U.S. Cls.: 1, 6 and 15

United States Patent and Trademark Office

Reg. No. 3,484,264

Registered Aug. 12, 2008

**TRADEMARK
PRINCIPAL REGISTER**

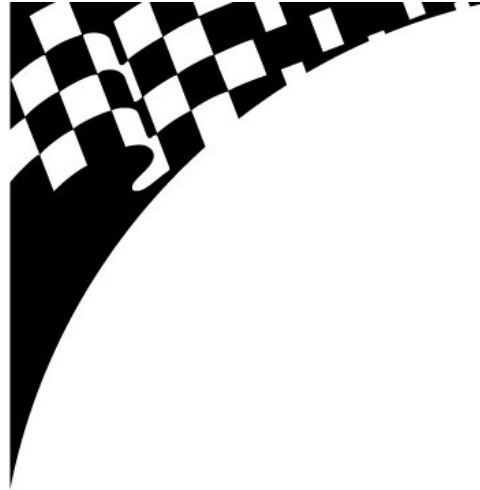

FINISH LINE TECHNOLOGIES, INC. (NEW YORK CORPORATION)
1545 5TH INDUSTRIAL COURT
BAY SHORE, NY 11706

FOR: ALL PURPOSE LUBRICANTS; SYNTHETIC OILS FOR USE ON BICYCLES; GENERAL PURPOSE GREASE; AND LUBRICATING PROTECTANTS FOR BICYCLES, MOTORCYCLES, AUTOMOBILE INTERIORS, AUTOMOBILE BUMPERS AND SNOWMOBILES, IN CLASS 4 (U.S. CLS. 1, 6 AND 15).

FIRST USE 6-6-2006; IN COMMERCE 6-6-2006.

OWNER OF U.S. REG. NO. 2,204,796.

THE MARK CONSISTS OF STYLIZED CHECKERED FLAG.

SER. NO. 77-366,233, FILED 1-8-2008.

CHRIS WELLS, EXAMINING ATTORNEY

Int. Cl.: 41

Prior U.S. Cls.: 100, 101 and 107

United States Patent and Trademark Office

Reg. No. 3,484,265

Registered Aug. 12, 2008

**SERVICE MARK
PRINCIPAL REGISTER**

RAISING HEALTHY VOICES

WILCOX, DINA (UNITED STATES INDIVIDUAL)
P. O. BOX 653
60 KRUM ROAD
KERHONKSON, NY 12446

FOR: CONDUCTING WORKSHOPS AND SEMINARS IN THE FIELD OF SELF-HELP AND MOTIVATION FOR ALL POPULATIONS, NAMELY, TEACHING PEOPLE TO HEAR AND TRUST THEIR OWN INTERNAL VOICES AS THEIR MOST VALUABLE RESOURCE FOR HEALTHY AND SMART DECISION-MAKING AND CHOICES IN THEIR PERSONAL AND BUSINESS LIVES AND RELATIONSHIPS, IN CLASS 41 (U.S. CLS. 100, 101 AND 107).

TIONSHIPS, IN CLASS 41 (U.S. CLS. 100, 101 AND 107).

FIRST USE 3-16-2000; IN COMMERCE 3-16-2000.

THE MARK CONSISTS OF STANDARD CHARACTERS WITHOUT CLAIM TO ANY PARTICULAR FONT, STYLE, SIZE, OR COLOR.

SER. NO. 77-366,237, FILED 1-8-2008.

CHRIS WELLS, EXAMINING ATTORNEY

Int. Cl.: 36

Prior U.S. Cls.: 100, 101 and 102

United States Patent and Trademark Office

Reg. No. 3,484,266

Registered Aug. 12, 2008

**SERVICE MARK
PRINCIPAL REGISTER**

AXICON PARTNERS

AXICON PARTNERS, LLC (CALIFORNIA LTD
LIAB CO)
1325 AVENUE OF THE AMERICAS
27TH FLOOR
NEW YORK, NY 10019

FOR: FINANCIAL PLANNING AND INVEST-
MENT ADVISORY SERVICES; FINANCIAL RE-
SEARCH AND INFORMATION SERVICES;
SECURITIES ARBITRAGE SERVICES , IN CLASS
36 (U.S. CLS. 100, 101 AND 102).

FIRST USE 7-15-2005; IN COMMERCE 7-15-2007.

THE MARK CONSISTS OF STANDARD CHAR-
ACTERS WITHOUT CLAIM TO ANY PARTICULAR
FONT, STYLE, SIZE, OR COLOR.

NO CLAIM IS MADE TO THE EXCLUSIVE
RIGHT TO USE "PARTNERS", APART FROM THE
MARK AS SHOWN.

SER. NO. 77-366,242, FILED 1-8-2008.

ESTHER A. BORSUK, EXAMINING ATTORNEY

Int. Cl.: 37

Prior U.S. Cls.: 100, 103 and 106

United States Patent and Trademark Office

Reg. No. 3,484,267

Registered Aug. 12, 2008

**SERVICE MARK
PRINCIPAL REGISTER**

DENT IMPRESSIONS

DENT IMPRESSIONS, INC (MINNESOTA CORPORATION)
22596 128TH AVE. NORTH
ROGERS, MN 55374

FOR: AUTOMOBILE BODY REPAIR SERVICES, NAMELY, PAINTLESS DENT REMOVAL, IN CLASS 37 (U.S. CLS. 100, 103 AND 106).

FIRST USE 3-1-2001; IN COMMERCE 3-1-2001.

THE MARK CONSISTS OF STANDARD CHARACTERS WITHOUT CLAIM TO ANY PARTICULAR FONT, STYLE, SIZE, OR COLOR.

NO CLAIM IS MADE TO THE EXCLUSIVE RIGHT TO USE "DENT", APART FROM THE MARK AS SHOWN.

SER. NO. 77-366,251, FILED 1-8-2008.

ALYSSA PALADINO, EXAMINING ATTORNEY

Int. Cl.: 36

Prior U.S. Cls.: 100, 101 and 102

United States Patent and Trademark Office

Reg. No. 3,484,268

Registered Aug. 12, 2008

SERVICE MARK
PRINCIPAL REGISTER

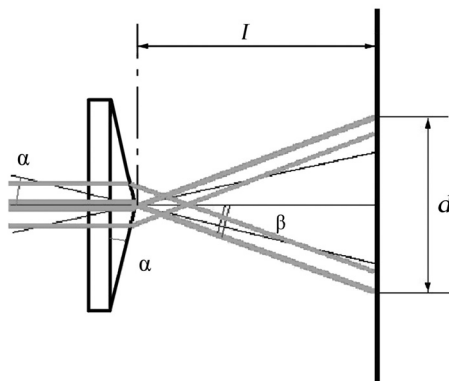

AXICON PARTNERS, LLC (CALIFORNIA LTD
LIAB CO)
27TH FLOOR
1325 AVENUE OF THE AMERICAS
NEW YORK, NY 10019

FOR: FINANCIAL ANALYSIS AND CONSULTA-
TION; FINANCIAL INFORMATION AND ADVI-
SORY SERVICES; SECURITIES ARBITRAGE
SERVICES, IN CLASS 36 (U.S. CLS. 100, 101 AND 102).

FIRST USE 7-15-2005; IN COMMERCE 7-15-2005.

THE MARK CONSISTS OF THE SCHEMATIC
SHOWING OF AN AXICON LENS ARRANGEMENT
WITH A LASER TRANSMITTED THROUGH WITH
THE MATHEMATICAL SYMBOLS, "A","B","I"
AND" D".

SER. NO. 77-366,265, FILED 1-8-2008.

ESTHER A. BORSUK, EXAMINING ATTORNEY

Int. Cl.: 36

Prior U.S. Cls.: 100, 101 and 102

United States Patent and Trademark Office

Reg. No. 3,484,269

Registered Aug. 12, 2008

**SERVICE MARK
PRINCIPAL REGISTER**



SACHS, NATE (UNITED STATES INDIVIDUAL)
SUITE 110
9332 EAST RAINTREE DRIVE
SCOTTSDALE, AZ 85260

FOR: FINANCIAL SERVICES, NAMELY, FINANCIAL CONSULTATION, FINANCIAL ANALYSIS, FINANCIAL PLANNING, FINANCIAL MANAGEMENT AND INSURANCE CONSULTATION, IN CLASS 36 (U.S. CLS. 100, 101 AND 102).

FIRST USE 1-1-2004; IN COMMERCE 1-1-2004.

OWNER OF U.S. REG. NO. 3,271,249.

THE COLOR(S) BLUE AND WHITE IS/ARE CLAIMED AS A FEATURE OF THE MARK.

THE MARK CONSISTS OF A BLUE CUBE WHOSE ADJACENT PLANES ARE BORDERED BY WHITE LINES IN THE FOREGROUND AGAINST A BACKGROUND CONSISTING OF WHITE GRAPH PAPER WITH BLUE GRAPH LINES IN THE LEFT QUADRANT OF THE LOGO WITH THE LETTERS "B", "F", AND "T" IN WHITE IN THE BLUE PLANES OF THE CUBE TO THE LEFT OF THE WORD "BLUEPRINTS" IN WHITE AGAINST A BLUE BACKGROUND ABOVE THE WORDS "FOR TOMORROW" IN BLUE AGAINST A WHITE BACKGROUND. OUTLINED WITH BLUE LINES.

SER. NO. 77-366,277, FILED 1-8-2008.

ESTHER A. BORSUK, EXAMINING ATTORNEY

Int. Cl.: 29

Prior U.S. Cl.: 46

United States Patent and Trademark Office

Reg. No. 3,484,270

Registered Aug. 12, 2008

**TRADEMARK
PRINCIPAL REGISTER**

NUGO DARK

LIFESTYLE EVOLUTION, INC. (PENNSYLVANIA CORPORATION)
817 MAIN STREET
SHARPSBURG, PA 15215

FOR: PROTEIN BASED, NUTRIENT-DENSE SNACK BARS, IN CLASS 29 (U.S. CL. 46).

FIRST USE 1-4-2008; IN COMMERCE 1-7-2008.

THE MARK CONSISTS OF STANDARD CHARACTERS WITHOUT CLAIM TO ANY PARTICULAR FONT, STYLE, SIZE, OR COLOR.

OWNER OF U.S. REG. NOS. 2,865,217, 2,909,172, AND 3,089,879.

NO CLAIM IS MADE TO THE EXCLUSIVE RIGHT TO USE "DARK", APART FROM THE MARK AS SHOWN.

SER. NO. 77-366,296, FILED 1-8-2008.

GINA HAYES, EXAMINING ATTORNEY

Int. Cl.: 41

Prior U.S. Cls.: 100, 101 and 107

United States Patent and Trademark Office

Reg. No. 3,484,271

Registered Aug. 12, 2008

**SERVICE MARK
PRINCIPAL REGISTER**

DARE TO BE CONTAGIOUS

OSORIO GROUP LLC (OREGON LTD LIAB CO)
711 MEDFORD CENTER #260
MEDFORD, OR 97504

FOR: PROFESSIONAL COACHING SERVICES IN
THE FIELD OF BUSINESS MARKETING AND
ADVERTISING; EDUCATIONAL AND ENTER-
TAINMENT SERVICES, NAMELY, PROVIDING
MOTIVATIONAL AND EDUCATIONAL SPEAK-
ERS; CONDUCTING WORKSHOPS AND SEMI-
NARS IN BUSINESS MARKETING AND

ADVERTISING, IN CLASS 41 (U.S. CLS. 100, 101
AND 107).

FIRST USE 12-17-2007; IN COMMERCE 1-6-2008.

THE MARK CONSISTS OF STANDARD CHAR-
ACTERS WITHOUT CLAIM TO ANY PARTICULAR
FONT, STYLE, SIZE, OR COLOR.

SER. NO. 77-366,316, FILED 1-8-2008.

BRENDAN REGAN, EXAMINING ATTORNEY

Int. Cl.: 35

Prior U.S. Cls.: 100, 101 and 102

United States Patent and Trademark Office

Reg. No. 3,484,272

Registered Aug. 12, 2008

**SERVICE MARK
PRINCIPAL REGISTER**



BUMPUS, FOSTER (UNITED STATES INDIVIDUAL)
3412 RIDGEVIEW DR.
EL DORADO HILLS, CA 95762

FOR: DIRECT MAIL MARKETING SERVICES, NAMELY, DISTRIBUTION OF MANUFACTURER PRODUCT SALES PROMOTION MATERIALS AND PROMOTIONAL DISCOUNT CHECKS TO POTENTIAL NEW CUSTOMERS , IN CLASS 35 (U.S. CLS. 100, 101 AND 102).

FIRST USE 2-10-2005; IN COMMERCE 6-10-2005.

THE STIPPLING IS FOR SHADING PURPOSES.

THE MARK CONSISTS OF A CIRCLE CONTAINING TWO CHEVRONS POINTING TO THE RIGHT WITH THE STYLIZED WORDS "DARTDIRECT-MARKETING" TO THE RIGHT OF THE CIRCLE.

SER. NO. 77-366,323, FILED 1-8-2008.

CYNTHIA TRIPI, EXAMINING ATTORNEY

Int. Cl.: 35

Prior U.S. Cls.: 100, 101 and 102

United States Patent and Trademark Office

Reg. No. 3,484,273

Registered Aug. 12, 2008

**SERVICE MARK
PRINCIPAL REGISTER**

PEOPLE IN BEAUTY

PEOPLE IN BEAUTY, INC. (CALIFORNIA CORPORATION)
SUITE 320
9454 WILSHIRE BLVD.
BEVERLY HILLS, CA 90212

FOR: EMPLOYMENT HIRING, RECRUITMENT, PLACEMENT, STAFFING AND CAREER NETWORKING SERVICES SPECIFICALLY FOR COMPANIES THAT MANUFACTURE COSMETICS, HEALTH AND BEAUTY PRODUCTS, AND OPERATE SALONS AND SPAS, IN CLASS 35 (U.S. CLS. 100, 101 AND 102).

FIRST USE 9-14-2006; IN COMMERCE 10-1-2006.

THE MARK CONSISTS OF STANDARD CHARACTERS WITHOUT CLAIM TO ANY PARTICULAR FONT, STYLE, SIZE, OR COLOR.

NO CLAIM IS MADE TO THE EXCLUSIVE RIGHT TO USE "BEAUTY", APART FROM THE MARK AS SHOWN.

SER. NO. 77-366,326, FILED 1-8-2008.

BRENDAN REGAN, EXAMINING ATTORNEY

Int. Cls.: 9 and 42

Prior U.S. Cls.: 21, 23, 26, 36, 38, 100 and 101

United States Patent and Trademark Office

Reg. No. 3,484,274

Registered Aug. 12, 2008

**TRADEMARK
SERVICE MARK
PRINCIPAL REGISTER**



LAGARDE, INCORPORATED (DELAWARE CORPORATION)
25055 WEST VALLEY PARKWAY
OLATHE, KS 66061

FOR: COMPUTER SOFTWARE USED BY BUSINESSES TO CONDUCT ELECTRONIC COMMERCE OVER A NETWORK, IN CLASS 9 (U.S. CLS. 21, 23, 26, 36 AND 38).

FIRST USE 6-4-2007; IN COMMERCE 6-4-2007.

FOR: PROVIDING A SERVICE TO BUSINESSES TO ALLOW BUSINESSES TO CONDUCT ELECTRONIC COMMERCE OVER A NETWORK, NAMELY, PROVIDING TEMPORARY USE OF COMPUTER E-COMMERCE SOFTWARE TO ALLOW USERS TO PERFORM ELECTRONIC BUSINESS TRANSACTIONS VIA A GLOBAL COMPUTER NETWORK, IN CLASS 42 (U.S. CLS. 100 AND 101).

FIRST USE 6-4-2007; IN COMMERCE 6-4-2007.

OWNER OF U.S. REG. NOS. 2,787,725 AND 2,866,087.

THE MARK CONSISTS OF CURVED AND WAVY LINES TO THE LEFT OF THE WORDING "LAGARDE".

THE ENGLISH TRANSLATION OF "LAGARDE" IN THE MARK IS THE GUARD OR THE GUARDIAN.

SER. NO. 77-366,334, FILED 1-8-2008.

RICHARD WHITE, EXAMINING ATTORNEY

Int. Cl.: 9

Prior U.S. Cls.: 21, 23, 26, 36 and 38

United States Patent and Trademark Office

Reg. No. 3,484,275

Registered Aug. 12, 2008

**TRADEMARK
PRINCIPAL REGISTER**

SynergyDMS

DEMIS THOMAS (UNITED STATES INDIVIDUAL)
10980 SOUTH OCEAN DR. # 612
JENSEN BEACH, FL 34957

FOR: DOCUMENT MANAGEMENT SOFTWARE,
IN CLASS 9 (U.S. CLS. 21, 23, 26, 36 AND 38).

FIRST USE 1-1-2003; IN COMMERCE 1-1-2003.

THE MARK CONSISTS OF STANDARD CHARACTERS WITHOUT CLAIM TO ANY PARTICULAR FONT, STYLE, SIZE, OR COLOR.

SER. NO. 77-366,363, FILED S.R. 1-8-2008 AM. P.R. 4-15-2008.

BRIAN PINO, EXAMINING ATTORNEY

Int. Cl.: 3

Prior U.S. Cls.: 1, 4, 6, 50, 51 and 52

United States Patent and Trademark Office

Reg. No. 3,484,276

Registered Aug. 12, 2008

**TRADEMARK
PRINCIPAL REGISTER**

IVY CLUB

VI-JON, INC. (TENNESSEE CORPORATION)
8515 PAGE AVE.
ST. LOUIS, MO 631146014

THE MARK CONSISTS OF STANDARD CHAR-
ACTERS WITHOUT CLAIM TO ANY PARTICULAR
FONT, STYLE, SIZE, OR COLOR.

FOR: AFTER-SHAVE; AFTER-SHAVE LOTIONS,
IN CLASS 3 (U.S. CLS. 1, 4, 6, 50, 51 AND 52).

SER. NO. 77-366,379, FILED 1-8-2008.

FIRST USE 11-22-1996; IN COMMERCE 11-22-1996.

HEATHER SAPP, EXAMINING ATTORNEY

Int. Cls.: 35 and 36

Prior U.S. Cls.: 100, 101 and 102

United States Patent and Trademark Office

Reg. No. 3,484,277

Registered Aug. 12, 2008

**SERVICE MARK
PRINCIPAL REGISTER**



CPA WEALTH MANAGEMENT SERVICES, P.A.
(FLORIDA CORPORATION)
215 BAYTREE DRIVE
MELBOURNE, FL 32940

FOR: CERTIFIED PUBLIC ACCOUNTING SERVICES; TAX AND TAXATION PLANNING, ADVICE, INFORMATION AND CONSULTANCY SERVICES, IN CLASS 35 (U.S. CLS. 100, 101 AND 102).

FIRST USE 6-0-1996; IN COMMERCE 6-0-1996.

FOR: CONSULTING SERVICES, NAMELY, CONSULTING, COUNSELING, ADVISING, PLANNING,

AND FINANCIAL MANAGEMENT SERVICES IN THE FIELDS OF WEALTH PLANNING, WEALTH MANAGEMENT, MONEY MANAGEMENT, AND PERSONAL FINANCE; ESTATE PLANNING, IN CLASS 36 (U.S. CLS. 100, 101 AND 102).

FIRST USE 6-0-1996; IN COMMERCE 6-0-1996.

SER. NO. 77-366,384, FILED 1-8-2008.

HEATHER SAPP, EXAMINING ATTORNEY

Int. Cl.: 5

Prior U.S. Cls.: 6, 18, 44, 46, 51 and 52

United States Patent and Trademark Office

Reg. No. 3,484,278

Registered Aug. 12, 2008

TRADEMARK
PRINCIPAL REGISTER



IBITTA ENTERPRISES INC. (CALIFORNIA CORPORATION)
SUITE 103
14340 CHANDLER BLVD
SHERMAN OAKS, CA 91401

FOR: DIETARY SUPPLEMENTAL DRINKS, HERBAL SUPPLEMENTS, VITAMIN AND MINERAL SUPPLEMENTS, VITAMIN AND MINERAL PREPARATIONS FOR USE AS INGREDIENTS IN THE FOOD AND PHARMACEUTICAL INDUSTRY, AND MEDICINAL HERB EXTRACTS; DIETARY FIBER AS AN ADDITIVE FOR FOOD PRODUCTS; POWDERED NUTRITIONAL SUPPLEMENT DRINK MIX, IN CLASS 5 (U.S. CLS. 6, 18, 44, 46, 51 AND 52).

FIRST USE 1-1-2007; IN COMMERCE 1-1-2007.

THE COLOR(S) BLACK, WHITE, BROWN, YELLOW, BLUE, ORANGE, PINK, GREEN AND BEIGE IS/ARE CLAIMED AS A FEATURE OF THE MARK.

THE MARK CONSISTS OF THE WORD "CHOCO" IN BROWN, THE WORD "KIDZ" WITH A BLUE "K," AN ORANGE "I," A PINK "D," AND A GREEN "Z," A FANCIFUL DEPICTION OF A CHILD'S HEAD WITH AN ATTACHED WAVING HAND IN BEIGE OUTLINED IN BLACK, A FANCIFUL DEPICTION OF A CHILD'S HEAD AND TORSO WITH OUTSTRETCHED ARMS OUTLINED IN BLACK, THE HEAD AND HANDS OF WHICH ARE COLORED BEIGE AND THE TORSO OF WHICH IS COLORED BLUE WITH A BLACK STAR, AND YELLOW AND WHITE SHADING SURROUNDING ALL OF THE PREVIOUSLY NAMED FEATURES OF THE MARK.

SER. NO. 77-366,413, FILED 1-8-2008.

RONALD AIKENS, EXAMINING ATTORNEY

Int. Cl.: 36

Prior U.S. Cls.: 100, 101 and 102

United States Patent and Trademark Office

Reg. No. 3,484,279

Registered Aug. 12, 2008

**SERVICE MARK
PRINCIPAL REGISTER**



Allegiance Inc.

REO ALLEGIANCE, INC (DELAWARE CORPORATION)
111 LINNET STREET
BAYONNE, NJ 07002

FOR: REAL ESTATE MANAGEMENT, NAMELY, EVICTION SERVICES, MAINTENANCE PROGRAMS, ASSET MANAGEMENT AND PROPERTY PRESERVATION ON BEHALF OF LANDLORDS, IN CLASS 36 (U.S. CLS. 100, 101 AND 102).

FIRST USE 11-0-1997; IN COMMERCE 11-0-1997.

NO CLAIM IS MADE TO THE EXCLUSIVE RIGHT TO USE "REO" AND "INC.", APART FROM THE MARK AS SHOWN.

SER. NO. 77-366,436, FILED 1-8-2008.

KEVIN DINALLO, EXAMINING ATTORNEY

Int. Cls.: 37 and 40

Prior U.S. Cls.: 100, 103 and 106

United States Patent and Trademark Office

Reg. No. 3,484,280

Registered Aug. 12, 2008

**SERVICE MARK
PRINCIPAL REGISTER**

DEMAND PERFORMANCE

DETROIT DIESEL CORPORATION (DELAWARE CORPORATION)
13400 OUTER DRIVE WEST
DETROIT, MI 482394001

FOR: SERVICING HEAVY DUTY DIESEL ENGINES, IN CLASS 37 (U.S. CLS. 100, 103 AND 106).

FIRST USE 10-19-2007; IN COMMERCE 10-19-2007.

FOR: MANUFACTURE OF HEAVY DUTY DIESEL ENGINES TO THE SPECIFICATION OF OTHERS, IN CLASS 40 (U.S. CLS. 100, 103 AND 106).

FIRST USE 10-19-2007; IN COMMERCE 10-19-2007.

THE MARK CONSISTS OF STANDARD CHARACTERS WITHOUT CLAIM TO ANY PARTICULAR FONT, STYLE, SIZE, OR COLOR.

SER. NO. 77-366,444, FILED 1-8-2008.

LINDA ORNDORFF, EXAMINING ATTORNEY

Int. Cl.: 36

Prior U.S. Cls.: 100, 101 and 102

United States Patent and Trademark Office

Reg. No. 3,484,281

Registered Aug. 12, 2008

**SERVICE MARK
PRINCIPAL REGISTER**

DOUBLE-LAYER MASTER LEASE

ELIASON, INC. (WISCONSIN CORPORATION)
P.O. BOX 219
ST. GERMAIN, WI 54558

FOR: REAL ESTATE LEASING, MANAGEMENT
AND INVESTMENT SERVICES, IN CLASS 36 (U.S.
CLS. 100, 101 AND 102).

FIRST USE 4-30-2007; IN COMMERCE 4-30-2007.

THE MARK CONSISTS OF STANDARD CHAR-
ACTERS WITHOUT CLAIM TO ANY PARTICULAR
FONT, STYLE, SIZE, OR COLOR.

NO CLAIM IS MADE TO THE EXCLUSIVE
RIGHT TO USE "MASTER LEASE", APART FROM
THE MARK AS SHOWN.

SER. NO. 77-366,448, FILED 1-8-2008.

KEVIN DINALLO, EXAMINING ATTORNEY

Int. Cl.: 3

Prior U.S. Cls.: 1, 4, 6, 50, 51 and 52

United States Patent and Trademark Office

Reg. No. 3,484,282

Registered Aug. 12, 2008

**TRADEMARK
PRINCIPAL REGISTER**

zogics

ZOGICS LLC (MASSACHUSETTS LTD LIAB CO)
PO BOX 50
RICHMOND, MA 01254

FIRST USE 9-6-2006; IN COMMERCE 9-6-2006.

FOR: CLEANING AGENTS AND PREPARATIONS; DISPOSABLE WIPES IMPREGNATED WITH CLEANSING COMPOUNDS FOR USE ON HEALTH CLUB AND EXERCISE EQUIPMENT; HAND CLEANING PREPARATIONS; DISPOSABLE WIPES IMPREGNATED WITH CHEMICALS OR COMPOUNDS FOR PERSONAL HYGIENE, IN CLASS 3 (U.S. CLS. 1, 4, 6, 50, 51 AND 52).

THE MARK CONSISTS OF STANDARD CHARACTERS WITHOUT CLAIM TO ANY PARTICULAR FONT, STYLE, SIZE, OR COLOR.

SER. NO. 77-366,504, FILED 1-8-2008.

ROBIN MITTLER, EXAMINING ATTORNEY

Int. Cl.: 9

Prior U.S. Cls.: 21, 23, 26, 36 and 38

Reg. No. 3,484,283

United States Patent and Trademark Office

Registered Aug. 12, 2008

**TRADEMARK
PRINCIPAL REGISTER**



CABELLO NOEMI (NEW MEXICO SOLE PROPRIETORSHIP), DBA VISMAR RECORDS
3514 TATUM HWY.
LOVINGTON, NM 88260

FOR: MUSICAL SOUND RECORDINGS, IN CLASS 9 (U.S. CLS. 21, 23, 26, 36 AND 38).

FIRST USE 1-1-2003; IN COMMERCE 1-1-2003.

NO CLAIM IS MADE TO THE EXCLUSIVE RIGHT TO USE "RECORDS", APART FROM THE MARK AS SHOWN.

THE COLOR(S) PINK, PURPLE, NAVY BLUE, LIGHT BLUE, GREEN, YELLOW AND ORANGE IS/ARE CLAIMED AS A FEATURE OF THE MARK.

THE MARK CONSISTS OF IT'S A HALF DISC WITH PINK, PURPLE, NAVY BLUE, LIGHT BLUE, GREEN AND YELLOW COLORS. THE WORD "RECORDS" IS INSIDE THE DISC WITH THE COLOR YELLOW AND ORANGE. THE WORD "VISMAR" IS ON THE HALF DISC WITH THE COLOR YELLOW AND ORANGE. THE COLORS IN THE WORDS ARE YELLOW AND ORANGE.

SER. NO. 77-366,546, FILED S.R. 1-8-2008 AM. P.R. 4-22-2008.

LINDA M. KING, EXAMINING ATTORNEY

Int. Cl.: 44

Prior U.S. Cls.: 100 and 101

United States Patent and Trademark Office

Reg. No. 3,484,284

Registered Aug. 12, 2008

**SERVICE MARK
PRINCIPAL REGISTER**

MICHAEL ANTHONY

M A BEAUTY GROUP, INC (ILLINOIS CORPORATION)

#1

2919 N. SOUTHPORT
CHICAGO, IL 60657

FOR: BEAUTY SALON SERVICES; AND HEALTH SPA SERVICES, NAMELY, COSMETIC BODY CARE SERVICES, IN CLASS 44 (U.S. CLS. 100 AND 101).

FIRST USE 0-0-1992; IN COMMERCE 0-0-1992.

THE MARK CONSISTS OF STANDARD CHARACTERS WITHOUT CLAIM TO ANY PARTICULAR FONT, STYLE, SIZE, OR COLOR.

THE NAME(S), PORTRAIT(S), AND/OR SIGNATURE(S) SHOWN IN THE MARK IDENTIFIES "MICHAEL ANTHONY" PIRAINO, WHOSE CONSENT(S) TO REGISTER IS MADE OF RECORD.

SER. NO. 77-366,566, FILED 1-8-2008.

LINDA M. KING, EXAMINING ATTORNEY

Int. Cl.: 41

Prior U.S. Cls.: 100, 101 and 107

United States Patent and Trademark Office

Reg. No. 3,484,285

Registered Aug. 12, 2008

**SERVICE MARK
PRINCIPAL REGISTER**



LAWPROSE, INC. (TEXAS CORPORATION)
14180 DALLAS PARKWAY
PACIFIC CENTER 1, SUITE 280
DALLAS, TX 75254

FIRST USE 1-3-2007; IN COMMERCE 1-3-2007.

THE MARK CONSISTS OF THE STYLIZED LET-
TERS "LP" WITHIN A CIRCLE.

FOR: EDUCATIONAL SERVICES, NAMELY,
CONDUCTING CLASSES, SEMINARS, WORK-
SHOPS, AND EDITORIAL SERVICES IN THE FIELD
OF LEGAL WRITING , IN CLASS 41 (U.S. CLS. 100,
101 AND 107).

SER. NO. 77-366,588, FILED 1-8-2008.

CHRISTINA SOBRAL, EXAMINING ATTORNEY

Int. Cl.: 42

Prior U.S. Cls.: 100 and 101

United States Patent and Trademark Office

Reg. No. 3,484,286

Registered Aug. 12, 2008

**SERVICE MARK
PRINCIPAL REGISTER**

StatStud

RUSS D'ARGENTO (UNITED STATES INDIVIDUAL)
45 MAGILL DRIVE
GRAFTON, MA 01519

FOR: COMPUTER SERVICES, NAMELY, CREATING INDEXES OF INFORMATION, SITES, AND OTHER RESOURCES REGARDING ATHLETIC PERFORMANCE AVAILABLE ON GLOBAL COMPUTER NETWORKS AND GLOBAL COMMUNICATION NETWORKS; CUSTOMIZED SEARCHING SERVICES, NAMELY, SEARCHING AND RETRIEVING INFORMATION, SITES AND OTHER RESOURCES AVAILABLE ON GLOBAL COMPUTER NETWORKS, GLOBAL COMMUNICATION NETWORKS, AND OTHER SOURCES OF INFORMATION TO CREATE ON-LINE INFORMATION SERVICES REGARDING ATHLETIC PERFORMANCE; EXTRACTION AND RETRIEVAL OF INFORMATION AND DATA MINING REGARDING

ATHLETIC PERFORMANCE BY MEANS OF GLOBAL COMPUTER NETWORKS, GLOBAL COMMUNICATION NETWORKS, AND OTHER SOURCES OF INFORMATION; COMPUTER SERVICES, NAMELY, MAINTAINING WEB PAGES, WEB SITES, WEB COMMUNITIES, HOME PAGES AND PERSONAL WEB PAGES PROVIDING INFORMATION REGARDING ATHLETIC PERFORMANCE, IN CLASS 42 (U.S. CLS. 100 AND 101).

FIRST USE 8-2-2007; IN COMMERCE 8-2-2007.

THE MARK CONSISTS OF STANDARD CHARACTERS WITHOUT CLAIM TO ANY PARTICULAR FONT, STYLE, SIZE, OR COLOR.

SER. NO. 77-366,593, FILED 1-8-2008.

CHRISTINA SOBRAL, EXAMINING ATTORNEY

Int. Cl.: 27

Prior U.S. Cls.: 19, 20, 37, 42 and 50

Reg. No. 3,484,287

United States Patent and Trademark Office

Registered Aug. 12, 2008

**TRADEMARK
PRINCIPAL REGISTER**

NEW MOON

KURTZ, JOHN D. (UNITED STATES INDIVIDUAL)
1701 N. LINCOLN ST.
WILMINGTON, DE 19806

THE MARK CONSISTS OF STANDARD CHARACTERS WITHOUT CLAIM TO ANY PARTICULAR FONT, STYLE, SIZE, OR COLOR.

FOR: CARPETS AND RUGS, IN CLASS 27 (U.S. CLS. 19, 20, 37, 42 AND 50).

SER. NO. 77-366,621, FILED 1-8-2008.

FIRST USE 1-1-1994; IN COMMERCE 1-1-1994.

ALYSSA PALADINO, EXAMINING ATTORNEY

Int. Cl.: 35

Prior U.S. Cls.: 100, 101 and 102

United States Patent and Trademark Office

Reg. No. 3,484,288

Registered Aug. 12, 2008

SERVICE MARK
PRINCIPAL REGISTER



DOLPHIN BLUE INCORPORATED (TEXAS CORPORATION)
3401A MAIN STREET
DALLAS, TX 75226

FOR: ON-LINE RETAIL ORDERING SERVICE
FEATURING RECYCLED OFFICE PRODUCTS, IN
CLASS 35 (U.S. CLS. 100, 101 AND 102).

FIRST USE 4-9-1993; IN COMMERCE 4-9-1993.

THE MARK CONSISTS OF THREE DOLPHINS,
ARRANGED IN A WAY THAT THEY ARE CHAS-
ING EACH OTHER IN A CIRCULAR PATTERN,
SURROUNDED BY AN OVAL BAND, WITHIN
WHICH THE WORDS "DOLPHIN BLUE" APPEAR
TWICE.

SER. NO. 77-366,645, FILED 1-8-2008.

ELISSA GARBER KON, EXAMINING ATTORNEY

Int. Cl.: 9

Prior U.S. Cls.: 21, 23, 26, 36 and 38

Reg. No. 3,484,289

United States Patent and Trademark Office

Registered Aug. 12, 2008

**TRADEMARK
PRINCIPAL REGISTER**

powerglide 

SOUTHWIRE COMPANY (DELAWARE COR-
PORATION)
ONE SOUTHWIRE DRIVE
CARROLLTON, GA 30119

FIRST USE 12-20-2007; IN COMMERCE 12-20-2007.

SER. NO. 77-366,657, FILED 1-8-2008.

FOR: UNDERGROUND RESIDENTIAL DISTRI-
BUTION ELECTRICAL CABLE, IN CLASS 9 (U.S.
CLS. 21, 23, 26, 36 AND 38).

CHRISTINE COOPER, EXAMINING ATTORNEY

Int. Cl.: 9

Prior U.S. Cls.: 21, 23, 26, 36 and 38

Reg. No. 3,484,290

United States Patent and Trademark Office

Registered Aug. 12, 2008

**TRADEMARK
PRINCIPAL REGISTER**

POWERGLIDE

SOUTHWIRE COMPANY (DELAWARE CORPORATION)
ONE SOUTHWIRE DRIVE
CARROLLTON, GA 30119

THE MARK CONSISTS OF STANDARD CHARACTERS WITHOUT CLAIM TO ANY PARTICULAR FONT, STYLE, SIZE, OR COLOR.

FOR: UNDERGROUND RESIDENTIAL DISTRIBUTION ELECTRICAL CABLE, IN CLASS 9 (U.S. CLS. 21, 23, 26, 36 AND 38).

SER. NO. 77-366,668, FILED 1-8-2008.

FIRST USE 12-20-2007; IN COMMERCE 12-20-2007.

CHRISTINE COOPER, EXAMINING ATTORNEY

Int. Cl.: 35

Prior U.S. Cls.: 100, 101 and 102

United States Patent and Trademark Office

Reg. No. 3,484,291

Registered Aug. 12, 2008

**SERVICE MARK
PRINCIPAL REGISTER**

Dolphin Blue

DOLPHIN BLUE INCORPORATED (TEXAS CORPORATION)
3401A MAIN STREET
DALLAS, TX 75226

THE MARK CONSISTS OF STANDARD CHARACTERS WITHOUT CLAIM TO ANY PARTICULAR FONT, STYLE, SIZE, OR COLOR.

FOR: ON-LINE RETAIL ORDERING SERVICE FEATURING RECYCLED OFFICE PRODUCTS, IN CLASS 35 (U.S. CLS. 100, 101 AND 102).

SER. NO. 77-366,724, FILED 1-8-2008.

FIRST USE 4-9-1993; IN COMMERCE 4-9-1993.

ELISSA GARBER KON, EXAMINING ATTORNEY

Int. Cl.: 41

Prior U.S. Cls.: 100, 101 and 107

United States Patent and Trademark Office

Reg. No. 3,484,292

Registered Aug. 12, 2008

**SERVICE MARK
PRINCIPAL REGISTER**

CLUB ELITE

ORKIN, NEIL (UNITED STATES INDIVIDUAL)
SUITE 104-104
11125 PARK BOULEVARD
SEMINOLE, FL 33772

THE MARK CONSISTS OF STANDARD CHARACTERS WITHOUT CLAIM TO ANY PARTICULAR FONT, STYLE, SIZE, OR COLOR.

FOR: ADULT NIGHT CLUBS; ENTERTAINMENT SERVICES, NAMELY, CONDUCTING ADULT THEMED SOCIAL EVENTS AND PARTIES AND PROVIDING A WEB SITE FEATURING ADULT-THEMED PHOTOGRAPHS, LINKS, EVENTS AND INFORMATION, IN CLASS 41 (U.S. CLS. 100, 101 AND 107).

NO CLAIM IS MADE TO THE EXCLUSIVE RIGHT TO USE "CLUB", APART FROM THE MARK AS SHOWN.

FIRST USE 8-0-2007; IN COMMERCE 10-0-2007.

SER. NO. 77-366,752, FILED 1-8-2008.

MICHAEL SOUDERS, EXAMINING ATTORNEY

Int. Cl.: 35

Prior U.S. Cls.: 100, 101 and 102

United States Patent and Trademark Office

Reg. No. 3,484,293

Registered Aug. 12, 2008

**SERVICE MARK
PRINCIPAL REGISTER**

First Bargain

FIRST BARGAIN, INC. (CALIFORNIA CORPORATION)

3300 W. 8TH STREET

LOS ANGELES, CA 90005

FOR: RETAIL DEPARTMENT STORE SERVICES,
IN CLASS 35 (U.S. CLS. 100, 101 AND 102).

FIRST USE 2-0-1997; IN COMMERCE 2-0-1997.

THE MARK CONSISTS OF STANDARD CHARACTERS WITHOUT CLAIM TO ANY PARTICULAR FONT, STYLE, SIZE, OR COLOR.

NO CLAIM IS MADE TO THE EXCLUSIVE RIGHT TO USE "BARGAIN", APART FROM THE MARK AS SHOWN.

SER. NO. 77-366,764, FILED 1-8-2008.

ALYSSA PALADINO, EXAMINING ATTORNEY

Int. Cl.: 43

Prior U.S. Cls.: 100 and 101

United States Patent and Trademark Office

Reg. No. 3,484,294

Registered Aug. 12, 2008

**SERVICE MARK
PRINCIPAL REGISTER**

GROOPL

GROOPL INC. (DELAWARE CORPORATION)
SUITE 220
10333 EAST DRY CREEK ROAD
ENGLEWOOD, CO 80112

THE MARK CONSISTS OF STANDARD CHARACTERS WITHOUT CLAIM TO ANY PARTICULAR FONT, STYLE, SIZE, OR COLOR.

FOR: RESERVATION OF HOTEL ROOMS FOR TRAVELERS; TRAVEL AGENCY SERVICES, NAMELY, MAKING RESERVATIONS AND BOOKINGS FOR ACCOMMODATIONS, IN CLASS 43 (U.S. CLS. 100 AND 101).

OWNER OF U.S. REG. NO. 3,092,511.

SER. NO. 77-366,772, FILED 1-8-2008.

FIRST USE 12-1-2003; IN COMMERCE 12-1-2003.

KHANH LE, EXAMINING ATTORNEY

Int. Cl.: 5

Prior U.S. Cls.: 6, 18, 44, 46, 51 and 52

Reg. No. 3,484,295

United States Patent and Trademark Office

Registered Aug. 12, 2008

**TRADEMARK
PRINCIPAL REGISTER**



CENTURY SYSTEMS INC. (GEORGIA CORPORATION)
120 SELIG DR SW
ATLANTA, GA 303362026

THE MARK CONSISTS OF A STYLIZED LETTER "V" FOLLOWED BY THE LETTERS ITAROL.

FOR: VITAMIN, HERBAL, AND MINERAL FOOD SUPPLEMENTS, IN CLASS 5 (U.S. CLS. 6, 18, 44, 46, 51 AND 52).

SER. NO. 77-366,803, FILED 1-8-2008.

FIRST USE 1-20-2004; IN COMMERCE 1-2-2008.

AHSEN KHAN, EXAMINING ATTORNEY

Int. Cls.: 35 and 37

Prior U.S. Cls.: 100, 101, 102, 103 and 106

United States Patent and Trademark Office

Reg. No. 3,484,296

Registered Aug. 12, 2008

**SERVICE MARK
PRINCIPAL REGISTER**

**FROM SIMPLE TO SIMPLY
SPECTACULAR**

VERSATILE ROOFING, INC. (WASHINGTON CORPORATION)
11805 NE 116TH ST.
KIRKLAND, WA 98034

FOR: PROVIDING RETAIL SHOWROOM SERVICES FOR THE GOODS OF OTHERS IN THE FIELDS OF HOME IMPROVEMENT AND REMODELING, IN CLASS 35 (U.S. CLS. 100, 101 AND 102).

FIRST USE 11-0-2000; IN COMMERCE 11-0-2000.

FOR: HOME IMPROVEMENT SERVICES, NAMELY, INSTALLATION, RENOVATION AND REPAIR SERVICES FOR SIDING, DECKS, ROOFS, DOORS,

WINDOWS AND OTHER PERSONAL AND COMMERCIAL BUILDING FEATURES; HOME IMPROVEMENT CONSTRUCTION AND REPAIR SERVICES, IN CLASS 37 (U.S. CLS. 100, 103 AND 106).

FIRST USE 11-0-2000; IN COMMERCE 11-20-2000.

THE MARK CONSISTS OF STANDARD CHARACTERS WITHOUT CLAIM TO ANY PARTICULAR FONT, STYLE, SIZE, OR COLOR.

SER. NO. 77-366,818, FILED 1-8-2008.

SHARON MEIER, EXAMINING ATTORNEY

Int. Cl.: 5

Prior U.S. Cls.: 6, 18, 44, 46, 51 and 52

Reg. No. 3,484,297

United States Patent and Trademark Office

Registered Aug. 12, 2008

**TRADEMARK
PRINCIPAL REGISTER**

DIABRITE

FRONTIER DENTAL LABORATORIES (CALI-
FORNIA CORPORATION)
2ND FLOOR
4944 WINDPLAY DRIVE
EL DORADO HILLS, CA 95762

FOR: POLISHING MATERIAL, NAMELY, PASTE
AND POWDER FOR POLISHING DENTAL COM-
POSITES, IN CLASS 5 (U.S. CLS. 6, 18, 44, 46, 51 AND
52).

FIRST USE 4-17-1997; IN COMMERCE 4-17-1997.

THE MARK CONSISTS OF STANDARD CHAR-
ACTERS WITHOUT CLAIM TO ANY PARTICULAR
FONT, STYLE, SIZE, OR COLOR.

THE WORDING "DIABRITE" HAS NO MEANING
IN A FOREIGN LANGUAGE.

SER. NO. 77-366,819, FILED 1-8-2008.

JENNIFER VASQUEZ, EXAMINING ATTORNEY

Int. Cl.: 20

Prior U.S. Cls.: 2, 13, 22, 25, 32 and 50

Reg. No. 3,484,298

United States Patent and Trademark Office

Registered Aug. 12, 2008

**TRADEMARK
PRINCIPAL REGISTER**

FRESHERVE

WILKINSON INDUSTRIES, INC. (DELAWARE
CORPORATION)
12TH & MADISON STREET
FORT CALHOUN, NE 68023

THE MARK CONSISTS OF STANDARD CHAR-
ACTERS WITHOUT CLAIM TO ANY PARTICULAR
FONT, STYLE, SIZE, OR COLOR.

FOR: PLASTIC FOOD CONTAINERS FOR COM-
MERCIAL USE SOLD TO DISTRIBUTORS AND
FOOD PROCESSORS; PLASTIC FOOD CONTAIN-
ERS FOR COMMERCIAL USE SOLD DIRECTLY TO
END USERS , IN CLASS 20 (U.S. CLS. 2, 13, 22, 25, 32
AND 50).

OWNER OF U.S. REG. NO. 1,334,359.

SER. NO. 77-366,820, FILED 1-8-2008.

FIRST USE 12-31-2004; IN COMMERCE 12-31-2004.

KIM MONINGHOFF, EXAMINING ATTORNEY

Int. Cl.: 20

Prior U.S. Cls.: 2, 13, 22, 25, 32 and 50

Reg. No. 3,484,299

United States Patent and Trademark Office

Registered Aug. 12, 2008

**TRADEMARK
PRINCIPAL REGISTER**

FRESH PERFORMANCE

WILKINSON INDUSTRIES, INC. (DELAWARE CORPORATION)
12TH & MADISON STREET
FORT CALHOUN, NE 68023

FOR: PLASTIC FOOD CONTAINERS FOR COMMERCIAL USE SOLD TO DISTRIBUTORS AND FOOD PROCESSORS; PLASTIC FOOD CONTAINERS FOR COMMERCIAL USE SOLD DIRECTLY TO END USERS , IN CLASS 20 (U.S. CLS. 2, 13, 22, 25, 32 AND 50).

FIRST USE 5-15-2005; IN COMMERCE 5-15-2005.

THE MARK CONSISTS OF STANDARD CHARACTERS WITHOUT CLAIM TO ANY PARTICULAR FONT, STYLE, SIZE, OR COLOR.

OWNER OF U.S. REG. NO. 1,769,342.

SER. NO. 77-366,828, FILED 1-8-2008.

KIM MONINGHOFF, EXAMINING ATTORNEY

Int. Cl.: 20

Prior U.S. Cls.: 2, 13, 22, 25, 32 and 50

Reg. No. 3,484,300

United States Patent and Trademark Office

Registered Aug. 12, 2008

**TRADEMARK
PRINCIPAL REGISTER**

HERBSHELL

WILKINSON INDUSTRIES, INC. (DELAWARE
CORPORATION)
12TH & MADISON STREET
FORT CALHOUN, NE 68023

FOR: PLASTIC FOOD CONTAINERS FOR COM-
MERCIAL USE SOLD TO DISTRIBUTORS AND
FOOD PROCESSORS; PLASTIC FOOD CONTAIN-
ERS FOR COMMERCIAL USE SOLD DIRECTLY TO
END USERS , IN CLASS 20 (U.S. CLS. 2, 13, 22, 25, 32
AND 50).

FIRST USE 6-30-2005; IN COMMERCE 6-30-2005.

THE MARK CONSISTS OF STANDARD CHAR-
ACTERS WITHOUT CLAIM TO ANY PARTICULAR
FONT, STYLE, SIZE, OR COLOR.

SER. NO. 77-366,835, FILED 1-8-2008.

KIM MONINGHOFF, EXAMINING ATTORNEY

Int. Cl.: 39

Prior U.S. Cls.: 100 and 105

United States Patent and Trademark Office

Reg. No. 3,484,301

Registered Aug. 12, 2008

**SERVICE MARK
PRINCIPAL REGISTER**

GROOPLE

GROOPLE INC. (DELAWARE CORPORATION)
SUITE 220
10333 EAST DRY CREEK ROAD
ENGLEWOOD, CO 80112

FOR: TRAVEL AGENCY SERVICES, NAMELY,
MAKING RESERVATIONS AND BOOKINGS FOR
TRANSPORTATION, IN CLASS 39 (U.S. CLS. 100
AND 105).

FIRST USE 12-1-2003; IN COMMERCE 12-1-2003.

THE MARK CONSISTS OF STANDARD CHAR-
ACTERS WITHOUT CLAIM TO ANY PARTICULAR
FONT, STYLE, SIZE, OR COLOR.

OWNER OF U.S. REG. NO. 3,092,511.

SER. NO. 77-366,849, FILED 1-8-2008.

KHANH LE, EXAMINING ATTORNEY

Int. Cl.: 35

Prior U.S. Cls.: 100, 101 and 102

United States Patent and Trademark Office

Reg. No. 3,484,302

Registered Aug. 12, 2008

**SERVICE MARK
PRINCIPAL REGISTER**



FIRST BARGAIN, INC. (CALIFORNIA CORPORATION)
3300 W. 8TH STREET
LOS ANGELES, CA 90010

FOR: RETAIL DEPARTMENT STORE SERVICES,
IN CLASS 35 (U.S. CLS. 100, 101 AND 102).

FIRST USE 2-0-1997; IN COMMERCE 2-0-1997.

NO CLAIM IS MADE TO THE EXCLUSIVE
RIGHT TO USE "BARGAIN CENTER", APART
FROM THE MARK AS SHOWN.

THE MARK CONSISTS OF A HAND WITH A
THUMB POINTING UPWARD, ENCLOSED WITHIN
TWO CONCENTRIC CIRCLES WITH THE OUTER
CIRCLE CONTAINING THE PHRASE "FIRST BAR-
GAIN CENTER".

SER. NO. 77-366,863, FILED 1-8-2008.

ALYSSA PALADINO, EXAMINING ATTORNEY

Int. Cl.: 29

Prior U.S. Cl.: 46

United States Patent and Trademark Office

Reg. No. 3,484,303

Registered Aug. 12, 2008

**TRADEMARK
PRINCIPAL REGISTER**

**THE FRESH OLIVE COMPANY OF
PROVENCE**

FRIENDLY FRUIT INC. (MASSACHUSETTS CORPORATION), DBA SID WAINER & SONS, INC.

2301 PURCHASE STREET
NEW BEDFORD, MA 02746

FOR: PROCESSED OLIVES; OLIVE OIL, IN CLASS 29 (U.S. CL. 46).

FIRST USE 12-12-2001; IN COMMERCE 12-12-2001.

THE MARK CONSISTS OF STANDARD CHARACTERS WITHOUT CLAIM TO ANY PARTICULAR FONT, STYLE, SIZE, OR COLOR.

OWNER OF U.S. REG. NO. 2,641,357.

NO CLAIM IS MADE TO THE EXCLUSIVE RIGHT TO USE "FRESH OLIVE COMPANY", APART FROM THE MARK AS SHOWN.

SEC. 2(F).

SER. NO. 77-366,880, FILED 1-8-2008.

EMILY CARLSEN, EXAMINING ATTORNEY

Int. Cl.: 31

Prior U.S. Cls.: 1 and 46

United States Patent and Trademark Office

Reg. No. 3,484,304

Registered Aug. 12, 2008

TRADEMARK
PRINCIPAL REGISTER



VERITAS V, LLC (CALIFORNIA LTD LIAB CO)
401 MONTEREY STREET, SUITE 201
SALINAS, CA 93901

FOR: ORGANIC FRESH VEGETABLES, IN CLASS
31 (U.S. CLS. 1 AND 46).

FIRST USE 5-4-2007; IN COMMERCE 5-4-2007.

NO CLAIM IS MADE TO THE EXCLUSIVE
RIGHT TO USE "ORGANIC" , APART FROM THE
MARK AS SHOWN.

THE COLOR(S) GREEN AND BLACK IS/ARE
CLAIMED AS A FEATURE OF THE MARK.

THE MARK CONSISTS OF THE LETTER "I", THE
WORD "ORGANIC", A HEART SHAPED DESIGN
AND AN OUTLINE OF A CIRCLE. THE COLOR
BLACK APPEARS IN THE WORDING "I" AND
"ORGANIC", IN THE OUTLINE OF THE HEART
DESIGN, AND ON THE CIRCLE CARRIER ENCOM-
PASSING THE WORDING AND THE DESIGN. THE
INTERIOR OF THE HEART DESIGN IS IN GREEN.
THE WHITE AREA THAT COMPRISES THE BACK-
GROUND AREA OF THE MARK WITHIN THE
CIRCLE IS INTENDED AS A TRANSPARENT AREA
AND IS NOT PART OF THE MARK.

SER. NO. 77-366,935, FILED 1-8-2008.

SHARON MEIER, EXAMINING ATTORNEY

Int. Cl.: 45

Prior U.S. Cls.: 100 and 101

United States Patent and Trademark Office

Reg. No. 3,484,305

Registered Aug. 12, 2008

**SERVICE MARK
PRINCIPAL REGISTER**

TRIGEIA

TRIGEIA INC. (CALIFORNIA CORPORATION)
1311 CANDLELIGHT GLEN
ESCONDIDO, CA 92029

THE MARK CONSISTS OF STANDARD CHAR-
ACTERS WITHOUT CLAIM TO ANY PARTICULAR
FONT, STYLE, SIZE, OR COLOR.

FOR: ONLINE SOCIAL NETWORKING SERVI-
CES, IN CLASS 45 (U.S. CLS. 100 AND 101).

SER. NO. 77-366,936, FILED 1-8-2008.

FIRST USE 1-8-2007; IN COMMERCE 1-8-2007.

BRIAN PINO, EXAMINING ATTORNEY

Int. Cls.: 33, 39 and 41

Prior U.S. Cls.: 47, 49, 100, 101, 105 and 107

Reg. No. 3,484,306

United States Patent and Trademark Office

Registered Aug. 12, 2008

**TRADEMARK
SERVICE MARK
PRINCIPAL REGISTER**



NJJ, LTD (WASHINGTON CORPORATION), DBA
VINO! A WINESHOP
222 S. WASHINGTON STREET
SPOKANE, WA 99201

FOR: WINES AND SPARKLING WINES, IN
CLASS 33 (U.S. CLS. 47 AND 49).

FIRST USE 10-10-1995; IN COMMERCE 10-10-1995.

FOR: WINE CLUB SERVICES FEATURING PER-
IODIC SHIPMENTS OF WINE TO MEMBERS, IN
CLASS 39 (U.S. CLS. 100 AND 105).

FIRST USE 10-10-1995; IN COMMERCE 10-10-1995.

FOR: ENTERTAINMENT SERVICES, NAMELY,
WINE TASTINGS, IN CLASS 41 (U.S. CLS. 100, 101
AND 107).

FIRST USE 10-10-1995; IN COMMERCE 10-10-1995.

NO CLAIM IS MADE TO THE EXCLUSIVE
RIGHT TO USE "VINO" OR "WINESHOP", APART
FROM THE MARK AS SHOWN.

THE STIPPLING IS FOR SHADING PURPOSES
ONLY.

THE MARK CONSISTS OF A BROADER LINE
CIRCLE, WITHIN A THIN CIRCLE AND A SPLASH
LINE ACROSS THE CENTER OF THE CIRCLE; THE
SPLASH LINE STARTS BROADLY ON THE LEFT
AND BECOMES MORE NARROW AS IT MOVES TO
THE RIGHT; ABOVE THE SPLASH LINE IS THE
TERM "VINO!" IN A LARGER STYLIZED FONT,
BELOW THE SPLASH LINE IS THE TERM "A
WINESHOP", IN A STYLED, BUT MORE CONSER-
VATIVE FONT. AT THE BASE OF THE CIRCLE IS
AN OBLONG CIRCLE, WHICH CONTAINS THREE
WINE GLASSES, IN A 3-D EFFECT WHERE THE
CENTER GLASS APPEARS TO CLOSER THAN THE
GLASSES TO ITS LEFT AND RIGHT.

THE FOREIGN WORDING IN THE MARK
TRANSLATES INTO ENGLISH AS WINE.

SEC. 2(F).

SER. NO. 77-366,937, FILED 1-8-2008.

KATHERINE M. DUBRAY, EXAMINING ATTOR-
NEY

Int. Cl.: 41

Prior U.S. Cls.: 100, 101 and 107

United States Patent and Trademark Office

Reg. No. 3,484,307

Registered Aug. 12, 2008

**SERVICE MARK
PRINCIPAL REGISTER**

DOOZA

CIC, LTD (COOK ISLANDS CORPORATION)
17328 VENTURA BLVD, SUITE 169
ENCINO, CA 91316

THE MARK CONSISTS OF STANDARD CHAR-
ACTERS WITHOUT CLAIM TO ANY PARTICULAR
FONT, STYLE, SIZE, OR COLOR.

FOR: ENTERTAINMENT SERVICES, NAMELY,
PROVIDING A WEB SITE FEATURING ADULT-
THEMED PHOTOGRAPHS AND VIDEOS, IN CLASS
41 (U.S. CLS. 100, 101 AND 107).

SER. NO. 77-366,952, FILED 1-8-2008.

FIRST USE 2-12-2002; IN COMMERCE 2-12-2002.

KIM MONINGHOFF, EXAMINING ATTORNEY

Int. Cl.: 41

Prior U.S. Cls.: 100, 101 and 107

United States Patent and Trademark Office

Reg. No. 3,484,308

Registered Aug. 12, 2008

**SERVICE MARK
PRINCIPAL REGISTER**



KAREN RUBIN PHOTOGRAPHY, INC. (COLOR-
ADO CORPORATION)
SUITE 2630
8340 NORTHFIELD BLVD.
DENVER, CO 80238

FOR: PORTRAIT PHOTOGRAPHY, IN CLASS 41
(U.S. CLS. 100, 101 AND 107).

FIRST USE 12-15-2007; IN COMMERCE 12-15-2007.

THE NAME(S), PORTRAIT(S), AND/OR SIGNA-
TURE(S) SHOWN IN THE MARK IDENTIFIES
"KAREN RUBIN", WHOSE CONSENT(S) TO REGIS-
TER IS MADE OF RECORD.

THE COLOR(S) SAGE GREEN AND COOL GRAY
IS/ARE CLAIMED AS A FEATURE OF THE MARK.

THE MARK CONSISTS OF SCROLLED RIBBON
GRAPHICS IN THE COLOR SAGE GREEN, AND
THE WORDING "KAREN RUBIN CHILDHOOD
EVERLASTING" IN THE COLOR COOL GRAY.
THE COLOR WHITE REPRESENTS A TRANSPAR-
ENT BACKGROUND AND IS NOT CLAIMED AS A
FEATURE OF THE MARK.

SER. NO. 77-366,959, FILED 1-8-2008.

JENNIFER DIXON, EXAMINING ATTORNEY

Int. Cl.: 38

Prior U.S. Cls.: 100, 101 and 104

United States Patent and Trademark Office

Reg. No. 3,484,309

Registered Aug. 12, 2008

**SERVICE MARK
PRINCIPAL REGISTER**

**El Corazón del Pueblo
Latino**

DAVIDSON MEDIA PENNSYLVANIA STA-
TIONS, LLC (DELAWARE LTD LIAB CO)
P.O. BOX 2368
DAVIDSON, NC 28036

FOR: RADIO BROADCASTING; INTERNET
BROADCASTING SERVICES, IN CLASS 38 (U.S.
CLS. 100, 101 AND 104).

FIRST USE 12-1-2007; IN COMMERCE 12-1-2007.

THE MARK CONSISTS OF STANDARD CHAR-
ACTERS WITHOUT CLAIM TO ANY PARTICULAR
FONT, STYLE, SIZE, OR COLOR.

THE FOREIGN WORDING IN THE MARK
TRANSLATES INTO ENGLISH AS THE HEART OF
THE LATINO COMMUNITY.

SER. NO. 77-366,965, FILED 1-8-2008.

KOURTNEE HODGES, EXAMINING ATTORNEY

Int. Cl.: 38

Prior U.S. Cls.: 100, 101 and 104

United States Patent and Trademark Office

Reg. No. 3,484,310

Registered Aug. 12, 2008

**SERVICE MARK
PRINCIPAL REGISTER**

Mega 1310 AM

DAVIDSON MEDIA PENNSYLVANIA STA-
TIONS, LLC (DELAWARE LTD LIAB CO)
P.O. BOX 2368
DAVIDSON, NC 28036

FOR: INTERNET BROADCASTING SERVICES;
RADIO BROADCASTING, IN CLASS 38 (U.S. CLS.
100, 101 AND 104).

FIRST USE 4-1-2007; IN COMMERCE 4-1-2007.

THE MARK CONSISTS OF STANDARD CHAR-
ACTERS WITHOUT CLAIM TO ANY PARTICULAR
FONT, STYLE, SIZE, OR COLOR.

NO CLAIM IS MADE TO THE EXCLUSIVE
RIGHT TO USE "1310 AM", APART FROM THE
MARK AS SHOWN.

SER. NO. 77-366,973, FILED 1-8-2008.

KOURTNEE HODGES, EXAMINING ATTORNEY

Int. Cl.: 35

Prior U.S. Cls.: 100, 101 and 102

United States Patent and Trademark Office

Reg. No. 3,484,311

Registered Aug. 12, 2008

**SERVICE MARK
PRINCIPAL REGISTER**

RINSTAR

FREEDOM GROUP INC. (NEVADA CORPORATION)
SUITE 430
5190 NEIL ROAD
RENO, NV 895028535

FOR: PROVIDING AN ON-LINE REGISTRY FOR RENEWABLE FUELS; PROVIDING AN ON-LINE REGISTRY USED TO TRACK, RECORD, AND VALIDATE THE RENEWABLE IDENTIFICATION NUMBERS ASSOCIATED WITH THE TRANSFER OF RENEWABLE FUELS IN ACCORDANCE WITH

THE US RENEWABLE FUEL STANDARD, IN CLASS 35 (U.S. CLS. 100, 101 AND 102).

FIRST USE 4-0-2007; IN COMMERCE 4-0-2007.

THE MARK CONSISTS OF STANDARD CHARACTERS WITHOUT CLAIM TO ANY PARTICULAR FONT, STYLE, SIZE, OR COLOR.

SER. NO. 77-367,058, FILED 1-8-2008.

RONALD MCMORROW, EXAMINING ATTORNEY

Int. Cl.: 41

Prior U.S. Cls.: 100, 101 and 107

United States Patent and Trademark Office

Reg. No. 3,484,312

Registered Aug. 12, 2008

**SERVICE MARK
PRINCIPAL REGISTER**

Pelly's Mini Golf

DEL MAR GOLF CENTER (CALIFORNIA LTD
LIAB CO), DBA SURF & TURF RECREATION
CENTER

15555 JIMMY DURANTE BLVD
DEL MAR, CA 92014

FOR: AMUSEMENT CENTERS, IN CLASS 41 (U.S.
CLS. 100, 101 AND 107).

FIRST USE 7-1-2007; IN COMMERCE 11-12-2007.

THE MARK CONSISTS OF STANDARD CHAR-
ACTERS WITHOUT CLAIM TO ANY PARTICULAR
FONT, STYLE, SIZE, OR COLOR.

NO CLAIM IS MADE TO THE EXCLUSIVE
RIGHT TO USE "MINI GOLF", APART FROM THE
MARK AS SHOWN.

SER. NO. 77-367,067, FILED 1-8-2008.

GIANCARLO CASTRO, EXAMINING ATTORNEY

Int. Cl.: 42

Prior U.S. Cls.: 100 and 101

United States Patent and Trademark Office

Reg. No. 3,484,313

Registered Aug. 12, 2008

**SERVICE MARK
PRINCIPAL REGISTER**

DTV Answer

LAWRENCE ERLICH (UNITED STATES INDIVIDUAL)
3554 HULMEVILLE ROAD
SUITE 108
BENSALEM, PA 19020

FOR: COMPUTER SERVICES, NAMELY, PROVIDING SEARCH ENGINES FOR OBTAINING DATA ON A GLOBAL COMPUTER NETWORK, IN CLASS 42 (U.S. CLS. 100 AND 101).

FIRST USE 6-7-2007; IN COMMERCE 6-7-2007.

THE MARK CONSISTS OF STANDARD CHARACTERS WITHOUT CLAIM TO ANY PARTICULAR FONT, STYLE, SIZE, OR COLOR.

SER. NO. 77-367,097, FILED 1-8-2008.

GIANCARLO CASTRO, EXAMINING ATTORNEY

Int. Cl.: 25

Prior U.S. Cls.: 22 and 39

United States Patent and Trademark Office

Reg. No. 3,484,314

Registered Aug. 12, 2008

**TRADEMARK
PRINCIPAL REGISTER**

Sixth Alliance

BAYVI LLC (HAWAII LTD LIAB CO)
758 KAPAHULU AVE, A306
HONOLULU, HI 96816

THE MARK CONSISTS OF STANDARD CHAR-
ACTERS WITHOUT CLAIM TO ANY PARTICULAR
FONT, STYLE, SIZE, OR COLOR.

FOR: CLOTHING, NAMELY, T-SHIRTS, SHIRTS,
SWEATSHIRTS, JACKETS, CAPS, BEANIES, PANTS,
SHORTS, BOARDSHORTS, IN CLASS 25 (U.S. CLS. 22
AND 39).

SER. NO. 77-367,100, FILED 1-8-2008.

FIRST USE 12-16-2007; IN COMMERCE 12-16-2007.

JASON ROTH, EXAMINING ATTORNEY

Int. Cl.: 36

Prior U.S. Cls.: 100, 101 and 102

United States Patent and Trademark Office

Reg. No. 3,484,315

Registered Aug. 12, 2008

**SERVICE MARK
PRINCIPAL REGISTER**

ON YOUR SIDE EVERY STEP OF
THE WAY

MELANIA SANDRA PC (NEVADA CORPORATION), DBA MELANIA SANDRA
3993 SPRING MOUNTAIN RD., #308
LAS VEGAS, NV 89102

THE MARK CONSISTS OF STANDARD CHARACTERS WITHOUT CLAIM TO ANY PARTICULAR FONT, STYLE, SIZE, OR COLOR.

FOR: REAL ESTATE AGENT SERVICES; REAL ESTATE CONSULTATION SERVICES, IN CLASS 36 (U.S. CLS. 100, 101 AND 102).

SER. NO. 77-367,115, FILED 1-9-2008.

FIRST USE 1-0-2007; IN COMMERCE 1-0-2007.

SUSAN STIGLITZ, EXAMINING ATTORNEY

Int. Cl.: 20

Prior U.S. Cls.: 2, 13, 22, 25, 32 and 50

United States Patent and Trademark Office

Reg. No. 3,484,316

Registered Aug. 12, 2008

**TRADEMARK
PRINCIPAL REGISTER**

CRYSTAL BEDDING

CRYSTAL BEDDING INC. (CALIFORNIA CORPORATION)

6418 E WASHINGTON BLVD

COMMERCE, CA 90040

FOR: MATTRESSES, IN CLASS 20 (U.S. CLS. 2, 13, 22, 25, 32 AND 50).

FIRST USE 0-0-1998; IN COMMERCE 0-0-1998.

THE MARK CONSISTS OF STANDARD CHARACTERS WITHOUT CLAIM TO ANY PARTICULAR FONT, STYLE, SIZE, OR COLOR.

NO CLAIM IS MADE TO THE EXCLUSIVE RIGHT TO USE "BEDDING", APART FROM THE MARK AS SHOWN.

SER. NO. 77-367,125, FILED 1-9-2008.

JAMES STEIN, EXAMINING ATTORNEY

Int. Cl.: 32

Prior U.S. Cls.: 45, 46 and 48

Reg. No. 3,484,317

United States Patent and Trademark Office

Registered Aug. 12, 2008

**TRADEMARK
PRINCIPAL REGISTER**

FORENSIC NUTRITION

DEVONE LAWSON, INC. (CALIFORNIA CORPORATION)
507
13428 MAXELLA AVENUE
MARINA DEL REY, CA 90292

FOR: BOTTLED DRINKING WATER; BOTTLED WATER; DRINKING WATER; FLAVORED BOTTLED WATER; FLAVORED WATERS; FLAVOURED WATERS, IN CLASS 32 (U.S. CLS. 45, 46 AND 48).

FIRST USE 1-7-2008; IN COMMERCE 1-7-2008.

THE MARK CONSISTS OF STANDARD CHARACTERS WITHOUT CLAIM TO ANY PARTICULAR FONT, STYLE, SIZE, OR COLOR.

NO CLAIM IS MADE TO THE EXCLUSIVE RIGHT TO USE "NUTRITION", APART FROM THE MARK AS SHOWN.

SER. NO. 77-367,146, FILED 1-9-2008.

JEAN IM, EXAMINING ATTORNEY

Int. Cl.: 21

Prior U.S. Cls.: 2, 13, 23, 29, 30, 33, 40 and 50

Reg. No. 3,484,318

United States Patent and Trademark Office

Registered Aug. 12, 2008

**TRADEMARK
PRINCIPAL REGISTER**

SPOONLIDZ

CROSS, PEGGY (UNITED STATES INDIVIDUAL), DBA SPOONLIDZ
74 MEADOWOOD DRIVE
LARKSPUR, CA 94939

THE MARK CONSISTS OF STANDARD CHARACTERS WITHOUT CLAIM TO ANY PARTICULAR FONT, STYLE, SIZE, OR COLOR.

FOR: DISPOSABLE SPOONS, IN CLASS 21 (U.S. CLS. 2, 13, 23, 29, 30, 33, 40 AND 50).

SER. NO. 77-367,159, FILED 1-9-2008.

FIRST USE 10-31-2006; IN COMMERCE 10-31-2006.

ANTHONY RINKER, EXAMINING ATTORNEY

Int. Cl.: 35

Prior U.S. Cls.: 100, 101 and 102

United States Patent and Trademark Office

Reg. No. 3,484,319

Registered Aug. 12, 2008

**SERVICE MARK
PRINCIPAL REGISTER**

GREATLISTS.COM

INFORMATION MARKETING SERVICES, INC.
(VIRGINIA CORPORATION)
SUITE 135
21351 GENTRY DRIVE
DULLES, VA 20166

FOR: POSTAL, EMAIL AND ELECTRONIC MAIL-
ING LIST BROKERAGE AND MANAGEMENT
SERVICES, IN CLASS 35 (U.S. CLS. 100, 101 AND 102).

FIRST USE 6-15-1999; IN COMMERCE 6-15-1999.

THE MARK CONSISTS OF STANDARD CHAR-
ACTERS WITHOUT CLAIM TO ANY PARTICULAR
FONT, STYLE, SIZE, OR COLOR.

OWNER OF U.S. REG. NO. 2,576,828.

SEC. 2(F).

SER. NO. 77-367,166, FILED 1-9-2008.

SALLY SHIH, EXAMINING ATTORNEY

Int. Cl.: 5

Prior U.S. Cls.: 6, 18, 44, 46, 51 and 52

United States Patent and Trademark Office

Reg. No. 3,484,320

Registered Aug. 12, 2008

**TRADEMARK
PRINCIPAL REGISTER**

**THE ICE-QUBE IN CASE OF
EMERGENCY**

LUFAS INDUSTRIES (NEW YORK LTD LIAB
CO)
P.O. BOX 129
OLD WESTBURY, NY 11568

FOR: EMERGENCY PREPAREDNESS KITS,
SOLD AS A UNIT, CONSISTING PRIMARILY OF
FIRST AID KIT COMPRISING SOME OR ALL OF
BANDAGES, COLD PACKS, AND BURN PADS,
AND ALSO INCORPORATING BOTTLED DRINK-
ING WATER, SURVIVAL SUPPLIES, HYGIENE
SUPPLIES AND COMFORT SUPPLIES COMPRIS-
ING SOME OR ALL OF SCISSORS, BATTERY
OPERATED RADIOS, LANTERNS, WATERPROOF
MATCHES, NEEDLE AND THREADS, FOOD
ITEMS, TOOTHBRUSHES, TOILET PAPER, SUN
SCREEN, MIRRORS, BLEACH, PONCHOS, FANS,

HEATING PACKS, PLASTIC SHEETING, TOOTH-
BRUSHES, RAZORS, GARBAGE BAGS, SOAP AND
SUNSCREEN, IN CLASS 5 (U.S. CLS. 6, 18, 44, 46, 51
AND 52).

FIRST USE 12-5-2007; IN COMMERCE 12-5-2007.

THE MARK CONSISTS OF STANDARD CHAR-
ACTERS WITHOUT CLAIM TO ANY PARTICULAR
FONT, STYLE, SIZE, OR COLOR.

OWNER OF U.S. REG. NO. 3,391,994.

SER. NO. 77-367,196, FILED 1-9-2008.

ADA HAN, EXAMINING ATTORNEY

Int. Cl.: 35

Prior U.S. Cls.: 100, 101 and 102

United States Patent and Trademark Office

Reg. No. 3,484,321

Registered Aug. 12, 2008

**SERVICE MARK
PRINCIPAL REGISTER**

MediaUSA Advertising

MEDIAUSA ADVERTISING, INC. (MINNESOTA CORPORATION)

319 EAST HIGHWAY 12

LITCHFIELD, MN 55355

FOR: ADVERTISING AND ADVERTISEMENT SERVICES, IN CLASS 35 (U.S. CLS. 100, 101 AND 102).

FIRST USE 12-20-2007; IN COMMERCE 12-20-2007.

THE MARK CONSISTS OF STANDARD CHARACTERS WITHOUT CLAIM TO ANY PARTICULAR FONT, STYLE, SIZE, OR COLOR.

NO CLAIM IS MADE TO THE EXCLUSIVE RIGHT TO USE "ADVERTISING", APART FROM THE MARK AS SHOWN.

SER. NO. 77-367,221, FILED 1-9-2008.

KIMBERLY FRYE, EXAMINING ATTORNEY

Int. Cls.: 9 and 28

Prior U.S. Cls.: 21, 22, 23, 26, 36, 38 and 50

United States Patent and Trademark Office

Reg. No. 3,484,322

Registered Aug. 12, 2008

**TRADEMARK
PRINCIPAL REGISTER**

FLIRTYGIRLFITNESS

FLIRTY GIRL FITNESS INC. (CANADA CORPORATION)

462 WELLINGTON STREET WEST, SUITE 110

TORONTO, CANADA M5V1E3

FOR: PRE-RECORDED DVDS FEATURING FITNESS, WORKOUT, EXERCISE, AND DANCE ROUTINES, AND INSTRUCTIONAL TIPS AND ADVICE, IN CLASS 9 (U.S. CLS. 21, 23, 26, 36 AND 38).

FIRST USE 7-13-2007; IN COMMERCE 7-13-2007.

FOR: EXERCISE EQUIPMENT, NAMELY, A VERTICAL DANCE POLE, IN CLASS 28 (U.S. CLS. 22, 23, 38 AND 50).

FIRST USE 7-13-2007; IN COMMERCE 7-13-2007.

THE MARK CONSISTS OF STANDARD CHARACTERS WITHOUT CLAIM TO ANY PARTICULAR FONT, STYLE, SIZE, OR COLOR.

SER. NO. 77-367,225, FILED 1-9-2008.

VERNA BETH RIRIE, EXAMINING ATTORNEY

Int. Cl.: 9

Prior U.S. Cls.: 21, 23, 26, 36 and 38

Reg. No. 3,484,323

United States Patent and Trademark Office

Registered Aug. 12, 2008

**TRADEMARK
PRINCIPAL REGISTER**

COLLECTOR'S TREASURY

QUESTAR, INC. (ILLINOIS CORPORATION)
680 NORTH LAKE SHORE DRIVE, SUITE 900
CHICAGO, IL 60611

FOR: SERIES OF MULTIMEDIA KITS COM-
PRISED OF A DVD, CD AND BOOKLET FEATUR-
ING PRESENTATIONS OF HISTORICAL EVENTS
AND MUSIC, IN CLASS 9 (U.S. CLS. 21, 23, 26, 36
AND 38).

FIRST USE 12-1-2007; IN COMMERCE 12-1-2007.

THE MARK CONSISTS OF STANDARD CHAR-
ACTERS WITHOUT CLAIM TO ANY PARTICULAR
FONT, STYLE, SIZE, OR COLOR.

NO CLAIM IS MADE TO THE EXCLUSIVE
RIGHT TO USE "COLLECTOR'S", APART FROM
THE MARK AS SHOWN.

SER. NO. 77-367,227, FILED 1-9-2008.

RUSS HERMAN, EXAMINING ATTORNEY

Int. Cl.: 28

Prior U.S. Cls.: 22, 23, 38 and 50

United States Patent and Trademark Office

Reg. No. 3,484,324

Registered Aug. 12, 2008

**TRADEMARK
PRINCIPAL REGISTER**

Angelic Solutions

FORLAND, MARIE ELAINE (MASSACHUSETTS
SOLE PROPRIETORSHIP), DBA ANGELIC SO-
LUTIONS
P.O. BOX 767
CENTERVILLE, MA 02632

FOR: GAMES, NAMELY, GAMES IN WHICH
DECORATED STONES ARE TAKEN OUT OF A
BAG AND ARE THEN INTERPRETED BY MEANS
OF AN ACCOMPANYING MANUAL , IN CLASS 28
(U.S. CLS. 22, 23, 38 AND 50).

FIRST USE 6-30-2007; IN COMMERCE 10-31-2007.

THE MARK CONSISTS OF STANDARD CHAR-
ACTERS WITHOUT CLAIM TO ANY PARTICULAR
FONT, STYLE, SIZE, OR COLOR.

SER. NO. 77-367,230, FILED 1-9-2008.

RUSS HERMAN, EXAMINING ATTORNEY

Int. Cl.: 35

Prior U.S. Cls.: 100, 101 and 102

United States Patent and Trademark Office

Reg. No. 3,484,325

Registered Aug. 12, 2008

**SERVICE MARK
PRINCIPAL REGISTER**



MEDIAUSA ADVERTISING, INC. (MINNESOTA CORPORATION)
319 HIGHWAY 12
LITCHFIELD, MN 55355

FOR: ADVERTISING AND ADVERTISEMENT SERVICES, IN CLASS 35 (U.S. CLS. 100, 101 AND 102).

FIRST USE 12-20-2007; IN COMMERCE 12-20-2007.

NO CLAIM IS MADE TO THE EXCLUSIVE RIGHT TO USE "ADVERTISING", APART FROM THE MARK AS SHOWN.

THE COLOR(S) GREEN, BLUE, WHITE IS/ARE CLAIMED AS A FEATURE OF THE MARK.

THE MARK CONSISTS OF THE PHRASE "MEDIAUSA ADVERTISING". THE LEFT HALF OF THE

"M" IN "MEDIA" IS WHITE WITH A LARGE NUMERAL "1", BLUE IN COLOR, EXTENDING OVER THE LEFT HALF OF THE "M". THE REMAINING PORTION OF THE WORD "MEDIA" IS BLUE, THE WORD "USA" IS GREEN, AND THE SUPERSCRIPT DOT OF THE "I" IS WHITE ON THE LOWER RIGHT PORTION AND FADES TO GREEN TO DENOTE SHADING. THE WORD "ADVERTISING" IS LOCATED UNDERNEATH THE PHRASE "MEDIAUSA" AND IS COLORED GREEN. A GREEN ARROW EXTENDS FROM THE LEFT OF THE WORD "ADVERTISING" CLOCKWISE TO THE AREA ABOVE THE "M" IN THE WORD "MEDIA".

SER. NO. 77-367,260, FILED 1-9-2008.

KIMBERLY FRYE, EXAMINING ATTORNEY

Int. Cl.: 5

Prior U.S. Cls.: 6, 18, 44, 46, 51 and 52

United States Patent and Trademark Office

Reg. No. 3,484,326

Registered Aug. 12, 2008

**TRADEMARK
PRINCIPAL REGISTER**

MASS XXPLOSION

NUTREX RESEARCH, INC. (FLORIDA CORPORATION)
SUITE 1001
5707 DOT COM COURT
OVIEDO, FL 32765

FOR: DIETARY SUPPLEMENTS, IN CLASS 5 (U.S. CLS. 6, 18, 44, 46, 51 AND 52).

FIRST USE 12-22-2007; IN COMMERCE 12-22-2007.

THE MARK CONSISTS OF STANDARD CHARACTERS WITHOUT CLAIM TO ANY PARTICULAR FONT, STYLE, SIZE, OR COLOR.

SER. NO. 77-367,273, FILED 1-9-2008.

KARANENDRA S. CHHINA, EXAMINING ATTORNEY

Int. Cl.: 41

Prior U.S. Cls.: 100, 101 and 107

United States Patent and Trademark Office

Reg. No. 3,484,327

Registered Aug. 12, 2008

**SERVICE MARK
PRINCIPAL REGISTER**

HARRIMAN CHEMSULT LTD

ACCESS INTELLIGENCE LLC (DELAWARE LTD
LIAB CO)
4 CHOKE CHERRY ROAD
ROCKVILLE, MD 20850

FOR: PROVIDING NEWSLETTERS IN THE
FIELD OF CHEMICALS VIA E-MAIL, IN CLASS 41
(U.S. CLS. 100, 101 AND 107).

FIRST USE 1-1-1985; IN COMMERCE 1-1-1985.

THE MARK CONSISTS OF STANDARD CHAR-
ACTERS WITHOUT CLAIM TO ANY PARTICULAR
FONT, STYLE, SIZE, OR COLOR.

NO CLAIM IS MADE TO THE EXCLUSIVE
RIGHT TO USE "LTD", APART FROM THE MARK
AS SHOWN.

SER. NO. 77-367,283, FILED 1-9-2008.

KYLE PEETE, EXAMINING ATTORNEY

Int. Cl.: 8

Prior U.S. Cls.: 23, 28 and 44

Reg. No. 3,484,328

United States Patent and Trademark Office

Registered Aug. 12, 2008

**TRADEMARK
PRINCIPAL REGISTER**

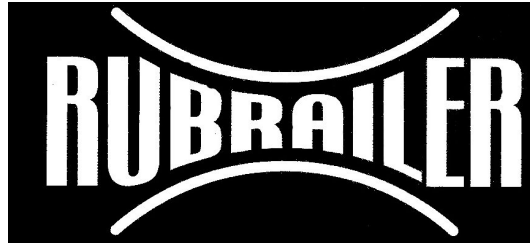

RUBRAILER, LLC (FLORIDA LTD LIAB CO)
3680 W. KING ST.
COCOA, FL 329264127

FIRST USE 2-19-2002; IN COMMERCE 2-19-2002.

FOR: HAND TOOLS TO APPLY RUBRAILS ON BOATS AND SIMILAR APPLICATIONS WHERE A MOLDED PLASTIC OR RUBBER IS INSERTED IN A PREFORMED BASE IN ORDER TO COVER THE FASTENER OF THE BASE AND TO PROVIDE PROTECTION AGAINST RIBBING AND IMPACT, IN CLASS 8 (U.S. CLS. 23, 28 AND 44).

THE MARK CONSISTS OF THE STYLIZED WORDS "RUBRAILER". ABOVE AND BELOW THE WORD "RUBRAILER" ARE "U" SHAPE DESIGNS.

SER. NO. 77-367,296, FILED 1-9-2008.

RICHARD WHITE, EXAMINING ATTORNEY

Int. Cl.: 38

Prior U.S. Cls.: 100, 101 and 104

United States Patent and Trademark Office

Reg. No. 3,484,329

Registered Aug. 12, 2008

**SERVICE MARK
PRINCIPAL REGISTER**



NORTHWESTERN COLLEGE (MINNESOTA
NON-PROFIT CORPORATION)
3003 SNELLING AVENUE NORTH
ST. PAUL, MN 551131598

FOR: RADIO BROADCASTING, IN CLASS 38 (U.S.
CLS. 100, 101 AND 104).

FIRST USE 10-31-2007; IN COMMERCE 10-31-2007.

NO CLAIM IS MADE TO THE EXCLUSIVE
RIGHT TO USE "98.5", APART FROM THE MARK
AS SHOWN.

THE MARK CONSISTS OF THE NUMBER "98.5",
DIRECTLY ABOVE THE BLOCK LETTERS "KTIS",
WITH THE PERIOD IN "98.5" DOTTING THE "I" OF
"KTIS", WITH THE LETTERS "KTIS" PARTIALLY
ENCLOSED WITHIN A CURVED LINE RESEM-
BLING A HALF ELLIPSE.

SER. NO. 77-367,313, FILED 1-9-2008.

JOHN WILKE, EXAMINING ATTORNEY

Int. Cl.: 45

Prior U.S. Cls.: 100 and 101

United States Patent and Trademark Office

Reg. No. 3,484,330

Registered Aug. 12, 2008

**SERVICE MARK
PRINCIPAL REGISTER**

THOMPSON HINE

THOMPSON HINE LLP (OHIO LIMITED LIABILITY PARTNERSHIP)
3900 KEY CENTER
127 PUBLIC SQUARE
CLEVELAND, OH 44114

FOR: LEGAL SERVICES, IN CLASS 45 (U.S. CLS. 100 AND 101).

FIRST USE 5-1-2001; IN COMMERCE 5-1-2001.

THE MARK CONSISTS OF STANDARD CHARACTERS WITHOUT CLAIM TO ANY PARTICULAR FONT, STYLE, SIZE, OR COLOR.

OWNER OF U.S. REG. NO. 2,479,513.

SER. NO. 77-367,315, FILED 1-9-2008.

LINDA LAVACHE, EXAMINING ATTORNEY

Int. Cl.: 42

Prior U.S. Cls.: 100 and 101

United States Patent and Trademark Office

Reg. No. 3,484,331

Registered Aug. 12, 2008

**SERVICE MARK
PRINCIPAL REGISTER**

Million Dollar Vixen

MILLION DOLLAR VIXEN, LLC (FLORIDA LTD
LIAB CO)
12620 BEACH BLVD. STE 3 #365
JACKSONVILLE, FL 32246

FOR: COMPUTER SERVICES, NAMELY, HOST-
ING AND MAINTAINING AN ONLINE WEBSITE
FOR OTHERS TO VIEW, READ, PARTICIPATE IN
OR LISTEN TO ADULT THEMED DISCUSSIONS
AND TOPICS INCLUDING ADULT THEMED IMA-
GES OF FEMALES AND NEWS CONSISTING OF
INFORMATION REGARDING ART, FASHION, EN-
TERTAINMENT, TELEVISION, MOVIES, MUSIC,
BOOKS, HEALTH, SPORTS, MUSIC, LIFESTYLE,

SEX, RELATIONSHIPS, GENDER POLITICS, AND
OTHER AREAS OF GENERAL INTEREST, IN
CLASS 42 (U.S. CLS. 100 AND 101).

FIRST USE 9-1-2007; IN COMMERCE 12-17-2007.

THE MARK CONSISTS OF STANDARD CHAR-
ACTERS WITHOUT CLAIM TO ANY PARTICULAR
FONT, STYLE, SIZE, OR COLOR.

SER. NO. 77-367,336, FILED 1-9-2008.

BARBARA RUTLAND, EXAMINING ATTORNEY

Int. Cl.: 6

Prior U.S. Cls.: 2, 12, 13, 14, 23, 25 and 50

Reg. No. 3,484,332

United States Patent and Trademark Office

Registered Aug. 12, 2008

**TRADEMARK
PRINCIPAL REGISTER**



WALDROP MANUFACTURING (ALABAMA CORPORATION)
7822 MCCLELLAN BLVD.
ANNISTON, AL 36206

FOR: PORTABLE METAL BUILDINGS; PREFABRICATED METAL BUILDINGS, IN CLASS 6 (U.S. CLS. 2, 12, 13, 14, 23, 25 AND 50).

FIRST USE 6-1-2007; IN COMMERCE 12-1-2007.

THE COLOR(S) BLUE, RED IS/ARE CLAIMED AS A FEATURE OF THE MARK.

THE MARK CONSISTS OF "WALDROP.BIZ" IS UNDERLINED AND THE "W" IS COVERED BY A ROOF LOOKING SYMBOL. THE ROOF SYMBOL AND UNDERLINE ARE CONNECTED AND ARE BLUE. THE "WALDROP" IS THE SAME COLOR BLUE. THE DOT (.) IS RED AND THE BIZ IS RED.

SER. NO. 77-367,342, FILED 1-9-2008.

JANICE KIM, EXAMINING ATTORNEY

Int. Cl.: 36

Prior U.S. Cls.: 100, 101 and 102

United States Patent and Trademark Office

Reg. No. 3,484,333

Registered Aug. 12, 2008

**SERVICE MARK
PRINCIPAL REGISTER**

obsessively working for
you!

WIENANDS, AMY (UNITED STATES INDIVIDUAL)
3731 PHEASANT LN.
WATERLOO, IA 50701

FOR: REAL ESTATE AGENCIES; REAL ESTATE BROKERAGE; REAL ESTATE INVESTMENT; REAL ESTATE INVESTMENT SERVICES IN THE NATURE OF PURCHASING AND SELLING OF REAL ESTATE FOR OTHERS; REAL ESTATE LISTING, IN CLASS 36 (U.S. CLS. 100, 101 AND 102).

FIRST USE 12-1-1999; IN COMMERCE 12-1-1999.

THE MARK CONSISTS OF STANDARD CHARACTERS WITHOUT CLAIM TO ANY PARTICULAR FONT, STYLE, SIZE, OR COLOR.

SER. NO. 77-367,367, FILED 1-9-2008.

KELLY MCCOY, EXAMINING ATTORNEY

Int. Cl.: 35

Prior U.S. Cls.: 100, 101 and 102

United States Patent and Trademark Office

Reg. No. 3,484,334

Registered Aug. 12, 2008

**SERVICE MARK
PRINCIPAL REGISTER**

LEAD THE WAY YOUR OWN WAY

SILYNX COMMUNICATIONS, INC. (DELAWARE CORPORATION)
SUITE 150
9901 BELWARD CAMPUS DR.
ROCKVILLE, MD 20850

FOR: ONLINE RETAIL STORE SERVICES FEATURING SURVEILLANCE HEADSETS, TACTICAL COMMUNICATION HEADSETS, AND RELATED ACCESSORIES, IN CLASS 35 (U.S. CLS. 100, 101 AND 102).

FIRST USE 10-0-2007; IN COMMERCE 10-0-2007.

THE MARK CONSISTS OF STANDARD CHARACTERS WITHOUT CLAIM TO ANY PARTICULAR FONT, STYLE, SIZE, OR COLOR.

SER. NO. 77-367,388, FILED 1-9-2008.

WILLIAM ROSSMAN, EXAMINING ATTORNEY

Int. Cl.: 35

Prior U.S. Cls.: 100, 101 and 102

United States Patent and Trademark Office

Reg. No. 3,484,335

Registered Aug. 12, 2008

**SERVICE MARK
PRINCIPAL REGISTER**

**WE'VE BEEN THERE, WE KNOW
WHAT IT TAKES**

SILYNX COMMUNICATIONS, INC. (DELAWARE CORPORATION)
SUITE 150
9901 BELWARD CAMPUS DR.
ROCKVILLE, MD 20850

FOR: ONLINE RETAIL STORE SERVICES FEATURING SURVEILLANCE HEADSETS, TACTICAL COMMUNICATION HEADSETS, AND RELATED ACCESSORIES, IN CLASS 35 (U.S. CLS. 100, 101 AND 102).

FIRST USE 10-0-2007; IN COMMERCE 10-0-2007.

THE MARK CONSISTS OF STANDARD CHARACTERS WITHOUT CLAIM TO ANY PARTICULAR FONT, STYLE, SIZE, OR COLOR.

SER. NO. 77-367,394, FILED 1-9-2008.

WILLIAM ROSSMAN, EXAMINING ATTORNEY

Int. Cl.: 30

Prior U.S. Cl.: 46

United States Patent and Trademark Office

Reg. No. 3,484,336

Registered Aug. 12, 2008

TRADEMARK
PRINCIPAL REGISTER



THE OAKBROOK CORP (PENNSYLVANIA CORPORATION)
PO BOX 138
404 MAPLE ST
IRWIN, PA 16542

FOR: BAKERY GOODS, IN CLASS 30 (U.S. CL. 46).

FIRST USE 1-1-2002; IN COMMERCE 1-1-2002.

THE COLOR(S) RED, BLACK, WHITE, AND GRAY IS/ARE CLAIMED AS A FEATURE OF THE MARK.

THE MARK CONSIST OF A GRAY OVEN WITH BLACK OVALS FORMING STONES, BLACK BACKGROUND WITH WHITE AND RED FLAMES, BLACK DOORS, A BLACK BAR, BLACK BAND CONTAINING TWO RED BARS AND WORD "OVENS" IN RED, AND WORD "OAKBROOK" IN RED WITH BLACK PIPING.

SER. NO. 77-367,415, FILED 1-9-2008.

HENRY S. ZAK, EXAMINING ATTORNEY

Int. Cl.: 36

Prior U.S. Cls.: 100, 101 and 102

United States Patent and Trademark Office

Reg. No. 3,484,337

Registered Aug. 12, 2008

**SERVICE MARK
PRINCIPAL REGISTER**

**Expert Advice, Personally
Delivered**

HANSON MCCLAIN, INC. (CALIFORNIA CORPORATION)
3620 FAIR OAKS BLVD, SUITE 300
FAIR OAKS, CA 95864

THE MARK CONSISTS OF STANDARD CHARACTERS WITHOUT CLAIM TO ANY PARTICULAR FONT, STYLE, SIZE, OR COLOR.

FOR: FINANCIAL PLANNING FOR RETIREMENT, IN CLASS 36 (U.S. CLS. 100, 101 AND 102).

SER. NO. 77-367,462, FILED 1-9-2008.

FIRST USE 12-14-2007; IN COMMERCE 1-2-2008.

ANDREA BUTLER, EXAMINING ATTORNEY

Int. Cl.: 25

Prior U.S. Cls.: 22 and 39

United States Patent and Trademark Office

Reg. No. 3,484,338

Registered Aug. 12, 2008

**TRADEMARK
PRINCIPAL REGISTER**



BESTSOLE INC (FLORIDA CORPORATION)
BAY #2 2950 COMMERCE PARK DR.
BOYNTON BEACH, FL 33424

FOR: INSOLES, IN CLASS 25 (U.S. CLS. 22 AND 39).

FIRST USE 12-1-2005; IN COMMERCE 12-3-2007.

NO CLAIM IS MADE TO THE EXCLUSIVE RIGHT TO USE "MASSAGING INSOLES" AND "BEST SOLE INC.", APART FROM THE MARK AS SHOWN.

SER. NO. 77-367,471, FILED 1-9-2008.

MICHAEL GAAFAR, EXAMINING ATTORNEY

Int. Cl.: 41

Prior U.S. Cls.: 100, 101 and 107

United States Patent and Trademark Office

Reg. No. 3,484,339

Registered Aug. 12, 2008

**SERVICE MARK
PRINCIPAL REGISTER**

FORE! Corners

FORE CORNERS JUNIOR GOLF ASSOCIATION,
LLC (NORTH CAROLINA LTD LIAB CO)
POST OFFICE BOX 1220
YOUNGSVILLE, NC 27596

THE MARK CONSISTS OF STANDARD CHAR-
ACTERS WITHOUT CLAIM TO ANY PARTICULAR
FONT, STYLE, SIZE, OR COLOR.

FOR: ORGANIZATION OF GOLF TOURNA-
MENTS, IN CLASS 41 (U.S. CLS. 100, 101 AND 107).

SER. NO. 77-367,482, FILED 1-9-2008.

FIRST USE 1-4-2008; IN COMMERCE 1-4-2008.

MICHAEL GAAFAR, EXAMINING ATTORNEY

Int. Cl.: 11

Prior U.S. Cls.: 13, 21, 23, 31 and 34

Reg. No. 3,484,340

United States Patent and Trademark Office

Registered Aug. 12, 2008

**TRADEMARK
PRINCIPAL REGISTER**

SPOTLIGHT ON WOMEN

THOMPSON HINE LLP (OHIO LIMITED LIABILITY PARTNERSHIP)
3900 KEY CENTER
127 PUBLIC SQUARE
CLEVELAND, OH 44114

THE MARK CONSISTS OF STANDARD CHARACTERS WITHOUT CLAIM TO ANY PARTICULAR FONT, STYLE, SIZE, OR COLOR.

FOR: FLASHLIGHTS, IN CLASS 11 (U.S. CLS. 13, 21, 23, 31 AND 34).

SER. NO. 77-367,486, FILED 1-9-2008.

FIRST USE 9-1-2006; IN COMMERCE 9-1-2006.

LINDA LAVACHE, EXAMINING ATTORNEY

Int. Cl.: 20

Prior U.S. Cls.: 2, 13, 22, 25, 32 and 50

Reg. No. 3,484,341

United States Patent and Trademark Office

Registered Aug. 12, 2008

**TRADEMARK
PRINCIPAL REGISTER**

PARTIPAK

WILKINSON INDUSTRIES, INC. (DELAWARE
CORPORATION)
12TH & MADISON STREET
FORT CALHOUN, NE 68023

FOR: PLASTIC FOOD CONTAINERS FOR COM-
MERCIAL USE SOLD TO DISTRIBUTORS AND
FOOD PROCESSORS; PLASTIC FOOD CONTAIN-
ERS FOR COMMERCIAL USE SOLD DIRECTLY TO
END USERS , IN CLASS 20 (U.S. CLS. 2, 13, 22, 25, 32
AND 50).

FIRST USE 12-31-1993; IN COMMERCE 12-31-1993.

THE MARK CONSISTS OF STANDARD CHAR-
ACTERS WITHOUT CLAIM TO ANY PARTICULAR
FONT, STYLE, SIZE, OR COLOR.

OWNER OF U.S. REG. NOS. 1,523,541 AND
1,769,342.

SER. NO. 77-367,498, FILED 1-9-2008.

KIM MONINGHOFF, EXAMINING ATTORNEY

Int. Cl.: 11

Prior U.S. Cls.: 13, 21, 23, 31 and 34

United States Patent and Trademark Office

Reg. No. 3,484,342

Registered Aug. 12, 2008

**TRADEMARK
PRINCIPAL REGISTER**



CECILWARE CORPORATION (DELAWARE CORPORATION)
43-05 20TH AVENUE
LONG ISLAND CITY, NY 11105

FOR: COOKING RANGES; ELECTRIC COFFEE MACHINES; ELECTRIC COFFEE MAKERS; ELECTRIC COOKING OVENS; ELECTRIC FOOD WARMERS; ELECTRIC GRILLS; ELECTRIC STOVES; ELECTRIC COOKWARE, NAMELY, BROILERS; ELECTRIC COOKWARE, NAMELY, ROASTERS; ELECTRIC TOASTERS; GAS COOKERS; GAS RANGES; GAS STOVES; DEEP FAT FRYERS; DRINKING FOUNTAINS; ELECTRIC BEVERAGE HEATERS; ELECTRIC GRIDDLES; ELECTRIC WAFFLE MAKER; TEMPERATURE-CONTROLLED FOOD AND

BEVERAGE DISPENSERS, AND COMPONENTS THEREOF, IN CLASS 11 (U.S. CLS. 13, 21, 23, 31 AND 34).

FIRST USE 3-0-1925; IN COMMERCE 0-0-1929.

OWNER OF U.S. REG. NOS. 585,533 AND 1,303,572.

THE MARK CONSISTS OF A BANNER CONTAINING THE WORD "CECILWARE".

SER. NO. 77-367,546, FILED 1-9-2008.

JULIE WATSON, EXAMINING ATTORNEY

Int. Cl.: 36

Prior U.S. Cls.: 100, 101 and 102

United States Patent and Trademark Office

Reg. No. 3,484,343

Registered Aug. 12, 2008

**SERVICE MARK
PRINCIPAL REGISTER**

CARLEON

CARLEON CAPITAL PARTNERS LLC (DELA-
WARE LTD LIAB CO)
23RD FLOOR, EAST TOWER
280 PARK AVENUE
NEW YORK, NY 10017

FOR: FINANCIAL SERVICES, NAMELY, FINAN-
CIAL ASSET MANAGEMENT, INVESTMENT AD-
VISORY SERVICES, INVESTMENT MANAGEMENT
AND WEALTH MANAGEMENT SERVICES , IN
CLASS 36 (U.S. CLS. 100, 101 AND 102).

FIRST USE 4-10-2007; IN COMMERCE 4-10-2007.

THE MARK CONSISTS OF STANDARD CHAR-
ACTERS WITHOUT CLAIM TO ANY PARTICULAR
FONT, STYLE, SIZE, OR COLOR.

OWNER OF U.S. REG. NO. 3,364,814.

SER. NO. 77-367,549, FILED 1-9-2008.

GEORGE LORENZO, EXAMINING ATTORNEY

Int. Cl.: 15

Prior U.S. Cls.: 2, 21 and 36

United States Patent and Trademark Office

Reg. No. 3,484,344

Registered Aug. 12, 2008

**TRADEMARK
PRINCIPAL REGISTER**

**SBS Suspended Bracing
System**

MORGAN HILL MUSIC, LLC (CALIFORNIA LTD
LIAB CO)
375 DIGITAL DRIVE
MORGAN HILL, CA 95037

FOR: STRUCTURAL PARTS OF STRING MUSI-
CAL INSTRUMENTS, NAMELY, A BRACE FOR
STRINGED MUSICAL INSTRUMENT SOUND-
BOARDS, IN CLASS 15 (U.S. CLS. 2, 21 AND 36).

FIRST USE 5-31-2006; IN COMMERCE 3-31-2007.

THE MARK CONSISTS OF STANDARD CHAR-
ACTERS WITHOUT CLAIM TO ANY PARTICULAR
FONT, STYLE, SIZE, OR COLOR.

NO CLAIM IS MADE TO THE EXCLUSIVE
RIGHT TO USE "SUSPENDED BRACING SYSTEM",
APART FROM THE MARK AS SHOWN.

SER. NO. 77-367,593, FILED 1-9-2008.

COURTNEY MCCORMICK, EXAMINING ATTOR-
NEY

Int. Cl.: 35

Prior U.S. Cls.: 100, 101 and 102

United States Patent and Trademark Office

Reg. No. 3,484,345

Registered Aug. 12, 2008

**SERVICE MARK
PRINCIPAL REGISTER**

COUPONWINNER

SURFMYADS.COM, INC. (CALIFORNIA CORPORATION)

#E

800 N. MILPAS ST.
SANTA BARBARA, CA 93103

FOR: PROMOTING THE GOODS AND SERVICES OF OTHERS BY PROVIDING A WEBSITE FEATURING COUPONS, REBATES, PRICE-COMPARISON INFORMATION, PRODUCT REVIEWS, LINKS TO THE RETAIL WEBSITES OF OTHERS, AND DISCOUNT INFORMATION, IN CLASS 35 (U.S. CLS. 100, 101 AND 102).

FIRST USE 1-30-2006; IN COMMERCE 1-30-2006.

THE MARK CONSISTS OF STANDARD CHARACTERS WITHOUT CLAIM TO ANY PARTICULAR FONT, STYLE, SIZE, OR COLOR.

SER. NO. 77-367,664, FILED 1-9-2008.

KAELIE KUNG, EXAMINING ATTORNEY

Int. Cls.: 9, 16, 36 and 39

**Prior U.S. Cls.: 2, 5, 21, 22, 23, 26, 29, 36, 37, 38, 50,
100, 101, 102 and 105**

Reg. No. 3,484,346

United States Patent and Trademark Office

Registered Aug. 12, 2008

**TRADEMARK
SERVICE MARK
PRINCIPAL REGISTER**

REDEMPTION 2000

MESSIANIC PERSPECTIVES (TEXAS CORPORATION)
611 BROADWAY
SAN ANTONIO, TX 78215

FOR: PRERECORDED VIDEO TAPES, AUDIO-TAPES AND DVD'S OF A RELIGIOUS NATURE, IN CLASS 9 (U.S. CLS. 21, 23, 26, 36 AND 38).

FIRST USE 10-0-1998; IN COMMERCE 10-0-1998.

FOR: BOOKS, PAMPHLETS, MAGAZINES, PERIODICALS, HANDBOOKS AND NEWSLETTERS IN THE FIELD OF RELIGION, PHOTOGRAPH ALBUMS, CALENDARS, COASTERS MADE OF PAPER, PENCILS, PENS, PAPERWEIGHTS, NEWSPAPERS, HANDBOOKS IN THE FIELD OF RELIGION, LOOSELEAF BINDERS, DRAWINGS, SIGNBOARDS OF PAPER, PHOTOGRAPHS, STATIONERY, WRITING PADS AND PAPER NAPKINS, IN CLASS 16 (U.S. CLS. 2, 5, 22, 23, 29, 37, 38 AND 50).

FIRST USE 10-0-1998; IN COMMERCE 10-0-1998.

FOR: CHARITABLE FUND RAISING, IN CLASS 36 (U.S. CLS. 100, 101 AND 102).

FIRST USE 10-0-1998; IN COMMERCE 10-0-1998.

FOR: ARRANGING TRAVEL TOURS, ORGANIZATION OF EXCURSIONS, SIGHTSEEING TOURS, HOLIDAYS, TOURS AND TRAVEL, TRAVEL AND TOUR INFORMATION SERVICES, TRAVEL BOOKING AGENCY SERVICES AND TRAVEL INFORMATION SERVICES, IN CLASS 39 (U.S. CLS. 100 AND 105).

FIRST USE 10-0-1998; IN COMMERCE 10-0-1998.

THE MARK CONSISTS OF STANDARD CHARACTERS WITHOUT CLAIM TO ANY PARTICULAR FONT, STYLE, SIZE, OR COLOR.

SER. NO. 77-367,666, FILED 1-9-2008.

JAMES A. RAUEN, EXAMINING ATTORNEY

Int. Cl.: 41

Prior U.S. Cls.: 100, 101 and 107

United States Patent and Trademark Office

Reg. No. 3,484,347

Registered Aug. 12, 2008

**SERVICE MARK
PRINCIPAL REGISTER**



FOLSOM, CHRISTY (UNITED STATES INDIVIDUAL)
446 CENTRAL PARK WEST #7A
NEW YORK, NY 10025

FOR: EDUCATIONAL SERVICES, NAMELY, TUTORING IN THE FIELD OF DEVELOPMENT OF ORGANIZATIONAL SKILLS, PROJECT MANAGEMENT SKILLS, PROBLEM SOLVING SKILLS, AND CREATIVE THINKING; CONDUCTING CLASSES, WORKSHOPS, SEMINARS IN THE FIELD OF PROFESSIONAL CURRICULUM DEVELOPMENT FOR OTHERS; EDUCATIONAL INFORMATION AND ADVICE IN THE FIELD OF CURRICULUM DEVELOPMENT AT THE UNIVERSITY LEVEL FOR TRAINING TEACHERS; CONDUCTING SEMINARS IN THE FIELD OF THE PREPARATION AND

TRAINING OF ELEMENTARY AND SECONDARY SCHOOL TEACHERS AND DISTRICT-WIDE AND BUILDING ADMINISTRATORS FOR ELEMENTARY AND SECONDARY SCHOOLS, IN CLASS 41 (U.S. CLS. 100, 101 AND 107).

FIRST USE 1-1-2001; IN COMMERCE 1-1-2001.

THE MARK CONSISTS OF DESIGN OF CONCENTRIC OVAL CIRCLES (SLANTED) ONE CONTAINING BARS.

SER. NO. 77-367,727, FILED 1-9-2008.

CYNTHIA SLOAN, EXAMINING ATTORNEY

Int. Cl.: 41

Prior U.S. Cls.: 100, 101 and 107

United States Patent and Trademark Office

Reg. No. 3,484,348

Registered Aug. 12, 2008

**SERVICE MARK
PRINCIPAL REGISTER**

The Master of Shadows

HOEK, ARIC CABOT (UNITED STATES INDIVIDUAL)
3730 KIRBY DR. #610
HOUSTON, TX 77098

THE MARK CONSISTS OF STANDARD CHARACTERS WITHOUT CLAIM TO ANY PARTICULAR FONT, STYLE, SIZE, OR COLOR.

FOR: PHOTOGRAPHY, IN CLASS 41 (U.S. CLS. 100, 101 AND 107).

SER. NO. 77-367,785, FILED 1-9-2008.

FIRST USE 4-1-2006; IN COMMERCE 4-1-2006.

DAWN HAN, EXAMINING ATTORNEY

Int. Cl.: 45

Prior U.S. Cls.: 100 and 101

United States Patent and Trademark Office

Reg. No. 3,484,349

Registered Aug. 12, 2008

**SERVICE MARK
PRINCIPAL REGISTER**

ContractCentral

CONTRACT CENTRAL INC (NEVADA CORPORATION)
PO BOX 4271
COSTA MESA, CA 92628

THE MARK CONSISTS OF STANDARD CHARACTERS WITHOUT CLAIM TO ANY PARTICULAR FONT, STYLE, SIZE, OR COLOR.

FOR: PROVIDING INFORMATION RELATING TO LEGAL AFFAIRS, IN CLASS 45 (U.S. CLS. 100 AND 101).

SER. NO. 77-367,787, FILED 1-9-2008.

FIRST USE 0-0-1998; IN COMMERCE 0-0-1998.

DAWN HAN, EXAMINING ATTORNEY

Int. Cl.: 42

Prior U.S. Cls.: 100 and 101

United States Patent and Trademark Office

Reg. No. 3,484,350

Registered Aug. 12, 2008

**SERVICE MARK
PRINCIPAL REGISTER**

INSPIRING EVERYDAY SPACES

THE DYKEMAN ARCHITECTS, P.S. (WASHINGTON CORPORATION), DBA DYKEMAN
1716 WEST MARINE VIEW DRIVE
EVERETT, WA 982012098

FOR: ARCHITECTURAL DESIGN; GRAPHIC DESIGN SERVICES; INTERIOR DESIGN SERVICES, IN CLASS 42 (U.S. CLS. 100 AND 101).

FIRST USE 1-1-2003; IN COMMERCE 1-1-2003.

THE MARK CONSISTS OF STANDARD CHARACTERS WITHOUT CLAIM TO ANY PARTICULAR FONT, STYLE, SIZE, OR COLOR.

SER. NO. 77-367,803, FILED 1-9-2008.

RAMONA ORTIGA, EXAMINING ATTORNEY

Int. Cl.: 35

Prior U.S. Cls.: 100, 101 and 102

United States Patent and Trademark Office

Reg. No. 3,484,351

Registered Aug. 12, 2008

**SERVICE MARK
PRINCIPAL REGISTER**

FANPRICE

FANPRICE, INC. (CALIFORNIA CORPORATION)
300 B STREET
SANTA ROSA, CA 95401

FOR: ONLINE TICKET MARKETPLACE FOR
BUYERS AND SELLERS OF TICKETS FOR SPORT-
ING EVENTS, MUSICAL AND NON-MUSICAL
CONCERTS, AND OTHER ENTERTAINMENT
EVENTS, IN CLASS 35 (U.S. CLS. 100, 101 AND 102).

FIRST USE 6-21-2007; IN COMMERCE 8-10-2007.

THE MARK CONSISTS OF STANDARD CHAR-
ACTERS WITHOUT CLAIM TO ANY PARTICULAR
FONT, STYLE, SIZE, OR COLOR.

SER. NO. 77-367,853, FILED 1-9-2008.

HEATHER SAPP, EXAMINING ATTORNEY

Int. Cl.: 10

Prior U.S. Cls.: 26, 39 and 44

United States Patent and Trademark Office

Reg. No. 3,484,352

Registered Aug. 12, 2008

**TRADEMARK
PRINCIPAL REGISTER**

TEETHING BONBON

BROTSKY, THERESSA (CANADA INDIVIDUAL)
2131 FAIR STREET
VICTORIA, CANADA V8R2G9

FOR: PACIFIERS FOR BABIES, IN CLASS 10 (U.S.
CLS. 26, 39 AND 44).

FIRST USE 8-25-2007; IN COMMERCE 9-28-2007.

THE MARK CONSISTS OF STANDARD CHAR-
ACTERS WITHOUT CLAIM TO ANY PARTICULAR
FONT, STYLE, SIZE, OR COLOR.

NO CLAIM IS MADE TO THE EXCLUSIVE
RIGHT TO USE "TEETHING", APART FROM THE
MARK AS SHOWN.

SER. NO. 77-367,874, FILED 1-9-2008.

MARK SPARACINO, EXAMINING ATTORNEY

Int. Cl.: 38

Prior U.S. Cls.: 100, 101 and 104

United States Patent and Trademark Office

Reg. No. 3,484,353

Registered Aug. 12, 2008

**SERVICE MARK
PRINCIPAL REGISTER**

FACEUPS

MINDACTIVE, LLC (MISSOURI LTD LIAB CO)
SUITE 830
1324 WASHINGTON AVENUE
ST. LOUIS, MO 63103

THE MARK CONSISTS OF STANDARD CHAR-
ACTERS WITHOUT CLAIM TO ANY PARTICULAR
FONT, STYLE, SIZE, OR COLOR.

FOR: DELIVERY OF PERSONALIZED VIDEO
MESSAGES TO OTHERS VIA ELECTRONIC MAIL,
IN CLASS 38 (U.S. CLS. 100, 101 AND 104).

SER. NO. 77-367,877, FILED 1-9-2008.

FIRST USE 12-0-2007; IN COMMERCE 12-0-2007.

JAMES LOVELACE, EXAMINING ATTORNEY

Int. Cl.: 35

Prior U.S. Cls.: 100, 101 and 102

United States Patent and Trademark Office

Reg. No. 3,484,354

Registered Aug. 12, 2008

**SERVICE MARK
PRINCIPAL REGISTER**

**powering the clean energy
revolution**

ELEMENT MARKETS LLC (TEXAS LTD LIAB
CO)
ONE SUGAR CREEK CENTER BLVD., STE. 250
SUGAR LAND, TX 77478

FOR: ENERGY MANAGEMENT SERVICES,
NAMELY, PROVIDING A SERVICE THAT ALLOWS
CUSTOMERS TO PURCHASE ENERGY, NAMELY,
ELECTRICITY, NATURAL GAS AND RENEWABLE
ENERGY, AT A FIXED PRICE; PROVIDING IN-
FORMATION ABOUT THE TRADING OF RENEW-
ABLE ENERGY CREDITS, EMISSION CREDITS,
AND OTHER ENVIRONMENTALLY-RELATED

CREDITS AND OFFSETS, IN CLASS 35 (U.S. CLS.
100, 101 AND 102).

FIRST USE 11-28-2007; IN COMMERCE 11-28-2007.

THE MARK CONSISTS OF STANDARD CHAR-
ACTERS WITHOUT CLAIM TO ANY PARTICULAR
FONT, STYLE, SIZE, OR COLOR.

SER. NO. 77-367,896, FILED 1-9-2008.

HEATHER BIDDULPH, EXAMINING ATTORNEY

Int. Cls.: 16, 17 and 28

Prior U.S. Cls.: 1, 2, 5, 12, 13, 22, 23, 29, 35, 37, 38 and 50

United States Patent and Trademark Office

Reg. No. 3,484,355

Registered Aug. 12, 2008

**TRADEMARK
PRINCIPAL REGISTER**

TOMMY TAPE

MIDSUN SPECIALTY PRODUCTS, INC. (CONNECTICUT CORPORATION)
135 REDSTONE STREET
SOUTHINGTON, CT 06489

FOR: FUSIBLE SILICONE RUBBER TAPE FOR HOUSEHOLD USE, IN CLASS 16 (U.S. CLS. 2, 5, 22, 23, 29, 37, 38 AND 50).

FIRST USE 10-9-1992; IN COMMERCE 10-9-1992.

FOR: FUSIBLE SILICONE RUBBER TAPE FOR AUTOMOTIVE, COMMERCIAL AND INDUSTRIAL USE, IN CLASS 17 (U.S. CLS. 1, 5, 12, 13, 35 AND 50).

FIRST USE 10-9-1992; IN COMMERCE 10-9-1992.

FOR: FUSIBLE SILICONE RUBBER TAPE FOR RACKET HANDLES AND GRIPS, IN CLASS 28 (U.S. CLS. 22, 23, 38 AND 50).

FIRST USE 10-9-1992; IN COMMERCE 10-9-1992.

THE MARK CONSISTS OF STANDARD CHARACTERS WITHOUT CLAIM TO ANY PARTICULAR FONT, STYLE, SIZE, OR COLOR.

NO CLAIM IS MADE TO THE EXCLUSIVE RIGHT TO USE "TAPE", APART FROM THE MARK AS SHOWN.

SER. NO. 77-367,909, FILED 1-9-2008.

JANET LEE, EXAMINING ATTORNEY

Int. Cl.: 35

Prior U.S. Cls.: 100, 101 and 102

United States Patent and Trademark Office

Reg. No. 3,484,356

Registered Aug. 12, 2008

**SERVICE MARK
PRINCIPAL REGISTER**

MYVIEW

BEYONDROI, INC. (TEXAS CORPORATION)
STE. 1003
5850 TOWN AND COUNTRY BLVD.
FRISCO, TX 75034

FOR: PROVIDING EVALUATIONS AND RE-
PORTS RELATING TO EMPLOYEE PERFOR-
MANCE AND SKILLS PREPARED FOR
BUSINESSES, IN CLASS 35 (U.S. CLS. 100, 101 AND
102).

FIRST USE 9-0-2007; IN COMMERCE 9-0-2007.

THE MARK CONSISTS OF STANDARD CHAR-
ACTERS WITHOUT CLAIM TO ANY PARTICULAR
FONT, STYLE, SIZE, OR COLOR.

SER. NO. 77-367,926, FILED 1-9-2008.

ANNE MADDEN, EXAMINING ATTORNEY

Int. Cl.: 41

Prior U.S. Cls.: 100, 101 and 107

United States Patent and Trademark Office

Reg. No. 3,484,357

Registered Aug. 12, 2008

**SERVICE MARK
PRINCIPAL REGISTER**

**BE A BETTER LEADER, HAVE A
RICHER LIFE**

TOTAL LEADERSHIP, INC. (PENNSYLVANIA
CORPORATION)
417 SYCAMORE ROAD
MERION, PA 19066

FOR: EDUCATION AND TRAINING SERVICES,
NAMELY, ARRANGING PROFESSIONAL WORK-
SHOPS AND TRAINING COURSES; PROVIDING
ON-LINE TRAINING AND INFORMATION; ONE-
ON-ONE COACHING; PUBLICATION AND ON-
LINE PUBLICATION OF PAPERS AND SKILLS
ASSESSMENT TESTS; AND ON-LINE BLOGS, ALL
IN THE FIELD OF LEADERSHIP AND PERSONAL
GROWTH, IN CLASS 41 (U.S. CLS. 100, 101 AND 107).

FIRST USE 11-30-2007; IN COMMERCE 11-30-2007.

THE MARK CONSISTS OF STANDARD CHAR-
ACTERS WITHOUT CLAIM TO ANY PARTICULAR
FONT, STYLE, SIZE, OR COLOR.

SER. NO. 77-367,933, FILED 1-9-2008.

ALICE SUE CARRUTHERS, EXAMINING ATTOR-
NEY

Int. Cl.: 41

Prior U.S. Cls.: 100, 101 and 107

United States Patent and Trademark Office

Reg. No. 3,484,358

Registered Aug. 12, 2008

**SERVICE MARK
PRINCIPAL REGISTER**

FOUR-WAY WINS

TOTAL LEADERSHIP, INC. (PENNSYLVANIA
CORPORATION)
417 SYCAMORE ROAD
MERION, PA 19066

FOR: EDUCATION AND TRAINING SERVICES,
NAMELY, ARRANGING PROFESSIONAL WORK-
SHOPS AND TRAINING COURSES; PROVIDING
ON-LINE TRAINING AND INFORMATION; ONE-
ON-ONE COACHING; PUBLICATION AND ON-
LINE PUBLICATION OF PAPERS AND SKILLS
ASSESSMENT TESTS; AND ON-LINE BLOGS, ALL
IN THE FIELD OF LEADERSHIP AND PERSONAL
GROWTH, IN CLASS 41 (U.S. CLS. 100, 101 AND 107).

FIRST USE 11-30-2007; IN COMMERCE 11-30-2007.

THE MARK CONSISTS OF STANDARD CHAR-
ACTERS WITHOUT CLAIM TO ANY PARTICULAR
FONT, STYLE, SIZE, OR COLOR.

SER. NO. 77-367,948, FILED 1-9-2008.

ALICE SUE CARRUTHERS, EXAMINING ATTOR-
NEY

Int. Cl.: 41

Prior U.S. Cls.: 100, 101 and 107

United States Patent and Trademark Office

Reg. No. 3,484,359

Registered Aug. 12, 2008

**SERVICE MARK
PRINCIPAL REGISTER**



**TOTAL
LEADERSHIP**

TOTAL LEADERSHIP, INC. (PENNSYLVANIA CORPORATION)
417 SYCAMORE ROAD
MERION, PA 19066

FOR: EDUCATION AND TRAINING SERVICES, NAMELY, ARRANGING PROFESSIONAL WORKSHOPS AND TRAINING COURSES; PROVIDING ON-LINE TRAINING AND INFORMATION; ONE-ON-ONE COACHING; PUBLICATION AND ON-LINE PUBLICATION OF PAPERS AND SKILLS ASSESSMENT TESTS; AND ON-LINE BLOGS, ALL IN THE FIELD OF LEADERSHIP AND PERSONAL GROWTH, IN CLASS 41 (U.S. CLS. 100, 101 AND 107).

FIRST USE 11-30-2007; IN COMMERCE 11-30-2007.

NO CLAIM IS MADE TO THE EXCLUSIVE RIGHT TO USE "LEADERSHIP", APART FROM THE MARK AS SHOWN.

THE COLOR(S) GRAY, DARK BLUE, LIGHT BLUE, ORANGE AND MUSTARD YELLOW IS/ ARE CLAIMED AS A FEATURE OF THE MARK.

THE DESIGN PORTION OF THE MARK CONSISTS OF A TARGET COMPOSED OF ALTERNATING COLORS FROM THE OUTER PERIMETER TO THE CENTER, AS FOLLOWS: GRAY, DARK BLUE, GRAY, LIGHT BLUE, GRAY, ORANGE, GRAY, MUSTARD YELLOW AND GRAY.

SER. NO. 77-367,963, FILED 1-9-2008.

ALICE SUE CARRUTHERS, EXAMINING ATTORNEY

Int. Cl.: 42

Prior U.S. Cls.: 100 and 101

United States Patent and Trademark Office

Reg. No. 3,484,360

Registered Aug. 12, 2008

**SERVICE MARK
PRINCIPAL REGISTER**

HPIHELP

HODGE PRODUCTS, INC. (CALIFORNIA CORPORATION)
P.O. BOX 1326
EL CAJON, CA 92022

THE MARK CONSISTS OF STANDARD CHARACTERS WITHOUT CLAIM TO ANY PARTICULAR FONT, STYLE, SIZE, OR COLOR.

FOR: ONLINE SEARCH SERVICES, NAMELY, PROVIDING A SEARCH ENGINE USED TO RETRIEVE PRODUCT INFORMATION FROM PARTICULAR WEBSITES, IN CLASS 42 (U.S. CLS. 100 AND 101).

OWNER OF U.S. REG. NO. 2,333,161.

SER. NO. 77-367,978, FILED 1-9-2008.

FIRST USE 12-31-2006; IN COMMERCE 12-31-2006.

SHANNON TWOHIG, EXAMINING ATTORNEY

Int. Cl.: 37

Prior U.S. Cls.: 100, 103 and 106

United States Patent and Trademark Office

Reg. No. 3,484,361

Registered Aug. 12, 2008

**SERVICE MARK
PRINCIPAL REGISTER**



DECORATING ELVES, INC. (FLORIDA CORPORATION)

SUITE 292

10460 ROOSEVELT BLVD.

ST. PETERSBURG, FL 33716

FOR: HOLIDAY LIGHTING INSTALLATION, MAINTENANCE AND REMOVAL SERVICES, ON RESIDENTIAL AND COMMERCIAL BUILDINGS AND/OR OUTSIDE LANDSCAPING, IN CLASS 37 (U.S. CLS. 100, 103 AND 106).

FIRST USE 5-1-2007; IN COMMERCE 5-1-2007.

THE COLOR(S) BLACK, WHITE AND RED IS/ ARE CLAIMED AS A FEATURE OF THE MARK.

THE MARK CONSISTS OF A CAPITALIZED LETTER "E" FACING DOWNWARDS; A CAPITALIZED LETTER "D" FACING UPWARDS SHADED IN RED AND WHITE; BLACK MARKS ABOVE THE "D" SYMBOLIZE ILLUMINATION. THE DESIGN IS IN A WHITE BOX OUTLINED IN BLACK.

SER. NO. 77-367,979, FILED 1-9-2008.

JENNIFER VASQUEZ, EXAMINING ATTORNEY

Int. Cl.: 39

Prior U.S. Cls.: 100 and 105

United States Patent and Trademark Office

Reg. No. 3,484,362

Registered Aug. 12, 2008

**SERVICE MARK
PRINCIPAL REGISTER**

UNIVERSITY LIFELINK

UNIVERSITY OF COLORADO HOSPITAL AU-
THORITY, A BODY CORPORATE AND POLI-
TICAL SUBDIVISION (COLORADO BODY
POLITIC AND CORPORATE), DBA UNIVER-
SITY OF COLORADO HOSPITAL
12401 E. 17TH AVE.
AURORA, CO 80045

FOR: AMBULANCE TRANSPORT, IN CLASS 39
(U.S. CLS. 100 AND 105).

FIRST USE 3-30-1990; IN COMMERCE 2-9-1992.

THE MARK CONSISTS OF STANDARD CHAR-
ACTERS WITHOUT CLAIM TO ANY PARTICULAR
FONT, STYLE, SIZE, OR COLOR.

OWNER OF U.S. REG. NO. 1,754,620.

SER. NO. 77-368,002, FILED 1-9-2008.

MICHAEL KEATING, EXAMINING ATTORNEY

Int. Cl.: 9

Prior U.S. Cls.: 21, 23, 26, 36 and 38

Reg. No. 3,484,363

United States Patent and Trademark Office

Registered Aug. 12, 2008

**TRADEMARK
PRINCIPAL REGISTER**



ARISTA CORPORATION (CALIFORNIA CORPORATION)
41300 BOYCE ROAD
FREMONT, CA 94538

THE MARK CONSISTS OF THE STYLIZED WORD "ARISTA" AND A TRIANGLE COMPRISING THREE GEOMETRIC SHAPES SUGGESTING THE LETTER "A".

FOR: COMPUTERS; COMPUTER OPERATING SYSTEMS; COMPUTER SERVERS, IN CLASS 9 (U.S. CLS. 21, 23, 26, 36 AND 38).

SER. NO. 77-368,009, FILED 1-9-2008.

FIRST USE 10-15-2007; IN COMMERCE 10-15-2007.

CYNTHIA TRIPI, EXAMINING ATTORNEY

Int. Cl.: 41

Prior U.S. Cls.: 100, 101 and 107

Reg. No. 3,484,364

United States Patent and Trademark Office

Registered Aug. 12, 2008

**SERVICE MARK
PRINCIPAL REGISTER**



THE ESCAL INSTITUTE OF ADVANCED TECHNOLOGIES (DELAWARE CORPORATION),
DBA THE SANS INSTITUTE
SUITE 205
8120 WOODMONT AVENUE
BETHESDA, MD 20814

FOR: EDUCATION SERVICES, NAMELY, PROVIDING LIVE AND ON-LINE CLASSES IN THE FIELD OF INFORMATION SECURITY, IN CLASS 41 (U.S. CLS. 100, 101 AND 107).

FIRST USE 5-5-2005; IN COMMERCE 5-5-2005.

NO CLAIM IS MADE TO THE EXCLUSIVE RIGHT TO USE "ON DEMAND", APART FROM THE MARK AS SHOWN.

THE MARK CONSISTS OF A PERSON MADE OF GEOMETRIC SHAPES HOLDING A CABLE WITH A PLUG ON EACH END AND SURROUNDED BY MULTIPLE INCOMPLETE CIRCLES.

SER. NO. 77-368,026, FILED 1-9-2008.

KATHLEEN LORENZO, EXAMINING ATTORNEY

Int. Cl.: 36

Prior U.S. Cls.: 100, 101 and 102

United States Patent and Trademark Office

Reg. No. 3,484,365

Registered Aug. 12, 2008

**SERVICE MARK
PRINCIPAL REGISTER**

THE FIDUCIARY DIFFERENCE

ALEXANDER, MICHAEL T. (UNITED STATES
INDIVIDUAL)

SUITE 113

936 EAST GREEN STREET

PASADENA, CA 91106 AND

ALEXANDER, PATRICIA A. (UNITED STATES IN-
DIVIDUAL)

SUITE 113

936 EAST GREEN STREET

PASADENA, CA 91106

FOR: PROVIDING INFORMATION AND ADVICE
IN THE FIELD OF FINANCE, FINANCIAL INVEST-
MENTS, FINANCIAL VALUATIONS, AND THE
FINANCIAL ASPECTS OF RETIREMENT, IN CLASS
36 (U.S. CLS. 100, 101 AND 102).

FIRST USE 10-26-2005; IN COMMERCE 10-26-2005.

THE MARK CONSISTS OF STANDARD CHAR-
ACTERS WITHOUT CLAIM TO ANY PARTICULAR
FONT, STYLE, SIZE, OR COLOR.

NO CLAIM IS MADE TO THE EXCLUSIVE
RIGHT TO USE "FIDUCIARY", APART FROM
THE MARK AS SHOWN.

SER. NO. 77-368,032, FILED 1-9-2008.

COURTNEY MCCORMICK, EXAMINING ATTOR-
NEY

Int. Cl.: 9

Prior U.S. Cls.: 21, 23, 26, 36 and 38

Reg. No. 3,484,366

United States Patent and Trademark Office

Registered Aug. 12, 2008

**TRADEMARK
PRINCIPAL REGISTER**

EDACONNECT

PERCEPTION SOFTWARE, INC. (DELAWARE CORPORATION)
105 W. RIVERSIDE DRIVE, SUITE 100
AUSTIN, TX 78704

FOR: COMPUTER SOFTWARE FOR MANAGING, SEARCHING, REPORTING, AND VIEWING ENGINEERING DATA; COMPUTER SOFTWARE FOR INTEGRATING ELECTRONIC DESIGN AUTOMATION (EDA) DATA AND MECHANICAL COMPUTER AIDED DESIGN DATA WITH ENTERPRISE PRODUCT LIFECYCLE MANAGEMENT AND PRODUCT DATA MANAGEMENT SYSTEMS; COMPUTER SOFTWARE FOR PROVIDING PROJECT MANAGEMENT AND COLLABORATION

FOR ELECTRICAL AND MECHANICAL DESIGN ENGINEERS; ELECTRONIC DESIGN AUTOMATION (EDA) SOFTWARE, IN CLASS 9 (U.S. CLS. 21, 23, 26, 36 AND 38).

FIRST USE 9-0-2006; IN COMMERCE 9-0-2006.

THE MARK CONSISTS OF STANDARD CHARACTERS WITHOUT CLAIM TO ANY PARTICULAR FONT, STYLE, SIZE, OR COLOR.

SER. NO. 77-368,040, FILED 1-9-2008.

KEVIN DINALLO, EXAMINING ATTORNEY

Int. Cl.: 9

Prior U.S. Cls.: 21, 23, 26, 36 and 38

United States Patent and Trademark Office

Reg. No. 3,484,367

Registered Aug. 12, 2008

TRADEMARK
PRINCIPAL REGISTER

EnterpriseFX

ACTFOREX, INC (DELAWARE CORPORATION)
110 WALL STREET, 7TH FLOOR
NEW YORK, NY 10005

FOR: COMPUTER SOFTWARE PLATFORMS,
NAMELY, COMPUTER E-COMMERCE SOFTWARE
TO ALLOW USERS TO PERFORM ELECTRONIC
FOREIGN CURRENCY EXCHANGE TRADING
TRANSACTIONS VIA A GLOBAL COMPUTER NET-
WORK, COMPUTER SOFTWARE FOR MONITOR-
ING FOREIGN CURRENCY EXCHANGE
TRADING TRANSACTIONS FOR FINANCIAL IN-

STITUTIONS, IN CLASS 9 (U.S. CLS. 21, 23, 26, 36
AND 38).

FIRST USE 12-19-2007; IN COMMERCE 12-19-2007.

THE MARK CONSISTS OF STANDARD CHAR-
ACTERS WITHOUT CLAIM TO ANY PARTICULAR
FONT, STYLE, SIZE, OR COLOR.

SER. NO. 77-368,063, FILED 1-9-2008.

SUSAN STIGLITZ, EXAMINING ATTORNEY

Int. Cl.: 36

Prior U.S. Cls.: 100, 101 and 102

United States Patent and Trademark Office

Reg. No. 3,484,368

Registered Aug. 12, 2008

**SERVICE MARK
PRINCIPAL REGISTER**

LIVE THE OUTDOORS

PLUM CREEK TIMBER COMPANY, INC. (DELA-
WARE CORPORATION)
SUITE 4300
999 THIRD AVENUE
SEATTLE, WA 98104

THE MARK CONSISTS OF STANDARD CHAR-
ACTERS WITHOUT CLAIM TO ANY PARTICULAR
FONT, STYLE, SIZE, OR COLOR.

FOR: REAL ESTATE ACQUISITION SERVICES;
REAL ESTATE MANAGEMENT, IN CLASS 36 (U.S.
CLS. 100, 101 AND 102).

SER. NO. 77-368,079, FILED 1-9-2008.

FIRST USE 7-10-2007; IN COMMERCE 7-10-2007.

KIMBERLY PERRY, EXAMINING ATTORNEY

Int. Cl.: 37

Prior U.S. Cls.: 100, 103 and 106

United States Patent and Trademark Office

Reg. No. 3,484,369

Registered Aug. 12, 2008

**SERVICE MARK
PRINCIPAL REGISTER**

LIVE THE OUTDOORS

PLUM CREEK TIMBER COMPANY, INC. (DELA-
WARE CORPORATION)
SUITE 4300
999 THIRD AVENUE
SEATTLE, WA 98104

FOR: REAL ESTATE DEVELOPMENT SERVICES;
ENVIRONMENTAL SERVICES, NAMELY, REAL
ESTATE SITE ANALYSIS AND SELECTION IN
THE PROCESS OF CONSTRUCTION, AND CON-
STRUCTION INSPECTION AND MANAGEMENT;
LAND DEVELOPMENT SERVICES, NAMELY,
PLANNING AND LAYING OUT OF RESIDENTIAL
AND/OR COMMERCIAL COMMUNITIES; CON-
STRUCTION PROJECT MANAGEMENT; CON-

STRUCTION MANAGEMENT AND SUPERVISION;
DEVELOPMENT OF RESORT HOTELS, IN CLASS 37
(U.S. CLS. 100, 103 AND 106).

FIRST USE 7-10-2007; IN COMMERCE 7-10-2007.

THE MARK CONSISTS OF STANDARD CHAR-
ACTERS WITHOUT CLAIM TO ANY PARTICULAR
FONT, STYLE, SIZE, OR COLOR.

SER. NO. 77-368,081, FILED 1-9-2008.

KIMBERLY PERRY, EXAMINING ATTORNEY

Int. Cl.: 42

Prior U.S. Cls.: 100 and 101

United States Patent and Trademark Office

Reg. No. 3,484,370

Registered Aug. 12, 2008

**SERVICE MARK
PRINCIPAL REGISTER**

TheCollegeFreeway

THECOLLEGEFREEWAY, INC. (DELAWARE
CORPORATION)
440 N. WOLFE ROAD
SUNNYVALE, CA 94085

FOR: COMPUTER SERVICES, NAMELY, HOST-
ING ON-LINE WEB FACILITIES FOR OTHERS FOR
ORGANIZING AND CONDUCTING ONLINE
MEETINGS, GATHERINGS, AND INTERACTIVE
DISCUSSIONS; COMPUTER SERVICES, NAMELY,
INTERACTIVE HOSTING SERVICES WHICH AL-
LOW THE USER TO PUBLISH AND SHARE THEIR

OWN CONTENT AND IMAGES ONLINE, IN CLASS
42 (U.S. CLS. 100 AND 101).

FIRST USE 10-31-2006; IN COMMERCE 10-31-2006.

THE MARK CONSISTS OF STANDARD CHAR-
ACTERS WITHOUT CLAIM TO ANY PARTICULAR
FONT, STYLE, SIZE, OR COLOR.

SER. NO. 77-368,091, FILED 1-9-2008.

KIMBERLY PERRY, EXAMINING ATTORNEY

Int. Cl.: 35

Prior U.S. Cls.: 100, 101 and 102

United States Patent and Trademark Office

Reg. No. 3,484,371

Registered Aug. 12, 2008

**SERVICE MARK
PRINCIPAL REGISTER**

Brandychase

BRANDYCHASE AT SHEPARD PARK OWNERS'
ASSOCIATION, INC. (MINNESOTA COR-
PORATION)
15350 25TH AVE N #108
PLYMOUTH, MN 55447

FOR: ASSOCIATION SERVICES, NAMELY, PRO-
MOTING THE INTERESTS OF HOMEOWNERS IN A
SPECIFIC COMMUNITY; BUSINESS MANAGE-
MENT OF THE NONPROFIT CORPORATIONS
AND TRADE ASSOCIATIONS OF OTHERS; BUSI-
NESS MANAGEMENT; BUSINESS OPERATION,
BUSINESS ADMINISTRATION AND OFFICE
FUNCTIONS; BUSINESS SERVICES, NAMELY, FA-

CILITIES MANAGEMENT OF TECHNICAL OPERA-
TIONS, IN CLASS 35 (U.S. CLS. 100, 101 AND 102).

FIRST USE 8-4-1982; IN COMMERCE 8-4-1982.

THE MARK CONSISTS OF STANDARD CHAR-
ACTERS WITHOUT CLAIM TO ANY PARTICULAR
FONT, STYLE, SIZE, OR COLOR.

SER. NO. 77-368,106, FILED 1-9-2008.

KIMBERLY PERRY, EXAMINING ATTORNEY

Int. Cl.: 9

Prior U.S. Cls.: 21, 23, 26, 36 and 38

Reg. No. 3,484,372

United States Patent and Trademark Office

Registered Aug. 12, 2008

**TRADEMARK
PRINCIPAL REGISTER**



AIRNET GROUP, INC. (TENNESSEE CORPORATION)
SUITE 220
801 BROAD STREET
CHATTANOOGA, TN 37402

FOR: COMPUTER SOFTWARE FOR THE COLLECTION, EDITING, ORGANIZING, MODIFYING, BOOK MARKING, TRANSMISSION, STORAGE AND SHARING OF DATA AND INFORMATION, IN CLASS 9 (U.S. CLS. 21, 23, 26, 36 AND 38).

FIRST USE 8-30-2006; IN COMMERCE 8-30-2006.

OWNER OF U.S. REG. NO. 3,161,111.

THE COLOR(S) ORANGE, BLUE, AND GRAY IS/ARE CLAIMED AS A FEATURE OF THE MARK.

THE MARK CONSISTS OF A BLUE "COMMUNICATION/THOUGHT BUBBLE" WHICH CASTS A GRAY SHADOW, FOLLOWED BY THE WORD "SMART" COLORED IN ORANGE AND THE WORD "COMMUNICATOR" COLORED IN BLUE.

SER. NO. 77-368,139, FILED 1-10-2008.

GEOFFREY FOSDICK, EXAMINING ATTORNEY

Int. Cl.: 18

Prior U.S. Cls.: 1, 2, 3, 22 and 41

United States Patent and Trademark Office

Reg. No. 3,484,373

Registered Aug. 12, 2008

**TRADEMARK
PRINCIPAL REGISTER**

IDA LUCE

LUCE IDA P. (UNITED STATES INDIVIDUAL)
200 NORTH PECOS
CAMP WOOD, TX 78833

THE MARK CONSISTS OF STANDARD CHAR-
ACTERS WITHOUT CLAIM TO ANY PARTICULAR
FONT, STYLE, SIZE, OR COLOR.

FOR: HANDBAGS, IN CLASS 18 (U.S. CLS. 1, 2, 3,
22 AND 41).

SER. NO. 77-368,140, FILED 1-10-2008.

FIRST USE 8-1-2006; IN COMMERCE 8-1-2006.

GEOFFREY FOSDICK, EXAMINING ATTORNEY

Int. Cl.: 35

Prior U.S. Cls.: 100, 101 and 102

United States Patent and Trademark Office

Reg. No. 3,484,374

Registered Aug. 12, 2008

**SERVICE MARK
PRINCIPAL REGISTER**

SHARE THE LA LA

RETAIL CONVERGENCE, INC. (DELAWARE
CORPORATION)
8TH FLOOR
10 MILK STREET
BOSTON, MA 02108

FOR: ON-LINE RETAIL STORE SERVICES FEATURING CLOTHING AND ACCESSORIES, FOOTWEAR, JEWELRY, LUGGAGE, HANDBAGS, WALLETS, SMALL LEATHER GOODS, SUNGLASSES, HOME FURNISHINGS, BATH LINENS, BED LINENS, APPLIANCES, COOKWARE, ELECTRONIC GOODS, AND TOYS ALL ON A LIMITED TIME

SALES EVENT BASIS, IN CLASS 35 (U.S. CLS. 100, 101 AND 102).

FIRST USE 4-11-2008; IN COMMERCE 4-11-2008.

THE MARK CONSISTS OF STANDARD CHARACTERS WITHOUT CLAIM TO ANY PARTICULAR FONT, STYLE, SIZE, OR COLOR.

SER. NO. 77-368,171, FILED 1-10-2008.

RUSS HERMAN, EXAMINING ATTORNEY

Int. Cl.: 35

Prior U.S. Cls.: 100, 101 and 102

United States Patent and Trademark Office

Reg. No. 3,484,375

Registered Aug. 12, 2008

SERVICE MARK
PRINCIPAL REGISTER

The logo for 'Ruelala' is written in a bold, black, cursive script. The letters are interconnected, with a large, flowing 'R' at the beginning and a 'la' at the end that loops back under the 'a'. The overall style is elegant and handwritten.

RETAIL CONVERGENCE, INC. (DELAWARE CORPORATION)
8TH FLOOR
10 MILK STREET
BOSTON, MA 02108

FOR: ON-LINE RETAIL STORE SERVICES FEATURING CLOTHING AND ACCESSORIES, FOOTWEAR, JEWELRY, LUGGAGE, HANDBAGS, WALLETS, SMALL LEATHER GOODS, SUNGLASSES, HOME FURNISHINGS, BATH LINENS, BED LINENS, APPLIANCES, COOKWARE, ELECTRONIC GOODS, AND TOYS ALL ON A LIMITED TIME

SALES EVENT BASIS, IN CLASS 35 (U.S. CLS. 100, 101 AND 102).

FIRST USE 4-11-2008; IN COMMERCE 4-11-2008.

THE MARK CONSISTS OF THE PHRASE "RUE LA LA" IN STYLIZED LETTERS.

SER. NO. 77-368,172, FILED 1-10-2008.

RUSS HERMAN, EXAMINING ATTORNEY

Int. Cl.: 35

Prior U.S. Cls.: 100, 101 and 102

United States Patent and Trademark Office

Reg. No. 3,484,376

Registered Aug. 12, 2008

**SERVICE MARK
PRINCIPAL REGISTER**

RUE LA LA

RETAIL CONVERGENCE, INC. (DELAWARE
CORPORATION)
8TH FLOOR
10 MILK STREET
BOSTON, MA 02108

FOR: ON-LINE RETAIL STORE SERVICES FEATURING CLOTHING AND ACCESSORIES, FOOTWEAR, JEWELRY, LUGGAGE, HANDBAGS, WALLETS, SMALL LEATHER GOODS, SUNGLASSES, HOME FURNISHINGS, BATH LINENS, BED LINENS, APPLIANCES, COOKWARE, ELECTRONIC GOODS, AND TOYS ALL ON A LIMITED TIME

SALES EVENT BASIS, IN CLASS 35 (U.S. CLS. 100, 101 AND 102).

FIRST USE 4-11-2008; IN COMMERCE 4-11-2008.

THE MARK CONSISTS OF STANDARD CHARACTERS WITHOUT CLAIM TO ANY PARTICULAR FONT, STYLE, SIZE, OR COLOR.

SER. NO. 77-368,173, FILED 1-10-2008.

RUSS HERMAN, EXAMINING ATTORNEY

Int. Cl.: 44

Prior U.S. Cls.: 100 and 101

United States Patent and Trademark Office

Reg. No. 3,484,377

Registered Aug. 12, 2008

**SERVICE MARK
PRINCIPAL REGISTER**

**The Order of the Healing
Angels**

THE GROWTH CORPORATION (MICHIGAN
CORPORATION)
657 CHERRY STREET, SE
GRAND RAPIDS, MI 49503

THE MARK CONSISTS OF STANDARD CHAR-
ACTERS WITHOUT CLAIM TO ANY PARTICULAR
FONT, STYLE, SIZE, OR COLOR.

FOR: PSYCHOLOGICAL COUNSELING, IN
CLASS 44 (U.S. CLS. 100 AND 101).

SER. NO. 77-368,177, FILED 1-10-2008.

FIRST USE 6-21-2006; IN COMMERCE 6-23-2006.

RUSS HERMAN, EXAMINING ATTORNEY

Int. Cl.: 28

Prior U.S. Cls.: 22, 23, 38 and 50

Reg. No. 3,484,378

United States Patent and Trademark Office

Registered Aug. 12, 2008

**TRADEMARK
PRINCIPAL REGISTER**

HOOPINI

BELL, KAREN (UNITED STATES INDIVIDUAL)
5261 HIGHLAND DRIVE
TRAVERSE CITY, MI 49684

THE MARK CONSISTS OF STANDARD CHARACTERS WITHOUT CLAIM TO ANY PARTICULAR FONT, STYLE, SIZE, OR COLOR.

FOR: EXERCISE HOOPS, IN CLASS 28 (U.S. CLS. 22, 23, 38 AND 50).

SER. NO. 77-368,193, FILED 1-10-2008.

FIRST USE 12-19-2007; IN COMMERCE 12-19-2007.

ALICE SUE CARRUTHERS, EXAMINING ATTORNEY

Int. Cl.: 28

Prior U.S. Cls.: 22, 23, 38 and 50

United States Patent and Trademark Office

Reg. No. 3,484,379

Registered Aug. 12, 2008

**TRADEMARK
PRINCIPAL REGISTER**

COMFORT FITNESS HOOPS

BELL, KAREN (UNITED STATES INDIVIDUAL)
5261 HIGHLAND DRIVE
TRAVERSE CITY, MI 49684

FOR: EXERCISE HOOPS, IN CLASS 28 (U.S. CLS.
22, 23, 38 AND 50).

FIRST USE 12-19-2007; IN COMMERCE 12-19-2007.

THE MARK CONSISTS OF STANDARD CHAR-
ACTERS WITHOUT CLAIM TO ANY PARTICULAR
FONT, STYLE, SIZE, OR COLOR.

NO CLAIM IS MADE TO THE EXCLUSIVE
RIGHT TO USE "FITNESS HOOPS", APART FROM
THE MARK AS SHOWN.

SER. NO. 77-368,195, FILED 1-10-2008.

ALICE SUE CARRUTHERS, EXAMINING ATTOR-
NEY

Int. Cl.: 43

Prior U.S. Cls.: 100 and 101

United States Patent and Trademark Office

Reg. No. 3,484,380

Registered Aug. 12, 2008

**SERVICE MARK
PRINCIPAL REGISTER**

LUCILE'S CREOLE CAFE

LUCILE'S, LTD. (COLORADO CORPORATION)
2124 FOURTEENTH ST.
BOULDER, CO 80302

OWNER OF U.S. REG. NO. 1,684,578.

FOR: RESTAURANT, IN CLASS 43 (U.S. CLS. 100
AND 101).

NO CLAIM IS MADE TO THE EXCLUSIVE
RIGHT TO USE "CREOLE CAFE", APART FROM
THE MARK AS SHOWN.

FIRST USE 1-1-1980; IN COMMERCE 1-1-1980.

SER. NO. 77-368,198, FILED 1-10-2008.

THE MARK CONSISTS OF STANDARD CHAR-
ACTERS WITHOUT CLAIM TO ANY PARTICULAR
FONT, STYLE, SIZE, OR COLOR.

CAROLINE WOOD, EXAMINING ATTORNEY

Int. Cl.: 43

Prior U.S. Cls.: 100 and 101

United States Patent and Trademark Office

Reg. No. 3,484,381

Registered Aug. 12, 2008

SERVICE MARK
PRINCIPAL REGISTER



LUCILE'S, LTD. (COLORADO CORPORATION)
2124 FOURTEENTH ST.,
BOULDER, CO 80302

FOR: RESTAURANT, IN CLASS 43 (U.S. CLS. 100
AND 101).

FIRST USE 1-1-1980; IN COMMERCE 1-1-1980.

OWNER OF U.S. REG. NO. 1,684,578.

THE MARK CONSISTS OF A ROSE ABOVE THE
WORD "LUCILE'S".

SER. NO. 77-368,207, FILED 1-10-2008.

CAROLINE WOOD, EXAMINING ATTORNEY

Int. Cl.: 16

Prior U.S. Cls.: 2, 5, 22, 23, 29, 37, 38 and 50

United States Patent and Trademark Office

Reg. No. 3,484,382

Registered Aug. 12, 2008

**TRADEMARK
PRINCIPAL REGISTER**

DATAPAK

ULTRA SCIENTIFIC, INCORPORATED (RHODE
ISLAND CORPORATION)
250 SMITH STREET
NORTH KINGSTOWN, RI 02852

FOR: REFERENCE PAMPHLETS FEATURING
ANALYTICAL DATA RELATING TO THE MANU-
FACTURE AND QUALITY CONTROL OF CHEMI-
CAL ANALYTICAL STANDARDS THAT
CALIBRATE ANALYTICAL INSTRUMENTATION
UTILIZED BY ANALYTICAL LABORATORIES IN
THE PERFORMANCE OF ENVIRONMENTAL

TESTING AND COMPLIANCE PROGRAMS, IN
CLASS 16 (U.S. CLS. 2, 5, 22, 23, 29, 37, 38 AND 50).

FIRST USE 1-1-1993; IN COMMERCE 1-1-1993.

THE MARK CONSISTS OF STANDARD CHAR-
ACTERS WITHOUT CLAIM TO ANY PARTICULAR
FONT, STYLE, SIZE, OR COLOR.

SER. NO. 77-368,213, FILED 1-10-2008.

CAROLINE WOOD, EXAMINING ATTORNEY

Int. Cl.: 3

Prior U.S. Cls.: 1, 4, 6, 50, 51 and 52

United States Patent and Trademark Office

Reg. No. 3,484,383

Registered Aug. 12, 2008

**TRADEMARK
PRINCIPAL REGISTER**

TEMPT MY LIPS

VICTORIA'S SECRET STORES BRAND MAN-
AGEMENT, INC. (DELAWARE CORPORA-
TION)

FOUR LIMITED PARKWAY
REYNOLDSBURG, OH 43068

FOR: LIP GLOSS, IN CLASS 3 (U.S. CLS. 1, 4, 6, 50,
51 AND 52).

FIRST USE 10-0-2006; IN COMMERCE 10-0-2006.

THE MARK CONSISTS OF STANDARD CHAR-
ACTERS WITHOUT CLAIM TO ANY PARTICULAR
FONT, STYLE, SIZE, OR COLOR.

NO CLAIM IS MADE TO THE EXCLUSIVE
RIGHT TO USE "LIPS", APART FROM THE MARK
AS SHOWN.

SER. NO. 77-368,214, FILED 1-10-2008.

JACQUELINE A. LAVINE, EXAMINING ATTOR-
NEY

Int. Cl.: 42

Prior U.S. Cls.: 100 and 101

United States Patent and Trademark Office

Reg. No. 3,484,384

Registered Aug. 12, 2008

**SERVICE MARK
PRINCIPAL REGISTER**

**Quality Analyses for
Informed Decisions**

A & L GREAT LAKES LABORATORIES, INC.
(INDIANA CORPORATION)
3505 CONESTOGA DRIVE
FORT WAYNE, IN 46808

THE MARK CONSISTS OF STANDARD CHAR-
ACTERS WITHOUT CLAIM TO ANY PARTICULAR
FONT, STYLE, SIZE, OR COLOR.

FOR: CHEMICAL, BIOCHEMICAL, BIOLOGICAL
AND BACTERIOLOGICAL RESEARCH AND ANA-
LYSIS, IN CLASS 42 (U.S. CLS. 100 AND 101).

SER. NO. 77-368,222, FILED 1-10-2008.

FIRST USE 8-27-2007; IN COMMERCE 9-10-2007.

TOBY BULLOFF, EXAMINING ATTORNEY

Int. Cl.: 11

Prior U.S. Cls.: 13, 21, 23, 31 and 34

Reg. No. 3,484,385

United States Patent and Trademark Office

Registered Aug. 12, 2008

**TRADEMARK
PRINCIPAL REGISTER**

CORELITE

RESCO PRODUCTS, INC. (PENNSYLVANIA
CORPORATION)
SUITE 430 2 PENN CENTER WEST
PITTSBURGH, PA 15276

THE MARK CONSISTS OF STANDARD CHAR-
ACTERS WITHOUT CLAIM TO ANY PARTICULAR
FONT, STYLE, SIZE, OR COLOR.

FOR: REFRACTORY SHELVES FOR POTTERY
KILNS, IN CLASS 11 (U.S. CLS. 13, 21, 23, 31 AND 34).

SER. NO. 77-368,241, FILED 1-10-2008.

FIRST USE 8-1-2007; IN COMMERCE 12-21-2007.

LINDA LAVACHE, EXAMINING ATTORNEY

Int. Cl.: 28

Prior U.S. Cls.: 22, 23, 38 and 50

United States Patent and Trademark Office

Reg. No. 3,484,386

Registered Aug. 12, 2008

**TRADEMARK
PRINCIPAL REGISTER**

TRAILMASTER

WRIGHT & MCGILL CO. (COLORADO COR-
PORATION)
4245 E. 46TH AVENUE
DENVER, CO 80216

THE MARK CONSISTS OF STANDARD CHAR-
ACTERS WITHOUT CLAIM TO ANY PARTICULAR
FONT, STYLE, SIZE, OR COLOR.

FOR: FISHING RODS, IN CLASS 28 (U.S. CLS. 22,
23, 38 AND 50).

SER. NO. 77-368,243, FILED 1-10-2008.

FIRST USE 8-1-1959; IN COMMERCE 8-1-1959.

SUSAN LESLIE DUBOIS, EXAMINING ATTORNEY

Int. Cl.: 35

Prior U.S. Cls.: 100, 101 and 102

United States Patent and Trademark Office

Reg. No. 3,484,387

Registered Aug. 12, 2008

**SERVICE MARK
PRINCIPAL REGISTER**

BKSENTRY

AUTOMATION RESEARCH, INC. (OHIO CORPORATION)
250 E. TOWN STREET
COLUMBUS, OH 43215

FOR: DATA PROCESSING SERVICES, NAMELY, PROCESSING OF CUSTOMER DATA TO IDENTIFY RECORDS THAT HAVE A BANKRUPTCY AND/OR DECEASED INDIVIDUALS, IN CLASS 35 (U.S. CLS. 100, 101 AND 102).

FIRST USE 12-1-2007; IN COMMERCE 12-1-2007.

THE MARK CONSISTS OF STANDARD CHARACTERS WITHOUT CLAIM TO ANY PARTICULAR FONT, STYLE, SIZE, OR COLOR.

SER. NO. 77-368,246, FILED 1-10-2008.

WENDY JUN, EXAMINING ATTORNEY

Int. Cl.: 41

Prior U.S. Cls.: 100, 101 and 107

United States Patent and Trademark Office

Reg. No. 3,484,388

Registered Aug. 12, 2008

**SERVICE MARK
PRINCIPAL REGISTER**

CABARAOKE

CABARAOKE.COM, LLC (MISSOURI LTD LIAB
CO)
706 BROADWAY, #302
KANSAS CITY, MO 64105

FOR: ENTERTAINMENT SERVICES IN THE
NATURE OF PROVIDING BACKGROUND IN-
STRUMENTAL MUSIC RECORDINGS AND DIS-
PLAYING SONG LYRICS ON A VIDEO MONITOR
FOR LIVE MUSICAL PERFORMANCES, CREAT-
ING AUDIO-VISUAL RECORDINGS OF SUCH PER-
FORMANCES, AND PROVIDING A WEB SITE

FEATURING SUCH PERFORMANCES, IN CLASS
41 (U.S. CLS. 100, 101 AND 107).

FIRST USE 6-24-2006; IN COMMERCE 6-24-2006.

THE MARK CONSISTS OF STANDARD CHAR-
ACTERS WITHOUT CLAIM TO ANY PARTICULAR
FONT, STYLE, SIZE, OR COLOR.

SER. NO. 77-368,289, FILED 1-10-2008.

CYNTHIA TRIPI, EXAMINING ATTORNEY

Int. Cls.: 9, 40 and 42

Prior U.S. Cls.: 21, 23, 26, 36, 38, 100, 101, 103 and 106

Reg. No. 3,484,389

United States Patent and Trademark Office

Registered Aug. 12, 2008

**TRADEMARK
SERVICE MARK
PRINCIPAL REGISTER**

ASAT

ASAT LIMITED (HONG KONG CORPORATION)
14/F, 138 TEXACO ROAD
TSUEN WAN, HONG KONG

FOR: ELECTRONIC COMPONENTS, NAMELY,
SEMICONDUCTORS AND INTEGRATED CIR-
CUITS, IN CLASS 9 (U.S. CLS. 21, 23, 26, 36 AND 38).

FIRST USE 10-23-1992; IN COMMERCE 10-23-1992.

FOR: CUSTOM ASSEMBLY OF SEMICONDUCT-
TORS AND INTEGRATED CIRCUITS, IN CLASS 40
(U.S. CLS. 100, 103 AND 106).

FIRST USE 10-23-1992; IN COMMERCE 10-23-1992.

FOR: DESIGN AND TESTING OF SEMICONDUCT-
TORS AND INTEGRATED CIRCUITS, IN CLASS 42
(U.S. CLS. 100 AND 101).

FIRST USE 10-23-1992; IN COMMERCE 10-23-1992.

THE MARK CONSISTS OF STANDARD CHAR-
ACTERS WITHOUT CLAIM TO ANY PARTICULAR
FONT, STYLE, SIZE, OR COLOR.

OWNER OF U.S. REG. NO. 1,791,940.

SER. NO. 77-368,303, FILED 1-10-2008.

BRENDAN REGAN, EXAMINING ATTORNEY

Int. Cl.: 44

Prior U.S. Cls.: 100 and 101

United States Patent and Trademark Office

Reg. No. 3,484,390

Registered Aug. 12, 2008

SERVICE MARK
PRINCIPAL REGISTER



Pain PACT
Partnership And Care Today

PURDUE PHARMA L.P. (DELAWARE LIMITED
PARTNERSHIP)

ONE STAMFORD FORUM

STAMFORD, CT 06901

FOR: INFORMATIONAL SERVICES, NAMELY,
PROVIDING INFORMATION IN THE FIELD OF
PAIN MANAGEMENT TO HEALTH CARE PROFES-
SIONALS, IN CLASS 44 (U.S. CLS. 100 AND 101).

FIRST USE 1-27-2008; IN COMMERCE 1-27-2008.

NO CLAIM IS MADE TO THE EXCLUSIVE
RIGHT TO USE "PAIN", APART FROM THE MARK
AS SHOWN.

THE MARK CONSISTS OF THE WORDS "PAIN
PACT PARTNERSHIP AND CARE TODAY" UN-
DERNEATH A LOGO DEPICTING A ROAD LEAD-
ING TO TWO MOUNTAINS WITH A SUN BEHIND
THEM.

SER. NO. 77-368,338, FILED 1-10-2008.

EUGENIA MARTIN, EXAMINING ATTORNEY

Int. Cl.: 42

Prior U.S. Cls.: 100 and 101

United States Patent and Trademark Office

Reg. No. 3,484,391

Registered Aug. 12, 2008

**SERVICE MARK
PRINCIPAL REGISTER**

MDV

MILLION DOLLAR VIXEN, LLC (FLORIDA LTD
LIAB CO)
12620 BEACH BLVD. STE 3 #365
JACKSONVILLE, FL 32246

FOR: COMPUTER SERVICES, NAMELY, HOST-
ING AND MAINTAINING AN ONLINE WEB SITE
FOR OTHERS TO VIEW, READ, PARTICIPATE IN
OR LISTEN TO ADULT THEMED DISCUSSIONS
AND TOPICS INCLUDING ADULT THEMED IMA-
GES OF FEMALES AND NEWS CONSISTING OF
INFORMATION REGARDING ART, FASHION, EN-
TERTAINMENT, TELEVISION, MOVIES, MUSIC,
BOOKS, HEALTH, SPORTS, MUSIC, LIFESTYLE,

SEX, RELATIONSHIPS, GENDER POLITICS AND
OTHER AREAS OF GENERAL INTEREST, IN
CLASS 42 (U.S. CLS. 100 AND 101).

FIRST USE 9-1-2007; IN COMMERCE 12-17-2007.

THE MARK CONSISTS OF STANDARD CHAR-
ACTERS WITHOUT CLAIM TO ANY PARTICULAR
FONT, STYLE, SIZE, OR COLOR.

SER. NO. 77-368,357, FILED 1-10-2008.

BARBARA RUTLAND, EXAMINING ATTORNEY

Int. Cl.: 25

Prior U.S. Cls.: 22 and 39

United States Patent and Trademark Office

Reg. No. 3,484,392

Registered Aug. 12, 2008

**TRADEMARK
PRINCIPAL REGISTER**

BECAUSE SHE LOVES...

BECAUSE SHE LOVES, L.L.C. (ARIZONA LTD
LIAB CO)
9827 SOUTH 47TH PLACE
PHOENIX, AZ 85044

THE MARK CONSISTS OF STANDARD CHAR-
ACTERS WITHOUT CLAIM TO ANY PARTICULAR
FONT, STYLE, SIZE, OR COLOR.

FOR: T-SHIRTS, IN CLASS 25 (U.S. CLS. 22 AND
39).

SER. NO. 77-368,363, FILED 1-10-2008.

FIRST USE 12-17-2007; IN COMMERCE 12-17-2007.

TINA KUAN, EXAMINING ATTORNEY

Int. Cl.: 35

Prior U.S. Cls.: 100, 101 and 102

United States Patent and Trademark Office

Reg. No. 3,484,393

Registered Aug. 12, 2008

SERVICE MARK
PRINCIPAL REGISTER



SOCIETY FOR
SCIENCE & THE PUBLIC

SOCIETY FOR SCIENCE & THE PUBLIC (DELAWARE CORPORATION), DBA SCIENCE SERVICE

1719 N STREET, N.W.

WASHINGTON, DC 20036

FOR: ASSOCIATION SERVICES, NAMELY, PROMOTING THE INTERESTS OF SCIENCE TEACHERS, SCIENCE STUDENTS AND OTHERS INTERESTED IN THE FIELD OF SCIENCE, IN CLASS 35 (U.S. CLS. 100, 101 AND 102).

FIRST USE 12-1-2007; IN COMMERCE 1-10-2008.

NO CLAIM IS MADE TO THE EXCLUSIVE RIGHT TO USE "SOCIETY FOR SCIENCE & THE PUBLIC", APART FROM THE MARK AS SHOWN.

THE MARK CONSISTS OF AN ABSTRACT IMAGE ON THE LEFT WHICH CAN BE CONSTRUED IN VARIOUS WAYS TO REPRESENT A GALAXY, A WHIRLPOOL, A HURRICANE, OR THE LETTER "S"; AND THE NAME OF THE ASSOCIATION WHICH IS "SOCIETY FOR SCIENCE & THE PUBLIC" ON TWO LINES TO THE RIGHT.

SER. NO. 77-368,371, FILED 1-10-2008.

PAUL F. GAST, EXAMINING ATTORNEY

Int. Cl.: 41

Prior U.S. Cls.: 100, 101 and 107

United States Patent and Trademark Office

Reg. No. 3,484,394

Registered Aug. 12, 2008

**SERVICE MARK
PRINCIPAL REGISTER**

A1A.TV

FLYNT, MARK W (UNITED STATES INDIVIDUAL)
2601 SW 110 WAY
DAVIE, FL 33328

FOR: ENTERTAINMENT SERVICES, NAMELY, PROVIDING A WEB SITE FEATURING MUSICAL PERFORMANCES, MUSICAL VIDEOS, RELATED FILM CLIPS, PHOTOGRAPHS, AND OTHER MULTIMEDIA MATERIALS, IN CLASS 41 (U.S. CLS. 100, 101 AND 107).

FIRST USE 1-1-2004; IN COMMERCE 4-5-2005.

THE MARK CONSISTS OF STANDARD CHARACTERS WITHOUT CLAIM TO ANY PARTICULAR FONT, STYLE, SIZE, OR COLOR.

NO CLAIM IS MADE TO THE EXCLUSIVE RIGHT TO USE "TV", APART FROM THE MARK AS SHOWN.

SER. NO. 77-368,377, FILED 1-10-2008.

RONALD MCMORROW, EXAMINING ATTORNEY

Int. Cl.: 35

Prior U.S. Cls.: 100, 101 and 102

United States Patent and Trademark Office

Reg. No. 3,484,395

Registered Aug. 12, 2008

**SERVICE MARK
PRINCIPAL REGISTER**

Film House

FILM HOUSE, INC. (TENNESSEE CORPORATION)
810 DOMINICAN DRIVE
NASHVILLE, TN 37228

FOR: ADVERTISING SERVICES, NAMELY, PROMOTING AND MARKETING THE GOODS AND SERVICES OF OTHERS THROUGH ALL PUBLIC COMMUNICATION MEANS, IN CLASS 35 (U.S. CLS. 100, 101 AND 102).

FIRST USE 1-29-1980; IN COMMERCE 1-29-1980.

THE MARK CONSISTS OF STANDARD CHARACTERS WITHOUT CLAIM TO ANY PARTICULAR FONT, STYLE, SIZE, OR COLOR.

NO CLAIM IS MADE TO THE EXCLUSIVE RIGHT TO USE "FILM", APART FROM THE MARK AS SHOWN.

SER. NO. 77-368,378, FILED 1-10-2008.

RONALD MCMORROW, EXAMINING ATTORNEY

Int. Cl.: 43

Prior U.S. Cls.: 100 and 101

United States Patent and Trademark Office

Reg. No. 3,484,396

Registered Aug. 12, 2008

**SERVICE MARK
PRINCIPAL REGISTER**



MEZZO RESTAURANTS LIMITED (OHIO LTD
LIAB CO)
ATTN: LEGAL DEPARTMENT
147 NORTH HIGH STREET
GAHANNA, OH 43230

NO CLAIM IS MADE TO THE EXCLUSIVE
RIGHT TO USE "ITALIAN KITCHEN & WINE",
APART FROM THE MARK AS SHOWN.

FOR: BAR AND RESTAURANT SERVICES, IN
CLASS 43 (U.S. CLS. 100 AND 101).

SER. NO. 77-368,381, FILED 1-10-2008.

FIRST USE 12-31-2006; IN COMMERCE 12-31-2006.

RONALD MCMORROW, EXAMINING ATTORNEY

Int. Cl.: 7

Prior U.S. Cls.: 13, 19, 21, 23, 31, 34 and 35

Reg. No. 3,484,397

United States Patent and Trademark Office

Registered Aug. 12, 2008

**TRADEMARK
PRINCIPAL REGISTER**

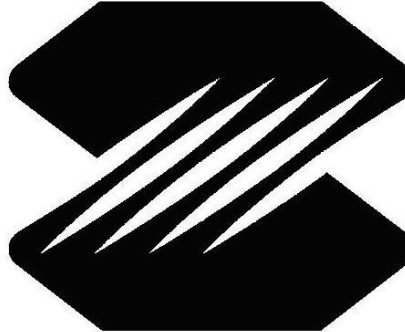

CHANGSHA ZOOMLION HEAVY INDUSTRY
SCIENCE & TECHNOLOGY DEVELOPMENT
CO., LTD. (CHINA CORPORATION)
361 YINPEN ROAD SOUTH
CHANGSHA, CHINA

FOR: CENTRIFUGAL PUMPS; HOISTS; AS-
PHALT PAVING MACHINES; FUEL PUMPS FOR
LAND VEHICLES; CONCRETE MIXERS; CON-
CRETE PLACING MACHINES; EARTH MOVING
MACHINES, NAMELY, EXCAVATORS, GRADERS
AND LOADERS; BULLDOZERS; HAND HELD
ELECTRIC PLANERS; HAND HELD ELECTRICAL
DRILLS; HAND HELD PNEUMATIC HAMMERS;
WASTE COMPACTING MACHINES; POWER
DRILLS; ELECTRIC MIXERS FOR HOUSEHOLD
PURPOSES; VEHICLE PNEUMATIC AND HY-

DRULIC COMPRESSORS; OIL HYDRAULIC
PRESSES FOR METALWORKING; HYDRAULIC
VALVE ACTUATORS; HYDRAULIC TURBINES;
HYDRAULIC HAMMERS; HYDRAULIC EXCAVA-
TORS; HYDRAULIC CONVEYORS; HYDRAULIC
TORQUE CONVERTERS (MACHINE ELEMENTS
NOT FOR LAND VEHICLES); ELEVATORS; ELEC-
TRIC PUMPS; CONCRETE CONSTRUCTION MA-
CHINES, IN CLASS 7 (U.S. CLS. 13, 19, 21, 23, 31, 34
AND 35).

FIRST USE 6-1-2000; IN COMMERCE 1-1-2007.

SER. NO. 77-368,385, FILED 1-10-2008.

RONALD MCMORROW, EXAMINING ATTORNEY

Int. Cl.: 41

Prior U.S. Cls.: 100, 101 and 107

Reg. No. 3,484,398

United States Patent and Trademark Office

Registered Aug. 12, 2008

**SERVICE MARK
PRINCIPAL REGISTER**

Zenyasa

BROWN, JASON RAY (UNITED STATES INDIVIDUAL)
APT. #8H
5800 ARLINGTON AVENUE
BRONX, NY 10471

FOR: EDUCATIONAL SERVICES, NAMELY, PROVIDING COURSES, WORKSHOPS AND TRAINING CLASSES IN THE FIELDS OF YOGA, FITNESS, HEALTH, BUDDHISM AND MEDITATION, IN BOTH PRIVATE AND GROUP SETTINGS, IN CLASS 41 (U.S. CLS. 100, 101 AND 107).

FIRST USE 1-10-2007; IN COMMERCE 9-4-2007.

THE MARK CONSISTS OF STANDARD CHARACTERS WITHOUT CLAIM TO ANY PARTICULAR FONT, STYLE, SIZE, OR COLOR.

SER. NO. 77-368,389, FILED 1-10-2008.

RONALD MCMORROW, EXAMINING ATTORNEY

Int. Cl.: 25

Prior U.S. Cls.: 22 and 39

United States Patent and Trademark Office

Reg. No. 3,484,399

Registered Aug. 12, 2008

TRADEMARK
PRINCIPAL REGISTER

inner force

DIAZ, EDINSON (UNITED STATES INDIVIDUAL)
29 VILLA STREET
WALTHAM, MA 02453

FOR: BELTS; CAPS; CLOTHING FOR WEAR IN JUDO PRACTICES; CLOTHING FOR WEAR IN WRESTLING GAMES; HOODS; JERSEYS; LEATHER BELTS; MUFFLERS; PERSPIRATION ABSORBENT UNDERWEAR CLOTHING; TIES; TOPS; TRIATHLON CLOTHING, NAMELY, TRIATHLON TIGHTS, TRIATHLON SHORTS, TRIATHLON SINGLET, TRIATHLON SHIRTS, TRIATHLON SUITS; BUTTON-FRONT ALOHA SHIRTS; DRESS SHIRTS; GOLF SHIRTS; HEADBANDS AGAINST SWEATING; KNIT SHIRTS; LONG-SLEEVED SHIRTS; OPEN-NECKED SHIRTS; PIQUE SHIRTS; POLO SHIRTS; SPORT SHIRTS; SPORTS SHIRTS; SPORTS SHIRTS WITH SHORT SLEEVES; SWEAT BANDS; SWEAT PANTS; SWEAT SHIRTS; SWEAT SUITS; T-SHIRTS; TEE SHIRTS; DENIMS; JOGGING PANTS; LOUNGE PANTS; PANTS; SKI PANTS;

SNOW PANTS; SNOWBOARD PANTS; STRETCH PANTS; WATERPROOF JACKETS AND PANTS; WIND PANTS; YOGA PANTS; COATS; COATS FOR MEN AND WOMEN; COATS MADE OF COTTON; FUR COATS; FUR COATS AND JACKETS; OVER COATS; RAIN COATS; SPORT COATS; SUIT COATS; TOP COATS; ATHLETIC FOOTWEAR; FOOTWEAR FOR MEN; FOOTWEAR FOR TRACK AND FIELD ATHLETICS; FOOTWEAR, NAMELY, WORK BOOTS, IN CLASS 25 (U.S. CLS. 22 AND 39).

FIRST USE 12-26-2007; IN COMMERCE 12-26-2007.

THE MARK CONSISTS OF STANDARD CHARACTERS WITHOUT CLAIM TO ANY PARTICULAR FONT, STYLE, SIZE, OR COLOR.

SER. NO. 77-368,390, FILED 1-10-2008.

JOHN DALIER, EXAMINING ATTORNEY

Int. Cl.: 41

Prior U.S. Cls.: 100, 101 and 107

United States Patent and Trademark Office

Reg. No. 3,484,400

Registered Aug. 12, 2008

**SERVICE MARK
PRINCIPAL REGISTER**

pupprentice

BROWN DOG AND BETTY, INC. (WASHINGTON
CORPORATION)
8902 222 STREET SE
WOODINVILLE, WA 98077

THE MARK CONSISTS OF STANDARD CHAR-
ACTERS WITHOUT CLAIM TO ANY PARTICULAR
FONT, STYLE, SIZE, OR COLOR.

FOR: OBEDIENCE SCHOOL TRAINING FOR
ANIMALS; TRAINING ANIMALS FOR OTHERS;
ANIMAL TRAINING, IN CLASS 41 (U.S. CLS. 100, 101
AND 107).

SER. NO. 77-368,391, FILED 1-10-2008.

FIRST USE 11-1-2007; IN COMMERCE 11-1-2007.

RONALD MCMORROW, EXAMINING ATTORNEY

Int. Cl.: 38

Prior U.S. Cls.: 100, 101 and 104

United States Patent and Trademark Office

Reg. No. 3,484,401

Registered Aug. 12, 2008

**SERVICE MARK
PRINCIPAL REGISTER**



GARRETT, JEMIR (UNITED STATES INDIVIDUAL)
316 COPPERFIELD DRIVE
WILLIAMSTOWN, NJ 08094

THE MARK CONSISTS OF AN ANIMATED COW WITH A TIE STANDING UPRIGHT WITH A BRIEFCASE, AND THE STYLIZED TEXT "NOTHING BUT CATTLE".

FOR: PROVIDING ON-LINE CHAT ROOMS AND ELECTRONIC BULLETIN BOARDS FOR TRANSMISSION OF MESSAGES AMONG USERS IN THE FIELD OF GENERAL INTEREST, IN CLASS 38 (U.S. CLS. 100, 101 AND 104).

SER. NO. 77-368,393, FILED 1-10-2008.

FIRST USE 11-30-2007; IN COMMERCE 11-30-2007.

RONALD MCMORROW, EXAMINING ATTORNEY

Int. Cl.: 25

Prior U.S. Cls.: 22 and 39

United States Patent and Trademark Office

Reg. No. 3,484,402

Registered Aug. 12, 2008

**TRADEMARK
PRINCIPAL REGISTER**

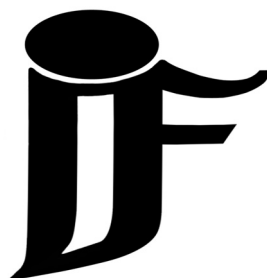

DIAZ, EDINSON (UNITED STATES INDIVIDUAL)
29 VILLA STREET
WALTHAM, MA 02453

FOR: BELTS; CAPS; CLOTHING FOR WEAR IN JUDO PRACTICES; CLOTHING FOR WEAR IN WRESTLING GAMES; HOODS; JERSEYS; LEATHER BELTS; MUFFLERS; PERSPIRATION ABSORBENT UNDERWEAR CLOTHING; TIES; TOPS; TRIATHLON CLOTHING, NAMELY, TRIATHLON TIGHTS, TRIATHLON SHORTS, TRIATHLON SINGLET, TRIATHLON SHIRTS, TRIATHLON SUITS; BUTTON-FRONT ALOHA SHIRTS; DRESS SHIRTS; GOLF SHIRTS; HEADBANDS AGAINST SWEATING; KNIT SHIRTS; LONG-SLEEVED SHIRTS; OPEN-NECKED SHIRTS; PIQUE SHIRTS; POLO SHIRTS; SPORT SHIRTS; SPORTS SHIRTS; SPORTS SHIRTS WITH SHORT SLEEVES; SWEAT BANDS; SWEAT PANTS; SWEAT SHIRTS; SWEAT SUITS; T-SHIRTS; TEE SHIRTS; DENIMS; JOGGING PANTS; LOUNGE PANTS; PANTS; SKI PANTS;

SNOW PANTS; SNOWBOARD PANTS; STRETCH PANTS; WATERPROOF JACKETS AND PANTS; WIND PANTS; YOGA PANTS; COATS; COATS FOR MEN AND WOMEN; COATS MADE OF COTTON; FUR COATS; FUR COATS AND JACKETS; OVER COATS; RAIN COATS; SPORT COATS; SUIT COATS; TOP COATS; ATHLETIC FOOTWEAR; FOOTWEAR FOR MEN; FOOTWEAR FOR TRACK AND FIELD ATHLETICS; FOOTWEAR, NAMELY, WORK BOOTS; ATHLETIC SHOES; ATHLETIC UNIFORMS, IN CLASS 25 (U.S. CLS. 22 AND 39).

FIRST USE 12-26-2007; IN COMMERCE 12-26-2007.

THE MARK CONSISTS OF LETTER "I" WITH LETTER "F".

SER. NO. 77-368,419, FILED 1-10-2008.

JOHN DALIER, EXAMINING ATTORNEY

Int. Cl.: 36

Prior U.S. Cls.: 100, 101 and 102

United States Patent and Trademark Office

Reg. No. 3,484,403

Registered Aug. 12, 2008

**SERVICE MARK
PRINCIPAL REGISTER**

KEEP POUNDING

CAROLINAS HEALTHCARE FOUNDATION
(NORTH CAROLINA NON-PROFIT CORPORATION)
P.O. BOX 32861
CHARLOTTE, NC 282322861

FOR: CHARITABLE FUNDRAISING SERVICES,
NAMELY, RAISING FUNDS FOR CANCER RE-
SEARCH BY MEANS OF SALE OF WRISTBANDS,
CAPS AND KEYCHAINS , IN CLASS 36 (U.S. CLS.
100, 101 AND 102).

FIRST USE 9-0-2004; IN COMMERCE 9-0-2004.

THE MARK CONSISTS OF STANDARD CHAR-
ACTERS WITHOUT CLAIM TO ANY PARTICULAR
FONT, STYLE, SIZE, OR COLOR.

SER. NO. 77-368,429, FILED 1-10-2008.

ALEXANDER L. POWERS, EXAMINING ATTOR-
NEY

Int. Cl.: 15

Prior U.S. Cls.: 2, 21 and 36

United States Patent and Trademark Office

Reg. No. 3,484,404

Registered Aug. 12, 2008

**TRADEMARK
PRINCIPAL REGISTER**

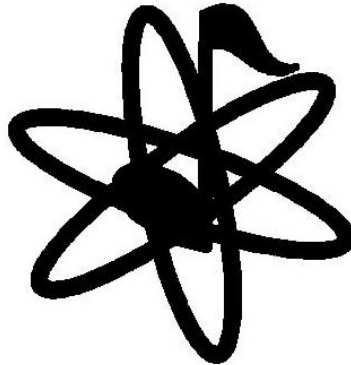

EASTWOOD GUITARS INC. (CANADA CORPORATION)
75 MAIN STREET
SOUTH BRAMPTON, CANADA L6Y1M9

FOR: STRINGED MUSICAL INSTRUMENTS, IN CLASS 15 (U.S. CLS. 2, 21 AND 36).

FIRST USE 8-29-2006; IN COMMERCE 8-29-2006.

THE MARK CONSISTS OF A STYLIZED MUSICAL NOTE AND ATOMIC SYMBOL.

SER. NO. 77-368,435, FILED 1-10-2008.

AMY GEARIN, EXAMINING ATTORNEY

Int. Cl.: 41

Prior U.S. Cls.: 100, 101 and 107

United States Patent and Trademark Office

Reg. No. 3,484,405

Registered Aug. 12, 2008

**SERVICE MARK
PRINCIPAL REGISTER**



KUCZMARSKI & ASSOCIATES, INC. (ILLINOIS CORPORATION)
SUITE 201
2001 N. HALSTED ST.
CHICAGO, IL 60614

FOR: EDUCATIONAL SERVICES, NAMELY, PROVIDING INCENTIVES TO BUSINESSES AND NONPROFIT ORGANIZATIONS TO DEMONSTRATE EXCELLENCE IN THE FIELD OF INNOVATIVE NEW PRODUCTS AND SERVICES THROUGH THE ISSUANCE OF AWARDS; PROVIDING RECOGNITION AND INCENTIVES BY THE WAY OF AWARDS TO DEMONSTRATE EXCEL-

LENCE IN THE FIELD OF INNOVATION, NAMELY, DEVELOPING INNOVATIVE NEW PRODUCTS AND SERVICES, IN CLASS 41 (U.S. CLS. 100, 101 AND 107).

FIRST USE 10-1-2004; IN COMMERCE 10-1-2004.

THE MARK CONSISTS OF A STYLIZED SIX-POINTED STAR.

SER. NO. 77-368,455, FILED 1-10-2008.

SIMON TENG, EXAMINING ATTORNEY

Int. Cl.: 9

Prior U.S. Cls.: 21, 23, 26, 36 and 38

United States Patent and Trademark Office

Reg. No. 3,484,406

Registered Aug. 12, 2008

**TRADEMARK
PRINCIPAL REGISTER**

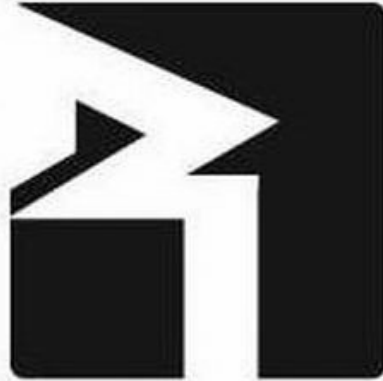

ROCKFORD CORPORATION (ARIZONA CORPORATION)
600 SOUTH ROCKFORD DRIVE
TEMPE, AZ 85281

FOR: AUDIO EQUIPMENT, NAMELY, STEREOS, CD PLAYERS, MP3 PLAYERS, RADIOS, AUDIO SPEAKERS, WOOFERS, SUBWOOFERS, SPEAKER ENCLOSURES, SPEAKER HOUSINGS, AMPLIFIERS, POWER AMPLIFIERS, PREAMPLIFIERS, EQUALIZERS, CROSSOVERS, SIGNAL PROCESSORS, ACCESSORIES FOR AUDIO EQUIPMENT, IN CLASS 9 (U.S. CLS. 21, 23, 26, 36 AND 38).

FIRST USE 8-1-2006; IN COMMERCE 8-1-2006.

OWNER OF U.S. REG. NOS. 1,524,277, 2,630,917, AND 3,321,037.

THE MARK CONSISTS OF A STYLIZED "R".

SER. NO. 77-368,509, FILED 1-10-2008.

PAUL F. GAST, EXAMINING ATTORNEY

Int. Cl.: 5

Prior U.S. Cls.: 6, 18, 44, 46, 51 and 52

United States Patent and Trademark Office

Reg. No. 3,484,407

Registered Aug. 12, 2008

**TRADEMARK
PRINCIPAL REGISTER**

DALCIPRAN

PIERRE FABRE MEDICAMENT (FRANCE SOCI-
ETE ANONYME (SA))
45, PLACE ABEL GANCE
BOULOGNE, FRANCE 92100

OWNER OF FRANCE REG. NO. 1,370,734, DATED
9-16-1986, RENEWED AS REG. NO. 1370734, DATED
6-26-2006, EXPIRES 6-26-2016.

FOR: PHARMACEUTICAL PREPARATIONS,
NAMELY, ANTIDEPRESSANTS; PHARMACEUTI-
CAL PREPARATIONS FOR THE TREATMENT OF
FIBROMYALGIA, IN CLASS 5 (U.S. CLS. 6, 18, 44, 46,
51 AND 52).

OWNER OF U.S. REG. NO. 1,471,926.

SER. NO. 77-368,537, FILED 1-10-2008.

THE MARK CONSISTS OF STANDARD CHAR-
ACTERS WITHOUT CLAIM TO ANY PARTICULAR
FONT, STYLE, SIZE, OR COLOR.

TOBY BULLOFF, EXAMINING ATTORNEY

Int. Cl.: 36

Prior U.S. Cls.: 100, 101 and 102

United States Patent and Trademark Office

Reg. No. 3,484,408

Registered Aug. 12, 2008

**SERVICE MARK
PRINCIPAL REGISTER**

Treasured Lives Breakfast

LIFELINK LEGACY FUND, INC. (FLORIDA
NON-PROFIT CORPORATION)

409 BAYSHORE BOULEVARD

TAMPA, FL 33606

FOR: CHARITABLE FUND RAISING SERVICES,
IN CLASS 36 (U.S. CLS. 100, 101 AND 102).

FIRST USE 11-1-2007; IN COMMERCE 11-1-2007.

THE MARK CONSISTS OF STANDARD CHAR-
ACTERS WITHOUT CLAIM TO ANY PARTICULAR
FONT, STYLE, SIZE, OR COLOR.

NO CLAIM IS MADE TO THE EXCLUSIVE
RIGHT TO USE "BREAKFAST", APART FROM
THE MARK AS SHOWN.

SER. NO. 77-368,547, FILED 1-10-2008.

ELLEN B. AWRICH, EXAMINING ATTORNEY

Int. Cl.: 42

Prior U.S. Cls.: 100 and 101

United States Patent and Trademark Office

Reg. No. 3,484,409

Registered Aug. 12, 2008

**SERVICE MARK
PRINCIPAL REGISTER**

Unimac Packaging Group

BIND-RITE/UNION GRAPHICS, L.L.C. (NEW
JERSEY LTD LIAB CO), TA UNIMAC PACKA-
GING GROUP
351 MICHELE PLACE
CARLSTADT, NJ 08540

OWNER OF U.S. REG. NOS. 2,994,032 AND
3,350,389.

FOR: DESIGNING OF PACKAGING AND WRAP-
PING MATERIALS; PACKAGING DESIGN FOR
OTHERS, IN CLASS 42 (U.S. CLS. 100 AND 101).

NO CLAIM IS MADE TO THE EXCLUSIVE
RIGHT TO USE "PACKAGING GROUP", APART
FROM THE MARK AS SHOWN.

FIRST USE 10-10-2007; IN COMMERCE 10-10-2007.

SER. NO. 77-368,554, FILED 1-10-2008.

THE MARK CONSISTS OF STANDARD CHAR-
ACTERS WITHOUT CLAIM TO ANY PARTICULAR
FONT, STYLE, SIZE, OR COLOR.

ASMAT KHAN, EXAMINING ATTORNEY

Int. Cl.: 9

Prior U.S. Cls.: 21, 23, 26, 36 and 38

Reg. No. 3,484,410

United States Patent and Trademark Office

Registered Aug. 12, 2008

**TRADEMARK
PRINCIPAL REGISTER**

GoMap!

MARSHALL AND ASSOCIATES, INC. (WA-SHINGTON CORPORATION)
1603 COOPER POINT RD NW
OLYMPIA, WA 98502

FOR: COMPUTER SOFTWARE FOR REMOTE STORAGE, RETRIEVAL, ANALYSIS AND DISPLAY OF GEOGRAPHIC LOCATION OF INFRASTRUCTURE AND ASSET DATA FOR UTILITIES USAGE AND GENERAL USE, IN CLASS 9 (U.S. CLS. 21, 23, 26, 36 AND 38).

FIRST USE 9-14-2006; IN COMMERCE 11-2-2006.

THE MARK CONSISTS OF STANDARD CHARACTERS WITHOUT CLAIM TO ANY PARTICULAR FONT, STYLE, SIZE, OR COLOR.

SER. NO. 77-368,562, FILED 1-10-2008.

PAUL CROWLEY, EXAMINING ATTORNEY

Int. Cl.: 1

Prior U.S. Cls.: 1, 5, 6, 10, 26 and 46

Reg. No. 3,484,411

United States Patent and Trademark Office

Registered Aug. 12, 2008

**TRADEMARK
PRINCIPAL REGISTER**

KaPrē

LIDOCHEM INC. (NEW JERSEY CORPORATION)
20 VILLAGE COURT
HAZLET, NJ 07730

OWNER OF U.S. REG. NO. 2,552,922.

THE MARK CONSISTS OF THE WORD "KAPRE"
WITH A LINE ABOVE THE "E".

FOR: AGRICULTURAL FERTILIZERS, IN CLASS
1 (U.S. CLS. 1, 5, 6, 10, 26 AND 46).

SER. NO. 77-368,564, FILED 1-10-2008.

FIRST USE 8-24-2001; IN COMMERCE 8-24-2001.

JOHN DALIER, EXAMINING ATTORNEY

Int. Cl.: 39

Prior U.S. Cls.: 100 and 105

United States Patent and Trademark Office

Reg. No. 3,484,412

Registered Aug. 12, 2008

**SERVICE MARK
PRINCIPAL REGISTER**



LOWCOUNTRY REGIONAL TRANSPORTATION
AUTHORITY (SOUTH CAROLINA REGIONAL
GOVERNMENT)
P.O. BOX 2029
BLUFFTON, SC 29910

FOR: TRANSPORTATION OF PASSENGERS
AND/OR GOODS BY BUS, IN CLASS 39 (U.S. CLS.
100 AND 105).

FIRST USE 4-5-2007; IN COMMERCE 4-5-2007.

THE COLOR(S) YELLOW, GREEN, BLUE, AND
GRAY IS/ARE CLAIMED AS A FEATURE OF THE
MARK.

THE MARK CONSISTS OF A YELLOW HALF
CIRCLE AT THE BOTTOM LEFT OF THE DRAW-
ING FROM WHICH FIVE WAVES EMANATE. THE
FIRST TWO WAVES ARE GREEN AND POINT IN
THE DIRECTION OF THE TOP OF THE DRAWING.
THE SECOND TWO WAVES CONTAIN THE COL-
ORS YELLOW, GREEN AND BLUE (IN THAT
ORDER AWAY FROM THE SEMI-CIRCLE) AND
POINT MORE IN THE DIRECTION OF THE RIGHT-

HAND SIDE OF THE DRAWING. THE FIFTH WAVE
ALSO CONTAINS THE COLORS OF YELLOW,
GREEN AND BLUE IN THAT ORDER AND IS
SIGNIFICANTLY LONGER THAN THE OTHER
WAVES. IT POINTS DIRECTLY AT THE RIGHT-
HAND SIDE OF THE DRAWING AND HAS FIVE
SMALLER WAVES WHICH APPEAR ABOVE AND
BELOW THE FIFTH WAVE. THE FIRST WAVE IS
ON TOP OF THE FIFTH WAVE, IS BLUE, AND
ARCHES DOWNWARD. THE SECOND WAVE IS
ALSO ON TOP, IS SHORTER THAN THE OTHER
WAVES, IS GRAY, AND ARCHES UPWARD. THE
THIRD WAVE IS LONGER THAN THE REST, IS
STRAIGHT AT FIRST, THEN ARCHES DOWN-
WARD AND EXTENDS BEYOND THE FIFTH
WAVE EMANATING FROM THE SEMI-CIRCLE.
THE THIRD WAVE APPEARS BELOW THE FIFTH
WAVE, IS GREEN AND BLUE, AND ARCHES
DOWNWARD. THE FIFTH WAVE APPEARS BE-
LOW ALSO, IS GRAY, AND ARCHES DOWNWARD.

SER. NO. 77-368,618, FILED 1-10-2008.

ASMAT KHAN, EXAMINING ATTORNEY

Int. Cl.: 41

Prior U.S. Cls.: 100, 101 and 107

United States Patent and Trademark Office

Reg. No. 3,484,413

Registered Aug. 12, 2008

**SERVICE MARK
PRINCIPAL REGISTER**

ADVENTURE EYE

ADVENTURE EYE VIDEO SYSTEMS, L.L.C.
(LOUISIANA LTD LIAB CO)
102 N. HOLLY ST.
HAMMOND, LA 70401

THE MARK CONSISTS OF STANDARD CHAR-
ACTERS WITHOUT CLAIM TO ANY PARTICULAR
FONT, STYLE, SIZE, OR COLOR.

FOR: RENTAL OF AUDIO-VISUAL EQUIPMENT,
IN CLASS 41 (U.S. CLS. 100, 101 AND 107).

SER. NO. 77-368,625, FILED 1-10-2008.

FIRST USE 4-18-2007; IN COMMERCE 4-18-2007.

ELLEN B. AWRICH, EXAMINING ATTORNEY

Int. Cl.: 41

Prior U.S. Cls.: 100, 101 and 107

United States Patent and Trademark Office

Reg. No. 3,484,414

Registered Aug. 12, 2008

**SERVICE MARK
PRINCIPAL REGISTER**

meetdifferent

MEETING PROFESSIONALS INTERNATIONAL
(ILLINOIS NON-PROFIT CORPORATION)
SUITE 1700
3030 LBJ FREEWAY
DALLAS, TX 75234

FOR: EDUCATIONAL SERVICES, NAMELY,
CONDUCTING CONFERENCES IN THE FIELD OF
MEETINGS, IN CLASS 41 (U.S. CLS. 100, 101 AND
107).

FIRST USE 10-19-2007; IN COMMERCE 10-19-2007.

THE MARK CONSISTS OF STANDARD CHAR-
ACTERS WITHOUT CLAIM TO ANY PARTICULAR
FONT, STYLE, SIZE, OR COLOR.

SER. NO. 77-368,641, FILED 1-10-2008.

CHRISTINA SOBRAL, EXAMINING ATTORNEY

Int. Cl.: 41

Prior U.S. Cls.: 100, 101 and 107

United States Patent and Trademark Office

Reg. No. 3,484,415

Registered Aug. 12, 2008

**SERVICE MARK
PRINCIPAL REGISTER**



MEETING PROFESSIONALS INTERNATIONAL
(ILLINOIS NON-PROFIT CORPORATION)
SUITE 1700
3030 LBJ FREEWAY
DALLAS, TX 75234

THE MARK CONSISTS OF "MEETDIFFERENT"
WITH THE E'S PLACED BACKWARDS AND AN
ARROW IN A CIRCLE TO THE UPPER RIGHT
WITH A STRIPE DOWN THE MIDDLE OF THE
ARROW.

FOR: EDUCATIONAL SERVICES, NAMELY,
CONDUCTING CONFERENCES IN THE FIELD OF
MEETINGS, IN CLASS 41 (U.S. CLS. 100, 101 AND
107).

SER. NO. 77-368,646, FILED 1-10-2008.

FIRST USE 10-19-2007; IN COMMERCE 10-19-2007.

CHRISTINA SOBRAL, EXAMINING ATTORNEY

Int. Cl.: 9

Prior U.S. Cls.: 21, 23, 26, 36 and 38

United States Patent and Trademark Office

Reg. No. 3,484,416

Registered Aug. 12, 2008

**TRADEMARK
PRINCIPAL REGISTER**

The WMDs

STURM, JAIME (UNITED STATES INDIVIDUAL)
357 GRAND ST.
NEW YORK, NY 10002 AND
BAUERS, BRIAN W. (UNITED STATES INDIVIDUAL)
113 WEST SUMMIT ST.
SOMERVILLE, NJ 08876

FOR: AUDIO RECORDINGS FEATURING ORIGINAL MUSICAL COMPOSITIONS; DOWNLOADABLE MUSICAL SOUND RECORDINGS; MUSICAL

SOUND RECORDINGS, IN CLASS 9 (U.S. CLS. 21, 23, 26, 36 AND 38).

FIRST USE 12-31-2004; IN COMMERCE 1-12-2005.

THE MARK CONSISTS OF STANDARD CHARACTERS WITHOUT CLAIM TO ANY PARTICULAR FONT, STYLE, SIZE, OR COLOR.

SER. NO. 77-368,655, FILED 1-10-2008.

AMY ALFIERI, EXAMINING ATTORNEY

Int. Cl.: 9

Prior U.S. Cls.: 21, 23, 26, 36 and 38

Reg. No. 3,484,417

United States Patent and Trademark Office

Registered Aug. 12, 2008

**TRADEMARK
PRINCIPAL REGISTER**

GoCollect!

MARSHALL AND ASSOCIATES, INC. (WASHINGTON CORPORATION)
1603 COOPER POINT RD NW
OLYMPIA, WA 98502

FOR: COMPUTER SOFTWARE FOR REMOTE COLLECTION OF GEOGRAPHIC LOCATION OF INFRASTRUCTURE AND ASSET DATA FOR UTILITIES USAGE AND GENERAL USE , IN CLASS 9 (U.S. CLS. 21, 23, 26, 36 AND 38).

FIRST USE 9-14-2006; IN COMMERCE 11-2-2006.

THE MARK CONSISTS OF STANDARD CHARACTERS WITHOUT CLAIM TO ANY PARTICULAR FONT, STYLE, SIZE, OR COLOR.

SER. NO. 77-368,662, FILED 1-10-2008.

PAUL CROWLEY, EXAMINING ATTORNEY

Int. Cl.: 37

Prior U.S. Cls.: 100, 103 and 106

United States Patent and Trademark Office

Reg. No. 3,484,418

Registered Aug. 12, 2008

**SERVICE MARK
PRINCIPAL REGISTER**

MHT

MANEKIN CONSTRUCTION LLC (MARYLAND
LTD LIAB CO)
8601 ROBERT FULTON DRIVE
COLUMBIA, MD 21046

FOR: CONSTRUCTION SERVICES, NAMELY,
CONSTRUCTION MANAGEMENT AND GENERAL
CONSTRUCTION CONTRACTING, BUILDING
CONSTRUCTION AND REPAIR, IN CLASS 37 (U.S.
CLS. 100, 103 AND 106).

FIRST USE 12-1-2006; IN COMMERCE 12-1-2006.

THE MARK CONSISTS OF STANDARD CHAR-
ACTERS WITHOUT CLAIM TO ANY PARTICULAR
FONT, STYLE, SIZE, OR COLOR.

SER. NO. 77-368,664, FILED 1-10-2008.

DORITT L. CARROLL, EXAMINING ATTORNEY

Int. Cl.: 41

Prior U.S. Cls.: 100, 101 and 107

United States Patent and Trademark Office

Reg. No. 3,484,419

Registered Aug. 12, 2008

**SERVICE MARK
PRINCIPAL REGISTER**

DJ Zimmie

SZYMKIEWICZ, MICHAEL, J (UNITED STATES
INDIVIDUAL)
1739 EAST CARSON STREET
#177
PITTSBURGH, PA 15203

NO CLAIM IS MADE TO THE EXCLUSIVE
RIGHT TO USE "DJ", APART FROM THE MARK
AS SHOWN.

FOR: DISC JOCKEYS FOR PARTIES AND SPE-
CIAL EVENTS, IN CLASS 41 (U.S. CLS. 100, 101 AND
107).

THE NAME "DJ ZIMMIE" IDENTIFIES A LIVING
INDIVIDUAL WHOSE CONSENT IS OF RECORD.

FIRST USE 0-0-2005; IN COMMERCE 0-0-2005.

SER. NO. 77-368,673, FILED 1-10-2008.

THE MARK CONSISTS OF STANDARD CHAR-
ACTERS WITHOUT CLAIM TO ANY PARTICULAR
FONT, STYLE, SIZE, OR COLOR.

SIMON TENG, EXAMINING ATTORNEY

Int. Cl.: 35

Prior U.S. Cls.: 100, 101 and 102

United States Patent and Trademark Office

Reg. No. 3,484,420

Registered Aug. 12, 2008

**SERVICE MARK
PRINCIPAL REGISTER**

BikeDenver

BIKEDENVER (COLORADO CORPORATION)
2440 QUITMAN ST
DENVER, CO 802121223

FOR: PUBLIC ADVOCACY TO PROMOTE
AWARENESS OF BICYCLING AS AN ENERGY
EFFICIENT NON-POLLUTING HEALTHY AND EN-
JOYABLE TRANSPORTATION ALTERNATIVE, IN
CLASS 35 (U.S. CLS. 100, 101 AND 102).

FIRST USE 5-1-2001; IN COMMERCE 5-1-2001.

THE MARK CONSISTS OF STANDARD CHAR-
ACTERS WITHOUT CLAIM TO ANY PARTICULAR
FONT, STYLE, SIZE, OR COLOR.

SER. NO. 77-368,679, FILED 1-10-2008.

KRISTIN CARLSON, EXAMINING ATTORNEY

Int. Cl.: 37

Prior U.S. Cls.: 100, 103 and 106

United States Patent and Trademark Office

Reg. No. 3,484,421

Registered Aug. 12, 2008

**SERVICE MARK
PRINCIPAL REGISTER**

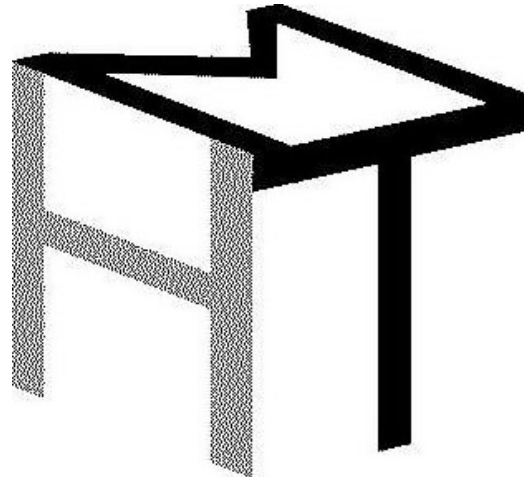

MANEKIN CONSTRUCTION LLC (MARYLAND
LTD LIAB CO)
8601 ROBERT FULTON DRIVE
COLUMBIA, MD 21046

FOR: CONSTRUCTION SERVICES, NAMELY,
CONSTRUCTION MANAGEMENT AND GENERAL
CONSTRUCTION CONTRACTING, BUILDING
CONSTRUCTION AND REPAIR, IN CLASS 37 (U.S.
CLS. 100, 103 AND 106).

FIRST USE 12-1-2006; IN COMMERCE 12-1-2006.

THE MARK CONSISTS OF THE CAPITAL LET-
TERS "M", "H", AND "T" ARRANGED TO APPEAR
AS THREE CONTIGUOUS FACES OF A THREE-
DIMENSIONAL CUBE..

SER. NO. 77-368,681, FILED 1-10-2008.

DORITT L. CARROLL, EXAMINING ATTORNEY

Int. Cl.: 44

Prior U.S. Cls.: 100 and 101

United States Patent and Trademark Office

Reg. No. 3,484,422

Registered Aug. 12, 2008

**SERVICE MARK
PRINCIPAL REGISTER**

BWMC

UNIVERSITY OF MARYLAND MEDICAL SYSTEM CORPORATION (MARYLAND NON-PROFIT CORPORATION)
250 W. PRATT STREET
BALTIMORE, MD 21201

THE MARK CONSISTS OF STANDARD CHARACTERS WITHOUT CLAIM TO ANY PARTICULAR FONT, STYLE, SIZE, OR COLOR.

FOR: HEALTH CARE SERVICES, IN CLASS 44 (U.S. CLS. 100 AND 101).

SER. NO. 77-368,697, FILED 1-10-2008.

FIRST USE 7-0-2005; IN COMMERCE 7-0-2005.

BARBARA A. GOLD, EXAMINING ATTORNEY

Int. Cl.: 42

Prior U.S. Cls.: 100 and 101

United States Patent and Trademark Office

Reg. No. 3,484,423

Registered Aug. 12, 2008

SERVICE MARK
PRINCIPAL REGISTER



NEW YORK CITY VACATIONS, INC. (PENNSYLVANIA CORPORATION), DBA NEW YORK CITY VACATION PACKAGES

300 MARKET STREET
KINGSTON, PA 18704

FOR: ON-LINE TRAVEL AGENCY SERVICES, NAMELY, PROVIDING TEMPORARY USE OF NON-DOWNLOADABLE COMPUTER SOFTWARE FOR MAKING TRAVEL ARRANGEMENTS OVER THE INTERNET, AND PROVIDING TEMPORARY USE OF NON-DOWNLOADABLE COMPUTER SOFTWARE FOR RECEIVING ESTIMATES FOR TRAVEL ARRANGEMENTS OVER THE INTERNET, IN CLASS 42 (U.S. CLS. 100 AND 101).

FIRST USE 1-26-2007; IN COMMERCE 1-26-2007.

NO CLAIM IS MADE TO THE EXCLUSIVE RIGHT TO USE "NYC TRIP QUOTE", APART FROM THE MARK AS SHOWN.

THE COLOR(S) RED, WHITE, AND BLUE IS/ARE CLAIMED AS A FEATURE OF THE MARK.

THE MARK CONSISTS OF ON A WHITE BACKGROUND, THE STYLIZED LETTERS "NYC", IN CAPITAL LETTERS, IN BLUE, FOLLOWED BY THE WORD "TRIP" IN STYLIZED LETTERS, IN LOWERCASE AND IN THE COLOR RED. THE FOREGOING LETTERS SIT ON TOP OF THE WORD "QUOTE", IN STYLIZED LETTERS, WRITTEN LARGER THAN THE ABOVE LETTERS, IN THE COLOR RED, WITH BLUE OUTLINING, WHERE THE "Q" IS CAPITALIZED AND THE OTHER LETTERS ARE LOWERCASE. FOR CLARIFICATION, THE AFOREMENTIONED "NYCTRIIP", IS POSITIONED DIRECTLY ON TOP OF THE AFOREMENTIONED "QUOTE", WHEREBY "NYCTRIIP" OCCUPIES SPACE DIRECTLY ABOVE THE "UOT" IN "QUOTE". THERE ARE ALSO THREE (3) HORIZONTAL RED WAVY LINES THAT BEGIN DIRECTLY TO THE LEFT OF THE "N" IN "NYCTRIIP" AND CONTINUE LEFT THROUGH "U" AND THE "Q" OF QUOTE UNTIL THE LINES REACH INDIVIDUAL ENDPOINTS TO THE LEFT OF THE "Q" IN "QUOTE".

SER. NO. 77-368,700, FILED 1-10-2008.

MARK T. MULLEN, EXAMINING ATTORNEY

Int. Cl.: 45

Prior U.S. Cls.: 100 and 101

United States Patent and Trademark Office

Reg. No. 3,484,424

Registered Aug. 12, 2008

**SERVICE MARK
PRINCIPAL REGISTER**

Safe Families

LYDIA HOME ASSOCIATION (ILLINOIS NON-
PROFIT CORPORATION)
4300 W. IRVING PARK RD.
CHICAGO, IL 60641

FOR: PROVIDING TEMPORARY FOSTER CARE
PLACEMENT SERVICES, NAMELY, SHORT-TERM
PLACEMENT IN HOUSEHOLDS FOR CARE OF
CHILDREN OF PARENTS EXPERIENCING AN
EMERGENCY OR CRISIS , IN CLASS 45 (U.S. CLS.
100 AND 101).

FIRST USE 7-1-2002; IN COMMERCE 7-1-2002.

THE MARK CONSISTS OF STANDARD CHAR-
ACTERS WITHOUT CLAIM TO ANY PARTICULAR
FONT, STYLE, SIZE, OR COLOR.

NO CLAIM IS MADE TO THE EXCLUSIVE
RIGHT TO USE "FAMILIES", APART FROM THE
MARK AS SHOWN.

SEC. 2(F).

SER. NO. 77-368,707, FILED 1-10-2008.

SIMON TENG, EXAMINING ATTORNEY

Int. Cl.: 36

Prior U.S. Cls.: 100, 101 and 102

United States Patent and Trademark Office

Reg. No. 3,484,425

Registered Aug. 12, 2008

**SERVICE MARK
PRINCIPAL REGISTER**

DPEC

DIVERSIFIED PRIVATE EQUITY CORP. (DELA-
WARE CORPORATION)
10TH FLOOR
135 FIFTH AVENUE
NEW YORK, NY 10010

FOR: FINANCIAL AND INVESTMENT SERVI-
CES, NAMELY, MANAGEMENT AND BROKER-
AGE IN THE FIELDS OF STOCKS, BONDS,
OPTIONS, COMMODITIES, FUTURES AND OTHER
SECURITIES, AND THE INVESTMENT OF FUNDS
OF OTHERS; FINANCIAL INVESTMENT IN THE
FIELD OF EQUITY CAPITAL INVESTMENT, SECU-

RITIES AND REAL ESTATE, IN CLASS 36 (U.S. CLS.
100, 101 AND 102).

FIRST USE 2-21-2007; IN COMMERCE 2-21-2007.

THE MARK CONSISTS OF STANDARD CHAR-
ACTERS WITHOUT CLAIM TO ANY PARTICULAR
FONT, STYLE, SIZE, OR COLOR.

SER. NO. 77-368,715, FILED 1-10-2008.

ANDREA HACK, EXAMINING ATTORNEY

Int. Cls.: 16, 35 and 39

**Prior U.S. Cls.: 2, 5, 22, 23, 29, 37, 38, 50, 100, 101, 102
and 105**

Reg. No. 3,484,426

United States Patent and Trademark Office

Registered Aug. 12, 2008

**TRADEMARK
SERVICE MARK
PRINCIPAL REGISTER**

**Daytona Beach
Way More Than A Beach**

DAYTONA BEACH AREA CONVENTION AND
VISITORS BUREAU, INC. (FLORIDA COR-
PORATION)
126 E. ORANGE AVENUE
DAYTONA BEACH, FL 32114

FOR: PRINTED PERIODICALS IN THE FIELD OF
TOURISM, IN CLASS 16 (U.S. CLS. 2, 5, 22, 23, 29, 37,
38 AND 50).

FIRST USE 1-4-2008; IN COMMERCE 1-4-2008.

FOR: PROMOTING TOURISM IN THE DAYTO-
NA BEACH, FLORIDA AREA, IN CLASS 35 (U.S.
CLS. 100, 101 AND 102).

FIRST USE 1-4-2008; IN COMMERCE 1-4-2008.

FOR: PROVIDING A WEBSITE THAT FEATURES
INFORMATION ON BEACH TOURISM, IN CLASS
39 (U.S. CLS. 100 AND 105).

FIRST USE 12-8-2007; IN COMMERCE 12-8-2007.

THE MARK CONSISTS OF STANDARD CHAR-
ACTERS WITHOUT CLAIM TO ANY PARTICULAR
FONT, STYLE, SIZE, OR COLOR.

NO CLAIM IS MADE TO THE EXCLUSIVE
RIGHT TO USE "DAYTONA BEACH", APART
FROM THE MARK AS SHOWN.

SER. NO. 77-368,724, FILED 1-10-2008.

DANIEL CAPSHAW, EXAMINING ATTORNEY

Int. Cl.: 30

Prior U.S. Cl.: 46

United States Patent and Trademark Office

Reg. No. 3,484,427

Registered Aug. 12, 2008

**TRADEMARK
PRINCIPAL REGISTER**

purpl-icious

DIXIE DALY (UNITED STATES INDIVIDUAL)
2215 BUCKINGHAM CIRCLE
LOVELAND, CO 80538

THE MARK CONSISTS OF STANDARD CHAR-
ACTERS WITHOUT CLAIM TO ANY PARTICULAR
FONT, STYLE, SIZE, OR COLOR.

FOR: CANDY; CANDY BARS; CHOCOLATE, IN
CLASS 30 (U.S. CL. 46).

SER. NO. 77-368,737, FILED 1-10-2008.

FIRST USE 12-3-2007; IN COMMERCE 12-14-2007.

RICHARD WHITE, EXAMINING ATTORNEY

Int. Cl.: 16

Prior U.S. Cls.: 2, 5, 22, 23, 29, 37, 38 and 50

Reg. No. 3,484,428

United States Patent and Trademark Office

Registered Aug. 12, 2008

**TRADEMARK
PRINCIPAL REGISTER**

Tickled Pink

DIXIE DALY (UNITED STATES INDIVIDUAL)
2215 BUCKINGHAM CIRCLE
LOVELAND, CO 80538

THE MARK CONSISTS OF STANDARD CHAR-
ACTERS WITHOUT CLAIM TO ANY PARTICULAR
FONT, STYLE, SIZE, OR COLOR.

FOR: GREETING CARDS, IN CLASS 16 (U.S. CLS.
2, 5, 22, 23, 29, 37, 38 AND 50).

SER. NO. 77-368,753, FILED 1-10-2008.

FIRST USE 5-8-2007; IN COMMERCE 6-9-2007.

RICHARD WHITE, EXAMINING ATTORNEY

Int. Cl.: 10

Prior U.S. Cls.: 26, 39 and 44

Reg. No. 3,484,429

United States Patent and Trademark Office

Registered Aug. 12, 2008

**TRADEMARK
PRINCIPAL REGISTER**

FLEXFIT

LITTLE RAPIDS CORPORATION (WISCONSIN
CORPORATION)
2273 LARSEN ROAD, P.O. BOX 19100
GREEN BAY, WI 543079100

THE MARK CONSISTS OF STANDARD CHAR-
ACTERS WITHOUT CLAIM TO ANY PARTICULAR
FONT, STYLE, SIZE, OR COLOR.

FOR: DISPOSABLE GARMENTS, NAMELY, PA-
TIENT DRAPES MADE OF NON-WOVEN MATERI-
AL, IN CLASS 10 (U.S. CLS. 26, 39 AND 44).

SER. NO. 77-368,761, FILED 1-10-2008.

FIRST USE 1-1-1999; IN COMMERCE 1-1-1999.

LEIGH CAROLINE CASE, EXAMINING ATTOR-
NEY

Int. Cl.: 41

Prior U.S. Cls.: 100, 101 and 107

United States Patent and Trademark Office

Reg. No. 3,484,430

Registered Aug. 12, 2008

**SERVICE MARK
PRINCIPAL REGISTER**



TOTAL LEADERSHIP, INC. (PENNSYLVANIA CORPORATION)
417 SYCAMORE ROAD
MERION, PA 19066

FOR: EDUCATION AND TRAINING SERVICES, NAMELY, ARRANGING PROFESSIONAL WORKSHOPS AND TRAINING COURSES; PROVIDING ON-LINE TRAINING AND INFORMATION; ONE-ON-ONE COACHING; PUBLICATION AND ON-LINE PUBLICATION OF PAPERS AND SKILLS ASSESSMENT TESTS; AND ON-LINE BLOGS, ALL IN THE FIELD OF LEADERSHIP AND PERSONAL GROWTH, IN CLASS 41 (U.S. CLS. 100, 101 AND 107).

FIRST USE 11-30-2007; IN COMMERCE 11-30-2007.

THE COLOR(S) GRAY, DARK BLUE, LIGHT BLUE, ORANGE, AND MUSTARD YELLOW IS/ARE CLAIMED AS A FEATURE OF THE MARK.

THE MARK CONSISTS OF A TARGET COMPOSED OF ALTERNATING COLORS FROM THE OUTER PERIMETER TO THE CENTER, AS FOLLOWS: GRAY, DARK BLUE, GRAY, LIGHT BLUE, GRAY, ORANGE, GRAY, MUSTARD YELLOW, AND GRAY.

SER. NO. 77-368,767, FILED 1-10-2008.

ALICE SUE CARRUTHERS, EXAMINING ATTORNEY

Int. Cl.: 41

Prior U.S. Cls.: 100, 101 and 107

United States Patent and Trademark Office

Reg. No. 3,484,431

Registered Aug. 12, 2008

**SERVICE MARK
PRINCIPAL REGISTER**



BLOCKSTARS PRODUCTIONS, LLC (NEW JERSEY LTD LIAB CO)
1084 BOND ST
ELIZABETH, NJ 07201

FOR: ENTERTAINMENT IN THE NATURE OF VISUAL AND AUDIO PERFORMANCES, NAMELY, MUSICAL BAND, ROCK GROUP, GYMNASTIC, DANCE, AND BALLET PERFORMANCES; ENTERTAINMENT SERVICES, NAMELY, NON-DOWNLOADABLE RINGTONES, PRE-RECORDED MUSIC, VIDEO AND GRAPHICS PRESENTED TO MOBILE COMMUNICATIONS DEVICES VIA A GLOBAL COMPUTER NETWORK AND WIRELESS NETWORKS; MUSIC PRODUCTION SERVICES; PRODUCTION OF SOUND AND MUSIC VIDEO RECORDINGS; PRODUCTION OF SOUND RE-

CORDINGS, IN CLASS 41 (U.S. CLS. 100, 101 AND 107).

FIRST USE 5-10-2006; IN COMMERCE 5-30-2006.

THE COLOR(S) RED, BLACK AND WHITE IS/ ARE CLAIMED AS A FEATURE OF THE MARK.

THE MARK CONSISTS OF THE WORDS "BLOCK STARS" IN BLACK WITH WHITE OUTLINE, THE LETTER A HAS A WHITE STAR ON IT. RED STAR IN BACKGROUND WITH BLACK OUTLINE.

SER. NO. 77-368,770, FILED 1-10-2008.

DAWN FELDMAN, EXAMINING ATTORNEY

Int. Cl.: 44

Prior U.S. Cls.: 100 and 101

United States Patent and Trademark Office

Reg. No. 3,484,432

Registered Aug. 12, 2008

**SERVICE MARK
PRINCIPAL REGISTER**



SP HOLDINGS LLC (VIRGINIA LTD LIAB CO)
8500 ARLINGTON BOULEVARD
FAIRFAX, VA 22031

FIRST USE 2-10-1998; IN COMMERCE 2-10-1998.

FOR: VETERINARY SERVICES; VETERINARY
SURGERY; VETERINARY MEDICINE, IN CLASS
44 (U.S. CLS. 100 AND 101).

SER. NO. 77-368,787, FILED 1-10-2008.

LINDA POWELL, EXAMINING ATTORNEY

Int. Cl.: 28

Prior U.S. Cls.: 22, 23, 38 and 50

United States Patent and Trademark Office

Reg. No. 3,484,433

Registered Aug. 12, 2008

**TRADEMARK
PRINCIPAL REGISTER**

TERRATEE

TERRACARE PRODUCTS, LLC (MICHIGAN
LTD LIAB CO)
2150 CENTER INDUSTRIAL CT.
JENISON, MI 49428

THE MARK CONSISTS OF STANDARD CHAR-
ACTERS WITHOUT CLAIM TO ANY PARTICULAR
FONT, STYLE, SIZE, OR COLOR.

FOR: GOLF TEES, IN CLASS 28 (U.S. CLS. 22, 23, 38
AND 50).

SER. NO. 77-368,795, FILED 1-10-2008.

FIRST USE 12-31-2007; IN COMMERCE 12-31-2007.

TINA KUAN, EXAMINING ATTORNEY

Int. Cls.: 9 and 42

Prior U.S. Cls.: 21, 23, 26, 36, 38, 100 and 101

United States Patent and Trademark Office

Reg. No. 3,484,434

Registered Aug. 12, 2008

**TRADEMARK
SERVICE MARK
PRINCIPAL REGISTER**

ActForex

ACTFOREX, INC (DELAWARE CORPORATION)
110 WALL STREET, 7TH FLOOR
NEW YORK, NY 10005

FOR: COMPUTER E-COMMERCE SOFTWARE TO ALLOW USERS TO PERFORM ELECTRONIC FINANCIAL EXCHANGE TRANSACTIONS VIA A GLOBAL COMPUTER NETWORK, COMPUTER SOFTWARE FOR MONITORING CURRENCY TRADING TRANSACTIONS, IN CLASS 9 (U.S. CLS. 21, 23, 26, 36 AND 38).

FIRST USE 9-1-2000; IN COMMERCE 9-1-2000.

FOR: APPLICATION SERVICE PROVIDER (ASP) FEATURING COMPUTER E-COMMERCE SOFT-

WARE TO ALLOW USERS TO PERFORM ELECTRONIC FINANCIAL EXCHANGE TRANSACTIONS VIA A GLOBAL COMPUTER NETWORK, COMPUTER SOFTWARE FOR MONITORING CURRENCY TRADING TRANSACTIONS, IN CLASS 42 (U.S. CLS. 100 AND 101).

FIRST USE 9-1-2000; IN COMMERCE 9-1-2000.

THE MARK CONSISTS OF STANDARD CHARACTERS WITHOUT CLAIM TO ANY PARTICULAR FONT, STYLE, SIZE, OR COLOR.

SER. NO. 77-368,820, FILED 1-10-2008.

SUSAN STIGLITZ, EXAMINING ATTORNEY

Int. Cl.: 44

Prior U.S. Cls.: 100 and 101

United States Patent and Trademark Office

Reg. No. 3,484,435

Registered Aug. 12, 2008

**SERVICE MARK
PRINCIPAL REGISTER**

COME GROW WITH US

KID FIXER WORKSHOP, LLC (TEXAS LTD LIAB
CO)
3616 BURTS DRIVE
KELLER, TX 76248

THE MARK CONSISTS OF STANDARD CHAR-
ACTERS WITHOUT CLAIM TO ANY PARTICULAR
FONT, STYLE, SIZE, OR COLOR.

FOR: PEDIATRIC MEDICAL SERVICES;
HEALTH CARE SERVICES FOR CHILDREN, IN
CLASS 44 (U.S. CLS. 100 AND 101).

SER. NO. 77-368,827, FILED 1-10-2008.

FIRST USE 1-13-2002; IN COMMERCE 1-13-2002.

SUSAN STIGLITZ, EXAMINING ATTORNEY

Int. Cl.: 31

Prior U.S. Cls.: 1 and 46

United States Patent and Trademark Office

Reg. No. 3,484,436

Registered Aug. 12, 2008

**TRADEMARK
PRINCIPAL REGISTER**

Atlas Farms

KARLENE'S LANDSCAPING, MICHIGAN DIVI-
SION LLC (MICHIGAN LTD LIAB CO)
4344 ATLAS ROAD
DAVISON, MI 48423 AND
KARLENE'S LANDSCAPING, MICHIGAN DIVI-
SION LLC (MICHIGAN LTD LIAB CO)
4344 ATLAS ROAD
DAVISON, MI 48423

FOR: FRESH AND RAW VEGETABLES, NAME-
LY, TOMATOES, PUMPKINS, SUMMER SQUASH
AND EGGPLANTS, IN CLASS 31 (U.S. CLS. 1 AND
46).

FIRST USE 12-22-2005; IN COMMERCE 12-22-2005.

THE MARK CONSISTS OF STANDARD CHAR-
ACTERS WITHOUT CLAIM TO ANY PARTICULAR
FONT, STYLE, SIZE, OR COLOR.

NO CLAIM IS MADE TO THE EXCLUSIVE
RIGHT TO USE "FARMS", APART FROM THE
MARK AS SHOWN.

SER. NO. 77-368,834, FILED 1-10-2008.

REBECCA GILBERT, EXAMINING ATTORNEY

Int. Cl.: 24

Prior U.S. Cls.: 42 and 50

United States Patent and Trademark Office

Reg. No. 3,484,437

Registered Aug. 12, 2008

**TRADEMARK
PRINCIPAL REGISTER**

INSTAKILT

JAMES ALEXANDER BUCHANAN (CANADA
INDIVIDUAL)
21 TRILLER AVENUE
TORONTO, ONTARIO, CANADA M6K3B7

THE MARK CONSISTS OF STANDARD CHAR-
ACTERS WITHOUT CLAIM TO ANY PARTICULAR
FONT, STYLE, SIZE, OR COLOR.

FOR: TOWELS, IN CLASS 24 (U.S. CLS. 42 AND 50).

SER. NO. 77-368,838, FILED 1-10-2008.

FIRST USE 4-30-2006; IN COMMERCE 1-31-2007.

SANI KHOURI, EXAMINING ATTORNEY

Int. Cl.: 35

Prior U.S. Cls.: 100, 101 and 102

United States Patent and Trademark Office

Reg. No. 3,484,438

Registered Aug. 12, 2008

**SERVICE MARK
PRINCIPAL REGISTER**

netQUOTE

NETQUOTE INC. (COLORADO CORPORATION)
1860 BLAKE STREET, SUITE 900
DENVER, CO 80202

FOR: INSURANCE REFERRAL SERVICES, IN
CLASS 35 (U.S. CLS. 100, 101 AND 102).

FIRST USE 8-15-2007; IN COMMERCE 8-15-2007.

OWNER OF U.S. REG. NOS. 2,247,258, 2,846,039,
AND 3,089,892.

THE MARK CONSISTS OF THE WORD "NET-
QUOTE" IN WHICH THE LETTER "Q" HAS AN
ARROWHEAD.

SER. NO. 77-368,850, FILED 1-10-2008.

MICHELE SWAIN, EXAMINING ATTORNEY

Int. Cl.: 9

Prior U.S. Cls.: 21, 23, 26, 36 and 38

Reg. No. 3,484,439

United States Patent and Trademark Office

Registered Aug. 12, 2008

**TRADEMARK
PRINCIPAL REGISTER**

GoWork!

MARSHALL AND ASSOCIATES, INC. (WASHINGTON CORPORATION)
1603 COOPER POINT RD NW
OLYMPIA, WA 98502

FOR: COMPUTER SOFTWARE FOR REMOTE RETRIEVAL, DISPLAY AND EDITING OF WORK ORDER DATA FOR UTILITIES USAGE AND GENERAL USE, IN CLASS 9 (U.S. CLS. 21, 23, 26, 36 AND 38).

FIRST USE 9-14-2006; IN COMMERCE 11-2-2006.

THE MARK CONSISTS OF STANDARD CHARACTERS WITHOUT CLAIM TO ANY PARTICULAR FONT, STYLE, SIZE, OR COLOR.

SER. NO. 77-368,856, FILED 1-10-2008.

PAUL CROWLEY, EXAMINING ATTORNEY

Int. Cl.: 9

Prior U.S. Cls.: 21, 23, 26, 36 and 38

Reg. No. 3,484,440

United States Patent and Trademark Office

Registered Aug. 12, 2008

**TRADEMARK
PRINCIPAL REGISTER**

MAGNABRITE

SMITHSON, MICHAEL H. (UNITED STATES IN-
DIVIDUAL)
2007 WEST STATE STREET
GARLAND, TX 75042

THE MARK CONSISTS OF STANDARD CHAR-
ACTERS WITHOUT CLAIM TO ANY PARTICULAR
FONT, STYLE, SIZE, OR COLOR.

FOR: OPTICAL MAGNIFYING LENSES, IN
CLASS 9 (U.S. CLS. 21, 23, 26, 36 AND 38).

SER. NO. 77-368,861, FILED 1-10-2008.

FIRST USE 11-0-1994; IN COMMERCE 11-0-1994.

PAUL CROWLEY, EXAMINING ATTORNEY

Int. Cl.: 35

Prior U.S. Cls.: 100, 101 and 102

United States Patent and Trademark Office

Reg. No. 3,484,441

Registered Aug. 12, 2008

**SERVICE MARK
PRINCIPAL REGISTER**

The logo for "eCotton" features the word "eCotton" in a stylized, lowercase serif font. The "e" is smaller and positioned to the left of the "C". Above the "C" and "o" are two stylized, cloud-like wisps of cotton, rendered in a light gray color with a soft, textured appearance.

EWR, INC. (TENNESSEE CORPORATION)
SUITE 100
6055 PRIMACY PARKWAY
CORDOVA, TN 38119

FOR: E-COMMERCE SERVICES IN THE FIELD OF COTTON, NAMELY, FACILITATING THE SALE AND PURCHASE OF COTTON BETWEEN COTTON FARMS AND COTTON MILLS AND OTHER RAW COTTON BUYERS VIA THE INTERNET, IN CLASS 35 (U.S. CLS. 100, 101 AND 102).

FIRST USE 3-1-2000; IN COMMERCE 3-1-2000.

THE MARK CONSISTS OF THE WORD "ECOTTON" WITH CLOUD-LIKE WISPS OF COTTON IN A GRAPHIC ABOVE THE WORD "ECOTTON".

SEC. 2(F).

SER. NO. 77-368,867, FILED 1-10-2008.

MARGERY A. TIERNEY, EXAMINING ATTORNEY

Int. Cls.: 16, 35 and 41

**Prior U.S. Cls.: 2, 5, 22, 23, 29, 37, 38, 50, 100, 101, 102
and 107**

Reg. No. 3,484,442

United States Patent and Trademark Office

Registered Aug. 12, 2008

**TRADEMARK
SERVICE MARK
PRINCIPAL REGISTER**



**NATIONAL CUTTING HORSE ASSOCIATION
(TEXAS CORPORATION)
260 BAILEY AVENUE
FORT WORTH, TX 76107**

**FOR: PRINTED TRADE AND HOBBY JOURNALS
IN THE FIELD OF CUTTING HORSES; PRINTED
PROGRAMS AND GUIDES FOR CUTTING HORSE
EVENTS AND COMPETITIONS; PRINTED MAN-
UALS FEATURING RULES AND BY-LAWS OF THE
NATIONAL CUTTING HORSE ASSOCIATION;
PRINTED INSTRUCTIONAL, EDUCATIONAL
AND TEACHING MATERIALS IN THE FIELD OF
CUTTING HORSES, IN CLASS 16 (U.S. CLS. 2, 5, 22,
23, 29, 37, 38 AND 50).**

FIRST USE 2-1-1983; IN COMMERCE 2-1-1983.

**FOR: ASSOCIATION SERVICES, NAMELY, PRO-
MOTING THE INTERESTS OF CUTTING HORSES
AND CUTTING HORSE COMPETITIONS, IN CLASS
35 (U.S. CLS. 100, 101 AND 102).**

FIRST USE 2-1-1983; IN COMMERCE 2-1-1983.

**FOR: CONDUCTING COMPETITIONS IN THE
FIELD OF CUTTING HORSES; PROVIDING COUR-
SES ABOUT THE SPORT OF CUTTING HORSE
COMPETITIONS AS IT RELATES TO HORSE CARE,
RIDERS, TRAINERS, JUDGES AND OTHERS IN-
VOLVED IN HORSE CUTTING COMPETITIONS;
PROVIDING INFORMATION ABOUT HORSE CUT-
TING COMPETITIONS; PROVIDING ONLINE IN-
FORMATION ABOUT HORSE CUTTING
COMPETITIONS, IN CLASS 41 (U.S. CLS. 100, 101
AND 107).**

FIRST USE 2-1-1983; IN COMMERCE 2-1-1983.

SER. NO. 77-368,875, FILED 1-10-2008.

MARGERY A. TIERNEY, EXAMINING ATTORNEY

Int. Cl.: 41

Prior U.S. Cls.: 100, 101 and 107

United States Patent and Trademark Office

Reg. No. 3,484,443

Registered Aug. 12, 2008

**SERVICE MARK
PRINCIPAL REGISTER**



THE MOYER FOUNDATION (WASHINGTON
NON-PROFIT CORPORATION)
2426 32ND AVE. W. #200
SEATTLE, WA 98199

FOR: RECREATIONAL CAMPS, NAMELY,
CAMPS FOR CHILDREN WHO HAVE LOST LOVED
ONES, IN CLASS 41 (U.S. CLS. 100, 101 AND 107).

FIRST USE 8-0-2003; IN COMMERCE 8-26-2005.

OWNER OF U.S. REG. NO. 3,090,650.

NO CLAIM IS MADE TO THE EXCLUSIVE
RIGHT TO USE "CAMP", APART FROM THE
MARK AS SHOWN.

THE MARK CONSISTS IN PART OF A FIVE-
POINT STAR SHADED BEHIND A SEA BIRD.

SER. NO. 77-368,878, FILED 1-10-2008.

IRA J. GOODSAY, EXAMINING ATTORNEY

Int. Cl.: 37

Prior U.S. Cls.: 100, 103 and 106

United States Patent and Trademark Office

Reg. No. 3,484,444

Registered Aug. 12, 2008

**SERVICE MARK
PRINCIPAL REGISTER**

RELAX IN YOUR CAR - WE DO
THE WASHING FOR YOU!

LAMAR, SR., BECK R. (UNITED STATES INDIVIDUAL)
6021 COCA COLA BLVD.
COLUMBUS, GA 31909

THE MARK CONSISTS OF STANDARD CHARACTERS WITHOUT CLAIM TO ANY PARTICULAR FONT, STYLE, SIZE, OR COLOR.

FOR: AUTOMOBILE CLEANING AND CAR WASHING, IN CLASS 37 (U.S. CLS. 100, 103 AND 106).

SER. NO. 77-368,880, FILED 1-10-2008.

FIRST USE 11-14-2007; IN COMMERCE 11-14-2007.

TARA PATE, EXAMINING ATTORNEY

Int. Cl.: 41

Prior U.S. Cls.: 100, 101 and 107

United States Patent and Trademark Office

Reg. No. 3,484,445

Registered Aug. 12, 2008

**SERVICE MARK
PRINCIPAL REGISTER**

THE MOYER FOUNDATION

THE MOYER FOUNDATION (WASHINGTON
NON-PROFIT CORPORATION)
2426 32ND AVE. W. #200
SEATTLE, WA 98199

OWNER OF U.S. REG. NOS. 2,988,371, 3,048,867
AND OTHERS.

FOR: RECREATIONAL CAMPS, NAMELY,
CAMPS FOR CHILDREN WHO HAVE LOST LOVED
ONES, IN CLASS 41 (U.S. CLS. 100, 101 AND 107).

NO CLAIM IS MADE TO THE EXCLUSIVE
RIGHT TO USE "FOUNDATION", APART FROM
THE MARK AS SHOWN.

FIRST USE 8-0-2003; IN COMMERCE 8-26-2005.

SER. NO. 77-368,887, FILED 1-10-2008.

THE MARK CONSISTS OF STANDARD CHAR-
ACTERS WITHOUT CLAIM TO ANY PARTICULAR
FONT, STYLE, SIZE, OR COLOR.

IRA J. GOODSaid, EXAMINING ATTORNEY

Int. Cl.: 41

Prior U.S. Cls.: 100, 101 and 107

United States Patent and Trademark Office

Reg. No. 3,484,446

Registered Aug. 12, 2008

**SERVICE MARK
PRINCIPAL REGISTER**

**BECAUSE NO CHILD SHOULD
GRIEVE ALONE**

THE MOYER FOUNDATION (WASHINGTON
NON-PROFIT CORPORATION)
2426 32ND AVE. W. #200
SEATTLE, WA 98199

THE MARK CONSISTS OF STANDARD CHAR-
ACTERS WITHOUT CLAIM TO ANY PARTICULAR
FONT, STYLE, SIZE, OR COLOR.

FOR: RECREATIONAL CAMPS, NAMELY,
CAMPS FOR CHILDREN WHO HAVE LOST LOVED
ONES, IN CLASS 41 (U.S. CLS. 100, 101 AND 107).

SER. NO. 77-368,896, FILED 1-10-2008.

FIRST USE 3-0-2007; IN COMMERCE 3-0-2007.

IRA J. GOODSaid, EXAMINING ATTORNEY

Int. Cl.: 25

Prior U.S. Cls.: 22 and 39

United States Patent and Trademark Office

Reg. No. 3,484,447

Registered Aug. 12, 2008

**TRADEMARK
PRINCIPAL REGISTER**

SKU

T.S.F. WHOLESALE AND T-SHIRT PRINTING
LLC (CALIFORNIA LTD LIAB CO)
3400 SOUTH MAIN STREET
LOS ANGELES, CA 90007

FOR: CLOTHING, NAMELY, MEN'S, WOMEN'S,
MISSY'S, JUNIORS', CHILDREN'S AND INFANTS'
JEANS, PANTS, TROUSERS, CAPRIS, LEGGINGS,
SHORTS, SKORTS, OVERALLS, SHORTALLS,
SKIRTS, DRESSES, TOPS, T-SHIRTS, TANK TOPS,
SWEATSHIRTS, SWEAT PANTS, BLOUSES, SHIRTS,
JACKETS, COATS, SWEATERS, VESTS, CARDI-
GANS, SCARVES, SOCKS, UNDERWEAR, LINGER-
IE, LOUNGEWEAR, THERMAL WEAR, NAMELY,
SOCKS AND UNDERWEAR, BANDANAS, WRIST-

BANDS, NECKTIES, FOOTWEAR, HATS, CAPS,
HEADWEAR, BOOTS, SANDALS AND BELTS, IN
CLASS 25 (U.S. CLS. 22 AND 39).

FIRST USE 1-5-2008; IN COMMERCE 1-5-2008.

THE MARK CONSISTS OF STANDARD CHAR-
ACTERS WITHOUT CLAIM TO ANY PARTICULAR
FONT, STYLE, SIZE, OR COLOR.

SER. NO. 77-368,903, FILED 1-10-2008.

DAVID YONTEF, EXAMINING ATTORNEY

Int. Cl.: 41

Prior U.S. Cls.: 100, 101 and 107

United States Patent and Trademark Office

Reg. No. 3,484,448

Registered Aug. 12, 2008

**SERVICE MARK
PRINCIPAL REGISTER**

Professor Mom

SHANKS, HEATHER C. (UNITED STATES INDIVIDUAL)
751 SUMMER CREEK RD.
OCONOMOWOC, WI 53066

THE MARK CONSISTS OF STANDARD CHARACTERS WITHOUT CLAIM TO ANY PARTICULAR FONT, STYLE, SIZE, OR COLOR.

FOR: EDUCATION SERVICES, NAMELY, PROVIDING LIVE AND ON-LINE CLASSES IN THE FIELD OF BUSINESS, IN CLASS 41 (U.S. CLS. 100, 101 AND 107).

SER. NO. 77-368,924, FILED 1-10-2008.

FIRST USE 1-4-2008; IN COMMERCE 1-7-2008.

JULIE WATSON, EXAMINING ATTORNEY

Int. Cl.: 5

Prior U.S. Cls.: 6, 18, 44, 46, 51 and 52

Reg. No. 3,484,449

United States Patent and Trademark Office

Registered Aug. 12, 2008

**TRADEMARK
PRINCIPAL REGISTER**

MiteGard

USAGRITECH, INC. (NEVADA CORPORATION)
179 NIBLICK RD., #405
PASO ROBLES, CA 93446

THE MARK CONSISTS OF STANDARD CHAR-
ACTERS WITHOUT CLAIM TO ANY PARTICULAR
FONT, STYLE, SIZE, OR COLOR.

FOR: NATURAL AND ORGANIC MITICIDE
SPRAY FOR CROP AND ANIMAL AGRICULTURE,
IN CLASS 5 (U.S. CLS. 6, 18, 44, 46, 51 AND 52).

SER. NO. 77-368,941, FILED 1-10-2008.

FIRST USE 1-0-2007; IN COMMERCE 3-0-2007.

ELLEN B. AWRICH, EXAMINING ATTORNEY

Int. Cl.: 14

Prior U.S. Cls.: 2, 27, 28 and 50

United States Patent and Trademark Office

Reg. No. 3,484,450

Registered Aug. 12, 2008

**TRADEMARK
PRINCIPAL REGISTER**

OSTASZ STUDIO

OSTASZ STUDIO INC. (NEW YORK CORPORATION)

64W 48TH STREET

NEW YORK, NY 10036

FOR: JEWELRY, IN CLASS 14 (U.S. CLS. 2, 27, 28 AND 50).

FIRST USE 11-30-2005; IN COMMERCE 11-30-2005.

THE MARK CONSISTS OF STANDARD CHARACTERS WITHOUT CLAIM TO ANY PARTICULAR FONT, STYLE, SIZE, OR COLOR.

NO CLAIM IS MADE TO THE EXCLUSIVE RIGHT TO USE "STUDIO", APART FROM THE MARK AS SHOWN.

SER. NO. 77-368,949, FILED 1-10-2008.

REBECCA GILBERT, EXAMINING ATTORNEY

Int. Cl.: 21

Prior U.S. Cls.: 2, 13, 23, 29, 30, 33, 40 and 50

United States Patent and Trademark Office

Reg. No. 3,484,451

Registered Aug. 12, 2008

**TRADEMARK
PRINCIPAL REGISTER**

BREAKFAST 101 BY TABLETOPS

TABLETOPS UNLIMITED, INC. (CALIFORNIA CORPORATION)
23000 AVALON BOULEVARD
CARSON, CA 90745

FOR: KITCHENWARE, NAMELY, COOKING POTS, IRON GRIDDLES, IRON BACON PRESSES, EGG RINGS, EGG POACHERS, POT LIDS, SLOTTED EGG TURNERS, LADLES, AND FRYING PANS, IN CLASS 21 (U.S. CLS. 2, 13, 23, 29, 30, 33, 40 AND 50).

FIRST USE 2-10-2006; IN COMMERCE 2-10-2006.

THE MARK CONSISTS OF STANDARD CHARACTERS WITHOUT CLAIM TO ANY PARTICULAR FONT, STYLE, SIZE, OR COLOR.

OWNER OF U.S. REG. NOS. 3,240,691, 3,283,715 AND OTHERS.

NO CLAIM IS MADE TO THE EXCLUSIVE RIGHT TO USE "BREAKFAST", APART FROM THE MARK AS SHOWN.

SER. NO. 77-368,951, FILED 1-10-2008.

DOMINIC FATHY, EXAMINING ATTORNEY

Int. Cl.: 21

Prior U.S. Cls.: 2, 13, 23, 29, 30, 33, 40 and 50

United States Patent and Trademark Office

Reg. No. 3,484,452

Registered Aug. 12, 2008

**TRADEMARK
PRINCIPAL REGISTER**

COOKIES 101 BY TABLETOPS

TABLETOPS UNLIMITED, INC. (CALIFORNIA CORPORATION)

23000 AVALON BOULEVARD

CARSON, CA 90745

FOR: KITCHENWARE, NAMELY, COOKIE SHEETS, COOLING RACKS FOR BAKED GOODS, MIXING BOWLS, WHISKS, SPATULAS, AND COOKIE CUTTERS, IN CLASS 21 (U.S. CLS. 2, 13, 23, 29, 30, 33, 40 AND 50).

FIRST USE 1-25-2006; IN COMMERCE 1-25-2006.

THE MARK CONSISTS OF STANDARD CHARACTERS WITHOUT CLAIM TO ANY PARTICULAR FONT, STYLE, SIZE, OR COLOR.

OWNER OF U.S. REG. NOS. 3,240,691, 3,283,715 AND OTHERS.

NO CLAIM IS MADE TO THE EXCLUSIVE RIGHT TO USE "COOKIES", APART FROM THE MARK AS SHOWN.

SER. NO. 77-368,953, FILED 1-10-2008.

DOMINIC FATHY, EXAMINING ATTORNEY

Int. Cls.: 41 and 42

Prior U.S. Cls.: 100, 101 and 107

United States Patent and Trademark Office

Reg. No. 3,484,453

Registered Aug. 12, 2008

**SERVICE MARK
PRINCIPAL REGISTER**

Tybu

BURNETT, TYRESE (UNITED STATES INDIVIDUAL)
SUITE 201
5050 SEPULVEDA BLVD
SHERMAN OAKS, CA 91403

FOR: FILM PRODUCTION AND TELEVISION PRODUCTION, IN CLASS 41 (U.S. CLS. 100, 101 AND 107).

FIRST USE 2-16-1999; IN COMMERCE 2-16-1999.

FOR: GRAPHIC DESIGN, WEB DESIGN, SET DESIGN FOR THEATRICAL ENTERPRISES AND

INTERIOR DESIGN, IN CLASS 42 (U.S. CLS. 100 AND 101).

FIRST USE 2-16-1999; IN COMMERCE 2-16-1999.

THE MARK CONSISTS OF STANDARD CHARACTERS WITHOUT CLAIM TO ANY PARTICULAR FONT, STYLE, SIZE, OR COLOR.

SER. NO. 77-368,963, FILED 1-10-2008.

BENJAMIN ALLEN, EXAMINING ATTORNEY

Int. Cl.: 5

Prior U.S. Cls.: 6, 18, 44, 46, 51 and 52

Reg. No. 3,484,454

United States Patent and Trademark Office

Registered Aug. 12, 2008

**TRADEMARK
PRINCIPAL REGISTER**

FEMAXIUM

SAVVIER LP (CALIFORNIA LIMITED PART-
NERSHIP)
SUITE 130
5790 FLEET STREET
CARLSBAD, CA 92210

FOR: NON-PRESCRIPTION HEALTH SUPPLE-
MENTS, NAMELY, DIETARY SUPPLEMENTS FOR
WOMEN, DIETARY SUPPLEMENTS FOR SEXUAL
ENHANCEMENT, VITAMIN AND MINERAL SUP-
PLEMENTS, HERBAL SUPPLEMENTS, BOTANI-
CAL SUPPLEMENTS, HOMEOPATHIC
SUPPLEMENTS, NUTRACEUTICALS FOR USE AS
A DIETARY SUPPLEMENT, FOOD SUPPLEMENTS,

NUTRITIONAL ADDITIVES FOR USE AS DIETARY
SUPPLEMENTS, ANTIOXIDANT SUPPLEMENTS,
IN CLASS 5 (U.S. CLS. 6, 18, 44, 46, 51 AND 52).

FIRST USE 2-19-2007; IN COMMERCE 2-19-2007.

THE MARK CONSISTS OF STANDARD CHAR-
ACTERS WITHOUT CLAIM TO ANY PARTICULAR
FONT, STYLE, SIZE, OR COLOR.

SER. NO. 77-368,965, FILED 1-10-2008.

REBECCA SMITH, EXAMINING ATTORNEY

Int. Cl.: 5

Prior U.S. Cls.: 6, 18, 44, 46, 51 and 52

Reg. No. 3,484,455

United States Patent and Trademark Office

Registered Aug. 12, 2008

**TRADEMARK
PRINCIPAL REGISTER**

DuoGard

USAGRITECH, INC. (NEVADA CORPORATION)
179 NIBLICK RD., #405
PASO ROBLES, CA 93446

THE MARK CONSISTS OF STANDARD CHAR-
ACTERS WITHOUT CLAIM TO ANY PARTICULAR
FONT, STYLE, SIZE, OR COLOR.

FOR: FUNGICIDES FOR AGRICULTURAL USE;
INSECTICIDES FOR AGRICULTURAL USE, IN
CLASS 5 (U.S. CLS. 6, 18, 44, 46, 51 AND 52).

SER. NO. 77-368,970, FILED 1-10-2008.

FIRST USE 8-0-2007; IN COMMERCE 8-0-2007.

ELLEN B. AWRICH, EXAMINING ATTORNEY

Int. Cl.: 35

Prior U.S. Cls.: 100, 101 and 102

United States Patent and Trademark Office

Reg. No. 3,484,456

Registered Aug. 12, 2008

**SERVICE MARK
PRINCIPAL REGISTER**

MPI GLOBAL MARKETPLACE

MEETING PROFESSIONALS INTERNATIONAL
(ILLINOIS NON-PROFIT CORPORATION)
SUITE 1700
3030 LBJ FREEWAY
DALLAS, TX 75234

FOR: PROVIDING AN ONLINE DATABASE OF
VENDORS IN THE FIELD OF MEETINGS AND
EVENTS, IN CLASS 35 (U.S. CLS. 100, 101 AND 102).

FIRST USE 9-3-2007; IN COMMERCE 9-3-2007.

THE MARK CONSISTS OF STANDARD CHAR-
ACTERS WITHOUT CLAIM TO ANY PARTICULAR
FONT, STYLE, SIZE, OR COLOR.

OWNER OF U.S. REG. NOS. 1,322,732, 2,522,213,
AND 3,029,759.

NO CLAIM IS MADE TO THE EXCLUSIVE
RIGHT TO USE "GLOBAL MARKETPLACE",
APART FROM THE MARK AS SHOWN.

SER. NO. 77-368,973, FILED 1-10-2008.

CHRISTINA SOBRAL, EXAMINING ATTORNEY

Int. Cl.: 41

Prior U.S. Cls.: 100, 101 and 107

United States Patent and Trademark Office

Reg. No. 3,484,457

Registered Aug. 12, 2008

**SERVICE MARK
PRINCIPAL REGISTER**



PHOTO PRODUCTIONS

85 PHOTO PRODUCTIONS INC. (NEW YORK
CORPORATION)
#5B
85 8TH AVENUE
NEW YORK, NY 10011

NO CLAIM IS MADE TO THE EXCLUSIVE
RIGHT TO USE "PHOTO PRODUCTIONS", APART
FROM THE MARK AS SHOWN.

FOR: COMMERCIAL PHOTOGRAPHY SERVI-
CES, IN CLASS 41 (U.S. CLS. 100, 101 AND 107).

SER. NO. 77-368,997, FILED 1-10-2008.

FIRST USE 11-30-2007; IN COMMERCE 11-30-2007. DOMINIC FATHY, EXAMINING ATTORNEY

Int. Cl.: 16

Prior U.S. Cls.: 2, 5, 22, 23, 29, 37, 38 and 50

United States Patent and Trademark Office

Reg. No. 3,484,458

Registered Aug. 12, 2008

TRADEMARK
PRINCIPAL REGISTER



WORDS FOR LIFE, LLC (NEVADA LTD LIAB
CO)
1835 A S. CENTER CITY PARKWAY #188
ESCONIDO, CA 920656504

FOR: MOTIVATIONAL CARDS, IN CLASS 16 (U.S.
CLS. 2, 5, 22, 23, 29, 37, 38 AND 50).

FIRST USE 8-1-2007; IN COMMERCE 8-1-2007.

THE COLOR(S) THE ACTUAL DESIGN WILL BE
PRINTED IN VARIEGATED LETTER AND BACK-
GROUND COLORS. BACKGROUND IS BROWN OR

WHITE. LETTERING AND LOGO WILL VARY IN
COLOR ON ACTUAL PRODUCT. IS/ARE CLAIMED
AS A FEATURE OF THE MARK.

THE MARK CONSISTS OF A BROKEN SEED ON
LEFT OF "SEEDPACKETS". WITH "WORDS FOR
LIFE" BELOW.

SER. NO. 77-369,000, FILED 1-10-2008.

GINA HAYES, EXAMINING ATTORNEY

Int. Cls.: 18, 20 and 25

Prior U.S. Cls.: 1, 2, 3, 13, 22, 25, 32, 39, 41 and 50

United States Patent and Trademark Office

Reg. No. 3,484,459

Registered Aug. 12, 2008

**TRADEMARK
PRINCIPAL REGISTER**

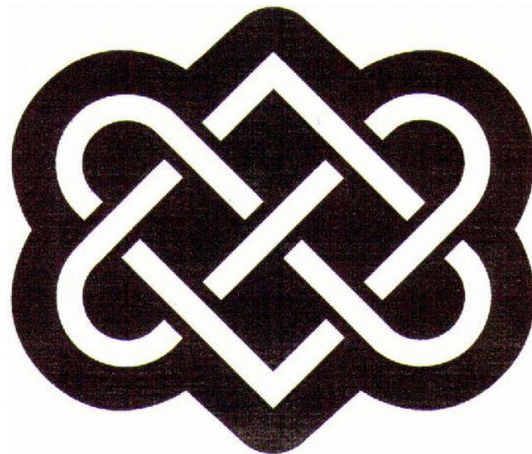

SHERPA ADVENTURE GEAR, INC. (WASHINGTON CORPORATION), DBA DUO WEAR
OAKESDALE COMMERCE CTR, BLDG W6, STE D
810 SW 34TH STREET
RENTON, WA 98057

FOR: BACKPACKS, IN CLASS 18 (U.S. CLS. 1, 2, 3, 22 AND 41).

FIRST USE 6-1-2000; IN COMMERCE 6-1-2000.

FOR: SLEEPING BAGS; SLEEPING BAGS, IN CLASS 20 (U.S. CLS. 2, 13, 22, 25, 32 AND 50).

FIRST USE 6-1-2000; IN COMMERCE 6-1-2000.

FOR: SHIRTS; JACKETS; SHORTS; PANTS; SOCKS; SHOES; HATS; SWEATERS, IN CLASS 25 (U.S. CLS. 22 AND 39).

FIRST USE 6-1-2000; IN COMMERCE 6-1-2000.

THE MARK CONSISTS OF INTERWOVEN LINES SHAPING TWO HEARTS, HORIZONTALLY AND VERTICALLY SYMMETRIC.

SER. NO. 77-369,015, FILED 1-10-2008.

THEODORE MCBRIDE, EXAMINING ATTORNEY

Int. Cl.: 9

Prior U.S. Cls.: 21, 23, 26, 36 and 38

Reg. No. 3,484,460

United States Patent and Trademark Office

Registered Aug. 12, 2008

**TRADEMARK
PRINCIPAL REGISTER**

R-TAB

WILSON, WAYNE M. (UNITED STATES INDIVIDUAL)
3613 S. 119TH E. AVE
TULSA, OK 74146

THE MARK CONSISTS OF STANDARD CHARACTERS WITHOUT CLAIM TO ANY PARTICULAR FONT, STYLE, SIZE, OR COLOR.

FOR: A SPECIALTY COMPUTER KEYBOARD WITH A MODIFIED NUMBER PAD, IN CLASS 9 (U.S. CLS. 21, 23, 26, 36 AND 38).

SER. NO. 77-369,022, FILED 1-10-2008.

FIRST USE 11-8-2007; IN COMMERCE 1-2-2008.

JANICE L. MCMORROW, EXAMINING ATTORNEY

Int. Cl.: 43

Prior U.S. Cls.: 100 and 101

United States Patent and Trademark Office

Reg. No. 3,484,461

Registered Aug. 12, 2008

**SERVICE MARK
PRINCIPAL REGISTER**

GET CRUNCHY

PATACHOU ON THE FLY, LLC (INDIANA LTD
LIAB CO)
6206 NORTH EVANSTON AVENUE
INDIANAPOLIS, IN 46220

FOR: RESTAURANT AND CATERING SERVI-
CES, IN CLASS 43 (U.S. CLS. 100 AND 101).

FIRST USE 1-10-2008; IN COMMERCE 1-10-2008.

THE MARK CONSISTS OF STANDARD CHAR-
ACTERS WITHOUT CLAIM TO ANY PARTICULAR
FONT, STYLE, SIZE, OR COLOR.

SER. NO. 77-369,034, FILED 1-10-2008.

JANICE L. MCMORROW, EXAMINING ATTOR-
NEY

Int. Cl.: 28

Prior U.S. Cls.: 22, 23, 38 and 50

Reg. No. 3,484,462

United States Patent and Trademark Office

Registered Aug. 12, 2008

TRADEMARK
PRINCIPAL REGISTER

The logo features the word "Schaper" in a large, black, cursive script. Below the word "Schaper", the word "HAWAII" is written in a smaller, black, sans-serif, all-caps font.

SCHAPER, CARL (UNITED STATES INDIVIDUAL)
59-450 A-1 ALAPIO ROAD
HALEIWA, HI 96712

NO CLAIM IS MADE TO THE EXCLUSIVE
RIGHT TO USE "HAWAII" , APART FROM THE
MARK AS SHOWN.

FOR: SURF BOARDS, IN CLASS 28 (U.S. CLS. 22,
23, 38 AND 50).

SER. NO. 77-369,060, FILED 1-10-2008.

FIRST USE 6-1-1980; IN COMMERCE 6-1-1980.

MARY MUNSON, EXAMINING ATTORNEY

Int. Cl.: 3

Prior U.S. Cls.: 1, 4, 6, 50, 51 and 52

United States Patent and Trademark Office

Reg. No. 3,484,463

Registered Aug. 12, 2008

**TRADEMARK
PRINCIPAL REGISTER**

BioCode
BEAUTY CARE

YEH, SHENG-JEN (TAIWAN INDIVIDUAL)
NO. 402, CHONG DE RD,
TAINAN CITY, TAIWAN

FOR: FACIAL BEAUTY MASKS; GEL EYE MASKS; FACIAL CREAM; FACIAL LOTION; PERFUME; FACE AND BODY MILK; FACE POWDER PASTE; LIPSTICK; FOUNDATION MAKE-UP; WRINKLE RESISTANT CREAM; SKIN WHITENING CREAMS; COSMETIC PRODUCTS IN THE FORM OF AEROSOLS FOR SKIN CARE; COSMETICS; FACIAL CLEANSING MILK; CLEANING PREPARATIONS FOR SKIN; ESSENTIAL OILS FOR PERSONAL USE; MASSAGE OIL, IN CLASS 3 (U.S. CLS. 1, 4, 6, 50, 51 AND 52).

FIRST USE 2-16-2006; IN COMMERCE 8-16-2006.

NO CLAIM IS MADE TO THE EXCLUSIVE RIGHT TO USE "BEAUTY CARE", APART FROM THE MARK AS SHOWN.

THE MARK CONSISTS OF THE COMPOUND WORD "BIOCODE" ON TOP OF "BEAUTY CARE", AND A STREAMLINED STROKE.

SER. NO. 77-369,075, FILED 1-10-2008.

PATRICIA EVANKO, EXAMINING ATTORNEY

Int. Cl.: 36

Prior U.S. Cls.: 100, 101 and 102

United States Patent and Trademark Office

Reg. No. 3,484,464

Registered Aug. 12, 2008

**SERVICE MARK
PRINCIPAL REGISTER**

CREDIT SAINT

CREDIT SAINT LIMITED LIABILITY COMPANY
(NEW JERSEY LTD LIAB CO)
276-278 BROADWAY STE 2A
ELMWOOD PARK, NJ 07407

FOR: FINANCIAL SERVICES, NAMELY, CREDIT
REPAIR AND RESTORATION; FINANCIAL SERVI-
CES, NAMELY, DEBT SETTLEMENT, IN CLASS 36
(U.S. CLS. 100, 101 AND 102).

FIRST USE 5-0-2007; IN COMMERCE 5-0-2007.

THE MARK CONSISTS OF STANDARD CHAR-
ACTERS WITHOUT CLAIM TO ANY PARTICULAR
FONT, STYLE, SIZE, OR COLOR.

NO CLAIM IS MADE TO THE EXCLUSIVE
RIGHT TO USE "CREDIT", APART FROM THE
MARK AS SHOWN.

SER. NO. 77-369,092, FILED 1-10-2008.

TARA PATE, EXAMINING ATTORNEY

Int. Cl.: 16

Prior U.S. Cls.: 2, 5, 22, 23, 29, 37, 38 and 50

United States Patent and Trademark Office

Reg. No. 3,484,465

Registered Aug. 12, 2008

TRADEMARK
PRINCIPAL REGISTER



Created by Survivors for Survivors.

KIMO KARDS (FLORIDA PARTNERSHIP)
116 KENNINGHALL CT SE
SMYRNA, GA 30082

FOR: GREETING CARDS, IN CLASS 16 (U.S. CLS.
2, 5, 22, 23, 29, 37, 38 AND 50).

FIRST USE 11-9-2007; IN COMMERCE 11-11-2007.

NO CLAIM IS MADE TO THE EXCLUSIVE
RIGHT TO USE "CHEMO CARDS", APART FROM
THE MARK AS SHOWN.

THE COLOR(S) BLACK, INDIGO, RED, ORANGE,
YELLOW, BLUE, AND GREEN IS/ARE CLAIMED
AS A FEATURE OF THE MARK.

THE MARK CONSISTS OF THE WORDS "KIMO"
AND "KARDS" ARE IN BLACK, ACCOMPANIED
BY A MULTI-COLORED REMEMBRANCE RIBBON
THAT, FROM THE LOWER LEFT EDGE CHANGES
FROM RED TO ORANGE, YELLOW, BLUE, INDI-
GO, BLUE, YELLOW, AND GREEN. DIRECTLY
BELOW THE WORDS "KIMO AND KARDS" ARE
THE WORDS "CREATED BY SURVIVORS FOR
SURVIVORS" IN INDIGO.

SER. NO. 77-369,098, FILED 1-10-2008.

CHRISTINA SOBRAL, EXAMINING ATTORNEY

Int. Cl.: 32

Prior U.S. Cls.: 45, 46 and 48

Reg. No. 3,484,466

United States Patent and Trademark Office

Registered Aug. 12, 2008

**TRADEMARK
PRINCIPAL REGISTER**

**Waterlicious Bikini Bottom
Berry**

DEVONE LAWSON, INC. (CALIFORNIA CORPORATION)
507
13428 MAXELLA AVENUE
MARINA DEL REY, CA 90292

FOR: BOTTLED WATER; DRINKING WATER; FLAVORED BOTTLED WATER; FLAVORED WATERS; FLAVOURED WATERS, ALL THE FOREGOING BEING BERRY FLAVORED, IN CLASS 32 (U.S. CLS. 45, 46 AND 48).

FIRST USE 1-8-2008; IN COMMERCE 1-8-2008.

THE MARK CONSISTS OF STANDARD CHARACTERS WITHOUT CLAIM TO ANY PARTICULAR FONT, STYLE, SIZE, OR COLOR.

NO CLAIM IS MADE TO THE EXCLUSIVE RIGHT TO USE "BERRY", APART FROM THE MARK AS SHOWN.

SER. NO. 77-369,138, FILED 1-11-2008.

JEAN IM, EXAMINING ATTORNEY

Int. Cl.: 41

Prior U.S. Cls.: 100, 101 and 107

United States Patent and Trademark Office

Reg. No. 3,484,467

Registered Aug. 12, 2008

**SERVICE MARK
PRINCIPAL REGISTER**

DealWatch

THE DEAL, LLC (DELAWARE LTD LIAB CO)
105 MADISON AVENUE
NEW YORK, NY 10016

FIRST USE 7-19-2001; IN COMMERCE 7-19-2001.

FOR: PROVIDING ON-LINE PUBLICATIONS IN THE NATURE OF NEWSPAPER AND MAGAZINE COLUMNS IN THE FIELD OF BUSINESS AND FINANCE; ON-LINE JOURNALS, NAMELY, BLOGS FEATURING NEWS AND INFORMATION IN THE FIELD OF BUSINESS AND FINANCE, IN CLASS 41 (U.S. CLS. 100, 101 AND 107).

THE MARK CONSISTS OF STANDARD CHARACTERS WITHOUT CLAIM TO ANY PARTICULAR FONT, STYLE, SIZE, OR COLOR.

SER. NO. 77-369,157, FILED 1-11-2008.

VERNA BETH RIRIE, EXAMINING ATTORNEY

Int. Cl.: 25

Prior U.S. Cls.: 22 and 39

United States Patent and Trademark Office

Reg. No. 3,484,468

Registered Aug. 12, 2008

**TRADEMARK
PRINCIPAL REGISTER**

Threaded Heritage

THREADED HERITAGE LLC (CALIFORNIA
LTD LIAB CO)
#111
15370 WEDDINGTON STREET
SHERMAN OAKS, CA 91411

FOR: BABY TOPS; CROP TOPS; HALTER TOPS;
MUSCLE TOPS; RUGBY TOPS; TANK TOPS; BABY
BOTTOMS; BOTTOMS; PAJAMA BOTTOMS; DRESS
SHIRTS; GOLF SHIRTS; KNIT SHIRTS; LONG-
SLEEVED SHIRTS; OPEN-NECKED SHIRTS; PIQUE
SHIRTS; POLO SHIRTS; RUGBY SHIRTS; SHIRTS;
SHIRTS FOR SUITS; SHORT-SLEEVED OR LONG-
SLEEVED T-SHIRTS; SHORT-SLEEVED SHIRTS;
CAPRI PANTS; CARGO PANTS; DENIMS; JOGGING
PANTS; LOUNGE PANTS; PANTS; PETTI-PANTS;
SKI PANTS; SNOW PANTS; SNOWBOARD PANTS;
STRETCH PANTS; SWEAT PANTS; CREWNECK
SWEATERS; MOCK TURTLE-NECK SWEATERS;
SWEATERS; TURTLENECK SWEATERS; V-NECK
SWEATERS; HEADBANDS AGAINST SWEATING;

SWEAT BANDS; SWEAT SHIRTS; SWEAT SUITS;
HATS; SMALL HATS; TOBOGGAN HATS, PANTS
AND CAPS; WOOLLY HATS; BRIEFS; LADIES'
UNDERWEAR; LONG UNDERWEAR; THERMAL
UNDERWEAR; THONGS; UNDERWEAR; UNDER-
WEAR, NAMELY, BOY SHORTS; WOMEN'S UN-
DERWEAR; WOVEN OR KNITTED UNDERWEAR;
CROSS-COUNTRY MITTENS; MITTENS; OUT-
DOOR MITTENS; SNOWBOARD MITTENS, IN
CLASS 25 (U.S. CLS. 22 AND 39).

FIRST USE 4-5-2007; IN COMMERCE 7-14-2007.

THE MARK CONSISTS OF STANDARD CHAR-
ACTERS WITHOUT CLAIM TO ANY PARTICULAR
FONT, STYLE, SIZE, OR COLOR.

SER. NO. 77-369,165, FILED 1-11-2008.

VERNA BETH RIRIE, EXAMINING ATTORNEY

Int. Cls.: 35 and 39

Prior U.S. Cls.: 100, 101, 102 and 105

United States Patent and Trademark Office

Reg. No. 3,484,469

Registered Aug. 12, 2008

**SERVICE MARK
PRINCIPAL REGISTER**



MOVER'S EQUIPMENT SERVICES, INC. (TEXAS CORPORATION)
2619 NOVA DRIVE
DALLAS, TX 75229

FOR: RETAIL STORE SERVICES FEATURING EQUIPMENT FOR MOVING AND STORAGE INCLUDING DOLLIES, CARTS, HAND TRUCKS, CARRIERS, BOXES, PACKAGING, STRAPS, AND PADS, IN CLASS 35 (U.S. CLS. 100, 101 AND 102).

FIRST USE 5-14-2001; IN COMMERCE 5-14-2001.

FOR: RENTAL OF MOVING EQUIPMENT, NAMELY, PADS, STRAPS, HITCHES, DOLLIES, BOXES, CARRIERS, AND HAND TRUCKS, IN CLASS 39 (U.S. CLS. 100 AND 105).

FIRST USE 5-14-2001; IN COMMERCE 5-14-2001.

NO CLAIM IS MADE TO THE EXCLUSIVE RIGHT TO USE "MESI MOVER'S EQUIPMENT SERVICES, INC.", APART FROM THE MARK AS SHOWN.

THE MARK CONSISTS OF THE LETTERS "MESI" ABOVE THE WORDS "MOVER'S EQUIPMENT SERVICES, INC.". ON THE LEFT HAND SIDE IS A DEPICTION OF A MOVING DOLLY WITH THE BOTTOM PORTION OF THE DOLLY FORMING A LINE UNDER THE LETTERS "MESI".

SER. NO. 77-369,203, FILED 1-11-2008.

LINDA M. KING, EXAMINING ATTORNEY

Int. Cl.: 43

Prior U.S. Cls.: 100 and 101

United States Patent and Trademark Office

Reg. No. 3,484,470

Registered Aug. 12, 2008

**SERVICE MARK
PRINCIPAL REGISTER**

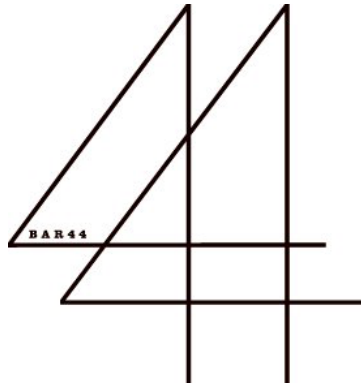

MORGANS GROUP LLC (DELAWARE LTD LIAB
CO)
475 10TH AVENUE
NEW YORK, NY 10018

THE MARK CONSISTS OF TWO TRIANGLES
FORMING THE NUMBER "44" AND THE WORD
"BAR 44" INSIDE ONE OF THE TRIANGLES.

FOR: BAR AND RESTAURANT SERVICES, IN
CLASS 43 (U.S. CLS. 100 AND 101).

SER. NO. 77-369,297, FILED 1-11-2008.

FIRST USE 10-1-2007; IN COMMERCE 10-1-2007.

KATHY DE JONGE, EXAMINING ATTORNEY

Int. Cl.: 30

Prior U.S. Cl.: 46

United States Patent and Trademark Office

Reg. No. 3,484,471

Registered Aug. 12, 2008

**TRADEMARK
PRINCIPAL REGISTER**

Cornoisseur

MISS JENNY, LLC (FLORIDA LTD LIAB CO)
11033 IRON HORSE WAY
FORT MYERS, FL 33913

FIRST USE 8-1-2007; IN COMMERCE 8-1-2007.

FOR: CANDY COATED POPCORN; CARAMEL POPCORN; GLAZED POPCORN; MICROWAVE POPCORN; POPCORN; POPPED POPCORN; PROCESSED POPCORN; PROCESSED UNPOPPED POPCORN; SNACK MIX CONSISTING PRIMARILY OF CRACKERS, PRETZELS, CANDIED NUTS AND/OR POPPED POPCORN; UNPOPPED POPCORN, IN CLASS 30 (U.S. CL. 46).

THE MARK CONSISTS OF STANDARD CHARACTERS WITHOUT CLAIM TO ANY PARTICULAR FONT, STYLE, SIZE, OR COLOR.

SER. NO. 77-369,303, FILED 1-11-2008.

ANTHONY RINKER, EXAMINING ATTORNEY

Int. Cl.: 17

Prior U.S. Cls.: 1, 5, 12, 13, 35 and 50

Reg. No. 3,484,472

United States Patent and Trademark Office

Registered Aug. 12, 2008

TRADEMARK
PRINCIPAL REGISTER



AIP, LLC (MASSACHUSETTS LTD LIAB CO)
31 SANFORD ROAD
WESTPORT, MA 02790

FOR: PLASTIC SHEETING USED IN THE CONSTRUCTION INDUSTRY AS A VAPOR BARRIER, IN CLASS 17 (U.S. CLS. 1, 5, 12, 13, 35 AND 50).

FIRST USE 4-1-2007; IN COMMERCE 4-1-2007.

NO CLAIM IS MADE TO THE EXCLUSIVE RIGHT TO USE "CRAWL", APART FROM THE MARK AS SHOWN.

THE MARK CONSISTS OF THE STYLIZED WORDS "CRAWL SHIELD" WITHIN THE SHAPE OF A SHIELD.

SER. NO. 77-369,326, FILED 1-11-2008.

SUSAN LESLIE DUBOIS, EXAMINING ATTORNEY

Int. Cl.: 41

Prior U.S. Cls.: 100, 101 and 107

United States Patent and Trademark Office

Reg. No. 3,484,473

Registered Aug. 12, 2008

**SERVICE MARK
PRINCIPAL REGISTER**



AIP, LLC (MASSACHUSETTS LTD LIAB CO)
31 SANFORD ROAD
WESTPORT, MA 02790

FOR: TRAINING IN THE USE AND OPERATION
OF BASEMENT WATERPROOFING MATERIALS,
NAMELY, THOSE MANUFACTURED AND SOLD
TO COMPANY'S BASEMENT WATERPROOFING
CONTRACTORS, IN CLASS 41 (U.S. CLS. 100, 101
AND 107).

FIRST USE 1-1-2006; IN COMMERCE 1-1-2006.

NO CLAIM IS MADE TO THE EXCLUSIVE
RIGHT TO USE "GRATE PRODUCTS L.L.C.",
APART FROM THE MARK AS SHOWN.

THE MARK CONSISTS OF THE STYLIZED
WORDS "GRATE PRODUCTS" WITHIN THE DE-
SIGN OF A GRATE.

SER. NO. 77-369,353, FILED 1-11-2008.

SUSAN LESLIE DUBOIS, EXAMINING ATTORNEY

Int. Cl.: 36

Prior U.S. Cls.: 100, 101 and 102

United States Patent and Trademark Office

Reg. No. 3,484,474

Registered Aug. 12, 2008

**SERVICE MARK
PRINCIPAL REGISTER**

**DaveHull.com "Advice You
Can Sleep On"**

HULL, DAVID (UNITED STATES INDIVIDUAL)
32 GREAT OAK ROAD
SAINT JAMES, NY 11780

THE MARK CONSISTS OF STANDARD CHAR-
ACTERS WITHOUT CLAIM TO ANY PARTICULAR
FONT, STYLE, SIZE, OR COLOR.

FOR: FINANCIAL PLANNING; INSURANCE IN-
FORMATION AND CONSULTANCY, IN CLASS 36
(U.S. CLS. 100, 101 AND 102).

SER. NO. 77-369,354, FILED 1-11-2008.

FIRST USE 1-10-2007; IN COMMERCE 1-10-2007.

SHANNON TWOHIG, EXAMINING ATTORNEY

Int. Cl.: 43

Prior U.S. Cls.: 100 and 101

United States Patent and Trademark Office

Reg. No. 3,484,475

Registered Aug. 12, 2008

SERVICE MARK
PRINCIPAL REGISTER

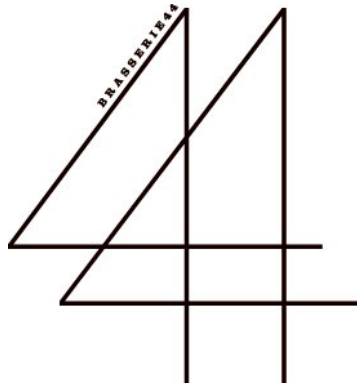

MORGANS GROUP LLC (DELAWARE LTD LIAB
CO)
475 10TH AVENUE
NEW YORK, NY 10018

FOR: BAR AND RESTAURANT SERVICES, IN
CLASS 43 (U.S. CLS. 100 AND 101).

FIRST USE 10-1-2007; IN COMMERCE 10-1-2007.

THE MARK CONSISTS OF TWO TRIANGLES
FORMING THE NUMBER "44" AND THE WORD
"BRASSERIE" OUTSIDE ONE OF THE TRIAN-
GLES.

SER. NO. 77-369,393, FILED 1-11-2008.

KATHY DE JONGE, EXAMINING ATTORNEY

Int. Cl.: 1

Prior U.S. Cls.: 1, 5, 6, 10, 26 and 46

Reg. No. 3,484,476

United States Patent and Trademark Office

Registered Aug. 12, 2008

**TRADEMARK
PRINCIPAL REGISTER**

MAGSENSE

MAGSENSE LIFE SCIENCES, INC. (INDIANA
CORPORATION)
3000 KENT AVENUE
WEST LAFAYETTE, IN 47906

THE MARK CONSISTS OF STANDARD CHAR-
ACTERS WITHOUT CLAIM TO ANY PARTICULAR
FONT, STYLE, SIZE, OR COLOR.

FOR: REGEANTS FOR SCIENTIFIC RESEARCH
USE, NAMELY, MICROPARTICLES AND MAG-
NETIC MICROPARTICLES, IN CLASS 1 (U.S. CLS.
1, 5, 6, 10, 26 AND 46).

SER. NO. 77-369,406, FILED 1-11-2008.

FIRST USE 0-0-2005; IN COMMERCE 0-0-2005.

WILLIAM BRECKENFELD, EXAMINING ATTOR-
NEY

Int. Cl.: 43

Prior U.S. Cls.: 100 and 101

United States Patent and Trademark Office

Reg. No. 3,484,477

Registered Aug. 12, 2008

**SERVICE MARK
PRINCIPAL REGISTER**

Pet Play Place

PET PLAY PLACE LLC (GEORGIA LTD LIAB
CO)
SUITE C
2687 MCCOLLUM PARKWAY
KENNESAW, GA 30144

FOR: PET BOARDING SERVICES, IN CLASS 43
(U.S. CLS. 100 AND 101).

FIRST USE 12-1-2006; IN COMMERCE 12-1-2006.

NO CLAIM IS MADE TO THE EXCLUSIVE
RIGHT TO USE "PET" AND "PLACE", APART
FROM THE MARK AS SHOWN.

THE COLOR(S) BLACK AND BLUE IS/ARE
CLAIMED AS A FEATURE OF THE MARK.

THE MARK CONSISTS OF THE BLACK WORDS
"PET PLAY PLACE" IN WHICH THE LETTER A IN
THE WORD "PLAY" IS REPLACED WITH A BLUE
PAW PRINT WITH A HEART CUT OUT IN THE
CENTER OF THE PAW.

SER. NO. 77-369,447, FILED 1-11-2008.

CHRISTINA SOBRAL, EXAMINING ATTORNEY

Int. Cls.: 35 and 36

Prior U.S. Cls.: 100, 101 and 102

United States Patent and Trademark Office

Reg. No. 3,484,478

Registered Aug. 12, 2008

**SERVICE MARK
PRINCIPAL REGISTER**

OUR WORLD, OUR FAMILY

WESTERN UNION HOLDINGS, INC. (GEORGIA CORPORATION)
12500 E. BELFORD AVE. M21A2
ENGLEWOOD, CO 80112

FOR: CHARITABLE SERVICES, NAMELY, ORGANIZING AND CONDUCTING VOLUNTEER PROGRAMS AND COMMUNITY SERVICE PROJECTS, IN CLASS 35 (U.S. CLS. 100, 101 AND 102).

FIRST USE 9-13-2007; IN COMMERCE 9-13-2007.

FOR: CHARITABLE FUND RAISING SERVICES; CHARITABLE SERVICES, NAMELY, PROVIDING FINANCIAL SUPPORT TO FINANCIALLY DISADVANTAGED PERSONS AND COMMUNITIES FOR THE PURPOSE OF FACILITATING COMMUNITY, SOCIAL, DISASTER RELIEF, EDUCATIONAL, CULTURAL, AND ECONOMIC DEVELOPMENT ACTIV-

ITIES AND PROGRAMS; PROVIDING EDUCATIONAL SCHOLARSHIPS TO DEVELOP SKILLS NECESSARY TO SUCCEED IN A DIVERSE AND GLOBAL WORK FORCE TO FINANCIALLY DISADVANTAGED PERSONS AND COMMUNITIES IN ORDER TO ECONOMICALLY ENHANCE COMMUNITIES AND DEVELOP ENTREPRENEURS, IN CLASS 36 (U.S. CLS. 100, 101 AND 102).

FIRST USE 9-13-2007; IN COMMERCE 9-13-2007.

THE MARK CONSISTS OF STANDARD CHARACTERS WITHOUT CLAIM TO ANY PARTICULAR FONT, STYLE, SIZE, OR COLOR.

SER. NO. 77-369,479, FILED 1-11-2008.

ZHALEH DELANEY, EXAMINING ATTORNEY

Int. Cl.: 43

Prior U.S. Cls.: 100 and 101

United States Patent and Trademark Office

Reg. No. 3,484,479

Registered Aug. 12, 2008

**SERVICE MARK
PRINCIPAL REGISTER**

ESPRESSO ELEGANCE

ESPRESSO ELEGANCE CATERING INCORPORATED (WASHINGTON CORPORATION)
122 ELLIOTT AVENUE W.
SEATTLE, WA 98121

FOR: RESTAURANT AND CATERING SERVICES FEATURING COFFEE AND ESPRESSO, IN CLASS 43 (U.S. CLS. 100 AND 101).

FIRST USE 1-1-1989; IN COMMERCE 1-1-1997.

THE MARK CONSISTS OF STANDARD CHARACTERS WITHOUT CLAIM TO ANY PARTICULAR FONT, STYLE, SIZE, OR COLOR.

NO CLAIM IS MADE TO THE EXCLUSIVE RIGHT TO USE "ESPRESSO", APART FROM THE MARK AS SHOWN.

SER. NO. 77-369,482, FILED 1-11-2008.

SANI KHOURI, EXAMINING ATTORNEY

Int. Cl.: 9

Prior U.S. Cls.: 21, 23, 26, 36 and 38

Reg. No. 3,484,480

United States Patent and Trademark Office

Registered Aug. 12, 2008

**TRADEMARK
PRINCIPAL REGISTER**

METALWARE

IPSEN, INC. (DELAWARE CORPORATION)
984 IPSEN ROAD
CHERRY VALLEY, IL 61016

FIRST USE 3-0-2004; IN COMMERCE 3-0-2004.

FOR: AUTOMATED PROCESS CONTROL SYSTEM, NAMELY, MICROPROCESSOR-BASED HARDWARE AND SOFTWARE USED TO MONITOR STATUS OF INDUSTRIAL MACHINERY, NAMELY, FURNACES FOR HEAT TREATING METAL PARTS, IN CLASS 9 (U.S. CLS. 21, 23, 26, 36 AND 38).

THE MARK CONSISTS OF STANDARD CHARACTERS WITHOUT CLAIM TO ANY PARTICULAR FONT, STYLE, SIZE, OR COLOR.

SER. NO. 77-369,507, FILED 1-11-2008.

STEVEN JACKSON, EXAMINING ATTORNEY

Int. Cl.: 9

Prior U.S. Cls.: 21, 23, 26, 36 and 38

Reg. No. 3,484,481

United States Patent and Trademark Office

Registered Aug. 12, 2008

**TRADEMARK
PRINCIPAL REGISTER**

DIGITRIM

IPSEN, INC. (DELAWARE CORPORATION)
984 IPSEN ROAD
CHERRY VALLEY, IL 61016

FIRST USE 4-0-2004; IN COMMERCE 4-0-2004.

FOR: COMPUTER HARDWARE AND SOFTWARE SYSTEM FOR REMOTELY ADJUSTING TEMPERATURE ZONES IN AN INDUSTRIAL HEAT TREATING FURNACE, IN CLASS 9 (U.S. CLS. 21, 23, 26, 36 AND 38).

THE MARK CONSISTS OF STANDARD CHARACTERS WITHOUT CLAIM TO ANY PARTICULAR FONT, STYLE, SIZE, OR COLOR.

SER. NO. 77-369,518, FILED 1-11-2008.

STEVEN JACKSON, EXAMINING ATTORNEY

Int. Cl.: 38

Prior U.S. Cls.: 100, 101 and 104

United States Patent and Trademark Office

Reg. No. 3,484,482

Registered Aug. 12, 2008

**SERVICE MARK
PRINCIPAL REGISTER**

**BUSINESS
TELECOMMUNICATIONS.
SIMPLIFIED.**

TELESPHERE NETWORKS LTD. (WASHINGTON CORPORATION)
5TH FLOOR
4150 NORTH DRINKWATER
SCOTTSDALE, AZ 85251

FOR: TELECOMMUNICATIONS SERVICES, NAMELY, TELEPHONE COMMUNICATIONS SERVICES, VIRTUAL PRIVATE NETWORK SERVICES, VOIP SERVICES, TELECOMMUNICATION NETWORK DATA CENTER SERVICES, TRANSMISSION OF DATA, VOICE, VIDEO, AUDIO, FACSIMILE AND IMAGES, PROVIDING ACCESS TO A TELECOMMUNICATIONS NETWORK, PROVIDING ACCESS TO AREA NETWORKS AND A GLOBAL INFORMATION NETWORK, PROVIDING TELECOMMUNICATION CONNECTIONS TO THE INTERNET, PROVIDING AUDIO, VIDEO AND DATA TELECONFERENCING SERVICES; TELECOMMUNICATIONS CONSULTING SERVICES IN THE

FIELD OF DESIGNING, INTEGRATING, OPERATING, MAINTAINING AND MONITORING TELECOMMUNICATIONS NETWORKS AND NETWORK SOLUTIONS, IN CLASS 38 (U.S. CLS. 100, 101 AND 104).

FIRST USE 2-0-2007; IN COMMERCE 2-0-2007.

THE MARK CONSISTS OF STANDARD CHARACTERS WITHOUT CLAIM TO ANY PARTICULAR FONT, STYLE, SIZE, OR COLOR.

NO CLAIM IS MADE TO THE EXCLUSIVE RIGHT TO USE "BUSINESS TELECOMMUNICATIONS", APART FROM THE MARK AS SHOWN.

SER. NO. 77-369,525, FILED 1-11-2008.

RICHARD A. STRASER, EXAMINING ATTORNEY

Int. Cl.: 38

Prior U.S. Cls.: 100, 101 and 104

United States Patent and Trademark Office

Reg. No. 3,484,483

Registered Aug. 12, 2008

**SERVICE MARK
PRINCIPAL REGISTER**

BUSINESSSPHERE

TELESPHERE NETWORKS LTD. (WASHINGTON CORPORATION)
5TH FLOOR
4150 NORTH DRINKWATER
SCOTTSDALE, AZ 85251

FOR: TELECOMMUNICATIONS SERVICES, NAMELY, TELEPHONE COMMUNICATIONS SERVICES, VIRTUAL PRIVATE NETWORK SERVICES, VOIP SERVICES, TELECOMMUNICATION NETWORK DATACENTER SERVICES, TRANSMISSION OF DATA, VOICE, VIDEO, AUDIO, FACSIMILE AND IMAGES, PROVIDING ACCESS TO A TELECOMMUNICATIONS NETWORK, PROVIDING ACCESS TO AREA NETWORKS AND A GLOBAL INFORMATION NETWORK, PROVIDING TELECOMMUNICATION CONNECTIONS TO THE INTERNET, PROVIDING AUDIO, VIDEO AND DATA

TELECONFERENCING SERVICES; TELECOMMUNICATIONS CONSULTING SERVICES IN THE FIELD OF DESIGNING, INTEGRATING, OPERATING, MAINTAINING AND MONITORING TELECOMMUNICATIONS NETWORKS AND NETWORK SOLUTIONS, IN CLASS 38 (U.S. CLS. 100, 101 AND 104).

FIRST USE 2-0-2007; IN COMMERCE 2-0-2007.

THE MARK CONSISTS OF STANDARD CHARACTERS WITHOUT CLAIM TO ANY PARTICULAR FONT, STYLE, SIZE, OR COLOR.

SER. NO. 77-369,530, FILED 1-11-2008.

RICHARD A. STRASER, EXAMINING ATTORNEY

Int. Cl.: 3

Prior U.S. Cls.: 1, 4, 6, 50, 51 and 52

United States Patent and Trademark Office

Reg. No. 3,484,484

Registered Aug. 12, 2008

**TRADEMARK
PRINCIPAL REGISTER**

Furfection Naturals

FURFECTION, INC. (CALIFORNIA CORPORATION)
635 TAMI WAY
MOUNTAIN VIEW, CA 94041

FOR: PET SHAMPOO, IN CLASS 3 (U.S. CLS. 1, 4, 6, 50, 51 AND 52).

FIRST USE 10-1-2004; IN COMMERCE 4-1-2005.

THE MARK CONSISTS OF STANDARD CHARACTERS WITHOUT CLAIM TO ANY PARTICULAR FONT, STYLE, SIZE, OR COLOR.

OWNER OF U.S. REG. NO. 3,258,276.

NO CLAIM IS MADE TO THE EXCLUSIVE RIGHT TO USE "NATURALS", APART FROM THE MARK AS SHOWN.

SER. NO. 77-369,546, FILED 1-11-2008.

LINDA ESTRADA, EXAMINING ATTORNEY

Int. Cl.: 45

Prior U.S. Cls.: 100 and 101

United States Patent and Trademark Office

Reg. No. 3,484,485

Registered Aug. 12, 2008

**SERVICE MARK
PRINCIPAL REGISTER**

Rainier Patents, P.S.

RAINIER PATENTS, P.S. (WASHINGTON CORPORATION)
505 W RIVERSIDE AVE. STE 500
SPOKANE, WA 99201

FOR: LEGAL SERVICES; LEGAL SERVICES, NAMELY, PREPARATION OF APPLICATIONS FOR TRADEMARK REGISTRATION, IN CLASS 45 (U.S. CLS. 100 AND 101).

FIRST USE 11-15-2007; IN COMMERCE 1-11-2008.

THE MARK CONSISTS OF STANDARD CHARACTERS WITHOUT CLAIM TO ANY PARTICULAR FONT, STYLE, SIZE, OR COLOR.

NO CLAIM IS MADE TO THE EXCLUSIVE RIGHT TO USE "PATENTS, P.S.", APART FROM THE MARK AS SHOWN.

SER. NO. 77-369,560, FILED 1-11-2008.

SARA THOMAS, EXAMINING ATTORNEY

Int. Cl.: 9

Prior U.S. Cls.: 21, 23, 26, 36 and 38

United States Patent and Trademark Office

Reg. No. 3,484,486

Registered Aug. 12, 2008

**TRADEMARK
PRINCIPAL REGISTER**

TWO WORLDS CONNECT

WILLIAMS, EDWARD L (UNITED STATES IN-
DIVIDUAL)
14743 COOL VALLEY ROAD
VALLEY CENTER, CA 92082

THE MARK CONSISTS OF STANDARD CHAR-
ACTERS WITHOUT CLAIM TO ANY PARTICULAR
FONT, STYLE, SIZE, OR COLOR.

FOR: AUDIO RECORDINGS FEATURING MU-
SIC, IN CLASS 9 (U.S. CLS. 21, 23, 26, 36 AND 38).

SER. NO. 77-369,589, FILED 1-11-2008.

FIRST USE 1-10-2008; IN COMMERCE 1-10-2008.

INGA ERVIN, EXAMINING ATTORNEY

Int. Cl.: 9

Prior U.S. Cls.: 21, 23, 26, 36 and 38

Reg. No. 3,484,487

United States Patent and Trademark Office

Registered Aug. 12, 2008

**TRADEMARK
PRINCIPAL REGISTER**

SCENE3D

COVENTOR, INC. (DELAWARE CORPORATION)
SUITE 190
4000 CENTREGREEN WAY
CARY, NC 27513

FOR: SOFTWARE FOR VIEWING AND ANIMATING THREE-DIMENSIONAL MODELS OF MICRO-ELECTROMECHANICAL SYSTEMS (MEMS), IN CLASS 9 (U.S. CLS. 21, 23, 26, 36 AND 38).

FIRST USE 10-4-2007; IN COMMERCE 11-7-2007.

THE MARK CONSISTS OF STANDARD CHARACTERS WITHOUT CLAIM TO ANY PARTICULAR FONT, STYLE, SIZE, OR COLOR.

SER. NO. 77-369,614, FILED 1-11-2008.

TARA PATE, EXAMINING ATTORNEY

Int. Cl.: 41

Prior U.S. Cls.: 100, 101 and 107

United States Patent and Trademark Office

Reg. No. 3,484,488

Registered Aug. 12, 2008

SERVICE MARK
PRINCIPAL REGISTER

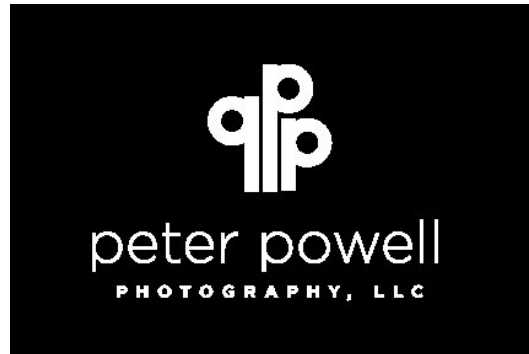

PETER POWELL PHOTOGRAPHY (NEW HAMPSHIRE LTD LIAB CO)
5 CARAWAY LANE
NASHUA, NH 03063

FOR: PHOTO EDITING; PHOTOGRAPHY SERVICES, IN CLASS 41 (U.S. CLS. 100, 101 AND 107).

FIRST USE 11-5-2007; IN COMMERCE 11-5-2007.

NO CLAIM IS MADE TO THE EXCLUSIVE RIGHT TO USE "PHOTOGRAPHY, LLC", APART FROM THE MARK AS SHOWN.

THE NAME "PETER POWELL" IDENTIFIES A LIVING INDIVIDUAL WHOSE CONSENT IS OF RECORD.

THE MARK CONSISTS OF A CLUSTER OF 3 OCCURRENCES OF THE LETTER "P" WITH THE FIRST BEING A REVERSE IMAGE AND EACH BEING A DIFFERENT HEIGHT AT THE TOP. BELOW, ON THE NEXT LINE "PETER POWELL". ON THE 3RD LINE "PHOTOGRAPHY, LLC".

SER. NO. 77-369,615, FILED 1-11-2008.

ELLEN B. AWRICH, EXAMINING ATTORNEY

Int. Cl.: 16

Prior U.S. Cls.: 2, 5, 22, 23, 29, 37, 38 and 50

United States Patent and Trademark Office

Reg. No. 3,484,489

Registered Aug. 12, 2008

**TRADEMARK
PRINCIPAL REGISTER**

DIRECT INVESTING

THE MONEYPAPER, INC. (NEW YORK CORPORATION)
555 THEODORE FREMD AVE.
RYE, NY 10580

FOR: PUBLICATIONS, NAMELY, NEWSLETTERS IN THE FIELD OF DIVIDEND REINVESTMENT PLANS, IN CLASS 16 (U.S. CLS. 2, 5, 22, 23, 29, 37, 38 AND 50).

FIRST USE 7-1-1997; IN COMMERCE 7-1-1997.

THE MARK CONSISTS OF STANDARD CHARACTERS WITHOUT CLAIM TO ANY PARTICULAR FONT, STYLE, SIZE, OR COLOR.

OWNER OF U.S. REG. NO. 2,170,609.

SEC. 2(F).

SER. NO. 77-369,617, FILED 1-11-2008.

CYNTHIA TRIPI, EXAMINING ATTORNEY

Int. Cl.: 41

Prior U.S. Cls.: 100, 101 and 107

United States Patent and Trademark Office

Reg. No. 3,484,490

Registered Aug. 12, 2008

**SERVICE MARK
PRINCIPAL REGISTER**



PHYSICIAN INSURERS ASSOCIATION OF
AMERICA (NEW JERSEY CORPORATION)
2275 RESEARCH BOULEVARD, STE. 250
ROCKVILLE, MD 208503268

FOR: EDUCATION SERVICES, NAMELY, PRO-
VIDING EDUCATIONAL WORKSHOPS AND CON-
FERENCES RELATED TO THE OPERATION,
ADMINISTRATION AND STRUCTURE OF PHYSI-
CIAN-OWNED AND/OR OPERATED MEDICAL
PROFESSIONAL LIABILITY INSURANCE COMPA-
NIES AND DISTRIBUTING COURSE MATERIALS

IN CONNECTION THEREWITH, IN CLASS 41 (U.S.
CLS. 100, 101 AND 107).

FIRST USE 12-28-2007; IN COMMERCE 12-28-2007.

OWNER OF U.S. REG. NO. 3,218,618.

SER. NO. 77-369,644, FILED 1-11-2008.

MELISSA VALLILLO, EXAMINING ATTORNEY

Int. Cls.: 41 and 42

Prior U.S. Cls.: 100, 101 and 107

United States Patent and Trademark Office

Reg. No. 3,484,491

Registered Aug. 12, 2008

**SERVICE MARK
PRINCIPAL REGISTER**

CAMPAIGN CIRCUS

ZIGVID, INC. (DELAWARE CORPORATION)
375 GREENWICH STREET, SUITE 711
NEW YORK, NY 10013

FOR: ENTERTAINMENT SERVICES, NAMELY, PROVIDING A WEBSITE FEATURING VIDEOS, VIDEO CLIPS, TEXT, PODCASTS, BLOGS, AND FILM CLIPS IN THE FIELD OF POLITICS, IN CLASS 41 (U.S. CLS. 100, 101 AND 107).

FIRST USE 10-17-2007; IN COMMERCE 10-17-2007.

FOR: COMPUTER SERVICES, NAMELY, CREATING AN ONLINE COMMUNITY FOR REGISTERED USERS TO SHOWCASE VIDEOS, VIDEO CLIPS, MUSICAL PERFORMANCES, MUSICAL VIDEOS,

AND FILM CLIPS, FORM VIRTUAL COMMUNITIES, PARTICIPATE IN COMPETITIONS, GET FEEDBACK FROM PEERS, AND ENGAGE IN SOCIAL NETWORKING, ALL IN THE FIELD OF POLITICS, IN CLASS 42 (U.S. CLS. 100 AND 101).

FIRST USE 10-17-2007; IN COMMERCE 10-17-2007.

THE MARK CONSISTS OF STANDARD CHARACTERS WITHOUT CLAIM TO ANY PARTICULAR FONT, STYLE, SIZE, OR COLOR.

SER. NO. 77-369,650, FILED 1-11-2008.

KAPIL BHANOT, EXAMINING ATTORNEY

Int. Cls.: 28 and 35

Prior U.S. Cls.: 22, 23, 38, 50, 100, 101 and 102

United States Patent and Trademark Office

Reg. No. 3,484,492

Registered Aug. 12, 2008

**TRADEMARK
SERVICE MARK
PRINCIPAL REGISTER**

NET RETURN

PAUL A. CRAWLEY (UNITED STATES INDIVIDUAL)
121 LINCOLN AVENUE
FAIR LAWN, NJ 07410

FOR: SPORTS NETS, IN CLASS 28 (U.S. CLS. 22, 23, 38 AND 50).

FIRST USE 3-0-2007; IN COMMERCE 3-0-2007.

FOR: RETAIL STORE AND ON-LINE RETAIL STORE SERVICES FEATURING SPORTS NETS, IN CLASS 35 (U.S. CLS. 100, 101 AND 102).

FIRST USE 3-0-2007; IN COMMERCE 3-0-2007.

THE MARK CONSISTS OF STANDARD CHARACTERS WITHOUT CLAIM TO ANY PARTICULAR FONT, STYLE, SIZE, OR COLOR.

SER. NO. 77-369,652, FILED 1-11-2008.

MICHAEL KAZAZIAN, EXAMINING ATTORNEY

Int. Cl.: 38

Prior U.S. Cls.: 100, 101 and 104

United States Patent and Trademark Office

Reg. No. 3,484,493

Registered Aug. 12, 2008

**SERVICE MARK
PRINCIPAL REGISTER**

SABER

GENESIS NETWORKS INC (DELAWARE COR-
PORATION)
ONE PENN PLAZA SUITE 2010
NEW YORK, NY 10119

THE MARK CONSISTS OF STANDARD CHAR-
ACTERS WITHOUT CLAIM TO ANY PARTICULAR
FONT, STYLE, SIZE, OR COLOR.

FOR: ELECTRONIC TRANSMISSION OF VOICE,
DATA AND IMAGES BY TELEVISION AND VIDEO
BROADCASTING, IN CLASS 38 (U.S. CLS. 100, 101
AND 104).

SER. NO. 77-369,658, FILED 1-11-2008.

FIRST USE 10-22-2007; IN COMMERCE 1-10-2008.

BRIAN NEVILLE, EXAMINING ATTORNEY

Int. Cls.: 37 and 42

Prior U.S. Cls.: 100, 101, 103 and 106

United States Patent and Trademark Office

Reg. No. 3,484,494

Registered Aug. 12, 2008

**SERVICE MARK
PRINCIPAL REGISTER**



CHEMSTRESS CONSTRUCTION COMPANY

CHEMSTRESS CONSULTANT COMPANY (OHIO CORPORATION)
55 E MILL STREET
AKRON, OH 44308

FOR: CONSTRUCTION PLANNING AND CONSTRUCTION SUPERVISION SERVICES, IN CLASS 37 (U.S. CLS. 100, 103 AND 106).

FIRST USE 12-1-1999; IN COMMERCE 12-1-1999.

FOR: CONSTRUCTION DRAFTING, ARCHITECTURAL DESIGNING, ENGINEERING DESIGNING SERVICES, AND CONSTRUCTION ENGINEERING, IN CLASS 42 (U.S. CLS. 100 AND 101).

FIRST USE 12-1-1999; IN COMMERCE 12-1-1999.

NO CLAIM IS MADE TO THE EXCLUSIVE RIGHT TO USE "CONSTRUCTION COMPANY", APART FROM THE MARK AS SHOWN.

THE MARK CONSISTS OF THE LETTER "C" WITH PARTIALLY FRACTURED "S" PARTIALLY LOCATED THEREIN WITH THE WORDS "CHEMSTRESS CONSTRUCTION COMPANY" TO THE RIGHT THEREOF.

SER. NO. 77-369,685, FILED 1-11-2008.

RUSS HERMAN, EXAMINING ATTORNEY

Int. Cl.: 36

Prior U.S. Cls.: 100, 101 and 102

United States Patent and Trademark Office

Reg. No. 3,484,495

Registered Aug. 12, 2008

**SERVICE MARK
PRINCIPAL REGISTER**

ONELIFE

NORRIS FINANCIAL GROUP, LLC (SOUTH
CAROLINA LTD LIAB CO)
800 E. WASHINGTON STREET SUITE F
GREENVILLE, SC 29601

FOR: FINANCIAL ADVICE AND CONSULTAN-
CY SERVICES; FINANCIAL CONSULTATION; FI-
NANCIAL CONSULTATION IN THE FIELD OF
ASSET AND CASH MANAGEMENT AND ESTATE,
TAX, RETIREMENT AND INSURANCE PLAN-
NING; FINANCIAL MANAGEMENT; FINANCIAL
PLANNING; FINANCIAL PLANNING, NAMELY,
THE CREATION OF PERSONALIZED STRATEGIES
TO ACHIEVE FINANCIAL INDEPENDENCE; FI-

NANCIAL PORTFOLIO MANAGEMENT, IN CLASS
36 (U.S. CLS. 100, 101 AND 102).

FIRST USE 1-1-2008; IN COMMERCE 1-11-2008.

THE MARK CONSISTS OF STANDARD CHAR-
ACTERS WITHOUT CLAIM TO ANY PARTICULAR
FONT, STYLE, SIZE, OR COLOR.

SER. NO. 77-369,711, FILED 1-11-2008.

JOHN GARTNER, EXAMINING ATTORNEY

Int. Cl.: 45

Prior U.S. Cls.: 100 and 101

United States Patent and Trademark Office

Reg. No. 3,484,496

Registered Aug. 12, 2008

**SERVICE MARK
PRINCIPAL REGISTER**

**Longing to Belong
Learning to Relate as the
Body of Christ**

PLOWPOINT, INC. (NORTH CAROLINA COR-
PORATION)
PO BOX 979
GRAHAM, NC 272530979

THE MARK CONSISTS OF STANDARD CHAR-
ACTERS WITHOUT CLAIM TO ANY PARTICULAR
FONT, STYLE, SIZE, OR COLOR.

FOR: MINISTERIAL SERVICES, IN CLASS 45 (U.S.
CLS. 100 AND 101).

SER. NO. 77-369,719, FILED 1-11-2008.

FIRST USE 3-15-2003; IN COMMERCE 9-1-2004.

KAPIL BHANOT, EXAMINING ATTORNEY

Int. Cl.: 42

Prior U.S. Cls.: 100 and 101

United States Patent and Trademark Office

Reg. No. 3,484,497

Registered Aug. 12, 2008

**SERVICE MARK
PRINCIPAL REGISTER**

GroGreenIt

COX, BRIAN E. (UNITED STATES INDIVIDUAL)
SUITE F
43625 N SIERRA HIGHWAY
LANCASTER, CA 93534

FOR: PROFESSIONAL CONSULTING SERVICES
AND ADVICE ABOUT AGRICULTURAL CHEMIS-
TRY, IN CLASS 42 (U.S. CLS. 100 AND 101).

FIRST USE 6-1-2005; IN COMMERCE 6-1-2005.

THE MARK CONSISTS OF STANDARD CHAR-
ACTERS WITHOUT CLAIM TO ANY PARTICULAR
FONT, STYLE, SIZE, OR COLOR.

SER. NO. 77-369,768, FILED 1-11-2008.

VIVIAN MICZNIK FIRST, EXAMINING ATTOR-
NEY

Int. Cls.: 37 and 42

Prior U.S. Cls.: 100, 101, 103 and 106

United States Patent and Trademark Office

Reg. No. 3,484,498

Registered Aug. 12, 2008

**SERVICE MARK
PRINCIPAL REGISTER**

CHEMSTRESS

CHEMSTRESS CONSULTANT COMPANY (OHIO CORPORATION)
55 E MILL STREET
AKRON, OH 44308

FOR: CONSTRUCTION PLANNING AND CONSTRUCTION SUPERVISION SERVICES, IN CLASS 37 (U.S. CLS. 100, 103 AND 106).

FIRST USE 12-1-1999; IN COMMERCE 12-1-1999.

FOR: CONSTRUCTION DRAFTING, ARCHITECTURAL DESIGNING, ENGINEERING DESIGNING SERVICES, AND CONSTRUCTION ENGINEERING, IN CLASS 42 (U.S. CLS. 100 AND 101).

FIRST USE 12-1-1999; IN COMMERCE 12-1-1999.

THE MARK CONSISTS OF STANDARD CHARACTERS WITHOUT CLAIM TO ANY PARTICULAR FONT, STYLE, SIZE, OR COLOR.

OWNER OF U.S. REG. NO. 2,621,042.

SER. NO. 77-369,793, FILED 1-11-2008.

RUSS HERMAN, EXAMINING ATTORNEY

Int. Cl.: 7

Prior U.S. Cls.: 13, 19, 21, 23, 31, 34 and 35

United States Patent and Trademark Office

Reg. No. 3,484,499

Registered Aug. 12, 2008

**TRADEMARK
PRINCIPAL REGISTER**



CHO, ABRAHAM (UNITED STATES INDIVIDUAL), DBA SATEC U.S.A., LLC
6 CHESTNUT STREET
PORT MONMOUTH, NJ 07758

THE ENTIRE MARK APPEARS IN THE COLOR BLUE.

FOR: DRYCLEANING MACHINES, IN CLASS 7 (U.S. CLS. 13, 19, 21, 23, 31, 34 AND 35).

SER. NO. 77-369,814, FILED 1-11-2008.

FIRST USE 0-0-2002; IN COMMERCE 0-0-2002.

THE COLOR(S) BLUE IS/ARE CLAIMED AS A FEATURE OF THE MARK.

ALICE SUE CARRUTHERS, EXAMINING ATTORNEY

Int. Cl.: 25

Prior U.S. Cls.: 22 and 39

United States Patent and Trademark Office

Reg. No. 3,484,500

Registered Aug. 12, 2008

**TRADEMARK
PRINCIPAL REGISTER**



WALRUS BRANDS, LLC (DELAWARE LTD LIAB
CO)
2444 W 16TH STREET, 5TH FLOOR
CHICAGO, IL 60608

FOR: ATHLETIC WEAR AND MEDICAL APPA-
REL, NAMELY, CAPS, HEADBANDS AGAINST
SWEATING, JACKETS, SHIRTS, SHOES, SPORTS
BRA, SWEAT SHIRTS, T SHIRTS, TIGHTS, TOPS
AND UNDERWEAR , IN CLASS 25 (U.S. CLS. 22
AND 39).

FIRST USE 9-1-2007; IN COMMERCE 12-1-2007.

THE COLOR(S) GREEN AND BLACK IS/ARE
CLAIMED AS A FEATURE OF THE MARK.

THE MARK CONSISTS OF THE WORD "BURCS"
IN BLACK TEXT WITH GREEN AND BLACK
CURVED LINES ON THE RIGHT-HAND SIDE
AND UNDERLINED BY A GREEN ARROW POINT-
ING TO THE LEFT.

SER. NO. 77-369,818, FILED 1-11-2008.

NAKWAMA ANKRAH, EXAMINING ATTORNEY

Int. Cl.: 30

Prior U.S. Cl.: 46

United States Patent and Trademark Office

Reg. No. 3,484,501

Registered Aug. 12, 2008

**TRADEMARK
PRINCIPAL REGISTER**

Evitalife

EVITALIFE (TEXAS CORPORATION), DBA EVI-
TALIFE HEALTH CORP
P.O. BOX 92615
AUSTIN, TX 78709

FOR: BEVERAGES MADE OF TEA; BLACK TEA;
COFFEE AND TEA; FRUIT TEAS; GREEN TEA;
HERB TEA; HERBAL TEA; ICED TEA; INSTANT
TEA; OOLONG TEA; TEA; TEA BAGS; TEA EX-
TRACTS; TEA FOR INFUSIONS; CAFFEINE-FREE
COFFEE; COFFEE; COFFEE AND ARTIFICIAL
COFFEE; COFFEE BEANS; COFFEE BEVERAGES
WITH MILK; COFFEE-BASED BEVERAGE CON-
TAINING MILK; COFFEE-BASED BEVERAGES;

GROUND COFFEE BEANS; INSTANT COFFEE;
ROASTED COFFEE BEANS; SUGAR-COATED COF-
FEE BEANS, IN CLASS 30 (U.S. CL. 46).

FIRST USE 12-14-2007; IN COMMERCE 1-8-2008.

THE MARK CONSISTS OF STANDARD CHAR-
ACTERS WITHOUT CLAIM TO ANY PARTICULAR
FONT, STYLE, SIZE, OR COLOR.

SER. NO. 77-369,819, FILED 1-11-2008.

HELENE LIWINSKI, EXAMINING ATTORNEY

Int. Cl.: 30

Prior U.S. Cl.: 46

United States Patent and Trademark Office

Reg. No. 3,484,502

Registered Aug. 12, 2008

**TRADEMARK
PRINCIPAL REGISTER**

Super Cleanse and Slim

EVITALIFE (TEXAS CORPORATION)
P.O. BOX 92615
AUSTIN, TX 78709

FIRST USE 12-14-2007; IN COMMERCE 1-8-2008.

FOR: BEVERAGES MADE OF TEA; BLACK TEA;
COFFEE AND TEA; FLAVOURINGS OF TEA;
FRUIT TEAS; GREEN TEA; HERB TEA; HERBAL
TEA; MIXES IN THE NATURE OF CONCENTRATES,
SYRUPS OR POWDERS USED IN THE PREPARATION
OF TEA BASED BEVERAGES; OOLONG TEA; TEA;
TEA BAGS; TEA EXTRACTS, IN CLASS 30 (U.S. CL. 46).

THE MARK CONSISTS OF STANDARD CHARACTERS
WITHOUT CLAIM TO ANY PARTICULAR FONT,
STYLE, SIZE, OR COLOR.

SER. NO. 77-369,878, FILED 1-11-2008.

HELENE LIWINSKI, EXAMINING ATTORNEY

Int. Cl.: 37

Prior U.S. Cls.: 100, 103 and 106

United States Patent and Trademark Office

Reg. No. 3,484,503

Registered Aug. 12, 2008

**SERVICE MARK
PRINCIPAL REGISTER**

UrbanCraft

URBANCRAFT CUSTOM BUILDERS, LP (TEXAS
LIMITED PARTNERSHIP), DBA URBAN-
CRAFT CUSTOM BUILDERS, LLC
1505 ELMEN ST
HOUSTON, TX 77019

THE MARK CONSISTS OF STANDARD CHAR-
ACTERS WITHOUT CLAIM TO ANY PARTICULAR
FONT, STYLE, SIZE, OR COLOR.

FOR: CUSTOM CONSTRUCTION OF HOMES, IN
CLASS 37 (U.S. CLS. 100, 103 AND 106).

SER. NO. 77-369,886, FILED 1-11-2008.

FIRST USE 9-17-2004; IN COMMERCE 2-1-2005.

JOHN WILKE, EXAMINING ATTORNEY

Int. Cl.: 45

Prior U.S. Cls.: 100 and 101

United States Patent and Trademark Office

Reg. No. 3,484,504

Registered Aug. 12, 2008

**SERVICE MARK
PRINCIPAL REGISTER**

ATHENA

ATHENA LAW GROUP LLP (DELAWARE LIMITED LIABILITY PARTNERSHIP)
543 WEST CRESCENT DRIVE
PALO ALTO, CA 94301

FOR: LEGAL SERVICES, IN CLASS 45 (U.S. CLS. 100 AND 101).

FIRST USE 1-5-2004; IN COMMERCE 1-5-2004.

THE MARK CONSISTS OF STANDARD CHARACTERS WITHOUT CLAIM TO ANY PARTICULAR FONT, STYLE, SIZE, OR COLOR.

OWNER OF U.S. REG. NO. 3,005,753.

SER. NO. 77-369,889, FILED 1-11-2008.

BRENDAN MCCAULEY, EXAMINING ATTORNEY

Int. Cl.: 44

Prior U.S. Cls.: 100 and 101

United States Patent and Trademark Office

Reg. No. 3,484,505

Registered Aug. 12, 2008

**SERVICE MARK
PRINCIPAL REGISTER**

EAT THIS NOT THAT

RODALE INC. (PENNSYLVANIA CORPORATION)
33 EAST MINOR STREET
EMMAUS, PA 180980099

FOR: PROVIDING ONLINE INFORMATION SERVICES IN THE FIELD OF HEALTH, DIET AND NUTRITION, IN CLASS 44 (U.S. CLS. 100 AND 101).

FIRST USE 9-0-2007; IN COMMERCE 9-0-2007.

THE MARK CONSISTS OF STANDARD CHARACTERS WITHOUT CLAIM TO ANY PARTICULAR FONT, STYLE, SIZE, OR COLOR.

OWNER OF U.S. REG. NO. 3,033,225.

SER. NO. 77-369,897, FILED 1-11-2008.

MAYUR VAGHANI, EXAMINING ATTORNEY

Int. Cl.: 33

Prior U.S. Cls.: 47 and 49

United States Patent and Trademark Office

Reg. No. 3,484,506

Registered Aug. 12, 2008

**TRADEMARK
PRINCIPAL REGISTER**

DVX

G. H. MUMM & CIE - SOCIETE VINICOLE DE
CHAMPAGNE, SUCESSEUR S.A. (FRANCE
CORPORATION)
29 RUE DU CHAMPS DE MARS
51100 REIMS, FRANCE

THE MARK CONSISTS OF STANDARD CHAR-
ACTERS WITHOUT CLAIM TO ANY PARTICULAR
FONT, STYLE, SIZE, OR COLOR.

FOR: WINES, IN CLASS 33 (U.S. CLS. 47 AND 49).

SER. NO. 77-369,900, FILED 1-11-2008.

FIRST USE 9-14-1994; IN COMMERCE 9-14-1994.

MICHAEL GAAFAR, EXAMINING ATTORNEY

Int. Cl.: 31

Prior U.S. Cls.: 1 and 46

United States Patent and Trademark Office

Reg. No. 3,484,507

Registered Aug. 12, 2008

TRADEMARK
PRINCIPAL REGISTER



THE PRODUCE EXCHANGE, INC. (CALIFORNIA CORPORATION)
7407 SOUTHFRONT ROAD
LIVERMORE, CA 94551

FOR: FRESH FRUIT AND VEGETABLES, IN CLASS 31 (U.S. CLS. 1 AND 46).

FIRST USE 6-1-1993; IN COMMERCE 6-1-1993.

NO CLAIM IS MADE TO THE EXCLUSIVE RIGHT TO USE "FARMS" AND "QUALITY PRODUCE", APART FROM THE MARK AS SHOWN.

THE MARK CONSISTS OF THE WORDS "GOOD DOG FARMS" ABOVE LINE DRAWING OF A DOG AND ITS PAWS AND THE WORD "QUALITY" TO THE LEFT OF THE DRAWING OF THE DOG AND THE WORD "PRODUCE" TO THE RIGHT OF THE DRAWING OF THE DOG.

SER. NO. 77-369,908, FILED 1-11-2008.

AMY GEARIN, EXAMINING ATTORNEY

Int. Cl.: 36

Prior U.S. Cls.: 100, 101 and 102

United States Patent and Trademark Office

Reg. No. 3,484,508

Registered Aug. 12, 2008

**SERVICE MARK
PRINCIPAL REGISTER**

First Dakota

FIRST DAKOTA FINANCIAL CORPORATION
(SOUTH DAKOTA CORPORATION)
225 CEDAR STREET
YANKTON, SD 57078

FOR: BANKING SERVICES, IN CLASS 36 (U.S.
CLS. 100, 101 AND 102).

FIRST USE 0-0-1941; IN COMMERCE 0-0-1941.

THE MARK CONSISTS OF STANDARD CHAR-
ACTERS WITHOUT CLAIM TO ANY PARTICULAR
FONT, STYLE, SIZE, OR COLOR.

OWNER OF U.S. REG. NO. 3,171,105.

NO CLAIM IS MADE TO THE EXCLUSIVE
RIGHT TO USE "FIRST", APART FROM THE
MARK AS SHOWN.

SER. NO. 77-369,942, FILED 1-11-2008.

MARK T. MULLEN, EXAMINING ATTORNEY

Int. Cl.: 15

Prior U.S. Cls.: 2, 21 and 36

United States Patent and Trademark Office

Reg. No. 3,484,509

Registered Aug. 12, 2008

**TRADEMARK
PRINCIPAL REGISTER**

AMERICAN SHOWSTER

HOFSCHEIDER, CHRISTOPHER (UNITED STATES INDIVIDUAL)

118 BLACK CREEK ROAD

MIDDLEBURGH, PA 12122

FOR: GUITARS, IN CLASS 15 (U.S. CLS. 2, 21 AND 36).

FIRST USE 0-0-1987; IN COMMERCE 0-0-1987.

THE MARK CONSISTS OF STANDARD CHARACTERS WITHOUT CLAIM TO ANY PARTICULAR FONT, STYLE, SIZE, OR COLOR.

NO CLAIM IS MADE TO THE EXCLUSIVE RIGHT TO USE "AMERICAN", APART FROM THE MARK AS SHOWN.

SER. NO. 77-369,961, FILED 1-11-2008.

ANDREW RHIM, EXAMINING ATTORNEY

Int. Cl.: 35

Prior U.S. Cls.: 100, 101 and 102

United States Patent and Trademark Office

Reg. No. 3,484,510

Registered Aug. 12, 2008

**SERVICE MARK
PRINCIPAL REGISTER**

Vinquire

VINQUIRE, INC. (CALIFORNIA CORPORATION)
368 7TH AVE. SUITE #2
SAN FRANCISCO, CA 94118

THE MARK CONSISTS OF STANDARD CHAR-
ACTERS WITHOUT CLAIM TO ANY PARTICULAR
FONT, STYLE, SIZE, OR COLOR.

FOR: ADVERTISING SERVICES, NAMELY, PRO-
MOTING THE FOOD AND WINE OF OTHERS, IN
CLASS 35 (U.S. CLS. 100, 101 AND 102).

SER. NO. 77-369,969, FILED 1-11-2008.

FIRST USE 5-1-2006; IN COMMERCE 11-1-2006.

ODESSA BIBBINS, EXAMINING ATTORNEY

Int. Cl.: 35

Prior U.S. Cls.: 100, 101 and 102

United States Patent and Trademark Office

Reg. No. 3,484,511

Registered Aug. 12, 2008

**SERVICE MARK
PRINCIPAL REGISTER**

COE

NEUSTRATEGY, INC. (ILLINOIS CORPORATION)
SUITE 5521
300 N. STATE STREET
CHICAGO, IL 60610

THE MARK CONSISTS OF STANDARD CHARACTERS WITHOUT CLAIM TO ANY PARTICULAR FONT, STYLE, SIZE, OR COLOR.

FOR: BUSINESS INFORMATION MANAGEMENT, IN CLASS 35 (U.S. CLS. 100, 101 AND 102).

SER. NO. 77-369,971, FILED 1-11-2008.

FIRST USE 10-28-2003; IN COMMERCE 10-28-2003.

MICHAEL KEATING, EXAMINING ATTORNEY

Int. Cls.: 41 and 42

Prior U.S. Cls.: 100, 101 and 107

United States Patent and Trademark Office

Reg. No. 3,484,512

Registered Aug. 12, 2008

**SERVICE MARK
PRINCIPAL REGISTER**



ILIKE, INC. (CALIFORNIA CORPORATION)
1605 BOYLSTON AVENUE, SUITE 202
SEATTLE, WA 98122

FOR: ENTERTAINMENT SERVICES, NAMELY, ARRANGING AND CONDUCTING INTERACTIVE MUSIC CONTESTS; PROVIDING REVIEWS AND RATINGS OF MUSICIANS, MUSIC AND VIDEOS; PROVIDING COMMENTARY AND INFORMATION ABOUT MUSIC, MUSICAL ARTISTS AND VIDEOS; PROVIDING INFORMATION ABOUT MUSICAL PERFORMANCES, CONCERTS AND ENTERTAINMENT, IN CLASS 41 (U.S. CLS. 100, 101 AND 107).

FIRST USE 5-24-2007; IN COMMERCE 5-24-2007.

FOR: PROVIDING TEMPORARY USE OF NON-DOWNLOADABLE SOFTWARE FOR ADDING MU-

SIC AND VIDEO TO PROFILES ON THE INTERNET, FOR LISTENING TO MP3'S AND FOR SHARING MP3'S AND MUSIC PLAYLISTS WITH OTHERS, IN CLASS 42 (U.S. CLS. 100 AND 101).

FIRST USE 5-24-2007; IN COMMERCE 5-24-2007.

THE COLOR(S) ORANGE AND WHITE IS/ARE CLAIMED AS A FEATURE OF THE MARK.

THE MARK CONSISTS OF ORANGE BOX WITH THE IMAGE OF A DIAGONALLY TILTED MUSIC NOTE IN WHITE.

SER. NO. 77-369,975, FILED 1-11-2008.

LOURDES AYALA, EXAMINING ATTORNEY

Int. Cl.: 43

Prior U.S. Cls.: 100 and 101

United States Patent and Trademark Office

Reg. No. 3,484,513

Registered Aug. 12, 2008

**SERVICE MARK
PRINCIPAL REGISTER**

Whisknladle

WHISKNLADLE HOSPITALITY, LLC (DELA-
WARE LTD LIAB CO)
7736 FAY AVENUE, SUITE 202
LA JOLLA, CA 92037

FOR: BAR AND RESTAURANT SERVICES; CAFE
AND RESTAURANT SERVICES; CAFE-RESTAU-
RANTS; CAFETERIA AND RESTAURANT SERVI-
CES; DELICATESSENS; RESTAURANT;
RESTAURANT AND BAR SERVICES; RESTAU-
RANT AND CAFE SERVICES; RESTAURANT AND
CATERING SERVICES; RESTAURANT SERVICES;
RESTAURANT, BAR AND CATERING SERVICES;
RESTAURANTS; RESTAURANTS FEATURING

HOME DELIVERY; TAKE-OUT RESTAURANT
SERVICES, IN CLASS 43 (U.S. CLS. 100 AND 101).

FIRST USE 9-17-2007; IN COMMERCE 9-17-2007.

THE MARK CONSISTS OF STANDARD CHAR-
ACTERS WITHOUT CLAIM TO ANY PARTICULAR
FONT, STYLE, SIZE, OR COLOR.

SER. NO. 77-369,981, FILED 1-11-2008.

DANIEL BRODY, EXAMINING ATTORNEY

Int. Cl.: 35

Prior U.S. Cls.: 100, 101 and 102

United States Patent and Trademark Office

Reg. No. 3,484,514

Registered Aug. 12, 2008

**SERVICE MARK
PRINCIPAL REGISTER**

1STABOARD BOAT CLASSIFIEDS

COLBY, GREG B. (UNITED STATES INDIVIDUAL)

1108 SOUTH DIVISION

BRISTOL, IN 46507

FOR: PROVIDING A WEB SITE THAT ENABLES USERS TO POST ITEMS FOR SALE THROUGH ON-LINE CLASSIFIED ADVERTISEMENTS, IN CLASS 35 (U.S. CLS. 100, 101 AND 102).

FIRST USE 8-31-2007; IN COMMERCE 8-31-2007.

THE MARK CONSISTS OF STANDARD CHARACTERS WITHOUT CLAIM TO ANY PARTICULAR FONT, STYLE, SIZE, OR COLOR.

OWNER OF U.S. REG. NO. 2,794,573.

NO CLAIM IS MADE TO THE EXCLUSIVE RIGHT TO USE "BOAT CLASSIFIEDS", APART FROM THE MARK AS SHOWN.

SER. NO. 77-369,983, FILED 1-11-2008.

ANNE E. GUSTASON, EXAMINING ATTORNEY

Int. Cls.: 35 and 42

Prior U.S. Cls.: 100, 101 and 102

United States Patent and Trademark Office

Reg. No. 3,484,515

Registered Aug. 12, 2008

**SERVICE MARK
PRINCIPAL REGISTER**

TAZOOM

MEDIA NETRIX LIMITED (UNITED KINGDOM
LIMITED COMPANY (LTD.))
14 LEASWAY
RAYLEIGH, UNITED KINGDOM SS67DW

FOR: DISSEMINATION OF ADVERTISING FOR
OTHERS VIA THE INTERNET, IN CLASS 35 (U.S.
CLS. 100, 101 AND 102).

FIRST USE 12-1-2007; IN COMMERCE 12-1-2007.

FOR: COMPUTER SERVICES, NAMELY, CREAT-
ING INDEXES OF INFORMATION, SITES AND

OTHER RESOURCES AVAILABLE ON COMPUTER
NETWORKS, IN CLASS 42 (U.S. CLS. 100 AND 101).

FIRST USE 12-1-2007; IN COMMERCE 12-1-2007.

THE MARK CONSISTS OF STANDARD CHAR-
ACTERS WITHOUT CLAIM TO ANY PARTICULAR
FONT, STYLE, SIZE, OR COLOR.

SER. NO. 77-370,005, FILED 1-11-2008.

ODESSA BIBBINS, EXAMINING ATTORNEY

Int. Cl.: 42

Prior U.S. Cls.: 100 and 101

United States Patent and Trademark Office

Reg. No. 3,484,516

Registered Aug. 12, 2008

**SERVICE MARK
PRINCIPAL REGISTER**

TGLdesigns

SALZMAN, ALLISON (UNITED STATES INDIVIDUAL)
220 BOTANICAL DRIVE
SWANSEA, IL 62226

THE MARK CONSISTS OF STANDARD CHARACTERS WITHOUT CLAIM TO ANY PARTICULAR FONT, STYLE, SIZE, OR COLOR.

FOR: GRAPHIC DESIGN SERVICES, IN CLASS 42 (U.S. CLS. 100 AND 101).

SER. NO. 77-370,009, FILED 1-11-2008.

FIRST USE 10-1-2007; IN COMMERCE 10-1-2007.

AMY ALFIERI, EXAMINING ATTORNEY

Int. Cl.: 33

Prior U.S. Cls.: 47 and 49

United States Patent and Trademark Office

Reg. No. 3,484,517

Registered Aug. 12, 2008

TRADEMARK
PRINCIPAL REGISTER



RIBERA VINEYARDS LLC (OREGON LTD LIAB
CO), DBA RIBERA VINEYARDS
21775 SW RIBERA LN
WEST LINN, OR 97068

FOR: GRAPE WINE, IN CLASS 33 (U.S. CLS. 47
AND 49).

FIRST USE 4-0-2006; IN COMMERCE 5-0-2006.

NO CLAIM IS MADE TO THE EXCLUSIVE
RIGHT TO USE "RIBERA" AND "VINEYARDS",
APART FROM THE MARK AS SHOWN.

THE MARK CONSISTS OF THE OUTLINE OF A
BOX WITH A CAPITAL LETTER "R" IN IT. CEN-
TERED BELOW THE BOX THE WORD "RIBERA",
AND THE WORD "VINEYARDS" CENTERED BE-
LOW THE WORD "RIBERA". THE LETTER "R"
AND THE WORDS "RIBERA" AND "VINEYARDS"
IN THE FONT TEMPUS SANS.

THE ENGLISH TRANSLATION OF THE WORD
"RIBERA" IN THE MARK IS BANK OR SHORE.

SER. NO. 77-370,016, FILED 1-11-2008.

RENEE SERVANCE, EXAMINING ATTORNEY

Int. Cl.: 1

Prior U.S. Cls.: 1, 5, 6, 10, 26 and 46

Reg. No. 3,484,518

United States Patent and Trademark Office

Registered Aug. 12, 2008

**TRADEMARK
PRINCIPAL REGISTER**

DELTAG

MCRIGHT SERVICES, LLC (MISSISSIPPI LTD
LIAB CO), DBA DELTAG FORMULATIONS
P.O. BOX 4812
GREENVILLE, MS 38704

THE MARK CONSISTS OF STANDARD CHAR-
ACTERS WITHOUT CLAIM TO ANY PARTICULAR
FONT, STYLE, SIZE, OR COLOR.

FOR: FERTILIZERS, IN CLASS 1 (U.S. CLS. 1, 5, 6,
10, 26 AND 46).

SER. NO. 77-370,039, FILED 1-11-2008.

FIRST USE 1-1-1991; IN COMMERCE 1-1-1991.

JENNY PARK, EXAMINING ATTORNEY

Int. Cl.: 35

Prior U.S. Cls.: 100, 101 and 102

United States Patent and Trademark Office

Reg. No. 3,484,519

Registered Aug. 12, 2008

**SERVICE MARK
PRINCIPAL REGISTER**

CIRCLEPIX

CIRCLEPIX.COM, LLC (UTAH LTD LIAB CO)
676 WEST 1200 NORTH
SPRINGVILLE, UT 84663

FOR: ADVERTISING AND MARKETING; ADVERTISING, MARKETING AND PROMOTION SERVICES; ON-LINE ADVERTISING AND MARKETING SERVICES; REAL ESTATE ADVERTISING SERVICES; REAL ESTATE MARKETING SERVICES, NAMELY, ON-LINE SERVICES FEATURING TOURS OF RESIDENTIAL AND COM-

MERCIAL REAL ESTATE, IN CLASS 35 (U.S. CLS. 100, 101 AND 102).

FIRST USE 1-15-2000; IN COMMERCE 1-15-2000.

THE MARK CONSISTS OF STANDARD CHARACTERS WITHOUT CLAIM TO ANY PARTICULAR FONT, STYLE, SIZE, OR COLOR.

SER. NO. 77-370,043, FILED 1-11-2008.

BRIAN PINO, EXAMINING ATTORNEY

Int. Cl.: 25

Prior U.S. Cls.: 22 and 39

United States Patent and Trademark Office

Reg. No. 3,484,520

Registered Aug. 12, 2008

**TRADEMARK
PRINCIPAL REGISTER**

**Because Life is an
Adventure!**

SHERPA ADVENTURE GEAR, INC. (WASHINGTON CORPORATION), DBA DUO WEAR
OAKESDALE COMMERCE CENTER
810 SW 34TH STREET, BLDG W6, SUITE D
RENTON, WA 98057

THE MARK CONSISTS OF STANDARD CHARACTERS WITHOUT CLAIM TO ANY PARTICULAR FONT, STYLE, SIZE, OR COLOR.

FOR: SHIRTS; JACKETS; SHORTS; PANTS; SOCKS; SHOES; HATS; SWEATERS, IN CLASS 25 (U.S. CLS. 22 AND 39).

SER. NO. 77-370,050, FILED 1-11-2008.

FIRST USE 2-1-2003; IN COMMERCE 2-1-2003.

THEODORE MCBRIDE, EXAMINING ATTORNEY

Int. Cl.: 9

Prior U.S. Cls.: 21, 23, 26, 36 and 38

United States Patent and Trademark Office

Reg. No. 3,484,521

Registered Aug. 12, 2008

**TRADEMARK
PRINCIPAL REGISTER**

HOUSTON

THE FONT BUREAU, INC. (MASSACHUSETTS
CORPORATION)
50 MELCHER STREET, SUITE 2
BOSTON, MA 02210

FOR: PRINTING FONTS THAT CAN BE DOWN-
LOADED PROVIDED BY MEANS OF ELECTRONIC
TRANSMISSION; TYPEFACE FONTS RECORDED
ON MAGNETIC MEDIA, IN CLASS 9 (U.S. CLS. 21,
23, 26, 36 AND 38).

FIRST USE 1-9-2008; IN COMMERCE 1-9-2008.

THE MARK CONSISTS OF STANDARD CHAR-
ACTERS WITHOUT CLAIM TO ANY PARTICULAR
FONT, STYLE, SIZE, OR COLOR.

SER. NO. 77-370,066, FILED 1-11-2008.

ODESSA BIBBINS, EXAMINING ATTORNEY

Int. Cl.: 25

Prior U.S. Cls.: 22 and 39

United States Patent and Trademark Office

Reg. No. 3,484,522

Registered Aug. 12, 2008

**TRADEMARK
PRINCIPAL REGISTER**

RASS

COTTON PLUS, INC. (FLORIDA CORPORATION)
SUITE 12
7225 NW 68 STREET
MIAMI, FL 33166

THE MARK CONSISTS OF STANDARD CHARACTERS WITHOUT CLAIM TO ANY PARTICULAR FONT, STYLE, SIZE, OR COLOR.

FOR: CLOTHING, NAMELY, SHIRTS, T-SHIRTS, SWEATERS, AND HATS, IN CLASS 25 (U.S. CLS. 22 AND 39).

SER. NO. 77-370,073, FILED 1-11-2008.

FIRST USE 1-8-2006; IN COMMERCE 1-8-2006.

ELIZABETH HUGHITT, EXAMINING ATTORNEY

Int. Cl.: 42

Prior U.S. Cls.: 100 and 101

United States Patent and Trademark Office

Reg. No. 3,484,523

Registered Aug. 12, 2008

**SERVICE MARK
PRINCIPAL REGISTER**

**Diagnostic Solutions
Diagnosing Problems,
Providing Solutions**

DIAGNOSTIC SOLUTIONS LLC (NORTH CAROLINA LTD LIAB CO)

916 FIRETOWER ROAD

JACKSONVILLE, NC 28540

FOR: DIAGNOSTIC SERVICES IN THE FIELD OF HELICOPTERS, IN CLASS 42 (U.S. CLS. 100 AND 101).

FIRST USE 11-30-2004; IN COMMERCE 6-1-2005.

THE MARK CONSISTS OF STANDARD CHARACTERS WITHOUT CLAIM TO ANY PARTICULAR FONT, STYLE, SIZE, OR COLOR.

NO CLAIM IS MADE TO THE EXCLUSIVE RIGHT TO USE "DIAGNOSTIC", APART FROM THE MARK AS SHOWN.

SER. NO. 77-370,129, FILED 1-11-2008.

JANICE L. MCMORROW, EXAMINING ATTORNEY

Int. Cl.: 3

Prior U.S. Cls.: 1, 4, 6, 50, 51 and 52

Reg. No. 3,484,524

United States Patent and Trademark Office

Registered Aug. 12, 2008

**TRADEMARK
PRINCIPAL REGISTER**

SHUTTER MAGIC

GASKEY, RICHARD (UNITED STATES INDIVIDUAL)
31915 RANCHO CALIFORNIA ROAD, #200-184
TEMECULA, CA 92591

FOR: WINDOW SHUTTER CLEANER AND WINDOW SHUTTER POLISH, IN CLASS 3 (U.S. CLS. 1, 4, 6, 50, 51 AND 52).

FIRST USE 11-20-2006; IN COMMERCE 11-20-2006.

THE MARK CONSISTS OF STANDARD CHARACTERS WITHOUT CLAIM TO ANY PARTICULAR FONT, STYLE, SIZE, OR COLOR.

NO CLAIM IS MADE TO THE EXCLUSIVE RIGHT TO USE "SHUTTER", APART FROM THE MARK AS SHOWN.

SER. NO. 77-370,147, FILED 1-11-2008.

MARIAM MAHMOUDI, EXAMINING ATTORNEY

Int. Cl.: 28

Prior U.S. Cls.: 22, 23, 38 and 50

United States Patent and Trademark Office

Reg. No. 3,484,525

Registered Aug. 12, 2008

**TRADEMARK
PRINCIPAL REGISTER**

DiBocca

DIBOCCA (NEVADA CORPORATION)
10501 HAWKS HAVEN ROAD
CEDAR RAPIDS, IA 52411

FOR: CASINO DICE GAME, IN CLASS 28 (U.S.
CLS. 22, 23, 38 AND 50).

FIRST USE 1-1-2006; IN COMMERCE 4-14-2008.

THE MARK CONSISTS OF STANDARD CHAR-
ACTERS WITHOUT CLAIM TO ANY PARTICULAR
FONT, STYLE, SIZE, OR COLOR.

THE WORDING "DIBOCCA" HAS NO MEANING
IN A FOREIGN LANGUAGE.

SER. NO. 77-370,171, FILED 1-11-2008.

KAPIL BHANOT, EXAMINING ATTORNEY

Int. Cl.: 41

Prior U.S. Cls.: 100, 101 and 107

United States Patent and Trademark Office

Reg. No. 3,484,526

Registered Aug. 12, 2008

**SERVICE MARK
PRINCIPAL REGISTER**

DOCUTOGRAPHY

REEVES, NICHOLAS B (UNITED STATES INDIVIDUAL), AKA NICK REEVES DBA NBR ENTERPRISES
1907 SADDLE DRIVE
PLACENTIA, CA 92870

THE MARK CONSISTS OF STANDARD CHARACTERS WITHOUT CLAIM TO ANY PARTICULAR FONT, STYLE, SIZE, OR COLOR.

FOR: PHOTOGRAPHY SERVICES, IN CLASS 41 (U.S. CLS. 100, 101 AND 107).

SER. NO. 77-370,195, FILED 1-12-2008.

FIRST USE 2-18-2005; IN COMMERCE 1-2-2006.

JASON ROTH, EXAMINING ATTORNEY

Int. Cl.: 35

Prior U.S. Cls.: 100, 101 and 102

United States Patent and Trademark Office

Reg. No. 3,484,527

Registered Aug. 12, 2008

**SERVICE MARK
PRINCIPAL REGISTER**

YLANG|23

JTCT, INC. (DELAWARE CORPORATION)
13350 DALLAS PARKWAY
SUITE 1300
DALLAS, TX 752406631

THE MARK CONSISTS OF STANDARD CHAR-
ACTERS WITHOUT CLAIM TO ANY PARTICULAR
FONT, STYLE, SIZE, OR COLOR.

FOR: RETAIL STORE SERVICES FEATURING
JEWELRY; ON-LINE RETAIL STORE SERVICES
FEATURING JEWELRY, IN CLASS 35 (U.S. CLS.
100, 101 AND 102).

SER. NO. 77-370,312, FILED 1-14-2008.

FIRST USE 1-0-2004; IN COMMERCE 1-0-2004.

KATHERINE E. HALMEN, EXAMINING ATTOR-
NEY

Int. Cl.: 33

Prior U.S. Cls.: 47 and 49

United States Patent and Trademark Office

Reg. No. 3,484,528

Registered Aug. 12, 2008

**TRADEMARK
PRINCIPAL REGISTER**

Calaboose Cellars

JAILHOUSE WINERY LLC (NORTH CAROLINA
LTD LIAB CO)
P.O. BOX 1818
ANDREWS, NC 28901

NO CLAIM IS MADE TO THE EXCLUSIVE
RIGHT TO USE "CELLARS", APART FROM THE
MARK AS SHOWN.

FOR: WINE, IN CLASS 33 (U.S. CLS. 47 AND 49).

FIRST USE 1-12-2008; IN COMMERCE 1-12-2008.

SER. NO. 77-370,320, FILED 1-13-2008.

THE MARK CONSISTS OF STANDARD CHAR-
ACTERS WITHOUT CLAIM TO ANY PARTICULAR
FONT, STYLE, SIZE, OR COLOR.

SANI KHOURI, EXAMINING ATTORNEY

Int. Cl.: 43

Prior U.S. Cls.: 100 and 101

United States Patent and Trademark Office

Reg. No. 3,484,529

Registered Aug. 12, 2008

**SERVICE MARK
PRINCIPAL REGISTER**



BEST OF BOTH WORLDS CATERING L.L.C.
(OHIO LTD LIAB CO)
5125 STANLEY AVE.
MAPLE HEIGHTS, OH 441372826

FOR: CATERING; CATERING FOR THE PROVISION OF FOOD AND BEVERAGES; CATERING OF FOOD AND DRINKS, IN CLASS 43 (U.S. CLS. 100 AND 101).

FIRST USE 1-1-2008; IN COMMERCE 1-1-2008.

NO CLAIM IS MADE TO THE EXCLUSIVE RIGHT TO USE "CATERING", APART FROM THE MARK AS SHOWN.

THE MARK CONSISTS OF A WORLD GLOBE CONTAINING OUTLINES OF LAND MASSES WITH THE WORDS "BEST OF BOTH" CURVING AROUND THE TOP OF THE GLOBE. THE WORLD GLOBE IS SEPARATED COMPLETELY BY EMPTY SPACE IN THE MIDDLE OF THE GLOBE WITH THE WORDS "WORLDS CATERING" STACKED DIAGONALLY. A SENTENCE THAT READS, IN QUOTATION MARKS, ""WITH A WORLD OF EXPERIENCE"" IS BELOW THE BOTTOM HALF OF THE WORLD GLOBE.

SER. NO. 77-370,324, FILED 1-13-2008.

REBECCA GILBERT, EXAMINING ATTORNEY

Int. Cl.: 30

Prior U.S. Cl.: 46

Reg. No. 3,484,530

United States Patent and Trademark Office

Registered Aug. 12, 2008

**TRADEMARK
PRINCIPAL REGISTER**

RED TRUCK RURAL BAKERY

BRIAN J. NOYES (VIRGINIA LTD LIAB CO),
DBA RED TRUCK RURAL BAKERY
1815 N. RANDOLPH ST
ARLINGTON, VA 22207

FOR: BISCUITS AND BREAD; BREAD; BREAD AND BUNS; BREAD AND PASTRY; BREAD MIXES; BREAD ROLLS; BREAD STICKS; BREAD WITH SOY BEAN; BRUSCHETTE-TOPPED BREAD; FOOD PACKAGE COMBINATIONS CONSISTING PRIMARILY OF BREAD, CRACKERS AND/OR COOKIES; FROZEN BREADS; MIXES FOR MAKING BREADING; PITA BREAD; PROTEIN REDUCED AND GLUTEN FREE FLOUR AND BREAD; ROLLS; STUFFING MIXES CONTAINING BREAD; UNLEAVENED BREAD IN THIN SHEETS; WHOLEMEAL BREAD; CHOCOLATE-BASED FILLINGS FOR CAKES AND PIES; CUSTARD-BASED FILLINGS FOR CAKES AND PIES; FRUIT PIES; MEAT PIES; MEAT PIES; MINCEMEAT PIES; PIES; POT PIES; SEAFOOD PIES; ALMOND CAKE; CAKE DOUGHS; CAKE MIXES; CAKES; CANDY CAKE DECORATIONS; CANDY DECORATIONS FOR CAKES; CUP CAKES; EDIBLE CAKE DECORATIONS; EDIBLE DECORATIONS FOR CAKES; FLAVORINGS, OTHER THAN ESSENTIAL OILS, FOR CAKES; FLAVOURINGS FOR CAKES OTHER THAN ESSENTIAL OILS; FLAVOURINGS, OTHER THAN ESSENTIAL OILS, FOR CAKES; FRUIT CAKES; ICE-CREAM CAKES; ICED CAKES; MOON CAKES; PETITS FOURS; SNACK CAKES; SPONGE CAKES; TARTS; COOKIE DOUGH; COOKIE MIXES; COOKIES; COOKIES AND CRACKERS; FRIED DOUGH COOKIES (KARINTOH); CANDIES; CANDY; CANDY BARS; CANDY COATED APPLES; CANDY COATED POPCORN; CANDY CONTAINING ALCOHOLIC BEVERAGE CONTENT AND FLAVOR; CANDY FOR FOOD; CANDY MINTS; CANDY WITH CARAMEL; CANDY WITH COCOA; CHOCO-

LATE CANDIES; GIFT BASKETS CONTAINING CANDY; GUMMY CANDIES; PEPPERMINT CANDY; SNACK MIX CONSISTING PRIMARILY OF CRACKERS, PRETZELS, CANDIED NUTS AND/OR POPPED POPCORN; SUGARLESS CANDIES; SWEETS; BEVERAGES MADE OF COFFEE; CAFFEINE-FREE COFFEE; COFFEE; COFFEE; COFFEE AND ARTIFICIAL COFFEE; COFFEE AND COFFEE SUBSTITUTES; COFFEE AND TEA; COFFEE BEANS; COFFEE BEVERAGES WITH MILK; GROUND COFFEE BEANS; PREPARED COFFEE AND COFFEE-BASED BEVERAGES; ROASTED COFFEE BEANS; DANISH PASTRIES; MACAROONS; PASTRIES; PASTRY; CHOCOLATE; CHOCOLATE AND CHOCOLATES; CHOCOLATE BARS; CHOCOLATE COVERED NUTS; CHOCOLATE COVERED RAISINS; CHOCOLATE TRUFFLES; CHOCOLATE-BASED READY-TO-EAT FOOD BARS; CHOCOLATE-COVERED POTATO CHIPS; FILLED CHOCOLATE; HOT CHOCOLATE; MILK CHOCOLATE; SPREAD CONTAINING CHOCOLATE AND NUTS; GRANOLA; GRANOLA SNACKS; GRANOLA-BASED SNACK BARS; HONEY; HONEY; HONEY BUNS , IN CLASS 30 (U.S. CL. 46).

FIRST USE 3-1-2005; IN COMMERCE 3-1-2005.

THE MARK CONSISTS OF STANDARD CHARACTERS WITHOUT CLAIM TO ANY PARTICULAR FONT, STYLE, SIZE, OR COLOR.

NO CLAIM IS MADE TO THE EXCLUSIVE RIGHT TO USE "RURAL BAKERY", APART FROM THE MARK AS SHOWN.

SER. NO. 77-370,328, FILED 1-13-2008.

BRENDAN REGAN, EXAMINING ATTORNEY

Int. Cls.: 35 and 36

Prior U.S. Cls.: 100, 101 and 102

United States Patent and Trademark Office

Reg. No. 3,484,531

Registered Aug. 12, 2008

**SERVICE MARK
PRINCIPAL REGISTER**

Gold Choice

GOLD CHOICE REALTY LLC (IDAHO LTD LIAB
CO)
SUITE 209
157 W. HAYDEN AVENUE
HAYDEN, ID 83835

FOR: REAL ESTATE MARKETING SERVICES,
NAMELY, ON-LINE SERVICES FEATURING
TOURS OF RESIDENTIAL AND COMMERCIAL
REAL ESTATE, IN CLASS 35 (U.S. CLS. 100, 101
AND 102).

FIRST USE 9-29-2007; IN COMMERCE 9-29-2007.

FOR: PROVIDING INFORMATION IN THE
FIELD OF REAL ESTATE VIA THE INTERNET;

PROVIDING REAL ESTATE LISTINGS AND REAL
ESTATE INFORMATION VIA THE INTERNET;
REAL ESTATE BROKERAGE; REAL ESTATE LIST-
ING, IN CLASS 36 (U.S. CLS. 100, 101 AND 102).

FIRST USE 9-29-2007; IN COMMERCE 9-29-2007.

THE MARK CONSISTS OF STANDARD CHAR-
ACTERS WITHOUT CLAIM TO ANY PARTICULAR
FONT, STYLE, SIZE, OR COLOR.

SER. NO. 77-370,330, FILED 1-13-2008.

BRENDAN REGAN, EXAMINING ATTORNEY

Int. Cl.: 29

Prior U.S. Cl.: 46

United States Patent and Trademark Office

Reg. No. 3,484,532

Registered Aug. 12, 2008

**TRADEMARK
PRINCIPAL REGISTER**

RED TRUCK RURAL BAKERY

BRIAN J. NOYES (VIRGINIA LTD LIAB CO),
DBA RED TRUCK RURAL BAKERY
1815 N. RANDOLPH ST
ARLINGTON, VA 22207

FOR: JELLIES; JELLIES AND JAMS; JELLIES FOR FOOD; JELLIES, JAMS; MEAT, FISH, FRUIT AND VEGETABLE JELLIES; MEAT, FRUIT AND VEGETABLE JELLIES, JAMS; MEAT, FRUIT AND VEGETABLE JELLIES, JAMS, EGGS; JAMS; JAMS AND MARMALADES; MARMALADES AND JAMS; CRYSTALLISED, FROSTED, FROZEN, AND PRESERVED FRUIT; EDIBLE OILS AND FATS, FISH AND MEAT PRESERVES; EDIBLE OILS AND FATS, PRESERVES; EDIBLE OILS AND FATS, PRESERVES AND PICKLES; EDIBLE OILS AND FATS, PRESERVES, PICKLES; MEAT, FISH, FRUIT AND VEGETABLE PRESERVES; MEAT, FISH, POULTRY AND GAME PRESERVES; PRESERVED FRUIT AND VEGETABLES; PRESERVED FRUITS; PRESERVED

MEATS AND SAUSAGES; PRESERVED VEGETABLES (IN OIL); PRESERVED, DRIED AND COOKED FRUIT AND VEGETABLES; PRESERVED, DRIED AND COOKED OLIVES; PRESERVED, DRIED, COOKED AND GRILLED VEGETABLES, IN CLASS 29 (U.S. CL. 46).

FIRST USE 3-1-2005; IN COMMERCE 3-1-2005.

THE MARK CONSISTS OF STANDARD CHARACTERS WITHOUT CLAIM TO ANY PARTICULAR FONT, STYLE, SIZE, OR COLOR.

NO CLAIM IS MADE TO THE EXCLUSIVE RIGHT TO USE "RURAL BAKERY", APART FROM THE MARK AS SHOWN.

SER. NO. 77-370,332, FILED 1-13-2008.

BRENDAN REGAN, EXAMINING ATTORNEY

Int. Cl.: 35

Prior U.S. Cls.: 100, 101 and 102

United States Patent and Trademark Office

Reg. No. 3,484,533

Registered Aug. 12, 2008

**SERVICE MARK
PRINCIPAL REGISTER**

Cobblestone Dream

COBBLESTONE HOTEL GROUP, LLC (WISCONSIN LTD LIAB CO)
SUITE 101
404 N MAIN STREET
OSHKOSH, WI 54901

FOR: BUSINESS DEVELOPMENT SERVICES, NAMELY, PROVIDING START-UP SUPPORT FOR BUSINESSES OF OTHERS, IN CLASS 35 (U.S. CLS. 100, 101 AND 102).

FIRST USE 1-12-2008; IN COMMERCE 1-12-2008.

THE MARK CONSISTS OF STANDARD CHARACTERS WITHOUT CLAIM TO ANY PARTICULAR FONT, STYLE, SIZE, OR COLOR.

SER. NO. 77-370,338, FILED 1-13-2008.

BRENDAN REGAN, EXAMINING ATTORNEY

Int. Cl.: 41

Prior U.S. Cls.: 100, 101 and 107

United States Patent and Trademark Office

Reg. No. 3,484,534

Registered Aug. 12, 2008

**SERVICE MARK
PRINCIPAL REGISTER**



WHILDIN, JOHN D. (UNITED STATES INDIVIDUAL), DBA WILD BORES
5103 ELKINS AVENUE
NASHVILLE, TN 37209

THE MARK CONSISTS OF BAND NAME "WILD BORES" (REF APPLICATION 77256213) WRITTEN IN THE SHAPE OF LIPS.

FOR: AUDIO RECORDINGS FEATURING MUSIC, IN CLASS 41 (U.S. CLS. 100, 101 AND 107).

SER. NO. 77-370,356, FILED 1-13-2008.

FIRST USE 1-1-1992; IN COMMERCE 1-1-1994.

NAAKWAMA ANKRAH, EXAMINING ATTORNEY

Int. Cl.: 35

Prior U.S. Cls.: 100, 101 and 102

United States Patent and Trademark Office

Reg. No. 3,484,535

Registered Aug. 12, 2008

SERVICE MARK
PRINCIPAL REGISTER



TOTAL STRATEGY, LLC (VIRGINIA LTD LIAB
CO)
6555 WILLIAMS WALK
FALLS CHURCH, VA 22042

FOR: ADVERTISING AND BUSINESS MANAGEMENT CONSULTANCY; BUSINESS MANAGEMENT CONSULTANCY AND ADVISORY SERVICES; BUSINESS MANAGEMENT CONSULTANCY AS WELL AS DEVELOPMENT OF PROCESSES FOR THE ANALYSIS AND THE IMPLEMENTATION OF STRATEGY PLANS AND MANAGEMENT PROJECTS; BUSINESS MANAGEMENT CONSULTANCY SERVICES; BUSINESS MANAGEMENT CONSULTATION; BUSINESS MANAGEMENT CONSULTING; BUSINESS MANAGEMENT CONSULTING AND ADVISORY SERVICES; BUSINESS MANAGEMENT CONSULTING WITH RELATION TO STRATEGY, MARKETING, PRODUCTION, PERSONNEL AND RETAIL SALE MATTERS; BUSINESS ORGANISATION AND MANAGEMENT CONSULTING SERVICES; BUSINESS ORGANIZATION AND MANAGEMENT CONSULTING; BUSINESS RISK MANAGEMENT CONSULTATION, IN CLASS 35 (U.S. CLS. 100, 101 AND 102).

FIRST USE 2-22-2007; IN COMMERCE 2-22-2007.

THE COLOR(S) BLACK, WHITE, MAROON IS/
ARE CLAIMED AS A FEATURE OF THE MARK.

THE MARK CONSISTS OF THE WORD "TOTAL" IN UPPER-CASE LETTERS AND MAROON COLOR WITH THE LETTER "O" UNDERLINED; THE MIDDLE LETTER "T" IS DEPICTED IN NEGATIVE SPACE - THAT IS A WHITE LETTER ENSCONCED IN A SQUARE BLACK BACKGROUND. THE SAME SQUARE BLACK BACKGROUND ENSCONCES THE "S" IN THE WORD "STRATEGY" WHICH STARTS IMMEDIATELY BELOW THE MIDDLE "T" OF "TOTAL" AND RUNS PARALLEL TO "TOTAL". "STRATEGY" IS CAPITALIZED AND MAROON IN COLOR, EXCEPT FOR THE "S" WHICH IS WHITE AND DEPICTED IN NEGATIVE SPACE THE SAME AS THE "T" ABOVE IT. BEGINNING ON THE SAME LINE IMMEDIATELY AFTER THE "Y" IN "STRATEGY" THE PHRASE "MANAGING THE FUTURE" IN BLACK. .

SER. NO. 77-370,407, FILED 1-13-2008.

DORITT L. CARROLL, EXAMINING ATTORNEY

Int. Cl.: 7

Prior U.S. Cls.: 13, 19, 21, 23, 31, 34 and 35

Reg. No. 3,484,536

United States Patent and Trademark Office

Registered Aug. 12, 2008

**TRADEMARK
PRINCIPAL REGISTER**

TRISTAR MACHINERY

TRISTAR MACHINERY USA, INC. (MISSOURI
CORPORATION)
12620 LAMPLIGHTER SQR SHPPNG CENTER
ST. LOUIS, MO 63128

FOR: GRINDING MACHINES FOR SHAPING
AND POLISHING STONE EDGES, IN CLASS 7 (U.S.
CLS. 13, 19, 21, 23, 31, 34 AND 35).

FIRST USE 12-28-2007; IN COMMERCE 12-28-2007.

THE MARK CONSISTS OF STANDARD CHAR-
ACTERS WITHOUT CLAIM TO ANY PARTICULAR
FONT, STYLE, SIZE, OR COLOR.

NO CLAIM IS MADE TO THE EXCLUSIVE
RIGHT TO USE "MACHINERY", APART FROM
THE MARK AS SHOWN.

SER. NO. 77-370,446, FILED 1-13-2008.

TERESA M. RUPP, EXAMINING ATTORNEY

Int. Cl.: 41

Prior U.S. Cls.: 100, 101 and 107

United States Patent and Trademark Office

Reg. No. 3,484,537

Registered Aug. 12, 2008

**SERVICE MARK
PRINCIPAL REGISTER**

Gottado College

ROZALIA CECELIA WILLIAMS (UNITED STATES INDIVIDUAL)
UNIT 923
3725 SOUTH OCEAN DRIVE
HOLLYWOOD, FL 33019

FOR: EDUCATION, ENTERTAINMENT, RECREATION AND CULTURAL SERVICES, NAME-
LY, CONDUCTING INTERACTIVE, REALITY-
BASED SIMULATIONS, PRESENTATIONS, PRO-
GRAMS, EVENTS AND COURSES OF INSTRU-
CTION AT THE SECONDARY AND POST-
SECONDARY LEVELS IN THE FIELD OF HIGHER
EDUCATION PREPARATION THAT REPLICATE
COLLEGE AND UNIVERSITY LIFE EXPERIENCES,

AND THE DISTRIBUTION OF EDUCATIONAL
MATERIALS IN CONNECTION THEREWITH, IN
CLASS 41 (U.S. CLS. 100, 101 AND 107).

FIRST USE 8-1-2007; IN COMMERCE 8-1-2007.

THE MARK CONSISTS OF STANDARD CHAR-
ACTERS WITHOUT CLAIM TO ANY PARTICULAR
FONT, STYLE, SIZE, OR COLOR.

SER. NO. 77-370,484, FILED 1-14-2008.

PAUL F. GAST, EXAMINING ATTORNEY

Int. Cls.: 35 and 42

Prior U.S. Cls.: 100, 101 and 102

United States Patent and Trademark Office

Reg. No. 3,484,538

Registered Aug. 12, 2008

**SERVICE MARK
PRINCIPAL REGISTER**

TECVAR

TECVAR, INC. (MISSOURI CORPORATION)
SUITE 118
149 WELDON PARKWAY
MARYLAND HEIGHTS, MO 63043

FOR: BUSINESS PROCESS OUTSOURCING SERVICES IN THE FIELD OF INFORMATION TECHNOLOGY; BUSINESS CONSULTING AND INFORMATION SERVICES , IN CLASS 35 (U.S. CLS. 100, 101 AND 102).

FIRST USE 1-16-2003; IN COMMERCE 1-16-2003.

FOR: CONSULTING SERVICES IN THE FIELD OF DESIGN, SELECTION, IMPLEMENTATION

AND USE OF COMPUTER HARDWARE AND SOFTWARE SYSTEMS FOR OTHERS, IN CLASS 42 (U.S. CLS. 100 AND 101).

FIRST USE 8-14-2000; IN COMMERCE 8-14-2000.

THE MARK CONSISTS OF STANDARD CHARACTERS WITHOUT CLAIM TO ANY PARTICULAR FONT, STYLE, SIZE, OR COLOR.

SER. NO. 77-370,489, FILED 1-14-2008.

GRETТА YAO, EXAMINING ATTORNEY

Int. Cls.: 21, 25, 28, 35, 36, 37, 41, 42 and 43

**Prior U.S. Cls.: 2, 13, 22, 23, 29, 30, 33, 38, 39, 40, 50,
100, 101, 102, 103, 106 and 107**

Reg. No. 3,484,539

United States Patent and Trademark Office

Registered Aug. 12, 2008

**TRADEMARK
SERVICE MARK
PRINCIPAL REGISTER**



SUNCADIA, LLC (DELAWARE LTD LIAB CO)
11777 SAN VICENTE BOULEVARD, SUITE 900
LOS ANGELES, CA 90049

FOR: BEVERAGE GLASSWARE; BAR RELATED PRODUCTS, NAMELY, CORK SCREWS, COOLERS FOR WINES, BEER MUGS AND FLASKS, IN CLASS 21 (U.S. CLS. 2, 13, 23, 29, 30, 33, 40 AND 50).

FIRST USE 4-0-2004; IN COMMERCE 7-0-2005.

FOR: HATS AND CLOTHING, NAMELY, T-SHIRTS, IN CLASS 25 (U.S. CLS. 22 AND 39).

FIRST USE 4-0-2004; IN COMMERCE 7-0-2005.

FOR: GOLF RELATED PRODUCTS, NAMELY, GOLF BAGS, BAGS SPECIALLY ADAPTED FOR GOLF SHOES, GOLF CLUB COVERS AND GOLF TEES, IN CLASS 28 (U.S. CLS. 22, 23, 38 AND 50).

FIRST USE 4-0-2004; IN COMMERCE 7-0-2005.

FOR: COMPUTERIZED ON-LINE ORDERING AND RETAIL STORE SERVICES FEATURING GOLF RELATED ITEMS, NAMELY, GOLF BAGS, GOLF SHOE BAGS, GOLF CLUB COVERS AND GOLF TEES, SPECIALTY FOOD ITEMS, NAMELY, CHOCOLATES, COFFEE AND BOTTLED WATER, SPA PRODUCTS, NAMELY, LOTIONS, SHAMPOOS AND SUN SCREENS; PROVIDING FACILITIES FOR BUSINESS CONFERENCES AND MEETINGS; MANAGING AND OPERATING RESORT HOTELS OF OTHERS; RETAIL STORE SERVICES FEATUR-

ING COCKTAIL AND BAR RELATED MERCHANDISE, IN CLASS 35 (U.S. CLS. 100, 101 AND 102).

FIRST USE 4-0-2004; IN COMMERCE 7-0-2005.

FOR: REAL ESTATE BROKERAGE SERVICES, HOMEOWNER SERVICES IN THE NATURE OF MANAGING RESIDENTIAL RENTAL PROPERTY FOR OTHERS, AND FINANCIAL MANAGEMENT OF FUNDS FOR THE ENHANCEMENT OF REAL PROPERTY, IN CLASS 36 (U.S. CLS. 100, 101 AND 102).

FIRST USE 4-0-2004; IN COMMERCE 7-0-2005.

FOR: LAND DEVELOPMENT SERVICES IN THE NATURE OF PLANNING AND LAYING OUT OF RESIDENTIAL AND/OR COMMERCIAL COMMUNITIES, IN CLASS 37 (U.S. CLS. 100, 103 AND 106).

FIRST USE 4-0-2004; IN COMMERCE 7-0-2005.

FOR: RECREATIONAL SERVICES, NAMELY, PROVIDING GOLF COURSES AND FACILITIES, AND THE PROVISION OF PROFESSIONAL GOLF INSTRUCTION; PROVIDING FACILITIES FOR RECREATION AND ATHLETIC ACTIVITIES, IN CLASS 41 (U.S. CLS. 100, 101 AND 107).

FIRST USE 4-0-2004; IN COMMERCE 7-0-2005.

FOR: LAND PRESERVATION AND LAND CONSERVATION SERVICES, NAMELY, MONITORING

OF ENVIRONMENTALLY SENSITIVE AREAS FOR THE CONSERVATION AND PRESERVATION OF NATURAL HABITATS AND NATIVE PLANT AND WILDLIFE, IN CLASS 42 (U.S. CLS. 100 AND 101).

FIRST USE 4-0-2004; IN COMMERCE 7-0-2005.

FOR: RESTAURANT SERVICES; RESORT HOTEL SERVICES; CONSULTATION IN THE FIELD OF HOSPITALITY, HOTEL AND RESORT LODGING SERVICES; COCKTAIL LOUNGE SERVICES; DELICATESSEN SERVICES, IN CLASS 43 (U.S. CLS. 100 AND 101).

FIRST USE 4-0-2004; IN COMMERCE 7-0-2005.

THE MARK CONSISTS OF A TREE TOP DESIGN ON TOP OF A STYLIZED "T" WITHIN A STYLIZED "C" OUTLINED IN A VERTICAL RECTANGULAR BORDER.

SER. NO. 77-370,497, FILED 1-14-2008.

WILLIAM VERHOSEK, EXAMINING ATTORNEY

Int. Cl.: 41

Prior U.S. Cls.: 100, 101 and 107

United States Patent and Trademark Office

Reg. No. 3,484,540

Registered Aug. 12, 2008

**SERVICE MARK
PRINCIPAL REGISTER**

CHARACTER PREFERENCE

DUSA, PIERO (ITALY INDIVIDUAL)
1453 THIRD ST PROMENADE GATEWAY, APT 608
SANTA MONICA, CA 90401

FOR: CONDUCTING WORKSHOPS AND SEMINARS IN PERSONAL AWARENESS; CONDUCTING WORKSHOPS AND SEMINARS IN SELF AWARENESS; CONDUCTING WORKSHOPS AND SEMINARS IN ACTING, PERFORMING, AND PERSONAL GROWTH; CONSULTANCY IN THE FIELD OF LEARNING DIFFICULTIES; DEVELOPING EDUCATIONAL MANUALS FOR OTHERS IN THE FIELD OF ACTING, PERFORMING, AND PERSONAL GROWTH; DEVELOPMENT AND DISSEMINATION OF EDUCATIONAL MATERIALS OF OTHERS IN THE FIELD OF ACTING, PERFORMING, AND PERSONAL GROWTH; EDUCATING AT UNIVERSITY OR COLLEGES; EDUCATION IN THE FIELD OF ACTING, PERFORMING, AND PERSONAL GROWTH RENDERED THROUGH CORRESPONDENCE COURSES; EDUCATION IN THE FIELD OF ACTING, PERFORMING, AND PERSONAL GROWTH RENDERED THROUGH VIDEO CONFERENCE; EDUCATION IN THE FIELDS OF ACTING, PERFORMING, AND PERSONAL GROWTH RENDERED THROUGH CORRESPONDENCE COURSES; EDUCATION INFORMATION; EDUCATION SERVICES IN THE NATURE OF COURSES AT THE UNIVERSITY LEVEL; EDUCATION SERVICES, NAMELY, MENTORING IN THE FIELD OF ACTING, PERFORMING, AND PERSONAL GROWTH; EDUCATION SERVICES, NAMELY, ONE-ON-ONE MENTORING IN THE FIELD OF ACTING, PERFORMING, AND PERSONAL GROWTH; EDUCATION SERVICES, NAMELY, ONE-ON-ONE MENTORING IN THE FIELDS OF ACTING, PERFORMING, AND PERSONAL GROWTH; EDUCATION SERVICES, NAMELY, PROVIDING CLASSES, SEMINARS, WORKSHOPS, TUTORING, AND MENTORING IN THE FIELD OF MIDDLE AND HIGH SCHOOL REFORM; EDUCATION SERVICES, NAMELY, PROVIDING LIVE AND

ON-LINE CLASSES, SEMINARS, WORKSHOPS, COURSES IN THE FIELD OF ACTING, PERFORMING, AND PERSONAL GROWTH; EDUCATION SERVICES, NAMELY, PROVIDING TUTORIAL SESSIONS IN THE FIELD(S) OF ACTING, PERFORMING, AND PERSONAL GROWTH; EDUCATION SERVICES, NAMELY, PROVIDING TUTORIAL SESSIONS IN THE FIELDS OF ACTING, PERFORMING, AND PERSONAL GROWTH; EDUCATION SERVICES, NAMELY, PROVIDING TUTORING IN THE FIELD OF ACTING, PERFORMING, AND PERSONAL GROWTH; EDUCATION SERVICES, NAMELY, PROVIDING TUTORING IN THE FIELDS OF ACTING, PERFORMING, AND PERSONAL GROWTH; EDUCATION SERVICES, NAMELY, PROVIDING CLASSES, SEMINARS, WORKSHOPS, COURSES IN THE FIELD OF ACTING, PERFORMING, AND PERSONAL GROWTH; EDUCATION SERVICES, NAMELY, PROVIDING CLASSES, SEMINARS, WORKSHOPS, COURSES IN THE FIELDS OF ACTING, PERFORMING, AND PERSONAL GROWTH; EDUCATIONAL AND ENTERTAINMENT SERVICES, NAMELY, A CONTINUING PROGRAM ABOUT ACTING, PERFORMING, AND PERSONAL GROWTH ACCESSIBLE BY RADIO, TELEVISION, SATELLITE, AUDIO, VIDEO AND COMPUTER NETWORKS; EDUCATIONAL AND ENTERTAINMENT SERVICES, NAMELY, PROVIDING MOTIVATIONAL AND EDUCATIONAL SPEAKERS; EDUCATIONAL AND ENTERTAINMENT SERVICES, NAMELY, PROVIDING MOTIVATIONAL AND EDUCATIONAL SPEAKERS IN THE FIELD OF SELF- AND PERSONAL IMPROVEMENT; EDUCATIONAL ASSESSMENT; EDUCATIONAL COURSE MONITORING, NAMELY, TRACKING STUDENT PERFORMANCE; EDUCATIONAL DEMONSTRATIONS; EDUCATIONAL SERVICES, NAMELY, CONDUCTING DISTANCE LEARNING INSTRUCTION AT THE SECONDARY, COLLEGE AND GRADUATE LEVELS; EDUCATIONAL SERVICES, NAMELY, CONDUCTING INFORMAL ON-LINE PROGRAMS IN THE FIELDS OF ACTING,

PERFORMING, AND PERSONAL GROWTH, AND PRINTABLE MATERIALS DISTRIBUTED THEREWITH; EDUCATIONAL SERVICES, NAMELY, CONDUCTING INFORMAL PROGRAMS IN THE FIELDS OF ACTING, PERFORMING, AND PERSONAL GROWTH, USING ON-LINE ACTIVITIES AND INTERACTIVE EXHIBITS, AND PRINTABLE MATERIALS DISTRIBUTED THEREWITH; EDUCATIONAL SERVICES, NAMELY, CONDUCTING ON-LINE EXHIBITIONS AND DISPLAYS AND INTERACTIVE EXHIBITS IN THE FIELD OF ACTING, PERFORMING, AND PERSONAL GROWTH; EDUCATIONAL SERVICES, NAMELY, CONDUCTING PROGRAMS IN THE FIELD OF ACTING, PERFORMING, AND PERSONAL GROWTH; EDUCATIONAL SERVICES, NAMELY, CONDUCTING CLASSES, SEMINARS, WORKSHOPS, COURSES IN THE FIELD OF ACTING, PERFORMING, AND PERSONAL GROWTH AND DISTRIBUTION OF COURSE MATERIAL IN CONNECTION THEREWITH; EDUCATIONAL SERVICES, NAMELY, DEVELOPING CURRICULUM FOR OTHERS IN THE FIELD OF ACTING, PERFORMING, AND PERSONAL GROWTH; EDUCATIONAL SERVICES, NAMELY, DEVELOPING, ARRANGING, AND CONDUCTING EDUCATIONAL CONFERENCES AND PROGRAMS AND PROVIDING COURSES OF INSTRUCTION IN THE FIELD OF ACTING, PERFORMING, AND PERSONAL GROWTH; EDUCATIONAL SERVICES, NAMELY, PROVIDING COURSES OF INSTRUCTION AT THE VOCATIONAL, POST SECONDARY LEVEL; EDUCATIONAL SERVICES, NAMELY, PROVIDING COURSES OF INSTRUCTION AT THE VOCATIONAL, POST SECONDARY LEVEL AND DISTRIBUTION OF COURSE MATERIAL IN CONNECTION ON THEREWITH; EDUCATIONAL SERVICES, NAMELY, PROVIDING INTERNSHIPS AND APPRENTICESHIPS IN THE FIELD OF ACTING, PERFORMING, AND PERSONAL GROWTH; EDUCATIONAL SERVICES, NAMELY, PROVIDING CLASSES, SEMINARS, WORKSHOPS, COURSES IN THE FIELDS OF ACTING, PERFORMING, AND PERSONAL GROWTH; EDUCATIONAL SERVICES, NAMELY, CONDUCTING CLASSES, SEMINARS, WORKSHOPS, COURSES IN THE FIELD OF ACTING, PERFORMING, AND PERSONAL GROWTH; ELECTRONIC PUBLISHING SERVICES, NAMELY, PUBLICATION OF TEXT AND GRAPHIC WORKS OF OTHERS ON CD, DVD, OR ONLINE FEATURING ACTING, PERFORMING, AND PERSONAL GROWTH; ENTERTAINMENT IN THE NATURE OF ON-GOING TELEVISION PROGRAMS IN THE FIELD OF ACTING, PERFORMING, AND PERSONAL GROWTH; ENTERTAINMENT IN THE NATURE OF THEATER PRODUCTIONS; ENTERTAINMENT INFORMATION; ENTERTAINMENT SERVICES IN THE NATURE OF AN ON-GOING REALITY BASED TELEVISION PROGRAM; ENTERTAINMENT SERVICES IN THE NATURE OF ON-GOING TELEVISION PROGRAMS IN THE FIELD OF CHILDREN'S ENTERTAINMENT; ENTERTAINMENT SERVICES, NAMELY, PROVIDING A WEB SITE FEATURING PHOTOGRAPHIC, AUDIO, VIDEO AND PROSE PRESENTATIONS FEATURING ACTING, PERFORMING, AND PERSONAL GROWTH; ENTERTAINMENT SERVICES,

NAMELY, AN ON-GOING SERIES FEATURING ACTING, PERFORMING, AND PERSONAL GROWTH PROVIDED THROUGH CABLE TELEVISION, WEBCASTS, RADIO BROADCASTS; ENTERTAINMENT SERVICES, NAMELY, PERSONAL APPEARANCES BY A MOVIE STAR OR OTHER CELEBRITY; ENTERTAINMENT SERVICES, NAMELY, PROVIDING A RADIO PROGRAM IN THE FIELD OF ACTING, PERFORMING, AND PERSONAL GROWTH VIA A GLOBAL COMPUTER NETWORK; ENTERTAINMENT SERVICES, NAMELY, PROVIDING A TELEVISION PROGRAM IN THE FIELD OF ACTING, PERFORMING, AND PERSONAL GROWTH VIA A GLOBAL COMPUTER NETWORK; ENTERTAINMENT, NAMELY, PRODUCTION OF TELEVISION SHOWS, PLAYS; ENTERTAINMENT SERVICES, NAMELY, PROVIDING WEBCASTS IN THE FIELD OF ACTING, PERFORMING, AND PERSONAL GROWTH; INFORMATION ABOUT EDUCATION; INFORMATION IN THE FIELD OF PARENTING CONCERNING ENTERTAINMENT OF CHILDREN; INFORMATION ON EDUCATION; INSTRUCTION IN THE FIELD OF ACTING, PERFORMING, AND PERSONAL GROWTH; LIFE COACHING SERVICES IN THE FIELD OF ACTING, PERFORMING, AND PERSONAL GROWTH; MEDIA PRODUCTION SERVICES, NAMELY, VIDEO AND FILM PRODUCTION; MEETING AND SEMINAR ARRANGING; ON-LINE JOURNALS, NAMELY, BLOGS FEATURING ACTING, PERFORMING, AND PERSONAL GROWTH; ONLINE ELECTRONIC PUBLISHING OF BOOKS AND PERIODICALS; PERSONAL COACHING SERVICES IN THE FIELD OF ACTING, PERFORMING, AND PERSONAL GROWTH; PRODUCTION OF DVDS, VIDEOTAPES AND TELEVISION PROGRAMS FEATURING ACTING, PERFORMING, AND PERSONAL GROWTH; PRODUCTION OF CABLE TELEVISION PROGRAMS; PRODUCTION OF FILM STUDIES; PRODUCTION OF FILMS; PRODUCTION OF RADIO AND TELEVISION PROGRAMMES; PRODUCTION OF VIDEO AND COMPUTER GAME SOFTWARE; PRODUCTION OF VIDEO AND CREATION OF VISUAL EFFECTS FOR OTHERS FOR USE IN DVDS, TELEVISION PROGRAMS AND ON WEB SITES; PRODUCTION OF VIDEO DISCS AND TAPES; PROFESSIONAL COACHING SERVICES IN THE FIELD OF ACTING, PERFORMING, AND PERSONAL GROWTH; PROVIDING A WEB SITE THAT FEATURES INFORMAL INSTRUCTION ON ACTING, PERFORMING, AND PERSONAL GROWTH; PROVIDING A WEB SITE WHERE USERS CAN POST RATINGS, REVIEWS AND RECOMMENDATIONS ON EVENTS AND ACTIVITIES IN THE FIELD OF ENTERTAINMENT AND EDUCATION; PROVIDING ADVICE AND INFORMATION IN THE FIELD OF EDUCATIONAL AND ENTERTAINMENT ACTIVITIES AND EVENTS FOR CHILDREN; PROVIDING CONTINUING LEGAL EDUCATION COURSES; PROVIDING COURSES OF INSTRUCTION AT THE VOCATIONAL, POST SECONDARY LEVEL; PROVIDING EDUCATIONAL MENTORING SERVICES AND PROGRAMS IN THE FIELD OF ACTING, PERFORMING, AND PERSONAL GROWTH; PROVIDING INFORMATION AND ARTICLES IN THE FIELD OF FILM, FILMMAKING, AND ENTER-

TAINMENT VIA A GLOBAL COMPUTER NETWORK; PROVIDING INFORMATION AND NEWS IN THE FIELD OF TEACHING METHODOLOGY AND EDUCATION; PROVIDING INFORMATION, NEWS AND COMMENTARY IN THE FIELD OF ENTERTAINMENT; PROVIDING NEWSLETTERS IN THE FIELD OF ACTING, PERFORMING, AND PERSONAL GROWTH VIA E-MAIL; PROVIDING ON-LINE RESOURCE GUIDES FOR RELATIVES CONCERNING CHILDREN IN THE FIELDS OF EDUCATION, RECREATION, AND ENTERTAINMENT; PROVIDING ON-LINE TRAINING CLASSES, SEMINARS, WORKSHOPS, COURSES IN THE FIELD OF ACTING, PERFORMING, AND PERSONAL GROWTH; PROVIDING VOICE OVERS FOR TAPES, RECORDS AND OTHER RECORDED MEDIA; PUBLICATION OF BOOKS; PUBLICATION OF BOOKS, MAGAZINES, ALMANACS AND JOURNALS; PUBLICATION OF PRINTED MATTER; PUBLICATION AND EDITING OF PRINTED MATTER; PUBLICATION OF BOOKS, OF MAGAZINES, OF JOURNALS, OF NEWSPAPERS, OF PERIODICALS, OF CATALOGS, OF BROCHURES; PUBLICATION OF BROCHURES; PUBLICATION OF ELECTRONIC MAGAZINES; PUBLICATION OF ELECTRONIC NEWSPAPERS ACCESSIBLE VIA A GLOBAL COMPUTER NETWORK; PUBLICATION OF JOURNALS; PUBLICATION OF LEAFLETS; PUBLICATION OF MAGAZINES; PUBLICATION OF MANUALS; PUBLICATION OF TEXT BOOKS; PUBLICATION OF TEXTS, BOOKS, JOURNALS; PUBLICATION OF TEXTS, BOOKS, MAGAZINES AND OTHER PRINTED MATTER; PUBLICATION OF THE EDITORIAL CONTENT OF SITES ACCESSIBLE VIA A GLOBAL COMPUTER NETWORK; PUBLICATION OF BOOKS, MAGAZINES; PUBLISHING OF BOOKS, MAGAZINES; PUBLISHING OF ELECTRONIC PUBLICATIONS; SCRIPT WRITING SERVICES; SCRIPT

WRITING SERVICES; TEACHING IN THE FIELD OF ACTING, PERFORMING, AND PERSONAL GROWTH; TELEPROMPTING SERVICES PROVIDED TO FILM AND TELEVISION AND CORPORATE PUBLIC SPEAKING; TRAINING COURSES IN STRATEGIC PLANNING RELATING TO ADVERTISING, PROMOTION, MARKETING AND BUSINESS; VIDEOTAPING LEGAL DEPOSITIONS; VOCATIONAL EDUCATION IN THE FIELD OF ACTING, PERFORMING, AND PERSONAL GROWTH; VOCATIONAL EDUCATION IN THE FIELDS OF ACTING, PERFORMING, AND PERSONAL GROWTH; VOCATIONAL GUIDANCE; WORKSHOPS AND SEMINARS IN THE FIELD OF ACTING, PERFORMING, AND PERSONAL GROWTH; WRITING OF ARTICLES FOR JOURNALS OTHER THAN FOR ADVERTISING OR PUBLICITY; WRITING OF ARTICLES FOR PERIODICALS OTHER THAN FOR ADVERTISING OR PUBLICITY; WRITING OF ARTICLES FOR PROFESSIONAL JOURNALS OTHER THAN FOR ADVERTISING OR PUBLICITY, IN CLASS 41 (U.S. CLS. 100, 101 AND 107).

FIRST USE 3-2-1998; IN COMMERCE 9-1-1998.

THE MARK CONSISTS OF STANDARD CHARACTERS WITHOUT CLAIM TO ANY PARTICULAR FONT, STYLE, SIZE, OR COLOR.

NO CLAIM IS MADE TO THE EXCLUSIVE RIGHT TO USE "CHARACTER", APART FROM THE MARK AS SHOWN.

SER. NO. 77-370,506, FILED 1-14-2008.

JAMES LOVELACE, EXAMINING ATTORNEY

Int. Cl.: 41

Prior U.S. Cls.: 100, 101 and 107

United States Patent and Trademark Office

Reg. No. 3,484,541

Registered Aug. 12, 2008

**SERVICE MARK
PRINCIPAL REGISTER**

ARHCP

KEENE, BOBBY (UNITED STATES INDIVIDUAL)
110 GLADWYN CT.
ALPHARETTA, GA 30004

FIRST USE 10-31-2004; IN COMMERCE 10-31-2004.

FOR: EDUCATIONAL SERVICES, NAMELY,
CONDUCTING CLASSES, SEMINARS, CONFEREN-
CES, WORKSHOPS IN THE FIELD OF MEDICINE
AND DISTRIBUTION OF COURSE MATERIAL IN
CONNECTION THEREWITH , IN CLASS 41 (U.S.
CLS. 100, 101 AND 107).

THE MARK CONSISTS OF STANDARD CHAR-
ACTERS WITHOUT CLAIM TO ANY PARTICULAR
FONT, STYLE, SIZE, OR COLOR.

SER. NO. 77-370,527, FILED 1-14-2008.

WILLIAM VERHOSEK, EXAMINING ATTORNEY

Int. Cl.: 35

Prior U.S. Cls.: 100, 101 and 102

United States Patent and Trademark Office

Reg. No. 3,484,542

Registered Aug. 12, 2008

SERVICE MARK
PRINCIPAL REGISTER



K.S.B. ENTERPRISES, INC. (GEORGIA CORPORATION)
1 GREENBRIAR DRIVE
SAVANNAH, GA 31419

FOR: INDEPENDENT SALES REPRESENTATIVES IN THE FIELD OF RETAIL MERCHANDISE, NAMELY T-SHIRTS AND FLAGS, IN CLASS 35 (U.S. CLS. 100, 101 AND 102).

FIRST USE 9-1-2006; IN COMMERCE 9-1-2006.

NO CLAIM IS MADE TO THE EXCLUSIVE RIGHT TO USE "PIRATE", APART FROM THE MARK AS SHOWN.

THE COLOR(S) BLUE, TURQUOISE, BROWN, OFF-WHITE, BLACK, AND WHITE IS/ARE CLAIMED AS A FEATURE OF THE MARK.

THE MARK CONSISTS OF THE WORDS "THE PIRATE PIPELINE" IN BLUE AND OUTLINED IN BLACK. THE SEA IS TURQUOISE. THE TWO SHIPS ON TOP OF THE SEA ARE BROWN WITH OFF-WHITE SAILS. THE SHIP IN THE FOREGROUND HAS A BLACK FLAG WITH A WHITE SKULL AND CROSSBONES DESIGN IS FLYING FROM THE TOP OF THE SHIP. THE SKY IS BLUE WITH WHITE CLOUDS.

SER. NO. 77-370,529, FILED 1-14-2008.

WILLIAM VERHOSEK, EXAMINING ATTORNEY

Int. Cl.: 41

Prior U.S. Cls.: 100, 101 and 107

United States Patent and Trademark Office

Reg. No. 3,484,543

Registered Aug. 12, 2008

**SERVICE MARK
PRINCIPAL REGISTER**

DO NOT PANIC PRODUCTIONS

DO NOT PANIC PRODUCTIONS, LLC (FLORIDA
LTD LIAB CO)

5523 ALHAMBRA CIRCLE

CORAL GABLES, FL 33146

FOR: FILM PRODUCTION, IN CLASS 41 (U.S.
CLS. 100, 101 AND 107).

FIRST USE 9-20-2007; IN COMMERCE 9-20-2007.

THE MARK CONSISTS OF STANDARD CHAR-
ACTERS WITHOUT CLAIM TO ANY PARTICULAR
FONT, STYLE, SIZE, OR COLOR.

NO CLAIM IS MADE TO THE EXCLUSIVE
RIGHT TO USE "PRODUCTIONS", APART FROM
THE MARK AS SHOWN.

SER. NO. 77-370,535, FILED 1-14-2008.

WILLIAM VERHOSEK, EXAMINING ATTORNEY

Int. Cl.: 35

Prior U.S. Cls.: 100, 101 and 102

United States Patent and Trademark Office

Reg. No. 3,484,544

Registered Aug. 12, 2008

**SERVICE MARK
PRINCIPAL REGISTER**

CF CONNECT

CHRYSLER LLC (DELAWARE LTD LIAB CO)
1000 CHRYSLER DRIVE
CIMS 483-02-19
AUBURN HILLS, MI 48326

FOR: PROVISION VIA A COMMUNICATION PORTAL AND POINT OF SALE SYSTEM OF DATA AND INFORMATION FOR USE BY DEALERS IN THE OPERATION OF AUTOMOBILE DEALERSHIPS RELATING TO FINANCE AND LEASE TRANSACTIONS, PROMOTIONAL PROGRAMS, ADVERTISING AND MARKETING MATERIALS, AND OTHER DOWNLOADABLE CUSTOMER AND VEHICLE DATA FOR USE BY THE DEALER IN (I) CUSTOMER RELATIONSHIP MANAGEMENT; (II) CREATING MARKETING PRODUCTS AND TOOLS; (III) ASSISTING WITH ALL ASPECTS OF THE DEALER'S ACCOUNTING, CUSTOMER SERVICE, CUSTOMER FINANCING AND INSURANCE SYSTEMS; (IV) SCHEDULING APPOINTMENTS

AND TASKS, MANAGING CUSTOMER AND POTENTIAL CUSTOMER INFORMATION, MANAGING SALES ACTIVITIES, AND GENERATING SALES AND CUSTOMER REPORTS; (V) MANAGING ACCOUNTS PAYABLE AND MONITORING OF THE FUNDING OF LEASE AND FINANCE CONTRACTS, THE FUNDING AND PAYMENT OF VEHICLE WHOLESALE LIABILITY, AND THE PAYMENT OF CONSUMER PAYMENTS AND PAYOFFS, IN CLASS 35 (U.S. CLS. 100, 101 AND 102).

FIRST USE 5-7-2005; IN COMMERCE 1-0-2006.

THE MARK CONSISTS OF STANDARD CHARACTERS WITHOUT CLAIM TO ANY PARTICULAR FONT, STYLE, SIZE, OR COLOR.

SER. NO. 77-370,537, FILED 1-14-2008.

HELENE LIWINSKI, EXAMINING ATTORNEY

Int. Cl.: 35

Prior U.S. Cls.: 100, 101 and 102

United States Patent and Trademark Office

Reg. No. 3,484,545

Registered Aug. 12, 2008

**SERVICE MARK
PRINCIPAL REGISTER**

**IT DOESN'T HAVE TO BE
LONELY AT THE TOP!**

CEO ADVISORY SERVICES LLC (DELAWARE
LTD LIAB CO)
7166 CONCH BOULEVARD
SEMINOLE, FL 33777

THE MARK CONSISTS OF STANDARD CHAR-
ACTERS WITHOUT CLAIM TO ANY PARTICULAR
FONT, STYLE, SIZE, OR COLOR.

FOR: BUSINESS MARKETING CONSULTING
SERVICES, IN CLASS 35 (U.S. CLS. 100, 101 AND 102).

SER. NO. 77-370,545, FILED 1-14-2008.

FIRST USE 7-0-2003; IN COMMERCE 7-0-2003.

GRETTA YAO, EXAMINING ATTORNEY

Int. Cl.: 21

Prior U.S. Cls.: 2, 13, 23, 29, 30, 33, 40 and 50

United States Patent and Trademark Office

Reg. No. 3,484,546

Registered Aug. 12, 2008

**TRADEMARK
PRINCIPAL REGISTER**

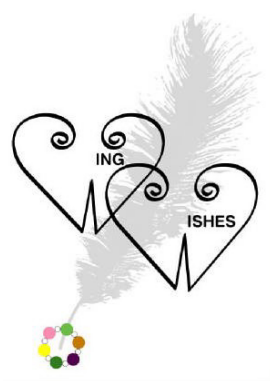

MALLERS, JOAN (UNITED STATES INDIVIDUAL)
1045 SOUTH SCOVILLE AVENUE
OAK PARK, IL 60304 AND
SMITH, JEAN (UNITED STATES INDIVIDUAL)
4733 CRYSTAL TRAIL
MCHENRY, IL 60050

FOR: ORNAMENTS OF CRYSTALS, IN CLASS 21
(U.S. CLS. 2, 13, 23, 29, 30, 33, 40 AND 50).

FIRST USE 9-13-2007; IN COMMERCE 9-13-2007.

THE COLOR(S) GREEN, ORANGE, PURPLE,
PINK, YELLOW, GRAY, AND BLACK IS/ARE
CLAIMED AS A FEATURE OF THE MARK.

THE MARK CONSISTS OF THE WORDING WING WISHES IN STYLIZED FORM IN THE COLOR BLACK WITH THE LETTER W IN EACH WORD, WING AND WISHES, FORMING A HEART-LIKE DESIGN. THE MARK ALSO CONSISTS OF A DESIGN OF A FEATHER IN THE COLOR GRAY APPEARING BENEATH THE WORDING WING WISHES. THE FEATHER'S TIP INTERSECTS A CIRCLE COMPOSED OF CIRCLES IN THE COLORS GREEN, ORANGE, PURPLE, PINK AND YELLOW CONNECTED BY SMALLER WHITE CIRCLES OUTLINED IN BLACK.

SER. NO. 77-370,551, FILED 1-14-2008.

ZHALEH DELANEY, EXAMINING ATTORNEY

Int. Cl.: 36

Prior U.S. Cls.: 100, 101 and 102

United States Patent and Trademark Office

Reg. No. 3,484,547

Registered Aug. 12, 2008

**SERVICE MARK
PRINCIPAL REGISTER**

TRADEWITHPROS

ARNOLDI, CHRISTOPHER (UNITED STATES
INDIVIDUAL)
NO. 4
3111 W. DE LEON STREET
TAMPA, FL 33609

THE MARK CONSISTS OF STANDARD CHAR-
ACTERS WITHOUT CLAIM TO ANY PARTICULAR
FONT, STYLE, SIZE, OR COLOR.

FOR: PROVIDING STOCK/SECURITIES MAR-
KET INFORMATION, IN CLASS 36 (U.S. CLS. 100,
101 AND 102).

SER. NO. 77-370,553, FILED 1-14-2008.

FIRST USE 10-1-2007; IN COMMERCE 10-1-2007.

CHRISTINA SOBRAL, EXAMINING ATTORNEY

Int. Cl.: 30

Prior U.S. Cl.: 46

United States Patent and Trademark Office

Reg. No. 3,484,548

Registered Aug. 12, 2008

**TRADEMARK
PRINCIPAL REGISTER**

STEVE'S & ED'S

MASTER SALES & MARKETING, LLC (NEW
JERSEY LTD LIAB CO)
11381 PROSPERITY FARMS ROAD
PALM BEACH GARDENS, FL 33410

FOR: SAUCES, SPICES AND RUBS, NAMELY,
CHICKEN WING SAUCE, STEAK SAUCE, TERIYA-
KI SAUCE, CHILI SAUCE, BARBEQUE SAUCE AND
HOT SAUCES; MUSTARD; KETCHUP; AND MAR-
INADE, IN CLASS 30 (U.S. CL. 46).

FIRST USE 3-20-1992; IN COMMERCE 3-20-1992.

THE MARK CONSISTS OF STANDARD CHAR-
ACTERS WITHOUT CLAIM TO ANY PARTICULAR
FONT, STYLE, SIZE, OR COLOR.

SER. NO. 77-370,588, FILED 1-14-2008.

GEORGE LORENZO, EXAMINING ATTORNEY

Int. Cl.: 42

Prior U.S. Cls.: 100 and 101

United States Patent and Trademark Office

Reg. No. 3,484,549

Registered Aug. 12, 2008

**SERVICE MARK
PRINCIPAL REGISTER**

LIGHTHOUSE

BOLIVAR GARCIA, ROSA MARIA (VENEZUELA
INDIVIDUAL)
108 BELMONT PLACE
BOYNTON BEACH, FL 33436

FOR: HOSTING AN INTERNET PORTAL SITE
FOR OTHERS; CUSTOM DESIGN OF COMPUTER
SOFTWARE FOR OTHERS; CUSTOM COMPUTER
SOFTWARE CONSULTING SERVICES; COMPUTER
SOFTWARE INSTALLATION, REPAIR, AND MAIN-
TENANCE IN THE HOSPITALITY INDUSTRY, IN
CLASS 42 (U.S. CLS. 100 AND 101).

FIRST USE 3-1-2006; IN COMMERCE 3-1-2006.

THE MARK CONSISTS OF STANDARD CHAR-
ACTERS WITHOUT CLAIM TO ANY PARTICULAR
FONT, STYLE, SIZE, OR COLOR.

SER. NO. 77-370,596, FILED 1-14-2008.

BRIAN CALLAGHAN, EXAMINING ATTORNEY

Int. Cl.: 21

Prior U.S. Cls.: 2, 13, 23, 29, 30, 33, 40 and 50

Reg. No. 3,484,550

United States Patent and Trademark Office

Registered Aug. 12, 2008

**TRADEMARK
PRINCIPAL REGISTER**

WING WISHES

MALLERS, JOAN (UNITED STATES INDIVIDUAL)
1045 SOUTH SCOVILLE AVENUE
OAK PARK, IL 60304 AND
SMITH, JEAN (UNITED STATES INDIVIDUAL)
4733 CRYSTAL TRAIL
MCHENRY, IL 60050

FIRST USE 9-13-2007; IN COMMERCE 9-13-2007.

THE MARK CONSISTS OF STANDARD CHARACTERS WITHOUT CLAIM TO ANY PARTICULAR FONT, STYLE, SIZE, OR COLOR.

SER. NO. 77-370,597, FILED 1-14-2008.

FOR: ORNAMENTS OF CRYSTALS, IN CLASS 21
(U.S. CLS. 2, 13, 23, 29, 30, 33, 40 AND 50).

ZHALEH DELANEY, EXAMINING ATTORNEY

Int. Cl.: 16

Prior U.S. Cls.: 2, 5, 22, 23, 29, 37, 38 and 50

Reg. No. 3,484,551

United States Patent and Trademark Office

Registered Aug. 12, 2008

**TRADEMARK
PRINCIPAL REGISTER**

12 MESES

MEREDITH CORPORATION (IOWA CORPORATION)
1716 LOCUST STREET
DES MOINES, IA 503093023

FOR: PRINTED MATTER, NAMELY, MAGAZINES AND NEWSLETTERS PRINTED IN SPANISH AND ENGLISH IN THE FIELD OF THE CARE OF NEWBORN INFANTS AT HOME, IN CLASS 16 (U.S. CLS. 2, 5, 22, 23, 29, 37, 38 AND 50).

FIRST USE 9-20-2005; IN COMMERCE 9-20-2005.

THE MARK CONSISTS OF STANDARD CHARACTERS WITHOUT CLAIM TO ANY PARTICULAR FONT, STYLE, SIZE, OR COLOR.

OWNER OF U.S. REG. NO. 2,501,114.

THE FOREIGN WORDING IN THE MARK TRANSLATES INTO ENGLISH AS MONTHS.

SER. NO. 77-370,614, FILED 1-14-2008.

SARA THOMAS, EXAMINING ATTORNEY

Int. Cl.: 21

Prior U.S. Cls.: 2, 13, 23, 29, 30, 33, 40 and 50

Reg. No. 3,484,552

United States Patent and Trademark Office

Registered Aug. 12, 2008

**TRADEMARK
PRINCIPAL REGISTER**

ANGEL HANGERS

MALLERS, JOAN (UNITED STATES INDIVIDUAL)

1045 SCOVILLE AVENUE

OAK PARK, IL 60304

FOR: ORNAMENTS OF CRYSTALS, IN CLASS 21
(U.S. CLS. 2, 13, 23, 29, 30, 33, 40 AND 50).

FIRST USE 9-13-2007; IN COMMERCE 9-13-2007.

THE MARK CONSISTS OF STANDARD CHARACTERS WITHOUT CLAIM TO ANY PARTICULAR FONT, STYLE, SIZE, OR COLOR.

NO CLAIM IS MADE TO THE EXCLUSIVE RIGHT TO USE "HANGERS", APART FROM THE MARK AS SHOWN.

SER. NO. 77-370,615, FILED 1-14-2008.

ZHALEH DELANEY, EXAMINING ATTORNEY

Int. Cl.: 9

Prior U.S. Cls.: 21, 23, 26, 36 and 38

Reg. No. 3,484,553

United States Patent and Trademark Office

Registered Aug. 12, 2008

**TRADEMARK
PRINCIPAL REGISTER**



ANTLER ENTERPRISES, INC. (NORTH CAROLINA CORPORATION)
5521 DEER HUNTER COURT
GARNER, NC 27529

CONTROLLED LOCKING AND UNLOCKING SYSTEMS IN MOTOR VEHICLES, IN CLASS 9 (U.S. CLS. 21, 23, 26, 36 AND 38).

FOR: AUDIO SIGNALING DEVICES, NAMELY, AUDIO AMPLIFIERS, AUDIO SPEAKERS AND SOUND REPRODUCING APPARATUS, NAMELY, AUDIO PLAYERS, AND ELECTRIC AUDIO PLAYBACK UNITS WITH LIGHTS AND SPEAKERS, ALL FOR USE WITH REMOTE RADIO FREQUENCY

FIRST USE 8-1-2006; IN COMMERCE 8-1-2007.

SER. NO. 77-370,657, FILED 1-14-2008.

MICHAEL GAAFAR, EXAMINING ATTORNEY

Int. Cl.: 1

Prior U.S. Cls.: 1, 5, 6, 10, 26 and 46

Reg. No. 3,484,554

United States Patent and Trademark Office

Registered Aug. 12, 2008

**TRADEMARK
PRINCIPAL REGISTER**

TERRACYCLE

TERRACYCLE, INC. (DELAWARE CORPORATION)
121 NEW YORK AVENUE
TRENTON, NJ 08638

FOR: FERTILIZER, PLANT FOOD, POTTING SOIL, SEED STARTER MIX FOR DOMESTIC USE, TREE AND SHRUB FERTILIZER SPIKES, SOIL CONDITIONERS FOR AGRICULTURAL, DOMESTIC AND HORTICULTURAL USE, IN CLASS 1 (U.S. CLS. 1, 5, 6, 10, 26 AND 46).

FIRST USE 5-11-2004; IN COMMERCE 5-11-2004.

THE MARK CONSISTS OF STANDARD CHARACTERS WITHOUT CLAIM TO ANY PARTICULAR FONT, STYLE, SIZE, OR COLOR.

SER. NO. 77-370,670, FILED 1-14-2008.

ALICE BENMAMAN, EXAMINING ATTORNEY

Int. Cl.: 32

Prior U.S. Cls.: 45, 46 and 48

United States Patent and Trademark Office

Reg. No. 3,484,555

Registered Aug. 12, 2008

**TRADEMARK
PRINCIPAL REGISTER**

RHINELANDER

MOUNTAIN CREST SRL (BARBADOS CORPORATION), DBA MINHAS CRAFT BREWERY

102 STEVMAR HOUSE

ROCKLEY, CHRIST CHURCH, BARBADOS

FOR: BEER, IN CLASS 32 (U.S. CLS. 45, 46 AND 48).

FIRST USE 0-0-1956; IN COMMERCE 0-0-1956.

THE MARK CONSISTS OF STANDARD CHARACTERS WITHOUT CLAIM TO ANY PARTICULAR FONT, STYLE, SIZE, OR COLOR.

OWNER OF U.S. REG. NO. 1,484,497.

SER. NO. 77-370,672, FILED 1-14-2008.

KRISTIN CARLSON, EXAMINING ATTORNEY

Int. Cl.: 41

Prior U.S. Cls.: 100, 101 and 107

United States Patent and Trademark Office

Reg. No. 3,484,556

Registered Aug. 12, 2008

**SERVICE MARK
PRINCIPAL REGISTER**

Problem-Solution-Change

BOGGS, ERNEST (UNITED STATES INDIVIDUAL)
15 BAILES DRIVE
NITRO, WV 25143

FOR: CONDUCTING AFTER-SCHOOL TUTORING PROGRAMS; EDUCATIONAL SERVICES, NAMELY, CONDUCTING PROGRAMS IN THE FIELD OF PERSONAL SKILLS NEEDED TO SUCCEED IN LIFE; MARTIAL ARTS INSTRUCTION, IN CLASS 41 (U.S. CLS. 100, 101 AND 107).

FIRST USE 1-1-1999; IN COMMERCE 1-1-1999.

THE MARK CONSISTS OF STANDARD CHARACTERS WITHOUT CLAIM TO ANY PARTICULAR FONT, STYLE, SIZE, OR COLOR.

SER. NO. 77-370,677, FILED 1-14-2008.

CHRISTINE BLOMQUIST, EXAMINING ATTORNEY

Int. Cl.: 7

Prior U.S. Cls.: 13, 19, 21, 23, 31, 34 and 35

Reg. No. 3,484,557

United States Patent and Trademark Office

Registered Aug. 12, 2008

**TRADEMARK
PRINCIPAL REGISTER**

CABFORMS

FORMS AND SURFACES, INC. (PENNSYLVANIA CORPORATION)
30 PINE STREET
PITTSBURGH, PA 15223

THE MARK CONSISTS OF STANDARD CHARACTERS WITHOUT CLAIM TO ANY PARTICULAR FONT, STYLE, SIZE, OR COLOR.

FOR: PRE-ENGINEERED ELEVATOR INTERIOR SYSTEMS, NAMELY, WALL PANELS, CEILINGS, FLOORS, HAND RAILINGS, LIGHT FIXTURES, DOORS AND CONTROL PANELS , IN CLASS 7 (U.S. CLS. 13, 19, 21, 23, 31, 34 AND 35).

OWNER OF U.S. REG. NO. 2,639,988.

SER. NO. 77-370,711, FILED 1-14-2008.

FIRST USE 0-0-1999; IN COMMERCE 0-0-1999.

AMY HELLA, EXAMINING ATTORNEY

Int. Cl.: 37

Prior U.S. Cls.: 100, 103 and 106

United States Patent and Trademark Office

Reg. No. 3,484,558

Registered Aug. 12, 2008

**SERVICE MARK
PRINCIPAL REGISTER**

REDGO DEVELOPMENT

CHESTER COUNTY FUND INC. (PENNSYLVANIA CORPORATION)

615 WILLOWBROOK LANE

WEST CHESTER, PA 19382

FOR: REAL ESTATE DEVELOPMENT, IN CLASS 37 (U.S. CLS. 100, 103 AND 106).

FIRST USE 1-1-1993; IN COMMERCE 1-1-1993.

THE MARK CONSISTS OF STANDARD CHARACTERS WITHOUT CLAIM TO ANY PARTICULAR FONT, STYLE, SIZE, OR COLOR.

NO CLAIM IS MADE TO THE EXCLUSIVE RIGHT TO USE "DEVELOPMENT", APART FROM THE MARK AS SHOWN.

SER. NO. 77-370,718, FILED 1-14-2008.

MICHAEL SOUDERS, EXAMINING ATTORNEY

Int. Cl.: 41

Prior U.S. Cls.: 100, 101 and 107

United States Patent and Trademark Office

Reg. No. 3,484,559

Registered Aug. 12, 2008

SERVICE MARK
PRINCIPAL REGISTER

The logo consists of the words "Martial Arts" in blue, "4" in a darker blue, and "Life" in red. The "4" is positioned between "Arts" and "Life", overlapping the "s" in "Arts" and the "L" in "Life".

MARTIAL ARTS 4 LIFE INCORPORATED
(TEXAS CORPORATION)
5108 BROOKLINE
CIBOLO, TX 78108

FOR: MARTIAL ARTS INSTRUCTION, IN CLASS
41 (U.S. CLS. 100, 101 AND 107).

FIRST USE 6-1-2007; IN COMMERCE 12-5-2007.

NO CLAIM IS MADE TO THE EXCLUSIVE
RIGHT TO USE "MARTIAL ARTS", APART FROM
THE MARK AS SHOWN.

THE COLOR(S) BLUE AND RED IS/ARE
CLAIMED AS A FEATURE OF THE MARK.

THE MARK CONSISTS OF THE BLUE WORDING
"MARTIAL ARTS", THE DARKER BLUE WORD-
ING "4", AND THE RED WORDING "LIFE".

SER. NO. 77-370,744, FILED 1-14-2008.

AMY HELLA, EXAMINING ATTORNEY

Int. Cl.: 10

Prior U.S. Cls.: 26, 39 and 44

Reg. No. 3,484,560

United States Patent and Trademark Office

Registered Aug. 12, 2008

**TRADEMARK
PRINCIPAL REGISTER**

RHYTHMX

CARDIAC SCIENCE CORPORATION (DELA-
WARE CORPORATION)
3303 MONTE VILLA PARKWAY
BOTHELL, WA 98021

FOR: COMPUTER SOFTWARE FOR TACHYAR-
RHYTHMIA DETECTION, DISCRIMINATION,
AND TREATMENT SOLD AS AN INTEGRAL COM-
PONENT OF EXTERNAL DEFIBRILLATORS, IN
CLASS 10 (U.S. CLS. 26, 39 AND 44).

FIRST USE 9-0-2003; IN COMMERCE 9-0-2003.

THE MARK CONSISTS OF STANDARD CHAR-
ACTERS WITHOUT CLAIM TO ANY PARTICULAR
FONT, STYLE, SIZE, OR COLOR.

OWNER OF U.S. REG. NO. 2,524,505.

SER. NO. 77-370,747, FILED 1-14-2008.

AMY HELLA, EXAMINING ATTORNEY

Int. Cl.: 42

Prior U.S. Cls.: 100 and 101

United States Patent and Trademark Office

Reg. No. 3,484,561

Registered Aug. 12, 2008

**SERVICE MARK
PRINCIPAL REGISTER**

DUCHENNECONNECT

THE PARENT PROJECT FOR MUSCULAR DYSTROPHY RESEARCH, INC. (OHIO CORPORATION)
1012 N. UNIVERSITY BLVD.
MIDDLETOWN, OH 45042

FOR: PROVIDING A WEB SITE THAT FEATURES MEDICAL AND SCIENTIFIC RESEARCH INFORMATION IN THE FIELD OF CLINICAL TRIALS, GENETIC TESTING AND ON-LINE RESOURCE GUIDES OF HELP AVAILABLE FOR THOSE CONCERNED WITH MUSCULAR DYSTROPHY, IN CLASS 42 (U.S. CLS. 100 AND 101).

FIRST USE 11-15-2007; IN COMMERCE 11-15-2007.

THE MARK CONSISTS OF STANDARD CHARACTERS WITHOUT CLAIM TO ANY PARTICULAR FONT, STYLE, SIZE, OR COLOR.

SER. NO. 77-370,774, FILED 1-14-2008.

IRA J. GOODSaid, EXAMINING ATTORNEY

Int. Cl.: 25

Prior U.S. Cls.: 22 and 39

United States Patent and Trademark Office

Reg. No. 3,484,562

Registered Aug. 12, 2008

**TRADEMARK
PRINCIPAL REGISTER**

GILMAR

GILMAR S.P.A. (ITALY CORPORATION)
VIA MALPASSO 723-725
S.GIOVANNI IN M., ITALY I-47842

FOR: MEN'S AND WOMEN'S CLOTHING,
NAMELY, MEN'S SHIRTS, WOMEN'S SHIRTS,
SUITS, COATS, TROUSERS, JUMPERS, SCARVES,
IN CLASS 25 (U.S. CLS. 22 AND 39).

FIRST USE 6-1-1976; IN COMMERCE 6-1-1976.

THE MARK CONSISTS OF STANDARD CHAR-
ACTERS WITHOUT CLAIM TO ANY PARTICULAR
FONT, STYLE, SIZE, OR COLOR.

OWNER OF ITALY REG. NO. 376927, DATED 11-8-
1985, EXPIRES 11-8-2015.

OWNER OF U.S. REG. NO. 1,480,359.

SER. NO. 77-370,776, FILED 1-14-2008.

IRA J. GOODSID, EXAMINING ATTORNEY

Int. Cl.: 36

Prior U.S. Cls.: 100, 101 and 102

United States Patent and Trademark Office

Reg. No. 3,484,563

Registered Aug. 12, 2008

**SERVICE MARK
PRINCIPAL REGISTER**

Arrowpoint CAPITAL

ARROWPOINT CAPITAL CORP. (DELAWARE CORPORATION)
3600 ARCO CORPORATE DRIVE
CHARLOTTE, NC 28273

FOR: WRITING PROPERTY CASUALTY INSURANCE; UNDERWRITING IN THE FIELDS OF PROPERTY AND CASUALTY INSURANCE; INSURANCE CLAIMS PROCESSING; INSURANCE CLAIMS SERVICING, NAMELY, CLAIMS ADMINISTRATION AND PREMIUM RATE COMPUTING; ACTUARIAL SERVICES; AND INSURANCE CONSULTING SERVICES, IN CLASS 36 (U.S. CLS. 100, 101 AND 102).

FIRST USE 3-4-2007; IN COMMERCE 3-4-2007.

NO CLAIM IS MADE TO THE EXCLUSIVE RIGHT TO USE "CAPITAL", APART FROM THE MARK AS SHOWN.

THE COLOR(S) RED AND BLUE IS/ARE CLAIMED AS A FEATURE OF THE MARK.

THE MARK CONSISTS OF THE WORDS "ARROWPOINT CAPITAL" IN BLUE STYLIZED TYPE WITH A RED ARROW FORMING PART OF THE "A" AND UNDERLINING THE WORDS.

SER. NO. 77-370,799, FILED 1-14-2008.

DAVID MURRAY, EXAMINING ATTORNEY

Int. Cl.: 36

Prior U.S. Cls.: 100, 101 and 102

United States Patent and Trademark Office

Reg. No. 3,484,564

Registered Aug. 12, 2008

**SERVICE MARK
PRINCIPAL REGISTER**

ARROWPOINT CAPITAL

ARROWPOINT CAPITAL CORP. (DELAWARE
CORPORATION)
3600 ARCO CORPORATE DRIVE
CHARLOTTE, NC 28273

FOR: WRITING PROPERTY CASUALTY INSURANCE; UNDERWRITING IN THE FIELDS OF PROPERTY AND CASUALTY INSURANCE; INSURANCE CLAIMS PROCESSING; INSURANCE CLAIMS SERVICING, NAMELY, CLAIMS ADMINISTRATION AND PREMIUM RATE COMPUTING; ACTUARIAL SERVICES; AND INSURANCE CONSULTING SERVICES, IN CLASS 36 (U.S. CLS. 100, 101 AND 102).

FIRST USE 3-4-2007; IN COMMERCE 3-4-2007.

THE MARK CONSISTS OF STANDARD CHARACTERS WITHOUT CLAIM TO ANY PARTICULAR FONT, STYLE, SIZE, OR COLOR.

NO CLAIM IS MADE TO THE EXCLUSIVE RIGHT TO USE "CAPITAL", APART FROM THE MARK AS SHOWN.

SER. NO. 77-370,803, FILED 1-14-2008.

DAVID MURRAY, EXAMINING ATTORNEY

Int. Cl.: 33

Prior U.S. Cls.: 47 and 49

United States Patent and Trademark Office

Reg. No. 3,484,565

Registered Aug. 12, 2008

**TRADEMARK
PRINCIPAL REGISTER**

YORBA



KRAEMER, ANN T. (UNITED STATES INDIVIDUAL)
PO BOX 1865
SUTTER CREEK, CA 95685

THE MARK CONSISTS OF THE STYLIZED WORD YORBA WITH A SWOOSH UNDERNEATH THE WORD YORBA.

FOR: WINES, IN CLASS 33 (U.S. CLS. 47 AND 49).

SER. NO. 77-370,845, FILED 1-14-2008.

FIRST USE 8-2-2007; IN COMMERCE 8-2-2007.

OWNER OF U.S. REG. NO. 3,341,189.

DANIEL CAPSHAW, EXAMINING ATTORNEY

Int. Cl.: 45

Prior U.S. Cls.: 100 and 101

United States Patent and Trademark Office

Reg. No. 3,484,566

Registered Aug. 12, 2008

**SERVICE MARK
PRINCIPAL REGISTER**

WEEKEND SPOUSE

INDUSTRIES UNLIMITED CORPORATION (NE-
VADA CORPORATION)
12804 MAGOUN STREET
CEDAR LAKE, IN 46303

FOR: COMPUTER DATING SERVICES; DATING
SERVICES; INTERNET BASED SOCIAL NETWORK-
ING, INTRODUCTION, AND DATING SERVICES,
IN CLASS 45 (U.S. CLS. 100 AND 101).

FIRST USE 1-13-2008; IN COMMERCE 1-13-2008.

THE MARK CONSISTS OF STANDARD CHAR-
ACTERS WITHOUT CLAIM TO ANY PARTICULAR
FONT, STYLE, SIZE, OR COLOR.

NO CLAIM IS MADE TO THE EXCLUSIVE
RIGHT TO USE "WEEKEND", APART FROM THE
MARK AS SHOWN.

SER. NO. 77-370,905, FILED 1-14-2008.

DORITT L. CARROLL, EXAMINING ATTORNEY

Int. Cls.: 9 and 42

Prior U.S. Cls.: 21, 23, 26, 36, 38, 100 and 101

United States Patent and Trademark Office

Reg. No. 3,484,567

Registered Aug. 12, 2008

**TRADEMARK
SERVICE MARK
PRINCIPAL REGISTER**



NATIONAL APPLIED RESEARCH LABORATOR-
IES; NATIONAL CENTER FOR HIGH-PER-
FORMANCE COMPUTING (TAIWAN
CORPORATION)

HSINCHU SCIENCE-BASED INDUSTRIAL PARK
NO.7 R&D 6TH RD.
HSINCHU CITY, TAIWAN 300

FOR: COMMUNICATIONS SOFTWARE FOR
CONNECTING GLOBAL COMPUTER NETWORKS;
COMPUTER BACKUP AND STORAGE SYSTEMS
WITH MULTIPLE REMOVABLE RAID CARTRID-
GES; COMPUTER COMMUNICATIONS SOFT-
WARE TO ALLOW CUSTOMERS TO ACCESS
BANK ACCOUNT INFORMATION AND TRANS-
ACT BANK BUSINESS; COMPUTER DATABASE
MANAGEMENT SOFTWARE FOR USE IN PERSO-
NALIZING THE CONTENT OF EMAIL COMMUNI-
CATIONS; COMPUTER HARDWARE AND
SOFTWARE FOR SETTING UP AND CONFIGUR-
ING WIDE AREA NETWORKS; COMPUTER HARD-
WARE AND COMPUTER SOFTWARE PROGRAMS
FOR THE INTEGRATION OF TEXT, AUDIO, GRA-
PHICS, STILL IMAGES AND MOVING PICTURES
INTO AN INTERACTIVE DELIVERY FOR MULTI-
MEDIA APPLICATIONS; COMPUTER HARDWARE
AND SOFTWARE SYSTEM FOR REMOTELY MON-
ITORING ENVIRONMENTAL CONDITIONS AND
CONTROLLING DEVICES WITHIN A BUILDING,
FACILITY, GROUNDS, OR DESIGNATED SPATIAL
AREA; COMPUTER SHAREWARE FOR OPEN
SOURCE CLONE SYSTEM; COMPUTER SOFT-
WARE DEVELOPMENT TOOLS; COMPUTER SOFT-
WARE FOR USING IN DATABASE

MANAGEMENT, IN CLASS 9 (U.S. CLS. 21, 23, 26,
36 AND 38).

FIRST USE 7-26-2004; IN COMMERCE 7-26-2004.

FOR: APPLICATION SERVICE PROVIDER FEA-
TURING SOFTWARE FOR PROVIDING AN ON-
LINE DATABASE IN THE FIELD OF TRANSACTION
PROCESSING TO UPLOAD TRANSACTIONAL
DATA, PROVIDE STATISTICAL ANALYSIS,
AND PRODUCE NOTIFICATIONS AND REPORTS;
APPLICATION SERVICE PROVIDER, NAMELY,
PROVIDING, HOSTING, MANAGING, DEVELOP-
ING, AND MAINTAINING APPLICATIONS, SOFT-
WARE, WEBSITES, AND DATABASES IN THE
FIELDS OF PERSONAL PRODUCTIVITY, WIRE-
LESS COMMUNICATION, MOBILE INFORMA-
TION ACCESS, AND REMOTE DATA
MANAGEMENT FOR WIRELESS DELIVERY OF
CONTENT TO HANDHELD COMPUTERS, LAP-
TOPS AND MOBILE ELECTRONIC DEVICES;
COMPUTER CODE CONVERSION FOR OTHERS;
COMPUTER MONITORING SERVICE WHICH
TRACKS HARDWARE PERFORMANCE AND PRO-
CESSES AND SENDS OUT HISTORICAL REPORTS
AND ALERTS; COMPUTER PROGRAMMING FOR
OTHERS; COMPUTER SERVICES, NAMELY, DATA
RECOVERY SERVICES; COMPUTER SERVICES,
NAMELY, REMOTE AND ON-SITE MANAGE-
MENT OF ELECTRONIC MESSAGING SYSTEMS
AND APPLICATIONS FOR OTHERS; COMPUTER
SERVICES, NAMELY, REMOTE MANAGEMENT
OF COMPUTER APPLICATIONS FOR OTHERS;
COMPUTER SOFTWARE CONSULTATION; COM-

PUTER SOFTWARE DESIGN FOR OTHERS, IN
CLASS 42 (U.S. CLS. 100 AND 101).

FIRST USE 7-26-2004; IN COMMERCE 7-26-2004.

THE MARK CONSISTS OF THE WORDING
"CLONEZILLA" AND A STYLIZED DESIGN.

SER. NO. 77-371,024, FILED 1-14-2008.

GEOFFREY FOSDICK, EXAMINING ATTORNEY

Int. Cl.: 20

Prior U.S. Cls.: 2, 13, 22, 25, 32 and 50

Reg. No. 3,484,568

United States Patent and Trademark Office

Registered Aug. 12, 2008

**TRADEMARK
PRINCIPAL REGISTER**

NoTrac

SPACENOW! CORPORATION (NEW JERSEY
CORPORATION)
234 EMMET STREET
NEWARK, NJ 07114

FOR: COMPACTABLE ROLLING SHELVING
FOR FILING AND STORAGE; HIGH DENSITY
MOBILE FILING AND STORAGE SHELVING; MOV-
ING-AISLE FILING AND STORAGE SHELVING, IN
CLASS 20 (U.S. CLS. 2, 13, 22, 25, 32 AND 50).

FIRST USE 1-10-2008; IN COMMERCE 1-10-2008.

THE MARK CONSISTS OF STANDARD CHAR-
ACTERS WITHOUT CLAIM TO ANY PARTICULAR
FONT, STYLE, SIZE, OR COLOR.

SER. NO. 77-371,067, FILED 1-14-2008.

JENNIFER VASQUEZ, EXAMINING ATTORNEY

Int. Cl.: 18

Prior U.S. Cls.: 1, 2, 3, 22 and 41

United States Patent and Trademark Office

Reg. No. 3,484,569

Registered Aug. 12, 2008

**TRADEMARK
PRINCIPAL REGISTER**

TRAIL GAITER

CIRCLE Y SADDLES, INC. (TEXAS CORPORATION)
201 W. MORRIS STREET
YOAKUM, TX 77995

THE MARK CONSISTS OF STANDARD CHARACTERS WITHOUT CLAIM TO ANY PARTICULAR FONT, STYLE, SIZE, OR COLOR.

FOR: SADDLES, IN CLASS 18 (U.S. CLS. 1, 2, 3, 22 AND 41).

SER. NO. 77-371,068, FILED 1-14-2008.

FIRST USE 9-24-2007; IN COMMERCE 9-24-2007.

JENNIFER VASQUEZ, EXAMINING ATTORNEY

Int. Cl.: 33

Prior U.S. Cls.: 47 and 49

United States Patent and Trademark Office

Reg. No. 3,484,570

Registered Aug. 12, 2008

**TRADEMARK
PRINCIPAL REGISTER**

ANALIVIA

PAGOS DEL REY S.L. (SPAIN CORPORATION)
CTRA. ARANDA-PALENCIA KM 23
OLMEDILLO DE ROA, SPAIN

THE MARK CONSISTS OF STANDARD CHAR-
ACTERS WITHOUT CLAIM TO ANY PARTICULAR
FONT, STYLE, SIZE, OR COLOR.

FOR: WINE, IN CLASS 33 (U.S. CLS. 47 AND 49).

SER. NO. 77-371,072, FILED 1-14-2008.

FIRST USE 5-0-2002; IN COMMERCE 7-0-2007.

MARIAM MAHMOUDI, EXAMINING ATTORNEY

Int. Cl.: 43

Prior U.S. Cls.: 100 and 101

United States Patent and Trademark Office

Reg. No. 3,484,571

Registered Aug. 12, 2008

**SERVICE MARK
PRINCIPAL REGISTER**



PARK LANE HOTEL, INC. (NEW YORK CORPORATION)
230 PARK AVENUE
NEW YORK, NY 10169

THE MARK CONSISTS OF THE LETTERS "PL" IN STYLIZED LETTERING.

FOR: HOTEL, BAR AND RESTAURANT SERVICES, IN CLASS 43 (U.S. CLS. 100 AND 101).

SER. NO. 77-371,079, FILED 1-14-2008.

FIRST USE 5-1-1971; IN COMMERCE 5-1-1971.

COLLEEN DOMBROW, EXAMINING ATTORNEY

Int. Cl.: 41

Prior U.S. Cls.: 100, 101 and 107

United States Patent and Trademark Office

Reg. No. 3,484,572

Registered Aug. 12, 2008

**SERVICE MARK
PRINCIPAL REGISTER**

RECREATION CONNECTION

RECREATION CONNECTION SERVICES, INC.
(CALIFORNIA CORPORATION), FORMERLY
DBA RECREATION CONNECTION
1682 SYCAMORE CANYON
WESTLAKE VILLAGE, CA 91361

FOR: PROVIDING EMPLOYERS AND ORGANIZATIONS WITH ENTERTAINMENT EVENT PLANNING AND DISCOUNT TICKET RESERVATIONS FOR SHOWS AND OTHER ENTERTAINMENT EVENTS, IN CLASS 41 (U.S. CLS. 100, 101 AND 107).

FIRST USE 1-0-1996; IN COMMERCE 1-0-1996.

THE MARK CONSISTS OF STANDARD CHARACTERS WITHOUT CLAIM TO ANY PARTICULAR FONT, STYLE, SIZE, OR COLOR.

NO CLAIM IS MADE TO THE EXCLUSIVE RIGHT TO USE "RECREATION", APART FROM THE MARK AS SHOWN.

SER. NO. 77-371,093, FILED 1-14-2008.

JOHN WILKE, EXAMINING ATTORNEY

Int. Cl.: 30

Prior U.S. Cl.: 46

United States Patent and Trademark Office

Reg. No. 3,484,573

Registered Aug. 12, 2008

**TRADEMARK
PRINCIPAL REGISTER**

Chips Delight

HANNAFORD LICENSING CORP. (MAINE CORPORATION)

LEGAL DEPT.

145 PLEASANT HILL ROAD

SCARBOROUGH, ME 04074

FOR: COOKIES, IN CLASS 30 (U.S. CL. 46).

FIRST USE 8-0-1996; IN COMMERCE 8-0-1996.

THE MARK CONSISTS OF STANDARD CHARACTERS WITHOUT CLAIM TO ANY PARTICULAR FONT, STYLE, SIZE, OR COLOR.

NO CLAIM IS MADE TO THE EXCLUSIVE RIGHT TO USE "CHIPS", APART FROM THE MARK AS SHOWN.

SER. NO. 77-371,099, FILED 1-14-2008.

GRETTA YAO, EXAMINING ATTORNEY

Int. Cl.: 42

Prior U.S. Cls.: 100 and 101

United States Patent and Trademark Office

Reg. No. 3,484,574

Registered Aug. 12, 2008

**SERVICE MARK
PRINCIPAL REGISTER**

**You can't spell profit
without IT**

GREENWIRE SOLUTIONS INC. (NEW YORK
CORPORATION)
2229 41ST STREET
ASTORIA, NY 11105

FOR: INFORMATION TECHNOLOGY CONSUL-
TATION, IN CLASS 42 (U.S. CLS. 100 AND 101).

FIRST USE 12-20-2007; IN COMMERCE 1-4-2008.

THE MARK CONSISTS OF STANDARD CHAR-
ACTERS WITHOUT CLAIM TO ANY PARTICULAR
FONT, STYLE, SIZE, OR COLOR.

SER. NO. 77-371,103, FILED 1-14-2008.

ALICE SUE CARRUTHERS, EXAMINING ATTOR-
NEY

Int. Cls.: 16 and 41

Prior U.S. Cls.: 2, 5, 22, 23, 29, 37, 38, 50, 100, 101 and 107

Reg. No. 3,484,575

United States Patent and Trademark Office

Registered Aug. 12, 2008

**TRADEMARK
SERVICE MARK
PRINCIPAL REGISTER**

Write Placer

COLLEGE ENTRANCE EXAMINATION BOARD
(NEW YORK NOT-FOR-PROFIT MEMBERSHIP ASSOCIATION)
LEGAL DEPARTMENT
45 COLUMBUS AVE
NEW YORK, NY 10023

FOR: PRINTED WRITING ASSESSMENT TEST BOOKLETS USED FOR COLLEGE PREPARATORY/ENTRANCE PURPOSES, PRINTED ORDER FORMS, PRINTED TEST ADMINISTRATION MANUALS, IN CLASS 16 (U.S. CLS. 2, 5, 22, 23, 29, 37, 38 AND 50).

FIRST USE 9-0-1998; IN COMMERCE 9-0-1998.

FOR: PROVIDING INFORMATION BY MEANS OF AN INTERACTIVE WEB SITE ON A GLOBAL COMPUTER NETWORK, NAMELY, PROVIDING WRITING ASSESSMENT TEST BOOKLETS USED FOR COLLEGE PREPARATORY/ENTRANCE PURPOSES, EDUCATIONAL TESTING SERVICES, NAMELY, DEVELOPMENT, ADMINISTRATION

AND EVALUATION OF PRINTED WRITING ASSESSMENT TESTS AND ONLINE WRITING ASSESSMENT TESTS VIA A WEB PAGE ON A GLOBAL COMPUTER NETWORK; PROVIDING INFORMATION BY MEANS OF AN INTERACTIVE WEB SITE ON A GLOBAL COMPUTER NETWORK, NAMELY, PROVIDING AN INTERACTIVE TUTORIAL TO PREPARE TEST TAKERS FOR WRITING ASSESSMENT TESTS, IN CLASS 41 (U.S. CLS. 100, 101 AND 107).

FIRST USE 9-0-1998; IN COMMERCE 9-0-1998.

THE MARK CONSISTS OF STANDARD CHARACTERS WITHOUT CLAIM TO ANY PARTICULAR FONT, STYLE, SIZE, OR COLOR.

SER. NO. 77-371,111, FILED 1-14-2008.

JILL C. ALT, EXAMINING ATTORNEY

Int. Cls.: 35 and 37

Prior U.S. Cls.: 100, 101, 102, 103 and 106

United States Patent and Trademark Office

Reg. No. 3,484,576

Registered Aug. 12, 2008

**SERVICE MARK
PRINCIPAL REGISTER**

LA COSTA OAKS

REAL ESTATE COLLATERAL MANAGEMENT
COMPANY (DELAWARE CORPORATION)
2700 SANDERS ROAD
PROSPECT HEIGHTS, IL 60070

FOR: ASSOCIATION SERVICES, NAMELY, PROMOTING THE INTERESTS OF A HOMEOWNERS' ASSOCIATION, IN CLASS 35 (U.S. CLS. 100, 101 AND 102).

FIRST USE 11-16-1997; IN COMMERCE 11-16-1997.

FOR: REAL ESTATE DEVELOPMENT, IN CLASS 37 (U.S. CLS. 100, 103 AND 106).

FIRST USE 7-24-2004; IN COMMERCE 7-24-2004.

THE MARK CONSISTS OF STANDARD CHARACTERS WITHOUT CLAIM TO ANY PARTICULAR FONT, STYLE, SIZE, OR COLOR.

SER. NO. 77-371,112, FILED 1-14-2008.

JILL C. ALT, EXAMINING ATTORNEY

Int. Cl.: 2

Prior U.S. Cls.: 6, 11 and 16

United States Patent and Trademark Office

Reg. No. 3,484,577

Registered Aug. 12, 2008

**TRADEMARK
PRINCIPAL REGISTER**

PRECISE

THE SHEPHERD COLOR COMPANY (OHIO
CORPORATION)
4539 DUES DRIVE
CINCINNATI, OH 45246

FOR: PIGMENTS USED IN FIBERS, FILMS,
PLASTICS, COMPOSITES AND OTHER SIMILAR
DECORATIVE APPLICATIONS, IN CLASS 2 (U.S.
CLS. 6, 11 AND 16).

FIRST USE 8-28-2007; IN COMMERCE 8-28-2007.

THE MARK CONSISTS OF STANDARD CHAR-
ACTERS WITHOUT CLAIM TO ANY PARTICULAR
FONT, STYLE, SIZE, OR COLOR.

SER. NO. 77-371,115, FILED 1-14-2008.

CHRISTOPHER BUONGIORNO, EXAMINING AT-
TORNEY

Int. Cl.: 9

Prior U.S. Cls.: 21, 23, 26, 36 and 38

Reg. No. 3,484,578

United States Patent and Trademark Office

Registered Aug. 12, 2008

**TRADEMARK
PRINCIPAL REGISTER**

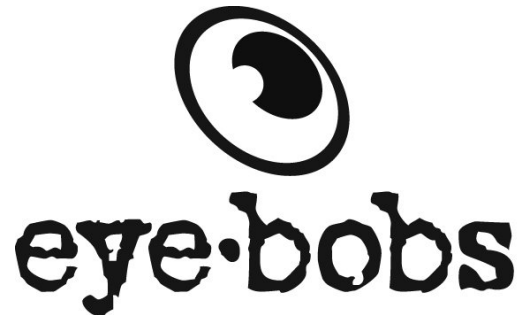

EYEBOBS INC. (MINNESOTA CORPORATION)
2940 HARRIET AVE. S.
MINNEAPOLIS, MN 55408

THE MARK CONSISTS OF THE WORDS "EYE
BOBS" AND AN EYEBALL WITH A PUPIL IN THE
CENTER.

FOR: EYEWEAR, IN CLASS 9 (U.S. CLS. 21, 23, 26,
36 AND 38).

SER. NO. 77-371,119, FILED 1-14-2008.

FIRST USE 4-30-2001; IN COMMERCE 4-30-2001.

NO CLAIM IS MADE TO THE EXCLUSIVE
RIGHT TO USE "EYE" , APART FROM THE MARK
AS SHOWN.

ALICE SUE CARRUTHERS, EXAMINING ATTOR-
NEY

Int. Cl.: 16

Prior U.S. Cls.: 2, 5, 22, 23, 29, 37, 38 and 50

Reg. No. 3,484,579

United States Patent and Trademark Office

Registered Aug. 12, 2008

**TRADEMARK
PRINCIPAL REGISTER**

MYTHOSTORY

SOWELU ENTERTAINMENT, LTD. (CALIFORNIA CORPORATION)
SUITE 365
9800 "D" TOPANGA CANYON BLVD.
CHATSWORTH, CA 91311

FOR: POSTCARDS, GREETING CARDS AND PHOTOGRAPHS, IN CLASS 16 (U.S. CLS. 2, 5, 22, 23, 29, 37, 38 AND 50).

FIRST USE 3-18-2002; IN COMMERCE 5-6-2002.

THE MARK CONSISTS OF STANDARD CHARACTERS WITHOUT CLAIM TO ANY PARTICULAR FONT, STYLE, SIZE, OR COLOR.

OWNER OF U.S. REG. NOS. 2,622,091, 2,629,150, AND 2,725,074.

SER. NO. 77-371,127, FILED 1-14-2008.

KEVIN DINALLO, EXAMINING ATTORNEY

Int. Cl.: 16

Prior U.S. Cls.: 2, 5, 22, 23, 29, 37, 38 and 50

United States Patent and Trademark Office

Reg. No. 3,484,580

Registered Aug. 12, 2008

**TRADEMARK
PRINCIPAL REGISTER**

MYTHOSTORIES

SOWELU ENTERTAINMENT, LTD. (CALIFORNIA CORPORATION)
SUITE 365
9800 "D" TOPANGA CANYON BLVD.
CHATSWORTH, CA 91311

FOR: POSTCARDS AND PHOTOGRAPHS, IN CLASS 16 (U.S. CLS. 2, 5, 22, 23, 29, 37, 38 AND 50).

FIRST USE 3-18-2002; IN COMMERCE 5-6-2002.

THE MARK CONSISTS OF STANDARD CHARACTERS WITHOUT CLAIM TO ANY PARTICULAR FONT, STYLE, SIZE, OR COLOR.

OWNER OF U.S. REG. NOS. 2,622,091, 2,629,150, AND 2,725,074.

SER. NO. 77-371,145, FILED 1-14-2008.

KEVIN DINALLO, EXAMINING ATTORNEY

Int. Cl.: 41

Prior U.S. Cls.: 100, 101 and 107

United States Patent and Trademark Office

Reg. No. 3,484,581

Registered Aug. 12, 2008

**SERVICE MARK
PRINCIPAL REGISTER**



HOUSTON COMMUNITY COLLEGE SYSTEM
(TEXAS EDUCATIONAL INSTITUTION)
3100 MAIN STREET
HOUSTON, TX 77266

THE MARK CONSISTS OF THE LETTERS "HCC"
WITH AN EAGLE FLYING THROUGH THE LET-
TER "H" AND THROUGH AND ABOVE THE FIRST
LETTER "C".

FOR: EDUCATIONAL SERVICES, NAMELY,
PROVIDING COURSES OF INSTRUCTION AT
THE COLLEGE LEVEL, IN CLASS 41 (U.S. CLS. 100,
101 AND 107).

SER. NO. 77-371,169, FILED 1-14-2008.

FIRST USE 1-1-2008; IN COMMERCE 1-1-2008.

KEVIN DINALLO, EXAMINING ATTORNEY

Int. Cl.: 30

Prior U.S. Cl.: 46

United States Patent and Trademark Office

Reg. No. 3,484,582

Registered Aug. 12, 2008

**TRADEMARK
PRINCIPAL REGISTER**

Pecan Pleasers

HANNAFORD LICENSING CORP. (MAINE CORPORATION)

HANNAFORD LEGAL DEPT.

145 PLEASANT HILL ROAD

SCARBOROUGH, ME 04074

FOR: COOKIES, IN CLASS 30 (U.S. CL. 46).

FIRST USE 8-0-1996; IN COMMERCE 8-0-1996.

THE MARK CONSISTS OF STANDARD CHARACTERS WITHOUT CLAIM TO ANY PARTICULAR FONT, STYLE, SIZE, OR COLOR.

NO CLAIM IS MADE TO THE EXCLUSIVE RIGHT TO USE "PECAN", APART FROM THE MARK AS SHOWN.

SER. NO. 77-371,180, FILED 1-14-2008.

GRETTA YAO, EXAMINING ATTORNEY

Int. Cl.: 35

Prior U.S. Cls.: 100, 101 and 102

United States Patent and Trademark Office

Reg. No. 3,484,583

Registered Aug. 12, 2008

**SERVICE MARK
PRINCIPAL REGISTER**

MAPSELECT

NAVICO, INC. (DELAWARE CORPORATION)
12000 E. SKELLY DRIVE
TULSA, OK 741282486

THE MARK CONSISTS OF STANDARD CHAR-
ACTERS WITHOUT CLAIM TO ANY PARTICULAR
FONT, STYLE, SIZE, OR COLOR.

FOR: ON-LINE RETAIL STORE SERVICES FEAT-
URING ELECTRONIC MAPS FOR USE IN CON-
NECTION WITH GLOBAL POSITIONING
SYSTEMS, IN CLASS 35 (U.S. CLS. 100, 101 AND 102).

SER. NO. 77-371,187, FILED 1-14-2008.

FIRST USE 12-21-2007; IN COMMERCE 12-21-2007.

LIEF MARTIN, EXAMINING ATTORNEY

Int. Cl.: 33

Prior U.S. Cls.: 47 and 49

United States Patent and Trademark Office

Reg. No. 3,484,584

Registered Aug. 12, 2008

**TRADEMARK
PRINCIPAL REGISTER**

SOL DE ESPAÑA

FELIX SOLIS S.A. (SPAIN CORPORATION)
CTRA. MADRID-CADIZ KM 199
VALDEPENAS-CIUDAD REAL, SPAIN CP13300

FOR: WINE, IN CLASS 33 (U.S. CLS. 47 AND 49).

FIRST USE 10-0-2003; IN COMMERCE 11-0-2005.

THE MARK CONSISTS OF STANDARD CHAR-
ACTERS WITHOUT CLAIM TO ANY PARTICULAR
FONT, STYLE, SIZE, OR COLOR.

NO CLAIM IS MADE TO THE EXCLUSIVE
RIGHT TO USE "ESPAÑA", APART FROM THE
MARK AS SHOWN.

THE FOREIGN WORDING IN THE MARK
TRANSLATES INTO ENGLISH AS "SPANISH SUN".

SER. NO. 77-371,190, FILED 1-14-2008.

MICHAEL GAAFAR, EXAMINING ATTORNEY

Int. Cl.: 5

Prior U.S. Cls.: 6, 18, 44, 46, 51 and 52

Reg. No. 3,484,585

United States Patent and Trademark Office

Registered Aug. 12, 2008

**TRADEMARK
PRINCIPAL REGISTER**

EPASHOL

NATURAL HEALTH CORPORATION (FLORIDA
CORPORATION)
10746 SW 186 STREET
MIAMI, FL 33157

THE MARK CONSISTS OF STANDARD CHAR-
ACTERS WITHOUT CLAIM TO ANY PARTICULAR
FONT, STYLE, SIZE, OR COLOR.

FOR: DIETARY SUPPLEMENTS, IN CLASS 5 (U.S.
CLS. 6, 18, 44, 46, 51 AND 52).

SER. NO. 77-371,227, FILED 1-14-2008.

FIRST USE 12-21-2007; IN COMMERCE 12-21-2007.

ANDREA BUTLER, EXAMINING ATTORNEY

Int. Cl.: 25

Prior U.S. Cls.: 22 and 39

United States Patent and Trademark Office

Reg. No. 3,484,586

Registered Aug. 12, 2008

**TRADEMARK
PRINCIPAL REGISTER**

NODBOD

NODBOD, LLC (MISSOURI LTD LIAB CO)
1248 RESEARCH BLVD.
ST. LOUIS, MO 63132

THE MARK CONSISTS OF STANDARD CHAR-
ACTERS WITHOUT CLAIM TO ANY PARTICULAR
FONT, STYLE, SIZE, OR COLOR.

FOR: CLOTHING, NAMELY, CUSTOM PRINTED
T-SHIRTS, IN CLASS 25 (U.S. CLS. 22 AND 39).

SER. NO. 77-371,237, FILED 1-14-2008.

FIRST USE 10-29-2007; IN COMMERCE 10-29-2007.

STEVEN R. FOSTER, EXAMINING ATTORNEY

Int. Cl.: 35

Prior U.S. Cls.: 100, 101 and 102

United States Patent and Trademark Office

Reg. No. 3,484,587

Registered Aug. 12, 2008

**SERVICE MARK
PRINCIPAL REGISTER**



JOURNAL SENTINEL INC. (WISCONSIN CORPORATION)
333 WEST STATE STREET
MILWAUKEE, WI 53201

FOR: PROVIDING ON-LINE INFORMATION IN THE FIELDS OF EMPLOYMENT, RECRUITMENT, CAREERS, PERSONAL ISSUES RELATED TO CAREERS AND WORK LIFE, JOB RESOURCES, JOB LISTINGS AND RESUMES; PROVIDING ON-LINE INTERACTIVE EMPLOYMENT COUNSELING AND RECRUITMENT SERVICES; PROVIDING ON-LINE EMPLOYMENT PLACEMENT SERVICES, NAMELY, RESUME MATCHING SERVICES VIA A

GLOBAL COMPUTER NETWORK, IN CLASS 35 (U.S. CLS. 100, 101 AND 102).

FIRST USE 9-24-2007; IN COMMERCE 9-24-2007.

THE MARK CONSISTS OF THE WORD "JOB-NOGGIN WITH .COM" BELOW IT AND A CHARACTER WEARING A TIE AND GLASSES AND POINTING TO HIS HEAD ABOVE THE LETTERS "NOG".

SER. NO. 77-371,246, FILED 1-14-2008.

MICHAEL ENGEL, EXAMINING ATTORNEY

Int. Cl.: 5

Prior U.S. Cls.: 6, 18, 44, 46, 51 and 52

Reg. No. 3,484,588

United States Patent and Trademark Office

Registered Aug. 12, 2008

**TRADEMARK
PRINCIPAL REGISTER**

YURINOSAW

NATURAL HEALTH CORPORATION (FLORIDA
CORPORATION)
10746 SW 186 STREET
MIAMI, FL 33157

THE MARK CONSISTS OF STANDARD CHAR-
ACTERS WITHOUT CLAIM TO ANY PARTICULAR
FONT, STYLE, SIZE, OR COLOR.

FOR: DIETARY SUPPLEMENTS, IN CLASS 5 (U.S.
CLS. 6, 18, 44, 46, 51 AND 52).

SER. NO. 77-371,255, FILED 1-14-2008.

FIRST USE 12-21-2007; IN COMMERCE 12-21-2007.

ANDREA BUTLER, EXAMINING ATTORNEY

Int. Cl.: 35

Prior U.S. Cls.: 100, 101 and 102

United States Patent and Trademark Office

Reg. No. 3,484,589

Registered Aug. 12, 2008

**SERVICE MARK
PRINCIPAL REGISTER**

BERTIN HENRI SELECTIONS

BELLE EPOQUE WINE IMPORTS (FLORIDA
LTD LIAB CO)
10900 N.W. 21ST STREET, UNIT 180
DORAL, FL 33172

FOR: IMPORT AND EXPORT AGENCIES;
WHOLESALE DISTRIBUTORSHIPS FEATURING
WINE AND WINE ACCESSORIES, IN CLASS 35
(U.S. CLS. 100, 101 AND 102).

FIRST USE 11-0-2007; IN COMMERCE 11-0-2007.

THE MARK CONSISTS OF STANDARD CHAR-
ACTERS WITHOUT CLAIM TO ANY PARTICULAR
FONT, STYLE, SIZE, OR COLOR.

NO CLAIM IS MADE TO THE EXCLUSIVE
RIGHT TO USE "SELECTIONS", APART FROM
THE MARK AS SHOWN.

SER. NO. 77-371,262, FILED 1-14-2008.

KIMBERLY PERRY, EXAMINING ATTORNEY

Int. Cl.: 7

Prior U.S. Cls.: 13, 19, 21, 23, 31, 34 and 35

United States Patent and Trademark Office

Reg. No. 3,484,590

Registered Aug. 12, 2008

TRADEMARK
PRINCIPAL REGISTER



PR DIAMOND PRODUCTS, INC. (NEVADA CORPORATION)

4488 WAGON TRAIL

LAS VEGAS, NV 89118

FOR: DIAMOND-EDGED SAW BLADES FOR POWER SAWS, IN CLASS 7 (U.S. CLS. 13, 19, 21, 23, 31, 34 AND 35).

FIRST USE 5-1-1988; IN COMMERCE 5-1-1988.

OWNER OF U.S. REG. NOS. 3,322,634 AND 3,342,761.

NO CLAIM IS MADE TO THE EXCLUSIVE RIGHT TO USE "DIAMOND PRODUCTS INC.", APART FROM THE MARK AS SHOWN.

THE MARK CONSISTS OF THE IMAGE OF A CIRCULAR SAW-BLADE, FEATURING A PRECISION DIAMOND AT ITS CENTER, AND ENCAPSULATED BY THE NAME OF "PR DIAMOND PRODUCTS INC." AT THE BORDER OF THE TOP HALF OF THE CIRCLE, AND THE PHRASE "ONE BLADE AND WE GOT-YA!" AT THE BOTTOM HALF OF THE CIRCLE.

SER. NO. 77-371,288, FILED 1-14-2008.

MICHAEL KEATING, EXAMINING ATTORNEY

Int. Cl.: 5

Prior U.S. Cls.: 6, 18, 44, 46, 51 and 52

United States Patent and Trademark Office

Reg. No. 3,484,591

Registered Aug. 12, 2008

**TRADEMARK
PRINCIPAL REGISTER**

LINAZA REDUCTORA

NATURAL HEALTH CORPORATION (FLORIDA
CORPORATION)
10746 SW 186 STREET
MIAMI, FL 33157

FOR: NUTRITIONAL SUPPLEMENTS, IN CLASS
5 (U.S. CLS. 6, 18, 44, 46, 51 AND 52).

FIRST USE 4-1-2007; IN COMMERCE 4-1-2007.

THE MARK CONSISTS OF STANDARD CHAR-
ACTERS WITHOUT CLAIM TO ANY PARTICULAR
FONT, STYLE, SIZE, OR COLOR.

NO CLAIM IS MADE TO THE EXCLUSIVE
RIGHT TO USE "LINAZA", APART FROM THE
MARK AS SHOWN.

THE FOREIGN WORDING IN THE MARK
TRANSLATES INTO ENGLISH AS LINSEED REDU-
CER.

SER. NO. 77-371,294, FILED 1-14-2008.

ANDREA BUTLER, EXAMINING ATTORNEY

Int. Cl.: 25

Prior U.S. Cls.: 22 and 39

United States Patent and Trademark Office

Reg. No. 3,484,592

Registered Aug. 12, 2008

**TRADEMARK
PRINCIPAL REGISTER**

{intimacy}

INTIMACY MANAGEMENT COMPANY LLC
(DELAWARE LTD LIAB CO)
SUITE 760
3980 DEKALB TECHNOLOGY PARKWAY
ATLANTA, GA 30340

FOR: LINGERIE; UNDERGARMENTS, IN CLASS
25 (U.S. CLS. 22 AND 39).

FIRST USE 3-1-2008; IN COMMERCE 3-1-2008.

OWNER OF U.S. REG. NOS. 3,290,017 AND
3,296,557.

THE MARK CONSISTS OF THE WORD "INTI-
MACY" IN BRACKETS.

SER. NO. 77-371,307, FILED 1-14-2008.

SHAUNIA CARLYLE, EXAMINING ATTORNEY

Int. Cl.: 35

Prior U.S. Cls.: 100, 101 and 102

United States Patent and Trademark Office

Reg. No. 3,484,593

Registered Aug. 12, 2008

SERVICE MARK
PRINCIPAL REGISTER



THE JOHN R. ELLIOTT FOUNDATION (NEW
JERSEY NON-PROFIT CORPORATION)
304 ROSEMARIE DRIVE
EGG HARBOR, NJ 08234

FOR: PROMOTING AWARENESS OF THE NEED
TO PREVENT DRIVING UNDER THE INFLUENCE
OF ALCOHOL AND DESIGNATED DRIVER PRO-
GRAMS, IN CLASS 35 (U.S. CLS. 100, 101 AND 102).

FIRST USE 10-31-2005; IN COMMERCE 10-31-2005.

OWNER OF U.S. REG. NOS. 2,620,809 AND
2,683,023.

NO CLAIM IS MADE TO THE EXCLUSIVE
RIGHT TO USE "CAMPAIGN FOR DESIGNATED
DRIVERS", APART FROM THE MARK AS SHOWN.

THE NAME IN THE MARK DOES NOT IDENTI-
FY A LIVING INDIVIDUAL.

SER. NO. 77-371,313, FILED 1-14-2008.

MIDGE BUTLER, EXAMINING ATTORNEY

Int. Cl.: 35

Prior U.S. Cls.: 100, 101 and 102

United States Patent and Trademark Office

Reg. No. 3,484,594

Registered Aug. 12, 2008

**SERVICE MARK
PRINCIPAL REGISTER**

{intimacy}

INTIMACY MANAGEMENT COMPANY LLC
(DELAWARE LTD LIAB CO)
SUITE 760
3980 DEKALB TECHNOLOGY PARKWAY
ATLANTA, GA 30340

FOR: RETAIL STORES FEATURING LINGERIE
AND UNDERGARMENTS, IN CLASS 35 (U.S. CLS.
100, 101 AND 102).

FIRST USE 12-13-2007; IN COMMERCE 12-13-2007.

OWNER OF U.S. REG. NOS. 3,290,017 AND
3,296,557.

THE MARK CONSISTS OF THE WORD "INTI-
MACY" IN BRACKETS.

SER. NO. 77-371,317, FILED 1-14-2008.

SHAUNIA CARLYLE, EXAMINING ATTORNEY

Int. Cl.: 41

Prior U.S. Cls.: 100, 101 and 107

United States Patent and Trademark Office

Reg. No. 3,484,595

Registered Aug. 12, 2008

**SERVICE MARK
PRINCIPAL REGISTER**



FARGO MARATHON, INC. (MINNESOTA
CHARITABLE CORPORATION)
2029 RUTTAN COURT
WEST FARGO, ND 580784258

FOR: ENTERTAINMENT SERVICES, NAMELY,
ARRANGING AND CONDUCTING OF COMPETI-
TIONS FOR RUNNING RACE EVENTS; ENCOURA-
GING AMATEUR SPORTS BY SPONSORING,
REGULATING AND GOVERNING AMATEUR
ATHLETIC PROGRAMS AND ACTIVITIES IN THE
NATURE OF RUNNING RACE EVENTS, IN CLASS
41 (U.S. CLS. 100, 101 AND 107).

FIRST USE 9-30-2007; IN COMMERCE 9-30-2007.

THE MARK CONSISTS OF THE WORD "HOW"
DISPLAYED VERTICALLY TO THE LEFT OF THE
HORIZONTALLY DISPLAYED WORD "FAR". AN
ARROW DESIGN APPEARS TO THE RIGHT OF
THE WORD "FAR". THE WORDS "HOW FAR" AND
THE ARROW DESIGN ARE DISPLAYED ABOVE
THE WORDS "WILL YOU GO". A DOTTED SEMI-
CIRCLE APPEARS UNDER THE LETTER "O" IN
THE WORD "GO", FOLLOWED BY A QUESTION
MARK.

SER. NO. 77-371,322, FILED 1-14-2008.

STEVEN JACKSON, EXAMINING ATTORNEY

Int. Cl.: 36

Prior U.S. Cls.: 100, 101 and 102

United States Patent and Trademark Office

Reg. No. 3,484,596

Registered Aug. 12, 2008

**SERVICE MARK
PRINCIPAL REGISTER**

**Broker
Focused...Technology Driven**

RESOURCE BROKERAGE, LLC (ILLINOIS LTD
LIAB CO)
1501 E. WOODFIELD ROAD SUITE 110E
SCHAUMBURG, IL 60173

THE MARK CONSISTS OF STANDARD CHAR-
ACTERS WITHOUT CLAIM TO ANY PARTICULAR
FONT, STYLE, SIZE, OR COLOR.

FOR: INSURANCE BROKERAGE, IN CLASS 36
(U.S. CLS. 100, 101 AND 102).

SER. NO. 77-371,325, FILED 1-14-2008.

FIRST USE 5-4-2005; IN COMMERCE 5-4-2005.

ELISSA GARBER KON, EXAMINING ATTORNEY

Int. Cl.: 9

Prior U.S. Cls.: 21, 23, 26, 36 and 38

Reg. No. 3,484,597

United States Patent and Trademark Office

Registered Aug. 12, 2008

**TRADEMARK
PRINCIPAL REGISTER**

MAGSNAP

DESCO INDUSTRIES, INC. (CALIFORNIA CORPORATION)
3651 WALNUT AVE.
CHINO, CA 91710

THE MARK CONSISTS OF STANDARD CHARACTERS WITHOUT CLAIM TO ANY PARTICULAR FONT, STYLE, SIZE, OR COLOR.

FOR: APPARATUS FOR ELECTROSTATIC GROUNDING OF WORKERS WHO ASSEMBLE ELECTRONIC PARTS AND DEVICES, NAMELY, PROTECTIVE WRIST STRAPS AND ELECTRICAL CORDS, IN CLASS 9 (U.S. CLS. 21, 23, 26, 36 AND 38).

SER. NO. 77-371,330, FILED 1-14-2008.

FIRST USE 10-31-2006; IN COMMERCE 10-31-2006.

WARREN L. OLANDRIA, EXAMINING ATTORNEY

Int. Cl.: 5

Prior U.S. Cls.: 6, 18, 44, 46, 51 and 52

Reg. No. 3,484,598

United States Patent and Trademark Office

Registered Aug. 12, 2008

**TRADEMARK
PRINCIPAL REGISTER**

PRÉ

INGFERTILITY, LLC (WASHINGTON LTD LIAB
CO)

17206 S. SPANGLE CREEK RD.

VALLEYFORD, WA 99036

FOR: MEDICAL LUBRICANT, NAMELY, VAGI-
NAL LUBRICANTS, IN CLASS 5 (U.S. CLS. 6, 18, 44,
46, 51 AND 52).

FIRST USE 1-29-2007; IN COMMERCE 1-29-2007.

THE MARK CONSISTS OF STANDARD CHAR-
ACTERS WITHOUT CLAIM TO ANY PARTICULAR
FONT, STYLE, SIZE, OR COLOR.

OWNER OF U.S. REG. NO. 2,972,756.

THE FOREIGN WORDING IN THE MARK
TRANSLATES INTO ENGLISH AS MEADOW.

SER. NO. 77-371,335, FILED 1-14-2008.

MIDGE BUTLER, EXAMINING ATTORNEY

Int. Cl.: 1

Prior U.S. Cls.: 1, 5, 6, 10, 26 and 46

Reg. No. 3,484,599

United States Patent and Trademark Office

Registered Aug. 12, 2008

TRADEMARK
PRINCIPAL REGISTER

MICROMEL

PLANT EXTRACTS INTERNATIONAL INCORPORATED (MINNESOTA CORPORATION)
6224 BELMORE LANE
HOPKINS, MN 55343

FOR: A PLANT TERPENE, NAMELY, NATURAL TERPINEN-4-OL CHEMICAL FOR USE PRINCIPALLY AS A MILD ANTIBACTERIAL AGENT IN THE MANUFACTURE OF SOAPS, COSMETICS, BODY CARE PRODUCTS, FACIAL CARE PRODUCTS, AND IN ATOMIZERS WHICH DIFFUSE WATER AND PLANT EXTRACTS INTO THE AIR IN THE

BUILT ENVIRONMENT, IN CLASS 1 (U.S. CLS. 1, 5, 6, 10, 26 AND 46).

FIRST USE 1-18-2008; IN COMMERCE 1-18-2008.

THE MARK CONSISTS OF STANDARD CHARACTERS WITHOUT CLAIM TO ANY PARTICULAR FONT, STYLE, SIZE, OR COLOR.

SER. NO. 77-371,351, FILED 1-14-2008.

RAMONA ORTIGA, EXAMINING ATTORNEY

Int. Cl.: 44

Prior U.S. Cls.: 100 and 101

United States Patent and Trademark Office

Reg. No. 3,484,600

Registered Aug. 12, 2008

**SERVICE MARK
PRINCIPAL REGISTER**



MEMORIAL GROUP, INC. (ILLINOIS NON-
PROFIT CORPORATION)
4500 MEMORIAL DRIVE
BELLEVILLE, IL 62226

THE MARK CONSISTS OF STYLIZED "M" WITH
THREE VERTICAL CURVED LINES FORMING A
STYLIZED FLAME ARISING FROM THE "M".

FOR: HOSPITALS; HEALTHCARE SERVICES, IN
CLASS 44 (U.S. CLS. 100 AND 101).

SER. NO. 77-371,360, FILED 1-14-2008.

FIRST USE 1-1-2008; IN COMMERCE 1-1-2008.

HENRY S. ZAK, EXAMINING ATTORNEY

Int. Cl.: 25

Prior U.S. Cls.: 22 and 39

United States Patent and Trademark Office

Reg. No. 3,484,601

Registered Aug. 12, 2008

**TRADEMARK
PRINCIPAL REGISTER**

NODBOD, LLC (MISSOURI LTD LIAB CO)
1248 RESEARCH BLVD.
ST. LOUIS, MO 63132

FOR: CLOTHING, NAMELY, CUSTOM PRINTED
T-SHIRTS, IN CLASS 25 (U.S. CLS. 22 AND 39).

FIRST USE 10-29-2007; IN COMMERCE 10-29-2007.

THE MARK CONSISTS OF THE LETTERS "NOD-
BOD", ALL IN LOWER CASE LETTERS. THE LET-

TER "N" AT THE BEGINNING OF THE MARK HAS
A LINE THAT PARTIALLY EXTENDS UNDER THE
WORD. THE LETTER "D" AT THE END OF THE
MARK HAS A LINE THAT PARTIALLY EXTENDS
ABOVE THE WORD.

SER. NO. 77-371,407, FILED 1-14-2008.

STEVEN R. FOSTER, EXAMINING ATTORNEY

Int. Cl.: 45

Prior U.S. Cls.: 100 and 101

United States Patent and Trademark Office

Reg. No. 3,484,602

Registered Aug. 12, 2008

**SERVICE MARK
PRINCIPAL REGISTER**

OUTLOUDSTOCK

OUTLOUD STOCK, INC. (CALIFORNIA CORPORATION)

#502-121

2514 JAMACHA RD.

EL CAJON, CA 92019

FOR: STOCK PHOTOGRAPHY SERVICES, NAMELY, LEASING REPRODUCTION RIGHTS OF PHOTOGRAPHS AND TRANSPARENCIES TO OTHERS, IN CLASS 45 (U.S. CLS. 100 AND 101).

FIRST USE 10-1-2007; IN COMMERCE 10-1-2007.

THE MARK CONSISTS OF STANDARD CHARACTERS WITHOUT CLAIM TO ANY PARTICULAR FONT, STYLE, SIZE, OR COLOR.

SER. NO. 77-371,438, FILED 1-14-2008.

WON TEAK OH, EXAMINING ATTORNEY

Int. Cl.: 35

Prior U.S. Cls.: 100, 101 and 102

United States Patent and Trademark Office

Reg. No. 3,484,603

Registered Aug. 12, 2008

**SERVICE MARK
PRINCIPAL REGISTER**



CIRCLEPIX.COM, LLC (UTAH LTD LIAB CO)
676 WEST 1200 NORTH
SPRINGVILLE, UT 84663

FOR: ADVERTISING AND MARKETING; ADVERTISING, MARKETING AND PROMOTION SERVICES; ON-LINE ADVERTISING AND MARKETING SERVICES; REAL ESTATE ADVERTISING SERVICES; REAL ESTATE MARKETING SERVICES, NAMELY, ON-LINE SERVICES FEATURING TOURS OF RESIDENTIAL AND COM-

MERCIAL REAL ESTATE, IN CLASS 35 (U.S. CLS. 100, 101 AND 102).

FIRST USE 1-15-2000; IN COMMERCE 1-15-2000.

THE MARK CONSISTS OF THE WORD "CIRCLEPIX" AND A PARTIALLY LATERAL AND OFF-CENTERED VIEW OF A SEGMENTED CIRCLE.

SER. NO. 77-371,439, FILED 1-14-2008.

BRIAN PINO, EXAMINING ATTORNEY

Int. Cl.: 35

Prior U.S. Cls.: 100, 101 and 102

United States Patent and Trademark Office

Reg. No. 3,484,604

Registered Aug. 12, 2008

**SERVICE MARK
PRINCIPAL REGISTER**



THOMAS-LACY, BONITA J (UNITED STATES
INDIVIDUAL)
6906 TREE CREST PARKWAY
DECATUR, GA 30035

FOR: PROMOTING THE GOODS AND SERVICES
OF OTHERS BY PROVIDING A WEB SITE AT
WHICH USERS CAN LINK TO HEIR INFORMA-
TION FOR POSSIBLE INHERITANCES FROM PRO-
BATE, ESTATES, WILL, TRUSTS AND OTHER
ASSETS AS WELL AS LINKS TO COURTS, ATTOR-
NEYS AND OTHER BUSINESS TO HELP VERIFY
AND SETTLE THEIR CLAIMS, IN CLASS 35 (U.S.
CLS. 100, 101 AND 102).

FIRST USE 1-22-2005; IN COMMERCE 11-21-2005.

THE COLOR(S) BLACK,ORANGE,WHITE IS/ARE
CLAIMED AS A FEATURE OF THE MARK.

THE MARK CONSISTS OF AN ORANGE PYRA-
MID, TRIMMED IN BLACK ON THE TOP OF TWO
BLACK PILLARS, WITH WHITE HORIZONTAL
SPACE BETWEEN THE BOTTOM HALF OF THE
PILLARS AND A CHARACTERIZED FACE WITH
TWO EYES AND A MOUTH ON THE TOP HALF OF
THE LEFT PILLAR. THE PILLARS SIT ON A BLACK
SLATE AND THERE IS AN ORANGE VERTICAL
BAR DIRECTLY BENEATH THE BLACK BAR ON
WHICH THE PILLARS REST. IN THE FRONT OF
THE PYRAMID TOP PILLARS IS A FLOATING
ROLLED SHEET OF WHITE PAPER WITH A BLACK
BALL POINT PEN ACROSS IT.

SER. NO. 77-371,464, FILED 1-14-2008.

LINDA E. BLOHM, EXAMINING ATTORNEY

Int. Cl.: 15

Prior U.S. Cls.: 2, 21 and 36

United States Patent and Trademark Office

Reg. No. 3,484,605

Registered Aug. 12, 2008

**TRADEMARK
PRINCIPAL REGISTER**

PICK GUY

PICK GUY, INC. (INDIANA CORPORATION)
426 VERNON PL.
WESTFIELD, IN 46074

FOR: GUITAR PICKS, IN CLASS 15 (U.S. CLS. 2, 21
AND 36).

FIRST USE 12-12-2006; IN COMMERCE 12-12-2006.

THE MARK CONSISTS OF STANDARD CHAR-
ACTERS WITHOUT CLAIM TO ANY PARTICULAR
FONT, STYLE, SIZE, OR COLOR.

NO CLAIM IS MADE TO THE EXCLUSIVE
RIGHT TO USE "PICK", APART FROM THE MARK
AS SHOWN.

SER. NO. 77-371,478, FILED 1-14-2008.

MELVIN AXILBUND, EXAMINING ATTORNEY

Int. Cl.: 33

Prior U.S. Cls.: 47 and 49

United States Patent and Trademark Office

Reg. No. 3,484,606

Registered Aug. 12, 2008

**TRADEMARK
PRINCIPAL REGISTER**

CHRISTIAN AUDIGIER

AUDIGIER, CHRISTIAN GEORGES (FRANCE
INDIVIDUAL)
8680 HAYDEN PLACE
CULVER CITY, CA 90232

FOR: WINES; SPARKLING WINES, IN CLASS 33
(U.S. CLS. 47 AND 49).

FIRST USE 11-20-2007; IN COMMERCE 11-20-2007.

THE MARK CONSISTS OF STANDARD CHAR-
ACTERS WITHOUT CLAIM TO ANY PARTICULAR
FONT, STYLE, SIZE, OR COLOR.

OWNER OF U.S. REG. NO. 3,348,997.

THE NAME(S), PORTRAIT(S), AND/OR SIGNA-
TURE(S) SHOWN IN THE MARK IDENTIFIES
CHRISTIAN GEORGES AUDIGIER, WHOSE CON-
SENT(S) TO REGISTER IS MADE OF RECORD.

SER. NO. 77-371,504, FILED 1-14-2008.

TRICIA SONNEBORN, EXAMINING ATTORNEY

Int. Cl.: 5

Prior U.S. Cls.: 6, 18, 44, 46, 51 and 52

Reg. No. 3,484,607

United States Patent and Trademark Office

Registered Aug. 12, 2008

**TRADEMARK
PRINCIPAL REGISTER**

POWER GLUTAMINE

CHAMPION PERFORMANCE PRODUCTS, INC.
(CALIFORNIA CORPORATION), DBA CHAM-
PION NUTRITION
2615 STANWELL DRIVE
CONCORD, CA 94520

FOR: DIETARY AND NUTRITIONAL SUPPLE-
MENTS, IN CLASS 5 (U.S. CLS. 6, 18, 44, 46, 51 AND
52).

FIRST USE 7-18-1997; IN COMMERCE 7-18-1997.

THE MARK CONSISTS OF STANDARD CHAR-
ACTERS WITHOUT CLAIM TO ANY PARTICULAR
FONT, STYLE, SIZE, OR COLOR.

NO CLAIM IS MADE TO THE EXCLUSIVE
RIGHT TO USE "GLUTAMINE", APART FROM
THE MARK AS SHOWN.

SER. NO. 77-371,514, FILED 1-14-2008.

STEVEN R. FOSTER, EXAMINING ATTORNEY

Int. Cl.: 25

Prior U.S. Cls.: 22 and 39

United States Patent and Trademark Office

Reg. No. 3,484,608

Registered Aug. 12, 2008

**TRADEMARK
PRINCIPAL REGISTER**

KROON

AMMEEN PROPERTIES, LLC (DELAWARE LTD
LIAB CO)
641 LEXINGTON AVENUE
NEW YORK, NY 10022

THE MARK CONSISTS OF STANDARD CHAR-
ACTERS WITHOUT CLAIM TO ANY PARTICULAR
FONT, STYLE, SIZE, OR COLOR.

FOR: SUITS; OVER COATS; SPORT COATS; TOP
COATS; BLAZERS; TUXEDOS; SPORTS JACKETS,
IN CLASS 25 (U.S. CLS. 22 AND 39).

SER. NO. 77-371,516, FILED 1-14-2008.

FIRST USE 9-0-2007; IN COMMERCE 9-0-2007.

DAVID HOFFMAN, EXAMINING ATTORNEY

Int. Cl.: 41

Prior U.S. Cls.: 100, 101 and 107

United States Patent and Trademark Office

Reg. No. 3,484,609

Registered Aug. 12, 2008

**SERVICE MARK
PRINCIPAL REGISTER**



MATA, LIONEL (UNITED STATES INDIVIDUAL)
199 BENDER CIRCLE
MORGAN HILL, CA 95037

FOR: MULTIMEDIA ENTERTAINMENT SERVICES IN THE NATURE OF RECORDING, PRODUCTION AND POST-PRODUCTION SERVICES IN THE FIELDS OF MUSIC, VIDEO, AND FILMS, IN CLASS 41 (U.S. CLS. 100, 101 AND 107).

FIRST USE 2-1-2006; IN COMMERCE 9-18-2007.

NO CLAIM IS MADE TO THE EXCLUSIVE RIGHT TO USE "RECORDS", APART FROM THE MARK AS SHOWN.

THE MARK CONSISTS OF TRIQUETRA SYMBOL WITH RECORD BEHIND AND "TRIQUE RECORDS" WRITTEN UNDERNEATH.

SER. NO. 77-371,539, FILED 1-14-2008.

DAVID MURRAY, EXAMINING ATTORNEY

Int. Cl.: 29

Prior U.S. Cl.: 46

United States Patent and Trademark Office

Reg. No. 3,484,610

Registered Aug. 12, 2008

**TRADEMARK
PRINCIPAL REGISTER**

EffectivEat

EFFECTIVE IMPORTS LLC (TEXAS LTD LIAB
CO)
6925 WINDWOOD TRL
FORT WORTH, TX 76132

THE MARK CONSISTS OF STANDARD CHAR-
ACTERS WITHOUT CLAIM TO ANY PARTICULAR
FONT, STYLE, SIZE, OR COLOR.

FOR: VEGETABLE-BASED SNACK FOODS, IN
CLASS 29 (U.S. CL. 46).

SER. NO. 77-371,554, FILED 1-14-2008.

FIRST USE 3-2-2006; IN COMMERCE 3-2-2006.

KOURTNEE HODGES, EXAMINING ATTORNEY

Int. Cls.: 16, 35, 36 and 41

**Prior U.S. Cls.: 2, 5, 22, 23, 29, 37, 38, 50, 100, 101, 102
and 107**

Reg. No. 3,484,611

United States Patent and Trademark Office

Registered Aug. 12, 2008

**TRADEMARK
SERVICE MARK
PRINCIPAL REGISTER**



SECURITIES INDUSTRY AND FINANCIAL
MARKETS ASSOCIATION (DELAWARE
NON-PROFIT CORPORATION)
360 MADISON AVENUE
NEW YORK, NY 100177111

FOR: PRINTED MATTER, NAMELY, BOOKS,
JOURNALS, NEWSLETTERS, DATABASE RE-
PORTS AND BROCHURES FOR SECURITIES
FIRMS, BANKS AND ASSET MANAGERS THAT
UNDERWRITE, TRADE OR INVEST IN DEBT SE-
CURITIES AND FOR OTHER FINANCIAL MAR-
KET PARTICIPANTS, IN CLASS 16 (U.S. CLS. 2, 5, 22,
23, 29, 37, 38 AND 50).

FIRST USE 11-8-2006; IN COMMERCE 11-8-2006.

FOR: ASSOCIATION SERVICES, NAMELY, PRO-
MOTING THE INTERESTS AND OBJECTIVES OF
ITS MEMBERS WHICH ARE SECURITIES FIRMS,
BANKS AND ASSET MANAGERS THAT UNDER-
WRITE, TRADE OR INVEST IN DEBT SECURITIES,
IN CLASS 35 (U.S. CLS. 100, 101 AND 102).

FIRST USE 11-8-2006; IN COMMERCE 11-8-2006.

FOR: FINANCIAL INFORMATION PROVIDED
BY ELECTRONIC MEANS TO SECURITIES FIRMS,
BANKS AND ASSET MANAGERS THAT UNDER-
WRITE, TRADE OR INVEST IN DEBT SECURITIES
AND TO OTHER FINANCIAL MARKET PARTICI-
PANTS, IN CLASS 36 (U.S. CLS. 100, 101 AND 102).

FIRST USE 11-8-2006; IN COMMERCE 11-8-2006.

FOR: EDUCATIONAL SERVICES, NAMELY,
CONDUCTING CONFERENCES IN THE FIELD OF
SECURITIES AND FINANCIAL MARKETS; EDU-
CATIONAL SERVICES, NAMELY, CONDUCTING
CLASSES, SEMINARS, CONFERENCES, WORK-
SHOPS AND ONLINE EXHIBITIONS, DISPLAYS
AND INTERACTIVE EXHIBITS IN THE FIELD OF
FINANCE, INVESTMENTS, LOANS, SECURITIES,
BONDS, STOCKS, MUTUAL FUNDS, AND FINAN-
CIAL MARKETS, IN CLASS 41 (U.S. CLS. 100, 101
AND 107).

FIRST USE 11-8-2006; IN COMMERCE 11-8-2006.

OWNER OF U.S. REG. NO. 3,365,892.

THE COLOR(S) BLUE, WHITE AND BLACK IS/
ARE CLAIMED AS A FEATURE OF THE MARK.

THE MARK CONSISTS OF A SQUARE SEPARA-
TED BY A WHITE ZIG-ZAG LINE, WITH BLACK
APPEARING ABOVE THE LINE AND BLUE AP-
PEARING BELOW THE LINE.

SER. NO. 77-371,566, FILED 1-14-2008.

ALICE BENMAMAN, EXAMINING ATTORNEY

Int. Cl.: 3

Prior U.S. Cls.: 1, 4, 6, 50, 51 and 52

Reg. No. 3,484,612

United States Patent and Trademark Office

Registered Aug. 12, 2008

**TRADEMARK
PRINCIPAL REGISTER**

WIFF

SPIVEY, SANFORD W. (UNITED STATES INDIVIDUAL)
226 EAST CANON PERDIDO, SUITE M
C/O KOENIG & ASSOCIATES
SANTA BARBARA, CA 93101

FOR: HAIR RINSES; HAIR SHAMPOO; HAIR SHAMPOOS AND CONDITIONERS; SHAMPOO-CONDITIONERS; SHAMPOOS, IN CLASS 3 (U.S. CLS. 1, 4, 6, 50, 51 AND 52).

FIRST USE 6-1-2007; IN COMMERCE 6-1-2007.

THE MARK CONSISTS OF STANDARD CHARACTERS WITHOUT CLAIM TO ANY PARTICULAR FONT, STYLE, SIZE, OR COLOR.

SER. NO. 77-371,594, FILED 1-14-2008.

DANIEL CAPSHAW, EXAMINING ATTORNEY

Int. Cl.: 29

Prior U.S. Cl.: 46

United States Patent and Trademark Office

Reg. No. 3,484,613

Registered Aug. 12, 2008

**TRADEMARK
PRINCIPAL REGISTER**

Greens Delight

EFFECTIVE IMPORTS LLC (TEXAS LTD LIAB
CO)

6925 WINDWOOD TRL

FORT WORTH, TX 76132

FOR: VEGETABLE-BASED SNACK FOODS, IN
CLASS 29 (U.S. CL. 46).

FIRST USE 11-8-2007; IN COMMERCE 12-9-2007.

THE MARK CONSISTS OF STANDARD CHAR-
ACTERS WITHOUT CLAIM TO ANY PARTICULAR
FONT, STYLE, SIZE, OR COLOR.

NO CLAIM IS MADE TO THE EXCLUSIVE
RIGHT TO USE "GREENS", APART FROM THE
MARK AS SHOWN.

SER. NO. 77-371,614, FILED 1-14-2008.

KOURTNEE HODGES, EXAMINING ATTORNEY

Int. Cl.: 29

Prior U.S. Cl.: 46

United States Patent and Trademark Office

Reg. No. 3,484,614

Registered Aug. 12, 2008

**TRADEMARK
PRINCIPAL REGISTER**

NaturEase

EFFECTIVE IMPORTS LLC (TEXAS LTD LIAB
CO)
6925 WINDWOOD TRL
FORT WORTH, TX 76132

THE MARK CONSISTS OF STANDARD CHAR-
ACTERS WITHOUT CLAIM TO ANY PARTICULAR
FONT, STYLE, SIZE, OR COLOR.

FOR: FRUIT-BASED SPREADS, IN CLASS 29 (U.S.
CL. 46).

SER. NO. 77-371,630, FILED 1-14-2008.

FIRST USE 11-8-2007; IN COMMERCE 12-9-2007.

KOURTNEE HODGES, EXAMINING ATTORNEY

Prior U.S. Cl.: A

United States Patent and Trademark Office

Reg. No. 3,484,615

Registered Aug. 12, 2008

CERTIFICATION MARK
PRINCIPAL REGISTER

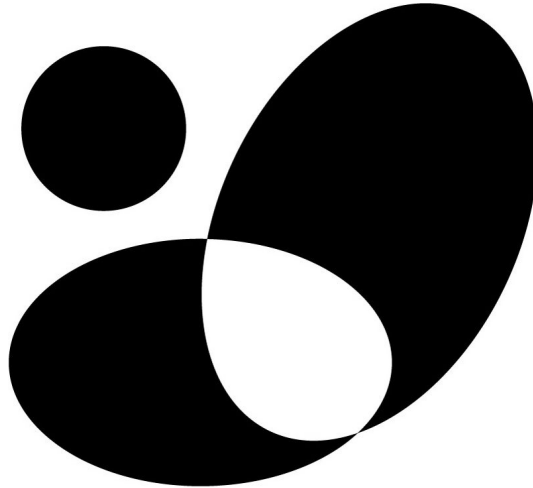

WIMAX FORUM (CALIFORNIA CORPORATION)
2495 LEGHORN STREET
MOUNTAIN VIEW, CA 94043

FOR: BROADBAND WIRELESS EQUIPMENT AND HARDWARE, NAMELY, NETWORKING AND TELECOMMUNICATIONS PRODUCTS, IN CLASS A (U.S. CL. A).

FIRST USE 10-31-2004; IN COMMERCE 1-24-2006.

THE MARK CONSISTS OF TWO INTERSECTING OVALS AND AN ADJACENT CIRCLE. THE FIRST OVAL FORMS THE LOWER LEFT PORTION OF THE MARK. THE LONG AXIS OF THIS OVAL IS HORIZONTAL. THE SECOND OVAL IS PLACED AT AN ANGLE TO FORM THE RIGHT SIDE OF THE

MARK. THE INTERSECTING PORTION OF THE TWO OVALS IS PRESENTED IN A CONTRASTING COLOR. ADJACENT TO THE POINT AT WHICH THE UPPER LINE OF THE FIRST OVAL INTERSECTS WITH THE LEFT SIDE OF THE SECOND OVAL IS A CIRCLE.

THE CERTIFICATION MARK, AS USED BY AUTHORIZED PERSONS, CERTIFIES THE PERFORMANCE AND INTEROPERABILITY OF THE GOODS BASED ON IMPLEMENTATIONS OF THE IEEE 802.16 STANDARD THAT THE CERTIFIER HAS SPECIFIED.

SER. NO. 77-371,643, FILED 1-14-2008.

MARTHA SANTOMARTINO, EXAMINING ATTORNEY

Int. Cl.: 35

Prior U.S. Cls.: 100, 101 and 102

United States Patent and Trademark Office

Reg. No. 3,484,616

Registered Aug. 12, 2008

**SERVICE MARK
PRINCIPAL REGISTER**

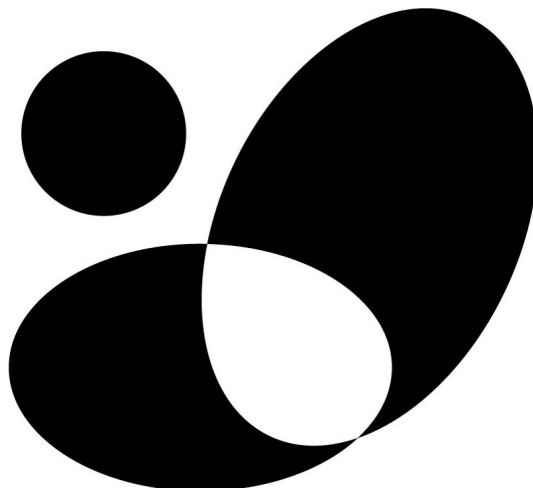

WIMAX FORUM (CALIFORNIA CORPORATION)
2495 LEGHORN STREET
MOUNTAIN VIEW, CA 94043

FOR: ASSOCIATION SERVICES, NAMELY, PROMOTING THE INTERESTS OF MANUFACTURERS OF WIRELESS NETWORKING AND TELECOMMUNICATIONS PRODUCTS, WIRELESS NETWORK OPERATORS AND OTHER PROVIDERS OF SERVICES USING WIRELESS COMPUTER AND TELECOMMUNICATIONS NETWORKS, AND CUSTOMERS OF SUCH PRODUCTS AND SERVICES; PROVIDING CONSUMER AND BUSINESS INFORMATION IN THE FIELD OF WIRELESS NETWORKING TECHNOLOGY AND STANDARDS, WIRELESS NETWORKING AND TELECOMMUNICATIONS PRODUCTS AND SERVICES, WIRELESS INDUSTRY REGULATION; AND PROVIDING INFORMATION ABOUT THE GOODS AND SERVICES OF OTHERS VIA THE INTERNET, IN CLASS 35 (U.S. CLS. 100, 101 AND 102).

FIRST USE 10-31-2004; IN COMMERCE 10-31-2004.

THE MARK CONSISTS OF TWO INTERSECTING OVALS AND AN ADJACENT CIRCLE. THE FIRST OVAL FORMS THE LOWER LEFT PORTION OF THE MARK. THE LONG AXIS OF THIS OVAL IS HORIZONTAL. THE SECOND OVAL IS PLACED AT AN ANGLE TO FORM THE RIGHT SIDE OF THE MARK. THE INTERSECTING PORTION OF THE TWO OVALS IS PRESENTED IN A CONTRASTING COLOR. ADJACENT TO THE POINT AT WHICH THE UPPER LINE OF THE FIRST OVAL INTERSECTS WITH THE LEFT SIDE OF THE SECOND OVAL IS A CIRCLE.

SER. NO. 77-371,646, FILED 1-15-2008.

MARTHA SANTOMARTINO, EXAMINING ATTORNEY

Int. Cl.: 9

Prior U.S. Cls.: 21, 23, 26, 36 and 38

United States Patent and Trademark Office

Reg. No. 3,484,617

Registered Aug. 12, 2008

**TRADEMARK
PRINCIPAL REGISTER**

DOCUMENT-IT

HAMPTON, WILLIAM S. (UNITED STATES IN-
DIVIDUAL)
PO BOX 6057
SPRING HILL, FL 34611

FOR: COMPUTER SOFTWARE FOR ORGANIZ-
ING, MANAGING, DOCUMENTING, SHARING,
AND SEARCHING FOR VEHICLE INFORMATION
AND VEHICLE HISTORY, FOR USE BY CLASSIC
CAR COLLECTORS, RESTORERS AND MUSEUMS,
IN CLASS 9 (U.S. CLS. 21, 23, 26, 36 AND 38).

FIRST USE 1-15-2008; IN COMMERCE 1-15-2008.

THE MARK CONSISTS OF STANDARD CHAR-
ACTERS WITHOUT CLAIM TO ANY PARTICULAR
FONT, STYLE, SIZE, OR COLOR.

SER. NO. 77-371,647, FILED 1-15-2008.

RUSS HERMAN, EXAMINING ATTORNEY

Int. Cl.: 35

Prior U.S. Cls.: 100, 101 and 102

United States Patent and Trademark Office

Reg. No. 3,484,618

Registered Aug. 12, 2008

**SERVICE MARK
PRINCIPAL REGISTER**



SHACKELFORD JR., ROGER L (UNITED STATES INDIVIDUAL)
236 JAMES DR.
HAVERTOWN, PA 19083

FOR: ARRANGING PERSONAL APPEARANCES BY PERSONS WORKING IN THE FIELD OF FILM, MUSIC, TELEVISION, ENTERTAINMENT OR SPORT, IN CLASS 35 (U.S. CLS. 100, 101 AND 102).

FIRST USE 7-26-2006; IN COMMERCE 11-30-2006.

THE MARK CONSISTS OF THE TWO WORDS "TAINTED" AND "REALITY" IN A SPECIALIZED FONT KNOWN AS "CRACKED DENDRITE" WITH AN ARTISTICALLY STYLIZED "T" IN THE CENTER BETWEEN THE TWO WORDS.

SER. NO. 77-371,661, FILED 1-15-2008.

KAREN BRACEY, EXAMINING ATTORNEY

Int. Cl.: 42

Prior U.S. Cls.: 100 and 101

United States Patent and Trademark Office

Reg. No. 3,484,619

Registered Aug. 12, 2008

**SERVICE MARK
PRINCIPAL REGISTER**

BETA

BETA ANALYTIC, INC. (FLORIDA CORPORATION)
4985 SW 74TH COURT
MIAMI, FL 33155

THE MARK CONSISTS OF STANDARD CHARACTERS WITHOUT CLAIM TO ANY PARTICULAR FONT, STYLE, SIZE, OR COLOR.

FOR: RADIOCARBON DATING SERVICES, IN CLASS 42 (U.S. CLS. 100 AND 101).

SER. NO. 77-371,672, FILED 1-15-2008.

FIRST USE 11-27-1979; IN COMMERCE 11-27-1979.

KIMBERLY FRYE, EXAMINING ATTORNEY

Int. Cl.: 9

Prior U.S. Cls.: 21, 23, 26, 36 and 38

Reg. No. 3,484,620

United States Patent and Trademark Office

Registered Aug. 12, 2008

**TRADEMARK
PRINCIPAL REGISTER**

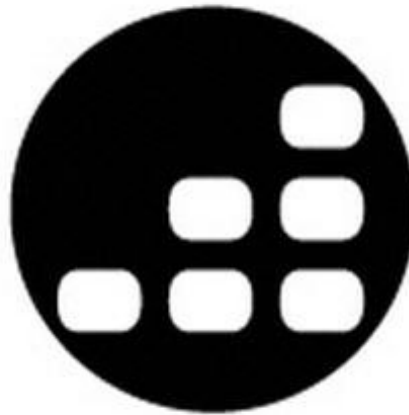

COMPEAT RESTAURANT MANAGEMENT SYSTEMS (LOUISIANA CORPORATION), DBA ALLWARE COMPUTER SERVICES, INC.
11940 JOLLYVILLE ROAD SUITE 200N
AUSTIN, TX 78759

THE MARK CONSISTS OF A SOLID CIRCLE CONTAINING SIX RECTANGLES WITH ROUNDED CORNERS, STACKED IN A "STAIR CASE", WHERE THE INTERNAL RECTANGLES ARE CONTRASTED WITH THE CIRCLE BACKGROUND.

FOR: ACCOUNTING SOFTWARE, EMPLOYEE PAYROLL SOFTWARE AND SOFTWARE FOR TRACKING INVENTORY ALL FOR USE IN RESTAURANT MANAGEMENT, IN CLASS 9 (U.S. CLS. 21, 23, 26, 36 AND 38).

SER. NO. 77-371,721, FILED 1-15-2008.

FIRST USE 11-1-2006; IN COMMERCE 11-1-2006.

SUSAN LESLIE DUBOIS, EXAMINING ATTORNEY

Int. Cls.: 29 and 30

Prior U.S. Cl.: 46

United States Patent and Trademark Office

Reg. No. 3,484,621

Registered Aug. 12, 2008

**TRADEMARK
PRINCIPAL REGISTER**

PRESS ‘N HEAT

ANRA SOURCING, LLC (FLORIDA LTD LIAB
CO)
6000 ISLAND BLVD., APT. 2606
AVENTURA, FL 33160

FOR: PREPARED AND PACKAGED ENTREES
OF MEAT, FISH, SEAFOOD, POULTRY AND/OR
VEGETABLES, IN CLASS 29 (U.S. CL. 46).

FIRST USE 5-0-2007; IN COMMERCE 5-0-2007.

FOR: PREPARED AND PACKAGED ENTREES
OF PASTA OR RICE, IN CLASS 30 (U.S. CL. 46).

FIRST USE 5-0-2007; IN COMMERCE 5-0-2007.

THE MARK CONSISTS OF STANDARD CHAR-
ACTERS WITHOUT CLAIM TO ANY PARTICULAR
FONT, STYLE, SIZE, OR COLOR.

SER. NO. 77-371,741, FILED 1-15-2008.

GEOFFREY FOSDICK, EXAMINING ATTORNEY

Int. Cl.: 44

Prior U.S. Cls.: 100 and 101

United States Patent and Trademark Office

Reg. No. 3,484,622

Registered Aug. 12, 2008

**SERVICE MARK
PRINCIPAL REGISTER**

**"A Healthy, Beautiful
Smile, It Happens In A
Flash, but The Memory Of
It Will Last Forever."**

HOOD, K MICHAEL (UNITED STATES INDIVI-
DUAL)
SUITE #302
4602 N. 16TH ST.
PHOENIX, AZ 85016

THE MARK CONSISTS OF STANDARD CHAR-
ACTERS WITHOUT CLAIM TO ANY PARTICULAR
FONT, STYLE, SIZE, OR COLOR.

FOR: COSMETIC DENTISTRY, IN CLASS 44 (U.S.
CLS. 100 AND 101).

SER. NO. 77-371,766, FILED 1-15-2008.

FIRST USE 1-1-1988; IN COMMERCE 1-1-1988.

ANGELA GAW, EXAMINING ATTORNEY

Int. Cl.: 38

Prior U.S. Cls.: 100, 101 and 104

United States Patent and Trademark Office

Reg. No. 3,484,623

Registered Aug. 12, 2008

**SERVICE MARK
PRINCIPAL REGISTER**

EASYNEWS

EASYNEWS HOLDINGS, INC. (FLORIDA CORPORATION), DBA EASYNEWS
SUITE 101
807 WEST MORSE BOULEVARD
WINTER PARK, FL 32789

FOR: COMPUTER SERVICES, NAMELY, TRANSMISSION OF NEWS FEEDS VIA A GLOBAL COMPUTER NETWORK FOR NEWS AND DISCUSSION GROUPS; USENET NEWS INFORMATION TRANSMISSION SERVICES VIA DIGITAL NETWORKS, IN CLASS 38 (U.S. CLS. 100, 101 AND 104).

FIRST USE 8-15-1995; IN COMMERCE 8-15-1995.

THE MARK CONSISTS OF STANDARD CHARACTERS WITHOUT CLAIM TO ANY PARTICULAR FONT, STYLE, SIZE, OR COLOR.

OWNER OF U.S. REG. NO. 2,622,573.

SER. NO. 77-371,808, FILED 1-15-2008.

JESSICA A. POWERS, EXAMINING ATTORNEY

Int. Cl.: 18

Prior U.S. Cls.: 1, 2, 3, 22 and 41

Reg. No. 3,484,624

United States Patent and Trademark Office

Registered Aug. 12, 2008

**TRADEMARK
PRINCIPAL REGISTER**

FANCY PANTS

KOZY KASHMIR, INC. (PENNSYLVANIA CORPORATION)
25825 SCIENCE PARK DRIVE
BEACHWOOD, OH 44122

THE MARK CONSISTS OF STANDARD CHARACTERS WITHOUT CLAIM TO ANY PARTICULAR FONT, STYLE, SIZE, OR COLOR.

FOR: CLOTHING FOR DOMESTIC PETS, IN CLASS 18 (U.S. CLS. 1, 2, 3, 22 AND 41).

SER. NO. 77-371,819, FILED 1-15-2008.

FIRST USE 6-20-2002; IN COMMERCE 6-20-2002.

KELLEY WELLS, EXAMINING ATTORNEY

Int. Cl.: 35

Prior U.S. Cls.: 100, 101 and 102

United States Patent and Trademark Office

Reg. No. 3,484,625

Registered Aug. 12, 2008

**SERVICE MARK
PRINCIPAL REGISTER**



DIRECT LOGIC, INC. (ILLINOIS CORPORATION)
2885 W. WILLOW LAKE DRIVE
PEORIA, IL 61614

OWNER OF U.S. REG. NO. 2,529,609.

FOR: DIRECT MARKETING AND E-COMMERCE ANALYTICAL SERVICES, NAMELY, ASSISTANCE IN MEASURING RESPONSES TO MARKET RESEARCH, ANALYZING MARKETING DATA, AND SALES AND INVENTORY FORECASTING, IN CLASS 35 (U.S. CLS. 100, 101 AND 102).

NO CLAIM IS MADE TO THE EXCLUSIVE RIGHT TO USE "SOLUTIONS", APART FROM THE MARK AS SHOWN.

SER. NO. 77-371,829, FILED 1-15-2008.

FIRST USE 4-30-2000; IN COMMERCE 4-30-2000.

ANNE FARRELL, EXAMINING ATTORNEY

Int. Cl.: 35

Prior U.S. Cls.: 100, 101 and 102

United States Patent and Trademark Office

Reg. No. 3,484,626

Registered Aug. 12, 2008

**SERVICE MARK
PRINCIPAL REGISTER**

Swiss Farms

SWISS FARM STORES ACQUISITION (DELA-
WARE LTD LIAB CO)
630 PARKWAY DRIVE
BROOMALL, PA 19008

THE MARK CONSISTS OF STANDARD CHAR-
ACTERS WITHOUT CLAIM TO ANY PARTICULAR
FONT, STYLE, SIZE, OR COLOR.

FOR: RETAIL GROCERY STORES, IN CLASS 35
(U.S. CLS. 100, 101 AND 102).

SER. NO. 77-371,858, FILED 1-15-2008.

FIRST USE 3-1-1972; IN COMMERCE 3-1-1972.

HANNO RITTNER, EXAMINING ATTORNEY

Int. Cl.: 35

Prior U.S. Cls.: 100, 101 and 102

United States Patent and Trademark Office

Reg. No. 3,484,627

Registered Aug. 12, 2008

**SERVICE MARK
PRINCIPAL REGISTER**

Swiss Farm

SWISS FARM STORES ACQUISITION (DELA-
WARE LTD LIAB CO)
630 PARKWAY DRIVE
BROOMALL, PA 19008

THE MARK CONSISTS OF STANDARD CHAR-
ACTERS WITHOUT CLAIM TO ANY PARTICULAR
FONT, STYLE, SIZE, OR COLOR.

FOR: RETAIL GROCERY STORES, IN CLASS 35
(U.S. CLS. 100, 101 AND 102).

SER. NO. 77-371,878, FILED 1-15-2008.

FIRST USE 3-1-1972; IN COMMERCE 3-1-1972.

HANNO RITTNER, EXAMINING ATTORNEY

Int. Cl.: 35

Prior U.S. Cls.: 100, 101 and 102

United States Patent and Trademark Office

Reg. No. 3,484,628

Registered Aug. 12, 2008

**SERVICE MARK
PRINCIPAL REGISTER**

GREEN WITH MV

BRAGONIER, DANA (UNITED STATES INDIVIDUAL)
POST OFFICE BOX #2244
VINEYARD HAVEN, MA 02568

FOR: PROMOTING PUBLIC AWARENESS OF THE NEED FOR BEHAVIORAL CHANGES THAT CAN SLOW OR DETER THE EFFECTS OF CLIMATE CHANGE, IN CLASS 35 (U.S. CLS. 100, 101 AND 102).

FIRST USE 6-29-2007; IN COMMERCE 6-29-2007.

THE MARK CONSISTS OF STANDARD CHARACTERS WITHOUT CLAIM TO ANY PARTICULAR FONT, STYLE, SIZE, OR COLOR.

SER. NO. 77-371,893, FILED 1-15-2008.

DANIEL CAPSHAW, EXAMINING ATTORNEY

Int. Cl.: 14

Prior U.S. Cls.: 2, 27, 28 and 50

United States Patent and Trademark Office

Reg. No. 3,484,629

Registered Aug. 12, 2008

**TRADEMARK
PRINCIPAL REGISTER**



LINEA ITALIA SILVER & GOLD S.R.L. (ITALY
LTD LIAB CO)
S.S. PASUBIO 159/161
VICENZA, ITALY 36030MOTT

THE MARK CONSISTS OF MISCELLANEOUS
DEVICE MARK.

FOR: JEWELRY; HOROLOGICAL INSTRUMENT,
NAMELY, WATCHES AND CLOCKS, IN CLASS 14
(U.S. CLS. 2, 27, 28 AND 50).

SER. NO. 77-371,901, FILED 1-15-2008.

FIRST USE 1-15-2006; IN COMMERCE 3-28-2007.

SANDRA MANIOS, EXAMINING ATTORNEY

Int. Cl.: 42

Prior U.S. Cls.: 100 and 101

United States Patent and Trademark Office

Reg. No. 3,484,630

Registered Aug. 12, 2008

**SERVICE MARK
PRINCIPAL REGISTER**



MAXETA TECHNOLOGIES, INC. (PENNSYLVANIA CORPORATION)
50 WALKER DRIVE
HILLSBOROUGH, NJ 08844

FOR: DESIGN, DEVELOPMENT AND IMPLEMENTATION OF SOFTWARE, IN CLASS 42 (U.S. CLS. 100 AND 101).

FIRST USE 2-6-2006; IN COMMERCE 6-7-2006.

THE MARK CONSISTS OF THE STYLIZED TEXT "MAXETA"; THE FORWARD SLASH OF THE LETTER "X" STARTS AS THE SAME FONT AS THE OTHER LETTERS AND ENDS AS A POINT JUST ABOVE THE LETTER "E".

SER. NO. 77-371,910, FILED 1-15-2008.

REBECCA EISINGER, EXAMINING ATTORNEY

Int. Cl.: 29

Prior U.S. Cl.: 46

United States Patent and Trademark Office

Reg. No. 3,484,631

Registered Aug. 12, 2008

**TRADEMARK
PRINCIPAL REGISTER**



NASH FAMILY LIMITED PARTNERSHIP (CALI-
FORNIA PARTNERSHIP)
3108 MILL CREEK ROAD
WALLA WALLA, WA 99362

FOR: CANNED PROCESSED OLIVES; OLIVE
OILS; OLIVE PASTES; PRESERVED, DRIED AND
COOKED OLIVES; PROCESSED OLIVE PUREE;
PROCESSED OLIVES; TINNED OLIVES, IN CLASS
29 (U.S. CL. 46).

FIRST USE 2-0-2006; IN COMMERCE 9-0-2006.

THE MARK CONSISTS OF A CARTOON MONK
LADLING OLIVE OIL INTO CERAMIC JARS, AND
THE STYLIZED TEXT "FINICKY FRIAR".

SER. NO. 77-371,915, FILED 1-15-2008.

REBECCA EISINGER, EXAMINING ATTORNEY

Int. Cl.: 35

Prior U.S. Cls.: 100, 101 and 102

United States Patent and Trademark Office

Reg. No. 3,484,632

Registered Aug. 12, 2008

**SERVICE MARK
PRINCIPAL REGISTER**

WHY WAIT?

MVD SPECIALISTS, LLC (NEW MEXICO LTD
LIAB CO)
[HTTP://WWW.MVDSPECIALISTS.COM](http://www.mvdspecialists.com)
5728 EDITH BLVD NE
ALBUQUERQUE, NM 87107

THE MARK CONSISTS OF STANDARD CHAR-
ACTERS WITHOUT CLAIM TO ANY PARTICULAR
FONT, STYLE, SIZE, OR COLOR.

FOR: STATE VEHICULAR REGISTRATION AND
TITLE TRANSFER, IN CLASS 35 (U.S. CLS. 100, 101
AND 102).

SER. NO. 77-371,966, FILED 1-15-2008.

FIRST USE 12-1-2002; IN COMMERCE 12-1-2002.

TINA BROWN, EXAMINING ATTORNEY

Int. Cl.: 41

Prior U.S. Cls.: 100, 101 and 107

United States Patent and Trademark Office

Reg. No. 3,484,633

Registered Aug. 12, 2008

**SERVICE MARK
PRINCIPAL REGISTER**

Textbase

BURSTEIN, ALAN (UNITED STATES INDIVIDUAL)
3 MAPLE STREET
MARLBORO, NJ 07746

FOR: EDUCATIONAL SERVICES, DEVELOPING CURRICULUM FOR OTHERS IN THE FIELDS OF MATH, SCIENCE, LANGUAGE ARTS, SOCIAL STUDIES, HISTORY, GEOGRAPHY FOR USE IN PRIMARY AND SECONDARY SCHOOLS; PROVIDING LIVE AND ON-LINE CLASSES, COURSES OF INSTRUCTION, SEMINARS, WORKSHOPS, TUTORING, AND MENTORING FOR PRIMARY AND SECONDARY SCHOOLS IN THE FIELDS OF MATH, SCIENCE, LANGUAGE ARTS, SOCIAL STUDIES, HISTORY, GEOGRAPHY AND DISTRIBUTION OF COURSE MATERIAL IN CONNECTION THERE-

WITH; PROVIDING INFORMATION ABOUT EDUCATION PROVIDED ON-LINE FROM A COMPUTER DATABASE OR THE INTERNET; ON-LINE ELECTRONIC PUBLISHING OF BOOKS AND PERIODICALS OF OTHERS, IN CLASS 41 (U.S. CLS. 100, 101 AND 107).

FIRST USE 5-1-2007; IN COMMERCE 9-6-2007.

THE MARK CONSISTS OF STANDARD CHARACTERS WITHOUT CLAIM TO ANY PARTICULAR FONT, STYLE, SIZE, OR COLOR.

SER. NO. 77-371,977, FILED 1-15-2008.

MICHAEL TANNER, EXAMINING ATTORNEY

Int. Cl.: 41

Prior U.S. Cls.: 100, 101 and 107

United States Patent and Trademark Office

Reg. No. 3,484,634

Registered Aug. 12, 2008

**SERVICE MARK
PRINCIPAL REGISTER**

Girotondo Italian School

ROSALIA PUSATERI (ITALY INDIVIDUAL),
DBA GIROTONDO ITALIAN SCHOOL
68 MEADOW DRIVE
MILL VALLEY, CA 94966

FOR: EDUCATION SERVICES, NAMELY, PROVIDING CLASSES IN THE FIELD OF ITALIAN IMMERSION EDUCATION, IN CLASS 41 (U.S. CLS. 100, 101 AND 107).

FIRST USE 12-1-2005; IN COMMERCE 8-29-2006.

THE MARK CONSISTS OF STANDARD CHARACTERS WITHOUT CLAIM TO ANY PARTICULAR FONT, STYLE, SIZE, OR COLOR.

NO CLAIM IS MADE TO THE EXCLUSIVE RIGHT TO USE "ITALIAN SCHOOL", APART FROM THE MARK AS SHOWN.

THE ENGLISH TRANSLATION OF THE WORD "GIROTONDO" IN THE MARK IS "GO AROUND IN CIRCLES"

SER. NO. 77-372,002, FILED 1-15-2008.

JOHN WILKE, EXAMINING ATTORNEY

Int. Cl.: 39

Prior U.S. Cls.: 100 and 105

United States Patent and Trademark Office

Reg. No. 3,484,635

Registered Aug. 12, 2008

**SERVICE MARK
PRINCIPAL REGISTER**

**CHANGING THE AMERICAN
EVENING**

THE DESIGNATE, LTD. (MICHIGAN CORPORATION)
233 PIERCE STREET
BIRMINGHAM, MI 48009

THE MARK CONSISTS OF STANDARD CHARACTERS WITHOUT CLAIM TO ANY PARTICULAR FONT, STYLE, SIZE, OR COLOR.

FOR: TRANSPORTATION SERVICES, NAMELY, TRANSPORTATION OF CUSTOMERS IN THEIR OWN VEHICLES, IN CLASS 39 (U.S. CLS. 100 AND 105).

SER. NO. 77-372,016, FILED 1-15-2008.

FIRST USE 3-17-2007; IN COMMERCE 3-17-2007.

JANICE KIM, EXAMINING ATTORNEY

Int. Cl.: 9

Prior U.S. Cls.: 21, 23, 26, 36 and 38

Reg. No. 3,484,636

United States Patent and Trademark Office

Registered Aug. 12, 2008

**TRADEMARK
PRINCIPAL REGISTER**

Software you can count on.

COMPEAT RESTAURANT MANAGEMENT SYSTEMS (LOUISIANA CORPORATION), DBA ALLWARE COMPUTER SERVICES, INC.
11940 JOLLYVILLE ROAD SUITE 200N
AUSTIN, TX 78759

FOR: ACCOUNTING SOFTWARE, EMPLOYEE PAYROLL SOFTWARE AND SOFTWARE FOR TRACKING INVENTORY ALL FOR USE IN RESTAURANT MANAGEMENT, IN CLASS 9 (U.S. CLS. 21, 23, 26, 36 AND 38).

FIRST USE 11-1-2006; IN COMMERCE 11-1-2006.

THE MARK CONSISTS OF STANDARD CHARACTERS WITHOUT CLAIM TO ANY PARTICULAR FONT, STYLE, SIZE, OR COLOR.

SER. NO. 77-372,019, FILED 1-15-2008.

SUSAN LESLIE DUBOIS, EXAMINING ATTORNEY

Int. Cls.: 36 and 41

Prior U.S. Cls.: 100, 101, 102 and 107

United States Patent and Trademark Office

Reg. No. 3,484,637

Registered Aug. 12, 2008

SERVICE MARK
PRINCIPAL REGISTER



PHI MU FRATERNITY (GEORGIA NON-PROFIT CORPORATION)
400 WESTPARK DRIVE
PEACHTREE CITY, GA 30269

FOR: FUND-RAISING FOR CHARITABLE CAUSES, COLLEGIATE FINANCIAL AID AND SCHOLARSHIPS, AND COLLEGIATE FINANCIAL AID AND SCHOLARSHIP ADMINISTRATION, IN CLASS 36 (U.S. CLS. 100, 101 AND 102).

FIRST USE 9-0-2005; IN COMMERCE 9-0-2005.

FOR: EDUCATIONAL SERVICES, NAMELY, CONDUCTING SEMINARS AND WORKSHOPS ON SUBJECTS OF GENERAL INTEREST TO COLLEGIANS IN THE NATURE OF ISSUES RELATED TO LEADERSHIP, CAREERS, NETWORKING, PERSONAL DEVELOPMENT AND OTHER RELATED ISSUES AND THE DISTRIBUTION OF COURSE MATERIALS IN CONNECTION THEREWITH, IN CLASS 41 (U.S. CLS. 100, 101 AND 107).

FIRST USE 9-0-2005; IN COMMERCE 9-0-2005.

FIRST USE 9-0-2005; IN COMMERCE 9-0-2005.

OWNER OF U.S. REG. NOS. 1,191,440, 2,546,029 AND OTHERS.

THE MARK CONSISTS OF THE WORDS "PHI MU FOUNDATION YESTERDAY . . . TODAY . . . FOREVER" WITH A BADGE DESIGN.

SER. NO. 77-372,039, FILED 1-15-2008.

JULIE WATSON, EXAMINING ATTORNEY

Int. Cl.: 41

Prior U.S. Cls.: 100, 101 and 107

United States Patent and Trademark Office

Reg. No. 3,484,638

Registered Aug. 12, 2008

SERVICE MARK
PRINCIPAL REGISTER



SARAKAUSS
P H O T O G R A P H Y

SARA KAUSS (FLORIDA SOLE PROPRIETORSHIP), DBA A POINT IN TIME PHOTOGRAPHY BY SARA
28 PINEHILL TRAIL EAST
TEQUESTA, FL 33469

FOR: PHOTOGRAPHY; PHOTOGRAPHY SERVICES; PORTRAIT PHOTOGRAPHY, IN CLASS 41 (U.S. CLS. 100, 101 AND 107).

FIRST USE 5-1-2007; IN COMMERCE 5-1-2007.

NO CLAIM IS MADE TO THE EXCLUSIVE RIGHT TO USE "PHOTOGRAPHY", APART FROM THE MARK AS SHOWN.

THE COLOR(S) PINK, TAN, BROWN, WHITE IS/ARE CLAIMED AS A FEATURE OF THE MARK.

THE MARK CONSISTS OF A WHITE PALM TREE, WITH A PINK SQUARE AROUND THE PALM TREE, A WHITE LINE AROUND THE PINK SQUARE, A SLIGHTLY TURNED BROWN SQUARE AROUND THE WHITE LINE, A SLIGHTLY TURNED TAN SQUARE AROUND THE BROWN SQUARE.

SER. NO. 77-372,044, FILED 1-15-2008.

CARRIE GENOVESE, EXAMINING ATTORNEY

Int. Cl.: 21

Prior U.S. Cls.: 2, 13, 23, 29, 30, 33, 40 and 50

United States Patent and Trademark Office

Reg. No. 3,484,639

Registered Aug. 12, 2008

**TRADEMARK
PRINCIPAL REGISTER**

GET IN THE BLACK!

AMMEX CORPORATION (WASHINGTON COR-
PORATION)
P.O. BOX 88047
TUKWILA, WA 98138

THE MARK CONSISTS OF STANDARD CHAR-
ACTERS WITHOUT CLAIM TO ANY PARTICULAR
FONT, STYLE, SIZE, OR COLOR.

FOR: DISPOSABLE LATEX AND NITRILE
GLOVES FOR GENERAL USE, IN CLASS 21 (U.S.
CLS. 2, 13, 23, 29, 30, 33, 40 AND 50).

SER. NO. 77-372,045, FILED 1-15-2008.

FIRST USE 1-15-2008; IN COMMERCE 1-15-2008.

CARRIE GENOVESE, EXAMINING ATTORNEY

Int. Cl.: 42

Prior U.S. Cls.: 100 and 101

United States Patent and Trademark Office

Reg. No. 3,484,640

Registered Aug. 12, 2008

**SERVICE MARK
PRINCIPAL REGISTER**

SUITETALK

JM DEALER SERVICES, INC. (DELAWARE CORPORATION)
500 JIM MORAN BOULEVARD
DEERFIELD BEACH, FL 33442

FOR: PROVIDING TEMPORARY USE OF NON-DOWNLOADABLE COMPUTER SOFTWARE FOR AUTOMOTIVE DEALERSHIP FACILITY MANAGEMENT; FOR MANAGING VEHICLE INVENTORY FOR NEW AND USED AUTOMOBILES; FOR APPRAISING VEHICLES; FOR MANAGING ON-LINE AUCTIONS AND WHOLESALE VEHICLE PURCHASING AND SALES; FOR PROCESSING THE SALE, FINANCING, INSURANCE AND WARRANTY OF VEHICLES; FOR MANAGING CUSTOMER RELATIONSHIPS AND CALL CENTERS; FOR AD-

VERTISING AND MARKETING THE SALE OF VEHICLES; FOR BUSINESS AND SALES TRAINING IN THE FIELD OF VEHICLE SALES; AND FOR POINT OF SALE DOCUMENTATION, IN CLASS 42 (U.S. CLS. 100 AND 101).

FIRST USE 12-14-2007; IN COMMERCE 12-14-2007.

THE MARK CONSISTS OF STANDARD CHARACTERS WITHOUT CLAIM TO ANY PARTICULAR FONT, STYLE, SIZE, OR COLOR.

SER. NO. 77-372,046, FILED 1-15-2008.

PAUL F. GAST, EXAMINING ATTORNEY

Int. Cl.: 36

Prior U.S. Cls.: 100, 101 and 102

United States Patent and Trademark Office

Reg. No. 3,484,641

Registered Aug. 12, 2008

**SERVICE MARK
PRINCIPAL REGISTER**

listen educate guide

KEHOE FINANCIAL ADVISORS LLC (OHIO LTD
LIAB CO)
125 BOGGS LANE
CINCINNATI, OH 45246

FOR: FINANCIAL ANALYSIS AND RESEARCH
SERVICES; FINANCIAL CONSULTANCY AND IN-
SURANCE CONSULTANCY; FINANCIAL PLAN-
NING AND INVESTMENT ADVISORY SERVICES,
IN CLASS 36 (U.S. CLS. 100, 101 AND 102).

FIRST USE 12-18-2007; IN COMMERCE 12-18-2007.

THE MARK CONSISTS OF STANDARD CHAR-
ACTERS WITHOUT CLAIM TO ANY PARTICULAR
FONT, STYLE, SIZE, OR COLOR.

SER. NO. 77-372,047, FILED 1-15-2008.

KRISTIN CARLSON, EXAMINING ATTORNEY

Int. Cl.: 8

Prior U.S. Cls.: 23, 28 and 44

Reg. No. 3,484,642

United States Patent and Trademark Office

Registered Aug. 12, 2008

TRADEMARK
PRINCIPAL REGISTER



RNR DIRECT LLC (NEW YORK LTD LIAB CO)
125 COMMERCE DRIVE
HAUPPAUGE, NY 11788

FOR: MANUALLY OPERATED HAND TOOLS,
NAMELY, PACKAGE AND CARTON OPENERS,
BOX OPENERS, BAG OPENERS, CLAMSHELL
PACKAGING OPENERS, AND AUDIO AND/OR
VIDEO DISC PACKAGE OPENERS , IN CLASS 8
(U.S. CLS. 23, 28 AND 44).

THE MARK CONSISTS OF A YIN AND YANG
SHAPED SYMBOL DISPOSED NEXT TO THE LIT-
ERAL ELEMENTS. THE LITERAL ELEMENT
"OPEN" IS POSITIONED ABOVE THE LITERAL
ELEMENT "SMART".

SER. NO. 77-372,048, FILED 1-15-2008.

FIRST USE 1-1-2007; IN COMMERCE 1-1-2007.

DAVID I, EXAMINING ATTORNEY

Int. Cl.: 44

Prior U.S. Cls.: 100 and 101

United States Patent and Trademark Office

Reg. No. 3,484,643

Registered Aug. 12, 2008

**SERVICE MARK
PRINCIPAL REGISTER**

CAPE COD MEDICAL SERVICES

CAPE COD HOSPITAL (MASSACHUSETTS NON-
PROFIT CORPORATION)
27 PARK STREET
HYANNIS, MA 02601

FOR: HEALTH CARE SERVICES, IN CLASS 44
(U.S. CLS. 100 AND 101).

FIRST USE 3-20-2001; IN COMMERCE 3-20-2001.

THE MARK CONSISTS OF STANDARD CHAR-
ACTERS WITHOUT CLAIM TO ANY PARTICULAR
FONT, STYLE, SIZE, OR COLOR.

OWNER OF U.S. REG. NOS. 2,528,709 AND
2,541,912.

NO CLAIM IS MADE TO THE EXCLUSIVE
RIGHT TO USE "MEDICAL SERVICES", APART
FROM THE MARK AS SHOWN.

SEC. 2(F).

SER. NO. 77-372,049, FILED 1-15-2008.

ALLISON HOLTZ, EXAMINING ATTORNEY

Int. Cl.: 33

Prior U.S. Cls.: 47 and 49

United States Patent and Trademark Office

Reg. No. 3,484,644

Registered Aug. 12, 2008

**TRADEMARK
PRINCIPAL REGISTER**

SHAMHAT

ENKIDU WINE, LLC (CALIFORNIA LTD LIAB
CO)
21684 EIGHTH STREET EAST #440
SONOMA, CA 95476

THE MARK CONSISTS OF STANDARD CHAR-
ACTERS WITHOUT CLAIM TO ANY PARTICULAR
FONT, STYLE, SIZE, OR COLOR.

FOR: WINE, IN CLASS 33 (U.S. CLS. 47 AND 49).

SER. NO. 77-372,055, FILED 1-15-2008.

FIRST USE 4-27-2007; IN COMMERCE 6-7-2007.

DANIEL CAPSHAW, EXAMINING ATTORNEY

Int. Cl.: 9

Prior U.S. Cls.: 21, 23, 26, 36 and 38

Reg. No. 3,484,645

United States Patent and Trademark Office

Registered Aug. 12, 2008

**TRADEMARK
PRINCIPAL REGISTER**



FIRICH ENTERPRISES COMPANY LIMITED
(TAIWAN CORPORATION)
10 FL., NO. 75, SEC. 1, SHINTAI 5TH RD.
SHIJR CITY, TAIWAN 221

PRINTERS; COMPUTER HARDWARE, NAMELY,
MOTHERBOARDS AND RAM; BAR CODE SCAN-
NERS; AND CHARGE CARD REGISTERS, IN
CLASS 9 (U.S. CLS. 21, 23, 26, 36 AND 38).

FOR: CASH REGISTERS; ELECTRONIC CASH
REGISTERS; LIQUID CRYSTAL DISPLAYS; TOUCH
PANELS; COMPUTER TERMINALS; KEYBOARDS;
PERSONAL COMPUTERS; HAND HELD LASER
BARCODE SCANNER; COMPUTER KEYBOARDS;
MAGNETIC CODE CARD READERS; COMPUTER
PRINTERS FOR RECEIPT PRINTING; COMPUTER

FIRST USE 2-1-2007; IN COMMERCE 4-1-2007.

SER. NO. 77-372,057, FILED 1-15-2008.

BRENDAN MCCAULEY, EXAMINING ATTORNEY

Int. Cl.: 42

Prior U.S. Cls.: 100 and 101

United States Patent and Trademark Office

Reg. No. 3,484,646

Registered Aug. 12, 2008

**SERVICE MARK
PRINCIPAL REGISTER**

DEMAND A HIGHER STANDARD

HORIZON ENGINEERING ASSOCIATES (NEW
YORK LTD LIAB CO)
30 BROAD STREET
NEW YORK, NY 10004

FOR: ENGINEERING SERVICES FOR BUILDING
AND PROPERTY CONDITION ASSESSMENT, FA-
CILITY MANAGEMENT, REPAIR AND RESTORA-
TION, BUILDING INSTRUMENTATION AND
MONITORING, AND ENVIRONMENTAL CON-
SULTING, IN CLASS 42 (U.S. CLS. 100 AND 101).

FIRST USE 1-1-2008; IN COMMERCE 1-1-2008.

THE MARK CONSISTS OF STANDARD CHAR-
ACTERS WITHOUT CLAIM TO ANY PARTICULAR
FONT, STYLE, SIZE, OR COLOR.

SER. NO. 77-372,058, FILED 1-15-2008.

DAVID H. STINE, EXAMINING ATTORNEY

Int. Cl.: 43

Prior U.S. Cls.: 100 and 101

United States Patent and Trademark Office

Reg. No. 3,484,647

Registered Aug. 12, 2008

**SERVICE MARK
PRINCIPAL REGISTER**

Where You Build It Better

PITA MANAGEMENT, INC. (CALIFORNIA CORPORATION), DBA BURGER HUT
3881 BENATAR WAY UNIT G
CHICO, CA 95928

THE MARK CONSISTS OF STANDARD CHARACTERS WITHOUT CLAIM TO ANY PARTICULAR FONT, STYLE, SIZE, OR COLOR.

FOR: FAST-FOOD RESTAURANTS, IN CLASS 43 (U.S. CLS. 100 AND 101).

SER. NO. 77-372,064, FILED 1-15-2008.

FIRST USE 7-3-2007; IN COMMERCE 7-3-2007.

ALLISON HOLTZ, EXAMINING ATTORNEY

Int. Cl.: 44

Prior U.S. Cls.: 100 and 101

United States Patent and Trademark Office

Reg. No. 3,484,648

Registered Aug. 12, 2008

**SERVICE MARK
PRINCIPAL REGISTER**

CAPE COD MEDICAL CENTER

CAPE COD HOSPITAL (MASSACHUSETTS NON-
PROFIT CORPORATION)
27 PARK STREET
HYANNIS, MA 02601

FOR: HEALTH CARE SERVICES, IN CLASS 44
(U.S. CLS. 100 AND 101).

FIRST USE 3-20-2001; IN COMMERCE 3-20-2001.

THE MARK CONSISTS OF STANDARD CHAR-
ACTERS WITHOUT CLAIM TO ANY PARTICULAR
FONT, STYLE, SIZE, OR COLOR.

OWNER OF U.S. REG. NOS. 2,528,709 AND
2,541,912.

NO CLAIM IS MADE TO THE EXCLUSIVE
RIGHT TO USE "MEDICAL CENTER", APART
FROM THE MARK AS SHOWN.

SEC. 2(F).

SER. NO. 77-372,066, FILED 1-15-2008.

ALLISON HOLTZ, EXAMINING ATTORNEY

Int. Cl.: 43

Prior U.S. Cls.: 100 and 101

United States Patent and Trademark Office

Reg. No. 3,484,649

Registered Aug. 12, 2008

SERVICE MARK
PRINCIPAL REGISTER



GASR, INCORPORATED (GEORGIA CORPORATION), DBA KOOL RUNNINGS
4977 MEMORIAL DRIVE
STONE MOUNTAIN, GA 30083

FOR: RESTAURANT AND CATERING SERVICES, IN CLASS 43 (U.S. CLS. 100 AND 101).

FIRST USE 7-2-1994; IN COMMERCE 7-2-1994.

THE COLOR(S) GREEN, RED, YELLOW, BLACK, AND WHITE IS/ARE CLAIMED AS A FEATURE OF THE MARK.

THE COLOR GREEN APPEARS IN THE WORD "RUNNING", THE SECOND SPIRAL-SHAPED LETTER "O" IN "KOOL", AND THE DESIGN OF PALM TREES. THE COLOR RED APPEARS IN THE LETTER "K" IN "KOOL". THE COLOR YELLOW APPEARS IN THE OVAL. THE COLOR BLACK APPEARS IN THE SHADING OF THE OVAL AND THE LETTER "L" IN "KOOL." THE COLOR WHITE APPEARS IN THE FIRST SPIRAL-SHAPED LETTER "O" IN "KOOL."

SER. NO. 77-372,069, FILED 1-15-2008.

ALLISON HOLTZ, EXAMINING ATTORNEY

Int. Cl.: 35

Prior U.S. Cls.: 100, 101 and 102

United States Patent and Trademark Office

Reg. No. 3,484,650

Registered Aug. 12, 2008

**SERVICE MARK
PRINCIPAL REGISTER**

CRANKYAPE.COM

MIDWEST RECREATIONAL CLEARINGHOUSE,
LLC (MINNESOTA LTD LIAB CO)
6352 - 320TH ST. WAY
CANNON FALLS, MN 55009

THE MARK CONSISTS OF STANDARD CHAR-
ACTERS WITHOUT CLAIM TO ANY PARTICULAR
FONT, STYLE, SIZE, OR COLOR.

FOR: ONLINE AUCTION SERVICES IN THE
FIELD OF RECREATIONAL VEHICLES AND WA-
TERCRAFT, IN CLASS 35 (U.S. CLS. 100, 101 AND
102).

SER. NO. 77-372,073, FILED 1-15-2008.

FIRST USE 11-0-2006; IN COMMERCE 11-0-2006.

INGA ERVIN, EXAMINING ATTORNEY

Int. Cl.: 37

Prior U.S. Cls.: 100, 103 and 106

United States Patent and Trademark Office

Reg. No. 3,484,651

Registered Aug. 12, 2008

**SERVICE MARK
PRINCIPAL REGISTER**



HAYES & LUNSFORD (NORTH CAROLINA CORPORATION)
P.O. BOX 2399
ASHEVILLE, NC 28802

FOR: ELECTRICAL CONTRACTING; ELECTRICAL CONTRACTOR SERVICES; ELECTRICAL REPAIRS AND INSTALLATION OF LOW VOLTAGE COMMUNICATION SYSTEMS, IN CLASS 37 (U.S. CLS. 100, 103 AND 106).

THE MARK CONSISTS OF THREE THREE-DIMENSIONAL ARROWS ROTATING CLOCK-WISE WITH A CIRCLE IN THE MIDDLE. STYLIZED "HAYES & LUNSFORD" COMPANY NAME TEXT TO THE RIGHT OF SAID ARROWS

SER. NO. 77-372,101, FILED 1-15-2008.

FIRST USE 0-0-1981; IN COMMERCE 0-0-1981.

MICHAEL TANNER, EXAMINING ATTORNEY

Int. Cl.: 31

Prior U.S. Cls.: 1 and 46

United States Patent and Trademark Office

Reg. No. 3,484,652

Registered Aug. 12, 2008

**TRADEMARK
PRINCIPAL REGISTER**

Sweet Thing

BOYD, FERNANDO CAMPBELL III (UNITED STATES INDIVIDUAL)
460 TENPENNY RD
MORRISON, TN 37357 AND
DODSON, GEORGE L. III (UNITED STATES INDIVIDUAL)
802 GREENBRIER DRIVE
MURFREESBORO, TN 37130

FOR: LIVING TREES, NAMELY, MAGNOLIAS AND MAGNOLIA VARIANTS , IN CLASS 31 (U.S. CLS. 1 AND 46).

FIRST USE 4-15-2004; IN COMMERCE 4-15-2004.

THE MARK CONSISTS OF STANDARD CHARACTERS WITHOUT CLAIM TO ANY PARTICULAR FONT, STYLE, SIZE, OR COLOR.

SER. NO. 77-372,112, FILED 1-15-2008.

MICHAEL TANNER, EXAMINING ATTORNEY

Int. Cl.: 15

Prior U.S. Cls.: 2, 21 and 36

United States Patent and Trademark Office

Reg. No. 3,484,653

Registered Aug. 12, 2008

**TRADEMARK
PRINCIPAL REGISTER**

PURESOUND

D'ADDARIO & COMPANY, INC. (NEW YORK CORPORATION)
595 SMITH STREET
FARMINGDALE, NY 11735

FOR: SNARE WIRES FOR USE WITH SNARE DRUMS; ACCESSORIES FOR PERCUSSION INSTRUMENTS, NAMELY, BASE DRUM BEATERS, IN CLASS 15 (U.S. CLS. 2, 21 AND 36).

FIRST USE 1-1-1999; IN COMMERCE 1-1-1999.

THE MARK CONSISTS OF STANDARD CHARACTERS WITHOUT CLAIM TO ANY PARTICULAR FONT, STYLE, SIZE, OR COLOR.

OWNER OF U.S. REG. NO. 2,510,290.

SER. NO. 77-372,132, FILED 1-15-2008.

JOHN DWYER, EXAMINING ATTORNEY

Int. Cl.: 41

Prior U.S. Cls.: 100, 101 and 107

United States Patent and Trademark Office

Reg. No. 3,484,654

Registered Aug. 12, 2008

**SERVICE MARK
PRINCIPAL REGISTER**

DIAMONDGIRL

SEMMEL, NEIL S. (UNITED STATES INDIVIDUAL)
230 MARINERS WAY
BEAR, DE 19701

FOR: ORGANIZING COMMUNITY SPORTING AND CULTURAL EVENTS, IN CLASS 41 (U.S. CLS. 100, 101 AND 107).

FIRST USE 1-11-2008; IN COMMERCE 1-11-2008.

THE MARK CONSISTS OF STANDARD CHARACTERS WITHOUT CLAIM TO ANY PARTICULAR FONT, STYLE, SIZE, OR COLOR.

OWNER OF U.S. REG. NO. 2,746,859.

SER. NO. 77-372,170, FILED 1-15-2008.

MARK RADEMACHER, EXAMINING ATTORNEY

Int. Cl.: 9

Prior U.S. Cls.: 21, 23, 26, 36 and 38

Reg. No. 3,484,655

United States Patent and Trademark Office

Registered Aug. 12, 2008

**TRADEMARK
PRINCIPAL REGISTER**

NetVizor

SPYTECH SOFTWARE AND DESIGN, INC. (MINNESOTA CORPORATION)
3318 KOSEC DRIVE
RED WING, MN 55066

FOR: COMPUTER SOFTWARE FOR MONITORING ALL PC AND INTERNET ACTIVITY OF EMPLOYEES AND USERS ON A NETWORK WHICH PROVIDES AN OVERALL VIEW OF COMPANY USE OF INTERNET, APPLICATIONS, AND NETWORK RESOURCES, IN CLASS 9 (U.S. CLS. 21, 23, 26, 36 AND 38).

FIRST USE 1-1-2002; IN COMMERCE 1-1-2002.

THE MARK CONSISTS OF STANDARD CHARACTERS WITHOUT CLAIM TO ANY PARTICULAR FONT, STYLE, SIZE, OR COLOR.

SER. NO. 77-372,195, FILED 1-15-2008.

TARAH HARDY, EXAMINING ATTORNEY

Int. Cls.: 6 and 19

Prior U.S. Cls.: 1, 2, 12, 13, 14, 23, 25, 33 and 50

United States Patent and Trademark Office

Reg. No. 3,484,656

Registered Aug. 12, 2008

**TRADEMARK
PRINCIPAL REGISTER**



NT WINDOW, INC. (TEXAS CORPORATION)
P. O. BOX 40547
FORT WORTH, TX 76140

FOR: METAL DOORS AND METAL WINDOWS,
IN CLASS 6 (U.S. CLS. 2, 12, 13, 14, 23, 25 AND 50).

FIRST USE 4-10-2007; IN COMMERCE 4-10-2007.

FOR: NON-METAL DOORS AND NON-METAL
WINDOWS, IN CLASS 19 (U.S. CLS. 1, 12, 33 AND 50).

FIRST USE 4-10-2007; IN COMMERCE 4-10-2007.

NO CLAIM IS MADE TO THE EXCLUSIVE
RIGHT TO USE "WINDOW", APART FROM THE
MARK AS SHOWN.

THE MARK CONSISTS OF THE WORDS "NT
WINDOW" AND A STYLIZED DRAWING OF A
WINDOW.

SER. NO. 77-372,269, FILED 1-15-2008.

KATINA MISTER, EXAMINING ATTORNEY

Int. Cl.: 16

Prior U.S. Cls.: 2, 5, 22, 23, 29, 37, 38 and 50

Reg. No. 3,484,657

United States Patent and Trademark Office

Registered Aug. 12, 2008

**TRADEMARK
PRINCIPAL REGISTER**

POWER THINKING

MENGRON, FRANK (UNITED STATES INDIVIDUAL)
3000 ISLAND BOULEVARD
AVENTURA, FL 33106 AND
LUCIANI, DR. JOSEPH (UNITED STATES INDIVIDUAL)
3000 ISLAND BOULEVARD
AVENTURA, FL 33160

FOR: PRINTED CORRESPONDENCE COURSE MATERIALS IN THE FIELD OF PSYCHOLOGY AND SELF-HELP; PRINTED INFORMATIONAL CARDS IN THE FIELD OF PSYCHOLOGY AND SELF-HELP; PRINTED INFORMATIONAL FOLDERS IN THE FIELD OF PSYCHOLOGY AND SELF-HELP; PRINTED INSTRUCTIONAL, EDUCATIONAL, AND TEACHING MATERIALS IN THE FIELD OF PSYCHOLOGY AND SELF-HELP; PRINTED LECTURES; PRINTED REPORTS FEATURING PSYCHOLOGY AND SELF-HELP; PRINTED SEMINAR NOTES; A SERIES OF BOOKS AND WRITTEN ARTICLES IN THE FIELD OF PSYCHOLOGY AND SELF-HELP; A SERIES OF BOOKS, WRITTEN AR-

TICLES, HANDOUTS AND WORKSHEETS IN THE FIELD OF PSYCHOLOGY AND SELF-HELP; BOOKS IN THE FIELD OF PSYCHOLOGY AND SELF-HELP; EDUCATIONAL BOOKS FEATURING PSYCHOLOGY AND SELF-HELP; EDUCATIONAL PUBLICATIONS, NAMELY, PSYCHOLOGY AND SELF-HELP IN THE FIELDS OF PSYCHOLOGY AND SELF-HELP; REFERENCE BOOKS IN THE FIELD OF PSYCHOLOGY AND SELF-HELP; MANUALS IN THE FIELD OF PSYCHOLOGY AND SELF-HELP, IN CLASS 16 (U.S. CLS. 2, 5, 22, 23, 29, 37, 38 AND 50).

FIRST USE 10-1-2007; IN COMMERCE 10-1-2007.

THE MARK CONSISTS OF STANDARD CHARACTERS WITHOUT CLAIM TO ANY PARTICULAR FONT, STYLE, SIZE, OR COLOR.

SER. NO. 77-372,315, FILED 1-15-2008.

ALEX KEAM, EXAMINING ATTORNEY

Int. Cl.: 9

Prior U.S. Cls.: 21, 23, 26, 36 and 38

United States Patent and Trademark Office

Reg. No. 3,484,658

Registered Aug. 12, 2008

**TRADEMARK
PRINCIPAL REGISTER**

CAPTURE IT ALL

OLYMPUS AMERICA INC. (DELAWARE CORPORATION)
3500 CORPORATE PARKWAY
CENTER VALLEY, PA 10834

THE MARK CONSISTS OF STANDARD CHARACTERS WITHOUT CLAIM TO ANY PARTICULAR FONT, STYLE, SIZE, OR COLOR.

FOR: DIGITAL CAMERAS AND CAMERA CASES, IN CLASS 9 (U.S. CLS. 21, 23, 26, 36 AND 38).

SER. NO. 77-372,325, FILED 1-15-2008.

FIRST USE 4-28-2007; IN COMMERCE 4-28-2007.

JESSICA A. POWERS, EXAMINING ATTORNEY

Int. Cl.: 35

Prior U.S. Cls.: 100, 101 and 102

United States Patent and Trademark Office

Reg. No. 3,484,659

Registered Aug. 12, 2008

**SERVICE MARK
PRINCIPAL REGISTER**

WELLVATION

WELLVATION, LLC (MINNESOTA LTD LIAB
CO)
8441 WAYZATA BLVD., SUITE 200
MINNEAPOLIS, MN 55426

FOR: PROVIDING ASSISTANCE, FITNESS EVALUATION AND CONSULTATION TO CORPORATE CLIENTS TO HELP THEIR EMPLOYEES MAKE HEALTH, WELLNESS AND NUTRITIONAL CHANGES IN THEIR DAILY LIVING TO INCREASE PRODUCTIVITY AND LOWER HEALTH CARE COSTS, IN CLASS 35 (U.S. CLS. 100, 101 AND 102).

FIRST USE 5-30-2007; IN COMMERCE 5-30-2007.

THE MARK CONSISTS OF STANDARD CHARACTERS WITHOUT CLAIM TO ANY PARTICULAR FONT, STYLE, SIZE, OR COLOR.

SER. NO. 77-372,328, FILED 1-15-2008.

JESSICA A. POWERS, EXAMINING ATTORNEY

Int. Cl.: 35

Prior U.S. Cls.: 100, 101 and 102

United States Patent and Trademark Office

Reg. No. 3,484,660

Registered Aug. 12, 2008

**SERVICE MARK
PRINCIPAL REGISTER**



DACOTAH-WALSH TIRE INCORPORATED
(MINNESOTA CORPORATION)
80 WEST 78TH STREET
CHANHASSEN, MN 55317

FOR: DISTRIBUTORSHIP SERVICES IN THE
FIELD OF MOTOR VEHICLE TIRES, IN CLASS 35
(U.S. CLS. 100, 101 AND 102).

FIRST USE 0-0-1990; IN COMMERCE 0-0-1990.

NO CLAIM IS MADE TO THE EXCLUSIVE
RIGHT TO USE "TIRE", APART FROM THE MARK
AS SHOWN.

THE NAME(S), PORTRAIT(S), AND/OR SIGNA-
TURE(S) SHOWN IN THE MARK IDENTIFIES
DAVID WALSH, WHOSE CONSENT(S) TO REGIS-
TER IS MADE OF RECORD.

THE MARK CONSISTS OF A FANCIFUL REPRE-
SENTATION OF A MAN'S FACE COVERED WITH A
CAP BEARING THE WORDS TIRE AUDITOR AND
BELOW THE DESIGN ARE THE WORDS "MR.
WALSH".

SER. NO. 77-372,352, FILED 1-15-2008.

COURTNEY MCCORMICK, EXAMINING ATTOR-
NEY

Int. Cl.: 25

Prior U.S. Cls.: 22 and 39

United States Patent and Trademark Office

Reg. No. 3,484,661

Registered Aug. 12, 2008

**TRADEMARK
PRINCIPAL REGISTER**



BENZENE CLOTHING, INC. (CALIFORNIA CORPORATION)
310 EAST 18TH STREET
LOS ANGELES, CA 90015

THE MARK CONSISTS OF STYLIZED LETTERS "AT" IN DIAMOND DESIGN SHAPE FOLLOWED BY APRICOTTREE.

FOR: SHIRTS; T-SHIRTS; JACKETS, IN CLASS 25 (U.S. CLS. 22 AND 39).

SER. NO. 77-372,383, FILED 1-15-2008.

FIRST USE 4-29-2004; IN COMMERCE 2-25-2005.

PATRICIA EVANKO, EXAMINING ATTORNEY

Int. Cl.: 18

Prior U.S. Cls.: 1, 2, 3, 22 and 41

United States Patent and Trademark Office

Reg. No. 3,484,662

Registered Aug. 12, 2008

**TRADEMARK
PRINCIPAL REGISTER**

PUPPYLOVE

CHENSON INDUSTRIAL CO. LTD., INC. (CALI-
FORNIA CORPORATION)
2101 SOUTH SANTA FE AVENUE
LOS ANGELES, CA 90058

THE MARK CONSISTS OF STANDARD CHAR-
ACTERS WITHOUT CLAIM TO ANY PARTICULAR
FONT, STYLE, SIZE, OR COLOR.

FOR: HANDBAGS FOR WOMEN, IN CLASS 18
(U.S. CLS. 1, 2, 3, 22 AND 41).

SER. NO. 77-372,411, FILED 1-15-2008.

FIRST USE 12-28-2007; IN COMMERCE 12-28-2007.

JOHN GARTNER, EXAMINING ATTORNEY

Int. Cl.: 9

Prior U.S. Cls.: 21, 23, 26, 36 and 38

United States Patent and Trademark Office

Reg. No. 3,484,663

Registered Aug. 12, 2008

**TRADEMARK
PRINCIPAL REGISTER**

BID PRO QUO

SAFEHOUSE SYSTEMS (MARYLAND CORPORATION)
8317 LILYBET LANE
CHARLOTTE, NC 28278

FOR: COMPUTER SOFTWARE FOR USE IN ASSISTING USERS IN THE PREPARATION OF MULTIPLE PREFERENTIAL BIDS FOR WORK, TRAINING AND VACATION SCHEDULES BY DISPLAYING THE SPECIFIC OPPORTUNITIES THAT MOST CLOSELY MATCH THEIR DESIRES, VERIFYING THE LEGALITIES OF THE REQUESTS, AND CONVERTING THE PREFERENCES INTO A REQUEST STATEMENT THAT MEETS ANY SYNTAX

REQUIREMENTS FOR FURTHER COMPUTERIZED PROCESSING, IN CLASS 9 (U.S. CLS. 21, 23, 26, 36 AND 38).

FIRST USE 9-1-2007; IN COMMERCE 9-1-2007.

THE MARK CONSISTS OF STANDARD CHARACTERS WITHOUT CLAIM TO ANY PARTICULAR FONT, STYLE, SIZE, OR COLOR.

SER. NO. 77-372,421, FILED 1-15-2008.

DAVID MURRAY, EXAMINING ATTORNEY

Int. Cl.: 12

Prior U.S. Cls.: 19, 21, 23, 31, 35 and 44

Reg. No. 3,484,664

United States Patent and Trademark Office

Registered Aug. 12, 2008

**TRADEMARK
PRINCIPAL REGISTER**

quick skirts

CHAMBERS, BRYON (UNITED STATES INDIVIDUAL)
3022 LAHRING RD.
FENTON, MI 48430

FOR: PANELS THAT REPLACE THE HARD SADDLE BAGS ON MOTORCYCLES FOR A DIFFERENT LOOK, COVERING UP THE SHOCKS AND BRACKETS FOR A SMOOTH FINISHED LOOK, IN CLASS 12 (U.S. CLS. 19, 21, 23, 31, 35 AND 44).

FIRST USE 12-0-2005; IN COMMERCE 2-0-2006.

THE MARK CONSISTS OF STANDARD CHARACTERS WITHOUT CLAIM TO ANY PARTICULAR FONT, STYLE, SIZE, OR COLOR.

SER. NO. 77-372,431, FILED 1-15-2008.

KAREN K. BUSH, EXAMINING ATTORNEY

Int. Cl.: 36

Prior U.S. Cls.: 100, 101 and 102

United States Patent and Trademark Office

Reg. No. 3,484,665

Registered Aug. 12, 2008

SERVICE MARK
PRINCIPAL REGISTER



DOWNEY INSURANCE AGENCY, INC (MASSACHUSETTS CORPORATION)
190 EAST MAIN ST.
MARLBORO, MA 01752

FOR: INSURANCE AGENCIES; FINANCIAL ADVICE AND FINANCIAL PLANNING SERVICES, IN CLASS 36 (U.S. CLS. 100, 101 AND 102).

FIRST USE 11-1-2005; IN COMMERCE 11-1-2005.

NO CLAIM IS MADE TO THE EXCLUSIVE RIGHT TO USE "INSURANCE GROUP" AND "IN-

SURANCE & FINANCIAL PLANNING", APART FROM THE MARK AS SHOWN.

THE MARK CONSISTS OF AN OVAL WITH A MOUNTAIN LANDSCAPE. BELOW THE OVAL ARE THE STYLIZED WORD "NORTHLAND DOWNEY INSURANCE GROUP INSURANCE & FINANCIAL PLANNING".

SER. NO. 77-372,433, FILED 1-15-2008.

KAREN K. BUSH, EXAMINING ATTORNEY

Int. Cl.: 37

Prior U.S. Cls.: 100, 103 and 106

United States Patent and Trademark Office

Reg. No. 3,484,666

Registered Aug. 12, 2008

**SERVICE MARK
PRINCIPAL REGISTER**

Because Excellence Matters

XL CONSTRUCTION CORPORATION (CALI-
FORNIA CORPORATION)
851 BUCKEYE COURT
MILPITAS, CA 95035

THE MARK CONSISTS OF STANDARD CHAR-
ACTERS WITHOUT CLAIM TO ANY PARTICULAR
FONT, STYLE, SIZE, OR COLOR.

FOR: RESIDENTIAL AND COMMERCIAL
BUILDING CONSTRUCTION, IN CLASS 37 (U.S.
CLS. 100, 103 AND 106).

SER. NO. 77-372,442, FILED 1-15-2008.

FIRST USE 7-18-2005; IN COMMERCE 7-18-2005.

CHRIS WELLS, EXAMINING ATTORNEY

Int. Cl.: 28

Prior U.S. Cls.: 22, 23, 38 and 50

United States Patent and Trademark Office

Reg. No. 3,484,667

Registered Aug. 12, 2008

**TRADEMARK
PRINCIPAL REGISTER**

POLETAP

HOPE, EDWARD (UNITED STATES INDIVIDUAL)
2905 FOX POINTE CIRCLE
WICHITA, KS 67226

THE MARK CONSISTS OF STANDARD CHARACTERS WITHOUT CLAIM TO ANY PARTICULAR FONT, STYLE, SIZE, OR COLOR.

FOR: FISHING TACKLE, NAMELY, BITE SENSORS, IN CLASS 28 (U.S. CLS. 22, 23, 38 AND 50).

SER. NO. 77-372,448, FILED 1-15-2008.

FIRST USE 4-21-2003; IN COMMERCE 3-8-2004.

CAROLINE WOOD, EXAMINING ATTORNEY

Int. Cl.: 12

Prior U.S. Cls.: 19, 21, 23, 31, 35 and 44

Reg. No. 3,484,668

United States Patent and Trademark Office

Registered Aug. 12, 2008

**TRADEMARK
PRINCIPAL REGISTER**

COBRA MAGNUM

SCRANTON MANUFACTURING COMPANY
INC. (IOWA CORPORATION)
101 STATE STREET
SCRANTON, IA 51462

FOR: REFUSE TRUCKS, IN CLASS 12 (U.S. CLS.
19, 21, 23, 31, 35 AND 44).

FIRST USE 5-27-2007; IN COMMERCE 5-27-2007.

THE MARK CONSISTS OF STANDARD CHAR-
ACTERS WITHOUT CLAIM TO ANY PARTICULAR
FONT, STYLE, SIZE, OR COLOR.

OWNER OF U.S. REG. NOS. 2,507,047 AND
2,576,749.

SER. NO. 77-372,450, FILED 1-15-2008.

CAROLINE WOOD, EXAMINING ATTORNEY

Int. Cl.: 44

Prior U.S. Cls.: 100 and 101

United States Patent and Trademark Office

Reg. No. 3,484,669

Registered Aug. 12, 2008

**SERVICE MARK
PRINCIPAL REGISTER**



PROMPT INJURY CARE CLINIC

NORTHWEST HAND SPECIALISTS, INC (WA-
SHINGTON CORPORATION)
19930 BALLINGER WAY NE
SHORELINE, WA 98155

FOR: MEDICAL SERVICES, NAMELY, PROMPT
INJURY CARE OF UPPER AND LOWER EXTRE-
MITIES PLUS IMAGING, RADIOLOGY, SURGERY
AND FOLLOW UP THERAPIES, IN CLASS 44 (U.S.
CLS. 100 AND 101).

FIRST USE 9-1-2007; IN COMMERCE 10-1-2007.

NO CLAIM IS MADE TO THE EXCLUSIVE
RIGHT TO USE "PROMPT INJURY CARE CLINIC",
APART FROM THE MARK AS SHOWN.

THE MARK CONSISTS OF A STYLIZED FRON-
TAL STANDING HUMAN FIGURE SURROUNDED
BY TWO SEMI-CIRCULAR DESIGNS. BELOW ARE
THE STYLIZED WORDS "MEND PROMPT INJURY
CARE CLINIC".

SER. NO. 77-372,452, FILED 1-15-2008.

CAROLINE WOOD, EXAMINING ATTORNEY

Int. Cl.: 35

Prior U.S. Cls.: 100, 101 and 102

United States Patent and Trademark Office

Reg. No. 3,484,670

Registered Aug. 12, 2008

**SERVICE MARK
PRINCIPAL REGISTER**

VKRfitness

VKR ENTERPRISES, INC. (CALIFORNIA CORPORATION)
8610 LARKSPUR LN.
GILROY, CA 95020

THE MARK CONSISTS OF STANDARD CHARACTERS WITHOUT CLAIM TO ANY PARTICULAR FONT, STYLE, SIZE, OR COLOR.

FOR: ON-LINE RETAIL STORE SERVICES FEATURING PEDOMETERS, AND EXERCISE/FITNESS PRODUCTS, IN CLASS 35 (U.S. CLS. 100, 101 AND 102).

SER. NO. 77-372,458, FILED 1-15-2008.

FIRST USE 6-2-2003; IN COMMERCE 6-2-2003.

CHRIS WELLS, EXAMINING ATTORNEY

Int. Cl.: 37

Prior U.S. Cls.: 100, 103 and 106

United States Patent and Trademark Office

Reg. No. 3,484,671

Registered Aug. 12, 2008

**SERVICE MARK
PRINCIPAL REGISTER**

We Build to Improve Lives

XL CONSTRUCTION CORPORATION (CALI-
FORNIA CORPORATION)
851 BUCKEYE COURT
MILPITAS, CA 95035

THE MARK CONSISTS OF STANDARD CHAR-
ACTERS WITHOUT CLAIM TO ANY PARTICULAR
FONT, STYLE, SIZE, OR COLOR.

FOR: RESIDENTIAL AND COMMERCIAL
BUILDING CONSTRUCTION, IN CLASS 37 (U.S.
CLS. 100, 103 AND 106).

SER. NO. 77-372,466, FILED 1-15-2008.

FIRST USE 9-17-2007; IN COMMERCE 11-8-2007.

CHRIS WELLS, EXAMINING ATTORNEY

Int. Cl.: 35

Prior U.S. Cls.: 100, 101 and 102

United States Patent and Trademark Office

Reg. No. 3,484,672

Registered Aug. 12, 2008

**SERVICE MARK
PRINCIPAL REGISTER**

CROSS:SCAN

CHRISTIAN BOOKSELLERS ASSOCIATION (IL-
LINOIS NON-PROFIT CORPORATION)
P.O. BOX 62000
COLORADO SPRINGS, CO 809622000

THE MARK CONSISTS OF STANDARD CHAR-
ACTERS WITHOUT CLAIM TO ANY PARTICULAR
FONT, STYLE, SIZE, OR COLOR.

FOR: BUSINESS SERVICES, NAMELY, COMPIL-
ING AND ANALYZING INFORMATION AND
DATA FOR CHRISTIAN RETAILERS, IN CLASS 35
(U.S. CLS. 100, 101 AND 102).

SER. NO. 77-372,475, FILED 1-15-2008.

FIRST USE 8-15-2005; IN COMMERCE 10-3-2005.

KAPIL BHANOT, EXAMINING ATTORNEY

Int. Cl.: 25

Prior U.S. Cls.: 22 and 39

United States Patent and Trademark Office

Reg. No. 3,484,673

Registered Aug. 12, 2008

**TRADEMARK
PRINCIPAL REGISTER**

SIMPLE PLAN

SIMPLE PLAN INC. (CANADA CORPORATION)
1100 EAST CREMAZIE BLVD., SUITE 211
MONTREAL, CANADA H2P2X2

FOR: CLOTHING, NAMELY, T-SHIRTS, LONG-SLEEVED SHIRTS, SLEEVELESS T-SHIRTS, TANK TOPS, SWEATSHIRTS, JERSEYS, HOODED JACKETS, WIND RESISTANT JACKETS, COATS; SHORTS, TROUSERS, CARGO PANTS, JEANS; UNDERWEAR, NAMELY, THONGS, BRIEFS, UNDERPANTS; HATS, BASEBALL CAPS, BEANIES, BANDANAS, IN CLASS 25 (U.S. CLS. 22 AND 39).

FIRST USE 9-1-1999; IN COMMERCE 9-1-1999.

THE MARK CONSISTS OF STANDARD CHARACTERS WITHOUT CLAIM TO ANY PARTICULAR FONT, STYLE, SIZE, OR COLOR.

OWNER OF U.S. REG. NO. 2,678,179.

SER. NO. 77-372,479, FILED 1-15-2008.

JOHN GARTNER, EXAMINING ATTORNEY

Int. Cl.: 19

Prior U.S. Cls.: 1, 12, 33 and 50

United States Patent and Trademark Office

Reg. No. 3,484,674

Registered Aug. 12, 2008

**TRADEMARK
PRINCIPAL REGISTER**

THERMOCROMEX

BUILDING MATERIAL IMPORTS, INC. (CALI-
FORNIA CORPORATION)
40 FOURTH STREET # 203
PETALUMA, CA 94952

THE MARK CONSISTS OF STANDARD CHAR-
ACTERS WITHOUT CLAIM TO ANY PARTICULAR
FONT, STYLE, SIZE, OR COLOR.

FOR: MORTAR MIX, IN CLASS 19 (U.S. CLS. 1, 12,
33 AND 50).

SER. NO. 77-372,486, FILED 1-15-2008.

FIRST USE 5-2-2007; IN COMMERCE 5-2-2007.

SALLY SHIH, EXAMINING ATTORNEY

Int. Cl.: 30

Prior U.S. Cl.: 46

United States Patent and Trademark Office

Reg. No. 3,484,675

Registered Aug. 12, 2008

**TRADEMARK
PRINCIPAL REGISTER**

honey love

WISE-ACRE, INC. (MAINE CORPORATION)
9 TRADEWINDS LANE
BLUE HILL, ME 04614

FOR: FROZEN CONFECTIONS, NAMELY, FREE-
ZER POPS, IN CLASS 30 (U.S. CL. 46).

FIRST USE 8-1-2007; IN COMMERCE 8-1-2007.

THE MARK CONSISTS OF STANDARD CHAR-
ACTERS WITHOUT CLAIM TO ANY PARTICULAR
FONT, STYLE, SIZE, OR COLOR.

NO CLAIM IS MADE TO THE EXCLUSIVE
RIGHT TO USE "HONEY", APART FROM THE
MARK AS SHOWN.

SER. NO. 77-372,487, FILED 1-15-2008.

TINA BROWN, EXAMINING ATTORNEY

Int. Cl.: 33

Prior U.S. Cls.: 47 and 49

United States Patent and Trademark Office

Reg. No. 3,484,676

Registered Aug. 12, 2008

**TRADEMARK
PRINCIPAL REGISTER**



THE TRUSTEES OF THE COPPOLA FAMILY
TRUST (CALIFORNIA TRUST)
1991 ST. HELENA HIGHWAY
RUTHERFORD, CA 94573

FOR: WINE, IN CLASS 33 (U.S. CLS. 47 AND 49).

FIRST USE 8-1-2007; IN COMMERCE 8-1-2007.

OWNER OF U.S. REG. NOS. 2,156,846, 2,731,938,
AND 2,827,105.

NO CLAIM IS MADE TO THE EXCLUSIVE
RIGHT TO USE "CALIFORNIA VINEYARDS",
APART FROM THE MARK AS SHOWN.

THE MARK CONSISTS OF A DOUBLE-LINED
DIAMOND DESIGN DISPLAYING GRAPE LEAVES
AND VINES. IN THE CENTER OF THE DIAMOND
IS A CIRCLE WITHIN A CIRCLE. THE OUTSIDE
CIRCLE SHOW THE WORDS "CALIFORNIA VINE-
YARDS" AND THE INNER CIRCLE HAS THE
LETTERING "NC" IN STYLIZED FORM.

SER. NO. 77-372,497, FILED 1-15-2008.

MICHAEL LITZAU, EXAMINING ATTORNEY

Int. Cl.: 9

Prior U.S. Cls.: 21, 23, 26, 36 and 38

Reg. No. 3,484,677

United States Patent and Trademark Office

Registered Aug. 12, 2008

**TRADEMARK
PRINCIPAL REGISTER**

STYLE + SUBSTANCE

FABRIK INC. (DELAWARE CORPORATION)
SUITE 200
1825 S. GRANT STREET
SAN MATEO, CA 94402

THE MARK CONSISTS OF STANDARD CHAR-
ACTERS WITHOUT CLAIM TO ANY PARTICULAR
FONT, STYLE, SIZE, OR COLOR.

FOR: EXTERNAL STORAGE AND BACKUP
HARD DRIVES AND ADAPTORS, IN CLASS 9 (U.S.
CLS. 21, 23, 26, 36 AND 38).

SER. NO. 77-372,498, FILED 1-15-2008.

FIRST USE 1-11-2008; IN COMMERCE 1-11-2008.

JOHN E. MICHOS, EXAMINING ATTORNEY

Int. Cl.: 41

Prior U.S. Cls.: 100, 101 and 107

United States Patent and Trademark Office

Reg. No. 3,484,678

Registered Aug. 12, 2008

**SERVICE MARK
PRINCIPAL REGISTER**

EnergyRICH

DOMINICK-KOSMICKI, HEATHER (UNITED STATES INDIVIDUAL)

#18

170 THOMPSON STREET
NEW YORK, NY 10012

THE MARK CONSISTS OF STANDARD CHARACTERS WITHOUT CLAIM TO ANY PARTICULAR FONT, STYLE, SIZE, OR COLOR.

FOR: PROFESSIONAL COACHING SERVICES IN THE FIELD OF BUSINESS FOR SOLO-ENTREPRENEURS, IN CLASS 41 (U.S. CLS. 100, 101 AND 107).

SER. NO. 77-372,509, FILED 1-15-2008.

FIRST USE 1-1-2005; IN COMMERCE 1-1-2005.

JENNIFER VASQUEZ, EXAMINING ATTORNEY

Int. Cl.: 43

Prior U.S. Cls.: 100 and 101

United States Patent and Trademark Office

Reg. No. 3,484,679

Registered Aug. 12, 2008

**SERVICE MARK
PRINCIPAL REGISTER**

southern soul barbeque

SAPKIN BROS. INC. (GEORGIA CORPORATION)

P.O. BOX 24195

ST. SIMONS ISLAND, GA 31522

FOR: RESTAURANT SERVICES, IN CLASS 43
(U.S. CLS. 100 AND 101).

FIRST USE 1-1-2007; IN COMMERCE 1-1-2007.

THE MARK CONSISTS OF STANDARD CHARACTERS WITHOUT CLAIM TO ANY PARTICULAR FONT, STYLE, SIZE, OR COLOR.

NO CLAIM IS MADE TO THE EXCLUSIVE RIGHT TO USE "BARBEQUE", APART FROM THE MARK AS SHOWN.

SER. NO. 77-372,516, FILED 1-15-2008.

JENNIFER VASQUEZ, EXAMINING ATTORNEY

Int. Cl.: 41

Prior U.S. Cls.: 100, 101 and 107

United States Patent and Trademark Office

Reg. No. 3,484,680

Registered Aug. 12, 2008

**SERVICE MARK
PRINCIPAL REGISTER**

economy superstar

HANSEN, TIMOTHY WARREN (UNITED STATES INDIVIDUAL)
2967 N. FARWELL AVE.
MILWAUKEE, WI 53211

FOR: AUDIO RECORDING AND PRODUCTION; ENTERTAINMENT SERVICES, NAMELY, PROVIDING A WEB SITE FEATURING MUSICAL PERFORMANCES, MUSICAL VIDEOS, RELATED FILM CLIPS, PHOTOGRAPHS, AND OTHER MULTIMEDIA MATERIALS; FILM AND VIDEO PRODUCTION; FILM DISTRIBUTION; FILM EDITING; FILM PRODUCTION; FILM STUDIOS; MEDIA PRODUCTION SERVICES, NAMELY, VIDEO AND FILM PRODUCTION; MOTION PICTURE FILM PRODUCTION; MOTION PICTURE SONG PRODUCTION; MULTIMEDIA ENTERTAINMENT SERVICES IN THE NATURE OF RECORDING, PRODUCTION AND POST-PRODUCTION SERVICES IN THE FIELDS OF MUSIC, VIDEO, AND FILMS; MUSIC PRODUCTION SERVICES; OPERATING OF FILM STUDIOS; OPERATION OF VIDEO EQUIPMENT OR AUDIO EQUIPMENT ETC. FOR PRODUCTION OF RADIO OR TELEVISION PROGRAMS; PRODUCTION AND DISTRIBUTION OF INDEPENDENT MOTION PICTURES; PRODUCTION AND DISTRIBUTION OF TELEVISION SHOWS AND MOVIES; PRODUCTION OF FILMS; PRODUCTION OF SOUND AND MUSIC VIDEO RECORDINGS; PRODUCTION OF SOUND RECORDINGS; PRODUC-

TION OF VIDEO AND CREATION OF VISUAL EFFECTS FOR OTHERS FOR USE IN DVDS, TELEVISION PROGRAMS AND ON WEB SITES; PRODUCTION OF VISUAL EFFECTS FOR VIDEOS, DVDS, TELEVISION AND FOR INTERNET WEB SITES; PROVIDING FACILITIES FOR PRODUCING VIDEO, CINEMA AND PHOTOGRAPHY PRODUCTIONS; INFORMATION RELATING TO ENTERTAINMENT AND EDUCATION, PROVIDED ONLINE FROM A COMPUTER DATABASE OR THE INTERNET; COMPOSITION OF MUSIC FOR OTHERS; CONSULTATION AND ADVICE REGARDING MUSICAL SELECTIONS AND ARRANGEMENTS FOR SOUND RECORDINGS AND LIVE PERFORMANCES; ENTERTAINMENT IN THE NATURE OF VISUAL AND AUDIO PERFORMANCES, AND MUSICAL, VARIETY, NEWS AND COMEDY SHOWS, IN CLASS 41 (U.S. CLS. 100, 101 AND 107).

FIRST USE 8-29-2004; IN COMMERCE 8-29-2004.

THE MARK CONSISTS OF STANDARD CHARACTERS WITHOUT CLAIM TO ANY PARTICULAR FONT, STYLE, SIZE, OR COLOR.

SER. NO. 77-372,524, FILED 1-15-2008.

JANET LEE, EXAMINING ATTORNEY

Int. Cl.: 35

Prior U.S. Cls.: 100, 101 and 102

United States Patent and Trademark Office

Reg. No. 3,484,681

Registered Aug. 12, 2008

**SERVICE MARK
PRINCIPAL REGISTER**

**Live Well. Do Good. Look
Gorgeous.**

FUTURENATURAL LLC (TEXAS LTD LIAB CO)
#318
222 E RIVERSIDE DRIVE
AUSTIN, TX 78704

FOR: ON-LINE RETAIL STORE SERVICES FEATURING ORGANIC AND NATURAL BEAUTY PRODUCTS, IN CLASS 35 (U.S. CLS. 100, 101 AND 102).

FIRST USE 6-1-2007; IN COMMERCE 10-1-2007.

THE MARK CONSISTS OF STANDARD CHARACTERS WITHOUT CLAIM TO ANY PARTICULAR FONT, STYLE, SIZE, OR COLOR.

SER. NO. 77-372,623, FILED 1-15-2008.

KIMBERLY FRYE, EXAMINING ATTORNEY

Int. Cls.: 6 and 19

Prior U.S. Cls.: 1, 2, 12, 13, 14, 23, 25, 33 and 50

Reg. No. 3,484,682

United States Patent and Trademark Office

Registered Aug. 12, 2008

**TRADEMARK
PRINCIPAL REGISTER**



MASTER CRAFTED DOORS

THE DOORSTORE OF AMERICA, INC. (NORTH
CAROLINA CORPORATION)
8732 GLENWOOD AVENUE
RALEIGH, NC 27617

NO CLAIM IS MADE TO THE EXCLUSIVE
RIGHT TO USE "MASTER CRAFTED DOORS",
APART FROM THE MARK AS SHOWN.

FOR: METAL DOORS, IN CLASS 6 (U.S. CLS. 2, 12,
13, 14, 23, 25 AND 50).

THE MARK CONSISTS OF A FLAG BEHIND THE
DSA LETTERS AND FOLLOWED BY "MASTER
CRAFTED DOORS".

FIRST USE 7-1-2007; IN COMMERCE 7-1-2007.

FOR: NON-METAL DOORS, IN CLASS 19 (U.S.
CLS. 1, 12, 33 AND 50).

SER. NO. 77-372,624, FILED 1-15-2008.

FIRST USE 7-1-2007; IN COMMERCE 7-1-2007.

KIMBERLY FRYE, EXAMINING ATTORNEY

Int. Cl.: 25

Prior U.S. Cls.: 22 and 39

United States Patent and Trademark Office

Reg. No. 3,484,683

Registered Aug. 12, 2008

**TRADEMARK
PRINCIPAL REGISTER**

Hey Cupcake!

HEY CUPCAKE!, INC. (TEXAS CORPORATION),
DBA HEY CUPCAKE!
3300 BEE CAVES ROAD SUITE 650 PMB 1231
AUSTIN, TX 78746

FOR: A-SHIRTS; BUTTON-FRONT ALOHA SHIRTS; CAMP SHIRTS; DRESS SHIRTS; GOLF SHIRTS; KNIT SHIRTS; LONG-SLEEVED SHIRTS; NIGHT SHIRTS; OPEN-NECKED SHIRTS; PIQUE SHIRTS; POLO SHIRTS; RUGBY SHIRTS; SHIRT FRONTS; SHIRT YOKES; SHIRTS; SHIRTS FOR SUITS; SHORT-SLEEVED OR LONG-SLEEVED T-SHIRTS; SHORT-SLEEVED SHIRTS; SLEEP SHIRTS; SPORT SHIRTS; SPORTS SHIRTS; SPORTS SHIRTS WITH SHORT SLEEVES; SWEAT SHIRTS; T-SHIRTS; TEE SHIRTS; TRIATHLON CLOTHING, NAMELY, TRIATHLON TIGHTS, TRIATHLON SHORTS,

TRIATHLON SINGLETS, TRIATHLON SHIRTS, TRIATHLON SUITS; WIND SHIRTS; YOGA SHIRTS, IN CLASS 25 (U.S. CLS. 22 AND 39).

FIRST USE 1-1-2007; IN COMMERCE 4-15-2007.

THE MARK CONSISTS OF STANDARD CHARACTERS WITHOUT CLAIM TO ANY PARTICULAR FONT, STYLE, SIZE, OR COLOR.

OWNER OF U.S. REG. NO. 3,410,057.

SER. NO. 77-372,666, FILED 1-15-2008.

KIMBERLY FRYE, EXAMINING ATTORNEY

Int. Cl.: 35

Prior U.S. Cls.: 100, 101 and 102

United States Patent and Trademark Office

Reg. No. 3,484,684

Registered Aug. 12, 2008

**SERVICE MARK
PRINCIPAL REGISTER**

ASIAN MBA

ASIAN DIVERSITY, INC. (NEW YORK CORPORATION)
1270 BROADWAY STE 703
NEW YORK, NY 10001

FOR: ORGANIZING AND CONDUCTING JOB FAIRS; BUSINESS NETWORKING; ARRANGING AND CONDUCTING BUSINESS CONFERENCES; BUSINESS LEADERSHIP DEVELOPMENT; EMPLOYMENT HIRING, RECRUITING, PLACEMENT, STAFFING AND CAREER NETWORKING SERVICES, IN CLASS 35 (U.S. CLS. 100, 101 AND 102).

FIRST USE 7-1-2007; IN COMMERCE 7-1-2007.

THE MARK CONSISTS OF STANDARD CHARACTERS WITHOUT CLAIM TO ANY PARTICULAR FONT, STYLE, SIZE, OR COLOR.

NO CLAIM IS MADE TO THE EXCLUSIVE RIGHT TO USE "ASIAN", APART FROM THE MARK AS SHOWN.

SER. NO. 77-372,670, FILED 1-15-2008.

JOHN WILKE, EXAMINING ATTORNEY

Int. Cl.: 44

Prior U.S. Cls.: 100 and 101

United States Patent and Trademark Office

Reg. No. 3,484,685

Registered Aug. 12, 2008

**SERVICE MARK
PRINCIPAL REGISTER**

NYDG

DAVID A. COLBERT, M.D., P.C. (NEW YORK
CORPORATION)
119 FIFTH AVE, 4TH FLOOR
NEW YORK, NY 10003

FOR: MEDICAL SERVICES; MEDICAL SERVI-
CES, NAMELY, DERMATOLOGY SERVICES, IN
CLASS 44 (U.S. CLS. 100 AND 101).

FIRST USE 10-1-2003; IN COMMERCE 10-1-2003.

THE MARK CONSISTS OF STANDARD CHAR-
ACTERS WITHOUT CLAIM TO ANY PARTICULAR
FONT, STYLE, SIZE, OR COLOR.

OWNER OF U.S. REG. NO. 3,365,546.

SER. NO. 77-372,700, FILED 1-16-2008.

SAIMA MAKHDOOM, EXAMINING ATTORNEY

Int. Cl.: 35

Prior U.S. Cls.: 100, 101 and 102

United States Patent and Trademark Office

Reg. No. 3,484,686

Registered Aug. 12, 2008

**SERVICE MARK
PRINCIPAL REGISTER**

KASS' KORNER

KIM A. SCHIDRICH (SOUTH CAROLINA SOLE
PROPRIETORSHIP), DBA KASS' KORNER
2 STILLWATER LANE
BLUFFTON, SC 29910

FOR: PROVIDING SPACE AT A WEB SITE FOR
THE ADVERTISEMENT OF THE GOODS AND
SERVICES OF OTHERS; OPERATING AN ONLINE
SHOPPING SITE IN THE FIELD OF WOMEN'S
ACCESSORIES AND GIFTS; PROVIDING A WEB
SITE AT WHICH USERS CAN OFFER GOODS FOR
SALE AND BUY GOODS OFFERED BY OTHERS;
PROVIDING A WEB SITE WHICH FEATURES AD-
VERTISEMENTS FOR THE GOODS AND SERVICES

OF OTHERS ON A GLOBAL COMPUTER NET-
WORK, IN CLASS 35 (U.S. CLS. 100, 101 AND 102).

FIRST USE 10-1-2006; IN COMMERCE 10-1-2006.

THE MARK CONSISTS OF STANDARD CHAR-
ACTERS WITHOUT CLAIM TO ANY PARTICULAR
FONT, STYLE, SIZE, OR COLOR.

SER. NO. 77-372,725, FILED 1-16-2008.

EDWARD FENNESSY, EXAMINING ATTORNEY

Int. Cl.: 35

Prior U.S. Cls.: 100, 101 and 102

United States Patent and Trademark Office

Reg. No. 3,484,687

Registered Aug. 12, 2008

**SERVICE MARK
PRINCIPAL REGISTER**

Besco Custom Jewelers

EDMONDSON, BRETT STEPHEN (UNITED STATES INDIVIDUAL), DBA BESCO JEWELERS

9864 VALLEY VIEW
COLLEGE STATION, TX 77845

FOR: RETAIL JEWELRY STORES, IN CLASS 35 (U.S. CLS. 100, 101 AND 102).

FIRST USE 4-15-1983; IN COMMERCE 4-15-1983.

THE MARK CONSISTS OF STANDARD CHARACTERS WITHOUT CLAIM TO ANY PARTICULAR FONT, STYLE, SIZE, OR COLOR.

NO CLAIM IS MADE TO THE EXCLUSIVE RIGHT TO USE "CUSTOM JEWELERS", APART FROM THE MARK AS SHOWN.

SER. NO. 77-372,742, FILED 1-16-2008.

KATINA MISTER, EXAMINING ATTORNEY

Int. Cl.: 16

Prior U.S. Cls.: 2, 5, 22, 23, 29, 37, 38 and 50

Reg. No. 3,484,688

United States Patent and Trademark Office

Registered Aug. 12, 2008

**TRADEMARK
PRINCIPAL REGISTER**



THE JOHN R. ELLIOTT FOUNDATION (NEW
JERSEY NON-PROFIT CORPORATION)
304 ROSEMARIE DRIVE
EGG HARBOR, NJ 08234

FOR: STICKERS, IN CLASS 16 (U.S. CLS. 2, 5, 22,
23, 29, 37, 38 AND 50).

FIRST USE 10-31-2005; IN COMMERCE 10-31-2005.

NO CLAIM IS MADE TO THE EXCLUSIVE
RIGHT TO USE "CAMPAIGN FOR DESIGNATED
DRIVERS", APART FROM THE MARK AS SHOWN.

THE NAME IN THE MARK DOES NOT IDENTIFY
A LIVING INDIVIDUAL.

SER. NO. 77-372,775, FILED 1-16-2008.

MIDGE BUTLER, EXAMINING ATTORNEY

Int. Cl.: 41

Prior U.S. Cls.: 100, 101 and 107

United States Patent and Trademark Office

Reg. No. 3,484,689

Registered Aug. 12, 2008

**SERVICE MARK
PRINCIPAL REGISTER**

IT'S YOUR SPEED

MICHIGAN INTERNATIONAL SPEEDWAY, INC.
(MICHIGAN CORPORATION)
ATTN: KAREN B. LEETZOW
1801 W. INTERNATIONAL SPEEDWAY BLVD.
DAYTONA BEACH, FL 32114

FOR: ENTERTAINMENT SERVICES, NAMELY,
CONDUCTING AND ORGANIZING MOTOR-
SPORTS RACING EVENTS, IN CLASS 41 (U.S. CLS.
100, 101 AND 107).

FIRST USE 4-30-2007; IN COMMERCE 4-30-2007.

THE MARK CONSISTS OF STANDARD CHAR-
ACTERS WITHOUT CLAIM TO ANY PARTICULAR
FONT, STYLE, SIZE, OR COLOR.

SER. NO. 77-372,835, FILED 1-16-2008.

BENJAMIN ALLEN, EXAMINING ATTORNEY

Int. Cl.: 36

Prior U.S. Cls.: 100, 101 and 102

United States Patent and Trademark Office

Reg. No. 3,484,690

Registered Aug. 12, 2008

SERVICE MARK
PRINCIPAL REGISTER



AMERICASBANK CORP. (MARYLAND CORPORATION)
500 YORK ROAD
TOWSON, MD 212045103

FOR: BANKING SERVICES, IN CLASS 36 (U.S. CLS. 100, 101 AND 102).

FIRST USE 8-1-2007; IN COMMERCE 9-10-2007.

OWNER OF U.S. REG. NOS. 2,246,780, 2,427,771, AND 3,207,470.

NO CLAIM IS MADE TO THE EXCLUSIVE RIGHT TO USE "ANNAPOLIS COMMUNITY BANK" AND "DIVISION", APART FROM THE MARK AS SHOWN.

THE MARK CONSISTS OF A LAMP POST WITH A HANGING FLAG CONTAINING THE CAPITAL LETTER "A" IN STYLIZED TEXT. IMMEDIATELY TO THE RIGHT OF THE LAMP POST ARE THE WORDS "ANNAPOLIS COMMUNITY BANK", (EACH WORD APPEARING ON A SEPARATE LINE) WITH THE WORD "ANNAPOLIS" APPEARING IN BOLD STYLIZED TEXT. DIRECTLY BENEATH THE WORD "BANK" ARE THE WORDS "A DIVISION OF AMERICASBANK" IN SMALLER LETTERS .

SER. NO. 77-372,867, FILED 1-16-2008.

ROBIN CHOSID, EXAMINING ATTORNEY

Int. Cl.: 35

Prior U.S. Cls.: 100, 101 and 102

United States Patent and Trademark Office

Reg. No. 3,484,691

Registered Aug. 12, 2008

**SERVICE MARK
PRINCIPAL REGISTER**

KROBAR

KROBAR CUSTOM WHEELS (OREGON LTD
LIAB CO)
13707 S.W. PACIFIC HWY.
TIGARD, OR 97223

THE MARK CONSISTS OF STANDARD CHAR-
ACTERS WITHOUT CLAIM TO ANY PARTICULAR
FONT, STYLE, SIZE, OR COLOR.

FOR: RETAIL STORE SERVICES FEATURING
CUSTOM WHEELS, CLOTHING, SKATEBOARDS,
AUDIO EQUIPMENT, ART PAINT PRODUCTS, IN
CLASS 35 (U.S. CLS. 100, 101 AND 102).

SER. NO. 77-372,874, FILED 1-16-2008.

FIRST USE 1-19-1997; IN COMMERCE 9-17-2007.

CAROLYN CATALDO, EXAMINING ATTORNEY

Int. Cl.: 20

Prior U.S. Cls.: 2, 13, 22, 25, 32 and 50

United States Patent and Trademark Office

Reg. No. 3,484,692

Registered Aug. 12, 2008

**TRADEMARK
PRINCIPAL REGISTER**

CHILEWICH

SANDRA CHILEWICH (UNITED STATES INDIVIDUAL)
44 EAST 32ND STREET
NEW YORK, NY 10016

FOR: WINDOW SHADES, IN CLASS 20 (U.S. CLS. 2, 13, 22, 25, 32 AND 50).

FIRST USE 10-11-2007; IN COMMERCE 10-11-2007.

THE MARK CONSISTS OF STANDARD CHARACTERS WITHOUT CLAIM TO ANY PARTICULAR FONT, STYLE, SIZE, OR COLOR.

OWNER OF U.S. REG. NOS. 2,687,261, 2,982,067, AND 3,082,689.

SER. NO. 77-372,875, FILED 1-16-2008.

CAROLYN CATALDO, EXAMINING ATTORNEY

Int. Cl.: 39

Prior U.S. Cls.: 100 and 105

United States Patent and Trademark Office

Reg. No. 3,484,693

Registered Aug. 12, 2008

**SERVICE MARK
PRINCIPAL REGISTER**

2 Clean Cut Guys

2 CLEAN CUT GUYS LLC (SOUTH CAROLINA
LTD LIAB CO)
4815 ORCHID WAY, UNIT 303
MYRTLE BEACH, SC 29577

THE MARK CONSISTS OF STANDARD CHAR-
ACTERS WITHOUT CLAIM TO ANY PARTICULAR
FONT, STYLE, SIZE, OR COLOR.

FOR: FURNITURE MOVING, IN CLASS 39 (U.S.
CLS. 100 AND 105).

SER. NO. 77-372,894, FILED 1-16-2008.

FIRST USE 10-26-2007; IN COMMERCE 1-1-2008.

MICHAEL KEATING, EXAMINING ATTORNEY

Int. Cl.: 42

Prior U.S. Cls.: 100 and 101

United States Patent and Trademark Office

Reg. No. 3,484,694

Registered Aug. 12, 2008

**SERVICE MARK
PRINCIPAL REGISTER**

CHEW ON THE WEB FOR A WHILE

LAKATOS, CHRIS (UNITED STATES INDIVIDUAL)
P.O. BOX 951
BIRMINGHAM, MI 48012

THE MARK CONSISTS OF STANDARD CHARACTERS WITHOUT CLAIM TO ANY PARTICULAR FONT, STYLE, SIZE, OR COLOR.

FOR: COMPUTER SERVICES, NAMELY, PROVIDING SEARCH ENGINES FOR OBTAINING DATA ON A GLOBAL COMPUTER NETWORK, IN CLASS 42 (U.S. CLS. 100 AND 101).

SER. NO. 77-372,957, FILED 1-16-2008.

FIRST USE 12-4-2007; IN COMMERCE 12-4-2007.

STEVEN R. FOSTER, EXAMINING ATTORNEY

Int. Cl.: 12

Prior U.S. Cls.: 19, 21, 23, 31, 35 and 44

Reg. No. 3,484,695

United States Patent and Trademark Office

Registered Aug. 12, 2008

**TRADEMARK
PRINCIPAL REGISTER**



SCRANTON MANUFACTURING COMPANY
INC. (IOWA CORPORATION)
101 STATE STREET
SCRANTON, IA 51462

FOR: REFUSE TRUCKS, IN CLASS 12 (U.S. CLS.
19, 21, 23, 31, 35 AND 44).

FIRST USE 9-17-2007; IN COMMERCE 9-17-2007.

THE COLOR(S) SILVER AND LIME GREEN IS/
ARE CLAIMED AS A FEATURE OF THE MARK.

THE MARK CONSISTS OF OUTER OVAL SHAPE
IS SILVER. A STYLIZED SILVER "N" EXTENDS
AROUND THE TOP AND LEFT AND AROUND
THE BOTTOM AND UPPER RIGHT, SITS ON TOP
OF A LIME GREEN COLORED BASE.

SER. NO. 77-372,961, FILED 1-16-2008.

CAROLINE WOOD, EXAMINING ATTORNEY

Int. Cl.: 25

Prior U.S. Cls.: 22 and 39

United States Patent and Trademark Office

Reg. No. 3,484,696

Registered Aug. 12, 2008

**TRADEMARK
PRINCIPAL REGISTER**

JAC A LINA

ROGERS, CINDY (UNITED STATES INDIVIDUAL)
1880 CHEROKEE DRIVE, UNIT F
SALINAS, CA 93906

FOR: BABY BODYSUITS; BABY BOTTOMS; BABY TOPS; CLOTH BIBS; INFANT AND TODDLER ONE PIECE CLOTHING; INFANT WEAR, IN CLASS 25 (U.S. CLS. 22 AND 39).

FIRST USE 11-1-2005; IN COMMERCE 11-1-2005.

THE MARK CONSISTS OF STANDARD CHARACTERS WITHOUT CLAIM TO ANY PARTICULAR FONT, STYLE, SIZE, OR COLOR.

SER. NO. 77-372,988, FILED 1-16-2008.

MIDGE BUTLER, EXAMINING ATTORNEY

Int. Cl.: 44

Prior U.S. Cls.: 100 and 101

United States Patent and Trademark Office

Reg. No. 3,484,697

Registered Aug. 12, 2008

**SERVICE MARK
PRINCIPAL REGISTER**



PRIORITY HOUSE, INC. (NORTH CAROLINA
NON-PROFIT CORPORATON), DBA PRIORITY
HOUSE OF STATESVILLE, INC.
117 MCELWEE ST.
STATESVILLE, NC 28677

FOR: REHABILITATION OF ALCOHOL ADDICTED
PATIENTS; REHABILITATION OF DRUG ADDICTED
PATIENTS; REHABILITATION OF NARCOTIC
ADDICTED PATIENTS, IN CLASS 44
(U.S. CLS. 100 AND 101).

FIRST USE 1-1-1998; IN COMMERCE 1-1-1998.

THE COLOR(S) BLUE, WHITE, AND YELLOW IS/
ARE CLAIMED AS A FEATURE OF THE MARK.

THE MARK CONSISTS OF THE BUSTS OF TWO
HEADS SHOWN IN PROFILE WITH ONE FACING
TO THE RIGHT THE OTHER TO THE LEFT. THE
BUSTS ARE SURROUNDED BY A HOUSE. THE
HOUSE IS SURROUNDED BY A SHADED REC-

TANGLE WHICH CONTAINS A WAVY BOTTOM
EDGE BELOW THE HOUSE. BELOW THE WAVY
EDGE IS AN OVAL OF THE LEFT SIDE OF THE
MARK. THE COLOR BLUE APPEARS IN THE
DEPICTION OF THE SHADED RECTANGLE WITH
A WAVY EDGE, THE DEPICTION OF THE HOUSE,
AS WELL AS IN THE BUST SHOWN IN PROFILE ON
THE LEFT SIDE. THE COLOR WHITE APPEARS IN
THE DEPICTION OF THE OUTER BORDER OF THE
HOUSE AND BUST SHOWN IN PROFILE ON THE
LEFT SIDE, AS WELL AS THE BUST SHOWN IN
PROFILE ON THE RIGHT SIDE. THE COLOR
YELLOW APPEARS IN THE DEPICTION OF THE
OVAL OF THE LEFT SIDE OF THE MARK BELOW
THE HOUSE. THE COLOR WHITE IN THE BOTTOM
WAVE PORTION OF THE MARK IS REPRESENTS
BACKGROUND OR A TRANSPARENT AREA AND
IS NOT PART OF THE MARK.

SER. NO. 77-372,995, FILED 1-16-2008.

MICHAEL TANNER, EXAMINING ATTORNEY

Int. Cl.: 25

Prior U.S. Cls.: 22 and 39

United States Patent and Trademark Office

Reg. No. 3,484,698

Registered Aug. 12, 2008

TRADEMARK
PRINCIPAL REGISTER

The image shows the trademark 'jaca lina' written in a cursive, handwritten style. The letters are black on a white background. Above the 'j' is a heart, above the 'a' is a heart, and above the 'l' is a heart. The 'i' in 'lina' has a dot.

ROGERS, CINDY (UNITED STATES INDIVIDUAL)
1880 CHEROKEE DRIVE, UNIT 5
SALINAS, CA 93906

THE MARK CONSISTS OF THE WORDS "JAC A LINA" IN SCRIPT WITH HEARTS ABOVE THE "J" AND THE "I" AND ON EITHER SIDE OF THE "A".

FOR: BABY BODYSUITS; BABY BOTTOMS; BABY TOPS; CLOTH BIBS; INFANT AND TODDLER ONE PIECE CLOTHING; INFANT WEAR, IN CLASS 25 (U.S. CLS. 22 AND 39).

SER. NO. 77-373,006, FILED 1-16-2008.

FIRST USE 11-1-2005; IN COMMERCE 11-1-2005.

MIDGE BUTLER, EXAMINING ATTORNEY

Int. Cl.: 9

Prior U.S. Cls.: 21, 23, 26, 36 and 38

Reg. No. 3,484,699

United States Patent and Trademark Office

Registered Aug. 12, 2008

**TRADEMARK
PRINCIPAL REGISTER**

GET CARDED

REGAL ENTERTAINMENT GROUP (DELA-
WARE CORPORATION)
7132 REGAL LANE
KNOXVILLE, TN 37918

THE MARK CONSISTS OF STANDARD CHAR-
ACTERS WITHOUT CLAIM TO ANY PARTICULAR
FONT, STYLE, SIZE, OR COLOR.

FOR: MAGNETIC CODED GIFT CARDS, IN
CLASS 9 (U.S. CLS. 21, 23, 26, 36 AND 38).

SER. NO. 77-373,009, FILED 1-16-2008.

FIRST USE 3-17-2006; IN COMMERCE 3-17-2006.

KEVIN DINALLO, EXAMINING ATTORNEY

Int. Cl.: 9

Prior U.S. Cls.: 21, 23, 26, 36 and 38

Reg. No. 3,484,700

United States Patent and Trademark Office

Registered Aug. 12, 2008

**TRADEMARK
PRINCIPAL REGISTER**

HAVE SOME FUN IN THE DARK

REGAL ENTERTAINMENT GROUP (DELA-
WARE CORPORATION)
7132 REGAL LANE
KNOXVILLE, TN 37918

THE MARK CONSISTS OF STANDARD CHAR-
ACTERS WITHOUT CLAIM TO ANY PARTICULAR
FONT, STYLE, SIZE, OR COLOR.

FOR: MAGNETIC CODED GIFT CARDS, IN
CLASS 9 (U.S. CLS. 21, 23, 26, 36 AND 38).

SER. NO. 77-373,011, FILED 1-16-2008.

FIRST USE 5-3-2006; IN COMMERCE 5-3-2006.

KEVIN DINALLO, EXAMINING ATTORNEY

Int. Cl.: 9

Prior U.S. Cls.: 21, 23, 26, 36 and 38

United States Patent and Trademark Office

Reg. No. 3,484,701

Registered Aug. 12, 2008

**TRADEMARK
PRINCIPAL REGISTER**

COMMVAULT GALAXY

COMMVAULT SYSTEMS, INC. (NEW JERSEY
CORPORATION)
PO BOX 900
OCEANPORT, NJ 07757

FOR: COMPUTER SOFTWARE FOR INFORMATION DATA STORAGE AND RETRIEVAL, NAME-
LY, TO ACCESS, RETRIEVE, MANAGE, AND RECOVER DATA STORED ON MAGNETIC DISK,
TAPE, AND OTHER FORMS OF STORAGE RE-SOURCES, IN CLASS 9 (U.S. CLS. 21, 23, 26, 36 AND
38).

FIRST USE 7-18-2000; IN COMMERCE 7-18-2000.

THE MARK CONSISTS OF STANDARD CHAR-
ACTERS WITHOUT CLAIM TO ANY PARTICULAR
FONT, STYLE, SIZE, OR COLOR.

OWNER OF U.S. REG. NOS. 1,650,465, 2,675,884
AND OTHERS.

SER. NO. 77-373,015, FILED 1-16-2008.

ESTHER BELENKER, EXAMINING ATTORNEY

Int. Cl.: 43

Prior U.S. Cls.: 100 and 101

United States Patent and Trademark Office

Reg. No. 3,484,702

Registered Aug. 12, 2008

SERVICE MARK
PRINCIPAL REGISTER

The logo for Priority House features the word "Priority" in a large, blue, serif font with a 3D effect, and the word "House" in a smaller, blue, serif font with a 3D effect. The letters are blue with a gray shadow behind them, giving the impression of depth.

PRIORITY HOUSE, INC. (NORTH CAROLINA
NON-PROFIT CORPORATION), DBA PRIOR-
ITY HOUSE OF STATESVILLE, INC.
117 MCELWEE STREET
STATESVILLE, NC 28677

FOR: PROVIDING CONGREGATE LIVING FA-
CILITIES, IN CLASS 43 (U.S. CLS. 100 AND 101).

FIRST USE 1-1-1998; IN COMMERCE 1-1-1998.

NO CLAIM IS MADE TO THE EXCLUSIVE
RIGHT TO USE "HOUSE", APART FROM THE
MARK AS SHOWN.

THE COLOR(S) BLUE AND GRAY IS/ARE
CLAIMED AS A FEATURE OF THE MARK.

THE COLOR BLUE APPEARS IN THE WORDING
"PRIORITY HOUSE"; THE COLOR GRAY APPEARS
AS THREE-DIMENSIONAL SHADING ON THE
WORDING "PRIORITY HOUSE".

SER. NO. 77-373,074, FILED 1-16-2008.

MICHAEL TANNER, EXAMINING ATTORNEY

Int. Cls.: 39 and 42

Prior U.S. Cls.: 100, 101 and 105

United States Patent and Trademark Office

Reg. No. 3,484,703

Registered Aug. 12, 2008

**SERVICE MARK
PRINCIPAL REGISTER**

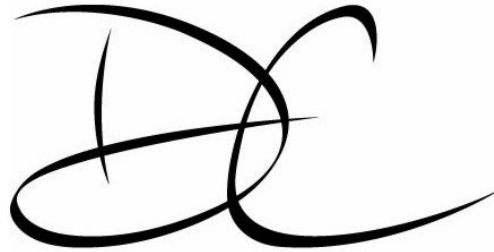

DIAMOND COACH LEASING, LLC (ILLINOIS
LTD LIAB CO)
533 HICKORY HILLS BLVD.
WHITES CREEK, TN 37189

FOR: LEASING OF CUSTOMIZED COACHES TO
THE ENTERTAINMENT INDUSTRY, IN CLASS 39
(U.S. CLS. 100 AND 105).

FIRST USE 3-0-2002; IN COMMERCE 3-0-2002.

FOR: CUSTOM DESIGN AND DEVELOPMENT
OF COACHES FOR THE ENTERTAINMENT IN-
DUSTRY, IN CLASS 42 (U.S. CLS. 100 AND 101).

FIRST USE 3-0-2002; IN COMMERCE 3-0-2002.

SER. NO. 77-373,080, FILED 1-16-2008.

KAELIE KUNG, EXAMINING ATTORNEY

Int. Cl.: 12

Prior U.S. Cls.: 19, 21, 23, 31, 35 and 44

Reg. No. 3,484,704

United States Patent and Trademark Office

Registered Aug. 12, 2008

**TRADEMARK
PRINCIPAL REGISTER**

POWERFAB

POWERSECURE, INC. (DELAWARE CORPORATION)
1609 HERITAGE COMMERCE COURT
WAKE FOREST, NC 27587

THE MARK CONSISTS OF STANDARD CHARACTERS WITHOUT CLAIM TO ANY PARTICULAR FONT, STYLE, SIZE, OR COLOR.

FOR: TRAILERS; MOBILE STORAGE TANKS, IN CLASS 12 (U.S. CLS. 19, 21, 23, 31, 35 AND 44).

SER. NO. 77-373,226, FILED 1-16-2008.

FIRST USE 1-10-2008; IN COMMERCE 3-7-2008.

PAUL F. GAST, EXAMINING ATTORNEY

Int. Cl.: 41

Prior U.S. Cls.: 100, 101 and 107

Reg. No. 3,484,705

United States Patent and Trademark Office

Registered Aug. 12, 2008

**SERVICE MARK
PRINCIPAL REGISTER**

BAMT

BAY AREA MOTORCYCLE TRAINING, INC.
(CALIFORNIA CORPORATION)
156 SOUTH SPRUCE AVENUE, SUITE 202
SOUTH SAN FRANCISCO, CA 94080

FIRST USE 9-21-2000; IN COMMERCE 9-21-2000.

FOR: EDUCATION SERVICES, NAMELY, ARRANGING AND CONDUCTING CLASSES, SEMINARS, AND WORKSHOPS IN THE FIELDS OF MOTORCYCLES AND MOTORCYCLE SAFETY, IN CLASS 41 (U.S. CLS. 100, 101 AND 107).

THE MARK CONSISTS OF STANDARD CHARACTERS WITHOUT CLAIM TO ANY PARTICULAR FONT, STYLE, SIZE, OR COLOR.

SER. NO. 77-373,257, FILED 1-16-2008.

KRISTIN CARLSON, EXAMINING ATTORNEY

Int. Cl.: 41

Prior U.S. Cls.: 100, 101 and 107

United States Patent and Trademark Office

Reg. No. 3,484,706

Registered Aug. 12, 2008

**SERVICE MARK
PRINCIPAL REGISTER**



BAY AREA MOTORCYCLE TRAINING, INC.
(CALIFORNIA CORPORATION)
156 SOUTH SPRUCE AVENUE, SUITE 202
SOUTH SAN FRANCISCO, CA 94080

FOR: EDUCATION SERVICES, NAMELY, ARRANGING AND CONDUCTING CLASSES, SEMINARS, AND WORKSHOPS IN THE FIELDS OF MOTORCYCLES AND MOTORCYCLE SAFETY, IN CLASS 41 (U.S. CLS. 100, 101 AND 107).

FIRST USE 7-0-1999; IN COMMERCE 7-0-1999.

THE MARK CONSISTS OF A DEPICTION OF AN INDIVIDUAL RIDING A MOTORCYCLE (FRONT VIEW) WITH A SUPPORT STRUCTURE FROM A SUSPENSION BRIDGE IN THE BACKGROUND.

SER. NO. 77-373,265, FILED 1-16-2008.

KRISTIN CARLSON, EXAMINING ATTORNEY

Int. Cl.: 37

Prior U.S. Cls.: 100, 103 and 106

United States Patent and Trademark Office

Reg. No. 3,484,707

Registered Aug. 12, 2008

**SERVICE MARK
PRINCIPAL REGISTER**



DUN-WELL PLUMBING AND DRAINS, INC.
(CALIFORNIA CORPORATION)
UNIT K
2300 CENTRAL AVE
DUARTE, CA 91010

FOR: COMMERCIAL AND RESIDENTIAL
PLUMBING SERVICES PLUMBING REPAIR
DRAIN AND SEWER CLEANING DRAIN AND
SEWER REPAIR, IN CLASS 37 (U.S. CLS. 100, 103
AND 106).

FIRST USE 4-10-2002; IN COMMERCE 4-10-2002.

THE COLOR(S) BLUE, LIGHT BLUE, BLACK,
WHITE, ORANGE, GREY IS/ARE CLAIMED AS A
FEATURE OF THE MARK.

THE MARK CONSISTS OF MAN WEARING A
BLUE HAT. THE FRONT OF THE HAT HAS A
LIGHT BLUE PATCH, AND THE BILL OF THE HAT
IS DARK BLUE. THE MAN HAS BLACK HAIR.
FACE IS WHITE WITH BLACK OUTLINE FOR
FACIAL FEATURES. THE MAN HAS AN ORANGE
TONGUE WHICH IS HANGING OUT. THE MAN IS
WEARING A BLUE SHIRT. THE MAN HAS WHITE
HANDS WHICH ARE HOLDING AN ORANGE PIPE
WRENCH. THE ORANGE PIPE WRENCH IS GRIP-
PING A GREY PIPE. THERE ARE THREE GREY
PIPES WHICH ARE CONNECTED ON OPPOSITE
ENDS AT A 90 DEGREE ANGLE..

SER. NO. 77-373,268, FILED 1-16-2008.

ANTHONY RINKER, EXAMINING ATTORNEY

Int. Cl.: 41

Prior U.S. Cls.: 100, 101 and 107

United States Patent and Trademark Office

Reg. No. 3,484,708

Registered Aug. 12, 2008

**SERVICE MARK
PRINCIPAL REGISTER**

Creative Groove

JONES, JENNIFER L. (UNITED STATES INDIVIDUAL)
APT. 103
1321 NORTH VISTA STREET
LOS ANGELES, CA 90046

FOR: DANCE INSTRUCTION; DANCE INSTRUCTION FOR CHILDREN; LIFE COACHING SERVICES IN THE FIELD OF CREATIVITY AND FULFILLMENT; PERSONAL COACHING SERVICES IN THE FIELD OF PERSONAL RELATIONSHIPS AND WELL-BEING; PROFESSIONAL COACHING SERVICES IN THE FIELD OF CAREER PLANNING; CUSTOM WRITING SERVICES; WRIT-

ING OF ARTICLES FOR PERIODICALS OTHER THAN FOR ADVERTISING OR PUBLICITY, IN CLASS 41 (U.S. CLS. 100, 101 AND 107).

FIRST USE 4-1-2005; IN COMMERCE 4-1-2005.

THE MARK CONSISTS OF STANDARD CHARACTERS WITHOUT CLAIM TO ANY PARTICULAR FONT, STYLE, SIZE, OR COLOR.

SER. NO. 77-373,341, FILED 1-16-2008.

MICHAEL KEATING, EXAMINING ATTORNEY

Int. Cl.: 43

Prior U.S. Cls.: 100 and 101

United States Patent and Trademark Office

Reg. No. 3,484,709

Registered Aug. 12, 2008

**SERVICE MARK
PRINCIPAL REGISTER**



CHAPARRO'S MEXICAN FOOD, INC. (CALI-
FORNIA CORPORATION)
2595 COMMERCE WAY
VISTA, CA 92081

FOR: RESTAURANT SERVICES; RESTAURANTS,
IN CLASS 43 (U.S. CLS. 100 AND 101).

FIRST USE 3-5-1996; IN COMMERCE 3-5-1996.

OWNER OF U.S. REG. NO. 1,976,736.

NO CLAIM IS MADE TO THE EXCLUSIVE
RIGHT TO USE "MEXICAN FOOD", APART FROM
THE MARK AS SHOWN.

THE MARK CONSISTS OF A WAITER WEARING
A SOMBRERO AND HOLDING A PLATTER SUR-
ROUNDED BY THE WORDING "ALBERTO'S MEX-
ICAN FOOD".

SER. NO. 77-373,347, FILED 1-16-2008.

KEVIN DINALLO, EXAMINING ATTORNEY

Int. Cls.: 6 and 12

**Prior U.S. Cls.: 2, 12, 13, 14, 19, 21, 23, 25, 31, 35, 44
and 50**

Reg. No. 3,484,710

United States Patent and Trademark Office

Registered Aug. 12, 2008

**TRADEMARK
PRINCIPAL REGISTER**

The logo consists of the words "Tail" and "Gator" stacked vertically. The letters are rendered in a bold, serif font with a highly textured, embossed appearance, similar to a metal surface or a stamp. The "T" in "Tail" is particularly prominent, and the "G" in "Gator" is also large and stylized.

MIZ ENGINEERING, LTD. (TAIWAN CORPORATION)
NO. 99 CHUNG SHAN SOUTH ROAD
KANSAN, KAOHSIUNG, TAIWAN

FOR: METAL LOCKS FOR THE TAILGATE OF
PICK-UP TRUCK VEHICLES, IN CLASS 6 (U.S. CLS.
2, 12, 13, 14, 23, 25 AND 50).

FIRST USE 5-1-2007; IN COMMERCE 5-1-2007.

FOR: ANTI-THEFT DEVICES FOR MOTOR CARS,
IN CLASS 12 (U.S. CLS. 19, 21, 23, 31, 35 AND 44).

FIRST USE 5-1-2007; IN COMMERCE 5-1-2007.

THE MARK CONSISTS OF THE WORDS "TAIL"
AND "GATOR" IN STYLIZED FONT, WITH THE
LETTER "T" IN "TAIL" AND THE LETTER "G" IN
"GATOR" CAPITALIZED WHILE THE REMAIN-
DER OF THE LETTERS ARE LOWERCASE; THE
LETTERS THEMSELVES ARE TEXTURED AND
ARE SURROUNDED BY A THIN, BARELY VISIBLE
SOLID BORDER; THE WORD "TAIL" IS LOCATED
ABOVE THE WORD "GATOR", WITH THE "A" IN
"TAIL" DIRECTLY OVER THE "G" IN "GATOR".

SER. NO. 77-373,353, FILED 1-16-2008.

JOHN WILKE, EXAMINING ATTORNEY

Int. Cl.: 35

Prior U.S. Cls.: 100, 101 and 102

United States Patent and Trademark Office

Reg. No. 3,484,711

Registered Aug. 12, 2008

**SERVICE MARK
PRINCIPAL REGISTER**

**UPSTREAM, DOWNSTREAM &
OVER THE DAM**

PREVENTCARE OF AMERICA, INC. (OHIO CORPORATION)
P.O. BOX 13074
AKRON, OH 44334

FIRST USE 11-15-2007; IN COMMERCE 11-15-2007.

FOR: BUSINESS CONSULTATION, NAMELY, SPECIALIZED HEALTH AND WELLNESS MANAGEMENT SERVICES FOCUSING ON FREE RADICAL OXIDATION MANAGEMENT FOR THE PURPOSE OF MEASURABLY AND PROACTIVELY CONTAINING, CONTROLLING AND REDUCING EMPLOYERS AND EMPLOYEES HEALTH CARE COSTS, IN CLASS 35 (U.S. CLS. 100, 101 AND 102).

THE MARK CONSISTS OF STANDARD CHARACTERS WITHOUT CLAIM TO ANY PARTICULAR FONT, STYLE, SIZE, OR COLOR.

SER. NO. 77-373,381, FILED 1-16-2008.

REBECCA GILBERT, EXAMINING ATTORNEY

Int. Cl.: 35

Prior U.S. Cls.: 100, 101 and 102

United States Patent and Trademark Office

Reg. No. 3,484,712

Registered Aug. 12, 2008

**SERVICE MARK
PRINCIPAL REGISTER**

TKDAinc.

DINE, KEVA (UNITED STATES INDIVIDUAL)
1611-A SOUTH MELROSE DRIVE, NO. 340
VISTA, CA 92081

FOR: CAREER PLACEMENT; CONSULTANCY OF PERSONNEL RECRUITMENT; EMPLOYMENT COUNSELING AND RECRUITING; EMPLOYMENT HIRING, RECRUITING, PLACEMENT, STAFFING AND CAREER NETWORKING SERVICES; EMPLOYMENT OUTPLACEMENT SERVICES; EMPLOYMENT RECRUITING CONSULTATION; EXECUTIVE SEARCH AND PLACEMENT SERVICES; TALENT AGENCIES; JOB AND PERSONNEL PLACEMENT, IN CLASS 35 (U.S. CLS. 100, 101 AND 102).

FIRST USE 5-0-2007; IN COMMERCE 5-0-2007.

NO CLAIM IS MADE TO THE EXCLUSIVE RIGHT TO USE "INC", APART FROM THE MARK AS SHOWN.

THE MARK CONSISTS OF THE LETTERS "TKDA" IN CAPITALS, FOLLOWED BY "INC" IN LOWER CASE.

SER. NO. 77-373,409, FILED 1-16-2008.

JOHN E. MICHOS, EXAMINING ATTORNEY

Int. Cl.: 35

Prior U.S. Cls.: 100, 101 and 102

United States Patent and Trademark Office

Reg. No. 3,484,713

Registered Aug. 12, 2008

**SERVICE MARK
PRINCIPAL REGISTER**

GOT PARTS?

GLOBAL PARTS SOLUTION, LLC (ARIZONA
LTD LIAB CO)
8340 N. THORNYDALE RD. #110-321
TUCSON, AZ 85741

FOR: ON-LINE PROCUREMENT SERVICES,
NAMELY, PURCHASING MINING, CONSTRUCTION
AND AGRICULTURAL EQUIPMENT; COMPUTERIZED
ON-LINE ORDERING SERVICES FEATURING
SURPLUS MINING, CONSTRUCTION AND
AGRICULTURAL EQUIPMENT, IN CLASS 35
(U.S. CLS. 100, 101 AND 102).

FIRST USE 1-31-2007; IN COMMERCE 1-31-2007.

THE MARK CONSISTS OF STANDARD CHARACTERS
WITHOUT CLAIM TO ANY PARTICULAR
FONT, STYLE, SIZE, OR COLOR.

NO CLAIM IS MADE TO THE EXCLUSIVE
RIGHT TO USE "PARTS", APART FROM THE
MARK AS SHOWN.

SER. NO. 77-373,438, FILED 1-16-2008.

TARAH HARDY, EXAMINING ATTORNEY

Int. Cl.: 4

Prior U.S. Cls.: 1, 6 and 15

United States Patent and Trademark Office

Reg. No. 3,484,714

Registered Aug. 12, 2008

**TRADEMARK
PRINCIPAL REGISTER**

STARDOM

TYLER CANDLE COMPANY, L.L.C. (TEXAS LTD
LIAB CO)
11733 HIGHWAY 155 NORTH
TYLER, TX 75708

THE MARK CONSISTS OF STANDARD CHAR-
ACTERS WITHOUT CLAIM TO ANY PARTICULAR
FONT, STYLE, SIZE, OR COLOR.

FOR: CANDLES, IN CLASS 4 (U.S. CLS. 1, 6 AND
15).

SER. NO. 77-373,440, FILED 1-16-2008.

FIRST USE 1-1-2008; IN COMMERCE 1-1-2008.

SANJEEV VOHRA, EXAMINING ATTORNEY

Int. Cl.: 42

Prior U.S. Cls.: 100 and 101

United States Patent and Trademark Office

Reg. No. 3,484,715

Registered Aug. 12, 2008

**SERVICE MARK
PRINCIPAL REGISTER**

CLUB STOGIE

FLARE HOLDINGS LLC (MINNESOTA LTD
LIAB CO)
14531 BATAAN ST NE
HAM LAKE, MN 55304

FOR: DESIGNING AND DEVELOPING WEBPA-
GES ON THE INTERNET, IN CLASS 42 (U.S. CLS. 100
AND 101).

FIRST USE 10-15-1998; IN COMMERCE 10-15-1998.

THE MARK CONSISTS OF STANDARD CHAR-
ACTERS WITHOUT CLAIM TO ANY PARTICULAR
FONT, STYLE, SIZE, OR COLOR.

NO CLAIM IS MADE TO THE EXCLUSIVE
RIGHT TO USE "STOGIE", APART FROM THE
MARK AS SHOWN.

SER. NO. 77-373,448, FILED 1-16-2008.

SANJEEV VOHRA, EXAMINING ATTORNEY

Int. Cl.: 35

Prior U.S. Cls.: 100, 101 and 102

United States Patent and Trademark Office

Reg. No. 3,484,716

Registered Aug. 12, 2008

**SERVICE MARK
PRINCIPAL REGISTER**

Perfect

PERFECT BUSINESS SERVICES, INC. (TEXAS
CORPORATION)
17194 PRESTON RD., STE 215
DALLAS, TX 75248

FOR: ACCOUNTING SERVICES AND TAX PRE-
PARATION AND CONSULTING SERVICES AND
BUSINESS MANAGEMENT AND CONSULTING
SERVICES INCLUDING TAX AND TAXATION
PLANNING AND INCORPORATION, IN CLASS 35
(U.S. CLS. 100, 101 AND 102).

FIRST USE 8-15-2002; IN COMMERCE 8-15-2002.

THE MARK CONSISTS OF STANDARD CHAR-
ACTERS WITHOUT CLAIM TO ANY PARTICULAR
FONT, STYLE, SIZE, OR COLOR.

SER. NO. 77-373,458, FILED 1-16-2008.

TARAH HARDY, EXAMINING ATTORNEY

Int. Cl.: 36

Prior U.S. Cls.: 100, 101 and 102

United States Patent and Trademark Office

Reg. No. 3,484,717

Registered Aug. 12, 2008

**SERVICE MARK
PRINCIPAL REGISTER**

NEPC

NEPC,LLC (DELAWARE LTD LIAB CO)
ONE MAIN STREET, 8TH FLOOR
CAMBRIDGE, MA 02142

THE MARK CONSISTS OF STANDARD CHAR-
ACTERS WITHOUT CLAIM TO ANY PARTICULAR
FONT, STYLE, SIZE, OR COLOR.

FOR: RESEARCH AND CONSULTING SERVICES
IN THE FIELDS OF INVESTMENT MANAGEMENT
AND PENSION MANAGEMENT, IN CLASS 36 (U.S.
CLS. 100, 101 AND 102).

SER. NO. 77-373,459, FILED 1-16-2008.

FIRST USE 0-0-1986; IN COMMERCE 0-0-1986.

EVELYN BRADLEY, EXAMINING ATTORNEY

Int. Cl.: 36

Prior U.S. Cls.: 100, 101 and 102

United States Patent and Trademark Office

Reg. No. 3,484,718

Registered Aug. 12, 2008

**SERVICE MARK
PRINCIPAL REGISTER**

EAGLES WALK

STAR/HIRSCH EAGLES WALK, L.L.C. (DELA-
WARE LTD LIAB CO)
C/O HIRSCHFELD PROPERTIES
1030 NEW BRITAIN AVENUE
WEST HARTFORD, CT 061102268

THE MARK CONSISTS OF STANDARD CHAR-
ACTERS WITHOUT CLAIM TO ANY PARTICULAR
FONT, STYLE, SIZE, OR COLOR.

FOR: REAL ESTATE SERVICES, NAMELY, MAN-
AGEMENT AND RENTAL OF APARTMENTS, IN
CLASS 36 (U.S. CLS. 100, 101 AND 102).

SER. NO. 77-373,466, FILED 1-16-2008.

FIRST USE 0-0-2006; IN COMMERCE 0-0-2006.

ANDREW RHIM, EXAMINING ATTORNEY

Int. Cl.: 43

Prior U.S. Cls.: 100 and 101

United States Patent and Trademark Office

Reg. No. 3,484,719

Registered Aug. 12, 2008

**SERVICE MARK
PRINCIPAL REGISTER**



HARPER'S RESTAURANTS, INC. (NORTH CAROLINA CORPORATION)
SUITE 100
1228 EAST MOREHEAD STREET
CHARLOTTE, NC 28204

FOR: RESTAURANT AND BAR SERVICES, IN CLASS 43 (U.S. CLS. 100 AND 101).

FIRST USE 5-0-2007; IN COMMERCE 7-1-2007.

THE MARK CONSISTS OF A STYLIZED LETTER "M" AND FIVE DOTS ARRANGED IN THE SAME MANNER AS IF ON A PAIR OF DICE WITH ONE DOT IN EACH CORNER AND ONE DOT IN THE CENTER.

SER. NO. 77-373,471, FILED 1-16-2008.

TARAH HARDY, EXAMINING ATTORNEY

Int. Cls.: 9, 16 and 41

**Prior U.S. Cls.: 2, 5, 21, 22, 23, 26, 29, 36, 37, 38, 50,
100, 101 and 107**

Reg. No. 3,484,720

United States Patent and Trademark Office

Registered Aug. 12, 2008

**TRADEMARK
SERVICE MARK
PRINCIPAL REGISTER**

**PURPOSE IN LIFE: ETHICS AND
ORGANIZATIONAL SUCCESS**

THE PACIFIC INSTITUTE INCORPORATED
(WASHINGTON CORPORATION)
1709 HARBOR AVENUE SW
SEATTLE, WA 981262049

FOR: AUDIO AND VIDEO MEDIA, NAMELY,
PRE-RECORDED CDS AND DVDS CONTAINING
EDUCATIONAL AND MOTIVATIONAL COURSE
MATERIAL IN THE FIELD OF BUSINESS ETHICS
AND PROFESSIONAL DEVELOPMENT, IN CLASS 9
(U.S. CLS. 21, 23, 26, 36 AND 38).

FIRST USE 5-0-2004; IN COMMERCE 5-0-2004.

FOR: PRINTED MATTER, NAMELY, INSTRUC-
TION MANUALS AND WORKBOOKS CONTAIN-
ING EDUCATIONAL AND MOTIVATIONAL
MATERIAL IN THE FIELD OF BUSINESS ETHICS
AND PROFESSIONAL DEVELOPMENT, IN CLASS
16 (U.S. CLS. 2, 5, 22, 23, 29, 37, 38 AND 50).

FIRST USE 10-1-1996; IN COMMERCE 10-1-1996.

FOR: EDUCATIONAL AND MOTIVATIONAL
SEMINAR SERVICES IN THE FIELD OF BUSINESS
ETHICS AND PROFESSIONAL DEVELOPMENT, IN
CLASS 41 (U.S. CLS. 100, 101 AND 107).

FIRST USE 10-29-1996; IN COMMERCE 10-29-1996.

THE MARK CONSISTS OF STANDARD CHAR-
ACTERS WITHOUT CLAIM TO ANY PARTICULAR
FONT, STYLE, SIZE, OR COLOR.

OWNER OF U.S. REG. NO. 2,158,414.

NO CLAIM IS MADE TO THE EXCLUSIVE
RIGHT TO USE "ETHICS AND ORGANIZATIONAL
SUCCESS" IN CLASS 9 ONLY, APART FROM THE
MARK AS SHOWN.

SER. NO. 77-373,485, FILED 1-16-2008.

DANIEL CAPSHAW, EXAMINING ATTORNEY

Int. Cls.: 9 and 16

Prior U.S. Cls.: 2, 5, 21, 22, 23, 26, 29, 36, 37, 38 and 50

Reg. No. 3,484,721

United States Patent and Trademark Office

Registered Aug. 12, 2008

**TRADEMARK
PRINCIPAL REGISTER**

CENTERSCENE

THE CALIFORNIA ENDOWMENT (CALIFORNIA CORPORATION)
1000 NORTH ALAMEDA STREET
LOS ANGELES, CA 90012

FOR: PROVIDING DOWNLOADABLE ELECTRONIC NEWSLETTERS IN THE FIELD OF EDUCATING THE PUBLIC AND PROMOTING PUBLIC AWARENESS ON COMMUNITY HEALTH AND HEALTH CARE ISSUES, IN CLASS 9 (U.S. CLS. 21, 23, 26, 36 AND 38).

FIRST USE 3-15-2006; IN COMMERCE 3-15-2006.

FOR: NEWSLETTERS IN THE FIELD OF EDUCATING THE PUBLIC AND PROMOTING PUBLIC

AWARENESS ON COMMUNITY HEALTH AND HEALTH CARE ISSUES, IN CLASS 16 (U.S. CLS. 2, 5, 22, 23, 29, 37, 38 AND 50).

FIRST USE 3-15-2006; IN COMMERCE 3-15-2006.

THE MARK CONSISTS OF STANDARD CHARACTERS WITHOUT CLAIM TO ANY PARTICULAR FONT, STYLE, SIZE, OR COLOR.

SER. NO. 77-373,505, FILED 1-16-2008.

WILLIAM BRECKENFELD, EXAMINING ATTORNEY

Int. Cl.: 35

Prior U.S. Cls.: 100, 101 and 102

United States Patent and Trademark Office

Reg. No. 3,484,722

Registered Aug. 12, 2008

**SERVICE MARK
PRINCIPAL REGISTER**



OPTIMUM WEB MARKETING CONSULTANTS
(NEW JERSEY LTD LIAB CO)
P.O. BOX 391
CEDAR KNOLLS, NJ 07869

FOR: ON-LINE ADVERTISING AND MARKET-
ING SERVICES, IN CLASS 35 (U.S. CLS. 100, 101 AND
102).

FIRST USE 11-19-2007; IN COMMERCE 12-1-2007.

THE MARK CONSISTS OF A RECTANGLE WITH
A SERIES OF CIRCLES IN THE FORM OF A SWIRL/
ARCH WITH THE STYLIZED TEXT "OPTIMUM7"
BELOW THE CIRCLES. TO THE RIGHT OF THE
RECTANGLE ARE THE STYLIZED WORDS "BE-
CAUSE YOU NEVER KNOW WHO'S SEARCH-
ING...".

SER. NO. 77-373,506, FILED 1-16-2008.

TARAH HARDY, EXAMINING ATTORNEY

Int. Cl.: 9

Prior U.S. Cls.: 21, 23, 26, 36 and 38

Reg. No. 3,484,723

United States Patent and Trademark Office

Registered Aug. 12, 2008

**TRADEMARK
PRINCIPAL REGISTER**

THE MOD SQUAD

SPELLING TELEVISION INC. (DELAWARE CORPORATION)
51 WEST 52ND STREET
NEW YORK, NY 10019

FOR: VIDEOS, LASER DISCS, AND DVDS FEATURING PRE-RECORDED ENTERTAINMENT IN THE NATURE OF A TELEVISION PROGRAM SERIES, IN CLASS 9 (U.S. CLS. 21, 23, 26, 36 AND 38).

FIRST USE 12-18-2007; IN COMMERCE 12-18-2007.

THE MARK CONSISTS OF STANDARD CHARACTERS WITHOUT CLAIM TO ANY PARTICULAR FONT, STYLE, SIZE, OR COLOR.

OWNER OF U.S. REG. NO. 2,481,263.

SER. NO. 77-373,534, FILED 1-16-2008.

KAREN K. BUSH, EXAMINING ATTORNEY

Int. Cl.: 35

Prior U.S. Cls.: 100, 101 and 102

United States Patent and Trademark Office

Reg. No. 3,484,724

Registered Aug. 12, 2008

**SERVICE MARK
PRINCIPAL REGISTER**



TRINITY TECHNICAL GROUP, INC. (TEXAS CORPORATION)
2300 VALLEY VIEW LN, SUITE 880
IRVING, TX 75062

THE MARK CONSISTS OF WHITE LETTERING USING A FORTE FONT ON A MAROON AND BLACK BACKGROUND.

FOR: PREPARING MAILING LISTS, IN CLASS 35 (U.S. CLS. 100, 101 AND 102).

SER. NO. 77-373,540, FILED 1-16-2008.

FIRST USE 10-1-2007; IN COMMERCE 1-10-2008.

THE COLOR(S) WHITE, MAROON AND BLACK IS/ARE CLAIMED AS A FEATURE OF THE MARK.

KAREN K. BUSH, EXAMINING ATTORNEY

Int. Cl.: 30

Prior U.S. Cl.: 46

United States Patent and Trademark Office

Reg. No. 3,484,725

Registered Aug. 12, 2008

**TRADEMARK
PRINCIPAL REGISTER**

**Italian Cookies for
Everyone**

BRUNO'S BISCOTTI, INC. (INDIANA CORPORATION)
3309 HAMILTON STREET
WEST LAFAYETTE, IN 47906

NO CLAIM IS MADE TO THE EXCLUSIVE
RIGHT TO USE "ITALIAN COOKIES", APART
FROM THE MARK AS SHOWN.

FOR: COOKIES, IN CLASS 30 (U.S. CL. 46).

FIRST USE 2-10-2007; IN COMMERCE 2-10-2007.

SER. NO. 77-373,553, FILED 1-16-2008.

THE MARK CONSISTS OF STANDARD CHARACTERS WITHOUT CLAIM TO ANY PARTICULAR FONT, STYLE, SIZE, OR COLOR.

JENNIFER HETU, EXAMINING ATTORNEY

Int. Cl.: 39

Prior U.S. Cls.: 100 and 105

United States Patent and Trademark Office

Reg. No. 3,484,726

Registered Aug. 12, 2008

**SERVICE MARK
PRINCIPAL REGISTER**

MIKE RODRIGUEZ TRUCKING

RODRIGUEZ, MICHAEL (UNITED STATES IN-
DIVIDUAL)
6657 STONEPINE LANE
SAN DIEGO, CA 921393868

FOR: EXPEDITED FREIGHT TRANSPORTA-
TION BY TRUCK, IN CLASS 39 (U.S. CLS. 100 AND
105).

FIRST USE 5-18-1983; IN COMMERCE 5-18-1983.

THE MARK CONSISTS OF STANDARD CHAR-
ACTERS WITHOUT CLAIM TO ANY PARTICULAR
FONT, STYLE, SIZE, OR COLOR.

NO CLAIM IS MADE TO THE EXCLUSIVE
RIGHT TO USE "TRUCKING", APART FROM THE
MARK AS SHOWN.

THE NAME "MIKE RODRIGUEZ" IDENTIFIES A
LIVING INDIVIDUAL WHOSE CONSENT IS OF
RECORD.

SER. NO. 77-373,554, FILED 1-16-2008.

JENNIFER HETU, EXAMINING ATTORNEY

Int. Cl.: 36

Prior U.S. Cls.: 100, 101 and 102

United States Patent and Trademark Office

Reg. No. 3,484,727

Registered Aug. 12, 2008

**SERVICE MARK
PRINCIPAL REGISTER**

SPECIALTY TRUST

SPECIALTY TRUST, INC. (MARYLAND CORPORATION)
6160 PLUMAS STEET
RENO, NV 89519

FOR: MORTGAGE BANKING SERVICES, NAME-
LY, ORIGINATION, ACQUISITION, SERVICING,
SECURITIZATION AND BROKERAGE OF SHORT
OF SHORT-TERM MORTGAGE LOANS, IN CLASS
36 (U.S. CLS. 100, 101 AND 102).

FIRST USE 5-7-2002; IN COMMERCE 5-7-2002.

THE MARK CONSISTS OF STANDARD CHAR-
ACTERS WITHOUT CLAIM TO ANY PARTICULAR
FONT, STYLE, SIZE, OR COLOR.

NO CLAIM IS MADE TO THE EXCLUSIVE
RIGHT TO USE "TRUST", APART FROM THE
MARK AS SHOWN.

SER. NO. 77-373,608, FILED 1-16-2008.

PAUL F. GAST, EXAMINING ATTORNEY

Int. Cl.: 36

Prior U.S. Cls.: 100, 101 and 102

United States Patent and Trademark Office

Reg. No. 3,484,728

Registered Aug. 12, 2008

**SERVICE MARK
PRINCIPAL REGISTER**



SPECIALTY TRUST

SPECIALTY TRUST, INC. (MARYLAND CORPORATION)
6160 PLUMAS STREET
RENO, NV 89519

FOR: MORTGAGE BANKING SERVICES, NAME-
LY, ORIGINATION, ACQUISITION, SERVICING,
SECURITIZATION AND BROKERAGE OF SHORT-
TERM MORTGAGE LOANS, IN CLASS 36 (U.S. CLS.
100, 101 AND 102).

FIRST USE 5-7-2002; IN COMMERCE 5-7-2002.

NO CLAIM IS MADE TO THE EXCLUSIVE
RIGHT TO USE "TRUST", APART FROM THE
MARK AS SHOWN.

THE MARK CONSISTS OF A SQUARE SUPER-
IMPOSED OVER THE CORNER OF ANOTHER
SQUARE NEXT TO THE STYLIZED WORDS "SPE-
CIALTY TRUST" WRITTEN IN BLACK.

SER. NO. 77-373,639, FILED 1-16-2008.

PAUL F. GAST, EXAMINING ATTORNEY

Int. Cl.: 36

Prior U.S. Cls.: 100, 101 and 102

United States Patent and Trademark Office

Reg. No. 3,484,729

Registered Aug. 12, 2008

**SERVICE MARK
PRINCIPAL REGISTER**

WRAP SCORE

WALZAK RISK ANALYSIS, LLC (FLORIDA LTD
LIAB CO)
SUITE 303
5550 GLADES ROAD
BOCA RATON, FL 33431

FOR: MORTGAGE INVESTMENT SERVICES,
NAMELY, LOAN PERFORMANCE PREDICTION
FOR INVESTMENT ANALYSTS AND BANKS, IN
CLASS 36 (U.S. CLS. 100, 101 AND 102).

FIRST USE 11-1-2005; IN COMMERCE 11-1-2005.

THE MARK CONSISTS OF STANDARD CHAR-
ACTERS WITHOUT CLAIM TO ANY PARTICULAR
FONT, STYLE, SIZE, OR COLOR.

NO CLAIM IS MADE TO THE EXCLUSIVE
RIGHT TO USE "SCORE", APART FROM THE
MARK AS SHOWN.

SER. NO. 77-373,647, FILED 1-16-2008.

MICHAEL KEATING, EXAMINING ATTORNEY

Int. Cl.: 35

Prior U.S. Cls.: 100, 101 and 102

United States Patent and Trademark Office

Reg. No. 3,484,730

Registered Aug. 12, 2008

SERVICE MARK
PRINCIPAL REGISTER



LUXURY DIVAS CORPORATION (NEW JERSEY CORPORATION)
512 MARLIN FARM ROAD
STEWARTSVILLE, NJ 08886

FOR: ON-LINE RETAIL STORE SERVICES FEATURING MEN AND WOMEN CLOTHING, ACCESSORIES AND JEWELRY, IN CLASS 35 (U.S. CLS. 100, 101 AND 102).

FIRST USE 1-1-2004; IN COMMERCE 1-1-2004.

THE MARK CONSISTS OF THE TEXT "LUXURY DIVAS" IN A SCRIPT FONT.

SER. NO. 77-373,698, FILED 1-16-2008.

SUE LAWRENCE, EXAMINING ATTORNEY

Int. Cl.: 16

Prior U.S. Cls.: 2, 5, 22, 23, 29, 37, 38 and 50

United States Patent and Trademark Office

Reg. No. 3,484,731

Registered Aug. 12, 2008

TRADEMARK
PRINCIPAL REGISTER



STRITTMATTER, MARCIA (UNITED STATES
INDIVIDUAL)
63 SOUTHMONT DRIVE
ENOLA, PA 17025

FOR: BOOKLETS IN THE FIELD OF BASIC
COMPUTER EDUCATION, IN CLASS 16 (U.S. CLS.
2, 5, 22, 23, 29, 37, 38 AND 50).

FIRST USE 2-4-2005; IN COMMERCE 4-19-2005.

THE MARK CONSISTS OF AN IMAGE OF A
GRANDMA STANDING ON AN OPEN LAPTOP

COMPUTER HOLDING A COMPUTER MOUSE IN
ONE HAND AND A CANE IN THE OTHER HAND.
BELOW THE LAPTOP ARE THE STYLIZED WORDS
"TEACHGRANDMA.COM". A CURVED LINE EX-
TENDS FROM THE WORDS AT THE BOTTOM, UP
AND BEHIND THE IMAGE OF THE GRANDMA.

SER. NO. 77-373,713, FILED 1-16-2008.

SHAUNIA CARLYLE, EXAMINING ATTORNEY

Int. Cl.: 45

Prior U.S. Cls.: 100 and 101

United States Patent and Trademark Office

Reg. No. 3,484,732

Registered Aug. 12, 2008

**SERVICE MARK
PRINCIPAL REGISTER**

Nectar & Flame

MARSH, AMY (UNITED STATES INDIVIDUAL)
1510 FRANCIS STREET
ALBANY, CA 94706

THE MARK CONSISTS OF STANDARD CHAR-
ACTERS WITHOUT CLAIM TO ANY PARTICULAR
FONT, STYLE, SIZE, OR COLOR.

FOR: COUNSELING IN THE FIELD OF HUMAN
SEXUALITY AND MARRIAGE AND FAMILY, IN
CLASS 45 (U.S. CLS. 100 AND 101).

SER. NO. 77-373,725, FILED 1-16-2008.

FIRST USE 6-0-2006; IN COMMERCE 8-0-2006.

JANET LEE, EXAMINING ATTORNEY

Int. Cl.: 44

Prior U.S. Cls.: 100 and 101

United States Patent and Trademark Office

Reg. No. 3,484,733

Registered Aug. 12, 2008

**SERVICE MARK
PRINCIPAL REGISTER**

PROACTIVE GENETICS

PROACTIVE GENETICS, INC. (MASSACHU-
SETTS CORPORATION)

SUITE 6

4268 BELAIR FRONTAGE RD.

AUGUSTA, GA 30909

FOR: GENETIC TESTING FOR MEDICAL PUR-
POSES, IN CLASS 44 (U.S. CLS. 100 AND 101).

FIRST USE 8-0-1999; IN COMMERCE 8-0-1999.

THE MARK CONSISTS OF STANDARD CHAR-
ACTERS WITHOUT CLAIM TO ANY PARTICULAR
FONT, STYLE, SIZE, OR COLOR.

NO CLAIM IS MADE TO THE EXCLUSIVE
RIGHT TO USE "GENETICS", APART FROM THE
MARK AS SHOWN.

SER. NO. 77-373,789, FILED 1-16-2008.

ALICE SUE CARRUTHERS, EXAMINING ATTOR-
NEY

Int. Cl.: 38

Prior U.S. Cls.: 100, 101 and 104

United States Patent and Trademark Office

Reg. No. 3,484,734

Registered Aug. 12, 2008

**SERVICE MARK
PRINCIPAL REGISTER**

**A PHONE IS ONLY AS GOOD AS
THE NETWORK IT'S ON**

CELLCO PARTNERSHIP (DELAWARE PART-
NERSHIP), DBA VERIZON WIRELESS
VC52N058
ONE VERIZON WAY
BASKING RIDGE, NJ 079201097

FOR: TELECOMMUNICATION SERVICES,
NAMELY, TRANSMISSION OF VOICE, DATA,
GRAPHICS, SOUND AND VIDEO BY MEANS OF
BROADBAND POWER LINE OR WIRELESS NET-
WORKS, IN CLASS 38 (U.S. CLS. 100, 101 AND 104).

FIRST USE 7-19-2007; IN COMMERCE 7-19-2007.

THE MARK CONSISTS OF STANDARD CHAR-
ACTERS WITHOUT CLAIM TO ANY PARTICULAR
FONT, STYLE, SIZE, OR COLOR.

SER. NO. 77-373,847, FILED 1-17-2008.

RENEE MCCRAY, EXAMINING ATTORNEY

Int. Cl.: 13

Prior U.S. Cls.: 2 and 9

United States Patent and Trademark Office

Reg. No. 3,484,735

Registered Aug. 12, 2008

**TRADEMARK
PRINCIPAL REGISTER**



ADVANCED ARMAMENT CORP. (GEORGIA CORPORATION)
1434 HILLCREST RD
NORCROSS, GA 30093

FOR: SILENCERS FOR FIREARMS, IN CLASS 13 (U.S. CLS. 2 AND 9).

FIRST USE 10-1-2003; IN COMMERCE 10-1-2003.

THE MARK CONSISTS OF THREE MONKEYS ARE SHOWN; ONE IS ACTING OUT "SEE NO EVIL",

ANOTHER "HEAR NO EVIL" AND FINALLY "SPEAK NO EVIL". THE EMPHASIS IS ON THE "HEAR NO EVIL" AS THE MONKEY IS HOLDING A SILENCED PISTOL. ALSO INCLUDED IS ADVANCED-ARMAMENT.COM IN THE UPPER RIGHT HAND CORNER.

SER. NO. 77-373,903, FILED 1-17-2008.

ADA HAN, EXAMINING ATTORNEY

Int. Cls.: 35 and 39

Prior U.S. Cls.: 100, 101, 102 and 105

United States Patent and Trademark Office

Reg. No. 3,484,736

Registered Aug. 12, 2008

**SERVICE MARK
PRINCIPAL REGISTER**

**MESI MOVER'S EQUIPMENT
SERVICES, INC.**

MOVER'S EQUIPMENT SERVICES, INC. (TEXAS
CORPORATION)
2619 NOVA DRIVE
DALLAS, TX 75229

FOR: RETAIL STORE SERVICES FEATURING
EQUIPMENT USED IN MOVING OF GOODS FROM
ONE LOCATION TO ANOTHER INCLUDING MOV-
ING DOLLIES, CARTS, STRAPS, PADS, BOXES,
PACKAGING AND RAMPS, IN CLASS 35 (U.S.
CLS. 100, 101 AND 102).

FIRST USE 1-21-1998; IN COMMERCE 1-21-1998.

FOR: RENTAL OF MOVING EQUIPMENT,
NAMELY, PADS, STRAPS, HITCHES, DOLLIES,

BOXES, CARRIERS, AND HAND TRUCKS, IN
CLASS 39 (U.S. CLS. 100 AND 105).

FIRST USE 1-21-1998; IN COMMERCE 1-21-1998.

THE MARK CONSISTS OF STANDARD CHAR-
ACTERS WITHOUT CLAIM TO ANY PARTICULAR
FONT, STYLE, SIZE, OR COLOR.

NO CLAIM IS MADE TO THE EXCLUSIVE
RIGHT TO USE "MOVER'S EQUIPMENT SERVICES,
INC.", APART FROM THE MARK AS SHOWN.

SER. NO. 77-373,926, FILED 1-17-2008.

LINDA M. KING, EXAMINING ATTORNEY

Int. Cl.: 41

Prior U.S. Cls.: 100, 101 and 107

United States Patent and Trademark Office

Reg. No. 3,484,737

Registered Aug. 12, 2008

**SERVICE MARK
PRINCIPAL REGISTER**

MedPen

MEDPEN, INC (NEW JERSEY CORPORATION)
52 MEMORY LANE
DENVER, NJ 07834

THE MARK CONSISTS OF STANDARD CHAR-
ACTERS WITHOUT CLAIM TO ANY PARTICULAR
FONT, STYLE, SIZE, OR COLOR.

FOR: CUSTOM WRITING SERVICES, IN CLASS
41 (U.S. CLS. 100, 101 AND 107).

SER. NO. 77-373,959, FILED 1-17-2008.

FIRST USE 5-28-1998; IN COMMERCE 6-9-1998.

FRED MANDIR, EXAMINING ATTORNEY

Int. Cl.: 29

Prior U.S. Cl.: 46

United States Patent and Trademark Office

Reg. No. 3,484,738

Registered Aug. 12, 2008

**TRADEMARK
PRINCIPAL REGISTER**



PERIDOT, INC. (NEW HAMPSHIRE CORPORATION)
736 PINE STREET
MANCHESTER, NH 03104

THE MARK CONSISTS OF JUMPING SERPENTINE FISH.

FOR: FISH FILLETS; FISH, IN CLASS 29 (U.S. CL. 46).

SER. NO. 77-374,133, FILED 1-17-2008.

FIRST USE 12-1-2003; IN COMMERCE 12-1-2003.

ANNE E. GUSTASON, EXAMINING ATTORNEY

Int. Cl.: 17

Prior U.S. Cls.: 1, 5, 12, 13, 35 and 50

United States Patent and Trademark Office

Reg. No. 3,484,739

Registered Aug. 12, 2008

**TRADEMARK
PRINCIPAL REGISTER**

PolySteel

FLOW SMART INC. (DELAWARE CORPORATION)
103 DAVIS DRIVE
SEAFORD, DE 19973

FOR: PRECISION PARTS MADE OF POLYTE-
TRAFLUORETHYLENE (PTFE) FOR INDUSTRIAL
USE, NAMELY, RODS, TUBES, SHEETS, SLABS, O-
RINGS, V-RINGS, DIAPHRAGMS, VALVE SEATS,
AND GASKETS FOR HIGH PURITY PROCESSING,
IN CLASS 17 (U.S. CLS. 1, 5, 12, 13, 35 AND 50).

FIRST USE 11-1-2003; IN COMMERCE 11-1-2003.

THE MARK CONSISTS OF STANDARD CHAR-
ACTERS WITHOUT CLAIM TO ANY PARTICULAR
FONT, STYLE, SIZE, OR COLOR.

SER. NO. 77-374,270, FILED 1-17-2008.

KATHERINE E. HALMEN, EXAMINING ATTOR-
NEY

Int. Cl.: 30

Prior U.S. Cl.: 46

United States Patent and Trademark Office

Reg. No. 3,484,740

Registered Aug. 12, 2008

TRADEMARK
PRINCIPAL REGISTER

金封

KABUSHIKI KAISHA MITSUKAN GROUP HON-
SHA (JAPAN JOINT STOCK COMPANY)
2-6, NAKAMURA-CHO, HANDA-SHI
AICHI-KEN, JAPAN 475-8585

THE NON-LATIN CHARACTER(S) IN THE
MARK TRANSLITERATE INTO KINPU.

FOR: VINEGAR, IN CLASS 30 (U.S. CL. 46).

FIRST USE 12-26-1968; IN COMMERCE 2-18-2003.

SER. NO. 77-374,333, FILED 1-17-2008.

THE FOREIGN WORDING IN THE MARK
TRANSLATES INTO ENGLISH AS CONGRATULA-
TORY MONEY-CONTAINING GIFT ENVELOPE.

SIMON TENG, EXAMINING ATTORNEY

Int. Cl.: 42

Prior U.S. Cls.: 100 and 101

United States Patent and Trademark Office

Reg. No. 3,484,741

Registered Aug. 12, 2008

**SERVICE MARK
PRINCIPAL REGISTER**

Artminers

INSTITUTE FOR SUSTAINABLE MINING (OREGON NON-PROFIT ORGANIZATION), DBA ARTMINERS
3806 SE YAMHILL STREET
PORTLAND, OR 97214

FOR: ENVIRONMENTAL SERVICES, NAMELY, TECHNICAL CONSULTATION IN THE FIELD OF ENVIRONMENTAL SCIENCE, ENGINEERING SERVICES, DESIGN FOR OTHERS IN THE FIELD OF ENVIRONMENTAL ENGINEERING, DESIGNING AND TESTING OF NEW ENVIRONMENTAL-

LY FRIENDLY PRODUCTS FOR OTHERS, IN CLASS 42 (U.S. CLS. 100 AND 101).

FIRST USE 10-5-2003; IN COMMERCE 10-5-2003.

THE MARK CONSISTS OF STANDARD CHARACTERS WITHOUT CLAIM TO ANY PARTICULAR FONT, STYLE, SIZE, OR COLOR.

SER. NO. 77-374,368, FILED 1-17-2008.

ADA HAN, EXAMINING ATTORNEY

Int. Cl.: 33

Prior U.S. Cls.: 47 and 49

United States Patent and Trademark Office

Reg. No. 3,484,742

Registered Aug. 12, 2008

**TRADEMARK
PRINCIPAL REGISTER**



DBC BREWING, LLC (MICHIGAN LTD LIAB CO)
322 N. OLD WOODWARD AVE.
BIRMINGHAM, MI 48009

FOR: ALCOHOLIC BEVERAGE PRODUCED
FROM A BREWED MALT BASE WITH NATURAL
FLAVORS, IN CLASS 33 (U.S. CLS. 47 AND 49).

FIRST USE 12-1-2007; IN COMMERCE 12-1-2007.

THE COLOR(S) GOLD AND WHITE IS/ARE
CLAIMED AS A FEATURE OF THE MARK.

THE MARK CONSISTS OF AN ILLUSTRATION
OF A "MAN CARRYING GRAIN ON HIS SHOULD-
ERS" IN A WOODCUT ART STYLE. THE FACE,
HAT AND PORTIONS OF THE MAN'S CLOTHES
ARE WHITE. THE MAN'S EYES, NOSE, MOUTH,
HAIR, PORTIONS OF HIS CLOTHES, SHOES, AND
THE GRAIN HE IS CARRYING, ARE GOLD.

SER. NO. 77-374,605, FILED 1-17-2008.

GINA HAYES, EXAMINING ATTORNEY

Int. Cl.: 44

Prior U.S. Cls.: 100 and 101

United States Patent and Trademark Office

Reg. No. 3,484,743

Registered Aug. 12, 2008

**SERVICE MARK
PRINCIPAL REGISTER**



SENSKE LAWN & TREE CARE, INC. (WASHINGTON CORPORATION)

400 N. QUAY

KENNEWICK, WA 99336

FOR: LANDSCAPE DESIGN; LANDSCAPE GARDENING; LAWN MOWING SERVICES; LAWN CARE; GARDEN OR FLOWER BED CARE; TREE CARE SERVICES; HORTICULTURAL SERVICES; WEED CONTROL; WEED KILLING , IN CLASS 44 (U.S. CLS. 100 AND 101).

FIRST USE 12-31-1984; IN COMMERCE 3-31-1985.

NO CLAIM IS MADE TO THE EXCLUSIVE RIGHT TO USE "LAWN AND TREE CARE", APART FROM THE MARK AS SHOWN.

THE MARK CONSISTS OF THE WORDS "SENSKE LAWN & TREE CARE", AN IMAGE OF A TREE IN THE SHAPE OF A PINE TREE TO THE LEFT OF THE WORDS WITH THE TREE TRUNK CURVING RIGHT TO FORM AN UNDERLINE BELOW THE WORDING, AND GRASS APPEARING BELOW THE WORDS ON THE UNDERLINE.

SER. NO. 77-374,798, FILED 1-17-2008.

JOHN GARTNER, EXAMINING ATTORNEY

Int. Cl.: 37

Prior U.S. Cls.: 100, 103 and 106

United States Patent and Trademark Office

Reg. No. 3,484,744

Registered Aug. 12, 2008

**SERVICE MARK
PRINCIPAL REGISTER**



SENSKE LAWN & TREE CARE, INC. (WASHINGTON CORPORATION)
400 N. QUAY
KENNEWICK, WA 99336

FOR: PEST CONTROL; TERMITE AND PEST CONTROL; INSECTICIDE SPRAYING, IN CLASS 37 (U.S. CLS. 100, 103 AND 106).

FIRST USE 12-31-1984; IN COMMERCE 3-31-1985.

NO CLAIM IS MADE TO THE EXCLUSIVE RIGHT TO USE "PEST CONTROL", APART FROM THE MARK AS SHOWN.

THE MARK CONSISTS OF THE WORDS "SENSKE PEST CONTROL", AN IMAGE OF A TREE TO THE LEFT OF THE WORDS, WITH THE TRUNK OF THE TREE EXTENDING AND CURVING UNDERNEATH THE WORDS TO FORM AN UNDERLINE, AND GRASS BENEATH THE WORDS ON THE UNDERLINE.

SER. NO. 77-374,823, FILED 1-17-2008.

JOHN GARTNER, EXAMINING ATTORNEY

Int. Cl.: 36

Prior U.S. Cls.: 100, 101 and 102

United States Patent and Trademark Office

Reg. No. 3,484,745

Registered Aug. 12, 2008

**SERVICE MARK
PRINCIPAL REGISTER**

POWER INDEX ANNUITY

AMERICAN INTERNATIONAL GROUP, INC.
(DELAWARE CORPORATION)
70 PINE STREET
NEW YORK, NY 10270

OWNER OF U.S. REG. NO. 3,299,813.

FOR: ANNUITY UNDERWRITING; ISSUANCE
AND ADMINISTRATION OF ANNUITIES, IN
CLASS 36 (U.S. CLS. 100, 101 AND 102).

NO CLAIM IS MADE TO THE EXCLUSIVE
RIGHT TO USE "INDEX ANNUITY", APART FROM
THE MARK AS SHOWN.

FIRST USE 1-1-2008; IN COMMERCE 1-1-2008.

SER. NO. 77-375,095, FILED 1-18-2008.

THE MARK CONSISTS OF STANDARD CHAR-
ACTERS WITHOUT CLAIM TO ANY PARTICULAR
FONT, STYLE, SIZE, OR COLOR.

THOMAS MANOR, EXAMINING ATTORNEY

Int. Cl.: 42

Prior U.S. Cls.: 100 and 101

United States Patent and Trademark Office

Reg. No. 3,484,746

Registered Aug. 12, 2008

**SERVICE MARK
PRINCIPAL REGISTER**



CORETELLIGENT, LLC. (MASSACHUSETTS
LTD LIAB CO)
P.O. BOX 687
WESTWOOD, MA 02090

THE MARK CONSISTS OF DARK YELLOW
"CORETELLIGENT", GRAY BAND AND A 3D
LOOKING BLUE SPHERE ATTACHED TO THE
AFOREMENTIONED BAND.

FOR: INFORMATION TECHNOLOGY CONSUL-
TATION, IN CLASS 42 (U.S. CLS. 100 AND 101).

SER. NO. 77-375,150, FILED 1-18-2008.

FIRST USE 6-1-2007; IN COMMERCE 6-1-2007.

THE COLOR(S) DARK YELLOW, GRAY, BLUE
IS/ARE CLAIMED AS A FEATURE OF THE MARK.

JOHN WILKE, EXAMINING ATTORNEY

Int. Cl.: 16

Prior U.S. Cls.: 2, 5, 22, 23, 29, 37, 38 and 50

United States Patent and Trademark Office

Reg. No. 3,484,747

Registered Aug. 12, 2008

**TRADEMARK
PRINCIPAL REGISTER**

**THE METRO-CHICAGO OFFICE
GUIDE**

LAW BULLETIN PUBLISHING COMPANY (DE-
LAWARE CORPORATION)
415 NORTH STATE STREET
CHICAGO, IL 60610

FOR: MAGAZINE IN THE FIELD OF COMMER-
CIAL REAL ESTATE, IN CLASS 16 (U.S. CLS. 2, 5, 22,
23, 29, 37, 38 AND 50).

FIRST USE 1-5-1986; IN COMMERCE 1-5-1986.

THE MARK CONSISTS OF STANDARD CHAR-
ACTERS WITHOUT CLAIM TO ANY PARTICULAR
FONT, STYLE, SIZE, OR COLOR.

OWNER OF U.S. REG. NO. 1,476,388.

NO CLAIM IS MADE TO THE EXCLUSIVE
RIGHT TO USE "OFFICE GUIDE", APART FROM
THE MARK AS SHOWN.

SEC. 2(F).

SER. NO. 77-375,639, FILED 1-18-2008.

HOWARD FRIEDMAN, EXAMINING ATTORNEY

Int. Cl.: 35

Prior U.S. Cls.: 100, 101 and 102

United States Patent and Trademark Office

Reg. No. 3,484,748

Registered Aug. 12, 2008

**SERVICE MARK
PRINCIPAL REGISTER**

Where Fans Set the Price

FANPRICE, INC. (CALIFORNIA CORPORATION)
300 B STREET
SANTA ROSA, CA 95401

FOR: ONLINE TICKET MARKETPLACE FOR
BUYERS AND SELLERS OF TICKETS FOR SPORT-
ING EVENTS, MUSICAL AND NON-MUSICAL
CONCERTS, AND OTHER ENTERTAINMENT
EVENTS, IN CLASS 35 (U.S. CLS. 100, 101 AND 102).

FIRST USE 6-21-2007; IN COMMERCE 8-15-2007.

THE MARK CONSISTS OF STANDARD CHAR-
ACTERS WITHOUT CLAIM TO ANY PARTICULAR
FONT, STYLE, SIZE, OR COLOR.

SER. NO. 77-376,019, FILED 1-19-2008.

HEATHER SAPP, EXAMINING ATTORNEY

Int. Cl.: 9

Prior U.S. Cls.: 21, 23, 26, 36 and 38

United States Patent and Trademark Office

Reg. No. 3,484,749

Registered Aug. 12, 2008

**TRADEMARK
PRINCIPAL REGISTER**

TRUFLOW

FINESSE SOLUTIONS, LLC. (DELAWARE LTD
LIAB CO)
BLDG. 1
3350 SCOTT BLVD
SANTA CLARA, CA 950543107

FOR: UNIT CONTAINING ONE OR MORE MASS
FLOW CONTROL VALVES TO REGULATE GAS
CONCENTRATION IN AQUEOUS BIOPROCESS
MEDIA, IN CLASS 9 (U.S. CLS. 21, 23, 26, 36 AND 38).

FIRST USE 11-8-2007; IN COMMERCE 11-8-2007.

THE MARK CONSISTS OF STANDARD CHAR-
ACTERS WITHOUT CLAIM TO ANY PARTICULAR
FONT, STYLE, SIZE, OR COLOR.

SER. NO. 77-376,773, FILED 1-21-2008.

GRETTA YAO, EXAMINING ATTORNEY

Int. Cl.: 30

Prior U.S. Cl.: 46

Reg. No. 3,484,750

United States Patent and Trademark Office

Registered Aug. 12, 2008

**TRADEMARK
PRINCIPAL REGISTER**

Red Truck Bakery

BRIAN J. NOYES (VIRGINIA LTD LIAB CO),
DBA RED TRUCK BAKERY
1815 N. RANDOLPH ST
ARLINGTON, VA 22207

FOR: BISCUITS AND BREAD; BREAD; BREAD AND BUNS; BREAD AND PASTRY; BREAD CRUMB; BREAD CRUMBS; BREAD DOUGHS; BREAD MIXES; BREAD ROLLS; BREAD STICKS; BREAD WITH SOY BEAN; BRUSCHETTE-TOPPED BREAD; FOOD PACKAGE COMBINATIONS CONSISTING PRIMARILY OF BREAD, CRACKERS AND/OR COOKIES; FROZEN BREADS; MIXES FOR MAKING BREADING; PITA BREAD; PROTEIN REDUCED AND GLUTEN FREE FLOUR AND BREAD; ROLLS; STUFFING MIXES CONTAINING BREAD; UNLEAVENED BREAD IN THIN SHEETS; WHOLEMEAL BREAD; BAKERY GOODS; BAKERY PRODUCTS, NAMELY, SWEET BAKERY GOODS; MIXES FOR BAKERY GOODS; MIXES FOR MAKING BAKING BATTERS; BISCUITS; BUTTER BISCUITS; MALT BISCUITS; ONION OR CHEESE BISCUITS; PETIT-BEURRE BISCUITS; SAVOURY AND SALTED BISCUITS; HONEY; HONEY; HONEY BUNS; GRANOLA; GRANOLA SNACKS; GRANOLA-BASED SNACK BARS; CHOCOLATE-BASED FILLINGS FOR CAKES AND PIES; CUSTARD-BASED FILLINGS FOR CAKES AND PIES; FRUIT PIES; MEAT PIES; MEAT PIES; MINCEMEAT PIES; PIES; POT PIES; SEAFOOD PIES; ALMOND CAKE; CAKE DOUGHS; CAKE MIXES; CAKES; CANDY CAKE DECORATIONS; CANDY DECORATIONS FOR CAKES; EDIBLE CAKE DECORATIONS; EDIBLE DECORATIONS FOR CAKES; FRUIT CAKES; ICE-CREAM CAKES; ICED CAKES; MOON CAKES; PETITS FOURS; SNACK CAKES; SPONGE CAKES; TARTS; CINNAMON ROLLS; SPRING ROLLS; CANDIES; CANDY; CANDY BARS; CANDY COATED APPLES; CANDY COATED POPCORN; CANDY CONTAINING ALCOHOLIC BEVERAGE CONTENT AND FLAVOR; CANDY FOR FOOD; CANDY MINTS; CANDY WITH CARAMEL; CANDY WITH

COCOA; CHOCOLATE CANDIES; GIFT BASKETS CONTAINING CANDY; GUMMY CANDIES; ICE CANDIES; MEXICAN CANDY; PEPPERMINT CANDY; SNACK MIX CONSISTING PRIMARILY OF CRACKERS, PRETZELS, CANDIED NUTS AND/OR POPPED POPCORN; STARCH-BASED CANDIES (AME); SUGARLESS CANDIES; SWEETS; CHOCOLATE; CHOCOLATE AND CHOCOLATES; CHOCOLATE BARS; CHOCOLATE CHIPS; CHOCOLATE COVERED NUTS; CHOCOLATE COVERED RAISINS; CHOCOLATE FONDUE; CHOCOLATE FOOD BEVERAGES NOT BEING DAIRY-BASED OR VEGETABLE BASED; CHOCOLATE MOUSSE; CHOCOLATE PASTES; CHOCOLATE POWDER; CHOCOLATE SYRUP; CHOCOLATE TOPPING; CHOCOLATE TRUFFLES; CHOCOLATE-BASED READY-TO-EAT FOOD BARS; CHOCOLATE-COVERED POTATO CHIPS; FILLED CHOCOLATE; HOT CHOCOLATE; MILK CHOCOLATE; SPREAD CONTAINING CHOCOLATE AND NUTS; ARTIFICIAL COFFEE; ARTIFICIAL COFFEE AND TEA; BEVERAGES MADE OF COFFEE; CAFFEINE-FREE COFFEE; CHICORY AND CHICORY MIXTURES, ALL FOR USE AS SUBSTITUTES FOR COFFEE; CHICORY BASED COFFEE SUBSTITUTE; COFFEE; COFFEE; COFFEE AND ARTIFICIAL COFFEE; COFFEE AND COFFEE SUBSTITUTES; COFFEE AND TEA; COFFEE BASED BEVERAGES; COFFEE BEANS; COFFEE BEVERAGES WITH MILK; COFFEE ESSENCES; COFFEE-BASED BEVERAGES; GROUND COFFEE BEANS; INSTANT COFFEE; MIXTURES OF COFFEE AND CHICORY; PREPARED COFFEE AND COFFEE-BASED BEVERAGES; ROASTED COFFEE BEANS; SUGAR-COATED COFFEE BEANS; COOKIE DOUGH; COOKIE MIXES; COOKIES; COOKIES AND CRACKERS; FRIED DOUGH COOKIES (KARINTOH); DANISH PASTRIES; MACAROONS; PASTRIES; PASTRY; PASTRY SHELLS FOR MONAKA; QUICHE, IN CLASS 30 (U.S. CL. 46).

FIRST USE 3-1-2005; IN COMMERCE 3-1-2005.

THE MARK CONSISTS OF STANDARD CHARACTERS WITHOUT CLAIM TO ANY PARTICULAR FONT, STYLE, SIZE, OR COLOR.

SER. NO. 77-377,164, FILED 1-22-2008.

NO CLAIM IS MADE TO THE EXCLUSIVE RIGHT TO USE "BAKERY", APART FROM THE MARK AS SHOWN.

BRENDAN REGAN, EXAMINING ATTORNEY

Int. Cl.: 36

Prior U.S. Cls.: 100, 101 and 102

United States Patent and Trademark Office

Reg. No. 3,484,751

Registered Aug. 12, 2008

**SERVICE MARK
PRINCIPAL REGISTER**

WORKS

AMERICAN INTERNATIONAL GROUP, INC.
(DELAWARE CORPORATION)
70 PINE STREET
NEW YORK, NY 10270

FOR: INSURANCE UNDERWRITING IN THE FIELD OF PROFESSIONAL LIABILITY, MANAGEMENT LIABILITY, GENERAL LIABILITY, EXCESS CASUALTY, PRIMARY CASUALTY, EMPLOYEE BENEFITS, ACCIDENT AND HEALTH FOR SMALL BUSINESSES AND ORGANIZATIONS; INSURANCE ADMINISTRATION IN THE FIELD OF PROFESSIONAL LIABILITY, MANAGEMENT LIABILITY, GENERAL LIABILITY, EXCESS CASUALTY, PRI-

MARY CASUALTY, EMPLOYEE BENEFITS, ACCIDENT AND HEALTH FOR SMALL BUSINESSES AND ORGANIZATIONS, IN CLASS 36 (U.S. CLS. 100, 101 AND 102).

FIRST USE 2-1-2008; IN COMMERCE 2-1-2008.

THE MARK CONSISTS OF THE WORD "WORKS" WITH A STYLIZED LETTER "O".

SER. NO. 77-377,500, FILED 1-22-2008.

THOMAS MANOR, EXAMINING ATTORNEY

Int. Cl.: 35

Prior U.S. Cls.: 100, 101 and 102

United States Patent and Trademark Office

Reg. No. 3,484,752

Registered Aug. 12, 2008

**SERVICE MARK
PRINCIPAL REGISTER**

**ADDING PRODUCTS. REMOVING
PROBLEMS.**

W.W. GRAINGER, INC. (ILLINOIS CORPORATION)
100 GRAINGER PARKWAY
LAKE FOREST, IL 600455201

FOR: TELEPHONE, ON-LINE AND MAIL ORDER CATALOG SERVICES IN THE FIELD OF INDUSTRIAL, INSTITUTIONAL, COMMERCIAL AND JANITORIAL EQUIPMENT AND SUPPLIES; WHOLESALE DISTRIBUTORSHIPS FEATURING INDUSTRIAL, INSTITUTIONAL, COMMERCIAL AND JANITORIAL EQUIPMENT AND SUPPLIES; WHOLESALE OUTLET STORES FEATURING INDUSTRIAL, INSTITUTIONAL, COMMERCIAL AND JANITORIAL EQUIPMENT AND SUPPLIES; COMPUTERIZED ON-LINE ORDERING SERVICES BY MEANS OF A COMPUTER MODEM OR OTHER ELECTRONIC LINK-UP, IN THE FIELD OF INDUSTRIAL, INSTITUTIONAL, COMMERCIAL AND JANITORIAL EQUIPMENT AND SUPPLIES; PROCUREMENT FOR OTHERS OF INDUSTRIAL,

INSTITUTIONAL, COMMERCIAL AND JANITORIAL EQUIPMENT AND SUPPLIES; AUTOMATED INVENTORY CONTROL FOR CUSTOMERS IN THE FIELD OF INDUSTRIAL, INSTITUTIONAL, COMMERCIAL AND JANITORIAL EQUIPMENT AND SUPPLIES; AND PROVIDING RELEVANT INFORMATION AND CONSULTING SERVICES IN CONNECTION THEREWITH, IN CLASS 35 (U.S. CLS. 100, 101 AND 102).

FIRST USE 2-1-2007; IN COMMERCE 2-1-2007.

THE MARK CONSISTS OF STANDARD CHARACTERS WITHOUT CLAIM TO ANY PARTICULAR FONT, STYLE, SIZE, OR COLOR.

SER. NO. 77-378,305, FILED 1-23-2008.

GIANCARLO CASTRO, EXAMINING ATTORNEY

Int. Cl.: 39

Prior U.S. Cls.: 100 and 105

United States Patent and Trademark Office

Reg. No. 3,484,753

Registered Aug. 12, 2008

**SERVICE MARK
PRINCIPAL REGISTER**

BIG OR SMALL WE SHIP IT ALL

UNITED PARCEL SERVICE OF AMERICA, INC.
(DELAWARE CORPORATION)
55 GLENLAKE PARKWAY
ATLANTA, GA 30328

FOR: TRANSPORTATION AND DELIVERY SERVICES BY AIR, ROAD, RAIL AND SEA; GLOBAL TRANSPORTATION OF FREIGHT FOR OTHERS BY ALL AVAILABLE MEANS, IN CLASS 39 (U.S. CLS. 100 AND 105).

FIRST USE 7-16-1993; IN COMMERCE 7-16-1993.

THE MARK CONSISTS OF STANDARD CHARACTERS WITHOUT CLAIM TO ANY PARTICULAR FONT, STYLE, SIZE, OR COLOR.

SER. NO. 77-378,810, FILED 1-23-2008.

JOHN HWANG, EXAMINING ATTORNEY

Int. Cl.: 25

Prior U.S. Cls.: 22 and 39

United States Patent and Trademark Office

Reg. No. 3,484,754

Registered Aug. 12, 2008

**TRADEMARK
PRINCIPAL REGISTER**

Pink-A-Licious

DALY, DIXIE (UNITED STATES INDIVIDUAL)
2215 BUCKINGHAM CIRCLE
LOVELAND, CO 80538

FOR: SHIRTS; SHORTS; PANTS; HATS; VESTS;
SWEAT SHIRTS; JACKETS; PAJAMAS; SOCKS;
APRONS; CAPS; CLOTH BIBS; INFANT AND TOD-
DLER ONE PIECE CLOTHING; INFANT WEAR, IN
CLASS 25 (U.S. CLS. 22 AND 39).

FIRST USE 10-26-2007; IN COMMERCE 11-7-2007.

THE MARK CONSISTS OF STANDARD CHAR-
ACTERS WITHOUT CLAIM TO ANY PARTICULAR
FONT, STYLE, SIZE, OR COLOR.

SER. NO. 77-379,271, FILED 1-24-2008.

RICHARD WHITE, EXAMINING ATTORNEY

Int. Cl.: 25

Prior U.S. Cls.: 22 and 39

United States Patent and Trademark Office

Reg. No. 3,484,755

Registered Aug. 12, 2008

**TRADEMARK
PRINCIPAL REGISTER**

Purpl-icious

DALY, DIXIE (UNITED STATES INDIVIDUAL)
2215 BUCKINGHAM CIRCLE
LOVELAND, CO 80538

FOR: SHIRTS; SHORTS; SWEAT SHIRTS; PANTS;
VESTS; JACKETS; PAJAMAS; CAPS; HATS; SOCKS;
APRONS; CLOTH BIBS; INFANT AND TODDLER
ONE PIECE CLOTHING; INFANT WEAR, IN CLASS
25 (U.S. CLS. 22 AND 39).

FIRST USE 12-26-2007; IN COMMERCE 1-7-2008.

THE MARK CONSISTS OF STANDARD CHAR-
ACTERS WITHOUT CLAIM TO ANY PARTICULAR
FONT, STYLE, SIZE, OR COLOR.

SER. NO. 77-379,295, FILED 1-24-2008.

RICHARD WHITE, EXAMINING ATTORNEY

Int. Cl.: 29

Prior U.S. Cl.: 46

United States Patent and Trademark Office

Reg. No. 3,484,756

Registered Aug. 12, 2008

**TRADEMARK
PRINCIPAL REGISTER**

VEJA-LINKS

KELLOGG NORTH AMERICA COMPANY (DE-
LAWARE CORPORATION)
LEGAL DEPARTMENT
ONE KELLOGG SQUARE, PO BOX 3599
BATTLE CREEK, MI 490163599

THE MARK CONSISTS OF STANDARD CHAR-
ACTERS WITHOUT CLAIM TO ANY PARTICULAR
FONT, STYLE, SIZE, OR COLOR.

FOR: TEXTURED VEGETABLE PROTEIN FOR
USE AS A MEAT SUBSTITUTE, IN CLASS 29 (U.S.
CL. 46).

SER. NO. 77-379,307, FILED 1-24-2008.

FIRST USE 9-0-1952; IN COMMERCE 9-0-1952.

H. M. FISHER, EXAMINING ATTORNEY

Int. Cl.: 28

Prior U.S. Cls.: 22, 23, 38 and 50

United States Patent and Trademark Office

Reg. No. 3,484,757

Registered Aug. 12, 2008

**TRADEMARK
PRINCIPAL REGISTER**

NANCY DREW GIRL DETECTIVE

SIMON & SCHUSTER, INC. (NEW YORK CORPORATION)
1230 AVENUE OF THE AMERICAS
NEW YORK, NY 10020

OWNER OF U.S. REG. NOS. 1,125,972 AND 3,056,587.

FOR: DOLLS AND ACCESSORIES THEREFOR, IN CLASS 28 (U.S. CLS. 22, 23, 38 AND 50).

THE NAME "NANCY DREW" DOES NOT IDENTIFY A LIVING INDIVIDUAL.

FIRST USE 1-7-2008; IN COMMERCE 1-7-2008.

SER. NO. 77-379,410, FILED 1-24-2008.

THE MARK CONSISTS OF STANDARD CHARACTERS WITHOUT CLAIM TO ANY PARTICULAR FONT, STYLE, SIZE, OR COLOR.

KEVIN DINALLO, EXAMINING ATTORNEY

Int. Cl.: 41

Prior U.S. Cls.: 100, 101 and 107

United States Patent and Trademark Office

Reg. No. 3,484,758

Registered Aug. 12, 2008

**SERVICE MARK
PRINCIPAL REGISTER**

MEREDITH AVENGING ANGELS

MEREDITH COLLEGE (NORTH CAROLINA
NON-PROFIT CORPORATION)
3800 HILLSBOROUGH STREET
RALEIGH, NC 276075298

FOR: ENTERTAINMENT SERVICES IN THE
NATURE OF VOLLEYBALL, TENNIS, BASKET-
BALL, SOCCER, CROSS COUNTRY AND SOFT-
BALL GAMES, IN CLASS 41 (U.S. CLS. 100, 101
AND 107).

FIRST USE 8-22-2007; IN COMMERCE 8-22-2007.

THE MARK CONSISTS OF STANDARD CHAR-
ACTERS WITHOUT CLAIM TO ANY PARTICULAR
FONT, STYLE, SIZE, OR COLOR.

SER. NO. 77-379,575, FILED 1-24-2008.

ALEXANDER L. POWERS, EXAMINING ATTOR-
NEY

Int. Cl.: 35

Prior U.S. Cls.: 100, 101 and 102

United States Patent and Trademark Office

Reg. No. 3,484,759

Registered Aug. 12, 2008

**SERVICE MARK
PRINCIPAL REGISTER**

Furfection

FURFECTION, INC. (CALIFORNIA CORPORATION)
635 TAMI WAY
MOUNTAIN VIEW, CA 94041

FOR: RETAIL PET STORES, IN CLASS 35 (U.S. CLS. 100, 101 AND 102).

FIRST USE 10-1-2004; IN COMMERCE 2-1-2005.

THE MARK CONSISTS OF STANDARD CHARACTERS WITHOUT CLAIM TO ANY PARTICULAR FONT, STYLE, SIZE, OR COLOR.

OWNER OF U.S. REG. NO. 3,258,276.

SER. NO. 77-379,915, FILED 1-24-2008.

LINDA ESTRADA, EXAMINING ATTORNEY

Int. Cl.: 25

Prior U.S. Cls.: 22 and 39

United States Patent and Trademark Office

Reg. No. 3,484,760

Registered Aug. 12, 2008

**TRADEMARK
PRINCIPAL REGISTER**

JET SLIPPER

HARRYS OF LONDON LIMITED (UNITED
KINGDOM COMPANY)

8A KINGLY STREET

LONDON W1B 5PQ, UNITED KINGDOM

FOR: SLIPPERS, MOCCASINS, CASUAL FOOT-
WEAR, IN CLASS 25 (U.S. CLS. 22 AND 39).

FIRST USE 1-0-2003; IN COMMERCE 1-0-2003.

THE MARK CONSISTS OF STANDARD CHAR-
ACTERS WITHOUT CLAIM TO ANY PARTICULAR
FONT, STYLE, SIZE, OR COLOR.

NO CLAIM IS MADE TO THE EXCLUSIVE
RIGHT TO USE "SLIPPER", APART FROM THE
MARK AS SHOWN.

SER. NO. 77-380,593, FILED 1-25-2008.

ZHALEH DELANEY, EXAMINING ATTORNEY

Int. Cl.: 35

Prior U.S. Cls.: 100, 101 and 102

United States Patent and Trademark Office

Reg. No. 3,484,761

Registered Aug. 12, 2008

**SERVICE MARK
PRINCIPAL REGISTER**

**LOOK LIKE A MILLION WITH
OUT SPENDING IT**

WOLLERT ENTERPRISES, INC. (NORTH CAROLINA CORPORATION)
2450 CORPORATION PARKWAY
BURLINGTON, NC 27215

FOR: RETAIL STORE SERVICES FEATURING WOMEN'S CLOTHING, FORMAL WEAR AND ACCESSORIES, IN CLASS 35 (U.S. CLS. 100, 101 AND 102).

FIRST USE 3-0-1996; IN COMMERCE 12-20-2001.

THE MARK CONSISTS OF STANDARD CHARACTERS WITHOUT CLAIM TO ANY PARTICULAR FONT, STYLE, SIZE, OR COLOR.

OWNER OF U.S. REG. NO. 2,596,271.

SER. NO. 77-380,625, FILED 1-25-2008.

ANDREA BUTLER, EXAMINING ATTORNEY

Int. Cl.: 5

Prior U.S. Cls.: 6, 18, 44, 46, 51 and 52

Reg. No. 3,484,762

United States Patent and Trademark Office

Registered Aug. 12, 2008

**TRADEMARK
PRINCIPAL REGISTER**

LIVE LAUGH LOVE

D-GENERATION, INC. (FLORIDA CORPORATION)
P. O. BOX 30
DAYTONA BEACH, FL 321150030

THE MARK CONSISTS OF STANDARD CHARACTERS WITHOUT CLAIM TO ANY PARTICULAR FONT, STYLE, SIZE, OR COLOR.

FOR: MEDICATED LIP BALM; MEDICATED PRE-MOISTENED WIPES; MEDICATED BABY POWDERS; MEDICATED SKIN CARE PREPARATIONS, NAMELY, CREAMS, LOTIONS, GELS, TONERS, CLEANERS AND PEELS, IN CLASS 5 (U.S. CLS. 6, 18, 44, 46, 51 AND 52).

OWNER OF U.S. REG. NOS. 3,368,922 AND 3,385,179.

SER. NO. 77-380,630, FILED 1-25-2008.

FIRST USE 5-21-2007; IN COMMERCE 5-21-2007.

MARY MUNSON, EXAMINING ATTORNEY

Int. Cl.: 19

Prior U.S. Cls.: 1, 12, 33 and 50

United States Patent and Trademark Office

Reg. No. 3,484,763

Registered Aug. 12, 2008

**TRADEMARK
PRINCIPAL REGISTER**

Wet & Set

ECHELON CORPORATION (NEW YORK COR-
PORATION)
P.O. BOX 589
890 ROUTE 35
CROSS RIVER, NY 10518

FOR: PATCH FOR REPAIRING OR FINISHING A
WALL OR CEILING, IN CLASS 19 (U.S. CLS. 1, 12, 33
AND 50).

FIRST USE 1-18-2001; IN COMMERCE 7-21-2001.

THE MARK CONSISTS OF STANDARD CHAR-
ACTERS WITHOUT CLAIM TO ANY PARTICULAR
FONT, STYLE, SIZE, OR COLOR.

OWNER OF U.S. REG. NO. 2,610,981.

SEC. 2(F).

SER. NO. 77-382,197, FILED 1-28-2008.

PAUL E. FAHRENKOPF, EXAMINING ATTORNEY

Int. Cl.: 45

Prior U.S. Cls.: 100 and 101

United States Patent and Trademark Office

Reg. No. 3,484,764

Registered Aug. 12, 2008

SERVICE MARK
PRINCIPAL REGISTER



AMERICAN EXPRESS MARKETING & DEVELOPMENT CORP. (DELAWARE CORPORATION)
200 VESEY STREET
NEW YORK, NY 10285

FOR: PROVISION OF A WEB SITE FEATURING INFORMATION ON FASHION, IN CLASS 45 (U.S. CLS. 100 AND 101).

FIRST USE 2-1-2008; IN COMMERCE 2-1-2008.

OWNER OF U.S. REG. NOS. 1,024,840 AND 3,136,643.

NO CLAIM IS MADE TO THE EXCLUSIVE RIGHT TO USE "FASHION NETWORK", APART FROM THE MARK AS SHOWN.

THE MARK CONSISTS OF THE WORDS "AMERICAN EXPRESS FASHION NETWORK" WITH A SCROLL ON THE BOTTOM LEFT CORNER.

SER. NO. 77-382,205, FILED 1-28-2008.

KEVON CHISOLM, EXAMINING ATTORNEY

Int. Cl.: 41

Prior U.S. Cls.: 100, 101 and 107

United States Patent and Trademark Office

Reg. No. 3,484,765

Registered Aug. 12, 2008

**SERVICE MARK
PRINCIPAL REGISTER**

The Classics IV

YOST, DENNIS (UNITED STATES INDIVIDUAL)
5304 BLOSSOM ST. #2212
HAMILTON, OH 45011 AND
YOST, LINDA (UNITED STATES INDIVIDUAL)
5304 BLOSSOM ST. #2212
HAMILTON, OH 45011

FOR: ENTERTAINMENT, NAMELY, LIVE PER-
FORMANCES BY A MUSICAL GROUP, IN CLASS
41 (U.S. CLS. 100, 101 AND 107).

FIRST USE 1-1-1965; IN COMMERCE 1-1-1965.

THE MARK CONSISTS OF STANDARD CHAR-
ACTERS WITHOUT CLAIM TO ANY PARTICULAR
FONT, STYLE, SIZE, OR COLOR.

NO CLAIM IS MADE TO THE EXCLUSIVE
RIGHT TO USE "CLASSICS", APART FROM THE
MARK AS SHOWN.

SER. NO. 77-382,279, FILED 1-28-2008.

APRIL ROACH, EXAMINING ATTORNEY

Int. Cl.: 38

Prior U.S. Cls.: 100, 101 and 104

United States Patent and Trademark Office

Reg. No. 3,484,766

Registered Aug. 12, 2008

**SERVICE MARK
PRINCIPAL REGISTER**

QMOE

QWEST COMMUNICATIONS INTERNATIONAL
INC. (DELAWARE CORPORATION)
1801 CALIFORNIA STREET
DENVER, CO 80202

THE MARK CONSISTS OF STANDARD CHAR-
ACTERS WITHOUT CLAIM TO ANY PARTICULAR
FONT, STYLE, SIZE, OR COLOR.

FOR: ELECTRONIC, ELECTRIC, AND DIGITAL
TRANSMISSION OF VOICE, DATA, IMAGES, SIG-
NALS, AND MESSAGES, IN CLASS 38 (U.S. CLS. 100,
101 AND 104).

SER. NO. 77-382,916, FILED 1-29-2008.

FIRST USE 11-19-2003; IN COMMERCE 11-19-2003.

WON TEAK OH, EXAMINING ATTORNEY

Int. Cl.: 10

Prior U.S. Cls.: 26, 39 and 44

United States Patent and Trademark Office

Reg. No. 3,484,767

Registered Aug. 12, 2008

**TRADEMARK
PRINCIPAL REGISTER**

Bio-Dermology

SUZUKI, DAVID S. (UNITED STATES INDIVIDUAL)
2244 1ST AVENUE SOUTH
SEATTLE, WA 98134

THE MARK CONSISTS OF STANDARD CHARACTERS WITHOUT CLAIM TO ANY PARTICULAR FONT, STYLE, SIZE, OR COLOR.

FOR: APPARATUS FOR CELLULITE TREATMENT, REDUCTION AND ELIMINATION, IN CLASS 10 (U.S. CLS. 26, 39 AND 44).

SER. NO. 77-382,994, FILED 1-29-2008.

FIRST USE 1-1-1999; IN COMMERCE 1-1-1999.

KELLY MCCOY, EXAMINING ATTORNEY

Int. Cl.: 9

Prior U.S. Cls.: 21, 23, 26, 36 and 38

Reg. No. 3,484,768

United States Patent and Trademark Office

Registered Aug. 12, 2008

**TRADEMARK
PRINCIPAL REGISTER**



SCHOOL-LINK TECHNOLOGIES, INC. (DELA-
WARE CORPORATION)
1437 6TH STREET
SANTA MONICA, CA 90407

FOR: INTERACTIVE COMPUTER KIOSKS COM-
PRISING COMPUTERS, COMPUTER HARDWARE,
COMPUTER PERIPHERALS, AND COMPUTER OP-
ERATING SOFTWARE FOR USE IN FOOD SER-

VICE PROGRAMS, IN CLASS 9 (U.S. CLS. 21, 23, 26,
36 AND 38).

FIRST USE 7-1-2005; IN COMMERCE 7-1-2005.

SER. NO. 77-383,873, FILED 1-30-2008.

REBECCA GILBERT, EXAMINING ATTORNEY

Int. Cl.: 35

Prior U.S. Cls.: 100, 101 and 102

United States Patent and Trademark Office

Reg. No. 3,484,769

Registered Aug. 12, 2008

**SERVICE MARK
PRINCIPAL REGISTER**

NATIONAL BUSINESS FURNITURE

NATIONAL BUSINESS FURNITURE, LLC (DE-
LAWARE LTD LIAB CO)
735 NORTH WATER STREET, SUITE 400
MILWAUKEE, WI 53202

FOR: ONLINE RETAIL STORE SERVICES FEATURING OFFICE FURNITURE AND ACCESSORIES; MAIL ORDER CATALOG SERVICES FEATURING OFFICE FURNITURE AND ACCESSORIES; DISTRIBUTORSHIP SERVICES IN THE FIELD OF OFFICE FURNITURE AND ACCESSORIES, IN CLASS 35 (U.S. CLS. 100, 101 AND 102).

FIRST USE 6-30-1975; IN COMMERCE 6-30-1975.

THE MARK CONSISTS OF STANDARD CHARACTERS WITHOUT CLAIM TO ANY PARTICULAR FONT, STYLE, SIZE, OR COLOR.

OWNER OF U.S. REG. NO. 1,669,799.

NO CLAIM IS MADE TO THE EXCLUSIVE RIGHT TO USE "BUSINESS FURNITURE", APART FROM THE MARK AS SHOWN.

SEC. 2(F).

SER. NO. 77-383,881, FILED 1-30-2008.

JENNIFER HETU, EXAMINING ATTORNEY

Int. Cl.: 35

Prior U.S. Cls.: 100, 101 and 102

United States Patent and Trademark Office

Reg. No. 3,484,770

Registered Aug. 12, 2008

**SERVICE MARK
PRINCIPAL REGISTER**

CLEANSTART

THE PROCTER & GAMBLE COMPANY (OHIO
CORPORATION)
1 P&G PLAZA
CINCINNATI, OH 45202

THE MARK CONSISTS OF STANDARD CHAR-
ACTERS WITHOUT CLAIM TO ANY PARTICULAR
FONT, STYLE, SIZE, OR COLOR.

FOR: CHARITABLE SERVICES, NAMELY, OR-
GANIZING AND CONDUCTING VOLUNTEER
PROGRAMS AND COMMUNITY SERVICE PRO-
JECTS, IN CLASS 35 (U.S. CLS. 100, 101 AND 102).

SER. NO. 77-384,408, FILED 1-30-2008.

FIRST USE 10-31-2005; IN COMMERCE 10-31-2005.

DOMINICK J. SALEMI, EXAMINING ATTORNEY

Int. Cl.: 41

Prior U.S. Cls.: 100, 101 and 107

United States Patent and Trademark Office

Reg. No. 3,484,771

Registered Aug. 12, 2008

**SERVICE MARK
PRINCIPAL REGISTER**

What Are My Chances?

CAPPEX.COM, LLC (ILLINOIS LTD LIAB CO)
1694 FIRST STREET
HIGHLAND PARK, IL 60035

FOR: PROVIDING ASSISTANCE IN CALCULATING THE LIKELIHOOD OF BEING OFFERED ADMISSION AT COLLEGES AND UNIVERSITIES, IN CLASS 41 (U.S. CLS. 100, 101 AND 107).

FIRST USE 8-4-2007; IN COMMERCE 8-4-2007.

THE MARK CONSISTS OF STANDARD CHARACTERS WITHOUT CLAIM TO ANY PARTICULAR FONT, STYLE, SIZE, OR COLOR.

SER. NO. 77-384,674, FILED 1-30-2008.

VIVIAN MICZNIK FIRST, EXAMINING ATTORNEY

Int. Cl.: 5

Prior U.S. Cls.: 6, 18, 44, 46, 51 and 52

Reg. No. 3,484,772

United States Patent and Trademark Office

Registered Aug. 12, 2008

**TRADEMARK
PRINCIPAL REGISTER**

PREMICIDE

METREX RESEARCH CORPORATION (WISCONSIN CORPORATION)
1717 WEST COLLINS AVENUE
ORANGE, CA 92867

FOR: ABSORBENT SOLIDIFYING POWDER FOR THE SANITIZATION/DISINFECTION OF BULK BLOOD AND BODY FLUIDS SUCTIONED OFF DURING A MEDICAL PROCEDURE AND COLLECTED IN CONTAINERS SUCH AS OPERATING ROOM SUCTION CANISTERS, CHEST DRAINAGE BAGS, ETC IN THE LABORATORY, HOSPITAL OR

MEDICAL ENVIRONMENT, IN CLASS 5 (U.S. CLS. 6, 18, 44, 46, 51 AND 52).

FIRST USE 3-8-1995; IN COMMERCE 4-25-1997.

THE MARK CONSISTS OF STANDARD CHARACTERS WITHOUT CLAIM TO ANY PARTICULAR FONT, STYLE, SIZE, OR COLOR.

SER. NO. 77-385,785, FILED 1-31-2008.

PAUL E. FAHRENKOPF, EXAMINING ATTORNEY

Int. Cl.: 35

Prior U.S. Cls.: 100, 101 and 102

United States Patent and Trademark Office

Reg. No. 3,484,773

Registered Aug. 12, 2008

**SERVICE MARK
PRINCIPAL REGISTER**

DauidsBridal.com

DBD, INC. (DELAWARE CORPORATION)
1001 WASHINGTON STREET
CONSHOHOCKEN, PA 19428

FOR: ON-LINE RETAIL STORE SERVICES FEATURING A WIDE VARIETY OF CONSUMER GOODS IN THE FIELDS OF WEDDINGS AND SPECIAL OCCASSIONS; PROMOTION OF GOODS AND SERVICES OF OTHERS IN THE FIELDS OF WEDDINGS AND SPECIAL OCCASSIONS BY PROVIDING HYPERTEXT LINKS TO THE WEB SITES OF OTHERS, IN CLASS 35 (U.S. CLS. 100, 101 AND 102).

FIRST USE 12-1-1988; IN COMMERCE 12-1-1988.

THE MARK CONSISTS OF STANDARD CHARACTERS WITHOUT CLAIM TO ANY PARTICULAR FONT, STYLE, SIZE, OR COLOR.

OWNER OF U.S. REG. NOS. 2,708,959, 2,817,374, AND 3,017,372.

SER. NO. 77-386,407, FILED 2-1-2008.

BENJAMIN ALLEN, EXAMINING ATTORNEY

Int. Cl.: 5

Prior U.S. Cls.: 6, 18, 44, 46, 51 and 52

United States Patent and Trademark Office

Reg. No. 3,484,774

Registered Aug. 12, 2008

**TRADEMARK
PRINCIPAL REGISTER**

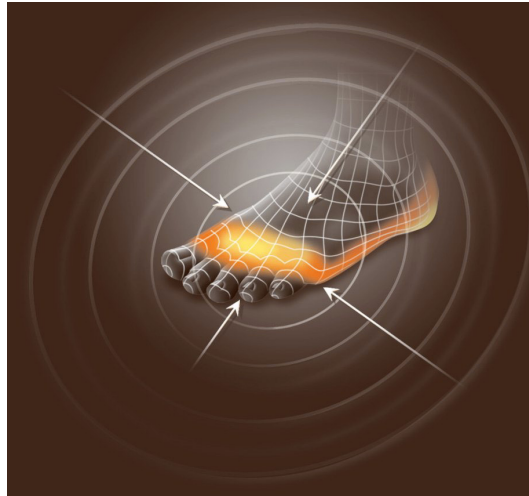

SCHERING CORPORATION (NEW YORK CORPORATION)
K-6-1 M1030
2000 GALLOPING HILL ROAD
KENILWORTH, NJ 070330530

THE MARK CONSISTS OF A FOOT DESIGN WITHIN A DARK AND LIGHT GREY BULLSEYE TARGET WITH FOUR WHITE ARROWS POINTING TO THE FOOT CONTAINING THE COLORS ORANGE AND YELLOW.

FOR: ANTIFUNGAL SKIN PREPARATIONS, IN CLASS 5 (U.S. CLS. 6, 18, 44, 46, 51 AND 52).

FIRST USE 1-31-2002; IN COMMERCE 1-31-2002.

SER. NO. 77-386,414, FILED 2-1-2008.

THE COLOR(S) DARK GREY, LIGHT GREY, WHITE, ORANGE, AND YELLOW IS/ARE CLAIMED AS A FEATURE OF THE MARK.

DARRYL SPRUILL, EXAMINING ATTORNEY

Int. Cl.: 25

Prior U.S. Cls.: 22 and 39

United States Patent and Trademark Office

Reg. No. 3,484,775

Registered Aug. 12, 2008

TRADEMARK
PRINCIPAL REGISTER

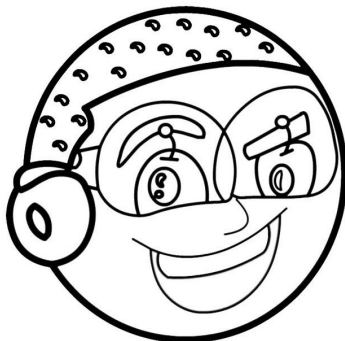

FRESH FRUIT APPAREL LLC (CALIFORNIA
LTD LIAB CO)
APT 210
11136 ACAMA ST
STUDIO CITY, CA 91602

FOR: HATS; JACKETS; BEANIES; BANDANAS; SHIRTS; PANTS; POLO SHIRTS; SHOES; SHORTS; SWEAT SHIRTS; T-SHIRTS; A-SHIRTS; BUTTON-FRONT ALOHA SHIRTS; CAMP SHIRTS; DRESS SHIRTS; GOLF SHIRTS; KNIT SHIRTS; LONG-SLEEVED SHIRTS; NIGHT SHIRTS; OPEN-NECKED SHIRTS; PIQUE SHIRTS; RUGBY SHIRTS; SHIRT FRONTS; SHIRT YOKES; SHIRTS FOR SUITS; SHORT-SLEEVED OR LONG-SLEEVED T-SHIRTS; SHORT-SLEEVED SHIRTS; SLEEP SHIRTS; SPORT SHIRTS; SPORTS SHIRTS; SPORTS SHIRTS WITH SHORT SLEEVES; TEE SHIRTS; TRIATHLON CLOTHING, NAMELY, TRIATHLON TIGHTS, TRIATHLON SHORTS, TRIATHLON SINGLET, TRIATHLON SHIRTS, TRIATHLON SUITS; WIND SHIRTS; YOGA SHIRTS; BALLOON PANTS; CAPRI PANTS; CARGO PANTS; DENIMS; JOGGING PANTS; LEATHER PANTS; LOUNGE PANTS; NON-DISPOSABLE CLOTH TRAINING PANTS; NURSE PANTS; PETTI-PANTS; SKI PANTS; SNOW PANTS; SNOWBOARD PANTS; STRETCH PANTS; SWEAT PANTS; TAP PANTS; TOBOGGAN HATS, PANTS AND CAPS; TRACK PANTS; WATERPROOF JACKETS AND PANTS; WIND PANTS; YOGA PANTS; CHEF'S HATS; FUR HATS; HAT BANDS; PAPER HATS FOR USE AS CLOTHING ITEMS; SEDGE HATS (SUGE-GASA); SMALL HATS; WOOLLY HATS; BED JACKETS; DENIM JACKETS; DOWN JACKETS; FISHERMEN'S JACKETS; FUR COATS AND JACKETS; FUR JACKETS; HEAVY JACKETS;

JACKET LINERS; LEATHER JACKETS; LIGHT-REFLECTING JACKETS; LONG JACKETS; MEN AND WOMEN JACKETS, COATS, TROUSERS, VESTS; RAIN JACKETS; RAINPROOF JACKETS; REVERSIBLE JACKETS; SHELL JACKETS; SKI JACKETS; SLEEVED OR SLEEVELESS JACKETS; SMOKING JACKETS; SPORTS JACKETS; STUFF JACKETS; SUEDE JACKETS; WIND RESISTANT JACKETS; BOARD SHORTS; BOXER SHORTS; FLEECE SHORTS; GYM SHORTS; PANTIES, SHORTS AND BRIEFS; RUGBY SHORTS; SHORT OVERCOAT FOR KIMONO (HAORI); SHORT PETTICOATS; SHORT SETS; SHORT TROUSERS; SLIDING SHORTS; SWEAT SHORTS; UNDERWEAR, NAMELY, BOY SHORTS; WALKING SHORTS; ANGLERS' SHOES; APRES-SKI SHOES; ATHLETIC SHOES; BALLET SHOES; BALLROOM DANCING SHOES; BASEBALL SHOES; BEACH SHOES; BOWLING SHOES; BOXING SHOES; CANVAS SHOES; CLEATS FOR ATTACHMENT TO SPORTS SHOES; CYCLING SHOES; DANCE SHOES; DECK-SHOES; DRIVERS; FOOTBALL SHOES; GOLF SHOES; GYMNAS TIC SHOES; HANDBALL SHOES; HEEL PIECES FOR SHOES; HOCKEY SHOES; INFANTS' SHOES AND BOOTS; INSOLES; LEATHER SHOES; PAPER SHOES USED WHEN GOING THROUGH METAL DETECTORS TO KEEP FEET AND SOCKS CLEAN; PROTECTIVE METAL MEMBERS FOR SHOES AND BOOTS; RUBBER SHOES; RUGBY SHOES; RUNNING SHOES; SHOE DOWELS; SHOE INSERTS FOR PRIMARILY NON-ORTHOPEDIC PURPOSES; SHOE PEGS; SHOE SOLES; SHOES SOLES FOR REPAIR; SKI AND SNOWBOARD SHOES AND PARTS THEREOF; SKIING SHOES; SOCCER SHOES; TAP SHOES; TENNIS SHOES; TONGUE OR PULLSTRAP FOR SHOES AND BOOTS; TRACK AND FIELD

SHOES; TRAINING SHOES; VOLLEYBALL SHOES;
WOMEN'S SHOES; WORK SHOES AND BOOTS , IN
CLASS 25 (U.S. CLS. 22 AND 39).

THE MARK CONSISTS OF A WATERMELON
HEAD WITH SEEDS IN THE HAIR AREA. AND
CHERRIES AS THE EYES WITH SUNGLASS.

SER. NO. 77-387,071, FILED 2-2-2008.

FIRST USE 6-16-2006; IN COMMERCE 10-27-2007.

BRIAN NEVILLE, EXAMINING ATTORNEY

Int. Cl.: 5

Prior U.S. Cls.: 6, 18, 44, 46, 51 and 52

Reg. No. 3,484,776

United States Patent and Trademark Office

Registered Aug. 12, 2008

**TRADEMARK
PRINCIPAL REGISTER**

WATERLICIOUS

DEVONE LAWSON, INC. (CALIFORNIA CORPORATION)

507

13428 MAXELLA AVENUE
MARINA DEL REY, CA 90292

FOR: NUTRITIONALLY FORTIFIED WATER;
VITAMIN ENRICHED WATER; VITAMIN FORTIFIED BEVERAGES; NUTRITIONALLY FORTIFIED BEVERAGES, IN CLASS 5 (U.S. CLS. 6, 18, 44, 46, 51 AND 52).

FIRST USE 11-1-2006; IN COMMERCE 11-1-2006.

THE MARK CONSISTS OF STANDARD CHARACTERS WITHOUT CLAIM TO ANY PARTICULAR FONT, STYLE, SIZE, OR COLOR.

SER. NO. 77-387,229, FILED 2-2-2008.

JEAN IM, EXAMINING ATTORNEY

Int. Cl.: 25

Prior U.S. Cls.: 22 and 39

United States Patent and Trademark Office

Reg. No. 3,484,777

Registered Aug. 12, 2008

**TRADEMARK
PRINCIPAL REGISTER**

Find Freedom

ZZ BIKER WEAR (ILLINOIS LTD LIAB CO)
500 EAST EUCLID AVENUE
ARLINGTON HEIGHTS, IL 60004

FOR: SPORT SHIRTS; SPORTS SHIRTS WITH SHORT SLEEVES; T-SHIRTS; TEE SHIRTS; A-SHIRTS; CAMP SHIRTS; DRESS SHIRTS; GOLF SHIRTS; KNIT SHIRTS; LONG-SLEEVED SHIRTS; OPEN-NECKED SHIRTS; SHIRT FRONTS; SHIRTS; SHIRTS FOR SUITS; SHORT-SLEEVED OR LONG-SLEEVED T-SHIRTS; SHORT-SLEEVED SHIRTS; CROP TOPS; HALTER TOPS; MUSCLE TOPS; RUG-

BY TOPS; TANK TOPS; TANK-TOPS; TOPS, IN CLASS 25 (U.S. CLS. 22 AND 39).

FIRST USE 12-1-2005; IN COMMERCE 1-23-2008.

THE MARK CONSISTS OF STANDARD CHARACTERS WITHOUT CLAIM TO ANY PARTICULAR FONT, STYLE, SIZE, OR COLOR.

SER. NO. 77-387,322, FILED 2-3-2008.

EVELYN BRADLEY, EXAMINING ATTORNEY

Int. Cl.: 41

Prior U.S. Cls.: 100, 101 and 107

United States Patent and Trademark Office

Reg. No. 3,484,778

Registered Aug. 12, 2008

**SERVICE MARK
PRINCIPAL REGISTER**

FAST Modules

CUSTOMER FOCUS, INC. (GEORGIA CORPORATION)

664 GLENOVER DRIVE

ALPHARETTA, GA 30004

FOR: TEACHING AND TRAINING IN BUSINESS,
INDUSTRY AND INFORMATION TECHNOLOGY,
IN CLASS 41 (U.S. CLS. 100, 101 AND 107).

FIRST USE 11-11-2003; IN COMMERCE 11-11-2003.

THE MARK CONSISTS OF STANDARD CHARACTERS WITHOUT CLAIM TO ANY PARTICULAR FONT, STYLE, SIZE, OR COLOR.

NO CLAIM IS MADE TO THE EXCLUSIVE RIGHT TO USE "MODULES", APART FROM THE MARK AS SHOWN.

SER. NO. 77-387,496, FILED 2-4-2008.

AMOS T. MATTHEWS, JR., EXAMINING ATTORNEY

Int. Cl.: 41

Prior U.S. Cls.: 100, 101 and 107

United States Patent and Trademark Office

Reg. No. 3,484,779

Registered Aug. 12, 2008

**SERVICE MARK
PRINCIPAL REGISTER**

The GIFTed Trainer

CUSTOMER FOCUS, INC. (GEORGIA CORPORATION)

664 GLENOVER DRIVE

ALPHARETTA, GA 30004

FOR: TEACHING AND TRAINING IN BUSINESS,
INDUSTRY AND INFORMATION TECHNOLOGY,
IN CLASS 41 (U.S. CLS. 100, 101 AND 107).

FIRST USE 12-17-2003; IN COMMERCE 12-17-2003.

THE MARK CONSISTS OF STANDARD CHARACTERS WITHOUT CLAIM TO ANY PARTICULAR FONT, STYLE, SIZE, OR COLOR.

NO CLAIM IS MADE TO THE EXCLUSIVE RIGHT TO USE "TRAINER", APART FROM THE MARK AS SHOWN.

SER. NO. 77-387,510, FILED 2-4-2008.

AMOS T. MATTHEWS, JR., EXAMINING ATTORNEY

Int. Cl.: 15

Prior U.S. Cls.: 2, 21 and 36

United States Patent and Trademark Office

Reg. No. 3,484,780

Registered Aug. 12, 2008

**TRADEMARK
PRINCIPAL REGISTER**

WIDOW

KUSTOM MUSICAL AMPLIFICATION, INC.
(OHIO CORPORATION)
2395 ARBOR TECH DRIVE
HEBRON, KY 41048

THE MARK CONSISTS OF STANDARD CHAR-
ACTERS WITHOUT CLAIM TO ANY PARTICULAR
FONT, STYLE, SIZE, OR COLOR.

FOR: GUITARS, IN CLASS 15 (U.S. CLS. 2, 21 AND
36).

SER. NO. 77-387,680, FILED 2-4-2008.

FIRST USE 6-9-2005; IN COMMERCE 6-9-2005.

ANN E. SAPPENFIELD, EXAMINING ATTORNEY

Int. Cl.: 36

Prior U.S. Cls.: 100, 101 and 102

United States Patent and Trademark Office

Reg. No. 3,484,781

Registered Aug. 12, 2008

**SERVICE MARK
PRINCIPAL REGISTER**



WYETH (DELAWARE CORPORATION)
FIVE GIRALDA FARMS
MADISON, NJ 07940

FOR: PROVIDING GRANTS OR EDUCATIONAL SCHOLARSHIPS TO ANIMAL SCIENCE AND VETERINARY STUDENTS; ESTABLISHING SCHOLARSHIPS AT INSTITUTIONS WITH AGRICULTURAL AND/OR ANIMAL HUSBANDRY PROGRAMS , IN CLASS 36 (U.S. CLS. 100, 101 AND 102).

FIRST USE 9-0-2007; IN COMMERCE 9-0-2007.

NO CLAIM IS MADE TO THE EXCLUSIVE RIGHT TO USE "SCHOLARSHIP PROGRAM", APART FROM THE MARK AS SHOWN.

THE MARK CONSISTS OF THE WORDS "LEGACY SCHOLARSHIP PROGRAM" WHICH FORM A CIRCLE AND IN THE CENTER OF THE CIRCLE THERE IS A SILHOUETTE OF A COW'S HEAD.

SER. NO. 77-388,109, FILED 2-4-2008.

VERNA BETH RIRIE, EXAMINING ATTORNEY

Int. Cl.: 32

Prior U.S. Cls.: 45, 46 and 48

United States Patent and Trademark Office

Reg. No. 3,484,782

Registered Aug. 12, 2008

**TRADEMARK
PRINCIPAL REGISTER**

Brainy Bear

DEVONE LAWSON, INC. (CALIFORNIA CORPORATION)

507

13428 MAXELLA AVENUE
MARINA DEL REY, CA 90292

FOR: BOTTLED DRINKING WATER; BOTTLED WATER; DRINKING WATER; FLAVORED BOTTLED WATER; FLAVORED WATERS; FLAVOURED WATERS, IN CLASS 32 (U.S. CLS. 45, 46 AND 48).

FIRST USE 1-4-2008; IN COMMERCE 1-4-2008.

THE MARK CONSISTS OF STANDARD CHARACTERS WITHOUT CLAIM TO ANY PARTICULAR FONT, STYLE, SIZE, OR COLOR.

SER. NO. 77-388,409, FILED 2-5-2008.

JEAN IM, EXAMINING ATTORNEY

Int. Cl.: 32

Prior U.S. Cls.: 45, 46 and 48

Reg. No. 3,484,783

United States Patent and Trademark Office

Registered Aug. 12, 2008

TRADEMARK
PRINCIPAL REGISTER

Waterlicious Krusty Krab
Kiwi

DEVONE LAWSON, INC. (CALIFORNIA CORPORATION)

507

13428 MAXELLA AVENUE
MARINA DEL REY, CA 90292

FOR: BOTTLED WATER; DRINKING WATER;
FLAVORED BOTTLED WATER; FLAVORED WATERS;
FLAVOURED WATERS, ALL THE FOREGOING BEING
KIWI FLAVORED, IN CLASS 32 (U.S. CLS. 45, 46 AND 48).

FIRST USE 1-4-2008; IN COMMERCE 1-4-2008.

THE MARK CONSISTS OF STANDARD CHARACTERS WITHOUT CLAIM TO ANY PARTICULAR FONT, STYLE, SIZE, OR COLOR.

OWNER OF U.S. REG. NO. 3,411,644.

NO CLAIM IS MADE TO THE EXCLUSIVE RIGHT TO USE "KIWI", APART FROM THE MARK AS SHOWN.

SER. NO. 77-388,416, FILED 2-5-2008.

JEAN IM, EXAMINING ATTORNEY

Int. Cl.: 36

Prior U.S. Cls.: 100, 101 and 102

United States Patent and Trademark Office

Reg. No. 3,484,784

Registered Aug. 12, 2008

**SERVICE MARK
PRINCIPAL REGISTER**

AIG HORIZONMYG

AMERICAN INTERNATIONAL GROUP, INC.
(DELAWARE CORPORATION)
70 PINE STREET
NEW YORK, NY 10270

FOR: ANNUITY UNDERWRITING; ISSUANCE
AND ADMINISTRATION OF ANNUITIES, IN
CLASS 36 (U.S. CLS. 100, 101 AND 102).

FIRST USE 2-1-2008; IN COMMERCE 2-1-2008.

THE MARK CONSISTS OF STANDARD CHAR-
ACTERS WITHOUT CLAIM TO ANY PARTICULAR
FONT, STYLE, SIZE, OR COLOR.

OWNER OF U.S. REG. NOS. 3,076,514, 3,077,573
AND OTHERS.

SER. NO. 77-389,709, FILED 2-6-2008.

BRIDGETT SMITH, EXAMINING ATTORNEY

Int. Cl.: 36

Prior U.S. Cls.: 100, 101 and 102

United States Patent and Trademark Office

Reg. No. 3,484,785

Registered Aug. 12, 2008

**SERVICE MARK
PRINCIPAL REGISTER**

AIG HORIZONSELECT

AMERICAN INTERNATIONAL GROUP, INC.
(DELAWARE CORPORATION)
70 PINE STREET
NEW YORK, NY 10270

FOR: ANNUITY UNDERWRITING; ISSUANCE
AND ADMINISTRATION OF ANNUITIES, IN
CLASS 36 (U.S. CLS. 100, 101 AND 102).

FIRST USE 2-1-2008; IN COMMERCE 2-1-2008.

THE MARK CONSISTS OF STANDARD CHAR-
ACTERS WITHOUT CLAIM TO ANY PARTICULAR
FONT, STYLE, SIZE, OR COLOR.

OWNER OF U.S. REG. NOS. 3,076,515, 3,109,993
AND OTHERS.

SER. NO. 77-390,085, FILED 2-6-2008.

BRIDGETT SMITH, EXAMINING ATTORNEY

Int. Cl.: 36

Prior U.S. Cls.: 100, 101 and 102

United States Patent and Trademark Office

Reg. No. 3,484,786

Registered Aug. 12, 2008

**SERVICE MARK
PRINCIPAL REGISTER**

AIG HORIZONFLEX

AMERICAN INTERNATIONAL GROUP, INC.
(DELAWARE CORPORATION)
70 PINE STREET
NEW YORK, NY 10270

FOR: ANNUITY UNDERWRITING; ISSUANCE
AND ADMINISTRATION OF ANNUITIES, IN
CLASS 36 (U.S. CLS. 100, 101 AND 102).

FIRST USE 2-1-2008; IN COMMERCE 2-1-2008.

THE MARK CONSISTS OF STANDARD CHAR-
ACTERS WITHOUT CLAIM TO ANY PARTICULAR
FONT, STYLE, SIZE, OR COLOR.

OWNER OF U.S. REG. NOS. 3,076,514, 3,077,573
AND OTHERS.

SER. NO. 77-390,107, FILED 2-6-2008.

BRIDGETT SMITH, EXAMINING ATTORNEY

Int. Cls.: 37 and 40

Prior U.S. Cls.: 100, 103 and 106

United States Patent and Trademark Office

Reg. No. 3,484,787

Registered Aug. 12, 2008

**SERVICE MARK
PRINCIPAL REGISTER**

WE'RE HERE FOR YOU

DISASTER BLASTER, INC. (PENNSYLVANIA
CORPORATION)
911 MAIN STREET
AVOCA, PA 18641

FOR: CONSTRUCTION AND RENOVATION OF
BUILDINGS, CLEANUP AND RESTORATION OF
BUILDING INTERIORS, EXTERIORS AND FURNI-
TURE DAMAGED BY FIRE, SMOKE, WATER AND
FLOOD, AIR DUCT CLEANING SERVICES, IN
CLASS 37 (U.S. CLS. 100, 103 AND 106).

FIRST USE 12-17-2007; IN COMMERCE 12-17-2007.

FOR: MOLD REMEDIATION SERVICES, IN
CLASS 40 (U.S. CLS. 100, 103 AND 106).

FIRST USE 12-17-2007; IN COMMERCE 12-17-2007.

THE MARK CONSISTS OF STANDARD CHAR-
ACTERS WITHOUT CLAIM TO ANY PARTICULAR
FONT, STYLE, SIZE, OR COLOR.

SER. NO. 77-390,492, FILED 2-6-2008.

CHRISTINE COOPER, EXAMINING ATTORNEY

Int. Cl.: 13

Prior U.S. Cls.: 2 and 9

United States Patent and Trademark Office

Reg. No. 3,484,788

Registered Aug. 12, 2008

TRADEMARK
PRINCIPAL REGISTER



ADVANCED ARMAMENT CORP. (GEORGIA CORPORATION)
1434 HILLCREST RD
NORCROSS, GA 30093

FOR: SILENCERS FOR FIREARMS, IN CLASS 13 (U.S. CLS. 2 AND 9).

FIRST USE 6-1-2004; IN COMMERCE 6-1-2004.

NO CLAIM IS MADE TO THE EXCLUSIVE RIGHT TO USE "ARMAMENT CORP. MADE IN U.S.A." , APART FROM THE MARK AS SHOWN.

THE MARK CONSISTS OF A SKULL WITH A PAIR OF CROSSED GUNS BELOW, WITH A STAR BELOW THE GUNS, WITH THE WORDING "ADVANCED ARMAMENT CORP. MADE IN U.S.A." APPEARING BELOW ALL DESIGN ELEMENTS.

SER. NO. 77-391,698, FILED 2-7-2008.

ADA HAN, EXAMINING ATTORNEY

Int. Cl.: 6

Prior U.S. Cls.: 2, 12, 13, 14, 23, 25 and 50

Reg. No. 3,484,789

United States Patent and Trademark Office

Registered Aug. 12, 2008

**TRADEMARK
PRINCIPAL REGISTER**

MY PRECIOUS

THE SAUL ZAENTZ COMPANY (DELAWARE
CORPORATION)
2600 TENTH STREET
BERKELEY, CA 94710

THE MARK CONSISTS OF STANDARD CHAR-
ACTERS WITHOUT CLAIM TO ANY PARTICULAR
FONT, STYLE, SIZE, OR COLOR.

FOR: FIGURINES AND FIGURAL PRODUCTS,
NAMELY, COLLECTIBLE FIGURINES AND FIG-
URINES INCORPORATED INTO SETTINGS, MADE
OF COMMON METALS AND THEIR ALLOYS, IN
CLASS 6 (U.S. CLS. 2, 12, 13, 14, 23, 25 AND 50).

OWNER OF U.S. REG. NOS. 3,369,891 AND
3,381,139.

SER. NO. 77-392,882, FILED 2-8-2008.

FIRST USE 1-28-2008; IN COMMERCE 1-28-2008.

MICHAEL LITZAU, EXAMINING ATTORNEY

Int. Cl.: 16

Prior U.S. Cls.: 2, 5, 22, 23, 29, 37, 38 and 50

United States Patent and Trademark Office

Reg. No. 3,484,790

Registered Aug. 12, 2008

**TRADEMARK
PRINCIPAL REGISTER**

ONE RING TO RULE THEM ALL

THE SAUL ZAENTZ COMPANY (DELAWARE
CORPORATION)
2600 TENTH STREET
BERKELEY, CA 94710

FOR: PAPER WEIGHTS, IN CLASS 16 (U.S. CLS. 2,
5, 22, 23, 29, 37, 38 AND 50).

FIRST USE 2-7-2008; IN COMMERCE 2-7-2008.

THE MARK CONSISTS OF STANDARD CHAR-
ACTERS WITHOUT CLAIM TO ANY PARTICULAR
FONT, STYLE, SIZE, OR COLOR.

OWNER OF U.S. REG. NOS. 3,064,025 AND
3,407,389.

SER. NO. 77-392,897, FILED 2-8-2008.

MICHAEL LITZAU, EXAMINING ATTORNEY

Int. Cl.: 21

Prior U.S. Cls.: 2, 13, 23, 29, 30, 33, 40 and 50

Reg. No. 3,484,791

United States Patent and Trademark Office

Registered Aug. 12, 2008

**TRADEMARK
PRINCIPAL REGISTER**

SMAUG

THE SAUL ZAENTZ COMPANY (DELAWARE
CORPORATION)
2600 TENTH STREET
BERKELEY, CA 94710

THE MARK CONSISTS OF STANDARD CHAR-
ACTERS WITHOUT CLAIM TO ANY PARTICULAR
FONT, STYLE, SIZE, OR COLOR.

FOR: PEWTER GOBLETS, IN CLASS 21 (U.S. CLS.
2, 13, 23, 29, 30, 33, 40 AND 50).

SER. NO. 77-392,904, FILED 2-8-2008.

FIRST USE 4-10-2002; IN COMMERCE 2-6-2008.

MICHAEL LITZAU, EXAMINING ATTORNEY

Int. Cl.: 21

Prior U.S. Cls.: 2, 13, 23, 29, 30, 33, 40 and 50

United States Patent and Trademark Office

Reg. No. 3,484,792

Registered Aug. 12, 2008

**TRADEMARK
PRINCIPAL REGISTER**

HOBBIT

THE SAUL ZAENTZ COMPANY (DELAWARE
CORPORATION)
2600 TENTH STREET
BERKELEY, CA 94710

FOR: PEWTER GOBLETS, IN CLASS 21 (U.S. CLS.
2, 13, 23, 29, 30, 33, 40 AND 50).

FIRST USE 4-11-2002; IN COMMERCE 9-20-2007.

THE MARK CONSISTS OF STANDARD CHAR-
ACTERS WITHOUT CLAIM TO ANY PARTICULAR
FONT, STYLE, SIZE, OR COLOR.

OWNER OF U.S. REG. NOS. 1,230,026, 2,976,573
AND OTHERS.

SER. NO. 77-392,916, FILED 2-8-2008.

MICHAEL LITZAU, EXAMINING ATTORNEY

Int. Cl.: 41

Prior U.S. Cls.: 100, 101 and 107

United States Patent and Trademark Office

Reg. No. 3,484,793

Registered Aug. 12, 2008

**SERVICE MARK
PRINCIPAL REGISTER**

BRIERMAN

SEMMELE, NEIL S. (UNITED STATES INDIVIDUAL)
230 MARINERS WAY
BEAR, DE 19701

FOR: ORGANIZING COMMUNITY SPORTING AND CULTURAL EVENTS, IN CLASS 41 (U.S. CLS. 100, 101 AND 107).

FIRST USE 1-6-2008; IN COMMERCE 1-6-2008.

THE MARK CONSISTS OF STANDARD CHARACTERS WITHOUT CLAIM TO ANY PARTICULAR FONT, STYLE, SIZE, OR COLOR.

SER. NO. 77-394,109, FILED 2-11-2008.

MARK RADEMACHER, EXAMINING ATTORNEY

Int. Cls.: 3 and 5

Prior U.S. Cls.: 1, 4, 6, 18, 44, 46, 50, 51 and 52

Reg. No. 3,484,794

United States Patent and Trademark Office

Registered Aug. 12, 2008

**TRADEMARK
PRINCIPAL REGISTER**



**BERNARD GROUP TECHNOLOGIES, LLC
(FLORIDA LTD LIAB CO)
20201 N.E. 15TH COURT
MIAMI, FL 33179**

**FOR: ANTIBACTERIAL HAND LOTIONS, ANTI-
BACTERIAL HANDWASH AND ALL PURPOSE
DISINFECTANTS, IN CLASS 5 (U.S. CLS. 6, 18, 44,
46, 51 AND 52).**

**FOR: HAND LOTIONS AND HAND SOAPS, IN
CLASS 3 (U.S. CLS. 1, 4, 6, 50, 51 AND 52).**

FIRST USE 10-31-2007; IN COMMERCE 10-31-2007.

SER. NO. 77-394,781, FILED 2-12-2008.

FIRST USE 10-31-2007; IN COMMERCE 10-31-2007.

AMY GEARIN, EXAMINING ATTORNEY

Int. Cl.: 30

Prior U.S. Cl.: 46

United States Patent and Trademark Office

Reg. No. 3,484,795

Registered Aug. 12, 2008

**TRADEMARK
PRINCIPAL REGISTER**

OMAR COFFEE

OMAR COFFEE COMPANY, THE (CONNECTI-
CUT CORPORATION)
41 COMMERCE COURT
NEWINGTON, CT 06111

OWNER OF U.S. REG. NO. 3,344,277.

FOR: COFFEE; GROUND COFFEE BEANS;
ROASTED COFFEE BEANS, IN CLASS 30 (U.S. CL.
46).

NO CLAIM IS MADE TO THE EXCLUSIVE
RIGHT TO USE "COFFEE", APART FROM THE
MARK AS SHOWN.

FIRST USE 10-31-1937; IN COMMERCE 10-31-1937.

SER. NO. 77-394,897, FILED 2-12-2008.

THE MARK CONSISTS OF STANDARD CHAR-
ACTERS WITHOUT CLAIM TO ANY PARTICULAR
FONT, STYLE, SIZE, OR COLOR.

DAVID MILLER, EXAMINING ATTORNEY

Int. Cl.: 3

Prior U.S. Cls.: 1, 4, 6, 50, 51 and 52

United States Patent and Trademark Office

Reg. No. 3,484,796

Registered Aug. 12, 2008

**TRADEMARK
PRINCIPAL REGISTER**

DEFENSE ULTIME

L'OREAL (FRANCE SOCIÉTÉ ANONYME (SA))
14 RUE ROYALE
PARIS, FRANCE 75008

FOR: SHAMPOOS; GELS, SPRAYS, MOUSSES
AND BALMS FOR THE HAIR STYLING AND HAIR
CARE; HAIR LACQUERS; HAIR COLOURING AND
HAIR DECOLORANT PREPARATIONS; PERMA-
NENT WAVING AND CURLING PREPARATIONS
, IN CLASS 3 (U.S. CLS. 1, 4, 6, 50, 51 AND 52).

THE MARK CONSISTS OF STANDARD CHAR-
ACTERS WITHOUT CLAIM TO ANY PARTICULAR
FONT, STYLE, SIZE, OR COLOR.

PRIORITY CLAIMED UNDER SEC. 44(D) ON
FRANCE APPLICATION NO. 073520831, FILED 8-
23-2007, REG. NO. 073520831, DATED 8-23-2007, EX-
PIRES 8-23-2017.

THE ENGLISH TRANSLATION OF THE WORD
"ULTIME" IN THE MARK IS "ULTIMATE".

SER. NO. 77-395,973, FILED 2-13-2008.

JANET LEE, EXAMINING ATTORNEY

Int. Cl.: 9

Prior U.S. Cls.: 21, 23, 26, 36 and 38

Reg. No. 3,484,797

United States Patent and Trademark Office

Registered Aug. 12, 2008

**TRADEMARK
PRINCIPAL REGISTER**

CONFIG600

EMERSON ELECTRIC CO. (MISSOURI CORPORATION)
8000 WEST FLORISSANT AVENUE
ST. LOUIS, MO 63136

THE MARK CONSISTS OF STANDARD CHARACTERS WITHOUT CLAIM TO ANY PARTICULAR FONT, STYLE, SIZE, OR COLOR.

FOR: SOFTWARE THAT ENABLES THE USER TO MONITOR, CONFIGURE AND CALIBRATE FLOW METERS, IN CLASS 9 (U.S. CLS. 21, 23, 26, 36 AND 38).

SER. NO. 77-396,368, FILED 2-13-2008.

FIRST USE 12-31-2003; IN COMMERCE 12-31-2003.

TARAH HARDY, EXAMINING ATTORNEY

Int. Cls.: 16, 25 and 36

**Prior U.S. Cls.: 2, 5, 22, 23, 29, 37, 38, 39, 50, 100, 101
and 102**

Reg. No. 3,484,798

United States Patent and Trademark Office

Registered Aug. 12, 2008

**TRADEMARK
SERVICE MARK
PRINCIPAL REGISTER**



THE MOYER FOUNDATION

Helping Children in Distress

THE MOYER FOUNDATION (WASHINGTON
NON-PROFIT CORPORATION)
2426 32ND AVE. W. #200
SEATTLE, WA 98199

FOR: PAPER GOODS AND PRINTED MATTER,
NAMELY, WALL CALENDARS, IN CLASS 16 (U.S.
CLS. 2, 5, 22, 23, 29, 37, 38 AND 50).

FIRST USE 6-0-2005; IN COMMERCE 3-0-2007.

FOR: CLOTHING, NAMELY, T-SHIRTS, IN
CLASS 25 (U.S. CLS. 22 AND 39).

FIRST USE 6-0-2005; IN COMMERCE 3-0-2007.

FOR: CHARITABLE FUNDRAISING SERVICES,
IN CLASS 36 (U.S. CLS. 100, 101 AND 102).

FIRST USE 6-0-2005; IN COMMERCE 3-0-2007.

OWNER OF U.S. REG. NOS. 2,988,371, 3,048,867
AND OTHERS.

NO CLAIM IS MADE TO THE EXCLUSIVE
RIGHT TO USE "FOUNDATION", APART FROM
THE MARK AS SHOWN.

SER. NO. 77-396,860, FILED 2-14-2008.

IRA J. GOODSaid, EXAMINING ATTORNEY

Int. Cl.: 25

Prior U.S. Cls.: 22 and 39

United States Patent and Trademark Office

Reg. No. 3,484,799

Registered Aug. 12, 2008

**TRADEMARK
PRINCIPAL REGISTER**

ABERCROMBIE

ABERCROMBIE & FITCH TRADING CO. (OHIO
CORPORATION)

6301 FITCH PATH

NEW ALBANY, OH 43054

FOR: COATS; JACKETS; KNIT SHIRTS; SHIRTS;
T-SHIRTS; UNDERWEAR; PANTS; JEANS; HATS;
SHOES, IN CLASS 25 (U.S. CLS. 22 AND 39).

FIRST USE 7-10-1998; IN COMMERCE 7-10-1998.

THE MARK CONSISTS OF STANDARD CHAR-
ACTERS WITHOUT CLAIM TO ANY PARTICULAR
FONT, STYLE, SIZE, OR COLOR.

OWNER OF U.S. REG. NOS. 2,305,464, 3,374,463
AND OTHERS.

SEC. 2(F).

SER. NO. 77-397,350, FILED 2-14-2008.

STEVEN PEREZ, EXAMINING ATTORNEY

Int. Cl.: 43

Prior U.S. Cls.: 100 and 101

United States Patent and Trademark Office

Reg. No. 3,484,800

Registered Aug. 12, 2008

**SERVICE MARK
PRINCIPAL REGISTER**

bright now

LA QUINTA WORLDWIDE, LLC (NEVADA LTD
LIAB CO)
101 CONVENTION CENTER DRIVE, SUITE 850
LAS VEGAS, NV 89109

THE MARK CONSISTS OF STANDARD CHAR-
ACTERS WITHOUT CLAIM TO ANY PARTICULAR
FONT, STYLE, SIZE, OR COLOR.

FOR: HOTEL SERVICES PROVIDING A GUEST
REWARD INCENTIVE PROGRAM, IN CLASS 43
(U.S. CLS. 100 AND 101).

SER. NO. 77-397,530, FILED 2-14-2008.

FIRST USE 2-2-2008; IN COMMERCE 2-2-2008.

JENNY PARK, EXAMINING ATTORNEY

Int. Cl.: 5

Prior U.S. Cls.: 6, 18, 44, 46, 51 and 52

Reg. No. 3,484,801

United States Patent and Trademark Office

Registered Aug. 12, 2008

**TRADEMARK
PRINCIPAL REGISTER**

Female Longevity

CENTURY SYSTEMS INC. (GEORGIA CORPORATION)

120 SELIG DR

ATLANTA, GA 30336

FOR: NUTRITIONAL SUPPLEMENTS, IN CLASS 5 (U.S. CLS. 6, 18, 44, 46, 51 AND 52).

FIRST USE 1-20-2004; IN COMMERCE 1-2-2008.

THE MARK CONSISTS OF STANDARD CHARACTERS WITHOUT CLAIM TO ANY PARTICULAR FONT, STYLE, SIZE, OR COLOR.

NO CLAIM IS MADE TO THE EXCLUSIVE RIGHT TO USE "FEMALE", APART FROM THE MARK AS SHOWN.

SER. NO. 77-397,798, FILED 2-15-2008.

AHSEN KHAN, EXAMINING ATTORNEY

Int. Cl.: 5

Prior U.S. Cls.: 6, 18, 44, 46, 51 and 52

Reg. No. 3,484,802

United States Patent and Trademark Office

Registered Aug. 12, 2008

**TRADEMARK
PRINCIPAL REGISTER**

Male Drive

CENTURY SYSTEMS INC. (GEORGIA CORPORATION)

120 SELIG DR

ATLANTA, GA 30336

FOR: NUTRITIONAL SUPPLEMENTS, IN CLASS 5 (U.S. CLS. 6, 18, 44, 46, 51 AND 52).

FIRST USE 1-20-2004; IN COMMERCE 1-2-2008.

THE MARK CONSISTS OF STANDARD CHARACTERS WITHOUT CLAIM TO ANY PARTICULAR FONT, STYLE, SIZE, OR COLOR.

NO CLAIM IS MADE TO THE EXCLUSIVE RIGHT TO USE "MALE", APART FROM THE MARK AS SHOWN.

SER. NO. 77-397,800, FILED 2-15-2008.

MELVIN AXILBUND, EXAMINING ATTORNEY

Int. Cl.: 5

Prior U.S. Cls.: 6, 18, 44, 46, 51 and 52

Reg. No. 3,484,803

United States Patent and Trademark Office

Registered Aug. 12, 2008

**TRADEMARK
PRINCIPAL REGISTER**

Male Longevity

CENTURY SYSTEMS INC. (GEORGIA CORPORATION)

120 SELIG DR

ATLANTA, GA 30336

FOR: NUTRITIONAL SUPPLEMENTS, IN CLASS 5 (U.S. CLS. 6, 18, 44, 46, 51 AND 52).

FIRST USE 1-20-2004; IN COMMERCE 1-2-2008.

THE MARK CONSISTS OF STANDARD CHARACTERS WITHOUT CLAIM TO ANY PARTICULAR FONT, STYLE, SIZE, OR COLOR.

NO CLAIM IS MADE TO THE EXCLUSIVE RIGHT TO USE "MALE", APART FROM THE MARK AS SHOWN.

SER. NO. 77-397,803, FILED 2-15-2008.

JENNIFER VASQUEZ, EXAMINING ATTORNEY

Int. Cl.: 35

Prior U.S. Cls.: 100, 101 and 102

United States Patent and Trademark Office

Reg. No. 3,484,804

Registered Aug. 12, 2008

**SERVICE MARK
PRINCIPAL REGISTER**

go cart

HANNAFORD LICENSING CORP. (MAINE CORPORATION)
LEGAL DEPT.
145 PLEASANT HILL ROAD
SCARBOROUGH, ME 04074

THE MARK CONSISTS OF STANDARD CHARACTERS WITHOUT CLAIM TO ANY PARTICULAR FONT, STYLE, SIZE, OR COLOR.

FOR: RETAIL SUPERMARKET SERVICES, IN CLASS 35 (U.S. CLS. 100, 101 AND 102).

SER. NO. 77-397,953, FILED 2-15-2008.

FIRST USE 11-13-2007; IN COMMERCE 11-13-2007.

GRETTA YAO, EXAMINING ATTORNEY

Int. Cl.: 9

Prior U.S. Cls.: 21, 23, 26, 36 and 38

Reg. No. 3,484,805

United States Patent and Trademark Office

Registered Aug. 12, 2008

**TRADEMARK
PRINCIPAL REGISTER**

ARNO

ADOBE SYSTEMS INCORPORATED (DELA-
WARE CORPORATION)
LEGAL DEPARTMENT
345 PARK AVENUE
SAN JOSE, CA 95110

FOR: DOWNLOADABLE TYPEFACE COMPU-
TER SOFTWARE AND COMPUTER SOFTWARE
FOR CREATING FONTS, AND INSTRUCTIONAL
BOOKS AND MANUALS SOLD AS A UNIT THERE-
WITH , IN CLASS 9 (U.S. CLS. 21, 23, 26, 36 AND 38).

FIRST USE 4-16-2007; IN COMMERCE 4-16-2007.

THE MARK CONSISTS OF STANDARD CHAR-
ACTERS WITHOUT CLAIM TO ANY PARTICULAR
FONT, STYLE, SIZE, OR COLOR.

SER. NO. 77-398,203, FILED 2-15-2008.

EMILY CARLSEN, EXAMINING ATTORNEY

Int. Cl.: 16

Prior U.S. Cls.: 2, 5, 22, 23, 29, 37, 38 and 50

Reg. No. 3,484,806

United States Patent and Trademark Office

Registered Aug. 12, 2008

**TRADEMARK
PRINCIPAL REGISTER**

LIVE LAUGH LOVE LIFE

D-GENERATION, INC. (FLORIDA CORPORATION)
P. O. BOX 30
DAYTONA BEACH, FL 321150030

FOR: CALENDARS; LOOSE LEAF BINDERS;
NOTEPADS; STICKERS; HOLIDAY CARDS, IN
CLASS 16 (U.S. CLS. 2, 5, 22, 23, 29, 37, 38 AND 50).

FIRST USE 3-5-1999; IN COMMERCE 3-5-1999.

THE MARK CONSISTS OF STANDARD CHARACTERS WITHOUT CLAIM TO ANY PARTICULAR FONT, STYLE, SIZE, OR COLOR.

OWNER OF U.S. REG. NOS. 3,368,922 AND 3,385,179.

SER. NO. 77-398,804, FILED 2-15-2008.

MARY MUNSON, EXAMINING ATTORNEY

Int. Cl.: 7

Prior U.S. Cls.: 13, 19, 21, 23, 31, 34 and 35

Reg. No. 3,484,807

United States Patent and Trademark Office

Registered Aug. 12, 2008

**TRADEMARK
PRINCIPAL REGISTER**

SKYHOOK

INSITU, INC. (WASHINGTON CORPORATION)
118 E. COLUMBIA RIVER WAY
BINGEN, WA 98605

FIRST USE 2-15-2008; IN COMMERCE 2-15-2008.

FOR: PORTABLE POWER-OPERATED MACHINERY COMPOSED OF A BOOM ARM WITH ATTACHED CAPTURE ROPE FOR THE LANDING AND RETRIEVAL OF UNMANNED AERIAL VEHICLES, IN CLASS 7 (U.S. CLS. 13, 19, 21, 23, 31, 34 AND 35).

THE MARK CONSISTS OF STANDARD CHARACTERS WITHOUT CLAIM TO ANY PARTICULAR FONT, STYLE, SIZE, OR COLOR.

SER. NO. 77-398,856, FILED 2-15-2008.

CURTIS FRENCH, EXAMINING ATTORNEY

Int. Cl.: 32

Prior U.S. Cls.: 45, 46 and 48

Reg. No. 3,484,808

United States Patent and Trademark Office

Registered Aug. 12, 2008

**TRADEMARK
PRINCIPAL REGISTER**

AGUALICIOSO

DEVONE LAWSON, INC. (CALIFORNIA CORPORATION)

507

13428 MAXELLA AVENUE
MARINA DEL REY, CA 90292

FOR: BOTTLED DRINKING WATER; BOTTLED WATER; DRINKING WATER; FLAVORED BOTTLED WATER; FLAVORED WATERS; MINERAL WATER, IN CLASS 32 (U.S. CLS. 45, 46 AND 48).

FIRST USE 2-4-2008; IN COMMERCE 2-4-2008.

THE MARK CONSISTS OF STANDARD CHARACTERS WITHOUT CLAIM TO ANY PARTICULAR FONT, STYLE, SIZE, OR COLOR.

THE ENGLISH TRANSLATION OF "AGUA" IN THE MARK IS WATER.

SER. NO. 77-399,202, FILED 2-17-2008.

JEAN IM, EXAMINING ATTORNEY

Int. Cl.: 25

Prior U.S. Cls.: 22 and 39

United States Patent and Trademark Office

Reg. No. 3,484,809

Registered Aug. 12, 2008

**TRADEMARK
PRINCIPAL REGISTER**

ESQUIRE

HEARST COMMUNICATIONS, INC. (DELA-
WARE CORPORATION)
959 EIGHTH AVENUE
NEW YORK, NY 10019

FOR: SHIRTS; SHORTS; UNDERWEAR; WO-
MEN'S UNDERWEAR, IN CLASS 25 (U.S. CLS. 22
AND 39).

FIRST USE 1-28-2008; IN COMMERCE 1-28-2008.

THE MARK CONSISTS OF STANDARD CHAR-
ACTERS WITHOUT CLAIM TO ANY PARTICULAR
FONT, STYLE, SIZE, OR COLOR.

OWNER OF U.S. REG. NOS. 168,186, 1,413,197 AND
OTHERS.

SER. NO. 77-400,540, FILED 2-19-2008.

DAVID I, EXAMINING ATTORNEY

Int. Cl.: 36

Prior U.S. Cls.: 100, 101 and 102

United States Patent and Trademark Office

Reg. No. 3,484,810

Registered Aug. 12, 2008

**SERVICE MARK
PRINCIPAL REGISTER**

AIG ACCIDENT EXPENSE PLUS

AMERICAN INTERNATIONAL GROUP, INC.
(DELAWARE CORPORATION)
70 PINE STREET
NEW YORK, NY 10270

OWNER OF U.S. REG. NOS. 1,151,229, 1,273,845
AND OTHERS.

FOR: INSURANCE UNDERWRITING IN THE
FIELD OF ACCIDENT AND HEALTH AND CRITI-
CAL ILLNESS, IN CLASS 36 (U.S. CLS. 100, 101 AND
102).

NO CLAIM IS MADE TO THE EXCLUSIVE
RIGHT TO USE "ACCIDENT EXPENSE", APART
FROM THE MARK AS SHOWN.

FIRST USE 2-4-2008; IN COMMERCE 2-4-2008.

SER. NO. 77-400,594, FILED 2-19-2008.

THE MARK CONSISTS OF STANDARD CHAR-
ACTERS WITHOUT CLAIM TO ANY PARTICULAR
FONT, STYLE, SIZE, OR COLOR.

BRIDGETT SMITH, EXAMINING ATTORNEY

Int. Cl.: 1

Prior U.S. Cls.: 1, 5, 6, 10, 26 and 46

Reg. No. 3,484,811

United States Patent and Trademark Office

Registered Aug. 12, 2008

**TRADEMARK
PRINCIPAL REGISTER**

PLANT POWER

MCRIGHT SERVICES, LLC (MISSISSIPPI LTD
LIAB CO), DBA DELTAG FORMULATIONS

P.O. BOX 4812

GREENVILLE, MS 38704

FOR: FERTILIZERS, IN CLASS 1 (U.S. CLS. 1, 5, 6,
10, 26 AND 46).

FIRST USE 5-0-2006; IN COMMERCE 5-0-2006.

THE MARK CONSISTS OF STANDARD CHAR-
ACTERS WITHOUT CLAIM TO ANY PARTICULAR
FONT, STYLE, SIZE, OR COLOR.

NO CLAIM IS MADE TO THE EXCLUSIVE
RIGHT TO USE "PLANT", APART FROM THE
MARK AS SHOWN.

SER. NO. 77-401,109, FILED 2-20-2008.

JENNY PARK, EXAMINING ATTORNEY

Int. Cl.: 35

Prior U.S. Cls.: 100, 101 and 102

United States Patent and Trademark Office

Reg. No. 3,484,812

Registered Aug. 12, 2008

**SERVICE MARK
PRINCIPAL REGISTER**

ABERCROMBIE

ABERCROMBIE & FITCH TRADING CO. (OHIO
CORPORATION)
6301 FITCH PATH
NEW ALBANY, OH 43054

FOR: ON-LINE RETAIL STORE SERVICES FEATURING CLOTHING, ACCESSORIES AND PERSONAL CARE ITEMS; RETAIL STORES FEATURING CLOTHING, ACCESSORIES AND PERSONAL CARE ITEMS, IN CLASS 35 (U.S. CLS. 100, 101 AND 102).

FIRST USE 7-10-1998; IN COMMERCE 7-10-1998.

THE MARK CONSISTS OF STANDARD CHARACTERS WITHOUT CLAIM TO ANY PARTICULAR FONT, STYLE, SIZE, OR COLOR.

OWNER OF U.S. REG. NOS. 2,305,464, 3,374,463 AND OTHERS.

SEC. 2(F).

SER. NO. 77-401,130, FILED 2-20-2008.

STEVEN PEREZ, EXAMINING ATTORNEY

Int. Cl.: 41

Prior U.S. Cls.: 100, 101 and 107

United States Patent and Trademark Office

Reg. No. 3,484,813

Registered Aug. 12, 2008

**SERVICE MARK
PRINCIPAL REGISTER**

NDTC

VARSITY SPIRIT CORPORATION (TENNESSEE
CORPORATION)
6745 LENOX CENTER COURT, SUITE 300
MEMPHIS, TN 38115

FOR: ENTERTAINMENT SERVICES, NAMELY,
ARRANGING AND CONDUCTING A NATIONAL
COMPETITION FOR HIGH SCHOOL AND JUNIOR
HIGH SCHOOL DANCE TEAMS, DRILL TEAMS
AND POMPON SQUADS, IN CLASS 41 (U.S. CLS. 100,
101 AND 107).

FIRST USE 2-2-2002; IN COMMERCE 2-2-2002.

THE MARK CONSISTS OF STANDARD CHAR-
ACTERS WITHOUT CLAIM TO ANY PARTICULAR
FONT, STYLE, SIZE, OR COLOR.

OWNER OF U.S. REG. NOS. 1,545,915 AND
1,776,825.

SER. NO. 77-401,387, FILED 2-20-2008.

MICHAEL TANNER, EXAMINING ATTORNEY

Int. Cl.: 41

Prior U.S. Cls.: 100, 101 and 107

United States Patent and Trademark Office

Reg. No. 3,484,814

Registered Aug. 12, 2008

**SERVICE MARK
PRINCIPAL REGISTER**

NHSCC

VARSITY SPIRIT CORPORATION (TENNESSEE
CORPORATION)
6745 LENOX CENTER COURT, SUITE 300
MEMPHIS, TN 38115

FOR: ARRANGING AND CONDUCTING A NA-
TIONAL COMPETITION FOR HIGH SCHOOL AND
JUNIOR HIGH SCHOOL CHEERLEADERS, IN
CLASS 41 (U.S. CLS. 100, 101 AND 107).

FIRST USE 2-9-2002; IN COMMERCE 2-9-2002.

THE MARK CONSISTS OF STANDARD CHAR-
ACTERS WITHOUT CLAIM TO ANY PARTICULAR
FONT, STYLE, SIZE, OR COLOR.

OWNER OF U.S. REG. NOS. 1,423,351 AND
1,576,926.

SER. NO. 77-401,408, FILED 2-20-2008.

MICHAEL TANNER, EXAMINING ATTORNEY

Int. Cl.: 41

Prior U.S. Cls.: 100, 101 and 107

United States Patent and Trademark Office

Reg. No. 3,484,815

Registered Aug. 12, 2008

**SERVICE MARK
PRINCIPAL REGISTER**

NASCC

VARSITY SPIRIT CORPORATION (TENNESSEE
CORPORATION)
6745 LENOX CENTER COURT, SUITE 300
MEMPHIS, TN 38115

FOR: ARRANGING AND CONDUCTING A NA-
TIONAL COMPETITION FOR HIGH SCHOOL AND
JUNIOR HIGH SCHOOL CHEERLEADERS, IN
CLASS 41 (U.S. CLS. 100, 101 AND 107).

FIRST USE 3-9-2002; IN COMMERCE 3-9-2002.

THE MARK CONSISTS OF STANDARD CHAR-
ACTERS WITHOUT CLAIM TO ANY PARTICULAR
FONT, STYLE, SIZE, OR COLOR.

OWNER OF U.S. REG. NOS. 1,576,926 AND
2,436,010.

SER. NO. 77-401,414, FILED 2-20-2008.

MICHAEL TANNER, EXAMINING ATTORNEY

Int. Cl.: 43

Prior U.S. Cls.: 100 and 101

United States Patent and Trademark Office

Reg. No. 3,484,816

Registered Aug. 12, 2008

**SERVICE MARK
PRINCIPAL REGISTER**

SEE VEGGIES DIFFERENTLY

KELLOGG NORTH AMERICA COMPANY (DE-
LAWARE CORPORATION)
ONE KELLOGG SQUARE, PO BOX 3599
BATTLE CREEK, MI 490163599

FOR: PROVIDING A DATABASE IN THE FIELD
OF RECIPES AND COOKING INFORMATION, IN
CLASS 43 (U.S. CLS. 100 AND 101).

FIRST USE 1-24-2007; IN COMMERCE 1-24-2007.

THE MARK CONSISTS OF STANDARD CHAR-
ACTERS WITHOUT CLAIM TO ANY PARTICULAR
FONT, STYLE, SIZE, OR COLOR.

NO CLAIM IS MADE TO THE EXCLUSIVE
RIGHT TO USE "VEGGIES", APART FROM THE
MARK AS SHOWN.

SER. NO. 77-401,431, FILED 2-20-2008.

H. M. FISHER, EXAMINING ATTORNEY

Int. Cl.: 29

Prior U.S. Cl.: 46

United States Patent and Trademark Office

Reg. No. 3,484,817

Registered Aug. 12, 2008

**TRADEMARK
PRINCIPAL REGISTER**

**PICKED AT THE PEAK OF
PERFECTION**

GENERAL MILLS MARKETING, INC. (DELA-
WARE CORPORATION)
NUMBER ONE GENERAL MILLS BOULEVARD
MINNEAPOLIS, MN 55426

FOR: CANNED VEGETABLES; FROZEN VEGE-
TABLES WITH OR WITHOUT SAUCE; FROZEN
VEGETABLE CASSEROLE; VEGETABLE-BASED
SNACK FOOD, NAMELY, NUGGETS MADE PRI-
MARILY OF PROCESSED VEGETABLES, IN CLASS
29 (U.S. CL. 46).

FIRST USE 10-22-2007; IN COMMERCE 10-22-2007.

THE MARK CONSISTS OF STANDARD CHAR-
ACTERS WITHOUT CLAIM TO ANY PARTICULAR
FONT, STYLE, SIZE, OR COLOR.

SER. NO. 77-401,480, FILED 2-20-2008.

CHRISTINE BLOMQUIST, EXAMINING ATTOR-
NEY

Int. Cl.: 21

Prior U.S. Cls.: 2, 13, 23, 29, 30, 33, 40 and 50

United States Patent and Trademark Office

Reg. No. 3,484,818

Registered Aug. 12, 2008

**TRADEMARK
PRINCIPAL REGISTER**

POPCORN 101 BY TABLETOPS

TABLETOPS UNLIMITED, INC. (CALIFORNIA
CORPORATION)
23000 AVALON BOULEVARD
CARSON, CA 90745

OWNER OF U.S. REG. NOS. 3,240,691, 3,283,715
AND OTHERS.

FOR: KITCHENWARE, NAMELY, SERVING
BOWLS, SMALL BOWLS, SEASONING SHAKERS,
IN CLASS 21 (U.S. CLS. 2, 13, 23, 29, 30, 33, 40 AND 50).

NO CLAIM IS MADE TO THE EXCLUSIVE
RIGHT TO USE "POPCORN", APART FROM THE
MARK AS SHOWN.

FIRST USE 7-19-2005; IN COMMERCE 7-19-2005.

SER. NO. 77-402,065, FILED 2-20-2008.

THE MARK CONSISTS OF STANDARD CHAR-
ACTERS WITHOUT CLAIM TO ANY PARTICULAR
FONT, STYLE, SIZE, OR COLOR.

DOMINIC FATHY, EXAMINING ATTORNEY

Int. Cl.: 21

Prior U.S. Cls.: 2, 13, 23, 29, 30, 33, 40 and 50

Reg. No. 3,484,819

United States Patent and Trademark Office

Registered Aug. 12, 2008

**TRADEMARK
PRINCIPAL REGISTER**

WOK 101 BY TABLETOPS

TABLETOPS UNLIMITED, INC. (CALIFORNIA CORPORATION)
23000 AVALON BOULEVARD
CARSON, CA 907455017

FOR: KITCHENWARE, NAMELY, WOKS, COOKING POT LIDS, COOKING POT RACKS, BAMBOO BASKETS WITH COVER FOR HOLDING AND STORING FOOD, BAMBOO STEAMER BASKETS, BASTING BRUSHES FOR USE WITH FOOD; KITCHEN UTENSILS, NAMELY, WIRE BASKETS, SERVING AND STIRRING SPOONS, SPATULAS, STRAINERS, CHOPSTICKS, IN CLASS 21 (U.S. CLS. 2, 13, 23, 29, 30, 33, 40 AND 50).

FIRST USE 2-24-2006; IN COMMERCE 2-24-2006.

THE MARK CONSISTS OF STANDARD CHARACTERS WITHOUT CLAIM TO ANY PARTICULAR FONT, STYLE, SIZE, OR COLOR.

OWNER OF U.S. REG. NOS. 3,240,691, 3,283,715 AND OTHERS.

NO CLAIM IS MADE TO THE EXCLUSIVE RIGHT TO USE "WOK", APART FROM THE MARK AS SHOWN.

SER. NO. 77-402,073, FILED 2-20-2008.

DOMINIC FATHY, EXAMINING ATTORNEY

Int. Cl.: 38

Prior U.S. Cls.: 100, 101 and 104

United States Patent and Trademark Office

Reg. No. 3,484,820

Registered Aug. 12, 2008

**SERVICE MARK
PRINCIPAL REGISTER**

SMARTSET

QWEST COMMUNICATIONS INTERNATIONAL
INC. (DELAWARE CORPORATION)
1801 CALIFORNIA STREET
DENVER, CO 80202

FOR: TELECOMMUNICATION SERVICES IN
THE NATURE OF PROVIDING TELEPHONE FEAT-
URES, NAMELY, CALL WAITING, CALL IDENTI-
FICATION, CALL FORWARDING, AND MESSAGE
WAITING, IN CLASS 38 (U.S. CLS. 100, 101 AND 104).

FIRST USE 11-30-1998; IN COMMERCE 11-30-1998.

THE MARK CONSISTS OF STANDARD CHAR-
ACTERS WITHOUT CLAIM TO ANY PARTICULAR
FONT, STYLE, SIZE, OR COLOR.

SER. NO. 77-402,558, FILED 2-21-2008.

WON TEAK OH, EXAMINING ATTORNEY

Int. Cls.: 16, 21 and 25

**Prior U.S. Cls.: 2, 5, 13, 22, 23, 29, 30, 33, 37, 38, 39, 40
and 50**

Reg. No. 3,484,821

United States Patent and Trademark Office

Registered Aug. 12, 2008

**TRADEMARK
PRINCIPAL REGISTER**

HOBBIT

THE SAUL ZAENTZ COMPANY (DELAWARE
CORPORATION)
2600 TENTH STREET
BERKELEY, CA 94710

FOR: FIGURES OF CARDBOARD, IN CLASS 16
(U.S. CLS. 2, 5, 22, 23, 29, 37, 38 AND 50).

FIRST USE 3-28-2002; IN COMMERCE 2-13-2008.

FOR: PEWTER SHOT GLASSES, PEWTER GOB-
LETS, IN CLASS 21 (U.S. CLS. 2, 13, 23, 29, 30, 33, 40
AND 50).

FIRST USE 4-8-2002; IN COMMERCE 2-13-2008.

FOR: COSTUME SHOE COVERS, IN CLASS 25
(U.S. CLS. 22 AND 39).

FIRST USE 8-30-2003; IN COMMERCE 2-13-2008.

THE MARK CONSISTS OF STANDARD CHAR-
ACTERS WITHOUT CLAIM TO ANY PARTICULAR
FONT, STYLE, SIZE, OR COLOR.

OWNER OF U.S. REG. NOS. 1,230,026, 2,976,573
AND OTHERS.

SER. NO. 77-403,156, FILED 2-21-2008.

MICHAEL LITZAU, EXAMINING ATTORNEY

Int. Cl.: 16

Prior U.S. Cls.: 2, 5, 22, 23, 29, 37, 38 and 50

United States Patent and Trademark Office

Reg. No. 3,484,822

Registered Aug. 12, 2008

**TRADEMARK
PRINCIPAL REGISTER**

THE ONE RING

THE SAUL ZAENTZ COMPANY (DELAWARE
CORPORATION)
2600 TENTH STREET
BERKELEY, CA 94710

FOR: BOOK MARKS, IN CLASS 16 (U.S. CLS. 2, 5,
22, 23, 29, 37, 38 AND 50).

FIRST USE 2-11-2008; IN COMMERCE 2-11-2008.

THE MARK CONSISTS OF STANDARD CHAR-
ACTERS WITHOUT CLAIM TO ANY PARTICULAR
FONT, STYLE, SIZE, OR COLOR.

OWNER OF U.S. REG. NOS. 3,064,025 AND
3,407,389.

SER. NO. 77-403,232, FILED 2-21-2008.

MICHAEL LITZAU, EXAMINING ATTORNEY

Int. Cl.: 3

Prior U.S. Cls.: 1, 4, 6, 50, 51 and 52

United States Patent and Trademark Office

Reg. No. 3,484,823

Registered Aug. 12, 2008

**TRADEMARK
PRINCIPAL REGISTER**

FORCERELAX

L'OREAL (FRANCE SOCIÉTÉ ANONYME (SA))
14 RUE ROYALE
PARIS, FRANCE 75008

FOR: SHAMPOOS; GELS, SPRAYS, MOUSSES
AND BALMS FOR THE HAIR STYLING AND HAIR
CARE; HAIR LACQUERS; HAIR COLOURING AND
HAIR DECOLORANT PREPARATIONS; PERMA-
NENT WAVING AND CURLING PREPARATIONS;
ESSENTIAL OILS FOR PERSONAL USE, IN CLASS 3
(U.S. CLS. 1, 4, 6, 50, 51 AND 52).

THE MARK CONSISTS OF STANDARD CHAR-
ACTERS WITHOUT CLAIM TO ANY PARTICULAR
FONT, STYLE, SIZE, OR COLOR.

PRIORITY CLAIMED UNDER SEC. 44(D) ON
FRANCE APPLICATION NO. 073523987, FILED 9-
12-2007, REG. NO. 073523987, DATED 9-12-2007, EX-
PIRES 9-12-2017.

SER. NO. 77-403,479, FILED 2-22-2008.

JANET LEE, EXAMINING ATTORNEY

Int. Cl.: 3

Prior U.S. Cls.: 1, 4, 6, 50, 51 and 52

United States Patent and Trademark Office

Reg. No. 3,484,824

Registered Aug. 12, 2008

**TRADEMARK
PRINCIPAL REGISTER**

OPTIC LIGHT

L'OREAL (FRANCE SOCIÉTÉ ANONYME (SA))
14 RUE ROYALE
PARIS, FRANCE 75008

FOR: SHAMPOOS; GELS, SPRAYS, MOUSSES
AND BALMS FOR THE HAIR STYLING AND HAIR
CARE; HAIR LACQUERS; HAIR COLOURING AND
HAIR DECOLORANT PREPARATIONS; PERMA-
NENT WAVING AND CURLING PREPARATIONS;
ESSENTIAL OILS FOR PERSONAL USE, IN CLASS 3
(U.S. CLS. 1, 4, 6, 50, 51 AND 52).

THE MARK CONSISTS OF STANDARD CHAR-
ACTERS WITHOUT CLAIM TO ANY PARTICULAR
FONT, STYLE, SIZE, OR COLOR.

PRIORITY CLAIMED UNDER SEC. 44(D) ON
FRANCE APPLICATION NO. 073523985, FILED 9-
12-2007, REG. NO. 073523985, DATED 9-12-2007, EX-
PIRES 9-12-2017.

SER. NO. 77-403,480, FILED 2-22-2008.

JANET LEE, EXAMINING ATTORNEY

Int. Cl.: 3

Prior U.S. Cls.: 1, 4, 6, 50, 51 and 52

United States Patent and Trademark Office

Reg. No. 3,484,825

Registered Aug. 12, 2008

**TRADEMARK
PRINCIPAL REGISTER**

COMPLEXE EYE FIRMÉ

PHARMAGEL INTERNATIONAL, INC. (CALI-
FORNIA CORPORATION)
9201 GAZETTE AVENUE
CHATSWORTH, CA 91311

FOR: NON-MEDICATED SKIN CARE PREPARA-
TIONS, IN CLASS 3 (U.S. CLS. 1, 4, 6, 50, 51 AND 52).

FIRST USE 12-30-1996; IN COMMERCE 12-30-1996.

THE MARK CONSISTS OF STANDARD CHAR-
ACTERS WITHOUT CLAIM TO ANY PARTICULAR
FONT, STYLE, SIZE, OR COLOR.

OWNER OF U.S. REG. NOS. 2,137,085 AND
2,137,087.

NO CLAIM IS MADE TO THE EXCLUSIVE
RIGHT TO USE "EYE FIRME", APART FROM THE
MARK AS SHOWN.

THE FOREIGN WORDING IN THE MARK
TRANSLATES INTO ENGLISH AS COMPLEX EYE
FIRM.

SER. NO. 77-403,742, FILED 2-22-2008.

ELIZABETH HUGHITT, EXAMINING ATTORNEY

Int. Cls.: 25 and 41

Prior U.S. Cls.: 22, 39, 100, 101 and 107

United States Patent and Trademark Office

Reg. No. 3,484,826

Registered Aug. 12, 2008

**TRADEMARK
SERVICE MARK
PRINCIPAL REGISTER**



FLIRTY GIRL FITNESS INC. (CANADA CORPORATION)
462 WELLINGTON STREET WEST SUITE 110
TORONTO, CANADA M5V1E3

FOR: TANK TOP, IN CLASS 25 (U.S. CLS. 22 AND 39).

FIRST USE 1-11-2007; IN COMMERCE 7-13-2007.

FOR: HEALTH CLUB SERVICES, NAMELY, PROVIDING INSTRUCTION AND EQUIPMENT IN THE

FIELD OF PHYSICAL EXERCISE, IN CLASS 41 (U.S. CLS. 100, 101 AND 107).

FIRST USE 4-0-2005; IN COMMERCE 12-0-2005.

THE MARK CONSISTS OF A BUTTERFLY.

SER. NO. 77-403,953, FILED 2-22-2008.

VERNA BETH RIRIE, EXAMINING ATTORNEY

Int. Cl.: 9

Prior U.S. Cls.: 21, 23, 26, 36 and 38

Reg. No. 3,484,827

United States Patent and Trademark Office

Registered Aug. 12, 2008

**TRADEMARK
PRINCIPAL REGISTER**



ADOBE SYSTEMS INCORPORATED (DELA-
WARE CORPORATION)
LEGAL DEPARTMENT
345 PARK AVENUE
SAN JOSE, CA 95110

FOR: COMPUTER SOFTWARE FOR FILE FOR-
MAT CONVERSION; COMPUTER SOFTWARE FOR
READING, STORING, SAVING, ARCHIVING, MA-
NIPULATING, FORMATTING, PROCESSING,
EDITING, CONVERTING, AND DISPLAYING
RAW DIGITAL FILES FROM DIGITAL CAMERAS
AND DIGITAL IMAGE RECORDERS; COMPUTER
SOFTWARE TO FACILITATE HARDWARE AND
SOFTWARE COMPATIBILITY; COMPUTER SOFT-
WARE FOR WRITING AND READING FILES AND
COMPUTER SOFTWARE FILES; FILE MANAGE-
MENT SOFTWARE FOR OPENING AND CON-
VERTING PHOTOGRAPHIC, DIGITAL AND
GRAPHIC IMAGES, DATA, AUDIO, VIDEO, AND
RECORDED INFORMATION TO VARIOUS FILE
FORMATS; COMPUTER SOFTWARE FOR CREAT-
ING, VIEWING, MANIPULATING, EDITING,
MANAGING, INDEXING, CATALOGUING, SORT-
ING, ORGANIZING, ARCHIVING, STORING,
TRANSFERRING, COMPRESSING, SYNCHRONIZ-
ING, PRINTING AND EXCHANGING DIGITAL
PHOTOGRAPHS, DIGITAL AND GRAPHIC IMA-

GES, DATA, AUDIO, VIDEO, AND RECORDED
INFORMATION; COMPUTER SOFTWARE FOR
TRANSFERRING DIGITAL PHOTOGRAPHS, DIGI-
TAL AND GRAPHIC IMAGES, DATA, AUDIO,
VIDEO, AND RECORDED INFORMATION TO CD-
ROM DISCS, DVD DISCS, DIGITAL VIDEO DISCS,
COMPACT FLASH, FLASH MEMORY, MEMORY
STICKS; COMPUTER SOFTWARE FOR TRANSFER-
RING DIGITAL PHOTOGRAPHS, DIGITAL AND
GRAPHIC IMAGES, DATA, AUDIO, VIDEO, AND
RECORDED INFORMATION FOR USE OVER COM-
PUTER NETWORKS, WIRELESS NETWORKS AND
GLOBAL COMMUNICATION NETWORKS; AND
USERS' MANUALS AND INSTRUCTIONAL BOOKS
SOLD AS A UNIT THEREWITH, IN CLASS 9 (U.S.
CLS. 21, 23, 26, 36 AND 38).

FIRST USE 9-27-2004; IN COMMERCE 9-27-2004.

THE MARK CONSISTS OF THE LETTERS "DNG"
WITHIN A DESIGN THAT LOOKS LIKE A FILM
FRAME.

SER. NO. 77-404,343, FILED 2-22-2008.

EMILY CARLSEN, EXAMINING ATTORNEY

Int. Cl.: 36

Prior U.S. Cls.: 100, 101 and 102

United States Patent and Trademark Office

Reg. No. 3,484,828

Registered Aug. 12, 2008

**SERVICE MARK
PRINCIPAL REGISTER**

AIG COMMERCIAL PLL

AMERICAN INTERNATIONAL GROUP, INC.
(DELAWARE CORPORATION)
70 PINE STREET
NEW YORK, NY 10270

OWNER OF U.S. REG. NOS. 1,151,229, 1,273,845
AND OTHERS.

FOR: INSURANCE UNDERWRITING IN THE
FIELD OF POLLUTION LIABILITY AND ENVIR-
ONMENTAL INSURANCE, IN CLASS 36 (U.S. CLS.
100, 101 AND 102).

NO CLAIM IS MADE TO THE EXCLUSIVE
RIGHT TO USE "COMMERCIAL PLL", APART
FROM THE MARK AS SHOWN.

FIRST USE 11-1-2007; IN COMMERCE 11-1-2007.

SER. NO. 77-405,046, FILED 2-25-2008.

THE MARK CONSISTS OF STANDARD CHAR-
ACTERS WITHOUT CLAIM TO ANY PARTICULAR
FONT, STYLE, SIZE, OR COLOR.

BRIDGETT SMITH, EXAMINING ATTORNEY

Int. Cl.: 36

Prior U.S. Cls.: 100, 101 and 102

United States Patent and Trademark Office

Reg. No. 3,484,829

Registered Aug. 12, 2008

**SERVICE MARK
PRINCIPAL REGISTER**

**AIG POLLUTION LEGAL
LIABILITY REAL ESTATE**

AMERICAN INTERNATIONAL GROUP, INC.
(DELAWARE CORPORATION)
70 PINE STREET
NEW YORK, NY 10270

OWNER OF U.S. REG. NOS. 1,151,229, 2,145,483
AND OTHERS.

FOR: INSURANCE UNDERWRITING IN THE
FIELD OF POLLUTION LIABILITY AND ENVIR-
ONMENTAL INSURANCE, IN CLASS 36 (U.S. CLS.
100, 101 AND 102).

NO CLAIM IS MADE TO THE EXCLUSIVE
RIGHT TO USE "POLLUTION LEGAL LIABILITY
REAL ESTATE", APART FROM THE MARK AS
SHOWN.

FIRST USE 2-1-2008; IN COMMERCE 2-1-2008.

SER. NO. 77-405,072, FILED 2-25-2008.

THE MARK CONSISTS OF STANDARD CHAR-
ACTERS WITHOUT CLAIM TO ANY PARTICULAR
FONT, STYLE, SIZE, OR COLOR.

BRIDGETT SMITH, EXAMINING ATTORNEY

Int. Cl.: 36

Prior U.S. Cls.: 100, 101 and 102

United States Patent and Trademark Office

Reg. No. 3,484,830

Registered Aug. 12, 2008

**SERVICE MARK
PRINCIPAL REGISTER**

AIG PLL REAL ESTATE

AMERICAN INTERNATIONAL GROUP, INC.
(DELAWARE CORPORATION)
70 PINE STREET
NEW YORK, NY 10270

OWNER OF U.S. REG. NOS. 1,151,229, 1,273,845
AND OTHERS.

FOR: INSURANCE UNDERWRITING IN THE
FIELD OF POLLUTION LIABILITY AND ENVIR-
ONMENTAL INSURANCE, IN CLASS 36 (U.S. CLS.
100, 101 AND 102).

NO CLAIM IS MADE TO THE EXCLUSIVE
RIGHT TO USE "PLL REAL ESTATE", APART
FROM THE MARK AS SHOWN.

FIRST USE 2-1-2008; IN COMMERCE 2-1-2008.

SER. NO. 77-405,081, FILED 2-25-2008.

THE MARK CONSISTS OF STANDARD CHAR-
ACTERS WITHOUT CLAIM TO ANY PARTICULAR
FONT, STYLE, SIZE, OR COLOR.

BRIDGETT SMITH, EXAMINING ATTORNEY

Int. Cl.: 36

Prior U.S. Cls.: 100, 101 and 102

United States Patent and Trademark Office

Reg. No. 3,484,831

Registered Aug. 12, 2008

**SERVICE MARK
PRINCIPAL REGISTER**

**AIG COMMERCIAL POLLUTION
LEGAL LIABILITY**

AMERICAN INTERNATIONAL GROUP, INC.
(DELAWARE CORPORATION)
70 PINE STREET
NEW YORK, NY 10270

OWNER OF U.S. REG. NOS. 1,151,229, 2,145,483
AND OTHERS.

FOR: INSURANCE UNDERWRITING IN THE
FIELD OF POLLUTION LIABILITY AND ENVIR-
ONMENTAL INSURANCE, IN CLASS 36 (U.S. CLS.
100, 101 AND 102).

NO CLAIM IS MADE TO THE EXCLUSIVE
RIGHT TO USE "COMMERCIAL POLLUTION LE-
GAL LIABILITY", APART FROM THE MARK AS
SHOWN.

FIRST USE 11-1-2007; IN COMMERCE 11-1-2007.

SER. NO. 77-405,106, FILED 2-25-2008.

THE MARK CONSISTS OF STANDARD CHAR-
ACTERS WITHOUT CLAIM TO ANY PARTICULAR
FONT, STYLE, SIZE, OR COLOR.

BRIDGETT SMITH, EXAMINING ATTORNEY

Int. Cl.: 36

Prior U.S. Cls.: 100, 101 and 102

United States Patent and Trademark Office

Reg. No. 3,484,832

Registered Aug. 12, 2008

**SERVICE MARK
PRINCIPAL REGISTER**

RBP

TRANSPARENT VALUE, LLC (DELAWARE LTD
LIAB CO)
100 WALL STREET, 8TH FLOOR
NEW YORK, NY 20004

FOR: PROVIDING INDEXES OF SECURITIES
VALUES, IN CLASS 36 (U.S. CLS. 100, 101 AND 102).

FIRST USE 6-30-2003; IN COMMERCE 6-30-2003.

THE MARK CONSISTS OF STANDARD CHAR-
ACTERS WITHOUT CLAIM TO ANY PARTICULAR
FONT, STYLE, SIZE, OR COLOR.

OWNER OF U.S. REG. NO. 3,142,132.

SER. NO. 77-405,903, FILED 2-26-2008.

ALICE SUE CARRUTHERS, EXAMINING ATTOR-
NEY

Int. Cl.: 25

Prior U.S. Cls.: 22 and 39

United States Patent and Trademark Office

Reg. No. 3,484,833

Registered Aug. 12, 2008

**TRADEMARK
PRINCIPAL REGISTER**

PEDISAVERS

FELIX DESIGNS, LTD. (MICHIGAN CORPORATION)
1241 PIEDMONT
TROY, MI 48083

FOR: SOCKS, IN CLASS 25 (U.S. CLS. 22 AND 39).

FIRST USE 2-0-2007; IN COMMERCE 2-0-2007.

THE MARK CONSISTS OF STANDARD CHARACTERS WITHOUT CLAIM TO ANY PARTICULAR FONT, STYLE, SIZE, OR COLOR.

OWNER OF U.S. REG. NO. 3,127,270.

SER. NO. 77-405,933, FILED 2-26-2008.

DANNAN HETZEL, EXAMINING ATTORNEY

Int. Cl.: 12

Prior U.S. Cls.: 19, 21, 23, 31, 35 and 44

Reg. No. 3,484,834

United States Patent and Trademark Office

Registered Aug. 12, 2008

**TRADEMARK
PRINCIPAL REGISTER**



CHANGSHA ZOOMLION HEAVY INDUSTRY
SCIENCE & TECHNOLOGY DEVELOPMENT
CO., LTD (CHINA CORPORATION)
361 YINPEN ROAD (SOUTH)
CHANGSHA, CHINA

FOR: RAILWAY ROLLING STOCK; GARDEN
HOSE CARTS; SNOWMOBILES; FORK LIFT
TRUCKS; COACHES; CONCRETE MIXING
TRUCKS; AUTOMOBILES; AUTOMOBILE CHAS-
SIS; MOTORCYCLES; BICYCLES; FUNICULAR

RAILCARS; TROLLEYS; TIRES (FOR AUTOMO-
BILES); AIRCRAFT; TRAILERS; GARBAGE HAUL-
ING TRAILERS, IN CLASS 12 (U.S. CLS. 19, 21, 23, 31,
35 AND 44).

FIRST USE 6-1-2000; IN COMMERCE 1-1-2007.

SER. NO. 77-407,706, FILED 2-27-2008.

RONALD MCMORROW, EXAMINING ATTORNEY

Int. Cl.: 12

Prior U.S. Cls.: 19, 21, 23, 31, 35 and 44

Reg. No. 3,484,835

United States Patent and Trademark Office

Registered Aug. 12, 2008

**TRADEMARK
PRINCIPAL REGISTER**

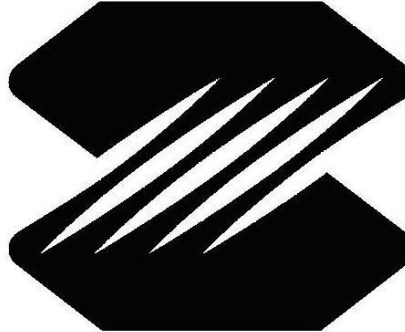

CHANGSHA ZOOMLION HEAVY INDUSTRY
SCIENCE & TECHNOLOGY DEVELOPMENT
CO., LTD. (CHINA CORPORATION)
361 YINPEN ROAD SOUTH
CHANGSHA, CHINA

RAILCARS; TROLLEYS; TIRES (FOR AUTOMO-
BILES); AIRCRAFT; TRAILERS; GARBAGE HAUL-
ING TRAILERS, IN CLASS 12 (U.S. CLS. 19, 21, 23, 31,
35 AND 44).

FOR: RAILWAY ROLLING STOCK; GARDEN
HOSE CARTS; SNOWMOBILES; FORK LIFT
TRUCKS; COACHES; CONCRETE MIXING
TRUCKS; AUTOMOBILES; AUTOMOBILE CHAS-
SIS; MOTORCYCLES; BICYCLES; FUNICULAR

FIRST USE 6-1-2000; IN COMMERCE 1-1-2007.

SER. NO. 77-407,724, FILED 2-27-2008.

RONALD MCMORROW, EXAMINING ATTORNEY

Int. Cl.: 35

Prior U.S. Cls.: 100, 101 and 102

United States Patent and Trademark Office

Reg. No. 3,484,836

Registered Aug. 12, 2008

**SERVICE MARK
PRINCIPAL REGISTER**

Shop like a Champion.

SURFMYADS.COM, INC. (CALIFORNIA CORPORATION)
SUITE #E
800 N. MILPAS ST.
SANTA BARBARA, CA 93103

FOR: PROMOTING THE GOODS AND SERVICES OF OTHERS BY PROVIDING A WEB SITE FEATURING COUPONS, REBATES, PRICE-COMPARISON INFORMATION, PRODUCT REVIEWS, LINKS TO THE RETAIL WEB SITES OF OTHERS, AND DISCOUNT INFORMATION, IN CLASS 35 (U.S. CLS. 100, 101 AND 102).

FIRST USE 2-1-2008; IN COMMERCE 2-1-2008.

THE MARK CONSISTS OF STANDARD CHARACTERS WITHOUT CLAIM TO ANY PARTICULAR FONT, STYLE, SIZE, OR COLOR.

SER. NO. 77-407,744, FILED 2-27-2008.

KAELIE KUNG, EXAMINING ATTORNEY

Int. Cl.: 12

Prior U.S. Cls.: 19, 21, 23, 31, 35 and 44

Reg. No. 3,484,837

United States Patent and Trademark Office

Registered Aug. 12, 2008

**TRADEMARK
PRINCIPAL REGISTER**

ZOOMLION

CHANGSHA ZOOMLION HEAVY INDUSTRY
SCIENCE & TECHNOLOGY DEVELOPMENT
CO., LTD. (CHINA CORPORATION)
361 YINPEN ROAD SOUTH
CHANGSHA, CHINA

FOR: RAILWAY ROLLING STOCK; GARDEN
HOSE CARTS; SNOWMOBILES; FORK LIFT
TRUCKS; COACHES; CONCRETE MIXING
TRUCKS; AUTOMOBILES; AUTOMOBILE CHAS-
SIS; MOTORCYCLES; BICYCLES; FUNICULAR

RAILCARS; TROLLEYS; TIRES (FOR AUTOMO-
BILES); AIRCRAFT; TRAILERS; GARBAGE HAUL-
ING TRAILERS, IN CLASS 12 (U.S. CLS. 19, 21, 23, 31,
35 AND 44).

FIRST USE 6-1-2000; IN COMMERCE 1-1-2007.

SER. NO. 77-407,746, FILED 2-27-2008.

RONALD MCMORROW, EXAMINING ATTORNEY

Int. Cls.: 36, 41 and 45

Prior U.S. Cls.: 100, 101, 102 and 107

United States Patent and Trademark Office

Reg. No. 3,484,838

Registered Aug. 12, 2008

**SERVICE MARK
PRINCIPAL REGISTER**

CJFM

MESSIANIC PERSPECTIVES (TEXAS CORPORATION)
611 BROADWAY
SAN ANTONIO, TX 78215

FOR: CHARITABLE FUND RAISING, IN CLASS 36 (U.S. CLS. 100, 101 AND 102).

FIRST USE 9-0-2004; IN COMMERCE 9-0-2004.

FOR: ENTERTAINMENT IN THE NATURE OF LIVE PERFORMANCES BY MUSICIANS, ACTORS AND MOTIVATIONAL AND EDUCATIONAL CHRISTIAN SPEAKERS, ENTERTAINMENT IN THE NATURE OF THEATER PRODUCTIONS, RECORDING STUDIOS, ENTERTAINMENT SERVICES, NAMELY, LIVE PERFORMANCES BY MUSICAL GROUPS AND BANDS, SUMMER,

SPORTING AND RELIGIOUS CAMPS, IN CLASS 41 (U.S. CLS. 100, 101 AND 107).

FIRST USE 6-0-2005; IN COMMERCE 6-0-2005.

FOR: CHURCH RELATED EVANGELISM, MINISTRY AND MISSIONARY SERVICES, IN CLASS 45 (U.S. CLS. 100 AND 101).

FIRST USE 9-0-2004; IN COMMERCE 9-0-2004.

THE MARK CONSISTS OF STANDARD CHARACTERS WITHOUT CLAIM TO ANY PARTICULAR FONT, STYLE, SIZE, OR COLOR.

SER. NO. 77-408,468, FILED 2-28-2008.

JAMES A. RAUEN, EXAMINING ATTORNEY

Int. Cl.: 35

Prior U.S. Cls.: 100, 101 and 102

United States Patent and Trademark Office

Reg. No. 3,484,839

Registered Aug. 12, 2008

**SERVICE MARK
PRINCIPAL REGISTER**

HEALTHY ANIMALS.HEALTHY
FOOD

PHIBRO ANIMAL HEALTH CORPORATION
(NEW YORK CORPORATION)
65 CHALLENGER ROAD, 3RD FLOOR
RIDGEFIELD PARK, NJ 07660

THE MARK CONSISTS OF STANDARD CHAR-
ACTERS WITHOUT CLAIM TO ANY PARTICULAR
FONT, STYLE, SIZE, OR COLOR.

FOR: DISTRIBUTORSHIP SERVICES IN THE
FIELD OF MEDICATED FEED ADDITIVES IN
VETERINARY MEDICINES FOR FOOD ANIMALS,
IN CLASS 35 (U.S. CLS. 100, 101 AND 102).

SER. NO. 77-408,547, FILED 2-28-2008.

FIRST USE 11-15-2004; IN COMMERCE 11-15-2004.

JENNIFER HETU, EXAMINING ATTORNEY

Int. Cl.: 3

Prior U.S. Cls.: 1, 4, 6, 50, 51 and 52

Reg. No. 3,484,840

United States Patent and Trademark Office

Registered Aug. 12, 2008

**TRADEMARK
PRINCIPAL REGISTER**

SWEET TONES

LOTTA LUV, LLC (NEW YORK LTD LIAB CO)
16 EAST 34TH STREET
NEW YORK, NY 10016

THE MARK CONSISTS OF STANDARD CHAR-
ACTERS WITHOUT CLAIM TO ANY PARTICULAR
FONT, STYLE, SIZE, OR COLOR.

FOR: LIP BALM; LIP BALM; LIP CREAM; LIP
GLOSS; LIP POLISHER; NON-MEDICATED LIP
PROTECTORS; LIPSTICK, IN CLASS 3 (U.S. CLS. 1,
4, 6, 50, 51 AND 52).

SER. NO. 77-408,772, FILED 2-28-2008.

FIRST USE 8-1-2007; IN COMMERCE 8-1-2007.

BRIAN PINO, EXAMINING ATTORNEY

Int. Cl.: 5

Prior U.S. Cls.: 6, 18, 44, 46, 51 and 52

United States Patent and Trademark Office

Reg. No. 3,484,841

Registered Aug. 12, 2008

**TRADEMARK
PRINCIPAL REGISTER**

ASAPLAVIX

SANOFI-AVENTIS (FRANCE CORPORATION)
174, AVENUE DE FRANCE
PARIS 75013, FRANCE

OWNER OF FRANCE REG. NO. 013128604, DATED 10-25-2001, EXPIRES 10-25-2011.

FOR: PHARMACEUTICAL PREPARATIONS FOR THE TREATMENT OF CARDIOVASCULAR DISEASES, IN CLASS 5 (U.S. CLS. 6, 18, 44, 46, 51 AND 52).

OWNER OF U.S. REG. NOS. 2,042,583, 2,380,297 AND OTHERS.

THE MARK CONSISTS OF STANDARD CHARACTERS WITHOUT CLAIM TO ANY PARTICULAR FONT, STYLE, SIZE, OR COLOR.

SER. NO. 77-409,615, FILED 2-29-2008.

CYNTHIA TRIPI, EXAMINING ATTORNEY

Int. Cl.: 16

Prior U.S. Cls.: 2, 5, 22, 23, 29, 37, 38 and 50

Reg. No. 3,484,842

United States Patent and Trademark Office

Registered Aug. 12, 2008

**TRADEMARK
PRINCIPAL REGISTER**

COZY CARE

WESTERN FAMILY FOODS, INC. (OREGON
CORPORATION)
6700 S.W. SANDBURG ST.
TIGARD, OR 97223

THE MARK CONSISTS OF STANDARD CHAR-
ACTERS WITHOUT CLAIM TO ANY PARTICULAR
FONT, STYLE, SIZE, OR COLOR.

FOR: DISPOSABLE DIAPERS, IN CLASS 16 (U.S.
CLS. 2, 5, 22, 23, 29, 37, 38 AND 50).

SER. NO. 77-410,166, FILED 2-29-2008.

FIRST USE 9-30-2005; IN COMMERCE 9-30-2005.

HENRY S. ZAK, EXAMINING ATTORNEY

Int. Cl.: 30

Prior U.S. Cl.: 46

United States Patent and Trademark Office

Reg. No. 3,484,843

Registered Aug. 12, 2008

**TRADEMARK
PRINCIPAL REGISTER**

BLACK SILK ESPRESSO BLEND

EQUAL EXCHANGE, INC. (MASSACHUSETTS
CORPORATION)
50 UNITED DRIVE
WEST BRIDGEWATER, MA 02379

FOR: COFFEE; COFFEE BEANS; GROUND COFFEE BEANS; ROASTED COFFEE BEANS, IN CLASS 30 (U.S. CL. 46).

FIRST USE 2-1-2006; IN COMMERCE 2-1-2006.

THE MARK CONSISTS OF STANDARD CHARACTERS WITHOUT CLAIM TO ANY PARTICULAR FONT, STYLE, SIZE, OR COLOR.

NO CLAIM IS MADE TO THE EXCLUSIVE RIGHT TO USE "ESPRESSO BLEND", APART FROM THE MARK AS SHOWN.

SER. NO. 77-410,217, FILED 2-29-2008.

DAWN FELDMAN, EXAMINING ATTORNEY

Int. Cl.: 30

Prior U.S. Cl.: 46

United States Patent and Trademark Office

Reg. No. 3,484,844

Registered Aug. 12, 2008

**TRADEMARK
PRINCIPAL REGISTER**

MIDNIGHT SUN

EQUAL EXCHANGE, INC. (MASSACHUSETTS
CORPORATION)
50 UNITED DRIVE
WEST BRIDGEWATER, MA 02379

THE MARK CONSISTS OF STANDARD CHAR-
ACTERS WITHOUT CLAIM TO ANY PARTICULAR
FONT, STYLE, SIZE, OR COLOR.

FOR: COFFEE; COFFEE BEANS; GROUND COF-
FEE BEANS; ROASTED COFFEE BEANS, IN CLASS
30 (U.S. CL. 46).

SER. NO. 77-410,220, FILED 2-29-2008.

FIRST USE 1-3-2005; IN COMMERCE 1-3-2005.

DAWN FELDMAN, EXAMINING ATTORNEY

Int. Cl.: 30

Prior U.S. Cl.: 46

United States Patent and Trademark Office

Reg. No. 3,484,845

Registered Aug. 12, 2008

**TRADEMARK
PRINCIPAL REGISTER**

BRIGHT DAY BREW

EQUAL EXCHANGE, INC. (MASSACHUSETTS
CORPORATION)
50 UNITED DRIVE
WEST BRIDGEWATER, MA 02379

FOR: COFFEE; COFFEE BEANS; GROUND COFFEE BEANS; ROASTED COFFEE BEANS, IN CLASS 30 (U.S. CL. 46).

FIRST USE 10-19-2007; IN COMMERCE 10-19-2007.

THE MARK CONSISTS OF STANDARD CHARACTERS WITHOUT CLAIM TO ANY PARTICULAR FONT, STYLE, SIZE, OR COLOR.

NO CLAIM IS MADE TO THE EXCLUSIVE RIGHT TO USE "BREW", APART FROM THE MARK AS SHOWN.

SER. NO. 77-410,224, FILED 2-29-2008.

DAWN FELDMAN, EXAMINING ATTORNEY

Int. Cl.: 16

Prior U.S. Cls.: 2, 5, 22, 23, 29, 37, 38 and 50

Reg. No. 3,484,846

United States Patent and Trademark Office

Registered Aug. 12, 2008

**TRADEMARK
PRINCIPAL REGISTER**

CRAYOLA BEGINNINGS

CRAYOLA PROPERTIES, INC. (DELAWARE CORPORATION), DBA BINNEY & SMITH PROPERTIES, INC.
2035 EDGEWOOD AVENUE
EASTON, PA 18042

FOR: COLORING BOOKS; PRINTED COLORING PAGES, IN CLASS 16 (U.S. CLS. 2, 5, 22, 23, 29, 37, 38 AND 50).

FIRST USE 6-1-2007; IN COMMERCE 6-1-2007.

THE MARK CONSISTS OF STANDARD CHARACTERS WITHOUT CLAIM TO ANY PARTICULAR FONT, STYLE, SIZE, OR COLOR.

OWNER OF U.S. REG. NOS. 3,405,985, 3,409,733 AND OTHERS.

SER. NO. 77-412,704, FILED 3-4-2008.

KRISTIN CARLSON, EXAMINING ATTORNEY

Int. Cl.: 16

Prior U.S. Cls.: 2, 5, 22, 23, 29, 37, 38 and 50

United States Patent and Trademark Office

Reg. No. 3,484,847

Registered Aug. 12, 2008

TRADEMARK
PRINCIPAL REGISTER



CRAYOLA PROPERTIES, INC. (DELAWARE CORPORATION), DBA BINNEY & SMITH PROPERTIES, INC.
2035 EDGEWOOD AVENUE
EASTON, PA 18042

FOR: COLORING BOOKS; PRINTED COLORING PAGES, IN CLASS 16 (U.S. CLS. 2, 5, 22, 23, 29, 37, 38 AND 50).

FIRST USE 6-1-2007; IN COMMERCE 6-1-2007.

OWNER OF U.S. REG. NOS. 3,405,985, 3,409,733 AND OTHERS.

THE MARK CONSISTS OF A RECTANGULAR BODY WITH A TRAPEZOID SHAPE CENTERED ACROSS THE TOP.

SER. NO. 77-412,755, FILED 3-4-2008.

KRISTIN CARLSON, EXAMINING ATTORNEY

Int. Cls.: 41 and 43

Prior U.S. Cls.: 100, 101 and 107

United States Patent and Trademark Office

Reg. No. 3,484,848

Registered Aug. 12, 2008

**SERVICE MARK
PRINCIPAL REGISTER**

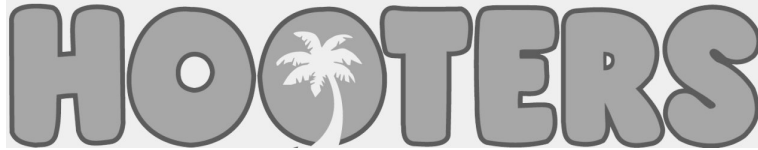

HI LIMITED PARTNERSHIP (FLORIDA LIMITED PARTNERSHIP)
SUITE 100
26133 U. S. HIGHWAY 19 NORTH
CLEARWATER, FL 33763

FOR: CASINOS; CONDUCTING AND PROVIDING FACILITIES FOR SPECIAL EVENTS FEATURING CASINO AND GAMING CONTESTS AND TOURNAMENTS; PROVIDING CASINO FACILITIES, IN CLASS 41 (U.S. CLS. 100, 101 AND 107).

FIRST USE 4-18-2005; IN COMMERCE 4-18-2005.

FOR: HOTELS; HOTEL SERVICES; HOTEL SERVICES FOR PREFERRED CUSTOMERS; HOTEL, BAR AND RESTAURANT SERVICES; RESERVA-

TION OF HOTEL ROOMS FOR TRAVELERS; RESORT HOTELS, IN CLASS 43 (U.S. CLS. 100 AND 101).

FIRST USE 4-18-2005; IN COMMERCE 4-18-2005.

OWNER OF U.S. REG. NOS. 1,320,029, 1,590,973 AND OTHERS.

THE MARK CONSISTS OF "HOOTERS" WORD MARK IN STYLIZED LETTERING WITH SILHOUETTE OF PALM TREE IN THE SECOND "O".

SER. NO. 77-412,760, FILED 3-4-2008.

ELLEN PERKINS, EXAMINING ATTORNEY

Int. Cl.: 10

Prior U.S. Cls.: 26, 39 and 44

Reg. No. 3,484,849

United States Patent and Trademark Office

Registered Aug. 12, 2008

**TRADEMARK
PRINCIPAL REGISTER**

CELERO

HOLOGIC, INC. (DELAWARE CORPORATION)
35 CROSBY DRIVE
BEDFORD, MA 01730

FOR: MEDICAL AND SURGICAL INSTRUMENTS FOR PERFORMING BIOPSIES, IN CLASS 10 (U.S. CLS. 26, 39 AND 44).

FIRST USE 4-0-2007; IN COMMERCE 4-0-2007.

THE MARK CONSISTS OF STANDARD CHARACTERS WITHOUT CLAIM TO ANY PARTICULAR FONT, STYLE, SIZE, OR COLOR.

THE WORDING "CELERO" HAS NO MEANING IN A FOREIGN LANGUAGE.

SER. NO. 77-413,686, FILED 3-5-2008.

MORGAN WYNNE, EXAMINING ATTORNEY

Int. Cl.: 11

Prior U.S. Cls.: 13, 21, 23, 31 and 34

Reg. No. 3,484,850

United States Patent and Trademark Office

Registered Aug. 12, 2008

**TRADEMARK
PRINCIPAL REGISTER**

LA PALMA

WATKINS MANUFACTURING CORPORATION
(CALIFORNIA CORPORATION)
1280 PARK CENTER DRIVE
VISTA, CA 92081

THE MARK CONSISTS OF STANDARD CHAR-
ACTERS WITHOUT CLAIM TO ANY PARTICULAR
FONT, STYLE, SIZE, OR COLOR.

FOR: HOT TUBS IN THE NATURE OF HEATED
POOLS, IN CLASS 11 (U.S. CLS. 13, 21, 23, 31 AND 34).

SER. NO. 77-415,118, FILED 3-6-2008.

FIRST USE 2-19-2008; IN COMMERCE 2-19-2008.

JAMES A. RAUEN, EXAMINING ATTORNEY

Int. Cl.: 35

Prior U.S. Cls.: 100, 101 and 102

United States Patent and Trademark Office

Reg. No. 3,484,851

Registered Aug. 12, 2008

**SERVICE MARK
PRINCIPAL REGISTER**



QWEST COMMUNICATIONS INTERNATIONAL
INC. (DELAWARE CORPORATION)
1801 CALIFORNIA ST.
DENVER, CO 80202

THE MARK CONSISTS OF DESIGN OF A LEAF.

FOR: PAPERLESS BILLING SERVICES, IN CLASS
35 (U.S. CLS. 100, 101 AND 102).

SER. NO. 77-416,191, FILED 3-7-2008.

FIRST USE 2-28-2008; IN COMMERCE 2-28-2008.

WON TEAK OH, EXAMINING ATTORNEY

Int. Cls.: 36 and 45

Prior U.S. Cls.: 100, 101 and 102

United States Patent and Trademark Office

Reg. No. 3,484,852

Registered Aug. 12, 2008

**SERVICE MARK
PRINCIPAL REGISTER**

AIG EDISCOVERY SOLUTIONS

AMERICAN INTERNATIONAL GROUP, INC.
(DELAWARE CORPORATION)
70 PINE STREET
NEW YORK, NY 10270

FOR: INSURANCE CLAIMS ADMINISTRATION,
IN CLASS 36 (U.S. CLS. 100, 101 AND 102).

FIRST USE 3-1-2008; IN COMMERCE 3-1-2008.

FOR: LITIGATION SUPPORT SERVICES, IN
CLASS 45 (U.S. CLS. 100 AND 101).

FIRST USE 3-1-2008; IN COMMERCE 3-1-2008.

THE MARK CONSISTS OF STANDARD CHAR-
ACTERS WITHOUT CLAIM TO ANY PARTICULAR
FONT, STYLE, SIZE, OR COLOR.

OWNER OF U.S. REG. NOS. 1,151,229, 1,273,845
AND OTHERS.

NO CLAIM IS MADE TO THE EXCLUSIVE
RIGHT TO USE "EDISCOVERY SOLUTIONS ",
APART FROM THE MARK AS SHOWN.

SER. NO. 77-416,309, FILED 3-7-2008.

BRIDGETT SMITH, EXAMINING ATTORNEY

Int. Cl.: 32

Prior U.S. Cls.: 45, 46 and 48

Reg. No. 3,484,853

United States Patent and Trademark Office

Registered Aug. 12, 2008

**TRADEMARK
PRINCIPAL REGISTER**

AGUALICIOSO

DEVONE LAWSON, INC. (CALIFORNIA CORPORATION)

507

13428 MAXELLA AVENUE
MARINA DEL REY, CA 90292

FOR: BOTTLED DRINKING WATER; BOTTLED WATER; DRINKING WATER; FLAVORED BOTTLED WATER; FLAVORED WATERS; MINERAL WATER, IN CLASS 32 (U.S. CLS. 45, 46 AND 48).

FIRST USE 2-4-2008; IN COMMERCE 2-4-2008.

THE MARK CONSISTS OF STANDARD CHARACTERS WITHOUT CLAIM TO ANY PARTICULAR FONT, STYLE, SIZE, OR COLOR.

THE ENGLISH TRANSLATION OF "AGUA" IN THE MARK IS WATER.

SER. NO. 77-416,776, FILED 3-8-2008.

JEAN IM, EXAMINING ATTORNEY

Int. Cl.: 5

Prior U.S. Cls.: 6, 18, 44, 46, 51 and 52

Reg. No. 3,484,854

United States Patent and Trademark Office

Registered Aug. 12, 2008

**TRADEMARK
PRINCIPAL REGISTER**

Blast

SCIENTIFIC NUTRITIONAL FORMULATIONS,
LLC (NEVADA LTD LIAB CO)
2765 WRONDEL WAY, #1
RENO, NV 89502

FOR: DIETARY AND NUTRITIONAL SUPPLEMENTS; DIETARY DRINK MIX FOR USE AS A MEAL REPLACEMENT; DIETARY FOOD SUPPLEMENTS; DIETARY SUPPLEMENTAL DRINKS; DIETARY SUPPLEMENTS; DIETARY SUPPLEMENTS FOR HUMAN CONSUMPTION; FOOD SUPPLEMENTS; FOOD SUPPLEMENTS, NAMELY, ANTI-OXIDANTS; HERBAL SUPPLEMENTS; MEAL REPLACEMENT AND DIETARY SUPPLEMENT DRINK MIXES; MINERAL FOOD SUPPLEMENTS; MINERAL NUTRITIONAL SUPPLEMENTS; MINERAL SUPPLEMENTS; MIXED VITAMIN PREPARATIONS; MULTI-VITAMIN PREPARATIONS; NUTRACEUTICALS FOR USE AS A DIETARY SUPPLEMENT; NUTRITIONAL ADDITIVES FOR MEDICAL PURPOSES FOR USE IN FOODS AND DIETARY SUPPLEMENTS FOR HUMAN CONSUMPTION; NUTRITIONAL SUPPLEMENTS; POWDERED FRUIT-FLAVORED DIETARY SUPPLEMENT DRINK MIX; POWDERED NUTRITIONAL SUPPLEMENT DRINK MIX; VITAMIN B

PREPARATIONS; VITAMIN C PREPARATIONS; VITAMIN D PREPARATIONS; VITAMIN AND MINERAL FORMED AND PACKAGED AS BARS; VITAMIN AND MINERAL PREPARATIONS FOR USE AS INGREDIENTS IN THE FOOD AND PHARMACEUTICAL INDUSTRY; VITAMIN AND MINERAL SUPPLEMENTS; VITAMIN DROPS; VITAMIN ENRICHED WATER; VITAMIN FORTIFIED BEVERAGES; VITAMIN PREPARATIONS; VITAMIN SUPPLEMENT IN TABLET FORM FOR USE IN MAKING AN EFFERVESCENT BEVERAGE WHEN ADDED TO WATER; VITAMIN SUPPLEMENTS; VITAMIN TABLETS; VITAMINS; VITAMINS AND VITAMIN PREPARATIONS, IN CLASS 5 (U.S. CLS. 6, 18, 44, 46, 51 AND 52).

FIRST USE 1-1-1996; IN COMMERCE 1-1-1996.

THE MARK CONSISTS OF STANDARD CHARACTERS WITHOUT CLAIM TO ANY PARTICULAR FONT, STYLE, SIZE, OR COLOR.

SER. NO. 77-416,842, FILED 3-8-2008.

DEZMONA MIZELLE, EXAMINING ATTORNEY

Int. Cl.: 1

Prior U.S. Cls.: 1, 5, 6, 10, 26 and 46

Reg. No. 3,484,855

United States Patent and Trademark Office

Registered Aug. 12, 2008

**TRADEMARK
PRINCIPAL REGISTER**

SPHERELITE

HALLIBURTON ENERGY SERVICES, INC. (DE-
LAWARE CORPORATION)
1-B-121
2601 BELTLINE ROAD
CARROLLTON, TX 75006

THE MARK CONSISTS OF STANDARD CHAR-
ACTERS WITHOUT CLAIM TO ANY PARTICULAR
FONT, STYLE, SIZE, OR COLOR.

FOR: CEMENT ADDITIVES USED IN OIL AND
GAS WELL DRILLING OPERATIONS, IN CLASS 1
(U.S. CLS. 1, 5, 6, 10, 26 AND 46).

SER. NO. 77-417,799, FILED 3-10-2008.

FIRST USE 12-31-1980; IN COMMERCE 12-31-1980.

JAMES LOVELACE, EXAMINING ATTORNEY

Int. Cl.: 1

Prior U.S. Cls.: 1, 5, 6, 10, 26 and 46

United States Patent and Trademark Office

Reg. No. 3,484,856

Registered Aug. 12, 2008

**TRADEMARK
PRINCIPAL REGISTER**

**More Growth. More Color.
Less Work.**

ENVIRO-SAFE LABORATORIES, INC. (FLORIDA
CORPORATION)
1579 BARBER ROAD
SARASOTA, FL 34240

THE MARK CONSISTS OF STANDARD CHAR-
ACTERS WITHOUT CLAIM TO ANY PARTICULAR
FONT, STYLE, SIZE, OR COLOR.

FOR: PLANT FOOD; FERTILIZERS, IN CLASS 1
(U.S. CLS. 1, 5, 6, 10, 26 AND 46).

SER. NO. 77-418,700, FILED 3-11-2008.

FIRST USE 2-1-2008; IN COMMERCE 2-1-2008.

BERNICE MIDDLETON, EXAMINING ATTORNEY

Int. Cl.: 12

Prior U.S. Cls.: 19, 21, 23, 31, 35 and 44

United States Patent and Trademark Office

Reg. No. 3,484,857

Registered Aug. 12, 2008

**TRADEMARK
PRINCIPAL REGISTER**

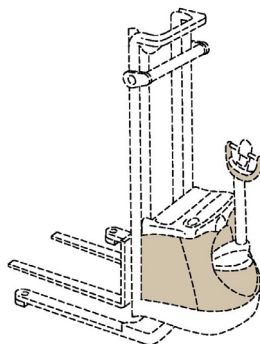

CROWN EQUIPMENT CORPORATION (OHIO CORPORATION)
40 SOUTH WASHINGTON STREET
NEW BREMEN, OH 45869

FOR: FORK LIFT TRUCKS, IN CLASS 12 (U.S. CLS. 19, 21, 23, 31, 35 AND 44).

FIRST USE 0-0-2004; IN COMMERCE 0-0-2004.

OWNER OF U.S. REG. NOS. 3,356,104, 3,390,669 AND OTHERS.

THE COLOR(S) BEIGE IS/ARE CLAIMED AS A FEATURE OF THE MARK.

THE MARK CONSISTS OF THE COLOR BEIGE AS APPLIED TO THE HOUSING FOR THE POWER UNIT, AND TO A PORTION OF THE HANDLE, OF A FORKLIFT TRUCK. THE DOTTED LINES ARE INTENDED TO SHOW THE POSITION OF THE MARK ON THE GOODS AND ARE NOT A PART OF THE MARK.

SEC. 2(F).

SER. NO. 77-420,087, FILED 3-12-2008.

WILLIAM VERHOSEK, EXAMINING ATTORNEY

Int. Cl.: 12

Prior U.S. Cls.: 19, 21, 23, 31, 35 and 44

Reg. No. 3,484,858

United States Patent and Trademark Office

Registered Aug. 12, 2008

**TRADEMARK
PRINCIPAL REGISTER**

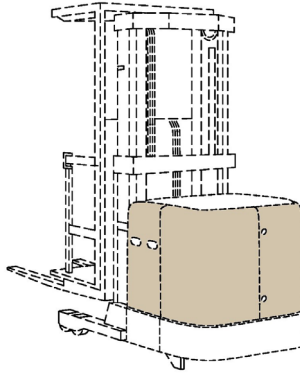

CROWN EQUIPMENT CORPORATION (OHIO CORPORATION)
40 SOUTH WASHINGTON STREET
NEW BREMEN, OH 45869

FOR: FORK LIFT TRUCKS, IN CLASS 12 (U.S. CLS. 19, 21, 23, 31, 35 AND 44).

FIRST USE 0-0-1995; IN COMMERCE 0-0-1995.

OWNER OF U.S. REG. NOS. 3,356,104, 3,390,669 AND OTHERS.

THE COLOR(S) BEIGE IS/ARE CLAIMED AS A FEATURE OF THE MARK.

THE MARK CONSISTS OF THE COLOR BEIGE AS APPLIED TO THE HOUSING FOR THE POWER UNIT OF A FORKLIFT TRUCK. THE DOTTED LINES ARE INTENDED TO SHOW THE POSITION OF THE MARK ON THE GOODS AND ARE NOT A PART OF THE MARK.

SEC. 2(F).

SER. NO. 77-420,091, FILED 3-12-2008.

WILLIAM VERHOSEK, EXAMINING ATTORNEY

Int. Cl.: 40

Prior U.S. Cls.: 100, 103 and 106

United States Patent and Trademark Office

Reg. No. 3,484,859

Registered Aug. 12, 2008

**SERVICE MARK
PRINCIPAL REGISTER**

ReadyLine

EMERSON ELECTRIC CO. (MISSOURI CORPORATION)
8000 WEST FLORISSANT AVENUE
ST. LOUIS, MO 63136

FOR: CUSTOM MANUFACTURE OF ELECTRIC MOTORS FOR MACHINES, IN CLASS 40 (U.S. CLS. 100, 103 AND 106).

FIRST USE 1-23-2007; IN COMMERCE 1-23-2007.

THE MARK CONSISTS OF STANDARD CHARACTERS WITHOUT CLAIM TO ANY PARTICULAR FONT, STYLE, SIZE, OR COLOR.

SER. NO. 77-421,217, FILED 3-13-2008.

TARAH HARDY, EXAMINING ATTORNEY

Int. Cl.: 40

Prior U.S. Cls.: 100, 103 and 106

United States Patent and Trademark Office

Reg. No. 3,484,860

Registered Aug. 12, 2008

**SERVICE MARK
PRINCIPAL REGISTER**

FastFlex

EMERSON ELECTRIC CO. (MISSOURI CORPORATION)
8000 WEST FLORISSANT AVENUE
ST. LOUIS, MO 63136

THE MARK CONSISTS OF STANDARD CHARACTERS WITHOUT CLAIM TO ANY PARTICULAR FONT, STYLE, SIZE, OR COLOR.

FOR: CUSTOM MANUFACTURE OF ELECTRIC MOTORS FOR MACHINES, IN CLASS 40 (U.S. CLS. 100, 103 AND 106).

SER. NO. 77-421,318, FILED 3-13-2008.

FIRST USE 1-23-2007; IN COMMERCE 1-23-2007.

TARAH HARDY, EXAMINING ATTORNEY

Int. Cl.: 20

Prior U.S. Cls.: 2, 13, 22, 25, 32 and 50

United States Patent and Trademark Office

Reg. No. 3,484,861

Registered Aug. 12, 2008

**TRADEMARK
PRINCIPAL REGISTER**

COUNTRY LIVING

HEARST COMMUNICATIONS, INC. (DELA-
WARE CORPORATION)
300 W 57TH ST
NEW YORK, NY 10019

FOR: PICTURE FRAMES; MIRRORS; PILLOWS;
CHAIR PADS; WINDOW BLINDS, IN CLASS 20 (U.S.
CLS. 2, 13, 22, 25, 32 AND 50).

FIRST USE 11-19-2007; IN COMMERCE 11-19-2007.

THE MARK CONSISTS OF STANDARD CHAR-
ACTERS WITHOUT CLAIM TO ANY PARTICULAR
FONT, STYLE, SIZE, OR COLOR.

OWNER OF U.S. REG. NOS. 2,442,089, 2,825,582
AND OTHERS.

SER. NO. 77-423,628, FILED 3-17-2008.

DAVID I, EXAMINING ATTORNEY

Int. Cl.: 21

Prior U.S. Cls.: 2, 13, 23, 29, 30, 33, 40 and 50

Reg. No. 3,484,862

United States Patent and Trademark Office

Registered Aug. 12, 2008

**TRADEMARK
PRINCIPAL REGISTER**

COUNTRY LIVING

HEARST COMMUNICATIONS, INC. (DELA-
WARE CORPORATION)
300 W 57TH ST
NEW YORK, NY 10019

FOR: COOKWARE, NAMELY, POTS AND PANS;
BAKEWARE; DINNERWARE; BEVERAGeware;
PLASTIC STORAGE CONTAINERS FOR DOMES-
TIC USE; FLOWER POTS; SERVING PLATTERS;
SERVINGWARE FOR SERVING FOOD, IN CLASS 21
(U.S. CLS. 2, 13, 23, 29, 30, 33, 40 AND 50).

FIRST USE 11-19-2007; IN COMMERCE 11-19-2007.

THE MARK CONSISTS OF STANDARD CHAR-
ACTERS WITHOUT CLAIM TO ANY PARTICULAR
FONT, STYLE, SIZE, OR COLOR.

OWNER OF U.S. REG. NOS. 2,442,089, 3,349,364
AND OTHERS.

SER. NO. 77-423,634, FILED 3-17-2008.

DAVID I, EXAMINING ATTORNEY

Int. Cl.: 12

Prior U.S. Cls.: 19, 21, 23, 31, 35 and 44

United States Patent and Trademark Office

Reg. No. 3,484,863

Registered Aug. 12, 2008

**TRADEMARK
PRINCIPAL REGISTER**

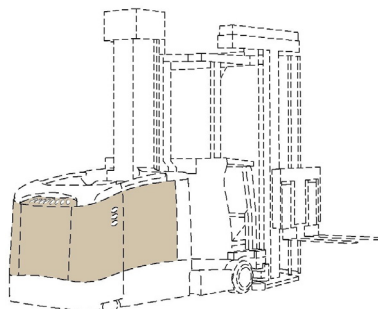

CROWN EQUIPMENT CORPORATION (OHIO CORPORATION)
40 SOUTH WASHINGTON STREET
NEW BREMEN, OH 45869

FOR: FORK LIFT TRUCKS, IN CLASS 12 (U.S. CLS. 19, 21, 23, 31, 35 AND 44).

FIRST USE 8-0-2005; IN COMMERCE 8-0-2005.

OWNER OF U.S. REG. NOS. 3,356,104, 3,390,669 AND OTHERS.

THE COLOR(S) BEIGE IS/ARE CLAIMED AS A FEATURE OF THE MARK.

THE MARK CONSISTS OF THE COLOR BEIGE AS APPLIED TO THE HOUSING FOR THE POWER UNIT OF A FORKLIFT TRUCK. THE DOTTED OUTLINE OF THE GOODS IS INTENDED TO SHOW THE POSITION OF THE MARK ON THE GOODS AND IS NOT PART OF THE MARK.

SEC. 2(F).

SER. NO. 77-423,939, FILED 3-17-2008.

WILLIAM VERHOSEK, EXAMINING ATTORNEY

Int. Cl.: 28

Prior U.S. Cls.: 22, 23, 38 and 50

Reg. No. 3,484,864

United States Patent and Trademark Office

Registered Aug. 12, 2008

**TRADEMARK
PRINCIPAL REGISTER**

COUNTRY LIVING

HEARST COMMUNICATIONS, INC. (DELA-
WARE CORPORATION)
300 W 57TH ST
NEW YORK, NY 10019

FOR: CHRISTMAS TREE ORNAMENTS AND
DECORATIONS; CHRISTMAS TREE SKIRTS;
CHRISTMAS TREE STANDS, IN CLASS 28 (U.S.
CLS. 22, 23, 38 AND 50).

FIRST USE 11-19-2007; IN COMMERCE 11-19-2007.

THE MARK CONSISTS OF STANDARD CHAR-
ACTERS WITHOUT CLAIM TO ANY PARTICULAR
FONT, STYLE, SIZE, OR COLOR.

OWNER OF U.S. REG. NOS. 2,442,089, 3,021,452
AND OTHERS.

SER. NO. 77-424,726, FILED 3-18-2008.

DAVID I, EXAMINING ATTORNEY

Int. Cl.: 42

Prior U.S. Cls.: 100 and 101

United States Patent and Trademark Office

Reg. No. 3,484,865

Registered Aug. 12, 2008

**SERVICE MARK
PRINCIPAL REGISTER**

JMSOLUTIONS

JM DEALER SERVICES, INC. (DELAWARE CORPORATION)
500 JIM MORAN BOULEVARD
DEERFIELD BEACH, FL 33442

FOR: PROVIDING TEMPORARY USE OF NON-DOWNLOADABLE COMPUTER SOFTWARE FOR AUTOMOTIVE DEALERSHIP FACILITY MANAGEMENT, FOR MANAGING VEHICLE INVENTORY FOR NEW AND USED AUTOMOBILES, FOR APPRAISING VEHICLES, FOR MANAGING ON-LINE AUCTIONS AND WHOLESALE VEHICLE PURCHASING AND SALES, FOR PROCESSING THE SALE, FINANCING, INSURANCE AND WARRANTY OF VEHICLES, FOR MANAGING CUSTOMER RELATIONSHIPS AND CALL CENTERS, FOR AD-

VERTISING AND MARKETING THE SALE OF VEHICLES, FOR BUSINESS AND SALES TRAINING IN THE FIELD OF VEHICLE SALES AND FOR POINT OF SALE DOCUMENTATION, IN CLASS 42 (U.S. CLS. 100 AND 101).

FIRST USE 1-23-2006; IN COMMERCE 1-23-2006.

THE MARK CONSISTS OF STANDARD CHARACTERS WITHOUT CLAIM TO ANY PARTICULAR FONT, STYLE, SIZE, OR COLOR.

SER. NO. 77-425,102, FILED 3-18-2008.

PAUL F. GAST, EXAMINING ATTORNEY

Int. Cl.: 24

Prior U.S. Cls.: 42 and 50

United States Patent and Trademark Office

Reg. No. 3,484,866

Registered Aug. 12, 2008

**TRADEMARK
PRINCIPAL REGISTER**

COUNTRY LIVING

HEARST COMMUNICATIONS, INC. (DELA-
WARE CORPORATION)
300 W 57TH ST
NEW YORK, NY 10019

FOR: TABLE LINEN OF TEXTILE; FABRIC WIN-
DOW COVERINGS AND TREATMENTS, NAMELY,
CURTAINS, DRAPERIES, SWAGS, VALANCES, IN
CLASS 24 (U.S. CLS. 42 AND 50).

FIRST USE 11-19-2007; IN COMMERCE 11-19-2007.

THE MARK CONSISTS OF STANDARD CHAR-
ACTERS WITHOUT CLAIM TO ANY PARTICULAR
FONT, STYLE, SIZE, OR COLOR.

OWNER OF U.S. REG. NOS. 2,442,089, 3,021,452
AND OTHERS.

SER. NO. 77-426,282, FILED 3-19-2008.

DAVID I, EXAMINING ATTORNEY

Int. Cls.: 1 and 5

Prior U.S. Cls.: 1, 5, 6, 10, 18, 26, 44, 46, 51 and 52

United States Patent and Trademark Office

Reg. No. 3,484,867

Registered Aug. 12, 2008

**TRADEMARK
PRINCIPAL REGISTER**

Reef Complete

SEACHEM LABORATORIES, INC. (GEORGIA CORPORATION)
1000 SEACHEM DRIVE
MADISON, GA 30650

FOR: CALCIUM NUTRIENT FOR AQUARIA ENVIRONMENTS, NAMELY, CALCIUM CHLORIDE, IN CLASS 1 (U.S. CLS. 1, 5, 6, 10, 26 AND 46).

FIRST USE 4-29-1994; IN COMMERCE 4-29-1994.

FOR: CALCIUM SUPPLEMENT FOR AQUARIA ENVIRONMENTS, IN CLASS 5 (U.S. CLS. 6, 18, 44, 46, 51 AND 52).

FIRST USE 4-29-1994; IN COMMERCE 4-29-1994.

THE MARK CONSISTS OF STANDARD CHARACTERS WITHOUT CLAIM TO ANY PARTICULAR FONT, STYLE, SIZE, OR COLOR.

SEC. 2(F) AS TO "REEF".

SER. NO. 77-428,824, FILED 3-21-2008.

KATHERINE E. HALMEN, EXAMINING ATTORNEY

Int. Cls.: 16, 25, 35, 36, 37 and 42

Prior U.S. Cls.: 2, 5, 22, 23, 29, 37, 38, 39, 50, 100, 101, 102, 103 and 106

Reg. No. 3,484,868

United States Patent and Trademark Office

Registered Aug. 12, 2008

**TRADEMARK
SERVICE MARK
PRINCIPAL REGISTER**

CARmax
— — — — —

CARMAX BUSINESS SERVICES, LLC (DELAWARE LTD LIAB CO)
12800 TUCKAHOE CREEK PARKWAY
RICHMOND, VA 23238

FOR: NEWSLETTERS IN THE FIELD OF CUSTOMER LOYALTY PROGRAMS , IN CLASS 16 (U.S. CLS. 2, 5, 22, 23, 29, 37, 38 AND 50).

FIRST USE 8-9-2006; IN COMMERCE 8-9-2006.

FOR: CLOTHING, NAMELY, SHIRTS, SWEATERS, SWEATSHIRTS, JACKETS, RAINCOATS AND HATS, IN CLASS 25 (U.S. CLS. 22 AND 39).

FIRST USE 9-30-1993; IN COMMERCE 9-30-1993.

FOR: RETAIL STORE SERVICES FEATURING AUTOMOBILES AND TRUCKS; PROVIDING ON-LINE INFORMATION REGARDING AUCTIONS OF MOTOR VEHICLES; CUSTOMER LOYALTY SERVICES AND CUSTOMER CLUB SERVICES, FOR COMMERCIAL, PROMOTIONAL AND/OR ADVERTISING PURPOSES; DIRECT MAIL ADVERTISING; AUCTIONEERING SERVICES, IN CLASS 35 (U.S. CLS. 100, 101 AND 102).

FIRST USE 9-22-1993; IN COMMERCE 9-22-1993.

FOR: PROVIDING EXTENDED WARRANTY CONTRACTS FOR AUTOMOBILES AND TRUCKS; AUTOMOBILE APPRAISAL; AUTOMOTIVE FINANCING SERVICES, IN CLASS 36 (U.S. CLS. 100, 101 AND 102).

FIRST USE 9-22-1993; IN COMMERCE 9-22-1993.

FOR: REPAIR AND MAINTENANCE OF AUTOMOBILES AND TRUCKS, IN CLASS 37 (U.S. CLS. 100, 103 AND 106).

FIRST USE 9-22-1993; IN COMMERCE 9-22-1993.

FOR: AUTOMOTIVE INSPECTION SERVICES, IN CLASS 42 (U.S. CLS. 100 AND 101).

FIRST USE 7-6-1996; IN COMMERCE 7-6-1996.

OWNER OF U.S. REG. NOS. 1,929,336, 2,092,728 AND OTHERS.

THE MARK CONSISTS OF THE WORD "CARMAX" WITH DASHES UNDERSCORING THE "MAX" PORTION OF THE MARK.

SER. NO. 77-439,129, FILED 4-3-2008.

TRICIA SONNEBORN, EXAMINING ATTORNEY

Int. Cls.: 11, 35, 38 and 42

Prior U.S. Cls.: 13, 21, 23, 31, 34, 100, 101, 102 and 104

United States Patent and Trademark Office

Reg. No. 3,484,869

Registered Aug. 12, 2008

**TRADEMARK
SERVICE MARK
PRINCIPAL REGISTER**

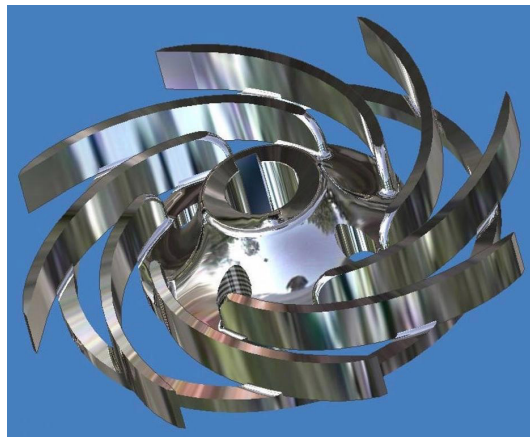

EDUR-PUMPENFABRIK, EDUARD REDLIEN
GMBH & CO. KG (FED REP GERMANY
CORPORATION)
HAMBURGER CHAUSSEE 148-152
KIEL, FED REP GERMANY 24113

FOR: WATER LINE INSTALLATIONS, NAMELY,
STRAINERS; WATER TAP DEVICES, NAMELY,
FAUCETS, IN CLASS 11 (U.S. CLS. 13, 21, 23, 31
AND 34).

FOR: OPERATING ONLINE MARKETPLACES
FOR SELLERS OF GOODS AND SERVICES; PUB-
LICITY AND BUSINESS MANAGEMENT CON-
SULTING; PUBLICITY SERVICES, NAMELY, THE
PRESENTATION OF INFORMATION FOR ADVER-
TISING PURPOSES; ADVERTISING CONSULTING
WITH RESPECT TO WEB ADVERTISING OF THIRD
PARTIES; MARKETING CONSULTING; PERSONAL
MANAGEMENT CONSULTING; MARKET-
ING CONSULTING FOR THIRD PARTIES IN
DIGITAL NETWORKS IN FORM OF PRODUCT
MERCHANTISING; PROVIDING AN ONLINE
COMMERCIAL INFORMATION DIRECTORY ON
THE INTERNET; ECONOMIC RESEARCH, IN
CLASS 35 (U.S. CLS. 100, 101 AND 102).

FOR: TELECOMMUNICATION SERVICES,
NAMELY, THE ELECTRONIC DELIVERY AND

TRANSMISSION OF MESSAGES AND DATA OF
ANY TYPE; ELECTRONIC TRANSFER OF MESSA-
GES VIA COMPUTER AND INTERNET, IN CLASS
38 (U.S. CLS. 100, 101 AND 104).

FOR: ENVIRONMENTAL COMPATIBILITY EX-
AMINATIONS, NAMELY, TESTING AND INSPEC-
TION SERVICES; PROVIDING TEMPORARY USE
ON-LINE NON-DOWNLOADABLE SOFTWARE
FOR ACCESSING THE INTERNET, IN CLASS 42
(U.S. CLS. 100 AND 101).

PRIORITY CLAIMED UNDER SEC. 44(D) ON FED
REP GERMANY APPLICATION NO. 30617637.8/0,
FILED 3-17-2006, REG. NO. 30617637, DATED 6-28-
2006, EXPIRES 3-31-2016.

THE COLOR(S) GRAY AND BLUE IS/ARE
CLAIMED AS A FEATURE OF THE MARK.

THE MARK CONSISTS OF AN IMPELLER IN
VARYING SHADES OF THE COLOR GRAY ON A
BLUE RECTANGULAR BACKGROUND.

SER. NO. 77-975,345, FILED 9-15-2006.

CHARLOTTE CORWIN, EXAMINING ATTORNEY

Int. Cls.: 35, 41, 42 and 44

Prior U.S. Cls.: 100, 101, 102 and 107

United States Patent and Trademark Office

Reg. No. 3,484,870

Registered Aug. 12, 2008

**SERVICE MARK
PRINCIPAL REGISTER**

 **Atrius Health**

ATRIUS HEALTH, INC. (MASSACHUSETTS
NON-PROFIT CORPORATION)
SUITE 3-300
275 GROVE STREET
NEWTON, MA 024662272

FOR: RETAIL PHARMACY SERVICES FOR
CLINIC PATIENTS, IN CLASS 35 (U.S. CLS. 100, 101
AND 102).

FIRST USE 9-0-2007; IN COMMERCE 9-0-2007.

FOR: EDUCATIONAL SERVICES, NAMELY,
CLASSES AND SEMINARS IN THE FIELD OF CPR
AND FIRST AID, GENERAL HEALTH AND FIT-
NESS, MIND/BODY, PARENTING, PREGNANCY
AND CHILDBIRTH, SEXUALITY AND REPRO-
DUCTION, SMOKING AND SUBSTANCE ABUSE,
SPECIAL MEDICAL PROGRAMS, WOMEN'S
HEALTH, MEN'S HEALTH, SUPPORT GROUPS,
AND HEALTH AND WELLNESS CLASSES FOR
CHILDREN AND TEENS, IN CLASS 41 (U.S. CLS.
100, 101 AND 107).

FIRST USE 9-0-2007; IN COMMERCE 9-0-2007.

FOR: MEDICAL LABORATORIES , IN CLASS 42
(U.S. CLS. 100 AND 101).

FIRST USE 9-0-2007; IN COMMERCE 9-0-2007.

FOR: MEDICAL SERVICES, WELLNESS PRO-
GRAMS, DENTIST SERVICES AND DENTAL HY-
GIENIST SERVICES, IN CLASS 44 (U.S. CLS. 100
AND 101).

FIRST USE 9-0-2007; IN COMMERCE 9-0-2007.

NO CLAIM IS MADE TO THE EXCLUSIVE
RIGHT TO USE "HEALTH", APART FROM THE
MARK AS SHOWN.

THE MARK CONSISTS OF THE WORDS "AT-
RIUS" AND "HEALTH", AND AN OVERLAPING
OVALS DESIGN.

SER. NO. 77-975,366, FILED 5-22-2007.

KATHRYN COWARD, EXAMINING ATTORNEY

Int. Cl.: 9

Prior U.S. Cls.: 21, 23, 26, 36 and 38

Reg. No. 3,484,871

United States Patent and Trademark Office

Registered Aug. 12, 2008

**TRADEMARK
PRINCIPAL REGISTER**

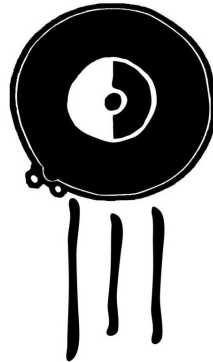

VERGE RECORDS INTERNATIONAL LLC (NEW
YORK CORPORATION)
200 HOPKINS STREET, APT. B
BROOKLYN, NY 11206

FIRST USE 5-1-2006; IN COMMERCE 1-23-2007.

FOR: MUSICAL SOUND AND VIDEO RECORD-
INGS OF MUSICAL GROUPS AND ARTISTS;
DOWNLOADABLE MUSICAL SOUND AND VIDEO
RECORDINGS OF GROUPS AND ARTISTS , IN
CLASS 9 (U.S. CLS. 21, 23, 26, 36 AND 38).

THE MARK CONSISTS OF A RECORD WITH
THREE VERTICAL LINES BENEATH IT.

SER. NO. 77-975,390, FILED 4-11-2007.

DAVID C. REIHNER, EXAMINING ATTORNEY

Int. Cl.: 9

Prior U.S. Cls.: 21, 23, 26, 36 and 38

Reg. No. 3,484,872

United States Patent and Trademark Office

Registered Aug. 12, 2008

**TRADEMARK
PRINCIPAL REGISTER**

VIKING DATA ENTRY

VIKING SOFTWARE SERVICES, INC. (OKLAHOMA CORPORATION)
6804 S. CANTON, SUITE 900
TULSA, OK 741363419

FIRST USE 12-31-1980; IN COMMERCE 12-31-1980.

FOR: COMPUTER SOFTWARE FOR DATA ENTRY AND DATABASE MANAGEMENT FOR USE IN THE FIELD OF VIDEO IMAGING, TEXT ENTRY, AND EDITING, IN CLASS 9 (U.S. CLS. 21, 23, 26, 36 AND 38).

NO CLAIM IS MADE TO THE EXCLUSIVE RIGHT TO USE "DATA ENTRY", APART FROM THE MARK AS SHOWN.

SER. NO. 78-028,828, FILED 10-3-2000.

DAVID TAYLOR, EXAMINING ATTORNEY

Int. Cls.: 9, 37, 39, 42 and 45

Prior U.S. Cls.: 21, 23, 26, 36, 38, 100, 101, 103, 105
and 106

Reg. No. 3,484,873

United States Patent and Trademark Office

Registered Aug. 12, 2008

TRADEMARK
SERVICE MARK
PRINCIPAL REGISTER



GROUP 4 FALCK A/S (DENMARK CORPORATION)
FALCK-HUSET, POLITORVET
COPENHAGEN V, DENMARK 1780

FOR: MARITIME PATROL RADAR; MARINE RADIO COMMUNICATIONS MACHINES AND APPARATUS; ELECTRIC AND ELECTRONIC VIDEO SURVEILLANCE INSTALLATIONS; ACCESS CONTROL AND ALARM MONITORING SYSTEMS; ELECTRONICALLY OPERATED HIGH SECURITY LOCK CYLINDERS; APPARATUS FOR RECORDING, REPRODUCTION AND TRANSMISSION OF SOUND AND IMAGES, NAMELY TELEVISION, RADIOS, VCRS, CD PLAYERS AND DVD PLAYERS; ALARM SYSTEMS, NAMELY FIRE ALARMS, SMOKE ALARMS, GAS AND POISON ALARMS, FLOOD ALARMS, THEFT AND BURGLARY ALARMS, ASSAULT ALARMS, NAMELY, PERSONAL ELECTRONIC SECURITY SYSTEMS, ACTIVATED BY AN INDIVIDUAL, AND RESULTING IN SIGNALING AN ALARM RECEIVING CENTER AND EMITTING A HIGH LEVEL NOISE; AND SAFETY ALARMS, NAMELY STATIONARY OR MOBILE ALARMS ACTIVATED BY AN INDIVIDUAL NEEDING CARE MEDICAL ATTENTION OR OTHER ASSISTANCE ON SHORT NOTICE, RESULTING IN SIGNALING AN ALARM CENTER AND EMITTING A HIGH LEVEL NOISE; PARTS NOT INCLUDED IN OTHER CLASSES, FOR THE

AFORESAID ALARM APPARATUS; FIRE EXTINGUISHING KITS CONTAINING FIRE BLANKETS, EXTINGUISHERS, DETECTORS, EMERGENCY PLANS, FIRE HOSE NOZZLES, FIRE RESISTANT GLOVES, WATER TANKS AND SPRINKLER SYSTEMS; ELECTRIC AND ELECTRONIC SURVEILLANCE AND SUPERVISION APPARATUS, NAMELY TV AND VIDEO SURVEILLANCE AND SUPERVISION APPARATUS, DETECTORS, SENSORS, PARTS NOT INCLUDED IN OTHER CLASSES, FOR ALL THE AFORESAID GOODS; ELECTRONIC CONTROL AND SECURITY APPARATUS AND INSTRUMENTS, NAMELY FOR SECURITY CHECK AND ACCESS CONTROL, INCLUDING PERIMETER PROTECTIVE SYSTEMS; MAGNETIC CARDS AND ELECTRONIC KEY-CARDS FOR ACCESS CONTROL; SECURITY SOFTWARE FOR SECURITY MANAGEMENT AND AS SUPPORT FOR GUARDING AND RECEPTION SERVICES; PATROL CONTROL SYSTEMS, NAMELY ACCESS CONTROL AND ALARM MONITORY SYSTEMS, INCLUDING AN ELECTRONIC CONTROL PANEL SYSTEM, IN CLASS 9 (U.S. CLS. 21, 23, 26, 36 AND 38).

FOR: INSTALLATION, REPAIR AND MAINTENANCE SERVICES, NAMELY, INSTALLATION, MAINTENANCE AND REPAIR OF ALARM APPARATUS, SUPERVISION APPARATUS, SECURITY CHECK APPARATUS, TV AND VIDEO SURVEIL-

LANCE APPARATUS, DETECTORS, INCLUDING FOR ACCESS CONTROL, SENSORS, CONTROL, SECURITY AND PROTECTION APPARATUS, LIFE-SAVING APPARATUS, FIRE EXTINGUISHING APPARATUS; PROVIDING INSTALLATION, REPAIR AND MAINTENANCE INFORMATION ABOUT ALARM, SUPERVISION, CONTROL AND SECURITY APPARATUS, IN CLASS 37 (U.S. CLS. 100, 103 AND 106).

FOR: ALARM EMERGENCY TRANSPORT SERVICES, NAMELY AMBULANCE TRANSPORT AND EMERGENCY AUTO TOWING; TRANSPORTATION OF SECURITY GUARDS, IN CLASS 39 (U.S. CLS. 100 AND 105).

FOR: DESIGN OF SECURITY SYSTEMS FOR OTHERS; TECHNICAL CONSULTATION CON-

CERNING THE SECURING OF BUILDINGS, COMMERCIAL COMPANIES AND OUTDOOR SPACES, IN CLASS 42 (U.S. CLS. 100 AND 101).

FOR: SECURITY GUARD SERVICES, NAMELY, RECEPTION DESK ATTENDANTS, ACCESS AND SECURITY CONTROL OF BUILDINGS, OF EMBASSIES, OF AIRPORTS, OF TRAIN AND BUS STATIONS, IN COMMERCIAL COMPANIES, AT CONFERENCES, EXHIBITIONS AND OTHER EVENTS, IN CLASS 45 (U.S. CLS. 100 AND 101).

OWNER OF BENELUX REG. NO. 0732029, DATED 2-18-2003, EXPIRES 2-18-2013.

SER. NO. 78-219,827, FILED 2-27-2003.

ANGELA M. MICHELI, EXAMINING ATTORNEY

Int. Cl.: 14

Prior U.S. Cls.: 2, 27, 28 and 50

United States Patent and Trademark Office

Reg. No. 3,484,874

Registered Aug. 12, 2008

**TRADEMARK
PRINCIPAL REGISTER**

COMBATSWORLD

DIAMOND SCENT LIMITED (BR.VIRGIN ISLANDS CORPORATION)
TRIDENT CHAMBERS, PO BOX 146
ROAD TOWN, TORTOLA, BR.VIRGIN ISLANDS

FOR: PRECIOUS METALS, THEIR ALLOYS AND GOODS IN PRECIOUS METALS OR COATED THEREWITH, NAMELY, JEWELRY, IMITATION JEWELRY, HOME AND HOLIDAY ORNAMENTS, TRAYS, PLATTERS, PLATES, CUPS, TEETHING RINGS, RATTLES, PICTURE FRAMES, BELT BUCKLES, PENS, PICTURE FRAMES AND VIDEO GAME AND ELECTRONIC ORGANIZER CASES, ALL OF PRECIOUS METAL; HOROLOGICAL AND CHRONOMETRIC INSTRUMENTS, NAMELY,

WATCHES, STOPWATCHES, CLOCKS, CHRONOGRAPHS FOR USE AS WATCHES; PARTS AND FITTINGS FOR ALL AFORESAID GOODS, IN CLASS 14 (U.S. CLS. 2, 27, 28 AND 50).

PRIORITY CLAIMED UNDER SEC. 44(D) ON ERPN CMNTY TM OFC APPLICATION NO. 3085016, FILED 3-17-2003, REG. NO. 003085016, DATED 9-28-2006, EXPIRES 9-28-2016.

SER. NO. 78-240,052, FILED 4-21-2003.

REBECCA GILBERT, EXAMINING ATTORNEY

Int. Cl.: 9

Prior U.S. Cls.: 21, 23, 26, 36 and 38

United States Patent and Trademark Office

Reg. No. 3,484,875

Registered Aug. 12, 2008

**TRADEMARK
PRINCIPAL REGISTER**

SOYNTEC

MASTER EXPLOTACIONES S.L. (SPAIN CORPORATION)
CAMINO VIEJO DE ALTEA, 31
03580 ALFAZ D
ALICANTE, SPAIN

FOR: SCIENTIFIC APPARATUS AND INSTRUMENTS, NAMELY, COMPUTER HARDWARE AND COMPUTER PERIPHERALS IN THE NATURE OF COMPUTERS, COMPUTER KEYBOARDS, FLASH MEMORIES, USB MEMORY STICKS, COMPUTER MICE, PRINTERS, JOYSTICKS, MOUSE PADS, WEB CAMERAS, AND SCANNERS; COMPUTER DATA PROCESSORS AND MICROPROCESSORS; VOLTAGE SURGE PROTECTORS; COMPUTER INTERFACE BOARDS AND CABLES; ACOUSTIC COUPLERS; MAGNETIC READERS; COMPUTER ACCESSORIES, NAMELY, DIGITAL STILL AND VIDEO CAMERAS, BLANK MAGNETIC DATA CARRIERS, BLANK COMPUTER DISCS, BLANK OPTICAL DISCS, BLANK MAGNETIC CARDS,

BLANK MAGNETIC DATA-CARRIERS, AND BLANK MAGNETIC AND OPTICAL RECORDING DISCS; COIN CHANGERS; VENDING MACHINES; CASH REGISTERS; CALCULATORS; FIRE EXTINGUISHERS; BLANK MAGNETIC COMPUTER TAPES; MAGNETIC CODED TAPE AND CARD RECORDERS AND READERS; COMPUTER MEMORY CARDS; MAGNETIC DISK CHANGERS; MAGNETIC CODED CARDS FOR IDENTIFICATION PURPOSES; AND BLANK INTEGRATED CIRCUIT CARDS, IN CLASS 9 (U.S. CLS. 21, 23, 26, 36 AND 38).

PRIORITY CLAIMED UNDER SEC. 44(D) ON ERPN CMNTY TM OFC APPLICATION NO. 3101706, FILED 3-25-2003, REG. NO. 3101706, DATED 12-15-2004, EXPIRES 12-15-2014.

SER. NO. 78-251,792, FILED 5-19-2003.

GENE MACIOL, EXAMINING ATTORNEY

Int. Cl.: 12

Prior U.S. Cls.: 19, 21, 23, 31, 35 and 44

Reg. No. 3,484,876

United States Patent and Trademark Office

Registered Aug. 12, 2008

**TRADEMARK
PRINCIPAL REGISTER**

PITBULL

BIG DOG MOTORCYCLES LLC (ARIZONA LTD
LIAB CO)
SUITE 170
2414 NORTH WOODLAWN STREET
WICHITA, KS 672203900

FIRST USE 9-1-1998; IN COMMERCE 9-1-1998.

SER. NO. 78-272,226, FILED 7-9-2003.

FOR: MOTORCYCLES, IN CLASS 12 (U.S. CLS. 19,
21, 23, 31, 35 AND 44).

GINA FINK, EXAMINING ATTORNEY

Int. Cl.: 24

Prior U.S. Cls.: 42 and 50

United States Patent and Trademark Office

Reg. No. 3,484,877

Registered Aug. 12, 2008

TRADEMARK
PRINCIPAL REGISTER



SEW-RITE MANUFACTURING CO., LTD. (CANADA CORPORATION)
11 DIRECTOR COURT
WOODBIDGE, ONTARIO, CANADA L4L 4S5

FOR: BATH ACCESSORIES, NAMELY, TOWELS, SHOWER CURTAINS; KITCHEN TEXTILES, NAMELY, TABLECLOTHS, NAPKINS AND PLACE-MATS; BED LINENS, NAMELY, SHEETS, PILLOW-CASES, PILLOW SHAMS, BED SKIRTS, DUVET COVERS, COMFORTERS, AND MATTRESS PADS; WINDOW COVERINGS, NAMELY, CURTAINS,

DRAPERIES AND VALANCES, IN CLASS 24 (U.S. CLS. 42 AND 50).

PRIORITY CLAIMED UNDER SEC. 44(D) ON CANADA APPLICATION NO. 1169510, FILED 2-27-2003, REG. NO. TMA708717, DATED 3-4-2008, EXPIRES 3-4-2023.

SER. NO. 78-273,425, FILED 7-11-2003.

LINDA MICKLEBURGH, EXAMINING ATTORNEY

Int. Cl.: 25

Prior U.S. Cls.: 22 and 39

United States Patent and Trademark Office

Reg. No. 3,484,878

Registered Aug. 12, 2008

**TRADEMARK
PRINCIPAL REGISTER**

VICTOIRE

VICTOIRE (FRANCE LIMITED COMPANY)
12 PLACE DES VICTOIRES
PARIS, FRANCE 75002

OWNER OF FRANCE REG. NO. 013127309, DATED 10-22-2001, EXPIRES 10-22-2011.

OWNER OF U.S. REG. NOS. 1,447,589 AND 1,512,757.

FOR: CLOTHING, NAMELY, SHIRTS, T-SHIRTS, SKIRTS, DRESSES, PULLOVERS, JACKETS, TROUSERS, COATS, RAINCOATS, BATHING SUITS, SWIMWEAR, SCARVES, TIES, HATS, SOCKS, STOCKINGS AND BELTS, SHOES , IN CLASS 25 (U.S. CLS. 22 AND 39).

THE FOREIGN WORDING IN THE MARK TRANSLATES INTO ENGLISH AS VICTORY.

SER. NO. 78-288,529, FILED 8-18-2003.

PAULA MAHONEY, EXAMINING ATTORNEY

Int. Cl.: 36

Prior U.S. Cls.: 100, 101 and 102

United States Patent and Trademark Office

Reg. No. 3,484,879

Registered Aug. 12, 2008

**SERVICE MARK
PRINCIPAL REGISTER**

COVERPOINT

SAFEONLINE LIMITED (UNITED KINGDOM CORPORATION)
1 RIDING HOUSE STREET
LONDON, UNITED KINGDOM W1A 3AS

FOR: INSURANCE SERVICES, NAMELY, INSURANCE BROKERAGE, INSURANCE UNDERWRITING SERVICES FOR ALL TYPES OF INSURANCE, INSURANCE CONSULTATION AND PROVIDING INFORMATION IN THE FIELD OF INSURANCE; ONLINE INSURANCE SERVICES, NAMELY, INSURANCE BROKERAGE, INSURANCE UNDERWRITING SERVICES FOR ALL TYPES OF INSURANCE, INSURANCE CONSULTATION AND PROVIDING INFORMATION IN THE FIELD OF INSURANCE, ALL VIA A GLOBAL COMPUTER NETWORK; INSURANCE AGENCY AND BROKERAGE SERVICES FOR RISK AND LOSS IN THE FIELD OF ELECTRONIC COMMERCE, GLOBAL COMPUTER INFORMATION NETWORKS, INFORMATION TECHNOLOGY, INTELLECTUAL PROPERTY AND COMPUTER FIELDS, NAMELY, COVERAGE FOR LOSS, DAMAGE, COSTS, LEGAL FEES, LOSS CONTROL SERVICES AND REHABILITATION RESULTING FROM FRAUDULENT AND MALICIOUS ACTS, VIRUSES, EXTORTION, BUSINESS INTERRUPTION, LIBEL OR SLANDER, INVASION OF PRIVACY, INTELLECTUAL PROPERTY INFRINGEMENT, PLAGIARISM, FALSE ADVERTISING, UNFAIR COMPETITION, ACTS OF GOD, UNAUTHORIZED ACCESS, VANDALISM, COMPUTER SYSTEM LIABILITY TO THIRD PARTIES AND THEFT OF TRADE SECRETS; APPRAISALS FOR INSURANCE CLAIMS ARISING OUT OF OR RELATING TO BREACHES OF ONLINE SECURITY OR ONLINE LOSSES, INSURANCE RISK MANAGEMENT SERVICES, IN CLASS 36 (U.S. CLS. 100, 101 AND 102).

TATION RESULTING FROM FRAUDULENT AND MALICIOUS ACTS, VIRUSES, EXTORTION, BUSINESS INTERRUPTION, LIBEL OR SLANDER, INVASION OF PRIVACY, INTELLECTUAL PROPERTY INFRINGEMENT, PLAGIARISM, FALSE ADVERTISING, UNFAIR COMPETITION, ACTS OF GOD, UNAUTHORIZED ACCESS, VANDALISM, COMPUTER SYSTEM LIABILITY TO THIRD PARTIES AND THEFT OF TRADE SECRETS; APPRAISALS FOR INSURANCE CLAIMS ARISING OUT OF OR RELATING TO BREACHES OF ONLINE SECURITY OR ONLINE LOSSES, INSURANCE RISK MANAGEMENT SERVICES, IN CLASS 36 (U.S. CLS. 100, 101 AND 102).

PRIORITY CLAIMED UNDER SEC. 44(D) ON ERPN CMNTY TM OFC APPLICATION NO. 3283415, FILED 7-21-2003, REG. NO. 003282415, DATED 2-8-2005, EXPIRES 7-21-2013.

SER. NO. 78-295,341, FILED 9-3-2003.

JOHN DWYER, EXAMINING ATTORNEY

Int. Cl.: 9

Prior U.S. Cls.: 21, 23, 26, 36 and 38

Reg. No. 3,484,880

United States Patent and Trademark Office

Registered Aug. 12, 2008

**TRADEMARK
PRINCIPAL REGISTER**

NexOSS

TRANSNEXUS, INC. (DELAWARE CORPORATION)
250 14TH STREET, NW SUITE 4001
ATLANTA, GA 30318

FOR: COMPUTER SOFTWARE PLATFORM FOR
MANAGING VOICE OVER IP NETWORKS, EX-
CLUDING AND UNRELATED TO PRODUCTS
AND SERVICES IN THE WIRELESS TELECOMMU-
NICATIONS INDUSTRY, IN CLASS 9 (U.S. CLS. 21,
23, 26, 36 AND 38).

FIRST USE 11-13-2001; IN COMMERCE 11-13-2001.

THE MARK CONSISTS OF STANDARD CHAR-
ACTERS WITHOUT CLAIM TO ANY PARTICULAR
FONT, STYLE, SIZE, OR COLOR.

SER. NO. 78-334,933, FILED 12-2-2003.

KHANH LE, EXAMINING ATTORNEY

Int. Cl.: 6

Prior U.S. Cls.: 2, 12, 13, 14, 23, 25 and 50

Reg. No. 3,484,881

United States Patent and Trademark Office

Registered Aug. 12, 2008

**TRADEMARK
PRINCIPAL REGISTER**

FLASH 'N ROLL

PEAK INNOVATIONS INC. (CANADA CORPORATION)
11782 HAMMERSMITH WAY
SUITE 203
RICHMOND, BRITISH COLUMBIA V7A 5E2

PRIORITY CLAIMED UNDER SEC. 44(D) ON CANADA APPLICATION NO. 1179442, FILED 6-6-2003, REG. NO. TMA630,224, DATED 1-17-2005, EXPIRES 1-17-2020.

FOR: METAL BUILDING FLASHING AND METAL FASTENERS, NAMELY, BOLTS, NAILS, RIVETS AND SCREWS, IN CLASS 6 (U.S. CLS. 2, 12, 13, 14, 23, 25 AND 50).

SER. NO. 78-335,742, FILED 12-3-2003.

THE MARK CONSISTS OF STANDARD CHARACTERS WITHOUT CLAIM TO ANY PARTICULAR FONT, STYLE, SIZE, OR COLOR.

KATHERINE CONNOLLY, EXAMINING ATTORNEY

Int. Cl.: 35

Prior U.S. Cls.: 100, 101 and 102

United States Patent and Trademark Office

Reg. No. 3,484,882

Registered Aug. 12, 2008

**SERVICE MARK
PRINCIPAL REGISTER**



PIKE PLACE FISH MARKET, INC. (WASHING-
TON CORPORATION)
86 PIKE PLACE
SEATTLE, WA 98101

FOR: RETAIL STORE AND ONLINE RETAIL
STORE SERVICES IN THE FIELD OF SEAFOOD,
IN CLASS 35 (U.S. CLS. 100, 101 AND 102).

FIRST USE 0-0-1975; IN COMMERCE 0-0-1975.

NO CLAIM IS MADE TO THE EXCLUSIVE
RIGHT TO USE "FISH MARKET", APART FROM
THE MARK AS SHOWN.

SEC. 2(F) AS TO "PIKE PLACE".

SER. NO. 78-352,023, FILED 1-14-2004.

LANA PHAM, EXAMINING ATTORNEY

Int. Cls.: 38 and 41

Prior U.S. Cls.: 100, 101, 104 and 107

United States Patent and Trademark Office

Reg. No. 3,484,883

Registered Aug. 12, 2008

**SERVICE MARK
PRINCIPAL REGISTER**

FREE YOUR RADIO

ENTERCOM COMMUNICATIONS CORP. (PENNSYLVANIA CORPORATION)
401 CITY AVENUE, SUITE 809
BALA CYNWYD, PA 19004

FOR: RADIO BROADCASTING SERVICES, IN CLASS 38 (U.S. CLS. 100, 101 AND 104).

FIRST USE 9-5-2003; IN COMMERCE 9-5-2003.

FOR: ENTERTAINMENT SERVICES, NAMELY, RADIO ENTERTAINMENT PRODUCTION, RADIO PROGRAMMING, AND RADIO PROGRAMS IN

THE FIELD OF MUSIC AND ENTERTAINMENT, IN CLASS 41 (U.S. CLS. 100, 101 AND 107).

FIRST USE 9-5-2003; IN COMMERCE 9-5-2003.

THE MARK CONSISTS OF STANDARD CHARACTERS WITHOUT CLAIM TO ANY PARTICULAR FONT, STYLE, SIZE, OR COLOR.

SER. NO. 78-372,527, FILED 2-23-2004.

ALICIA COLLINS, EXAMINING ATTORNEY

Int. Cl.: 5

Prior U.S. Cls.: 6, 18, 44, 46, 51 and 52

Reg. No. 3,484,884

United States Patent and Trademark Office

Registered Aug. 12, 2008

**TRADEMARK
PRINCIPAL REGISTER**

**T2 DISINFECTANT
SPRAY**

TRIOSYN HOLDING INC. (CANADA CORPORATION)
14163 LABELLE BOULEVARD
MIRABEL, CANADA J7J 1M3

FOR: DISINFECTANT SPRAY FOR ELIMINATION OF MICROORGANISMS, IN CLASS 5 (U.S. CLS. 6, 18, 44, 46, 51 AND 52).

THE MARK CONSISTS OF STANDARD CHARACTERS WITHOUT CLAIM TO ANY PARTICULAR FONT, STYLE, SIZE, OR COLOR.

PRIORITY CLAIMED UNDER SEC. 44(D) ON CANADA APPLICATION NO. 1200961, FILED 12-31-2003, REG. NO. 705123, DATED 1-21-2008, EXPIRES 1-21-2023.

NO CLAIM IS MADE TO THE EXCLUSIVE RIGHT TO USE "DISINFECTANT SPRAY", APART FROM THE MARK AS SHOWN.

SER. NO. 78-402,510, FILED 4-15-2004.

ARETHA SOMERVILLE, EXAMINING ATTORNEY

Int. Cls.: 35 and 39

Prior U.S. Cls.: 100, 101, 102 and 105

United States Patent and Trademark Office

Reg. No. 3,484,885

Registered Aug. 12, 2008

SERVICE MARK
PRINCIPAL REGISTER



The logo consists of the text "1ST KIOSK" in a stylized font. The "1" and "ST" are blue, while "KIOSK" is red with blue outlines. Below the text is a thick horizontal line that is red on top and blue on the bottom.

EGGER, WOLFGANG (AUSTRIA INDIVIDUAL)
HACIENDA DEL SOL AV. TRANSVERSAL NORTE,
5;
38660 PLAYA DE LAS AMERICAS (TENERIFE),
SPAIN

FOR: DISTRIBUTORSHIP SERVICES IN THE
FIELD OF CANNED FOOD, FOOD PRODUCTS,
PERFUMERY, COSMETIC AND PERSONAL HY-
GIENE PRODUCTS, UNDERWEAR, SWIMMING
SUITS, AND CLOTHING; VENDING MACHINE
SERVICES IN THE FIELD OF CANNED FOOD,
FOOD PRODUCTS, PERFUMERY, COSMETIC
AND PERSONAL HYGIENE PRODUCTS, UNDER-
WEAR, SWIMMING SUITS, AND CLOTHING, IN
CLASS 35 (U.S. CLS. 100, 101 AND 102).

FOR: STORAGE OF CANNED FOOD, FOOD
PRODUCTS, PERFUMERY, COSMETIC AND PER-
SONAL HYGIENE PRODUCTS, UNDERWEAR,
SWIMMING SUITS, AND CLOTHING; DELIVERY
OF CANNED FOOD AND FOOD PRODUCTS, IN
CLASS 39 (U.S. CLS. 100 AND 105).

OWNER OF SPAIN REG. NO. 1971984, DATED 6-
19-1995, EXPIRES 6-19-2015.

NO CLAIM IS MADE TO THE EXCLUSIVE
RIGHT TO USE "KIOSK", APART FROM THE
MARK AS SHOWN.

THE COLOR(S) RED AND BLUE IS/ARE
CLAIMED AS A FEATURE OF THE MARK.

THE COLORS BLUE AND RED APPEAR IN THE
NUMBER "1", IN THE WORD "KIOSK", AND IN
THE LINE UNDERNEATH THE WORDING IN THE
MARK. THE COLOR BLUE APPEARS IN THE
LETTERS "ST".

SER. NO. 78-426,901, FILED 5-28-2004.

EVELYN BRADLEY, EXAMINING ATTORNEY

Int. Cl.: 14

Prior U.S. Cls.: 2, 27, 28 and 50

United States Patent and Trademark Office

Reg. No. 3,484,886

Registered Aug. 12, 2008

**TRADEMARK
PRINCIPAL REGISTER**

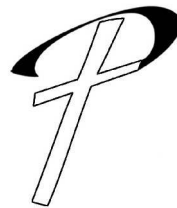

SEXTON, PRESTON T. (UNITED STATES INDIVIDUAL)
312 SE 24TH AVENUE
CAPE CORAL, FL 33990

FOR: JEWELRY, NAMELY, EARRINGS, BRACELETS, RINGS, NECKLACES, BROOCHES, PINS, IN CLASS 14 (U.S. CLS. 2, 27, 28 AND 50).

FIRST USE 6-1-1999; IN COMMERCE 6-1-1999.

THE MARK CONSISTS OF A STYLIZED "P" WITH A CROSS (CRUCIFIX) WITHIN THE STYLIZED "P".

SEC. 2(F).

SER. NO. 78-463,874, FILED 8-7-2004.

SUSAN STIGLITZ, EXAMINING ATTORNEY

Int. Cls.: 3 and 4

Prior U.S. Cls.: 1, 4, 6, 15, 50, 51 and 52

United States Patent and Trademark Office

Reg. No. 3,484,887

Registered Aug. 12, 2008

**TRADEMARK
PRINCIPAL REGISTER**



SEA OLOGY, LLC (FLORIDA LTD LIAB CO)
SUITE 205-B
200 GRAND BOULEVARD
DESTIN, FL 32550

FOR: SKIN CARE PRODUCTS, NAMELY, BATH SOAK BAGS CONTAINING BATH SOAK BEADS; BODY LOTION; NON-MEDICATED FACE WASH, BATH AND SHOWER PRODUCTS, NAMELY, LIQUID SHOWER GEL, LIQUID BATH GEL; HYDRATING SKIN MIST; FACIAL MUD MASK; BODY SCRUB; NON-MEDICATED HAND WASH; NON-MEDICATED FOOT CREAM; BATH SEA SALTS; HAND LOTION; HAIR CARE PREPARATIONS, NAMELY SHAMPOO, CONDITIONER AND SPORT WASH FOR HAIR, NAMELY, SHAMPOO, IN CLASS 3 (U.S. CLS. 1, 4, 6, 50, 51 AND 52).

FIRST USE 6-11-2004; IN COMMERCE 6-11-2004.

FOR: CANDLES, IN CLASS 4 (U.S. CLS. 1, 6 AND 15).

FIRST USE 6-11-2004; IN COMMERCE 6-11-2004.

THE MARK CONSISTS OF SEAHORSE OVERLAI D BY THE WORDS SEA OLOGY PLANT AIR MARINE.

SER. NO. 78-497,073, FILED 10-8-2004.

SANI KHOURI, EXAMINING ATTORNEY

Int. Cl.: 30

Prior U.S. Cl.: 46

United States Patent and Trademark Office

Reg. No. 3,484,888

Registered Aug. 12, 2008

**TRADEMARK
PRINCIPAL REGISTER**

COSMIC CRANBERRY

MILLENNIUM PRODUCTS, INC. (CALIFORNIA
CORPORATION)

1248 W. 134TH STREET, STE 4

GARDENA, CA 90247

FOR: NON-ALCOHOLIC BEVERAGES, NAMELY,
TEA-BASED BEVERAGES WITH CRANBERRY
FLAVORING, IN CLASS 30 (U.S. CL. 46).

FIRST USE 7-27-1999; IN COMMERCE 7-27-1999.

THE MARK CONSISTS OF STANDARD CHAR-
ACTERS WITHOUT CLAIM TO ANY PARTICULAR
FONT, STYLE, SIZE, OR COLOR.

NO CLAIM IS MADE TO THE EXCLUSIVE
RIGHT TO USE "CRANBERRY", APART FROM
THE MARK AS SHOWN.

SER. NO. 78-510,540, FILED 11-3-2004.

SAMUEL E. SHARPER JR., EXAMINING ATTOR-
NEY

Int. Cl.: 25

Prior U.S. Cls.: 22 and 39

United States Patent and Trademark Office

Reg. No. 3,484,889

Registered Aug. 12, 2008

**TRADEMARK
PRINCIPAL REGISTER**

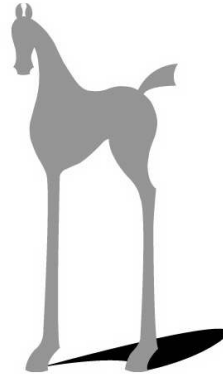

O'HARA HEATHER (CANADA INDIVIDUAL)
8131 RIDEAU DRIVE
RICHMOND
BRITISH COLUMBIA, CANADA V7A 4M6

FOR: CLOTHING FOR GIRLS AND WOMEN,
NAMELY, SHIRTS AND T-SHIRTS, TANK TOPS,
SWEATSHIRTS, TURTLENECKS, JACKETS,
PANTS, SWEATPANTS, HEADWEAR, NAMELY,
HATS, CAPS, LINGERIE, NAMELY, UNDERWEAR,

PAJAMAS, AND CAMISOLES, SCARVES, TIGHTS
AND LEGGINGS, IN CLASS 25 (U.S. CLS. 22 AND
39).

OWNER OF CANADA REG. NO. TMA700065,
DATED 11-2-2007, EXPIRES 11-2-2022.

SER. NO. 78-519,680, FILED 11-18-2004.

JENNIFER DIXON, EXAMINING ATTORNEY

Int. Cl.: 35

Prior U.S. Cls.: 100, 101 and 102

United States Patent and Trademark Office

Reg. No. 3,484,890

Registered Aug. 12, 2008

**SERVICE MARK
PRINCIPAL REGISTER**

**NYGARD FASHION
WORLD**

NYGARD INTERNATIONAL PARTNERSHIP
(CANADA PARTNERSHIP)
1771 INKSTER BLVD.
WINNIPEG, MANITOBA, CANADA R2X 1R3

FOR: RETAIL STORE SERVICES FEATURING
CLOTHING, APPAREL, FASHION ACCESSORIES,
HOME FURNISHINGS AND DECORATIVE ACCES-
SORIES, IN CLASS 35 (U.S. CLS. 100, 101 AND 102).

THE MARK CONSISTS OF STANDARD CHAR-
ACTERS WITHOUT CLAIM TO ANY PARTICULAR
FONT, STYLE, SIZE, OR COLOR.

OWNER OF CANADA REG. NO. TMA682,355,
DATED 2-26-2007, EXPIRES 2-26-2022.

OWNER OF U.S. REG. NOS. 2,080,489, 2,667,459,
AND 2,716,981.

NO CLAIM IS MADE TO THE EXCLUSIVE
RIGHT TO USE "FASHION", APART FROM THE
MARK AS SHOWN.

SER. NO. 78-550,065, FILED 1-19-2005.

ELLEN PERKINS, EXAMINING ATTORNEY

Int. Cl.: 8

Prior U.S. Cls.: 23, 28 and 44

United States Patent and Trademark Office

Reg. No. 3,484,891

Registered Aug. 12, 2008

**TRADEMARK
PRINCIPAL REGISTER**

DIESEL

FISKARS BRANDS, INC. (WISCONSIN CORPORATION)
2537 DANIELS STREET
MADISON, WI 537186772

FOR: MULTI-FUNCTION HAND TOOLS FOR OUTDOOR RECREATIONAL USE COMPRISING ALL OR A COMBINATION OF THE FOLLOWING - PLIERS, SCREWDRIVERS, BOTTLE OPENERS, KNIFE BLADE, CAN OPENER, FILE, SAW, SCISSORS AND TWEEZERS, IN CLASS 8 (U.S. CLS. 23, 28 AND 44).

FIRST USE 4-1-2005; IN COMMERCE 4-1-2005.

THE MARK CONSISTS OF STANDARD CHARACTERS WITHOUT CLAIM TO ANY PARTICULAR FONT, STYLE, SIZE, OR COLOR.

SER. NO. 78-554,103, FILED 1-26-2005.

GENE MACIOL, EXAMINING ATTORNEY

Int. Cl.: 36

Prior U.S. Cls.: 100, 101 and 102

United States Patent and Trademark Office

Reg. No. 3,484,892

Registered Aug. 12, 2008

**SERVICE MARK
PRINCIPAL REGISTER**

MUSIC FOR RELIEF

MUSIC FOR RELIEF (CALIFORNIA CHARITABLE, NON-PROFIT CORPORATION)
C/O GUDVI, SUSSMAN & OPPENHEIM
15260 VENTURA BOULEVARD, SUITE 2100
SHERMAN OAKS, CA 91403

FOR: CHARITABLE FUNDRAISING SERVICES,
IN CLASS 36 (U.S. CLS. 100, 101 AND 102).

FIRST USE 12-27-2004; IN COMMERCE 12-27-2004.

THE MARK CONSISTS OF STANDARD CHARACTERS WITHOUT CLAIM TO ANY PARTICULAR FONT, STYLE, SIZE, OR COLOR.

SER. NO. 78-555,481, FILED 1-27-2005.

DAVID TOOLEY, EXAMINING ATTORNEY

Int. Cl.: 9

Prior U.S. Cls.: 21, 23, 26, 36 and 38

Reg. No. 3,484,893

United States Patent and Trademark Office

Registered Aug. 12, 2008

**TRADEMARK
PRINCIPAL REGISTER**



METAMORPHOSIS PRODUCTIONS, LLC (WIS-
CONSIN LTD LIAB CO)
1579 S. MOORLAND ROAD, #208
NEW BERLIN, WI 53151

FOR: PRERECORDED DVDS FEATURING SELF-
DEFENSE STRATEGIES AND INFORMATION FOR
WOMEN, IN CLASS 9 (U.S. CLS. 21, 23, 26, 36 AND 38).

FIRST USE 5-29-2004; IN COMMERCE 5-29-2004.

NO CLAIM IS MADE TO THE EXCLUSIVE
RIGHT TO USE "WOMEN", APART FROM THE
MARK AS SHOWN.

THE MARK CONSISTS OF THE WORDS "NO!
EMPOWERING WOMEN" IN STYLIZED FORM.

SER. NO. 78-568,956, FILED 2-16-2005.

IRA J. GOODSID, EXAMINING ATTORNEY

Int. Cl.: 12

Prior U.S. Cls.: 19, 21, 23, 31, 35 and 44

United States Patent and Trademark Office

Reg. No. 3,484,894

Registered Aug. 12, 2008

**TRADEMARK
PRINCIPAL REGISTER**

FACE

HONDA MOTOR CO., LTD. (JAPAN CORPORATION)

1-1, MINAMI-AOYAMA 2-CHOME, MINATO-KU

TOKYO 107-8556, JAPAN

FOR: MOTORCYCLES AND THEIR STRUCTURAL PARTS AND FITTINGS, IN CLASS 12 (U.S. CLS. 19, 21, 23, 31, 35 AND 44).

THE MARK CONSISTS OF STANDARD CHARACTERS WITHOUT CLAIM TO ANY PARTICULAR FONT, STYLE, SIZE, OR COLOR.

OWNER OF JAPAN REG. NO. 4975952, DATED 8-4-2006, EXPIRES 8-4-2016.

SER. NO. 78-583,825, FILED 3-9-2005.

TINA L. SNAPP, EXAMINING ATTORNEY

Int. Cl.: 41

Prior U.S. Cls.: 100, 101 and 107

United States Patent and Trademark Office

Reg. No. 3,484,895

Registered Aug. 12, 2008

**SERVICE MARK
PRINCIPAL REGISTER**

**REX ROUNDTABLES
FOR EXECUTIVES**

QM2, INC (CALIFORNIA CORPORATION)
13929 OLIVE MESA COURT
POWAY, CA 92064

FOR: EDUCATION SERVICES, NAMELY, CONDUCTING ROUND TABLE EDUCATIONAL CONFERENCES FOR EXECUTIVES, IN CLASS 41 (U.S. CLS. 100, 101 AND 107).

FIRST USE 4-20-2004; IN COMMERCE 4-20-2004.

THE MARK CONSISTS OF STANDARD CHARACTERS WITHOUT CLAIM TO ANY PARTICULAR FONT, STYLE, SIZE, OR COLOR.

NO CLAIM IS MADE TO THE EXCLUSIVE RIGHT TO USE "ROUNDTABLES FOR EXECUTIVES", APART FROM THE MARK AS SHOWN.

SER. NO. 78-585,097, FILED 3-11-2005.

MAUREEN DALL, EXAMINING ATTORNEY

Int. Cls.: 7, 29, 30, 31, 35, 37, 40 and 42

Prior U.S. Cls.: 1, 13, 19, 21, 23, 31, 34, 35, 46, 100, 101, 102, 103 and 106

Reg. No. 3,484,896

United States Patent and Trademark Office

Registered Aug. 12, 2008

**TRADEMARK
SERVICE MARK
PRINCIPAL REGISTER**

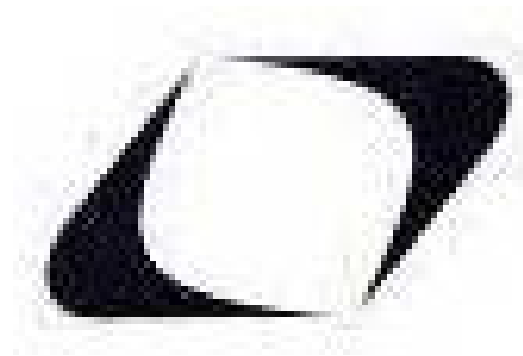

FOODCAP INTERNATIONAL LIMITED (NEW ZEALAND CORPORATION)
SUITE 3, LEVEL 3, 8A CLEVELAND ROAD
PARNELL, AUCKLAND, NEW ZEALAND 1001

FOR: FRESH FRUIT, VEGETABLES, RAW, FRESH AND UNPROCESSED GRAINS AND NUTS; FOODSTUFFS FOR ANIMALS, IN CLASS 31 (U.S. CLS. 1 AND 46).

FOR: MACHINES FOR HANDLING, PROCESSING, TREATING, STORING AND TRANSPORTING PRODUCTS INCLUDING PERISHABLE PRODUCTS, FOOD PRODUCTS, BEVERAGES AND BEVERAGE PRODUCTS, INGREDIENTS FOR PERISHABLE PRODUCTS, FOOD PRODUCTS; MACHINES FOR STORAGE, TREATMENT, PREPARATION AND PRESENTATION OF PERISHABLE MATERIALS, NAMELY, FOOD AND BEVERAGES, IN CLASS 7 (U.S. CLS. 13, 19, 21, 23, 31, 34 AND 35).

FOR: WHOLESALE STORE FEATURING FOOD AND BEVERAGES, MACHINERY FOR STORAGE, TREATMENT, PREPARATION AND PRESENTATION OF PERISHABLE MATERIALS, NAMELY, FOOD AND BEVERAGES AND PARTS AND FITTINGS FOR THE FOREGOING; RETAIL STORE SERVICES FEATURING FOOD AND BEVERAGES, MACHINERY FOR STORAGE, TREATMENT, PREPARATION AND PRESENTATION OF PERISHABLE MATERIALS, NAMELY, FOOD AND BEVERAGES, PARTS AND FITTINGS FOR THE FOREGOING; ONLINE RETAIL STORE SERVICES FEATURING FOOD AND BEVERAGES, MACHINERY FOR STORAGE, TREATMENT, PREPARATION AND PRESENTATION OF PERISHABLE MATERIALS, NAMELY, FOOD AND BEVERAGES, PARTS AND FITTINGS FOR THE FOREGOING; BUSINESS ADVISORY CONSULTANCY, MANAGEMENT, ADMINISTRATION AND INFORMATION SERVICES; FRANCHISING, NAMELY, CONSULTATION AND ASSISTANCE IN BUSINESS MANAGEMENT, ORGANIZATION AND PROMOTION; LICENSING OF FOOD AND BEVERAGE PROCESSING KNOW HOW AND MACHINERY; CONDUCTING AN ONLINE TRADE SHOW EXHIBITION IN THE FIELD OF MACHINERY FOR STORAGE, TREATMENT, PREPARATION AND PRESENTATION OF PERISHABLE MATERIALS, NAMELY, FOOD AND BEVERAGES; PROVIDING AN ONLINE

FOR: FRESH MEAT, FISH, POULTRY AND GAME; DRIED, CANNED, PRESERVED, PROCESSED AND/OR COOKED MEAT, FISH, POULTRY AND GAME; EGGS; EDIBLE OILS AND FATS; MILK AND MILK PRODUCTS, NAMELY, YOGURT, CHEESE, CREAM; PICKLES AND FRUIT PRESERVES; PREPARED FOODSTUFFS, NAMELY, PROCESSED FOODS CONSISTING PRIMARILY OF MEAT, FISH, POULTRY OR GAME OR EXTRACTS THEREOF, IN CLASS 29 (U.S. CL. 46).

FOR: PROCESSED GRAIN; FARINACEOUS FOOD AND FOOD PRODUCTS FOR HUMAN CONSUMPTION; BREAD; FLAVORING INGREDIENTS, NAMELY, SAUCES, SALT, MUSTARD AND VINEGAR, IN CLASS 30 (U.S. CL. 46).

COMPUTER DATABASE FEATURING TRADE INFORMATION IN THE FIELD OF MACHINERY FOR STORAGE, TREATMENT, PREPARATION AND PRESENTATION OF PERISHABLE MATERIALS, NAMELY, FOOD AND BEVERAGES; ADVERTISING AGENCY; PUBLICITY AND SALES PROMOTION SERVICES; PRODUCT DEMONSTRATION, IN CLASS 35 (U.S. CLS. 100, 101 AND 102).

FOR: CONSTRUCTION, REPAIR, MAINTENANCE AND INSTALLATION OF MACHINERY FOR STORAGE, TREATMENT, PREPARATION AND PRESENTATION OF PERISHABLE MATERIALS, FOOD AND BEVERAGE PRODUCTS; ADVISORY AND CONSULTANCY SERVICES IN THE FIELD OF CONSTRUCTION, REPAIR, MAINTENANCE AND INSTALLATION OF THE FOREGOING MACHINERY, IN CLASS 37 (U.S. CLS. 100, 103 AND 106).

FOR: FOOD PROCESSING SERVICES; ADVISORY AND CONSULTANCY IN THE FIELD OF

FOOD PROCESSING, IN CLASS 40 (U.S. CLS. 100, 103 AND 106).

FOR: RESEARCH IN THE FIELD OF FOOD PROCESSING, SURVEYING AND ENGINEERING SERVICES, LICENSING OF INTELLECTUAL PROPERTY AND/OR TECHNOLOGY IN THE AREAS OF MATERIALS HANDLING, TREATMENT, PRESERVATION AND TRANSPORTATION OF PERISHABLE PRODUCTS; TESTING, INSPECTION AND RESEARCH ON AGRICULTURE, LIVESTOCK BREEDING OR FISHERIES; DESIGN FOR OTHERS IN THE FIELD OF FOOD PROCESSING, IN CLASS 42 (U.S. CLS. 100 AND 101).

PRIORITY CLAIMED UNDER SEC. 44(D) ON NEW ZEALAND APPLICATION NO. 719978, FILED 10-15-2004, REG. NO. 719978, DATED 10-15-2004, EXPIRES 10-15-2011.

SER. NO. 78-608,957, FILED 4-14-2005.

JUSTINE D. PARKER, EXAMINING ATTORNEY

Int. Cls.: 9 and 41

Prior U.S. Cls.: 21, 23, 26, 36, 38, 100, 101 and 107

Reg. No. 3,484,897

United States Patent and Trademark Office

Registered Aug. 12, 2008

**TRADEMARK
SERVICE MARK
PRINCIPAL REGISTER**

OBSCURA

OBSCURA DIGITAL, INC. (CALIFORNIA CORPORATION)
462 BRYANT STREET
SAN FRANCISCO, CA 94107

FOR: DIGITAL VIDEO CREATION, CAPTURE, PROCESSING, AND PROJECTION SYSTEM, COMPRISED OF COMPUTER HARDWARE AND SOFTWARE USED FOR MAPPING AND INTEGRATING DIGITAL VIDEO AND DIGITAL STILL IMAGES ON HIGH RESOLUTION DISPLAYS, DIGITAL VIDEO AND DIGITAL STILL CAPTURE CAMERAS, DIGITAL VIDEO SCREENS AND PROJECTORS FOR USE IN THE CREATION, CAPTURE, PROCESSING, AND PROJECTION OF STILL AND MOVING IMAGES, IN CLASS 9 (U.S. CLS. 21, 23, 26, 36 AND 38).

FIRST USE 6-26-2000; IN COMMERCE 6-26-2000.

FOR: EDUCATIONAL AND ENTERTAINMENT SERVICES, NAMELY, PROVIDING AUDIO AND VISUAL PERFORMANCES; AUDIO-VISUAL CONTENT PRODUCTION IN THE NATURE OF PRODUCTION OF VIDEO AND CREATION OF VISUAL EFFECTS FOR OTHERS FOR USE IN DIGITAL

VIDEOS; CONDUCTING LIVE EXHIBITIONS, DISPLAYS AND INTERACTIVE EXHIBITS IN THE FIELD OF BUSINESS-TO-BUSINESS MARKETING, BUSINESS-TO-CONSUMER MARKETING, AND CONSUMER AND BUSINESS ENTERTAINMENT AND EDUCATION, LIGHTING PRODUCTION, LIGHT SHOWS, PROJECTION OF IMAGES IN CONNECTION WITH LIGHT SHOWS, AND/OR PREPARATION OF SPECIAL EFFECTS, IN CLASS 41 (U.S. CLS. 100, 101 AND 107).

FIRST USE 6-26-2000; IN COMMERCE 6-26-2000.

THE MARK CONSISTS OF STANDARD CHARACTERS WITHOUT CLAIM TO ANY PARTICULAR FONT, STYLE, SIZE, OR COLOR.

THE WORDING "OBSCURA" HAS NO MEANING IN A FOREIGN LANGUAGE.

SER. NO. 78-625,121, FILED 5-8-2005.

SUE LAWRENCE, EXAMINING ATTORNEY

Int. Cl.: 12

Prior U.S. Cls.: 19, 21, 23, 31, 35 and 44

Reg. No. 3,484,898

United States Patent and Trademark Office

Registered Aug. 12, 2008

TRADEMARK
PRINCIPAL REGISTER

The logo for "Parts Depot Preferred" features the words "Parts Depot Preferred" in a bold, italicized, sans-serif font. A thin horizontal line runs through the middle of the letters. To the left of the word "Parts" is a circular crest containing a stylized gear or wheel.

PARTS DEPOT CO., L.P. (DELAWARE LIMITED
PARTNERSHIP)
2177 DALE AVENUE SE
ROANOKE, VA 24013

NO CLAIM IS MADE TO THE EXCLUSIVE
RIGHT TO USE "PARTS DEPOT", APART FROM
THE MARK AS SHOWN.

FOR: AUTOMOTIVE EQUIPMENT, NAMELY,
LAND VEHICLE TRANSMISSION BELTS, TRUCK
AIR BRAKE HOSES, BRAKE SHOES AND PAD,
BRAKE CALIPERS, CHASSIS, BRAKE DRUMS AND
ROTORS, SHOCK ABSORBERS AND SUSPENSION
STRUTS, BRAKE AND CLUTCH CABLE, AND
BRAKE WHEEL CYLINDERS, IN CLASS 12 (U.S.
CLS. 19, 21, 23, 31, 35 AND 44).

THE MARK CONSISTS OF BOLD LETTERS WITH
A THIN LINE AROUND THE WORDS "PARTS
DEPOT PREFERRED" AND A CREST BEFORE
THE WORD "PARTS".

SER. NO. 78-629,626, FILED 5-13-2005.

FIRST USE 1-0-1993; IN COMMERCE 1-0-1993.

INGRID C. EULIN, EXAMINING ATTORNEY

Int. Cl.: 29

Prior U.S. Cl.: 46

United States Patent and Trademark Office

Reg. No. 3,484,899

Registered Aug. 12, 2008

**TRADEMARK
PRINCIPAL REGISTER**

SKIPPER'S BEST

GROBEST USA, INC. (CALIFORNIA CORPORATION)
255 EAST SANTA CLARA AVENUE, SUITE 310
ARCADIA, CA 91006

FOR: FROZEN SEAFOOD SOLD EXCLUSIVELY
IN THE WHOLESALE AND RETAIL GROCERY
CHANNELS OF TRADE, IN CLASS 29 (U.S. CL. 46).

FIRST USE 1-1-2003; IN COMMERCE 1-1-2003.

THE MARK CONSISTS OF STANDARD CHARACTERS WITHOUT CLAIM TO ANY PARTICULAR FONT, STYLE, SIZE, OR COLOR.

NO CLAIM IS MADE TO THE EXCLUSIVE RIGHT TO USE "BEST", APART FROM THE MARK AS SHOWN.

SER. NO. 78-630,826, FILED 5-16-2005.

JENNIFER MARTIN, EXAMINING ATTORNEY

Int. Cls.: 12 and 41

Prior U.S. Cls.: 19, 21, 23, 31, 35, 44, 100, 101 and 107

United States Patent and Trademark Office

Reg. No. 3,484,900

Registered Aug. 12, 2008

**TRADEMARK
SERVICE MARK
PRINCIPAL REGISTER**



NEMESIS AIR RACING (CALIFORNIA CORPORATION)
17329 ROPER STREET # 990
MOJAVE, CA 93501

FOR: AIRCRAFT FOR COMPETITION AND GENERAL AVIATION USE, IN CLASS 12 (U.S. CLS. 19, 21, 23, 31, 35 AND 44).

FIRST USE 3-25-2001; IN COMMERCE 3-25-2001.

FOR: ENTERTAINMENT IN THE NATURE OF LIVE AIRCRAFT RACING, AIR RACING DEMON-

STRATIONS AND AIR SHOW PERFORMANCES, IN CLASS 41 (U.S. CLS. 100, 101 AND 107).

FIRST USE 5-31-1991; IN COMMERCE 9-12-1991.

OWNER OF U.S. REG. NO. 2,001,000.

SER. NO. 78-631,549, FILED 5-17-2005.

DAVID MURRAY, EXAMINING ATTORNEY

Int. Cls.: 9 and 28

Prior U.S. Cls.: 21, 22, 23, 26, 36, 38 and 50

United States Patent and Trademark Office

Reg. No. 3,484,901

Registered Aug. 12, 2008

**TRADEMARK
PRINCIPAL REGISTER**



FEARLESS PLANET (ARIZONA CORPORATION)
7521 N LAKESIDE LANE
PARADISE VALLEY, AZ 85253

FOR: FABRIC BAGS FOR LAPTOP COMPUTERS,
IN CLASS 9 (U.S. CLS. 21, 23, 26, 36 AND 38).

FIRST USE 9-1-2004; IN COMMERCE 9-1-2004.

FOR: FABRIC BAGS FOR YOGA MATS, IN CLASS
28 (U.S. CLS. 22, 23, 38 AND 50).

FIRST USE 9-1-2004; IN COMMERCE 9-1-2004.

SER. NO. 78-633,891, FILED 5-20-2005.

KHANH LE, EXAMINING ATTORNEY

Int. Cls.: 9, 35, 36, 38, 41, 42, 44 and 45

**Prior U.S. Cls.: 21, 23, 26, 36, 38, 100, 101, 102, 104
and 107**

Reg. No. 3,484,902

United States Patent and Trademark Office

Registered Aug. 12, 2008

**TRADEMARK
SERVICE MARK
PRINCIPAL REGISTER**

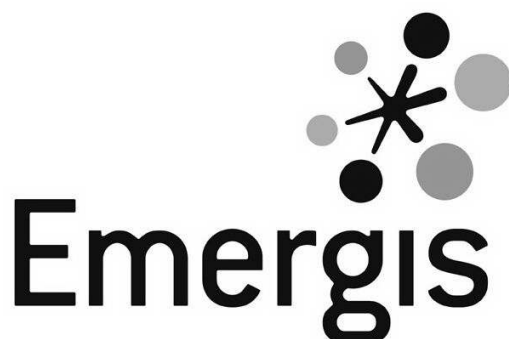

EMERGIS INC. (CANADA CORPORATION)
1000 RUE DE SERIGNY
SUITE 600
LONGUEUIL (QUEBEC), CANADA J4K 5B1

FOR: COMPUTER PROGRAMS AND SOFTWARE FOR CREATING, MAINTAINING AND MANAGING TRANSACTIONAL WEBSITES AND ELECTRONIC CATALOGS; COMPUTER PROGRAMS AND SOFTWARE RELATING TO THE OPERATION AND MANAGEMENT OF PHARMACIES, HOSPITALS AND OTHER INSTITUTIONS IN THE FIELD OF HEALTHCARE; MAGNETICALLY ENCODED CREDIT CARDS, DEBIT CARDS, MEDICAL IDENTIFICATION CARDS AND HEALTHCARE INSURANCE CARDS, IN CLASS 9 (U.S. CLS. 21, 23, 26, 36 AND 38).

FOR: BUSINESS MANAGEMENT SERVICES, NAMELY, ELECTRONIC PROCUREMENT, NAMELY, PURCHASING OF OPERATING RESOURCES FOR OTHERS; ELECTRONIC PROCESSING OF ORDERS FOR OTHERS; ELECTRONIC AUCTIONEERING SERVICES; AUCTION MANAGEMENT SERVICES PROVIDED TO OTHERS OVER AN ON-LINE WEB SITE ACCESSED THROUGH A GLOBAL COMPUTER NETWORK; ON-LINE CONSIGNMENT SERVICES WHEREBY GOODS ARE RECEIVED ON CONSIGNMENT FOR AUCTION ON AN ON-LINE AUCTION SITE; PROVIDING ONLINE DATABASES CONTAINING CONSUMER INFORMATION ON PHARMACEUTICAL AND MEDICAL PRODUCTS; COMPUTERIZED ONLINE ORDER-

ING SERVICES IN THE FIELD OF PRESCRIPTION DRUGS; OUTSOURCING IN THE FIELD OF MEDICAL MANAGEMENT; PROVIDING BUSINESS INFORMATION BY ELECTRONIC MEANS; FACILITATING THE EXCHANGE OF NEEDED INFORMATION FOR FINANCIAL COMPENSATION VIA THE INTERNET; ELECTRONIC TAX FILING SERVICES; ELECTRONIC TAX PREPARATION SERVICES; BUSINESS MANAGEMENT; ELECTRONIC INVOICING AND BILLING SERVICES; BUSINESS MANAGEMENT, NAMELY, ORDER MANAGEMENT AND SUPPLY CHAIN MANAGEMENT SERVICES; BUSINESS MANAGEMENT SERVICES RELATING TO PRODUCT DISTRIBUTION, OPERATIONS MANAGEMENT SERVICES, LOGISTICS, REVERSE LOGISTICS, SUPPLY CHAIN, AND PRODUCTION SYSTEM, AND DISTRIBUTION SOLUTIONS, IN CLASS 35 (U.S. CLS. 100, 101 AND 102).

FOR: FINANCIAL MANAGEMENT SERVICES; BUSINESS BROKERAGE SERVICES IN THE FIELD OF INSURANCE AND HEALTHCARE; INSURANCE CLAIM PROCESSING AND ADJUDICATION SERVICES; ELECTRONIC BILL PAYMENT; ELECTRONIC FUNDS TRANSFER; ELECTRONIC PAYMENT, NAMELY, ELECTRONIC PROCESSING AND TRANSMISSION OF BILL PAYMENT DATA; PROVIDING ELECTRONIC PROCESSING OF CREDIT CARD TRANSACTIONS AND ELECTRONIC PAYMENTS VIA A GLOBAL COMPUTER NETWORK; PROVIDING FINANCIAL INFORMATION BY ELECTRONIC MEANS; ELECTRONIC MORT-

GAGE AND LOAN PROCESSING SERVICES; ELECTRONIC CASH TRANSACTIONS; ELECTRONIC COMMERCE PAYMENT SERVICES ESTABLISHING FUNDED ACCOUNTS USED TO PURCHASE GOODS AND SERVICES ON THE INTERNET; ELECTRIC CREDIT CARD TRANSACTIONS; ELECTRONIC DEBIT TRANSACTIONS; FIDUCIARY TAX PAYMENT PROCESSING SERVICES; PAYROLL TAX DEBITING SERVICES; TAX PAYMENT PROCESSING SERVICES, IN CLASS 36 (U.S. CLS. 100, 101 AND 102).

FOR: PROVIDING A HIGH SPEED ACCESS TO AREA NETWORKS AND A GLOBAL COMPUTER INFORMATION NETWORK; PROVIDING MULTIPLE-USER ACCESS TO A GLOBAL COMPUTER INFORMATION NETWORK; TELECOMMUNICATIONS ROUTING AND JUNCTION SERVICES, NAMELY, MANAGEMENT OF MESSAGE ROUTING THROUGH A GRID OR NETWORK; ELECTRONIC MESSAGING STORE AND FORWARD SERVICES; ELECTRONIC MESSAGING SERVICES; ELECTRONIC MESSAGING SYSTEM, NAMELY, ELECTRONIC QUEUING SERVICES; ELECTRONIC STORE-AND-FORWARD MESSAGING; INSTANT MESSAGING SERVICES; WEB MESSAGING; DELIVERY OF MESSAGES BY ELECTRONIC TRANSMISSION; ELECTRONIC DATA INTERCHANGE (EDI) SERVICES; ELECTRONIC DATA INTERCHANGE, IN CLASS 38 (U.S. CLS. 100, 101 AND 104).

FOR: EDUCATIONAL SERVICES, NAMELY, CONDUCTING WORKSHOPS AND SEMINARS IN THE FIELD OF HEALTH AND ELECTRONIC COMMERCE, IN CLASS 41 (U.S. CLS. 100, 101 AND 107).

FOR: DOCUMENT DESIGN SERVICES; ELECTRONIC BUSINESS DOCUMENT DESIGN FOR OTHERS; HOSTING AND MAINTENANCE OF WEBSITES OF OTHERS ON A COMPUTER SERVER FOR A GLOBAL COMPUTER NETWORK; COMPUTER SOFTWARE DESIGN FOR OTHERS; COMPU-

TER CONSULTATION IN THE FIELD OF COMPUTER SECURITY; COMPUTER SECURITY SERVICES, NAMELY, RESTRICTING ACCESS TO AND BY COMPUTER NETWORKS TO AND OF UNDESIRE WEB SITES, MEDIA, AND INDIVIDUALS AND FACILITIES; ON-LINE SECURITY SERVICES, NAMELY, PROVIDING SECURITY AND ANONYMITY FOR ELECTRONICALLY TRANSMITTED CREDIT CARD TRANSACTIONS; HOSTING OF DATABASES CONTAINING HEALTH RECORDS AND MEDICAL INFORMATION, IN CLASS 42 (U.S. CLS. 100 AND 101).

FOR: PROVIDING INFORMATION RELATING TO HEALTH CARE ABOUT PHARMACEUTICAL AND MEDICAL PRODUCTS VIA AN ONLINE DATABASE, IN CLASS 44 (U.S. CLS. 100 AND 101).

FOR: MONITORING OF COMPUTER SYSTEMS FOR SECURITY PURPOSES; COMPUTER SECURITY SERVICES IN THE NATURE OF PROVIDING AN INTERNET TRUST CENTER, NAMELY, COMPUTER SECURITY ASSURANCE AND ADMINISTRATION OF DIGITAL KEYS AND DIGITAL CERTIFICATES; CONSULTING SERVICES IN THE FIELD OF MAINTAINING THE SECURITY AND INTEGRITY OF DATABASES, IN CLASS 45 (U.S. CLS. 100 AND 101).

PRIORITY CLAIMED UNDER SEC. 44(D) ON CANADA APPLICATION NO. 1238922, FILED 11-23-2004, REG. NO. TMA702012, DATED 11-29-2007, EXPIRES 11-29-2022.

OWNER OF U.S. REG. NOS. 2,322,777 AND 2,999,475.

SER. NO. 78-634,929, FILED 5-23-2005.

AMOS T. MATTHEWS, JR., EXAMINING ATTORNEY

Int. Cls.: 36 and 38

Prior U.S. Cls.: 100, 101, 102 and 104

United States Patent and Trademark Office

Reg. No. 3,484,903

Registered Aug. 12, 2008

**SERVICE MARK
PRINCIPAL REGISTER**

TuYo

IDT NETHERLANDS, B.V. (PUERTO RICO BRANCH) (NETHERLANDS CORPORATION) GANGES PLAZA, 108 GANGES STREET, SUITE A 1, EL PARAISO INDUSTRIAL PARK SAN JUAN, PUERTO RICO 00926

FOR: FINANCIAL SERVICES, NAMELY, PROVIDING MONEY TRANSFER SERVICES AND DEBIT CARD SERVICES; PREPAID TELECOMMUNICATIONS CALLING CARD AND TELEPHONE DEBIT CARD SERVICES; PREPAID AND POSTPAID WIRELESS, NAMELY, TELECOMMUNICATIONS CALLING CARD AND TELEPHONE DEBIT CARD, SERVICES, IN CLASS 36 (U.S. CLS. 100, 101 AND 102).

FIRST USE 10-29-2005; IN COMMERCE 11-17-2005.

FOR: WIRELESS COMMUNICATIONS SERVICES; TELEPHONE COMMUNICATION SERVICES,

NAMELY, LOCAL, DOMESTIC, INTERNATIONAL AND LONG DISTANCE TELEPHONE SERVICES; VOICE OVER INTERNET PROTOCOL (VOIP) SERVICES; INTERNET TELEPHONY SERVICES, IN CLASS 38 (U.S. CLS. 100, 101 AND 104).

FIRST USE 10-29-2005; IN COMMERCE 11-17-2005.

THE MARK CONSISTS OF STANDARD CHARACTERS WITHOUT CLAIM TO ANY PARTICULAR FONT, STYLE, SIZE, OR COLOR.

THE ENGLISH TRANSLATION OF "TUYO" AS A NOUN IS THINE AND AS AN ADJECTIVE IS YOUR OR YOURS.

SER. NO. 78-636,014, FILED 5-24-2005.

ALICIA COLLINS, EXAMINING ATTORNEY

Int. Cls.: 12 and 28

Prior U.S. Cls.: 19, 21, 22, 23, 31, 35, 38, 44 and 50

United States Patent and Trademark Office

Reg. No. 3,484,904

Registered Aug. 12, 2008

**TRADEMARK
PRINCIPAL REGISTER**



TRANS AMERICAN RUBBER, INC. (COLORADO CORPORATION)

4250 SOUTH SANTA FE DRIVE
ENGLEWOOD, CO 80110

FOR: INNER TUBES, NAMELY, INNER TUBES FOR VEHICLE TIRES, INNER TUBES FOR TRUCK TIRES, INNER TUBES FOR TRAILER TIRES, INNER TUBES FOR THE WHEELS OF FORESTRY VEHICLES, INNER TUBES FOR THE WHEELS OF AGRICULTURAL VEHICLES, INNER TUBES FOR THE WHEELS OF IRRIGATION SYSTEMS, INNER TUBES FOR THE WHEELS OF CONSTRUCTION VEHICLES, INNER TUBES FOR OFF-THE-ROAD VEHICLE TIRES, INNER TUBES FOR THE WHEELS OF MINING VEHICLES, INNER TUBES FOR THE WHEELS OF AIRCRAFT, INNER TUBES FOR THE WHEELS OF AIRCRAFT TUGS, INNER TUBES FOR THE WHEELS OF LUGGAGE TUGS AND TRAILERS, INNER TUBES FOR THE WHEELS OF WHEELBARROWS, INNER TUBES FOR THE WHEELS OF MOTORIZED HANDCARTS, INNER TUBES FOR THE WHEELS OF NON-MOTORIZED HANDCARTS, INNER TUBES FOR THE WHEELS OF WHEELCHAIRS, INNER TUBES WITH AIR VALVE ASSEMBLIES FOR USE WITH VEHICLES, AND INNER TUBES WITH BOTH AIR AND WATER VALVE ASSEMBLIES FOR USE WITH VEHICLES; TIRES, NAMELY, VEHICLE TIRES, TRUCK TIRES, TRAILER TIRES, TIRES FOR FORESTRY VEHICLES, TIRES FOR AGRICULTURAL VEHICLES, TIRES FOR THE WHEELS OF IRRIGATION SYSTEMS, TIRES FOR CONSTRUCTION VEHICLES, TIRES FOR OFF-THE-ROAD VEHICLES, TIRES FOR MINING VEHICLES, TIRES FOR AIRCRAFT TUGS, TIRES FOR LUGGAGE TUGS AND TRAILERS, TIRES FOR GOLF CARTS, TIRES FOR ALL

TERRAIN VEHICLES, TIRES FOR WHEELBARROWS, TIRES FOR MOTORIZED HANDCARTS AND TIRES FOR NON-MOTORIZED HANDCARTS; VEHICLE WHEEL PARTS, NAMELY, FLAPS MADE OF RUBBER FOR USE IN PROTECTING INNER TUBES FROM INNER WHEEL SURFACES; AND ENVELOPES MADE OF RUBBER FOR USE IN RETREADING TIRES, IN CLASS 12 (U.S. CLS. 19, 21, 23, 31, 35 AND 44).

FIRST USE 1-1-1984; IN COMMERCE 1-1-1984.

FOR: INNER TUBES FOR RECREATIONAL USE, SUCH AS USE ON RIVERS, LAKES, AND ON SNOW, IN CLASS 28 (U.S. CLS. 22, 23, 38 AND 50).

FIRST USE 1-1-1984; IN COMMERCE 1-1-1984.

NO CLAIM IS MADE TO THE EXCLUSIVE RIGHT TO USE "TRANS AMERICAN RUBBER INC." AND THE DEPICTION OF THE OUTLINE OF THE MAP OF THE UNITED STATES, APART FROM THE MARK AS SHOWN.

THE COLOR(S) RED, WHITE, AND BLUE IS/ARE CLAIMED AS A FEATURE OF THE MARK.

THE MARK CONSISTS OF AN OUTLINE MAP OF THE CONTINENTAL UNITED STATES WITH THE WORDS "TRANS AMERICAN RUBBER INC." APPEARING DIAGONALLY, STACKED FROM THE UPPER LEFT PORTION OF THE MAP OUTLINE TO THE LOWER RIGHT PORTION OF THE MAP OUTLINE, AND COLORED IN WHITE. THE PORTION OF THE OUTLINE MAP ABOVE THE WORDS "TRANS AMERICAN RUBBER INC." IS COLORED

RED, AND THE PORTION OF THE OUTLINE MAP
BELOW THE WORDS "TRANS AMERICAN RUB-
BER INC". IS COLORED BLUE.

SER. NO. 78-638,286, FILED 5-26-2005.

KELLY MCCOY, EXAMINING ATTORNEY

Int. Cl.: 35

Prior U.S. Cls.: 100, 101 and 102

United States Patent and Trademark Office

Reg. No. 3,484,905

Registered Aug. 12, 2008

**SERVICE MARK
PRINCIPAL REGISTER**



INDEPENDENT ELECTRICITY SYSTEM OPERA-
TOR (CANADA CORPORATION)
655 BAY STREET, SUITE 410, P.O. BOX 1
TORONTO, CANADA M5G 2K4

FOR: FORECASTING AND ANALYSIS OF THE
ELECTRICITY SUPPLY NEEDS OF OTHERS AND
OF ELECTRICITY MARKETS; OVERSEEING THE
SCHEDULING, DISPATCHING, GENERATION
AND TRANSMISSION OF ELECTRICITY OF OTH-
ERS TO MATCH CUSTOMER NEEDS AND MAIN-
TAIN RELIABILITY, IN CLASS 35 (U.S. CLS. 100, 101
AND 102).

PRIORITY CLAIMED UNDER SEC. 44(D) ON
CANADA APPLICATION NO. 1241007, FILED 12-16-

2004, REG. NO. TMA697348, DATED 9-26-2007, EX-
PIRES 9-26-2022.

OWNER OF U.S. REG. NOS. 2,696,930, 2,865,958
AND OTHERS.

NO CLAIM IS MADE TO THE EXCLUSIVE
RIGHT TO USE "POWER TO ONTARIO" AND "ON
DEMAND", APART FROM THE MARK AS SHOWN.

SER. NO. 78-644,184, FILED 6-6-2005.

JULIE GUTTADAURO, EXAMINING ATTORNEY

Int. Cl.: 9

Prior U.S. Cls.: 21, 23, 26, 36 and 38

Reg. No. 3,484,906

United States Patent and Trademark Office

Registered Aug. 12, 2008

**TRADEMARK
PRINCIPAL REGISTER**

UNISOKU

UNISOKU CO., LTD. (JAPAN CORPORATION)
4-3, KASUGANO, 2-CHOUME
HIRAKATA-SHI, JAPAN

NAMELY, ELECTRON MICROSCOPES, IN CLASS 9
(U.S. CLS. 21, 23, 26, 36 AND 38).

FOR: MEASURING AND TESTING MACHINES
AND INSTRUMENTS, NAMELY, LUMINOFLUX
METERS, ALTIMETERS, SURFACE ROUGHNESS
TESTING MACHINES AND INSTRUMENTS, ME-
TAL COMPRESSION TESTING MACHINES, METAL
HARDNESS TESTING MACHINES, METAL
STRENGTH TESTING MACHINES, MAGNETOM-
ETERS, RESISTANCE MEASURING INSTRU-
MENTS, VOLTMETERS, AMMETERS; AND
LABORATORY APPARATUS AND INSTRUMENTS,

THE MARK CONSISTS OF STANDARD CHAR-
ACTERS WITHOUT CLAIM TO ANY PARTICULAR
FONT, STYLE, SIZE, OR COLOR.

OWNER OF JAPAN REG. NO. 1452015, DATED 1-
30-1981, EXPIRES 1-30-2011.

SER. NO. 78-649,332, FILED 6-13-2005.

ROBIN CHOSID, EXAMINING ATTORNEY

Int. Cl.: 7

Prior U.S. Cls.: 13, 19, 21, 23, 31, 34 and 35

Reg. No. 3,484,907

United States Patent and Trademark Office

Registered Aug. 12, 2008

**TRADEMARK
PRINCIPAL REGISTER**

VINFINITY

LUIS, ARMANDO (UNITED STATES INDIVIDUAL)
126 WASHINGTON STREET
HOBOKEN, NJ 07030

FOR: ELECTRIC VACUUM PUMPS FOR PRESERVATION OF WINE; WINE PRESERVATION SYSTEM COMPRISING VACUUM PUMPS, BOTTLE SEALS AND BOTTLE STOPPERS, FOR COMMERCIAL USE AND BEING OF A PROFESSIONAL GRADE NATURE, AND INTENDED FOR HIGH VOLUME USE IN SETTINGS SUCH AS RESTAU-

RANTS, BARS, WINE SHOPS AND VINEYARDS, IN CLASS 7 (U.S. CLS. 13, 19, 21, 23, 31, 34 AND 35).

FIRST USE 10-28-2006; IN COMMERCE 11-4-2006.

THE MARK CONSISTS OF STANDARD CHARACTERS WITHOUT CLAIM TO ANY PARTICULAR FONT, STYLE, SIZE, OR COLOR.

SER. NO. 78-688,077, FILED 8-8-2005.

REBECCA SMITH, EXAMINING ATTORNEY

Int. Cl.: 37

Prior U.S. Cls.: 100, 103 and 106

Reg. No. 3,484,908

United States Patent and Trademark Office

Registered Aug. 12, 2008

**SERVICE MARK
PRINCIPAL REGISTER**

Pet Butler

PET BUTLER, INC. (UTAH CORPORATION)
5300 TOWN AND COUNTRY BLVD., STE. 440
FRISCO, TX 75034

FOR: CLEANING SERVICES, NAMELY, WASTE
DISPOSAL FOR OTHERS, IN CLASS 37 (U.S. CLS.
100, 103 AND 106).

FIRST USE 3-1-1998; IN COMMERCE 3-1-1998.

THE MARK CONSISTS OF STANDARD CHAR-
ACTERS WITHOUT CLAIM TO ANY PARTICULAR
FONT, STYLE, SIZE, OR COLOR.

NO CLAIM IS MADE TO THE EXCLUSIVE
RIGHT TO USE "PET", APART FROM THE MARK
AS SHOWN.

SER. NO. 78-692,263, FILED 8-14-2005.

ARETHA SOMERVILLE, EXAMINING ATTORNEY

Int. Cl.: 9

Prior U.S. Cls.: 21, 23, 26, 36 and 38

Reg. No. 3,484,909

United States Patent and Trademark Office

Registered Aug. 12, 2008

**TRADEMARK
PRINCIPAL REGISTER**

Kaon Advisor

KAON INTERACTIVE, INC. (DELAWARE CORPORATION)
SUITE 100
2 CLOCK TOWER PLACE
MAYNARD, MA 01754

FOR: SOFTWARE, FOR USE IN IMPROVING SALES PRODUCTIVITY, THAT DEMONSTRATES PRODUCTS IN A VIRTUAL ENVIRONMENT WITHOUT REQUIRING THE ACTUAL PHYSICAL PRODUCTS, IN CLASS 9 (U.S. CLS. 21, 23, 26, 36 AND 38).

FIRST USE 5-1-2005; IN COMMERCE 6-1-2005.

THE MARK CONSISTS OF STANDARD CHARACTERS WITHOUT CLAIM TO ANY PARTICULAR FONT, STYLE, SIZE, OR COLOR.

OWNER OF U.S. REG. NOS. 2,537,793, 2,539,374, AND 2,827,625.

NO CLAIM IS MADE TO THE EXCLUSIVE RIGHT TO USE "ADVISOR", APART FROM THE MARK AS SHOWN.

"KAON" HAS NO MEANING IN A FOREIGN LANGUAGE.

SER. NO. 78-696,083, FILED 8-19-2005.

WENDY JUN, EXAMINING ATTORNEY

Int. Cl.: 10

Prior U.S. Cls.: 26, 39 and 44

Reg. No. 3,484,910

United States Patent and Trademark Office

Registered Aug. 12, 2008

**TRADEMARK
PRINCIPAL REGISTER**



TIMELESS IMAGE, INC. (CALIFORNIA CORPORATION)
1672 HONEYSUCKLE ROAD
LIVERMORE, CA 94551

THE MARK CONSISTS OF "A" STYLIZED LETTER "A" BETWEEN THE WORD "ALPH" AND "DERM" REPRESENTING THE "A" IN "ALPHA-
DERM".

FOR: MICRODERMABRASION MACHINE FOR SURFACE SKIN EXFOLIATION FOR BEAUTICIANS, ESTHETICIANS AND DERMOTOLOGIST IN THE BEAUTY/SKIN CARE INDUSTRY, IN CLASS 10 (U.S. CLS. 26, 39 AND 44).

SER. NO. 78-702,007, FILED 8-28-2005.

FIRST USE 0-0-2004; IN COMMERCE 0-0-2004.

TRACY CROSS, EXAMINING ATTORNEY

Int. Cls.: 29, 32 and 33

Prior U.S. Cls.: 45, 46, 47, 48 and 49

Reg. No. 3,484,911

United States Patent and Trademark Office

Registered Aug. 12, 2008

**TRADEMARK
PRINCIPAL REGISTER**

CENTICAL

CENTRITION LTD. (ISRAEL CORPORATION)
D.N EMEK SOREK
MOSHAV NETA'IM 76870, ISRAEL

FOR: (BASED ISRAEL REGISTRATION 162178)
MILK SUBSTITUTES, NAMELY, RICE MILK, SOY
MILK, ALMOND MILK, GRAIN MILK, LUPIN
MILK, IN CLASS 29 (U.S. CL. 46).

FOR: (BASED ISRAEL REGISTRATION 182661)
MALTERNATIVE DRINKS COMPRISED PRINCIPALLY OF BEER; BEERS; MINERAL AND AERATED WATERS AND OTHER NON-ALCOHOLIC DRINKS, NAMELY, SOFT DRINKS, NAMELY, CARBONATED SOFT DRINKS, NON-CARBONATED SOFT DRINKS, LOW-CALORIES SOFT DRINKS, ENERGY DRINKS, VEGETABLE DRINKS, VEGETABLE JUICES, FRUIT NECTARS, FRUIT DRINKS AND FRUIT JUICES; SYRUPS AND OTHER PREPARATIONS FOR MAKING BEVERAGES, NAMELY, FRUIT DRINKS AND SOFT DRINKS, IN CLASS 32 (U.S. CLS. 45, 46 AND 48).

FOR: (BASED ISRAEL REGISTRATION 182662)
MALTERNATIVE DRINKS COMPRISED PRINCIPALLY OF SPIRITS, NAMELY, COGNAC, VODKA, GIN, WHISKEY, BRANDY AND RUM, AND BEER; ALCOHOLIC BEVERAGES, NAMELY, WINES, SPARKLING WINES, LIQUEURS, AND SPIRITS, NAMELY, COGNAC, VODKA, GIN, WHISKEY AND RUM; MIXED ALCOHOLIC DRINKS, NAMELY, COCKTAILS, PUNCHES, SHOTS AND SHOOTERS, IN CLASS 33 (U.S. CLS. 47 AND 49).

THE MARK CONSISTS OF STANDARD CHARACTERS WITHOUT CLAIM TO ANY PARTICULAR FONT, STYLE, SIZE, OR COLOR.

OWNER OF ISRAEL REG. NO. 182662, DATED 4-23-2007, EXPIRES 4-23-2017.

OWNER OF ISRAEL REG. NO. 182661, DATED 4-23-2007, EXPIRES 4-23-2017.

OWNER OF ISRAEL REG. NO. 162178, DATED 4-23-2007, EXPIRES 4-23-2017.

SER. NO. 78-704,048, FILED 8-31-2005.

JOHN LINCOSKI, EXAMINING ATTORNEY

Int. Cl.: 36

Prior U.S. Cls.: 100, 101 and 102

United States Patent and Trademark Office

Reg. No. 3,484,912

Registered Aug. 12, 2008

**SERVICE MARK
PRINCIPAL REGISTER**



WALL ST. FUNDING, INC. (CALIFORNIA CORPORATION)
4675 MACARTHUR COURT
NEWPORT BEACH, CA 92660

NO CLAIM IS MADE TO THE EXCLUSIVE RIGHT TO USE "LENDING" AND "RESIDENTIAL & COMMERCIAL REAL ESTATE MORTGAGE SERVICES", APART FROM THE MARK AS SHOWN.

FOR: COMMERCIAL AND RESIDENTIAL REAL ESTATE SERVICES, NAMELY, APPRAISAL, ESCROW, MORTGAGE LENDING, FINANCING AND CONSULTATION, IN CLASS 36 (U.S. CLS. 100, 101 AND 102).

SER. NO. 78-709,198, FILED 9-8-2005.

FIRST USE 6-7-2004; IN COMMERCE 6-7-2004.

REBECCA EISINGER, EXAMINING ATTORNEY

Int. Cl.: 10

Prior U.S. Cls.: 26, 39 and 44

United States Patent and Trademark Office

Reg. No. 3,484,913

Registered Aug. 12, 2008

**TRADEMARK
PRINCIPAL REGISTER**

**ACCESS SURGICAL
INTERNATIONAL**

TNCO INC. (MASSACHUSETTS CORPORATION)
15 COLEBROOK BLVD.
WHITMAN, MA 02382

FOR: ENDOSCOPIC INSTRUMENTS, IN CLASS
10 (U.S. CLS. 26, 39 AND 44).

FIRST USE 7-9-1992; IN COMMERCE 1-6-1994.

THE MARK CONSISTS OF STANDARD CHAR-
ACTERS WITHOUT CLAIM TO ANY PARTICULAR
FONT, STYLE, SIZE, OR COLOR.

NO CLAIM IS MADE TO THE EXCLUSIVE
RIGHT TO USE "SURGICAL", APART FROM THE
MARK AS SHOWN.

SER. NO. 78-715,400, FILED 9-19-2005.

BARBARA GAYNOR, EXAMINING ATTORNEY

Int. Cl.: 43

Prior U.S. Cls.: 100 and 101

United States Patent and Trademark Office

Reg. No. 3,484,914

Registered Aug. 12, 2008

**SERVICE MARK
PRINCIPAL REGISTER**



PREPARE TO DINE, INC. (ALABAMA CORPORATION)
SUITE 213
181 MAIN STREET
HOOVER, AL 35244

FOR: FOOD PREPARATION; PREPARATION OF FOOD AND BEVERAGES; SELF SERVICE RESTAURANTS; TAKE-OUT RESTAURANT SERVICES, IN CLASS 43 (U.S. CLS. 100 AND 101).

FIRST USE 8-1-2005; IN COMMERCE 8-1-2005.

NO CLAIM IS MADE TO THE EXCLUSIVE RIGHT TO USE "MEALS", APART FROM THE MARK AS SHOWN.

THE MARK CONSISTS OF THE WORD "MEALS" FOLLOWED BY A COOKING POT THAT CONTAINS THE WORDS "IN THE" FOLLOWED BY THE WORD "MAKING".

SER. NO. 78-715,544, FILED 9-19-2005.

STEVEN JACKSON, EXAMINING ATTORNEY

Int. Cl.: 3

Prior U.S. Cls.: 1, 4, 6, 50, 51 and 52

Reg. No. 3,484,915

United States Patent and Trademark Office

Registered Aug. 12, 2008

**TRADEMARK
PRINCIPAL REGISTER**

ONSEN 温泉

OD INTERNATIONAL, INC (CALIFORNIA LIMITED PARTNERSHIP)
9420 LURLINE AVE # E
WWW.ONSENSECRET.COM
CHATSWORTH, CA 91311

THE NON-LATIN CHARACTER(S) IN THE MARK TRANSLITERATES INTO ONSEN , AND THIS MEANS HOT SPRINGS IN ENGLISH.

FOR: COSMETICS, IN CLASS 3 (U.S. CLS. 1, 4, 6, 50, 51 AND 52).

SER. NO. 78-716,098, FILED 9-19-2005.

FIRST USE 7-1-2005; IN COMMERCE 7-1-2005.

DOMINICK J. SALEMI, EXAMINING ATTORNEY

Int. Cl.: 9

Prior U.S. Cls.: 21, 23, 26, 36 and 38

Reg. No. 3,484,916

United States Patent and Trademark Office

Registered Aug. 12, 2008

**TRADEMARK
PRINCIPAL REGISTER**

MTi

XSENS TECHNOLOGIES B.V. (NETHERLANDS
LTD LIAB CO)
CAPITool 50,
7521 PL ENSCHEDE, NETHERLANDS

FOR: MEASURING DEVICES, NAMELY, INERTIAL MEASUREMENT UNITS FOR MEASUREMENT OF 3D MOTION, ORIENTATION, POSITION, ANGULAR VELOCITY AND ACCELERATION, COMPRISED OF GYROSCOPES, ACCELEROMETERS AND/OR MAGNETOMETERS; ATTITUDE AND HEADING REFERENCE SYSTEMS FOR MEASUREMENT OF 3D MOTION, ORIENTATION, POSITION, ANGULAR VELOCITY AND ACCELERATION, COMPRISED OF GYROSCOPES, ACCELEROMETERS AND/OR MAGNETOMETERS, FOR USE IN ROBOTICS, AEROSPACE, AUTONOMOUS VEHICLES, MARINE INDUSTRY AND/OR BORE INDUSTRY; ATTITUDE AND HEADING REFERENCE SYSTEMS FOR MEASUREMENT OF 3D MOTION, ORIENTATION, POSITION, ANGULAR VELOCITY AND ACCELERATION,

COMPRISED OF GYROSCOPES, ACCELEROMETERS, MAGNETOMETER AND/OR GLOBAL POSITIONING SYSTEM, FOR USE IN ROBOTICS, AEROSPACE, AUTONOMOUS VEHICLES, MARINE INDUSTRY AND/OR BORE INDUSTRY, IN CLASS 9 (U.S. CLS. 21, 23, 26, 36 AND 38).

FIRST USE 3-29-2005; IN COMMERCE 6-6-2005.

THE MARK CONSISTS OF STANDARD CHARACTERS WITHOUT CLAIM TO ANY PARTICULAR FONT, STYLE, SIZE, OR COLOR.

PRIORITY CLAIMED UNDER SEC. 44(D) ON ERPN CMNTY TM OFC APPLICATION NO. 004364725, FILED 3-31-2005, REG. NO. 004364725, DATED 8-10-2007, EXPIRES 3-31-2015.

SER. NO. 78-718,389, FILED 9-22-2005.

FLORENTINA BLANDU, EXAMINING ATTORNEY

Int. Cl.: 35

Prior U.S. Cls.: 100, 101 and 102

United States Patent and Trademark Office

Reg. No. 3,484,917

Registered Aug. 12, 2008

**SERVICE MARK
PRINCIPAL REGISTER**

FORE! HONORS

FORE HONORS, LLC (MICHIGAN LTD LIAB CO)
SUITE 202
720 N. LAPEER ROAD
LAKE ORION, NV 48362

FOR: INCENTIVE AWARD PROGRAMS FOR GOLFERS FEATURING AWARDS AND DISCOUNTS TO PROMOTE THE SALE OF PRODUCTS AND SERVICES OF OTHERS; CUSTOMER LOYALTY SERVICES FOR GOLFERS FOR PROMOTIONAL AND/OR ADVERTISING PURPOSES, IN CLASS 35 (U.S. CLS. 100, 101 AND 102).

FIRST USE 10-31-2003; IN COMMERCE 10-31-2003.

THE MARK CONSISTS OF STANDARD CHARACTERS WITHOUT CLAIM TO ANY PARTICULAR FONT, STYLE, SIZE, OR COLOR.

OWNER OF U.S. REG. NO. 2,891,721.

SER. NO. 78-718,949, FILED 9-22-2005.

CURTIS FRENCH, EXAMINING ATTORNEY

Int. Cl.: 5

Prior U.S. Cls.: 6, 18, 44, 46, 51 and 52

Reg. No. 3,484,918

United States Patent and Trademark Office

Registered Aug. 12, 2008

**TRADEMARK
PRINCIPAL REGISTER**

HEALTHY NAIL

KRAMER LABORATORIES, INC. (FLORIDA
CORPORATION)
8778 S.W. EIGHTH STREET
MIAMI, FL 33174

FOR: PHARMACEUTICAL PREPARATION,
NAMELY, A NAIL TREATMENT WITH NUTRI-
ENTS, IN CLASS 5 (U.S. CLS. 6, 18, 44, 46, 51 AND 52).

FIRST USE 5-16-1995; IN COMMERCE 5-16-1995.

THE MARK CONSISTS OF STANDARD CHAR-
ACTERS WITHOUT CLAIM TO ANY PARTICULAR
FONT, STYLE, SIZE, OR COLOR.

NO CLAIM IS MADE TO THE EXCLUSIVE
RIGHT TO USE "NAIL", APART FROM THE MARK
AS SHOWN.

SER. NO. 78-720,723, FILED 9-26-2005.

REBECCA GILBERT, EXAMINING ATTORNEY

Int. Cls.: 36 and 42

Prior U.S. Cls.: 100, 101 and 102

United States Patent and Trademark Office

Reg. No. 3,484,919

Registered Aug. 12, 2008

**SERVICE MARK
PRINCIPAL REGISTER**

**STRATEGIES. SOLUTIONS.
SUCCESS.**

CATO HOLDING COMPANY (NORTH CAROLINA CORPORATION)
4364 SOUTH ALSTON AVENUE
DURHAM, NC 27713

FOR: FINANCIAL ANALYSIS AND FINANCIAL CONSULTATION SERVICES TO ENTITIES IN THE FIELDS OF PHARMACEUTICALS, BIOTECHNOLOGIES AND MEDICAL DEVICES; VENTURE CAPITAL FINANCING SERVICES, NAMELY, PRIVATE INVESTMENT IN PUBLIC EQUITY FINANCING FOR ENTITIES IN THE FIELDS OF PHARMACEUTICALS, BIOTECHNOLOGIES AND MEDICAL DEVICES, IN CLASS 36 (U.S. CLS. 100, 101 AND 102).

FIRST USE 12-0-2003; IN COMMERCE 12-0-2003.

FOR: CONTRACT RESEARCH AND CLINICAL TRIAL SERVICES FOR OTHERS IN THE FIELDS OF PHARMACEUTICALS, BIOTECHNOLOGIES AND MEDICAL DEVICES, IN CLASS 42 (U.S. CLS. 100 AND 101).

FIRST USE 12-0-2003; IN COMMERCE 12-0-2003.

THE MARK CONSISTS OF STANDARD CHARACTERS WITHOUT CLAIM TO ANY PARTICULAR FONT, STYLE, SIZE, OR COLOR.

SER. NO. 78-722,040, FILED 9-28-2005.

JEFF DEFORD, EXAMINING ATTORNEY

Int. Cl.: 5

Prior U.S. Cls.: 6, 18, 44, 46, 51 and 52

United States Patent and Trademark Office

Reg. No. 3,484,920

Registered Aug. 12, 2008

**TRADEMARK
PRINCIPAL REGISTER**

PrandiMet

NOVO NORDISK A/S (DENMARK LTD LIAB CO)

NOVO ALLE

DK-2880 BAGSVAERD, DENMARK

FOR: PHARMACEUTICAL PREPARATIONS FOR
THE TREATMENT OF DIABETES, IN CLASS 5 (U.S.
CLS. 6, 18, 44, 46, 51 AND 52).

THE MARK CONSISTS OF STANDARD CHAR-
ACTERS WITHOUT CLAIM TO ANY PARTICULAR
FONT, STYLE, SIZE, OR COLOR.

OWNER OF DENMARK REG. NO. VR200700908,
DATED 4-3-2007, EXPIRES 4-2-2017.

SER. NO. 78-724,149, FILED 9-30-2005.

MYRIAH HABEEB, EXAMINING ATTORNEY

Int. Cl.: 27

Prior U.S. Cls.: 19, 20, 37, 42 and 50

Reg. No. 3,484,921

United States Patent and Trademark Office

Registered Aug. 12, 2008

**TRADEMARK
PRINCIPAL REGISTER**



THE NATIONAL TRUST (ENTERPRISES) LTD.
(UNITED KINGDOM COMPANY)
HELLIS KEMBLE DRIVE
SWINDON, UNITED KINGDOM SN2 2NA

TAPESTRY STYLE WALL HANGINGS AND CARPET HANGINGS, IN CLASS 27 (U.S. CLS. 19, 20, 37, 42 AND 50).

FOR: CARPETS; RUGS; MATS FOR HOUSEHOLD PURPOSES, NAMELY, DOOR MATS; MATTING, NAMELY, COIR, RUSH, AND JUTE MATTING USED FOR DOOR MATS AND FOR USE IN THE HOME; FLOOR COVERINGS FOR COVERING EXISTING FLOORS; WALL PAPER; NON-TEXTILE

OWNER OF ERPN CMNTY TM OFC REG. NO. 000633552, DATED 4-16-2000, EXPIRES 9-19-2017.

SER. NO. 78-728,619, FILED 10-7-2005.

DAWN FELDMAN, EXAMINING ATTORNEY

Int. Cl.: 35

Prior U.S. Cls.: 100, 101 and 102

United States Patent and Trademark Office

Reg. No. 3,484,922

Registered Aug. 12, 2008

**SERVICE MARK
PRINCIPAL REGISTER**

PatientLinkIQ

CATALINA MARKETING CORPORATION (DE-
LAWARE CORPORATION)
200 CARILLON PARKWAY
LEGAL DEPARTMENT
ST. PETERSBURG, FL 33716

FOR: PROMOTING THE GOODS AND SERVICES
OF OTHERS BY DISTRIBUTING ADVERTISING
MATERIALS THROUGH A VARIETY OF METH-
ODS, IN CLASS 35 (U.S. CLS. 100, 101 AND 102).

FIRST USE 2-25-2005; IN COMMERCE 2-25-2005.

THE MARK CONSISTS OF STANDARD CHAR-
ACTERS WITHOUT CLAIM TO ANY PARTICULAR
FONT, STYLE, SIZE, OR COLOR.

SER. NO. 78-733,205, FILED 10-14-2005.

MICHELLE DUBOIS, EXAMINING ATTORNEY

Int. Cl.: 25

Prior U.S. Cls.: 22 and 39

United States Patent and Trademark Office

Reg. No. 3,484,923

Registered Aug. 12, 2008

**TRADEMARK
PRINCIPAL REGISTER**

MOSHULU

COASTGUARD ROAD LIMITED (UNITED
KINGDOM CORPORATION)
DEVON ROAD, HEATHPARK
HONITON, UNITED KINGDOM EX14 1SD

OWNER OF UNITED KINGDOM REG. NO.
2105138, DATED 1-3-1997, RENEWED AS REG. NO.
2105138, DATED 7-12-2006, EXPIRES 7-12-2016.

FOR: CLOTHING, NAMELY, HATS, CAPS,
GLOVES AND SCARVES; FOOTWEAR, IN CLASS
25 (U.S. CLS. 22 AND 39).

SER. NO. 78-741,545, FILED 10-27-2005.

THE MARK CONSISTS OF STANDARD CHAR-
ACTERS WITHOUT CLAIM TO ANY PARTICULAR
FONT, STYLE, SIZE, OR COLOR.

BILL DAWE, EXAMINING ATTORNEY

Int. Cl.: 35

Prior U.S. Cls.: 100, 101 and 102

United States Patent and Trademark Office

Reg. No. 3,484,924

Registered Aug. 12, 2008

**SERVICE MARK
PRINCIPAL REGISTER**

CASTING NETWORKS

CASTING NETWORKS, INC. (CALIFORNIA CORPORATION)

6671 SUNSET BLVD. #1517

LOS ANGELES, CA 90028

FOR: BUSINESS NETWORKING SERVICES, NAMELY, PROVIDING EMPLOYER- EMPLOYEE INTRODUCTIONS, FEATURING ENTERTAINER CASTING, IN CLASS 35 (U.S. CLS. 100, 101 AND 102).

FIRST USE 1-21-1999; IN COMMERCE 3-31-2003.

THE MARK CONSISTS OF STANDARD CHARACTERS WITHOUT CLAIM TO ANY PARTICULAR FONT, STYLE, SIZE, OR COLOR.

NO CLAIM IS MADE TO THE EXCLUSIVE RIGHT TO USE "NETWORKS", APART FROM THE MARK AS SHOWN.

SEC. 2(F).

SER. NO. 78-744,953, FILED 11-1-2005.

LYDIA BELZER, EXAMINING ATTORNEY

Int. Cls.: 19, 20, 24 and 27

**Prior U.S. Cls.: 1, 2, 12, 13, 19, 20, 22, 25, 32, 33, 37, 42
and 50**

Reg. No. 3,484,925

United States Patent and Trademark Office

Registered Aug. 12, 2008

**TRADEMARK
PRINCIPAL REGISTER**

GRAFIX

THYBONY WALLCOVERINGS CO. (ILLINOIS
CORPORATION)
3720 NORTH KEDZIE
CHICAGO, IL 60618

FOR: DIGITALLY PRINTED FLOOR AND WALL
COVERINGS, NAMELY, CERAMIC FLOOR TILES,
IN CLASS 19 (U.S. CLS. 1, 12, 33 AND 50).

FIRST USE 7-1-2005; IN COMMERCE 7-1-2005.

FOR: PLASTIC SIGNAGE PANELS, NAMELY,
PLASTIC SIGNS THAT ADHERE TO WINDOWS,
WALLS, BOARDS AND OTHER SURFACES, IN
CLASS 20 (U.S. CLS. 2, 13, 22, 25, 32 AND 50).

FIRST USE 7-1-2005; IN COMMERCE 7-1-2005.

FOR: DIGITALLY PRINTED WINDOW TREAT-
MENTS, NAMELY, FABRIC CURTAINS, IN CLASS
24 (U.S. CLS. 42 AND 50).

FIRST USE 7-1-2005; IN COMMERCE 7-1-2005.

FOR: DIGITALLY PRINTED FLOOR AND WALL
COVERINGS, NAMELY, PAPER SUBSTRATES
WALLCOVERINGS, VINYL FLOOR AND WALL
COVERINGS, CLOTH WALL COVERINGS, PLEXI-
GLASS FLOOR AND WALL COVERINGS, CORK
FLOOR AND WALL COVERINGS AND WOOD
FLOOR AND WALL COVERINGS, IN CLASS 27
(U.S. CLS. 19, 20, 37, 42 AND 50).

FIRST USE 7-1-2005; IN COMMERCE 7-1-2005.

THE MARK CONSISTS OF STANDARD CHAR-
ACTERS WITHOUT CLAIM TO ANY PARTICULAR
FONT, STYLE, SIZE, OR COLOR.

SER. NO. 78-745,858, FILED 11-2-2005.

ARETHA SOMERVILLE, EXAMINING ATTORNEY

Int. Cl.: 20

Prior U.S. Cls.: 2, 13, 22, 25, 32 and 50

United States Patent and Trademark Office

Reg. No. 3,484,926

Registered Aug. 12, 2008

**TRADEMARK
PRINCIPAL REGISTER**

COUNTERSMART

EVANS CONSOLES CORPORATION (CANADA
CORPORATION)

1616 - 27 AVENUE NE

CALGARY, ALBERTA, CANADA T2E 8W4

FOR: COMMERCIAL COUNTERS FOR TRANS-
ACTIONAL, CLERICAL, ADMINISTRATIVE AND
DISPLAY PURPOSES, IN CLASS 20 (U.S. CLS. 2, 13,
22, 25, 32 AND 50).

THE MARK CONSISTS OF STANDARD CHAR-
ACTERS WITHOUT CLAIM TO ANY PARTICULAR
FONT, STYLE, SIZE, OR COLOR.

OWNER OF CANADA REG. NO. TMA688796,
DATED 5-31-2007, EXPIRES 5-31-2022.

SER. NO. 78-747,395, FILED 11-4-2005.

RICHARD A. STRASER, EXAMINING ATTORNEY

Int. Cl.: 33

Prior U.S. Cls.: 47 and 49

United States Patent and Trademark Office

Reg. No. 3,484,927

Registered Aug. 12, 2008

**TRADEMARK
PRINCIPAL REGISTER**

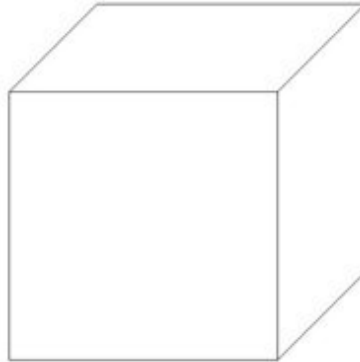

TARGET BRANDS, INC. (MINNESOTA CORPORATION)
TPS-3165
1000 NICOLLET MALL
MINNEAPOLIS, MN 55403

THE MARK CONSISTS OF A THREE-DIMENSIONAL CONFIGURATION OF A CUBIC CONTAINER CONSISTING OF SIX CONGRUENT SQUARE FACES.

SEC. 2(F).

FOR: WINE, IN CLASS 33 (U.S. CLS. 47 AND 49).

SER. NO. 78-751,340, FILED 11-10-2005.

FIRST USE 9-0-2003; IN COMMERCE 9-0-2003.

ROBERT LAVACHE, EXAMINING ATTORNEY

Int. Cl.: 21

Prior U.S. Cls.: 2, 13, 23, 29, 30, 33, 40 and 50

Reg. No. 3,484,928

United States Patent and Trademark Office

Registered Aug. 12, 2008

**TRADEMARK
PRINCIPAL REGISTER**

OXFORD

OXFORD S/A INDUSTRIA E COMERCIO (BRAZIL CORPORATION)
88 OXFORD, JORGE DIENER STREET
SAO BENTO DO SUL - SANTA CATARINA, BRAZIL

THE MARK CONSISTS OF STANDARD CHARACTERS WITHOUT CLAIM TO ANY PARTICULAR FONT, STYLE, SIZE, OR COLOR.

FOR: HOUSEHOLD DINING ARTICLES MADE OF PORCELAIN, NAMELY DISHES, BOWLS, SERVING DISHES, SERVING PLATTERS, MUGS, AND BEVERAGE WARE, IN CLASS 21 (U.S. CLS. 2, 13, 23, 29, 30, 33, 40 AND 50).

SER. NO. 78-751,839, FILED 11-11-2005.

FIRST USE 1-1-1976; IN COMMERCE 1-1-1976.

WARREN L. OLANDRIA, EXAMINING ATTORNEY

Int. Cl.: 1

Prior U.S. Cls.: 1, 5, 6, 10, 26 and 46

United States Patent and Trademark Office

Reg. No. 3,484,929

Registered Aug. 12, 2008

**TRADEMARK
PRINCIPAL REGISTER**

GATOR BLOCK BOND

ALLIANCE DESIGNER PRODUCTS INC./ PRO-
DUITS DESIGNER ALLIANCE INC. (CANADA
CORPORATION)
1421 BOUL. ST-ELZÉAR
LAVAL, CANADA H7L 3N6

FOR: POLYURETHANE ADHESIVE USED FOR
CONCRETE PAVERS AND BLOCKS, IN CLASS 1
(U.S. CLS. 1, 5, 6, 10, 26 AND 46).

THE MARK CONSISTS OF STANDARD CHAR-
ACTERS WITHOUT CLAIM TO ANY PARTICULAR
FONT, STYLE, SIZE, OR COLOR.

OWNER OF CANADA REG. NO. 1274642, DATED
12-10-2007, EXPIRES 12-10-2022.

NO CLAIM IS MADE TO THE EXCLUSIVE
RIGHT TO USE "BLOCK BOND", APART FROM
THE MARK AS SHOWN.

SER. NO. 78-757,248, FILED 11-18-2005.

HOWARD B. LEVINE, EXAMINING ATTORNEY

Int. Cl.: 3

Prior U.S. Cls.: 1, 4, 6, 50, 51 and 52

United States Patent and Trademark Office

Reg. No. 3,484,930

Registered Aug. 12, 2008

**TRADEMARK
PRINCIPAL REGISTER**

The logo for "Speed bronzer" features the word "Speed" in a yellow, italicized, sans-serif font, followed by "bronzer" in a dark brown, lowercase, sans-serif font. A thick yellow underline runs beneath both words.

BORIS BARTEL (FED REP GERMANY INDIVIDUAL)
C/O BODY COSMETICS GMBH RATHAUSUFER 22
DUSSELDORF, FED REP GERMANY 40213

FOR: COSMETICS; PREPARATIONS FOR PERSONAL HYGIENE AND BEAUTY CARE, NAMELY, COLD CREAMS, SKIN CREAMS AND MOISTURIZERS, BATH GELS, BODY OIL, HAIR SHAMPOO AND CONDITIONERS, SKIN SOAP, PERSONAL DEODORANTS; COSMETIC SUN-TANNING PREPARATIONS, SELF-TANNING SUNTAN LOTIONS, NON-SELF TANNING SKIN CARE LOTIONS, ALL FOR USE IN NATURAL SUN AND IN SOLARIUMS, IN CLASS 3 (U.S. CLS. 1, 4, 6, 50, 51 AND 52).

PRIORITY CLAIMED UNDER SEC. 44(D) ON ERPNTY CMNTY TM OFC APPLICATION NO. 004485702, FILED 6-6-2005, REG. NO. 004485702, DATED 10-16-2006, EXPIRES 6-6-2015.

NO CLAIM IS MADE TO THE EXCLUSIVE RIGHT TO USE "BRONZER", APART FROM THE MARK AS SHOWN.

THE COLOR(S) YELLOW AND DARK BROWN IS/ARE CLAIMED AS A FEATURE OF THE MARK.

THE MARK CONSISTS OF THE WORDS "SPEED BRONZER". THE COLOR YELLOW APPEARS IN THE WORD "SPEED" AND IN THE UNDERLINE, AND THE COLOR DARK BROWN APPEARS IN THE WORD "BRONZER".

SER. NO. 78-757,890, FILED 11-21-2005.

SHANNON TWOHIG, EXAMINING ATTORNEY

Int. Cl.: 12

Prior U.S. Cls.: 19, 21, 23, 31, 35 and 44

Reg. No. 3,484,931

United States Patent and Trademark Office

Registered Aug. 12, 2008

**TRADEMARK
PRINCIPAL REGISTER**

AWC

MITSUBISHI JIDOSHA KOGYO KABUSHIKI
KAISHA (JAPAN CORPORATION)
33-8, SHIBA 5-CHOME, MINATO-KU
TOKYO, JAPAN

FOR: AUTOMOBILES, BUSES, VANS, WAGONS, TRUCKS, AMBULANCES, REFRIGERATED VEHICLES, ALL-TERRAIN VEHICLES, SPORTS UTILITY VEHICLES, TRACTORS, RACING MOTOR CARS, CYCLE CARS, NAMELY, BICYCLES AND TWO WHEELED CARTS, REMOTE CONTROL VEHICLES OTHER THAN TOYS, NAMELY, GO-CARTS AND GOLF CARTS, CAMPING CARS, SPORT CARS, MOTOR HOMES, FORK LIFT TRUCKS, MOTORCYCLES, LUGGAGE TRUCKS, AUTOMOBILE BODIES, AUTOMOBILE CHASSIS, AXLES FOR VEHICLES, BRAKES FOR VEHICLES, CLUTCHES FOR LAND VEHICLES, ENGINES FOR LAND VEHICLES, GEAR BOXES FOR LAND VEHICLES, GEARING FOR LAND VEHICLES, SUSPENSION SYSTEMS FOR AUTOMOBILES AND BICYCLES, STEERING WHEELS FOR VEHICLES, TORQUE CONVERTERS FOR LAND VEHICLES, WINDSHIELDS BEING LAND VEHICLE PARTS, REDUCTION GEARS FOR LAND VEHICLES, TRANSMISSIONS FOR LAND VEHICLES, MOTORS FOR LAND VEHICLES, DOORS FOR VEHICLES,

AIR DAM, NAMELY, AN AIR RESISTANT DEVICE FOR LAND VEHICLES, AUTOMOBILE GRILLS, AUTOMOBILE BUMPER GUARDS, BUMPERS FOR AUTOMOBILES, GRILLE GUARD FOR AUTOMOBILES, HOODS FOR VEHICLES, HOODS PROTECTOR, NAMELY, HOOD SHIELD BEING A STRUCTURAL PART OF A VEHICLE, SPOILER FOR VEHICLE, AUTOMOBILE SUN ROOF, ANTI-THEFT DEVICES FOR VEHICLE, REVERSING ALARMS FOR VEHICLES, REARVIEW MIRRORS FOR AUTOMOBILES, AUTOMOBILE HORNS, AND DIRECTION INDICATORS FOR AUTOMOBILES, NAMELY, TURN SIGNALS FOR AUTOMOBILES, IN CLASS 12 (U.S. CLS. 19, 21, 23, 31, 35 AND 44).

THE MARK CONSISTS OF STANDARD CHARACTERS WITHOUT CLAIM TO ANY PARTICULAR FONT, STYLE, SIZE, OR COLOR.

OWNER OF JAPAN REG. NO. 4950025, DATED 5-12-2006, EXPIRES 5-12-2016.

SER. NO. 78-759,990, FILED 11-23-2005.

AMY ALFIERI, EXAMINING ATTORNEY

Int. Cl.: 41

Prior U.S. Cls.: 100, 101 and 107

Reg. No. 3,484,932

United States Patent and Trademark Office

Registered Aug. 12, 2008

**SERVICE MARK
PRINCIPAL REGISTER**

ICI

DES MOINES AREA COMMUNITY COLLEGE
(IOWA NON PROFIT CORPORATION)
2006 SOUTH ANKENY BLVD.
DES MOINES, IA 50023

FOR: EDUCATION SERVICES IN THE NATURE
OF COURSES AT THE COMMUNITY COLLEGE
LEVEL IN THE AREA OF CULINARY ARTS, IN
CLASS 41 (U.S. CLS. 100, 101 AND 107).

FIRST USE 1-24-2006; IN COMMERCE 1-24-2006.

THE MARK CONSISTS OF STANDARD CHAR-
ACTERS WITHOUT CLAIM TO ANY PARTICULAR
FONT, STYLE, SIZE, OR COLOR.

THE ENGLISH TRANSLATION OF "ICI" IN THE
MARK IS HERE.

SER. NO. 78-763,317, FILED 11-30-2005.

NELSON SNYDER, EXAMINING ATTORNEY

Int. Cl.: 25

Prior U.S. Cls.: 22 and 39

United States Patent and Trademark Office

Reg. No. 3,484,933

Registered Aug. 12, 2008

**TRADEMARK
PRINCIPAL REGISTER**

akiko

AYMB DIGITAL INC (CALIFORNIA CORPORATION)

903

834 S. BROADWAY SUITE 903

LOS ANGELES, CA 90014

FOR: WOMEN'S AND MEN'S CLOTHING, NAMELY T-SHIRTS, TOPS, BLOUSES, DRESSES, JACKETS, PANTS, SHORTS, SOCKS, SWIMWEAR, SHOES, SWEATERS, SHIRTS, BELTS, HATS, SCARVES, GLOVES, LINGERIE, IN CLASS 25 (U.S. CLS. 22 AND 39).

FIRST USE 1-15-2003; IN COMMERCE 1-15-2003.

THE MARK CONSISTS OF STANDARD CHARACTERS WITHOUT CLAIM TO ANY PARTICULAR FONT, STYLE, SIZE, OR COLOR.

SER. NO. 78-770,644, FILED S.R. 12-9-2005 AM. P.R. 12-19-2006.

DAVID ELTON, EXAMINING ATTORNEY

Int. Cls.: 9, 35 and 42

Prior U.S. Cls.: 21, 23, 26, 36, 38, 100, 101 and 102

Reg. No. 3,484,934

United States Patent and Trademark Office

Registered Aug. 12, 2008

**TRADEMARK
SERVICE MARK
PRINCIPAL REGISTER**

OWN THE STREET

IMPACT MOBILE, INC. (CANADA CORPORATION)
460 RICHMOND STREET WEST
SUITE 700
TORONTO, ONTARIO M5V 1Y1

FOR: SOFTWARE FOR USE IN THE FIELD OF MOBILE COMMUNICATIONS AND ENTERTAINMENT SERVICES, NAMELY, SOFTWARE FOR ENABLING THE DISSEMINATION OF ADVERTISEMENTS OF GOODS AND SERVICES OF OTHERS VIA MOBILE COMMUNICATIONS TO INTERACT WITH TV ADVERTISING, PRINT MEDIA ADVERTISING, AND RADIO ADVERTISING, IN CLASS 9 (U.S. CLS. 21, 23, 26, 36 AND 38).

FIRST USE 10-30-2005; IN COMMERCE 10-30-2005.

FOR: MARKETING CONSULTING SERVICES AND ADVERTISING SERVICES DESIGNED TO ENCOURAGE INTERACTION BETWEEN ADVERTISERS AND CONSUMERS USING MOBILE COMMUNICATIONS TO INTERACT WITH TV ADVERTISING, PRINT MEDIA ADVERTISING, AND RADIO ADVERTISING, IN CLASS 35 (U.S. CLS. 100, 101 AND 102).

FIRST USE 10-0-2003; IN COMMERCE 10-0-2003.

FOR: APPLICATION SERVICE PROVIDER (ASP) FEATURING SOFTWARE FOR USE IN THE FIELD

OF MOBILE COMMUNICATIONS AND ENTERTAINMENT SERVICES, NAMELY, SOFTWARE WHICH ENABLES THE DISSEMINATION OF ADVERTISEMENTS OF GOODS AND SERVICES OF OTHERS VIA MOBILE COMMUNICATIONS TO INTERACT WITH TV ADVERTISING, PRINT MEDIA ADVERTISING, AND RADIO ADVERTISING; TECHNICAL SUPPORT SERVICES, NAMELY, TROUBLESHOOTING OF PROBLEMS WITH SOFTWARE WHICH ENABLES THE DISSEMINATION OF ADVERTISEMENTS OF GOODS AND SERVICES OF OTHERS VIA MOBILE COMMUNICATIONS TO INTERACT WITH TV ADVERTISING, PRINT MEDIA ADVERTISING, AND RADIO ADVERTISING, IN CLASS 42 (U.S. CLS. 100 AND 101).

FIRST USE 10-0-2003; IN COMMERCE 10-0-2003.

THE MARK CONSISTS OF STANDARD CHARACTERS WITHOUT CLAIM TO ANY PARTICULAR FONT, STYLE, SIZE, OR COLOR.

PRIORITY CLAIMED UNDER SEC. 44(D) ON CANADA APPLICATION NO. 1262002, FILED 6-13-2005, REG. NO. TMA668563, DATED 7-24-2006, EXPIRES 7-24-2021.

SER. NO. 78-771,878, FILED 12-13-2005.

PAULA MAHONEY, EXAMINING ATTORNEY

Int. Cl.: 41

Prior U.S. Cls.: 100, 101 and 107

United States Patent and Trademark Office

Reg. No. 3,484,935

Registered Aug. 12, 2008

**SERVICE MARK
PRINCIPAL REGISTER**



DES MOINES AREA COMMUNITY COLLEGE
(IOWA NON-PROFIT CORPORATION)
2006 SOUTH ANKENY BLVD
ANKENY, IA 50023

FOR: EDUCATION SERVICES IN THE NATURE
OF COURSES AT THE COMMUNITY COLLEGE
LEVEL IN THE AREA OF CULINARY ARTS, IN
CLASS 41 (U.S. CLS. 100, 101 AND 107).

FIRST USE 1-24-2006; IN COMMERCE 1-24-2006.

THE ENGLISH TRANSLATION OF "ICI" IN THE
MARK IS "HERE".

SER. NO. 78-774,356, FILED 12-15-2005.

NELSON SNYDER, EXAMINING ATTORNEY

Int. Cl.: 36

Prior U.S. Cls.: 100, 101 and 102

United States Patent and Trademark Office

Reg. No. 3,484,936

Registered Aug. 12, 2008

**SERVICE MARK
PRINCIPAL REGISTER**

COMPRENDIUM

COMPRENDIUM INVESTMENT AG (SWITZER-
LAND AKTIENGESELLSCHAFT)
ZUGERSTRASSE 50
BAAR, SWITZERLAND 6341

FOR: FINANCIAL AFFAIRS, NAMELY, FINAN-
CIAL PLANNING AND FINANCIAL RESEARCH
FOR BUSINESSES; MONETARY AFFAIRS, IN PAR-
TICULAR, FINANCING OF TECHNOLOGY ASSETS
FOR BUSINESSES, IN CLASS 36 (U.S. CLS. 100, 101
AND 102).

THE MARK CONSISTS OF STANDARD CHAR-
ACTERS WITHOUT CLAIM TO ANY PARTICULAR
FONT, STYLE, SIZE, OR COLOR.

PRIORITY CLAIMED UNDER SEC. 44(D) ON
SWITZERLAND APPLICATION NO. 60107/2005,
FILED 12-8-2005, REG. NO. 543043, DATED 2-23-
2006, EXPIRES 12-8-2015.

OWNER OF U.S. REG. NOS. 2,623,412 AND
2,651,087.

SER. NO. 78-776,839, FILED 12-20-2005.

JASON ROTH, EXAMINING ATTORNEY

Int. Cls.: 11 and 21

Prior U.S. Cls.: 2, 13, 21, 23, 29, 30, 31, 33, 34, 40 and 50

Reg. No. 3,484,937

United States Patent and Trademark Office

Registered Aug. 12, 2008

**TRADEMARK
PRINCIPAL REGISTER**

STANZA

ASESORIA Y DESARROLLOS URREA, S.A. DE
C.V. (MEXICO CORPORATION)
DR. ROBERTO MICHEL NO. 825
GUADALAJARA, JALISCO, MEXICO 44900

FOR: APPARATUS FOR THE DISTRIBUTION OF WATER, NAMELY, LAVATORY FAUCETS, FAUCETS; SANITARY INSTALLATIONS AND BATH AND PLUMBING FITTINGS, NAMELY, DRAIN COCKS, BATH TUBS, SHOWERS, SHOWER CONTROL VALVES AND TUB CONTROL VALVES, METALLIC DRAIN TRAPS AS PART OF SANITARY INSTALLATIONS NAMELY PARTS OF BATHROOM AND KITCHEN BASINS OR SINKS; TUB PARTS, NAMELY TUB WASTES, BIDETS, SHOWER AND BATH ENCLOSURES, URINALS, TOILETS, CERAMIC BATHTUBS, FIBER-GLASS BATHTUBS, CERAMIC AND FIBER-GLASS HYDRO MASSAGE BATHTUBS, IN CLASS 11 (U.S. CLS. 13, 21, 23, 31 AND 34).

FOR: TOWEL HOLDERS, TOWEL RAILS, TOWEL RAIL BARS, TOWEL RAIL BARS OF WOOD, TOWEL RINGS, SOAP DISPENSERS, SOAP DISHES,

TOILET PAPER HOLDERS, DISPOSABLE FACIAL TISSUE HOLDERS, GLASS, PORCELAIN AND EARTHENWARE BATHROOM GLASS HOLDERS NOT OF PRECIOUS METAL, TRASH CONTAINERS, WASHBASINS, WASH BASINS WITHOUT PEDESTAL, WASHBASINS WITH PEDESTAL, CERAMIC WASHBASINS, HAND WASH BASINS, IN CLASS 21 (U.S. CLS. 2, 13, 23, 29, 30, 33, 40 AND 50).

THE MARK CONSISTS OF STANDARD CHARACTERS WITHOUT CLAIM TO ANY PARTICULAR FONT, STYLE, SIZE, OR COLOR.

OWNER OF MEXICO REG. NO. 747160, DATED 4-26-2002, EXPIRES 4-26-2012.

OWNER OF MEXICO REG. NO. 756090, DATED 4-26-2002, EXPIRES 4-26-2012.

SER. NO. 78-776,963, FILED 12-20-2005.

ROBERT STRUCK, EXAMINING ATTORNEY

Int. Cl.: 35

Prior U.S. Cls.: 100, 101 and 102

United States Patent and Trademark Office

Reg. No. 3,484,938

Registered Aug. 12, 2008

**SERVICE MARK
PRINCIPAL REGISTER**

**THE INTELLIGENT
ALTERNATIVE TO NEW**

WERNER MANAGEMENT, INC. (NEBRASKA
CORPORATION)
14507 FRONTIER ROAD
OMAHA, NE 68138

THE MARK CONSISTS OF STANDARD CHAR-
ACTERS WITHOUT CLAIM TO ANY PARTICULAR
FONT, STYLE, SIZE, OR COLOR.

FOR: RETAIL DEALERSHIP SERVICES FEATUR-
ING USED TRUCKS, IN CLASS 35 (U.S. CLS. 100, 101
AND 102).

SER. NO. 78-783,073, FILED 12-30-2005.

FIRST USE 2-12-2001; IN COMMERCE 2-12-2001.

NAKIA HENRY, EXAMINING ATTORNEY

Int. Cl.: 38

Prior U.S. Cls.: 100, 101 and 104

United States Patent and Trademark Office

Reg. No. 3,484,939

Registered Aug. 12, 2008

**SERVICE MARK
PRINCIPAL REGISTER**

BET MOBILE

BLACK ENTERTAINMENT TELEVISION, INC.
(D.C. CORPORATION)
1235 W STREET, N.E.
ONE BET PLAZA
WASHINGTON, DC 20018

FOR: TELECOMMUNICATIONS SERVICES,
NAMELY, THE WIRELESS ELECTRONIC AND
DIGITAL TRANSMISSION OF VOICE, DATA, IMA-
GES, AUDIO, VIDEO, SIGNALS, INFORMATION,
GAMES, RING TONES, AND MESSAGES, IN CLASS
38 (U.S. CLS. 100, 101 AND 104).

FIRST USE 12-7-2005; IN COMMERCE 12-7-2005.

THE MARK CONSISTS OF STANDARD CHAR-
ACTERS WITHOUT CLAIM TO ANY PARTICULAR
FONT, STYLE, SIZE, OR COLOR.

OWNER OF U.S. REG. NOS. 1,511,259, 2,593,427
AND OTHERS.

NO CLAIM IS MADE TO THE EXCLUSIVE
RIGHT TO USE "MOBILE", APART FROM THE
MARK AS SHOWN.

SER. NO. 78-785,947, FILED 1-5-2006.

HOWARD B. LEVINE, EXAMINING ATTORNEY

Int. Cl.: 38

Prior U.S. Cls.: 100, 101 and 104

United States Patent and Trademark Office

Reg. No. 3,484,940

Registered Aug. 12, 2008

**SERVICE MARK
PRINCIPAL REGISTER**

BET★MOBILE)))

BLACK ENTERTAINMENT TELEVISION, LLC
(D.C. LTD LIAB CO)
ONE BET PLAZA
1235 W STREET, N.E.
WASHINGTON, DC 20018

OWNER OF U.S. REG. NOS. 1,511,259, 2,593,427
AND OTHERS.

FOR: TELECOMMUNICATIONS SERVICES,
NAMELY, THE WIRELESS ELECTRONIC AND
DIGITAL TRANSMISSION OF VOICE, DATA, IMA-
GES, AUDIO, VIDEO, SIGNALS, INFORMATION,
GAMES, RING TONES, AND MESSAGES, IN CLASS
38 (U.S. CLS. 100, 101 AND 104).

NO CLAIM IS MADE TO THE EXCLUSIVE
RIGHT TO USE "MOBILE", APART FROM THE
MARK AS SHOWN.

SER. NO. 78-787,265, FILED 1-9-2006.

FIRST USE 12-7-2005; IN COMMERCE 12-7-2005.

LANA PHAM, EXAMINING ATTORNEY

Int. Cls.: 10 and 37

Prior U.S. Cls.: 26, 39, 44, 100, 103 and 106

United States Patent and Trademark Office

Reg. No. 3,484,941

Registered Aug. 12, 2008

**TRADEMARK
SERVICE MARK
PRINCIPAL REGISTER**

**atenda Home Medical
Equipment**

ATENDA HEALTHCARE SOLUTIONS, INC.
(FLORIDA CORPORATION)
SUITE 18
15712 S.W. 41ST STREET
DAVIE, FL 33331

FOR: MEDICAL EQUIPMENT FOR HOME USE,
NAMELY, OXYGEN MONITORS, IN CLASS 10 (U.S.
CLS. 26, 39 AND 44).

FIRST USE 1-1-2006; IN COMMERCE 1-1-2006.

FOR: SERVICING AND REPAIR OF MEDICAL
EQUIPMENT, IN CLASS 37 (U.S. CLS. 100, 103 AND
106).

FIRST USE 1-1-2006; IN COMMERCE 1-1-2006.

THE MARK CONSISTS OF STANDARD CHAR-
ACTERS WITHOUT CLAIM TO ANY PARTICULAR
FONT, STYLE, SIZE, OR COLOR.

OWNER OF U.S. REG. NOS. 3,266,339 AND
3,327,095.

NO CLAIM IS MADE TO THE EXCLUSIVE
RIGHT TO USE "HOME MEDICAL EQUIPMENT",
APART FROM THE MARK AS SHOWN.

SER. NO. 78-789,037, FILED 1-11-2006.

HOWARD FRIEDMAN, EXAMINING ATTORNEY

Int. Cl.: 35

Prior U.S. Cls.: 100, 101 and 102

United States Patent and Trademark Office

Reg. No. 3,484,942

Registered Aug. 12, 2008

**SERVICE MARK
PRINCIPAL REGISTER**

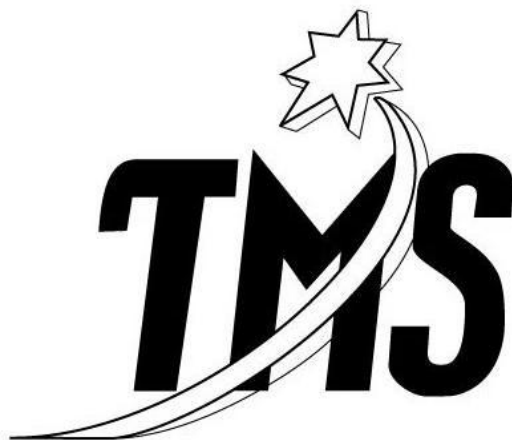

TMS GROUP PTE. LTD. (SINGAPORE CORPORATION)
7 TEMASEK BOULEVARD
#08-08 SUNTEC TOWER ONE
SINGAPORE, SINGAPORE 038987

FOR: EMPLOYMENT RECRUITMENT; EMPLOYMENT AGENCY SERVICES; BUSINESS PERSONNEL RECRUITMENT SERVICES; EXECUTIVE RECRUITMENT AND PLACEMENT SERVICES; ADVERTISING SERVICES RELATING TO THE RECRUITMENT OF PERSONNEL; BUSINESS AND COMPANY OFFICE SECRETARIAL SERVICES; PERSONNEL RESOURCES MANAGEMENT; ACCOUNTANCY; ADVISORY AND CONSULTANCY SERVICES RELATING TO PERSONNEL RECRUITMENT AND PLACEMENT OF STAFF; ASSISTANCE RELATING TO RECRUITMENT AND PLACEMENT OF STAFF; SECRETARIAL EMPLOYMENT SERVICES; EXECUTIVE SEARCH AND SELECTION SERVICES; INTERVIEWING SERVICES FOR PERSONNEL RECRUITMENT; MANAGEMENT ADVICE RELATING TO THE RECRUITMENT OF STAFF; OFFICE SUPPORT STAFF, EXECUTIVE STAFF AND PERMANENT STAFF RECRUITMENT SERVICES; PROVISION OF INFORMATION REGARDING EMPLOYMENT RECRUITMENT; ADVERTISING SERVICES RELATING TO THE TRAVEL INDUSTRIES; ADVERTISING OF TRAVEL; EMPLOYMENT AGENCY SERVICES RELAT-

ING TO BILINGUAL STAFF; SELECTION OF STAFF; STAFF UTILIZATION PLANNING; COMPUTERIZED PAYROLL PREPARATION; PAYROLL ADVISORY SERVICES; PAYROLL PROCESSING SERVICES FOR OTHERS; PAYROLL ASSISTANCE AND PREPARATION; PREPARATION OF DOCUMENTS RELATING TO TAXATION; TAXATION ADVICE AND CONSULTATION; RECRUITMENT CONSULTANCY FOR LEGAL SECRETARIES; ADMINISTRATION, BILLING, AND RECONCILIATION OF ACCOUNTS ON BEHALF OF OTHERS; AUDITING OF ACCOUNT; COSTS ACCOUNTING; TAX PLANNING AND ASSESSMENT; BUSINESS CONSULTATION REGARDING PROVISION OF CONTRACT SALES FORCES; CAREER PLANNING; PROVIDING CAREER INFORMATION; BUSINESS ADVISORY SERVICES TO DETERMINE PAY AND GRADING STRUCTURES BY JOB EVALUATION; PROVISION OF SECRETARIAL SERVICES; SHORTHAND SECRETARIAL SERVICES; CONSULTANCY SERVICES IN THE FIELD OF HUMAN RESOURCES, IN CLASS 35 (U.S. CLS. 100, 101 AND 102).

OWNER OF SINGAPORE REG. NO. T06/02367H,
DATED 2-8-2006, EXPIRES 2-8-2016.

SER. NO. 78-795,242, FILED 1-19-2006.

RONALD MCMORROW, EXAMINING ATTORNEY

Int. Cls.: 25 and 37

Prior U.S. Cls.: 22, 39, 100, 103 and 106

United States Patent and Trademark Office

Reg. No. 3,484,943

Registered Aug. 12, 2008

**TRADEMARK
SERVICE MARK
PRINCIPAL REGISTER**

**YOU DON'T NEED IT... YOU
JUST GOTTA HAVE IT!**

SHIN, JAI (UNITED STATES INDIVIDUAL)
3434 BLADENSBURG ROAD
BRENTWOOD, MD 20722

FOR: APPAREL, NAMELY, T-SHIRTS; HATS;
CAPS; PANTS; JACKETS; COATS, IN CLASS 25
(U.S. CLS. 22 AND 39).

FIRST USE 9-1-2004; IN COMMERCE 9-1-2004.

FOR: VEHICLE DETAILING SERVICES, NAME-
LY, PRESERVATION, REPAIR AND RECONDI-
TIONING SERVICES; AUTOMOBILE REPAIR AND
MAINTENANCE; AUTOMOBILE CUSTOMIZA-
TION SERVICES, NAMELY, VEHICLE PERFOR-

MANCE ENHANCEMENT; VEHICLE EXTERIOR
AND INTERIOR UPGRADING SERVICES; VEHI-
CLE MECHANICAL UPGRADING SERVICES, IN
CLASS 37 (U.S. CLS. 100, 103 AND 106).

FIRST USE 9-1-2004; IN COMMERCE 9-1-2004.

THE MARK CONSISTS OF STANDARD CHAR-
ACTERS WITHOUT CLAIM TO ANY PARTICULAR
FONT, STYLE, SIZE, OR COLOR.

SER. NO. 78-796,572, FILED 1-22-2006.

MARK SPARACINO, EXAMINING ATTORNEY

Int. Cls.: 25, 28 and 35

Prior U.S. Cls.: 22, 23, 38, 39, 50, 100, 101 and 102

Reg. No. 3,484,944

United States Patent and Trademark Office

Registered Aug. 12, 2008

**TRADEMARK
SERVICE MARK
PRINCIPAL REGISTER**



SDL GROUP LIMITED (GREAT BRITAIN CORPORATION)
BRITANNIA CENTRE
NETWORK 65 BUSINESS PARK
BURNLEY, LANCASHIRE, ENGLAND BB11 5ST

FOR: FOOTWEAR; HEAD GEAR, NAMELY, HATS AND CAPS; CLOTHING, NAMELY, SHIRTS, SWEATERS, T-SHIRTS, VESTS, TROUSERS, PANTS, SHORTS, JACKETS, RAIN JACKETS, TRACK SUITS, TRACK SUIT BOTTOMS, SOCKS, GLOVES; CRICKET CLOTHING, NAMELY, SHIRTS, SWEATERS, SLEEVELESS SWEATERS, T-SHIRTS, VESTS, TROUSERS, PANTS, SHORTS, JACKETS, RAIN JACKETS, TRACK SUITS, TRACK SUIT BOTTOMS, CAPS, SUN HATS, SOCKS, INNER GLOVES; SOCCER CLOTHING, NAMELY, SOCCER STRIPS IN THE NATURE OF SOCCER TOPS AND SOCCER PANTS, SOCCER SHIRTS, SOCCER SHORTS, SOCCER SOCKS, GOAL KEEPERS SHIRTS, GOAL KEEPERS GLOVES, SOCCER BIB OVERALLS, POLO SHIRTS, RAIN JACKETS, TRAINING JACKETS, SWEAT SHIRTS, TRACK SUITS, TRACK SUIT BOTTOMS, CAPS; RUGBY CLOTHING, NAMELY, RUGBY SHIRTS, RUGBY SHORTS, RUGBY SOCKS, POLO SHIRTS, RAIN JACKETS, TRAINING JACKETS, SWEAT SHIRTS, TRACK SUITS, TRACK SUIT BOTTOMS, CAPS, IN CLASS 25 (U.S. CLS. 22 AND 39).

FOR: EQUIPMENT AND APPARATUS FOR USE IN THE GAME OF CRICKET, NAMELY, CRICKET BATS, PROTECTIVE COVERS FOR BATS, RUBBER HANDLE GRIPS FOR CRICKET BATS, GRIP APPLICATORS TO ASSIST WITH THE APPLICATION

OF RUBBER HANDLE GRIPS TO CRICKET BATS, WICKETS, CRICKET BALLS, CRICKET EQUIPMENT BAGS, CRICKET BALL BAGS, SHIN PADS, BATTING GLOVES, WICKET KEEPING GLOVES, WICKET KEEPING PADS, ABDO GUARDS, THIGH PADS, ARM GUARDS, BRIEFS WITH BOXES, NAMELY, CRICKET BOXES, PROTECTIVE CUPS FOR PROTECTING MALE PRIVATE PARTS, ATHLETIC SUPPORTS FOR JOINTS AND WRISTS; EQUIPMENT AND APPARATUS FOR USE IN THE GAME OF SOCCER, NAMELY, BALLS, PUMPS FOR INFLATING SOCCER BALLS, SOCCER BALL SACKS, GOAL CORNER POSTS, PRACTICE FIELD CONES, SPEED HURDLES, REFEREE LINESMAN'S FLAGS, GOAL FLAG POLES, GOAL NET CLIPS USED FOR ATTACHING NETS TO SOCCER GOALS, FIELD MARKER CONES, CAPTAIN'S ARMBANDS, SPORTS WATER BOTTLE CARRIERS INCLUDED IN THIS CLASS; EQUIPMENT AND APPARATUS FOR USE IN THE GAME OF RUGBY, NAMELY, RUGBY BALLS, RUGBY BALL PUMPS, RUGBY BALL SACKS, FIELD MARKER CONES, SPEED HURDLES, IN CLASS 28 (U.S. CLS. 22, 23, 38 AND 50).

FOR: BRINGING TOGETHER, FOR THE BENEFIT OF OTHERS, OF A VARIETY OF GOODS, ENABLING CUSTOMERS TO CONVENIENTLY VIEW AND PURCHASE IN PERSON, BY MAIL ORDER, BY MEANS OF TELECOMMUNICATIONS, FROM A TELEVISION SHOPPING CHANNEL, IN A RETAIL SPORTS STORE, FROM A GENERAL MERCHANDISE CATALOGUE, OR FROM A GENERAL INTERNET WEB SITE, ALL OF THE AFORESAID SPECIALIZING IN SPORTS AND LEISURE CLOTH-

ING AND SPORTS EQUIPMENT AND RELATED ACCESSORIES, IN CLASS 35 (U.S. CLS. 100, 101 AND 102).

PRIORITY CLAIMED UNDER SEC. 44(D) ON ERPN CMNTY TM OFC APPLICATION NO. 4572475, FILED 8-2-2005, REG. NO. 004572475, DATED 1-11-2007, EXPIRES 8-2-2015.

THE COLOR(S) BLUE, RED, GRAY AND WHITE IS/ARE CLAIMED AS A FEATURE OF THE MARK.

THE MARK CONSISTS OF "S" IN WHITE WITH BLUE AND GRAY OUTLINE, "S" IN WHITE WITH BLUE AND GRAY OUTLINE, A PORTION OF A "S" IN GRAY WITH RED AND GRAY OUTLINE, BLUE VERTICAL BACKGROUND STRIPE WITH GRAY OUTLINE.

SER. NO. 78-799,323, FILED 1-25-2006.

KAPIL BHANOT, EXAMINING ATTORNEY

Int. Cls.: 9, 16 and 25

**Prior U.S. Cls.: 2, 5, 21, 22, 23, 26, 29, 36, 37, 38, 39
and 50**

Reg. No. 3,484,945

United States Patent and Trademark Office

Registered Aug. 12, 2008

**TRADEMARK
PRINCIPAL REGISTER**



QUANTUM UNIVERSAL LTD (UNITED KING-
DOM LIMITED COMPANY)
STAG GATES HOUSE
63-64 THE AVENUE
SOUTHAMPTON, HAMPSHIRE SO17 1XS, UNITED
KINGDOM

FOR: PRE-RECORDED CDS, MINI-CDS, LASER DISCS, TAPES, AUDIO TAPES, VIDEO TAPES, DVDS, MINI-DVDS, MINI-DVDS AND DIGITAL AUDIO TAPES (DAT) ALL FEATURING MUSIC, MUSIC VIDEOS, FILMS, TELEVISION PROGRAMS, TUTORIAL MATERIAL AND EDUCATIONAL MATERIAL, ALL IN THE FIELDS OF ECOLOGY, NATURE, ANIMALS, WILDLIFE, CONSERVATION, RESEARCH, ENVIRONMENTAL ISSUES, HOUSE AND HOME, LIFESTYLE, INTERIOR DESIGN, GARDENING, DECORATING, HEALTH, BEAUTY, SLIMMING/DIET, NUTRITION, HOME IMPROVEMENTS, CONSTRUCTION, ARCHITECTURE, REAL ESTATE, ELECTRICAL GOODS, PHOTOGRAPHY, COMPUTERS, COMPUTING, FURNITURE, HOBBIES, CRAFTS, COOKING, FASHION, DRESSMAKING, ART, SPORTS, MOTORING, AUTOMOBILES, SCIENCE, SCIENCE FICTION, ASTROLOGY, ASTRONOMY, SPACE, VACATIONS, TRAVEL, LEISURE, GEOGRAPHY, EXPLORING, BABY CARE, MATERNITY CARE, CHILDCARE, WELLBEING, ALTERNATIVE THERAPIES, MEDICINE, FANTASY, HEALTHCARE, LEISURE PURSUITS AND CAREERS, TRAINING MATERIALS IN THE NATURE OF PRERECORDED VIDEOTAPES IN THE FIELDS OF ECOLOGY, NATURE, ANIMALS, WILDLIFE, CONSERVATION, RESEARCH, ENVIRONMENTAL ISSUES, HOUSE AND HOME,

LIFESTYLE, INTERIOR DESIGN, GARDENING, DECORATING, HEALTH, BEAUTY, SLIMMING/DIET, NUTRITION, HOME IMPROVEMENTS, CONSTRUCTION, ARCHITECTURE, REAL ESTATE, ELECTRICAL GOODS, PHOTOGRAPHY, COMPUTERS, COMPUTING, FURNITURE, HOBBIES, CRAFTS, COOKING, FASHION, DRESSMAKING, ART, SPORTS, MOTORING, AUTOMOBILES, SCIENCE, SCIENCE FICTION, ASTROLOGY, ASTRONOMY, SPACE, VACATIONS, TRAVEL, LEISURE, GEOGRAPHY, EXPLORING, BABY CARE, MATERNITY CARE, CHILDCARE, WELLBEING, ALTERNATIVE THERAPIES, MEDICINE, FANTASY, HEALTHCARE, LEISURE PURSUITS AND CAREERS, HEALTH INFORMATION AND ADVICE, AND ALL FORMS OF EXERCISE TRAINING AND REGIMENTS, IN CLASS 9 (U.S. CLS. 21, 23, 26, 36 AND 38).

FOR: PAPER, CARDBOARD, PAPER ARTICLES, NAMELY, SWING TAGS AND SWING LABELS IN THE NATURE OF HANGTAGS, PAPER BAGS, ENVELOPES FOR SHIPPING, PADDED BAGS, GIFT BAGS, GIFT WRAPPING PAPER, BANNERS, TOILET PAPER, KITCHEN TOWELS, TISSUES AND NAPKINS, CARDBOARD ARTICLES, NAMELY, BOXES, POUCHES FOR PACKAGING, CARDBOARD PACKING, SWING TAGS AND SWING LABELS IN THE NATURE OF HANGTAGS, GIFT HANG TAGS AND GIFT LABELS, CARDBOARD ADVERTISING AND POINT OF SALE ARTICLES, NAMELY FLOOR DISPLAY UNITS FOR MERCHANDISING PRODUCTS, CARDBOARD PACKAGING FOR GOODS, PRINTED MATTER AND PRINTED PUBLICATIONS, NAMELY, BOOKS, MA-

GAZINES, MANUALS, JOURNALS, ADVERTISING MATERIALS, NEWSLETTERS, NEWSPAPERS, FLYERS, CATALOGUES AND HANDBOOKS ABOUT EDUCATION AND ENTERTAINMENT AND IN THE FIELDS OF ECOLOGY, NATURE, ANIMALS, WILDLIFE, CONSERVATION, RESEARCH, ENVIRONMENTAL ISSUES, HOUSE AND HOME, LIFESTYLE, INTERIOR DESIGN, GARDENING, DECORATING, HEALTH, BEAUTY, SLIMMING/DIET, NUTRITION, HOME IMPROVEMENTS, CONSTRUCTION, ARCHITECTURE, REAL ESTATE, ELECTRICAL GOODS, PHOTOGRAPHY, COMPUTERS, COMPUTING, FURNITURE, HOBBIES, CRAFTS, COOKING, FASHION, DRESSMAKING, ART, SPORTS, MOTORING, AUTOMOBILES, SCIENCE, SCIENCE FICTION, ASTROLOGY, ASTRONOMY, SPACE, VACATIONS, TRAVEL, LEISURE, GEOGRAPHY, EXPLORING, BABY CARE, MATERNITY CARE, CHILDCARE, WELLBEING, ALTERNATIVE THERAPIES, MEDICINE, FANTASY, HEALTHCARE, LEISURE PURSUITS AND CAREERS, PHOTOGRAPHS, STATIONERY, CALENDARS, GREETING CARDS, COMIC BOOKS, STICKERS, DECALCOMANIAS, WRITING SETS COMPRISING PENCILS AND PAPER, PENS, PENCILS, PAINTING SETS, STAMP PADS, RUBBER STAMPS, POSTAGE STAMPS, STENCILS, TRAINING MATERIAL IN THE NATURE OF BOOKS IN THE FIELDS OF ECOLOGY, NATURE, ANIMALS, WILDLIFE, CONSERVATION, RESEARCH, ENVIRONMENTAL ISSUES, HOUSE AND HOME, LIFESTYLE, INTERIOR DESIGN, GARDENING, DECORATING, HEALTH, BEAUTY, SLIMMING/DIET, NUTRITION, HOME IMPROVEMENTS, CONSTRUCTION, ARCHITECTURE, REAL ESTATE, ELECTRICAL GOODS, PHOTOGRAPHY, COMPUTERS, COMPUTING, FURNITURE, HOBBIES, CRAFTS, COOKING, FASHION, DRESSMAKING, ART, SPORTS, MOTORING, AUTOMOBILES, SCIENCE, SCIENCE FICTION, ASTROLOGY, ASTRONOMY, SPACE, VACATIONS, TRAVEL, LEISURE, GEOGRAPHY, EXPLORING, BABY CARE, MATERNITY CARE, CHILDCARE, WELLBEING, ALTERNATIVE THERAPIES, MEDICINE, FANTASY, HEALTHCARE, LEISURE PURSUITS AND CAREERS, HEALTH INFORMATION AND ADVICE, AND ALL FORMS OF EXERCISE TRAINING AND

REGIMENTS, IN CLASS 16 (U.S. CLS. 2, 5, 22, 23, 29, 37, 38 AND 50).

FOR: CLOTHING, NOT INCLUDING INTIMATE APPAREL OR MEN'S UNDERWEAR, NAMELY, SHIRTS, T-SHIRTS, VESTS, POLO SHIRTS, STRAP TOPS, JACKETS, TROUSERS, PANTS, SHORTS, JEANS, SKIRTS, BLOUSES, CARDIGANS, TANK TOPS, DRESSES, WRAP-AROUNDS, SARONGS, BATHROBES, BATH WRAPS, PAJAMAS, NIGHT SHIRTS AND NIGHT CLOTHES, NAMELY, NIGHT T-SHIRTS, NIGHTDRESSES, SPORTS CLOTHING, NAMELY, SPORTS UNIFORMS, ICE HOCKEY UNIFORMS, BASEBALL UNIFORMS, SOCCER UNIFORMS, FOOTBALL UNIFORMS, BASKETBALL UNIFORMS, SPORTSWEAR, NAMELY, SPORTS SHIRTS, SPORTS PANTS, SURFINGWEAR, SWIMWEAR, GOLF SHORTS, GOLF PANTS, GOLF SHIRTS, GOLF JACKETS, GOLF CULOTTES, GOLF SWEATERS, GOLF SWEATSHIRTS, GOLF SWEATJACKETS, TENNIS SHORTS, TENNIS SHIRTS, TENNIS DRESSES, TENNIS CATSUITS, JOGGING SUITS, SWEAT SUITS, SWIMWEAR, SWEATERS, SWEATSHIRTS, BLOUSONS, DUNGAREES, COVERALLS, OVERALLS, SLACKS, JUMPERS, COATS, WIND RESISTANT JACKETS, WATERPROOF CLOTHING, NAMELY, WATERPROOF JACKETS, WATERPROOF COATS, WATERPROOF PANTS, WATERPROOF SKIRTS, WATERPROOF SHORTS, WATERPROOF HATS, WATERPROOF CAPS, SKIWEAR, LEISUREWEAR, NAMELY, KAFTANS, SHELL SUITS, CATSUITS, SHIRTS, LEOTARDS, LEGGINGS, BELTS, MEN'S SUSPENDERS, TIES, SCARVES AND GLOVES; FOOTWEAR, BUT NOT INCLUDING SOCKS; HEADGEAR, NAMELY, CAPS, HATS, BERETS, HOODS, VISORS, HEADBANDS, BANDANAS, AND TOBOGGANS, IN CLASS 25 (U.S. CLS. 22 AND 39).

OWNER OF ERPN CMNTY TM OFC REG. NO. 003928249, DATED 11-17-2005, EXPIRES 7-12-2014.

THE MARK CONSISTS OF A HEART OVERLAID ON A GLOBE DESIGN.

SER. NO. 78-801,042, FILED 1-27-2006.

GENE MACIOL, EXAMINING ATTORNEY

Int. Cls.: 9 and 20

Prior U.S. Cls.: 2, 13, 21, 22, 23, 25, 26, 32, 36, 38 and 50

United States Patent and Trademark Office

Reg. No. 3,484,946

Registered Aug. 12, 2008

**TRADEMARK
PRINCIPAL REGISTER**

VANGUARD ID SYSTEMS

WARTHER, RICHARD (UNITED STATES INDIVIDUAL)
1210 AMERICAN BOULEVARD
WEST CHESTER, PA 19380

FOR: RADIO-FREQUENCY IDENTIFICATION (RFID) TAGS, LABELS, AND CARDS FOR ACCESS CONTROL, INFORMATION RETRIEVAL, REDEMPTION, AND IDENTIFYING, TRACKING, RECORDING AND MONITORING OBJECTS TO WHICH THEY ARE APPLIED OR AFFIXED, IN CLASS 9 (U.S. CLS. 21, 23, 26, 36 AND 38).

FIRST USE 4-0-2003; IN COMMERCE 4-0-2003.

FOR: PLASTIC LABELS AND KEY TAGS, NAME-LY, BLANK AND PARTIALLY PRINTED PLASTIC KEY TAGS AND CARD KEYS, PRINTED PLASTIC LABELS, KEY TAGS AND CARD KEYS, LAMINATED PLASTIC LABELS, KEY TAGS AND CARD

KEYS; PLASTIC BAR CODE LABELS, IN CLASS 20 (U.S. CLS. 2, 13, 22, 25, 32 AND 50).

FIRST USE 1-0-1987; IN COMMERCE 1-0-1987.

THE MARK CONSISTS OF STANDARD CHARACTERS WITHOUT CLAIM TO ANY PARTICULAR FONT, STYLE, SIZE, OR COLOR.

OWNER OF U.S. REG. NO. 3,306,733.

NO CLAIM IS MADE TO THE EXCLUSIVE RIGHT TO USE "ID SYSTEMS", APART FROM THE MARK AS SHOWN.

SER. NO. 78-804,474, FILED 2-1-2006.

SEAN CROWLEY, EXAMINING ATTORNEY

Int. Cl.: 9

Prior U.S. Cls.: 21, 23, 26, 36 and 38

Reg. No. 3,484,947

United States Patent and Trademark Office

Registered Aug. 12, 2008

**TRADEMARK
PRINCIPAL REGISTER**

2GeeksinaLab

2GEEKSINALAB INC. (CALIFORNIA CORPORATION)
SUITE 103
41319 12TH STREET WEST
PALMDALE, CA 93551

FOR: COMPUTER SOFTWARE AND HARDWARE FOR MONITORING AND METERING THE DISTRIBUTION OF, ACCESS TO, LICENSE OF, AND USE OF SOFTWARE PROGRAMS AND COMPILATIONS OF DATA, AND FOR THE PREVENTION OF UNAUTHORIZED COPYING, USE, AND ACCESS TO SOFTWARE PROGRAMS AND COMPILATIONS OF DATA STORED IN AND ACCESSED THROUGH CONVENTIONAL ELECTRONIC MEDIA, NAMELY, DVDS, CDS, AND VIDEO GAMES, OR

THROUGH A GLOBAL COMPUTER NETWORK, AND USER MANUALS SOLD TOGETHER AS A UNIT THEREWITH, IN CLASS 9 (U.S. CLS. 21, 23, 26, 36 AND 38).

FIRST USE 10-21-2004; IN COMMERCE 10-21-2004.

THE MARK CONSISTS OF STANDARD CHARACTERS WITHOUT CLAIM TO ANY PARTICULAR FONT, STYLE, SIZE, OR COLOR.

SER. NO. 78-806,949, FILED 2-3-2006.

DANIEL CAPSHAW, EXAMINING ATTORNEY

Int. Cls.: 9, 35 and 38

Prior U.S. Cls.: 21, 23, 26, 36, 38, 100, 101, 102 and 104

United States Patent and Trademark Office

Reg. No. 3,484,948

Registered Aug. 12, 2008

**TRADEMARK
SERVICE MARK
PRINCIPAL REGISTER**



ZINGY, INC. (DELAWARE CORPORATION)
500 SEVENTH AVENUE 17TH FLOOR
NEW YORK, NY 10018

FOR: PROVIDING DOWNLOADABLE CUSTOMIZED RING TONES, VOICE RECORDINGS AND APPLICATIONS TO MOBILE COMMUNICATION DEVICES FOR USE AS CONTENT TO PERSONALIZE OWNER'S MOBILE COMMUNICATION DEVICES FOR USE IN THE FIELD OF CONSUMER AND BUSINESS COMMUNICATION, IN CLASS 9 (U.S. CLS. 21, 23, 26, 36 AND 38).

FIRST USE 8-4-2005; IN COMMERCE 8-4-2005.

FOR: ONLINE RETAIL STORE FEATURING RING TONES, VOICE RECORDINGS AND APPLICATIONS FOR USE BY USERS OF MOBILE COMMUNICATION DEVICES IN THE FIELD OF CONSUMER AND BUSINESS COMMUNICATION, IN CLASS 35 (U.S. CLS. 100, 101 AND 102).

FIRST USE 8-4-2005; IN COMMERCE 8-4-2005.

FOR: ELECTRONIC TRANSMISSION OF MESSAGES AND DATA, NAMELY, TEXT MESSAGES, IMAGE MESSAGES, POSTCARDS AND GROUP MESSAGES, TO MOBILE COMMUNICATIONS DEVICES; PROVIDING ON-LINE CHAT ROOMS FOR TRANSMISSION OF MESSAGES OF GENERAL INTEREST AMONG USERS OF MOBILE COMMUNICATION DEVICES, IN CLASS 38 (U.S. CLS. 100, 101 AND 104).

FIRST USE 8-4-2005; IN COMMERCE 8-4-2005.

OWNER OF U.S. REG. NO. 2,730,682.

THE MARK CONSISTS OF THE WORD "ZINGY" WITH A CURVED LINE OVER "ZINGY".

SER. NO. 78-810,111, FILED 2-8-2006.

WARREN L. OLANDRIA, EXAMINING ATTORNEY

Int. Cl.: 42

Prior U.S. Cls.: 100 and 101

United States Patent and Trademark Office

Reg. No. 3,484,949

Registered Aug. 12, 2008

**SERVICE MARK
PRINCIPAL REGISTER**



KULSHRESTHA DHEERAJ (UNITED STATES
INDIVIDUAL)
186, LAKE BLUFF DRIVE
COLUMBUS, OH 43235

FOR: APPLICATION SERVICES PROVIDER (ASP)
FEATURING SOFTWARE FOR AUTOMATING
BUSINESS PROCESS MANAGEMENT AND COL-
LABORATION WITH EXTERNAL AGENCIES, IN
CLASS 42 (U.S. CLS. 100 AND 101).

FIRST USE 8-1-2004; IN COMMERCE 8-1-2004.

THE COLOR(S) DARK BLUE, LIGHT BLUE AND
WHITE IS/ARE CLAIMED AS A FEATURE OF THE
MARK.

THE COLOR DARK BLUE APPEARS IN THE
DOCUMENTS AND IN THE WORD "DOCS", THE
COLOR LIGHT BLUE APPEARS IN THE WORD
"FLAIR" AND THE COLOR WHITE APPEARS IN
THE BACK GROUND.

SER. NO. 78-812,451, FILED 2-10-2006.

DAYNA BROWNE, EXAMINING ATTORNEY

Int. Cls.: 25, 35, 37 and 41

Prior U.S. Cls.: 22, 39, 100, 101, 102, 103, 106 and 107

United States Patent and Trademark Office

Reg. No. 3,484,950

Registered Aug. 12, 2008

TRADEMARK
SERVICE MARK
PRINCIPAL REGISTER



FOUR STATE INTERNATIONAL TRUCKS, INC.
(MISSOURI CORPORATION), DBA 4 STATE
TRUCKS INC
P.O. BOX 1691
JOPLIN, MO 64802

FOR: CLOTHING, NAMELY, SHIRTS, JACKETS,
HATS, SWEATSHIRTS, AND COATS, IN CLASS 25
(U.S. CLS. 22 AND 39).

FIRST USE 5-12-2004; IN COMMERCE 6-1-2004.

FOR: ONLINE RETAIL STORE SERVICES FEATURING CLOTHING AND TRUCK ACCESSORIES, NAMELY, CHROME GOODS FOR THE TRUCKING INDUSTRY; PROVIDING A WEBSITE FEATURING INFORMATION ON HOW TO PURCHASE BIG RIG TRUCKS, IN CLASS 35 (U.S. CLS. 100, 101 AND 102).

FIRST USE 5-12-2004; IN COMMERCE 6-1-2004.

FOR: PROVIDING A WEBSITE FEATURING INFORMATION ON REPAIR SERVICES FOR BIG RIG TRUCKS, IN CLASS 37 (U.S. CLS. 100, 103 AND 106).

FIRST USE 2-26-2008; IN COMMERCE 2-26-2008.

FOR: PROVIDING A WEBSITE FEATURING ARTICLES ABOUT BIG RIG TRUCKS, IN CLASS 41 (U.S. CLS. 100, 101 AND 107).

FIRST USE 5-12-2004; IN COMMERCE 6-1-2004.

NO CLAIM IS MADE TO THE EXCLUSIVE RIGHT TO USE "CHROME SHOP" FOR CLASS 35 ONLY, APART FROM THE MARK AS SHOWN.

SER. NO. 78-817,481, FILED 2-17-2006.

AMY GEARIN, EXAMINING ATTORNEY

Int. Cl.: 9

Prior U.S. Cls.: 21, 23, 26, 36 and 38

Reg. No. 3,484,951

United States Patent and Trademark Office

Registered Aug. 12, 2008

TRADEMARK
PRINCIPAL REGISTER

BELIVEAU, ROBERT GREGORY (UNITED STATES INDIVIDUAL)
384 S. MIRALESTE DR. #465
SAN PEDRO, CA 90732

FOR: SUNGLASS AND SKI GOGGLE'S ACCESSORIES IN THE NATURE OF FABRIC NOSE COVERS THAT ARE ATTACHED TO THE EYEWEAR, IN CLASS 9 (U.S. CLS. 21, 23, 26, 36 AND 38).

FIRST USE 10-22-1992; IN COMMERCE 11-1-1993.

THE LETTERS "BEKO" OUTLINED IN BOLD BLOCK LETTERS WITH THE "B" AND "K" IN UPPER CASE LETTERS AND THE "E" AND "O" IN LOWER CASE LETTERS. THE "E" HAS A LINE ACROSS THE TOP OF IT.

THE ENGLISH TRANSLATION OF THE WORD "BEKO" IN THE MARK IS "BIRD BEAK".

SER. NO. 78-823,058, FILED 2-24-2006.

ELLEN PERKINS, EXAMINING ATTORNEY

Int. Cls.: 25, 35, 37 and 41

Prior U.S. Cls.: 22, 39, 100, 101, 102, 103, 106 and 107

United States Patent and Trademark Office

Reg. No. 3,484,952

Registered Aug. 12, 2008

**TRADEMARK
SERVICE MARK
PRINCIPAL REGISTER**

Chrome Shop Mafia

FOUR STATE INTERNATIONAL TRUCKS, INC.
(MISSOURI CORPORATION), DBA 4 STATE
TRUCKS INC

PO BOX 1691
JOPLIN, MO 64802

FOR: CLOTHING, NAMELY, SHIRTS, JACKETS,
HATS, SWEATSHIRTS, AND COATS, IN CLASS 25
(U.S. CLS. 22 AND 39).

FIRST USE 5-12-2004; IN COMMERCE 6-1-2004.

FOR: ONLINE RETAIL STORE SERVICES FEATURING CLOTHING AND TRUCK ACCESSORIES, NAMELY, CHROME GOODS FOR THE TRUCKING INDUSTRY; PROVIDING A WEBSITE FEATURING INFORMATION ON HOW TO PURCHASE BIG RIG TRUCKS, IN CLASS 35 (U.S. CLS. 100, 101 AND 102).

FIRST USE 5-12-2004; IN COMMERCE 6-1-2004.

FOR: PROVIDING A WEBSITE FEATURING INFORMATION ON REPAIR SERVICES FOR BIG RIG TRUCKS, IN CLASS 37 (U.S. CLS. 100, 103 AND 106).

FIRST USE 2-26-2008; IN COMMERCE 2-26-2008.

FOR: PROVIDING A WEBSITE FEATURING ARTICLES ABOUT BIG RIG TRUCKS, IN CLASS 41 (U.S. CLS. 100, 101 AND 107).

FIRST USE 5-12-2004; IN COMMERCE 6-1-2004.

THE MARK CONSISTS OF STANDARD CHARACTERS WITHOUT CLAIM TO ANY PARTICULAR FONT, STYLE, SIZE, OR COLOR.

NO CLAIM IS MADE TO THE EXCLUSIVE RIGHT TO USE "CHROME SHOP" IN INTERNATIONAL CLASS 35 ONLY, APART FROM THE MARK AS SHOWN.

SER. NO. 78-823,276, FILED 2-24-2006.

AMY GEARIN, EXAMINING ATTORNEY

Int. Cl.: 37

Prior U.S. Cls.: 100, 103 and 106

United States Patent and Trademark Office

Reg. No. 3,484,953

Registered Aug. 12, 2008

**SERVICE MARK
PRINCIPAL REGISTER**



DKI SERVICES CORPORATION (DELAWARE CORPORATION)
SUITE 205
611 BUSSE ROAD
BENSENVILLE, IL 60106

FOR: CLEANING AND RESTORATION SERVICES FOR INDOOR AND OUTDOOR STRUCTURES AND THEIR CONTENTS DAMAGED BY FIRE, WATER, WIND OR CATASTROPHES, NAMELY, CLEANING AND RESTORATION OF BUILDINGS, INTERIOR BUILDING SURFACES, INDUSTRIAL PREMISES AND RESIDENTIAL HOUSES, IN CLASS 37 (U.S. CLS. 100, 103 AND 106).

FIRST USE 12-17-1976; IN COMMERCE 12-17-1976.

OWNER OF U.S. REG. NO. 1,146,912.

NO CLAIM IS MADE TO THE EXCLUSIVE RIGHT TO USE "WIND , FIRE AND/OR WATER", APART FROM THE MARK AS SHOWN.

THE COLOR(S) WHITE, RED AND BLUE IS/ARE CLAIMED AS A FEATURE OF THE MARK.

THE MARK CONSISTS OF THE COLOR RED APPEARS IN THE FORM OF A TRIANGLE CONTAINING TWO BLUE TRIANGLES PLACED BACK TO BACK; THE COLOR WHITE APPEARS IN THE TEXT "WIND", "FIRE" AND "WATER" IN THE OUTLINE OF THE TWO BLUE TRIANGLES.

SER. NO. 78-823,552, FILED 2-26-2006.

SEAN CROWLEY, EXAMINING ATTORNEY

Int. Cls.: 29, 30 and 35

Prior U.S. Cls.: 46, 100, 101 and 102

United States Patent and Trademark Office

Reg. No. 3,484,954

Registered Aug. 12, 2008

**TRADEMARK
SERVICE MARK
PRINCIPAL REGISTER**

DIPALO'S

DIPALO'S FINE FOODS INC. (NEW YORK CORPORATION)
200 GRAND STREET
NEW YORK, NY 100133712

FOR: PROCESSED FRUITS AND VEGETABLES; EDIBLE OIL; MEAT; CHEESE; FISH; DAIRY PRODUCTS EXCLUDING ICE CREAM, ICE MILK AND FROZEN YOGURT, FOOD PACKAGE COMBINATIONS CONSISTING PRIMARILY OF CHEESE, MEAT AND/OR PROCESSED FRUIT, PROCESSED OLIVES, PRE-PACKAGED DINNERS CONSISTING PRIMARILY OF MEAT, SEAFOOD, POULTRY, PASTA, RICE OR VEGETABLES; PROCESSED NUTS, IN CLASS 29 (U.S. CL. 46).

FIRST USE 1-1-1925; IN COMMERCE 1-1-1925.

FOR: TOMATO PASTE, TOMATO PUREE, PASTA, BAKERY GOODS, BREADS, COFFEE, BISCUITS, BREADCRUMBS, CAPERS, CAPPUCCINO, CHOCOLATE, COOKIES, BISCOTTI, ESPRESSO, FOOD PACKAGE COMBINATIONS CONSISTING PRIMARILY OF BREAD, CRACKERS AND/OR COOKIES, GELATO, POLENTA, MACARONI, ALIMENTARY PASTE, NOODLES, PREPARED PASTA, RAVIOLI, PREPARED RAVIOLI, SAUCES, RI-

SOTTO, SEASONINGS, SPICES, VINEGAR, COFFEE BASED BEVERAGES, IN CLASS 30 (U.S. CL. 46).

FIRST USE 1-1-1925; IN COMMERCE 1-1-1925.

FOR: RETAIL GROCERY STORE SERVICES; RETAIL STORE SERVICES FEATURING RETAIL GROCERY STORE SERVICES, IMPORTING SERVICES FEATURING FOOD AND BEVERAGE PRODUCTS, APPAREL, PRINTED GOODS, CUTLERY, COOKING UTENSILS AND EQUIPMENT, CHEESE BOARDS, COFFEE MAKERS, ESPRESSO MACHINES, IN CLASS 35 (U.S. CLS. 100, 101 AND 102).

FIRST USE 1-1-1925; IN COMMERCE 1-1-1925.

THE MARK CONSISTS OF STANDARD CHARACTERS WITHOUT CLAIM TO ANY PARTICULAR FONT, STYLE, SIZE, OR COLOR.

OWNER OF U.S. REG. NO. 3,293,742.

SEC. 2(F).

SER. NO. 78-826,521, FILED 3-1-2006.

EDWARD NELSON, EXAMINING ATTORNEY

Int. Cl.: 9

Prior U.S. Cls.: 21, 23, 26, 36 and 38

United States Patent and Trademark Office

Reg. No. 3,484,955

Registered Aug. 12, 2008

**TRADEMARK
PRINCIPAL REGISTER**

BLUEFIN

CALREC AUDIO LIMITED (UNITED KINGDOM
LIMITED COMPANY)
NUTCLOUGH MILL, HEBDEN BRIDGE
WEST YORKSHIRE, UNITED KINGDOM HX7 8EZ

FOR: DIGITAL SIGNAL PROCESSING SYSTEMS
FOR SOUND MIXING CONSOLES, NAMELY, DI-
GITAL SIGNAL PROCESSORS, IN CLASS 9 (U.S.
CLS. 21, 23, 26, 36 AND 38).

THE MARK CONSISTS OF STANDARD CHAR-
ACTERS WITHOUT CLAIM TO ANY PARTICULAR
FONT, STYLE, SIZE, OR COLOR.

OWNER OF ERPN CMNTY TM OFC REG. NO.
004933958, DATED 6-2-2007, EXPIRES 2-27-2016.

SER. NO. 78-828,310, FILED 3-3-2006.

SHARON MEIER, EXAMINING ATTORNEY

Int. Cls.: 6, 9, 17 and 20

Prior U.S. Cls.: 1, 2, 5, 12, 13, 14, 21, 22, 23, 25, 26, 32, 35, 36, 38 and 50

Reg. No. 3,484,956

United States Patent and Trademark Office

Registered Aug. 12, 2008

**TRADEMARK
PRINCIPAL REGISTER**

ChildProTech

M.A.G. ENGINEERING & MANUFACTURING,
CO., INC. (CALIFORNIA CORPORATION)
15381 ASSEMBLY LANE
HUNTINGTON BEACH, CA 92649

FOR: METAL DOOR STOP FOR CHILD SAFETY PURPOSES; METAL SAFETY GATES FOR CHILD SAFETY PURPOSES; METAL APPLIANCE, CABINET, AND DRAWER LATCHES FOR PURPOSES OF PREVENTING CHILDREN FROM OPENING APPLIANCES, CABINETS, AND DRAWERS; METAL TOILET LID LOCKS FOR THE PURPOSES OF PREVENTING CHILDREN FROM OPENING TOILETS, IN CLASS 6 (U.S. CLS. 2, 12, 13, 14, 23, 25 AND 50).

FIRST USE 6-1-2005; IN COMMERCE 9-1-2005.

FOR: ELECTRICAL OUTLET PLUGS AND COVERS FOR PURPOSES OF PREVENTING ELECTRICAL SHOCK, IN CLASS 9 (U.S. CLS. 21, 23, 26, 36 AND 38).

FIRST USE 6-1-2005; IN COMMERCE 9-1-2005.

FOR: RUBBER FINGER PINCH GUARD FOR PURPOSES OF PROTECTING CHILDREN'S FINGERS FROM GETTING CAUGHT IN DOORS, IN CLASS 17 (U.S. CLS. 1, 5, 12, 13, 35 AND 50).

FIRST USE 6-1-2005; IN COMMERCE 9-1-2005.

FOR: NON-METAL APPLIANCE, CABINET, AND DRAWER LATCHES FOR PURPOSES OF PREVENTING CHILDREN FROM OPENING APPLIANCES, CABINETS, AND DRAWERS; NON-METAL TOILET LID LOCKS FOR THE PURPOSES OF PREVENTING CHILDREN FROM OPENING TOILETS; NON-METAL DOOR KNOB COVERS FOR PURPOSES OF PREVENTING CHILDREN FROM OPENING DOORS; RUBBER CORNER CUSHIONS FOR PURPOSES OF PROTECTING CHILDREN FROM FURNITURE WITH CORNERS, IN CLASS 20 (U.S. CLS. 2, 13, 22, 25, 32 AND 50).

FIRST USE 6-1-2005; IN COMMERCE 9-1-2005.

THE MARK CONSISTS OF STANDARD CHARACTERS WITHOUT CLAIM TO ANY PARTICULAR FONT, STYLE, SIZE, OR COLOR.

NO CLAIM IS MADE TO THE EXCLUSIVE RIGHT TO USE "TECH", APART FROM THE MARK AS SHOWN.

SER. NO. 78-831,040, FILED 3-7-2006.

TIMOTHY FINNEGAN, EXAMINING ATTORNEY

Int. Cls.: 5 and 20

**Prior U.S. Cls.: 2, 6, 13, 18, 22, 25, 32, 44, 46, 50, 51
and 52**

Reg. No. 3,484,957

United States Patent and Trademark Office

Registered Aug. 12, 2008

**TRADEMARK
PRINCIPAL REGISTER**

DENTACO

DENTACO DENTALINDUSTRIE UND -MAR-
KETING GMBH (FED REP GERMANY LIM-
ITED LIABILITY COMPANY)
BENZSTRASSE 13, D-61352
BAD HOMBURG, FED REP GERMANY

FOR: DIAGNOSTIC MEANS, NAMELY, DIAG-
NOSTIC PREPARATIONS FOR MEDICAL AND
DENTISTRY PURPOSES FOR PRECISE IDENTIFI-
CATION OF FALSE CONTACT POINTS AND PRE-
MATURITIES ON THE INNER OR OUTER
SURFACES OF CROWNS, BRIDGES, INLAYS, ON-
LAYS AND OTHER DENTAL TREATMENTS; DE-
LUSTERING MEANS, NAMELY, DELUSTERING
AGENTS FOR MEDICAL AND DENTISTRY PUR-
POSES FOR PREPARATION OF TEETH FOR
CROWNS, BRIDGES, INLAYS, ONLAYS, AND
OTHER DENTAL TREATMENTS; CHEMICAL PRE-
PARATIONS AND REAGENTS FOR MEDICAL
AND DENTISTRY PURPOSES FOR PREPARATION
FOR TEETH FOR CROWNS, BRIDGES, INLAYS,
ONLAYS, AND OTHER DENTAL TREATMENTS;
CONTACT MEANS, NAMELY, ADHESIVES FOR

DENTISTRY AND DENTAL TECHNICAL PURPO-
SES; TINCTURES FOR MEDICAL AND DENTISTRY
PURPOSE FOR PREPARATION OF TEETH FOR
CROWNS, BRIDGES, INLAYS, ONLAYS AND
OTHER DENTAL TREATMENTS, IN CLASS 5 (U.S.
CLS. 6, 18, 44, 46, 51 AND 52).

FIRST USE 12-31-1991; IN COMMERCE 12-31-1995.

FOR: PACKING CONTAINERS MADE OF PLAS-
TIC, IN CLASS 20 (U.S. CLS. 2, 13, 22, 25, 32 AND 50).

FIRST USE 12-31-1991; IN COMMERCE 12-31-1995.

THE MARK CONSISTS OF STANDARD CHAR-
ACTERS WITHOUT CLAIM TO ANY PARTICULAR
FONT, STYLE, SIZE, OR COLOR.

SER. NO. 78-832,654, FILED 3-8-2006.

CARYN GLASSER, EXAMINING ATTORNEY

Int. Cl.: 25

Prior U.S. Cls.: 22 and 39

United States Patent and Trademark Office

Reg. No. 3,484,958

Registered Aug. 12, 2008

**TRADEMARK
PRINCIPAL REGISTER**

ELLA BLEU

ELLA BLEU INC. (COLORADO CORPORATION)
BUILDING 500, SUITE 109
200 QUEBEC ST.
DENVER, CO 80230

FOR: HATS; ONE PIECE GARMENT FOR INFANTS AND TODDLERS; SCARVES; SHIRTS, IN CLASS 25 (U.S. CLS. 22 AND 39).

FIRST USE 9-1-2003; IN COMMERCE 9-1-2003.

THE MARK CONSISTS OF STANDARD CHARACTERS WITHOUT CLAIM TO ANY PARTICULAR FONT, STYLE, SIZE, OR COLOR.

THE NAME "ELLA BLEU" DOES NOT IDENTIFY A LIVING INDIVIDUAL.

SER. NO. 78-840,400, FILED 3-17-2006.

MICHAEL WIENER, EXAMINING ATTORNEY

Int. Cls.: 9, 10, 37 and 41

**Prior U.S. Cls.: 21, 23, 26, 36, 38, 39, 44, 100, 101, 103,
106 and 107**

Reg. No. 3,484,959

United States Patent and Trademark Office

Registered Aug. 12, 2008

**TRADEMARK
SERVICE MARK
PRINCIPAL REGISTER**

HANSEN MEDICAL

HANSEN MEDICAL, INC. (DELAWARE CORPORATION)
380 NORTH BERNARDO AVENUE
MOUNTAIN VIEW, CA 94043

FOR: SOFTWARE AND COMPUTER HARDWARE FOR USE WITH ROBOTIC SURGICAL INSTRUMENTS IN THE HUMAN BODY, IN CLASS 9 (U.S. CLS. 21, 23, 26, 36 AND 38).

FIRST USE 6-13-2007; IN COMMERCE 6-13-2007.

FOR: ROBOTIC CATHETERS; SURGICAL ROBOTS FOR USE IN THE HUMAN BODY, IN CLASS 10 (U.S. CLS. 26, 39 AND 44).

FIRST USE 6-13-2007; IN COMMERCE 6-13-2007.

FOR: MAINTENANCE AND REPAIR OF MEDICAL MACHINES AND APPARATUS, IN CLASS 37 (U.S. CLS. 100, 103 AND 106).

FIRST USE 1-24-2008; IN COMMERCE 1-24-2008.

FOR: TRAINING IN THE USE OF MEDICAL DEVICES, IN CLASS 41 (U.S. CLS. 100, 101 AND 107).

FIRST USE 1-24-2008; IN COMMERCE 1-24-2008.

THE MARK CONSISTS OF STANDARD CHARACTERS WITHOUT CLAIM TO ANY PARTICULAR FONT, STYLE, SIZE, OR COLOR.

NO CLAIM IS MADE TO THE EXCLUSIVE RIGHT TO USE "MEDICAL", APART FROM THE MARK AS SHOWN.

SEC. 2(F).

SER. NO. 78-840,508, FILED 3-17-2006.

MICHAEL SOUDERS, EXAMINING ATTORNEY

Int. Cl.: 41

Prior U.S. Cls.: 100, 101 and 107

United States Patent and Trademark Office

Reg. No. 3,484,960

Registered Aug. 12, 2008

**SERVICE MARK
PRINCIPAL REGISTER**

WISH WORKSHOPS

STARWOOD HOTELS & RESORTS WORLD-
WIDE, INC. (MARYLAND CORPORATION)
1111 WESTCHESTER AVENUE
WHITE PLAINS, NY 10604

FOR: ARRANGING MEETINGS, CONFERENCES
AND SOCIAL FUNCTIONS; ARRANGING SEMI-
NARS AND CLASSES IN THE FIELD OF ARTS,
CRAFTS, WINE, FOOD, TRAVEL, CULINARY
ARTS, SPORTS, YOGA AND PHYSICAL FITNESS,
IN CLASS 41 (U.S. CLS. 100, 101 AND 107).

FIRST USE 1-0-2006; IN COMMERCE 1-0-2006.

THE MARK CONSISTS OF STANDARD CHAR-
ACTERS WITHOUT CLAIM TO ANY PARTICULAR
FONT, STYLE, SIZE, OR COLOR.

NO CLAIM IS MADE TO THE EXCLUSIVE
RIGHT TO USE "WORKSHOPS", APART FROM
THE MARK AS SHOWN.

SER. NO. 78-840,724, FILED 3-19-2006.

MICHAEL WIENER, EXAMINING ATTORNEY

Int. Cl.: 44

Prior U.S. Cls.: 100 and 101

United States Patent and Trademark Office

Reg. No. 3,484,961

Registered Aug. 12, 2008

**SERVICE MARK
PRINCIPAL REGISTER**

HMS PxDX

HEALTH MARKET SCIENCE (PENNSYLVANIA
CORPORATION)
SUITE 200
2700 HORIZON DRIVE
KING OF PRUSSIA, PA 19428

FOR: PROVIDING DATABASES OF INFORMATION IN THE FIELD OF HEALTHCARE FOR PURPOSES OF TRACKING PHYSICIAN INFORMATION RELATING TO PROCEDURE AND DIAGNOSES ACTIVITY , IN CLASS 44 (U.S. CLS. 100 AND 101).

FIRST USE 5-16-2005; IN COMMERCE 5-16-2005.

THE MARK CONSISTS OF STANDARD CHARACTERS WITHOUT CLAIM TO ANY PARTICULAR FONT, STYLE, SIZE, OR COLOR.

NO CLAIM IS MADE TO THE EXCLUSIVE RIGHT TO USE "PDX", APART FROM THE MARK AS SHOWN.

SER. NO. 78-840,883, FILED 3-20-2006.

JAMES GRIFFIN, EXAMINING ATTORNEY

Int. Cl.: 9

Prior U.S. Cls.: 21, 23, 26, 36 and 38

United States Patent and Trademark Office

Reg. No. 3,484,962

Registered Aug. 12, 2008

**TRADEMARK
PRINCIPAL REGISTER**

PagePilot

KABUSHIKI KAISHA ACCESS (JAPAN CORPORATION), TA ACCESS CO., LTD.
8-16, SARUGAKU-CHO 2-CHOME
CHIYODA-KU, TOKYO, JAPAN

FOR: COMPUTER SOFTWARE AND COMPUTER PROGRAMS FOR OPERATING WIRELESS AND WIRED COMMUNICATION DEVICES, BROWSER SOFTWARE, NETWORK CONTROLLER SOFTWARE, DATA COMPRESSION SOFTWARE, ENCRYPTION SOFTWARE AND AUTHENTICATION SOFTWARE, IN CLASS 9 (U.S. CLS. 21, 23, 26, 36 AND 38).

THE MARK CONSISTS OF STANDARD CHARACTERS WITHOUT CLAIM TO ANY PARTICULAR FONT, STYLE, SIZE, OR COLOR.

OWNER OF JAPAN REG. NO. 4997214, DATED 10-20-2006, EXPIRES 10-20-2016.

SER. NO. 78-842,040, FILED 3-21-2006.

JAMES GRIFFIN, EXAMINING ATTORNEY

Int. Cl.: 36

Prior U.S. Cls.: 100, 101 and 102

United States Patent and Trademark Office

Reg. No. 3,484,963

Registered Aug. 12, 2008

**SERVICE MARK
PRINCIPAL REGISTER**

Bainbridge Capital

BAINBRIDGE CAPITAL, INC. (DELAWARE CORPORATION)
SUITE 500, #5003
4660 LAJOLLA VILLAGE DR.
SAN DIEGO, CA 92122

FOR: CAPITAL INVESTMENT CONSULTATION; EQUITY CAPITAL INVESTMENT; INVESTMENT ADVISORY SERVICES; INVESTMENT BANKING SERVICES; INVESTMENT CONSULTATION; INVESTMENT MANAGEMENT; INVESTMENT SERVICES, NAMELY ASSET ACQUISITION, CONSULTATION, DEVELOPMENT AND MANAGEMENT SERVICES, IN CLASS 36 (U.S. CLS. 100, 101 AND 102).

FIRST USE 1-1-2000; IN COMMERCE 2-1-2000.

THE MARK CONSISTS OF STANDARD CHARACTERS WITHOUT CLAIM TO ANY PARTICULAR FONT, STYLE, SIZE, OR COLOR.

OWNER OF U.S. REG. NOS. 2,156,896, 2,624,153, AND 2,624,155.

NO CLAIM IS MADE TO THE EXCLUSIVE RIGHT TO USE CAPITAL, APART FROM THE MARK AS SHOWN.

SER. NO. 78-844,137, FILED 3-23-2006.

REBECCA EISINGER, EXAMINING ATTORNEY

Int. Cl.: 14

Prior U.S. Cls.: 2, 27, 28 and 50

United States Patent and Trademark Office

Reg. No. 3,484,964

Registered Aug. 12, 2008

**TRADEMARK
PRINCIPAL REGISTER**

TONY BENNETT

BENEDETTO ARTS GMBH (FED REP GERMA-
NY GMBH)
GRUENEWALDER STR. 30
SOLINGEN, FED REP GERMANY 42657

FOR: CLOCKS; COLLECTIBLE OR COMMEM-
ORATIVE COINS; ITEMS MADE OF PRECIOUS
METAL, NAMELY, DECORATIVE BOXES, FIGUR-
INES, KEY RINGS, MONEY CLIPS, SILVERWARE,
SERVING TRAYS, TEA POTS, CANDLESTICKS OF
PRECIOUS METAL, CIGARETTE CASES MADE OF
PRECIOUS METAL; JEWELRY; CUFF-LINKS;
NECKTIE FASTENERS; RINGS BEING JEWELRY;
TIE PINS; TIE CLIPS; WEDDING BANDS; PRE-
CIOUS GEMSTONES; WATCHES, IN CLASS 14
(U.S. CLS. 2, 27, 28 AND 50).

THE MARK CONSISTS OF STANDARD CHAR-
ACTERS WITHOUT CLAIM TO ANY PARTICULAR
FONT, STYLE, SIZE, OR COLOR.

PRIORITY CLAIMED UNDER SEC. 44(D) ON FED
REP GERMANY APPLICATION NO. 305569139,
FILED 9-27-2005, REG. NO. 30556913, DATED 12-1-
2005, EXPIRES 9-30-2015.

THE NAME(S), PORTRAIT(S), AND/OR SIGNA-
TURE(S) SHOWN IN THE MARK IDENTIFIES
"TONY BENNETT" WHOSE CONSENT(S) TO REG-
ISTER IS SUBMITTED.

SER. NO. 78-845,766, FILED 3-24-2006.

JAMES MACFARLANE, EXAMINING ATTORNEY

Int. Cl.: 41

Prior U.S. Cls.: 100, 101 and 107

United States Patent and Trademark Office

Reg. No. 3,484,965

Registered Aug. 12, 2008

**SERVICE MARK
PRINCIPAL REGISTER**

CUBBY THE CLOWN

SCHNEIDER, MAUREEN (UNITED STATES IN-
DIVIDUAL)
PO BOX 413 – 37 OLEETA RD.
MT SINAI, NY 11766

FOR: PERSONAL APPEARANCES OF A CLOWN
FOR ENTERTAINMENT PURPOSES THAT PER-
FORMS MAGIC, FACE PAINTING, BALLOON
TOYS, AND ANIMAL TRICKS, IN CLASS 41 (U.S.
CLS. 100, 101 AND 107).

FIRST USE 6-15-1982; IN COMMERCE 6-15-1982.

THE MARK CONSISTS OF STANDARD CHAR-
ACTERS WITHOUT CLAIM TO ANY PARTICULAR
FONT, STYLE, SIZE, OR COLOR.

NO CLAIM IS MADE TO THE EXCLUSIVE
RIGHT TO USE "CLOWN", APART FROM THE
MARK AS SHOWN.

SER. NO. 78-848,407, FILED 3-28-2006.

SIMON TENG, EXAMINING ATTORNEY

Int. Cl.: 16

Prior U.S. Cls.: 2, 5, 22, 23, 29, 37, 38 and 50

United States Patent and Trademark Office

Reg. No. 3,484,966

Registered Aug. 12, 2008

**TRADEMARK
PRINCIPAL REGISTER**

**HAWAII EARLY LEARNING
PROFILE**

VORT CORPORATION (CALIFORNIA CORPORATION)

P. O. BOX G

PALO ALTO, CA 94304

FOR: PRINTED EDUCATIONAL MATERIAL FOR EARLY LEARNING DEVELOPMENTAL SKILLS ASSESSMENT AND ACTIVITIES, IN CLASS 16 (U.S. CLS. 2, 5, 22, 23, 29, 37, 38 AND 50).

FIRST USE 9-27-1979; IN COMMERCE 9-27-1979.

THE MARK CONSISTS OF STANDARD CHARACTERS WITHOUT CLAIM TO ANY PARTICULAR FONT, STYLE, SIZE, OR COLOR.

NO CLAIM IS MADE TO THE EXCLUSIVE RIGHT TO USE "EARLY LEARNING PROFILE", APART FROM THE MARK AS SHOWN.

SEC. 2(F).

SER. NO. 78-848,435, FILED 3-28-2006.

LESLEY LAMOTHE, EXAMINING ATTORNEY

Int. Cl.: 10

Prior U.S. Cls.: 26, 39 and 44

United States Patent and Trademark Office

Reg. No. 3,484,967

Registered Aug. 12, 2008

**TRADEMARK
PRINCIPAL REGISTER**

POLYMED

POLYGON COMPANY (INDIANA CORPORATION)
P.O. BOX 176, 103 INDUSTRIAL PARK DRIVE
WALKERTON, IN 46574

FOR: RIGID MEDICAL TUBING FOR VISUAL
OBSERVATION USED BY MEDICAL EQUIPMENT
MANUFACTURERS AS A COMPONENT IN LA-
PAROSCOPES, ENDOSCOPES, AND OTHER MINI-
MALLY EVASIVE SURGICAL INSTRUMENTS, IN
CLASS 10 (U.S. CLS. 26, 39 AND 44).

FIRST USE 0-0-1988; IN COMMERCE 0-0-1988.

THE MARK CONSISTS OF STANDARD CHAR-
ACTERS WITHOUT CLAIM TO ANY PARTICULAR
FONT, STYLE, SIZE, OR COLOR.

SER. NO. 78-849,222, FILED 3-29-2006.

ODESSA BIBBINS, EXAMINING ATTORNEY

Int. Cl.: 42

Prior U.S. Cls.: 100 and 101

United States Patent and Trademark Office

Reg. No. 3,484,968

Registered Aug. 12, 2008

**SERVICE MARK
PRINCIPAL REGISTER**

HMS Investigators

HEALTH MARKET SCIENCE (PENNSYLVANIA
CORPORATION)
SUITE 200
2700 HORIZON DRIVE
KING OF PRUSSIA, PA 19406

FOR: PROVIDING ONLINE DATABASES OF INFORMATION ABOUT CLINICAL TRIALS, INCLUDING INFORMATION ABOUT CLINICAL TRIAL INVESTIGATORS AND CLINICAL TRIAL SITES AND THE CLINICAL TRIALS OF DRUGS, MEDICAL DEVICES AND MEDICAL EQUIPMENT, IN CLASS 42 (U.S. CLS. 100 AND 101).

FIRST USE 5-16-2005; IN COMMERCE 5-16-2005.

THE MARK CONSISTS OF STANDARD CHARACTERS WITHOUT CLAIM TO ANY PARTICULAR FONT, STYLE, SIZE, OR COLOR.

NO CLAIM IS MADE TO THE EXCLUSIVE RIGHT TO USE "INVESTIGATORS", APART FROM THE MARK AS SHOWN.

SER. NO. 78-849,758, FILED 3-30-2006.

JAMES GRIFFIN, EXAMINING ATTORNEY

Int. Cls.: 35, 39, 40, 42 and 45

Prior U.S. Cls.: 100, 101, 102, 103, 105 and 106

United States Patent and Trademark Office

Reg. No. 3,484,969

Registered Aug. 12, 2008

**SERVICE MARK
PRINCIPAL REGISTER**

ENCORE LEGAL SOLUTIONS

ENCORE LEGAL SOLUTIONS, INC. (DELA-
WARE CORPORATION)
SUITE 350
10200 GROGAN'S MILL ROAD
THE WOODLANDS, TX 77380

FOR: DOCUMENT REPRODUCTION; DATA
PROCESSING IN THE NATURE OF ELECTRONIC
CODING AND INDEXING OF LEGAL DOCU-
MENTS FOR ATTORNEYS, IN CLASS 35 (U.S. CLS.
100, 101 AND 102).

FIRST USE 11-0-2003; IN COMMERCE 11-0-2003.

FOR: ELECTRONIC ONLINE STORAGE FOR
LEGAL DOCUMENTS, IN CLASS 39 (U.S. CLS. 100
AND 105).

FIRST USE 11-0-2003; IN COMMERCE 11-0-2003.

FOR: ELECTRONIC SCANNING OF LEGAL
DOCUMENTS, IN CLASS 40 (U.S. CLS. 100, 103
AND 106).

FIRST USE 11-0-2003; IN COMMERCE 11-0-2003.

FOR: GRAPHIC DESIGN SERVICES FOR LEGAL
TRIALS, IN CLASS 42 (U.S. CLS. 100 AND 101).

FIRST USE 11-0-2003; IN COMMERCE 11-0-2003.

FOR: LEGAL DOCUMENT PREPARATION FOR
ATTORNEYS; CONDUCTING ELECTRONIC ON-
LINE DATA DISCOVERY SERVICES FOR ATTOR-
NEYS; LEGAL SERVICES IN THE NATURE OF
TRIAL CONSULTING, IN CLASS 45 (U.S. CLS. 100
AND 101).

FIRST USE 11-0-2003; IN COMMERCE 11-0-2003.

THE MARK CONSISTS OF STANDARD CHAR-
ACTERS WITHOUT CLAIM TO ANY PARTICULAR
FONT, STYLE, SIZE, OR COLOR.

OWNER OF U.S. REG. NOS. 2,955,790 AND
2,955,791.

NO CLAIM IS MADE TO THE EXCLUSIVE
RIGHT TO USE "LEGAL SOLUTIONS" , APART
FROM THE MARK AS SHOWN.

SER. NO. 78-854,266, FILED 4-5-2006.

HOWARD B. LEVINE, EXAMINING ATTORNEY

Int. Cl.: 12

Prior U.S. Cls.: 19, 21, 23, 31, 35 and 44

Reg. No. 3,484,970

United States Patent and Trademark Office

Registered Aug. 12, 2008

**TRADEMARK
PRINCIPAL REGISTER**



HONDA MOTOR CO., LTD. (JAPAN CORPORATION)
NO. 1-1, 2-CHOME, MINAMIAOYAMA,
MINATO-KU, TOKYO, JAPAN 107-8556

FIRST USE 6-5-2003; IN COMMERCE 6-5-2003.

SER. NO. 78-854,319, FILED 4-5-2006.

FOR: MOTORCYCLES AND STRUCTURAL
PARTS THEREFOR, IN CLASS 12 (U.S. CLS. 19, 21,
23, 31, 35 AND 44).

MELISSA VALLILLO, EXAMINING ATTORNEY

Int. Cl.: 10

Prior U.S. Cls.: 26, 39 and 44

Reg. No. 3,484,971

United States Patent and Trademark Office

Registered Aug. 12, 2008

**TRADEMARK
PRINCIPAL REGISTER**

DECATHLON

SPIRE CORPORATION (MASSACHUSETTS COR-
PORATION)
ONE PATRIOTS PARK
BEDFORD, MA 017302396

THE MARK CONSISTS OF STANDARD CHAR-
ACTERS WITHOUT CLAIM TO ANY PARTICULAR
FONT, STYLE, SIZE, OR COLOR.

FOR: HEMODIALYSIS CATHETERS, IN CLASS 10
(U.S. CLS. 26, 39 AND 44).

SER. NO. 78-856,442, FILED 4-7-2006.

FIRST USE 3-25-2004; IN COMMERCE 3-25-2004.

CAROLYN CATALDO, EXAMINING ATTORNEY

Int. Cls.: 2, 17, 19, 37 and 41

Prior U.S. Cls.: 1, 5, 6, 11, 12, 13, 16, 33, 35, 50, 100, 101, 103, 106 and 107

Reg. No. 3,484,972

United States Patent and Trademark Office

Registered Aug. 12, 2008

**TRADEMARK
SERVICE MARK
PRINCIPAL REGISTER**

RHINOPATCH

ASI SOLUTIONS PLC (UNITED KINGDOM PUBLIC LIMITED COMPANY (PLC))
DENBIGH INDUSTRIAL ESTATE BLETCHLEY
1 TILLING HOUSE, DENBIGH ROAD
MILTON KEYNES, UNITED KINGDOM MK1 1RB

FOR: PAVEMENT COATING, IN CLASS 2 (U.S. CLS. 6, 11 AND 16).

FOR: GROUT SEALANTS; PAVEMENT SEALANTS, IN CLASS 17 (U.S. CLS. 1, 5, 12, 13, 35 AND 50).

FOR: TAR BASED SEALANTS FOR ASPHALT; ASPHALT COMPOSITION PAVING; BITUMEN ASPHALT; ASPHALT REJUVENANTS; ASPHALT, PITCH, BITUMEN, MACADAM, AGGREGATE MATERIAL, NAMELY, GRAVEL; STONE; CRUSHED STONE; CONCRETE, SILICA STONE, SAND AND SLAG, NAMELY, SMELTING ORE; ALL THE AFORESAID GOODS BEING FOR USE IN THE MAKING, COATING, REPAIRING, MAINTAINING AND REJUVENATING OF BITUMINOUS AND ASPHALT WEARING COURSES, THOROUGHFARES, ROADS, FOOTWAYS, HIGHWAYS, AIRCRAFT RUNWAYS, PLAYGROUNDS, PAVEMENTS, CAR PARKS, RAILWAY STATION PLATFORMS AND DRIVEWAYS, IN CLASS 19 (U.S. CLS. 1, 12, 33 AND 50).

FOR: REPAIR AND MAINTENANCE OF BITUMINOUS AND ASPHALT WEARING COURSES, THOROUGHFARES, ROADS, FOOTWAYS, HIGHWAYS, AIRCRAFT RUNWAYS, PLAYGROUNDS, PAVEMENTS, CARPARKS, RAILWAY STATION PLATFORMS AND DRIVEWAYS, IN CLASS 37 (U.S. CLS. 100, 103 AND 106).

FOR: PROVIDING ONLINE PUBLICATIONS IN THE NATURE OF INSTRUCTION MANUALS, TRAINING HANDBOOKS AND INFORMATION SHEETS IN THE FIELD OF THE CONSTRUCTION, MAINTENANCE AND REPAIR OF BITUMINOUS AND ASPHALT WEARING COURSES, THOROUGHFARES, ROADS, FOOTWAYS, HIGHWAYS, AIRCRAFT RUNWAYS, PLAYGROUNDS, PAVEMENTS, CAR PARKS, RAILWAY STATION PLATFORMS AND DRIVEWAYS, NOT DOWNLOADABLE; EDUCATIONAL SERVICES, NAMELY, PROVIDING TRAINING, TEACHING, LECTURES, SEMINARS, COURSES, ON-SITE PRACTICAL TRAINING, DEMONSTRATION OF EQUIPMENT AND PROCESSES; ARRANGING AND CONDUCTING OF SEMINARS AND TRAINING WORKSHOPS, ALL THE AFORESAID SERVICES RELATING TO THE REPAIR AND MAINTENANCE OF BITUMINOUS AND ASPHALT WEARING COURSES, THOROUGHFARES, ROADS, FOOTWAYS, HIGHWAYS, AIRCRAFT RUNWAYS, PLAYGROUNDS, PAVEMENTS, CARPARKS, RAILWAY STATION PLATFORMS AND DRIVEWAYS, IN CLASS 41 (U.S. CLS. 100, 101 AND 107).

THE MARK CONSISTS OF STANDARD CHARACTERS WITHOUT CLAIM TO ANY PARTICULAR FONT, STYLE, SIZE, OR COLOR.

OWNER OF UNITED KINGDOM REG. NO. 003815537, DATED 9-8-2005, EXPIRES 4-27-2014.

SER. NO. 78-861,123, FILED 4-13-2006.

ANNE MADDEN, EXAMINING ATTORNEY

Int. Cls.: 2, 17, 19, 37 and 41

Prior U.S. Cls.: 1, 5, 6, 11, 12, 13, 16, 33, 35, 50, 100, 101, 103, 106 and 107

Reg. No. 3,484,973

United States Patent and Trademark Office

Registered Aug. 12, 2008

**TRADEMARK
SERVICE MARK
PRINCIPAL REGISTER**

RhinoSeal

ASI SOLUTIONS PLC (UNITED KINGDOM PUBLIC LIMITED COMPANY (PLC))
DENBIGH INDUSTRIAL ESTATE BLETCHLEY
1 TILLING HOUSE, DENBIGH ROAD
MILTON KEYNES, UNITED KINGDOM MK1 1RB

FOR: PAVEMENT COATING, IN CLASS 2 (U.S. CLS. 6, 11 AND 16).

FOR: GROUT SEALANTS; PAVEMENT SEALANTS, IN CLASS 17 (U.S. CLS. 1, 5, 12, 13, 35 AND 50).

FOR: TAR BASED SEALANTS FOR ASPHALT; ASPHALT COMPOSITION PAVING; BITUMEN ASPHALT; ASPHALT REJUVENANTS; ASPHALT, PITCH, BITUMEN, MACADAM, AGGREGATE MATERIAL, NAMELY, GRAVEL; STONE; CRUSHED STONE; CONCRETE, SILICA STONE, SAND AND SLAG, NAMELY, SMELTING ORE; ALL THE AFORESAID GOODS BEING FOR USE IN THE MAKING, COATING, REPAIRING, MAINTAINING AND REJUVENATING OF BITUMINOUS AND ASPHALT WEARING COURSES, THOROUGHFARES, ROADS, FOOTWAYS, HIGHWAYS, AIRCRAFT RUNWAYS, PLAYGROUNDS, PAVEMENTS, CAR PARKS, RAILWAY STATION PLATFORMS AND DRIVEWAYS, IN CLASS 19 (U.S. CLS. 1, 12, 33 AND 50).

FOR: REPAIR AND MAINTENANCE OF BITUMINOUS AND ASPHALT WEARING COURSES, THOROUGHFARES, ROADS, FOOTWAYS, HIGHWAYS, AIRCRAFT RUNWAYS, PLAYGROUNDS, PAVEMENTS, CARPARKS, RAILWAY STATION PLATFORMS AND DRIVEWAYS, IN CLASS 37 (U.S. CLS. 100, 103 AND 106).

FOR: PROVIDING ONLINE PUBLICATIONS IN THE NATURE OF INSTRUCTION MANUALS, TRAINING HANDBOOKS AND INFORMATION SHEETS IN THE FIELD OF THE CONSTRUCTION, MAINTENANCE AND REPAIR OF BITUMINOUS AND ASPHALT WEARING COURSES, THOROUGHFARES, ROADS, FOOTWAYS, HIGHWAYS, AIRCRAFT RUNWAYS, PLAYGROUNDS, PAVEMENTS, CAR PARKS, RAILWAY STATION PLATFORMS AND DRIVEWAYS, NOT DOWNLOADABLE; EDUCATIONAL SERVICES, NAMELY, PROVIDING TRAINING, TEACHING, LECTURES, SEMINARS, COURSES, ON-SITE PRACTICAL TRAINING, DEMONSTRATION OF EQUIPMENT AND PROCESSES; ARRANGING AND CONDUCTING OF SEMINARS AND TRAINING WORKSHOPS, ALL THE AFORESAID SERVICES RELATING TO THE REPAIR AND MAINTENANCE OF BITUMINOUS AND ASPHALT WEARING COURSES, THOROUGHFARES, ROADS, FOOTWAYS, HIGHWAYS, AIRCRAFT RUNWAYS, PLAYGROUNDS, PAVEMENTS, CARPARKS, RAILWAY STATION PLATFORMS AND DRIVEWAYS, IN CLASS 41 (U.S. CLS. 100, 101 AND 107).

THE MARK CONSISTS OF STANDARD CHARACTERS WITHOUT CLAIM TO ANY PARTICULAR FONT, STYLE, SIZE, OR COLOR.

OWNER OF UNITED KINGDOM REG. NO. 2307431, DATED 1-24-2003, EXPIRES 8-7-2012.

SER. NO. 78-861,165, FILED 4-13-2006.

ANNE MADDEN, EXAMINING ATTORNEY

Int. Cls.: 11, 37 and 41

**Prior U.S. Cls.: 13, 21, 23, 31, 34, 100, 101, 103, 106
and 107**

Reg. No. 3,484,974

United States Patent and Trademark Office

Registered Aug. 12, 2008

**TRADEMARK
SERVICE MARK
PRINCIPAL REGISTER**

RHINOTHERM

ASI SOLUTIONS PLC (UNITED KINGDOM PUBLIC LIMITED COMPANY (PLC))
DENBIGH INDUSTRIAL ESTATE BLETCHLEY
1 TILLING HOUSE, DENBIGH ROAD
MILTON KEYNES, UNITED KINGDOM MK1 1RB

FOR: HEATERS, HEATING MACHINES AND HEATING EQUIPMENT, NAMELY, HEATERS, HEATING MACHINES AND HEATING EQUIPMENT FOR THE HEATING OF BITUMINOUS AND ASPHALT MATERIALS, I.E., FOR USE IN THE CONSTRUCTION, MAINTENANCE AND REPAIR OF BITUMINOUS AND ASPHALT WEARING COURSES, THOROUGHFARES, ROADS, FOOTWAYS, HIGHWAYS, AIRCRAFT RUNWAYS, PLAYGROUNDS, PAVEMENTS, CAR PARKS, RAILWAY STATION PLATFORMS AND DRIVEWAYS, IN CLASS 11 (U.S. CLS. 13, 21, 23, 31 AND 34).

FOR: REPAIR AND MAINTENANCE OF BITUMINOUS AND ASPHALT WEARING COURSES, THOROUGHFARES, ROADS, FOOTWAYS, HIGHWAYS, AIRCRAFT RUNWAYS, PLAYGROUNDS, PAVEMENTS, CARPARKS, RAILWAY STATION PLATFORMS AND DRIVEWAYS, IN CLASS 37 (U.S. CLS. 100, 103 AND 106).

FOR: EDUCATIONAL SERVICES, NAMELY, PROVIDING TRAINING, TEACHING, LECTURES, SEMINARS, COURSES, ON-SITE PRACTICAL TRAINING, DEMONSTRATION OF EQUIPMENT AND PROCESSES; PROVIDING ONLINE PUBLICATIONS IN THE NATURE OF INSTRUCTIONS MANUALS, TRAINING HANDBOOKS AND INFORMATION SHEETS IN THE FIELD OF THE CONSTRUCTION, MAINTENANCE AND REPAIR OF BITUMINOUS AND ASPHALT WEARING COURSES, THOROUGHFARES, ROADS, FOOTWAYS, HIGHWAYS, AIRCRAFT RUNWAYS, PLAYGROUNDS, PAVEMENTS, CAR PARKS, RAILWAY STATION PLATFORMS AND DRIVEWAYS, NOT DOWNLOADABLE, IN CLASS 41 (U.S. CLS. 100, 101 AND 107).

THE MARK CONSISTS OF STANDARD CHARACTERS WITHOUT CLAIM TO ANY PARTICULAR FONT, STYLE, SIZE, OR COLOR.

OWNER OF UNITED KINGDOM REG. NO. 003815479, DATED 9-8-2005, EXPIRES 4-27-2014.

SER. NO. 78-861,612, FILED 4-14-2006.

ANNE MADDEN, EXAMINING ATTORNEY

Int. Cl.: 19

Prior U.S. Cls.: 1, 12, 33 and 50

United States Patent and Trademark Office

Reg. No. 3,484,975

Registered Aug. 12, 2008

TRADEMARK
PRINCIPAL REGISTER



NEWPORT MILLWORK, LLC (OHIO LTD LIAB
CO)
5143 FISCHER PLACE
CINCINNATI, OH 45217

FOR: WOODEN DOOR CASINGS, FRAMES,
JAMBS, PANELS, PATIO DOORS, RUNNERS FOR
SLIDING DOORS AND SLIDING DOORS, IN CLASS
19 (U.S. CLS. 1, 12, 33 AND 50).

FIRST USE 12-15-2005; IN COMMERCE 2-20-2006.

NO CLAIM IS MADE TO THE EXCLUSIVE
RIGHT TO USE "NEWPORT" OR "MILLWORK",
APART FROM THE MARK AS SHOWN.

THE COLOR(S) GREEN, BROWN, SILVER AND
BLACK IS/ARE CLAIMED AS A FEATURE OF THE
MARK.

THE MARK CONSISTS OF AN OVAL BACK-
GROUND IN BROWN WITH WOOD GRAIN,
GREEN LETTERS ACROSS THE TOP ARCH OF
THE BACKGROUND SPELLING "NEWPORT",
GREEN LETTERS ACROSS THE BOTTOM ARCH
OF THE OVAL SPELLING "MILLWORK", AND A
GREEN DOT ON EITHER SIDE OF THE CIRCLE. IN
THE CENTER OF THE CIRCLE IS A WOOD PLA-
NER TOOL COLORED IN BLACK AND SILVER
WITH A BROWN CURLING SHAVING COMING
OUT OF THE TOOL.

SER. NO. 78-870,145, FILED 4-26-2006.

ALYSSA PALADINO, EXAMINING ATTORNEY

Int. Cl.: 35

Prior U.S. Cls.: 100, 101 and 102

United States Patent and Trademark Office

Reg. No. 3,484,976

Registered Aug. 12, 2008

**SERVICE MARK
PRINCIPAL REGISTER**

THISBIZNOW

QUIXTAR INC. (VIRGINIA CORPORATION)
5101 SPAULDING PLAZA
ADA, MI 49355

THE MARK CONSISTS OF STANDARD CHAR-
ACTERS WITHOUT CLAIM TO ANY PARTICULAR
FONT, STYLE, SIZE, OR COLOR.

FOR: PROVIDING INFORMATION IN THE
FIELD OF SALES, MARKETING AND OPERATING
A SMALL BUSINESS, IN CLASS 35 (U.S. CLS. 100, 101
AND 102).

SER. NO. 78-874,635, FILED 5-2-2006.

FIRST USE 8-24-2005; IN COMMERCE 8-24-2005.

JILL PRATER, EXAMINING ATTORNEY

Int. Cl.: 5

Prior U.S. Cls.: 6, 18, 44, 46, 51 and 52

United States Patent and Trademark Office

Reg. No. 3,484,977

Registered Aug. 12, 2008

**TRADEMARK
PRINCIPAL REGISTER**

HORSLIC

CARRS AGRICULTURE LIMITED (UNITED
KINGDOM COMPANY)
OLD CROFT, STANWIX, CARLISLE
CUMBRIA, UNITED KINGDOM CA3 9BA

OWNER OF U.S. REG. NOS. 2,545,336 AND
2,922,064.

FOR: LIVESTOCK FEED SUPPLEMENT, IN
CLASS 5 (U.S. CLS. 6, 18, 44, 46, 51 AND 52).

SEC. 2(F).

FIRST USE 9-1-1999; IN COMMERCE 9-1-1999.

SER. NO. 78-875,728, FILED 5-3-2006.

THE MARK CONSISTS OF STANDARD CHAR-
ACTERS WITHOUT CLAIM TO ANY PARTICULAR
FONT, STYLE, SIZE, OR COLOR.

ADA HAN, EXAMINING ATTORNEY

Int. Cl.: 12

Prior U.S. Cls.: 19, 21, 23, 31, 35 and 44

Reg. No. 3,484,978

United States Patent and Trademark Office

Registered Aug. 12, 2008

**TRADEMARK
PRINCIPAL REGISTER**

NORDIC

DAVIS BOAT MANUFACTURING-NORDIC, INC.
(ARIZONA CORPORATION)
8780 PRESTIGE COURT
RANCHO CUCAMONGA, CA 91730

THE MARK CONSISTS OF STANDARD CHAR-
ACTERS WITHOUT CLAIM TO ANY PARTICULAR
FONT, STYLE, SIZE, OR COLOR.

FOR: SPORT BOATS, PERFORMANCE BOATS,
POWER BOATS, SKI BOATS AND PARA-SAIL
BOATS., IN CLASS 12 (U.S. CLS. 19, 21, 23, 31, 35
AND 44).

SER. NO. 78-878,700, FILED 5-8-2006.

FIRST USE 7-12-1966; IN COMMERCE 7-12-1966.

HOWARD B. LEVINE, EXAMINING ATTORNEY

Int. Cl.: 3

Prior U.S. Cls.: 1, 4, 6, 50, 51 and 52

United States Patent and Trademark Office

Reg. No. 3,484,979

Registered Aug. 12, 2008

**TRADEMARK
PRINCIPAL REGISTER**

MAXI PROFESSIONAL

JINNY BEAUTY SUPPLY CO., INC. (FLORIDA
CORPORATION)
16241 N.W. 48TH AVENUE
HIALEAH, FL 33014

FOR: HAIR CARE PREPARATIONS, NAMELY,
STYLING GELS, SHAMPOOS, CONDITIONERS,
HAIR OIL, HAIR SPRITZ; EYE LINER, LIP GLOSS,
LIP STICK, MASCARA, NAIL POLISH, BONDING
GLUE REMOVER, NAIL POLISH REMOVER, LO-
TION FOR HAIR AND SCALP, HAND AND FACE
CREAM, IN CLASS 3 (U.S. CLS. 1, 4, 6, 50, 51 AND 52).

FIRST USE 11-2-1995; IN COMMERCE 11-2-1995.

THE MARK CONSISTS OF STANDARD CHAR-
ACTERS WITHOUT CLAIM TO ANY PARTICULAR
FONT, STYLE, SIZE, OR COLOR.

NO CLAIM IS MADE TO THE EXCLUSIVE
RIGHT TO USE "PROFESSIONAL", APART FROM
THE MARK AS SHOWN.

SER. NO. 78-882,572, FILED 5-12-2006.

NAAKWAMA ANKRAH, EXAMINING ATTORNEY

Int. Cls.: 9, 12, 14, 16, 18, 25, 28 and 38

Prior U.S. Cls.: 1, 2, 3, 5, 19, 21, 22, 23, 26, 27, 28, 29, 31, 35, 36, 37, 38, 39, 41, 44, 50, 100, 101 and 104

Reg. No. 3,484,980

United States Patent and Trademark Office

Registered Aug. 12, 2008

**TRADEMARK
SERVICE MARK
PRINCIPAL REGISTER**

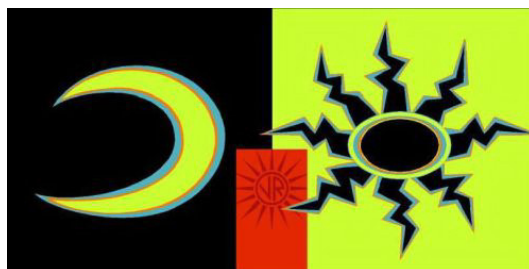

ROSSI, VALENTINO (ITALY INDIVIDUAL)
FLAT 4
DOWN STREET 23
LONDON, UNITED KINGDOM W1J7AR

FOR: PHOTOGRAPHIC APPARATUS AND INSTRUMENTS, NAMELY, CAMERA LENSES AND LENS HOODS; CINEMATOGRAPHIC APPARATUS AND INSTRUMENTS, NAMELY, CINEMATOGRAPHIC FILM; OPTICAL APPARATUS AND INSTRUMENTS, NAMELY, CORRECTIVE OPTICAL LENSES, FRAMES FOR EYE GLASSES AND SUNGLASSES, MAGNIFYING GLASSES, INSTRUMENTS CONTAINING EYEPIECES, NAMELY, MICROSCOPES, TELESCOPES, OPTICAL LENS SIGHTS, TELESCOPIC LENS SIGHTS, AND MAGNIFYING PEEPHOLES FOR DOORS; MEASURING APPARATUS AND INSTRUMENTS, NAMELY, MEASURING LABORATORY GLASSWARE, GRADUATED GLASSWARE; EYE GLASSES AND SUNGLASSES; PINCE-NEZ; EYEPIECES; CASES FOR EYE GLASSES AND SUNGLASSES; CONTACT LENS CASES; CORDS AND CHAINS FOR EYE GLASSES, SUNGLASSES AND PINCE-NEZ; PINCE-NEZ CASES; MOTORCYCLE GOGGLES; APPARATUS AND INSTRUMENTS FOR CONDUCTING, SWITCHING, TRANSFORMING, ACCUMULATING, REGULATING OR CONTROLLING ELECTRICITY, NAMELY, CAPACITORS; APPARATUS FOR RECORDING, TRANSMISSION OR REPRODUCTION OF DATA, SOUND AND IMAGES, NAMELY, VIDEO TELEPHONES, PORTABLE TELEPHONES, PERSONAL DIGITAL AUDIO PLAYERS, ELECTRONIC AGENDAS, JUKEBOXES, VIDEO GAME MACHINES FOR USE WITH TELEVISIONS, ELECTRONIC GAME CONSOLES FOR USE WITH TELEVISIONS, FACSIMILE MACHINES, RADIOS, VEHICLE RADIOS; BLANK MAGNETIC DATA

CARRIERS, NAMELY, VIDEOCASSETTES, AUDIO CASSETTES, AND RECORDING DISCS, NAMELY, FLOPPY DISCS, CDS, CD-ROMS AND DVDS; PRE-RECORDED PHONOGRAPHIC RECORDS, AUDIO CASSETTES, VIDEO CASSETTES AND COMPACT DISCS FEATURING AUDIO CONTENT IN THE NATURE OF MUSIC AND INTERVIEWS, VIDEO CONTENT IN THE FIELD OF SPORTS AND OF MOTORCYCLE RACING, AND COMPUTER PROGRAMS FOR PRERECORDED GAMES; PRERECORDED VIDEO GAME MEMORY CARTRIDGES; AUTOMATIC VENDING MACHINES; CASH REGISTERS; CALCULATING MACHINES, NAMELY, ACCOUNTING MACHINES, ADDING MACHINES, POCKET CALCULATORS; DATA PROCESSING EQUIPMENT, NAMELY, NOTEBOOK COMPUTERS, LAPTOP COMPUTERS, COMPUTER HARDWARE; COMPUTER SOFTWARE, NAMELY, COMPUTER APPLICATION SOFTWARE FOR MOBILE PHONES AND FOR DIGITAL CAMERAS AND COMPUTER GAME SOFTWARE, COMPUTER OPERATING SYSTEMS, AND DOWNLOADABLE ELECTRONIC PUBLICATIONS IN THE NATURE OF MAGAZINES AND JOURNALS IN THE FIELD OF SPORTS, GAMES, RECREATION, MUSIC, CLOTHING FASHION, TRAVEL, THEATRE, FILMS, CARTOONS, EDUCATION, HEALTH AND ECOLOGY; VIDEO DISKS AND VIDEO TAPES WITH RECORDED ANIMATED CARTOONS; PROTECTIVE HELMETS; DIVING HELMETS; SCUBA DIVING MASKS; DIVING SUITS, IN CLASS 9 (U.S. CLS. 21, 23, 26, 36 AND 38).

FOR: LAND VEHICLES; AIR AND WATER VEHICLES, NAMELY, HELICOPTERS, BOATS, AND STRUCTURAL PARTS THEREFOR; APPARATUS FOR LOCOMOTION BY LAND, AIR OR WATER, NAMELY, AUTOMOBILES, TRICYCLES, BI-

CYCLES, MOTORCYCLE SIDECARS; MOTORCYCLES; AUTOMOBILES; BOATS; PARTS AND ACCESSORIES FOR VEHICLES, NAMELY, WINDSHIELD WIPERS; SLEIGHS, IN CLASS 12 (U.S. CLS. 19, 21, 23, 31, 35 AND 44).

FOR: PRECIOUS METALS AND THEIR ALLOYS; GOODS IN PRECIOUS METALS OR COATED THEREWITH, NAMELY, AMULETS, BADGES, JEWELRY BOXES, BUCKLES FOR WATCHSTRAPS, JEWELRY CASES, KEY CHAINS, JEWELRY CHAINS, CHARMS, COLLECTIBLE COINS, COMMEMORATIVE COINS, PILLBOXES MADE OF PRECIOUS METAL, MEDALS, ORNAMENTAL PINS, ORNAMENTS, STATUETTES, WATCH STRAPS, TIE CLIPS, TIE PINS, CUFF LINKS, AND TRINKETS BEING JEWELRY; JEWELRY; PRECIOUS STONES; NECKLACES; BRACELETS; RINGS BEING JEWELRY; EARRINGS; ANKLE BRACELETS; PENDANTS; BROOCHES; WRISTWATCHES; POCKET WATCHES; TABLE CLOCKS; PENDULUM CLOCKS; HOROLOGICAL AND CHRONOMETRIC INSTRUMENTS, IN CLASS 14 (U.S. CLS. 2, 27, 28 AND 50).

FOR: PAPER; CARDBOARD; ARTICLES MADE FROM PAPER OR CARDBOARD, NAMELY, BOXES, CARTONS, LABELS, ADHESIVES FOR STATIONERY PURPOSES; PRINTED MAGAZINES, EVENT PROGRAMS AND PERIODICALS IN THE FIELD OF MOTORCYCLE RACING, SPORTS, GAMES, RECREATION, MUSIC, CLOTHING, FASHION, TRAVEL, THEATRE, FILMS, CARTOONS, EDUCATION, HEALTH AND ECOLOGY; PHOTOGRAPHS; STATIONERY, IN CLASS 16 (U.S. CLS. 2, 5, 22, 23, 29, 37, 38 AND 50).

FOR: LEATHER; IMITATION LEATHER SOLD IN BULK; GOODS MADE OF LEATHER AND IMITATION LEATHER, NAMELY, HATBOXES FOR TRAVEL NOT OF PAPER OR CARDBOARD, ANIMAL LEASHES, SHOULDER BELTS, STRAPS, THONGS, RIDING SADDLES AND VANITY CASES SOLD EMPTY; ANIMAL SKINS; TRUNKS; SUITCASES; BAGS, NAMELY, BACKPACKS, BEACH BAGS, HANDBAGS, HAVERSACKS, NET MESH BAGS FOR SHOPPING, POUCHES OF LEATHER OR FELT, PURSES, RUCKSACKS, SACHELS, SCHOOL BAGS, SCHOOL SACHELS, LEATHER SHOPPING BAGS, SLING BAGS FOR CARRYING INFANTS, TOOL BAGS SOLD EMPTY, TRAVELING BAGS, VALISES, AND WHEELED SHOPPING BAGS; WALLETS; BRIEFCASES; UMBRELLAS, PARASOLS; WALKING STICKS; PURSES MADE OF PRECIOUS METAL, IN CLASS 18 (U.S. CLS. 1, 2, 3, 22 AND 41).

FOR: CLOTHING, NAMELY, APRONS, ASCOTS, BABIES' PANTS, BANDANAS AND NECKERCHIEFS, BATHROBES, BATHING DRAWERS; BATHING SUITS, BATHING TRUNKS, BEACHWEAR, BOAS, BODICES, BRASSIERES, BREECHES, CAMISOLES, CAP PEAKS, CAPS, CHEMISETTES, GYMNASTICS WEAR, NAMELY, LEOTARDS, TRACK SUITS, COATS, TOPCOATS, CYCLIST CLOTHING, NAMELY, JERSEYS, SHORTS, PANTS, HATS, GLOVES, DRAWERS, DRESS SHIELDS, DRESSING GOWNS, FOOTMUFFS, FROCKS, FUR STOLES,

FUR COATS, GABARDINES, GARTER BELTS, GIRDLES, GLOVES, HOSIERY, JACKETS, JERSEYS, JUMPERS, KNITWEAR, NAMELY, SWEATERS, SCARVES, HATS, AND GLOVES, BODY LINEN, NAMELY, PANTIES AND UNDERWEAR, MITTENS, MONEY BELTS, MUFFS, NECKTIES, OUTERWEAR, NAMELY, COATS, RAINCOATS; OVERALLS, OVERCOATS, PAJAMAS, PANTS, PELERINES, PELISSES, PULLOVERS, SASHES, SCARVES, SHAWLS, SHIRT YOKES, SHIRTS, SHOULDER WRAPS, STOCKINGS, SUITS, SUNVISORS, SWEATERS, SWIMSUITS, TEDDIES, T-SHIRTS, TIGHTS, TROUSERS, UNDERGARMENTS, UNDERPANTS, UNDERWEAR, UNIFORMS, VEILS, VESTS, VISORS, WATERPROOF PANTS, WATERPROOF SHIRTS, WATERPROOF JACKETS, WATERPROOF COATS, RAIN SLICKERS, WIMPLES, AND WRISTBANDS; FOOTWEAR; HEADGEAR, NAMELY, HATS, BERETS, HOODS, SKULL CAPS, TOP HATS, TURBANS, AND HEADBANDS; GOODS MADE OF LEATHER AND IMITATION LEATHER, NAMELY, HEADBANDS, ARMBANDS, WRISTBANDS, SASHES, AND BELTS, IN CLASS 25 (U.S. CLS. 22 AND 39).

FOR: PLAYTHINGS, NAMELY, SOCCER BALLS, BASEBALLS, BASKET BALLS, GOLF BALLS, FOOTBALLS, CRICKET BALLS, TENNIS BALLS, GYMNASTICS EXERCISE BALLS, AND PLAY BALLOONS; TOYS, NAMELY BATH TOYS, DOLLS, PUPPETS; TOY MODEL VEHICLES; GYMNASTIC APPARATUS; SPORTING ARTICLES, NAMELY, BATTING GLOVES, BOB-SLEIGHS, BODY BOARDS, BODY-BUILDING APPARATUS, NAMELY WEIGHT WORK-OUT BENCHES, BODY TRAINING APPARATUS, NAMELY, ELLIPTICAL EXERCISE MACHINES, EXERCISE EQUIPMENT, NAMELY, STATIONARY CYCLES, ELECTRONIC SPORTS TRAINING SIMULATORS, NAMELY, SKI SIMULATORS AND JOGGING SIMULATORS, CHEST EXPANDERS, COVERS FOR SKI BINDINGS, ELBOW GUARDS FOR ATHLETIC USE, CHEST EXPANDERS, FLIPPERS FOR SWIMMING, SPORTS GLOVES, NAMELY, SOFTBALL GLOVES, BASEBALL GLOVES, BOXING GLOVES, GOLF GLOVES, GOLF CLUBS, TOY GUNS; SCUBA EQUIPMENT, NAMELY, SPEAR FISHING HARPOON GUNS AND SPEAR FISHING HARPOONS THEREFOR, HARNESES FOR SAILBOARDS, ICE SKATES, IN-LINE ROLLER SKATES, KNEE GUARDS FOR ATHLETIC USE, MACHINES FOR PHYSICAL EXERCISE, MASTS FOR SAILBOARDS, RACKETS, EXERCISE APPARATUS FOR THE BODY, NAMELY, TREADMILLS, ROWING MACHINES, ROLLER SKATES, SAILBOARDS FOR BOARD SAILING, SHINGUARDS FOR ATHLETIC USE, SKATEBOARDS, SKIS, PLAYGROUND EQUIPMENT, NAMELY, SLIDES, SNOWSHOES, STATIONARY EXERCISE BICYCLES, SURFBOARDS, SURF SKIS AND WATER SKIS; CHRISTMAS TREE DECORATIONS NOT INCLUDING CONFECTIONERY OR ILLUMINATION ARTICLES; PLAYING CARDS; HANG GLIDERS; GOLF CLUB BAGS, IN CLASS 28 (U.S. CLS. 22, 23, 38 AND 50).

FOR: TELECOMMUNICATIONS SERVICES, NAMELY PERSONAL COMMUNICATION SERVI-

CES, PROVIDING MULTIPLE USER DIAL-UP AND DEDICATED ACCESS TO THE INTERNET, PROVIDING REMOTE INTERNET ACCESS, PROVIDING MULTIPLE USER DIAL-UP AND DEDICATED ACCESS TO THE INTERNET INCLUDING PORTALS ON THE INTERNET, PROVIDING INTERNET CHATROOMS, INTERNET BASED VOICE CHAT SERVICES, ELECTRONIC MAIL SERVICES, WEB MESSAGING, COMPUTER-AIDED TRANSMISSION OF MESSAGES AND IMAGES; TELEPHONE COMMUNICATIONS SERVICES, IN CLASS 38 (U.S. CLS. 100, 101 AND 104).

OWNER OF ERPN CMNTY TM OFC REG. NO. 003276003, DATED 3-21-2005, EXPIRES 3-21-2015.

OWNER OF ERPN CMNTY TM OFC REG. NO. 004586624, DATED 8-3-2006, EXPIRES 8-3-2016.

THE COLOR(S) GREEN, ORANGE, BLUE, BLACK, RED AND DARK RED IS/ARE CLAIMED AS A FEATURE OF THE MARK.

THE MARK CONSISTS OF A GREEN CRESCENT MOON OUTLINED BY AN ORANGE STRIP INSIDE A BLUE STRIP ON A BLACK BACKGROUND ON THE LEFT SIDE. IN THE CENTER THERE IS A RED RECTANGLE WITH A SUN AND THE LETTERS VR BOTH IN DARK RED WITH A STYLIZED BLACK SUN OUTLINED BY AN ORANGE STRIP WITHIN A BLUE STRIP ON A GREEN BACKGROUND ON THE RIGHT SIDE. THE RAYS OF THE SUN ARE IN BLACK OUTLINED BY A BLUE STRIP WITHIN AN ORANGE STRIP ON A GREEN BACKGROUND.

SER. NO. 78-883,773, FILED 5-15-2006.

JAMES LOVELACE, EXAMINING ATTORNEY

Int. Cl.: 25

Prior U.S. Cls.: 22 and 39

United States Patent and Trademark Office

Reg. No. 3,484,981

Registered Aug. 12, 2008

**TRADEMARK
PRINCIPAL REGISTER**

**pink petshop
by bobbyjack**

J & F DESIGN, INC. (CALIFORNIA CORPORATION)
5578 BANDINI BLVD
BELL, CA 90201

THE NAME BOBBY JACK DOES NOT IDENTIFY
A LIVING INDIVIDUAL.

FOR: T-SHIRTS, IN CLASS 25 (U.S. CLS. 22 AND
39).

SER. NO. 78-885,035, FILED 5-16-2006.

FIRST USE 11-1-2004; IN COMMERCE 11-1-2004.

LINDA ORNDORFF, EXAMINING ATTORNEY

Int. Cls.: 9, 38 and 42

Prior U.S. Cls.: 21, 23, 26, 36, 38, 100, 101 and 104

Reg. No. 3,484,982

United States Patent and Trademark Office

Registered Aug. 12, 2008

**TRADEMARK
SERVICE MARK
PRINCIPAL REGISTER**

VSQI

TELEFONAKTIEBOLAGET L M ERICSSON
(SWEDEN CORPORATION)
SE-164 83
STOCKHOLM, SWEDEN

FOR: COMPUTER SOFTWARE FOR THIRD PARTY MANUFACTURERS FOR COMMUNICATIONS NETWORKS, TEST EQUIPMENT FOR COMMUNICATION NETWORKS AND IN TELECOMMUNICATIONS EQUIPMENT AND APPARATUS, NAMELY, SOFTWARE FOR EVALUATING THE QUALITY OF TRANSMISSION OF VIDEO, MULTIMEDIA AND OTHER SIGNALS; EQUIPMENT AND APPARATUS FOR TESTING, MONITORING AND/OR OPTIMIZING COMMUNICATIONS NETWORKS; HARDWARE FOR MONITORING AND MEASURING QUALITY, FOR USE IN TELEPHONE EXCHANGES AND COMMUNICATIONS NETWORKS; MOBILE PHONES, IN CLASS 9 (U.S. CLS. 21, 23, 26, 36 AND 38).

FOR: TELECOMMUNICATION SERVICES, NAMELY, MONITORING PERFORMANCE OF VIDEO STREAMING OVER HIGH-SPEED MOBILE TELEPHONE NETWORKS, AND TRANSMISSION OF DATA; CONSULTING IN THE FIELD OF TELECOMMUNICATIONS, IN CLASS 38 (U.S. CLS. 100, 101 AND 104).

FOR: PROGRAMMING COMPUTER SOFTWARE FOR USE IN DESIGNING, MEASURING AND OPTIMIZING THE QUALITY OF TELECOMMUNICATIONS NETWORKS AND EQUIPMENTS; CONSULTANCY SERVICES TO MANUFACTURERS OF COMMUNICATIONS NETWORKS, TEST EQUIPMENT OR NETWORK EQUIPMENT, RELATING TO DESIGNING, MEASURING AND/OR OPTIMIZING THE QUALITY OF NETWORKS AND NETWORK EQUIPMENTS , IN CLASS 42 (U.S. CLS. 100 AND 101).

THE MARK CONSISTS OF STANDARD CHARACTERS WITHOUT CLAIM TO ANY PARTICULAR FONT, STYLE, SIZE, OR COLOR.

PRIORITY CLAIMED UNDER SEC. 44(D) ON ERPN CMNTY TM OFC APPLICATION NO. 005103718, FILED 5-11-2006, REG. NO. 005103718, DATED 4-17-2007, EXPIRES 5-11-2016.

SER. NO. 78-890,070, FILED 5-23-2006.

NAAKWAMA ANKRAH, EXAMINING ATTORNEY

Int. Cl.: 21

Prior U.S. Cls.: 2, 13, 23, 29, 30, 33, 40 and 50

Reg. No. 3,484,983

United States Patent and Trademark Office

Registered Aug. 12, 2008

**TRADEMARK
PRINCIPAL REGISTER**

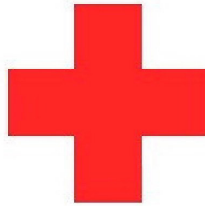

THE AMERICAN NATIONAL RED CROSS (UNI-
TED STATES FEDERALLY CHARTERED
NONPROFIT CORPORATION)
OFFICE OF THE GENERAL COUNSEL
2025 E STREET, N.W.
WASHINGTON, DC 20006

FOR: DISPOSABLE GLOVES FOR HOME USE;
DISPOSABLE LATEX GLOVES FOR GENERAL
USE; HOUSEHOLD GLOVES FOR GENERAL USE,
IN CLASS 21 (U.S. CLS. 2, 13, 23, 29, 30, 33, 40 AND 50).

FIRST USE 3-0-2006; IN COMMERCE 3-0-2006.

OWNER OF U.S. REG. NOS. 2,740,133, 2,818,967
AND OTHERS.

THE COLOR(S) RED IS/ARE CLAIMED AS A
FEATURE OF THE MARK.

THE MARK CONSISTS OF A RED CROSS.

SER. NO. 78-891,842, FILED 5-24-2006.

KHANH LE, EXAMINING ATTORNEY

Int. Cls.: 7, 9 and 42

**Prior U.S. Cls.: 13, 19, 21, 23, 26, 31, 34, 35, 36, 38, 100
and 101**

Reg. No. 3,484,984

United States Patent and Trademark Office

Registered Aug. 12, 2008

**TRADEMARK
SERVICE MARK
PRINCIPAL REGISTER**

FLEXICON

FLEXICON CORPORATION (NEW JERSEY CORPORATION)
2400 EMRICK BOULEVARD
BETHLEHEM, PA 180208006

FOR: BULK MATERIAL HANDLING AND PROCESSING EQUIPMENT IN THE NATURE OF FLEXIBLE SCREW CONVEYORS, MECHANICAL CONVEYORS, VOLUMETRIC FEEDERS FOR POWDERS AND BULK SOLIDS; AND BULK MATERIAL HANDLING AND PROCESSING SYSTEMS COMPRISING SOME OR ALL OF THE FOREGOING: CONTINUOUS BLENDING UNITS, HOPPERS AND HOPPERING AIDS; BULK BAG FILLERS, BULK BAG LOADING AND UNLOADING STATIONS; DRUM AND CONTAINER DUMPERS, MANUAL DUMPING STATIONS; PNEUMATIC CONVEYORS AND VACUUM CONVEYORS; PNEUMATIC CONVEYOR SYSTEMS COMPRISED OF SOME OR ALL OF THE FOLLOWING, NAMELY, PNEUMATIC CONVEYORS AND PARTS THEREFOR, NAMELY, PRESSURE BLOWERS, VACUUM PUMPS, ROTARY AIRLOCK VALVES, DIVERTERS, LINE DIVERTERS, FILTER RECEIVERS, CYCLONE SEPARATORS, WEIGHT BATCHING SYSTEMS, DUST COLLECTORS AND BIN VENTS, PICK-UP AND STORAGE VESSELS, IN CLASS 7 (U.S. CLS. 13, 19, 21, 23, 31, 34 AND 35).

FIRST USE 12-19-2000; IN COMMERCE 12-19-2000.

FOR: VOLUMETRIC METERING DEVICES FOR POWDERS AND BULK SOLIDS; AUTOMATED

BATCH WEIGHING SYSTEMS FOR POWDERS AND BULK SOLIDS COMPRISING THE PRINCIPAL COMPONENTS OF FLEXIBLE SCREW CONVEYORS, HOPPERS AND PROGRAMMABLE BATCH CONTROLLERS; AUTOMATIC VALVES; CONTROLS AND ELECTRICAL EQUIPMENT FOR OPERATING PNEUMATIC CONVEYORS AND CONVEYOR SYSTEMS AND STRUCTURAL PARTS THEREFOR, IN CLASS 9 (U.S. CLS. 21, 23, 26, 36 AND 38).

FIRST USE 12-19-2000; IN COMMERCE 12-19-2000.

FOR: TECHNOLOGY CONSULTATION, DESIGN AND CUSTOM ENGINEERING IN THE FIELD OF BULK MATERIAL HANDLING AND PROCESSING SYSTEMS, IN CLASS 42 (U.S. CLS. 100 AND 101).

FIRST USE 12-0-1974; IN COMMERCE 12-0-1974.

THE MARK CONSISTS OF STANDARD CHARACTERS WITHOUT CLAIM TO ANY PARTICULAR FONT, STYLE, SIZE, OR COLOR.

OWNER OF U.S. REG. NOS. 1,048,025 AND 1,682,650.

SER. NO. 78-894,305, FILED 5-26-2006.

REGINA DRUMMOND, EXAMINING ATTORNEY

Int. Cls.: 35 and 37

Prior U.S. Cls.: 100, 101, 102, 103 and 106

United States Patent and Trademark Office

Reg. No. 3,484,985

Registered Aug. 12, 2008

**SERVICE MARK
PRINCIPAL REGISTER**

Copier World

WORD PROCESSING INDUSTRIES, INC. (ILLINOIS CORPORATION)
4545 N. RAVENSWOOD
CHICAGO, IL 60640

FOR: RETAIL STORE SERVICES FEATURING COPY MACHINES AND RELATED EQUIPMENT AND ACCESSORIES, IN CLASS 35 (U.S. CLS. 100, 101 AND 102).

FIRST USE 1-1-1982; IN COMMERCE 1-1-1982.

FOR: MAINTENANCE AND REPAIR OF COPY MACHINES AND RELATED EQUIPMENT AND ACCESSORIES, IN CLASS 37 (U.S. CLS. 100, 103 AND 106).

FIRST USE 1-1-1982; IN COMMERCE 1-1-1982.

THE MARK CONSISTS OF STANDARD CHARACTERS WITHOUT CLAIM TO ANY PARTICULAR FONT, STYLE, SIZE, OR COLOR.

NO CLAIM IS MADE TO THE EXCLUSIVE RIGHT TO USE "COPIER", APART FROM THE MARK AS SHOWN.

SER. NO. 78-897,596, FILED 5-31-2006.

KEVON CHISOLM, EXAMINING ATTORNEY

Int. Cls.: 9 and 25

Prior U.S. Cls.: 21, 22, 23, 26, 36, 38 and 39

United States Patent and Trademark Office

Reg. No. 3,484,986

Registered Aug. 12, 2008

TRADEMARK
PRINCIPAL REGISTER



CINDY FOX FITNESS, LLC (NEW JERSEY LTD
LIAB CO)
169 BLUE HERON DRIVE
SECAUCUS, NJ 07094

FOR: PRE-RECORDED CD'S, AUDIO AND VIDEO CASSETTE TAPES, LASER DISCS AND DVD'S FEATURING FITNESS, EXERCISE, AND MUSIC, DANCING, AND/OR INSPIRATIONAL MATERIAL, NAMELY, MUSIC, DANCING AND/OR INSPIRATIONAL MATERIAL, IN CLASS 9 (U.S. CLS. 21, 23, 26, 36 AND 38).

FIRST USE 10-27-2005; IN COMMERCE 10-27-2005.

FOR: SHORT SLEEVED AND LONG SLEEVED T-SHIRTS, IN CLASS 25 (U.S. CLS. 22 AND 39).

FIRST USE 10-27-2005; IN COMMERCE 10-27-2005.

NO CLAIM IS MADE TO THE EXCLUSIVE RIGHT TO USE "FITNESS.COM", APART FROM THE MARK AS SHOWN.

THE NAME CINDY FOX IDENTIFIES A LIVING INDIVIDUAL WHOSE CONSENT IS OF RECORD.

THE COLOR(S) BROWN, ORANGE-BROWN, BLUE, YELLOW, WHITE AND BLACK IS/ARE CLAIMED AS A FEATURE OF THE MARK.

THE MARK CONSISTS OF A FOX HEAD IN ORANGE-BROWN; THE IRIS IN THE EYES IS BLUE, THE SCLERA IS WHITE AND THE HEAD-BAND IS BLUE WITH THE WORDING "CINDY FOX FITNESS.COM" IN WHITE; THE FUR INSIDE THE EARS, ON TOP OF NOSE, ON TOP OF HEAD, AND ON SIDES FACE IS YELLOW; THE TIP OF NOSE AND TRIM AROUND THE EARS ARE BROWN; AND THE ENTIRE MARK IS OUTLINED BLACK.

SER. NO. 78-902,325, FILED 6-6-2006.

MICHELE SWAIN, EXAMINING ATTORNEY

Int. Cl.: 9

Prior U.S. Cls.: 21, 23, 26, 36 and 38

Reg. No. 3,484,987

United States Patent and Trademark Office

Registered Aug. 12, 2008

**TRADEMARK
PRINCIPAL REGISTER**

REEL FX

REEL FX, INC. (TEXAS CORPORATION)
301 N. CROWDUS STREET
DALLAS, TX 75226

FIRST USE 9-0-2003; IN COMMERCE 9-0-2003.

FOR: PRE-RECORDED AUDIO AND VIDEO TAPES, CASSETTES AND CARTRIDGES IN THE FIELD OF ENTERTAINMENT; PRE-RECORDED AUDIO AND VIDEO DISCS IN THE FIELD OF ENTERTAINMENT; PHONOGRAPH RECORDS IN THE FIELD OF ENTERTAINMENT; COMPUTER PROGRAMS FOR PRE-RECORDED GAMES IN THE FIELD OF ENTERTAINMENT; MUSICAL SOUND RECORDINGS IN THE FIELD OF ENTERTAINMENT; AND PRE-RECORDED LASER DISCS, CDS, AND DVDS IN THE FIELD OF ENTERTAINMENT, IN CLASS 9 (U.S. CLS. 21, 23, 26, 36 AND 38).

THE MARK CONSISTS OF STANDARD CHARACTERS WITHOUT CLAIM TO ANY PARTICULAR FONT, STYLE, SIZE, OR COLOR.

OWNER OF U.S. REG. NO. 1,947,610.

NO CLAIM IS MADE TO THE EXCLUSIVE RIGHT TO USE "FX", APART FROM THE MARK AS SHOWN.

SER. NO. 78-902,806, FILED 6-7-2006.

INGA ERVIN, EXAMINING ATTORNEY

Int. Cl.: 36

Prior U.S. Cls.: 100, 101 and 102

United States Patent and Trademark Office

Reg. No. 3,484,988

Registered Aug. 12, 2008

**SERVICE MARK
PRINCIPAL REGISTER**

NCF GIVING FUND

NATIONAL CHRISTIAN CHARITABLE FOUNDATION, INC. (GEORGIA NON-PROFIT CORPORATION)
1100 JOHNSON FERRY RD., SUITE 900
ATLANTA, GA 30342

FOR: CHARITABLE FUND RAISING SERVICES; DONOR-ADVISED INVESTMENT OF FUNDS FOR CHARITABLE PURPOSES; CHARITABLE FUND MANAGEMENT, NAMELY, ACCEPTING AND ADMINISTERING MONETARY CHARITABLE CONTRIBUTIONS; RAISING AND DISTRIBUTING CHARITABLE FUNDS; MANAGING DONOR-ADVISED FUNDS FOR CHARITABLE PURPOSES; MANAGING ENDOWMENT FUNDS FOR CHARITABLE PURPOSES; ADMINISTRATION OF PRIVATE FOUNDATIONS IN CONNECTION WITH PHILANTHROPIC CONTRIBUTIONS FOR CHARITABLE PURPOSES; FINANCIAL CONSULTATION, NAMELY, INVESTMENT CONSULTING IN THE FIELD OF DONOR-ADVISED FUNDS AND PHILANTHROPIC CONTRIBUTIONS FOR CHARITABLE PURPOSES; PROVIDING INFORMATION IN

THE FIELDS OF DONOR-ADVISED FUNDS FOR CHARITABLE PURPOSES, PHILANTHROPIC CONTRIBUTIONS FOR CHARITABLE PURPOSES, AND CHARITABLE FUND MANAGEMENT NAMELY, ACCEPTING AND ADMINISTERING MONETARY CHARITABLE CONTRIBUTIONS, IN CLASS 36 (U.S. CLS. 100, 101 AND 102).

FIRST USE 3-0-2006; IN COMMERCE 3-0-2006.

THE MARK CONSISTS OF STANDARD CHARACTERS WITHOUT CLAIM TO ANY PARTICULAR FONT, STYLE, SIZE, OR COLOR.

NO CLAIM IS MADE TO THE EXCLUSIVE RIGHT TO USE "GIVING FUND", APART FROM THE MARK AS SHOWN.

SER. NO. 78-903,758, FILED 6-8-2006.

WILLIAM ROSSMAN, EXAMINING ATTORNEY

Int. Cl.: 33

Prior U.S. Cls.: 47 and 49

United States Patent and Trademark Office

Reg. No. 3,484,989

Registered Aug. 12, 2008

**TRADEMARK
PRINCIPAL REGISTER**

HICKINBOTHAM

BRATASIUK, ROMAN (AUSTRALIA INDIVIDUAL)
363 THE PARADE
KENSINGTON PARK, AUSTRALIA 5065

FOR: TABLE WINES; WINE, IN CLASS 33 (U.S. CLS. 47 AND 49).

FIRST USE 0-0-1996; IN COMMERCE 0-0-1996.

THE MARK CONSISTS OF STANDARD CHARACTERS WITHOUT CLAIM TO ANY PARTICULAR FONT, STYLE, SIZE, OR COLOR.

SEC. 2(F).

SER. NO. 78-907,575, FILED 6-14-2006.

MICHAEL WEBSTER, EXAMINING ATTORNEY

Int. Cl.: 3

Prior U.S. Cls.: 1, 4, 6, 50, 51 and 52

United States Patent and Trademark Office

Reg. No. 3,484,990

Registered Aug. 12, 2008

**TRADEMARK
PRINCIPAL REGISTER**

AVENA INSTITUTO ESPANOL

INSTITUTO ESPANOL S.A. (SPAIN SOCIEDAD ANONIMA)
POLIGONO INDUSTRIAL LAS DUENAS, NAVE 1
HINOJOS (HUELVA), SPAIN

FOR: BATH AND SHOWER GEL, LIQUID SOAP, SKIN MOISTURIZING CREAM, PERSONAL DEODORANT, HAND AND BODY LOTION, IN CLASS 3 (U.S. CLS. 1, 4, 6, 50, 51 AND 52).

FIRST USE 6-30-1997; IN COMMERCE 6-30-1997.

THE MARK CONSISTS OF STANDARD CHARACTERS WITHOUT CLAIM TO ANY PARTICULAR FONT, STYLE, SIZE, OR COLOR.

NO CLAIM IS MADE TO THE EXCLUSIVE RIGHT TO USE "AVENA", APART FROM THE MARK AS SHOWN.

THE FOREIGN WORDING IN THE MARK TRANSLATES INTO ENGLISH AS OAT SPANISH INSTITUTE.

SER. NO. 78-908,000, FILED 6-14-2006.

DAYNA BROWNE, EXAMINING ATTORNEY

Int. Cl.: 33

Prior U.S. Cls.: 47 and 49

United States Patent and Trademark Office

Reg. No. 3,484,991

Registered Aug. 12, 2008

**TRADEMARK
PRINCIPAL REGISTER**

BROOKMAN

BRATASIUK, ROMAN (AUSTRALIA INDIVIDUAL)
363 THE PARADE
KENSINGTON PARK, AUSTRALIA 5068

FOR: WINES, INCLUDING TABLE WINES, IN
CLASS 33 (U.S. CLS. 47 AND 49).

FIRST USE 0-0-1996; IN COMMERCE 0-0-1996.

THE MARK CONSISTS OF STANDARD CHARACTERS WITHOUT CLAIM TO ANY PARTICULAR FONT, STYLE, SIZE, OR COLOR.

SEC. 2(F).

SER. NO. 78-908,540, FILED 6-14-2006.

HANNO RITTNER, EXAMINING ATTORNEY

Int. Cls.: 3 and 5

Prior U.S. Cls.: 1, 4, 6, 18, 44, 46, 50, 51 and 52

United States Patent and Trademark Office

Reg. No. 3,484,992

Registered Aug. 12, 2008

**TRADEMARK
PRINCIPAL REGISTER**

OPTIGENEX^X

OPTIGENEX, INC. (DELAWARE CORPORATION)
750 LEXINGTON AVE.
NEW YORK, NY 10022

OWNER OF U.S. REG. NOS. 2,635,190, 2,707,026,
AND 3,000,287.

FOR: TOPICAL SKIN CREAMS AND LOTIONS,
IN CLASS 3 (U.S. CLS. 1, 4, 6, 50, 51 AND 52).

THE MARK CONSISTS OF THE LITERAL ELEMENT WITH A LETTER "X" OVER THE LETTER "X" OF THE LITERAL ELEMENT.

FIRST USE 3-1-2006; IN COMMERCE 3-1-2006.

FOR: VITAMIN SUPPLEMENTS, IN CLASS 5 (U.S. CLS. 6, 18, 44, 46, 51 AND 52).

SER. NO. 78-909,998, FILED 6-16-2006.

FIRST USE 10-30-2003; IN COMMERCE 10-30-2003.

TIMOTHY FINNEGAN, EXAMINING ATTORNEY

Int. Cl.: 42

Prior U.S. Cls.: 100 and 101

United States Patent and Trademark Office

Reg. No. 3,484,993

Registered Aug. 12, 2008

**SERVICE MARK
PRINCIPAL REGISTER**

2unify

2UNIFY LLC (PENNSYLVANIA LTD LIAB CO)
3135 MARION AVENUE, SUITE 200
LAURELDALE, PA 19605

FIRST USE 1-30-2006; IN COMMERCE 4-28-2006.

FOR: COMPUTER SERVICE, NAMELY, ACTING AS AN APPLICATION SERVICE PROVIDER IN THE FIELD OF KNOWLEDGE MANAGEMENT TO HOST COMPUTER APPLICATION SOFTWARE FOR THE COLLECTION, EDITING, ORGANIZING, MODIFYING, BOOK MARKING, TRANSMISSION, STORAGE AND SHARING OF DATA AND INFORMATION, IN CLASS 42 (U.S. CLS. 100 AND 101).

THE MARK CONSISTS OF STANDARD CHARACTERS WITHOUT CLAIM TO ANY PARTICULAR FONT, STYLE, SIZE, OR COLOR.

SER. NO. 78-910,161, FILED 6-16-2006.

AMY GEARIN, EXAMINING ATTORNEY

Int. Cl.: 42

Prior U.S. Cls.: 100 and 101

Reg. No. 3,484,994

United States Patent and Trademark Office

Registered Aug. 12, 2008

**SERVICE MARK
PRINCIPAL REGISTER**



2UNIFY LLC (PENNSYLVANIA LTD LIAB CO)
3135 MARION AVENUE, SUITE 200
LAURELDALE, PA 19605

THE COLOR(S) GREEN, ORANGE AND WHITE
IS/ARE CLAIMED AS A FEATURE OF THE MARK.

FOR: COMPUTER SERVICE, NAMELY, ACTING
AS AN APPLICATION SERVICE PROVIDER IN THE
FIELD OF KNOWLEDGE MANAGEMENT TO
HOST COMPUTER APPLICATION SOFTWARE
FOR THE COLLECTION, EDITING, ORGANIZING,
MODIFYING, BOOK MARKING, TRANSMISSION,
STORAGE AND SHARING OF DATA AND INFOR-
MATION, IN CLASS 42 (U.S. CLS. 100 AND 101).

THE MARK CONSISTS OF THE WORD,
"2UNIFY" IN GREEN LETTERING SUPERIM-
POSED OVER THE WORD, "2UNIFY" IN WHITE
AND ORANGE LETTERING.

SER. NO. 78-910,206, FILED 6-16-2006.

FIRST USE 1-30-2006; IN COMMERCE 4-28-2006.

AMY GEARIN, EXAMINING ATTORNEY

Int. Cls.: 10, 25 and 28

Prior U.S. Cls.: 22, 23, 26, 38, 39, 44 and 50

United States Patent and Trademark Office

Reg. No. 3,484,995

Registered Aug. 12, 2008

**TRADEMARK
PRINCIPAL REGISTER**



HOSUNG NY TRADING INC (NEW YORK CORPORATION)
300 KINGSLAND AVENUE
BROOKLYN, NY 11222

FOR: TEETHING RINGS INCORPORATING BABY RATTLES, BABY NURSERS, PACIFIERS FOR BABIES, ALL MADE OF ORGANIC MATERIALS, IN CLASS 10 (U.S. CLS. 26, 39 AND 44).

FIRST USE 10-1-2004; IN COMMERCE 10-1-2004.

FOR: CHILDREN'S AND INFANTS' CLOTH BIBS, CHILDREN'S CLOTH EATING BIBS, CHILDREN'S HEADWEAR, INFANT WEAR, ALL MADE OF ORGANIC MATERIALS, IN CLASS 25 (U.S. CLS. 22 AND 39).

FIRST USE 10-1-2004; IN COMMERCE 10-1-2004.

FOR: CRIB TOYS, DOG TOYS, INFANT TOYS, INFANT'S RATTLES, MUSICAL TOYS, PET TOYS, PLUSH TOYS, SQUEEZABLE SQUEAKING TOYS, SQUEEZE TOYS, STUFFED PUPPETS, STUFFED TOY ANIMALS, STUFFED TOYS, ALL MADE OF ORGANIC MATERIALS, IN CLASS 28 (U.S. CLS. 22, 23, 38 AND 50).

FIRST USE 10-1-2004; IN COMMERCE 10-1-2004.

NO CLAIM IS MADE TO THE EXCLUSIVE RIGHT TO USE "ORGANIC", APART FROM THE MARK AS SHOWN.

THE COLOR(S) GREEN, LIGHT GREEN, WHITE AND YELLOW IS/ARE CLAIMED AS A FEATURE OF THE MARK.

THE MARK CONSISTS OF AN OUTER OUTLINE LOGO IN A SQUARE SHAPE IN THE COLOR GREEN WITH LIGHT GREEN BORDER. THE STYLIZED WORD "MIYIM" IS IN THE COLOR WHITE WITH DOTS ON THE LETTER "I" IN YELLOW. "MIYIM" IS UNDERLINED WITH A YELLOW COLORED LINE. THE STYLIZED WORD "SIMPLY ORGANIC" IS IN WHITE AND IN ALL CAPS.

THE FOREIGN WORDING IN THE MARK TRANSLATES INTO ENGLISH AS "WATER".

SER. NO. 78-910,455, FILED 6-16-2006.

DAVID MURRAY, EXAMINING ATTORNEY

Int. Cls.: 9 and 16

Prior U.S. Cls.: 2, 5, 21, 22, 23, 26, 29, 36, 37, 38 and 50

United States Patent and Trademark Office

Reg. No. 3,484,996

Registered Aug. 12, 2008

**TRADEMARK
PRINCIPAL REGISTER**

WORLD IMPACT

WORLD IMPACT, INC. (CALIFORNIA NON-
PROFIT CORPORATION)
2001 SOUTH VERMONT AVENUE
LOS ANGELES, CA 90007

FOR: PRE-RECORDED CD'S, VIDEOTAPES,
DVD'S, AND FILM FEATURING WORSHIP AND
GOSPEL MUSIC AND TOPICS IN THE AREA OF
CHRISTIANITY, BIBLE INSTRUCTION, EVANGE-
LISM AND DISCIPLESHIP, IN CLASS 9 (U.S. CLS. 21,
23, 26, 36 AND 38).

FIRST USE 10-18-1978; IN COMMERCE 10-18-1978.

FOR: SERIES OF NON-FICTION BOOKS, BOOK-
LETS, AND PUBLICATIONS, NAMELY, PAMPH-
LETS, BROCHURES, NEWSLETTERS, AND

CATALOGS IN THE FIELD OF CHRISTIANITY
AND BIBLE INSTRUCTION., IN CLASS 16 (U.S.
CLS. 2, 5, 22, 23, 29, 37, 38 AND 50).

FIRST USE 12-1-1971; IN COMMERCE 12-1-1971.

THE MARK CONSISTS OF STANDARD CHAR-
ACTERS WITHOUT CLAIM TO ANY PARTICULAR
FONT, STYLE, SIZE, OR COLOR.

OWNER OF U.S. REG. NO. 2,362,575.

SER. NO. 78-912,280, FILED 6-20-2006.

BARBARA RUTLAND, EXAMINING ATTORNEY

Int. Cls.: 41, 43, 44 and 45

Prior U.S. Cls.: 100, 101 and 107

United States Patent and Trademark Office

Reg. No. 3,484,997

Registered Aug. 12, 2008

**SERVICE MARK
PRINCIPAL REGISTER**

WORLD IMPACT

WORLD IMPACT, INC. (CALIFORNIA NON-PROFIT CORPORATION)
2001 SOUTH VERMONT AVENUE
LOS ANGELES, CA 90007

FOR: RELIGIOUS INSTRUCTION SERVICES IN THE FIELD OF CHRISTIAN DISCIPLESHIP; EDUCATIONAL SERVICES, NAMELY, CONDUCTING CLASSES, CONFERENCES, SEMINARS, WORKSHOPS IN THE FIELD OF CHRISTIAN EDUCATION, BIBLE INSTRUCTION, EVANGELISM AND DISCIPLESHIP AND DISTRIBUTION OF COURSE MATERIALS IN CONNECTION THEREWITH; BASIC VOCATIONAL GUIDANCE; EDUCATIONAL SERVICES, NAMELY, PROVIDING COURSES OF INSTRUCTIONS AT THE PRIMARY LEVEL AND DISTRIBUTION OF COURSE MATERIALS IN CONNECTION THEREWITH; RECREATIONAL CAMPS; RECREATIONAL SERVICES IN THE NATURE OF SPORTS PROGRAMS, ARTS AND CRAFTS PROGRAMS, AND GAMES; CHARITABLE SERVICES, NAMELY, ACADEMIC MENTORING OF SCHOOL-AGE CHILDREN, IN CLASS 41 (U.S. CLS. 100, 101 AND 107).

FIRST USE 3-31-1971; IN COMMERCE 3-31-1971.

FOR: CHARITABLE SERVICES, NAMELY, PROVIDING FOOD TO NEEDY PERSONS; AND PROVIDING TEMPORARY HOUSING, IN CLASS 43 (U.S. CLS. 100 AND 101).

FIRST USE 3-31-1971; IN COMMERCE 3-31-1971.

FOR: CHARITABLE SERVICES, NAMELY, PROVIDING MEDICAL AND DENTIST AND DENTAL HYGIENIST SERVICES TO NEEDY PERSONS, IN CLASS 44 (U.S. CLS. 100 AND 101).

FIRST USE 3-31-1971; IN COMMERCE 3-31-1971.

FOR: CHARITABLE SERVICES, NAMELY, PROVIDING CLOTHING TO NEEDY PERSONS; EVANGELISTIC AND MINISTERIAL SERVICES, EVANGELISTIC MINISTERIAL SERVICES IN THE NATURE OF EVANGELISTIC CRUSADES AND ESTABLISHMENT OF EVANGELICAL CHURCHES, IN CLASS 45 (U.S. CLS. 100 AND 101).

FIRST USE 3-31-1971; IN COMMERCE 3-31-1971.

THE MARK CONSISTS OF STANDARD CHARACTERS WITHOUT CLAIM TO ANY PARTICULAR FONT, STYLE, SIZE, OR COLOR.

OWNER OF U.S. REG. NO. 2,362,575.

SER. NO. 78-912,582, FILED 6-20-2006.

BARBARA RUTLAND, EXAMINING ATTORNEY

Int. Cls.: 16 and 41

Prior U.S. Cls.: 2, 5, 22, 23, 29, 37, 38, 50, 100, 101 and 107

Reg. No. 3,484,998

United States Patent and Trademark Office

Registered Aug. 12, 2008

**TRADEMARK
SERVICE MARK
PRINCIPAL REGISTER**

**BIBLICAL PERSPECTIVES ON
CURRENT EVENTS**

UNITED CHURCH OF GOD, AN INTERNATIONAL ASSOCIATION (CALIFORNIA NON-POFIT RELIGIOUS CORPORATION)
555 TECHNECENTER DRIVE
MILFORD, OH 45150

FOR: PUBLICATIONS, NAMELY, A SERIES OF MAGAZINES CONCERNING INSPIRATIONAL, MOTIVATIONAL, POLITICAL AND RELIGIOUS ISSUES, IN CLASS 16 (U.S. CLS. 2, 5, 22, 23, 29, 37, 38 AND 50).

FIRST USE 8-0-1998; IN COMMERCE 8-0-1998.

FOR: ONLINE PUBLICATIONS, NAMELY, PERIODICALS AND MAGAZINES CONCERNING INSPIRATIONAL, MOTIVATIONAL, POLITICAL AND

RELIGIOUS ISSUES, IN CLASS 41 (U.S. CLS. 100, 101 AND 107).

FIRST USE 8-0-1998; IN COMMERCE 8-0-1998.

THE MARK CONSISTS OF STANDARD CHARACTERS WITHOUT CLAIM TO ANY PARTICULAR FONT, STYLE, SIZE, OR COLOR.

NO CLAIM IS MADE TO THE EXCLUSIVE RIGHT TO USE "BIBLICAL" AND "CURRENT EVENTS", APART FROM THE MARK AS SHOWN.

SER. NO. 78-912,855, FILED 6-21-2006.

RAMONA ORTIGA, EXAMINING ATTORNEY

Int. Cls.: 9, 16, 25 and 41

**Prior U.S. Cls.: 2, 5, 21, 22, 23, 26, 29, 36, 37, 38, 39,
50, 100, 101 and 107**

Reg. No. 3,484,999

United States Patent and Trademark Office

Registered Aug. 12, 2008

**TRADEMARK
SERVICE MARK
PRINCIPAL REGISTER**

**STUPID, UGLY, UNLUCKY, AND
RICH**

TRAIN OF THOUGHT ARTS, INC. (CANADA
COMPANY)
230 NIAGARA STREET
TORONTO, ONTARIO, CANADA M6J 2L4

FOR: PRERECORDED VIDEO AND AUDIO
TAPES, COMPACT DISCS, DVDS, AND CD-ROMS
FEATURING EDUCATIONAL AND MOTIVATION-
AL MATERIALS CONCERNING THE FACTORS
THAT LEAD TO SUCCESS; ELECTRONIC COMPU-
TER NOTEPADS; ELECTRONIC PUBLICATIONS,
NAMELY, BOOKS AND MAGAZINES ON THE
FACTORS THAT LEAD TO SUCCESS RECORDED
ON COMPUTER MEDIA; MOTION PICTURE FILMS
AND AUDIOVISUAL RECORDINGS ON THE FAC-
TORS THAT LEAD TO SUCCESS, IN CLASS 9 (U.S.
CLS. 21, 23, 26, 36 AND 38).

FOR: BOOKS, PAMPHLETS, PRINTED CARDS,
RESEARCH PAPERS, BROCHURES, GREETING
CARDS, CALENDARS AND ALBUMS ON THE
FACTORS THAT LEAD TO SUCCESS , IN CLASS
16 (U.S. CLS. 2, 5, 22, 23, 29, 37, 38 AND 50).

FOR: CLOTHING, NAMELY, HATS, T-SHIRTS,
SWEATSHIRTS, GOLF SHIRTS, JACKETS, CASUAL
PANTS AND UNIFORMS, IN CLASS 25 (U.S. CLS. 22
AND 39).

FOR: EDUCATIONAL AND MOTIVATIONAL
SERVICES, NAMELY, WORKSHOPS, SEMINARS,
AND LECTURES ON THE FACTORS THAT LEAD
TO SUCCESS; INTERNET SERVICES, NAMELY,
PROVIDING INFORMATION VIA A GLOBAL
ELECTRONIC NETWORK FEATURING EDUCA-
TIONAL AND MOTIVATIONAL MATERIALS CON-
CERNING THE FACTORS THAT LEAD TO
SUCCESS; PUBLICATION OF ELECTRONIC BOOKS
AND MAGAZINES, IN CLASS 41 (U.S. CLS. 100, 101
AND 107).

THE MARK CONSISTS OF STANDARD CHAR-
ACTERS WITHOUT CLAIM TO ANY PARTICULAR
FONT, STYLE, SIZE, OR COLOR.

PRIORITY CLAIMED UNDER SEC. 44(D) ON
CANADA APPLICATION NO. 1302125, FILED 5-18-
2006, REG. NO. TMA705,371, DATED 1-23-2008, EX-
PIRES 1-23-2023.

SER. NO. 78-913,174, FILED 6-21-2006.

ALICIA COLLINS, EXAMINING ATTORNEY

Int. Cl.: 25

Prior U.S. Cls.: 22 and 39

United States Patent and Trademark Office

Reg. No. 3,485,000

Registered Aug. 12, 2008

**TRADEMARK
PRINCIPAL REGISTER**

G5

G5 OUTDOORS, LLC (MICHIGAN LTD LIAB CO)
34775 POTTER ST.
PO BOX 59
MEMPHIS, MI 48041

THE MARK CONSISTS OF STANDARD CHAR-
ACTERS WITHOUT CLAIM TO ANY PARTICULAR
FONT, STYLE, SIZE, OR COLOR.

FOR: CLOTHING, NAMELY, SHIRTS, T-SHIRTS,
JACKETS, AND HATS, IN CLASS 25 (U.S. CLS. 22
AND 39).

SER. NO. 78-913,585, FILED 6-21-2006.

FIRST USE 3-27-2003; IN COMMERCE 3-27-2003.

LANA PHAM, EXAMINING ATTORNEY

Int. Cls.: 9, 36 and 41

Prior U.S. Cls.: 21, 23, 26, 36, 38, 100, 101, 102 and 107

Reg. No. 3,485,001

United States Patent and Trademark Office

Registered Aug. 12, 2008

**TRADEMARK
SERVICE MARK
PRINCIPAL REGISTER**

PARADISE POKER

INTERNET OPPORTUNITY ENTERTAINMENT
(SPORTS) LTD. (ANTIGUA & BARBUDA LTD
LIAB CO)
C/O CORPORATE & TRUST SERVICES
PO BOX 990 FD ICIC BLDG LOWER FACTORY
ROAD
ST JOHNS, ANTIGUA & BARBUDA

FOR: COMPUTER SOFTWARE FOR USE IN
CONNECTION WITH BETTING, GAMBLING,
GAMING, AND CASINO GAMING SERVICES,
THAT IS DOWNLOADED FROM A REMOTE COM-
PUTER SITE, IN CLASS 9 (U.S. CLS. 21, 23, 26, 36 AND
38).

FIRST USE 9-30-1999; IN COMMERCE 9-30-1999.

FOR: FINANCIAL SERVICES RENDERED IN
CONNECTION WITH BETTING, GAMBLING,
GAMING, AND CASINO GAMING SERVICES VIA
THE INTERNET, NAMELY, CASH ACCESS SERVI-
CES IN THE NATURE OF ELECTRONIC CASH
TRANSACTIONS AND CASH DISBURSEMENT
SERVICES, NAMELY, CASH REPLACEMENT REN-
DERED BY CREDIT CARDS AND DEBIT CARDS,
CREDIT CARD SERVICES, CHECK CASHING AND
AUTOMATED CLEARING HOUSE SERVICES, IN
CLASS 36 (U.S. CLS. 100, 101 AND 102).

FIRST USE 9-30-1999; IN COMMERCE 9-30-1999.

FOR: ENTERTAINMENT SERVICES, NAMELY,
ORGANIZING, CONDUCTING AND PROVIDING
ONLINE AND WIRELESS GAMING SERVICES VIA
THE INTERNET; PROVIDING GAMING NEWS
AND INFORMATION VIA THE INTERNET; BET-
TING SERVICES; GAMBLING SERVICES; GAMING
SERVICES; CASINO GAMING SERVICES; PROVID-
ING ONLINE SERVICES TO OTHERS TO ENABLE
PARTICIPANTS TO WAGER ON SPORTING
EVENTS; INTERNET WAGERING SERVICES; AND
PROVIDING WEBSITES FOR WAGERING, IN
CLASS 41 (U.S. CLS. 100, 101 AND 107).

FIRST USE 9-30-1999; IN COMMERCE 9-30-1999.

THE MARK CONSISTS OF STANDARD CHAR-
ACTERS WITHOUT CLAIM TO ANY PARTICULAR
FONT, STYLE, SIZE, OR COLOR.

PRIORITY CLAIMED UNDER SEC. 44(D) ON
ERPNTY CMNTY TM OFC APPLICATION NO.
005112719, FILED 6-6-2006.

NO CLAIM IS MADE TO THE EXCLUSIVE
RIGHT TO USE "POKER" , APART FROM THE
MARK AS SHOWN.

SER. NO. 78-914,739, FILED 6-22-2006.

BRIDGETT SMITH, EXAMINING ATTORNEY

Int. Cls.: 9, 36 and 41

Prior U.S. Cls.: 21, 23, 26, 36, 38, 100, 101, 102 and 107

United States Patent and Trademark Office

Reg. No. 3,485,002

Registered Aug. 12, 2008

**TRADEMARK
SERVICE MARK
PRINCIPAL REGISTER**



INTERNET OPPORTUNITY ENTERTAINMENT
(SPORTS) LTD. (ANTIGUA & BARBUDA LTD
LIAB CO)

C/O CORPORATE & TRUST SERVICES
PO BOX 990 FD ICIC BLDG LOWER FACTORY
ROAD
ST JOHNS, ANTIGUA & BARBUDA

FOR: COMPUTER SOFTWARE FOR USE IN
CONNECTION WITH BETTING, GAMBLING,
GAMING, AND CASINO GAMING SERVICES,
THAT IS DOWNLOADED FROM A REMOTE COM-
PUTER SITE, IN CLASS 9 (U.S. CLS. 21, 23, 26, 36 AND
38).

FIRST USE 9-30-1999; IN COMMERCE 9-30-1999.

FOR: FINANCIAL SERVICES RENDERED IN
CONNECTION WITH BETTING, GAMBLING,
GAMING, AND CASINO GAMING SERVICES VIA
THE INTERNET, NAMELY, CASH ACCESS SERVIC-
ES IN THE NATURE OF ELECTRONIC CASH
TRANSACTIONS AND CASH DISBURSEMENT
SERVICES, NAMELY, CASH REPLACEMENT REND-
ERED BY CREDIT CARDS AND DEBIT CARDS,
CREDIT CARD SERVICES, CHECK CASHING AND

AUTOMATED CLEARING HOUSE SERVICES, IN
CLASS 36 (U.S. CLS. 100, 101 AND 102).

FIRST USE 9-30-1999; IN COMMERCE 9-30-1999.

FOR: ENTERTAINMENT SERVICES, NAMELY,
ORGANIZING, CONDUCTING AND PROVIDING
ONLINE AND WIRELESS GAMING SERVICES VIA
THE INTERNET; PROVIDING GAMING NEWS
AND INFORMATION VIA THE INTERNET; BET-
TING SERVICES; GAMBLING SERVICES; GAMING
SERVICES; CASINO GAMING SERVICES; PROVID-
ING ONLINE SERVICES TO OTHERS TO ENABLE
PARTICIPANTS TO WAGER ON SPORTING
EVENTS, IN CLASS 41 (U.S. CLS. 100, 101 AND 107).

FIRST USE 9-30-1999; IN COMMERCE 9-30-1999.

PRIORITY CLAIMED UNDER SEC. 44(D) ON
CANADA APPLICATION NO. 1287066, FILED 1-23-
2006.

SER. NO. 78-914,784, FILED 6-22-2006.

BRIDGETT SMITH, EXAMINING ATTORNEY

Int. Cls.: 9 and 41

Prior U.S. Cls.: 21, 23, 26, 36, 38, 100, 101 and 107

Reg. No. 3,485,003

United States Patent and Trademark Office

Registered Aug. 12, 2008

**TRADEMARK
SERVICE MARK
PRINCIPAL REGISTER**



INTERNET OPPORTUNITY ENTERTAINMENT
(SPORTS) LTD. (ANTIGUA & BARBUDA LTD
LIAB CO)
C/O CORPORATE & TRUST SERVICES
PO BOX 990 FD ICIC BLDG LOWER FACTORY
ROAD
ST JOHNS, ANTIGUA & BARBUDA

FOR: COMPUTER SOFTWARE FOR USE IN
CONNECTION WITH BETTING, GAMBLING,
GAMING, AND CASINO GAMING SERVICES,
THAT IS DOWNLOADED FROM A REMOTE COM-
PUTER SITE, IN CLASS 9 (U.S. CLS. 21, 23, 26, 36 AND
38).

FIRST USE 9-30-1999; IN COMMERCE 9-30-1999.

FOR: ENTERTAINMENT SERVICES, NAMELY,
ORGANIZING, CONDUCTING AND PROVIDING
ONLINE AND WIRELESS GAMING SERVICES VIA
THE INTERNET; PROVIDING GAMING NEWS

AND INFORMATION VIA THE INTERNET; BET-
TING SERVICES; GAMBLING SERVICES; GAMING
SERVICES; CASINO GAMING SERVICES; PROVID-
ING ONLINE SERVICES TO OTHERS TO ENABLE
PARTICIPANTS TO WAGER ON SPORTING
EVENTS, IN CLASS 41 (U.S. CLS. 100, 101 AND 107).

FIRST USE 9-30-1999; IN COMMERCE 9-30-1999.

PRIORITY CLAIMED UNDER SEC. 44(D) ON
CANADA APPLICATION NO. 1288326, FILED 2-2-
2006.

NO CLAIM IS MADE TO THE EXCLUSIVE
RIGHT TO USE "POKER" AND ".NET", APART
FROM THE MARK AS SHOWN.

SER. NO. 78-914,883, FILED 6-22-2006.

BRIDGETT SMITH, EXAMINING ATTORNEY

Int. Cls.: 9, 16, 35, 38 and 42

**Prior U.S. Cls.: 2, 5, 21, 22, 23, 26, 29, 36, 37, 38, 50,
100, 101, 102 and 104**

Reg. No. 3,485,004

United States Patent and Trademark Office

Registered Aug. 12, 2008

**TRADEMARK
SERVICE MARK
PRINCIPAL REGISTER**

MUNDO MOVISTAR

TELEFONICA, S.A. (SPAIN CORPORATION)
GRAN VIA, 28
28013 MADRID, SPAIN

FOR: SCIENTIFIC, NAUTICAL, SURVEYING, PHOTOGRAPHIC, CINEMATOGRAPHIC, OPTICAL, WEIGHING, MEASURING, SIGNALING, CHECKING, LIFE-SAVING AND TEACHING APPARATUS AND INSTRUMENTS, NAMELY, CAMERAS, DIGITAL CAMERAS, MOVIE CAMERAS, MOTION PICTURE CAMERAS, SCALES, TELESCOPES, MICROSCOPES, FIBER OPTICS; APPARATUS AND INSTRUMENTS FOR CONDUCTING, SWITCHING, TRANSFORMING, ACCUMULATING, REGULATING OR CONTROLLING ELECTRICITY, NAMELY, ELECTRICAL TRANSFORMERS, INTEGRATED CIRCUITS, GENERATORS, BATTERIES, ELECTRIC WIRES, MICROCIRCUITS, CIRCUIT BOARDS, BATTERY CHARGERS; APPARATUS FOR RECORDING, TRANSMISSION OR REPRODUCTION OF SOUND OR IMAGES, NAMELY, TELEPHONES, MOBILE TELEPHONES, CORDLESS TELEPHONES, RADIO TELEPHONES, TELEPHONE SWITCHBOARDS, TELEPHONE ANSWERING MACHINES, TAPE RECORDERS, VIDEO AND AUDIO CASSETTE RECORDERS, CD-ROM AND DVD RECORDERS AND PLAYERS, PERSONAL STEREOS, MOVIE PROJECTORS, DIGITAL PROJECTORS, TELEVISIONS, RADIOS, PAGERS, REMOTE E-MAIL TRANSCEIVERS; BLANK MAGNETIC DATA CARRIERS AND RECORDING DISCS, PRERECORDED MAGNETIC DATA CARRIERS AND RECORDING DISCS FEATURING ENTERTAINMENT, NEWS, INSTRUCTION IN THE FIELDS OF ELECTRONIC EQUIPMENT, TELECOMMUNICATIONS, SPEECH, COMMUNICATION, DATA COMMUNICATION, INFORMATION IN THE FIELDS OF ELECTRONIC EQUIPMENT, TELECOMMUNICATIONS, SPEECH, COMMUNI-

CATION, DATA COMMUNICATION, FICTION AND NON-FICTION WORKS IN A WIDE VARIETY OF SUBJECTS AND THE FIELDS OF ELECTRONIC EQUIPMENT, TELECOMMUNICATIONS, SPEECH, COMMUNICATION, DATA COMMUNICATION; AUTOMATIC VENDING MACHINES AND MECHANISMS FOR COIN-OPERATED VENDING APPARATUS; CASH REGISTERS, CALCULATORS; DATA PROCESSORS AND COMPUTERS; FIRE-EXTINGUISHERS, IN CLASS 9 (U.S. CLS. 21, 23, 26, 36 AND 38).

FOR: PAPER, CARDBOARD AND GOODS MADE FROM THESE MATERIALS, NAMELY, ADVERTISING BOARDS NOTEPAPER OR CARDBOARD, BOXES OF PAPER OR CARDBOARD, CARDBOARD CONTAINERS, CARDBOARD PACKAGING; PRINTED MATTER, NAMELY, NEWSPAPERS, MAGAZINES, NEWSLETTERS, BROCHURES, PAMPHLETS, BOOKS AND JOURNALS DEALING WITH TELECOMMUNICATIONS, ECONOMIC, FINANCIAL AND LEGAL SUBJECTS, AND RELATED TO COMPUTER SERVICES AND NETWORK COMPUTER SERVICES; BOOKBINDING MATERIAL, NAMELY, TAPE, WIRE AND CLOTH; PHOTOGRAPHS; STATIONERY; ADHESIVES FOR STATIONERY OR HOUSEHOLD PURPOSES; ARTISTS' MATERIALS, NAMELY, PAINT BRUSHES, PASTELS, PENCILS AND PENS; TYPEWRITERS AND OFFICE REQUISITES, NAMELY, PUNCHES, RUBBER BANDS, STAPLERS, ADHESIVE TAPE DISPENSERS, FRANKING MACHINES, PAPER EMBOSSERS; PRINTED INSTRUCTIONAL AND TEACHING MATERIAL IN THE FIELD OF TELECOMMUNICATIONS, ECONOMIC, FINANCIAL AND LEGAL SUBJECTS, AND RELATED TO COMPUTER SERVICES AND NETWORK COMPUTER SERVICES; PLASTIC MATERIALS FOR PACKAGING, NAMELY, PLASTIC BAGS, PLASTIC

BUBBLE PACKS; PRINTERS' TYPE; PRINTING BLOCKS, IN CLASS 16 (U.S. CLS. 2, 5, 22, 23, 29, 37, 38 AND 50).

FOR: ADVERTISING; BUSINESS MANAGEMENT; BUSINESS ADMINISTRATION; PROVIDING OFFICE FUNCTIONS; IMPORT AND EXPORT AGENCIES; RETAIL STORES AND ONLINE RETAIL STORES FEATURING A WIDE VARIETY OF CONSUMER PRODUCTS IN THE FIELD OF TELECOMMUNICATIONS, ECONOMIC, FINANCIAL AND LEGAL SUBJECTS, AND RELATED TO COMPUTER SERVICES AND NETWORK COMPUTER SERVICES, IN CLASS 35 (U.S. CLS. 100, 101 AND 102).

FOR: TELECOMMUNICATIONS, NAMELY, LOCAL AND LONG DISTANCE TRANSMISSION OR VOICE, DATA, GRAPHICS BY MEANS OF TELEPHONE, TELEGRAPHIC, CABLE, AND SATELLITE TRANSMISSIONS, CELLULAR TELEPHONE SERVICES PROVIDING ACCESS FOR MULTIPLE USERS TO A COMPUTERIZED GLOBAL INFORMATION NETWORK FOR TRANSMISSION AND DISSEMINATION OF ANY TYPE OF INFORMATION, IMAGE OR SOUND; PROVIDING ACCESS TO GLOBAL COMPUTER NETWORKS AND AREA NETWORK; TELECOMMUNICATION SERVICES, NAMELY, PROVISION OF WIRELESS COMMUNICATION AND TELECOMMUNICATION AIRTIME PRICE PACKAGING SERVICES; TELECOMMUNICATION NETWORK DESIGN, PLANNING, MAINTENANCE AND MANAGEMENT SERVICES; TELECOMMUNICATION GATEWAY SERVICES; VIDEO CONFERENCING SERVICES; WIRELESS DIGITAL MESSAGING SERVICES; CELLULAR TELEPHONE SERVICES; PERSONAL COMMUNICATION SERVICES; PROVISION OF MULTIPLE USER ACCESS TO A GLOBAL COMPUTER NETWORK; DATA TRANSMISSION SERVICES VIA SATELLITE, WIRELESS, TELEPHONE LINES AND CELLULAR, NAMELY, ELECTRONIC TRANSMISSION OF ANY TYPE OF INFORMATION, IMAGE OR SOUND VIA COMPUTER TERMINALS; PROVIDING MULTIPLE USER ACCESS TO INFORMATION BY MEANS OF A GLOBAL COMPUTER

INFORMATION NETWORK; DIGITAL COMMUNICATIONS SERVICES, NAMELY, BROADCAST, TRANSMISSION AND RECEIPT OF INTERACTIVE AND NON-INTERACTIVE AUDIO, VIDEO AND DIGITAL SIGNALS OFFERED OVER A COMMUNICATIONS NETWORK; FACSIMILE SERVICES, ELECTRONIC MAIL SERVICES, ELECTRONIC TRANSMISSION OF MESSAGES AND DATA , IN CLASS 38 (U.S. CLS. 100, 101 AND 104).

FOR: SCIENTIFIC RESEARCH; TECHNOLOGY CONSULTATION IN THE FIELD OF TELECOMMUNICATIONS, ECONOMIC, FINANCIAL AND LEGAL SUBJECTS, AND RELATED TO COMPUTER SERVICES AND NETWORK COMPUTER SERVICES; INDUSTRIAL DESIGN; DESIGN AND DEVELOPMENT OF COMPUTER HARDWARE AND SOFTWARE; LEGAL SERVICES, IN CLASS 42 (U.S. CLS. 100 AND 101).

THE MARK CONSISTS OF STANDARD CHARACTERS WITHOUT CLAIM TO ANY PARTICULAR FONT, STYLE, SIZE, OR COLOR.

OWNER OF SPAIN REG. NO. 2684848, DATED 5-29-2006, EXPIRES 12-14-2015.

OWNER OF SPAIN REG. NO. 2684845, DATED 5-29-2006, EXPIRES 12-14-2015.

OWNER OF SPAIN REG. NO. 2684843, DATED 5-29-2006, EXPIRES 12-14-2015.

OWNER OF SPAIN REG. NO. 2684841, DATED 5-29-2006, EXPIRES 12-14-2015.

OWNER OF SPAIN REG. NO. 2684840, DATED 5-29-2006, EXPIRES 12-14-2015.

THE ENGLISH TRANSLATION OF THE WORD "MUNDO" IN THE MARK IS "WORLD".

SER. NO. 78-919,128, FILED 6-28-2006.

NICHOLAS ALTREE, EXAMINING ATTORNEY

Int. Cls.: 35, 41 and 42

Prior U.S. Cls.: 100, 101, 102 and 107

United States Patent and Trademark Office

Reg. No. 3,485,005

Registered Aug. 12, 2008

**SERVICE MARK
PRINCIPAL REGISTER**

CAUSE COMMUNICATIONS

CAUSE COMMUNICATIONS (CALIFORNIA CORPORATION)
1336 FIFTH STREET
SANTA MONICA, CA 904011415

FOR: ADVERTISING, MARKETING AND PUBLICITY SERVICES, NAMELY, PROMOTING THE SERVICES OF NON-PROFIT ORGANIZATIONS THROUGH PRINT MEDIA, NEWSPAPER, MAGAZINE, DIRECT-MAIL, BROCHURES, SALES KITS, ANNUAL REPORTS, OUTDOOR BILLBOARDS, AND INTERNET WEBSITES; CREATING BRANDS AND LOGOS FOR NON-PROFIT ORGANIZATIONS; DEVELOPING AND IMPLEMENTING INTEGRATED MARKETING PLANS, MARKETING CAMPAIGNS, STRATEGIC COMMUNICATION PLANS AND MARKETING AUDITS FOR NON-PROFIT ORGANIZATIONS; MARKETING CONSULTING SERVICES FOR NON-PROFIT ORGANIZATIONS; BRAND CONSULTING SERVICES, NAMELY, DEVELOPING AND IMPLEMENTING BRAND AUDITS AND PROVIDING ASSESSMENTS OF BRAND POSITION AND CORPORATE IDENTITY FOR NON-PROFIT ORGANIZATIONS; PUBLIC RELATIONS CONSULTING SERVICES FOR NON-PROFIT ORGANIZATIONS; ADVERTISING, PUBLICITY AND MARKETING RESEARCH SERVICES, NAMELY, AUDITING AUDIENCES, CONDUCTING MEDIA RELATIONS AND DEVELOPING AND IMPLEMENTING DIRECT RESPONSE PACKAGES; DISSEMINATION OF ADVERTISING AND PROMOTIONAL MATERIALS FOR NON-PROFIT ORGANIZATIONS; DEVELOPMENT AND UPDATING OF ADVERTISING, PROMOTIONAL AND PUBLICITY MATERIALS FOR NON-PROFIT ORGANIZATIONS; COPY-WRITING, NAMELY,

WRITING TEXT TO BE USED IN ADVERTISING AND MARKETING MATERIALS FOR NON-PROFIT ORGANIZATIONS, IN CLASS 35 (U.S. CLS. 100, 101 AND 102).

FIRST USE 12-31-1999; IN COMMERCE 12-31-1999.

FOR: PUBLICATION OF BOOKS, WHITE PAPERS, ANNUAL REPORTS, SALES KITS, BROCHURES AND PAMPHLETS, IN CLASS 41 (U.S. CLS. 100, 101 AND 107).

FIRST USE 12-31-1999; IN COMMERCE 12-31-1999.

FOR: GRAPHIC DESIGN SERVICES FOR ADVERTISING, PROMOTIONAL AND COLLATERAL SALES MATERIAL AND ANNUAL REPORTS; GRAPHIC ILLUSTRATION SERVICES; PACKAGING DESIGN; DESIGN AND DEVELOPMENT OF WEBSITES, IN CLASS 42 (U.S. CLS. 100 AND 101).

FIRST USE 12-31-1999; IN COMMERCE 12-31-1999.

THE MARK CONSISTS OF STANDARD CHARACTERS WITHOUT CLAIM TO ANY PARTICULAR FONT, STYLE, SIZE, OR COLOR.

NO CLAIM IS MADE TO THE EXCLUSIVE RIGHT TO USE "COMMUNICATIONS", APART FROM THE MARK AS SHOWN.

SER. NO. 78-920,400, FILED 6-29-2006.

JOHN E. MICHOS, EXAMINING ATTORNEY

Int. Cl.: 33

Prior U.S. Cls.: 47 and 49

United States Patent and Trademark Office

Reg. No. 3,485,006

Registered Aug. 12, 2008

TRADEMARK
PRINCIPAL REGISTER



MASLYUKOV, PAVEL (RUSSIAN FED. INDIVIDUAL)
3-IA VLADIMIRSKAIYA, 12-2-9
MOSCOW, RUSSIAN FED. 111401

FOR: ALCOHOLIC BEVERAGE PRODUCED FROM A BREWED MALT BASE WITH NATURAL FLAVORS; ALCOHOLIC BEVERAGES OF FRUIT; ALCOHOLIC EXTRACTS; DISTILLED SPIRITS; DISTILLED SPIRITS OF BANANA; EXTRACTS OF SPIRITOUS LIQUORS; FLAVORED BREWED MALT BEVERAGE; FRUIT WINE; PREPARED ALCOHOLIC COCKTAIL; VODKA, IN CLASS 33 (U.S. CLS. 47 AND 49).

PRIORITY CLAIMED UNDER SEC. 44(D) ON UNITED KINGDOM APPLICATION NO. 2421830, FILED 5-15-2006, REG. NO. 2421830, DATED 5-15-2006, EXPIRES 5-15-2016.

THE COLOR(S) RED, YELLOW, BLUE, WHITE, ORANGE, BROWN AND BLACK IS/ARE CLAIMED AS A FEATURE OF THE MARK.

THE MARK CONSISTS OF A CONFIGURATION OF A NARROW BOTTLE WITH A DESIGN OF BANANA HAVING A SLENDER BASE AND A WIDE

TOP AND A WHITE, YELLOW AND ORANGE LABEL CONSISTING OF THE WORD "BANANIA" WRITTEN IN BLUE; ABOVE A DRAWING OF THE FAMOUS SMILING COMMANDO-MACHINEGUNNER IN RED, YELLOW, ORANGE, WHITE, BROWN AND BLACK SITTING ON THE GROUND IN FRONT OF A TREE, THE TREE, GROUND AND SKY ARE RED, YELLOW, ORANGE, WHITE AND BLACK, NEXT TO THE BATTLE SLANG WORDING "Y'A BON" IN RED AND A YELLOW CARTRIDGE BOX WITH THE WORDS "BANANIA LE PLUS NOURRISSANT DES ALIMENTS FRANCAIS EN VENTE PARTOUT" WRITTEN IN BLACK IN FRENCH LANGUAGE. THE COLOR OF THE GLASS IS BLACK.

THE ENGLISH TRANSLATION OF "LE PLUS NOURRISSANT DES ALIMENTS FRANCAIS EN VENTE PARTOUT" AND "Y'A BON" IN THE MARK IS THE MOST NOURISHING OF FRENCH SOURCES, FOR SALE EVERYWHERE AND IT'S DELICIOUS.

SER. NO. 78-920,857, FILED 6-30-2006.

KATHERINE M. DUBRAY, EXAMINING ATTORNEY

Int. Cls.: 35, 36, 37, 39 and 42

Prior U.S. Cls.: 100, 101, 102, 103, 105 and 106

Reg. No. 3,485,007

United States Patent and Trademark Office

Registered Aug. 12, 2008

**SERVICE MARK
PRINCIPAL REGISTER**

The logo for Delcan features a stylized, bold letter 'D' on the left, which contains a white arrow pointing to the right. To the right of the 'D' is the word 'elcan' in a lowercase, bold, sans-serif font. The 'e' is connected to the 'D'. The 'n' has three horizontal lines extending from its base to the right.

DELCAN GROUP INC. (CANADA CORPORATION)
SUITE 500
625 COCHRANE DRIVE
MARKHAM, ONTARIO, CANADA L3R 9R9

FOR: ECONOMIC ANALYSIS; REGULATORY AUDIT REPORTING AND AUDIT PLANNING IN THE FIELDS OF TRAFFIC CONTROL, CONGESTION MANAGEMENT, EMERGENCY SERVICES INTEGRATION, ALL FOR THE TRANSPORTATION INDUSTRY; BUSINESS CONSULTATION, BUSINESS MANAGEMENT; BUSINESS SERVICES, NAMELY, FACILITIES MANAGEMENT AND TECHNICAL OPERATIONS; BUSINESS MANAGEMENT SERVICES, NAMELY, MANAGING LOGISTICS, REVERSE LOGISTICS, SUPPLY CHAIN SERVICES, SUPPLY CHAIN VISIBILITY AND SYNCHRONIZATION, SUPPLY AND DEMAND FORECASTING AND PRODUCT DISTRIBUTION PROCESSES FOR OTHERS, IN CLASS 35 (U.S. CLS. 100, 101 AND 102).

FIRST USE 6-26-2006; IN COMMERCE 6-26-2006.

FOR: FINANCING OF PURCHASES; FINANCIAL PLANNING, IN CLASS 36 (U.S. CLS. 100, 101 AND 102).

FIRST USE 6-26-2006; IN COMMERCE 6-26-2006.

FOR: CONSULTATION CONCERNING THE CONSTRUCTION AND REHABILITATION OF WATER FACILITIES, IN CLASS 37 (U.S. CLS. 100, 103 AND 106).

FIRST USE 6-26-2006; IN COMMERCE 6-26-2006.

FOR: INTER-MODAL FREIGHT EFFICIENCY, NAMELY, CONSULTATION IN THE MOVEMENT OF INTER-MODAL FREIGHT THROUGH THE ENTIRE DELIVERY SYSTEM, AIMED AT IMPROVING SAFETY AND DELIVERY TIMES, REDUCING

DELAYS, FUEL CONSUMPTION, COSTS AND EMISSIONS, AND ENHANCING DELIVERY OPERATIONS FOR ALL TRAVEL MODES; TECHNICAL CONSULTATION IN THE FIELDS OF PUBLIC TRANSPORTATION AND INTELLIGENT TRANSPORTATION SYSTEMS, IN CLASS 39 (U.S. CLS. 100 AND 105).

FIRST USE 6-26-2006; IN COMMERCE 6-26-2006.

FOR: ENGINEERING CONSULTATION IN THE FIELDS OF PUBLIC TRANSPORTATION AND INTELLIGENT TRANSPORTATION SYSTEMS; INFORMATION TECHNOLOGY CONSULTATION; COMPUTER SOFTWARE DESIGN FOR OTHERS; AND SYSTEMS ENGINEERING FOR THE TRANSPORTATION INFRASTRUCTURE INDUSTRY; CONSULTATION SERVICES IN THE FIELD OF TRAFFIC ENGINEERING; AND TRANSPORTATION PLANNING STUDIES; ENGINEERING AND TECHNICAL CONSULTATION IN THE FIELDS OF DESIGNING PORTS AND HARBORS, RAILROADS, HIGHWAYS, AIRPORTS, AND PARKING STRUCTURES; ARCHITECTURAL DESIGN AND PLANNING OF RAILROADS AND HIGHWAYS; ENGINEERING SERVICES FOR THE CONSTRUCTION OF WATER TREATMENT AND PURIFICATION PLANTS, SOLID WASTE TREATMENT PLANTS, INTELLIGENT WATER SYSTEMS AND OTHER MUNICIPAL INFRASTRUCTURE FACILITIES; CONSULTING SERVICES IN THE FIELD OF ENVIRONMENTAL ASSESSMENT, COMPLIANCE AND PLANNING; PLANNING OF BUILDINGS AND INFRASTRUCTURE SYSTEMS FOR BUILDINGS, IN CLASS 42 (U.S. CLS. 100 AND 101).

FIRST USE 6-26-2006; IN COMMERCE 6-26-2006.

OWNER OF U.S. REG. NO. 2,177,563.

SER. NO. 78-926,634, FILED 7-11-2006.

RONALD AIKENS, EXAMINING ATTORNEY

Int. Cls.: 35, 36, 37, 39 and 42

Prior U.S. Cls.: 100, 101, 102, 103, 105 and 106

United States Patent and Trademark Office

Reg. No. 3,485,008

Registered Aug. 12, 2008

**SERVICE MARK
PRINCIPAL REGISTER**



DELSCAN GROUP INC. (CANADA CORPORATION)
SUITE 500
625 COCHRANE DRIVE
MARKHAM, ONTARIO, CANADA L3R 9R9

FOR: ECONOMIC ANALYSIS; REGULATORY AUDIT REPORTING AND AUDIT PLANNING IN THE FIELDS OF TRAFFIC CONTROL, CONGESTION MANAGEMENT, EMERGENCY SERVICES INTEGRATION, ALL FOR THE TRANSPORTATION INDUSTRY; BUSINESS CONSULTATION, BUSINESS MANAGEMENT; BUSINESS SERVICES, NAMELY, FACILITIES MANAGEMENT AND TECHNICAL OPERATIONS; BUSINESS MANAGEMENT SERVICES, NAMELY, MANAGING LOGISTICS, REVERSE LOGISTICS, SUPPLY CHAIN SERVICES, SUPPLY CHAIN VISIBILITY AND SYNCHRONIZATION, SUPPLY AND DEMAND FORECASTING AND PRODUCT DISTRIBUTION PROCESSES FOR OTHERS, IN CLASS 35 (U.S. CLS. 100, 101 AND 102).

FIRST USE 6-26-2006; IN COMMERCE 6-26-2006.

FOR: FINANCING OF PURCHASES; FINANCIAL PLANNING, IN CLASS 36 (U.S. CLS. 100, 101 AND 102).

FIRST USE 6-26-2006; IN COMMERCE 6-26-2006.

FOR: CONSULTATION CONCERNING THE CONSTRUCTION AND REHABILITATION OF WATER FACILITIES, IN CLASS 37 (U.S. CLS. 100, 103 AND 106).

FIRST USE 6-26-2006; IN COMMERCE 6-26-2006.

FOR: INTER-MODAL FREIGHT EFFICIENCY, NAMELY, CONSULTATION IN THE MOVEMENT OF INTER-MODAL FREIGHT THROUGH THE ENTIRE DELIVERY SYSTEM, AIMED AT IMPROV-

ING SAFETY AND DELIVERY TIMES, REDUCING DELAYS, FUEL CONSUMPTION, COSTS AND EMISSIONS, AND ENHANCING DELIVERY OPERATIONS FOR ALL TRAVEL MODES; TECHNICAL CONSULTATION IN THE FIELDS OF PUBLIC TRANSPORTATION AND INTELLIGENT TRANSPORTATION SYSTEMS, IN CLASS 39 (U.S. CLS. 100 AND 105).

FIRST USE 6-26-2006; IN COMMERCE 6-26-2006.

FOR: ENGINEERING CONSULTATION IN THE FIELDS OF PUBLIC TRANSPORTATION AND INTELLIGENT TRANSPORTATION SYSTEMS; INFORMATION TECHNOLOGY CONSULTATION; COMPUTER SOFTWARE DESIGN FOR OTHERS; AND SYSTEMS ENGINEERING FOR THE TRANSPORTATION INFRASTRUCTURE INDUSTRY; CONSULTATION SERVICES IN THE FIELD OF TRAFFIC ENGINEERING; AND TRANSPORTATION PLANNING STUDIES; ENGINEERING AND TECHNICAL CONSULTATION IN THE FIELDS OF DESIGNING PORTS AND HARBORS, RAILROADS, HIGHWAYS, AIRPORTS, AND PARKING STRUCTURES; ARCHITECTURAL DESIGN AND PLANNING OF RAILROADS AND HIGHWAYS; ENGINEERING SERVICES FOR THE CONSTRUCTION OF WATER TREATMENT AND PURIFICATION PLANTS, SOLID WASTE TREATMENT PLANTS, INTELLIGENT WATER SYSTEMS AND OTHER MUNICIPAL INFRASTRUCTURE FACILITIES; CONSULTING SERVICES IN THE FIELD OF ENVIRONMENTAL ASSESSMENT, COMPLIANCE AND PLANNING; PLANNING OF BUILDINGS AND INFRASTRUCTURE SYSTEMS FOR BUILDINGS, IN CLASS 42 (U.S. CLS. 100 AND 101).

FIRST USE 6-26-2006; IN COMMERCE 6-26-2006.

OWNER OF U.S. REG. NO. 2,177,563.

NO CLAIM IS MADE TO THE EXCLUSIVE
RIGHT TO USE "TRANSPORTATION INFORMA-
TION TECHNOLOGY WATER", APART FROM THE
MARK AS SHOWN.

SER. NO. 78-926,640, FILED 7-11-2006.

RONALD AIKENS, EXAMINING ATTORNEY

Int. Cl.: 12

Prior U.S. Cls.: 19, 21, 23, 31, 35 and 44

Reg. No. 3,485,009

United States Patent and Trademark Office

Registered Aug. 12, 2008

**TRADEMARK
PRINCIPAL REGISTER**



T6 & CO., INC. (CALIFORNIA CORPORATION)
2020 S. HATHAWAY STREET, UNIT B
SANTA ANA, CA 92705

FOR: ADHESIVE RUBBER PATCHES FOR REPAIRING TUBES OR TIRES; AIR BAGS FOR VEHICLES; AIR SPRINGS FOR VEHICLE SUSPENSION COMPONENTS FOR CUSHIONING DRIVER'S SEATS AND CABS; AUTOMOBILE BODIES; INNER TUBES FOR VEHICLE TIRES; LAND VEHICLE PARTS, NAMELY, WHEELS; SPARE TIRE CARRIERS FOR VEHICLES; AUTOMOBILE TIRES; AUTOMOBILE WHEEL SHIELDS; CAPS FOR WHEEL RIMS; PNEUMATIC TIRES AND INNER TUBES FOR MOTORCYCLES; BADGES FOR VEHICLE TRIM; BAND BRAKES FOR LAND VEHICLES; BRAKE BLOCKS FOR LAND VEHICLES; BRAKE CYLINDER REPAIR KITS, SOLD AS A UNIT FOR LAND VEHICLES; BRAKE HARDWARE FOR VEHICLES, NAMELY, BRAKE DISKS, BRAKE CYLIN-

DERS, BRAKE DRUMS, DISC BRAKE PADS; BRAKE FACINGS FOR VEHICLES; STEERING BRAKES, BRAKE SYSTEMS FOR VEHICLES; AUTOMOBILE SEAT CUSHIONS, AIR-CUSHION VEHICLES, IN CLASS 12 (U.S. CLS. 19, 21, 23, 31, 35 AND 44).

FIRST USE 6-5-2005; IN COMMERCE 6-5-2005.

THE MARK CONSISTS OF HIGHLY STYLIZED "K" ABOVE THE WORD "KLÄSSEN" WITH THE LETTER "A" HAVING AN UMLAUT NOTATION ABOVE IT.

THE FOREIGN WORDING IN THE MARK TRANSLATES INTO ENGLISH AS CLASSY.

SER. NO. 78-927,548, FILED 7-12-2006.

LINDA MICKLEBURGH, EXAMINING ATTORNEY

Int. Cls.: 35, 38 and 41

Prior U.S. Cls.: 100, 101, 102, 104 and 107

Reg. No. 3,485,010

United States Patent and Trademark Office

Registered Aug. 12, 2008

**SERVICE MARK
PRINCIPAL REGISTER**



ILIKEMUSIC.COM LTD (UNITED KINGDOM CORPORATION)
ILIKEMUSIC.COM LTD 16 PORT LANE HURSLEY
16 PORT LANE, HAMPSHIRE
HURSLEY, UNITED KINGDOM SO21 2JS

FOR: ON-LINE ADVERTISING SERVICES; ON-LINE RETAIL STORE SERVICES FEATURING MUSIC PRODUCTS INCLUDING CDS, RECORDS, TAPES, DISCS, VIDEO, SOUND OR IMAGE RECORDINGS; ON-LINE RETAIL MUSIC AND RECORD STORES THAT ENABLE CUSTOMERS TO CONVENIENTLY VIEW AND PURCHASE MUSIC PRODUCTS ON-LINE OR VIA THE INTERNET; RETAIL STORE SERVICES FEATURING MUSIC PRODUCTS INCLUDING CDS, RECORDS, TAPES, DISCS, VIDEO, SOUND OR IMAGE RECORDINGS, IN CLASS 35 (U.S. CLS. 100, 101 AND 102).

FOR: PROVIDING ON-LINE FORUMS FOR TRANSMISSION OF MESSAGES AMONG COMPUTER USERS, CONCERNING MUSIC, MUSIC BANDS, LIVE MUSIC PERFORMANCES AND EVENTS, AND CURRENT EVENTS AND NEWS IN RELATION TO THE MUSIC INDUSTRY, IN CLASS 38 (U.S. CLS. 100, 101 AND 104).

FOR: PUBLISHING SERVICES, NAMELY, PUBLISHING MAGAZINES AND BOOKS; PUBLISHING OF PRINTED PUBLICATIONS, NAMELY, MAGAZINES, BOOKS AND PUBLISHING OF ELECTRONIC PUBLICATIONS; PUBLISHING MAGAZINES AND BOOKS CARRIED OUT BY COMPUTERISED MEANS; PUBLISHING OF MAGAZINES AND

BOOKS BY ELECTRONIC MEANS; PUBLISHING OF ARTICLES AND MAGAZINES RELATING TO MUSIC, ARTISTS AND BANDS; MUSIC PUBLISHING; ENTERTAINMENT SERVICES, NAMELY, PROVIDING PRE-RECORDED MUSIC, INFORMATION IN THE FIELD OF MUSIC, AND COMMENTARY AND ARTICLES ABOUT MUSIC, ALL ON-LINE VIA A GLOBAL COMPUTER NETWORK; MUSIC PRODUCTION SERVICES AND PRESENTATION OF MUSICAL PERFORMANCE; EDUCATIONAL SERVICES, NAMELY, PROVIDING SEMINARS AND WORKSHOPS IN THE FIELDS OF MUSIC, THE MUSIC RECORDING INDUSTRY AND THE MUSIC PROMOTING INDUSTRY; ENTERTAINMENT SERVICES, NAMELY, CONDUCTING CONTESTS AND PARTIES; ENTERTAINMENT SERVICES IN THE NATURE OF ORGANIZING AND CONDUCTING THEATRE PRODUCTIONS AND STAGE SHOWS; PRESENTATION OF LIVE SHOW PERFORMANCES, IN CLASS 41 (U.S. CLS. 100, 101 AND 107).

PRIORITY CLAIMED UNDER SEC. 44(D) ON ERPN CMNTY TM OFC APPLICATION NO. 004871448, FILED 2-1-2006, REG. NO. 004871448, DATED 9-14-2007, EXPIRES 2-1-2016.

THE COLOR(S) BLUE, DARK BLUE AND WHITE IS/ARE CLAIMED AS A FEATURE OF THE MARK.

THE MARK CONSISTS OF THE WORDS "ILIKEMUSIC" IN BLUE BENEATH A WHITE OVAL WHICH CONTAINS THREE CURVED BANDS

WHICH ARE BLUE AT THE BOTTOM AND DARK
BLUE AT THE TOP THAT GET LARGER FROM
LEFT TO RIGHT.

SER. NO. 78-928,928, FILED 7-13-2006.

JAMES LOVELACE, EXAMINING ATTORNEY

Int. Cl.: 9

Prior U.S. Cls.: 21, 23, 26, 36 and 38

Reg. No. 3,485,011

United States Patent and Trademark Office

Registered Aug. 12, 2008

**TRADEMARK
PRINCIPAL REGISTER**

bluefin
HIGH DENSITY SIGNAL PROCESSING

CALREC AUDIO LIMITED (UNITED KINGDOM
LIMITED COMPANY)
NUTCLOUGH MILL, HEGDEN BRIDGE
YORKSHIRE, UNITED KINGDOM HX7 8EZ

FOR: SOUND AND AUDIO MIXING EQUIP-
MENT AND INSTRUMENTS, NAMELY, SOUND
MIXERS AND AUDIO MIXERS; SOUND AND
AUDIO PROCESSING APPARATUS AND INSTRU-
MENTS, NAMELY, LIMITERS AND COMPRES-
SORS; VIDEO MIXING AND PROCESSING
APPARATUS; MICROPHONES; APPARATUS AND
INSTRUMENTS FOR RECORDING, REPRODU-
CING, TRANSMISSION AND PROCESSING OF
SOUND AND VIDEO, NAMELY, MICROPHONES
AND CONTROL SURFACES; DIGITAL SIGNAL
PROCESSING SYSTEMS FOR SOUND MIXING
CONSOLES, NAMELY, DIGITAL SIGNAL PROCES-
SORS, IN CLASS 9 (U.S. CLS. 21, 23, 26, 36 AND 38).

PRIORITY CLAIMED UNDER SEC. 44(D) ON
GREAT BRITAIN APPLICATION NO. 005011937,
FILED 3-27-2006.

OWNER OF ERPN CMNTY TM OFC REG. NO.
005011937, DATED 12-2-2007, EXPIRES 3-27-2016.

NO CLAIM IS MADE TO THE EXCLUSIVE
RIGHT TO USE "SIGNAL PROCESSING", APART
FROM THE MARK AS SHOWN.

THE MARK CONSISTS OF BLOCK LETTER
FORMAT WITH A "WATER DROP" DESIGN USED
TO DOT THE LETTER "I" IN THE WORD "BLUE-
FIN".

SER. NO. 78-928,975, FILED 7-13-2006.

SHARON MEIER, EXAMINING ATTORNEY

Int. Cl.: 9

Prior U.S. Cls.: 21, 23, 26, 36 and 38

Reg. No. 3,485,012

United States Patent and Trademark Office

Registered Aug. 12, 2008

**TRADEMARK
PRINCIPAL REGISTER**

HDK

HOKURIKU ELECTRIC INDUSTRY CO., LTD.
(JAPAN CORPORATION)
3158, SHIMO-OKUBO
TOYAMA-SHI, JAPAN 939-2292

FOR: VARIABLE ELECTRIC RESISTORS; FIXED ELECTRIC RESISTORS; CHIPS ELECTRIC RESISTORS; HIGH VOLTAGE ELECTRIC RESISTORS; HIGH FREQUENCY ELECTRIC RESISTORS; TERMINATIONS, NAMELY, ELECTRIC RESISTORS INSTALLED AT WIRING TERMINALS; ATTENUATOR; PRINTED HYBRID INTEGRATED CIRCUITS; CIRCUIT BOARDS; ELECTRIC SWITCHES; ELECTRIC SENSOR DEVICE FOR DETECTING HUMIDITY; ELECTRIC SENSOR DEVICE FOR DETECTING TEMPERATURE; ELECTRIC SENSOR DEVICE FOR DETECTING PRESSURE; ELECTRIC SENSOR DEVICE FOR DETECTING FORCE; ELECTRIC SENSOR DEVICE FOR DETECTING ACCELERATION; ELECTRIC SENSOR DEVICE FOR DETECTING GAS; PYROELECTRIC INFRARED MOTION SENSORS; VOLTAGE CONTROLLED OSCILLATORS; CRYSTAL OSCILLATORS; CRYSTAL UNITS, NAMELY, CRYSTAL OSCILLATORS USED TO GENERATE A REFERENCE SIGNAL, TYPICALLY USED IN A CPU; MONOLITHIC CRYSTAL FILTERS, NAMELY, FILTERS USING A CRYSTAL UNIT TO REMOVE A SIGNAL HAVING A PARTICULAR FREQUENCY; SAW FILTERS, NAMELY, ELECTRONIC COMPONENTS USED TO FILTER A SIGNAL, USING SURFACE ACOUSTIC WAVES; PIEZOELECTRIC CERAMIC TRANSFORMERS; PIEZOELECTRIC RECEIVERS FOR USE IN CORDLESS AND CELLULAR PHONES; PIEZOELECTRIC LOUDSPEAKER; BUZZERS; PIEZOELECTRIC DIAPHRAGMS USED IN ELECTRONIC MACHINES AND APPARATUS; VARISTORS; ELECTRIC FUSES; ELECTRICAL

CONNECTORS; POTENTIOMETER; CONDUCTORS; ELECTRON BEAM TUBES; SEMICONDUCTOR DEVICES; THERMISTOR; CINEMATOGRAPHIC MACHINES AND APPARATUS; ROTARY CONVERTERS; BATTERIES AND CELLS; ELECTRIC WIRES AND CABLES; ELECTRIC FLAT IRONS; ELECTRIC HAIR-CURLERS; ELECTRIC BUZZERS; MAGNETIC CORES; RESISTANCE WIRES; ELECTRODES; FIRE ENGINES; CIGAR LIGHTERS FOR AUTOMOBILES; GLOVES FOR PROTECTION AGAINST ACCIDENTS; DUST MASKS; GAS MASKS; WELDING MASKS; FIRE-PROOF GARMENTS; CONSUMER VIDEO GAMES; ELECTRONIC CIRCUITS AND CD-ROMS RECORDED PROGRAMS FOR HAND-HELD GAMES WITH LIQUID CRYSTAL DISPLAYS; SLOT MACHINES; PROTECTIVE HELMETS FOR SPORTS; METRONOMES; SLIDE-RULES; EXPOSED CINEMATOGRAPHIC FILMS; EXPOSED SLIDE FILMS; SLIDE FILM MOUNTS, IN CLASS 9 (U.S. CLS. 21, 23, 26, 36 AND 38).

THE MARK CONSISTS OF STANDARD CHARACTERS WITHOUT CLAIM TO ANY PARTICULAR FONT, STYLE, SIZE, OR COLOR.

PRIORITY CLAIMED UNDER SEC. 44(D) ON JAPAN APPLICATION NO. 2006-3542, FILED 1-19-2006, REG. NO. 4997151, DATED 10-20-2006, EXPIRES 10-20-2016.

OWNER OF U.S. REG. NO. 1,473,984.

SER. NO. 78-931,266, FILED 7-17-2006.

GISELLE AGOSTO, EXAMINING ATTORNEY

Int. Cl.: 13

Prior U.S. Cls.: 2 and 9

United States Patent and Trademark Office

Reg. No. 3,485,013

Registered Aug. 12, 2008

**TRADEMARK
PRINCIPAL REGISTER**

Buck Gold

MILLETT INDUSTRIES (CALIFORNIA CORPORATION)
16131 GOTHARD ST. UNIT K
HUNTINGTON BEACH, CA 92647

THE MARK CONSISTS OF STANDARD CHARACTERS WITHOUT CLAIM TO ANY PARTICULAR FONT, STYLE, SIZE, OR COLOR.

FOR: GUN SIGHTS, NAMELY, GUN SCOPES FOR FIREARMS, IN CLASS 13 (U.S. CLS. 2 AND 9).

SER. NO. 78-932,078, FILED 7-18-2006.

FIRST USE 1-1-2002; IN COMMERCE 1-1-2002.

GEORGE LORENZO, EXAMINING ATTORNEY

Int. Cl.: 9

Prior U.S. Cls.: 21, 23, 26, 36 and 38

Reg. No. 3,485,014

United States Patent and Trademark Office

Registered Aug. 12, 2008

**TRADEMARK
PRINCIPAL REGISTER**



JODY CLARK TIPTON (NORTH CAROLINA CORPORATION)
110 BENT CREEK RANCH ROAD
ASHEVILLE, NC 28806

FIRST USE 1-1-2005; IN COMMERCE 1-1-2005.

FOR: BLANK ELECTRONIC CHIP CARDS ;
ELECTRONIC CIRCUIT BOARD; ENCODED ELECTRONIC CHIP CARDS CONTAINING PROGRAMMING USED TO ENHANCE THE PERFORMANCE OF DIESEL AND GASOLINE VEHICLES, IN CLASS 9 (U.S. CLS. 21, 23, 26, 36 AND 38).

THE MARK CONSISTS OF LOGO OF COMPANY AND LOCATED ON COMPANY'S INTERNET WEBSITE.

SER. NO. 78-933,432, FILED 7-20-2006.

ANGELA M. MICHELI, EXAMINING ATTORNEY

Int. Cls.: 9, 35, 36, 38 and 42

Prior U.S. Cls.: 21, 23, 26, 36, 38, 100, 101, 102 and 104

United States Patent and Trademark Office

Reg. No. 3,485,015

Registered Aug. 12, 2008

**TRADEMARK
SERVICE MARK
PRINCIPAL REGISTER**

Properazzi

PROPERAZZI LIMITED (UNITED KINGDOM
LIMITED COMPANY)
STE 388 2 OLD BROMPTON ROAD
LONDON, UNITED KINGDOM

FOR: COMPUTER SOFTWARE, NAMELY, COM-
PUTER SEARCH ENGINE SOFTWARE, IN CLASS 9
(U.S. CLS. 21, 23, 26, 36 AND 38).

FOR: ADVERTISING; BUSINESS MANAGE-
MENT; BUSINESS ADMINISTRATION; OFFICE
FUNCTIONS, NAMELY, DISSEMINATION OF AD-
VERTISING FOR OTHERS VIA THE INTERNET, IN
CLASS 35 (U.S. CLS. 100, 101 AND 102).

FOR: REAL ESTATE SERVICES, NAMELY, MUL-
TIPLE LISTING SERVICES FEATURING REAL
PROPERTY PHOTOGRAPHS, DESCRIPTIONS,
NEWS, COMMENTARY, BUYING GUIDES, STA-
TISTICS, TRENDS AND REPORTS, IN CLASS 36
(U.S. CLS. 100, 101 AND 102).

FOR: INTERNET SERVICES PROVIDER SERVI-
CES, NAMELY, PROVIDING MULTIPLE USER AC-
CESS TO GLOBAL COMPUTER INFORMATION

FOR THE TRANSFERRING AND DISSEMINATING
OF INFORMATION AND DATA VIA COMPUTER
NETWORKS AND THE INTERNET; PROVIDING
THIRD PARTY USERS WITH ACCESS TO TELE-
COMMUNICATION SOFTWARE INFRASTRUC-
TURE, IN CLASS 38 (U.S. CLS. 100, 101 AND 104).

FOR: DESIGN, MAINTENANCE AND UPDAT-
ING OF TELECOMMUNICATION NETWORK
SEARCH ENGINE, IN CLASS 42 (U.S. CLS. 100
AND 101).

THE MARK CONSISTS OF STANDARD CHAR-
ACTERS WITHOUT CLAIM TO ANY PARTICULAR
FONT, STYLE, SIZE, OR COLOR.

PRIORITY CLAIMED UNDER SEC. 44(D) ON
ERPNTY CMNTY TM OFC APPLICATION NO.
005193545, FILED 7-12-2006, REG. NO. 005193545,
DATED 5-14-2007, EXPIRES 7-12-2016.

SER. NO. 78-935,626, FILED 7-24-2006.

ALYSSA PALADINO, EXAMINING ATTORNEY

Int. Cl.: 43

Prior U.S. Cls.: 100 and 101

United States Patent and Trademark Office

Reg. No. 3,485,016

Registered Aug. 12, 2008

**SERVICE MARK
PRINCIPAL REGISTER**

subs conscious

WHITE HOUSE SUBS, INC. (NEW YORK CORPORATION)
1213 AMSTERDAM AVENUE
NEW YORK, NY 10027

FOR: CAFE-RESTAURANTS; CARRY-OUT RESTAURANTS; DELICATESSENS, IN CLASS 43 (U.S. CLS. 100 AND 101).

FIRST USE 1-6-2006; IN COMMERCE 1-6-2006.

THE MARK CONSISTS OF STANDARD CHARACTERS WITHOUT CLAIM TO ANY PARTICULAR FONT, STYLE, SIZE, OR COLOR.

NO CLAIM IS MADE TO THE EXCLUSIVE RIGHT TO USE "SUBS", APART FROM THE MARK AS SHOWN.

SER. NO. 78-936,769, FILED 7-25-2006.

JOHN DWYER, EXAMINING ATTORNEY

Int. Cls.: 25 and 35

Prior U.S. Cls.: 22, 39, 100, 101 and 102

United States Patent and Trademark Office

Reg. No. 3,485,017

Registered Aug. 12, 2008

**TRADEMARK
SERVICE MARK
PRINCIPAL REGISTER**



WAREHOUSE ONE CLOTHING LTD. (CANADA CORPORATION)
UNITS 1 & 2
1680 NOTRE DAME AVENUE
WINNIPEG, CANADA R3H 1H6

FOR: CLOTHING, NAMELY, JEANS, T-SHIRTS, BLOUSES, HOODED SWEATSHIRTS, SHIRTS, SLEEPWEAR, SWEATERS, SWEATSHIRTS AND JACKETS AND RELATED ACCESSORIES, NAMELY, HATS, CAPS, TOQUES, GLOVES, SCARVES AND BELTS, IN CLASS 25 (U.S. CLS. 22 AND 39).

FOR: THE OPERATION OF RETAIL CLOTHING STORES, IN CLASS 35 (U.S. CLS. 100, 101 AND 102).

PRIORITY CLAIMED UNDER SEC. 44(D) ON CANADA APPLICATION NO. 1308248, FILED 7-7-2006, REG. NO. 694412, DATED 8-21-2007, EXPIRES 8-21-2022.

NO CLAIM IS MADE TO THE EXCLUSIVE RIGHT TO USE "WAREHOUSE AND DENIM", APART FROM THE MARK AS SHOWN.

SER. NO. 78-937,625, FILED 7-26-2006.

ARETHA SOMERVILLE, EXAMINING ATTORNEY

Int. Cl.: 35

Prior U.S. Cls.: 100, 101 and 102

United States Patent and Trademark Office

Reg. No. 3,485,018

Registered Aug. 12, 2008

**SERVICE MARK
PRINCIPAL REGISTER**



PALM LIVING MAGAZINES, INC (FLORIDA CORPORATION)
1217W 11TH TERRACE
CAPE CORAL,, FL 33993

FOR: PUBLISHING OF ADVERTISING TEXTS, IN CLASS 35 (U.S. CLS. 100, 101 AND 102).

FIRST USE 7-10-2006; IN COMMERCE 7-10-2006.

NO CLAIM IS MADE TO THE EXCLUSIVE RIGHT TO USE "MAGAZINES", APART FROM THE MARK AS SHOWN.

THE COLOR(S) DARK GREEN, DARK ORANGE AND DARK TEAL IS/ARE CLAIMED AS A FEATURE OF THE MARK.

THE MARK CONSISTS OF THE WORDS "PALM LIVING MAGAZINES" AND A DESIGN, NAMELY, A PALM TREE, WHICH FORMS THE "P" IN THE WORD "PALM" IN WHICH THE TRUNK IS IN THE COLOR DARK ORANGE AND THE LEAVES OF TREE ARE IN THE COLOR DARK GREEN. THE WORDS "PALM LIVING" ARE IN THE COLOR TEAL AND THE WORD "MAGAZINES" IS IN THE COLOR DARK ORANGE.

SER. NO. 78-938,578, FILED 7-27-2006.

WANDA KAY PRICE, EXAMINING ATTORNEY

Int. Cl.: 29

Prior U.S. Cl.: 46

United States Patent and Trademark Office

Reg. No. 3,485,019

Registered Aug. 12, 2008

**TRADEMARK
PRINCIPAL REGISTER**

**WILCOX FAMILY FARMS ALL
NATURAL**

WILCOX FARMS, INC. (WASHINGTON COR-
PORATION)
40400 HARTS LAKE VALLEY ROAD
ROY, WA 98580

FOR: EGGS, IN CLASS 29 (U.S. CL. 46).

FIRST USE 4-0-2006; IN COMMERCE 4-0-2006.

THE MARK CONSISTS OF STANDARD CHAR-
ACTERS WITHOUT CLAIM TO ANY PARTICULAR
FONT, STYLE, SIZE, OR COLOR.

OWNER OF U.S. REG. NO. 1,786,895.

NO CLAIM IS MADE TO THE EXCLUSIVE
RIGHT TO USE "FAMILY FARMS ALL NATURAL",
APART FROM THE MARK AS SHOWN.

SEC. 2(F) AS TO "WILCOX".

SER. NO. 78-938,891, FILED 7-27-2006.

BARNEY CHARLON, EXAMINING ATTORNEY

Int. Cls.: 3 and 5

Prior U.S. Cls.: 1, 4, 6, 18, 44, 46, 50, 51 and 52

United States Patent and Trademark Office

Reg. No. 3,485,020

Registered Aug. 12, 2008

**TRADEMARK
PRINCIPAL REGISTER**



AIRE-MASTER OF AMERICA, INC. (MISSOURI CORPORATION)
1821 NIXA HIGHWAY CC
NIXA, MO 65714

FOR: RESTROOM CLEANING PREPARATIONS, HOUSEHOLD CLEANING PREPARATIONS; ALL PURPOSE CLEANING PREPARATIONS; HAND SOAPS; HAND LOTIONS; DEGREASING PREPARATIONS FOR FLOORS, WALLS, CARPETS, URINALS, SINKS, FAUCETS AND FIXTURES, CHROME, TILE, TUB AND SHOWER ENCLOSURES, DRINKING FOUNTAINS, ENGINES AND ENGINE PARTS, TIRES, CONCRETE, MACHINERY, AND OTHER WATER WASHABLE SURFACE, IN CLASS 3 (U.S. CLS. 1, 4, 6, 50, 51 AND 52).

FIRST USE 10-4-2005; IN COMMERCE 10-4-2005.

FOR: DEODORIZING PREPARATION IN LIQUID, AEROSOL, POWDER AND ENZYME FORM FOR USE IN INTERIOR SPACES TO ADDRESS

AIRBORNE ODORS; ODOR ERADICATING PREPARATIONS FOR USE IN INTERIOR SPACES TO ADDRESS AIRBORNE ODORS; DEODORANT BAR BLOCKS AND LIQUIDS FOR USE IN INTERIOR SPACES TO ADDRESS AIRBORNE ODORS; URINAL DEODORIZERS AND RESTROOM DEODORIZERS AND DISINFECTANTS, IN CLASS 5 (U.S. CLS. 6, 18, 44, 46, 51 AND 52).

FIRST USE 10-4-2005; IN COMMERCE 10-4-2005.

OWNER OF U.S. REG. NOS. 1,170,645 AND 2,073,146.

THE MARK CONSISTS OF A SKUNK WEARING A DIAPER AND HOLDING A SPRAY BOTTLE, FOREGROUND OF A DIAMOND-SHAPED FRAME.

SER. NO. 78-943,641, FILED 8-2-2006.

HOWARD B. LEVINE, EXAMINING ATTORNEY

Int. Cl.: 1

Prior U.S. Cls.: 1, 5, 6, 10, 26 and 46

Reg. No. 3,485,021

United States Patent and Trademark Office

Registered Aug. 12, 2008

**TRADEMARK
PRINCIPAL REGISTER**

EM Technology

EM RESEARCH ORGANIZATION, INC. (JAPAN CORPORATION)
2440 N. COYOTE DR., SUITE 126
TUCSON, AZ 85745

FOR: CHEMICAL PRESERVATIVE COMPOSITIONS, NAMELY, ANTIOXIDANTS AND ANTIOXIDANT AGENTS FOR USE IN THE MANUFACTURE OF SOAP AND VEGETABLE OILS, AND FOR USE IN THE PRODUCTION OF A WIDE VARIETY OF CHEMICALS; AND ANTIOXIDANT FOOD PRESERVATIVE COMPOSITIONS; RUST INHIBITORS FOR INDUSTRIAL USE; PLANT GROWTH REGULATING AND PLANT GROWTH STIMULATING AND ENHANCING PREPARATIONS; SOIL CONDITIONERS; ORGANIC FERTILIZERS; FERTILIZERS AND COMPOST, IN CLASS 1 (U.S. CLS. 1, 5, 6, 10, 26 AND 46).

FIRST USE 12-0-1986; IN COMMERCE 12-0-1986.

THE MARK CONSISTS OF STANDARD CHARACTERS WITHOUT CLAIM TO ANY PARTICULAR FONT, STYLE, SIZE, OR COLOR.

OWNER OF JAPAN REG. NO. 15571/057, DATED 7-25-2000, RENEWED AS REG. NO. 15571/057, DATED 7-25-2007, EXPIRES 7-25-2014.

OWNER OF U.S. REG. NOS. 2,276,378, 3,151,313 AND OTHERS.

SEC. 2(F).

SER. NO. 78-944,395, FILED 8-3-2006.

CHERYL CLAYTON, EXAMINING ATTORNEY

Int. Cl.: 40

Prior U.S. Cls.: 100, 103 and 106

United States Patent and Trademark Office

Reg. No. 3,485,022

Registered Aug. 12, 2008

**SERVICE MARK
PRINCIPAL REGISTER**

ADVANTIS

ADVANTIS MEDICAL, INC. (INDIANA CORPORATION)
2121 SOUTHTECH DRIVE, SUITE 600
GREENWOOD, IN 46143

THE MARK CONSISTS OF STANDARD CHARACTERS WITHOUT CLAIM TO ANY PARTICULAR FONT, STYLE, SIZE, OR COLOR.

FOR: CUSTOM MANUFACTURE OF MEDICAL AND DENTAL INSTRUMENT CASES AND TRAYS, IN CLASS 40 (U.S. CLS. 100, 103 AND 106).

SER. NO. 78-945,424, FILED 8-4-2006.

FIRST USE 10-0-2001; IN COMMERCE 10-0-2001.

MICHAEL TANNER, EXAMINING ATTORNEY

Int. Cl.: 43

Prior U.S. Cls.: 100 and 101

United States Patent and Trademark Office

Reg. No. 3,485,023

Registered Aug. 12, 2008

**SERVICE MARK
PRINCIPAL REGISTER**



DOWNTOWN ENTERPRISES, LLC (NEW MEXI-
CO LTD LIAB CO)
215 CENTRAL AVENUE
ALBUQUERQUE, NM 87102

FOR: RESTAURANT SERVICES, IN CLASS 43
(U.S. CLS. 100 AND 101).

FIRST USE 10-15-2006; IN COMMERCE 10-15-2006.

NO CLAIM IS MADE TO THE EXCLUSIVE
RIGHT TO USE "NEW YORK PIZZA", APART
FROM THE MARK AS SHOWN.

SER. NO. 78-947,789, FILED 8-8-2006.

DANIEL BRODY, EXAMINING ATTORNEY

Int. Cl.: 12

Prior U.S. Cls.: 19, 21, 23, 31, 35 and 44

Reg. No. 3,485,024

United States Patent and Trademark Office

Registered Aug. 12, 2008

**TRADEMARK
PRINCIPAL REGISTER**



LAND ROVER (UNITED KINGDOM CORPORATION)
BANBURY ROAD, GAYDON, WARWICK
WARWICKSHIRE, UNITED KINGDOM CV350RR

FOR: SPORTS UTILITY VEHICLES, IN CLASS 12
(U.S. CLS. 19, 21, 23, 31, 35 AND 44).

FIRST USE 0-0-1948; IN COMMERCE 0-0-1986.

OWNER OF U.S. REG. NOS. 541,722, 1,201,939 AND OTHERS.

THE MARK CONSISTS OF THE WORDS "LAND ROVER" INSIDE AN OVAL WITH ZAG Z ELEMENTS AFTER "LAND" AND BEFORE "ROVER".

SER. NO. 78-948,722, FILED 8-9-2006.

HEATHER BIDDULPH, EXAMINING ATTORNEY

Int. Cl.: 11

Prior U.S. Cls.: 13, 21, 23, 31 and 34

United States Patent and Trademark Office

Reg. No. 3,485,025

Registered Aug. 12, 2008

**TRADEMARK
PRINCIPAL REGISTER**

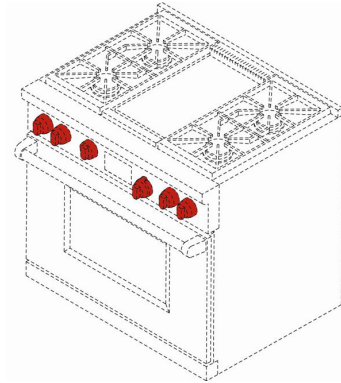

WOLF APPLIANCE, INC. (WISCONSIN CORPORATION)
2866 BUD'S DRIVE
FITCHBURG, WI 53719

FOR: DOMESTIC GAS AND ELECTRIC COOKING APPLIANCES, NAMELY, RANGES, DUAL-FUEL RANGES, COOKTOPS, AND BARBEQUE GRILLS, IN CLASS 11 (U.S. CLS. 13, 21, 23, 31 AND 34).

FIRST USE 2-28-2000; IN COMMERCE 2-28-2000.

THE COLOR(S) RED IS/ARE CLAIMED AS A FEATURE OF THE MARK.

THE MARK CONSISTS OF A RED KNOB OR KNOBS OF THE GOODS. THE BROKEN LINES ARE INTENDED ONLY TO EXEMPLIFY A POSITION OF THE MARK AND DO NOT FORM PART OF THE MARK. THE COLOR WHITE IS SHOWN ONLY AS ENVIRONMENT AND DOES NOT FORM A PART OF THE MARK.

SEC. 2(F).

SER. NO. 78-948,732, FILED 8-9-2006.

WILLIAM VERHOSEK, EXAMINING ATTORNEY

Int. Cls.: 24, 40 and 42

Prior U.S. Cls.: 42, 50, 100, 101, 103 and 106

United States Patent and Trademark Office

Reg. No. 3,485,026

Registered Aug. 12, 2008

**TRADEMARK
SERVICE MARK
PRINCIPAL REGISTER**



V2 COMPOSITES, INC. (DELAWARE CORPORATION)
770 LEE ROAD 191
AUBURN, AL 36830

FOR: NON-METAL NATURAL AND/OR SYNTHETIC COMPOSITE FABRIC FIBERS FOR REINFORCING MATERIALS USED IN AEROSPACE APPLICATIONS SPORTING GOODS APPLICATIONS, MARINE APPLICATIONS, MILITARY APPLICATIONS, TRANSPORTATION APPLICATIONS, STRUCTURAL REINFORCEMENT APPLICATIONS AND BALLISTIC APPLICATIONS, IN CLASS 24 (U.S. CLS. 42 AND 50).

FIRST USE 7-1-2006; IN COMMERCE 7-1-2006.

FOR: MANUFACTURING SERVICES FOR OTHERS IN THE FIELD OF NATURAL AND/OR SYNTHETIC REINFORCING MATERIALS FOR REINFORCING MATERIALS USED IN AEROSPACE APPLICATIONS, SPORTING GOODS APPLICATIONS, MARINE APPLICATIONS, MILITARY APPLICATIONS, TRANSPORTATION APPLICATIONS, STRUCTURAL REINFORCEMENT APPLICATIONS AND BALLISTIC APPLICATIONS, IN CLASS 40 (U.S. CLS. 100, 103 AND 106).

FIRST USE 7-1-2006; IN COMMERCE 7-1-2006.

FOR: DESIGN SERVICES IN THE FIELD OF NATURAL AND/OR SYNTHETIC REINFORCEMENT MATERIALS FOR REINFORCING MATERIALS USED IN AEROSPACE APPLICATIONS, SPORTING GOODS APPLICATIONS, MARINE APPLICATIONS, MILITARY APPLICATIONS, TRANSPORTATION APPLICATIONS, STRUCTURAL REINFORCEMENT APPLICATIONS AND BALLISTIC APPLICATIONS, IN CLASS 42 (U.S. CLS. 100 AND 101).

FIRST USE 7-1-2006; IN COMMERCE 7-1-2006.

NO CLAIM IS MADE TO THE EXCLUSIVE RIGHT TO USE "COMPOSITES", APART FROM THE MARK AS SHOWN.

THE MARK CONSISTS OF "V2" SUPERIMPOSED OVER A GLOBE WITH THE WORD "COMPOSITE" BELOW THE NUMBER 2.

SER. NO. 78-952,498, FILED 8-15-2006.

RICHARD WHITE, EXAMINING ATTORNEY

Int. Cl.: 42

Prior U.S. Cls.: 100 and 101

United States Patent and Trademark Office

Reg. No. 3,485,027

Registered Aug. 12, 2008

**SERVICE MARK
PRINCIPAL REGISTER**

NAVQUEST

LITVACK, KEN (UNITED STATES INDIVIDUAL)
102-54E SHEARWATER CT.
JERSEY CITY, NJ 07305

THE MARK CONSISTS OF STANDARD CHAR-
ACTERS WITHOUT CLAIM TO ANY PARTICULAR
FONT, STYLE, SIZE, OR COLOR.

FOR: CARTOGRAPHY AND MAPPING SERVI-
CES FOR OTHERS FOR USE IN THE PRODUCTION
OF MAPS, IN CLASS 42 (U.S. CLS. 100 AND 101).

SER. NO. 78-955,068, FILED 8-18-2006.

FIRST USE 3-23-2006; IN COMMERCE 3-23-2006.

MARK SPARACINO, EXAMINING ATTORNEY

Int. Cl.: 6

Prior U.S. Cls.: 2, 12, 13, 14, 23, 25 and 50

Reg. No. 3,485,028

United States Patent and Trademark Office

Registered Aug. 12, 2008

**TRADEMARK
PRINCIPAL REGISTER**

austenitex

VERTEX INDUSTRIES, INC. (DELAWARE CORPORATION)
818C SOUTH HEALD ST.
WILMINGTON, DE 19801

FOR: METAL PIPES FOR USE IN SANITARY FACILITIES, IN CLASS 6 (U.S. CLS. 2, 12, 13, 14, 23, 25 AND 50).

FIRST USE 5-0-2006; IN COMMERCE 7-0-2006.

THE COLOR(S) SILVER IS/ARE CLAIMED AS A FEATURE OF THE MARK.

THE MARK CONSISTS OF THE COLOR SILVER IN THE WORDING "AUSTENITEX".

SER. NO. 78-955,336, FILED 8-18-2006.

KELLEY WELLS, EXAMINING ATTORNEY

Int. Cl.: 44

Prior U.S. Cls.: 100 and 101

United States Patent and Trademark Office

Reg. No. 3,485,029

Registered Aug. 12, 2008

**SERVICE MARK
PRINCIPAL REGISTER**

**EXPRESSCARE NO WAIT, FEEL
GREAT!**

EMERGENCY MEDICAL ASSOCIATES OF NEW
JERSEY (NEW JERSEY CORPORATION)

651 W. MT. PLEASANT AVENUE

LIVINGSTON, NJ 07039

FOR: EMERGENCY MEDICAL SERVICES, IN
CLASS 44 (U.S. CLS. 100 AND 101).

FIRST USE 6-29-2006; IN COMMERCE 6-29-2006.

THE MARK CONSISTS OF STANDARD CHAR-
ACTERS WITHOUT CLAIM TO ANY PARTICULAR
FONT, STYLE, SIZE, OR COLOR.

NO CLAIM IS MADE TO THE EXCLUSIVE
RIGHT TO USE "EXPRESSCARE", APART FROM
THE MARK AS SHOWN.

SER. NO. 78-955,384, FILED 8-18-2006.

FLORENTINA BLANDU, EXAMINING ATTORNEY

Int. Cl.: 25

Prior U.S. Cls.: 22 and 39

United States Patent and Trademark Office

Reg. No. 3,485,030

Registered Aug. 12, 2008

**TRADEMARK
PRINCIPAL REGISTER**



INTERNATIONAL BROTHERHOOD OF OMEGA
DELTA PHI (TEXAS CORPORATION)
1007 STREAMSIDE DRIVE
CEDAR HILL, TX 75104

FOR: CLOTHING, NAMELY, SHIRTS, SWEAT-
SHIRTS, T-SHIRTS, HATS, SHORTS, JACKETS,
SWEATERS, PANTS, SOCKS, SHOES, AND ATH-
LETIC CLOTHING IN THE NATURE OF WARM UP
SUITS, IN CLASS 25 (U.S. CLS. 22 AND 39).

FIRST USE 12-15-1987; IN COMMERCE 6-15-1988.

THE MARK CONSISTS OF THE GREEK CHAR-
ACTERS OMEGA DELTA PHI.

SER. NO. 78-955,634, FILED 8-18-2006.

BRIAN PINO, EXAMINING ATTORNEY

Int. Cl.: 5

Prior U.S. Cls.: 6, 18, 44, 46, 51 and 52

Reg. No. 3,485,031

United States Patent and Trademark Office

Registered Aug. 12, 2008

TRADEMARK
PRINCIPAL REGISTER

IVY BLOCK

STANDARD HOMEOPATHIC COMPANY (NEVADA CORPORATION)

210 WEST 131ST STREET

LOS ANGELES, CA 90061

FOR: TOPICAL PHARMACEUTICAL PREPARATION FOR THE PREVENTION OF CONTACT DERMATITIS, IN CLASS 5 (U.S. CLS. 6, 18, 44, 46, 51 AND 52).

FIRST USE 11-13-1996; IN COMMERCE 11-13-1996.

THE MARK CONSISTS OF STANDARD CHARACTERS WITHOUT CLAIM TO ANY PARTICULAR FONT, STYLE, SIZE, OR COLOR.

NO CLAIM IS MADE TO THE EXCLUSIVE RIGHT TO USE "BLOCK", APART FROM THE MARK AS SHOWN.

SEC. 2(F).

SER. NO. 78-956,018, FILED 8-20-2006.

KAPIL BHANOT, EXAMINING ATTORNEY

Int. Cls.: 1, 2, 11 and 37

**Prior U.S. Cls.: 1, 5, 6, 10, 11, 13, 16, 21, 23, 26, 31, 34,
46, 100, 103 and 106**

Reg. No. 3,485,032

United States Patent and Trademark Office

Registered Aug. 12, 2008

**TRADEMARK
SERVICE MARK
PRINCIPAL REGISTER**



NU FLOW AMERICA, INC. (NEW YORK CORPORATION)
7150 CARROLL ROAD
SUITE 100
SAN DIEGO, CA 92121

FOR: EPOXY GLUE FOR GENERAL BONDING AND REPAIR, EPOXY RESINS, PHENOLIC RESINS, POLYAMIDE RESINS, POLYESTER RESINS, POLYETHYLENE RESINS, POLYPROPYLENE RESINS, POLYSTYRENE RESINS, SYNTHETIC RESINS FOR USE IN A WIDE VARIETY OF INDUSTRIES AND APPLICATIONS, IN CLASS 1 (U.S. CLS. 1, 5, 6, 10, 26 AND 46).

FIRST USE 1-1-2005; IN COMMERCE 1-1-2005.

FOR: RUST PRESERVATIVES IN THE NATURE OF A COATING; COATING COMPOSITIONS IN THE NATURE OF PAINT FOR USE IN A WIDE VARIETY OF INDUSTRIES AND APPLICATIONS, INCLUDING COMMERCIAL MARINE USE, IN CLASS 2 (U.S. CLS. 6, 11 AND 16).

FIRST USE 1-1-2005; IN COMMERCE 1-1-2005.

FOR: REGULATING ACCESSORIES FOR WATER SUPPLY, NAMELY, METERED VALVES, VENTI-

LATING FANS, IN CLASS 11 (U.S. CLS. 13, 21, 23, 31 AND 34).

FIRST USE 1-1-2005; IN COMMERCE 1-1-2005.

FOR: BUILDING CONSTRUCTION AND REPAIR, BUILDING MAINTENANCE AND REPAIR, HOUSE BUILDING AND REPAIR, INSTALLATION, REPAIR AND MAINTENANCE OF CONDENSING APPARATUS, STEAM CONDENSERS, RADIATORS AND MOTORS, PIPELINE INSTALLATION AND REPAIR, IN CLASS 37 (U.S. CLS. 100, 103 AND 106).

FIRST USE 1-1-2005; IN COMMERCE 1-1-2005.

NO CLAIM IS MADE TO THE EXCLUSIVE RIGHT TO USE "RELINE REPAIR RENEW", APART FROM THE MARK AS SHOWN.

THE MARK CONSISTS OF THE WORDS "NU FLOW RELINE REPAIR RENEW" IN STYLIZED FORM WITH A WATER DROPLET DESIGN FORMING THE LETTER "O" IN THE WORD "FLOW".

SER. NO. 78-956,618, FILED 8-21-2006.

DAVID H. STINE, EXAMINING ATTORNEY

Int. Cl.: 36

Prior U.S. Cls.: 100, 101 and 102

United States Patent and Trademark Office

Reg. No. 3,485,033

Registered Aug. 12, 2008

**SERVICE MARK
PRINCIPAL REGISTER**



PACIFIC ANCHOR HOLDINGS, LLC (DELA-
WARE LTD LIAB CO)
10508 LOWER AZUSA ROAD SUITE #200
EL MONTE, CA 91731

FOR: REAL ESTATE INVESTMENT, IN CLASS 36
(U.S. CLS. 100, 101 AND 102).

FIRST USE 2-17-2006; IN COMMERCE 2-17-2006.

THE COLOR(S) BLUE, BLACK AND ORANGE IS/
ARE CLAIMED AS A FEATURE OF THE MARK.

THE MARK CONSISTS OF A SQUARE DESIGN
ENCLOSING THE TWO TRANSPARENT LETTERS
'P' AND 'A' WHERE THE 'P' APPEARS ON A BLUE

BACKGROUND AND THE 'A' APPEARS ON A
BLACK BACKGROUND. THE 'A' FEATURES A
STYLIZED CURVING ORANGE LINE IN PLACE
OF THE HORIZONTAL LINE IN THE LETTER A.
THE WORDING 'PA' APPEARS ABOVE THE WORD-
ING 'PACIFIC ANCHOR' WHERE THE WORD
'PACIFIC' IS IN BLUE AND THE WORD 'ANCHOR'
IS IN BLACK. THE LETTER 'A' IN 'ANCHOR'
FEATURES A STYLIZED CURVING ORANGE LINE
IN PLACE OF THE HORIZONTAL BAR IN THE
LETTER A. THE MARK APPEARS ON A TRANS-
PARENT BACKGROUND.

SER. NO. 78-957,080, FILED 8-21-2006.

CHRISTINE COOPER, EXAMINING ATTORNEY

Int. Cl.: 20

Prior U.S. Cls.: 2, 13, 22, 25, 32 and 50

Reg. No. 3,485,034

United States Patent and Trademark Office

Registered Aug. 12, 2008

**TRADEMARK
PRINCIPAL REGISTER**

MDI

MINNESOTA DIVERSIFIED INDUSTRIES, INC.
(MINNESOTA NON-PROFIT CORPORATION)
1700 WYNNE AVENUE
ST. PAUL, MN 55402

FOR: CORRUGATED REUSABLE PLASTIC CONTAINERS FOR COMMERCIAL AND INDUSTRIAL PACKAGING, NAMELY, TOTE BOXES, BOXES, AND TRAYS, IN CLASS 20 (U.S. CLS. 2, 13, 22, 25, 32 AND 50).

FIRST USE 12-31-1992; IN COMMERCE 12-31-1992.

THE MARK CONSISTS OF STANDARD CHARACTERS WITHOUT CLAIM TO ANY PARTICULAR FONT, STYLE, SIZE, OR COLOR.

SER. NO. 78-959,338, FILED 8-24-2006.

WENDY JUN, EXAMINING ATTORNEY

Int. Cls.: 9 and 42

Prior U.S. Cls.: 21, 23, 26, 36, 38, 100 and 101

United States Patent and Trademark Office

Reg. No. 3,485,035

Registered Aug. 12, 2008

**TRADEMARK
SERVICE MARK
PRINCIPAL REGISTER**



STOCK BLOCKS, INC. (DELAWARE CORPORATION)
P.O. BOX 416
NORTH STONINGTON, DE 06359

FOR: COMPUTER SOFTWARE FOR ANALYZING STOCK TRADING FOR USE IN THE FIELD OF STOCK TRADING AND TECHNICAL ANALYSIS, IN CLASS 9 (U.S. CLS. 21, 23, 26, 36 AND 38).

FIRST USE 10-23-1995; IN COMMERCE 10-23-1995.

FOR: DESIGN, DEVELOPMENT AND IMPLEMENTATION OF SOFTWARE IN THE FIELD OF

STOCK TRADING AND TECHNICAL ANALYSIS AND SUPPORT SERVICES IN CONNECTION THEREWITH, IN CLASS 42 (U.S. CLS. 100 AND 101).

FIRST USE 10-23-1995; IN COMMERCE 10-23-1995.

NO CLAIM IS MADE TO THE EXCLUSIVE RIGHT TO USE "STOCK" AND "INC", APART FROM THE MARK AS SHOWN.

SER. NO. 78-960,721, FILED 8-25-2006.

LINDA ORNDORFF, EXAMINING ATTORNEY

Int. Cl.: 39

Prior U.S. Cls.: 100 and 105

United States Patent and Trademark Office

Reg. No. 3,485,036

Registered Aug. 12, 2008

**SERVICE MARK
PRINCIPAL REGISTER**

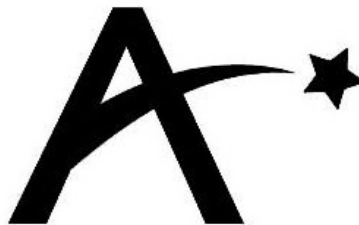

GREAT NORTHWEST MOVING COMPANY (WA-
SHINGTON CORPORATION)
10510 NE NORTHUP WAY, SUITE 110
KIRKLAND, WA 98033

THE MARK CONSISTS OF THE LETTER "A"
WITH THE DESIGN OF AN ARC AND A STAR.

FOR: PHYSICAL STORAGE OF ELECTRONIC
MEDIA, NAMELY, STORAGE OF DATA BACK-UP
TAPES, IN CLASS 39 (U.S. CLS. 100 AND 105).

SER. NO. 78-961,081, FILED 8-25-2006.

FIRST USE 6-10-2005; IN COMMERCE 6-10-2005.

EDWARD FENNESSY, EXAMINING ATTORNEY

Int. Cl.: 9

Prior U.S. Cls.: 21, 23, 26, 36 and 38

Reg. No. 3,485,037

United States Patent and Trademark Office

Registered Aug. 12, 2008

**TRADEMARK
PRINCIPAL REGISTER**

POWERFLEX 90

AMERICAN INSULATED WIRE CORPORATION
(RHODE ISLAND CORPORATION)
260 FORBES BLVD.
MANSFIELD, MA 02048

THE MARK CONSISTS OF STANDARD CHAR-
ACTERS WITHOUT CLAIM TO ANY PARTICULAR
FONT, STYLE, SIZE, OR COLOR.

FOR: ELECTRICAL WIRE AND CABLE, IN
CLASS 9 (U.S. CLS. 21, 23, 26, 36 AND 38).

SER. NO. 78-963,502, FILED 8-30-2006.

FIRST USE 10-2-1970; IN COMMERCE 10-2-1970.

BRIDGETT SMITH, EXAMINING ATTORNEY

Int. Cl.: 41

Prior U.S. Cls.: 100, 101 and 107

United States Patent and Trademark Office

Reg. No. 3,485,038

Registered Aug. 12, 2008

**SERVICE MARK
PRINCIPAL REGISTER**



VIE, LLC (CONNECTICUT LTD LIAB CO)
58 DRUMLIN ROAD
SIMSBURY, CT 06092

THE MARK CONSISTS OF STANDARD CHAR-
ACTERS WITHOUT CLAIM TO ANY PARTICULAR
FONT, STYLE, SIZE, OR COLOR.

FOR: BUSINESS TRAINING, IN CLASS 41 (U.S.
CLS. 100, 101 AND 107).

SER. NO. 78-963,855, FILED 8-30-2006.

FIRST USE 8-1-2006; IN COMMERCE 8-8-2006.

KEVIN DINALLO, EXAMINING ATTORNEY

Int. Cl.: 9

Prior U.S. Cls.: 21, 23, 26, 36 and 38

Reg. No. 3,485,039

United States Patent and Trademark Office

Registered Aug. 12, 2008

**TRADEMARK
PRINCIPAL REGISTER**

Reels & Deals

CUSTOM GAME DESIGN, INC. (TEXAS CORPORATION)
5055 W. PARK BLVD., SUITE 550
PLANO, TX 75093

FOR: COMPUTER SOFTWARE AND FIRMWARE FOR GAMES OF CHANCE ON ANY COMPUTERIZED PLATFORM, INCLUDING DEDICATED GAMING CONSOLES, VIDEO BASED SLOT MACHINES, REEL BASED SLOT MACHINES, AND VIDEO LOTTERY TERMINALS; GAMING DEVICES, NAMELY, GAMING MACHINES, SLOT MACHINES, BINGO MACHINES, WITH OR WITHOUT VIDEO OUTPUT; INTERACTIVE VIDEO GAME

PROGRAMS; VIDEO GAME SOFTWARE, IN CLASS 9 (U.S. CLS. 21, 23, 26, 36 AND 38).

FIRST USE 5-26-2006; IN COMMERCE 5-26-2006.

THE MARK CONSISTS OF STANDARD CHARACTERS WITHOUT CLAIM TO ANY PARTICULAR FONT, STYLE, SIZE, OR COLOR.

SER. NO. 78-966,713, FILED 9-4-2006.

RICHARD A. STRASER, EXAMINING ATTORNEY

Int. Cl.: 41

Prior U.S. Cls.: 100, 101 and 107

United States Patent and Trademark Office

Reg. No. 3,485,040

Registered Aug. 12, 2008

**SERVICE MARK
PRINCIPAL REGISTER**

Liquid Films

CABRERA, CHARLEY (UNITED STATES INDIVIDUAL)
5400 NW 107 AVE #401
DORAL, FL 33178

FOR: MOTION PICTURE FILM PRODUCTION AND TELEVISION SHOW PRODUCTION, IN CLASS 41 (U.S. CLS. 100, 101 AND 107).

FIRST USE 7-3-1997; IN COMMERCE 7-3-1997.

THE MARK CONSISTS OF STANDARD CHARACTERS WITHOUT CLAIM TO ANY PARTICULAR FONT, STYLE, SIZE, OR COLOR.

NO CLAIM IS MADE TO THE EXCLUSIVE RIGHT TO USE "FILMS", APART FROM THE MARK AS SHOWN.

SER. NO. 78-966,983, FILED 9-5-2006.

RICHARD A. STRASER, EXAMINING ATTORNEY

Int. Cl.: 29

Prior U.S. Cl.: 46

United States Patent and Trademark Office

Reg. No. 3,485,041

Registered Aug. 12, 2008

**TRADEMARK
PRINCIPAL REGISTER**

SANTA FE

TORN & GLASSER, INC. (CALIFORNIA CORPORATION)
P.O. BOX 21823
1622 EAST OLYMPIC BOULEVARD
LOS ANGELES, CA 90021

THE MARK CONSISTS OF STANDARD CHARACTERS WITHOUT CLAIM TO ANY PARTICULAR FONT, STYLE, SIZE, OR COLOR.

FOR: SNACK MIX CONSISTING PRIMARILY OF PROCESSED FRUITS, PROCESSED NUTS AND/OR RAISINS, IN CLASS 29 (U.S. CL. 46).

SER. NO. 78-967,134, FILED 9-5-2006.

FIRST USE 8-1-2000; IN COMMERCE 8-1-2000.

KEVON CHISOLM, EXAMINING ATTORNEY

Int. Cl.: 25

Prior U.S. Cls.: 22 and 39

United States Patent and Trademark Office

Reg. No. 3,485,042

Registered Aug. 12, 2008

**TRADEMARK
PRINCIPAL REGISTER**

THE APRON MUSE

BARBARA KAYE (UNITED STATES INDIVIDUAL)
80 DUNDEE DRIVE
BRIDGEWATER, MA 02324

FOR: KITCHEN CLOTHING, NAMELY, NOVELTY KITCHEN APRONS, NOT SOLD IN CLOTHING STORES, IN CLASS 25 (U.S. CLS. 22 AND 39).

FIRST USE 8-0-2005; IN COMMERCE 8-0-2005.

THE MARK CONSISTS OF STANDARD CHARACTERS WITHOUT CLAIM TO ANY PARTICULAR FONT, STYLE, SIZE, OR COLOR.

NO CLAIM IS MADE TO THE EXCLUSIVE RIGHT TO USE "APRON", APART FROM THE MARK AS SHOWN.

SER. NO. 78-968,612, FILED 9-6-2006.

RAMONA ORTIGA, EXAMINING ATTORNEY

Int. Cl.: 9

Prior U.S. Cls.: 21, 23, 26, 36 and 38

Reg. No. 3,485,043

United States Patent and Trademark Office

Registered Aug. 12, 2008

**TRADEMARK
PRINCIPAL REGISTER**

ROADSTER

MESA/BOOGIE, LTD. (CALIFORNIA CORPORATION)
1317 ROSS STREET
PETALUMA, CA 94954

THE MARK CONSISTS OF STANDARD CHARACTERS WITHOUT CLAIM TO ANY PARTICULAR FONT, STYLE, SIZE, OR COLOR.

FOR: AMPLIFIERS FOR MUSICAL INSTRUMENTS, IN CLASS 9 (U.S. CLS. 21, 23, 26, 36 AND 38).

SER. NO. 78-969,506, FILED 9-7-2006.

FIRST USE 4-20-2006; IN COMMERCE 4-20-2006.

MARILYN IZZI, EXAMINING ATTORNEY

Int. Cl.: 9

Prior U.S. Cls.: 21, 23, 26, 36 and 38

Reg. No. 3,485,044

United States Patent and Trademark Office

Registered Aug. 12, 2008

**TRADEMARK
PRINCIPAL REGISTER**

ROAD KING

MESA/BOOGIE, LTD. (CALIFORNIA CORPORATION)
1317 ROSS STREET
PETALUMA, CA 94954

THE MARK CONSISTS OF STANDARD CHARACTERS WITHOUT CLAIM TO ANY PARTICULAR FONT, STYLE, SIZE, OR COLOR.

FOR: AMPLIFIERS FOR MUSICAL INSTRUMENTS, IN CLASS 9 (U.S. CLS. 21, 23, 26, 36 AND 38).

SER. NO. 78-969,511, FILED 9-7-2006.

FIRST USE 1-9-2002; IN COMMERCE 1-9-2002.

MARILYN IZZI, EXAMINING ATTORNEY

Int. Cl.: 1

Prior U.S. Cls.: 1, 5, 6, 10, 26 and 46

Reg. No. 3,485,045

United States Patent and Trademark Office

Registered Aug. 12, 2008

**TRADEMARK
PRINCIPAL REGISTER**

PETRO-PIPE

SPI BRANDS LLC (CONNECTICUT LTD LIAB
CO)
215 VILLAGE STREET
NORTHFORD, CT 06472

FOR: CHEMICALS, NAMELY, COMPOSITIONS
FOR FILTERING CONTAMINATED WATER AND
FOR SEPARATING HYDRCARBONS FROM WA-
TER, IN CLASS 1 (U.S. CLS. 1, 5, 6, 10, 26 AND 46).

FIRST USE 7-21-2001; IN COMMERCE 7-21-2001.

THE MARK CONSISTS OF STANDARD CHAR-
ACTERS WITHOUT CLAIM TO ANY PARTICULAR
FONT, STYLE, SIZE, OR COLOR.

OWNER OF CANADA REG. NO. TMA704,857,
DATED 1-17-2008, EXPIRES 1-17-2023.

OWNER OF U.S. REG. NO. 2,876,581.

SER. NO. 78-973,349, FILED 9-13-2006.

MARCIE MILONE, EXAMINING ATTORNEY

Int. Cl.: 9

Prior U.S. Cls.: 21, 23, 26, 36 and 38

Reg. No. 3,485,046

United States Patent and Trademark Office

Registered Aug. 12, 2008

**TRADEMARK
PRINCIPAL REGISTER**

NETWORKSAGE

DIVERSE NETWORK COMMUNICATIONS, INC.
(COLORADO CORPORATION)
P.O. BOX 672
EVERGREEN, CO 80437

FIRST USE 8-1-2006; IN COMMERCE 8-1-2006.

FOR: COMPUTER SOFTWARE FOR CONDUCTING AN ASSET INVENTORY OF A COMPUTER SYSTEM TO ANALYZE, COMPILE AND REPORT THE DETAILS OF THE SYSTEM TECHNOLOGY, INFRASTRUCTURE AND CONFIGURATION, IN CLASS 9 (U.S. CLS. 21, 23, 26, 36 AND 38).

THE MARK CONSISTS OF STANDARD CHARACTERS WITHOUT CLAIM TO ANY PARTICULAR FONT, STYLE, SIZE, OR COLOR.

SER. NO. 78-973,750, FILED 9-13-2006.

COLLEEN DOMBROW, EXAMINING ATTORNEY

Int. Cl.: 35

Prior U.S. Cls.: 100, 101 and 102

United States Patent and Trademark Office

Reg. No. 3,485,047

Registered Aug. 12, 2008

**SERVICE MARK
PRINCIPAL REGISTER**

TRIAD SENIOR LIVING

TRIAD SENIOR LIVING, INC. (TEXAS CORPORATION)
SUITE 210
14160 DALLAS PARKWAY
DALLAS, TX 75254

FOR: MANAGEMENT OF SENIOR LIVING FACILITIES FOR OTHERS, IN CLASS 35 (U.S. CLS. 100, 101 AND 102).

FIRST USE 12-0-1995; IN COMMERCE 12-0-1995.

THE MARK CONSISTS OF STANDARD CHARACTERS WITHOUT CLAIM TO ANY PARTICULAR FONT, STYLE, SIZE, OR COLOR.

NO CLAIM IS MADE TO THE EXCLUSIVE RIGHT TO USE "SENIOR LIVING", APART FROM THE MARK AS SHOWN.

SER. NO. 78-974,840, FILED 9-14-2006.

MICHAEL GAAFAR, EXAMINING ATTORNEY

Int. Cls.: 16 and 25

Prior U.S. Cls.: 2, 5, 22, 23, 29, 37, 38, 39 and 50

Reg. No. 3,485,048

United States Patent and Trademark Office

Registered Aug. 12, 2008

**TRADEMARK
PRINCIPAL REGISTER**

DOH-DOH

SHORTY'S, INC. (CALIFORNIA CORPORATION)
1125 MARK AVENUE
CARPINTERIA, CA 93013

FOR: STICKERS, IN CLASS 16 (U.S. CLS. 2, 5, 22,
23, 29, 37, 38 AND 50).

FIRST USE 11-0-1991; IN COMMERCE 11-0-1991.

FOR: CLOTHING, NAMELY, T-SHIRTS, HATS
AND BEANIES, IN CLASS 25 (U.S. CLS. 22 AND 39).

FIRST USE 11-0-1991; IN COMMERCE 11-0-1991.

SER. NO. 78-976,071, FILED 6-9-2003.

NORA BUCHANAN WILL, EXAMINING ATTOR-
NEY

Int. Cls.: 41 and 43

Prior U.S. Cls.: 100, 101 and 107

United States Patent and Trademark Office

Reg. No. 3,485,049

Registered Aug. 12, 2008

**SERVICE MARK
PRINCIPAL REGISTER**

LAX

HOLLYWOOD BAR, LLC (NEVADA LTD LIAB
CO)
2121 S. INDUSTRIAL ROAD
SUITE 107
LAS VEGAS, NV 89102

FOR: NIGHTCLUBS; ENTERTAINMENT IN THE
NATURE OF LIVE MUSICAL PERFORMANCES, IN
CLASS 41 (U.S. CLS. 100, 101 AND 107).

FIRST USE 1-0-2006; IN COMMERCE 1-0-2006.

FOR: BAR AND RESTAURANT SERVICES, IN
CLASS 43 (U.S. CLS. 100 AND 101).

FIRST USE 1-0-2006; IN COMMERCE 1-0-2006.

THE MARK CONSISTS OF STANDARD CHAR-
ACTERS WITHOUT CLAIM TO ANY PARTICULAR
FONT, STYLE, SIZE, OR COLOR.

SER. NO. 78-978,966, FILED 2-3-2006.

JAY BESCH, EXAMINING ATTORNEY

Int. Cls.: 18 and 31

Prior U.S. Cls.: 1, 2, 3, 22, 41 and 46

United States Patent and Trademark Office

Reg. No. 3,485,050

Registered Aug. 12, 2008

**TRADEMARK
PRINCIPAL REGISTER**

Canine Essentials

TAHITIAN NONI INTERNATIONAL, INC.
(UTAH CORPORATION)
333 WEST RIVER PARK DRIVE
PROVO, UT 84604

FOR: APPAREL FOR DOGS AND DOG COLLARS, IN CLASS 18 (U.S. CLS. 1, 2, 3, 22 AND 41).

FIRST USE 3-0-2006; IN COMMERCE 3-0-2006.

FOR: DOG FOOD, IN CLASS 31 (U.S. CLS. 1 AND 46).

FIRST USE 3-0-2006; IN COMMERCE 3-0-2006.

THE MARK CONSISTS OF STANDARD CHARACTERS WITHOUT CLAIM TO ANY PARTICULAR FONT, STYLE, SIZE, OR COLOR.

NO CLAIM IS MADE TO THE EXCLUSIVE RIGHT TO USE "CANINE", APART FROM THE MARK AS SHOWN.

SER. NO. 78-979,312, FILED 7-6-2005.

JENNY PARK, EXAMINING ATTORNEY

Int. Cl.: 11

Prior U.S. Cls.: 13, 21, 23, 31 and 34

Reg. No. 3,485,051

United States Patent and Trademark Office

Registered Aug. 12, 2008

**TRADEMARK
PRINCIPAL REGISTER**

PS SEASONING

WOODLAND MANUFACTURING, INC. (WIS-
CONSIN CORPORATION)
120 SOUTH MAIN STREET
IRON RIDGE, WI 53035

FOR: SMOKER OVENS FOR COMMERCIAL
COOKING, ELECTRIC SMOKER GRILLS, AND
ELECTRIC SMOKE HOUSES AND REPAIR AND
REPLACEMENT PARTS THEREFORE, IN CLASS 11
(U.S. CLS. 13, 21, 23, 31 AND 34).

FIRST USE 4-19-1984; IN COMMERCE 1-7-1987.

THE MARK CONSISTS OF STANDARD CHAR-
ACTERS WITHOUT CLAIM TO ANY PARTICULAR
FONT, STYLE, SIZE, OR COLOR.

NO CLAIM IS MADE TO THE EXCLUSIVE
RIGHT TO USE "SEASONING", APART FROM
THE MARK AS SHOWN.

SER. NO. 78-979,678, FILED 3-23-2006.

HOWARD FRIEDMAN, EXAMINING ATTORNEY

Int. Cl.: 43

Prior U.S. Cls.: 100 and 101

United States Patent and Trademark Office

Reg. No. 3,485,052

Registered Aug. 12, 2008

**SERVICE MARK
PRINCIPAL REGISTER**

SAKE BOMB

MERRITT OLESKI (UNITED STATES INDIVIDUAL)
416 ALTAVIEW COURT
CINCINNATI, OH 45231

FOR: RESTAURANT SERVICES, NAMELY, THE SERVICE OF FOOD FOR OTHERS AND EXCLUDING THE SERVICE OF ALCOHOLIC BEVERAGES, IN CLASS 43 (U.S. CLS. 100 AND 101).

FIRST USE 10-14-2004; IN COMMERCE 10-14-2004.

THE MARK CONSISTS OF STANDARD CHARACTERS WITHOUT CLAIM TO ANY PARTICULAR FONT, STYLE, SIZE, OR COLOR.

SER. NO. 78-979,824, FILED 4-13-2006.

NORA BUCHANAN WILL, EXAMINING ATTORNEY

Int. Cls.: 9, 16, 35 and 41

**Prior U.S. Cls.: 2, 5, 21, 22, 23, 26, 29, 36, 37, 38, 50,
100, 101, 102 and 107**

Reg. No. 3,485,053

United States Patent and Trademark Office

Registered Aug. 12, 2008

**TRADEMARK
SERVICE MARK
PRINCIPAL REGISTER**

A PLACE IN THE SUN

FREEFORM PRODUCTIONS LIMITED (UNITED KINGDOM CORPORATION)
301-304 GREENHEATH CENTRE THREE COLTS LANE
LONDON, UNITED KINGDOM E2 6JB

FOR: PRE-RECORDED MAGNETIC AND OPTICAL MEDIA RELATING TO THE BUYING, SELLING, LEASING, AND LETTING OF REAL ESTATE PROPERTY, NAMELY, CD-ROMS FEATURING SOUND AND VIDEO RECORDINGS, AUDIO AND VIDEO TAPES, AND DISCS, IN CLASS 9 (U.S. CLS. 21, 23, 26, 36 AND 38).

FOR: PRINTED MATTER RELATING TO THE BUYING, SELLING, LEASING AND LETTING OF REAL ESTATE PROPERTY, NAMELY, CALENDARS, STATIONERY, WRITING AND DRAWING INSTRUMENTS, PAPER LABELS, NOTEBOOKS, NOTE PADS, WRITING PADS, LETTER PADS, LETTERHEAD STATIONERY, AND PAPER; AND BUSINESS FORMS RELATING TO THE BUSINESS OF BUYING SELLING, LEASING AND LETTING OF REAL ESTATE PROPERTY, NAMELY, INVOICES, STICKERS, ENVELOPES, BUSINESS CARDS, FOLDERS, DOCUMENT HOLDERS, PHOTOGRAPHS, POSTERS, PHOTOGRAPH ALBUMS, POST CARDS, GREETING CARDS, DIARIES AND PERSONAL ORGANIZERS, IN CLASS 16 (U.S. CLS. 2, 5, 22, 23, 29, 37, 38 AND 50).

FOR: MARKETING AND PROMOTIONAL SERVICES RELATING TO THE BUYING, SELLING, LEASING AND LETTING OF REAL ESTATE PROPERTY, NAMELY, PRODUCTION, DISSEMINATION AND DISTRIBUTION OF ADVERTISING AND PROMOTIONAL MATERIAL, PREPARATION AND PLACING OF ADVERTISEMENTS, AND PUBLICA-

TION OF PUBLICITY TEXTS; AND ADVISORY, CONSULTANCY AND INFORMATION SERVICES RELATING TO THE AFORESAID SERVICES, IN CLASS 35 (U.S. CLS. 100, 101 AND 102).

FOR: PUBLICATION SERVICES RELATING TO THE BUYING, SELLING AND LEASING AND LETTING OF REAL ESTATE PROPERTY, NAMELY, PUBLICATION AND PUBLISHING OF PRINTED MATTER, NAMELY, NEWSPAPERS, MAGAZINES, PROMOTIONAL AND MARKETING AND ADVERTISING MATERIALS, BOOKS, GREETING CARDS AND STATIONERY; PUBLICATION AND PUBLISHING OF NEWSPAPERS RELATING TO THE BUYING, SELLING, LEASING AND LETTING OF REAL ESTATE PROPERTY; ELECTRONIC PUBLICATION ON OPTICAL AND MAGNETIC DATA CARRIERS AND ON-LINE OF NEWSPAPERS AND MAGAZINES RELATING TO THE BUYING, SELLING, LEASING AND LETTING OF REAL ESTATE PROPERTY; ON-LINE PUBLICATION OF TEXT AND GRAPHIC WORKS OF OTHERS RELATING TO THE BUYING, SELLING, LEASING AND LETTING OF REAL ESTATE PROPERTY; ARRANGING AND CONDUCTING COURSES, SEMINARS, WORKSHOPS, EVENTS, SHOWS, CONFERENCES, LECTURES, SYMPOSIA AND CLASSES RELATING TO THE BUYING, SELLING, LEASING AND LETTING OF REAL ESTATE PROPERTY; ARRANGING, CONDUCTING AND ORGANIZING EXHIBITIONS RELATING TO THE BUYING, SELLING, LEASING AND LETTING OF REAL PROPERTY FOR ENTERTAINMENT, CULTURAL AND EDUCATIONAL PURPOSES; PROVISION OF EDUCATIONAL AND INSTRUCTIONAL SERVICES RELATING TO THE BUYING, SELLING, LEASING AND LETTING OF REAL ESTATE PROPERTY, NAMELY, TEACHING, TRAINING AND TUTORING OF OTHERS; WRIT-

ING AND COMPILATION OF ARTICLES AND COLUMNS RELATING TO THE BUYING, SELLING, LEASING AND LETTING OF REAL ESTATE PROPERTY FOR OTHERS FOR USE IN, BUT NOT LIMITED TO, NEWSPAPERS, MAGAZINES, INTERNET SITES AND RADIO PROGRAMS; AND ADVISORY AND CONSULTANCY AND INFORMATION SERVICES RELATING TO THE AFORESAID SERVICES, IN CLASS 41 (U.S. CLS. 100, 101 AND 107).

THE MARK CONSISTS OF STANDARD CHARACTERS WITHOUT CLAIM TO ANY PARTICULAR FONT, STYLE, SIZE, OR COLOR.

OWNER OF ERPN CMNTY TM OFC REG. NO. 004131793, DATED 1-4-2007, EXPIRES 11-23-2014.

SER. NO. 78-979,865, FILED 11-29-2004.

KATHRYN COWARD, EXAMINING ATTORNEY

Int. Cl.: 16

Prior U.S. Cls.: 2, 5, 22, 23, 29, 37, 38 and 50

United States Patent and Trademark Office

Reg. No. 3,485,054

Registered Aug. 12, 2008

**TRADEMARK
PRINCIPAL REGISTER**

ATV MAGAZINE

EHLERT PUBLISHING GROUP, INC. (MINNE-
SOTA CORPORATION)
SUITE 100
6420 SYCAMORE LN. N.
MAPLE GROVE, MN 55369

FOR: MAGAZINES RELATING TO OUTDOOR
ACTIVITIES, IN CLASS 16 (U.S. CLS. 2, 5, 22, 23, 29, 37,
38 AND 50).

FIRST USE 6-1-1995; IN COMMERCE 6-1-1995.

THE MARK CONSISTS OF STANDARD CHAR-
ACTERS WITHOUT CLAIM TO ANY PARTICULAR
FONT, STYLE, SIZE, OR COLOR.

OWNER OF U.S. REG. NOS. 2,127,883 AND
2,388,184.

NO CLAIM IS MADE TO THE EXCLUSIVE
RIGHT TO USE "MAGAZINE", APART FROM THE
MARK AS SHOWN.

SEC. 2(F).

SER. NO. 78-980,051, FILED 4-12-2006.

AMEETA JORDAN, EXAMINING ATTORNEY

Int. Cls.: 18 and 25

Prior U.S. Cls.: 1, 2, 3, 22, 39 and 41

Reg. No. 3,485,055

United States Patent and Trademark Office

Registered Aug. 12, 2008

**TRADEMARK
PRINCIPAL REGISTER**

Love Jeans

LOVE JEANS GMBH (FED REP GERMANY LTD
LIAB CO)
HAMMER LANDSTR. 91
D-41460 NEUSS
FED REP GERMANY

FOR: LEATHER AND IMITATION LEATHER GOODS, NAMELY, CASES, BAGS; WALLETS, BRIEF CASES, CREDIT CARD CASES, PASSPORT CASES, BUSINESS CARD CASES, CALLING CARD CASES, CARRYING CASES, DOCUMENT CASES, TRAVELING CASES, VANITY CASES SOLD EMPTY, CASES FOR KEYS, LEATHER FOR SHOES, HANDBAGS, LEATHER KEY CHAINS, PURSES, SPORTS BAGS, LEATHER SHOPPING BAGS, STRAPS, AND LUGGAGE; LEATHER SOLD IN BULK; SUITCASES, IN CLASS 18 (U.S. CLS. 1, 2, 3, 22 AND 41).

FOR: CLOTHING, NAMELY, BLOUSES, SHIRTS, T-SHIRTS, SWEAT-SHIRTS, JACKETS, PULL-OVERS, TANK-TOPS, CROP TOPS, HALTER TOPS, TOPS, TROUSERS, SKIRTS, BATHING COSTUMES FOR WOMEN, FOLK COSTUMES, COSTUMES FOR USE IN ROLE-PLAYING GAMES, DANCE COS-

TUMES, FITTED SWIMMING COSTUMES WITH BRA CUPS, HALLOWEEN COSTUMES AND MASKS SOLD IN CONNECTION THEREWITH, MASQUERADE COSTUMES AND MASKS SOLD IN CONNECTION THEREWITH, COATS, UNDERWEAR, BATHING SUITS, BATHING COSTUMES, SUITS, JOGGING PANTS, JOGGING SUITS, BIKINIS, SCARVES, GLOVES, BELTS AND TIES; FOOTWEAR; HEADGEAR, NAMELY, HATS, HEADBANDS, CAPS, AND BANDANNAS, IN CLASS 25 (U.S. CLS. 22 AND 39).

OWNER OF INTERNATIONAL REGISTRATION
0799052 DATED 2-28-2003, EXPIRES 2-28-2013.

NO CLAIM IS MADE TO THE EXCLUSIVE RIGHT TO USE "JEANS", APART FROM THE MARK AS SHOWN.

SER. NO. 79-002,424, FILED 4-7-2004.

RICHARD A. STRASER, EXAMINING ATTORNEY

Int. Cl.: 12

Prior U.S. Cls.: 19, 21, 23, 31, 35 and 44

United States Patent and Trademark Office

Reg. No. 3,485,056

Registered Aug. 12, 2008

**TRADEMARK
PRINCIPAL REGISTER**

LA SALLE

ARISTIDE & CO ANTIQUAIRE DE MARQUES
(FRANCE SARL)
57, RUE D'AMSTERDAM
F-75008 PARIS
FRANCE

FOR: MOTOR VEHICLES, NAMELY AUTOMOBILES, BOATS, MOTORCYCLES; CAR BODIES; AUTOMOBILE CHASSIS; ENGINES AND OTHER PARTS FOR MOTOR VEHICLES, NAMELY AXLES, DRIVE GEARS, TRANSMISSIONS; MOTOR BUSES; RECREATIONAL VEHICLES, NAMELY CAMPERS; MOTOR COACHES; BICYCLES; LORRIES, NAMELY LIGHT LORRIES, TRANSPORTATION LORRIES; VANS, NAMELY CARAVANS; MOTORCYCLES; TRACTORS; MOPEDS, IN CLASS 12 (U.S. CLS. 19, 21, 23, 31, 35 AND 44).

THE MARK CONSISTS OF STANDARD CHARACTERS WITHOUT CLAIM TO ANY PARTICULAR FONT, STYLE, SIZE, OR COLOR.

PRIORITY DATE OF 12-15-2003 IS CLAIMED.

OWNER OF INTERNATIONAL REGISTRATION 0833635 DATED 6-7-2004, EXPIRES 6-7-2014.

THE ENGLISH TRANSLATION OF LA SALLE IS "THE ROOM".

SER. NO. 79-005,477, FILED 6-7-2004.

MELVIN AXILBUND, EXAMINING ATTORNEY

Int. Cls.: 9, 35, 38 and 42

Prior U.S. Cls.: 21, 23, 26, 36, 38, 100, 101, 102 and 104

United States Patent and Trademark Office

Reg. No. 3,485,057

Registered Aug. 12, 2008

**TRADEMARK
SERVICE MARK
PRINCIPAL REGISTER**

telemotive

ARMIN STARK (FED REP GERMANY INDIVIDUAL)
ULRICH SCHWEIZER STR. 18
73326 DEGGINGEN
FED REP GERMANY AND
PETER KERSTEN (FED REP GERMANY INDIVIDUAL)
EICHENWEG 10
73345 HOHENSTADT
FED REP GERMANY

FOR: DEVICES FOR RECORDING, TRANSMITTING AND REPRODUCING SOUNDS AND IMAGES, NAMELY RECORDING APPARATUS FOR TESTING AUTOMOBILE DATA PROCESSING SYSTEMS, IN PARTICULAR FOR TESTING AUTOMOBILE DATA-BUS-SYSTEMS, EXCEPT CRANE CONTROL APPARATUS; COMPUTER HARDWARE; NAMELY TESTING AND RECORDING DEVICES, IN PARTICULAR A DATA LOGGER FOR TESTING AUTOMOBILE DATA PROCESSING SYSTEMS, IN PARTICULAR FOR TESTING AUTOMOBILE DATA-BUS-SYSTEMS AND COMPUTER INTERFACES FOR CONNECTING MOBILE DEVICES, E.G., MP3-PLAYER OR CELLULAR PHONES, WITH THE AUTOMOBILE-ELECTRONIC OR -AUDIO-SYSTEM, EXCEPT CRANE CONTROL APPARATUS, IN CLASS 9 (U.S. CLS. 21, 23, 26, 36 AND 38).

FOR: ADVERTISING; BUSINESS ADMINISTRATION AND MANAGEMENT; COMPILATION, SYSTEMIZATION OF DATA IN COMPUTER DATABASES; COMPUTERIZED DATA MANAGEMENT; BUSINESS ORGANIZATIONAL CONSULTING; INFORMATION, INQUIRIES,

INVESTIGATIONS IN BUSINESS MATTERS; PREPARATION OF BUSINESS APPRAISALS; PREPARATION OF ECONOMIC FORECASTS, IN CLASS 35 (U.S. CLS. 100, 101 AND 102).

FOR: ONLINE SERVICES, NAMELY ELECTRONIC, ELECTRIC AND DIGITAL TRANSMISSION OF INFORMATION AND MESSAGES OF ALL AND ANY KIND OF SOUND OR IMAGES FOR THE PURPOSES OF REMOTE MONITORING, TESTING AND SERVICING OF AUTOMOBILE ELECTRONICS, IN CLASS 38 (U.S. CLS. 100, 101 AND 104).

FOR: CONSULTING SERVICES IN THE FIELD OF ENGINEERING, NAMELY IN THE FIELD OF AUTOMOTIVE RESEARCH AND DEVELOPMENT, EXCEPT FOR CONSULTATIONS CONCERNING CRANE CONTROL APPARATUS AND SYSTEMS; COMPUTER-SYSTEM ANALYSIS FOR THE PURPOSES OF TESTING AUTOMOBILE DATA-BUS-SYSTEMS AND AUTOMOBILE ELECTRONICS, EXCEPT CRANE CONTROL APPARATUS, IN CLASS 42 (U.S. CLS. 100 AND 101).

THE MARK CONSISTS OF STANDARD CHARACTERS WITHOUT CLAIM TO ANY PARTICULAR FONT, STYLE, SIZE, OR COLOR.

OWNER OF INTERNATIONAL REGISTRATION
0849445 DATED 6-14-2004, EXPIRES 6-14-2014.

SER. NO. 79-010,866, FILED 6-14-2004.

DANIEL CAPSHAW, EXAMINING ATTORNEY

Int. Cls.: 18 and 25

Prior U.S. Cls.: 1, 2, 3, 22, 39 and 41

United States Patent and Trademark Office

Reg. No. 3,485,058

Registered Aug. 12, 2008

**TRADEMARK
PRINCIPAL REGISTER**

PZERO

PIRELLI & C. S.P.A. (ITALY JOINT STOCK
COMPANY)
VIA GAETANO NEGRI, 10
I-20123 MILANO (MI)
ITALY

FOR: HANDBAGS, SUITCASES, WALLETS,
BRIEFCASES, SCHOOL BAGS, HANDBAGS FOR
MEN, TRUNKS FOR TRAVEL, LEATHER AND
IMITATION LEATHER SOLD IN BULK , IN CLASS
18 (U.S. CLS. 1, 2, 3, 22 AND 41).

FOR: CLOTHING ARTICLES FOR MEN, WOMEN
AND CHILDREN; NAMELY, SHIRTS, BLOUSES,
SKIRTS, COATS, TROUSERS, PANTS, VESTS, JER-
SEYS, PAJAMAS, SOCKS AND STOCKINGS, SING-
LETS, CORSETS, GARTERS, UNDERPANTS,
PETTICOATS, HATS, HEADSCARVES, NECKTIES,
RAINCOATS, OVERCOATS, GREATCOATS, BATH-

ING SUITS, SPORTS OVERALLS, WIND-RESIS-
TANT JACKETS, SKI PANTS, BELTS, FUR COATS,
SCARVES, GLOVES, DRESSING GOWNS, FOOT-
WEAR; NAMELY, SHOES, SPORTS SHOES, SLIP-
PERS AND BOOTS, IN CLASS 25 (U.S. CLS. 22 AND
39).

THE MARK CONSISTS OF STANDARD CHAR-
ACTERS WITHOUT CLAIM TO ANY PARTICULAR
FONT, STYLE, SIZE, OR COLOR.

OWNER OF INTERNATIONAL REGISTRATION
0777901 DATED 2-22-2002, EXPIRES 2-22-2012.

SER. NO. 79-011,408, FILED 3-25-2005.

KRISTINA MORRIS, EXAMINING ATTORNEY

Int. Cl.: 14

Prior U.S. Cls.: 2, 27, 28 and 50

United States Patent and Trademark Office

Reg. No. 3,485,059

Registered Aug. 12, 2008

**TRADEMARK
PRINCIPAL REGISTER**

P ZEROTEMPO

PIRELLI & C. S.P.A. (ITALY JOINT STOCK
COMPANY)
VIA GAETANO NEGRI, 10
I-20123 MILANO (MI)
ITALY

FOR: JEWELRY; BELT BUCKLES OF PRECIOUS METALS; BRACELETS OF PRECIOUS METALS; BROOCHES; CUFF-LINKS; DIAMONDS; EARRINGS; NECKLACES; PEARLS; PRECIOUS METALS AND THEIR ALLOYS; RINGS; BRACELETS, CHARMS; EARRINGS IN PRECIOUS METAL OR COATED THEREWITH; PRECIOUS STONES; HOROLOGICAL AND CHRONOMETRIC INSTRUMENTS, NAMELY TIMEPIECES, WRISTWATCHES, WATCHES, CLOCKS AND PARTS THEREOF, IN CLASS 14 (U.S. CLS. 2, 27, 28 AND 50).

THE MARK CONSISTS OF STANDARD CHARACTERS WITHOUT CLAIM TO ANY PARTICULAR FONT, STYLE, SIZE, OR COLOR.

OWNER OF INTERNATIONAL REGISTRATION
0797686 DATED 1-22-2003, EXPIRES 1-22-2013.

THE ENGLISH TRANSLATION OF THE FOREIGN WORD(S) IN THE MARK IS: P ZERO TIME.

SER. NO. 79-011,411, FILED 3-25-2005.

ANTHONY RINKER, EXAMINING ATTORNEY

Int. Cls.: 39 and 40

Prior U.S. Cls.: 100, 103, 105 and 106

United States Patent and Trademark Office

Reg. No. 3,485,060

Registered Aug. 12, 2008

**SERVICE MARK
PRINCIPAL REGISTER**

Supergrid 
the power to connect

AIRTRICITY HOLDINGS LIMITED (IRELAND
COMPANY)
THE FORUM
29-31 GLASTHULE ROAD; GLASTHULE, CO. DU-
BLIN
IRELAND

FOR: ELECTRICITY DISTRIBUTION; PROVID-
ING INFORMATION IN THE FIELD OF ELECTRI-
CITY DISTRIBUTION; CONSULTATION SERVICES
IN THE FIELD OF ELECTRICITY DISTRIBUTION,
IN CLASS 39 (U.S. CLS. 100 AND 105).

FOR: ELECTRICITY GENERATION; PROVIDING
INFORMATION IN THE FIELD OF ELECTRICITY

GENERATION; CONSULTATION SERVICES IN
THE FIELD OF ELECTRICITY GENERATION, IN
CLASS 40 (U.S. CLS. 100, 103 AND 106).

PRIORITY DATE OF 12-9-2004 IS CLAIMED.

OWNER OF INTERNATIONAL REGISTRATION
0858383 DATED 6-7-2005, EXPIRES 6-7-2015.

SER. NO. 79-014,047, FILED 6-7-2005.

CAROLYN GRAY, EXAMINING ATTORNEY

Int. Cl.: 30

Prior U.S. Cl.: 46

United States Patent and Trademark Office

Reg. No. 3,485,061

Registered Aug. 12, 2008

**TRADEMARK
PRINCIPAL REGISTER**

COMPAGNIA DELL'ARABICA

CORSINO CORSINI SPA (ITALY CORPORATION)
62/64, VIA DEL SEMBOLINO
I-52040 CIVITELLA DELLA CHIANA
ITALY

FOR: COFFEE, IN CLASS 30 (U.S. CL. 46).

OWNER OF INTERNATIONAL REGISTRATION
0587892 DATED 7-23-1992, EXPIRES 7-23-2012.

NO CLAIM IS MADE TO THE EXCLUSIVE
RIGHT TO USE "ARABICA", APART FROM THE
MARK AS SHOWN.

THE ENGLISH TRANSLATION OF THE WORD
"COMPAGNIA" IS "COMPANY" AND THE ENGLISH
TRANSLATION OF THE WORD "DELL" IS
"OF THE". "ARABICA" IS AN ENGLISH WORD FOR
A TYPE OF COFFEE BEAN. THE MARK COMBINES
ITALIAN WORDS WITH AN ENGLISH WORD.

SEC. 2(F).

SER. NO. 79-014,220, FILED 4-4-2005.

ROBERT C. CLARK JR., EXAMINING ATTORNEY

Int. Cl.: 25

Prior U.S. Cls.: 22 and 39

United States Patent and Trademark Office

Reg. No. 3,485,062

Registered Aug. 12, 2008

**TRADEMARK
PRINCIPAL REGISTER**



DOSENBACH-OCHSNER AG SCHUHE UND
SPORT (SWITZERLAND CORPORATION)
ALLMENDSTRASSE 25
CH-8953 DIETIKON, SWITZERLAND

FOR: FOOTWEAR; CLOTHING, NAMELY, MONEY BELTS, BELTS, SCARVES, GLOVES, JUMPERS, SHIRTS, TROUSERS, SHORT TROUSERS, SUSPENDERS, GIRDLES, JACKETS, JERSEYS, NECKTIES, ASCOTS, PARKAS, PULLOVERS, PYJAMAS, WATERPROOF JACKETS AND PANTS, SOCKS, STOCKINGS, TIGHTS, SWEATERS, SPORT JERSEYS, SINGLETs, T-SHIRTS, POLO SHIRTS; HEADGEAR, NAMELY, HATS AND CAPS, IN CLASS 25 (U.S. CLS. 22 AND 39).

PRIORITY DATE OF 8-17-2005 IS CLAIMED.

OWNER OF INTERNATIONAL REGISTRATION
0868271 DATED 9-26-2005, EXPIRES 9-26-2015.

THE COLOR(S) BLUE, YELLOW, BLACK IS/ARE
CLAIMED AS A FEATURE OF THE MARK.

THE COLORS BLUE, BLACK AND YELLOW
APPEAR IN THE DESIGN WITH THE WORDING
CLIMA OPERATOR IN BLACK.

SER. NO. 79-017,670, FILED 9-26-2005.

CURTIS FRENCH, EXAMINING ATTORNEY

Int. Cls.: 3, 7, 8 and 11

**Prior U.S. Cls.: 1, 4, 6, 13, 19, 21, 23, 28, 31, 34, 35, 44,
50, 51 and 52**

Reg. No. 3,485,063

United States Patent and Trademark Office

Registered Aug. 12, 2008

**TRADEMARK
PRINCIPAL REGISTER**

MOMO DESIGN

MOMO DESIGN S.R.L. (ITALY LTD LIAB CO)
VIA MEDA, 45
I-20141 MILANO
ITALY

FOR: SOAPS, PERFUMERY, COSMETICS, ESSENTIAL OILS FOR PERSONAL USE, DEODORANTS FOR PERSONAL USE, HAIR SHAMPOOS, IN CLASS 3 (U.S. CLS. 1, 4, 6, 50, 51 AND 52).

FOR: SMALL ELECTRIC KITCHEN TOOLS FOR DOMESTIC USE IN PROCESSING FOOD, NAMELY, MINCERS, MEAT GRINDERS, FRUIT AND VEGETABLE SPIN-DRYERS AND WHISKERS, BABY FOOD HOMOGENIZERS, KNEADING MACHINES, SLICERS AND ELECTRIC FOOD PRESSES, ELECTRIC TIN OPENERS, CLOTHES WASHING MACHINES, DISHWASHERS, ELECTRIC VACUUM CLEANERS, ELECTRIC CARPET CLEANING MACHINES; ELECTRIC MACHINES FOR CLEANING SURFACES USING HIGH PRESSURE WATER; ELECTRIC CARPET BEATERS; ELECTRIC FLOOR POLISHERS, LAWN MOWERS, AND SEWING MACHINES, IN CLASS 7 (U.S. CLS. 13, 19, 21, 23, 31, 34 AND 35).

FOR: HAND GARDEN TOOLS, NAMELY, TROWELS, RAKES, HOES, WEEDING FORKS, SHOVELS, AND SPADES; NON ELECTRIC TIN OPENERS; NUTCRACKERS; POUNDING MORTARS; MOLLUSK AND OYSTER OPENERS; CUTLERY; FORKS AND SPOONS; ICE PICKS; NON-ELECTRIC FOOD SLICERS AND MINCERS; CUTTING TOOLS; BLADE SHARPENING INSTRUMENTS; ELECTRIC AND NON-ELECTRIC RAZORS, RAZOR BLADES, RAZOR CASES; NAIL FILES; ELECTRIC AND NON-ELECTRIC BEARD CLIPPERS AND HAIR CLIPPERS FOR PERSONAL USE, MANICURE AND PEDICURE SETS; ELECTRIC AND NON-ELECTRIC NAIL CLEANERS; NAIL NIPPERS; NAIL AND HAIR SCISSORS; NON-ELECTRIC HAIR CURLING HAND IMPLEMENTS; ELECTRIC AND NON-ELECTRIC DEPILATION APPLIANCES; ELECTRIC NAIL CLIPPERS, IN CLASS 8 (U.S. CLS. 23, 28 AND 44).

FOR: INDOOR AND OUTDOOR LIGHTING APPARATUS, NAMELY, LAMPS AND LIGHT BULBS, CHANDELIERS, LANTERNS, NAMELY, CANDLE LANTERNS, ELECTRIC LANTERNS, OIL LANTERNS; LAMP CASINGS, LAMP HANGING SUPPORTS AND PEDESTALS; LAMP GLASSES; SAFETY LAMPS; STREET LAMPS; DIVING LIGHTS; TORCHES FOR LIGHTING; WARMING PANS FOR BEDS; ELECTRIC HEATING CUSHIONS NOT FOR MEDICAL PURPOSES, ELECTRICALLY HEATED FOOTMUFFS AND FOOTWARMERS; HEARTHES, NAMELY, WOOD BURNING STOVES; ELECTRIC AND OIL COOKING STOVES, ELECTRIC STOVES, GAS STOVES, SOLID FUEL BURNING STOVES; ELECTRIC AND STEAM RADIATORS FOR HEATING BUILDINGS; ELECTRIC HEATING BOILERS; GAS BOILERS, ELECTRIC HEATERS FOR FEEDING BOTTLES; STEAM FACIAL APPARATUS IN THE NATURE OF FACIAL SAUNAS; DOMESTIC COOKING OVENS; ELECTRIC COOKING OVENS; GAS COOKING OVENS; MICROWAVE OVENS, BARBECUES; CHARCOAL GRILLS, ELECTRIC GRILLS, GAS GRILLS; ELECTRIC TOASTERS; ELECTRIC WAFFLE IRONS; ELECTRIC COFFEE MAKERS; ELECTRIC ROASTERS; ELECTRIC BOILERS, ELECTRIC DEEP FRYERS, ELECTRIC PRESSURE COOKERS, ROTISSERIES; ELECTRIC AND GAS PORTABLE COOKERS FOR CAMPING; AIR CONDITIONERS, REFRIGERATORS, ELECTRIC PORTABLE REFRIGERATORS, FREEZERS, PORTABLE THERMOELECTRIC COOLING UNITS FOR BEVERAGES; ELECTRIC LAUNDRY DRYERS; CEILING FANS AND ELECTRIC FANS; ELECTRIC FANS FOR PERSONAL USE; AIR SCENTING AND AIR PURIFYING APPARATUS, NAMELY, DISPENSING UNITS FOR AIR FRESHENERS AND AIR PURIFIERS; DEHUMIDIFIERS; ELECTRIC STERILIZERS FOR FEEDING BOTTLES AND HAND TOOLS; HAIR DRYERS, HAIR CURLING LAMPS; ELECTRIC DISTILLATION APPARATUS; ELECTRIC GAS LIGHTERS FOR LIGHTING GRILLS, FIREPLACES AND CANDLES; ELECTRICALLY HEATED FLASK-TYPE RECEPTACLES FOR HOT WATER AND FOOD; REGULATING AND SAFETY ACCESSORIES FOR GAS APPARATUS, NAMELY,

VALVES FOR REGULATING GAS RADIATORS,
GAS STOVES, GAS COOKING OVENS AND GAS
GRILLS, IN CLASS 11 (U.S. CLS. 13, 21, 23, 31 AND
34).

THE MARK CONSISTS OF STANDARD CHAR-
ACTERS WITHOUT CLAIM TO ANY PARTICULAR
FONT, STYLE, SIZE, OR COLOR.

PRIORITY DATE OF 5-13-2005 IS CLAIMED.

OWNER OF INTERNATIONAL REGISTRATION
0875146 DATED 6-10-2005, EXPIRES 6-10-2015.

OWNER OF U.S. REG. NOS. 2,576,528, 3,041,899
AND OTHERS.

NO CLAIM IS MADE TO THE EXCLUSIVE
RIGHT TO USE "DESIGN", APART FROM THE
MARK AS SHOWN.

SER. NO. 79-020,275, FILED 6-10-2005.

ELIZABETH HUGHITT, EXAMINING ATTORNEY

Int. Cl.: 6

Prior U.S. Cls.: 2, 12, 13, 14, 23, 25 and 50

Reg. No. 3,485,064

United States Patent and Trademark Office

Registered Aug. 12, 2008

**TRADEMARK
PRINCIPAL REGISTER**

BERCOWELD

BERKENHOFF GMBH (FED REP GERMANY
GMBH)
BERKENHOFFSTR. 14
35452 HEUCHELHEIM
FED REP GERMANY

PRIORITY DATE OF 12-13-2005 IS CLAIMED.

OWNER OF INTERNATIONAL REGISTRATION
0876831 DATED 1-11-2006, EXPIRES 1-11-2016.

FOR: WELDING WIRE, SOLDERING WIRE AND
METAL WELDING RODS, OF METAL; METAL
BRAZING RODS WITH FLUXES; SPRAY WIRE OF
ALLOYS OF ALL KINDS; WELDING BRONZE;
WELD FILLER MATERIALS, NAMELY, METAL
WELDING RODS, IN CLASS 6 (U.S. CLS. 2, 12, 13,
14, 23, 25 AND 50).

SER. NO. 79-020,867, FILED 1-11-2006.

TRACY WHITTAKER-BROWN, EXAMINING AT-
TORNEY

Int. Cls.: 1, 5, 29 and 30

Prior U.S. Cls.: 1, 5, 6, 10, 18, 26, 44, 46, 51 and 52

United States Patent and Trademark Office

Reg. No. 3,485,065

Registered Aug. 12, 2008

**TRADEMARK
PRINCIPAL REGISTER**

INSUVITAL

DSM IP ASSETS B.V. (NETHERLANDS LTD LIAB
CO)
HET OVERLOON 1
NL-6411 TE HEERLEN
NETHERLANDS

FOR: CHEMICAL AND BIOCHEMICAL PRO-
DUCTS FOR USE AS AN INGREDIENT IN FOOD
PRODUCTS AND IN PHARMACEUTICAL PRO-
DUCTS; CHEMICAL AND BIOCHEMICAL PRO-
DUCTS FOR THE FRESHKEEPING AND
PRESERVING OF FOOD AND PHARMACEUTI-
CALS, IN CLASS 1 (U.S. CLS. 1, 5, 6, 10, 26 AND 46).

FOR: DIETETIC FOODS ADAPTED FOR MEDI-
CAL USE, FOOD FOR BABIES, IN CLASS 5 (U.S. CLS.
6, 18, 44, 46, 51 AND 52).

FOR: MEAT, FISH, POULTRY AND GAME;
MEAT EXTRACTS; PRESERVED, DRIED AND
COOKED FRUITS AND VEGETABLES; JELLIES,
JAMS; EGGS, MILK AND MILK PRODUCTS EX-
CLUDING ICE CREAM, ICE MILK AND FROZEN
YOGHURT; EDIBLE OILS AND FATS, IN CLASS 29
(U.S. CL. 46).

FOR: FLOUR; PREPARATIONS MADE FROM
CEREALS, NAMELY CEREAL BASED SNACK
FOODS, CEREAL BASED FOOD BARS, CEREAL
CAKES, BREAKFAST CEREALS, PROCESSED CER-
EALS; CONSUMPTION ICE; FRUIT-BASED SAUCES
NOT SIDE-DISHES, IN CLASS 30 (U.S. CL. 46).

THE MARK CONSISTS OF STANDARD CHAR-
ACTERS WITHOUT CLAIM TO ANY PARTICULAR
FONT, STYLE, SIZE, OR COLOR.

PRIORITY DATE OF 2-28-2005 IS CLAIMED.

OWNER OF INTERNATIONAL REGISTRATION
0879386 DATED 8-25-2005, EXPIRES 8-25-2015.

SER. NO. 79-021,790, FILED 8-25-2005.

VERNA BETH RIRIE, EXAMINING ATTORNEY

Int. Cls.: 2, 7, 9, 16, 40 and 42

Prior U.S. Cls.: 2, 5, 6, 11, 13, 16, 19, 21, 22, 23, 26, 29, 31, 34, 35, 36, 37, 38, 50, 100, 101, 103 and 106

Reg. No. 3,485,066

United States Patent and Trademark Office

Registered Aug. 12, 2008

**TRADEMARK
SERVICE MARK
PRINCIPAL REGISTER**

SPARK

SICPA HOLDING SA (SWITZERLAND SOCIÉTÉ ANONYME)
AVENUE DE FLORISSANT 41
CH-1008 PRILLY
SWITZERLAND

FOR: PRINTING INKS, SECURITY INKS FOR APPLICATION BY PRINTING, PAINTING, SPRAYING AND FOIL TRANSFERRING, COPYING INKS, PRINTING INK PASTES, COLORANTS FOR USE IN THE MANUFACTURE OF PRINTING INK FOR ALL SORTS OF GRAPHIC PRINTING TECHNIQUES, SUCH AS RELIEF, INTAGLIO, STENCIL AND PIANO PRINTING; PRINTING VARNISHES AND LACQUERS, NAMELY, THERMOGRAPHIC, PRINTERS' AND DRY INK PREPARATIONS - COMPOSED OF ONE OR MORE COMBINATIONS OF THE FOREGOING COMPONENTS - FOR SECURITY MARKS OR FOR VISIBLE AND INVISIBLE MARKINGS, IN CLASS 2 (U.S. CLS. 6, 11 AND 16).

FOR: PRINTING MACHINES, MATRICES, NAMELY, AS DIE SETS AND TEMPLATE FORMS, NAMELY, STEEL DIE SETS, HIGH TENSILE CAST IRON PRECISION DIE SETS AND HIGH PRECISION METAL STAMPED DIE SETS - FOR USE IN PRINTING AND PRINTING PRESSES, PRINTING PLATES, EQUIPMENT AND MEANS FOR PRODUCING DESIGNS INDUCED BY MAGNETISM IN A COMPOSITION OF COATINGS CONTAINING MAGNETIC PARTICLES, NAMELY, MACHINE PARTS, NAMELY, ROLLER BEARINGS, MAGNETIC APPARATUS USED TO CREATE PRE-DEFINED MAGNETIC FIELDS WHICH ALLOW FOR THE ORIENTATION OF MAGNETIC PIGMENTS IN A WET INK FILM DURING PRINTING, NAMELY, MACHINE PARTS, NAMELY, GRADIENT MAGNET, IN CLASS 7 (U.S. CLS. 13, 19, 21, 23, 31, 34 AND 35).

FOR: ELECTRONIC EQUIPMENT OR EQUIPMENT OPERATED ELECTRONICALLY FOR PRO-

DUCING, READING AND/OR FOR RECORDING LAYERS AND MARKINGS OR SECURITY MARKS CREATED BY PRINTING OR OTHER MEANS, NAMELY, ELECTRONIC, DIGITAL OR ELECTRICALLY OPERATED PRINTERS, ELECTRONIC READERS FOR DETECTION OF THE COMPONENTS OR COMPOSITION OF THE LAYERS AND MARKINGS OR SECURITY MARKS, SCANNERS, LIGHT ABSORPTION MEASUREMENT APPARATUS FOR FEELING SURFACES AND FOR DISPLAYING OR READING MARKINGS WITH A FREQUENCY WITHIN OR OUTSIDE THE VISIBLE COLOR AND/OR LIGHT SPECTRUM, APPARATUS FOR RECORDING MARKINGS WHICH CAN BE TRACED ELECTROMAGNETICALLY OR MAGNETICALLY, NAMELY, MAGNETIC READING HEADS, IN CLASS 9 (U.S. CLS. 21, 23, 26, 36 AND 38).

FOR: PRINTED MATTER -, NAMELY, BLANK OR PARTIALLY PRINTED PAPER LABELS AND/OR BAR CODE LABELS, PAPER -, NAMELY, ACID RESISTANT PAPER AND/OR ADHESIVE NOTE PAPER, BANK NOTES, PRINTED TICKETS, PRINTED PAPER LABELS, PRINTED DOCUMENTS IN THE FINANCIAL, FIDUCIARY AND FISCAL FIELDS, NAMELY, STOCK CERTIFICATES, IDENTIFICATION CARDS AND BUSINESS FORMS, PLASTIC FILMS AND SHEETS FOR PACKAGING, NOT FOR COMMERCIAL OR INDUSTRIAL PACKAGING, STATIONERY, PACKAGING MATERIALS, NAMELY, PLASTIC BAGS, PLASTIC ENVELOPES AND PLASTIC SLEEVES FOR PACKAGING, IN CLASS 16 (U.S. CLS. 2, 5, 22, 23, 29, 37, 38 AND 50).

FOR: TREATMENT OF MATERIALS, NAMELY, PRINTING, DIGITAL PRINTING AND MARKING, NAMELY, APPLYING SECURITY MARKS, MARKINGS, COATINGS AND COMPOSITIONS FOR READING AND ENCODING USED FOR FIGHTING COUNTERFEITING, FORGERY AND FRAUD;

TECHNICAL CONSULTING WITH REGARD TO PRINTING, IN CLASS 40 (U.S. CLS. 100, 103 AND 106).

FOR: SECURITY CONSULTING FOR THE PROTECTION OF ASSETS, NAMELY, PROFESSIONAL CONSULTING REGARDING THE USE OF SECURITY ELEMENTS, NAMELY, DECORATIVE MARKINGS AS WELL AS LAYERS WITH COLORS WHICH BECOME VISIBLE DEPENDING ON THE VIEWING ANGLE, FOR THE PURPOSE OF AUTHENTICATING AND IDENTIFYING BANK NOTES, SECURITY DOCUMENTS, FIDUCIARY DOCUMENTS AND CREDENTIALS, IN CLASS 42 (U.S. CLS. 100 AND 101).

THE MARK CONSISTS OF STANDARD CHARACTERS WITHOUT CLAIM TO ANY PARTICULAR FONT, STYLE, SIZE, OR COLOR.

PRIORITY DATE OF 9-26-2005 IS CLAIMED.

OWNER OF INTERNATIONAL REGISTRATION 0883997 DATED 3-7-2006, EXPIRES 3-7-2016.

SER. NO. 79-023,576, FILED 3-7-2006.

SARA THOMAS, EXAMINING ATTORNEY

Int. Cl.: 5

Prior U.S. Cls.: 6, 18, 44, 46, 51 and 52

Reg. No. 3,485,067

United States Patent and Trademark Office

Registered Aug. 12, 2008

**TRADEMARK
PRINCIPAL REGISTER**

NUTRINI

N.V. NUTRICIA (NETHERLANDS NAAMLOZE
VENNOOTSCHAP)
STATIONSSTRAAT 186
NL-2712 HM ZOETERMEER
NETHERLANDS

OWNER OF INTERNATIONAL REGISTRATION
0663627 DATED 10-24-1996, EXPIRES 10-24-2016.

FOR: DIETETIC FOODS ADAPTED FOR MEDI-
CAL USE, NAMELY, TUBE FEED FOR CHILDREN
ONE TO SIX; BABY FOOD, NAMELY, TUBE FEED
FOR CHILDREN ONE TO SIX , IN CLASS 5 (U.S.
CLS. 6, 18, 44, 46, 51 AND 52).

SER. NO. 79-024,168, FILED 4-5-2006.

KAELIE KUNG, EXAMINING ATTORNEY

Int. Cls.: 35, 36 and 42

Prior U.S. Cls.: 100, 101 and 102

United States Patent and Trademark Office

Reg. No. 3,485,068

Registered Aug. 12, 2008

**SERVICE MARK
PRINCIPAL REGISTER**

FORTIS PRIME FUND SOLUTIONS

FORTIS NV (NETHERLANDS NAAMLOZE VEN-
NOOTSCHAP)
ARCHIMEDES LAAN 6
NL-3584 BA UTRECHT, NETHERLANDS AND
FORTIS SA/NV (BELGIUM NAAMLOZE VENNOOT-
SCHAP)
KONINGSSTRAAT 20
B-1000 BRUSSELS, BELGIUM

FOR: BUSINESS MANAGEMENT, IN CLASS 35
(U.S. CLS. 100, 101 AND 102).

FOR: BANKING SERVICES; FINANCIAL SERVI-
CES, NAMELY, FINANCIAL CONSULTATION SER-
VICES, FINANCIAL CLEARING HOUSE SERVICES,
FINANCIAL MANAGEMENT AND FINANCIAL
PORTFOLIO MANAGEMENT, FINANCIAL PLAN-
NING, FINANCIAL RESEARCH, FINANCIAL SER-
VICES IN THE NATURE OF AN INVESTMENT
SECURITY, ASSISTING OTHERS WITH THE COM-
PLETION OF FINANCIAL TRANSACTIONS FOR
STOCKS, BONDS, SECURITIES AND EQUITIES,
FUND INVESTMENTS CONSULTATION, FUNDS
INVESTMENT, MANAGEMENT OF A CAPITAL
INVESTMENT FUND, INVESTMENT SERVICES;
INSURANCE SERVICES, NAMELY, UNDERWRIT-
ING AND ADMINISTRATION OF ALL TYPES OF

INSURANCE, IN CLASS 36 (U.S. CLS. 100, 101 AND
102).

FOR: REAL ESTATE RESEARCH SERVICES IN
CONNECTION WITH THE DEVELOPMENT OF
BUILDING PROJECTS, IN CLASS 42 (U.S. CLS. 100
AND 101).

THE MARK CONSISTS OF STANDARD CHAR-
ACTERS WITHOUT CLAIM TO ANY PARTICULAR
FONT, STYLE, SIZE, OR COLOR.

OWNER OF INTERNATIONAL REGISTRATION
0809097 DATED 7-10-2003, EXPIRES 7-10-2013.

OWNER OF U.S. REG. NOS. 1,902,973, 2,960,093
AND OTHERS.

NO CLAIM IS MADE TO THE EXCLUSIVE
RIGHT TO USE "PRIME FUND", APART FROM
THE MARK AS SHOWN.

SER. NO. 79-024,382, FILED 4-4-2006.

DAYNA BROWNE, EXAMINING ATTORNEY

Int. Cls.: 7, 37 and 42

**Prior U.S. Cls.: 13, 19, 21, 23, 31, 34, 35, 100, 101, 103
and 106**

Reg. No. 3,485,069

United States Patent and Trademark Office

Registered Aug. 12, 2008

**TRADEMARK
SERVICE MARK
PRINCIPAL REGISTER**

G E B O

SIDEL PARTICIPATIONS (FRANCE SOCIETE
PAR ACTIONS SIMPLIFIEE)
AVENUE DE LA PATROUILLE DE FRANCE
F-76930 OCTEVILLE-SUR-MER, FRANCE

FOR: CONVEYORS OR PNEUMATIC TRANSPORTERS USED ON PACKAGING LINES FOR FLUIDS OR LIQUIDS; CONVEYORS OR PNEUMATIC TRANSPORTERS OF BOTTLES, BOXES, DRUMS, PALLETS, CASES, PACKAGES, LOADS, CARDBOARD PACKAGING, PLUGS, CAPS USED ON PACKAGING LINES FOR LIQUIDS OR FLUIDS OR BEVERAGES; BELT, ROLLER, CARPET, CHAIN OR PALLET CONVEYORS OR PNEUMATIC TRANSPORTERS USED ON PACKAGING LINES FOR FLUIDS, LIQUIDS OR BEVERAGES; CONVEYORS OR PNEUMATIC TRANSPORTERS USING AIR TO MOVE CONTENTS OR CONTAINERS, AND TO MOVE PLUGS AND CAPS, USED ON PACKAGING LINES FOR FLUIDS OR BEVERAGES; PACKAGING MACHINES IN THE NATURE OF PLUG AND CAP FEEDING MACHINES USED ON PACKAGING LINES FOR FLUIDS, LIQUIDS OR BEVERAGES; FEEDING APPARATUS FOR BOTTLING AND PACKAGING FLUIDS AND LIQUIDS; BELTS FOR CONVEYORS; ELEVATORS IN THE NATURE OF LIFTS; LIFTING APPARATUS, NAMELY, LIFTING INSTALLATIONS FOR THE TRANSPORT OF PERSONS AND GOODS; PNEUMATIC TRANSPORTERS; MACHINE PARTS, NAMELY, SHUFFLES AND SPRINGS; WHEELS BEING PARTS OF MACHINES; MACHINE PARTS, NAMELY, BALL AND ROLLER BEARINGS; POWER TRANSMISSIONS FOR MACHINES, IN CLASS 7 (U.S. CLS. 13, 19, 21, 23, 31, 34 AND 35).

FOR: REPAIR, MAINTENANCE, ASSEMBLY INSTALLATION, HONING FOR MAINTENANCE PURPOSES AND INSTALLATION RELATING TO BELT CONVEYORS AND TRANSPORTERS, CONVEYOR BELTS, LIFTS, FEEDING MACHINES FOR PACKAGING LINES, BOTTLING LINES AND BODY ASSEMBLY LINES, IN CLASS 37 (U.S. CLS. 100, 103 AND 106).

FOR: MECHANICAL ENGINEERING IN THE NATURE OF TECHNICAL CONSULTANCY, TECHNICAL STUDIES AND CONSULTANCY PROVIDED BY ENGINEERS AND TECHNICIANS IN THE FIELD OF MACHINES, CONVEYORS, TRANSPORTERS, CONVEYOR BELTS, LIFTS AND FEEDING MACHINES FOR PACKAGING LINES, BOTTLING LINES AND CONTAINER ASSEMBLY LINES, IN CLASS 42 (U.S. CLS. 100 AND 101).

THE MARK CONSISTS OF STANDARD CHARACTERS WITHOUT CLAIM TO ANY PARTICULAR FONT, STYLE, SIZE, OR COLOR.

PRIORITY DATE OF 9-30-2005 IS CLAIMED.

OWNER OF INTERNATIONAL REGISTRATION
0889064 DATED 3-17-2006, EXPIRES 3-17-2016.

SEC. 2(F).

SER. NO. 79-025,419, FILED 3-17-2006.

LYDIA BELZER, EXAMINING ATTORNEY

Int. Cls.: 9 and 42

Prior U.S. Cls.: 21, 23, 26, 36, 38, 100 and 101

United States Patent and Trademark Office

Reg. No. 3,485,070

Registered Aug. 12, 2008

**TRADEMARK
SERVICE MARK
PRINCIPAL REGISTER**

crossvision

SOFTWARE AG (FED REP GERMANY AKTIEN-
GESELLSCHAFT)
12, UHLANDSTRASSE
64297 DARMSTADT
FED REP GERMANY

FOR: COMPUTER PROGRAMS AND SOFTWARE
FOR USE IN DESIGNING AND DEVELOPING
SERVICE-ORIENTED ARCHITECTURES, IN CLASS
9 (U.S. CLS. 21, 23, 26, 36 AND 38).

FOR: DESIGN FOR OTHERS AND DEVELOP-
MENT OF COMPUTER PROGRAMS, LICENSING
AND RENTING OF COMPUTER PROGRAMS;
MAINTENANCE AND INSTALLATION OF COM-
PUTER PROGRAMS, IN CLASS 42 (U.S. CLS. 100
AND 101).

THE MARK CONSISTS OF STANDARD CHAR-
ACTERS WITHOUT CLAIM TO ANY PARTICULAR
FONT, STYLE, SIZE, OR COLOR.

PRIORITY DATE OF 2-3-2006 IS CLAIMED.

OWNER OF INTERNATIONAL REGISTRATION
0891488 DATED 5-16-2006, EXPIRES 5-16-2016.

SER. NO. 79-026,266, FILED 5-16-2006.

LEIGH LOWRY, EXAMINING ATTORNEY

Int. Cls.: 9, 14, 18, 25 and 34

Prior U.S. Cls.: 1, 2, 3, 8, 9, 17, 21, 22, 23, 26, 27, 28,
36, 38, 39, 41 and 50

Reg. No. 3,485,071

United States Patent and Trademark Office

Registered Aug. 12, 2008

TRADEMARK
PRINCIPAL REGISTER

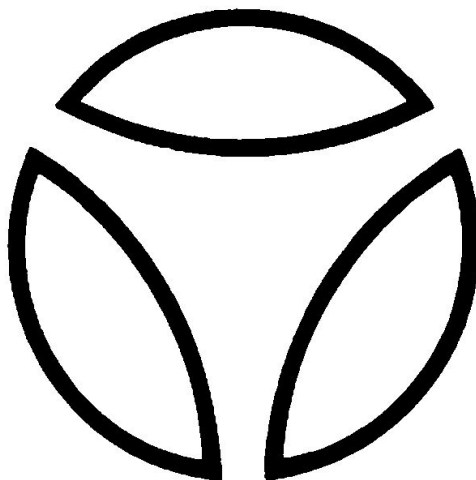

MOMO DESIGN S.R.L. (ITALY LTD LIAB CO)
VIA MEDA, 45
I-20141 MILANO
ITALY

FOR: ELECTRIC CIGARETTE LIGHTERS FOR LAND, AIR, AND WATER VEHICLES; LOUDSPEAKERS AND LOUDSPEAKER CABINETS FOR VEHICLES; RADIOS AND COMPACT DISC PLAYERS; DVDS FEATURING MUSIC, SPORTS EVENT, AND INFORMATION ON INDUSTRIAL DESIGN AND INTERIOR DESIGN; RADIO AERIALS; VIDEO CAMERAS; CAMERAS; TELEPHONES, CORDLESS TELEPHONES, SATELLITE TELEPHONES, AND MOBILE TELEPHONES; NAVIGATION APPARATUS FOR VEHICLES IN THE NATURE OF ON-BOARD COMPUTERS; BAROMETERS; MARINE COMPASSES; ECHO SOUNDERS; MEASURING INSTRUMENTS, NAMELY, TAPE MEASURES AND SCALES; SAFETY HELMETS AND PROTECTIVE CLOTHING AGAINST FIRE FOR MOTORISTS AND MOTORCYCLISTS; TABLE AND POCKET ELECTRONIC CALCULATING MACHINES; COMPUTERS, COMPUTER PRINTERS AND PARTS AND FITTINGS THEREOF; ELECTRONIC VIDEO GAME APPARATUS TO BE ADAPTED TO TV RECEIVERS; TRAVELING ELECTRIC IRONS; ELECTRIC SWITCHES; FIRE ALARMS; BURGLAR ALARMS NOT FOR VEHICLES; LUMINOUS SIGNALS FOR IDENTIFYING EMERGENCY EXITS IN BUILDINGS, CINEMAS, THEATERS, INDUSTRIAL

PLANTS, TRAINS, BOATS, AND AIRPLANES; SUNGLASSES, EYEGASSES, SPECTACLES, LENSES AND FRAMES FOR SUNGLASSES, EYEGASSES, AND SPECTACLES, AND CASES AND CHAINS FOR SUNGLASSES, EYEGASSES, AND SPECTACLES; CREDIT CARD HOLDERS MADE OF LEATHER, IN CLASS 9 (U.S. CLS. 21, 23, 26, 36 AND 38).

FOR: TABLE CLOCKS AND WRISTWATCHES; CLOCKS FOR VEHICLES; CLOCKS; AND ARTICLES OF PRECIOUS METAL OR COATED THEREWITH, NAMELY, CIGAR LIGHTERS, ASHTRAYS, CIGAR AND CIGARETTE HOLDERS, BOXES FOR JEWELS, PURSES, KEY RINGS, AND MONEY CLIPS, IN CLASS 14 (U.S. CLS. 2, 27, 28 AND 50).

FOR: ARTICLES MADE OF LEATHER AND IMITATIONS OF LEATHER, NAMELY, HAND BAGS, SHOULDER BAGS, TRAVEL BAGS, TRUNKS, RUCKSACKS, PURSES, WALLETS, BRIEFCASES, COSMETIC CASES SOLD EMPTY, AND KEY CASES; UMBRELLAS; AND WALKING STICKS, IN CLASS 18 (U.S. CLS. 1, 2, 3, 22 AND 41).

FOR: CLOTHING ARTICLES, NAMELY, PANTS, TROUSERS, SKIRTS, SOCKS, JACKETS, OVERCOATS, RAINCOATS, JERKINS, SHIRTS, T-SHIRTS, SWEATERS, DRESSES, SCARVES, SHAWLS, TIES, BOW TIES, GLOVES, OVERALLS, HANDKERCHIEFS, PAJAMAS, UNDERWEAR, BATHROBES; CLOTHING ARTICLES MADE OF LEATHER AND

IMITATIONS OF LEATHER, NAMELY, JACKETS, JERKINS, OVERCOATS, PANTS, TROUSERS, SKIRTS, WAISTCOATS, TIES, GLOVES; BELTS; CLOTHING INTENDED FOR USE BY MOTORCAR DRIVERS, MOTORCYCLISTS, AND CYCLISTS, NAMELY, RACING SUITS, BALACLAVAS, SOCKS, JACKETS, OVERALLS, SHIRTS, SWEATSHIRTS, VESTS, AND PANTS; SWIMSUITS; GOLF CLOTHING, NAMELY GOLF TROUSERS, SHIRTS, JACKETS, SWEATERS; SKI CLOTHING, NAMELY, SKI SUITS, SKI JACKETS, SKI PANTS, SKI GLOVES, BALACLAVAS, HAIR BANDS, WIND RESISTANT JACKETS, SOCKS, SWEATERS, SKI BOOTS, AND AFTER-SKI BOOTS; TENNIS CLOTHING, NAMELY, SHORTS, SKIRTS, T-SHIRTS, WRIST BANDS, HAIR BANDS; FENCING OVERALLS; OILSKIN JACKETS AND WATERPROOF JERKINS AND

TROUSERS FOR SAILING; HORSE RIDING PANTS AND JACKETS; FOOTWEAR; AND HATS AND CAPS, IN CLASS 25 (U.S. CLS. 22 AND 39).

FOR: CIGAR AND CIGARETTE HOLDERS MADE OF LEATHER, IN CLASS 34 (U.S. CLS. 2, 8, 9 AND 17).

OWNER OF INTERNATIONAL REGISTRATION 0895146 DATED 10-3-2005, EXPIRES 10-3-2015.

SER. NO. 79-027,602, FILED 10-3-2005.

CHRISTOPHER BUONGIORNO, EXAMINING ATTORNEY

Int. Cl.: 33

Prior U.S. Cls.: 47 and 49

United States Patent and Trademark Office

Reg. No. 3,485,072

Registered Aug. 12, 2008

**TRADEMARK
PRINCIPAL REGISTER**

BABIČKA ORIGINAL WORMWOOD VODKA

RUSSELL, ARRAN (AUSTRALIA INDIVIDUAL)
UNIT 10
16-18 WOLSELEY ROAD; POINT PIPER NSW 2027
AUSTRALIA AND
CLARKE, ALEX (AUSTRALIA INDIVIDUAL)
UNIT 10
16-18 WOLSELEY ROAD; POINT PIPER NSW 2027
AUSTRALIA

FOR: VODKA; PRE-MIXED ALCOHOLIC BEV-
ERAGES CONTAINING OR BASED ON VODKA, IN
CLASS 33 (U.S. CLS. 47 AND 49).

OWNER OF INTERNATIONAL REGISTRATION
0896893 DATED 7-17-2006, EXPIRES 7-17-2016.

NO CLAIM IS MADE TO THE EXCLUSIVE
RIGHT TO USE "ORIGINAL WORMWOOD VOD-
KA", APART FROM THE MARK AS SHOWN.

THE FOREIGN WORDING IN THE MARK
TRANSLATES INTO ENGLISH AS GRANDMOTH-
ER.

SER. NO. 79-028,229, FILED 7-17-2006.

AMY ALFIERI, EXAMINING ATTORNEY

Int. Cl.: 3

Prior U.S. Cls.: 1, 4, 6, 50, 51 and 52

United States Patent and Trademark Office

Reg. No. 3,485,073

Registered Aug. 12, 2008

TRADEMARK
PRINCIPAL REGISTER

The logo features the word "Expertise" in a serif font, with the "E" being significantly larger and more stylized. Below "Expertise" are the letters "3p" in a bold, italicized, sans-serif font.

CLARINS S.A. (FRANCE SOCIÉTÉ ANONYME)
4, RUE BERTEAUX DUMAS
F-92200 NEUILLY-SUR-SEINE
FRANCE

FOR: COSMETIC PRODUCTS FOR WOMEN AND MEN FOR VARIOUS PARTS OF THE HUMAN BODY, FACE, EYES, LIPS, TEETH, HAIR, NECK, BUST, BODY, HANDS, FEET, NAIL, NAMELY, BEAUTY CREAMS, BEAUTY SERUMS, BEAUTY MILKS, BEAUTY LOTIONS, TONIC LOTIONS, BEAUTY MASKS, BEAUTY GELS, BEAUTY OILS, MAKE-UP REMOVING MILKS, MAKE-UP REMOVING RINSES, TOILET SOAPS, SCRUBBING AND EXFOLIATING PRODUCTS NAMELY, CREAMS AND GELS, BODY POWDERS, TALCUM POWDERS, MAKE-UP PRODUCTS, PERFUMES, EAU DE TOILETTE, EAU-DE-COLOGNE, DEODORANTS FOR PERSONAL USE, HAIR LOTIONS, SHAMPOOS,

BATH AND SHOWER PRODUCTS, NAMELY, GELS, CREAMS, TONICS AND LOTIONS, BATH FOAM, REFRESHING AEROSOLS FOR THE SKIN, MOISTURIZING PRODUCTS, NAMELY, CREAMS, SPRAYS, TONICS, GELS AND LOTIONS THAT MOISTURIZE THE SKIN, IN CLASS 3 (U.S. CLS. 1, 4, 6, 50, 51 AND 52).

PRIORITY DATE OF 2-27-2006 IS CLAIMED.

OWNER OF INTERNATIONAL REGISTRATION
0897711 DATED 8-24-2006, EXPIRES 8-24-2016.

SER. NO. 79-028,559, FILED 8-24-2006.

MARK PILARO, EXAMINING ATTORNEY

Int. Cls.: 9, 38 and 42

Prior U.S. Cls.: 21, 23, 26, 36, 38, 100, 101 and 104

United States Patent and Trademark Office

Reg. No. 3,485,074

Registered Aug. 12, 2008

**TRADEMARK
SERVICE MARK
PRINCIPAL REGISTER**

WAYFINDER

WAYFINDER SYSTEMS AB (SWEDEN CORPORATION)
P.O. BOX 1154
SE-221 05 LUND
SWEDEN

FOR: WIRELESS NAVIGATION DEVICE, NAME-
LY, COMBINED SOFTWARE AND ACTIVATION
CODE INSTALLED ON A CELLULAR PHONE TO
PERMIT ACCESS TO AN ON-LINE PLATFORM VIA
THE MOBILE NETWORK; ACCESSORIES THERE-
FOR, NAMELY, GPS RECEIVERS THAT OPERATE
OVER A WIRELESS CONNECTION STANDARD
BETWEEN MOBILE PHONES AND GPS RECEIVERS
INTEGRATED INTO MOBILE PHONES, MOBILE
COMPUTERS AND HANDHELD COMPUTERS;
BATTERY CHARGERS FOR THE GPS RECEIVER;
CAR CHARGERS FOR THE GPS RECEIVER; MUL-
TIMEDIA CARD (MMC) MEMORY CARDS FOR
USE WITH GPS SOFTWARE, IN CLASS 9 (U.S. CLS.
21, 23, 26, 36 AND 38).

FOR: TELECOMMUNICATION SERVICES,
NAMELY, TRANSMISSION OF DATA IN THE

FIELD OF WIRELESS LOCATION BASED SERVI-
CES, IN CLASS 38 (U.S. CLS. 100, 101 AND 104).

FOR: SCIENTIFIC AND TECHNOLOGICAL SER-
VICES AND RESEARCH AND DESIGN RELATED
THERETO WITHIN THE FIELD OF WIRELESS
NAVIGATION; INDUSTRIAL ANALYSIS AND RE-
SEARCH SERVICES WITHIN THE FIELD OF WIRE-
LESS NAVIGATION; DESIGN AND
DEVELOPMENT OF COMPUTER HARDWARE
AND SOFTWARE WITHIN THE FIELD OF WIRE-
LESS NAVIGATION, IN CLASS 42 (U.S. CLS. 100
AND 101).

OWNER OF INTERNATIONAL REGISTRATION
0898768 DATED 5-23-2006, EXPIRES 5-23-2016.

SER. NO. 79-028,995, FILED 5-23-2006.

TINA BROWN, EXAMINING ATTORNEY

Int. Cl.: 9

Prior U.S. Cls.: 21, 23, 26, 36 and 38

Reg. No. 3,485,075

United States Patent and Trademark Office

Registered Aug. 12, 2008

**TRADEMARK
PRINCIPAL REGISTER**

IDS

IREX TECHNOLOGIES B.V. (NETHERLANDS
LLC)
HIGH TECH CAMPUS 46
NL-5656 AE EINDHOVEN
NETHERLANDS

FOR: ELECTRONIC DOCUMENT READERS FOR RECEIVING, PROCESSING, TRANSMITTING AND REPRODUCING, ELECTRONIC MESSAGES, PUBLICATIONS, NEWSPAPERS, PERIODICALS, ALL DISTRIBUTED THROUGH ELECTRONIC MEANS OR VIA THE INTERNET; COMPUTERS; MINIATURE COMPUTERS; COMPUTER SOFTWARE FOR OPERATING PROGRAMS FOR ELECTRONIC DOCUMENT READERS, IN CLASS 9 (U.S. CLS. 21, 23, 26, 36 AND 38).

THE MARK CONSISTS OF STANDARD CHARACTERS WITHOUT CLAIM TO ANY PARTICULAR FONT, STYLE, SIZE, OR COLOR.

PRIORITY DATE OF 3-17-2006 IS CLAIMED.

OWNER OF INTERNATIONAL REGISTRATION
0901004 DATED 9-13-2006, EXPIRES 9-13-2016.

SER. NO. 79-029,662, FILED 9-13-2006.

MICHAEL LEWIS, EXAMINING ATTORNEY

Int. Cl.: 33

Prior U.S. Cls.: 47 and 49

United States Patent and Trademark Office

Reg. No. 3,485,076

Registered Aug. 12, 2008

**TRADEMARK
PRINCIPAL REGISTER**

MOSCOW NIGHTS

OBSHESTVO S OGRANICHENNOI OTVETST-
VENNOTJU "SKB-FORMAT" (RUSSIAN FED.
LTD LIAB CO)
11 KRUPSKOI UL., BALASHIKHA
RU-143900 MOSKOVSKAYA OBL., RUSSIAN FED.

FOR: DISTILLED SPIRITS, IN CLASS 33 (U.S. CLS.
47 AND 49).

THE MARK CONSISTS OF STANDARD CHAR-
ACTERS WITHOUT CLAIM TO ANY PARTICULAR
FONT, STYLE, SIZE, OR COLOR.

OWNER OF INTERNATIONAL REGISTRATION
0901983 DATED 4-19-2006, EXPIRES 4-19-2016.

NO CLAIM IS MADE TO THE EXCLUSIVE
RIGHT TO USE "MOSCOW", APART FROM THE
MARK AS SHOWN.

SER. NO. 79-030,321, FILED 4-19-2006.

ERNEST SHOSHO, EXAMINING ATTORNEY

Int. Cls.: 7, 8, 9, 11, 12 and 17

**Prior U.S. Cls.: 1, 5, 12, 13, 19, 21, 23, 26, 28, 31, 34,
35, 36, 38, 44 and 50**

Reg. No. 3,485,077

United States Patent and Trademark Office

Registered Aug. 12, 2008

**TRADEMARK
PRINCIPAL REGISTER**

Together we move the world

INA-SCHAEFFLER KG (FED REP GERMANY
KOMMANDITGESELLSCHAFT (LIMITED
PARTNERSHIP))

INDUSTRIESTRAÙE 1-3
91074 HERZOGENAURACH
FED REP GERMANY

FOR: MACHINE PARTS, NAMELY, NEEDLE ROLLER THRUST BEARINGS; MACHINE PARTS, NAMELY, SELF-ALIGNING THRUST ROLLER BEARINGS; MACHINE PARTS, NAMELY, DEEP-GROOVE THRUST BALL BEARINGS; MACHINE PARTS, NAMELY, ANGULAR CONTACT THRUST BALL BEARINGS; MACHINE PARTS, NAMELY, CYLINDRICAL ROLLER THRUST BEARINGS; MACHINE PARTS, NAMELY, TORQUE LIMITERS, REPLACEMENT PARTS THEREFORE, INCLUDING DISKS AND DISK SPRINGS AS MACHINE PARTS; SLEWING CONNECTIONS FOR MACHINES; MACHINE PARTS, NAMELY, THIN SECTION BEARINGS; MACHINE PARTS, NAMELY, THIN SECTION BEARINGS; MACHINE PARTS, NAMELY, FINE BLANKS FOR MACHINES; MACHINE PARTS, NAMELY, SWIVEL HEADS FOR MACHINES; MACHINE PARTS, NAMELY, SPHERICAL PLAIN BEARINGS; MACHINE PARTS, NAMELY, SLIDING GUIDES FOR MACHINES; MACHINE PARTS, NAMELY, SLIDING BEARINGS; BUSH-TYPE OVERRUNNING CLUTCHES FOR MACHINES WITH AND WITHOUT BEARING SUPPORTS; MACHINE PARTS, NAMELY, CAGE GUIDES FOR MACHINES; MACHINE PARTS, NAMELY, TAPERED ROLLER BEARINGS; ENGINE TIMING COMPONENTS, NAMELY, CHAIN TENSIONING CAM SPROCKETS; MACHINE PARTS, NAMELY, COMBINED THRUST AND RADIAL BEARINGS; FORCE TRANSMISSION DEVICES FOR MACHINES, NAMELY, CLUTCHES; MACHINE PARTS, NAMELY, RECIRCULATING BALL GUIDES FOR MACHINES; CLUTCH DISKS, RELEASERS, RELEASING AND ACTUATING MECHANISMS, TRANSMISSIONS FOR MACHINES; BEARINGS AND ASSEMBLED UNITS FOR TEXTILE MACHINES; TRACK ROLLER GUIDES FOR MACHINES; LINEAR BALL BEARING GUIDES FOR MACHINES; MACHINE PARTS, NAMELY,

LINEAR MODULES FOR MACHINES; HYDRAULIC LIFT LINEAR SUPPORTING TABLES; MACHINE PARTS, NAMELY, NEEDLE ROLLER BEARINGS; MACHINE PARTS, NAMELY, SELF-ALIGNING BALL BEARINGS; MACHINE PARTS, NAMELY, SELF-ALIGNING ROLLER BEARINGS; MACHINE PARTS, NAMELY, SELF-ALIGNING SPLIT ROLLER BEARINGS; BELT-TENSIONING ROLLERS FOR MACHINES; MACHINE PARTS, NAMELY, DEEP-GROOVE AND ANGULAR CONTACT BALL BEARINGS; ROLLER SCREW DRIVES FOR INDUSTRIAL MACHINERY; MACHINE PARTS, NAMELY, RECIRCULATING ROLLER GUIDES FOR MACHINES; MACHINE PARTS, NAMELY, INSERT BEARINGS AND HOUSING UNITS FOR MACHINES; MACHINE PARTS, NAMELY, SPINDLE BEARINGS; MACHINE PARTS, NAMELY, YOKE-TYPE AND STUD-TYPE TRACK ROLLERS FOR MACHINES; MACHINE PARTS, NAMELY, SPHERICAL ROLLER BEARINGS; MACHINE PARTS, NAMELY, FOUR-POINT CONTACT BEARINGS; MACHINE PARTS, NAMELY, ROLLING BEARING PARTS THEREFOR; SHAFTS FOR MACHINES; MACHINE PARTS, NAMELY, ACCESSORIES FOR LINEAR GUIDES; MACHINE PARTS, NAMELY, CYLINDRICAL ROLLER BEARINGS; MACHINE PARTS, NAMELY, CYLINDRICAL ROLLER BEARINGS, WITH ANGULAR ADJUSTMENT; EXHAUSTS, NAMELY, EXHAUST MANIFOLD FOR ENGINES; MACHINE PARTS, NAMELY, BALL, ROLLER, CONE AND SLIDING BEARINGS; ENGINE PARTS, NAMELY, EXHAUST MANIFOLD FOR ENGINES; OIL, AIR AND FUEL FILTERS FOR MOTORS AND ENGINES; MACHINE PARTS, NAMELY, BELT PULLEYS, BELT TENSIONING PULLEYS, TENSIONING ROLLERS FOR MACHINES; NON-RETURN VALVES BEING PART OF MACHINES; MACHINE FLYWHEELS; CONTROL VALVES BEING PART OF MACHINES; VALVE TAPPETS FOR MOTORS AND ENGINES; CARBURETORS; DISTRIBUTORS FOR VEHICLES; WATER PUMPS FOR USE IN MOTORS AND ENGINES; ELECTRONIC IGNITION SYSTEMS FOR VEHICLES, CONSISTING PRIMARILY OF IGNITION COILS, IGNITION WIRES, CONDENSERS, CABLE PLUGS; MACHINE PARTS, NAMELY, CY-

LINDER HEADS; FUEL PUMPS FOR LAND VEHICLES, IN CLASS 7 (U.S. CLS. 13, 19, 21, 23, 31, 34 AND 35).

FOR: MANUALLY OPERATED HAND TOOLS FOR THE WORKSHOP FOR INSTALLING AND DEINSTALLING MACHINE, ENGINE AND MOTOR PARTS, IN CLASS 8 (U.S. CLS. 23, 28 AND 44).

FOR: CAR THERMOSTATS; BATTERIES, IN CLASS 9 (U.S. CLS. 21, 23, 26, 36 AND 38).

FOR: AIR CONDITIONERS FOR VEHICLES CONSISTING MAINLY OF COMPRESSORS; LAMPS; LAMP PROTECTING COVERS FOR VEHICLES; FOG LAMPS; FOG TAIL LIGHTS FOR VEHICLES; HEADLIGHTS FOR AUTOMOBILES; FLASHER LIGHTS, NAMELY, FLASHLIGHTS; FLASHING STROBE LIGHT APPARATUS; EMERGENCY FLASHER SYSTEMS, CONSISTING MAINLY OF RELAYS AND SWITCHES, NAMELY, FLASHING STROBE LIGHT APPARATUS, IN CLASS 11 (U.S. CLS. 13, 21, 23, 31 AND 34).

FOR: LAND, AIR AND WATER VEHICLE CONSOLE PARTS, NAMELY, WIRING HARNESSSES FOR CONTROL, MONITORING AND PROTECTION OF INDUSTRIAL GASOLINE AND DIESEL ENGINES; VEHICLE CLUTCH RELEASE FORKS; LAND, AIR AND WATER VEHICLE PARTS, NAMELY, AUTOMATIC TRANSMISSIONS, INCLUDING THEIR INDIVIDUAL PARTS, NAMELY, BRAKE BANDS AND DISKS; BRAKES FOR LAND, AIR AND WATER VEHICLES; LAND, AIR AND WATER VEHICLE BRAKE PARTS AND LININGS, NAMELY, BRAKE PADS, BRAKE SHOES AND BRAKE LININGS; LAND, AIR AND WATER VEHICLE TORQUE LIMITERS, AND REPLACEMENT PARTS THEREFOR, NAMELY, DISKS AND DISK SPRINGS AS AUTOMOTIVE PARTS ELECTRONIC TRANSMISSIONS; VEHICLE PARTS, NAMELY, SUSPENSION STRUTS; WHEEL RIMS; VEHICLE PARTS, NAMELY, POWER WINDOW LIFTERS; PROPELLER SHAFTS AND DRIVING SHAFTS FOR LAND, AIR AND WATER VEHICLES; LAND, AIR AND WATER VEHICLE PARTS, NAMELY, HYDRAULIC CLUTCH CONTROLS AND REPLACEMENT PARTS THEREFOR, IN PARTICULAR PIPES, TUBES, MASTER AND

SLAVE CYLINDERS, RELEASE BEARINGS, SHAFT SEALING RINGS; LAND, AIR AND WATER VEHICLE PARTS, NAMELY, HYDRAULIC AND MECHANICAL BELT DRIVES; LAND, AIR AND WATER VEHICLE PARTS, NAMELY, HYDRAULIC AND MECHANICAL VALVE LASH ADJUSTERS; LAND, AIR AND WATER VEHICLE PARTS, NAMELY, CHAIN DRIVES; FORCE TRANSMISSION DEVICES FOR VEHICLES, NAMELY, CLUTCHES; CLUTCHES FOR LAND, AIR AND WATER VEHICLES; CLUTCH DISKS AND CLUTCH RELEASE BEARINGS FOR LAND, AIR AND WATER VEHICLES; LAND, AIR AND WATER VEHICLE PARTS, NAMELY, CLUTCH DISKS, CLUTCH RELEASERS, CLUTCH RELEASING AND ACTUATING MECHANISMS, TRANSMISSIONS; CLUTCH REPLACEMENT PARTS; LAND, AIR AND WATER VEHICLE PARTS, NAMELY, CAMSHAFT PHASING UNITS; PILOT OR CLUTCH GUIDE BEARINGS FOR LAND, AIR AND WATER VEHICLES; WHEEL BEARING UNITS FOR LAND, AIR AND WATER VEHICLES; LAND, AIR AND WATER VEHICLE PARTS, NAMELY, WINDSHIELD WIPER SYSTEMS, CONSISTING MAINLY OF WIPER MOTORS; WINDSHIELD WIPER LINKAGE AND WIPER BLADES FOR VEHICLES; VEHICLE PARTS, NAMELY, WINDSHIELD WIPERS; LAND, AIR AND WATER VEHICLE PARTS, NAMELY, VIBRATION DAMPERS; LAND, AIR AND WATER VEHICLE PARTS, NAMELY, SHOCK ABSORBERS, IN CLASS 12 (U.S. CLS. 19, 21, 23, 31, 35 AND 44).

FOR: NON-METAL SEALS FOR USE IN PREVENTING THE LEAKING OF FLUIDS IN LAND VEHICLE ENGINES, IN CLASS 17 (U.S. CLS. 1, 5, 12, 13, 35 AND 50).

THE MARK CONSISTS OF STANDARD CHARACTERS WITHOUT CLAIM TO ANY PARTICULAR FONT, STYLE, SIZE, OR COLOR.

OWNER OF INTERNATIONAL REGISTRATION 0902774 DATED 3-30-2005, EXPIRES 3-30-2015.

SER. NO. 79-030,620, FILED 3-30-2005.

BARBARA RUTLAND, EXAMINING ATTORNEY

Int. Cls.: 7, 12 and 42

Prior U.S. Cls.: 13, 19, 21, 23, 31, 34, 35, 44, 100 and 101

Reg. No. 3,485,078

United States Patent and Trademark Office

Registered Aug. 12, 2008

**TRADEMARK
SERVICE MARK
PRINCIPAL REGISTER**



AUMUND-FÖRDERERBAU; GMBH & CO. KG
(FED REP GERMANY LIMITED JOINT
STOCK COMPANY)
SAALHOFFER STRAÙE 17
47495 RHEINBERG
FED REP GERMANY

FOR: INDUSTRIAL MACHINES, NAMELY, APRON FEEDERS, HEAVY-DUTY APRON FEEDERS, DEEP DRAWN PAN CONVEYORS, BUCKET APRON CONVEYORS, PIVOTING PAN CONVEYORS, DRAG CHAIN CONVEYORS, MOBILE LINK CONVEYORS, FLAT PLATE CONVEYORS WITH PLATE, SHORT PLATE CONVEYORS, BELT BUCKET ELEVATORS, CENTRAL CHAIN BUCKET ELEVATORS, DOUBLE BUCKET ELEVATORS, BUCKET ELEVATORS WITH GRAVITY DISCHARGE, PENDULUM BUCKET ELEVATORS FOR TRANSPORTING, STORING, DISTRIBUTING, WITHDRAWING, MIXING, DOSING, HOMOGENIZING, BUNKERING AND APPORTIONING OF BULK MATERIALS; MACHINES AND MECHANICAL APPARATUS, NAMELY, ROTARY DISCHARGED MACHINES, ALSO ROTATING, GRAVITY DISCHARGE GATES, GRAB UNLOADING HOPPERS, ARMORED CHAIN CONVEYORS, CLEANING CONVEYORS, TELESCOPIC LOADING SPOUTS, STOCKYARDS AND BLENDING BED SYSTEMS, BRIDGE-TYPE SCRAPER RECLAIMERS, PORTAL- AND SEMI PORTAL SCRAPER RECLAIMERS, MULTIPLE PURPOSE PORTAL BRIDGE RECLAIMERS, CANTILEVER SCRAPER RECLAIMERS, COMBINED STACKER/SCRAPER RECLAIMERS, CIRCULAR STORAGES WITH STACKER AND CANTILEVER RECLAIMERS OR BRIDGE-TYPE SCRAPER RECLAIMERS FOR EMPTYING BUNKERS, SILOS AND LARGE STORAGE ROOMS AS WELL AS FOR LOOSENING BULK MATERIAL

STORED THEREIN; CHAIN CONVEYORS AND CONVEYORS FOR HOT MATERIAL; BELT CONVEYOR SYSTEMS, PARTICULARLY CONSISTING OF STEEL PLATE CONVEYORS AND CONVEYORS OF DIFFERENT CONSTRUCTION, BELT CONVEYORS; VERTICAL AND PENDULUM BUCKET CONVEYORS INCORPORATING SUPPORTING CONSTRUCTIONS IN THE FORM OF BELT BRIDGES AND DELIVERY TOWERS; SYSTEMS FOR TIPPING WAGONS IN THE FORM OF FRONT TIPPERS, ROTARY TIPPERS AND SIDE TIPPERS, IN CLASS 7 (U.S. CLS. 13, 19, 21, 23, 31, 34 AND 35).

FOR: CARS FOR EMPTYING BUNKERS, IN CLASS 12 (U.S. CLS. 19, 21, 23, 31, 35 AND 44).

FOR: PRODUCT DEVELOPMENT, NAMELY, TECHNICAL PLANNING, DEVELOPMENT, PROJECTING AND DESIGNING OF APPARATUS, MACHINES AND FACILITIES FOR TRANSPORTING, STORING, DISTRIBUTING, WITHDRAWING, WIPING OFF, DOSING, HOMOGENIZING, BUNKERING AND APPORTIONING OF BULK MATERIAL; ENGINEERING SERVICES, NAMELY, TECHNICAL ANALYSIS SERVICES AND TECHNICAL SURVEY IN THE FIELD OF APPARATUS, MACHINES AND FACILITIES FOR TRANSPORTING, STORING, DISTRIBUTING, MIXING, DOSING, HOMOGENIZING, BUNKERING AND APPORTIONING OF BULK MATERIAL; TECHNICAL CONSULTING RELATING TO PRODUCT RESEARCH AND DEVELOPMENT IN THE FIELD OF ENGINEERING, IN CLASS 42 (U.S. CLS. 100 AND 101).

PRIORITY DATE OF 3-31-2006 IS CLAIMED.

OWNER OF INTERNATIONAL REGISTRATION
0904989 DATED 9-19-2006, EXPIRES 9-19-2016.

SER. NO. 79-031,491, FILED 9-19-2006.

OWNER OF U.S. REG. NO. 1,158,812.

SHARON MEIER, EXAMINING ATTORNEY

Int. Cls.: 7, 9, 11, 35, 37, 39, 40 and 42

**Prior U.S. Cls.: 13, 19, 21, 23, 26, 31, 34, 35, 36, 38,
100, 101, 102, 103, 105 and 106**

Reg. No. 3,485,079

United States Patent and Trademark Office

Registered Aug. 12, 2008

**TRADEMARK
SERVICE MARK
PRINCIPAL REGISTER**



IMMARK AG (SWITZERLAND CORPORATION)
BAHNSTRASSE 142
CH-8105 REGENSDORF, SWITZERLAND

FOR: MACHINES AND MACHINE TOOLS, NAMELY, INDUSTRIAL TRASH COMPACTING MACHINES, ROTARY DIES, EARTH COMPACTING MACHINES, BACKHOES, GRADERS, LOADERS, EXCAVATORS, CARTONING MACHINES, CUTTING TORCHES, ELECTRIC SCISSORS, POWER-OPERATED SAWS AND SHEARS, GRINDING MACHINES, INDUSTRIAL MACHINE PRESSES, MACHINES AND MACHINE TOOLS FOR CUTTING AND FORMING MATERIALS, SHREDDING MACHINES, AND WASTE COMPACTING MACHINES, ALL FOR USE IN CONNECTION WITH THE PROCESSING, SORTING, SEPARATING, TRANSFORMING, CRUSHING AND/OR DISMANTLING OF ELECTRIC AND ELECTRONIC EQUIPMENT AND WASTE THEREFROM OR FOR THE SEPARATE DISPOSAL OF POLLUTANTS, RESIDUES AND HAZARDOUS WASTE; MACHINES, SPECIAL MECHANICAL INSTALLATIONS AND EQUIPMENT, NAMELY, CONVEYORS, PALLETIZERS, BLOWERS, ELEVATORS, VIBRATORY SCREEN SEPARATORS, AND PALLET DISPENSING MACHINES, IN THE FIELD OF SORTING TECHNOLOGY; MOTORS AND ENGINES FOR THE ABOVE; AND MACHINE COUPLING AND TRANSMISSION COMPONENTS FOR THE ABOVE, IN CLASS 7 (U.S. CLS. 13, 19, 21, 23, 31, 34 AND 35).

FOR: CASH REGISTERS; FIRE EXTINGUISHERS; COMPUTERS AND COMPUTER PERIPHERALS;

COMPUTER SOFTWARE FOR FACTORY AUTOMATION, NAMELY, SOFTWARE TO INTEGRATE MACHINES FOR USE IN CONNECTION WITH THE PROCESSING, SORTING, SEPARATING, TRANSFORMING, CRUSHING AND/OR DISMANTLING OF ELECTRIC AND ELECTRONIC EQUIPMENT AND WASTE THEREFROM OR FOR THE SEPARATE DISPOSAL OF POLLUTANTS, RESIDUES AND HAZARDOUS WASTE, OR TO TRACK PROBLEMS AND GENERATE PRODUCTION REPORTS, IN CLASS 9 (U.S. CLS. 21, 23, 26, 36 AND 38).

FOR: LAMPS, LAMP CHIMNEYS, AND LIGHT BULBS FOR LAMPS; AND LIGHT DIFFUSERS, IN CLASS 11 (U.S. CLS. 13, 21, 23, 31 AND 34).

FOR: ADVERTISING; COMPANY MANAGEMENT; BUSINESS ADMINISTRATION; OFFICE AND SECRETARIAL FUNCTIONS; RETAIL STORES AND ONLINE RETAIL STORE SERVICES FEATURING REPAIRED, RECYCLED AND RE-FURNISHED ELECTRONICS GOODS; SERVICES PROVIDED BY A PROCURER, NAMELY, PROCUREMENT OF REPAIRED, RECYCLED AND RE-FURNISHED ELECTRONICS GOODS FOR OTHERS, AND CONCLUSION OF BUSINESS DEALS FOR THIRD PARTIES IN THE FIELD OF MACHINES, MACHINE TOOLS AND SPECIAL MECHANICAL INSTALLATIONS AND EQUIPMENT IN THE FIELD OF RECYCLING AS WELL AS IN THE FIELD OF SORTING TECHNOLOGY; COMMERCIAL, CORPORATE AND ORGANIZATION ADVICE WITH REGARD TO EQUIPMENT, CONSTRUCTION AND OPERATION OF RECYCLING COMPANIES AND

WASTE MANAGEMENT FACILITIES; COMMERCIAL, CORPORATE AND ORGANIZATION ADVICE WITH REGARD TO DESIGN OF CONCEPTS FOR WASTE DISPOSAL AND PROCESSING; CARRYING OUT BUSINESS ANALYSES RELATING TO A SITE; DATABASE MANAGEMENT, NAMELY, COMPILATION, STORAGE, SYSTEMIZATION, UPDATING AND ARCHIVING OF BUSINESS DATA IN A DATABASE; COMPILATION OF STATISTICS, CARRYING OUT ECONOMIC ANALYSES AND FORECASTING IN THE FIELD OF RECYCLING; MARKET STUDY AND PUBLIC RELATIONS IN THE FIELD OF RECYCLING, IN CLASS 35 (U.S. CLS. 100, 101 AND 102).

FOR: CONSTRUCTION, NAMELY, SUPERVISION, PLANNING AND BUILDING OF FACILITIES FOR OTHERS FOR USE IN SORTING, REFURBISHING AND REBUILDING COMPUTERS AND OTHER ELECTRONICS AND FOR DISPOSING OF WASTE; REPAIR OF COMPUTERS AND OTHER ELECTRONICS; REPAIR OF MACHINES, MACHINE TOOLS AND EQUIPMENT USED IN SORTING, REBUILDING AND RECYCLING COMPUTERS AND OTHER ELECTRONICS AND FOR DISPOSING OF WASTE; INSTALLATION OF MACHINES, MACHINE TOOLS AND EQUIPMENT USED IN SORTING, REBUILDING AND RECYCLING COMPUTERS AND OTHER ELECTRONICS AND FOR DISPOSING OF WASTE; ASSEMBLY, UPKEEP, REPAIR, CLEANING, MAINTENANCE, AND SERVICING OF MACHINES, MACHINE TOOLS AND SPECIAL MECHANICAL INSTALLATIONS AND EQUIPMENT IN THE FIELD OF SORTING, RECYCLING; RENTAL OF MACHINES, MACHINE TOOLS AND SPECIAL INSTALLATIONS AND EQUIPMENT IN THE FIELD OF RECYCLING, IN CLASS 37 (U.S. CLS. 100, 103 AND 106).

FOR: TRANSPORT, PACKAGING, STORAGE, AND ROUTING OF WASTE, RAW MATERIALS, RESIDUES, HAZARDOUS WASTE, WASTE FROM ELECTRIC AND ELECTRONIC EQUIPMENT; ADVICE, NAMELY, CONSULTATION SERVICES AND SUPPLY CHAIN LOGISTICS SERVICES IN THE FIELD OF TRANSPORT, PACKAGING AND STORAGE OF WASTE, RAW MATERIALS, RESIDUES, HAZARDOUS WASTE, WASTE FROM ELECTRIC AND ELECTRONIC EQUIPMENT FOR OTHERS BY AIR, RAIL, SHIP, OR TRUCK; RENTAL OF STORAGE TANKS, STORAGE CONTAINERS, STORAGE SITES AS WELL AS STORAGE PREMISES; RENTAL OF SPECIAL VEHICLES FOR COLLECTION AND TRANSPORT OF ALL THE AFORESAID GOODS AND MATERIALS, NAMELY, WASTE, RAW MATERIALS, RESIDUES, HAZARDOUS WASTE, WASTE FROM ELECTRIC AND ELECTRONIC EQUIPMENT, IN CLASS 39 (U.S. CLS. 100 AND 105).

FOR: RECYCLING; OPERATING RECYCLING CENTERS FOR GOODS AND MATERIALS OF ALL TYPES, FOR WASTE FROM ELECTRIC AND ELECTRONIC EQUIPMENT AS WELL AS FOR PRODUCER AND CONSUMER GOODS; DISMANTLING, SHREDDING, SPLITTING, RECOVERY, TRANSFORMATION AND RECLAMATION OF WASTE FROM ELECTRIC AND ELECTRONIC EQUIPMENT; DESTRUCTION OF POLLUTANTS, RESIDUES AND HAZARDOUS WASTE; CONSULTANCY AND PROFESSIONAL ASSISTANCE WITH REGARD TO TREATMENT OF MATERIALS DURING RECYCLING PROCESSES; RENTAL OF INSTALLATIONS, MACHINES, MACHINE TOOLS AND SPECIAL MECHANICAL INSTALLATIONS AND EQUIPMENT FOR TREATMENT OF MATERIALS IN RECYCLING CENTERS; DISMANTLING, CRUSHING, SPLITTING AND RECYCLING OF COMPUTERS AND OTHER ELECTRONICS WITH A VIEW TO THEIR REUTILIZATION, IN CLASS 40 (U.S. CLS. 100, 103 AND 106).

FOR: SCIENTIFIC AND TECHNOLOGICAL SERVICES, NAMELY, ENGINEERING AND DESIGN, AS WELL AS SCIENTIFIC RESEARCH AND DEVELOPMENT SERVICES RELATING THERETO; INDUSTRIAL RESEARCH AND ANALYSES IN THE FIELD OF RECYCLING AND REUSE OF COMPUTERS AND OTHER ELECTRONICS AND OF THE DISPOSAL OF WASTE THEREFROM; TECHNICAL CONSULTATION IN THE FIELD OF OPERATION OF RECYCLING INSTALLATIONS; PROCESS DEVELOPMENT IN THE FIELD OF RECYCLING TO MAKE IT MORE ENVIRONMENTALLY SOUND; CARRYING OUT SITE ANALYSES AND ENVIRONMENTAL COMPATIBILITY STUDIES IN THE FIELD OF RECYCLING; ENVIRONMENTAL PLANNING AND CONSULTING SERVICES ON HOW TO AVOID PRODUCING WASTE; ANALYSIS AND EVALUATION OF THE GOODS AND SERVICES OF OTHERS FOR THE PURPOSE OF GRANTING OF LICENSES AND PREPARATION OF CERTIFICATES, NAMELY, MONITORING QUALITY STANDARDS AND CARRYING OUT QUALITY INSPECTIONS IN THE FIELD OF RECYCLING; DESIGN AND DEVELOPMENT OF COMPUTER SOFTWARE; LEGAL SERVICES; MATERIALS TESTING OF COMPUTERS AND OTHER ELECTRONICS WITH A VIEW TO THEIR REUTILIZATION, IN CLASS 42 (U.S. CLS. 100 AND 101).

OWNER OF INTERNATIONAL REGISTRATION
0848928 DATED 2-24-2005, EXPIRES 2-24-2015.

SER. NO. 79-031,536, FILED 11-12-2006.

LEIGH CAROLINE CASE, EXAMINING ATTORNEY

Int. Cls.: 7, 9, 11, 35, 37, 39, 40 and 42

**Prior U.S. Cls.: 13, 19, 21, 23, 26, 31, 34, 35, 36, 38,
100, 101, 102, 103, 105 and 106**

Reg. No. 3,485,080

United States Patent and Trademark Office

Registered Aug. 12, 2008

**TRADEMARK
SERVICE MARK
PRINCIPAL REGISTER**

immark

IMMARK AG (SWITZERLAND CORPORATION)
BAHNSTRASSE 142
CH-8105 REGENSDORF, SWITZERLAND

FOR: MACHINES AND MACHINE TOOLS, NAMELY, INDUSTRIAL TRASH COMPACTING MACHINES, ROTARY DIES, EARTH COMPACTING MACHINES, BACKHOES, GRADERS, LOADERS, EXCAVATORS, CARTONING MACHINES, CUTTING TORCHES, ELECTRIC SCISSORS, POWER-OPERATED SAWS AND SHEARS, GRINDING MACHINES, INDUSTRIAL MACHINE PRESSES, MACHINES AND MACHINE TOOLS FOR CUTTING AND FORMING MATERIALS, SHREDDING MACHINES, AND WASTE COMPACTING MACHINES, ALL FOR USE IN CONNECTION WITH THE PROCESSING, SORTING, SEPARATING, TRANSFORMING, CRUSHING AND/OR DISMANTLING OF ELECTRIC AND ELECTRONIC EQUIPMENT AND WASTE THEREFROM OR FOR THE SEPARATE DISPOSAL OF POLLUTANTS, RESIDUES AND HAZARDOUS WASTE; MACHINES, SPECIAL MECHANICAL INSTALLATIONS AND EQUIPMENT, NAMELY, CONVEYORS, PALLETIZERS, BLOWERS, ELEVATORS, VIBRATORY SCREEN SEPARATORS, AND PALLET DISPENSING MACHINES, IN THE FIELD OF SORTING TECHNOLOGY; MOTORS AND ENGINES FOR THE ABOVE; AND MACHINE COUPLING AND TRANSMISSION COMPONENTS FOR THE ABOVE, IN CLASS 7 (U.S. CLS. 13, 19, 21, 23, 31, 34 AND 35).

FOR: CASH REGISTERS; FIRE EXTINGUISHERS; COMPUTERS AND COMPUTER PERIPHERALS; COMPUTER SOFTWARE FOR FACTORY AUTOMATION, NAMELY, SOFTWARE TO INTEGRATE MACHINES FOR USE IN CONNECTION WITH THE PROCESSING, SORTING, SEPARATING, TRANSFORMING, CRUSHING AND/OR DISMANTLING OF ELECTRIC AND ELECTRONIC EQUIPMENT

AND WASTE THEREFROM OR FOR THE SEPARATE DISPOSAL OF POLLUTANTS, RESIDUES AND HAZARDOUS WASTE, OR TO TRACK PROBLEMS AND GENERATE PRODUCTION REPORTS, IN CLASS 9 (U.S. CLS. 21, 23, 26, 36 AND 38).

FOR: LAMPS, LAMP CHIMNEYS, AND LIGHT BULBS FOR LAMPS; AND LIGHT DIFFUSERS, IN CLASS 11 (U.S. CLS. 13, 21, 23, 31 AND 34).

FOR: ADVERTISING; COMPANY MANAGEMENT; BUSINESS ADMINISTRATION; OFFICE AND SECRETARIAL FUNCTIONS; RETAIL STORES AND ONLINE RETAIL STORE SERVICES FEATURING REPAIRED, RECYCLED AND REFURBISHED ELECTRONICS GOODS; SERVICES PROVIDED BY A PROCURER, NAMELY, PROCUREMENT OF REPAIRED, RECYCLED AND REFURBISHED ELECTRONICS GOODS FOR OTHERS, AND CONCLUSION OF BUSINESS DEALS FOR THIRD PARTIES IN THE FIELD OF MACHINES, MACHINE TOOLS AND SPECIAL MECHANICAL INSTALLATIONS AND EQUIPMENT IN THE FIELD OF RECYCLING AS WELL AS IN THE FIELD OF SORTING TECHNOLOGY; COMMERCIAL, CORPORATE AND ORGANIZATION ADVICE WITH REGARD TO EQUIPMENT, CONSTRUCTION AND OPERATION OF RECYCLING COMPANIES AND WASTE MANAGEMENT FACILITIES; COMMERCIAL, CORPORATE AND ORGANIZATION ADVICE WITH REGARD TO DESIGN OF CONCEPTS FOR WASTE DISPOSAL AND PROCESSING; CARRYING OUT BUSINESS ANALYSES RELATING TO A SITE; DATABASE MANAGEMENT, NAMELY, COMPILATION, STORAGE, SYSTEMIZATION, UPDATING AND ARCHIVING OF BUSINESS DATA IN A DATABASE; COMPILATION OF STATISTICS, CARRYING OUT ECONOMIC ANALYSES AND FORECASTING IN THE FIELD OF RECYCLING; MARKET STUDY AND PUBLIC RELATIONS IN

THE FIELD OF RECYCLING, IN CLASS 35 (U.S. CLS. 100, 101 AND 102).

FOR: CONSTRUCTION, NAMELY, SUPERVISION, PLANNING AND BUILDING OF FACILITIES FOR OTHERS FOR USE IN SORTING, REFURBISHING AND REBUILDING COMPUTERS AND OTHER ELECTRONICS AND FOR DISPOSING OF WASTE; REPAIR OF COMPUTERS AND OTHER ELECTRONICS; REPAIR OF MACHINES, MACHINE TOOLS AND EQUIPMENT USED IN SORTING, REBUILDING AND RECYCLING COMPUTERS AND OTHER ELECTRONICS AND FOR DISPOSING OF WASTE; INSTALLATION OF MACHINES, MACHINE TOOLS AND EQUIPMENT USED IN SORTING, REBUILDING AND RECYCLING COMPUTERS AND OTHER ELECTRONICS AND FOR DISPOSING OF WASTE; ASSEMBLY, UPKEEP, REPAIR, CLEANING, MAINTENANCE, AND SERVICING OF MACHINES, MACHINE TOOLS AND SPECIAL MECHANICAL INSTALLATIONS AND EQUIPMENT IN THE FIELD OF SORTING, RECYCLING; RENTAL OF MACHINES, MACHINE TOOLS AND SPECIAL INSTALLATIONS AND EQUIPMENT IN THE FIELD OF RECYCLING, IN CLASS 37 (U.S. CLS. 100, 103 AND 106).

FOR: TRANSPORT, PACKAGING, STORAGE, AND ROUTING OF WASTE, RAW MATERIALS, RESIDUES, HAZARDOUS WASTE, WASTE FROM ELECTRIC AND ELECTRONIC EQUIPMENT; ADVICE, NAMELY, CONSULTATION SERVICES AND SUPPLY CHAIN LOGISTICS SERVICES IN THE FIELD OF TRANSPORT, PACKAGING AND STORAGE OF WASTE, RAW MATERIALS, RESIDUES, HAZARDOUS WASTE, WASTE FROM ELECTRIC AND ELECTRONIC EQUIPMENT FOR OTHERS BY AIR, RAIL, SHIP, OR TRUCK; RENTAL OF STORAGE TANKS, STORAGE CONTAINERS, STORAGE SITES AS WELL AS STORAGE PREMISES; RENTAL OF SPECIAL VEHICLES FOR COLLECTION AND TRANSPORT OF ALL THE AFORESAID GOODS AND MATERIALS, NAMELY, WASTE, RAW MATERIALS, RESIDUES, HAZARDOUS WASTE, WASTE FROM ELECTRIC AND ELECTRONIC EQUIPMENT, IN CLASS 39 (U.S. CLS. 100 AND 105).

FOR: RECYCLING; OPERATING RECYCLING CENTERS FOR GOODS AND MATERIALS OF ALL TYPES, FOR WASTE FROM ELECTRIC AND ELECTRONIC EQUIPMENT AS WELL AS FOR PRODUCER AND CONSUMER GOODS; DISMANTLING, SHREDDING, SPLITTING, RECOVERY, TRANSFORMATION AND RECLAMATION OF WASTE FROM ELECTRIC AND ELECTRONIC

EQUIPMENT; DESTRUCTION OF POLLUTANTS, RESIDUES AND HAZARDOUS WASTE; CONSULTANCY AND PROFESSIONAL ASSISTANCE WITH REGARD TO TREATMENT OF MATERIALS DURING RECYCLING PROCESSES; RENTAL OF INSTALLATIONS, MACHINES, MACHINE TOOLS AND SPECIAL MECHANICAL INSTALLATIONS AND EQUIPMENT FOR TREATMENT OF MATERIALS IN RECYCLING CENTERS; DISMANTLING, CRUSHING, SPLITTING AND RECYCLING OF COMPUTERS AND OTHER ELECTRONICS WITH A VIEW TO THEIR REUTILIZATION, IN CLASS 40 (U.S. CLS. 100, 103 AND 106).

FOR: SCIENTIFIC AND TECHNOLOGICAL SERVICES, NAMELY, ENGINEERING AND DESIGN, AS WELL AS SCIENTIFIC RESEARCH AND DEVELOPMENT SERVICES RELATING THERETO; INDUSTRIAL RESEARCH AND ANALYSES IN THE FIELD OF RECYCLING AND REUSE OF COMPUTERS AND OTHER ELECTRONICS AND OF THE DISPOSAL OF WASTE THEREFROM; TECHNICAL CONSULTATION IN THE FIELD OF OPERATION OF RECYCLING INSTALLATIONS; PROCESS DEVELOPMENT IN THE FIELD OF RECYCLING TO MAKE IT MORE ENVIRONMENTALLY SOUND; CARRYING OUT SITE ANALYSES AND ENVIRONMENTAL COMPATIBILITY STUDIES IN THE FIELD OF RECYCLING; ENVIRONMENTAL PLANNING AND CONSULTING SERVICES ON HOW TO AVOID PRODUCING WASTE; ANALYSIS AND EVALUATION OF THE GOODS AND SERVICES OF OTHERS FOR THE PURPOSE OF GRANTING OF LICENSES AND PREPARATION OF CERTIFICATES, NAMELY, MONITORING QUALITY STANDARDS AND CARRYING OUT QUALITY INSPECTIONS IN THE FIELD OF RECYCLING; DESIGN AND DEVELOPMENT OF COMPUTER SOFTWARE; LEGAL SERVICES; MATERIALS TESTING OF COMPUTERS AND OTHER ELECTRONICS WITH A VIEW TO THEIR REUTILIZATION, IN CLASS 42 (U.S. CLS. 100 AND 101).

THE MARK CONSISTS OF STANDARD CHARACTERS WITHOUT CLAIM TO ANY PARTICULAR FONT, STYLE, SIZE, OR COLOR.

OWNER OF INTERNATIONAL REGISTRATION 0848926 DATED 2-24-2005, EXPIRES 2-24-2015.

SER. NO. 79-031,932, FILED 11-12-2006.

LEIGH CAROLINE CASE, EXAMINING ATTORNEY

Int. Cl.: 9

Prior U.S. Cls.: 21, 23, 26, 36 and 38

Reg. No. 3,485,081

United States Patent and Trademark Office

Registered Aug. 12, 2008

**TRADEMARK
PRINCIPAL REGISTER**



ATMEL GERMANY GMBH (FED REP GERMA-
NY CORPORATION)
THERESIENSTRASSE 2
74072 HEILBRONN, FED REP GERMANY

FOR: MICROELECTROINC COMPONENTS,
NAMELY, CIRCUIT BOARDS, HIGH FREQUENCY
SWITCHES, AMPLIFIERS, POWER AMPLIFIERS,
LOW NOISE AMPLIFIERS, AND COMPONENTS
FOR MOBILE PHONES; AND SEMICONDUCTOR
CIRCUITS, IN CLASS 9 (U.S. CLS. 21, 23, 26, 36 AND
38).

PRIORITY DATE OF 7-18-2006 IS CLAIMED.

OWNER OF INTERNATIONAL REGISTRATION
0907171 DATED 11-17-2006, EXPIRES 11-17-2016.

SER. NO. 79-032,396, FILED 11-17-2006.

JOHN WILKE, EXAMINING ATTORNEY

Int. Cl.: 9

Prior U.S. Cls.: 21, 23, 26, 36 and 38

Reg. No. 3,485,082

United States Patent and Trademark Office

Registered Aug. 12, 2008

**TRADEMARK
PRINCIPAL REGISTER**



ATMEL GERMANY GMBH (FED REP GERMA-
NY CORPORATION)
THERESIENSTRASSE 2
74072 HEILBRONN, FED REP GERMANY

FOR: MICROELECTROINC COMPONENTS,
NAMELY, CIRCUIT BOARDS, HIGH FREQUENCY
SWITCHES, AMPLIFIERS, POWER AMPLIFIERS,
LOW NOISE AMPLIFIERS, AND COMPONENTS
FOR MOBILE PHONES; AND SEMICONDUCTOR
CIRCUITS, IN CLASS 9 (U.S. CLS. 21, 23, 26, 36 AND
38).

PRIORITY DATE OF 7-18-2006 IS CLAIMED.

OWNER OF INTERNATIONAL REGISTRATION
0907177 DATED 11-17-2006, EXPIRES 11-17-2016.

SER. NO. 79-032,400, FILED 11-17-2006.

JOHN WILKE, EXAMINING ATTORNEY

Int. Cls.: 5, 29, 30 and 32

Prior U.S. Cls.: 6, 18, 44, 45, 46, 48, 51 and 52

United States Patent and Trademark Office

Reg. No. 3,485,083

Registered Aug. 12, 2008

**TRADEMARK
PRINCIPAL REGISTER**

ActiRegularis

COMPAGNIE GERVAIS DANONE (FRANCE SOCIETE ANONYME)

17, BOULEVARD HAUSSMANN

F-75009 PARIS

FRANCE

FOR: PHARMACEUTICAL PRODUCTS, NAME-
LY, PHARMACEUTICAL PRODUCTS TO IMPROVE
INTESTINAL TRANSIT, MILK FERMENTS FOR
PHARMACEUTICAL USE, NAMELY, MILK FER-
MENTS TO IMPROVE INTESTINAL TRANSIT, LAC-
TOSE, NAMELY, DIETARY SUPPLEMENTAL
DRINKS; DIETETIC FOODS ADAPTED FOR MED-
ICAL USE, FOOD FOR BABIES, NAMELY, LAC-
TEAL FLOUR, SOUPS, MILK, POWDERED MILK,
FRUIT COMPOTES, VEGETABLE PUREES, FRUIT
AND VEGETABLE JUICES, CEREAL FOR BABIES,
IN CLASS 5 (U.S. CLS. 6, 18, 44, 46, 51 AND 52).

FOR: DRIED FRUITS AND VEGETABLES, PRE-
SERVED FRUITS AND VEGETABLES, COOKED
FRUITS AND VEGETABLES; COMPOTES, JAMS,
FRUIT COULIS, JELLIES; SOUPS, MILK, MILK
POWDER, FLAVOURED JELLIFIED MILKS AND
WHIPPED MILK PRODUCTS EXCLUDING ICE
CREAM, ICE MILK AND FROZEN YOGHURT;
MILK PRODUCTS, NAMELY, MILKY DESSERTS
IN THE NATURE OF CREAM MOULD, YO-
GHURTS, DRINKING YOGHURTS, MOUSSES,
NAMELY, VEGETABLE MOUSSE, CHICKEN
MOUSSE, FISH MOUSSE, MEAT BASED MOUSSE,
CREAMS, CREAM PUDDINGS, NAMELY, BLACK
PUDDING, FRESH CREAM, BUTTER, CHEESE
SPREADS, CHEESES, RIPENED CHEESES,
MOULD-RIPENED CHEESES, FRESH UNRIPENED
CHEESES AND CHEESE IN BRINE, SOFT WHITE
CHEESE, PLAIN FRESH CHEESE IN PASTE, PLAIN
FRESH CHEESE IN LIQUID FORM, AROMATISED
FRESH CHEESE IN PASTE, AROMATISED FRESH
CHEESE IN LIQUID FORM; BEVERAGES MAINLY
CONSISTING OF MILK OR DAIRY PRODUCTS,
NAMELY, MILK BEVERAGES WITH HIGH MILK
CONTENT, MILK BEVERAGES WITH MILK PRE-
DOMINATING, NAMELY, MILK BASED BEVERA-
GES CONTAINING COFFEE, MILK BASED

BEVERAGES CONTAINING FRUITS; PLAIN FER-
MENTED DAIRY PRODUCTS EXCLUDING ICE
CREAM, ICE MILK AND FROZEN YOGHURT,
AROMATISED FERMENTED DAIRY PRODUCTS
EXCLUDING ICE CREAM, ICE MILK AND FRO-
ZEN YOGURT, LACTIC FERMENTS, NAMELY,
FERMENTED MILK, LACTIC ACID BACTERIA
DRINKS AND LACTIC ACID BACTERIA YO-
GHURT, IN CLASS 29 (U.S. CL. 46).

FOR: COFFEE, TEA, COCOA, CHOCOLATE, BEV-
ERAGES MADE WITH COFFEE, BEVERAGES
MADE WITH COCOA, BEVERAGES MADE WITH
CHOCOLATE; SWEET AND SAVOURY TARTS AND
PIES; CEREAL PREPARATIONS, NAMELY, CER-
EAL BASED SNACK FOODS READY TO EAT
CEREAL DERIVED FOODS BARS, BREAKFAST
CEREALS; PREPARED DISHES ESSENTIALLY
CONSISTING OF PASTRY; BREAD, RUSKS, SWEET
BISCUITS, SAVOURY BISCUITS, WAFERS, WAF-
FLES, CAKES, PASTRIES; ALL THESE GOODS
BEING PLAIN, TOPED, FILLED AND FLA-
VOURED; CONFECTIONERY, NAMELY, CONFEC-
TIONERY CHIPS FOR BAKING, CRYSTAL SUGAR
PIECES, FRUIT JELLIES, EDIBLE ICES, NAMELY,
FRUIT ICES, FLAVOURED ICES, ICE CREAMS
ESSENTIALLY MADE WITH YOGHURT, ICE
CREAM, SHERBETS, FROZEN YOGHURT, FLA-
VOURED FROZEN WATER, IN CLASS 30 (U.S. CL.
46).

FOR: STILL MINERAL WATER AND SPARK-
LING MINERAL WATER; FRUIT JUICES, VEGE-
TABLE JUICES, FRUIT BASED BEVERAGES,
NAMELY, FRUITS BEVERAGES AND VEGETABLE
BASED BEVERAGES, NAMELY, VEGETABLES
BASED BEVERAGES; SODAS, NAMELY, ICE
CREAM SODAS, SODAS WATER, SODA POP, BEV-
ERAGES, NAMELY, SHERBETS; PREPARATIONS
FOR MAKING BEVERAGES, NAMELY, SYRUPS,
CONCENTRATES AND POWDERS FOR MAKING
SOFT DRINKS AND FRUIT DRINKS; SYRUPS FOR
BEVERAGES, NON-ALCOHOLIC FRUIT AND VE-
GETABLE EXTRACTS USED IN THE PREPARA-
TION OF BEVERAGES; NON-ALCOHOLIC

BEVERAGES CONTAINING LACTIC FERMENTS,
NAMELY, NON-ALCOHOLIC MALT BEVERAGE,
IN CLASS 32 (U.S. CLS. 45, 46 AND 48).

THE MARK CONSISTS OF STANDARD CHAR-
ACTERS WITHOUT CLAIM TO ANY PARTICULAR
FONT, STYLE, SIZE, OR COLOR.

OWNER OF INTERNATIONAL REGISTRATION
0842107 DATED 9-27-2004, EXPIRES 9-27-2014.

SER. NO. 79-032,790, FILED 9-8-2006.

MARLENE BELL, EXAMINING ATTORNEY

Int. Cl.: 9

Prior U.S. Cls.: 21, 23, 26, 36 and 38

Reg. No. 3,485,084

United States Patent and Trademark Office

Registered Aug. 12, 2008

**TRADEMARK
PRINCIPAL REGISTER**

EYECREEN

MICROEMISSIVE DISPLAYS LIMITED (UNITED KINGDOM LIMITED COMPANY)
SCOTTISH MICROELECTRONICS CENTRE
WEST MAINS ROAD
EDINBURGH, UNITED KINGDOM EH9 3JF

FOR: LOW-POWER LIGHT EMITTING POLYMER DISPLAYS; LIGHT EMITTING DIODE DISPLAYS; LIGHT EMITTING POLYMER DISPLAYS; LIGHT EMITTING DIODE MICRODISPLAYS; POLYMER ORGANIC LIGHT EMITTING DIODES (P-OLEDTS); ELECTRONIC VIEW FINDERS (EVES); ELECTRONIC VIEW FINDERS FOR USE IN DIGITAL CAMERAS, DIGITAL VIDEO RECORDERS, CAMCORDERS, PDAS, PHONES AND MOBILE PHONES; HEAD-MOUNTED DIGITAL IMAGE AND VIDEO DISPLAYS; LIGHT EMITTING DIODE DISPLAYS FOR PERSONAL TV'S, DVD VIEWERS, PORTABLE GAMES VIEWERS AND VIRTUAL REALITY HEADSETS; PORTABLE HANDHELD AND HANDS-FREE DIGITAL ELECTRONIC IMAGE AND VIDEO VIEWERS FOR BOOKS AND ELECTRONIC NOTEBOOKS; PORTABLE HANDHELD AND HANDS-FREE DIGITAL ELECTRONIC IMAGE, VIDEO AND TV VIEWERS FOR USE WITH MOBILE PHONES; PERSONAL DIGITAL IMAGE AND VIDEO VIEWERS AND ELECTRONIC VIEWFINDERS FOR MEDICAL APPLIANCES, HOMELAND SECURITY, TOYS, OUTDOOR PURSUITS, HUNTING; PERSONAL DIGITAL IMAGE AND VIDEO VIEWERS AND ELECTRONIC VIEWFINDERS FOR USE WITH MOBILE PHONES, 3G PHONES, SMART PHONES, CONVERGENT DEVICES, POCKET PC'S; PERSONAL DIGITAL IMAGE AND VIDEO VIEWERS AND ELECTRONIC VIEWFINDERS FOR POLICE, MILITARY, SECURITY, RESCUE SERVICES, TRADESMEN (PLUMBERS, ELECTRICIANS, CAR ENGINEERS), PROFESSION-

ALS (ARCHITECTS, DESIGNERS, CIVIL ENGINEERS, SURVEYORS); PERSONAL DIGITAL IMAGE AND VIDEO VIEWERS AND ELECTRONIC VIEWFINDERS FOR LOGISTICS, WAREHOUSE, STOCK CONTROL, PILOTS, NAVIGATORS; PERSONAL DIGITAL IMAGE AND VIDEO VIEWERS FOR ENTERTAINMENT PURPOSES, SUCH AS VIEWING MOVIES AND SPORTS AND FOR ACCESSING INFORMATION SUCH AS MAPS, WEATHER, TRAFFIC, GPS AND NAVIGATION; PERSONAL DIGITAL IMAGE AND VIDEO VIEWERS FOR USE IN CONNECTION WITH SPORTS FOR ACCESSING RELATIVE INFORMATION; PERSONAL DIGITAL IMAGE AND VIDEO VIEWERS FOR MULTIMEDIA PLAYERS FOR VIEWING VIDEO, GRAPHICS AND TEXT; PERSONAL DIGITAL IMAGE AND VIDEO VIEWERS AND ELECTRONIC VIEWFINDERS FOR NIGHT SCOPES, TELESCOPES, MICROSCOPES, BINOCULARS; PERSONAL DIGITAL IMAGE AND VIDEO VIEWERS AND ELECTRONIC VIEWFINDERS FOR COMPUTER GAMES CONSOLES, PERSONAL COMPUTER GAMES; PERSONAL DIGITAL IMAGE AND VIDEO VIEWERS AND ELECTRONIC VIEWFINDERS FOR VIRTUAL REALITY AND AUGMENTED REALITY; PERSONAL DIGITAL IMAGE AND VIDEO VIEWERS FOR USE IN AIRPLANES, SHIPS, BOATS, TRAINS BUSES AND OTHER PASSENGER TRANSPORT, IN CLASS 9 (U.S. CLS. 21, 23, 26, 36 AND 38).

OWNER OF INTERNATIONAL REGISTRATION
0908795 DATED 8-1-2006, EXPIRES 8-1-2016.

SER. NO. 79-033,004, FILED 8-1-2006.

SUE LAWRENCE, EXAMINING ATTORNEY

Int. Cl.: 25

Prior U.S. Cls.: 22 and 39

United States Patent and Trademark Office

Reg. No. 3,485,085

Registered Aug. 12, 2008

**TRADEMARK
PRINCIPAL REGISTER**

KEYS

MIBER S.P.A. (ITALY JOINT STOCK COMPANY)
VIA E. FERMI, 39/45
I-25020 PONCARALE (BRESCIA), ITALY

FOR: FOOTWEAR, SHOES, BOOTS, SPORT
SHOES, IN CLASS 25 (U.S. CLS. 22 AND 39).

THE MARK CONSISTS OF STANDARD CHAR-
ACTERS WITHOUT CLAIM TO ANY PARTICULAR
FONT, STYLE, SIZE, OR COLOR.

PRIORITY DATE OF 4-7-2006 IS CLAIMED.

OWNER OF INTERNATIONAL REGISTRATION
0908826 DATED 9-28-2006, EXPIRES 9-28-2016.

SER. NO. 79-033,017, FILED 9-28-2006.

JUSTINE D. PARKER, EXAMINING ATTORNEY

Int. Cls.: 9, 37 and 42

Prior U.S. Cls.: 21, 23, 26, 36, 38, 100, 101, 103 and 106

United States Patent and Trademark Office

Reg. No. 3,485,086

Registered Aug. 12, 2008

**TRADEMARK
SERVICE MARK
PRINCIPAL REGISTER**

The logo for PrestoSpace is rendered in a bold, blue, sans-serif font. The word "Presto" is positioned above "Space". The letter "P" in "Presto" is significantly larger and more stylized than the other letters, extending downwards and to the left. The "S" in "Space" is also large and stylized, with a thick stroke and a slight curve.

INA (INSTITUT NATIONAL DE; L'AUDIOVISUEL) (FRANCE CORPORATION)
4, AVENUE DE L'EUROPE
BRY-SUR-MARNE, FRANCE F94360

FOR: APPARATUS FOR RECORDING, TRANSMITTING AND REPRODUCING DIGITAL SOUND, IMAGES AND DATA, NAMELY, VIDEO TAPE AND AUDIO TAPE PLAYERS, VIDEO-CASSETTE AND AUDIO-CASSETTE PLAYERS, ANALOGUE AUDIO DISC AND CYLINDERS PLAYERS, DVD PLAYERS, FILM SCANNERS, MAGNETIC TAPE AND FILM CLEANERS, DIGITAL RECORDING MEDIA, NAMELY, BLANK MAGNETIC DISCS, BLANK MAGNETIC TAPES, RE-WRITABLE AND WRITE-ONCE CDS AND DVDS; RECORDED COMPUTER PROGRAMS FEATURING THE BACKUP, RESTORATION, STORAGE AND USE OF AUDIOVISUAL AND SOUND PROGRAMS; RECORDED SOFTWARE FEATURING THE BACKUP, RESTORATION, STORAGE AND USE OF AUDIOVISUAL AND SOUND PROGRAMS; ELECTRONICS DATABASES IN CONNECTION WITH THE BACKUP, RESTORATION, STORAGE AND USE OF AUDIOVISUAL AND PROGRAMS RECORDED ON COMPUTER MEDIA, IN CLASS 9 (U.S. CLS. 21, 23, 26, 36 AND 38).

FOR: PHYSICAL RESTORATION AND MAINTENANCE OF COLLECTIONS OF ARCHIVES OF AUDIOVISUAL AND SOUND PROGRAMS, EMPLOYING MANUAL LABOR TO REPAIR PHYSICAL MEDIA SUCH AS TAPES, CASSETTES, FILM ROLLS, AUDIO DISKS AND REPLACING PARTS, IN CLASS 37 (U.S. CLS. 100, 103 AND 106).

FOR: ADVISORY, ASSISTANCE, RESEARCH SERVICES IN CONNECTION WITH SCIENTIFIC AND TECHNICAL ISSUES; DESIGN, DEVELOPMENT AND UPDATING OF SOFTWARE; SOFTWARE MAINTENANCE; DATABASE RECONSTRUCTION; CONVERSION OF DATA OR DOCUMENTS FROM PHYSICAL TO ELECTRONIC MEDIA; ALL THESE SERVICES IN CONNECTION WITH THE BACKUP, RESTORATION, STORAGE AND USE OF AUDIOVISUAL AND SOUND PROGRAMS; BACKUP OF COLLECTIONS OF ARCHIVES OF AUDIOVISUAL AND SOUND PROGRAMS, IN CLASS 42 (U.S. CLS. 100 AND 101).

PRIORITY DATE OF 12-16-2005 IS CLAIMED.

OWNER OF INTERNATIONAL REGISTRATION 0908998 DATED 5-19-2006, EXPIRES 5-19-2016.

THE COLOR(S) PANTONE REFLEX BLUE C IS/ARE CLAIMED AS A FEATURE OF THE MARK.

THE COLOR PANTONE REFLEX BLUE C APPEARS IN THE WORDING.

SER. NO. 79-033,088, FILED 5-19-2006.

RON FAIRBANKS, EXAMINING ATTORNEY

Int. Cls.: 7, 11 and 37

Prior U.S. Cls.: 13, 19, 21, 23, 31, 34, 35, 100, 103 and 106

Reg. No. 3,485,087

United States Patent and Trademark Office

Registered Aug. 12, 2008

**TRADEMARK
SERVICE MARK
PRINCIPAL REGISTER**

MEMBRIGHT

BRIGHTWATER ENGINEERING LIMITED (UNITED KINGDOM CORPORATION)
BRIGHTWATER HOUSE
BUSINESS CENTRE EAST AVENUE ONE, BUSINESS PARK LETCHWORTH GARDEN CITY
HERTFORDSHIRE SG6 2HB
UNITED KINGDOM

FOR: MECHANICAL SEPARATORS FOR THE CLEANING AND PURIFICATION OF WATER, WASTE WATER AND SEWAGE AND PARTS AND FITTINGS THEREFOR, IN CLASS 7 (U.S. CLS. 13, 19, 21, 23, 31, 34 AND 35).

FOR: INSTALLATIONS FOR THE TREATMENT OF WATER, WASTE WATER AND SEWAGE, NAMELY, MEMBRANE REACTOR SYSTEMS AND PARTS AND FITTINGS THEREFOR; MEDIA FOR FILTRATION AND BIOLOGICAL TREATMENT OF

WATER, WASTE WATER, AND SEWAGE, IN CLASS 11 (U.S. CLS. 13, 21, 23, 31 AND 34).

FOR: CONSTRUCTION, REPAIR AND REFURBISHMENT OF INSTALLATIONS AND APPARATUS FOR THE TREATMENT OF WATER, WASTE WATER AND SEWAGE; TREATMENT OF WATER, WASTE WATER AND SEWAGE, IN CLASS 37 (U.S. CLS. 100, 103 AND 106).

OWNER OF INTERNATIONAL REGISTRATION 0909111 DATED 12-4-2006, EXPIRES 12-4-2016.

SER. NO. 79-033,139, FILED 12-4-2006.

ALYSSA PALADINO, EXAMINING ATTORNEY

Int. Cl.: 3

Prior U.S. Cls.: 1, 4, 6, 50, 51 and 52

Reg. No. 3,485,088

United States Patent and Trademark Office

Registered Aug. 12, 2008

**TRADEMARK
PRINCIPAL REGISTER**

RES PLANTA

RES PHARMA INDUSTRIALE S.R.L. (ITALY
SOCIETA A RESPONSABILITA LIMITATA)
VIA GIACOMO LEOPARDI, 10
I-20123 MILANO
ITALY

OWNER OF INTERNATIONAL REGISTRATION
0659764 DATED 8-23-1996, EXPIRES 8-23-2016.

FOR: SOAPS; PERFUMERY; ESSENTIAL OILS;
COSMETICS; HAIR LOTIONS; DENTIFRICES, IN
CLASS 3 (U.S. CLS. 1, 4, 6, 50, 51 AND 52).

NO CLAIM IS MADE TO THE EXCLUSIVE
RIGHT TO USE "PLANTA", APART FROM THE
MARK AS SHOWN.

THE MARK CONSISTS OF STANDARD CHAR-
ACTERS WITHOUT CLAIM TO ANY PARTICULAR
FONT, STYLE, SIZE, OR COLOR.

SER. NO. 79-033,246, FILED 8-24-2006.

COLLEEN KEARNEY, EXAMINING ATTORNEY

Int. Cls.: 11, 37 and 40

Prior U.S. Cls.: 13, 21, 23, 31, 34, 100, 103 and 106

Reg. No. 3,485,089

United States Patent and Trademark Office

Registered Aug. 12, 2008

**TRADEMARK
SERVICE MARK
PRINCIPAL REGISTER**

BRIGHTWATER

BRIGHTWATER ENGINEERING LIMITED (UNITED KINGDOM CORPORATION)
BRIGHTWATER HOUSE
BUSINESS CENTRE EAST, AVENUE ONE, BUSINESS PARK; LETCHWORTH GARDEN CITY,; HERTFORDSHIRE SG6 2HB
UNITED KINGDOM

FOR: INSTALLATIONS, APPARATUS AND MEDIA FOR THE TREATMENT OF WATER, WASTEWATER AND SEWAGE, NAMELY, (A) MEMBRANE REACTOR SYSTEMS AND PARTS AND FITTINGS THEREFOR, NAMELY, REACTOR TANKS, MEMBRANES, RIGID MEMBRANE PLATES, MULTIPLE MEMBRANE PLATE MODULES, AERATION DIFFUSER SYSTEMS, AERATION FEEDER PIPEWORKS, EFFLUENT INLET PIPEWORKS AND TREATED EFFLUENT OUTLET PIPEWORKS; (B) FILTERS AND FILTERING MEMBRANES FOR THE TREATMENT OF WATER, WASTE WATER AND SEWAGE; (C) MEDIA FOR FILTRATION AND BIOLOGICAL TREATMENT OF WATER, WASTE WATER AND SEWAGE; (D) SUBMERGED AERATED FILTER SYSTEMS AND PARTS AND FITTINGS THEREFOR, NAMELY, REACTORS, AERATION EQUIPMENT COMPRISING SPARGERS AND SUPPLY TUBES, HYDRAULIC DISTRIBUTION AND COLLECTION EQUIPMENT COMPRISING PUMPS AND EFFLUENT INLET AND OUTLET CONDUITS, ELECTRONIC CONTROL SYSTEMS AND DESLUDGING SYSTEMS; (E) BIOLOGICAL AERATED FLOODED FILTER SYSTEMS AND PARTS AND FITTINGS THEREFOR, NAMELY, REACTORS, MESHES, SPARGERS, OUTLET CONDUITS, ELECTRONIC CONTROL SYSTEMS, DESLUDGING SYSTEMS, PIPEWORK

AND VALVES; (F) DIFFUSED AERATION SYSTEMS AND PARTS AND FITTINGS THEREFOR, NAMELY, DIFFUSERS, HOLDERS, SUPPORTS, MANIFOLDS, LATERALS, FIXINGS, CONDENSATE REMOVAL ASSEMBLIES, VALVES, FLEXIBLE COUPLINGS, MEMBRANES, MEMBRANE PLATES, LIDS AND DIAPHRAGMS; AND (G) MOVING BED BIOLOGICAL REACTOR SYSTEMS AND PARTS AND FITTINGS THEREOF, NAMELY, TANKS, BUBBLE AERATION SYSTEMS, MESHES, EFFLUENT INLET AND TREATED EFFLUENT OUTLET CONDUITS, ELECTRONIC CONTROL SYSTEMS AND DESLUDGING SYSTEMS, IN CLASS 11 (U.S. CLS. 13, 21, 23, 31 AND 34).

FOR: CONSTRUCTION, REPAIR AND REFURBISHMENT OF INSTALLATIONS AND APPARATUS FOR THE TREATMENT OF WATER, WASTE WATER AND SEWAGE; CONSULTANCY SERVICES IN RELATION TO THE AFORESAID CONSTRUCTION, REPAIR AND REFURBISHMENT, IN CLASS 37 (U.S. CLS. 100, 103 AND 106).

FOR: CONSULTANCY SERVICES IN RELATION TO THE TREATMENT OF WATER, WASTEWATER AND SEWAGE, IN CLASS 40 (U.S. CLS. 100, 103 AND 106).

OWNER OF INTERNATIONAL REGISTRATION 0909656 DATED 12-4-2006, EXPIRES 12-4-2016.

SER. NO. 79-033,416, FILED 12-4-2006.

ALYSSA PALADINO, EXAMINING ATTORNEY

Int. Cl.: 19

Prior U.S. Cls.: 1, 12, 33 and 50

United States Patent and Trademark Office

Reg. No. 3,485,090

Registered Aug. 12, 2008

TRADEMARK
PRINCIPAL REGISTER



CLAUDIOFORESI S.R.L. (ITALY LTD LIAB CO)
VIA FOSSO, 2/4
FRAZIONE SAN BIAGIO; I-60027 OSIMO
ITALY

FOR: NON-METAL BUILDING MATERIAL, NAMELY, WOODEN BEAMS, RUBBER BEAMS AND RESIN BEAMS; NON-METALLIC RIGID PIPES FOR BUILDING; ASPHALT, PITCH, AND BITUMEN, NAMELY, BITUMEN ASPHALT; NON-METALLIC TRANSPORTABLE BUILDINGS; MONUMENTS NOT OF METAL; BUILDING MATERIALS, NAMELY, PLASTIC MODULES FOR CRAWL SPACES AND PROTECTION OF THE GROUND WALLS; MODULAR NON-METAL BUILDING ELEMENTS, SELF-LOCKING OR NOT, FOR DRAINING OR CATCH BASINS, NAMELY, PLASTIC AND RESIN CONDUITS FOR DRAINAGE; BUILDING MATERIALS, NAMELY, DRAINAGE FORMS FOR ROOF-GARDENS MADE OF PLASTIC AND RESIN; NON-METAL FORMS AND VARIOUS FORMWORKS, NAMELY, NON-METAL FORMS FOR USE IN CONCRETE CASTING; CATCHPITS FOR WATER DISPERSION, NAMELY, CONCRETE TRENCH DRAINS AND STORM MANHOLES; PLASTIC GRIDS IN THE NATURE OF SCREENS FOR GARDEN PROTECTION, FOR AERATION PURPOSES, AGAINST INSECTS AND FOUL WEATHER; NON-METAL GUTTER PIPES WITH PLASTIC GRIDS FOR ROOF-GARDENS, FOOTPATHS, SQUARES AND SWIMMING POOLS; PAVING SPACERS; NON-METAL ROOF DRAINS AND LEAF GUARDS; NON-METAL ROOF VENTS; NON-METAL DUCTS; ROUND-SHAPED BUILDING ELEMENTS MADE OF PLASTIC, RUBBER AND RESIN FOR FILLING IN AND BALANCING RAISED FLOORS, NAMELY, SUPPORTS FOR FLAGSTONES AND LEVELING; NON-METAL BALCONY DRIP DRAINS; NON-METAL BUILDING MATERIALS, NAMELY, GRATES FOR PREVENTING BIRDS FROM BUILDING NESTS UNDER TILES; BUILD-

ING PROFILES, NAMELY, NON-METAL WALL CORNER PROTECTIONS; RIGID PIPES OF PLASTIC AND RESIN; NON-METAL TILES; NON-METAL PANTILES; BRICKS; BLOCK BUILDS AND PADDINGS, NAMELY, CONCRETE MODULES FOR WALLS, PLAFOND AND ENCLOSURES FOR GARDENS; NON-METAL PARKING CURBS; NON-METAL MANHOLE COVERS AND DRAINS; NON-METAL CEILING TILES; PROTECTIVE COVERING FOR FOUNDATIONS, GROUND WALLS, FLOORS AND GARDENS, NAMELY, MULTI-LAYER WATER CONSERVATION TEXTILES DESIGNED FOR NURSERIES, GREENHOUSES AND GARDEN CENTERS; BUILDING PAVING ELEMENTS FOR FLOOR MODULAR COVERINGS, NAMELY RESIN AND PLASTIC FIXED-HEIGHT PAVING SUPPORTS, BALANCERS AND LEVELING DISCS; NON-METAL ALVEOLAR BLOCKS FOR THE DRAINAGE AND CONSTRUCTION OF ROADS, SQUARES, ESCARPMENTS AND FLOORS; NON-METAL ALVEOLAR PANELS FOR WALL AND PLAFOND CONSTRUCTION AND WALL AND PLAFOND PATCHING MADE OF RESIN, PLASTIC OR SILICA COMPOUNDS, NAMELY, SPACKLING PASTE, IN CLASS 19 (U.S. CLS. 1, 12, 33 AND 50).

OWNER OF INTERNATIONAL REGISTRATION
0860737 DATED 10-12-2004, EXPIRES 10-12-2014.

THE MARK CONSISTS OF THE WORD "MODI", HALF IN NEGATIVE HALF IN POSITIVE, IN SPECIAL TYPES PLACED INTO A RECTANGULAR FRAME.

THE ENGLISH MEANING OF THE WORD "MODI" IS MANNERS.

SER. NO. 79-033,599, FILED 7-21-2006.

DAYNA BROWNE, EXAMINING ATTORNEY

Int. Cls.: 9, 16, 35, 38, 41 and 42

**Prior U.S. Cls.: 2, 5, 21, 22, 23, 26, 29, 36, 37, 38, 50,
100, 101, 102, 104 and 107**

Reg. No. 3,485,091

United States Patent and Trademark Office

Registered Aug. 12, 2008

**TRADEMARK
SERVICE MARK
PRINCIPAL REGISTER**

CYBERARTS

AEC ARS ELECTRONICA CENTER LINZ; MUSEUMSGESELLSCHAFT MBH (AUSTRIA GMBH)

HAUPTSTRASSE 2
A-4040 LINZ
AUSTRIA

FOR: SCIENTIFIC APPLIANCES, WEIGHING, MEASURING, SIGNALING, SUPERVISION, LIFE-SAVING AND TEACHING APPARATUS AND INSTRUMENTS, NAMELY, CAMERAS, MICROSCOPES, LETTER SCALES; WALKIE-TALKIES; MOBILE TELEPHONES; PHOTOCOPIERS; PORTABLE STEREO PLAYERS; AUTOMATIC VENDING MACHINES AND MECHANISMS FOR COIN-OPERATED APPARATUS, NAMELY, COIN ACCEPTORS FOR SEPARATING GOOD COINS FROM COUNTERFEITS; NAVIGATIONAL APPLIANCES FOR VEHICLES; PROTECTIVE CLOTHING INCLUDING PROTECTIVE SPECTACLES; PROTECTIVE DUST MASKS; PROTECTIVE HELMETS, ESPECIALLY FOR SPORTS PURPOSES; PROTECTIVE SCREENS, NAMELY, PROTECTIVE EAR COVERINGS AND FACE PROTECTION SHIELDS; SPECTACLES; SPECTACLE FRAMES; SPECTACLE CASES; GLASSES FRAMES; SUNGLASSES; SPORTS SPECTACLES; HEADPHONES; SPECIAL CONTAINERS THAT ARE MATCHED TO THE APPARATUS AND INSTRUMENTS CLASSIFIED INTO THIS CLASS, NAMELY, MOBILE TELEPHONE CASES, CASES FOR VIDEO TAPES; ILLUMINATING MARKING, LIFE-SAVING AND SIGNALLING BUOYS; WIND DROGUES IN THE NATURE OF WIND SOCKS FOR INDICATING WIND DIRECTION AND INTENSITY; MAGNETS; FIRE-EXTINGUISHING APPARATUS, NAMELY, FIRE EXTINGUISHERS, FIRE SPRINKLERS; SOLAR ACCUMULATORS, IN CLASS 9 (U.S. CLS. 21, 23, 26, 36 AND 38).

FOR: SLATE BLACKBOARDS FOR WRITING, OFFICE REQUISITES, NAMELY, STAPLERS AND RUBBER BANDS, PLASTIC MATERIALS FOR PACKAGING, NAMELY, PLASTIC BAGS, IN CLASS 16 (U.S. CLS. 2, 5, 22, 23, 29, 37, 38 AND 50).

FOR: BUSINESS MANAGEMENT AND ORGANIZATION CONSULTANCY, BUSINESS INQUIRIES, MARKET RESEARCH, MARKETING, NAMELY, BUSINESS MARKETING, DISTRIBUTION OF SAMPLES, MARKET OPINION POLLING AND COMPILING AND EVALUATING OF MATHEMATICAL OR STATISTICAL DATA FOR DOCUMENTATION PURPOSES FOR MARKETING PURPOSES, COMPUTERIZED FILE MANAGEMENT, SYSTEMIZATION AND COMPILATION OF INFORMATION INTO COMPUTER DATABASES, PREPARATION OF BUSINESS STATISTICS AND RECRUITMENT OF PERSONNEL, TELEPHONE ANSWERING SERVICE FOR UNAVAILABLE SUBSCRIBERS, PROVIDING OFFICE FUNCTIONS, DOCUMENT REPRODUCTION, SECRETARIAL SERVICES, TEXT PROCESSING FOR OTHERS, RENTAL OF VENDING MACHINES, IN CLASS 35 (U.S. CLS. 100, 101 AND 102).

FOR: TELECOMMUNICATIONS, NAMELY, PROVIDING TELECOMMUNICATIONS ACCESS TO A GLOBAL COMPUTER NETWORK, IN CLASS 38 (U.S. CLS. 100, 101 AND 104).

FOR: ORGANIZATION AND ARRANGEMENT OF SPORTS COMPETITIONS; ENTERTAINMENT IN THE NATURE OF LIVE AND RECORDED ONGOING TELEVISION AND RADIO PROGRAMS IN THE FIELD OF MUSIC SHOWS AND FILM SHOWS, PROVIDING KARAOKE FACILITIES, TRANSLATION, CONSULTANCY CONCERNING INDIVIDUAL TRAINING AND INDIVIDUAL FITNESS EXERCISES, PERSONAL TRAINING CONCERNING BODY AND BEAUTY CARE, SPORT CAMP SERVICES, PROVIDING SPORTS FACILITIES, TIMING OF SPORTS EVENTS, IN CLASS 41 (U.S. CLS. 100, 101 AND 107).

FOR: CONSULTANCY CONCERNING ELECTRONIC DATA PROCESSING, NAMELY, CONSULTANCY IN THE FIELD OF DEVELOPMENT OF DATA PROGRAMS, CONSULTANCY IN THE FIELD OF COMPUTER HARDWARE, NAMELY,

HARDWARE SELECTION, SERVICES OF A NETWORK OPERATOR AND PROVIDER, NAMELY, RENTAL OF DATABASE SERVERS; RESEARCH SERVICES IN DATABASES AND THE INTERNET CONCERNING NEW PRODUCTS FOR THIRD PARTIES, LICENSING OF INTELLECTUAL PROPERTY BEING SOFTWARE, TECHNICAL CONSULTANCY CONCERNING THE INTERNET; ALLOCATION, REGISTRATION AND ADMINISTRATION OF DOMAIN NAMES AND E-MAIL ADDRESSES, WEB HOSTING IN THE NATURE OF PLACING OF WEBSITES ON THE INTERNET FOR THIRD PARTIES, DEVELOPMENT AND DESIGN OF COMPUTER HARDWARE, LEGAL CONSULTANCY, LEGAL RESEARCH, INTELLECTUAL PROPERTY CONSULTANCY, INTELLECTUAL PROPERTY MONITORING SERVICES, RESEARCH AND DESIGN FOR OTHERS IN THE FIELD OF INFORMA-

TION TECHNOLOGY; SCIENTIFIC RESEARCH, IN CLASS 42 (U.S. CLS. 100 AND 101).

THE MARK CONSISTS OF STANDARD CHARACTERS WITHOUT CLAIM TO ANY PARTICULAR FONT, STYLE, SIZE, OR COLOR.

PRIORITY DATE OF 8-10-2005 IS CLAIMED.

OWNER OF INTERNATIONAL REGISTRATION 0910574 DATED 2-9-2006, EXPIRES 2-9-2016.

SER. NO. 79-033,615, FILED 2-9-2006.

DOMINIC FATHY, EXAMINING ATTORNEY

Int. Cl.: 9

Prior U.S. Cls.: 21, 23, 26, 36 and 38

Reg. No. 3,485,092

United States Patent and Trademark Office

Registered Aug. 12, 2008

**TRADEMARK
PRINCIPAL REGISTER**

Web-VV

VEGA GRIESHABER KG (FED REP GERMANY
KG (LIMITED PARTNERSHIP))
HAUPTSTRASSE 1-5
WOLFACH, FED REP GERMANY 77709

FOR: COMPUTER SOFTWARE FOR COLLECTING, PROCESSING, VISUALIZING AND INVENTORY MANAGEMENT OF QUANTITIES OF MATERIAL AS WELL AS FOR DISPLAYING MEASURED VALUES AND BOUNDARY LEVELS, IN PARTICULAR OF FILLING LEVEL, VOLUME, PRESSURE, TEMPERATURE, FLOW, DENSITY, HUMIDITY AND ANALYZING VALUES FOR USE IN CONNECTION WITH INDUSTRIAL MEASURING, CONTROL AND RECORDING INSTRUMENTS, NAMELY PRESSURE SENSORS, LEVEL RESPONSIVE SWITCHES, REMOTE LEVEL AND PRESSURE INDICATORS, VIBRATING PROBE LEVEL SWITCHES, CONDUCTIVE LEVEL SWITCHES, SONIC LEVEL MEASURING INSTRUMENTS, ELECTRODE ROD TYPE CAPACITIVE LEVEL MEASURING INSTRUMENTS, TIME DELAY RELAYS, PULSE COUNTERS, AND DIGITAL TO ANALOG CONVERTERS; COMPUTER SOFTWARE FOR COLLECTING, PROCESSING, VISUALIZING AND INVENTORY MANAGEMENT OF QUANTITIES OF MATERIAL AS WELL AS FOR DISPLAYING MEASURED VALUES AND BOUNDARY LEVELS, IN PARTICULAR OF FILLING LEVEL, VOLUME,

PRESSURE, TEMPERATURE, FLOW, DENSITY, HUMIDITY AND ANALYZING VALUES FOR USE IN CONNECTION WITH ELECTRIC AND ELECTRONIC MEASURING DEVICES FOR MEASURING AND CONTROLLING THE FILLING LEVEL OF TANKS AND CONTAINERS BY SIGNALING AND ACTUATION AND CONTROL, NAMELY, ELECTRONIC, ELECTRO-MECHANICAL, OPTICAL, LASER, CAPACITIVE, HYDROSTATIC, ULTRASONIC, RADIO, RADAR, MICROWAVE AND VIBRATIONAL LEVEL DETECTION SENSORS AND DISPLAYS, IN CLASS 9 (U.S. CLS. 21, 23, 26, 36 AND 38).

THE MARK CONSISTS OF STANDARD CHARACTERS WITHOUT CLAIM TO ANY PARTICULAR FONT, STYLE, SIZE, OR COLOR.

PRIORITY DATE OF 11-15-2005 IS CLAIMED.

OWNER OF INTERNATIONAL REGISTRATION
0910831 DATED 1-10-2006, EXPIRES 1-10-2016.

SER. NO. 79-033,722, FILED 1-10-2006.

DOMINIC FATHY, EXAMINING ATTORNEY

Int. Cls.: 25 and 28

Prior U.S. Cls.: 22, 23, 38, 39 and 50

Reg. No. 3,485,093

United States Patent and Trademark Office

Registered Aug. 12, 2008

**TRADEMARK
PRINCIPAL REGISTER**



LA SPORTIVA N.A. INC. (COLORADO CORPORATION)
3850 FRONTIER AVE. #100
BOULDER, COLORADO 80301
UNITED STATES

FOR: MOUNTAINEERING SHOES; FREE CLIMBING SHOES AND BOOTS; TREKKING SHOES AND BOOTS; HIKING SHOES AND BOOTS; GYMNASTIC SHOES; SHOES; MOUNTAINEERING BOOTS; SKI BOOTS; BOOTS FOR WALKING ON ICE; BOOTS; SLIPPERS; SANDALS; T-SHIRTS; SWEATERS; TROUSERS; JACKETS; CAPS; SOCKS AND STOCKINGS; PULLOVERS; GLOVES; CARDIGANS; JERSEYS; NECKWEAR, TIGHTS; LEGGINGS; SKIRTS; JERKINS; SHIRTS; VESTS; WAISTCOATS; JUMPERS; TRACK SUITS; BLOUSES; BLOUSONS; JEANS; SWEAT PANTS; GYM SUITS; KNICKERS; PANTS; SHORTS; SWEAT-SHIRTS; SUITS AND DRESSES; OVERCOATS; COATS; ANORAKS; RAINCOATS; BELTS; SUSPENDERS; LOUNGEWEAR, UNDERWEAR, BEACHWEAR, SLEEPWEAR, IN CLASS 25 (U.S. CLS. 22 AND 39).

FOR: SKI RACKETS; SKIS AND SKI BINDINGS; TENNIS RACKETS; BADMINTON RACKETS; TABLE TENNIS RACKETS; SQUASH RACKETS; BALLS, BEING SPORTING ARTICLES AND BALLS FOR GAMES, NAMELY, TENNIS BALLS, SQUASH

BALLS, TABLE TENNIS BALLS, SPORTS BALLS; ROLLER-SKATES AND ICE SKATES, IN CLASS 28 (U.S. CLS. 22, 23, 38 AND 50).

OWNER OF INTERNATIONAL REGISTRATION
0911432A DATED 7-14-2006, EXPIRES 7-14-2016.

NO CLAIM IS MADE TO THE EXCLUSIVE RIGHT TO USE "LA SPORTIVA", APART FROM THE MARK AS SHOWN.

THE MARK CONSISTS OF A SIGN DEPICTING A FIGURE OF A STYLIZED MOUNTAIN INSCRIBED WITHIN TWO STYLIZED SEMICIRCLES OF DIFFERENT SIZES AND INSCRIBED ONE WITHIN THE OTHER, BELOW ALL OF WHICH THERE IS THE WORDING "LA SPORTIVA" IN FANCY CHARACTERS.

THE ENGLISH TRANSLATION OF THE FOREIGN WORD IN THE MARK IS THE SPORTSWOMAN.

SER. NO. 79-033,917, FILED 7-14-2006.

LINDA ESTRADA, EXAMINING ATTORNEY

Int. Cl.: 9

Prior U.S. Cls.: 21, 23, 26, 36 and 38

Reg. No. 3,485,094

United States Patent and Trademark Office

Registered Aug. 12, 2008

**TRADEMARK
PRINCIPAL REGISTER**

POWERED BY SIAscopy

ASTRON CLINICA LIMITED (UNITED KING-
DOM LTD LIAB CO)
THE MOUNT, TOFT
CAMBRIDGESHIRE CB3 7RL
UNITED KINGDOM

FOR: SCIENTIFIC, ELECTRIC, ELECTRONIC, PHOTOGRAPHIC, CINEMATOGRAPHIC, OPTICAL AND MEASURING APPARATUS AND INSTRUMENTS, ALL FOR USE IN SKIN IMAGING TECHNOLOGY THAT ENABLES EXAMINATION OF THE SKIN AND NON-INVASIVE VIEWING BENEATH THE SURFACE OF THE SKIN FOR NON-MEDICAL PURPOSES, NAMELY, COMPUTER-OPERATED SCANNERS AND CAMERAS; CAMERAS; COMPUTERS FOR USE WITH OR AS SCANNERS; COMPUTER PERIPHERALS; COMPUTER HARDWARE; DIGITAL GRAPHIC SCANNERS AND HAND-HELD SCANNERS; COMPUTER PROGRAMS FOR SCANNERS FOR SCANNING OF THE SKIN AND NON-INVASIVE VIEWING BENEATH THE SURFACE OF THE SKIN FOR NON-MEDICAL PURPOSES AND FOR USE IN THE FIELD OF SKIN TECHNOLOGY DEALING WITH UNDERSTANDING THE CONSTRUCTION OF THE SKIN AND IDENTIFYING THE PRESENCE OF SKIN CONDITIONS; SCANNING AND COMPUTER SOFTWARE PROGRAMS FOR THE DIAGNOSIS OF SKIN CANCER, SKIN HEALTH, SKIN CONDITIONS; SCANNERS FOR ENTERING DATA AND IMAGES INTO COMPUTERS; SCANNERS FOR SCIENTIFIC USE; EXPOSED CINEMATOGRAPHIC FILMS; COMPACT DISCS AND LASER DISCS FEATURING MEDICAL MONITORING, TESTING AND EVALUATING PROGRAMS; COMPUTER SOFTWARE, FOR THE DIAGNOSIS AND MANAGEMENT OF SKIN COMPLAINTS INCLUDING PSORIASIS, ECZEMA AND BASAL CELL CARCINOMA; COMPUTER SOFTWARE TO ENABLE SEARCHING FOR DATA; DOWNLOADABLE ELECTRONIC PUBLICATIONS

PROVIDED ONLINE FROM DATABASES OR THE INTERNET, NAMELY, MAGAZINES AND LEARNED PAPERS IN THE FIELD OF THE EXAMINATION OF THE SKIN AND BENEATH THE SKIN; ELECTRIC APPLICATORS FOR APPLYING COMPUTER GENERATED DATA TO THE BODY FOR NON-MEDICAL PURPOSES; COMPUTER SOFTWARE TO ENABLE THE NON-INVASIVE SCANNING AND PROBING, CAPTURING, VISUAL INSPECTION, ANALYZING, UNDERSTANDING AND MONITORING OF THE SKIN SURFACE AND BENEATH THE SKIN BY CONTACT OR WITHOUT SKIN CONTACT; COMPUTER SOFTWARE FOR USE IN MONITORING AND DIAGNOSING BIOCHEMICAL REACTIONS AND PHENOMENA; OPTICAL DETECTION, MEASURING, TESTING, VIEWING AND RECORDING APPARATUS AND INSTRUMENTS FOR NON-MEDICAL PURPOSES, NAMELY, OPTICAL TRANSMITTERS, OPTICAL RECEIVERS, OPTICAL DATA LINKS AND OPTICAL TRANSCEIVERS; SPECTROPHOTOMETERS; LABORATORY EQUIPMENT, NAMELY, SPECTRAL MEASURING AND IMAGING APPARATUS AND INSTRUMENTS IN THE NATURE OF SPECTROSCOPES; CASES, BAGS, HOLD-ALLS, CARRIERS AND CONTAINERS, ALL ADAPTED FOR CARRYING OR FOR STORING ANY OF THE AFORESAID GOODS; PARTS AND FITTINGS FOR ALL THE AFORESAID GOODS, IN CLASS 9 (U.S. CLS. 21, 23, 26, 36 AND 38).

OWNER OF INTERNATIONAL REGISTRATION
0911459 DATED 8-2-2006, EXPIRES 8-2-2016.

SER. NO. 79-033,923, FILED 8-2-2006.

SANDRA MANIOS, EXAMINING ATTORNEY

Int. Cls.: 35, 41 and 42

Prior U.S. Cls.: 100, 101, 102 and 107

Reg. No. 3,485,095

United States Patent and Trademark Office

Registered Aug. 12, 2008

**SERVICE MARK
PRINCIPAL REGISTER**

AVANTO

LINDE AKTIENGESELLSCHAFT (FED REP
GERMANY JOINT STOCK COMPANY)
LEOPOLDSTRASSE 252
80807 MÜNCHEN
FED REP GERMANY

FOR: BUSINESS CONSULTANCY IN THE FIELDS OF GAS SUPPLY AND REQUIRED GAS QUALITY AND QUALITY ASSURANCE, NAMELY, BUSINESS ORGANIZATION CONSULTANCY IN THE FIELDS OF FACTORY-WISE GAS SUPPLY AND GAS STORING AND QUALITY ASSURANCE OF STOCKS AND PROCESSES IN CONNECTION THEREWITH, BUSINESS MANAGEMENT OF GAS CYLINDER STOCKS, ALL OF THE AFORESAID SERVICES IN THE FIELD OF FOOD TECHNOLOGY; COMPILATION OF DATA IN COMPUTER DATABASES, IN CLASS 35 (U.S. CLS. 100, 101 AND 102).

FOR: EDUCATIONAL SERVICES, NAMELY, PROVIDING CLASSES, SEMINARS, WORKSHOPS TO PERSONS IN THE FIELDS OF GAS SUPPLY TECHNOLOGY AND THE APPLICATION OF GASES IN CONNECTION WITH FOOD TECHNOLOGY; PUBLICATION OF PRINTED MATERIALS, NAMELY, TEXT BOOKS AND MANUALS TO PROVIDE INFORMATION AND SERVE AS TEACHING MATERIALS CONCERNING THE USE AND APPLICATIONS OF GASES IN CONNECTION WITH FOOD TECHNOLOGY, IN CLASS 41 (U.S. CLS. 100, 101 AND 107).

FOR: ENGINEERING SERVICES, NAMELY, TECHNOLOGICAL CONSULTING IN THE FIELDS OF FOOD TECHNOLOGY, FOOD PROCESSING, FOOD CONDITIONING, AND FOOD PRODUCTION, PLANNING, DESIGNING, AND DEVELOPING MACHINERY FOR FOOD PROCESSING, FOOD CONDITIONING, AND FOOD PRODUCTION, EXECUTION OF TESTS ON MACHINES FOR EVALUATING MACHINERY FOR FOOD PRO-

CESSING, FOOD CONDITIONING, AND FOOD PRODUCTION, DEVELOPMENT OF TECHNOLOGICAL PROCESSES FOR OTHERS IN THE FIELDS OF FOOD TECHNOLOGY AND FOOD PROCESSING, FOOD CONDITIONING AND FOOD PRODUCTION, ALL OF THE AFORESAID SERVICES RELATING IN PARTICULAR TO THE USE OF GAS; PREPARATION OF TECHNICAL CALCULATIONS, ANALYSIS, TECHNICAL ADVICE, SCIENTIFIC STUDIES AND INVESTIGATIONS IN THE FIELDS OF GAS SUPPLY TECHNOLOGY AND APPLICATION OF GASES, IN PARTICULAR CONCERNING FOOD TECHNOLOGY; DESIGN AND DEVELOPMENT OF COMPUTER SOFTWARE FOR OTHERS FOR VARIOUS FIELDS OF GAS APPLICATION RELATING TO FOOD TECHNOLOGY; TESTING, ANALYSIS AND EVALUATION OF GOODS AND SERVICES FOR OTHERS FOR THE PURPOSE OF CERTIFICATION OF COMPANIES FOR FOOD TECHNOLOGY; PROVIDING QUALITY ASSURANCE SERVICES IN THE FIELD OF FOOD TECHNOLOGY, NAMELY, MONITORING SERVICES FOR QUALITY ASSURANCE OF PROCESS GASES, IN CLASS 42 (U.S. CLS. 100 AND 101).

THE MARK CONSISTS OF STANDARD CHARACTERS WITHOUT CLAIM TO ANY PARTICULAR FONT, STYLE, SIZE, OR COLOR.

OWNER OF INTERNATIONAL REGISTRATION
0911705 DATED 8-3-2006, EXPIRES 8-3-2016.

THE FOREIGN WORDING IN THE MARK TRANSLATES INTO ENGLISH AS HOLE IN THE ICE.

SER. NO. 79-034,013, FILED 8-3-2006.

MARY MUNSON, EXAMINING ATTORNEY

Int. Cls.: 5, 29, 30, 32, 41 and 42

**Prior U.S. Cls.: 6, 18, 44, 45, 46, 48, 51, 52, 100, 101
and 107**

Reg. No. 3,485,096

United States Patent and Trademark Office

Registered Aug. 12, 2008

**TRADEMARK
SERVICE MARK
PRINCIPAL REGISTER**



NUTREND D.S., A.S. (CZECH REPUBLIC JOINT STOCK COMPANY)
SELSKÉ NÁM. 9/43
CZ-772 00 OLOMOUC-CHVÁLKOVICE, CZECH REPUBLIC

FOR: NUTRITIONAL SUPPLEMENTS, VITAMINS, MINERAL SUPPLEMENTS, TRACE ELEMENTS, DIETARY AND HERBAL SUPPLEMENTS, DIETETIC FOODS ADAPTED FOR MEDICAL USE, FOOD SUPPLEMENTS WITH ADDED VITAMINS OR MINERALS OR TRACE ELEMENTS USED AS NUTRITIONAL SUPPLEMENTS, NAMELY, CHEMICALS FOR ENSURING THE PROPER GROWTH, DEVELOPMENT, AND PHYSIOLOGY OF THE BODY, VITAMIN PREPARATIONS, MULTIVITAMIN PREPARATIONS, MINERALS AND MULTIMINERAL PREPARATIONS FOR MEDICAL USE AND NUTRITIONAL USE; HERBAL TEAS FOR MEDICAL PURPOSES PLANT EXTRACTS FOR MEDICAL PURPOSES, DIETETIC FOODS ADAPTED FOR MEDICAL USE, PROTEIN PRODUCTS FOR MEDICAL PURPOSES, NAMELY, WATER SOLUBLE POWDERS FOR REGENERATING AND BUILDING MUSCLES, HERBAL EXTRACTS OR SYRUPS FOR MEDICAL PURPOSES, NUTRITIONAL VITAMIN SUPPLEMENTS IN THE FORM OF CONCENTRATES, PROTEIN CONCENTRATES AS NUTRITIONAL SUPPLEMENTS FOR FOODSTUFFS ADAPTED FOR MEDICAL USE, MEDICAL CONFECTIONERY PRODUCTS AND CANDIES FOR MEDICAL PURPOSES, NUTRITIONAL ADDITIVES TO FOODSTUFFS CONTAINING BIOLOGICAL ACCELERANTS, NAMELY, ENZYMES, FOR USE BY PHYSICALLY ACTIVE PERSONS, SPORTSMEN, AND CONVALESCENTS USED AS NUTRITIONAL SUPPLEMENTS IN RESTORING THEIR ENERGY LEVEL, FOODSTUFFS, NAMELY, NUTRITIONAL SUPPLEMENTS FOR USE IN RESTORING MUSCLES, MEAT, FISH AND VEGETABLE EXTRACTS FOR NUTRITIONAL USE, DIABETIC

FOODS, SOLID AND LIQUID FOOD SUPPLEMENTS FOR VITALIZING THE IMMUNITY OF THE ORGANISM AND INVIGORATING HEALTH IN THE FORM OF POWDERED MIXTURES, DROPS, SYRUPS, GELS, CREAMS, TABLETS, FIZZY TABLETS, PASTILLES, COATED TABLETS, CAPSULES, BONBONS, JELLIES, POWDERS, ALL FOR MEDICAL USE, DIETETIC BEVERAGES ADAPTED FOR MEDICAL PURPOSES, DIABETIC BEVERAGES ADAPTED FOR MEDICAL PURPOSES, NATURAL SPRING WATERS AND WATERS FOR INFANTS FOR MEDICAL PURPOSES, ENRICHED VITAMIN BEVERAGES AND EXTRACTS FOR MEDICAL PURPOSES, IN CLASS 5 (U.S. CLS. 6, 18, 44, 46, 51 AND 52).

FOR: FOOD SUPPLEMENTS NOT ADAPTED FOR MEDICAL USE, WITH A BASE OF ANIMAL PROTEINS, FATS AND FATTY ACIDS, EITHER SINGLY OR IN COMBINATION, PROTEINS FOR HUMAN CONSUMPTION, FOODSTUFFS IN THE FORM OF SNACK BARS, FRUIT PASTES, MEAT PASTES, VEGETABLE PASTES, AND EDIBLE OILS CONTAINING PROTEIN AND CALCIUM FOR ATHLETES OR FOR INDIVIDUALS WITH HIGH ENERGY EXPENDITURE, NUTRITIONAL PREPARATIONS FOR DAILY FOOD SUPPLEMENT IN THE FORM OF INSTANT FOOD OR SUBSTANTIVE MIXTURE COMPOSED OF ANIMAL OR PLANT PROTEINS, NAMELY, POWDERED MILK, WHEY MEAT EXTRACTS, VEGETABLE EXTRACTS, MILK EXTRACTS, MILK ISOLATES, WHEY ISOLATES, PROTEIN ISOLATES, SOYA ISOLATES, CASEINATES FOR USE AS FOOD ADDITIVES, GELATINE HYDROLYSATES, ISOLATED AMINO ACIDS, MINERAL SUPPLEMENTS OR TRACE ELEMENTS, SUGAR, PRESERVED FOOD AND SNACKS MADE FROM VEGETABLES, FRUITS, PROTEINS, HERBS, OILSEEDS AND CULTURED DAIRY PRODUCTS, FRUIT PULP, NUTRITIONAL HERBAL SUPPLEMENTS FOR SOUPS, TEXTURED PROTEINS AND

THEIR MIXTURES, MEAL REPLACEMENT AND DIETARY SUPPLEMENT DRINK MIXES FOR HUMAN CONSUMPTION, IN CLASS 29 (U.S. CL. 46).

FOR: FOOD AND DRINK SUPPLEMENTS OF PLANT ORIGIN TO VITALIZE THE IMMUNITY OF THE ORGANISM AND INVIGORATE HEALTH IN THE FORM OF POWDERED MIXTURES, DROPS, SYRUPS, GELS, CREAMS, TABLETS, FIZZY TABLETS, PASTILLES, COATED TABLETS, CAPSULES, BONBONS, JELLIES, POWDERS, ALL FOR NON-MEDICAL PURPOSES, PROTEIN PREPARATIONS FOR NUTRITIONAL PURPOSES, COFFEE AND COFFEE SUBSTANCES, NAMELY, COFFEE FLAVORED SYRUP USED IN MAKING FOOD BEVERAGES, PROCESSED CEREAL, MUESLI, TEA, BAKERY PRODUCTS AND CONFECTIONERY, NAMELY, CANDIES, WAFFLES, COOKIES, BISCUITS, BONBONS, IN CLASS 30 (U.S. CL. 46).

FOR: NON-ALCOHOLIC BEVERAGES, SATURATED AND UNSATURATED, NAMELY, MINERAL BEVERAGES, EFFERVESCING BEVERAGES, AND IONIC BEVERAGES, ALL SOLD AS SOFT DRINKS, ENERGY DRINKS, SYRUPS, CONCENTRATES AND OTHER PREPARATIONS FOR MAKING SOFT DRINKS AND FRUIT DRINKS, SPORTS DRINKS, FRUIT JUICES AND VEGETABLE JUICES INCLUDED IN THIS CLASS, MUST, FRUIT NECTAR AND BEVERAGES FROM FRUIT JUICES, TABLE WATERS, MINERAL WATERS, POWDERED NUTRITIONAL SUPPLEMENT DRINK MIXES, NONALCOHOLIC APERITIFS, NATURAL SPRING WATERS, IN CLASS 32 (U.S. CLS. 45, 46 AND 48).

FOR: ORGANIZATION OF GAMES, SPORTS EVENTS, ATHLETIC COMPETITIONS AND CULTURAL EVENTS FOR EDUCATION AND ENTERTAINMENT PURPOSES IN THE FIELDS OF FITNESS AND HEALTHY LIFE STYLES, OPERATION OF HEALTH CLUB FACILITIES AND FITNESS CENTERS FOR BODY REGENERATION, BODY CONDITIONING AND SOCIAL ACTIVITIES, EDUCATION AND CONSULTING SERVICES IN THE FIELDS OF SPORTS, HEALTH AND FITNESS,

NAMELY, WORKSHOPS, TRAINING COURSES AND INSTRUCTION FOR AEROBIC TRAINERS, GYM INSTRUCTORS, CONDITIONERS, COACHES AND REFEREES, EDUCATIONAL AND ENTERTAINMENT SERVICES, NAMELY, PROVIDING MOTIVATIONAL AND EDUCATIONAL SPEAKERS, IN CLASS 41 (U.S. CLS. 100, 101 AND 107).

FOR: CONDUCTING RESEARCH STUDIES FOR DEVELOPING PRODUCTS AND TRENDS IN THE FIELD OF HUMAN AND ANIMAL NUTRITION, RESEARCH STUDIES FOCUSING ON OPTIMIZED NUTRITION PLANNING AND ATHLETIC ACTIVITIES, PARTICULARLY IN STRESSFUL SITUATIONS, LONG-TERM AND SHORT-TERM PHYSICAL AND MENTAL FATIGUE, POOR ENVIRONMENT CONDITIONS AND HEAVY PHYSICAL WORK, EXPERIMENTAL RESEARCH ACTIVITIES RELATED TO OPTIMAL COMPOSITION OF FOOD AND FOOD SUPPLEMENTS FOR HUMANS, CONSULTANCY IN RELATION TO NUTRITIVE COMPOSITION AND CHEMICAL COMPOSITION OF FOOD AND FOOD SUPPLEMENTS FOR HUMANS, IN CLASS 42 (U.S. CLS. 100 AND 101).

PRIORITY DATE OF 9-19-2005 IS CLAIMED.

OWNER OF INTERNATIONAL REGISTRATION 0911718 DATED 3-17-2006, EXPIRES 3-17-2016.

THE COLOR(S) RED AND WHITE IS/ARE CLAIMED AS A FEATURE OF THE MARK.

THE MARK CONSISTS OF A RED RECTANGLE WITH THE WORD NUTREND, WHICH APPEARS IN WHITE.

SER. NO. 79-034,017, FILED 3-17-2006.

JAMES A. RAUEN, EXAMINING ATTORNEY

Int. Cls.: 6, 9, 19 and 20

Prior U.S. Cls.: 1, 2, 12, 13, 14, 21, 22, 23, 25, 26, 32, 33, 36, 38 and 50

Reg. No. 3,485,097

United States Patent and Trademark Office

Registered Aug. 12, 2008

**TRADEMARK
PRINCIPAL REGISTER**

FERMOD

FERMOD (FRANCE SOCIÉTÉ ANONYME À
CONSEIL D'ADMINISTRATION)
3, AVENUE EUGÈNE GAZEAU
F-60300 SENLIS
FRANCE

FOR: IRONMONGERY AND SMALL ITEMS OF METAL HARDWARE, NAMELY, LOCKS OF METAL, SECURITY LOCKS OF METAL, METAL KEYS, FLAT BOLTS OF METAL, LOCK BOLTS OF METAL, PADLOCKS OF METAL, NUTS OF METAL; METAL SHORT LATCHES AND LATCHES, METAL HINGES, METAL PIVOT FRAMES FOR DOORS, METAL STRIKE PLATES, METAL DOOR FRAMES, DOOR BOLTS, NON-ELECTRIC METAL LOCKS, NON ELECTRICAL DEVICES FOR OPENING AND CLOSING DOORS, NAMELY, HANDLES, BRACKETS, KNOBS, LATCHES, SLIDES, AND HINGES; METAL PUSH LEVERS FOR OPENING AND CLOSING DOORS; METAL DOOR PANELS, METAL DOORS, FLEXIBLE METAL DOORS, METAL DOOR HANDLES, METAL POT HOOKS; METAL DOOR FRAMES; METAL DOOR FITTINGS, NAMELY, PROTECTIVE FITTINGS, CHAINS, CLASPS; SUSPENSION DEVICES FOR SLIDING WATERTIGHT DOORS OF METAL, NAMELY, METAL SUSPENSION TRACKS FOR SLIDING WATERTIGHT DOORS OF METAL; METAL RAILS FOR SLIDING DOORS; METAL FURNITURE FITTINGS, NAMELY, HANDLES, BRACKETS, KNOBS, LATCHES, SLIDES, HINGES; METAL VALVES, OTHER THAN PARTS OF MACHINES, FOR EQUALIZING PRESSURE INSIDE COLD STORAGE ROOMS AND PREMISES, METAL TRACKS FOR CURTAINS, IN CLASS 6 (U.S. CLS. 2, 12, 13, 14, 23, 25 AND 50).

FOR: ELECTRIC LOCKS, ELECTRIC OR ELECTRONIC DEVICES FOR OPENING AND CLOSING DOORS, NAMELY, ELECTRIC OR ELECTRONIC DOOR OPENING AND CLOSING SYSTEMS, ELECTRONIC CARD AND BADGE READERS FOR OPENING AND CLOSING DOORS, ELECTRONICALLY ENCODED KEY CARDS FOR OPENING AND CLOSING DOORS, ELECTRONIC DIGITAL

FINGERPRINT READERS FOR OPENING AND CLOSING DOORS, ELECTRIC VOICE RECOGNITION READERS FOR OPENING AND CLOSING DOORS, ELECTRONIC CHIP READERS FOR OPENING AND CLOSING DOORS, ELECTRIC OR ELECTRONIC LOCKS, ELECTRIC OR ELECTRONIC DOOR OPENERS AND CLOSERS, ELECTRIC OR ELECTRONIC DOOR OPENING AND CLOSING SYSTEMS INTEGRATED WITH FIRE ALARMS; APPARATUS AND INSTRUMENTS FOR REGULATING AND CONTROLLING THE OPENING AND CLOSING OF DOORS, NAMELY, DOOR OPENING REGULATORS, AND DOOR CLOSING REGULATORS; MEASURING, SIGNALING, CHECKING, AND SURVEILLANCE APPARATUS AND INSTRUMENTS, NAMELY, COMPUTER PROGRAMS TO CONTROL ACCESS TO DOORS AND LOCKS, ALARM LOCKS, FIRE AND SMOKE DETECTING APPARATUS, WARNING DEVICES, NAMELY, BELLS, ELECTRIC DOORBELLS, APPARATUS FOR WIRELESS TRANSMISSION OF VIDEO SIGNALS AND ACOUSTIC INFORMATION, RADIO TRANSMITTERS AND RECEIVERS FOR REMOTE CONTROLS; APPARATUS FOR CONTROLLING, REGULATING, AND MONITORING TEMPERATURE AND/OR PRESSURE, NAMELY, THERMOSTATS, THERMOMETERS, PRESSURE DETECTORS, AND SENSORS; PRESENCE OR DYNAMIC MOVEMENT DETECTORS, ELECTRIC AND/OR OPTICAL MONITORING APPARATUS, NAMELY, ACCESS CONTROL AND ALARM MONITORING SYSTEM, VIDEO AND PHOTOGRAPHIC SECURITY CAMERAS, AUDIO AND VIDEO TRANSMITTERS, AUDIO AND VIDEO RECEIVERS, ALARMS, AND WARNING SIGNAL TRANSMITTERS AND RECEIVERS, IN CLASS 9 (U.S. CLS. 21, 23, 26, 36 AND 38).

FOR: NON-METALLIC DOOR PANELS, SUSPENSION DEVICES FOR NON-METALLIC SLIDING WATERTIGHT DOORS, NAMELY, SUSPENSION TRACKS FOR NON METALLIC SLIDING WATERTIGHT DOORS; NON-METALLIC DOOR FRAMES, NON-METALLIC FLEXIBLE DOORS, NON-METAL-

LIC TRACKS FOR SLIDING DOORS, IN CLASS 19 (U.S. CLS. 1, 12, 33 AND 50).

FOR: FURNITURE PARTS, NAMELY, LOCKERS, SHELVES AND DOORS; FURNITURE, INCLUDING COUNTERS AND BARS; NON-METAL FURNITURE FITTINGS, NAMELY, NON-METAL HANDLES, NON-METAL PROTECTIVE FURNITURE FITTINGS; NONMETAL DOOR FITTINGS, NAMELY, NON METAL PINS FOR DOORS, NON METAL PROTECTIVE FITTINGS, NAMELY, HANDLES, BRACKETS, KNOBS, LATCHES, SLIDES, AND HINGES; NON METAL FITTINGS, NAMELY, NON-METAL DOOR HANDLES AND HINGES; MOVA-BLE TRAY SHELVING UNITS FOR FOOD STUFFS, NAMELY, SHELVES AND BRACKETS SOLD TO-GETHER AS A UNIT; MOBILE RACKS, NAMELY, SHELVES, MOBILE SHELVES, NON-METAL

LOCKS, NON-METAL LATCHES AND SHORT LAT-CHES, NON-METAL HINGES; NON-METAL VALVES THAT ARE NOT MACHINE PARTS FOR EQUALIZING PRESSURE INSIDE COLD STORAGE ROOMS AND PREMISES; NON-METAL CURTAIN TRACKS, IN CLASS 20 (U.S. CLS. 2, 13, 22, 25, 32 AND 50).

PRIORITY DATE OF 2-28-2006 IS CLAIMED.

OWNER OF INTERNATIONAL REGISTRATION 0912008 DATED 8-24-2006, EXPIRES 8-24-2016.

SER. NO. 79-034,090, FILED 8-24-2006.

ESTHER BELENKER, EXAMINING ATTORNEY

Int. Cls.: 9, 16, 18, 25, 28, 35, 38, 39, 41 and 42

Prior U.S. Cls.: 1, 2, 3, 5, 21, 22, 23, 26, 29, 36, 37, 38, 39, 41, 50, 100, 101, 102, 104, 105 and 107

Reg. No. 3,485,098

United States Patent and Trademark Office

Registered Aug. 12, 2008

**TRADEMARK
SERVICE MARK
PRINCIPAL REGISTER**

POWERED BY ME

DADA S.P.A. (ITALY JOINT STOCK COMPANY)
BORGO DEGLI ALBIZI, 12
I-50122 FIRENZE
ITALY

FOR: PRODUCTS FOR COMPUTERS AND RELATED PROGRAMS, NAMELY, BLANK MAGNETIC DATA-CARRIERS AND RECORDING DISCS, COMPUTER GAME SOFTWARE, AND COMPUTER PROGRAMS FOR EDITING IMAGES, SOUND AND VIDEO; PROTECTIVE HELMETS; DOWNLOADABLE SOFTWARE FOR USE IN TELECOMMUNICATIONS, NAMELY, CONTENT SOFTWARE TO WIRELESS COMMUNICATION DEVICES CONCERNING RING TONES, GAMES, GRAPHICS, LOGOS AND SCREEN SAVERS, IN CLASS 9 (U.S. CLS. 21, 23, 26, 36 AND 38).

FOR: STATIONERY, MAGAZINES IN THE FIELD OF COMPUTER PROGRAMMING, WIRELESS TELECOMMUNICATIONS AND ENTERTAINMENT; NEWSPAPERS, CATALOGUES IN THE FIELD OF WIRELESS TELECOMMUNICATIONS COMMUNICATIONS, IN CLASS 16 (U.S. CLS. 2, 5, 22, 23, 29, 37, 38 AND 50).

FOR: LEATHER AND IMITATIONS OF LEATHER, AND GOODS MADE OF THESE MATERIALS, NAMELY, BAGS, HANDBAGS, TRUNKS AND TRAVELING BAGS, IN CLASS 18 (U.S. CLS. 1, 2, 3, 22 AND 41).

FOR: CLOTHING, NAMELY, T-SHIRTS, SPORTS JERSEYS, SWEATERS, UNDERSHIRTS, SHIRTS, HEADSCARVES, SCARVES, HEADGEAR, NAMELY, HATS, CAPS AND VISORS, IN CLASS 25 (U.S. CLS. 22 AND 39).

FOR: GAMES AND PLAYTHINGS, NAMELY, HAND HELD UNITS FOR PLAYING ELECTRONIC GAMES, IN CLASS 28 (U.S. CLS. 22, 23, 38 AND 50).

FOR: ADVERTISING SERVICES; INSERTION OF ADVERTISEMENTS, NAMELY, PLACEMENT OF ADVERTISING FOR OTHERS; SALES PROMOTION

SERVICES THROUGH THE DISTRIBUTION OF E-CATALOGUES; RENTAL OF ADVERTISING SPACE; BUSINESS MANAGEMENT; BUSINESS ADMINISTRATION, IN CLASS 35 (U.S. CLS. 100, 101 AND 102).

FOR: TELECOMMUNICATIONS GATEWAY SERVICES; COMMUNICATIONS SERVICES BY COMPUTER VIA DATA TRANSMISSION NETWORKS, NAMELY, ELECTRONIC TRANSMISSION OF IMAGES, PHOTOS AND USER GENERATED CONTENT; ELECTRONIC MAIL SERVICES, IN CLASS 38 (U.S. CLS. 100, 101 AND 104).

FOR: TRAVEL ARRANGEMENT, NAMELY, MAKING RESERVATIONS AND BOOKINGS FOR TRANSPORTATION, IN CLASS 39 (U.S. CLS. 100 AND 105).

FOR: TRAINING SERVICES IN THE FIELD OF COMPUTER PROGRAMMING, MULTIMEDIA CREATION AND WEBSITE DESIGN; EDUCATION SERVICES, NAMELY, PROVIDING CLASSES, SEMINARS, WORKSHOPS AND ONLINE COURSES IN THE FIELD OF COMPUTER PROGRAMMING, MULTIMEDIA CREATION AND WEBSITE DESIGN; ENTERTAINMENT SERVICES, NAMELY, PROVIDING A WEB SITE FEATURING MUSICAL PERFORMANCES, MUSICAL VIDEOS, RELATED FILM CLIPS, PHOTOGRAPHS AND OTHER MULTIMEDIA MATERIALS; PROVIDING NEWS HEADLINES IN THE NATURE OF CURRENT EVENT REPORTING; PRODUCTION OF MUSICAL VIDEOS AND MOTION PICTURE FILMS; TELEVISION PRODUCTIONS; ENTERTAINMENT SERVICES, NAMELY, PROVIDING NON-DOWNLOADABLE WIRELESS GAMES, RING TONES, SCREEN SAVERS, LOGOS AND IMAGES TO MOBILE PHONES AND OTHER WIRELESS DEVICES, IN CLASS 41 (U.S. CLS. 100, 101 AND 107).

FOR: COMPUTER PROGRAMMING; MULTIMEDIA CREATIONS, NAMELY, DESIGN AND DEVELOPMENT OF MULTIMEDIA PRODUCTS; HOSTING COMPUTER WEB SITES; PROVIDING MOBILE

SERVICES FOR MOBILE SITES, NAMELY, HOSTING, MANAGING, DEVELOPING AND MAINTAINING APPLICATIONS, SOFTWARE AND WEBSITES IN THE FIELD OF WIRELESS COMMUNICATION, MOBILE INFORMATION ACCESS AND REMOTE DATA MANAGEMENT FOR WIRELESS DELIVERY OF CONTENT TO HANDHELD COMPUTERS, LAPTOPS AND MOBILE ELECTRONIC DEVICES; DESIGN AND DEVELOPMENT OF ELECTRONIC CATALOGUES ENABLING USERS TO VIEW AND PURCHASE GOODS VIA INTERNET SITES, IN CLASS 42 (U.S. CLS. 100 AND 101).

THE MARK CONSISTS OF STANDARD CHARACTERS WITHOUT CLAIM TO ANY PARTICULAR FONT, STYLE, SIZE, OR COLOR.

PRIORITY DATE OF 8-4-2006 IS CLAIMED.

OWNER OF INTERNATIONAL REGISTRATION 0912453 DATED 10-24-2006, EXPIRES 10-24-2016.

SER. NO. 79-034,240, FILED 10-24-2006.

RON FAIRBANKS, EXAMINING ATTORNEY

Int. Cls.: 11 and 42

Prior U.S. Cls.: 13, 21, 23, 31, 34, 100 and 101

United States Patent and Trademark Office

Reg. No. 3,485,099

Registered Aug. 12, 2008

**TRADEMARK
SERVICE MARK
PRINCIPAL REGISTER**



KOCH MEMBRANE SYSTEMS GMBH (FED REP
GERMANY GMBH)

KACKERTSTRASSE 10

52070 AACHEN, FED REP GERMANY

FOR: MEMBRANES, MEMBRANE MODULES, FILTER CARTRIDGES, AND PARTS THEREOF FOR PREPARATION, TREATMENT, FILTRATION, RECYCLING, PURIFICATION, SEPARATION AND CLEANING OF FLUID, WATER, DRINKING WATER, AND WASTE WATER FOR PRIVATE, MUNICIPAL AND INDUSTRIAL PURPOSES; MODULAR APPARATUS AND APPLIANCES CONTAINING MEMBRANES FOR PREPARATION, TREATMENT, FILTRATION, RECYCLING, PURIFICATION, SEPARATION AND CLEANING OF FLUID, WATER, DRINKING WATER, AND WASTE WATER FOR PRIVATE, MUNICIPAL, AND INDUSTRIAL PURPOSES; WATER TREATMENT EQUIPMENT, NAMELY, REVERSE OSMOSIS, NANOFILTRATION, ULTRAFILTRATION AND MICROFILTRATION UNITS, IN CLASS 11 (U.S. CLS. 13, 21, 23, 31 AND 34).

FOR: SCIENTIFIC AND INDUSTRIAL RESEARCH SERVICES IN THE FIELD OF PREPARATION, TREATMENT, FILTRATION, RECYCLING, PURIFICATION, SEPARATION AND CLEANING OF FLUID, WATER, DRINKING WATER AND WASTE WATER, IN CLASS 42 (U.S. CLS. 100 AND 101).

OWNER OF INTERNATIONAL REGISTRATION
0913068 DATED 5-8-2006, EXPIRES 5-8-2016.

THE COLOR(S) LIGHT BLUE AND DARK BLUE IS/ARE CLAIMED AS A FEATURE OF THE MARK.

THE COLOR LIGHT BLUE APPEARS IN THE THREE WAVY LINES. THE COLOR DARK BLUE APPEARS IN THE ARROW BELOW THE THREE WAVY LINES.

SER. NO. 79-034,459, FILED 5-8-2006.

AMEETA JORDAN, EXAMINING ATTORNEY

Int. Cls.: 1, 6, 7, 8, 9, 13, 20 and 37

Prior U.S. Cls.: 1, 2, 5, 6, 9, 10, 12, 13, 14, 19, 21, 22, 23, 25, 26, 28, 31, 32, 34, 35, 36, 38, 44, 46, 50, 100, 103 and 106

Reg. No. 3,485,100

United States Patent and Trademark Office

Registered Aug. 12, 2008

**TRADEMARK
SERVICE MARK
PRINCIPAL REGISTER**

Outperform.Outlast.

HILTI AKTIENGESELLSCHAFT (LIECHTEN-
STEIN CORPORATION)
FL-9494 SCHAAN
LIECHTENSTEIN

FOR: ORGANIC AND INORGANIC CURABLE SINGLE-COMPONENT AND MULTI-COMPONENT ADHESIVES IN THE FORM OF CARTRIDGES, FOIL PACKS, FOIL HOLDERS AND FOIL CONTAINERS FOR INDUSTRIAL PURPOSES; ORGANIC AND INORGANIC DIMENSIONALLY STABLE, MOULDED, FORMABLE, FOAMED OR FOAMABLE FIRE EXTINGUISHING COMPOSITIONS IN THE FORM OF CARTRIDGES, FOIL PACKS OR CONTAINERS, IN CLASS 1 (U.S. CLS. 1, 5, 6, 10, 26 AND 46).

FOR: METAL FASTENING, JOINING, INSULATION AND INSTALLATION COMPONENTS, NAMELY, THREADED STUDS, NAILS, SCREWS, PLUGS, ANCHORS, RIVETS, HOOKS, RING-SHAPED FITTINGS, PIPE RINGS, INSULATION ANCHORS AND THREADED FASTENERS, ANGLE BRACKETS, INSTALLATION CHANNELS, NAMELY, STRUTS, SUSPENSION COMPONENTS IN THE NATURE OF METAL SUSPENDED CEILING SYSTEMS COMPRISING HANGERS AND LOOPS; FASTENING COMPONENTS IN THE NATURE OF METAL EXPANSION JOINTS FOR FLOORS AND WALLS, METAL JOINERY FITTINGS FOR ALL OF THE AFOREMENTIONED GOODS, IN CLASS 6 (U.S. CLS. 2, 12, 13, 14, 23, 25 AND 50).

FOR: TOOLS, IN THE NATURE OF ELECTRICALLY POWERED, POWDER-ACTUATED, GAS-OPERATED, PNEUMATIC, COMBUSTION TYPE, STATIONERY AND HAND-HELD POWER-OPERATED TOOLS, NAMELY, POWDER-ACTUATED TOOLS FOR THREADED STUDS AND NAILS, NAMELY, POWER DRILLS AND POWER-OPERATED SCREWDRIVERS; TACKING TOOLS IN THE NATURE OF FASTENERS FOR HEAVY DUTY STEEL AND METAL APPLICATIONS, ELECTRIC SCREWDRIVERS, DRILLING MACHINES, POWER

OPERATED DRILL HAMMERS, BREAKERS IN THE NATURE OF HYDRAULIC HAMMER, PNEUMATIC HAMMER AND POWERED HOLE OPENERS USED TO ENLARGE HOLES IN THE GROUND, DIAMOND CORING AND CUTTING MACHINES, POWER OPERATED CHISELING HAMMERS, POWER OPERATED SAWS, SLITTING AND CUTTING MACHINES, GRINDERS, VACUUM CLEANERS, NAMELY, VACUUM CLEANERS FOR WORKING STONE, MASONRY AND WOOD; SPARE PARTS AND ACCESSORIES FOR THE AFOREMENTIONED MACHINES AND TOOLS, NAMELY, TOOL AND MACHINE SUSPENSIONS IN THE NATURE OF TOOL AND MACHINE STANDS, DRIVE UNITS, DRILL BITS, DIAMOND DRILL BITS AND CORE BITS, SAW BLADES, GRINDING AND CUTTING DISCS AND BITS; STATIC MIXERS FOR CONCRETE, IN CLASS 7 (U.S. CLS. 13, 19, 21, 23, 31, 34 AND 35).

FOR: HAND-OPERATED TOOLS, NAMELY, TOOLS FOR METERING, DISPENSING, APPLYING AND INJECTING LIQUID, PASTY AND SOLID MASSES IN THE NATURE OF PRIMERS, MORTARS AND ADHESIVES IN THE FORM OF CAPSULES, CONTAINERS, BOXES, CARTRIDGES, FOIL PACKS, FOIL HOLDERS, AND FOIL CONTAINERS, NAMELY, DISPOSABLE, PLASTIC, NONELECTRIC, INLINE STATIC MIXING MACHINES USED FOR MIXING AND DISPENSING ADHESIVES, SEALANTS, AND THE LIKE, IN CLASS 8 (U.S. CLS. 23, 28 AND 44).

FOR: ELECTRIC, ELECTRONIC, MAGNETIC, OPTICAL AND LASER MEASURING, SIGNALING, INSPECTING, ALIGNING, POSITIONING, DETECTING AND CONTROLLING APPARATUS AND INSTRUMENTS FOR BUILDING CONSTRUCTION EQUIPMENT AND ACCESSORIES, NAMELY, STANDS AND HOLDERS FOR THE AFOREMENTIONED APPARATUS AND INSTRUMENTS, NAMELY, TRIPODS AND STANDS FOR LASER

POSITIONING SYSTEMS IN THE CONSTRUCTION INDUSTRY; BEAM CATCHERS, NAMELY, TARGET PLATES AND LASER RECEIVER FOR DETECTING LASER BEAMS OF LASER MEASURING APPARATUS; PLASTIC SAFETY HELMETS; CABLE TRUNK LINES IN THE NATURE OF ELECTRICAL CABLES; COAXIAL CABLES; POWER CABLES, IN CLASS 9 (U.S. CLS. 21, 23, 26, 36 AND 38).

FOR: EXPLOSIVES AND EXPLOSIVE CARTRIDGES FOR COMMERCIAL PURPOSES, NAMELY, POWDER-ACTUATED TOOLS AND EQUIPMENT; MAGAZINES FOR EXPLOSIVES AND EXPLOSIVE CARTRIDGES; CASELESS EXPLOSIVES, NAMELY, EXPLOSIVES IGNITED BY AN ELECTRIC CHARGE OR IMPACT; MAGAZINE-FED EXPLOSIVES AND EXPLOSIVE CARTRIDGES, IN CLASS 13 (U.S. CLS. 2 AND 9).

FOR: NON-METAL FASTENING, JOINING AND INSTALLATION COMPONENTS, NAMELY, THREADED STUDS, SCREWS, PLUGS, ANCHORS, RIVETS, HOOKS, RING-SHAPED FITTINGS, INSULATION ANCHORS AND PACKING CONTAINERS OF PLASTIC FOR MACHINES AND TOOLS, IN CLASS 20 (U.S. CLS. 2, 13, 22, 25, 32 AND 50).

FOR: CONSULTING, NAMELY, ADVICE RELATING TO FASTENING CONSTRUCTION, BUILDING CONSTRUCTION, CONSTRUCTION AND BUILDING DEMOLITION FIELDS; REPAIR OF MACHINES AND TOOLS FOR FASTENING, CUTTING, MEASURING, POSITIONING, DRILLING AND CHISELING AND DEMOLITION TOOLS AND MACHINES TO MAINTAIN, IMPROVE OR REINSTATE THEIR PROPER FUNCTIONING, IN CLASS 37 (U.S. CLS. 100, 103 AND 106).

THE MARK CONSISTS OF STANDARD CHARACTERS WITHOUT CLAIM TO ANY PARTICULAR FONT, STYLE, SIZE, OR COLOR.

PRIORITY DATE OF 10-3-2005 IS CLAIMED.

OWNER OF INTERNATIONAL REGISTRATION 0913596 DATED 3-13-2006, EXPIRES 3-13-2016.

SER. NO. 79-034,603, FILED 3-13-2006.

TINA BROWN, EXAMINING ATTORNEY

Int. Cl.: 9

Prior U.S. Cls.: 21, 23, 26, 36 and 38

Reg. No. 3,485,101

United States Patent and Trademark Office

Registered Aug. 12, 2008

**TRADEMARK
PRINCIPAL REGISTER**

PACEMAKER

TONIUM AB (SWEDEN JOINT STOCK COMPANY)
FINLANDSGATAN 60
SE-164 74 KISTA
SWEDEN

FOR: PORTABLE MUSIC PLAYERS, NAMELY, MP3 PLAYERS, COMPACT DISC PLAYERS, RADIOS, DIGITAL AUDIO PLAYERS, NAMELY, PORTABLE DJ PLAYERS; COMPUTER SOFTWARE FOR PROCESSING DIGITAL MUSIC AND VIDEO FILES AND FOR MANIPULATING DIGITAL AUDIO AND VIDEO FILES FOR USE WITH PORTABLE MUSIC PLAYERS, IN CLASS 9 (U.S. CLS. 21, 23, 26, 36 AND 38).

THE MARK CONSISTS OF STANDARD CHARACTERS WITHOUT CLAIM TO ANY PARTICULAR FONT, STYLE, SIZE, OR COLOR.

PRIORITY DATE OF 5-12-2006 IS CLAIMED.

OWNER OF INTERNATIONAL REGISTRATION 0914171 DATED 11-9-2006, EXPIRES 11-9-2016.

SER. NO. 79-034,725, FILED 11-9-2006.

MICHAEL LITZAU, EXAMINING ATTORNEY

Int. Cl.: 9

Prior U.S. Cls.: 21, 23, 26, 36 and 38

Reg. No. 3,485,102

United States Patent and Trademark Office

Registered Aug. 12, 2008

**TRADEMARK
PRINCIPAL REGISTER**

SIKORA

SIKORA AG (FED REP GERMANY STOCK CORPORATION)
BRUCHWEIDE 2
28307 BREMEN
FED REP GERMANY

FOR: MEASURING AND TESTING APPARATUS, NAMELY, GAUGES FOR MEASURING DIMENSIONAL CHARACTERISTICS OF CABLES, GAUGES FOR MEASURING DIMENSIONAL CHARACTERISTICS OF TUBES, GAUGES FOR WALL THICKNESS MEASUREMENT, GAUGES FOR TEMPERATURE MEASUREMENT, GAUGES FOR ECCENTRICITY MEASUREMENT, GAUGES FOR CAPACITANCE MEASUREMENT, GAUGES FOR LENGTH MEASUREMENT, GAUGES FOR SURFACE INSPECTION, DIAMETER MEASURING

GAUGES, LUMP-DETECTORS FOR TUBES AND CABLES, GAUGES FOR HIGH VOLTAGE TESTS, IN CLASS 9 (U.S. CLS. 21, 23, 26, 36 AND 38).

PRIORITY DATE OF 11-29-2006 IS CLAIMED.

OWNER OF INTERNATIONAL REGISTRATION 0915113 DATED 12-19-2006, EXPIRES 12-19-2016.

SEC. 2(F).

SER. NO. 79-035,093, FILED 12-19-2006.

WILLIAM VERHOSEK, EXAMINING ATTORNEY

Int. Cls.: 29 and 33

Prior U.S. Cls.: 46, 47 and 49

United States Patent and Trademark Office

Reg. No. 3,485,103

Registered Aug. 12, 2008

TRADEMARK
PRINCIPAL REGISTER

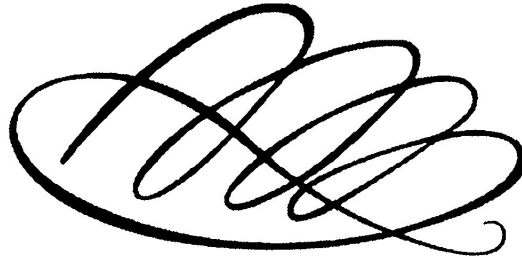

TENUTE MATER DOMINI S.S.; SOCIETÀ AGRICOLA (ITALY PARTNERSHIP)
VIA TEMPLARI, 11
I-73100 LECCE (LE)
ITALY

FOR: EDIBLE OILS AND FATS, IN CLASS 29 (U.S. CL. 46).

FOR: ALCOHOLIC BEVERAGES, EXCEPT BEERS, NAMELY, BRANDY, GIN, RUM, VODKA, WHISKEY, GRAPPA; WINES, IN CLASS 33 (U.S. CLS. 47 AND 49).

PRIORITY DATE OF 7-18-2006 IS CLAIMED.

OWNER OF INTERNATIONAL REGISTRATION 0915163 DATED 1-15-2007, EXPIRES 1-15-2017.

SER. NO. 79-035,108, FILED 1-15-2007.

SHANNON TWOHIG, EXAMINING ATTORNEY

Int. Cls.: 9, 35 and 42

Prior U.S. Cls.: 21, 23, 26, 36, 38, 100, 101 and 102

Reg. No. 3,485,104

United States Patent and Trademark Office

Registered Aug. 12, 2008

**TRADEMARK
SERVICE MARK
PRINCIPAL REGISTER**

GLT-System

CAIROS TECHNOLOGIES AG (FED REP GER-
MANY CORPORATION (AG))

IM STÖCKMÄDLE 18

76307 KARLSBAD

FED REP GERMANY

FOR: SCIENTIFIC INSTRUMENTS, NAMELY, INSTRUMENTS FOR TRACKING POSITION AND/OR MOTION OF OBJECTS, ANIMALS AND PERSONS IN THE NATURE OF COMPUTER HARDWARE, AND ELECTRONIC TRANSMITTERS AND RECEIVERS FOR TRACKING POSITION AND/OR MOTION OF OBJECTS, ANIMALS AND PERSONS; SURVEYING MACHINES AND INSTRUMENTS, INSTRUMENTS FOR WEIGHING, NAMELY, WEIGHING OF PERSONS, ANIMALS AND OBJECTS; INSTRUMENTS FOR MEASURING, NAMELY, INSTRUMENTS FOR MEASURING POSITION AND/OR MOTION OF OBJECTS, ANIMALS AND PERSONS; SIGNALLING, CHECKING, AND TEACHING APPARATUS AND INSTRUMENTS, NAMELY, INSTRUMENTS FOR TRACKING POSITION AND/OR MOTION OF OBJECTS, ANIMALS AND PERSONS IN THE NATURE OF COMPUTER HARDWARE, AND ELECTRONIC TRANSMITTERS AND RECEIVERS FOR TRACKING POSITION AND/OR MOTION OF OBJECTS, ANIMALS AND PERSONS; APPARATUS AND INSTRUMENTS FOR CONDUCTING, SWITCHING, TRANSFORMING, ACCUMULATING, REGULATING AND CONTROLLING ELECTRICITY, NAMELY, TRANSFORMERS, TRANSMITTERS OF ELECTRONIC SIGNALS, ELECTRONIC RECEIVERS FOR ELECTRONIC SIGNALS, CONDUCTIVE FIBRES AND CABLES, ELECTRIC ACCUMULATORS, ELECTRICAL CONTROLLING DEVICES, ALL IN CONNECTION WITH INSTRUMENTS FOR TRACKING POSITION AND MOTION OF OBJECTS, ANIMALS AND PERSONS; MAGNETIC DATA CARRIERS RECORDED WITH PREPROGRAMMED DATA, NAMELY, COMPUTER OPERATING PROGRAMS AND COMPUTER OPERATING SYSTEMS; CALCULATING MACHINES, NAMELY, CALCULATORS;

DATA PROCESSING EQUIPMENT, NAMELY, DATA PROCESSORS AND COMPUTERS FOR TRACKING POSITION AND/OR MOTION OF OBJECTS, ANIMALS AND PERSONS; ALL AFOREMENTIONED GOODS NOT IN CONNECTION OR ASSOCIATION WITH CENTRAL BUILDING CONTROL SYSTEMS OR WITH INSULATION RELATED GOODS, IN CLASS 9 (U.S. CLS. 21, 23, 26, 36 AND 38).

FOR: ADVERTISING AND MARKETING SERVICES; BUSINESS MANAGEMENT; BUSINESS ADMINISTRATION; PROVIDING OFFICE FUNCTIONS, NAMELY, SERVICES RELATED TO THE REGISTRATION, TRANSCRIPTION, COMPOSING, ARRANGING OR SYSTEMATICALLY DISPOSING OF WRITTEN NOTICES AND RECORDS AND COMPILATION AND PROVISION OF STATISTICAL INFORMATION FOR BUSINESS PURPOSES IN THE NATURE OF ANALYSIS OR COMBINATION OF MATHEMATICAL OR STATISTICAL DATA; ALL OF THE FOREGOING SERVICES IN CONNECTION WITH INSTRUMENTS FOR TRACKING POSITION AND MOTION OF OBJECTS, ANIMALS AND PERSONS SERVICES AND NOT IN CONNECTION OR ASSOCIATION WITH CENTRAL BUILDING CONTROL SYSTEMS OR WITH INSULATION RELATED GOODS, IN CLASS 35 (U.S. CLS. 100, 101 AND 102).

FOR: SCIENTIFIC AND TECHNOLOGICAL SERVICES AND RESEARCH AND DESIGNER SERVICES RELATING THERETO IN THE FIELD OF TRACKING POSITION AND/OR MOTION OF OBJECTS, ANIMALS AND PERSONS AND IN THE FIELD OF PROVIDING STATISTICAL INFORMATION FOR BUSINESS PURPOSES; INDUSTRIAL ANALYSIS AND RESEARCH SERVICES IN THE FIELD OF TRACKING POSITION AND/OR MOTION OF OBJECTS, ANIMALS AND PERSONS AND IN THE FIELD OF PROVIDING STATISTICAL INFORMATION FOR BUSINESS PURPOSES; DESIGN AND DEVELOPMENT OF COMPUTER HARDWARE AND SOFTWARE; ALL AFOREMEN-

TIONED SERVICES NOT IN CONNECTION OR ASSOCIATION WITH CENTRAL BUILDING CONTROL SYSTEMS OR WITH INSULATION RELATED GOODS, IN CLASS 42 (U.S. CLS. 100 AND 101).

THE MARK CONSISTS OF STANDARD CHARACTERS WITHOUT CLAIM TO ANY PARTICULAR FONT, STYLE, SIZE, OR COLOR.

PRIORITY DATE OF 8-4-2006 IS CLAIMED.

OWNER OF INTERNATIONAL REGISTRATION 0915189 DATED 1-25-2007, EXPIRES 1-25-2017.

SER. NO. 79-035,115, FILED 1-25-2007.

LYDIA BELZER, EXAMINING ATTORNEY

Int. Cls.: 5, 10, 40, 41 and 42

Prior U.S. Cls.: 6, 18, 26, 39, 44, 46, 51, 52, 100, 101, 103, 106 and 107

Reg. No. 3,485,105

United States Patent and Trademark Office

Registered Aug. 12, 2008

**TRADEMARK
SERVICE MARK
PRINCIPAL REGISTER**

CEREC

SIRONA DENTAL SYSTEMS GMBH (FED REP
GERMANY LTD LIAB CO)
FABRIKSTRASSE 31
64625 BENSHEIM
FED REP GERMANY

FOR: PHARMACEUTICAL PRODUCTS FOR DENTAL TREATMENTS, NAMELY, BACTERIOSTATS FOR DENTAL USE; AND SANITARY STERILIZING PREPARATIONS; MATERIAL FOR STOPPING TEETH AND DENTAL WAX; EMBEDDING COMPOUNDS, NAMELY, EMBEDDING MATERIAL FOR DENTAL AND DENTAL TECHNICAL PURPOSES; DENTAL CEMENTS, NAMELY, MATERIALS FOR GLUING CERAMIC PARTS AND TEETH; DENTAL LACQUER, NAMELY, CONDUCTIVE LACQUER FOR DENTAL PURPOSES; MATT LACQUER FOR SCANNING TEETH, NAMELY, CONTRAST SPRAY; POWDER FOR SCANNING TEETH, NAMELY, CONTRAST POWDER; COMPOSITE MATERIALS FOR DENTAL AND DENTAL TECHNICAL PURPOSES; LINING MATERIALS FOR DENTAL USE AND FOR ORAL PROPHYLAXIS; MATERIALS FOR CROWNS AND BRIDGES FOR DENTAL USE AND FOR ORAL PROPHYLAXIS; UNPROCESSED DENTAL CERAMICS; DENTAL PROSTHESES OF ALL KINDS, NAMELY, CROWNS AND BRIDGES, IN CLASS 5 (U.S. CLS. 6, 18, 44, 46, 51 AND 52).

FOR: MEDICAL AND DENTAL INSTRUMENTS, NAMELY, DENTAL BURRS, DENTAL PICKS, DENTAL MIRRORS, DENTAL ULTRASONIC HAND PIECES AND TIPS THEREFORE, SPRAYING INSTRUMENTS FOR DENTAL USE, DENTAL DRILLS, CAVITY PREPARATION INSTRUMENTS, NAMELY, CAVITY BRUSHES; DENTAL SCALPELS, MILLING INSTRUMENTS FOR DENTAL USE, ORAL IRRIGATORS, PROSTHETIC INSTRUMENTS FOR DENTAL PURPOSES, DRILLING JIGS FOR SURGICAL AND DENTAL APPLICATIONS; MEDI-

CAL AND DENTAL APPARATUS, NAMELY, EXTRA-ORAL AND INTRA-ORAL LIGHT SYSTEMS, INTRAORAL SCANNING DEVICES, INTRAORAL X-RAY SENSORS, INTRAORAL AND EXTRAORAL X-RAY SCANNING DEVICES, X-RAY APPARATUS FOR MEDICAL AND DENTAL USE, DIGITAL SENSOR USED FOR TAKING DIGITAL DENTAL RADIOGRAPHS; DENTAL PROPHYLACTIC INSTRUMENTS, NAMELY, POLISHING INSTRUMENTS; INTRA-ORAL DENTAL LIGHT SYSTEM; POLYMERIZATIONS APPARATUS FOR DENTAL PURPOSES; FURNITURE FOR MEDICAL AND DENTAL USE, NAMELY, DENTAL EXAMINATION CHAIRS, DENTAL PATIENT TREATMENT CHAIRS WITH OR WITHOUT BASINS FOR RINSING THE MOUTH, TREATMENT SITES FOR ORAL PROPHYLACTICS COMPRISING A DENTAL PATIENT EXAMINATION CHAIR AND DENTAL INSTRUMENTS, AS LISTED ABOVE IN THIS CLASS, CONNECTION CONSOLES FOR DENTAL HAND PIECES, NAMELY, PLATES AND HOLDER FOR DENTAL HAND PIECES, INSTRUMENT CABINETS, DENTISTS' ELEMENTS, DENTAL ASSISTANT'S ELEMENTS, TREATMENT TABLES, FOOTRESTS, SINKS, CUSPIDORS, LAMPS, TROLLEYS; DENTAL HAND PIECES, NAMELY, DENTAL BURRS, DENTAL ULTRASONIC HAND PIECES, OPTICAL SCANNING APPLIANCES FOR MEDICAL AND DENTAL USE; X-RAY APPLIANCES FOR DENTAL AND MEDICAL USE, IN CLASS 10 (U.S. CLS. 26, 39 AND 44).

FOR: ASSEMBLY OF PRODUCTS FOR OTHERS, NAMELY, MATERIALS FOR PROSTHESES AND DENTAL BODIES FITTED FOR THIRD PARTIES, IN CLASS 40 (U.S. CLS. 100, 103 AND 106).

FOR: TRAINING SERVICES IN THE FIELD OF DENTAL SCIENCE; ORGANIZATION AND CONDUCTING OF SEMINARS IN THE FIELD OF DENTAL SCIENCE; EDUCATIONAL SERVICES,

NAMELY, PROVIDING CLASSES, SEMINARS, WORKSHOPS IN THE FIELD OF DENTAL HEALTH; PROVIDING CONTINUING DENTAL EDUCATION COURSES; MULTIMEDIA ENTERTAINMENT SERVICES IN DENTISTRY IN THE NATURE OF RECORDING, PRODUCTION AND POST-PRODUCTION SERVICES IN THE FIELDS OF VIDEO AND FILMS, IN CLASS 41 (U.S. CLS. 100, 101 AND 107).

FOR: COMPUTER PROGRAMMING IN THE FIELD OF MEDICINE AND DENTISTRY; DEVELOPMENT OF COMPUTER PROGRAMS RECORDED ON DATA MEDIA (SOFTWARE) DESIGNED FOR USE IN THE FIELD OF MEDICINE AND DENTISTRY; MEASURING AND EXECUTION OF IMAGES IN THE FIELD OF MEDICINE AND

DENTISTRY, NAMELY, IMAGE PROCESSING SOFTWARE DESIGN, IN CLASS 42 (U.S. CLS. 100 AND 101).

THE MARK CONSISTS OF STANDARD CHARACTERS WITHOUT CLAIM TO ANY PARTICULAR FONT, STYLE, SIZE, OR COLOR.

OWNER OF INTERNATIONAL REGISTRATION 0748088 DATED 9-11-2000, EXPIRES 9-11-2010.

OWNER OF U.S. REG. NO. 1,527,765.

SER. NO. 79-035,119, FILED 5-5-2006.

BERNICE MIDDLETON, EXAMINING ATTORNEY

Int. Cls.: 9, 10 and 38

Prior U.S. Cls.: 21, 23, 26, 36, 38, 39, 44, 100, 101 and 104

Reg. No. 3,485,106

United States Patent and Trademark Office

Registered Aug. 12, 2008

**TRADEMARK
SERVICE MARK
PRINCIPAL REGISTER**

ST MAP

KONINKLIJKE PHILIPS ELECTRONICS N.V.
(NETHERLANDS LLC)
GROENEWOUDSEWEG 1
NL-5621 BA EINDHOVEN, NETHERLANDS

FOR: COMPUTERS AND SOFTWARE FOR RECORDING, PROCESSING, ANALYZING AND REPRODUCING MEDICAL AND PATIENT RELATED DATA, FOR COLLECTING ST VALUES, ST SEGMENT MONITORING AND GRAPHICAL DISPLAY THEREOF, IN CLASS 9 (U.S. CLS. 21, 23, 26, 36 AND 38).

FOR: MEDICAL AND SURGICAL APPARATUS AND INSTRUMENTS, NAMELY, PATIENT MONITORS USED IN HOSPITALS FOR THE MONITORING AND OBSERVATION OF MYOCARDIAL INFARCTION, POST-MI ISCHEMIA, MYOCARDIAL ISCHEMIA AND PREVENTION OF RESPIRATORY FAILURE, INTRA- AND POST-OPERATIVE ISCHEMIA FOR CARDIAC AND SURGICAL PROCEDURES, IN CLASS 10 (U.S. CLS. 26, 39 AND 44).

FOR: TELECOMMUNICATIONS SERVICES, NAMELY, TRANSFERRING AND EXCHANGING PATIENT DATA BETWEEN PROFESSIONAL HEALTH CENTERS, PHYSICIANS AND PATIENTS; TELECOMMUNICATION SERVICES, NAMELY, PROVIDING ACCESS TO TELECOMMUNICATION

NETWORKS FOR THE BENEFIT OF HOSPITAL MANAGEMENT AND FOR MONITORING PATIENT HEALTH CASE HISTORIES; INTERNET SERVICES, NAMELY, STREAMING OF AUDIO AND VIDEO MATERIAL OVER THE INTERNET FOR THE BENEFIT OF HOSPITAL MANAGEMENT AND FOR MONITORING PATIENT HEALTH CASE HISTORIES, IN CLASS 38 (U.S. CLS. 100, 101 AND 104).

THE MARK CONSISTS OF STANDARD CHARACTERS WITHOUT CLAIM TO ANY PARTICULAR FONT, STYLE, SIZE, OR COLOR.

PRIORITY DATE OF 6-27-2006 IS CLAIMED.

OWNER OF INTERNATIONAL REGISTRATION 0915748 DATED 12-13-2006, EXPIRES 12-13-2016.

NO CLAIM IS MADE TO THE EXCLUSIVE RIGHT TO USE "ST", APART FROM THE MARK AS SHOWN.

SER. NO. 79-035,336, FILED 12-13-2006.

CAROLYN CATALDO, EXAMINING ATTORNEY

Int. Cls.: 9, 38 and 42

Prior U.S. Cls.: 21, 23, 26, 36, 38, 100, 101 and 104

Reg. No. 3,485,107

United States Patent and Trademark Office

Registered Aug. 12, 2008

**TRADEMARK
SERVICE MARK
PRINCIPAL REGISTER**

HiMed

SIEMENS AKTIENGESELLSCHAFT (FED REP
GERMANY JOINT STOCK COMPANY)
WITTELSBACHERPLATZ 2
80333 MÜNCHEN
FED REP GERMANY

FOR: ELECTRICAL APPARATUS FOR RECORDING, TRANSMISSION, OR REPRODUCTION OF DATA, SOUNDS, SIGNALS, CHARACTERS AND/OR IMAGES; COMMUNICATIONS COMPUTERS, COMPUTER SOFTWARE FOR USE IN OPERATING COMMUNICATIONS AND ENTERTAINMENT SYSTEMS IN HOSPITALS AND FOR PROVIDING HOSPITAL PATIENTS WITH ACCESS TO MULTIMEDIA SERVICES IN THE NATURE OF TELEPHONE, INTERNET, INTRANET, TELEVISION, RADIO, AUDIO AND VIDEO ENTERTAINMENT, AND FOR RECORDING, PROCESSING, ACCESSING AND DISPLAYING PATIENT HEALTH RECORDS AND DATA AND HOSPITAL BILLING INFORMATION AND DATA; COMPUTER SOFTWARE FOR USE BY HOSPITAL PERSONNEL AND PHYSICIANS TO ACCESS HOSPITAL INFORMATION SYSTEMS; OPTICAL, ELECTROTECHNICAL AND ELECTRONIC EQUIPMENT IN THE FIELD OF VOICE, IMAGE, TEXT, DATA, MULTIMEDIA AND FULL-MOTION VIDEO COMMUNICATIONS TECHNOLOGY, NAMELY, COMPUTER HARDWARE, TELEPHONES, VIDEOPHONES; DOMESTIC TELEPHONE SETS, PRIVATE AUTOMATIC TELEPHONE BRANCH EXCHANGES; TELECOMMUNICATION NETWORKS CONSISTING OF TELECOMMUNICATIONS SWITCHES, APPARATUS FOR TRANSMISSION OF COMMUNICATION, POWER SUPPLIES, TELECOMMUNICATIONS CABLES, FIBER OPTIC CABLES, CONNECTION CABLES; AND PERTINENT CONNECTION ELEMENTS IN THE NATURE OF ELECTRICAL CONNECTIONS; DEVICES FOR WIRELESS COMMUNICATION, NAMELY, INFRARED AND RADIO TRANSMITTERS AND INFRARED AND RADIO RECEIVERS; REMOTE CONTROLS FOR

MULTIMEDIA ENTERTAINMENT AND COMMUNICATION SYSTEMS; ENCODED SMART CARDS FOR USE BY HOSPITAL PATIENTS TO ACCESS MULTIMEDIA ENTERTAINMENT AND COMMUNICATION SERVICES, VIEW MEDICAL RECORDS AND MEDICAL BILLING INFORMATION AND TO PURCHASE IN HOSPITAL GOODS AND SERVICES; ENCODED SMART CARDS FOR USE BY HOSPITAL PERSONNEL AND PHYSICIANS TO ACCESS HOSPITAL INFORMATION SYSTEMS; ALL OF THE AFOREMENTIONED APPARATUS AND DEVICES FOR USE IN MODULAR COMMUNICATION SYSTEMS FOR HOSPITALS, IN CLASS 9 (U.S. CLS. 21, 23, 26, 36 AND 38).

FOR: PROVIDING ACCESS TO TELECOMMUNICATION NETWORKS, ELECTRONIC EXCHANGE OF DATA STORED IN DATABASES ACCESSIBLE VIA TELECOMMUNICATION NETWORKS, RENTING OF TELECOMMUNICATION EQUIPMENT AND RENTAL OF ACCESS TIME TO TELECOMMUNICATION NETWORKS, IN CLASS 38 (U.S. CLS. 100, 101 AND 104).

FOR: TECHNOLOGICAL CONSULTANCY IN THE SETTING-UP OF TELECOMMUNICATION SYSTEMS, DATA PROCESSING SYSTEMS AND TELECOMMUNICATION NETWORKS; DEVELOPMENT AND PROJECT-DESIGN OF TELECOMMUNICATION AND INFORMATION PROCESSING SERVICES AND FACILITIES AND TELECOMMUNICATION NETWORKS; TECHNICAL PLANNING AND PROJECT-DESIGN OF TELECOMMUNICATION AND DATA PROCESSING SYSTEMS, TELECOMMUNICATION NETWORKS AND TELECOMMUNICATION FACILITIES AND PARTS FOR SUCH FACILITIES AND NETWORKS; DEVELOPMENT, GENERATION AND RENTING OF DATA PROCESSING COMPUTER PROGRAMS, IN CLASS 42 (U.S. CLS. 100 AND 101).

THE MARK CONSISTS OF STANDARD CHAR-
ACTERS WITHOUT CLAIM TO ANY PARTICULAR
FONT, STYLE, SIZE, OR COLOR.

OWNER OF INTERNATIONAL REGISTRATION
0915763 DATED 1-10-2007, EXPIRES 1-10-2017.

SER. NO. 79-035,338, FILED 1-10-2007.

PRIORITY DATE OF 8-31-2006 IS CLAIMED.

SUE LAWRENCE, EXAMINING ATTORNEY

Int. Cls.: 35 and 42

Prior U.S. Cls.: 100, 101 and 102

United States Patent and Trademark Office

Reg. No. 3,485,108

Registered Aug. 12, 2008

**SERVICE MARK
PRINCIPAL REGISTER**

RelationsIntelligence

ENALYZER A/S (DENMARK LIMITED COMPAN-
NY)
HAVNEGADE 39, 1.
DK-1058 COPENHAGEN K
DENMARK

FOR: ADVERTISING SERVICES, NAMELY,
MARKET RESEARCH, OPINION POLLING, SUR-
VEYS AND DIALOGUE FACILITATION, IN CLASS
35 (U.S. CLS. 100, 101 AND 102).

FOR: DESIGN AND DEVELOPMENT OF COM-
PUTER HARDWARE AND SOFTWARE, IN CLASS
42 (U.S. CLS. 100 AND 101).

THE MARK CONSISTS OF STANDARD CHAR-
ACTERS WITHOUT CLAIM TO ANY PARTICULAR
FONT, STYLE, SIZE, OR COLOR.

OWNER OF INTERNATIONAL REGISTRATION
0915835 DATED 11-25-2006, EXPIRES 11-25-2016.

SER. NO. 79-035,363, FILED 11-25-2006.

AMY HELLA, EXAMINING ATTORNEY

Int. Cls.: 29 and 33

Prior U.S. Cls.: 46, 47 and 49

United States Patent and Trademark Office

Reg. No. 3,485,109

Registered Aug. 12, 2008

**TRADEMARK
PRINCIPAL REGISTER**

TENUTE MATER DOMINI

TENUTE MATER DOMINI S.S.; SOCIETÀ AGRICOLA (ITALY PARTNERSHIP)
VIA TEMPLARI, 11
I-73100 LECCE (LE)
ITALY

FOR: EDIBLE OILS AND FATS, IN CLASS 29 (U.S. CL. 46).

FOR: ALCOHOLIC BEVERAGES, EXCEPT BEERS, NAMELY, BRANDY, GIN, RUM, VODKA, WHISKEY, GRAPPA; WINES, IN CLASS 33 (U.S. CLS. 47 AND 49).

THE MARK CONSISTS OF STANDARD CHARACTERS WITHOUT CLAIM TO ANY PARTICULAR FONT, STYLE, SIZE, OR COLOR.

PRIORITY DATE OF 7-18-2006 IS CLAIMED.

OWNER OF INTERNATIONAL REGISTRATION 0915883 DATED 1-15-2007, EXPIRES 1-15-2017.

THE FOREIGN WORDING IN THE MARK TRANSLATES INTO ENGLISH AS "MOTHER OF LORD ESTATES".

SER. NO. 79-035,372, FILED 1-15-2007.

SHANNON TWOHIG, EXAMINING ATTORNEY

Int. Cls.: 9, 35 and 42

Prior U.S. Cls.: 21, 23, 26, 36, 38, 100, 101 and 102

Reg. No. 3,485,110

United States Patent and Trademark Office

Registered Aug. 12, 2008

**TRADEMARK
SERVICE MARK
PRINCIPAL REGISTER**

ENALYZER

ENALYZER A/S (DENMARK LIMITED COMPANY)
HAVNEGADE 39, 1.
DK-1058 COPENHAGEN K
DENMARK

FOR: SURVEYING INSTRUMENTS, NAMELY, SOFTWARE AND DOWNLOADABLE WEB-BASED SOFTWARE FOR CONDUCTING ONLINE AND OFFLINE SURVEYS AND DIALOG PROGRAMS, IN CLASS 9 (U.S. CLS. 21, 23, 26, 36 AND 38).

FOR: ADVERTISING SERVICES; BUSINESS MANAGEMENT; BUSINESS ADMINISTRATION AND MANAGEMENT; PROVIDING OFFICE FUNCTIONS, IN CLASS 35 (U.S. CLS. 100, 101 AND 102).

FOR: COMPUTER PROGRAMMING, IN CLASS 42 (U.S. CLS. 100 AND 101).

THE MARK CONSISTS OF STANDARD CHARACTERS WITHOUT CLAIM TO ANY PARTICULAR FONT, STYLE, SIZE, OR COLOR.

OWNER OF INTERNATIONAL REGISTRATION 0916117 DATED 11-29-2006, EXPIRES 11-29-2016.

SER. NO. 79-035,439, FILED 11-29-2006.

KATHERINE E. HALMEN, EXAMINING ATTORNEY

Int. Cls.: 7, 9 and 11

Prior U.S. Cls.: 13, 19, 21, 23, 26, 31, 34, 35, 36 and 38

Reg. No. 3,485,111

United States Patent and Trademark Office

Registered Aug. 12, 2008

**TRADEMARK
PRINCIPAL REGISTER**

CoolAct

WILO AG (FED REP GERMANY JOINT STOCK COMPANY)

NORTKIRCHENSTRASSE 100

44263 DORTMUND, FED REP GERMANY

FOR: PUMPS, NAMELY, PUMPS FOR HEATING UNITS EXCEPT FOR PUMPS FOR MEDICAL PURPOSES, AGRICULTURAL PUMPS FOR PUMPING FLUIDS, SLUDGES, ENTRAINED AIR, OR SLURRIES FOR IRRIGATION, DRAINAGE, APPLYING PESTICIDES, MANURE, AND FERTILIZER, SUBMERSIBLE PUMPS, BOREHOLE PUMPS, HIGH PRESSURE CENTRIFUGAL PUMPS, PUMPS FOR PRESSURE BOOSTING, HEATING INSTALLATION PUMPS, COOLING INSTALLATION PUMPS, PUMPS FOR MACHINES EXCEPT PUMPS FOR MEDICAL PURPOSES, NAMELY, MACERATOR PUMPS, GLANDLESS PUMPS FOR HEATING SYSTEMS, HORIZONTAL CENTRIFUGAL PUMPS, CHILLED WATER PUMPS; HIGH PRESSURE PUMPS FOR WASHING APPLIANCES AND INSTALLATIONS; BUILDING INSTALLATION PUMPS, NAMELY, PUMPS FOR HEATING INSTALLATIONS, COOLING INSTALLATIONS, FRESH WATER SUPPLY INSTALLATIONS, WASTE WATER INSTALLATIONS, SEWAGE AND FECES TREATMENT INSTALLATIONS; ELECTRICAL WATER PUMPS, NAMELY, WATER SUPPLY PUMPS, SEWAGE TREATMENT PUMPS, PUMPS FOR SWIMMING POOLS, WHIRLPOOLS, BATHS, PONDS, WATER FILTERING UNITS; INDUSTRIAL ELECTRIC MOTORS OTHER THAN FOR LAND VEHICLES, NAMELY, ELECTRIC MOTORS FOR MACHINES AND PUMPS; SPARE PARTS FOR PUMPS, NAMELY, WATER FILTERS, IN CLASS 7 (U.S. CLS. 13, 19, 21, 23, 31, 34 AND 35).

FOR: REGULATING AND CONTROLLING APPARATUS, NAMELY, SWITCHING DEVICES FOR THE OPERATION OF ONE OR MORE PUMPS WITH A DRIVE MOTOR, CONTROL UNITS IN THE NATURE OF SWITCH BOXES AND OPERATING UNITS FOR THE ELECTRICAL CONNECTION OF AC AND THREE PHASE PUMPS, FLOW REGULA-

TORS FOR COMMERCIAL AND DOMESTIC USE, ELECTRONIC FLOW AND PRESSURE CONTROLLERS; ELECTRO-TECHNICAL APPARATUS AND INSTRUMENTS, NAMELY, DRY-RUNNING PROTECTION DEVICES IN THE NATURE OF ELECTRICAL SENSORS AND ELECTRICAL CONTROLLERS FOR STOPPING A PUMP WHEN THERE IS NO FLUID LEFT TO PUMP, PRESSURE SWITCHES, FLOAT SWITCHES, IMMERSION PROBES FOR DETECTING TEMPERATURE, PRESSURE AND FLOW PARAMETERS, ELECTRICAL AND MAGNETIC ROTORS FOR ELECTRIC MOTORS, ELECTRIC COILS, TIME SWITCHES, PRESSURE SENSORS, ELECTRIC CONTROL PANELS, SWITCH GEARS FOR APPLICATION AS CONTRACTOR FOR AC AND THREE-PHASE CURRENT PUMPS; ELECTRONIC OPERATIONAL MONITORING UNITS FOR CONTROL AND CHECK OF OPERATING STATUS OF ELECTRIC PUMPS; COMPUTER SOFTWARE FOR USE IN CONTROL AND MONITORING OF PUMPS AND MOTORS, SOFTWARE FOR USE IN DATABASE MANAGEMENT, IN CLASS 9 (U.S. CLS. 21, 23, 26, 36 AND 38).

FOR: HEATING INSTALLATIONS, NAMELY, HOT WATER HEATING INSTALLATIONS, RADIATORS, ELECTRICAL WATER HEATING APPARATUS, HEATING BOILERS, HEAT PUMPS, HEAT AND STEAM ACCUMULATORS, HEAT EXCHANGER, SOLAR COLLECTORS FOR HEATING INSTALLATIONS; HOT-WATER SPACE HEATING APPARATUS, HEATING APPARATUS, NAMELY, PUMPS FOR DOMESTIC HOT WATER CIRCULATORS AND SECONDARY CIRCULATORS FOR MECHANICAL BUILDING AND INDUSTRIAL SERVICES BEING PARTS OF WATER HEATING INSTALLATIONS, SOLAR THERMIC PUMPS AND PARTS THEREFOR; HOT-WATER HEATERS, NAMELY, CENTRAL HOT WATER HEATERS, HOT WATER CIRCULATING PUMPS FOR HOT WATER CIRCULATORS, SECONDARY AND SERVICE WATER HEATERS AND OPEN CONDENSATION WATER HEATERS, GLANDLESS PUMPS ALL BEING PARTS OF WATER HEATERS OF ALL

KINDS, CLOSED CHILLED WATER CIRCULATORS AND INDUSTRIAL CIRCULATORS AND PARTS THEREFOR BEING PARTS OF HEATING SYSTEMS; HOT WATER APPARATUS, NAMELY, HOT WATER SPACE HEATING APPARATUS, HOT WATER TANKS, HOT WATER HEATERS, ELECTRIC HOT WATER BOTTLES; ELECTRIC HEATING BOILERS, AIR CONDITIONING INSTALLATIONS, HEAT PUMPS, HEAT ACCUMULATORS, PRESSURE STEAM ACCUMULATORS AS PART OF HEATING AND/OR WATER CONDUIT INSTALLATIONS, INSULATION TUBES AS PARTS OF PUMPS AND HEATING AND/OR WATER CONDUIT INSTALLATIONS, IN CLASS 11 (U.S. CLS. 13, 21, 23, 31 AND 34).

THE MARK CONSISTS OF STANDARD CHARACTERS WITHOUT CLAIM TO ANY PARTICULAR FONT, STYLE, SIZE, OR COLOR.

PRIORITY DATE OF 6-10-2006 IS CLAIMED.

OWNER OF INTERNATIONAL REGISTRATION 0916596 DATED 12-6-2006, EXPIRES 12-6-2016.

SER. NO. 79-035,612, FILED 12-6-2006.

DAVID HOFFMAN, EXAMINING ATTORNEY

Int. Cls.: 9, 16, 38 and 41

**Prior U.S. Cls.: 2, 5, 21, 22, 23, 26, 29, 36, 37, 38, 50,
100, 101, 104 and 107**

Reg. No. 3,485,112

United States Patent and Trademark Office

Registered Aug. 12, 2008

**TRADEMARK
SERVICE MARK
PRINCIPAL REGISTER**

PLC^CFastDraft

LEGAL & COMMERCIAL PUBLISHING LIMITED (UNITED KINGDOM LIMITED COMPANY)
19 HATFIELDS
LONDON SE1 8DJ, UNITED KINGDOM

FOR: ELECTRONIC PUBLICATIONS, NAMELY, NEWS BULLETINS AND WRITTEN ARTICLES FEATURING INFORMATIONAL BRIEFINGS AND UPDATES IN THE FIELDS OF LAW, BUSINESS, MEDICINE, HEALTHCARE, SCIENCES, DENTISTRY, ACCOUNTING, INSURANCE, REAL ESTATE, ARCHITECTURE, OR EDUCATION, ALL RECORDED ON COMPUTER MEDIA OR DOWNLOADABLE VIA COMPUTER AND COMMUNICATION NETWORKS; LEGAL TRANSACTIONAL DOCUMENTS, NAMELY, BLANK LEGAL FORMS AND LEGAL DRAFTING TEMPLATES, ALL RECORDED ON COMPUTER MEDIA OR DOWNLOADABLE VIA COMPUTER AND COMMUNICATION NETWORKS; DOWNLOADABLE PUBLICATIONS IN ELECTRONIC FORM SUPPLIED ON-LINE FROM A DATABASE, FROM WEBSITES ON THE INTERNET, OR THROUGH OTHER GLOBAL COMPUTER NETWORKS, NAMELY, NEWS BULLETINS AND WRITTEN ARTICLES FEATURING INFORMATIONAL BRIEFINGS AND UPDATES IN THE FIELDS OF LAW, BUSINESS, MEDICINE, HEALTHCARE, SCIENCES, DENTISTRY, ACCOUNTING, INSURANCE, REAL ESTATE, ARCHITECTURE, OR EDUCATION; SOFTWARE FOR USE IN GENERATING LEGAL TRANSACTIONAL DOCUMENTS FOR USE BY LEGAL PRACTITIONERS AND FOR USE IN GENERATING DOCUMENTS FOR USE IN VARIOUS PROFESSIONAL FIELDS, NAMELY, ACCOUNTANCY, MEDICINE AND HEALTHCARE, LAW, INSURANCE, REAL ESTATE, ARCHITECTURE, SCIENCE, EDUCATION, AND BUSINESS, IN CLASS 9 (U.S. CLS. 21, 23, 26, 36 AND 38).

FOR: PRINTED TRANSACTIONAL DOCUMENTS, NAMELY, BLANK LEGAL FORMS AND LEGAL TEMPLATES; PRINTED PUBLICATIONS, NAMELY, MAGAZINES, NEWS BULLETINS, AND WRITTEN ARTICLES, ALL IN THE FIELDS OF LAW, BUSINESS, MEDICINE, HEALTHCARE, SCIENCES, DENTISTRY, ACCOUNTING, INSURANCE, REAL ESTATE, ARCHITECTURE, OR EDUCATION, IN CLASS 16 (U.S. CLS. 2, 5, 22, 23, 29, 37, 38 AND 50).

FOR: PROVIDING ACCESS OVER THE INTERNET TO A DATABASE; PROVIDING ACCESS TO DATA OR DOCUMENTS STORED ELECTRONICALLY IN CENTRAL FILES FOR REMOTE CONSULTATION, IN CLASS 38 (U.S. CLS. 100, 101 AND 104).

FOR: ELECTRONIC PUBLISHING SERVICES, NAMELY, ON-LINE PUBLICATION OF NEWS BULLETINS AND WRITTEN ARTICLES FEATURING INFORMATIONAL BRIEFINGS AND UPDATES IN THE FIELDS OF LAW, BUSINESS, MEDICINE, HEALTHCARE, SCIENCES, DENTISTRY, ACCOUNTING, INSURANCE, REAL ESTATE, ARCHITECTURE, OR EDUCATION; INFORMATION AND ADVISORY SERVICES RELATING TO ELECTRONIC PUBLISHING, IN CLASS 41 (U.S. CLS. 100, 101 AND 107).

OWNER OF INTERNATIONAL REGISTRATION
0916809 DATED 9-25-2006, EXPIRES 9-25-2016.

SER. NO. 79-035,690, FILED 9-25-2006.

CORY BOONE, EXAMINING ATTORNEY

Int. Cl.: 1

Prior U.S. Cls.: 1, 5, 6, 10, 26 and 46

United States Patent and Trademark Office

Reg. No. 3,485,113

Registered Aug. 12, 2008

**TRADEMARK
PRINCIPAL REGISTER**

POWERLYTE

UBE INDUSTRIES, LTD. (JAPAN CORPORATION)
1978-96 O-AZA KOGUSHI
UBE-SHI; YAMAGUCHI-KEN 755-8633
JAPAN

FOR: ELECTROLYTE SOLUTIONS AS CHEMICALS FOR USE IN BATTERIES AND CONDENSERS, IN CLASS 1 (U.S. CLS. 1, 5, 6, 10, 26 AND 46).

THE MARK CONSISTS OF STANDARD CHARACTERS WITHOUT CLAIM TO ANY PARTICULAR FONT, STYLE, SIZE, OR COLOR.

PRIORITY DATE OF 6-16-2006 IS CLAIMED.

OWNER OF INTERNATIONAL REGISTRATION
0917214 DATED 12-4-2006, EXPIRES 12-4-2016.

SER. NO. 79-035,860, FILED 12-4-2006.

GILBERT SWIFT, EXAMINING ATTORNEY

Int. Cls.: 7, 9 and 42

**Prior U.S. Cls.: 13, 19, 21, 23, 26, 31, 34, 35, 36, 38, 100
and 101**

Reg. No. 3,485,114

United States Patent and Trademark Office

Registered Aug. 12, 2008

**TRADEMARK
SERVICE MARK
PRINCIPAL REGISTER**

optoGuard

PROMINENT DOSIERTECHNIK GMBH (FED
REP GERMANY GMBH)
IM SCHUHMACHERGEWANN 5-11
69123 HEIDELBERG
FED REP GERMANY

FOR: ELECTRIC PUMPS, NAMELY, DOSAGE
PUMPS, IN CLASS 7 (U.S. CLS. 13, 19, 21, 23, 31, 34
AND 35).

FOR: MEASURING, SIGNALING, CHECKING,
CONTROLLING, MONITORING AND REGULAT-
ING APPARATUS AND INSTRUMENTS, NAMELY,
ELECTRIC SENSORS FOR FLOW CONTROL; AP-
PARATUS AND INSTRUMENTS FOR MEASURING
AND CONTROLLING THE QUALITY OF THE
DOSING PERFORMANCE AND FOR CORRECT-
ING PRESSURE FLUCTUATION, NAMELY, AUTO-
MATIC PRESSURE CONTROL MACHINES AND
INSTRUMENTS; PHYSICAL APPARATUS AND IN-
STRUMENTS, NAMELY, PRESSURE SENSORS,
FLOW REGULATOR FOR DOMESTIC, COMMER-
CIAL, AGRICULTURAL USE; FLOWMETERS; PRO-
CESSORS, NAMELY VIDEO PROCESSORS,
MICROPROCESSORS, COMPUTER CENTRAL PRO-
CESSING UNITS; APPARATUS AND INSTRU-
MENTS FOR CONDUCTING, SWITCHING,
REGULATING AND CONTROLLING OF ELECTRI-
CITY, NAMELY, ELECTRIC CONDUCTORS, ELEC-
TRIC SWITCHES, VOLTAGE REGULATORS FOR
ELECTRIC POWER, ELECTRIC CONTROLLERS,
ELECTRICAL CONTROLLING DEVICES FOR

MAGNETS; ELECTRICAL CONTROLLING DEVI-
CES FOR PUMPS; DOSING APPARATUS, NAMELY,
DOSIMETERS, MACHINES FOR DISPENSING PRE-
DETERMINED DOSAGES OF LIQUIDS AND GA-
SES; APPARATUS AND INSTRUMENTS FOR
REGULATING AND CONTROLLING OF DOSING
PERFORMANCES, NAMELY, ELECTRICAL AIR
SENSORS, PRESSURE SENSORS, DISTANCE SEN-
SORS, POSITION SENSORS, IN CLASS 9 (U.S. CLS.
21, 23, 26, 36 AND 38).

FOR: DESIGN AND DEVELOPMENT OF COM-
PUTER HARDWARE AND COMPUTER SOFT-
WARE, IN CLASS 42 (U.S. CLS. 100 AND 101).

THE MARK CONSISTS OF STANDARD CHAR-
ACTERS WITHOUT CLAIM TO ANY PARTICULAR
FONT, STYLE, SIZE, OR COLOR.

PRIORITY DATE OF 4-7-2006 IS CLAIMED.

OWNER OF INTERNATIONAL REGISTRATION
0917682 DATED 9-13-2006, EXPIRES 9-13-2016.

SER. NO. 79-036,094, FILED 9-13-2006.

KATHERINE E. HALMEN, EXAMINING ATTOR-
NEY

Int. Cls.: 9, 35, 38, 41 and 42

**Prior U.S. Cls.: 21, 23, 26, 36, 38, 100, 101, 102, 104
and 107**

Reg. No. 3,485,115

United States Patent and Trademark Office

Registered Aug. 12, 2008

**TRADEMARK
SERVICE MARK
PRINCIPAL REGISTER**



KONINKLIJKE KPN N.V. (NETHERLANDS LTD
LIAB CO)
MAANPLEIN 55
NL-2516 CK THE HAGUE
NETHERLANDS

SEMINARS, AND ON-GOING SCHOOL TELEVI-
SION PROGRAMS IN THE FIELD OF TELECOM-
MUNICATION AND INFORMATION
COMMUNICATION TECHNOLOGY, IN CLASS 41
(U.S. CLS. 100, 101 AND 107).

FOR: APPARATUS AND INTERFACES FOR TEL-
ECOMMUNICATION NETWORKS, NAMELY,
COMPUTER HARDWARE AND SOFTWARE FOR
THE OPERATION OF TELECOMMUNICATION
NETWORKS; DECODING APPARATUS FOR DE-
CODING CELLULAR SIGNALS; MAGNETIC AND
OPTIC DATA AND SOUND CARRIERS, NAMELY,
MP3 PLAYERS; PHOTOGRAPHIC CAMERAS; COM-
PUTER CHIPS; BLANK ELECTRONIC CHIP
CARDS; SIM CARDS, NAMELY, SUBSCRIBER
IDENTITY MODULE CARDS; MOBILE TELE-
PHONES; TELEPHONE ANSWERING MACHINES,
IN CLASS 9 (U.S. CLS. 21, 23, 26, 36 AND 38).

FOR: TECHNICAL ADVICE IN RELATION TO
THE INSTALLATION OF COMPUTER SOFTWARE;
TECHNICAL ADVICE IN THE FIELD OF DESIGN-
ING, DEVELOPING, APPLYING AND INSTALLING
TELECOMMUNICATION AND COMPUTERIZA-
TION NETWORK APPARATUS AND INTERFACES
IN PERSON, BY TELEPHONE, AND OVER THE
INTERNET; TECHNICAL ADVICE IN THE FIELD
OF SOFTWARE AND HARDWARE, NAMELY, AD-
VICE RELATING TO THE INSTALLATION OF
SOFTWARE IN PERSON, BY TELEPHONE, AND
OVER THE INTERNET; INSTALLATION OF COM-
PUTER SOFTWARE; INSTALLING, MAINTAINING
AND UPDATING OF COMPUTER SOFTWARE FOR
OTHERS, IN CLASS 42 (U.S. CLS. 100 AND 101).

FOR: ADVERTISING SERVICES; BUSINESS
MANAGEMENT; BUSINESS ADMINISTRATION;
ARRANGING AND CONDUCTING FAIRS AND
EXHIBITIONS FOR PUBLICITY AND COMMER-
CIAL PURPOSES, IN CLASS 35 (U.S. CLS. 100, 101
AND 102).

PRIORITY DATE OF 8-26-2006 IS CLAIMED.

FOR: TELECOMMUNICATION SERVICES,
NAMELY, PROVIDING CELLULAR TELEPHONE
NETWORK SERVICES; PROVIDING MULTIPLE
USER DIAL-UP AND DEDICATED ACCESS TO
THE INTERNET; ELECTRONIC DATA TRANSFER
BY TELECOMMUNICATIONS, IN CLASS 38 (U.S.
CLS. 100, 101 AND 104).

OWNER OF INTERNATIONAL REGISTRATION
0917950 DATED 9-29-2006, EXPIRES 9-29-2016.

OWNER OF U.S. REG. NO. 2,457,515.

SER. NO. 79-036,176, FILED 9-29-2006.

FOR: EDUCATION AND ENTERTAINMENT
SERVICES, NAMELY, PROVIDING COURSES,

KATHERINE E. HALMEN, EXAMINING ATTOR-
NEY

Int. Cl.: 7

Prior U.S. Cls.: 13, 19, 21, 23, 31, 34 and 35

Reg. No. 3,485,116

United States Patent and Trademark Office

Registered Aug. 12, 2008

TRADEMARK
PRINCIPAL REGISTER

KAYABA

KAYABA INDUSTRY CO., LTD.; (KAYABA KOGYO KABUSHIKI KAISHA) (JAPAN CORPORATION)
WORLD TRADE CENTER BLDG.,
4-1, HAMAMATSU-CHO 2-CHOME., MINATO-KU;-
TOKYO 105-6111
JAPAN

FOR: CUTTER LOADERS; ROCK DRILLS; TRUCK CRANES; CONCRETE MIXERS; POWER JACKS; HYDRAULIC JACKS; WINCHES; DISINTEGRATORS FOR CHEMICAL PROCESSING; AGITATING MACHINES FOR CHEMICAL PROCESSING; MIXING OR BLENDING MACHINES FOR CHEMICAL PROCESSING; RICE OR BARLEY POLISHING MACHINES; AGRICULTURAL MACHINES, NAMELY, WHEELLOADERS, HARVESTERS, COMBINES, LOAD ROLLERS AND CARRIERS FOR HARVESTING; FOOD MIXING MACHINES FOR COMMERCIAL USE; FOOD PEELING MACHINES FOR COMMERCIAL USE; DISH WASHING MACHINES FOR INDUSTRIAL PURPOSES; FOOD CUTTING, CHOPPING AND SLICING MACHINES FOR COMMERCIAL USE; HYDRAULIC ACTUATORS, NAMELY, MACHINE ELEMENTS NOT FOR LAND VEHICLES; CYLINDERS ,NAMELY, MACHINE ELEMENTS NOT FOR LAND VEHICLES; REDUCTION GEARS, NAMELY, MACHINE ELEMENTS NOT FOR LAND VEHICLES; HYDRAULIC SPEED CHANGE GEARS NOT FOR LAND VEHICLES; OTHER POWER TRANSMISSIONS AND

GEARINGS FOR MACHINES MACHINE ELEMENTS NOT FOR LAND VEHICLES; SHOCK ABSORBERS, NAMELY, MACHINE ELEMENTS NOT FOR LAND VEHICLES; OIL BUFFERS, NAMELY, MACHINE ELEMENTS NOT FOR LAND VEHICLES; DISC BRAKES, NAMELY, MACHINE ELEMENTS NOT FOR LAND VEHICLES; BRAKE PADS, NAMELY, MACHINE ELEMENTS NOT FOR LAND VEHICLES; BRAKES FOR MACHINES AND NOT FOR LAND VEHICLES; PISTON PUMPS, VANE PUMPS AND GEAR PUMPS; RELIEF BALL VALVES AND CHECK BALL VALVES NOT FOR LAND VEHICLES; LAWNMOWERS; ELECTRIC STEERING PUMPS AND HYDRAULIC STEERING PUMPS, IN CLASS 7 (U.S. CLS. 13, 19, 21, 23, 31, 34 AND 35).

THE MARK CONSISTS OF STANDARD CHARACTERS WITHOUT CLAIM TO ANY PARTICULAR FONT, STYLE, SIZE, OR COLOR.

OWNER OF INTERNATIONAL REGISTRATION 0833559 DATED 2-6-2004, EXPIRES 2-6-2014.

OWNER OF U.S. REG. NOS. 1,036,733, 2,703,551 AND OTHERS.

SER. NO. 79-036,229, FILED 6-12-2006.

DOMINIC FATHY, EXAMINING ATTORNEY

Int. Cls.: 9 and 41

Prior U.S. Cls.: 21, 23, 26, 36, 38, 100, 101 and 107

Reg. No. 3,485,117

United States Patent and Trademark Office

Registered Aug. 12, 2008

**TRADEMARK
SERVICE MARK
PRINCIPAL REGISTER**

ETTAMOGAH

SOUTHERN EQUITY PTY LTD (AUSTRALIA
INCORPORATED COMPANY)
228-230 BAY STREET
BRIGHTON VIC 3186
AUSTRALIA

FOR: LUMINOUS INFLATABLE SIGNS; AUTOMATIC VENDING MACHINES AND COIN ACCEPTORS FOR COIN-OPERATED APPARATUS FOR SEPARATING GOOD COINS FROM COUNTERFEITS; PRERECORDED VIDEO DISKS AND VIDEO TAPES FEATURING ANIMATED CARTOONS; BINOCULARS; CALCULATORS; RADIOS INCORPORATING CLOCKS, TIME CLOCKS, TELEPHONES INCORPORATING CLOCKS; DIRECTIONAL COMPASSES; COMPUTER HARDWARE AND COMPUTER SOFTWARE, NAMELY, COMPUTER GAME PROGRAMS AND COMPUTER GAME SOFTWARE; DOWNLOADABLE COMPUTER GAME PROGRAMS; COMPUTER GAME PROGRAMS AND COMPUTER GAME SOFTWARE FOR USE WITH ELECTRONIC GAMES OF ALL KINDS; MOTION PICTURE FILMS IN THE FIELD OF ANIMATION, DRAMA, COMEDY, MUSICALS AND DOCUMENTARIES; CD-ROMS, DVDS AND COMPUTER MEDIA FEATURING ANIMATED CARTOONS, LIVE ACTION, MOTION PICTURE FILMS IN THE FIELD OF DRAMA, COMEDY, MUSICALS, DOCUMENTARIES, TELEVISION SERIES AND INTERSTITIALS; PRERECORDED AUDIO AND VIDEO CASSETTES FEATURING ANIMATED CARTOONS, LIVE ACTION, MOTION PICTURE FILMS IN THE FIELD OF DRAMA, COMEDY, MUSICALS, DOCUMENTARIES, SHORT FILMS, TELEVISION SERIES OR MUSIC; DOWNLOADABLE ELECTRONIC PUBLICATIONS IN THE NATURE OF MAGAZINES, BOOKS, AND DOCUMENTS FEATURING ANIMATED CARTOONS, DRAWINGS, STORIES AND PHOTOGRAPHIC IMAGES; ELECTRONIC MULTIMEDIA PUBLICATIONS IN THE NATURE OF MAGAZINES, BOOKS, AND DOCUMENTS FEATURING ANIMATED CARTOONS, LIVE ACTION, MOTION PICTURE FILMS IN THE FIELD OF DRAMA, COMEDY, MUSICALS, DOCUMENTARIES, TELEVISION SERIES AND INTERSTITIALS RECORDED ON COMPUTER MED-

IA; MOUSE PADS; EYEGLASS CASES; SUNGLASSES, EYEGLASS SUPPORT BANDS, CHAINS, CORDS AND STRAPS; PROTECTION AND SAFETY FLOATS FOR BATHING AND SWIMMING IN THE NATURE OF FLOTATION VESTS AND INFLATABLE FLOTATION DEVICES; GOGGLES FOR SPORTS; SWIMMING MASKS AND SNORKELS; PROTECTIVE FOOTWEAR INCLUDING BOOTS AND REINFORCED SHOES FOR PROTECTION AGAINST ACCIDENTS, IRRADIATION AND FIRE; PROTECTIVE HELMETS FOR SPORTS; BLANK SMART CARDS IN THE NATURE OF BLANK INTEGRATED CIRCUIT CARDS; MOBILE PHONE COVERS; PORTABLE AND MOBILE TELEPHONES; WALKIE-TALKIES; DECORATIVE MAGNETS; CAMERAS; RADIOS; AUDIO AND VIDEO CASSETTE PLAYERS AND RECORDERS; VIDEO GAME CARTRIDGES, PRERECORDED VIDEOTAPES, CDS, DVDS AND COMPUTER MEDIA FEATURING ANIMATED CARTOONS, LIVE ACTION, MOTION PICTURES, FILMS, SHORT FILMS, TELEVISION SERIES OR MUSIC; STEREOSCOPIC SLIDE VIEWERS IN THE NATURE OF A SLIDE PROJECTION APPARATUS AND EXPOSED SLIDE REEL FILMS; CONTACT LENSES; DOWNLOADABLE ANIMATED FILMS, CARTOONS, LIVE ACTION FILMS, DRAMA, COMEDY, MUSICAL AND DOCUMENTARY FILMS, MUSICAL PERFORMANCES, MUSICAL VIDEOS, MUSICAL RELATED FILM CLIPS, PHOTOGRAPHS AND OTHER MULTI-MEDIA MATERIALS VIA A GLOBAL COMPUTER NETWORK, IN CLASS 9 (U.S. CLS. 21, 23, 26, 36 AND 38).

FOR: ENTERTAINMENT SERVICES IN THE NATURE OF ON-GOING TELEVISION PROGRAMS, INTERSTITIALS, DIRECT TO VIDEO FILMS, SERIALIZED STORIES, PROGRAMS AND FILMS IN THE FIELD OF ANIMATED CARTOONS AND LIVE ACTION; EDUCATIONAL SERVICES, NAMELY, CONDUCTING CLASSES IN THE FIELD OF CHILDREN'S LEARNING AND DEVELOPMENT; ORGANIZING COMMUNITY SPORTING AND CULTURAL ACTIVITIES; PROVIDING AMUSEMENT PARK AND THEME PARK SERVICES;

AMUSEMENT CENTERS; NIGHT CLUBS, MOVIE THEATRES AND CINEMA THEATRES; PROVIDING AMUSEMENT ARCADE SERVICES; PRODUCING MOTION PICTURES, PLAYS, VIDEOS, MULTI-MEDIA ENTERTAINMENT SOFTWARE, COMPUTER GAMES, ANIMATED MOTION PICTURE FILMS, ANIMATED CARTOONS, TELEVISION PROGRAMS, LIVE ACTION, PLAYS, MOTION PICTURES, SHORT FILMS AND INTERSTITIALS; PROVIDING ON-LINE ELECTRONIC PUBLICATIONS IN THE NATURE OF MAGAZINES, BOOKS AND DOCUMENTS FEATURING ANIMATED CARTOONS, PHOTOGRAPHIC IMAGES, DRAWINGS AND STORIES; PUBLICATION OF BOOKS; ENTERTAINMENT IN THE FORM OF VISUAL AND AUDIO PERFORMANCES, DRAMATIC PLAYS AND LIVE MUSICAL PERFORMANCES BY A MUSICAL BAND OR ARTISTS; ENTERTAINMENT IN THE FORM LIVE PERFORMANCES FEATURING PRE-RECORDED DRAMATIC, ANIMATED AND MUSICAL PERFORMANCES VIEWED ON A BIG SCREEN; ENTERTAINMENT, NAMELY, PROVIDING A WEBSITE FEATURING NON-DOWNLOADABLE, AND STREAMED ANIMATED FILMS, CARTOONS, LIVE ACTION FILMS,

DRAMA, COMEDY, MUSICAL AND DOCUMENTARY FILMS, MUSICAL PERFORMANCES, MUSICAL VIDEOS, MUSICAL RELATED FILM CLIPS, PHOTOGRAPHS AND OTHER MULTI-MEDIA MATERIALS VIA A GLOBAL COMPUTER NETWORK, IN CLASS 41 (U.S. CLS. 100, 101 AND 107).

THE MARK CONSISTS OF STANDARD CHARACTERS WITHOUT CLAIM TO ANY PARTICULAR FONT, STYLE, SIZE, OR COLOR.

OWNER OF INTERNATIONAL REGISTRATION 0918263 DATED 11-2-2006, EXPIRES 11-2-2016.

OWNER OF U.S. REG. NOS. 2,790,502 AND 3,184,034.

THE ENGLISH TRANSLATION OF "ETTAMOGAH" IS LET'S HAVE A DRINK.

SER. NO. 79-036,295, FILED 11-2-2006.

PAULA MAHONEY, EXAMINING ATTORNEY

Int. Cls.: 9, 16 and 42

**Prior U.S. Cls.: 2, 5, 21, 22, 23, 26, 29, 36, 37, 38, 50,
100 and 101**

Reg. No. 3,485,118

United States Patent and Trademark Office

Registered Aug. 12, 2008

**TRADEMARK
SERVICE MARK
PRINCIPAL REGISTER**

SAFETI

DET NORSKE VERITAS AS (NORWAY COR-
PORATION)
VERITASVELEN 1
N-1363 HØVIK
NORWAY

FOR: COMPUTER SOFTWARE FOR QUANTITA-
TIVE RISK ASSESSMENT FOR USE IN THE PRO-
CESS INDUSTRY, CHEMICAL INDUSTRY,
PETROCHEMICAL INDUSTRY, OFFSHORE IN-
DUSTRY AND MARITIME INDUSTRY, IN CLASS
9 (U.S. CLS. 21, 23, 26, 36 AND 38).

FOR: BROCHURES IN THE FIELD OF THE
PROCESS INDUSTRY, CHEMICAL INDUSTRY,
PETROCHEMICAL INDUSTRY, OFFSHORE IN-
DUSTRY AND MARITIME INDUSTRY, IN CLASS
16 (U.S. CLS. 2, 5, 22, 23, 29, 37, 38 AND 50).

FOR: SCIENTIFIC RESEARCH AND SCIENTIFIC
TECHNOLOGICAL CONSULTATION SERVICES IN
THE FIELD OF QUANTITATIVE RISK ASSES-
MENT; DESIGN AND DEVELOPMENT OF COMPU-
TER SOFTWARE AND SERVICES FOR OTHERS;

COMPUTER SERVICES, NAMELY, INSTALLATION
AND MAINTENANCE OF COMPUTER SOFTWARE
FOR OTHERS, UPDATING OF COMPUTER SOFT-
WARE FOR OTHERS, COMPUTER SYSTEMS ANA-
LYSIS FOR OTHERS; TECHNICAL SUPPORT
SERVICES, NAMELY, TROUBLESHOOTING OF
COMPUTER SOFTWARE PROBLEMS FOR OTH-
ERS, IN CLASS 42 (U.S. CLS. 100 AND 101).

THE MARK CONSISTS OF STANDARD CHAR-
ACTERS WITHOUT CLAIM TO ANY PARTICULAR
FONT, STYLE, SIZE, OR COLOR.

PRIORITY DATE OF 4-6-2006 IS CLAIMED.

OWNER OF INTERNATIONAL REGISTRATION
0918415 DATED 10-5-2006, EXPIRES 10-5-2016.

SER. NO. 79-036,358, FILED 10-5-2006.

WILLIAM ROSSMAN, EXAMINING ATTORNEY

Int. Cl.: 33

Prior U.S. Cls.: 47 and 49

United States Patent and Trademark Office

Reg. No. 3,485,119

Registered Aug. 12, 2008

**TRADEMARK
PRINCIPAL REGISTER**

HIGHER OCTAVE

HUNGERFORD HILL WINES; PTY LIMITED
(AUSTRALIA PRIVATE PROPRIETARY LIMITED COMPANY)

SUITE 115

JONES BAY WHARF, 19-21 PIRRAMA ROAD
PYRMONT NSW 2009, AUSTRALIA

FOR: ALCOHOLIC BEVERAGES, NAMELY,
WINE AND PORT WINE, IN CLASS 33 (U.S. CLS. 47
AND 49).

THE MARK CONSISTS OF STANDARD CHARACTERS WITHOUT CLAIM TO ANY PARTICULAR FONT, STYLE, SIZE, OR COLOR.

OWNER OF INTERNATIONAL REGISTRATION
0918593 DATED 3-6-2007, EXPIRES 3-6-2017.

SER. NO. 79-036,435, FILED 3-6-2007.

GIANCARLO CASTRO, EXAMINING ATTORNEY

Int. Cl.: 33

Prior U.S. Cls.: 47 and 49

United States Patent and Trademark Office

Reg. No. 3,485,120

Registered Aug. 12, 2008

**TRADEMARK
PRINCIPAL REGISTER**

HEAVY METAL

HUNGERFORD HILL WINES; PTY LIMITED
(AUSTRALIA PRIVATE PROPRIETARY LIMITED COMPANY)

SUITE 115

JONES BAY WHARF, 19-21 PIRRAMA ROAD
PYRMONT NSW 2009, AUSTRALIA

FOR: ALCOHOLIC BEVERAGES, NAMELY,
WINE AND PORT WINE, IN CLASS 33 (U.S. CLS. 47
AND 49).

THE MARK CONSISTS OF STANDARD CHARACTERS WITHOUT CLAIM TO ANY PARTICULAR FONT, STYLE, SIZE, OR COLOR.

OWNER OF INTERNATIONAL REGISTRATION
0918594 DATED 3-6-2007, EXPIRES 3-6-2017.

SER. NO. 79-036,436, FILED 3-6-2007.

GIANCARLO CASTRO, EXAMINING ATTORNEY

Int. Cls.: 3, 5, 8, 9, 11, 21 and 35

Prior U.S. Cls.: 1, 2, 4, 6, 13, 18, 21, 23, 26, 28, 29, 30, 31, 33, 34, 36, 38, 40, 44, 46, 50, 51, 52, 100, 101 and 102

Reg. No. 3,485,121

United States Patent and Trademark Office

Registered Aug. 12, 2008

**TRADEMARK
SERVICE MARK
PRINCIPAL REGISTER**



KEVIN.MURPHY

THE LAZY AUSSIE PTY LTD; ACN 090 677 455
(AUSTRALIA CORPORATION)

23A WESTSIDE DRIVE

LAVERTON NORTH VIC 3026, AUSTRALIA

FOR: TALCUM POWDER FOR COSMETIC PURPOSES; NON-MEDICATED HAIR CARE PREPARATIONS; HAIR STYLING PREPARATIONS; COLOGNE AND EAU DE TOILETTE; HAIR BLEACHING PREPARATIONS AND LIGHTENERS; SHAVING CREAMS; HAIR GELS AND HAIR LOTIONS; AFTER-SHAVE LOTIONS; PERFUMERY; ESSENTIAL OILS; COSMETICS; DENTIFRICES, IN CLASS 3 (U.S. CLS. 1, 4, 6, 50, 51 AND 52).

FOR: MEDICATED HAIR CARE PREPARATIONS; HAIR GROWTH STIMULANTS FOR MEDICAL PURPOSES AND VITAMIN AND MINERAL SUPPLEMENTS, IN CLASS 5 (U.S. CLS. 6, 18, 44, 46, 51 AND 52).

FOR: ELECTRIC AND NON-ELECTRIC RAZORS, MANICURE AND PEDICURE IMPLEMENTS, NAMELY, NAIL FILES, NAIL CLIPPERS, CUTICLE PUSHERS, TWEEZERS, NAIL AND CUTICLE SCISSORS; HAND TOOLS AND HAND OPERATED IMPLEMENTS, NAMELY, NON-ELECTRIC CURLING IRONS, NON-ELECTRIC FLAT IRONS FOR HAIR, AND EYELASH CURLERS; CUTLERY; RAZORS, IN CLASS 8 (U.S. CLS. 23, 28 AND 44).

FOR: ELECTRIC HAIR CURLERS AND ELECTRIC CURLING IRONS; APPARATUS FOR RECORDING, TRANSMISSION OR REPRODUCTION OF SOUND OR IMAGES; BLANK MAGNETIC DATA CARRIERS, RECORDING DISCS, NAMELY, BLANK RECORDABLE OPTICAL DISCS; AUTOMATIC VENDING MACHINES; CASH REGISTERS, CALCULATING MACHINES; FIRE-EXTINGUISHERS, IN CLASS 9 (U.S. CLS. 21, 23, 26, 36 AND 38).

FOR: HAND-HELD ELECTRIC HAIR DRYERS; CURLING LAMPS, HAIR DRYERS AND ELECTRIC FACIAL STEAMERS, IN CLASS 11 (U.S. CLS. 13, 21, 23, 31 AND 34).

FOR: SHAVING BRUSHES; HOUSEHOLD UTENSILS, NAMELY, COSMETIC BRUSHES AND SOAP DISPENSERS; COMBS, NAMELY, ELECTRIC COMBS AND HAIR COMBS; BATH AND BODY SPONGES; BRUSHES, NAMELY, HAIR BRUSHES, ABRASIVE SCRUBBING BRUSHES FOR THE SKIN, NAIL BRUSHES AND LIP BRUSHES; BRUSH-MAKING MATERIALS; STEEL WOOL FOR CLEANING; UNWORKED OR SEMI-WORKED GLASS NOT FOR BUILDING; BEVERAGE GLASSWARE AND PORCELAIN BOWLS, IN CLASS 21 (U.S. CLS. 2, 13, 23, 29, 30, 33, 40 AND 50).

FOR: RETAIL STORES FEATURING HAIR CARE PRODUCTS, SKIN CARE PRODUCTS, TALCUM POWDER, PERFUMERY, ESSENTIAL OILS, COLOGNE AND EAU DE TOILETTE, SHAVING

CREAMS, GELS AND LOTIONS, SOAPS, HAIR GROWTH STIMULANTS AND VITAMIN AND MINERAL SUPPLEMENTS, COSMETICS, RAZORS, MANICURE AND PEDICURE PRODUCTS, ELECTRIC HAIR DRYERS, CURLERS AND CURLING IRONS, SHAVING BRUSHES AND APPARATUS FOR RECORDING, TRANSMISSION OR REPRODUCTION OF SOUND OR IMAGES; BUSINESS INTERMEDIARY AND ADVISORY SERVICES IN THE FIELD OF SELLING PRODUCTS AND RENDERING SERVICES, NAMELY, INTERMEDIARY BUSINESS SERVICES RELATING TO THE COMMERCIALIZATION OF HAIR CARE PRODUCTS, SKIN CARE PRODUCTS, TALCUM POWDER, PERFUMERY, ESSENTIAL OILS, COLOGNE AND EAU DE TOILETTE, SHAVING CREAMS, GELS AND LOTIONS, SOAPS, HAIR GROWTH STIMULANTS AND VITAMIN AND MINERAL SUPPLEMENTS, COSMETICS, RAZORS, MANICURE AND PEDICURE PRODUCTS, ELECTRIC HAIR DRYERS, CURLERS AND CURLING IRONS, SHAVING BRUSHES AND APPARATUS FOR RECORDING, TRANSMISSION OR REPRODUCTION OF SOUND OR IMAGES; DISTRIBUTORSHIPS IN THE FIELD OF HAIR CARE PRODUCTS, SKIN CARE PRODUCTS, TALCUM POWDER, PERFUMERY, ESSEN-

TIAL OILS, COLOGNE AND EAU DE TOILETTE, SHAVING CREAMS, GELS AND LOTIONS, SOAPS, HAIR GROWTH STIMULANTS AND VITAMIN AND MINERAL SUPPLEMENTS, COSMETICS, RAZORS, MANICURE AND PEDICURE PRODUCTS, ELECTRIC HAIR DRYERS, CURLERS AND CURLING IRONS, SHAVING BRUSHES AND APPARATUS FOR RECORDING, TRANSMISSION OR REPRODUCTION OF SOUND OR IMAGES, IN CLASS 35 (U.S. CLS. 100, 101 AND 102).

PRIORITY DATE OF 11-1-2006 IS CLAIMED.

OWNER OF INTERNATIONAL REGISTRATION 0919233 DATED 11-22-2006, EXPIRES 11-22-2016.

THE NAME "KEVIN MURPHY" IDENTIFIES A LIVING INDIVIDUAL WHOSE CONSENT IS OF RECORD.

SER. NO. 79-036,643, FILED 11-22-2006.

KATHERINE E. HALMEN, EXAMINING ATTORNEY

Int. Cl.: 16

Prior U.S. Cls.: 2, 5, 22, 23, 29, 37, 38 and 50

Reg. No. 3,485,122

United States Patent and Trademark Office

Registered Aug. 12, 2008

TRADEMARK
PRINCIPAL REGISTER

LIHIT LAB.

LIHIT LAB. INC. (JAPAN CORPORATION)
1-22, NONINBASHI 1-CHOME,
CHUO-KU, OSAKA-SHI., OSAKA 540-8526
JAPAN

FOR: PAPER OTHER THAN "JAPANESE PAPER"; PAPERBOARD; JAPANESE PAPER; SEMI-PROCESSED PAPER; CELLOPHANE PAPER; SYNTHETIC PAPER; PAPERBOARD BOXES FOR INDUSTRIAL PACKAGING; PAPER BAGS AND SACKS; CORRUGATED CARDBOARD BOXES; FIBERBOARD BOXES; FOOD WRAPPING PLASTIC FILM FOR HOUSEHOLD USE; GARBAGE BAGS OF PAPER FOR HOUSEHOLD USE; GARBAGE BAGS OF PLASTIC FOR HOUSEHOLD USE; HYGIENIC PAPER; TOWELS OF PAPER; TABLE NAPKINS OF PAPER; HAND TOWELS OF PAPER; HANDKERCHIEFS OF PAPER; TAILORS' CHALKS; TABLE CLOTHS OF PAPER; BANNERS OF PAPER; FLAGS OF PAPER; BAGGAGE TAGS; PICTURE POSTCARDS; SHEET MUSIC; SONG BOOKS; CATALOGUES IN THE FIELD OF STATIONERY, OFFICE EQUIPMENT AND SUPPLIES, AND SUNDRIES; CALENDARS; NEWSPAPERS; GEOGRAPHICAL MAPS; DIARIES; NEWSLETTERS IN THE FIELD OF STATIONERY, OFFICE EQUIPMENT AND SUPPLIES, AND SUNDRIES; PAMPHLETS AND BROCHURES IN THE FIELD OF STATIONERY, OFFICE EQUIPMENT AND SUPPLIES, AND SUNDRIES; PAINTINGS AND THEIR REPRODUCTIONS; HANGING SCROLLS OF PAPER FOR MOUNTING PICTURES, NAMELY, CALLIGRAPHIC WORK OR THE LIKE KNOWN AS JIKU IN JAPANESE; CALLIGRAPHIC WORKS AND THEIR REPRODUCTIONS; ENGRAVINGS AND THEIR REPRODUCTIONS; PHOTOGRAPHS; PHOTOGRAPH STANDS; FILES FOR STATIONARY PURPOSES; FOLDERS; METAL PAPER FASTENERS USED IN FILES; PLASTIC PAPER FASTENERS USED IN FILES; PAPER FASTENERS USED IN FILES; FILING BOXES MADE OF PAPER OR OF PLASTIC; CASES FOR STAMPS; INDEX CARDS; PAPER INDEXES USED IN BINDERS AND FILES; INDEX TABS USED IN BINDERS AND FILES; PHOTO AND STAMP ALBUMS; ALBUMS USED FOR COLLECTIONS OF CLIPPINGS; GREETING CARDS, NOTE CARDS; CARBON PAPER; RULED PAPER; SCRAPBOOKS; SKETCH

BOOKS; SCORE-CARDS; SCORE-BOOKS; ACCOUNT BOOKS; POCKET MEMORANDUM BOOKS; ACCOUNT SLIP PADS; STENCIL PAPER; TRACING CLOTH, NAMELY, TRACING PAPER FOR WRITING AND DRAWING; TRACING PAPER; WRITING PADS; ENVELOPES; GRAPH PLOTTING PAPERS; BUSINESS CARD PAPER; LETTER PAPER; PENCILS; PENCIL POINT PROTECTORS; FELT WRITING PENS; MECHANICAL PENCILS; SLATE PENCILS; STEEL PENS; CHALKS; FELT MARKING PENS; PEN NIBS; PENHOLDERS; BALLPOINT PENS; FOUNTAIN PENS; WRITING BRUSHES; PAINTERS' EASELS; SILK CANVAS FOR PAINTING; DRAWING BOARDS; CANVAS FOR PAINTING; CRAYONS; PAINTBRUSHES; PASTELLES; PALETTES FOR PAINTING; CHARCOAL PENCILS; WRITING INK; INK ERASERS; INKWELLS; SEALING STAMPS; STAMP CASES; STAMP STANDS; SEAL INK PADS; NON-ELECTRIC PENCIL SHARPENERS; THUMB TACKS; PAPER CLIPS; RUBBER ERASERS; BLACKBOARDS; BLACKBOARD ERASERS; PRICE TAGS; PAPER GIFT TAGS; SEALS; BOOKMARKS; RULERS FOR DRAFTING AND DRAWING, UNGRADUATED RULERS; LETTER RACKS; PAPER FOLDERS; INK STONES; INKING PADS FOR SEALS AND STAMPS; STICKERS; WRITING SLATES; ADHESIVE TAPES FOR STATIONERY PURPOSES; ADHESIVE TAPE DISPENSERS; TANZAKU, NAMELY, STRIPS OF FANCY PAPER; TERRESTRIAL GLOBES; PRICE TAGS; NUMBERING STAMPS; DATE STAMPS; STANDS FOR PEN AND PENCIL; PEN AND PENCIL CASES AND BOXES; PAPERWEIGHTS; PROTRACTORS; PAPER KNIVES; INDIA INKS; STAPLING PRESSES; MIZUHIKI, NAMELY, JAPANESE CEREMONIAL ENVELOPES; FINGER-STALLS; PAPER AND PLASTIC LABELS, ADDRESS LABELS NOT OF TEXTILE; ELECTRIC OFFICE PUNCHES; NON-ELECTRIC TWO-HOLE PUNCHES; OFFICE PAPER DRILLS INCLUDING ONES CONTROLLED BY MICROCOMPUTERS; PARTS FOR ELECTRIC OFFICE PUNCHES, NAMELY, BORING BITS AND PROTECTION PLATES; WIRES AND TAPES FOR BOOKBINDING; PAPER CUTTERS; PAPER HOLE PUNCHES; BLANK TAPES AND CARDS FOR THE RECORDING OF COMPUTER PROGRAMS; PAPER SHREDDERS; ADDRESSING MACHINES; INKING RIBBONS;

HECTOGRAPH DUPLICATING MACHINES; AUTOMATIC STAMP PUTTING-ON MACHINES FOR OFFICES; ELECTRIC STAPLERS FOR OFFICES; ENVELOPE SEALING MACHINES FOR OFFICES; STAMP OBLITERATING MACHINES FOR OFFICES; DRAWING INSTRUMENTS; TYPEWRITERS; CHECK WRITING MACHINES FOR OFFICES; MIMEOGRAPHS; RELIEF DUPLICATING MACHINE; FRANKING MACHINES; ROTARY DUPLICATORS; PRINTERS' REGLETS; PRINTING TYPES; MARKING TEMPLATES; DECORATORS PAINTBRUSHES; MARKING TEMPLATES; PASSPORT HOLDERS;

HOLDERS FOR CHECKBOOKS; COMMUTER-PASS HOLDERS, IN CLASS 16 (U.S. CLS. 2, 5, 22, 23, 29, 37, 38 AND 50).

OWNER OF INTERNATIONAL REGISTRATION
0761671 DATED 1-19-2001, EXPIRES 1-19-2011.

SER. NO. 79-036,809, FILED 7-31-2006.

WILLIAM ROSSMAN, EXAMINING ATTORNEY

Int. Cls.: 1, 5, 29, 30, 31, 32, 33, 35, 39 and 40

**Prior U.S. Cls.: 1, 5, 6, 10, 18, 26, 44, 45, 46, 47, 48, 49,
51, 52, 100, 101, 102, 103, 105 and 106**

Reg. No. 3,485,123

United States Patent and Trademark Office

Registered Aug. 12, 2008

**TRADEMARK
SERVICE MARK
PRINCIPAL REGISTER**

DROGA KOLINSKA

DROGA KOLINSKA, ZIVILSKA INDUSTRIJA,
D.D. (SLOVENIA JOINT STOCK COMPANY)

KOLINSKA ULICA 1

SI-1544 LJUBLJANA, SLOVENIA

FOR: CHEMICAL PRODUCTS FOR INDUSTRIAL USE FOR PRESERVING, PRODUCING AND PROCESSING FOOD IN THE FIELD OF SCIENCE, AGRICULTURE, HORTICULTURE AND FORESTRY; CHEMICAL PRODUCTS FOR FRESH KEEPING AND PRESERVING FOOD; CHEMICAL ADDITIVES FOR USE IN THE MANUFACTURE OF FOOD AND IN THE FOOD PROCESSING INDUSTRY; CHEMICAL ADDITIVES FOR USE IN THE MANUFACTURE OF PHARMACEUTICALS, IN CLASS 1 (U.S. CLS. 1, 5, 6, 10, 26 AND 46).

FOR: SANITARY PREPARATIONS FOR MEDICAL PURPOSES; DIETETIC FOODS ADAPTED FOR MEDICAL USE, FOOD FOR BABIES; MEDICAL PLASTERS, WOUND DRESSINGS; ALL PURPOSE DISINFECTANTS; FOOD FOR CHILDREN ON MEDICALLY RESTRICTED DIETS; FOOD FOR DIABETIC CHILDREN; FOOD FOR INFANTS; MEDICINAL TEAS; MEDICINAL HERB EXTRACTS; MEDICATED CONFECTIONERY; CONFECTIONERY FOR MEDICAL PURPOSES; TINCTURES OF MEDICINAL AND AROMATIC HERBS FOR PHARMACEUTICAL USE; EXTRACTS OF MEDICINAL AND AROMATIC HERBS FOR PHARMACEUTICAL USE; HERBAL MUD PACKS FOR MEDICINAL BATHS; HERBAL MUD PACKS FOR MEDICINAL USE, IN CLASS 5 (U.S. CLS. 6, 18, 44, 46, 51 AND 52).

FOR: MEAT, FISH, POULTRY AND GAME; MEAT EXTRACTS; PRESERVED, DRIED AND COOKED FRUITS AND VEGETABLES, JELLIES, JAMS, COMPOTES; EGGS, MILK AND MILK PRODUCTS, EXCLUDING ICE CREAM, ICE MILK AND FROZEN YOGURT; EDBLE OILS AND FATS, IN CLASS 29 (U.S. CL. 46).

FOR: COFFEE, TEA, COCOA, SUGAR, RICE, TAPIOCA, SAGO, ARTIFICIAL COFFEE; FLOURS; PREPARATIONS MADE FROM CEREALS, NAMELY, WHOLE WHEAT BARS, GRANOLA BARS, ENERGY BARS, BUCKWHEAT PORRIDGE, PROCESSED BARLEY OATS, SPELT, MILLET PORRIDGE, POLENTA, COUSCOUS, GROATS, PROCESSED SEMOLINA, CORN MUSH, BUCKWHEAT MUSH, WHEAT MUSH, BRAN FLAKES, CORN FLAKES, MUESLI, MUESLI FLAKES; BREAD, PASTRY; CONFECTIONERY, NAMELY, CANDY AND CRYSTAL SUGAR PIECES, PASTILLES, FRUIT JELLIES, CONFECTIONERY CHIPS FOR BAKING, LOLLIPOPS, CANDIES, SWEETS, GUM SWEETS, SUGAR BARS, CHEWING GUM, COCOA SPREADS, CHOCOLATE AND CHOCOLATES, CHOCOLATE BARS, CHOCOLATE CANDIES, CHOCOLATE COVERED CHERRIES, CHOCOLATE COVERED WAFERS, AND WAFERS; EDIBLE FRUIT ICES; FLAVOURED ICES; FRUIT ICES; HONEY; TREACLE SYRUP; YEAST; BAKING-POWDER; SALT, MUSTARD; VINEGAR; SAUCES; CONDIMENTS, NAMELY, PEPPER SAUCE, PICKLED GINGER, PIMENTO, SOYA BEAN PASTE, HORSE RADISH SAUCE; SPICES; ICE FOR REFRESHMENT, IN CLASS 30 (U.S. CL. 46).

FOR: FRESH FRUITS AND VEGETABLES; NATURAL SEEDS, PLANTS AND FLOWERS; ANIMAL FOODSTUFFS; MALT FOR BREWING AND DISTILLING, IN CLASS 31 (U.S. CLS. 1 AND 46).

FOR: BEERS; MINERAL AND AERATED WATERS AND OTHER NON-ALCOHOLIC DRINKS, NAMELY NON-ALCOHOLIC COCKTAIL MIXES, ENERGY DRINKS, CARAMEL DRINKS, HERBAL DRINKS, NATURAL MINERAL WATERS, FRUIT MINERAL DRINKS, CARBONATED SOFT DRINKS, AND NON-CARBONATED SOFT DRINKS; FRUIT DRINKS AND FRUIT JUICES; SYRUPS FOR MAKING BEVERAGES; DRINKING WATERS, TABLE WATERS, AERATED WATERS, SPRING WATERS, FRUIT FLAVOURED BEVERAGES MADE WITH WATER AND FRUIT EXTRACTS; MINERAL WA-

TER WITH HIGH MAGNESIUM CONTENT, IN CLASS 32 (U.S. CLS. 45, 46 AND 48).

FOR: ALCOHOLIC BEVERAGES, EXCEPT BEERS, IN CLASS 33 (U.S. CLS. 47 AND 49).

FOR: ADVERTISING SERVICES; BUSINESS MANAGEMENT; BUSINESS ADMINISTRATION; PROVIDING OFFICE FUNCTIONS; MARKET RESEARCH, MARKET RESEARCH STUDIES; BUSINESS MEDIATION SERVICES FOR OTHERS; INDEPENDENT SALES REPRESENTATIVES IN THE FIELD OF FOOD PRODUCTS, CONFECTIONERY, NON ALCOHOLIC BEVERAGES, ALCOHOLIC BEVERAGES, PHARMACEUTICALS, CHEMICAL PRODUCTS FOR USE IN THE FOOD AND FOOD PROCESSING INDUSTRIES, VETERINARY PRODUCTS, SANITARY PRODUCTS, MEDICINAL PRODUCTS, DISINFECTANTS, HERBAL AND NUTRITIONAL PRODUCTS, ANIMAL FOOD PRODUCTS AND SUPPLEMENTS, AND FOOD AND BEVERAGE INGREDIENTS; MANUFACTURER REPRESENTATIVES IN THE FIELD OF FOOD PRODUCTS, CONFECTIONERY, NON ALCOHOLIC BEVERAGES, ALCOHOLIC BEVERAGES, PHARMACEUTICALS, CHEMICAL PRODUCTS FOR USE IN THE FOOD AND FOOD PROCESSING INDUSTRIES, VETERINARY PRODUCTS, SANITARY PRODUCTS, MEDICINAL PRODUCTS, DISINFECTANTS, HERBAL AND NUTRITIONAL PRODUCTS, ANIMAL FOOD PRODUCTS AND SUPPLEMENTS, AND FOOD AND BEVERAGE INGREDIENTS; WHOLESALE DISTRIBUTORSHIPS FEATURING FOOD PRODUCTS, CONFECTIONERY, NON ALCOHOLIC BEVERAGES, ALCOHOLIC BEVERAGES, PHARMACEUTICALS, CHEMICAL PRODUCTS FOR USE IN THE FOOD AND FOOD PROCESSING INDUSTRIES, VETERINARY PRODUCTS, SANITARY PRODUCTS, MEDICINAL PRODUCTS, DISINFECTANTS, HERBAL AND NUTRITIONAL PRODUCTS, ANIMAL FOOD PRODUCTS AND SUPPLEMENTS, AND FOOD AND BEVERAGE INGREDIENTS; DISTRIBUTORSHIP

SERVICES IN THE FIELD OF FOOD PRODUCTS, CONFECTIONERY, NON ALCOHOLIC BEVERAGES, ALCOHOLIC BEVERAGES, PHARMACEUTICALS, CHEMICAL PRODUCTS FOR USE IN THE FOOD AND FOOD PROCESSING INDUSTRIES, VETERINARY PRODUCTS, SANITARY PRODUCTS, MEDICINAL PRODUCTS, DISINFECTANTS, HERBAL AND NUTRITIONAL PRODUCTS, ANIMAL FOOD PRODUCTS AND SUPPLEMENTS, AND FOOD AND BEVERAGE INGREDIENTS, IN CLASS 35 (U.S. CLS. 100, 101 AND 102).

FOR: TRANSPORT BY BOAT, AIR AND IN ROAD TRAFFIC; PACKAGING AND STORAGE OF FOOD PRODUCTS AND SEMIFINISHED PRODUCTS, BEVERAGES, FURNITURE, AND MOTOR VEHICLELESS, IN CLASS 39 (U.S. CLS. 100 AND 105).

FOR: TREATMENT OF MATERIALS, NAMELY, FOOD AND DRINK PRESERVATION, FLOUR MILLING, FREEZING OF FOODS; FOOD PROCESSING, NAMELY, PROCESSING OF SPICES, ARTIFICIAL COFFEE, COFFEE, TEA, FRUITS, VEGETABLES, MEDICINAL AND AROMATIC HERBS, SEEDS AND GRAINS, FOREST FRUITS, MEAT, SEAFOOD, CEREALS AND SALT, IN CLASS 40 (U.S. CLS. 100, 103 AND 106).

OWNER OF INTERNATIONAL REGISTRATION 0920275 DATED 12-13-2006, EXPIRES 12-13-2016.

THE COLOR(S) RED IS/ARE CLAIMED AS A FEATURE OF THE MARK.

THE MARK CONSISTS OF THE WORD "DROGA-KOLINSKA" IN THE COLOR RED.

SER. NO. 79-037,010, FILED 12-13-2006.

WENDY JUN, EXAMINING ATTORNEY

Int. Cls.: 7, 12 and 42

Prior U.S. Cls.: 13, 19, 21, 23, 31, 34, 35, 44, 100 and 101

Reg. No. 3,485,124

United States Patent and Trademark Office

Registered Aug. 12, 2008

**TRADEMARK
SERVICE MARK
PRINCIPAL REGISTER**



MECAPROM

MECAPROM TECHNOLOGIES; CORPORATION
ITALIA S.R.L. (ITALY LTD LIAB CO)
VIALE PAPA GIOVANNI XXIII, 94/D
I-24121 BERGAMO, ITALY

FOR: AUTOMOTIVE PARTS AND COMPONENTS THEREFOR, NAMELY, ENGINE CYLINDER HEADS, CRANKCASES FOR MOTORS AND ENGINES, CRANKSHAFTS FOR AUTOMOTIVE MOTORS AND ENGINES, CAMSHAFTS, ENGINE RODS, PISTONS, TIMING BELTS, INTAKE AND EXHAUST MANIFOLDS, MACHINE PARTS, NAMELY, MOLDS FOR USE IN THE MANUFACTURE OF AUTOMOTIVE MOTORS, ENGINES, TRANSMISSIONS, CYLINDER HEADS, CRANKCASES, CRANKSHAFTS, CAMSHAFTS, RODS, PISTONS, TIMING BELTS, MANIFOLDS, GEARS, AND POWER TRAINS, IN CLASS 7 (U.S. CLS. 13, 19, 21, 23, 31, 34 AND 35).

FOR: LAND MOTOR VEHICLES, AUTOMOBILES AND STRUCTURAL PARTS THEREFOR, NAMELY,

BRAKES, ENGINES AND TIRES FOR LAND MOTOR VEHICLES, IN CLASS 12 (U.S. CLS. 19, 21, 23, 31, 35 AND 44).

FOR: SCIENTIFIC AND TECHNOLOGICAL SERVICES, NAMELY, ENGINEERING, RESEARCH, DEVELOPMENT AND DESIGN OF AUTOMOTIVE ENGINES, MOTORS AND TRANSMISSIONS AND COMPONENTS AND PARTS THEREFOR, IN CLASS 42 (U.S. CLS. 100 AND 101).

PRIORITY DATE OF 12-12-2006 IS CLAIMED.

OWNER OF INTERNATIONAL REGISTRATION 0920452 DATED 1-10-2007, EXPIRES 1-10-2017.

SER. NO. 79-037,076, FILED 1-10-2007.

Laurie Kaufman, Examining Attorney

Int. Cls.: 9, 25 and 28

Prior U.S. Cls.: 21, 22, 23, 26, 36, 38, 39 and 50

United States Patent and Trademark Office

Reg. No. 3,485,125

Registered Aug. 12, 2008

**TRADEMARK
PRINCIPAL REGISTER**



POC SWEDEN AB (SWEDEN LTD LIAB CO)
SKOGSÖVÄGEN 22
SE-133 34 SALTSJÖBADEN
SWEDEN

FOR: PROTECTIVE HELMETS FOR SPORTS, GOGGLES FOR SPORTS; SUN GLASSES, IN CLASS 9 (U.S. CLS. 21, 23, 26, 36 AND 38).

FOR: ARTICLES OF CLOTHING, NAMELY, PANTS, JACKETS, TROUSERS, JEANS, SHORTS, WIND JACKETS, COATS, OVERCOATS, RAIN-COATS, SWEATERS, CARDIGANS, SHIRTS, POLO SHIRTS, PULLOVERS, T-SHIRTS, TANK TOPS, TOPS, PYJAMAS, OVERALLS, DRESSES, TIGHTS, SKIRTS, GOWNS, SOCKS, UNDERWEAR AND SLEEPWEAR, HOSIERY, ROBES, SWEAT BANDS, BEACHWEAR, SWIMWEAR, BATHROBES, SKI-WEAR, SURFWEAR, SNOWBOARD WEAR AND OTHER CLOTHING FOR SPORTS, NAMELY, SKATEBOARDING BODYSUITS, SUITS FOR ALPINE SKIING, TRACKSUITS, TRACKSUIT TOPS AND TRACKSUIT TROUSERS; FASHION ACCESSORIES IN THIS CLASS, NAMELY, BELTS, GLOVES AND MITTENS, SCARVES, TIES, DECORATIVE STRAPS FOR CLOTHING; FOOTWEAR, NAMELY, SOCKS, SHOES, SPORT AND ATHLETIC SHOES, BOOTS, SANDALS, THONGS, SLIPPERS; HEADWEAR, NAMELY, HATS, CAPS, BATHING CAPS, BEANIES, BANDANAS, HEADBANDS, PEAKS AND VISORS; RASH GUARDS, NAMELY, RASH SHIRTS AND RASH VESTS; WETSUITS, WETSUIT VESTS, WETSUIT BOOTS, WETSUIT GLOVES, WETSUIT

HOODS, WETSUIT HOODS AND WETSUIT TOPS; MONEY BELTS, IN CLASS 25 (U.S. CLS. 22 AND 39).

FOR: SHIN GUARDS FOR ATHLETIC USE; ELBOW GUARDS FOR ATHLETIC USE; BACK GUARDS FOR ATHLETIC USE, HAND AND ARM GUARDS FOR USE ON SKI POLES; PROTECTIVE GLOVES FOR SPORTS, NAMELY SKI GLOVES WITH PROTECTIVE PADDING; SKI STRAPS FOR SKI LOCKING; SKI POLES, IN CLASS 28 (U.S. CLS. 22, 23, 38 AND 50).

PRIORITY DATE OF 6-30-2006 IS CLAIMED.

OWNER OF INTERNATIONAL REGISTRATION 0920768 DATED 12-21-2006, EXPIRES 12-21-2016.

OWNER OF U.S. REG. NO. 3,055,689.

THE COLOR(S) ORANGE IS/ARE CLAIMED AS A FEATURE OF THE MARK.

THE MARK CONSISTS OF TWO TRIANGLES WITH CURVED EDGES, PEAKING TOWARDS EACH OTHER. THE COLOR ORANGE APPEARS IN THE DESIGN, NAMELY IN THE TRIANGLES.

SER. NO. 79-037,212, FILED 12-21-2006.

ROBERT STRUCK, EXAMINING ATTORNEY

Int. Cls.: 14, 18 and 25

Prior U.S. Cls.: 1, 2, 3, 22, 27, 28, 39, 41 and 50

Reg. No. 3,485,126

United States Patent and Trademark Office

Registered Aug. 12, 2008

TRADEMARK
PRINCIPAL REGISTER

ROPÉ

JUN CO., LTD. (JAPAN CORPORATION)
8-22, KOUNAN 1-CHOME
MINATO-KU, TOKYO 108-8484
JAPAN

FOR: KEY RINGS AND KEY CHAINS OF PRECIOUS METAL; TABLEWARE, NAMELY, GOBLETs, NON-ELECTRIC COFFEEPOTS, TEAPOTS, DISHES AND PLATES, SALAD BOWLS, SOUP BOWLS AND JUGS, ALL MADE OF PRECIOUS METALS OR THOSE COATED THEREWITH; NUT-CRACKERS, PEPPER POTS, SUGAR BOWLS, SALT SHAKERS, EGG CUPS, NAPKIN HOLDERS, NAPKIN RINGS, TRAYS AND TOOTHPICK HOLDERS, ALL MADE OF PRECIOUS METAL OR THOSE COATED THEREWITH; NEEDLE CASSETTES OF PRECIOUS METAL OR THOSE COATED THEREWITH; CANDLE EXTINGUISHERS, CANDLE HOLDERS AND CANDLESTICKS OF PRECIOUS METAL OR THOSE COATED THEREWITH; JEWELRY CASES OF PRECIOUS METAL OR THOSE COATED THEREWITH; FLOWER VASES AND BOWLS OF PRECIOUS METAL OR THOSE COATED THEREWITH; COMMEMORATIVE STATUARY CUPS AND COMMEMORATIVE SHIELDS OF PRECIOUS METAL; EARRINGS, TIE PINS, TIE CLIPS, NECKLACES, BRACELETS, BROOCHES, PENDANTS, MEDALS, MEDALLIONS AND RINGS BEING TRINKETS; BELT BUCKLES FOR CLOTHING OF PRECIOUS METAL OR THOSE COATED THEREWITH; BADGES OF PRECIOUS METAL OR THOSE COATED THEREWITH; LAPEL PINS AND BONNET PINS OF PRECIOUS METAL OR THOSE COATED THEREWITH; CUFF LINKS; PURSES AND WALLETS OF PRECIOUS METAL OR THOSE COATED THEREWITH; JEWELRY AND THEIR IMITATIONS; UNCUT AND SEMI-CUT PRECIOUS STONES AND THEIR IMITATIONS; POWDER COMPACTS OF PRECIOUS METAL OR THOSE COATED

THEREWITH; SHOE ORNAMENTS OF PRECIOUS METAL OR THOSE COATED THEREWITH; HOROLOGICAL AND CHRONOMETRIC INSTRUMENTS AND CASES THEREFORE; ASHTRAYS, CIGARETTE HOLDERS AND CIGARETTE CASES, ALL MADE OF PRECIOUS METALS OR THOSE COATED THEREWITH, IN CLASS 14 (U.S. CLS. 2, 27, 28 AND 50).

FOR: LEATHER BOXES FOR STORING GREETING CARDS SOLD EMPTY; DOG COLLARS, DOG HARNESES AND DOG SHOES; CLOTHING FOR DOMESTIC PETS; BAGS, NAMELY, HANDBAGS, BRIEFCASES, ATTACHÉ CASES, LEATHER SHOPPING BAGS, TEXTILE SHOPPING BAGS, SHOULDER BAGS, TRAVEL BAGS, GYM BAGS, ALL-PURPOSE SPORT BAGS, BEACH BAGS, SCHOOL BAGS, SHOPPING BAGS WITH WHEELS ATTACHED, TRAVEL BAGS WITH WHEELS ATTACHED, OVERNIGHT BAGS, BACKPACKS, SUITCASES AND BRIEFCASES; WALLETS NOT OF PRECIOUS METALS, PURSES NOT OF PRECIOUS METALS, DRAWSTRING POUCHES, KEY CASES NOT OF PRECIOUS METALS; UNFITTED VANITY CASES SOLD EMPTY; UMBRELLAS AND PARASOLS (SUN UMBRELLAS); WALKING STICKS, WALKING CANES FOR NON-MEDICAL PURPOSES; SADDLERY; LEATHER STRAPS; RAWHIDES, TANNED LEATHER AND IMITATION LEATHER; FUR, IN CLASS 18 (U.S. CLS. 1, 2, 3, 22 AND 41).

FOR: OVERCOATS, TOPCOATS, RAINCOATS, SUITS, DRESSES, JACKETS, VESTS AND WAISTCOATS, JUMPERS, TROUSERS, SKIRTS, JEANS, FUR COATS, FUR VESTS, LEATHER COATS, LEATHER JACKETS, LEATHER PANTS, LEATHER SUITS, LEATHER JUMPSUITS, SCHOOL UNIFORMS, EVENING DRESSES AND DINNER JACK-

ETS, NAMELY, TUXEDO JACKETS; SWEATERS, PULLOVERS, CARDIGANS, SHIRTS FOR SUITS, BLOUSES, SPORT SHIRTS, POLO SHIRTS AND T-SHIRTS (TEE SHIRTS); UNDERWEAR, NAMELY, UNDERSHIRTS, SHORTS, BRIEFS, CORSETS, BRASSIERES, GIRDLES, PETTICOATS, AND CAMISOLES; NIGHTWEAR, NAMELY, PAJAMAS, NIGHT GOWNS, NEGLIGES AND BATH ROBES; BATHING WEAR, NAMELY, SWIMMING PANTS, SWIMMING SUITS AND SWIMMING CAPS; JAPANESE TRADITIONAL OUTERWEAR, NAMELY KIMONO, JAPANESE TRADITIONAL HOMEWEAR, NAMELY, YUKATA, JAPANESE SASH BANDS FOR KIMONO AND YUKATA (OBI) AND UNDERSHIRTS FOR KIMONO (JUBAN); TIES, BOW TIES, STOCKINGS, SOCKS, HEAD SWEATBANDS, SHAWLS, BANDANAS, NECKERCHIEFS, SCARVES, FUR STOLEES, EAR MUFFS AND GLOVES; HEADGEAR, NAMELY, HATS AND CAPS, VISORS, HATS OF FUR, NIGHT CAPS AND SHOWER CAPS; GARTERS, SOCK SUSPENDERS, SUSPENDERS (BRACES), WAISTBANDS AND BELTS FOR CLOTHING; FOOTWEAR, NAMELY, SHOES, BOOTS, SNEAKERS, SANDALS AND BEACH SANDALS; SLIPPERS, JAPANESE STYLE SANDALS (ZORI), CLOGS AND JAPANESE STYLE WOODEN CLOGS (GETA); MASQUERADE COS-

TUMES; CLOTHING FOR SPORTS, NAMELY, KARATE SUITS, JUDO SUITS, HEADBANDS AND WRISTBANDS; FOOTWEAR FOR SPORTS, NAMELY, TENNIS SHOES, BASKETBALL SNEAKERS AND CLIMBING BOOTS, NAMELY, MOUNTAINEERING BOOTS; HORSE-RIDING BOOTS, IN CLASS 25 (U.S. CLS. 22 AND 39).

PRIORITY DATE OF 7-28-2006 IS CLAIMED.

OWNER OF INTERNATIONAL REGISTRATION 0920998 DATED 11-7-2006, EXPIRES 11-7-2016.

OWNER OF U.S. REG. NO. 1,158,180.

THE MARK CONSISTS OF THE STYLIZED WORDING "ROPÉ".

THE WORDING "ROPÉ" HAS NO KNOWN MEANING IN A FOREIGN LANGUAGE.

SER. NO. 79-037,285, FILED 11-7-2006.

MARY BOAGNI, EXAMINING ATTORNEY

Int. Cl.: 9

Prior U.S. Cls.: 21, 23, 26, 36 and 38

Reg. No. 3,485,127

United States Patent and Trademark Office

Registered Aug. 12, 2008

**TRADEMARK
PRINCIPAL REGISTER**

Anno

SUNFLOWERS INTERACTIVE ENTERTAINMENT SOFTWARE GMBH (FED REP GERMANY LTD LIAB CO)
SELIGENSTAEDTER GRUND 1
63150 HEUSENSTAMM, FED REP GERMANY

FOR: OPTICAL COMPACT DISKS FEATURING COMPUTER AND VIDEO GAMES; DVDS FEATURING COMPUTER AND VIDEO GAMES; RECORDED COMPUTER GAME AND VIDEO GAME PROGRAMS; DOWNLOADABLE COMPUTER VIDEO GAME PROGRAMS; COMPUTER GAMING SOFTWARE, IN CLASS 9 (U.S. CLS. 21, 23, 26, 36 AND 38).

THE MARK CONSISTS OF STANDARD CHARACTERS WITHOUT CLAIM TO ANY PARTICULAR FONT, STYLE, SIZE, OR COLOR.

OWNER OF INTERNATIONAL REGISTRATION 0826671 DATED 2-16-2004, EXPIRES 2-16-2014.

THE FOREIGN WORDING IN THE MARK TRANSLATES INTO ENGLISH AS YEAR.

SER. NO. 79-037,333, FILED 9-11-2006.

JENNIFER VASQUEZ, EXAMINING ATTORNEY

Int. Cls.: 35, 36 and 38

Prior U.S. Cls.: 100, 101, 102 and 104

United States Patent and Trademark Office

Reg. No. 3,485,128

Registered Aug. 12, 2008

**SERVICE MARK
PRINCIPAL REGISTER**

MOBILEAXEPT

MOBILEAXEPT AS (NORWAY AS)
POSTBOKS 219
LYSAKER
NORWAY

FOR: SALES PROMOTIONAL SERVICES FOR THIRD PARTIES; SALES PROMOTIONAL SERVICES FOR THIRD PARTIES THROUGH USE OF MOBILE TELEPHONE SERVICES; ONLINE ADVERTISING ON COMPUTER COMMUNICATION NETWORKS, IN CLASS 35 (U.S. CLS. 100, 101 AND 102).

FOR: BANKING SERVICES; BILL PAYMENT SERVICES; BANK AND BILL PAYMENT SERVICES THROUGH USE OF MOBILE TELEPHONE SERVICES; FUNDRAISING ACTIVITIES, NAMELY, CHARITABLE FUNDRAISING SERVICES, NAMELY, SHARING PROFITS FROM NEWSPAPER SUBSCRIPTION SALES WITH NOT-FOR-PROFIT ORGANIZATIONS, MEMORIAL FUND RAISING, POLITICAL FUND RAISING, PROVIDING FUNDRAISING FOR OTHERS VIA A GLOBAL COMMUNICATIONS NETWORK, IN CLASS 36 (U.S. CLS. 100, 101 AND 102).

FOR: TELECOMMUNICATIONS, NAMELY, PROVIDING ELECTRONIC TELECOMMUNICATION CONNECTIONS, TELECOMMUNICATION ACCESS SERVICES, TELECOMMUNICATION BY EMAIL, TELECOMMUNICATION CONSULTATION SERVICES, AND MOBILE TELEPHONE COMMUNICATION SERVICES, IN CLASS 38 (U.S. CLS. 100, 101 AND 104).

THE MARK CONSISTS OF STANDARD CHARACTERS WITHOUT CLAIM TO ANY PARTICULAR FONT, STYLE, SIZE, OR COLOR.

PRIORITY DATE OF 12-27-2006 IS CLAIMED.

OWNER OF INTERNATIONAL REGISTRATION 0922778 DATED 1-17-2007, EXPIRES 1-17-2017.

SER. NO. 79-037,994, FILED 1-17-2007.

DARRYL SPRUILL, EXAMINING ATTORNEY

Int. Cls.: 35, 36 and 38

Prior U.S. Cls.: 100, 101, 102 and 104

United States Patent and Trademark Office

Reg. No. 3,485,129

Registered Aug. 12, 2008

**SERVICE MARK
PRINCIPAL REGISTER**

mobile **Axept**

MOBILEAXEPT AS (NORWAY AS)
POSTBOKS 219
LYSAKER
NORWAY

FOR: SALES PROMOTIONAL SERVICES FOR THIRD PARTIES; SALES PROMOTIONAL SERVICES FOR THIRD PARTIES THROUGH USE OF MOBILE TELEPHONE SERVICES; ONLINE ADVERTISING ON COMPUTER COMMUNICATION NETWORKS, IN CLASS 35 (U.S. CLS. 100, 101 AND 102).

FOR: BANKING SERVICES; BILL PAYMENT SERVICES; BANK AND BILL PAYMENT SERVICES THROUGH USE OF MOBILE TELEPHONE SERVICES; FUNDRAISING ACTIVITIES, NAMELY, CHARITABLE FUNDRAISING SERVICES, NAMELY, SHARING PROFITS FROM NEWSPAPER SUBSCRIPTION SALES WITH NOT-FOR-PROFIT ORGANIZATIONS, MEMORIAL FUND RAISING, POLITICAL FUND RAISING, PROVIDING FUNDRAISING FOR OTHERS VIA A GLOBAL COM-

MUNICATIONS NETWORK, IN CLASS 36 (U.S. CLS. 100, 101 AND 102).

FOR: TELECOMMUNICATIONS, NAMELY, PROVIDING ELECTRONIC TELECOMMUNICATION CONNECTIONS, TELECOMMUNICATION ACCESS SERVICES, TELECOMMUNICATION BY EMAIL, TELECOMMUNICATION CONSULTATION SERVICES, AND MOBILE TELEPHONE COMMUNICATION SERVICES, IN CLASS 38 (U.S. CLS. 100, 101 AND 104).

PRIORITY DATE OF 10-30-2006 IS CLAIMED.

OWNER OF INTERNATIONAL REGISTRATION
0922779 DATED 1-18-2007, EXPIRES 1-18-2017.

SER. NO. 79-037,995, FILED 1-18-2007.

DARRYL SPRUILL, EXAMINING ATTORNEY

Int. Cls.: 35, 41 and 44

Prior U.S. Cls.: 100, 101, 102 and 107

Reg. No. 3,485,130

United States Patent and Trademark Office

Registered Aug. 12, 2008

**SERVICE MARK
PRINCIPAL REGISTER**

PHILIP KINGSLEY

PHILIP KINGSLEY (UNITED KINGDOM INDIVIDUAL)
54 GREEN STREET
LONDON W1K 6RU
UNITED KINGDOM

FOR: RETAIL STORE SERVICES, NAMELY, THE BRINGING TOGETHER, FOR THE BENEFIT OF OTHERS, OF A VARIETY OF GOODS, ENABLING CUSTOMERS CONVENIENTLY TO VIEW AND PURCHASE THOSE GOODS IN A RETAIL DEPARTMENT STORE AND IN HIGH STREET STAND-ALONE RETAIL STORES IN THE FIELD OF PREPARATIONS FOR THE CARE AND TREATMENT OF HAIR AND SCALP; WHOLESALE DISTRIBUTORSHIPS AND DISTRIBUTORSHIP SERVICES, BOTH IN THE FIELD OF PREPARATIONS FOR THE CARE AND TREATMENT OF THE HAIR AND SCALP; COMPILATION OF MAILING LISTS; MAIL, ON-LINE, TELEPHONE AND ON-LINE CATALOG ORDERING SERVICES, ALL IN THE FIELD OF PREPARATIONS FOR THE CARE AND TREATMENT OF THE HAIR AND SCALP; DIRECT MAILING ADVERTISING SERVICES; ADVERTISING; BUSINESS RESEARCH AND BUSINESS MANAGEMENT INFORMATION SERVICES; PROVISION OF COMMERCIAL INFORMATION VIA DATABASES, ELECTRONIC MAIL, AND ELECTRONIC MEDIUMS; PROVISION OF COMMERCIAL INFORMATION VIA PAPER FORMATS; COMPILATION OF COMMERCIAL INFORMATION INTO DATABASES; BUSINESS MERCHANDISING DISPLAY SERVICES; PUBLICITY SERVICES; MARKETING AND PROMOTIONAL SERVICES; ADVISORY AND CONSULTANCY SERVICES RELATING TO THE AFORESAID, IN CLASS 35 (U.S. CLS. 100, 101 AND 102).

FOR: EDUCATIONAL INSTRUCTION AND TRAINING SERVICES FOR TRICHOLOGISTS AND HAIRDRESSERS IN THE FIELD OF TRICHOLOGY AND CARE OF THE HAIR AND SCALP; ADVISORY SERVICES RELATED TO TRAINING, NAMELY, EDUCATIONAL CONSULTING SERVICES FEATURING

EDUCATIONAL INFORMATION REGARDING THE APPROPRIATE METHODS TO TEACH THE SUBJECT OF TRICHOLOGY; ORGANIZATION OF TRAINING COURSES AND SEMINARS IN THE FIELD OF TRICHOLOGY; PRODUCTION OF TRAINING VIDEOTAPES AND MOTION PICTURE FILMS; PROVIDING WRITTEN TRAINING COURSES IN THE FIELD OF TRICHOLOGY, IN CLASS 41 (U.S. CLS. 100, 101 AND 107).

FOR: PROVISION OF HAIRCARE AND HAIR AND SCALP TREATMENT SERVICES IN THE NATURE OF HAIRDRESSING AND COSMETIC SCALP CARE SERVICES, ALL PROVIDED AT TRICHOLOGY CLINICS AND ADVISORY CENTRES; ADVISORY SERVICES RELATING TO ALL THE AFORESAID; HAIRDRESSING SERVICES; PROVIDING HAIRDRESSING AND BEAUTY SALONS FOR HAIR TREATMENT AND HAIRDRESSING DEMONSTRATIONS AND EXHIBITIONS, IN CLASS 44 (U.S. CLS. 100 AND 101).

THE MARK CONSISTS OF STANDARD CHARACTERS WITHOUT CLAIM TO ANY PARTICULAR FONT, STYLE, SIZE, OR COLOR.

PRIORITY DATE OF 1-26-2007 IS CLAIMED.

OWNER OF INTERNATIONAL REGISTRATION 0923703 DATED 2-12-2007, EXPIRES 2-12-2017.

OWNER OF U.S. REG. NOS. 1,389,638, 1,391,160, AND 2,471,728.

THE NAME "PHILIP KINGSLEY" IDENTIFIES A LIVING INDIVIDUAL WHOSE CONSENT IS OF RECORD.

SER. NO. 79-038,321, FILED 2-12-2007.

MAUREEN DALL, EXAMINING ATTORNEY

Int. Cl.: 8

Prior U.S. Cls.: 23, 28 and 44

United States Patent and Trademark Office

Reg. No. 3,485,131

Registered Aug. 12, 2008

**TRADEMARK
PRINCIPAL REGISTER**

FEIDA 飞达

JIANGSU FEIDA TOOLS STOCK CO., LTD.
GAOSHIQIAO VILLAGE,
HOUXIANG TOWN, DANYANG CITY, JIANGSU
PROVINCE
CHINA

FOR: HAND OPERATED AGRICULTURAL IMPLEMENTS, NAMELY, HAND OPERATED SPREADERS FOR SEED AND DRY LAWN CHEMICALS, HAND OPERATED LAWN EDGERS, HAND OPERATED SHEARS, HAND OPERATED TILLER; HAND OPERATED APPLIANCES AND INSTRUMENTS FOR SLAUGHTERING BUTCHERS' ANIMALS, NAMELY, HAND OPERATED BUTCHER KNIVES AND SLEDGEHAMMER; HAND TOOLS FOR SLAUGHTERING AND HANGING BUTCHERS' ANIMALS, NAMELY, HARPOONS; BEARD CLIPPERS; SIDE ARMS, NOT INCLUDING FIREARMS, NAMELY, HUNTING KNIVES AND SWORDS; HAND TOOLS, NAMELY, AUGERS; HAND TOOLS, NAMELY, GRAVING TOOLS; KNIVES, NAMELY, HUNTING KNIVES, FOLDING KNIVES, CHEF KNIVES, KITCHEN KNIVES, FISHING KNIVES,

SPORT KNIVES, BUTCHER KNIVES AND PARING KNIVES; ELECTRIC AND NON-ELECTRIC NAIL CLIPPERS; EYELASH CURLERS, IN CLASS 8 (U.S. CLS. 23, 28 AND 44).

OWNER OF INTERNATIONAL REGISTRATION
0923976 DATED 5-8-2007, EXPIRES 5-8-2017.

OWNER OF U.S. REG. NO. 2,819,761.

THE ENGLISH TRANSLATION OF THE FOREIGN WORD(S) IN THE MARK IS: "FEI" MEANS FLY, "DA" MEANS REACH, THE MARK AS A WHOLE HAS NO MEANING.

THE TRANSLITERATION OF THE NON-LATIN CHARACTERS IN THE MARK IS: "FEI DA".

SER. NO. 79-038,418, FILED 5-8-2007.

DAVID MURRAY, EXAMINING ATTORNEY

Int. Cls.: 9 and 42

Prior U.S. Cls.: 21, 23, 26, 36, 38, 100 and 101

United States Patent and Trademark Office

Reg. No. 3,485,132

Registered Aug. 12, 2008

**TRADEMARK
SERVICE MARK
PRINCIPAL REGISTER**

The logo features the word "Spaun" in a large, bold, italicized sans-serif font. Below it, the word "Schaltnetzteile" is written in a smaller, bold, sans-serif font. A stylized, curved graphic element resembling a swoosh or a partial arc is positioned behind the text, starting under "Spaun" and ending under "Schaltnetzteile".

SPAUN SCHALTNETZTEILE GMBH (FED REP
GERMANY LTD LIAB CO)
UNTERE GIEßWIESEN 6 B
78247 HILZINGEN, FED REP GERMANY

FOR: ELECTRICAL AND ELECTRONIC DEVICES FOR POWER SUPPLY TECHNOLOGY, CONSISTING OF POWER SUPPLIES AND UNINTERRUPTIBLE POWER SUPPLIES, NAMELY, CURRENT-VOLTAGE CONVERTERS, SWITCH MODE POWER SUPPLIES, DC CONVERTERS, POWER SUPPLY TOOLS, NAMELY, VOLTAGE REGULATOR ALL OF THE ABOVE PRODUCTS IN PARTICULAR FOR PURPOSES OF AUTOMATION, CONTROL, MEASURING, REGULATING, COMMUNICATIONS, COMPUTER, MEDICAL, TRAFFIC, TELECOMMUNICATIONS, AUTOMOTIVE, MILITARY, SOLAR, SECURITY, WEIGHING, TELEVISION, CABLE AND SATELLITE RECEIVING TECHNOLOGIES, MECHANICAL ENGINEERING, PLANT ENGINEERING, AND SENSOR TECHNOLOGY, IN CLASS 9 (U.S. CLS. 21, 23, 26, 36 AND 38).

FOR: INDUSTRIAL AND SCIENTIFIC RESEARCH AND DEVELOPMENT IN PARTICULAR REGARDING POWER SUPPLY TECHNOLOGIES;

DEVELOPMENT OF COMPUTER PROGRAMS, IN PARTICULAR FOR PURPOSES OF CONTROL AND CONFIGURATION IN POWER SUPPLY TECHNOLOGIES, IN CLASS 42 (U.S. CLS. 100 AND 101).

PRIORITY DATE OF 10-5-2006 IS CLAIMED.

OWNER OF INTERNATIONAL REGISTRATION
0924911 DATED 3-21-2007, EXPIRES 3-21-2017.

NO CLAIM IS MADE TO THE EXCLUSIVE RIGHT TO USE "SCHALTNETZTEILE" , APART FROM THE MARK AS SHOWN.

THE FOREIGN WORDING "SCHALTNETZTEILE" IN THE MARK TRANSLATES INTO ENGLISH AS SWITCHED-MODE POWER SUPPLY UNITS.

SER. NO. 79-038,759, FILED 3-21-2007.

TASHIA BUNCH, EXAMINING ATTORNEY

Int. Cl.: 14

Prior U.S. Cls.: 2, 27, 28 and 50

United States Patent and Trademark Office

Reg. No. 3,485,133

Registered Aug. 12, 2008

**TRADEMARK
PRINCIPAL REGISTER**

Bird's nest

DEVON UELI KÜNG (SWITZERLAND INDIVIDUAL ENTERPRISE)
STUTZERSTRASSE 23
CH-6402 MERLISCHACHEN
SWITZERLAND

FOR: GOODS MADE OF OR COATED WITH PRECIOUS METALS, NAMELY, RINGS, EARRINGS, BRACELETS, NECKLACES, BROOCHES, CUFF LINKS, NAPKIN RINGS; JEWELRY, PRECIOUS STONES; TIMEPIECES AND CHRONOMETRIC INSTRUMENTS, IN CLASS 14 (U.S. CLS. 2, 27, 28 AND 50).

THE MARK CONSISTS OF STANDARD CHARACTERS WITHOUT CLAIM TO ANY PARTICULAR FONT, STYLE, SIZE, OR COLOR.

PRIORITY DATE OF 12-14-2006 IS CLAIMED.

OWNER OF INTERNATIONAL REGISTRATION 0924966 DATED 5-23-2007, EXPIRES 5-23-2017.

SER. NO. 79-038,781, FILED 5-23-2007.

DAWN HAN, EXAMINING ATTORNEY

Int. Cl.: 17

Prior U.S. Cls.: 1, 5, 12, 13, 35 and 50

United States Patent and Trademark Office

Reg. No. 3,485,134

Registered Aug. 12, 2008

TRADEMARK
PRINCIPAL REGISTER



DẦU TIẾNG

CONG TY CAO SU DAU TIENG (VIETNAM A
STATE OWNED ENTERPRISE)

THI TRAN DAU TIENG,

HUYEN DAU TIENG; TINH BINH DUONG
VIETNAM

FOR: RAW RUBBER AND PROCESSED RUBBER, NAMELY, ACRYLIC RUBBER, BLOCK RUBBER, CONSTANT VISCOSITY RUBBER, CHLORINATED RUBBER, CRUDE RUBBER, FLUORO RUBBER, FOAM RUBBER, ISOBUTYLENE-ISOPRENE RUBBER, LATEX RUBBER FOR USE IN THE MANUFACTURE OF A WIDE VARIETY OF GOODS, LIQUID RUBBER, NATURAL RUBBER, NITRILE RUBBER, POLYSULFIDE RUBBER, RECLAIMED RUBBER, RUBBER RAW OR SEMI-WORKED, RUBBER BARS AND RODS, RUBBER SHEETS, SILICONE RUBBER AND STYRENE-BUTADIENE RUBBER, IN CLASS 17 (U.S. CLS. 1, 5, 12, 13, 35 AND 50).

OWNER OF INTERNATIONAL REGISTRATION
0925037 DATED 12-27-2006, EXPIRES 12-27-2016.

NO CLAIM IS MADE TO THE EXCLUSIVE RIGHT TO USE "DAU TIENG", APART FROM THE MARK AS SHOWN.

THE COLOR(S) GREEN, WHITE AND BLACK IS/ARE CLAIMED AS A FEATURE OF THE MARK.

"THE MARK CONSISTS OF A FIGURE ELEMENT AND WORD ELEMENT IN WHICH THE WORD PART IS THE PHRASE "DẦU TIẾNG" IN BLACK. ABOVE THIS WORDING IS THE FIGURE, IN GREEN, REPRESENTED INSIDE A CIRCLE, COMPRISING A DEVICE OF A STYLIZED LETTER "A" PLACED HORIZONTALLY. THE CAPITAL LETTERS D, R, AND C ARE PRESENTED ON THE LOWER SIDE OF THE AFORESAID STYLIZED LETTER "A." THE BACKGROUND OF THE STYLIZED LETTER "A" AND THE CIRCLE IS WHITE."

THE WORD "DAU TIENG" HAS NO MEANING IN ANY FOREIGN LANGUAGE.

SER. NO. 79-038,811, FILED 12-27-2006.

WANDA KAY PRICE, EXAMINING ATTORNEY

Int. Cls.: 4, 21 and 24

Prior U.S. Cls.: 1, 2, 6, 13, 15, 23, 29, 30, 33, 40, 42 and 50

Reg. No. 3,485,135

United States Patent and Trademark Office

Registered Aug. 12, 2008

TRADEMARK
PRINCIPAL REGISTER

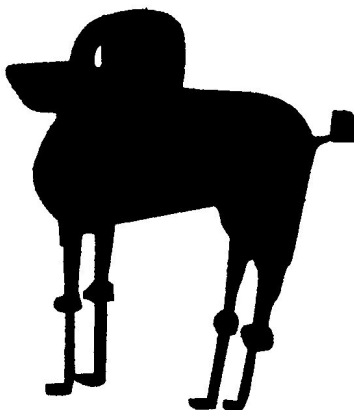

ZHEJIANG NEEQ; HOME DECORATION
CO.,LTD (CHINA CORPORATION)
SONGXINGTANG CHENGJIANG
HUANGYAN TAIZHOU; ZHEJIANG
CHINA

FOR: CERESINE, NAMELY, OZOCERITE FOR USE IN THE MAKING OF CANDLES; FRAGRANT CANDLE; PARAFFIN; ILLUMINATING WAX FOR USE AS CANDLES; CANDLES; CHRISTMAS TREE CANDLES; TAPERS; CARNAUBA WAX; WICKS FOR CANDLES; BEESWAX FOR USE IN THE MANUFACTURE OF CANDLES, IN CLASS 4 (U.S. CLS. 1, 6 AND 15).

FOR: BEVERAGE GLASSWARE; CERAMIC SCULPTURES, VASES, VESSELS, BOWLS, PLATES AND POTS ;WORKS OF ART, OF PORCELAIN, TERRA-COTTA OR GLASS; CHINA ORNAMENTS; CANDLE RINGS NOT OF PRECIOUS METAL; NON-ELECTRIC CANDELABRA NOT OF PRECIOUS

METAL; CANDLE EXTINGUISHERS NOT OF PRECIOUS METAL, IN CLASS 21 (U.S. CLS. 2, 13, 23, 29, 30, 33, 40 AND 50).

FOR: UPHOLSTERY FABRICS;TEXTILE FABRICS FOR THE MANUFACTURE OF CLOTHING; COTTON FABRICS; FIBERGLASS FABRICS FOR TEXTILE USE; NON-WOVEN TEXTILE FABRICS; WALL HANGINGS OF TEXTILE; FELT; BED LINEN; PLACE MATS NOT OF PAPER, IN CLASS 24 (U.S. CLS. 42 AND 50).

OWNER OF INTERNATIONAL REGISTRATION
0925062 DATED 5-21-2007, EXPIRES 5-21-2017.

SER. NO. 79-038,825, FILED 5-21-2007.

MARCIE MILONE, EXAMINING ATTORNEY

Int. Cls.: 4, 21 and 24

Prior U.S. Cls.: 1, 2, 6, 13, 15, 23, 29, 30, 33, 40, 42 and 50

United States Patent and Trademark Office

Reg. No. 3,485,136

Registered Aug. 12, 2008

TRADEMARK
PRINCIPAL REGISTER



ZHEJIANG NEEQ; HOME DECORATION
CO.,LTD (CHINA CORPORATION)
SONGXINGTANG CHENGJIANG
HUANGYAN TAIZHOU; ZHEJIANG
CHINA

FOR: CERESINE, NAMELY, OZOCERITE FOR
USE THE MAKING OF CANDLES; FRAGRANT
CANDLE; PARAFFIN; ILLUMINATING WAX FOR
USE AS CANDLES; CANDLES; CHRISTMAS TREE
CANDLES; TAPERS; CARNAUBA WAX; WICKS
FOR CANDLES; BEESWAX FOR USE IN THE
MANUFACTURE OF CANDLES, IN CLASS 4 (U.S.
CLS. 1, 6 AND 15).

FOR: BEVERAGE GLASSWARE; CERAMIC
SCULPTURES, VASES, VESSELS, BOWLS, PLATES
AND POTS; WORKS OF ART, OF PORCELAIN,
TERRA-COTTA OR GLASS; CHINA ORNAMENTS;
CANDLE RINGS NOT OF PRECIOUS METAL; NON-
ELECTRIC CANDELABRA NOT OF PRECIOUS

METAL; CANDLE EXTINGUISHERS NOT OF PRE-
CIOUS METAL, IN CLASS 21 (U.S. CLS. 2, 13, 23, 29,
30, 33, 40 AND 50).

FOR: UPHOLSTERY FABRICS; TEXTILE FAB-
RICS FOR THE MANUFACTURE OF CLOTHING;
COTTON FABRICS; FIBERGLASS FABRICS FOR
TEXTILE USE; NON-WOVEN TEXTILE FABRICS;
WALL HANGINGS OF TEXTILE; FELT; BED
LINEN; PLACE MATS NOT OF PAPER, IN CLASS
24 (U.S. CLS. 42 AND 50).

OWNER OF INTERNATIONAL REGISTRATION
0925063 DATED 5-21-2007, EXPIRES 5-21-2017.

SER. NO. 79-038,826, FILED 5-21-2007.

MARCIE MILONE, EXAMINING ATTORNEY

Int. Cls.: 7 and 37

Prior U.S. Cls.: 13, 19, 21, 23, 31, 34, 35, 100, 103 and 106

United States Patent and Trademark Office

Reg. No. 3,485,137

Registered Aug. 12, 2008

**TRADEMARK
SERVICE MARK
PRINCIPAL REGISTER**

SLEEVEJACK

PLUMETTAZ S.A. (SWITZERLAND SOCIÉTÉ ANONYME)
Z.I. EN VANNEL C
ROUTE DE LA GRIBANNAZ 12; CH-1880 BEX
SWITZERLAND

FOR: MACHINES FOR INSTALLING, LINING AND REPLACING CABLES, IN CLASS 7 (U.S. CLS. 13, 19, 21, 23, 31, 34 AND 35).

FOR: MAINTENANCE AND REPAIR OF MACHINES FOR INSTALLING, LINING AND REPLACING CABLES; INSTALLATION OF CABLES AND CABLE LINING, IN CLASS 37 (U.S. CLS. 100, 103 AND 106).

THE MARK CONSISTS OF STANDARD CHARACTERS WITHOUT CLAIM TO ANY PARTICULAR FONT, STYLE, SIZE, OR COLOR.

PRIORITY DATE OF 12-19-2006 IS CLAIMED.

OWNER OF INTERNATIONAL REGISTRATION 0925349 DATED 5-16-2007, EXPIRES 5-16-2017.

SER. NO. 79-038,949, FILED 5-16-2007.

EDWARD NELSON, EXAMINING ATTORNEY

Int. Cls.: 5 and 10

Prior U.S. Cls.: 6, 18, 26, 39, 44, 46, 51 and 52

United States Patent and Trademark Office

Reg. No. 3,485,138

Registered Aug. 12, 2008

**TRADEMARK
PRINCIPAL REGISTER**

VENSPAN

MERCK KGAA (FED REP GERMANY PART-
NERSHIP LIMITED BY SHARES)
FRANKFURTER STRASSE 250
64293 DARMSTADT
FED REP GERMANY

FOR: PHARMACEUTICAL PREPARATIONS FOR THE TREATMENT OF DIABETES, CARDIOVASCULAR DISEASES AND DISORDERS, DISEASES AND DISORDERS OF THE PERIPHERAL AND CENTRAL NERVOUS SYSTEM, GASTROINTESTINAL DISEASES AND DISORDERS, CANCER, INFLAMMATION AND INFLAMMATORY DISEASES, RESPIRATORY DISEASES AND DISORDERS, OSTEOPOROSIS, MENOPAUSAL SYMPTOMS AND DISORDERS; ANTI-INFECTIVE PREPARATIONS, ANTI-VIRAL PREPARATIONS, IMMUNOLOGICAL PREPARATIONS AND ANALGESIC PREPARATIONS; DIETETIC FOODS ADAPTED FOR MEDICAL USE, IN CLASS 5 (U.S. CLS. 6, 18, 44, 46, 51 AND 52).

FOR: MEDICAL APPARATUS FOR TREATING DIABETIC CONDITIONS; MEDICAL APPARATUS FOR TREATING CARDIOVASCULAR CONDITIONS; MEDICAL APPARATUS FOR TREATING PERIPHERAL AND CENTRAL NERVOUS SYSTEM

CONDITIONS; MEDICAL APPARATUS FOR TREATING GASTROINTESTINAL CONDITIONS; MEDICAL APPARATUS FOR TREATING ONCOLOGICAL CONDITIONS; MEDICAL APPARATUS FOR TREATING INFLAMMATION AND INFLAMMATORY CONDITIONS; MEDICAL APPARATUS FOR TREATING RESPIRATORY CONDITIONS; MEDICAL APPARATUS FOR TREATING OSTEOPOROTIC CONDITIONS; MEDICAL APPARATUS FOR TREATING MENOPAUSAL CONDITIONS, IN CLASS 10 (U.S. CLS. 26, 39 AND 44).

THE MARK CONSISTS OF STANDARD CHARACTERS WITHOUT CLAIM TO ANY PARTICULAR FONT, STYLE, SIZE, OR COLOR.

PRIORITY DATE OF 10-11-2006 IS CLAIMED.

OWNER OF INTERNATIONAL REGISTRATION
0925367 DATED 4-5-2007, EXPIRES 4-5-2017.

SER. NO. 79-038,958, FILED 4-5-2007.

ELI HELLMAN, EXAMINING ATTORNEY

Int. Cls.: 9, 10, 38 and 42

Prior U.S. Cls.: 21, 23, 26, 36, 38, 39, 44, 100, 101 and 104

Reg. No. 3,485,139

United States Patent and Trademark Office

Registered Aug. 12, 2008

**TRADEMARK
SERVICE MARK
PRINCIPAL REGISTER**

BetaCup

WALDEMAR LINK GMBH & CO. KG (FED REP GERMANY LIMITED LIABILITY PARTNERSHIP)

BARKHAUSENWEG 10
22339 HAMBURG
FED REP GERMANY

FOR: COMPUTER PROGRAMS FOR CONTROLLING SURGICAL APPARATUS AND INSTRUMENTS FOR USE IN CARRYING OUT SURGICAL TREATMENTS, IN CLASS 9 (U.S. CLS. 21, 23, 26, 36 AND 38).

FOR: SURGICAL, MEDICAL, DENTAL AND VETERINARY INSTRUMENTS AND APPARATUS, NAMELY, SURGICAL INSTRUMENTS FOR INSERTING, FIXING AND REMOVING OF ENDOPROSTHESES, SURGICAL CUTLERY, DRILLS, CHISELS, HAMMERS, RESECTION GUIDES, REAMERS AND MEDULLAR RASPS; ARTIFICIAL LIMBS, EYES AND TEETH; IMPLANTS MADE FROM ARTIFICIAL MATERIALS, ENDOPROSTHESES, NAMELY, JOINT ENDOPROSTHESES; SUTURES; ORTHOPAEDIC ARTICLES, NAMELY, ORTHOPAEDIC SUPPORT BANDAGES AND SPLINTS, IN CLASS 10 (U.S. CLS. 26, 39 AND 44).

FOR: PROVIDING MULTIPLE USER ACCESS TO A GLOBAL INFORMATION NETWORK, NAMELY, TO RETRIEVE MEDICAL INFORMATION IN THE INTERNET; ELECTRONIC TRANSMITTING OF DATA, NAMELY, TRANSMITTING OF PREVIOUSLY GENERATED DATA FOR CONTROLLING COMPUTER-BASED APPARATUSES FOR MANUFACTURING INDIVIDUAL IMPLANTS OR FOR CARRYING OUT SURGICAL TREATMENTS, IN CLASS 38 (U.S. CLS. 100, 101 AND 104).

FOR: PROVIDING OF MEDICAL INFORMATION ON THE INTERNET, IN CLASS 42 (U.S. CLS. 100 AND 101).

THE MARK CONSISTS OF STANDARD CHARACTERS WITHOUT CLAIM TO ANY PARTICULAR FONT, STYLE, SIZE, OR COLOR.

OWNER OF INTERNATIONAL REGISTRATION 0925401 DATED 5-10-2006, EXPIRES 5-10-2016.

SER. NO. 79-038,977, FILED 5-10-2006.

KAELIE KUNG, EXAMINING ATTORNEY

Int. Cls.: 9, 11 and 37

**Prior U.S. Cls.: 13, 21, 23, 26, 31, 34, 36, 38, 100, 103
and 106**

Reg. No. 3,485,140

United States Patent and Trademark Office

Registered Aug. 12, 2008

**TRADEMARK
SERVICE MARK
PRINCIPAL REGISTER**

AVANCIS

AVANCIS GMBH & CO. KG (FED REP GERMA-
NY LIMITED PARTNERSHIP)
OTTO-HAHN-RING 6
81739 MÜNCHEN
FED REP GERMANY

FOR: SOLAR PANELS FOR ELECTRICITY GEN-
ERATION; SOLAR MODULES FOR ELECTRICITY
GENERATION; PHOTOVOLTAIC PANELS FOR
ELECTRICITY GENERATION; PHOTOVOLTAIC
MODULES FOR ELECTRICITY GENERATION, IN
CLASS 9 (U.S. CLS. 21, 23, 26, 36 AND 38).

FOR: SOLAR COLLECTORS, IN CLASS 11 (U.S.
CLS. 13, 21, 23, 31 AND 34).

FOR: INSTALLATION AND REPAIR OF SOLAR
PANELS, SOLAR MODULES, PHOTOVOLTAIC PA-
NELS, PHOTOVOLTAIC MODULES, BATTERIES,
SOLAR COLLECTORS, SOLAR HEATING APPARA-
TUS, SOLAR POWERED HEATING, COOLING AND
VENTILATION APPARATUS AND COMPONENTS

FOR ALL THE AFOREMENTIONED GOODS, IN
CLASS 37 (U.S. CLS. 100, 103 AND 106).

THE MARK CONSISTS OF STANDARD CHAR-
ACTERS WITHOUT CLAIM TO ANY PARTICULAR
FONT, STYLE, SIZE, OR COLOR.

PRIORITY DATE OF 9-11-2006 IS CLAIMED.

OWNER OF INTERNATIONAL REGISTRATION
0925474 DATED 3-8-2007, EXPIRES 3-8-2017.

THE MARK HAS NO MEANING IN A FOREIGN
LANGUAGE.

SER. NO. 79-039,005, FILED 3-8-2007.

KRISTINA MORRIS, EXAMINING ATTORNEY

Int. Cl.: 11

Prior U.S. Cls.: 13, 21, 23, 31 and 34

United States Patent and Trademark Office

Reg. No. 3,485,141

Registered Aug. 12, 2008

**TRADEMARK
PRINCIPAL REGISTER**

GEOtronic

PELTECH S.R.L. (ITALY LTD LIAB CO)
VIA MAZZINI, S.N.C.
I-23801 CALOLZIOCORTE (LECCO)
ITALY

FOR: HEATING, STEAM GENERATING, RE-
FRIGERATING, DRYING, VENTILATING AND
AIR-CONDITIONING APPARATUS AND DEVICES,
NAMELY, AIR CONDITIONERS, HUMIDIFIERS,
DEHUMIDIFIERS; THERMOELECTRIC HEAT
PUMPS; HEAT EXCHANGERS; REPLACEMENT

PARTS AND COMPONENTS OF THE AFORESAID
GOODS NOT INCLUDED IN OTHER CLASSES, IN
CLASS 11 (U.S. CLS. 13, 21, 23, 31 AND 34).

OWNER OF INTERNATIONAL REGISTRATION
0925719 DATED 4-13-2007, EXPIRES 4-13-2017.

SER. NO. 79-039,106, FILED 4-13-2007.

MARTHA FROMM, EXAMINING ATTORNEY

Int. Cl.: 29

Prior U.S. Cl.: 46

Reg. No. 3,485,142

United States Patent and Trademark Office

Registered Aug. 12, 2008

**TRADEMARK
PRINCIPAL REGISTER**

Västan

MILKO EKONOMISK FÖRENING (SWEDEN
EKONOMISK FÖRENING)
BOX 362
SE-831 25 ÖSTERSUND
SWEDEN

THE FOREIGN WORDING IN THE MARK
TRANSLATES INTO ENGLISH AS SOMETHING
COMING FROM THE WEST OR WIND FROM THE
WEST.

FOR: MILK; CHEESE; AND MILK PRODUCTS
EXCLUDING ICE CREAM, ICE MILK AND FRO-
ZEN YOGURT, IN CLASS 29 (U.S. CL. 46).

SER. NO. 79-039,207, FILED 5-16-2007.

OWNER OF INTERNATIONAL REGISTRATION
0883670 DATED 2-9-2006, EXPIRES 2-9-2016.

TASHIA BUNCH, EXAMINING ATTORNEY

Int. Cl.: 16

Prior U.S. Cls.: 2, 5, 22, 23, 29, 37, 38 and 50

Reg. No. 3,485,143

United States Patent and Trademark Office

Registered Aug. 12, 2008

**TRADEMARK
PRINCIPAL REGISTER**

TITANGO

TITAN UMREIFUNGSTECHNIK; GMBH & CO.
KG (FED REP GERMANY LIMITED PART-
NERSHIP)
BERLINER STRASSE 51-55
58332 SCHWELM
FED REP GERMANY

FOR: MAGAZINES IN THE FIELD OF MATERI-
AL PACKAGING, CURRENT EVENTS, CULTURAL
HERITAGE, BUSINESS, FINANCE, COMMERCE,
INDUSTRY, METALWORKING, INDUSTRIAL MA-
CHINERY, SCIENCE, TECHNOLOGY, COMMUNI-
CATIONS, IN CLASS 16 (U.S. CLS. 2, 5, 22, 23, 29, 37, 38
AND 50).

THE MARK CONSISTS OF STANDARD CHAR-
ACTERS WITHOUT CLAIM TO ANY PARTICULAR
FONT, STYLE, SIZE, OR COLOR.

PRIORITY DATE OF 11-24-2006 IS CLAIMED.

OWNER OF INTERNATIONAL REGISTRATION
0926147 DATED 5-16-2007, EXPIRES 5-16-2017.

SER. NO. 79-039,303, FILED 5-16-2007.

EDWARD NELSON, EXAMINING ATTORNEY

Int. Cl.: 30

Prior U.S. Cl.: 46

United States Patent and Trademark Office

Reg. No. 3,485,144

Registered Aug. 12, 2008

**TRADEMARK
PRINCIPAL REGISTER**



MASDAC CO., LTD. (JAPAN CORPORATION
LIMITED)
1-27-20, KOTESASHIMOTOMACHI,
TOKOROZAWA; SAITAMA 359-1147
JAPAN

OWNER OF INTERNATIONAL REGISTRATION
0926150 DATED 5-25-2007, EXPIRES 5-25-2017.

FOR: BREAD, PASTRIES; AND CONFECTIONS,
NAMELY, STEAMED CAKES, SPONGE CAKES,
CREAM PUFFS, COOKIES, MELBA TOAST, WAF-
FLES AND PANCAKES, IN CLASS 30 (U.S. CL. 46).

SER. NO. 79-039,304, FILED 5-25-2007.

HEATHER BIDDULPH, EXAMINING ATTORNEY

Int. Cls.: 9, 18 and 25

Prior U.S. Cls.: 1, 2, 3, 21, 22, 23, 26, 36, 38, 39 and 41

United States Patent and Trademark Office

Reg. No. 3,485,145

Registered Aug. 12, 2008

**TRADEMARK
PRINCIPAL REGISTER**



PORTOBELLO LIMITED (UNITED KINGDOM
LIMITED COMPANY)
14 GRAVEL LANE
LONDON E1 7AW
UNITED KINGDOM

FOR: SUNGLASSES, IN CLASS 9 (U.S. CLS. 21, 23,
26, 36 AND 38).

FOR: HANDBAGS, IN CLASS 18 (U.S. CLS. 1, 2, 3,
22 AND 41).

FOR: SOCKS, TIGHTS, SCARVES, HATS, CAPS,
CAP VISORS, ARM WARMERS, LEG WARMERS,

LEGGINS, SHIRTS, TSHIRTS, TROUSERS, GLOVES,
IN CLASS 25 (U.S. CLS. 22 AND 39).

OWNER OF INTERNATIONAL REGISTRATION
0926244 DATED 3-30-2007, EXPIRES 3-30-2017.

MACAHEL DO NOT IDENTIFY ANY LIVING
INDIVIDUAL.

SER. NO. 79-039,333, FILED 3-30-2007.

RON FAIRBANKS, EXAMINING ATTORNEY

Int. Cl.: 41

Prior U.S. Cls.: 100, 101 and 107

Reg. No. 3,485,146

United States Patent and Trademark Office

Registered Aug. 12, 2008

**SERVICE MARK
PRINCIPAL REGISTER**

WKO
World Karate Organization

NPO WORLD KARATE ORGANIZATION (JAPAN NON PROFIT ORGANIZATION)
9-21, SHINOGAWAMACHI
SHINJUKU-KU
TOKYO, JAPAN 1620814

NO CLAIM IS MADE TO THE EXCLUSIVE RIGHT TO USE "KARATE ORGANIZATION", APART FROM THE MARK AS SHOWN.

FOR: KARATE INSTRUCTION, IN CLASS 41 (U.S. CLS. 100, 101 AND 107).

SER. NO. 79-039,400, FILED 1-31-2007.

OWNER OF INTERNATIONAL REGISTRATION 0926457 DATED 1-31-2007, EXPIRES 1-31-2017.

BERNICE MIDDLETON, EXAMINING ATTORNEY

Int. Cl.: 12

Prior U.S. Cls.: 19, 21, 23, 31, 35 and 44

United States Patent and Trademark Office

Reg. No. 3,485,147

Registered Aug. 12, 2008

**TRADEMARK
PRINCIPAL REGISTER**

ANTARA

OPEL EISENACH GMBH (FED REP GERMANY
LTD LIAB CO)

ADAM-OPEL-STRASSE 100

99817 EISENACH

FED REP GERMANY

THE MARK CONSISTS OF STANDARD CHAR-
ACTERS WITHOUT CLAIM TO ANY PARTICULAR
FONT, STYLE, SIZE, OR COLOR.

OWNER OF INTERNATIONAL REGISTRATION
0494305 DATED 6-22-1985, EXPIRES 6-22-2015.

FOR: MOTOR LAND VEHICLES, NAMELY,
SPORT UTILITY VEHICLES, IN CLASS 12 (U.S.
CLS. 19, 21, 23, 31, 35 AND 44).

SER. NO. 79-039,486, FILED 6-12-2007.

LINDSEY RUBIN, EXAMINING ATTORNEY

Int. Cl.: 41

Prior U.S. Cls.: 100, 101 and 107

United States Patent and Trademark Office

Reg. No. 3,485,148

Registered Aug. 12, 2008

**SERVICE MARK
PRINCIPAL REGISTER**

LALIQUÉ

LALIQUÉ (FRANCE SOCIÉTÉ ANONYME)
11, RUE ROYALE
F-75008 PARIS
FRANCE

FOR: CULTURAL ACTIVITIES, NAMELY, BOOK
AND MAGAZINE PUBLISHING, PRODUCTION OF
TELEVISION SHOWS, ORGANIZATION OF EXHI-
BITIONS, NAMELY, ART SHOWS FOR CULTURAL
PURPOSES, IN CLASS 41 (U.S. CLS. 100, 101 AND
107).

THE MARK CONSISTS OF STANDARD CHAR-
ACTERS WITHOUT CLAIM TO ANY PARTICULAR
FONT, STYLE, SIZE, OR COLOR.

OWNER OF INTERNATIONAL REGISTRATION
0716466 DATED 7-12-1999, EXPIRES 7-12-2009.

SER. NO. 79-039,490, FILED 6-11-2007.

CAROLINE WOOD, EXAMINING ATTORNEY

Int. Cl.: 12

Prior U.S. Cls.: 19, 21, 23, 31, 35 and 44

Reg. No. 3,485,149

United States Patent and Trademark Office

Registered Aug. 12, 2008

**TRADEMARK
PRINCIPAL REGISTER**



ITALDESIGN-GIUGIARO S.P.A. (ITALY CORPORATION)
VIA SAN QUINTINO, 28
I-10121 TORINO
ITALY

THE COLOR(S) RED, WHITE, SILVER AND BLACK IS/ARE CLAIMED AS A FEATURE OF THE MARK.

FOR: LAND VEHICLES, NAMELY, AUTOMOBILES, MOTORCYCLES, AND STRUCTURAL PARTS THEREFOR, IN CLASS 12 (U.S. CLS. 19, 21, 23, 31, 35 AND 44).

THE COLOR RED APPEARS IN THE LETTER "G", THE COLOR SILVER AND WHITE APPEARS AS SHADING IN THE THICK BORDER OF THE LETTER "G", AND THE COLOR BLACK APPEARS AS THE OUTLINE OF THE BORDER OF THE LETTER "G".

PRIORITY DATE OF 3-9-2007 IS CLAIMED.

SER. NO. 79-039,515, FILED 5-15-2007.

OWNER OF INTERNATIONAL REGISTRATION 0926722 DATED 5-15-2007, EXPIRES 5-15-2017.

CARYN GLASSER, EXAMINING ATTORNEY

Int. Cl.: 9

Prior U.S. Cls.: 21, 23, 26, 36 and 38

United States Patent and Trademark Office

Reg. No. 3,485,150

Registered Aug. 12, 2008

**TRADEMARK
PRINCIPAL REGISTER**

ESPROS Photonics

ESPROS PHOTONICS AG (SWITZERLAND SOCI-
ÉTÉ ANONYME)
KANTONSSTRASSE 14
CH-7302 LANDQUART
SWITZERLAND

OWNER OF INTERNATIONAL REGISTRATION
0926838 DATED 5-16-2007, EXPIRES 5-16-2017.

FOR: OPTICAL SEMICONDUCTORS, OPTOE-
LECTRONIC INTEGRATED SENSOR CIRCUITS,
IN CLASS 9 (U.S. CLS. 21, 23, 26, 36 AND 38).

NO CLAIM IS MADE TO THE EXCLUSIVE
RIGHT TO USE "PHOTONICS", APART FROM
THE MARK AS SHOWN.

THE MARK CONSISTS OF STANDARD CHAR-
ACTERS WITHOUT CLAIM TO ANY PARTICULAR
FONT, STYLE, SIZE, OR COLOR.

SER. NO. 79-039,561, FILED 5-16-2007.

PRIORITY DATE OF 11-16-2006 IS CLAIMED.

TASHIA BUNCH, EXAMINING ATTORNEY

Int. Cl.: 33

Prior U.S. Cls.: 47 and 49

United States Patent and Trademark Office

Reg. No. 3,485,151

Registered Aug. 12, 2008

**TRADEMARK
PRINCIPAL REGISTER**

SPRINGFONTEIN

WEBER, ANJA (FED REP GERMANY INDIVI-
DUAL)
HUNSRÜCKSTR. 3B
45133 ESSEN
FED REP GERMANY

OWNER OF INTERNATIONAL REGISTRATION
0927124 DATED 5-14-2007, EXPIRES 5-14-2017.

SER. NO. 79-039,676, FILED 5-14-2007.

FOR: WINES, IN CLASS 33 (U.S. CLS. 47 AND 49).

BERNICE MIDDLETON, EXAMINING ATTORNEY

Int. Cl.: 10

Prior U.S. Cls.: 26, 39 and 44

United States Patent and Trademark Office

Reg. No. 3,485,152

Registered Aug. 12, 2008

**TRADEMARK
PRINCIPAL REGISTER**

NOVAFLOW

NOVALUNG GMBH (FED REP GERMANY PRIVATE LIMITED LIABILITY COMPANY)

LOTZENÄCKER 3

72379 HECHINGEN, FED REP GERMANY

FOR: MEDICAL APPARATUSES AND INSTRUMENTS FOR SUPPORTING LUNG FUNCTION OF A HUMAN BEING, NAMELY, ARTIFICIAL LUNGS; MEDICAL DEVICES FOR MEASURING BLOOD FLOW, NAMELY, BLOOD FLOW METERS; DILATORS, NAMELY BRONCHIAL DILATORS; SCALPELS, IN CLASS 10 (U.S. CLS. 26, 39 AND 44).

THE MARK CONSISTS OF STANDARD CHARACTERS WITHOUT CLAIM TO ANY PARTICULAR FONT, STYLE, SIZE, OR COLOR.

PRIORITY DATE OF 12-19-2006 IS CLAIMED.

OWNER OF INTERNATIONAL REGISTRATION 0927922 DATED 4-18-2007, EXPIRES 4-18-2017.

SER. NO. 79-039,934, FILED 4-18-2007.

BILL DAWE, EXAMINING ATTORNEY

Int. Cl.: 9

Prior U.S. Cls.: 21, 23, 26, 36 and 38

United States Patent and Trademark Office

Reg. No. 3,485,153

Registered Aug. 12, 2008

**TRADEMARK
PRINCIPAL REGISTER**

EZ FLIGHT NAV

VILLENEUVE JOSEPH (FRANCE INDIVIDUAL)
ALLÉE DES COCOTIERS
VERNOU
F-97170 PETIT-BOURG (GUADELOUPE), FRANCE

OWNER OF INTERNATIONAL REGISTRATION
0928390 DATED 1-30-2007, EXPIRES 1-30-2017.

FOR: APPARATUS FOR CHECKING FLIGHT
PARAMETERS, IN CLASS 9 (U.S. CLS. 21, 23, 26, 36
AND 38).

NO CLAIM IS MADE TO THE EXCLUSIVE
RIGHT TO USE "FLIGHT NAV", APART FROM
THE MARK AS SHOWN.

SER. NO. 79-040,087, FILED 1-30-2007.

THE MARK CONSISTS OF STANDARD CHAR-
ACTERS WITHOUT CLAIM TO ANY PARTICULAR
FONT, STYLE, SIZE, OR COLOR.

KATHERINE E. HALMEN, EXAMINING ATTOR-
NEY

Int. Cl.: 9

Prior U.S. Cls.: 21, 23, 26, 36 and 38

Reg. No. 3,485,154

United States Patent and Trademark Office

Registered Aug. 12, 2008

TRADEMARK
PRINCIPAL REGISTER

LLSENSOR

エルエルセンサー

XIROKU, INC. (JAPAN CORPORATION)
2-1-6, SENGEN
TSUKUBA-SHI; IBARAKI 305-0047
JAPAN

OWNER OF INTERNATIONAL REGISTRATION
0928588 DATED 12-7-2006, EXPIRES 12-7-2016.

FOR: INPUT DEVICES FOR COMPUTER GAMES;
MEASURING OR TESTING INSTRUMENTS,
NAMELY, FLOOR SENSORS FOR THE DETECTION
OF INTRUDERS AND PRESSURE DISTRIBUTION
MEASUREMENT GAUGES AND SENSORS; CHIP
AND FLASH CARD READERS; METAL DETEC-
TORS; COMPUTER PERIPHERALS; INPUT DEVI-
CES FOR VIDEO GAMES, IN CLASS 9 (U.S. CLS. 21,
23, 26, 36 AND 38).

"THE NON-LATIN CHARACTER(S) IN THE
MARK TRANSLITERATES INTO "ERUERU SEN-
SAA", AND THIS MEANS "LL SENSOR" IN ENG-
LISH."

SER. NO. 79-040,164, FILED 12-7-2006.

PRIORITY DATE OF 9-1-2006 IS CLAIMED.

DANIEL CAPSHAW, EXAMINING ATTORNEY

Int. Cl.: 9

Prior U.S. Cls.: 21, 23, 26, 36 and 38

United States Patent and Trademark Office

Reg. No. 3,485,155

Registered Aug. 12, 2008

**TRADEMARK
PRINCIPAL REGISTER**

BUGATTI
e y e w e a r

SDIM (FRANCE SOCIÉTÉ À RESPONSABILITÉ
LIMITÉE)
101 RUE DE LA RÉPUBLIQUE
F-39400 MOREZ, FRANCE

FOR: SPECTACLES; SUNGLASSES; SPECTACLE
CASES; SPECTACLE LENSES; SPECTACLE
FRAMES, IN CLASS 9 (U.S. CLS. 21, 23, 26, 36 AND
38).

PRIORITY DATE OF 12-1-2006 IS CLAIMED.

OWNER OF INTERNATIONAL REGISTRATION
0928662 DATED 5-31-2007, EXPIRES 5-31-2017.

OWNER OF U.S. REG. NO. 1,169,043.

NO CLAIM IS MADE TO THE EXCLUSIVE
RIGHT TO USE "EYEWEAR", APART FROM THE
MARK AS SHOWN.

THE COLOR(S) RED AND BLACK IS/ARE
CLAIMED AS A FEATURE OF THE MARK.

THE COLOR RED APPEARS IN THE WORDING
"BUGATTI". THE COLOR BLACK APPEARS IN THE
WORDING "EYEWEAR".

SER. NO. 79-040,194, FILED 5-31-2007.

ROBERT STRUCK, EXAMINING ATTORNEY

Int. Cl.: 33

Prior U.S. Cls.: 47 and 49

United States Patent and Trademark Office

Reg. No. 3,485,156

Registered Aug. 12, 2008

**TRADEMARK
PRINCIPAL REGISTER**

VERDEO

PAVITOR S.L. (SPAIN SOCIEDAD LIMITADA)
COMERCIO, 22
E-08720 VILAFRANCA DEL PENEDES (BARCELONA)
SPAIN

FOR: WINES, IN CLASS 33 (U.S. CLS. 47 AND 49).

THE MARK CONSISTS OF STANDARD CHARACTERS WITHOUT CLAIM TO ANY PARTICULAR FONT, STYLE, SIZE, OR COLOR.

OWNER OF INTERNATIONAL REGISTRATION
0928837 DATED 5-16-2007, EXPIRES 5-16-2017.

NO CLAIM IS MADE TO THE EXCLUSIVE RIGHT TO USE "VINHO VERDE", APART FROM THE MARK AS SHOWN.

THE FOREIGN WORDING IN THE MARK TRANSLATES INTO ENGLISH AS "CROP OF OLIVES BEFORE THEY RIPEN."

SER. NO. 79-040,249, FILED 5-16-2007.

TINA BROWN, EXAMINING ATTORNEY

Int. Cl.: 19

Prior U.S. Cls.: 1, 12, 33 and 50

United States Patent and Trademark Office

Reg. No. 3,485,157

Registered Aug. 12, 2008

**TRADEMARK
PRINCIPAL REGISTER**

PRET A PORTER

CERÁMICAS DEL FOIX, S.A. (SPAIN SOCIEDAD ANÓNIMA)
AV. DELS PAÏSOS CATALANS, 27
POL. IND. CASANOVA; E-08730 SANTA MARGARIDA I ELS MONJOS
SPAIN

PRIORITY DATE OF 1-19-2007 IS CLAIMED.

OWNER OF INTERNATIONAL REGISTRATION
0928890 DATED 5-16-2007, EXPIRES 5-16-2017.

FOR: NON-METALLIC BUILDING MATERIALS, NAMELY, TILES OF CLAY, PLASTER, CERAMIC AND TERRACOTTA FOR WALLS, FLOORS OR ROOFS , IN CLASS 19 (U.S. CLS. 1, 12, 33 AND 50).

THE FOREIGN WORDING IN THE MARK TRANSLATES INTO ENGLISH AS READY TO WEAR

THE MARK CONSISTS OF STANDARD CHARACTERS WITHOUT CLAIM TO ANY PARTICULAR FONT, STYLE, SIZE, OR COLOR.

SER. NO. 79-040,276, FILED 5-16-2007.

TASHIA BUNCH, EXAMINING ATTORNEY

Int. Cl.: 29

Prior U.S. Cl.: 46

United States Patent and Trademark Office

Reg. No. 3,485,158

Registered Aug. 12, 2008

**TRADEMARK
PRINCIPAL REGISTER**

WIJNGAARD KAAS B.V. (NETHERLANDS B.V.)

GOLF VAN BISKAJE 8

NL-3446 CP WOERDEN

NETHERLANDS

THE MARK CONSISTS OF STANDARD CHARACTERS WITHOUT CLAIM TO ANY PARTICULAR FONT, STYLE, SIZE, OR COLOR.

OWNER OF INTERNATIONAL REGISTRATION
0928917 DATED 6-12-2007, EXPIRES 6-12-2017.

FOR: MILK AND MILK PRODUCTS, EXCLUDING ICE CREAM, ICE MILK AND FROZEN YOGURT; CHEESE, IN CLASS 29 (U.S. CL. 46).

SER. NO. 79-040,287, FILED 6-12-2007.

KRISTINA MORRIS, EXAMINING ATTORNEY

Int. Cl.: 21

Prior U.S. Cls.: 2, 13, 23, 29, 30, 33, 40 and 50

United States Patent and Trademark Office

Reg. No. 3,485,159

Registered Aug. 12, 2008

**TRADEMARK
PRINCIPAL REGISTER**



HI-TECH

ALTRO LIMITED (UNITED KINGDOM LIMITED
LIABILITY COMPANY OF ENGLAND AND
WALES)
WORKS ROAD
LETCHWORTH GARDEN CITY; HERTFORDSHIRE
SG6 1NW
UNITED KINGDOM

FOR: NON-ELECTRIC CLEANING AND DRY-
ING ARTICLES, NAMELY, CLEANING HAND
PADS, FINISHING CLOTHS, INTERIOR AND EX-
TERIOR MICROFIBRE CLOTHS; WIPING CLOTHS,
NAMELY, SYNTHETIC CHAMOIS LEATHERS;
WIPING APPARATUS AND DEVICES FOR CLEAN-
ING AND DRYING NAMELY FLEXIBLE WATER
BLADES; BRUSHES, NAMELY, WHEEL BRUSHES;
CLOTHS FOR CLEANING, DRYING AND POLISH-
ING NAMELY, SYNTHETIC CHAMOIS LEATHERS,
INTERIOR AND EXTERIOR MICROFIBRE
CLOTHS; CLEANING AND DRYING LEATHERS,
NAMELY, SYNTHETIC CHAMOIS LEATHERS;
CLEANING PADS, DUSTERS, GLOVES FOR

CLEANING USE, NAMELY, COTTON GLOVES
FOR CLEANING USE AND DISPOSABLE GLOVES
FOR CLEANING USE; COMBS AND CLEANING
SPONGES, IN CLASS 21 (U.S. CLS. 2, 13, 23, 29, 30, 33,
40 AND 50).

OWNER OF INTERNATIONAL REGISTRATION
0928934 DATED 6-19-2007, EXPIRES 6-19-2017.

OWNER OF U.S. REG. NO. 1,529,179.

NO CLAIM IS MADE TO THE EXCLUSIVE
RIGHT TO USE "AUTO" AND "HI-TECH", APART
FROM THE MARK AS SHOWN.

SER. NO. 79-040,315, FILED 6-19-2007.

WARREN L. OLANDRIA, EXAMINING ATTOR-
NEY

Int. Cl.: 29

Prior U.S. Cl.: 46

United States Patent and Trademark Office

Reg. No. 3,485,160

Registered Aug. 12, 2008

**TRADEMARK
PRINCIPAL REGISTER**

СОМУЛЬ

OBSHCHESTVO S OGRANICHENNOY; OT-
VETSTVENNOSTYU; "KOMPANIYA ZOLO-
TOY TEREM" (RUSSIAN FED. LTD LIAB CO)
4, STR. 15, NAB. DANILOVSKAYA
RU-113114 MOSCOW
RUSSIAN FED.

FOR: CHARCUTERIE; SAUSAGES; CAVIAR;
PRESERVED MEAT; PRESERVED FISH; SHRIMPS
NOT LIVE; CLAMS NOT LIVE; MUSSELS NOT LIVE;
OYSTERS NOT LIVE; MEAT; PRESERVED VEGE-
TABLES; COOKED VEGETABLES; POTATO FRIT-
TERS; MILK PRODUCTS EXCLUDING ICE
CREAM, ICE MILK AND FROZEN YOGURT; PRE-
SERVED MUSHROOMS; FOODS PREPARED FROM
FISH, NAMELY, FROZEN, PREPARED, OR PACK-
AGED ENTREES CONSISTING PRIMARILY OF
FISH; VEGETABLE JUICES FOR COOKING; SOUPS;

PRESERVED POTATO FLAKES; POTATO CHIPS, IN
CLASS 29 (U.S. CL. 46).

OWNER OF INTERNATIONAL REGISTRATION
0929063 DATED 4-5-2007, EXPIRES 4-5-2017.

THE MARK HAS NO MEANING IN A FOREIGN
LANGUAGE.

THE TRANSLITERATION OF THE NON-LATIN
CHARACTERS IN THE MARK IS: "SOMUL".

SER. NO. 79-040,364, FILED 4-5-2007.

BERNICE MIDDLETON, EXAMINING ATTORNEY

Int. Cl.: 7

Prior U.S. Cls.: 13, 19, 21, 23, 31, 34 and 35

Reg. No. 3,485,161

United States Patent and Trademark Office

Registered Aug. 12, 2008

**TRADEMARK
PRINCIPAL REGISTER**



GERHARDUS A.M. SMOORS (NETHERLANDS
INDIVIDUAL)
BERRIEHOEK 93 NL-7546 JR
ENSCHDEDE, NETHERLANDS

FOR: PROPULSION MECHANISMS OTHER THAN FOR LAND VEHICLES, NAMELY, BEVEL GEARBOXES AND SPUR GEARBOXES, QUARTER TURN GEARBOXES, FOR USE IN THE VALVE INDUSTRY, THE PIPELINE INDUSTRY AND THE FLUID PROCESSING INDUSTRY; DRIVING MOTORS OTHER THAN FOR LAND VEHICLES, NAMELY, BEVEL GEARBOXES AND SPUR GEARBOXES, QUARTER TURN GEARBOXES, FOR USE IN THE VALVE INDUSTRY, THE PIPELINE INDUSTRY AND THE FLUID PROCESSING INDUSTRY; CLUTCHES AND TRANSMISSIONS OTHER THAN FOR LAND VEHICLES FOR USE IN THE VALVE INDUSTRY, THE PIPELINE INDUSTRY AND THE FLUID PROCESSING INDUSTRY; MOTORS, OTHER THAN FOR LAND VEHICLES, NAMELY, FOR USE IN THE VALVE INDUSTRY, THE PIPELINE INDUSTRY AND THE FLUID PROCESSING INDUSTRY; MOTOR PARTS, NAMELY, BEVEL GEARBOXES AND SPUR GEARBOXES, QUARTER

TURN GEARBOXES, FOR USE IN THE VALVE INDUSTRY, THE PIPELINE INDUSTRY AND THE FLUID PROCESSING INDUSTRY; MECHANICAL DRIVES FOR BEVEL GEARBOXES AND SPUR GEARBOXES, QUARTER TURN GEARBOXES, FOR USE IN THE VALVE INDUSTRY, THE PIPELINE INDUSTRY AND THE FLUID PROCESSING INDUSTRY; PARTS FOR ALL THE AFOREMENTIONED GOODS, NAMELY, HOUSINGS FOR GEARBOXES, SHAFTS FOR GEARBOXES AND FASTENERS FOR GEARBOXES, IN CLASS 7 (U.S. CLS. 13, 19, 21, 23, 31, 34 AND 35).

PRIORITY DATE OF 1-9-2007 IS CLAIMED.

OWNER OF INTERNATIONAL REGISTRATION
0929641 DATED 6-4-2007, EXPIRES 6-4-2017.

SER. NO. 79-040,577, FILED 6-4-2007.

FLORENTINA BLANDU, EXAMINING ATTORNEY

Int. Cls.: 9, 11 and 42

Prior U.S. Cls.: 13, 21, 23, 26, 31, 34, 36, 38, 100 and 101

Reg. No. 3,485,162

United States Patent and Trademark Office

Registered Aug. 12, 2008

**TRADEMARK
SERVICE MARK
PRINCIPAL REGISTER**

PROTEROS BIOSTRUCTURES GMBH (FED REP GERMANY GMBH)
AM KLOPFERSPITZ 19
82152 PLANEGG-MARTINSRIED
FED REP GERMANY

FOR: SCIENTIFIC, SURVEYING, OPTICAL, MEASURING, SIGNALING, CHECKING OR SUPERVISION APPARATUS AND INSTRUMENTS, NAMELY, APPARATUS FOR GENERATING AND CONTROLLING HUMID AIR STREAMS FOR USE IN LABORATORY, SCIENTIFIC AND MEDICAL RESEARCH; SCIENTIFIC, SURVEYING, OPTICAL, MEASURING, SIGNALING, CHECKING OR SUPERVISION APPARATUS AND INSTRUMENTS, NAMELY, APPARATUS FOR GENERATING AND CONTROLLING HUMID AIR STREAMS FOR CRYSTALLOGRAPHIC ANALYSIS AND OPTIMIZATION OF PROTEINS AND PROTEIN CRYSTALS FOR USE IN LABORATORY, SCIENTIFIC AND MEDICAL RESEARCH, IN CLASS 9 (U.S. CLS. 21, 23, 26, 36 AND 38).

FOR: APPARATUS FOR LIGHTING, HEATING, STEAM GENERATING, REFRIGERATING, DRYING, VENTILATING, NAMELY, HUMIDIFIER APPARATUS AND PARTS THEREFOR FOR GENERATING AND CONTROLLING HUMID AIR STREAMS; APPARATUS FOR LIGHTING, HEATING, STEAM GENERATING, REFRIGERATING, DRYING, VENTILATING, NAMELY, HUMIDIFIER

APPARATUS AND PARTS THEREFOR FOR GENERATING AND CONTROLLING HUMID AIR STREAMS FOR CRYSTALLOGRAPHIC ANALYSIS AND OPTIMIZATION OF PROTEINS AND PROTEIN CRYSTALS, IN CLASS 11 (U.S. CLS. 13, 21, 23, 31 AND 34).

FOR: SCIENTIFIC RESEARCH AND DEVELOPMENT; TECHNOLOGICAL RESEARCH AND DEVELOPMENT IN THE FIELD OF CRYSTALLOGRAPHY, X-RAY STRUCTURE ANALYSIS, AND PROTEIN AND PROTEIN-LIGAND STRUCTURE ANALYSIS; INDUSTRIAL ANALYSIS AND RESEARCH SERVICES, NAMELY, RESEARCH RELATED TO CRYSTALS, PROTEINS, AND OPTIMIZING PROTEINS PROTEIN CRYSTAL STRUCTURES, IN CLASS 42 (U.S. CLS. 100 AND 101).

THE MARK CONSISTS OF STANDARD CHARACTERS WITHOUT CLAIM TO ANY PARTICULAR FONT, STYLE, SIZE, OR COLOR.

OWNER OF INTERNATIONAL REGISTRATION 0929765 DATED 2-26-2007, EXPIRES 2-26-2017.

SER. NO. 79-040,668, FILED 2-26-2007.

GINA FINK, EXAMINING ATTORNEY

Int. Cls.: 9, 10 and 42

Prior U.S. Cls.: 21, 23, 26, 36, 38, 39, 44, 100 and 101

United States Patent and Trademark Office

Reg. No. 3,485,163

Registered Aug. 12, 2008

**TRADEMARK
SERVICE MARK
PRINCIPAL REGISTER**

TOFINSIGHT

TOFWERK AG (SWITZERLAND SOCIÉTÉ
ANONYME)
FEUERWERKERSTRASSE 39
CH-3602 THUN
SWITZERLAND

FOR: ANALYSIS APPARATUS NOT FOR MEDICAL USE, PARTICULARLY MASS SPECTROMETERS; GAS ANALYSIS APPARATUS; AIR ANALYSIS APPARATUS, IN CLASS 9 (U.S. CLS. 21, 23, 26, 36 AND 38).

FOR: ANALYSIS APPARATUS FOR MEDICAL USE, PARTICULARLY MASS SPECTROMETERS, IN CLASS 10 (U.S. CLS. 26, 39 AND 44).

FOR: CONDUCTING CHEMICAL ANALYSES; RESEARCH IN THE FIELDS OF SCIENCE, IN CLASS 42 (U.S. CLS. 100 AND 101).

THE MARK CONSISTS OF STANDARD CHARACTERS WITHOUT CLAIM TO ANY PARTICULAR FONT, STYLE, SIZE, OR COLOR.

PRIORITY DATE OF 2-16-2007 IS CLAIMED.

OWNER OF INTERNATIONAL REGISTRATION 0929892 DATED 6-7-2007, EXPIRES 6-7-2017.

SER. NO. 79-040,715, FILED 6-7-2007.

ANNE FARRELL, EXAMINING ATTORNEY

Int. Cl.: 9

Prior U.S. Cls.: 21, 23, 26, 36 and 38

United States Patent and Trademark Office

Reg. No. 3,485,164

Registered Aug. 12, 2008

**TRADEMARK
PRINCIPAL REGISTER**

D I S C A T H L O N

TEAC CORPORATION (JAPAN CORPORATION)
1-47 OCHIAI
TAMA-SHITOKYO 206-8530
JAPAN

PRIORITY DATE OF 1-10-2007 IS CLAIMED.

FOR: DISC LABEL PRINTERS; LABEL PRINTERS, IN CLASS 9 (U.S. CLS. 21, 23, 26, 36 AND 38).

OWNER OF INTERNATIONAL REGISTRATION
0930083 DATED 6-5-2007, EXPIRES 6-5-2017.

THE MARK CONSISTS OF STANDARD CHARACTERS WITHOUT CLAIM TO ANY PARTICULAR FONT, STYLE, SIZE, OR COLOR.

SER. NO. 79-040,781, FILED 6-5-2007.

CHRISIE B. KING, EXAMINING ATTORNEY

Int. Cls.: 3 and 9

Prior U.S. Cls.: 1, 4, 6, 21, 23, 26, 36, 38, 50, 51 and 52

United States Patent and Trademark Office

Reg. No. 3,485,165

Registered Aug. 12, 2008

**TRADEMARK
PRINCIPAL REGISTER**



MULBERRY COMPANY (DESIGN) LTD (UNITED KINGDOM COMPANY)
THE ROOKERY, CHILCOMPTON BATH
BATH & NORTH EASTSOMERSET BA3 4EH
UNITED KINGDOM

FOR: COSMETICS; PERFUMES; ESSENTIAL OILS; NON-MEDICATED TOILETRIES; SOAPS; COSMETIC PREPARATIONS FOR BODY CARE; HAIR CARE PREPARATIONS; PRE-SHAVE AND AFTER-SHAVE PREPARATIONS; SHAVING SOAPS; SHAVING FOAM; COLOGNES; DENTIFRICES; ANTI-PERSPIRANTS; NON-MEDICATED SKIN AND BODY CARE PREPARATIONS, NAMELY, CREAMS AND LOTIONS; POTPOURRIS; PERFUMES IMPREGNATED INTO SACHETS, IN CLASS 3 (U.S. CLS. 1, 4, 6, 50, 51 AND 52).

FOR: OPTICAL GOODS, NAMELY, SUNGLASSES, SPECTACLES, OPTICAL LENSES, OPTICAL FRAMES, CASES AND CHAINS THEREFOR, IN CLASS 9 (U.S. CLS. 21, 23, 26, 36 AND 38).

PRIORITY DATE OF 5-30-2007 IS CLAIMED.

OWNER OF INTERNATIONAL REGISTRATION
0930202 DATED 6-13-2007, EXPIRES 6-13-2017.

OWNER OF U.S. REG. NOS. 1,123,282, 2,748,219
AND OTHERS.

NO CLAIM IS MADE TO THE EXCLUSIVE RIGHT TO USE "MULBERRY" ONLY AS TO THE CLASS 3 GOODS, APART FROM THE MARK AS SHOWN.

SER. NO. 79-040,816, FILED 6-13-2007.

SCOTT BIBB, EXAMINING ATTORNEY

Int. Cl.: 25

Prior U.S. Cls.: 22 and 39

United States Patent and Trademark Office

Reg. No. 3,485,166

Registered Aug. 12, 2008

**TRADEMARK
PRINCIPAL REGISTER**



VANNI VANESSA (ITALY INDIVIDUAL)
VIA PISANA, 104
I-53036 POGGIBONSI (SI)
ITALY

FOR: CLOTHING FOR MEN, WOMEN AND CHILDREN, NAMELY, COATS, RAINCOATS, JACKETS, TROUSERS, SKIRTS, DRESSES, SUITS, SHIRTS AND CHEMISES, T-SHIRT, SWEATERS, UNDERWEAR, SWIMWEAR, BEACHWEAR, SOCKS AND STOCKINGS, GLOVES, TIES, SCARVES, FOULARDS, IN CLASS 25 (U.S. CLS. 22 AND 39).

OWNER OF INTERNATIONAL REGISTRATION
0930210 DATED 6-7-2007, EXPIRES 6-7-2017.

THE MARK CONSISTS OF THE WORD "DIVA-CATTIVA" ON A BACKGROUND COMPOSED BY A PICTURE OF THE FACE OF A DOLL.

THE ENGLISH TRANSLATION OF THE FOREIGN WORD(S) IN THE MARK IS "NASTY STAR".

SER. NO. 79-040,821, FILED 6-7-2007.

RAMONA ORTIGA, EXAMINING ATTORNEY

Int. Cl.: 6

Prior U.S. Cls.: 2, 12, 13, 14, 23, 25 and 50

Reg. No. 3,485,167

United States Patent and Trademark Office

Registered Aug. 12, 2008

**TRADEMARK
PRINCIPAL REGISTER**

The logo for JINDUN features the word "JINDUN" in a bold, sans-serif font. The letter "D" is stylized, appearing as a dark, curved shape that resembles a crescent moon or a stylized letter, positioned between the "I" and "N".

ZHEJIANG JINDUN PRESSURE VESSEL; CO.,
LTD (CHINA CORPORATION)
QIANTIAN VILLAGE
XIAOYUE TOWN, SHANGYU CITY; 312367 ZHE-
JIANG PROVINCE
CHINA

FOR: CONTAINERS OF METAL FOR STORING
ACIDS; CONTAINERS OF METAL FOR COMPRES-
SED GAS OR LIQUID AIR; CONTAINERS OF
METAL FOR LIQUID FUEL; STEEL BOTTLES FOR
COMPRESSED GAS, IN CLASS 6 (U.S. CLS. 2, 12, 13,
14, 23, 25 AND 50).

OWNER OF INTERNATIONAL REGISTRATION
0930369 DATED 5-9-2007, EXPIRES 5-9-2017.

THIS MARK HAS NO SIGNIFICANCE IN THE
RELEVANT TRADE OR INDUSTRY, AND HAS NO
GEOGRAPHICAL SIGNIFICANCE, AND HAS NO
MEANING IN A FOREIGN LANGUAGE, AND HAS
NO SIGNIFICANCE AS APPLIED TO THE GOODS.

SER. NO. 79-040,877, FILED 5-9-2007.

DAVID I, EXAMINING ATTORNEY

Int. Cls.: 5 and 10

Prior U.S. Cls.: 6, 18, 26, 39, 44, 46, 51 and 52

United States Patent and Trademark Office

Reg. No. 3,485,168

Registered Aug. 12, 2008

**TRADEMARK
PRINCIPAL REGISTER**

RHIZARTHRUM

LABORATOIRE DE; CONTACTOLOGIE APPLI-
QUÉE - LCA (FRANCE SOCIÉTÉ ANONYME)
9 ALLÉE PROMÉTHÉE
F-28000 CHARTRES
FRANCE

FOR: PHARMACEUTICAL PREPARATIONS FOR
PREPARATIONS FOR TREATING ARTHROSIS
AND OTHER JOINT DISEASES; PHARMACEUTI-
CAL PREPARATIONS FOR TREATING PAIN AND
JOINT DISEASES, ARTHROSIS IN PARTICULAR;
INJECTABLE PHARMACEUTICAL PREPARA-
TIONS FOR RHEUMATOLOGICAL USE, IN THE
FORM OF PRE-FILLED DISPOSABLE STERILE
SYRINGES CONTAINING PHARMACEUTICAL
PREPARATIONS FOR RHEUMATOLOGICAL USE
CONTAINING SODIUM HYALURONATE, IN
CLASS 5 (U.S. CLS. 6, 18, 44, 46, 51 AND 52).

FOR: MEDICAL DEVICES FOR INTRACORPOR-
EAL INJECTION, NAMELY NEEDLES AND SYR-

INGES FOR INJECTIONS; MEDICAL DEVICES FOR
INTRACORPoreal INJECTION COMPOSED OF A
DISPOSABLE STERILE SYRINGE, IN CLASS 10 (U.S.
CLS. 26, 39 AND 44).

THE MARK CONSISTS OF STANDARD CHAR-
ACTERS WITHOUT CLAIM TO ANY PARTICULAR
FONT, STYLE, SIZE, OR COLOR.

PRIORITY DATE OF 12-11-2006 IS CLAIMED.

OWNER OF INTERNATIONAL REGISTRATION
0930508 DATED 6-5-2007, EXPIRES 6-5-2017.

SER. NO. 79-041,010, FILED 6-5-2007.

CHRISIE B. KING, EXAMINING ATTORNEY

Int. Cls.: 5 and 10

Prior U.S. Cls.: 6, 18, 26, 39, 44, 46, 51 and 52

United States Patent and Trademark Office

Reg. No. 3,485,169

Registered Aug. 12, 2008

**TRADEMARK
PRINCIPAL REGISTER**

ARTHRUM H

LABORATOIRE DE; CONTACTOLOGIE APPLI-
QUÉE - LCA (FRANCE SOCIÉTÉ ANONYME)
9 ALLÉE PROMÉTHÉE
F-28000 CHARTRES
FRANCE

FOR: PHARMACEUTICAL PREPARATIONS FOR
PREPARATIONS FOR TREATING ARTHROSIS
AND OTHER JOINT DISEASES; PHARMACEUTI-
CAL PREPARATIONS FOR TREATING PAIN AND
JOINT DISEASES, ARTHROSIS IN PARTICULAR;
INJECTABLE PHARMACEUTICAL PREPARA-
TIONS FOR RHEUMATOLOGICAL USE, IN THE
FORM OF PRE-FILLED DISPOSABLE STERILE
SYRINGES CONTAINING PHARMACEUTICAL
PREPARATIONS FOR RHEUMATOLOGICAL USE
CONTAINING SODIUM HYALURONATE, IN
CLASS 5 (U.S. CLS. 6, 18, 44, 46, 51 AND 52).

FOR: MEDICAL DEVICES FOR INTRACORPOR-
EAL INJECTION, NAMELY NEEDLES AND SYR-

INGES FOR INJECTIONS; MEDICAL DEVICES FOR
INTRACORPoreal INJECTION COMPOSED OF A
DISPOSABLE STERILE SYRINGE, IN CLASS 10 (U.S.
CLS. 26, 39 AND 44).

THE MARK CONSISTS OF STANDARD CHAR-
ACTERS WITHOUT CLAIM TO ANY PARTICULAR
FONT, STYLE, SIZE, OR COLOR.

PRIORITY DATE OF 12-11-2006 IS CLAIMED.

OWNER OF INTERNATIONAL REGISTRATION
0930509 DATED 6-5-2007, EXPIRES 6-5-2017.

SER. NO. 79-041,011, FILED 6-5-2007.

CHRISIE B. KING, EXAMINING ATTORNEY

Int. Cls.: 5 and 10

Prior U.S. Cls.: 6, 18, 26, 39, 44, 46, 51 and 52

United States Patent and Trademark Office

Reg. No. 3,485,170

Registered Aug. 12, 2008

**TRADEMARK
PRINCIPAL REGISTER**

COXARTHRUM

LABORATOIRE DE; CONTACTOLOGIE APPLI-
QUÉE - LCA (FRANCE SOCIÉTÉ ANONYME)
9 ALLÉE PROMÉTHÉE
F-28000 CHARTRES
FRANCE

FOR: PHARMACEUTICAL PREPARATIONS FOR
PREPARATIONS FOR TREATING ARTHROSIS
AND OTHER JOINT DISEASES; PHARMACEUTI-
CAL PREPARATIONS FOR TREATING PAIN AND
JOINT DISEASES, ARTHROSIS IN PARTICULAR;
INJECTABLE PHARMACEUTICAL PREPARA-
TIONS FOR RHEUMATOLOGICAL USE, IN THE
FORM OF PRE-FILLED DISPOSABLE STERILE
SYRINGES CONTAINING PHARMACEUTICAL
PREPARATIONS FOR RHEUMATOLOGICAL USE
CONTAINING SODIUM HYALURONATE, IN
CLASS 5 (U.S. CLS. 6, 18, 44, 46, 51 AND 52).

FOR: MEDICAL DEVICES FOR INTRACORPOR-
EAL INJECTION, NAMELY NEEDLES AND SYR-

INGES FOR INJECTIONS; MEDICAL DEVICES FOR
INTRACORPoreal INJECTION COMPOSED OF A
DISPOSABLE STERILE SYRINGE, IN CLASS 10 (U.S.
CLS. 26, 39 AND 44).

THE MARK CONSISTS OF STANDARD CHAR-
ACTERS WITHOUT CLAIM TO ANY PARTICULAR
FONT, STYLE, SIZE, OR COLOR.

PRIORITY DATE OF 12-11-2006 IS CLAIMED.

OWNER OF INTERNATIONAL REGISTRATION
0930510 DATED 6-5-2007, EXPIRES 6-5-2017.

SER. NO. 79-041,012, FILED 6-5-2007.

CHRISIE B. KING, EXAMINING ATTORNEY

Int. Cl.: 18

Prior U.S. Cls.: 1, 2, 3, 22 and 41

United States Patent and Trademark Office

Reg. No. 3,485,171

Registered Aug. 12, 2008

**TRADEMARK
PRINCIPAL REGISTER**

Tila March

TTNB (FRANCE SOCIETE A RESPONSABILITE
LIMITEE)
90 RUE D'ASSAS
F-75006 PARIS
FRANCE

OWNER OF INTERNATIONAL REGISTRATION
0930619 DATED 4-17-2007, EXPIRES 4-17-2017.

FOR: LEATHER GOODS, NAMELY, WALLETS,
BRIEFCASES, HANDBAGS, IN CLASS 18 (U.S. CLS.
1, 2, 3, 22 AND 41).

SER. NO. 79-041,046, FILED 4-17-2007.

PRIORITY DATE OF 10-19-2006 IS CLAIMED.

WENDY JUN, EXAMINING ATTORNEY

Int. Cls.: 12, 18 and 25

Prior U.S. Cls.: 1, 2, 3, 19, 21, 22, 23, 31, 35, 39, 41 and 44

Reg. No. 3,485,172

United States Patent and Trademark Office

Registered Aug. 12, 2008

TRADEMARK
PRINCIPAL REGISTER

NEW BLUE

NCR S.R.L. (ITALY LTD LIAB CO)
VIA EMILIA, 262
I-40068 SAN LAZZARO DI SAVENA (BOLOGNA)
ITALY

FOR: LAND VEHICLES; ENGINES FOR LAND VEHICLES; TRANSMISSION BELTS FOR LAND VEHICLES; TRANSMISSION CASES FOR LAND VEHICLES; TRANSMISSION MECHANISMS FOR LAND VEHICLES; UNIVERSAL JOINTS FOR LAND VEHICLES; DRIVE SHAFTS FOR LAND VEHICLES; DRIVE SHAFT JOINTS FOR LAND VEHICLES; TORSION SHAFTS FOR LAND VEHICLES; GEARS FOR LAND VEHICLES; CHASSIS FOR LAND VEHICLES; STEERING ARMS FOR LAND VEHICLES; AXLES FOR LAND VEHICLES; RIMS FOR VEHICLE WHEELS; VEHICLE BRAKES; SPRINGS FOR LAND VEHICLES; SHOCK ABSORBERS FOR LAND VEHICLES; TIRES FOR LAND VEHICLES; PNEUMATIC TYRES AND INNER TUBES FOR MOTORCYCLES; MOTORCYCLE SADDLEBAGS; MOTORCYCLE SIDECARS; MOTORCYCLE ENGINES; STRUCTURAL PARTS FOR MOTORCYCLES; MOTORCYCLE PARTS, NAMELY, HEEL GUARDS, CHROMED SAFETY PADS, BRAKE CABLES, CLUTCH CABLES, FORK BEARING AND RACES, FORK DUST BOOTS, FORK SEALS, HANDLE BARS, HANDLE BAR GRIPS, BRAKE CALIPERS, BRAKE PEDALS, BRAKE ROTORS, FRONT SPACERS, FRONT DASH PANELS, SHIFT LEVERS, HEADLIGHT MOUNTS; MOTORCYCLES; MOTORBIKES, IN CLASS 12 (U.S. CLS. 19, 21, 23, 31, 35 AND 44).

FOR: LUGGAGE OF LEATHER AND LEATHER IMITATIONS; ATTACHÉ CASES OF LEATHER AND LEATHER IMITATIONS; CASES OF LEATHER AND LEATHER IMITATIONS; KEY CASES OF LEATHER AND LEATHER IMITATIONS; KNAPSACKS OF LEATHER AND LEATHER IMITA-

TIONS; UMBRELLAS, BEACH BAGS, CLUTCH BAGS, ALL PURPOSE SPORTS BAGS, SCHOOL BAGS, TOTE BAGS, SHOULDER BAGS, POCKET WALLETS; BRIEFCASES; PURSES NOT OF PRECIOUS METAL; HAVERSACKS; HANDBAGS; TRAVELLING BAGS; VALISES; SUITCASES; RUCKSACKS, IN CLASS 18 (U.S. CLS. 1, 2, 3, 22 AND 41).

FOR: PULLOVERS, GLOVES, CARDIGANS, JERSEYS, NECKWEAR, SWEATERS, SOCKS, STOCKINGS, TIGHTS, TROUSERS, LEGGINGS, SKIRTS, JACKETS, JERKINS, SHIRTS, VESTS, WAISTCOATS, JUMPERS, TRACK SUITS, BLOUSES, BLOUSONS, JEANS, SWEAT PANTS, GYM SUITS, KNICKERS, PANTS, SHORTS, T-SHIRTS, SWEATSHIRTS, SUITS AND DRESSES, OVERCOATS, COATS, ANORAKS, RAINCOATS, BELTS, SUSPENDERS, LOUNGEWEAR, UNDERWEAR, BEACHWEAR, SLEEPWEAR, BOOTS, SHOES, SLIPPERS, HEADWEAR, IN CLASS 25 (U.S. CLS. 22 AND 39).

PRIORITY DATE OF 1-31-2007 IS CLAIMED.

OWNER OF INTERNATIONAL REGISTRATION
0931545 DATED 4-27-2007, EXPIRES 4-27-2017.

THE MARK CONSISTS OF THE WORDING IN ENGLISH "NEW BLUE" MEANING "NUOVO BLU" IN FANCY CHARACTERS THE STROKES OF WHICH ARE COMPOSED OF TWO PAIRS OF LINES SLIGHTLY SPACED APART PARALLEL TO ONE ANOTHER.

SER. NO. 79-041,354, FILED 4-27-2007.

MARK PILARO, EXAMINING ATTORNEY

Int. Cls.: 29 and 32

Prior U.S. Cls.: 45, 46 and 48

United States Patent and Trademark Office

Reg. No. 3,485,173

Registered Aug. 12, 2008

**TRADEMARK
PRINCIPAL REGISTER**

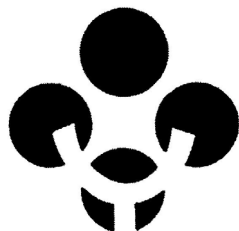

**李子园
LIZIYUAN**

ZHEJIANG LIZIYUAN MILK; AND FOOD CO.,
LTD (CHINA CORPORATION)
LIZIYUAN INDUSTRY PARK
CAOZHAI TOWN, JINDONG DISTRICT; 321031 JIN-
HUA, ZHEJIANG
CHINA

FOR: MILK; MILK PRODUCTS, EXCLUDING
ICE CREAM, ICE MILK, AND FROZEN YOGURT;
MILK BEVERAGES WITH HIGH MILK CONTENT;
ACIDOPHILUS MILK; SAUSAGES; HAM; FRUIT,
PRESERVED; VEGETABLES, CANNED; CRYSTAL-
LIZED FRUITS; MARMALADE; VEGETABLES,
DRIED; VEGETABLES, PRESERVED; FROZEN VE-
GETABLES; SOYBEAN MILK, IN CLASS 29 (U.S. CL.
46).

FOR: BEER; MINERAL WATER USED AS A
BEVERAGE; NON-ALCOHOLIC BEVERAGES,
NAMELY, NON-ALCOHOLIC BEVERAGES CON-
TAINING FRUIT JUICES, CORN JUICE BEVERA-
GES, CARBONATED BEVERAGES; FRUIT JUICES;
WATERS, NAMELY, DRINKING WATER, BOT-
TLED WATER, STILL WATERS; FRUIT BEVERA-
GES WITH LACTIC ACID, NOT BEING MILK

SUBSTITUTES; MILK OF ALMONDS USED AS A
BEVERAGE, IN CLASS 32 (U.S. CLS. 45, 46 AND 48).

OWNER OF INTERNATIONAL REGISTRATION
0931751 DATED 4-10-2007, EXPIRES 4-10-2017.

NO CLAIM IS MADE TO THE EXCLUSIVE
RIGHT TO USE THE NON-LATIN CHARACTERS
THAT MEAN "PLUM", APART FROM THE MARK
AS SHOWN.

THE FIRST NON-LATIN CHARACTER MEANS
"PLUM", THE SECOND NON-LATIN CHARACTER
MEANS "CHILD", THE THIRD NON-LATIN CHAR-
ACTER MEANS "PLUM", AND THE WHOLE WORD
COMBINATION HAS NO MEANING.

THE TRANSLITERATION OF THE NON-LATIN
CHARACTERS IN THE MARK IS: "LI ZI YUAN".

SER. NO. 79-041,449, FILED 4-10-2007.

MARK PILARO, EXAMINING ATTORNEY

Int. Cl.: 9

Prior U.S. Cls.: 21, 23, 26, 36 and 38

United States Patent and Trademark Office

Reg. No. 3,485,174

Registered Aug. 12, 2008

**TRADEMARK
PRINCIPAL REGISTER**

EVENT ZERO

EVENT ZERO PTY LTD (AUSTRALIA CORPORATION)
TECHNOLOGY OFFICE PARK
10E, 107 MILES PLATTING ROAD, EIGHT MILE
PLAINS QLD 4113
AUSTRALIA

FOR: COMPUTER SOFTWARE FOR USE IN DATA MANAGEMENT, DATABASE MANAGEMENT, COMPLIANCE AND CERTIFICATION MANAGEMENT, AND NETWORK MANAGEMENT; SOFTWARE FOR PROCESSING REAL TIME INFORMATION; SOFTWARE FOR REAL TIME MONITORING OF NETWORK EVENTS; SOFTWARE FOR PROCESSING REAL TIME INPUT WITH RESPECT TO KEY PERFORMANCE INDICATORS, POLICIES AND RULES; INDUSTRY-SPECIFIC SOFTWARE FOR PROCESSING REAL TIME INFORMATION; ACCOUNTING SOFTWARE; AND SOFTWARE FOR HUMAN RESOURCES MANAGEMENT, IN CLASS 9 (U.S. CLS. 21, 23, 26, 36 AND 38).

THE MARK CONSISTS OF STANDARD CHARACTERS WITHOUT CLAIM TO ANY PARTICULAR FONT, STYLE, SIZE, OR COLOR.

PRIORITY DATE OF 2-22-2007 IS CLAIMED.

OWNER OF INTERNATIONAL REGISTRATION 0931764 DATED 5-14-2007, EXPIRES 5-14-2017.

NO CLAIM IS MADE TO THE EXCLUSIVE RIGHT TO USE "EVENT", APART FROM THE MARK AS SHOWN.

SER. NO. 79-041,456, FILED 5-14-2007.

KATHERINE E. HALMEN, EXAMINING ATTORNEY

Int. Cls.: 3 and 5

Prior U.S. Cls.: 1, 4, 6, 18, 44, 46, 50, 51 and 52

United States Patent and Trademark Office

Reg. No. 3,485,175

Registered Aug. 12, 2008

**TRADEMARK
PRINCIPAL REGISTER**

BIOPHYCEE

PIERRE FABRE DERMOCOSMETIQUE
(FRANCE SOCIÉTÉ ANONYME)
45, PLACE ABEL GANCE
F-92100 BOULOGNE
FRANCE

FOR: COSMETICS CONTAINING CYANOPHYTA
(BLUE-GREEN ALGAE), IN CLASS 3 (U.S. CLS. 1, 4,
6, 50, 51 AND 52).

FOR: DERMOTOLOGICALS FOR HYGIENE AND
CARE OF THE SKIN CONTAINING CYANOPHYTA
(BLUE-GREEN ALGAE), IN CLASS 5 (U.S. CLS. 6, 18,
44, 46, 51 AND 52).

THE MARK CONSISTS OF STANDARD CHAR-
ACTERS WITHOUT CLAIM TO ANY PARTICULAR
FONT, STYLE, SIZE, OR COLOR.

PRIORITY DATE OF 1-16-2007 IS CLAIMED.

OWNER OF INTERNATIONAL REGISTRATION
0931801 DATED 6-29-2007, EXPIRES 6-29-2017.

SER. NO. 79-041,472, FILED 6-29-2007.

JOHN SCHUYLER YARD, EXAMINING ATTOR-
NEY

Int. Cl.: 1

Prior U.S. Cls.: 1, 5, 6, 10, 26 and 46

United States Patent and Trademark Office

Reg. No. 3,485,176

Registered Aug. 12, 2008

**TRADEMARK
PRINCIPAL REGISTER**

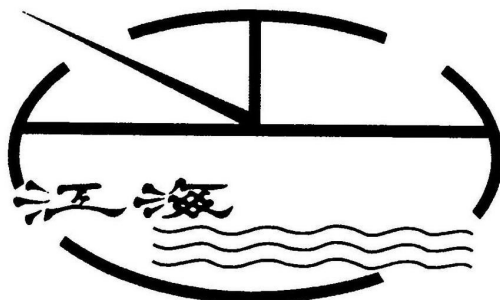

JIANGSU JIANGHAI CHEMICAL GROUP CO.,
LTD (CHINA CORPORATION)
JIAOXI TOWN
WUJIN DISTRICT, CHANGZHOU CITY; JIANGSU-
PROVINCE 213116
CHINA

FOR: STABILIZATION PREPARATIONS CHEMI-
CALS FOR WATER QUALITY NAMELY, FLOCCU-
LANTS FOR USE IN WATER AND WASTE WATER
TREATMENT, LIQUID CORROSION AND DEPOSI-
TION INHIBITOR CHEMICALS FOR USE IN WA-
TER STABILIZATION TREATMENT FOR
INFLUENT WATER, IN CLASS 1 (U.S. CLS. 1, 5, 6,
10, 26 AND 46).

OWNER OF INTERNATIONAL REGISTRATION
0931861 DATED 5-28-2007, EXPIRES 5-28-2017.

THE MARK CONSISTS OF THE CHINESE CHAR-
ACTERS REPRESENTING THE WORDS "JIANG
HAI" TO THE LEFT OF AND ABOVE THREE WAVY
LINES REPRESENTING WAVES, ALL WITH A
OVAL OUTLINED BACKGROUND WHICH IS
OPEN ON THE FOUR CORNERS AND SEPARATED
INTO SECTIONS BY SEVERAL LINES.

THE ENGLISH TRANSLATION OF THE FOR-
EIGN WORD(S) IN THE MARK IS: RIVER AND SEA.

THE TRANSLITERATION OF THE NON-LATIN
CHARACTERS IN THE MARK IS: JIANG HAI.

SER. NO. 79-041,497, FILED 5-28-2007.

CARYN GLASSER, EXAMINING ATTORNEY

Int. Cl.: 9

Prior U.S. Cls.: 21, 23, 26, 36 and 38

Reg. No. 3,485,177

United States Patent and Trademark Office

Registered Aug. 12, 2008

TRADEMARK
PRINCIPAL REGISTER



GUANGDONG HUASHENG ELECTRICAL; INDUSTRIAL CO., LTD. (CHINA CORPORATION)

NO. 13 EAST HUAKOUCHANGBAO ROAD
RONGGUI STREET SCENE,; SHUNDE DISTRICT;-
FOSHAN CITY,; GUANGDONG PROVINCE
CHINA

FOR: ELECTRICAL CABLES; ELECTRIC WIRES;
IDENTIFICATION THREADS SOLD AS A COMPONENT PART OF FINISHED ELECTRIC WIRES;
MAGNETIC TELEGRAPH WIRES; INSULATED COPPER ELECTRICAL WIRE; MAGNETIC TELEPHONE WIRES; JUMPER CABLES FOR MOTORS;
COAXIAL CABLES; ELECTRIC CABLES FOR ELECTRICITY MAINS; ELECTRIC WIRES FOR ELECTRICITY MAINS; ELECTRICAL SOCKETS;

ELECTRIC PLUGS; ELECTRICAL CONNECTORS, IN CLASS 9 (U.S. CLS. 21, 23, 26, 36 AND 38).

OWNER OF INTERNATIONAL REGISTRATION 0932125 DATED 7-13-2007, EXPIRES 7-13-2017.

THE MARK CONSISTS OF THE WORDING "WASUNG" ALONG WITH AN ABSTRACT DESIGN COMPRISED OF THREE ARC BANDS FORMING A SEMI-CIRCLE ON THE LEFT SIDE OF THE WORDING "WASUNG"

SER. NO. 79-041,617, FILED 7-13-2007.

MICHAEL GAAFAR, EXAMINING ATTORNEY

Int. Cl.: 28

Prior U.S. Cls.: 22, 23, 38 and 50

Reg. No. 3,485,178

United States Patent and Trademark Office

Registered Aug. 12, 2008

**TRADEMARK
PRINCIPAL REGISTER**



GUANGDONG HUASHENG ELECTRICAL; INDUSTRIAL CO., LTD. (CHINA CORPORATION)

NO. 13 EAST HUAKOUCHANGBAO ROAD
RONGGUI STREET SCENE.; SHUNDE DISTRICT;-
FOSHAN CITY.; GUANGDONG PROVINCE
CHINA

FOR: GAMES, NAMELY, DICE GAMES, ACTION SKILL GAMES, ARCADE GAMES, PARTY GAMES, PARLOR GAMES; ELECTROMOTIVE ENTERTAINMENT TOY VEHICLES; TOYS, NAMELY, BATH TOYS, MECHANICAL TOYS, MUSICAL TOYS; EXERCISE MACHINES; GYMNAS TIC APPARATUS; FISHING TACKLE; RADIO-CONTROLLED TOY VEHICLES; INTELLIGENT TOYS, NAMELY, BATTERY OPERATED ACTION TOYS, CHILDREN'S MULTIPLE ACTIVITY TOYS, ELECTRONIC

LEARNING TOYS; CHESS SETS; BOARD GAMES; RING GAMES, IN CLASS 28 (U.S. CLS. 22, 23, 38 AND 50).

OWNER OF INTERNATIONAL REGISTRATION
0932126 DATED 7-13-2007, EXPIRES 7-13-2017.

THE MARK CONSISTS OF THE WORDING "WASUNG" ALONG WITH AN ABSTRACT DESIGN COMPRISED OF THREE ARC BANDS FORMING A SEMI-CIRCLE ON THE LEFT SIDE OF THE WORDING "WASUNG".

SER. NO. 79-041,618, FILED 7-13-2007.

MICHAEL GA AFAR, EXAMINING ATTORNEY

Int. Cl.: 37

Prior U.S. Cls.: 100, 103 and 106

United States Patent and Trademark Office

Reg. No. 3,485,179

Registered Aug. 12, 2008

**SERVICE MARK
PRINCIPAL REGISTER**



HOUSE BUILDING SPA (ITALY CORPORATION)
VIA SELICE, 90
I-40026 IMOLA (BO), ITALY

FOR: CONSTRUCTION AND RENOVATION OF
BUILDING, IN CLASS 37 (U.S. CLS. 100, 103 AND
106).

PRIORITY DATE OF 5-30-2007 IS CLAIMED.

OWNER OF INTERNATIONAL REGISTRATION
0932139 DATED 6-8-2007, EXPIRES 6-8-2017.

NO CLAIM IS MADE TO THE EXCLUSIVE
RIGHT TO USE "HOUSE BUILDING", APART
FROM THE MARK AS SHOWN.

SER. NO. 79-041,625, FILED 6-8-2007.

TASHIA BUNCH, EXAMINING ATTORNEY

Int. Cl.: 29

Prior U.S. Cl.: 46

United States Patent and Trademark Office

Reg. No. 3,485,180

Registered Aug. 12, 2008

TRADEMARK
PRINCIPAL REGISTER



LAITERIES HUBERT TRIBALLAT (FRANCE
CORPORATION)
RIANS
F-18220 LES AIX D'ANGILLON
FRANCE

FOR: CHEESE; DAIRY PRODUCTS EXCLUDING
ICE CREAM, ICE MILK AND FROZEN YOGURT;
CREAM; YOGHURT; BUTTER; MILK, IN CLASS 29
(U.S. CL. 46).

PRIORITY DATE OF 1-26-2007 IS CLAIMED.

OWNER OF INTERNATIONAL REGISTRATION
0932160 DATED 7-5-2007, EXPIRES 7-5-2017.

OWNER OF U.S. REG. NOS. 3,211,538, 3,213,605
AND OTHERS.

THE COLOR(S) WHITE AND GREEN IS/ARE
CLAIMED AS A FEATURE OF THE MARK.

THE WORDS "LE ROULÉ" ARE IN WHITE; THE
REST OF THE MARK IS IN GREEN.

THE FOREIGN WORDING IN THE MARK
TRANSLATES INTO ENGLISH AS THE ROLL.

SEC. 2(F).

SER. NO. 79-041,633, FILED 7-5-2007.

BRENDAN MCCAULEY, EXAMINING ATTORNEY

Int. Cls.: 9 and 42

Prior U.S. Cls.: 21, 23, 26, 36, 38, 100 and 101

United States Patent and Trademark Office

Reg. No. 3,485,181

Registered Aug. 12, 2008

**TRADEMARK
SERVICE MARK
PRINCIPAL REGISTER**



CODRA INGÉNIERIE INFORMATIQUE
(FRANCE SOCIÉTÉ ANONYME)
19 AVENUE DE NORVÈGE
F-91953 COURTABOEUF
FRANCE

FOR: COMPUTER HARDWARE; CALCULATORS; COMPUTER TERMINALS, COMPUTER SOFTWARE FOR MONITORING OF INDUSTRIAL MACHINERY, ENCRYPTION OF DATA, IN THE FIELD OF GENERAL MANUFACTURING, IN CLASS 9 (U.S. CLS. 21, 23, 26, 36 AND 38).

FOR: SERVICES IN THE FIELD OF INDUSTRIAL OR TECHNICAL COMPUTING AND CONNECTING SECTORS, NAMELY, CONSULTING IN THE FIELD OF COMPUTER HARDWARE AND SOFTWARE; SELECTION, IMPLEMENTATION AND USE OF COMPUTER HARDWARE AND SOFTWARE; CONDUCTING FEASIBILITY STUDIES WITH THE AIM OF DESIGNING AND DEVELOPING COMPUTER SOFTWARE; DESIGN, DEVELOPMENT, IMPLEMENTATION OF SOFTWARE AND COMPUTER

HARDWARE; MAINTENANCE IN OPERATIONAL CONDITIONS OF COMPUTER HARDWARE AND SOFTWARE SYSTEMS, IN CLASS 42 (U.S. CLS. 100 AND 101).

OWNER OF INTERNATIONAL REGISTRATION 0932169 DATED 7-2-2007, EXPIRES 7-2-2017.

THE COLOR(S) BLUE IS/ARE CLAIMED AS A FEATURE OF THE MARK.

THE COLOR BLUE APPEARS IN THE STYLIZED TEXT CODRA.

THE WORDING "CODRA" HAS NO MEANING IN A FOREIGN LANGUAGE.

SER. NO. 79-041,639, FILED 7-2-2007.

REBECCA EISINGER, EXAMINING ATTORNEY

Int. Cl.: 36

Prior U.S. Cls.: 100, 101 and 102

United States Patent and Trademark Office

Reg. No. 3,485,182

Registered Aug. 12, 2008

**SERVICE MARK
PRINCIPAL REGISTER**

OLIVANT

LUQMAN ARNOLD (UNITED KINGDOM INDIVIDUAL)
FLAT 12, 8 QUEEN ANNE'S GATE
LONDON, UNITED KINGDOM SW1H 9AA

FOR: INSURANCE BROKERAGE AND FINANCIAL AFFAIRS, NAMELY, REAL ESTATE BROKERAGE, INSURANCE BROKERAGE, EQUITY CAPITAL INVESTMENT, FINANCIAL CLEARING HOUSES, FINANCIAL EVALUATIONS FOR INVESTMENT AND INSURANCE PURPOSES, FINANCIAL EVALUATIONS FOR REAL ESTATE INVESTMENT, PROVIDING FINANCIAL INFORMATION, FINANCIAL MANAGEMENT, FINANCING SERVICES, FUND INVESTMENTS, LEASE PURCHASE FINANCING, CONSUMER LENDING SERVICES, SECURITIES BROKERAGE, STOCKS AND BONDS BROKERAGE, TRUSTEESHIP REPRESENTATION, BANKING SERVICES, CREDIT BUREAU, CREDIT CARD SERVICES, ISSU-

ANCE OF CREDIT CARDS, DEBIT CARD SERVICES, CURRENCY EXCHANGE, ISSUANCE OF TRAVELLERS CHEQUES, MORTGAGE LENDING, SAVINGS ACCOUNT SERVICES, ELECTRONIC FUNDS TRANSFER SERVICES, IN CLASS 36 (U.S. CLS. 100, 101 AND 102).

THE MARK CONSISTS OF STANDARD CHARACTERS WITHOUT CLAIM TO ANY PARTICULAR FONT, STYLE, SIZE, OR COLOR.

OWNER OF INTERNATIONAL REGISTRATION
0922637 DATED 12-11-2006, EXPIRES 12-11-2016.

SER. NO. 79-041,689, FILED 7-13-2007.

G. MAYERSCHOFF, EXAMINING ATTORNEY

Int. Cl.: 29

Prior U.S. Cl.: 46

United States Patent and Trademark Office

Reg. No. 3,485,183

Registered Aug. 12, 2008

**TRADEMARK
PRINCIPAL REGISTER**

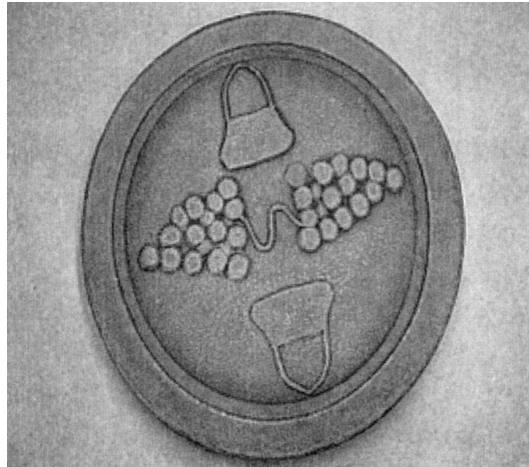

EWALD SCHAFFER (SWITZERLAND INDIVIDUAL)
ROUTE DE L'ECOLE 3
CH-1785 CRESSIER FR
SWITZERLAND

OWNER OF INTERNATIONAL REGISTRATION
0932280 DATED 6-11-2007, EXPIRES 6-11-2017.

FOR: DAIRY PRODUCTS, EXCLUDING ICE CREAM, ICE MILK AND FROZEN YOGURT; CHEESE, IN CLASS 29 (U.S. CL. 46).

SER. NO. 79-041,717, FILED 6-11-2007.

PRIORITY DATE OF 2-19-2007 IS CLAIMED.

JEFF DEFORD, EXAMINING ATTORNEY

Int. Cl.: 3

Prior U.S. Cls.: 1, 4, 6, 50, 51 and 52

Reg. No. 3,485,184

United States Patent and Trademark Office

Registered Aug. 12, 2008

**TRADEMARK
PRINCIPAL REGISTER**

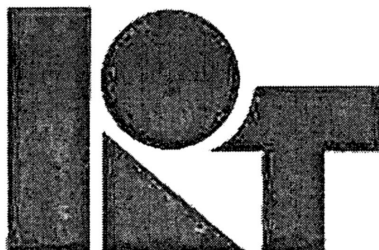

开泰 KAITAI

SHANDONG KAITAI; INDUSTRIAL TECHNOLOGIES CO., LTD (CHINA CORPORATION)
QINGYANG TOWN
ZOUPIING; 256217 SHANDONG
CHINA

FOR: JEWELERS' ROUGE; POLISHING ROUGE; POLISHING PREPARATIONS; GENERAL PURPOSE CLEANING, POLISHING AND ABRASIVE LIQUIDS AND POWDER, NAMELY, CORUNDUM AND SMOOTHING POWDER, IN CLASS 3 (U.S. CLS. 1, 4, 6, 50, 51 AND 52).

OWNER OF INTERNATIONAL REGISTRATION
0932354 DATED 5-18-2007, EXPIRES 5-18-2017.

THE ENGLISH TRANSLATION OF THE FOREIGN WORD(S) IN THE MARK IS: THE FIRST

CHINESE CHARACTER WHOSE TRANSLITERATION IS "KAI" MEANS OPEN; THE SECOND CHINESE CHARACTER WHOSE TRANSLITERATION IS "TAI" MEANS SAFE; THE COMBINATION OF THE TWO CHINESE CHARACTERS HAS NO SIGNIFICANCE IN THE RELEVANT TRADE OR INDUSTRY, AND HAS NO GEOGRAPHICAL SIGNIFICANCE, AND HAS NO MEANING IN A FOREIGN LANGUAGE, AND HAS NO SIGNIFICANCE AS APPLIED TO THE GOODS.

THE TRANSLITERATION OF THE NON-LATIN CHARACTERS IN THE MARK IS: "KAITAI".

SER. NO. 79-041,743, FILED 5-18-2007.

AMY MCMENAMIN, EXAMINING ATTORNEY

Int. Cls.: 35 and 36

Prior U.S. Cls.: 100, 101 and 102

United States Patent and Trademark Office

Reg. No. 3,485,185

Registered Aug. 12, 2008

**SERVICE MARK
PRINCIPAL REGISTER**



AON ACCURACY (FRANCE SOCIÉTÉ PAR ACTIONS SIMPLIFIÉE)
45 AVENUE KLÉBER
F-92300 LEVALLOIS PERRET, FRANCE

FOR: BUSINESS ORGANISATION AND MANAGEMENT CONSULTANCY, IN CLASS 35 (U.S. CLS. 100, 101 AND 102).

FOR: FINANCIAL SERVICES IN THE NATURE OF FINANCIAL CONSULTANCY, FINANCIAL MANAGEMENT CONSULTANCY AND FINANCIAL RISK MANAGEMENT, CONSULTANCY RELATING TO FINANCIAL MANAGEMENT; CONSULTANCY RELATING TO FINANCIAL MANAGEMENT AND STRATEGIES, IN CLASS 36 (U.S. CLS. 100, 101 AND 102).

PRIORITY DATE OF 11-23-2006 IS CLAIMED.

OWNER OF INTERNATIONAL REGISTRATION 0932463 DATED 5-22-2007, EXPIRES 5-22-2017.

NO CLAIM IS MADE TO THE EXCLUSIVE RIGHT TO USE "CONSEIL FINANCIER D'ENTREPRISE", APART FROM THE MARK AS SHOWN.

THE COLOR(S) BURGUNDY IS/ARE CLAIMED AS A FEATURE OF THE MARK.

THE MARK CONSISTS OF THE BURGUNDY WORDING "ACCURACY CONSEIL FINANCIER D'ENTREPRISE" LOCATED BELOW A BURGUNDY COMPLETELY SHADED SEMI-CIRCLE PLACED ABOVE A BURGUNDY COMPLETELY SHADED TRIANGLE.

THE ENGLISH TRANSLATION OF THE FOREIGN WORD(S) IN THE MARK IS ACCURACY COMPANY FINANCIAL ADVISOR.

SER. NO. 79-041,789, FILED 5-22-2007.

JENNIFER VASQUEZ, EXAMINING ATTORNEY

Int. Cls.: 5 and 44

Prior U.S. Cls.: 6, 18, 44, 46, 51, 52, 100 and 101

United States Patent and Trademark Office

Reg. No. 3,485,186

Registered Aug. 12, 2008

**TRADEMARK
SERVICE MARK
PRINCIPAL REGISTER**

PHARMA VIE

JOSEPH PHILIPPE BENWAÏCHE (FRANCE INDIVIDUAL)
CHEMIN DE HAITZELEKU
ARCANGUES, FRANCE F64200

FOR: A FULL LINE OF PHARMACEUTICAL AND VETERINARY PREPARATIONS, NAMELY, TABLETS, OINTMENTS, SYRUPS, INJECTABLE SERUMS, AND PATCHES FOR THE TREATMENT OF PHYSICAL AND MENTAL DISEASES; SANITARY PREPARATIONS FOR MEDICAL PURPOSES; DISINFECTANTS FOR MEDICAL PURPOSES, EXCLUDING SOAPS; DIAGNOSTIC PREPARATIONS FOR MEDICAL PURPOSES; DIETETIC FOODS ADAPTED FOR MEDICAL USE; MATERIALS FOR DENTAL FILLINGS AND IMPRESSIONS; BABY FOODS; MEDICAL PLASTERS; DRESSINGS FOR WOUNDS AND BURNS; SANITARY PADS AND NAPKINS FOR PERSONAL HYGIENE; DISINFECTANTS FOR HYGIENE PURPOSES EXCEPT FOR SOAPS; PREPARATIONS FOR DESTROYING VERMIN; FUNGICIDES, IN CLASS 5 (U.S. CLS. 6, 18, 44, 46, 51 AND 52).

FOR: PHARMACY CONSULTING; HOSPITAL AND MEDICAL CENTER SERVICES; HOSPICE CARE PROVIDED IN HOSPICE ASSISTANCE CENTERS AND HOMES; PROFESSIONAL CONSULTING CONCERNING HEALTH ISSUES; PROVIDING

TECHNICAL INFORMATION AND ASSISTANCE IN THE FIELDS OF PHARMACOLOGY, VETERINARY SCIENCE AND SANITARY MEDICAL CARE; CONVALESCENT HOMES; NURSING HOMES WITH MEDICAL CARE; OPTICIAN'S SERVICES; MEDICAL ASSISTANCE; HEALTH CARE; RENTAL OF SANITATION FACILITIES; DENTISTRY; VETERINARY SERVICES; AROMA THERAPY SERVICES; NURSING CARE; PROVIDING PHYSICAL THERAPY; PROVIDING MENTAL HEALTH REHABILITATION FACILITIES; PSYCHOLOGICAL COUNSELING; AND TURKISH BATHS, IN CLASS 44 (U.S. CLS. 100 AND 101).

THE MARK CONSISTS OF STANDARD CHARACTERS WITHOUT CLAIM TO ANY PARTICULAR FONT, STYLE, SIZE, OR COLOR.

OWNER OF INTERNATIONAL REGISTRATION 0932508 DATED 3-27-2007, EXPIRES 3-27-2017.

THE ENGLISH TRANSLATION OF THE FOREIGN WORD(S) IN THE MARK IS "PHARMA LIFE".

SER. NO. 79-041,813, FILED 3-27-2007.

MARK T. MULLEN, EXAMINING ATTORNEY

Int. Cls.: 3, 5 and 10

Prior U.S. Cls.: 1, 4, 6, 18, 26, 39, 44, 46, 50, 51 and 52

Reg. No. 3,485,187

United States Patent and Trademark Office

Registered Aug. 12, 2008

**TRADEMARK
PRINCIPAL REGISTER**

HYALUDERM REJUVENATION

LABORATOIRE DE CONTACTOLOGIE APPLI-
QUÉE - LCA (FRANCE SOCIÉTÉ ANONYME)
9 ALLÉE PROMÉTHÉE
F-28000 CHARTRES, FRANCE

FOR: COSMETIC ANTI-WRINKLE CREAMS;
SKIN CARE PRODUCTS, NAMELY, NON-MEDICA-
TED SKIN CREAMS, MILKS, FLUIDS, SERUMS,
LOTIONS, GELS, OILS, TONERS, CLEANSERS,
PEELS AND SOAPS; SKIN CARE PRODUCTS FOR
THE FACE, NAMELY, NON-MEDICATED TONING
AND ANTI-WRINKLE CREAMS, MILKS, FLUIDS,
SERUMS, LOTIONS, GELS, OILS, TONERS,
CLEANSERS, PEELS AND SOAPS; NON-MEDICA-
TED INJECTABLE SKIN CARE PRODUCTS FOR
THE FACE, NAMELY, NON-MEDICATED TONING
AND ANTI-WRINKLE SERUMS AND FLUIDS, IN
CLASS 3 (U.S. CLS. 1, 4, 6, 50, 51 AND 52).

FOR: PHARMACEUTICAL PREPARATIONS FOR
FILLING FACIAL WRINKLES; PHARMACEUTI-
CAL PREPARATIONS FOR DERMATOLOGICAL
USE; INJECTABLE PHARMACEUTICAL PREPARA-
TIONS FOR DERMATOLOGICAL USE, IN THE
FORM OF PRE-FILLED DISPOSABLE STERILE
SYRINGES CONTAINING ANTI-WRINKLE AND
TONING INJECTABLE PHARMACEUTICAL PRE-
PARATIONS FOR DERMATOLOGICAL USE CON-
TAINING SODIUM HYALURONATE, IN CLASS 5
(U.S. CLS. 6, 18, 44, 46, 51 AND 52).

FOR: MEDICAL DEVICES FOR INTRACORPOR-
EAL INJECTION, NAMELY, NEEDLES AND SYR-
INGES FOR INJECTIONS; MEDICAL DEVICES FOR
INTRACORPOREAL INJECTION COMPOSED OF A
DISPOSABLE STERILE SYRINGE , IN CLASS 10
(U.S. CLS. 26, 39 AND 44).

THE MARK CONSISTS OF STANDARD CHAR-
ACTERS WITHOUT CLAIM TO ANY PARTICULAR
FONT, STYLE, SIZE, OR COLOR.

PRIORITY DATE OF 12-11-2006 IS CLAIMED.

OWNER OF INTERNATIONAL REGISTRATION
0932578 DATED 6-5-2007, EXPIRES 6-5-2017.

NO CLAIM IS MADE TO THE EXCLUSIVE
RIGHT TO USE "REJUVENATION" FOR CLASSES
3 AND 5 ONLY, APART FROM THE MARK AS
SHOWN.

THE WORDING "HYALUDERM" HAS NO
MEANING IN A FOREIGN LANGUAGE.

SER. NO. 79-041,848, FILED 6-5-2007.

CHRISIE B. KING, EXAMINING ATTORNEY

Int. Cls.: 1, 7 and 42

**Prior U.S. Cls.: 1, 5, 6, 10, 13, 19, 21, 23, 26, 31, 34, 35,
46, 100 and 101**

Reg. No. 3,485,188

United States Patent and Trademark Office

Registered Aug. 12, 2008

**TRADEMARK
SERVICE MARK
PRINCIPAL REGISTER**

ALCHIMER

ALCHIMER (FRANCE SOCIÉTÉ ANONYME
(SA))
15, RUE DU BUISSON AUX FRAISES
ZONE INDUSTRIELLE DE LA BONDE; F-91300
MASSY, FRANCE

FOR: CHEMICAL COMPOUNDS NAMELY MO-
LECULES, CHEMICAL PRODUCTS AND CHEMI-
CAL REAGENTS FOR NON-MEDICAL PURPOSES
FOR USE IN INDUSTRY, SUCH PRODUCTS BEING
USED FOR THE FUNCTIONALIZING OF SURFA-
CES, NAMELY, FOR USE IN THE COATING OF
SURFACES, IN CLASS 1 (U.S. CLS. 1, 5, 6, 10, 26 AND
46).

FOR: INDUSTRIAL MACHINES, NAMELY, MA-
CHINES FOR COATING SURFACES USED FOR
THE FUNCTIONALIZING OF ALL TYPE OF SUR-
FACES, FOR USE IN MICROSYSTEMS, PRINTED
CIRCUITS, SEMICONDUCTORS, MICROELECTRO-
NICS, INTEGRATED CIRCUITS AND ELECTRO-

NICS INDUSTRY, IN CLASS 7 (U.S. CLS. 13, 19, 21, 23,
31, 34 AND 35).

FOR: PRODUCT RESEARCH AND DEVELOP-
MENT, PRODUCT RESEARCH AND DEVELOP-
MENT, NAMELY, REFINEMENT OF NEW
PRODUCTS, AND ENGINEERING FOR OTHERS,
IN THE FUNCTIONALIZING OF SURFACES SEC-
TOR, IN CLASS 42 (U.S. CLS. 100 AND 101).

THE MARK CONSISTS OF STANDARD CHAR-
ACTERS WITHOUT CLAIM TO ANY PARTICULAR
FONT, STYLE, SIZE, OR COLOR.

OWNER OF INTERNATIONAL REGISTRATION
0932624 DATED 6-25-2007, EXPIRES 6-25-2017.

SER. NO. 79-041,859, FILED 6-25-2007.

LESLIE RICHARDS, EXAMINING ATTORNEY

Int. Cl.: 5

Prior U.S. Cls.: 6, 18, 44, 46, 51 and 52

United States Patent and Trademark Office

Reg. No. 3,485,189

Registered Aug. 12, 2008

**TRADEMARK
PRINCIPAL REGISTER**

LACTIS

HERO (SWITZERLAND CORPORATION)
CH-5600 LENZBURG
SWITZERLAND

OWNER OF INTERNATIONAL REGISTRATION
0932674 DATED 7-18-2007, EXPIRES 7-18-2017.

FOR: FOOD FOR BABIES, IN CLASS 5 (U.S. CLS. 6,
18, 44, 46, 51 AND 52).

THE WORDING "LACTIS" HAS NO MEANING IN
A FOREIGN LANGUAGE.

THE MARK CONSISTS OF STANDARD CHAR-
ACTERS WITHOUT CLAIM TO ANY PARTICULAR
FONT, STYLE, SIZE, OR COLOR.

SER. NO. 79-041,874, FILED 7-18-2007.

PRIORITY DATE OF 4-24-2007 IS CLAIMED.

SHAILA SETTLES, EXAMINING ATTORNEY

Int. Cl.: 15

Prior U.S. Cls.: 2, 21 and 36

United States Patent and Trademark Office

Reg. No. 3,485,190

Registered Aug. 12, 2008

TRADEMARK
PRINCIPAL REGISTER



海乐尔

BEIJING XING HAI YUE HUA; MUSICAL INSTRUMENTS CO., LTD. (CHINA CORPORATION)
HONGSONGYUAN
DONGBAXIANG.; CHAOYANGQU; 100018 BEIJING CHINA

FOR: MUSICAL INSTRUMENTS, IN CLASS 15 (U.S. CLS. 2, 21 AND 36).

OWNER OF INTERNATIONAL REGISTRATION 0932776 DATED 6-26-2007, EXPIRES 6-26-2017.

"THE MARK CONSISTS OF IN PART OF A STYLIZED REPRESENTATION OF TWO NOTES AND A STYLIZED METRONOME."

THE NON-LATIN CHARACTERS IN THE MARK TRANSLITERATE TO "HAI LE ER", AND THIS HAS NO MEANING IN ENGLISH.

SER. NO. 79-041,903, FILED 6-26-2007.

STEVEN R. FINE, EXAMINING ATTORNEY

Int. Cls.: 41 and 43

Prior U.S. Cls.: 100, 101 and 107

United States Patent and Trademark Office

Reg. No. 3,485,191

Registered Aug. 12, 2008

**SERVICE MARK
PRINCIPAL REGISTER**

BRANCHE

KENMARK BRAND B.V. (NETHERLANDS CORPORATION)
VONDELLAAN 35
NL-3818 WN AMERSFOORT
NETHERLANDS

FOR: ARRANGING OF EXHIBITIONS, SEMINARS AND CONFERENCES; MEETING AND SEMINAR ARRANGING; ENTERTAINMENT SERVICES, NAMELY, LIVE MUSIC CONCERT SERVICES; ENTERTAINMENT SERVICES FEATURING MUSIC, NAMELY, LIVE PERFORMANCES BY INDIVIDUALS AND GROUPS PLAYING JAZZ AND LOUNGE MUSIC, IN CLASS 41 (U.S. CLS. 100, 101 AND 107).

FOR: CAFÉ, RESTAURANT, BAR AND CATERING SERVICES; PRIVATE DINING SERVICES, NAMELY, PROVIDING OF FOOD AND DRINK, IN CLASS 43 (U.S. CLS. 100 AND 101).

THE MARK CONSISTS OF STANDARD CHARACTERS WITHOUT CLAIM TO ANY PARTICULAR FONT, STYLE, SIZE, OR COLOR.

OWNER OF INTERNATIONAL REGISTRATION 0932855 DATED 6-7-2007, EXPIRES 6-7-2017.

SER. NO. 79-041,931, FILED 6-7-2007.

RAMONA ORTIGA, EXAMINING ATTORNEY

Int. Cl.: 9

Prior U.S. Cls.: 21, 23, 26, 36 and 38

Reg. No. 3,485,192

United States Patent and Trademark Office

Registered Aug. 12, 2008

**TRADEMARK
PRINCIPAL REGISTER**

SECUREADVANTAGE

KONINKLIJKE PHILIPS ELECTRONICS N.V.
(NETHERLANDS LTD LIAB CO)
GROENEWOUDSEWEG 1
NL-5621 BA EINDHOVEN
NETHERLANDS

FOR: SOFTWARE FOR RECORDING, CHECKING, DISTRIBUTING, ANALYZING AND REPORTING MEDICAL IMAGES AND INFORMATION; SOFTWARE FOR MEDICAL DIAGNOSTICS AND TREATMENT; SOFTWARE FOR IMAGE AND INFORMATION MANAGEMENT CONCERNING MEDICAL APPLICATIONS; SOFTWARE FOR DIAGNOSING PATIENT ILLNESSES AND MALADIES BY ANALYZING INFORMATION ON PATIENTS' SYMPTOMS AND COMPARING THIS INFORMATION WITH A DATABASE OF RECOGNIZED

SYMPTOMS FOR VARIOUS ILLNESSES AND MALADIES, IN CLASS 9 (U.S. CLS. 21, 23, 26, 36 AND 38).

THE MARK CONSISTS OF STANDARD CHARACTERS WITHOUT CLAIM TO ANY PARTICULAR FONT, STYLE, SIZE, OR COLOR.

PRIORITY DATE OF 1-22-2007 IS CLAIMED.

OWNER OF INTERNATIONAL REGISTRATION 0932887 DATED 7-20-2007, EXPIRES 7-20-2017.

SER. NO. 79-041,940, FILED 7-20-2007.

NAKIA HENRY, EXAMINING ATTORNEY

Int. Cl.: 9

Prior U.S. Cls.: 21, 23, 26, 36 and 38

Reg. No. 3,485,193

United States Patent and Trademark Office

Registered Aug. 12, 2008

**TRADEMARK
PRINCIPAL REGISTER**

SVI

SCIENTIFIC VOLUME IMAGING HOLDING B.V.
(NETHERLANDS PRIVATE LIMITED COMPAN-
NY)

ALEXANDERLAAN 14
NL-1213 XS HILVERSUM
NETHERLANDS

FOR: SOFTWARE FOR IMAGE PROCESSING IN THE FIELDS OF MEDICAL OR BIOLOGICAL RESEARCH, NAMELY, FOR PROCESSING OF MICROSCOPIC IMAGES OBTAINED BY MEANS OF ELECTRON, ATOMIC FORCE AND/OR LIGHT MICROSCOPIC TECHNIQUES, FOR EXAMPLE, FLUORESCENCE, SEM (SCANNING ELECTRON MICROSCOPY), TIRF (TOTAL INTERNAL REFLECTIONS FLUORESCENCE), TURF (TOTAL REFLECTIONS X-RAY FLUORESCENCE), STED (STIMULATED EMISSION DEPLETION MICROSCOPY), CLEM (CONTROLLED LIGHT EXPOSURE MICROSCOPY), BRIGHTFIELD, DARKFIELD, CONFOCAL, MULIT-PHOTON, OR SCANNING PROBE MICROSCOPY, BY MEANS OF DECONVOLUTION, VISUALIZATION AND ANALYSIS OF THESE IMAGES ON COMPUTERS OR SERVERS IN ORDER TO RESTORE AND IMPROVE THE IMAGE QUALITY; SOFTWARE FOR IMAGE RE-

COGNITION PROCESSING OF MICROSCOPIC MEDICAL OR BIOLOGICAL SPECIMEN IMAGES; DIAGNOSTIC SOFTWARE FOR CLOSER INTERPRETATION ON AN INTRA-CELLULAR, CELLULAR, OR MULTIPLE CELLULAR LEVEL OF MICROSCOPIC MEDICAL OR BIOLOGICAL IMAGES, AND APPARATUS FOR PROCESSING MEDICAL OR BIOLOGICAL IMAGES THROUGH USE OF IMAGE PROCESSING SOFTWARE, IN CLASS 9 (U.S. CLS. 21, 23, 26, 36 AND 38).

THE MARK CONSISTS OF STANDARD CHARACTERS WITHOUT CLAIM TO ANY PARTICULAR FONT, STYLE, SIZE, OR COLOR.

PRIORITY DATE OF 2-6-2007 IS CLAIMED.

OWNER OF INTERNATIONAL REGISTRATION
0932973 DATED 7-20-2007, EXPIRES 7-20-2017.

SER. NO. 79-041,978, FILED 7-20-2007.

SANDRA MANIOS, EXAMINING ATTORNEY

Int. Cl.: 5

Prior U.S. Cls.: 6, 18, 44, 46, 51 and 52

United States Patent and Trademark Office

Reg. No. 3,485,194

Registered Aug. 12, 2008

**TRADEMARK
PRINCIPAL REGISTER**

The word "Lactis" is rendered in a large, rounded, blue-outlined font. The letters are white with a thick blue border. The 'L' is tall and has a rounded top. The 'a' is lowercase and has a rounded bottom. The 'c' is lowercase and has a rounded bottom. The 't' is lowercase and has a rounded top. The 'i' is lowercase and has a rounded top. The 's' is lowercase and has a rounded bottom.

HERO (SWITZERLAND CORPORATION)
CH-5600 LENZBURG
SWITZERLAND

FOR: FOOD FOR BABIES, IN CLASS 5 (U.S. CLS. 6,
18, 44, 46, 51 AND 52).

PRIORITY DATE OF 4-24-2007 IS CLAIMED.

OWNER OF INTERNATIONAL REGISTRATION
0933041 DATED 7-18-2007, EXPIRES 7-18-2017.

THE COLOR(S) BLUE AND WHITE IS/ARE
CLAIMED AS A FEATURE OF THE MARK.

THE MARK CONSISTS OF THE WORD "LACTIS"
IN WHITE, STYLIZED LETTERS WITH A BLUE
OUTLINE.

THE WORDING "LACTIS" HAS NO MEANING IN
A FOREIGN LANGUAGE.

SER. NO. 79-042,000, FILED 7-18-2007.

SHAILA SETTLES, EXAMINING ATTORNEY

Int. Cl.: 7

Prior U.S. Cls.: 13, 19, 21, 23, 31, 34 and 35

United States Patent and Trademark Office

Reg. No. 3,485,195

Registered Aug. 12, 2008

**TRADEMARK
PRINCIPAL REGISTER**

WALTER MULTI COLOR

WALTER AG (FED REP GERMANY AKTIENGE-
SELLSCHAFT)
DERENDINGER STRAÙE 53,
72072 TÜBINGEN
FED REP GERMANY

FOR: PARTS OF TOOLS FOR MACHINE TOOLS,
NAMELY INDEXABLE CUTTING INSERTS, IN
PARTICULAR COATED INDEXABLE CUTTING
INSERTS, IN CLASS 7 (U.S. CLS. 13, 19, 21, 23, 31, 34
AND 35).

THE MARK CONSISTS OF STANDARD CHAR-
ACTERS WITHOUT CLAIM TO ANY PARTICULAR
FONT, STYLE, SIZE, OR COLOR.

PRIORITY DATE OF 2-14-2007 IS CLAIMED.

OWNER OF INTERNATIONAL REGISTRATION
0933172 DATED 6-22-2007, EXPIRES 6-22-2017.

SER. NO. 79-042,051, FILED 6-22-2007.

JAMES A. RAUEN, EXAMINING ATTORNEY

Int. Cl.: 9

Prior U.S. Cls.: 21, 23, 26, 36 and 38

Reg. No. 3,485,196

United States Patent and Trademark Office

Registered Aug. 12, 2008

**TRADEMARK
PRINCIPAL REGISTER**

CINEGRAN

MAILLEFER SA (SWITZERLAND SOCIÉTÉ
ANONYME (SA))
ROUTE DU BOIS 37
CH-1024 ECUBLENS
SWITZERLAND

FOR: SCIENTIFIC AND ELECTRONIC PHOTOGRAPHIC CAMERAS; OPTICAL CHARACTER RECOGNITION APPARATUS; WEIGHING EQUIPMENT, NAMELY, SCALES AND BALANCES; INSTRUMENTS FOR MEASURING LENGTH; ELECTRONIC INSTRUMENTS FOR USE IN REMOTE MONITORING AND INSPECTION OF INDUSTRIAL COMPONENTS USING REMOTE VISUAL DEVICES; OPTICAL INSPECTION APPARATUS FOR INDUSTRIAL USE FOR MEASURING AND DETERMINING THE VOLUME AND MASS FLOW OF VARIOUS PULVERULENT, GRANULAR OR FRAGMENTARY MATERIALS THAT ARE USED IN AN EXTRUDER MACHINE FOR PRODUCING PLASTIC SECTIONS; APPARATUS FOR RECORDING, TRANSMITTING AND REPRODUCING SOUND AND IMAGES; PRE-RECORDED ELECTRONIC MEDIA IN THE FIELD OF REMOTE MONITORING AND INSPECTION OF INDUSTRIAL COMPONENTS USING REMOTE VISUAL DEVICES; BLANK OPTICAL MEDIA DISKS; COMPUTERS AND COMPUTER SOFTWARE USED IN THE FIELD OF REMOTE MONITORING AND INSPECTION OF INDUSTRIAL COMPONENTS USING REMOTE VISUAL DEVICES, COMPUTER PERIPH-

ERALS; COMPONENTS AND SPARE PARTS FOR COMPUTERS, OPTICAL CHARACTER RECOGNITION APPARATUS, ELECTRONIC INSTRUMENTS FOR USE IN REMOTE MONITORING AND INSPECTION OF INDUSTRIAL COMPONENTS USING REMOTE VISUAL DEVICES, OPTICAL INSPECTION APPARATUS FOR INDUSTRIAL USE FOR MEASURING AND DETERMINING THE VOLUME AND MASS FLOW OF VARIOUS PULVERULENT, GRANULAR OR FRAGMENTARY MATERIALS THAT ARE USED IN AN EXTRUDER MACHINE FOR PRODUCING PLASTIC SECTIONS, ALL OF WHICH ARE SOLD AS A UNIT, IN CLASS 9 (U.S. CLS. 21, 23, 26, 36 AND 38).

THE MARK CONSISTS OF STANDARD CHARACTERS WITHOUT CLAIM TO ANY PARTICULAR FONT, STYLE, SIZE, OR COLOR.

PRIORITY DATE OF 12-14-2006 IS CLAIMED.

OWNER OF INTERNATIONAL REGISTRATION 0933266 DATED 6-12-2007, EXPIRES 6-12-2017.

SER. NO. 79-042,088, FILED 6-12-2007.

SIMON TENG, EXAMINING ATTORNEY

Int. Cl.: 5

Prior U.S. Cls.: 6, 18, 44, 46, 51 and 52

Reg. No. 3,485,197

United States Patent and Trademark Office

Registered Aug. 12, 2008

**TRADEMARK
PRINCIPAL REGISTER**

TWIMBLET

OREXO AB (SWEDEN LTD LIAB CO)
BOX 303
SE-751 05 UPPSALA
SWEDEN

FOR: PHARMACEUTICAL PREPARATIONS,
NAMELY FOR THE TREATMENT OF HEART-
BURN, MIGRAINE, INSOMNIA, URINARY INCON-
TINENCE, ASTHMA, RHINITIS,
OSTEOARTHROSIS, INFLAMMATORY DISEASES,
CHRONIC OBSTRUCTIVE PULMONARY DISEASE
(COPD) AS WELL AS PAIN RELIEF AND PAIN
KILLERS, IN CLASS 5 (U.S. CLS. 6, 18, 44, 46, 51 AND
52).

THE MARK CONSISTS OF STANDARD CHAR-
ACTERS WITHOUT CLAIM TO ANY PARTICULAR
FONT, STYLE, SIZE, OR COLOR.

PRIORITY DATE OF 2-16-2007 IS CLAIMED.

OWNER OF INTERNATIONAL REGISTRATION
0933283 DATED 7-6-2007, EXPIRES 7-6-2017.

SER. NO. 79-042,094, FILED 7-6-2007.

ELLEN BURNS, EXAMINING ATTORNEY

Int. Cl.: 5

Prior U.S. Cls.: 6, 18, 44, 46, 51 and 52

Reg. No. 3,485,198

United States Patent and Trademark Office

Registered Aug. 12, 2008

**TRADEMARK
PRINCIPAL REGISTER**

DIRAPARID

OREXO AB (SWEDEN LTD LIAB CO)
BOX 303
SE-751 05 UPPSALA
SWEDEN

FOR: PHARMACEUTICAL PREPARATIONS,
NAMELY FOR THE TREATMENT OF HEART-
BURN, MIGRAINE, INSOMNIA, URINARY INCON-
TINENCE, ASTHMA, RHINITIS,
OSTEOARTHROSIS, INFLAMMATORY DISEASES,
CHRONIC OBSTRUCTIVE PULMONARY DISEASE
(COPD) AS WELL AS PAIN RELIEF AND PAIN
KILLERS, IN CLASS 5 (U.S. CLS. 6, 18, 44, 46, 51 AND
52).

THE MARK CONSISTS OF STANDARD CHAR-
ACTERS WITHOUT CLAIM TO ANY PARTICULAR
FONT, STYLE, SIZE, OR COLOR.

PRIORITY DATE OF 2-16-2007 IS CLAIMED.

OWNER OF INTERNATIONAL REGISTRATION
0933284 DATED 7-6-2007, EXPIRES 7-6-2017.

SER. NO. 79-042,095, FILED 7-6-2007.

ELLEN BURNS, EXAMINING ATTORNEY

Int. Cl.: 5

Prior U.S. Cls.: 6, 18, 44, 46, 51 and 52

United States Patent and Trademark Office

Reg. No. 3,485,199

Registered Aug. 12, 2008

**TRADEMARK
PRINCIPAL REGISTER**

REALGEAR

YAC CO., LTD. (JAPAN CORPORATION)
3, HINANISHI-MACHI
OKAZAKI-SHI;
AICHI-KEN 444-8516, JAPAN

FOR: CAR DEODORIZERS; CAR DEODORANTS;
DEODORIZERS FOR VEHICLE SEATS FOR PETS;
DEODORANTS FOR VEHICLE SEATS FOR PETS;
ROOM DEODORIZERS; ROOM DEODORANTS;
AIR DEODORANTS, IN CLASS 5 (U.S. CLS. 6, 18,
44, 46, 51 AND 52).

THE MARK CONSISTS OF STANDARD CHAR-
ACTERS WITHOUT CLAIM TO ANY PARTICULAR
FONT, STYLE, SIZE, OR COLOR.

OWNER OF INTERNATIONAL REGISTRATION
0933487 DATED 6-8-2007, EXPIRES 6-8-2017.

OWNER OF U.S. REG. NO. 3,107,132.

SER. NO. 79-042,187, FILED 6-8-2007.

TINA BROWN, EXAMINING ATTORNEY

Int. Cls.: 1 and 2

Prior U.S. Cls.: 1, 5, 6, 10, 11, 16, 26 and 46

Reg. No. 3,485,200

United States Patent and Trademark Office

Registered Aug. 12, 2008

**TRADEMARK
PRINCIPAL REGISTER**

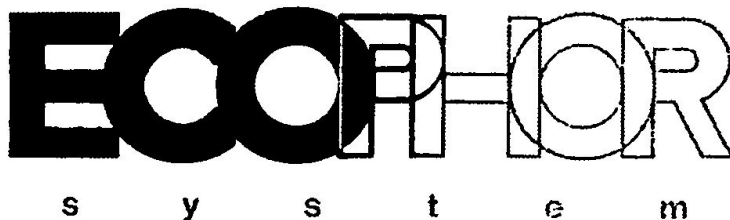

PAI-KOR S.R.L. (ITALY LTD LIAB CO)
VIA TECCHIONE, 7
SAN GIULIANO MILANESE
ITALY

NO CLAIM IS MADE TO THE EXCLUSIVE
RIGHT TO USE "SYSTEM", APART FROM THE
MARK AS SHOWN.

FOR: CHEMICALS USED IN INDUSTRY, IN
CLASS 1 (U.S. CLS. 1, 5, 6, 10, 26 AND 46).

THE MARK CONSISTS IN THE NAME "ECO-
PHOR" IN CAPITAL LETTERS, BELOW IT IS THE
NAME "SYSTEM" IN SMALL ITALIC CHARAC-
TERS. PARTICULARLY, THE NAME "ECOPHOR"
IS CHARACTERIZED BY THE FIRST THREE LET-
TERS "ECO" IN BLACK, WHILE THE REMAINDER
OF THE NAME "PHOR" IS WRITTEN WITH
SLIGHTLY OVERLAPPED LETTERS ON A LIGHT
BACKGROUND.

FOR: PAINTS, VARNISHES, LACQUERS; PRE-
SERVATIVES AGAINST RUST, NAMELY, ANTI-
TARNISHING PREPARATIONS FOR COATING
METALS, PHOSPHATE COATINGS, ANTI-RUST
GREASES, ANTI-RUST OILS, ANTI-CORROSIVE
COATINGS FOR METAL, IN CLASS 2 (U.S. CLS. 6,
11 AND 16).

PRIORITY DATE OF 4-4-2007 IS CLAIMED.

SER. NO. 79-042,211, FILED 6-6-2007.

OWNER OF INTERNATIONAL REGISTRATION
0933518 DATED 6-6-2007, EXPIRES 6-6-2017.

BERNICE MIDDLETON, EXAMINING ATTORNEY

Int. Cls.: 5, 29, 30 and 32

Prior U.S. Cls.: 6, 18, 44, 45, 46, 48, 51 and 52

United States Patent and Trademark Office

Reg. No. 3,485,201

Registered Aug. 12, 2008

**TRADEMARK
PRINCIPAL REGISTER**

SEMPER

HERO (SWITZERLAND SOCIÉTÉ ANONYME
(SA))
CH-5600 LENZBURG
SWITZERLAND

FOR: GLUTEN-FREE FOOD PREPARATIONS
AND SUBSTANCES AND GLUTEN-FREE FOODS
AND ADDITIVES, ALL FOR MEDICAL USE; FOOD-
STUFFS WITH LOW PROTEIN CONTENT, ALL FOR
MEDICAL USE; FOOD FOR BABIES; SUBSTITUTE
FOR MOTHER'S MILK, NAMELY, POWDERED
MILK FOR BABIES; MILK SUBSTITUTE FOR BA-
BIES, NAMELY, POWDERED MILK FOR BABIES,
IN CLASS 5 (U.S. CLS. 6, 18, 44, 46, 51 AND 52).

FOR: PRESERVED, DRIED AND COOKED
FRUIT AND VEGETABLES; JELLIES, JAMS, COM-
POTES, IN CLASS 29 (U.S. CL. 46).

FOR: HONEY, IN CLASS 30 (U.S. CL. 46).

FOR: FRUIT DRINKS AND FRUIT JUICES, IN
CLASS 32 (U.S. CLS. 45, 46 AND 48).

THE MARK CONSISTS OF STANDARD CHAR-
ACTERS WITHOUT CLAIM TO ANY PARTICULAR
FONT, STYLE, SIZE, OR COLOR.

PRIORITY DATE OF 2-12-2007 IS CLAIMED.

OWNER OF INTERNATIONAL REGISTRATION
0933615 DATED 5-7-2007, EXPIRES 5-7-2017.

THE ENGLISH TRANSLATION OF THE WORD
"SEMPER" IS "ALWAYS."

SER. NO. 79-042,252, FILED 5-7-2007.

SHAILA SETTLES, EXAMINING ATTORNEY

Int. Cls.: 7, 12, 17 and 37

**Prior U.S. Cls.: 1, 5, 12, 13, 19, 21, 23, 31, 34, 35, 44,
50, 100, 103 and 106**

Reg. No. 3,485,202

United States Patent and Trademark Office

Registered Aug. 12, 2008

**TRADEMARK
SERVICE MARK
PRINCIPAL REGISTER**

Sachs

ZF SACHS AG (FED REP GERMANY CORPORATION)
ERNST-SACHS-STRASSE 62
97424 SCHWEINFURT
FED REP GERMANY

FOR: CLUTCHES OTHER THAN FOR LAND VEHICLES, NAMELY, CLUTCHES FOR MACHINES; SHOCK ABSORBERS OTHER THAN FOR LAND VEHICLES, NAMELY, SHOCK ABSORBERS FOR MACHINES; SHOCK ABSORBER PLUNGERS FOR MACHINES; STARTERS FOR MOTORS AND ENGINES, IN CLASS 7 (U.S. CLS. 13, 19, 21, 23, 31, 34 AND 35).

FOR: AUTOMOBILES, MOTORCYCLES AND RAIL VEHICLES, NAMELY, LOCOMOTIVES AND RAILWAY CARS; AND PARTS OF AUTOMOBILES, MOTORCYCLES AND RAIL VEHICLES, NAMELY, CLUTCHES, CLUTCH RELEASE BEARINGS, TWO-MASS FLYWHEELS, TORQUE CONVERTERS, GEAR BOXES, SHOCK ABSORBERS, WHEEL SUSPENSIONS, SHOCK ABSORBING SPRINGS, SUSPENSION STRUTS AND STABILIZER BARS FOR VEHICLE SUSPENSIONS; ELECTRIC MOTORS FOR LAND VEHICLES; HYBRID DRIVES FOR LAND VEHICLES; ACTUATORS AS PARTS OF AUTOMOBILES, MOTORCYCLES AND RAIL VEHICLES, IN PARTICULAR, FOR CLUTCHES, GEAR BOXES

AND VEHICLE SUSPENSIONS, IN CLASS 12 (U.S. CLS. 19, 21, 23, 31, 35 AND 44).

FOR: CLUTCH LININGS, IN CLASS 17 (U.S. CLS. 1, 5, 12, 13, 35 AND 50).

FOR: REPAIR AND MAINTENANCE OF AUTOMOBILE PARTS, IN CLASS 37 (U.S. CLS. 100, 103 AND 106).

THE MARK CONSISTS OF STANDARD CHARACTERS WITHOUT CLAIM TO ANY PARTICULAR FONT, STYLE, SIZE, OR COLOR.

PRIORITY DATE OF 12-21-2006 IS CLAIMED.

OWNER OF INTERNATIONAL REGISTRATION 0933694 DATED 3-6-2007, EXPIRES 3-6-2017.

OWNER OF U.S. REG. NOS. 849,750, 3,175,940 AND OTHERS.

SEC. 2(F).

SER. NO. 79-042,290, FILED 3-6-2007.

DAYNA BROWNE, EXAMINING ATTORNEY

Int. Cls.: 17, 40 and 42

Prior U.S. Cls.: 1, 5, 12, 13, 35, 50, 100, 101, 103 and 106

Reg. No. 3,485,203

United States Patent and Trademark Office

Registered Aug. 12, 2008

**TRADEMARK
SERVICE MARK
PRINCIPAL REGISTER**

P L A G E N O M

HEXA CHEMICAL CO., LTD. (JAPAN JOINT-STOCK CORPORATION)
10-30, YOKOMAKURANISHI,
HIGASHIOSAKA-SHI; OSAKA, 578-0956
JAPAN

FOR: SEMI-PROCESSED PLASTIC IN THE FORM OF FILMS, SHEETS, TUBES, BARS, RODS, SLABS, BALLS, OR BLOCKS; CRUDE RUBBER; WASHERS OF RUBBER OR VULCANIZED FIBER; VALVES OR RUBBER OR VULCANIZED FIBER NOT INCLUDING MACHINE ELEMENTS; RUBBER STOPPERS; RUBBER LIDS AND CAPS FOR INDUSTRIAL PACKAGING CONTAINERS; INDUSTRIAL PACKAGING CONTAINERS OF RUBBER; VULCANIZED FIBER; ELECTRICAL INSULATING MATERIALS; FLOATING ANTI-POLLUTION BARRIERS; PIPE GASKETS; JUNCTIONS NOT OF METAL FOR PIPES; FIRE HOSES; INSULATING GLOVES; PLASTIC SHEETING FOR AGRICULTURAL PURPOSES; PACKING MATERIAL FOR FORMING SEALS; SOUNDPROOFING MATERIALS FOR BUILDINGS AND MACHINERY, IN CLASS 17 (U.S. CLS. 1, 5, 12, 13, 35 AND 50).

FOR: PROCESSING FOR RUBBER, FORMING OF RUBBER; PROCESSING OF PLASTICS, NAMELY, FORMING OF PLASTICS; PROVIDING INFORMATION ON FORMING AND COMPOSITE FABRICATION PROCESSES OF RUBBER AND PLASTIC PRODUCTS; DISPOSAL OF DOMESTIC WASTE AND TRASH, NAMELY, WASTE INCINERATION;

DISPOSAL OF INDUSTRIAL WASTE AND TRASH, NAMELY, TRASH INCINERATION; RECYCLING OF WASTE; COLLECTION AND SORTING OF DOMESTIC WASTE AND TRASH, NAMELY, WASTE MANAGEMENT; COLLECTION AND SORTING OF INDUSTRIAL WASTE AND TRASH, NAMELY, WASTE MANAGEMENT, IN CLASS 40 (U.S. CLS. 100, 103 AND 106).

FOR: TESTING, INSPECTION OR RESEARCH ON RUBBER/PLASTICS, NAMELY, TESTING OF RAW MATERIALS AND PRODUCT RESEARCH, IN CLASS 42 (U.S. CLS. 100 AND 101).

THE MARK CONSISTS OF STANDARD CHARACTERS WITHOUT CLAIM TO ANY PARTICULAR FONT, STYLE, SIZE, OR COLOR.

PRIORITY DATE OF 12-6-2006 IS CLAIMED.

OWNER OF INTERNATIONAL REGISTRATION 0933714 DATED 2-13-2007, EXPIRES 2-13-2017.

THE MARK HAS NO MEANING IN A FOREIGN LANGUAGE.

SER. NO. 79-042,295, FILED 2-13-2007.

ROBERT STRUCK, EXAMINING ATTORNEY

Int. Cls.: 29 and 30

Prior U.S. Cl.: 46

United States Patent and Trademark Office

Reg. No. 3,485,204

Registered Aug. 12, 2008

**TRADEMARK
PRINCIPAL REGISTER**



OBSHCHESTVO S OGRANICHENNOI OTVESTSTVENNOSTJU "KOMPANIA ZOLOTOI TEREM" (RUSSIAN FED. LIMITED LIABILITY COMPANY)

BLDG. 4, STROENIE 15,
DANILOVSKAYA NAB.RU-113114 MOSCOW
RUSSIAN FED.

FOR: POTATO CHIPS; POTATO FLAKES, IN CLASS 29 (U.S. CL. 46).

FOR: CORN FLAKES , IN CLASS 30 (U.S. CL. 46).

OWNER OF INTERNATIONAL REGISTRATION 0933751 DATED 5-3-2007, EXPIRES 5-3-2017.

THE COLOR(S) YELLOW, WHITE AND BLUE IS/ ARE CLAIMED AS A FEATURE OF THE MARK.

THE MARK CONSISTS OF THE TERM "MINIFREE", WHICH IS DEPICTED IN YELLOW WITH WHITE AND BLUE SHADOWING ON EACH LETTER.

SER. NO. 79-042,313, FILED 5-3-2007.

SHAILA SETTLES, EXAMINING ATTORNEY

Int. Cls.: 5, 29, 30, 31, 32 and 33

Prior U.S. Cls.: 1, 6, 18, 44, 45, 46, 47, 48, 49, 51 and 52

United States Patent and Trademark Office

Reg. No. 3,485,205

Registered Aug. 12, 2008

TRADEMARK
PRINCIPAL REGISTER



MONDELLI GROUP S.R.L. (ITALY LTD LIAB
CO)
VIA VILLAFRANCESCA, 7
I-03039 SORA (FR)
ITALY

FOR: DIETARY AND NUTRITIONAL SUPPLEMENTS; NUTRITIONAL ADDITIVES FOR MEDICAL PURPOSES FOR USE IN FOODS AND DIETARY SUPPLEMENTS FOR HUMAN CONSUMPTION, IN CLASS 5 (U.S. CLS. 6, 18, 44, 46, 51 AND 52).

FOR: MEAT, FISH, POULTRY AND GAME; MEAT EXTRACTS; FRUITS, NAMELY, PRESERVED DRIED AND COOKED FRUITS; VEGETABLES, NAMELY, PRESERVED DRIED AND COOKED VEGETABLES, PRESERVED DRIED AND COOKED MUSHROOMS; PROCESSED VEGETABLE AND FRUITS; PROCESSED MUSHROOMS; PRESERVED BERRIES; PREPARED VEGETABLES, PREPARED MUSHROOMS; MUSHROOM EXTRACTS USED AS INGREDIENTS OF SAUSAGES; FRUIT PRESERVES; VEGETABLE PRESERVES AND MUSHROOM PRESERVES; MUSHROOM-BASED SPREADS; FROZEN VEGETABLES, FROZEN MUSHROOMS; JELLIES, JAMS, FRUIT COMPOTES; EGGS, MILK AND DAIRY PRODUCTS, NAMELY, CHEESE, YOGURT, BUTTER; EDIBLE OILS AND FATS; PREPARATIONS FOR MAKING SOUPS; PREPARATIONS FOR MAKING BOUILLON, IN CLASS 29 (U.S. CL. 46).

FOR: COFFEE, TEA, COCOA, SUGAR, RICE, FLOUR; YEAST; BAKER PRODUCTS, BREAD; PASTRY; CANDY, BISCUITS, CAKES, BAKERY DES-

SERTS, PUDDINGS; HONEY, TREACLE; SALT, MUSTARD; KETCHUP, SAUCES, MARINARA SAUCE, SPICY PEPPER SAUCE, GARLIC SAUCE, GREEN AND BLACK OLIVE SAUCE, PASTA SAUCE, TOMATO SAUCE, MUSHROOMS SAUCE, SALAD DRESSINGS; MAYONNAISE; SPICES, IN CLASS 30 (U.S. CL. 46).

FOR: FRESH FRUITS AND VEGETABLES, NAMELY FRESH MUSHROOMS, IN CLASS 31 (U.S. CLS. 1 AND 46).

FOR: BEER AND OTHER NON-ALCOHOLIC DRINKS, NAMELY, FRUIT FLAVORED DRINKS, FRUIT JUICES, FRUIT NECTARS, LEMONADES, SODA, SOFT DRINKS, SYRUPS FOR MAKING BEVERAGES; DRINKING WATERS, NAMELY, MINERAL AND AERATED WATERS, IN CLASS 32 (U.S. CLS. 45, 46 AND 48).

FOR: ALCOHOLIC BEVERAGES, NAMELY, WINES, DISTILLED SPIRITS AND LIQUORS, EXCEPT BEERS, IN CLASS 33 (U.S. CLS. 47 AND 49).

PRIORITY DATE OF 10-5-2006 IS CLAIMED.

OWNER OF INTERNATIONAL REGISTRATION 0933919 DATED 11-27-2006, EXPIRES 11-27-2016.

NO CLAIM IS MADE TO THE EXCLUSIVE RIGHT TO USE "QUALITA," "COTTURA A FUOCO MEDIO," "15 MIN.," "PRODOTTO" AND "QUALITA GARANTITA", APART FROM THE MARK AS SHOWN.

THE NAME(S), PORTRAIT(S), AND/OR SIGNATURE(S) SHOWN IN THE MARK IDENTIFIES MR. NUNZIO ROSCILLI, THE MANAGER OF THE OWNER COMPANY, A LIVING INDIVIDUAL, WHOSE CONSENT(S) TO REGISTER IS SUBMITTED.

THE MARK CONSISTS OF A STYLIZED LABEL WITH AN UPPER AND LOWER OVAL DESIGN. WITHIN THE LABEL IS A DARKER BACKGROUND CONTAINING LEAF DESIGNS. THE MIDDLE OF THE MARK CONTAINS THE WORDING "DAL BOSCO A VOI, SOLO NOI!" AND THE WORDING "I ROSCILLI". THE WORDING "I ROSCILLI " IS WITHIN A RECTANGULAR BOX AND THE LETTER "O" CONTAINS A TREE AND ROOT DESIGN. ON THE LEFT OF THE WORDING ARE THREE MUSHROOMS. ON THE RIGHT OF THE WORDING IS A LEAF DESIGN. CONTAINED WITHIN THE LEAF DESIGN IS THE SIGNATURE "NUNZIO ROSCILLI". ON THE RIGHT HAND SIDE

OF THE MARK IS A CIRCULAR CLOCK DESIGN CONTAINING THE WORDING "COTTURA A FUOCO MEDIO" AND "15 MIN". UNDERNEATH THE CLOCK IS THE WORDING "NOVITA & QUALITA". ON THE LEFT HAND SIDE OF THE MARK IN THE UNDERNEATH SCROLLING IS THE WORDING "PRODOTTO A VISTA = QUALITA' GARANTITA".

THE ENGLISH TRANSLATION OF THE FOLLOWING PHRASES "DAL BOSCO A VOI, SOLO NOI!" "NOVITA & QUALITA" "COTTURA A FUOCO MEDIO" AND "PRODOTTO A VISTA = QUALITA GARANTITA" ARE "ONLY US FROM THE WOODS TO YOU" "NOVELTY & QUALITY" "MEDIUM COOKING" AND "VISIBLE PRODUCT = QUALITY GUARANTEED."

SER. NO. 79-042,385, FILED 11-27-2006.

TARAH HARDY, EXAMINING ATTORNEY

Int. Cl.: 9

Prior U.S. Cls.: 21, 23, 26, 36 and 38

Reg. No. 3,485,206

United States Patent and Trademark Office

Registered Aug. 12, 2008

**TRADEMARK
PRINCIPAL REGISTER**

Technology to Inspire Innovation

JAPAN AVIATION ELECTRONICS; INDUSTRY,
LIMITED (JAPAN CORPORATION)
21-2, DOGENZAKA 1-CHOME
SHIBUYA-KU; TOKYO 150-0043
JAPAN

FOR: MEASURING OR TESTING MACHINES AND INSTRUMENTS, NAMELY, AN ANGLE SENSOR; LEVEL INDICATORS (SPIRIT LEVELS); ACCELEROMETERS; ALTIMETERS; VIBRATION METERS; SPEED INDICATORS; FLOWMETERS; INCLINOMETERS; INTERFEROMETERS; AUTOMATIC LIQUID-LEVEL CONTROL MACHINES AND INSTRUMENTS; SURVEYING MACHINES AND INSTRUMENTS; CLINOMETERS; MAGNETIC COMPASSES FOR SURVEYING; GYROCOMPASSES; MAGNETIC GYROCOMPASSES; ROTARY CONVERTERS; PHASE MODIFIERS; ELECTRIC SWITCHES; ELECTRIC RELAYS; CIRCUIT BREAKERS; ELECTRIC CONNECTORS; ELECTRIC CIRCUIT CLOSERS; LOCAL SWITCHES; ELECTRIC WIRES AND CABLES; JUNCTION BOXES; JUNCTION SLEEVES FOR ELECTRIC CABLES; TELECOMMUNICATION CABLES; POWER CABLES; OPTICAL FIBER CABLES; NAVIGATION APPARATUS FOR VEHICLES BEING ON-BOARD COMPUTERS; RADIO BEACON MACHINES AND APPARATUS; RADIO DIRECTION FINDERS; CONNECTORS FOR TELECOMMUNICATION APPARATUS; ELECTRONIC MACHINES, APPARATUS AND THEIR PARTS, NAMELY, ACTIVE VIBRATION CONTROL PRODUCTS FOR LITHOGRAPH SYSTEMS AND LINEAR MOTORS, SENSOR AND SEN-

SOR APPLIED PRODUCTS FOR THE OIL DRILLING INDUSTRY, CAMERA STABILIZERS, LCD DISPLAYS FOR RAILROAD VESSELS, LCD DRIVER PRINTED WIRED BOARD, PANEL UNITS, OPTICAL TOUCH PANELS, TOUCH PANEL MONITORS, TEACHING PENDANTS, OPTICAL FILTER, OPTICAL SWITCHES, OPTICAL MODULATOR MODULES, GYROSCOPES, RING LASER GYROS, AND FIBER OPTIC GYROS; SEISMIC EXPLORATION MACHINES AND APPARATUS; ELECTRONIC CIRCUITS NOT INCLUDING THOSE RECORDED WITH COMPUTER PROGRAMS; INTEGRATED CIRCUITS; DATA READING MACHINES AND INSTRUMENTS, NAMELY, OPTICAL DATA READERS, BAR CODE READERS; LIGHT EMITTING DEVICES, NAMELY, LIGHT EMITTING DIODES; PHOTODETECTORS; PHOTO-COUPPLERS; FIBER OPTIC COUPLERS; OPTICAL LIGHTWAVE DATA LINKS; OPTICAL CONNECTORS, IN CLASS 9 (U.S. CLS. 21, 23, 26, 36 AND 38).

PRIORITY DATE OF 12-22-2006 IS CLAIMED.

OWNER OF INTERNATIONAL REGISTRATION
0933961 DATED 6-20-2007, EXPIRES 6-20-2017.

SER. NO. 79-042,401, FILED 6-20-2007.

RON FAIRBANKS, EXAMINING ATTORNEY

Int. Cl.: 9

Prior U.S. Cls.: 21, 23, 26, 36 and 38

Reg. No. 3,485,207

United States Patent and Trademark Office

Registered Aug. 12, 2008

**TRADEMARK
PRINCIPAL REGISTER**

Technology to Inspire Innovation



JAE

JAPAN AVIATION ELECTRONICS; INDUSTRY,
LIMITED (JAPAN CORPORATION)

21-2, DOGENZAKA 1-CHOME
SHIBUYA-KU; TOKYO 150-0043
JAPAN

FOR: MEASURING OR TESTING MACHINES AND INSTRUMENTS, NAMELY, AN ANGLE SENSOR; LEVEL INDICATORS (SPIRIT LEVELS); ACCELEROMETERS; ALTIMETERS; VIBRATION METERS; SPEED INDICATORS; FLOWMETERS; INCLINOMETERS; INTERFEROMETERS; AUTOMATIC LIQUID-LEVEL CONTROL MACHINES AND INSTRUMENTS; SURVEYING MACHINES AND INSTRUMENTS; CLINOMETERS; MAGNETIC COMPASSES FOR SURVEYING; GYROCOMPASSES; MAGNETIC GYROCOMPASSES; ROTARY CONVERTERS; PHASE MODIFIERS; ELECTRIC SWITCHES; ELECTRIC RELAYS; CIRCUIT BREAKERS; ELECTRIC CONNECTORS; ELECTRIC CIRCUIT CLOSERS; LOCAL SWITCHES; ELECTRIC WIRES AND CABLES; JUNCTION BOXES; JUNCTION SLEEVES FOR ELECTRIC CABLES; TELECOMMUNICATION CABLES; POWER CABLES; OPTICAL FIBER CABLES; NAVIGATION APPARATUS FOR VEHICLES BEING ON-BOARD COMPUTERS; RADIO BEACON MACHINES AND APPARATUS; RADIO DIRECTION FINDERS; CONNECTORS FOR TELECOMMUNICATION APPARATUS; ELECTRONIC MACHINES, APPARATUS AND THEIR PARTS, NAMELY, ACTIVE VIBRATION CONTROL PRODUCTS FOR LITHOGRAPH SYSTEMS AND LINEAR MOTORS, SENSOR AND SENSOR APPLIED PRODUCTS FOR THE OIL DRILLING INDUSTRY, CAMERA STABILIZERS, LCD DISPLAYS FOR RAILROAD VESSELS, LCD DRIVER PRINTED WIRED BOARD, PANEL UNITS, OPTICAL TOUCH PANELS, TOUCH PANEL MONITORS, TEACHING PENDANTS, OPTICAL FILTER,

OPTICAL SWITCHES, OPTICAL MODULATOR MODULES, GYROSCOPES, RING LASER GYROS, AND FIBER OPTIC GYROS; SEISMIC EXPLORATION MACHINES AND APPARATUS; ELECTRONIC CIRCUITS NOT INCLUDING THOSE RECORDED WITH COMPUTER PROGRAMS; INTEGRATED CIRCUITS; DATA READING MACHINES AND INSTRUMENTS, NAMELY, OPTICAL DATA READERS, BAR CODE READERS; LIGHT EMITTING DEVICES, NAMELY, LIGHT EMITTING DIODES; PHOTODETECTORS; PHOTO-COUPPLERS; FIBER OPTIC COUPLERS; OPTICAL LIGHTWAVE DATA LINKS; OPTICAL CONNECTORS, IN CLASS 9 (U.S. CLS. 21, 23, 26, 36 AND 38).

PRIORITY DATE OF 12-22-2006 IS CLAIMED.

OWNER OF INTERNATIONAL REGISTRATION
0933964 DATED 6-19-2007, EXPIRES 6-19-2017.

OWNER OF U.S. REG. NO. 2,477,305.

THE COLOR(S) BLUE AND BLACK IS/ARE
CLAIMED AS A FEATURE OF THE MARK.

BLUE: THE TWO OBLONG BARS; BLACK;
WORDS IN THE LATIN ALPHABET.

THE ENGLISH TRANSLATION OF THE FOREIGN WORD(S) IN THE MARK IS: COMBINATION OF THE INITIAL LETTERS OF THE OWNER'S FIRM NAME.

SER. NO. 79-042,402, FILED 6-19-2007.

RON FAIRBANKS, EXAMINING ATTORNEY

Int. Cl.: 3

Prior U.S. Cls.: 1, 4, 6, 50, 51 and 52

United States Patent and Trademark Office

Reg. No. 3,485,208

Registered Aug. 12, 2008

**TRADEMARK
PRINCIPAL REGISTER**

ATO GUARD

PARK, BYEONG-SEONG (FED REP GERMANY
INDIVIDUAL)
IM PANNENHACK 60
51503 RÖSRATH
FED REP GERMANY

OWNER OF INTERNATIONAL REGISTRATION
0933983 DATED 7-12-2007, EXPIRES 7-12-2017.

FOR: COSMETICS, IN CLASS 3 (U.S. CLS. 1, 4, 6, 50,
51 AND 52).

THE WORDING "ATO" HAS NO MEANING IN A
FOREIGN LANGUAGE.

THE MARK CONSISTS OF STANDARD CHAR-
ACTERS WITHOUT CLAIM TO ANY PARTICULAR
FONT, STYLE, SIZE, OR COLOR.

SER. NO. 79-042,411, FILED 7-12-2007.

PRIORITY DATE OF 1-12-2007 IS CLAIMED.

LINDA LAVACHE, EXAMINING ATTORNEY

Int. Cls.: 18 and 24

Prior U.S. Cls.: 1, 2, 3, 22, 41, 42 and 50

Reg. No. 3,485,209

United States Patent and Trademark Office

Registered Aug. 12, 2008

**TRADEMARK
PRINCIPAL REGISTER**

Twiny

SACHSEN FAHNEN GMBH & CO. KG (FED REP
GERMANY KG)
AM WIESENGRUND 2
01917 KAMENZ
FED REP GERMANY

FOR: UMBRELLAS, IN CLASS 18 (U.S. CLS. 1, 2, 3,
22 AND 41).

FOR: SINGLE AND MULTI-LAYERED TEXTILES
USED FOR ADVERTISING PURPOSES, NAMELY
FLAGS, PENNANTS, BUNTINGS, STREAMERS,
TIGHTENING DRAPERIES, STANDARDS IN THE
NATURE OF CIVIL, MILITARY AND NAVAL EN-
SIGNS, BANNERS; DRAPERY USED FOR COVER-
ING UMBRELLAS; SINGLE AND MULTI-
LAYERED FABRIC TEXTILES USED FOR ADVER-

TISING PURPOSES, NAMELY PLANES IN THE
NATURE OF PANELS, POSTERS AND PANELS
FEATURING LARGE FORMAT PICTURES, IN
CLASS 24 (U.S. CLS. 42 AND 50).

THE MARK CONSISTS OF STANDARD CHAR-
ACTERS WITHOUT CLAIM TO ANY PARTICULAR
FONT, STYLE, SIZE, OR COLOR.

OWNER OF INTERNATIONAL REGISTRATION
0934043 DATED 11-9-2006, EXPIRES 11-9-2016.

SER. NO. 79-042,427, FILED 11-9-2006.

KRISTINA MORRIS, EXAMINING ATTORNEY

Int. Cls.: 3 and 5

Prior U.S. Cls.: 1, 4, 6, 18, 44, 46, 50, 51 and 52

United States Patent and Trademark Office

Reg. No. 3,485,210

Registered Aug. 12, 2008

**TRADEMARK
PRINCIPAL REGISTER**

LYTRAZAC

COLLAGENEX PHARMACEUTICALS, INC. (DE-
LAWARE CORPORATION)
41 UNIVERSITY DRIVE, SUITE 200
NEWTOWN, PA 18940

FOR: NON-MEDICATED SKIN AND SCALP PREPARATIONS; SOAPS; DISPOSABLE IMPREGNATED WIPES CONTAINING NON-MEDICATED SKIN CARE PREPARATIONS; DISPOSABLE IMPREGNATED WIPES CONTAINING NON-MEDICATED TOOTH CLEANING PREPARATIONS; DISPOSABLE IMPREGNATED WIPES CONTAINING NON-MEDICATED PREPARATIONS FOR THE CARE OF THE ORAL CAVITY; NON-MEDICATED TOOTH CLEANING AND GARGLE PREPARATIONS FOR ORAL HYGIENE OR FOR THE CARE OF THE ORAL CAVITY; MOUTHWASH; NON-MEDICATED MOUTH RINSE, TOOTH-PASTES; NON-MEDICATED SUNSCREEN AND SUN BLOCK; DISPOSABLE WIPES IMPREGNATED WITH CHEMICALS OR COMPOUNDS FOR PERSONAL HYGIENE; PREPARATIONS FOR PERSONAL HYGIENE, NAMELY, BODY DEODORANT, IN CLASS 3 (U.S. CLS. 1, 4, 6, 50, 51 AND 52).

FOR: MEDICAL, MEDICATED AND VETERINARY PREPARATIONS FOR THE TREATMENT OF

SKIN DISORDERS OF MAMMALS OR ANIMALS; MEDICINAL AND VETERINARY PREPARATIONS FOR THE TREATMENT OF THE MOUTH OR THE ORAL CAVITY; MEDICINAL AND VETERINARY SPRAYS FOR THE TREATMENT OF SKIN DISORDERS OF MAMMALS OR ANIMALS; MEDICINAL AND VETERINARY SPRAYS FOR THE TREATMENT OF THE MOUTH OR THE ORAL CAVITY; MEDICINAL PREPARATIONS FOR THE TREATMENT OF INFECTIOUS DISEASES, IN CLASS 5 (U.S. CLS. 6, 18, 44, 46, 51 AND 52).

PRIORITY DATE OF 1-9-2007 IS CLAIMED.

OWNER OF INTERNATIONAL REGISTRATION
0934094 DATED 7-9-2007, EXPIRES 7-9-2017.

OWNER OF U.S. REG. NO. 3,243,052.

SER. NO. 79-042,445, FILED 7-9-2007.

ELLEN B. AWRICH, EXAMINING ATTORNEY

Int. Cls.: 3 and 5

Prior U.S. Cls.: 1, 4, 6, 18, 44, 46, 50, 51 and 52

United States Patent and Trademark Office

Reg. No. 3,485,211

Registered Aug. 12, 2008

**TRADEMARK
PRINCIPAL REGISTER**

ACfine

PARK, BYEONG-SEONG (FED REP GERMANY
INDIVIDUAL)

IM PANNENHACK 60

51503 RÖSRATH

FED REP GERMANY

FOR: COSMETICS, IN CLASS 3 (U.S. CLS. 1, 4, 6, 50,
51 AND 52).

FOR: PHARMACEUTICAL PREPARATIONS,
NAMELY, DERMATOLOGICALS , IN CLASS 5
(U.S. CLS. 6, 18, 44, 46, 51 AND 52).

THE MARK CONSISTS OF STANDARD CHAR-
ACTERS WITHOUT CLAIM TO ANY PARTICULAR
FONT, STYLE, SIZE, OR COLOR.

PRIORITY DATE OF 1-12-2007 IS CLAIMED.

OWNER OF INTERNATIONAL REGISTRATION
0934114 DATED 7-12-2007, EXPIRES 7-12-2017.

SER. NO. 79-042,453, FILED 7-12-2007.

LINDA LAVACHE, EXAMINING ATTORNEY

Int. Cls.: 9, 35, 38 and 42

Prior U.S. Cls.: 21, 23, 26, 36, 38, 100, 101, 102 and 104

United States Patent and Trademark Office

Reg. No. 3,485,212

Registered Aug. 12, 2008

**TRADEMARK
SERVICE MARK
PRINCIPAL REGISTER**



BIRGER WUNDERLICH (FED REP GERMANY
INDIVIDUAL)
ERINSTRASSE 16
44575 CASTROP-RAUXEL
FED REP GERMANY

FOR: COMPUTERS, COMPUTER SOFTWARE
FOR USE IN DATABASE MANAGEMENT, RADIO
TRANSMITTERS OF ELECTRONIC SIGNALS, TEL-
ECOMMUNICATION TRANSMITTERS, IN CLASS 9
(U.S. CLS. 21, 23, 26, 36 AND 38).

FOR: ON-LINE ADVERTISING ON A COMPUTER
COMMUNICATION NETWORK, IN CLASS 35 (U.S.
CLS. 100, 101 AND 102).

FOR: TELECOMMUNICATIONS SERVICES,
NAMELY, PERSONAL COMMUNICATIONS SERVI-
CES, IN CLASS 38 (U.S. CLS. 100, 101 AND 104).

FOR: COMPUTER SOFTWARE DESIGN FOR
OTHERS, COMPUTER SOFTWARE CONSULTAN-
CY, IN CLASS 42 (U.S. CLS. 100 AND 101).

PRIORITY DATE OF 11-21-2006 IS CLAIMED.

OWNER OF INTERNATIONAL REGISTRATION
0934265 DATED 5-15-2007, EXPIRES 5-15-2017.

SER. NO. 79-042,530, FILED 5-15-2007.

ROBERT STRUCK, EXAMINING ATTORNEY

Int. Cls.: 7 and 9

Prior U.S. Cls.: 13, 19, 21, 23, 26, 31, 34, 35, 36 and 38

Reg. No. 3,485,213

United States Patent and Trademark Office

Registered Aug. 12, 2008

**TRADEMARK
PRINCIPAL REGISTER**

SHOPMAT

SMV SRL (ITALY LTD LIAB CO)
VIALE DELL'INDUSTRIA, 303
I-62014 CORRIDONIA (MC)
ITALY

FOR: INDUSTRIAL AUTOMATION PLANTS, NAMELY, MACHINE FOR AUTOMATIC STORAGE, AUTOMATIC ORDERS ASSEMBLY AND AUTOMATIC DIRECT DELIVERY TO THE CUSTOMER OF GENERIC GOODS, INDUSTRIAL ROBOTS, INDUSTRIAL PLANTS FOR AUTOMATIC STORAGE, NAMELY, MACHINE OPERATED PLATFORMS CAPABLE OF ELEVATION ABOVE GROUND LEVEL AND USED FOR STORAGE; PLANTS FOR THE MANIPULATION AND MOVING GOODS, NAMELY, PACKAGING MACHINES, IN CLASS 7 (U.S. CLS. 13, 19, 21, 23, 31, 34 AND 35).

FOR: AUTOMATIC VENDING MACHINES, COMPUTER SOFTWARE FOR THE SUPERVISION AND CONTROL OF VENDING MACHINE AND INDUS-

TRIAL PLANTS AND ROBOT SYSTEMS USED FOR STORAGE, ORDER ASSEMBLY AND DELIVERY OF GENERIC GOODS, MUSICAL SOUND AND VIDEO RECORDINGS, BLANK OPTICAL AND MAGNETIC DISCS, COMPACT OPTICAL DISCS, NAMELY, BLANK OPTICAL DISCS, IN CLASS 9 (U.S. CLS. 21, 23, 26, 36 AND 38).

OWNER OF INTERNATIONAL REGISTRATION 0934309 DATED 5-15-2007, EXPIRES 5-15-2017.

THE TRADEMARK CONSISTS OF THE WORD "SHOPMAT" IN SPECIAL TYPE.

THE MARK HAS NO MEANING IN A FOREIGN LANGUAGE.

SER. NO. 79-042,550, FILED 5-15-2007.

ROBERT STRUCK, EXAMINING ATTORNEY

Int. Cls.: 33 and 39

Prior U.S. Cls.: 47, 49, 100 and 105

United States Patent and Trademark Office

Reg. No. 3,485,214

Registered Aug. 12, 2008

TRADEMARK
SERVICE MARK
PRINCIPAL REGISTER



BODEGA RIBEIRA DO MIÑO,; S. COOP. GALEGA (SPAIN COOPERATIVE CORPORATION)
CRIXÓ, ALXÉN, 8
E-36458 SALVATERRA DO MIÑO (PONTEVEDRA)
SPAIN

FOR: ALCOHOLIC BEVERAGES EXCEPT BEERS,
IN CLASS 33 (U.S. CLS. 47 AND 49).

FOR: TRANSPORT OF GOODS; PACKAGING
ARTICLES FOR TRANSPORTATION AND STORAGE OF GOODS; ARRANGING OF TRAVEL
TOURS, IN CLASS 39 (U.S. CLS. 100 AND 105).

PRIORITY DATE OF 1-18-2007 IS CLAIMED.

OWNER OF INTERNATIONAL REGISTRATION
0934445 DATED 5-16-2007, EXPIRES 5-16-2017.

THE COLOR(S) GREYISH GREEN, LIGHT GREEN AND DARK GREEN IS/ARE CLAIMED AS A FEATURE OF THE MARK.

THE MARK CONSISTS OF THE SHADOWED WORD "EIDOSELA" AND THREE LEAVES ABOVE THE FIRST E. THE COLOR DARK GREEN APPEARS IN THE WORD "EIDOSELA"; THE COLORS LIGHT GREEN AND GREYISH GREEN APPEAR IN THE LEAVES AND IN THE SHADOW OF THE WORD "EIDOSELA".

THE MARK HAS NO MEANING IN A FOREIGN LANGUAGE.

SER. NO. 79-042,600, FILED 5-16-2007.

ROBERT STRUCK, EXAMINING ATTORNEY

Int. Cl.: 12

Prior U.S. Cls.: 19, 21, 23, 31, 35 and 44

United States Patent and Trademark Office

Reg. No. 3,485,215

Registered Aug. 12, 2008

**TRADEMARK
PRINCIPAL REGISTER**

ANÍBAL

SANTANA MOTOR, S.A. (SPAIN S.A.)
C/ GOYA, 77,
ESC. IZQUIERDA 3º DCHA. B; E-28001 MADRID
SPAIN

OWNER OF INTERNATIONAL REGISTRATION
0934478 DATED 7-10-2007, EXPIRES 7-10-2017.

FOR: STRUCTURAL PARTS FOR AUTOMO-
BILES EXCLUDING AUTOMOBILE CHASSIS, IN
CLASS 12 (U.S. CLS. 19, 21, 23, 31, 35 AND 44).

SER. NO. 79-042,613, FILED 7-10-2007.

WENDY JUN, EXAMINING ATTORNEY

Int. Cls.: 18 and 25

Prior U.S. Cls.: 1, 2, 3, 22, 39 and 41

United States Patent and Trademark Office

Reg. No. 3,485,216

Registered Aug. 12, 2008

**TRADEMARK
PRINCIPAL REGISTER**

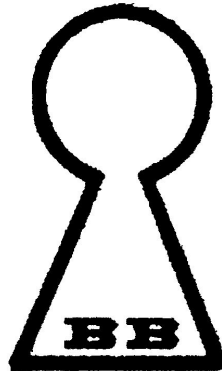

GLAM S.R.L. CON SOCIO UNICO (ITALY SOLE
MAN LIMITED LIABILITY COMPANY)
CORSO VENEZIA, 37
I-20121 MILANO
ITALY

FOR: LEATHER PRODUCTS AND ITS IMITA-
TIONS, NAMELY, BAGS, SUITCASES, TRAVEL-
LING BAGS, WALLETS; UMBRELLAS, IN CLASS
18 (U.S. CLS. 1, 2, 3, 22 AND 41).

FOR: CLOTHING, NAMELY, TROUSERS, PANTS,
SHORTS, SHIRTS, T-SHIRT, CHEMISSETTES,
SWEATSHIRTS, PULLOVERS, SHORT-TOPS, JOG-
GING SUITS; FOOTWEAR, NAMELY, MOCASSINS,

SANDALS, SLIPPERS, BOOTS, JOGGING SHOES,
SPORT SHOES; HEADGEAR, NAMELY, CAPS;
BELTS, IN CLASS 25 (U.S. CLS. 22 AND 39).

PRIORITY DATE OF 3-23-2007 IS CLAIMED.

OWNER OF INTERNATIONAL REGISTRATION
0934520 DATED 7-13-2007, EXPIRES 7-13-2017.

SER. NO. 79-042,626, FILED 7-13-2007.

SANI KHOURI, EXAMINING ATTORNEY

Int. Cl.: 24

Prior U.S. Cls.: 42 and 50

United States Patent and Trademark Office

Reg. No. 3,485,217

Registered Aug. 12, 2008

**TRADEMARK
PRINCIPAL REGISTER**

DEVEAUX

DEVEAUX S.A. (FRANCE SOCIÉTÉ ANONYME)
F-69240 SAINT VINCENT DE REINS
FRANCE

OWNER OF INTERNATIONAL REGISTRATION
0934833 DATED 5-23-2007, EXPIRES 5-23-2017.

FOR: FABRICS FOR TEXTILE USE, NAMELY,
WOVEN FABRIC, PRINTED CLOTH FABRIC FOR
THE MANUFACTURE OF CLOTHING AND MESH
TERRY CLOTH FABRICS, IN CLASS 24 (U.S. CLS. 42
AND 50).

SEC. 2(F).

SER. NO. 79-042,704, FILED 5-23-2007.

THE MARK CONSISTS OF STANDARD CHAR-
ACTERS WITHOUT CLAIM TO ANY PARTICULAR
FONT, STYLE, SIZE, OR COLOR.

ELI HELLMAN, EXAMINING ATTORNEY

Int. Cls.: 3, 5 and 35

**Prior U.S. Cls.: 1, 4, 6, 18, 44, 46, 50, 51, 52, 100, 101
and 102**

Reg. No. 3,485,218

United States Patent and Trademark Office

Registered Aug. 12, 2008

**TRADEMARK
SERVICE MARK
PRINCIPAL REGISTER**

ZINKORAL

EFI AS (NORWAY LTD LIAB CO)
STENERSGATA 2
N-0184 OSLO
NORWAY

FOR: NON-MEDICATED MOUTH SPRAY AND MOUTH RINSES FOR PREVENTING BAD BREATH; NON-MEDICATED MOUTH CARE PREPARATIONS, NAMELY, GUM, MINTS, AND LOZENGES; DEODORANTS FOR PERSONAL USE, IN CLASS 3 (U.S. CLS. 1, 4, 6, 50, 51 AND 52).

FOR: MINERAL AND FOOD SUPPLEMENTS; MEDICATED LOZENGES AGAINST BAD BREATH, IN CLASS 5 (U.S. CLS. 6, 18, 44, 46, 51 AND 52).

FOR: MAIL ORDER RETAILING SERVICES, ONLINE RETAIL STORE SERVICES AND MAIL ORDER SUBSCRIPTION RETAILING SERVICES FEATURING MOUTH SPRAY, MOUTH RINSES,

LOZENGES AGAINST BAD BREATH, PREPARATIONS AGAINST BAD BREATH, MOUTH CARE PREPARATIONS, DEODORANTS FOR PERSONAL USE, AND FOOD SUPPLEMENTS, IN CLASS 35 (U.S. CLS. 100, 101 AND 102).

THE MARK CONSISTS OF STANDARD CHARACTERS WITHOUT CLAIM TO ANY PARTICULAR FONT, STYLE, SIZE, OR COLOR.

PRIORITY DATE OF 3-28-2007 IS CLAIMED.

OWNER OF INTERNATIONAL REGISTRATION 0934859 DATED 4-12-2007, EXPIRES 4-12-2017.

SER. NO. 79-042,711, FILED 4-12-2007.

DAYNA BROWNE, EXAMINING ATTORNEY

Int. Cls.: 9 and 40

Prior U.S. Cls.: 21, 23, 26, 36, 38, 100, 103 and 106

United States Patent and Trademark Office

Reg. No. 3,485,219

Registered Aug. 12, 2008

**TRADEMARK
SERVICE MARK
PRINCIPAL REGISTER**



MAURER MAGNETIC AG (SWITZERLAND SOCIÉTÉ ANONYME)
8, INDUSTRIESTRASSE
CH-8627 GRÜNINGEN
SWITZERLAND

FOR: MOBILE, FIXED AND BUILT-IN APPARATUS FOR DEMAGNETIZING, NAMELY, HAND-HELD APPARATUS FOR DEMAGNETIZING, PLATFORM-MOUNTED DEMAGNETIZING APPARATUS, DEMAGNETIZING TUNNELS WITH ROUND AND RECTANGULAR CROSS-SECTION AS WELL AS HIGH-YIELD DEMAGNETIZING INSTALLATIONS CAPABLE OF BEING INTEGRATED INTO THE DEMAGNETIZING PROCESS PARTICULARLY FOR BULK GOODS IN A CONTAINER, AND LARGE AND SMALL PIECES AND COMPLEX CONSTRUCTIONS; ALL FOR USE IN DEMAGNETIZING FERROMAGNETIC METALS, IN CLASS 9 (U.S. CLS. 21, 23, 26, 36 AND 38).

FOR: TREATMENT OF MATERIALS FOR OTHERS, NAMELY, DEMAGNETIZING OBJECTS MADE OF FERROMAGNETIC METAL IN PARTICULAR MACHINES AND COMPONENT PARTS OF

MACHINES AS WELL AS COMPONENT PARTS OF ELECTRICAL OR ELECTRONIC APPARATUS AND INSTRUMENTS, IN CLASS 40 (U.S. CLS. 100, 103 AND 106).

PRIORITY DATE OF 2-15-2007 IS CLAIMED.

OWNER OF INTERNATIONAL REGISTRATION 0935088 DATED 6-14-2007, EXPIRES 6-14-2017.

OWNER OF U.S. REG. NO. 3,215,922.

NO CLAIM IS MADE TO THE EXCLUSIVE RIGHT TO USE "DEGAUSSING", APART FROM THE MARK AS SHOWN.

THE FOREIGN WORDING IN THE MARK TRANSLATES INTO ENGLISH AS BRICKLAYER.

SER. NO. 79-042,785, FILED 6-14-2007.

DAYNA BROWNE, EXAMINING ATTORNEY

Int. Cl.: 3

Prior U.S. Cls.: 1, 4, 6, 50, 51 and 52

Reg. No. 3,485,220

United States Patent and Trademark Office

Registered Aug. 12, 2008

TRADEMARK
PRINCIPAL REGISTER

The image shows a stylized, cursive trademark logo. The word "Dolce" is written in a large, elegant script, with a small ampersand "&" positioned below the "l" and to the left of the "M" in "Mania". The word "Mania" is also written in a cursive script, slightly smaller than "Dolce". The overall appearance is that of a handwritten signature or a highly decorative calligraphic font.

SO.DI.CO. SOCIETA' DISTRIBUZIONE; COSMETICI DI COLOMBONI L.E. C. SAS (ITALY SOCIETA' IN ACCOMANDITA SEMPLICE)
VIA R. SANZIO, 190/194
I-60019 SENIGALLIA (AN)
ITALY

FOR: SOAPS; PERFUMERY, ESSENTIAL OILS, COSMETICS, HAIR LOTIONS; DENTIFRICES, IN CLASS 3 (U.S. CLS. 1, 4, 6, 50, 51 AND 52).

PRIORITY DATE OF 3-30-2007 IS CLAIMED.

OWNER OF INTERNATIONAL REGISTRATION 0935099 DATED 6-19-2007, EXPIRES 6-19-2017.

THE ENGLISH TRANSLATION OF THE MARK IS "SWEET & MANIA".

SER. NO. 79-042,789, FILED 6-19-2007.

DAYNA BROWNE, EXAMINING ATTORNEY

Int. Cl.: 7

Prior U.S. Cls.: 13, 19, 21, 23, 31, 34 and 35

Reg. No. 3,485,221

United States Patent and Trademark Office

Registered Aug. 12, 2008

**TRADEMARK
PRINCIPAL REGISTER**

TURBUFLOW

MÖLLER MATERIALS HANDLING GMBH (FED
REP GERMANY CORPORATION)
HADERSLEBENER STRASSE 7
25421 PINNEBERG
FED REP GERMANY

FOR: TRANSPORTERS FOR THE PNEUMATIC
AND HYDRAULIC TRANSPORT OF GOODS,
NAMELY, RIGID METAL TRANSPORT TUBES
WITH INTEGRATED TURBULENCE GENERA-
TORS FOR PNEUMATIC AND HYDRAULIC
TRANSPORT OF SOLIDS AS PARTS OF TRANS-

PORT INSTALLATIONS, IN CLASS 7 (U.S. CLS. 13,
19, 21, 23, 31, 34 AND 35).

OWNER OF INTERNATIONAL REGISTRATION
0511261 DATED 4-8-1987, EXPIRES 4-8-2017.

SER. NO. 79-042,815, FILED 4-17-2007.

JOHN DALIER, EXAMINING ATTORNEY

Int. Cls.: 1, 5 and 31

Prior U.S. Cls.: 1, 5, 6, 10, 18, 26, 44, 46, 51 and 52

United States Patent and Trademark Office

Reg. No. 3,485,222

Registered Aug. 12, 2008

**TRADEMARK
PRINCIPAL REGISTER**

POKON

POKON & CHRYSAL INTERNATIONAL B.V.
(NETHERLANDS CORPORATION)
GOOIMEER 7
NL-1411 DD NAARDEN
NETHERLANDS

FOR: CHEMICAL PRODUCTS FOR AGRICULTURE, HORTICULTURE AND FLORICULTURE USE, NAMELY, CHEMICAL PREPARATIONS FOR THE TREATMENT OF SEEDS, PLANT FOOD, PLANT GROWTH REGULATORS, SUBSTANCES FOR PRESERVING CUT FLOWERS, FLOWER PRESERVATIVES, NATURAL AND SYNTHETIC FERTILIZERS; LEAF LUSTERING PRODUCTS, NAMELY, LEAFSHINE; HUMUS; COMPOST, IN CLASS 1 (U.S. CLS. 1, 5, 6, 10, 26 AND 46).

FOR: ALL-PURPOSE DISINFECTANTS; PREPARATIONS FOR DESTROYING VERMIN; FUNGICIDES; HERBICIDES, IN CLASS 5 (U.S. CLS. 6, 18, 44, 46, 51 AND 52).

FOR: AGRICULTURAL, HORTICULTURAL AND FORESTRY PRODUCTS AND GRAINS, NAMELY, PLANT SEEDS, AGRICULTURAL GRAINS FOR PLANTING, UNPROCESSED GRAIN, GRASS SEED, HAY, LIVING TREES, PINE CONES, UNSAWN TIMBER; PLANT SEEDS; NATURAL PLANTS, NAMELY, LIVING PLANTS, DRIED PLANTS AND FLOWERS, NAMELY, CUT FLOWERS, IN CLASS 31 (U.S. CLS. 1 AND 46).

OWNER OF INTERNATIONAL REGISTRATION
0646672 DATED 10-31-1995, EXPIRES 10-31-2015.

THE WORDING "POKON" HAS NO MEANING
IN A FOREIGN LANGUAGE.

SER. NO. 79-042,825, FILED 1-8-2007.

TARAH HARDY, EXAMINING ATTORNEY

Int. Cls.: 14, 25 and 35

Prior U.S. Cls.: 2, 22, 27, 28, 39, 50, 100, 101 and 102

United States Patent and Trademark Office

Reg. No. 3,485,223

Registered Aug. 12, 2008

**TRADEMARK
SERVICE MARK
PRINCIPAL REGISTER**

FRIDAY'S PROJECT

JULIAN IMAZ VILLAR (SPAIN INDIVIDUAL)
POLÍGONO INDUSTRIAL VALLDEGATA-DRA-
PER,
C/ A, PARCELA 3; E-08350 ARENYS DE MAR
(BARCELONA)
SPAIN

FOR: PRECIOUS METALS AND THEIR ALLOYS,
NAMELY, GOLD, SILVER AND PLATINUM; JEW-
ELRY; PRECIOUS STONES; HOROLOGICAL AND
CHRONOMETRIC INSTRUMENTS, IN CLASS 14
(U.S. CLS. 2, 27, 28 AND 50).

FOR: CLOTHING, NAMELY, SHIRTS, T-SHIRTS,
BLOUSES, WINDCHEATERS, SWEATSHIRTS, PAR-
KAS, JACKETS, TROUSERS, GLOVES, STOLES,
SUITS, KNITWEAR, SOCKS, STOCKINGS, UNDER-
WEAR, PAJAMAS, NIGHTDRESSES, WAISTCOATS,
CLOAKS, RAINCOATS, SHAWLS, COATS, MUF-
FLERS, JERSEYS, SKIRTS, DRESSES, NECKTIES,
DRESSING GOWN, BELTS, BRACES; SPORTS-
WEAR, NAMELY, KNICKERS, ANORAKS, SWIM-
SUITS, BATH ROBES, BATHING DRAWERS, BATH
SLIPPERS, BATHING CAPS, BATH SANDALS,
BATHING SUITS, SINGLETS, DRESSING GOWNS,
WARM UP SUITS, JUMP SUITS, SKI SUITS, SHOW-

ER CAPS, TRACK SUITS, FOOTBALL BOOTS,
STUDS FOR FOOTBALL BOOTS, CLEATS FOR
ATTACHMENT TO SPORTS SHOES, TIPS FOR
FOOTWEAR AND SHOES FOR SPORTS; FOOT-
WEAR; AND HEADGEAR, NAMELY, HATS AND
CAPS, IN CLASS 25 (U.S. CLS. 22 AND 39).

FOR: ADVERTISING AGENCIES; BUSINESS
MANAGEMENT; FRANCHISING SERVICES IN
COMMERCIAL COMPANY OPERATIONAL OR
MANAGEMENT ASSISTANCE, NAMELY, OFFER-
ING TECHNICAL ASSISTANCE IN THE ESTAB-
LISHMENT AND/OR OPERATION OF SHOE
STORES, RESTAURANTS, PERFUMERY SHOPS,
JEWELRY SHOPS, BED BLANKETS AND TABLE
CLOTHS SHOPS, CLOTHING SHOPS, IN CLASS 35
(U.S. CLS. 100, 101 AND 102).

OWNER OF INTERNATIONAL REGISTRATION
0905204 DATED 10-30-2006, EXPIRES 10-30-2016.

SER. NO. 79-042,866, FILED 6-27-2007.

LINDA ESTRADA, EXAMINING ATTORNEY

Int. Cls.: 6 and 20

Prior U.S. Cls.: 2, 12, 13, 14, 22, 23, 25, 32 and 50

United States Patent and Trademark Office

Reg. No. 3,485,224

Registered Aug. 12, 2008

**TRADEMARK
PRINCIPAL REGISTER**



STEMA S.R.L. (ITALY LTD LIAB CO)
VIA E. MATTEI, 9/21
I-20050 RONCO BRIANTINO (MI)
ITALY

THE COLOR(S) GREY, SKY-BLUE AND WHITE
IS/ARE CLAIMED AS A FEATURE OF THE MARK.

FOR: TUBULAR ELEMENTS, HOOKS AND METAL MECHANISMS FOR SOFA BEDS, IN CLASS 6 (U.S. CLS. 2, 12, 13, 14, 23, 25 AND 50).

THE MARK CONSISTS OF THE WORD "STEMA" IN GRAY INSIDE A GRAY RECTANGLE. ABOVE AND BELOW THE WORDS ARE HORIZONTAL STRIPES OF GRAY WITH A CURVED OVAL LIGHT BLUE SHAPE INSIDE.

FOR: MATTRESS SUPPORTS FOR BEDS, FOR SOFAS, FOR SOFA BEDS, FOR ARMCHAIRS, IN CLASS 20 (U.S. CLS. 2, 13, 22, 25, 32 AND 50).

PRIORITY DATE OF 1-12-2007 IS CLAIMED.

SER. NO. 79-042,900, FILED 7-11-2007.

OWNER OF INTERNATIONAL REGISTRATION 0935223 DATED 7-11-2007, EXPIRES 7-11-2017.

JACQUELINE A. LAVINE, EXAMINING ATTORNEY

Int. Cls.: 16, 38, 41 and 42

**Prior U.S. Cls.: 2, 5, 22, 23, 29, 37, 38, 50, 100, 101, 104
and 107**

Reg. No. 3,485,225

United States Patent and Trademark Office

Registered Aug. 12, 2008

**TRADEMARK
SERVICE MARK
PRINCIPAL REGISTER**



**Centre
Tecnològic
de Telecomunicacions
de Catalunya**

FUNDACIÓ CENTRE TECNOLÒGIC DE; TELECOMUNICACIONS DE CATALUNYA (CTTC) (SPAIN NON-PROFIT CORPORATION)

EDIFICI PARC MEDITERRANI DE LA TECNOLOGIA AV. CANAL OLIMPIC, S/N; E-08860 CASTELLDEFELS (BARCELONA)
SPAIN

FOR: BOOKS IN THE FIELD OF TELECOMMUNICATIONS; MAGAZINES FEATURING ADVANCES IN THE TELECOMMUNICATIONS INDUSTRY AND TECHNOLOGY; PUBLICATIONS, NAMELY, NEWSLETTERS FEATURING ADVANCES IN THE TELECOMMUNICATIONS INDUSTRY AND TECHNOLOGY; CATALOGUES IN THE FIELD OF TELECOMMUNICATIONS; ENVELOPES; CARDS, NAMELY, GREETING CARDS; AGENDAS; POSTERS; CALENDARS; NOTEBOOKS; POSTCARDS; GUIDEBOOKS FEATURING ADVANCES IN THE TELECOMMUNICATIONS INDUSTRY AND TECHNOLOGY; ADHESIVES FOR STATIONERY OR HOUSEHOLD PURPOSES; BOOKBINDING MATERIALS; WRITING MATERIALS, NAMELY, PENCILS AND BALLPOINT PENS; PRINTED INSTRUCTIONAL AND TEACHING MATERIALS IN THE FIELD OF TELECOMMUNICATIONS; PHOTOGRAPHS, IN CLASS 16 (U.S. CLS. 2, 5, 22, 23, 29, 37, 38 AND 50).

FOR: CONSULTING AND ADVISORY SERVICES IN THE FIELD OF TELECOMMUNICATIONS; PROVIDING INFORMATION RELATING TO TELE-

COMMUNICATIONS NETWORKS, IN CLASS 38 (U.S. CLS. 100, 101 AND 104).

FOR: EDUCATIONAL SERVICES, NAMELY, PROVIDING TRAINING IN THE FIELDS OF TELECOMMUNICATIONS SYSTEMS AND TECHNOLOGY; ARRANGING AND CONDUCTING OF EDUCATIONAL CONFERENCES, CONGRESSES, COLLOQUIUMS, SEMINARS AND SYMPOSIUMS IN THE FIELDS OF THE TELECOMMUNICATIONS INDUSTRY AS WELL AS TELECOMMUNICATIONS SYSTEMS AND TECHNOLOGY; ORGANIZATION OF EXHIBITIONS FOR CULTURAL OR EDUCATIONAL PURPOSES DESIGNED TO ENCOURAGE INTEREST IN THE TELECOMMUNICATIONS INDUSTRY AS WELL AS IN TELECOMMUNICATIONS SYSTEMS AND TECHNOLOGY; PUBLISHING OF NON-ADVERTISING TEXTS IN THE NATURE OF BOOKS, MAGAZINES, JOURNALS AND NEWSLETTERS IN THE FIELDS OF THE TELECOMMUNICATIONS INDUSTRY, TELECOMMUNICATIONS SYSTEMS AND TELECOMMUNICATIONS TECHNOLOGY AND ITS CONSTANT ADVANCES; PUBLICATION OF BOOKS, ONLINE PUBLICATION OF ELECTRONIC BOOKS AND JOURNALS, IN CLASS 41 (U.S. CLS. 100, 101 AND 107).

FOR: SCIENTIFIC AND TECHNOLOGICAL SERVICES, NAMELY, RESEARCH AND DESIGN SERVICES RELATED TO COMPUTER AND SOFTWARE DESIGN AND DEVELOPMENT; INDUSTRIAL RESEARCH IN THE FIELD OF TELECOMMUNICA-

TIONS AND ADVANCES IN THE TELECOMMUNICATIONS INDUSTRY AND TECHNOLOGY AND ADVISORY SERVICES IN CONNECTION THEREWITH; RESEARCH AND DEVELOPMENT FOR NEW PRODUCTS FOR OTHERS, IN CLASS 42 (U.S. CLS. 100 AND 101).

OWNER OF INTERNATIONAL REGISTRATION 0935230 DATED 6-8-2007, EXPIRES 6-8-2017.

NO CLAIM IS MADE TO THE EXCLUSIVE RIGHT TO USE "CENTRE TECNOLÓGIC DE TELECOMUNICACIONES DE CATALUNYA", APART FROM THE MARK AS SHOWN.

THE MARK CONSISTS IN THE DENOMINATION "CTTC CENTRE TECNOLÓGIC DE TELECOMUNICACIONES DE CATALUNYA", WRITTEN IN PRINT AND ARRANGED ON FIVE LINES; THE INITIALS "CTTC" WHICH OCCUPY THE FIRST LINE, APPEAR IN UPPER-CASE, AND ARE IN BIGGER FONT THAN THE REST OF THE DENOMINATION

AND ALSO THE LAST THREE LETTERS "T", "T", "C" ARE THICKER; THE EXPRESSION "CENTRE TECNOLÓGIC DE TELECOMUNICACIONES DE CATALUNYA" WHICH APPEARS IN LOWER-CASE, APART FROM ITS INITIALS, IS ARRANGED ON THE SECOND, THIRD, FOURTH AND FIFTH LINES, ALL ALINEATED AND PLACED BELOW THE FIRST "T" OF THE ABOVEMENTIONED GROUP OF INITIALS "CTTC"; OVER THE SAID DENOMINATION IS A FANCY GRAPHIC FORMED BY FIVE CURVED LINES, SEMICONVERGING AT THEIR LEFT EXTREMITY, OF DIFFERENT LENGTHS AND IRREGULAR THICKNESS; ALL AS SHOWN IN THE ATTACHED DESIGN.

THE ENGLISH TRANSLATION OF THE FOREIGN WORD(S) IN THE MARK IS: "CTTC TECHNOLOGICAL CENTER OF TELECOMMUNICATIONS OF CATALONIA".

SER. NO. 79-042,905, FILED 6-8-2007.

RUSS HERMAN, EXAMINING ATTORNEY

Int. Cls.: 1, 3 and 5

Prior U.S. Cls.: 1, 4, 5, 6, 10, 18, 26, 44, 46, 50, 51 and 52

Reg. No. 3,485,226

United States Patent and Trademark Office

Registered Aug. 12, 2008

**TRADEMARK
PRINCIPAL REGISTER**

ECOLIFE

HENKEL KGAA (FED REP GERMANY PART-
NERSHIP LIMITED BY SHARES)
HENKELSTRASSE 67
40589 DÜSSELDORF
FED REP GERMANY

FOR: CHEMICAL PREPARATIONS FOR USE IN
THE MANUFACTURE OF ALL-PURPOSE HOUSE-
HOLD CLEANERS, HOUSEHOLD DETERGENTS,
AND INDUSTRIAL CLEANERS, IN CLASS 1 (U.S.
CLS. 1, 5, 6, 10, 26 AND 46).

FOR: BLEACHING PREPARATIONS FOR LAUN-
DRY USE; CLEANING PREPARATIONS FOR
LAUNDRY AND TABLEWARE, NAMELY, RIN-
SING AGENTS FOR LAUNDRY AND TABLE-
WARE; GENERAL PURPOSE CLEANING,
POLISHING, SCOURING AND ABRASIVE LI-
QUIDS, POWDERS AND GELS; CLEANING PRE-
PARATIONS FOR METAL, METAL SHEETS AND
PLATES WITH ENAMEL COATING, WOOD, CORK,
CERAMICS, GLASS, SYNTHETICS, LEATHER AND
TEXTILES; STAIN REMOVERS; INDUSTRIAL
SOAP; SKIN SOAPS; PERFUMERY AND ESSEN-

TIAL OILS FOR PERSONAL USE, IN CLASS 3 (U.S.
CLS. 1, 4, 6, 50, 51 AND 52).

FOR: ALL-PURPOSE DISINFECTING AND DEO-
DORIZING PREPARATIONS; AIR FRESHENERS
AND AIR DEODORIZERS, IN CLASS 5 (U.S. CLS. 6,
18, 44, 46, 51 AND 52).

THE MARK CONSISTS OF STANDARD CHAR-
ACTERS WITHOUT CLAIM TO ANY PARTICULAR
FONT, STYLE, SIZE, OR COLOR.

PRIORITY DATE OF 3-9-2007 IS CLAIMED.

OWNER OF INTERNATIONAL REGISTRATION
0935267 DATED 7-5-2007, EXPIRES 7-5-2017.

SER. NO. 79-042,927, FILED 7-5-2007.

EDWARD NELSON, EXAMINING ATTORNEY

Int. Cls.: 9 and 25

Prior U.S. Cls.: 21, 22, 23, 26, 36, 38 and 39

United States Patent and Trademark Office

Reg. No. 3,485,227

Registered Aug. 12, 2008

**TRADEMARK
PRINCIPAL REGISTER**



JAL GROUP PARTICIPATIONS S.A.R.L. (LUX-
EMBOURG S.A.R.L.)
5, RUE JEAN MONNET
L-2180 LUXEMBOURG
LUXEMBOURG

THE COLOR(S) RED, BLACK IS/ARE CLAIMED
AS A FEATURE OF THE MARK.

FOR: SAFETY AND PROTECTIVE FOOTWEAR,
IN CLASS 9 (U.S. CLS. 21, 23, 26, 36 AND 38).

THE COLOR BLACK APPEARS IN THE LETTERS
"AI" AND "ONT" AND IN THE CIRCLE DESIGN
THAT SERVES AS A CARRIER FOR A RED STY-
LIZED LETTER "M".

FOR: FOOTWEAR, IN CLASS 25 (U.S. CLS. 22 AND
39).

PRIORITY DATE OF 12-12-2006 IS CLAIMED.

SER. NO. 79-042,949, FILED 6-11-2007.

OWNER OF INTERNATIONAL REGISTRATION
0935315 DATED 6-11-2007, EXPIRES 6-11-2017.

RUSS HERMAN, EXAMINING ATTORNEY

Int. Cls.: 1 and 21

**Prior U.S. Cls.: 1, 2, 5, 6, 10, 13, 23, 26, 29, 30, 33, 40,
46 and 50**

Reg. No. 3,485,228

United States Patent and Trademark Office

Registered Aug. 12, 2008

**TRADEMARK
PRINCIPAL REGISTER**

SILAYRA

EVONIK DEGUSSA GMBH
RELLINGHAUSER STRAÙE 1-11
45128 ESSEN
FED REP GERMANY

FOR: CHEMICALS FOR SCIENTIFIC PURPOSES; CHEMICALS FOR INDUSTRIAL PURPOSES; CHEMICALS FOR USE IN THE MANUFACTURE OF A WIDE VARIETY OF GOODS; CHEMICALS FOR USE IN INDUSTRY; PHOTOGRAPHIC CHEMICALS; UNPROCESSED ARTIFICIAL RESINS; UNPROCESSED PLASTICS, NAMELY, PLASTICS IN PRIMARY FORM AND FOR INDUSTRIAL USE; CHEMICAL PRODUCTS FOR THE FRESH KEEPING AND PRESERVING OF FOOD; TANNING AGENTS FOR USE IN THE MANUFACTURE OF LEATHER; ADHESIVES FOR INDUSTRIAL PURPOSES; ADHESIVES FOR USE IN INDUSTRY; CHEMICALS FOR USE IN AGRICULTURE; HORTICULTURE CHEMICALS, EXCEPT FUNGICIDES, HERBICIDES, INSECTICIDES AND PARASITICIDES; CHEMICALS FOR FORESTRY, EXCEPT FUNGICIDES, HERBICIDES, INSECTICIDES AND PARASITICIDES, IN CLASS 1 (U.S. CLS. 1, 5, 6, 10, 26 AND 46).

FOR: ARTICLES MADE FROM GLASS, NAMELY, INGOTS, TUBES, DISCS, PLATES, AND RINGS ALL FOR GENERAL INDUSTRIAL AND FURTHER MANUFACTURING USE; COLORED SHEET GLASS NOT FOR BUILDING; COMMON SHEET GLASS NOT FOR BUILDING; FIGURES OF GLASS; FILTERING MATERIALS, NAMELY, FILTERING

MATERIALS MADE OF CELLULAR GLASS AND CELLULAR GLASS PARTICLES FOR USE AS A FILTERING MEDIA IN SEWAGE AND WASTE WATER TREATMENT; GLASS RODS AND BARS NOT FOR BUILDING; LAMINATED FLAT GLASS NOT FOR BUILDING; MODIFIED SHEET GLASS NOT FOR BUILDING; PARTLY WORKED GLASS, NAMELY, INGOTS TUBES, DISCS, PLATES, AND RINGS ALL FOR GENERAL INDUSTRIAL AND FURTHER MANUFACTURING USE; DRAWER PULLS OF GLASS, PORCELAIN OR EARTHENWARE; FIGURES OF EARTHENWARE AND PORCELAIN; DOORKNOBS OF EARTHENWARE AND PORCELAIN; PORCELAIN KNOBS; PORCELAIN MUGS; SCULPTURES OF EARTHENWARE AND PORCELAIN; STATUES OF EARTHENWARE AND PORCELAIN; STATUETTES OF EARTHENWARE AND PORCELAIN, IN CLASS 21 (U.S. CLS. 2, 13, 23, 29, 30, 33, 40 AND 50).

THE MARK CONSISTS OF STANDARD CHARACTERS WITHOUT CLAIM TO ANY PARTICULAR FONT, STYLE, SIZE, OR COLOR.

OWNER OF INTERNATIONAL REGISTRATION
0935451 DATED 7-19-2007, EXPIRES 7-19-2017.

SER. NO. 79-042,997, FILED 7-19-2007.

GISELLE AGOSTO, EXAMINING ATTORNEY

Int. Cl.: 5

Prior U.S. Cls.: 6, 18, 44, 46, 51 and 52

Reg. No. 3,485,229

United States Patent and Trademark Office

Registered Aug. 12, 2008

TRADEMARK
PRINCIPAL REGISTER

DUPRAFAM

OREXO AB (SWEDEN LTD LIAB CO)
BOX 303
SE-751 05 UPPSALA
SWEDEN

FOR: PHARMACEUTICAL PREPARATIONS,
NAMELY FOR THE TREATMENT OF HEART-
BURN, MIGRAINE, INSOMNIA, URINARY INCON-
TINENCE, ASTHMA, RHINITIS,
OSTEOARTHROSIS, INFLAMMATORY DISEASES,
CHRONIC OBSTRUCTIVE PULMONARY DISEASE
(COPD) AS WELL AS PAIN RELIEF AND PAIN
KILLERS, IN CLASS 5 (U.S. CLS. 6, 18, 44, 46, 51 AND
52).

THE MARK CONSISTS OF STANDARD CHAR-
ACTERS WITHOUT CLAIM TO ANY PARTICULAR
FONT, STYLE, SIZE, OR COLOR.

PRIORITY DATE OF 2-16-2007 IS CLAIMED.

OWNER OF INTERNATIONAL REGISTRATION
0935680 DATED 7-6-2007, EXPIRES 7-6-2017.

SER. NO. 79-043,089, FILED 7-6-2007.

ELLEN BURNS, EXAMINING ATTORNEY

Int. Cls.: 38 and 41

Prior U.S. Cls.: 100, 101, 104 and 107

United States Patent and Trademark Office

Reg. No. 3,485,230

Registered Aug. 12, 2008

**SERVICE MARK
PRINCIPAL REGISTER**

You Are Wow!

MÜLLER-BAIST, MARTIN (FED REP GERMANY
INDIVIDUAL)
BEUELSWEG 22-24
50733 KÖLN
FED REP GERMANY

FOR: ELECTRONIC TRANSMISSION OF MESSAGES AND DATA, NAMELY, DELIVERY OF GREETING CARDS, DOCUMENTS, PICTURES, AND TEXTS, ALL IN THE FIELD OF ART, TO OTHERS VIA ELECTRONIC MAIL, IN CLASS 38 (U.S. CLS. 100, 101 AND 104).

FOR: PROVIDING ON-LINE PUBLICATIONS IN THE NATURE OF MAGAZINES IN THE FIELD OF CULTURE AND ENTERTAINMENT; ENTERTAINMENT SERVICES, NAMELY, PROVIDING A WEB SITE FEATURING PHOTOGRAPHIC, VIDEO AND PROSE PRESENTATIONS FEATURING WORKS OF ART AND INFORMATION ON WORKS OF ART;

PUBLICATION OF TEXTS, BOOKS, MAGAZINES AND OTHER PRINTED MATTER; ART EXHIBITIONS, IN CLASS 41 (U.S. CLS. 100, 101 AND 107).

THE MARK CONSISTS OF STANDARD CHARACTERS WITHOUT CLAIM TO ANY PARTICULAR FONT, STYLE, SIZE, OR COLOR.

PRIORITY DATE OF 1-24-2007 IS CLAIMED.

OWNER OF INTERNATIONAL REGISTRATION
0935692 DATED 7-12-2007, EXPIRES 7-12-2017.

SER. NO. 79-043,094, FILED 7-12-2007.

MICHAEL GAAFAR, EXAMINING ATTORNEY

Int. Cls.: 37, 41, 42 and 45

Prior U.S. Cls.: 100, 101, 103, 106 and 107

United States Patent and Trademark Office

Reg. No. 3,485,231

Registered Aug. 12, 2008

**SERVICE MARK
PRINCIPAL REGISTER**



DAVY PROCESS TECHNOLOGY LIMITED (UNITED KINGDOM PRIVATE LIMITED COMPANY)
20 EASTBOURNE TERRACE
LONDON W2 6LE
UNITED KINGDOM

FOR: CONSTRUCTION OF CHEMICAL AND PETROCHEMICAL PLANTS; COMMISSIONING OF CHEMICAL OR PETROCHEMICAL PLANTS, NAMELY, CONSULTING IN THE FIELD OF CHEMICAL AND PETROCHEMICAL PLANT CONSTRUCTION, CUSTOM CONSTRUCTION, INSTALLATION AND RENOVATION OF CHEMICAL AND PETROCHEMICAL PLANTS; REPAIR OF CHEMICAL OR PETROCHEMICAL PLANTS, IN CLASS 37 (U.S. CLS. 100, 103 AND 106).

FOR: EDUCATION SERVICES, NAMELY, CLASSES, SEMINARS, WORKSHOPS IN THE FIELD OF CHEMICAL PROCESSING, PETROCHEMICAL PROCESSING OR CHEMICAL ENGINEERING; TRAINING SERVICES IN THE FIELD OF CHEMICAL PROCESSING, PETROCHEMICAL PROCESSING OR CHEMICAL ENGINEERING, IN CLASS 41 (U.S. CLS. 100, 101 AND 107).

FOR: SCIENTIFIC AND TECHNOLOGICAL SERVICES AND RESEARCH AND DESIGN SERVICES RELATING THERETO, NAMELY, SCIENTIFIC RE-

SEARCH, TECHNOLOGICAL CONSULTATION IN THE TECHNOLOGY FIELD OF CHEMISTRY AND PETROCHEMICAL PROCESSES, AND PRODUCT RESEARCH; INDUSTRIAL ANALYSIS AND RESEARCH SERVICES IN THE FIELD OF CHEMISTRY AND PETROCHEMICAL PROCESSES; CHEMICAL RESEARCH SERVICES; PETROCHEMICAL RESEARCH SERVICES; DESIGN OF CHEMICAL AND PETROCHEMICAL PROCESSES AND PLANTS; CHEMICAL ENGINEERING SERVICES; TECHNICAL PROJECT STUDIES, NAMELY, RESEARCH IN THE FIELD OF CHEMISTRY, RESEARCH IN THE FIELD OF CHEMICAL AND PETROCHEMICAL PLANT TECHNOLOGY, IN CLASS 42 (U.S. CLS. 100 AND 101).

FOR: LICENSING OF INTELLECTUAL PROPERTY, IN CLASS 45 (U.S. CLS. 100 AND 101).

PRIORITY DATE OF 9-6-2006 IS CLAIMED.

OWNER OF INTERNATIONAL REGISTRATION 0935766 DATED 3-1-2007, EXPIRES 3-1-2017.

SER. NO. 79-043,116, FILED 3-1-2007.

TINA BROWN, EXAMINING ATTORNEY

Int. Cls.: 16, 28 and 41

Prior U.S. Cls.: 2, 5, 22, 23, 29, 37, 38, 50, 100, 101 and 107

Reg. No. 3,485,232

United States Patent and Trademark Office

Registered Aug. 12, 2008

**TRADEMARK
SERVICE MARK
PRINCIPAL REGISTER**

SHIRAVEN

PANSYDAISY CORPORATION (REPUBLIC OF KOREA CORPORATION)
3RD FLR. WOOAM BUILDING, 355-22
SEOKYO-DONG, MAPO-KU
SEOUL, REPUBLIC OF KOREA 121838

FOR: BOOKS DEALING WITH THE TOPICS OF TOYS AND GAMING; COMIC BOOKS; PICTURE POSTCARDS; CALENDARS; DIARIES; POCKET NOTEBOOKS; BALL POINT PENS; SKETCHBOOKS; RUBBER ERASERS; PLASTIC SHEET FOR WRITING, IN CLASS 16 (U.S. CLS. 2, 5, 22, 23, 29, 37, 38 AND 50).

FOR: PLASTIC AND RUBBER CHARACTER TOYS; CLOCKWORK TOYS; PLUSH TOYS; BOARD GAMES; PLAY BALLOONS; JIGSAW PUZZLES; ROLLER SKATES; SKATEBOARDS, IN CLASS 28 (U.S. CLS. 22, 23, 38 AND 50).

FOR: ENTERTAINMENT SERVICES, NAMELY, PROVIDING AN ON-LINE COMPUTER GAME; NEWS REPORTERS SERVICES; PUBLICATION OF ELECTRONIC BOOKS AND JOURNALS ON-LINE;

PROVIDING NON-DOWNLOADABLE ON-LINE ELECTRONIC PUBLICATIONS IN THE NATURE OF BOOKS, JOURNALS, MANUALS AND CATALOGUES IN THE FIELDS OF ENTERTAINMENT, GAMING, SPECIAL EVENTS PLANNING AND CULTURE; PROVIDING INFORMATION IN THE FIELD OF ENTERTAINMENT; DIGITAL IMAGING SERVICES; ANIMATION FILM PRODUCTION; SPECIAL EVENT PLANNING, IN CLASS 41 (U.S. CLS. 100, 101 AND 107).

THE MARK CONSISTS OF STANDARD CHARACTERS WITHOUT CLAIM TO ANY PARTICULAR FONT, STYLE, SIZE, OR COLOR.

OWNER OF INTERNATIONAL REGISTRATION 0935791 DATED 4-20-2007, EXPIRES 4-20-2017.

SER. NO. 79-043,122, FILED 4-20-2007.

WILLIAM ROSSMAN, EXAMINING ATTORNEY

Int. Cl.: 11

Prior U.S. Cls.: 13, 21, 23, 31 and 34

United States Patent and Trademark Office

Reg. No. 3,485,233

Registered Aug. 12, 2008

**TRADEMARK
PRINCIPAL REGISTER**



ONCLINX-VIERIN N.V. (BELGIUM LIMITED
LIABILITY COMPANY (N.V.))
TERVUURSEVEST 362/4
B-3000 LEUVEN
BELGIUM

FOR: ENVIRONMENTALLY FRIENDLY LAMPS;
LAMPS, ENERGY-SAVING BULBS, LAMP BASES,
LAMP HOLDERS, LAMPSHADES AND LAMP-
SHADE HOLDERS, IN CLASS 11 (U.S. CLS. 13, 21,
23, 31 AND 34).

OWNER OF INTERNATIONAL REGISTRATION
0935846 DATED 7-11-2007, EXPIRES 7-11-2017.

NO CLAIM IS MADE TO THE EXCLUSIVE
RIGHT TO USE "ENERGY", APART FROM THE
MARK AS SHOWN.

THE COLOR(S) BLUE, RED, ORANGE, GREY,
BLACK, AND WHITE IS/ARE CLAIMED AS A
FEATURE OF THE MARK.

BLUE: UPPER PART IN THE CIRCLE AS BACK-
GROUND AROUND THE PENGUIN AND LITTLE
PART OF HIS CHEST; RED: NECK AND BEAK OF
THE PENGUIN; ORANGE: NECK AND BEAK OF
THE PENGUIN AND SHADOW OF HIS BEAK ON
HIS CHEST; GREY: OUTER CIRCLE AROUND THE
PENGUIN AND EYEBROW OF THE PENGUIN
AND SHADOW ON HIS BACK; BLACK: HEAD,
ARM, HAND, CHEST AND PUPIL OF THE TWO
EYES OF THE PENGUIN; WHITE: LETTERS IN THE
OUTER CIRCLE: "SAVE ENERGY, SAVE THE PEN-
GUIN", THE WHITE OF THE TWO EYES AND PART
OF THE CHEST OF THE PENGUIN.

SER. NO. 79-043,135, FILED 7-11-2007.

JACQUELINE A. LAVINE, EXAMINING ATTOR-
NEY

Int. Cl.: 25

Prior U.S. Cls.: 22 and 39

United States Patent and Trademark Office

Reg. No. 3,485,234

Registered Aug. 12, 2008

TRADEMARK
PRINCIPAL REGISTER



LIASPORT S.P.A. (ITALY SOCIETÀ PER AZIO-
NI (SPA))
VIA ZOTTI N. 20
I-47100 FORLÌ
ITALY

FOR: CLOTHING ITEMS, NAMELY, BAN-
DEAUX, BATHING SUITS, BIKINIS, BERMUDA
SHORTS, TANKINIS, THONGS, UNDERWEAR,
BRAS, BRASSIERES, BRIEFS, BUSTIERS, CAF-
TANS, CAMISETTES, CAMISOLES, COLLARS, COR-
SETS, CULOTTES, DRESSES, FOUNDATION
GARMENT, GARTER BELTS, GARTERS, GIRDLES,
GLOVES, HOSIERY, LINGERIE, NIGHT GOWNS,
NIGHT SHIRTS, PAJAMA BOTTOMS, PANTS, PAR-
EOS, PONCHOS, STRAPLESS BRAS, SWIMWEAR;

FOOTWEAR AND HATS, IN CLASS 25 (U.S. CLS. 22
AND 39).

OWNER OF INTERNATIONAL REGISTRATION
0935862 DATED 7-5-2007, EXPIRES 7-5-2017.

THE FOREIGN WORDING IN THE MARK
TRANSLATES INTO ENGLISH AS VERY COOL
AND TRENDY.

SER. NO. 79-043,137, FILED 7-5-2007.

GINA FINK, EXAMINING ATTORNEY

Int. Cls.: 29 and 40

Prior U.S. Cls.: 46, 100, 103 and 106

United States Patent and Trademark Office

Reg. No. 3,485,235

Registered Aug. 12, 2008

**TRADEMARK
SERVICE MARK
PRINCIPAL REGISTER**



INTELLECTUAL PROPERTY HOLDINGS AS
(NORWAY AKSJESELSKAP (AS))
P.O. BOX 1423 VIKÅ
N-0114 OSLO
NORWAY

FOR: MEAT, FISH, POULTRY AND GAME;
MEAT EXTRACTS; PRESERVED, FROZEN, DRIED
AND COOKED FRUITS AND VEGETABLES; JEL-
LIES, JAMS, COMPOTES; EGGS, MILK AND MILK
PRODUCTS EXCLUDING ICE CREAM, ICE MILK,
AND FROZEN YOGURT; EDIBLE OILS AND FATS,
IN CLASS 29 (U.S. CL. 46).

FOR: TREATMENT OF MATERIALS, NAMELY,
FREEZING, SALTING, SMOKING, CUTTING AND

ICE-PACKING OF RAW FISH, IN CLASS 40 (U.S.
CLS. 100, 103 AND 106).

OWNER OF INTERNATIONAL REGISTRATION
0935954 DATED 5-9-2007, EXPIRES 5-9-2017.

NO CLAIM IS MADE TO THE EXCLUSIVE
RIGHT TO USE "SEAFOODS", APART FROM THE
MARK AS SHOWN.

SER. NO. 79-043,178, FILED 5-9-2007.

LINDA LAVACHE, EXAMINING ATTORNEY

Int. Cls.: 29, 30, 32 and 33

Prior U.S. Cls.: 45, 46, 47, 48 and 49

United States Patent and Trademark Office

Reg. No. 3,485,236

Registered Aug. 12, 2008

**TRADEMARK
PRINCIPAL REGISTER**

PURENorway

PURE NORWAY AS (NORWAY AS)
FJORDVEIEN 1
N-1323 HØVIK
NORWAY

FOR: MEAT, FISH, POULTRY AND GAME AND PRODUCTS MADE THEREOF, NAMELY, SPREAD, SAUSAGES OF GAME, CANNED SALMON AND CANNED CRAB; MEAT EXTRACTS, PRESERVED, DRIED AND COOKED FRUITS AND VEGETABLES; JELLIES, JAMS, COMPOTES, MILK AND MILK PRODUCTS, EXCLUDING ICE CREAM, ICE MILK AND FROZEN YOGURT; EDIBLE FATS AND OILS, IN CLASS 29 (U.S. CL. 46).

FOR: COFFEE, TEA, COCOA, SUGAR, ARTIFICIAL COFFEE; FLOUR AND PREPARATIONS MADE FROM CEREALS, NAMELY MUESLI, BREAD, PASTRY; HONEY, TREACLE; BAKING-POWDER; SAUCES, CONDIMENTS; SPICES; ICE, IN CLASS 30 (U.S. CL. 46).

FOR: BEERS; MINERAL AND AERATED WATERS, DINKING WATER AND OTHER NON-ALCOHOLIC DRINKS; FRUIT DRINKS AND FRUIT JUICES; SYRUPS AND OTHER PREPARATIONS FOR MAKING BEVERAGES, IN CLASS 32 (U.S. CLS. 45, 46 AND 48).

FOR: ALCOHOLIC BEVERAGES EXCEPT BEERS, IN CLASS 33 (U.S. CLS. 47 AND 49).

PRIORITY DATE OF 5-23-2007 IS CLAIMED.

OWNER OF INTERNATIONAL REGISTRATION 0935971 DATED 6-20-2007, EXPIRES 6-20-2017.

SER. NO. 79-043,185, FILED 6-20-2007.

SHANNON TWOHIG, EXAMINING ATTORNEY

Int. Cl.: 11

Prior U.S. Cls.: 13, 21, 23, 31 and 34

Reg. No. 3,485,237

United States Patent and Trademark Office

Registered Aug. 12, 2008

**TRADEMARK
PRINCIPAL REGISTER**



ILVE SPA (ITALY CORPORATION)
VIA ANTONIANA, 100
I-35011 CAMPODARSEGO (PD)
ITALY

FOR: GAS AND ELECTRIC COOKING PARTS, NAMELY, BUILT-IN OR NOT COOKTOPS, COOKING RANGES, ELECTRIC PRESSURE COOKERS; GAS AND ELECTRIC KITCHEN STOVES; BUILT-IN GAS AND ELECTRIC KITCHEN STOVES; OVENS, NAMELY, ELECTRIC COOKING OVENS, GAS COOKING OVENS, MICROWAVE OVENS; BUILT-IN GAS AND ELECTRIC COOKING OVENS; GAS AND ELECTRIC COOKING HOBS, NAMELY, ELECTRIC FOOD WARMERS, GRILL ACCESSORIES IN THE NATURE OF WARMING TRAYS; EXTRACTOR HOODS, NAMELY, EXHAUST HOODS FOR

KITCHENS, RANGE HOODS, VENTILATION HOODS; FRIDGES, NAMELY, REFRIGERATORS, ELECTRIC REFRIGERATORS, GAS REFRIGERATORS; INDUSTRIAL GAS AND ELECTRIC KITCHEN STOVES, IN CLASS 11 (U.S. CLS. 13, 21, 23, 31 AND 34).

OWNER OF INTERNATIONAL REGISTRATION
0755165 DATED 2-16-2001, EXPIRES 2-16-2011.

OWNER OF U.S. REG. NO. 2,200,191.

SER. NO. 79-043,229, FILED 3-16-2007.

TINA BROWN, EXAMINING ATTORNEY

Int. Cls.: 9, 38 and 42

Prior U.S. Cls.: 21, 23, 26, 36, 38, 100, 101 and 104

United States Patent and Trademark Office

Reg. No. 3,485,238

Registered Aug. 12, 2008

**TRADEMARK
SERVICE MARK
PRINCIPAL REGISTER**



OCTO TELEMATICS S.R.L. (ITALY LTD LIAB
CO)
VIA OBERDAN, 16
I-42100 REGGIO EMILIA
ITALY

FOR: RADIO TRANSMITTERS, TELEPHONE TRANSMITTERS; ACCESS CONTROL AND ALARM MONITORING SYSTEMS; ALARM CENTRAL UNITS; AMPLIFIERS; ANTENNAS; ANTI-INTRUSION ALARMS; APPARATUS FOR RECORDING, TRANSMISSION OR REPRODUCTION OF SOUND AND IMAGES; APPARATUS FOR TRANSMISSION OF COMMUNICATION; AUDIO-VIDEO RECEIVERS; AUTOMATIC PRESSURE CONTROL MACHINES AND INSTRUMENTS; AUTOMATIC SWITCHING APPARATUS FOR TELECOMMUNICATION; BATTERIES; CAR NAVIGATION COMPUTERS; CENTRAL PROCESSING UNITS; CENTRAL PROCESSING UNITS FOR PROCESSING INFORMATION, DATA, SOUND OR IMAGES; COMPUTER HARDWARE FOR TELECOMMUNICATIONS; COMPUTER OPERATING PROGRAMS; COMPUTER PROGRAMS FOR EDITING IMAGES, SOUND AND VIDEO; COMPUTER OPERATING SYSTEMS; COMPUTER SOFTWARE FOR CREATING SEARCHABLE DATABASES OF INFORMATION AND DATA; DATA PROCESSORS; DEVICES FOR HANDS-FREE USE OF MOBILE PHONES; DIGITAL SIGNAL PROCESSORS; DISC MEMORIES; DVD PLAYERS; DVD RECORDING

APPARATUS; ELECTRIC NAVIGATIONAL INSTRUMENTS; ELECTRONIC INTEGRATED CIRCUITS; EMERGENCY SIGNAL TRANSMITTERS; ENCODERS; GLOBAL POSITIONING SYSTEM (GPS) CONSISTING OF COMPUTERS, COMPUTER SOFTWARE, TRANSMITTERS, RECEIVERS, AND NETWORK INTERFACE DEVICES; HANDS FREE KITS FOR PHONES; INTEGRATED CIRCUITS; INTEGRATED CIRCUITS AND INTEGRATED CIRCUIT CORES FOR USE IN WIRELESS COMMUNICATION EQUIPMENT AND DIGITAL SIGNAL PROCESSORS (DPS); LEVEL INDICATORS; LIQUID LEVEL SENSORS; LOUDSPEAKER SYSTEMS; LOUDSPEAKERS; LOUDSPEAKERS WITH BUILT IN AMPLIFIERS; MECHANICAL AND ELECTRONIC MEASURING MACHINES FOR IDENTIFYING AND ANALYZING STRUCTURAL DAMAGE TO VEHICLES; MEMORY CARDS; MICROPHONES FOR TELECOMMUNICATION APPARATUS; MICROPROCESSORS; MP3 PLAYERS; MP4 PLAYERS; MULTIFUNCTION KEYBOARDS; NAVIGATION APPARATUS FOR VEHICLES; OPTICAL DISK DRIVES; OPTICAL DISK READERS; PRESSURE SENSORS; PRE-AMPLIFIERS; PROXIMITY SENSORS; RADIO TRANSMITTERS AND RECEIVERS FOR REMOTE CONTROLS, RADIO CONTROLS; RADIO FOR VEHICLES; RECEIVERS FOR SATELLITES; RECONFIGURABLE PROCESSORS FOR USE IN WIRELESS COMMUNICATION HANDSETS AND NETWORK EQUIPMENT IN THE FIELD OF WIDEBAND COMMUNICATIONS;

SATELLITE AND MICROWAVE COMMUNICATIONS APPARATUS TO TRANSMIT COMMUNICATIONS FROM A VEHICLE TO ANOTHER VEHICLE, OR FROM A VEHICLE TO A SATELLITE; SATELLITE RECEIVERS; SATELLITE TELEPHONES; SENSORS FOR THE DETERMINATION OF TEMPERATURES, POSITIONS AND DISTANCES; SIRENS; SIRENS FOR VEHICLES; SOFTWARE FOR PROCESSING IMAGES, GRAPHICS AND TEXT; SOUND AMPLIFIERS; SPEED INDICATORS; SPEEDOMETER TESTERS; SPEEDOMETERS; SPEEDOMETERS FOR VEHICLES; TELECOMMUNICATION CABLES; TELECOMMUNICATION EXCHANGERS; TELECOMMUNICATION SWITCHES; TELECOMMUNICATION TOWERS; TELECOMMUNICATIONS TRANSMITTERS; TEMPERATURE INDICATORS; TEMPERATURE SENSORS; TIME AND DATE STAMPING MACHINES; TIME CLOCKS; TYRE-PRESSURE MEASURERS; VEHICLE LOCATING, TRACKING AND SECURITY SYSTEM COMPRISED OF AN ANTENNA AND RADIO TRANSMITTER TO BE PLACED IN A VEHICLE; VEHICLE LOCATOR AND RECOVERY DEVICE PROGRAMMED TO USE GLOBAL POSITIONING SYSTEM (GPS) AND CELLULAR TELECOMMUNICATIONS; VEHICLE MOUNTED GPS SENSOR FOR DETERMINING THE RATE OF MOTION FOR A VEHICLE; VIDEO TELEPHONES; WIRELESS COMPUTER PERIPHERALS; WIRELESS CONTROLLERS TO MONITOR AND CONTROL THE FUNCTIONING OF OTHER ELECTRONIC DEVICES; WIRELESS TELEPHONY APPARATUS, IN CLASS 9 (U.S. CLS. 21, 23, 26, 36 AND 38).

FOR: COMMUNICATION BY ELECTRONIC COMPUTER TERMINALS; COMMUNICATION BY MOBILE TELEPHONE; COMMUNICATION SERVICES, NAMELY, ELECTRONIC TRANSMISSION OF DATA AND DOCUMENTS AMONG USERS OF COMPUTERS; COMMUNICATION VIA ANALOGUE AND DIGITAL COMPUTER TERMINALS; COMMUNICATION VIA COMPUTER TERMINALS, BY DIGITAL TRANSMISSION OR BY SATELLITE; COMMUNICATION VIA FIBRE OPTICAL NETWORKS; ELECTRONIC TRANSMISSION OF DATA AND DOCUMENTS VIA COMPUTER TERMINALS; ELECTRONIC, ELECTRIC, AND DIGITAL TRANSMISSION OF VOICE, DATA, IMAGES, SIGNALS AND MESSAGES; LOCAL AND LONG DISTANCE TELEPHONE SERVICES; PROVIDING ACCESS TO TELECOMMUNICATION NETWORKS; PROVIDING ELECTRONIC TELECOMMUNICATION CONNECTIONS; PROVIDING MULTIPLE-USER ACCESS TO A GLOBAL COMPUTER INFORMATION NETWORK; RADIO COMMUNICATION; RENTAL OF EQUIPMENT FOR TELECOMMUNICATIONS; RENTAL OF TELEPROCESSING AND COMPUTER COMMUNICATION APPARATUS

AND INSTRUMENTS; SATELLITE TRANSMISSION SERVICES; SATELLITE TRANSMISSION OF MESSAGES AND DATA FOR NAVIGATION BY AIR; TRANSMISSION OF DATA, SOUND AND IMAGES BY SATELLITE; TRANSMISSION, RECEPTION AND PROCESSING OF CODED AND EMERGENCY SIGNALS; WIRELESS BROADBAND COMMUNICATION SERVICES; WIRELESS ELECTRONIC TRANSMISSION OF VOICE, SIGNALS, DATA, FACSIMILES, IMAGES AND INFORMATION; LONG DISTANCE TELEPHONE COMMUNICATION SERVICES; SATELLITE COMMUNICATION SERVICES; ELECTRONIC TRANSMISSION OF MESSAGES AND DATA, IN CLASS 38 (U.S. CLS. 100, 101 AND 104).

FOR: APPLICATION SERVICE PROVIDER, NAMELY, PROVIDING, HOSTING, MANAGING, DEVELOPING, AND MAINTAINING APPLICATIONS, SOFTWARE, WEBSITES, AND DATABASES IN THE FIELDS OF PERSONAL PRODUCTIVITY, WIRELESS COMMUNICATION, MOBILE INFORMATION ACCESS, AND REMOTE DATA MANAGEMENT FOR WIRELESS DELIVERY OF CONTENT TO HANDHELD COMPUTERS, LAPTOPS AND MOBILE ELECTRONIC DEVICES; AUTOMOBILE TRANSMISSION DIAGNOSTIC SERVICES; COMPUTER HARDWARE DEVELOPMENT; COMPUTER PROGRAMMING; COMPUTER SYSTEMS ANALYSIS; DEVELOPMENT OF TECHNOLOGIES FOR THE FABRICATION OF CIRCUITS FOR WIRELESS COMMUNICATION, ELECTRONIC DATA PROCESSING, CONSUMER ELECTRONICS, AUTOMOTIVE ELECTRONICS; ENGINEERING; INSTALLATION OF COMPUTER SOFTWARE; RESEARCH RELATING TO MECHANICAL ENGINEERING; COMPUTER SOFTWARE DEVELOPMENT, IN CLASS 42 (U.S. CLS. 100 AND 101).

OWNER OF INTERNATIONAL REGISTRATION 0936183 DATED 5-18-2007, EXPIRES 5-18-2017.

NO CLAIM IS MADE TO THE EXCLUSIVE RIGHT TO USE "TELEMATICS", APART FROM THE MARK AS SHOWN.

THE MARK CONSISTS OF THE FANCY LEGEND "OCTO TELEMATICS", WRITTEN IN FANCY BLOCK LETTERS AND PLACED INSIDE A POLYGONAL SHAPE WITH AN OUTLINED FRAME, WHICH IS SUBDIVIDED BY A NUMBER OF STROKES; THE WORDING "OCTO" IS WRITTEN ABOVE THE WORDING "TELEMATICS".

SER. NO. 79-043,309, FILED 5-18-2007.

ROBERT STRUCK, EXAMINING ATTORNEY

Int. Cl.: 19

Prior U.S. Cls.: 1, 12, 33 and 50

United States Patent and Trademark Office

Reg. No. 3,485,239

Registered Aug. 12, 2008

**TRADEMARK
PRINCIPAL REGISTER**

F L O O R S T Y L



NMC, SOCIÉTÉ ANONYME
GERT-NOËL-STRASSE
B-4731 EYNATTEN
BELGIUM

OF VARIOUS COMPOSITIONS, IN CLASS 19 (U.S.
CLS. 1, 12, 33 AND 50).

PRIORITY DATE OF 1-25-2007 IS CLAIMED.

FOR: CONSTRUCTION MATERIALS NOT OF
METAL, NAMELY, MOLDINGS MADE OF FOAM
OF VARIOUS COMPOSITION, NON-METAL DEC-
ORATIVE MOLDINGS MADE OF FOAM OR PLAS-
TIC FOR USE IN BUILDING CONSTRUCTION AND
DECORATIVE APPLICATIONS, NON-METALLIC
RIGID PIPES FOR BUILDING, ASPHALT, PITCH
AND BITUMEN; NON-METALLIC TRANSPORTA-
BLE CONSTRUCTIONS BEING BUILDINGS;
MONUMENTS NOT OF METAL MADE OF FOAM

OWNER OF INTERNATIONAL REGISTRATION
0936212 DATED 7-16-2007, EXPIRES 7-16-2017.

OWNER OF U.S. REG. NOS. 1,429,246, 1,452,144,
AND 2,915,757.

SER. NO. 79-043,318, FILED 7-16-2007.

LYDIA BELZER, EXAMINING ATTORNEY

Int. Cl.: 29

Prior U.S. Cl.: 46

United States Patent and Trademark Office

Reg. No. 3,485,240

Registered Aug. 12, 2008

TRADEMARK
PRINCIPAL REGISTER

ONIRO



AGROTIKI DIAFIMISTIKI AE.; TRADING AS
ATE ADVERTISING (GREECE SOCIETE
ANONYME)
PANEPISTIMIOU 25-29
GR-105 64 ATHENS
GREECE

FOR: OLIVE OIL; PRESERVED OLIVES, DRIED
OLIVES, COOKED OLIVES, PROCESSED OLIVES,
TINNED OLIVES, CANNED PROCESSED OLIVES;
EDIBLE OILS; EDIBLE FATS, IN CLASS 29 (U.S. CL.
46).

PRIORITY DATE OF 10-19-2006 IS CLAIMED.

OWNER OF INTERNATIONAL REGISTRATION
0936417 DATED 3-5-2007, EXPIRES 3-5-2017.

THE COLOR(S) LIGHT GREEN, DARK GREEN
AND WHITE IS/ARE CLAIMED AS A FEATURE OF
THE MARK.

THE MARK CONSISTS OF THE WORD, "ONIRO"
APPEARING IN THE COLOR DARK GREEN AND A
DESIGN OF STYLIZED SHIP ENCASED IN A REC-
TANGLE, SUPERIMPOSED ON A DARK GREEN
BACKGROUND. THE OUTLINE OF THE SHIP, THE
WAVES AND THE SAIL OF THE SHIP ALL APPEAR
IN THE COLOR WHITE. THE SAIL OF THE SHIP IS
DEPICTED BY A STYLIZED LEAF IN A LIGHT
GREEN COLOR WITH A LINE IN THE MIDDLE OF
THE LEAF APPEARING IN THE COLOR WHITE.

THE WORD "ONIRO" IN GREEK LANGUAGE
MEANS DREAM.

SER. NO. 79-043,397, FILED 3-5-2007.

CHARISMA HAMPTON, EXAMINING ATTORNEY

Int. Cl.: 29

Prior U.S. Cl.: 46

United States Patent and Trademark Office

Reg. No. 3,485,241

Registered Aug. 12, 2008

TRADEMARK
PRINCIPAL REGISTER

FILION



AGROTIKI DIAFIMISTIKI AE.; TRADING AS
ATE ADVERTISING (GREECE SOCIETE
ANONYME)
PANEPISTIMIOU 25-29
GR-105 64 ATHENS
GREECE

FOR: OLIVE OIL, PRESERVED OLIVES, DRIED
OLIVES, COOKED OLIVES, PROCESSED OLIVES,
TINNED OLIVES, CANNED PROCESSED OLIVES,
EDIBLE OILS, EDIBLE FATS, IN CLASS 29 (U.S. CL.
46).

PRIORITY DATE OF 10-19-2006 IS CLAIMED.

OWNER OF INTERNATIONAL REGISTRATION
0936418 DATED 3-5-2007, EXPIRES 3-5-2017.

THE COLOR(S) LIGHT GREEN, DARK GREEN
AND WHITE IS/ARE CLAIMED AS A FEATURE OF
THE MARK.

THE MARK CONSISTS OF THE WORD "FILION"
APPEARING IN THE COLOR DARK GREEN AND A
DESIGN OF STYLIZED SHIP ENCASED IN A REC-
TANGLE, SUPERIMPOSED ON A DARK GREEN
BACKGROUND. THE OUTLINE OF THE SHIP, THE
WAVES AND THE SAIL OF THE SHIP ALL APPEAR
IN THE COLOR WHITE. THE SAIL OF THE SHIP IS
DEPICTED BY A STYLIZED LEAF IN A LIGHT
GREEN COLOR WITH A LINE IN THE MIDDLE OF
THE LEAF APPEARING IN THE COLOR WHITE.

THE WORD "FILION" IN ANCIENT GREEK
LANGUAGE MEANT THE LOVED ONE; THE
WORD IS NOT USED ANYMORE IN MODERN
GREEK.

SER. NO. 79-043,398, FILED 3-5-2007.

CHARISMA HAMPTON, EXAMINING ATTORNEY

Int. Cl.: 26

Prior U.S. Cls.: 37, 39, 40, 42 and 50

United States Patent and Trademark Office

Reg. No. 3,485,242

Registered Aug. 12, 2008

**TRADEMARK
PRINCIPAL REGISTER**

STRUPAI

MAGARI S.R.L.
VIA TIZIANO, 32
I-20145 MILAN
ITALY

FOR: SHOE LACES, IN CLASS 26 (U.S. CLS. 37, 39,
40, 42 AND 50).

THE MARK CONSISTS OF STANDARD CHAR-
ACTERS WITHOUT CLAIM TO ANY PARTICULAR
FONT, STYLE, SIZE, OR COLOR.

PRIORITY DATE OF 5-4-2007 IS CLAIMED.

OWNER OF INTERNATIONAL REGISTRATION
0936570 DATED 7-13-2007, EXPIRES 7-13-2017.

SER. NO. 79-043,463, FILED 7-13-2007.

MICHAEL GAAFAR, EXAMINING ATTORNEY

Int. Cl.: 3

Prior U.S. Cls.: 1, 4, 6, 50, 51 and 52

United States Patent and Trademark Office

Reg. No. 3,485,243

Registered Aug. 12, 2008

**TRADEMARK
PRINCIPAL REGISTER**

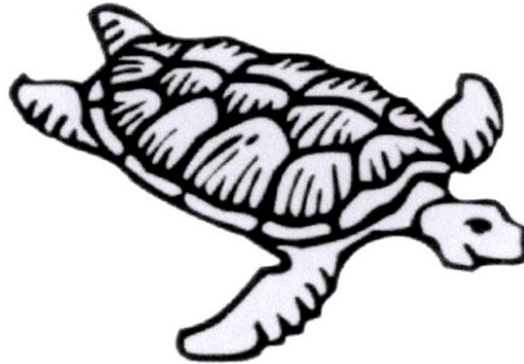

LA RIVE M. SZYMULA,; P. SZOSTAK SPÓLKA
JAWNA (POLAND GENERAL PARTNERSHIP)
UL. SKŁADOWA 2-6
PL-86-300 GRUDZIADZ, POLAND

THE MARK CONSISTS OF A STYLIZED SEA
TORTOISE.

FOR: COSMETICS, IN CLASS 3 (U.S. CLS. 1, 4, 6, 50,
51 AND 52).

SER. NO. 79-043,472, FILED 8-31-2007.

OWNER OF INTERNATIONAL REGISTRATION
0936579 DATED 8-31-2007, EXPIRES 8-31-2017.

ELI HELLMAN, EXAMINING ATTORNEY

Int. Cls.: 14, 20, 21 and 28

Prior U.S. Cls.: 2, 13, 22, 23, 25, 27, 28, 29, 30, 32, 33,
38, 40 and 50

Reg. No. 3,485,244

United States Patent and Trademark Office

Registered Aug. 12, 2008

TRADEMARK
PRINCIPAL REGISTER



FÜRSTENBERG EHEMALIGE; HERZOGLICH
BRAUNSCHWEIGISCHE; PORZELLANMANU-
FAKTUR (FED REP GERMANY GMBH)
MEINBREXENER STR. 2
37699 FÜRSTENBERG/WESER
FED REP GERMANY

KNOBS, MUGS; PLAQUES OF PORCELAIN, TER-
RA-COTTA AND GLASS; STATUES OF PORCE-
LAIN, TERRA-COTTA, GLASS, STONES AND
ARTIFICIAL STONE, IN CLASS 21 (U.S. CLS. 2, 13,
23, 29, 30, 33, 40 AND 50).

FOR: JEWELRY BOXES NOT MADE OF PRE-
CIOUS METAL, IN CLASS 14 (U.S. CLS. 2, 27, 28 AND
50).

FOR: DECORATION FOR CHRISTMAS TREES,
CHRISTMAS TREE STANDS, CANDLE HOLDERS
AND LITTLE BELLS FOR CHRISTMAS TREES;
MASKS, NAMELY, THEATRICAL MASKS OF POR-
CELAIN, TERRA-COTTA, STONE AND EARTHEN-
WARE; DOLLS, NAMELY, PORCELAIN DOLLS, IN
CLASS 28 (U.S. CLS. 22, 23, 38 AND 50).

FOR: DECORATIONS FOR THE HOME AND
HOUSEHOLD, NAMELY, WINDOWS AND DOOR
HANDLES OF PORCELAIN, TERRA-COTTA,
GLASS AND EARTHENWARE, IN CLASS 20 (U.S.
CLS. 2, 13, 22, 25, 32 AND 50).

PRIORITY DATE OF 4-10-2007 IS CLAIMED.

FOR: UNWORKED OR SEMI-WORKED GLASS;
GLASS PRODUCTS, NAMELY, GLASS BOXES,
GLASS DISHES, GLASS BOWLS; WORK OF ART
OF PORCELAIN, TERRA-COTTA, GLASS, EARTH-
ENWARE, STONES AND ARTIFICIAL STONES;
TABLEWARE, NAMELY, PLATES AND DISHES
NOT OF PRECIOUS METAL; POTS, JUGS, CAR-
AFES AND VASES, NOT OF PRECIOUS METAL;
CANDLESTICKS, CANDLE RINGS AND CANDLE
SNUFFERS, NOT OF PRECIOUS METAL; PORCE-
LAIN AND PORCELAINWARE, NAMELY, DISHES,

OWNER OF INTERNATIONAL REGISTRATION
0936648 DATED 4-23-2007, EXPIRES 4-23-2017.

OWNER OF U.S. REG. NOS. 844,566 AND 848,754.

SER. NO. 79-043,509, FILED 4-23-2007.

CURTIS FRENCH, EXAMINING ATTORNEY

Int. Cl.: 16

Prior U.S. Cls.: 2, 5, 22, 23, 29, 37, 38 and 50

Reg. No. 3,485,245

United States Patent and Trademark Office

Registered Aug. 12, 2008

**TRADEMARK
PRINCIPAL REGISTER**

METSÄ-SERLA

M-REAL CORPORATION (FINLAND FINNISH
PUBLIC JOINT STOCK COMPANY)
REVONTULENTIE 6
FI-02100 ESPOO
FINLAND

FOR: MAGAZINE PRINTING PAPERS; PRINTING PAPERS; NEWSPRINT; FINE PAPERS; ART PAPERS AND CARDBOARD; DRAWING PAPERS; TRANSPARENT PAPERS; HIGH DENSITY PAPERS, BLEACHED AND UNBLEACHED; METALLIZED PAPERS, CARDBOARDS AND FOILS FOR PRINTING PURPOSES; ALUMINUM FOIL LAMINATED PAPER FOR PRINTING PURPOSES; LAMINATED PAPER AND CARDBOARD; COATED PAPERS, CARDBOARD AND FOILS FOR PRINTING PURPOSES; GREASE PROOF PAPERS; BAKING PAPERS; PARCHMENT PAPER; CHEMICAL PULP PAPERS; PRINTING PAPERS; WRITING PAPERS; OFFICE PAPERS; COPYING PAPERS; BASE PAPERS; RAW PAPERS; FOLDING BOX CARDBOARD, COATED AND UNCOATED; FLUTING PAPER; MULTI-LAYER CARDBOARD; CORRUGATED CARDBOARD; BOXES OF CARDBOARD AND PAPER; CONTAINERS OF CARDBOARD AND PA-

PER; TISSUE PAPER; SOFT TISSUE PAPER; HOUSEHOLD PAPER; TOILET PAPER AND DISPOSABLE DIAPERS, IN CLASS 16 (U.S. CLS. 2, 5, 22, 23, 29, 37, 38 AND 50).

THE MARK CONSISTS OF STANDARD CHARACTERS WITHOUT CLAIM TO ANY PARTICULAR FONT, STYLE, SIZE, OR COLOR.

OWNER OF INTERNATIONAL REGISTRATION
0936649 DATED 4-25-2007, EXPIRES 4-25-2017.

OWNER OF U.S. REG. NO. 1,537,359.

THE TRANSLITERATION OF THE NON-LATIN CHARACTERS IN THE MARK IS: "METSÄ" IS THE FINNISH WORD FOR "FOREST", THE WORD "SERLA" HAS NO MEANING.

SER. NO. 79-043,510, FILED 4-25-2007.

CURTIS FRENCH, EXAMINING ATTORNEY

Int. Cl.: 9

Prior U.S. Cls.: 21, 23, 26, 36 and 38

Reg. No. 3,485,246

United States Patent and Trademark Office

Registered Aug. 12, 2008

**TRADEMARK
PRINCIPAL REGISTER**



VISUALMARK INTERNATIONAL, S.L. (SPAIN
CORPORATION)
POLÍGONO INDUSTRIAL DE POCOMACO
SECTOR A2, NAVE 3; E-15190 LA CORUÑA
SPAIN

FOR: APPARATUS FOR RECORDING, TRANSMISSION OR REPRODUCTION OF SOUND AND IMAGES, IN CLASS 9 (U.S. CLS. 21, 23, 26, 36 AND 38).

PRIORITY DATE OF 12-28-2006 IS CLAIMED.

OWNER OF INTERNATIONAL REGISTRATION
0936657 DATED 3-26-2007, EXPIRES 3-26-2017.

THE MARK CONSISTS OF MIXED DISTINCTIVE SIGN FORMED BY THE DENOMINATION "M METALPLAST", THE ELEMENT "METALPLAST" APPEARING IN THICK LOWER-CASE LETTERS (EXCEPT THE INITIAL M), THE BYSYLLABLE "METAL", AND APPEARING ON THE LEFT OF THE DENOMINATION AN UPPER-CASE LETTER "M" SUPERIMPOSED ON GRAPHIC FORM FEATURING TWO ARROW HEAD, ONE POINTING UP AND THE OTHER DOWN.

SER. NO. 79-043,517, FILED 3-26-2007.

CURTIS FRENCH, EXAMINING ATTORNEY

Int. Cl.: 1

Prior U.S. Cls.: 1, 5, 6, 10, 26 and 46

Reg. No. 3,485,247

United States Patent and Trademark Office

Registered Aug. 12, 2008

**TRADEMARK
PRINCIPAL REGISTER**



VIDKRYTE AKTSIONERNE TOVARYSTVO;
"KONTSERN STYROL" (UKRAINE JOINT
STOCK COMPANY)
10, VUL. GORLIVSKOI DYVIZII
GORLIVKA 84610
UKRAINE

FOR: AMMONIA FOR INDUSTRIAL PURPOSES,
ARNINONIUM NITRATE, FERTILIZERS FOR
AGRICULTURAL USE, UREA FERTILIZER , IN
CLASS 1 (U.S. CLS. 1, 5, 6, 10, 26 AND 46).

OWNER OF INTERNATIONAL REGISTRATION
0936756 DATED 8-10-2007, EXPIRES 8-10-2017.

THE CIRCLE DESIGN IN THE MARK REPRESENTS A LABORATORY RETORT BEING PART OF THE LETTER "C", WHICH IS A SYMBOL OF THE CHEMICAL INDUSTRY, ENCLOSED IN A CIRCLE. TO THE RIGHT OF THE CIRCLE DESIGN IS THE WORLD "STIROL", REPRESENTING THE SHORT NAME OF THE JOINT STOCK COMPANY "CONCERN STIROL".

SER. NO. 79-043,562, FILED 8-10-2007.

JAMES STEIN, EXAMINING ATTORNEY

Int. Cl.: 9

Prior U.S. Cls.: 21, 23, 26, 36 and 38

United States Patent and Trademark Office

Reg. No. 3,485,248

Registered Aug. 12, 2008

**TRADEMARK
PRINCIPAL REGISTER**



ANGLIA BUSINESS SOLUTIONS LTD (UNITED
KINGDOM PRIVATE "LTD" COMPANY)
HARSTON MILL
HARSTON, CAMBRIDGE CB22 7GG
UNITED KINGDOM

FOR: COMPUTER PROGRAMS FOR USE IN
ENTERPRISE RESOURCE PLANNING (ERP) AND
BUSINESS MANAGEMENT APPLICATIONS, IN
THE FIELD OF FOOD SUPPLY CHAIN; COMPUTER
SOFTWARE FOR USE IN ENTERPRISE RESOURCE
PLANNING (ERP) AND BUSINESS MANAGEMENT
APPLICATIONS, IN THE FIELD OF FOOD SUPPLY
CHAIN, IN CLASS 9 (U.S. CLS. 21, 23, 26, 36 AND 38).

OWNER OF INTERNATIONAL REGISTRATION
0937012 DATED 6-9-2007, EXPIRES 6-9-2017.

THE COLOR(S) BLACK, BLUE, GREEN, YELLOW
AND ORANGE IS/ARE CLAIMED AS A FEATURE
OF THE MARK.

THE MARK CONSISTS OF THE COLOUR BLACK
APPEARS IN THE WORDING, THE COLOURS
BLUE AND GREEN APPEAR IN THE UPPER PART
OF THE ELIPSE, AND THE COLOURS YELLOW
AND ORANGE APPEAR IN THE LOWER PART OF
THE ELIPSE.

SER. NO. 79-043,672, FILED 6-9-2007.

KRISTINA MORRIS, EXAMINING ATTORNEY

Int. Cls.: 9 and 42

Prior U.S. Cls.: 21, 23, 26, 36, 38, 100 and 101

United States Patent and Trademark Office

Reg. No. 3,485,249

Registered Aug. 12, 2008

**TRADEMARK
SERVICE MARK
PRINCIPAL REGISTER**

i|NORIS

NORIS INGENIEURBÜRO GMBH (FED REP
GERMANY PRIVATE LIMITED COMPANY)
KOPERNIKUSSTRASSE 18
90459 NÜRNBERG, FED REP GERMANY

PRIORITY DATE OF 6-20-2007 IS CLAIMED.

FOR: COMPUTER SOFTWARE FOR PREPAR-
ING, CONTROLLING AND MANAGING BUSINESS
DATA IN THE FIELDS OF DOCUMENTATION,
LOGISTICS, PRODUCTION, SERVICE AND QUAL-
ITY CONTROL, IN CLASS 9 (U.S. CLS. 21, 23, 26, 36
AND 38).

OWNER OF INTERNATIONAL REGISTRATION
0937272 DATED 8-10-2007, EXPIRES 8-10-2017.

SER. NO. 79-043,755, FILED 8-10-2007.

FOR: DESIGN, DEVELOPMENT AND PRO-
GRAMMING OF COMPUTER SOFTWARE, IN
CLASS 42 (U.S. CLS. 100 AND 101).

JAMES STEIN, EXAMINING ATTORNEY

Int. Cls.: 16, 35 and 42

Prior U.S. Cls.: 2, 5, 22, 23, 29, 37, 38, 50, 100, 101 and 102

Reg. No. 3,485,250

United States Patent and Trademark Office

Registered Aug. 12, 2008

**TRADEMARK
SERVICE MARK
PRINCIPAL REGISTER**

TheSourceTECHdata

THESOURCETECHDATA S.A.
2, PARC D'ACTIVITÉS SYRDALL
LU-5365 MUNSBACH
LUXEMBOURG

FOR: PRINTED MATTER, NAMELY, BOOKS IN THE FIELD OF WATCHES; MAGAZINES IN THE FIELD OF WATCHES, BROCHURES IN THE FIELD OF WATCHES, PRINTED REVIEWS IN THE FIELD OF WATCHES; PRINTED PUBLICATIONS, NAMELY, NEWSPAPERS IN THE FIELD OF WATCHES; PAPER AND STATIONERY ITEMS INCLUDED IN THIS CLASS, IN THE NATURE OF WRITING PAPER, POST CARDS AND NOTE CARDS; PRINTED INSTRUCTIONAL AND TEACHING MATERIALS IN THE FIELD OF WATCHES, IN CLASS 16 (U.S. CLS. 2, 5, 22, 23, 29, 37, 38 AND 50).

FOR: PROCESSING INFORMATION FOR COMMERCIAL OR INDUSTRIAL PURPOSES, IN THE NATURE OF DATA PROCESSING; PROVIDING COMMERCIAL INFORMATION VIA GLOBAL COMPUTER NETWORKS IN THE FIELD OF WATCHES; COLLECTION AND PROCESSING OF STATISTICAL DATA FOR OTHERS; COLLECTION, PROCESSING AND SYSTEMATIZATION OF DATA IN COMPUTER DATA BANKS FOR OTHERS; COMPUTER-BASED FILE MANAGEMENT; COLLECTION AND SYSTEMATIZATION OF PUBLIC AND PRIVATE DATA IN COMPUTER DATA BANKS FOR OTHERS; CONSULTING CONCERNING COMPANY ORGANIZATION AND MANAGEMENT; BUSINESS ADMINISTRATION; BUSINESS ADVICE ON PERFORMANCE OF COMMERCIAL OPERATIONS; RETAIL TRADING, NAMELY, RETAIL STORE SERVICES FEATURING WATCHES; RETAIL TRADING VIA THE INTERNET, NAMELY, ON-LINE TRADING SERVICES IN WHICH THE

SELLER POSTS PRODUCTS TO BE AUCTIONED AND BIDDING IS DONE VIA THE INTERNET WITH GOODS OF ALL KINDS; ARRANGING AND CONDUCTION OF AUCTION SALES OF WORKS OF ART; EFFICIENCY EXPERTS; BUSINESS CONSULTING WITH REGARD TO ALL THE AFOREMENTIONED SERVICES, IN CLASS 35 (U.S. CLS. 100, 101 AND 102).

FOR: QUALITY CONTROL FOR OTHERS; CERTIFICATION FOR OTHERS OF PROCEDURES, PRODUCTS, INSTRUMENTS AND SERVICES INCLUDING DELIVERY OF TEST OR CONTROL MARKS AND CERTIFICATES OF APPROVAL; SCIENTIFIC AND INDUSTRIAL RESEARCH IN THE FIELD OF WATCHES; EXPERT TECHNICAL REPORTS IN THE FIELD OF WATCHES; DEVELOPMENT OF DATA PROCESSING PROGRAMS; COMPUTER CONSULTING SERVICES; TECHNICAL CONSULTING FOR ALL THE ABOVE-MENTIONED SERVICES, IN CLASS 42 (U.S. CLS. 100 AND 101).

THE MARK CONSISTS OF STANDARD CHARACTERS WITHOUT CLAIM TO ANY PARTICULAR FONT, STYLE, SIZE, OR COLOR.

PRIORITY DATE OF 1-31-2007 IS CLAIMED.

OWNER OF INTERNATIONAL REGISTRATION 0937426 DATED 7-17-2007, EXPIRES 7-17-2017.

SER. NO. 79-043,839, FILED 7-17-2007.

ANN E. SAPPENFIELD, EXAMINING ATTORNEY

Int. Cl.: 10

Prior U.S. Cls.: 26, 39 and 44

United States Patent and Trademark Office

Reg. No. 3,485,251

Registered Aug. 12, 2008

**TRADEMARK
PRINCIPAL REGISTER**

NAIDA

SONOVA HOLDING AG (SWITZERLAND SOCI-
ÉTÉ ANONYME)
LAUBISRÜTISTRASSE 28
CH-8712 STÄFA, SWITZERLAND

OWNER OF INTERNATIONAL REGISTRATION
0937709 DATED 8-29-2007, EXPIRES 8-29-2017.

FOR: ACOUSTIC APPARATUS, NAMELY, HEAR-
ING AIDS AND PARTS THEREOF FOR THE HEAR-
ING IMPAIRED, IN CLASS 10 (U.S. CLS. 26, 39 AND
44).

THE ENGLISH TRANSLATION OF THE WORD
"NAIDA" IN THE MARK IS "MARRY".

THE MARK CONSISTS OF STANDARD CHAR-
ACTERS WITHOUT CLAIM TO ANY PARTICULAR
FONT, STYLE, SIZE, OR COLOR.

SER. NO. 79-043,901, FILED 8-29-2007.

PRIORITY DATE OF 6-25-2007 IS CLAIMED.

MYRIAH HABEEB, EXAMINING ATTORNEY

Int. Cl.: 9

Prior U.S. Cls.: 21, 23, 26, 36 and 38

Reg. No. 3,485,252

United States Patent and Trademark Office

Registered Aug. 12, 2008

TRADEMARK
PRINCIPAL REGISTER



WEIDMÜLLER INTERFACE GMBH & CO. KG
(FED REP GERMANY LIMITED PARTNER-
SHIP)

KLINGENBERGSTRASSE 16
32758 DETMOLD, FED REP GERMANY AND
BTR NETCOM GMBH (FED REP GERMANY LTD
LIAB CO)

IM TAL 2
78176 BLUMBERG, FED REP GERMANY AND
TELEGÄRTNER KARL GÄRTNER GMBH (FED
REP GERMANY LTD LIAB CO)
LERCHENSTRASSE 35
71144 STEINENBRONN, FED REP GERMANY

FOR: ELECTRIC AND ELECTRONIC CONNECTING APPARATUS IN THE FIELD OF THE TRANSMISSION OF ELECTRICAL ENERGY, DATA, AND ELECTRICAL SIGNALS FOR INDUSTRIAL, RESIDENTIAL AND COMMERCIAL USE, NAMELY, ELECTRICAL POWER SUPPLIES, ELECTRICAL COMPONENTS IN THE NATURE OF PROTECTION RELAYS, VOLTAGE SURGE PROTECTORS, ELECTRIC ACCUMULATORS, ELECTRIC CAPACITORS, ELECTRIC CABLES, ELECTRIC CURRENT SWITCHES, ELECTRIC DIODES, ELECTRIC CONVERTERS, ELECTRIC FUSE BOXES, ELECTRIC INSTALLATIONS FOR THE REMOTE CONTROL OF INDUSTRIAL OPERATIONS; ELECTRIC AND ELECTRONIC CONNECTING TERMINALS AND CONNECTORS IN THE FIELDS OF DATA, ENERGY AND SIGNAL TRANSMISSION, NAMELY, ETHERNET CABLE CONNECTORS, PLUG CONNECTORS, PLUG-IN CONNECTORS, TOOL-LESS ELECTRICAL CONNECTORS, CRIMP ELECTRICAL CONNECTORS, INSULATION-PIERCING ELECTRICAL CONNECTORS, DUPLEX ELECTRICAL CONNECTORS, ADAPTOR PLUGS, ADAPTERS, CABLE CONNECTORS, ELECTRIC CONNECTORS, BATTERY TERMINAL CONNECTOR CLAMPS, INSULATED ELECTRICAL CONNECTORS, ELECTRICAL CONNECTION BOXES, ELECTRIC FUSE BOXES; ELECTRONIC DEVICES INCLUDING THEIR PARTS, NAMELY, ELECTRIC DOOR OPENING AND CLOSING SYSTEMS; ELECTRICAL

CABLES FOR TRANSMITTING ENERGY AND DATA FOR INDUSTRIAL, RESIDENTIAL AND OFFICE USE, NAMELY, FLAT CABLES, ROUND CABLES, DUCTING FOR ELECTRICAL CABLES, ELECTRIC WIRES, ELECTRICAL CABLES AND CORD SETS, ELECTRICAL PLUG-IN DEVICES ENABLING CONNECTION AND DISCONNECTION OF POWER AND CONTROL CABLES, ETHERNET CABLES, FIBER-OPTIC CABLES, BATTERY CABLES; INSULATED HOUSINGS FOR ELECTRIC APPARATUS, NAMELY, ELECTRIC JUNCTION BOX HOUSINGS, ELECTRIC SWITCH HOUSINGS, ELECTRICAL CONNECTOR HOUSINGS, HOUSINGS FOR PRINTED CIRCUIT BOARDS, ELECTRICALLY INSULATED HOUSINGS FOR ELECTRICAL APPARATUS MADE FROM SYNTHETIC PLASTIC MATERIAL, ELECTRIC PLUG HOUSINGS, ELECTRIC JUNCTION BOXES, ELECTRIC OUTLET BOXES, WATERPROOF JUNCTION BOXES, PROTECTIVE HOUSINGS IN THE NATURE OF ELECTRICAL ACCUMULATORS, ELECTRIC CAPACITORS, ELECTRIC CABLES, ELECTRIC CURRENT SWITCHES, ELECTRIC DIODES, ELECTRIC CONVERTERS, ELECTRIC FUSE BOXES WITH AND WITHOUT INTEGRATED ELECTRICAL DISTRIBUTORS AND ELECTRIC COUPLINGS; ELECTRICAL POWER SUPPLIES, NAMELY, HIGH-FREQUENCY SWITCHING POWER SUPPLIES, BATTERIES, BATTERY CHARGERS, VOLTAGE STABILIZING POWER SUPPLIES, CURRENT CONVERTERS; REPEATERS, NAMELY, ETHERNET REPEATERS; GATEWAYS, NAMELY, GATEWAY ROUTERS IN THE NATURE OF COMPUTER CONTROL HARDWARE; ELECTRIC AND ELECTRONIC SENSORS FOR MEASURING SOLAR RADIATION, WATER LEVELS, TEMPERATURE, HUMIDITY, DISTANCE, DIGITAL INPUT AND OUTPUT SCANNERS, TRACK BALL INPUT DEVICES; COMPUTER HARDWARE IN THE NATURE OF CIRCUIT BOARDS PROVIDED WITH INTEGRATED CIRCUITS, COMPUTER EXPANSION BOARDS, COMPUTER INTERFACE BOARDS; AND VOLTAGE AND POWER DISTRIBUTION AND PROTECTION SYSTEMS COMPOSED OF BREAKERS AND

SWITCHGEAR, NAMELY, ELECTRICAL FUSES, ELECTRICAL CURRENT SWITCHES, ELECTRICAL CONNECTION BOXES, ELECTRIC FUSE BOXES, CIRCUIT BREAKERS, ELECTRIC SWITCHES, ELECTRICAL CONNECTION BOXES, ELECTRIC FUSE BOXES, SWITCH BOXES, AND RELAYS AND MODULES FOR OVERVOLTAGE PROTECTION, NAMELY, STATIC VOLTAGE REGULATORS, VOLTAGE SURGE SUPPRESSORS, VOLTAGE SURGE PROTECTORS, VOLTAGE REGULATORS FOR ELECTRIC POWER, ELECTRIC VOLTAGE TRANSFORMERS, IN CLASS 9 (U.S. CLS. 21, 23, 26, 36 AND 38).

OWNER OF INTERNATIONAL REGISTRATION 0937779 DATED 7-5-2007, EXPIRES 7-5-2017.

THE FOREIGN WORDING IN THE MARK TRANSLATES INTO ENGLISH AS "STEADYTEC THE RELIABLE CONNECTION".

SER. NO. 79-043,930, FILED 7-5-2007.

MICHAEL TANNER, EXAMINING ATTORNEY

Int. Cl.: 9

Prior U.S. Cls.: 21, 23, 26, 36 and 38

Reg. No. 3,485,253

United States Patent and Trademark Office

Registered Aug. 12, 2008

TRADEMARK
PRINCIPAL REGISTER



WEIDMÜLLER INTERFACE GMBH & CO. KG
(FED REP GERMANY LIMITED PARTNER-
SHIP)

KLINGENBERGSTRASSE 16
32758 DETMOLD

FED REP GERMANY AND

BTR NETCOM GMBH (FED REP GERMANY LIM-
ITED LIABILITY COMPANY)

IM TAL 2

78176 BLUMBERG

FED REP GERMANY AND

TELEGÄRTNER KARL GÄRTNER GMBH (FED
REP GERMANY LIMITED LIABILITY COMPA-
NY)

LERCHENSTRASSE 35

71144 STEINENBRONN

FED REP GERMANY

FOR: ELECTRIC AND ELECTRONIC CONNECT-
ING APPARATUS IN THE FIELD OF THE TRANS-
MISSION OF ELECTRICAL ENERGY, DATA, AND
ELECTRICAL SIGNALS FOR INDUSTRIAL, RESI-
DENTIAL AND COMMERCIAL USE, NAMELY,
ELECTRICAL POWER SUPPLIES, ELECTRICAL
COMPONENTS IN THE NATURE OF PROTECTION
RELAYS, VOLTAGE SURGE PROTECTORS, ELEC-
TRIC ACCUMULATORS, ELECTRIC CAPACITORS,
ELECTRIC CABLES, ELECTRIC CURRENT
SWITCHES, ELECTRIC DIODES, ELECTRIC CON-
VERTERS, ELECTRIC FUSE BOXES, ELECTRIC
INSTALLATIONS FOR THE REMOTE CONTROL
OF INDUSTRIAL OPERATIONS; ELECTRIC AND
ELECTRONIC CONNECTING TERMINALS AND
CONNECTORS IN THE FIELDS OF DATA, ENERGY

AND SIGNAL TRANSMISSION, NAMELY, ETHER-
NET CABLE CONNECTORS, PLUG CONNECTORS,
PLUG-IN CONNECTORS, TOOL-LESS ELECTRICAL
CONNECTORS, CRIMP ELECTRICAL CON-
NECTORS, INSULATION-PIERCING ELECTRICAL
CONNECTORS, DUPLEX ELECTRICAL CONNEC-
TORS, ADAPTOR PLUGS, ADAPTERS, CABLE
CONNECTORS, ELECTRIC CONNECTORS, BAT-
TERY TERMINAL CONNECTOR CLAMPS, INSU-
LATED ELECTRICAL CONNECTORS,
ELECTRICAL CONNECTION BOXES, ELECTRIC
FUSE BOXES; ELECTRONIC DEVICES INCLUDING
THEIR PARTS, NAMELY, ELECTRIC DOOR OPEN-
ING AND CLOSING SYSTEMS; ELECTRICAL
CABLES FOR TRANSMITTING ENERGY AND
DATA FOR INDUSTRIAL, RESIDENTIAL AND
OFFICE USE, NAMELY, FLAT CABLES, ROUND
CABLES, DUCTING FOR ELECTRICAL CABLES,
ELECTRIC WIRES, ELECTRICAL CABLES AND
CORD SETS, ELECTRICAL PLUG-IN DEVICES EN-
ABLING CONNECTION AND DISCONNECTION
OF POWER AND CONTROL CABLES, ETHERNET
CABLES, FIBER-OPTIC CABLES, BATTERY
CABLES; INSULATED HOUSINGS FOR ELECTRIC
APPARATUS, NAMELY, ELECTRIC JUNCTION
BOX HOUSINGS, ELECTRIC SWITCH HOUSINGS,
ELECTRICAL CONNECTOR HOUSINGS, HOUS-
INGS FOR PRINTED CIRCUIT BOARDS, ELECTRI-
CALLY INSULATED HOUSINGS FOR
ELECTRICAL APPARATUS MADE FROM SYN-
THETIC PLASTIC MATERIAL, ELECTRIC JUNG
HOUSINGS, ELECTRIC JUNCTION BOXES, ELEC-
TRIC OUTLET BOXES, WATERPROOF JUNCTION
BOXES, PROTECTIVE HOUSINGS IN THE NATURE

OF ELECTRICAL ACCUMULATORS, ELECTRIC CAPACITORS, ELECTRIC CABLES, ELECTRIC CURRENT SWITCHES, ELECTRIC DIODES, ELECTRIC CONVERTERS, ELECTRIC FUSE BOXES WITH AND WITHOUT INTEGRATED ELECTRICAL DISTRIBUTORS AND ELECTRIC COUPLINGS; ELECTRICAL POWER SUPPLIES, NAMELY, HIGH-FREQUENCY SWITCHING POWER SUPPLIES, BATTERIES, BATTERY CHARGERS, VOLTAGE STABILIZING POWER SUPPLIES, CURRENT CONVERTERS; REPEATERS, NAMELY, ETHERNET REPEATERS; GATEWAYS, NAMELY, GATEWAY ROUTERS IN THE NATURE OF COMPUTER CONTROL HARDWARE; ELECTRIC AND ELECTRONIC SENSORS FOR MEASURING SOLAR RADIATION, WATER LEVELS, TEMPERATURE, HUMIDITY, DISTANCE, DIGITAL INPUT AND OUTPUT SCANNERS, TRACK BALL INPUT DEVICES; COMPUTER HARDWARE IN THE NATURE OF CIRCUIT BOARDS PROVIDED WITH INTEGRATED CIRCUITS, COMPUTER EXPANSION BOARDS, COMPUTER INTERFACE BOARDS; AND VOLTAGE AND POWER DISTRIBUTION AND PROTECTION

SYSTEMS COMPOSED OF BREAKERS AND SWITCHGEAR, NAMELY, ELECTRICAL FUSES, ELECTRICAL CURRENT SWITCHES, ELECTRICAL CONNECTION BOXES, ELECTRIC FUSE BOXES, CIRCUIT BREAKERS, ELECTRIC SWITCHES, ELECTRICAL CONNECTION BOXES, ELECTRIC FUSE BOXES, SWITCH BOXES, AND RELAYS AND MODULES FOR OVERVOLTAGE PROTECTION, NAMELY, STATIC VOLTAGE REGULATORS, VOLTAGE SURGE SUPPRESSORS, VOLTAGE SURGE PROTECTORS, VOLTAGE REGULATORS FOR ELECTRIC POWER, ELECTRIC VOLTAGE TRANSFORMERS, IN CLASS 9 (U.S. CLS. 21, 23, 26, 36 AND 38).

OWNER OF INTERNATIONAL REGISTRATION
0937780 DATED 7-5-2007, EXPIRES 7-5-2017.

SER. NO. 79-043,931, FILED 7-5-2007.

MICHAEL TANNER, EXAMINING ATTORNEY

Int. Cls.: 1 and 3

Prior U.S. Cls.: 1, 4, 5, 6, 10, 26, 46, 50, 51 and 52

United States Patent and Trademark Office

Reg. No. 3,485,254

Registered Aug. 12, 2008

**TRADEMARK
PRINCIPAL REGISTER**

STEMSOME

PARFUMS CHRISTIAN DIOR (FRANCE SOCI-
ÉTÉ ANONYME (SA))
33 AVENUE HOCHÉ
F-75008 PARIS
FRANCE

FOR: INGREDIENTS, NAMELY BOTANICAL EX-
TRACTS AND CHEMICAL SUBSTANCES FOR USE
IN THE MANUFACTURE OF COSMETIC PRO-
DUCTS, IN CLASS 1 (U.S. CLS. 1, 5, 6, 10, 26 AND 46).

FOR: FACE AND BODY CARE COSMETICS, IN
CLASS 3 (U.S. CLS. 1, 4, 6, 50, 51 AND 52).

PRIORITY DATE OF 3-7-2007 IS CLAIMED.

OWNER OF INTERNATIONAL REGISTRATION
0937885 DATED 8-30-2007, EXPIRES 8-30-2017.

SER. NO. 79-043,958, FILED 8-30-2007.

SHAILA SETTLES, EXAMINING ATTORNEY

Int. Cl.: 25

Prior U.S. Cls.: 22 and 39

United States Patent and Trademark Office

Reg. No. 3,485,255

Registered Aug. 12, 2008

TRADEMARK
PRINCIPAL REGISTER

依奴珈
enaga

ZHEJIANG ZHONGHUI; FUR & LEATHER CO.,
LTD (CHINA CORPORATION)
NANMEN, CHONGFU TOWN
TONGXIANG CITY; 314511 ZHEJIANG PROVINCE
CHINA

FOR: CLOTHING, NAMELY, LEATHER BELTS,
LEATHER PANTS AND LEATHER COATS, HOSI-
ERY, FOOTWEAR, BASKETBALL SHOES, BASKET-
BALL SNEAKERS, T-SHIRTS, SHIRTS,
SWEATSHIRTS, SWEATPANTS, PANTS, NIGHT-
SHIRTS, HATS, JACKETS, COATS, CAPS, GLOVES,
WOVEN AND KNIT SHIRTS, UNIFORMS, LAY-
ETTES, SCARVES, GIRDLES, NECKTIES, SWIM-
SUITS, IN CLASS 25 (U.S. CLS. 22 AND 39).

OWNER OF INTERNATIONAL REGISTRATION
0937959 DATED 8-28-2007, EXPIRES 8-28-2017.

THE FIRST CHINESE CHARACTER WHOSE
TRANSLITERATION IS "YI" MEANS "DEPEND
ON"; THE SECOND CHINESE CHARACTER
WHOSE TRANSLITERATION IS "NU" MEANS
"SERVANT"; THE LAST CHINESE CHARACTER
WHOSE TRANSLITERATION IS "JIA" MEANS "AN
ANCIENT WOMAN'S PERSONAL ORNAMENTS";
THE COMBINATION OF THE THREE CHINESE
CHARACTERS HAS NO FOREIGN SIGNIFICANCE.

THE TRANSLITERATION OF THE NON-LATIN
CHARACTERS IN THE MARK IS: "YI" "NU" "JIA".

SER. NO. 79-043,984, FILED 8-28-2007.

DOMINIC FATHY, EXAMINING ATTORNEY

Int. Cls.: 18, 25 and 35

Prior U.S. Cls.: 1, 2, 3, 22, 39, 41, 100, 101 and 102

Reg. No. 3,485,256

United States Patent and Trademark Office

Registered Aug. 12, 2008

**TRADEMARK
SERVICE MARK
PRINCIPAL REGISTER**



CEBIR GIYIM; SANAYI VE TICARET LIMITED
SIRKETI (TURKEY JOINT STOCK COMPANY)
EVREN MAHALLESİ KEREM SOKAK NO: 11
BAGCILAR, ISTANBUL
TURKEY

FOR: ANIMAL SKINS, HIDES, TRUNKS AND
TRAVELING BAGS; UMBRELLAS, PARASOLS
AND WALKING STICKS; WHIPS, HARNESS AND
SADDLERY, BRIEF CASES, WALLETS, GRIP-
SACKS, SPORTS BAGS, SUITCASES AND LUG-
GAGE, IN CLASS 18 (U.S. CLS. 1, 2, 3, 22 AND 41).

FOR: CLOTHING, NAMELY, PANTS, SHIRTS, T-
SHIRTS, SWEATPANTS, SWEAT SHORTS, SKIRTS,
JACKETS, SOCKS, UNDERWEAR, DICKEY BOW
TIES, RAINCOATS, SKI WEAR, DUFFLE COATS,
PAJAMAS, SWIMSUITS, TENNIS WEAR, CAPS,
SANDALS, SHOES, ATHLETIC FOOTWEAR AND
HEADWEAR, IN CLASS 25 (U.S. CLS. 22 AND 39).

FOR: THE BRINGING TOGETHER, FOR THE
BENEFIT OF OTHERS, OF A VARIETY OF GOODS
ENABLING CUSTOMERS TO CONVENIENTLY
VIEW AND PURCHASE THOSE GOODS IN THE
FIELD OF CLOTHING AND LEATHER GOODS, IN
CLASS 35 (U.S. CLS. 100, 101 AND 102).

OWNER OF INTERNATIONAL REGISTRATION
0937988 DATED 8-20-2007, EXPIRES 8-20-2017.

THE MARK CONSISTS OF THE WORDING
"MARATONRUN" IN BLUE BELOW A DESIGN IN
RED.

SER. NO. 79-043,994, FILED 8-20-2007.

KEVIN DINALLO, EXAMINING ATTORNEY

Int. Cls.: 36 and 37

Prior U.S. Cls.: 100, 101, 102, 103 and 106

Reg. No. 3,485,257

United States Patent and Trademark Office

Registered Aug. 12, 2008

**SERVICE MARK
PRINCIPAL REGISTER**



THREADNEEDLE ASSET MANAGEMENT;
HOLDINGS LIMITED (UNITED KINGDOM
LTD LIAB CO)
60 ST MARY AXE
LONDON EC3A 8JQ
UNITED KINGDOM

FOR: FINANCIAL SERVICES, NAMELY, ADVICE RELATING TO INVESTMENTS, ASSET MANAGEMENT, CASH MANAGEMENT, FINANCIAL PORTFOLIO MANAGEMENT AND INSURANCE BROKERAGE SERVICES; ADMINISTRATION OF EMPLOYEE PENSION PLANS; ADVISORY SERVICES FOR PENSION VALUATION SERVICES; INVESTMENT SERVICES, NAMELY, ASSET ACQUISITION; INVESTMENT MANAGEMENT SERVICES IN THE FIELD OF MUTUAL FUNDS; INSURANCE UNDERWRITING FOR ALL TYPES OF INSURANCE; GUARANTEE ASSURANCE UNDERWRITING; CHARITABLE FUND RAISING SERVICES; HEDGE FUND INVESTMENT AND MANAGEMENT SERVICES; MANAGEMENT OF PRIVATE EQUITY FUNDS; FINANCING SERVICES; ACQUISITION AND TRANSFER OF MONETARY CLAIMS; INVESTMENT SERVICES, NAMELY, ASSET ACQUISITION, CONSULTATION, AND MANAGEMENT SERVICES; LEASE PURCHASE FINANCING; REAL ESTATE INVESTMENT; REAL ESTATE ACQUISITION; REAL ESTATE AGENCIES; REAL ESTATE MANAGEMENT; VALUATION OF PROPERTIES BASED ON A SURVEY; REAL ESTATE MANAGEMENT; REAL ESTATE DEVELOPMENT; LEASING OF REAL ESTATE; RENTING OF BUILDINGS; RENTAL OF APARTMENTS; ADVISORY SERVICES FOR FINANCING OF PROPERTY DEVELOPMENT; REAL ESTATE PROJECT MANAGEMENT SERVICES;

RENT COLLECTION AGENCIES AND LEASING OF REAL ESTATE; APARTMENT HOUSE MANAGEMENT, NAMELY, MANAGEMENT OF RENT REVIEWS, LEASE RENEWALS, AND TENANT MANAGEMENT SERVICES; DEBT RECOVERY AND COLLECTION AGENCIES; REAL ESTATE MANAGEMENT SERVICES; REAL ESTATE PROPERTY PORTFOLIO MANAGEMENT SERVICES; ADVISORY, CONSULTANCY, AND PROVIDING INFORMATION RELATING TO THE AFOREMENTIONED SERVICES, IN CLASS 36 (U.S. CLS. 100, 101 AND 102).

FOR: HOUSING SERVICES, NAMELY, DEVELOPMENT OF REAL PROPERTY; BUILDING AND CONSTRUCTION OF ACCOMMODATIONS, NAMELY, HOUSES; RENOVATION, RESTORATION, CONVERSION, AND REFURBISHMENT OF BUILDINGS; REAL ESTATE DEVELOPMENT; PROPERTY AND HOME MAINTENANCE SERVICES; HOUSING SERVICES, NAMELY, RESIDENTIAL REAL PROPERTY IMPROVEMENT SERVICES; INSTALLATION SERVICES OF BUILDING PLATFORMS; BUILDING REPAIR, IN CLASS 37 (U.S. CLS. 100, 103 AND 106).

PRIORITY DATE OF 6-13-2007 IS CLAIMED.

OWNER OF INTERNATIONAL REGISTRATION
0938091 DATED 7-18-2007, EXPIRES 7-18-2017.

SER. NO. 79-044,030, FILED 7-18-2007.

DANNEAN HETZEL, EXAMINING ATTORNEY

Int. Cl.: 41

Prior U.S. Cls.: 100, 101 and 107

United States Patent and Trademark Office

Reg. No. 3,485,258

Registered Aug. 12, 2008

**SERVICE MARK
PRINCIPAL REGISTER**

TO THE MAX

FSN PUBLISHING LIMITED (UNITED KING-
DOM LIMITED COMPANY)

32 HILL CRESCENT
TOTTERIDGE, LONDON N20 8HD
UNITED KINGDOM

FOR: BOOK PUBLISHING; ELECTRONIC TEXT PUBLISHING SERVICES FOR OTHERS ON CD, DVD, AND ONLINE IN THE FIELDS OF BUSINESS, FINANCE, ACCOUNTING AND INVESTMENTS; MAGAZINE PUBLISHING; PROVISION OF INFORMATION RELATING TO PUBLISHING; ONLINE PUBLISHING BY ELECTRONIC MEANS OF BOOKS, PERIODICALS, DOCUMENTS, EDUCATIONAL MATERIAL, NEWSLETTERS, AND NEWSPAPERS; PUBLISHING OF BOOKS AND PERIODICALS; PUBLISHING OF DOCUMENTS; PUBLISHING OF EDUCATIONAL MATERIAL; PUBLISHING OF EDUCATIONAL MATTER; PUBLISHING OF INSTRUCTIONAL BOOKS; PUBLISHING OF NEWSLETTERS; PUBLISHING OF NEWSPAPERS; PUBLISHING OF PRINTED MATTER; PUBLISHING SERVICES FOR BOOKS; PUBLISHING SERVICES CARRIED OUT BY

COMPUTERIZED MEANS, NAMELY, PUBLICATION OF TEXT AND GRAPHIC WORKS OF OTHERS ON CD, DVD, AND ONLINE IN THE FIELDS OF BUSINESS, FINANCE, ACCOUNTING AND INVESTMENTS; CONSULTANCY AND ADVISORY SERVICES ALL IN RELATION TO THE AFORESAID, IN CLASS 41 (U.S. CLS. 100, 101 AND 107).

THE MARK CONSISTS OF STANDARD CHARACTERS WITHOUT CLAIM TO ANY PARTICULAR FONT, STYLE, SIZE, OR COLOR.

PRIORITY DATE OF 4-18-2007 IS CLAIMED.

OWNER OF INTERNATIONAL REGISTRATION 0938124 DATED 7-16-2007, EXPIRES 7-16-2017.

SER. NO. 79-044,040, FILED 7-16-2007.

ZACHARY BELLO, EXAMINING ATTORNEY

Int. Cl.: 8

Prior U.S. Cls.: 23, 28 and 44

United States Patent and Trademark Office

Reg. No. 3,485,259

Registered Aug. 12, 2008

**TRADEMARK
PRINCIPAL REGISTER**

ROLLERFLAM

L'AIR LIQUIDE, SOCIÉTÉ ANONYME; POUR
L'ÉTUDE ET L'EXPLOITATION; DES PRO-
CÉDÉS GEORGES CLAUDE (FRANCE COR-
PORATION)
75, QUAI D'ORSAY
F-75007 PARIS
FRANCE

OWNER OF INTERNATIONAL REGISTRATION
0619172 DATED 6-8-1994, EXPIRES 6-8-2014.

SER. NO. 79-044,085, FILED 7-30-2007.

FOR: GAS WELDING MACHINES, NAMELY,
MOBILE NON-ELECTRIC WELDING UNITS, IN
CLASS 8 (U.S. CLS. 23, 28 AND 44).

LINDSEY RUBIN, EXAMINING ATTORNEY

Int. Cl.: 30

Prior U.S. Cl.: 46

United States Patent and Trademark Office

Reg. No. 3,485,260

Registered Aug. 12, 2008

**TRADEMARK
PRINCIPAL REGISTER**

CHOCO - SOFTIES

LIDL STIFTUNG & CO. KG (FED REP GERMA-
NY KOMMANDITGESELLSCHAFT (LIMITED
PARTNERSHIP))
STIFTSBERGSTRASSE 1
74167 NECKARSULM, FED REP GERMANY

FOR: PASTRY AND CONFECTIONERY, NAME-
LY, CHOCOLATES, CHOCOLATE CHIPS, CHOCO-
LATE MARSHMALLOWS, COOKIES, TARTS,
MUFFINS, DONUTS, WAFFLES; PROFITEROLES
("MOHRENKÖPFE"), NAMELY, CREAM PUFFS;
CAKES; EDIBLE FLAVORED ICE, IN CLASS 30
(U.S. CL. 46).

THE MARK CONSISTS OF STANDARD CHAR-
ACTERS WITHOUT CLAIM TO ANY PARTICULAR
FONT, STYLE, SIZE, OR COLOR.

OWNER OF INTERNATIONAL REGISTRATION
0671809 DATED 3-4-1997, EXPIRES 3-4-2017.

OWNER OF U.S. REG. NO. 2,577,893.

SER. NO. 79-044,092, FILED 3-4-2007.

RICHARD A. STRASER, EXAMINING ATTORNEY

Int. Cls.: 29 and 30

Prior U.S. Cl.: 46

Reg. No. 3,485,261

United States Patent and Trademark Office

Registered Aug. 12, 2008

TRADEMARK
PRINCIPAL REGISTER

Cusina

LIDL STIFTUNG & CO. KG (FED REP GERMA-
NY KOMMANDITGESELLSCHAFT (LIMITED
PARTNERSHIP))
STIFTSBERGSTRASSE 1
74167 NECKARSULM
FED REP GERMANY

FOR: MEAT EXTRACTS, MEAT, FISH; JELLY
BREAD SPREADS, NAMELY, FRUIT AND VEGE-
TABLE JELLIES; FRUIT JAMS; MEAT, FISH, FRUIT
AND VEGETABLE SALADS; PICKLES; CANNED
MEAT, FISH, FRUIT AND VEGETABLES; SOUPS;
INSTANT SOUPS, IN CLASS 29 (U.S. CL. 46).

FOR: CHOCOLATE SPREAD; SPICES; SPICE PRE-
PARATIONS, NAMELY, PROCESSED SPICES, SPICE
BLENDS, FLAVORINGS MAINLY CONSISTING OF
SPICES; FINE HERBS AND AROMATIC LEAVES,
NAMELY, PROCESSED HERBS; AROMATIC OILS,
AROMATIC SALTS; SPICED SAUCES; CONDI-
MENTS, NAMELY, ALLSPICE, BAKING SPICES,
CHILLI PASTE, CHILLI POWDERS, CHILLI SEA-
SONINGS, CHUTNEYS, CINNAMON POWDER,
PEPPER SAUCE, CURRY PASTES, CURRY POW-
DER, DRY SPICE RUB FOR MEATS AND FISH,
EXTRACTS USED AS FLAVORING, FRUIT PASTE
FOR FLAVORING OF FOOD, GARLIC PASTE,
GARLIC SALT, GINGER PASTE, HOT PEPPER
POWDER, ONION SALT, PICKLED GINGER, PI-
MIENTO, POWDERED GARLIC, MUSTARD, PRE-
PARED WASABI, RELISH, SAFFRON, SALSA, SOY
BEAN PASTE, SOY SAUCE, VEGETABLE CONCEN-
TRATES USED AS SEASONINGS, STEAK SEASON-
ING; FOOD FLAVORINGS, SOUP FLAVORINGS;

VINEGAR, COARSE SALT, MAYONNAISE; COF-
FEE, TEA, HERBAL TEAS, COCOA, CHOCOLATE;
CONFECTIONERY, NAMELY, BISCUITS, COOK-
IES, CINNAMON ROLLS, CHOCOLATE, CHOCO-
LATE CONFECTIONERY, PASTILLES, FROZEN
CONFECTIONERY, SUGAR CONFECTIONERY,
PEANUT BUTTER CONFECTIONERY CHIPS, CON-
FECTIONERY CHIPS FOR BAKING, CHOCOLATE
MOUSSE, CHOCOLATE TRUFFLES, PRALINES,
CHOCOLATE-COVERED NUTS AND ALMONDS,
MARZIPAN, LIQUORICE, CANDIES, CHEWING
GUM, SWEETMEATS, LOLLIPOPS, CANDY
COATED POPCORN, CANDY MINTS, CAMEL,
TOFFEE; PASTRY, HONEY, YEAST, BAKING POW-
DER, KETCHUP; SAUCES; SALAD DRESSINGS;
PREPARED MEALS AND DRY MIXTURES FOR
PREPARED MEALS, MAINLY CONSISTING OF
RICE OR NOODLES, IN CLASS 30 (U.S. CL. 46).

THE MARK CONSISTS OF STANDARD CHAR-
ACTERS WITHOUT CLAIM TO ANY PARTICULAR
FONT, STYLE, SIZE, OR COLOR.

OWNER OF INTERNATIONAL REGISTRATION
0678053 DATED 3-20-1997, EXPIRES 3-20-2017.

OWNER OF U.S. REG. NO. 2,852,372.

SER. NO. 79-044,093, FILED 3-21-2007.

RICHARD A. STRASER, EXAMINING ATTORNEY

Int. Cl.: 5

Prior U.S. Cls.: 6, 18, 44, 46, 51 and 52

Reg. No. 3,485,262

United States Patent and Trademark Office

Registered Aug. 12, 2008

**TRADEMARK
PRINCIPAL REGISTER**



MERIAL (FRANCE SOCIÉTÉ PAR ACTIONS
SIMPLIFIÉE)
29, AVENUE TONY GARNIER
F-69007 LYON
FRANCE

OWNER OF INTERNATIONAL REGISTRATION
0848102 DATED 3-18-2005, EXPIRES 3-18-2015.

FOR: VETERINARY VACCINES, NAMELY, VE-
TERINARY VACCINES FOR SWINE, IN CLASS 5
(U.S. CLS. 6, 18, 44, 46, 51 AND 52).

SER. NO. 79-044,112, FILED 8-1-2007.

DAVID HOFFMAN, EXAMINING ATTORNEY

Int. Cl.: 11

Prior U.S. Cls.: 13, 21, 23, 31 and 34

United States Patent and Trademark Office

Reg. No. 3,485,263

Registered Aug. 12, 2008

**TRADEMARK
PRINCIPAL REGISTER**

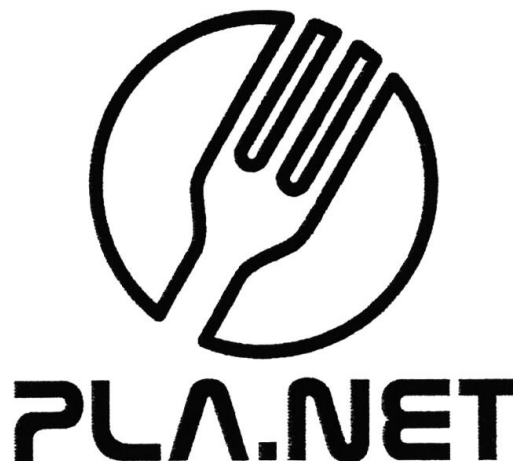

HAMPTON HOLDINGS LIMITED (UNITED
KINGDOM LIMITED COMPANY)
3 LIMPSFIELD ROAD
SOUTH CROYDON, SURREY CR2 9LA
UNITED KINGDOM

FOR: APPARATUS FOR COOKING, NAMELY,
ELECTRIC AND GAS HOT PLATES, ELECTRIC
AND GAS FRY TOPS, ELECTRICAL AND GAS
BRAZIER, FULL GAS GRILL COUNTERS, FULL
ELECTRIC GRILL COUNTERS, ELECTRIC TOAST-
ERS, ELECTRIC AND GAS GRILLS, ELECTRIC
AND GAS OVENS, ELECTRIC AND GAS DEEP
FAT FRYERS, GAS AND LAVA STONE BARBE-
CUES, ALL MANUFACTURED FOR INDUSTRIAL
AND HOME USE, IN CLASS 11 (U.S. CLS. 13, 21, 23, 31
AND 34).

OWNER OF INTERNATIONAL REGISTRATION
0938308 DATED 7-11-2007, EXPIRES 7-11-2017.

THE TRADE MARK CONSISTS OF THE WORD
"PLA.NET" IN SPECIAL CHARACTERS, TOGE-
THER WITH A SCHEMATISED DRAWING OF A
FORK ON A PLATE.

SER. NO. 79-044,139, FILED 7-11-2007.

WARREN L. OLANDRIA, EXAMINING ATTOR-
NEY

Int. Cl.: 7

Prior U.S. Cls.: 13, 19, 21, 23, 31, 34 and 35

United States Patent and Trademark Office

Reg. No. 3,485,264

Registered Aug. 12, 2008

**TRADEMARK
PRINCIPAL REGISTER**



SAMKOOK INDUSTRIAL CO., LTD. (REPUBLIC
OF KOREA LIMITED COMPANY)
SAMKOOK BLDG., 263-5
GAJWA 3-DONG, SEO-GU, INCHEON
REPUBLIC OF KOREA

FOR: GAS HOSE REEL FOR GAS WELDING,
NAMELY, REELS FOR HOSES FOR USE WITH GAS-
OPERATED WELDING MACHINES; MECHANICAL
HOSE REEL FOR SUPPLYING GEAR OIL, NAME-
LY, POWER OPERATED HOSE REELS FOR USE
WITH GEAR OIL SUPPLYING MACHINE; CABLE
REEL FOR ARC WELDING, NAMELY, REELS FOR
HOSES FOR USE WITH ELECTRIC ARC WELDING
MACHINES; CRANE REELS, NAMELY, POWER
OPERATED REELS FOR USE WITH FORKLIFT
TRUCK CRANES, IN CLASS 7 (U.S. CLS. 13, 19, 21,
23, 31, 34 AND 35).

OWNER OF INTERNATIONAL REGISTRATION
0938493 DATED 3-9-2007, EXPIRES 3-9-2017.

THE COLOR(S) BURGUNDY AND WHITE IS/
ARE CLAIMED AS A FEATURE OF THE MARK.

THE COLOR WHITE APPEARS IN THE WORD-
ING "KOREEL" AND THE COLOR BURGUNDY
APPEARS IN THE OVAL SURROUNDING THE
WORDING.

SER. NO. 79-044,226, FILED 3-9-2007.

DAYNA BROWNE, EXAMINING ATTORNEY

Int. Cl.: 33

Prior U.S. Cls.: 47 and 49

United States Patent and Trademark Office

Reg. No. 3,485,265

Registered Aug. 12, 2008

**TRADEMARK
PRINCIPAL REGISTER**

BRICCO ASINARI

GANCIA S.P.A. (ITALY CORPORATION)
CORSO LIBERTÀ, 70
I-14053 CANELLI (AT)
ITALY

OWNER OF INTERNATIONAL REGISTRATION
0938567 DATED 8-10-2007, EXPIRES 8-10-2017.

FOR: ALCOHOLIC BEVERAGES, NAMELY,
WINES, SPARKLING WINES, FRUIT WINES,
GRAPE WINES, APERITIFS, APERITIFS WITH A
WINE BASE, IN CLASS 33 (U.S. CLS. 47 AND 49).

NO CLAIM IS MADE TO THE EXCLUSIVE
RIGHT TO USE "BRICCO", APART FROM THE
MARK AS SHOWN.

THE MARK CONSISTS OF STANDARD CHAR-
ACTERS WITHOUT CLAIM TO ANY PARTICULAR
FONT, STYLE, SIZE, OR COLOR.

THE ENGLISH TRANSLATION OF "BRICCO" IS
"JUG".

PRIORITY DATE OF 8-1-2007 IS CLAIMED.

SER. NO. 79-044,245, FILED 8-10-2007.

JAMES STEIN, EXAMINING ATTORNEY

Int. Cl.: 33

Prior U.S. Cls.: 47 and 49

United States Patent and Trademark Office

Reg. No. 3,485,266

Registered Aug. 12, 2008

**TRADEMARK
PRINCIPAL REGISTER**

NAVEA

MIGUEL TORRES S.A. (SPAIN SOCIEDAD ANÓNIMA)
MIQUEL TORRES I CARBÓ, 6
E-08720 VILAFRANCA DEL PENEDES (BARCELONA)
SPAIN

OWNER OF INTERNATIONAL REGISTRATION
0938574 DATED 7-19-2007, EXPIRES 7-19-2017.

FOR: WINES, IN CLASS 33 (U.S. CLS. 47 AND 49).

SER. NO. 79-044,249, FILED 7-19-2007.

THE MARK CONSISTS OF STANDARD CHARACTERS WITHOUT CLAIM TO ANY PARTICULAR FONT, STYLE, SIZE, OR COLOR.

WILLIAM ROSSMAN, EXAMINING ATTORNEY

Int. Cl.: 36

Prior U.S. Cls.: 100, 101 and 102

United States Patent and Trademark Office

Reg. No. 3,485,267

Registered Aug. 12, 2008

**SERVICE MARK
PRINCIPAL REGISTER**

UNICAPT

COMPAGNIE INDUSTRIELLE ET FINANCIERE
D'INGENIERIE - INGENICO (FRANCE SOCI-
ETE ANONYME)

192 AVENUE CHARLES DE GAULLE
F-92200 NEUILLY SUR SEINE
FRANCE

FOR: PAYMENT AND FUND TRANSFER SER-
VICES BY MEANS OF ELECTRONIC CREDIT AND
DEBIT CARDS AND ELECTRONIC PAY TERMIN-
ALS; ELECTRONIC FUNDS TRANSFER; ISSUANCE
OF CREDIT CARDS AND DEBIT CARDS; SERVICES
FOR FUNDS INVESTMENT, FINANCIAL AND
STOCK EXCHANGE TRANSACTIONS, NAMELY,
INVESTMENT FUND TRANSFER AND TRANSAC-
TION SERVICES, SERVICES FOR PLACING OF
ORDERS ON FINANCIAL MARKETS BY ALL
MEANS AND ESPECIALLY BY MEANS OF ELEC-
TRONIC DEBIT OR CREDIT CARDS AND ESPE-
CIALLY THOSE USING A PAY TERMINAL,

NAMELY, BROKERAGE IN THE FIELD OF SECU-
RITIES, IN CLASS 36 (U.S. CLS. 100, 101 AND 102).

THE MARK CONSISTS OF STANDARD CHAR-
ACTERS WITHOUT CLAIM TO ANY PARTICULAR
FONT, STYLE, SIZE, OR COLOR.

PRIORITY DATE OF 1-15-2007 IS CLAIMED.

OWNER OF INTERNATIONAL REGISTRATION
0938691 DATED 6-22-2007, EXPIRES 6-22-2017.

OWNER OF U.S. REG. NOS. 2,717,486 AND
3,087,814.

SER. NO. 79-044,287, FILED 6-22-2007.

DAYNA BROWNE, EXAMINING ATTORNEY

Int. Cl.: 25

Prior U.S. Cls.: 22 and 39

United States Patent and Trademark Office

Reg. No. 3,485,268

Registered Aug. 12, 2008

**TRADEMARK
PRINCIPAL REGISTER**



SHANGHAI BOSIDENG INTERNATIONAL;
FASHION, LTD. (CHINA CORPORATION)
16/F, PINGSHENG BUILDING
NO. 98 SONGHU ROAD,; YANGPU DISTRICT;
SHANGHAI
CHINA

FOR: CLOTHING, NAMELY, SHIRTS, JACKETS,
TROUSERS, T-SHIRTS; DOWN WEAR, NAMELY,
JACKETS AND TROUSERS FILLED WITH DOWN;
GLOVES AND NECKTIES; SHOES; HEADGEAR,
NAMELY, HATS, VISORS, CAPS AND HEAD-
BANDS, IN CLASS 25 (U.S. CLS. 22 AND 39).

OWNER OF INTERNATIONAL REGISTRATION
0938986 DATED 7-26-2007, EXPIRES 7-26-2017.

THE NON-LATIN CHARACTERS IN THE MARK
TRANSLITERATE TO XUEZHONGFEI AND THIS
MEANS FLY IN THE SNOW IN ENGLISH.

SER. NO. 79-044,399, FILED 7-26-2007.

KATHLEEN M. VANSTON, EXAMINING ATTOR-
NEY

Int. Cl.: 30

Prior U.S. Cl.: 46

United States Patent and Trademark Office

Reg. No. 3,485,269

Registered Aug. 12, 2008

**TRADEMARK
PRINCIPAL REGISTER**

FONDENTENERO

ELAH DUFOUR S.P.A. (ITALY JOINT STOCK
COMPANY)
VIA PIANDILUCCO, 7
I-16155 GENOVA (GE)
ITALY

FOR: COFFEE, TEA, COCOA, SUGAR, RICE,
TAPIOCA, SAGO, ARTIFICIAL COFFEE; FLOUR;
PREPARATIONS MADE FROM CEREALS, BREAD,
PASTRY AND CONFECTIONERY, NAMELY, BIS-
CUITS, MACAROONS, CAKES, PIES, CROISSANTS,
BUNS, BRIOCHES, CRACKERS, BREADSTICKS;
CONFECTIONERY, NAMELY, PASTILLES, FON-
DANTS, FRUIT JELLIES, CANDIES, TOFFEES,
CARMELS, CHOCOLATES, CHOCOLATE
CREAMS, CANDY EASTER EGGS; CHOCOLATE
PRODUCTS, NAMELY, CHOCOLATE BARS, CHO-
COLATE CANDIES, CHOCOLATE CHIPS, CHOC-
OLATE COVERED NUTS, CHOCOLATE MOUSSE,
CHOCOLATE POWDER, CHOCOLATE TRUFFLES,
FILLED CHOCOLATE; ICES, NAMELY, EDIBLE
ICES, FLAVORED ICES; HONEY, TREACLE;

YEAST, BAKING-POWDER; SALT, MUSTARD; VI-
NEGAR, SAUCES; SPICES; ICE, ICE-CREAM PRO-
DUCTS, NAMELY, ICE CREAMS, ICE CREAM
DRINKS, ICE CREAM CAKES, ICE CREAM SAND-
WICHES, IN CLASS 30 (U.S. CL. 46).

THE MARK CONSISTS OF STANDARD CHAR-
ACTERS WITHOUT CLAIM TO ANY PARTICULAR
FONT, STYLE, SIZE, OR COLOR.

OWNER OF INTERNATIONAL REGISTRATION
0898118 DATED 5-2-2006, EXPIRES 5-2-2016.

THE ENGLISH TRANSLATION OF "FONDENTE
NERO" IS BLACK DARK OR BLACK PLAIN.

SER. NO. 79-044,431, FILED 3-7-2007.

BARBARA RUTLAND, EXAMINING ATTORNEY

Int. Cls.: 17 and 40

Prior U.S. Cls.: 1, 5, 12, 13, 35, 50, 100, 103 and 106

United States Patent and Trademark Office

Reg. No. 3,485,270

Registered Aug. 12, 2008

**TRADEMARK
SERVICE MARK
PRINCIPAL REGISTER**

MECIT ÇELİK (TURKEY CORPORATION)
ORGANİZE SANAYİ BÖLGESİ
MOR CADDESİ, NO:2 KISIM:5-6; BURSA
TURKEY

FOR: RUBBER SHOCK ABSORBERS FOR INDUSTRIAL MACHINERY; EXPANSION JOINT FILLERS MADE OF RUBBER; RUBBER STOPPERS FOR INDUSTRIAL PACKAGING CONTAINERS; RUBBER SEALING PLUGS MADE PRIMARILY FROM RUBBER; RUBBER IN BILLET FORM; RUBBER SLEEVES AND RUBBER FOAM FOR PROTECTING PARTS OF MACHINERY; RINGS OF RUBBER FOR USE AS PIPE CONNECTION SEALS; AND, GASKET SEALER FOR USE IN PLUMBING, IN CLASS 17 (U.S. CLS. 1, 5, 12, 13, 35 AND 50).

FOR: MATERIAL TREATMENT SERVICES, NAMELY, GALVANIZING OF METALS, METAL COATING, METAL TREATING AND CASTING, HARDENING OF METAL AND METAL PRODUCTS, MANUFACTURE OF BOILERS TO THE SPECIFICATIONS OF OTHERS; PROVIDING MATERIAL TREATMENT INFORMATION; MATERIAL TREATMENT OF CLOTH, NAMELY, TREATING CLOTH WITH THREAD WARPING CHEMICALS FOR USE IN THE MANUFACTURE OF CLOTHING; APPLICATION OF MOTHPROOFING CHEMICALS TO CLOTH MATERIAL USED IN THE MANUFACTURE OF CLOTHING, SERVICES; MATERIAL TREATMENT OF CLOTH, NAMELY, APPLYING FINISHES TO CLOTH, CUTTING OF

CLOTH, DYEING OF CLOTH, BLEACHING OF CLOTH, CREASE-RESISTANT TREATMENT OF CLOTH, FIREPROOFING OF CLOTH, EDGING OF CLOTH, WATERPROOFING OF CLOTH, PERMANENT PRESS TREATMENT OF CLOTH; LIQUID, CHEMICAL MATERIAL, GAS, AIR TREATMENT SERVICES NAMELY AIR DEODORIZING SERVICES, ENVIRONMENTAL REMEDIATION SERVICES, NAMELY, SOIL, WASTE AND/OR WATER TREATMENT SERVICES, SOIL AND WASTE RECYCLING SERVICES, SORTING OF WASTE AND RECYCLABLE MATERIAL, OIL REFINING; ASSEMBLY OF PRODUCTS FOR OTHERS, IN CLASS 40 (U.S. CLS. 100, 103 AND 106).

OWNER OF INTERNATIONAL REGISTRATION
0929770 DATED 3-21-2007, EXPIRES 3-21-2017.

THE COLOR(S) RED AND BLACK IS/ARE CLAIMED AS A FEATURE OF THE MARK.

THE MARK CONSISTS OF THE TERM "CONNECT" PRIMARILY IN BLACK, EXCEPT FOR THE "O" BEING THE COLOR RED WHICH IS THEN BISECTED BY A BLACK LINE.

SER. NO. 79-044,439, FILED 9-14-2007.

JOHN DALIER, EXAMINING ATTORNEY

Int. Cl.: 9

Prior U.S. Cls.: 21, 23, 26, 36 and 38

United States Patent and Trademark Office

Reg. No. 3,485,271

Registered Aug. 12, 2008

**TRADEMARK
PRINCIPAL REGISTER**

NAGRALAM

KUDELSKI SA (SWITZERLAND SOCIÉTÉ
ANONYME)
ROUTE DE GENÈVE 22
CH-1033 CHESEAUX
SWITZERLAND

FOR: ELECTRONIC APPARATUS, DEVICES AND
CIRCUITS, NAMELY ELECTRONIC CHIP AND
MICROPROCESSORS AND THEIR CARRIERS;
ELECTRONIC APPARATUS AND DEVICES FOR
SITE ACCESS CONTROL OR FOR PUBLIC OR
PRIVATE ACCESS SERVICES; CHIP CARDS FOR
COMPUTERS, MICROPROCESSOR CARDS FOR
COMPUTERS; ELECTRONIC SECURITY MOD-
ULES AND CARDS, ELECTRONIC IDENTIFICA-
TION MODULES AND CARDS, ELECTRONIC
AUTHENTICATION CARDS FOR EXCHANGING
AND STORING DATA; ELECTRONIC LABELS;
READERS FOR ELECTRONIC CARDS OR MOD-
ULES, IN CLASS 9 (U.S. CLS. 21, 23, 26, 36 AND 38).

THE MARK CONSISTS OF STANDARD CHAR-
ACTERS WITHOUT CLAIM TO ANY PARTICULAR
FONT, STYLE, SIZE, OR COLOR.

PRIORITY DATE OF 3-21-2007 IS CLAIMED.

OWNER OF INTERNATIONAL REGISTRATION
0938996 DATED 9-20-2007, EXPIRES 9-20-2017.

OWNER OF U.S. REG. NOS. 3,042,059 AND
3,107,071.

SER. NO. 79-044,441, FILED 9-20-2007.

ZACHARY BELLO, EXAMINING ATTORNEY

Int. Cl.: 9

Prior U.S. Cls.: 21, 23, 26, 36 and 38

United States Patent and Trademark Office

Reg. No. 3,485,272

Registered Aug. 12, 2008

**TRADEMARK
PRINCIPAL REGISTER**

NAGRAPRINT

KUDELSKI SA (SWITZERLAND SOCIÉTÉ
ANONYME)
ROUTE DE GENÈVE 22
CH-1033 CHESEAUX
SWITZERLAND

FOR: ELECTRONIC APPARATUS, DEVICES AND
CIRCUITS, NAMELY ELECTRONIC CHIP AND
MICROPROCESSORS AND THEIR CARRIERS;
ELECTRONIC APPARATUS AND DEVICES FOR
SITE ACCESS CONTROL OR FOR PUBLIC OR
PRIVATE ACCESS SERVICES; CHIP CARDS FOR
COMPUTERS, MICROPROCESSOR CARDS FOR
COMPUTERS; ELECTRONIC SECURITY MOD-
ULES AND CARDS, ELECTRONIC IDENTIFICA-
TION MODULES AND CARDS, ELECTRONIC
AUTHENTICATION CARDS FOR EXCHANGING
AND STORING DATA; ELECTRONIC LABELS;
READERS FOR ELECTRONIC CARDS OR MOD-
ULES, IN CLASS 9 (U.S. CLS. 21, 23, 26, 36 AND 38).

THE MARK CONSISTS OF STANDARD CHAR-
ACTERS WITHOUT CLAIM TO ANY PARTICULAR
FONT, STYLE, SIZE, OR COLOR.

PRIORITY DATE OF 3-21-2007 IS CLAIMED.

OWNER OF INTERNATIONAL REGISTRATION
0938997 DATED 9-20-2007, EXPIRES 9-20-2017.

OWNER OF U.S. REG. NOS. 3,042,059 AND
3,107,071.

SER. NO. 79-044,442, FILED 9-20-2007.

ZACHARY BELLO, EXAMINING ATTORNEY

Int. Cl.: 36

Prior U.S. Cls.: 100, 101 and 102

United States Patent and Trademark Office

Reg. No. 3,485,273

Registered Aug. 12, 2008

**SERVICE MARK
PRINCIPAL REGISTER**

QUESTIM

UWE BLÜHER (FED REP GERMANY INDIVIDUAL)
HÖHENWEG 30
82541 MÜNSING
FED REP GERMANY

FOR: PROVIDING REAL ESTATE SERVICES, NAMELY, MULTIPLE LISTING AND SEARCH SERVICES FEATURING REAL ESTATE PROPERTY PHOTOGRAPHS, SLIDESHOWS, VIDEOS, DESCRIPTIONS, NEWS, COMMENTARY, BUYING GUIDES, STATISTICS, TRENDS AND REPORTS; PROVIDING FINANCIAL SERVICES AND ADVISORY IN THE FIELD OF REAL ESTATE, NAMELY, MONEY LENDING, FINANCIAL ANALYSIS, INVESTMENT, RESEARCH SERVICES, CONSULTANCY SERVICES, IN CLASS 36 (U.S. CLS. 100, 101 AND 102).

THE MARK CONSISTS OF STANDARD CHARACTERS WITHOUT CLAIM TO ANY PARTICULAR FONT, STYLE, SIZE, OR COLOR.

PRIORITY DATE OF 3-8-2007 IS CLAIMED.

OWNER OF INTERNATIONAL REGISTRATION 0939161 DATED 9-7-2007, EXPIRES 9-7-2017.

SER. NO. 79-044,501, FILED 9-7-2007.

DAVID HOFFMAN, EXAMINING ATTORNEY

Int. Cls.: 16, 18 and 25

Prior U.S. Cls.: 1, 2, 3, 5, 22, 23, 29, 37, 38, 39, 41 and 50

Reg. No. 3,485,274

United States Patent and Trademark Office

Registered Aug. 12, 2008

TRADEMARK
PRINCIPAL REGISTER



BRUNEAU VALÉRIE ALBERTE JACQUELINE
(FRANCE INDIVIDUAL)
25 RUE ALBERT DE MUN
F-94100 SAINT MAUR
FRANCE

FOR: UNPROCESSED, SEMI-PROCESSED, STATIONERY USE AND PRINTER PAPER; UNPROCESSED, SEMI-PROCESSED, STATIONERY USE AND PRINTER CARDBOARD; CARDBOARD ARTICLES, NAMELY, CARDBOARD CONTAINERS, CARDBOARD CARTONS AND CARDBOARD BOXES; CARDBOARD STORAGE BOXES; PRINTED MATTER, NAMELY, BOOKS, MANUALS, PAMPHLETS, AND PERIODICAL REVIEWS IN THE FIELD OF MECHANICAL SPORTS AND VEHICLE RACES; WRAPPING PAPER; PAPER AND PLASTIC BAGS FOR PACKAGING; PAPER SHEETS FOR PACKAGING; PAPER SEALS IN THE NATURE OF DRAWING SHIELDS; PAPER AND CARDBOARD SIGNBOARDS; NON-TEXTILE LABELS, NAMELY, ADDRESS LABELS, PAPER NAME LABELS; PAPER PENNANTS; POSTERS; POSTCARDS, LETTER PAPER, BUSINESS CARDS; PAMPHLETS IN THE FIELD OF MECHANICAL SPORTS AND VEHICLE RACES; IRON-ON TRANSFERS; GRAPHIC ART PRINTS; ENGRAVINGS; PICTURES; PHOTOENGRAVINGS; PRINTING BLOCKS; WRITING PAPER PADS; PRINTED PROSPECTUSES IN THE FIELD OF MECHANICAL SPORTS AND VEHICLE RACES; PRINTED PUBLICATIONS, NAMELY, REVIEWS AND PERIODICALS IN THE FIELD OF MECHANICAL SPORTS AND VEHICLE RACES; NEWSPAPERS; CALENDARS; AGENDA DESKTOP ORGANIZERS; BOOKS IN THE FIELD OF MECHANICAL SPORTS AND VEHICLE RACES; SCRAPBOOKS; STATIONERY; SELF ADHESIVE PAPER GIFT WRAPPING RIBBONS AND STRIPS OF FANCY PAPER FOR STATIONERY PURPOSES; OFFICE REQUISITES EXCEPT FURNITURE,

NAMELY, PAPER HOLE PUNCHES, WRITING INSTRUMENTS, RUBBER ERASERS; PENS, PENCIL HOLDERS, BALL-POINT PENS AND PEN CASES AND OTHER WRITING INSTRUMENTS; DRAWING MATERIALS FOR BLACKBOARDS; SCHOOL SUPPLIES, NAMELY, WRITING INSTRUMENTS, RUBBER ERASERS, UNGRADUATED RULERS, DRAWING RULERS, DRAFTING RULERS, PAPER HOLE PUNCHES, PEN CASES, PENCIL HOLDERS; WASTE PAPER BASKETS; ENVELOPES FOR STATIONERY USE; RUBBER ERASERS, IN CLASS 16 (U.S. CLS. 2, 5, 22, 23, 29, 37, 38 AND 50).

FOR: TRUNKS AND SUITCASES; UMBRELLAS; PARASOLS AND WALKING STICKS; HANDBAGS, TRAVELING BAGS AND SCHOOL BAGS; RUCKSACKS; CARD WALLETS, PURSES NOT OF PRECIOUS METAL, KEY CASES, ATTACHÉ CASES, IN CLASS 18 (U.S. CLS. 1, 2, 3, 22 AND 41).

FOR: CLOTHING, NAMELY, JACKETS, PARKAS, SHIRTS, COMBINATIONS, WATERPROOF JACKETS AND PANTS, WAISTCOATS, SCARVES, SASHES FOR WEAR, GLOVES, TEE-SHIRTS, PULLOVERS, SWEATERS; FOOTWEAR EXCEPT ORTHOPEDIC FOOTWEAR; HEADGEAR, NAMELY, HATS, CAPS, IN CLASS 25 (U.S. CLS. 22 AND 39).

OWNER OF INTERNATIONAL REGISTRATION
0939173 DATED 6-11-2007, EXPIRES 6-11-2017.

THE WORDING "RACINGER" HAS NO MEANING IN A FOREIGN LANGUAGE.

SER. NO. 79-044,505, FILED 6-11-2007.

COLLEEN DOMBROW, EXAMINING ATTORNEY

Int. Cls.: 41 and 42

Prior U.S. Cls.: 100, 101 and 107

United States Patent and Trademark Office

Reg. No. 3,485,275

Registered Aug. 12, 2008

**SERVICE MARK
PRINCIPAL REGISTER**

DIAL

DEUTSCHES INSTITUT FÜR ANGEWANDTE
LICHTTECHNIK; GMBH (FED REP GERMA-
NY GMBH)
GUSTAV-ADOLF-STR. 4
58507 LÜDENSCHIED
FED REP GERMANY

FOR: FURTHER TRAINING INITIATIVES IN
THE FIELD OF SOFTWARE FOR LIGHTING EN-
GINEERING AND FOR ELECTROTECHNICAL
AND ELECTRONIC BUILDING INSTALLATION
TECHNOLOGY, IN CLASS 41 (U.S. CLS. 100, 101
AND 107).

FOR: RESEARCH, DEVELOPMENT AND CREAT-
ING OF SOFTWARE IN THE FIELD OF LIGHTING

ENGINEERING AND ELECTROTECHNICAL AND
ELECTRONIC BUILDING INSTALLATION TECH-
NOLOGY, IN CLASS 42 (U.S. CLS. 100 AND 101).

OWNER OF INTERNATIONAL REGISTRATION
0939716 DATED 8-30-2007, EXPIRES 8-30-2017.

OWNER OF U.S. REG. NO. 3,057,962.

SER. NO. 79-044,641, FILED 8-30-2007.

LAURIE KAUFMAN, EXAMINING ATTORNEY

Int. Cls.: 9, 12, 14, 16, 18, 20, 21, 24, 25, 28, 29, 30, 35 and 41

Prior U.S. Cls.: 1, 2, 3, 5, 13, 19, 21, 22, 23, 25, 26, 27, 28, 29, 30, 31, 32, 33, 35, 36, 37, 38, 39, 40, 41, 42, 44, 46, 50, 100, 101, 102 and 107

Reg. No. 3,485,276

United States Patent and Trademark Office

Registered Aug. 12, 2008

**TRADEMARK
SERVICE MARK
PRINCIPAL REGISTER**

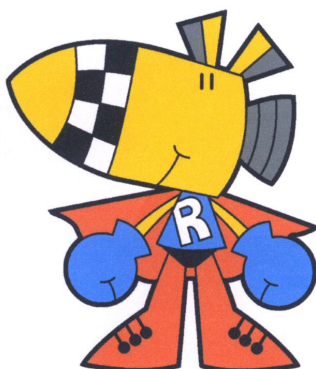

IMAGESTONE INC. (REPUBLIC OF KOREA LIMITED COMPANY)
SUITE 907,
E&C VENTURE DREAM TOWER 6.; 197-28, GURO-DONG, GURO-GU; SEOUL
REPUBLIC OF KOREA

FOR: AMUSEMENT APPARATUS ADAPTED FOR USE WITH TELEVISION RECEIVERS ONLY; DVDS FEATURING RECORDED ANIMATED CARTOONS; RADIOS INCORPORATING CLOCKS; COMPACT DISC PLAYERS (CDP), COMPUTER KEYBOARDS, DIGITAL VERSATILE DISC (DVD) PLAYERS; BATTERIES, NAMELY, DRY CELLS, DUST MASKS, DOWNLOADABLE MUSIC VIA THE INTERNET AND WIRELESS DEVICES; DOWNLOADABLE ELECTRONIC PUBLICATIONS IN THE NATURE OF STUDY BOOKS IN THE FIELD OF GENERAL EDUCATION SUBJECT MATTERS, NAMELY, READING, SPELLING, MATHEMATICS, SOCIAL SCIENCE, SCIENCE, HISTORY, LANGUAGE ART; ELECTRONIC VENDING MACHINES, EYEGLOSS CASES, EYEGASSES, GOGGLES FOR SPORTS, HEADPHONES; COMPUTER PERIPHERALS, NAMELY, JUKE BOXES; MUSICAL JUKE BOXES; DECORATIVE MAGNETS; COMPUTER MOUSE; MOUSE PADS; MP3 PLAYERS; PORTABLE TELECOMMUNICATIONS APPARATUS, NAMELY WIRELESS TELEPHONES; PROTECTIVE HELMETS, PROTECTIVE HELMETS FOR SPORTS; PROTECTIVE FACE MASKS NOT FOR MEDICAL PURPOSES; AUDIO-VIDEO RECEI-

VERS RECORDED COMPACT DISCS FEATURING MUSIC; RECORDED VIDEOTAPE FEATURING MUSIC AND ANIMATED CARTOONS; SUNGLASSES, SWIMMING GOGGLES, TELEPHONE, VIDEO GAME CARTRIDGES, BLANK VIDEOTAPES, WALKIE-TALKIES, WRIST RESTS FOR USE WITH COMPUTERS, CARD READERS FOR CREDIT CARDS; WIND INDICATORS NOT OF METAL, IN CLASS 9 (U.S. CLS. 21, 23, 26, 36 AND 38).

FOR: TRICYCLES FOR CHILDREN, IN CLASS 12 (U.S. CLS. 19, 21, 23, 31, 35 AND 44).

FOR: ALARM CLOCKS, AMULETS BEING JEWELRY; ANKLETS BEING JEWELRY; BADGES OF PRECIOUS METAL, BELT ORNAMENTS OF PRECIOUS METALS; BRACELETS BEING JEWELRY; BROOCHES BEING JEWELRY; BELT BUCKLES OF PRECIOUS METAL; CABARETS BEING TRAYS OF PRECIOUS METAL; CHARMS BEING JEWELRY; CLOCKS AND WATCHES; TEACUPS OF PRECIOUS METALS, COMMEMORATIVE CUPS OF PRECIOUS METALS, COMMEMORATIVE TABLETS OF PRECIOUS METALS, CUFFLINKS, CUPS OF PRECIOUS METAL; DIALS FOR CLOCK AND WATCH-MAKING; DISHES OF PRECIOUS METAL; EARRINGS; HAT ORNAMENTS OF PRECIOUS METAL; KEY RINGS OF PRECIOUS METAL BEING TRINKETS AND FOBS; MEDALS; NECKLACES BEING JEWELRY; ORNAMENTAL PINS; TIE PINS; PINS BEING JEWELRY; SAUCERS OF PRECIOUS METAL; SUN-DIALS; TABLE CLOCKS; TIE CLIPS; WALL

CLOCKS; WATCH CASES; WATCH GLASSES; WATCH STRAPS; WRISTWATCHES; POCKET WATCHES; JEWELRY CASES BEING JEWELRY CASKETS, IN CLASS 14 (U.S. CLS. 2, 27, 28 AND 50).

FOR: ADHESIVE TAPES FOR STATIONERY PURPOSES; ADVERTISEMENT BOARDS OF PAPER OR CARDBOARD; PHOTOGRAPH ALBUMS; ARTISTS' WATERCOLOR SAUCERS; BABIES' DIAPERS OF PAPER AND CELLULOSE; BALL POINT PENS; BOOKS FOR USE IN THE TEACHING OF MUSIC; BOXES FOR PENS; BOXES MADE OF PAPER, BROMIDE PHOTOGRAPHS; CALENDARS; CATALOGUES IN THE FIELD OF COMIC BOOKS AND ANIMATED CHARACTERS; CHARCOAL PENCILS; COMIC BOOKS; CORRUGATED CARDBOARD BOXES; NON-ELECTRIC CREDIT CARD IMPRINTER; DIARIES; DOCUMENT FILES BEING STATIONERY; ENVELOPES BEING STATIONERY; FACE TOWELS OF PAPER; FELT PENS FOR WRITING; FLAGS OF PAPER; FLOWER-POT COVERS OF PAPER; PRINTED FORMS; FOUNTAIN PENS; GLUE FOR STATIONERY PURPOSE; GREETING CARDS; GUMS BEING ADHESIVES FOR STATIONERY PURPOSES; HANDBOOKS BEING MANUALS IN THE FIELD OF COMIC BOOK ILLUSTRATION; HANDKERCHIEFS OF PAPER; PAPER AND CARDBOARD INSECT COLLECTORS' BOXES; PAPER LABELS; LETTER STANDS; MAGAZINES IN THE FIELD OF COMIC BOOKS, ANIMATIONS, CARTOONS AND ANIMATED CHARACTERS; MATERIALS FOR MAKING STAMPS AND SEALS, NAMELY, STAMP PADS; PAPER AND CARDBOARD MATS FOR BEER GLASSES; MODELING PASTE FOR HANDICRAFT, STATIONERY OR HOUSEHOLD PURPOSES; ANATOMICAL MODELS FOR SCIENTIFIC, INSTRUCTIONAL, AND EDUCATIONAL PURPOSES; MUSICAL GREETING CARDS; TABLE NAPKINS OF PAPER; NEWSLETTERS IN THE FIELD OF COMICS, ANIMATIONS AND CARTOONS; PEN NIBS; NOTE BOOKS; PLASTIC BAGS FOR MERCHANDISE PACKAGING BEING POUCHES AND ENVELOPES; ARTS AND CRAFT PAINT KITS FOR SCHOOL USE; PAINTBRUSHES; PALETTES FOR PAINTERS; PAMPHLETS IN THE FIELD PAINTING, COMIC BOOK ILLUSTRATION AND CARTOON CHARACTERS; PAPER KNIVES; PAPER-CLIPS; PASTEL CRAYONS; PEN CASES; PENCIL HOLDERS; PENCIL SHARPENERS; PENCILS; PENHOLDERS; PENNANTS OF PAPER; PENS; PRINTED PERIODICALS IN THE FIELD OF ART, ANIMATION, COMIC BOOK ILLUSTRATION; PHOTOGRAPH STANDS; PICTURES; PLACARDS OF PAPER OR CARDBOARD; PLACE MATS OF PAPER; POCKET NOTEBOOKS; POSTAGE STAMPS; POSTCARD PAPER; POSTCARDS; POSTERS; RUBBER ERASERS; SCRAPBOOKS; SHARP PENCILS; SIGNBOARDS OF PAPER OR CARDBOARD; SONG BOOKS; STAMPS BEING SEALS; STANDS FOR PENS AND PENCILS; STARCH BASE BEING ADHESIVE FOR STATIONERY OR HOUSEHOLD PURPOSES; STICKERS BEING STATIONERY; PRINTED TEACHING BOOKS BEING STUDY BOOKS IN THE FIELD OF GENERAL EDUCATION SUBJECTS, NAMELY, ART, HISTORY, MATH, SCIENCE, LANGUAGE ART; TABLE LINEN OF PAPER; TABLE MATS OF

PAPER; PRE-PAID TELEPHONE CARDS NOT MAGNETICALLY ENCODED; PRINTED TICKETS; TISSUES OF PAPER REMOVING MAKE-UP; TOILET PAPER; TOWELS OF PAPER; WET TOWELS OF PAPER, NAMELY, PAPER TOWELS CAPABLE OF BEING USED WET; WRAPPING PAPER; WRISTBANDS FOR THE RETENTION OF WRITING INSTRUMENTS; WRITING CASES CONTAINING SETS OF WRITING INSTRUMENTS; WRITING AND DRAWING BOOKS; WRITING PADS, CARD CASES FOR BUSINESS CARDS, IN CLASS 16 (U.S. CLS. 2, 5, 22, 23, 29, 37, 38 AND 50).

FOR: BACKPACKS; LEATHER BAGS FOR MERCHANDISE PACKAGING IN THE NATURE OF ENVELOPES AND POUCHES; BEACH BAGS; BEACH UMBRELLAS IN THE NATURE OF BEACH PARASOLS; LEATHER BOXES FOR STORING GREETING CARDS; HAT BOXES FOR TRAVEL AND UTILITY BOXES FOR STORING SMALL ITEMS MADE OF LEATHER AND MADE OF VULCANIZED FIBER; CLOTHING FOR PETS, DIAPER BAGS, DOG COLLARS, KEY CASES OF LEATHER; LEATHER STRAPS, NOSE BAGS BEING FEED BAGS FOR ANIMALS; PAPER UMBRELLAS; PARASOLS; PURSES NOT OF PRECIOUS METAL; SCHOOL BAGS; TRAVELING BAGS; TRAVELING TRUNKS; UMBRELLA COVERS; UMBRELLA HANDLES; UMBRELLAS; UNFITTED VANITY CASES, IN CLASS 18 (U.S. CLS. 1, 2, 3, 22 AND 41).

FOR: KOREAN CUSHIONS FOR SITTING ON (BANGSUK); BEDS; BLINDS OF RATTAN OR BAMBOO; BOOK RESTS BEING FURNITURE; BOOKSTANDS; BOTTLE CAPS OF WOOD OR PLASTICS; BOTTLE STOPPERS OF WOOD OR PLASTICS; BOXES OF WOOD OR PLASTIC; CHAIRS; CLOTHES HANGERS; CONTAINERS FOR AROMATICS NOT OF METAL NOR OF MASONRY SOLD EMPTY; CONTAINERS FOR STOCK FEED NOT OF METAL NOR OF MASONRY SOLD EMPTY; WARDROBES; CRADLES; CURTAIN HOOKS; CURTAIN RAILS; CURTAIN RINGS; CURTAIN RODS; CURTAIN ROLLERS; CUSHIONS; DESKS; DOG KENNELS; DRESSING TABLES; DRINKING STRAWS; NON-ELECTRIC FANS FOR PERSONAL USE; FLOWER-POT PEDESTALS; INDOOR WINDOW BLINDS; INFANTS' WALKERS; INFLATABLE PUBLICITY OBJECTS; KENNELS FOR HOUSEHOLD PETS; PLASTIC KEY CARDS NOT ENCODED; LIDS OF WOOD OR PLASTICS FOR PACKING; MANNEQUINS; MATTRESSES; MIRROR TILES; NON-PORTABLE MIRRORS; PET CUSHIONS; PICTURE FRAMES; MOLDINGS FOR PICTURE FRAMES; PILLOWS; WOOD PINWHEELS FOR GARDEN DECORATION; PLACARDS OF WOOD OR PLASTICS; PLAYPENS FOR BABIES; SEALING CAPS OF WOOD OR PLASTICS; SCULPTURES MADE OF PLASTER; SCULPTURES MADE OF PLASTIC; SCULPTURES MADE OF WAX; SCULPTURES MADE OF WOOD; SHOWCASES BEING FURNITURE; SIGNBOARDS OF WOOD OR PLASTICS; SLATTED INDOOR BLINDS; SLEEPING BAGS FOR CAMPING; STOPPERS OF WOOD OR PLASTICS FOR PACKING; TABLES; TENT PEGS NOT OF METAL; WIND CHIMES FOR USE AS DECORATION; WOVEN TIMBER BLINDS BEING FURNI-

TURE; DINNER TABLES; UMBRELLA STANDS; SLEEPING MATS, IN CLASS 20 (U.S. CLS. 2, 13, 22, 25, 32 AND 50).

FOR: ABRASIVE SPONGES FOR SCRUBBING THE SKIN; AMPULE BOTTLES SOLD EMPTY; PORTABLE BABY BATH TUBS; BASINS BEING BOWLS; BOTTLE GOURDS; BOTTLE OPENERS; BOTTLES SOLD EMPTY FOR BEVERAGES, COSMETICS, FOODS AND MEDICINES; BROOMS; BRUSHES FOR CLEANING TANKS AND CONTAINERS; BRUSHES FOR COSMETICS; BUCKETS; PERFUME BURNERS; CABARETS BEING TRAYS NOT OF PRECIOUS METAL; CAGES FOR HOUSEHOLD PETS; CAKE MOLDS; CARBOYS, NAMELY, BOTTLES SOLD EMPTY; CARPET BEATERS BEING HAND INSTRUMENTS; CASSEROLE POTS AND PANS; CHAMBER POTS; CHOPSTICKS; CLOTH RAGS FOR CLEANING; CLOTHES DRYING RACKS; CLOTHES-PINS; NON-ELECTRIC COFFEE-POTS NOT OF PRECIOUS METAL; NON-ELECTRIC PORTABLE COLDBOXES; COMB CASES, COMBS; MANICURE SET CASES SOLD EMPTY; CUPS OF PAPER OR PLASTIC; CUTTING BOARDS FOR THE KITCHEN; DECANTERS; DISHES NOT OF PRECIOUS METAL; DISHWASHING BRUSHES; DRYING RACKS FOR WASHING; DUSTPANS; EYEBROW BRUSHES; FLOSS FOR DENTAL PURPOSES; FLOWER POTS; FLOWER-POT COVERS NOT OF PAPER; FURNITURE DUSTERS; HAIR BRUSHES; KITCHEN CONTAINERS NOT OF PRECIOUS METAL; KOREAN RICE BOWLS NOT OF PRECIOUS METAL; LAMP-GLASS BRUSHES; POT LIDS OF GLASS OR PORCELAIN; LUNCH BOXES; NON-ELECTRIC APPLIANCES FOR REMOVING MAKE-UP, NAMELY, MAKE-UP BRUSHES AND SPONGES; DRIP MATS FOR TEACUPS NOT OF PRECIOUS METAL; MESS-TINS; MIXING SPOONS BEING KITCHEN UTENSILS; MOPS; MUGS NOT OF PRECIOUS METAL; NAIL BRUSHES; NAPKIN RINGS NOT OF PRECIOUS METAL; PADS FOR CLEANING; PANS; PAPER PLATES; PERFUME SPRAYERS; PIGGY BANKS NOT OF METAL; PITCHERS NOT OF PRECIOUS METAL; PLASTIC BOTTLES SOLD EMPTY; PLUNGERS FOR CLEARING BLOCKED DRAINS; POPCORN PANS; POWDER COMPACTS NOT OF PRECIOUS METAL; POWDER PUFFS; RAGS OF CLOTH FOR CLEANING GLASS; SAUCERS NOT OF PRECIOUS METAL; HOUSEHOLD SCRAPERS FOR CLEANING PURPOSES; SCRUBBING BRUSHES; SCULPTURES MADE OF GLASS; SEALING CAPS OF GLASS OR PORCELAIN; SHAVING BRUSH STANDS; SHAVING BRUSHES; SIGNBOARDS OF PORCELAIN OR GLASS; SOAP BOXES; SOAP DISPENSERS; SOUP BOWLS NOT OF PRECIOUS METAL; SPATULAS BEING KITCHEN UTENSILS; SPONGES FOR COSMETICS; STATUES OF PORCELAIN, TERRA-COTTA OR GLASS; STEEL WOOL FOR CLEANING; GLASS STOPPERS; STOPPERS OF GLASS OR PORCELAIN FOR PACKAGING; TEACUPS NOT OF PRECIOUS METAL; TOILET PAPER HOLDERS; TOOTHBRUSH CASES; TOOTHBRUSHES; ELECTRIC TOOTHBRUSHES; TRASH CANS; FITTED VANITY CASES; VASES NOT OF PRECIOUS METAL; NON-ELECTRIC WAFFLE IRONS; WASH BASINS BEING RECEPTACLES; WASHING BOARDS; WASHTUBS;

WATER APPARATUS FOR CLEANING TEETH AND GUMS; GARDEN HOSE SPRAYERS FOR WATERING; WATERING CANS FOR FLOWER-POTS; WHISK BROOM; MEMORIAL CUPS NOT OF METAL, IN CLASS 21 (U.S. CLS. 2, 13, 23, 29, 30, 33, 40 AND 50).

FOR: BAND FABRICS OF TEXTILE MATERIALS; BED BLANKETS; BED COVERS, NAMELY, BED-SPREAD, COVERLETS, BED PADS, BED SKIRTS, BED SHEETS; CLOTHS FOR COVERING DESKS, NAMELY, TABLE CLOTH; UNFITTED FABRIC COVERS FOR PIANOS; COVERS FOR CUSHIONS; UNFITTED FABRIC COVERS FOR TELEVISIONS; CURTAINS OF TEXTILE AND PLASTIC; DUVET COVERS; DUVETS; COTTON, SILK, LINEN, NYLON, POLYESTER FABRICS MADE WITH RIBBONS; FITTED FABRIC TOILET LID COVERS; FABRIC FLAGS; HANDKERCHIEFS OF TEXTILE; CLOTH LABELS; LEATHER CLOTH FOR USE IN THE MANUFACTURE OF TABLECLOTHS; MATTRESS COVERS; MOSQUITO NETS; OILCLOTH FOR USE AS TABLECLOTHS; PENNANTS OF TEXTILE; PILLOWCASES; PLACE MATS NOT OF PAPER; QUILTS; QUILT FOR LITTLE CHILDREN; RUBBERIZED CLOTH; SCROLLS OF TEXTILE FOR USE AS WALL HANGINGS; SHOWER CURTAINS; SHOWER CURTAINS OF TEXTILE AND PLASTIC; SINGLE-LAYER QUILT FOR SLEEPING MATS; BED SHEETS IN THE NATURE OF SLEEPING BAGS; TEXTILE TABLE CLOTHS; FABRIC TABLE RUNNERS; TABLE CLOTHS NOT OF PAPER; TABLE LINEN NOT OF PAPER; TABLE MATS NOT OF PAPER; TOWELS OF TEXTILE; TRACED CLOTHS FOR EMBROIDERY; VINYL COATED CLOTH FOR TEXTILE USE, FOR USE IN THE MANUFACTURE OF TABLECLOTHS; WALL HANGINGS OF TEXTILE, IN CLASS 24 (U.S. CLS. 42 AND 50).

FOR: BABIES' DIAPERS OF TEXTILE; BASKETBALL SHOES; BATH ROBES; BATH SANDALS; BATH SLIPPERS; BATHING CAPS FOR SWIMMING; BATHING TRUNKS; BEACH SHOES; BELTS; BLUE JEANS; BOOTS; BOOTS FOR PROTECTION AGAINST COLD WEATHER CONDITIONS; BRACES FOR CLOTHING, NAMELY, SUSPENDERS; CAPS; EAR MUFFS; GLOVES FOR PROTECTION AGAINST COLD WEATHER CONDITIONS; GOLF SHOES; JACKETS; JUMPERS; KNEE-LENGTH TROUSERS; MANTLES; MASQUERADE COSTUMES; MITTENS; MOUNTAINEERING BOOTS; MUFFLERS; NECKTIES; SUITS; DRESSES; PAJAMAS; NIGHTWEAR; PARKAS; POLO SHIRTS; RAIN BOOTS; RAINCOATS; SANDALS; SCARVES; SHIRTS; SHOES; SHOES MADE OF VINYL; SKI BOOTS; SKIRTS; SLIPPERS; SOCKS; SPORTS SHOES; SWIMSUITS; TANK TOPS; T-SHIRTS; TIGHTS; UNIFORMS; SKI GLOVES; CHILDREN'S CLOTHING, NAMELY, CHILDREN'S PANTS, SHIRTS, JACKETS, SWEATERS, CHILDREN'S FOOTWEAR AND CHILDREN'S HEADWEAR; INFANTS' CLOTHING, NAMELY, INFANT SLEEPERS, INFANT WEAR, INFANTS CLOTH BIBS, INFANT AND TODDLER ONE PIECE CLOTHING, INFANT'S SHOES AND BOOTS, INFANT'S TROUSERS, IN CLASS 25 (U.S. CLS. 22 AND 39).

FOR: AUTOMATIC ARCADE-TYPE ELECTRONIC VIDEO GAMES, STAND ALONE VIDEO GAME MACHINES OTHER THAN THOSE ADAPTED FOR USE WITH TELEVISION RECEIVERS ONLY; AMUSEMENT PARK RIDES; APPARATUS AND DEVICES FOR AMUSEMENT PARKS, NAMELY, SLEDS FOR USE IN DOWNHILL AMUSEMENT RIDES, ROLLER-COASTERS, ARCADE GAMES; BACKGAMMON GAMES; BAGS ESPECIALLY DESIGNED FOR SKIS AND SURFBOARDS; BARBELLS; BILLIARD BALLS; BILLIARD CUE TIPS; BILLIARD CUES; BILLIARD MARKERS; BILLIARD TABLE CUSHIONS; BILLIARD TABLES; BINGO CARDS; TOY BUILDING BLOCKS; BOARD GAMES; BODY BOARDS; CHALK FOR BILLIARD CUES; CHECKERBOARDS; CHECKERS; CHESS GAMES; CHESSBOARDS; CONFETTI; CONJURING APPARATUS, NAMELY, MAGIC TRICKS; COSAQUES BEING TOY FIREWORKS; CUPS FOR DICE; DARTS; DICE; DOLLS' BEDS; DOLLS' CLOTHES; DOLLS' FEEDING BOTTLES; DOLLS' HOUSES; DOLLS' ROOMS; DOMINOES; FLYING DISCS; GAME PIECES OR APPARATUS MADE WITH DIAMONDS, NAMELY, CHESS PIECES; GOLF BAGS, WITH OR WITHOUT WHEELS; GOLF BALLS; GOLF GLOVES; HORSESHOE GAMES; JIGSAW PUZZLES; KALEIDOSCOPES; KITE REELS; KITES; KNEE GUARDS FOR ATHLETIC USE; KOREAN CHECKER BOARDS KNOWN AS "BADUK BOARDS;" KOREAN CHECKER BOARDS KNOWN AS "BADUK STINES;" KOREAN CHESS PIECES KNOWN AS "JANGGI BOARDS;" KOREAN CHESS PIECES KNOWN AS "JANGGI PIECES;" MAH-JONG GAMES; MARBLES FOR GAMES; MARIONETTE PUPPETS; MASCOT DOLLS; TOY MOBILES; MUSICAL TOYS; PACHINKO MACHINES; PAPER TOYS, NAMELY, PAPER AIRPLANES, PAPER DOLLS; PINATAS; PLASTIC TOYS, NAMELY, MODELED PLASTIC TOY FIGURINES, PLASTIC CHARACTER TOYS, PLASTIC TOY HOOPS, PLASTIC CAR AND TRUCKS; PLAY BALLOONS; PLAYING BALLS, NAMELY, BEACH BALLS, SPORT BALLS, PLAYGROUND BALLS; PLAYING CARDS; PLUSH TOYS; PRACTICAL JOKES TOYS, NAMELY, FALSE TEETH, FAKE WARMS AND SNAKES, FAKE HANDS; PREFABRICATED PLAY SWIMMING POOLS; PUNCHING-BALLS; PUPPETS; QUILTS; RACKET COVERS; RACKETS; BABY RATTLES; REMOTE CONTROLLED AMUSEMENT APPARATUS, NAMELY, REMOTE CONTROL BOATS AND AIRPLANES; REMOTE CONTROLLED TOY VEHICLES; RING GAMES; ROCKING HORSES; ROLLER SKATES; ROULETTE WHEELS; ROWING MACHINES FOR PHYSICAL EXERCISE; RUBBER TOYS, NAMELY, RUBBER CHARACTER TOYS, RUBBER BALLS; RUNNING MACHINES, NAMELY, POWERED TREADMILLS; SCALE MODEL VEHICLES FOR CHILDREN; TOY SCOOTERS; SEESAWS; SKATEBOARDS; SKIPPING ROPES; PLAYGROUND SLIDES; TOY SLOT MACHINES; SOCCER BALLS; SPINNING TOPS; STATIONARY EXERCISE BICYCLES; PLAYGROUND SWINGS, BABY SWINGS; TEDDY BEARS; TOY MASKS; TOY PISTOLS; TOY SETS, NAMELY, TOY CONSTRUCTION SETS, TOY MODEL TRAIN SETS; TOYS FOR DOMESTIC PETS; TOYS MADE OF METALS, NAMELY, CLOCKWORK TOYS OF METAL,

HORSESHOES FOR RECREATIONAL PURPOSES, ACTIONS FIGURES MADE OF METALS, CARS, TRAINS, TRUCKS MADE OF METAL; TRAMPOLINES; WOODEN TOYS, NAMELY, WOODEN TOY TRAINS, WOODEN TOY BUILDING BLOCKS, IN CLASS 28 (U.S. CLS. 22, 23, 38 AND 50).

FOR: BUTTER; CANDIED FRUITS AND VEGETABLES; SOUPS CONTAINING CEREAL PREPARATIONS; CHEESE; CHOCOLATE NUT BUTTER; COCOA BUTTER FOR FOOD PURPOSES; COCONUT BUTTER; CRANBERRY SAUCE; FRUIT JELLIES; CANNED FRUITS; HAM; LACTIC ACID DRINKS; MARGARINE; CANNED COOKED MEAT; MILK; PEANUT BUTTER; PORK CUTLETS; POTATO CHIPS; SAUSAGES; SOYA MILK FOR FOOD; CANNED VEGETABLES; YOGURT; SAUSAGES MADE OF GRAINS; YOGURT BASED DRINKS BEING LACTIC ACID BACTERIA DRINKS, IN CLASS 29 (U.S. CL. 46).

FOR: ALMOND CONFECTIONERY, NAMELY, CANDY COVERED ALMONDS, SUGAR-COATED ALMONDS; BARS OF SWEET JELLIED BEAN PASTE; BAVAROIS; BISCUITS; BONBONS; BREAD; BREAD ROLLS; BREADCRUMBS; BUNS FILLED WITH CREAM; BUNS FILLED WITH SWEET BEAN PASTE; JAM BUNS; CAKE PASTE, NAMELY, CHOCOLATE PASTE, FRUIT PASTE FOR FLAVORING OF FOOD; CAKES; EDIBLE DECORATIONS FOR CAKES; CANDY; CANDY FOR FOOD; CANDY MADE OF DRIED SLICED GINGER; CARMELS; CHEWING GUM, NOT FOR MEDICAL PURPOSES; CHOCOLATE; CHOCOLATE-BASED FOOD BEVERAGES NOT BEING DAIRY-BASED OR VEGETABLE BASED; COCOA; COCOA BEVERAGES WITH MILK; PREPARED COCOA-BASED BEVERAGES; CONFECTIONERY FOR DECORATING CHRISTMAS TREES, NAMELY, CANDY CANES, GINGERBREAD COOKIES; COOKIES; CORN CHIPS; CORN FLAKES; CRACKERS; CREAM PUFFS; CREPES; CUSTARD; DOUGHNUTS; CONFECTIONERY DROPS, NAMELY, PEPPERMINT CANDY DROPS, BUTTERSCOTCH CANDY DROPS, ASSORTED FRUIT CANDY DROPS; DRY CAKES; DUMPLINGS; FARINACEOUS FOOD PASTES FOR HUMAN CONSUMPTION; FONDANTS; FROZEN YOGURT; GINGERBREAD; GLUTINOUS CONFECTIONERY FRIZZLED IN OIL, NAMELY, GLUTINOUS RICE CRACKERS; HALVAH; HAMBURGER BUNS; HARDTACK; HO-DDEOK (CHINESE PANCAKE STUFFED WITH SUGAR); HOTCAKES; HOT DOG SANDWICHES; ICE CAKES; ICE CANDY; ICE CREAM; FRUIT JELLIES; JEUN-KWA (CONFECTIONERY MADE FROM FRUIT, GINGER, CARROT OR GINSENG PRESERVED IN OR HARDBOILED WITH HONEY OR SUGAR), LICORICE; LOLLYPOPS; MACARONI; MACAROONS; MALT BISCUITS; MARZIPAN; MUFFINS; NOUGAT; OATMEAL; PANCAKES; PASTA; PASTILLES; PASTRIES; PASTIES; PATE AS PASTRY, NAMELY, PATE A CHOUX; PATTERN-PRESSED CANDY MADE MAINLY FROM RICE AND SESAME, KNOWN AS "DA-SIK;" PEANUT CONFECTIONERY, NAMELY, PEANUT BRITTLE; PEPPERMINT SWEETS; PETIT-BEURRE BISCUITS; PETIT FOURS; PIES; PIZZAS; POPCORN; PRALINES; PUDDINGS; PUFFED RICE;

RA-MYUN (INSTANT NOODLE); RAVIOLI; RUSKS; SANDWICHES; SAN-JA (OIL-AND-HONEY PASTRY OF RICE, KOREAN CRACKER); SHERBETS; SHORTBREAD; SPAGHETTI; SPONGE CAKE (CASTELLA); SPRING ROLLS; SWEET CANDY IN THE SHAPE OF BALLS; SWEETMEATS; TAFFY; TARTS; TOAST; TOFFEES; TORTILLAS; UNLEAVENED BREAD; WAFERS; WAFFLES; YAK-KWA (KOREAN TRADITIONAL CAKES MADE FROM WHEATFLOUR, OIL AND HONEY), IN CLASS 30 (U.S. CL. 46).

FOR: ADVERTISEMENT PLANNING FOR OTHERS; ADVERTISING BY MAIL ORDER; DIRECT MAIL ADVERTISING; PREPARING AND PLACING FILM ADVERTISING FOR OTHERS; ON-LINE ADVERTISING ON A COMPUTER COMMUNICATIONS NETWORK; ORGANIZATION OF EXHIBITIONS FOR COMMERCIAL OR ADVERTISING PURPOSES; ORGANIZATION OF TRADE FAIRS FOR COMMERCIAL OR ADVERTISING PURPOSES; PREPARING AND PLACING OUTDOOR ADVERTISING FOR OTHERS; PUBLICATION OF PUBLICITY TEXTS; PUBLICITY MATERIAL RENTAL; PROVIDING TELEVISION ADVERTISING FOR OTHERS, IN CLASS 35 (U.S. CLS. 100, 101 AND 102).

FOR: AMUSEMENT PARKS; PROVIDING CASINO FACILITIES FOR GAMBLING; DIGITAL IMAGING SERVICES; SPECIAL EVENT PLANNING FOR OTHERS; MOTION PICTURE FILM PRODUCTION; PROVIDING ON-LINE COMPUTER GAMES; HOLIDAY CAMP SERVICES, NAMELY, PROVIDING SUMMER CAMPS AND RECREATIONAL CAMPS; PROVIDING INSTRUCTION AT THE KINDERGARTEN LEVEL; PRESENTATION OF MUSICAL AND THEATRICAL AND LIVE SHOW PERFORMANCES; CONDUCTING ENTERTAINMENT EXHIBITIONS IN THE NATURE OF VARIETY SHOW FEATURING CARTOON AND ANIMATED CHARACTERS, MAGIC SHOWS; MOBILE LIBRARY SERVICES; PROVIDING MOVIE THEATRE FACILITIES; NURSERY SCHOOLS; ORGANIZING EXHIBITIONS FEATURING ANIMATED CARTOON FOR CHILDREN FOR CULTURAL AND EDUCATION PURPOSE; ENTERTAINMENT SERVICES, NAMELY, PARTY PLANNING; PRESENTATION OF LIVE SHOW

PERFORMANCES; PROVIDING RECREATIONAL AREAS IN THE NATURE OF CHILDREN'S PLAY-GROUNDS; RENTAL OF VIDEO TAPES; PRODUCTION OF RADIO AND TELEVISION PROGRAMS; PROVIDING AMUSEMENT ARCADE SERVICES; PROVIDING ON-LINE PUBLICATIONS IN THE NATURE OF NEWSLETTERS IN THE FIELD OF COMICS, CARTOONS, ANIMATIONS AND ANIMATED CHARACTERS; PUBLICATION OF BOOKS; ON-LINE PUBLICATION OF ELECTRONIC BOOKS AND JOURNALS; PUBLICATION OF TEXTS OTHER THAN PUBLICITY TEXTS; RENTAL OF RECORDED MUSIC AND OTHER FORMS OF RECORDED AUDIO; RENTAL OF VIDEOTAPES; ENTERTAINMENT IN THE NATURE OF ON-GOING TELEVISION PROGRAMS IN THE FIELD OF CARTOONS, COMEDY, VARIETY, IN CLASS 41 (U.S. CLS. 100, 101 AND 107).

PRIORITY DATE OF 11-3-2006 IS CLAIMED.

OWNER OF INTERNATIONAL REGISTRATION 0939949 DATED 12-29-2006, EXPIRES 12-29-2016.

THE COLOR(S) BLACK, ORANGE, BLUE, YELLOW, GRAY AND WHITE IS/ARE CLAIMED AS A FEATURE OF THE MARK.

THE MARK CONSISTS OF THE FOLLOWING: THE COLOR BLACK APPEARS IN THE OUTLINED FEATURES OF THE MARK, THE UNDERWEAR, THE CHECKERED PATTERN APPEARING ON THE HEAD, AND THE SHOELACES. THE COLOR ORANGE APPEARS IN THE CAPE AND THE PANTS. THE COLOR BLUE APPEARS IN THE SHIRT AND HANDS. THE COLOR YELLOW APPEARS IN THE HEAD, THE ARMS AND THE HAIR. THE COLOR GREY APPEARS IN THE HAIR. THE COLOR WHITE APPEARS IN THE LETTER "R" APPEARING ON THE SHIRT AND THE CHECKERED PATTERN APPEARING ON THE HEAD.

SER. NO. 79-044,763, FILED 12-29-2006.

DANIEL BRODY, EXAMINING ATTORNEY

Int. Cl.: 28

Prior U.S. Cls.: 22, 23, 38 and 50

United States Patent and Trademark Office

Reg. No. 3,485,277

Registered Aug. 12, 2008

TRADEMARK
PRINCIPAL REGISTER



RAÚL GUTIÉRREZ (COLOMBIA INDIVIDUAL)
7 CH. DES GRANDS-CHAMPS
CH-1299 CRANS-PRÈS-CÉLIGNY
SWITZERLAND

FOR: BOARD GAMES, IN CLASS 28 (U.S. CLS. 22,
23, 38 AND 50).

PRIORITY DATE OF 5-4-2007 IS CLAIMED.

OWNER OF INTERNATIONAL REGISTRATION
0940120 DATED 9-21-2007, EXPIRES 9-21-2017.

NO CLAIM IS MADE TO THE EXCLUSIVE
RIGHT TO USE "JEU DE SOCIÉTÉ", APART FROM
THE MARK AS SHOWN.

THE FOREIGN WORDING IN THE MARK
TRANSLATES INTO ENGLISH AS "BOARD GAME".
THE WORD "TREMUNDI" HAS NO FOREIGN
MEANING.

SER. NO. 79-044,812, FILED 9-21-2007.

PATRICIA EVANKO, EXAMINING ATTORNEY

Int. Cl.: 43

Prior U.S. Cls.: 100 and 101

United States Patent and Trademark Office

Reg. No. 3,485,278

Registered Aug. 12, 2008

**SERVICE MARK
PRINCIPAL REGISTER**

Leroy's KFe

LEROY CHRISTOPHE (FRANCE INDIVIDUAL)
38 RUE GEORGES CLEMENCEAU
F-83990 SAINT TROPEZ, FRANCE

OWNER OF INTERNATIONAL REGISTRATION
0940201 DATED 7-13-2007, EXPIRES 7-13-2017.

FOR: PROVIDING OF FOOD AND DRINK IN
RESTAURANTS; CATERING SERVICES; TEMPOR-
ARY ACCOMMODATION; HOTEL SERVICES, IN
CLASS 43 (U.S. CLS. 100 AND 101).

SER. NO. 79-044,846, FILED 7-13-2007.

PRIORITY DATE OF 2-1-2007 IS CLAIMED.

JAY FLOWERS, EXAMINING ATTORNEY

Int. Cls.: 1, 9, 40 and 42

Prior U.S. Cls.: 1, 5, 6, 10, 21, 23, 26, 36, 38, 46, 100, 101, 103 and 106

Reg. No. 3,485,279

United States Patent and Trademark Office

Registered Aug. 12, 2008

**TRADEMARK
SERVICE MARK
PRINCIPAL REGISTER**



BIO MATRIX RESEARCH INC. (JAPAN CORPORATION)
105 HIGASHIFUKAI
NAGAREYAMA-SHI; CHIBA 270-0101
JAPAN

FOR: REAGENTS FOR SCIENCE AND RESEARCH, NAMELY, MONOCLONAL ANTIBODIES AND PURIFIED PROTEINS NOT FOR MEDICAL OR VETERINARY USE, IN CLASS 1 (U.S. CLS. 1, 5, 6, 10, 26 AND 46).

FOR: LABORATORY APPARATUS AND INSTRUMENTS, NAMELY, PROTEIN PURIFICATION COLUMNS, IN CLASS 9 (U.S. CLS. 21, 23, 26, 36 AND 38).

FOR: MANUFACTURING SERVICES FOR OTHERS IN THE FIELD OF PHARMACEUTICALS AND CHEMICALS, IN CLASS 40 (U.S. CLS. 100, 103 AND 106).

FOR: TESTING, INSPECTION OR RESEARCHES OF PHARMACEUTICALS, CHEMICALS AND FOODSTUFFS, IN CLASS 42 (U.S. CLS. 100 AND 101).

OWNER OF INTERNATIONAL REGISTRATION 0940212 DATED 1-26-2007, EXPIRES 1-26-2017.

OWNER OF U.S. REG. NOS. 3,280,246 AND 3,280,247.

NO CLAIM IS MADE TO THE EXCLUSIVE RIGHT TO USE "RESEARCH", APART FROM THE MARK AS SHOWN.

THE COLOR(S) GREEN, PINK AND BLACK IS/ARE CLAIMED AS A FEATURE OF THE MARK.

THE MARK CONSISTS OF THE GREEN LETTERS ARRANGED COUNTER-CLOCKWISE, "B", "M" AND "R" CONNECTED BY THREE PINK DOUBLES LINES WHICH INDICATE AN ANTIBODY, AND THE BLACK WORDING "BIO MATRIX RESEARCH".

SER. NO. 79-044,852, FILED 1-26-2007.

CHRISTINA SOBRAL, EXAMINING ATTORNEY

Int. Cl.: 17

Prior U.S. Cls.: 1, 5, 12, 13, 35 and 50

United States Patent and Trademark Office

Reg. No. 3,485,280

Registered Aug. 12, 2008

**TRADEMARK
PRINCIPAL REGISTER**



EIFFEL INDUSTRIA MATERIE; PLASTICHE
S.P.A. (ITALY JOINT STOCK COMPANY)
VIA PROVINCIALE, 35
FONTANELLATO (PARMA), ITALY I43012

FOR: PLASTIC MATERIALS IN THE NATURE OF
SHEETS, FILMS OR ROLLS FOR AGRICULTURE
APPLICATIONS, IN CLASS 17 (U.S. CLS. 1, 5, 12, 13, 35
AND 50).

OWNER OF INTERNATIONAL REGISTRATION
0416690 DATED 8-4-1975, EXPIRES 8-4-2015.

THE COLOR(S) RED AND WHITE IS/ARE
CLAIMED AS A FEATURE OF THE MARK.

THE COLOR RED APPEARS IN THE BACK-
GROUND OF THE MARK, AND THE COLOR
WHITE APPEARS IN THE WORDING "EIFFEL".

SER. NO. 79-044,871, FILED 9-7-2007.

SEAN CROWLEY, EXAMINING ATTORNEY

Int. Cl.: 21

Prior U.S. Cls.: 2, 13, 23, 29, 30, 33, 40 and 50

United States Patent and Trademark Office

Reg. No. 3,485,281

Registered Aug. 12, 2008

**TRADEMARK
PRINCIPAL REGISTER**

LA ROCHÈRE

LA ROCHÈRE., SOCIÉTÉ PAR ACTIONS SIMPLIFIÉE (FRANCE SOCIÉTÉ PAR ACTIONS SIMPLIFIÉE)
F-70210 PASSAVANT-LA-ROCHÈRE
FRANCE

FOR: GLASS GOODS FOR THE TABLE, KITCHEN, HOME AND FOR DECORATION, NAMELY, DRINKING GLASSES, MUGS, DECANTERS, BOTTLES SOLD EMPTY, JARS, PITCHERS, BOWLS, DISHES, VASES, IN CLASS 21 (U.S. CLS. 2, 13, 23, 29, 30, 33, 40 AND 50).

OWNER OF INTERNATIONAL REGISTRATION
0605071 DATED 8-16-1993, EXPIRES 8-16-2013.

THE WORDING "LA ROCHERE" HAS NO MEANING IN ENGLISH.

SER. NO. 79-044,877, FILED 5-10-2007.

LESLIE RICHARDS, EXAMINING ATTORNEY

Int. Cl.: 5

Prior U.S. Cls.: 6, 18, 44, 46, 51 and 52

Reg. No. 3,485,282

United States Patent and Trademark Office

Registered Aug. 12, 2008

**TRADEMARK
PRINCIPAL REGISTER**

KATOXYN

DEVERGE'; MEDICINA E MEDICALIZZAZIONE
S.R.L. (ITALY SOCIÉTÉ A RESPONSABILITÉE
LIMITÉE)

CORSO CHERI N. 11
I-10132 TORINO (TO)
ITALY

NAPPIES, IN CLASS 5 (U.S. CLS. 6, 18, 44, 46, 51
AND 52).

OWNER OF INTERNATIONAL REGISTRATION
0763588 DATED 6-21-2001, EXPIRES 6-21-2011.

FOR: DERMATOLOGICAL MEDICINES FOR
THE TREATMENT OF INJURED SKIN, NAMELY,
FOR THE TREATMENT OF ABRASIONS,
WOUNDS, SORES, BURNS, MACERATIONS TO
DUE INCONTINENCE, AND ERYTHEMA FOR

SER. NO. 79-044,890, FILED 5-11-2007.

MICHAEL TANNER, EXAMINING ATTORNEY

Int. Cl.: 24

Prior U.S. Cls.: 42 and 50

United States Patent and Trademark Office

Reg. No. 3,485,283

Registered Aug. 12, 2008

**TRADEMARK
PRINCIPAL REGISTER**

LINEN HOUSE

LINEN HOUSE PTY LTD (AUSTRALIA PROPRIETARY LIMITED COMPANY)
60 CORPORATE DRIVE
MOORABBIN VIC 3189
AUSTRALIA

FOR: LINEN AND TEXTILE GOODS, NAMELY, BED SHEETS, PILLOW CASES, SHAMS, PILLOW SHAMS, QUILTS, QUILT COVERS, DUVETS, DUVET COVERS, COMFORTERS, BED SPREADS, BED SKIRTS, FABRIC VALANCES AND DRAPERY, AND TEXTILE BED COVERS; THROWS; COVERS FOR CUSHIONS; UNFITTED FABRIC COUCH COVERS; BED BLANKETS; BATH LINEN NAMELY TOWELS, BEACH TOWELS, FACE TOWELS, HAND TOWELS, AND TEXTILE BATH MATS; NAPERY NAMELY TEXTILE TABLE CLOTHS, TABLE RUNNERS, TABLE TOPPERS, TEXTILE NAPKINS, AND TEXTILE PLACE MATS; TEXTILE OVEN MITTS AND POT HOLDERS; DISH TOWELS; TEA TOWELS; FABRIC WINDOW COVERINGS AND TREAT-

MENTS NAMELY CURTAINS AND DRAPES; AND SHOWER CURTAINS, IN CLASS 24 (U.S. CLS. 42 AND 50).

THE MARK CONSISTS OF STANDARD CHARACTERS WITHOUT CLAIM TO ANY PARTICULAR FONT, STYLE, SIZE, OR COLOR.

OWNER OF INTERNATIONAL REGISTRATION 0880041 DATED 1-6-2006, EXPIRES 1-6-2016.

NO CLAIM IS MADE TO THE EXCLUSIVE RIGHT TO USE "LINEN", APART FROM THE MARK AS SHOWN.

SER. NO. 79-044,924, FILED 3-22-2007.

MATTHEW MCDOWELL, EXAMINING ATTORNEY

Int. Cl.: 3

Prior U.S. Cls.: 1, 4, 6, 50, 51 and 52

Reg. No. 3,485,284

United States Patent and Trademark Office

Registered Aug. 12, 2008

**TRADEMARK
PRINCIPAL REGISTER**

APPARITION SKY

EMANUEL UNGARO ITALIA S.R.L. (ITALY LTD
LIAB CO)
VIA VITTOR PISANI, 12/A
I-20124 MILANO, ITALY

FOR: PERFUMES, EAU DE PARFUM, COLOGNE,
TOILET WATER, ESSENTIAL OILS, COLD CREAM,
PERSONAL DEODORANTS, ANTIPERSPIRANTS,
CLEANSING LOTIONS, SKIN MOISTURIZER,
BODY OIL, SKIN EMOLLIENT, SOAPS, BATH
SOAPS, BATH AND SHOWER GEL, BODY LO-
TIONS, SKIN LOTIONS, IN CLASS 3 (U.S. CLS. 1, 4,
6, 50, 51 AND 52).

THE MARK CONSISTS OF STANDARD CHAR-
ACTERS WITHOUT CLAIM TO ANY PARTICULAR
FONT, STYLE, SIZE, OR COLOR.

OWNER OF INTERNATIONAL REGISTRATION
0915373 DATED 1-19-2007, EXPIRES 1-19-2017.

OWNER OF U.S. REG. NO. 3,011,515.

SER. NO. 79-044,942, FILED 9-14-2007.

LINDA ESTRADA, EXAMINING ATTORNEY

Int. Cls.: 18 and 25

Prior U.S. Cls.: 1, 2, 3, 22, 39 and 41

United States Patent and Trademark Office

Reg. No. 3,485,285

Registered Aug. 12, 2008

**TRADEMARK
PRINCIPAL REGISTER**



L.T. S.R.L. (ITALY LTD LIAB CO)
VIA VARESE, 10
I-20121 MILANO, ITALY AND
CRISTINA TARONI (ITALY INDIVIDUAL)
PIAZZA DELLA PORTA, 6
I-42018 S. MARTINO IN RIO
(REGGIO EMILIA), ITALY

FOR: PURSES, HANDBAGS, TRUNKS, LUG-
GAGE, VALISES, UMBRELLAS, LEATHER GOODS,
NAMELY, WALLETS FOR CARRYING BUSINESS
CARDS, CALLING CARDS, CREDIT CARDS AND
NAME CARDS; LEATHER AND IMITATION LEA-
THER, IN CLASS 18 (U.S. CLS. 1, 2, 3, 22 AND 41).

FOR: BELTS, FOOTWEAR, HEADWEAR, CLOTH-
ING OF IMITATIONS OF LEATHER, CLOTHING
OF LEATHER AND CLOTHING, NAMELY, COATS,

SINGLETS, SHIRTS, STOCKINGS, NECKTIES,
TROUSERS, SKIRTS, FOULARDS FOR WEAR,
GLOVES, SCARVES, SWIMSUITS, UNDERWEAR,
IN CLASS 25 (U.S. CLS. 22 AND 39).

OWNER OF INTERNATIONAL REGISTRATION
0940503 DATED 6-12-2007, EXPIRES 6-12-2017.

THE STIPPLING IS A FEATURE OF THE MARK.

THE MARK CONSISTS OF "077" SHOWN WITH
STIPPLING, WHICH IS A FEATURE OF THE
MARK.

SER. NO. 79-045,034, FILED 6-12-2007.

GISELLE AGOSTO, EXAMINING ATTORNEY

Int. Cl.: 10

Prior U.S. Cls.: 26, 39 and 44

United States Patent and Trademark Office

Reg. No. 3,485,286

Registered Aug. 12, 2008

**TRADEMARK
PRINCIPAL REGISTER**



SOCIETE DE RECHERCHES TECHNIQUES DENTAIRE - R.T.D. (FRANCE SOCIÉTÉ À RESPONSABILITÉ LIMITÉE)

3 RUE LOUIS NEEL -

TECHNOPARC ESPACE GAVANIÈRE; F-38120 SAINT-EGREVE

FRANCE

FOR: SURGICAL, MEDICAL, DENTAL AND VETERINARY APPARATUS AND INSTRUMENTS, NAMELY, DENTAL PROSTHESIS; DENTAL PROSTHETIC APPARATUS, NAMELY, ARTIFICIAL TEETH AND DENTAL ROOT POSTS, IN CLASS 10 (U.S. CLS. 26, 39 AND 44).

PRIORITY DATE OF 3-16-2007 IS CLAIMED.

OWNER OF INTERNATIONAL REGISTRATION 0940551 DATED 8-28-2007, EXPIRES 8-28-2017.

THE COLOR(S) BLUE AND YELLOW IS/ARE CLAIMED AS A FEATURE OF THE MARK.

THE MARK CONSISTS OF A STYLIZED DEPICTION OF "RTD" UNDERLINED; THE COLOR BLUE APPEARS IN THE WORDING "RTD" AND THE COLOR YELLOW APPEARS IN THE STROKE THAT UNDERLINES THE WORDING "RTD".

SER. NO. 79-045,062, FILED 8-28-2007.

DAVID HOFFMAN, EXAMINING ATTORNEY

Int. Cl.: 16

Prior U.S. Cls.: 2, 5, 22, 23, 29, 37, 38 and 50

United States Patent and Trademark Office

Reg. No. 3,485,287

Registered Aug. 12, 2008

**TRADEMARK
PRINCIPAL REGISTER**



STARMINEN AG (SWITZERLAND SOCIÉTÉ
ANONYME)
ROMANSHORNER STRASSE 110
CH-8280 KREUZLINGEN
SWITZERLAND

PRIORITY DATE OF 6-15-2007 IS CLAIMED.

OWNER OF INTERNATIONAL REGISTRATION
0940604 DATED 9-6-2007, EXPIRES 9-6-2017.

FOR: INK STICKS FOR BALL-POINT PENS,
BALL-POINT PEN REFILLS, BALL-POINT PENS,
LEAD HOLDER RECORDERS, NAMELY, PENCIL
LEAD HOLDERS, PENCIL LEADS , IN CLASS 16
(U.S. CLS. 2, 5, 22, 23, 29, 37, 38 AND 50).

SER. NO. 79-045,089, FILED 9-6-2007.

ALLISON SCHRODY, EXAMINING ATTORNEY

Int. Cls.: 9 and 11

Prior U.S. Cls.: 13, 21, 23, 26, 31, 34, 36 and 38

United States Patent and Trademark Office

Reg. No. 3,485,288

Registered Aug. 12, 2008

**TRADEMARK
PRINCIPAL REGISTER**

TAPIND

MASCHINENFABRIK REINHAUSEN GMBH
(FED REP GERMANY COMPANY WITH LIMITED LIABILITY)

FALKENSTEINSTRASSE 8
93059 REGENSBURG
FED REP GERMANY

FOR: ANALOG AND DIGITAL INDICATOR DEVICES, NAMELY, INDICATORS OF OPERATING POSITIONS AND OPERATING STATES OF ELECTRICAL POWER SUPPLY NETWORKS; LIGHT EMITTING DIODES (LEDS) FOR THE INDICATION OF OPERATING POSITIONS AND OPERATING STATES OF ELECTRICAL POWER SUPPLY NETWORKS; REGULATING TRANSFORMERS; ON-LOAD TAP-CHANGERS AND OFF-CIRCUIT TAP-CHANGERS FOR SECURING AND IMPROVING THE QUALITY OF PUBLIC AND INDUSTRIAL POWER SUPPLY SYSTEMS AND FOR INFLUENCING AND COMPENSATING SUPPLY; ELECTRICAL CONTROLLERS FOR TRANSFORMING AND REGULATING THE OPERATING POSITIONS AND OPERATING STATES OF ELECTRICAL POWER

SUPPLY NETWORKS, IN CLASS 9 (U.S. CLS. 21, 23, 26, 36 AND 38).

FOR: LIGHT BULBS FOR THE INDICATION OF OPERATING POSITIONS AND OPERATING STATES OF ELECTRICAL POWER SUPPLY NETWORKS, IN CLASS 11 (U.S. CLS. 13, 21, 23, 31 AND 34).

THE MARK CONSISTS OF STANDARD CHARACTERS WITHOUT CLAIM TO ANY PARTICULAR FONT, STYLE, SIZE, OR COLOR.

PRIORITY DATE OF 1-18-2007 IS CLAIMED.

OWNER OF INTERNATIONAL REGISTRATION 0940783 DATED 3-30-2007, EXPIRES 3-30-2017.

SER. NO. 79-045,167, FILED 3-30-2007.

SHAILA SETTLES, EXAMINING ATTORNEY

Int. Cls.: 3, 9, 14, 16, 18, 24, 25, 27 and 28

Prior U.S. Cls.: 1, 2, 3, 4, 5, 6, 19, 20, 21, 22, 23, 26, 27, 28, 29, 36, 37, 38, 39, 41, 42, 50, 51 and 52

Reg. No. 3,485,289

United States Patent and Trademark Office

Registered Aug. 12, 2008

TRADEMARK
PRINCIPAL REGISTER

Chicaloca

PROJECT109 INC. (REPUBLIC OF KOREA CORPORATION)
3F K-BLDG., 408-27 SEO-KYO DONG,
MAPO-GU, SEOUL,
REPUBLIC OF KOREA

FOR: DETERGENTS PREPARED FROM PETROLEUM FOR HOUSEHOLD CLEANING USE, LAUNDRY SOAPS, GLASS CLEANING PREPARATIONS, AND TOILET BOWL DETERGENTS, IN CLASS 3 (U.S. CLS. 1, 4, 6, 50, 51 AND 52).

FOR: DUSTPROOF GLASSES; ANTI-GLARE GLASSES; SWIMMING GOGGLES; SPORTS GLASSES; SPECTACLE GLASSES; EYEGLASS CHAINS; EYEGLASS CASES; EYEGLASS FRAMES; PINCE-NEZ; PINCE-NEZ CORDS; PINCE-NEZ CASES; PINCE-NEZ MOUNTINGS; CONTACT LENSES; CONTAINERS FOR CONTACT LENSES; PRE-RECORDED AUDIOTAPES FEATURING MUSIC; PRE-RECORDED VIDEO TAPES FEATURING MUSIC; PRE-RECORDED AUDIO TAPES OF NON-MUSIC, NAMELY, FEATURING SELF-IMPROVEMENT AND MATHEMATICS INSTRUCTION; PRE-RECORDED VIDEOTAPES OF NON-MUSIC, NAMELY, FEATURING SELF-IMPROVEMENT AND MATHEMATICS INSTRUCTION, IN CLASS 9 (U.S. CLS. 21, 23, 26, 36 AND 38).

FOR: JEWEL CASES OF PRECIOUS METAL; WALL CLOCK; STOPWATCHES; MOVEMENTS FOR CLOCKS AND WATCHES; DIALS FOR CLOCK- AND WATCH-MAKING; CLOCK HANDS FOR CLOCK- AND WATCH-MAKING; WATCH SPRINGS; WATCH GLASSES; WATCH STRAPS; PENDULUMS CLOCKS; WATCH CASES; AUTOMOBILE CLOCKS; ALARM CLOCKS; CLOCKS AND WATCHES, ELECTRIC; ELECTRONIC CLOCKS AND WATCHES; CHRONOGRAPHS FOR USE AS WATCHES; CHRONOMETERS; CHRONOSCOPES; TABLE CLOCKS; WRISTWATCHES; POCKET WATCHES; GARNETS ; OLIVINE; MALACHITE; DIAMONDS; OPAL; RUBY; AGATES; CAT'S EYE

EMERALDS; MOONSTONE JEWELLERY; BERYL JEWELLERY; JASPER JEWELLERY; GREEN JADEITE JEWELLERY; SAPPHIRE; CORAL JEWELLERY; IVORY JEWELLERY; CRYSTAL JEWELLERY; STAR RUBY JEWELLERY; STAR SAPPHIRE JEWELLERY; ALEXANDRITE JEWELLERY; AQUAMARINE JEWELLERY; EMERALD JEWELLERY; CHALCEDONY; COSTUME JEWELLERY; ZIRCON JEWELLERY; PEARLS; SPINEL AS PRECIOUS STONES; CLOISONNE JEWELRY; CUBIC ZIRCONIA JEWELLERY; CHRYSOBERYL JEWELLERY; TURQUOISE JEWELRY; TOPAZ JEWELLERY; TOURMALINE JEWELLERY; TIGER-EYE JEWELLERY; YELLOW JADE JEWELLERY; BLACK JADE JEWELLERY; GOLD ALLOY INGOTS; GOLD, NAMELY, BEATEN GOLD; GOLD INGOTS; RHODIUM; RUTHENIUM; CASTINGS OF PLATINUM OR PLATINUM ALLOY; PLATINUM INGOTS; PLATINUM ALLOY INGOTS; OSMIUM; SILVER INGOTS; SILVER ALLOY INGOTS; IRIIDIUM; PALLADIUM; EARRINGS; HAT ORNAMENTS OF PRECIOUS METALS; BADGES OF PRECIOUS METAL; BUCKLES FOR WATCH-STRAPS OF PRECIOUS METAL; BELT ORNAMENTS OF PRECIOUS METALS; PINS BEING JEWELLERY; TIE PINS; MEDALS; NECKLACES; RINGS; ANKLE BRACELETS; AMULETS; BROOCHES; ORNAMENTAL PINS; CHARMS; TIE CLIPS; BRACELETS; CUFF LINKS, IN CLASS 14 (U.S. CLS. 2, 27, 28 AND 50).

FOR: PAPER LABELS; STICKERS; SIGNBOARDS OF PAPER OR CARDBOARD; PLACARDS OF PAPER OR CARDBOARD; ADVERTISEMENT BOARDS OF PAPER OR CARDBOARD; CORRUGATED CARDBOARDS; ACID-RESISTANT PAPER; NAPKIN PAPER; LUMINOUS PAPER; WATER-PROOF PAPER; OILPROOF PAPER; FIREPROOF PAPER; WHITE PAPERBOARD; DUPLICATING PAPER; CARDBOARD MADE FROM PAPER MULBERRY; CELLOPHANE PAPER; NEWSPRINT PAPER; FILTER PAPER; PARAFFINED PAPER; WAXED PAPER; OILPAPER; PRINTING PAPER;

PAPER FLOOR MATS; HEAT TRANSFER PAPER; PAPER TOWELS; HANKERCHIEFS OF PAPER; TOWELS OF PAPER; FACE TOWELS OF PAPER; PAPER FOR COFFEE FILTERS; CARDBOARD; FACSIMILE TRANSMISSION PAPER; POSTCARD PAPER; PACKING PAPER; MILLBOARD AND PAPERBOARD; WRITING AND DRAWING PAPER; XUAN PAPER FOR CHINESE PAINTING AND CALLIGRAPHY; PAPIER MACHE; TOILET PAPER; TISSUES OF PAPER FOR REMOVING MAKE-UP; TOILET PAPER; PARCHMENT PAPER; PAPERBOARD; TAGS FOR INDEX CARDS; PRINTED CALCULATING TABLES; NOTE BOOKS; PRINTED PLAN; RULED PAPER; LEDGER BOOKS; MEMO PAPER; BUSINESS CARD PAPER; INDEX CARDS; ENVELOPES; STATIONERY PADS; PAPER FILE JACKETS; POCKET NOTEBOOKS; SKETCHBOOKS; SCRAPBOOKS; ALBUMS FOR PHOTOGRAPHS; CARBON PAPER; PRINTED TRACING PATTERNS FOR DRESSES AND KNITTING; TRACING PAPER; WRITING PADS; FOUNTAIN PENS; BALL POINT PENS; CHALKS; WRITING BRUSHES; FELT PENS FOR WRITING; MECHANICAL PENCILS; PENCILS; STEEL PENS; PENS AS WRITING INSTRUMENTS; PENHOLDERS; PEN NIBS; PAINT BOXES AS ARTICLES FOR USE IN SCHOOL; CHARCOAL PENCILS; ARTISTS' WATERCOLOR; ETCHING NEEDLES; ENGRAVING PLATES; CANVAS FOR PAINTING; CRAYONS; PASTELS; PAINTBRUSHES; PAINTERS' EASELS; PALETTES FOR PAINTERS; RUBBER ERASERS; DRY ERASE WRITING BOARDS AND WRITING SURFACES; MEMO PADS; SEALING STAMPS; SEALS STATIONERY; INK STICKS; INDIAN INKS; GUMMED TAPE AND ADHESIVES FOR STATIONERY; PACKAGING AND CONTAINERS COMPRISED OF STARCH-BASED MATERIALS IN THE NATURE OF A PAPER SUBSTITUTE FOR FOOD, BEVERAGES AND CONSUMER PRODUCTS; DOCUMENT FILES; GUMMED TAPE FOR STATIONERY; ADHESIVE TAPES FOR STATIONERY; GLUE FOR STATIONERY; BOOKENDS; PROTRACTORS FOR STATIONERY AND OFFICE USE; CHALK ERASERS; CHALK HOLDERS; ELASTIC BANDS FOR OFFICES; FINGER-STALLS; FINGER MOISTENERS; STAPLES FOR OFFICES; PAPER CLIPS; PUNCHES; PHOTOGRAPH STANDS; FOLDERS FOR PAPERS; CHALK FOR LITHOGRAPHY; CORRECTING FLUIDS FOR TYPE; STAMP STANDS; STAMP PADS; CASES FOR STAMPS; BLOTTERS; THUMB TACKS; PENCIL SHARPENERS; PENCIL LEADS; PENCIL LEAD HOLDERS; PENCIL HOLDERS; FRENCH CURVES; RED STAMPING INK; DATE STAMPS; DUPLICATING INK; INKWELLS; INK STANDS; INK ERASERS; INKING PADS; MAGNETIC BOARDS; THUMB TACKS; DRAWING SQUARES; COMPASSES FOR DRAWING; TRACING NEEDLES FOR DRAWING PURPOSES; DRAWING PADS; DRAWING T-SQUARES; DRAFTING PAPER; PAPER BOWS FOR GIFT WRAP; DRAWER LINERS OF PAPER, SCENTED OR UNSCENTED; PAPER FASTENERS; TERRESTRIAL GLOBES; FILING FOLDERS, PAPER LABELS AND PRINTED INSTRUCTIONAL MATERIALS FOR ORGANIZING PERSONAL FILES; DRAWING RULER; PRINTED CHARTS; BLACKBOARDS; BLACKBOARD ERASERS; PUSH PINS; CLIPBOARDS; PAPER KNIVES; PAPER CLIPS;

STANDS FOR PENS AND PENCILS; BOXES FOR PENS; PEN CASES; PEN CLIPS; LETTER STANDS; STATIONERY CASES; WRISTBANDS FOR THE RETENTION OF WRITING INSTRUMENTS; PEN AND PENCIL CASES AND BOXES; SLATE BOARDS FOR WRITING; WRITING BOARDS ERASERS; PAINT APPLICATORS IN THE NATURE OF SPONGES; STAPLERS; INKING PADS; CORRUGATED CARDBOARD BOXES; BOXES MADE OF PAPER; PAPER SACKS FOR WRAPPING; BRUSHES FOR ARTIST; PICTURE POSTCARDS; SONG BOOKS; CALENDARS; DIAGRAMS FOR BUILDING COMPUTER CIRCUITS; COMIC BOOKS; MUSICAL GREETING CARDS; BOOKS IN THE FIELD OF FASHION; PLANS FOR BUILDING CONSTRUCTION AND BUSINESS DEVELOPMENT; BOOKLETS IN THE FIELD OF FASHION; BANK CHECKS; SCHOOL WRITING BOOKS OR DRAWING PADS; NEWSPAPERS; MUSICAL NOTES, NAMELY SHEET MUSIC; SCHOOL YEARBOOKS; GREETING CARDS; POSTCARDS; PATTERNS OTHER THAN FLOWER PATTERNS FOR KNITTING, NAMELY, FOR DRESSES; ADDRESS STAMPS; BOOKS FOR USE IN THE TEACHING OF MUSIC; PRINTED FORMS; PRINTED TIMETABLES; DIARIES; MAGAZINES FEATURING FASHION; TELEPHONE DIRECTORIES; PRINTED PERIODICALS IN THE FIELD OF FIGURATIVE ARTS; GEOGRAPHICAL MAPS; CATALOGUES IN THE FIELD OF FASHION; PRINTED TICKETS; PAMPHLETS IN THE FIELD OF REAL ESTATE SALES; POSTERS; STUDY GUIDES; HANDBOOKS IN THE FIELD OF EDUCATIONAL ACTIVITY; NEWSLETTERS IN THE FIELD OF FASHION; COLLECTOR'S PHOTOGRAPHS OF PLAYERS; PHOTOGRAPHS, IN CLASS 16 (U.S. CLS. 2, 5, 22, 23, 29, 37, 38 AND 50).

FOR: VANITY CASES SOLD EMPTY; DIAPER BAGS; BACKPACKS, RUCKSACKS; BUSINESS CARD CASES; BACKPACKS; BOSTON BAGS; PURSES, NOT OF PRECIOUS METAL; BEACH BAGS; BRIEFCASES; BANKNOTE HOLDERS; SUITCASES; CASES FOR CREDIT CARDS; TRAVELLING BAGS; TRAVELLING TRUNKS; OPERA BAGS; PACKING BAGS, NAMELY, LEATHER BAGS FOR MERCHANDISE PACKAGING; SCHOOL BAGS; HANDBAGS; BEACH UMBRELLAS, BEACH PARASOLS; PARASOLS, SUN UMBRELLAS; UMBRELLAS AND THEIR PARTS, NAMELY, UMBRELLA OR PARASOL RIBS, FRAMES FOR UMBRELLA OR PARASOLS, UMBRELLA STICKS; UMBRELLA HANDLES; UMBRELLA RINGS; UMBRELLA COVERS; PAPER UMBRELLAS, IN CLASS 18 (U.S. CLS. 1, 2, 3, 22 AND 41).

FOR: NAPKINS, OF CLOTH, FOR REMOVING MAKE-UP; FITTED TOILET LID COVERS OF FABRIC; SHOWER CURTAINS; SHOWER CURTAINS OF TEXTILE OR PLASTIC; UNFITTED FURNITURE COVERINGS OF TEXTILE; COVERINGS OF PLASTICS FOR FURNITURE; TABLECLOTHS OF TEXTILE; UNFITTED WASHING MACHINE COVERS; PLACEMATS, NAMELY, ASHTRAY MATS AND TELEPHONE MATS MADE OF TEXTILE; CURTAINS OF TEXTILE OR PLASTIC EXCEPT SHOWER CURTAINS; PLACE MATS OF TEXTILE; TABLE CLOTHS OF TEXTILE; WALL HANGINGS

OF TEXTILE FOR DECORATION; TABLE LINEN OF TEXTILE; TABLE MATS OF TEXTILE; DESK CLOTHS; TABLE RUNNERS; UNFITTED TELEVISION COVERS OF CLOTH; UNFITTED PIANO COVERS OF CLOTH; QUILTS; DUVETS; MATTRESS COVERS; BED BLANKETS; PILLOWCASES; SINGLE-LAYER QUILT FOR SLEEPING MATS; QUILTS; QUILT COVERS; BED BLANKETS; BED COVERS; COVERS FOR CUSHIONS; QUILTS FOR LITTLE CHILDREN; WRAPPING CLOTH FOR GENERAL PURPOSES; HANDKERCHIEFS OF TEXTILE; TOWELS OF TEXTILE, IN CLASS 24 (U.S. CLS. 42 AND 50).

FOR: MONEY BELTS; LEATHER SHOES; RUBBER SHOES; GOLF SHOES; SHOE SOLES; WOODEN SHOES; ANGLERS' SHOES; BASKETBALL SHOES; SHOES; HEELPIECES FOR BOOTS AND SHOES; MOUNTAINEERING BOOTS; RUGBY SHOES; LACE BOOTS; BATH SANDALS; BATH SLIPPERS; HALF-BOOTS; WINTER BOOTS; BOXING SHOES; BOOTS; VINYL SHOES; BEACH SHOES; SANDALS; SKI BOOTS; SLIPPERS; INNER SOLES; SOLES FOR FOOTWEAR; FOOTWEAR UPPERS; HEELPIECES FOR BOOTS AND SHOES; TIPS FOR FOOTWEAR; TRAINING SHOES; BASEBALL SHOES; ESPARTO SHOES OR SANDALS; OVERSHOES; RAIN BOOTS; FOOTWEAR FOR TRACK AND FIELD ATHLETICS; WORK SHOES AND BOOTS; LONG BOOTS; GYMNASIATIC SHOES; FOOTBALL SHOES; LACE BOOTS; HOCKEY SHOES; HANDBALL SHOES; CYCLISTS' JERSEYS; CYCLING SHOES; TROUSERS FOR CYCLISTS; WET SUITS FOR WATER-SKIING; ANORAKS FOR EXERCISES; JUDO SUITS; SUITS FOR GYMNASIATICS; TAEKWONDO SUITS; MASQUERADE COSTUMES; LIVERIES; MANTLES; KNEE TROUSERS; HALF-COATS; BLOUSONS; SARIS; SAFARI SUITS; SUITS; SMOCKS; SKIRTS; SLACK; MENS' SUITS; ANORAKS, NOT FOR EXERCISES; CHILDREN'S AND INFANTS' CLOTH BIBS; TROUSERS; CEREMONIAL DRESSES; OVERALLS; OVERCOATS; ONE PIECE SUITS; INFANTS WEAR; EVENING DRESSES; JACKETS AS CLOTHING; WORKING OVERALLS; JUMPERS; SHIRT FRONTS; PAPER HATS FOR USE AS CLOTHING ITEMS; CHASUBLES; BLUE JEANS; CAPES; COMBINATIONS; TOPCOATS; TUXEDOS; TOGAS; TWO PIECE SUITS; TUNICS; PARKAS; PELISSES; FROCKS; RAINCOATS; OVERCOATS; GIRDLES; NIGHTGOWNS; BUTTON-FRONT ALOHA SHIRTS; NEG-LIGES; DRESSING GOWNS, ROMPERS;

LEOTARDS; MANTILLAS; BATH ROBES; BODY SHIRTS; BRASSIERES; BLOUSES; SHOWER CAPS; SHIRT YOKES; SHIRT FRONTS; UNDERWEAR; DRAWERS; UNDERSHIRTS; UNDERPANTS; BATHING CAPS; SWIMSUITS; BATHING TRUNKS; CHEMISETTES ; CHEMISES; SWEATERS; SWEAT SHIRTS; SWEAT PANTS; SPORTS SHIRTS; SLIPS AS UNDERGARMENTS; WHITE SHIRT; UNIFORMS FOR EXERCISES; UNITARDS; COLLARS; NIGHTWEAR; JERSEYS; VESTS; CARDIGANS; COLLAR PROTECTORS; COLLAR CUFFS; CAMISOLES; CORSETS AS UNDERCLOTHING; CORSELETS; COMBINATIONS; TANK TOPS; TEDDIES; TRACKSUITS; PYJAMAS; PANTYHOSE; PETTICOATS; POLO SHIRTS; PULLOVERS; TEE-SHIRTS; NECKTIES; LEGGINGS; SCARFS; STOCKINGS; SOCKS; SOCKS SUSPENDERS; APRONS; BABIES' DIAPERS OF TEXTILE; POCKET SQUARES; TIGHTS; PELERINES; CAPS AS HEADWEAR; SUN VISORS; BERETS; TOP HATS; GAITERS; STOCKING SUSPENDERS; SOCK SUSPENDERS; BRACES SUSPENDERS; LEATHER BELTS, IN CLASS 25 (U.S. CLS. 22 AND 39).

FOR: RUGS; FLOOR MATS; WALLPAPER, IN CLASS 27 (U.S. CLS. 19, 20, 37, 42 AND 50).

FOR: TOY MASKS; JACK-IN-THE-BOXES; TOYS MOBILES; TOY CONSTRUCTION SETS; PUPPETS; DOLLS' ROOMS; DOLLS' FEEDING BOTTLES; CLOTHES FOR DOLLS; DOLLS' HOUSES; TEDDY BEARS; TOY PISTOLS; PAPER DOLLS; PLUSH TOYS; PLASTIC CHARACTER TOYS, IN CLASS 28 (U.S. CLS. 22, 23, 38 AND 50).

PRIORITY DATE OF 4-10-2006 IS CLAIMED.

OWNER OF INTERNATIONAL REGISTRATION 0941200 DATED 8-8-2006, EXPIRES 8-8-2016.

THE MARK CONSISTS OF THE WORDING "CHICALOCA" WITH THE FIRST "C" CONTAINING A STYLIZED BORDER.

THE ENGLISH TRANSLATION OF THE FOREIGN WORD(S) IN THE MARK IS: "CRAZY GIRL".

SER. NO. 79-045,300, FILED 8-8-2006.

BERNICE MIDDLETON, EXAMINING ATTORNEY

Int. Cl.: 32

Prior U.S. Cls.: 45, 46 and 48

United States Patent and Trademark Office

Reg. No. 3,485,290

Registered Aug. 12, 2008

**TRADEMARK
PRINCIPAL REGISTER**

LA GOUDALE

LES BRASSEURS DE GAYANT S.A.S. (FRANCE
SOCIETE PAR ACTIONS SIMPLIFIEE)
63 FAUBOURG DE PARIS
F-59500 DOUAI, FRANCE

OWNER OF INTERNATIONAL REGISTRATION
0636344 DATED 5-29-1995, EXPIRES 5-29-2015.

FOR: BEERS, IN CLASS 32 (U.S. CLS. 45, 46 AND
48).

SER. NO. 79-045,324, FILED 10-1-2007.

SHARON MEIER, EXAMINING ATTORNEY

Int. Cl.: 32

Prior U.S. Cls.: 45, 46 and 48

Reg. No. 3,485,291

United States Patent and Trademark Office

Registered Aug. 12, 2008

**TRADEMARK
PRINCIPAL REGISTER**

BONONI

DÖRRENHAUS, KLAUS (FED REP GERMANY
INDIVIDUAL)
EUPENER STRAÙE 139
50933 KÖLN, FED REP GERMANY

FOR: BEERS; MINERAL AND AERATED WATERS; NON-ALCOHOLIC DRINKS, NAMELY, SPORTS DRINKS AND SOFT DRINKS AND NON-ALCOHOLIC COCKTAIL MIXES, FRUIT DRINKS AND FRUIT JUICES, FRUIT NECTARS, WHEY BEVERAGES AND NON-ALCOHOLIC COCKTAIL MIXES CONTAINING MILK, NON-ALCOHOLIC ENERGY DRINKS, VEGETABLE JUICES, FRUIT DRINKS AND FRUIT JUICES; SYRUPS FOR BEVERAGES; PREPARATIONS FOR MAKING FRUIT DRINK, VEGETABLE JUICES, FRUIT JUICES, SPORTS DRINKS, SOFT DRINKS AND NON-ALCOHOLIC ENERGY DRINKS, NAMELY, EFFERVES-

CENT TABLETS OR POWDERS, IN CLASS 32 (U.S. CLS. 45, 46 AND 48).

THE MARK CONSISTS OF STANDARD CHARACTERS WITHOUT CLAIM TO ANY PARTICULAR FONT, STYLE, SIZE, OR COLOR.

OWNER OF INTERNATIONAL REGISTRATION 0889053 DATED 2-13-2006, EXPIRES 2-13-2016.

THE WORDING "BONINI" HAS NO MEANING IN A FOREIGN LANGUAGE.

SER. NO. 79-045,346, FILED 4-30-2007.

WARREN L. OLANDRIA, EXAMINING ATTORNEY

Int. Cl.: 7

Prior U.S. Cls.: 13, 19, 21, 23, 31, 34 and 35

United States Patent and Trademark Office

Reg. No. 3,485,292

Registered Aug. 12, 2008

**TRADEMARK
PRINCIPAL REGISTER**

LM 2000

SATA GMBH & CO. KG (FED REP GERMANY
GMBH & CO. KG)
DOMERTALSTR. 20
70806 KORNWESTHEIM
FED REP GERMANY

PRIORITY DATE OF 4-20-2007 IS CLAIMED.

OWNER OF INTERNATIONAL REGISTRATION
0941374 DATED 10-9-2007, EXPIRES 10-9-2017.

FOR: PAINT SPRAY GUNS AND PARTS THERE-
OF, PARTICULARLY NOZZLES AND NOZZLE SETS
FOR PAINT SPRAY GUNS AND PAINT CUPS FOR
PAINT SPRAY GUNS, IN CLASS 7 (U.S. CLS. 13, 19,
21, 23, 31, 34 AND 35).

SER. NO. 79-045,361, FILED 10-9-2007.

MELISSA VALLILLO, EXAMINING ATTORNEY

Int. Cl.: 3

Prior U.S. Cls.: 1, 4, 6, 50, 51 and 52

United States Patent and Trademark Office

Reg. No. 3,485,293

Registered Aug. 12, 2008

TRADEMARK
PRINCIPAL REGISTER

好文木

BAIEIDO CO., LTD. (JAPAN JOINT-STOCK COMPANY)
1-1-4 KURUMANO-CHO HIGASHI,
SAKAI-KU.; SAKAI-SHI; OSAKA 590-0943
JAPAN

FOR: FUMIGATING INCENSES (KUNKO); INCENSE; INCENSE STICKS; JOSS STICKS; PERFUMES; SYNTHETIC PERFUMERY; SYNTHETIC MUSK; PERFUMING SACHETS; ROOM FRAGRANCES; FRAGRANCES FOR AUTOMOBILES, IN CLASS 3 (U.S. CLS. 1, 4, 6, 50, 51 AND 52).

OWNER OF INTERNATIONAL REGISTRATION
0941816 DATED 8-10-2007, EXPIRES 8-10-2017.

THE ENGLISH TRANSLATION OF "KOUN" IS LIKE LEARNING AND THE ENGLISH TRANSLATION OF "BOKU" IS TREE. THE JAPANESE WORD "KOBUNBOKU" IS ANOTHER NAME OF UME TREE, JAPANESE APRICOT TREE.

THE TANSLITERATION OF THE NON-LATIN CHARACTERS IN THE MARK IS: KOBUNBOKU.

SER. NO. 79-045,506, FILED 8-10-2007.

CURTIS FRENCH, EXAMINING ATTORNEY

Int. Cl.: 12

Prior U.S. Cls.: 19, 21, 23, 31, 35 and 44

Reg. No. 3,485,294

United States Patent and Trademark Office

Registered Aug. 12, 2008

**TRADEMARK
PRINCIPAL REGISTER**

R-SYS

SALOMON S.A. (FRANCE SOCIÉTÉ ANONYME)
LIEU DIT LES CROISELETS
F-74370 METZ-TESSY
FRANCE

FOR: LAND VEHICLES; NAMELY, BICYCLES AND MOTORCYCLES AND PARTS AND ACCESSORIES THEREFOR, NAMELY, GEARS, PEDALS, WHEEL HUBS, HANDLEBARS, CHASSIS, WHEEL SUSPENSIONS, AIR PUMPS, TIRES, VALVES FOR TIRES, TIRE INNERTUBES, WHEEL SPOKES, MUDGUARDS, SHOCK ABSORBERS, SADDLES, SADDLECOVERS, BRACKET SHELLS, CHILDREN'S SAFETY SEATS, HORNS, LUGGAGE CARRIERS, KICKSTANDS; SPEED REDUCTION UNITS, NAMELY, BRAKES AND BRAKE CABLES; SPOKE CLIPS TO PROTECT USER'S APPAREL FROM BEING CAUGHT IN WHEELS .BICYCLE PARTS,

NAMELY WHEEL RIMS, DERAILLEUR GEARS, DERAILLEUR GEAR LEVERS, FRAMES, CHAINS, CHAIN WHEEL CRANKS, AND BICYCLE BELLS; TRICYCLES AND MOPEDS, IN CLASS 12 (U.S. CLS. 19, 21, 23, 31, 35 AND 44).

THE MARK CONSISTS OF STANDARD CHARACTERS WITHOUT CLAIM TO ANY PARTICULAR FONT, STYLE, SIZE, OR COLOR.

OWNER OF INTERNATIONAL REGISTRATION
0941828 DATED 9-28-2007, EXPIRES 9-28-2017.

SER. NO. 79-045,511, FILED 9-28-2007.

REBECCA SMITH, EXAMINING ATTORNEY

Int. Cl.: 7

Prior U.S. Cls.: 13, 19, 21, 23, 31, 34 and 35

United States Patent and Trademark Office

Reg. No. 3,485,295

Registered Aug. 12, 2008

**TRADEMARK
PRINCIPAL REGISTER**

GALVI

GALVI S.R.L. (ITALY JOINT STOCK COMPANY
WITH LIMITED LIABILITY)
VIA DELLA BETULLA, 7
I-20035 LISSONE (MILANO)
ITALY

FOR: DISC AND TREAD BRAKES FOR INDUS-
TRIAL USE IN MACHINES; PULLEYS BEING
PARTS OF MACHINES; DRUMS AS PART OF
MACHINES FOR WINDING CABLES; HOISTS;
AND LIFTING INSTALLATIONS FOR THE TRANS-

PORT OF PERSONS AND GOODS, IN CLASS 7 (U.S.
CLS. 13, 19, 21, 23, 31, 34 AND 35).

OWNER OF INTERNATIONAL REGISTRATION
0424826 DATED 5-6-1976, EXPIRES 5-6-2016.

SER. NO. 79-045,575, FILED 5-10-2006.

VERNA BETH RIRIE, EXAMINING ATTORNEY

Int. Cl.: 28

Prior U.S. Cls.: 22, 23, 38 and 50

United States Patent and Trademark Office

Reg. No. 3,485,296

Registered Aug. 12, 2008

**TRADEMARK
PRINCIPAL REGISTER**

BOOKCHASE

ANTONY DAVIS (UNITED KINGDOM INDIVIDUAL)
VINE COTTAGE, SOUTH STREET,
AVEBURY TRUSLOE; WILTSHIRE SN8 1QX
UNITED KINGDOM

FOR: BOARD GAMES; PARTS AND FITTINGS
FOR BOARD GAMES, NAMELY, PLAYING PIECES
AND PLAYING CARDS, IN CLASS 28 (U.S. CLS. 22,
23, 38 AND 50).

THE MARK CONSISTS OF STANDARD CHARACTERS WITHOUT CLAIM TO ANY PARTICULAR FONT, STYLE, SIZE, OR COLOR.

OWNER OF INTERNATIONAL REGISTRATION
0942112 DATED 5-15-2007, EXPIRES 5-15-2017.

SER. NO. 79-045,659, FILED 5-15-2007.

SHAILA SETTLES, EXAMINING ATTORNEY

Int. Cls.: 7, 9 and 42

**Prior U.S. Cls.: 13, 19, 21, 23, 26, 31, 34, 35, 36, 38, 100
and 101**

Reg. No. 3,485,297

United States Patent and Trademark Office

Registered Aug. 12, 2008

**TRADEMARK
SERVICE MARK
PRINCIPAL REGISTER**

LeyCaT

OERLIKON LEYBOLD VACUUM GMBH (FED
REP GERMANY GMBH)
BONNER STR. 498
50968 KÖLN
FED REP GERMANY

FOR: VACUUM PUMPS, VACUUM PUMP SYS-
TEMS COMPRISING SEVERAL VACUUM PUMPS,
IN CLASS 7 (U.S. CLS. 13, 19, 21, 23, 31, 34 AND 35).

FOR: COMPUTER SOFTWARE FOR USE IN
DATA PROCESSING AND. DESIGNING VACUUM
ASSEMBLIES, IN CLASS 9 (U.S. CLS. 21, 23, 26, 36
AND 38).

FOR: TECHNICAL CONSULTANCY PROVIDED
BY ENGINEERS IN THE FIELD OF VACUUM
TECHNOLOGY, DESIGN AND DEVELOPMENT
OF VACUUM ASSEMBLIES, AND TECHNICAL
CALCULATIONS RELATING THERETO, IN CLASS
42 (U.S. CLS. 100 AND 101).

THE MARK CONSISTS OF STANDARD CHAR-
ACTERS WITHOUT CLAIM TO ANY PARTICULAR
FONT, STYLE, SIZE, OR COLOR.

PRIORITY DATE OF 1-26-2007 IS CLAIMED.

OWNER OF INTERNATIONAL REGISTRATION
0942237 DATED 7-24-2007, EXPIRES 7-24-2017.

THE TERM LEYCAT HAS NO MEANING IN A
FOREIGN LANGUAGE.

SER. NO. 79-045,698, FILED 7-24-2007.

AISHA SALEM, EXAMINING ATTORNEY

Int. Cl.: 9

Prior U.S. Cls.: 21, 23, 26, 36 and 38

United States Patent and Trademark Office

Reg. No. 3,485,298

Registered Aug. 12, 2008

**TRADEMARK
PRINCIPAL REGISTER**

ACUSTICA BEYMA, S.A. (SPAIN SOCIEDAD ANONIMA)
C/ DEL PONT SEC, 1-C
PLGNO. IND. MONCADA II
E-46113 MONCADA (VALENCIA), SPAIN

FOR: APPARATUS FOR RECORDING, TRANSMITTING OR REPRODUCING SOUND, IN CLASS 9 (U.S. CLS. 21, 23, 26, 36 AND 38).

OWNER OF INTERNATIONAL REGISTRATION
0942379 DATED 6-4-2007, EXPIRES 6-4-2017.

OWNER OF U.S. REG. NO. 2,938,390.

SER. NO. 79-045,744, FILED 6-4-2007.

JAMES MACFARLANE, EXAMINING ATTORNEY

Int. Cl.: 20

Prior U.S. Cls.: 2, 13, 22, 25, 32 and 50

United States Patent and Trademark Office

Reg. No. 3,485,299

Registered Aug. 12, 2008

**TRADEMARK
PRINCIPAL REGISTER**



LEOPLAST SRL (ITALY LTD LIAB CO)
VIA DELL'INDUSTRIA, 2
I-10020 ARIGNANO (TO), ITALY

OWNER OF INTERNATIONAL REGISTRATION
0942392 DATED 7-13-2007, EXPIRES 7-13-2017.

FOR: PLASTIC CONTAINERS AND PLASTIC
CLOSURES DEVICES, FOR THE COSMETIC, PHAR-
MACEUTICAL, PERFUME, HYGIENIC AND
PACKAGING INDUSTRY, NAMELY, BOXES,
CASES, CAPS, LIDS, COVERS AND EMPTY
SQUEEZE TUBES, IN CLASS 20 (U.S. CLS. 2, 13, 22,
25, 32 AND 50).

NO CLAIM IS MADE TO THE EXCLUSIVE
RIGHT TO USE "VEGETAL PLASTIC", APART
FROM THE MARK AS SHOWN.

SER. NO. 79-045,750, FILED 7-13-2007.

PRIORITY DATE OF 5-28-2007 IS CLAIMED.

LEIGH CAROLINE CASE, EXAMINING ATTOR-
NEY

Int. Cl.: 3

Prior U.S. Cls.: 1, 4, 6, 50, 51 and 52

United States Patent and Trademark Office

Reg. No. 3,485,300

Registered Aug. 12, 2008

**TRADEMARK
PRINCIPAL REGISTER**



CATALFER SRL (ITALY LIMITED LIABILITY
COMPANY)
VIA CAMPO DEI FIORI, 9
I-21010 BRUNELLO (VA)
ITALY

FOR: COATED ABRASIVES AND SANDPAPER
IN THE FORM OF DISCS; ABRASIVE CLOTH;
SANDPAPER, IN CLASS 3 (U.S. CLS. 1, 4, 6, 50, 51
AND 52).

PRIORITY DATE OF 3-30-2007 IS CLAIMED.

OWNER OF INTERNATIONAL REGISTRATION
0942445 DATED 9-4-2007, EXPIRES 9-4-2017.

THE COLOR(S) BLUE AND YELLOW IS/ARE
CLAIMED AS A FEATURE OF THE MARK.

THE MARK CONSISTS OF A RECTANGLE
WHICH IS IN BLUE AND YELLOW. THE WORD-
ING "ONETECH" IS IN YELLOW. THE DESIGN
ELEMENT TO THE RIGHT OF THE WORDING
"ONETECH" IS IN BLUE AND YELLOW.

SER. NO. 79-045,773, FILED 9-4-2007.

GRETTA YAO, EXAMINING ATTORNEY

Int. Cls.: 3 and 5

Prior U.S. Cls.: 1, 4, 6, 18, 44, 46, 50, 51 and 52

Reg. No. 3,485,301

United States Patent and Trademark Office

Registered Aug. 12, 2008

**TRADEMARK
PRINCIPAL REGISTER**

RUBAZIL

COLLAGENEX PHARMACEUTICALS, INC.
(UNITED STATES CORPORATION)
41 UNIVERSITY DRIVE, SUITE 200
NEWTOWN, PA 19840
UNITED STATES

FOR: NON-MEDICATED SKIN AND SCALP PREPARATIONS; SOAPS; DISPOSABLE IMPREGNATED WIPES CONTAINING NON-MEDICATED SKIN CARE PREPARATIONS; DISPOSABLE IMPREGNATED WIPES CONTAINING NON-MEDICATED TOOTH CLEANING PREPARATIONS; DISPOSABLE IMPREGNATED WIPES CONTAINING NON-MEDICATED PREPARATIONS FOR THE CARE OF THE ORAL CAVITY; NON-MEDICATED TOOTH CLEANING AND GARGLE PREPARATIONS FOR ORAL HYGIENE OR FOR THE CARE OF THE ORAL CAVITY; MOUTHWASH; NON-MEDICATED MOUTH RINSE, TOOTH-PASTES; NON-MEDICATED SUNSCREEN AND SUN BLOCK; DISPOSABLE WIPES IMPREGNATED WITH CHEMICALS OR COMPOUNDS FOR PERSONAL HYGIENE; PREPARATIONS FOR PERSONAL HYGIENE, NAMELY, BODY DEODORANT, IN CLASS 3 (U.S. CLS. 1, 4, 6, 50, 51 AND 52).

FOR: MEDICAL, MEDICATED AND VETERINARY PREPARATIONS FOR THE TREATMENT OF SKIN DISORDERS OF MAMMALS OR ANIMALS; MEDICINAL AND VETERINARY PREPARATIONS FOR THE TREATMENT OF THE MOUTH OR THE ORAL CAVITY; MEDICINAL AND VETERINARY SPRAYS FOR THE TREATMENT OF SKIN DISORDERS OF MAMMALS OR ANIMALS; MEDICINAL AND VETERINARY SPRAYS FOR THE TREATMENT OF THE MOUTH OR THE ORAL CAVITY; MEDICINAL PREPARATIONS FOR THE TREATMENT OF INFECTIOUS DISEASES, IN CLASS 5 (U.S. CLS. 6, 18, 44, 46, 51 AND 52).

PRIORITY DATE OF 1-9-2007 IS CLAIMED.

OWNER OF INTERNATIONAL REGISTRATION
0942481 DATED 7-9-2007, EXPIRES 7-9-2017.

SER. NO. 79-045,788, FILED 7-9-2007.

TASHIA BUNCH, EXAMINING ATTORNEY

Int. Cls.: 9 and 18

Prior U.S. Cls.: 1, 2, 3, 21, 22, 23, 26, 36, 38 and 41

United States Patent and Trademark Office

Reg. No. 3,485,302

Registered Aug. 12, 2008

**TRADEMARK
PRINCIPAL REGISTER**

PossePouch

SUZANNE RILEY (AUSTRALIA INDIVIDUAL)
2 HETHERINGTON DRIVE
TWIN WATERS QLD 4564
AUSTRALIA AND
DEBORAH NIELSEN (NEW ZEALAND INDIVIDUAL)
2 HETHERINGTON DRIVE
TWIN WATERS QLD 4564
AUSTRALIA

FOR: ACCESSORIES FOR PORTABLE COMMUNICATION DEVICES AND PORTABLE DIGITAL ELECTRONIC DEVICES, NAMELY, BAGS, CASES AND HOLDERS FOR PORTABLE COMMUNICATION DEVICES AND PORTABLE DIGITAL ELECTRONIC DEVICES AND BAGS, CASES AND HOLDERS ADAPTED OR SHAPED TO CONTAIN PORTABLE COMMUNICATION DEVICES AND PORTABLE DIGITAL ELECTRONIC DEVICES, NAMELY, CASES FOR MOBILE PHONES, CASES FOR DIGITAL CAMERAS, CASES FOR PORTABLE MUSIC DEVICES, CASES FOR ELECTRONIC DIA-

RIES, CASES FOR GAME CONSOLES AND CASES FOR PORTABLE MEDIA PLAYERS, IN CLASS 9 (U.S. CLS. 21, 23, 26, 36 AND 38).

FOR: CASES, COVERS, BAGS AND HOLDERS FOR PORTABLE COMMUNICATION DEVICES AND PORTABLE DIGITAL ELECTRONIC DEVICES MADE OF LEATHER, IMITATION LEATHER OR FABRIC, NAMELY, ALL-PURPOSE CARRYING BAGS, IN CLASS 18 (U.S. CLS. 1, 2, 3, 22 AND 41).

THE MARK CONSISTS OF STANDARD CHARACTERS WITHOUT CLAIM TO ANY PARTICULAR FONT, STYLE, SIZE, OR COLOR.

OWNER OF INTERNATIONAL REGISTRATION 0942735 DATED 9-18-2007, EXPIRES 9-18-2017.

SER. NO. 79-045,875, FILED 9-18-2007.

KATHRYN COWARD, EXAMINING ATTORNEY

Int. Cl.: 6

Prior U.S. Cls.: 2, 12, 13, 14, 23, 25 and 50

United States Patent and Trademark Office

Reg. No. 3,485,303

Registered Aug. 12, 2008

**TRADEMARK
PRINCIPAL REGISTER**



HUBEI YONGHEAN MENYE; YOUXIAN GONG-
SI (CHINA CORPORATION)
CHENGDONG GONGYEYUAN, HANCHUAN
HUBEI 431600
CHINA

FOR: METAL DOORS FOR FIRE PROTECTION,
METAL DOORS FOR GARAGES, METAL WIN-
DOWS, BUCKLES OF COMMON METAL, METAL
DOOR HANDLES, METAL FURNITURE FITTINGS,
METALLIC LOADING PALLETS, SIGNBOARDS OF
METAL, RODS OF METAL FOR WELDING, IN
CLASS 6 (U.S. CLS. 2, 12, 13, 14, 23, 25 AND 50).

OWNER OF INTERNATIONAL REGISTRATION
0886273 DATED 2-8-2006, EXPIRES 2-8-2016.

THE STIPPLING IN THE DRAWING IS FOR
SHADING PURPOSE ONLY.

THE ENGLISH TRANSLATION OF THE WORD
"YOUNG HE AN" IN THE MARK IS FOREVER,
ACCORDANCE, GOOD HEALTH.

THE TANSLITERATION OF THE NON-LATIN
CHARACTERS IN THE MARK IS: YONG HE AN.

SER. NO. 79-045,941, FILED 3-1-2007.

MICHAEL LEWIS, EXAMINING ATTORNEY

Int. Cls.: 7, 12 and 37

**Prior U.S. Cls.: 13, 19, 21, 23, 31, 34, 35, 44, 100, 103
and 106**

Reg. No. 3,485,304

United States Patent and Trademark Office

Registered Aug. 12, 2008

**TRADEMARK
SERVICE MARK
PRINCIPAL REGISTER**

HIAB

CARGOTEC PATENTER AB; C/O KALMAR INDUSTRIES AB (SWEDEN JOINT STOCK COMPANY)
SE-341 81 LJUNGBY
SWEDEN

FOR: MACHINES, NAMELY, POWER-OPERATED AND MECHANICAL LIFTS AND LOADERS, POWER-OPERATED AND MECHANICAL MACHINES FOR LOAD AND CONTAINER HANDLING, HARVESTERS, POWER-OPERATED AND MECHANICAL MACHINES FOR DOCKING AND MOORING, FORKLIFTS AND CRANES, ALL FOR LIFTING, LOADING, UNLOADING, AND FREIGHTING PURPOSES, MOTORS AND ENGINES EXCEPT FOR LAND VEHICLES FOR CRANES, LIFTS, LOADERS, LOAD AND CONTAINER HANDLING MACHINES, HARVESTERS; FORKLIFTS AND CRANES, ALL FOR LIFTING, LOADING, UNLOADING, AND FREIGHTING PURPOSES; MACHINE BELTS AND COUPLINGS NOT FOR LAND VEHICLES; LOADING AND LIFTING CRANES, HYDRAULIC LOADERS, LIFTING MACHINES AND APPARATUS, NAMELY, LIFTS AND HOISTS; LOADERS FOR HARVESTERS, MECHANICAL RAMPS; STRUCTURAL PARTS AND FITTINGS FOR THE AFORESAID GOODS NOT INCLUDED IN OTHER CLASSES, IN CLASS 7 (U.S. CLS. 13, 19, 21, 23, 31, 34 AND 35).

FOR: MOTOR VEHICLES INCORPORATING LIFTING APPARATUS AND CRANES, NAMELY,

PLATFORM TRUCKS, TRUCKS AND TRACTORS WITH MOUNTED WINCHES, HOISTS AND CRANES; FORK-LIFT TRUCKS; REPLACEABLE VEHICLE PLATFORMS FOR LOAD AND FREIGHT HANDLING, NAMELY, LOAD AND FREIGHT TRAILERS AND LOAD AND FREIGHT DEMOUNTABLE PLATFORMS; AUTOMOBILE CHASSIS, IN CLASS 12 (U.S. CLS. 19, 21, 23, 31, 35 AND 44).

FOR: INSTALLATION, REPAIR AND MAINTENANCE OF LIFTING, LOADING, UNLOADING AND FREIGHTING MACHINES AND MACHINE TOOLS, MOTORS AND ENGINES, MACHINE BELTS AND COUPLINGS, LOADING AND LIFTING CRANES, HYDRAULIC LOADERS, LIFTING MACHINES AND APPARATUS, HAULING ENGINES AND APPARATUS, TRANSMISSION COMPONENTS, LOADERS FOR HARVESTERS, MOTOR VEHICLES, VEHICLES INCORPORATING LIFTING APPARATUS AND CRANES, FORK-LIFT TRUCKS, REPLACEABLE VEHICLE PLATFORMS, VEHICLES CHASSIS AND TRACTION VEHICLES, IN CLASS 37 (U.S. CLS. 100, 103 AND 106).

OWNER OF INTERNATIONAL REGISTRATION
0905566 DATED 9-27-2006, EXPIRES 9-27-2016.

SER. NO. 79-045,945, FILED 6-27-2007.

BRIAN CALLAGHAN, EXAMINING ATTORNEY

Int. Cls.: 35, 38 and 41

Prior U.S. Cls.: 100, 101, 102, 104 and 107

Reg. No. 3,485,305

United States Patent and Trademark Office

Registered Aug. 12, 2008

**SERVICE MARK
PRINCIPAL REGISTER**

LUXURYSOCIETY

BARNET PHILIPPE (FRANCE INDIVIDUAL)
18 RUE FEYDEAU
F-75002 PARIS
FRANCE

FOR: ADVERTISING AND BUSINESS INFORMATION SERVICES; BUSINESS NETWORKING, NAMELY, ESTABLISHING BUSINESS CONTACTS; COMMERCIAL CONSULTANCY; BUSINESS SERVICES, NAMELY, SEEKING BUSINESS PARTNERS FOR BUSINESS SERVICE PROVIDERS; PUBLIC RELATIONS; DISSEMINATION OF ADVERTISEMENTS; RENTAL OF ADVERTISING SPACE, IN PARTICULAR ON DIGITAL SCREENS; ADVERTISING MANAGEMENT; PROVIDING COMMERCIAL BUSINESS INFORMATION VIA DATABASES; DATABASE MANAGEMENT, NAMELY, CONDUCTING DATA SEARCHES FOR OTHERS; DOCUMENT MANAGEMENT, NAMELY, COMPUTERIZED COMPILATION OF CUSTOMER INDEXES; RECORDS MANAGEMENT SERVICES, NAMELY, INPUTTING AND SYSTEMIZATION OF DOCUMENTS; DATABASE MANAGEMENT, NAMELY, PROCESSING AND CHECKING DATA IN DATABASES; MANAGEMENT OF COMPUTERIZED FILES; BUSINESS ADVICE, INQUIRIES AND INFORMATION; ARRANGING BUSINESS CONTRACTUAL SERVICES WITH THIRD PARTIES; PROVIDING INFORMATION ABOUT BUSINESS MANAGEMENT AND ORGANIZATION; PROVIDING INFORMATION ABOUT EMPLOYMENT RECRUITING; EMPLOYMENT HIRING SERVICES; EMPLOYMENT AGENCIES; COMMERCIAL PROMOTIONAL SERVICES FOR OTHERS; BUSINESS MARKETING; SALES PROMOTION FOR OTHERS; MARKETING AND PROMOTING THE GOODS OF OTHERS, NAMELY, DISPLAYING THE GOODS OF OTHERS TO ENABLE CUSTOMERS AND USERS TO OBTAIN INFORMATION ABOUT THESE GOODS; ARRANGING SUBSCRIPTIONS TO THE PUBLICATIONS OF OTHERS; ARRANGING SUBSCRIPTIONS TO ELECTRONIC PUBLICATIONS OF OTHERS; PUBLISHING OF ADVERTISING TEXTS; ORGANIZATION OF EXHIBITIONS FOR COMMERCIAL AND ADVERTISING PURPOSES VIA A GLOBAL COMPUTER NETWORK; ORGANIZING

PROMOTIONS FOR THE GOODS AND SERVICES OF OTHERS ON COMPUTER COMMUNICATION NETWORKS; PROMOTING THE GOOD AND SERVICES OF OTHERS USING POINT OF SALE PROMOTIONS; ORGANIZATION OF PROMOTIONAL ACTIVITIES, ADVERTISING CAMPAIGNS, AND DIRECT MARKETING CAMPAIGNS; PERSONNEL RECRUITMENT AGENCIES; CONDUCTING MARKET RESEARCH STUDIES; ORGANIZATION OF COMPETITIONS FOR ADVERTISING OR BUSINESS PURPOSES; ALL THE AFORESAID SERVICES OFFERED ONLINE VIA GLOBAL COMPUTER NETWORKS, IN CLASS 35 (U.S. CLS. 100, 101 AND 102).

FOR: ONLINE OR INTERNET TELECOMMUNICATIONS SERVICES, NAMELY, ELECTRONIC TRANSMISSION AND DELIVERY OF MESSAGES, DATA, IMAGES AND TEXTS; PROVIDING ACCESS TO TELECOMMUNICATIONS NETWORKS VIA PROFESSIONAL NETWORK PLATFORMS; PROVIDING TELECOMMUNICATION ACCESS TO COMPUTER DATABASES; TRANSMISSION OF INFORMATION, TEXTS, DRAWINGS, IMAGES AND DATA BY ELECTRONIC COMMUNICATION NETWORKS; GRANTING ACCESS TO ELECTRONIC BULLETIN BOARDS; PROVIDING ACCESS TO WEBSITES AND COMPUTER SEARCH ENGINES; GRANTING USER ACCESS TO GLOBAL COMPUTER NETWORKS; ELECTRONIC TRANSMISSION OF DATA CONTAINED IN DATABASES OR STORED ON COMPUTER, IN CLASS 38 (U.S. CLS. 100, 101 AND 104).

FOR: PUBLISHING AND PUBLICATION OF BOOKS, MAGAZINES AND TEXTS OTHER THAN ADVERTISING TEXTS; PUBLICATION OF ELECTRONIC PERIODICALS AND BOOKS; ORGANIZATION OF EXHIBITIONS FOR CULTURAL OR EDUCATIONAL PURPOSES; PROVIDING ENTERTAINMENT AND RECREATIONAL INFORMATION; PROVIDING INFORMATION ON CULTURAL EVENTS; ARRANGING OF ATHLETIC COMPETITIONS FOR EDUCATIONAL OR ENTERTAINMENT PURPOSES; ARRANGING AND CONDUCTING SPECIAL EVENTS; CLUB SERVICES,

NAMELY, GOLF CLUB SERVICES; ALL THE AFORESAID SERVICES PROVIDED ONLINE VIA GLOBAL COMPUTER NETWORKS, IN CLASS 41 (U.S. CLS. 100, 101 AND 107).

OWNER OF INTERNATIONAL REGISTRATION 0942988 DATED 9-27-2007, EXPIRES 9-27-2017.

SER. NO. 79-046,016, FILED 9-27-2007.

PRIORITY DATE OF 8-5-2007 IS CLAIMED.

EVELYN BRADLEY, EXAMINING ATTORNEY

Int. Cls.: 6, 8, 9, 11, 14, 16, 20, 21, 28 and 34

Prior U.S. Cls.: 2, 5, 8, 9, 12, 13, 14, 17, 21, 22, 23, 25, 26, 27, 28, 29, 30, 31, 32, 33, 34, 36, 37, 38, 40, 44 and 50

Reg. No. 3,485,306

United States Patent and Trademark Office

Registered Aug. 12, 2008

**TRADEMARK
PRINCIPAL REGISTER**

EVA SOLO

EVA DENMARK A/S (DENMARK PLC)
MÅLØV TEKNIKERBY 18-20
DK-2760 MÅLØV, DENMARK

FOR: CREDIT CARD HOLDERS OF METAL, HOOKS OF METAL; NOTICE AND MESSAGE BOARDS OF METAL, IN CLASS 6 (U.S. CLS. 2, 12, 13, 14, 23, 25 AND 50).

FOR: NUTCRACKERS NOT OF PRECIOUS METALS; MALLETS, NAMELY, NUTHAMMERS NOT OF PRECIOUS METALS; NON-ELECTRIC FRUIT PEELERS; PARING KNIVES; FRUIT KNIVES; POME CORERS; HAND-OPERATED VEGETABLE SHREDDERS; NON-ELECTRIC TIN CAN OPENERS; NON-ELECTRIC PARSLEY MINCERS; NON-ELECTRIC PIZZA CUTTERS; NON-ELECTRIC CHEESE SLICERS; KNIFE STANDS; KNIFE MAGNETS, IN CLASS 8 (U.S. CLS. 23, 28 AND 44).

FOR: KITCHEN SCALES, TIMERS AND THERMOMETERS; HOLDERS FOR MUSICAL, GAME AND VIDEO COMPACT DISCS; RAIN LEVEL GAUGES; MAGNET BOARDS, IN CLASS 9 (U.S. CLS. 21, 23, 26, 36 AND 38).

FOR: BARBECUE GRILLS; ELECTRIC GRILLS; ROASTING JACKS WITH SPITS, IN CLASS 11 (U.S. CLS. 13, 21, 23, 31 AND 34).

FOR: BATTERY-POWERED CLOCKS, IN CLASS 14 (U.S. CLS. 2, 27, 28 AND 50).

FOR: OFFICE REQUISITES, NAMELY, MEMORANDUM BOARDS AND PRESENTATION BOARDS, IN CLASS 16 (U.S. CLS. 2, 5, 22, 23, 29, 37, 38 AND 50).

FOR: WINE RACKS, IN CLASS 20 (U.S. CLS. 2, 13, 22, 25, 32 AND 50).

FOR: VASES NOT OF PRECIOUS METAL; FLOWERPOTS; FLOWERPOT COVERS NOT OF PAPER; CARAFES AND JUGS OF GLASS; VACUUM JUGS AND FLASKS; ICE BUCKETS; ICE CUBE MOLDS FOR REFRIGERATORS; CUPS, SAUCERS AND DRINKING GLASSES NOT OF PRECIOUS METALS; SPICE JARS; COFFEE AND TEA POTS, NOT ELECTRIC AND NOT OF PRECIOUS METALS; NON-ELECTRIC COFFEE MAKERS; NON-ELECTRIC WHISKS; LADLES FOR COOKING; SPATULAS; CAKE AND PIE SERVERS; FRUIT AND GARLIC PRESSES; NON-ELECTRIC GRATERS FOR KITCHEN PURPOSES; UTENSILS FOR BARBECUES, NAMELY, FORKS, TONGS, AND TURNERS; CHOPPING BOARDS FOR KITCHEN USE; BREAD BOXES; POT HOLDERS OF SILICONE; FEEDING TROUGH AND TABLES FOR ANIMALS; NONE OF THE AFORESAID GOODS IN THE FORM OF DISPOSABLE GOODS OR REUSABLE DISPOSABLE GOODS, IN CLASS 21 (U.S. CLS. 2, 13, 23, 29, 30, 33, 40 AND 50).

FOR: PLAYING CARDS AND PLAYING CARD HOLDERS, IN CLASS 28 (U.S. CLS. 22, 23, 38 AND 50).

FOR: ASHTRAYS NOT OF PRECIOUS METALS FOR SMOKERS, IN CLASS 34 (U.S. CLS. 2, 8, 9 AND 17).

OWNER OF INTERNATIONAL REGISTRATION 0942992 DATED 10-9-2007, EXPIRES 10-9-2017.

THE NAME(S), PORTRAIT(S), AND/OR SIGNATURE(S) SHOWN IN THE MARK DOES NOT IDENTIFY A PARTICULAR LIVING INDIVIDUAL.

SER. NO. 79-046,018, FILED 10-9-2007.

LINDA M. KING, EXAMINING ATTORNEY

Int. Cls.: 9, 14, 18 and 25

**Prior U.S. Cls.: 1, 2, 3, 21, 22, 23, 26, 27, 28, 36, 38, 39,
41 and 50**

Reg. No. 3,485,307

United States Patent and Trademark Office

Registered Aug. 12, 2008

**TRADEMARK
PRINCIPAL REGISTER**



O.I.W.

Officine Italiane Wrist Watch

S.I.F.O. S.R.L. (ITALY LIMITED COMPANY)
VIA DELLE GONDOLLE, 141
I-00121 OSTIA LIDO, ROMA
ITALY

FOR: OPTICAL APPARATUS AND INSTRUMENTS, NAMELY, CAMERAS, CAMERA LENSES, TELESCOPES, VIDEO RECORDERS, VIDEO TAPE RECORDERS, VIDEO PROJECTORS, PHOTOGRAPHIC EXPOSURE METERS, CAMERA FLASHES, PROJECTION AND VIDEO SCREENS, EXPOSED CAMERA FILM, TRIPODS, BAGS FOR CAMERAS AND PHOTOGRAPHIC EQUIPMENT; GRADUATED GLASSWARE, SUNGLASSES, IN CLASS 9 (U.S. CLS. 21, 23, 26, 36 AND 38).

FOR: PRECIOUS METALS AND THEIR ALLOYS AND GOODS IN PRECIOUS METALS OR COATED THEREWITH, NAMELY, PENDANTS, RINGS; JEWELLERY, PRECIOUS STONES; HOROLOGICAL AND CHRONOMETRIC INSTRUMENTS; AGATES, ALARM CLOCKS, ALLOYS OF PRECIOUS METAL, JEWELRY, NAMELY, AMULETS, ANCHORS BEING PARTS OF CLOCKS AND WATCHES, ATOMIC CLOCKS, BADGES OF PRECIOUS METAL, BARRELS BEING PARTS OF CLOCKS AND WATCHES, BOXES OF PRECIOUS METAL, BRACELETS, BROOCHES, BUSTS OF PRECIOUS METAL, CASES FOR CLOCK AND WATCHMAKING, CASES FOR WATCHES, JEWELRY CHAINS, WATCH CHAINS, CHARMS, CHRONOGRAPHS FOR USE AS WATCHES, CHRONOMETERS, CHRONOMETRICAL INSTRUMENTS, CHRONOSCOPES, TIE CLIPS, CLOCK CASES, CLOCK HANDS BEING PARTS OF CLOCKS AND WATCHES, CLOCKS, ELECTRIC CLOCKS AND WATCHES, CLOCKWORKS, CLOISONNE JEWELLERY PINS, COLLECTIBLE COINS, CONTROL CLOCKS, COLLECTIBLE COPPER TOKENS, CUFF LINKS, CLOCK AND WATCH DIALS, SUN DIALS, DIAMONDS, EARR-

INGS, FIGURINES OF PRECIOUS METAL, GOLD THREAD BEING JEWELRY, GOLD, UNWROUGHT OR BEATEN, HAT ORNAMENTS OF PRECIOUS METAL, INGOTS OF PRECIOUS METALS, IRIIDIUM, JEWELRY OF IVORY, ORNAMENTS OF JET, JET, UNWROUGHT OR SEMI-WROUGHT, JEWELLERY, JEWELLERY CASES, JEWELLERY OF YELLOW AMBER, PASTE JEWELLERY, JEWELRY, KEY RINGS OF PRECIOUS METAL, CUFF LINKS, MASTER CLOCKS, MEDALLIONS, MEDALS, MOVEMENTS FOR CLOCKS AND WATCHES, NECKLACES, OLIVINE, ORNAMENTAL PINS, ORNAMENTS BEING JEWELRY, SHOE ORNAMENTS OF PRECIOUS METAL, OSMIUM, PALLADIUM, PEARLS, PEARLS MADE OF AMBROID, NAMELY, PRESSED AMBER, PENDULUMS BEING PARTS OF CLOCKS AND WATCHES, PINS BEING JEWELRY, TIE PINS, PLATINUM, PRECIOUS METALS, UNWROUGHT OR SEMI-WROUGHT, PRECIOUS STONES, RHODIUM, RINGS BEING JEWELRY, RUTHENIUM, SEMIPRECIOUS STONES, SILVER ORNAMENTS, SILVER THREAD FOR USE IN MAKING JEWELRY, SILVER, UNWROUGHT OR BEATEN, SPINEL BEING PRECIOUS STONES, WATCH SPRINGS, SPUN SILVER FOR USE IN JEWELRY, STATUES OF PRECIOUS METAL, STATUETTES OF PRECIOUS METAL, STOPWATCHES, STRAPS FOR WRISTWATCHES, THREADS OF PRECIOUS METAL FOR USE IN JEWELRY, TRINKETS BEING RINGS, WATCH BANDS, WATCH CASES, WATCH CRYSTALS, WATCH GLASSES, WATCH STRAPS, WATCHES, WIRE OF PRECIOUS METAL FOR USE IN MAKING JEWELRY, WORKS OF ART OF PRECIOUS METAL, WRISTWATCHES, IN CLASS 14 (U.S. CLS. 2, 27, 28 AND 50).

FOR: LEATHER AND IMITATIONS OF LEATHER, AND GOODS MADE OF THESE MATERIAL, NAMELY, SHOPPING BAGS AND MESH NET

SHOPPING BAGS, VALISES, SACHELS, WALLETS, PURSES AND KEY CASES, TRUNKS, WALLET, DOCUMENT BAGS, SUITCASES, WALKING STICKS, HAVERSACK, SPORTS AND TRAVELING BAGS, GARMENT BAGS FOR TRAVEL, SEA BAGS FOR TRAVEL, BRIEF CASES, PURSES, KEY CASES, SHOULDER BAGS, CARRY-ON BAGS, TOTE BAGS, HANDBAGS, LEATHER LEASHES FOR ANIMALS, SACHEL BAGS, BEAUTY CASES SOLD EMPTY, WAIST BAGS; ANIMAL SKINS, HIDES; TRUNKS AND TRAVELLING BAGS; UMBRELLAS, PARASOLS, AND WALKING STICKS; WHIPS, HARNESS AND SADDLERY; ALPENSTOCKS, ATTACHÉ CASES, BACKPACKS, BAGS OF LEATHER, FOR MERCHANDISE PACKAGING, BAGS FOR CAMPER, NAMELY, BACKPACKS, BAGS FOR CLIMBERS, NAMELY, BACKPACKS, BAGS FOR SPORTS, HUNTERS' GAME BAGS, GARMENT BAGS FOR TRAVEL, NET MESH BAGS FOR SHOPPING, NOSE BAGS FOR FEEDING ANIMALS, BANDOLIERS, BANDS OF LEATHER, BEACH BAGS, LEATHER SHOULDER BELTS, BITS FOR ANIMALS, BLINDERS FOR HORSES, BLINKERS FOR HORSES; HAT BOXES OF LEATHER, BOXES OF LEATHER FOR STORING GREETING CARDS, BOXES OF LEATHER FOR STORING ANIMAL SKINS, BRIDLES FOR HORSES, BRIDDOONS FOR HORSES, BRIEFCASES, BUTTS BEING ANIMAL HIDES, CANES, BUSINESS CARD CASES, CASES, OF LEATHER OR LEATHERBOARD, CAT O' NINE TAILS, CATTLE SKINS, CHAIN MESH PURSES, CHAMOIS LEATHER, OTHER THAN FOR CLEANING PURPOSES, CHIN STRAPS, OF LEATHER, OTHER THAN FOR FOOTBALL HELMETS, CLOTHING FOR PETS, COLLARS FOR ANIMALS, FURNITURE COVERINGS OF LEATHER, COVERINGS OF SKINS, NAMELY, FURS, COVERS FOR ANIMALS, COVERS FOR HORSE-SADDLES, UMBRELLA COVERS, CURRIED ANIMAL SKINS, DOG COLLARS, ENVELOPES, OF LEATHER, FOR MERCHANDISE PACKAGING, FASTENINGS FOR SADDLES, HARNESS FITTINGS, FRAMES FOR UMBRELLAS OR PARASOLS, HANDBAG FRAMES, FUR, LEATHER TRIMMINGS FOR FURNITURE, FUR-SKINS, GOLD BEATERS' ANIMAL SKIN, GUT FOR MAKING SAUSAGE CASINGS, HORSE HALTERS, HANDBAGS, SUITCASE HANDLES, WALKING STICK HANDLES, HARNESS FOR ANIMALS, HARNESS STRAPS, HARNESS TRACES, HAVERSACKS, HEAD-STALLS FOR HORSES, HORSE BLANKETS, HORSE COLLARS, HORSESHOES, IMITATION LEATHER, SLINGS FOR CARRYING INFANTS, KEY CASES, KNEE-PADS FOR HORSES, LEATHER LACES BEING HORSE TACK, LEATHER LEASHES FOR ANIMALS, LEATHER AND IMITATION LEATHER LEADS BEING HORSE TACK, LEATHER STRAPS BEING HORSE TACK, LEATHER THONGS, LEATHER THREAD, LEATHER TWIST FOR TRUNKS AND BAGS, LEATHER, UNWORKED OR SEMI-WORKED, MOLESKIN BEING IMITATION LEATHER, MOUNTAINEERING STICKS, PADS FOR HORSE SADDLES, PELTS, POCKET WALLETS, POUCHES, OF LEATHER, FOR PACKAGING, PURSES, REINS, UMBRELLA OR PARASOL RIBS, RIDING SADDLES, RUCKSACKS, SADDLE CLOTHS FOR HORSES, SADDLE TREES, SADDLERY, PADS FOR HORSE SADDLES,

SCHOOL SACHELS, SCHOOL BAGS, SHOPPING BAGS, NOT OF PAPER, SHOULDER BELTS OF LEATHER, STRAPS FOR HOLDING SKATES, SLING BAGS FOR CARRYING INFANTS, LEATHER STRAPS FOR HOLDING SOLDIERS' EQUIPMENT, PARTS OF STIRRUPS OF RUBBER, STRAPS OF LEATHER BEING SADDLERY, SUITCASES, TOOL BAGS OF LEATHER SOLD EMPTY, TRAVELING BAGS, TRAVELLING TRUNKS, TRIMMINGS OF LEATHER FOR FURNITURE, TRUNKS, UMBRELLA HANDLES, UMBRELLA RINGS, UMBRELLA STICKS, UMBRELLAS, VALISES, VANITY CASES, NOT FITTED, WALKING CANE HANDLES, WALKING STICK SEATS, WALKING STICKS, WHEELED SHOPPING BAGS, NOT OF PAPER, WHIPS, IN CLASS 18 (U.S. CLS. 1, 2, 3, 22 AND 41).

FOR: CLOTHING, NAMELY, SHIRTS, T-SHIRTS, SHORTS, BERMUDA SHORTS, SWEATSHIRTS, PANTS, TROUSERS, JACKETS, OVERCOATS, COATS, SKIRTS, SUITS, JERSEYS, WAISTCOATS, DRESSES, PAJAMAS, PULLOVERS, JEANS, TRACKSUITS, RAINWEAR, BEACHWEAR, SWIMMING SUITS, FOOTWEAR, HEADGEAR, NAMELY, HATS AND CAPS, SKULL CAPS, SPORTS CAPS, BERETS; APRONS, ASCOTS, BABIES' DIAPERS OF TEXTILE, BABIES' NAPKINS OF TEXTILE, NAMELY, BIBS, BABIES' PANTS, BANDANAS, BATH ROBES, BATH SANDALS, BATH SLIPPERS, BATHING CAPS, BATHING DRAWERS, BATHING SUITS, BATHING TRUNKS, BEACH CLOTHES, NAMELY, BEACH COVER-UPS, BEACH SHOES, BELTS, BERETS, BIBS, NOT OF PAPER, BOAS, BODICES IN THE NATURE OF LINGERIE, BOOT UPPERS, BOOTS, BOOTS FOR SPORTS, HEELPIECES FOR BOOTS, IRON FITTINGS FOR BOOTS, NON-SLIPPING BOOTS, BREECHES FOR WEAR, CAMISOLES, PEAKS BEING PARTS OF CAPS, CAPS, SHOWER CAPS, CHASUBLES, CHEMISETTES, CLOTHING FOR GYMNASTICS, NAMELY, SHOES, CAPS, SHIRTS, SPORTS JERSEYS, CLOTHING OF IMITATIONS OF LEATHER, NAMELY, SHIRTS, CLOTHING OF LEATHER, NAMELY, SHIRTS, COATS, TOP COATS, COLLAR PROTECTORS, COLLARS, COMBINATIONS, CORSELETS, CORSETS, MASQUERADE COSTUMES, CUFFS, CYCLISTS' CLOTHING, NAMELY, SHIRTS, DETACHABLE COLLARS, DRAWERS, DRESS SHIELDS, DRESSING GOWNS, EAR MUFFS, ESPARTO SHOES AND SANDALS, FISHING VESTS, FITTINGS OF METAL FOR SHOES AND BOOTS, FOOTBALL BOOTS, STUDS FOR FOOTBALL BOOTS, FOOTBALL SHOES, FOOTMUFFS, NOT ELECTRICALLY HEATED, FOOTWEAR, TIPS FOR FOOTWEAR, FOOTWEAR UPPERS, FRAMES BEING PARTS OF HATS, FROCKS, FUR STOLES, FUR COATS, GABARDINES IN THE NATURE OF SMOCKS, GAITER STRAPS, GAITERS, GALOSHES, GARTERS, GIRDLES, GLOVES, GYMNASTIC SHOES, HALF-BOOTS, HATS, PAPER HATS FOR USE AS CLOTHING ITEMS, HEADBANDS, HEADGEAR FOR WEAR, NAMELY, HATS, HEELPIECES FOR SHOES, HEELPIECES FOR STOCKINGS, HEELS, HOODS, HOSIERY, INNER SOLES, JACKETS, STUFF JACKETS, JERSEYS, JUMPERS, KNITWEAR, NAMELY, PULLOVERS, LACE BOOTS, LAYETTES, LEG-

TINGS, BODY LINEN, FINISHED TEXTILE LININGS FOR GARMENTS, LIVERIES, MANIPLES, MANTILLAS, SLEEP MASKS, MITERS, NAMELY, HATS, MITRES, NAMELY, HATS, MITTENS, MONEY BELTS, MOTORISTS' CLOTHING, NAMELY, SHIRTS, CAPS, JACKETS, PULLOVERS, JEANS, MUFFS, NECKTIES, NON-SLIPPING DEVICES BEING PARTS OF BOOTS AND SHOES, OUTER CLOTHING, NAMELY, COAT, JACKET, OVERALLS, OVERCOATS, PAJAMAS, PANTS, PAPER CLOTHING, NAMELY, SHIRTS, PARKAS, PELERINES, PELISSES, PETTICOATS, POCKET SQUARES, POCKETS FOR CLOTHING, PULLOVERS, PYJAMAS, READY-MADE CLOTHING, NAMELY, JACKET, SHIRTS, SANDALS, SARIS, SASHES FOR WEAR, SCARFS, SCARVES, SHAWLS, SHIRT FRONTS, SHIRT YOKES, SHIRTS, SHOES, HEELPIECES FOR SHOES, IRON FITTINGS BEING PARTS OF SHOES, NON SLIPPING DEVICES BEING PARTS OF SHOES, NAMELY, WELTS, SHOULDER WRAPS, SINGLETS, SKI BOOTS, SKIRTS, SKULL CAPS, SLIPPERS, SLIPS, SMOCKS, SOCK SUSPENDERS, SOCKS, SOLES FOR FOOTWEAR, SPATS BEING PARTS OF SHOES, SPORTS JERSEYS, SPORTS SHOES, STOCKING SUSPENDERS, STOCKINGS, SWEAT-ABSORBENT STOCKINGS, SUITS, SUN VISORS, SUSPENDERS, SWEAT-ABSORBENT UNDERCLOTHING, NAMELY, UNDERWEAR, SWEATERS, SWIMSUITS, TEDDIES, TEE-SHIRTS, TIGHTS, TIPS FOR FOOTWEAR, TOGAS, TOP HATS, TOPCOATS, TROUSER STRAPS, TROUSERS, TURBANS, UNDERCLOTHING, NAMELY, SHIRTS, ANTI-SWEAT UNDERCLOTHING, NAMELY, SHIRTS, UNDERPANTS, UNDERWEAR, ANTI-SWEAT UNDERWEAR, UNIFORMS, FOOTWEAR

UPPERS, VEILS, VESTS, FISHING VESTS, VISORS, WAISTCOATS, WATERPROOF CLOTHING, NAMELY, SHIRTS, WELTS BEING PARTS OF BOOTS AND SHOES, WET SUITS FOR WATER SKIING, WIMPLES, WOODEN SHOES, WRISTBANDS, IN CLASS 25 (U.S. CLS. 22 AND 39).

PRIORITY DATE OF 7-6-2007 IS CLAIMED.

OWNER OF INTERNATIONAL REGISTRATION 0943352 DATED 7-12-2007, EXPIRES 7-12-2017.

NO CLAIM IS MADE TO THE EXCLUSIVE RIGHT TO USE "ITALIAN" AND "WRIST WATCH", APART FROM THE MARK AS SHOWN.

THE COLOR(S) BLACK, RED AND GREEN IS/ ARE CLAIMED AS A FEATURE OF THE MARK.

THE MARK CONSISTS OF THE COLOR BLACK APPEARS IN THE LITERAL ELEMENTS OF THE MARK AND THE COLOR RED APPEARS IN THE DESIGN OF A CHILI PEPPER WITH A GREEN STEM, FOUND ABOVE THE LITERAL ELEMENT.

THE ENGLISH TRANSLATION OF THE FOREIGN WORD(S) IN THE MARK IS: ITALIAN WRIST WATCH WORKSHOP.

SER. NO. 79-046,150, FILED 7-12-2007.

DAVID HOFFMAN, EXAMINING ATTORNEY

Int. Cl.: 11

Prior U.S. Cls.: 13, 21, 23, 31 and 34

United States Patent and Trademark Office

Reg. No. 3,485,308

Registered Aug. 12, 2008

**TRADEMARK
PRINCIPAL REGISTER**

RTCS

Realtime Temperature Control System

INDUCS AG (SWITZERLAND SOCIÉTÉ ANON-
YME)

BAHNHOFSTRASSE 25

CH-9100 HERISAU, SWITZERLAND

FOR: ELECTRIC INDUCTION COOKING POTS
AND FRYING PANS WITH NON-CONTACT TEM-
PERATURE MEASUREMENT AND REAL-TIME
TEMPERATURE CONTROL OF THE BASE OF
THE PAN OR OF THE GRILL PLATE , IN CLASS
11 (U.S. CLS. 13, 21, 23, 31 AND 34).

OWNER OF INTERNATIONAL REGISTRATION
0798555 DATED 1-3-2003, EXPIRES 1-3-2013.

NO CLAIM IS MADE TO THE EXCLUSIVE
RIGHT TO USE "REALTIME TEMPERATURE CON-
TROL SYSTEM", APART FROM THE MARK AS
SHOWN.

SER. NO. 79-046,202, FILED 10-18-2007.

DORITT L. CARROLL, EXAMINING ATTORNEY

Int. Cl.: 11

Prior U.S. Cls.: 13, 21, 23, 31 and 34

United States Patent and Trademark Office

Reg. No. 3,485,309

Registered Aug. 12, 2008

**TRADEMARK
PRINCIPAL REGISTER**

SOLARINOX

NUNO GONÇALO MACHADO SIMÕES (PORTUGAL INDIVIDUAL)
RUA JOÃO DE FREITAS BRANCO, N.º41-4º E
P-1500-627 LISBOA
PORTUGAL

THE COLOR(S) BLACK AND YELLOW IS/ARE CLAIMED AS A FEATURE OF THE MARK.

FOR: SOLAR COLLECTORS FOR HEATING PRESSURE WATER TANKS, IN CLASS 11 (U.S. CLS. 13, 21, 23, 31 AND 34).

THE LETTERS ARE YELLOW AND THE BACKGROUND IS BLACK.

PRIORITY DATE OF 4-17-2007 IS CLAIMED.

SER. NO. 79-046,360, FILED 10-15-2007.

OWNER OF INTERNATIONAL REGISTRATION 0943782 DATED 10-15-2007, EXPIRES 10-15-2017.

DOMINIC FATHY, EXAMINING ATTORNEY

Int. Cls.: 8, 11, 14, 16, 19, 20, 21, 24, 26, 34 and 37

Prior U.S. Cls.: 1, 2, 5, 8, 9, 12, 13, 17, 21, 22, 23, 25, 27, 28, 29, 30, 31, 32, 33, 34, 37, 38, 39, 40, 42, 44, 50, 100, 103 and 106

Reg. No. 3,485,310

United States Patent and Trademark Office

Registered Aug. 12, 2008

**TRADEMARK
SERVICE MARK
PRINCIPAL REGISTER**



ADALBERT PRINZ VON BAYERN GMBH (FED
REP GERMANY LTD LIAB CO)
SCHUMANNSTRASSE 10
81679 MÜNCHEN, FED REP GERMANY

FOR: CUTLERY MADE OF PRECIOUS METAL; SILVER-PLATED CUTLERY; HAND-OPERATED TOOLS AND DEVICES, NAMELY, CAKE CUTTERS, FIREPLACE TONGS, ICE TONGS, SUGAR TONGS, BAGEL SLICERS, CHERRY PITTERS, NON-ELECTRIC CHEESE SLICERS; RAZORS; RAZOR CASES; RAZOR BLADES; TOILETRY BAGS CONTAINING RAZORS, SOLD AS A UNIT, IN CLASS 8 (U.S. CLS. 23, 28 AND 44).

FOR: APPARATUS FOR LIGHTING, NAMELY, CHANDELIERS AND ELECTRIC LAMPS; LAMP-SHADES SOLD WITH FASTENERS; ELECTRICAL LAMP BASES, ELECTRICAL LIGHTING FIXTURES USED TO HANG LAMPS FROM WALLS AND CEILINGS; SANITARY APPARATUS AND FACILITIES, NAMELY, SINKS, TOILETS, SHOWERS, BATH TUBS, BATHTUB SURROUNDS, IN CLASS 11 (U.S. CLS. 13, 21, 23, 31 AND 34).

FOR: PRECIOUS METALS AND THEIR ALLOYS, NAMELY, GOLD, SILVER, PLATINUM; GOODS OF PRECIOUS METALS OR COATED THEREWITH, NAMELY, PINS, MEDALS, ORNAMENTS; LAPEL PINS, AND KEY HOLDERS OF PRECIOUS METAL; PHONOLOGICAL AND CHRONOMETRICAL INSTRUMENTS AND CASES THEREFORE; JEWEL-

RY; PRECIOUS STONES; COLLECTIBLE COINS; JEWELRY CASES, NOT OF PRECIOUS METAL, IN CLASS 14 (U.S. CLS. 2, 27, 28 AND 50).

FOR: PRINTED MATTER, NAMELY, SERIES OF NON-FICTION BOOKS IN THE FIELD OF HISTORY, PORCELAIN, STONEWARE AND COOKERY BOOKS; WRITING INSTRUMENTS; STICKERS; ARTISTS' MATERIALS, NAMELY, STENCILS, CANVAS FOR PAINTING, PAINT BRUSHES; PRINTED INSTRUCTIONAL AND TEACHING MATERIALS IN THE FIELD OF PORCELAIN MANUFACTURING, PORCELAIN PAINTING AND MODELING; PAPER AND CARDBOARD; AND GOODS MADE FROM PAPER AND CARDBOARD, NAMELY, PAPER BAGS, CARDBOARD BOXES, POSTERS, POSTCARDS, GREETING CARDS, PICTURES, PHOTOGRAPHS, DIARIES, CALENDARS, ADDRESS BOOKS, NOTEBOOKS AND PAPER HANDKERCHIEFS, IN CLASS 16 (U.S. CLS. 2, 5, 22, 23, 29, 37, 38 AND 50).

FOR: WORKS OF ART AND FIGURES OF MARBLE, STONE AND CONCRETE; MONUMENTS AND TOMBS OF MARBLE, STONE AND CONCRETE; BUILDING MATERIALS FOR OUTDOOR AND HORTICULTURAL USE, NAMELY, CONCRETE BLOCKS, BUILDING STONES, WALL STONES, PAVING STONES, NON-PRECIOUS STONES FOR GARDEN OR ORNAMENTAL USE, ENGRAVED AND CUT STONE PLAQUES, IN CLASS 19 (U.S. CLS. 1, 12, 33 AND 50).

FOR: WORKS OF ART OF PLASTER; WORKS OF ART AND STATUES OF WOOD, PLASTICS AND WAX; FURNITURE; MIRRORS; PICTURE FRAMES; WOOD AND PLASTIC BOXES; WOOD AND PLASTIC CONTAINERS FOR INDUSTRIAL AND COMMERCIAL USE; WOOD AND PLASTIC CASES, NAMELY, DISPLAY CASES AND DISPLAY CASES FOR MERCHANDISE; SIGNBOARDS OF WOOD AND PLASTICS, IN CLASS 20 (U.S. CLS. 2, 13, 22, 25, 32 AND 50).

FOR: GOODS OF PORCELAIN, CLAY AND GLASS, NAMELY, WORKS OF ART, COFFEE SERVICES, TEA SERVICES, MOCHA SERVICES, VASES, BOWLS, BOXES, DECORATIVE WALL PLATES AND DINNER SERVICES, BOTH PAINTED AND UNPAINTED, COMPRISED OF PLATES, CUPS, AND SAUCERS; DRINKING VESSELS; MAJOLICA EARTHENWARE, CRYSTAL GLASSWARE FOR BEVERAGES; SIGNBOARDS OF PORCELAIN, CLAY AND GLASS; HOUSEHOLD AND KITCHEN UTENSILS AND CONTAINERS, NAMELY, SERVING TONGS, WIRE BASKETS, SPATULAS, STRAINERS, CORKSCREWS, SERVING SPOONS, SERVING FORKS, SALT AND PEPPER CELLARS, PEPPER MILLS, FRUIT PRESSES, GARLIC PRESSES, KITCHEN GRATERS, NON-ELECTRIC EGG BEATERS FOR KITCHEN USE, SERVING TRAYS NOT OF PRECIOUS METAL, BREAD BOARDS, WICKER BASKETS, OIL AND VINEGAR CRUETS NOT OF PRECIOUS METAL, CRUET STANDS FOR OIL OR VINEGAR NOT OF PRECIOUS METAL, SALT AND PEPPER SHAKERS, HAND OPERATED PEPPER MILLS, TOOTHPICKS AND TOOTHPICK HOLDERS; DOOR KNOBS AND DRAWER PULLS OF PORCELAIN; FLOWER POTS; FLOWER-POT COVERS, NOT OF PAPER, IN CLASS 21 (U.S. CLS. 2, 13, 23, 29, 30, 33, 40 AND 50).

FOR: TEXTILES FOR THE MANUFACTURE OF CLOTHING; TEXTILE GOODS, NAMELY, TEXTILE WALL HANGINGS, PLACE MATS; HOUSEHOLD TABLE AND BED LINEN; HOUSEHOLD TEXTILES,

NAMELY, HANDKERCHIEFS, TOWELS, BATH TOWELS, SAUNA TOWELS, KITCHEN TOWELS, CURTAINS, PLACE MATS AND NAPKINS; UPHOLSTERY FABRICS; FABRIC CURTAINS SOLD WITH LININGS; TEXTILE BED COVERS; BED LINEN, NAMELY, PILLOW SHAMS AND TABLE CLOTHS AND TABLE RUNNERS, ALL AFOREMENTIONED GOODS NOT OF PAPER, IN CLASS 24 (U.S. CLS. 42 AND 50).

FOR: BUTTONS OF PORCELAIN, IN CLASS 26 (U.S. CLS. 37, 39, 40, 42 AND 50).

FOR: ASHTRAYS, NOT OF PRECIOUS METAL; CIGARETTE LIGHTERS FOR SMOKERS; SNUFF BOXES; CIGAR BOXES, BOTH WITH AND WITHOUT HUMIDORS, NOT OF PRECIOUS METAL; MATCH BOXES AND MATCH HOLDERS, NOT OF PRECIOUS METAL, SOLD BOTH WITH AND WITHOUT MATCHES; MOUTH PIECE HOLDERS FOR CIGARETTES, SMALL CIGARS AND CIGARS; TOBACCO PIPES; AND PIPE RACK, IN CLASS 34 (U.S. CLS. 2, 8, 9 AND 17).

FOR: PRESERVATION, CLEANING AND RESTORATION OF WORKS OF ART; REFINISHING OF GOODS MADE OF PORCELAIN AND FURNITURE, IN CLASS 37 (U.S. CLS. 100, 103 AND 106).

PRIORITY DATE OF 2-1-2007 IS CLAIMED.

OWNER OF INTERNATIONAL REGISTRATION 0943970 DATED 5-23-2007, EXPIRES 5-23-2017.

THE MARK CONSISTS OF A CROWN ON TOP OF A DIAMOND-SHAPED CHECKERED SHIELD.

SER. NO. 79-046,436, FILED 5-23-2007.

WENDY JUN, EXAMINING ATTORNEY

Int. Cl.: 33

Prior U.S. Cls.: 47 and 49

United States Patent and Trademark Office

Reg. No. 3,485,311

Registered Aug. 12, 2008

**TRADEMARK
PRINCIPAL REGISTER**



OPTIMEX TRADING SARL, C/O ME SANDRO
VECCHIO (SWITZERLAND CORPORATION)
AVENUE KRIEG 7
CH-1208 GENÈVE, SWITZERLAND

OWNER OF INTERNATIONAL REGISTRATION
0944105 DATED 10-4-2007, EXPIRES 10-4-2017.

FOR: ALCOHOLIC BEVERAGES EXCEPT BEERS,
IN CLASS 33 (U.S. CLS. 47 AND 49).

SER. NO. 79-046,474, FILED 10-4-2007.

PRIORITY DATE OF 7-4-2007 IS CLAIMED.

JAMES MACFARLANE, EXAMINING ATTORNEY

Int. Cl.: 33

Prior U.S. Cls.: 47 and 49

United States Patent and Trademark Office

Reg. No. 3,485,312

Registered Aug. 12, 2008

**TRADEMARK
PRINCIPAL REGISTER**

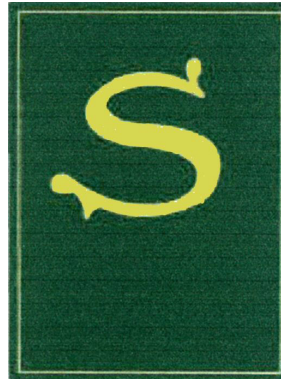

SOCIETE A.S. (FRANCE SOCIETE ANONYME)
RUE DE LA BRÈCHE D'OGER
F-51190 LE MESNIL SUR OGER, FRANCE

THE COLOR(S) GREEN AND YELLOW IS/ARE
CLAIMED AS A FEATURE OF THE MARK.

FOR: ALCOHOLIC BEVERAGES EXCEPT BEERS;
WINES, SPARKLING WINES, WINES WITH PRO-
TECTED LABEL OF ORIGIN CHAMPAGNE;
CHAMPAGNE COCKTAILS, IN CLASS 33 (U.S.
CLS. 47 AND 49).

THE MARK CONSISTS OF A STYLIZED "S"
COLORED YELLOW AGAINST A RECTANGULAR
BACKGROUND WHICH IS COLORED GREEN EX-
CEPT FOR A BORDER WHICH IS COLORED YEL-
LOW APPEARING WITHIN THE RECTANGLE.

PRIORITY DATE OF 5-7-2007 IS CLAIMED.

SER. NO. 79-046,480, FILED 10-24-2007.

OWNER OF INTERNATIONAL REGISTRATION
0944133 DATED 10-24-2007, EXPIRES 10-24-2017.

CARYN GLASSER, EXAMINING ATTORNEY

Int. Cls.: 11, 16 and 42

**Prior U.S. Cls.: 2, 5, 13, 21, 22, 23, 29, 31, 34, 37, 38,
50, 100 and 101**

Reg. No. 3,485,313

United States Patent and Trademark Office

Registered Aug. 12, 2008

**TRADEMARK
SERVICE MARK
PRINCIPAL REGISTER**

SIGNIA

SIEMATIC MÖBELWERKE GMBH & CO. KG
(FED REP GERMANY PARTNERSHIP LIM-
ITED BY SHARES)

AUGUST-SIEKMANN-STRABE 1-5
32584 LÖHNE
FED REP GERMANY

FOR: SINKS; ELECTRIC LAMPS, LAMPS FOR
LIGHTING, CEILING LIGHTS, FITTED LAMPS
FOR FURNITURE, IN CLASS 11 (U.S. CLS. 13, 21,
23, 31 AND 34).

FOR: PRINTED MATTER, NAMELY, BRO-
CHURES ABOUT INTERIOR DECORATING,
BOOKS ABOUT INTERIOR DECORATING AND
MAGAZINES ABOUT INTERIOR DECORATING,
IN CLASS 16 (U.S. CLS. 2, 5, 22, 23, 29, 37, 38 AND 50).

FOR: DESIGN OF INTERIOR DECOR; PLAN-
NING AND ADVICE WITH RESPECT TO INTERIOR

DECORATION, IN CLASS 42 (U.S. CLS. 100 AND
101).

THE MARK CONSISTS OF STANDARD CHAR-
ACTERS WITHOUT CLAIM TO ANY PARTICULAR
FONT, STYLE, SIZE, OR COLOR.

PRIORITY DATE OF 6-8-2007 IS CLAIMED.

OWNER OF INTERNATIONAL REGISTRATION
0944207 DATED 9-15-2007, EXPIRES 9-15-2017.

SER. NO. 79-046,514, FILED 9-15-2007.

SUSAN STIGLITZ, EXAMINING ATTORNEY

Int. Cl.: 7

Prior U.S. Cls.: 13, 19, 21, 23, 31, 34 and 35

United States Patent and Trademark Office

Reg. No. 3,485,314

Registered Aug. 12, 2008

**TRADEMARK
PRINCIPAL REGISTER**

SATA clean

SATA GMBH & CO. KG (FED REP GERMANY
GMBH & CO. KG)
DOMERTALSTR. 20
70806 KORNWESTHEIM
FED REP GERMANY

FOR: MACHINES, PARTICULARLY CLEANING
MACHINES, NAMELY, PNEUMATIC CLEANING
MACHINES FOR CLEANING OF PAINT SPRAY
APPARATUS, SPRAY GUNS, PAINT CUPS, AND
PARTS THEREFOR, IN CLASS 7 (U.S. CLS. 13, 19, 21,
23, 31, 34 AND 35).

PRIORITY DATE OF 10-18-2007 IS CLAIMED.

OWNER OF INTERNATIONAL REGISTRATION
0944315 DATED 10-26-2007, EXPIRES 10-26-2017.

OWNER OF U.S. REG. NOS. 1,310,808 AND
1,381,057.

NO CLAIM IS MADE TO THE EXCLUSIVE
RIGHT TO USE "CLEAN", APART FROM THE
MARK AS SHOWN.

SER. NO. 79-046,558, FILED 10-26-2007.

MELISSA VALLILLO, EXAMINING ATTORNEY

Int. Cls.: 9 and 42

Prior U.S. Cls.: 21, 23, 26, 36, 38, 100 and 101

United States Patent and Trademark Office

Reg. No. 3,485,315

Registered Aug. 12, 2008

**TRADEMARK
SERVICE MARK
PRINCIPAL REGISTER**



HIGH TECHNOLOGY WORLD COMPANY S.R.L.
(ITALY LIMITED COMPANY)
VIALE AMERICA, 125
I-00144 ROMA
ITALY

OWNER OF INTERNATIONAL REGISTRATION
0944372 DATED 11-6-2007, EXPIRES 11-6-2017.

FOR: APPLICATION MIDDLEWARE FOR THE
MIGRATION AND EXECUTION OF MISSION CRITICAL
APPLICATIONS FOR COMPUTER OPERATING
PLATFORMS THAT ALLOWS EXISTING
MAINFRAME APPLICATIONS TO BE REHOSTED
ON COMPUTER OPERATING SYSTEMS, IN CLASS
9 (U.S. CLS. 21, 23, 26, 36 AND 38).

NO CLAIM IS MADE TO THE EXCLUSIVE
RIGHT TO USE "HIGH TECHNOLOGY WORLD
COMPANY", APART FROM THE MARK AS
SHOWN.

SER. NO. 79-046,576, FILED 11-6-2007.

FOR: DESIGN AND DEVELOPMENT OF COM-
PUTERS AND COMPUTER PROGRAMS, IN CLASS
42 (U.S. CLS. 100 AND 101).

WILLIAM VERHOSEK, EXAMINING ATTORNEY

Int. Cl.: 33

Prior U.S. Cls.: 47 and 49

United States Patent and Trademark Office

Reg. No. 3,485,316

Registered Aug. 12, 2008

TRADEMARK
PRINCIPAL REGISTER



ZACCAGNINI

AZIENDA AGRICOLA; CICCIO ZACCAGNINI
SAS; DI MARCELLO ZACCAGNINI & C. (ITA-
LY LIMITED PARTNERSHIP)
CONTRADA POZZO
I-65020 BOLOGNANO (PE)
ITALY

OWNER OF INTERNATIONAL REGISTRATION
0944595 DATED 11-5-2007, EXPIRES 11-5-2017.

SER. NO. 79-046,640, FILED 11-5-2007.

FOR: ALCOHOLIC BEVERAGES, NAMELY,
WINES, IN CLASS 33 (U.S. CLS. 47 AND 49).

FLORENTINA BLANDU, EXAMINING ATTORNEY

Int. Cls.: 6, 19 and 37

**Prior U.S. Cls.: 1, 2, 12, 13, 14, 23, 25, 33, 50, 100, 103
and 106**

Reg. No. 3,485,317

United States Patent and Trademark Office

Registered Aug. 12, 2008

**TRADEMARK
SERVICE MARK
PRINCIPAL REGISTER**



JULIUS THURNHER (AUSTRIA INDIVIDUAL)
FRIEDRICH SCHLÖGL-GASSE 4
A-3011 PURKERSDORF
AUSTRIA

FOR: METAL BUILDING MATERIALS, NAMELY METAL BUILDING FLASHING, METAL TRIM FOR BUILDINGS, METAL WINDOWS; METAL WINDOW CASEMENTS, METAL WINDOW FRAMES; METAL WINDOW SILLS; BUILDING WALL FRAMING MADE PRIMARILY OF METAL; SHORES, SUPPORTS AND BRACES MADE OF METAL, IN CLASS 6 (U.S. CLS. 2, 12, 13, 14, 23, 25 AND 50).

FOR: NON METALLIC BUILDING MATERIALS, NAMELY NON-METAL EXTERIOR WINDOW SHADES, NON-METAL SASH FASTENERS FOR WINDOWS, NON-METAL WINDOW CASEMENTS, NON-METAL WINDOW FRAMES, NON-METAL SCREENS, NON-METAL WINDOW SHUTTERS, NON-METAL WINDOW SILLS, NON-METAL WINDOWS, WINDOW GLASS, WINDOW PANES, IN CLASS 19 (U.S. CLS. 1, 12, 33 AND 50).

FOR: CONSTRUCTION OF BUILDINGS, IN CLASS 37 (U.S. CLS. 100, 103 AND 106).

OWNER OF INTERNATIONAL REGISTRATION 0741409 DATED 8-8-2000, EXPIRES 8-8-2010.

NO CLAIM IS MADE TO THE EXCLUSIVE RIGHT TO USE "WINDOWS", APART FROM THE MARK AS SHOWN.

THE COLOR(S) WHITE AND BLUE IS/ARE CLAIMED AS A FEATURE OF THE MARK.

THE MARK CONSISTS OF THE TERM "IKU WINDOWS" IN BLUE AGAINST A WHITE BACKGROUND WITHIN A BLUE BOX.

SER. NO. 79-046,682, FILED 7-23-2007.

BRIAN NEVILLE, EXAMINING ATTORNEY

Int. Cls.: 3, 9, 16, 18, 24 and 25

Prior U.S. Cls.: 1, 2, 3, 4, 5, 6, 21, 22, 23, 26, 29, 36, 37, 38, 39, 41, 42, 50, 51 and 52

Reg. No. 3,485,318

United States Patent and Trademark Office

Registered Aug. 12, 2008

**TRADEMARK
PRINCIPAL REGISTER**



RADLEY + CO. LIMITED
GREATER LONDON HOUSE,
MORNINGTON CRESCENT LONDON NW1 7QX
UNITED KINGDOM

FOR: HAND SOAPS, SKIN SOAPS, TOILET SOAPS; PERFUMERY, ESSENTIAL OILS, COSMETICS, HAIR LOTIONS; DENTIFRICES; HAND CREAM; SKIN CARE CREAMS AND LOTIONS; PREPARATIONS AND SUBSTANCES FOR USE IN THE CARE AND APPEARANCE OF THE HAIR, SCALP, FACE, SKIN, NAILS AND EYES, NAMELY, HAIR SHAMPOO, FACE CREAM, BODY CREAMS, HAND CREAMS, FACE LOTIONS, AFTER-SHAVE LOTIONS, SKIN CLEANSING CREAMS, SKIN CLEANSING LOTIONS, SUN SCREEN PREPARATION, NAIL POLISH, NAIL POLISH REMOVER, FACE CREAMS, HAIR DYES AND COLORANTS, HAIR SPRAYS, HAIR CONDITIONER, HAIR STYLING GEL, ANTI-DANDRUFF SHAMPOOS; COSMETIC AND TOILETRY PREPARATIONS, NAMELY, COSMETIC PENCILS, FOUNDATION MAKE-UP, FACE POWDERS, ROUGES, LIPSTICKS, MASCARAS, ANTI-AGING CREAM; NON-MEDICATED TOILETRIES; DEPILATORY PREPARATIONS; SUN-SCREENING AND TANNING PREPARATIONS; NON-MEDICATED BATH PREPARATIONS, IN CLASS 3 (U.S. CLS. 1, 4, 6, 50, 51 AND 52).

FOR: SUNGLASSES; SPECTACLES; PROTECTIVE EYEWEAR; EYE GLASS CASES, IN CLASS 9 (U.S. CLS. 21, 23, 26, 36 AND 38).

FOR: PAPER, NOT INCLUDED IN OTHER CLASSES, NAMELY, ART PAPER; PRINTED MATTER, NAMELY, PRINTED INVITATIONS, PRINTED FORMS, WRITING PAPER, LETTER HEADED PAPER; PHOTOGRAPHS; STATIONERY; WRITING SETS, NAMELY, PENS, PENCILS; NOTE BOOKS, ADDRESS BOOKS, PHOTO ALBUMS; DIARIES, ORGANIZERS, NAMELY, ORGANIZERS FOR STATIONERY USE; PASSPORT CASES, TICKET FOLDERS; GREETINGS CARDS, GIFT CARDS; POSTCARDS; PAINT BRUSHES, IN CLASS 16 (U.S. CLS. 2, 5, 22, 23, 29, 37, 38 AND 50).

FOR: ARTICLES OF LEATHER AND IMITATION LEATHER, NAMELY, HANDBAGS; LUGGAGE; TRAVEL ACCESSORIES, NAMELY, COSMETIC CASES SOLD EMPTY; JEWELRY ROLLS IN THE NATURE OF JEWELRY ORGANIZERS FOR TRAVEL; ATTACHÉ CASES, BAGS, NAMELY, HANDBAGS, TRAVELING BAGS, BUMBAGS, SPORTS BAGS, LEATHER ENVELOPES FOR PACKAGING AND CARRYING AND LEATHER POUCHES, HANDBAGS, VALISES, HAT BOXES OF LEATHER AND LEATHER BOARD, TRUNKS, VANITY CASES SOLD EMPTY, BRIEFCASES, WALLETS, PURSES, KEY CASES, CREDIT CARD CASES, TICKET FOLDERS IN THE NATURE OF BUSINESS CARD CASES; UMBRELLAS, PARASOLS, SMALL CONTAINERS, NAMELY, SMALL BACKPACKS, SMALL RUCKSACKS, SMALL BAGS FOR MEN, SMALL HANDBAGS; ANIMAL LEASHES AND LEADS, LEAD, TAIL AND HARNESS STRAPS FOR ANIMALS, FUR, FUR PELTS AND FUR SOLD IN BULK, IN CLASS 18 (U.S. CLS. 1, 2, 3, 22 AND 41).

FOR: BED AND TABLE COVERS NOT OF PAPER;
CUSHION COVERS; THROWS, IN CLASS 24 (U.S.
CLS. 42 AND 50).

FOR: CLOTHING, NAMELY, SHIRTS, PANTS,
TOPS, SHORTS, SKIRTS, SOCKS, BLOUSES, UN-
DERWEAR, GLOVES, T-SHIRTS, FOOTWEAR,
HEADGEAR, NAMELY HATS, CAPS, VISORS,
SHOES, BOOTS; SCARVES, SHAWLS; LADIES' AP-
PAREL, NAMELY, SHIRTS, PANTS, TOPS, SHORTS;
CLOTHING BELTS, IN CLASS 25 (U.S. CLS. 22 AND
39).

OWNER OF INTERNATIONAL REGISTRATION
0913104 DATED 9-8-2006, EXPIRES 9-8-2016.

OWNER OF U.S. REG. NOS. 3,237,558 AND
3,385,678.

THE COLOR(S) BLACK, RED AND WHITE IS/
ARE CLAIMED AS A FEATURE OF THE MARK.

THE MARK CONSISTS OF THE COLOR BLACK
APPEARING IN THE BODY OF THE DOG DESIGN,
THE COLOR RED APPEARING IN THE COLLAR,
AND THE COLOR WHITE APPEARING IN THE
DOG'S EYE.

SER. NO. 79-046,702, FILED 11-7-2007.

SUSAN STIGLITZ, EXAMINING ATTORNEY

Int. Cl.: 6

Prior U.S. Cls.: 2, 12, 13, 14, 23, 25 and 50

Reg. No. 3,485,319

United States Patent and Trademark Office

Registered Aug. 12, 2008

**TRADEMARK
PRINCIPAL REGISTER**



FUJIAN NANPING ALUMINIUM CO., LTD (CHINA CORPORATION)
NO. 65, GONGYE ROAD
NANPING; 353000 FUJIAN, CHINA

FOR: INGOTS OF ALUMINIUM; ALUMINIUM FOIL; PLATES OF ALUMINUM; POLES OF ALUMINUM; ALLOYS OF ALUMINUM; ALUMINUM WIRE GAUZE; CASTING AND ROLLING ALUMINUM; ALUMINUM BAND STRIP; FOUNDRY

CHILL-MOULDING, IN CLASS 6 (U.S. CLS. 2, 12, 13, 14, 23, 25 AND 50).

OWNER OF INTERNATIONAL REGISTRATION
0944767 DATED 6-13-2007, EXPIRES 6-13-2017.

SER. NO. 79-046,738, FILED 6-13-2007.

LAURIE KAUFMAN, EXAMINING ATTORNEY

Int. Cl.: 21

Prior U.S. Cls.: 2, 13, 23, 29, 30, 33, 40 and 50

Reg. No. 3,485,320

United States Patent and Trademark Office

Registered Aug. 12, 2008

**TRADEMARK
PRINCIPAL REGISTER**

SHAPE THAT BOOTY

MIRIAM MCKAY (AUSTRALIA INDIVIDUAL)
3/16 SOMERSET PLACE
MELBOURNE VIC 3000
AUSTRALIA

PRIORITY DATE OF 5-15-2007 IS CLAIMED.

FOR: SHOE AND BOOT SHAPERS, NAMELY,
INFLATABLE BOOT SUPPORTS, SHOE TREES AND
SHOE STRETCHERS OF PLASTIC, IN CLASS 21 (U.S.
CLS. 2, 13, 23, 29, 30, 33, 40 AND 50).

OWNER OF INTERNATIONAL REGISTRATION
0945150 DATED 10-23-2007, EXPIRES 10-23-2017.

THE MARK CONSISTS OF STANDARD CHAR-
ACTERS WITHOUT CLAIM TO ANY PARTICULAR
FONT, STYLE, SIZE, OR COLOR.

SER. NO. 79-046,872, FILED 10-23-2007.

MICHAEL TANNER, EXAMINING ATTORNEY

Int. Cl.: 38

Prior U.S. Cls.: 100, 101 and 104

United States Patent and Trademark Office

Reg. No. 3,485,321

Registered Aug. 12, 2008

**SERVICE MARK
PRINCIPAL REGISTER**

ADT

ADT SERVICES AG (SWITZERLAND CORPORATION)
BAHNHOFSTRASSE 29
CH-8200 SCHAFFHAUSEN
SWITZERLAND

FOR: TELECOMMUNICATION SERVICES, NAMELY, PROVIDING ACCESS TO IMAGES, VIDEO, ALARM STATUS, BUILDING PLANS AND OTHER BUILDING AND SECURITY INFORMATION AT A REMOTE STATION; TELECOMMUNICATION SERVICES, NAMELY, ELECTRONIC TRANSMISSION OF VOICE, MESSAGES AND DATA; TELECOMMUNICATION SERVICES, NAMELY, INFORMATION TRANSMISSION VIA ELECTRONIC COMMUNICATIONS NETWORKS; TRANSMISSION OF SOUND, VIDEO AND INFORMATION OVER COMPUTER NETWORKS; AND TRANSMISSION OF SOUND, VIDEO AND INFORMATION IN THE FIELDS OF SECURITY SYSTEMS, FIRE ALARMS, ALARM CENTRAL UNITS, ANTI-INTRUSION ALARMS, BURGLAR ALARMS, PERSONAL HEALTH AND SECURITY ALARMS, SMOKE AND GAS ALARMS, HOME SURVEILLANCE SYSTEMS, LIGHTING CONTROLS, HOME

AUTOMATION DEVICES, SPRINKLER SYSTEMS FOR FIRE PROTECTION, VEHICLE, PET AND HUMAN LOCATION, AUTOMOBILE SAFETY, VEHICLE THEFT, TRAFFIC, AND ROAD NAVIGATION, IN CLASS 38 (U.S. CLS. 100, 101 AND 104).

THE MARK CONSISTS OF STANDARD CHARACTERS WITHOUT CLAIM TO ANY PARTICULAR FONT, STYLE, SIZE, OR COLOR.

PRIORITY DATE OF 7-31-2007 IS CLAIMED.

OWNER OF INTERNATIONAL REGISTRATION 0945471 DATED 11-6-2007, EXPIRES 11-6-2017.

OWNER OF U.S. REG. NOS. 838,956, 2,857,796 AND OTHERS.

SER. NO. 79-046,998, FILED 11-6-2007.

ELLEN B. AWRICH, EXAMINING ATTORNEY

Int. Cl.: 10

Prior U.S. Cls.: 26, 39 and 44

United States Patent and Trademark Office

Reg. No. 3,485,322

Registered Aug. 12, 2008

**TRADEMARK
PRINCIPAL REGISTER**

VISION α

NOVALUNG GMBH (FED REP GERMANY PRIVATE LIMITED LIABILITY COMPANY)
LOTZENÄCKER 3
72379 HECHINGEN
FED REP GERMANY

FOR: MEDICAL APPARATUS, NAMELY, RESPIRATORS AND HIGH FREQUENCY RESPIRATORS FOR ARTIFICIAL RESPIRATION, IN CLASS 10 (U.S. CLS. 26, 39 AND 44).

PRIORITY DATE OF 4-16-2007 IS CLAIMED.

OWNER OF INTERNATIONAL REGISTRATION
0945589 DATED 9-27-2007, EXPIRES 9-27-2017.

THE NON-LATIN CHARACTER IN THE MARK
TRANSLITERATES INTO A AND THIS HAS NO
MEANING IN ENGLISH.

SER. NO. 79-047,038, FILED 9-27-2007.

LINDA ORNDORFF, EXAMINING ATTORNEY

Int. Cls.: 9 and 42

Prior U.S. Cls.: 21, 23, 26, 36, 38, 100 and 101

United States Patent and Trademark Office

Reg. No. 3,485,323

Registered Aug. 12, 2008

**TRADEMARK
SERVICE MARK
PRINCIPAL REGISTER**

CLABERMETEO

CLABER S.P.A. (ITALY S.P.A. DI DIRITTO ITALIANO)
VIA PONTEBBANA, 22
I-33080 FIUME VENETO (PN)
ITALY

FOR: COMPUTER SOFTWARE FOR THE CENTRALIZED MANAGEMENT OF IRRIGATION SYSTEMS; ELECTRONIC CONTROL UNITS WITH TIMER FOR PROGRAMMED OPERATION OF WATER SUPPLY INSTALLATIONS, IN CLASS 9 (U.S. CLS. 21, 23, 26, 36 AND 38).

FOR: DESIGN AND DEVELOPMENT OF SOFTWARE FOR THE CENTRALIZED MANAGEMENT OF IRRIGATION SYSTEMS; CREATION AND MAINTENANCE OF WEBSITES FOR OTHERS FOR PROGRAMMING AND REMOTE CONTROL

OF IRRIGATION SYSTEMS VIA ACCESS TO RESERVED AREAS, IN CLASS 42 (U.S. CLS. 100 AND 101).

PRIORITY DATE OF 6-13-2007 IS CLAIMED.

OWNER OF INTERNATIONAL REGISTRATION 0945636 DATED 10-17-2007, EXPIRES 10-17-2017.

THE WORDING "CLABERMETEO" HAS NO MEANING IN A FOREIGN LANGUAGE

SER. NO. 79-047,051, FILED 10-17-2007.

GEOFFREY FOSDICK, EXAMINING ATTORNEY

Int. Cls.: 25, 28 and 38

Prior U.S. Cls.: 22, 23, 38, 39, 50, 100, 101 and 104

Reg. No. 3,485,324

United States Patent and Trademark Office

Registered Aug. 12, 2008

**TRADEMARK
SERVICE MARK
PRINCIPAL REGISTER**

PROFESSIONAL GENERATION

GOLDBERG, OLIVIER (FRANCE INDIVIDUAL)
VIA DELLE VELE, 7
I-18012 BORDIGHERA
ITALY

FOR: CLOTHING, NAMELY, ARM WARMERS, KNEE WARMERS, NECK TUBES, THOBES, WRAP-AROUNDS, FOULARDS, HOODS, JERSEYS, LEATHER BELTS, MANTLES, MUFFLERS, SHIFTS, SHORT SETS, SHOULDER WRAPS, TIES, TOPS, WRAPS, UNDERWEAR, JEANS, KNITTED UNDERWEAR, LADIES' UNDERWEAR, LONG UNDERWEAR, WOMEN'S UNDERWEAR, BATHING SUITS, DRESS SUITS, JOGGING SUITS, LADIES' SUITS, MEN'S SUITS, RAIN SUITS, VESTED SUITS, BERMUDA SHORTS, BERETS, BIKINIS, BLAZERS, BLOUSES, BOXER SHORTS, BOXER BRIEFS, SUSPENDERS, STOCKINGS, SOCKS, SHIRTS, SWEAT SHIRTS, POLO SHIRTS, SPORT SHIRTS, T-SHIRTS, VESTS, OVERCOATS, CARDIGANS, BELTS, BONNETS, SHOES STRAPS, STRAPS FOR BRAS, HEAD WEAR, COATS, DRAWERS, PANTS, SHORTS, COATS, RAINCOATS, SKIRTS, GLOVES, TRENCH COATS, SWEATERS, V-NECK SWEATERS, JUMPERS, FUR CLOAKS, DRAWERS, PANTS, LOUNGE PANTS, SKI PANTS, LEATHER PANTS, SHORTS, TROUSERS, SLIPPERS, PAREOS, EAR WARMERS, PARKAS, FUR STOLE, FUR JACKETS, FUR COATS AND JACKETS, FUR CLOAKS, PYJAMAS, CUFFS, BRAS, SANDALS, SHOES, SHAWLS, SCARVES, BRIEFS, JACKETS, LEATHER JACKETS, RAIN JACKETS, UNDERSKIRTS, PETTICOATS, BOOTS, TRENCH COATS, OVERALLS, DRESSING GOWNS, SABOTS; HEADGEAR, NAMELY, BERETS, HATS, CAPS, BASCO, FUR HATS, IN CLASS 25 (U.S. CLS. 22 AND 39).

FOR: GAMES AND PLAYTHINGS, NAMELY, ACTION SKILL GAMES, ACTION TARGET GAMES, AMUSEMENT GAME MACHINES, CHILDREN'S PLAY COSMETICS, CASES FOR PLAY ACCESSORIES, PLAY BALLS AND PLAY BALLOONS, PLAY

MOTOR CARS; GYMNAS TIC AND SPORTING ARTICLES, NAMELY, GYMNAS TIC APPARATUS, SPRING BOARDS; ATHLETIC SPORTING GOODS, NAMELY, ATHLETIC WRIST AND JOINT SUPPORTS; SPORTING GOODS AND EQUIPMENT FOR SPEED TRAINING, NAMELY, RINGS, CONES, SPEED LADDERS, COACHING STICKS, TRAINING ARCHES, ANKLE BANDS, RESISTANCE CHUTES, HURDLES, IN CLASS 28 (U.S. CLS. 22, 23, 38 AND 50).

FOR: PROVIDING TELECOMMUNICATIONS CONNECTIONS TO THE INTERNET; PROVIDING ACCESS TO TELECOMMUNICATION NETWORKS; TELECOMMUNICATION SERVICES, NAMELY, AERONAUTICAL TELECOMMUNICATION SERVICES, BROADCASTING SERVICES AND PROVISION OF TELECOMMUNICATION ACCESS TO FILMS AND TELEVISION PROGRAMS PROVIDED VIA A VIDEO-ON-DEMAND SERVICE, COMMUNICATIONS VIA MULTINATIONAL TELECOMMUNICATION NETWORKS, TRANSMISSION OF VOICE, AUDIO, VISUAL IMAGES AND DATA BY TELECOMMUNICATIONS NETWORKS, WIRELESS COMMUNICATION NETWORKS, THE INTERNET, INFORMATION SERVICES NETWORKS AND DATA NETWORKS, ELECTRONIC EXCHANGE OF DATA STORED IN DATABASES ACCESSIBLE VIA TELECOMMUNICATION NETWORKS, INTERNET CAFE SERVICES, NAMELY, PROVIDING TELECOMMUNICATIONS CONNECTIONS TO THE INTERNET IN A CAFE ENVIRONMENT, TELECOMMUNICATIONS BY E-MAIL, IN CLASS 38 (U.S. CLS. 100, 101 AND 104).

OWNER OF INTERNATIONAL REGISTRATION
0945672 DATED 10-31-2007, EXPIRES 10-31-2017.

SER. NO. 79-047,064, FILED 10-31-2007.

HEATHER SAPP, EXAMINING ATTORNEY

Int. Cls.: 7, 9, 11 and 42

**Prior U.S. Cls.: 13, 19, 21, 23, 26, 31, 34, 35, 36, 38, 100
and 101**

Reg. No. 3,485,325

United States Patent and Trademark Office

Registered Aug. 12, 2008

**TRADEMARK
SERVICE MARK
PRINCIPAL REGISTER**

X-Roll

SMS DEMAG AG (FED REP GERMANY CORPORATION)
EDUARD-SCHLOEMANN-STRASSE 4
40237 DÜSSELDORF, FED REP GERMANY

FOR: CONTINUOUS CASTING MACHINES, ROLLING MACHINES FOR THE ROLLING OF METALS, FORGING MACHINES, METAL PRESSES, PARTS OF THE FOREGOING MACHINES, NAMELY, CO₂-SEPARATION APPARATUSES, SHEARS, REELS, ROLLS, COILERS, ROLL STANDS, BLADES, GEARS, COUPLINGS, AND GRINDING MACHINES, IN CLASS 7 (U.S. CLS. 13, 19, 21, 23, 31, 34 AND 35).

FOR: ELECTRONIC REGULATING AND CONTROL DEVICES FOR THE OPERATION OF CONTINUOUS CASTING MACHINES, ROLLING MACHINES FOR THE ROLLING OF METALS, FORGING MACHINES AND METAL PRESSES; ELECTRICAL AND ELECTRONIC DEVICES AND INSTRUMENTS FOR RECORDING AND ANALYZING SIGNALS, NAMELY, ELECTRICAL AND MAGNETIC SIGNALS, AS WELL AS DETERMINING OPTIMIZED PROCESS PARAMETERS OF ROLLING PROCESSES FOR THE CREATION OF ROLLING PROGRAMS, ESPECIALLY FOR THE ROLLING OF METALS; DATA PROCESSING EQUIPMENT AND COMPUTERS; COMPUTER PROGRAMS STORED ON DATA CARRIERS FOR REGULATING AND CONTROLLING CONTINUOUS CASTING MACHINES, ROLLING MACHINES FOR THE ROLLING OF METALS, FORGING MACHINES, METAL PRESSES, PARTS OF THE FOREGOING MACHINES, NAMELY, CO₂-SEPARATION APPARATUSES, SHEARS, REELS, ROLLS, COILERS, ROLL STANDS, BLADES, GEARS, COU-

PLINGS, AND GRINDING MACHINES, IN CLASS 9 (U.S. CLS. 21, 23, 26, 36 AND 38).

FOR: FURNACES FOR CONTINUOUS CASTING PLANTS, FOR ROLLING MILLS, FOR FORGING SYSTEMS AND METAL PRESSES, IN CLASS 11 (U.S. CLS. 13, 21, 23, 31 AND 34).

FOR: BUILDING AND CONSTRUCTION PLANNING; ENGINEERING; DESIGN AND DEVELOPMENT OF COMPUTER SOFTWARE; TECHNOLOGY CONSULTATION IN THE FIELD OF CONTINUOUS CASTING MACHINES, ROLLING MACHINES FOR THE ROLLING OF METALS, FORGING MACHINES, METAL PRESSES, PARTS OF THE FOREGOING MACHINES, NAMELY, CO₂-SEPARATION APPARATUSES, SHEARS, REELS, ROLLS, COILERS, ROLL STANDS, BLADES, GEARS, COUPLINGS, AND GRINDING MACHINES, IN CLASS 42 (U.S. CLS. 100 AND 101).

THE MARK CONSISTS OF STANDARD CHARACTERS WITHOUT CLAIM TO ANY PARTICULAR FONT, STYLE, SIZE, OR COLOR.

PRIORITY DATE OF 2-26-2007 IS CLAIMED.

OWNER OF INTERNATIONAL REGISTRATION 0946102 DATED 8-21-2007, EXPIRES 8-21-2017.

OWNER OF U.S. REG. NO. 3,216,061.

SER. NO. 79-047,223, FILED 8-21-2007.

SKYE YOUNG, EXAMINING ATTORNEY

Int. Cl.: 39

Prior U.S. Cls.: 100 and 105

United States Patent and Trademark Office

Reg. No. 3,485,326

Registered Aug. 12, 2008

**SERVICE MARK
PRINCIPAL REGISTER**



AIR FOUR S.P.A. (ITALY JOINT STOCK COMPANY)
VIA CESARE CANTU', 1
I-20123 MILANO
ITALY

FOR: TRANSPORT OF GOODS AND PERSONS BY AIR; PACKAGING GOODS FOR TRANSPORTATION AND STORAGE OF GOODS; TRAVEL ARRANGEMENT, IN CLASS 39 (U.S. CLS. 100 AND 105).

OWNER OF INTERNATIONAL REGISTRATION 0946139 DATED 11-6-2007, EXPIRES 11-6-2017.

THE MARK CONSISTS IN THE WORDS "AIR FOUR" IN SPECIAL CHARACTERS AND IN THE DESIGN OF THE NUMBER FOUR. BETWEEN WORDS "AIR FOUR" IS DESIGNED AN ARROW. BESIDE WORDS "AIR FOUR" THERE IS A CIRCLE INSIDE OF WHICH IS DESIGNED THE NUMBER FOUR. THE RIGHT EXTREMITY OF THE NUMBER FOUR CULMINATES WITH AN ARROW THAT RESUMES THE DESIGN OF THE ARROW THAT IS PRESENT ALSO BETWEEN WORDS AIR FOUR.

SER. NO. 79-047,236, FILED 11-6-2007.

JAMES GRIFFIN, EXAMINING ATTORNEY

Int. Cl.: 16

Prior U.S. Cls.: 2, 5, 22, 23, 29, 37, 38 and 50

Reg. No. 3,485,327

United States Patent and Trademark Office

Registered Aug. 12, 2008

**TRADEMARK
PRINCIPAL REGISTER**

NeroUno

RICHEMONT ITALIA S.P.A. (ITALY JOINT
STOCK COMPANY)
VIA LUDOVICO DI BREME, 44
I-20156 MILANO
ITALY

PRIORITY DATE OF 5-11-2007 IS CLAIMED.

OWNER OF INTERNATIONAL REGISTRATION
0946348 DATED 10-19-2007, EXPIRES 10-19-2017.

FOR: FOUNTAIN PENS, PENS, BALL-POINT
PENS, PENCILS, FELT-TIP PENS, ROLLER BALL
PENS, POUCHES FOR WRITING INSTRUMENTS,
GIFT CASES FOR WRITING INSTRUMENTS, INKS
AND REFILLS, PEN AND PENCIL HOLDERS, IN
CLASS 16 (U.S. CLS. 2, 5, 22, 23, 29, 37, 38 AND 50).

THE FOREIGN WORDING IN THE MARK
TRANSLATES INTO ENGLISH AS "BLACK ONE".

THE MARK CONSISTS OF STANDARD CHAR-
ACTERS WITHOUT CLAIM TO ANY PARTICULAR
FONT, STYLE, SIZE, OR COLOR.

SER. NO. 79-047,317, FILED 10-19-2007.

ANN E. SAPPENFIELD, EXAMINING ATTORNEY

Int. Cl.: 11

Prior U.S. Cls.: 13, 21, 23, 31 and 34

Reg. No. 3,485,328

United States Patent and Trademark Office

Registered Aug. 12, 2008

**TRADEMARK
PRINCIPAL REGISTER**



ZHEJIANG DAFA AUTOMOBILE PARTS; CO.,
LTD (CHINA CORPORATION)
NO.292, XINQIAO ROAD
XINQIAO TOWN, LUQIAO, TAIZHOU; ZHEJIANG
CHINA

FOR: LIGHTS FOR VEHICLES; HEADLIGHTS
FOR AUTOMOBILES; BICYCLE LIGHTS; LIGHT
BULBS FOR DIRECTIONAL SIGNALS FOR VEHI-
CLES; VEHICLE REFLECTORS; LIGHTING APPA-
RATUS FOR VEHICLES; LIGHTS FOR

AUTOMOBILES, IN CLASS 11 (U.S. CLS. 13, 21, 23,
31 AND 34).

OWNER OF INTERNATIONAL REGISTRATION
0946656 DATED 11-27-2007, EXPIRES 11-27-2017.

SER. NO. 79-047,433, FILED 11-27-2007.

MICHAEL KAZAZIAN, EXAMINING ATTORNEY

Int. Cl.: 25

Prior U.S. Cls.: 22 and 39

United States Patent and Trademark Office

Reg. No. 3,485,329

Registered Aug. 12, 2008

**TRADEMARK
PRINCIPAL REGISTER**

YKX & CO

FANTASY SHOES S.R.L. (ITALY SOCIETÀ A
RESPONSABILITÀ LIMITATA (SRL))
PIAZZA MARTIRI DI MARZABOTTO, 63
I-55015 MONSUMMANO TERME (PT)
ITALY

FOR: FOOTWEAR AND THEIR PARTS AND
COMPONENTS, NAMELY, UPPERS, SOLES, IN-
SOLES, IN CLASS 25 (U.S. CLS. 22 AND 39).

THE MARK CONSISTS OF STANDARD CHAR-
ACTERS WITHOUT CLAIM TO ANY PARTICULAR
FONT, STYLE, SIZE, OR COLOR.

OWNER OF INTERNATIONAL REGISTRATION
0946767 DATED 11-21-2007, EXPIRES 11-21-2017.

NO CLAIM IS MADE TO THE EXCLUSIVE
RIGHT TO USE "CO", APART FROM THE MARK
AS SHOWN.

SER. NO. 79-047,476, FILED 11-21-2007.

KATHRYN COWARD, EXAMINING ATTORNEY

Int. Cls.: 9 and 11

Prior U.S. Cls.: 13, 21, 23, 26, 31, 34, 36 and 38

United States Patent and Trademark Office

Reg. No. 3,485,330

Registered Aug. 12, 2008

**TRADEMARK
PRINCIPAL REGISTER**

LINEARlight-DRAGON

OSRAM; GESELLSCHAFT MIT BESCHRÄNKTER
HAFTUNG (FED REP GERMANY LTD LIAB
CO)
HELLABRUNNER STR. 1
81543 MÜNCHEN
FED REP GERMANY

FOR: APPARATUS FOR CONTROLLING ELECTRICITY, NAMELY, ELECTRONIC CONTROL GEAR FOR LIGHT SOURCES; LIGHT EMITTING DIODES, NAMELY, ORGANIC AND INORGANIC LIGHT EMITTING DIODES (LED), LED MODULES, NAMELY, MODULES WITH LAMP FUNCTIONS, CONSTRUCTED FROM LIGHT EMITTING DIODES, USED FOR SIGNALING AND ILLUMINATING; LED MODULE SYSTEMS, NAMELY, MODULES CONSTRUCTED FROM A PLURALITY OF LIGHT EMITTING DIODES, OPTICS TO DIRECT LIGHT EMITTED THEREFROM, AND AN INTEGRATED HEAT SINK FOR DISSIPATION OF HEAT PRODUCED BY THE DIODES; ELECTRONIC LAMP

BALLASTS FOR LIGHTING PURPOSES AND FOR LIGHT EMITTING DIODES AND LASER DIODES, IN CLASS 9 (U.S. CLS. 21, 23, 26, 36 AND 38).

FOR: APPARATUS FOR LIGHTING, NAMELY, ELECTRIC LAMPS AND LUMINAIRES; STRUCTURAL PARTS OF THE AFORESAID GOODS, IN CLASS 11 (U.S. CLS. 13, 21, 23, 31 AND 34).

OWNER OF INTERNATIONAL REGISTRATION 0947025 DATED 7-30-2007, EXPIRES 7-30-2017.

OWNER OF U.S. REG. NOS. 3,174,343, 3,213,710, AND 3,280,234.

SER. NO. 79-047,582, FILED 7-30-2007.

WILLIAM ROSSMAN, EXAMINING ATTORNEY

Int. Cls.: 1 and 3

Prior U.S. Cls.: 1, 4, 5, 6, 10, 26, 46, 50, 51 and 52

United States Patent and Trademark Office

Reg. No. 3,485,331

Registered Aug. 12, 2008

**TRADEMARK
PRINCIPAL REGISTER**



TAKASAGO LONGOZAL

TAKASAGO KORYO KOGYO KABUSHIKI
KAISHA; (ALSO TRADING AS TAKASAGO;
INTERNATIONAL CORPORATION) (JAPAN
CORPORATION)
37-1, KAMATA 5-CHOME
OHTA-KU; TOKYO 144-8721
JAPAN

FOR: CHEMICALS FOR USE IN THE MANUFACTURE OF PERFUMERY, FLAVORINGS, COSMETICS, TOILETRIES, AND HOUSEHOLD PRODUCTS; AROMATIC CHEMICALS FOR USE IN THE MANUFACTURE OF PERFUMERY, FLAVORINGS, COSMETICS, TOILETRIES, AND HOUSEHOLD PRODUCTS, IN CLASS 1 (U.S. CLS. 1, 5, 6, 10, 26 AND 46).

FOR: PERFUMERY; ESSENTIAL OILS; AROMATIC SUBSTANCES AND PREPARATIONS, NAMELY, ESSENTIAL OILS FOR USE IN THE MANUFACTURE OF PERFUMERY, FLAVORINGS, COSMETICS, TOILETRIES, DEODORANTS AND HOUSEHOLD PRODUCTS; ESSENTIAL OILS WITH SYNTHETIC AROMATIC CHEMICAL COMPO-

NENT FOR USE IN THE MANUFACTURE OF PERFUMERY, FLAVORINGS, COSMETICS, TOILETRIES, DEODORANTS AND HOUSEHOLD PRODUCTS, IN CLASS 3 (U.S. CLS. 1, 4, 6, 50, 51 AND 52).

PRIORITY DATE OF 10-10-2007 IS CLAIMED.

OWNER OF INTERNATIONAL REGISTRATION
0947598 DATED 11-29-2007, EXPIRES 11-29-2017.

OWNER OF U.S. REG. NOS. 1,724,832, 2,807,742
AND OTHERS.

THE ENGLISH TRANSLATION OF THE WORD
"TAKASAGO LONGOZAL" IN THE MARK IS CELEBRATION.

SER. NO. 79-047,770, FILED 11-29-2007.

RON FAIRBANKS, EXAMINING ATTORNEY

Int. Cls.: 1 and 3

Prior U.S. Cls.: 1, 4, 5, 6, 10, 26, 46, 50, 51 and 52

United States Patent and Trademark Office

Reg. No. 3,485,332

Registered Aug. 12, 2008

**TRADEMARK
PRINCIPAL REGISTER**

RINGONOL

TAKASAGO KORYO KOGYO KABUSHIKI
KAISHA; (ALSO TRADING AS TAKASAGO;
INTERNATIONAL CORPORATION) (JAPAN
CORPORATION)

37-1, KAMATA 5-CHOME
OHTA-KU; TOKYO 144-8721
JAPAN

FOR: CHEMICALS FOR USE IN THE MANUFACTURE OF PERFUMERY, FLAVORINGS, COSMETICS, TOILETRIES, AND HOUSEHOLD PRODUCTS; AROMATIC CHEMICALS FOR USE IN THE MANUFACTURE OF PERFUMERY, FLAVORINGS, COSMETICS, TOILETRIES, AND HOUSEHOLD PRODUCTS, IN CLASS 1 (U.S. CLS. 1, 5, 6, 10, 26 AND 46).

FOR: PERFUMERY; ESSENTIAL OILS; AROMATIC SUBSTANCES AND PREPARATIONS, NAMELY, ESSENTIAL OILS FOR USE IN THE MANUFACTURE OF PERFUMERY, FLAVORINGS, COSMETICS, TOILETRIES, DEODORANTS AND

HOUSEHOLD PRODUCTS; ESSENTIAL OILS WITH SYNTHETIC AROMATIC CHEMICAL COMPONENT FOR USE IN THE MANUFACTURE OF PERFUMERY, FLAVORINGS, COSMETICS, TOILETRIES, DEODORANTS AND HOUSEHOLD PRODUCTS, IN CLASS 3 (U.S. CLS. 1, 4, 6, 50, 51 AND 52).

THE MARK CONSISTS OF STANDARD CHARACTERS WITHOUT CLAIM TO ANY PARTICULAR FONT, STYLE, SIZE, OR COLOR.

PRIORITY DATE OF 9-6-2007 IS CLAIMED.

OWNER OF INTERNATIONAL REGISTRATION
0947599 DATED 11-29-2007, EXPIRES 11-29-2017.

SER. NO. 79-047,771, FILED 11-29-2007.

RON FAIRBANKS, EXAMINING ATTORNEY

Int. Cl.: 9

Prior U.S. Cls.: 21, 23, 26, 36 and 38

Reg. No. 3,485,333

United States Patent and Trademark Office

Registered Aug. 12, 2008

**TRADEMARK
PRINCIPAL REGISTER**

Miracel PLUS

KNÜRR AG (FED REP GERMANY AG (JOINT-STOCK COMPANY))
MARIAKIRCHENER STRASSE
94424 ARNSTORF
FED REP GERMANY

HEAT EXCHANGERS, ELECTRIC FANS, IN CLASS 9 (U.S. CLS. 21, 23, 26, 36 AND 38).

PRIORITY DATE OF 2-22-2007 IS CLAIMED.

FOR: STORAGE DEVICES FOR ELECTRONIC DEVICES, NAMELY, RACKS, CABINETS AND CASES FOR COMPUTER SERVERS, TELECOMMUNICATIONS HARDWARE, BATTERY PACKS, ELECTRONICALLY BASED MONITORING SYSTEMS FOR TEMPERATURE, HUMIDITY AND ACCESS CONTROL, AIR CONDITIONING UNITS,

OWNER OF INTERNATIONAL REGISTRATION 0947868 DATED 7-12-2007, EXPIRES 7-12-2017.

SER. NO. 79-047,890, FILED 7-12-2007.

CURTIS FRENCH, EXAMINING ATTORNEY

Int. Cls.: 3 and 10

Prior U.S. Cls.: 1, 4, 6, 26, 39, 44, 50, 51 and 52

United States Patent and Trademark Office

Reg. No. 3,485,334

Registered Aug. 12, 2008

**TRADEMARK
PRINCIPAL REGISTER**

TEOSYAL

TEOXANE S.A. (SWITZERLAND COMPANY)
105, RUE DE LYON
GENÈVE, SWITZERLAND CH1203

FOR: BLEACHING PREPARATIONS AND OTHER SUBSTANCES FOR LAUNDRY USE, NAMELY, SOAPS AND STARCH; CLEANING, POLISHING, SCOURING AND ABRASIVE PREPARATIONS; SKIN SOAPS; PERFUMES; ESSENTIAL OILS, COSMETICS, HAIR LOTIONS; COSMETICS AGAINST WRINKLES; DENTIFRICES, IN CLASS 3 (U.S. CLS. 1, 4, 6, 50, 51 AND 52).

FOR: SURGICAL INSTRUMENTS; MEDICAL, DENTAL AND VETERINARY APPARATUS AND INSTRUMENTS, NAMELY, ARTIFICIAL LIMBS AND TEETH; SYRINGES FOR THE INJECTION OF

DERMATOLOGICAL PRODUCTS; ORTHOPAEDIC ARTICLES, NAMELY, SUPPORTS; SUTURE MATERIALS, IN CLASS 10 (U.S. CLS. 26, 39 AND 44).

THE MARK CONSISTS OF STANDARD CHARACTERS WITHOUT CLAIM TO ANY PARTICULAR FONT, STYLE, SIZE, OR COLOR.

OWNER OF INTERNATIONAL REGISTRATION
0851523 DATED 3-23-2005, EXPIRES 3-23-2015.

OWNER OF U.S. REG. NO. 3,098,382.

SER. NO. 79-048,063, FILED 9-19-2007.

DAVID H. STINE, EXAMINING ATTORNEY

Int. Cl.: 12

Prior U.S. Cls.: 19, 21, 23, 31, 35 and 44

Reg. No. 3,485,335

United States Patent and Trademark Office

Registered Aug. 12, 2008

**TRADEMARK
PRINCIPAL REGISTER**



ART-INOX S.R.L. (ITALY CORPORATION)
VIA EINAUDI, 17/A
I-61032 FANO (PU)
ITALY

OWNER OF INTERNATIONAL REGISTRATION
0948803 DATED 9-17-2007, EXPIRES 9-17-2017.

FOR: STRUCTURAL PARTS OF BOATS AND SHIPS; SAILCRAFT, NAMELY, SAIL BOATS; YACHTS; DINGHIES; MOTOR BOATS; NAUTICAL CRAFT, NAMELY, MOTOR CRUISERS IN THE NATURE OF YACHTS AND BOATS; AND NAVAL VESSELS, IN CLASS 12 (U.S. CLS. 19, 21, 23, 31, 35 AND 44).

THE FOREIGN WORDING IN THE MARK TRANSLATES INTO ENGLISH AS "STAINLESS."

SER. NO. 79-048,229, FILED 9-17-2007.

PRIORITY DATE OF 6-12-2007 IS CLAIMED.

ROBERT STRUCK, EXAMINING ATTORNEY

Int. Cl.: 10

Prior U.S. Cls.: 26, 39 and 44

Reg. No. 3,485,336

United States Patent and Trademark Office

Registered Aug. 12, 2008

**TRADEMARK
PRINCIPAL REGISTER**

ADVANSYS

NEWDEAL (FRANCE SOCIÉTÉ PAR ACTIONS
SIMPLIFIÉE)
10, PLACE D'HELVÉTIE
F-69006 LYON
FRANCE

FOR: SURGICAL EQUIPMENT FOR ORTHOPEDICS AND TRAUMATOLOGY, NAMELY, IMPACTORS, SURGICAL DRILLS; ARTIFICIAL SURGICAL IMPLANTS FOR OSTEOSYNTHESIS IN THE FIELD OF TRAUMATOLOGY AND LIMB AND TRUNK ORTHOPEDICS; JOINT PROSTHESES; SURGICAL SCREWS; ARTIFICIAL SURGICAL IMPLANTS; SURGICAL PINS; SURGICAL APPARATUS AND INSTRUMENTS FOR USE IN ORTHOPEDIC AND TRAUMATOLOGY SURGERIES, IN CLASS 10 (U.S. CLS. 26, 39 AND 44).

THE MARK CONSISTS OF STANDARD CHARACTERS WITHOUT CLAIM TO ANY PARTICULAR FONT, STYLE, SIZE, OR COLOR.

PRIORITY DATE OF 4-26-2007 IS CLAIMED.

OWNER OF INTERNATIONAL REGISTRATION 0950172 DATED 10-9-2007, EXPIRES 10-9-2017.

THE WORDING "ADVANSYS" HAS NO MEANING IN A FOREIGN LANGUAGE.

SER. NO. 79-048,760, FILED 10-9-2007.

JACLYN KIDWELL, EXAMINING ATTORNEY

Int. Cls.: 18 and 25

Prior U.S. Cls.: 1, 2, 3, 22, 39 and 41

United States Patent and Trademark Office

Reg. No. 3,485,337

Registered Aug. 12, 2008

TRADEMARK
PRINCIPAL REGISTER

VONIN

CHO, KYOUNG TAE (REPUBLIC OF KOREA
INDIVIDUAL)
2ND FLOOR
910-23 BONGCHENBON-DONG
GWANAK-GU, REPUBLIC OF KOREA

FOR: BACKPACKS, SPORTS BAGS FOR CLIMBERS, BRIEFCASES, BUSINESS CARD CASES, CREDIT CARD CASES, KEY CASES OF LEATHER, CLOTHING FOR PETS, FUR, HANDBAGS, PARASOLS FOR THE BEACH, PURSES NOT OF PRECIOUS METAL, RUCKSACKS, SCHOOL BAGS, SUITCASES, TRAVELING BAGS, UMBRELLAS, WALKING STICKS, IN CLASS 18 (U.S. CLS. 1, 2, 3, 22 AND 41).

FOR: SHOES OF LEATHER, GOLF SHOES, LOW SHOES, SLIPPERS, FOOTBALL SHOES, BOOTS, SANDALS, ATHLETIC SPORTS SHOES, GARTERS, HATS, JACKETS, JUMPERS, PANTS OF LEATHER, JACKETS OF LEATHER, PETTICOATS, WAISTCOATS, SUITS, SWEATERS, PANTS, PAJAMAS,

UNDERPANTS, UNDERWEAR, TEE-SHIRTS, TUXEDOS, PULLOVERS, CORSELETS, SWIMSUITS, LIVERIES, VESTS, SOCKS, SUN VISORS, STOCKINGS, NECKTIES, SCARVES, STOCKING SUSPENDERS, LEGGINGS, GLOVES, MONEY BELTS, MASQUERADE COSTUMES, ATHLETIC UNIFORMS, OVERALLS, DRESSING GOWNS, DRESS SHIRTS, BATHING SUITS, BATHING COVER-UPS, IN CLASS 25 (U.S. CLS. 22 AND 39).

OWNER OF INTERNATIONAL REGISTRATION
0950309 DATED 9-17-2007, EXPIRES 9-17-2017.

THE WORD "VONIN" HAS NO SIGNIFICANCE
OTHER THAN TRADEMARK SIGNIFICANCE.

SER. NO. 79-048,808, FILED 9-17-2007.

CARYN GLASSER, EXAMINING ATTORNEY

Int. Cl.: 14

Prior U.S. Cls.: 2, 27, 28 and 50

United States Patent and Trademark Office

Reg. No. 3,485,338

Registered Aug. 12, 2008

**TRADEMARK
PRINCIPAL REGISTER**

Silver Cup

MONTRES CORUM SÀRL (SWITZERLAND SO-
CIÉTÉ ANONYME)
1, RUE DU PETIT-CHÂTEAU
CH-2300 LA CHAUX-DE-FONDS
SWITZERLAND

FOR: TIMEPIECES AND CHRONOMETRIC IN-
STRUMENTS, NAMELY, CLOCKS, WATCHES, TA-
BLE CLOCKS, CHRONOMETERS, ALL THE
AFORESAID GOODS MADE OF SILVER, IN CLASS
14 (U.S. CLS. 2, 27, 28 AND 50).

THE MARK CONSISTS OF STANDARD CHAR-
ACTERS WITHOUT CLAIM TO ANY PARTICULAR
FONT, STYLE, SIZE, OR COLOR.

PRIORITY DATE OF 7-11-2007 IS CLAIMED.

OWNER OF INTERNATIONAL REGISTRATION
0950347 DATED 11-27-2007, EXPIRES 11-27-2017.

NO CLAIM IS MADE TO THE EXCLUSIVE
RIGHT TO USE "SILVER", APART FROM THE
MARK AS SHOWN.

SER. NO. 79-048,823, FILED 11-27-2007.

REBECCA EISINGER, EXAMINING ATTORNEY

Int. Cl.: 14

Prior U.S. Cls.: 2, 27, 28 and 50

Reg. No. 3,485,339

United States Patent and Trademark Office

Registered Aug. 12, 2008

**TRADEMARK
PRINCIPAL REGISTER**

Gold Cup

MONTRES CORUM SÀRL (SWITZERLAND SO-
CIÉTÉ ANONYME)
1, RUE DU PETIT-CHATEAU
CH-2300 LA CHAUX-DE-FONDS
SWITZERLAND

FOR: TIMEPIECES AND CHRONOMETRIC IN-
STRUMENTS, NAMELY, CLOCKS, WATCHES, TA-
BLE CLOCKS, CHRONOMETERS, ALL THE
AFORESAID GOODS MADE OF GOLD , IN CLASS
14 (U.S. CLS. 2, 27, 28 AND 50).

THE MARK CONSISTS OF STANDARD CHAR-
ACTERS WITHOUT CLAIM TO ANY PARTICULAR
FONT, STYLE, SIZE, OR COLOR.

PRIORITY DATE OF 7-11-2007 IS CLAIMED.

OWNER OF INTERNATIONAL REGISTRATION
0950348 DATED 11-27-2007, EXPIRES 11-27-2017.

NO CLAIM IS MADE TO THE EXCLUSIVE
RIGHT TO USE "GOLD", APART FROM THE
MARK AS SHOWN.

SER. NO. 79-048,824, FILED 11-27-2007.

REBECCA EISINGER, EXAMINING ATTORNEY

Int. Cl.: 10

Prior U.S. Cls.: 26, 39 and 44

Reg. No. 3,485,340

United States Patent and Trademark Office

Registered Aug. 12, 2008

**TRADEMARK
PRINCIPAL REGISTER**

RESOUND SPARX

GN RESOUND A/S (DENMARK LTD LIAB CO)
LAUTRUPBJERG 9
DK-2750 BALLERUP
DENMARK

OWNER OF INTERNATIONAL REGISTRATION
0950357 DATED 11-29-2007, EXPIRES 11-29-2017.

FOR: HEARING AIDS, IN CLASS 10 (U.S. CLS. 26,
39 AND 44).

OWNER OF U.S. REG. NOS. 1,517,106, 3,181,119
AND OTHERS.

THE MARK CONSISTS OF STANDARD CHAR-
ACTERS WITHOUT CLAIM TO ANY PARTICULAR
FONT, STYLE, SIZE, OR COLOR.

SER. NO. 79-048,829, FILED 11-29-2007.

PRIORITY DATE OF 7-2-2007 IS CLAIMED.

DAYNA BROWNE, EXAMINING ATTORNEY

Int. Cl.: 5

Prior U.S. Cls.: 6, 18, 44, 46, 51 and 52

Reg. No. 3,485,341

United States Patent and Trademark Office

Registered Aug. 12, 2008

**TRADEMARK
PRINCIPAL REGISTER**

INTIDEN

MERCK KGAA (FED REP GERMANY PART-
NERSHIP)
FRANKFURTER STRASSE 250
64293 DARMSTADT
FED REP GERMANY

FOR: PHARMACEUTICAL PREPARATIONS FOR
INFLAMMATORY AND IMMUNOLOGICAL DIS-
EASES AND DISORDERS, REPRODUCTIVE
HEALTH DISEASES AND DISORDERS, NEUROLOGI-
CAL DISEASES AND DISORDERS, ONCOLOGI-
CAL DISEASES AND DISORDERS,
CARDIOVASCULAR DISEASES AND DISORDERS,
PULMONARY DISEASES AND DISORDERS, EN-
DOCRINOLOGICAL DISEASES AND DISORDERS,
GROWTH HORMONE DISEASES AND DISOR-
DERS, GENETIC DISEASES AND DISORDERS, ME-
TABOLIC DISEASES AND DISORDERS, DIABETIC

DISEASES AND DISORDERS, IN CLASS 5 (U.S. CLS.
6, 18, 44, 46, 51 AND 52).

THE MARK CONSISTS OF STANDARD CHAR-
ACTERS WITHOUT CLAIM TO ANY PARTICULAR
FONT, STYLE, SIZE, OR COLOR.

PRIORITY DATE OF 6-14-2007 IS CLAIMED.

OWNER OF INTERNATIONAL REGISTRATION
0950360 DATED 12-11-2007, EXPIRES 12-11-2017.

SER. NO. 79-048,831, FILED 12-11-2007.

BARNEY CHARLON, EXAMINING ATTORNEY

Int. Cl.: 5

Prior U.S. Cls.: 6, 18, 44, 46, 51 and 52

United States Patent and Trademark Office

Reg. No. 3,485,342

Registered Aug. 12, 2008

**TRADEMARK
PRINCIPAL REGISTER**

STARNIIVA

MERCK KGAA (FED REP GERMANY PART-
NERSHIP)
FRANKFURTER STRASSE 250
64293 DARMSTADT
FED REP GERMANY

FOR: PHARMACEUTICAL PREPARATIONS FOR
INFLAMMATORY AND IMMUNOLOGICAL DIS-
EASES AND DISORDERS, REPRODUCTIVE
HEALTH DISEASES AND DISORDERS, NEUROLO-
GICAL DISEASES AND DISORDERS, ONCOLOGI-
CAL DISEASES AND DISORDERS,
CARDIOVASCULAR DISEASES AND DISORDERS,
PULMONARY DISEASES AND DISORDERS, EN-
DOCRINOLOGICAL DISEASES AND DISORDERS,
GROWTH HORMONE DISEASES AND DISOR-
DERS, GENETIC DISEASES AND DISORDERS, ME-
TABOLIC DISEASES AND DISORDERS, DIABETIC

DISEASES AND DISORDERS, IN CLASS 5 (U.S. CLS.
6, 18, 44, 46, 51 AND 52).

THE MARK CONSISTS OF STANDARD CHAR-
ACTERS WITHOUT CLAIM TO ANY PARTICULAR
FONT, STYLE, SIZE, OR COLOR.

PRIORITY DATE OF 6-14-2007 IS CLAIMED.

OWNER OF INTERNATIONAL REGISTRATION
0950361 DATED 12-11-2007, EXPIRES 12-11-2017.

SER. NO. 79-048,832, FILED 12-11-2007.

BARNEY CHARLON, EXAMINING ATTORNEY

Int. Cl.: 44

Prior U.S. Cls.: 100 and 101

United States Patent and Trademark Office

Reg. No. 3,485,343

Registered Aug. 12, 2008

**SERVICE MARK
PRINCIPAL REGISTER**

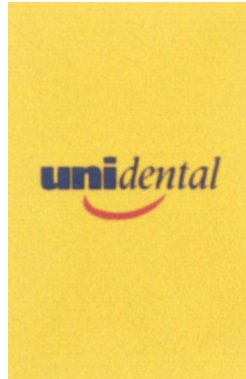

SIC 98, S.L. (SPAIN SOCIEDAD LIMITADA)

MÓSTOLES, 50

E-28943 FUENLABRADA (MADRID)

SPAIN

FOR: MEDICAL SERVICES; VETERINARY SERVICES; HYGIENIC AND BEAUTY CARE FOR HUMAN BEINGS OR ANIMALS; AGRICULTURAL SERVICES, NAMELY AGRICULTURAL ADVICE; HORTICULTURAL SERVICES, IN CLASS 44 (U.S. CLS. 100 AND 101).

PRIORITY DATE OF 9-19-2006 IS CLAIMED.

OWNER OF INTERNATIONAL REGISTRATION
0950689 DATED 2-15-2007, EXPIRES 2-15-2017.

THE COLOR(S) BLUE, RED AND YELLOW IS/
ARE CLAIMED AS A FEATURE OF THE MARK.

THE WORD "UNIDENTAL" IS IN BLUE, THE
CURVED LINE UNDER THE DENOMINATION, IS
IN RED, AND THE BACKGROUND IS IN YELLOW.

SER. NO. 79-048,942, FILED 2-15-2007.

LINDSEY RUBIN, EXAMINING ATTORNEY

Int. Cl.: 33

Prior U.S. Cls.: 47 and 49

United States Patent and Trademark Office

Reg. No. 3,485,344

Registered Aug. 12, 2008

**TRADEMARK
PRINCIPAL REGISTER**

RAIMONDA

MARTI DE DALT, S.A. (SPAIN SOCIEDAD ANO-
NIMA)
CAN MARTÍ DE BAIX
E-08790 GELIDA (BARCELONA)
SPAIN

OWNER OF INTERNATIONAL REGISTRATION
0950713 DATED 8-8-2007, EXPIRES 8-8-2017.

FOR: WINE, QUALITY SPARKLING WINES,
SPIRITS AND LIQUEURS, IN CLASS 33 (U.S. CLS.
47 AND 49).

THE MARK HAS NO MEANING IN A FOREIGN
LANGUAGE

THE MARK CONSISTS OF STANDARD CHAR-
ACTERS WITHOUT CLAIM TO ANY PARTICULAR
FONT, STYLE, SIZE, OR COLOR.

SER. NO. 79-048,956, FILED 8-8-2007.

WILLIAM ROSSMAN, EXAMINING ATTORNEY

Int. Cl.: 3

Prior U.S. Cls.: 1, 4, 6, 50, 51 and 52

United States Patent and Trademark Office

Reg. No. 3,485,345

Registered Aug. 12, 2008

TRADEMARK
PRINCIPAL REGISTER



Pioneers in Naturkosmetik

BÖRLIND; GESELLSCHAFT FÜR KOSMETISCHE ERZEUGNISSE MBH (FED REP GERMANY GMBH)
LINDENSTR. 15
75365 CALW
FED REP GERMANY

PRIORITY DATE OF 6-22-2007 IS CLAIMED.

OWNER OF INTERNATIONAL REGISTRATION 0950978 DATED 10-10-2007, EXPIRES 10-10-2017.

OWNER OF U.S. REG. NOS. 1,224,769 AND 2,392,952.

NO CLAIM IS MADE TO THE EXCLUSIVE RIGHT TO USE "GROUP" AND "NATURKOSMETIK", APART FROM THE MARK AS SHOWN.

THE COLOR(S) BLACK AND PINK IS/ARE CLAIMED AS A FEATURE OF THE MARK.

THE COLOR BLACK APPEARS IN THE WORDING "BÖRLIND GROUP PIONEERS IN NATURKOSMETIK" AND THE COLOR PINK APPEARS IN THE LEAF DESIGN.

THE ENGLISH TRANSLATION OF "NATURKOSMETIK" IN THE MARK IS "NATURAL COSMETIC."

SER. NO. 79-049,038, FILED 10-10-2007.

FOR: PERFUMERY AND COSMETICS, NAMELY, FACIAL LOTIONS, SKIN CREAMS, FACIAL BEAUTY MASKS, BODY POWDER AND FACE POWDER, SKIN OILS AND SUNSCREEN OILS, LIPSTICKS, PRE-SHAVE AND AFTER-SHAVE FACIAL LOTIONS, EYE SHADOW, EYE-BROW PENCIL, MASCARA, LIQUID FACE POWDER, FACE AND BODY EMULSIONS, SKIN LOTION, SHOWER GEL, VANISHING CREAM, ANTI-WRINKLE CREAM, FACE ROUGE, HAND CREAM, EYE MAKE-UP REMOVER; EYE-LINER, NAIL CARE PREPARATIONS, NAMELY, NAIL POLISH, PROTECTIVE BASE FOR THE NAILS, NAIL POLISH REMOVERS, NAIL DYEING AND DECORATING MATERIALS; COSMETICS, NAMELY, SKIN MILK, SKIN FRESHENING TONERS, NON-MEDICATED LIP BALM, SOLID FACE POWDER FOR COMPACT USE, BODY GEL FOR MASSAGE USE, PERSONAL DEODORANT, BEAUTY ADDITIVE FOR BATH WATER, NAMELY, BATH BEADS, BATH LOTION, BATH FOAM, BATH GEL, BATH PEARLS, BATH CRYSTALS, NON-MEDICATED BATH SALTS, BATH POWDER, BATH OIL; HAIR LOTIONS, HAIR SHAMPOO; SOAPS, IN CLASS 3 (U.S. CLS. 1, 4, 6, 50, 51 AND 52).

LAURA HAMMEL, EXAMINING ATTORNEY

Int. Cls.: 9, 41, 42 and 44

Prior U.S. Cls.: 21, 23, 26, 36, 38, 100, 101 and 107

Reg. No. 3,485,346

United States Patent and Trademark Office

Registered Aug. 12, 2008

**TRADEMARK
SERVICE MARK
PRINCIPAL REGISTER**

eARena

SIEMENS AUDIOLOGISCHE TECHNIK GMBH
(FED REP GERMANY LTD LIAB CO)
GEBBERTSTRASSE 125
91058 ERLANGEN
FED REP GERMANY

FOR: DATA PROCESSORS AND COMPUTER SOFTWARE PROGRAMS FOR ANALYZING AND ADJUSTING THE FUNCTIONS OF MEDICAL HEARING AIDS, IN CLASS 9 (U.S. CLS. 21, 23, 26, 36 AND 38).

FOR: TRAINING OF OTHERS IN THE FIELD OF ADAPTATION AND ADJUSTMENT OF MEDICAL HEARING AIDS, IN CLASS 41 (U.S. CLS. 100, 101 AND 107).

FOR: DESIGN AND DEVELOPMENT AND UP-DATING OF HEARING AIDS SOFTWARE, IN CLASS 42 (U.S. CLS. 100 AND 101).

FOR: HEARING AID SERVICES, NAMELY, ADAPTATION AND ADJUSTMENT OF MEDICAL HEARING AIDS, IN CLASS 44 (U.S. CLS. 100 AND 101).

THE MARK CONSISTS OF STANDARD CHARACTERS WITHOUT CLAIM TO ANY PARTICULAR FONT, STYLE, SIZE, OR COLOR.

PRIORITY DATE OF 4-26-2007 IS CLAIMED.

OWNER OF INTERNATIONAL REGISTRATION 0951091 DATED 10-10-2007, EXPIRES 10-10-2017.

SER. NO. 79-049,065, FILED 10-10-2007.

GINA FINK, EXAMINING ATTORNEY

Int. Cl.: 25

Prior U.S. Cls.: 22 and 39

United States Patent and Trademark Office

Reg. No. 3,485,347

Registered Aug. 12, 2008

**TRADEMARK
PRINCIPAL REGISTER**

KAVAT

SKOFABRIKEN KAVAT AB (SWEDEN COR-
PORATION)
PO BOX 101
SE-692 22 KUMLA
SWEDEN

FOR: CHILDREN'S FOOTWEAR, IN CLASS 25
(U.S. CLS. 22 AND 39).

THE MARK CONSISTS OF STANDARD CHAR-
ACTERS WITHOUT CLAIM TO ANY PARTICULAR
FONT, STYLE, SIZE, OR COLOR.

OWNER OF INTERNATIONAL REGISTRATION
0951130 DATED 11-30-2007, EXPIRES 11-30-2017.

THE ENGLISH TRANSLATION OF THE FOR-
EIGN WORD(S) IN THE MARK IS "PLUCKY".

SER. NO. 79-049,075, FILED 11-30-2007.

KEVIN CORWIN, EXAMINING ATTORNEY

Int. Cls.: 1, 5 and 32

Prior U.S. Cls.: 1, 5, 6, 10, 18, 26, 44, 45, 46, 48, 51 and 52

United States Patent and Trademark Office

Reg. No. 3,485,348

Registered Aug. 12, 2008

**TRADEMARK
PRINCIPAL REGISTER**



DSM IP ASSETS B.V. (NETHERLANDS BESLO-
TEN VENNOOTSCHAP)
HET OVERLOON 1
NL-6411 TE HEERLEN
NETHERLANDS

FOR: CHEMICAL AND BIOCHEMICAL ADDI-
TIVES FOR USE IN THE MANUFACTURE OF
FOOD, BEVERAGES, PHARMACEUTICAL PRE-
PARATIONS AND COSMETICS; CHEMICAL AND
BIOCHEMICAL ADDITIVES FOR PRESERVING
FOODSTUFFS AND BEVERAGES, IN CLASS 1
(U.S. CLS. 1, 5, 6, 10, 26 AND 46).

FOR: FOOD SUPPLEMENTS FOR MEDICAL
PURPOSES; FOOD INGREDIENTS, NAMELY, VI-
TAMIN SUPPLEMENTS AND VITAMIN PREPARA-
TIONS, DIETETIC FOODS ADAPTED FOR
MEDICAL PURPOSES; VITAMINS AND VITAMIN
PREPARATIONS, IN CLASS 5 (U.S. CLS. 6, 18, 44, 46,
51 AND 52).

FOR: MINERAL AND AERATED WATERS;
OTHER NON-ALCOHOLIC DRINKS, NAMELY,
FRUIT JUICE BEVERAGES; FRUIT DRINKS AND
FRUIT JUICES; SYRUPS AND OTHER PREPARA-
TIONS, NAMELY, CONCENTRATES AND POW-
DERS FOR MAKING SOFT DRINKS AND FRUIT
DRINKS; SPORT DRINKS AND ENERGY DRINKS,
IN CLASS 32 (U.S. CLS. 45, 46 AND 48).

PRIORITY DATE OF 7-2-2007 IS CLAIMED.

OWNER OF INTERNATIONAL REGISTRATION
0951136 DATED 12-17-2007, EXPIRES 12-17-2017.

SER. NO. 79-049,080, FILED 12-17-2007.

CURTIS FRENCH, EXAMINING ATTORNEY

Int. Cl.: 31

Prior U.S. Cls.: 1 and 46

United States Patent and Trademark Office

Reg. No. 3,485,349

Registered Aug. 12, 2008

**TRADEMARK
PRINCIPAL REGISTER**



BIONORICA AG (FED REP GERMANY STOCK CORPORATION)
KERSCHENSTEINERSTRASSE 11-15
92318 NEUMARKT
FED REP GERMANY

OWNER OF U.S. REG. NO. 2,781,184.

FOR: LIVING PLANTS; DRIED PLANTS; UNPROCESSED HERBS, IN CLASS 31 (U.S. CLS. 1 AND 46).

NO CLAIM IS MADE TO THE EXCLUSIVE RIGHT TO USE "EXTRACT SOLUTIONS" AND "COMPANY", APART FROM THE MARK AS SHOWN.

PRIORITY DATE OF 9-6-2007 IS CLAIMED.

SER. NO. 79-049,083, FILED 12-14-2007.

OWNER OF INTERNATIONAL REGISTRATION 0951143 DATED 12-14-2007, EXPIRES 12-14-2017.

TINA BROWN, EXAMINING ATTORNEY

Int. Cl.: 5

Prior U.S. Cls.: 6, 18, 44, 46, 51 and 52

United States Patent and Trademark Office

Reg. No. 3,485,350

Registered Aug. 12, 2008

**TRADEMARK
PRINCIPAL REGISTER**

IMABEQ

MERCK KGAA (FED REP GERMANY PART-
NERSHIP LIMITED BY SHARES, CONSIST-
ING OF THE PARTNERS KARL-LUDWIG
KLEY (CHAIRMAN) (GERMAN CITIZEN),
MICHAEL BECKER (GERMAN CITIZEN),
BERND RECKMANN (GERMAN CITIZEN),
EIMAR SCHNEE (SWISS CITIZEN), WALTER
W. ZYWOTTEK (GERMAN CITIZEN))

FRANKFURTER STRASSE 250
64293 DARMSTADT
FED REP GERMANY

FOR: PHARMACEUTICAL PREPARATIONS FOR
THE PREVENTION AND TREATMENT OF CAN-
CER, IN CLASS 5 (U.S. CLS. 6, 18, 44, 46, 51 AND 52).

PRIORITY DATE OF 8-14-2007 IS CLAIMED.

OWNER OF INTERNATIONAL REGISTRATION
0951317 DATED 12-6-2007, EXPIRES 12-6-2017.

OWNER OF U.S. REG. NO. 3,011,571.

SER. NO. 79-049,116, FILED 12-6-2007.

BARNEY CHARLON, EXAMINING ATTORNEY

Int. Cl.: 10

Prior U.S. Cls.: 26, 39 and 44

United States Patent and Trademark Office

Reg. No. 3,485,351

Registered Aug. 12, 2008

**TRADEMARK
PRINCIPAL REGISTER**

RESOUND ZIGA

GN RESOUND A/S (DENMARK LTD LIAB CO)
LAUTRUPBJERG 9
DK-2750 BALLERUP
DENMARK

OWNER OF INTERNATIONAL REGISTRATION
0951343 DATED 12-15-2007, EXPIRES 12-15-2017.

FOR: HEARING AIDS, IN CLASS 10 (U.S. CLS. 26,
39 AND 44).

OWNER OF U.S. REG. NOS. 1,517,106, 3,181,119
AND OTHERS.

THE MARK CONSISTS OF STANDARD CHAR-
ACTERS WITHOUT CLAIM TO ANY PARTICULAR
FONT, STYLE, SIZE, OR COLOR.

SER. NO. 79-049,128, FILED 12-15-2007.

PRIORITY DATE OF 8-16-2007 IS CLAIMED.

DAYNA BROWNE, EXAMINING ATTORNEY

Int. Cl.: 20

Prior U.S. Cls.: 2, 13, 22, 25, 32 and 50

Reg. No. 3,485,352

United States Patent and Trademark Office

Registered Aug. 12, 2008

**TRADEMARK
PRINCIPAL REGISTER**



STOSA S.P.A. (ITALY SOCIETÀ PER AZIONI
(SPA))
VIA C. COLOMBO N. 1
BARBERINO VAL D'ELSA (FI)
ITALY

FOR: KITCHEN FURNITURE WITH FITTINGS,
NAMELY, NON-METAL HANDLES AND PULLS, IN
CLASS 20 (U.S. CLS. 2, 13, 22, 25, 32 AND 50).

OWNER OF INTERNATIONAL REGISTRATION
0951397 DATED 11-21-2007, EXPIRES 11-21-2017.

NO CLAIM IS MADE TO THE EXCLUSIVE
RIGHT TO USE "CUCINE", APART FROM THE
MARK AS SHOWN.

THE COLOR(S) BLUE AND WHITE IS/ARE
CLAIMED AS A FEATURE OF THE MARK.

THE MARK CONSISTS OF A SQUARE FORM
MARK WITH BLUE BACKGROUND AND RELIEF
EFFECT, WITH THE NAME OF THE COMPANY
"STOSA" PLACED IN THE MIDDLE IN BIG WHITE
CHARACTERS AND UNDER IT THE WORD "CU-
CINE" (I.E. KITCHENS) IN WHITE COLOR AND
SMALLER CHARACTERS.

THE ENGLISH TRANSLATION OF THE FOR-
EIGN WORD(S) IN THE MARK IS: STOSA KITCH-
ENS.

SER. NO. 79-049,150, FILED 11-21-2007.

MELVIN AXILBUND, EXAMINING ATTORNEY

Int. Cl.: 28

Prior U.S. Cls.: 22, 23, 38 and 50

United States Patent and Trademark Office

Reg. No. 3,485,353

Registered Aug. 12, 2008

**TRADEMARK
PRINCIPAL REGISTER**

omnipro

ORANGE INTERNATIONAL TRADING; (TIAN-
JIN) INC. (CHINA CORPORATION)
ROOM. 202 SUITE 1
155 XINGANG BIG ROAD.; FREE TRADE ZONE;-
TIANJIN
CHINA

OWNER OF INTERNATIONAL REGISTRATION
0951517 DATED 1-10-2008, EXPIRES 1-10-2018.

SER. NO. 79-049,189, FILED 1-10-2008.

FOR: BODY-TRAINING APPARATUS, IN CLASS
28 (U.S. CLS. 22, 23, 38 AND 50).

SAIMA MAKHDOOM, EXAMINING ATTORNEY

Int. Cl.: 9

Prior U.S. Cls.: 21, 23, 26, 36 and 38

United States Patent and Trademark Office

Reg. No. 3,485,354

Registered Aug. 12, 2008

TRADEMARK
PRINCIPAL REGISTER

fullymax

SHENZHEN FULLY BATTERY CO., LTD. (CHINA CORPORATION)
NO. 11, 13, 15, 17 NORTHERN ZONE EAST
2/F BUILDING E-2, INDUSTRIAL PARK; HUAQIAOCHENG EAST; NANSHAN DISTRICT;
SHENZHEN, GUANGDONG
CHINA

FOR: BATTERY CHARGERS; BATTERIES, IN CLASS 9 (U.S. CLS. 21, 23, 26, 36 AND 38).

OWNER OF INTERNATIONAL REGISTRATION
0951586 DATED 1-10-2008, EXPIRES 1-10-2018.

SER. NO. 79-049,231, FILED 1-10-2008.

SAIMA MAKHDOOM, EXAMINING ATTORNEY

Int. Cl.: 1

Prior U.S. Cls.: 1, 5, 6, 10, 26 and 46

United States Patent and Trademark Office

Reg. No. 3,485,355

Registered Aug. 12, 2008

**TRADEMARK
PRINCIPAL REGISTER**

SILANDE

ZHENGZHOU ZHONGYUAN; APPLIED TECHNOLOGY RESEARCH AND; DEVELOPMENT CO., LTD. (CHINA CORPORATION)
NO. 94 HUASHAN ROAD
ZHENGZHOU; 450007 HENAN
CHINA

OWNER OF INTERNATIONAL REGISTRATION
0951605 DATED 1-11-2008, EXPIRES 1-11-2018.

SER. NO. 79-049,241, FILED 1-11-2008.

FOR: ADHESIVES FOR INDUSTRIAL PURPOSES;
VISCOSE; GELATINE FOR INDUSTRIAL PURPOSES, IN CLASS 1 (U.S. CLS. 1, 5, 6, 10, 26 AND 46).

COURTNEY MCCORMICK, EXAMINING ATTORNEY

Int. Cl.: 3

Prior U.S. Cls.: 1, 4, 6, 50, 51 and 52

United States Patent and Trademark Office

Reg. No. 3,485,356

Registered Aug. 12, 2008

TRADEMARK
PRINCIPAL REGISTER



DEBRECENI EGYETEM ORVOS-; ÉS EGÉSZSÉG-
TUDOMÁNYI CENTRUM (HUNGARY STATE
UNIVERSITY)

NAGYERDEI KRT. 98

H-4032 DEBRECEN

HUNGARY

FOR: COSMETICS, COSMETIC PREPARATIONS
FOR SKIN CARE, COSMETIC CREAMS, IN CLASS 3
(U.S. CLS. 1, 4, 6, 50, 51 AND 52).

PRIORITY DATE OF 10-26-2007 IS CLAIMED.

OWNER OF INTERNATIONAL REGISTRATION
0951618 DATED 11-20-2007, EXPIRES 11-20-2017.

THE COLOR(S) BLACK, RED, GREEN, GRAY
AND BLUE IS/ARE CLAIMED AS A FEATURE OF
THE MARK.

THE MARK CONSISTS OF A BRANCH WITH
FLOWER, A PAIR OF CHERRIES AND THE WORD
"OLABELLA"; THE COLOR BLACK APPEARS IN
THE TERM "OLABELLA" AND THE BRANCH; THE
COLOR RED APPEARS IN THE CHERRIES; THE
COLOR GREEN APPEARS IN THE LEAVES AND
THE STEM OF THE CHERRIES; THE COLOR GRAY
APPEARS IN THE BRANCH; AND THE COLOR
BLUE APPEARS IN THE FLOWER.

SER. NO. 79-049,246, FILED 11-20-2007.

DANIEL BRODY, EXAMINING ATTORNEY

Int. Cl.: 5

Prior U.S. Cls.: 6, 18, 44, 46, 51 and 52

United States Patent and Trademark Office

Reg. No. 3,485,357

Registered Aug. 12, 2008

**TRADEMARK
PRINCIPAL REGISTER**

SiryX

CRV HOLDING BV (NETHERLANDS LTD LIAB
CO)
WASSENAARWEG 20
NL-6843 NW ARNHEM, NETHERLANDS

FOR: ANIMAL SPERM, IN CLASS 5 (U.S. CLS. 6,
18, 44, 46, 51 AND 52).

THE MARK CONSISTS OF STANDARD CHAR-
ACTERS WITHOUT CLAIM TO ANY PARTICULAR
FONT, STYLE, SIZE, OR COLOR.

PRIORITY DATE OF 6-30-2007 IS CLAIMED.

OWNER OF INTERNATIONAL REGISTRATION
0951702 DATED 12-3-2007, EXPIRES 12-3-2017.

SER. NO. 79-049,273, FILED 12-3-2007.

MICHAEL WIENER, EXAMINING ATTORNEY

Int. Cl.: 10

Prior U.S. Cls.: 26, 39 and 44

United States Patent and Trademark Office

Reg. No. 3,485,358

Registered Aug. 12, 2008

**TRADEMARK
PRINCIPAL REGISTER**

PURE

SIEMENS AUDIOLOGISCHE TECHNIK GMBH
(FED REP GERMANY LTD LIAB CO)
GEBBERTSTRASSE 125
91058 ERLANGEN
FED REP GERMANY

FOR: MEDICAL HEARING AIDS AND THEIR
PARTS, IN CLASS 10 (U.S. CLS. 26, 39 AND 44).

THE MARK CONSISTS OF STANDARD CHAR-
ACTERS WITHOUT CLAIM TO ANY PARTICULAR
FONT, STYLE, SIZE, OR COLOR.

PRIORITY DATE OF 9-18-2007 IS CLAIMED.

OWNER OF INTERNATIONAL REGISTRATION
0951851 DATED 12-27-2007, EXPIRES 12-27-2017.

SER. NO. 79-049,336, FILED 12-27-2007.

WENDY GOODMAN, EXAMINING ATTORNEY

Int. Cls.: 1 and 3

Prior U.S. Cls.: 1, 4, 5, 6, 10, 26, 46, 50, 51 and 52

Reg. No. 3,485,359

United States Patent and Trademark Office

Registered Aug. 12, 2008

**TRADEMARK
PRINCIPAL REGISTER**

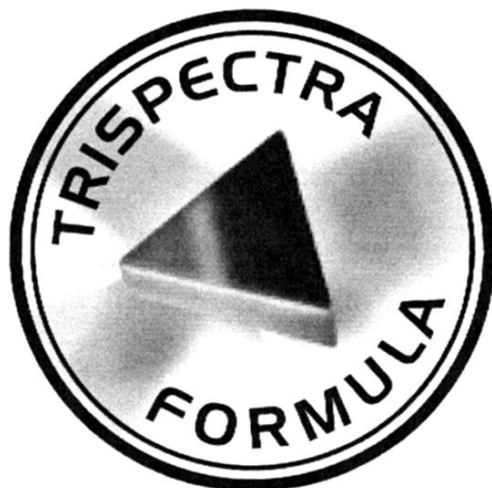

WELLA AKTIENGESELLSCHAFT (FED REP
GERMANY AKTIENGESELLSCHAFT)
BERLINER ALLEE 65
64274 DARMSTADT, FED REP GERMANY

FOR: CHEMICAL PREPARATIONS USED IN IN-
DUSTRY FOR THE PRODUCTION OF COSMETIC
PREPARATIONS, HAIR DYE PREPARATIONS,
PERMANENT WAVE PREPARATIONS AND
CLEANING PREPARATIONS FOR THE BODY,
NAMELY, SKIN CLEANSERS AND SHOWER GEL,
IN CLASS 1 (U.S. CLS. 1, 5, 6, 10, 26 AND 46).

FOR: TOILET SOAPS, PERFUMERIES, ESSEN-
TIAL OILS FOR PERSONAL USE, COSMETICS,
NAMELY, SHAMPOOS AND HAIR CONDITION-
ERS; HAIR COLOR AND DYES, COLOR REMOVAL
AND LIGHTENING PREPARATIONS AND HAIR
BLEACHES; HAIR STYLING AND FINISHING PRO-
DUCTS, NAMELY, HAIR SPRAYS, SPRAY GELS,
GELS, MOUSSES, CREAMS, LOTIONS, POMADES

AND HAIR WAX; HAIR AND SCALP TREAT-
MENTS, NAMELY, RESTRUCTURIZERS AND
SCALP CONDITIONERS, HAIR LOTIONS, DENTI-
FRICES, IN CLASS 3 (U.S. CLS. 1, 4, 6, 50, 51 AND 52).

PRIORITY DATE OF 8-16-2007 IS CLAIMED.

OWNER OF INTERNATIONAL REGISTRATION
0952502 DATED 11-30-2007, EXPIRES 11-30-2017.

NO CLAIM IS MADE TO THE EXCLUSIVE
RIGHT TO USE "FORMULA", APART FROM THE
MARK AS SHOWN.

SER. NO. 79-049,551, FILED 11-30-2007.

CHRISTOPHER BUONGIORNO, EXAMINING AT-
TORNEY

Int. Cl.: 10

Prior U.S. Cls.: 26, 39 and 44

United States Patent and Trademark Office

Reg. No. 3,485,360

Registered Aug. 12, 2008

**TRADEMARK
PRINCIPAL REGISTER**

ERAGON

RICHARD WOLF GMBH (FED REP GERMANY
LTD LIAB CO)
PFORZHEIMER STRASSE 32
75438 KNITTLINGEN
FED REP GERMANY

FOR: SURGICAL, MEDICAL, DENTAL AND VET-
ERINARY INSTRUMENTS AND APPARATUS, IN
PARTICULAR ENDOSCOPES, ENDOSCOPIC IN-
STRUMENTS AND THEIR PARTS AS FAR AS
INCLUDED IN THIS CLASS, IN CLASS 10 (U.S.
CLS. 26, 39 AND 44).

THE MARK CONSISTS OF STANDARD CHAR-
ACTERS WITHOUT CLAIM TO ANY PARTICULAR
FONT, STYLE, SIZE, OR COLOR.

OWNER OF INTERNATIONAL REGISTRATION
0952930 DATED 1-11-2008, EXPIRES 1-11-2018.

SER. NO. 79-049,721, FILED 1-11-2008.

SHAILA SETTLES, EXAMINING ATTORNEY

Int. Cl.: 45

Prior U.S. Cls.: 100 and 101

United States Patent and Trademark Office

Reg. No. 3,485,361

Registered Aug. 12, 2008

**SERVICE MARK
PRINCIPAL REGISTER**

Powering the Planet

SILICON FIRE AG (SWITZERLAND SOCIÉTÉ
ANONYME)
NAUMATTHALDE 11
CH-6045 MEGGEN
SWITZERLAND

FOR: GRANTING OF LICENSES FOR INDUS-
TRIAL PROPERTY RIGHTS, IN CLASS 45 (U.S. CLS.
100 AND 101).

THE MARK CONSISTS OF STANDARD CHAR-
ACTERS WITHOUT CLAIM TO ANY PARTICULAR
FONT, STYLE, SIZE, OR COLOR.

PRIORITY DATE OF 7-11-2007 IS CLAIMED.

OWNER OF INTERNATIONAL REGISTRATION
0953040 DATED 1-9-2008, EXPIRES 1-9-2018.

SER. NO. 79-049,812, FILED 1-9-2008.

MEGHAN REINHART, EXAMINING ATTORNEY

Int. Cls.: 11, 12 and 37

**Prior U.S. Cls.: 13, 19, 21, 23, 31, 34, 35, 44, 100, 103
and 106**

Reg. No. 3,485,362

United States Patent and Trademark Office

Registered Aug. 12, 2008

**TRADEMARK
SERVICE MARK
PRINCIPAL REGISTER**

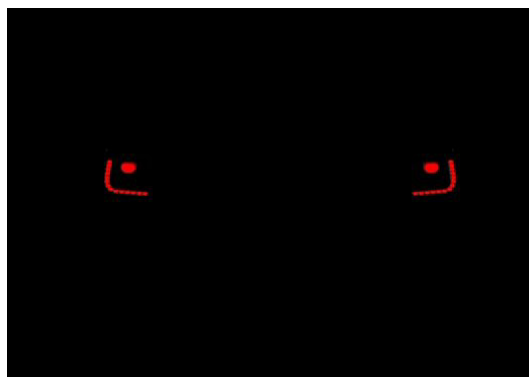

VOLKSWAGEN AG (FED REP GERMANY JOINT
STOCK COMPANY)
38436 WOLFSBURG
FED REP GERMANY

FOR: APPARATUS FOR LIGHTING, NAMELY,
FLASHLIGHTS; POCKET TORCHES, NAMELY,
POCKET FLASHLIGHTS, VEHICLE HEADLIGHTS
AND THEIR PARTS, NAMELY, HEAD LAMPS;
VEHICLE LIGHTS AND THEIR PARTS, NAMELY,
VEHICLE BREAKDOWN WARNING LAMPS,
LIGHT BULBS, IN CLASS 11 (U.S. CLS. 13, 21, 23, 31
AND 34).

FOR: VEHICLES FOR LOCOMOTION BY LAND,
AIR AND/OR WATER, NAMELY, AUTOMOBILES,
TRUCKS, VANS, SPORT UTILITY VEHICLES, LOR-
RIES, TRAILERS, BUSES, TRAINS, LOCOMO-
TIVES, BICYCLES, TRICYCLES, SNOWMOBILES,
AIRPLANES, BOATS AND SHIPS, HOT AIR BAL-
LOONS AND DIRIGIBLES, CAMPING TRAILERS,
FOLDING AND HARD SIDE TRUCK CAMPING
TRAILERS, MOTOR HOMES, CONVERSION VANS,
TRAVEL TRAILERS, CAMPER COACHES, AND
STRUCTURAL PARTS FOR ALL OF THE AFORE-
SAID GOODS; ENGINES FOR LAND VEHICLES;
WHEEL URNS; MOTORIZED SCOOTERS AND MO-
TORIZED AUTOMOBILES FOR CHILDREN, IN
CLASS 12 (U.S. CLS. 19, 21, 23, 31, 35 AND 44).

FOR: RECONSTRUCTION IN THE NATURE OF
CUSTOM REBUILDING, REPAIR, SERVICING, DIS-
MANTLING, CLEANING, MAINTENANCE AND

VARNISHING OF VEHICLES AND THEIR STRUC-
TURAL PARTS AND OF MOTORS AND THEIR
STRUCTURAL PARTS, INCLUDING VEHICLE RE-
PAIR IN THE COURSE OF VEHICLE BREAKDOWN
SERVICE; REFINEMENT AND TUNING OF AUTO-
MOBILES, NAMELY, REPAIR, WASHING, CLEAN-
ING, CUSTOMIZE AND MAINTENANCE OF
AUTOMOBILES, IN CLASS 37 (U.S. CLS. 100, 103
AND 106).

PRIORITY DATE OF 8-6-2007 IS CLAIMED.

OWNER OF INTERNATIONAL REGISTRATION
0953047 DATED 12-17-2007, EXPIRES 12-17-2017.

THE COLOR(S) BLACK AND RED IS/ARE
CLAIMED AS A FEATURE OF THE MARK.

THE MARK ILLUSTRATES THE APPEARANCE
OF A MOTOR VEHICLE IN THE DARK; RED
PICTURED ARE THE LUMINOUS REMITTANCES
OF A MOTOR VEHICLE, WHICH ARE SUBMITTED
BY THE MOTOR VEHICLE WHEN LIGHTING IS
ACTIVATED.

SER. NO. 79-049,818, FILED 12-17-2007.

JOHN DALIER, EXAMINING ATTORNEY

Int. Cls.: 11, 12 and 37

**Prior U.S. Cls.: 13, 19, 21, 23, 31, 34, 35, 44, 100, 103
and 106**

Reg. No. 3,485,363

United States Patent and Trademark Office

Registered Aug. 12, 2008

**TRADEMARK
SERVICE MARK
PRINCIPAL REGISTER**



VOLKSWAGEN AG (FED REP GERMANY JOINT STOCK COMPANY)
38436 WOLFSBURG
FED REP GERMANY

FOR: APPARATUS FOR LIGHTING, NAMELY, FLASHLIGHTS; POCKET TORCHES, NAMELY, POCKET FLASHLIGHTS, VEHICLE HEADLIGHTS AND THEIR PARTS, NAMELY, HEADLAMPS; VEHICLE LIGHTS AND THEIR PARTS, NAMELY, VEHICLE BREAKDOWN WARNING LAMPS, LIGHT BULBS, IN CLASS 11 (U.S. CLS. 13, 21, 23, 31 AND 34).

FOR: VEHICLES FOR LOCOMOTION BY LAND, AIR AND/OR WATER, NAMELY, AUTOMOBILES, TRUCKS, VANS, SPORT UTILITY VEHICLES, LORRIES, TRAILERS, BUSES, TRAINS, LOCOMOTIVES, BICYCLES, TRICYCLES, SNOWMOBILES, AIRPLANES, BOATS AND SHIPS, HOT AIR BALLOONS AND DIRIGIBLES, CAMPING TRAILERS, FOLDING AND HARD SIDE TRUCK CAMPING TRAILERS, MOTOR HOMES, CONVERSION VANS, TRAVEL TRAILERS, CAMPER COACHES, AND STRUCTURAL PARTS FOR ALL OF THE AFORESAID GOODS; ENGINES FOR LAND VEHICLES; WHEEL RIMS; MOTORIZED SCOOTERS AND MOTORIZED AUTOMOBILES FOR CHILDREN, IN CLASS 12 (U.S. CLS. 19, 21, 23, 31, 35 AND 44).

FOR: RECONSTRUCTION IN THE NATURE OF CUSTOM REBUILDING, REPAIR, SERVICING, DISMANTLING, CLEANING, MAINTENANCE AND

VARNISHING OF VEHICLES AND THEIR STRUCTURAL PARTS AND OF MOTORS AND THEIR STRUCTURAL PARTS, INCLUDING VEHICLE REPAIR IN THE COURSE OF VEHICLE BREAKDOWN SERVICE; REFINEMENT AND TUNING OF AUTOMOBILES, NAMELY, REPAIR, WASHING, CLEANING, CUSTOMIZE AND MAINTENANCE OF AUTOMOBILES, IN CLASS 37 (U.S. CLS. 100, 103 AND 106).

PRIORITY DATE OF 8-2-2007 IS CLAIMED.

OWNER OF INTERNATIONAL REGISTRATION 0953049 DATED 12-17-2007, EXPIRES 12-17-2017.

THE COLOR(S) BLACK, RED IS/ARE CLAIMED AS A FEATURE OF THE MARK.

THE MARK ILLUSTRATES THE APPEARANCE OF A MOTOR VEHICLE IN THE DARK; RED PICTURED ARE THE LUMINOUS EMISSIONS OF A MOTOR VEHICLE, WHICH ARE SUBMITTED BY THE MOTOR VEHICLE WHEN LIGHTING IS ACTIVATED.

SER. NO. 79-049,820, FILED 12-17-2007.

JOHN DALIER, EXAMINING ATTORNEY

Int. Cl.: 3

Prior U.S. Cls.: 1, 4, 6, 50, 51 and 52

United States Patent and Trademark Office

Reg. No. 3,485,364

Registered Aug. 12, 2008

**TRADEMARK
PRINCIPAL REGISTER**

SCENTED DEMONS

THE FIRST S.P.A. (ITALY SOCIETA' PER AZIO-
NI)
VIALE SARCA, 223
I-20126 MILANO
ITALY

FOR: BLEACHING PREPARATIONS AND
OTHER SUBSTANCES FOR LAUNDRY USE;
CLEANING, POLISHING, SCOURING AND ABRA-
SIVE PREPARATIONS; SOAPS; PERFUMERY; ES-
SENTIAL OILS, COSMETICS, HAIR LOTIONS;
DENTIFRICES, IN CLASS 3 (U.S. CLS. 1, 4, 6, 50, 51
AND 52).

PRIORITY DATE OF 1-9-2008 IS CLAIMED.

OWNER OF INTERNATIONAL REGISTRATION
0953237 DATED 1-24-2008, EXPIRES 1-24-2018.

SER. NO. 79-049,879, FILED 1-24-2008.

FRED MANDIR, EXAMINING ATTORNEY

Int. Cl.: 3

Prior U.S. Cls.: 1, 4, 6, 50, 51 and 52

United States Patent and Trademark Office

Reg. No. 3,485,365

Registered Aug. 12, 2008

**TRADEMARK
PRINCIPAL REGISTER**

SCENTEDHOSTS

THE FIRST S.P.A. (ITALY SOCIETA PER AZIO-
NI)
VIALE SARCA, 223
I-20126 MILANO
ITALY

FOR: BLEACHING PREPARATIONS AND
OTHER SUBSTANCES FOR LAUNDRY USE;
CLEANING, POLISHING, SCOURING AND ABRA-
SIVE PREPARATIONS; SOAPS; PERFUMERY, ES-
SENTIAL OILS, COSMETICS, HAIR LOTIONS;
DENTIFRICES, IN CLASS 3 (U.S. CLS. 1, 4, 6, 50, 51
AND 52).

PRIORITY DATE OF 1-9-2008 IS CLAIMED.

OWNER OF INTERNATIONAL REGISTRATION
0953238 DATED 1-24-2008, EXPIRES 1-24-2018.

SER. NO. 79-049,880, FILED 1-24-2008.

FRED MANDIR, EXAMINING ATTORNEY

Int. Cls.: 12, 35 and 37

**Prior U.S. Cls.: 19, 21, 23, 31, 35, 44, 100, 101, 102,
103 and 106**

Reg. No. 3,485,366

United States Patent and Trademark Office

Registered Aug. 12, 2008

**TRADEMARK
SERVICE MARK
PRINCIPAL REGISTER**



The Car.

VOLKSWAGEN AG (FED REP GERMANY JOINT STOCK COMPANY)
38436 WOLFSBURG
FED REP GERMANY

FOR: VEHICLES FOR LOCOMOTION BY LAND, AIR AND/OR WATER, NAMELY, AUTOMOBILES, TRUCKS, VANS, SPORT UTILITY VEHICLES, LORRIES, TRAILERS, BUSES, TRAINS, LOCOMOTIVES, BICYCLES, TRICYCLES, SNOWMOBILES, AIRPLANES, BOATS AND SHIPS, HOT AIR BALLOONS AND DIRIGIBLES, CAMPING TRAILERS, FOLDING AND HARD SIDE TRUCK CAMPING TRAILERS, MOTOR HOMES, CONVERSION VANS, TRAVEL TRAILERS, CAMPER COACHES, AND STRUCTURAL PARTS FOR ALL OF THE AFORESAID GOODS; ENGINES FOR LAND VEHICLES; WHEEL RIMS; MOTORIZED SCOOTERS AND MOTORIZED AUTOMOBILES FOR CHILDREN, IN CLASS 12 (U.S. CLS. 19, 21, 23, 31, 35 AND 44).

FOR: RETAIL AND WHOLESALE STORE SERVICES FEATURING MOTOR VEHICLES AND THEIR PARTS AND FITTINGS; RETAIL AND WHOLESALE MAIL-ORDER SERVICES FEATURING MOTOR VEHICLES AND THEIR PARTS AND FITTINGS; ONLINE RETAIL AID WHOLESALE STORE SERVICES FEATURING MOTOR VEHICLES AND THEIR PARTS AND FITTINGS; RETAIL AND WHOLESALE STORE SERVICES VIA TEleshopping, NAMELY, CATALOG ORDERING SERVICE FEATURING MOTOR VEHICLES AND THEIR PARTS AND FITTINGS; BRINGING TOGETHER, BUT NOT TRANSPORTING, A VARIETY OF MO-

TOR VEHICLES AND PARTS AND FITTINGS THEREFOR FOR THE BENEFIT OF OTHERS, THEREBY ENABLING CUSTOMERS TO VIEW AND PURCHASE THE GOODS IN A RETAIL OUTLET; NEGOTIATION OF CONTRACTS FOR THE BENEFIT OF OTHERS ABOUT SALE AND PURCHASE OF MOTOR VEHICLES AND THEIR PARTS AND FITTINGS, NAMELY, NEGOTIATION AND SETTLEMENT OF COMMERCIAL TRANSACTIONS FOR THIRD PARTIES; CONSULTANCY AND ASSISTANCE IN ORGANIZATION AND MANAGEMENT OF RETAIL AND BUSINESS COMPANIES, IN CLASS 35 (U.S. CLS. 100, 101 AND 102).

FOR: RECONSTRUCTION IN THE NATURE OF CUSTOM REBUILDING, REPAIR, SERVICING, DISMANTLING, CLEANING, MAINTENANCE AND VARNISHING OF VEHICLES AND THEIR STRUCTURAL PARTS AND OF MOTORS AND THEIR STRUCTURAL PARTS, INCLUDING VEHICLE REPAIR IN THE COURSE OF VEHICLE BREAKDOWN SERVICE; REFINEMENT AND TUNING OF AUTOMOBILES, NAMELY, REPAIR, WASHING, CLEANING, CUSTOMIZE AND MAINTENANCE OF AUTOMOBILES, IN CLASS 37 (U.S. CLS. 100, 103 AND 106).

PRIORITY DATE OF 7-24-2007 IS CLAIMED.

OWNER OF INTERNATIONAL REGISTRATION
0954026 DATED 1-4-2008, EXPIRES 1-4-2018.

OWNER OF U.S. REG. NOS. 2,647,965, 3,245,055
AND OTHERS.

SER. NO. 79-050,200, FILED 1-4-2008.

NO CLAIM IS MADE TO THE EXCLUSIVE
RIGHT TO USE "THE CAR", APART FROM THE
MARK AS SHOWN.

JOHN DALIER, EXAMINING ATTORNEY

Int. Cls.: 12, 35 and 37

**Prior U.S. Cls.: 19, 21, 23, 31, 35, 44, 100, 101, 102,
103 and 106**

Reg. No. 3,485,367

United States Patent and Trademark Office

Registered Aug. 12, 2008

**TRADEMARK
SERVICE MARK
PRINCIPAL REGISTER**



Das Auto.

VOLKSWAGEN AG (FED REP GERMANY JOINT STOCK COMPANY)
38436 WOLFSBURG
FED REP GERMANY

FOR: VEHICLES FOR LOCOMOTION BY LAND, AIR AND/OR WATER, NAMELY, AUTOMOBILES, TRUCKS, VANS, SPORT UTILITY VEHICLES, LORRIES, TRAILERS, BUSES, TRAINS, LOCOMOTIVES, BICYCLES, TRICYCLES, SNOWMOBILES, AIRPLANES, BOATS AND SHIPS, HOT AIR BALLOONS AND DIRIGIBLES, CAMPING TRAILERS, FOLDING AND HARD SIDE TRUCK CAMPING TRAILERS, MOTOR HOMES, CONVERSION VANS, TRAVEL TRAILERS, CAMPER COACHES, AND STRUCTURAL PARTS FOR ALL OF THE AFORESAID GOODS; ENGINES FOR LAND VEHICLES; WHEEL RIMS; MOTORIZED SCOOTERS AND MOTORIZED AUTOMOBILES FOR CHILDREN, IN CLASS 12 (U.S. CLS. 19, 21, 23, 31, 35 AND 44).

FOR: RETAIL AND WHOLESALE STORE SERVICES FEATURING MOTOR VEHICLES AND THEIR PARTS AND FITTINGS; RETAIL AND WHOLESALE MAIL-ORDER SERVICES FEATURING MOTOR VEHICLES AND THEIR PARTS AND FITTINGS; ONLINE RETAIL AND WHOLESALE STORE SERVICES FEATURING MOTOR VEHICLES AND THEIR PARTS AND FITTINGS; RETAIL AND WHOLESALE STORE SERVICES VIA TELESOPPING, NAMELY, CATALOG ORDERING SERVICE FEATURING MOTOR VEHICLES AND THEIR PARTS AND FITTINGS; BRINGING TOGETHER, BUT NOT TRANSPORTING, A VARIETY OF MO-

TOR VEHICLES AND PARTS AND FITTINGS THEREFOR FOR THE BENEFIT OF OTHERS, THEREBY ENABLING CUSTOMERS TO VIEW AND PURCHASE THE GOODS IN A RETAIL OUTLET; NEGOTIATION OF CONTRACTS FOR THE BENEFIT OF OTHERS ABOUT SALE AND PURCHASE OF MOTOR VEHICLES AND THEIR PARTS AND FITTINGS, NAMELY, NEGOTIATION AND SETTLEMENT OF COMMERCIAL TRANSACTIONS FOR THIRD PARTIES; CONSULTANCY AID ASSISTANCE IN ORGANIZATION AND MANAGEMENT OF RETAIL AND BUSINESS COMPANIES, IN CLASS 35 (U.S. CLS. 100, 101 AND 102).

FOR: RECONSTRUCTION IN THE NATURE OF CUSTOM REBUILDING, REPAIR, SERVICING, DISMANTLING, CLEANING, MAINTENANCE AND VARNISHING OF VEHICLES AND THEIR STRUCTURAL PARTS AND OF MOTORS AND THEIR STRUCTURAL PARTS, INCLUDING VEHICLE REPAIR IN THE COURSE OF VEHICLE BREAKDOWN SERVICES, REFINEMENT AND TUNING OF AUTOMOBILES, NAMELY, REPAIR, WASHING, CLEANING, CUSTOMIZE AND MAINTENANCE OF AUTOMOBILES, IN CLASS 37 (U.S. CLS. 100, 103 AND 106).

PRIORITY DATE OF 7-24-2007 IS CLAIMED.

OWNER OF INTERNATIONAL REGISTRATION
0954027 DATED 1-4-2008, EXPIRES 1-4-2018.

OWNER OF U.S. REG. NOS. 2,647,965, 3,245,055
AND OTHERS.

NO CLAIM IS MADE TO THE EXCLUSIVE
RIGHT TO USE "DAS AUTO", APART FROM THE
MARK AS SHOWN.

THE ENGLISH TRANSLATION OF "DAS AUTO"
IS "THE CAR".

SER. NO. 79-050,201, FILED 1-4-2008.

JOHN DALIER, EXAMINING ATTORNEY

Int. Cls.: 11, 12 and 37

Prior U.S. Cls.: 13, 19, 21, 23, 31, 34, 35, 44, 100, 103
and 106

Reg. No. 3,485,368

United States Patent and Trademark Office

Registered Aug. 12, 2008

TRADEMARK
SERVICE MARK
PRINCIPAL REGISTER

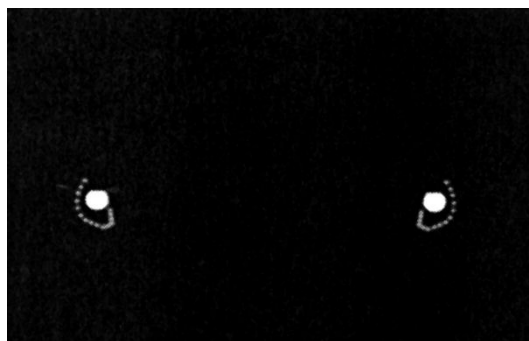

VOLKSWAGEN AG (GERMAN DEM REP JOINT
STOCK COMPANY)
38436 WOLFSBURG
FED REP GERMANY

FOR: APPARATUS FOR LIGHTING, NAMELY, FLASHLIGHTS; POCKET TORCHES, NAMELY, POCKET FLASHLIGHTS, VEHICLE HEADLIGHTS AND THEIR PARTS, NAMELY, HEADLAMPS; VEHICLE LIGHTS AND THEIR PADS, NAMELY, VEHICLE BREAKDOWN WARNING LAMPS, LIGHT BULBS, IN CLASS 11 (U.S. CLS. 13, 21, 23, 31 AND 34).

FOR: VEHICLES FOR LOCOMOTION BY LAND, AIR AND/OR WATER, NAMELY, AUTOMOBILES, TRUCKS, VANS, SPORT UTILITY VEHICLES, LORRIES, TRAILERS, BUSES, TRAINS, LOCOMOTIVES, BICYCLES, TRICYCLES, SNOWMOBILES, AIRPLANES, BOATS AND SHIPS, HOT AIR BALLOONS AND DIRIGIBLES, CAMPING TRAILERS, FOLDING AND HARD SIDE TRUCK CAMPING TRAILERS, MOTOR HOMES, CONVERSION VANS, TRAVEL TRAILERS, CAMPER COACHES, AND STRUCTURAL PARTS FOR ALL OF THE AFORESAID GOODS; ENGINES FOR LAND VEHICLES; WHEEL RIMS; MOTORIZED SCOOTERS AND MOTORIZED AUTOMOBILES FOR CHILDREN, IN CLASS 12 (U.S. CLS. 19, 21, 23, 31, 35 AND 44).

FOR: RECONSTRUCTION IN THE NATURE OF CUSTOM REBUILDING, REPAIR, SERVICING, DISMANTLING, CLEANING, MAINTENANCE AND VARNISHING OF VEHICLES AND THEIR STRUCTURAL PARTS AND OF MOTORS AND THEIR STRUCTURAL PARTS, INCLUDING VEHICLE REPAIR IN THE COURSE OF VEHICLE BREAKDOWN SERVICE; REFINEMENT AND TUNING OF AUTOMOBILES, NAMELY, REPAIR, WASHING, CLEANING, CUSTOMIZE AND MAINTENANCE OF AUTOMOBILES, IN CLASS 37 (U.S. CLS. 100, 103 AND 106).

PRIORITY DATE OF 8-2-2007 IS CLAIMED.

OWNER OF INTERNATIONAL REGISTRATION
0954731 DATED 12-17-2007, EXPIRES 12-17-2017.

THE MARK ILLUSTRATES THE APPEARANCE OF A MOTOR VEHICLE IN THE DARK; BRIGHT PICTURED ARE THE LUMINOUS EMISSIONS OF A MOTOR VEHICLE, WHICH ARE SUBMITTED BY THE MOTOR VEHICLE WHEN LIGHTING IS ACTIVATED.

SER. NO. 79-050,398, FILED 12-17-2007.

JOHN DALIER, EXAMINING ATTORNEY

Int. Cls.: 16 and 25

Prior U.S. Cls.: 2, 5, 22, 23, 29, 37, 38, 39 and 50

Reg. No. 3,485,369

United States Patent and Trademark Office

Registered Aug. 12, 2008

**TRADEMARK
PRINCIPAL REGISTER**

ODAI A

REDCATS (FRANCE SOCIÉTÉ ANONYME)
110, RUE DE BLANCHEMAILLE
F-59100 ROUBAIX
FRANCE

FOR: MAIL ORDER CATALOGS NAMELY, IN THE FIELD OF CLOTHING, HEADGEAR AND FOOTWEAR, IN CLASS 16 (U.S. CLS. 2, 5, 22, 23, 29, 37, 38 AND 50).

FOR: CLOTHING NAMELY, SHORTS, SHIRTS, T-SHIRTS, BATHING SUITS, BLOUSES, SKIRTS, SASHES FOR WEAR, GLOVES, TROUSERS, PULL-OVERS, SOCKS, JACKETS, SUITS, VESTS, NECKTIES, BELTS, SUSPENDERS, DRESSES, COATS, RAINCOATS, OVERCOATS, UNDERWEAR, PAJAMAS, BRASSIERES, CORSETS, PANTIES AND

UNDERPANTS, LINGERIE; HEADGEAR NAMELY, HATS, CAPS AND BERETS; FOOTWEAR NAMELY BOOTS, SANDALS, SHOES AND SLIPPERS, IN CLASS 25 (U.S. CLS. 22 AND 39).

THE MARK CONSISTS OF STANDARD CHARACTERS WITHOUT CLAIM TO ANY PARTICULAR FONT, STYLE, SIZE, OR COLOR.

OWNER OF INTERNATIONAL REGISTRATION 0724463 DATED 12-10-1999, EXPIRES 12-10-2009.

SER. NO. 79-050,971, FILED 10-17-2007.

DANIEL BRODY, EXAMINING ATTORNEY

Int. Cl.: 5

Prior U.S. Cls.: 6, 18, 44, 46, 51 and 52

United States Patent and Trademark Office

Reg. No. 3,485,370

Registered Aug. 12, 2008

**TRADEMARK
PRINCIPAL REGISTER**

ORINUZA

SANOFI-AVENTIS (FRANCE SOCIETE ANON-
YME)
174 AVENUE DE FRANCE
F-75013 PARIS
FRANCE

FOR: PHARMACEUTICAL PREPARATIONS FOR
THE PREVENTION AND TREATMENT OF DISEA-
SES OF THE CENTRAL NERVOUS SYSTEM, IN
CLASS 5 (U.S. CLS. 6, 18, 44, 46, 51 AND 52).

THE MARK CONSISTS OF STANDARD CHAR-
ACTERS WITHOUT CLAIM TO ANY PARTICULAR
FONT, STYLE, SIZE, OR COLOR.

PRIORITY DATE OF 8-24-2007 IS CLAIMED.

OWNER OF INTERNATIONAL REGISTRATION
0956372 DATED 2-1-2008, EXPIRES 2-1-2018.

SER. NO. 79-051,005, FILED 2-1-2008.

CYNTHIA TRIPI, EXAMINING ATTORNEY

Int. Cl.: 20

Prior U.S. Cls.: 2, 13, 22, 25, 32 and 50

Reg. No. 3,485,371

United States Patent and Trademark Office

Registered Aug. 12, 2008

**TRADEMARK
PRINCIPAL REGISTER**



LOGYKS WORLDWIDE S.L. (SPAIN SOCIEDAD
LIMITADA)
POL. IND. LES GOULES C/ FUSTERIA, 20
E-08551 TONA (BARCELONA)
SPAIN

THE COLOR(S) BLACK, RED IS/ARE CLAIMED
AS A FEATURE OF THE MARK.

FOR: DISPLAY STANDS FOR GOODS, CABINETS
AND CHAIRS EXCLUSIVELY FOR HAIRDRES-
SING AND BEAUTY SALONS, FURNITURE EX-
CLUSIVELY FOR HAIRDRESSING AND BEAUTY
SALONS, MIRRORS, IN CLASS 20 (U.S. CLS. 2, 13, 22,
25, 32 AND 50).

LETTERS LOG, S IN BLACK; LETTERS YK IN
RED.

SER. NO. 79-051,355, FILED 1-15-2008.

OWNER OF INTERNATIONAL REGISTRATION
0957293 DATED 1-15-2008, EXPIRES 1-15-2018.

ANDREA BUTLER, EXAMINING ATTORNEY

Int. Cl.: 19

Prior U.S. Cls.: 1, 12, 33, and 50

Reg. No. 3,485,372

United States Patent and Trademark Office

Registered Aug. 12, 2008

**TRADEMARK
PRINCIPAL REGISTER**



EVERGREEN
HARDWOODS

EVERGREEN HARDWOODS, INC. (WASHINGTON CORPORATION)
1600 LIND AVE SW, SUITE 250
RENTON, WA 98055

FOR: HARDWOOD PRODUCTS, NAMELY, VENEER, CORESTOCK, PLATFORMS, PLYWOOD, LUMBER, LOGS, IN CLASS 19 (U.S. CLS. 1, 12, 33 AND 50).

FIRST USE 9-0-1999; IN COMMERCE 9-0-1999.

OWNER OF U.S. REG. NO. 2,581,647.

NO CLAIM IS MADE TO THE EXCLUSIVE RIGHT TO USE "HARDWOODS", APART FROM THE MARK AS SHOWN.

THE MARK INCLUDES THE LETTER "E" IN STYLIZED FORM.

SN 75-800,967, FILED 9-16-1999.

MATTHEW PAPPAS, EXAMINING ATTORNEY

Int. Cl.: 42

Prior U.S. Cls.: 100 and 101

United States Patent and Trademark Office

Reg. No. 3,485,373

Registered Aug. 12, 2008

**SERVICE MARK
PRINCIPAL REGISTER**

PLANET EARTH DIGITAL

PLANET EARTH FOUNDATION (WASHINGTON
NOT-PROFIT CORPORATION)
P.O. BOX 1190
SEATTLE, WA 98111

FOR: NEWS AGENCY SERVICES, NAMELY, DIS-
SEMINATION OF NEWS AND INFORMATION OF
LOCAL, NATIONAL AND GLOBAL INTEREST VIA
PRINTED PUBLICATIONS, AUDIO MEDIA,
AUDIO-VISUAL MEDIA, AND VIA A GLOBAL
COMPUTER NETWORK, IN CLASS 42 (U.S. CLS.
100 AND 101).

FIRST USE 5-1-2000; IN COMMERCE 5-1-2000.

NO CLAIM IS MADE TO THE EXCLUSIVE
RIGHT TO USE "DIGITAL", APART FROM THE
MARK AS SHOWN.

SN 76-044,872, FILED 5-9-2000.

ROBERT C. CLARK JR., EXAMINING ATTORNEY

Int. Cl.: 25

Prior U.S. Cls.: 22 and 39

United States Patent and Trademark Office

Reg. No. 3,485,374

Registered Aug. 12, 2008

**TRADEMARK
PRINCIPAL REGISTER**

AJAX

ASPEN SKIING COMPANY, L.L.C. (COLORADO
LTD LIAB CO)
P.O. BOX 1248
ASPEN, CO 81612

RESORT-RELATED SERVICES, IN CLASS 25 (U.S.
CLS. 22 AND 39).

FIRST USE 6-1-2008; IN COMMERCE 6-1-2008.

FOR: CLOTHING, NAMELY, HATS WHICH ARE
MARKETED AND SOLD IN CONNECTION WITH
THE PROMOTION OF APPLICANT'S SKI- AND

SN 76-082,070, FILED 6-30-2000.

MICHAEL ENGEL, EXAMINING ATTORNEY

Int. Cl.: 9

Prior U.S. Cls.: 21, 23, 26, 36, and 38

United States Patent and Trademark Office

Reg. No. 3,485,375

Registered Aug. 12, 2008

**TRADEMARK
PRINCIPAL REGISTER**

NUMAFLEX

SILICON GRAPHICS, INC. (DELAWARE CORPORATION)
1140 E. ARQUES AVENUE
SUNNYVALE, CA 94085

FIRST USE 0-0-2001; IN COMMERCE 0-0-2001.

SN 76-110,858, FILED 8-15-2000.

FOR: COMPUTER HARDWARE AND SOFTWARE FOR CONNECTING MEMORY ARCHITECTURES FOR COMPUTER SYSTEMS, IN CLASS 9 (U.S. CLS. 21, 23, 26, 36 AND 38).

ALICE BENMAMAN, EXAMINING ATTORNEY

Int. Cls.: 2 and 17

Prior U.S. Cls.: 1, 5, 6, 11, 12, 13, 16, 35, and 50

United States Patent and Trademark Office

Reg. No. 3,485,376

Registered Aug. 12, 2008

**TRADEMARK
PRINCIPAL REGISTER**

COATINGSDIRECT

IFS INDUSTRIES, INC. (PENNSYLVANIA CORPORATION)
400 ORRTON AVENUE
READING, PA 19603

FOR: INTERIOR AND EXTERIOR CONSUMER HOUSE PAINTS; SPECIALTY CONSUMERS PAINTS, NAMELY, FLOOR ENAMELS; WOOD STAINS, WATER-BASED INDUSTRIAL PAINTS AND COATINGS, NAMELY, PAINTS FOR METAL; PAINTS FOR USE IN THE MANUFACTURE FOR DOORS, WINDOW FRAMES, MOLDINGS, WOOD COMPONENTS; SEALER COATINGS FOR DOOR SKINS, WOOD AND WOOD COMPOSITE PANELS, IN CLASS 2 (U.S. CLS. 6, 11 AND 16).

FIRST USE 3-17-2008; IN COMMERCE 3-17-2008.

FOR: ACRYLIC-BASED DRIVEWAY, CONCRETE, AND PAVING STONE SEALANTS; DRIVEWAY, CONCRETE, AND PAVING STONE SEALANTS COMPOSED PRIMARILY OF ACRYLIC, IN CLASS 17 (U.S. CLS. 1, 5, 12, 13, 35 AND 50).

FIRST USE 3-17-2008; IN COMMERCE 3-17-2008.

PRIORITY CLAIMED UNDER SEC. 44(D) ON CANADA APPLICATION NO. 1055215, FILED 4-14-2000, REG. NO. 679483, DATED 1-16-2007, EXPIRES 1-16-2022.

SN 76-113,847, FILED 8-22-2000.

JOHN DALIER, EXAMINING ATTORNEY

Int. Cl.: 1

Prior U.S. Cls.: 1, 5, 6, 10, 26, and 46

United States Patent and Trademark Office

Reg. No. 3,485,377

Registered Aug. 12, 2008

**TRADEMARK
PRINCIPAL REGISTER**

ADHESIVESDIRECT

IFS INDUSTRIES, INC. (PENNSYLVANIA CORPORATION)
400 ORRTON AVENUE
READING, PA 19603

FOR: SYNTHETIC RESIN FOR USE IN THE MANUFACTURE OF ADHESIVES AND COATINGS; WATER-BASED ADHESIVES FOR USE IN WOODWORKING, PACKAGING PRODUCT ASSEMBLY; WATER-BASED ADHESIVES FOR APPLYING FLOOR TILES, CERAMIC TILES AND CONSTRUCTION AND BUILDING APPLICATIONS; CLAY ALCOHOLS AND DEXTRINES FOR USE IN THE MANUFACTURE OF PAPER PRODUCTS/TUBES (PAPER CONVERTING); CONTACT CEMENTS FOR LAMINATING; HOT MELTS FOR

PACKAGING, BOOKBINDING POLYURETHANE ADHESIVES FOR PRODUCT ASSEMBLY, IN CLASS 1 (U.S. CLS. 1, 5, 6, 10, 26 AND 46).

FIRST USE 3-17-2008; IN COMMERCE 3-17-2008.

PRIORITY CLAIMED UNDER SEC. 44(D) ON CANADA APPLICATION NO. 1055217, FILED 4-14-2000, REG. NO. TMA679481, DATED 1-16-2007, EXPIRES 1-16-2022.

SN 76-113,848, FILED 8-22-2000.

JOHN DALIER, EXAMINING ATTORNEY

Int. Cl.: 35

Prior U.S. Cls.: 100, 101, and 102

United States Patent and Trademark Office

Reg. No. 3,485,378

Registered Aug. 12, 2008

**SERVICE MARK
PRINCIPAL REGISTER**

GUINNESS WEBSTORE

DIAGEO IRELAND (IRELAND PRIVATE UN-
LIMITED COMPANY)
ST.JAMES' GATE
DUBLIN 8, IRELAND

FOR: COMPUTERIZED ONLINE RETAIL STORE
SERVICES FEATURING HOUSEWARES AND
HOUSEWARE ACCESSORIES, ARTWORK AND
COLLECTIBLES, CLOTHING AND FASHION AC-
CESSORIES, BACKPACKS, SPORTS EQUIPMENT
AND SPORTS ACCESSORIES, IN CLASS 35 (U.S.
CLS. 100, 101 AND 102).

FIRST USE 9-30-2000; IN COMMERCE 9-30-2000.

OWNER OF U.S. REG. NOS. 321,014, 1,182,992,
AND OTHERS.

NO CLAIM IS MADE TO THE EXCLUSIVE
RIGHT TO USE "WEBSTORE", APART FROM THE
MARK AS SHOWN.

SEC. 2(F).

SN 76-140,062, FILED 10-3-2000.

JEFFERY COWARD, EXAMINING ATTORNEY

Int. Cl.: 5

Prior U.S. Cls.: 6, 18, 44, 46, 51, and 52

Reg. No. 3,485,379

United States Patent and Trademark Office

Registered Aug. 12, 2008

**TRADEMARK
PRINCIPAL REGISTER**

DIET SOLUTIONS

NUTRITION & FITNESS, INC. (NORTH CAROLINA CORPORATION)
4525 CAMPGROUND ROAD
FAYETTEVILLE, NC 28314

NO CLAIM IS MADE TO THE EXCLUSIVE RIGHT TO USE "DIET", APART FROM THE MARK AS SHOWN.

FOR: DIETARY SUPPLEMENTS, IN CLASS 5 (U.S. CLS. 6, 18, 44, 46, 51 AND 52).

SN 76-192,166, FILED 1-11-2001.

FIRST USE 5-21-2008; IN COMMERCE 5-21-2008.

KATHRYN COWARD, EXAMINING ATTORNEY

Int. Cls.: 9 and 42

Prior U.S. Cls.: 21, 23, 26, 36, 38, 100, and 101

Reg. No. 3,485,380

United States Patent and Trademark Office

Registered Aug. 12, 2008

**TRADEMARK
SERVICE MARK
PRINCIPAL REGISTER**

FINDS

SUNGARD REFERENCE DATA SOLUTIONS
LLC (DELAWARE LTD LIAB CO)
1209 ORANGE STREET
C/O THE CORPORATION TRUST COMPANY
WILMINGTON, DE 19801

FOR: COMPUTER SOFTWARE THAT DELIVERS
DATA FROM A LOCAL OR REMOTE LOCATION
AND PROVIDES DATA MANAGEMENT SERVICES
IN THE FIELDS OF FINANCE AND ENERGY, IN
CLASS 9 (U.S. CLS. 21, 23, 26, 36 AND 38).

FIRST USE 1-2-2001; IN COMMERCE 1-2-2001.

FOR: PROVIDING TEMPORARY USE OF NON-
DOWNLOADABLE SOFTWARE THAT DELIVERS
DATA FROM A LOCAL OR REMOTE LOCATION
AND PROVIDES DATA MANAGEMENT SERVICES
IN THE FIELDS OF FINANCE AND ENERGY, IN
CLASS 42 (U.S. CLS. 100 AND 101).

FIRST USE 1-2-2001; IN COMMERCE 1-2-2001.

SN 76-365,637, FILED 1-31-2002.

BRIAN PINO, EXAMINING ATTORNEY

Int. Cl.: 45

Prior U.S. Cls.: 100 and 101

United States Patent and Trademark Office

Reg. No. 3,485,381

Registered Aug. 12, 2008

**SERVICE MARK
PRINCIPAL REGISTER**



CPP NORTH AMERICA LLC (DELAWARE LTD
LIAB CO)
10900 WAYZATA BLVD.
MINNETONKA, MN 55305

FIRST USE 3-0-2003; IN COMMERCE 3-0-2003.

SEC. 2(F) AS TO "IDENTITYPROTECTOR".

FOR: CREDIT CARD SERVICES, NAMELY, CON-
SULTING SERVICES TO CONSUMERS REGARD-
ING IDENTITY THEFT PREVENTION AND
RESOLUTION, IN CLASS 45 (U.S. CLS. 100 AND 101).

SN 76-403,231, FILED 5-3-2002.

ELIZABETH HUGHITT, EXAMINING ATTORNEY

Int. Cl.: 43

Prior U.S. Cls.: 100 and 101

United States Patent and Trademark Office

Reg. No. 3,485,382

Registered Aug. 12, 2008

**SERVICE MARK
PRINCIPAL REGISTER**

IL CAMPO

BARRY, ALISA (UNITED STATES INDIVIDUAL)
1870 MURPHY AVENUE SW
ATLANTA, GA 303104837

THE ENGLISH TRANSLATION OF IL CAMPO IS
"THE COUNTRY" OR "THE FARM".

FOR: RESTAURANT AND CATERING SERVICES, IN CLASS 43 (U.S. CLS. 100 AND 101).

SN 76-418,769, FILED 6-7-2002.

FIRST USE 4-24-2008; IN COMMERCE 1-24-2008.

ZACHARY BELLO, EXAMINING ATTORNEY

Int. Cl.: 9

Prior U.S. Cls.: 21, 23, 26, 36, and 38

Reg. No. 3,485,383

United States Patent and Trademark Office

Registered Aug. 12, 2008

**TRADEMARK
PRINCIPAL REGISTER**

POCKET ASSESSMENT

ADVANCED MEDICAL PSYCHIATRIC SOFTWARE (CALIFORNIA CORPORATION)
180 NORTH SAN GABRIEL BOULEVARD
SOUTH PASADENA, CA 91107

FOR: COMPUTER SOFTWARE, NAMELY, SOFTWARE THAT CONTROLS THE ORGANIZATION, STORAGE, RETRIEVAL, SECURITY, AND INTEGRITY OF DATA IN A DATA BASE FOR USE WITH COMPUTER AIDED EXAMINATION, DIAGNOSTIC, AND REPORTING SYSTEMS FOR USE IN THE FIELD OF MEDICINE AND PSYCHIATRY;

AND COMPUTER HARDWARE FOR USE WITH COMPUTER AIDED EXAMINATION, DIAGNOSTIC, AND REPORTING SYSTEMS IN THE FIELD OF MEDICINE AND PSYCHIATRY, IN CLASS 9 (U.S. CLS. 21, 23, 26, 36 AND 38).

FIRST USE 5-1-2007; IN COMMERCE 5-1-2007.

SN 76-481,525, FILED 1-9-2003.

JOHN DALIER, EXAMINING ATTORNEY

Int. Cl.: 14

Prior U.S. Cls.: 2, 27, 28, and 50

United States Patent and Trademark Office

Reg. No. 3,485,384

Registered Aug. 12, 2008

**TRADEMARK
PRINCIPAL REGISTER**

ROCK-BAND

LACROIX, PASCAL (UNITED STATES INDIVIDUAL)
14481 LIGHTING TREE ROAD
PO BOX 1096
NEVADA CITY, CA 95959

FIRST USE 6-19-2008; IN COMMERCE 6-19-2008.

SN 76-515,640, FILED 4-25-2003.

FOR: FINE JEWELRY HAVING PRECIOUS AND SEMIPRECIOUS STONES, IN CLASS 14 (U.S. CLS. 2, 27, 28 AND 50).

ZACHARY BELLO, EXAMINING ATTORNEY

Int. Cl.: 25

Prior U.S. Cls.: 22 and 39

United States Patent and Trademark Office

Reg. No. 3,485,385

Registered Aug. 12, 2008

**TRADEMARK
PRINCIPAL REGISTER**



THE FREESTYLE COLLECTION, INC. (MICHIGAN CORPORATION)
23682 PADDOCK DRIVE
FARMINGTON HILLS, MI 48336

FIRST USE 1-15-2008; IN COMMERCE 1-15-2008.

SN 76-540,634, FILED 8-28-2003.

FOR: T-SHIRTS, IN CLASS 25 (U.S. CLS. 22 AND 39).

PAULA MAHONEY, EXAMINING ATTORNEY

Int. Cl.: 25

Prior U.S. Cls.: 22 and 39

United States Patent and Trademark Office

Reg. No. 3,485,386

Registered Aug. 12, 2008

**TRADEMARK
PRINCIPAL REGISTER**



THE FREESTYLE COLLECTION, INC. (MICHIGAN CORPORATION)
23682 PADDOCK DRIVE
FARMINGTON HILLS, MI 48336

NO CLAIM IS MADE TO THE EXCLUSIVE RIGHT TO USE "COLLECTION" , APART FROM THE MARK AS SHOWN.

FOR: T-SHIRTS, IN CLASS 25 (U.S. CLS. 22 AND 39).

SN 76-540,635, FILED 8-28-2003.

FIRST USE 1-15-2008; IN COMMERCE 1-15-2008.

PAULA MAHONEY, EXAMINING ATTORNEY

Int. Cl.: 41

Prior U.S. Cls.: 100, 101, and 107

United States Patent and Trademark Office

Reg. No. 3,485,387

Registered Aug. 12, 2008

**SERVICE MARK
PRINCIPAL REGISTER**

DEFENDING THE CAVEWOMAN

MOGUL HOLDING EHF. (ICELAND CORPORATION)
REYKJAVIKURVEGUR 68
220 HAFNARFJORDUR, ICELAND

OWNER OF U.S. REG. NOS. 2,130,623, 2,130,624,
AND 2,130,625.

FOR: ENTERTAINMENT SERVICES IN THE
NATURE OF LIVE COMEDY PERFORMANCES,
IN CLASS 41 (U.S. CLS. 100, 101 AND 107).

SN 76-540,831, FILED 8-15-2003.

FIRST USE 9-18-2007; IN COMMERCE 9-18-2007.

JEAN IM, EXAMINING ATTORNEY

Int. Cl.: 30

Prior U.S. Cl.: 46

United States Patent and Trademark Office

Reg. No. 3,485,388

Registered Aug. 12, 2008

TRADEMARK
PRINCIPAL REGISTER



SUNSTAR OVERSEAS LIMITED (INDIA CORPORATION)
40 KM. STONE, G.T. KARNAL ROAD
BAHAGARH-SONEPAT, HARYANA, INDIA

NO CLAIM IS MADE TO THE EXCLUSIVE
RIGHT TO USE "PURE" , APART FROM THE
MARK AS SHOWN.

FOR: RICE, IN CLASS 30 (U.S. CL. 46).

SN 76-562,984, FILED 12-3-2003.

FIRST USE 12-27-2007; IN COMMERCE 12-27-2007.

ELISSA GARBER KON, EXAMINING ATTORNEY

Int. Cl.: 30

Prior U.S. Cl.: 46

United States Patent and Trademark Office

Reg. No. 3,485,389

Registered Aug. 12, 2008

TRADEMARK
PRINCIPAL REGISTER



OLIVE INDUSTRIES LTD. (CALIFORNIA CORPORATION)
PO BOX 8311
TAHOE CITY, CA 96145

THE NAME SHOWN IN THE MARK DOES NOT IDENTIFY A PARTICULAR LIVING INDIVIDUAL.

FOR: SAUCES, PIZZA SAUCES, SALAD DRESSINGS, IN CLASS 30 (U.S. CL. 46).

SN 76-568,156, FILED 12-22-2003.

FIRST USE 12-1-2007; IN COMMERCE 12-1-2007.

CAROLYN GRAY, EXAMINING ATTORNEY

Int. Cl.: 1

Prior U.S. Cls.: 1, 5, 6, 10, 26, and 46

Reg. No. 3,485,390

United States Patent and Trademark Office

Registered Aug. 12, 2008

**TRADEMARK
PRINCIPAL REGISTER**

OPTBEADS

NISSAN CHEMICAL INDUSTRIES, LTD. (JAPAN CORPORATION)
3-7-1, KANDA NISHIKI-CHO
CHIYODA-KU, TOKYO, JAPAN

THE MARK CONSISTS OF STANDARD CHARACTERS WITHOUT CLAIM TO ANY PARTICULAR FONT, STYLE, SIZE, OR COLOR.

FOR: CHEMICALS FOR INDUSTRIAL USE, NAMELY, COMPOSITE PARTICLES COMPOSED OF UNPROCESSED PLASTICS AND METALLIC OXIDES, IN CLASS 1 (U.S. CLS. 1, 5, 6, 10, 26 AND 46).

SN 76-574,128, FILED 2-5-2004.

FIRST USE 8-10-2003; IN COMMERCE 5-23-2008.

ROBERT C. CLARK JR., EXAMINING ATTORNEY

Int. Cl.: 11

Prior U.S. Cls.: 13, 21, 23, 31, and 34

Reg. No. 3,485,391

United States Patent and Trademark Office

Registered Aug. 12, 2008

**TRADEMARK
PRINCIPAL REGISTER**

VERNICA

TOTO U.S.A., INC. (DELAWARE CORPORATION)
1155 SOUTHERN ROAD
MORROW, GA 30260

FOR: TOILETS, BIDETS, SHOWERS, BATHTUBS,
SINKS, FAUCETS; BATHROOM ACCESSORIES,
NAMESLY, SHOWER SPRAYERS, TAP WATER FAU-

CETS, BATHTUB FAUCETS, BIDET FAUCETS, IN
CLASS 11 (U.S. CLS. 13, 21, 23, 31 AND 34).

FIRST USE 1-16-2008; IN COMMERCE 1-16-2008.

SN 76-575,586, FILED 2-17-2004.

HOWARD SMIGA, EXAMINING ATTORNEY

Int. Cl.: 41

Prior U.S. Cls.: 100, 101, and 107

United States Patent and Trademark Office

Reg. No. 3,485,392

Registered Aug. 12, 2008

SERVICE MARK
PRINCIPAL REGISTER

FIRST SERVE

FIRST SERVE, INC. (FLORIDA CORPORATION)
3042 NORTH FEDERAL HIGHWAY, SUITE 200
FORT LAUDERDALE, FL 33306

FOR: SPORTS INSTRUCTION, NAMELY, TENNIS; EDUCATIONAL SERVICES, NAMELY, CONDUCTING COURSES, WORKSHOPS, PROGRAMS AND INSTRUCTION IN THE FIELDS OF NUTRITION, HEALTH, ACADEMIC STUDIES AND LIFE SKILLS; SERVICES RELATING TO DEVELOPING THE CAPABILITIES OF YOUNG MEN AND WOMEN THROUGH EXPOSURE TO SPORTS, NAME-

LY, A CURRICULUM OF SPORTS AND LIFE SKILL COURSES, IN CLASS 41 (U.S. CLS. 100, 101 AND 107).

FIRST USE 3-0-1991; IN COMMERCE 9-0-2001.

THE MARK CONSISTS OF STANDARD CHARACTERS WITHOUT CLAIM TO ANY PARTICULAR FONT, STYLE, SIZE, OR COLOR.

SN 76-582,422, FILED 3-19-2004.

KELLY BOULTON, EXAMINING ATTORNEY

Int. Cl.: 30

Prior U.S. Cl.: 46

United States Patent and Trademark Office

Reg. No. 3,485,393

Registered Aug. 12, 2008

**TRADEMARK
PRINCIPAL REGISTER**

Brew for the Crew

BRUEGGER'S ENTERPRISES, INC. (DELAWARE
CORPORATION)
159 BANK STREET
BURLINGTON, VT 05401

THE MARK CONSISTS OF STANDARD CHAR-
ACTERS WITHOUT CLAIM TO ANY PARTICULAR
FONT, STYLE, SIZE, OR COLOR.

FOR: COFFEE, IN CLASS 30 (U.S. CL. 46).

SN 76-585,145, FILED 4-1-2004.

FIRST USE 12-13-2005; IN COMMERCE 11-1-2007.

C. DIONNE CLYBURN, EXAMINING ATTORNEY

Int. Cl.: 28

Prior U.S. Cls.: 22, 23, 38, and 50

United States Patent and Trademark Office

Reg. No. 3,485,394

Registered Aug. 12, 2008

**TRADEMARK
PRINCIPAL REGISTER**

GOO

STELOR PRODUCTIONS, LLC (DELAWARE LTD
LIAB CO)
14701 MOCKINGBIRD DRIVE
DARNESTOWN, MD 20874

THE MARK CONSISTS OF STANDARD CHAR-
ACTERS WITHOUT CLAIM TO ANY PARTICULAR
FONT, STYLE, SIZE, OR COLOR.

FOR: TOYS, NAMELY, STUFFED AND PLUSH
TOYS, IN CLASS 28 (U.S. CLS. 22, 23, 38 AND 50).

SN 76-591,382, FILED 5-7-2004.

FIRST USE 6-20-2008; IN COMMERCE 6-20-2008.

ERNEST SHOSHO, EXAMINING ATTORNEY

Int. Cl.: 25

Prior U.S. Cls.: 22 and 39

United States Patent and Trademark Office

Reg. No. 3,485,395

Registered Aug. 12, 2008

**TRADEMARK
PRINCIPAL REGISTER**

GOOGEAR

STELOR PRODUCTIONS, LLC (DELAWARE LTD
LIAB CO)
14701 MOCKINGBIRD DRIVE
DARNESTOWN, MD 20874

THE MARK CONSISTS OF STANDARD CHAR-
ACTERS WITHOUT CLAIM TO ANY PARTICULAR
FONT, STYLE, SIZE, OR COLOR.

FOR: FOOTWEAR, HEAD WEAR, AND COMBI-
NATIONS OF THE AFOREMENTIONED GOODS,
IN CLASS 25 (U.S. CLS. 22 AND 39).

SN 76-591,387, FILED 5-7-2004.

FIRST USE 6-20-2008; IN COMMERCE 6-20-2008.

ERNEST SHOSHO, EXAMINING ATTORNEY

Int. Cl.: 25

Prior U.S. Cls.: 22 and 39

United States Patent and Trademark Office

Reg. No. 3,485,396

Registered Aug. 12, 2008

**TRADEMARK
PRINCIPAL REGISTER**

GOOWEAR

STELOR PRODUCTIONS, LLC (DELAWARE LTD
LIAB CO)
14701 MOCKINGBIRD DRIVE
DARNESTOWN, MD 20874

FOR: CLOTHING, NAMELY, HOSIERY, SHIRTS,
T-SHIRTS, JACKETS, PANTS, GLOVES, STOCK-
INGS, UNDERWEAR, PAJAMAS, NIGHTGOWNS,
SCARVES, JERSEYS, SKIRTS, DRESSES, TIES,
BELTS, BATHING SUITS AND SWIMMING
TRUNKS; SPORT CLOTHES, NAMELY, ATHLETIC
UNIFORMS AND COMBINATIONS OF THE

AFOREMENTIONED GOODS, IN CLASS 25 (U.S.
CLS. 22 AND 39).

FIRST USE 6-20-2008; IN COMMERCE 6-20-2008.

THE MARK CONSISTS OF STANDARD CHAR-
ACTERS WITHOUT CLAIM TO ANY PARTICULAR
FONT, STYLE, SIZE, OR COLOR.

SN 76-591,391, FILED 5-7-2004.

ERNEST SHOSHO, EXAMINING ATTORNEY

Int. Cls.: 8, 9, 10, 11, 13, 18, 25, and 28

Prior U.S. Cls.: 1, 2, 3, 9, 13, 21, 22, 23, 26, 28, 31, 34, 36, 38, 39, 41, 44, and 50

Reg. No. 3,485,397

United States Patent and Trademark Office

Registered Aug. 12, 2008

**TRADEMARK
PRINCIPAL REGISTER**



BLACKWATER LODGE AND TRAINING CENTER, INC. (DELAWARE CORPORATION),
DBA BLACKWATER USA,
850 PUDDIN RIDGE ROAD
MOYOCK, NC 27958

FOR: BATON POUCHES; KNIVES, NAMELY, TACTICAL KNIVES, SPORT KNIVES, HUNTING KNIVES, AND FOLDING KNIVES; KNIFE SHEATHS, IN CLASS 8 (U.S. CLS. 23, 28 AND 44).

FIRST USE 10-21-2004; IN COMMERCE 1-31-2005.

FOR: BULLET-PROOF VESTS; FALL PROTECTION EQUIPMENT FOR FALL RESTRAINT AND FALL ARREST, NAMELY, HARNESSSES; RIFLE SCOPES; PROTECTIVE TACTICAL SHOOTING GLOVES AND TRAFFIC CONTROL GLOVES; LASER DESIGNATORS, NAMELY, OPTICAL LASER SIGHTS FOR FIREARMS AND MUNITIONS; PROTECTIVE ARMORED PLATE CARRIERS; PROTECTIVE VEST SIDE PANELS; PROTECTIVE RAPPELLING BELTS; PROTECTIVE RETENTION LANYARDS; GAS MASK POUCHES; NIGHT VISION EQUIPMENT POUCHES; RADIO POUCHES, IN CLASS 9 (U.S. CLS. 21, 23, 26, 36 AND 38).

FIRST USE 10-21-2004; IN COMMERCE 1-31-2005.

FOR: MEDICAL POUCHES FOR MEDICAL INSTRUMENTS, IN CLASS 10 (U.S. CLS. 26, 39 AND 44).

FIRST USE 10-21-2004; IN COMMERCE 1-31-2005.

FOR: FLASHLIGHTS; FLASHLIGHT POUCHES, IN CLASS 11 (U.S. CLS. 13, 21, 23, 31 AND 34).

FIRST USE 10-21-2004; IN COMMERCE 1-31-2005.

FOR: LAW ENFORCEMENT AND MILITARY TACTICAL OPERATIONS PRODUCTS AND ACCESSORIES, NAMELY, TACTICAL EQUIPMENT POUCHES, MAGAZINE POUCHES, GRENADE POUCHES, RIFLE SHELL POUCHES, FLASH BANG PYROTECHNIC EQUIPMENT POUCHES, WEAPON SUPPRESSOR POUCHES, CARTRIDGE POUCHES, DUMP POUCHES, BREACHING EQUIPMENT POUCHES, HANDCUFF CASES, WEAPON DROP LEG PLATFORMS, ZIP RACKS, TACTICAL PACKS FOR AMMUNITION, AMMO EQUIPMENT BAGS, RIFLE CASES; FIREARMS; HOLSTERS; BELTS FOR MILITARY EQUIPMENT; RIFLE SLINGS, IN CLASS 13 (U.S. CLS. 2 AND 9).

FIRST USE 10-21-2004; IN COMMERCE 1-31-2005.

FOR: BACKPACKS; HARNESSSES; TOOL POUCHES SOLD EMPTY; ALL-PURPOSE TACTICAL EQUIPMENT BAGS, FIELD BAGS AND GEAR BAGS; DUFFEL BAGS; UTILITY POUCHES, IN CLASS 18 (U.S. CLS. 1, 2, 3, 22 AND 41).

FIRST USE 10-21-2004; IN COMMERCE 1-31-2005.

FOR: APPAREL, NAMELY, SHIRTS, T-SHIRTS, PANTS, SHORTS, BRIEFS, BOXER BRIEFS, BALACLAVAS, JACKETS, CAPS; VESTS; BELTS; GLOVES, IN CLASS 25 (U.S. CLS. 22 AND 39).

FIRST USE 1-24-1998; IN COMMERCE 1-24-19 98.

FOR: CLIMBING HARNESSSES; RAPPELLING BELTS; SHOOTING GLOVES; TACTICAL SHOOTING GLOVES, IN CLASS 28 (U.S. CLS. 22, 23, 38 AND 50).

FIRST USE 10-21-2004; IN COMMERCE 1-31-2005.

SN 76-592,665, FILED 5-18-2004.

ANNE MADDEN, EXAMINING ATTORNEY

Int. Cl.: 9

Prior U.S. Cls.: 21, 23, 26, 36, and 38

United States Patent and Trademark Office

Reg. No. 3,485,398

Registered Aug. 12, 2008

TRADEMARK
PRINCIPAL REGISTER



SILICON INFORMATICS, INC. (DELAWARE CORPORATION)
3601 MINNESOTA DRIVE, SUITE 800
MINNEAPOLIS, MN 55435

FOR: COMPUTER HARDWARE AND SOFTWARE FOR USE BY DRUG AND BIOTECHNOLOGY RESEARCHERS IN DEVELOPING, CREATING, SCREENING, OPTIMIZING AND TESTING PHARMACEUTICAL AND BIOTECH MATERIALS AND COMPOSITIONS, IN CLASS 9 (U.S. CLS. 21, 23, 26, 36 AND 38).

FIRST USE 12-28-2007; IN COMMERCE 12-28-2007.

NO CLAIM IS MADE TO THE EXCLUSIVE RIGHT TO USE "SILICON INFORMATICS", APART FROM THE MARK AS SHOWN.

SN 76-594,279, FILED 5-25-2004.

DAWN HAN, EXAMINING ATTORNEY

Int. Cl.: 9

Prior U.S. Cls.: 21, 23, 26, 36, and 38

Reg. No. 3,485,399

United States Patent and Trademark Office

Registered Aug. 12, 2008

**TRADEMARK
PRINCIPAL REGISTER**



SPIRIT, LLC (WISCONSIN LTD LIAB CO)
2480 NORTH STOWELL AVENUE
MILWAUKEE, WI 53211

SOUND RECORDINGS, IN CLASS 9 (U.S. CLS. 21, 23,
26, 36 AND 38).

FIRST USE 11-21-2005; IN COMMERCE 11-21-2005.

FOR: PRE-RECORDED DVDS AND COMPACT
DISCS FEATURING THEATRICAL, MUSICAL,
LIGHT AND DANCE PERFORMANCES; MUSICAL

SN 76-596,535, FILED 6-10-2004.

DAWN HAN, EXAMINING ATTORNEY

Int. Cl.: 41

Prior U.S. Cls.: 100, 101, and 107

United States Patent and Trademark Office

Reg. No. 3,485,400

Registered Aug. 12, 2008

**SERVICE MARK
PRINCIPAL REGISTER**

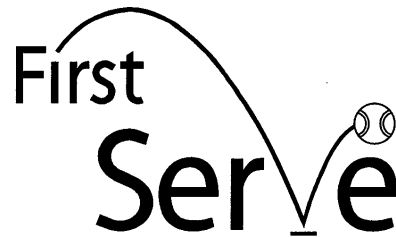

FIRST SERVE, INC. (FLORIDA CORPORATION)
3042 NORTH FEDERAL HIGHWAY, SUITE 200
FORT LAUDERDALE, FL 33306

FOR: SPORTS INSTRUCTION, NAMELY, TENNIS; EDUCATIONAL SERVICES, NAMELY, CONDUCTING COURSES, WORKSHOPS, PROGRAMS AND INSTRUCTION IN THE FIELDS OF NUTRITION, HEALTH, ACADEMIC STUDIES AND LIFE SKILLS; SERVICES RELATING TO DEVELOPING

THE CAPABILITIES OF YOUNG MEN AND WOMEN THROUGH EXPOSURE TO SPORTS, NAMELY, A CURRICULUM OF SPORTS AND LIFE SKILL COURSES, IN CLASS 41 (U.S. CLS. 100, 101 AND 107).

FIRST USE 4-1-2003; IN COMMERCE 4-1-2003.

SN 76-603,679, FILED 7-22-2004.

KELLY BOULTON, EXAMINING ATTORNEY

Int. Cls.: 28 and 41

Prior U.S. Cls.: 22, 23, 38, 50, 100, 101, and 107

United States Patent and Trademark Office

Reg. No. 3,485,401

Registered Aug. 12, 2008

**TRADEMARK
SERVICE MARK
PRINCIPAL REGISTER**



OSIECKI, LORI LYNN (UNITED STATES INDIVIDUAL)
123 WEST 2ND STREET
MESA, AZ 85201 AND
SANFELICE, ANTHONY (UNITED STATES INDIVIDUAL), AKA TONY FELICE,
6911 EAST PUEBLO AVENUE
MESA, AZ 85208

FOR: GAMES, PLAYTHINGS AND EDUCATIONAL TOYS ALL FOR CHILDREN, NAMELY, BOARD GAMES; CRIB MOBILES; BABY MULTIPLE ACTIVITY TOYS; CARD GAMES; STUFFED TOY ANIMALS; MAGNETIC DART BOARDS; CHILDREN'S TOY GLOBES; CUBE, MANIPULATIVE AND JIGSAW PUZZLES; BATH TOYS; WATER WING SWIM AIDS FOR RECREATIONAL USE; KICK BOARD FLOTATION DEVICES FOR RECREATIONAL USE; AND INFLATABLE FLOATS FOR RECREATIONAL USE, NAMELY, TUBES AND SIMILAR-SHAPED

OBJECT SWIM FLOATS, IN CLASS 28 (U.S. CLS. 22, 23, 38 AND 50).

FIRST USE 5-20-2008; IN COMMERCE 5-20-2008.

FOR: ENTERTAINMENT SERVICES IN THE NATURE OF ON-GOING TELEVISION AND CABLE PROGRAMS FOR CHILDREN, IN CLASS 41 (U.S. CLS. 100, 101 AND 107).

FIRST USE 5-20-2008; IN COMMERCE 5-20-2008.

THE STIPPLING IS A FEATURE OF THE MARK.

"SUNNY PEPPER" DOES NOT IDENTIFY A LIVING INDIVIDUAL.

SN 76-608,428, FILED 8-24-2004.

RICHARD A. STRASER, EXAMINING ATTORNEY

Int. Cl.: 30

Prior U.S. Cl.: 46

United States Patent and Trademark Office

Reg. No. 3,485,402

Registered Aug. 12, 2008

**TRADEMARK
PRINCIPAL REGISTER**

MAID MARIAN PHOLOURIE QUICKMIX

SEABOARD CORPORATION (DELAWARE CORPORATION)
9000 WEST 67TH STREET
SHAWNEE MISSION, KS 66201

FOR: MIX, COMPRISED PRIMARILY OF FLOUR,
USED FOR PREPARING FRIED FOODS, IN CLASS
30 (U.S. CL. 46).

FIRST USE 6-9-2008; IN COMMERCE 6-9-2008.

THE MARK CONSISTS OF STANDARD CHARACTERS WITHOUT CLAIM TO ANY PARTICULAR FONT, STYLE, SIZE, OR COLOR.

NO CLAIM IS MADE TO THE EXCLUSIVE RIGHT TO USE "PHOLOURIE QUICKMIX", APART FROM THE MARK AS SHOWN.

SN 76-608,653, FILED 8-23-2004.

SUNG IN, EXAMINING ATTORNEY

Int. Cl.: 30

Prior U.S. Cl.: 46

United States Patent and Trademark Office

Reg. No. 3,485,403

Registered Aug. 12, 2008

**TRADEMARK
PRINCIPAL REGISTER**

SPICE IT UP WITH BASILE'S

BZK PRODUCTIONS, INC. (NORTH CAROLINA CORPORATION)
2018 CAROLINA BEACH RD.
WILMINGTON, NC 28401

FOR: DRY SEASONINGS AND DRY SPICES, IN CLASS 30 (U.S. CL. 46).

FIRST USE 11-1-2004; IN COMMERCE 11-1-2004.

THE MARK CONSISTS OF STANDARD CHARACTERS WITHOUT CLAIM TO ANY PARTICULAR FONT, STYLE, SIZE, OR COLOR.

NO CLAIM IS MADE TO THE EXCLUSIVE RIGHT TO USE "SPICE IT UP", APART FROM THE MARK AS SHOWN.

THE NAME "BASILE Z KATSIKIS" IDENTIFIES A LIVING INDIVIDUAL WHOSE CONSENT IS OF RECORD.

SN 76-614,522, FILED 10-1-2004.

JOHN KELLY, EXAMINING ATTORNEY

Int. Cl.: 40

Prior U.S. Cls.: 100, 103, and 106

United States Patent and Trademark Office

Reg. No. 3,485,404

Registered Aug. 12, 2008

**SERVICE MARK
PRINCIPAL REGISTER**

PALLADEO

PALLADEO (CALIFORNIA CORPORATION)
900 WESTERN AVENUE
GLENDALE, CA 91201

FOR: CUSTOM MANUFACTURER OF RETAIL
MERCHANDISE DISPLAYS, NAMELY, CASES,
RACKS, TABLES, COUNTERS AND STANDS, AND
TRADE SHOW DISPLAYS, NAMELY, CASES,
RACKS, TABLES, COUNTERS AND STANDS , IN
CLASS 40 (U.S. CLS. 100, 103 AND 106).

FIRST USE 5-9-2008; IN COMMERCE 5-9-2008.

THE MARK CONSISTS OF STANDARD CHAR-
ACTERS WITHOUT CLAIM TO ANY PARTICULAR
FONT, STYLE, SIZE, OR COLOR.

SN 76-617,243, FILED 10-20-2004.

JEFF DEFORD, EXAMINING ATTORNEY

Int. Cl.: 37

Prior U.S. Cls.: 100, 103, and 106

United States Patent and Trademark Office

Reg. No. 3,485,405

Registered Aug. 12, 2008

**SERVICE MARK
PRINCIPAL REGISTER**

SERMAFILL

SERMATECH INTERNATIONAL INCORPORATED (PENNSYLVANIA CORPORATION)
1566 MEDICAL DRIVE
POTTSTOWN, PA 19464

FOR: REPAIR OF CRACKS IN TURBINE VANE COMPONENTS, IN CLASS 37 (U.S. CLS. 100, 103 AND 106).

FIRST USE 9-6-2001; IN COMMERCE 9-6-2001.

THE MARK CONSISTS OF STANDARD CHARACTERS WITHOUT CLAIM TO ANY PARTICULAR FONT, STYLE, SIZE, OR COLOR.

OWNER OF U.S. REG. NOS. 2,190,840, 2,190,846, AND OTHERS.

SN 76-619,557, FILED 11-5-2004.

BARBARA GAYNOR, EXAMINING ATTORNEY

Int. Cl.: 10

Prior U.S. Cls.: 26, 39, and 44

United States Patent and Trademark Office

Reg. No. 3,485,406

Registered Aug. 12, 2008

**TRADEMARK
PRINCIPAL REGISTER**

CLEAR SMILE

REIZENSON, IGOR (UNITED STATES INDIVIDUAL)
5053 BELAIR BLUCC CT SE
MABLETON, GA 30126

FOR: DENTAL INSTRUMENTS, NAMELY, TEETH AND GUM CLEANING INSTRUMENTS AND APPARATUSES, DENTAL BLEACHING INSTRUMENTS AND APPARATUSES, MOUTH CLEANING DEVICES AND APPARATUSES, AND DENTAL ANESTHETIC DELIVERY DEVICES AND APPARATUSES, IN CLASS 10 (U.S. CLS. 26, 39 AND 44).

FIRST USE 6-18-2008; IN COMMERCE 6-18-2008.

THE MARK CONSISTS OF STANDARD CHARACTERS WITHOUT CLAIM TO ANY PARTICULAR FONT, STYLE, SIZE, OR COLOR.

SN 76-621,393, FILED 11-19-2004.

PAULA MAHONEY, EXAMINING ATTORNEY

Int. Cl.: 25

Prior U.S. Cls.: 22 and 39

United States Patent and Trademark Office

Reg. No. 3,485,407

Registered Aug. 12, 2008

**TRADEMARK
PRINCIPAL REGISTER**

RELIGION LAUNDRY

WHITE HORSES TRADING COMPANY LIMITED
(GUERNSEY CORPORATION)
P.O. BOX 336
ANSON COURT LA ROUTE DES CAMPS
ST. MARTIN, GUERNSEY GY4 6AD, CHANNEL
ISLANDS

FOR: CLOTHING, NAMELY, TROUSERS, T-
SHIRTS, SWEAT SHIRTS, TOPS, IN CLASS 25 (U.S.
CLS. 22 AND 39).

FIRST USE 3-0-2008; IN COMMERCE 3-0-2008.

THE MARK CONSISTS OF STANDARD CHAR-
ACTERS WITHOUT CLAIM TO ANY PARTICULAR
FONT, STYLE, SIZE, OR COLOR.

OWNER OF U.S. REG. NO. 2,798,396.

SN 76-622,629, FILED 11-30-2004.

KATHRYN COWARD, EXAMINING ATTORNEY

Int. Cl.: 34

Prior U.S. Cls.: 2, 8, 9, and 17

United States Patent and Trademark Office

Reg. No. 3,485,408

Registered Aug. 12, 2008

**TRADEMARK
PRINCIPAL REGISTER**

FLECHAS ESPECIALES

INTERMATCH SWEDEN AB (SWEDEN CORPORATION)

ROSENLUNDSGATAN 36, SE

STOCKHOLM 11885, SWEDEN

FOR: CIGARS, IN CLASS 34 (U.S. CLS. 2, 8, 9 AND 17).

FIRST USE 10-8-2004; IN COMMERCE 10-8-2004.

THE MARK CONSISTS OF STANDARD CHARACTERS WITHOUT CLAIM TO ANY PARTICULAR FONT, STYLE, SIZE, OR COLOR.

THE FOREIGN WORDING IN THE MARK TRANSLATES INTO ENGLISH AS ARROWS SPECIALS.

SN 76-635,735, FILED 4-12-2005.

MICHAEL LEWIS, EXAMINING ATTORNEY

Int. Cl.: 43

Prior U.S. Cls.: 100 and 101

United States Patent and Trademark Office

Reg. No. 3,485,409

Registered Aug. 12, 2008

SERVICE MARK
PRINCIPAL REGISTER



TID BITS RESTAURANTS, INC. (FLORIDA CORPORATION)
1076 HENDRICKS AVENUE
JACKSONVILLE, FL 32207

FIRST USE 12-18-2004, AS TO TIDBITS 02/28/1985.;
IN COMMERCE 12-18-2004, AS TO TIDBITS
12/30/1999..

FOR: RESTAURANT SERVICES, NAMELY, EAT-
IN AND TAKE-OUT SERVICES AND CORPORATE
LUNCH CATERING, IN CLASS 43 (U.S. CLS. 100
AND 101).

SN 76-637,948, FILED 5-5-2005.

COLLEEN KEARNEY, EXAMINING ATTORNEY

Int. Cl.: 30

Prior U.S. Cl.: 46

Reg. No. 3,485,410

United States Patent and Trademark Office

Registered Aug. 12, 2008

TRADEMARK
PRINCIPAL REGISTER



MOLINOS DE EL SALVADOR, SOCIEDAD ANONIMA DE CAPITAL VARIABLE (EL SALVADOR SOCIEDAD ANONIMA)
BOULEVARD DEL EJERCITO NACIONAL
50 AVENIDA NORTE
SAN SALVADOR, EL SALVADOR

FIRST USE 5-1-2006; IN COMMERCE 5-1-2006.

SN 76-638,271, FILED 5-6-2005.

FOR: COOKIES, IN CLASS 30 (U.S. CL. 46).

MARY BOAGNI, EXAMINING ATTORNEY

Int. Cls.: 1 and 40

Prior U.S. Cls.: 1, 5, 6, 10, 26, 46, 100, 103, and 106

United States Patent and Trademark Office

Reg. No. 3,485,411

Registered Aug. 12, 2008

**TRADEMARK
SERVICE MARK
PRINCIPAL REGISTER**

MELT-TEK

DAK AMERICAS, LLC (DELAWARE LTD LIAB
CO)
5925 CARNEGIE BOULEVARD, SUITE 500
CHARLOTTE, NC 282094659

FOR: SYNTHETIC RESINS FOR BOTTLING AND
PACKAGING, IN CLASS 1 (U.S. CLS. 1, 5, 6, 10, 26
AND 46).

FIRST USE 5-26-2005; IN COMMERCE 12-13-2007.

FOR: CUSTOM MANUFACTURE OF RESINS;
TREATMENT OF MATERIALS FOR THE MANU-

FACTURE OF RESINS, IN CLASS 40 (U.S. CLS. 100,
103 AND 106).

FIRST USE 5-26-2005; IN COMMERCE 12-13-2007.

THE MARK CONSISTS OF STANDARD CHAR-
ACTERS WITHOUT CLAIM TO ANY PARTICULAR
FONT, STYLE, SIZE, OR COLOR.

SN 76-639,501, FILED 5-26-2005.

ARETHA SOMERVILLE, EXAMINING ATTORNEY

Int. Cl.: 41

Prior U.S. Cls.: 100, 101, and 107

United States Patent and Trademark Office

Reg. No. 3,485,412

Registered Aug. 12, 2008

**SERVICE MARK
PRINCIPAL REGISTER**

YOUR WORKOUT. NOT YOUR LIFE

PM HOTEL ASSOCIATES, L.P. (GEORGIA LIMITED PARTNERSHIP)
58 SAXON WAY
NEW ROCHELLE, NY 10804

THE MARK CONSISTS OF STANDARD CHARACTERS WITHOUT CLAIM TO ANY PARTICULAR FONT, STYLE, SIZE, OR COLOR.

FOR: PHYSICAL FITNESS CONSULTATION, IN CLASS 41 (U.S. CLS. 100, 101 AND 107).

SN 76-650,309, FILED 11-15-2005.

FIRST USE 11-0-2005; IN COMMERCE 11-0-2005.

KIMBERLY PERRY, EXAMINING ATTORNEY

Int. Cl.: 29

Prior U.S. Cl.: 46

United States Patent and Trademark Office

Reg. No. 3,485,413

Registered Aug. 12, 2008

**TRADEMARK
PRINCIPAL REGISTER**

CANTINAS

QUIRCH FOODS CO. (FLORIDA CORPORATION)
7600 N.W. 82ND PLACE
MIAMI, FL 33166

THE MARK CONSISTS OF STANDARD CHARACTERS WITHOUT CLAIM TO ANY PARTICULAR FONT, STYLE, SIZE, OR COLOR.

FOR: FROZEN, PREPARED MEALS CONSISTING PRIMARILY OF MEAT, FISH, POULTRY OR VEGETABLES, IN CLASS 29 (U.S. CL. 46).

SN 76-650,503, FILED 11-17-2005.

FIRST USE 4-1-2006; IN COMMERCE 4-1-2006.

JOHN GARTNER, EXAMINING ATTORNEY

Int. Cl.: 3

Prior U.S. Cls.: 1, 4, 6, 50, 51, and 52

Reg. No. 3,485,414

United States Patent and Trademark Office

Registered Aug. 12, 2008

**TRADEMARK
PRINCIPAL REGISTER**

BODY FIRST

WALSH, JOHN P. (UNITED STATES INDIVIDUAL)
352 FOSTER STREET
NORTH ANDOVER, MA 01845

FOR: SKIN CARE PRODUCTS, NAMELY, BODY WASHES, BODY SCRUBS, SKIN MOISTURIZERS, BODY OILS, BODY DEODORANTS FOR BODY CARE, BODY MASQUES, AND BODY MAKEUP, IN CLASS 3 (U.S. CLS. 1, 4, 6, 50, 51 AND 52).

FIRST USE 4-30-2008; IN COMMERCE 4-30-2008.

THE MARK CONSISTS OF STANDARD CHARACTERS WITHOUT CLAIM TO ANY PARTICULAR FONT, STYLE, SIZE, OR COLOR.

NO CLAIM IS MADE TO THE EXCLUSIVE RIGHT TO USE "BODY", APART FROM THE MARK AS SHOWN.

SN 76-650,699, FILED 11-21-2005.

JORDAN BAKER, EXAMINING ATTORNEY

Int. Cl.: 25

Prior U.S. Cls.: 22 and 39

United States Patent and Trademark Office

Reg. No. 3,485,415

Registered Aug. 12, 2008

**TRADEMARK
PRINCIPAL REGISTER**

NEIGHBORHOOD

NEIGHBORHOOD CO., LTD. (JAPAN CORPORATION)
2-9-1 NH BLDG., SENDAGAYA SHIBUYA-KU
TOKYO, JAPAN 1510051

FOR: JACKETS, SWEATSHIRTS, BUSINESS SUITS, COATS, SWEATERS, T-SHIRTS, UNDERWEAR, NECK BANDS, CAPS, BELTS, SHOES, FOOTWEAR, BOOTS FOR SPORTS, TROUSERS, PANTS, IN CLASS 25 (U.S. CLS. 22 AND 39).

FIRST USE 12-20-2005; IN COMMERCE 12-20-2005.

THE MARK CONSISTS OF STANDARD CHARACTERS WITHOUT CLAIM TO ANY PARTICULAR FONT, STYLE, SIZE, OR COLOR.

SN 76-650,792, FILED 11-22-2005.

KAPIL BHANOT, EXAMINING ATTORNEY

Int. Cl.: 35

Prior U.S. Cls.: 100, 101, and 102

United States Patent and Trademark Office

Reg. No. 3,485,416

Registered Aug. 12, 2008

**SERVICE MARK
PRINCIPAL REGISTER**

LIFE LABORATORY

BADOLATO, DAVID J. (UNITED STATES INDIVIDUAL)
1721 CLOVERLY AVENUE
JENKINTOWN, PA 19046

THE MARK CONSISTS OF STANDARD CHARACTERS WITHOUT CLAIM TO ANY PARTICULAR FONT, STYLE, SIZE, OR COLOR.

FOR: CONSULTING SERVICES PERTAINING TO HEALTHCARE COST CONTAINMENT, IN CLASS 35 (U.S. CLS. 100, 101 AND 102).

SN 76-652,460, FILED 12-27-2005.

FIRST USE 12-31-2007; IN COMMERCE 12-31-2007.

LESLEY LAMOTHE, EXAMINING ATTORNEY

Int. Cl.: 42

Prior U.S. Cls.: 100 and 101

United States Patent and Trademark Office

Reg. No. 3,485,417

Registered Aug. 12, 2008

**SERVICE MARK
PRINCIPAL REGISTER**

GENOSTAT

FORENSIC BIOINFORMATIC SERVICES, INC.
(OHIO CORPORATION)
2850 PRESIDENTIAL DRIVE, SUITE 150
FAIRBORN, OH 45324

THE MARK CONSISTS OF STANDARD CHAR-
ACTERS WITHOUT CLAIM TO ANY PARTICULAR
FONT, STYLE, SIZE, OR COLOR.

FOR: FORENSIC DNA ANALYSIS SERVICES;
EXPERT WITNESS SERVICES IN THE FIELD OF
FORENSICS, IN CLASS 42 (U.S. CLS. 100 AND 101).

SN 76-653,953, FILED 1-26-2006.

FIRST USE 10-20-2005; IN COMMERCE 5-3-2006.

DAWN HAN, EXAMINING ATTORNEY

Int. Cl.: 10

Prior U.S. Cls.: 26, 39, and 44

United States Patent and Trademark Office

Reg. No. 3,485,418

Registered Aug. 12, 2008

**TRADEMARK
PRINCIPAL REGISTER**

SERONO

ARES TRADING S.A. (SWITZERLAND SOCIETE ANONYME)
ZONE INDUSTRIELLE DE L'OURIETTAZ
CH-1170 AUBONNE, SWITZERLAND

FOR: MEDICAL AND SURGICAL APPARATUS AND INSTRUMENTS, NAMELY, AUTO-INJECTORS, PEN INJECTORS, NEEDLE-FREE INJECTION DEVICES FOR MEDICAL USE, AND NON-INVASIVE POWER INJECTORS USED FOR SUBCUTANEOUS INJECTION OF MEDICINE, IN CLASS 10 (U.S. CLS. 26, 39 AND 44).

FIRST USE 0-0-2000; IN COMMERCE 0-0-2000.

THE MARK CONSISTS OF STANDARD CHARACTERS WITHOUT CLAIM TO ANY PARTICULAR FONT, STYLE, SIZE, OR COLOR.

OWNER OF U.S. REG. NOS. 1,666,397, 2,059,423, AND OTHERS.

SN 76-654,709, FILED 2-7-2006.

PAUL CROWLEY, EXAMINING ATTORNEY

Int. Cl.: 25

Prior U.S. Cls.: 22 and 39

United States Patent and Trademark Office

Reg. No. 3,485,419

Registered Aug. 12, 2008

**TRADEMARK
PRINCIPAL REGISTER**

SEDONA WEST

SEDONA WEST, INC. (CALIFORNIA CORPORATION)
14350 GARFIELD UNIT 800
PARAMOUNT, CA 90723

THE MARK CONSISTS OF STANDARD CHARACTERS WITHOUT CLAIM TO ANY PARTICULAR FONT, STYLE, SIZE, OR COLOR.

FOR: CLOTHING, NAMELY, WOMEN'S SHIRTS, HATS, BELTS AND FOOTWEAR, IN CLASS 25 (U.S. CLS. 22 AND 39).

SN 76-654,898, FILED 2-10-2006.

FIRST USE 4-25-2006; IN COMMERCE 4-25-2006.

LESLEY LAMOTHE, EXAMINING ATTORNEY

Int. Cl.: 41

Prior U.S. Cls.: 100, 101, and 107

United States Patent and Trademark Office

Reg. No. 3,485,420

Registered Aug. 12, 2008

**SERVICE MARK
PRINCIPAL REGISTER**

FLYING HORSE RANCH

ELITE PROPERTIES OF AMERICA, INC. (COLORADO CORPORATION)
6385 CORPORATE CENTER DRIVE, SUITE 200
COLORADO SPRINGS, CO 80919

OWNER OF U.S. REG. NOS. 3,038,231, 3,068,757,
AND 3,068,798.

FOR: PROVIDING RECREATIONAL AREAS IN THE NATURE OF CHILDREN'S PLAY AREAS, IN CLASS 41 (U.S. CLS. 100, 101 AND 107).

NO CLAIM IS MADE TO THE EXCLUSIVE RIGHT TO USE "HORSE RANCH", APART FROM THE MARK AS SHOWN.

FIRST USE 5-12-2008; IN COMMERCE 5-12-2008.

SN 76-655,453, FILED 2-22-2006.

THE MARK CONSISTS OF STANDARD CHARACTERS WITHOUT CLAIM TO ANY PARTICULAR FONT, STYLE, SIZE, OR COLOR.

BRENDAN REGAN, EXAMINING ATTORNEY

Int. Cl.: 41

Prior U.S. Cls.: 100, 101, and 107

United States Patent and Trademark Office

Reg. No. 3,485,421

Registered Aug. 12, 2008

SERVICE MARK
PRINCIPAL REGISTER



FLYING HORSE RANCH

ELITE PROPERTIES OF AMERICA, INC. (COLORADO CORPORATION)
6385 CORPORATE CENTER DRIVE, SUITE 200
COLORADO SPRINGS, CO 80919

FOR: PROVIDING RECREATIONAL AREAS IN THE NATURE OF CHILDREN'S PLAY AREAS, IN CLASS 41 (U.S. CLS. 100, 101 AND 107).

FIRST USE 5-12-2008; IN COMMERCE 5-12-2008.

OWNER OF U.S. REG. NOS. 3,038,231, 3,068,757, AND 3,068,798.

NO CLAIM IS MADE TO THE EXCLUSIVE RIGHT TO USE "HORSE RANCH", APART FROM THE MARK AS SHOWN.

SN 76-656,028, FILED 3-3-2006.

BRENDAN REGAN, EXAMINING ATTORNEY

Int. Cl.: 10

Prior U.S. Cls.: 26, 39, and 44

United States Patent and Trademark Office

Reg. No. 3,485,422

Registered Aug. 12, 2008

**TRADEMARK
PRINCIPAL REGISTER**

POSTUREJAC

MAKOFSKY, HOWARD (UNITED STATES INDIVIDUAL)
89 LINCOLN AVENUE
MASTIC BEACH, NY 11951

THE MARK CONSISTS OF STANDARD CHARACTERS WITHOUT CLAIM TO ANY PARTICULAR FONT, STYLE, SIZE, OR COLOR.

FOR: POSTURE CORRECTION AND EXERCISE JACKET TO BE USED BY INDIVIDUALS WITH POSTURALLY-RELATED IMPAIRMENTS, IN CLASS 10 (U.S. CLS. 26, 39 AND 44).

SN 76-656,335, FILED 3-9-2006.

FIRST USE 3-9-2005; IN COMMERCE 3-21-2005.

BRENDAN REGAN, EXAMINING ATTORNEY

Int. Cl.: 9

Prior U.S. Cls.: 21, 23, 26, 36, and 38

United States Patent and Trademark Office

Reg. No. 3,485,423

Registered Aug. 12, 2008

**TRADEMARK
PRINCIPAL REGISTER**

GRANITE ISOLATOR

YASHAR, FRANK (UNITED STATES INDIVIDUAL)
10040 CARMEN ROAD
CUPERTINO, CA 95014

FOR: VIBRATION CONTROL PRODUCTS FOR USE WITH TEST, MEASURING AND SCIENTIFIC EQUIPMENT, NAMELY, VIBRATION CONTROL PLATFORMS, IN CLASS 9 (U.S. CLS. 21, 23, 26, 36 AND 38).

FIRST USE 4-0-2006; IN COMMERCE 4-0-2006.

THE MARK CONSISTS OF STANDARD CHARACTERS WITHOUT CLAIM TO ANY PARTICULAR FONT, STYLE, SIZE, OR COLOR.

SN 76-656,462, FILED 3-13-2006.

ARETHA SOMERVILLE, EXAMINING ATTORNEY

Int. Cl.: 9

Prior U.S. Cls.: 21, 23, 26, 36, and 38

Reg. No. 3,485,424

United States Patent and Trademark Office

Registered Aug. 12, 2008

**TRADEMARK
PRINCIPAL REGISTER**

XLS

RMI CORPORATION (DELAWARE CORPORATION)
18920 FORGE DRIVE
LEGAL DEPARTMENT
CUPERTINO, CA 95014

FOR: INTEGRATED CIRCUITS; COMPUTER HARDWARE AND SOFTWARE FOR CONNECTING GLOBAL COMPUTER NETWORKS; TELECOMMUNICATIONS EQUIPMENT AND SYSTEMS HARDWARE, NAMELY, TELECOMMUNICATIONS AND NETWORKING MICROPROCESSORS, SWITCHES, ROUTERS, LINE CARDS AND INTERFACE CIRCUITS; COMPUTER SOFTWARE FOR TELECOMMUNICATIONS EQUIPMENT AND SYSTEMS, NAMELY, FOR FACILITATING THE OPERATION OF TELECOMMUNICATIONS AND NETWORKING MICROPROCESSORS, SWITCHES,

ROUTERS, LINE CARDS AND INTERFACE CIRCUITS; AND SOFTWARE PROGRAMMABLE SEMICONDUCTORS THAT ENABLE BROADBAND COMMUNICATIONS, ACCESS AND NETWORKING SERVICES FOR VOICE, VIDEO AND DATA, IN CLASS 9 (U.S. CLS. 21, 23, 26, 36 AND 38).

FIRST USE 6-23-2004; IN COMMERCE 12-3-2004.

THE MARK CONSISTS OF STANDARD CHARACTERS WITHOUT CLAIM TO ANY PARTICULAR FONT, STYLE, SIZE, OR COLOR.

SN 76-657,095, FILED 3-22-2006.

ELLEN B. AWRICH, EXAMINING ATTORNEY

Int. Cl.: 35

Prior U.S. Cls.: 100, 101, and 102

United States Patent and Trademark Office

Reg. No. 3,485,425

Registered Aug. 12, 2008

**SERVICE MARK
PRINCIPAL REGISTER**



BROKER BANC LLC (CALIFORNIA LTD LIAB
CO)
P.O. BOX 576302
MICHAEL M. HOLL
MODESTO, CA 95357

FOR: MARKETING SERVICES, NAMELY, PROVIDING INFORMATIONAL WEB PAGES DESIGNED TO GENERATE SALES TRAFFIC FOR OTHERS VIA HYPERLINKS TO OTHERS' WEB SITES IN THE FIELDS OF BROKERED REAL ESTATE, MORTGAGES, SECURITIES, AND INSURANCE SERVICES; PROVIDING CONSUMER PRODUCT AND SERVICES INFORMATION, VIA THE INTERNET, IN THE FIELDS OF BROKER-RELATED REAL ESTATE, MORTGAGES, SECURITIES AND INSURANCE SERVICES; PROVIDING AN ON-LINE COMMERCIAL INFORMATION DIRECTORY ON THE INTERNET; PROVIDING SPACE ON A WEB SITE FOR THE ADVERTISEMENT OF THE GOODS AND SERVICES OF OTHERS, IN CLASS 35 (U.S. CLS. 100, 101 AND 102).

FIRST USE 8-11-2007; IN COMMERCE 8-11-2007.

NO CLAIM IS MADE TO THE EXCLUSIVE RIGHT TO USE "BROKER BANK", APART FROM THE MARK AS SHOWN.

THE COLOR(S) RED, BLUE AND BLACK IS/ARE CLAIMED AS A FEATURE OF THE MARK.

THE BACKWARDS "B" APPEARS IN RED, THE FORWARD "B" AND "BROKER BANC" APPEARS IN BLUE, AND THE CIRCLE AROUND THE DOUBLE "B" DESIGN IS BLACK.

SN 76-659,262, FILED 4-28-2006.

JILL C. ALT, EXAMINING ATTORNEY

Int. Cls.: 35 and 42

Prior U.S. Cls.: 100, 101, and 102

United States Patent and Trademark Office

Reg. No. 3,485,426

Registered Aug. 12, 2008

**SERVICE MARK
PRINCIPAL REGISTER**

FANATICAL

RACKSPACE US, INC. (DELAWARE CORPORATION), DBA RACKSPACE MANAGED HOSTING,
9725 DATAPOINT DRIVE, SUITE 100
SAN ANTONIO, TX 78229

FOR: PROVIDING CUSTOMER SERVICE IN THE COMPUTER AND INTERNET FIELDS, NAMELY, PROVIDING ASSISTANCE TO CUSTOMERS WHEN THEY HAVE A BUSINESS PROBLEM OR CONCERN IN THE FIELD OF INTERNET-RELATED HOSTING AND IN THE FIELD OF MANAGEMENT AND ACCESS SERVICES FOR E-MAIL, WEBSITES, ELECTRONIC DATABASES, AND COMPUTER SOFTWARE, APPLICATIONS, AND DIGITAL CONTENT ACCESSIBLE VIA THE INTERNET, IN CLASS 35 (U.S. CLS. 100, 101 AND 102).

FIRST USE 6-16-2008; IN COMMERCE 6-16-2008.

FOR: PROVIDING CONSULTING IN THE COMPUTER AND INTERNET FIELDS, NAMELY, IN THE FIELD OF INTERNET-RELATED HOSTING AND IN THE FIELD OF MANAGEMENT AND ACCESS SERVICES FOR E-MAIL, WEBSITES, ELEC-

TRONIC DATABASES, AND COMPUTER SOFTWARE, APPLICATIONS, AND DIGITAL CONTENT ACCESSIBLE VIA THE INTERNET; AND PROVIDING TECHNICAL CUSTOMER SUPPORT SERVICES IN THE COMPUTER AND INTERNET FIELDS, NAMELY, TROUBLESHOOTING OF COMPUTER HARDWARE AND SOFTWARE PROBLEMS, IN THE FIELD OF INTERNET-RELATED HOSTING AND IN THE FIELD OF MANAGEMENT, AND ACCESS SERVICES FOR E-MAIL, WEBSITES, ELECTRONIC DATABASES, AND COMPUTER SOFTWARE, APPLICATIONS, AND DIGITAL CONTENT ACCESSIBLE VIA THE INTERNET, IN CLASS 42 (U.S. CLS. 100 AND 101).

FIRST USE 6-16-2008; IN COMMERCE 6-16-2008.

THE MARK CONSISTS OF STANDARD CHARACTERS WITHOUT CLAIM TO ANY PARTICULAR FONT, STYLE, SIZE, OR COLOR.

SN 76-659,587, FILED 5-4-2006.

KATHERINE CHANG, EXAMINING ATTORNEY

Int. Cl.: 36

Prior U.S. Cls.: 100, 101, and 102

United States Patent and Trademark Office

Reg. No. 3,485,427

Registered Aug. 12, 2008

**SERVICE MARK
PRINCIPAL REGISTER**

CONSECO COMMAND

CDOC, INC. (DELAWARE CORPORATION)
11815 N. PENNSYLVANIA STREET
P.O. BOX 1911
CARMEL, IN 460821911

FOR: ANNUITIES UNDERWRITING, IN CLASS
36 (U.S. CLS. 100, 101 AND 102).

FIRST USE 9-15-2005; IN COMMERCE 10-20-2006.

THE MARK CONSISTS OF STANDARD CHAR-
ACTERS WITHOUT CLAIM TO ANY PARTICULAR
FONT, STYLE, SIZE, OR COLOR.

OWNER OF U.S. REG. NOS. 2,253,197, 2,659,774,
AND OTHERS.

SN 76-659,879, FILED 5-10-2006.

MICHAEL LEWIS, EXAMINING ATTORNEY

Int. Cls.: 24 and 25

Prior U.S. Cls.: 22, 39, 42, and 50

United States Patent and Trademark Office

Reg. No. 3,485,428

Registered Aug. 12, 2008

**TRADEMARK
PRINCIPAL REGISTER**

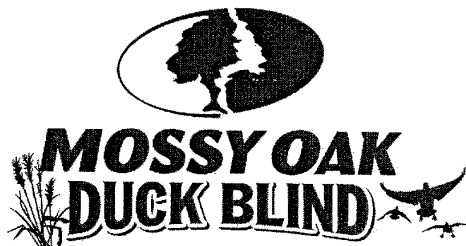

HAAS OUTDOORS, INC. (MISSISSIPPI CORPORATION)
200 E. MAIN STREET
P. O. DRAWER 757
WEST POINT, MS 39773

FOR: TEXTILE CAMOUFLAGE FABRIC, IN CLASS 24 (U.S. CLS. 42 AND 50).

FIRST USE 1-11-2007; IN COMMERCE 1-11-2007.

FOR: CLOTHING, NAMELY, SHIRTS, PANTS, COATS, CAPS, HATS, FOUL WEATHER GEAR, GLOVES, JACKETS, SHORTS, SWEATERS, T-SHIRTS, VESTS, BELTS, BLOUSES, HEAD NETS IN

THE NATURE OF VEILS, COVERALLS, OVERALLS AND JEANS, IN CLASS 25 (U.S. CLS. 22 AND 39).

FIRST USE 1-11-2007; IN COMMERCE 1-11-2007.

OWNER OF U.S. REG. NOS. 1,525,739, 2,227,642, AND OTHERS.

NO CLAIM IS MADE TO THE EXCLUSIVE RIGHT TO USE "DUCK BLIND", APART FROM THE MARK AS SHOWN.

SN 76-662,537, FILED 7-3-2006.

ANGELA GAW, EXAMINING ATTORNEY

Int. Cl.: 9

Prior U.S. Cls.: 21, 23, 26, 36, and 38

United States Patent and Trademark Office

Reg. No. 3,485,429

Registered Aug. 12, 2008

**TRADEMARK
PRINCIPAL REGISTER**

STATURE FMEA

DYADEM INTERNATIONAL LTD. (CANADA CORPORATION)
SUITE 401, 9050 YONGE STREET
RICHMOND HILL, ONTARIO, CANADA L4C 9S6

FOR: COMPUTER SOFTWARE THAT FACILITATES FAILURE MODE AND EFFECTS ANALYSIS STUDIES, IDENTIFIES AND MANAGES QUALITY CHARACTERISTICS AND CONTROLS, AND LINKS THEM ACROSS A PRODUCT OR PROCESS'S LIFE-CYCLE, THAT FEATURES SYSTEM DECOMPOSITION BY FUNCTION, ITEM AND PROCESS, ANALYSIS AND AUTHORING OF FMEAS, QUALITY CHARACTERISTICS MANAGEMENT, PUBLISHING OF CONTROL PLANS AND INSPECTION PLANS, AND OTHER QUALITY-CENTRIC DATA AND PROCESSES, AND THAT INCLUDES CORE FUNCTIONS SUPPORTING THESE FEATURES IN THE NATURE OF STUDY AUTHORING, WORKFLOW, DOCUMENT MANAGEMENT, DOCUMENT PUBLISHING, VERSION CONTROL, CONFIGURATION MANAGEMENT, CHANGE MANAGEMENT,

AND ENTERPRISE INTEGRATION TO OTHER SYSTEMS, FOR USE BY MANUFACTURERS IN DISCRETE AND PROCESS MANUFACTURING AND OTHER INDUSTRIES OR FUNCTIONS WITH COMPLEX QUALITY PROCESSES, IN CLASS 9 (U.S. CLS. 21, 23, 26, 36 AND 38).

FIRST USE 12-13-2007; IN COMMERCE 12-13-2007.

THE MARK CONSISTS OF STANDARD CHARACTERS WITHOUT CLAIM TO ANY PARTICULAR FONT, STYLE, SIZE, OR COLOR.

NO CLAIM IS MADE TO THE EXCLUSIVE RIGHT TO USE "FMEA", APART FROM THE MARK AS SHOWN.

SN 76-662,557, FILED 6-30-2006.

PAUL E. FAHRENKOPF, EXAMINING ATTORNEY

Int. Cl.: 36

Prior U.S. Cls.: 100, 101, and 102

United States Patent and Trademark Office

Reg. No. 3,485,430

Registered Aug. 12, 2008

**SERVICE MARK
PRINCIPAL REGISTER**

CONSECO PROVIDENCE

CDOC, INC. (DELAWARE CORPORATION)
11815 N. PENNSYLVANIA STREET
P.O. BOX 1911
CARMEL, IN 460821911

FOR: LIFE INSURANCE UNDERWRITING, IN
CLASS 36 (U.S. CLS. 100, 101 AND 102).

FIRST USE 8-1-2006; IN COMMERCE 9-1-2006.

THE MARK CONSISTS OF STANDARD CHAR-
ACTERS WITHOUT CLAIM TO ANY PARTICULAR
FONT, STYLE, SIZE, OR COLOR.

OWNER OF U.S. REG. NOS. 2,253,197, 2,659,774,
AND OTHERS.

SN 76-663,042, FILED 7-13-2006.

MICHAEL LEWIS, EXAMINING ATTORNEY

Int. Cls.: 6 and 19

Prior U.S. Cls.: 1, 2, 12, 13, 14, 23, 25, 33, and 50

United States Patent and Trademark Office

Reg. No. 3,485,431

Registered Aug. 12, 2008

**TRADEMARK
PRINCIPAL REGISTER**

FIBERLOK

CENTERLINE SUPPLY LTD. (TEXAS LIMITED
PARTNERSHIP)
530 JESSE STREET
GRAND PRAIRIE, TX 750511141

FOR: METAL ROAD SIGN PANEL SYSTEM
COMPRISING INTERLOCKING METAL PANELS,
IN CLASS 6 (U.S. CLS. 2, 12, 13, 14, 23, 25 AND 50).

FIRST USE 7-17-2006; IN COMMERCE 7-17-2006.

FOR: NON-METAL ROAD SIGN PANEL SYSTEM
COMPRISING INTERLOCKING NON-METAL PA-
NELS, IN CLASS 19 (U.S. CLS. 1, 12, 33 AND 50).

FIRST USE 7-17-2006; IN COMMERCE 7-17-2006.

THE MARK CONSISTS OF STANDARD CHAR-
ACTERS WITHOUT CLAIM TO ANY PARTICULAR
FONT, STYLE, SIZE, OR COLOR.

SN 76-663,175, FILED 7-17-2006.

KEVON CHISOLM, EXAMINING ATTORNEY

Int. Cl.: 42

Prior U.S. Cls.: 100 and 101

United States Patent and Trademark Office

Reg. No. 3,485,432

Registered Aug. 12, 2008

**SERVICE MARK
PRINCIPAL REGISTER**

ELEVATING VALUE

SYNCHRONOUS SOLUTIONS, INC. (ILLINOIS CORPORATION)
SUITE 300
211 WEST WACKER
CHICAGO, IL 60606

FOR: COMPUTER SOFTWARE MAINTENANCE, SERVICE, NAMELY, ENTERPRISE RESOURCE PLANNING, WEB PORTALS AND RELATED SYSTEMS INTEGRATION, REPAIR AND CONSULTING SERVICES IN THE FIELD OF DESIGN, SELECTION, IMPLEMENTATION AND USE OF

SOFTWARE SYSTEMS FOR OTHERS, IN CLASS 42 (U.S. CLS. 100 AND 101).

FIRST USE 7-1-2006; IN COMMERCE 9-1-2006.

THE MARK CONSISTS OF STANDARD CHARACTERS WITHOUT CLAIM TO ANY PARTICULAR FONT, STYLE, SIZE, OR COLOR.

SN 76-665,384, FILED 8-31-2006.

BENJAMIN OKEKE, EXAMINING ATTORNEY

Int. Cl.: 34

Prior U.S. Cls.: 2, 8, 9, and 17

United States Patent and Trademark Office

Reg. No. 3,485,433

Registered Aug. 12, 2008

**TRADEMARK
PRINCIPAL REGISTER**

LUXX GLASS

MELOGRANO, RICHARD (UNITED STATES IN-
DIVIDUAL)
P.O. BOX 109
HERMOSA BEACH, CA 90254

THE MARK CONSISTS OF STANDARD CHAR-
ACTERS WITHOUT CLAIM TO ANY PARTICULAR
FONT, STYLE, SIZE, OR COLOR.

FOR: SMOKER'S ARTICLES, NAMELY, ASH-
TRAYS NOT OF PRECIOUS METAL AND NOT OF
GLASS, SMOKING PIPES NOT OF GLASS, CIGARS,
TOBACCO, IN CLASS 34 (U.S. CLS. 2, 8, 9 AND 17).

OWNER OF U.S. REG. NO. 3,142,266.

SN 76-666,021, FILED 9-14-2006.

FIRST USE 1-16-2008; IN COMMERCE 1-16-2008.

ALLISON SCHRODY, EXAMINING ATTORNEY

Int. Cl.: 44

Prior U.S. Cls.: 100 and 101

United States Patent and Trademark Office

Reg. No. 3,485,434

Registered Aug. 12, 2008

SERVICE MARK
PRINCIPAL REGISTER



LAFAYETTE GENERAL MEDICAL CENTER,
INC. (LOUISIANA CORPORATION)
1214 COOLIDGE BLVD.
LAFAYETTE, LA 70503

NO CLAIM IS MADE TO THE EXCLUSIVE
RIGHT TO USE THE PAVILION FOR WOMEN
AND CHILDREN, APART FROM THE MARK AS
SHOWN.

FOR: MEDICAL, HEALTHCARE, AND HOSPI-
TAL SERVICES, IN CLASS 44 (U.S. CLS. 100 AND
101).

SN 76-666,179, FILED 9-18-2006.

FIRST USE 3-12-2008; IN COMMERCE 3-12-2008.

PATRICIA EVANKO, EXAMINING ATTORNEY

Int. Cl.: 43

Prior U.S. Cls.: 100 and 101

United States Patent and Trademark Office

Reg. No. 3,485,435

Registered Aug. 12, 2008

**SERVICE MARK
PRINCIPAL REGISTER**

Grub for Cowboys

10 STAR ENTERPRISES, INC. (FLORIDA CORPORATION)

2306 U.S. HIGHWAY 377

PILOT POINT, TX 76258

FOR: RESTAURANT PROVIDING BISON MEAT PRODUCTS, ORGANIC PASTRIES, FOOD AND DRINK, IN CLASS 43 (U.S. CLS. 100 AND 101).

FIRST USE 1-21-2006; IN COMMERCE 1-21-2006.

THE MARK CONSISTS OF STANDARD CHARACTERS WITHOUT CLAIM TO ANY PARTICULAR FONT, STYLE, SIZE, OR COLOR.

NO CLAIM IS MADE TO THE EXCLUSIVE RIGHT TO USE "GRUB", APART FROM THE MARK AS SHOWN.

SN 76-667,125, FILED 10-6-2006.

DAVID HOFFMAN, EXAMINING ATTORNEY

Int. Cl.: 6

Prior U.S. Cls.: 2, 12, 13, 14, 23, 25, and 50

United States Patent and Trademark Office

Reg. No. 3,485,436

Registered Aug. 12, 2008

**TRADEMARK
PRINCIPAL REGISTER**

BikeDocker

BACJAC, INC. (ILLINOIS CORPORATION)
1600 S. PRAIRIE AVENUE #1502
CHICAGO, IL 60616

THE MARK CONSISTS OF STANDARD CHARACTERS WITHOUT CLAIM TO ANY PARTICULAR FONT, STYLE, SIZE, OR COLOR.

FOR: METAL BRACKETS FOR MOUNTING RACKS, NAMELY, BICYCLE RACKS, GUN RACKS, EQUIPMENT RACKS AND SKI RACKS, IN CLASS 6 (U.S. CLS. 2, 12, 13, 14, 23, 25 AND 50).

SN 76-667,604, FILED 10-13-2006.

FIRST USE 7-19-2007; IN COMMERCE 7-19-2007.

SHARON MEIER, EXAMINING ATTORNEY

Int. Cl.: 35

Prior U.S. Cls.: 100, 101, and 102

United States Patent and Trademark Office

Reg. No. 3,485,437

Registered Aug. 12, 2008

**SERVICE MARK
PRINCIPAL REGISTER**

BEDROOM EXPERIENCE

WELLS, THOMAS J. (UNITED STATES INDIVIDUAL)
801 COUNTRY CLUB ROAD
CARTHAGE, MO 64836

NO CLAIM IS MADE TO THE EXCLUSIVE RIGHT TO USE "BEDROOM", APART FROM THE MARK AS SHOWN.

FOR: RETAIL BEDDING STORE SERVICES, IN CLASS 35 (U.S. CLS. 100, 101 AND 102).

SN 76-667,778, FILED 10-20-2006.

FIRST USE 3-15-2008; IN COMMERCE 3-15-2008.

THE MARK CONSISTS OF STANDARD CHARACTERS WITHOUT CLAIM TO ANY PARTICULAR FONT, STYLE, SIZE, OR COLOR.

JANICE L. MCMORROW, EXAMINING ATTORNEY

Int. Cl.: 41

Prior U.S. Cls.: 100, 101, and 107

United States Patent and Trademark Office

Reg. No. 3,485,438

Registered Aug. 12, 2008

**SERVICE MARK
PRINCIPAL REGISTER**

YOUR NEXT STEPS

AMERICAN ALLIANCE FOR HEALTH, PHYSICAL EDUCATION, RECREATION AND DANCE (D.C. NON-PROFIT CORPORATION)
1900 ASSOCIATION DRIVE
RESTON, VA 201911599

FOR: EDUCATION SERVICES, NAMELY, PROVIDING ONLINE INFORMATIONAL RESOURCES, CLASSES, SEMINARS, AND WORKSHOPS, IN THE FIELD OF ATHLETICS, ACADEMICS AND CAREER COUNSELING, IN CLASS 41 (U.S. CLS. 100, 101 AND 107).

FIRST USE 4-9-2008; IN COMMERCE 4-9-2008.

THE MARK CONSISTS OF STANDARD CHARACTERS WITHOUT CLAIM TO ANY PARTICULAR FONT, STYLE, SIZE, OR COLOR.

SN 76-668,064, FILED 10-25-2006.

MELVIN AXILBUND, EXAMINING ATTORNEY

Int. Cl.: 45

Prior U.S. Cls.: 100 and 101

United States Patent and Trademark Office

Reg. No. 3,485,439

Registered Aug. 12, 2008

**SERVICE MARK
PRINCIPAL REGISTER**

POWER DRINKER

NBPC LLC (ARIZONA LTD LIAB CO)
1136 W. BASELINE ROAD
MESA, AZ 85210

THE MARK CONSISTS OF STANDARD CHAR-
ACTERS WITHOUT CLAIM TO ANY PARTICULAR
FONT, STYLE, SIZE, OR COLOR.

FOR: PERSONAL SERVICES, NAMELY, INTER-
NET BASED SOCIAL NETWORKING, IN CLASS 45
(U.S. CLS. 100 AND 101).

SN 76-668,348, FILED 11-1-2006.

FIRST USE 10-19-2006; IN COMMERCE 10-19-2006.

ANNE E. GUSTASON, EXAMINING ATTORNEY

Int. Cl.: 9

Prior U.S. Cls.: 21, 23, 26, 36, and 38

Reg. No. 3,485,440

United States Patent and Trademark Office

Registered Aug. 12, 2008

**TRADEMARK
PRINCIPAL REGISTER**

KÖHLT

SEIKAKU TECHNICAL GROUP LIMITED (SAMOA CORPORATION)
OFFSHORE CHAMBERS
P.O. BOX 217
APIA, SAMOA

AMPLIFIERS; MICROPHONES; EAR PLUGS FOR SOUNDPROOFING; EAR PLUGS NOT FOR MEDICAL PURPOSES; ELECTRONIC SOUND PICKUP FOR GUITARS AND BASSES, IN CLASS 9 (U.S. CLS. 21, 23, 26, 36 AND 38).

FOR: AUDIO EQUIPMENT FOR VEHICLES, NAMELY, STEREOS, SPEAKERS, AMPLIFIERS, EQUALIZERS, CROSSOVERS AND SPEAKER HOUSINGS; AUDIO SPEAKER ENCLOSURES; AUDIO SPEAKERS; ELECTRIC AUDIO PLAYBACK UNITS WITH LIGHTS AND SPEAKERS; LOUD-SPEAKER SYSTEMS; SPEAKER ENCLOSURES; AUDIO MIXERS; SOUND MIXERS; SOUND MIXERS WITH INTEGRATED AMPLIFIERS; TELEPHONE TRANSMITTERS; RECEIVERS FOR TELEPHONES; CABINETS FOR LOUDSPEAKERS;

FIRST USE 5-10-2007; IN COMMERCE 5-10-2007.

THE MARK CONSISTS OF STANDARD CHARACTERS WITHOUT CLAIM TO ANY PARTICULAR FONT, STYLE, SIZE, OR COLOR.

SN 76-668,717, FILED 11-8-2006.

AISHA CLARKE, EXAMINING ATTORNEY

Int. Cl.: 3

Prior U.S. Cls.: 1, 4, 6, 50, 51, and 52

Reg. No. 3,485,441

United States Patent and Trademark Office

Registered Aug. 12, 2008

TRADEMARK
PRINCIPAL REGISTER

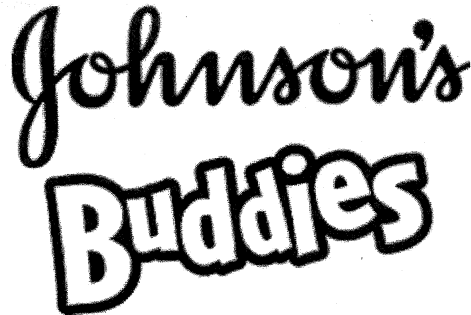
The logo for "Johnson's Buddies" features the word "Johnson's" in a black, cursive script font. Below it, the word "Buddies" is written in a bold, white, blocky font with a thick black outline and a slight 3D effect.

JOHNSON & JOHNSON (NEW JERSEY CORPORATION)
ONE JOHNSON & JOHNSON PLAZA
NEW BRUNSWICK, NJ 089337001

FOR: HAIR SHAMPOO, HAIR CONDITIONER,
HAIR DETANGLER, BAR SOAP, SKIN CLEANSERS
AND BODY WASHES, IN CLASS 3 (U.S. CLS. 1, 4, 6,
50, 51 AND 52).

FIRST USE 2-0-2007; IN COMMERCE 2-0-2007.

OWNER OF U.S. REG. NOS. 648,450, 1,419,912,
AND OTHERS.

SN 76-668,964, FILED 11-13-2006.

KEVIN DINALLO, EXAMINING ATTORNEY

Int. Cl.: 9

Prior U.S. Cls.: 21, 23, 26, 36, and 38

Reg. No. 3,485,442

United States Patent and Trademark Office

Registered Aug. 12, 2008

TRADEMARK
PRINCIPAL REGISTER

The logo for Depo Racing features the word "Depo" in a bold, italicized, sans-serif font. The letter "D" is significantly larger and more stylized, with a thick, curved underline that sweeps across the top of the "e" and "p". Below "Depo", the word "Racing" is written in a smaller, cursive script font.

MING-TSUNG, CHOU (TAIWAN INDIVIDUAL)
1F., NO. 17, LANE 89, PAO-CHING STREET
SUNG SAN DISTRICT
TAIPEI, TAIWAN

FOR: SPEEDOMETERS; ENGINE RPM OR REVOLUTIONS PER MINUTE GAUGES; AUTOMOTIVE MEASURING INSTRUMENTS, NAMELY, WATER TEMPERATURE GAUGES, OIL PRESSURE GAUGES, OIL TEMPERATURE GAUGES, VOLTMETER GAUGES, AMMETER GAUGES, AIR FUEL/RATIO GAUGES, BOOST GAUGES, VACUUM GAUGES; FUEL LEVEL GAUGES; FUEL PRESSURE GAUGES;

TACHOMETERS; EXHAUST GAS TEMP GAUGES, IN CLASS 9 (U.S. CLS. 21, 23, 26, 36 AND 38).

FIRST USE 5-14-2008; IN COMMERCE 5-14-2008.

NO CLAIM IS MADE TO THE EXCLUSIVE RIGHT TO USE "RACING", APART FROM THE MARK AS SHOWN.

SN 76-669,059, FILED 11-15-2006.

KEVON CHISOLM, EXAMINING ATTORNEY

Int. Cl.: 5

Prior U.S. Cls.: 6, 18, 44, 46, 51, and 52

Reg. No. 3,485,443

United States Patent and Trademark Office

Registered Aug. 12, 2008

**TRADEMARK
PRINCIPAL REGISTER**

DR. STEVE'S

FEMACEUTICALS, LLC (NEW YORK LIMITED
LIABILITY COMPANY)
2071 BOSTON POST ROAD
LARCHMONT, NY 10538

FOR: MEDICAL DEVICES, NAMELY, BOTH
PADS AND TAMPONS, FOR USE IN TREATING
VAGINAL AND VULVAR TISSUE IRRITATION,
PADS FOR TREATING BREAST AND NIPPLE IR-
RITATION IN NURSING MOTHERS, PADS FOR
USE IN TREATMENT OF INFANT DIAPER RASH
AND ADULT INCONTINENCE RASH, PADS FOR
PERI-ANAL USE IN TREATMENT OF HEMOR-

RHOIDAL IRRITATION, IN CLASS 5 (U.S. CLS. 6,
18, 44, 46, 51 AND 52).

FIRST USE 5-0-2008; IN COMMERCE 5-0-2008.

THE MARK CONSISTS OF STANDARD CHAR-
ACTERS WITHOUT CLAIM TO ANY PARTICULAR
FONT, STYLE, SIZE, OR COLOR.

SN 76-670,595, FILED 12-20-2006.

BILL DAWE, EXAMINING ATTORNEY

Int. Cl.: 24

Prior U.S. Cls.: 42 and 50

United States Patent and Trademark Office

Reg. No. 3,485,444

Registered Aug. 12, 2008

**TRADEMARK
PRINCIPAL REGISTER**

COZY FAUX

COZY FAUX (CALIFORNIA CORPORATION)

11351 GLADWIN STREET

LOS ANGELES, CA 90049

FOR: FAKE FUR BLANKET THROWS, IN CLASS
24 (U.S. CLS. 42 AND 50).

FIRST USE 7-15-2007; IN COMMERCE 7-15-2007.

THE MARK CONSISTS OF STANDARD CHAR-
ACTERS WITHOUT CLAIM TO ANY PARTICULAR
FONT, STYLE, SIZE, OR COLOR.

NO CLAIM IS MADE TO THE EXCLUSIVE
RIGHT TO USE "FAUX", APART FROM THE
MARK AS SHOWN.

SN 76-670,639, FILED 12-21-2006.

LINDA E. BLOHM, EXAMINING ATTORNEY

Int. Cl.: 7

Prior U.S. Cls.: 13, 19, 21, 23, 31, 34, and 35

Reg. No. 3,485,445

United States Patent and Trademark Office

Registered Aug. 12, 2008

**TRADEMARK
PRINCIPAL REGISTER**



NORTHLAND/SCOTT FETZER COMPANY (DE-
LAWARE CORPORATION)
968 BRADLEY STREET
WATERTOWN, NY 13601

NO CLAIM IS MADE TO THE EXCLUSIVE
RIGHT TO USE "BRUSHLESS BLOWERS", APART
FROM THE MARK AS SHOWN.

FOR: ELECTRIC MOTORS FOR MACHINES,
NAMELY, BRUSHLESS BLOWER MOTORS, IN
CLASS 7 (U.S. CLS. 13, 19, 21, 23, 31, 34 AND 35).

SN 76-670,931, FILED 12-29-2006.

FIRST USE 5-15-2007; IN COMMERCE 5-15-2007.

DAVID TAYLOR, EXAMINING ATTORNEY

Int. Cl.: 44

Prior U.S. Cls.: 100 and 101

United States Patent and Trademark Office

Reg. No. 3,485,446

Registered Aug. 12, 2008

**SERVICE MARK
PRINCIPAL REGISTER**



THE FOOT & ANKLE TREATMENT CENTER OF
SAN ANTONIO (TEXAS CORPORATION)
10130 HUEBNER ROAD
SAN ANTONIO, TX 78240

FIRST USE 2-1-2007; IN COMMERCE 2-1-2007.

SN 76-671,017, FILED 1-4-2007.

FOR: HEALTH CARE AND MEDICAL CLINIC, IN
CLASS 44 (U.S. CLS. 100 AND 101).

KELLEY WELLS, EXAMINING ATTORNEY

Int. Cl.: 25

Prior U.S. Cls.: 22 and 39

United States Patent and Trademark Office

Reg. No. 3,485,447

Registered Aug. 12, 2008

**TRADEMARK
PRINCIPAL REGISTER**

2 LIFE

AGE GROUP, LTD. (NEW YORK CORPORATION)
180 MADISON AVENUE
NEW YORK, NY 10016

FOR: INTIMATE APPAREL, NAMELY, LINGERIE, UNDERWEAR, BRAS, PANTIES, SLEEPWEAR, PAJAMAS, LOUNGEWEAR AND ROBES, IN CLASS 25 (U.S. CLS. 22 AND 39).

FIRST USE 2-23-2007; IN COMMERCE 2-23-2007.

THE MARK CONSISTS OF STANDARD CHARACTERS WITHOUT CLAIM TO ANY PARTICULAR FONT, STYLE, SIZE, OR COLOR.

SN 76-671,366, FILED 1-16-2007.

LINDA MICKLEBURGH, EXAMINING ATTORNEY

Int. Cl.: 9

Prior U.S. Cls.: 21, 23, 26, 36, and 38

Reg. No. 3,485,448

United States Patent and Trademark Office

Registered Aug. 12, 2008

**TRADEMARK
PRINCIPAL REGISTER**

Mapad

E-LEAD ELECTRONIC CO., LTD. (TAIWAN CORPORATION)
NO.37, GUNGDUNG 1ST RD.
SHENGANG SHIANG
CHANGHUA, TAIWAN

HELD GLOBAL POSITIONING SATELLITE BASED NAVIGATION COMPUTERS, PERSONAL DIGITAL ASSISTANTS, IN CLASS 9 (U.S. CLS. 21, 23, 26, 36 AND 38).

FOR: AUTOMOTIVE DIGITAL TELEVISIONS, AUTOMOTIVE DIGITAL VIDEO PLAYERS, AUTOMOTIVE LCD DISPLAYS, AUTOMOTIVE STEREOS, GLOBAL POSITIONING SATELLITE BASED AUTOMOBILE NAVIGATION COMPUTERS, GLOBAL POSITIONING SATELLITE RECEIVERS, HAND-

FIRST USE 1-19-2007; IN COMMERCE 1-19-2007.

SN 76-671,518, FILED 1-19-2007.

MICHELE SWAIN, EXAMINING ATTORNEY

Int. Cl.: 9

Prior U.S. Cls.: 21, 23, 26, 36, and 38

Reg. No. 3,485,449

United States Patent and Trademark Office

Registered Aug. 12, 2008

**TRADEMARK
PRINCIPAL REGISTER**

MOSAIC

DATAMATIC, LTD. (TEXAS LIMITED PART-
NERSHIP)
3600 K AVENUE
PLANO, TX 75074

THE MARK CONSISTS OF STANDARD CHAR-
ACTERS WITHOUT CLAIM TO ANY PARTICULAR
FONT, STYLE, SIZE, OR COLOR.

FOR: AUTOMATED OPTICAL READERS FOR
READING UTILITY METERS, IN CLASS 9 (U.S. CLS.
21, 23, 26, 36 AND 38).

SN 76-672,307, FILED 2-7-2007.

FIRST USE 6-0-2007; IN COMMERCE 6-0-2007.

DAWN HAN, EXAMINING ATTORNEY

Int. Cl.: 3

Prior U.S. Cls.: 1, 4, 6, 50, 51, and 52

Reg. No. 3,485,450

United States Patent and Trademark Office

Registered Aug. 12, 2008

**TRADEMARK
PRINCIPAL REGISTER**

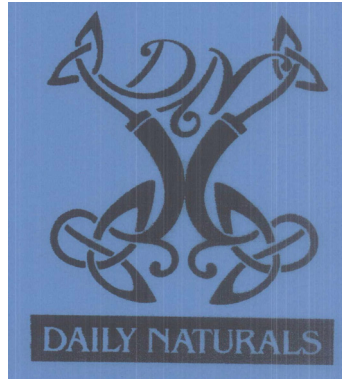

DAILY NATURALS, LLC. (MINNESOTA LTD
LIAB CO)
3366 XYLON AVE. N.
NEW HOPE, MN 55427

FOR: NATURAL FACE AND BODY CARE SOAP,
BAR SOAP, SHAMPOO, HAIR CONDITIONER, LIP
BALM, HAND LOTION, FACE LOTION, BODY
LOTION, TOOTHPASTE, SUNSCREEN LOTION, IN
CLASS 3 (U.S. CLS. 1, 4, 6, 50, 51 AND 52).

FIRST USE 6-23-2007; IN COMMERCE 6-23-2007.

NO CLAIM IS MADE TO THE EXCLUSIVE
RIGHT TO USE "NATURALS", APART FROM THE
MARK AS SHOWN.

THE COLOR(S) BLACK AND CORNFLOWER
BLUE IS/ARE CLAIMED AS A FEATURE OF THE
MARK.

THE COLOR BLACK APPEARS AS THE COLOR
OF THE WORDING "DAILY NATURALS", THE
"DN" AND THE DESIGN ELEMENT. THE COLOR
CORNFLOWER BLUE APPEARS AS THE BACK-
GROUND COLOR.

SN 76-672,862, FILED 2-20-2007.

JANICE KIM, EXAMINING ATTORNEY

Int. Cl.: 36

Prior U.S. Cls.: 100, 101, and 102

United States Patent and Trademark Office

Reg. No. 3,485,451

Registered Aug. 12, 2008

**SERVICE MARK
PRINCIPAL REGISTER**

CHX CONNECT

CHICAGO STOCK EXCHANGE, INCORPORATED (DELAWARE CORPORATION)
ONE FINANCIAL PLACE, 32ND FLOOR
440 SOUTH LASALLE
CHICAGO, IL 60605

FOR: AUTOMATED ORDER ROUTING SERVICES FOR BROKER-DEALERS INVOLVED IN SECURITIES TRADING, IN CLASS 36 (U.S. CLS. 100, 101 AND 102).

FIRST USE 10-26-2007; IN COMMERCE 10-26-2007.

THE MARK CONSISTS OF STANDARD CHARACTERS WITHOUT CLAIM TO ANY PARTICULAR FONT, STYLE, SIZE, OR COLOR.

SN 76-673,401, FILED 3-1-2007.

ANNE MADDEN, EXAMINING ATTORNEY

Int. Cl.: 28

Prior U.S. Cls.: 22, 23, 38, and 50

United States Patent and Trademark Office

Reg. No. 3,485,452

Registered Aug. 12, 2008

**TRADEMARK
PRINCIPAL REGISTER**

BUSY ACTIVITY BLOCKS

HASBRO, INC. (RHODE ISLAND CORPORATION)
1027 NEWPORT AVENUE
PAWTUCKET, RI 02862

FOR: CHILDREN'S MULTIPLE ACTIVITY TOYS,
IN CLASS 28 (U.S. CLS. 22, 23, 38 AND 50).

FIRST USE 7-3-2007; IN COMMERCE 7-3-2007.

THE MARK CONSISTS OF STANDARD CHARACTERS WITHOUT CLAIM TO ANY PARTICULAR FONT, STYLE, SIZE, OR COLOR.

OWNER OF U.S. REG. NO. 2,935,968 AND OTHERS.

NO CLAIM IS MADE TO THE EXCLUSIVE RIGHT TO USE "ACTIVITY BLOCKS", APART FROM THE MARK AS SHOWN.

SN 76-673,454, FILED 3-2-2007.

DORITT L. CARROLL, EXAMINING ATTORNEY

Int. Cl.: 9

Prior U.S. Cls.: 21, 23, 26, 36, and 38

United States Patent and Trademark Office

Reg. No. 3,485,453

Registered Aug. 12, 2008

**TRADEMARK
PRINCIPAL REGISTER**

WEATHER DIRECT 2 YOU

LA CROSSE TECHNOLOGY LTD. (MINNESOTA CORPORATION)
2809 LOSEY BLVD. SOUTH
LA CROSSE, WI 54601

FOR: INSTRUMENTS FOR MONITORING AND PREDICTING METEOROLOGICAL CONDITIONS, NAMELY, THERMOMETERS, HYGROMETERS, ANEMOMETERS, RAIN GAUGES, AND BAROMETERS; RADIO RECEIVERS AND TRANSMITTERS; AND DIGITAL INDOOR AND OUTDOOR WEATHER STATION COMPRISING WIRELESS REMOTE AIR, TEMPERATURE AND HUMIDITY SENSORS, WIND CHILL, WIND DIRECTION AND WIND SPEED SENSORS, DEW POINT SENSOR, AUDIO-VIDEO RECEIVERS, STORM WARNING AND WEATHER ALARMS, PRECIPITATION SENSOR

AND LCD ALARM CLOCK, IN CLASS 9 (U.S. CLS. 21, 23, 26, 36 AND 38).

FIRST USE 4-1-2008; IN COMMERCE 4-1-2008.

THE MARK CONSISTS OF STANDARD CHARACTERS WITHOUT CLAIM TO ANY PARTICULAR FONT, STYLE, SIZE, OR COLOR.

NO CLAIM IS MADE TO THE EXCLUSIVE RIGHT TO USE "WEATHER", APART FROM THE MARK AS SHOWN.

SN 76-673,659, FILED 3-6-2007.

CAROLYN GRAY, EXAMINING ATTORNEY

Int. Cls.: 16, 24, and 41

**Prior U.S. Cls.: 2, 5, 22, 23, 29, 37, 38, 42, 50, 100, 101,
and 107**

Reg. No. 3,485,454

United States Patent and Trademark Office

Registered Aug. 12, 2008

**TRADEMARK
SERVICE MARK
PRINCIPAL REGISTER**

M'LISS

HAWLEY, M'LISS RAE (UNITED STATES INDIVIDUAL)

5749 SOUTH DOUBLE BLUFF ROAD
FREELAND, WA 98249

FOR: PRINTED PUBLICATIONS, NAMELY, BOOKS IN THE FIELD OF QUILTING AND EMBROIDERY, PATTERNS FOR MAKING QUILTS, AND EMBROIDERY DESIGN PATTERNS, IN CLASS 16 (U.S. CLS. 2, 5, 22, 23, 29, 37, 38 AND 50).

FIRST USE 9-1-1998; IN COMMERCE 9-1-1998.

FOR: FABRICS OF COTTON, SILK, AND WOOL, IN CLASS 24 (U.S. CLS. 42 AND 50).

FIRST USE 6-1-2002; IN COMMERCE 6-1-2002.

FOR: EDUCATIONAL SERVICES, NAMELY, CLASSES AND SEMINARS IN QUILTING, SEWING AND QUILT DESIGN, AND ENTERTAINMENT SERVICES, NAMELY, ONGOING TELEVISION PROGRAMS IN THE FIELD OF QUILTING, IN CLASS 41 (U.S. CLS. 100, 101 AND 107).

FIRST USE 12-31-1991; IN COMMERCE 12-31-1998.

THE MARK CONSISTS OF STANDARD CHARACTERS WITHOUT CLAIM TO ANY PARTICULAR FONT, STYLE, SIZE, OR COLOR.

OWNER OF U.S. REG. NO. 3,091,168.

SN 76-673,797, FILED 3-8-2007.

STEVEN PEREZ, EXAMINING ATTORNEY

Int. Cl.: 35

Prior U.S. Cls.: 100, 101, and 102

United States Patent and Trademark Office

Reg. No. 3,485,455

Registered Aug. 12, 2008

**SERVICE MARK
PRINCIPAL REGISTER**

TECHKNOWLEDGE OPINION PANEL

COMMON KNOWLEDGE, INC. (TEXAS CORPORATION)

16200 DALLAS PARKWAY, SUITE 140

DALLAS, TX 752486897

FOR: MARKET RESEARCH SERVICES, IN CLASS 35 (U.S. CLS. 100, 101 AND 102).

FIRST USE 2-0-2008; IN COMMERCE 2-0-2008.

THE MARK CONSISTS OF STANDARD CHARACTERS WITHOUT CLAIM TO ANY PARTICULAR FONT, STYLE, SIZE, OR COLOR.

NO CLAIM IS MADE TO THE EXCLUSIVE RIGHT TO USE "OPINION PANEL", APART FROM THE MARK AS SHOWN.

SN 76-674,299, FILED 3-20-2007.

MARGERY A. TIERNEY, EXAMINING ATTORNEY

Int. Cl.: 36

Prior U.S. Cls.: 100, 101, and 102

United States Patent and Trademark Office

Reg. No. 3,485,456

Registered Aug. 12, 2008

**SERVICE MARK
PRINCIPAL REGISTER**



APPLIED BANK (DELAWARE CORPORATION),
FORMERLY APPLIED CARD BANK,
601 DELAWARE AVENUE
WILMINGTON, DE 19801

FOR: BANKING AND FINANCING SERVICES,
IN CLASS 36 (U.S. CLS. 100, 101 AND 102).

FIRST USE 5-10-2007; IN COMMERCE 5-10-2007.

OWNER OF U.S. REG. NOS. 2,328,599, 2,699,666,
AND 2,752,332.

NO CLAIM IS MADE TO THE EXCLUSIVE
RIGHT TO USE "BANK", APART FROM THE
MARK AS SHOWN.

SN 76-674,422, FILED 3-22-2007.

LINDA E. BLOHM, EXAMINING ATTORNEY

Int. Cl.: 36

Prior U.S. Cls.: 100, 101, and 102

United States Patent and Trademark Office

Reg. No. 3,485,457

Registered Aug. 12, 2008

**SERVICE MARK
PRINCIPAL REGISTER**



APPLIED BANK (DELAWARE CORPORATION),
FORMERLY APPLIED CARD BANK,
601 DELAWARE AVENUE
WILMINGTON, DE 19801

FIRST USE 5-10-2007; IN COMMERCE 5-10-2007.

SN 76-674,423, FILED 3-22-2007.

FOR: BANKING AND FINANCING SERVICES,
IN CLASS 36 (U.S. CLS. 100, 101 AND 102).

LINDA E. BLOHM, EXAMINING ATTORNEY

Int. Cl.: 36

Prior U.S. Cls.: 100, 101, and 102

United States Patent and Trademark Office

Reg. No. 3,485,458

Registered Aug. 12, 2008

**SERVICE MARK
PRINCIPAL REGISTER**

MAKING THE MOST OF YOUR TIME AND MONEY

APPLIED BANK (DELAWARE CORPORATION),
FORMERLY APPLIED CARD BANK,
601 DELAWARE AVENUE
WILMINGTON, DE 19801

THE MARK CONSISTS OF STANDARD CHAR-
ACTERS WITHOUT CLAIM TO ANY PARTICULAR
FONT, STYLE, SIZE, OR COLOR.

FOR: BANKING AND FINANCING SERVICES,
IN CLASS 36 (U.S. CLS. 100, 101 AND 102).

SN 76-674,424, FILED 3-22-2007.

FIRST USE 5-10-2007; IN COMMERCE 5-10-2007.

LINDA E. BLOHM, EXAMINING ATTORNEY

Int. Cl.: 36

Prior U.S. Cls.: 100, 101, and 102

United States Patent and Trademark Office

Reg. No. 3,485,459

Registered Aug. 12, 2008

**SERVICE MARK
PRINCIPAL REGISTER**



APPLIED BANK (DELAWARE CORPORATION),
FORMERLY APPLIED CARD BANK,
601 DELAWARE AVENUE
WILMINGTON, DE 19801

FOR: BANKING AND FINANCING SERVICES,
IN CLASS 36 (U.S. CLS. 100, 101 AND 102).

FIRST USE 5-10-2007; IN COMMERCE 5-10-2007.

OWNER OF U.S. REG. NOS. 2,328,599, 2,752,332,
AND OTHERS.

NO CLAIM IS MADE TO THE EXCLUSIVE
RIGHT TO USE "BANK", APART FROM THE
MARK AS SHOWN.

SN 76-674,430, FILED 3-22-2007.

LINDA E. BLOHM, EXAMINING ATTORNEY

Int. Cl.: 25

Prior U.S. Cls.: 22 and 39

United States Patent and Trademark Office

Reg. No. 3,485,460

Registered Aug. 12, 2008

**TRADEMARK
PRINCIPAL REGISTER**



MICHAEL T. DOUGHER (UNITED STATES IN-
DIVIDUAL)
6 DREAM LAKE ROAD SOUTH
QUEENSBURY, NY 12804

FIRST USE 9-1-2007; IN COMMERCE 9-1-2007.

SN 76-674,804, FILED 3-29-2007.

FOR: CLOTHING, NAMELY, SHIRTS, HATS;
CLOTHING, NAMELY, T-SHIRT, BASEBALL CAPS,
IN CLASS 25 (U.S. CLS. 22 AND 39).

ROBERT STRUCK, EXAMINING ATTORNEY

Int. Cl.: 22

Prior U.S. Cls.: 1, 2, 7, 19, 22, 42, and 50

Reg. No. 3,485,461

United States Patent and Trademark Office

Registered Aug. 12, 2008

**TRADEMARK
PRINCIPAL REGISTER**



GIANTLOK CO., LTD. (TAIWAN CORPORATION)
2, 26TH RD.
TAICHUNG INDUSTRIAL PARK
TAICHUNG, TAIWAN

FOR: CABLE TIES AND STRAPS FOR FASTENING AND SECURING OBJECTS SUCH AS BUNDLES OF WIRE TOGETHER; NON-METAL STRAPPING OR TIE DOWNS; PLASTIC TIES FOR

HOME OR GARDEN USE; TIE DOWN STRAPS; BANDS FOR WRAPPING OR BINDING, IN CLASS 22 (U.S. CLS. 1, 2, 7, 19, 22, 42 AND 50).

FIRST USE 12-10-2007; IN COMMERCE 12-10-2007.

SN 76-675,017, FILED 4-4-2007.

COLLEEN KEARNEY, EXAMINING ATTORNEY

Int. Cl.: 29

Prior U.S. Cl.: 46

United States Patent and Trademark Office

Reg. No. 3,485,462

Registered Aug. 12, 2008

**TRADEMARK
PRINCIPAL REGISTER**

THINK INSIDE THE SHELL

SUNRICH LLC (MINNESOTA LTD LIAB CO),
DBA SUNOPTA SUNFLOWER,
227 SIXTH STREET NORTH
BRECKENRIDGE, MN 56520

THE MARK CONSISTS OF STANDARD CHAR-
ACTERS WITHOUT CLAIM TO ANY PARTICULAR
FONT, STYLE, SIZE, OR COLOR.

FOR: PROCESSED SUNFLOWER SEEDS FOR
HUMAN CONSUMPTION, IN CLASS 29 (U.S. CL. 46).

SN 76-675,286, FILED 4-10-2007.

FIRST USE 1-20-2008; IN COMMERCE 2-6-2008.

LINDA POWELL, EXAMINING ATTORNEY

Int. Cl.: 9

Prior U.S. Cls.: 21, 23, 26, 36, and 38

United States Patent and Trademark Office

Reg. No. 3,485,463

Registered Aug. 12, 2008

**TRADEMARK
PRINCIPAL REGISTER**

CRMToday

TOYOTA MATERIAL HANDLING U.S.A., INC.
(CALIFORNIA CORPORATION)
ONE PARK PLAZA, 10TH FLOOR
IRVINE, CA 92618

FOR: COMPUTER SOFTWARE FOR FACILITATING INTERACTION AND INTEGRATION BETWEEN TWO OTHER RECOGNIZED COMPUTER PROGRAMS, IN THE FIELD OF CUSTOMER RELATIONSHIP MANAGEMENT, IN CLASS 9 (U.S. CLS. 21, 23, 26, 36 AND 38).

FIRST USE 5-3-2007; IN COMMERCE 5-3-2007.

THE MARK CONSISTS OF STANDARD CHARACTERS WITHOUT CLAIM TO ANY PARTICULAR FONT, STYLE, SIZE, OR COLOR.

SN 76-675,375, FILED 4-9-2007.

MARY I. SPARROW, EXAMINING ATTORNEY

Int. Cl.: 35

Prior U.S. Cls.: 100, 101, and 102

United States Patent and Trademark Office

Reg. No. 3,485,464

Registered Aug. 12, 2008

**SERVICE MARK
PRINCIPAL REGISTER**

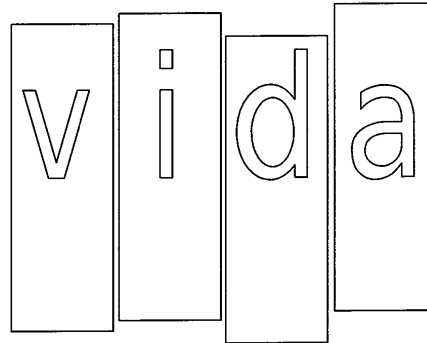

SAFeway INC. (DELAWARE CORPORATION)
5918 STONERIDGE MALL ROAD
PLEASANTON, CA 945882322

FOR: RETAIL GROCERY STORE, PHARMACY
AND DRUGSTORE SERVICES; RETAIL STORE
SERVICES FEATURING CONVENIENCE STORE
ITEMS AND GASOLINE; RETAIL STORE SERVICES
FEATURING A FULL LINE OF GROCERIES, PRE-
PARED FOODS, PHARMACEUTICAL GOODS AND
OTHER SUPERMARKET PRODUCTS, IN CLASS 35
(U.S. CLS. 100, 101 AND 102).

FIRST USE 6-15-2005; IN COMMERCE 6-15-2005.

OWNER OF U.S. REG. NO. 3,216,882.

THE ENGLISH TRANSLATION OF "VIDA" IN
THE MARK IS "LIFE."

SN 76-675,384, FILED 4-11-2007.

ZHALEH DELANEY, EXAMINING ATTORNEY

Int. Cl.: 9

Prior U.S. Cls.: 21, 23, 26, 36, and 38

United States Patent and Trademark Office

Reg. No. 3,485,465

Registered Aug. 12, 2008

**TRADEMARK
PRINCIPAL REGISTER**

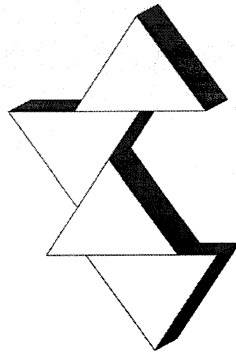

PARICON TECHNOLOGIES CORPORATION
(MASSACHUSETTS CORPORATION)
421 CURRANT ROAD
FALL RIVER, MA 02720

FOR: CONFORMABLE INTERCONNECTION DEVICES FOR USE BETWEEN ONE OR MORE ELECTRICAL COMPONENTS, NAMELY, CIRCUIT BOARDS, COMPUTER CHIPS, LAND GRID ARRAYS, BALL GRID ARRAYS, FLEX CIRCUITS AND HEAT SINKS, IN CLASS 9 (U.S. CLS. 21, 23, 26, 36 AND 38).

FIRST USE 5-0-2008; IN COMMERCE 5-0-2008.

OWNER OF U.S. REG. NOS. 2,443,992 AND 2,530,457.

FOUR TRIANGLES DESIGN

SN 76-675,644, FILED 4-18-2007.

ERNEST SHOSHO, EXAMINING ATTORNEY

Int. Cl.: 9

Prior U.S. Cls.: 21, 23, 26, 36, and 38

Reg. No. 3,485,466

United States Patent and Trademark Office

Registered Aug. 12, 2008

**TRADEMARK
PRINCIPAL REGISTER**

PINNACLE SWIFT DRAW

UFER, MICHAEL (UNITED STATES INDIVIDUAL)

809 GLASTONBURY CIRCLE

TRAVERSE CITY, MI 49686

FOR: CONSTRUCTION MANAGEMENT SOFTWARE, IN CLASS 9 (U.S. CLS. 21, 23, 26, 36 AND 38).

FIRST USE 1-4-2008; IN COMMERCE 1-4-2008.

THE MARK CONSISTS OF STANDARD CHARACTERS WITHOUT CLAIM TO ANY PARTICULAR FONT, STYLE, SIZE, OR COLOR.

NO CLAIM IS MADE TO THE EXCLUSIVE RIGHT TO USE "DRAW", APART FROM THE MARK AS SHOWN.

SN 76-676,737, FILED 5-11-2007.

KATHY DE JONGE, EXAMINING ATTORNEY

Int. Cl.: 31

Prior U.S. Cls.: 1 and 46

United States Patent and Trademark Office

Reg. No. 3,485,467

Registered Aug. 12, 2008

**TRADEMARK
PRINCIPAL REGISTER**

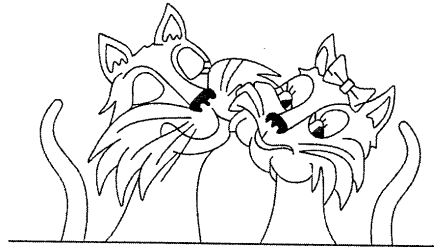

PET CENTER, INC. (CALIFORNIA CORPORATION)
4105 WEST JEFFERSON BOULEVARD
LOS ANGELES, CA 90016

THE MARK CONSISTS OF THE MISCELLANEOUS DESIGN OF THE UPPER PORTION OF TWO CATS RUBBING THEIR CHEEKS TOGETHER AS SHOWN IN THE DRAWING.

FOR: CAT FOOD AND CAT TREATS, IN CLASS 31 (U.S. CLS. 1 AND 46).

SN 76-676,922, FILED 5-16-2007.

FIRST USE 6-16-2008; IN COMMERCE 6-16-2008.

ELLEN PERKINS, EXAMINING ATTORNEY

Int. Cl.: 42

Prior U.S. Cls.: 100 and 101

United States Patent and Trademark Office

Reg. No. 3,485,468

Registered Aug. 12, 2008

SERVICE MARK
PRINCIPAL REGISTER

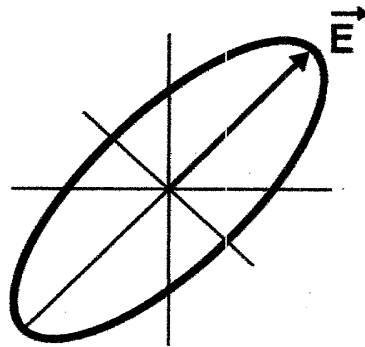

J.A. WOOLLAM CO., INC. (NEBRASKA CORPORATION)
645 M ST.
LINCOLN, NE 68508

FIRST USE 5-15-2007; IN COMMERCE 5-15-2007.

OWNER OF U.S. REG. NO. 2,414,052.

SN 76-677,896, FILED 6-6-2007.

FOR: MATERIALS TESTING AND ANALYZING FOR OTHERS, NAMELY, ELLIPSOmetry SERVICES, IN CLASS 42 (U.S. CLS. 100 AND 101).

STEVEN PEREZ, EXAMINING ATTORNEY

Int. Cl.: 6

Prior U.S. Cls.: 2, 12, 13, 14, 23, 25, and 50

United States Patent and Trademark Office

Reg. No. 3,485,469

Registered Aug. 12, 2008

**TRADEMARK
PRINCIPAL REGISTER**

ADVANTAGE*plus*

PHILADELPHIA HARDWARE GROUP INC. (CALIFORNIA CORPORATION)
6590 TOP GUN STREET
SAN DIEGO, CA 92121

FIRST USE 3-8-2008; IN COMMERCE 3-8-2008.

SN 76-678,113, FILED 6-12-2007.

FOR: DOOR METAL LOCKS, IN CLASS 6 (U.S. CLS. 2, 12, 13, 14, 23, 25 AND 50).

WENDY GOODMAN, EXAMINING ATTORNEY

Int. Cl.: 20

Prior U.S. Cls.: 2, 13, 22, 25, 32, and 50

Reg. No. 3,485,470

United States Patent and Trademark Office

Registered Aug. 12, 2008

**TRADEMARK
PRINCIPAL REGISTER**

COZY CAT

L&P PROPERTY MANAGEMENT COMPANY
(DELAWARE CORPORATION)
4095 FIRESTONE BOULEVARD
SOUTH GATE, CA 90280

THE MARK CONSISTS OF STANDARD CHAR-
ACTERS WITHOUT CLAIM TO ANY PARTICULAR
FONT, STYLE, SIZE, OR COLOR.

FOR: MATTRESSES AND BEDDING FOUNDA-
TIONS, IN CLASS 20 (U.S. CLS. 2, 13, 22, 25, 32 AND
50).

SN 76-678,263, FILED 6-15-2007.

FIRST USE 6-12-2008; IN COMMERCE 6-12-2008.

MICHAEL SOUDERS, EXAMINING ATTORNEY

Int. Cl.: 29

Prior U.S. Cl.: 46

United States Patent and Trademark Office

Reg. No. 3,485,471

Registered Aug. 12, 2008

**TRADEMARK
PRINCIPAL REGISTER**

EL SABOR DE EL SALVADOR

TROPICAL CHEESE INDUSTRIES, INC. (NEW
JERSEY CORPORATION)
450-452 FAYETTE STREET
PERTH AMBOY, NJ 08861

FOR: CHEESE, SOUR CREAM, MEAT, AND
HEAVY CREAM, IN CLASS 29 (U.S. CL. 46).

FIRST USE 7-1-2007; IN COMMERCE 7-1-2007.

THE MARK CONSISTS OF STANDARD CHAR-
ACTERS WITHOUT CLAIM TO ANY PARTICULAR
FONT, STYLE, SIZE, OR COLOR.

OWNER OF U.S. REG. NOS. 2,358,191, 2,419,501,
AND OTHERS.

NO CLAIM IS MADE TO THE EXCLUSIVE
RIGHT TO USE "EL SALVADOR", APART FROM
THE MARK AS SHOWN.

THE ENGLISH TRANSLATION OF THE MARK IS
"THE FLAVOR OF EL SALVADOR."

SN 76-678,624, FILED 6-22-2007.

JENNY PARK, EXAMINING ATTORNEY

Int. Cl.: 36

Prior U.S. Cls.: 100, 101, and 102

United States Patent and Trademark Office

Reg. No. 3,485,472

Registered Aug. 12, 2008

**SERVICE MARK
PRINCIPAL REGISTER**

CEFCU.MOBI

CITIZENS EQUITY FIRST CREDIT UNION (IL-
LINOIS CREDIT UNION)
5401 W. EVERETT MCKINLEY DIRKSEN PARK-
WAY
PEORIA, IL 616561715

FOR: ON-LINE BANKING SERVICES, IN CLASS
36 (U.S. CLS. 100, 101 AND 102).

FIRST USE 11-15-2007; IN COMMERCE 11-15-2007.

THE MARK CONSISTS OF STANDARD CHAR-
ACTERS WITHOUT CLAIM TO ANY PARTICULAR
FONT, STYLE, SIZE, OR COLOR.

OWNER OF U.S. REG. NOS. 2,179,439, 2,256,993,
AND OTHERS.

SN 76-678,625, FILED 6-22-2007.

SARA THOMAS, EXAMINING ATTORNEY

Int. Cl.: 9

Prior U.S. Cls.: 21, 23, 26, 36, and 38

United States Patent and Trademark Office

Reg. No. 3,485,473

Registered Aug. 12, 2008

**TRADEMARK
PRINCIPAL REGISTER**

REALITY AGENT

EXTENDED TECHNOLOGIES (LOUISIANA CORPORATION)
303 SOUTH PINE STREET
HAMMOND, LA 70403

FOR: COMPUTER SOFTWARE FOR AUTOMATING THE BUSINESS ACTIVITIES OF HAIR AND SKIN CARE SALONS AND SPAS FOR ACCOUNTING, APPOINTMENT SCHEDULING, BUSINESS PLANNING, AND ASSISTING SERVICE PERSONNEL IN PROVIDING HAIR TREATMENT SERVICES, IN CLASS 9 (U.S. CLS. 21, 23, 26, 36 AND 38).

FIRST USE 4-1-2008; IN COMMERCE 4-1-2008.

THE MARK CONSISTS OF STANDARD CHARACTERS WITHOUT CLAIM TO ANY PARTICULAR FONT, STYLE, SIZE, OR COLOR.

SN 76-679,458, FILED 7-12-2007.

JENNIFER DIXON, EXAMINING ATTORNEY

Int. Cl.: 41

Prior U.S. Cls.: 100, 101, and 107

United States Patent and Trademark Office

Reg. No. 3,485,474

Registered Aug. 12, 2008

**SERVICE MARK
PRINCIPAL REGISTER**

STORKED!

ADVANCE MAGAZINE PUBLISHERS INC. (NEW
YORK CORPORATION)
FOUR TIMES SQUARE
NEW YORK, NY 10036

THE MARK CONSISTS OF STANDARD CHAR-
ACTERS WITHOUT CLAIM TO ANY PARTICULAR
FONT, STYLE, SIZE, OR COLOR.

FOR: ONLINE JOURNALS, NAMELY, BLOGS
FEATURING INFORMATION CONCERNING
PREGNANCY, IN CLASS 41 (U.S. CLS. 100, 101
AND 107).

SN 76-679,558, FILED 7-16-2007.

FIRST USE 8-1-2007; IN COMMERCE 8-1-2007.

LAURA HAMMEL, EXAMINING ATTORNEY

Int. Cl.: 12

Prior U.S. Cls.: 19, 21, 23, 31, 35, and 44

Reg. No. 3,485,475

United States Patent and Trademark Office

Registered Aug. 12, 2008

**TRADEMARK
PRINCIPAL REGISTER**

EFFICIENCY PLUS

ASF-KEYSTONE, INC. (DELAWARE CORPORATION)
1700 WALNUT STREET
GRANITE CITY, IL 62040

THE MARK CONSISTS OF STANDARD CHARACTERS WITHOUT CLAIM TO ANY PARTICULAR FONT, STYLE, SIZE, OR COLOR.

FOR: BEARING SEALS IN ROLLER BEARINGS FOR RAILWAY CARS, IN CLASS 12 (U.S. CLS. 19, 21, 23, 31, 35 AND 44).

SN 76-680,211, FILED 8-2-2007.

FIRST USE 4-30-2008; IN COMMERCE 4-30-2008.

HOWARD B. LEVINE, EXAMINING ATTORNEY

Int. Cl.: 41

Prior U.S. Cls.: 100, 101, and 107

United States Patent and Trademark Office

Reg. No. 3,485,476

Registered Aug. 12, 2008

**SERVICE MARK
PRINCIPAL REGISTER**

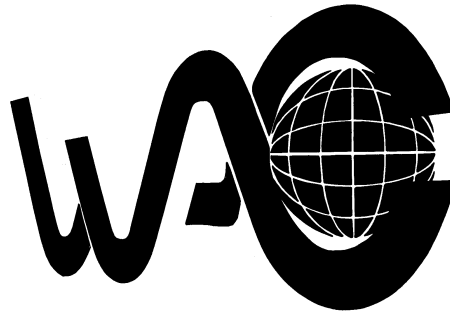

WORLD AFFAIRS COUNCIL OF SOUTH TEXAS,
INC. (TEXAS CORPORATION)
P.O. BOX 260096
CORPUS CHRISTI, TX 78426

FOR: EDUCATIONAL SERVICES, NAMELY,
CONDUCTING SEMINARS, WORKSHOPS, AND
CONFERENCES IN THE FIELD OF CURRENT

WORLD AFFAIRS, IN CLASS 41 (U.S. CLS. 100, 101
AND 107).

FIRST USE 3-31-2008; IN COMMERCE 3-31-2008.

SN 76-681,362, FILED 8-31-2007.

PAUL F. GAST, EXAMINING ATTORNEY

Int. Cl.: 9

Prior U.S. Cls.: 21, 23, 26, 36, and 38

Reg. No. 3,485,477

United States Patent and Trademark Office

Registered Aug. 12, 2008

**TRADEMARK
PRINCIPAL REGISTER**

DEMANDFLEX

UNIVERSAL LIGHTING TECHNOLOGIES, INC.
(DELAWARE CORPORATION)
26 CENTURY BOULEVARD, SUITE 500
NASHVILLE, TN 372143683

THE MARK CONSISTS OF STANDARD CHARACTERS WITHOUT CLAIM TO ANY PARTICULAR FONT, STYLE, SIZE, OR COLOR.

FOR: DIMMING AND ENERGY MANAGEMENT
FLUORESCENT BALLASTS, IN CLASS 9 (U.S. CLS.
21, 23, 26, 36 AND 38).

SN 76-681,747, FILED 9-11-2007.

FIRST USE 2-1-2008; IN COMMERCE 2-1-2008.

KELLEY WELLS, EXAMINING ATTORNEY

Int. Cl.: 9

Prior U.S. Cls.: 21, 23, 26, 36, and 38

Reg. No. 3,485,478

United States Patent and Trademark Office

Registered Aug. 12, 2008

**TRADEMARK
PRINCIPAL REGISTER**

BLINX BY ANDREA

ANDREA ELECTRONICS CORPORATION (NEW
YORK CORPORATION)
65 ORVILLE DRIVE, SUITE ONE
BOHEMIA, NY 11716

FOR: AUDIO HEADPHONES AND HEADSETS
FOR USE WITH PORTABLE AUDIO AND MEDIA
PLAYERS, COMPUTERS AND OTHER AUDIO
EQUIPMENT, IN CLASS 9 (U.S. CLS. 21, 23, 26, 36
AND 38).

FIRST USE 12-7-2006; IN COMMERCE 12-7-2006.

THE MARK CONSISTS OF STANDARD CHAR-
ACTERS WITHOUT CLAIM TO ANY PARTICULAR
FONT, STYLE, SIZE, OR COLOR.

OWNER OF U.S. REG. NOS. 648,171, 1,082,108,
AND OTHERS.

SN 77-000,519, FILED 9-15-2006.

WENDY GOODMAN, EXAMINING ATTORNEY

Int. Cl.: 5

Prior U.S. Cls.: 6, 18, 44, 46, 51, and 52

Reg. No. 3,485,479

United States Patent and Trademark Office

Registered Aug. 12, 2008

**TRADEMARK
PRINCIPAL REGISTER**

18 AGAIN

BRISBOIS, STEVEN (UNITED STATES INDIVIDUAL)
15401 AMBERBEAM BLVD
GOTHA, FL 34734

FOR: DIETARY AND NUTRITIONAL SUPPLEMENTS; DIETARY FOOD SUPPLEMENTS; DIETARY SUPPLEMENTS; HERBAL SUPPLEMENTS; MINERAL NUTRITIONAL SUPPLEMENTS; MINERAL SUPPLEMENTS; NUTRITIONAL ADDITIVES FOR USE IN FOODS AND DIETARY SUPPLEMENTS FOR HUMAN CONSUMPTION; NUTRITIONAL SUPPLEMENTS; VITAMIN AND MINERAL SUPPLEMENTS; VITAMIN SUPPLE-

MENTS, IN CLASS 5 (U.S. CLS. 6, 18, 44, 46, 51 AND 52).

FIRST USE 1-1-2008; IN COMMERCE 1-1-2008.

THE MARK CONSISTS OF STANDARD CHARACTERS WITHOUT CLAIM TO ANY PARTICULAR FONT, STYLE, SIZE, OR COLOR.

SN 77-000,535, FILED 9-15-2006.

WENDY GOODMAN, EXAMINING ATTORNEY

Int. Cl.: 3

Prior U.S. Cls.: 1, 4, 6, 50, 51, and 52

Reg. No. 3,485,480

United States Patent and Trademark Office

Registered Aug. 12, 2008

**TRADEMARK
PRINCIPAL REGISTER**

BEAUTIFUL HOLD

TED GIBSON & COMPANY, INC. (NEW YORK CORPORATION)
C/O KANTOR, DAVIDOFF ET AL.
51 EAST 42ND STREET
NEW YORK, NY 10017

FOR: HAIR CARE PRODUCTS, NAMELY, HAIR-SPRAY, IN CLASS 3 (U.S. CLS. 1, 4, 6, 50, 51 AND 52).

FIRST USE 9-10-2006; IN COMMERCE 9-10-2006.

THE MARK CONSISTS OF STANDARD CHARACTERS WITHOUT CLAIM TO ANY PARTICULAR FONT, STYLE, SIZE, OR COLOR.

NO CLAIM IS MADE TO THE EXCLUSIVE RIGHT TO USE "HOLD", APART FROM THE MARK AS SHOWN.

SN 77-000,541, FILED 9-15-2006.

WENDY GOODMAN, EXAMINING ATTORNEY

Int. Cl.: 36

Prior U.S. Cls.: 100, 101, and 102

United States Patent and Trademark Office

Reg. No. 3,485,481

Registered Aug. 12, 2008

**SERVICE MARK
PRINCIPAL REGISTER**

LENDERS ADVANTAGE

THE FIRST AMERICAN CORPORATION (CALIFORNIA CORPORATION)
1 FIRST AMERICAN WAY
SANTA ANA, CA 92707

OWNER OF U.S. REG. NOS. 2,028,977, 2,269,478, AND 2,462,056.

FOR: PROVIDING INFORMATION VIA A GLOBAL COMPUTER NETWORK IN THE FIELD OF REAL ESTATE RELATED FINANCIAL INFORMATION, IN CLASS 36 (U.S. CLS. 100, 101 AND 102).

NO CLAIM IS MADE TO THE EXCLUSIVE RIGHT TO USE "LENDERS", APART FROM THE MARK AS SHOWN.

FIRST USE 6-22-2000; IN COMMERCE 6-22-2000.

SN 77-000,584, FILED 9-15-2006.

THE MARK CONSISTS OF STANDARD CHARACTERS WITHOUT CLAIM TO ANY PARTICULAR FONT, STYLE, SIZE, OR COLOR.

PAULA MAHONEY, EXAMINING ATTORNEY

Int. Cl.: 39

Prior U.S. Cls.: 100 and 105

United States Patent and Trademark Office

Reg. No. 3,485,482

Registered Aug. 12, 2008

**SERVICE MARK
PRINCIPAL REGISTER**

Berkshire Buggy

ARNOLD HUBERMAN ASSOCIATES, INC (NEW
YORK CORPORATION)

51 EAST 25TH STREET, SUITE 501

NEW YORK, NY 10010

FOR: BUS TRANSPORT, IN CLASS 39 (U.S. CLS.
100 AND 105).

FIRST USE 4-15-2008; IN COMMERCE 4-15-2008.

THE MARK CONSISTS OF STANDARD CHAR-
ACTERS WITHOUT CLAIM TO ANY PARTICULAR
FONT, STYLE, SIZE, OR COLOR.

NO CLAIM IS MADE TO THE EXCLUSIVE
RIGHT TO USE "BERKSHIRE", APART FROM
THE MARK AS SHOWN.

SN 77-001,291, FILED 9-18-2006.

REGINA DRUMMOND, EXAMINING ATTORNEY

Int. Cl.: 34

Prior U.S. Cls.: 2, 8, 9, and 17

United States Patent and Trademark Office

Reg. No. 3,485,483

Registered Aug. 12, 2008

**TRADEMARK
PRINCIPAL REGISTER**

MEMORIES

CUBAN CIGAR BRANDS, N.V. (NETHERLD AN-
TILLES CORPORATION)
5900 NORTH ANDREWS AVENUE
FORT LAUDERDALE, FL 33309

THE MARK CONSISTS OF STANDARD CHAR-
ACTERS WITHOUT CLAIM TO ANY PARTICULAR
FONT, STYLE, SIZE, OR COLOR.

FOR: CIGARS, LITTLE CIGARS, ROLL-YOUR-
OWN TOBACCO, PIPE TOBACCO AND SMOKE-
LESS TOBACCO, IN CLASS 34 (U.S. CLS. 2, 8, 9 AND
17).

SN 77-001,380, FILED 9-18-2006.

FIRST USE 12-23-2002; IN COMMERCE 12-23-2002.

SHARON MEIER, EXAMINING ATTORNEY

Int. Cl.: 5

Prior U.S. Cls.: 6, 18, 44, 46, 51, and 52

Reg. No. 3,485,484

United States Patent and Trademark Office

Registered Aug. 12, 2008

**TRADEMARK
PRINCIPAL REGISTER**

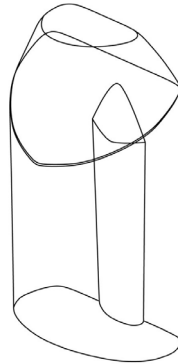

3M COMPANY (DELAWARE CORPORATION)
220-9E-01
3M CENTER 2501 HUDSON ROAD
ST. PAUL, MN 55144

FOR: ADHESIVE BANDAGES, IN CLASS 5 (U.S.
CLS. 6, 18, 44, 46, 51 AND 52).

FIRST USE 1-30-2007; IN COMMERCE 1-30-2007.

THE MARK CONSISTS OF THE THREE-DIMENSIONAL SHAPE OF THE PACKAGING FOR THE GOODS. THE DRAWING SHOWS A TRANSPARENT VIEW OF THE PACKAGING SO THAT ALL SIDES ARE SHOWN. THE DISTINCTIVE TORPEDO-SHAPED DESIGN ON THE BACK OF THE PACKAGE IS INDENTED.

SN 77-001,509, FILED 9-18-2006.

NAKWAMA ANKRAH, EXAMINING ATTORNEY

Int. Cl.: 43

Prior U.S. Cls.: 100 and 101

United States Patent and Trademark Office

Reg. No. 3,485,485

Registered Aug. 12, 2008

**SERVICE MARK
PRINCIPAL REGISTER**

The Vibe Lounge

OAKTOWN INVESTMENT PARTNERS, INC.
(CALIFORNIA CORPORATION)

5818 FLEMING AVENUE

OAKLAND, CA 94605

FOR: COCKTAIL LOUNGES, IN CLASS 43 (U.S.
CLS. 100 AND 101).

FIRST USE 11-26-2007; IN COMMERCE 11-26-2007.

THE MARK CONSISTS OF STANDARD CHAR-
ACTERS WITHOUT CLAIM TO ANY PARTICULAR
FONT, STYLE, SIZE, OR COLOR.

NO CLAIM IS MADE TO THE EXCLUSIVE
RIGHT TO USE "LOUNGE", APART FROM THE
MARK AS SHOWN.

SN 77-002,117, FILED 9-19-2006.

DAVID C. REIHNER, EXAMINING ATTORNEY

Int. Cl.: 36

Prior U.S. Cls.: 100, 101, and 102

United States Patent and Trademark Office

Reg. No. 3,485,486

Registered Aug. 12, 2008

**SERVICE MARK
PRINCIPAL REGISTER**

Equity Lease Program

RENTER APPROVED LLC (ARIZONA LTD LIAB
CO)

8137 E OLLA AVE

MESA, AZ 85212

FOR: REAL ESTATE PROPERTY MANAGE-
MENT SERVICES, IN CLASS 36 (U.S. CLS. 100, 101
AND 102).

FIRST USE 7-28-2006; IN COMMERCE 7-28-2006.

THE MARK CONSISTS OF STANDARD CHAR-
ACTERS WITHOUT CLAIM TO ANY PARTICULAR
FONT, STYLE, SIZE, OR COLOR.

NO CLAIM IS MADE TO THE EXCLUSIVE
RIGHT TO USE "LEASE PROGRAM", APART
FROM THE MARK AS SHOWN.

SN 77-002,687, FILED S.R. 9-19-2006; AM. P.R.
9-5-2007.

DAVID MURRAY, EXAMINING ATTORNEY

Int. Cl.: 19

Prior U.S. Cls.: 1, 12, 33, and 50

United States Patent and Trademark Office

Reg. No. 3,485,487

Registered Aug. 12, 2008

**TRADEMARK
PRINCIPAL REGISTER**

VERSAILLES

JELD-WEN, INC. (OREGON CORPORATION)
3250 LAKEPORT BOULEVARD
KLAMATH FALLS, OR 97601

THE MARK CONSISTS OF STANDARD CHAR-
ACTERS WITHOUT CLAIM TO ANY PARTICULAR
FONT, STYLE, SIZE, OR COLOR.

FOR: DECORATIVE WROUGHT IRON DOOR
GRILLES SOLD AS AN INTEGRAL COMPONENT
OF NON-METALLIC DOORS, IN CLASS 19 (U.S.
CLS. 1, 12, 33 AND 50).

SN 77-004,223, FILED 9-21-2006.

FIRST USE 1-31-2007; IN COMMERCE 1-31-2007.

KYLE PEETE, EXAMINING ATTORNEY

Int. Cl.: 19

Prior U.S. Cls.: 1, 12, 33, and 50

United States Patent and Trademark Office

Reg. No. 3,485,488

Registered Aug. 12, 2008

**TRADEMARK
PRINCIPAL REGISTER**

CENTURY

JELD-WEN, INC. (OREGON CORPORATION)
3250 LAKEPORT BOULEVARD
KLAMATH FALLS, OR 97601

THE MARK CONSISTS OF STANDARD CHAR-
ACTERS WITHOUT CLAIM TO ANY PARTICULAR
FONT, STYLE, SIZE, OR COLOR.

FOR: DECORATIVE WROUGHT IRON DOOR
GRILLES SOLD AS AN INTEGRAL COMPONENT
OF NON-METALLIC DOORS, IN CLASS 19 (U.S.
CLS. 1, 12, 33 AND 50).

OWNER OF U.S. REG. NO. 1,425,765.

SN 77-004,246, FILED 9-21-2006.

FIRST USE 1-31-2007; IN COMMERCE 1-31-2007.

KYLE PEETE, EXAMINING ATTORNEY

Int. Cl.: 8

Prior U.S. Cls.: 23, 28, and 44

United States Patent and Trademark Office

Reg. No. 3,485,489

Registered Aug. 12, 2008

**TRADEMARK
PRINCIPAL REGISTER**

GEARWRENCH

EASCO HAND TOOLS, INC. (DELAWARE CORPORATION)
125 POWDER FOREST DRIVE
SIMSBURY, CT 06070

FOR: HAND TOOLS, NAMELY, TORQUE WRENCHES, RATCHETING AND NON-RATCHETING SCREWDRIVERS, RATCHETING AND NON-RATCHETING PLIERS, RATCHETS, IMPACT AND NON-IMPACT SOCKETS, NON-RATCHETING BOX END AND OPEN END WRENCHES, TAP AND DIE SETS, SERPENTINE BELT TOOLS FOR USE WITH AUTOMOTIVE SERPENTINE BELTS, INSERT BITS FOR HAND TOOLS, ADJUSTABLE WRENCHES, PRY BARS AND RATCHET ADAPTERS, IN CLASS 8 (U.S. CLS. 23, 28 AND 44).

FIRST USE 7-31-2003; IN COMMERCE 7-31-2003.

THE MARK CONSISTS OF STANDARD CHARACTERS WITHOUT CLAIM TO ANY PARTICULAR FONT, STYLE, SIZE, OR COLOR.

OWNER OF U.S. REG. NOS. 2,129,955 AND 2,928,469.

SN 77-004,258, FILED 9-21-2006.

SHARON MEIER, EXAMINING ATTORNEY

Int. Cl.: 8

Prior U.S. Cls.: 23, 28, and 44

United States Patent and Trademark Office

Reg. No. 3,485,490

Registered Aug. 12, 2008

**TRADEMARK
PRINCIPAL REGISTER**

 **GEARWRENCH**

EASCO HAND TOOLS, INC. (DELAWARE CORPORATION)
125 POWDER FOREST DRIVE
SIMSBURY, CT 06070

FOR: HAND TOOLS, NAMELY, TORQUE WRENCHES, RATCHETING AND NON-RATCHETING SCREWDRIVERS, RATCHETING AND NON-RATCHETING PLIERS, RATCHETS, IMPACT AND NON-IMPACT SOCKETS, NON-RATCHETING BOX END AND OPEN END WRENCHES, TAP AND DIE SETS, SERPENTINE BELT TOOLS FOR USE WITH AUTOMOTIVE SERPENTINE BELTS, INSERT BITS FOR HAND TOOLS, ADJUSTABLE WRENCHES, PRY BARS AND RATCHET ADAPTERS, IN CLASS 8 (U.S. CLS. 23, 28 AND 44).

FIRST USE 7-31-2003; IN COMMERCE 7-31-2003.

OWNER OF U.S. REG. NOS. 2,129,955 AND 2,928,469.

THE MARK CONSISTS OF THE WORDS GEARWRENCH PRECEDED BY A SQUARE WITH CURVED LINE.

SN 77-004,406, FILED 9-21-2006.

SHARON MEIER, EXAMINING ATTORNEY

Int. Cls.: 5, 10, 11, 12, and 20

Prior U.S. Cls.: 2, 6, 13, 18, 19, 21, 22, 23, 25, 26, 31, 32, 34, 35, 39, 44, 46, 50, 51, and 52

Reg. No. 3,485,491

United States Patent and Trademark Office

Registered Aug. 12, 2008

**TRADEMARK
PRINCIPAL REGISTER**



PSS WORLD MEDICAL, INC. (FLORIDA CORPORATION)
4345 SOUTHPOINT BOULEVARD
JACKSONVILLE, FL 32216

FOR: WOUND DRESSINGS, IN CLASS 5 (U.S. CLS. 6, 18, 44, 46, 51 AND 52).

FIRST USE 2-28-2007; IN COMMERCE 2-28-2007.

FOR: DISPOSABLE MEDICAL SUPPLIES AND DURABLE MEDICAL EQUIPMENT, NAMELY, NEEDLES, AND SYRINGES, SCISSORS, FORCEPS, GLOVES, EXAMINATION TABLES, CRUTCHES, INVALID WALKERS, CANES AND IV POLES, AND PAPER FOR COVERING EXAMINATION TABLES USED IN HOSPITALS, DOCTOR'S OFFICES, AND OTHER SIMILAR HEALTH CARE ENVIRONMENTS, IN CLASS 10 (U.S. CLS. 26, 39 AND 44).

FIRST USE 6-29-2007; IN COMMERCE 6-29-2007.

FOR: ELECTRIC LIGHTING FIXTURES, IN CLASS 11 (U.S. CLS. 13, 21, 23, 31 AND 34).

FIRST USE 6-29-2007; IN COMMERCE 6-29-2007.

FOR: WHEELCHAIRS, IN CLASS 12 (U.S. CLS. 19, 21, 23, 31, 35 AND 44).

FIRST USE 8-14-2007; IN COMMERCE 8-14-2007.

FOR: STOOLS AND TABLES, IN CLASS 20 (U.S. CLS. 2, 13, 22, 25, 32 AND 50).

FIRST USE 6-29-2007; IN COMMERCE 6-29-2007.

NO CLAIM IS MADE TO THE EXCLUSIVE RIGHT TO USE "MEDICAL PRODUCTS", APART FROM THE MARK AS SHOWN.

SN 77-004,599, FILED 9-21-2006.

STEVEN PEREZ, EXAMINING ATTORNEY

Int. Cl.: 9

Prior U.S. Cls.: 21, 23, 26, 36, and 38

Reg. No. 3,485,492

United States Patent and Trademark Office

Registered Aug. 12, 2008

**TRADEMARK
PRINCIPAL REGISTER**

DJMIX

MUSICIP CORPORATION (DELAWARE CORPORATION)
SUITE 201
605 E. HUNTINGTON DRIVE
MONROVIA, CA 91016

FOR: COMPUTER SOFTWARE FOR MANAGING, IDENTIFYING AND SELECTING MUSIC AND FOR CREATING MUSIC PLAYLISTS; SOFTWARE DEVELOPMENT KITS (SDK) COMPRISED OF COMPUTER SOFTWARE FOR ADAPTING THE AFOREMENTIONED COMPUTER SOFTWARE FOR USE WITH MP3 PLAYERS, CD PLAYERS, FIRMWARE EMBEDDED IN THIRD PARTY CONSUMER PRODUCTS, AND ENTERPRISE NET-

WORK SERVERS, AND FOR ENABLING THE AFOREMENTIONED COMPUTER SOFTWARE, IN CLASS 9 (U.S. CLS. 21, 23, 26, 36 AND 38).

FIRST USE 12-0-2006; IN COMMERCE 12-0-2007.

THE MARK CONSISTS OF STANDARD CHARACTERS WITHOUT CLAIM TO ANY PARTICULAR FONT, STYLE, SIZE, OR COLOR.

SN 77-005,761, FILED 9-22-2006.

MARY MUNSON, EXAMINING ATTORNEY

Int. Cl.: 9

Prior U.S. Cls.: 21, 23, 26, 36, and 38

Reg. No. 3,485,493

United States Patent and Trademark Office

Registered Aug. 12, 2008

**TRADEMARK
PRINCIPAL REGISTER**

REALSTRUCTURE

OPTIFRAME SOFTWARE, LLC (COLORADO
LTD LIAB CO)
SUITE 400
8400 E. CRESENT PARKWAY
GREENWOOD VILLAGE, CO 80111

THE MARK CONSISTS OF STANDARD CHAR-
ACTERS WITHOUT CLAIM TO ANY PARTICULAR
FONT, STYLE, SIZE, OR COLOR.

FOR: SOFTWARE USED IN THE DESIGN AND
CONSTRUCTION OF COMMERCIAL AND RESI-
DENTIAL BUILDINGS, IN CLASS 9 (U.S. CLS. 21, 23,
26, 36 AND 38).

SN 77-006,812, FILED 9-25-2006.

FIRST USE 1-1-2008; IN COMMERCE 1-1-2008.

ALICE SUE CARRUTHERS, EXAMINING ATTOR-
NEY

Int. Cl.: 2

Prior U.S. Cls.: 6, 11, and 16

United States Patent and Trademark Office

Reg. No. 3,485,494

Registered Aug. 12, 2008

**TRADEMARK
PRINCIPAL REGISTER**

CLING-ON

NAZDAR COMPANY (ILLINOIS CORPORATION)
8501 HEDGE LANE TERRACE
SHAWNEE, KS 66227

THE MARK CONSISTS OF STANDARD CHARACTERS WITHOUT CLAIM TO ANY PARTICULAR FONT, STYLE, SIZE, OR COLOR.

FOR: UV-CURABLE SCREEN PRINTING INKS,
IN CLASS 2 (U.S. CLS. 6, 11 AND 16).

SN 77-007,503, FILED 9-26-2006.

FIRST USE 7-20-2007; IN COMMERCE 7-20-2007.

JASON TURNER, EXAMINING ATTORNEY

Int. Cl.: 36

Prior U.S. Cls.: 100, 101, and 102

United States Patent and Trademark Office

Reg. No. 3,485,495

Registered Aug. 12, 2008

**SERVICE MARK
PRINCIPAL REGISTER**

BNY CONNECT

THE BANK OF NEW YORK MELLON CORPORATION (DELAWARE CORPORATION)
ONE WALL STREET
NEW YORK, NY 10286

FOR: ON-LINE BROKERAGE SERVICES IN THE FIELD OF STOCKS AND FINANCIAL INFORMATION PROVIDED BY ELECTRONIC MEANS, NAMELY, PROVIDING BANK CUSTOMERS WITH ACCESS TO THEIR CUSTODY, TRUST AND INVESTMENT MANAGEMENT ACCOUNTS FOR MANAGING AND TRANSACTING THEIR FINANCIAL AFFAIRS; PROVIDING FINANCIAL ADVISORS WITH ACCESS TO CUSTODY, TRUST AND INVESTMENT MANAGEMENT ACCOUNTS FOR

MANAGING AND TRANSACTING FINANCIAL AFFAIRS OF OTHERS, IN CLASS 36 (U.S. CLS. 100, 101 AND 102).

FIRST USE 3-31-2002; IN COMMERCE 3-31-2002.

THE MARK CONSISTS OF STANDARD CHARACTERS WITHOUT CLAIM TO ANY PARTICULAR FONT, STYLE, SIZE, OR COLOR.

SN 77-008,266, FILED 9-27-2006.

HOWARD B. LEVINE, EXAMINING ATTORNEY

Int. Cl.: 9

Prior U.S. Cls.: 21, 23, 26, 36, and 38

Reg. No. 3,485,496

United States Patent and Trademark Office

Registered Aug. 12, 2008

**TRADEMARK
PRINCIPAL REGISTER**

PRODIGI

SPIELO MANUFACTURING ULC (CANADA
CORPORATION)
328 URQUHART AVENUE
MONCTON, NEW BRUNSWICK, CANADA E1H2R6

FOR: RECONFIGURABLE CASINO AND LOT-
TERY GAMING EQUIPMENT, NAMELY, SLOT
MACHINES AND VIDEO LOTTERY TERMINALS
AND OPERATIONAL COMPUTER GAME SOFT-
WARE THEREFOR, IN CLASS 9 (U.S. CLS. 21, 23, 26,
36 AND 38).

FIRST USE 3-26-2007; IN COMMERCE 3-27-2007.

THE MARK CONSISTS OF STANDARD CHAR-
ACTERS WITHOUT CLAIM TO ANY PARTICULAR
FONT, STYLE, SIZE, OR COLOR.

SN 77-008,302, FILED 9-27-2006.

VERNA BETH RIRIE, EXAMINING ATTORNEY

Int. Cl.: 35

Prior U.S. Cls.: 100, 101, and 102

United States Patent and Trademark Office

Reg. No. 3,485,497

Registered Aug. 12, 2008

**SERVICE MARK
PRINCIPAL REGISTER**

LIPSTICK QUEEN

LIPSTICK QUEEN, LLC (DELAWARE LTD LIAB
CO)
PENTHOUSE
284 MOTT ST.
NEW YORK, NY 10012

FOR: ON-LINE RETAIL STORE SERVICES FEATURING COSMETICS, IN CLASS 35 (U.S. CLS. 100, 101 AND 102).

FIRST USE 5-19-2008; IN COMMERCE 5-19-2008.

THE MARK CONSISTS OF STANDARD CHARACTERS WITHOUT CLAIM TO ANY PARTICULAR FONT, STYLE, SIZE, OR COLOR.

NO CLAIM IS MADE TO THE EXCLUSIVE RIGHT TO USE "LIPSTICK", APART FROM THE MARK AS SHOWN.

SN 77-008,705, FILED 9-27-2006.

ELIZABETH HUGHITT, EXAMINING ATTORNEY

Int. Cl.: 5

Prior U.S. Cls.: 6, 18, 44, 46, 51, and 52

United States Patent and Trademark Office

Reg. No. 3,485,498

Registered Aug. 12, 2008

**TRADEMARK
PRINCIPAL REGISTER**

VECTUCINE

AGELESS RESEARCH LABS (FLORIDA CORPORATION)
12021 SW 47TH STREET
FORT LAUDERDALE, FL 33330

THE MARK CONSISTS OF STANDARD CHARACTERS WITHOUT CLAIM TO ANY PARTICULAR FONT, STYLE, SIZE, OR COLOR.

FOR: NUTRITIONAL SUPPLEMENTS, IN CLASS 5 (U.S. CLS. 6, 18, 44, 46, 51 AND 52).

SN 77-009,276, FILED 9-28-2006.

FIRST USE 3-28-2008; IN COMMERCE 3-28-2008.

G. MAYERSCHOFF, EXAMINING ATTORNEY

Int. Cl.: 3

Prior U.S. Cls.: 1, 4, 6, 50, 51, and 52

Reg. No. 3,485,499

United States Patent and Trademark Office

Registered Aug. 12, 2008

**TRADEMARK
PRINCIPAL REGISTER**



NOVENA COSMECEUTICALS INC. (FLORIDA CORPORATION)
1155 S. ALHAMBRA CIRCLE
CORAL GABLES, FL 33146

FOR: NON-MEDICATED SKIN CARE PREPARATIONS AND NON-MEDICATED PRE AND POST NATAL SKIN CARE PREPARATIONS; SKIN CARE PRODUCTS FOR WOMEN WHO ARE PREGNANT, NAMELY, COSMETICS, CREAMS, LOTIONS, MOISTURIZERS, TONERS, CLEANSERS, SUNSCREEN, SOAPS, MAKEUP REMOVER, FACIAL CLAY MASKS, IN CLASS 3 (U.S. CLS. 1, 4, 6, 50, 51 AND 52).

FIRST USE 4-11-2008; IN COMMERCE 4-11-2008.

NO CLAIM IS MADE TO THE EXCLUSIVE RIGHT TO USE "MATERNAL SKIN CARE", APART FROM THE MARK AS SHOWN.

THE FOREIGN WORDING IN THE MARK TRANSLATES INTO ENGLISH AS NINE.

SN 77-009,388, FILED 9-28-2006.

HENRY S. ZAK, EXAMINING ATTORNEY

Int. Cl.: 9

Prior U.S. Cls.: 21, 23, 26, 36, and 38

Reg. No. 3,485,500

United States Patent and Trademark Office

Registered Aug. 12, 2008

TRADEMARK
PRINCIPAL REGISTER

prodigi.

SPIELO MANUFACTURING ULC (CANADA CORPORATION)
328 URQUHART AVENUE
MONCTON, NEW BRUNSWICK, CANADA E1H2R6

FOR: RECONFIGURABLE CASINO AND LOTTERY GAMING EQUIPMENT, NAMELY, SLOT MACHINES AND VIDEO LOTTERY TERMINALS AND OPERATIONAL COMPUTER GAME SOFT-

WARE THEREFOR, IN CLASS 9 (U.S. CLS. 21, 23, 26, 36 AND 38).

FIRST USE 3-26-2007; IN COMMERCE 3-26-2007.

SN 77-010,351, FILED 9-29-2006.

VERNA BETH RIRIE, EXAMINING ATTORNEY

Int. Cl.: 43

Prior U.S. Cls.: 100 and 101

United States Patent and Trademark Office

Reg. No. 3,485,501

Registered Aug. 12, 2008

**SERVICE MARK
PRINCIPAL REGISTER**

be who you are

OAKTOWN INVESTMENT PARTNERS, INC.
(CALIFORNIA CORPORATION)
5818 FLEMING AVENUE
OAKLAND, CA 94605

THE MARK CONSISTS OF STANDARD CHAR-
ACTERS WITHOUT CLAIM TO ANY PARTICULAR
FONT, STYLE, SIZE, OR COLOR.

FOR: COCKTAIL LOUNGES, IN CLASS 43 (U.S.
CLS. 100 AND 101).

SN 77-011,318, FILED 10-1-2006.

FIRST USE 11-26-2007; IN COMMERCE 11-26-2007.

DAVID C. REIHNER, EXAMINING ATTORNEY

Int. Cls.: 1, 5, and 9

Prior U.S. Cls.: 1, 5, 6, 10, 18, 21, 23, 26, 36, 38, 44, 46, 51, and 52

Reg. No. 3,485,502

United States Patent and Trademark Office

Registered Aug. 12, 2008

**TRADEMARK
PRINCIPAL REGISTER**

FLEXMIR

LUMINEX CORPORATION (DELAWARE CORPORATION)
12212 TECHNOLOGY BOULEVARD
AUSTIN, TX 78727

FOR: REAGENT PREPARATIONS FOR RESEARCH USE, NAMELY, MIRNA DETECTION KITS COMPOSED OF REAGENTS AND PROTOCOLS USED IN THE DETERMINATION OF PARTICULAR MIRNA SEQUENCES IN SAMPLES OF NUCLEIC ACID, IN CLASS 1 (U.S. CLS. 1, 5, 6, 10, 26 AND 46).

FIRST USE 12-0-2006; IN COMMERCE 12-0-2006.

FOR: REAGENT PREPARATIONS FOR MEDICAL DIAGNOSTIC USE, CLINICAL DIAGNOSTIC USE OR MEDICAL LABORATORY DIAGNOSTIC USE, NAMELY, MIRNA DETECTION KITS COMPOSED OF REAGENTS AND PROTOCOLS USED IN

THE DETERMINATION OF PARTICULAR MIRNA SEQUENCES IN SAMPLES OF NUCLEIC ACID, IN CLASS 5 (U.S. CLS. 6, 18, 44, 46, 51 AND 52).

FIRST USE 12-0-2006; IN COMMERCE 12-0-2006.

FOR: COMPUTER SOFTWARE FOR SCIENTIFIC AND MEDICAL ANALYSIS OF MIRNA SEQUENCES, IN CLASS 9 (U.S. CLS. 21, 23, 26, 36 AND 38).

FIRST USE 12-0-2006; IN COMMERCE 12-0-2006.

THE MARK CONSISTS OF STANDARD CHARACTERS WITHOUT CLAIM TO ANY PARTICULAR FONT, STYLE, SIZE, OR COLOR.

SN 77-011,527, FILED 10-2-2006.

MICHAEL SOUDERS, EXAMINING ATTORNEY

Int. Cl.: 42

Prior U.S. Cls.: 100 and 101

United States Patent and Trademark Office

Reg. No. 3,485,503

Registered Aug. 12, 2008

**SERVICE MARK
PRINCIPAL REGISTER**

access411

MORRISON CONSULTING, INC. (PENNSYLVANIA CORPORATION)
280 W. MARKET STREET
YORK, PA 17401

FOR: DEVELOPING AND INSTALLING CUSTOMIZED SOFTWARE PACKAGES FOR USE IN SCHOOLS, WHEREIN THE SOFTWARE ENABLES THE SCHOOL TO TRACK STUDENT ATTENDANCE, STUDENT GRADES AND STUDENT DISCIPLINARY ACTIONS, CREATE CLASS SCHEDULES AND TRACK TEXBOOKS, IN CLASS 42 (U.S. CLS. 100 AND 101).

FIRST USE 8-0-2006; IN COMMERCE 8-0-2006.

THE MARK CONSISTS OF STANDARD CHARACTERS WITHOUT CLAIM TO ANY PARTICULAR FONT, STYLE, SIZE, OR COLOR.

SN 77-011,705, FILED 10-2-2006.

NELSON SNYDER, EXAMINING ATTORNEY

Int. Cls.: 35 and 42

Prior U.S. Cls.: 100, 101, and 102

United States Patent and Trademark Office

Reg. No. 3,485,504

Registered Aug. 12, 2008

**SERVICE MARK
PRINCIPAL REGISTER**

SPARKS GROVE

SPARKS GROVE, INC. (GEORGIA CORPORATION)
SUITE 850
550 PHARR ROAD
ATLANTA, GA 30305

FOR: BUSINESS CONSULTING, MARKETING AND PROMOTIONAL SERVICES, NAMELY, PROVIDING ADVICE IN THE AREAS OF CORPORATE IDENTITY AND BRANDING DESIGN, PUBLIC RELATIONS, NAMELY, DEVELOPING AND IMPLEMENTING MEDIA RELATIONS STRATEGIES AND DESIGNING MULTIMEDIA COMMUNICATIONS, DEVELOPING COLLATERAL AND PROMOTIONAL MATERIALS RELATED TO THE FOREGOING; DATABASE MANAGEMENT, IN CLASS 35 (U.S. CLS. 100, 101 AND 102).

FIRST USE 10-31-2006; IN COMMERCE 10-31-2006.

FOR: DESIGN OF WEBSITE INTERFACES; DATABASE DEVELOPMENT SERVICES, IN CLASS 42 (U.S. CLS. 100 AND 101).

FIRST USE 10-31-2006; IN COMMERCE 10-31-2006.

THE MARK CONSISTS OF STANDARD CHARACTERS WITHOUT CLAIM TO ANY PARTICULAR FONT, STYLE, SIZE, OR COLOR.

SN 77-013,444, FILED 10-4-2006.

PAM WILLIS, EXAMINING ATTORNEY

Int. Cls.: 29, 30, and 43

Prior U.S. Cls.: 46, 100, and 101

United States Patent and Trademark Office

Reg. No. 3,485,505

Registered Aug. 12, 2008

TRADEMARK
SERVICE MARK
PRINCIPAL REGISTER

とんかつ
銀座梅林

GINZA BAIRIN COMPANY (JAPAN CORPORATION)
8-1, GINZA 7-CHOME
CHUO-KU, TOKYO, JAPAN 104-0061

FOR: FOOD PRODUCTS, NAMELY, PRE-PACKAGED BOX LUNCHESES CONSISTING PRIMARILY OF MEAT, SEAFOOD OR POULTRY SERVED WITH PASTA, RICE AND VEGETABLES, IN CLASS 29 (U.S. CL. 46).

FIRST USE 5-9-2007; IN COMMERCE 5-9-2007.

FOR: FOOD PRODUCTS, NAMELY, SANDWICHES, SUSHI, PIZZAS, MEAT PIES, RAVIOLI AND PRE-PACKAGED BOX LUNCHESES CONSISTING PRIMARILY OF PASTA OR RICE, IN CLASS 30 (U.S. CL. 46).

FIRST USE 5-9-2007; IN COMMERCE 5-9-2007.

FOR: SERVICES FOR PROVIDING FOOD AND COOKING, SUCH AS JAPANESE FOOD AND COOKING, NAMELY, RESTAURANTS, CAFETERIAS AND CATERING, IN CLASS 43 (U.S. CLS. 100 AND 101).

FIRST USE 5-9-2007; IN COMMERCE 5-9-2007.

NO CLAIM IS MADE TO THE EXCLUSIVE RIGHT TO USE "TONKATSU" AND "GINZA", APART FROM THE MARK AS SHOWN.

THE MARK CONSISTS OF SIX JAPANESE CHARACTERS, WITH TWO CHARACTERS ON THE TOP LINE AND FOUR CHARACTERS ON THE BOTTOM LINE.

THE JAPANESE CHARACTERS ON THE TOP LINE TRANSLITERATE TO "TONKATSU", AND THIS MEANS "DEEP FRIED PORK CUTLET" IN ENGLISH. THE FIRST TWO JAPANESE CHARACTERS ON THE BOTTOM LINE OF THE MARK TRANSLITERATE TO "GINZA", WHICH IS THE NAME OF A DISTRICT IN TOKYO. THE LAST TWO JAPANESE CHARACTERS ON THE BOTTOM LINE TRANSLITERATE TO "BAIRIN", AND THIS MEANS "PLUM-GROVE" IN ENGLISH.

SN 77-013,565, FILED 10-4-2006.

MARIAM MAHMOUDI, EXAMINING ATTORNEY

Int. Cls.: 29, 30, and 43

Prior U.S. Cls.: 46, 100, and 101

United States Patent and Trademark Office

Reg. No. 3,485,506

Registered Aug. 12, 2008

**TRADEMARK
SERVICE MARK
PRINCIPAL REGISTER**

TONKATSU GINZA BAIRIN

GINZA BAIRIN COMPANY (JAPAN CORPORATION)
8-1, GINZA 7-CHOME
CHUO-KU, TOKYO, JAPAN 104-0061

FOR: FOOD PRODUCTS, NAMELY, PRE-PACKAGED BOX LUNCHES CONSISTING PRIMARILY OF MEAT, SEAFOOD OR POULTRY SERVED WITH PASTA, RICE AND VEGETABLES , IN CLASS 29 (U.S. CL. 46).

FIRST USE 5-9-2007; IN COMMERCE 5-9-2007.

FOR: FOOD PRODUCTS, NAMELY, SANDWICHES, SUSHI, PIZZAS, MEAT PIES, RAVIOLI AND PRE-PACKAGED BOX LUNCHES CONSISTING PRIMARILY OF PASTA OR RICE, IN CLASS 30 (U.S. CL. 46).

FIRST USE 5-9-2007; IN COMMERCE 5-9-2007.

FOR: SERVICES FOR PROVIDING FOOD AND COOKING, SUCH AS JAPANESE FOOD AND COOKING, NAMELY, RESTAURANTS, CAFETER-

IAS AND CATERING, IN CLASS 43 (U.S. CLS. 100 AND 101).

FIRST USE 5-9-2007; IN COMMERCE 5-9-2007.

THE MARK CONSISTS OF STANDARD CHARACTERS WITHOUT CLAIM TO ANY PARTICULAR FONT, STYLE, SIZE, OR COLOR.

NO CLAIM IS MADE TO THE EXCLUSIVE RIGHT TO USE "TONKATSU GINZA", APART FROM THE MARK AS SHOWN.

THE ENGLISH TRANSLATION OF THE JAPANESE WORD "TONKATSU" IN THE MARK IS "DEEP FRIED PORK CUTLET". THE ENGLISH TRANSLATION OF THE JAPANESE WORD "BAIRIN" IN THE MARK IS "PLUM-GROVE".

SN 77-013,694, FILED 10-4-2006.

MARIAM MAHMOUDI, EXAMINING ATTORNEY

Int. Cls.: 29, 30, and 43

Prior U.S. Cls.: 46, 100, and 101

United States Patent and Trademark Office

Reg. No. 3,485,507

Registered Aug. 12, 2008

TRADEMARK
SERVICE MARK
PRINCIPAL REGISTER



GINZA BAIRIN COMPANY (JAPAN CORPORATION)
8-1, GINZA 7-CHOME
CHUO-KU, TOKYO, JAPAN 104-0061

FOR: FOOD PRODUCTS, NAMELY, PRE-PACKAGED BOX LUNCHES CONSISTING PRIMARILY OF MEAT, SEAFOOD OR POULTRY SERVED WITH PASTA, RICE AND VEGETABLES, IN CLASS 29 (U.S. CL. 46).

FIRST USE 5-9-2007; IN COMMERCE 5-9-2007.

FOR: FOOD PRODUCTS, NAMELY, SANDWICHES, SUSHI, PIZZAS, MEAT PIES, RAVIOLI AND PRE-PACKAGED BOX LUNCHES CONSISTING PRIMARILY OF PASTA OR RICE, IN CLASS 30 (U.S. CL. 46).

FIRST USE 5-9-2007; IN COMMERCE 5-9-2007.

FOR: SERVICES FOR PROVIDING FOOD AND COOKING, SUCH AS JAPANESE FOOD AND COOKING, NAMELY, RESTAURANTS, CAFETERIAS AND CATERING, IN CLASS 43 (U.S. CLS. 100 AND 101).

FIRST USE 5-9-2007; IN COMMERCE 5-9-2007.

NO CLAIM IS MADE TO THE EXCLUSIVE RIGHT TO USE "TOKYO," "GINZA," "TO ROKU" AND "TONKATSU", APART FROM THE MARK AS SHOWN.

THE JAPANESE CHARACTERS APPEARING ABOVE THE PIG DESIGN TRANSLITERATE TO "CHIN-TON-SHAN" AND THIS MEANS "RARE BEAUTIFUL PIG" AND/OR "VERY DELICIOUS PORK" IN ENGLISH. THE JAPANESE CHARACTER APPEARING ABOVE THE WORD "TOKYO" TRANSLITERATES TO "TO" AND THE JAPANESE CHARACTER APPEARING ABOVE THE WORD "GINZA" TRANSLITERATES TO "ROKU" AND THESE TWO CHARACTERS ARE TO BE INTERPRETED TOGETHER SO AS TO BE PRONOUNCED "TOROKU" WHICH MEANS "REGISTERED" AND/OR "THE DESIGN IS REGISTERED UNDER THE JAPANESE TRADEMARK LAW" IN ENGLISH. THE ENGLISH TRANSLATION OF THE JAPANESE WORD "TONKATSU" IN THE MARK IS "DEEP FRIED PORK CUTLET". THE ENGLISH TRANSLATION OF THE JAPANESE WORD "BAIRIN" IN THE MARK IS "PLUM-GROVE".

SN 77-014,397, FILED 10-5-2006.

MARIAM MAHMOUDI, EXAMINING ATTORNEY

Int. Cl.: 12

Prior U.S. Cls.: 19, 21, 23, 31, 35, and 44

Reg. No. 3,485,508

United States Patent and Trademark Office

Registered Aug. 12, 2008

**TRADEMARK
PRINCIPAL REGISTER**

Seat Armour

INSYNC BUSINESS SOLUTIONS, INC. (FLORIDA
CORPORATION)
1421 BANKS ROAD
MARGATE, FL 33063

FOR: VEHICLE SEAT COVERS IN THE NATURE
OF TOWELS SPECIALLY DESIGN TO FIT ON
VEHICLE SEATS, IN CLASS 12 (U.S. CLS. 19, 21, 23,
31, 35 AND 44).

FIRST USE 12-1-2006; IN COMMERCE 12-1-2006.

THE MARK CONSISTS OF STANDARD CHAR-
ACTERS WITHOUT CLAIM TO ANY PARTICULAR
FONT, STYLE, SIZE, OR COLOR.

NO CLAIM IS MADE TO THE EXCLUSIVE
RIGHT TO USE "SEAT", APART FROM THE MARK
AS SHOWN.

SN 77-014,548, FILED 10-5-2006.

STEVEN PEREZ, EXAMINING ATTORNEY

Int. Cl.: 11

Prior U.S. Cls.: 13, 21, 23, 31, and 34

Reg. No. 3,485,509

United States Patent and Trademark Office

Registered Aug. 12, 2008

**TRADEMARK
PRINCIPAL REGISTER**



GOLD MEDAL PRODUCTS CO. (OHIO CORPORATION)
10700 MEDALLION DRIVE
CINCINNATI, OH 452414807

FOR: COMMERCIAL COOKING OVENS FOR BAKING PIZZA, SANDWICHES AND OTHER QUICK PREPARATION FOODS FOR HUMAN CONSUMPTION, IN CLASS 11 (U.S. CLS. 13, 21, 23, 31 AND 34).

FIRST USE 8-4-2005; IN COMMERCE 8-4-2005.

NO CLAIM IS MADE TO THE EXCLUSIVE RIGHT TO USE "HIGH SPEED OVEN", APART FROM THE MARK AS SHOWN.

THE MARK CONSISTS OF THE WORDS "BAKE-IT-ALL HIGH SPEED OVEN" AND HAT DESIGN.

SN 77-015,929, FILED 10-6-2006.

BERYL GARDNER, EXAMINING ATTORNEY

Int. Cl.: 14

Prior U.S. Cls.: 2, 27, 28, and 50

United States Patent and Trademark Office

Reg. No. 3,485,510

Registered Aug. 12, 2008

TRADEMARK
PRINCIPAL REGISTER



WINGS OF THE WOODLAND (WEST VIRGINIA
LTD LIAB CO)
PO BOX 465
KEEDYSVILLE, MD 21756

FOR: JEWELRY, IN CLASS 14 (U.S. CLS. 2, 27, 28
AND 50).

FIRST USE 5-1-2006; IN COMMERCE 2-1-2007.

THE COLOR(S) BLACK, GREEN, YELLOW, RED,
BLUE, PURPLE, ORANGE, WHITE, AND GRAY IS/
ARE CLAIMED AS A FEATURE OF THE MARK.

THE COLOR BLACK APPEARS IN THE OUTLINE
OF THE BUTTERFLY WINGS, WITHIN THE BUT-
TERFLY WINGS DESIGN, IN THE OUTLINE OF
THE CHRYSALIS, AND IN THE TWO LETTERS
"W." THE COLORS GREEN, YELLOW, ORANGE,
RED, BLUE, PURPLE, AND WHITE APPEAR IN A
RAINBOW FASHION FROM THE TOP TO THE

BOTTOM OF THE BUTTERFLY WINGS. THE COL-
OR GREEN APPEARS IN THE SHADING OF THE
CHRYSALIS. THE COLOR YELLOW ALSO AP-
PEARS IN THREE CIRCLES AND A CURVED LINE
WITHIN THE CHRYSALIS. THE COLOR GRAY
APPEARS AS SHADING LINES ON THE CHRYSALIS.
THE COLOR WHITE LOCATED BEHIND THE
LETTER AND DESIGN OF THE MARK IS NOT A
FEATURE OF THE MARK, BUT REPRESENTS A
TRANSPARENCY THROUGH TO THE BACK-
GROUND OF THE MARK."

THE MARK CONSISTS OF THE LETTERS "WW"
IN STYLIZED FORMAT WITH THE LETTERS SE-
PARATED BY A CHRYSALIS AND COMPRISED OF
BUTTERFLY WING DESIGN.

SN 77-016,030, FILED 10-6-2006.

AMY MCMENAMIN, EXAMINING ATTORNEY

Int. Cl.: 43

Prior U.S. Cls.: 100 and 101

United States Patent and Trademark Office

Reg. No. 3,485,511

Registered Aug. 12, 2008

**SERVICE MARK
PRINCIPAL REGISTER**

WHERE DOGS HAVE A BALL

MANN, VICTORIA (UNITED STATES INDIVIDUAL)
777 6TH AVE #233
SAN DIEGO, CA 92101

THE MARK CONSISTS OF STANDARD CHARACTERS WITHOUT CLAIM TO ANY PARTICULAR FONT, STYLE, SIZE, OR COLOR.

FOR: KENNEL SERVICES, IN CLASS 43 (U.S. CLS. 100 AND 101).

SN 77-016,429, FILED 10-7-2006.

FIRST USE 1-7-2007; IN COMMERCE 3-7-2007.

BRIAN PINO, EXAMINING ATTORNEY

Int. Cl.: 9

Prior U.S. Cls.: 21, 23, 26, 36, and 38

Reg. No. 3,485,512

United States Patent and Trademark Office

Registered Aug. 12, 2008

**TRADEMARK
PRINCIPAL REGISTER**

PassPro-Tech

JSM TECHNOLOGIES, LLC (TEXAS LTD LIAB
CO)
615 ARAPAHO RD
RICHARDSON, TX 75080

THE MARK CONSISTS OF STANDARD CHAR-
ACTERS WITHOUT CLAIM TO ANY PARTICULAR
FONT, STYLE, SIZE, OR COLOR.

FOR: COMPUTER SOFTWARE AND COMPUTER
HARDWARE FOR GENERATION AND AUTHEN-
TICATION OF PASSWORDS, IN CLASS 9 (U.S. CLS.
21, 23, 26, 36 AND 38).

SN 77-016,624, FILED 10-9-2006.

FIRST USE 1-14-2007; IN COMMERCE 1-14-2007.

KATHLEEN M. VANSTON, EXAMINING ATTOR-
NEY

Int. Cl.: 10

Prior U.S. Cls.: 26, 39, and 44

United States Patent and Trademark Office

Reg. No. 3,485,513

Registered Aug. 12, 2008

**TRADEMARK
PRINCIPAL REGISTER**

CLEARLY SUPERIOR

CANNUFLOW, INC. (CALIFORNIA CORPORATION)
1190 COLEMAN ROAD, SUITE 250
SAN JOSE, CA 95710

FOR: SURGICAL INSTRUMENTS FOR USE IN ARTHROSCOPIC SURGERY, IN CLASS 10 (U.S. CLS. 26, 39 AND 44).

FIRST USE 5-15-2008; IN COMMERCE 5-15-2008.

THE MARK CONSISTS OF STANDARD CHARACTERS WITHOUT CLAIM TO ANY PARTICULAR FONT, STYLE, SIZE, OR COLOR.

NO CLAIM IS MADE TO THE EXCLUSIVE RIGHT TO USE "SUPERIOR", APART FROM THE MARK AS SHOWN.

SN 77-017,340, FILED 10-10-2006.

ALLISON SCHRODY, EXAMINING ATTORNEY

Int. Cl.: 10

Prior U.S. Cls.: 26, 39, and 44

United States Patent and Trademark Office

Reg. No. 3,485,514

Registered Aug. 12, 2008

**TRADEMARK
PRINCIPAL REGISTER**

EXTRAVASTOPPER

CANNUFLOW, INC. (CALIFORNIA CORPORATION)
1190 COLEMAN ROAD, SUITE 250
SAN JOSE, CA 95710

THE MARK CONSISTS OF STANDARD CHARACTERS WITHOUT CLAIM TO ANY PARTICULAR FONT, STYLE, SIZE, OR COLOR.

FOR: SURGICAL INSTRUMENTS FOR USE IN ARTHROSCOPIC SURGERY, IN CLASS 10 (U.S. CLS. 26, 39 AND 44).

SN 77-017,341, FILED 10-10-2006.

FIRST USE 5-15-2008; IN COMMERCE 5-15-2008.

ALLISON SCHRODY, EXAMINING ATTORNEY

Int. Cl.: 33

Prior U.S. Cls.: 47 and 49

United States Patent and Trademark Office

Reg. No. 3,485,515

Registered Aug. 12, 2008

**TRADEMARK
PRINCIPAL REGISTER**

PALM CAY

CC DISTRIBUTION, LLC (FLORIDA LTD LIAB
CO)
94500 OVERSEAS HIGHWAY
KEY LARGO, FL 33037

THE MARK CONSISTS OF STANDARD CHAR-
ACTERS WITHOUT CLAIM TO ANY PARTICULAR
FONT, STYLE, SIZE, OR COLOR.

FOR: DISTILLED SPIRITS, NAMELY, VODKA, IN
CLASS 33 (U.S. CLS. 47 AND 49).

SN 77-017,555, FILED 10-10-2006.

FIRST USE 3-6-2007; IN COMMERCE 3-6-2007.

JEFF DEFORD, EXAMINING ATTORNEY

Int. Cl.: 10

Prior U.S. Cls.: 26, 39, and 44

United States Patent and Trademark Office

Reg. No. 3,485,516

Registered Aug. 12, 2008

**TRADEMARK
PRINCIPAL REGISTER**

BACKSAVER FOWLER

HILL-ROM SERVICES, INC. (DELAWARE CORPORATION)
1069 STATE ROUTE 46 EAST
BATESVILLE, IN 47006

FOR: INTEGRAL FEATURE OF MEDICAL BEDS AND MEDICAL STRETCHERS SOLD AS A UNIT, NAMELY, A BACK SUPPORT ARTICULATION MECHANISM USED TO RAISE AND LOWER THE HEAD SECTION OF THE BED OR STRETCHER, IN CLASS 10 (U.S. CLS. 26, 39 AND 44).

FIRST USE 1-10-2007; IN COMMERCE 1-10-2007.

THE MARK CONSISTS OF STANDARD CHARACTERS WITHOUT CLAIM TO ANY PARTICULAR FONT, STYLE, SIZE, OR COLOR.

NO CLAIM IS MADE TO THE EXCLUSIVE RIGHT TO USE "FOWLER", APART FROM THE MARK AS SHOWN.

SN 77-018,851, FILED 10-11-2006.

JUSTINE D. PARKER, EXAMINING ATTORNEY

Int. Cl.: 16

Prior U.S. Cls.: 2, 5, 22, 23, 29, 37, 38, and 50

United States Patent and Trademark Office

Reg. No. 3,485,517

Registered Aug. 12, 2008

**TRADEMARK
PRINCIPAL REGISTER**

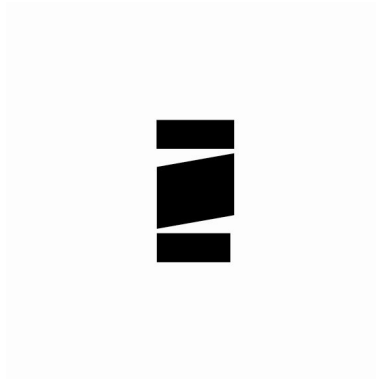

THE ZONDERVAN CORPORATION L.L.C. (DE-
LAWARE LTD LIAB CO)
5300 PATTERSON AVENUE S.E.
GRAND RAPIDS, MI 49530

FOR: SERIES OF PRINTED FICTION AND NON-
FICTION BOOKS, JOURNALS, GIFT BOOKS FEA-
TURING RELIGIOUS THEMES; BOOK COVERS
MADE FROM IMITATION LEATHER, NYLON,
CANVAS, VINYL, PVC, POLYURETHANE, MICRO
FIBER AND POLY CANVAS, IN CLASS 16 (U.S. CLS.
2, 5, 22, 23, 29, 37, 38 AND 50).

FIRST USE 11-0-2006; IN COMMERCE 11-0-2006.

THE MARK CONSISTS OF A HIGHLY STYLIZED
LETTER "Z".

SN 77-019,006, FILED 10-11-2006.

DANNEAN HETZEL, EXAMINING ATTORNEY

Int. Cl.: 9

Prior U.S. Cls.: 21, 23, 26, 36, and 38

United States Patent and Trademark Office

Reg. No. 3,485,518

Registered Aug. 12, 2008

**TRADEMARK
PRINCIPAL REGISTER**

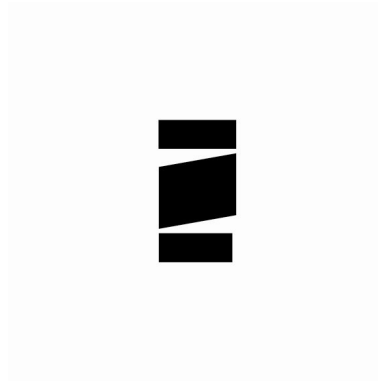

THE ZONDERVAN CORPORATION L.L.C. (DE-
LAWARE LTD LIAB CO)
5300 PATTERSON AVENUE S.E.
GRAND RAPIDS, MI 49530

FOR: SERIES OF PRE-RECORDED COMPACT
DISCS AND DVDS ON RELIGIOUS AND SPIRI-
TUAL SUBJECTS; COMPUTER SOFTWARE, NAME-
LY, CD-ROMS FEATURING SEARCH ENGINE
SOFTWARE; WIRELESS SEARCH ENGINE SOFT-
WARE; COMPUTER SOFTWARE FOR VIEWING E-
BOOKS IN THE FIELD OF RELIGION AND SPIRI-

TUALITY, IN CLASS 9 (U.S. CLS. 21, 23, 26, 36 AND
38).

FIRST USE 2-0-2007; IN COMMERCE 2-0-2007.

THE MARK CONSISTS OF A HIGHLY STYLIZED
LETTER Z.

SN 77-019,011, FILED 10-11-2006.

DANNEAN HETZEL, EXAMINING ATTORNEY

Int. Cl.: 12

Prior U.S. Cls.: 19, 21, 23, 31, 35, and 44

Reg. No. 3,485,519

United States Patent and Trademark Office

Registered Aug. 12, 2008

**TRADEMARK
PRINCIPAL REGISTER**

ASTRO BODY

GENERAL MOTORS CORPORATION (DELA-
WARE CORPORATION)
300 RENAISSANCE CENTER P.O. BOX 300
DETROIT, MI 482653000

FOR: MOTOR LAND VEHICLES, NAMELY,
TRUCKS, IN CLASS 12 (U.S. CLS. 19, 21, 23, 31, 35
AND 44).

FIRST USE 12-12-2006; IN COMMERCE 12-12-2006.

THE MARK CONSISTS OF STANDARD CHAR-
ACTERS WITHOUT CLAIM TO ANY PARTICULAR
FONT, STYLE, SIZE, OR COLOR.

NO CLAIM IS MADE TO THE EXCLUSIVE
RIGHT TO USE "BODY", APART FROM THE
MARK AS SHOWN.

SN 77-019,617, FILED 10-12-2006.

ANGELA M. MICHELI, EXAMINING ATTORNEY

Int. Cl.: 29

Prior U.S. Cl.: 46

United States Patent and Trademark Office

Reg. No. 3,485,520

Registered Aug. 12, 2008

**TRADEMARK
PRINCIPAL REGISTER**

HARLEY-DAVIDSON

H-D MICHIGAN, INC. (MICHIGAN CORPORATION)
315 W. HURON, SUITE 400
ANN ARBOR, MI 48103

THE MARK CONSISTS OF STANDARD CHARACTERS WITHOUT CLAIM TO ANY PARTICULAR FONT, STYLE, SIZE, OR COLOR.

FOR: BEEF STEAK JERKY; MEAT SNACK STICKS, NAMELY, JERKY, IN CLASS 29 (U.S. CL. 46).

SN 77-019,637, FILED 10-12-2006.

FIRST USE 1-0-2007; IN COMMERCE 1-0-2007.

RUDY R. SINGLETON, EXAMINING ATTORNEY

Int. Cl.: 35

Prior U.S. Cls.: 100, 101, and 102

United States Patent and Trademark Office

Reg. No. 3,485,521

Registered Aug. 12, 2008

**SERVICE MARK
PRINCIPAL REGISTER**

QUINTEX WIRELESS

RELIANCE COMMUNICATIONS, LLC (NEW
JERSEY CORPORATION)
TWO FOSTER COURT
SOUTH ORANGE, NJ 07079

FOR: RETAIL STORE SERVICES FEATURING
TELEPHONES, WIRELESS HAND-HELD DEVICES
FOR ACCESS TO GLOBAL COMPUTER NET-
WORKS, PAGERS, AND RELATED ACCESSORIES
AND EQUIPMENT; ADVERTISING SERVICES,
NAMELY, PROMOTION OF THE GOODS AND
SERVICES OF OTHERS, IN CLASS 35 (U.S. CLS.
100, 101 AND 102).

FIRST USE 7-1-2007; IN COMMERCE 7-1-2007.

THE MARK CONSISTS OF STANDARD CHAR-
ACTERS WITHOUT CLAIM TO ANY PARTICULAR
FONT, STYLE, SIZE, OR COLOR.

OWNER OF U.S. REG. NO. 1,489,656.

NO CLAIM IS MADE TO THE EXCLUSIVE
RIGHT TO USE "WIRELESS", APART FROM THE
MARK AS SHOWN.

SN 77-020,021, FILED 10-12-2006.

ALICE SUE CARRUTHERS, EXAMINING ATTOR-
NEY

Int. Cl.: 16

Prior U.S. Cls.: 2, 5, 22, 23, 29, 37, 38, and 50

Reg. No. 3,485,522

United States Patent and Trademark Office

Registered Aug. 12, 2008

**TRADEMARK
PRINCIPAL REGISTER**

A Notch Above

ALON, EDWARD (UNITED STATES INDIVIDUAL)
1915 NORTH EDMONT STREET
LOS ANGELES, CA 90027

THE MARK CONSISTS OF STANDARD CHARACTERS WITHOUT CLAIM TO ANY PARTICULAR FONT, STYLE, SIZE, OR COLOR.

FOR: PAPER, IN CLASS 16 (U.S. CLS. 2, 5, 22, 23, 29, 37, 38 AND 50).

SN 77-020,452, FILED 10-13-2006.

FIRST USE 10-13-2006; IN COMMERCE 1-1-2008.

PAUL CROWLEY, EXAMINING ATTORNEY

Int. Cl.: 21

Prior U.S. Cls.: 2, 13, 23, 29, 30, 33, 40, and 50

United States Patent and Trademark Office

Reg. No. 3,485,523

Registered Aug. 12, 2008

**TRADEMARK
PRINCIPAL REGISTER**

HOME STUDIO

KOHL'S ILLINOIS, INC. (NEVADA CORPORATION)
4340 FOX VALLEY CENTER DRIVE
NEW YORK SQUARE
AURORA, IL 60504

FOR: CANDLE HOLDERS NOT OF PRECIOUS METAL; BOWLS; VASES; FLOWER VASES; FIGURES OF GLASS AND CERAMIC; BASKETS OF WICKER, STRAW, AND CLOTH; DINNERWARE; BEVERAGE GLASSWARE; PITCHERS; SERVING DISHES; CERAMIC SERVING PLATTERS; CERAMIC SERVING TRAYS; SERVING FORKS; SERVING SPOONS, IN CLASS 21 (U.S. CLS. 2, 13, 23, 29, 30, 33, 40 AND 50).

FIRST USE 1-0-2008; IN COMMERCE 1-0-2008.

THE MARK CONSISTS OF STANDARD CHARACTERS WITHOUT CLAIM TO ANY PARTICULAR FONT, STYLE, SIZE, OR COLOR.

OWNER OF U.S. REG. NO. 2,936,720.

SN 77-021,323, FILED 10-14-2006.

SHARON MEIER, EXAMINING ATTORNEY

Int. Cl.: 24

Prior U.S. Cls.: 42 and 50

United States Patent and Trademark Office

Reg. No. 3,485,524

Registered Aug. 12, 2008

**TRADEMARK
PRINCIPAL REGISTER**

HOME STUDIO

KOHL'S ILLINOIS, INC. (NEVADA CORPORATION)
4340 FOX VALLEY CENTER DRIVE
NEW YORK SQUARE
AURORA, IL 60504

FOR: BATH TOWELS; HAND TOWELS; KITCHEN TOWELS; SHOWER CURTAINS; TABLE LINEN, NAMELY PLACEMATS, NAPKINS, TABLE-CLOTHS, AND TABLE RUNNERS; TOWELS , IN CLASS 24 (U.S. CLS. 42 AND 50).

FIRST USE 1-0-2008; IN COMMERCE 1-0-2008.

THE MARK CONSISTS OF STANDARD CHARACTERS WITHOUT CLAIM TO ANY PARTICULAR FONT, STYLE, SIZE, OR COLOR.

OWNER OF U.S. REG. NO. 2,936,720.

SN 77-021,328, FILED 10-14-2006.

SHARON MEIER, EXAMINING ATTORNEY

Int. Cl.: 20

Prior U.S. Cls.: 2, 13, 22, 25, 32, and 50

Reg. No. 3,485,525

United States Patent and Trademark Office

Registered Aug. 12, 2008

**TRADEMARK
PRINCIPAL REGISTER**

HOME STUDIO

KOHL'S ILLINOIS, INC. (NEVADA CORPORATION)
4340 FOX VALLEY CENTER DRIVE
NEW YORK SQUARE
AURORA, IL 60504

FOR: DECORATIVE FIGURES OF WOOD AND RESIN; DECORATIVE WOOD SCULPTURES; PICTURE FRAMES OF WOOD AND METAL, IN CLASS 20 (U.S. CLS. 2, 13, 22, 25, 32 AND 50).

FIRST USE 1-0-2008; IN COMMERCE 1-0-2008.

THE MARK CONSISTS OF STANDARD CHARACTERS WITHOUT CLAIM TO ANY PARTICULAR FONT, STYLE, SIZE, OR COLOR.

OWNER OF U.S. REG. NO. 2,936,720.

SN 77-021,331, FILED 10-14-2006.

SHARON MEIER, EXAMINING ATTORNEY

Int. Cl.: 10

Prior U.S. Cls.: 26, 39, and 44

Reg. No. 3,485,526

United States Patent and Trademark Office

Registered Aug. 12, 2008

**TRADEMARK
PRINCIPAL REGISTER**

Iglacath

KOLLSUT SCIENTIFIC CORPORATION (FLORIDA CORPORATION)
3286 NORTH 29TH CT
HOLLYWOOD, FL 33020

THE MARK CONSISTS OF STANDARD CHARACTERS WITHOUT CLAIM TO ANY PARTICULAR FONT, STYLE, SIZE, OR COLOR.

FOR: CATHETERS AND PARTS AND FITTINGS THEREFOR, IN CLASS 10 (U.S. CLS. 26, 39 AND 44).

SN 77-024,367, FILED 10-18-2006.

FIRST USE 8-1-2007; IN COMMERCE 1-16-2008.

BILL DAWE, EXAMINING ATTORNEY

Int. Cl.: 9

Prior U.S. Cls.: 21, 23, 26, 36, and 38

Reg. No. 3,485,527

United States Patent and Trademark Office

Registered Aug. 12, 2008

**TRADEMARK
PRINCIPAL REGISTER**

SIRIUS INV

SIRIUS SATELLITE RADIO INC. (DELAWARE
CORPORATION)
36TH FLOOR
1221 AVENUE OF THE AMERICAS
NEW YORK, NY 10020

FOR: EQUIPMENT FOR RECEIVING BROAD-
CAST RADIO TRANSMISSIONS AND AUDIO AND
DATA INFORMATION, NAMELY, RADIOS, RECEI-
VERS, TUNERS, DECODERS, DEMODULATORS,
AND ANTENNAS, IN CLASS 9 (U.S. CLS. 21, 23, 26, 36
AND 38).

FIRST USE 11-0-2006; IN COMMERCE 11-0-2006.

THE MARK CONSISTS OF STANDARD CHAR-
ACTERS WITHOUT CLAIM TO ANY PARTICULAR
FONT, STYLE, SIZE, OR COLOR.

OWNER OF U.S. REG. NOS. 2,481,900, 3,114,505,
AND OTHERS.

SN 77-024,941, FILED 10-19-2006.

PAULA MAHONEY, EXAMINING ATTORNEY

Int. Cl.: 7

Prior U.S. Cls.: 13, 19, 21, 23, 31, 34, and 35

Reg. No. 3,485,528

United States Patent and Trademark Office

Registered Aug. 12, 2008

**TRADEMARK
PRINCIPAL REGISTER**

IllumiTub

LG ELECTRONICS INC. (REPUBLIC OF KOREA
CORPORATION)
20, YOIDO-DONG, YONGDUNGPO-GU
SEOUL, REPUBLIC OF KOREA

FOR: DISH WASHING MACHINES FOR HOUSE-
HOLD PURPOSES; FOOD WASTE DISPOSALS;
ELECTRIC MIXERS FOR HOUSEHOLD PURPOSES;
ELECTRIC FOOD GRINDERS FOR DOMESTIC
USE; CLOTHES WASHING MACHINES; VACUUM
CLEANERS; BRUSHES FOR VACUUM CLEANERS,
IN CLASS 7 (U.S. CLS. 13, 19, 21, 23, 31, 34 AND 35).

FIRST USE 10-0-2006; IN COMMERCE 10-0-2006.

THE MARK CONSISTS OF STANDARD CHAR-
ACTERS WITHOUT CLAIM TO ANY PARTICULAR
FONT, STYLE, SIZE, OR COLOR.

SN 77-025,048, FILED 10-19-2006.

KATHLEEN M. VANSTON, EXAMINING ATTOR-
NEY

Int. Cl.: 35

Prior U.S. Cls.: 100, 101, and 102

United States Patent and Trademark Office

Reg. No. 3,485,529

Registered Aug. 12, 2008

**SERVICE MARK
PRINCIPAL REGISTER**

Ready. Fresh. NOW!

SPEEDWAY SUPERAMERICA LLC (DELAWARE
LTD LIAB CO)
500 SPEEDWAY DRIVE
ENON, OH 45323

FOR: RETAIL STORES FEATURING HOT AND
COLD SANDWICHES, HOT DOGS, PIZZA, PRE-
PARED SALADS, NACHOS, FRUIT AND VEGETA-
BLE CUPS, BAKED GOODS, HOT AND COLD
DRINKS, AND OTHER FOOD SERVICE ITEMS, IN
CLASS 35 (U.S. CLS. 100, 101 AND 102).

FIRST USE 12-31-2006; IN COMMERCE 12-31-2006.

THE MARK CONSISTS OF STANDARD CHAR-
ACTERS WITHOUT CLAIM TO ANY PARTICULAR
FONT, STYLE, SIZE, OR COLOR.

NO CLAIM IS MADE TO THE EXCLUSIVE
RIGHT TO USE "FRESH", APART FROM THE
MARK AS SHOWN.

SN 77-026,094, FILED 10-20-2006.

JUSTINE D. PARKER, EXAMINING ATTORNEY

Int. Cl.: 16

Prior U.S. Cls.: 2, 5, 22, 23, 29, 37, 38, and 50

Reg. No. 3,485,530

United States Patent and Trademark Office

Registered Aug. 12, 2008

**TRADEMARK
PRINCIPAL REGISTER**

CZECH THIS OUT

NIEMANN, CAROL J (UNITED STATES INDIVIDUAL)
4000 N 23RD
LINCOLN, NE 68521

FOR: BOOKS, CALENDARS, PRINTED GUIDES, AND TEACHING MATERIAL IN THE FIELD OF SELF-HELP, COPING SKILLS, RECIPES, COOKING, LIFE EXPERIENCES, INSIGHTS, AND INSPIRATIONAL THOUGHTS, IN CLASS 16 (U.S. CLS. 2, 5, 22, 23, 29, 37, 38 AND 50).

FIRST USE 11-0-2006; IN COMMERCE 11-0-2006.

THE MARK CONSISTS OF STANDARD CHARACTERS WITHOUT CLAIM TO ANY PARTICULAR FONT, STYLE, SIZE, OR COLOR.

SN 77-026,576, FILED 10-21-2006.

MIDGE BUTLER, EXAMINING ATTORNEY

Int. Cls.: 29 and 30

Prior U.S. Cl.: 46

United States Patent and Trademark Office

Reg. No. 3,485,531

Registered Aug. 12, 2008

**TRADEMARK
PRINCIPAL REGISTER**

AMERICAN IDOL

FREMANTLEMEDIA NORTH AMERICA, INC.
(DELAWARE CORPORATION)
4000 W. ALAMEDA AVENUE
3RD FLOOR
BURBANK, CA 91505

FOR: CHILDREN'S COMBINATION MEAL CONSISTING OF CHICKEN NUGGETS SERVED WITH FRENCH FRIED POTATOES AND A SOFT DRINK FOR CONSUMPTION ON OR OFF THE PREMISES , IN CLASS 29 (U.S. CL. 46).

FIRST USE 4-20-2007; IN COMMERCE 4-20-2007.

FOR: CHILDREN'S COMBINATION MEAL CONSISTING OF A HAMBURGER SANDWICH SERVED

WITH FRENCH FRIED POTATOES AND A SOFT DRINK FOR CONSUMPTION ON OR OFF THE PREMISES, IN CLASS 30 (U.S. CL. 46).

FIRST USE 4-20-2007; IN COMMERCE 4-20-2007.

THE MARK CONSISTS OF STANDARD CHARACTERS WITHOUT CLAIM TO ANY PARTICULAR FONT, STYLE, SIZE, OR COLOR.

SN 77-026,693, FILED 10-23-2006.

JEFF DEFORD, EXAMINING ATTORNEY

Int. Cls.: 35, 38, and 42

Prior U.S. Cls.: 100, 101, 102, and 104

United States Patent and Trademark Office

Reg. No. 3,485,532

Registered Aug. 12, 2008

**SERVICE MARK
PRINCIPAL REGISTER**

S.O.C.I.A.L.

DAVE NETWORKS, INC. (GEORGIA CORPORATION)
4712 ADMIRALTY WAY
SUITE 897
MARINA DEL RAY, CA 902926905

FOR: ADVERTISING AND PUBLICITY SERVICES, NAMELY, PROMOTING THE GOODS, SERVICES, BRAND IDENTITY AND BRAND AWARENESS OF THIRD PARTIES VIA THE INTERNET THROUGH WEB CASTING; DEVELOPMENT OF MARKETING STRATEGIES AND CONCEPTS, NAMELY, SERVICES ENABLING COMPANIES TO PROMOTE FREE REIGN, USER-GENERATED CONTENT DEVELOPMENT AND SOCIAL INTERACTION TO BUILD AUDIENCE PARTICIPATION, IN CLASS 35 (U.S. CLS. 100, 101 AND 102).

FIRST USE 2-0-2007; IN COMMERCE 2-0-2007.

FOR: GLOBAL COMPUTER NETWORK WEB-CASTING AND BROADCASTING SERVICES; TRANSMITTING DIGITAL CONTENT OVER A GLOBAL COMPUTER NETWORK, IN CLASS 38 (U.S. CLS. 100, 101 AND 104).

FIRST USE 2-0-2007; IN COMMERCE 2-0-2007.

FOR: APPLICATION SERVICE PROVIDER (ASP), NAMELY, HOSTING COMPUTER TECHNOLOGY PLATFORM SOFTWARE APPLICATIONS OF OTHERS TO CREATE QUICK TIME-TO-MARKET, INTERACTIVE SOCIAL COMMUNITY GLOBAL COMPUTER NETWORK PORTALS THAT FUNCTION AS A PUBLIC HUB WHERE CUSTOMERS, FANS, AND USERS CAN DEVELOP DYNAMIC PERSONALIZED PROFILES, UPLOAD AND SHARE CONTENT, BLOG AND VIDEO BLOG, COMMENT ON MESSAGE BOARDS, IN CLASS 42 (U.S. CLS. 100 AND 101).

FIRST USE 2-0-2007; IN COMMERCE 2-0-2007.

THE MARK CONSISTS OF STANDARD CHARACTERS WITHOUT CLAIM TO ANY PARTICULAR FONT, STYLE, SIZE, OR COLOR.

SN 77-028,006, FILED 10-24-2006.

AMY MCMENAMIN, EXAMINING ATTORNEY

Int. Cl.: 25

Prior U.S. Cls.: 22 and 39

United States Patent and Trademark Office

Reg. No. 3,485,533

Registered Aug. 12, 2008

**TRADEMARK
PRINCIPAL REGISTER**

LIMITED ADDICTION

HAYDEN MORRIS (UNITED STATES INDIVIDUAL)
APARTMENT D
815 DEL MAR DOWNS ROAD
SOLANA BEACH, CA 92075

FOR: MEN'S CLOTHING, NAMELY, BANDANAS; BATHING SUITS FOR MEN; BOARD SHORTS; BOTTOMS; DUNGAREES; FLEECE PULLOVERS; FLIP FLOPS; HEADWEAR; KNIT SHIRTS; PANTS; SHIRTS; SHORTS; SURF WEAR; SWEAT PANTS; SWEAT SHIRTS; SWEAT SHORTS; SWEATERS;

SWIM TRUNKS; T-SHIRTS, IN CLASS 25 (U.S. CLS. 22 AND 39).

FIRST USE 10-24-2006; IN COMMERCE 4-30-2007.

THE MARK CONSISTS OF STANDARD CHARACTERS WITHOUT CLAIM TO ANY PARTICULAR FONT, STYLE, SIZE, OR COLOR.

SN 77-028,027, FILED 10-24-2006.

CHRISTINA SOBRAL, EXAMINING ATTORNEY

Int. Cl.: 9

Prior U.S. Cls.: 21, 23, 26, 36, and 38

Reg. No. 3,485,534

United States Patent and Trademark Office

Registered Aug. 12, 2008

**TRADEMARK
PRINCIPAL REGISTER**

BaumConnect

HEIDELBERGER DRUCKMASCHINEN AG (FED
REP. GERMANY CORPORATION)
KURFÜRSTEN ANLAGE 52 - 60
HEIDELBERG, FED REP GERMANY D-69115

FOR: SOFTWARE FOR NETWORKING MA-
CHINERY IN THE GRAPHIC INDUSTRY; SOFT-
WARE FOR PROCESSING PRINT JOBS;
SOFTWARE FOR MACHINERY FOR FURTHER
PROCESSING OF PRINT JOBS; AND SOFTWARE
FOR THE OPERATION OF FOLDING MACHINES,
IN CLASS 9 (U.S. CLS. 21, 23, 26, 36 AND 38).

FIRST USE 5-31-2007; IN COMMERCE 5-31-2007.

THE MARK CONSISTS OF STANDARD CHAR-
ACTERS WITHOUT CLAIM TO ANY PARTICULAR
FONT, STYLE, SIZE, OR COLOR.

SN 77-028,688, FILED 10-25-2006.

HOWARD B. LEVINE, EXAMINING ATTORNEY

Int. Cl.: 42

Prior U.S. Cls.: 100 and 101

United States Patent and Trademark Office

Reg. No. 3,485,535

Registered Aug. 12, 2008

**SERVICE MARK
PRINCIPAL REGISTER**

O B A

INTERNATIONAL INSPECTION CONTROL CO.,
LTD. (TAIWAN LTD LIAB CO)
HSING LUNG RD.
4F, NO. 6, LANE 195, SEC. 4
TAIPEI, TAIWAN

FOR: QUALITY CONTROL AND MATERIAL
TESTING FOR OTHERS OF POWER SUPPLIES,
MOTHERBOARDS, AND KEYBOARDS OF COM-
PUTERS, COMPUTER DISKS AND CARTRIDGES,
COLOR MONITORS, BLACK-AND-WHITE MONI-
TORS, THIN FILM TRANSISTOR LIQUID CRYSTAL
DISPLAYS, CELL PHONES, TELEVISIONS,
COAXIAL CABLES, NOTEBOOK COMPUTERS

AND DESKTOP COMPUTERS, IN CLASS 42 (U.S.
CLS. 100 AND 101).

FIRST USE 1-31-2007; IN COMMERCE 11-23-2007.

THE MARK CONSISTS OF STANDARD CHAR-
ACTERS WITHOUT CLAIM TO ANY PARTICULAR
FONT, STYLE, SIZE, OR COLOR.

SN 77-029,553, FILED 10-25-2006.

DAVID MILLER, EXAMINING ATTORNEY

Int. Cl.: 32

Prior U.S. Cls.: 45, 46, and 48

Reg. No. 3,485,536

United States Patent and Trademark Office

Registered Aug. 12, 2008

**TRADEMARK
PRINCIPAL REGISTER**

AMMO

BARBATO, A J (UNITED STATES INDIVIDUAL)
2971 NE 16TH AVE
OAKLAND PARK, FL 333345211

FOR: NON-ALCOHOLIC BEVERAGES, NAMELY,
FRUIT FLAVORED DRINKS AND CONCENTRATES,
IN CLASS 32 (U.S. CLS. 45, 46 AND 48).

FIRST USE 1-10-2007; IN COMMERCE 5-3-2007.

THE MARK CONSISTS OF STANDARD CHARACTERS
WITHOUT CLAIM TO ANY PARTICULAR FONT,
STYLE, SIZE, OR COLOR.

SN 77-029,967, FILED 10-26-2006.

KATHERINE CONNOLLY, EXAMINING ATTORNEY

Int. Cl.: 35

Prior U.S. Cls.: 100, 101, and 102

United States Patent and Trademark Office

Reg. No. 3,485,537

Registered Aug. 12, 2008

**SERVICE MARK
PRINCIPAL REGISTER**

CRAZY 8

GYM-MARK, INC. (CALIFORNIA CORPORATION)
500 HOWARD STREET
SAN FRANCISCO, CA 94105

THE MARK CONSISTS OF STANDARD CHARACTERS WITHOUT CLAIM TO ANY PARTICULAR FONT, STYLE, SIZE, OR COLOR.

FOR: RETAIL STORE SERVICES AND ONLINE RETAIL STORE SERVICES IN THE FIELD OF CLOTHING, ACCESSORIES FOR CLOTHING, TOYS, IN CLASS 35 (U.S. CLS. 100, 101 AND 102).

SN 77-030,303, FILED 10-26-2006.

FIRST USE 8-3-2007; IN COMMERCE 8-3-2007.

G. MAYERSCHOFF, EXAMINING ATTORNEY

Int. Cl.: 20

Prior U.S. Cls.: 2, 13, 22, 25, 32, and 50

United States Patent and Trademark Office

Reg. No. 3,485,538

Registered Aug. 12, 2008

**TRADEMARK
PRINCIPAL REGISTER**

EASY-REEL

BADGER PLUG COMPANY (WISCONSIN CORPORATION)
N1045 TECHNICAL DRIVE
GREENVILLE, WI 54942

FOR: DISPENSING PACKAGING SYSTEM CONSISTING OF A CARDBOARD BOX CONTAINING A NON-METAL REEL FOR USE IN DISPENSING ROPE, WIRE, WEBBING, OR OTHER MATERIAL THAT MAY BE WOUND ABOUT A NON-METAL REEL AND DISPENSED THEREFROM FOR USE BY MANUFACTURERS, DISTRIBUTORS OR SUPPLIERS OF PRODUCTS WHICH MAY BE WOUND

ABOUT A NON-METAL REEL, IN CLASS 20 (U.S. CLS. 2, 13, 22, 25, 32 AND 50).

FIRST USE 3-1-2006; IN COMMERCE 3-1-2006.

THE MARK CONSISTS OF STANDARD CHARACTERS WITHOUT CLAIM TO ANY PARTICULAR FONT, STYLE, SIZE, OR COLOR.

SN 77-030,447, FILED 10-26-2006.

BRENDAN MCCAULEY, EXAMINING ATTORNEY

Int. Cl.: 35

Prior U.S. Cls.: 100, 101, and 102

United States Patent and Trademark Office

Reg. No. 3,485,539

Registered Aug. 12, 2008

**SERVICE MARK
PRINCIPAL REGISTER**

BUY AND WALK

ZUKERMAN, DAVID BENADERET (URUGUAY
INDIVIDUAL)
18 DE JULIO AV. 878 OFFICE 1006
MONTEVIDEO, URUGUAY 11100

THE MARK CONSISTS OF STANDARD CHAR-
ACTERS WITHOUT CLAIM TO ANY PARTICULAR
FONT, STYLE, SIZE, OR COLOR.

FOR: ON-LINE RETAIL STORE SERVICES FEATURING FOOTWEAR, IN CLASS 35 (U.S. CLS. 100, 101 AND 102).

SN 77-030,502, FILED 10-26-2006.

FIRST USE 8-17-2007; IN COMMERCE 8-17-2007.

ESTHER A. BORSUK, EXAMINING ATTORNEY

Int. Cl.: 44

Prior U.S. Cls.: 100 and 101

United States Patent and Trademark Office

Reg. No. 3,485,540

Registered Aug. 12, 2008

**SERVICE MARK
PRINCIPAL REGISTER**



BAYLOR UNIVERSITY (TEXAS CORPORATION)
718 BAYLOR AVENUE
WACO, TX 76706

FOR: MEDICAL SERVICES, IN CLASS 44 (U.S.
CLS. 100 AND 101).

FIRST USE 1-0-2007; IN COMMERCE 1-0-2007.

NO CLAIM IS MADE TO THE EXCLUSIVE
RIGHT TO USE "THE HEART HOSPITAL" AND
"PLANO" , APART FROM THE MARK AS SHOWN.

THE MARK CONSISTS OF A STYLIZED HEART
LOGO THAT INCLUDES THE WORDS "THE
HEART HOSPITAL BAYLOR PLANO".

SEC. 2(F) AS TO "BAYLOR".

SN 77-031,475, FILED 10-27-2006.

JACQUELINE A. LAVINE, EXAMINING ATTOR-
NEY

Int. Cl.: 12

Prior U.S. Cls.: 19, 21, 23, 31, 35, and 44

Reg. No. 3,485,541

United States Patent and Trademark Office

Registered Aug. 12, 2008

**TRADEMARK
PRINCIPAL REGISTER**

SOUTHERN 358

SOUTHERN MOTOR COMPANY, LLC (SOUTH
CAROLINA LTD LIAB CO)
140 TECHNOLOGY PLACE
LIBERTY, SC 29657

THE MARK CONSISTS OF STANDARD CHAR-
ACTERS WITHOUT CLAIM TO ANY PARTICULAR
FONT, STYLE, SIZE, OR COLOR.

FOR: AUTOMOBILES, IN CLASS 12 (U.S. CLS. 19,
21, 23, 31, 35 AND 44).

SN 77-031,976, FILED 10-30-2006.

FIRST USE 11-1-2006; IN COMMERCE 11-1-2006.

RENEE MCCRAY, EXAMINING ATTORNEY

Int. Cls.: 16, 35, and 38

Prior U.S. Cls.: 2, 5, 22, 23, 29, 37, 38, 50, 100, 101, 102, and 104

Reg. No. 3,485,542

United States Patent and Trademark Office

Registered Aug. 12, 2008

**TRADEMARK
SERVICE MARK
PRINCIPAL REGISTER**

SECCION AMARILLA

ANUNCIOS EN DIRECTORIOS, S.A. DE C.V.
(MEXICO CORPORATION)
RIO PANUCO NO. 38 COL. CUAUHTEMOC
MEXICO, D.F., MEXICO C.P.06500

FOR: TELEPHONE DIRECTORIES; REFERENCE BOOKS, PAMPHLETS, GUIDES, REPAIR AND USE MANUALS, ALL IN THE FIELD OF TELECOMMUNICATIONS; NON-MAGNETIC PREPAID TELEPHONE CALLING CARDS, IN CLASS 16 (U.S. CLS. 2, 5, 22, 23, 29, 37, 38 AND 50).

FIRST USE 3-0-2008; IN COMMERCE 3-0-2008.

FOR: ADVERTISING SERVICES, NAMELY, PREPARING AND PLACING ADVERTISEMENTS FOR OTHERS, PROMOTING THE GOODS AND SERVICES OF OTHERS THROUGH PRINTED DIRECTORIES, PRINTED ADVERTISING AND THROUGH DISSEMINATION OF PROMOTIONAL MATERIALS; BUSINESS SERVICES, NAMELY, PROVIDING ONLINE TELEPHONE DIRECTORIES AND INFORMATION, PROVIDING RETAIL STORE INFORMATION, SHOPPERS GUIDE INFORMATION AND BUSINESS LISTINGS BY ELECTRONIC MEANS; PREPARING BUSINESS REPORTS AND CONDUCTING BUSINESS RESEARCH; BUSINESS CONSULTATION ALL IN THE FIELD OF TELECOMMUNICATIONS, IN CLASS 35 (U.S. CLS. 100, 101 AND 102).

FIRST USE 3-0-2008; IN COMMERCE 3-0-2008.

FOR: TELECOMMUNICATION SERVICES, NAMELY, LONG DISTANCE AND INTERNATIONAL TRANSMISSION OF VOICE, SOUND, VIDEO, IMAGES, TEXT, DOCUMENTS, INFORMATION

AND DATA; TELECOMMUNICATION SERVICES PROVIDED VIA PREPAID TELEPHONE CALLING CARDS; VIDEO AND VOICE TELECONFERENCING SERVICES; PROVIDING MULTI USER ACCESS TO A GLOBAL COMPUTER NETWORK FOR THE TRANSMISSION, RECEPTION AND EXCHANGE OF VOICE, TEXT MESSAGING, AND ELECTRONIC MAIL, SOUND, VIDEO, IMAGES, TEXT, DOCUMENTS, INFORMATION AND DATA; PROVISION OF ACCESS TO ELECTRONIC SITES, NAMELY, PROVIDING ACCESS TO WEBSITES FEATURING TELEPHONE DIRECTORIES AND TELEPHONE DIRECTORY INFORMATION IN THE FIELD OF TELECOMMUNICATIONS, IN CLASS 38 (U.S. CLS. 100, 101 AND 104).

FIRST USE 3-0-2008; IN COMMERCE 3-0-2008.

OWNER OF U.S. REG. NO. 3,111,272.

NO CLAIM IS MADE TO THE EXCLUSIVE RIGHT TO USE "SECCION AMARILLA", APART FROM THE MARK AS SHOWN.

THE MARK CONSISTS OF THE WORDS "SECCION AMARILLA" WITH A DEPICTION OF AN OPEN BOOK INSIDE THE LETTER "O" ALL APPEARING ON A RECTANGLE.

THE ENGLISH TRANSLATION OF "SECCION AMARILLA" IS YELLOW SECTION.

SN 77-032,626, FILED 10-30-2006.

TOBY BULLOFF, EXAMINING ATTORNEY

Int. Cl.: 10

Prior U.S. Cls.: 26, 39, and 44

United States Patent and Trademark Office

Reg. No. 3,485,543

Registered Aug. 12, 2008

**TRADEMARK
PRINCIPAL REGISTER**

PnueView

HEMOSTASIS, LLC (DELAWARE LTD LIAB CO)
5000 TOWNSHIP PARKWAY
WHITE BEAR LAKE, MN 55110

THE MARK CONSISTS OF STANDARD CHAR-
ACTERS WITHOUT CLAIM TO ANY PARTICULAR
FONT, STYLE, SIZE, OR COLOR.

FOR: MEDICAL DEVICE, NAMELY, SMOKE
EVACUATOR FOR USE DURING LAPAROSCOPIC
SURGERY, IN CLASS 10 (U.S. CLS. 26, 39 AND 44).

SN 77-034,061, FILED 11-1-2006.

FIRST USE 1-22-2008; IN COMMERCE 1-22-2008.

HOWARD B. LEVINE, EXAMINING ATTORNEY

Int. Cl.: 36

Prior U.S. Cls.: 100, 101, and 102

United States Patent and Trademark Office

Reg. No. 3,485,544

Registered Aug. 12, 2008

**SERVICE MARK
PRINCIPAL REGISTER**

MODIFY MY LOAN

MODIFIED LENDING, INC. (D.C. CORPORATION)
3933 N. 27TH ROAD
ARLINGTON, VA 22207

FOR: FINANCIAL SERVICES, NAMELY, MORTGAGE LENDING AND FINANCING, IN CLASS 36 (U.S. CLS. 100, 101 AND 102).

FIRST USE 10-20-2006; IN COMMERCE 5-1-2007.

THE MARK CONSISTS OF STANDARD CHARACTERS WITHOUT CLAIM TO ANY PARTICULAR FONT, STYLE, SIZE, OR COLOR.

NO CLAIM IS MADE TO THE EXCLUSIVE RIGHT TO USE "MODIFY" OR "LOAN", APART FROM THE MARK AS SHOWN.

SN 77-037,712, FILED 11-6-2006.

STEVEN PEREZ, EXAMINING ATTORNEY

Int. Cl.: 36

Prior U.S. Cls.: 100, 101, and 102

United States Patent and Trademark Office

Reg. No. 3,485,545

Registered Aug. 12, 2008

**SERVICE MARK
PRINCIPAL REGISTER**

MODIFY MY MORTGAGE

MODIFIED LENDING, INC. (VIRGINIA CORPORATION)
3933 N. 27TH ROAD
ARLINGTON, VA 22207

FOR: FINANCIAL SERVICES, NAMELY, MORTGAGE LENDING AND FINANCING, IN CLASS 36 (U.S. CLS. 100, 101 AND 102).

FIRST USE 5-1-2007; IN COMMERCE 5-1-2007.

THE MARK CONSISTS OF STANDARD CHARACTERS WITHOUT CLAIM TO ANY PARTICULAR FONT, STYLE, SIZE, OR COLOR.

NO CLAIM IS MADE TO THE EXCLUSIVE RIGHT TO USE "MODIFY" OR "MORTGAGE", APART FROM THE MARK AS SHOWN.

SN 77-037,715, FILED 11-6-2006.

STEVEN PEREZ, EXAMINING ATTORNEY

Int. Cl.: 22

Prior U.S. Cls.: 1, 2, 7, 19, 22, 42, and 50

Reg. No. 3,485,546

United States Patent and Trademark Office

Registered Aug. 12, 2008

**TRADEMARK
PRINCIPAL REGISTER**

**GREEN BY NATURE
FASHIONABLE BY DESIGN**

SHAW INDUSTRIES GROUP, INC. (GEORGIA
CORPORATION)
616 EAST WALNUT AVENUE
P.O. DRAWER 2128
DALTON, GA 307222128

FIRST USE 11-0-2006; IN COMMERCE 11-0-2006.

THE MARK CONSISTS OF STANDARD CHAR-
ACTERS WITHOUT CLAIM TO ANY PARTICULAR
FONT, STYLE, SIZE, OR COLOR.

FOR: SYNTHETIC FIBERS AND FILAMENTS
FOR USE IN THE MANUFACTURE OF FABRICS,
TEXTILES, YARNS, AND CARPETS, IN CLASS 22
(U.S. CLS. 1, 2, 7, 19, 22, 42 AND 50).

SN 77-037,738, FILED 11-6-2006.

VERNA BETH RIRIE, EXAMINING ATTORNEY

Int. Cl.: 42

Prior U.S. Cls.: 100 and 101

United States Patent and Trademark Office

Reg. No. 3,485,547

Registered Aug. 12, 2008

**SERVICE MARK
PRINCIPAL REGISTER**

TOGETHER

**Targeting Optimal Goals Early,
in The Hypertensive/Dyslipidemic at Extra Risk**

C.P. PHARMACEUTICALS INTERNATIONAL
C.V. (NETHERLANDS LIMITED PARTNER-
SHIP)
235 EAST 42ND STREET
NEW YORK, NY 10017

FOR: MEDICAL AND SCIENTIFIC RESEARCH,
NAMELY, CONDUCTING CLINICAL TRIALS FOR
PHARMACEUTICAL PREPARATIONS FOR CAR-
DIOVASCULAR DISEASES AND DISORDERS , IN
CLASS 42 (U.S. CLS. 100 AND 101).

FIRST USE 3-0-2007; IN COMMERCE 3-0-2007.

NO CLAIM IS MADE TO THE EXCLUSIVE
RIGHT TO USE "HYPERTENSIVE/DYSLIPI-
DEMIC", APART FROM THE MARK AS SHOWN.

SN 77-038,408, FILED 11-7-2006.

ALICE BENMAMAN, EXAMINING ATTORNEY

Int. Cl.: 1

Prior U.S. Cls.: 1, 5, 6, 10, 26, and 46

Reg. No. 3,485,548

United States Patent and Trademark Office

Registered Aug. 12, 2008

**TRADEMARK
PRINCIPAL REGISTER**

MEDIAPRO

ARCHER-DANIELS-MIDLAND COMPANY (DE-
LAWARE CORPORATION)
4666 FARIES PARKWAY
DECATUR, IL 62526

FOR: A FERMENTATION MEDIUM, NAMELY,
THE CULTURE OF MICROORGANISMS TO FEED
MICROBES FOR THE PRODUCTION OF ANTIBIO-
TICS, ENZYMES, AND SOY SAUCES, IN CLASS 1
(U.S. CLS. 1, 5, 6, 10, 26 AND 46).

FIRST USE 12-0-2006; IN COMMERCE 12-0-2006.

THE MARK CONSISTS OF STANDARD CHAR-
ACTERS WITHOUT CLAIM TO ANY PARTICULAR
FONT, STYLE, SIZE, OR COLOR.

SN 77-038,618, FILED 11-7-2006.

MICHAEL LEWIS, EXAMINING ATTORNEY

Int. Cl.: 8

Prior U.S. Cls.: 23, 28, and 44

Reg. No. 3,485,549

United States Patent and Trademark Office

Registered Aug. 12, 2008

**TRADEMARK
PRINCIPAL REGISTER**

SOCKETS WITH BITE

SUNEX INTERNATIONAL INC. (SOUTH CAROLINA CORPORATION)
315 HAWKINS ROAD
TRAVELERS REST, SC 29690

FOR: HAND TOOLS, NAMELY, SOCKETS, SOCKET RATCHETS, AND EXTENSIONS; SOCKET WRENCH SETS, NAMELY, SOCKETS, SOCKET RATCHETS, AND EXTENSIONS SOLD AS A UNIT, IN CLASS 8 (U.S. CLS. 23, 28 AND 44).

FIRST USE 2-21-2008; IN COMMERCE 2-21-2008.

THE MARK CONSISTS OF STANDARD CHARACTERS WITHOUT CLAIM TO ANY PARTICULAR FONT, STYLE, SIZE, OR COLOR.

NO CLAIM IS MADE TO THE EXCLUSIVE RIGHT TO USE "SOCKETS", APART FROM THE MARK AS SHOWN.

SN 77-039,203, FILED 11-8-2006.

ASMAT KHAN, EXAMINING ATTORNEY

Int. Cls.: 16 and 24

Prior U.S. Cls.: 2, 5, 22, 23, 29, 37, 38, 42, and 50

United States Patent and Trademark Office

Reg. No. 3,485,550

Registered Aug. 12, 2008

**TRADEMARK
PRINCIPAL REGISTER**

NORTHERN LODGE

CARSON PIRIE SCOTT II, INC. (MISSISSIPPI
CORPORATION)
2801 EAST MARKET STREET
YORK, PA 17402

FOR: ART PRINTS, IN CLASS 16 (U.S. CLS. 2, 5, 22,
23, 29, 37, 38 AND 50).

FIRST USE 7-31-2007; IN COMMERCE 7-31-2007.

FOR: TOWELS AND BED LINENS, IN CLASS 24
(U.S. CLS. 42 AND 50).

FIRST USE 7-31-2007; IN COMMERCE 7-31-2007.

THE MARK CONSISTS OF STANDARD CHAR-
ACTERS WITHOUT CLAIM TO ANY PARTICULAR
FONT, STYLE, SIZE, OR COLOR.

SN 77-040,773, FILED 11-9-2006.

CHRISTINE COOPER, EXAMINING ATTORNEY

Int. Cl.: 3

Prior U.S. Cls.: 1, 4, 6, 50, 51, and 52

United States Patent and Trademark Office

Reg. No. 3,485,551

Registered Aug. 12, 2008

**TRADEMARK
PRINCIPAL REGISTER**

Well-Connected

SPARITUAL, LLC (CALIFORNIA LTD LIAB CO)
7710 HASKELL AVENUE
VAN NUYS, CA 91406

THE MARK CONSISTS OF STANDARD CHAR-
ACTERS WITHOUT CLAIM TO ANY PARTICULAR
FONT, STYLE, SIZE, OR COLOR.

FOR: MASSAGE OILS; BODY CREAMS, IN CLASS
3 (U.S. CLS. 1, 4, 6, 50, 51 AND 52).

SN 77-042,572, FILED 11-13-2006.

FIRST USE 1-29-2007; IN COMMERCE 1-29-2007.

SHARON MEIER, EXAMINING ATTORNEY

Int. Cl.: 44

Prior U.S. Cls.: 100 and 101

United States Patent and Trademark Office

Reg. No. 3,485,552

Registered Aug. 12, 2008

**SERVICE MARK
PRINCIPAL REGISTER**

Stat Records

ON CALL HEALTH SERVICES LLC (CONNECTI-
CUT LTD LIAB CO)
38 OLD DUCK HOLE ROAD
MADISON, CT 06443

FOR: MAINTAINING FILES AND RECORDS
CONCERNING THE MEDICAL CONDITION OF
INDIVIDUALS; MAINTAINING PERSONAL MEDI-
CAL HISTORY RECORDS AND FILES, IN CLASS 44
(U.S. CLS. 100 AND 101).

FIRST USE 2-8-2007; IN COMMERCE 3-12-2007.

THE MARK CONSISTS OF STANDARD CHAR-
ACTERS WITHOUT CLAIM TO ANY PARTICULAR
FONT, STYLE, SIZE, OR COLOR.

NO CLAIM IS MADE TO THE EXCLUSIVE
RIGHT TO USE "RECORDS", APART FROM THE
MARK AS SHOWN.

SN 77-043,374, FILED 11-14-2006.

KAREN K. BUSH, EXAMINING ATTORNEY

Int. Cl.: 20

Prior U.S. Cls.: 2, 13, 22, 25, 32, and 50

United States Patent and Trademark Office

Reg. No. 3,485,553

Registered Aug. 12, 2008

**TRADEMARK
PRINCIPAL REGISTER**

**THE PRIMABED BY
TEMPUR-PEDIC**

DAN-FOAM APS (DENMARK CORPORATION)
HOLMELUND 43
AARUP DK-5560, DENMARK

FOR: SEATING AND COUCHING MATS IN THE
NATURE OF A PILLOW OR SEAT LINER, PIL-
LOWS, CUSHIONS, MATTRESSES, TOP MATTRES-
SES, BOLSTERS AND CHAIR PADS, IN CLASS 20
(U.S. CLS. 2, 13, 22, 25, 32 AND 50).

FIRST USE 1-2-2007; IN COMMERCE 1-2-2007.

THE MARK CONSISTS OF STANDARD CHAR-
ACTERS WITHOUT CLAIM TO ANY PARTICULAR
FONT, STYLE, SIZE, OR COLOR.

OWNER OF U.S. REG. NO. 1,853,088.

SN 77-043,804, FILED 11-14-2006.

TINA BROWN, EXAMINING ATTORNEY

Int. Cl.: 25

Prior U.S. Cls.: 22 and 39

United States Patent and Trademark Office

Reg. No. 3,485,554

Registered Aug. 12, 2008

**TRADEMARK
PRINCIPAL REGISTER**

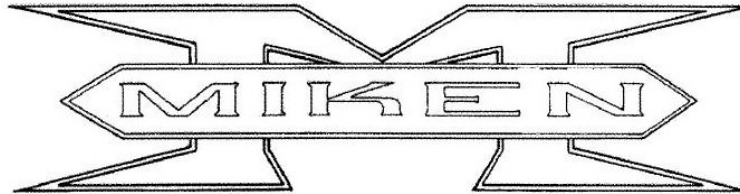

MIKEN SPORTS LLC (DELAWARE LTD LIAB
CO)
510 MARYVILLE UNIVERSITY DR. #110
ST. LOUIS, MO 63141

FOR: CLOTHING, NAMELY, HOODED SWEAT-
SHIRTS, WIND RESISTANT JACKETS, CAPS, VI-
SORS, TEE SHIRTS, POLO SHIRTS, MESH SHORTS,
SWEATSHIRTS, IN CLASS 25 (U.S. CLS. 22 AND 39).

FIRST USE 5-1-2008; IN COMMERCE 5-1-2008.

OWNER OF U.S. REG. NOS. 2,152,528, 2,706,499,
AND OTHERS.

THE MARK CONSISTS OF A STYLIZED LETTER
"M" WITH A POINTED RECTANGULAR SHIELD
CENTERED IN FRONT OF THE "M". THE STY-
LIZED WORD "MIKEN" APPEARS IN THE SHIELD.

SN 77-046,003, FILED 11-16-2006.

MONIQUE MILLER, EXAMINING ATTORNEY

Int. Cls.: 35 and 44

Prior U.S. Cls.: 100, 101, and 102

United States Patent and Trademark Office

Reg. No. 3,485,555

Registered Aug. 12, 2008

**SERVICE MARK
PRINCIPAL REGISTER**

**ALLONE HEALTH MANAGEMENT
SOLUTIONS, INC.**

ALLONE HEALTH GROUP, INC. (PENNSYLVANIA CORPORATION)
19 NORTH MAIN STREET
WILKES-BARRE, PA 18711

FOR: HEALTH MANAGEMENT SERVICES, NAMELY, PROVIDING ASSISTANCE, EVALUATION AND CONSULTATION TO ENTITIES TO HELP THEIR EMPLOYEES AND MEMBERS MAKE HEALTH, WELLNESS AND NUTRITIONAL CHANGES TO INCREASE PRODUCTIVITY AND LOWER HEALTH CARE COSTS, IN CLASS 35 (U.S. CLS. 100, 101 AND 102).

FIRST USE 4-30-2008; IN COMMERCE 4-30-2008.

FOR: HEALTH MANAGEMENT SERVICES, NAMELY, PROVIDING WELLNESS PROGRAMS FOR HEALTHY INDIVIDUALS, INDIVIDUALS AT RISK FOR HEALTH PROBLEMS, AND INDIVIDUALS WITH ILLNESSES; HEALTH MANAGE-

MENT SERVICES, NAMELY, PROVIDING DISEASE MANAGEMENT PROGRAMS FOR INDIVIDUALS WITH ILLNESSES, IN CLASS 44 (U.S. CLS. 100 AND 101).

FIRST USE 4-30-2008; IN COMMERCE 4-30-2008.

THE MARK CONSISTS OF STANDARD CHARACTERS WITHOUT CLAIM TO ANY PARTICULAR FONT, STYLE, SIZE, OR COLOR.

NO CLAIM IS MADE TO THE EXCLUSIVE RIGHT TO USE "HEALTH MANAGEMENT SOLUTIONS, INC.", APART FROM THE MARK AS SHOWN.

SN 77-046,753, FILED 11-17-2006.

JOHN KELLY, EXAMINING ATTORNEY

Int. Cl.: 3

Prior U.S. Cls.: 1, 4, 6, 50, 51, and 52

Reg. No. 3,485,556

United States Patent and Trademark Office

Registered Aug. 12, 2008

TRADEMARK
PRINCIPAL REGISTER



WRIGHT, EDWINA (UNITED STATES INDIVIDUAL)
1139 DR. MARTIN LUTHER KING JR. STREET
INDIANAPOLIS, IN 46202

FOR: COSMETICS AND PERSONAL CARE PRODUCTS, NAMELY, LIP BALMS, LIP POMADES, FINGERNAIL OILS, FINGERNAIL CREAMS, DEODORANTS, BODY LOTIONS, BODY OILS, BODY BUTTERS, LOTION STICKS, BODY SERUMS, BODY EXFOLIANTS, BODY MASKS, BODY WRAPS, FOAMING BODY WASHES, BODY MASSAGE OILS, ANTI-CELLULITE MASSAGE OILS, BODY GELS, BODY SPRAYS, BODY POWDER, MILK BATHS, BAR SOAPS, BATH SALTS, HERBAL BATHS, BATH OILS, BATH TEAS, FOAMING FACIAL WASH, FACIAL EXFOLIANTS, FACIAL LOTIONS, FACIAL CREAMS, FACIAL SERUMS, FACIAL CLEANSING CREAMS, FACIAL TONERS, FACIAL MASKS, EYE GEL, EYE CREAM, EYE COMPRESSES, PEELING FACIAL MASKS, ANTI-BLEMISH TONICS, ANTI-BLEMISH CREAMS, ANTI BLEMISH MASK, NECK CREAM, BREAST CREAMS, HAND LOTIONS, HAND CREAMS, FOOT CREAMS, FOOT SOAKS, FOOT POWDER, FOOT SPRAY, AFTER SHAVE GEL, AFTER SHAVE LOTIONS, SHAVING BALMS, SHAVING GELS, TOOTHPASTE, HAIR SHAMPOOS, HAIR CONDITIONERS, HAIR POMADES, HERBAL SCALP OILS, HAIR GELS, HAIR MASKS, EYE MAKEUP REMOVER LOTION, EYE MAKEUP RE-

MOVER PADS, FACIAL POWDERS, FACIAL MAKEUP, CONCEALER, BLUSHERS, LIP PENCILS, LIPSTICKS, EYE PENCILS, EYE BROW POWDERS, EYE BROW GEL, MASCARA, AFTER-SUN CARE LOTIONS, SUN SCREEN LOTIONS, AND ESSENTIAL OILS FOR PERSONAL USE, IN CLASS 3 (U.S. CLS. 1, 4, 6, 50, 51 AND 52).

FIRST USE 4-5-2008; IN COMMERCE 5-8-2008.

THE COLOR(S) BROWN AND GREEN IS/ARE CLAIMED AS A FEATURE OF THE MARK.

THE COLOR BROWN APPEARS IN THE WORDING AND THE COLOR GREEN APPEARS IN THE LEAF DESIGN.

THE MARK CONSISTS OF THE WORD "CLĒNAPURE" IN LOWER CASE LETTERS WITH 3 LEAVES POSITIONED OVER THE TOP OF THE LETTER "L" AND A HORIZONTAL LINE OVER THE FIRST LETTER "E".

SN 77-047,054, FILED 11-17-2006.

ANNE MADDEN, EXAMINING ATTORNEY

Int. Cls.: 1 and 2

Prior U.S. Cls.: 1, 5, 6, 10, 11, 16, 26, and 46

United States Patent and Trademark Office

Reg. No. 3,485,557

Registered Aug. 12, 2008

**TRADEMARK
PRINCIPAL REGISTER**

INFRACOOOL

PLASTICOLORS, INC. (OHIO CORPORATION)
2600 MICHIGAN AVENUE
ASHTABULA, OH 44005

FOR: CHEMICAL ADDITIVES USED TO INCREASE REFLECTANCE OF INFRA-RED ENERGY IN THERMOSET PLASTICS, PAINTS, AND COATINGS, AND INK APPLICATIONS, IN CLASS 1 (U.S. CLS. 1, 5, 6, 10, 26 AND 46).

FIRST USE 9-6-2006; IN COMMERCE 9-6-2006.

FOR: COLORANTS USED TO INCREASE REFLECTANCE OF INFRA-RED ENERGY IN THER-

MOSET PLASTICS, PAINTS, AND COATINGS, AND INK APPLICATIONS, IN CLASS 2 (U.S. CLS. 6, 11 AND 16).

FIRST USE 9-6-2006; IN COMMERCE 9-6-2006.

THE MARK CONSISTS OF STANDARD CHARACTERS WITHOUT CLAIM TO ANY PARTICULAR FONT, STYLE, SIZE, OR COLOR.

SN 77-047,472, FILED 11-20-2006.

SUNG IN, EXAMINING ATTORNEY

Int. Cls.: 36 and 37

Prior U.S. Cls.: 100, 101, 102, 103, and 106

United States Patent and Trademark Office

Reg. No. 3,485,558

Registered Aug. 12, 2008

**SERVICE MARK
PRINCIPAL REGISTER**

JOHN LAING HOMES
L U X U R Y

WL HOMES LLC (DELAWARE LTD LIAB CO)
895 DOVE STREET, SUITE 200
NEWPORT BEACH, CA 92660

FOR: REAL ESTATE ACQUISITION SERVICES; REAL ESTATE AGENCIES, REAL ESTATE BROKERAGE SERVICES, REAL ESTATE CONSULTATION, REAL ESTATE APPRAISAL; REAL ESTATE ESCROW SERVICES; REAL ESTATE INVESTMENT; REAL ESTATE LISTING; REAL ESTATE MANAGEMENT; REAL ESTATE MANAGEMENT CONSULTATION; REAL ESTATE PROCUREMENT FOR OTHERS; REAL ESTATE SYNDICATION; REAL ESTATE VALUATION SERVICES; PROVIDING INFORMATION IN THE FIELD OF REAL ESTATE BY MEANS OF WEBSITES FEATURING REAL ESTATE INFORMATION AND LINKING TO OTHER WEBSITES FEATURING REAL ESTATE INFORMATION; MORTGAGE LENDING, MORTGAGE BROKERAGE, MORTGAGE PROCUREMENT FOR OTHERS, MORTGAGE SERVICES, NAMELY, BUYER PRE-QUALIFICATION OF MORTGAGES FOR MORTGAGE BROKERS AND FINANCIAL INSTITUTIONS; MAINTAINING MORTGAGE ESCROW ACCOUNTS, IN CLASS 36 (U.S. CLS. 100, 101 AND 102).

FIRST USE 3-1-2007; IN COMMERCE 3-1-2007.

FOR: REAL ESTATE DEVELOPMENT SERVICES, RESIDENTIAL AND COMMERCIAL BUILDING

CONSTRUCTION, REAL ESTATE SITE SELECTION; CONSTRUCTION, MAINTENANCE AND RENOVATION OF PROPERTY; CONSTRUCTION CONSULTATION; CONSTRUCTION MANAGEMENT; CONSTRUCTION SERVICES, NAMELY, PLANNING, LAYING OUT AND CONSTRUCTION OF RESIDENTIAL AND COMMERCIAL COMMUNITIES; GENERAL CONSTRUCTION CONTRACTING; CUSTOM CONSTRUCTION OF HOMES; ROAD CONSTRUCTION, IN CLASS 37 (U.S. CLS. 100, 103 AND 106).

FIRST USE 3-1-2007; IN COMMERCE 3-1-2007.

OWNER OF U.S. REG. NOS. 2,567,065, 2,653,451, AND OTHERS.

NO CLAIM IS MADE TO THE EXCLUSIVE RIGHT TO USE "HOMES" AND "LUXURY", APART FROM THE MARK AS SHOWN.

THE NAME SHOWN IN THE MARK DOES NOT IDENTIFY A PARTICULAR LIVING INDIVIDUAL.

THE MARK CONSISTS OF THE WORDS "JOHN LAING HOMES" WITH THE WORD "LUXURY" APPEARING BELOW, ALL IN A STYLIZED FONT.

SN 77-048,943, FILED 11-21-2006.

JENNIFER DIXON, EXAMINING ATTORNEY

Int. Cl.: 12

Prior U.S. Cls.: 19, 21, 23, 31, 35, and 44

Reg. No. 3,485,559

United States Patent and Trademark Office

Registered Aug. 12, 2008

**TRADEMARK
PRINCIPAL REGISTER**



CACTUS CORPORATION CO., LTD. (JAPAN
CORPORATION)
3-37-1 NONOUE
HABIKINO, OSAKA, JAPAN

FOR: STRUCTURAL PARTS FOR AUTOMO-
BILES, IN CLASS 12 (U.S. CLS. 19, 21, 23, 31, 35 AND
44).

FIRST USE 11-16-2006; IN COMMERCE 6-1-2007.

THE MARK CONSISTS OF THE LETTERS "D A
D" IN STYLIZED FORM, WITH PART OF THE
FIRST LETTER "D," INVERTED, AND PART OF
THE LAST LETTER "D" BEING FORMED BY THE
LETTER "A".

SN 77-049,060, FILED 11-21-2006.

KATHERINE M. DUBRAY, EXAMINING ATTOR-
NEY

Int. Cl.: 33

Prior U.S. Cls.: 47 and 49

United States Patent and Trademark Office

Reg. No. 3,485,560

Registered Aug. 12, 2008

**TRADEMARK
PRINCIPAL REGISTER**



PACIFIC RIM WINEMAKERS, INC. (WASHING-
TON CORPORATION)
1111 E BURNSIDE STREET
PORTLAND, OR 97214

FIRST USE 3-15-2007; IN COMMERCE 3-15-2007.

SN 77-049,675, FILED 11-22-2006.

FOR: WINE, IN CLASS 33 (U.S. CLS. 47 AND 49).

MARIAM MAHMOUDI, EXAMINING ATTORNEY

Int. Cl.: 9

Prior U.S. Cls.: 21, 23, 26, 36, and 38

Reg. No. 3,485,561

United States Patent and Trademark Office

Registered Aug. 12, 2008

**TRADEMARK
PRINCIPAL REGISTER**

LG SHINE

LG CORP. (REPUBLIC OF KOREA CORPORATION)
20, YOIDO-DONG, YONGDONGPO-GU
SEOUL, REPUBLIC OF KOREA

FOR: PORTABLE COMMUNICATIONS APPARATUS IN THE NATURE OF PORTABLE TELEPHONE, RADIO; HANDSETS IN THE NATURE OF TELEPHONE HANDSETS; WALKIE-TALKIES; SATELLITE TELEPHONES; LAND LINE TELEPHONES; DIGITAL CELLULAR PHONES, IN CLASS 9 (U.S. CLS. 21, 23, 26, 36 AND 38).

FIRST USE 11-0-2006; IN COMMERCE 11-0-2006.

THE MARK CONSISTS OF STANDARD CHARACTERS WITHOUT CLAIM TO ANY PARTICULAR FONT, STYLE, SIZE, OR COLOR.

OWNER OF U.S. REG. NOS. 2,334,058, 2,660,965, AND OTHERS.

SN 77-049,692, FILED 11-22-2006.

LYDIA BELZER, EXAMINING ATTORNEY

Int. Cl.: 21

Prior U.S. Cls.: 2, 13, 23, 29, 30, 33, 40, and 50

United States Patent and Trademark Office

Reg. No. 3,485,562

Registered Aug. 12, 2008

**TRADEMARK
PRINCIPAL REGISTER**



HAUSENWARE, INC. (CALIFORNIA CORPORATION)
8868 LAKEWOOD DR. #337
WINDSOR, CA 95492

FOR: CERAMIC AND PORCELAIN DINNERWARE AND BAKEWARE, AND HAND-PAINTED GLASS KITCHENWARE, NAMELY, PASTA BOWLS, PITCHERS, MUGS, COOKIE JARS AND CANNISTER SETS, IN CLASS 21 (U.S. CLS. 2, 13, 23, 29, 30, 33, 40 AND 50).

FIRST USE 1-10-2008; IN COMMERCE 1-10-2008.

THE COLOR(S) GREEN IS/ARE CLAIMED AS A FEATURE OF THE MARK.

THE MARK CONSISTS OF THE LETTERS "HW" IN LOWERCASE GREEN STYLIZED TEXT.

SN 77-050,115, FILED 11-22-2006.

BRIAN PINO, EXAMINING ATTORNEY

Int. Cl.: 36

Prior U.S. Cls.: 100, 101, and 102

United States Patent and Trademark Office

Reg. No. 3,485,563

Registered Aug. 12, 2008

**SERVICE MARK
PRINCIPAL REGISTER**

CORRELATION VENTURES

FOLIO VENTURES MANAGEMENT LLC (DELA-
WARE LTD LIAB CO)
9905 RUE CHANTEMAR
SAN DIEGO, CA 92131

FOR: INVESTMENT SERVICES, NAMELY, VEN-
TURE CAPITAL SERVICES, NAMELY, PROVIDING
FINANCING TO PRIVATE COMPANIES, INCLUD-
ING EQUITY AND DEBT FINANCING TO EMER-
GING AND START-UP AND MORE MATURE
PRIVATE COMPANIES, AND MAKING PRIVATE
INVESTMENTS IN PUBLIC COMPANIES, COM-
MONLY REFERRED TO AS PIPES PRIVATE IN-
VESTMENTS IN PUBLIC ENTITIES; FUNDS
INVESTMENT CONSULTATION; INVESTMENT
MANAGEMENT; AND PUBLIC EQUITY INVEST-

MENT MANAGEMENT, IN CLASS 36 (U.S. CLS. 100,
101 AND 102).

FIRST USE 3-29-2007; IN COMMERCE 4-25-2007.

THE MARK CONSISTS OF STANDARD CHAR-
ACTERS WITHOUT CLAIM TO ANY PARTICULAR
FONT, STYLE, SIZE, OR COLOR.

NO CLAIM IS MADE TO THE EXCLUSIVE
RIGHT TO USE "VENTURES", APART FROM THE
MARK AS SHOWN.

SN 77-050,947, FILED 11-27-2006.

LAURIE KAUFMAN, EXAMINING ATTORNEY

Int. Cl.: 29

Prior U.S. Cl.: 46

United States Patent and Trademark Office

Reg. No. 3,485,564

Registered Aug. 12, 2008

**TRADEMARK
PRINCIPAL REGISTER**



WIN SOON, INC. (CALIFORNIA CORPORATION), DBA EPOCA,
4569 FIRESTONE BLVD.
SOUTH GATE, CA 90280

FOR: DAIRY-BASED BEVERAGES, IN CLASS 29
(U.S. CL. 46).

FIRST USE 12-19-2006; IN COMMERCE 12-19-2006.

THE MARK CONSISTS OF THE WORDING "EPOCA COOL" IN STYLIZED FORM ENCLOSED IN A CIRCLE.

THE FOREIGN WORDING IN THE MARK TRANSLATES INTO ENGLISH AS EPOCH.

SN 77-053,340, FILED 11-29-2006.

MARY BOAGNI, EXAMINING ATTORNEY

Int. Cl.: 43

Prior U.S. Cls.: 100 and 101

United States Patent and Trademark Office

Reg. No. 3,485,565

Registered Aug. 12, 2008

**SERVICE MARK
PRINCIPAL REGISTER**

RIX

SPRING FOOD SERVICES, L.C. (FLORIDA LTD
LIAB CO)
1610 AVENUE OF THE STAR, TRL A16
LAKE BUENA VISTA, FL 32830

THE MARK CONSISTS OF STANDARD CHAR-
ACTERS WITHOUT CLAIM TO ANY PARTICULAR
FONT, STYLE, SIZE, OR COLOR.

FOR: RESTAURANT AND BAR SERVICES, IN
CLASS 43 (U.S. CLS. 100 AND 101).

SN 77-053,727, FILED 11-30-2006.

FIRST USE 1-1-2008; IN COMMERCE 1-1-2008.

SUNG IN, EXAMINING ATTORNEY

Int. Cl.: 43

Prior U.S. Cls.: 100 and 101

United States Patent and Trademark Office

Reg. No. 3,485,566

Registered Aug. 12, 2008

**SERVICE MARK
PRINCIPAL REGISTER**

CAFE RIX

SPRING FOOD SERVICES, L.C. (FLORIDA LTD
LIAB CO)

1610 AVENUE OF THE STAR, TRL A16

LAKE BUENA VISTA, FL 32830

FOR: RESTAURANT AND BAR SERVICES, IN
CLASS 43 (U.S. CLS. 100 AND 101).

FIRST USE 1-1-2008; IN COMMERCE 1-1-2008.

THE MARK CONSISTS OF STANDARD CHAR-
ACTERS WITHOUT CLAIM TO ANY PARTICULAR
FONT, STYLE, SIZE, OR COLOR.

NO CLAIM IS MADE TO THE EXCLUSIVE
RIGHT TO USE "CAFE", APART FROM THE MARK
AS SHOWN.

SN 77-053,735, FILED 11-30-2006.

SUNG IN, EXAMINING ATTORNEY

Int. Cl.: 21

Prior U.S. Cls.: 2, 13, 23, 29, 30, 33, 40, and 50

United States Patent and Trademark Office

Reg. No. 3,485,567

Registered Aug. 12, 2008

**TRADEMARK
PRINCIPAL REGISTER**

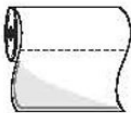
Single  **Tear**

POLDER, INC. (DELAWARE CORPORATION)
8 SLATER STREET
PORT CHESTER, NY 10573

NO CLAIM IS MADE TO THE EXCLUSIVE
RIGHT TO USE "SINGLE TEAR", APART FROM
THE MARK AS SHOWN.

FOR: PAPER TOWEL HOLDER, IN CLASS 21 (U.S.
CLS. 2, 13, 23, 29, 30, 33, 40 AND 50).

SN 77-054,002, FILED 11-30-2006.

FIRST USE 6-0-2007; IN COMMERCE 6-0-2007.

MARK PILARO, EXAMINING ATTORNEY

Int. Cl.: 25

Prior U.S. Cls.: 22 and 39

United States Patent and Trademark Office

Reg. No. 3,485,568

Registered Aug. 12, 2008

**TRADEMARK
PRINCIPAL REGISTER**

MOTIONWEAR

MOTIONWEAR, INC. (DELAWARE CORPORATION)
1315 SUNDAY DRIVE
INDIANAPOLIS, IN 46217

FOR: FOOTWEAR, IN CLASS 25 (U.S. CLS. 22 AND 39).

FIRST USE 1-15-2007; IN COMMERCE 1-15-2007.

THE MARK CONSISTS OF STANDARD CHARACTERS WITHOUT CLAIM TO ANY PARTICULAR FONT, STYLE, SIZE, OR COLOR.

OWNER OF U.S. REG. NO. 2,487,980.

SN 77-056,421, FILED 12-4-2006.

JOHN DWYER, EXAMINING ATTORNEY

Int. Cl.: 3

Prior U.S. Cls.: 1, 4, 6, 50, 51, and 52

Reg. No. 3,485,569

United States Patent and Trademark Office

Registered Aug. 12, 2008

**TRADEMARK
PRINCIPAL REGISTER**

ALLURING AVOCADO

THE GILLETTE COMPANY (DELAWARE CORPORATION)
PRUDENTIAL TOWER BUILDING
BOSTON, MA 02199

FOR: SHAVE PREPARATIONS, NAMELY, SHAVING CREAMS, SHAVING LOTIONS, AND SHAVING GELS, IN CLASS 3 (U.S. CLS. 1, 4, 6, 50, 51 AND 52).

FIRST USE 2-1-2008; IN COMMERCE 2-1-2008.

THE MARK CONSISTS OF STANDARD CHARACTERS WITHOUT CLAIM TO ANY PARTICULAR FONT, STYLE, SIZE, OR COLOR.

NO CLAIM IS MADE TO THE EXCLUSIVE RIGHT TO USE "AVOCADO", APART FROM THE MARK AS SHOWN.

SN 77-056,894, FILED 12-5-2006.

CHRISTINE COOPER, EXAMINING ATTORNEY

Int. Cl.: 16

Prior U.S. Cls.: 2, 5, 22, 23, 29, 37, 38, and 50

Reg. No. 3,485,570

United States Patent and Trademark Office

Registered Aug. 12, 2008

**TRADEMARK
PRINCIPAL REGISTER**

Louis Carton

EDELSBACHER DESIGN GROUP, INC (FLORIDA CORPORATION)

7158 CAPTAIN KIDD AVENUE

SARASOTA, FL 34231

FOR: CARDBOARD PACKAGING, IN CLASS 16
(U.S. CLS. 2, 5, 22, 23, 29, 37, 38 AND 50).

FIRST USE 4-1-2008; IN COMMERCE 4-1-2008.

THE MARK CONSISTS OF STANDARD CHARACTERS WITHOUT CLAIM TO ANY PARTICULAR FONT, STYLE, SIZE, OR COLOR.

THE NAME(S), PORTRAIT(S), AND/OR SIGNATURE(S) SHOWN IN THE MARK DOES NOT IDENTIFY A PARTICULAR LIVING INDIVIDUAL.

SN 77-056,946, FILED 12-5-2006.

DEIRDRE ROBERTSON, EXAMINING ATTORNEY

Int. Cl.: 21

Prior U.S. Cls.: 2, 13, 23, 29, 30, 33, 40, and 50

United States Patent and Trademark Office

Reg. No. 3,485,571

Registered Aug. 12, 2008

**TRADEMARK
PRINCIPAL REGISTER**

THE BOTTLE BOAT

KING, SONYA G. (UNITED STATES INDIVIDUAL)

4112 PELICAN LANE

FLORENCE, SC 29501

FOR: PORTABLE CADDY FOR MEDICINE CONTAINERS OR OTHER SMALL CONTAINERS, IN CLASS 21 (U.S. CLS. 2, 13, 23, 29, 30, 33, 40 AND 50).

FIRST USE 12-31-2002; IN COMMERCE 12-31-2002.

THE MARK CONSISTS OF STANDARD CHARACTERS WITHOUT CLAIM TO ANY PARTICULAR FONT, STYLE, SIZE, OR COLOR.

NO CLAIM IS MADE TO THE EXCLUSIVE RIGHT TO USE "BOTTLE", APART FROM THE MARK AS SHOWN.

SN 77-057,205, FILED 12-5-2006.

AMOS T. MATTHEWS, JR., EXAMINING ATTORNEY

Int. Cl.: 42

Prior U.S. Cls.: 100 and 101

United States Patent and Trademark Office

Reg. No. 3,485,572

Registered Aug. 12, 2008

**SERVICE MARK
PRINCIPAL REGISTER**

TCA Instant!

TARA TEMPLETON INC. (TEXAS CORPORATION)
1390 LEAGUE CITY PARKWAY
LEAGUE CITY, TX 77573

FOR: PROVIDING TEMPORARY USE OF ONLINE NON-DOWNLOADABLE SOFTWARE THAT ALLOWS THE ENTRY, STORAGE, AND RETRIEVAL OF SAFETY PROGRAM COMPLIANCE DATA, IN CLASS 42 (U.S. CLS. 100 AND 101).

FIRST USE 3-31-2002; IN COMMERCE 3-31-2002.

THE MARK CONSISTS OF STANDARD CHARACTERS WITHOUT CLAIM TO ANY PARTICULAR FONT, STYLE, SIZE, OR COLOR.

OWNER OF U.S. REG. NOS. 2,487,197 AND 2,840,019.

SN 77-058,145, FILED 12-6-2006.

SHARON MEIER, EXAMINING ATTORNEY

Int. Cl.: 11

Prior U.S. Cls.: 13, 21, 23, 31, and 34

United States Patent and Trademark Office

Reg. No. 3,485,573

Registered Aug. 12, 2008

**TRADEMARK
PRINCIPAL REGISTER**



THE STAY & PLAY LIGHT

WOBBLE LIGHT, LLC (DELAWARE LTD LIAB
CO)
SUITE 180
3721 N. VENTURA ROAD
ARLINGTON HEIGHTS, IL 600047489

FOR: ALL-WEATHER PORTABLE OUTDOOR
LIGHT, IN CLASS 11 (U.S. CLS. 13, 21, 23, 31 AND 34).

FIRST USE 5-18-2007; IN COMMERCE 5-18-2007.

NO CLAIM IS MADE TO THE EXCLUSIVE
RIGHT TO USE "PATIOLIGHT" AND "LIGHT",
APART FROM THE MARK AS SHOWN.

THE COLOR(S) YELLOW IS/ARE CLAIMED AS A
FEATURE OF THE MARK.

THE MARK CONSISTS OF THE TEXT "PATIOLIGHT THE STAY & PLAY LIGHT" IN WHICH THE "O" IN "PATIOLIGHT" IS LARGER THAN THE SURROUNDING TEXT, TILTED SLIGHTLY TO THE RIGHT AND STYLIZED WITH INCREASINGLY BRIGHTER YELLOW COLORS, FROM OUTSIDE IN, TO CREATE A LIGHT EMITTING EFFECT.

SN 77-058,148, FILED 12-6-2006.

CAROLYN GRAY, EXAMINING ATTORNEY

Int. Cl.: 11

Prior U.S. Cls.: 13, 21, 23, 31, and 34

United States Patent and Trademark Office

Reg. No. 3,485,574

Registered Aug. 12, 2008

TRADEMARK
PRINCIPAL REGISTER



WOBBLE LIGHT, LLC (DELAWARE LTD LIAB
CO)
3721 N. VENTURA DRIVE
SUITE 180
ARLINGTON HEIGHTS, IL 600047489

FOR: ALL-WEATHER PORTABLE OUTDOOR
LIGHT, IN CLASS 11 (U.S. CLS. 13, 21, 23, 31 AND 34).

FIRST USE 5-18-2007; IN COMMERCE 5-18-2007.

NO CLAIM IS MADE TO THE EXCLUSIVE
RIGHT TO USE "PATIOLIGHT", APART FROM
THE MARK AS SHOWN.

THE COLOR(S) YELLOW IS/ARE CLAIMED AS A
FEATURE OF THE MARK.

THE MARK CONSISTS OF THE TEXT "PATIOLIGHT" IN WHICH THE "O" IN "PATIOLIGHT" IS LARGER THAN THE SURROUNDING TEXT, TILTED SLIGHTLY TO THE RIGHT AND STYLIZED WITH INCREASINGLY BRIGHTER YELLOW COLORS, FROM OUTSIDE IN, TO CREATE A LIGHT EMITTING EFFECT.

SN 77-058,157, FILED 12-6-2006.

CAROLYN GRAY, EXAMINING ATTORNEY

Int. Cl.: 11

Prior U.S. Cls.: 13, 21, 23, 31, and 34

United States Patent and Trademark Office

Reg. No. 3,485,575

Registered Aug. 12, 2008

**TRADEMARK
PRINCIPAL REGISTER**

THE STAY & PLAY LIGHT

WOBBLE LIGHT, LLC (DELAWARE LTD LIAB
CO)
SUITE 180
3721 N. VENTURA ROAD
ARLINGTON HEIGHTS, IL 60004

FOR: ALL-WEATHER PORTABLE OUTDOOR
LIGHT, IN CLASS 11 (U.S. CLS. 13, 21, 23, 31 AND 34).

FIRST USE 5-18-2007; IN COMMERCE 5-18-2007.

THE MARK CONSISTS OF STANDARD CHAR-
ACTERS WITHOUT CLAIM TO ANY PARTICULAR
FONT, STYLE, SIZE, OR COLOR.

NO CLAIM IS MADE TO THE EXCLUSIVE
RIGHT TO USE "LIGHT", APART FROM THE
MARK AS SHOWN.

SN 77-058,165, FILED 12-6-2006.

CAROLYN GRAY, EXAMINING ATTORNEY

Int. Cls.: 25, 28, and 35

Prior U.S. Cls.: 22, 23, 38, 39, 50, 100, 101, and 102

United States Patent and Trademark Office

Reg. No. 3,485,576

Registered Aug. 12, 2008

TRADEMARK
SERVICE MARK
PRINCIPAL REGISTER



THE FROG HOUSE, INC. (CALIFORNIA CORPORATION)
6908 W. COAST HWY.
NEWPORT BEACH, CA 92663

FOR: WEARING APPAREL, NAMELY, T-SHIRTS, SWEATSHIRTS, HATS, JACKETS, SWIMMING TRUNKS, SHORTS, SWIMWEAR, SHOES, PANTS AND BELTS, IN CLASS 25 (U.S. CLS. 22 AND 39).

FIRST USE 5-1-1978; IN COMMERCE 5-1-1978.

FOR: SPORTING GOODS, NAMELY, SURFBOARDS, WETSUITS, BODY BOARDS, SKATEBOARDS, AND SURFBOARD RACKS, LEASHES AND TRACTION PADS, IN CLASS 28 (U.S. CLS. 22, 23, 38 AND 50).

FIRST USE 5-1-1978; IN COMMERCE 5-1-1978.

FOR: RETAIL STORE SERVICES FEATURING WEARING APPAREL AND SPORTING GOODS, IN CLASS 35 (U.S. CLS. 100, 101 AND 102).

FIRST USE 5-1-1978; IN COMMERCE 5-1-1978.

NO CLAIM IS MADE TO THE EXCLUSIVE RIGHT TO USE "NEWPORT BEACH, CA", APART FROM THE MARK AS SHOWN.

THE STIPPLING SHOWN IN THE DRAWING REPRESENTS SHADING IN THE MARK.

SN 77-058,494, FILED 12-6-2006.

DAVID MILLER, EXAMINING ATTORNEY

Int. Cls.: 32 and 43

Prior U.S. Cls.: 45, 46, 48, 100, and 101

United States Patent and Trademark Office

Reg. No. 3,485,577

Registered Aug. 12, 2008

**TRADEMARK
SERVICE MARK
PRINCIPAL REGISTER**

IN RING

RULE 66, LLC (CALIFORNIA LTD LIAB CO)
2078 FORTUNA DEL NORTE
ESCONDIDO, CA 92029

FOR: ENERGY DRINKS; SODA, IN CLASS 32 (U.S.
CLS. 45, 46 AND 48).

FIRST USE 3-1-2008; IN COMMERCE 3-1-2008.

FOR: RESTAURANT SERVICES , IN CLASS 43
(U.S. CLS. 100 AND 101).

FIRST USE 3-1-2008; IN COMMERCE 3-1-2008.

THE MARK CONSISTS OF STANDARD CHAR-
ACTERS WITHOUT CLAIM TO ANY PARTICULAR
FONT, STYLE, SIZE, OR COLOR.

SN 77-058,650, FILED 12-6-2006.

CAROLYN CATALDO, EXAMINING ATTORNEY

Int. Cl.: 9

Prior U.S. Cls.: 21, 23, 26, 36, and 38

Reg. No. 3,485,578

United States Patent and Trademark Office

Registered Aug. 12, 2008

**TRADEMARK
PRINCIPAL REGISTER**



WUHAN FUTE TECHNOLOGY CO., LTD (CHI-
NA CORPORATION)
NO.21 JIEFANG ROAD QIAOKOU DISTRICT
CHANGFENG TECHNOLOGY INDUSTRY GAR-
DEN
WUHAN HUBEI, CHINA 00000

FOR: AMMETERS, BATTERIES, BATTERIES FOR
VEHICLES, BATTERY CHARGERS, ELECTRIC
STORAGE BATTERIES, ELECTRICAL CELL AND
BATTERIES, MOBILE BATTERIES, RECHARGE-
ABLE ELECTRIC BATTERIES, SOLAR CELLS, IN
CLASS 9 (U.S. CLS. 21, 23, 26, 36 AND 38).

FIRST USE 12-7-2006; IN COMMERCE 12-7-2006.

"FANSO" APPEARING IN THE MARK HAS NO
SIGNIFICANCE IN THE RELEVANT TRADE OR
INDUSTRY OR AS APPLIED TO THE GOODS/
SERVICES LISTED IN THE APPLICATION, NO
GEOGRAPHICAL SIGNIFICANCE, NOR ANY
MEANING IN A FOREIGN LANGUAGE.

SN 77-058,671, FILED 12-7-2006.

LINDA E. BLOHM, EXAMINING ATTORNEY

Int. Cl.: 7

Prior U.S. Cls.: 13, 19, 21, 23, 31, 34, and 35

Reg. No. 3,485,579

United States Patent and Trademark Office

Registered Aug. 12, 2008

TRADEMARK
PRINCIPAL REGISTER

WAYLEAD

CIXI HUILI MACHINERY & ELECTRIC CO.,
LTD. (CHINA CORPORATION)
DATANG VILLAGE, KUANGYAN TOWN
CIXI CITY
ZHEJIANG PROVINCE, CHINA

FOR: AGRICULTURAL MACHINES, NAMELY, CULTIVATORS, HARVESTORS, DISK HARROWS, SEEDERS; SANDING MACHINES FOR WOODWORKING; PAPER MAKING MACHINES; LABEL PRINTING MACHINE; PLANOGRAPHIC PRINTING MACHINES; FOOD PREPARATION MACHINES, NAMELY, ELECTRIC FOOD CHOPPERS, BLENDERS, AND SLICERS; ELECTRIC FOOD PREPARATION APPARATUS, NAMELY, TUMBLERS FOR MARINATING FOOD; PACKING MACHINES; ELECTRIC FOOD PROCESSORS; CLOTHES WASHING MACHINES; EMBOSSING MACHINES; RAILROAD CONSTRUCTING MACHINES, NAMELY, COMBINATION WINCH AND BUMPERS, FAIRLEADS, AND HIGHWAY GUARDRAIL POST DRIVERS; ELEVATING WORK PLATFORM; FOUNDRY MACHINES, NAMELY, CASTING MA-

CHINES; FOUNDRY MACHINES, NAMELY MOLDING MACHINES; SPARK PLUGS; HYDRAULIC ENGINES AND MOTORS FOR MACHINES; ENGINE PARTS, NAMELY, IGNITING MAGNETOS FOR INTERNAL COMBUSTION ENGINES; ELECTRIC GENERATORS; STATORS BEING PARTS OF MACHINES FOR MOTORS; PISTONS FOR MACHINES OR GENERATORS; ELECTRIC MOTORS FOR MACHINES; MACHINES, NAMELY, VACUUM PUMPS; VALVES FOR PUMPS; COMPRESSORS FOR MACHINES; SHAFT COUPLINGS FOR MACHINES; AXLES FOR MACHINES; MACHINE PARTS NAMELY, BEARINGS; VACUUM CLEANERS; POWER-OPERATED TOOLS, NAMELY, GRINDERS, IN CLASS 7 (U.S. CLS. 13, 19, 21, 23, 31, 34 AND 35).

FIRST USE 2-10-2006; IN COMMERCE 2-10-2006.

SN 77-058,675, FILED 12-7-2006.

CHERYL CLAYTON, EXAMINING ATTORNEY

Int. Cl.: 41

Prior U.S. Cls.: 100, 101, and 107

United States Patent and Trademark Office

Reg. No. 3,485,580

Registered Aug. 12, 2008

**SERVICE MARK
PRINCIPAL REGISTER**

DAILY LAUGH BREAK

SUPERSTATION, INC. (GEORGIA CORPORATION)
C/O TURNER BROADCASTING SYSTEM, INC.
ONE CNN CENTER, 13 NORTH
ATLANTA, GA 30303

FOR: ENTERTAINMENT IN THE NATURE OF A CONTINUING COMEDY PROGRAM SERIES, PROVIDED THROUGH THE GLOBAL COMPUTER INFORMATION NETWORK, IN CLASS 41 (U.S. CLS. 100, 101 AND 107).

FIRST USE 9-0-2007; IN COMMERCE 9-0-2007.

THE MARK CONSISTS OF STANDARD CHARACTERS WITHOUT CLAIM TO ANY PARTICULAR FONT, STYLE, SIZE, OR COLOR.

OWNER OF U.S. REG. NO. 2,738,590.

NO CLAIM IS MADE TO THE EXCLUSIVE RIGHT TO USE "DAILY", APART FROM THE MARK AS SHOWN.

SN 77-058,715, FILED 12-7-2006.

AMY MCMENAMIN, EXAMINING ATTORNEY

Int. Cl.: 30

Prior U.S. Cl.: 46

United States Patent and Trademark Office

Reg. No. 3,485,581

Registered Aug. 12, 2008

**TRADEMARK
PRINCIPAL REGISTER**

CHRONIC ICE

CHRONIC ICE ESTABLISHMENT (LIECHTEN-
STEIN CORPORATION)
IM ALTEN RIET 22
9494 SCHAAN, LIECHTENSTEIN 9494

THE MARK CONSISTS OF STANDARD CHAR-
ACTERS WITHOUT CLAIM TO ANY PARTICULAR
FONT, STYLE, SIZE, OR COLOR.

FOR: BEVERAGES MADE OF TEA; GREEN TEA;
HERBAL TEA; ICED TEA; TEA; TEA-BASED BEV-
ERAGES WITH FRUIT FLAVORING, IN CLASS 30
(U.S. CL. 46).

SN 77-059,121, FILED 12-7-2006.

FIRST USE 9-6-2007; IN COMMERCE 6-6-2007.

DAVID TAYLOR, EXAMINING ATTORNEY

Int. Cl.: 35

Prior U.S. Cls.: 100, 101, and 102

United States Patent and Trademark Office

Reg. No. 3,485,582

Registered Aug. 12, 2008

**SERVICE MARK
PRINCIPAL REGISTER**

ACOMP

U.S. TAX AND BOOKKEEPING SERVICES, LLC
(CONNECTICUT LTD LIAB CO)
SUITE 434
185 MAIN STREET
NEW BRITAIN, CT 06051

FOR: FINANCIAL SERVICES, NAMELY, IN-
COME TAX CONSULTATION AND PREPARA-
TION, BOOKKEEPING SERVICES, PAYROLL
PREPARATION SERVICES, AND ADMINISTRA-
TION OF PAYROLL FOR OTHERS, IN CLASS 35
(U.S. CLS. 100, 101 AND 102).

FIRST USE 1-4-2007; IN COMMERCE 1-4-2007.

THE MARK CONSISTS OF STANDARD CHAR-
ACTERS WITHOUT CLAIM TO ANY PARTICULAR
FONT, STYLE, SIZE, OR COLOR.

SN 77-059,819, FILED 12-8-2006.

ROBERT STRUCK, EXAMINING ATTORNEY

Int. Cls.: 9, 16, and 41

**Prior U.S. Cls.: 2, 5, 21, 22, 23, 26, 29, 36, 37, 38, 50,
100, 101, and 107**

Reg. No. 3,485,583

United States Patent and Trademark Office

Registered Aug. 12, 2008

**TRADEMARK
SERVICE MARK
PRINCIPAL REGISTER**

FSTJ

FUJITSU LIMITED (JAPAN CORPORATION)
1-1 KAMIKODANAKA 4-CHOME
NAKAHARA-KU, KAWASAKI-SHI
KANAGAWA-KEN, 211-8588, JAPAN

FOR: DOWNLOADABLE ELECTRONIC PUBLICATIONS FEATURING RESEARCH IN COMMUNICATIONS, ELECTRONICS AND RELATED FIELDS; ELECTRONIC PUBLICATIONS FEATURING RESEARCH IN COMMUNICATIONS, ELECTRONICS AND RELATED FIELDS RECORDED ON COMPUTER MEDIA, IN CLASS 9 (U.S. CLS. 21, 23, 26, 36 AND 38).

FIRST USE 1-0-2007; IN COMMERCE 1-0-2007.

FOR: PRINTED MATTER AND PRINTED PUBLICATIONS, NAMELY, BOOKS, NEWSLETTERS AND PAPERS FEATURING RESEARCH IN COMMUNICATIONS, ELECTRONICS AND RELATED

FIELDS, IN CLASS 16 (U.S. CLS. 2, 5, 22, 23, 29, 37, 38 AND 50).

FIRST USE 1-0-2007; IN COMMERCE 1-0-2007.

FOR: PROVIDING ON-LINE, NON-DOWNLOADABLE ELECTRONIC PUBLICATIONS FEATURING RESEARCH IN COMMUNICATIONS, ELECTRONICS AND RELATED FIELDS, IN CLASS 41 (U.S. CLS. 100, 101 AND 107).

FIRST USE 1-0-2007; IN COMMERCE 1-0-2007.

THE MARK CONSISTS OF STANDARD CHARACTERS WITHOUT CLAIM TO ANY PARTICULAR FONT, STYLE, SIZE, OR COLOR.

SN 77-059,907, FILED 12-8-2006.

JEFF DEFORD, EXAMINING ATTORNEY

Int. Cl.: 3

Prior U.S. Cls.: 1, 4, 6, 50, 51, and 52

United States Patent and Trademark Office

Reg. No. 3,485,584

Registered Aug. 12, 2008

**TRADEMARK
PRINCIPAL REGISTER**

**ABERCROMBIE NEW YORK
COLOGNE 15**

ABERCROMBIE & FITCH TRADING CO. (OHIO
CORPORATION)
6301 FITCH PATH
NEW ALBANY, OH 43054

OWNER OF U.S. REG. NOS. 951,410, 2,500,146,
AND OTHERS.

FOR: COLOGNE; FRAGRANCES FOR PERSONAL USE; PERFUME, IN CLASS 3 (U.S. CLS. 1, 4, 6, 50, 51 AND 52).

NO CLAIM IS MADE TO THE EXCLUSIVE RIGHT TO USE "NEW YORK COLOGNE", APART FROM THE MARK AS SHOWN.

FIRST USE 10-0-2007; IN COMMERCE 10-0-2007.

SN 77-061,014, FILED 12-11-2006.

THE MARK CONSISTS OF STANDARD CHARACTERS WITHOUT CLAIM TO ANY PARTICULAR FONT, STYLE, SIZE, OR COLOR.

AMY MCMENAMIN, EXAMINING ATTORNEY

Int. Cl.: 3

Prior U.S. Cls.: 1, 4, 6, 50, 51, and 52

United States Patent and Trademark Office

Reg. No. 3,485,585

Registered Aug. 12, 2008

**TRADEMARK
PRINCIPAL REGISTER**

**ABERCROMBIE NEW YORK
PERFUME 15**

ABERCROMBIE & FITCH TRADING CO. (OHIO
CORPORATION)
6301 FITCH PATH
NEW ALBANY, OH 43054

OWNER OF U.S. REG. NOS. 951,410, 2,500,146,
AND OTHERS.

FOR: COLOGNE; FRAGRANCES FOR PERSONAL USE; PERFUME, IN CLASS 3 (U.S. CLS. 1, 4, 6, 50, 51 AND 52).

NO CLAIM IS MADE TO THE EXCLUSIVE RIGHT TO USE "NEW YORK PERFUME", APART FROM THE MARK AS SHOWN.

FIRST USE 10-0-2007; IN COMMERCE 10-0-2007.

SN 77-061,015, FILED 12-11-2006.

THE MARK CONSISTS OF STANDARD CHARACTERS WITHOUT CLAIM TO ANY PARTICULAR FONT, STYLE, SIZE, OR COLOR.

DAVID MILLER, EXAMINING ATTORNEY

Int. Cl.: 17

Prior U.S. Cls.: 1, 5, 12, 13, 35, and 50

Reg. No. 3,485,586

United States Patent and Trademark Office

Registered Aug. 12, 2008

**TRADEMARK
PRINCIPAL REGISTER**

KING KAULK

RED DEVIL, INC. (NEW JERSEY CORPORATION)
SUITE 750
1437 SOUTH BOULDER AVENUE
TULSA, OK 74119

FOR: SILICONE-BASED ADHESIVE AND SEALANTS, AND CAULKING COMPOUND FOR USE IN HOME CONSTRUCTION, MAINTENANCE AND REPAIR, AND FOR USE IN DO-IT-YOURSELF CRAFTS AND WOOD WORKING PROJECTS, IN CLASS 17 (U.S. CLS. 1, 5, 12, 13, 35 AND 50).

FIRST USE 4-26-2006; IN COMMERCE 5-10-2006.

THE MARK CONSISTS OF STANDARD CHARACTERS WITHOUT CLAIM TO ANY PARTICULAR FONT, STYLE, SIZE, OR COLOR.

NO CLAIM IS MADE TO THE EXCLUSIVE RIGHT TO USE "CAULK", APART FROM THE MARK AS SHOWN.

SN 77-063,168, FILED 12-13-2006.

CHRISTINE COOPER, EXAMINING ATTORNEY

Int. Cl.: 33

Prior U.S. Cls.: 47 and 49

United States Patent and Trademark Office

Reg. No. 3,485,587

Registered Aug. 12, 2008

**TRADEMARK
PRINCIPAL REGISTER**

DOGS 4 A CAUSE.ORG

CHATEAU MORRISETTE (VIRGINIA CORPORATION)
P.O. BOX 766
MEADOWS OF DAN, VA 24120

FOR: WINE, IN CLASS 33 (U.S. CLS. 47 AND 49).

FIRST USE 9-26-2006; IN COMMERCE 10-8-2006.

THE MARK CONSISTS OF STANDARD CHARACTERS WITHOUT CLAIM TO ANY PARTICULAR FONT, STYLE, SIZE, OR COLOR.

SN 77-063,796, FILED 12-13-2006.

LYDIA BELZER, EXAMINING ATTORNEY

Int. Cl.: 28

Prior U.S. Cls.: 22, 23, 38, and 50

Reg. No. 3,485,588

United States Patent and Trademark Office

Registered Aug. 12, 2008

**TRADEMARK
PRINCIPAL REGISTER**

PODSTOMPER

LANDSCAPE STRUCTURES, INC. (MINNESOTA
CORPORATION)
P.O. BOX 198
601 7TH STREET SOUTH
DELANO, MN 553280198

THE MARK CONSISTS OF STANDARD CHAR-
ACTERS WITHOUT CLAIM TO ANY PARTICULAR
FONT, STYLE, SIZE, OR COLOR.

FOR: PLAYGROUND EQUIPMENT, NAMELY,
BALANCING DISCS, CLIMBING STRUCTURES,
IN CLASS 28 (U.S. CLS. 22, 23, 38 AND 50).

SN 77-064,075, FILED 12-14-2006.

FIRST USE 12-7-2006; IN COMMERCE 12-7-2006.

EMILY CARLSEN, EXAMINING ATTORNEY

Int. Cl.: 42

Prior U.S. Cls.: 100 and 101

United States Patent and Trademark Office

Reg. No. 3,485,589

Registered Aug. 12, 2008

**SERVICE MARK
PRINCIPAL REGISTER**



MORRISON CONSULTING, INC. (PENNSYLVANIA CORPORATION)
280 W. MARKET STREET
YORK, PA 17401

FOR: DEVELOPING AND INSTALLING CUSTOMIZED SOFTWARE PACKAGES FOR USE IN SCHOOLS, WHEREIN THE SOFTWARE ENABLES THE SCHOOL TO TRACK STUDENT ATTENDANCE, STUDENT GRADES AND STUDENT DISCIPLINARY ACTIONS, CREATE CLASS SCHEDULES AND TRACK TEXTBOOKS, IN CLASS 42 (U.S. CLS. 100 AND 101).

FIRST USE 8-0-2006; IN COMMERCE 8-0-2006.

THE MARK CONSISTS OF THE WORDS "ACCESS 411" IN AN OVAL WITH A SILHOUETTE OF A MAN.

SN 77-066,142, FILED 12-18-2006.

NELSON SNYDER, EXAMINING ATTORNEY

Int. Cl.: 42

Prior U.S. Cls.: 100 and 101

United States Patent and Trademark Office

Reg. No. 3,485,590

Registered Aug. 12, 2008

**SERVICE MARK
PRINCIPAL REGISTER**

CREATING ISLANDS OF SAFETY

MORRISON CONSULTING, INC. (PENNSYLVANIA CORPORATION)
280 W. MARKET STREET
YORK, PA 17401

FOR: DEVELOPING AND INSTALLING CUSTOMIZED SOFTWARE PACKAGES FOR USE IN SCHOOLS, WHEREIN THE SOFTWARE ENABLES THE SCHOOL TO TRACK STUDENT ATTENDANCE, STUDENT GRADES AND STUDENT DISCIPLINARY ACTIONS, CREATE CLASS SCHEDULES AND TRACK TEXTBOOKS, IN CLASS 42 (U.S. CLS. 100 AND 101).

FIRST USE 8-0-2006; IN COMMERCE 8-0-2006.

THE MARK CONSISTS OF STANDARD CHARACTERS WITHOUT CLAIM TO ANY PARTICULAR FONT, STYLE, SIZE, OR COLOR.

SN 77-066,146, FILED 12-18-2006.

NELSON SNYDER, EXAMINING ATTORNEY

Int. Cl.: 28

Prior U.S. Cls.: 22, 23, 38, and 50

United States Patent and Trademark Office

Reg. No. 3,485,591

Registered Aug. 12, 2008

TRADEMARK
PRINCIPAL REGISTER



TWIN TOWER ENTERPRISE CORPORATION
(TAIWAN CORPORATION)
YUNG KANG CITY
17F.-10, NO. 22, CHUNG HUA RD.
TAINAN HSIEN R.O.C., TAIWAN

FOR: BOXING GLOVES; BOXING SWIVELS; BOXING BALLS, NAMELY, PUNCHING BALLS FOR BOXING PRACTICE; SPORTS ARTICLES, NAMELY, DUMB-BELLS, WEIGHT LIFTING BELTS, AND WEIGHT AND SANDBAG BEARING VESTS FOR EXERCISE; EXERCISE MACHINES, NAMELY, SIT-UP CHAIRS; CHEST EXPANDERS; EXERCISING PULL RODS, NAMELY, SIT-UP BARS; EXERCISE MACHINES, NAMELY, SUSPENDING TRAINING MACHINES; SPORTS BALLS; PARTS OF SPORTS SUITS FOR ATHLETIC USE, NAMELY, KNEE PADS AND GUARDS, WRIST BRACERS, CHEST PROTECTORS, SHOULDER PADS AND GUARDS, NECK GUARDS, HAND PADS AND GUARDS, ELBOW PADS AND GUARDS, ARM BRACERS, LEG PADS AND GUARDS FOR BOXING, KARATE, KICKBOXING AND KUNG-FU, SHIN PADS AND GUARDS, ANKLE PADS AND GUARDS, CROTCH GUARDS, MOUTH GUARDS, FACE MASKS FOR BOXING, KARATE, KICKBOXING AND KUNG-FU, BODY GUARDS FOR BOXING, KARATE, KICKBOXING AND KUNG-FU, HEAD GUARDS EXCLUDING SPORTS HELMETS FOR BOXING, KARATE, KICKBOXING AND KUNG-FU, HEAD GUARDING

BELTS, NAMELY, PROTECTIVE HEADBAND HEAD GUARDS FOR ATHLETIC USE, SPORTS GLOVES, NAMELY, BOXING AND KICK BOXING GLOVES AND BODY PROTECTORS FOR BOXING, KARATE, KICKBOXING AND KUNG-FU; WAIST PROTECTORS FOR BOXING, KARATE, KICKBOXING AND KUNG-FU, AND ABDOMEN GUARDS FOR BOXING, KARATE, KICKBOXING AND KUNG-FU; BAGS SPECIALLY ADAPTED FOR CARRYING SPORTS ARTICLES; FENCING EQUIPMENT, NAMELY, FOILS, MASKS, GAUNTLETS AND ARM GUARDS; MACHINES FOR PHYSICAL EXERCISE; ARCHERY ARROWS; ARCHERY BOWS; KENDO WOODEN SWORDS; KENDO MASKS; KENDO PLASTRONS; AND YOGA MATS, IN CLASS 28 (U.S. CLS. 22, 23, 38 AND 50).

FIRST USE 11-1-2006; IN COMMERCE 11-1-2006.

THE MARK CONSISTS OF DESIGN OF A LETTER "C" AND A SWIRL WITH THE WORD "WACOKU".

THE FOREIGN WORDING IN THE MARK TRANSLATES INTO ENGLISH AS OLD JAPAN.

SN 77-068,443, FILED 12-20-2006.

HEATHER BIDDULPH, EXAMINING ATTORNEY

Int. Cl.: 35

Prior U.S. Cls.: 100, 101, and 102

United States Patent and Trademark Office

Reg. No. 3,485,592

Registered Aug. 12, 2008

**SERVICE MARK
PRINCIPAL REGISTER**

ACCESS CONNECT ECOSYSTEM

ACCESS SYSTEMS AMERICAS, INC. (DELA-
WARE CORPORATION)
1188 EAST ARQUES AVENUE
SUNNYVALE, CA 94085

FOR: BUSINESS CONSULTING, MARKETING
AND PROMOTION SERVICES PROVIDED IN THE
NATURE OF A COMPUTER SOFTWARE DEVEL-
OPER PARTNER PROGRAM, NAMELY, PROVID-
ING PRODUCT INFORMATION ON COMPUTER
SOFTWARE TO COMPUTER SOFTWARE DEVEL-
OPERS FOR MARKETING PURPOSES, AND PRO-
VIDING MARKETING INFORMATION AND
MARKETING CONSULTING, ALL RELATED TO

COMPUTER SOFTWARE, IN CLASS 35 (U.S. CLS.
100, 101 AND 102).

FIRST USE 2-13-2007; IN COMMERCE 2-13-2007.

THE MARK CONSISTS OF STANDARD CHAR-
ACTERS WITHOUT CLAIM TO ANY PARTICULAR
FONT, STYLE, SIZE, OR COLOR.

SN 77-068,867, FILED 12-20-2006.

SHARON MEIER, EXAMINING ATTORNEY

Int. Cl.: 35

Prior U.S. Cls.: 100, 101, and 102

United States Patent and Trademark Office

Reg. No. 3,485,593

Registered Aug. 12, 2008

**SERVICE MARK
PRINCIPAL REGISTER**

ACE

ACCESS SYSTEMS AMERICAS, INC. (DELA-
WARE CORPORATION)
1188 EAST ARQUES AVENUE
SUNNYVALE, CA 94085

FOR: BUSINESS CONSULTING, MARKETING
AND PROMOTION SERVICES PROVIDED IN THE
NATURE OF A COMPUTER SOFTWARE DEVEL-
OPER PARTNER PROGRAM, NAMELY, PROVID-
ING PRODUCT INFORMATION ON COMPUTER
SOFTWARE TO COMPUTER SOFTWARE DEVEL-
OPERS FOR MARKETING PURPOSES, AND PRO-
VIDING MARKETING INFORMATION AND
MARKETING CONSULTING, ALL RELATED TO

COMPUTER SOFTWARE, IN CLASS 35 (U.S. CLS.
100, 101 AND 102).

FIRST USE 2-13-2007; IN COMMERCE 2-13-2007.

THE MARK CONSISTS OF STANDARD CHAR-
ACTERS WITHOUT CLAIM TO ANY PARTICULAR
FONT, STYLE, SIZE, OR COLOR.

SN 77-069,510, FILED 12-21-2006.

SHARON MEIER, EXAMINING ATTORNEY

Int. Cl.: 6

Prior U.S. Cls.: 2, 12, 13, 14, 23, 25, and 50

Reg. No. 3,485,594

United States Patent and Trademark Office

Registered Aug. 12, 2008

**TRADEMARK
PRINCIPAL REGISTER**

HOMEPLACE SERIES

OVERHEAD DOOR CORPORATION (INDIANA
CORPORATION)
SUITE 200
2501 SOUTH STATE HWY 121
LEWISVILLE, TX 75067

FOR: RESIDENTIAL METAL GARAGE DOORS,
IN CLASS 6 (U.S. CLS. 2, 12, 13, 14, 23, 25 AND 50).

FIRST USE 1-0-2007; IN COMMERCE 1-0-2007.

THE MARK CONSISTS OF STANDARD CHAR-
ACTERS WITHOUT CLAIM TO ANY PARTICULAR
FONT, STYLE, SIZE, OR COLOR.

NO CLAIM IS MADE TO THE EXCLUSIVE
RIGHT TO USE "SERIES", APART FROM THE
MARK AS SHOWN.

SN 77-069,989, FILED 12-21-2006.

WON TEAK OH, EXAMINING ATTORNEY

Int. Cl.: 6

Prior U.S. Cls.: 2, 12, 13, 14, 23, 25, and 50

Reg. No. 3,485,595

United States Patent and Trademark Office

Registered Aug. 12, 2008

**TRADEMARK
PRINCIPAL REGISTER**

BLAKBOLT

CLICK BOND, INC. (NEVADA CORPORATION)
2151 LOCKHEED WAY
CARSON CITY, NV 89706

THE MARK CONSISTS OF STANDARD CHAR-
ACTERS WITHOUT CLAIM TO ANY PARTICULAR
FONT, STYLE, SIZE, OR COLOR.

FOR: METAL FASTENER DEVICES, NAMELY,
STUDS, BOLTS, PINS AND SCREWS, ALL WITH
NON-METAL OVERLAY CAPS, IN CLASS 6 (U.S.
CLS. 2, 12, 13, 14, 23, 25 AND 50).

SN 77-071,711, FILED 12-27-2006.

FIRST USE 4-10-2008; IN COMMERCE 4-10-2008.

DAVID C. REIHNER, EXAMINING ATTORNEY

Int. Cl.: 16

Prior U.S. Cls.: 2, 5, 22, 23, 29, 37, 38, and 50

Reg. No. 3,485,596

United States Patent and Trademark Office

Registered Aug. 12, 2008

**TRADEMARK
PRINCIPAL REGISTER**

THE WISDOM OF MENOPAUSE

CHRISTIANE NORTHRUP, INC. (MAINE CORPORATION)
12 PORTLAND STREET
YARMOUTH, ME 04096

FOR: A SERIES OF BOOKS, WRITTEN ARTICLES, HANDOUTS AND WORKSHEETS IN THE FIELD OF WOMEN'S HEALTH ISSUES, IN CLASS 16 (U.S. CLS. 2, 5, 22, 23, 29, 37, 38 AND 50).

FIRST USE 12-31-2007; IN COMMERCE 12-31-2007.

THE MARK CONSISTS OF STANDARD CHARACTERS WITHOUT CLAIM TO ANY PARTICULAR FONT, STYLE, SIZE, OR COLOR.

NO CLAIM IS MADE TO THE EXCLUSIVE RIGHT TO USE "MENOPAUSE", APART FROM THE MARK AS SHOWN.

SN 77-072,337, FILED 12-28-2006.

ELLEN PERKINS, EXAMINING ATTORNEY

Int. Cl.: 36

Prior U.S. Cls.: 100, 101, and 102

United States Patent and Trademark Office

Reg. No. 3,485,597

Registered Aug. 12, 2008

**SERVICE MARK
PRINCIPAL REGISTER**

BLUE SKY

3M COMPANY (DELAWARE CORPORATION)
220-9E-01 3M CENTER, 2501 HUDSON ROAD
ST. PAUL, MN 55144

THE MARK CONSISTS OF STANDARD CHAR-
ACTERS WITHOUT CLAIM TO ANY PARTICULAR
FONT, STYLE, SIZE, OR COLOR.

FOR: PROVIDING EXTENDED WARRANTIES
ON FLUORO-CHEMICALS FOR FIRE SUPPRES-
SION AND FIRE EXTINGUISHING COMPOSI-
TIONS, IN CLASS 36 (U.S. CLS. 100, 101 AND 102).

SN 77-072,675, FILED 12-28-2006.

FIRST USE 2-27-2007; IN COMMERCE 2-27-2007.

WENDY GOODMAN, EXAMINING ATTORNEY

Int. Cl.: 25

Prior U.S. Cls.: 22 and 39

United States Patent and Trademark Office

Reg. No. 3,485,598

Registered Aug. 12, 2008

**TRADEMARK
PRINCIPAL REGISTER**

Maggy

MAGGY BOUTIQUE, LTD. (NEW YORK COR-
PORATION)
6TH FLOOR
530 7TH AVENUE
NEW YORK, NY 10018

THE MARK CONSISTS OF STANDARD CHAR-
ACTERS WITHOUT CLAIM TO ANY PARTICULAR
FONT, STYLE, SIZE, OR COLOR.

FOR: WOMEN'S CLOTHING, NAMELY, DRES-
SES, IN CLASS 25 (U.S. CLS. 22 AND 39).

SN 77-072,930, FILED 12-28-2006.

FIRST USE 1-11-2008; IN COMMERCE 1-11-2008.

WON TEAK OH, EXAMINING ATTORNEY

Int. Cl.: 9

Prior U.S. Cls.: 21, 23, 26, 36, and 38

Reg. No. 3,485,599

United States Patent and Trademark Office

Registered Aug. 12, 2008

**TRADEMARK
PRINCIPAL REGISTER**

GreenerWay

BEATTY, JOSHUA (UNITED STATES INDIVIDUAL)
2145 LOWELL AVENUE
LOUISVILLE, KY 40205

FOR: AUTOMATED PROCESS CONTROL SYSTEM, NAMELY, MICRO-PROCESSOR BASED HARDWARE AND SOFTWARE USED TO MONITOR THE STATUS OF INDUSTRIAL PROCESSES, NAMELY, POWER GENERATION, ELECTRICAL DISTRIBUTION AND OIL AND GAS PROCESSING; COMPUTER MONITORS; COMPUTER SOFTWARE TO MONITOR AND CONTROL FACTORY MANUFACTURING PROCESSES; VOLTAGE MONITOR MODULES; WIRELESS CONTROLLER TO MONITOR AND CONTROL THE FUNCTIONING OF

OTHER ELECTRONIC DEVICES; WIRELESS REMOTE TEMPERATURE AND HUMIDITY MONITORS FOR BUILDING MAINTENANCE, IN CLASS 9 (U.S. CLS. 21, 23, 26, 36 AND 38).

FIRST USE 8-14-2006; IN COMMERCE 3-24-2008.

THE MARK CONSISTS OF STANDARD CHARACTERS WITHOUT CLAIM TO ANY PARTICULAR FONT, STYLE, SIZE, OR COLOR.

SN 77-073,738, FILED 12-30-2006.

DANIEL BRODY, EXAMINING ATTORNEY

Int. Cl.: 37

Prior U.S. Cls.: 100, 103, and 106

United States Patent and Trademark Office

Reg. No. 3,485,600

Registered Aug. 12, 2008

**SERVICE MARK
PRINCIPAL REGISTER**



KILLICK AEROSPACE USA LLC (DELAWARE
LTD LIAB CO), DBA AVATAS ENGINE SUP-
PORT SERVICES,
SUITE 200
1615 DIPLOMAT DRIVE
CARROLLTON, TX 75006

FIRST USE 7-26-2007; IN COMMERCE 7-26-2007.

SN 77-074,516, FILED 1-2-2007.

FOR: MECHANIC SERVICES, NAMELY, THE
REPAIR AND OVERHAUL OF AIRCRAFT EN-
GINES, IN CLASS 37 (U.S. CLS. 100, 103 AND 106).

HEATHER BIDDULPH, EXAMINING ATTORNEY

Int. Cl.: 41

Prior U.S. Cls.: 100, 101, and 107

United States Patent and Trademark Office

Reg. No. 3,485,601

Registered Aug. 12, 2008

SERVICE MARK
PRINCIPAL REGISTER

*precise*News

ENTRACITY (CALIFORNIA SOLE PROPRIETOR-
SHIP)
2731 GALICIA WAY
CARLSBAD, CA 92009

FOR: PROVIDING NEWS IN THE NATURE OF
CURRENT EVENT REPORTING, IN CLASS 41 (U.S.
CLS. 100, 101 AND 107).

FIRST USE 2-1-2007; IN COMMERCE 2-1-2007.

THE MARK CONSISTS OF THE WORD "PRE-
CISE" ITALICIZED AND THE WORD "NEWS" HAV-
ING A CAPITAL "N", BOTH WORDS BEING
JOINED IN COMPOUND FORM.

SN 77-075,456, FILED 1-3-2007.

AISHA CLARKE, EXAMINING ATTORNEY

Int. Cl.: 37

Prior U.S. Cls.: 100, 103, and 106

United States Patent and Trademark Office

Reg. No. 3,485,602

Registered Aug. 12, 2008

**SERVICE MARK
PRINCIPAL REGISTER**



K. HOV IP, II, INC. (CALIFORNIA CORPORATION)
110 WEST FRONT STREET
RED BANK, NJ 07701

FOR: REAL ESTATE DEVELOPMENT; REAL ESTATE SITE SELECTION; PLANNING, AND LAYING OUT OF RESIDENTIAL BUILDINGS; LAND DEVELOPMENT SERVICES; LAND DEVELOPMENT SERVICES, NAMELY, PLANNING AND LAYING OUT RESIDENTIAL OR COMMERCIAL COMMUNITIES, IN CLASS 37 (U.S. CLS. 100, 103 AND 106).

FIRST USE 2-28-2006; IN COMMERCE 2-28-2006.

OWNER OF U.S. REG. NO. 3,071,666.

THE MARK CONSISTS OF STYLIZED "M&M" ABOVE "MATZEL & MUMFORD".

SN 77-077,141, FILED 1-5-2007.

ANDREA BUTLER, EXAMINING ATTORNEY

Int. Cl.: 30

Prior U.S. Cl.: 46

United States Patent and Trademark Office

Reg. No. 3,485,603

Registered Aug. 12, 2008

**TRADEMARK
PRINCIPAL REGISTER**

BRUMARK

VALENTINO'S ITALIAN FOODS, LLC (MICHIGAN LTD LIAB CO)
24545 FORD ROAD
DEARBORN, MI 48128

FOR: PREPARED ITALIAN-STYLE ENTREES CONSISTING PRIMARILY OF PASTA, NAMELY, LASAGNA AND RAVIOLI, AND PREPARED AND PACKAGED FROZEN ENTREES CONSISTING PRIMARILY OF PASTA , IN CLASS 30 (U.S. CL. 46).

FIRST USE 1-5-2007; IN COMMERCE 1-5-2007.

THE MARK CONSISTS OF STANDARD CHARACTERS WITHOUT CLAIM TO ANY PARTICULAR FONT, STYLE, SIZE, OR COLOR.

SN 77-077,169, FILED 1-5-2007.

LOURDES AYALA, EXAMINING ATTORNEY

Int. Cl.: 36

Prior U.S. Cls.: 100, 101, and 102

United States Patent and Trademark Office

Reg. No. 3,485,604

Registered Aug. 12, 2008

**SERVICE MARK
PRINCIPAL REGISTER**



K. HOV IP, II, INC. (CALIFORNIA CORPORATION)
110 WEST FRONT STREET
RED BANK, NJ 07701

FOR: REAL ESTATE AGENCY; REAL ESTATE
BROKERAGE; REAL ESTATE LISTING; REAL ES-
TATE MANAGEMENT, IN CLASS 36 (U.S. CLS. 100,
101 AND 102).

FIRST USE 2-28-2006; IN COMMERCE 2-28-2006.

OWNER OF U.S. REG. NO. 3,071,666.

THE MARK CONSISTS OF STYLIZED "M&M"
ABOVE "MATZEL & MUMFORD".

SN 77-077,184, FILED 1-5-2007.

ANDREA BUTLER, EXAMINING ATTORNEY

Int. Cl.: 38

Prior U.S. Cls.: 100, 101, and 104

United States Patent and Trademark Office

Reg. No. 3,485,605

Registered Aug. 12, 2008

**SERVICE MARK
PRINCIPAL REGISTER**

MIRROR  **IMAGE**
Internet

MIRROR IMAGE INTERNET, INC. (DELAWARE CORPORATION)
TWO HIGHWOOD DRIVE
TEWKSBURY, MA 01876

FOR: TELECOMMUNICATION SERVICES, NAMELY, LOCAL AND LONG DISTANCE TRANSMISSION OF VOICE, DATA, AND GRAPHICS BY MEANS OF TELEPHONE, TELEGRAPHIC, CABLE, AND SATELLITE TRANSMISSIONS; DATA TRANSMISSION AND RECEPTION SERVICES VIA TELECOMMUNICATION MEANS; ELECTRONIC DELIVERY AND EXCHANGE OF VOICE, DATA, AND GRAPHICS FILES VIA COMPUTER AND TELECOMMUNICATION NETWORKS; ELECTRONIC EXCHANGE OF VOICE, DATA, AND GRAPHICS FILES STORED IN DATABASES ACCESSIBLE VIA TELECOMMUNICATION NETWORKS; PROVIDING MULTIPLE-USER ACCESS TO A GLOBAL COMPUTER INFORMATION NETWORK; STREAMING SERVICES, NAMELY, TRANSMITTING STREAMED SOUND AND AUDIO-VIDEO RECORDINGS VIA THE INTERNET; FACILITATING EXCHANGE OF INTEREST-SPECIFIC INFORMATION AND FILES AMONG INTERNET USERS COMMUNICATIONS SERVICES, NAMELY, TRANSMITTING SOUND, DATA, GRAPHICS, AND AUDIO-VISUAL RECORDINGS VIA THE INTERNET, PROVIDING ONLINE ELECTRONIC BULLETIN BOARD AND DISCUSSION

GROUP SERVICES FOR TRANSMISSION OF MESSAGES AMONG USERS IN THE FIELD OF GENERAL INTEREST; ELECTRONIC MAIL SERVICES; WORKGROUP COMMUNICATIONS SERVICES OVER COMPUTER NETWORKS IN THE NATURE OF ONLINE COMMUNITIES; AND INSTANT MESSAGING SERVICE, IN CLASS 38 (U.S. CLS. 100, 101 AND 104).

FIRST USE 4-11-2007; IN COMMERCE 4-11-2007.

OWNER OF U.S. REG. NOS. 2,454,641 AND 2,522,782.

NO CLAIM IS MADE TO THE EXCLUSIVE RIGHT TO USE "INTERNET", APART FROM THE MARK AS SHOWN.

THE MARK CONSISTS OF THE LITERAL ELEMENT "MIRROR IMAGE INTERNET" WITH A DESIGN BETWEEN THE WORDS "MIRROR" AND "IMAGE", NAMELY, AN INCOMPLETE, PARTLY SHADED ELLIPSE FORMED BY TWO CURVED BANDS.

SN 77-077,814, FILED 1-8-2007.

WANDA KAY PRICE, EXAMINING ATTORNEY

Int. Cl.: 5

Prior U.S. Cls.: 6, 18, 44, 46, 51, and 52

Reg. No. 3,485,606

United States Patent and Trademark Office

Registered Aug. 12, 2008

**TRADEMARK
PRINCIPAL REGISTER**

MULTI-PREP

CLINICIAN'S CHOICE DENTAL PRODUCTS
INC. (CANADA CORPORATION)
1980 HYDE PARK ROAD
LONDON, ONTARIO, CANADA N6H5L9

FOR: DENTAL IMPRESSION MATERIALS, IN
CLASS 5 (U.S. CLS. 6, 18, 44, 46, 51 AND 52).

FIRST USE 2-9-2007; IN COMMERCE 2-9-2007.

THE MARK CONSISTS OF STANDARD CHAR-
ACTERS WITHOUT CLAIM TO ANY PARTICULAR
FONT, STYLE, SIZE, OR COLOR.

SN 77-078,648, FILED 1-9-2007.

JOHN SCHUYLER YARD, EXAMINING ATTOR-
NEY

Int. Cl.: 35

Prior U.S. Cls.: 100, 101, and 102

United States Patent and Trademark Office

Reg. No. 3,485,607

Registered Aug. 12, 2008

**SERVICE MARK
PRINCIPAL REGISTER**

QUO VADIS

THE QUO VADIS AGENCY, LLC (GEORGIA LTD
LIAB CO)
800 EAST AVENUE
ATLANTA, GA 30312

FOR: ADVERTISING AND PUBLICITY SERVICES, NAMELY, PROMOTING THE GOODS, SERVICES, BRAND IDENTITY, AND COMMERCIAL INFORMATION OF THIRD PARTIES THROUGH PRINT, AUDIO, VIDEO, DIGITAL AND ON-LINE MEDIA; MARKET RESEARCH; CONSULTING SERVICES IN THE AREA OF ADVERTISING; PROVIDING ADVERTISING, MARKETING AND PROMOTIONAL SERVICES, NAMELY, DEVELOPMENT OF ADVERTISING CAMPAIGNS IN ANALOG AND DIGITAL MEDIA, IN CLASS 35 (U.S. CLS. 100, 101 AND 102).

FIRST USE 3-30-2007; IN COMMERCE 3-30-2007.

THE MARK CONSISTS OF STANDARD CHARACTERS WITHOUT CLAIM TO ANY PARTICULAR FONT, STYLE, SIZE, OR COLOR.

THE FOREIGN WORDING IN THE MARK TRANSLATES INTO ENGLISH AS WHERE ARE YOU GOING?.

SN 77-078,795, FILED 1-9-2007.

JOHN DALIER, EXAMINING ATTORNEY

Int. Cls.: 35 and 41

Prior U.S. Cls.: 100, 101, 102, and 107

United States Patent and Trademark Office

Reg. No. 3,485,608

Registered Aug. 12, 2008

**SERVICE MARK
PRINCIPAL REGISTER**

DPRWORLD

ADVANSTAR COMMUNICATIONS INC. (NEW
YORK CORPORATION)
131 WEST FIRST STREET
DULUTH, MN 55802

FOR: ARRANGING AND CONDUCTING TRADE
SHOW EXHIBITIONS IN THE FIELD OF DENTIS-
TRY, IN CLASS 35 (U.S. CLS. 100, 101 AND 102).

FIRST USE 5-15-2008; IN COMMERCE 5-15-2008.

FOR: ARRANGING AND CONDUCTING EDU-
CATIONAL CONFERENCES IN THE FIELD OF
DENTISTRY, IN CLASS 41 (U.S. CLS. 100, 101 AND
107).

FIRST USE 5-15-2008; IN COMMERCE 5-15-2008.

THE MARK CONSISTS OF STANDARD CHAR-
ACTERS WITHOUT CLAIM TO ANY PARTICULAR
FONT, STYLE, SIZE, OR COLOR.

OWNER OF U.S. REG. NO. 1,060,282.

SN 77-078,839, FILED 1-9-2007.

HOWARD B. LEVINE, EXAMINING ATTORNEY

Int. Cl.: 19

Prior U.S. Cls.: 1, 12, 33, and 50

United States Patent and Trademark Office

Reg. No. 3,485,609

Registered Aug. 12, 2008

**TRADEMARK
PRINCIPAL REGISTER**

MERIDIAN

ASSOCIATED MATERIALS, LLC (DELAWARE
LTD LIAB CO), DBA ALSIDE,
3773 STATE RD
CUYAHOGA FALLS, OH 44223

THE MARK CONSISTS OF STANDARD CHAR-
ACTERS WITHOUT CLAIM TO ANY PARTICULAR
FONT, STYLE, SIZE, OR COLOR.

FOR: BUILDING MATERIALS, NAMELY, VINYL
WINDOWS AND VINYL SIDING, IN CLASS 19 (U.S.
CLS. 1, 12, 33 AND 50).

SN 77-079,156, FILED 1-9-2007.

FIRST USE 3-1-2008; IN COMMERCE 3-1-2008.

BONNIE LUKEN, EXAMINING ATTORNEY

Int. Cl.: 9

Prior U.S. Cls.: 21, 23, 26, 36, and 38

Reg. No. 3,485,610

United States Patent and Trademark Office

Registered Aug. 12, 2008

**TRADEMARK
PRINCIPAL REGISTER**

Drift Racer

GLOBAL GAMING GROUP (NEVADA CORPORATION)
3035 E PATRICK LN #14
LAS VEGAS, NV 89120

THE MARK CONSISTS OF STANDARD CHARACTERS WITHOUT CLAIM TO ANY PARTICULAR FONT, STYLE, SIZE, OR COLOR.

FOR: GAMING EQUIPMENT, NAMELY, SLOT MACHINES WITH OR WITHOUT VIDEO OUTPUT, IN CLASS 9 (U.S. CLS. 21, 23, 26, 36 AND 38).

SN 77-079,228, FILED 1-9-2007.

FIRST USE 8-1-2007; IN COMMERCE 8-1-2007.

DAVID MURRAY, EXAMINING ATTORNEY

Int. Cl.: 33

Prior U.S. Cls.: 47 and 49

United States Patent and Trademark Office

Reg. No. 3,485,611

Registered Aug. 12, 2008

**TRADEMARK
PRINCIPAL REGISTER**



AZZARO VINEYARDS (CALIFORNIA LTD LIAB
CO)
1355 NORTH CASTLE ROAD
SONOMA, CA 95476

THE MARK CONSISTS OF STYLIZED LETTERS
IN THE NAME "AZZARO" AND THE WINE CAVE
DRAWING.

FOR: RED WINE, IN CLASS 33 (U.S. CLS. 47 AND
49).

SN 77-079,422, FILED 1-9-2007.

FIRST USE 11-1-2006; IN COMMERCE 11-1-2006.

SEAN CROWLEY, EXAMINING ATTORNEY

Int. Cl.: 21

Prior U.S. Cls.: 2, 13, 23, 29, 30, 33, 40, and 50

Reg. No. 3,485,612

United States Patent and Trademark Office

Registered Aug. 12, 2008

**TRADEMARK
PRINCIPAL REGISTER**

KOKU

CCB TECHNOLOGIES, LLC (NORTH CAROLINA
LTD LIAB CO)
SUITE 200
520 ELLIOT STREET
CHARLOTTE, NC 28202

THE MARK CONSISTS OF STANDARD CHAR-
ACTERS WITHOUT CLAIM TO ANY PARTICULAR
FONT, STYLE, SIZE, OR COLOR.

FOR: CUTTING BOARDS, IN CLASS 21 (U.S. CLS.
2, 13, 23, 29, 30, 33, 40 AND 50).

SN 77-080,108, FILED 1-10-2007.

FIRST USE 5-20-2008; IN COMMERCE 5-20-2008.

JEFF DEFORD, EXAMINING ATTORNEY

Int. Cl.: 3

Prior U.S. Cls.: 1, 4, 6, 50, 51, and 52

United States Patent and Trademark Office

Reg. No. 3,485,613

Registered Aug. 12, 2008

TRADEMARK
PRINCIPAL REGISTER



BEJAR BEAUTY LLC (ARIZONA LTD LIAB CO)
12641 N 65TH PLACE
SCOTTSDALE, AZ 85254

FOR: BEAUTY CREAMS FOR BODY CARE;
BODY AND BEAUTY CARE COSMETICS; BODY
AND BEAUTY CARE PREPARATIONS; COSMETIC
CREAMS FOR SKIN CARE; COSMETIC PREPARA-
TIONS FOR BODY CARE; COSMETIC PREPARA-
TIONS FOR SKIN RENEWAL; SKIN CARE
PRODUCTS, NAMELY, NON-MEDICATED SKIN
SERUM; SKIN CLARIFIERS; SKIN CLEANSERS;
SKIN CLEANSING CREAM; SKIN CLEANSING
LOTION; SKIN CONDITIONERS; SKIN CREAM;

SKIN CREAMS; SKIN EMOLLIENTS; SKIN LO-
TION; SKIN LOTIONS; SKIN MASKS; SKIN MOIST-
URIZER; SKIN MOISTURIZER MASKS; SKIN SOAP;
WRINKLE REMOVING SKIN CARE PREPARA-
TIONS, IN CLASS 3 (U.S. CLS. 1, 4, 6, 50, 51 AND 52).

FIRST USE 11-1-2006; IN COMMERCE 1-15-2008.

THE MARK CONSISTS OF "BEJAR BEAUTY"
STYLIZED.

SN 77-080,185, FILED 1-10-2007.

CAROLYN GRAY, EXAMINING ATTORNEY

Int. Cl.: 16

Prior U.S. Cls.: 2, 5, 22, 23, 29, 37, 38, and 50

Reg. No. 3,485,614

United States Patent and Trademark Office

Registered Aug. 12, 2008

**TRADEMARK
PRINCIPAL REGISTER**

CELEBLIFE

GOLDEN EAGLE PUBLISHING HOUSE INC.
(CALIFORNIA CORPORATION)
9201 WILSHIRE BLVD., SUITE 205
BEVERLY HILLS, CA 90210

THE MARK CONSISTS OF STANDARD CHAR-
ACTERS WITHOUT CLAIM TO ANY PARTICULAR
FONT, STYLE, SIZE, OR COLOR.

FOR: GENERAL FEATURE MAGAZINES, IN
CLASS 16 (U.S. CLS. 2, 5, 22, 23, 29, 37, 38 AND 50).

SN 77-081,056, FILED 1-11-2007.

FIRST USE 12-15-2007; IN COMMERCE 12-15-2007.

MONIQUE MILLER, EXAMINING ATTORNEY

Int. Cl.: 28

Prior U.S. Cls.: 22, 23, 38, and 50

Reg. No. 3,485,615

United States Patent and Trademark Office

Registered Aug. 12, 2008

**TRADEMARK
PRINCIPAL REGISTER**

TYRO

BRINE, INC. (MASSACHUSETTS CORPORATION)
47 SUMNER STREET
MILFORD, MA 01757

FOR: LACROSSE GLOVES, LACROSSE ARM PADS, LACROSSE SHOULDER PADS, LACROSSE RIB PADS; SOCCER BALLS, SOCCER SHIN GUARDS AND SOCCER GLOVES, IN CLASS 28 (U.S. CLS. 22, 23, 38 AND 50).

FIRST USE 12-0-2007; IN COMMERCE 12-0-2007.

THE MARK CONSISTS OF STANDARD CHARACTERS WITHOUT CLAIM TO ANY PARTICULAR FONT, STYLE, SIZE, OR COLOR.

SN 77-081,269, FILED 1-11-2007.

GEORGE LORENZO, EXAMINING ATTORNEY

Int. Cl.: 9

Prior U.S. Cls.: 21, 23, 26, 36, and 38

United States Patent and Trademark Office

Reg. No. 3,485,616

Registered Aug. 12, 2008

**TRADEMARK
PRINCIPAL REGISTER**

ANTIBIOTIC ASSISTANT LE

THERADOC, INC. (DELAWARE CORPORATION)
SUITE 600
127 SOUTH 500 EAST
SALT LAKE CITY, UT 84102

FOR: COMPUTER SOFTWARE EXPERT SYSTEMS, NAMELY, SOFTWARE THAT COLLECTS, EVALUATES AND ANALYZES CLINICAL DATA TO PROVIDE PATIENT TREATMENT RECOMMENDATIONS AND TREATMENT ALTERNATIVES IN THE FIELD OF CLINICAL DECISION SUPPORT, IN CLASS 9 (U.S. CLS. 21, 23, 26, 36 AND 38).

FIRST USE 12-28-2006; IN COMMERCE 12-28-2006.

THE MARK CONSISTS OF STANDARD CHARACTERS WITHOUT CLAIM TO ANY PARTICULAR FONT, STYLE, SIZE, OR COLOR.

OWNER OF U.S. REG. NO. 2,667,082.

NO CLAIM IS MADE TO THE EXCLUSIVE RIGHT TO USE "ANTIBIOTIC", APART FROM THE MARK AS SHOWN.

SN 77-081,482, FILED 1-11-2007.

BRENDAN REGAN, EXAMINING ATTORNEY

Int. Cl.: 39

Prior U.S. Cls.: 100 and 105

United States Patent and Trademark Office

Reg. No. 3,485,617

Registered Aug. 12, 2008

**SERVICE MARK
PRINCIPAL REGISTER**



RITWAY BUS SERVICE, INC. (WISCONSIN CORPORATION)
W201 N13900 FOND DU LAC AVENUE
RICHFIELD, WI 53076

THE MARK CONSISTS OF THE WORD "RITWAY" WITH UNDERLINING AND DEPICTION OF A ROAD IN PERSPECTIVE VIEW TO THE RIGHT OF THE WORD.

FOR: TRANSPORTATION OF PASSENGERS AND/OR GOODS BY MOTORCOACH, BUS, SCHOOL BUS, EXECUTIVE SEDAN AND LIMOUSINE, IN CLASS 39 (U.S. CLS. 100 AND 105).

SN 77-083,781, FILED 1-16-2007.

FIRST USE 2-16-2007; IN COMMERCE 2-16-2007.

JOHN DALIER, EXAMINING ATTORNEY

Int. Cl.: 36

Prior U.S. Cls.: 100, 101, and 102

United States Patent and Trademark Office

Reg. No. 3,485,618

Registered Aug. 12, 2008

**SERVICE MARK
PRINCIPAL REGISTER**

FIELDTURF FINANCIAL

FIELDTURF TARKETT INC. (CANADA CORPORATION)
8088 MONTVIEW ROAD
TMR-MONTREAL, CANADA H4P2L7

FOR: FINANCING SERVICES, IN CLASS 36 (U.S. CLS. 100, 101 AND 102).

FIRST USE 4-30-2005; IN COMMERCE 4-30-2005.

THE MARK CONSISTS OF STANDARD CHARACTERS WITHOUT CLAIM TO ANY PARTICULAR FONT, STYLE, SIZE, OR COLOR.

OWNER OF U.S. REG. NOS. 2,593,572 AND 3,179,178.

NO CLAIM IS MADE TO THE EXCLUSIVE RIGHT TO USE FINANCIAL, APART FROM THE MARK AS SHOWN.

SN 77-083,798, FILED 1-16-2007.

WENDY GOODMAN, EXAMINING ATTORNEY

Int. Cl.: 30

Prior U.S. Cl.: 46

United States Patent and Trademark Office

Reg. No. 3,485,619

Registered Aug. 12, 2008

**TRADEMARK
PRINCIPAL REGISTER**

TOASTED CINNAMON SQUARES

MALT-O-MEAL COMPANY (MINNESOTA CORPORATION)
2700 IDS CENTER, 80 SOUTH EIGHTH STREET
MINNEAPOLIS, MN 55402

FOR: BREAKFAST CEREAL, IN CLASS 30 (U.S. CL. 46).

FIRST USE 6-6-2008; IN COMMERCE 6-6-2008.

THE MARK CONSISTS OF STANDARD CHARACTERS WITHOUT CLAIM TO ANY PARTICULAR FONT, STYLE, SIZE, OR COLOR.

OWNER OF U.S. REG. NOS. 1,065,379, 3,130,593, AND OTHERS.

NO CLAIM IS MADE TO THE EXCLUSIVE RIGHT TO USE "TOASTED CINNAMON", APART FROM THE MARK AS SHOWN.

SN 77-083,809, FILED 1-16-2007.

ANTHONY RINKER, EXAMINING ATTORNEY

Int. Cl.: 20

Prior U.S. Cls.: 2, 13, 22, 25, 32, and 50

Reg. No. 3,485,620

United States Patent and Trademark Office

Registered Aug. 12, 2008

**TRADEMARK
PRINCIPAL REGISTER**

HUGMEES

CHASTAIN, MELODY J. (UNITED STATES IN-
DIVIDUAL)
1465 ARIKAREE DRIVE
LOVELAND, CO 80538

FOR: REMOVABLE REUSABLE GRAVESTONE
DECORATION COMPRISING RESIN ENCASED AR-
TICLES OF VARIOUS SHAPES THAT ADHERE TO
CRYPTS, OR UPRIGHT OR FLAT HEADSTONES,
IN CLASS 20 (U.S. CLS. 2, 13, 22, 25, 32 AND 50).

FIRST USE 2-21-2007; IN COMMERCE 6-6-2007.

THE MARK CONSISTS OF STANDARD CHAR-
ACTERS WITHOUT CLAIM TO ANY PARTICULAR
FONT, STYLE, SIZE, OR COLOR.

SN 77-083,839, FILED 1-16-2007.

JOHN DALIER, EXAMINING ATTORNEY

Int. Cl.: 36

Prior U.S. Cls.: 100, 101, and 102

United States Patent and Trademark Office

Reg. No. 3,485,621

Registered Aug. 12, 2008

**SERVICE MARK
PRINCIPAL REGISTER**

P2 CAPITAL PARTNERS

P2 CAPITAL PARTNERS LLC (DELAWARE LTD
LIAB CO)
9TH FLOOR
445 PARK AVENUE
NEW YORK, NY 10022

FOR: FINANCIAL SERVICES, NAMELY, INVEST-
MENT MANAGEMENT SERVICES, INVESTMENT
ADVISORY SERVICES AND ASSET MANAGE-
MENT SERVICES, NAMELY, ASSET ACQUISITION
, IN CLASS 36 (U.S. CLS. 100, 101 AND 102).

FIRST USE 7-14-2004; IN COMMERCE 11-1-2004.

THE MARK CONSISTS OF STANDARD CHAR-
ACTERS WITHOUT CLAIM TO ANY PARTICULAR
FONT, STYLE, SIZE, OR COLOR.

NO CLAIM IS MADE TO THE EXCLUSIVE
RIGHT TO USE "CAPITAL PARTNERS", APART
FROM THE MARK AS SHOWN.

SN 77-084,406, FILED 1-17-2007.

SALLY SHIH, EXAMINING ATTORNEY

Int. Cl.: 45

Prior U.S. Cls.: 100 and 101

United States Patent and Trademark Office

Reg. No. 3,485,622

Registered Aug. 12, 2008

SERVICE MARK
PRINCIPAL REGISTER



E4 SAFETY PROFESSIONALS, LLC (OHIO LTD
LIAB CO)
35 S. GALENA ROAD, SUITE B
SUNBURY, OH 43074

FOR: CONSULTATION SERVICES IN THE FIELD OF THE SAFETY NEEDS OF COMMERCIAL AND INDUSTRIAL COMPANIES; INSPECTION OF FACTORIES FOR SAFETY PURPOSES; SAFETY INSPECTION AUDITS TO IMPROVE SAFETY OF CONSTRUCTION WORKERS ON RESIDENTIAL CONSTRUCTION SITES, IN CLASS 45 (U.S. CLS. 100 AND 101).

FIRST USE 2-1-2007; IN COMMERCE 2-1-2007.

NO CLAIM IS MADE TO THE EXCLUSIVE RIGHT TO USE "SAFETY PROFESSIONALS, EDUCATE, ENGINEER AND ENFORCE", APART FROM THE MARK AS SHOWN.

THE COLOR(S) GREEN, BLACK AND WHITE IS/ ARE CLAIMED AS A FEATURE OF THE MARK.

THE MARK CONSISTS OF THE COLOR WHITE APPEARS IN THE NUMBER "4," THE COLOR BLACK APPEARS IN THE WORDS "SAFETY PROFESSIONALS, ENGINEER", AND "ENFORCE" AND IN THE BLOCK BACKGROUND BEHIND THE LETTER "E" AND THE NUMBER "4," THE COLOR GREEN APPEARS IN THE LETTER "E" AND THE WORDING "EDUCATE", AND "ENCOURAGE."

SN 77-084,636, FILED 1-17-2007.

LOURDES AYALA, EXAMINING ATTORNEY

Int. Cls.: 25 and 44

Prior U.S. Cls.: 22, 39, 100, and 101

United States Patent and Trademark Office

Reg. No. 3,485,623

Registered Aug. 12, 2008

**TRADEMARK
SERVICE MARK
PRINCIPAL REGISTER**

PUREFIT

PUREFIT, INC. (CALIFORNIA CORPORATION)
2 AVELLINO
IRVINE, CA 92620

FOR: CLOTHING, NAMELY, T-SHIRTS, HATS,
SOCKS AND VISORS, IN CLASS 25 (U.S. CLS. 22
AND 39).

FIRST USE 0-0-2001; IN COMMERCE 0-0-2001.

FOR: PROVIDING INFORMATION ABOUT DIET
AND NUTRITION, IN CLASS 44 (U.S. CLS. 100 AND
101).

FIRST USE 0-0-2001; IN COMMERCE 0-0-2001.

THE MARK CONSISTS OF STANDARD CHAR-
ACTERS WITHOUT CLAIM TO ANY PARTICULAR
FONT, STYLE, SIZE, OR COLOR.

OWNER OF U.S. REG. NO. 2,599,568.

SN 77-085,300, FILED 1-18-2007.

BRENDAN REGAN, EXAMINING ATTORNEY

Int. Cls.: 39 and 41

Prior U.S. Cls.: 100, 101, 105, and 107

United States Patent and Trademark Office

Reg. No. 3,485,624

Registered Aug. 12, 2008

**SERVICE MARK
PRINCIPAL REGISTER**



PAPI, DANIELA (UNITED STATES INDIVIDUAL)
105 SCHRADE ROAD
BRIARCLIFF MANOR, NY 10510

FOR: ARRANGING TRAVEL TOURS, IN CLASS 39 (U.S. CLS. 100 AND 105).

FIRST USE 4-15-2006; IN COMMERCE 4-15-2006.

FOR: EDUCATIONAL SERVICES, NAMELY, CONDUCTING CLASSES, WORKSHOPS, CONFERENCES, SEMINARS, IN THE FIELDS OF EDUCATION OPPORTUNITIES, HEALTH, ENVIRONMENT AND AID FOR UNDERPRIVILEGED CHILDREN; DISTRIBUTING OF COURSE MATERIALS IN CONNECTION THEREWITH, ALL THE ABOVE THROUGH AN INTERNATIONAL NOT FOR PROFIT ORGANIZATION, IN CLASS 41 (U.S. CLS. 100, 101 AND 107).

FIRST USE 4-15-2006; IN COMMERCE 4-15-2006.

"THE COLOR(S) BLUE, GREEN, GREY, WHITE IS/ARE CLAIMED AS A FEATURE OF THE MARK."

THE COLOR BLUE APPEARS IN THE WORDING "PEPY" IN THE MARK; THE COLOR GREEN APPEARS IN THE TIRE AND LEAF DESIGN IN THE MARK; THE COLOR GREY APPEARS IN THE SPOKE DESIGN IN THE MARK; THE COLOR WHITE APPEARS IN THE BACKGROUND OF THE MARK.

SN 77-085,677, FILED 1-18-2007.

JOHN DALIER, EXAMINING ATTORNEY

Int. Cl.: 21

Prior U.S. Cls.: 2, 13, 23, 29, 30, 33, 40, and 50

Reg. No. 3,485,625

United States Patent and Trademark Office

Registered Aug. 12, 2008

**TRADEMARK
PRINCIPAL REGISTER**

Cocina al Máximo

HY CITE CORPORATION (WISCONSIN CORPORATION)
333 HOLTZMAN ROAD
MADISON, WI 53713

FOR: COOKING UTENSILS WITH PLASTIC HANDLES, NAMELY, LADLES, SKIMMERS, SOLID TURNERS, SLOTTED SERVING SPOONS, LADLES, SERVING FORKS, PASTA SERVERS AND SERVING SPATULAS; AND SOLID VEGETABLE MASHERS; BAKEWARE; STAINLESS STEEL SERVING UTENSILS, NAMELY, CAKE SERVERS, COLD MEAT FORKS, SALAD SERVING SPOONS, SALAD SERVING FORKS, SOLID SERVING SPOONS, SLOTTED SERVING SPOONS, LADLES, SERVING FORKS, PASTA SERVERS AND SERVING SPATULAS; COOKWARE, NAMELY, SAUCE PANS, SKILLETS, DUTCH OVENS, STEAMER/COLANDERS, FLAT AND DOME COVERS FOR POTS AND PANS; KITCHENWARE, NAMELY, COOKIE SHEETS, CAKE PANS, PIZZA PANS, OMELET PANS, SALAD SPINNERS, MIXING BOWLS, NON-ELECTRIC GRIDDLES; CHINA, NAMELY, DINNER PLATES, LUNCH PLATES, CUPS, SAUCERS, SERVING BOWLS, GRAVY BOATS AND PLATTERS; GLASS DINNERWARE, NAMELY, GLASS DISHES, DINNER PLATES, LUNCH PLATES, CUPS, SAUCERS, SERVING BOWLS, GRAVY BOATS AND PLAT-

TERS; CHINA AND PORCELAIN DINNERWARE, NAMELY, PLATES AND BOWLS; AND GLASS BEVERAGE WARE; COOKWARE LIDS HAVING A WHISTLE WHICH SOUNDS WHEN THE COOKWARE REACHES THE PROPER TEMPERATURE; STAINLESS STEEL COOKWARE, NAMELY, POTS AND PANS, IN CLASS 21 (U.S. CLS. 2, 13, 23, 29, 30, 33, 40 AND 50).

FIRST USE 2-15-2007; IN COMMERCE 2-15-2007.

THE MARK CONSISTS OF STANDARD CHARACTERS WITHOUT CLAIM TO ANY PARTICULAR FONT, STYLE, SIZE, OR COLOR.

NO CLAIM IS MADE TO THE EXCLUSIVE RIGHT TO USE "COCINA", APART FROM THE MARK AS SHOWN.

THE FOREIGN WORDING IN THE MARK TRANSLATES INTO ENGLISH AS THE BEST COOKING.

SN 77-086,004, FILED 1-18-2007.

INGRID C. EULIN, EXAMINING ATTORNEY

Int. Cl.: 25

Prior U.S. Cls.: 22 and 39

United States Patent and Trademark Office

Reg. No. 3,485,626

Registered Aug. 12, 2008

**TRADEMARK
PRINCIPAL REGISTER**

D-THRONE

WHITE, LANCE R. (UNITED STATES INDIVIDUAL)
TRADEMARK
5413 LEEWARD POINT DRIVE
BAKERSFIELD, CA 93312

FOR: CLOTHING, NAMELY, SHIRTS, SHORT-SLEEVED AND LONG-SLEEVED SHIRTS, SHORT-SLEEVED AND LONG-SLEEVED T-SHIRTS, DRESS SHIRTS, TANK TOPS; SWEATSHIRTS; PANTS, JEANS, CARGO PANTS, DICKIES, SHORTS, SLACKS, SWEATPANTS; UNDERGARMENTS; THERMAL UNDERWEAR; JACKETS; COATS, WIND COATS; HEADGEAR, NAMELY, HATS,

CAPS, SUN VISORS, BEANIES, AND BANDANAS; AND SOCKS, IN CLASS 25 (U.S. CLS. 22 AND 39).

FIRST USE 4-19-2008; IN COMMERCE 4-19-2008.

THE MARK CONSISTS OF STANDARD CHARACTERS WITHOUT CLAIM TO ANY PARTICULAR FONT, STYLE, SIZE, OR COLOR.

SN 77-086,019, FILED 1-18-2007.

RENEE SERVANCE, EXAMINING ATTORNEY

Int. Cl.: 33

Prior U.S. Cls.: 47 and 49

United States Patent and Trademark Office

Reg. No. 3,485,627

Registered Aug. 12, 2008

**TRADEMARK
PRINCIPAL REGISTER**

RIESLING RULES

PACIFIC RIM WINEMAKERS, INC. (WASHINGTON CORPORATION)
1111 E BURNSIDE STREET
PORTLAND, OR 97214

FOR: WINE, IN CLASS 33 (U.S. CLS. 47 AND 49).

FIRST USE 3-15-2007; IN COMMERCE 3-15-2007.

THE MARK CONSISTS OF STANDARD CHARACTERS WITHOUT CLAIM TO ANY PARTICULAR FONT, STYLE, SIZE, OR COLOR.

SN 77-086,957, FILED 1-19-2007.

MARIAM MAHMOUDI, EXAMINING ATTORNEY

Int. Cl.: 9

Prior U.S. Cls.: 21, 23, 26, 36, and 38

United States Patent and Trademark Office

Reg. No. 3,485,628

Registered Aug. 12, 2008

**TRADEMARK
PRINCIPAL REGISTER**

FileForce

MANAGING EDITOR INC. (DELAWARE CORPORATION)
610 OLD YORK ROAD, SUITE 250
JENKINTOWN, PA 19046

FOR: COMPUTER SOFTWARE FOR THE COLLECTION, EDITING, ORGANIZING, MODIFYING, BOOK MARKING, TRANSMISSION, STORAGE AND SHARING OF DATA AND INFORMATION; COMPUTER SOFTWARE FOR THE FIELD OF WAREHOUSING AND DISTRIBUTION, TO MANAGE TRANSACTIONAL DATA, PROVIDE STATISTICAL ANALYSIS, AND PRODUCE NOTIFICATIONS AND REPORTS; COMPUTER SOFTWARE FOR USE IN THE SAFEGUARDING OF DIGITAL FILES, INCLUDING AUDIO, VIDEO, TEXT, BINARY, STILL IMAGES, GRAPHICS AND MULTIMEDIA FILES; COMPUTER SOFTWARE FOR TRANSFORMING DATA FILES; COMPUTER

SOFTWARE THAT PROVIDES REAL-TIME, INTEGRATED BUSINESS MANAGEMENT INTELLIGENCE BY COMBINING INFORMATION FROM VARIOUS DATABASES AND PRESENTING IT IN AN EASY-TO-UNDERSTAND USER INTERFACE; DESKTOP PUBLISHING SOFTWARE; SOFTWARE FOR PROCESSING IMAGES, GRAPHICS AND TEXT, IN CLASS 9 (U.S. CLS. 21, 23, 26, 36 AND 38).

FIRST USE 7-12-2007; IN COMMERCE 1-7-2008.

THE MARK CONSISTS OF STANDARD CHARACTERS WITHOUT CLAIM TO ANY PARTICULAR FONT, STYLE, SIZE, OR COLOR.

SN 77-087,647, FILED 1-22-2007.

JAMES A. RAUEN, EXAMINING ATTORNEY

Int. Cl.: 30

Prior U.S. Cl.: 46

United States Patent and Trademark Office

Reg. No. 3,485,629

Registered Aug. 12, 2008

TRADEMARK
PRINCIPAL REGISTER



MERABY COMPANY, LLC (ALABAMA LTD
LIAB CO)
104 ARABIAN DRIVE
MADISON, AL 35758

FOR: INSTANT PANCAKE MIXES; MUFFIN
MIXES, IN CLASS 30 (U.S. CL. 46).

FIRST USE 4-15-2007; IN COMMERCE 6-1-2007.

NO CLAIM IS MADE TO THE EXCLUSIVE
RIGHT TO USE "ALLERGY" AND "FOODS" ,
APART FROM THE MARK AS SHOWN.

THE COLOR(S) BLACK, BLUE, YELLOW AND
PINK IS/ARE CLAIMED AS A FEATURE OF THE
MARK.

THE WORD "MERABY'S" IS BLUE, THE OVAL
OUTLINE IS YELLOW, THE AREA INSIDE THE
HEART IS PINK, AND THE REMAINDER OF THE
MARK IS BLACK.

SN 77-088,841, FILED 1-23-2007.

ALICE SUE CARRUTHERS, EXAMINING ATTOR-
NEY

Int. Cl.: 35

Prior U.S. Cls.: 100, 101, and 102

United States Patent and Trademark Office

Reg. No. 3,485,630

Registered Aug. 12, 2008

**SERVICE MARK
PRINCIPAL REGISTER**



RIDEMAKERZ, LLC (DELAWARE LTD LIAB
CO)
8191 STRAWBERRY LANE SUITE 300
FALL CHURCH, VA 22042

FOR: RETAIL STORE SERVICES AND RETAIL
STORE SERVICES VIA A GLOBAL COMPUTER
NETWORK IN THE FIELD OF TOY VEHICLES,
PARTS AND ACCESSORIES THEREFOR, IN CLASS
35 (U.S. CLS. 100, 101 AND 102).

FIRST USE 6-1-2007; IN COMMERCE 6-1-2007.

THE COLOR(S) BLACK, GRAY, RED AND
WHITE IS/ARE CLAIMED AS A FEATURE OF
THE MARK.

THE MARK CONSISTS OF A RECTANGULAR
BLACK FIELD BORDERED ON TOP AND BOTTOM
BY A GRAY STRIPE. ON THE LEFT SIDE OF THE
BLACK FIELD IS A CIRCULAR SYMBOL INCOR-
PORATING A STYLIZED LETTER "R" IN WHITE
AND "Z" IN RED. THE WORD "RIDEMAKERZ" IN
BLOCK LETTERS APPEARS AT AN UPWARD
ANGLE ON THE REMAINDER OF THE BLACK
FIELD WITH THE LETTERS "R", "I", "D", "E" AND
"Z" IN RED AND THE LETTERS "M", "A", "K", "E"
AND "R" IN WHITE. ON THE LOWER GRAY
STRIPE THE WORDS "CHOOZE - CUSTOMIZE -
CRUIZE" IN BLOCK LETTERS APPEAR IN BLACK.

SN 77-089,693, FILED 1-24-2007.

MICHELE SWAIN, EXAMINING ATTORNEY

Int. Cl.: 45

Prior U.S. Cls.: 100 and 101

United States Patent and Trademark Office

Reg. No. 3,485,631

Registered Aug. 12, 2008

**SERVICE MARK
PRINCIPAL REGISTER**

GET LEGAL

GET LEGAL TV, INC. (TEXAS CORPORATION)
1601 AIRPORT FREEWAY
EULESS, TX 76040

FOR: COMPUTER SERVICES, NAMELY, PROVIDING ON-LINE INFORMATION AND ON-LINE INTERACTIVE DATABASES IN THE FIELDS OF LAW, LEGAL NEWS, AND LEGAL SERVICES, IN CLASS 45 (U.S. CLS. 100 AND 101).

FIRST USE 2-1-2007; IN COMMERCE 4-1-2007.

THE MARK CONSISTS OF STANDARD CHARACTERS WITHOUT CLAIM TO ANY PARTICULAR FONT, STYLE, SIZE, OR COLOR.

NO CLAIM IS MADE TO THE EXCLUSIVE RIGHT TO USE "LEGAL", APART FROM THE MARK AS SHOWN.

SN 77-089,817, FILED 1-24-2007.

ERNEST SHOSHO, EXAMINING ATTORNEY

Int. Cl.: 3

Prior U.S. Cls.: 1, 4, 6, 50, 51, and 52

United States Patent and Trademark Office

Reg. No. 3,485,632

Registered Aug. 12, 2008

**TRADEMARK
PRINCIPAL REGISTER**

X PHOBIC

WANSTRATH, KERRY A. (UNITED STATES IN-
DIVIDUAL)

#106

50 RIVERS OAK DR.

DURANGO, CO 81303 AND

CMAFIELD, RICHARD A. (UNITED STATES IN-
DIVIDUAL)

2024 WEST LIBERTY COURT

GRAND JUNCTION, CO 81501

FOR: GENERAL PURPOSE CLEANING PRE-
PARATIONS FOR REMOVING CONTAMINANTS

FROM WINDSHIELDS AND OTHER SURFACES, IN
CLASS 3 (U.S. CLS. 1, 4, 6, 50, 51 AND 52).

FIRST USE 5-11-2007; IN COMMERCE 5-11-2007.

THE MARK CONSISTS OF STANDARD CHAR-
ACTERS WITHOUT CLAIM TO ANY PARTICULAR
FONT, STYLE, SIZE, OR COLOR.

SN 77-090,082, FILED 1-24-2007.

MARILYN IZZI, EXAMINING ATTORNEY

Int. Cls.: 9 and 41

Prior U.S. Cls.: 21, 23, 26, 36, 38, 100, 101, and 107

United States Patent and Trademark Office

Reg. No. 3,485,633

Registered Aug. 12, 2008

TRADEMARK
SERVICE MARK
PRINCIPAL REGISTER



CHANG, ANTHONY (UNITED STATES INDIVIDUAL)
15665 SILVERPOINTE AVE
CHINO HILLS, CA 91709

FOR: PRE-RECORDED CDS, VIDEO TAPES, LASER DISKS AND DVDS FEATURING MUSIC AND ENGLISH, CHINESE, SPANISH, RUSSIAN, POLISH, FRENCH, GERMAN, ITALIAN, THAI, JAPANESE, KOREAN, HINDI, VIETNAMESE, PORTUGUESE, FARSI AND ARABIC LANGUAGE INSTRUCTION, IN CLASS 9 (U.S. CLS. 21, 23, 26, 36 AND 38).

FIRST USE 6-16-2008; IN COMMERCE 6-16-2008.

FOR: PUBLISHING OF BOOKS AND REVIEWS; PUBLISHING OF BOOKS, MAGAZINES; PUBLISH-

ING OF ELECTRONIC PUBLICATIONS, IN CLASS 41 (U.S. CLS. 100, 101 AND 107).

FIRST USE 6-16-2008; IN COMMERCE 6-16-2008.

THE MARK CONSISTS OF THE WORDING "SING2LEARN.COM" WITH A MUSICAL CLEF SYMBOL APPEARING ON EITHER SIDE, AND THE WORDS "IF YOU CAN SING, YOU CAN LEARN" UNDERNEATH".

SN 77-090,339, FILED 1-24-2007.

SHANNON TWOHIG, EXAMINING ATTORNEY

Int. Cls.: 9 and 41

Prior U.S. Cls.: 21, 23, 26, 36, 38, 100, 101, and 107

United States Patent and Trademark Office

Reg. No. 3,485,634

Registered Aug. 12, 2008

**TRADEMARK
SERVICE MARK
PRINCIPAL REGISTER**

Understanding Images

DEFINIENS AG (FED REP GERMANY CORPORATION)

TRAPPENTREUSTRASSE 1

MUNICH, FED REP GERMANY 80339

FOR: COMPUTER SOFTWARE FOR PROCESSING AND ANALYZING DIGITAL DATA IN BIOMEDICAL, GEOSPATIAL, INDUSTRIAL, CONSUMER OR MATERIALS SCIENCE APPLICATIONS AND INSTRUCTIONAL MANUALS INCLUDED THEREWITH, IN CLASS 9 (U.S. CLS. 21, 23, 26, 36 AND 38).

FIRST USE 1-1-2007; IN COMMERCE 5-29-2008.

FOR: COMPUTER EDUCATION TRAINING SERVICES IN THE FIELD OF BIOMEDICAL, GEOSPATIAL, INDUSTRIAL OR MATERIAL SCIENCE APPLICATIONS, IN CLASS 41 (U.S. CLS. 100, 101 AND 107).

FIRST USE 5-29-2008; IN COMMERCE 5-29-2008.

THE MARK CONSISTS OF STANDARD CHARACTERS WITHOUT CLAIM TO ANY PARTICULAR FONT, STYLE, SIZE, OR COLOR.

SN 77-091,628, FILED 1-25-2007.

JOHN GARTNER, EXAMINING ATTORNEY

Int. Cl.: 12

Prior U.S. Cls.: 19, 21, 23, 31, 35, and 44

Reg. No. 3,485,635

United States Patent and Trademark Office

Registered Aug. 12, 2008

**TRADEMARK
PRINCIPAL REGISTER**

SKY SLIDER

CHRYSLER LLC (DELAWARE LTD LIAB CO)
1000 CHRYSLER DRIVE
CIMS 483-02-19
AUBURN HILLS, MI 48326

THE MARK CONSISTS OF STANDARD CHAR-
ACTERS WITHOUT CLAIM TO ANY PARTICULAR
FONT, STYLE, SIZE, OR COLOR.

FOR: MOTOR VEHICLE SUNROOF, IN CLASS 12
(U.S. CLS. 19, 21, 23, 31, 35 AND 44).

SN 77-092,415, FILED 1-26-2007.

FIRST USE 9-6-2007; IN COMMERCE 9-6-2007.

ALYSSA PALADINO, EXAMINING ATTORNEY

Int. Cl.: 35

Prior U.S. Cls.: 100, 101, and 102

United States Patent and Trademark Office

Reg. No. 3,485,636

Registered Aug. 12, 2008

**SERVICE MARK
PRINCIPAL REGISTER**



IFIND GROUP LLC (NEW YORK LTD LIAB CO)
415 MADISON AVENUE
NEW YORK, NY 10017

FIRST USE 2-1-2007; IN COMMERCE 2-1-2007.

FOR: PERSONNEL PLACEMENT AND RE-
CRUITMENT; EMPLOYMENT CONSULTING AND
RECRUITING SERVICES, NAMELY, EXECUTIVE
AND PROFESSIONAL SEARCH, RECRUITING,
AND CONSULTING SERVICES , IN CLASS 35 (U.S.
CLS. 100, 101 AND 102).

NO CLAIM IS MADE TO THE EXCLUSIVE
RIGHT TO USE "GROUP", APART FROM THE
MARK AS SHOWN.

SN 77-094,239, FILED 1-30-2007.

CHRISTINA SOBRAL, EXAMINING ATTORNEY

Int. Cl.: 16

Prior U.S. Cls.: 2, 5, 22, 23, 29, 37, 38, and 50

Reg. No. 3,485,637

United States Patent and Trademark Office

Registered Aug. 12, 2008

**TRADEMARK
PRINCIPAL REGISTER**

BOTANICA MAGNIFICA

SINGER, JONATHAN, M (UNITED STATES INDIVIDUAL)
744 AVENUE C
BAYONNE, NJ 07002 AND
SINGER, JONATHAN, M (UNITED STATES INDIVIDUAL)
744 AVENUE C
BAYONNE, NJ 07002

FOR: PHOTOGRAPHS, IN THE NATURE OF LIMITED EDITION ARTISITC DIGITAL IMAGES OF FLOWERS PRINTED ON SPECIALLY DESIGNED PAPERS TO PRODUCE A MUSEUM QUALITY WATERCOLOR IMAGE, IN CLASS 16 (U.S. CLS. 2, 5, 22, 23, 29, 37, 38 AND 50).

FIRST USE 3-1-2007; IN COMMERCE 9-1-2007.

THE MARK CONSISTS OF STANDARD CHARACTERS WITHOUT CLAIM TO ANY PARTICULAR FONT, STYLE, SIZE, OR COLOR.

NO CLAIM IS MADE TO THE EXCLUSIVE RIGHT TO USE "BOTANICA", APART FROM THE MARK AS SHOWN.

"THE FOREIGN WORDING IN THE MARK TRANSLATES INTO ENGLISH AS MAGNIFICENT PLANTS."

SN 77-096,326, FILED 1-31-2007.

ANDREA HACK, EXAMINING ATTORNEY

Int. Cl.: 41

Prior U.S. Cls.: 100, 101, and 107

United States Patent and Trademark Office

Reg. No. 3,485,638

Registered Aug. 12, 2008

**SERVICE MARK
PRINCIPAL REGISTER**

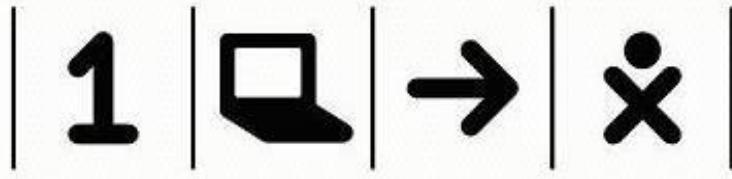

ONE LAPTOP PER CHILD ASSOCIATION, INC.
(DELAWARE NON-STOCK CORPORATION)
10TH FLOOR
ONE CAMBRIDGE CENTER
CAMBRIDGE, MA 02142

FOR: PROVIDING EDUCATION AND TRAINING
IN THE FIELD OF COMPUTERS, COMMUNICA-
TIONS AND INFORMATION TECHNOLOGY VIA
IN-PERSON ON SITE VISITS, SEMINARS, WORK-
SHOPS, LECTURES, EXHIBITIONS, AND ONLINE
TRAINING; CHARITABLE SERVICES, NAMELY,
PROVIDING EDUCATION AND TRAINING IN
THE FIELD OF COMPUTERS, COMMUNICATIONS
AND INFORMATION TECHNOLOGY TO POPULA-
TIONS IN DEVELOPING NATIONS AND COMMU-

NITIES IN NEED, IN CLASS 41 (U.S. CLS. 100, 101
AND 107).

FIRST USE 3-6-2007; IN COMMERCE 3-6-2007.

THE MARK CONSISTS OF THE NUMERAL ONE,
A STYLIZED LAPTOP COMPUTER, AN ARROW
POINTING TO THE RIGHT AND A STYLIZED
HUMAN FIGURE. EACH IMAGE IS SEPARATED
BY A SOLID VERTICAL LINE.

SN 77-096,493, FILED 2-1-2007.

TINA BROWN, EXAMINING ATTORNEY

Int. Cls.: 20 and 21

Prior U.S. Cls.: 2, 13, 22, 23, 25, 29, 30, 32, 33, 40, and 50

United States Patent and Trademark Office

Reg. No. 3,485,639

Registered Aug. 12, 2008

**TRADEMARK
PRINCIPAL REGISTER**

SUPERMAC

HARDIGG INDUSTRIES, INC. (MASSACHUSETTS CORPORATION)
147 NORTH MAIN STREET, P.O. BOX 201
SOUTH DEERFIELD, MA 01373

FOR: PLASTIC CASES FOR INDUSTRIAL AND COMMERCIAL USE; NAMELY, PACKAGING, SHIPPING, TRANSPORTATION, PROTECTION OF CONTENTS AND STORAGE, IN CLASS 20 (U.S. CLS. 2, 13, 22, 25, 32 AND 50).

FIRST USE 2-20-2008; IN COMMERCE 2-20-2008.

FOR: PLASTIC CASES FOR PERSONAL USE; NAMELY, PACKAGING, SHIPPING, TRANSPOR-

TATION, PROTECTION OF CONTENTS AND STORAGE, IN CLASS 21 (U.S. CLS. 2, 13, 23, 29, 30, 33, 40 AND 50).

FIRST USE 2-20-2008; IN COMMERCE 2-20-2008.

THE MARK CONSISTS OF STANDARD CHARACTERS WITHOUT CLAIM TO ANY PARTICULAR FONT, STYLE, SIZE, OR COLOR.

SN 77-096,953, FILED 2-1-2007.

AMY MCMENAMIN, EXAMINING ATTORNEY

Int. Cl.: 17

Prior U.S. Cls.: 1, 5, 12, 13, 35, and 50

Reg. No. 3,485,640

United States Patent and Trademark Office

Registered Aug. 12, 2008

**TRADEMARK
PRINCIPAL REGISTER**

DAD'S TAPE

LANGTRY, KEN G. (CANADA INDIVIDUAL)
8575 EAST SAANICH ROAD
NORTH SAANICH, CANADA V8L1G9

PRIORITY CLAIMED UNDER SEC. 44(D) ON
CANADA APPLICATION NO. 1311912, FILED 8-4-
2006.

FOR: PEEL AND STICK ADHESIVE PATCHES
MADE OF POLYETHYLENE AND WOVEN
STRANDS, FOR REPAIRING TARPAULINS,
SHEETING AND HAND TOOLS, IN CLASS 17 (U.S.
CLS. 1, 5, 12, 13, 35 AND 50).

NO CLAIM IS MADE TO THE EXCLUSIVE
RIGHT TO USE "TAPE", APART FROM THE MARK
AS SHOWN.

FIRST USE 5-5-2007; IN COMMERCE 5-5-2007.

SN 77-097,942, FILED 2-2-2007.

THE MARK CONSISTS OF STANDARD CHAR-
ACTERS WITHOUT CLAIM TO ANY PARTICULAR
FONT, STYLE, SIZE, OR COLOR.

MICHAEL WEBSTER, EXAMINING ATTORNEY

Int. Cl.: 33

Prior U.S. Cls.: 47 and 49

United States Patent and Trademark Office

Reg. No. 3,485,641

Registered Aug. 12, 2008

**TRADEMARK
PRINCIPAL REGISTER**

DOMAINE PARADOX

PARADOX VENTURES, LLC (OREGON LTD
LIAB CO)
3204 HIGH MEADOW DR.
GRAPEVINE, TX 76051

FOR: WINES, IN CLASS 33 (U.S. CLS. 47 AND 49).

FIRST USE 5-17-2008; IN COMMERCE 5-17-2008.

THE MARK CONSISTS OF STANDARD CHAR-
ACTERS WITHOUT CLAIM TO ANY PARTICULAR
FONT, STYLE, SIZE, OR COLOR.

NO CLAIM IS MADE TO THE EXCLUSIVE
RIGHT TO USE "DOMAINE", APART FROM THE
MARK AS SHOWN.

THE FOREIGN WORDING IN THE MARK
TRANSLATES INTO ENGLISH AS ESTATE.

SN 77-098,310, FILED 2-2-2007.

ALLISON SCHRODY, EXAMINING ATTORNEY

Int. Cl.: 8

Prior U.S. Cls.: 23, 28, and 44

Reg. No. 3,485,642

United States Patent and Trademark Office

Registered Aug. 12, 2008

**TRADEMARK
PRINCIPAL REGISTER**

EXTREMEDGE TITANIUM

ACME UNITED CORPORATION (CONNECTI-
CUT CORPORATION)
60 ROUND HILL ROAD
FAIRFIELD, CT 06824

FOR: SCISSORS AND MULTI-PURPOSE SHEARS
AND COATED WITH TITANIUM, IN CLASS 8 (U.S.
CLS. 23, 28 AND 44).

FIRST USE 10-17-2007; IN COMMERCE 10-17-2007.

THE MARK CONSISTS OF STANDARD CHAR-
ACTERS WITHOUT CLAIM TO ANY PARTICULAR
FONT, STYLE, SIZE, OR COLOR.

NO CLAIM IS MADE TO THE EXCLUSIVE
RIGHT TO USE "TITANIUM", APART FROM THE
MARK AS SHOWN.

SN 77-099,229, FILED 2-5-2007.

HEATHER SAPP, EXAMINING ATTORNEY

Int. Cl.: 29

Prior U.S. Cl.: 46

United States Patent and Trademark Office

Reg. No. 3,485,643

Registered Aug. 12, 2008

**TRADEMARK
PRINCIPAL REGISTER**

Gran Terre

PARMAREGGIO S.P.A. (ITALY CORPORATION)
DI QUATTRO CASTELLA (RE)
VIA PALMIRO TOGLIATTI, 34/A-B
MONTECAVOLO, ITALY 42020

FOR: DAIRY PRODUCTS, NAMELY, CHEESE, IN
CLASS 29 (U.S. CL. 46).

FIRST USE 8-8-2007; IN COMMERCE 8-8-2007.

THE MARK CONSISTS OF STANDARD CHAR-
ACTERS WITHOUT CLAIM TO ANY PARTICULAR
FONT, STYLE, SIZE, OR COLOR.

THE ENGLISH TRANSLATION OF THE WORD
"GRAN TERRE" IN THE MARK IS "GRAND
EARTH".

SN 77-100,656, FILED 2-6-2007.

VERNA BETH RIRIE, EXAMINING ATTORNEY

Int. Cl.: 29

Prior U.S. Cl.: 46

United States Patent and Trademark Office

Reg. No. 3,485,644

Registered Aug. 12, 2008

**TRADEMARK
PRINCIPAL REGISTER**



PARMAREGGIO S.P.A. (ITALY CORPORATION)
DI QUATTRO CASTELLA (RE) VIA PALMIRO TOG
MONTECAVOLO, ITALY 42020

THE ENGLISH TRANSLATION OF "GRAN
TERRE" IS GRAND EARTH.

FOR: DAIRY PRODUCTS, NAMELY, CHEESE, IN
CLASS 29 (U.S. CL. 46).

SN 77-100,664, FILED 2-6-2007.

FIRST USE 8-8-2007; IN COMMERCE 8-8-2007.

VERNA BETH RIRIE, EXAMINING ATTORNEY

Int. Cls.: 35, 37, and 45

Prior U.S. Cls.: 100, 101, 102, 103, and 106

United States Patent and Trademark Office

Reg. No. 3,485,645

Registered Aug. 12, 2008

**SERVICE MARK
PRINCIPAL REGISTER**

**DRIVING THE BUILDING
PROCESS FOR OPTIMAL RESULTS**

BOYKEN INTERNATIONAL, INC. (GEORGIA
CORPORATION)
SUITE 1200
400 NORTHRIDGE ROAD
ATLANTA, GA 30350

FOR: ESTIMATING CONTRACTING WORK, IN
CLASS 35 (U.S. CLS. 100, 101 AND 102).

FIRST USE 6-1-2007; IN COMMERCE 6-1-2007.

FOR: CONSTRUCTION CONSULTATION; CON-
STRUCTION MANAGEMENT; PROJECT MANAGE-
MENT IN THE FIELD OF COMMERCIAL
CONSTRUCTION; CONSULTATION IN BUILDING
CONSTRUCTION SUPERVISION; RESIDENTIAL
AND BUILDING CONSTRUCTION CONSULTING,
IN CLASS 37 (U.S. CLS. 100, 103 AND 106).

FIRST USE 6-1-2007; IN COMMERCE 6-1-2007.

FOR: EXPERT WITNESS SERVICES IN LEGAL
MATTERS IN THE FIELDS OF CONSTRUCTION
AND PROJECT MANAGEMENT, IN CLASS 45 (U.S.
CLS. 100 AND 101).

FIRST USE 6-1-2007; IN COMMERCE 6-1-2007.

THE MARK CONSISTS OF STANDARD CHAR-
ACTERS WITHOUT CLAIM TO ANY PARTICULAR
FONT, STYLE, SIZE, OR COLOR.

SN 77-101,287, FILED 2-7-2007.

STEVEN PEREZ, EXAMINING ATTORNEY

Int. Cl.: 36

Prior U.S. Cls.: 100, 101, and 102

United States Patent and Trademark Office

Reg. No. 3,485,646

Registered Aug. 12, 2008

**SERVICE MARK
PRINCIPAL REGISTER**

STARMARK HEALTHY INCENTIVES

TRUSTMARK INSURANCE COMPANY (ILLINOIS INSURANCE CORPORATION)
400 FIELD DRIVE
LAKE FOREST, IL 60045

FOR: HEALTH INSURANCE UNDERWRITING AND ADMINISTRATION; ADMINISTRATION OF PREFERRED PROVIDER PLANS IN THE FIELDS OF MEDICAL AND DENTAL CARE; ORGANIZING PRE-PAID CONSUMER DIRECTED HEALTH PLANS (CDHP) FOR USE WITH HEALTH SAVINGS ACCOUNTS; ADMINISTRATION OF SELF-FUNDED HEALTH COVERAGE PLANS, IN CLASS 36 (U.S. CLS. 100, 101 AND 102).

FIRST USE 1-3-2007; IN COMMERCE 1-3-2007.

THE MARK CONSISTS OF STANDARD CHARACTERS WITHOUT CLAIM TO ANY PARTICULAR FONT, STYLE, SIZE, OR COLOR.

OWNER OF U.S. REG. NO. 1,428,726.

SN 77-101,334, FILED 2-7-2007.

DAWN HAN, EXAMINING ATTORNEY

Int. Cl.: 25

Prior U.S. Cls.: 22 and 39

United States Patent and Trademark Office

Reg. No. 3,485,647

Registered Aug. 12, 2008

**TRADEMARK
PRINCIPAL REGISTER**

ORGANIC GENES

ORGANIC GENES (NEVADA CORPORATION)
PO BOX 4156
REDONDO BEACH, CA 90277

FOR: CLOTHING MADE WHOLLY OR SIGNIFICANTLY IN PART OF ORGANIC FIBERS, NAME-
LY, JEANS, PANTS, SHORTS, T-SHIRTS, IN CLASS
25 (U.S. CLS. 22 AND 39).

FIRST USE 1-28-2007; IN COMMERCE 6-6-2008.

THE MARK CONSISTS OF STANDARD CHAR-
ACTERS WITHOUT CLAIM TO ANY PARTICULAR
FONT, STYLE, SIZE, OR COLOR.

NO CLAIM IS MADE TO THE EXCLUSIVE
RIGHT TO USE "ORGANIC", APART FROM THE
MARK AS SHOWN.

SN 77-102,026, FILED 2-7-2007.

DAVID MILLER, EXAMINING ATTORNEY

Int. Cl.: 33

Prior U.S. Cls.: 47 and 49

United States Patent and Trademark Office

Reg. No. 3,485,648

Registered Aug. 12, 2008

**TRADEMARK
PRINCIPAL REGISTER**

MICHEL STROGOFF

GGN ALFORT SARL (FRANCE SOCIETE A
RESPONSABILITE LIMITEE)
1, PLACE DU PETIT PONT
ALFORTVILLE, FRANCE F-94140

FOR: ALCOHOLIC BEVERAGES, NAMELY, VOD-
KA, IN CLASS 33 (U.S. CLS. 47 AND 49).

FIRST USE 11-30-2007; IN COMMERCE 11-30-2007.

THE MARK CONSISTS OF STANDARD CHAR-
ACTERS WITHOUT CLAIM TO ANY PARTICULAR
FONT, STYLE, SIZE, OR COLOR.

OWNER OF U.S. REG. NO. 634,694.

THE NAME(S), PORTRAIT(S), AND/OR SIGNA-
TURE(S) SHOWN IN THE MARK DOES NOT IDEN-
TIFY A PARTICULAR LIVING INDIVIDUAL.

SN 77-102,385, FILED 2-8-2007.

ASMAT KHAN, EXAMINING ATTORNEY

Int. Cl.: 35

Prior U.S. Cls.: 100, 101, and 102

United States Patent and Trademark Office

Reg. No. 3,485,649

Registered Aug. 12, 2008

**SERVICE MARK
PRINCIPAL REGISTER**

WMUMS

INNOVATION INSIGHTS, LLC (LOUISIANA LTD
LIAB CO)
232 SHADY OAKS CT.
BATON ROUGE, LA 70810

THE MARK CONSISTS OF STANDARD CHAR-
ACTERS WITHOUT CLAIM TO ANY PARTICULAR
FONT, STYLE, SIZE, OR COLOR.

FOR: CONSULTANCY SERVICES REGARDING
BUSINESS STRATEGIES, IN CLASS 35 (U.S. CLS. 100,
101 AND 102).

SN 77-102,679, FILED 2-8-2007.

FIRST USE 12-8-2006; IN COMMERCE 12-8-2006.

MICHAEL GAAFAR, EXAMINING ATTORNEY

Int. Cl.: 9

Prior U.S. Cls.: 21, 23, 26, 36, and 38

Reg. No. 3,485,650

United States Patent and Trademark Office

Registered Aug. 12, 2008

**TRADEMARK
PRINCIPAL REGISTER**

**Flying Tiger
Entertainment's Rascal
Roundup**

FLYING TIGER ENTERTAINMENT, INC (NEVADA CORPORATION)

251 EAST IMPERIAL HWY, SUITE 410

FULLERTON, CA 92835

FOR: ELECTRONIC GAME SOFTWARE FOR CELLULAR TELEPHONES, IN CLASS 9 (U.S. CLS. 21, 23, 26, 36 AND 38).

FIRST USE 5-20-2008; IN COMMERCE 5-30-2008.

THE MARK CONSISTS OF STANDARD CHARACTERS WITHOUT CLAIM TO ANY PARTICULAR FONT, STYLE, SIZE, OR COLOR.

NO CLAIM IS MADE TO THE EXCLUSIVE RIGHT TO USE "ENTERTAINMENT'S", APART FROM THE MARK AS SHOWN.

SN 77-102,701, FILED 2-8-2007.

JACQUELINE A. LAVINE, EXAMINING ATTORNEY

Int. Cl.: 9

Prior U.S. Cls.: 21, 23, 26, 36, and 38

Reg. No. 3,485,651

United States Patent and Trademark Office

Registered Aug. 12, 2008

**TRADEMARK
PRINCIPAL REGISTER**

**Flying Tiger
Entertainment's Loteria**

FLYING TIGER ENTERTAINMENT, INC. (NE-
VADA CORPORATION)
251 EAST IMPERIAL HWY, SUITE 410
FULLERTON, CA 92835

NO CLAIM IS MADE TO THE EXCLUSIVE
RIGHT TO USE "ENTERTAINMENT", APART
FROM THE MARK AS SHOWN.

FOR: ELECTRONIC GAME SOFTWARE FOR
CELLULAR TELEPHONES, IN CLASS 9 (U.S. CLS.
21, 23, 26, 36 AND 38).

THE FOREIGN WORDING IN THE MARK
TRANSLATES INTO ENGLISH AS "LOTTERY."

FIRST USE 5-20-2008; IN COMMERCE 5-30-2008.

SN 77-102,722, FILED 2-8-2007.

THE MARK CONSISTS OF STANDARD CHAR-
ACTERS WITHOUT CLAIM TO ANY PARTICULAR
FONT, STYLE, SIZE, OR COLOR.

JACQUELINE A. LAVINE, EXAMINING ATTOR-
NEY

Int. Cl.: 3

Prior U.S. Cls.: 1, 4, 6, 50, 51, and 52

Reg. No. 3,485,652

United States Patent and Trademark Office

Registered Aug. 12, 2008

**TRADEMARK
PRINCIPAL REGISTER**

CALM COOL & PROTECTED

BATH & BODY WORKS BRAND MANAGEMENT, INC. (DELAWARE CORPORATION)
7 LIMITED PARKWAY EAST
REYNOLDSBURG, OH 43068

FOR: PERSONAL CARE PRODUCTS, NAMELY, AEROSOL TANNING BODY SPRAY, BODY BRONZER, BODY MOISTURIZER, BODY SHIMMER, BODY WASH, BRONZING BODY LOTION, EAU DE TOILETTE, EAU DE TOILETTE SPRAY, FACE SUN BLOCK, FACE BRONZER, SOAP FOR THE FACE IN THE FORM OF PETALS, GRADUAL BODY TANNING LOTION AND CREAM, GRADUAL FACIAL TANNING LOTION AND CREAM, LEG BRONZER, LIP SUN BLOCK, NON-MEDICATED LIP PROTECTOR, POST-SUN TANNING LOTION FOR THE BODY, POST-SUN TANNING LOTION FOR THE FACE, PRE-SUN TANNING LOTION FOR THE BODY, PRE-SUN TANNING LOTION FOR THE FACE, SELF-TANNING PRE-

PARATIONS, SELF-TANNING CREAM AND LOTION, SELF-TANNING FACIAL PADS, SKIN BRONZING CREAM, SUN BLOCK FOR THE BODY, SUN BLOCK FOR THE FACE, SUN SCREEN, SUNLESS TANNING LOTION AND CREAM FOR THE BODY AND FACE, SUNTAN LOTION FOR THE BODY, SUNTAN LOTION FOR THE FACE, TINTED FACE LOTION, IN CLASS 3 (U.S. CLS. 1, 4, 6, 50, 51 AND 52).

FIRST USE 4-30-2007; IN COMMERCE 4-30-2007.

THE MARK CONSISTS OF STANDARD CHARACTERS WITHOUT CLAIM TO ANY PARTICULAR FONT, STYLE, SIZE, OR COLOR.

SN 77-103,646, FILED 2-9-2007.

GISELLE AGOSTO, EXAMINING ATTORNEY

Int. Cls.: 9 and 37

Prior U.S. Cls.: 21, 23, 26, 36, 38, 100, 103, and 106

United States Patent and Trademark Office

Reg. No. 3,485,653

Registered Aug. 12, 2008

**TRADEMARK
SERVICE MARK
PRINCIPAL REGISTER**

Andalay Solar

AKEENA SOLAR INC. (DELAWARE CORPORATION)
605 UNIVERSITY AVE.
LOS GATOS, CA 95032

FOR: COMPUTER SOFTWARE FOR PHOTOVOLTAIC SYSTEMS FOR EVALUATING ELECTRIC CONSUMPTION, DETERMINING SYSTEM SIZING, ESTIMATING ELECTRICAL OUTPUT, ESTIMATING CUSTOMER COSTS, AND ESTIMATING FINANCIAL LIFE CYCLES SAVINGS, FOR USE BY CONSUMERS AND BUSINESSES, IN CLASS 9 (U.S. CLS. 21, 23, 26, 36 AND 38).

FIRST USE 7-15-2007; IN COMMERCE 7-15-2007.

FOR: INSTALLATION OF RENEWABLE ENERGY SYSTEMS, NAMELY, PHOTOVOLTAIC SYSTEMS COMPOSED OF PHOTOVOLTAIC SOLAR

MODULES, BATTERIES, VOLTAGE REGULATORS, INVERTERS, RACKS, AND ELECTRIC CONTROLS, IN CLASS 37 (U.S. CLS. 100, 103 AND 106).

FIRST USE 7-15-2007; IN COMMERCE 7-15-2007.

THE MARK CONSISTS OF STANDARD CHARACTERS WITHOUT CLAIM TO ANY PARTICULAR FONT, STYLE, SIZE, OR COLOR.

NO CLAIM IS MADE TO THE EXCLUSIVE RIGHT TO USE "SOLAR", APART FROM THE MARK AS SHOWN.

SN 77-104,231, FILED 2-9-2007.

EMILY CHUO, EXAMINING ATTORNEY

Int. Cl.: 10

Prior U.S. Cls.: 26, 39, and 44

Reg. No. 3,485,654

United States Patent and Trademark Office

Registered Aug. 12, 2008

**TRADEMARK
PRINCIPAL REGISTER**

WHACK-O-DOODLE

ENERGY UNLIMITED PRODUCTIONS, INC.
(CALIFORNIA CORPORATION)
721 KITTY STREET
NEWBURY PARK, CA 91320

THE MARK CONSISTS OF STANDARD CHAR-
ACTERS WITHOUT CLAIM TO ANY PARTICULAR
FONT, STYLE, SIZE, OR COLOR.

FOR: MESSAGE APPARATUS; MASSAGING AP-
PARATUS FOR PERSONAL USE, IN CLASS 10 (U.S.
CLS. 26, 39 AND 44).

SN 77-106,157, FILED 2-13-2007.

FIRST USE 2-15-2008; IN COMMERCE 2-15-2008.

KYLE PEETE, EXAMINING ATTORNEY

Int. Cl.: 43

Prior U.S. Cls.: 100 and 101

United States Patent and Trademark Office

Reg. No. 3,485,655

Registered Aug. 12, 2008

**SERVICE MARK
PRINCIPAL REGISTER**

OPERATION RECOGNITION

OPERATION RECOGNITION (MAINE CORPORATION)
66 BOARD ROAD
BRUNSWICK, ME 04011

FOR: CHARITABLE SERVICES, NAMELY, PROVIDING HOTEL AND RESORT LODGING SERVICES TO MILITARY PERSONNEL AND FAMILIES OF MILITARY PERSONNEL, IN CLASS 43 (U.S. CLS. 100 AND 101).

FIRST USE 6-25-2007; IN COMMERCE 6-25-2007.

THE MARK CONSISTS OF STANDARD CHARACTERS WITHOUT CLAIM TO ANY PARTICULAR FONT, STYLE, SIZE, OR COLOR.

NO CLAIM IS MADE TO THE EXCLUSIVE RIGHT TO USE "OPERATION", APART FROM THE MARK AS SHOWN.

SN 77-106,276, FILED 2-13-2007.

ELIZABETH KAJUBI, EXAMINING ATTORNEY

Int. Cl.: 36

Prior U.S. Cls.: 100, 101, and 102

United States Patent and Trademark Office

Reg. No. 3,485,656

Registered Aug. 12, 2008

**SERVICE MARK
PRINCIPAL REGISTER**

echo 
trade

ECHOTRADE LLC (ARIZONA LTD LIAB CO)
2525 E. CAMELBACK ROAD, STE 1040
PHOENIX, AZ 85016

FOR: SECURITIES TRADING AND INVESTING
SERVICES FOR OTHERS VIA THE INTERNET, IN
CLASS 36 (U.S. CLS. 100, 101 AND 102).

FIRST USE 9-28-2000; IN COMMERCE 9-28-2000.

OWNER OF U.S. REG. NO. 2,575,856.

NO CLAIM IS MADE TO THE EXCLUSIVE
RIGHT TO USE "TRADE", APART FROM THE
MARK AS SHOWN.

THE MARK CONSISTS OF THE WORDS "ECHO
TRADE" AND THE DESIGN OF SOUND WAVES.

SN 77-106,553, FILED 2-13-2007.

KELLY BOULTON, EXAMINING ATTORNEY

Int. Cl.: 45

Prior U.S. Cls.: 100 and 101

United States Patent and Trademark Office

Reg. No. 3,485,657

Registered Aug. 12, 2008

**SERVICE MARK
PRINCIPAL REGISTER**

NO DRAWING-SENSORY MARK

ROSENBERGER, RONALD J. (UNITED STATES
INDIVIDUAL)
506 STERLING ST.
NEWTOWN, PA 18940

FOR: LICENSING OF INTELLECTUAL PROPER-
TY RELATING TO CREDIT CARD SERVICES AND
DEBIT CARD SERVICES, IN CLASS 45 (U.S. CLS. 100
AND 101).

FIRST USE 2-2-2007; IN COMMERCE 2-2-2007.

THE MARK IS A SOUND. THE MARK CONSISTS
OF THE SOUND OF AN AMPHIBIAN, SUCH AS A
FROG, CROAKING OR OTHERWISE VERBALIZ-
ING THE WORD "CREBIT".

SN 77-107,881, FILED 2-14-2007.

JASON BLAIR, EXAMINING ATTORNEY

Int. Cl.: 8

Prior U.S. Cls.: 23, 28, and 44

United States Patent and Trademark Office

Reg. No. 3,485,658

Registered Aug. 12, 2008

**TRADEMARK
PRINCIPAL REGISTER**



MEGA BRANDS INTERNATIONAL, LUXEM-
BOURG, ZUG BRANCH (LUXEMBOURG
CORPORATION)
POSTSTRASSE 6
ZUG, SWITZERLAND CH-6300

OWNER OF U.S. REG. NOS. 1,822,018, 3,159,675,
AND OTHERS.

FOR: SCISSORS, IN CLASS 8 (U.S. CLS. 23, 28 AND
44).

SN 77-109,000, FILED 2-16-2007.

FIRST USE 8-31-2007; IN COMMERCE 8-31-2007.

SHARON MEIER, EXAMINING ATTORNEY

Int. Cl.: 36

Prior U.S. Cls.: 100, 101, and 102

United States Patent and Trademark Office

Reg. No. 3,485,659

Registered Aug. 12, 2008

**SERVICE MARK
PRINCIPAL REGISTER**

BROADRIDGE

BROADRIDGE FINANCIAL SOLUTIONS, LLC
(DELAWARE LTD LIAB CO)
200 PARK AVENUE
C/O GREENBERG TRAURIG, LLP
NEW YORK, NY 10166

FOR: FINANCIAL SERVICES, NAMELY, PROVIDING SECURITIES BROKERAGE SERVICES, NAMELY, SECURITIES TRANSACTION PROCESSING AND CORRESPONDENT CLEARING SERVICES, CONTACTING INVESTORS REGARDING SECURITIES TRANSACTIONS, NAMELY, TRANSACTION REPORTING, IN CLASS 36 (U.S. CLS. 100, 101 AND 102).

FIRST USE 3-30-2007; IN COMMERCE 3-30-2007.

THE MARK CONSISTS OF STANDARD CHARACTERS WITHOUT CLAIM TO ANY PARTICULAR FONT, STYLE, SIZE, OR COLOR.

SN 77-109,656, FILED 2-16-2007.

KARANENDRA S. CHHINA, EXAMINING ATTORNEY

Int. Cl.: 36

Prior U.S. Cls.: 100, 101, and 102

United States Patent and Trademark Office

Reg. No. 3,485,660

Registered Aug. 12, 2008

**SERVICE MARK
PRINCIPAL REGISTER**



Broadridge

BROADRIDGE FINANCIAL SOLUTIONS, LLC
(DELAWARE LTD LIAB CO)
200 PARK AVENUE
C/O GREENBERG TRAURIG, LLP
NEW YORK, NY 10166

FOR: FINANCIAL SERVICES, NAMELY, PROVIDING SECURITIES BROKERAGE SERVICES, NAMELY, SECURITIES TRANSACTION PROCESSING AND CORRESPONDENT CLEARING SERVICES, CONTACTING INVESTORS REGARDING SECURITIES TRANSACTIONS, NAMELY, TRANSACTION REPORTING, IN CLASS 36 (U.S. CLS. 100, 101 AND 102).

FIRST USE 3-30-2007; IN COMMERCE 3-30-2007.

THE MARK CONSISTS OF TWO ARROWS POINTING TO EACH OTHER CONTAINED WITHIN MIRRORED RECTANGULAR SHAPES AND THE WORD "BROADRIDGE".

SN 77-109,674, FILED 2-16-2007.

KARANENDRA S. CHHINA, EXAMINING ATTORNEY

Int. Cl.: 39

Prior U.S. Cls.: 100 and 105

United States Patent and Trademark Office

Reg. No. 3,485,661

Registered Aug. 12, 2008

**SERVICE MARK
PRINCIPAL REGISTER**

Big Front Seat

SPIRIT AIRLINES, INC. (DELAWARE CORPORATION)
2800 EXECUTIVE WAY
MIRAMAR, FL 33025

FOR: AIR TRANSPORTATION SERVICES, NAMELY, TRANSPORTATION OF PASSENGERS, PARCELS AND CARGO, IN CLASS 39 (U.S. CLS. 100 AND 105).

FIRST USE 6-20-2007; IN COMMERCE 6-20-2007.

THE MARK CONSISTS OF STANDARD CHARACTERS WITHOUT CLAIM TO ANY PARTICULAR FONT, STYLE, SIZE, OR COLOR.

SN 77-110,846, FILED 2-19-2007.

BARBARA RUTLAND, EXAMINING ATTORNEY

Int. Cl.: 10

Prior U.S. Cls.: 26, 39, and 44

United States Patent and Trademark Office

Reg. No. 3,485,662

Registered Aug. 12, 2008

**TRADEMARK
PRINCIPAL REGISTER**

Ligaprene Silk

POLY-MED, INC. (SOUTH CAROLINA CORPORATION)

6309 HWY 187

ANDERSON, SC 29625

FOR: SILK SUTURES, IN CLASS 10 (U.S. CLS. 26, 39 AND 44).

FIRST USE 2-20-2007; IN COMMERCE 3-27-2008.

THE MARK CONSISTS OF STANDARD CHARACTERS WITHOUT CLAIM TO ANY PARTICULAR FONT, STYLE, SIZE, OR COLOR.

NO CLAIM IS MADE TO THE EXCLUSIVE RIGHT TO USE "SILK", APART FROM THE MARK AS SHOWN.

SN 77-111,153, FILED 2-20-2007.

GISELLE AGOSTO, EXAMINING ATTORNEY

Int. Cl.: 3

Prior U.S. Cls.: 1, 4, 6, 50, 51, and 52

Reg. No. 3,485,663

United States Patent and Trademark Office

Registered Aug. 12, 2008

**TRADEMARK
PRINCIPAL REGISTER**

**KIS - kreative.
innovative. smart.**

TRESSA, INC. (OHIO CORPORATION)
2711 CIRCLEPORT DRIVE
ERLANGER, KY 41018

FIRST USE 8-1-2007; IN COMMERCE 8-1-2007.

FOR: HAIR CARE PREPARATIONS, NAMELY, SHAMPOOS, CONDITIONERS, HAIR SPRAYS, GELS, MOUSSES, POMADES, HAIR STYLING PREPARATIONS, AND HAIR STRAIGHTENING PREPARATIONS, ALL FOR SALE AND USE IN PROFESSIONAL SALONS, IN CLASS 3 (U.S. CLS. 1, 4, 6, 50, 51 AND 52).

THE MARK CONSISTS OF STANDARD CHARACTERS WITHOUT CLAIM TO ANY PARTICULAR FONT, STYLE, SIZE, OR COLOR.

SN 77-112,467, FILED 2-21-2007.

KARANENDRA S. CHHINA, EXAMINING ATTORNEY

Int. Cl.: 42

Prior U.S. Cls.: 100 and 101

United States Patent and Trademark Office

Reg. No. 3,485,664

Registered Aug. 12, 2008

**SERVICE MARK
PRINCIPAL REGISTER**

Acceleran

ACCELERAN, LLC (WISCONSIN LTD LIAB CO)
7900 S. CHAPEL HILL DRIVE
FRANKLIN, WI 53132

FIRST USE 1-7-2007; IN COMMERCE 1-1-2007.

FOR: COMPUTER SERVICE, NAMELY, ACTING AS AN APPLICATION SERVICE PROVIDER IN THE FIELD OF KNOWLEDGE MANAGEMENT TO HOST COMPUTER APPLICATION SOFTWARE FOR THE COLLECTION, EDITING, ORGANIZING, MODIFYING, BOOK MARKING, TRANSMISSION, STORAGE AND SHARING OF DATA AND INFORMATION, IN CLASS 42 (U.S. CLS. 100 AND 101).

THE MARK CONSISTS OF STANDARD CHARACTERS WITHOUT CLAIM TO ANY PARTICULAR FONT, STYLE, SIZE, OR COLOR.

SN 77-113,230, FILED 2-22-2007.

WENDY GOODMAN, EXAMINING ATTORNEY

Int. Cl.: 41

Prior U.S. Cls.: 100, 101, and 107

United States Patent and Trademark Office

Reg. No. 3,485,665

Registered Aug. 12, 2008

**SERVICE MARK
PRINCIPAL REGISTER**

Courageous Selling

ILLUMINATE INCORPORATED (MASSACHU-
SETTS CORPORATION)
27-43 WORMWOOD STREET, SUITE 510
BOSTON, MA 02210

FOR: EDUCATIONAL SERVICES, NAMELY,
SEMINARS, PROGRAMS, CLASSES AND WORK-
SHOPS ON SALES TECHNIQUES AND BUSINESS
PERFORMANCE, AND DISTRIBUTING COURSE
MATERIALS IN CONNECTION THEREWITH, IN
CLASS 41 (U.S. CLS. 100, 101 AND 107).

FIRST USE 7-1-2007; IN COMMERCE 7-1-2007.

THE MARK CONSISTS OF STANDARD CHAR-
ACTERS WITHOUT CLAIM TO ANY PARTICULAR
FONT, STYLE, SIZE, OR COLOR.

NO CLAIM IS MADE TO THE EXCLUSIVE
RIGHT TO USE "SELLING", APART FROM THE
MARK AS SHOWN.

SN 77-113,926, FILED 2-22-2007.

RAMONA ORTIGA, EXAMINING ATTORNEY

Int. Cl.: 9

Prior U.S. Cls.: 21, 23, 26, 36, and 38

United States Patent and Trademark Office

Reg. No. 3,485,666

Registered Aug. 12, 2008

**TRADEMARK
PRINCIPAL REGISTER**

**The User is the Killer
Application**

JACKBE CORPORATION (DELAWARE CORPORATION)
4600 NORTH PARK AVE. SUITE 200
CHEVY CHASE, MD 20815

FOR: SOFTWARE PLATFORM FOR FACILITATING END-USER DEVELOPMENT AND ASSEMBLY OF WEB APPLICATIONS AND ALLOWS APPLICATIONS TO CONSUME INTERNAL AND EXTERNAL SERVICES AT RUN-TIME WHILE ENFORCING SECURITY AND GOVERNANCE POLICIES ESTABLISHED BY IT THAT COMBINES SERVICE-ORIENTED ARCHITECTURE (SOA), ASYNCHRONOUS DHTML, CSS AND XML (AJAX) WITH STRONG GOVERNANCE AND STANDARDIZATION OF ALLOWABLE USAGE THAT OPERATES AS A SURFACE LAYER OVER EXISTING MIDDLEWARE

AND SERVICES, IN CLASS 9 (U.S. CLS. 21, 23, 26, 36 AND 38).

FIRST USE 2-1-2007; IN COMMERCE 2-1-2007.

THE MARK CONSISTS OF STANDARD CHARACTERS WITHOUT CLAIM TO ANY PARTICULAR FONT, STYLE, SIZE, OR COLOR.

NO CLAIM IS MADE TO THE EXCLUSIVE RIGHT TO USE "KILLER APPLICATION", APART FROM THE MARK AS SHOWN.

SN 77-114,060, FILED 2-22-2007.

CAROLYN GRAY, EXAMINING ATTORNEY

Int. Cl.: 38

Prior U.S. Cls.: 100, 101, and 104

United States Patent and Trademark Office

Reg. No. 3,485,667

Registered Aug. 12, 2008

**SERVICE MARK
PRINCIPAL REGISTER**

BUTACA

VERANDA ENTERTAINMENT, LLC (CALIFORNIA LTD LIAB CO)
12342 MONTANA AVENUE, SUITE 4
LOS ANGELES, CA 90049

FOR: AUDIO AND VIDEO STREAMING SERVICES, ELECTRONIC TRANSMISSION OF AUDIO AND VISUAL CONTENT IN THE NATURE OF MOTION PICTURES, MOTION PICTURE TRAILERS, DOCUMENTARIES/BIOGRAPHIES, SPORTS, ANIMATION AND MUSIC VIA A GLOBAL COMPUTER NETWORK, IN CLASS 38 (U.S. CLS. 100, 101 AND 104).

FIRST USE 4-25-2008; IN COMMERCE 4-25-2008.

THE MARK CONSISTS OF STANDARD CHARACTERS WITHOUT CLAIM TO ANY PARTICULAR FONT, STYLE, SIZE, OR COLOR.

SN 77-114,066, FILED 2-22-2007.

CAROLYN GRAY, EXAMINING ATTORNEY

Int. Cl.: 9

Prior U.S. Cls.: 21, 23, 26, 36, and 38

Reg. No. 3,485,668

United States Patent and Trademark Office

Registered Aug. 12, 2008

**TRADEMARK
PRINCIPAL REGISTER**

The User is the Kille App

JACKBE CORPORATION (DELAWARE CORPORATION)
4600 NORTH PARK AVE. SUITE 200
CHEVY CHASE, MD 20815

FOR: SOFTWARE PLATFORM FOR FACILITATING END-USER DEVELOPMENT AND ASSEMBLY OF WEB APPLICATIONS AND ALLOWS APPLICATIONS TO CONSUME INTERNAL AND EXTERNAL SERVICES AT RUN-TIME WHILE ENFORCING SECURITY AND GOVERNANCE POLICIES ESTABLISHED BY IT THAT COMBINES SERVICE-ORIENTED ARCHITECTURE (SOA), ASYNCHRONOUS DHTML, CSS AND XML (AJAX) WITH STRONG GOVERNANCE AND STANDARDIZATION OF ALLOWABLE USAGE THAT OPERATES AS A SURFACE LAYER OVER EXISTING MIDDLEWARE

AND SERVICES, IN CLASS 9 (U.S. CLS. 21, 23, 26, 36 AND 38).

FIRST USE 2-1-2007; IN COMMERCE 2-1-2007.

THE MARK CONSISTS OF STANDARD CHARACTERS WITHOUT CLAIM TO ANY PARTICULAR FONT, STYLE, SIZE, OR COLOR.

NO CLAIM IS MADE TO THE EXCLUSIVE RIGHT TO USE "KILLE APP", APART FROM THE MARK AS SHOWN.

SN 77-114,069, FILED 2-22-2007.

CAROLYN GRAY, EXAMINING ATTORNEY

Int. Cl.: 41

Prior U.S. Cls.: 100, 101, and 107

United States Patent and Trademark Office

Reg. No. 3,485,669

Registered Aug. 12, 2008

**SERVICE MARK
PRINCIPAL REGISTER**

HELL DATE

BLACK ENTERTAINMENT TELEVISION LLC
(D.C. LTD LIAB CO)
LEGAL AFFAIRS
ONE BET PLAZA, 1235 W STREET, N.E.
WASHINGTON, DC 20018

FOR: ENTERTAINMENT SERVICES, NAMELY,
PROVIDING AN ON-GOING REALITY BASED TEL-
EVISION PROGRAM VIA THE INTERNET, TELE-
VISION, CABLE AND WIRELESS, IN CLASS 41 (U.S.
CLS. 100, 101 AND 107).

FIRST USE 7-2-2007; IN COMMERCE 7-2-2007.

THE MARK CONSISTS OF STANDARD CHAR-
ACTERS WITHOUT CLAIM TO ANY PARTICULAR
FONT, STYLE, SIZE, OR COLOR.

NO CLAIM IS MADE TO THE EXCLUSIVE
RIGHT TO USE "DATE", APART FROM THE MARK
AS SHOWN.

SN 77-114,081, FILED 2-22-2007.

BENJAMIN OKEKE, EXAMINING ATTORNEY

Int. Cl.: 32

Prior U.S. Cls.: 45, 46, and 48

United States Patent and Trademark Office

Reg. No. 3,485,670

Registered Aug. 12, 2008

**TRADEMARK
PRINCIPAL REGISTER**

KOOL-AID BURSTIN' WATERS

KRAFT FOODS HOLDINGS, INC. (DELAWARE
CORPORATION)
THREE LAKES DRIVE
NF-577
NORTHFIELD, IL 60093

FOR: FLAVORED WATERS, IN CLASS 32 (U.S.
CLS. 45, 46 AND 48).

FIRST USE 1-1-2008; IN COMMERCE 1-1-2008.

THE MARK CONSISTS OF STANDARD CHAR-
ACTERS WITHOUT CLAIM TO ANY PARTICULAR
FONT, STYLE, SIZE, OR COLOR.

OWNER OF U.S. REG. NOS. 317,955, 1,133,277,
AND OTHERS.

NO CLAIM IS MADE TO THE EXCLUSIVE
RIGHT TO USE "WATERS", APART FROM THE
MARK AS SHOWN.

SN 77-114,663, FILED 2-23-2007.

KELLY MCCOY, EXAMINING ATTORNEY

Int. Cl.: 35

Prior U.S. Cls.: 100, 101, and 102

United States Patent and Trademark Office

Reg. No. 3,485,671

Registered Aug. 12, 2008

**SERVICE MARK
PRINCIPAL REGISTER**

MORE THAN A BUNCH

BLOOMSPRESS, INC. (FLORIDA CORPORATION)
SUITE 100
8323 NW 12TH STREET
MIAMI, FL 33126

THE MARK CONSISTS OF STANDARD CHARACTERS WITHOUT CLAIM TO ANY PARTICULAR FONT, STYLE, SIZE, OR COLOR.

FOR: ONLINE RETAIL STORE SERVICES FEATURING FRESH FLOWERS, IN CLASS 35 (U.S. CLS. 100, 101 AND 102).

SN 77-115,099, FILED 2-23-2007.

FIRST USE 4-0-2008; IN COMMERCE 4-0-2008.

WENDY GOODMAN, EXAMINING ATTORNEY

Int. Cl.: 5

Prior U.S. Cls.: 6, 18, 44, 46, 51, and 52

United States Patent and Trademark Office

Reg. No. 3,485,672

Registered Aug. 12, 2008

**TRADEMARK
PRINCIPAL REGISTER**

ONE SHOT

BF PRODUCTS, LLC (NEW YORK LTD LIAB CO)
200 WESTERLY ROAD
BELLINGHAM, WA 98226

THE MARK CONSISTS OF STANDARD CHAR-
ACTERS WITHOUT CLAIM TO ANY PARTICULAR
FONT, STYLE, SIZE, OR COLOR.

FOR: HOUSEHOLD INSECTICIDES FOR CONSU-
MER USE, IN CLASS 5 (U.S. CLS. 6, 18, 44, 46, 51 AND
52).

SN 77-115,747, FILED 2-26-2007.

FIRST USE 3-17-2008; IN COMMERCE 3-17-2008.

INGRID C. EULIN, EXAMINING ATTORNEY

Int. Cl.: 35

Prior U.S. Cls.: 100, 101, and 102

United States Patent and Trademark Office

Reg. No. 3,485,673

Registered Aug. 12, 2008

**SERVICE MARK
PRINCIPAL REGISTER**

CLASSY CASUALS

CLASSY CASUALS, INC. (IDAHO CORPORATION)
C/O BECKY CUNNINGHAM
5117 CANARY LANE
NAMPA, ID 83687

FOR: RETAIL APPAREL STORE, IN CLASS 35
(U.S. CLS. 100, 101 AND 102).

FIRST USE 8-1-2007; IN COMMERCE 8-1-2007.

THE MARK CONSISTS OF STANDARD CHARACTERS WITHOUT CLAIM TO ANY PARTICULAR FONT, STYLE, SIZE, OR COLOR.

NO CLAIM IS MADE TO THE EXCLUSIVE RIGHT TO USE "CASUALS", APART FROM THE MARK AS SHOWN.

SN 77-116,396, FILED 2-26-2007.

ANNE MADDEN, EXAMINING ATTORNEY

Int. Cl.: 10

Prior U.S. Cls.: 26, 39, and 44

United States Patent and Trademark Office

Reg. No. 3,485,674

Registered Aug. 12, 2008

**TRADEMARK
PRINCIPAL REGISTER**

REVERSATILITY

EXACTECH, INC. (FLORIDA CORPORATION)
2320 NW 66TH COURT
GAINESVILLE, FL 32653

FOR: A FEATURE THAT IS SOLD AS AN INTEGRAL COMPONENT OF ORTHOPEDIC SHOULDER PROSTHESIS THAT ENABLES THE CREATION OF A REVERSE SHOULDER CONSTRUCTION, IN CLASS 10 (U.S. CLS. 26, 39 AND 44).

FIRST USE 3-0-2007; IN COMMERCE 3-0-2007.

THE MARK CONSISTS OF STANDARD CHARACTERS WITHOUT CLAIM TO ANY PARTICULAR FONT, STYLE, SIZE, OR COLOR.

SN 77-117,023, FILED 2-27-2007.

JOHN DALIER, EXAMINING ATTORNEY

Int. Cl.: 31

Prior U.S. Cls.: 1 and 46

United States Patent and Trademark Office

Reg. No. 3,485,675

Registered Aug. 12, 2008

**TRADEMARK
PRINCIPAL REGISTER**

ODOR WALL

NORMERICA INC. (CANADA CORPORATION)
SUITE 600
703 EVANS AVENUE
TORONTO, CANADA M9C 5E9

FOR: CAT LITTER, IN CLASS 31 (U.S. CLS. 1 AND 46).

FIRST USE 4-0-2007; IN COMMERCE 4-0-2007.

THE MARK CONSISTS OF STANDARD CHARACTERS WITHOUT CLAIM TO ANY PARTICULAR FONT, STYLE, SIZE, OR COLOR.

NO CLAIM IS MADE TO THE EXCLUSIVE RIGHT TO USE "ODOR", APART FROM THE MARK AS SHOWN.

SN 77-117,199, FILED 2-27-2007.

SHARON MEIER, EXAMINING ATTORNEY

Int. Cl.: 40

Prior U.S. Cls.: 100, 103, and 106

United States Patent and Trademark Office

Reg. No. 3,485,676

Registered Aug. 12, 2008

**SERVICE MARK
PRINCIPAL REGISTER**

MindSpeakers

DELOS REYES, JUSTIN E (CALIFORNIA SOLE
PROPRIETORSHIP)
8400 YERMO WAY
SACRAMENTO, CA 95828

THE MARK CONSISTS OF STANDARD CHAR-
ACTERS WITHOUT CLAIM TO ANY PARTICULAR
FONT, STYLE, SIZE, OR COLOR.

FOR: IMPRINTING MESSAGES ON T-SHIRTS, IN
CLASS 40 (U.S. CLS. 100, 103 AND 106).

SN 77-117,260, FILED 2-27-2007.

FIRST USE 7-1-2006; IN COMMERCE 7-1-2006.

CAROLYN GRAY, EXAMINING ATTORNEY

Int. Cl.: 33

Prior U.S. Cls.: 47 and 49

United States Patent and Trademark Office

Reg. No. 3,485,677

Registered Aug. 12, 2008

**TRADEMARK
PRINCIPAL REGISTER**

CANOPIA

BODEGAS ESMERALDA S.A. (ARGENTINA
CORPORATION)
RIVADAVIA 413, 9TH FLOOR
BUENOS AIRES, ARGENTINA

THE MARK CONSISTS OF STANDARD CHAR-
ACTERS WITHOUT CLAIM TO ANY PARTICULAR
FONT, STYLE, SIZE, OR COLOR.

FOR: ALCOHOLIC BEVERAGES, NAMELY,
WINES, IN CLASS 33 (U.S. CLS. 47 AND 49).

SN 77-117,261, FILED 2-27-2007.

FIRST USE 8-31-2007; IN COMMERCE 8-31-2007.

CAROLYN GRAY, EXAMINING ATTORNEY

Int. Cl.: 6

Prior U.S. Cls.: 2, 12, 13, 14, 23, 25, and 50

United States Patent and Trademark Office

Reg. No. 3,485,678

Registered Aug. 12, 2008

TRADEMARK
PRINCIPAL REGISTER

 CHROME HEARTS 

CHROME HEARTS LLC (DELAWARE LTD LIAB
CO)
915 N. MANSFIELD
HOLLYWOOD, CA 90038

FOR: DECORATIVE HARDWARE, NAMELY,
METAL DOORKNOBS, METAL DOOR HANDLES,
COMMON METAL DRAWER PULLS, METAL HIN-
GES; AND METAL FASTENERS, NAMELY, BOLTS,
SCREWS AND RIVETS, IN CLASS 6 (U.S. CLS. 2, 12,
13, 14, 23, 25 AND 50).

FIRST USE 5-1-2007; IN COMMERCE 5-1-2007.

OWNER OF U.S. REG. NOS. 2,307,126, 2,375,507,
AND OTHERS.

NO CLAIM IS MADE TO THE EXCLUSIVE
RIGHT TO USE "CHROME", APART FROM THE
MARK AS SHOWN.

THE WORDING "HEARTS" HAS NO MEANING
IN A FOREIGN LANGUAGE.

SN 77-117,670, FILED 2-27-2007.

DAWN HAN, EXAMINING ATTORNEY

Int. Cl.: 10

Prior U.S. Cls.: 26, 39, and 44

United States Patent and Trademark Office

Reg. No. 3,485,679

Registered Aug. 12, 2008

**TRADEMARK
PRINCIPAL REGISTER**

**No wrinkles, No sags, No
Bags, Naturally**

JCN INTERNATIONAL, INC. (FLORIDA CORPORATION)
P.O BOX 209607
FORT LAUDERDALE, FL 33329

THE MARK CONSISTS OF STANDARD CHARACTERS WITHOUT CLAIM TO ANY PARTICULAR FONT, STYLE, SIZE, OR COLOR.

FOR: MOUTH EXERCISER FOR USE IN EXERCISING AND STRENGTHENING MOUTH AND FACIAL MUSCLES FOR MEDICAL AND BEAUTY BENEFITS, IN CLASS 10 (U.S. CLS. 26, 39 AND 44).

SN 77-117,879, FILED 2-28-2007.

FIRST USE 7-15-2007; IN COMMERCE 7-15-2007.

MICHAEL TANNER, EXAMINING ATTORNEY

Int. Cl.: 10

Prior U.S. Cls.: 26, 39, and 44

Reg. No. 3,485,680

United States Patent and Trademark Office

Registered Aug. 12, 2008

**TRADEMARK
PRINCIPAL REGISTER**

The totally natural way to
accomplish what plastic
surgeons charge thousands
and thousands of dollars
to do or cannot do

JCN INTERNATIONAL, INC. (FLORIDA COR-
PORATION)
P.O BOX 209607
FORT LAUDERDALE, FL 33329

THE MARK CONSISTS OF STANDARD CHAR-
ACTERS WITHOUT CLAIM TO ANY PARTICULAR
FONT, STYLE, SIZE, OR COLOR.

FOR: MOUTH EXERCISER FOR USE IN EXER-
CISING AND STRENGTHENING MOUTH AND
FACIAL MUSCLES FOR MEDICAL AND BEAUTY
BENEFITS, IN CLASS 10 (U.S. CLS. 26, 39 AND 44).

SN 77-117,883, FILED 2-28-2007.

FIRST USE 7-15-2007; IN COMMERCE 7-15-2007.

MICHAEL TANNER, EXAMINING ATTORNEY

Int. Cl.: 30

Prior U.S. Cl.: 46

United States Patent and Trademark Office

Reg. No. 3,485,681

Registered Aug. 12, 2008

**TRADEMARK
PRINCIPAL REGISTER**

CHOCOCAFE

ZAVIDA COFFEE COMPANY INC. (CANADA
CORPORATION)
70 CONNIE CRESCENT
CONCORD, ONTARIO, CANADA L4K1L6

FOR: COFFEE; (BASED ON 44(E)) CHOCOLATE
FLAVORED BEVERAGES, NAMELY, CHOCOLATE
FLAVORED COFFEE, CHOCOLATE FLAVORED
COFFEE DRINK, AND INSTANT COFFEE WITH
CHOCOLATE POWDER, IN CLASS 30 (U.S. CL. 46).

FIRST USE 2-22-2007; IN COMMERCE 10-15-2007.

THE MARK CONSISTS OF STANDARD CHAR-
ACTERS WITHOUT CLAIM TO ANY PARTICULAR
FONT, STYLE, SIZE, OR COLOR.

OWNER OF CANADA REG. NO. 466115, DATED
11-20-1996, EXPIRES 11-20-2011.

OWNER OF U.S. REG. NO. 1,558,284.

SN 77-118,875, FILED 2-28-2007.

CYNTHIA SLOAN, EXAMINING ATTORNEY

Int. Cl.: 16

Prior U.S. Cls.: 2, 5, 22, 23, 29, 37, 38, and 50

Reg. No. 3,485,682

United States Patent and Trademark Office

Registered Aug. 12, 2008

**TRADEMARK
PRINCIPAL REGISTER**

CONSTRU-GUIA AL DIA

THE CLOUD PEAK FIRM, INC. (GEORGIA CORPORATION)
2618 TWIN LAKES WAY
MARIETTA, GA 30062

FOR: MAGAZINES IN THE FIELDS OF HOME CONSTRUCTION AND REMODELING, IN CLASS 16 (U.S. CLS. 2, 5, 22, 23, 29, 37, 38 AND 50).

FIRST USE 7-1-2007; IN COMMERCE 7-1-2007.

THE MARK CONSISTS OF STANDARD CHARACTERS WITHOUT CLAIM TO ANY PARTICULAR FONT, STYLE, SIZE, OR COLOR.

THE FOREIGN WORDING IN THE MARK TRANSLATES INTO ENGLISH AS UP TO DATE CONSTRUCTION MENTOR.

SN 77-119,155, FILED 2-28-2007.

MICHAEL LEWIS, EXAMINING ATTORNEY

Int. Cl.: 41

Prior U.S. Cls.: 100, 101, and 107

United States Patent and Trademark Office

Reg. No. 3,485,683

Registered Aug. 12, 2008

**SERVICE MARK
PRINCIPAL REGISTER**

BY THE HAND CLUB FOR KIDS

KIDS' CLUB NORTH AMERICA (ILLINOIS NOT
FOR PROFIT CORPORATION)
1000 NORTH SEDGWICK
CHICAGO, IL 60610

FOR: EDUCATIONAL SERVICES, NAMELY,
CONDUCTING AFTER-SCHOOL HOLISTIC PRO-
GRAMS TO DEVELOP CHILDREN'S MINDS, BOD-
IES AND SOULS, IN CLASS 41 (U.S. CLS. 100, 101
AND 107).

FIRST USE 10-1-2007; IN COMMERCE 10-1-2007.

THE MARK CONSISTS OF STANDARD CHAR-
ACTERS WITHOUT CLAIM TO ANY PARTICULAR
FONT, STYLE, SIZE, OR COLOR.

NO CLAIM IS MADE TO THE EXCLUSIVE
RIGHT TO USE "CLUB FOR KIDS", APART FROM
THE MARK AS SHOWN.

SN 77-119,304, FILED 3-1-2007.

PAUL E. FAHRENKOPF, EXAMINING ATTORNEY

Int. Cl.: 5

Prior U.S. Cls.: 6, 18, 44, 46, 51, and 52

Reg. No. 3,485,684

United States Patent and Trademark Office

Registered Aug. 12, 2008

**TRADEMARK
PRINCIPAL REGISTER**

VANILLA PASSION

RECKITT BENCKISER INC. (DELAWARE CORPORATION)
399 INTERPACE PARKWAY
PARSIPPANY, NJ 07054

THE MARK CONSISTS OF STANDARD CHARACTERS WITHOUT CLAIM TO ANY PARTICULAR FONT, STYLE, SIZE, OR COLOR.

FOR: AIR FRESHENING PREPARATIONS; AIR PURIFYING PREPARATIONS; ROOM AIR FRESHENERS; AIR FRESHENERS IN THE NATURE OF PREPARATIONS FOR PERFUMING OR FRAGRANCING THE AIR; ROOM DEODORANTS; PREPARATIONS FOR NEUTRALISING ODOURS FOR USE IN THE AIR, IN CLASS 5 (U.S. CLS. 6, 18, 44, 46, 51 AND 52).

NO CLAIM IS MADE TO THE EXCLUSIVE RIGHT TO USE "VANILLA", APART FROM THE MARK AS SHOWN.

SN 77-120,838, FILED 3-2-2007.

FIRST USE 6-29-2007; IN COMMERCE 6-29-2007.

JENNY PARK, EXAMINING ATTORNEY

Int. Cl.: 35

Prior U.S. Cls.: 100, 101, and 102

United States Patent and Trademark Office

Reg. No. 3,485,685

Registered Aug. 12, 2008

**SERVICE MARK
PRINCIPAL REGISTER**

SHAMELESS PROMOTIONS

SHAMELESS PROMOTIONS, INC. (CALIFORNIA CORPORATION)
23772 NEW DELHI STREET
MISSION VIEJO, CA 92691

FOR: PROMOTING THE SPECIAL EVENTS OF OTHERS, NAMELY, THE PROMOTION OF LIVE MUSICAL CONCERTS, SPORTING EVENTS, PERSONAL APPEARANCES AND PARTIES; PROMOTING A VARIETY OF LIVE ENTERTAINMENT EVENTS IN THE NATURE OF LIVE PERFORMANCES BY MUSICAL BANDS, AS WELL AS MERCHANDISE RELATED THERETO, BY MEANS OF DISTRIBUTING ADVERTISING MATERIALS THROUGH A VARIETY OF METHODS; PROMOTING THE GOODS AND SERVICES OF OTHERS IN THE INDUSTRIES OF ADULT ENTERTAINMENT, MUSIC, TELEVISION AND FILM BY MEANS OF DISTRIBUTING ADVERTISING MATERIALS

THROUGH A VARIETY OF METHODS; AND PROMOTING THE GOODS AND SERVICES OF OTHERS VIA A GLOBAL COMPUTER NETWORK, IN CLASS 35 (U.S. CLS. 100, 101 AND 102).

FIRST USE 3-12-2007; IN COMMERCE 4-1-2007.

THE MARK CONSISTS OF STANDARD CHARACTERS WITHOUT CLAIM TO ANY PARTICULAR FONT, STYLE, SIZE, OR COLOR.

NO CLAIM IS MADE TO THE EXCLUSIVE RIGHT TO USE "PROMOTIONS", APART FROM THE MARK AS SHOWN.

SN 77-121,197, FILED 3-2-2007.

NANCY CLARKE, EXAMINING ATTORNEY

Int. Cls.: 35 and 41

Prior U.S. Cls.: 100, 101, 102, and 107

United States Patent and Trademark Office

Reg. No. 3,485,686

Registered Aug. 12, 2008

**SERVICE MARK
PRINCIPAL REGISTER**

COMPREHENSIVENET

COMPREHENSIVE NETWORK, INC. (NEW YORK CORPORATION)
1663 EAST 17TH STREET
BROOKLYN, NY 11229

FOR: PROFESSIONAL STAFFING, PLACEMENT AND MANAGEMENT SERVICES RENDERED TO HEALTH, REHABILITATION, THERAPY, EDUCATION AND BUSINESS PRACTITIONERS, IN CLASS 35 (U.S. CLS. 100, 101 AND 102).

FIRST USE 2-8-1999; IN COMMERCE 6-5-2008.

FOR: TRANSLATION SERVICES; LANGUAGE AND SIGN LANGUAGE INTERPRETING; CONTINUING EDUCATIONAL SERVICES, NAMELY, PROVIDING PROGRAMS, LECTURES, WORKSHOPS AND COURSES OF INSTRUCTION IN THE FIELDS OF SPEECH PATHOLOGY, SIGN LAN-

GUAGE INTERPRETING, OCCUPATIONAL THERAPY, PHYSICAL THERAPY, NURSING, MENTAL HEALTH AND PSYCHOLOGY; SUPPLEMENTAL EDUCATIONAL SERVICES, NAMELY, PROVIDING MONOLINGUAL AND BILINGUAL TUTORING AND REMEDIATION IN THE FIELDS OF READING, MATH, SCIENCE AND LANGUAGE ARTS, IN CLASS 41 (U.S. CLS. 100, 101 AND 107).

FIRST USE 2-8-1999; IN COMMERCE 6-5-2008.

THE MARK CONSISTS OF STANDARD CHARACTERS WITHOUT CLAIM TO ANY PARTICULAR FONT, STYLE, SIZE, OR COLOR.

SN 77-121,501, FILED 3-2-2007.

JEFFERY COWARD, EXAMINING ATTORNEY

Int. Cl.: 44

Prior U.S. Cls.: 100 and 101

United States Patent and Trademark Office

Reg. No. 3,485,687

Registered Aug. 12, 2008

**SERVICE MARK
PRINCIPAL REGISTER**

A CRISIS HAS NO SCHEDULE

INTEGRATED HEALTH SERVICES, LLC (GEORGIA CORPORATION), DBA BEHAVIORAL HEALTH LINK,
75 PIEDMONT AVENUE, NE, SUITE 910
ATLANTA, GA 30303

FOR: PROVIDING MENTAL HEALTH COUNSELING VIA TELEPHONE; PROVIDING DRUG AND ALCOHOL ABUSE TREATMENT AND COUNSELING VIA TELEPHONE , IN CLASS 44 (U.S. CLS. 100 AND 101).

FIRST USE 3-15-2007; IN COMMERCE 3-15-2007.

THE MARK CONSISTS OF STANDARD CHARACTERS WITHOUT CLAIM TO ANY PARTICULAR FONT, STYLE, SIZE, OR COLOR.

SN 77-121,536, FILED 3-2-2007.

ESTHER BELENKER, EXAMINING ATTORNEY

Int. Cl.: 41

Prior U.S. Cls.: 100, 101, and 107

Reg. No. 3,485,688

United States Patent and Trademark Office

Registered Aug. 12, 2008

**SERVICE MARK
PRINCIPAL REGISTER**

Nag Me

RACHIT HARJAI (INDIA INDIVIDUAL)
B-126,FF,SHIVALIK, MALVIYA NAGAR
NEW DELHI, INDIA 110017

THE MARK CONSISTS OF STANDARD CHAR-
ACTERS WITHOUT CLAIM TO ANY PARTICULAR
FONT, STYLE, SIZE, OR COLOR.

FOR: PERSONAL IMPROVEMENT PLANNING
AND TRAINING, ADVISORY SERVICES IN THE
FIELD OF PERSONAL PLANNING AND IMPROVE-
MENT, IN CLASS 41 (U.S. CLS. 100, 101 AND 107).

SN 77-121,763, FILED 3-4-2007.

FIRST USE 11-5-2007; IN COMMERCE 2-2-2008.

ANNE MADDEN, EXAMINING ATTORNEY

Int. Cl.: 35

Prior U.S. Cls.: 100, 101, and 102

United States Patent and Trademark Office

Reg. No. 3,485,689

Registered Aug. 12, 2008

**SERVICE MARK
PRINCIPAL REGISTER**

GREETINGSDIRECT.COM

PRUDENT PUBLISHING COMPANY (NEW JERSEY CORPORATION)
65 CHALLENGER ROAD
RIDGEFIELD PARK, NJ 07660

THE MARK CONSISTS OF STANDARD CHARACTERS WITHOUT CLAIM TO ANY PARTICULAR FONT, STYLE, SIZE, OR COLOR.

FOR: COMPUTERIZED ON-LINE ORDERING SERVICES IN THE FIELD OF CUSTOM GREETING CARDS, IN CLASS 35 (U.S. CLS. 100, 101 AND 102).

SN 77-122,587, FILED 3-5-2007.

FIRST USE 4-13-2007; IN COMMERCE 4-13-2007.

HEATHER THOMPSON, EXAMINING ATTORNEY

Int. Cl.: 16

Prior U.S. Cls.: 2, 5, 22, 23, 29, 37, 38, and 50

Reg. No. 3,485,690

United States Patent and Trademark Office

Registered Aug. 12, 2008

**TRADEMARK
PRINCIPAL REGISTER**

A PROGRAM DESIGNED TO PLAN
YOUR TIME AND ACHIEVE YOUR
GOALS

THE MEYER RESOURCE GROUP, INC. (TEXAS
CORPORATION)
4565 LAKE SHORE DRIVE
WACO, TX 76710

FOR: BOOKS, BOOKLETS, MANUALS AND
PRINTED INSTRUCTIONAL MATERIALS RELAT-
ING TO PERSONAL DEVELOPMENT, SELF-MOTI-
VATION AND IMPROVEMENT, GOAL SETTING,
PLANNING, LEADERSHIP AND MANAGEMENT,
IN CLASS 16 (U.S. CLS. 2, 5, 22, 23, 29, 37, 38 AND 50).

FIRST USE 0-0-1979; IN COMMERCE 0-0-1979.

THE MARK CONSISTS OF STANDARD CHAR-
ACTERS WITHOUT CLAIM TO ANY PARTICULAR
FONT, STYLE, SIZE, OR COLOR.

SN 77-122,861, FILED 3-6-2007.

MONIQUE MILLER, EXAMINING ATTORNEY

Int. Cl.: 42

Prior U.S. Cls.: 100 and 101

United States Patent and Trademark Office

Reg. No. 3,485,691

Registered Aug. 12, 2008

**SERVICE MARK
PRINCIPAL REGISTER**

MI-LINK EMR

INCREMEDICAL, LLC (INDIANA LTD LIAB CO)
8259 WICKER AVENUE
ST. JOHN, IN 46373

FOR: PROVIDING TEMPORARY USE OF NON-DOWNLOADABLE COMPUTER SOFTWARE FOR MEDICAL PRACTICE MANAGEMENT AND MEDICAL RECORD DOCUMENTATION, STORAGE AND RETRIEVAL, IN CLASS 42 (U.S. CLS. 100 AND 101).

FIRST USE 7-16-2007; IN COMMERCE 7-16-2007.

THE MARK CONSISTS OF STANDARD CHARACTERS WITHOUT CLAIM TO ANY PARTICULAR FONT, STYLE, SIZE, OR COLOR.

NO CLAIM IS MADE TO THE EXCLUSIVE RIGHT TO USE "EMR", APART FROM THE MARK AS SHOWN.

SN 77-122,897, FILED 3-6-2007.

ANNE MADDEN, EXAMINING ATTORNEY

Int. Cl.: 18

Prior U.S. Cls.: 1, 2, 3, 22, and 41

United States Patent and Trademark Office

Reg. No. 3,485,692

Registered Aug. 12, 2008

**TRADEMARK
PRINCIPAL REGISTER**

MONSERAT DE LUCCA

SHIH ACCESSORIES, INC. (CALIFORNIA CORPORATION)

369 SOUTH DOHENY DRIVE, #289

BEVERLY HILLS, CA 90211

FOR: HANDBAGS, IN CLASS 18 (U.S. CLS. 1, 2, 3, 22 AND 41).

FIRST USE 6-1-2007; IN COMMERCE 6-1-2007.

THE MARK CONSISTS OF STANDARD CHARACTERS WITHOUT CLAIM TO ANY PARTICULAR FONT, STYLE, SIZE, OR COLOR.

THE NAME(S), PORTRAIT(S), AND/OR SIGNATURE(S) SHOWN IN THE MARK DOES NOT IDENTIFY A PARTICULAR LIVING INDIVIDUAL.

SN 77-123,191, FILED 3-6-2007.

KRISTINA MORRIS, EXAMINING ATTORNEY

Int. Cl.: 9

Prior U.S. Cls.: 21, 23, 26, 36, and 38

Reg. No. 3,485,693

United States Patent and Trademark Office

Registered Aug. 12, 2008

**TRADEMARK
PRINCIPAL REGISTER**

INTYPE

PHAM, DON N (UNITED STATES INDIVIDUAL)
1851 LAKESHORE CIRCLE
LONGWOOD, FL 32750

FIRST USE 1-1-2008; IN COMMERCE 1-1-2008.

FOR: COMPUTER HARDWARE, SOFTWARE
AND FIRMWARE FOR PROCESSING OR TRANS-
FERRING USER INPUT TO PORTABLE COMMU-
NICATION DEVICES, PORTABLE COMPUTING
DEVICES, REMOTE CONTROLLERS, PORTABLE
AUDIO PLAYERS OR PORTABLE VIDEO PLAY-
ERS, IN CLASS 9 (U.S. CLS. 21, 23, 26, 36 AND 38).

THE MARK CONSISTS OF STANDARD CHAR-
ACTERS WITHOUT CLAIM TO ANY PARTICULAR
FONT, STYLE, SIZE, OR COLOR.

SN 77-124,488, FILED 3-7-2007.

BRIAN PINO, EXAMINING ATTORNEY

Int. Cl.: 35

Prior U.S. Cls.: 100, 101, and 102

United States Patent and Trademark Office

Reg. No. 3,485,694

Registered Aug. 12, 2008

**SERVICE MARK
PRINCIPAL REGISTER**

WE ASSIST WITH ASSISTANTS

SAIP INVESTMENTS, LLC (NEW JERSEY LTD
LIAB CO)
35 HORIZON DRIVE
WAYNE, NJ 07470

FOR: EMPLOYMENT, SCHEDULING AND
STAFFING SERVICES FOR THE HEALTHCARE
INDUSTRY, NAMELY, RECRUITING AND PRO-
VIDING PHYSICIANS AND HEALTHCARE PER-
SONNEL FOR HOSPITALS, CLINICS AND OTHER
HEALTHCARE FACILITIES, IN CLASS 35 (U.S. CLS.
100, 101 AND 102).

FIRST USE 2-15-2007; IN COMMERCE 2-15-2007.

THE MARK CONSISTS OF STANDARD CHAR-
ACTERS WITHOUT CLAIM TO ANY PARTICULAR
FONT, STYLE, SIZE, OR COLOR.

SN 77-124,845, FILED 3-7-2007.

ELLEN BURNS, EXAMINING ATTORNEY

Int. Cl.: 21

Prior U.S. Cls.: 2, 13, 23, 29, 30, 33, 40, and 50

United States Patent and Trademark Office

Reg. No. 3,485,695

Registered Aug. 12, 2008

**TRADEMARK
PRINCIPAL REGISTER**

THE MEDICINE MATE

THE MEDICINE MATE, INC. (NEW JERSEY
CORPORATION)

19 LITTLE BROOK ROAD NORTH

PRINCETON, NJ 085404063

FOR: BOTTLE OPENERS, IN CLASS 21 (U.S. CLS.
2, 13, 23, 29, 30, 33, 40 AND 50).

FIRST USE 6-1-2008; IN COMMERCE 6-1-2008.

THE MARK CONSISTS OF STANDARD CHAR-
ACTERS WITHOUT CLAIM TO ANY PARTICULAR
FONT, STYLE, SIZE, OR COLOR.

NO CLAIM IS MADE TO THE EXCLUSIVE
RIGHT TO USE "MEDICINE", APART FROM THE
MARK AS SHOWN.

SN 77-125,360, FILED 3-8-2007.

RUDY R. SINGLETON, EXAMINING ATTORNEY

Int. Cl.: 5

Prior U.S. Cls.: 6, 18, 44, 46, 51, and 52

Reg. No. 3,485,696

United States Patent and Trademark Office

Registered Aug. 12, 2008

**TRADEMARK
PRINCIPAL REGISTER**

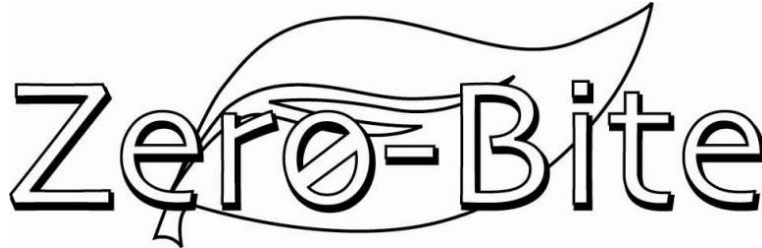

PYRANHA, INC. (TEXAS CORPORATION)
6602 CUNNINGHAM ROAD
HOUSTON, TX 77041

FOR: REPELLENTS FOR FLIES, TICKS, FLEAS, MOSQUITOES, GNATS, LICE AND OTHER FLYING, HOPPING AND BITING INSECTS THAT ATTACK HORSES AND OTHER FARM, RANCH AND PET ANIMALS , IN CLASS 5 (U.S. CLS. 6, 18, 44, 46, 51 AND 52).

FIRST USE 5-14-2008; IN COMMERCE 5-14-2008.

THE MARK CONSISTS OF THE WORDS "ZERO-BITE" SUPERIMPOSED OVER A LEAF DESIGN WITH A DIAGONAL SLASH THROUGH THE "O" OF "ZERO".

SN 77-125,998, FILED 3-8-2007.

MICHAEL LEWIS, EXAMINING ATTORNEY

Int. Cls.: 9, 16, and 41

**Prior U.S. Cls.: 2, 5, 21, 22, 23, 26, 29, 36, 37, 38, 50,
100, 101, and 107**

Reg. No. 3,485,697

United States Patent and Trademark Office

Registered Aug. 12, 2008

**TRADEMARK
SERVICE MARK
PRINCIPAL REGISTER**



LABYRINTH PUBLICATIONS, INC. (CALIFORNIA CORPORATION)
5275 CARRIAGE DRIVE
EL SOBRANTE, CA 94803

FOR: EDUCATIONAL COMPUTER SOFTWARE AND INSTRUCTION MANUALS SOLD THEREWITH FOR USE WITH TUTORIALS AND GRADING OF EXERCISES IN CONNECTION WITH SOFTWARE APPLICATIONS, COMPUTER LITERACY, AND COMPUTER TECHNOLOGY, IN CLASS 9 (U.S. CLS. 21, 23, 26, 36 AND 38).

FIRST USE 5-25-2007; IN COMMERCE 5-25-2007.

FOR: TEXTBOOKS ON EDUCATION AND INSTRUCTION REGARDING COMPUTER SOFTWARE APPLICATIONS, COMPUTER LITERACY, AND COMPUTER TECHNOLOGY, IN CLASS 16 (U.S. CLS. 2, 5, 22, 23, 29, 37, 38 AND 50).

FIRST USE 3-16-2007; IN COMMERCE 3-16-2007.

FOR: PROVIDING ON-LINE PUBLICATIONS AND TRAINING COURSES IN THE FIELD OF COMPUTER SOFTWARE APPLICATIONS, COMPUTER LITERACY AND COMPUTER TECHNOLOGY, IN CLASS 41 (U.S. CLS. 100, 101 AND 107).

FIRST USE 6-1-2007; IN COMMERCE 6-1-2007.

OWNER OF U.S. REG. NO. 2,227,471.

NO CLAIM IS MADE TO THE EXCLUSIVE RIGHT TO USE "LEARNING", APART FROM THE MARK AS SHOWN.

THE MARK CONSISTS OF A MAZE IN THE FORM OF THE LETTER "L" WITH THE WORDS "LABYRINTH LEARNING" APPEARING UNDER IT.

SN 77-126,258, FILED 3-8-2007.

GISELLE AGOSTO, EXAMINING ATTORNEY

Int. Cl.: 29

Prior U.S. Cl.: 46

United States Patent and Trademark Office

Reg. No. 3,485,698

Registered Aug. 12, 2008

**TRADEMARK
PRINCIPAL REGISTER**

SEÑOR GUACAMOLE

TOLEDO, JOSE ULISES (UNITED STATES INDIVIDUAL)
221 ROCKLEDGE DRIVE
NITRO, WV 25143

THE MARK CONSISTS OF STANDARD CHARACTERS WITHOUT CLAIM TO ANY PARTICULAR FONT, STYLE, SIZE, OR COLOR.

FOR: AVOCADO PASTE, IN CLASS 29 (U.S. CL. 46).

SN 77-126,337, FILED 3-9-2007.

FIRST USE 2-28-2007; IN COMMERCE 2-28-2007.

AMY MCMENAMIN, EXAMINING ATTORNEY

Int. Cl.: 41

Prior U.S. Cls.: 100, 101, and 107

United States Patent and Trademark Office

Reg. No. 3,485,699

Registered Aug. 12, 2008

**SERVICE MARK
PRINCIPAL REGISTER**

IT'S ALL ABOUT THE PROMISES

JOHN HANCOCK LIFE INSURANCE COMPANY
(MASSACHUSETTS CORPORATION)
JOHN HANCOCK PLACE, POST OFFICE BOX 111
197 CLARENDON STREET
BOSTON, MA 02116

THE MARK CONSISTS OF STANDARD CHAR-
ACTERS WITHOUT CLAIM TO ANY PARTICULAR
FONT, STYLE, SIZE, OR COLOR.

FOR: PROMOTING SPORTING EVENTS AND
ATHLETIC COMPETITIONS OF OTHERS, IN CLASS
41 (U.S. CLS. 100, 101 AND 107).

SN 77-127,145, FILED 3-9-2007.

FIRST USE 4-30-2007; IN COMMERCE 4-30-2007.

WENDY GOODMAN, EXAMINING ATTORNEY

Int. Cl.: 25

Prior U.S. Cls.: 22 and 39

United States Patent and Trademark Office

Reg. No. 3,485,700

Registered Aug. 12, 2008

**TRADEMARK
PRINCIPAL REGISTER**

REBA

THE SMITH TRUST, A TENNESSEE TRUST,
COMPRISING REBA MCENTIRE BLACK-
STOCK, A U.S. CITIZEN (TENNESSEE TRUST)
40 MUSIC SQUARE WEST
NASHVILLE, TN 37203

FOR: FOOTWEAR FOR WOMEN, IN CLASS 25
(U.S. CLS. 22 AND 39).

FIRST USE 3-0-2008; IN COMMERCE 3-0-2008.

THE MARK CONSISTS OF STANDARD CHAR-
ACTERS WITHOUT CLAIM TO ANY PARTICULAR
FONT, STYLE, SIZE, OR COLOR.

OWNER OF U.S. REG. NOS. 1,981,268, 2,163,066,
AND OTHERS.

THE NAME "REBA" IDENTIFIES A LIVING
INDIVIDUAL WHOSE CONSENT IS OF RECORD.

SN 77-127,449, FILED 3-9-2007.

BRIAN PINO, EXAMINING ATTORNEY

Int. Cls.: 20 and 21

Prior U.S. Cls.: 2, 13, 22, 23, 25, 29, 30, 32, 33, 40, and 50

United States Patent and Trademark Office

Reg. No. 3,485,701

Registered Aug. 12, 2008

**TRADEMARK
PRINCIPAL REGISTER**

SpinningLeaf

SPINNINGLEAF (NEBRASKA SOLE PROPRIETORSHIP)
P.O. BOX 222
OGALLALA, NE 69153

FOR: PLASTIC MOLDS FOR MAKING SOAP; PLASTIC MOLDS FOR MAKING SOAP FOR COMMERCIAL PRODUCTION PURPOSES, IN CLASS 20 (U.S. CLS. 2, 13, 22, 25, 32 AND 50).

FIRST USE 3-10-2007; IN COMMERCE 3-10-2007.

FOR: CHOCOLATE MOLDS; CONFECTIONERS' MOLDS; PLASTIC MOLDS FOR HOUSEHOLD USE

IN MAKING SOAP, IN CLASS 21 (U.S. CLS. 2, 13, 23, 29, 30, 33, 40 AND 50).

FIRST USE 3-10-2007; IN COMMERCE 3-10-2007.

THE MARK CONSISTS OF STANDARD CHARACTERS WITHOUT CLAIM TO ANY PARTICULAR FONT, STYLE, SIZE, OR COLOR.

SN 77-127,706, FILED 3-10-2007.

MICHAEL LEWIS, EXAMINING ATTORNEY

Int. Cl.: 38

Prior U.S. Cls.: 100, 101, and 104

United States Patent and Trademark Office

Reg. No. 3,485,702

Registered Aug. 12, 2008

**SERVICE MARK
PRINCIPAL REGISTER**

Reside@HOME

BLUE HERON NETWORK, LLC (MICHIGAN
LTD LIAB CO)
2908 BARON CT SW
GRANDVILLE, MI 49418

FOR: PROVIDING MULTIPLE USE ACCESS TO
GLOBAL COMPUTER INFORMATION NET-
WORKS FOR THE TRANSFER AND DISSEMINA-
TION OF A WIDE RANGE OF INFORMATION, IN
CLASS 38 (U.S. CLS. 100, 101 AND 104).

FIRST USE 6-1-2007; IN COMMERCE 4-19-2008.

THE MARK CONSISTS OF STANDARD CHAR-
ACTERS WITHOUT CLAIM TO ANY PARTICULAR
FONT, STYLE, SIZE, OR COLOR.

SN 77-127,743, FILED 3-10-2007.

AMOS T. MATTHEWS, JR., EXAMINING ATTOR-
NEY

Int. Cls.: 35, 41, 42, and 45

Prior U.S. Cls.: 100, 101, 102, and 107

United States Patent and Trademark Office

Reg. No. 3,485,703

Registered Aug. 12, 2008

**SERVICE MARK
PRINCIPAL REGISTER**

BPTV

BP P.L.C. (UNITED KINGDOM PUBLIC LIMITED
COMPANY (PLC))
1 ST. JAMES'S SQUARE
LONDON SW1Y 4PD, UNITED KINGDOM

FOR: ON-LINE ADVERTISING AND MARKET-
ING SERVICES, IN CLASS 35 (U.S. CLS. 100, 101 AND
102).

FIRST USE 3-27-2007; IN COMMERCE 3-27-2007.

FOR: ENTERTAINMENT IN THE NATURE OF
TELEVISION AND NEWS SHOWS, IN CLASS 41 (U.S.
CLS. 100, 101 AND 107).

FIRST USE 3-27-2007; IN COMMERCE 3-27-2007.

FOR: PROVIDING WEATHER CONDITION IN-
FORMATION, IN CLASS 42 (U.S. CLS. 100 AND 101).

FIRST USE 3-27-2007; IN COMMERCE 3-27-2007.

FOR: PROVIDING INFORMATION IN THE
FIELD OF GENERAL SAFETY PRACTICES AND
DRIVER SAFETY, IN CLASS 45 (U.S. CLS. 100 AND
101).

FIRST USE 3-27-2007; IN COMMERCE 3-27-2007.

THE MARK CONSISTS OF STANDARD CHAR-
ACTERS WITHOUT CLAIM TO ANY PARTICULAR
FONT, STYLE, SIZE, OR COLOR.

SN 77-128,054, FILED 3-12-2007.

AISHA CLARKE, EXAMINING ATTORNEY

Int. Cl.: 35

Prior U.S. Cls.: 100, 101, and 102

United States Patent and Trademark Office

Reg. No. 3,485,704

Registered Aug. 12, 2008

**SERVICE MARK
PRINCIPAL REGISTER**

MAKE IT WORK

CORPORATE FAMILY NETWORK, INC. (NEW YORK CORPORATION)
60 EAST 42ND STREET
NEW YORK, NY 10165

FOR: CONSULTING SERVICES PROVIDED TO HUMAN RESOURCE PROFESSIONALS IN THE FIELD OF HUMAN RESOURCE DEVELOPMENT FOR THE PROMOTION OF EMPLOYEE WORK PRODUCTIVITY AND EMOTIONAL WELL BEING; PROVIDING INFORMATION AND ADVICE TO HUMAN RESOURCE PROFESSIONALS FOR HELPING EMPLOYEES WITH BUSINESS AND RELOCATION SUBJECTS; PROVIDING REFERRALS TO HELP EMPLOYEES IN THE FIELDS OF FAMILY PROBLEMS, STRESS, ANXIETY, MARITAL AND OTHER DOMESTIC DISCORD, ALCOHOL AND SUBSTANCE ABUSE, PARENTING, CHILDCARE AND ELDER CARE, PET CARE, EDUCATION,

BUSINESS AND REAL ESTATE, RELOCATION, FINANCES AND ON HOME AND MEDICAL SUBJECTS; ARRANGING AND CONDUCTING FAIRS FOR BUSINESS PURPOSES; CONDUCTING EMPLOYEE HEALTH AND BENEFITS FAIRS, IN CLASS 35 (U.S. CLS. 100, 101 AND 102).

FIRST USE 1-0-2007; IN COMMERCE 1-0-2007.

THE MARK CONSISTS OF STANDARD CHARACTERS WITHOUT CLAIM TO ANY PARTICULAR FONT, STYLE, SIZE, OR COLOR.

SN 77-128,267, FILED 3-12-2007.

KARANENDRA S. CHHINA, EXAMINING ATTORNEY

Int. Cl.: 10

Prior U.S. Cls.: 26, 39, and 44

United States Patent and Trademark Office

Reg. No. 3,485,705

Registered Aug. 12, 2008

**TRADEMARK
PRINCIPAL REGISTER**

SERIES 210

LINVATEC CORPORATION (FLORIDA CORPORATION)
11311 CONCEPT BOULEVARD
LARGO, FL 33773

OWNER OF U.S. REG. NOS. 1,846,644 AND 1,846,645.

FOR: SURGICAL INSTRUMENTS, NAMELY, CUTTERS, FORCEPS AND SCISSORS FOR USE IN ENDOSCOPIC SURGERY, IN CLASS 10 (U.S. CLS. 26, 39 AND 44).

NO CLAIM IS MADE TO THE EXCLUSIVE RIGHT TO USE "SERIES", APART FROM THE MARK AS SHOWN.

FIRST USE 9-20-2007; IN COMMERCE 9-20-2007.

SN 77-128,431, FILED 3-12-2007.

THE MARK CONSISTS OF STANDARD CHARACTERS WITHOUT CLAIM TO ANY PARTICULAR FONT, STYLE, SIZE, OR COLOR.

GISELLE AGOSTO, EXAMINING ATTORNEY

Int. Cl.: 30

Prior U.S. Cl.: 46

United States Patent and Trademark Office

Reg. No. 3,485,706

Registered Aug. 12, 2008

**TRADEMARK
PRINCIPAL REGISTER**

**SAND MOUNTAIN COUNTRY
STYLE CORN RELISH**

THOMAS, BURMA F. (UNITED STATES INDIVIDUAL)
P.O. BOX 824
SCOTTSBORO, AL 357680824

OWNER OF U.S. REG. NOS. 707,644, 3,135,584,
AND 3,221,649.

FOR: CORN RELISH, IN CLASS 30 (U.S. CL. 46).

NO CLAIM IS MADE TO THE EXCLUSIVE
RIGHT TO USE "COUNTRY STYLE CORN RELISH",
APART FROM THE MARK AS SHOWN.

FIRST USE 5-30-2007; IN COMMERCE 5-30-2007.

SN 77-128,706, FILED 3-12-2007.

THE MARK CONSISTS OF STANDARD CHARACTERS
WITHOUT CLAIM TO ANY PARTICULAR FONT,
STYLE, SIZE, OR COLOR.

BRIAN PINO, EXAMINING ATTORNEY

Int. Cl.: 30

Prior U.S. Cl.: 46

United States Patent and Trademark Office

Reg. No. 3,485,707

Registered Aug. 12, 2008

**TRADEMARK
PRINCIPAL REGISTER**

**SAND MOUNTAIN COUNTRY
STYLE SALSA**

THOMAS, BURMA F. (UNITED STATES INDIVIDUAL)
P.O. BOX 824
SCOTTSBORO, AL 357680824

OWNER OF U.S. REG. NOS. 707,644, 3,135,584,
AND 3,221,649.

FOR: SALSA, IN CLASS 30 (U.S. CL. 46).

NO CLAIM IS MADE TO THE EXCLUSIVE
RIGHT TO USE "COUNTRY STYLE SALSA",
APART FROM THE MARK AS SHOWN.

FIRST USE 5-30-2007; IN COMMERCE 5-30-2007.

SN 77-128,719, FILED 3-12-2007.

THE MARK CONSISTS OF STANDARD CHARACTERS WITHOUT CLAIM TO ANY PARTICULAR FONT, STYLE, SIZE, OR COLOR.

BRIAN PINO, EXAMINING ATTORNEY

Int. Cl.: 9

Prior U.S. Cls.: 21, 23, 26, 36, and 38

Reg. No. 3,485,708

United States Patent and Trademark Office

Registered Aug. 12, 2008

**TRADEMARK
PRINCIPAL REGISTER**

SINGING BIRD PRODUCTIONS

SINGING BIRD PRODUCTIONS, INC. (CALIFORNIA CORPORATION)
SUITE 120
2140 PROFESSIONAL DRIVE
ROSEVILLE, CA 95661

FOR: AUDIO RECORDINGS FEATURING MUSIC; DIGITAL MATERIALS, NAMELY, CDS, DOWNLOADABLE AUDIO FILES FEATURING MUSIC; MUSICAL SOUND RECORDINGS; DOWNLOADABLE MUSICAL SOUND RECORDINGS; SOUND RECORDINGS FEATURING MUSIC; DOWNLOADABLE MUSIC VIA THE INTERNET AND WIRELESS DEVICES, IN CLASS 9 (U.S. CLS. 21, 23, 26, 36 AND 38).

FIRST USE 9-1-2006; IN COMMERCE 9-1-2006.

THE MARK CONSISTS OF STANDARD CHARACTERS WITHOUT CLAIM TO ANY PARTICULAR FONT, STYLE, SIZE, OR COLOR.

NO CLAIM IS MADE TO THE EXCLUSIVE RIGHT TO USE "PRODUCTIONS", APART FROM THE MARK AS SHOWN.

SN 77-129,036, FILED 3-12-2007.

ALLISON SCHRODY, EXAMINING ATTORNEY

Int. Cls.: 16, 18, 21, and 25

Prior U.S. Cls.: 1, 2, 3, 5, 13, 22, 23, 29, 30, 33, 37, 38, 39, 40, 41, and 50

Reg. No. 3,485,709

United States Patent and Trademark Office

Registered Aug. 12, 2008

**TRADEMARK
PRINCIPAL REGISTER**

NOT TONIGHT...

NOT TONIGHT, LLC (SOUTH CAROLINA LTD
LIAB CO)
699 WILLOW STREET
ROCK HILL, SC 29732

FOR: PRINTED MATTER, NAMELY, POSTERS, DECALS, BUMPER STICKERS, LABELS, DOOR-HANGERS IN THE NATURE OF PRINTED PAPER SIGNS FOR ATTACHING TO DOORKNOBS, BINDERS, PAPER SIGN BOARDS; PAMPHLETS IN THE FIELD OF ALL PURPOSE-BAGS, HOUSEWARES, AND CLOTHING; CATALOGS IN THE FIELD OF ALL-PURPOSE BAGS, HOUSEWARES, AND CLOTHING; NOTE CARDS, NOTE PADS, GREETING CARDS, AND STATIONERY; COASTERS MADE OF PAPER, IN CLASS 16 (U.S. CLS. 2, 5, 22, 23, 29, 37, 38 AND 50).

FIRST USE 9-18-2007; IN COMMERCE 9-18-2007.

FOR: ALL-PURPOSE BAGS, NAMELY, SPORTS BAGS, CARRYING BAGS, FANNY PACKS, BEACH BAGS, BOOK BAGS, CARRY-ALL BAGS, CLUTCH BAGS, COSMETIC BAGS SOLD EMPTY, DUFFEL BAGS, AND GARMENT BAGS FOR TRAVEL, IN CLASS 18 (U.S. CLS. 1, 2, 3, 22 AND 41).

FIRST USE 9-18-2007; IN COMMERCE 9-18-2007.

FOR: HOUSE WARES AND GLASS, NAMELY, BEVERAGE GLASSWARE, MUGS, THERMAL INSULATED CONTAINERS FOR FOOD OR BEVERAGES, PORTABLE COOLERS; COASTERS NOT OF PAPER AND NOT BEING TABLE LINEN, IN CLASS 21 (U.S. CLS. 2, 13, 23, 29, 30, 33, 40 AND 50).

FIRST USE 9-18-2007; IN COMMERCE 9-18-2007.

FOR: CLOTHING, NAMELY, TOPS, HATS, NIGHT SHIRTS, SHIRTS, SOCKS, SWEAT SHIRTS, T-SHIRTS, TANK TOPS, CAPS, JACKETS, SHORTS, VISORS, SWEAT PANTS, SWEATERS, SWEAT SUITS, AND PANTS, IN CLASS 25 (U.S. CLS. 22 AND 39).

FIRST USE 9-18-2007; IN COMMERCE 9-18-2007.

THE MARK CONSISTS OF STANDARD CHARACTERS WITHOUT CLAIM TO ANY PARTICULAR FONT, STYLE, SIZE, OR COLOR.

SN 77-129,137, FILED 3-13-2007.

JOHN KELLY, EXAMINING ATTORNEY

Int. Cl.: 32

Prior U.S. Cls.: 45, 46, and 48

Reg. No. 3,485,710

United States Patent and Trademark Office

Registered Aug. 12, 2008

**TRADEMARK
PRINCIPAL REGISTER**

FRUTISTA FREEZE

TACO BELL CORP. (CALIFORNIA CORPORATION)
LEGAL - TRADEMARKS
LEGAL 17901 VON KARMAN, IRVINE
IRVINE, CA 92614

FOR: FROZEN NON-ALCOHOLIC FRUIT-BASED
BEVERAGE, IN CLASS 32 (U.S. CLS. 45, 46 AND 48).

FIRST USE 8-2-2007; IN COMMERCE 8-2-2007.

THE MARK CONSISTS OF STANDARD CHARACTERS WITHOUT CLAIM TO ANY PARTICULAR FONT, STYLE, SIZE, OR COLOR.

SN 77-129,237, FILED 3-13-2007.

KARANENDRA S. CHHINA, EXAMINING ATTORNEY

Int. Cl.: 9

Prior U.S. Cls.: 21, 23, 26, 36, and 38

Reg. No. 3,485,711

United States Patent and Trademark Office

Registered Aug. 12, 2008

TRADEMARK
PRINCIPAL REGISTER



SINGING BIRD PRODUCTIONS, INC. (CALIFORNIA CORPORATION)
SUITE 120
2140 PROFESSIONAL DRIVE
ROSEVILLE, CA 95661

FOR: AUDIO RECORDINGS FEATURING MUSIC; DIGITAL MATERIALS, NAMELY, CDS, DOWNLOADABLE AUDIO FILES FEATURING MUSIC; MUSICAL SOUND RECORDINGS; DOWNLOADABLE MUSICAL SOUND RECORDINGS; SOUND RECORDINGS FEATURING MUSIC; DOWNLOADABLE MUSIC VIA THE INTERNET AND WIRELESS DEVICES, IN CLASS 9 (U.S. CLS. 21, 23, 26, 36 AND 38).

FIRST USE 9-1-2006; IN COMMERCE 9-1-2006.

NO CLAIM IS MADE TO THE EXCLUSIVE RIGHT TO USE "PRODUCTIONS, INC", APART FROM THE MARK AS SHOWN.

THE MARK CONSISTS OF A CIRCULAR DESIGN WITH WORDS SCRIPTED AROUND A SINGING BIRD WITH MUSICAL NOTES IN THE CENTER OF A SNOWFLAKE.

SN 77-129,396, FILED 3-13-2007.

ALLISON SCHRODY, EXAMINING ATTORNEY

Int. Cl.: 25

Prior U.S. Cls.: 22 and 39

United States Patent and Trademark Office

Reg. No. 3,485,712

Registered Aug. 12, 2008

**TRADEMARK
PRINCIPAL REGISTER**

Boston Tea Shirt Co.

HELENA COLLINS (UNITED STATES INDIVIDUAL)
108 HAYWARD STREET
HOPKINTON, MA 01748

FOR: CLOTHING, NAMELY, SHORT-SLEEVED OR LONG-SLEEVED T-SHIRTS, IN CLASS 25 (U.S. CLS. 22 AND 39).

FIRST USE 5-1-2007; IN COMMERCE 9-15-2007.

THE MARK CONSISTS OF STANDARD CHARACTERS WITHOUT CLAIM TO ANY PARTICULAR FONT, STYLE, SIZE, OR COLOR.

NO CLAIM IS MADE TO THE EXCLUSIVE RIGHT TO USE "BOSTON TEE SHIRT CO.", APART FROM THE MARK AS SHOWN.

SN 77-129,463, FILED 3-13-2007.

ELLEN PERKINS, EXAMINING ATTORNEY

Int. Cl.: 25

Prior U.S. Cls.: 22 and 39

United States Patent and Trademark Office

Reg. No. 3,485,713

Registered Aug. 12, 2008

**TRADEMARK
PRINCIPAL REGISTER**

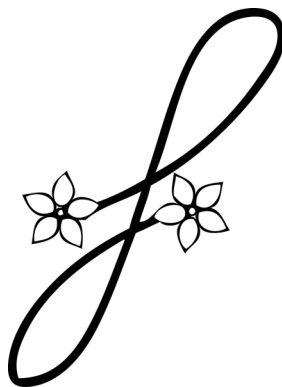

MPL FASHIONS, LLC (FLORIDA LTD LIAB CO)
3531 GRIFFIN ROAD
FT. LAUDERDALE, FL 33312

FOR: CLOTHING, NAMELY, COATS, LEATHER COATS, PANTS, TROUSERS, JEANS, OVERALLS, JACKETS, EVENING JACKETS, TUXEDOS, BLOUSONS, FLEECE PULLOVERS, WAISTCOATS, BUSINESS SHIRTS, VESTS, BLAZERS, SUITS, DRESSES, GOWNS, KNIT CARDIGANS, KNIT PANTS, SWEATERS, CARDIGAN SWEATERS, KNIT SHIRTS, PULLOVERS, BLOUSES, SPORTS SHIRTS, SPORT JERSEYS, POLO SHIRTS, GOLF TROUSERS, GOLF SHOES, T-SHIRTS, JOGGING SUITS, TANK TOPS, KNIT SKIRTS, SKIRTS, SWIMSUITS, PAJAMAS, BATHROBES, DRESSING GOWNS, CLOAKS, SHORTS, FOOTWEAR, HEADWEAR; CLOTHING

ACCESSORIES, NAMELY, NECKTIES, GLOVES, BOXER SHORTS, SCARVES, SUSPENDERS, CUMMERBUNDS, BELTS, UNDERWEAR, HATS, SUN VISORS, SWEAT BANDS, SOCKS, STOCKINGS AND TIGHTS, SHAWLS, HOSIERY AND WATERPROOF CLOTHING, NAMELY, RAINCOATS AND RAIN BOOTS, IN CLASS 25 (U.S. CLS. 22 AND 39).

FIRST USE 8-1-2007; IN COMMERCE 8-1-2007.

THE MARK CONSISTS OF A DRAWN LINE WITH A FLOWER AT THE BEGINNING OF THE LINE AND A FLOWER AT THE END OF THE LINE.

SN 77-129,894, FILED 3-13-2007.

PAM WILLIS, EXAMINING ATTORNEY

Int. Cl.: 43

Prior U.S. Cls.: 100 and 101

United States Patent and Trademark Office

Reg. No. 3,485,714

Registered Aug. 12, 2008

**SERVICE MARK
PRINCIPAL REGISTER**



FOX RESTAURANT CONCEPTS LLC (ARIZONA
LTD LIAB CO)
8800 N GAINNEY CTR DR #152
SCOTTSDALE, AZ 85258

FOR: RESTAURANT SERVICES, IN CLASS 43
(U.S. CLS. 100 AND 101).

FIRST USE 4-26-2007; IN COMMERCE 4-26-2007.

NO CLAIM IS MADE TO THE EXCLUSIVE
RIGHT TO USE "TACOS + TEQUILA", APART
FROM THE MARK AS SHOWN.

THE COLOR(S) ORANGE, BROWN AND BLUE IS/
ARE CLAIMED AS A FEATURE OF THE MARK.

THE MARK CONSISTS OF THE WORD "BLAN-
CO" IN BROWN ABOVE THE WORDS "TACOS"
AND "TEQUILA" IN ORANGE WITH THE + BE-
TWEEN THE WORDS "TACO" AND "TEQUILA" IN
BROWN ALL BELOW A BLUE BOX WITH AN
ORANGE BOX IN THE UPPER LEFT HAND COR-
NER OF THE BLUE BOX AND A BROWN BOX JUST
BELOW THE ORANGE BOX.

THE FOREIGN WORDING IN THE MARK
TRANSLATES INTO ENGLISH AS "WHITE".

SN 77-130,287, FILED 3-13-2007.

JULIE GUTTADAURO, EXAMINING ATTORNEY

Int. Cl.: 9

Prior U.S. Cls.: 21, 23, 26, 36, and 38

United States Patent and Trademark Office

Reg. No. 3,485,715

Registered Aug. 12, 2008

**TRADEMARK
PRINCIPAL REGISTER**

SANSA SHAKER

SANDISK CORPORATION (DELAWARE CORPORATION)
601 MCCARTHY BLVD.
MILPITAS, CA 95035

THE MARK CONSISTS OF STANDARD CHARACTERS WITHOUT CLAIM TO ANY PARTICULAR FONT, STYLE, SIZE, OR COLOR.

FOR: DIGITAL AUDIO PLAYERS, IN CLASS 9 (U.S. CLS. 21, 23, 26, 36 AND 38).

SN 77-130,491, FILED 3-14-2007.

FIRST USE 4-30-2007; IN COMMERCE 4-30-2007.

TAMARA FRAZIER, EXAMINING ATTORNEY

Int. Cl.: 35

Prior U.S. Cls.: 100, 101, and 102

United States Patent and Trademark Office

Reg. No. 3,485,716

Registered Aug. 12, 2008

**SERVICE MARK
PRINCIPAL REGISTER**

After the Vows

BUTLER, ROBERT (UNITED STATES INDIVIDUAL)
13943 BARRYMORE STREET
SAN DIEGO, CA 92129

FOR: PROMOTING THE GOODS AND SERVICES OF OTHERS BY PROVIDING HYPERTEXT LINKS TO THE WEB SITES OF OTHERS, IN CLASS 35 (U.S. CLS. 100, 101 AND 102).

FIRST USE 5-14-2008; IN COMMERCE 5-14-2008.

THE MARK CONSISTS OF STANDARD CHARACTERS WITHOUT CLAIM TO ANY PARTICULAR FONT, STYLE, SIZE, OR COLOR.

SN 77-130,561, FILED 3-14-2007.

JOHN DALIER, EXAMINING ATTORNEY

Int. Cl.: 38

Prior U.S. Cls.: 100, 101, and 104

United States Patent and Trademark Office

Reg. No. 3,485,717

Registered Aug. 12, 2008

**SERVICE MARK
PRINCIPAL REGISTER**

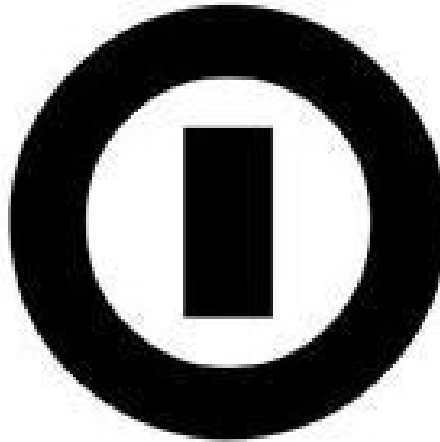

MATT, STEVEN S. (UNITED STATES INDIVIDUAL)
200 WASHINGTON PARK #1
BROOKLYN, NY 11205

FOR: PROVIDING ON-LINE FORUMS AND DISCUSSION BOARDS FOR TRANSMISSION OF MESSAGES AMONG COMPUTER USERS CONCERNING SOCIAL, ECONOMIC AND ENVIR-

ONMENTAL SUSTAINABILITY AND ENERGY EFFICIENCY, IN CLASS 38 (U.S. CLS. 100, 101 AND 104).

FIRST USE 5-1-2006; IN COMMERCE 11-15-2007.

SN 77-130,606, FILED 3-14-2007.

JAMES LOVELACE, EXAMINING ATTORNEY

Int. Cl.: 37

Prior U.S. Cls.: 100, 103, and 106

United States Patent and Trademark Office

Reg. No. 3,485,718

Registered Aug. 12, 2008

**SERVICE MARK
PRINCIPAL REGISTER**

SANTOSHA RESORT AND VILLAS

SANTOSHA DEVELOPMENT, INC. (CALIFORNIA CORPORATION)
2619 HIGHLAND DRIVE
CARLSBAD, CA 92008

FOR: REAL ESTATE DEVELOPMENT; HOUSING SERVICES, NAMELY, DEVELOPMENT OF REAL PROPERTY, NAMELY, REPAIR, IMPROVEMENT, AND NEW CONSTRUCTION, IN CLASS 37 (U.S. CLS. 100, 103 AND 106).

FIRST USE 1-5-2007; IN COMMERCE 4-25-2007.

THE MARK CONSISTS OF STANDARD CHARACTERS WITHOUT CLAIM TO ANY PARTICULAR FONT, STYLE, SIZE, OR COLOR.

NO CLAIM IS MADE TO THE EXCLUSIVE RIGHT TO USE "RESORT AND VILLAS", APART FROM THE MARK AS SHOWN.

SN 77-131,282, FILED 3-14-2007.

HOWARD B. LEVINE, EXAMINING ATTORNEY

Int. Cl.: 5

Prior U.S. Cls.: 6, 18, 44, 46, 51, and 52

Reg. No. 3,485,719

United States Patent and Trademark Office

Registered Aug. 12, 2008

**TRADEMARK
PRINCIPAL REGISTER**



NodorO

SYNERFIED CAPITAL INC. (FLORIDA CORPORATION)
SUITE #1207
10 S.W. SOUTH RIVER DRIVE
MIAMI, FL 33130

FOR: ANTIFUNGAL CREAMS FOR MEDICAL USE; FUNGAL MEDICATIONS, IN CLASS 5 (U.S. CLS. 6, 18, 44, 46, 51 AND 52).

FIRST USE 6-1-2007; IN COMMERCE 11-1-2007.

THE MARK CONSISTS OF "NODORO" WITH THE "N" AND "O" INSIDE SQUARES.

SN 77-131,627, FILED 3-15-2007.

BRIAN PINO, EXAMINING ATTORNEY

Int. Cl.: 9

Prior U.S. Cls.: 21, 23, 26, 36, and 38

United States Patent and Trademark Office

Reg. No. 3,485,720

Registered Aug. 12, 2008

**TRADEMARK
PRINCIPAL REGISTER**

Common Cents

C2 GAMING, LLC (NEVADA LTD LIAB CO)
1945 PAMA LANE
LAS VEGAS, NV 89119

THE MARK CONSISTS OF STANDARD CHAR-
ACTERS WITHOUT CLAIM TO ANY PARTICULAR
FONT, STYLE, SIZE, OR COLOR.

FOR: GAMING EQUIPMENT, NAMELY, SLOT
MACHINES WITH OR WITHOUT VIDEO OUTPUT,
IN CLASS 9 (U.S. CLS. 21, 23, 26, 36 AND 38).

SN 77-131,739, FILED 3-15-2007.

FIRST USE 8-20-2007; IN COMMERCE 8-20-2007.

ANNE MADDEN, EXAMINING ATTORNEY

Int. Cl.: 41

Prior U.S. Cls.: 100, 101, and 107

United States Patent and Trademark Office

Reg. No. 3,485,721

Registered Aug. 12, 2008

**SERVICE MARK
PRINCIPAL REGISTER**

CURTIS ADAMS

THE MAGIC OF CURTIS ADAMS, INC. (NEVADA CORPORATION)

8129 HORIZON LAKE

LAS VEGAS, NV 89128

FOR: ENTERTAINMENT IN THE NATURE OF MAGIC SHOWS, IN CLASS 41 (U.S. CLS. 100, 101 AND 107).

FIRST USE 9-14-2003; IN COMMERCE 9-14-2003.

THE MARK CONSISTS OF STANDARD CHARACTERS WITHOUT CLAIM TO ANY PARTICULAR FONT, STYLE, SIZE, OR COLOR.

THE NAME(S), PORTRAIT(S), AND/OR SIGNATURE(S) SHOWN IN THE MARK IDENTIFIES "CURTIS ADAMS", WHOSE CONSENT(S) TO REGISTER IS MADE OF RECORD.

SN 77-132,082, FILED 3-15-2007.

JOHN DALIER, EXAMINING ATTORNEY

Int. Cl.: 41

Prior U.S. Cls.: 100, 101, and 107

United States Patent and Trademark Office

Reg. No. 3,485,722

Registered Aug. 12, 2008

**SERVICE MARK
PRINCIPAL REGISTER**

**YOU SHOOT IT, WE'LL SHARE
IT**

FOX TELEVISION STATIONS, INC. (DELAWARE
CORPORATION)
10201 WEST PICO BOULEVARD
LOS ANGELES, CA 90035

FOR: ENTERTAINMENT SERVICES IN THE
NATURE OF ON-GOING TELEVISION PROGRAM
SEGMENTS FEATURING SPORTS, NEWS AND
ENTERTAINMENT; PROVIDING ON-LINE INFOR-
MATION IN THE FIELD OF SPORTS, NEWS AND
ENTERTAINMENT, IN CLASS 41 (U.S. CLS. 100, 101
AND 107).

FIRST USE 4-17-2007; IN COMMERCE 4-17-2007.

THE MARK CONSISTS OF STANDARD CHAR-
ACTERS WITHOUT CLAIM TO ANY PARTICULAR
FONT, STYLE, SIZE, OR COLOR.

SN 77-133,455, FILED 3-16-2007.

HEATHER BIDDULPH, EXAMINING ATTORNEY

Int. Cl.: 41

Prior U.S. Cls.: 100, 101, and 107

United States Patent and Trademark Office

Reg. No. 3,485,723

Registered Aug. 12, 2008

**SERVICE MARK
PRINCIPAL REGISTER**

SALES LOUNGE

ABERNETHY, JENNIFER E. (UNITED STATES
INDIVIDUAL)
20799 AMBERVIEW CT.
ASHBURN, VA 20147

FOR: (BASED ON USE IN COMMERCE) CONDUCTING WORKSHOPS AND SEMINARS FOR ASSISTING PROFESSIONALS IN USING PERSONAL AND PROFESSIONAL ASSETS AND ATTRIBUTES IN THE DEVELOPMENT OF A UNIQUE SALES STYLE (BASED ON INTENT TO USE) EDUCATIONAL SERVICES, NAMELY, CONDUCTING SEMINARS ON-LINE AND VIA TELECONFERENCING FOR ASSISTING PROFESSIONALS IN USING PERSONAL AND PROFESSIONAL ASSETS AND ATTRIBUTES IN THE DEVELOPMENT OF A UNIQUE SALES STYLE; (BASED ON INTENT TO USE) PROFESSIONAL COACHING SERVICES FOR ASSISTING PROFESSIONALS IN USING PERSONAL

AND PROFESSIONAL ASSETS AND ATTRIBUTES IN THE DEVELOPMENT OF A UNIQUE SALES STYLE, IN CLASS 41 (U.S. CLS. 100, 101 AND 107).

FIRST USE 3-12-2005; IN COMMERCE 3-12-2005.

THE MARK CONSISTS OF STANDARD CHARACTERS WITHOUT CLAIM TO ANY PARTICULAR FONT, STYLE, SIZE, OR COLOR.

NO CLAIM IS MADE TO THE EXCLUSIVE RIGHT TO USE "SALES", APART FROM THE MARK AS SHOWN.

SN 77-133,499, FILED 3-16-2007.

KATHLEEN M. VANSTON, EXAMINING ATTORNEY

Int. Cl.: 41

Prior U.S. Cls.: 100, 101, and 107

United States Patent and Trademark Office

Reg. No. 3,485,724

Registered Aug. 12, 2008

**SERVICE MARK
PRINCIPAL REGISTER**

XTREME COUTURE

NATURAL COUTURE, INC. (NEVADA CORPORATION)
4055 WEST SUNSET
LAS VEGAS, NV 89118

FOR: OPERATION OF TRAINING CENTERS IN THE FIELDS OF FITNESS, EXERCISE, AND MIXED MARTIAL ARTS; PROVIDING CLASSES, WORKSHOPS, AND SEMINARS IN THE FIELDS OF FITNESS, EXERCISE, AND MIXED MARTIAL ARTS; PROVIDING A WEBSITE FEATURING INFORMATION IN THE FIELDS OF FITNESS, EXERCISE,

AND MIXED MARTIAL ARTS TRAINING, IN CLASS 41 (U.S. CLS. 100, 101 AND 107).

FIRST USE 2-0-2007; IN COMMERCE 2-0-2007.

THE MARK CONSISTS OF STANDARD CHARACTERS WITHOUT CLAIM TO ANY PARTICULAR FONT, STYLE, SIZE, OR COLOR.

SN 77-133,523, FILED 3-16-2007.

BARNEY CHARLON, EXAMINING ATTORNEY

Int. Cls.: 28 and 45

Prior U.S. Cls.: 22, 23, 38, 50, 100, and 101

United States Patent and Trademark Office

Reg. No. 3,485,725

Registered Aug. 12, 2008

**TRADEMARK
SERVICE MARK
PRINCIPAL REGISTER**

Emotional Baggage

EMOTIONALLIE, LLC (CALIFORNIA LTD LIAB
CO)
SUITE 780
409 N. PACIFIC COAST HIGHWAY
REDONDO BEACH, CA 90277

FOR: PLUSH TOYS; SOFT SCULPTURE DOLLS;
SOFT SCULPTURE PLUSH TOYS; SOFT SCULP-
TURE TOYS, IN CLASS 28 (U.S. CLS. 22, 23, 38 AND
50).

FIRST USE 6-10-2008; IN COMMERCE 6-10-2008.

FOR: PREPARATION OF CUSTOMIZED GIFT
BASKETS; PREPARATION OF CUSTOMIZED GIFT

BASKETS WITH SELECTED ITEMS REGARDING A
PARTICULAR OCCASION OR THEME, IN CLASS 45
(U.S. CLS. 100 AND 101).

FIRST USE 6-10-2008; IN COMMERCE 6-10-2008.

THE MARK CONSISTS OF STANDARD CHAR-
ACTERS WITHOUT CLAIM TO ANY PARTICULAR
FONT, STYLE, SIZE, OR COLOR.

SN 77-133,594, FILED 3-16-2007.

THEODORE MCBRIDE, EXAMINING ATTORNEY

Int. Cls.: 35 and 43

Prior U.S. Cls.: 100, 101, and 102

United States Patent and Trademark Office

Reg. No. 3,485,726

Registered Aug. 12, 2008

**SERVICE MARK
PRINCIPAL REGISTER**

WYNDHAM REWARDS

WYNDHAM TM CORP. (DELAWARE CORPORATION)
10750 WEST CHARLESTON BLVD., SUITE 130
LAS VEGAS, NV 89135

FOR: PROMOTING THE GOODS AND SERVICES OF OTHERS BY AWARDED PURCHASE POINTS FOR MEMBERSHIP CARD AND MEMBERSHIP NUMBER USE; DEVELOPING AND ADMINISTERING A MEMBERSHIP REWARDS PROGRAM FOR LODGING GUESTS TO OBTAIN DISCOUNTS ON GOODS AND SERVICES, IN CLASS 35 (U.S. CLS. 100, 101 AND 102).

FIRST USE 5-1-2008; IN COMMERCE 5-1-2008.

FOR: HOTEL SERVICES FEATURING FREQUENT GUEST REWARD PROGRAM SERVICES WITH ADDED FEATURES WHICH ALLOW PARTICIPANTS TO EARN FREE LODGING AND OTHER TRAVEL-RELATED BENEFITS, AND ACQUIRE

POINTS REDEEMABLE FOR CONSUMER PRODUCTS AND SERVICES, IN CLASS 43 (U.S. CLS. 100 AND 101).

FIRST USE 5-1-2008; IN COMMERCE 5-1-2008.

THE MARK CONSISTS OF STANDARD CHARACTERS WITHOUT CLAIM TO ANY PARTICULAR FONT, STYLE, SIZE, OR COLOR.

OWNER OF U.S. REG. NOS. 2,300,685, 3,025,534, AND OTHERS.

NO CLAIM IS MADE TO THE EXCLUSIVE RIGHT TO USE "REWARDS", APART FROM THE MARK AS SHOWN.

SN 77-133,962, FILED 3-19-2007.

BARNEY CHARLON, EXAMINING ATTORNEY

Int. Cl.: 10

Prior U.S. Cls.: 26, 39, and 44

United States Patent and Trademark Office

Reg. No. 3,485,727

Registered Aug. 12, 2008

**TRADEMARK
PRINCIPAL REGISTER**

SABRETOOTH

ARTHREX, INC. (DELAWARE CORPORATION)
1370 CREEKSIDE BLVD.
NAPLES, FL 34109

THE MARK CONSISTS OF STANDARD CHAR-
ACTERS WITHOUT CLAIM TO ANY PARTICULAR
FONT, STYLE, SIZE, OR COLOR.

FOR: MEDICAL DEVICES, NAMELY, BONE AND
TISSUE SHAVERS, IN CLASS 10 (U.S. CLS. 26, 39
AND 44).

SN 77-134,188, FILED 3-19-2007.

FIRST USE 3-9-2008; IN COMMERCE 3-9-2008.

REBECCA EISINGER, EXAMINING ATTORNEY

Int. Cl.: 21

Prior U.S. Cls.: 2, 13, 23, 29, 30, 33, 40, and 50

Reg. No. 3,485,728

United States Patent and Trademark Office

Registered Aug. 12, 2008

**TRADEMARK
PRINCIPAL REGISTER**

**AS CARE FREE AS A PET CAN
BE**

NATURE IN GLASS LTD. (NEW YORK COR-
PORATION)
469 ATLANTIC AVENUE
EAST ROCKAWAY, NY 11518

THE MARK CONSISTS OF STANDARD CHAR-
ACTERS WITHOUT CLAIM TO ANY PARTICULAR
FONT, STYLE, SIZE, OR COLOR.

FOR: AQUARIUMS, IN CLASS 21 (U.S. CLS. 2, 13,
23, 29, 30, 33, 40 AND 50).

SN 77-134,586, FILED 3-19-2007.

FIRST USE 5-18-2007; IN COMMERCE 5-18-2007.

TINA BROWN, EXAMINING ATTORNEY

Int. Cl.: 41

Prior U.S. Cls.: 100, 101, and 107

United States Patent and Trademark Office

Reg. No. 3,485,729

Registered Aug. 12, 2008

**SERVICE MARK
PRINCIPAL REGISTER**

**A CALL TO PEACE MULTIMEDIA
EVENTS**

DEL SIGNORE, AEDWARD (UNITED STATES
INDIVIDUAL)
23852 PACIFIC COAST HWY. #697
MALIBU, CA 90265

FOR: ARRANGING AND CONDUCTING OF
CONCERTS; ENTERTAINMENT, NAMELY, LIVE
MUSIC CONCERTS, IN CLASS 41 (U.S. CLS. 100, 101
AND 107).

FIRST USE 12-17-2003; IN COMMERCE 5-9-2008.

THE MARK CONSISTS OF STANDARD CHAR-
ACTERS WITHOUT CLAIM TO ANY PARTICULAR
FONT, STYLE, SIZE, OR COLOR.

NO CLAIM IS MADE TO THE EXCLUSIVE
RIGHT TO USE "MULTIMEDIA EVENTS", APART
FROM THE MARK AS SHOWN.

SN 77-134,763, FILED 3-19-2007.

MICHAEL LEWIS, EXAMINING ATTORNEY

Int. Cl.: 32

Prior U.S. Cls.: 45, 46, and 48

United States Patent and Trademark Office

Reg. No. 3,485,730

Registered Aug. 12, 2008

**TRADEMARK
PRINCIPAL REGISTER**

European RENDEZ VOUS

EUROBUBBLIES, INC. (CALIFORNIA CORPORATION)
58 UNION STREET
ASHLAND, MA 01721

THE MARK CONSISTS OF STANDARD CHARACTERS WITHOUT CLAIM TO ANY PARTICULAR FONT, STYLE, SIZE, OR COLOR.

FOR: LEMONADE, IN CLASS 32 (U.S. CLS. 45, 46 AND 48).

SN 77-135,044, FILED 3-20-2007.

FIRST USE 4-0-2007; IN COMMERCE 4-0-2007.

REGINA DRUMMOND, EXAMINING ATTORNEY

Int. Cl.: 25

Prior U.S. Cls.: 22 and 39

United States Patent and Trademark Office

Reg. No. 3,485,731

Registered Aug. 12, 2008

**TRADEMARK
PRINCIPAL REGISTER**

SEXY TIME

ABDULLA, DANNY (UNITED STATES INDIVIDUAL)
980 CYNTHIA AVE
PASADENA, CA 91107

FOR: PANTS, SLIPS, CAMISOLES, ROBES, SOCKS, VESTS, JACKETS, BRAS, PANTIES, T-SHIRTS, TANK TOPS, SWEAT PANTS, SLEEPWEAR, SHIRTS, BOXERS, SCARVES, HATS, BODY SUITS, BUSTIERS, FOUNDATION GARMENTS, GARTER BELTS, GIRDLES, BATHROBES, BEACH COVERUPS, BELTS, BLAZERS, BLOUSES, BOOTS, BOXER SHORTS, CAPS, COATS, DRESSES, GLOVES, GOWNS, HALTER TOPS, HEADBANDS, JACKETS, JEANS, JOGGING SUITS, KNIT SHIRTS, KNIT TOPS, LEOTARDS, LINGERIE, MITTENS, NEGLIGEEES, NIGHT GOWNS, NIGHT SHIRTS, PAJAMAS, PANTIES, PANTS, PANTYHOSE, SANDALS, SAR-

ONGS, SHOES, SHORTS, SKIRTS, SLACKS, SLIPPERS, STOCKINGS, SUITS, SWEAT SHIRTS, SWEAT SHORTS, SWEAT SUITS, SWEATERS, SWIMSUITS, TEDDIES, TIES, TIGHTS, UNDERPANTS, UNDERSHIRTS, AND UNDERWEAR, IN CLASS 25 (U.S. CLS. 22 AND 39).

FIRST USE 5-1-2008; IN COMMERCE 5-1-2008.

THE MARK CONSISTS OF STANDARD CHARACTERS WITHOUT CLAIM TO ANY PARTICULAR FONT, STYLE, SIZE, OR COLOR.

SN 77-135,158, FILED 3-20-2007.

B. PARADEWELAI, EXAMINING ATTORNEY

Int. Cl.: 35

Prior U.S. Cls.: 100, 101, and 102

United States Patent and Trademark Office

Reg. No. 3,485,732

Registered Aug. 12, 2008

**SERVICE MARK
PRINCIPAL REGISTER**

LIFE CHANGERS CLUB

NEXSTAR, INC. (WISCONSIN CORPORATION)
125 LITTLE CANADA ROAD WEST
WHITE BEAR LAKE, MN 55117

FOR: CONDUCTING MEMBER AWARD PROGRAMS TO PROMOTE COMPANY DEVELOPMENT; PROMOTING COMPANY DEVELOPMENT BY PROVIDING RECOGNITION AND INCENTIVES TO MEMBERS, IN CLASS 35 (U.S. CLS. 100, 101 AND 102).

FIRST USE 8-29-2006; IN COMMERCE 8-29-2006.

THE MARK CONSISTS OF STANDARD CHARACTERS WITHOUT CLAIM TO ANY PARTICULAR FONT, STYLE, SIZE, OR COLOR.

SN 77-135,269, FILED 3-20-2007.

JILL PRATER, EXAMINING ATTORNEY

Int. Cl.: 42

Prior U.S. Cls.: 100 and 101

United States Patent and Trademark Office

Reg. No. 3,485,733

Registered Aug. 12, 2008

**SERVICE MARK
PRINCIPAL REGISTER**

NEXSTAR SELECT SERVICE

NEXSTAR, INC. (WISCONSIN CORPORATION)
125 LITTLE CANADA ROAD WEST
STE. 200
WHITE BEAR LAKE, MN 55117

FOR: ACCREDITATION SERVICES, NAMELY, DEVELOPING, EVALUATING, AND TESTING STANDARDS FOR PLUMBING, ELECTRICAL, HEATING, VENTILATING, AND AIR CONDITIONING SERVICE PROVIDERS, FOR THE PURPOSE OF ACCREDITATION; ANALYSIS AND EVALUATION OF THE SERVICES OF OTHERS FOR THE PURPOSE OF CERTIFICATION; PROVIDING QUALITY ASSURANCE SERVICES IN THE FIELD OF PLUMBING, ELECTRICAL, HEATING, VENTILATING,

AND AIR CONDITIONING SERVICE PROVIDERS, IN CLASS 42 (U.S. CLS. 100 AND 101).

FIRST USE 2-21-2004; IN COMMERCE 2-21-2004.

THE MARK CONSISTS OF STANDARD CHARACTERS WITHOUT CLAIM TO ANY PARTICULAR FONT, STYLE, SIZE, OR COLOR.

NO CLAIM IS MADE TO THE EXCLUSIVE RIGHT TO USE "SERVICE", APART FROM THE MARK AS SHOWN.

SN 77-135,310, FILED 3-20-2007.

JILL PRATER, EXAMINING ATTORNEY

Int. Cl.: 42

Prior U.S. Cls.: 100 and 101

United States Patent and Trademark Office

Reg. No. 3,485,734

Registered Aug. 12, 2008

**SERVICE MARK
PRINCIPAL REGISTER**

HOISHIK

CINEMAPLEX TECHNOLOGIES CORPORATION
(PENNSYLVANIA CORPORATION)
238 RIDGE ROAD
SPRING CITY, PA 19475

THE MARK CONSISTS OF STANDARD CHAR-
ACTERS WITHOUT CLAIM TO ANY PARTICULAR
FONT, STYLE, SIZE, OR COLOR.

FOR: CONSULTING SERVICES IN THE FIELD
OF HOME AUTOMATION, IN CLASS 42 (U.S. CLS.
100 AND 101).

SN 77-135,374, FILED 3-20-2007.

FIRST USE 9-30-2007; IN COMMERCE 9-30-2007.

KAREN BRACEY, EXAMINING ATTORNEY

Int. Cl.: 34

Prior U.S. Cls.: 2, 8, 9, and 17

United States Patent and Trademark Office

Reg. No. 3,485,735

Registered Aug. 12, 2008

**TRADEMARK
PRINCIPAL REGISTER**

FUNDACIÓN ANCESTRAL

EL CENTAURO DE ORO, LTDA. (COSTA RICA CORPORATION), DBA TACACOS DE LA CORDILLERA,
SANTA MARTA, MERCEDES SUR, PURISCAL
300 METERS SUR DE LA ESCUELA DE LA
SAN JOSE, COSTA RICA

FOR: CIGARS, IN CLASS 34 (U.S. CLS. 2, 8, 9 AND 17).

FIRST USE 8-0-2007; IN COMMERCE 8-0-2007.

THE MARK CONSISTS OF STANDARD CHARACTERS WITHOUT CLAIM TO ANY PARTICULAR FONT, STYLE, SIZE, OR COLOR.

THE FOREIGN WORDING IN THE MARK TRANSLATES INTO ENGLISH AS ANCESTRAL FOUNDATION.

SN 77-135,594, FILED 3-20-2007.

MICHAEL LEWIS, EXAMINING ATTORNEY

Int. Cl.: 35

Prior U.S. Cls.: 100, 101, and 102

United States Patent and Trademark Office

Reg. No. 3,485,736

Registered Aug. 12, 2008

**SERVICE MARK
PRINCIPAL REGISTER**

**Working To Be Your
Supplier Of Choice**

BABCOCK LUMBER COMPANY (PENNSYLVANIA CORPORATION)
2220 PALMER STREET
PITTSBURGH, PA 15218

FOR: WHOLESALE DISTRIBUTORSHIPS FEATURING LUMBER, BUILDING MATERIALS, CONSTRUCTION MATERIALS AND HOME FURNISHINGS; WHOLESALE ORDERING SERVICES IN THE FIELD OF LUMBER, BUILDING MATERIALS, CONSTRUCTION MATERIALS AND HOME FURNISHINGS, IN CLASS 35 (U.S. CLS. 100, 101 AND 102).

FIRST USE 4-15-2008; IN COMMERCE 4-15-2008.

THE MARK CONSISTS OF STANDARD CHARACTERS WITHOUT CLAIM TO ANY PARTICULAR FONT, STYLE, SIZE, OR COLOR.

SN 77-135,596, FILED 3-20-2007.

MICHAEL LEWIS, EXAMINING ATTORNEY

Int. Cl.: 10

Prior U.S. Cls.: 26, 39, and 44

United States Patent and Trademark Office

Reg. No. 3,485,737

Registered Aug. 12, 2008

**TRADEMARK
PRINCIPAL REGISTER**

MASTER-VU

SONOMED, INC. (NEW YORK CORPORATION)
1979 MARCUS AVENUE
LAKE SUCCESS, NY 11042

THE MARK CONSISTS OF STANDARD CHAR-
ACTERS WITHOUT CLAIM TO ANY PARTICULAR
FONT, STYLE, SIZE, OR COLOR.

FOR: OPHTHALMIC ULTRASOUND DIAGNOS-
TIC APPARATUS, IN CLASS 10 (U.S. CLS. 26, 39 AND
44).

SN 77-135,599, FILED 3-20-2007.

FIRST USE 1-2-2008; IN COMMERCE 1-2-2008.

MICHAEL LEWIS, EXAMINING ATTORNEY

Prior U.S. Cl.: A

United States Patent and Trademark Office

Reg. No. 3,485,738

Registered Aug. 12, 2008

CERTIFICATION MARK
GOODS
PRINCIPAL REGISTER



THE MICHAEL STEIN AND JOYCE KEYSER
PARTNERSHIP (FLORIDA PARTNERSHIP)
618 LOCK ROAD
DEERFIELD, FL 33442

FOR: BEEF, PORK, POULTRY, EGGS, MILK,
CHEESE, AND CREAM, IN CLASS A (U.S. CL. A).

FIRST USE 3-21-2007; IN COMMERCE 3-21-2007.

NO CLAIM IS MADE TO THE EXCLUSIVE
RIGHT TO USE "CERTIFIED CLONE FREE," "SEAL
OF ASSURANCE," AND "THIS PRODUCT WAS
NOT DERIVED FROM CLONED ANIMALS OR

THEIR OFFSPRING", APART FROM THE MARK
AS SHOWN.

THE CERTIFICATION MARK, AS INTENDED TO
BE USED BY AUTHORIZED PERSONS, IS INTEN-
DED TO CERTIFY THAT THESE PRODUCTS WERE
NOT DERIVED FROM CLONED ANIMALS OR
THEIR OFFSPRING.

SN 77-135,611, FILED 3-20-2007.

ALICE SUE CARRUTHERS, EXAMINING ATTOR-
NEY

Int. Cl.: 35

Prior U.S. Cls.: 100, 101, and 102

United States Patent and Trademark Office

Reg. No. 3,485,739

Registered Aug. 12, 2008

SERVICE MARK
PRINCIPAL REGISTER

CELLFISH

CELLFISH MEDIA LLC (DELAWARE LTD LIAB
CO)
1633 BROADWAY
NEW YORK, NY 10019

FOR: COMMERCIAL ADMINISTRATION OF
THE LICENSING FOR OTHERS OF THEIR ELEC-
TRONIC CONTENT, NAMELY, PICTURES, GRA-
PHICS, TEXTUAL MATERIALS, DATA,
POSTCARDS, GROUP MESSAGES, ONLINE CHAT
SERVICES, VOICE, SOUND RECORDINGS, MO-
VIES, RADIO PROGRAMMING, TELEVISION PRO-
GRAMMING, VIDEO, MUSIC, GAMES AND
RINGTONES, FOR USE WITH MOBILE COMMU-
NICATIONS DEVICES; ONLINE RETAIL STORE
SERVICES FEATURING THE ELECTRONIC CON-
TENT OF OTHERS, NAMELY, PICTURES, GRA-
PHICS, TEXTUAL MATERIALS, DATA,

POSTCARDS, GROUP MESSAGES, ONLINE CHAT
SERVICES, VOICE, SOUND RECORDINGS, MO-
VIES, RADIO PROGRAMMING, TELEVISION PRO-
GRAMMING, VIDEO, MUSIC, GAMES AND
RINGTONES, TO USERS OF MOBILE COMMUNI-
CATIONS DEVICES, IN CLASS 35 (U.S. CLS. 100, 101
AND 102).

FIRST USE 4-10-2006; IN COMMERCE 4-10-2006.

THE MARK CONSISTS OF STANDARD CHAR-
ACTERS WITHOUT CLAIM TO ANY PARTICULAR
FONT, STYLE, SIZE, OR COLOR.

SN 77-136,647, FILED 3-21-2007.

MATTHEW PAPPAS, EXAMINING ATTORNEY

Int. Cl.: 36

Prior U.S. Cls.: 100, 101, and 102

United States Patent and Trademark Office

Reg. No. 3,485,740

Registered Aug. 12, 2008

**SERVICE MARK
PRINCIPAL REGISTER**

TEAM ADVANTAGE BANKING

FULTON FINANCIAL CORPORATION (PENNSYLVANIA CORPORATION)

ONE PENN SQUARE, P.O. BOX 4887

LANCASTER, PA 17604

FOR: BANKING SERVICES, IN CLASS 36 (U.S. CLS. 100, 101 AND 102).

FIRST USE 6-14-2007; IN COMMERCE 6-14-2007.

THE MARK CONSISTS OF STANDARD CHARACTERS WITHOUT CLAIM TO ANY PARTICULAR FONT, STYLE, SIZE, OR COLOR.

NO CLAIM IS MADE TO THE EXCLUSIVE RIGHT TO USE "BANKING", APART FROM THE MARK AS SHOWN.

SN 77-137,693, FILED 3-22-2007.

KELLEY WELLS, EXAMINING ATTORNEY

Int. Cl.: 36

Prior U.S. Cls.: 100, 101, and 102

United States Patent and Trademark Office

Reg. No. 3,485,741

Registered Aug. 12, 2008

**SERVICE MARK
PRINCIPAL REGISTER**



VALUE CITY OF MICHIGAN, INC. (MICHIGAN CORPORATION)
36901 WARREN ROAD
WESTLAND, MI 48185

FOR: INSURANCE SERVICES, NAMELY, PROVIDING EXTENDED SERVICE CONTRACTS FOR THE REPAIR OF APPLIANCES AND CONSUMER ELECTRONICS, IN CLASS 36 (U.S. CLS. 100, 101 AND 102).

FIRST USE 3-18-2007; IN COMMERCE 3-18-2007.

NO CLAIM IS MADE TO THE EXCLUSIVE RIGHT TO USE "EXTENDED SERVICE PROGRAM", APART FROM THE MARK AS SHOWN.

THE COLOR(S) RED, BLACK AND WHITE IS/ ARE CLAIMED AS A FEATURE OF THE MARK.

THE MARK CONSISTS OF THE TEXT "V ASSURED EXTENDED SERVICE PROGRAM" WITH THE LETTER "V" IN RED AND LOCATED BEHIND THE REMAINING TEXT, THE WORD "ASSURED" IN BLACK LETTERS, THE WORDS "EXTENDED SERVICE PROGRAM" IN WHITE LETTERS INSIDE A BLACK RECTANGLE LOCATED BELOW THE WORD "ASSURED" AND WITH A HORIZONTAL BLACK LINE ABOVE THE WORD "ASSURED".

SN 77-137,773, FILED 3-22-2007.

BENJAMIN OKEKE, EXAMINING ATTORNEY

Int. Cl.: 9

Prior U.S. Cls.: 21, 23, 26, 36, and 38

Reg. No. 3,485,742

United States Patent and Trademark Office

Registered Aug. 12, 2008

**TRADEMARK
PRINCIPAL REGISTER**

eScholar RADAR

ESCHOLAR LLC (NEW YORK LTD LIAB CO)
222 BLOOMINGDALE RD., SUITE 107
WHITE PLAINS, NY 10605

THE MARK CONSISTS OF STANDARD CHAR-
ACTERS WITHOUT CLAIM TO ANY PARTICULAR
FONT, STYLE, SIZE, OR COLOR.

FOR: COMPUTER SOFTWARE THAT REVIEWS
DATA BEING STORED IN A DATA WAREHOUSE
OR OTHER SOURCE SYSTEM, FINDS ANOMALIES
IN THE DATA, AND REPORTS THOSE ANOMA-
LIES TO THE RELEVANT AGENCY, IN CLASS 9
(U.S. CLS. 21, 23, 26, 36 AND 38).

OWNER OF U.S. REG. NO. 2,467,490.

SN 77-137,906, FILED 3-22-2007.

FIRST USE 12-22-2006; IN COMMERCE 12-22-2006.

DAVID TAYLOR, EXAMINING ATTORNEY

Int. Cl.: 12

Prior U.S. Cls.: 19, 21, 23, 31, 35, and 44

Reg. No. 3,485,743

United States Patent and Trademark Office

Registered Aug. 12, 2008

**TRADEMARK
PRINCIPAL REGISTER**

BARBER S2-86

STANDARD CAR TRUCK COMPANY (DELA-
WARE CORPORATION)
865 BUSSE HIGHWAY
PARK RIDGE, IL 60068

THE MARK CONSISTS OF STANDARD CHAR-
ACTERS WITHOUT CLAIM TO ANY PARTICULAR
FONT, STYLE, SIZE, OR COLOR.

FOR: MOUNTING ASSEMBLIES FOR RAIL-
ROAD CAR TRUCK AXLES, NAMELY, SHEAR
PADS AND ADAPTORS, IN CLASS 12 (U.S. CLS. 19,
21, 23, 31, 35 AND 44).

SN 77-138,700, FILED 3-23-2007.

FIRST USE 4-30-2008; IN COMMERCE 4-30-2008.

C. DIONNE CLYBURN, EXAMINING ATTORNEY

Int. Cl.: 33

Prior U.S. Cls.: 47 and 49

United States Patent and Trademark Office

Reg. No. 3,485,744

Registered Aug. 12, 2008

**TRADEMARK
PRINCIPAL REGISTER**

Tiger Hill

CHAMPAGNE INDAGE LIMITED (INDIA PUBLIC LIMITED COMPANY (PLC))
INDAGE HOUSE, 82, DR. ANNIE BESANT ROAD
WORLI, MUMBAI-400 018, INDIA

FOR: WINE, IN CLASS 33 (U.S. CLS. 47 AND 49).

FIRST USE 5-14-2007; IN COMMERCE 5-14-2007.

THE MARK CONSISTS OF STANDARD CHARACTERS WITHOUT CLAIM TO ANY PARTICULAR FONT, STYLE, SIZE, OR COLOR.

SN 77-139,371, FILED 3-23-2007.

ANDREA K. NADELMAN, EXAMINING ATTORNEY

Int. Cl.: 9

Prior U.S. Cls.: 21, 23, 26, 36, and 38

United States Patent and Trademark Office

Reg. No. 3,485,745

Registered Aug. 12, 2008

**TRADEMARK
PRINCIPAL REGISTER**

SOUTHPEAK GAMES

SOUTHPEAK INTERACTIVE LLC (VIRGINIA
LTD LIAB CO)
SUITE 104
2400 POLO PARKWAY
MIDLOTHIAN, VA 23113

FOR: SOFTWARE AND ELECTRONIC GAMES,
NAMELY, SOFTWARE GAMES RECORDED ON
CD-ROM AND DIGITAL VIDEO DISCS FOR COM-
PUTERS; SOFTWARE GAMES RECORDED ON CD-
ROMS, DIGITAL VIDEO DISCS, AND CARTRIDGES
FOR CONSOLE AND INDIVIDUAL PORTABLE
GAMING SYSTEMS; SOFTWARE GAMES THAT
ARE DOWNLOADABLE FROM A REMOTE COM-
PUTER SITE; AND SOFTWARE GAMES FOR MO-
BILE PHONES, PERSONAL DIGITAL ASSISTANTS,
AND HANDHELD COMPUTERS, IN CLASS 9 (U.S.
CLS. 21, 23, 26, 36 AND 38).

FIRST USE 5-24-2007; IN COMMERCE 5-24-2007.

THE MARK CONSISTS OF STANDARD CHAR-
ACTERS WITHOUT CLAIM TO ANY PARTICULAR
FONT, STYLE, SIZE, OR COLOR.

OWNER OF U.S. REG. NOS. 2,279,627, 2,312,135,
AND OTHERS.

NO CLAIM IS MADE TO THE EXCLUSIVE
RIGHT TO USE "GAMES", APART FROM THE
MARK AS SHOWN.

SN 77-139,467, FILED 3-23-2007.

ANDREW RHIM, EXAMINING ATTORNEY

Int. Cl.: 25

Prior U.S. Cls.: 22 and 39

United States Patent and Trademark Office

Reg. No. 3,485,746

Registered Aug. 12, 2008

**TRADEMARK
PRINCIPAL REGISTER**

SCOTT LANGTON

PAN MELLOTEX LLC (NEW YORK LTD LIAB
CO)
200 CENTRE STREET, 3RD FLOOR
NEW YORK, NY 10013

FOR: SHIRTS; PANTS; JEANS; SKIRTS; JACKETS;
COATS; VESTS; SUITS; ASCOTS; SCARVES; NECK-
TIES; BELTS; GLOVES; HEADWEAR; CAPS; HATS;
FOOTWEAR; DRESSES; SHORTS; PAJAMAS; UN-
DERGARMENTS; ROBES; TOPS; BLOUSES, IN
CLASS 25 (U.S. CLS. 22 AND 39).

FIRST USE 2-15-2005; IN COMMERCE 2-15-2005.

THE MARK CONSISTS OF STANDARD CHAR-
ACTERS WITHOUT CLAIM TO ANY PARTICULAR
FONT, STYLE, SIZE, OR COLOR.

THE NAME(S), PORTRAIT(S), AND/OR SIGNA-
TURE(S) SHOWN IN THE MARK IDENTIFIES
"SCOTT LANGTON", WHOSE CONSENT(S) TO
REGISTER IS MADE OF RECORD.

SN 77-139,896, FILED 3-26-2007.

MATTHEW PAPPAS, EXAMINING ATTORNEY

Int. Cl.: 29

Prior U.S. Cl.: 46

United States Patent and Trademark Office

Reg. No. 3,485,747

Registered Aug. 12, 2008

**TRADEMARK
PRINCIPAL REGISTER**

SATIN DOLL

CHEESYGIRL CHEESE CO., LLC (TEXAS LTD
LIAB CO)
3701 OUTLET CENTER DRIVE #350A
SEALY, TX 774741103

THE MARK CONSISTS OF STANDARD CHAR-
ACTERS WITHOUT CLAIM TO ANY PARTICULAR
FONT, STYLE, SIZE, OR COLOR.

FOR: CHEESE, NAMELY, GOAT CHEESE, IN
CLASS 29 (U.S. CL. 46).

SN 77-140,151, FILED 3-26-2007.

FIRST USE 8-22-2007; IN COMMERCE 8-22-2007.

STEVEN PEREZ, EXAMINING ATTORNEY

Int. Cl.: 29

Prior U.S. Cl.: 46

Reg. No. 3,485,748

United States Patent and Trademark Office

Registered Aug. 12, 2008

**TRADEMARK
PRINCIPAL REGISTER**

PLAIN JANE

CHEESYGIRL CHEESE CO., LLC (TEXAS LTD
LIAB CO)
3701 OUTLET CENTER DRIVE #350A
SEALY, TX 774741103

THE MARK CONSISTS OF STANDARD CHAR-
ACTERS WITHOUT CLAIM TO ANY PARTICULAR
FONT, STYLE, SIZE, OR COLOR.

FOR: CHEESE, NAMELY, GOAT CHEESE, IN
CLASS 29 (U.S. CL. 46).

SN 77-140,162, FILED 3-26-2007.

FIRST USE 6-27-2007; IN COMMERCE 6-27-2007.

STEVEN PEREZ, EXAMINING ATTORNEY

Int. Cl.: 29

Prior U.S. Cl.: 46

United States Patent and Trademark Office

Reg. No. 3,485,749

Registered Aug. 12, 2008

**TRADEMARK
PRINCIPAL REGISTER**

FEMME FATALE

CHEESYGIRL CHEESE CO., LLC (TEXAS LTD
LIAB CO)
3701 OUTLET CENTER DRIVE #350A
SEALY, TX 774741103

FOR: CHEESE, NAMELY, GOAT CHEESE, IN
CLASS 29 (U.S. CL. 46).

FIRST USE 6-27-2007; IN COMMERCE 6-27-2007.

THE MARK CONSISTS OF STANDARD CHAR-
ACTERS WITHOUT CLAIM TO ANY PARTICULAR
FONT, STYLE, SIZE, OR COLOR.

THE ENGLISH TRANSLATION OF "FEMME
FATALE" IS DEADLY WOMEN.

SN 77-140,198, FILED 3-26-2007.

STEVEN PEREZ, EXAMINING ATTORNEY

Int. Cl.: 29

Prior U.S. Cl.: 46

Reg. No. 3,485,750

United States Patent and Trademark Office

Registered Aug. 12, 2008

**TRADEMARK
PRINCIPAL REGISTER**

BUFF

CHEESYGIRL CHEESE CO., LLC (TEXAS LTD
LIAB CO)
3701 OUTLET CENTER DRIVE #350A
SEALY, TX 774741103

THE MARK CONSISTS OF STANDARD CHAR-
ACTERS WITHOUT CLAIM TO ANY PARTICULAR
FONT, STYLE, SIZE, OR COLOR.

FOR: CHEESE, NAMELY, GOAT CHEESE, IN
CLASS 29 (U.S. CL. 46).

SN 77-140,219, FILED 3-26-2007.

FIRST USE 6-27-2007; IN COMMERCE 6-27-2007.

STEVEN PEREZ, EXAMINING ATTORNEY

Int. Cl.: 5

Prior U.S. Cls.: 6, 18, 44, 46, 51, and 52

Reg. No. 3,485,751

United States Patent and Trademark Office

Registered Aug. 12, 2008

**TRADEMARK
PRINCIPAL REGISTER**

VP Nutrition

V P CONSULTANTS, INC. (FLORIDA CORPORATION)

PO BOX 188

OSPREY, FL 34229

FOR: NUTRITIONAL SUPPLEMENTS, IN CLASS 5 (U.S. CLS. 6, 18, 44, 46, 51 AND 52).

FIRST USE 4-15-2002; IN COMMERCE 4-15-2002.

THE MARK CONSISTS OF STANDARD CHARACTERS WITHOUT CLAIM TO ANY PARTICULAR FONT, STYLE, SIZE, OR COLOR.

NO CLAIM IS MADE TO THE EXCLUSIVE RIGHT TO USE "NUTRITION", APART FROM THE MARK AS SHOWN.

SN 77-140,247, FILED 3-26-2007.

JOHN GARTNER, EXAMINING ATTORNEY

Int. Cl.: 29

Prior U.S. Cl.: 46

United States Patent and Trademark Office

Reg. No. 3,485,752

Registered Aug. 12, 2008

**TRADEMARK
PRINCIPAL REGISTER**



CHEESYGIRL CHEESE CO., LLC (TEXAS LTD
LIAB CO)

#350A

3701 OUTLET CENTER DRIVE
SEALY, TX 774741103

FOR: CHEESE, NAMELY, GOAT CHEESE, IN
CLASS 29 (U.S. CL. 46).

FIRST USE 6-27-2007; IN COMMERCE 6-27-2007.

NO CLAIM IS MADE TO THE EXCLUSIVE
RIGHT TO USE "VEGETARIAN CHEESE COMPA-
NY", APART FROM THE MARK AS SHOWN.

THE NAME(S), PORTRAIT(S), AND/OR SIGNA-
TURE(S) SHOWN IN THE MARK IDENTIFIES A
LIVING INDIVIDUAL, WHOSE CONSENT(S) TO
REGISTER IS SUBMITTED.

SN 77-140,267, FILED 3-26-2007.

STEVEN PEREZ, EXAMINING ATTORNEY

Int. Cl.: 9

Prior U.S. Cls.: 21, 23, 26, 36, and 38

Reg. No. 3,485,753

United States Patent and Trademark Office

Registered Aug. 12, 2008

**TRADEMARK
PRINCIPAL REGISTER**



MICROSOFT CORPORATION (WASHINGTON CORPORATION)
ONE MICROSOFT WAY
REDMOND, WA 980526399

FOR: OPERATING SYSTEM SOFTWARE; COMPUTER SOFTWARE FOR CREATING AND EDITING DVDS, IN CLASS 9 (U.S. CLS. 21, 23, 26, 36 AND 38).

FIRST USE 1-30-2007; IN COMMERCE 1-30-2007.

OWNER OF U.S. REG. NOS. 2,738,877 AND 2,744,843.

THE MARK CONSISTS OF AN IMAGE OF THREE SUPERIMPOSED DVD DISCS WITH A FLOWER DESIGN ON THE DISCS WHICH ARE LOCATED IN THE CENTER OF THREE TRANSPARENT DVD CASES WITH STYLIZED FLAGS BELOW THE DISCS.

SN 77-140,509, FILED 3-26-2007.

THOMAS MANOR, EXAMINING ATTORNEY

Int. Cl.: 29

Prior U.S. Cl.: 46

United States Patent and Trademark Office

Reg. No. 3,485,754

Registered Aug. 12, 2008

**TRADEMARK
PRINCIPAL REGISTER**

MI MERCEDITA

BEEF INTERNATIONAL CORP. (PENNSYLVANIA CORPORATION)
7010 CENTRAL HIGHWAY
PENNSAUKEN, PA 08109

THE FOREIGN WORDING IN THE MARK
TRANSLATES INTO ENGLISH AS MY LITTLE
GIFT.

FOR: MEAT, IN CLASS 29 (U.S. CL. 46).

FIRST USE 9-27-2007; IN COMMERCE 9-27-2007.

SN 77-140,546, FILED 3-26-2007.

THE MARK CONSISTS OF STANDARD CHARACTERS WITHOUT CLAIM TO ANY PARTICULAR FONT, STYLE, SIZE, OR COLOR.

JEFF DEFORD, EXAMINING ATTORNEY

Int. Cl.: 25

Prior U.S. Cls.: 22 and 39

United States Patent and Trademark Office

Reg. No. 3,485,755

Registered Aug. 12, 2008

**TRADEMARK
PRINCIPAL REGISTER**

**WISH DREAM
REALIZE**

KAREN THOMPSON, LLC (PENNSYLVANIA
LTD LIAB CO)
P.O. BOX 427
310 CAROUSEL LANE
LAHASKA, PA 18931

THE MARK CONSISTS OF STANDARD CHAR-
ACTERS WITHOUT CLAIM TO ANY PARTICULAR
FONT, STYLE, SIZE, OR COLOR.

FOR: CLOTHING, NAMELY, SLEEP WEAR AND
LOUNGE WEAR, IN CLASS 25 (U.S. CLS. 22 AND 39).

SN 77-140,887, FILED 3-26-2007.

FIRST USE 5-23-2008; IN COMMERCE 5-23-2008.

C. DIONNE CLYBURN, EXAMINING ATTORNEY

Int. Cls.: 25 and 36

Prior U.S. Cls.: 22, 39, 100, 101, and 102

United States Patent and Trademark Office

Reg. No. 3,485,756

Registered Aug. 12, 2008

**TRADEMARK
SERVICE MARK
PRINCIPAL REGISTER**

WISHES FOR WOMEN

KAREN THOMPSON, LLC (PENNSYLVANIA
LTD LIAB CO)
PO BOX 427
310 CAROUSEL LANE
LAHASKA, PA 18931

FOR: CLOTHING, NAMELY, SLEEP WEAR AND
LOUNGE WEAR, IN CLASS 25 (U.S. CLS. 22 AND 39).

FIRST USE 5-23-2008; IN COMMERCE 5-23-2008.

FOR: CHARITABLE DONATIONS OF A PERCENTAGE
OF PROFITS TO WOMEN'S CAUSES, IN
CLASS 36 (U.S. CLS. 100, 101 AND 102).

FIRST USE 5-23-2008; IN COMMERCE 5-23-2008.

THE MARK CONSISTS OF STANDARD CHARACTERS
WITHOUT CLAIM TO ANY PARTICULAR
FONT, STYLE, SIZE, OR COLOR.

NO CLAIM IS MADE TO THE EXCLUSIVE
RIGHT TO USE "WOMEN", APART FROM THE
MARK AS SHOWN.

SN 77-140,888, FILED 3-26-2007.

C. DIONNE CLYBURN, EXAMINING ATTORNEY

Int. Cl.: 25

Prior U.S. Cls.: 22 and 39

United States Patent and Trademark Office

Reg. No. 3,485,757

Registered Aug. 12, 2008

**TRADEMARK
PRINCIPAL REGISTER**

WISH POCKET

KAREN THOMPSON, LLC (PENNSYLVANIA
LTD LIAB CO)
PO BOX 427
310 CAROUSEL LANE
LAHASKA, PA 18931

THE MARK CONSISTS OF STANDARD CHAR-
ACTERS WITHOUT CLAIM TO ANY PARTICULAR
FONT, STYLE, SIZE, OR COLOR.

FOR: CLOTHING, NAMELY, SLEEP WEAR AND
LOUNGE WEAR, IN CLASS 25 (U.S. CLS. 22 AND 39).

SN 77-140,895, FILED 3-26-2007.

FIRST USE 5-23-2008; IN COMMERCE 5-23-2008.

C. DIONNE CLYBURN, EXAMINING ATTORNEY

Int. Cl.: 25

Prior U.S. Cls.: 22 and 39

United States Patent and Trademark Office

Reg. No. 3,485,758

Registered Aug. 12, 2008

**TRADEMARK
PRINCIPAL REGISTER**

KAREN THOMPSON

KAREN THOMPSON, LLC (PENNSYLVANIA
LTD LIAB CO)

PO BOX 427

310 CAROUSEL LANE

LAHASKA, PA 18931

FOR: CLOTHING, NAMELY, SLEEP WEAR AND
LOUNGE WEAR, IN CLASS 25 (U.S. CLS. 22 AND 39).

FIRST USE 5-23-2008; IN COMMERCE 5-23-2008.

THE MARK CONSISTS OF STANDARD CHAR-
ACTERS WITHOUT CLAIM TO ANY PARTICULAR
FONT, STYLE, SIZE, OR COLOR.

THE NAME(S), PORTRAIT(S), AND/OR SIGNA-
TURE(S) SHOWN IN THE MARK IDENTIFIES
"KAREN THOMPSON", WHOSE CONSENT(S) TO
REGISTER IS MADE OF RECORD.

SN 77-141,439, FILED 3-27-2007.

C. DIONNE CLYBURN, EXAMINING ATTORNEY

Int. Cl.: 33

Prior U.S. Cls.: 47 and 49

United States Patent and Trademark Office

Reg. No. 3,485,759

Registered Aug. 12, 2008

**TRADEMARK
PRINCIPAL REGISTER**

RIUNITE WINEMAKER'S BLEND

CANTINE COOPERATIVE RIUNITE - SOCIETA
COOPERATIVA AGRICOLA (ITALY COR-
PORATION)

24 VIA G. BRODOLINI
42040 CAMPEGINE, ITALY

FOR: WINES, IN CLASS 33 (U.S. CLS. 47 AND 49).

FIRST USE 8-8-2007; IN COMMERCE 9-27-2007.

THE MARK CONSISTS OF STANDARD CHAR-
ACTERS WITHOUT CLAIM TO ANY PARTICULAR
FONT, STYLE, SIZE, OR COLOR.

OWNER OF U.S. REG. NOS. 1,006,101, 2,108,246,
AND OTHERS.

NO CLAIM IS MADE TO THE EXCLUSIVE
RIGHT TO USE "WINEMAKER'S BLEND", APART
FROM THE MARK AS SHOWN.

THE FOREIGN WORDING IN THE MARK
TRANSLATES INTO ENGLISH AS "UNITED" OR
"REUNITED".

SN 77-141,509, FILED 3-27-2007.

EMILY CHUO, EXAMINING ATTORNEY

Int. Cl.: 5

Prior U.S. Cls.: 6, 18, 44, 46, 51, and 52

United States Patent and Trademark Office

Reg. No. 3,485,760

Registered Aug. 12, 2008

**TRADEMARK
PRINCIPAL REGISTER**

XPRESS YOURSELF

PROMAX NUTRITION CORP. (DELAWARE
CORPORATION)
1915 MARK COURT, SUITE 150
CONCORD, CA 94520

FOR: NUTRITIONAL SUPPLEMENTS, IN CLASS
5 (U.S. CLS. 6, 18, 44, 46, 51 AND 52).

FIRST USE 8-1-2007; IN COMMERCE 8-1-2007.

THE MARK CONSISTS OF STANDARD CHAR-
ACTERS WITHOUT CLAIM TO ANY PARTICULAR
FONT, STYLE, SIZE, OR COLOR.

SN 77-141,726, FILED 3-27-2007.

ANDREA K. NADELMAN, EXAMINING ATTOR-
NEY

Int. Cl.: 27

Prior U.S. Cls.: 19, 20, 37, 42, and 50

United States Patent and Trademark Office

Reg. No. 3,485,761

Registered Aug. 12, 2008

**TRADEMARK
PRINCIPAL REGISTER**

PUR

FIELDTURF TARKETT INC. (CANADA CORPORATION)
8088 MONTVIEW ROAD
TMR-MONTREAL, CANADA H4P2L7

FOR: SYNTHETIC SURFACING CONSISTING OF RIBBONS OF SYNTHETIC FIBERS WOVEN ON A BACKING AND PARTIALLY COVERED BY A PARTICULATE INFILL FOR THE PLAYING OF SOCCER, AMERICAN FOOTBALL, LACROSSE, FIELD HOCKEY, CRICKET, GOLF AND OTHER ATHLETIC ACTIVITIES, IN CLASS 27 (U.S. CLS. 19, 20, 37, 42 AND 50).

FIRST USE 12-31-2005; IN COMMERCE 12-31-2005.

THE MARK CONSISTS OF STANDARD CHARACTERS WITHOUT CLAIM TO ANY PARTICULAR FONT, STYLE, SIZE, OR COLOR.

SN 77-142,358, FILED 3-28-2007.

WENDY GOODMAN, EXAMINING ATTORNEY

Int. Cl.: 25

Prior U.S. Cls.: 22 and 39

United States Patent and Trademark Office

Reg. No. 3,485,762

Registered Aug. 12, 2008

**TRADEMARK
PRINCIPAL REGISTER**

ATOM & ETHER

IAMEDIA, INC. (MONTANA CORPORATION)
PO BOX 4224
MISSOULA, MT 59806

FOR: SHORT-SLEEVED OR LONG-SLEEVED T-SHIRTS; HATS; CAPS; APRONS; TANK TOPS; INFANT AND TODDLER ONE-PIECE CLOTHING; BIBS NOT OF CLOTH OR PAPER; CLOTH BIBS; SWEATSHIRTS; SCARVES; UNDERWEAR; SLIPPERS , IN CLASS 25 (U.S. CLS. 22 AND 39).

FIRST USE 4-15-2007; IN COMMERCE 4-15-2007.

THE MARK CONSISTS OF STANDARD CHARACTERS WITHOUT CLAIM TO ANY PARTICULAR FONT, STYLE, SIZE, OR COLOR.

SN 77-143,036, FILED 3-28-2007.

ALICE SUE CARRUTHERS, EXAMINING ATTORNEY

Int. Cl.: 25

Prior U.S. Cls.: 22 and 39

United States Patent and Trademark Office

Reg. No. 3,485,763

Registered Aug. 12, 2008

**TRADEMARK
PRINCIPAL REGISTER**

KOKREATION

PHANKONSY, SAM (UNITED STATES INDIVIDUAL)
800 N RAINBOW BLVD STE 215
LAS VEGAS, NV 89107

FOR: SHIRTS; PANTS; SHORTS; BEANIES;
SWEAT SHIRTS; HATS; JACKETS; SHOES; JEANS;
TANK-TOPS; SWIM WEAR; HEADBANDS, IN
CLASS 25 (U.S. CLS. 22 AND 39).

FIRST USE 0-0-2007; IN COMMERCE 0-0-2007.

THE MARK CONSISTS OF STANDARD CHARACTERS WITHOUT CLAIM TO ANY PARTICULAR FONT, STYLE, SIZE, OR COLOR.

SN 77-143,245, FILED 3-28-2007.

MICHELE SWAIN, EXAMINING ATTORNEY

Int. Cls.: 9 and 11

Prior U.S. Cls.: 13, 21, 23, 26, 31, 34, 36, and 38

United States Patent and Trademark Office

Reg. No. 3,485,764

Registered Aug. 12, 2008

**TRADEMARK
PRINCIPAL REGISTER**

HEATMASTER

BEAUTY HOLDING LLC (DELAWARE LTD
LIAB CO)
3001 COLORADO BOULEVARD
DENTON, TX 76210

FOR: ELECTRIC FLAT IRONS; ELECTRIC HAIR
CURLING IRONS, IN CLASS 9 (U.S. CLS. 21, 23, 26, 36
AND 38).

FIRST USE 9-30-2007; IN COMMERCE 9-30-2007.

FOR: HAND-HELD ELECTRIC HAIR DRYERS,
IN CLASS 11 (U.S. CLS. 13, 21, 23, 31 AND 34).

FIRST USE 9-30-2007; IN COMMERCE 9-30-2007.

THE MARK CONSISTS OF STANDARD CHAR-
ACTERS WITHOUT CLAIM TO ANY PARTICULAR
FONT, STYLE, SIZE, OR COLOR.

SN 77-143,478, FILED 3-29-2007.

DAVID HOFFMAN, EXAMINING ATTORNEY

Int. Cls.: 35, 41, and 42

Prior U.S. Cls.: 100, 101, 102, and 107

United States Patent and Trademark Office

Reg. No. 3,485,765

Registered Aug. 12, 2008

**SERVICE MARK
PRINCIPAL REGISTER**

SOLOSO

THE AMERICAN INSTITUTE OF ARCHITECTS
(NEW YORK CORPORATION)
1735 NEW YORK AVENUE, NW
WASHINGTON, DC 20006

FOR: PROVIDING BUSINESS RESEARCH SERVICES AND BUSINESS INFORMATION FOR THE ARCHITECTURE PROFESSION VIA THE INTERNET, IN CLASS 35 (U.S. CLS. 100, 101 AND 102).

FIRST USE 3-15-2007; IN COMMERCE 5-3-2007.

FOR: PROVIDING ONLINE EDUCATION SERVICES, NAMELY, CONDUCTING ONLINE SEMINARS AND COURSES OF INSTRUCTION IN THE FIELD OF ARCHITECTURE VIA THE INTERNET, IN CLASS 41 (U.S. CLS. 100, 101 AND 107).

FIRST USE 3-15-2007; IN COMMERCE 5-3-2007.

FOR: PROVIDING TECHNICAL INFORMATION IN THE FIELD OF ARCHITECTURE VIA THE INTERNET, IN CLASS 42 (U.S. CLS. 100 AND 101).

FIRST USE 3-15-2007; IN COMMERCE 5-3-2007.

THE MARK CONSISTS OF STANDARD CHARACTERS WITHOUT CLAIM TO ANY PARTICULAR FONT, STYLE, SIZE, OR COLOR.

SN 77-143,611, FILED 3-29-2007.

DAVID H. STINE, EXAMINING ATTORNEY

Int. Cl.: 35

Prior U.S. Cls.: 100, 101, and 102

United States Patent and Trademark Office

Reg. No. 3,485,766

Registered Aug. 12, 2008

**SERVICE MARK
PRINCIPAL REGISTER**

**PROTECTING THE BREATH OF
LIFE SINCE 1903**

BREATHE CALIFORNIA OF LOS ANGELES
COUNTY (CALIFORNIA CORPORATION)
SUITE 300
5858 WILSHIRE BOULEVARD
LOS ANGELES, CA 90036

FOR: PROMOTING PUBLIC AWARENESS OF
LUNG HEALTH ISSUES; ADMINISTERING AND
MANAGING RESEARCH GRANTS, IN CLASS 35
(U.S. CLS. 100, 101 AND 102).

FIRST USE 2-3-2006; IN COMMERCE 2-3-2006.

THE MARK CONSISTS OF STANDARD CHAR-
ACTERS WITHOUT CLAIM TO ANY PARTICULAR
FONT, STYLE, SIZE, OR COLOR.

OWNER OF U.S. REG. NO. 2,993,554.

NO CLAIM IS MADE TO THE EXCLUSIVE
RIGHT TO USE "SINCE 1903", APART FROM THE
MARK AS SHOWN.

SN 77-143,708, FILED 3-29-2007.

LINDA ORNDORFF, EXAMINING ATTORNEY

Int. Cl.: 9

Prior U.S. Cls.: 21, 23, 26, 36, and 38

Reg. No. 3,485,767

United States Patent and Trademark Office

Registered Aug. 12, 2008

**TRADEMARK
PRINCIPAL REGISTER**

VUB

DIVERSIFIED TECHNOLOGY CORP. (PENNSYLVANIA CORPORATION)
205 RIVER DRIVE
BLOOMSBURG, PA 17815

FOR: COMPUTER SOFTWARE FOR USE BY UTILITIES, MUNICIPALITIES, AND MUNICIPAL AUTHORITIES FOR PURPOSES OF BILLING AND CUSTOMER CARE, IN CLASS 9 (U.S. CLS. 21, 23, 26, 36 AND 38).

FIRST USE 1-0-2007; IN COMMERCE 1-0-2007.

THE MARK CONSISTS OF STANDARD CHARACTERS WITHOUT CLAIM TO ANY PARTICULAR FONT, STYLE, SIZE, OR COLOR.

SN 77-143,721, FILED 3-29-2007.

PATRICIA EVANKO, EXAMINING ATTORNEY

Int. Cls.: 35 and 41

Prior U.S. Cls.: 100, 101, 102, and 107

United States Patent and Trademark Office

Reg. No. 3,485,768

Registered Aug. 12, 2008

**SERVICE MARK
PRINCIPAL REGISTER**



GUITAR CENTER, INC. (DELAWARE CORPORATION)
5795 LINDERO CANYON ROAD
WESTLAKE VILLAGE, CA 91362

FOR: RETAIL STORE SERVICES FEATURING MUSICAL INSTRUMENTS; ON-LINE RETAIL STORE SERVICES FEATURING MUSICAL INSTRUMENTS; RETAIL SERVICES BY DIRECT SOLICITATION BY SALES AGENTS IN THE FIELD OF MUSICAL INSTRUMENTS; RETAIL STORE SERVICES FEATURING MUSICAL INSTRUMENTS PURSUANT TO CONTRACTS WITH SCHOOLS WHICH ARE PROCURED AFTER A BIDDING PROCESS WHEREBY BIDS ARE SUBMITTED TO SCHOOLS, IN CLASS 35 (U.S. CLS. 100, 101 AND 102).

FIRST USE 4-1-2007; IN COMMERCE 4-1-2007.

FOR: RENTAL OF MUSICAL INSTRUMENTS; INSTRUCTION IN THE FIELD OF MUSIC, IN CLASS 41 (U.S. CLS. 100, 101 AND 107).

FIRST USE 4-1-2007; IN COMMERCE 4-1-2007.

OWNER OF U.S. REG. NOS. 2,866,149 AND 2,868,579.

NO CLAIM IS MADE TO THE EXCLUSIVE RIGHT TO USE "MUSIC & ARTS", APART FROM THE MARK AS SHOWN.

THE COLOR(S) RED, BROWN, YELLOW, KHAKI AND GRAY IS/ARE CLAIMED AS A FEATURE OF THE MARK.

THE MARK CONSISTS OF THE WORDINGS "MUSIC" AND "ARTS" IN RED WITH A YELLOW AMPERSAND ENCASED IN A BROWN BOX BETWEEN THEM. A BROWN MUSIC NOTE APPEARS AFTER "ARTS". THE COLOR KHAKI APPEARS AS A "SHADOW" FOR THE WORDINGS, THE MUSIC NOTE AND THE BROWN BOX. THE BACKGROUND OF THE MARK IS IN GRAY COLOR.

SN 77-144,164, FILED 3-29-2007.

DAWN HAN, EXAMINING ATTORNEY

Int. Cl.: 25

Prior U.S. Cls.: 22 and 39

United States Patent and Trademark Office

Reg. No. 3,485,769

Registered Aug. 12, 2008

TRADEMARK
PRINCIPAL REGISTER

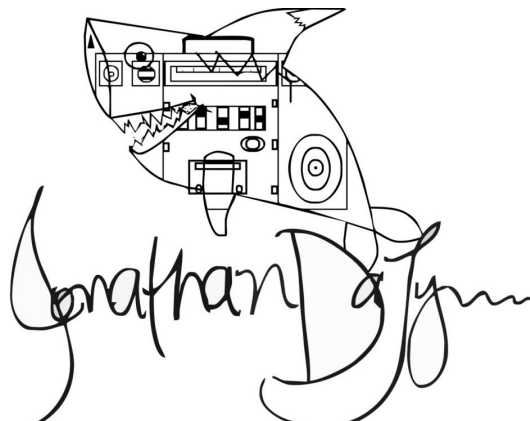

BUTLER, JONATHAN DA LYNN (VIRGINIA
SOLE PROPRIETORSHIP)
2270 KINGS CREEK LANE
NEWPORT NEWS, VA 23602

FOR: BELTS; CAPS; HOODS; JERSEYS; LEATHER BELTS; SHORT SETS; TIES; TOPS; COATS FOR MEN AND WOMEN; FOOTWEAR FOR MEN; FOOTWEAR FOR MEN AND WOMEN; MEN AND WOMEN JACKETS, COATS, TROUSERS, VESTS; MEN'S SOCKS; MEN'S SUITS; MEN'S SUITS, WOMEN'S SUITS; SUSPENDER BELTS FOR MEN; SHORT-SLEEVED OR LONG-SLEEVED T-SHIRTS; T-SHIRTS; SWEATERS; TURTLENECK SWEATERS; DENIM JACKETS; DOWN JACKETS; FUR COATS AND JACKETS; FUR JACKETS; HEAVY JACKETS; JACKET LINERS; JACKETS; LEATHER JACKETS; LONG JACKETS; RAIN JACKETS; RAINPROOF JACKETS; SKI JACKETS; SLEEVED OR SLEEVELESS JACKETS; SPORTS JACKETS; SUEDE JACK-

ETS; WATERPROOF JACKETS AND PANTS; WIND RESISTANT JACKETS; WIND-JACKETS; BICYCLE GLOVES; BICYCLING GLOVES; GLOVES; RIDING GLOVES; SKI GLOVES; SNOWBOARD GLOVES, IN CLASS 25 (U.S. CLS. 22 AND 39).

FIRST USE 1-21-2006; IN COMMERCE 6-29-2008.

THE NAME "JONATHAN DA LYNN" IDENTIFIES A LIVING INDIVIDUAL WHOSE CONSENT IS OF RECORD.

THE MARK CONSISTS OF A SHARK WITH A BOOMBOX BODY ABOVE "JONATHAN DA LYNN" ORIGINAL SIGNATURE.

SN 77-144,357, FILED 3-29-2007.

STEVEN JACKSON, EXAMINING ATTORNEY

Int. Cls.: 35 and 41

Prior U.S. Cls.: 100, 101, 102, and 107

United States Patent and Trademark Office

Reg. No. 3,485,770

Registered Aug. 12, 2008

**SERVICE MARK
PRINCIPAL REGISTER**

EXCITENITE

EXCITENITE.COM INC. (NEW YORK CORPORATION)
33 BENTAY DRIVE
HARRISON, NY 10528

FOR: ARRANGING AND CONDUCTING MARKETING AND PROMOTIONAL EVENTS FOR OTHERS; ONLINE SERVICES IN THE NATURE OF ARRANGING AND CONDUCTING MARKETING AND PROMOTIONAL EVENTS FOR OTHERS, IN CLASS 35 (U.S. CLS. 100, 101 AND 102).

FIRST USE 1-0-2008; IN COMMERCE 1-0-2008.

FOR: SPECIAL EVENTS PLANNING AND PARTY PLANNING CONSULTATION SERVICES, IN CLASS 41 (U.S. CLS. 100, 101 AND 107).

FIRST USE 1-0-2008; IN COMMERCE 1-0-2008.

THE MARK CONSISTS OF STANDARD CHARACTERS WITHOUT CLAIM TO ANY PARTICULAR FONT, STYLE, SIZE, OR COLOR.

SN 77-144,629, FILED 3-30-2007.

BRIAN PINO, EXAMINING ATTORNEY

Int. Cl.: 33

Prior U.S. Cls.: 47 and 49

United States Patent and Trademark Office

Reg. No. 3,485,771

Registered Aug. 12, 2008

TRADEMARK
PRINCIPAL REGISTER

MOVENDO

CANTINE COOPERATIVE RIUNITE SOCIETA
COOPERATIVA AGRICOLA (ITALY COR-
PORATION)

VIA G. BRODOLINI, 24
42040 CAMPEGINE, ITALY

FOR: WINES, IN CLASS 33 (U.S. CLS. 47 AND 49).

FIRST USE 4-29-2008; IN COMMERCE 6-17-2008.

THE MARK CONSISTS OF STANDARD CHAR-
ACTERS WITHOUT CLAIM TO ANY PARTICULAR
FONT, STYLE, SIZE, OR COLOR.

THE MARK HAS NO MEANING IN A FOREIGN
LANGUAGE.

SN 77-144,762, FILED 3-30-2007.

TINA KUAN, EXAMINING ATTORNEY

Int. Cl.: 36

Prior U.S. Cls.: 100, 101, and 102

United States Patent and Trademark Office

Reg. No. 3,485,772

Registered Aug. 12, 2008

**SERVICE MARK
PRINCIPAL REGISTER**

NYMEX CAT RISK

NEW YORK MERCANTILE EXCHANGE, INC.
(DELAWARE CORPORATION)
WORLD FINANCIAL CENTER
ONE NORTH END AVENUE
NEW YORK, NY 10282

FOR: PROVIDING FINANCIAL AND INVESTMENT INFORMATION SERVICES; PROVIDING FINANCIAL SERVICES, NAMELY, TRADING OF FUTURES AND OPTIONS ON FUTURES CONTRACTS BASED ON AN INSURANCE CLAIMS INDEX FOR OTHERS, THROUGH A COMPUTER NETWORK AND PROVIDING INFORMATION CONCERNING THE TRADING OF FUTURES AND OPTIONS ON FUTURES CONTRACTS BASED ON AN INSURANCE RISK INDEX, THROUGH A COMPUTER NETWORK, IN CLASS 36 (U.S. CLS. 100, 101 AND 102).

FIRST USE 2-9-2007; IN COMMERCE 2-9-2007.

THE MARK CONSISTS OF STANDARD CHARACTERS WITHOUT CLAIM TO ANY PARTICULAR FONT, STYLE, SIZE, OR COLOR.

OWNER OF U.S. REG. NOS. 1,731,593, 3,087,793, AND OTHERS.

NO CLAIM IS MADE TO THE EXCLUSIVE RIGHT TO USE "CAT RISK", APART FROM THE MARK AS SHOWN.

SN 77-145,234, FILED 3-30-2007.

ANDREA K. NADELMAN, EXAMINING ATTORNEY

Int. Cls.: 14, 18, 24, and 25

Prior U.S. Cls.: 1, 2, 3, 22, 27, 28, 39, 41, 42, and 50

United States Patent and Trademark Office

Reg. No. 3,485,773

Registered Aug. 12, 2008

**TRADEMARK
PRINCIPAL REGISTER**

JACKIE HEINSOHN

WENGER HEINSOHN, JACQUELINE (UNITED STATES INDIVIDUAL)
#12E 311 EAST 38TH STREET
NEW YORK, NY 10016

FOR: JEWELRY, NAMELY, BRACELETS, RINGS, EARRINGS, NECKLACES AND PINS; JEWELRY FOR PETS, NAMELY, NECKLACES, IN CLASS 14 (U.S. CLS. 2, 27, 28 AND 50).

FIRST USE 3-15-2007; IN COMMERCE 3-15-2007.

FOR: TOTE BAGS, POCKETBOOKS; CLOTHING FOR PETS, NAMELY, T-SHIRTS, IN CLASS 18 (U.S. CLS. 1, 2, 3, 22 AND 41).

FIRST USE 3-15-2007; IN COMMERCE 3-15-2007.

FOR: HOME DECOR, NAMELY, PILLOWCASES, IN CLASS 24 (U.S. CLS. 42 AND 50).

FIRST USE 3-15-2007; IN COMMERCE 3-15-2007.

FOR: BABY CLOTHING, NAMELY, BABY HATS, BABY T-SHIRTS, BABY PANTS; CLOTHING FOR WOMEN, NAMELY, T-SHIRTS, TOPS, SKIRTS, SHORTS, DRESSES, BELTS, BEACHWEAR, SCARVES; CLOTHING FOR MEN, NAMELY, T-SHIRTS, CLOTHING FOR KIDS, NAMELY, T-SHIRTS, PANTS, DRESSES, TROUSERS AND SHORTS, IN CLASS 25 (U.S. CLS. 22 AND 39).

FIRST USE 3-15-2007; IN COMMERCE 3-15-2007.

THE MARK CONSISTS OF STANDARD CHARACTERS WITHOUT CLAIM TO ANY PARTICULAR FONT, STYLE, SIZE, OR COLOR.

THE NAME(S), PORTRAIT(S), AND/OR SIGNATURE(S) SHOWN IN THE MARK IDENTIFIES A LIVING INDIVIDUAL, WHOSE CONSENT(S) TO REGISTER IS SUBMITTED.

SN 77-145,248, FILED 3-30-2007.

WON TEAK OH, EXAMINING ATTORNEY

Int. Cl.: 16

Prior U.S. Cls.: 2, 5, 22, 23, 29, 37, 38, and 50

Reg. No. 3,485,774

United States Patent and Trademark Office

Registered Aug. 12, 2008

**TRADEMARK
PRINCIPAL REGISTER**

A & A

IBASIS, INC. (DELAWARE CORPORATION)
20 SECOND AVENUE
BURLINGTON, MA 01803

FIRST USE 5-29-2008; IN COMMERCE 5-29-2008.

FOR: PRE-PAID TELEPHONE CALLING CARDS,
NOT MAGNETICALLY ENCODED; TELEPHONE
CALLING CARDS, NOT MAGNETICALLY ENCO-
DED, IN CLASS 16 (U.S. CLS. 2, 5, 22, 23, 29, 37, 38
AND 50).

THE MARK CONSISTS OF STANDARD CHAR-
ACTERS WITHOUT CLAIM TO ANY PARTICULAR
FONT, STYLE, SIZE, OR COLOR.

SN 77-145,333, FILED 3-30-2007.

CHERYL CLAYTON, EXAMINING ATTORNEY

Int. Cl.: 41

Prior U.S. Cls.: 100, 101, and 107

United States Patent and Trademark Office

Reg. No. 3,485,775

Registered Aug. 12, 2008

**SERVICE MARK
PRINCIPAL REGISTER**

Answers From The Organizer

FLARIDA, BETH (UNITED STATES INDIVIDUAL)
5028 EAST GLENVIEW AVENUE
ANAHEIM HILLS, CA 92807

FOR: PROVIDING NEWSLETTERS IN THE FIELD OF PROFESSIONAL ORGANIZING VIA E-MAIL, IN CLASS 41 (U.S. CLS. 100, 101 AND 107).

FIRST USE 11-2-2007; IN COMMERCE 11-1-2007.

THE MARK CONSISTS OF STANDARD CHARACTERS WITHOUT CLAIM TO ANY PARTICULAR FONT, STYLE, SIZE, OR COLOR.

SN 77-145,692, FILED 4-1-2007.

JEFF DEFORD, EXAMINING ATTORNEY

Int. Cl.: 16

Prior U.S. Cls.: 2, 5, 22, 23, 29, 37, 38, and 50

Reg. No. 3,485,776

United States Patent and Trademark Office

Registered Aug. 12, 2008

**TRADEMARK
PRINCIPAL REGISTER**

DRAW CLAW

SCHREFF, DAVID (UNITED STATES INDIVIDUAL)
42 STONEBROOK LANE
COS COB, CT 06807 AND
LINDSAY, D.J. (UNITED STATES INDIVIDUAL)
2183 EAGLE POINT ROAD
HUDDLESTON, VA 24104

FOR: DRAFTING COMPASSES; DRAFTING INSTRUMENTS; DRAWING COMPASSES; SCHOOL SUPPLY KITS CONTAINING VARIOUS COMBINATIONS OF SELECTED SCHOOL SUPPLIES, NAMELY, WRITING INSTRUMENTS, PENS, PENCILS, MECHANICAL PENCILS, ERASERS, MARKERS, CRAYONS, HIGHLIGHTERS, GRADUATED RULERS, PROTRACTORS, CRAYONS; PASTEL CRAYONS; COLOR PENCILS; DRAWING PENCILS; LIQUID PAINT FELT TIP MARKING AND COLORING APPLICATORS; PEN AND PENCIL CASES AND BOXES; PEN OR PENCIL HOLDERS; PENCILS FOR

PAINTING AND DRAWING; ARTISTS' PENS; BALL POINT PENS; COLOURED PENS; INK PENS; MARKING PENS; PEN NIBS; PENS FOR MARKING; PROTRACTORS, IN CLASS 16 (U.S. CLS. 2, 5, 22, 23, 29, 37, 38 AND 50).

FIRST USE 3-31-2008; IN COMMERCE 3-31-2008.

THE MARK CONSISTS OF STANDARD CHARACTERS WITHOUT CLAIM TO ANY PARTICULAR FONT, STYLE, SIZE, OR COLOR.

NO CLAIM IS MADE TO THE EXCLUSIVE RIGHT TO USE "DRAW", APART FROM THE MARK AS SHOWN.

SN 77-145,724, FILED 4-1-2007.

JEFF DEFORD, EXAMINING ATTORNEY

Int. Cls.: 18 and 30

Prior U.S. Cls.: 1, 2, 3, 22, 41, and 46

United States Patent and Trademark Office

Reg. No. 3,485,777

Registered Aug. 12, 2008

**TRADEMARK
PRINCIPAL REGISTER**

Deliciously Girlie

OSTER, DEMETRIA O. (UNITED STATES INDIVIDUAL)
P.O. BOX 286
KEALAKEKUA, HI 96750

FOR: PURSES, IN CLASS 18 (U.S. CLS. 1, 2, 3, 22 AND 41).

FIRST USE 2-1-2008; IN COMMERCE 2-1-2008.

FOR: COFFEE, IN CLASS 30 (U.S. CL. 46).

FIRST USE 2-1-2008; IN COMMERCE 2-1-2008.

THE MARK CONSISTS OF STANDARD CHARACTERS WITHOUT CLAIM TO ANY PARTICULAR FONT, STYLE, SIZE, OR COLOR.

SN 77-145,767, FILED 4-1-2007.

SHARON MEIER, EXAMINING ATTORNEY

Int. Cl.: 25

Prior U.S. Cls.: 22 and 39

United States Patent and Trademark Office

Reg. No. 3,485,778

Registered Aug. 12, 2008

**TRADEMARK
PRINCIPAL REGISTER**

URBAN UNDERGROUND

STAR RIDE KIDS, INC. (NEW YORK CORPORATION)
112 WEST 34TH STREET
NEW YORK, NY 10120

FOR: WEARING APPAREL FOR BOYS, NAME-
LY, SLACKS, PANTS, JEANS, SHORTS, SHIRTS,
JACKETS, SWIMSUITS, SWEAT PANTS AND
SWEATSHIRTS, IN CLASS 25 (U.S. CLS. 22 AND 39).

FIRST USE 6-15-2007; IN COMMERCE 6-15-2007.

THE MARK CONSISTS OF STANDARD CHAR-
ACTERS WITHOUT CLAIM TO ANY PARTICULAR
FONT, STYLE, SIZE, OR COLOR.

SN 77-146,166, FILED 4-2-2007.

DAVID YONTEF, EXAMINING ATTORNEY

Int. Cl.: 1

Prior U.S. Cls.: 1, 5, 6, 10, 26, and 46

Reg. No. 3,485,779

United States Patent and Trademark Office

Registered Aug. 12, 2008

**TRADEMARK
PRINCIPAL REGISTER**

PLEMAT

THE COCA-COLA COMPANY (DELAWARE
CORPORATION)
ONE COCA-COLA PLAZA
ATLANTA, GA 30313

THE MARK CONSISTS OF STANDARD CHAR-
ACTERS WITHOUT CLAIM TO ANY PARTICULAR
FONT, STYLE, SIZE, OR COLOR.

FOR: CHEMICAL ADDITIVE FOR USE IN THE
MANUFACTURE OF POLYETHYLENE TEREPH-
THALATE BOTTLES, IN CLASS 1 (U.S. CLS. 1, 5, 6, 10,
26 AND 46).

SN 77-146,215, FILED 4-2-2007.

FIRST USE 6-0-2007; IN COMMERCE 6-0-2007.

TASHIA BUNCH, EXAMINING ATTORNEY

Int. Cl.: 34

Prior U.S. Cls.: 2, 8, 9, and 17

United States Patent and Trademark Office

Reg. No. 3,485,780

Registered Aug. 12, 2008

**TRADEMARK
PRINCIPAL REGISTER**

EUREKA

EL CENTAURO DE ORO, LTDA. (COSTA RICA CORPORATION), DBA TACACOS DE LA CORDILLERA,
SANTA MARTA, MERCEDES SUR, PURISCAL
300 METERS SUR DE LA ESCUELA DE LA
SAN JOSE, COSTA RICA

THE MARK CONSISTS OF STANDARD CHARACTERS WITHOUT CLAIM TO ANY PARTICULAR FONT, STYLE, SIZE, OR COLOR.

FOR: CIGARS, IN CLASS 34 (U.S. CLS. 2, 8, 9 AND 17).

SN 77-146,403, FILED 4-2-2007.

FIRST USE 12-0-2007; IN COMMERCE 12-0-2007.

MICHAEL LEWIS, EXAMINING ATTORNEY

Int. Cl.: 18

Prior U.S. Cls.: 1, 2, 3, 22, and 41

United States Patent and Trademark Office

Reg. No. 3,485,781

Registered Aug. 12, 2008

**TRADEMARK
PRINCIPAL REGISTER**

tramp

ERWIN, JENNIFER (UNITED STATES INDIVIDUAL)
86 N. SPRINGER RD.
LOS ALTOS, CA 94024

FOR: DOG APPAREL; DOG CLOTHING; DOG COLLARS; DOG LEASHES; DOG PARKAS; DOG SHOES; PET COLLAR ACCESSORIES, NAMELY, BOWS AND CHARMS, IN CLASS 18 (U.S. CLS. 1, 2, 3, 22 AND 41).

FIRST USE 6-1-2008; IN COMMERCE 6-6-2008.

THE MARK CONSISTS OF STANDARD CHARACTERS WITHOUT CLAIM TO ANY PARTICULAR FONT, STYLE, SIZE, OR COLOR.

SN 77-146,925, FILED 4-2-2007.

JENNIFER VASQUEZ, EXAMINING ATTORNEY

Int. Cls.: 18 and 25

Prior U.S. Cls.: 1, 2, 3, 22, 39, and 41

United States Patent and Trademark Office

Reg. No. 3,485,782

Registered Aug. 12, 2008

TRADEMARK
PRINCIPAL REGISTER



ART BY *Hollis*
INTERNATIONAL
WearBags

HOLLIS MCCRAY-CLARK, ESQ. (UNITED STATES INDIVIDUAL)
SUITE 200
468 NORTH CAMDEN DRIVE
BEVERLY HILLS, CA 90210 AND
CHARLES HENRY CLARK, ESQ. (UNITED STATES INDIVIDUAL)
SUITE 200
468 NORTH CAMDEN DRIVE
BEVERLY HILLS, CA 90210

FOR: LEATHER FOR FURNITURE; LEATHER FOR HARNESSSES; LEATHER FOR SHOES; ATHLETIC BAGS; FURS SOLD IN BULK; BRIEFCASES; IMITATION LEATHER; IMITATION LEATHER SOLD IN BULK; KEY-CASES OF LEATHER AND SKINS; LEATHER; LEATHER AND IMITATION LEATHER BAGS; LEATHER BAGS FOR MERCHANDISE PACKAGING; LEATHER BAGS, SUITCASES AND WALLETS; LEATHER BOXES FOR STORING GREETING CARDS; LEATHER BRIEFCASES; LEATHER CASES; LEATHER CASES FOR KEYS; LEATHER HANDBAGS; LEATHER KEY CASES; LEATHER KEY CHAINS; LEATHER PURSES; LEATHER SHOPPING BAGS; LEATHER SOLD IN BULK; LEATHER STRAPS; PET ACCESSORIES, NAMELY, CANVAS, VINYL AND LEATHER POUCHES FOR HOLDING DISPOSABLE BAGS TO PLACE PET WASTE IN; POUCHES OF LEATHER; SADDLERY OF LEATHER; TANNED LEATHER; THONGS; TRAVELLING CASES OF LEATHER; EVENING HANDBAGS; HANDBAG FRAMES; HANDBAGS; HANDBAGS FOR MEN; STRAPS FOR HANDBAGS; ALL PURPOSE SPORT BAGS; ALL-PURPOSE ATHLETIC BAGS; ALL-PURPOSE CARRYING BAGS; ANIMAL GAME BAGS; BABY

CARRYING BAGS; CHAIN MESH PURSES; CHANGE PURSES; CLUTCH PURSES; CLUTCHES; COIN PURSES; COIN PURSES NOT MADE OF PRECIOUS METAL; COIN PURSES, NOT OF PRECIOUS METALS; MULTI-PURPOSE PURSES; PURSE FRAMES; PURSES; PURSES; PURSES AND WALLETS OF PRECIOUS METAL; SMALL CLUTCH PURSES; SMALL PURSES; WRIST MOUNTED PURSES; BACK FRAMES FOR CARRYING CHILDREN; BAGS AND HOLDALLS FOR SPORTS CLOTHING; BAGS FOR CARRYING BABIES' ACCESSORIES; BAGS FOR SPORTS; BAGS FOR UMBRELLAS; BARREL BAGS; BEACH BAGS; BELT BAGS; BOOK BAGS; BOSTON BAGS; CARRY-ALL BAGS; CARRY-ON BAGS; CARRYING CASES; CARRYING CASES FOR DOCUMENTS; CHALK BAGS; CHARM BAGS (OMAMORI-IRE); CLUTCH BAGS; COSMETIC BAGS SOLD EMPTY; DIAPER BAGS; DUFFEL BAGS; DUFFEL BAGS FOR TRAVEL; DUFFLE BAGS; FEED BAGS FOR ANIMALS; FLEXIBLE BAGS FOR GARMENTS; GARMENT BAGS FOR TRAVEL; GENERAL PURPOSE BAGS FOR CARRYING YOGA EQUIPMENT; GLADSTONE BAGS; GYM BAGS; HIKING BAGS; HORSE TAIL BAGS; HUNTERS' GAME BAGS; HUNTING BAGS; KEY BAGS; KIT BAGS; MAKE-UP BAGS SOLD EMPTY; MESH SHOPPING BAGS; MESSENGER BAGS; OVERNIGHT BAGS; ROLL BAGS; SCHOOL BAGS; SCHOOL BOOK BAGS; SHAVING BAGS SOLD EMPTY; SHOE BAGS FOR TRAVEL; SHOPPING BAGS MADE OF SKIN; SHOPPING BAGS WITH WHEELS ATTACHED; SHOULDER BAGS; SLING BAGS; SMALL BAGS FOR MEN; SOUVENIR BAGS; SPORTS BAGS; SPORTSMAN'S HUNTING BAGS; STRING BAGS FOR SHOPPING; SUIT BAGS; TEXTILE SHOPPING BAGS; TOOL BAGS SOLD EMPTY;

TOTE BAGS; TRAVEL BAGS; TRAVELING BAGS; TRAVELLING BAGS; WAIST BAGS; WASH BAGS FOR CARRYING TOILETRIES; WINE BAGS WITH HANDLES FOR CARRYING OR HOLDING WINE; WRIST MOUNTED CARRYALL BAGS; WRISTLET BAGS; DRAWSTRING POUCHES; FELT POUCHES; JAPANESE UTILITY POUCHES (SHINGEN-BUKURO); HAT BOXES FOR TRAVEL NOT OF PAPER OR CARDBOARD; STRAPS FOR CARRYING CASES; BRIEFCASE-TYPE PORTFOLIOS; BRIEFCASES; BRIEFCASES; FOLDING BRIEFCASES; OVER-NIGHT SUITCASES; SMALL SUITCASES; SUITCASES, IN CLASS 18 (U.S. CLS. 1, 2, 3, 22 AND 41).

FIRST USE 1-3-2008; IN COMMERCE 1-3-2008.

FOR: BED JACKETS; DENIM JACKETS; DOWN JACKETS; FISHERMEN'S JACKETS; FUR COATS AND JACKETS; FUR JACKETS; HEAVY JACKETS; JACKET LINERS; JACKETS; LEATHER JACKETS; LIGHT-REFLECTING JACKETS; LONG JACKETS; MEN AND WOMEN JACKETS, COATS, TROUSERS, VESTS; RAIN JACKETS; RAINPROOF JACKETS; SKI JACKETS; SLEEVED OR SLEEVELESS JACKETS; SMOKING JACKETS; SPORTS JACKETS; STUFF JACKETS; SUEDE JACKETS; WATER-PROOF JACKETS AND PANTS; WIND RESISTANT JACKETS; WIND-JACKETS; COATS; COATS FOR MEN AND WOMEN; COATS MADE OF COTTON; COATS OF DENIM; DUST COATS; FUR COATS; BUTTON-FRONT ALOHA SHIRTS; CAMP SHIRTS; DRESS SHIRTS; GOLF SHIRTS; KNIT SHIRTS; NIGHT SHIRTS; OPEN-NECKED SHIRTS; PIQUE SHIRTS; POLO SHIRTS; SHIRT FRONTS; SHIRT YOKES; SHIRTS; SHIRTS FOR SUITS; SHORT-SLEEVED OR LONG-SLEEVED T-SHIRTS; SHORT-SLEEVED SHIRTS; SLEEP SHIRTS; SPORT SHIRTS; SPORTS SHIRTS; BELTS; BIBS NOT OF CLOTH OR PAPER; CAPS; CHILDREN'S AND INFANTS' CLOTH BIBS; CHILDREN'S CLOTH EATING BIBS; CLOTH BIBS; CLOTH BIBS FOR ADULT DINERS; CLOTH BIBS FOR USE BY SENIOR CITIZENS OR PHYSICALLY- OR MENTALLY-CHALLENGED PERSONS; CLOTH DIAPERS; CLOTHING FOR WEAR IN JUDO PRACTICES; CLOTHING FOR WEAR IN WRESTLING GAMES; CLOTHING, NAMELY, ARM WARMERS; CLOTHING, NAMELY, FOLK COSTUMES; CLOTHING, NAMELY, KNEE WARMERS; CLOTHING, NAMELY, NECK TUBES; CLOTHING, NAMELY, WRAP-AROUNDS; CORSETS; DUSTERS; FIGURE SKATING CLOTHING, NAMELY, DRESSES; FOULARDS; HOODS; INFANT AND TODDLER ONE PIECE CLOTHING; INFANT CLOTH DIAPERS; JERSEYS; LEATHER BELTS; MANTLES; MUFFLERS; NON-DISPOSABLE CLOTH TRAINING PANTS; PAPER HATS FOR USE AS CLOTHING ITEMS; PARTS OF CLOTHING, NAMELY, GUSSETS FOR TIGHTS, GUSSETS FOR STOCKINGS, GUSSETS FOR BATHING SUITS, GUSSETS FOR UNDERWEAR, GUSSETS FOR LEOTARDS AND GUSSETS FOR FOOTLETS; PERSPIRATION ABSORBENT UNDERWEAR CLOTHING; SHIFTS; SHORT SETS; SHOULDER WRAPS; SWADDLING CLOTHES; TIES; TOPS; UNDERARM CLOTHING SHIELDS; WRAPS; BALLOON PANTS; CAPRI PANTS; CARGO PANTS;

DENIMS; JOGGING PANTS; LEATHER PANTS; NURSE PANTS; PANTS; PETTI-PANTS; SKI PANTS; SNOW PANTS; SNOWBOARD PANTS; SWEAT PANTS; TAP PANTS; TOBOGGAN HATS, PANTS AND CAPS; TRACK PANTS; YOGA PANTS; LAB COATS; LEATHER COATS; LIGHT-REFLECTING COATS; MORNING COATS; OVER COATS; RAIN COATS; RIDING COATS; SPORT COATS; SUIT COATS; TOP COATS; TRENCH COATS; WIND COATS; FOOTWEAR NOT FOR SPORTS; ATHLETIC FOOTWEAR; ATHLETIC SHOES; ATHLETIC UNIFORMS; FOOTWEAR FOR TRACK AND FIELD ATHLETICS; CLEATS FOR ATTACHMENT TO SPORTS SHOES; HUNTING BOOT BAGS; SKI BOOT BAGS; SPORTS BRA; SPORTS JERSEYS; SPORTS JERSEYS AND BREECHES FOR SPORTS; SPORTS OVERUNIFORMS; SPORTS SHIRTS WITH SHORT SLEEVES; BLOUSES; SWEAT SHIRTS; T-SHIRTS; WIND SHIRTS; YOGA SHIRTS; BELTS MADE OF LEATHER; JAPANESE STYLE SANDALS OF LEATHER; LEATHER HEADWEAR; LEATHER SHOES; LEATHER SLIPPERS; SUITS OF LEATHER; TROUSERS OF LEATHER; CAPES; DRESS SHIELDS; DRESS SUITS; DRESSES; DRESSES MADE FROM SKINS; DRESSING GOWNS; EVENING DRESSES; NURSE DRESSES; SKIRTS AND DRESSES; WEDDING DRESSES; WOMEN'S CEREMONIAL DRESSES; FISHING VESTS; HUNTING VESTS; LONG SLEEVED VESTS; QUILTED VESTS; VEST EXTENDERS; VESTED SUITS; VESTS; WIND VESTS; BERMUDA SHORTS; BOARD SHORTS; BOXER SHORTS; FLEECE SHORTS; GYM SHORTS; PANTIES, SHORTS AND BRIEFS; RUGBY SHORTS; SHORT OVERCOAT FOR KIMONO (HAORI); SHORT PETTICOATS; SHORTS; SLIDING SHORTS; SWEAT SHORTS; WALKING SHORTS; SHORT TROUSERS; BRIEFS; DISPOSABLE UNDERWEAR; KNITTED UNDERWEAR; LADIES' UNDERWEAR; THERMAL UNDERWEAR; THONGS; UNDERWEAR; WOMEN'S UNDERWEAR; WOVEN OR KNITTED UNDERWEAR; CHEF'S HATS; FUR HATS; HAT BANDS; HATS; HEADGEAR, NAMELY, SCARVES; SEDGE HATS (SUGE-GASA); SMALL HATS; WOOLLY HATS; PAJAMAS; JAPANESE SLEEPING ROBES (NEMAKI); ROBES; PLEATED SKIRTS FOR FORMAL KIMONOS (HAKAMA); SKIRT SUITS; SKIRTS; MOCK TURTLE-NECK SWEATERS; SWEATERS; TURTLENECK SWEATERS; HEADBANDS AGAINST SWEATING; BATHING SUITS; BATHING SUITS FOR MEN; BODY SUITS; DRY SUITS; FITTED SWIMMING COSTUMES WITH BRA CUPS; FLIGHT SUITS; GYM SUITS; JOGGING SUITS; JUDO SUITS; KARATE SUITS; LADIES' SUITS; MEN'S SUITS, MEN'S SUITS, WOMEN'S SUITS; PLAY SUITS; RAIN SUITS; SKI SUITS; SKI SUITS FOR COMPETITION; SNOW BOARDING SUITS; SNOW SUITS; SUITS; SWEAT SUITS; SWIM CAPS; SWIM TRUNKS; SWIM WEAR; SWIM WEAR FOR GENTLEMEN AND LADIES; SWIMMING CAPS; SWIMMING CAPS; SWIMMING COSTUMES; SWIMMING TRUNKS; SWIMSUITS; TRACK SUITS; TRAINING SUITS; WARM UP SUITS; WET SUIT GLOVES; WET SUITS; WET SUITS FOR WATER-SKIING AND SUB-AQUA; ZOOT SUITS; BASEBALL CAPS; BATHING CAPS; CAP VISORS; CAPS WITH VISORS; GOLF CAPS; KNIT-

TED CAPS; SHOWER CAPS; SKULL CAPS; TOE CAPS, IN CLASS 25 (U.S. CLS. 22 AND 39).

FIRST USE 1-3-2008; IN COMMERCE 1-3-2008.

OWNER OF U.S. REG. NO. 2,965,530.

NO CLAIM IS MADE TO THE EXCLUSIVE RIGHT TO USE "INTERNATIONAL WEAR BAGS", APART FROM THE MARK AS SHOWN.

THE STIPPLING IS A FEATURE OF THE MARK AND DOES NOT INDICATE COLOR; THE STIPPLING IS FOR SHADING PURPOSES ONLY.

THE NAME "HOLLIS" IDENTIFIES A LIVING INDIVIDUAL WHOSE CONSENT IS OF RECORD.

THE MARK CONSISTS OF A SPECIMEN THAT APPEARS AS AN IMAGE OF A FIGURE WITH A PARTIAL BODY, SHOWING A CHEST AREA, AND WEARING A JACKET.

SN 77-146,956, FILED 4-3-2007.

BENJAMIN OKEKE, EXAMINING ATTORNEY

Int. Cls.: 16 and 44

Prior U.S. Cls.: 2, 5, 22, 23, 29, 37, 38, 50, 100, and 101

Reg. No. 3,485,783

United States Patent and Trademark Office

Registered Aug. 12, 2008

**TRADEMARK
SERVICE MARK
PRINCIPAL REGISTER**

**BECAUSE EVERY PATIENT IS
UNIQUE**

DEPUY, INC. (DELAWARE CORPORATION)
700 ORTHOPAEDIC DRIVE
WARSAW, IN 46581

FOR: PRINTED EDUCATIONAL AND INFORMATIONAL MATERIALS ON THE SUBJECTS OF ORTHOPAEDICS, ORTHOPAEDIC IMPLANTS AND ORTHOPAEDIC SURGERY, IN CLASS 16 (U.S. CLS. 2, 5, 22, 23, 29, 37, 38 AND 50).

FIRST USE 7-10-2007; IN COMMERCE 7-10-2007.

FOR: PROVIDING INFORMATION IN THE FIELD OF ORTHOPAEDICS, ORTHOPAEDIC IMPLANTS AND ORTHOPAEDIC SURGERY; PRO-

VIDING INFORMATION VIA THE INTERNET RELATING TO ORTHOPAEDICS, ORTHOPAEDIC IMPLANTS AND ORTHOPAEDIC SURGERY, IN CLASS 44 (U.S. CLS. 100 AND 101).

FIRST USE 7-10-2007; IN COMMERCE 7-10-2007.

THE MARK CONSISTS OF STANDARD CHARACTERS WITHOUT CLAIM TO ANY PARTICULAR FONT, STYLE, SIZE, OR COLOR.

SN 77-147,338, FILED 4-3-2007.

ALICE SUE CARRUTHERS, EXAMINING ATTORNEY

Int. Cl.: 16

Prior U.S. Cls.: 2, 5, 22, 23, 29, 37, 38, and 50

Reg. No. 3,485,784

United States Patent and Trademark Office

Registered Aug. 12, 2008

**TRADEMARK
PRINCIPAL REGISTER**

THE WOLFPIRE SAGA

RAYMOND JAMES VAN ZLEER (UNITED STATES INDIVIDUAL)

260 GOODWIN ROAD

SANTA MARIA, CA 93455

FOR: SERIES OF FICTION BOOKS, IN CLASS 16 (U.S. CLS. 2, 5, 22, 23, 29, 37, 38 AND 50).

FIRST USE 4-7-2007; IN COMMERCE 6-11-2008.

THE MARK CONSISTS OF STANDARD CHARACTERS WITHOUT CLAIM TO ANY PARTICULAR FONT, STYLE, SIZE, OR COLOR.

NO CLAIM IS MADE TO THE EXCLUSIVE RIGHT TO USE "SAGA", APART FROM THE MARK AS SHOWN.

SN 77-147,366, FILED 4-3-2007.

ODESSA BIBBINS, EXAMINING ATTORNEY

Int. Cl.: 9

Prior U.S. Cls.: 21, 23, 26, 36, and 38

United States Patent and Trademark Office

Reg. No. 3,485,785

Registered Aug. 12, 2008

**TRADEMARK
PRINCIPAL REGISTER**



MICROSOFT CORPORATION (WASHINGTON CORPORATION)
ONE MICROSOFT WAY
REDMOND, WA 980526399

FOR: OPERATING SYSTEM SOFTWARE; COMPUTER SOFTWARE FOR CREATING AND EDITING DVDS, IN CLASS 9 (U.S. CLS. 21, 23, 26, 36 AND 38).

FIRST USE 1-30-2007; IN COMMERCE 1-30-2007.

PRIORITY CLAIMED UNDER SEC. 44(D) ON FED REP GERMANY APPLICATION NO. 30662546, FILED 10-12-2006, REG. NO. 30662546, DATED 11-14-2006, EXPIRES 10-31-2016.

OWNER OF U.S. REG. NOS. 2,738,877 AND 2,744,843.

THE COLOR(S) BLUE, GREEN, WHITE, YELLOW, ORANGE, RED AND GREY IS/ARE CLAIMED AS A FEATURE OF THE MARK.

THE MARK CONSISTS OF AN IMAGE OF THREE SUPERIMPOSED BLUE, GREEN, WHITE AND GREY DVD DISCS WITH AN ORANGE AND YELLOW FLOWER DESIGN UNDER A BLUE SKY ON THE DISCS, LOCATED IN THE CENTER OF THREE TRANSPARENT GREEN AND BLUE DVD CASES WITH WHITE STYLIZED FLAGS BELOW THE DISCS ON EACH CASE.

SN 77-147,677, FILED 4-3-2007.

THOMAS MANOR, EXAMINING ATTORNEY

Int. Cl.: 45

Prior U.S. Cls.: 100 and 101

United States Patent and Trademark Office

Reg. No. 3,485,786

Registered Aug. 12, 2008

**SERVICE MARK
PRINCIPAL REGISTER**

FAIRVORCE

CHAPLIN, JAMES B. (UNITED STATES INDIVIDUAL)
18TH FLOOR
ONE FINANCIAL PLAZA
FORT LAUDERDALE, FL 33394

THE MARK CONSISTS OF STANDARD CHARACTERS WITHOUT CLAIM TO ANY PARTICULAR FONT, STYLE, SIZE, OR COLOR.

FOR: DIVORCE MEDIATION SERVICES, IN CLASS 45 (U.S. CLS. 100 AND 101).

SN 77-147,742, FILED 4-3-2007.

FIRST USE 5-29-2007; IN COMMERCE 9-23-2007.

ANGELA GAW, EXAMINING ATTORNEY

Int. Cl.: 35

Prior U.S. Cls.: 100, 101, and 102

United States Patent and Trademark Office

Reg. No. 3,485,787

Registered Aug. 12, 2008

**SERVICE MARK
PRINCIPAL REGISTER**

Tucel

FRONTERA COMMUNICATIONS, INC. (ARIZONA CORPORATION)

4

1220 S. PARK LANE
TEMPE, AZ 85281

FOR: WHOLESALER DISTRIBUTORSHIPS FEATURING CELL PHONES AND CELL PHONE ACCESSORIES AND CALLING PLANS; ON-LINE RETAIL STORE SERVICES FEATURING CELL PHONES AND CELL PHONE ACCESSORIES AND CALLING PLANS; RETAIL STORE SERVICES FEATURING CELL PHONES AND CELL PHONE AC-

CESSORIES AND CALLING PLANS, IN CLASS 35 (U.S. CLS. 100, 101 AND 102).

FIRST USE 4-1-2007; IN COMMERCE 4-1-2007.

THE MARK CONSISTS OF STANDARD CHARACTERS WITHOUT CLAIM TO ANY PARTICULAR FONT, STYLE, SIZE, OR COLOR.

SN 77-147,798, FILED 4-3-2007.

ESTHER A. BORSUK, EXAMINING ATTORNEY

Int. Cl.: 25

Prior U.S. Cls.: 22 and 39

United States Patent and Trademark Office

Reg. No. 3,485,788

Registered Aug. 12, 2008

**TRADEMARK
PRINCIPAL REGISTER**

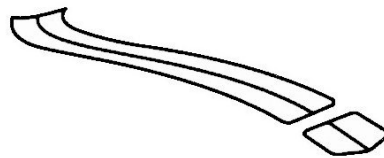

L.A. GEAR, INC. (CALIFORNIA CORPORATION)
844 MORAGA DRIVE
LOS ANGELES, CA 90049

FOR: FOOTWEAR, IN CLASS 25 (U.S. CLS. 22 AND 39).

FIRST USE 12-31-2006; IN COMMERCE 12-31-2006.

OWNER OF U.S. REG. NOS. 1,768,103 AND 1,792,665.

THE MARK CONSISTS OF NARROW FLASH DESIGN.

SN 77-148,952, FILED 4-4-2007.

G. MAYERSCHOFF, EXAMINING ATTORNEY

Int. Cl.: 14

Prior U.S. Cls.: 2, 27, 28, and 50

United States Patent and Trademark Office

Reg. No. 3,485,789

Registered Aug. 12, 2008

**TRADEMARK
PRINCIPAL REGISTER**

GPW

E-MARKETINGUSA, INC. (WASHINGTON COR-
PORATION)
P.O. BOX 2263
WENATCHEE, WA 98807

THE MARK CONSISTS OF STANDARD CHAR-
ACTERS WITHOUT CLAIM TO ANY PARTICULAR
FONT, STYLE, SIZE, OR COLOR.

FOR: CASES FOR WATCHES AND CLOCKS;
PARTS FOR WATCHES; WATCHES; WRIST
WATCHES, IN CLASS 14 (U.S. CLS. 2, 27, 28 AND 50).

SN 77-148,977, FILED 4-4-2007.

FIRST USE 8-0-2007; IN COMMERCE 8-0-2007.

ROBERT C. CLARK JR., EXAMINING ATTORNEY

Int. Cl.: 12

Prior U.S. Cls.: 19, 21, 23, 31, 35, and 44

Reg. No. 3,485,790

United States Patent and Trademark Office

Registered Aug. 12, 2008

**TRADEMARK
PRINCIPAL REGISTER**

TRAFFIC BOSS

NOVA ELECTRONICS INC. (CONNECTICUT CORPORATION)
36 DOCTOR FOOTE ROAD
COLCHESTER, CT 064151523

FOR: SIGNAL BAR FOR MOUNTING ON MOTOR VEHICLES SUCH AS POLICE CARS OR WRECKERS THAT USES SIGNAL LIGHTS TO DIRECT TRAFFIC, IN CLASS 12 (U.S. CLS. 19, 21, 23, 31, 35 AND 44).

FIRST USE 4-24-2007; IN COMMERCE 4-27-2007.

THE MARK CONSISTS OF STANDARD CHARACTERS WITHOUT CLAIM TO ANY PARTICULAR FONT, STYLE, SIZE, OR COLOR.

NO CLAIM IS MADE TO THE EXCLUSIVE RIGHT TO USE "TRAFFIC", APART FROM THE MARK AS SHOWN.

SN 77-149,495, FILED 4-5-2007.

CORY BOONE, EXAMINING ATTORNEY

Int. Cl.: 16

Prior U.S. Cls.: 2, 5, 22, 23, 29, 37, 38, and 50

United States Patent and Trademark Office

Reg. No. 3,485,791

Registered Aug. 12, 2008

**TRADEMARK
PRINCIPAL REGISTER**

ECO HIPPO

CROWN POLY, INC. (CALIFORNIA CORPORATION)
5700 BICKETT STREET
HUNTINGTON PARK, CA 90255

THE MARK CONSISTS OF STANDARD CHARACTERS WITHOUT CLAIM TO ANY PARTICULAR FONT, STYLE, SIZE, OR COLOR.

FOR: PLASTIC BAGS FOR PACKAGING; PLASTIC TRASH BAGS, IN CLASS 16 (U.S. CLS. 2, 5, 22, 23, 29, 37, 38 AND 50).

SN 77-149,949, FILED 4-5-2007.

FIRST USE 2-28-2007; IN COMMERCE 3-15-2007.

AISHA CLARKE, EXAMINING ATTORNEY

Int. Cl.: 41

Prior U.S. Cls.: 100, 101, and 107

United States Patent and Trademark Office

Reg. No. 3,485,792

Registered Aug. 12, 2008

**SERVICE MARK
PRINCIPAL REGISTER**

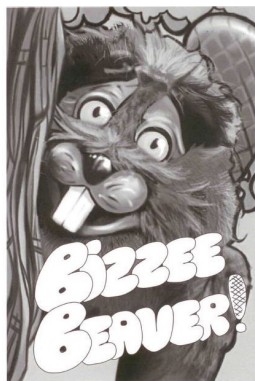

GREG KING ENTERPRISES, INC. (ILLINOIS CORPORATION)
4745 N. RAVENSWOOD #212
CHICAGO, IL 60640

FOR: CONTINUING PUBLIC SERVICE PROGRAMS IN THE FIELD OF CHILDREN ISSUES PRODUCED AND DISTRIBUTED OVER TELEVISION, SATELLITE, FILM, AUDIO, VIDEO, INTERNET, AND 3-D VIRTUAL REALITY MEDIA; DIRECTION OF MAKING RADIO OR TELEVISION PROGRAMS; DISTRIBUTION OF TELEVISION PROGRAMS FOR OTHERS; ENTERTAINMENT IN THE NATURE OF ON-GOING TELEVISION PROGRAMS IN THE FIELD OF CHILDREN SHOWS; ENTERTAINMENT IN THE NATURE OF TELEVISION NEWS SHOWS; ENTERTAINMENT IN THE NATURE OF MUSICAL GROUP, PLAYS, COMEDY SHOWS, VARIETY SHOWS; ENTERTAINMENT, NAMELY, PRODUCTION OF MUSICAL GROUP, PLAYS, COMEDY SHOWS, VARIETY SHOWS; PRODUCTION AND DISTRIBUTION OF TELEVISION SHOWS AND MOVIES; EDUCATIONAL PROGRAMS, NAMELY, PRE-SCHOOLS; COMPUTER EDUCATION TRAINING; DEVELOPING EDUCATIONAL MANUALS FOR OTHERS IN THE FIELD OF GENERAL K-12 SUBJECTS; EDUCATION SER-

VICES, NAMELY, PROVIDING TUTORIAL SESSIONS IN THE FIELD(S) OF ENGLISH, SPANISH, MUSIC, MATH, SCIENCE, HISTORY, ARTS, THE ENVIRONMENT AND PHYSICAL EDUCATION; INFORMATION ON EDUCATION; PROVIDING AFTER SCHOOL EDUCATIONAL PROGRAMS FOR CHILDREN IN GRADES K-12; ENTERTAINMENT IN THE NATURE OF MAGIC SHOWS; ENTERTAINMENT IN THE NATURE OF VISUAL AND AUDIO PERFORMANCES, AND MUSICAL, VARIETY, NEWS AND COMEDY SHOWS; ENTERTAINMENT SERVICES IN THE NATURE OF AN AMUSEMENT PARK SHOW; ENTERTAINMENT, NAMELY, TELEVISION NEWS SHOWS, IN CLASS 41 (U.S. CLS. 100, 101 AND 107).

FIRST USE 6-1-2008; IN COMMERCE 6-1-2008.

THE MARK CONSISTS OF THE WORDS "BIZZEE BEAVER!" INFRONT OF THE IMAGE OF A BEAVER AND A TREE.

SN 77-150,762, FILED 4-6-2007.

ALICE BENMAMAN, EXAMINING ATTORNEY

Int. Cl.: 11

Prior U.S. Cls.: 13, 21, 23, 31, and 34

United States Patent and Trademark Office

Reg. No. 3,485,793

Registered Aug. 12, 2008

**TRADEMARK
PRINCIPAL REGISTER**

STRADA

VILLEROY & BOCH A.G. (FED REP GERMANY
CORPORATION)
POSTFACH 1120
METTLACH, FED REP GERMANY D66688

FOR: SANITARY EQUIPMENT, NAMELY, BATH
TUBS, WASH BASINS, LAVATORIES, TOILET
TANKS, AND TOILET SEATS, IN CLASS 11 (U.S.
CLS. 13, 21, 23, 31 AND 34).

FIRST USE 0-0-2007; IN COMMERCE 0-0-2007.

THE MARK CONSISTS OF STANDARD CHAR-
ACTERS WITHOUT CLAIM TO ANY PARTICULAR
FONT, STYLE, SIZE, OR COLOR.

THE FOREIGN WORDING IN THE MARK
TRANSLATES INTO ENGLISH AS ROAD.

SN 77-151,480, FILED 4-9-2007.

JOHN WILKE, EXAMINING ATTORNEY

Int. Cl.: 30

Prior U.S. Cl.: 46

United States Patent and Trademark Office

Reg. No. 3,485,794

Registered Aug. 12, 2008

**TRADEMARK
PRINCIPAL REGISTER**

PADA SUSHI

GAUGE CONSULTING INC. (CALIFORNIA CORPORATION)
SUITE A
1594 S. ANAHEIM BLVD.
ANAHEIM, CA 92805

FOR: SUSHI, IN CLASS 30 (U.S. CL. 46).

FIRST USE 5-23-2008; IN COMMERCE 5-23-2008.

THE MARK CONSISTS OF STANDARD CHARACTERS WITHOUT CLAIM TO ANY PARTICULAR FONT, STYLE, SIZE, OR COLOR.

NO CLAIM IS MADE TO THE EXCLUSIVE RIGHT TO USE "SUSHI", APART FROM THE MARK AS SHOWN.

THE FOREIGN WORDING IN THE MARK TRANSLATES INTO ENGLISH AS OCEAN.

SN 77-151,817, FILED 4-9-2007.

KATHLEEN M. VANSTON, EXAMINING ATTORNEY

Int. Cl.: 37

Prior U.S. Cls.: 100, 103, and 106

United States Patent and Trademark Office

Reg. No. 3,485,795

Registered Aug. 12, 2008

**SERVICE MARK
PRINCIPAL REGISTER**

EMERALD SOLUTIONS

CLEAN POWER, L.L.C. (WISCONSIN LTD LIAB
CO)
124 NORTH 121ST STREET
WAUWATOSA, WI 53226

THE MARK CONSISTS OF STANDARD CHAR-
ACTERS WITHOUT CLAIM TO ANY PARTICULAR
FONT, STYLE, SIZE, OR COLOR.

FOR: GENERAL CLEANING OF OFFICE, MED-
ICAL, INSTITUTIONAL AND INDUSTRIAL BUILD-
INGS, IN CLASS 37 (U.S. CLS. 100, 103 AND 106).

SN 77-152,031, FILED 4-9-2007.

FIRST USE 4-18-2007; IN COMMERCE 4-18-2007.

ESTHER A. BORSUK, EXAMINING ATTORNEY

Int. Cl.: 29

Prior U.S. Cl.: 46

United States Patent and Trademark Office

Reg. No. 3,485,796

Registered Aug. 12, 2008

**TRADEMARK
PRINCIPAL REGISTER**

**SAND MOUNTAIN COUNTRY
STYLE GREEN TOMATO PICKLES**

THOMAS, BURMA F. (UNITED STATES INDIVIDUAL)
P.O. BOX 824
SCOTTSBORO, AL 357680824

OWNER OF U.S. REG. NOS. 707,644, 3,135,584,
AND 3,221,649.

FOR: GREEN TOMATO PICKLES, IN CLASS 29
(U.S. CL. 46).

NO CLAIM IS MADE TO THE EXCLUSIVE
RIGHT TO USE "COUNTRY STYLE GREEN TOMATO
PICKLES", APART FROM THE MARK AS
SHOWN.

FIRST USE 5-30-2007; IN COMMERCE 5-30-2007.

SN 77-153,037, FILED 4-10-2007.

THE MARK CONSISTS OF STANDARD CHARACTERS
WITHOUT CLAIM TO ANY PARTICULAR
FONT, STYLE, SIZE, OR COLOR.

BRIAN PINO, EXAMINING ATTORNEY

Int. Cl.: 29

Prior U.S. Cl.: 46

United States Patent and Trademark Office

Reg. No. 3,485,797

Registered Aug. 12, 2008

**TRADEMARK
PRINCIPAL REGISTER**

**SAND MOUNTAIN COUNTRY
STYLE JALAPENO PEPPERS**

THOMAS, BURMA F. (UNITED STATES INDIVIDUAL)
P.O. BOX 824
SCOTTSBORO, AL 357680824

OWNER OF U.S. REG. NOS. 707,644, 3,135,584,
AND 3,221,649.

FOR: PROCESSED JALAPENO PEPPERS, IN
CLASS 29 (U.S. CL. 46).

NO CLAIM IS MADE TO THE EXCLUSIVE
RIGHT TO USE "COUNTRY STYLE JALAPENO
PEPPERS", APART FROM THE MARK AS SHOWN.

FIRST USE 5-30-2007; IN COMMERCE 5-30-2007.

SN 77-153,041, FILED 4-10-2007.

THE MARK CONSISTS OF STANDARD CHARACTERS WITHOUT CLAIM TO ANY PARTICULAR FONT, STYLE, SIZE, OR COLOR.

BRIAN PINO, EXAMINING ATTORNEY

Int. Cl.: 30

Prior U.S. Cl.: 46

United States Patent and Trademark Office

Reg. No. 3,485,798

Registered Aug. 12, 2008

**TRADEMARK
PRINCIPAL REGISTER**

**SAND MOUNTAIN COUNTRY
STYLE NACHO CHEESE SAUCE**

THOMAS, BURMA F. (UNITED STATES INDIVIDUAL)
P.O. BOX 824
SCOTTSBORO, AL 357680824

OWNER OF U.S. REG. NOS. 707,644, 3,135,584,
AND 3,221,649.

FOR: NACHO CHEESE SAUCE, IN CLASS 30 (U.S. CL. 46).

NO CLAIM IS MADE TO THE EXCLUSIVE RIGHT TO USE "COUNTRY STYLE NACHO CHEESE SAUCE", APART FROM THE MARK AS SHOWN.

FIRST USE 5-30-2007; IN COMMERCE 5-30-2007.

SN 77-153,047, FILED 4-10-2007.

THE MARK CONSISTS OF STANDARD CHARACTERS WITHOUT CLAIM TO ANY PARTICULAR FONT, STYLE, SIZE, OR COLOR.

BRIAN PINO, EXAMINING ATTORNEY

Int. Cls.: 40 and 42

Prior U.S. Cls.: 100, 101, 103, and 106

United States Patent and Trademark Office

Reg. No. 3,485,799

Registered Aug. 12, 2008

**SERVICE MARK
PRINCIPAL REGISTER**

EMCON TECHNOLOGIES

EMCON TECHNOLOGIES LLC (DELAWARE
LTD LIAB CO)
CORPORATION TRUST CENTER, 1209 ORANGE
STREET
WILMINGTON, DE 19801

FOR: MANUFACTURING SERVICES FOR OTHERS IN THE FIELD OF LIGHT AND COMMERCIAL VEHICLE EMISSION AND EXHAUST SYSTEMS AND COMPONENTS, NAMELY, CATALYTIC CONVERTERS, DIESEL PARTICULATE FILTERS, DIESEL EMISSION AFTER-TREATMENT PRODUCTS, MUFFLERS, EXHAUST PIPES, AND MOUNTING BRACKETS, IN CLASS 40 (U.S. CLS. 100, 103 AND 106).

FIRST USE 5-17-2008; IN COMMERCE 5-17-2008.

FOR: ENGINEERING SERVICES, NAMELY, ENGINEERING OF LIGHT AND COMMERCIAL VEHICLE EMISSION AND EXHAUST SYSTEMS AND

COMPONENTS, NAMELY, CATALYTIC CONVERTERS, DIESEL PARTICULATE FILTERS, DIESEL EMISSION AFTER-TREATMENT PRODUCTS, MUFFLERS, EXHAUST PIPES, AND MOUNTING BRACKETS, IN CLASS 42 (U.S. CLS. 100 AND 101).

FIRST USE 5-17-2008; IN COMMERCE 5-17-2008.

THE MARK CONSISTS OF STANDARD CHARACTERS WITHOUT CLAIM TO ANY PARTICULAR FONT, STYLE, SIZE, OR COLOR.

NO CLAIM IS MADE TO THE EXCLUSIVE RIGHT TO USE "TECHNOLOGIES", APART FROM THE MARK AS SHOWN.

SN 77-153,080, FILED 4-10-2007.

PAUL F. GAST, EXAMINING ATTORNEY

Int. Cl.: 5

Prior U.S. Cls.: 6, 18, 44, 46, 51, and 52

Reg. No. 3,485,800

United States Patent and Trademark Office

Registered Aug. 12, 2008

**TRADEMARK
PRINCIPAL REGISTER**

LIVITAMINE

WESTERN HOLDINGS, LLC. (WYOMING LTD
LIAB CO)
1821 LOGAN AVENUE
CHEYENE, WY 82001

THE MARK CONSISTS OF STANDARD CHAR-
ACTERS WITHOUT CLAIM TO ANY PARTICULAR
FONT, STYLE, SIZE, OR COLOR.

FOR: DIETARY SUPPLEMENTS, IN CLASS 5 (U.S.
CLS. 6, 18, 44, 46, 51 AND 52).

SN 77-153,200, FILED 4-10-2007.

FIRST USE 7-19-2007; IN COMMERCE 7-19-2007.

JILL PRATER, EXAMINING ATTORNEY

Int. Cl.: 25

Prior U.S. Cls.: 22 and 39

United States Patent and Trademark Office

Reg. No. 3,485,801

Registered Aug. 12, 2008

**TRADEMARK
PRINCIPAL REGISTER**

**THE STEPHENSON DENIM
FINERY**

STEPHENSON, AMY (UNITED STATES INDIVIDUAL)
80 VARICK STREET, STUDIO 2B
NEW YORK, NY 10013

FOR: JEANS; PANTS; SWEATERS; T-SHIRTS; JACKETS, ALL OF THE FOREGOING MADE IN WHOLE OR SUBSTANTIALLY IN PART OF DENIM, IN CLASS 25 (U.S. CLS. 22 AND 39).

FIRST USE 6-29-2007; IN COMMERCE 6-29-2007.

THE MARK CONSISTS OF STANDARD CHARACTERS WITHOUT CLAIM TO ANY PARTICULAR FONT, STYLE, SIZE, OR COLOR.

NO CLAIM IS MADE TO THE EXCLUSIVE RIGHT TO USE "DENIM FINERY", APART FROM THE MARK AS SHOWN.

SN 77-153,373, FILED 4-10-2007.

ALYSSA PALADINO, EXAMINING ATTORNEY

Int. Cl.: 25

Prior U.S. Cls.: 22 and 39

United States Patent and Trademark Office

Reg. No. 3,485,802

Registered Aug. 12, 2008

**TRADEMARK
PRINCIPAL REGISTER**

TWIN FIN

SECURITY SOURCING INTERNATIONAL, INC.
(CALIFORNIA CORPORATION)
1457 E. WASHINGTON BLVD.
LOS ANGELES, CA 90021

FOR: CLOTHING, NAMELY, BLOUSES, DRESSES, JACKETS, JEANS, JERSEYS, PANTS, SHIRTS, SHORTS, SKIRTS, SWEAT PANTS, SWEAT SHIRTS, SWEATERS, T-SHIRTS, AND TANK TOPS , IN CLASS 25 (U.S. CLS. 22 AND 39).

FIRST USE 8-1-2007; IN COMMERCE 8-1-2007.

THE MARK CONSISTS OF STANDARD CHARACTERS WITHOUT CLAIM TO ANY PARTICULAR FONT, STYLE, SIZE, OR COLOR.

SN 77-153,567, FILED 4-10-2007.

DAVID HOFFMAN, EXAMINING ATTORNEY

Int. Cls.: 25 and 36

Prior U.S. Cls.: 22, 39, 100, 101, and 102

United States Patent and Trademark Office

Reg. No. 3,485,803

Registered Aug. 12, 2008

**TRADEMARK
SERVICE MARK
PRINCIPAL REGISTER**



AMERICAN FARMERS & RANCHERS MUTUAL
INSURANCE COMPANY (OKLAHOMA COR-
PORATION)
P.O. BOX 24000
OKLAHOMA CITY, OK 73124

FOR: PROMOTIONAL ITEMS, NAMELY, T-
SHIRTS AND HATS, IN CLASS 25 (U.S. CLS. 22
AND 39).

FIRST USE 2-9-2007; IN COMMERCE 11-26-2007.

FOR: INSURANCE SERVICES, NAMELY, WRIT-
ING AND UNDERWRITING OF LIFE INSURANCE,
CASUALTY INSURANCE AND PROPERTY INSUR-

ANCE, AND PROVIDING ANCILLARY SERVICES
THERETO, NAMELY, ADMINISTRATION, CLAIMS
ADJUSTMENT AND BROKERAGE, IN CLASS 36
(U.S. CLS. 100, 101 AND 102).

FIRST USE 2-9-2007; IN COMMERCE 11-26-2007.

THE MARK CONSISTS OF A WINDMILL WITH
GRASS AT THE BASE OF THE WINDMILL WHICH
APPEARS TO BE BLOWING IN THE WIND.

SN 77-154,219, FILED 4-11-2007.

DAVID TOOLEY, EXAMINING ATTORNEY

Int. Cl.: 36

Prior U.S. Cls.: 100, 101, and 102

United States Patent and Trademark Office

Reg. No. 3,485,804

Registered Aug. 12, 2008

**SERVICE MARK
PRINCIPAL REGISTER**

VALLERIITE

BLACKROCK, INC. (DELAWARE CORPORATION)
40 EAST 52ND STREET
NEW YORK, NY 10022

THE MARK CONSISTS OF STANDARD CHARACTERS WITHOUT CLAIM TO ANY PARTICULAR FONT, STYLE, SIZE, OR COLOR.

FOR: INVESTMENT MANAGEMENT SERVICES,
IN CLASS 36 (U.S. CLS. 100, 101 AND 102).

SN 77-154,260, FILED 4-11-2007.

FIRST USE 3-0-2007; IN COMMERCE 3-0-2007.

ZHALEH DELANEY, EXAMINING ATTORNEY

Int. Cl.: 36

Prior U.S. Cls.: 100, 101, and 102

United States Patent and Trademark Office

Reg. No. 3,485,805

Registered Aug. 12, 2008

**SERVICE MARK
PRINCIPAL REGISTER**

All Things RealEstate, LLC

SCHUBERTH, CHRISTOPHER JAMES (UNITED STATES INDIVIDUAL)
109 N SIX STREET
DARBY, PA 19023 AND
HARRIS, MARSHALL WILLIAM (UNITED STATES INDIVIDUAL)
519 S PINE STREET
DARBY, PA 19023

FOR: REAL ESTATE INVESTMENT; REAL ESTATE MANAGEMENT, IN CLASS 36 (U.S. CLS. 100, 101 AND 102).

FIRST USE 4-21-2008; IN COMMERCE 4-21-2008.

THE MARK CONSISTS OF STANDARD CHARACTERS WITHOUT CLAIM TO ANY PARTICULAR FONT, STYLE, SIZE, OR COLOR.

NO CLAIM IS MADE TO THE EXCLUSIVE RIGHT TO USE "REAL ESTATE, LLC", APART FROM THE MARK AS SHOWN.

SN 77-154,276, FILED 4-11-2007.

DAVID TAYLOR, EXAMINING ATTORNEY

Int. Cl.: 7

Prior U.S. Cls.: 13, 19, 21, 23, 31, 34, and 35

Reg. No. 3,485,806

United States Patent and Trademark Office

Registered Aug. 12, 2008

**TRADEMARK
PRINCIPAL REGISTER**

KERMA

MIGLIORE, CHARLES W. (UNITED STATES IN-
DIVIDUAL)
185 W 1430 N
TOOELE, UT 84074

THE MARK CONSISTS OF STANDARD CHAR-
ACTERS WITHOUT CLAIM TO ANY PARTICULAR
FONT, STYLE, SIZE, OR COLOR.

FOR: MECHANICAL ENGINE PARTS FOR LAND
VEHICLES, IN CLASS 7 (U.S. CLS. 13, 19, 21, 23, 31, 34
AND 35).

SN 77-154,426, FILED 4-11-2007.

FIRST USE 10-15-2002; IN COMMERCE 10-15-2002.

HANNO RITTNER, EXAMINING ATTORNEY

Int. Cl.: 29

Prior U.S. Cl.: 46

United States Patent and Trademark Office

Reg. No. 3,485,807

Registered Aug. 12, 2008

**TRADEMARK
PRINCIPAL REGISTER**

NATURAL TASTE, NATURALLY

JONMOR INVESTMENTS, INC. (DELAWARE
CORPORATION)
103 BAYNARD BUILDING
3411 SILVERSIDE ROAD
WILMINGTON, DE 19810

THE MARK CONSISTS OF STANDARD CHAR-
ACTERS WITHOUT CLAIM TO ANY PARTICULAR
FONT, STYLE, SIZE, OR COLOR.

SN 77-154,796, FILED 4-12-2007.

FOR: PORK, IN CLASS 29 (U.S. CL. 46).

FIRST USE 11-0-2007; IN COMMERCE 11-0-2007.

KEVIN CORWIN, EXAMINING ATTORNEY

Int. Cl.: 21

Prior U.S. Cls.: 2, 13, 23, 29, 30, 33, 40, and 50

Reg. No. 3,485,808

United States Patent and Trademark Office

Registered Aug. 12, 2008

**TRADEMARK
PRINCIPAL REGISTER**

KENILWORTH

THE HOMER LAUGHLIN CHINA COMPANY
(DELAWARE CORPORATION)
672 FIESTA DRIVE
NEWELL, WV 260501077

THE MARK CONSISTS OF STANDARD CHAR-
ACTERS WITHOUT CLAIM TO ANY PARTICULAR
FONT, STYLE, SIZE, OR COLOR.

FOR: DINNERWARE, IN CLASS 21 (U.S. CLS. 2, 13,
23, 29, 30, 33, 40 AND 50).

SN 77-154,829, FILED 4-12-2007.

FIRST USE 5-19-2007; IN COMMERCE 5-19-2007.

MICHAEL LEWIS, EXAMINING ATTORNEY

Int. Cl.: 43

Prior U.S. Cls.: 100 and 101

United States Patent and Trademark Office

Reg. No. 3,485,809

Registered Aug. 12, 2008

**SERVICE MARK
PRINCIPAL REGISTER**

EVEN SWEETER AFTER DARK

AMERICA'S DRIVE-IN BRAND PROPERTIES
LLC (KANSAS LTD LIAB CO)
BUILDING 1100
3500 NORTH ROCK ROAD
WICHITA, KS 67226

THE MARK CONSISTS OF STANDARD CHAR-
ACTERS WITHOUT CLAIM TO ANY PARTICULAR
FONT, STYLE, SIZE, OR COLOR.

FOR: RESTAURANT SERVICES, IN CLASS 43
(U.S. CLS. 100 AND 101).

SN 77-155,589, FILED 4-12-2007.

FIRST USE 5-1-2007; IN COMMERCE 5-1-2007.

MARTHA FROMM, EXAMINING ATTORNEY

Int. Cl.: 25

Prior U.S. Cls.: 22 and 39

United States Patent and Trademark Office

Reg. No. 3,485,810

Registered Aug. 12, 2008

**TRADEMARK
PRINCIPAL REGISTER**

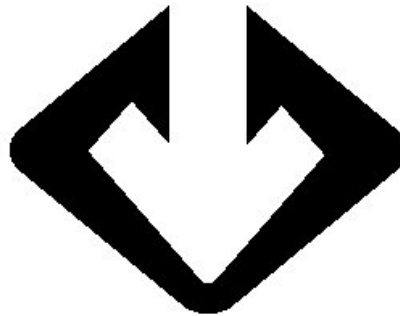

2FEETSOUTH (NEVADA LTD LIAB CO)
1R 149 WEST STREET
GARDNER, MA 01440

FOR: HATS; PANTS; SHIRTS; SWEAT SHIRTS;
WRISTBANDS, IN CLASS 25 (U.S. CLS. 22 AND 39).

FIRST USE 4-1-2007; IN COMMERCE 4-1-2007.

THE MARK CONSISTS OF A ARROW POINTING
DOWN IN A DIAMOND SHAPED AREA WITH
ROUNDED CORNERS.

SN 77-156,128, FILED 4-13-2007.

JEFF DEFORD, EXAMINING ATTORNEY

Int. Cl.: 35

Prior U.S. Cls.: 100, 101, and 102

United States Patent and Trademark Office

Reg. No. 3,485,811

Registered Aug. 12, 2008

**SERVICE MARK
PRINCIPAL REGISTER**

RxTRA ADVANTAGE

HEB GROCERY COMPANY, L.P. (TEXAS LIMITED PARTNERSHIP)
646 SOUTH MAIN
SAN ANTONIO, TX 78204

FOR: PROMOTING THE GOODS OF OTHERS THROUGH A CUSTOMER LOYALTY PROGRAM BY PROVIDING MERCHANDISE DISCOUNTS AND SPECIAL INCENTIVES TO CUSTOMERS, IN CLASS 35 (U.S. CLS. 100, 101 AND 102).

FIRST USE 8-0-2007; IN COMMERCE 8-0-2007.

THE MARK CONSISTS OF STANDARD CHARACTERS WITHOUT CLAIM TO ANY PARTICULAR FONT, STYLE, SIZE, OR COLOR.

SN 77-156,428, FILED 4-13-2007.

CARRIE GENOVESE, EXAMINING ATTORNEY

Int. Cl.: 39

Prior U.S. Cls.: 100 and 105

United States Patent and Trademark Office

Reg. No. 3,485,812

Registered Aug. 12, 2008

**SERVICE MARK
PRINCIPAL REGISTER**

ITRANSPORTATION

BAUER'S LIMOUSINE SERVICE, INC. (CALI-
FORNIA CORPORATION)
PIER 27, THE EMBARCADERO
SAN FRANCISCO, CA 94111

THE MARK CONSISTS OF STANDARD CHAR-
ACTERS WITHOUT CLAIM TO ANY PARTICULAR
FONT, STYLE, SIZE, OR COLOR.

FOR: CHAUFFEURED TRANSPORTATION SER-
VICES, IN CLASS 39 (U.S. CLS. 100 AND 105).

SN 77-156,779, FILED 4-13-2007.

FIRST USE 6-17-2008; IN COMMERCE 6-17-2008.

CHARLOTTE CORWIN, EXAMINING ATTORNEY

Int. Cl.: 28

Prior U.S. Cls.: 22, 23, 38, and 50

Reg. No. 3,485,813

United States Patent and Trademark Office

Registered Aug. 12, 2008

**TRADEMARK
PRINCIPAL REGISTER**

PLAY MORE. WIN MORE.

LOB-STER INC. (NEW JERSEY CORPORATION)
7340 FULTON AVENUE
NORTH HOLLYWOOD, CA 91605

THE MARK CONSISTS OF STANDARD CHAR-
ACTERS WITHOUT CLAIM TO ANY PARTICULAR
FONT, STYLE, SIZE, OR COLOR.

FOR: TENNIS BALL THROWING MACHINES, IN
CLASS 28 (U.S. CLS. 22, 23, 38 AND 50).

SN 77-157,304, FILED 4-16-2007.

FIRST USE 3-21-2007; IN COMMERCE 5-21-2007.

JASON BLAIR, EXAMINING ATTORNEY

Int. Cl.: 3

Prior U.S. Cls.: 1, 4, 6, 50, 51, and 52

Reg. No. 3,485,814

United States Patent and Trademark Office

Registered Aug. 12, 2008

**TRADEMARK
PRINCIPAL REGISTER**

PRINCESSE DU SAHARA

SOCIETE PARISIENNE DE PARFUMS ET COS-
METIQUES (FRANCE CORPORATION)
11, RUE MARGUERITTE
PARIS, FRANCE 75017

FOR: PERFUMES AND COLOGNES, IN CLASS 3
(U.S. CLS. 1, 4, 6, 50, 51 AND 52).

FIRST USE 5-0-1996; IN COMMERCE 9-0-2007.

THE MARK CONSISTS OF STANDARD CHAR-
ACTERS WITHOUT CLAIM TO ANY PARTICULAR
FONT, STYLE, SIZE, OR COLOR.

THE NAME "PRINCESSE DU SAHARA" DOES
NOT IDENTIFY A LIVING INDIVIDUAL.

THE ENGLISH TRANSLATION OF THE WORD-
ING "PRINCESSE DU" IN THE MARK IS PRINCESS
OF.

SN 77-157,515, FILED 4-16-2007.

CARRIE GENOVESE, EXAMINING ATTORNEY

Int. Cl.: 9

Prior U.S. Cls.: 21, 23, 26, 36, and 38

Reg. No. 3,485,815

United States Patent and Trademark Office

Registered Aug. 12, 2008

**TRADEMARK
PRINCIPAL REGISTER**

WORLDVISTA EHR

WORLDVISTA (CALIFORNIA NON-PROFIT
PUBLIC BENEFIT CORPORATION)
925 SOUTH WISTERIA DRIVE
MALVERN, PA 19355

FOR: COMPUTER SOFTWARE FOR MANAGING
THE DELIVERY OF HEALTH CARE SERVICES FOR
USE BY HEALTH CARE PROFESSIONALS, IN
CLASS 9 (U.S. CLS. 21, 23, 26, 36 AND 38).

FIRST USE 12-31-2007; IN COMMERCE 12-31-2007.

THE MARK CONSISTS OF STANDARD CHAR-
ACTERS WITHOUT CLAIM TO ANY PARTICULAR
FONT, STYLE, SIZE, OR COLOR.

NO CLAIM IS MADE TO THE EXCLUSIVE
RIGHT TO USE "EHR", APART FROM THE MARK
AS SHOWN.

SN 77-157,578, FILED 4-16-2007.

GINA FINK, EXAMINING ATTORNEY

Int. Cls.: 16, 35, and 41

Prior U.S. Cls.: 2, 5, 22, 23, 29, 37, 38, 50, 100, 101, 102, and 107

Reg. No. 3,485,816

United States Patent and Trademark Office

Registered Aug. 12, 2008

**TRADEMARK
SERVICE MARK
PRINCIPAL REGISTER**



ILLINOIS CPA SOCIETY (ILLINOIS NON-PROFIT CORPORATION)
550 W. JACKSON, SUITE 900
CHICAGO, IL 606615716

FOR: PUBLICATIONS, NAMELY, MAGAZINES AND NEWSLETTERS IN THE FIELD OF ACCOUNTING AND FINANCIAL SERVICES AND BUSINESS TOPICS OF INTEREST TO PROFESSIONALS IN THE ACCOUNTING AND FINANCIAL SERVICES FIELDS, IN CLASS 16 (U.S. CLS. 2, 5, 22, 23, 29, 37, 38 AND 50).

FIRST USE 6-1-2007; IN COMMERCE 8-1-2007.

FOR: ASSOCIATION SERVICES, NAMELY, PROMOTING THE INTERESTS OF CERTIFIED PUBLIC ACCOUNTANTS AND OTHER PROFESSIONALS IN

THE FIELD OF ACCOUNTING AND FINANCIAL SERVICES, IN CLASS 35 (U.S. CLS. 100, 101 AND 102).

FIRST USE 6-1-2007; IN COMMERCE 8-1-2007.

FOR: EDUCATIONAL SERVICES, NAMELY, PROVIDING COURSES, CLASSES, CONFERENCES AND FORUMS IN THE FIELDS OF ACCOUNTING AND FINANCIAL SERVICES AND BUSINESS TOPICS OF INTEREST TO PROFESSIONALS IN THE ACCOUNTING AND FINANCIAL SERVICES FIELDS, IN CLASS 41 (U.S. CLS. 100, 101 AND 107).

FIRST USE 6-1-2007; IN COMMERCE 8-1-2007.

SN 77-157,795, FILED 4-16-2007.

LINDSEY RUBIN, EXAMINING ATTORNEY

Int. Cl.: 14

Prior U.S. Cls.: 2, 27, 28, and 50

United States Patent and Trademark Office

Reg. No. 3,485,817

Registered Aug. 12, 2008

**TRADEMARK
PRINCIPAL REGISTER**

DOBERMAN

SCOTT KAY, INC. (NEW JERSEY CORPORATION)
780 PALISADE AVENUE
TEANECK, NJ 07666

THE MARK CONSISTS OF STANDARD CHARACTERS WITHOUT CLAIM TO ANY PARTICULAR FONT, STYLE, SIZE, OR COLOR.

FOR: JEWELRY, IN CLASS 14 (U.S. CLS. 2, 27, 28 AND 50).

SN 77-157,847, FILED 4-16-2007.

FIRST USE 1-31-2008; IN COMMERCE 5-31-2008.

ANNE E. GUSTASON, EXAMINING ATTORNEY

Int. Cl.: 22

Prior U.S. Cls.: 1, 2, 7, 19, 22, 42, and 50

Reg. No. 3,485,818

United States Patent and Trademark Office

Registered Aug. 12, 2008

**TRADEMARK
PRINCIPAL REGISTER**



SHINING SEA TRADING COMPANY (UTAH
CORPORATION)
5079 WEST 2100 SOUTH
WEST VALLEY, UT 84120

FOR: BAGS, NAMELY, FABRIC BAGS FOR
STORING ARTIFICIAL CHRISTMAS TREES, IN
CLASS 22 (U.S. CLS. 1, 2, 7, 19, 22, 42 AND 50).

FIRST USE 7-1-2007; IN COMMERCE 7-1-2007.

NO CLAIM IS MADE TO THE EXCLUSIVE
RIGHT TO USE "BAGS", APART FROM THE MARK
AS SHOWN.

THE MARK CONSISTS OF A PICTURE OF SAN-
TA CARRYING A BAG.

SN 77-158,010, FILED 4-16-2007.

HEATHER THOMPSON, EXAMINING ATTORNEY

Int. Cl.: 25

Prior U.S. Cls.: 22 and 39

United States Patent and Trademark Office

Reg. No. 3,485,819

Registered Aug. 12, 2008

TRADEMARK
PRINCIPAL REGISTER

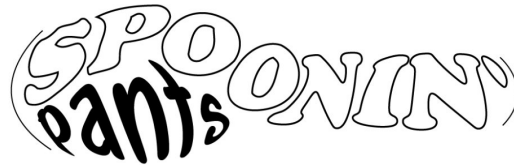

SPOONIN' PANTS INC. (COLORADO CORPORATION)
77 RED BARN STREET
EDWARDS, CO 81632

FOR: BOTTOMS; CAMISOLES; SLIPPERS; SOCKS;
T-SHIRTS; BASEBALL CAPS, IN CLASS 25 (U.S. CLS.
22 AND 39).

FIRST USE 1-0-2008; IN COMMERCE 1-0-2008.

NO CLAIM IS MADE TO THE EXCLUSIVE
RIGHT TO USE "PANTS", APART FROM THE
MARK AS SHOWN.

THE MARK CONSISTS OF THE STYLIZED
WORDS "SPOONIN' PANTS" IN THE FANCIFUL
SHAPE OF A SPOON.

SN 77-158,076, FILED 4-16-2007.

G. MAYERSCHOFF, EXAMINING ATTORNEY

Int. Cl.: 11

Prior U.S. Cls.: 13, 21, 23, 31, and 34

United States Patent and Trademark Office

Reg. No. 3,485,820

Registered Aug. 12, 2008

**TRADEMARK
PRINCIPAL REGISTER**

WHISPER · CLOSE

BEMIS MANUFACTURING COMPANY (WIS-
CONSIN CORPORATION)
300 MILL STREET
SHEBOYGAN FALLS, WI 530851807

THE MARK CONSISTS OF STANDARD CHAR-
ACTERS WITHOUT CLAIM TO ANY PARTICULAR
FONT, STYLE, SIZE, OR COLOR.

FOR: TOILET SEAT HINGES, IN CLASS 11 (U.S.
CLS. 13, 21, 23, 31 AND 34).

SN 77-158,155, FILED 4-17-2007.

FIRST USE 4-3-2008; IN COMMERCE 4-17-2008.

JAMES STEIN, EXAMINING ATTORNEY

Int. Cl.: 3

Prior U.S. Cls.: 1, 4, 6, 50, 51, and 52

Reg. No. 3,485,821

United States Patent and Trademark Office

Registered Aug. 12, 2008

**TRADEMARK
PRINCIPAL REGISTER**

VIVID IMPACT

NOXELL CORPORATION (MARYLAND COR-
PORATION)
11050 YORK ROAD
HUNT VALLEY, MD 21030

THE MARK CONSISTS OF STANDARD CHAR-
ACTERS WITHOUT CLAIM TO ANY PARTICULAR
FONT, STYLE, SIZE, OR COLOR.

FOR: COSMETICS, IN CLASS 3 (U.S. CLS. 1, 4, 6, 50,
51 AND 52).

SN 77-158,473, FILED 4-17-2007.

FIRST USE 12-10-2007; IN COMMERCE 12-10-2007.

SHARON MEIER, EXAMINING ATTORNEY

Int. Cls.: 3 and 5

Prior U.S. Cls.: 1, 4, 6, 18, 44, 46, 50, 51, and 52

United States Patent and Trademark Office

Reg. No. 3,485,822

Registered Aug. 12, 2008

**TRADEMARK
PRINCIPAL REGISTER**

RESTORENOL

DREAM QUEST NUTRACEUTICALS (NEVADA
CORPORATION)
4660 AIRCENTER CIRCLE
RENO, NV 895027917

FOR: HAIR CARE PREPARATION, IN CLASS 3
(U.S. CLS. 1, 4, 6, 50, 51 AND 52).

FIRST USE 5-1-2008; IN COMMERCE 5-1-2008.

FOR: TOPICAL APPLICATION FOR HAIR RE-
GROWTH, IN CLASS 5 (U.S. CLS. 6, 18, 44, 46, 51 AND
52).

FIRST USE 5-1-2008; IN COMMERCE 5-1-2008.

THE MARK CONSISTS OF STANDARD CHAR-
ACTERS WITHOUT CLAIM TO ANY PARTICULAR
FONT, STYLE, SIZE, OR COLOR.

SN 77-158,683, FILED 4-17-2007.

PAULA MAHONEY, EXAMINING ATTORNEY

Int. Cl.: 16

Prior U.S. Cls.: 2, 5, 22, 23, 29, 37, 38, and 50

Reg. No. 3,485,823

United States Patent and Trademark Office

Registered Aug. 12, 2008

**TRADEMARK
PRINCIPAL REGISTER**

Bio-Diary

KARNER, MARIE (UNITED STATES INDIVIDUAL)
11325 SUNRISE GOLD CIR STE C
RANCHO CORDOVA, CA 95742

FIRST USE 8-20-2007; IN COMMERCE 8-20-2007.

FOR: PRINTED PUBLICATION IN THE NATURE OF A DIARY FOR RECORDING DAILY INFORMATION ON NUTRITION, EXERCISE, MENSTRUAL CYCLE, HEALTH, SYMPTOMS, AND NOTES , IN CLASS 16 (U.S. CLS. 2, 5, 22, 23, 29, 37, 38 AND 50).

THE MARK CONSISTS OF STANDARD CHARACTERS WITHOUT CLAIM TO ANY PARTICULAR FONT, STYLE, SIZE, OR COLOR.

SN 77-158,712, FILED 4-17-2007.

JORDAN BAKER, EXAMINING ATTORNEY

Int. Cl.: 44

Prior U.S. Cls.: 100 and 101

United States Patent and Trademark Office

Reg. No. 3,485,824

Registered Aug. 12, 2008

**SERVICE MARK
PRINCIPAL REGISTER**

JUST UNDO IT

ROTHMAN, DR. RICHARD (UNITED STATES
INDIVIDUAL)
8190 S. MARYLAND PKWY., #100
LAS VEGAS, NV 89123

THE MARK CONSISTS OF STANDARD CHAR-
ACTERS WITHOUT CLAIM TO ANY PARTICULAR
FONT, STYLE, SIZE, OR COLOR.

FOR: MEDICAL SERVICES, NAMELY, PROVID-
ING COSMETIC AND AESTHETIC MEDICAL PRO-
CEDURES, IN CLASS 44 (U.S. CLS. 100 AND 101).

SN 77-158,738, FILED 4-17-2007.

FIRST USE 5-1-2007; IN COMMERCE 5-1-2007.

DAVID C. REIHNER, EXAMINING ATTORNEY

Int. Cl.: 41

Prior U.S. Cls.: 100, 101, and 107

United States Patent and Trademark Office

Reg. No. 3,485,825

Registered Aug. 12, 2008

**SERVICE MARK
PRINCIPAL REGISTER**

THE BIG SHEBANG

LEAPFROG STRATEGIES, INC. (MINNESOTA CORPORATION)
2227 FOXTAIL COURT
WHITE BEAR LAKE, MN 55110

FOR: ARRANGING PROFESSIONAL WORKSHOP AND TRAINING COURSES; BUSINESS TRAINING; EDUCATIONAL SERVICES, NAMELY, DEVELOPING, ARRANGING, AND CONDUCTING EDUCATIONAL CONFERENCES AND PROGRAMS AND PROVIDING COURSES OF INSTRUCTION IN THE FIELD OF SALES AND MARKETING; PROVIDING ON-LINE TRAINING COURSES, SEMINARS AND WORKSHOPS IN THE FIELD OF

SALES AND MARKETING, IN CLASS 41 (U.S. CLS. 100, 101 AND 107).

FIRST USE 6-1-2008; IN COMMERCE 6-1-2008.

THE MARK CONSISTS OF STANDARD CHARACTERS WITHOUT CLAIM TO ANY PARTICULAR FONT, STYLE, SIZE, OR COLOR.

SN 77-158,883, FILED 4-17-2007.

RICHARD A. STRASER, EXAMINING ATTORNEY

Int. Cl.: 44

Prior U.S. Cls.: 100 and 101

United States Patent and Trademark Office

Reg. No. 3,485,826

Registered Aug. 12, 2008

**SERVICE MARK
PRINCIPAL REGISTER**

PALMPEDIA

OUER, DEAN A. (UNITED STATES INDIVIDUAL)
73-1557 HAO STREET
KAILUA-KONA, HI 96740

THE MARK CONSISTS OF STANDARD CHARACTERS WITHOUT CLAIM TO ANY PARTICULAR FONT, STYLE, SIZE, OR COLOR.

FOR: PROVIDING INFORMATION ONLINE IN THE FIELD OF GENERAL HORTICULTURAL KNOWLEDGE, IN CLASS 44 (U.S. CLS. 100 AND 101).

SN 77-158,944, FILED 4-17-2007.

FIRST USE 5-0-2007; IN COMMERCE 5-0-2007.

GISELLE AGOSTO, EXAMINING ATTORNEY

Int. Cl.: 35

Prior U.S. Cls.: 100, 101, and 102

United States Patent and Trademark Office

Reg. No. 3,485,827

Registered Aug. 12, 2008

**SERVICE MARK
PRINCIPAL REGISTER**



COLLINS, AUSTIN (TEXAS SOLE PROPRIETOR-
SHIP)
1005 IVORY CREEK
SCHERTZ, TX 78154

FIRST USE 5-1-2007; IN COMMERCE 5-1-2007.

SN 77-159,113, FILED 4-18-2007.

FOR: RETAIL SHOPS FEATURING GIFTS,
GAMES, POSTERS, IN CLASS 35 (U.S. CLS. 100, 101
AND 102).

PAULA MAHONEY, EXAMINING ATTORNEY

Int. Cl.: 9

Prior U.S. Cls.: 21, 23, 26, 36, and 38

Reg. No. 3,485,828

United States Patent and Trademark Office

Registered Aug. 12, 2008

**TRADEMARK
PRINCIPAL REGISTER**

PATROLLER

I.P. HOLDINGS, INC. (TEXAS CORPORATION)
805 W. N. CARRIER PARKWAY, STE. 260
GRAND PRAIRIE, TX 75050

THE MARK CONSISTS OF STANDARD CHARACTERS WITHOUT CLAIM TO ANY PARTICULAR FONT, STYLE, SIZE, OR COLOR.

FOR: MOTION DETECTING LIGHT AND DIGITAL CAMERA NOT FOR VEHICLES; MOTION DETECTING LIGHT AND DIGITAL VIDEO CAMERA NOT FOR VEHICLES, IN CLASS 9 (U.S. CLS. 21, 23, 26, 36 AND 38).

SN 77-159,304, FILED 4-18-2007.

FIRST USE 9-1-2007; IN COMMERCE 9-1-2007.

CHRISTOPHER BUONGIORNO, EXAMINING ATTORNEY

Int. Cl.: 29

Prior U.S. Cl.: 46

United States Patent and Trademark Office

Reg. No. 3,485,829

Registered Aug. 12, 2008

**TRADEMARK
PRINCIPAL REGISTER**

NUTRISYSTEM ADVANCED

NUTRI/SYSTEM IPHC, INC. (DELAWARE CORPORATION)
SUITE 1704
300 DELAWARE AVE.
WILMINGTON, DE 19801

FOR: BREAKFAST, LUNCH AND DINNER ENTREES, AND SNACKS CONTAINING MEAT, FISH AND POULTRY, EGGS, MILK AND MILK PRODUCTS, NAMELY, CREAM CHEESE SPREAD, CHEESE SPREAD, COTTAGE CHEESE, SOUR CREAM, DRIED AND COOKED FRUITS AND VEGETABLES, JELLIES, SAUCES, NAMELY, APPLE SAUCE, SNACK DIPS AND SOUPS; PROTEIN BASED NUTRIENT-DENSE SNACK BARS, YOGURTS, IN CLASS 29 (U.S. CL. 46).

FIRST USE 12-15-2007; IN COMMERCE 12-15-2007.

THE MARK CONSISTS OF STANDARD CHARACTERS WITHOUT CLAIM TO ANY PARTICULAR FONT, STYLE, SIZE, OR COLOR.

OWNER OF U.S. REG. NOS. 1,297,847, 3,251,743, AND OTHERS.

NO CLAIM IS MADE TO THE EXCLUSIVE RIGHT TO USE "ADVANCED", APART FROM THE MARK AS SHOWN.

SN 77-159,309, FILED 4-18-2007.

BRIAN PINO, EXAMINING ATTORNEY

Int. Cl.: 30

Prior U.S. Cl.: 46

United States Patent and Trademark Office

Reg. No. 3,485,830

Registered Aug. 12, 2008

**TRADEMARK
PRINCIPAL REGISTER**

NUTRISYSTEM ADVANCED

NUTRI/SYSTEM IPHC, INC. (DELAWARE CORPORATION)
SUITE 1704
300 DELAWARE AVE.
WILMINGTON, DE 19801

FOR: MILKSHAKES, PUDDINGS; BREAKFAST, LUNCH, DINNER ENTREES, SNACKS AND DESSERTS, NAMELY, CEREALS; CEREAL BARS, NAMELY, READY TO EAT, CEREAL DERIVED FOOD BARS, MUFFINS, BREADS, DESSERT BARS, NAMELY, BROWNIES, COFFEE FLAVORED DESSERT BARS, CHOCOLATE CRUNCH BARS, PEANUT BUTTER, CARAMEL AND MINT CHEWY CHOCOLATE BARS, FRUIT BARS, NUT BARS, RICE, SAUCES, NAMELY, SALSAS AND TOMATO SAUCES, GRAVIES, SALAD DRESSINGS, FROZEN BARS AND ICES, NAMELY FUDGE BARS, FROZEN CONFECTIONS AND ICE POPS, FOOD BEVERAGES WITH A COFFEE, TEA OR COCOA BASE, NAMELY, COFFEE BASED BEVERAGES CONTAINING MILK,

COCOA BASED BEVERAGES CONTAINING MILK, ICED TEAS, IN CLASS 30 (U.S. CL. 46).

FIRST USE 12-15-2007; IN COMMERCE 12-15-2007.

THE MARK CONSISTS OF STANDARD CHARACTERS WITHOUT CLAIM TO ANY PARTICULAR FONT, STYLE, SIZE, OR COLOR.

OWNER OF U.S. REG. NOS. 1,297,847, 3,251,743, AND OTHERS.

NO CLAIM IS MADE TO THE EXCLUSIVE RIGHT TO USE "ADVANCED", APART FROM THE MARK AS SHOWN.

SN 77-159,313, FILED 4-18-2007.

BRIAN PINO, EXAMINING ATTORNEY

Int. Cl.: 41

Prior U.S. Cls.: 100, 101, and 107

United States Patent and Trademark Office

Reg. No. 3,485,831

Registered Aug. 12, 2008

SERVICE MARK
PRINCIPAL REGISTER



SHERI FRIEDMAN (UNITED STATES INDIVIDUAL)
162 HARTSHORN DRIVE
SHORT HILLS, NJ 07078

FOR: EDUCATION SERVICES, NAMELY, PROVIDING CLASSES AND WORKSHOPS IN THE FIELD OF COLOR AWARENESS, IN CLASS 41 (U.S. CLS. 100, 101 AND 107).

FIRST USE 8-6-2007; IN COMMERCE 8-6-2007.

NO CLAIM IS MADE TO THE EXCLUSIVE RIGHT TO USE "CHILDREN", APART FROM THE MARK AS SHOWN.

THE COLOR(S) RED, ORANGE, YELLOW, GREEN, LIGHT BLUE, BLUE, DARK BLUE, PINK, VIOLET, BLACK AND WHITE IS/ARE CLAIMED AS A FEATURE OF THE MARK.

THE MARK CONSISTS OF THE WORD "COLORKITZ" IN STYLIZED FORM WITH EACH LETTER IN A DIFFERENT COLOR AS FOLLOWS: "C" IS RED, "O" IS ORANGE, "L" IS YELLOW, "O" IS GREEN, "R" IS LIGHT BLUE, "K" IS BLUE, "I" IS DARK BLUE, "T" IS PINK AND "Z" IS VIOLET. ALL OF THE LETTERS ARE OUTLINED IN BLACK. THE WORD "COLORKITZ" IS SURROUNDED BY A BLACK OVAL. ON TOP OF THE OVAL ARE THE WORDS "UNIQUE EXPERIENCES IN COLOR FOR CHILDREN" WHICH ARE ALSO IN BLACK.

SN 77-159,388, FILED 4-18-2007.

HEATHER SAPP, EXAMINING ATTORNEY

Int. Cl.: 7

Prior U.S. Cls.: 13, 19, 21, 23, 31, 34, and 35

Reg. No. 3,485,832

United States Patent and Trademark Office

Registered Aug. 12, 2008

**TRADEMARK
PRINCIPAL REGISTER**

HEDGIVORE

THE DARIEN GROUP, INC. (DELAWARE COR-
PORATION)
10462 COLBY ROAD
DARIEN CENTER, NY 140409714

THE MARK CONSISTS OF STANDARD CHAR-
ACTERS WITHOUT CLAIM TO ANY PARTICULAR
FONT, STYLE, SIZE, OR COLOR.

FOR: POWER-OPERATED ROTARY HEDGE
TRIMMERS, IN CLASS 7 (U.S. CLS. 13, 19, 21, 23, 31,
34 AND 35).

SN 77-159,820, FILED 4-18-2007.

FIRST USE 5-21-2008; IN COMMERCE 5-21-2008.

KAREN BRACEY, EXAMINING ATTORNEY

Int. Cl.: 35

Prior U.S. Cls.: 100, 101, and 102

United States Patent and Trademark Office

Reg. No. 3,485,833

Registered Aug. 12, 2008

**SERVICE MARK
PRINCIPAL REGISTER**

allureblues

COMMON ELEMENTS INC. (CALIFORNIA CORPORATION)
616 WEST COLLEGE STREET
LOS ANGELES, CA 90012

FOR: RETAIL STORE SERVICES FEATURING CLOTHING, FOOTWEAR AND HEADGEAR, ORNAMENTS AND FASHION ACCESSORIES FOR MEN, WOMEN AND KIDS, TRAVELING BAGS, LUGGAGE, SHOPPING BAGS, HANDBAGS, PURSES, WALLETS; WHOLESALE STORES FEATURING CLOTHING, FOOTWEAR AND HEADGEAR, ORNAMENTS AND FASHION ACCESSORIES FOR MEN, WOMEN AND KIDS, TRAVELING BAGS, LUGGAGE, SHOPPING BAGS, HANDBAGS, PURSES, WALLETS; DISTRIBUTORSHIPS IN THE FIELD OF CLOTHING, FOOTWEAR AND HEAD-

GEAR, ORNAMENTS AND FASHION ACCESSORIES FOR MEN, WOMEN AND KIDS, TRAVELING BAGS, LUGGAGE, SHOPPING BAGS, HANDBAGS, PURSES, WALLETS; ONLINE RETAIL CONSIGNMENT STORES FEATURING CLOTHING, FOOTWEAR AND HEADGEAR, ORNAMENTS AND FASHION ACCESSORIES FOR MEN, WOMEN AND KIDS, TRAVELING BAGS, LUGGAGE, SHOPPING BAGS, HANDBAGS, PURSES, WALLETS, IN CLASS 35 (U.S. CLS. 100, 101 AND 102).

FIRST USE 9-1-2007; IN COMMERCE 2-10-2008.

SN 77-160,221, FILED 4-18-2007.

REBECCA GILBERT, EXAMINING ATTORNEY

Int. Cl.: 35

Prior U.S. Cls.: 100, 101, and 102

United States Patent and Trademark Office

Reg. No. 3,485,834

Registered Aug. 12, 2008

**SERVICE MARK
PRINCIPAL REGISTER**



WILCOSKY, WILLIAM A (UNITED STATES INDIVIDUAL)
2057 LAKE PARK DR SE APT O
SMYRNA, GA 30080

FOR: ON-LINE BUSINESS DIRECTORIES FEATURING VENUES, BARS, AND CLUBS; PROMOTING THE CONCERTS OF OTHERS; PROVIDING AN ON-LINE SEARCHABLE DATABASE FEATURING CLASSIFIED AD LISTINGS AND EMPLOYMENT OPPORTUNITIES; ARRANGING AND CONDUCTING MARKETING PROMOTIONAL EVENTS FOR OTHERS; PROMOTING THE PARTIES AND SPECIAL EVENTS OF OTHERS; PROVIDING CONSUMER INFORMATION SERVICES AND MAKING REFERRALS IN THE FIELD OF ENTERTAINMENT SERVICES FOR PRODUCTS, SERVICES, EVENTS, ACTIVITIES, FACILITIES AND LOCATIONS; PROVIDING MARKETING AND PROMOTION OF SPECIAL EVENTS, IN CLASS 35 (U.S. CLS. 100, 101 AND 102).

FIRST USE 3-1-2007; IN COMMERCE 3-1-2007.

NO CLAIM IS MADE TO THE EXCLUSIVE RIGHT TO USE "INDIE SHOWS", APART FROM THE MARK AS SHOWN.

THE COLOR(S) BLUE, AND BLACK IS/ARE CLAIMED AS A FEATURE OF THE MARK.

THE MARK CONSISTS OF A DESIGN OF A TICKET WITH THE COLOR BLACK APPEARING IN THE WORDING "INDIESHOWS" LOCATED AT THE TOP OF THE TICKET AND "BRINGING THE FANS TO THE BANDS" LOCATED DIRECTLY UNDER "INDIESHOWS" AND THE COLOR BLUE APPEARS SHADED IN THE BACKGROUND OF THE STYLIZED DESIGN OF THE TICKET AND IN THE TWO RECTANGULAR BOXES THAT BORDER THE WORDING "INDIESHOWS" AND "BRINGING THE FANS TO THE BANDS".

SN 77-160,237, FILED 4-19-2007.

MICHAEL LEWIS, EXAMINING ATTORNEY

Int. Cl.: 31

Prior U.S. Cls.: 1 and 46

United States Patent and Trademark Office

Reg. No. 3,485,835

Registered Aug. 12, 2008

**TRADEMARK
PRINCIPAL REGISTER**

GREEN ACRES PET BAKERY

FINNEY, CARRIE (UNITED STATES INDIVIDUAL)
P.O. BOX 475
331 CLIFTON ROAD
SOUTH CHARLESTON, OH 45368

FOR: PET FOOD; PET TREATS, IN CLASS 31 (U.S. CLS. 1 AND 46).

FIRST USE 8-31-2007; IN COMMERCE 5-30-2008.

THE MARK CONSISTS OF STANDARD CHARACTERS WITHOUT CLAIM TO ANY PARTICULAR FONT, STYLE, SIZE, OR COLOR.

NO CLAIM IS MADE TO THE EXCLUSIVE RIGHT TO USE "PET BAKERY", APART FROM THE MARK AS SHOWN.

SN 77-160,289, FILED 4-19-2007.

CARYN GLASSER, EXAMINING ATTORNEY

Int. Cl.: 43

Prior U.S. Cls.: 100 and 101

United States Patent and Trademark Office

Reg. No. 3,485,836

Registered Aug. 12, 2008

**SERVICE MARK
PRINCIPAL REGISTER**

HOLEMAN AND FINCH PUBLIC
HOUSE

FIVE FORKS RESTAURANT GROUP, LLC
(GEORGIA LTD LIAB CO)
NE SUITE A
2277 PEACH TREE ROAD
ATLANTA, GA 30309

FOR: RESTAURANT AND BAR SERVICES, IN
CLASS 43 (U.S. CLS. 100 AND 101).

FIRST USE 4-14-2008; IN COMMERCE 4-14-2008.

THE MARK CONSISTS OF STANDARD CHAR-
ACTERS WITHOUT CLAIM TO ANY PARTICULAR
FONT, STYLE, SIZE, OR COLOR.

NO CLAIM IS MADE TO THE EXCLUSIVE
RIGHT TO USE "PUBLIC HOUSE", APART FROM
THE MARK AS SHOWN.

SN 77-161,397, FILED 4-20-2007.

DOMINIC J. FERRAIUOLO, EXAMINING ATTOR-
NEY

Int. Cl.: 28

Prior U.S. Cls.: 22, 23, 38, and 50

United States Patent and Trademark Office

Reg. No. 3,485,837

Registered Aug. 12, 2008

**TRADEMARK
PRINCIPAL REGISTER**

WEIRD U.S.

WEIRD NJ, INC. (NEW JERSEY CORPORATION)
357 BROAD STREET, REAR #2
BLOOMFIELD, NJ 07003

FOR: BOARD GAMES, IN CLASS 28 (U.S. CLS. 22,
23, 38 AND 50).

FIRST USE 9-1-2007; IN COMMERCE 9-1-2007.

THE MARK CONSISTS OF STANDARD CHAR-
ACTERS WITHOUT CLAIM TO ANY PARTICULAR
FONT, STYLE, SIZE, OR COLOR.

NO CLAIM IS MADE TO THE EXCLUSIVE
RIGHT TO USE "U.S.", APART FROM THE MARK
AS SHOWN.

SN 77-161,406, FILED 4-20-2007.

SUNG IN, EXAMINING ATTORNEY

Int. Cl.: 9

Prior U.S. Cls.: 21, 23, 26, 36, and 38

Reg. No. 3,485,838

United States Patent and Trademark Office

Registered Aug. 12, 2008

**TRADEMARK
PRINCIPAL REGISTER**

WaveMatrix

ILLINOIS TOOL WORKS INC. (DELAWARE
CORPORATION)
3600 WEST LAVE AVENUE
GLENVIEW, IL 600261215

THE MARK CONSISTS OF STANDARD CHAR-
ACTERS WITHOUT CLAIM TO ANY PARTICULAR
FONT, STYLE, SIZE, OR COLOR.

FOR: MATERIALS TESTING SOFTWARE FOR
USE IN FATIGUE TESTING, IN CLASS 9 (U.S. CLS.
21, 23, 26, 36 AND 38).

SN 77-161,594, FILED 4-20-2007.

FIRST USE 9-19-2007; IN COMMERCE 9-19-2007.

MICHAEL SOUDERS, EXAMINING ATTORNEY

Int. Cl.: 8

Prior U.S. Cls.: 23, 28, and 44

Reg. No. 3,485,839

United States Patent and Trademark Office

Registered Aug. 12, 2008

**TRADEMARK
PRINCIPAL REGISTER**

SOFT-N-SASSY

UNIVERSAL RAZOR INDUSTRIES, LLC (CALI-
FORNIA LTD LIAB CO)
6031 MALBURG WAY
LOS ANGELES, CA 90058

THE MARK CONSISTS OF STANDARD CHAR-
ACTERS WITHOUT CLAIM TO ANY PARTICULAR
FONT, STYLE, SIZE, OR COLOR.

FOR: RAZORS, IN CLASS 8 (U.S. CLS. 23, 28 AND
44).

SN 77-161,698, FILED 4-20-2007.

FIRST USE 3-4-2008; IN COMMERCE 3-4-2008.

JILL PRATER, EXAMINING ATTORNEY

Int. Cl.: 36

Prior U.S. Cls.: 100, 101, and 102

United States Patent and Trademark Office

Reg. No. 3,485,840

Registered Aug. 12, 2008

**SERVICE MARK
PRINCIPAL REGISTER**

YUM-O!

RACHAEL RAY (UNITED STATES INDIVIDUAL)
C/O WATCH ENTERTAINMENT
375 GREENWICH STREET
NEW YORK, NY 10013

THE MARK CONSISTS OF STANDARD CHARACTERS WITHOUT CLAIM TO ANY PARTICULAR FONT, STYLE, SIZE, OR COLOR.

FOR: CHARITABLE FUNDRAISING SERVICES,
IN CLASS 36 (U.S. CLS. 100, 101 AND 102).

SN 77-161,867, FILED 4-20-2007.

FIRST USE 9-27-2007; IN COMMERCE 9-27-2007.

PAUL CROWLEY, EXAMINING ATTORNEY

Int. Cl.: 43

Prior U.S. Cls.: 100 and 101

United States Patent and Trademark Office

Reg. No. 3,485,841

Registered Aug. 12, 2008

**SERVICE MARK
PRINCIPAL REGISTER**

YUM-O!

RACHAEL RAY (UNITED STATES INDIVIDUAL)
C/O WATCH ENTERTAINMENT
375 GREENWICH STREET
NEW YORK, NY 10013

THE MARK CONSISTS OF STANDARD CHARACTERS WITHOUT CLAIM TO ANY PARTICULAR FONT, STYLE, SIZE, OR COLOR.

FOR: PROVIDING INFORMATION ABOUT FOOD PREPARATION FOR CHILDREN, IN CLASS 43 (U.S. CLS. 100 AND 101).

SN 77-161,948, FILED 4-20-2007.

FIRST USE 4-30-2007; IN COMMERCE 4-30-2007.

PAUL CROWLEY, EXAMINING ATTORNEY

Int. Cl.: 44

Prior U.S. Cls.: 100 and 101

United States Patent and Trademark Office

Reg. No. 3,485,842

Registered Aug. 12, 2008

**SERVICE MARK
PRINCIPAL REGISTER**

YUM-O!

RACHAEL RAY (UNITED STATES INDIVIDUAL)
C/O WATCH ENTERTAINMENT
375 GREENWICH STREET
NEW YORK, NY 10013

THE MARK CONSISTS OF STANDARD CHARACTERS WITHOUT CLAIM TO ANY PARTICULAR FONT, STYLE, SIZE, OR COLOR.

FOR: PROVIDING INFORMATION ABOUT NUTRITION AND HEALTHY EATING HABITS FOR CHILDREN, IN CLASS 44 (U.S. CLS. 100 AND 101).

SN 77-161,963, FILED 4-20-2007.

FIRST USE 4-30-2007; IN COMMERCE 4-30-2007.

PAUL CROWLEY, EXAMINING ATTORNEY

Int. Cl.: 9

Prior U.S. Cls.: 21, 23, 26, 36, and 38

Reg. No. 3,485,843

United States Patent and Trademark Office

Registered Aug. 12, 2008

**TRADEMARK
PRINCIPAL REGISTER**

DOCUSCRIPTS

J&H OFFICE EQUIPMENT, INC. (MONTANA
CORPORATION)
203 HAGGERTY LANE
BOZEMAN, MT 59715

THE MARK CONSISTS OF STANDARD CHAR-
ACTERS WITHOUT CLAIM TO ANY PARTICULAR
FONT, STYLE, SIZE, OR COLOR.

FOR: COMPUTER SOFTWARE FOR CAPTUR-
ING, APPROVING, FILLING AND ARCHIVING
ORDERS FOR PHARMACEUTICALS, IN CLASS 9
(U.S. CLS. 21, 23, 26, 36 AND 38).

SN 77-162,544, FILED 4-22-2007.

FIRST USE 11-3-2007; IN COMMERCE 11-3-2007.

PAUL E. FAHRENKOPF, EXAMINING ATTORNEY

Int. Cl.: 5

Prior U.S. Cls.: 6, 18, 44, 46, 51, and 52

Reg. No. 3,485,844

United States Patent and Trademark Office

Registered Aug. 12, 2008

**TRADEMARK
PRINCIPAL REGISTER**

enhance^{it}

ZISOOK, SHELDON (UNITED STATES INDIVIDUAL)
SUITE 289
640 NORTH LASALLE STREET
CHICAGO, IL 60610

FIRST USE 1-5-2008; IN COMMERCE 2-0-2008.

SN 77-163,510, FILED 4-23-2007.

FOR: DIETARY SUPPLEMENTS, IN CLASS 5 (U.S. CLS. 6, 18, 44, 46, 51 AND 52).

MELVIN AXILBUND, EXAMINING ATTORNEY

Int. Cl.: 35

Prior U.S. Cls.: 100, 101, and 102

United States Patent and Trademark Office

Reg. No. 3,485,845

Registered Aug. 12, 2008

**SERVICE MARK
PRINCIPAL REGISTER**

PRIOR 2 ARRIVAL

MARK F. VALENTI (UNITED STATES INDIVIDUAL)
C/O KEVIN J. SNYDER
5375 LONESOME BIKER LANE
LAS VEGAS, NV 89113

FOR: ADVERTISING AND PUBLICITY SERVICES, NAMELY, PROMOTING THE GOODS, SERVICES, BRAND IDENTITY AND COMMERCIAL INFORMATION AND NEWS OF THIRD PARTIES THROUGH PRINT, AUDIO, VIDEO, DIGITAL AND ON-LINE MEDIUM, IN CLASS 35 (U.S. CLS. 100, 101 AND 102).

FIRST USE 1-1-2008; IN COMMERCE 1-1-2008.

THE MARK CONSISTS OF STANDARD CHARACTERS WITHOUT CLAIM TO ANY PARTICULAR FONT, STYLE, SIZE, OR COLOR.

SN 77-163,674, FILED 4-23-2007.

JEFF DEFORD, EXAMINING ATTORNEY

Int. Cls.: 3 and 5

Prior U.S. Cls.: 1, 4, 6, 18, 44, 46, 50, 51, and 52

United States Patent and Trademark Office

Reg. No. 3,485,846

Registered Aug. 12, 2008

**TRADEMARK
PRINCIPAL REGISTER**

OCEAN PLACENTA

JUSTICE CO., LTD. (JAPAN CORPORATION)

2-4-13 UMEDA, KITA-KU

OSAKA, JAPAN

FOR: COSMETICS, SKIN WHITENING CREAMS, LOTIONS FOR COSMETIC PURPOSES, NAMELY, FOR ANTI-AGING, NON-MEDICATED COSMETIC PREPARATIONS FOR SKIN CARE AND NON-MEDICATED TOILETRIES, ALL SUBSTANTIALLY CONTAINING PLACENTAL INGREDIENTS; TOILET WATER, IN CLASS 3 (U.S. CLS. 1, 4, 6, 50, 51 AND 52).

FIRST USE 10-20-2007; IN COMMERCE 2-3-2008.

FOR: DIETARY SUPPLEMENTS SUBSTANTIALLY CONTAINING PLACENTAL INGREDIENTS, IN CLASS 5 (U.S. CLS. 6, 18, 44, 46, 51 AND 52).

FIRST USE 10-20-2007; IN COMMERCE 2-3-2008.

THE MARK CONSISTS OF STANDARD CHARACTERS WITHOUT CLAIM TO ANY PARTICULAR FONT, STYLE, SIZE, OR COLOR.

NO CLAIM IS MADE TO THE EXCLUSIVE RIGHT TO USE "PLACENTA", APART FROM THE MARK AS SHOWN.

SN 77-163,930, FILED 4-24-2007.

HANNO RITTNER, EXAMINING ATTORNEY

Int. Cl.: 16

Prior U.S. Cls.: 2, 5, 22, 23, 29, 37, 38, and 50

United States Patent and Trademark Office

Reg. No. 3,485,847

Registered Aug. 12, 2008

**TRADEMARK
PRINCIPAL REGISTER**

REVEAL-N-SEAL

CENVEO CORPORATION (DELAWARE CORPORATION)
ONE CANTERBURY GREEN, 201 BROAD STREET
6TH FLOOR
STAMFORD, CT 06901

THE MARK CONSISTS OF STANDARD CHARACTERS WITHOUT CLAIM TO ANY PARTICULAR FONT, STYLE, SIZE, OR COLOR.

FOR: ENVELOPES, IN CLASS 16 (U.S. CLS. 2, 5, 22, 23, 29, 37, 38 AND 50).

SN 77-163,936, FILED 4-24-2007.

FIRST USE 11-1-2007; IN COMMERCE 11-1-2007.

MYRIAH HABEEB, EXAMINING ATTORNEY

Int. Cl.: 35

Prior U.S. Cls.: 100, 101, and 102

United States Patent and Trademark Office

Reg. No. 3,485,848

Registered Aug. 12, 2008

**SERVICE MARK
PRINCIPAL REGISTER**



ARMADA GROUP, LTD. (PENNSYLVANIA CORPORATION)
641 ALPHA DRIVE
PITTSBURGH, PA 15238

FOR: BUSINESS CONSULTING SERVICES RELATING TO PRODUCT DISTRIBUTION, OPERATIONS MANAGEMENT SERVICES, LOGISTICS, REVERSE LOGISTICS, SUPPLY CHAIN, AND PRODUCTION SYSTEMS AND DISTRIBUTION SOLUTIONS; BUSINESS MANAGEMENT SERVICES, NAMELY, MANAGING LOGISTICS, REVERSE LOGISTICS, SUPPLY CHAIN SERVICES, SUPPLY CHAIN VISIBILITY AND SYNCHRONIZATION, SUPPLY AND DEMAND FORECASTING AND PRO-

DUCT DISTRIBUTION PROCESSES FOR OTHERS, IN CLASS 35 (U.S. CLS. 100, 101 AND 102).

FIRST USE 6-0-2007; IN COMMERCE 6-0-2007.

THE COLOR(S) RED IS/ARE CLAIMED AS A FEATURE OF THE MARK.

THE MARK CONSISTS OF RED STYLIZED LETTERS.

SN 77-164,663, FILED 4-24-2007.

SUNG IN, EXAMINING ATTORNEY

Int. Cl.: 16

Prior U.S. Cls.: 2, 5, 22, 23, 29, 37, 38, and 50

Reg. No. 3,485,849

United States Patent and Trademark Office

Registered Aug. 12, 2008

TRADEMARK
PRINCIPAL REGISTER

DRAW PAW

CLAW LLC (VIRGINIA LTD LIAB CO)
2183 EAGLE POINT RD.
HUDDLESTON, VA 24104

FOR: DRAFTING COMPASSES; DRAFTING INSTRUMENTS; DRAWING COMPASSES; SCHOOL SUPPLY KITS CONTAINING VARIOUS COMBINATIONS OF SELECTED SCHOOL SUPPLIES, NAMELY, WRITING INSTRUMENTS, PENS, PENCILS, MECHANICAL PENCILS, ERASERS, MARKERS, CRAYONS, HIGHLIGHTERS, FOLDERS, NOTEBOOKS, PAPER, GRADUATED RULERS, PROTRACTORS, PAPER CLIPS, PENCIL SHARPENERS, WRITING GRIPS, GLUE AND BOOK MARKS; SCHOOL WRITING BOOKS; WRITING PEN KITS COMPRISING PARTS FOR MAKING WRITING PENS; CRAYONS; PASTEL CRAYONS; ARTISTS' PENCILS; COLOR PENCILS; DECORATIONS FOR PENCILS; DECORATIVE PENCIL-TOP ORNAMENTS; PENCIL BOXES; PENCIL CASES; PENCIL ORNAMENTS; PENCIL SHARPENERS; PENCILS; PENCILS FOR PAINTING AND DRAWING; INT PADDLES; A SERIES OF BOOKS, WRITTEN ARTICLES, HANDOUTS AND WORKSHEETS IN THE FIELD OF COLORING; ARTS AND CRAFTS PAINT KITS; BOOK COVERS; BOOKS IN THE FIELD OF COLORING; CHILDREN'S ACTIVITY BOOKS; CHILDREN'S BOOKS; CHILDREN'S INTERACTIVE EDUCATIONAL BOOKS; COLORING BOOKS; CO-

MIC BOOKS; COMPOSITION BOOKS; EDUCATIONAL PUBLICATIONS, NAMELY, EDUCATIONAL LEARNING CARDS, FLASH CARDS, ACTIVITY CARDS, WORKBOOKS, TEXTBOOKS, ACTIVITY BOOKS, STORY BOOKS, PUZZLE BOOKS, PUZZLES, TEACHER GUIDES, MANUALS, POSTERS, EDUCATIONAL CARD GAMES AND EDUCATIONAL BOOKLETS IN THE FIELD OF COLORING; FLIP BOOKS; NON-FICTION BOOKS ON A VARIETY OF TOPICS; PASTES AND OTHER ADHESIVES FOR STATIONERY OR HOUSEHOLD PURPOSES; PICTURE BOOKS; SKETCH BOOKS; STATIONERY WRITING PAPER AND ENVELOPES; STORY BOOKS; TALKING CHILDREN'S BOOKS, IN CLASS 16 (U.S. CLS. 2, 5, 22, 23, 29, 37, 38 AND 50).

FIRST USE 5-1-2008; IN COMMERCE 5-1-2008.

THE MARK CONSISTS OF STANDARD CHARACTERS WITHOUT CLAIM TO ANY PARTICULAR FONT, STYLE, SIZE, OR COLOR.

NO CLAIM IS MADE TO THE EXCLUSIVE RIGHT TO USE "DRAW", APART FROM THE MARK AS SHOWN.

SN 77-164,846, FILED 4-25-2007.

JEFF DEFORD, EXAMINING ATTORNEY

Int. Cl.: 36

Prior U.S. Cls.: 100, 101, and 102

United States Patent and Trademark Office

Reg. No. 3,485,850

Registered Aug. 12, 2008

**SERVICE MARK
PRINCIPAL REGISTER**



RAY MARKS CO. LLC (NEW YORK LTD LIAB
CO)
C/O WATCH ENTERTAINMENT, INC.
375 GREENWICH ST.
NEW YORK, NY 10013

FOR: CHARITABLE FUNDRAISING SERVICES,
IN CLASS 36 (U.S. CLS. 100, 101 AND 102).

FIRST USE 9-27-2007; IN COMMERCE 9-27-2007.

THE COLOR(S) ORANGE AND YELLOW IS/ARE
CLAIMED AS A FEATURE OF THE MARK.

THE MARK CONSISTS OF "YUM-O" IN GRADA-
TIONS OF ORANGE AND YELLOW, FOLLOWED
BY A YELLOW AND ORANGE WHISK.

SN 77-165,564, FILED 4-25-2007.

PAUL CROWLEY, EXAMINING ATTORNEY

Int. Cl.: 43

Prior U.S. Cls.: 100 and 101

United States Patent and Trademark Office

Reg. No. 3,485,851

Registered Aug. 12, 2008

**SERVICE MARK
PRINCIPAL REGISTER**



RAY, RACHAEL (UNITED STATES INDIVIDUAL)
C/O WATCH ENTERTAINMENT
375 GREENWICH STREET
NEW YORK, NY 10013

FOR: PROVIDING INFORMATION ABOUT FOOD PREPARATION FOR CHILDREN, IN CLASS 43 (U.S. CLS. 100 AND 101).

FIRST USE 4-30-2007; IN COMMERCE 4-30-2007.

THE COLOR(S) ORANGE AND YELLOW IS/ARE CLAIMED AS A FEATURE OF THE MARK.

THE MARK CONSISTS OF "YUM-O" IN GRADATIONS OF ORANGE AND YELLOW, FOLLOWED BY A YELLOW AND ORANGE WHISK.

SN 77-165,635, FILED 4-25-2007.

PAUL CROWLEY, EXAMINING ATTORNEY

Int. Cl.: 44

Prior U.S. Cls.: 100 and 101

United States Patent and Trademark Office

Reg. No. 3,485,852

Registered Aug. 12, 2008

**SERVICE MARK
PRINCIPAL REGISTER**



RAY, RACHAEL (UNITED STATES INDIVIDUAL)
C/O WATCH ENTERTAINMENT
375 GREENWICH STREET
NEW YORK, NY 10013

FOR: PROVIDING INFORMATION ABOUT NUTRITION AND HEALTHY EATING HABITS FOR CHILDREN, IN CLASS 44 (U.S. CLS. 100 AND 101).

FIRST USE 4-30-2007; IN COMMERCE 4-30-2007.

THE COLOR(S) ORANGE AND YELLOW IS/ARE CLAIMED AS A FEATURE OF THE MARK.

THE MARK CONSISTS OF "YUM-O" IN GRADATIONS OF ORANGE AND YELLOW, FOLLOWED BY A YELLOW AND ORANGE WHISK.

SN 77-165,704, FILED 4-25-2007.

PAUL CROWLEY, EXAMINING ATTORNEY

Int. Cl.: 25

Prior U.S. Cls.: 22 and 39

United States Patent and Trademark Office

Reg. No. 3,485,853

Registered Aug. 12, 2008

**TRADEMARK
PRINCIPAL REGISTER**

**PROFIL8
athletic**

CHRIQUI CLAUDE (UNITED STATES INDIVIDUAL)
1605 CLUB DRIVE
DOUGLAS, GA 31533

FOR: COATS FOR MEN AND WOMEN; DRESS SUITS; DRY SUITS; FOOTWEAR FOR MEN; FOOTWEAR FOR MEN AND WOMEN; GOLF TROUSERS; LEOTARDS AND TIGHTS FOR WOMEN, MEN AND CHILDREN OF NYLON, COTTON OR OTHER TEXTILE FIBERS; MEN AND WOMEN JACKETS, COATS, TROUSERS, VESTS; MEN'S SOCKS; MEN'S SUITS; MEN'S SUITS, WOMEN'S SUITS; SHORT TROUSERS; BATHING SUITS FOR MEN; DRESS SHIRTS; GOLF SHIRTS; KNIT SHIRTS, IN CLASS 25 (U.S. CLS. 22 AND 39).

FIRST USE 4-30-2008; IN COMMERCE 1-30-2008.

THE MARK CONSISTS OF STANDARD CHARACTERS WITHOUT CLAIM TO ANY PARTICULAR FONT, STYLE, SIZE, OR COLOR.

NO CLAIM IS MADE TO THE EXCLUSIVE RIGHT TO USE "ATHLETIC", APART FROM THE MARK AS SHOWN.

SN 77-165,707, FILED 4-25-2007.

BILL DAWE, EXAMINING ATTORNEY

Int. Cl.: 36

Prior U.S. Cls.: 100, 101, and 102

United States Patent and Trademark Office

Reg. No. 3,485,854

Registered Aug. 12, 2008

**SERVICE MARK
PRINCIPAL REGISTER**

SENS8TIONAL HOMES

THE BELO COMPANY (DELAWARE BUSINESS
TRUST)
SILVERSIDE CARR EXECUTIVE CENTER
501 SILVERSIDE ROAD, SUITE 410
WILMINGTON, DE 19809

FOR: CHARITABLE FUND RAISING SERVICES
BY MEANS OF HOUSE TOURS, IN CLASS 36 (U.S.
CLS. 100, 101 AND 102).

FIRST USE 10-18-2007; IN COMMERCE 10-18-2007.

THE MARK CONSISTS OF STANDARD CHAR-
ACTERS WITHOUT CLAIM TO ANY PARTICULAR
FONT, STYLE, SIZE, OR COLOR.

NO CLAIM IS MADE TO THE EXCLUSIVE
RIGHT TO USE "HOMES", APART FROM THE
MARK AS SHOWN.

SN 77-166,084, FILED 4-26-2007.

JEAN IM, EXAMINING ATTORNEY

Int. Cl.: 9

Prior U.S. Cls.: 21, 23, 26, 36, and 38

Reg. No. 3,485,855

United States Patent and Trademark Office

Registered Aug. 12, 2008

**TRADEMARK
PRINCIPAL REGISTER**

EYE ON PERFORMANCE

UNITED STATES OLYMPIC COMMITTEE (UNI-
TED STATES CONGRESSIONALLY CHAR-
TERED NONPROFIT ORGANIZATION)
OFFICE OF THE GENERAL COUNSEL
1 OLYMPIC PLAZA
COLORADO SPRINGS, CO 80909

FOR: A COACHING TOOL COMPRISED OF
VIDEO EQUIPMENT, NAMELY, VIDEO CAMERAS,
COMPUTER HARDWARE AND SOFTWARE THAT
ALLOWS FOR RECORDING AND REVIEW OF
ATHLETE PERFORMANCES, IN CLASS 9 (U.S.
CLS. 21, 23, 26, 36 AND 38).

FIRST USE 1-31-2007; IN COMMERCE 1-31-2007.

THE MARK CONSISTS OF STANDARD CHAR-
ACTERS WITHOUT CLAIM TO ANY PARTICULAR
FONT, STYLE, SIZE, OR COLOR.

SN 77-166,337, FILED 4-26-2007.

JEFFERY COWARD, EXAMINING ATTORNEY

Int. Cl.: 36

Prior U.S. Cls.: 100, 101, and 102

United States Patent and Trademark Office

Reg. No. 3,485,856

Registered Aug. 12, 2008

**SERVICE MARK
PRINCIPAL REGISTER**

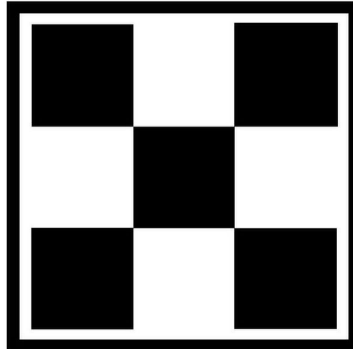

SOCIETE DES PRODUITS NESTLE S.A. (SWITZERLAND SOCIETE ANONYME)
INTELLECTUAL PROPERTY DEPARTMENT
CASE POSTALE 353
VEVEY, SWITZERLAND 1800

FOR: INSURANCE UNDERWRITING IN THE FIELD OF HEALTH INSURANCE FOR ANIMALS AND PETS, IN CLASS 36 (U.S. CLS. 100, 101 AND 102).

FIRST USE 6-6-2008; IN COMMERCE 6-6-2008.

OWNER OF U.S. REG. NOS. 126,543, 1,120,673, AND OTHERS.

THE MARK CONSISTS OF 9 SQUARE CHECKERBOARD DESIGN INSIDE A SQUARE FRAME.

SN 77-166,561, FILED 4-26-2007.

SALLY SHIH, EXAMINING ATTORNEY

Int. Cl.: 36

Prior U.S. Cls.: 100, 101, and 102

United States Patent and Trademark Office

Reg. No. 3,485,857

Registered Aug. 12, 2008

**SERVICE MARK
PRINCIPAL REGISTER**

PURINA

SOCIETE DES PRODUITS NESTLE S.A. (SWITZERLAND SOCIETE ANONYME)
INTELLECTUAL PROPERTY DEPARTMENT
CASE POSTALE 353
VEVEY, SWITZERLAND 1800

FOR: INSURANCE UNDERWRITING IN THE
FIELD OF HEALTH INSURANCE FOR ANIMALS
AND PETS, IN CLASS 36 (U.S. CLS. 100, 101 AND 102).

FIRST USE 6-6-2008; IN COMMERCE 6-6-2008.

THE MARK CONSISTS OF STANDARD CHARACTERS WITHOUT CLAIM TO ANY PARTICULAR FONT, STYLE, SIZE, OR COLOR.

OWNER OF U.S. REG. NOS. 61,064, 772,457, AND OTHERS.

SN 77-166,570, FILED 4-26-2007.

SALLY SHIH, EXAMINING ATTORNEY

Int. Cl.: 9

Prior U.S. Cls.: 21, 23, 26, 36, and 38

Reg. No. 3,485,858

United States Patent and Trademark Office

Registered Aug. 12, 2008

**TRADEMARK
PRINCIPAL REGISTER**

DOCKNPARTY

FKA DISTRIBUTING CO. (MICHIGAN CORPORATION), DBA HOMEDICS, INC.,
3000 PONTIAC TRAIL
COMMERCE TOWNSHIP, MI 48390

CES AND MEDIA PLAYERS; DIGITAL SOUND MACHINES FOR REPRODUCING SOUNDS OF THE ENVIRONMENT, IN CLASS 9 (U.S. CLS. 21, 23, 26, 36 AND 38).

FOR: ELECTRONIC PRODUCTS IN THE NATURE OF AUDIO EQUIPMENT, NAMELY, AMPLIFIERS AND SPEAKERS, RADIOS INCORPORATING CLOCKS, RADIOS INCORPORATING ALARM CLOCKS, RADIOS INCORPORATING ALARM CLOCKS WITH MP3 PLAYERS; MEDIA PLAYERS INCORPORATING RADIOS, MEDIA PLAYERS INCORPORATING CLOCKS, MEDIA PLAYERS INCORPORATING SPEAKERS; COMPUTER DOCKING STATIONS INCLUDING SPEAKERS FOR PORTABLE ELECTRONIC DEVI-

FIRST USE 8-0-2007; IN COMMERCE 8-0-2007.

THE MARK CONSISTS OF STANDARD CHARACTERS WITHOUT CLAIM TO ANY PARTICULAR FONT, STYLE, SIZE, OR COLOR.

SN 77-166,688, FILED 4-26-2007.

MARLENE BELL, EXAMINING ATTORNEY

Int. Cls.: 7, 11, and 20

**Prior U.S. Cls.: 2, 13, 19, 21, 22, 23, 25, 31, 32, 34, 35,
and 50**

Reg. No. 3,485,859

United States Patent and Trademark Office

Registered Aug. 12, 2008

**TRADEMARK
PRINCIPAL REGISTER**



AUTOMATIC BAR CONTROLS, INC. (CALIFORNIA CORPORATION)
790 EUBANKS DRIVE
VACAVILLE, CA 95688

FOR: DISPENSING MACHINES, NAMELY, BEVERAGE DISPENSING MACHINES, LIQUOR DISPENSING MACHINES AND CONDIMENT DISPENSING MACHINES, AND PARTS FOR EACH OF THE FOREGOING; MIXING MACHINES, NAMELY, BEVERAGE MIXERS, IN CLASS 7 (U.S. CLS. 13, 19, 21, 23, 31, 34 AND 35).

FIRST USE 9-15-1998; IN COMMERCE 9-15-1998.

FOR: ENVIRONMENTAL CONTROL DISPENSING EQUIPMENT, NAMELY, REFRIGERATED BEVERAGE DISPENSING UNITS, REFRIGERATED

LIQUOR DISPENSING UNITS, HEATED BEVERAGE DISPENSING UNITS; AND HEATED CONDIMENT DISPENSING UNITS, IN CLASS 11 (U.S. CLS. 13, 21, 23, 31 AND 34).

FIRST USE 7-10-2001; IN COMMERCE 7-10-2001.

FOR: STORAGE AND DISPLAY EQUIPMENT, NAMELY, BEVERAGE RACKS, LIQUOR RACKS, BEVERAGE CABINETS, LIQUOR CABINETS, AND CONDIMENT CABINETS, IN CLASS 20 (U.S. CLS. 2, 13, 22, 25, 32 AND 50).

FIRST USE 6-29-2000; IN COMMERCE 6-29-2000.

SN 77-166,700, FILED 4-26-2007.

MELVIN AXILBUND, EXAMINING ATTORNEY

Int. Cl.: 28

Prior U.S. Cls.: 22, 23, 38, and 50

United States Patent and Trademark Office

Reg. No. 3,485,860

Registered Aug. 12, 2008

**TRADEMARK
PRINCIPAL REGISTER**

REBECCA THE RHYMING RACCOON

BREWER EDUCATIONAL RESOURCES, INC.
(TEXAS CORPORATION)
205 LEDGENEST DRIVE
MCKINNEY, TX 75070

FOR: PUPPETS FOR USE IN CLASSROOM INSTRUCTION AND TEACHER TRAINING IN THE FIELD OF LANGUAGE PROGRAMMING FOR YOUNG CHILDREN, IN CLASS 28 (U.S. CLS. 22, 23, 38 AND 50).

FIRST USE 9-1-2002; IN COMMERCE 9-1-2002.

THE MARK CONSISTS OF STANDARD CHARACTERS WITHOUT CLAIM TO ANY PARTICULAR FONT, STYLE, SIZE, OR COLOR.

SN 77-166,836, FILED 4-26-2007.

PAUL F. GAST, EXAMINING ATTORNEY

Int. Cl.: 28

Prior U.S. Cls.: 22, 23, 38, and 50

United States Patent and Trademark Office

Reg. No. 3,485,861

Registered Aug. 12, 2008

**TRADEMARK
PRINCIPAL REGISTER**

PUPPETS WITH A PURPOSE

BREWER EDUCATIONAL RESOURCES, INC.
(TEXAS CORPORATION)
205 LEDGENEST DRIVE
MCKINNEY, TX 75070

FOR: PUPPETS FOR USE IN CLASSROOM INSTRUCTION AND TEACHER TRAINING IN THE FIELD OF LANGUAGE PROGRAMMING FOR YOUNG CHILDREN, IN CLASS 28 (U.S. CLS. 22, 23, 38 AND 50).

FIRST USE 9-1-2002; IN COMMERCE 9-1-2002.

THE MARK CONSISTS OF STANDARD CHARACTERS WITHOUT CLAIM TO ANY PARTICULAR FONT, STYLE, SIZE, OR COLOR.

SN 77-166,846, FILED 4-26-2007.

PAUL F. GAST, EXAMINING ATTORNEY

Int. Cl.: 29

Prior U.S. Cl.: 46

United States Patent and Trademark Office

Reg. No. 3,485,862

Registered Aug. 12, 2008

**TRADEMARK
PRINCIPAL REGISTER**

FLAVOR YOUR WORLD

WHITEWAVE SERVICES, INC. (DELAWARE CORPORATION)

546

300 DELAWARE AVENUE
WILMINGTON, DE 19801

FOR: NON-DAIRY CREAMER, IN CLASS 29 (U.S. CL. 46).

FIRST USE 4-1-2008; IN COMMERCE 4-1-2008.

THE MARK CONSISTS OF STANDARD CHARACTERS WITHOUT CLAIM TO ANY PARTICULAR FONT, STYLE, SIZE, OR COLOR.

NO CLAIM IS MADE TO THE EXCLUSIVE RIGHT TO USE "FLAVOR", APART FROM THE MARK AS SHOWN.

SN 77-167,231, FILED 4-27-2007.

CAROLYN GRAY, EXAMINING ATTORNEY

Int. Cls.: 41, 42, and 44

Prior U.S. Cls.: 100, 101, and 107

United States Patent and Trademark Office

Reg. No. 3,485,863

Registered Aug. 12, 2008

**SERVICE MARK
PRINCIPAL REGISTER**



NORTH SHORE-LONG ISLAND JEWISH
HEALTH SYSTEM, INC. (NEW YORK COR-
PORATION)
145 COMMUNITY DRIVE
GREAT NECK, NY 11021

FOR: PROVIDING CONTINUING MEDICAL
EDUCATION COURSES IN THE FIELD OF UROL-
OGY; MEDICAL TRAINING AND TEACHING IN
THE FIELD OF UROLOGY, IN CLASS 41 (U.S. CLS.
100, 101 AND 107).

FIRST USE 2-12-2007; IN COMMERCE 2-12-2007.

FOR: MEDICAL AND SCIENTIFIC RESEARCH
IN THE FIELD OF UROLOGY; MEDICAL LABORA-
TORIES IN THE FIELD OF UROLOGY, IN CLASS 42
(U.S. CLS. 100 AND 101).

FIRST USE 2-12-2007; IN COMMERCE 2-12-2007.

FOR: UROLOGY HOSPITALS; MEDICAL SERVI-
CES IN THE FIELD OF UROLOGY; MEDICAL
ASSISTANCE SERVICES IN THE FIELD OF UROL-

OGY; PROVIDING MEDICAL INFORMATION,
CONSULTANCY AND ADVISORY SERVICES IN
THE FIELD OF UROLOGY; MEDICAL CLINICS IN
THE FIELD OF UROLOGY; MEDICAL COUNSEL-
ING IN THE FIELD OF UROLOGY; MEDICAL
TESTING IN THE FIELD OF UROLOGY, IN CLASS
44 (U.S. CLS. 100 AND 101).

FIRST USE 2-12-2007; IN COMMERCE 2-12-2007.

NO CLAIM IS MADE TO THE EXCLUSIVE
RIGHT TO USE "INSTITUTE FOR UROLOGY",
APART FROM THE MARK AS SHOWN.

THE MARK CONSISTS OF A DESIGN OF A
THREE-DIMENSIONAL TRIANGLE FOLLOWED
BY THE WORDS "THE SMITH INSTITUTE FOR
UROLOGY" WITH A BAR UNDERNEATH.

SN 77-167,374, FILED 4-27-2007.

MICHAEL GAAFAR, EXAMINING ATTORNEY

Int. Cl.: 37

Prior U.S. Cls.: 100, 103, and 106

United States Patent and Trademark Office

Reg. No. 3,485,864

Registered Aug. 12, 2008

**SERVICE MARK
PRINCIPAL REGISTER**

TOO TRICK

YANKUN, CHRISTOPHER (UNITED STATES IN-
DIVIDUAL)

90 WILDCAT LN.

NORWELL, MA 02061

FOR: AUTOMOBILE CUSTOMIZATION SERVI-
CES, IN CLASS 37 (U.S. CLS. 100, 103 AND 106).

FIRST USE 12-29-2003; IN COMMERCE 5-24-2007.

THE MARK CONSISTS OF STANDARD CHAR-
ACTERS WITHOUT CLAIM TO ANY PARTICULAR
FONT, STYLE, SIZE, OR COLOR.

NO CLAIM IS MADE TO THE EXCLUSIVE
RIGHT TO USE "TRICK", APART FROM THE
MARK AS SHOWN.

SN 77-168,819, FILED 4-30-2007.

HOWARD SMIGA, EXAMINING ATTORNEY

Int. Cl.: 8

Prior U.S. Cls.: 23, 28, and 44

United States Patent and Trademark Office

Reg. No. 3,485,865

Registered Aug. 12, 2008

**TRADEMARK
PRINCIPAL REGISTER**

EZ-RETRIEVER

AGRI-COVER, INC. (NORTH DAKOTA COR-
PORATION)
3000 HIGHWAY 281 SE
JAMESTOWN, ND 58401

THE MARK CONSISTS OF STANDARD CHAR-
ACTERS WITHOUT CLAIM TO ANY PARTICULAR
FONT, STYLE, SIZE, OR COLOR.

FOR: HAND TOOL FOR REACHING AND MOV-
ING OUT OF REACH OBJECTS, IN CLASS 8 (U.S.
CLS. 23, 28 AND 44).

SN 77-170,152, FILED 5-1-2007.

FIRST USE 7-1-2007; IN COMMERCE 7-1-2007.

LINDA POWELL, EXAMINING ATTORNEY

Int. Cl.: 41

Prior U.S. Cls.: 100, 101, and 107

United States Patent and Trademark Office

Reg. No. 3,485,866

Registered Aug. 12, 2008

**SERVICE MARK
PRINCIPAL REGISTER**

DANCE ANYWHERE

BETH FEIN (UNITED STATES INDIVIDUAL)
P.O. BOX 21363
OAKLAND, CA 94620

FOR: ENTERTAINMENT, NAMELY, PRESENTATION OF MUSICAL AND DANCE PERFORMANCE ART AND LIVE PERFORMANCES IN THE NATURE OF MUSICAL AND DANCE PERFORMANCE ART, IN CLASS 41 (U.S. CLS. 100, 101 AND 107).

FIRST USE 1-0-2005; IN COMMERCE 1-0-2005.

THE MARK CONSISTS OF STANDARD CHARACTERS WITHOUT CLAIM TO ANY PARTICULAR FONT, STYLE, SIZE, OR COLOR.

NO CLAIM IS MADE TO THE EXCLUSIVE RIGHT TO USE "DANCE", APART FROM THE MARK AS SHOWN.

SN 77-170,311, FILED 5-1-2007.

KATHERINE CONNOLLY, EXAMINING ATTORNEY

Int. Cl.: 16

Prior U.S. Cls.: 2, 5, 22, 23, 29, 37, 38, and 50

Reg. No. 3,485,867

United States Patent and Trademark Office

Registered Aug. 12, 2008

**TRADEMARK
PRINCIPAL REGISTER**

EVERGREEN PACKAGING

EVERGREEN PACKAGING INC. (DELAWARE
CORPORATION)
SUITE 510
6410 POPLAR AVENUE
MEMPHIS, TN 38119

FOR: BOXES, CONTAINERS, AND CARTONS OF
PAPERBOARD FOR COMMERCIAL PACKAGING,
IN CLASS 16 (U.S. CLS. 2, 5, 22, 23, 29, 37, 38 AND 50).

FIRST USE 2-28-2007; IN COMMERCE 2-28-2007.

THE MARK CONSISTS OF STANDARD CHAR-
ACTERS WITHOUT CLAIM TO ANY PARTICULAR
FONT, STYLE, SIZE, OR COLOR.

OWNER OF U.S. REG. NO. 1,880,374.

NO CLAIM IS MADE TO THE EXCLUSIVE
RIGHT TO USE "PACKAGING", APART FROM
THE MARK AS SHOWN.

SN 77-170,341, FILED 5-1-2007.

STEVEN PEREZ, EXAMINING ATTORNEY

Int. Cl.: 25

Prior U.S. Cls.: 22 and 39

United States Patent and Trademark Office

Reg. No. 3,485,868

Registered Aug. 12, 2008

**TRADEMARK
PRINCIPAL REGISTER**

POWER RANGERS JUNGLE FURY

BVS ENTERTAINMENT, INC. (DELAWARE
CORPORATION)
500 SOUTH BUENA VISTA STREET
BURBANK, CA 91521

THE MARK CONSISTS OF STANDARD CHAR-
ACTERS WITHOUT CLAIM TO ANY PARTICULAR
FONT, STYLE, SIZE, OR COLOR.

FOR: PAJAMAS; TANK TOPS; T-SHIRTS; SWIM-
SUITS; SHIRTS; SLEEPWEAR; UNDERWEAR, IN
CLASS 25 (U.S. CLS. 22 AND 39).

SN 77-170,450, FILED 5-1-2007.

FIRST USE 6-5-2008; IN COMMERCE 6-5-2008.

MIDGE BUTLER, EXAMINING ATTORNEY

Int. Cl.: 20

Prior U.S. Cls.: 2, 13, 22, 25, 32, and 50

Reg. No. 3,485,869

United States Patent and Trademark Office

Registered Aug. 12, 2008

**TRADEMARK
PRINCIPAL REGISTER**

FEEL GOOD BAG

FEEL GOOD BAG, LLC (FLORIDA LTD LIAB
CO)
#203
1408 N. KILLIAN DRIVE
LAKE PARK, FL 33403

FOR: NOVELTY ITEM, NAMELY, A VELVET
SACK CONTAINING SMALL STONES WITH IN-
SPIRATIONAL, MOTIVATIONAL PHRASES, SENTI-
MENTS, SCRIPTURES OR MESSAGES ETCHED
AND ENGRAVED THEREON, IN CLASS 20 (U.S.
CLS. 2, 13, 22, 25, 32 AND 50).

FIRST USE 6-7-2007; IN COMMERCE 7-2-2007.

THE MARK CONSISTS OF STANDARD CHAR-
ACTERS WITHOUT CLAIM TO ANY PARTICULAR
FONT, STYLE, SIZE, OR COLOR.

NO CLAIM IS MADE TO THE EXCLUSIVE
RIGHT TO USE "BAG", APART FROM THE MARK
AS SHOWN.

SN 77-170,632, FILED 5-2-2007.

CYNTHIA SLOAN, EXAMINING ATTORNEY

Int. Cl.: 21

Prior U.S. Cls.: 2, 13, 23, 29, 30, 33, 40, and 50

Reg. No. 3,485,870

United States Patent and Trademark Office

Registered Aug. 12, 2008

**TRADEMARK
PRINCIPAL REGISTER**

RUB-A-DUB-SCRUBS

BATH & BODY WORKS BRAND MANAGE-
MENT, INC. (DELAWARE CORPORATION)
7 LIMITED PARKWAY EAST
REYNOLDSBURG, OH 43068

THE MARK CONSISTS OF STANDARD CHAR-
ACTERS WITHOUT CLAIM TO ANY PARTICULAR
FONT, STYLE, SIZE, OR COLOR.

FOR: BATH SPONGES, IN CLASS 21 (U.S. CLS. 2,
13, 23, 29, 30, 33, 40 AND 50).

SN 77-171,193, FILED 5-2-2007.

FIRST USE 11-30-2007; IN COMMERCE 11-30-2007.

SUNG IN, EXAMINING ATTORNEY

Int. Cl.: 35

Prior U.S. Cls.: 100, 101, and 102

United States Patent and Trademark Office

Reg. No. 3,485,871

Registered Aug. 12, 2008

**SERVICE MARK
PRINCIPAL REGISTER**

LIVE NATION

LIVE NATION WORLDWIDE, INC. (DELAWARE
CORPORATION)
9348 CIVIC CENTER DRIVE
BEVERLY HILLS, CA 90210

FOR: BUSINESS MANAGEMENT SERVICES,
EVENT MANAGEMENT SERVICES, NAMELY,
PROVIDING MARKETING, PROMOTION AND OR-
GANIZATION OF SPECIAL EVENTS; BUSINESS
MARKETING AND CONSULTING SERVICES IN
THE FIELDS OF MUSIC, NEWS AND ENTERTAIN-
MENT, IN CLASS 35 (U.S. CLS. 100, 101 AND 102).

FIRST USE 1-1-2006; IN COMMERCE 1-1-2006.

THE MARK CONSISTS OF STANDARD CHAR-
ACTERS WITHOUT CLAIM TO ANY PARTICULAR
FONT, STYLE, SIZE, OR COLOR.

OWNER OF U.S. REG. NOS. 3,223,715, 3,223,721,
AND 3,226,595.

SN 77-171,978, FILED 5-3-2007.

STEVEN JACKSON, EXAMINING ATTORNEY

Int. Cl.: 16

Prior U.S. Cls.: 2, 5, 22, 23, 29, 37, 38, and 50

Reg. No. 3,485,872

United States Patent and Trademark Office

Registered Aug. 12, 2008

**TRADEMARK
PRINCIPAL REGISTER**

IDENTITY THEFT BUSTER

VISIONWORKS GROUP LLC (ILLINOIS LTD
LIAB CO)
2201 WAUKEGAN ROAD SUITE 255
BANNOCKBURN, IL 60015

FOR: PAPER SHREDDERS FOR HOME AND
OFFICE USE, IN CLASS 16 (U.S. CLS. 2, 5, 22, 23, 29,
37, 38 AND 50).

FIRST USE 1-17-2008; IN COMMERCE 1-17-2008.

THE MARK CONSISTS OF STANDARD CHAR-
ACTERS WITHOUT CLAIM TO ANY PARTICULAR
FONT, STYLE, SIZE, OR COLOR.

NO CLAIM IS MADE TO THE EXCLUSIVE
RIGHT TO USE "IDENTITY THEFT", APART FROM
THE MARK AS SHOWN.

SN 77-172,163, FILED 5-3-2007.

TAMARA FRAZIER, EXAMINING ATTORNEY

Int. Cl.: 28

Prior U.S. Cls.: 22, 23, 38, and 50

Reg. No. 3,485,873

United States Patent and Trademark Office

Registered Aug. 12, 2008

**TRADEMARK
PRINCIPAL REGISTER**

CHOCOLATE FIX

THINKFUN, INC. (VIRGINIA CORPORATION)
1321 CAMERON STREET
ALEXANDRIA, VA 22314

THE MARK CONSISTS OF STANDARD CHAR-
ACTERS WITHOUT CLAIM TO ANY PARTICULAR
FONT, STYLE, SIZE, OR COLOR.

FOR: AMUSEMENT DEVICES, NAMELY, MA-
NIPULABLE GAMES AND PUZZLES, IN CLASS 28
(U.S. CLS. 22, 23, 38 AND 50).

SN 77-172,718, FILED 5-4-2007.

FIRST USE 2-12-2008; IN COMMERCE 2-12-2008.

AMY MCMENAMIN, EXAMINING ATTORNEY

Int. Cl.: 35

Prior U.S. Cls.: 100, 101, and 102

United States Patent and Trademark Office

Reg. No. 3,485,874

Registered Aug. 12, 2008

**SERVICE MARK
PRINCIPAL REGISTER**

UNREALIZED RISK

BASIS POINT GROUP, LLC (MASSACHUSETTS
LTD LIAB CO)
470 ATLANTIC AVENUE
BOSTON, MA 02210

FOR: BUSINESS CONSULTING SERVICES DI-
RECTED TO FINANCIAL INSTITUTIONS TO PRO-
VIDE A MEASUREMENT OF THE QUALITY OF
FLOW OF THEIR FINANCIAL PROCESSES, IN
CLASS 35 (U.S. CLS. 100, 101 AND 102).

FIRST USE 6-24-2008; IN COMMERCE 6-24-2008.

THE MARK CONSISTS OF STANDARD CHAR-
ACTERS WITHOUT CLAIM TO ANY PARTICULAR
FONT, STYLE, SIZE, OR COLOR.

NO CLAIM IS MADE TO THE EXCLUSIVE
RIGHT TO USE "RISK", APART FROM THE MARK
AS SHOWN.

SN 77-173,963, FILED 5-7-2007.

JOHN DWYER, EXAMINING ATTORNEY

Int. Cl.: 36

Prior U.S. Cls.: 100, 101, and 102

United States Patent and Trademark Office

Reg. No. 3,485,875

Registered Aug. 12, 2008

**SERVICE MARK
PRINCIPAL REGISTER**

SUNTRUST GAMEPLAN

SUNTRUST BANKS, INC. (GEORGIA CORPORATION)
MC FL/ORL 1093
200 SOUTH ORANGE AVENUE
ORLANDO, FL 32801

FOR: FINANCIAL PLANNING FOR RETIREMENT, IN CLASS 36 (U.S. CLS. 100, 101 AND 102).

FIRST USE 7-1-2007; IN COMMERCE 11-1-2007.

THE MARK CONSISTS OF STANDARD CHARACTERS WITHOUT CLAIM TO ANY PARTICULAR FONT, STYLE, SIZE, OR COLOR.

OWNER OF U.S. REG. NOS. 2,634,807, 3,002,966, AND 3,128,013.

SN 77-174,038, FILED 5-7-2007.

CAROLYN CATALDO, EXAMINING ATTORNEY

Int. Cls.: 35, 41, and 44

Prior U.S. Cls.: 100, 101, 102, and 107

United States Patent and Trademark Office

Reg. No. 3,485,876

Registered Aug. 12, 2008

**SERVICE MARK
PRINCIPAL REGISTER**

NUVITA

RJM INVESTMENT, LLC (NEW MEXICO LTD
LIAB CO)
9600 SAN MATEO, NE
ALBUQUERQUE, NM 87113

FOR: COST MANAGEMENT FOR THE HEALTH
BENEFIT PLANS OF OTHERS; COST MANAGE-
MENT FOR THE HEALTH CARE BENEFIT PLANS
OF OTHERS; MEDICAL COST MANAGEMENT , IN
CLASS 35 (U.S. CLS. 100, 101 AND 102).

FIRST USE 11-1-2007; IN COMMERCE 11-1-2007.

FOR: PHYSICAL FITNESS CONDITIONING
CLASSES; PHYSICAL FITNESS CONSULTATION;
PHYSICAL FITNESS INSTRUCTION; PROVIDING
ASSISTANCE, PERSONAL TRAINING AND PHYSI-
CAL FITNESS CONSULTATION TO CORPORATE
CLIENTS TO HELP THEIR EMPLOYEES MAKE
PHYSICAL FITNESS, STRENGTH, CONDITION-
ING, AND EXERCISE ALTE RATIONS IN THEIR
DAILY LIVING, IN CLASS 41 (U.S. CLS. 100, 101 AND
107).

FIRST USE 11-1-2007; IN COMMERCE 11-1-2007.

FOR: HEALTH CARE SERVICES, NAMELY, DIS-
EASE MANAGEMENT PROGRAMS; HEALTH
CARE SERVICES, NAMELY, WELLNESS PRO-
GRAMS; HOME HEALTH CARE SERVICES; MAN-
AGED HEALTH CARE SERVICES; PROVIDING
HEALTH CARE INFORMATION BY TELEPHONE;
PROVIDING HEALTH CARE INFORMATION BY

TELEPHONE AND THE INTERNET; PROVIDING
HEALTH INFORMATION; MEDICAL EVALUA-
TION SERVICES, NAMELY, FUNCTIONAL ASSES-
MENT PROGRAM FOR PATIENTS RECEIVING
MEDICAL REHABILITATION SERVICES FOR PUR-
POSES OF GUIDING TREATMENT AND ASSES-
SING PROGRAM EFFECTIVENESS; PROVIDING A
WEBSITE FEATURING INFORMATION IN THE
FIELD OF MENTAL HEALTH AND WELLNESS;
PROVIDING ASSISTANCE, FITNESS EVALUATION
AND CONSULTATION TO CORPORATE CLIENTS
TO HELP THEIR EMPLOYEES MAKE HEALTH,
WELLNESS AND NUTRITIONAL CHANGES IN
THEIR DAILY LIVING TO IMPROVE HEALTH;
PROVIDING WELLNESS SERVICES, NAMELY,
PERSONAL ASSESSMENTS, PERSONALIZED ROU-
TINES, MAINTENANCE SCHEDULES, AND COUN-
SELING, IN CLASS 44 (U.S. CLS. 100 AND 101).

FIRST USE 11-1-2007; IN COMMERCE 11-1-2007.

THE MARK CONSISTS OF STANDARD CHAR-
ACTERS WITHOUT CLAIM TO ANY PARTICULAR
FONT, STYLE, SIZE, OR COLOR.

THE FOREIGN WORDING IN THE MARK
TRANSLATES INTO ENGLISH AS NEW LIFE.

SN 77-174,220, FILED 5-7-2007.

TEJBIR SINGH, EXAMINING ATTORNEY

Int. Cl.: 38

Prior U.S. Cls.: 100, 101, and 104

Reg. No. 3,485,877

United States Patent and Trademark Office

Registered Aug. 12, 2008

**SERVICE MARK
PRINCIPAL REGISTER**

RBI

INTERNATIONAL BLUEGRASS MUSIC MUSE-
UM, INC. (KENTUCKY NON-PROFIT COR-
PORATION)
207 EAST SECOND STREET
OWENSBORO, KY 42303

THE MARK CONSISTS OF STANDARD CHAR-
ACTERS WITHOUT CLAIM TO ANY PARTICULAR
FONT, STYLE, SIZE, OR COLOR.

FOR: BROADCASTING MUSIC PROGRAMS VIA
A GLOBAL COMPUTER NETWORK, IN CLASS 38
(U.S. CLS. 100, 101 AND 104).

SN 77-174,508, FILED 5-7-2007.

FIRST USE 5-1-2007; IN COMMERCE 5-1-2007.

ESTHER A. BORSUK, EXAMINING ATTORNEY

Int. Cl.: 35

Prior U.S. Cls.: 100, 101, and 102

United States Patent and Trademark Office

Reg. No. 3,485,878

Registered Aug. 12, 2008

**SERVICE MARK
PRINCIPAL REGISTER**

SILVALUTIONS

WILBUR-ELLIS COMPANY (CALIFORNIA CORPORATION)
345 CALIFORNIA STREET, 27TH FLOOR
SAN FRANCISCO, CA 94104

THE MARK CONSISTS OF STANDARD CHARACTERS WITHOUT CLAIM TO ANY PARTICULAR FONT, STYLE, SIZE, OR COLOR.

FOR: FOREST MANAGEMENT; FOREST MANAGEMENT CONSULTATION, IN CLASS 35 (U.S. CLS. 100, 101 AND 102).

SN 77-174,758, FILED 5-7-2007.

FIRST USE 11-16-2007; IN COMMERCE 11-16-2007.

ANNE MADDEN, EXAMINING ATTORNEY

Int. Cl.: 9

Prior U.S. Cls.: 21, 23, 26, 36, and 38

Reg. No. 3,485,879

United States Patent and Trademark Office

Registered Aug. 12, 2008

**TRADEMARK
PRINCIPAL REGISTER**

AIRCELL ON BOARD

AIRCELL LLC (DELAWARE LTD LIAB CO)
BUILDING B, SUITE 280
1172 CENTURY DRIVE
LOUISVILLE, CO 80027

FOR: COMPUTER AND TELECOMMUNICATIONS NETWORK HARDWARE AND SOFTWARE FOR IMPLEMENTING LOCAL AREA NETWORKS ONBOARD AIRCRAFTS TO ENABLE USERS TO TRANSMIT AND RECEIVE VOICE, VIDEO, AND DATA WITHIN THE AIRCRAFTS, BETWEEN THE AIRCRAFTS, BETWEEN THE AIRCRAFTS AND THE GROUND, AND BETWEEN THE GROUND AND THE AIRCRAFTS; LOCAL AREA NETWORK ACCESS POINTS FOR COMMUNICATING WITH COMPUTER AND TELECOMMUNICATIONS USERS LOCATED ONBOARD AIRCRAFTS FOR TRANSMITTING AND RECEIVING VOICE, VIDEO, AND DATA WITHIN THE AIRCRAFTS, BETWEEN THE AIRCRAFTS, BETWEEN THE AIRCRAFTS AND THE GROUND, AND BETWEEN THE GROUND AND THE AIRCRAFTS; COMPUTER AND TELECOMMUNICATIONS NETWORK HARDWARE AND SOFTWARE FOR TRANSMITTING AND RECEIVING VOICE, VIDEO, AND DATA BETWEEN COMPUTER AND TELECOMMUNICATIONS USERS, LOCATED ONBOARD AN AIRCRAFT, AND COMPUTER, AND TELECOMMUNICATIONS SYSTEMS LOCATED ONBOARD THE AIRCRAFT, COMPUTER AND

TELECOMMUNICATION SYSTEMS LOCATED ONBOARD ANOTHER AIRCRAFT, AND COMPUTER AND TELECOMMUNICATIONS SYSTEMS LOCATED ON THE GROUND; COMPUTER AND TELECOMMUNICATIONS NETWORK ACCESS SERVER HARDWARE AND SOFTWARE ONBOARD AIRCRAFTS FOR TRANSMITTING AND RECEIVING VOICE, VIDEO, AND DATA FROM THE GROUND TO IDENTIFIED USERS LOCATED ONBOARD THE AIRCRAFTS, FROM IDENTIFIED USERS LOCATED ONBOARD THE AIRCRAFTS TO THE GROUND, AND FROM IDENTIFIED USERS LOCATED ONBOARD ONE AIRCRAFT TO IDENTIFIED USERS ONBOARD ANOTHER AIRCRAFT, AND BETWEEN IDENTIFIED USERS WITHIN AN AIRCRAFT, IN CLASS 9 (U.S. CLS. 21, 23, 26, 36 AND 38).

FIRST USE 5-13-2000; IN COMMERCE 5-13-2000.

THE MARK CONSISTS OF STANDARD CHARACTERS WITHOUT CLAIM TO ANY PARTICULAR FONT, STYLE, SIZE, OR COLOR.

OWNER OF U.S. REG. NOS. 2,552,129 AND 2,606,334.

SN 77-175,198, FILED 5-8-2007.

BRENDAN MCCAULEY, EXAMINING ATTORNEY

Int. Cl.: 9

Prior U.S. Cls.: 21, 23, 26, 36, and 38

Reg. No. 3,485,880

United States Patent and Trademark Office

Registered Aug. 12, 2008

**TRADEMARK
PRINCIPAL REGISTER**

HIGHLIGHT

COHERENT, INC. (DELAWARE CORPORATION)
5100 PATRICK HENRY DRIVE
SANTA CLARA, CA 95054

FOR: LASERS NOT FOR MEDICAL USE, IN
CLASS 9 (U.S. CLS. 21, 23, 26, 36 AND 38).

FIRST USE 5-0-2007; IN COMMERCE 5-0-2007.

THE MARK CONSISTS OF STANDARD CHAR-
ACTERS WITHOUT CLAIM TO ANY PARTICULAR
FONT, STYLE, SIZE, OR COLOR.

SN 77-175,450, FILED 5-8-2007.

KATHLEEN M. VANSTON, EXAMINING ATTOR-
NEY

Int. Cl.: 45

Prior U.S. Cls.: 100 and 101

United States Patent and Trademark Office

Reg. No. 3,485,881

Registered Aug. 12, 2008

**SERVICE MARK
PRINCIPAL REGISTER**

GO BEYOND GO POGO

POWELL GOLDSTEIN LLP (GEORGIA LIMITED
LIABILITY PARTNERSHIP)
FOURTEENTH FLOOR
1201 WEST PEACHTREE STREET, NW
ATLANTA, GA 30309

FOR: LEGAL SERVICES, IN CLASS 45 (U.S. CLS.
100 AND 101).

FIRST USE 6-15-2007; IN COMMERCE 6-15-2007.

THE MARK CONSISTS OF STANDARD CHAR-
ACTERS WITHOUT CLAIM TO ANY PARTICULAR
FONT, STYLE, SIZE, OR COLOR.

OWNER OF U.S. REG. NOS. 3,075,981 AND
3,181,673.

SN 77-175,886, FILED 5-8-2007.

LOURDES AYALA, EXAMINING ATTORNEY

Int. Cl.: 35

Prior U.S. Cls.: 100, 101, and 102

United States Patent and Trademark Office

Reg. No. 3,485,882

Registered Aug. 12, 2008

SERVICE MARK
PRINCIPAL REGISTER



YOU WISH NO MORE, INC. (MISSOURI CORPORATION)
P.O. BOX 460125
ST. LOUIS, MO 63146

THE MARK CONSISTS OF A LADLE POURING SMILEY FACES INTO A MUG AND THE WORDING "SOUP SAYS IT ALL".

FOR: ONLINE RETAIL STORE SERVICES FEATURING GIFT BASKETS CONTAINING FOOD AND NOVELTY GIFT ITEMS, IN CLASS 35 (U.S. CLS. 100, 101 AND 102).

SN 77-176,244, FILED 5-9-2007.

FIRST USE 5-0-2008; IN COMMERCE 5-0-2008.

JENNIFER HETU, EXAMINING ATTORNEY

Int. Cl.: 3

Prior U.S. Cls.: 1, 4, 6, 50, 51, and 52

United States Patent and Trademark Office

Reg. No. 3,485,883

Registered Aug. 12, 2008

**TRADEMARK
PRINCIPAL REGISTER**

24 HOUR MODEL

NEW U, INC. (FLORIDA CORPORATION)
3589 SW 10TH STREET
POMPANO BEACH, FL 33069

THE MARK CONSISTS OF STANDARD CHAR-
ACTERS WITHOUT CLAIM TO ANY PARTICULAR
FONT, STYLE, SIZE, OR COLOR.

FOR: COSMETICS, IN CLASS 3 (U.S. CLS. 1, 4, 6, 50,
51 AND 52).

SN 77-177,344, FILED 5-10-2007.

FIRST USE 6-18-2008; IN COMMERCE 6-18-2008.

ERNEST SHOSHO, EXAMINING ATTORNEY

Int. Cl.: 3

Prior U.S. Cls.: 1, 4, 6, 50, 51, and 52

Reg. No. 3,485,884

United States Patent and Trademark Office

Registered Aug. 12, 2008

**TRADEMARK
PRINCIPAL REGISTER**

PROTECTING POWDER

THE PROCTER & GAMBLE COMPANY (OHIO
CORPORATION)
C2- MAIL STOP 11
ONE PROCTER & GAMBLE PLAZA
CINCINNATI, OH 45202

FOR: BODY SPRAYS; DEODORANTS AND ANTI-
PERSPIRANTS, IN CLASS 3 (U.S. CLS. 1, 4, 6, 50, 51
AND 52).

FIRST USE 4-19-2008; IN COMMERCE 4-19-2008.

THE MARK CONSISTS OF STANDARD CHAR-
ACTERS WITHOUT CLAIM TO ANY PARTICULAR
FONT, STYLE, SIZE, OR COLOR.

NO CLAIM IS MADE TO THE EXCLUSIVE
RIGHT TO USE "POWDER", APART FROM THE
MARK AS SHOWN.

SN 77-177,528, FILED 5-10-2007.

SHANNON TWOHIG, EXAMINING ATTORNEY

Int. Cl.: 31

Prior U.S. Cls.: 1 and 46

United States Patent and Trademark Office

Reg. No. 3,485,885

Registered Aug. 12, 2008

**TRADEMARK
PRINCIPAL REGISTER**

FRESHWAY

PROFORMANCE PET PRODUCTS, INC. (MISSISSIPPI CORPORATION)
P.O. BOX 1550
MADISON, MS 39130

THE MARK CONSISTS OF STANDARD CHARACTERS WITHOUT CLAIM TO ANY PARTICULAR FONT, STYLE, SIZE, OR COLOR.

FOR: DRY PET FOOD, IN CLASS 31 (U.S. CLS. 1 AND 46).

SN 77-177,741, FILED 5-10-2007.

FIRST USE 12-22-2007; IN COMMERCE 12-27-2007.

DAVID C. REIHNER, EXAMINING ATTORNEY

Int. Cls.: 29, 30, and 35

Prior U.S. Cls.: 46, 100, 101, and 102

United States Patent and Trademark Office

Reg. No. 3,485,886

Registered Aug. 12, 2008

**TRADEMARK
SERVICE MARK
PRINCIPAL REGISTER**

COOKING SHOW TO GO

HANNAFORD LICENSING CORP. (MAINE CORPORATION)
HANNAFORD LEGAL DEPT.
145 PLEASANT HILL ROAD
SCARBOROUGH, ME 04074

FOR: PREPACKAGED, UNCOOKED MEALS CONSISTING PRIMARILY OF MEAT, FISH, SEAFOOD OR POULTRY SERVED WITH PASTA, RICE OR VEGETABLES THAT ARE PREWASHED, CHOPPED AND MEASURED AND INCLUDE A RECIPE FOR PREPARATION, IN CLASS 29 (U.S. CL. 46).

FIRST USE 6-25-2007; IN COMMERCE 6-25-2007.

FOR: PREPACKAGED, UNCOOKED MEALS CONSISTING PRIMARILY OF PASTA OR RICE AND SERVED WITH VEGETABLES THAT ARE PREWASHED, CHOPPED AND MEASURED AND INCLUDE A RECIPE FOR PREPARATION, IN CLASS 30 (U.S. CL. 46).

FIRST USE 6-25-2007; IN COMMERCE 6-25-2007.

FOR: RETAIL FOOD SERVICES, NAMELY, RETAIL STORE SERVICES PROVIDING CUSTOMERS WITH A RECIPE AND ALL THE INGREDIENTS FOR A HOME-COOKED MEAL IN ONE CONVENIENT PACKAGE, IN CLASS 35 (U.S. CLS. 100, 101 AND 102).

FIRST USE 6-25-2007; IN COMMERCE 6-25-2007.

THE MARK CONSISTS OF STANDARD CHARACTERS WITHOUT CLAIM TO ANY PARTICULAR FONT, STYLE, SIZE, OR COLOR.

NO CLAIM IS MADE TO THE EXCLUSIVE RIGHT TO USE "TO GO", APART FROM THE MARK AS SHOWN.

SN 77-177,792, FILED 5-10-2007.

ANDREA K. NADELMAN, EXAMINING ATTORNEY

Int. Cl.: 5

Prior U.S. Cls.: 6, 18, 44, 46, 51, and 52

Reg. No. 3,485,887

United States Patent and Trademark Office

Registered Aug. 12, 2008

**TRADEMARK
PRINCIPAL REGISTER**

Enzyflex

TRIARCO INDUSTRIES, INC. (DELAWARE
CORPORATION)
400 HAMBURG TURNPIKE
WAYNE, NJ 07470

THE MARK CONSISTS OF STANDARD CHAR-
ACTERS WITHOUT CLAIM TO ANY PARTICULAR
FONT, STYLE, SIZE, OR COLOR.

FOR: VITAMINS, MINERAL SUPPLEMENTS,
NUTRITIONAL AND DIETARY SUPPLEMENTS,
IN CLASS 5 (U.S. CLS. 6, 18, 44, 46, 51 AND 52).

SN 77-178,562, FILED 5-11-2007.

FIRST USE 5-11-2007; IN COMMERCE 5-11-2007.

MATTHEW PAPPAS, EXAMINING ATTORNEY

Int. Cl.: 3

Prior U.S. Cls.: 1, 4, 6, 50, 51, and 52

Reg. No. 3,485,888

United States Patent and Trademark Office

Registered Aug. 12, 2008

**TRADEMARK
PRINCIPAL REGISTER**

TENSO LIFT

JAFER LIMITED (BERMUDA CORPORATION)
CLARENDON HOUSE, 2 CHURCH STREET
HAMILTON, BERMUDA HM12

FOR: COSMETIC CREAMS, LOTIONS, BALSAM
AND GELS FOR THE FACE, EYE CONTOUR AND
EYELIDS, NAMELY, HYDRANTS, HUMECTANTS,
ANTI-WRINKLE, REAFFIRMING, IN CLASS 3 (U.S.
CLS. 1, 4, 6, 50, 51 AND 52).

FIRST USE 2-25-2008; IN COMMERCE 4-30-2008.

THE MARK CONSISTS OF STANDARD CHAR-
ACTERS WITHOUT CLAIM TO ANY PARTICULAR
FONT, STYLE, SIZE, OR COLOR.

OWNER OF PERU REG. NO. 126010, DATED 4-2-
2007, EXPIRES 4-2-2017.

THE ENGLISH TRANSLATION OF THE WORD
"TENSO" IN THE MARK IS "TENSE"

SN 77-179,119, FILED 5-11-2007.

LINDA ORNDORFF, EXAMINING ATTORNEY

Int. Cls.: 40 and 41

Prior U.S. Cls.: 100, 101, 103, 106, and 107

United States Patent and Trademark Office

Reg. No. 3,485,889

Registered Aug. 12, 2008

**SERVICE MARK
PRINCIPAL REGISTER**



DIGEPRINT.COM, LLC. (GEORGIA LTD LIAB
CO)
200 VICARAGE CT.
JOHNS CREEK, GA 30005

FOR: DESIGN PRINTING FOR OTHERS, IN
CLASS 40 (U.S. CLS. 100, 103 AND 106).

FIRST USE 4-11-2007; IN COMMERCE 4-11-2007.

FOR: DESKTOP PUBLISHING FOR OTHERS, IN
CLASS 41 (U.S. CLS. 100, 101 AND 107).

FIRST USE 4-11-2007; IN COMMERCE 4-11-2007.

THE MARK CONSISTS OF THE NAME "DIGE-
PRINT.COM". THERE IS A GRAPHIC OF AN OVAL
WITH AN ARROW POINT. SMALL SQUARES
INTERSECT THE OVAL.

SN 77-179,376, FILED 5-11-2007.

ANTHONY RINKER, EXAMINING ATTORNEY

Int. Cl.: 9

Prior U.S. Cls.: 21, 23, 26, 36, and 38

United States Patent and Trademark Office

Reg. No. 3,485,890

Registered Aug. 12, 2008

**TRADEMARK
PRINCIPAL REGISTER**

OUTDOOR BY CHEFS BASICS

STYLE ASIA INC (NEW JERSEY CORPORATION)
101 MOONACHIE AVE
MOONACHIE, NJ 07074

FOR: THERMOMETERS IN THE NATURE OF A
FORK, IN CLASS 9 (U.S. CLS. 21, 23, 26, 36 AND 38).

FIRST USE 4-30-2008; IN COMMERCE 4-30-2008.

THE MARK CONSISTS OF STANDARD CHARACTERS WITHOUT CLAIM TO ANY PARTICULAR FONT, STYLE, SIZE, OR COLOR.

OWNER OF U.S. REG. NO. 2,936,053.

NO CLAIM IS MADE TO THE EXCLUSIVE RIGHT TO USE "OUTDOOR AND CHEFS", APART FROM THE MARK AS SHOWN.

SN 77-179,807, FILED 5-14-2007.

MIDGE BUTLER, EXAMINING ATTORNEY

Int. Cl.: 31

Prior U.S. Cls.: 1 and 46

United States Patent and Trademark Office

Reg. No. 3,485,891

Registered Aug. 12, 2008

**TRADEMARK
PRINCIPAL REGISTER**

RIDGELAND

SWEETENER SUPPLY CORPORATION (ILLINOIS CORPORATION)
9501 W. SOUTH VIEW AVENUE
BROOKFIELD, IL 60513

FOR: ANIMAL FEED ADDITIVES FOR NON-NUTRITIONAL PURPOSES FOR USE AS INGREDIENT OR FILLER, NAMELY, FIBER INGREDIENTS, IN CLASS 31 (U.S. CLS. 1 AND 46).

FIRST USE 12-0-2007; IN COMMERCE 12-0-2007.

THE MARK CONSISTS OF STANDARD CHARACTERS WITHOUT CLAIM TO ANY PARTICULAR FONT, STYLE, SIZE, OR COLOR.

SN 77-180,566, FILED 5-14-2007.

DANNEAN HETZEL, EXAMINING ATTORNEY

Int. Cl.: 36

Prior U.S. Cls.: 100, 101, and 102

United States Patent and Trademark Office

Reg. No. 3,485,892

Registered Aug. 12, 2008

**SERVICE MARK
PRINCIPAL REGISTER**

Acacia Advisor Term

AMERITAS HOLDING COMPANY (NEBRASKA
CORPORATION)
5900 O STREET
LINCOLN, NE 68510

OWNER OF U.S. REG. NOS. 2,697,553, 2,859,369,
AND OTHERS.

FOR: INSURANCE AND FINANCIAL SERVICES,
NAMELY, ISSUANCE, UNDERWRITING, AND AD-
MINISTRATION OF LIFE INSURANCE, IN CLASS
36 (U.S. CLS. 100, 101 AND 102).

NO CLAIM IS MADE TO THE EXCLUSIVE
RIGHT TO USE "ADVISOR TERM", APART FROM
THE MARK AS SHOWN.

FIRST USE 6-1-2007; IN COMMERCE 6-1-2007.

SN 77-181,341, FILED 5-15-2007.

THE MARK CONSISTS OF STANDARD CHAR-
ACTERS WITHOUT CLAIM TO ANY PARTICULAR
FONT, STYLE, SIZE, OR COLOR.

GISELLE AGOSTO, EXAMINING ATTORNEY

Int. Cl.: 36

Prior U.S. Cls.: 100, 101, and 102

United States Patent and Trademark Office

Reg. No. 3,485,893

Registered Aug. 12, 2008

**SERVICE MARK
PRINCIPAL REGISTER**

**Ameritas Advisor Select No
Load Variable Annuity**

AMERITAS HOLDING COMPANY (NEBRASKA
CORPORATION)
5900 O STREET
LINCOLN, NE 68510

OWNER OF U.S. REG. NOS. 1,487,761, 1,674,511,
AND OTHERS.

FOR: INSURANCE AND FINANCIAL SERVICES,
NAMELY, ISSUANCE, UNDERWRITING, AND AD-
MINISTRATION OF VARIABLE ANNUITIES, IN
CLASS 36 (U.S. CLS. 100, 101 AND 102).

NO CLAIM IS MADE TO THE EXCLUSIVE
RIGHT TO USE "ADVISOR SELECT NO LOAD
VARIABLE ANNUITY", APART FROM THE MARK
AS SHOWN.

FIRST USE 5-1-2007; IN COMMERCE 5-1-2007.

SN 77-181,380, FILED 5-15-2007.

THE MARK CONSISTS OF STANDARD CHAR-
ACTERS WITHOUT CLAIM TO ANY PARTICULAR
FONT, STYLE, SIZE, OR COLOR.

GISELLE AGOSTO, EXAMINING ATTORNEY

Int. Cl.: 41

Prior U.S. Cls.: 100, 101, and 107

United States Patent and Trademark Office

Reg. No. 3,485,894

Registered Aug. 12, 2008

**SERVICE MARK
PRINCIPAL REGISTER**

YOUR BRAIN WILL THANK YOU

POSIT SCIENCE CORPORATION (CALIFORNIA CORPORATION)
225 BUSH STREET, 7TH FLOOR
SAN FRANCISCO, CA 94104

FOR: EDUCATIONAL AND TRAINING SERVICES, NAMELY, CONDUCTING PROGRAMS, CLASSES, SEMINARS, AND WORKSHOPS AND PROVIDING TRAINING SERVICES REGARDING MAINTENANCE OR IMPROVEMENT OF COGNITIVE PERFORMANCE AND/OR BRAIN PLASTICITY, IN CLASS 41 (U.S. CLS. 100, 101 AND 107).

FIRST USE 7-1-2007; IN COMMERCE 7-1-2007.

THE MARK CONSISTS OF STANDARD CHARACTERS WITHOUT CLAIM TO ANY PARTICULAR FONT, STYLE, SIZE, OR COLOR.

SN 77-181,878, FILED 5-15-2007.

MATTHEW PAPPAS, EXAMINING ATTORNEY

Int. Cl.: 36

Prior U.S. Cls.: 100, 101, and 102

United States Patent and Trademark Office

Reg. No. 3,485,895

Registered Aug. 12, 2008

**SERVICE MARK
PRINCIPAL REGISTER**

MARANON

MARANON CAPITAL, L.P. (DELAWARE LIMITED PARTNERSHIP)
SUITE 2700
ONE NORTH FRANKLIN STREET
CHICAGO, IL 60606

FOR: INVESTMENT MANAGEMENT; INVESTMENTS AND FINANCING IN LEVERAGED BUY OUTS AND FINANCIALLY DISTRESSED OR UNDERPERFORMING COMPANIES; PRIVATE EQUITY FUND INVESTMENT SERVICES; VENTURE CAPITAL FUNDING SERVICES TO EMERGING AND START-UP COMPANIES; AND ALTERNA-

TIVE ASSET MANAGEMENT, IN CLASS 36 (U.S. CLS. 100, 101 AND 102).

FIRST USE 3-17-2008; IN COMMERCE 3-17-2008.

THE MARK CONSISTS OF STANDARD CHARACTERS WITHOUT CLAIM TO ANY PARTICULAR FONT, STYLE, SIZE, OR COLOR.

SN 77-181,904, FILED 5-15-2007.

AMY MCMENAMIN, EXAMINING ATTORNEY

Int. Cl.: 2

Prior U.S. Cls.: 6, 11, and 16

United States Patent and Trademark Office

Reg. No. 3,485,896

Registered Aug. 12, 2008

**TRADEMARK
PRINCIPAL REGISTER**

SUPER SPEC

BENJAMIN MOORE & CO. (NEW JERSEY CORPORATION)
101 PARAGON DRIVE
MONTVALE, NJ 07645

FOR: INTERIOR AND EXTERIOR PAINT DESIGNED FOR PROFESSIONAL PAINTERS, IN CLASS 2 (U.S. CLS. 6, 11 AND 16).

FIRST USE 6-2-2008; IN COMMERCE 6-2-2008.

THE MARK CONSISTS OF STANDARD CHARACTERS WITHOUT CLAIM TO ANY PARTICULAR FONT, STYLE, SIZE, OR COLOR.

OWNER OF U.S. REG. NO. 2,286,409.

SN 77-182,230, FILED 5-16-2007.

MICHAEL LEWIS, EXAMINING ATTORNEY

Int. Cl.: 31

Prior U.S. Cls.: 1 and 46

United States Patent and Trademark Office

Reg. No. 3,485,897

Registered Aug. 12, 2008

**TRADEMARK
PRINCIPAL REGISTER**

N♥URISH

NORTH AMERICAN NUTRITION COMPANIES,
INC. (DELAWARE CORPORATION)
6531 ST. RT. 503
LEWISBURG, OH 45338

THE MARK CONSISTS OF THE WORD "NOUR-
ISH" WITH A STYLIZED HEART IN PLACE OF THE
LETTER "O".

FOR: NON-MEDICATED ANIMAL FEED ADDI-
TIVES; ANIMAL FEED, NAMELY, LIVESTOCK
FEED, HORSE FEED, PET FOOD, IN CLASS 31
(U.S. CLS. 1 AND 46).

SN 77-182,674, FILED 5-16-2007.

FIRST USE 12-12-2007; IN COMMERCE 1-24-2008.

DAWN HAN, EXAMINING ATTORNEY

Int. Cl.: 3

Prior U.S. Cls.: 1, 4, 6, 50, 51, and 52

Reg. No. 3,485,898

United States Patent and Trademark Office

Registered Aug. 12, 2008

**TRADEMARK
PRINCIPAL REGISTER**

SENTIVA TENSO LIFT

JAFER LIMITED (BERMUDA CORPORATION)
CLARENDON HOUSE, 2 CHURCH STREET
HAMILTON, BERMUDA HM12

FOR: FACIAL CREAMS, COSMETIC CREAMS,
FACIAL LOTIONS, SKIN MOISTURIZER, ANTI-
WRINKLE CREAMS, ANTI-WRINKLE LOTIONS,
ANTI-AGING CREAMS, ANTI-AGING LOTIONS,
WRINKLE REMOVING SKIN CARE PREPARA-
TIONS, IN CLASS 3 (U.S. CLS. 1, 4, 6, 50, 51 AND 52).

FIRST USE 4-21-2008; IN COMMERCE 5-30-2008.

THE MARK CONSISTS OF STANDARD CHAR-
ACTERS WITHOUT CLAIM TO ANY PARTICULAR
FONT, STYLE, SIZE, OR COLOR.

OWNER OF U.S. REG. NOS. 2,982,274, 3,033,178,
AND OTHERS.

THE ENGLISH TRANSLATION OF "TENSO" IN
THE MARK IS "TENSE."

SN 77-183,471, FILED 5-17-2007.

LINDA ORNDORFF, EXAMINING ATTORNEY

Int. Cl.: 30

Prior U.S. Cl.: 46

United States Patent and Trademark Office

Reg. No. 3,485,899

Registered Aug. 12, 2008

**TRADEMARK
PRINCIPAL REGISTER**

VITALIZE

MARS, INCORPORATED (DELAWARE CORPORATION)
6885 ELM STREET
MCLEAN, VA 22101

THE MARK CONSISTS OF STANDARD CHARACTERS WITHOUT CLAIM TO ANY PARTICULAR FONT, STYLE, SIZE, OR COLOR.

FOR: CONFECTIONERY, NAMELY, CANDY, IN CLASS 30 (U.S. CL. 46).

SN 77-183,894, FILED 5-17-2007.

FIRST USE 12-0-2007; IN COMMERCE 12-0-2007.

BRIAN PINO, EXAMINING ATTORNEY

Int. Cl.: 9

Prior U.S. Cls.: 21, 23, 26, 36, and 38

Reg. No. 3,485,900

United States Patent and Trademark Office

Registered Aug. 12, 2008

**TRADEMARK
PRINCIPAL REGISTER**

STELLAR

WEYERHAEUSER COMPANY (WASHINGTON
CORPORATION)
33663 WEYERHAEUSER WAY SOUTH
FEDERAL WAY, WA 98003

FOR: COMPUTER SOFTWARE FOR USE IN
MANAGING, TRACKING AND CONTROLLING
CUSTOMIZED ENGINEERED WOOD PRODUCTS
DURING THE DESIGN, FABRICATION, SHIPPING,
DISTRIBUTING AND INSTALLATION PROCESSES,
IN CLASS 9 (U.S. CLS. 21, 23, 26, 36 AND 38).

FIRST USE 8-1-2007; IN COMMERCE 8-1-2007.

THE MARK CONSISTS OF STANDARD CHAR-
ACTERS WITHOUT CLAIM TO ANY PARTICULAR
FONT, STYLE, SIZE, OR COLOR.

SN 77-184,120, FILED 5-17-2007.

GISELLE AGOSTO, EXAMINING ATTORNEY

Int. Cls.: 5 and 31

Prior U.S. Cls.: 1, 6, 18, 44, 46, 51, and 52

United States Patent and Trademark Office

Reg. No. 3,485,901

Registered Aug. 12, 2008

**TRADEMARK
PRINCIPAL REGISTER**

**NUTRITION HORIZONS
VETERINARY CARE**

NORTH AMERICAN NUTRITION COMPANIES,
INC. (DELAWARE CORPORATION)
P.O. BOX 5002
6531 ST. RT. 503
LEWISBURG, OH 453385002

FOR: ANIMAL FEED SUPPLEMENTS; ANIMAL
FEED ADDITIVES FOR USE AS AN ANIMAL FEED
SUPPLEMENT, IN CLASS 5 (U.S. CLS. 6, 18, 44, 46, 51
AND 52).

FIRST USE 1-4-2008; IN COMMERCE 1-4-2008.

FOR: NON-MEDICATED ANIMAL FEED ADDI-
TIVES, IN CLASS 31 (U.S. CLS. 1 AND 46).

FIRST USE 1-4-2008; IN COMMERCE 1-4-2008.

THE MARK CONSISTS OF STANDARD CHAR-
ACTERS WITHOUT CLAIM TO ANY PARTICULAR
FONT, STYLE, SIZE, OR COLOR.

NO CLAIM IS MADE TO THE EXCLUSIVE
RIGHT TO USE "NUTRITION" AND "VETERINARY
CARE", APART FROM THE MARK AS SHOWN.

SN 77-184,929, FILED 5-18-2007.

MATTHEW PAPPAS, EXAMINING ATTORNEY

Int. Cl.: 30

Prior U.S. Cl.: 46

United States Patent and Trademark Office

Reg. No. 3,485,902

Registered Aug. 12, 2008

**TRADEMARK
PRINCIPAL REGISTER**

There's an  in everyone.

MARS, INCORPORATED (DELAWARE CORPORATION)
6885 ELM STREET
MCLEAN, VA 22101

FIRST USE 8-0-2007; IN COMMERCE 8-0-2007.

SN 77-185,023, FILED 5-18-2007.

FOR: CONFECTIONERY, NAMELY, CANDY, IN
CLASS 30 (U.S. CL. 46).

BRIAN PINO, EXAMINING ATTORNEY

Int. Cl.: 41

Prior U.S. Cls.: 100, 101, and 107

United States Patent and Trademark Office

Reg. No. 3,485,903

Registered Aug. 12, 2008

**SERVICE MARK
PRINCIPAL REGISTER**

MASTERS OF TIME

BRENDA JOYCE DREAMS UNLIMITED, INC.
(NEW YORK CORPORATION)
51 SOUTH MUSTANG RANCH PLACE
TUCSON, AZ 85748

THE MARK CONSISTS OF STANDARD CHAR-
ACTERS WITHOUT CLAIM TO ANY PARTICULAR
FONT, STYLE, SIZE, OR COLOR.

FOR: A SERIES OF PROGRAMS AND AUDIO
AND AUDIO VISUAL PRODUCTIONS FEATURING
DRAMA AND FICTION PROVIDED VIA THE IN-
TERNET, IN CLASS 41 (U.S. CLS. 100, 101 AND 107).

SN 77-187,183, FILED 5-22-2007.

FIRST USE 6-30-2007; IN COMMERCE 6-30-2007.

INGRID C. EULIN, EXAMINING ATTORNEY

Int. Cl.: 33

Prior U.S. Cls.: 47 and 49

United States Patent and Trademark Office

Reg. No. 3,485,904

Registered Aug. 12, 2008

**TRADEMARK
PRINCIPAL REGISTER**

NEWHARBOR

DIAGEO NORTH AMERICA, INC. (CONNECTI-
CUT CORPORATION)
801 MAIN AVENUE
NORWALK, CT 06851

THE MARK CONSISTS OF STANDARD CHAR-
ACTERS WITHOUT CLAIM TO ANY PARTICULAR
FONT, STYLE, SIZE, OR COLOR.

FOR: WINES, IN CLASS 33 (U.S. CLS. 47 AND 49).

SN 77-187,248, FILED 5-22-2007.

FIRST USE 9-0-2007; IN COMMERCE 9-0-2007.

SETH A. RAPPAPORT, EXAMINING ATTORNEY

Int. Cl.: 26

Prior U.S. Cls.: 37, 39, 40, 42, and 50

United States Patent and Trademark Office

Reg. No. 3,485,905

Registered Aug. 12, 2008

**TRADEMARK
PRINCIPAL REGISTER**

TOPCAP

MODEL MODEL HAIR FASHION, INC. (NEW
YORK CORPORATION)
113-25 14TH AVENUE
COLLEGE POINT, NY 11356

THE MARK CONSISTS OF STANDARD CHAR-
ACTERS WITHOUT CLAIM TO ANY PARTICULAR
FONT, STYLE, SIZE, OR COLOR.

FOR: PONYTAIL HAIR PIECES, HAIR WEAVES,
HAIR EXTENSIONS, WIGS AND BRAIDS, IN CLASS
26 (U.S. CLS. 37, 39, 40, 42 AND 50).

SN 77-187,295, FILED 5-22-2007.

FIRST USE 11-26-2007; IN COMMERCE 11-26-2007.

MICHAEL LEWIS, EXAMINING ATTORNEY

Int. Cl.: 19

Prior U.S. Cls.: 1, 12, 33, and 50

United States Patent and Trademark Office

Reg. No. 3,485,906

Registered Aug. 12, 2008

**TRADEMARK
PRINCIPAL REGISTER**

INFINICOR

GEORGIA-PACIFIC WOOD PRODUCTS LLC
(DELAWARE LTD LIAB CO)
133 PEACHTREE STREET NE
ATLANTA, GA 30303

THE MARK CONSISTS OF STANDARD CHAR-
ACTERS WITHOUT CLAIM TO ANY PARTICULAR
FONT, STYLE, SIZE, OR COLOR.

FOR: HARDBOARD, IN CLASS 19 (U.S. CLS. 1, 12,
33 AND 50).

SN 77-189,091, FILED 5-24-2007.

FIRST USE 8-1-2007; IN COMMERCE 8-1-2007.

JACLYN KIDWELL, EXAMINING ATTORNEY

Int. Cl.: 28

Prior U.S. Cls.: 22, 23, 38, and 50

Reg. No. 3,485,907

United States Patent and Trademark Office

Registered Aug. 12, 2008

**TRADEMARK
PRINCIPAL REGISTER**

VENDETTA

SULENTA, JOHN A. (UNITED STATES INDIVIDUAL)
P.O. BOX DRAWER F
PINEDALE, WY 82941

THE MARK CONSISTS OF STANDARD CHARACTERS WITHOUT CLAIM TO ANY PARTICULAR FONT, STYLE, SIZE, OR COLOR.

FOR: SPORTS AND HOCKEY EQUIPMENT, NAMELY, HOCKEY STICKS, IN CLASS 28 (U.S. CLS. 22, 23, 38 AND 50).

SN 77-189,792, FILED 5-24-2007.

FIRST USE 9-0-2007; IN COMMERCE 9-0-2007.

GISELLE AGOSTO, EXAMINING ATTORNEY

Int. Cl.: 41

Prior U.S. Cls.: 100, 101, and 107

United States Patent and Trademark Office

Reg. No. 3,485,908

Registered Aug. 12, 2008

**SERVICE MARK
PRINCIPAL REGISTER**

LOVE OBJECTS

DITTERICH-SHILAKES, KIRSTEN (UNITED STATES INDIVIDUAL)
104 OAKDALE AVE.
MILL VALLEY, CA 94941

FOR: EDUCATIONAL AND ENTERTAINMENT SERVICES, NAMELY, ARRANGING AND CONDUCTING EDUCATIONAL AND ENTERTAINMENT DEMONSTRATIONS, MULTIMEDIA PRESENTATIONS, AND LECTURES IN THE FIELDS OF ART, FOOD, WINE, THE HUMANITIES, AND THEMATIC LECTURES ON LOVE AT PARTIES, CONFERENCES, CORPORATE EVENTS AND

OTHER SPECIAL EVENTS, IN CLASS 41 (U.S. CLS. 100, 101 AND 107).

FIRST USE 7-1-2007; IN COMMERCE 7-1-2007.

THE MARK CONSISTS OF STANDARD CHARACTERS WITHOUT CLAIM TO ANY PARTICULAR FONT, STYLE, SIZE, OR COLOR.

SN 77-191,095, FILED 5-25-2007.

ESTHER BELENKER, EXAMINING ATTORNEY

Int. Cl.: 9

Prior U.S. Cls.: 21, 23, 26, 36, and 38

Reg. No. 3,485,909

United States Patent and Trademark Office

Registered Aug. 12, 2008

**TRADEMARK
PRINCIPAL REGISTER**

DOC4000

PLANT AUTOMATION SERVICES (TEXAS COR-
PORATION)
16055 SPACE CENTER BLVD. SUITE 600
HOUSTON, TX 77062

THE MARK CONSISTS OF STANDARD CHAR-
ACTERS WITHOUT CLAIM TO ANY PARTICULAR
FONT, STYLE, SIZE, OR COLOR.

FOR: COMPUTER SOFTWARE TO MONITOR
AND CONTROL FACTORY MANUFACTURING
PROCESSES, IN CLASS 9 (U.S. CLS. 21, 23, 26, 36
AND 38).

SN 77-192,932, FILED 5-30-2007.

FIRST USE 1-1-2007; IN COMMERCE 7-1-2007.

ANNE MADDEN, EXAMINING ATTORNEY

Int. Cl.: 37

Prior U.S. Cls.: 100, 103, and 106

United States Patent and Trademark Office

Reg. No. 3,485,910

Registered Aug. 12, 2008

**SERVICE MARK
PRINCIPAL REGISTER**

Aqua-SERVE

AQUATECH INTERNATIONAL (PENNSYLVANIA CORPORATION)
ONE FOUR COINS DRIVE
CANONSBURG, PA 15317

THE MARK CONSISTS OF STANDARD CHARACTERS WITHOUT CLAIM TO ANY PARTICULAR FONT, STYLE, SIZE, OR COLOR.

FOR: REPAIR AND MAINTENANCE SERVICES FOR INDUSTRIAL WATER AND WASTEWATER TREATMENT SYSTEMS, IN CLASS 37 (U.S. CLS. 100, 103 AND 106).

SN 77-193,214, FILED 5-30-2007.

FIRST USE 5-31-2007; IN COMMERCE 5-31-2007.

JILL C. ALT, EXAMINING ATTORNEY

Int. Cls.: 16, 18, and 25

Prior U.S. Cls.: 1, 2, 3, 5, 22, 23, 29, 37, 38, 39, 41, and 50

Reg. No. 3,485,911

United States Patent and Trademark Office

Registered Aug. 12, 2008

**TRADEMARK
PRINCIPAL REGISTER**



GLOBAL SPORTS, INC. (NEW JERSEY CORPORATION)
313 STATE ST. SUITE 713
PERTH AMBOY, NJ 08861

FOR: WRITING INSTRUMENTS, STATIONERY, MECHANICAL PENCILS, PENCILS, PENCIL LEADS, COLOUR PENCILS, CHALKS, WRITING AND COLOURING FELT-TIP PENS, DRAWING RULERS, STAPLER, CRAYONS, PENCIL SHARPENERS, PENHOLDERS, PEN NIBS, INKS FOR WRITING INSTRUMENTS, DRAWING COMPASSES, OFFICE PERFORATORS, FOUNTAIN PENS, HIGHLIGHTERS, MARKERS, WRITING SLATES, CORRECTION TAPES, CORRECTION FLUIDS AND CORRECTION PENS FOR DOCUMENTS, RUBBER ERASERS, NOTEBOOKS; BINDERS; ZIPPERED POUCHES AND CASES FOR STORING WRITING INSTRUMENTS; FILLER PAPER; STATIONERY PRODUCTS, NAMELY, PAPER EXPANDING FILES; BOOK COVERS; STATIONERY-TYPE PORTFOLIOS; INDEX CARDS, INDEX DIVIDERS, FILE POCKETS AND CASES FOR STORING INDEX CARDS; PADDOLIOS; DATE PLANNERS; COMPOSITION BOOKS, IN CLASS 16 (U.S. CLS. 2, 5, 22, 23, 29, 37, 38 AND 50).

FIRST USE 2-6-2007; IN COMMERCE 8-10-2007.

FOR: HANDBAGS, ALL PURPOSE CARRYING BAGS, TOTE BAGS, TRAVELLING BAGS, ATHLET-

IC BAGS, DUFFEL BAGS, BACKPACKS, SPORT BAGS AND SPORT PACKS, BACKPACKS WITH SEPARATE STORAGE COMPARTMENTS, PURSES, WALLETS AND COIN PURSES, UMBRELLAS AND PARASOLS, IN CLASS 18 (U.S. CLS. 1, 2, 3, 22 AND 41).

FIRST USE 2-6-2007; IN COMMERCE 8-10-2007.

FOR: CLOTHING AND FOOTWEAR, NAMELY, SHIRTS, CAPS, HATS, SHORTS, SWEATPANTS, UNDERWEAR, BRASSIERES, T-SHIRTS, SWEATSHIRTS, HEADBANDS, WRISTBANDS, TOPS, PANTS, JACKETS, SOCKS, GLOVES, ATHLETIC SNEAKERS, SHOES AND SLIPPERS, IN CLASS 25 (U.S. CLS. 22 AND 39).

FIRST USE 2-6-2007; IN COMMERCE 8-10-2007.

OWNER OF U.S. REG. NOS. 2,100,839 AND 2,827,019.

THE MARK CONSISTS OF A DESIGNED LOWER CASE "G" ON THE LEFT AND A DESIGNED UPPER CASE "G" ON THE RIGHT.

SN 77-194,087, FILED 5-31-2007.

KYLE PEETE, EXAMINING ATTORNEY

Int. Cl.: 43

Prior U.S. Cls.: 100 and 101

United States Patent and Trademark Office

Reg. No. 3,485,912

Registered Aug. 12, 2008

**SERVICE MARK
PRINCIPAL REGISTER**

GasseY Jack's

MEINER, SAM C. (UNITED STATES INDIVIDUAL)
6319 GIBSON DR.
ORLANDO, FL 32809

THE MARK CONSISTS OF STANDARD CHARACTERS WITHOUT CLAIM TO ANY PARTICULAR FONT, STYLE, SIZE, OR COLOR.

FOR: CATERING; RESTAURANT AND BAR SERVICES, IN CLASS 43 (U.S. CLS. 100 AND 101).

SN 77-194,103, FILED 5-31-2007.

FIRST USE 1-12-2003; IN COMMERCE 1-12-2003.

CHARLOTTE CORWIN, EXAMINING ATTORNEY

Int. Cl.: 9

Prior U.S. Cls.: 21, 23, 26, 36, and 38

Reg. No. 3,485,913

United States Patent and Trademark Office

Registered Aug. 12, 2008

TRADEMARK
PRINCIPAL REGISTER

SIMPANA

COMMVAULT SYSTEMS, INC. (NEW JERSEY CORPORATION)
2 CRESCENT PLACE, PO BOX
OCEANPORT, NJ 07757

FOR: COMPUTER SOFTWARE FOR USE IN SYSTEMS MANAGEMENT; COMPUTER SOFTWARE FOR USE IN DATA STORAGE MANAGEMENT AND STORAGE AREA NETWORKS; COMPUTER SOFTWARE AND HARDWARE FOR USE IN DATA COMMUNICATIONS; COMPUTER SOFTWARE FOR BACKING UP AND RESTORING COMPUTER DATA; COMPUTER SOFTWARE FOR USE IN DISASTER RECOVERY; COMPUTER SOFTWARE FOR USE IN REMOVABLE STORAGE MEDIA MANAGEMENT; COMPUTER SOFTWARE FOR USE IN THE FIELD OF ENTERPRISE INFORMATION MANAGEMENT; COMPUTER SOFTWARE FOR GENERATING REPORTS FROM DATABASES; COMPUTER SOFTWARE FOR USE IN THE CENTRAL MANAGEMENT OF COMPUTERS ATTACHED TO A COMPUTER NETWORK; COMPUTER SOFTWARE FOR REPLICATING AND ARCHIVING FILES FROM ONE DATA STORE TO ANOTHER; COMPUTER SOFTWARE FOR USE IN DEVELOPING DATA ANALYSIS APPLICATIONS AND OTHER COMPUTER SOFTWARE; COMPUTER SOFTWARE FOR MONITORING, ANALYZING, REPORTING AND SOLVING PER-

FORMANCE AND DATA AVAILABILITY ISSUES OF APPLICATION SOFTWARE, DATABASES, NETWORK, STORAGE, AND OTHER COMPUTER COMPONENTS AND PROGRAMS; INSTRUCTION MANUALS SUPPLIED AS A UNIT WITH THE FOREGOING; PUBLICATIONS IN ELECTRONIC FORM, ON MAGNETIC AND OPTICAL COMPUTER-READABLE MEDIA OR DOWNLOADABLE VIA COMPUTER AND COMMUNICATION NETWORKS, INCLUDING THE INTERNET, NAMELY, WORK BOOKS, QUICK REFERENCE GUIDES, TECHNICAL REFERENCE MANUALS, USER MANUALS, AND EVALUATION GUIDES IN THE FIELD OF COMPUTERS, COMPUTER SOFTWARE, COMPUTER PERIPHERALS, AND COMPUTER NETWORKS, IN CLASS 9 (U.S. CLS. 21, 23, 26, 36 AND 38).

FIRST USE 3-1-2007; IN COMMERCE 7-9-2007.

THE MARK CONSISTS OF THE WORD "SIMPANA" IN STYLIZED FORM.

THE WORDING "SIMPANA" HAS NO MEANING IN A FOREIGN LANGUAGE.

SN 77-194,591, FILED 5-31-2007.

JILL C. ALT, EXAMINING ATTORNEY

Int. Cl.: 35

Prior U.S. Cls.: 100, 101, and 102

United States Patent and Trademark Office

Reg. No. 3,485,914

Registered Aug. 12, 2008

**SERVICE MARK
PRINCIPAL REGISTER**

FOSTER & KLEISER

FOSTER & KLEISER BILLBOARD COMPANY,
INC. (CALIFORNIA CORPORATION)
SUITE 2003
23901 CALABASAS ROAD
CALABASAS, CA 913028808

THE MARK CONSISTS OF STANDARD CHAR-
ACTERS WITHOUT CLAIM TO ANY PARTICULAR
FONT, STYLE, SIZE, OR COLOR.

FOR: RENTAL OF BILLBOARD SPACE FOR
ADVERTISING PURPOSES, IN CLASS 35 (U.S. CLS.
100, 101 AND 102).

SN 77-194,989, FILED 5-31-2007.

FIRST USE 5-1-2008; IN COMMERCE 5-1-2008.

REBECCA EISINGER, EXAMINING ATTORNEY

Int. Cls.: 3 and 5

Prior U.S. Cls.: 1, 4, 6, 18, 44, 46, 50, 51, and 52

United States Patent and Trademark Office

Reg. No. 3,485,915

Registered Aug. 12, 2008

**TRADEMARK
PRINCIPAL REGISTER**

BEYOND BELIEF

BEAUTY HOLDING LLC (DELAWARE LTD
LIAB CO)
3001 COLORADO BOULEVARD
DENTON, TX 76210

FOR: NON-MEDICATED ACNE TREATMENT
PREPARATIONS, IN CLASS 3 (U.S. CLS. 1, 4, 6, 50,
51 AND 52).

FIRST USE 11-30-2007; IN COMMERCE 11-30-2007.

FOR: ACNE MEDICATIONS; ACNE TREAT-
MENT PREPARATIONS, IN CLASS 5 (U.S. CLS. 6,
18, 44, 46, 51 AND 52).

FIRST USE 11-30-2007; IN COMMERCE 11-30-2007.

THE MARK CONSISTS OF STANDARD CHAR-
ACTERS WITHOUT CLAIM TO ANY PARTICULAR
FONT, STYLE, SIZE, OR COLOR.

OWNER OF U.S. REG. NOS. 2,265,665 AND
2,846,710.

SN 77-195,156, FILED 6-1-2007.

DAVID HOFFMAN, EXAMINING ATTORNEY

Int. Cl.: 38

Prior U.S. Cls.: 100, 101, and 104

United States Patent and Trademark Office

Reg. No. 3,485,916

Registered Aug. 12, 2008

**SERVICE MARK
PRINCIPAL REGISTER**

EliteTrak

ATLANTA AUTO TRACKER, INC. (GEORGIA
CORPORATION)
338 VETERANS MEMORIAL HWY
MABLETON, GA 30126

FOR: WIRELESS DATA COMMUNICATIONS
SERVICES, NAMELY, PROVIDING GLOBAL POSI-
TIONING SERVICES FOR VEHICLES TO A CEN-
TRAL COMPUTER SYSTEM USING WIRELESS
NETWORKS, IN CLASS 38 (U.S. CLS. 100, 101 AND
104).

FIRST USE 6-20-2007; IN COMMERCE 6-20-2007.

THE MARK CONSISTS OF STANDARD CHAR-
ACTERS WITHOUT CLAIM TO ANY PARTICULAR
FONT, STYLE, SIZE, OR COLOR.

SN 77-195,216, FILED 6-1-2007.

LINDA E. BLOHM, EXAMINING ATTORNEY

Int. Cl.: 28

Prior U.S. Cls.: 22, 23, 38, and 50

United States Patent and Trademark Office

Reg. No. 3,485,917

Registered Aug. 12, 2008

**TRADEMARK
PRINCIPAL REGISTER**

THINK OUTSIDE THE BLOX

SCARBOROUGH, DANE (UNITED STATES IN-
DIVIDUAL)
PO BOX 3351
HAILEY, ID 83333

FOR: CONSTRUCTION TOYS, NAMELY, KITS
COMPRISED OF PLASTIC CONNECTOR PIECES
FOR CONSTRUCTING CARS, BOATS, AIRPLANES
AND THE LIKE, IN CLASS 28 (U.S. CLS. 22, 23, 38
AND 50).

FIRST USE 6-1-2007; IN COMMERCE 6-1-2007.

THE MARK CONSISTS OF STANDARD CHAR-
ACTERS WITHOUT CLAIM TO ANY PARTICULAR
FONT, STYLE, SIZE, OR COLOR.

SN 77-195,264, FILED 6-1-2007.

LINDA E. BLOHM, EXAMINING ATTORNEY

Int. Cl.: 41

Prior U.S. Cls.: 100, 101, and 107

United States Patent and Trademark Office

Reg. No. 3,485,918

Registered Aug. 12, 2008

**SERVICE MARK
PRINCIPAL REGISTER**

METROPOLITAN CHESS

NORTHERN VIRGINIA CHESS CENTER LLC
(VIRGINIA LTD LIAB CO)
1960 LIMB TREE LN
VIENNA, VA 22182

FOR: INSTRUCTION IN THE FIELD OF PROFESSIONAL CHESS; ENTERTAINMENT IN THE NATURE OF CHESS TOURNAMENTS, IN CLASS 41 (U.S. CLS. 100, 101 AND 107).

FIRST USE 6-1-2007; IN COMMERCE 7-1-2007.

THE MARK CONSISTS OF STANDARD CHARACTERS WITHOUT CLAIM TO ANY PARTICULAR FONT, STYLE, SIZE, OR COLOR.

NO CLAIM IS MADE TO THE EXCLUSIVE RIGHT TO USE "CHESS", APART FROM THE MARK AS SHOWN.

SN 77-195,304, FILED 6-1-2007.

HANNO RITTNER, EXAMINING ATTORNEY

Int. Cl.: 9

Prior U.S. Cls.: 21, 23, 26, 36, and 38

Reg. No. 3,485,919

United States Patent and Trademark Office

Registered Aug. 12, 2008

**TRADEMARK
PRINCIPAL REGISTER**

SAWGAS

DELAWARE CAPITAL FORMATION, INC. (DE-
LAWARE CORPORATION)
501 SILVERSIDE ROAD, SUITE 5
WILMINGTON, DE 19809

THE MARK CONSISTS OF STANDARD CHAR-
ACTERS WITHOUT CLAIM TO ANY PARTICULAR
FONT, STYLE, SIZE, OR COLOR.

FOR: GAS SENSORS FOR MEASURING GAS
CONCENTRATION, IN CLASS 9 (U.S. CLS. 21, 23,
26, 36 AND 38).

SN 77-195,553, FILED 6-1-2007.

FIRST USE 11-30-2006; IN COMMERCE 11-30-2006.

SUSAN LESLIE DUBOIS, EXAMINING ATTORNEY

Int. Cl.: 36

Prior U.S. Cls.: 100, 101, and 102

United States Patent and Trademark Office

Reg. No. 3,485,920

Registered Aug. 12, 2008

**SERVICE MARK
PRINCIPAL REGISTER**

TICKERSPY

INDIE RESEARCH, LLC (NEW JERSEY LTD
LIAB CO)
254 WITHERSPOON STREET
PRINCETON, NJ 08542

THE MARK CONSISTS OF STANDARD CHAR-
ACTERS WITHOUT CLAIM TO ANY PARTICULAR
FONT, STYLE, SIZE, OR COLOR.

FOR: PROVIDING ONLINE INFORMATION IN
THE FIELD OF FINANCIAL SERVICES, IN CLASS
36 (U.S. CLS. 100, 101 AND 102).

SN 77-197,010, FILED 6-4-2007.

FIRST USE 9-1-2007; IN COMMERCE 9-1-2007.

ANNE MADDEN, EXAMINING ATTORNEY

Int. Cls.: 36 and 43

Prior U.S. Cls.: 100, 101, and 102

United States Patent and Trademark Office

Reg. No. 3,485,921

Registered Aug. 12, 2008

**SERVICE MARK
PRINCIPAL REGISTER**

**THERE IS A PLACE IN OUR
FAMILY FOR YOURS**

WYNDHAM TM CORP. (DELAWARE CORPORATION)
10750 WEST CHARLESTON BLVD., SUITE 130
LAS VEGAS, NJ 89135

FOR: REAL ESTATE AND VACATION PROPERTY EXCHANGE, MANAGEMENT, LEASING AND LISTING SERVICES, VACATION REAL ESTATE TIME SHARE EXCHANGE SERVICES AND VACATION REAL ESTATE TIMESHARE SERVICES, IN CLASS 36 (U.S. CLS. 100, 101 AND 102).

FIRST USE 6-16-2008; IN COMMERCE 6-16-2008.

FOR: RESORT HOTEL, CONDOMINIUM HOTEL, HOTEL, MOTEL AND RESTAURANT SERVICES; MAKING LODGING RESERVATIONS FOR OTHERS, IN CLASS 43 (U.S. CLS. 100 AND 101).

FIRST USE 6-16-2008; IN COMMERCE 6-16-2008.

THE MARK CONSISTS OF STANDARD CHARACTERS WITHOUT CLAIM TO ANY PARTICULAR FONT, STYLE, SIZE, OR COLOR.

SN 77-198,150, FILED 6-5-2007.

JILL C. ALT, EXAMINING ATTORNEY

Int. Cl.: 36

Prior U.S. Cls.: 100, 101, and 102

United States Patent and Trademark Office

Reg. No. 3,485,922

Registered Aug. 12, 2008

**SERVICE MARK
PRINCIPAL REGISTER**

LIRNs

MERRILL LYNCH & CO., INC. (DELAWARE
CORPORATION)
4 WORLD FINANCIAL CENTER
NEW YORK, NY 10080

FOR: FINANCIAL SERVICES IN THE NATURE
OF AN INVESTMENT SECURITY, IN CLASS 36 (U.S.
CLS. 100, 101 AND 102).

FIRST USE 4-16-2008; IN COMMERCE 4-16-2008.

THE MARK CONSISTS OF STANDARD CHAR-
ACTERS WITHOUT CLAIM TO ANY PARTICULAR
FONT, STYLE, SIZE, OR COLOR.

SN 77-198,290, FILED 6-5-2007.

WILLIAM BRECKENFELD, EXAMINING ATTOR-
NEY

Int. Cl.: 36

Prior U.S. Cls.: 100, 101, and 102

United States Patent and Trademark Office

Reg. No. 3,485,923

Registered Aug. 12, 2008

**SERVICE MARK
PRINCIPAL REGISTER**

WEST FINANCIAL

WEST FINANCIAL CREDIT UNION (MINNESOTA CREDIT UNION)

13600 INDUSTRIAL PARK BLVD.

PLYMOUTH, MN 55441

FOR: CREDIT UNIONS, IN CLASS 36 (U.S. CLS. 100, 101 AND 102).

FIRST USE 5-31-2007; IN COMMERCE 5-31-2007.

THE MARK CONSISTS OF STANDARD CHARACTERS WITHOUT CLAIM TO ANY PARTICULAR FONT, STYLE, SIZE, OR COLOR.

NO CLAIM IS MADE TO THE EXCLUSIVE RIGHT TO USE "FINANCIAL", APART FROM THE MARK AS SHOWN.

SN 77-198,311, FILED 6-5-2007.

ERNEST SHOSHO, EXAMINING ATTORNEY

Int. Cl.: 41

Prior U.S. Cls.: 100, 101, and 107

Reg. No. 3,485,924

United States Patent and Trademark Office

Registered Aug. 12, 2008

**SERVICE MARK
PRINCIPAL REGISTER**

URBAN ACTIVE

IP HOLDINGS, LLC (KENTUCKY LTD LIAB CO)
3500 NATIONAL CITY TOWER
101 SOUTH FIFTH STREET
LOUISVILLE, KY 40202

FOR: HEALTH CLUB SERVICES, NAMELY, PROVIDING INSTRUCTION AND EQUIPMENT IN THE FIELD OF PHYSICAL EXERCISE; PROVIDING FITNESS AND EXERCISE FACILITIES, IN CLASS 41 (U.S. CLS. 100, 101 AND 107).

FIRST USE 11-20-2007; IN COMMERCE 11-20-2007.

THE MARK CONSISTS OF STANDARD CHARACTERS WITHOUT CLAIM TO ANY PARTICULAR FONT, STYLE, SIZE, OR COLOR.

SN 77-199,323, FILED 6-6-2007.

KIMBERLY PERRY, EXAMINING ATTORNEY

Int. Cl.: 42

Prior U.S. Cls.: 100 and 101

United States Patent and Trademark Office

Reg. No. 3,485,925

Registered Aug. 12, 2008

**SERVICE MARK
PRINCIPAL REGISTER**



KEL-SAN, INC. (TENNESSEE CORPORATION)
5109 NATIONAL DRIVE
KNOXVILLE, TN 37914

OWNER OF U.S. REG. NO. 2,197,029.

FOR: BUSINESS SERVICES IN THE NATURE OF ASSISTING OTHERS IN THE IMPLEMENTATION OF CONSERVATION, RECYCLING, AND ENVIRONMENTALLY-FRIENDLY PRACTICES IN DAY-TO-DAY BUSINESS OPERATIONS , IN CLASS 42 (U.S. CLS. 100 AND 101).

NO CLAIM IS MADE TO THE EXCLUSIVE RIGHT TO USE "GREEN", APART FROM THE MARK AS SHOWN.

SN 77-199,452, FILED 6-6-2007.

FIRST USE 9-21-2007; IN COMMERCE 10-15-2007.

KELLEY WELLS, EXAMINING ATTORNEY

Int. Cl.: 35

Prior U.S. Cls.: 100, 101, and 102

United States Patent and Trademark Office

Reg. No. 3,485,926

Registered Aug. 12, 2008

**SERVICE MARK
PRINCIPAL REGISTER**

Sales Force FUSION

SOLSTICE BUSINESS COMMUNICATIONS, INC.
(GEORGIA CORPORATION)
6730 WOLFORD CT
DULUTH, GA 30097

FOR: SALES PROCESS MANAGEMENT AND
SALES SYSTEM IMPLEMENTATION CONSULT-
ING, IN CLASS 35 (U.S. CLS. 100, 101 AND 102).

FIRST USE 4-4-2007; IN COMMERCE 4-5-2007.

THE MARK CONSISTS OF STANDARD CHAR-
ACTERS WITHOUT CLAIM TO ANY PARTICULAR
FONT, STYLE, SIZE, OR COLOR.

NO CLAIM IS MADE TO THE EXCLUSIVE
RIGHT TO USE "SALES FORCE", APART FROM
THE MARK AS SHOWN.

SN 77-199,549, FILED 6-6-2007.

BRIAN NEVILLE, EXAMINING ATTORNEY

Int. Cl.: 36

Prior U.S. Cls.: 100, 101, and 102

United States Patent and Trademark Office

Reg. No. 3,485,927

Registered Aug. 12, 2008

SERVICE MARK
PRINCIPAL REGISTER



LOCKTON RISK SERVICES, INC. (KANSAS CORPORATION)

SUITE 500

7300 COLLEGE BOULEVARD

OVERLAND PARK, KS 66210

FOR: INSURANCE ADMINISTRATION IN THE FIELD OF PROFESSIONAL LIABILITY; INSURANCE AGENCY AND BROKERAGE, IN CLASS 36 (U.S. CLS. 100, 101 AND 102).

FIRST USE 5-15-2007; IN COMMERCE 5-15-2007.

NO CLAIM IS MADE TO THE EXCLUSIVE RIGHT TO USE "LAWYERS PROFESSIONAL LIABILITY", APART FROM THE MARK AS SHOWN.

THE MARK CONSISTS OF A COLUMN DESIGN NEXT TO THE STYLIZED WORDS "DEFENSEINSURE", WHICH APPEAR ABOVE THE WORDS "LAWYERS PROFESSIONAL LIABILITY". A HORIZONTAL LINE APPEARS BENEATH THE WORD "DEFENSE".

SN 77-199,600, FILED 6-6-2007.

ANDREW RHIM, EXAMINING ATTORNEY

Int. Cl.: 35

Prior U.S. Cls.: 100, 101, and 102

United States Patent and Trademark Office

Reg. No. 3,485,928

Registered Aug. 12, 2008

SERVICE MARK
PRINCIPAL REGISTER



Impulsive

IMPULSIVE ENTERPRISES LTD. (CAYMAN ISLANDS CORPORATION)
SCOTIA BANK BUILDING
P.O. BOX 268
GRAND CAYMAN, CAYMAN ISLANDS

THE MARK CONSISTS OF THE WORD "IMPULSIVE" UNDER WHICH IS ONE VERTICAL LINE, AND A SECOND JAGGED LINE REPRESENTING A HEARTBEAT.

FOR: ADMINISTRATIVE HOTEL MANAGEMENT, IN CLASS 35 (U.S. CLS. 100, 101 AND 102).

SN 77-201,333, FILED 6-8-2007.

FIRST USE 9-30-2006; IN COMMERCE 9-30-2006.

OWNER OF U.S. REG. NO. 3,289,828.

STEVEN PEREZ, EXAMINING ATTORNEY

Int. Cl.: 41

Prior U.S. Cls.: 100, 101, and 107

United States Patent and Trademark Office

Reg. No. 3,485,929

Registered Aug. 12, 2008

**SERVICE MARK
PRINCIPAL REGISTER**

BROWN BEAR VILLAGE

CAR WASH ENTERPRISES, INC. DBA BROWN
BEAR CAR WASH (WASHINGTON COR-
PORATION)
3977 LEARY WAY NW
SEATTLE, WA 98107

FOR: PROVIDING FACILITIES FOR RECREA-
TIONAL ACTIVITIES, NAMELY, SKI INSTRU-
TION SERVICES FACILITIES; SKI RESORT
SERVICES, NAMELY, PROVIDING SKI LESSONS
IN THE NATURE OF A LEARN TO SKI PROGRAM
FOR KIDS, IN CLASS 41 (U.S. CLS. 100, 101 AND 107).

FIRST USE 11-0-2007; IN COMMERCE 11-0-2007.

THE MARK CONSISTS OF STANDARD CHAR-
ACTERS WITHOUT CLAIM TO ANY PARTICULAR
FONT, STYLE, SIZE, OR COLOR.

SN 77-203,223, FILED 6-11-2007.

THOMAS MANOR, EXAMINING ATTORNEY

Int. Cl.: 9

Prior U.S. Cls.: 21, 23, 26, 36, and 38

Reg. No. 3,485,930

United States Patent and Trademark Office

Registered Aug. 12, 2008

**TRADEMARK
PRINCIPAL REGISTER**

DuraSteel

BANOM, INC. (PENNSYLVANIA CORPORATION)
BOX 687
WAYNE, PA 19087

THE MARK CONSISTS OF STANDARD CHARACTERS WITHOUT CLAIM TO ANY PARTICULAR FONT, STYLE, SIZE, OR COLOR.

FOR: CUT-RESISTANT GLOVES FOR INDUSTRIAL USE, IN CLASS 9 (U.S. CLS. 21, 23, 26, 36 AND 38).

SN 77-203,549, FILED 6-12-2007.

FIRST USE 9-13-2007; IN COMMERCE 9-13-2007.

REGINA DRUMMOND, EXAMINING ATTORNEY

Int. Cl.: 39

Prior U.S. Cls.: 100 and 105

United States Patent and Trademark Office

Reg. No. 3,485,931

Registered Aug. 12, 2008

**SERVICE MARK
PRINCIPAL REGISTER**

enviroCAB

ENVIROCAB (VIRGINIA LTD LIAB CO)
#464
1415 S. EDGEWOOD ST.
ARLINGTON, VA 22204

THE MARK CONSISTS OF STANDARD CHAR-
ACTERS WITHOUT CLAIM TO ANY PARTICULAR
FONT, STYLE, SIZE, OR COLOR.

FOR: TAXI TRANSPORT, IN CLASS 39 (U.S. CLS.
100 AND 105).

SN 77-203,576, FILED 6-12-2007.

FIRST USE 1-15-2008; IN COMMERCE 1-15-2008.

BRIAN NEVILLE, EXAMINING ATTORNEY

Int. Cl.: 25

Prior U.S. Cls.: 22 and 39

United States Patent and Trademark Office

Reg. No. 3,485,932

Registered Aug. 12, 2008

**TRADEMARK
PRINCIPAL REGISTER**

GWYNETH

BOADU, GWENDOLYN FREMPONG (UNITED STATES INDIVIDUAL)
127 BOUTONVILLE ROAD
POUND RIDGE, NY 10576

FOR: LADIES' SHOES, IN CLASS 25 (U.S. CLS. 22 AND 39).

FIRST USE 9-0-2007; IN COMMERCE 9-0-2007.

THE MARK CONSISTS OF STANDARD CHARACTERS WITHOUT CLAIM TO ANY PARTICULAR FONT, STYLE, SIZE, OR COLOR.

SN 77-204,052, FILED 6-12-2007.

KATHERINE CONNOLLY, EXAMINING ATTORNEY

Int. Cl.: 9

Prior U.S. Cls.: 21, 23, 26, 36, and 38

Reg. No. 3,485,933

United States Patent and Trademark Office

Registered Aug. 12, 2008

**TRADEMARK
PRINCIPAL REGISTER**

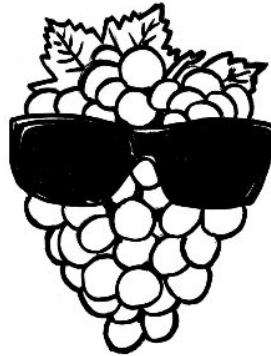

SAMBRAILO PACKAGING CORPORATION (CALIFORNIA CORPORATION)
800 WALKER STREET
WATSONVILLE, CA 95076

THE MARK CONSISTS OF A DRAWING OF A BUNCH OF GRAPES WEARING GLASSES.

FOR: REFRIGERATOR MAGNETS, IN CLASS 9 (U.S. CLS. 21, 23, 26, 36 AND 38).

SN 77-204,225, FILED 6-12-2007.

FIRST USE 10-22-2006; IN COMMERCE 10-13-2007.

CAROLYN CATALDO, EXAMINING ATTORNEY

Int. Cl.: 9

Prior U.S. Cls.: 21, 23, 26, 36, and 38

Reg. No. 3,485,934

United States Patent and Trademark Office

Registered Aug. 12, 2008

**TRADEMARK
PRINCIPAL REGISTER**



BEST RAINBOW TECHNOLOGY LIMITED
(HONG KONG LTD LIAB CO)
FLAT/RM 2009, 20/F, PAUL Y. CENTRE
51 HUNG TO ROAD, KWUN TONG
KOWLOON, HONG KONG

FOR: BLANK RECORDABLE DVDS; BLANK CD-
ROMS FOR SOUND OR VIDEO RECORDING;
BLANK OPTICAL DISCS; BLANK RECORDABLE

OPTICAL DISC; BLANK RECORD DISKS, IN CLASS
9 (U.S. CLS. 21, 23, 26, 36 AND 38).

FIRST USE 6-1-2005; IN COMMERCE 6-1-2005.

SN 77-204,623, FILED 6-13-2007.

KATHERINE M. DUBRAY, EXAMINING ATTOR-
NEY

Int. Cl.: 36

Prior U.S. Cls.: 100, 101, and 102

United States Patent and Trademark Office

Reg. No. 3,485,935

Registered Aug. 12, 2008

**SERVICE MARK
PRINCIPAL REGISTER**



SPARTA INSURANCE HOLDINGS, INC. (DELAWARE CORPORATION)
185 ASYLUM AVENUE, CITYPLACE II
HARTFORD, CT 06103

FOR: INSURANCE SERVICES, NAMELY, UNDERWRITING PROPERTY AND CASUALTY INSURANCE; PROPERTY AND CASUALTY UNDERWRITING IN THE FIELD OF UNBUNDLED PROGRAM AND ALTERNATIVE RISK TRANSFER INSURANCE; REINSURANCE UNDERWRITING, IN CLASS 36 (U.S. CLS. 100, 101 AND 102).

FIRST USE 8-3-2007; IN COMMERCE 8-3-2007.

NO CLAIM IS MADE TO THE EXCLUSIVE RIGHT TO USE "INSURANCE", APART FROM THE MARK AS SHOWN.

THE MARK CONSISTS OF THE WORD "SPARTA" DISPLAYED OVER THE WORD "INSURANCE". OVER THE TOP OF THE "S" ON "SPARTA" ARE LINES RADIATING OUTWARD IN A CIRCULAR PATTERN.

SN 77-205,032, FILED 6-13-2007.

REGINA DRUMMOND, EXAMINING ATTORNEY

Int. Cls.: 41 and 43

Prior U.S. Cls.: 100, 101, and 107

United States Patent and Trademark Office

Reg. No. 3,485,936

Registered Aug. 12, 2008

**SERVICE MARK
PRINCIPAL REGISTER**

1 OAK

COLUMBIA CONSULTANTS LLC (FLORIDA
LTD LIAB CO)
1005 NORTH EAST 26TH STREET
HALLANDALE, FL 33009 AND
RICHARD AKIVA, INC. (NEW YORK CORPORA-
TION)
415 LAFAYETTE STREET
NEW YORK, NY 10003

FOR: NIGHT CLUB SERVICES, IN CLASS 41 (U.S.
CLS. 100, 101 AND 107).

FIRST USE 9-15-2007; IN COMMERCE 12-13-2007.

FOR: RESTAURANT, BAR AND COCKTAIL
LOUNGE SERVICES, IN CLASS 43 (U.S. CLS. 100
AND 101).

FIRST USE 9-15-2007; IN COMMERCE 12-13-2007.

THE MARK CONSISTS OF STANDARD CHAR-
ACTERS WITHOUT CLAIM TO ANY PARTICULAR
FONT, STYLE, SIZE, OR COLOR.

SN 77-205,233, FILED 6-13-2007.

MATTHEW PAPPAS, EXAMINING ATTORNEY

Int. Cl.: 25

Prior U.S. Cls.: 22 and 39

United States Patent and Trademark Office

Reg. No. 3,485,937

Registered Aug. 12, 2008

**TRADEMARK
PRINCIPAL REGISTER**

Cargies

WHITNEY, ANDREW (UNITED STATES INDIVIDUAL)

#103

11946 MONTANA AVE.

LOS ANGELES, CA 90049

THE MARK CONSISTS OF STANDARD CHARACTERS WITHOUT CLAIM TO ANY PARTICULAR FONT, STYLE, SIZE, OR COLOR.

FOR: CLOTHING, NAMELY, MESH CARGO SHORTS AND PANTS, IN CLASS 25 (U.S. CLS. 22 AND 39).

SN 77-205,377, FILED 6-13-2007.

FIRST USE 7-5-2007; IN COMMERCE 8-10-2007.

DANIEL BRODY, EXAMINING ATTORNEY

Int. Cl.: 5

Prior U.S. Cls.: 6, 18, 44, 46, 51, and 52

Reg. No. 3,485,938

United States Patent and Trademark Office

Registered Aug. 12, 2008

**TRADEMARK
PRINCIPAL REGISTER**

QUICK2SIP

WEIDER GLOBAL NUTRITION, LLC (NEVADA
LTD LIAB CO)
2002 SOUTH 5070 WEST
SALT LAKE CITY, UT 84104

FIRST USE 6-6-2008; IN COMMERCE 6-6-2008.

FOR: DIETARY AND NUTRITIONAL SUPPLEMENTS; DIETARY SUPPLEMENTAL DRINKS; DIETARY SUPPLEMENTS; NUTRITIONAL SUPPLEMENTS; DIETARY FOOD SUPPLEMENTS; DIETARY SUPPLEMENTS FOR HUMAN CONSUMPTION; POWDERED NUTRITIONAL SUPPLEMENT DRINK MIX, IN CLASS 5 (U.S. CLS. 6, 18, 44, 46, 51 AND 52).

THE MARK CONSISTS OF STANDARD CHARACTERS WITHOUT CLAIM TO ANY PARTICULAR FONT, STYLE, SIZE, OR COLOR.

SN 77-206,615, FILED 6-14-2007.

KAREN BRACEY, EXAMINING ATTORNEY

Int. Cl.: 9

Prior U.S. Cls.: 21, 23, 26, 36, and 38

United States Patent and Trademark Office

Reg. No. 3,485,939

Registered Aug. 12, 2008

**TRADEMARK
PRINCIPAL REGISTER**



PETRA SOLAR, INC. (DELAWARE CORPORATION)
25 WORLDS FAIR DRIVE
SOMERSET, NJ 08873

FOR: APPARATUS FOR CONVERTING ELECTRONIC RADIATION TO ELECTRICAL ENERGY, NAMELY, PHOTOVOLTAIC SOLAR HYBRID MODULES; APPARATUS FOR CONVERTING ELECTRONIC RADIATION TO ELECTRICAL ENERGY, NAMELY, PHOTOVOLTAIC SOLAR MODULES;

PHOTOVOLTAIC CELLS; INVERTERS, IN CLASS 9 (U.S. CLS. 21, 23, 26, 36 AND 38).

FIRST USE 3-1-2007; IN COMMERCE 1-15-2008.

THE MARK CONSISTS OF A GLOBE WITH WAVY LINES AS DISPLAYED ON WEBPAGE.

SN 77-206,957, FILED 6-15-2007.

LINDA M. KING, EXAMINING ATTORNEY

Int. Cl.: 36

Prior U.S. Cls.: 100, 101, and 102

United States Patent and Trademark Office

Reg. No. 3,485,940

Registered Aug. 12, 2008

**SERVICE MARK
PRINCIPAL REGISTER**

Austin Apartment Guy

HUMPHREYS, MICHAEL E. (UNITED STATES
INDIVIDUAL)
SUITE #575
3407 WELLS BRANCH PKWY
AUSTIN, TX 78728

FOR: REAL ESTATE LISTING; REAL ESTATE
PROCUREMENT FOR OTHERS, IN CLASS 36 (U.S.
CLS. 100, 101 AND 102).

FIRST USE 1-1-2005; IN COMMERCE 1-1-2005.

THE MARK CONSISTS OF STANDARD CHAR-
ACTERS WITHOUT CLAIM TO ANY PARTICULAR
FONT, STYLE, SIZE, OR COLOR.

NO CLAIM IS MADE TO THE EXCLUSIVE
RIGHT TO USE "AUSTIN APARTMENT", APART
FROM THE MARK AS SHOWN.

SN 77-208,020, FILED 6-17-2007.

HEATHER THOMPSON, EXAMINING ATTORNEY

Int. Cl.: 14

Prior U.S. Cls.: 2, 27, 28, and 50

United States Patent and Trademark Office

Reg. No. 3,485,941

Registered Aug. 12, 2008

**TRADEMARK
PRINCIPAL REGISTER**

UNKAGED

SCOTT KAY, INC. (NEW JERSEY CORPORATION)
780 PALISADE AVENUE
TEANECK, NJ 07666

THE MARK CONSISTS OF STANDARD CHARACTERS WITHOUT CLAIM TO ANY PARTICULAR FONT, STYLE, SIZE, OR COLOR.

FOR: JEWELRY, IN CLASS 14 (U.S. CLS. 2, 27, 28 AND 50).

SN 77-208,160, FILED 6-18-2007.

FIRST USE 5-31-2008; IN COMMERCE 5-31-2008.

ANNE E. GUSTASON, EXAMINING ATTORNEY

Int. Cl.: 12

Prior U.S. Cls.: 19, 21, 23, 31, 35, and 44

Reg. No. 3,485,942

United States Patent and Trademark Office

Registered Aug. 12, 2008

**TRADEMARK
PRINCIPAL REGISTER**

NOVIBE

IG HOLDINGS, LLC (WISCONSIN LTD LIAB CO)
204 N WAHSINGTON
MELROSE, WI 54642

THE MARK CONSISTS OF STANDARD CHAR-
ACTERS WITHOUT CLAIM TO ANY PARTICULAR
FONT, STYLE, SIZE, OR COLOR.

FOR: MOTORCYCLE SEATS, IN CLASS 12 (U.S.
CLS. 19, 21, 23, 31, 35 AND 44).

SN 77-208,494, FILED 6-18-2007.

FIRST USE 5-30-2008; IN COMMERCE 5-30-2008.

ZACHARY BELLO, EXAMINING ATTORNEY

Int. Cl.: 36

Prior U.S. Cls.: 100, 101, and 102

United States Patent and Trademark Office

Reg. No. 3,485,943

Registered Aug. 12, 2008

**SERVICE MARK
PRINCIPAL REGISTER**



WEST FINANCIAL CREDIT UNION (MINNESOTA CREDIT UNION)
13600 INDUSTRIAL PARK BLVD.
PLYMOUTH, MN 55441

FOR: CREDIT UNIONS, IN CLASS 36 (U.S. CLS. 100, 101 AND 102).

FIRST USE 5-31-2007; IN COMMERCE 5-31-2007.

NO CLAIM IS MADE TO THE EXCLUSIVE RIGHT TO USE "FINANCIAL", APART FROM THE MARK AS SHOWN.

THE COLOR(S) BLACK AND GREEN IS/ARE CLAIMED AS A FEATURE OF THE MARK.

THE MARK CONSISTS OF THE WORD "WEST" IN BLACK OVER THE WORD "FINANCIAL" WHICH IS IN GREEN; THERE IS A GREEN STAR WITH A BLACK BORDER AT THE END OF THE WORD "WEST" AND A BLACK LINE IN-BETWEEN THE WORDS IN THE MARK.

SN 77-208,653, FILED 6-18-2007.

ERNEST SHOSHO, EXAMINING ATTORNEY

Int. Cls.: 35 and 36

Prior U.S. Cls.: 100, 101, and 102

United States Patent and Trademark Office

Reg. No. 3,485,944

Registered Aug. 12, 2008

**SERVICE MARK
PRINCIPAL REGISTER**

TRUOPTIONS

MATTHEWS, BRUCE (UNITED STATES INDIVIDUAL)
PO BOX 91433
RALEIGH, NC 27675

FOR: BUSINESS MANAGEMENT CONSULTING AND ADVISORY SERVICES; BUSINESS MANAGEMENT PLANNING; CONSULTING SERVICES IN BUSINESS ORGANIZATION AND MANAGEMENT; BUSINESS SUCCESSION PLANNING, IN CLASS 35 (U.S. CLS. 100, 101 AND 102).

FIRST USE 6-27-2007; IN COMMERCE 6-1-2008.

FOR: INSURANCE SERVICES, NAMELY, WRITING PROPERTY AND CASUALTY INSURANCE, MEDICAL INSURANCE, DENTAL HEALTH IN-

SURANCE, DISABILITY INSURANCE AND LIFE INSURANCE; MUTUAL FUND AND ANNUITY BROKERAGE; ESTATE PLANNING AND ADMINISTRATION OF GROUP RETIREMENT BENEFIT PLANS CONCERNING INSURANCE AND INVESTMENT, IN CLASS 36 (U.S. CLS. 100, 101 AND 102).

FIRST USE 6-27-2007; IN COMMERCE 6-1-2008.

THE MARK CONSISTS OF STANDARD CHARACTERS WITHOUT CLAIM TO ANY PARTICULAR FONT, STYLE, SIZE, OR COLOR.

SN 77-211,121, FILED 6-20-2007.

BARBARA BROWN, EXAMINING ATTORNEY

Int. Cl.: 41

Prior U.S. Cls.: 100, 101, and 107

United States Patent and Trademark Office

Reg. No. 3,485,945

Registered Aug. 12, 2008

**SERVICE MARK
PRINCIPAL REGISTER**

LISTINGLIFE

LISTINGBOOK, LLC (NORTH CAROLINA LTD
LIAB CO)
7029 ALBERT PICK ROAD
GREENSBORO, NC 27409

THE MARK CONSISTS OF STANDARD CHAR-
ACTERS WITHOUT CLAIM TO ANY PARTICULAR
FONT, STYLE, SIZE, OR COLOR.

FOR: ONLINE MAGAZINES ON THE SUBJECT
OF REAL ESTATE, IN CLASS 41 (U.S. CLS. 100, 101
AND 107).

SN 77-211,158, FILED 6-20-2007.

FIRST USE 7-17-2007; IN COMMERCE 7-17-2007.

HEATHER THOMPSON, EXAMINING ATTORNEY

Int. Cls.: 35, 40, and 42

Prior U.S. Cls.: 100, 101, 102, 103, and 106

United States Patent and Trademark Office

Reg. No. 3,485,946

Registered Aug. 12, 2008

**SERVICE MARK
PRINCIPAL REGISTER**

**CREATING MORE RELEVANT
INTERACTIONS**

THE ROYAL GROUP LLC (NEW YORK LTD
LIAB CO)
460 WEST 34TH STREET
NEW YORK, NY 10001

FOR: CREATIVE MARKETING DESIGN SERVICES, NAMELY, CUSTOM DESIGN OF MARKETING COLLATERAL, DOCUMENTS AND COMMUNICATIONS FOR OTHERS , IN CLASS 35 (U.S. CLS. 100, 101 AND 102).

FIRST USE 7-1-2007; IN COMMERCE 7-1-2007.

FOR: DIGITAL PRINTING, OFFSET LITHOGRAPHY AND LARGE-FORMAT DIGITAL COLOR PRINTING, IN CLASS 40 (U.S. CLS. 100, 103 AND 106).

FIRST USE 7-1-2007; IN COMMERCE 7-1-2007.

FOR: GRAPHIC DESIGN AND WEB PAGE DESIGN FOR OTHERS, IN CLASS 42 (U.S. CLS. 100 AND 101).

FIRST USE 7-1-2007; IN COMMERCE 7-1-2007.

THE MARK CONSISTS OF STANDARD CHARACTERS WITHOUT CLAIM TO ANY PARTICULAR FONT, STYLE, SIZE, OR COLOR.

SN 77-211,634, FILED 6-21-2007.

KATHRYN COWARD, EXAMINING ATTORNEY

Int. Cl.: 43

Prior U.S. Cls.: 100 and 101

United States Patent and Trademark Office

Reg. No. 3,485,947

Registered Aug. 12, 2008

**SERVICE MARK
PRINCIPAL REGISTER**



ROI'S BAR-B-Q, INC. (FLORIDA CORPORATION)
2535 SUCCESS DRIVE
ODESSA, FL 33556

THE MARK CONSISTS OF PIG SITTING IN A
ROCKING CHAIR WITH A STRAW HAT HANGING
ON THE ROCKING CHAIR.

FOR: RESTAURANT SERVICES, IN CLASS 43
(U.S. CLS. 100 AND 101).

SN 77-212,126, FILED 6-21-2007.

FIRST USE 5-22-2008; IN COMMERCE 5-22-2008.

HEATHER THOMPSON, EXAMINING ATTORNEY

Int. Cl.: 3

Prior U.S. Cls.: 1, 4, 6, 50, 51, and 52

United States Patent and Trademark Office

Reg. No. 3,485,948

Registered Aug. 12, 2008

**TRADEMARK
PRINCIPAL REGISTER**

SHEER MYSTERY POWDER

MAKE-UP ART COSMETICS INC. (DELAWARE
CORPORATION)

767 FIFTH AVENUE

NEW YORK, NY 10153

FOR: COSMETICS, IN CLASS 3 (U.S. CLS. 1, 4, 6, 50,
51 AND 52).

FIRST USE 11-30-2006; IN COMMERCE 11-30-2006.

THE MARK CONSISTS OF STANDARD CHAR-
ACTERS WITHOUT CLAIM TO ANY PARTICULAR
FONT, STYLE, SIZE, OR COLOR.

NO CLAIM IS MADE TO THE EXCLUSIVE
RIGHT TO USE "POWDER", APART FROM THE
MARK AS SHOWN.

SN 77-212,492, FILED 6-21-2007.

PATRICIA EVANKO, EXAMINING ATTORNEY

Int. Cl.: 20

Prior U.S. Cls.: 2, 13, 22, 25, 32, and 50

Reg. No. 3,485,949

United States Patent and Trademark Office

Registered Aug. 12, 2008

**TRADEMARK
PRINCIPAL REGISTER**

DON'T SWEAT IT

MOORECO, INC. (TEXAS CORPORATION)
2885 LORRAINE AVENUE
TEMPLE, TX 76501

THE MARK CONSISTS OF STANDARD CHAR-
ACTERS WITHOUT CLAIM TO ANY PARTICULAR
FONT, STYLE, SIZE, OR COLOR.

FOR: CHAIRS; FURNITURE, IN CLASS 20 (U.S.
CLS. 2, 13, 22, 25, 32 AND 50).

SN 77-214,761, FILED 6-25-2007.

FIRST USE 11-0-2007; IN COMMERCE 11-0-2007.

DAVID YONTEF, EXAMINING ATTORNEY

Int. Cl.: 35

Prior U.S. Cls.: 100, 101, and 102

United States Patent and Trademark Office

Reg. No. 3,485,950

Registered Aug. 12, 2008

**SERVICE MARK
PRINCIPAL REGISTER**

Tax Day to May Day

TCIP, LLC (WYOMING LTD LIAB CO)
60 EAST SIMPSON AVE.
JACKSON, WY 83001

THE MARK CONSISTS OF STANDARD CHAR-
ACTERS WITHOUT CLAIM TO ANY PARTICULAR
FONT, STYLE, SIZE, OR COLOR.

FOR: ADVERTISING, MARKETING AND PRO-
MOTION SERVICES; ADVERTISING PARTICU-
LARLY SERVICES FOR THE PROMOTION OF
GOODS, IN CLASS 35 (U.S. CLS. 100, 101 AND 102).

SN 77-215,034, FILED 6-25-2007.

FIRST USE 4-15-2008; IN COMMERCE 4-20-2008.

MATTHEW PAPPAS, EXAMINING ATTORNEY

Int. Cl.: 11

Prior U.S. Cls.: 13, 21, 23, 31, and 34

Reg. No. 3,485,951

United States Patent and Trademark Office

Registered Aug. 12, 2008

**TRADEMARK
PRINCIPAL REGISTER**

I-ZAP

VIOLIGHT, INC. (NEW YORK CORPORATION)
175 CLEARBROOK ROAD
ELMSFORD, NY 10523

FOR: SANITIZING APPARATUS FOR TOOTH-
BRUSHES THAT USES ULTRAVIOLET LIGHT AS A
SANITIZING AGENT FOR HOME USE AND NOT
FOR MEDICAL PURPOSES, IN CLASS 11 (U.S. CLS.
13, 21, 23, 31 AND 34).

FIRST USE 1-7-2008; IN COMMERCE 2-28-2008.

THE MARK CONSISTS OF STANDARD CHAR-
ACTERS WITHOUT CLAIM TO ANY PARTICULAR
FONT, STYLE, SIZE, OR COLOR.

SN 77-215,235, FILED 6-26-2007.

JUDITH HELFMAN, EXAMINING ATTORNEY

Int. Cl.: 41

Prior U.S. Cls.: 100, 101, and 107

United States Patent and Trademark Office

Reg. No. 3,485,952

Registered Aug. 12, 2008

**SERVICE MARK
PRINCIPAL REGISTER**



HYUNDAI MOTOR AMERICA (CALIFORNIA CORPORATION)

10550 TALBERT AVENUE

FOUNTAIN VALLEY, CA 92728

FOR: BUSINESS TRAINING, IN CLASS 41 (U.S. CLS. 100, 101 AND 107).

FIRST USE 9-18-2007; IN COMMERCE 9-18-2007.

OWNER OF U.S. REG. NOS. 1,104,727, 2,562,908, AND OTHERS.

THE COLOR(S) BLACK, WHITE, GRAY AND BLUE IS/ARE CLAIMED AS A FEATURE OF THE MARK.

THE MARK CONSISTS OF THE STYLIZED "H" LOGO IN BLACK AND GRAY TO THE LEFT OF THE WORD "HYUNDAI" WHICH IS ABOVE THE WORDS "PRIORITY MY CUSTOMER - MY PRIORITY". ALL WORDING IS IN BLACK. TO THE LEFT IS A DESIGN CONSISTING OF TWO COLUMNS OF SQUARES IN THE COLORS GRAY, WHITE AND BLUE; THE SQUARE ON TOP OF THE INNER COLUMN IS BLUE; ALL THE OTHER SQUARES ARE VARYING SHADES OF GRAY AND WHITE.

THE ENGLISH TRANSLATION OF THE WORD "HYUNDAI" IN THE MARK IS PRESENT AGE OR MODERN.

SN 77-215,583, FILED 6-26-2007.

JEFFERY COWARD, EXAMINING ATTORNEY

Int. Cl.: 9

Prior U.S. Cls.: 21, 23, 26, 36, and 38

United States Patent and Trademark Office

Reg. No. 3,485,953

Registered Aug. 12, 2008

**TRADEMARK
PRINCIPAL REGISTER**

AQUASORP

DECAGON DEVICES, INC. (WASHINGTON CORPORATION)
2365 NE HOPKINS COURT
PULLMAN, WA 99163

FOR: MEASURING APPARATUS, NAMELY, ISOTHERM GENERATORS FOR DETERMINING THE RELATIONSHIP BETWEEN WATER ACTIVITY AND MOISTURE CONTENT IN ORDER TO PROVIDE INFORMATION ABOUT PRODUCT FORMULATION SHELF LIFE, STABILITY, TEMPERATURE EFFECTS, MOISTURE SENSITIVITY, AND DRY-

ING CHARACTERISTICS, IN CLASS 9 (U.S. CLS. 21, 23, 26, 36 AND 38).

FIRST USE 10-1-2007; IN COMMERCE 10-1-2007.

THE MARK CONSISTS OF STANDARD CHARACTERS WITHOUT CLAIM TO ANY PARTICULAR FONT, STYLE, SIZE, OR COLOR.

SN 77-215,618, FILED 6-26-2007.

JEFFERY COWARD, EXAMINING ATTORNEY

Int. Cls.: 6 and 19

Prior U.S. Cls.: 1, 2, 12, 13, 14, 23, 25, 33, and 50

United States Patent and Trademark Office

Reg. No. 3,485,954

Registered Aug. 12, 2008

**TRADEMARK
PRINCIPAL REGISTER**

Wherever you go, there we
are

ADA SOLUTIONS, INC. (MASSACHUSETTS
CORPORATION)
34 SULLIVAN ROAD
N. BILLERICA, MA 01862

FOR: METAL PANELS FOR IDENTIFYING
AMERICANS WITH DISABILITIES ACT COMPLI-
ANT SURFACES, FOR USE ON CURB RAMPS,
PEDESTRIAN CROSSINGS, HAZARDOUS VEHICU-
LAR WAYS, TRANSIT FACILITY PLATFORMS,
AND WALKING SURFACES, IN CLASS 6 (U.S.
CLS. 2, 12, 13, 14, 23, 25 AND 50).

FIRST USE 4-0-2002; IN COMMERCE 3-21-2008.

FOR: NON-METAL PANELS FOR IDENTIFYING
AMERICANS WITH DISABILITIES ACT COMPLI-

ANT SURFACES, FOR USE ON CURB RAMPS,
PEDESTRIAN CROSSINGS, HAZARDOUS VEHICU-
LAR WAYS, TRANSIT FACILITY PLATFORMS,
AND WALKING SURFACES, IN CLASS 19 (U.S.
CLS. 1, 12, 33 AND 50).

FIRST USE 4-0-2002; IN COMMERCE 3-21-2008.

THE MARK CONSISTS OF STANDARD CHAR-
ACTERS WITHOUT CLAIM TO ANY PARTICULAR
FONT, STYLE, SIZE, OR COLOR.

SN 77-215,961, FILED 6-26-2007.

KATHRYN COWARD, EXAMINING ATTORNEY

Int. Cl.: 9

Prior U.S. Cls.: 21, 23, 26, 36, and 38

United States Patent and Trademark Office

Reg. No. 3,485,955

Registered Aug. 12, 2008

**TRADEMARK
PRINCIPAL REGISTER**

SORPTRAC

DECAGON DEVICES, INC. (WASHINGTON CORPORATION)
2365 NE HOPKINS COURT
PULLMAN, WA 99163

FOR: COMPUTER SOFTWARE FOR COLLECTING, SAVING, ANALYZING, RETRIEVING, AND DISPLAYING DATA RELATING TO ISOTHERM GENERATORS, IN CLASS 9 (U.S. CLS. 21, 23, 26, 36 AND 38).

FIRST USE 10-1-2007; IN COMMERCE 10-1-2007.

THE MARK CONSISTS OF STANDARD CHARACTERS WITHOUT CLAIM TO ANY PARTICULAR FONT, STYLE, SIZE, OR COLOR.

SN 77-216,167, FILED 6-26-2007.

JEFFERY COWARD, EXAMINING ATTORNEY

Int. Cl.: 5

Prior U.S. Cls.: 6, 18, 44, 46, 51, and 52

United States Patent and Trademark Office

Reg. No. 3,485,956

Registered Aug. 12, 2008

**TRADEMARK
PRINCIPAL REGISTER**

IT'S HID IN THE LID

THE RISING BEVERAGE COMPANY (CALIFORNIA LTD LIAB CO)
723 1/2 LA CIENEGA BOULEVARD
LOS ANGELES, CA 90069

THE MARK CONSISTS OF STANDARD CHARACTERS WITHOUT CLAIM TO ANY PARTICULAR FONT, STYLE, SIZE, OR COLOR.

FOR: NUTRITIONALLY FORTIFIED BEVERAGES; AND VITAMIN FORTIFIED BEVERAGES, IN CLASS 5 (U.S. CLS. 6, 18, 44, 46, 51 AND 52).

SN 77-216,197, FILED 6-26-2007.

FIRST USE 3-1-2008; IN COMMERCE 3-1-2008.

BERYL GARDNER, EXAMINING ATTORNEY

Int. Cl.: 5

Prior U.S. Cls.: 6, 18, 44, 46, 51, and 52

United States Patent and Trademark Office

Reg. No. 3,485,957

Registered Aug. 12, 2008

**TRADEMARK
PRINCIPAL REGISTER**

OASIS TEARS

OASIS MEDICAL, INC. (CALIFORNIA CORPORATION)
514 S. VERMONT AVENUE
GLEN DORA, CA 91741

FOR: EYE DROPS OR SOLUTIONS OF ARTIFICIAL TEARS TO PROVIDE LUBRICATION TO TREAT DRY EYE SYMPTOMS, IN CLASS 5 (U.S. CLS. 6, 18, 44, 46, 51 AND 52).

FIRST USE 11-0-2007; IN COMMERCE 11-0-2007.

THE MARK CONSISTS OF STANDARD CHARACTERS WITHOUT CLAIM TO ANY PARTICULAR FONT, STYLE, SIZE, OR COLOR.

NO CLAIM IS MADE TO THE EXCLUSIVE RIGHT TO USE "TEARS", APART FROM THE MARK AS SHOWN.

SN 77-216,831, FILED 6-27-2007.

ANNE MADDEN, EXAMINING ATTORNEY

Int. Cl.: 21

Prior U.S. Cls.: 2, 13, 23, 29, 30, 33, 40, and 50

United States Patent and Trademark Office

Reg. No. 3,485,958

Registered Aug. 12, 2008

**TRADEMARK
PRINCIPAL REGISTER**

**HAUSENWARE
DESIGNING A LIFESTYLE**

HAUSENWARE, INC. (CALIFORNIA CORPORATION)
8868 LAKEWOOD DR. #337
WINDSOR, CA 95492

FOR: CERAMIC AND PORCELAIN DINNERWARE AND BAKEWARE; CERAMIC, PORCELAIN AND GLASS KITCHENWARE, NAMELY, PASTA BOWLS, PITCHERS, MUGS, COOKIE JARS, CANNISTER SETS, TOWEL HOLDERS, NAPKIN HOLDERS, TRIVETS, SPOON RESTS, VINEGAR AND OIL CRUETS NOT OF PRECIOUS METAL, COMPOTE DISHES, FLOWER POTS, SALT AND PEPPER SHAKERS, GRAVY BOATS, RELISH DISHES, SOAP DISPENSERS, SOUP TUREENS, VASES, SERVING DISHES FOR CHIPS AND DIPS; WOODEN SER-

VING SPOONS; AND GLASS JARS FOR JAMS AND JELLIES, IN CLASS 21 (U.S. CLS. 2, 13, 23, 29, 30, 33, 40 AND 50).

FIRST USE 1-17-2008; IN COMMERCE 1-17-2008.

THE MARK CONSISTS OF STANDARD CHARACTERS WITHOUT CLAIM TO ANY PARTICULAR FONT, STYLE, SIZE, OR COLOR.

OWNER OF U.S. REG. NO. 2,241,581.

SN 77-219,480, FILED 6-29-2007.

WON TEAK OH, EXAMINING ATTORNEY

Int. Cl.: 16

Prior U.S. Cls.: 2, 5, 22, 23, 29, 37, 38, and 50

United States Patent and Trademark Office

Reg. No. 3,485,959

Registered Aug. 12, 2008

**TRADEMARK
PRINCIPAL REGISTER**

BAG EFX

PASCHKE-PLASTICS, LLC (FLORIDA LTD LIAB
CO)
13014 SANCTUARY COVE DRIVE, UNIT 204
TAMPA, FL 33637

FOR: RECLOSABLE PLASTIC BAGS FOR HOUSE-
HOLD USE, IN CLASS 16 (U.S. CLS. 2, 5, 22, 23, 29, 37,
38 AND 50).

FIRST USE 1-15-2008; IN COMMERCE 1-15-2008.

THE MARK CONSISTS OF STANDARD CHAR-
ACTERS WITHOUT CLAIM TO ANY PARTICULAR
FONT, STYLE, SIZE, OR COLOR.

NO CLAIM IS MADE TO THE EXCLUSIVE
RIGHT TO USE "BAG", APART FROM THE MARK
AS SHOWN.

SN 77-220,262, FILED 7-2-2007.

G. MAYERSCHOFF, EXAMINING ATTORNEY

Int. Cl.: 28

Prior U.S. Cls.: 22, 23, 38, and 50

United States Patent and Trademark Office

Reg. No. 3,485,960

Registered Aug. 12, 2008

**TRADEMARK
PRINCIPAL REGISTER**

JOIN THE UPRISING

WILSON SPORTING GOODS CO. (DELAWARE
CORPORATION)
8750 W. BRYN MAWR AVE.
CHICAGO, IL 60631

THE MARK CONSISTS OF STANDARD CHAR-
ACTERS WITHOUT CLAIM TO ANY PARTICULAR
FONT, STYLE, SIZE, OR COLOR.

FOR: BASEBALL AND SOFTBALL BATS, IN
CLASS 28 (U.S. CLS. 22, 23, 38 AND 50).

SN 77-220,723, FILED 7-2-2007.

FIRST USE 9-1-2007; IN COMMERCE 9-1-2007.

MICHAEL ENGEL, EXAMINING ATTORNEY

Int. Cl.: 43

Prior U.S. Cls.: 100 and 101

United States Patent and Trademark Office

Reg. No. 3,485,961

Registered Aug. 12, 2008

**SERVICE MARK
PRINCIPAL REGISTER**

MASTER THE LONG TRIP

MARRIOTT INTERNATIONAL, INC. (DELA-
WARE CORPORATION)
10400 FERNWOOD ROAD
BETHESDA, MD 20817

FOR: HOTEL SERVICES; RESTAURANT SERVI-
CES; PROVISION OF GENERAL PURPOSE FACIL-
ITIES FOR MEETINGS, CONFERENCES AND
EXHIBITIONS; PROVISION OF BANQUET AND
SOCIAL FUNCTION FACILITIES FOR SPECIAL
OCCASIONS; AND RESERVATION SERVICES FOR
HOTEL ACCOMMODATIONS FOR OTHERS, IN
CLASS 43 (U.S. CLS. 100 AND 101).

FIRST USE 6-18-2007; IN COMMERCE 6-18-2007.

THE MARK CONSISTS OF STANDARD CHAR-
ACTERS WITHOUT CLAIM TO ANY PARTICULAR
FONT, STYLE, SIZE, OR COLOR.

SN 77-221,275, FILED 7-3-2007.

DAVID HOFFMAN, EXAMINING ATTORNEY

Int. Cl.: 44

Prior U.S. Cls.: 100 and 101

United States Patent and Trademark Office

Reg. No. 3,485,962

Registered Aug. 12, 2008

**SERVICE MARK
PRINCIPAL REGISTER**

BALANCED CENTER LIVING

MARTIN, ANDREW T (UNITED STATES INDIVIDUAL)
6616 MADELINE COVE DR
RANCHO PALOS VERDES, CA 90275

THE MARK CONSISTS OF STANDARD CHARACTERS WITHOUT CLAIM TO ANY PARTICULAR FONT, STYLE, SIZE, OR COLOR.

FOR: HEALTH CARE SERVICES, NAMELY, WELLNESS PROGRAMS, IN CLASS 44 (U.S. CLS. 100 AND 101).

SN 77-222,682, FILED 7-5-2007.

FIRST USE 12-15-2007; IN COMMERCE 3-1-2008.

CORY BOONE, EXAMINING ATTORNEY

Int. Cl.: 25

Prior U.S. Cls.: 22 and 39

United States Patent and Trademark Office

Reg. No. 3,485,963

Registered Aug. 12, 2008

TRADEMARK
PRINCIPAL REGISTER

CommodiTees

SHERI LYNN GAGLIONE (UNITED STATES IN-
DIVIDUAL)
APT B 226 NORTH KEYSTONE ST
BURBANK, CA 91506

FOR: T-SHIRTS; SHORT-SLEEVED OR LONG-
SLEEVED T-SHIRTS, IN CLASS 25 (U.S. CLS. 22
AND 39).

FIRST USE 5-4-2008; IN COMMERCE 5-4-2008.

THE MARK CONSISTS OF ALL BLACK LET-
TERS. THE LETTERS ARE "C O M M O D I T E E S".
THE LETTER "C" AND "T" ARE UPPER-CASE. THE
OTHER LETTERS ARE LOWER-CASE. THE FONT
IS CALLED PARTY LET.

SN 77-223,127, FILED 7-6-2007.

DEZMONA MIZELLE, EXAMINING ATTORNEY

Int. Cl.: 41

Prior U.S. Cls.: 100, 101, and 107

United States Patent and Trademark Office

Reg. No. 3,485,964

Registered Aug. 12, 2008

**SERVICE MARK
PRINCIPAL REGISTER**

CONVERSANTLIFE.COM

CONVERSANT MEDIA GROUP (WASHINGTON
PARTNERSHIP)
P.O. BOX 3006
REDMOND, WA 98073

FOR: ONLINE PUBLICATION OF NEWSLET-
TERS, ARTICLES, ESSAYS AND ONLINE JOUR-
NALS, NAMELY, BLOGS, ALL FEATURING
INFORMATION IN THE FIELD OF RELIGION, IN
CLASS 41 (U.S. CLS. 100, 101 AND 107).

FIRST USE 11-1-2007; IN COMMERCE 11-1-2007.

THE MARK CONSISTS OF STANDARD CHAR-
ACTERS WITHOUT CLAIM TO ANY PARTICULAR
FONT, STYLE, SIZE, OR COLOR.

SN 77-223,632, FILED 7-6-2007.

KELLEY WELLS, EXAMINING ATTORNEY

Int. Cl.: 27

Prior U.S. Cls.: 19, 20, 37, 42, and 50

United States Patent and Trademark Office

Reg. No. 3,485,965

Registered Aug. 12, 2008

**TRADEMARK
PRINCIPAL REGISTER**

STAYTAC

JOY CARPETS, INC. (GEORGIA CORPORATION)
104 WEST FORREST ROAD
FT. OGLETHORPE, GA 30742

THE MARK CONSISTS OF STANDARD CHAR-
ACTERS WITHOUT CLAIM TO ANY PARTICULAR
FONT, STYLE, SIZE, OR COLOR.

FOR: FLOOR COVERINGS AND CARPETS, IN
CLASS 27 (U.S. CLS. 19, 20, 37, 42 AND 50).

SN 77-223,709, FILED 7-6-2007.

FIRST USE 9-1-2007; IN COMMERCE 9-1-2007.

ROBERT C. CLARK JR., EXAMINING ATTORNEY

Int. Cl.: 28

Prior U.S. Cls.: 22, 23, 38, and 50

United States Patent and Trademark Office

Reg. No. 3,485,966

Registered Aug. 12, 2008

**TRADEMARK
PRINCIPAL REGISTER**

NEO-GRIP

FRANKLIN SPORTS, INC. (DELAWARE CORPORATION)
17 CAMPANELLI PARKWAY
STOUGHTON, MA 02072

THE MARK CONSISTS OF STANDARD CHARACTERS WITHOUT CLAIM TO ANY PARTICULAR FONT, STYLE, SIZE, OR COLOR.

FOR: FOOT BALLS; SOCCER BALLS; VOLLEYBALLS; BASKETBALLS, IN CLASS 28 (U.S. CLS. 22, 23, 38 AND 50).

SN 77-224,556, FILED 7-9-2007.

FIRST USE 11-14-2007; IN COMMERCE 11-14-2007.

ANTHONY RINKER, EXAMINING ATTORNEY

Int. Cls.: 35 and 42

Prior U.S. Cls.: 100, 101, and 102

United States Patent and Trademark Office

Reg. No. 3,485,967

Registered Aug. 12, 2008

**SERVICE MARK
PRINCIPAL REGISTER**



SUMAS CORPORATION (NEW JERSEY CORPORATION)
55 CARTER DRIVE, STE L-2
EDISON, NJ 08817

FOR: BUSINESS CONSULTING AND INFORMATION SERVICES; BUSINESS MANAGEMENT CONSULTANCY AS WELL AS DEVELOPMENT OF PROCESSES FOR THE ANALYSIS AND THE IMPLEMENTATION OF STRATEGY PLANS AND MANAGEMENT PROJECTS; CONSULTANCY OF PERSONNEL RECRUITMENT; HUMAN RESOURCES CONSULTATION; INFORMATION, ADVISORY AND CONSULTANCY SERVICES RELATING TO BUSINESS AND MANAGEMENT OR BUSINESS ADMINISTRATION, INCLUDING SUCH SERVICES PROVIDED ON LINE OR VIA THE INTERNET, IN CLASS 35 (U.S. CLS. 100, 101 AND 102).

FIRST USE 7-10-2007; IN COMMERCE 7-10-2007.

FOR: COMPUTER CONSULTATION; COMPUTER CONSULTATION IN THE FIELD OF COMPUTER SECURITY; COMPUTER SOFTWARE CONSULTANCY; COMPUTER SOFTWARE CONSULTATION; CONSULTANCY IN THE FIELD OF SOFTWARE DESIGN; CONSULTATION SERVICES IN THE FIELDS OF SELECTION, IMPLEMENTATION AND USE OF COMPUTER HARDWARE AND SOFTWARE SYSTEMS FOR OTHERS; INFORMATION TECHNOLOGY CONSULTATION; PRODUCT DEVELOPMENT CONSULTATION; TECHNICAL CONSULTATION IN THE FIELD OF REAL-TIME

RECONFIGURABLE WIRELESS COMMUNICATION HANDSETS AND NETWORK EQUIPMENT FOR USE IN WIDEBAND COMMUNICATIONS; TECHNOLOGICAL CONSULTATION IN THE TECHNOLOGY FIELD OF COMPUTER, SOFTWARE DEVELOPMENT, IN CLASS 42 (U.S. CLS. 100 AND 101).

FIRST USE 7-9-2007; IN COMMERCE 7-9-2007.

THE COLOR(S) ORANGE, BLUE, PURPLE, GREY, RED AND BROWN IS/ARE CLAIMED AS A FEATURE OF THE MARK.

THE MARK CONSISTS OF THE WORD "SUMAS" APPEARING IN THE COLOR ORANGE; THE COLOR BLUE APPEARS IN THE WORDING "VISION. COMMITMENT. SUCCESS"; THE COLORS RED, PURPLE, ORANGE, BROWN AND GREY APPEAR IN THE DESIGN OF FIVE FEATHERS THAT FORM A STAR SHAPE.

THE TERM "SUMAS" DOES NOT HAVE ANY TRANSLATION AND DOES NOT HAVE ANY SIGNIFICANCE WITH RESPECT TO THE RECITED SERVICES.

SN 77-225,134, FILED 7-9-2007.

MICHAEL LEWIS, EXAMINING ATTORNEY

Int. Cls.: 16, 20, 21, 28, and 31

Prior U.S. Cls.: 1, 2, 5, 13, 22, 23, 25, 29, 30, 32, 33, 37, 38, 40, 46, and 50

Reg. No. 3,485,968

United States Patent and Trademark Office

Registered Aug. 12, 2008

TRADEMARK
PRINCIPAL REGISTER



JAKKS PACIFIC, INC. (DELAWARE CORPORATION)
22619 PACIFIC COAST HIGHWAY
MALIBU, CA 90265

FOR: DISPOSABLE HOUSEBREAKING PADS FOR PETS; PLASTIC BAGS FOR DISPOSING OF PET WASTE, IN CLASS 16 (U.S. CLS. 2, 5, 22, 23, 29, 37, 38 AND 50).

FIRST USE 7-0-2007; IN COMMERCE 7-0-2007.

FOR: PET CRATES, BEDS, CHAISE LOUNGES, AND PILLOWS FOR HOUSEHOLD PETS, WINDOW SHELF PERCH FOR CATS, PORTABLE PET KENNELS AND PLAYPENS, NON-METAL BINS FOR PET FOOD, IN CLASS 20 (U.S. CLS. 2, 13, 22, 25, 32 AND 50).

FIRST USE 7-0-2007; IN COMMERCE 7-0-2007.

FOR: PET FEEDING DISHES AND EMPTY WATER BOTTLES; FLEA COMBS; CANISTERS AND GLASS JARS FOR PET FOOD; PET BRUSHES AND PET COMBS; CAT LITTER BOXES; SCOOPS FOR THE DISPOSAL OF PET WASTE, IN CLASS 21 (U.S. CLS. 2, 13, 23, 29, 30, 33, 40 AND 50).

FIRST USE 7-0-2007; IN COMMERCE 6-0-2008.

FOR: PET TOYS; BALLS OF ALL KINDS, NAMELY, BASKET BALLS, FOOT BALLS, SOCCER BALLS, SOFT TENNIS BALLS, IN CLASS 28 (U.S. CLS. 22, 23, 38 AND 50).

FIRST USE 7-0-2007; IN COMMERCE 7-0-2007.

FOR: PET FOOD AND TREATS; DIGESTIBLE CHEWING BONES FOR DOGS; CATNIP, IN CLASS 31 (U.S. CLS. 1 AND 46).

FIRST USE 7-0-2007; IN COMMERCE 9-0-2007.

OWNER OF U.S. REG. NO. 2,267,543.

NO CLAIM IS MADE TO THE EXCLUSIVE RIGHT TO USE "PETS", APART FROM THE MARK AS SHOWN.

SN 77-226,346, FILED 7-10-2007.

JAMES LOVELACE, EXAMINING ATTORNEY

Int. Cl.: 35

Prior U.S. Cls.: 100, 101, and 102

United States Patent and Trademark Office

Reg. No. 3,485,969

Registered Aug. 12, 2008

**SERVICE MARK
PRINCIPAL REGISTER**

SmartTrac

WATSON, SCOTT C. (UNITED STATES INDIVIDUAL)
STE.1003
5850 TOWN AND COUNTRY BLVD.
FRISCO, TX 75034

FOR: CONSULTATION IN THE FIELD OF DATA ANALYSIS AND MEASUREMENT SERVICES PROVIDED TO MEASURE THE IMPACT OF NEW BUSINESS PROCESSES, METHODS AND TOOLS ON A BUSINESS AND ITS EMPLOYEES, IN CLASS 35 (U.S. CLS. 100, 101 AND 102).

FIRST USE 6-13-2007; IN COMMERCE 6-13-2007.

THE MARK CONSISTS OF STANDARD CHARACTERS WITHOUT CLAIM TO ANY PARTICULAR FONT, STYLE, SIZE, OR COLOR.

SN 77-227,076, FILED 7-11-2007.

AISHA CLARKE, EXAMINING ATTORNEY

Int. Cl.: 33

Prior U.S. Cls.: 47 and 49

United States Patent and Trademark Office

Reg. No. 3,485,970

Registered Aug. 12, 2008

**TRADEMARK
PRINCIPAL REGISTER**

FUEGO DE ATTECA

FINE ESTATES FROM SPAIN (MASSACHU-
SETTS CORPORATION)
745 HIGH STREET
DEDHAM, MA 02026

FOR: WINE, IN CLASS 33 (U.S. CLS. 47 AND 49).

FIRST USE 6-2-2008; IN COMMERCE 6-2-2008.

THE MARK CONSISTS OF STANDARD CHAR-
ACTERS WITHOUT CLAIM TO ANY PARTICULAR
FONT, STYLE, SIZE, OR COLOR.

OWNER OF U.S. REG. NOS. 3,299,288 AND
3,299,289.

THE ENGLISH TRANSLATION OF "FUEGO DE
ATTECA" IN THE MARK IS FIRE OF ATTECA."

SN 77-228,058, FILED 7-12-2007.

JEFF DEFORD, EXAMINING ATTORNEY

Int. Cl.: 28

Prior U.S. Cls.: 22, 23, 38, and 50

Reg. No. 3,485,971

United States Patent and Trademark Office

Registered Aug. 12, 2008

**TRADEMARK
PRINCIPAL REGISTER**

ALFREDO'S FOOD FIGHT!

FUNDEX GAMES, LTD. (NEVADA CORPORATION)
2920 FORTUNE CIRCLE WEST
INDIANAPOLIS, IN 46241

FOR: PLAY MEATBALLS, FORKS, AND A SPINNING CENTERED PIECE ALL SOLD AS A UNIT TO PLAY AN ACTION SKILL GAME, BY THROWING FAKE FOOD AT THE CENTERED PIECE AND HAVING IT STICK THERETO, IN CLASS 28 (U.S. CLS. 22, 23, 38 AND 50).

FIRST USE 4-0-2005; IN COMMERCE 4-0-2005.

THE MARK CONSISTS OF STANDARD CHARACTERS WITHOUT CLAIM TO ANY PARTICULAR FONT, STYLE, SIZE, OR COLOR.

NO CLAIM IS MADE TO THE EXCLUSIVE RIGHT TO USE "FOOD FIGHT", APART FROM THE MARK AS SHOWN.

SN 77-228,345, FILED 7-12-2007.

KELLEY WELLS, EXAMINING ATTORNEY

Int. Cls.: 16, 20, 21, 28, and 31

Prior U.S. Cls.: 1, 2, 5, 13, 22, 23, 25, 29, 30, 32, 33, 37, 38, 40, 46, and 50

Reg. No. 3,485,972

United States Patent and Trademark Office

Registered Aug. 12, 2008

TRADEMARK
PRINCIPAL REGISTER



JAKKS PACIFIC, INC. (DELAWARE CORPORATION)
22619 PACIFIC COAST HIGHWAY
MALIBU, CA 90265

FOR: DISPOSABLE HOUSEBREAKING PADS FOR PETS; PLASTIC BAGS FOR DISPOSING OF PET WASTE, IN CLASS 16 (U.S. CLS. 2, 5, 22, 23, 29, 37, 38 AND 50).

FIRST USE 7-0-2007; IN COMMERCE 7-0-2007.

FOR: PET CRATES, BEDS, CHAISE LOUNGES, AND PILLOWS FOR HOUSEHOLD PETS, WINDOW SHELF PERCH FOR CATS; PORTABLE PET KENNELS AND PLAYPENS, NON-METAL BINS FOR PET FOOD, IN CLASS 20 (U.S. CLS. 2, 13, 22, 25, 32 AND 50).

FIRST USE 7-0-2007; IN COMMERCE 6-0-2008.

FOR: PET FEEDING DISHES AND EMPTY WATER BOTTLES; FLEA COMBS; CANISTERS AND GLASS JARS FOR PET FOOD; PET BRUSHES AND PET COMBS; CAT LITTER BOXES; SCOOPS FOR THE DISPOSAL OF PET WASTE, IN CLASS 21 (U.S. CLS. 2, 13, 23, 29, 30, 33, 40 AND 50).

FIRST USE 7-0-2007; IN COMMERCE 7-0-2007.

FOR: PET TOYS; BALLS OF ALL KINDS, NAMELY, BASKET BALLS, FOOT BALLS, SOCCER BALLS, SOFT TENNIS BALLS, IN CLASS 28 (U.S. CLS. 22, 23, 38 AND 50).

FIRST USE 7-0-2007; IN COMMERCE 7-0-2007.

FOR: PET FOOD AND TREATS; DIGESTIBLE CHEWING BONES FOR DOGS; CATNIP, IN CLASS 31 (U.S. CLS. 1 AND 46).

FIRST USE 7-0-2007; IN COMMERCE 9-0-2007.

OWNER OF U.S. REG. NO. 2,267,543.

NO CLAIM IS MADE TO THE EXCLUSIVE RIGHT TO USE "PETS", APART FROM THE MARK AS SHOWN.

THE COLOR(S) WHITE, RED, BLUE, GREEN AND GRAY IS/ARE CLAIMED AS A FEATURE OF THE MARK.

THE MARK CONSISTS OF A LOGO CONTAINING THE WORDS "JAKKS PETS" WITH A RED OVOID AND GRAY SHADING WITH WHITE INTERIOR; WITHIN THE OVOID: THE LETTER "J" AND THE SECOND LETTER "K" IN "JAKKS" ARE RED; THE "T" IN "PETS" IS ALSO RED; THE LETTERS "A" AND "S" IN "JAKKS" AND "E" AND "S" IN "PETS" ARE GREEN; THE FIRST "K" IN "JAKKS" AND THE "P" IN "PETS" ARE BLUE.

SN 77-228,364, FILED 7-12-2007.

JAMES LOVELACE, EXAMINING ATTORNEY

Int. Cl.: 43

Prior U.S. Cls.: 100 and 101

United States Patent and Trademark Office

Reg. No. 3,485,973

Registered Aug. 12, 2008

**SERVICE MARK
PRINCIPAL REGISTER**

PACIFIC BUSINESS CONNECTION

OUTRIGGER HOTELS HAWAII (HAWAII LIMITED PARTNERSHIP)
2375 KUHIO AVENUE
HONOLULU, HI 96815

FOR: HOTEL SERVICES; HOTEL SERVICES RENDERED IN CONNECTION WITH A PROGRAM FOR FREQUENT BUSINESS TRAVELERS, IN CLASS 43 (U.S. CLS. 100 AND 101).

FIRST USE 10-15-2007; IN COMMERCE 10-15-2007.

THE MARK CONSISTS OF STANDARD CHARACTERS WITHOUT CLAIM TO ANY PARTICULAR FONT, STYLE, SIZE, OR COLOR.

NO CLAIM IS MADE TO THE EXCLUSIVE RIGHT TO USE "BUSINESS", APART FROM THE MARK AS SHOWN.

SN 77-228,583, FILED 7-12-2007.

ANDREA SAUNDERS, EXAMINING ATTORNEY

Int. Cl.: 35

Prior U.S. Cls.: 100, 101, and 102

United States Patent and Trademark Office

Reg. No. 3,485,974

Registered Aug. 12, 2008

**SERVICE MARK
PRINCIPAL REGISTER**

COOLEMLOYER

EXCELSIOR MEDIA LLP (MISSOURI LIMITED
PARTNERSHIP)
405 SOUTH DALE MABRY HIGHWAY #346
TAMPA, FL 33609

THE MARK CONSISTS OF STANDARD CHAR-
ACTERS WITHOUT CLAIM TO ANY PARTICULAR
FONT, STYLE, SIZE, OR COLOR.

FOR: MODEL AND EMPLOYEE RECRUITMENT;
WEBSITE FEATURING MODEL AND EMPLOYEE
RECRUITING, IN CLASS 35 (U.S. CLS. 100, 101 AND
102).

SN 77-228,734, FILED 7-12-2007.

FIRST USE 3-31-2007; IN COMMERCE 6-11-2008.

LINDA M. KING, EXAMINING ATTORNEY

Int. Cl.: 25

Prior U.S. Cls.: 22 and 39

United States Patent and Trademark Office

Reg. No. 3,485,975

Registered Aug. 12, 2008

**TRADEMARK
PRINCIPAL REGISTER**

SHARK ATTACK

HEFTER, MAX (UNITED STATES INDIVIDUAL)
12735 NW 15TH STREET
SUNRISE, FL 33323

FOR: FOOTWEAR, IN CLASS 25 (U.S. CLS. 22 AND
39).

FIRST USE 2-19-2008; IN COMMERCE 2-19-2008.

THE MARK CONSISTS OF STANDARD CHAR-
ACTERS WITHOUT CLAIM TO ANY PARTICULAR
FONT, STYLE, SIZE, OR COLOR.

OWNER OF U.S. REG. NO. 1,535,374.

SN 77-228,865, FILED 7-13-2007.

SHARON MEIER, EXAMINING ATTORNEY

Int. Cl.: 41

Prior U.S. Cls.: 100, 101, and 107

United States Patent and Trademark Office

Reg. No. 3,485,976

Registered Aug. 12, 2008

**SERVICE MARK
PRINCIPAL REGISTER**

CAUSE CELEBRE

CAUSE CELEBRE (NEW YORK CORPORATION)
420 WEST 42ND STREET, SUITE 25F
NEW YORK, NY 10036

THE MARK CONSISTS OF STANDARD CHAR-
ACTERS WITHOUT CLAIM TO ANY PARTICULAR
FONT, STYLE, SIZE, OR COLOR.

FOR: ENTERTAINMENT SERVICES IN THE
NATURE OF A SERIES OF PERFORMANCES BY
ACTORS OF PLAYS, IN CLASS 41 (U.S. CLS. 100, 101
AND 107).

SN 77-229,120, FILED 7-13-2007.

FIRST USE 9-1-2007; IN COMMERCE 9-1-2007.

LINDA ESTRADA, EXAMINING ATTORNEY

Int. Cl.: 41

Prior U.S. Cls.: 100, 101, and 107

United States Patent and Trademark Office

Reg. No. 3,485,977

Registered Aug. 12, 2008

**SERVICE MARK
PRINCIPAL REGISTER**

OCEAN FORCE

COURTROOM TELEVISION NETWORK LLC
(NEW YORK LTD LIAB CO)
600 THIRD AVENUE
NEW YORK, NY 10016

FOR: ENTERTAINMENT SERVICES, NAMELY, A CONTINUING TELEVISION PROGRAM SERIES PROVIDED THROUGH CABLE TELEVISION, BROADCAST TELEVISION, INTERNET, VIDEO-ON-DEMAND, AND THROUGH OTHER DISTRIBUTION PLATFORMS IN THE FIELD OF COMEDY, DRAMA, ACTION AND/OR ADVENTURE; PROVIDING INFORMATION, NAMELY, ENTERTAIN-

MENT INFORMATION, OVER THE INTERNET, IN CLASS 41 (U.S. CLS. 100, 101 AND 107).

FIRST USE 8-27-2007; IN COMMERCE 8-27-2007.

THE MARK CONSISTS OF STANDARD CHARACTERS WITHOUT CLAIM TO ANY PARTICULAR FONT, STYLE, SIZE, OR COLOR.

SN 77-229,261, FILED 7-13-2007.

MICHELLE DUBOIS, EXAMINING ATTORNEY

Int. Cl.: 44

Prior U.S. Cls.: 100 and 101

United States Patent and Trademark Office

Reg. No. 3,485,978

Registered Aug. 12, 2008

**SERVICE MARK
PRINCIPAL REGISTER**

NUTRITHRIVE

BIORX, LLC (OHIO LTD LIAB CO)
10828 KENWOOD ROAD
CINCINNATI, OH 45242

THE MARK CONSISTS OF STANDARD CHAR-
ACTERS WITHOUT CLAIM TO ANY PARTICULAR
FONT, STYLE, SIZE, OR COLOR.

FOR: MEDICAL SERVICES, NAMELY, ADMIN-
ISTRATION OF NUTRITIONAL PRODUCTS FOR
ENTERAL THERAPY AND TOTAL PARENTERAL
NUTRITION, IN CLASS 44 (U.S. CLS. 100 AND 101).

SN 77-229,275, FILED 7-13-2007.

FIRST USE 6-18-2007; IN COMMERCE 6-18-2007.

MICHAEL LEWIS, EXAMINING ATTORNEY

Int. Cl.: 36

Prior U.S. Cls.: 100, 101, and 102

United States Patent and Trademark Office

Reg. No. 3,485,979

Registered Aug. 12, 2008

**SERVICE MARK
PRINCIPAL REGISTER**

C.F.O.

THE MILLER CONSULTING GROUP I, LLC
(NEW YORK LTD LIAB CO)
12 MID PLACE
CHAPPAQUA, NY 10514

THE MARK CONSISTS OF STANDARD CHAR-
ACTERS WITHOUT CLAIM TO ANY PARTICULAR
FONT, STYLE, SIZE, OR COLOR.

FOR: CONSULTING SERVICES RELATING TO
FUNDRAISING FOR CHARITABLE ORGANIZA-
TIONS, IN CLASS 36 (U.S. CLS. 100, 101 AND 102).

SN 77-230,143, FILED 7-16-2007.

FIRST USE 5-0-2007; IN COMMERCE 5-0-2007.

LINDA POWELL, EXAMINING ATTORNEY

Int. Cl.: 33

Prior U.S. Cls.: 47 and 49

United States Patent and Trademark Office

Reg. No. 3,485,980

Registered Aug. 12, 2008

**TRADEMARK
PRINCIPAL REGISTER**

GARNACHA DE ATECA

FINE ESTATES FROM SPAIN (MASSACHU-
SETTS CORPORATION)
745 HIGH SCHOOL
DEDHAM, MA 02109

FOR: WINE, IN CLASS 33 (U.S. CLS. 47 AND 49).

FIRST USE 6-2-2006; IN COMMERCE 6-2-2006.

THE MARK CONSISTS OF STANDARD CHAR-
ACTERS WITHOUT CLAIM TO ANY PARTICULAR
FONT, STYLE, SIZE, OR COLOR.

OWNER OF U.S. REG. NOS. 3,299,288 AND
3,299,289.

NO CLAIM IS MADE TO THE EXCLUSIVE
RIGHT TO USE "GARNACHA", APART FROM
THE MARK AS SHOWN.

THE ENGLISH TRANSLATION OF "GARNA-
CHA" IN THE MARK IS GRENACHE OF ATECA.
THE WORDING "ATECA" HAS NO MEANING IN A
FOREIGN LANGUAGE.

SN 77-230,496, FILED 7-16-2007.

JEFF DEFORD, EXAMINING ATTORNEY

Int. Cl.: 9

Prior U.S. Cls.: 21, 23, 26, 36, and 38

Reg. No. 3,485,981

United States Patent and Trademark Office

Registered Aug. 12, 2008

**TRADEMARK
PRINCIPAL REGISTER**

TURAFLEXIES

TURA LP (NEW YORK LIMITED PARTNER-
SHIP)
40 CUTTERMILL ROAD, SUITE 400
GREAT NECK, NY 11021

FOR: EYEGLASS FRAMES, IN CLASS 9 (U.S. CLS.
21, 23, 26, 36 AND 38).

FIRST USE 11-16-2007; IN COMMERCE 11-16-2007.

THE MARK CONSISTS OF STANDARD CHAR-
ACTERS WITHOUT CLAIM TO ANY PARTICULAR
FONT, STYLE, SIZE, OR COLOR.

OWNER OF U.S. REG. NO. 1,939,880.

SN 77-231,235, FILED 7-17-2007.

SETH A. RAPPAPORT, EXAMINING ATTORNEY

Int. Cl.: 43

Prior U.S. Cls.: 100 and 101

United States Patent and Trademark Office

Reg. No. 3,485,982

Registered Aug. 12, 2008

**SERVICE MARK
PRINCIPAL REGISTER**

REEL CLUB

LETTUCE ENTERTAIN YOU ENTERPRISES,
INC. (ILLINOIS CORPORATION)

5419 NORTH SHERIDAN ROAD

CHICAGO, IL 60640

FOR: RESTAURANT SERVICES, IN CLASS 43
(U.S. CLS. 100 AND 101).

FIRST USE 11-8-2007; IN COMMERCE 11-8-2007.

THE MARK CONSISTS OF STANDARD CHAR-
ACTERS WITHOUT CLAIM TO ANY PARTICULAR
FONT, STYLE, SIZE, OR COLOR.

NO CLAIM IS MADE TO THE EXCLUSIVE
RIGHT TO USE "CLUB", APART FROM THE MARK
AS SHOWN.

SN 77-231,790, FILED 7-17-2007.

SHARON MEIER, EXAMINING ATTORNEY

Int. Cls.: 7 and 11

Prior U.S. Cls.: 13, 19, 21, 23, 31, 34, and 35

Reg. No. 3,485,983

United States Patent and Trademark Office

Registered Aug. 12, 2008

**TRADEMARK
PRINCIPAL REGISTER**

SURE-2-FIT

ELECTROLUX HOME PRODUCTS, INC. (DELA-
WARE CORPORATION)
SUITE 250
20445 EMERALD PARKWAY, SW
CLEVELAND, OH 441350920

FOR: DISHWASHERS, IN CLASS 7 (U.S. CLS. 13,
19, 21, 23, 31, 34 AND 35).

FIRST USE 1-25-2008; IN COMMERCE 1-25-2008.

FOR: COOKING RANGES; DOMESTIC COOK-
ING OVENS, IN CLASS 11 (U.S. CLS. 13, 21, 23, 31
AND 34).

FIRST USE 1-25-2008; IN COMMERCE 1-25-2008.

THE MARK CONSISTS OF STANDARD CHAR-
ACTERS WITHOUT CLAIM TO ANY PARTICULAR
FONT, STYLE, SIZE, OR COLOR.

SN 77-232,528, FILED 7-18-2007.

KRISTINA MORRIS, EXAMINING ATTORNEY

Int. Cl.: 35

Prior U.S. Cls.: 100, 101, and 102

United States Patent and Trademark Office

Reg. No. 3,485,984

Registered Aug. 12, 2008

**SERVICE MARK
PRINCIPAL REGISTER**

COUParison Shopping

MYCOUPONS, LLC (DELAWARE CORPORATION)
P.O. BOX 16527
PITTSBURGH, PA 15242

FOR: PROMOTING THE GOODS AND SERVICES OF OTHERS BY PROVIDING A WEBSITE FEATURING COUPONS, REBATES, PRICE-COMPARISON INFORMATION, PRODUCT REVIEWS, LINKS TO THE RETAIL WEBSITES OF OTHERS, AND DISCOUNT INFORMATION, IN CLASS 35 (U.S. CLS. 100, 101 AND 102).

FIRST USE 9-1-2007; IN COMMERCE 9-15-2007.

THE MARK CONSISTS OF STANDARD CHARACTERS WITHOUT CLAIM TO ANY PARTICULAR FONT, STYLE, SIZE, OR COLOR.

NO CLAIM IS MADE TO THE EXCLUSIVE RIGHT TO USE "SHOPPING", APART FROM THE MARK AS SHOWN.

SN 77-233,789, FILED 7-19-2007.

ANNE MADDEN, EXAMINING ATTORNEY

Int. Cl.: 25

Prior U.S. Cls.: 22 and 39

United States Patent and Trademark Office

Reg. No. 3,485,985

Registered Aug. 12, 2008

**TRADEMARK
PRINCIPAL REGISTER**

LOGISTERRA

NGUYEN, TAN (UNITED STATES INDIVIDUAL)
6190-K FAIRMOUNT AVENUE
SAN DIEGO, CA 92120

FIRST USE 6-19-2008; IN COMMERCE 6-19-2008.

FOR: APPAREL, NAMELY, FOOTWEAR, SHOES, SNEAKERS, SANDALS, SHIRTS, T-SHIRTS, SWEAT-SHIRTS, TANK TOPS, SWEATPANTS, SHORTS, PANTS, TROUSERS, JEANS, WOMEN'S SUITS, DRESSES, TOPS, SKIRTS, MEN'S SUITS, SWIMWEAR, UNDERWEAR, SOCKS, BELTS, HATS, CAPS, SCARVES AND NECKTIES, IN CLASS 25 (U.S. CLS. 22 AND 39).

THE MARK CONSISTS OF STANDARD CHARACTERS WITHOUT CLAIM TO ANY PARTICULAR FONT, STYLE, SIZE, OR COLOR.

SN 77-234,010, FILED 7-19-2007.

JOHN GARTNER, EXAMINING ATTORNEY

Int. Cl.: 25

Prior U.S. Cls.: 22 and 39

United States Patent and Trademark Office

Reg. No. 3,485,986

Registered Aug. 12, 2008

**TRADEMARK
PRINCIPAL REGISTER**

RICEJONES

NGUYEN, TAN (UNITED STATES INDIVIDUAL)
6190-K FAIRMOUNT AVENUE
SAN DIEGO, CA 92120

FIRST USE 6-19-2008; IN COMMERCE 6-19-2008.

FOR: APPAREL, NAMELY, FOOTWEAR, SHOES, SNEAKERS, SANDALS, SHIRTS, T-SHIRTS, SWEAT-SHIRTS, TANK TOPS, SWEATPANTS, SHORTS, PANTS, TROUSERS, JEANS, WOMEN'S SUITS, DRESSES, TOPS, SKIRTS, MEN'S SUITS, SWIMWEAR, UNDERWEAR, SOCKS, BELTS, HATS, CAPS, SCARVES AND NECKTIES, IN CLASS 25 (U.S. CLS. 22 AND 39).

THE MARK CONSISTS OF STANDARD CHARACTERS WITHOUT CLAIM TO ANY PARTICULAR FONT, STYLE, SIZE, OR COLOR.

SN 77-234,029, FILED 7-19-2007.

JOHN GARTNER, EXAMINING ATTORNEY

Int. Cl.: 5

Prior U.S. Cls.: 6, 18, 44, 46, 51, and 52

United States Patent and Trademark Office

Reg. No. 3,485,987

Registered Aug. 12, 2008

**TRADEMARK
PRINCIPAL REGISTER**

Scent on the Go

OSMEGEN, INC. (PENNSYLVANIA CORPORATION)
700 N. FENWICK STREET
ALLENTOWN, PA 18109

FOR: DEODORIZING PRODUCTS, NAMELY, ALL-PURPOSE DEODORIZER PREPARATIONS FOR HOUSEHOLD, COMMERCIAL AND INDUSTRIAL USE, IN CLASS 5 (U.S. CLS. 6, 18, 44, 46, 51 AND 52).

FIRST USE 3-0-2008; IN COMMERCE 3-0-2008.

THE MARK CONSISTS OF STANDARD CHARACTERS WITHOUT CLAIM TO ANY PARTICULAR FONT, STYLE, SIZE, OR COLOR.

NO CLAIM IS MADE TO THE EXCLUSIVE RIGHT TO USE "SCENT", APART FROM THE MARK AS SHOWN.

SN 77-234,403, FILED 7-20-2007.

ALICE SUE CARRUTHERS, EXAMINING ATTORNEY

Int. Cl.: 41

Prior U.S. Cls.: 100, 101, and 107

United States Patent and Trademark Office

Reg. No. 3,485,988

Registered Aug. 12, 2008

**SERVICE MARK
PRINCIPAL REGISTER**



MONSTER MINI GOLF, LLC (CONNECTICUT
LTD LIAB CO)
SUITE 401
75 WESTMINSTER STREET
PROVIDENCE, RI 02903

FOR: ENTERTAINMENT SERVICES, NAMELY, A
GLOW IN THE DARK MINIATURE GOLF COURSE,
VIDEO GAME ARCADE, REDEMPTION GAME
ARCADE, NAMELY, AN AMUSEMENT ARCADE
FEATURING GAMES THAT DISPENSE TICKETS
WHICH MAY BE REDEEMED FOR PRIZES AND
CONDUCTING BIRTHDAY PARTIES, IN CLASS 41
(U.S. CLS. 100, 101 AND 107).

FIRST USE 4-0-2007; IN COMMERCE 4-0-2007.

THE NAME(S), PORTRAIT(S), AND/OR SIGNA-
TURE(S) SHOWN IN THE MARK DOES NOT IDEN-
TIFY A PARTICULAR LIVING INDIVIDUAL.

THE COLOR(S) BLUE, GREEN, PURPLE, WHITE,
BROWN, BLACK AND GRAY IS/ARE CLAIMED AS
A FEATURE OF THE MARK.

THE MARK CONSISTS OF THE COLOR BLUE
APPEARS IN THE FIGURINE'S HAIR, THE COLOR
GREEN APPEARS IN THE DRESS, THE COLOR
BLACK APPEARS IN THE OUTLINE OF THE
GOGGLES, IN THE JACKET, IN THE BELT, IN
THE INTERIOR OF THE BOOTS, IN THE VARIOUS
OUTLINES OF THE DESIGN, IN THE EYELASHES
AND EYES, AND IN THE RECTANGULAR BACK-
GROUND. THE COLOR PURPLE APPEARS IN THE
GLOVES AND BOOTS AND THE COLOR WHITE
APPEARS IN VARIOUS ACCENTS IN THE HAIR,
JACKET, GLOVES, BOOTS, IN THE FACE, EYES,
AND EARS, IN THE BONE IN THE HAIR, IN THE
INTERIOR OF THE GOGGLES, IN THE SKULL
DESIGN AND CIRCLES IN THE BELT AND IN THE
SKELETAL ARMS AND LEGS. THE COLOR
BROWN APPEARS IN THE EYES AND THE COLOR
GRAY APPEARS IN THE TOP OUTLINE OF THE
BELT.

SN 77-234,687, FILED 7-20-2007.

ALEX KEAM, EXAMINING ATTORNEY

Int. Cls.: 3 and 4

Prior U.S. Cls.: 1, 4, 6, 15, 50, 51, and 52

United States Patent and Trademark Office

Reg. No. 3,485,989

Registered Aug. 12, 2008

**TRADEMARK
PRINCIPAL REGISTER**

SCENTSPIRATIONS

STARLUME, INC. (DELAWARE CORPORATION)
2000 WEST 94TH STREET
BLOOMINGTON, MN 55431

FOR: PASSIVE SCENT DIFFUSERS, NAMELY,
AIR DIFFUSERS COMPRISED OF A REED AND
OIL IN THE CONTAINER USED TO EMIT SCENT
BY DIFFUSION INTO THE AIR , IN CLASS 3 (U.S.
CLS. 1, 4, 6, 50, 51 AND 52).

FIRST USE 10-22-2007; IN COMMERCE 10-22-2007.

FOR: CANDLES, IN CLASS 4 (U.S. CLS. 1, 6 AND
15).

FIRST USE 10-22-2007; IN COMMERCE 10-22-2007.

THE MARK CONSISTS OF STANDARD CHAR-
ACTERS WITHOUT CLAIM TO ANY PARTICULAR
FONT, STYLE, SIZE, OR COLOR.

SN 77-235,110, FILED 7-20-2007.

DAWN HAN, EXAMINING ATTORNEY

Int. Cls.: 9 and 25

Prior U.S. Cls.: 21, 22, 23, 26, 36, 38, and 39

United States Patent and Trademark Office

Reg. No. 3,485,990

Registered Aug. 12, 2008

**TRADEMARK
PRINCIPAL REGISTER**

KAREN KANE

KAREN KANE, INC. (CALIFORNIA CORPORATION)
2275 EAST 37TH STREET
LOS ANGELES, CA 900581427

FOR: CASES FOR SPECTACLES AND SUNGLASSES; SUNGLASSES, IN CLASS 9 (U.S. CLS. 21, 23, 26, 36 AND 38).

FIRST USE 5-0-2008; IN COMMERCE 5-0-2008.

FOR: LEATHER BELTS, IN CLASS 25 (U.S. CLS. 22 AND 39).

FIRST USE 0-0-1989; IN COMMERCE 0-0-1989.

THE MARK CONSISTS OF STANDARD CHARACTERS WITHOUT CLAIM TO ANY PARTICULAR FONT, STYLE, SIZE, OR COLOR.

OWNER OF U.S. REG. NOS. 1,303,865, 3,118,386, AND OTHERS.

THE NAME(S), PORTRAIT(S), AND/OR SIGNATURE(S) SHOWN IN THE MARK IDENTIFIES "KAREN KANE", WHOSE CONSENT(S) TO REGISTER IS SUBMITTED.

SN 77-236,396, FILED 7-23-2007.

WON TEAK OH, EXAMINING ATTORNEY

Int. Cl.: 5

Prior U.S. Cls.: 6, 18, 44, 46, 51, and 52

Reg. No. 3,485,991

United States Patent and Trademark Office

Registered Aug. 12, 2008

**TRADEMARK
PRINCIPAL REGISTER**

PROSTAHEART

NUTRACEUTICAL SCIENCES INSTITUTE, INC.
(DELAWARE CORPORATION)
SUITE 500
5400 BROKEN SOUND BLVD., N.W.
BOCA RATON, FL 33487

THE MARK CONSISTS OF STANDARD CHAR-
ACTERS WITHOUT CLAIM TO ANY PARTICULAR
FONT, STYLE, SIZE, OR COLOR.

FOR: DIETARY AND NUTRITIONAL SUPPLE-
MENTS, IN CLASS 5 (U.S. CLS. 6, 18, 44, 46, 51 AND
52).

SN 77-236,800, FILED 7-24-2007.

FIRST USE 2-18-2008; IN COMMERCE 2-18-2008.

MICHAEL GAAFAR, EXAMINING ATTORNEY

Int. Cl.: 17

Prior U.S. Cls.: 1, 5, 12, 13, 35, and 50

Reg. No. 3,485,992

United States Patent and Trademark Office

Registered Aug. 12, 2008

**TRADEMARK
PRINCIPAL REGISTER**

WEATHER READY

GOSSEN CORPORATION (WISCONSIN CORPORATION)
2030 WEST BENDER ROAD
MILWAUKEE, WI 53209

FOR: EXTRUDED PLASTIC MATERIALS FOR USE IN WINDOW CASINGS, DOOR CASINGS, TRIM, INSULATION AND OTHER CONSTRUCTION APPLICATIONS, IN CLASS 17 (U.S. CLS. 1, 5, 12, 13, 35 AND 50).

FIRST USE 11-30-2007; IN COMMERCE 11-30-2007.

THE MARK CONSISTS OF STANDARD CHARACTERS WITHOUT CLAIM TO ANY PARTICULAR FONT, STYLE, SIZE, OR COLOR.

SN 77-236,958, FILED 7-24-2007.

ESTHER A. BORSUK, EXAMINING ATTORNEY

Int. Cl.: 21

Prior U.S. Cls.: 2, 13, 23, 29, 30, 33, 40, and 50

Reg. No. 3,485,993

United States Patent and Trademark Office

Registered Aug. 12, 2008

**TRADEMARK
PRINCIPAL REGISTER**

FLIPSIDE

THE HOMER LAUGHLIN CHINA COMPANY
(DELAWARE CORPORATION)
672 FIESTA DRIVE
NEWELL, WV 26050

THE MARK CONSISTS OF STANDARD CHAR-
ACTERS WITHOUT CLAIM TO ANY PARTICULAR
FONT, STYLE, SIZE, OR COLOR.

FOR: DINNERWARE, IN CLASS 21 (U.S. CLS. 2, 13,
23, 29, 30, 33, 40 AND 50).

SN 77-237,367, FILED 7-24-2007.

FIRST USE 3-18-2008; IN COMMERCE 3-18-2008.

MICHAEL LEWIS, EXAMINING ATTORNEY

Int. Cl.: 29

Prior U.S. Cl.: 46

United States Patent and Trademark Office

Reg. No. 3,485,994

Registered Aug. 12, 2008

TRADEMARK
PRINCIPAL REGISTER



MEI, YUE QIN WILLIAM (UNITED STATES
INDIVIDUAL)
5410 W. ROOSEVELT ROAD
UNIT 111, DOCK 35B
CHICAGO, IL 60644

THE NON-LATIN CHARACTER(S) IN THE
MARK TRANSLITERATES INTO XIN XIN, AND
THIS MEANS RELY IN ENGLISH.

FOR: PROCESSED BEANS, FROZEN FISH, AND
PROCESSED HERBAL ROOTS FOR HUMAN CON-
SUMPTION, IN CLASS 29 (U.S. CL. 46).

SN 77-237,460, FILED 7-24-2007.

FIRST USE 1-1-2008; IN COMMERCE 1-1-2008.

REBECCA SMITH, EXAMINING ATTORNEY

Int. Cl.: 42

Prior U.S. Cls.: 100 and 101

United States Patent and Trademark Office

Reg. No. 3,485,995

Registered Aug. 12, 2008

**SERVICE MARK
PRINCIPAL REGISTER**

RP Design Web Services

RPD, INC. (CONNECTICUT CORPORATION),
DBA RP DESIGN WEB SERVICES, RP DE-
SIGN, REFERENCE POINT,
1187 HIGHLAND AVENUE
CHESHIRE, CT 06410

FOR: DESIGN, CREATION, HOSTING AND
MAINTENANCE OF INTERNET SITES FOR THIRD
PARTIES; HOSTING OF DIGITAL CONTENT ON
THE INTERNET , IN CLASS 42 (U.S. CLS. 100 AND
101).

FIRST USE 6-1-2000; IN COMMERCE 6-1-2000.

THE MARK CONSISTS OF STANDARD CHAR-
ACTERS WITHOUT CLAIM TO ANY PARTICULAR
FONT, STYLE, SIZE, OR COLOR.

NO CLAIM IS MADE TO THE EXCLUSIVE
RIGHT TO USE "DESIGN WEB SERVICES", APART
FROM THE MARK AS SHOWN.

SN 77-238,056, FILED 7-25-2007.

ALICE SUE CARRUTHERS, EXAMINING ATTOR-
NEY

Int. Cl.: 25

Prior U.S. Cls.: 22 and 39

United States Patent and Trademark Office

Reg. No. 3,485,996

Registered Aug. 12, 2008

**TRADEMARK
PRINCIPAL REGISTER**

CHIZZARO

SYLLABLES, INC. (NEW JERSEY CORPORATION)
150 ROOSEVELT PLACE
PALISADES PARK, NJ 07650

FOR: CLOTHING, NAMELY, WOVEN SHIRTS, POLO SHIRTS, SWEATERS, CASUAL TROUSERS, DRESS SHIRTS, JEANS, PANTS, SUITS, SPORT COATS, T-SHIRTS, JERSEYS, TANK TOPS, LEATHER JACKETS, AND SUEDE JACKETS, IN CLASS 25 (U.S. CLS. 22 AND 39).

FIRST USE 3-0-2006; IN COMMERCE 3-0-2006.

THE MARK CONSISTS OF STANDARD CHARACTERS WITHOUT CLAIM TO ANY PARTICULAR FONT, STYLE, SIZE, OR COLOR.

SN 77-238,227, FILED 7-25-2007.

PAUL CROWLEY, EXAMINING ATTORNEY

Int. Cls.: 9 and 42

Prior U.S. Cls.: 21, 23, 26, 36, 38, 100, and 101

United States Patent and Trademark Office

Reg. No. 3,485,997

Registered Aug. 12, 2008

**TRADEMARK
SERVICE MARK
PRINCIPAL REGISTER**

The logo for KILAWORX features the word "KILAWORX" in a bold, black, serif font. A grey, stylized swoosh or ribbon-like graphic element curves through the letters, starting from the left side of the 'K', passing behind the 'A' and 'W', and ending on the right side of the 'X'.

NCI GROUP, INC. (NEVADA CORPORATION)
10943 N. SAM HOUSTON PARKWAY WEST
HOUSTON, TX 77064

FOR: COMPUTER SOFTWARE THAT GIVES AN ONLINE USER THE CAPABILITY TO PRICE AND PURCHASE A PRE-ENGINEERED METAL BUILDING AND METAL BUILDING ACCESSORIES, IN CLASS 9 (U.S. CLS. 21, 23, 26, 36 AND 38).

FIRST USE 2-11-2008; IN COMMERCE 2-11-2008.

FOR: PROVIDING TEMPORARY USE OF ONLINE NON-DOWNLOADABLE COMPUTER SOFTWARE THAT GIVES AN ONLINE USER THE CAPABILITY TO PRICE AND PURCHASE A PRE-

ENGINEERED METAL BUILDING AND METAL BUILDING ACCESSORIES, IN CLASS 42 (U.S. CLS. 100 AND 101).

FIRST USE 2-11-2008; IN COMMERCE 2-11-2008.

THE MARK CONSISTS OF STYLIZED LETTERS THAT SPELL "KILAWORX" WITH A SWOOSH DESIGN RUNNING THROUGH "KILAWORX".

THE ENGLISH TRANSLATION OF THE WORD "KILA" IN THE MARK IS STEEL.

SN 77-238,305, FILED 7-25-2007.

DAVID MURRAY, EXAMINING ATTORNEY

Int. Cl.: 25

Prior U.S. Cls.: 22 and 39

United States Patent and Trademark Office

Reg. No. 3,485,998

Registered Aug. 12, 2008

**TRADEMARK
PRINCIPAL REGISTER**

NAUGHTY MONKEY'S CLOSET

KIA INCORPORATED (CALIFORNIA CORPORATION)
SUITE 100
16516 VIA ESPRILLO
SAN DIEGO, CA 92127

THE MARK CONSISTS OF STANDARD CHARACTERS WITHOUT CLAIM TO ANY PARTICULAR FONT, STYLE, SIZE, OR COLOR.

FOR: FOOTWEAR, IN CLASS 25 (U.S. CLS. 22 AND 39).

SN 77-238,414, FILED 7-25-2007.

FIRST USE 11-13-2007; IN COMMERCE 11-13-2007.

JULIE WATSON, EXAMINING ATTORNEY

Int. Cl.: 29

Prior U.S. Cl.: 46

United States Patent and Trademark Office

Reg. No. 3,485,999

Registered Aug. 12, 2008

**TRADEMARK
PRINCIPAL REGISTER**

**BETTER FOR YOU. BETTER FOR
EVERYONE.**

AB FOODS, LLC (MISSOURI LTD LIAB CO)
8 TERRY HILL LANE
ST. LOUIS, MO 63131

FOR: MEAT SUBSTITUTES; PROTEIN FOR USE
AS AN INGREDIENT IN COOKING, BAKED
GOODS AND AS A MEAT ADDITIVE; PROTEIN
FOOD PRODUCTS, NAMELY, CHOPPED BEEF
SUBSTITUTE, CHICKEN SUBSTITUTE, PORK SUB-
STITUTE, CRAB SUBSTITUTE, LAMB SUBSTI-
TUTE, FISH SUBSTITUTE, SAUSAGE
SUBSTITUTE, MEAT SUBSTITUTES, HAM SUBSTI-

TUTE, BACON SUBSTITUTE, VEAL SUBSTITUTE,
IN CLASS 29 (U.S. CL. 46).

FIRST USE 11-0-2007; IN COMMERCE 11-0-2007.

THE MARK CONSISTS OF STANDARD CHAR-
ACTERS WITHOUT CLAIM TO ANY PARTICULAR
FONT, STYLE, SIZE, OR COLOR.

SN 77-238,675, FILED 7-25-2007.

JUSTINE D. PARKER, EXAMINING ATTORNEY

Int. Cl.: 16

Prior U.S. Cls.: 2, 5, 22, 23, 29, 37, 38, and 50

Reg. No. 3,486,000

United States Patent and Trademark Office

Registered Aug. 12, 2008

**TRADEMARK
PRINCIPAL REGISTER**

Look Smarter Than You Are

INTERREL CONSULTING SERVICES, INC.
(TEXAS CORPORATION)
SUITE 304
1000 BALLPARK WAY
ARLINGTON, TX 76011

FOR: SERIES OF BOOKS IN THE FIELD OF
COMPUTERS, COMPUTER SOFTWARE AND DA-
TABASES, IN CLASS 16 (U.S. CLS. 2, 5, 22, 23, 29, 37, 38
AND 50).

FIRST USE 4-18-2008; IN COMMERCE 4-18-2008.

THE MARK CONSISTS OF STANDARD CHAR-
ACTERS WITHOUT CLAIM TO ANY PARTICULAR
FONT, STYLE, SIZE, OR COLOR.

SN 77-239,199, FILED 7-26-2007.

ESTHER A. BORSUK, EXAMINING ATTORNEY

Int. Cl.: 9

Prior U.S. Cls.: 21, 23, 26, 36, and 38

Reg. No. 3,486,001

United States Patent and Trademark Office

Registered Aug. 12, 2008

**TRADEMARK
PRINCIPAL REGISTER**

THE BLADE OF FATE

KABUSHIKI KAISHA SHUEISHA (JAPAN CORPORATION), DBA A/T/A SHUEISHA INC.,
5-10 HITOTSUBASHI 2-CHOME
CHIYODA-KU, TOKYO, JAPAN

THE MARK CONSISTS OF STANDARD CHARACTERS WITHOUT CLAIM TO ANY PARTICULAR FONT, STYLE, SIZE, OR COLOR.

FOR: VIDEO GAME SOFTWARE, IN CLASS 9
(U.S. CLS. 21, 23, 26, 36 AND 38).

SN 77-239,463, FILED 7-26-2007.

FIRST USE 10-9-2007; IN COMMERCE 10-9-2007.

CHRISTINE COOPER, EXAMINING ATTORNEY

Int. Cl.: 35

Prior U.S. Cls.: 100, 101, and 102

United States Patent and Trademark Office

Reg. No. 3,486,002

Registered Aug. 12, 2008

**SERVICE MARK
PRINCIPAL REGISTER**

EAT! DRINK! MOVE! THINK!

EAT! DRINK! MOVE! THINK! (IOWA LTD LIAB
CO)
207 NORTH CHESTNUT ST.
GLENWOOD, IA 51534

THE MARK CONSISTS OF STANDARD CHAR-
ACTERS WITHOUT CLAIM TO ANY PARTICULAR
FONT, STYLE, SIZE, OR COLOR.

FOR: ON-LINE RETAIL STORE SERVICES FEA-
TURING PARENTING TOOLS AND CHILDREN'S
TOYS, IN CLASS 35 (U.S. CLS. 100, 101 AND 102).

SN 77-241,260, FILED 7-27-2007.

FIRST USE 5-1-2008; IN COMMERCE 5-1-2008.

DORITT L. CARROLL, EXAMINING ATTORNEY

Int. Cl.: 25

Prior U.S. Cls.: 22 and 39

United States Patent and Trademark Office

Reg. No. 3,486,003

Registered Aug. 12, 2008

**TRADEMARK
PRINCIPAL REGISTER**

TAKE NO BULL

INGUI DESIGN, LLC (NEW JERSEY LTD LIAB
CO), DBA TAKE NO BULL,
46 NORTH CENTRAL AVENUE
RAMSEY, NJ 07446

FOR: SWEAT SHIRTS; T-SHIRTS; JEANS; KNIT
SHIRTS; KNITTED CAPS; NIGHT SHIRTS; PIQUE
SHIRTS; SHIRTS; SKULL CAPS; SLEEP SHIRTS;
SPORT SHIRTS; CAP VISORS, IN CLASS 25 (U.S.
CLS. 22 AND 39).

FIRST USE 11-12-2007; IN COMMERCE 11-12-2007.

THE MARK CONSISTS OF STANDARD CHAR-
ACTERS WITHOUT CLAIM TO ANY PARTICULAR
FONT, STYLE, SIZE, OR COLOR.

SN 77-241,948, FILED 7-30-2007.

JAMES GRIFFIN, EXAMINING ATTORNEY

Int. Cl.: 5

Prior U.S. Cls.: 6, 18, 44, 46, 51, and 52

Reg. No. 3,486,004

United States Patent and Trademark Office

Registered Aug. 12, 2008

**TRADEMARK
PRINCIPAL REGISTER**

TRICOR

UNITED PHOSPHORUS, INC. (DELAWARE COR-
PORATION)
630 FREEDOM BUSINESS CENTER, SUITE 402
KING OF PRUSSIA, PA 19406

THE MARK CONSISTS OF STANDARD CHAR-
ACTERS WITHOUT CLAIM TO ANY PARTICULAR
FONT, STYLE, SIZE, OR COLOR.

FOR: AGRICULTURAL HERBICIDE, IN CLASS 5
(U.S. CLS. 6, 18, 44, 46, 51 AND 52).

SN 77-242,096, FILED 7-30-2007.

FIRST USE 6-11-2008; IN COMMERCE 6-11-2008.

ANTHONY RINKER, EXAMINING ATTORNEY

Int. Cl.: 19

Prior U.S. Cls.: 1, 12, 33, and 50

United States Patent and Trademark Office

Reg. No. 3,486,005

Registered Aug. 12, 2008

**TRADEMARK
PRINCIPAL REGISTER**

EARTHSMART

ALPHA 7 GYPSUM, LLC (GEORGIA LTD LIAB
CO)
P.O. BOX 1008
FAIRBURN, GA 30213

THE MARK CONSISTS OF ONE WORD IN THE
FONT "JUANITA ITC" WITH A CAPITAL E AND
CAPITAL S.

FOR: FABRIC FOR UNDERLAYMENT OF
FLOORING; FLOORING UNDERLAYMENTS; GYP-
SUM, IN CLASS 19 (U.S. CLS. 1, 12, 33 AND 50).

SN 77-242,199, FILED 7-30-2007.

FIRST USE 7-30-2007; IN COMMERCE 9-27-2007.

LINDA E. BLOHM, EXAMINING ATTORNEY

Int. Cl.: 41

Prior U.S. Cls.: 100, 101, and 107

United States Patent and Trademark Office

Reg. No. 3,486,006

Registered Aug. 12, 2008

SERVICE MARK
PRINCIPAL REGISTER



NUNEZ, JOEL J (MEXICO INDIVIDUAL)
100 NW 204 STREET APT G-11
MIAMI, FL 33169

FOR: PRODUCTION AND DISTRIBUTION OF
TELEVISION SHOWS AND MOVIES, IN CLASS 41
(U.S. CLS. 100, 101 AND 107).

FIRST USE 3-4-2008; IN COMMERCE 3-4-2008.

NO CLAIM IS MADE TO THE EXCLUSIVE
RIGHT TO USE "FILMS", APART FROM THE
MARK AS SHOWN.

THE COLOR(S) BLACK, WHITE, AND BLUE IS/
ARE CLAIMED AS A FEATURE OF THE MARK.

THE MARK CONSISTS OF A FULL BLACK
BACKGROUND, THE HANDWRITTEN STYLED
LETTERS IN BLUE AND THE TYPED LETTERS IN
WHITE.

SN 77-242,915, FILED 7-31-2007.

CYNTHIA SLOAN, EXAMINING ATTORNEY

Int. Cl.: 9

Prior U.S. Cls.: 21, 23, 26, 36, and 38

Reg. No. 3,486,007

United States Patent and Trademark Office

Registered Aug. 12, 2008

**TRADEMARK
PRINCIPAL REGISTER**

GEM

SYLER, RENE (UNITED STATES INDIVIDUAL)
6 BEDFORD ROAD
CHAPPAQUA, NY 10514

FIRST USE 2-2-2006; IN COMMERCE 2-2-2006.

FOR: SERIES OF PRE-RECORDED ELECTRONIC MEDIA, NAMELY, AUDIO/VIDEO DISCS AND TAPES, DIGITAL RECORDING DISCS AND TAPES FEATURING INSTRUCTION AND SPEECHES, MUSIC AND SOUND EFFECTS ON TOPICS OF INTEREST TO WOMEN, IN CLASS 9 (U.S. CLS. 21, 23, 26, 36 AND 38).

THE MARK CONSISTS OF STANDARD CHARACTERS WITHOUT CLAIM TO ANY PARTICULAR FONT, STYLE, SIZE, OR COLOR.

SN 77-244,036, FILED 8-1-2007.

HEATHER THOMPSON, EXAMINING ATTORNEY

Int. Cl.: 25

Prior U.S. Cls.: 22 and 39

United States Patent and Trademark Office

Reg. No. 3,486,008

Registered Aug. 12, 2008

**TRADEMARK
PRINCIPAL REGISTER**

Vardon & Ray

SEJUNG USA HARRY VARDON GOLF, COR-
PORATION (MINNESOTA CORPORATION)
1220 E. 7TH STREET
WINONA, MN 55987

FOR: CLOTHING, NAMELY, CAPS, HATS,
CLOTHING OF LEATHER, NAMELY, LEATHER
JACKETS, JACKETS, JUMPERS, KNITWEAR IN
THE NATURE OF SWEATERS, LONG AND SHORT
SLEEVED GOLF SHIRTS AND VESTS, LONG AND
SHORT PANTS, PARKAS, SPORTS JERSEYS, SWEA-
TERS, TEE-SHIRTS, UNDERCLOTHING, NAMELY,

UNDERGARMENTS, AND VESTS, IN CLASS 25
(U.S. CLS. 22 AND 39).

FIRST USE 12-1-2006; IN COMMERCE 12-1-2006.

THE MARK CONSISTS OF STANDARD CHAR-
ACTERS WITHOUT CLAIM TO ANY PARTICULAR
FONT, STYLE, SIZE, OR COLOR.

SN 77-244,352, FILED 8-1-2007.

SHARON MEIER, EXAMINING ATTORNEY

Int. Cls.: 25 and 34

Prior U.S. Cls.: 2, 8, 9, 17, 22, and 39

United States Patent and Trademark Office

Reg. No. 3,486,009

Registered Aug. 12, 2008

TRADEMARK
PRINCIPAL REGISTER



BLUNT WRAP U.S.A., INC (LOUISIANA CORPORATION)
594 ASBURY DRIVE, SUITE C
MANDEVILLE, LA 70471

FOR: CLOTHING, NAMELY, SHIRTS, AND HATS, IN CLASS 25 (U.S. CLS. 22 AND 39).

FIRST USE 2-1-2008; IN COMMERCE 2-1-2008.

FOR: TOBACCO PRODUCTS, ACCESSORIES, AND SMOKING ARTICLES, NAMELY, CIGARS, ROLLING PAPERS MADE OUT OF PAPER, TOBACCO, CELLULOSE, AND/OR OTHER MATERIALS FOR CIGARETTES AND/OR CIGARS, AND PRE-ROLLED TOBACCO SHELLS, TOBACCO SHEETS,

AND/OR CIGARETTE PAPERS, IN CLASS 34 (U.S. CLS. 2, 8, 9 AND 17).

FIRST USE 2-1-2008; IN COMMERCE 2-1-2008.

NO CLAIM IS MADE TO THE EXCLUSIVE RIGHT TO USE "THE ORIGINAL BLUNT WRAP" FOR CLASS 34 ONLY, APART FROM THE MARK AS SHOWN.

THE MARK CONSISTS OF LOGO WHICH INCORPORATES TOBACCO PLANT.

SN 77-244,727, FILED 8-1-2007.

HOWARD B. LEVINE, EXAMINING ATTORNEY

Int. Cl.: 5

Prior U.S. Cls.: 6, 18, 44, 46, 51, and 52

Reg. No. 3,486,010

United States Patent and Trademark Office

Registered Aug. 12, 2008

**TRADEMARK
PRINCIPAL REGISTER**

PNEUMASURF

PNEUMA PARTNERS, LLC (NEW YORK LTD
LIAB CO)
1576 SWEET HOME ROAD
AMHERST, NY 14228

FIRST USE 6-26-2008; IN COMMERCE 6-26-2008.

FOR: PHARMACEUTICAL PREPARATIONS,
NAMELY, A NATURAL SURFACTANT USED IN
THE PREVENTION/TREATMENT OF RESPIRA-
TORY DISTRESS SYNDROME IN ADULTS, IN
CLASS 5 (U.S. CLS. 6, 18, 44, 46, 51 AND 52).

THE MARK CONSISTS OF STANDARD CHAR-
ACTERS WITHOUT CLAIM TO ANY PARTICULAR
FONT, STYLE, SIZE, OR COLOR.

SN 77-245,143, FILED 8-2-2007.

SETH A. RAPPAPORT, EXAMINING ATTORNEY

Int. Cl.: 3

Prior U.S. Cls.: 1, 4, 6, 50, 51, and 52

Reg. No. 3,486,011

United States Patent and Trademark Office

Registered Aug. 12, 2008

**TRADEMARK
PRINCIPAL REGISTER**

CITY BEAUTY

LERNER NEW YORK, INC. (DELAWARE CORPORATION)
450 WEST 33RD STREET
NEW YORK, NY 10001

FOR: PERSONAL CARE PRODUCTS, NAMELY, BODY MIST, BODY SCRUB, CREAM FOR THE BODY, CREAM FOR THE HANDS, LOTION FOR THE BODY AND SHOWER GEL, IN CLASS 3 (U.S. CLS. 1, 4, 6, 50, 51 AND 52).

FIRST USE 10-25-2007; IN COMMERCE 10-25-2007.

THE MARK CONSISTS OF STANDARD CHARACTERS WITHOUT CLAIM TO ANY PARTICULAR FONT, STYLE, SIZE, OR COLOR.

NO CLAIM IS MADE TO THE EXCLUSIVE RIGHT TO USE "BEAUTY", APART FROM THE MARK AS SHOWN.

SN 77-245,507, FILED 8-2-2007.

WENDY GOODMAN, EXAMINING ATTORNEY

Int. Cls.: 35 and 41

Prior U.S. Cls.: 100, 101, 102, and 107

United States Patent and Trademark Office

Reg. No. 3,486,012

Registered Aug. 12, 2008

**SERVICE MARK
PRINCIPAL REGISTER**

Ucare.TV

MARTIN, ANDREW (UNITED STATES INDIVIDUAL)
PO BOX 225
58 HATCHERY HOLLOW
BIG INDIAN, NY 12464

FOR: ADVERTISING AND PUBLICITY SERVICES, NAMELY, PROMOTING THE GOODS, SERVICES, BRAND IDENTITY AND COMMERCIAL INFORMATION AND NEWS OF THIRD PARTIES THROUGH PRINT, AUDIO, VIDEO, DIGITAL AND ON-LINE MEDIUM; ADVERTISING, PARTICULARLY SERVICES FOR THE PROMOTION OF GOODS; ADVERTISING VIA ELECTRONIC MEDIA AND SPECIFICALLY THE INTERNET; CHARITABLE SERVICES, NAMELY, PROMOTING PUBLIC AWARENESS ABOUT POVERTY IN THE UNITED STATES THROUGH A MEDIA FAST PROGRAM CONDUCTED BY YOUNG PEOPLE; COMPUTERIZED ON-LINE RETAIL STORE SERVICES IN THE FIELD OF DOCUMENTARIES ON GLOBAL WARMING, WOMEN, CHILDREN AND POVERTY; ON-LINE ORDERING SERVICES FEATURING DOCUMENTARIES ON GLOBAL WARMING, WOMEN, CHILDREN AND POVERTY; ON-LINE RETAIL STORE SERVICES FEATURING DOWNLOADABLE PRE-RECORDED MUSIC AND VIDEO; ON-LINE RETAIL STORE SERVICES FEATURING DOCUMENTARIES ON GLOBAL WARMING, WOMEN, CHILDREN AND POVERTY; OPERATING AN ON-LINE SHOPPING SITE IN THE FIELD OF DOCUMENTARIES ON GLOBAL WARMING, WOMEN, CHILDREN AND POVERTY; OPERATING ON-LINE MARKETPLACES FOR SELLERS OF GOODS AND/OR SERVICES; PROMOTING THE GOODS AND SERVICES OF OTHERS BY MEANS OF OPERATING AN ON-LINE SHOPPING MALL WITH LINKS TO THE RETAIL WEB SITES OF OTHERS; PROMOTING THE GOODS

AND SERVICES OF OTHERS BY PROVIDING A WEB SITE AT WHICH USERS CAN LINK TO DOCUMENTARIES ON GLOBAL WARMING, WOMEN, CHILDREN AND POVERTY; PROMOTING THE GOODS AND SERVICES OF OTHERS BY PROVIDING HYPERTEXT LINKS TO THE WEB SITES OF OTHERS; PROVIDING CONSUMER INFORMATION IN THE FIELD OF DOCUMENTARIES ON GLOBAL WARMING, WOMEN, CHILDREN AND POVERTY; PROVIDING INFORMATION ABOUT AND MAKING REFERRALS IN THE FIELD OF CONSUMER PRODUCTS AND SERVICES FOR RETAIL SERVICES CONCERNING PRODUCTS, SERVICES, EVENTS, ACTIVITIES, ATTRACTIONS AND FACILITIES IN PARTICULAR GEOGRAPHIC LOCATIONS, IN CLASS 35 (U.S. CLS. 100, 101 AND 102).

FIRST USE 5-15-2008; IN COMMERCE 5-15-2008.

FOR: EDUCATIONAL SERVICES IN THE NATURE OF PROVIDING DOCUMENTARIES ON GLOBAL WARMING, WOMEN, CHILDREN AND POVERTY; ON-LINE JOURNALS, NAMELY, BLOGS FEATURING GLOBAL WARMING, WOMEN, CHILDREN AND POVERTY, IN CLASS 41 (U.S. CLS. 100, 101 AND 107).

FIRST USE 5-1 5-2008; IN COMMERCE 5-15-2008.

THE MARK CONSISTS OF STANDARD CHARACTERS WITHOUT CLAIM TO ANY PARTICULAR FONT, STYLE, SIZE, OR COLOR.

SN 77-245,525, FILED 8-2-2007.

ALICE SUE CARRUTHERS, EXAMINING ATTORNEY

Int. Cl.: 14

Prior U.S. Cls.: 2, 27, 28, and 50

United States Patent and Trademark Office

Reg. No. 3,486,013

Registered Aug. 12, 2008

**TRADEMARK
PRINCIPAL REGISTER**

RACE DRAGON

MONTRES ANTIMA SA (SWITZERLAND COR-
PORATION)
THEODOR KOCHER-STRASSE 11
2502 BIENNE, SWITZERLAND

FOR: WATCHES, IN CLASS 14 (U.S. CLS. 2, 27, 28
AND 50).

FIRST USE 2-25-2008; IN COMMERCE 2-25-2008.

THE MARK CONSISTS OF STANDARD CHAR-
ACTERS WITHOUT CLAIM TO ANY PARTICULAR
FONT, STYLE, SIZE, OR COLOR.

OWNER OF U.S. REG. NO. 3,024,220.

SN 77-245,792, FILED 8-2-2007.

RAUL CORDOVA, EXAMINING ATTORNEY

Int. Cl.: 9

Prior U.S. Cls.: 21, 23, 26, 36, and 38

United States Patent and Trademark Office

Reg. No. 3,486,014

Registered Aug. 12, 2008

**TRADEMARK
PRINCIPAL REGISTER**

REDEYE

OCEAN OPTICS, INC. (FLORIDA CORPORATION)
830 DOUGLAS AVENUE
DUNEDIN, FL 34698

FOR: OXYGEN SENSORS IN THE NATURE OF AN OXYGEN INDICATOR PATCH, NAMELY, AN ADHESIVE PATCH WITH OXYGEN DETECTING CHEMICALS EMBEDDED IN A MATRIX USED FOR DETECTION OF OXYGEN LEVELS IN PACKAGING AND CONTAINERS, IN CLASS 9 (U.S. CLS. 21, 23, 26, 36 AND 38).

FIRST USE 5-1-2007; IN COMMERCE 8-1-2007.

THE MARK CONSISTS OF STANDARD CHARACTERS WITHOUT CLAIM TO ANY PARTICULAR FONT, STYLE, SIZE, OR COLOR.

SN 77-246,202, FILED 8-3-2007.

PAUL CROWLEY, EXAMINING ATTORNEY

Int. Cl.: 8

Prior U.S. Cls.: 23, 28, and 44

United States Patent and Trademark Office

Reg. No. 3,486,015

Registered Aug. 12, 2008

**TRADEMARK
PRINCIPAL REGISTER**

PHAT MASTER

ANDIS COMPANY (WISCONSIN CORPORATION)
1800 RENAISSANCE BLVD.
STURTEVANT, WI 53177

FOR: ELECTRIC HAIR CLIPPERS AND BLADES
FOR ELECTRIC HAIR CLIPPERS, IN CLASS 8 (U.S.
CLS. 23, 28 AND 44).

FIRST USE 4-15-2008; IN COMMERCE 4-15-2008.

THE MARK CONSISTS OF STANDARD CHARACTERS WITHOUT CLAIM TO ANY PARTICULAR FONT, STYLE, SIZE, OR COLOR.

OWNER OF U.S. REG. NOS. 2,121,349, 2,488,678,
AND OTHERS.

SN 77-246,400, FILED 8-3-2007.

BRIAN CALLAGHAN, EXAMINING ATTORNEY

Int. Cl.: 35

Prior U.S. Cls.: 100, 101, and 102

United States Patent and Trademark Office

Reg. No. 3,486,016

Registered Aug. 12, 2008

**SERVICE MARK
PRINCIPAL REGISTER**

VANYAH WINE IMPORTS

LEDERER, MICHAEL (UNITED STATES INDIVIDUAL)
2612 ELMBROOK DRIVE
CARROLLTON, TX 75010

FOR: WHOLESALE DISTRIBUTORSHIPS FEATURING WINE AND WINE ACCESSORIES; ONLINE RETAIL STORE SERVICES FEATURING WINE AND WINE ACCESSORIES; IMPORT AGENCIES FEATURING WINE , IN CLASS 35 (U.S. CLS. 100, 101 AND 102).

FIRST USE 11-0-2007; IN COMMERCE 11-0-2007.

THE MARK CONSISTS OF STANDARD CHARACTERS WITHOUT CLAIM TO ANY PARTICULAR FONT, STYLE, SIZE, OR COLOR.

NO CLAIM IS MADE TO THE EXCLUSIVE RIGHT TO USE "WINE IMPORTS", APART FROM THE MARK AS SHOWN.

SN 77-246,469, FILED 8-3-2007.

MICHAEL LEWIS, EXAMINING ATTORNEY

Int. Cl.: 39

Prior U.S. Cls.: 100 and 105

United States Patent and Trademark Office

Reg. No. 3,486,017

Registered Aug. 12, 2008

**SERVICE MARK
PRINCIPAL REGISTER**

**A COLLECTION OF SMALLER,
MORE PERSONAL TRAVEL
EXPERIENCES**

COLLETTE TRAVEL SERVICE, INC. (RHODE
ISLAND CORPORATION)
162 MIDDLE ST.
PAWTUCKET, RI 02860

FOR: ARRANGING TRAVEL TOURS; COORDI-
NATING TRAVEL ARRANGEMENTS FOR INDIVI-
DUALS AND FOR GROUPS; ORGANIZATION OF
EXCURSIONS, SIGHTSEEING TOURS, HOLIDAYS,
TOURS AND TRAVEL; TRAVEL AGENCY SERVI-
CES, NAMELY, MAKING RESERVATIONS AND
BOOKINGS FOR TRANSPORTATION; TRAVEL

BOOKING AGENCIES, IN CLASS 39 (U.S. CLS. 100
AND 105).

FIRST USE 1-1-2008; IN COMMERCE 1-1-2008.

THE MARK CONSISTS OF STANDARD CHAR-
ACTERS WITHOUT CLAIM TO ANY PARTICULAR
FONT, STYLE, SIZE, OR COLOR.

SN 77-246,563, FILED 8-3-2007.

NELSON SNYDER, EXAMINING ATTORNEY

Int. Cls.: 18 and 26

Prior U.S. Cls.: 1, 2, 3, 22, 37, 39, 40, 41, 42, and 50

United States Patent and Trademark Office

Reg. No. 3,486,018

Registered Aug. 12, 2008

**TRADEMARK
PRINCIPAL REGISTER**



Personalized Pooch

ETHICAL PRODUCTS, INC. (NEW JERSEY CORPORATION)
27 FEDERAL PLAZA
BLOOMFIELD, NJ 07003

FOR: CLOTHING FOR PETS, IN CLASS 18 (U.S. CLS. 1, 2, 3, 22 AND 41).

FIRST USE 9-30-2007; IN COMMERCE 9-30-2007.

FOR: HOT-FIX AND IRON-ON ORNAMENTAL ACCESSORIES FOR DECORATIVE EMBELLISHMENT OF PET CLOTHING, NAMELY, GLUE-BACKED PEARLS, RHINESTONES, NAIL HEADS AND NON-PRECIOUS CRYSTALS AND COMBINA-

TIONS OF THE SAME, IN CLASS 26 (U.S. CLS. 37, 39, 40, 42 AND 50).

FIRST USE 9-30-2007; IN COMMERCE 9-30-2007.

THE MARK CONSISTS OF THE WORDING "PERSONALIZED POOCH" WITH HEXAGONAL DESIGNS ABOVE AND NEAR THE LETTERS "S", "Z", AND "C".

SN 77-246,780, FILED 8-3-2007.

KATINA MISTER, EXAMINING ATTORNEY

Int. Cl.: 21

Prior U.S. Cls.: 2, 13, 23, 29, 30, 33, 40, and 50

Reg. No. 3,486,019

United States Patent and Trademark Office

Registered Aug. 12, 2008

**TRADEMARK
PRINCIPAL REGISTER**

SIMPLY PLATED

FOH, INC. (FLORIDA CORPORATION)
9315 PARK DRIVE
MIAMI SHORES, FL 33138

FOR: DINNERWARE; DINNERWARE, NAMELY, PLATES, BOWLS, DISHES, SPOONS, LADLES, FORKS, TRAYS, PLATTERS, AND GLASSES; CERAMIC SCULPTURES, VASES, VESSELS, BOWLS, PLATES AND POTS; COMMEMORATIVE PLATES; DECORATIVE PLATES; DISHES AND PLATES; PLATES; PLATES FOR HORS D'OEUVRE; SOUVENIR PLATES; BOWLS; FINGER BOWLS; FLOWER BOWLS; FLOWER VASES AND BOWLS; FRUIT BOWLS; FRUIT BOWLS OF GLASS; GLASS BOWLS; JAPANESE RICE BOWLS (CHAWAN); JAPANESE RICE BOWLS NOT OF PRECIOUS METAL (CHAWAN); JAPANESE STYLE SOUP SERVING BOWLS (WAN); PEPPER POTS, SUGAR BOWLS AND SALT SHAKERS; SALAD BOWLS; SALAD BOWLS; SERVING BOWLS (HACHI); SHALLOW BOWLS; SUGAR BOWLS; BAKING DISHES; BUTTER DISHES; BUTTER-DISH AND CHEESE-DISH COVERS; CASSEROLES; DISH COVERS; DISHES; GLASS DISHES; ROASTING DISHES; SERVING DISHES; CANDY DISHES; SERVING SPOONS; SPOON RESTS; KITCHEN LADLES; LADLES, FOR KITCHEN USE; SERVING LADLES; COOKING FORKS; PASTA SERVING FORKS; SERVING FORKS; BUTLERS'

TRAYS; CRUMB TRAYS; JAPANESE STYLE PERSONAL DINING TRAYS OR STANDS (ZEN); MEAL TRAYS; SERVING TRAYS; SERVING TRAYS NOT OF PRECIOUS METAL; TRAYS; SERVING PLATTERS; SERVING PLATTERS NOT OF PRECIOUS METAL; DRINKING GLASSES; GLASS BEVERAGEWARE; GLASS CARAFES; GLASS MUGS; JARS FOR JAMS AND JELLIES OF PORCELAIN AND GLASS; PILSNER DRINKING GLASSES; SHOT GLASSES; COFFEE CUPS; CUPS; DRINKING CUPS; EGG CUPS; EGG CUPS; MIXING CUPS; SAKE CUPS; BEER MUGS; MUGS; PORCELAIN MUGS, IN CLASS 21 (U.S. CLS. 2, 13, 23, 29, 30, 33, 40 AND 50).

FIRST USE 6-1-2008; IN COMMERCE 6-1-2008.

THE MARK CONSISTS OF STANDARD CHARACTERS WITHOUT CLAIM TO ANY PARTICULAR FONT, STYLE, SIZE, OR COLOR.

NO CLAIM IS MADE TO THE EXCLUSIVE RIGHT TO USE "PLATED", APART FROM THE MARK AS SHOWN.

SN 77-246,994, FILED 8-3-2007.

LINDA M. KING, EXAMINING ATTORNEY

Int. Cl.: 3

Prior U.S. Cls.: 1, 4, 6, 50, 51, and 52

Reg. No. 3,486,020

United States Patent and Trademark Office

Registered Aug. 12, 2008

**TRADEMARK
PRINCIPAL REGISTER**

**BUILD
-A-
LASH**

NEW MILANI GROUP, INC. (CALIFORNIA CORPORATION)
2111 EAST 49TH STREET
LOS ANGELES, CA 90058

FOR: COSMETICS, IN CLASS 3 (U.S. CLS. 1, 4, 6, 50, 51 AND 52).

FIRST USE 1-0-2008; IN COMMERCE 1-0-2008.

THE MARK CONSISTS OF THE WORD "BUILD" STACKED ABOVE THE LETTER "A", WITH A DASH ON EITHER SIDE OF THE "A", ALL STACKED ABOVE THE WORD "LASH", WITH A TILDE SERVING AS THE CROSSBAR TO THE "H" IN "LASH".

SN 77-247,105, FILED 8-3-2007.

JENNIFER VASQUEZ, EXAMINING ATTORNEY

Int. Cls.: 8 and 11

Prior U.S. Cls.: 13, 21, 23, 28, 31, 34, and 44

United States Patent and Trademark Office

Reg. No. 3,486,021

Registered Aug. 12, 2008

**TRADEMARK
PRINCIPAL REGISTER**

LEATHERMAN

LEATHERMAN TOOL GROUP, INC. (OREGON CORPORATION)
P.O. BOX 20595
PORTLAND, OR 97294

FOR: KNIVES, NAMELY, POCKET KNIVES, FOLDING KNIVES, SPORT KNIVES, HUNTING KNIVES, FIXED BLADE KNIVES, CAMPING KNIVES AND SURVIVAL KNIVES; KNIFE SHARPENERS; HAND TOOLS, NAMELY, PRUNERS AND GAME SHEARS; SHEATHS FOR KNIVES AND MULTI-FUNCTION TOOLS; MULTI-FUNCTION HUNTING KNIFE COMPRISED OF TWO OR MORE OF THE FOLLOWING COMPONENTS: KNIFE BLADE, GUT HOOK, BONE SAW AND SHARPENER; MULTI-FUNCTION HUNTING HAND TOOL COMPRISED OF TWO OR MORE OF THE FOLLOWING COMPONENTS: BYPASS SHEARS, WIRE CUTTERS, SAW, KNIFE BLADE, CHOKE TUBE TOOL, SCREWDRIVER, AWL AND BOTTLE OPENER; MULTI-FUNCTION GARDENING HAND TOOL COMPRISED TWO OR MORE OF THE FOLLOWING COMPONENTS: BYPASS PRUNERS, WIRE CUT-

TERS, WEED REMOVER, GRAFTING KNIFE, BARK LIFTER, SAW, SCREWDRIVER, SPRINKLER TOOL, BOTTLE OPENER, AND RULER, IN CLASS 8 (U.S. CLS. 23, 28 AND 44).

FIRST USE 11-30-2005; IN COMMERCE 11-30-2005.

FOR: FLASHLIGHTS, IN CLASS 11 (U.S. CLS. 13, 21, 23, 31 AND 34).

FIRST USE 10-0-2007; IN COMMERCE 10-0-2007.

THE MARK CONSISTS OF STANDARD CHARACTERS WITHOUT CLAIM TO ANY PARTICULAR FONT, STYLE, SIZE, OR COLOR.

OWNER OF U.S. REG. NOS. 1,325,473, 3,177,625, AND OTHERS.

SN 77-247,116, FILED 8-3-2007.

WENDY GOODMAN, EXAMINING ATTORNEY

Int. Cl.: 5

Prior U.S. Cls.: 6, 18, 44, 46, 51, and 52

Reg. No. 3,486,022

United States Patent and Trademark Office

Registered Aug. 12, 2008

**TRADEMARK
PRINCIPAL REGISTER**

ARNIKA FORTE

DERMAVANCE (DELAWARE CORPORATION)
1055 WESTLAKES DRIVE, SUITE 300
BERWYN, PA 19312

FOR: DIETARY SUPPLEMENT, IN CLASS 5 (U.S.
CLS. 6, 18, 44, 46, 51 AND 52).

FIRST USE 9-4-2007; IN COMMERCE 9-4-2007.

THE MARK CONSISTS OF STANDARD CHAR-
ACTERS WITHOUT CLAIM TO ANY PARTICULAR
FONT, STYLE, SIZE, OR COLOR.

NO CLAIM IS MADE TO THE EXCLUSIVE
RIGHT TO USE "ARNICA", APART FROM THE
MARK AS SHOWN.

SN 77-248,928, FILED 8-7-2007.

KYLE PEETE, EXAMINING ATTORNEY

Int. Cl.: 9

Prior U.S. Cls.: 21, 23, 26, 36, and 38

Reg. No. 3,486,023

United States Patent and Trademark Office

Registered Aug. 12, 2008

**TRADEMARK
PRINCIPAL REGISTER**

TRACE**X**

EXPRESS LOGIC, INC. (CALIFORNIA CORPORATION)
11423 W. BERNARDO COURT
SAN DIEGO, CA 92127

FIRST USE 2-6-2008; IN COMMERCE 2-6-2008.

SN 77-249,860, FILED 8-8-2007.

FOR: COMPUTER SOFTWARE FOR ANALYSIS OF DATA CAPTURED BY A RUNNING PROGRAM, IN CLASS 9 (U.S. CLS. 21, 23, 26, 36 AND 38).

KAREN BRACEY, EXAMINING ATTORNEY

Int. Cls.: 37 and 42

Prior U.S. Cls.: 100, 101, 103, and 106

United States Patent and Trademark Office

Reg. No. 3,486,024

Registered Aug. 12, 2008

**SERVICE MARK
PRINCIPAL REGISTER**



MCFARLAND-JOHNSON, INC. (NEW YORK CORPORATION)
49 COURT STREET, P.O. BOX 1980
BINGHAMTON, NY 139021980

FOR: CONSTRUCTION MANAGEMENT, IN CLASS 37 (U.S. CLS. 100, 103 AND 106).

FIRST USE 10-2-2007; IN COMMERCE 10-2-2007.

FOR: SURVEYING AND ENGINEERING; CONSULTING SERVICES IN THE FIELD OF ENVIRON-

MENTAL ASSESSMENT, COMPLIANCE AND PLANNING, IN CLASS 42 (U.S. CLS. 100 AND 101).

FIRST USE 10-2-2007; IN COMMERCE 10-2-2007.

THE MARK CONSISTS OF THE LETTERS "M" AND "J" FORMING A DIAMOND SHAPE.

SN 77-250,966, FILED 8-9-2007.

BRENDAN MCCAULEY, EXAMINING ATTORNEY

Int. Cl.: 5

Prior U.S. Cls.: 6, 18, 44, 46, 51, and 52

Reg. No. 3,486,025

United States Patent and Trademark Office

Registered Aug. 12, 2008

**TRADEMARK
PRINCIPAL REGISTER**

ETHISTLE

CASS LABORATORIES LLC (MICHIGAN LTD
LIAB CO)
4300 BARN MEADOW LANE
WEST BLOOMFIELD, MI 48323

THE MARK CONSISTS OF STANDARD CHAR-
ACTERS WITHOUT CLAIM TO ANY PARTICULAR
FONT, STYLE, SIZE, OR COLOR.

FOR: DIETARY AND NUTRITIONAL SUPPLE-
MENTS CONTAINING VITAMIN E AND MILK
THISTLE, IN CLASS 5 (U.S. CLS. 6, 18, 44, 46, 51
AND 52).

SN 77-251,320, FILED 8-9-2007.

FIRST USE 11-6-2007; IN COMMERCE 11-6-2007.

IRA J. GOODSaid, EXAMINING ATTORNEY

Int. Cls.: 32 and 40

Prior U.S. Cls.: 45, 46, 48, 100, 103, and 106

Reg. No. 3,486,026

United States Patent and Trademark Office

Registered Aug. 12, 2008

**TRADEMARK
SERVICE MARK
PRINCIPAL REGISTER**

LIVIE

AQUA PURE, LLC (FLORIDA LTD LIAB CO)
PO BOX 2068
ORLANDO, FL 32802

FOR: BOTTLED DRINKING WATER; DISTILLED
DRINKING WATER; SPRING WATER, IN CLASS 32
(U.S. CLS. 45, 46 AND 48).

FIRST USE 1-11-2008; IN COMMERCE 1-11-2008.

FOR: BOTTLING; MANUFACTURE OF BOT-
TLED DRINKING WATER TO ORDER AND/OR
SPECIFICATION OF OTHERS; WATER TREAT-

MENT AND PURIFICATION, IN CLASS 40 (U.S.
CLS. 100, 103 AND 106).

FIRST USE 10-24-2007; IN COMMERCE 10-24-2007.

THE MARK CONSISTS OF STANDARD CHAR-
ACTERS WITHOUT CLAIM TO ANY PARTICULAR
FONT, STYLE, SIZE, OR COLOR.

SN 77-253,232, FILED 8-12-2007.

TAMARA FRAZIER, EXAMINING ATTORNEY

Int. Cl.: 1

Prior U.S. Cls.: 1, 5, 6, 10, 26, and 46

Reg. No. 3,486,027

United States Patent and Trademark Office

Registered Aug. 12, 2008

**TRADEMARK
PRINCIPAL REGISTER**

FreeCAL

AMEGA SCIENCES (FLORIDA CORPORATION)
3954 MERLIN DRIVE
KISSIMMEE, FL 34741

THE MARK CONSISTS OF STANDARD CHAR-
ACTERS WITHOUT CLAIM TO ANY PARTICULAR
FONT, STYLE, SIZE, OR COLOR.

FOR: CHEMICAL SOIL CONDITIONERS, IN
CLASS 1 (U.S. CLS. 1, 5, 6, 10, 26 AND 46).

SN 77-253,580, FILED 8-13-2007.

FIRST USE 2-1-2007; IN COMMERCE 2-1-2007.

BRENDAN REGAN, EXAMINING ATTORNEY

Int. Cl.: 25

Prior U.S. Cls.: 22 and 39

United States Patent and Trademark Office

Reg. No. 3,486,028

Registered Aug. 12, 2008

**TRADEMARK
PRINCIPAL REGISTER**



ISABELLA VALENTINA, LLC (FLORIDA LTD
LIAB CO)
SUITE #9
1336 NORTH CITRUS AVE
HOLLYWOOD, CA 90034

THE MARK CONSISTS OF A FANCIFUL DESIGN
INCLUDING FILIGREE WORK AND TWO STY-
LIZED, BACK TO BACK, WINGED, FEMALE FIG-
URES.

FOR: BIKINIS; LINGERIE; SWIM WEAR, IN
CLASS 25 (U.S. CLS. 22 AND 39).

SN 77-254,576, FILED 8-14-2007.

FIRST USE 7-19-2007; IN COMMERCE 7-28-2007.

JILL PRATER, EXAMINING ATTORNEY

Int. Cl.: 35

Prior U.S. Cls.: 100, 101, and 102

United States Patent and Trademark Office

Reg. No. 3,486,029

Registered Aug. 12, 2008

**SERVICE MARK
PRINCIPAL REGISTER**

REFRESH, INDULGE & PAMPER

LERNER NEW YORK, INC. (DELAWARE CORPORATION)
450 WEST 33RD STREET
NEW YORK, NY 10001

THE MARK CONSISTS OF STANDARD CHARACTERS WITHOUT CLAIM TO ANY PARTICULAR FONT, STYLE, SIZE, OR COLOR.

FOR: RETAIL STORE SERVICES, MAIL ORDER CATALOG SERVICES AND ON-LINE STORE SERVICES FEATURING PERSONAL CARE PRODUCTS, IN CLASS 35 (U.S. CLS. 100, 101 AND 102).

SN 77-255,645, FILED 8-15-2007.

FIRST USE 10-25-2007; IN COMMERCE 10-25-2007.

WENDY GOODMAN, EXAMINING ATTORNEY

Int. Cl.: 37

Prior U.S. Cls.: 100, 103, and 106

United States Patent and Trademark Office

Reg. No. 3,486,030

Registered Aug. 12, 2008

**SERVICE MARK
PRINCIPAL REGISTER**

Guardian Pest Control

GUARDIAN PEST CONTROL, INC. (MINNESOTA CORPORATION)

701 EAST 4TH STREET

DULUTH, MN 55805

FOR: PEST CONTROL, IN CLASS 37 (U.S. CLS. 100, 103 AND 106).

FIRST USE 4-1-1966; IN COMMERCE 4-1-1966.

THE MARK CONSISTS OF STANDARD CHARACTERS WITHOUT CLAIM TO ANY PARTICULAR FONT, STYLE, SIZE, OR COLOR.

NO CLAIM IS MADE TO THE EXCLUSIVE RIGHT TO USE "PEST CONTROL", APART FROM THE MARK AS SHOWN.

SN 77-256,094, FILED 8-15-2007.

AMY GEARIN, EXAMINING ATTORNEY

Int. Cl.: 9

Prior U.S. Cls.: 21, 23, 26, 36, and 38

Reg. No. 3,486,031

United States Patent and Trademark Office

Registered Aug. 12, 2008

**TRADEMARK
PRINCIPAL REGISTER**

TRIPLE PRO

OHAUS CORPORATION (NEW JERSEY CORPORATION)
19A CHAPIN ROAD, P.O. BOX 2033
PINE BROOK, NJ 070582033

THE MARK CONSISTS OF STANDARD CHARACTERS WITHOUT CLAIM TO ANY PARTICULAR FONT, STYLE, SIZE, OR COLOR.

FOR: WEIGHING EQUIPMENT, NAMELY, SCALES AND BALANCES, IN CLASS 9 (U.S. CLS. 21, 23, 26, 36 AND 38).

SN 77-256,838, FILED 8-16-2007.

FIRST USE 4-28-2008; IN COMMERCE 4-28-2008.

LAURA KOVALSKY, EXAMINING ATTORNEY

Int. Cl.: 9

Prior U.S. Cls.: 21, 23, 26, 36, and 38

Reg. No. 3,486,032

United States Patent and Trademark Office

Registered Aug. 12, 2008

**TRADEMARK
PRINCIPAL REGISTER**

**beyond ordinary
intelligence**

ANDERSON CREATIVE ENTERPRISES, INC
(CALIFORNIA CORPORATION), DBA BE-
YOND ORDINARY SOFTWARE SOLUTIONS,
10636 SCRIPPS SUMMIT CT SUITE 134
SAN DIEGO, CA 92131

FOR: COMMUNICATIONS SOFTWARE FOR
CONNECTING COMPUTER NETWORKS FROM
INSURANCE COMPANIES TO CONSUMER INTEL-
LIGENCE BUREAUS FEATURING CONSUMER
MARKET RESEARCH INFORMATION; COMPU-
TER E-COMMERCE SOFTWARE TO ALLOW
USERS TO PERFORM ELECTRONIC BUSINESS
TRANSACTIONS VIA A GLOBAL COMPUTER NET-
WORK; COMPUTER SOFTWARE FOR APPLICA-
TION AND DATABASE INTEGRATION;
COMPUTER SOFTWARE FOR COMPUTER SYS-
TEM AND APPLICATION DEVELOPMENT, DE-
PLOYMENT AND MANAGEMENT; COMPUTER
SOFTWARE FOR INTEGRATING CONSUMER FI-

NANCIAL INFORMATION INTO INSURANCE
COMPANY DATABASES; COMPUTER SOFTWARE
THAT PROVIDES REAL-TIME, INTEGRATED
BUSINESS MANAGEMENT INTELLIGENCE BY
COMBINING INFORMATION FROM VARIOUS
DATABASES AND PRESENTING IT IN AN EASY-
TO-UNDERSTAND USER INTERFACE; CREDIT
SCREENING SOFTWARE, IN CLASS 9 (U.S. CLS.
21, 23, 26, 36 AND 38).

FIRST USE 3-1-2008; IN COMMERCE 3-25-2008.

THE MARK CONSISTS OF STANDARD CHAR-
ACTERS WITHOUT CLAIM TO ANY PARTICULAR
FONT, STYLE, SIZE, OR COLOR.

SN 77-257,454, FILED 8-16-2007.

ESTHER BELENKER, EXAMINING ATTORNEY

Int. Cl.: 25

Prior U.S. Cls.: 22 and 39

United States Patent and Trademark Office

Reg. No. 3,486,033

Registered Aug. 12, 2008

**TRADEMARK
PRINCIPAL REGISTER**



SEJUNG USA HARRY VARDON GOLF, COR-
PORATION (MINNESOTA CORPORATION)
1220 E. 7TH STREET
WINONA, MN 55987

FOR: CLOTHING, NAMELY, CAPS, HATS,
CLOTHING OF LEATHER, NAMELY, LEATHER
JACKETS, JACKETS, JUMPERS, KNITWEAR IN
THE NATURE OF SWEATERS, LONG AND SHORT
SLEEVED GOLF SHIRTS AND VESTS, NECKTIES,
LONG AND SHORT PANTS, PARKAS, SPORTS
JERSEYS, SWEATERS, TEE-SHIRTS, UNDER-
CLOTHING, NAMELY, UNDERGARMENTS, AND
VESTS, IN CLASS 25 (U.S. CLS. 22 AND 39).

FIRST USE 6-30-2007; IN COMMERCE 6-30-2007.

THE NAME "HARRY VARDON" DOES NOT
IDENTIFY A LIVING INDIVIDUAL.

THE MARK CONSISTS OF THE WORDS "HAR-
RY" AND "VARDON" SPLIT BY THE STYLIZED,
SILHOUETTED IMAGE OF A GOLFER IN POST-
SWING FOLLOW THROUGH.

SN 77-258,629, FILED 8-18-2007.

SHARON MEIER, EXAMINING ATTORNEY

Int. Cl.: 35

Prior U.S. Cls.: 100, 101, and 102

United States Patent and Trademark Office

Reg. No. 3,486,034

Registered Aug. 12, 2008

**SERVICE MARK
PRINCIPAL REGISTER**

"YOU SPEAK...WE LISTEN"

QUALSCRIPT, LLC (ARKANSAS LTD LIAB CO)
306 SALEM RD., S-107
CONWAY, AR 72034

FOR: MEDICAL TRANSCRIPTION SERVICES, IN
CLASS 35 (U.S. CLS. 100, 101 AND 102).

FIRST USE 10-0-2006; IN COMMERCE 10-0-2006.

THE MARK CONSISTS OF STANDARD CHAR-
ACTERS WITHOUT CLAIM TO ANY PARTICULAR
FONT, STYLE, SIZE, OR COLOR.

SN 77-259,431, FILED 8-20-2007.

JACQUELINE A. LAVINE, EXAMINING ATTOR-
NEY

Int. Cl.: 28

Prior U.S. Cls.: 22, 23, 38, and 50

United States Patent and Trademark Office

Reg. No. 3,486,035

Registered Aug. 12, 2008

**TRADEMARK
PRINCIPAL REGISTER**

FAIRYFLY

WOWWEE GROUP LIMITED (HONG KONG
CORPORATION)
ENERGY PLAZA, 92 GRANVILLE ROAD
UNIT 301-C
TSIM SHA TSUI EAST, HONG KONG

FOR: REMOTE CONTROL TOYS, NAMELY,
FANCIFUL CHARACTERS ; FANTASY CHARAC-
TER TOYS; PLASTIC CHARACTER TOYS, IN CLASS
28 (U.S. CLS. 22, 23, 38 AND 50).

FIRST USE 5-18-2008; IN COMMERCE 5-18-2008.

THE MARK CONSISTS OF STANDARD CHAR-
ACTERS WITHOUT CLAIM TO ANY PARTICULAR
FONT, STYLE, SIZE, OR COLOR.

SN 77-259,911, FILED 8-20-2007.

SHARON MEIER, EXAMINING ATTORNEY

Int. Cl.: 8

Prior U.S. Cls.: 23, 28, and 44

United States Patent and Trademark Office

Reg. No. 3,486,036

Registered Aug. 12, 2008

**TRADEMARK
PRINCIPAL REGISTER**

AMERICAN LAWMAN

COLD STEEL, INC. (CALIFORNIA CORPORATION)
3036-A SEABORG AVENUE
VENTURA, CA 93003

FOR: FOLDING KNIVES, IN CLASS 8 (U.S. CLS. 23, 28 AND 44).

FIRST USE 2-2-2008; IN COMMERCE 2-2-2008.

THE MARK CONSISTS OF STANDARD CHARACTERS WITHOUT CLAIM TO ANY PARTICULAR FONT, STYLE, SIZE, OR COLOR.

NO CLAIM IS MADE TO THE EXCLUSIVE RIGHT TO USE "AMERICAN", APART FROM THE MARK AS SHOWN.

SN 77-260,920, FILED 8-21-2007.

KATHERINE CONNOLLY, EXAMINING ATTORNEY

Int. Cl.: 25

Prior U.S. Cls.: 22 and 39

United States Patent and Trademark Office

Reg. No. 3,486,037

Registered Aug. 12, 2008

**TRADEMARK
PRINCIPAL REGISTER**

LIMON Y SAL

ORANGE CLOTHING CO. (FLORIDA CORPORATION)
141 NE 3RD AVENUE, 12TH FLOOR
MIAMI, FL 33132

FOR: HEADGEAR, NAMELY, HATS AND CAPS; BLOUSES; BOXER SHORTS; DRESS SHIRTS; FOOTWEAR; NECKWEAR; PANTS; POLO SHIRTS; SHIRTS; SHORTS; SKIRTS AND DRESSES; SWEAT PANTS; SWEAT SHIRTS; SWEAT SHORTS; SWIMSUITS; T-SHIRTS; UNDERWEAR, IN CLASS 25 (U.S. CLS. 22 AND 39).

FIRST USE 10-0-2007; IN COMMERCE 10-0-2007.

THE MARK CONSISTS OF STANDARD CHARACTERS WITHOUT CLAIM TO ANY PARTICULAR FONT, STYLE, SIZE, OR COLOR.

THE FOREIGN WORDING IN THE MARK TRANSLATES INTO ENGLISH AS LEMON AND SALT.

SN 77-261,348, FILED 8-22-2007.

JOHN DWYER, EXAMINING ATTORNEY

Int. Cl.: 35

Prior U.S. Cls.: 100, 101, and 102

United States Patent and Trademark Office

Reg. No. 3,486,038

Registered Aug. 12, 2008

**SERVICE MARK
PRINCIPAL REGISTER**

Clearview Galleries

CLEARVIEW GROUP HOLDINGS LLC (DELA-
WARE LTD LIAB CO)
BLDG D, SUITE 110
11345 LEGACY AVE.
PALM BEACH GARDENS, FL 33410

FOR: ART GALLERIES, IN CLASS 35 (U.S. CLS.
100, 101 AND 102).

FIRST USE 2-1-2008; IN COMMERCE 2-1-2008.

THE MARK CONSISTS OF STANDARD CHAR-
ACTERS WITHOUT CLAIM TO ANY PARTICULAR
FONT, STYLE, SIZE, OR COLOR.

NO CLAIM IS MADE TO THE EXCLUSIVE
RIGHT TO USE "GALLERIES", APART FROM THE
MARK AS SHOWN.

SN 77-262,587, FILED 8-23-2007.

CAROLYN GRAY, EXAMINING ATTORNEY

Int. Cl.: 33

Prior U.S. Cls.: 47 and 49

United States Patent and Trademark Office

Reg. No. 3,486,039

Registered Aug. 12, 2008

**TRADEMARK
PRINCIPAL REGISTER**

Gilded Vine

CANNONBALL WINE & SPIRITS LLC (CALI-
FORNIA LTD LIAB CO)
1520 WITHERS AVENUE
MONTEREY, CA 93940

THE MARK CONSISTS OF STANDARD CHAR-
ACTERS WITHOUT CLAIM TO ANY PARTICULAR
FONT, STYLE, SIZE, OR COLOR.

FOR: WINE, IN CLASS 33 (U.S. CLS. 47 AND 49).

SN 77-263,310, FILED 8-24-2007.

FIRST USE 9-24-2007; IN COMMERCE 9-24-2007.

CYNTHIA SLOAN, EXAMINING ATTORNEY

Int. Cl.: 35

Prior U.S. Cls.: 100, 101, and 102

United States Patent and Trademark Office

Reg. No. 3,486,040

Registered Aug. 12, 2008

**SERVICE MARK
PRINCIPAL REGISTER**

CONTRACTOR UNIVERSITY

AFFORDABLE CONTRACTORS INFORMATION
SERVICES, INC. (CALIFORNIA CORPORATION)
P.O. BOX 5495
EL DORADO HILLS, CA 95762

FOR: ASSISTING OTHERS IN PREPARING AND
FILING APPLICATIONS FOR CONTRACTORS'S
LICENSES WITH STATE LICENSING BOARDS, IN
CLASS 35 (U.S. CLS. 100, 101 AND 102).

FIRST USE 11-1-2007; IN COMMERCE 11-1-2007.

THE MARK CONSISTS OF STANDARD CHAR-
ACTERS WITHOUT CLAIM TO ANY PARTICULAR
FONT, STYLE, SIZE, OR COLOR.

NO CLAIM IS MADE TO THE EXCLUSIVE
RIGHT TO USE "CONTRACTOR", APART FROM
THE MARK AS SHOWN.

SN 77-263,890, FILED 8-24-2007.

MICHAEL ENGEL, EXAMINING ATTORNEY

Int. Cl.: 9

Prior U.S. Cls.: 21, 23, 26, 36, and 38

Reg. No. 3,486,041

United States Patent and Trademark Office

Registered Aug. 12, 2008

**TRADEMARK
PRINCIPAL REGISTER**

LapFlap

STEMMER, JANET (UNITED STATES INDIVIDUAL)
2662 W. CEZANNE CIRCLE
TUCSON, AZ 85741 AND
JARRETT, KRISTINE (UNITED STATES INDIVIDUAL)
3862 W. PERSEUS ST.
TUCSON, AZ 85742

FOR: LAPTOP COMPUTER ACCESSORIES,
NAMELY, FOAM AND FABRIC PADS DESIGNED
TO PLACE ON THE LAP TO MINIMIZE HEAT

TRANSFER FROM LAPTOP COMPUTERS, IN
CLASS 9 (U.S. CLS. 21, 23, 26, 36 AND 38).

FIRST USE 10-1-2007; IN COMMERCE 10-1-2007.

THE MARK CONSISTS OF STANDARD CHARACTERS WITHOUT CLAIM TO ANY PARTICULAR FONT, STYLE, SIZE, OR COLOR.

SN 77-264,214, FILED 8-24-2007.

CARYN GLASSER, EXAMINING ATTORNEY

Int. Cl.: 36

Prior U.S. Cls.: 100, 101, and 102

United States Patent and Trademark Office

Reg. No. 3,486,042

Registered Aug. 12, 2008

**SERVICE MARK
PRINCIPAL REGISTER**



LOCKTON RISK SERVICES, INC. (KANSAS CORPORATION)
SUITE 500
7300 COLLEGE BOULEVARD
OVERLAND PARK, KS 66210

FOR: BROKERAGE IN THE FIELD OF LEGAL PROFESSIONAL LIABILITY INSURANCE; INSURANCE ADMINISTRATION IN THE FIELD OF LEGAL PROFESSIONAL LIABILITY INSURANCE, IN CLASS 36 (U.S. CLS. 100, 101 AND 102).

FIRST USE 8-15-2007; IN COMMERCE 8-15-2007.

NO CLAIM IS MADE TO THE EXCLUSIVE RIGHT TO USE "LAWYERS INSURANCE", APART FROM THE MARK AS SHOWN.

THE MARK CONSISTS OF A CIRCLE OVERLAID WITH A SCALE WITH THE STYLIZED WORDS "LAWYERS INSURANCE ADVANTAGE" AT THE BOTTOM OF THE LOGO.

SN 77-264,247, FILED 8-24-2007.

HEATHER THOMPSON, EXAMINING ATTORNEY

Int. Cl.: 43

Prior U.S. Cls.: 100 and 101

United States Patent and Trademark Office

Reg. No. 3,486,043

Registered Aug. 12, 2008

**SERVICE MARK
PRINCIPAL REGISTER**

Baby Bon Appetit

BABY BON APPETIT, LLC (FLORIDA LTD LIAB
CO)
120 JEFFERSON AVENUE #12012
MIAMI BEACH, FL 33139

FOR: CATERING OF FOOD AND DRINKS, IN
CLASS 43 (U.S. CLS. 100 AND 101).

FIRST USE 9-15-2007; IN COMMERCE 9-15-2007.

THE MARK CONSISTS OF STANDARD CHAR-
ACTERS WITHOUT CLAIM TO ANY PARTICULAR
FONT, STYLE, SIZE, OR COLOR.

NO CLAIM IS MADE TO THE EXCLUSIVE
RIGHT TO USE "BABY", APART FROM THE MARK
AS SHOWN.

THE FOREIGN WORDING IN THE MARK
TRANSLATES INTO ENGLISH AS GOOD APPE-
TITE.

SN 77-265,006, FILED 8-27-2007.

LINDA E. BLOHM, EXAMINING ATTORNEY

Int. Cl.: 9

Prior U.S. Cls.: 21, 23, 26, 36, and 38

Reg. No. 3,486,044

United States Patent and Trademark Office

Registered Aug. 12, 2008

**TRADEMARK
PRINCIPAL REGISTER**

Zen Underwater

ZEN UNDERWATER, LLC (FLORIDA LTD LIAB
CO)
3320 NE 32ND STREET
FT. LAUDERDALE, FL 33308

FOR: UNDERWATER CAMERAS; SPECIALLY
DESIGNED CASES FOR PHOTOGRAPHIC EQUIP-
MENT FOR UNDERWATER PHOTOGRAPHY, IN
CLASS 9 (U.S. CLS. 21, 23, 26, 36 AND 38).

FIRST USE 5-1-2008; IN COMMERCE 5-1-2008.

THE MARK CONSISTS OF STANDARD CHAR-
ACTERS WITHOUT CLAIM TO ANY PARTICULAR
FONT, STYLE, SIZE, OR COLOR.

NO CLAIM IS MADE TO THE EXCLUSIVE
RIGHT TO USE "UNDERWATER", APART FROM
THE MARK AS SHOWN.

SN 77-265,887, FILED 8-28-2007.

PAULA MAHONEY, EXAMINING ATTORNEY

Int. Cl.: 1

Prior U.S. Cls.: 1, 5, 6, 10, 26, and 46

Reg. No. 3,486,045

United States Patent and Trademark Office

Registered Aug. 12, 2008

**TRADEMARK
PRINCIPAL REGISTER**

BLACKJACK ZN

LOVELAND PRODUCTS, INC. (COLORADO
CORPORATION)

7251 W. 4TH STREET

GREELEY, CO 80634

FOR: FERTILIZER CONTAINING ZINC, IN
CLASS 1 (U.S. CLS. 1, 5, 6, 10, 26 AND 46).

FIRST USE 11-14-2007; IN COMMERCE 11-14-2007.

THE MARK CONSISTS OF STANDARD CHAR-
ACTERS WITHOUT CLAIM TO ANY PARTICULAR
FONT, STYLE, SIZE, OR COLOR.

NO CLAIM IS MADE TO THE EXCLUSIVE
RIGHT TO USE "ZN", APART FROM THE MARK
AS SHOWN.

SN 77-266,587, FILED 8-28-2007.

JOHN DWYER, EXAMINING ATTORNEY

Int. Cl.: 1

Prior U.S. Cls.: 1, 5, 6, 10, 26, and 46

United States Patent and Trademark Office

Reg. No. 3,486,046

Registered Aug. 12, 2008

**TRADEMARK
PRINCIPAL REGISTER**



BIOLOGICAL SYSTEMS INC (TEXAS CORPORATION), DBA BIO-SYS,
PO BOX 17893
AUSTIN, TX 787607893

FOR: CHEMICAL PREPARATIONS FOR CLEANING PURPOSES IN THE FOOD AND FOOD PROCESSING INDUSTRIES, IN CLASS 1 (U.S. CLS. 1, 5, 6, 10, 26 AND 46).

FIRST USE 3-1-2008; IN COMMERCE 3-1-2008.

NO CLAIM IS MADE TO THE EXCLUSIVE RIGHT TO USE "GREEN LABEL REGISTERED PRODUCT", APART FROM THE MARK AS SHOWN.

THE COLOR(S) GREEN, WHITE, BLUE, AND RED IS/ARE CLAIMED AS A FEATURE OF THE MARK.

THE MARK CONSISTS OF A BLUE GLOBE WITH WHITE LONGITUDE AND LATITUDE LINES SURROUNDED BY A GREEN RING WITH A RED CHECK MARK SUPERIMPOSED; THE GREEN RING HAS WHITE LETTERING THAT SPELLS "A GREEN LABEL REGISTERED PRODUCT".

SN 77-267,283, FILED 8-29-2007.

JOHN HWANG, EXAMINING ATTORNEY

Int. Cl.: 30

Prior U.S. Cl.: 46

United States Patent and Trademark Office

Reg. No. 3,486,047

Registered Aug. 12, 2008

**TRADEMARK
PRINCIPAL REGISTER**

DOUBLES

WELLS' DAIRY, INC. (IOWA CORPORATION)
P.O. BOX 1310, ONE BLUE BUNNY DRIVE
LE MARS, IA 51031

THE MARK CONSISTS OF STANDARD CHAR-
ACTERS WITHOUT CLAIM TO ANY PARTICULAR
FONT, STYLE, SIZE, OR COLOR.

FOR: FROZEN CONFECTIONS, IN CLASS 30 (U.S.
CL. 46).

SN 77-267,448, FILED 8-29-2007.

FIRST USE 2-1-2008; IN COMMERCE 2-1-2008.

MARLENE BELL, EXAMINING ATTORNEY

Int. Cl.: 32

Prior U.S. Cls.: 45, 46, and 48

Reg. No. 3,486,048

United States Patent and Trademark Office

Registered Aug. 12, 2008

**TRADEMARK
PRINCIPAL REGISTER**

GINSENG PLUS

NATURAL SPIRITS USA, INC. (CALIFORNIA CORPORATION)

7050 VILLAGE DRIVE SUITE A2

BUENA PARK, CA 90621

FOR: ENERGY DRINKS, IN CLASS 32 (U.S. CLS. 45, 46 AND 48).

FIRST USE 6-1-2008; IN COMMERCE 6-1-2008.

THE MARK CONSISTS OF STANDARD CHARACTERS WITHOUT CLAIM TO ANY PARTICULAR FONT, STYLE, SIZE, OR COLOR.

NO CLAIM IS MADE TO THE EXCLUSIVE RIGHT TO USE "GINSENG", APART FROM THE MARK AS SHOWN.

SN 77-269,096, FILED 8-31-2007.

KYLE PEETE, EXAMINING ATTORNEY

Int. Cl.: 7

Prior U.S. Cls.: 13, 19, 21, 23, 31, 34, and 35

Reg. No. 3,486,049

United States Patent and Trademark Office

Registered Aug. 12, 2008

**TRADEMARK
PRINCIPAL REGISTER**

APOLLO

CHOI, JAE K. (UNITED STATES INDIVIDUAL)
P.O. BOX 4089
CERRITOS, CA 90703

THE MARK CONSISTS OF STANDARD CHARACTERS WITHOUT CLAIM TO ANY PARTICULAR FONT, STYLE, SIZE, OR COLOR.

FOR: ELECTRIC FOOD BLENDERS, IN CLASS 7
(U.S. CLS. 13, 19, 21, 23, 31, 34 AND 35).

SN 77-269,918, FILED 8-31-2007.

FIRST USE 8-18-2007; IN COMMERCE 3-1-2008.

ALICE SUE CARRUTHERS, EXAMINING ATTORNEY

Int. Cl.: 36

Prior U.S. Cls.: 100, 101, and 102

United States Patent and Trademark Office

Reg. No. 3,486,050

Registered Aug. 12, 2008

**SERVICE MARK
PRINCIPAL REGISTER**

Abundance For Life

ABUNDANCE FOR LIFE (CALIFORNIA CORPORATION)
PO BOX 133
APTOS, CA 95003

FOR: ACCEPTING AND ADMINISTERING
MONETARY CHARITABLE CONTRIBUTIONS;
CHARITABLE FUND RAISING, IN CLASS 36 (U.S.
CLS. 100, 101 AND 102).

FIRST USE 8-1-2007; IN COMMERCE 8-1-2007.

THE MARK CONSISTS OF STANDARD CHARACTERS WITHOUT CLAIM TO ANY PARTICULAR FONT, STYLE, SIZE, OR COLOR.

SN 77-270,201, FILED 9-2-2007.

WENDY GOODMAN, EXAMINING ATTORNEY

Int. Cl.: 34

Prior U.S. Cls.: 2, 8, 9, and 17

United States Patent and Trademark Office

Reg. No. 3,486,051

Registered Aug. 12, 2008

**TRADEMARK
PRINCIPAL REGISTER**

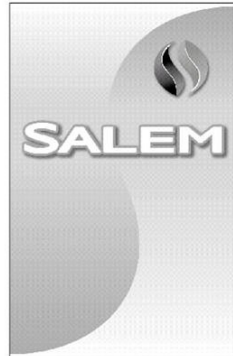

GMB, INC. (NORTH CAROLINA CORPORATION)
JEFFERSON SQUARE, SUITE D
P.O. BOX 2202
KING, NC 27021

FOR: CIGARETTES, IN CLASS 34 (U.S. CLS. 2, 8, 9 AND 17).

FIRST USE 12-1-2007; IN COMMERCE 12-1-2007.

OWNER OF U.S. REG. NOS. 637,365, 3,279,801, AND OTHERS.

THE MARK CONSISTS OF THE WORD "SALEM" AND A MISCELLANEOUS DESIGN COMPOSED OF TWO OPPOSING LEAF-LIKE IMAGES.

SN 77-271,130, FILED 9-4-2007.

AMY MCMENAMIN, EXAMINING ATTORNEY

Int. Cls.: 9 and 16

Prior U.S. Cls.: 2, 5, 21, 22, 23, 26, 29, 36, 37, 38, and 50

United States Patent and Trademark Office

Reg. No. 3,486,052

Registered Aug. 12, 2008

**TRADEMARK
PRINCIPAL REGISTER**

BRAINETICS

BRAINETICS, LLC (COLORADO LTD LIAB CO)
SUITE 100
7315 E. ORCHARD
GREENWOOD VILLAGE, CO 80111

FOR: DVDS FEATURING MATHEMATICS INSTRUCTION, IN CLASS 9 (U.S. CLS. 21, 23, 26, 36 AND 38).

FIRST USE 12-1-2007; IN COMMERCE 12-1-2007.

FOR: WORKBOOKS DIRECTED TO MATHEMATICS INSTRUCTION; EDUCATIONAL BOOKS

FEATURING MATHEMATICS INSTRUCTION, IN CLASS 16 (U.S. CLS. 2, 5, 22, 23, 29, 37, 38 AND 50).

FIRST USE 12-1-2007; IN COMMERCE 12-1-2007.

THE MARK CONSISTS OF STANDARD CHARACTERS WITHOUT CLAIM TO ANY PARTICULAR FONT, STYLE, SIZE, OR COLOR.

SN 77-271,168, FILED 9-4-2007.

ELIZABETH HUGHITT, EXAMINING ATTORNEY

Int. Cl.: 9

Prior U.S. Cls.: 21, 23, 26, 36, and 38

United States Patent and Trademark Office

Reg. No. 3,486,053

Registered Aug. 12, 2008

TRADEMARK
PRINCIPAL REGISTER



SOUNDWIN NETWORK INC. (TAIWAN CORPORATION)
10FL.-4, NO. 295, SEC.2, KUANGFU RD.
HSINCHU CITY 360, TAIWAN

FOR: INTERNET PROTOCOL PHONE; VOICE OVER INTERNET PROTOCOL GATEWAY; INTERNET PROTOCOL - PRIVATE BRANCH EXCHANGE; WI-FI VOICE OVER INTERNET PROTOCOL PHONE; WI-FI VOICE OVER INTERNET PROTOCOL GATEWAY; VOICE OVER INTERNET PROTOCOL SESSION INITIATION, IN CLASS 9 (U.S. CLS. 21, 23, 26, 36 AND 38).

FIRST USE 6-15-2005; IN COMMERCE 1-15-2008.

THE MARK CONSISTS OF THE WORD SOUNDWIN WITH AN ARCED LINE STARTING AT THE BOTTOM OF THE S AND ENDING AT THE TOP OF THE I IN THE WORDING..

SN 77-271,232, FILED 9-4-2007.

C. DIONNE CLYBURN, EXAMINING ATTORNEY

Int. Cl.: 41

Prior U.S. Cls.: 100, 101, and 107

United States Patent and Trademark Office

Reg. No. 3,486,054

Registered Aug. 12, 2008

**SERVICE MARK
PRINCIPAL REGISTER**

WITHOUT A TOUT

RESEARCH PUBLISHERS LLC (WISCONSIN LTD
LIAB CO)
660 JOHN NOLEN DRIVE
SUITE 100
MADISON, WI 53713

THE MARK CONSISTS OF STANDARD CHAR-
ACTERS WITHOUT CLAIM TO ANY PARTICULAR
FONT, STYLE, SIZE, OR COLOR.

FOR: PROVIDING ON-LINE INFORMATION IN
THE FIELD OF SPORTS VIA THE INTERNET, IN
CLASS 41 (U.S. CLS. 100, 101 AND 107).

SN 77-271,626, FILED 9-5-2007.

FIRST USE 5-2-2008; IN COMMERCE 5-0-2008.

SALLY SHIH, EXAMINING ATTORNEY

Int. Cls.: 17 and 19

Prior U.S. Cls.: 1, 5, 12, 13, 33, 35, and 50

United States Patent and Trademark Office

Reg. No. 3,486,055

Registered Aug. 12, 2008

**TRADEMARK
PRINCIPAL REGISTER**

MultiQuiet

SLONIM INTERNATIONAL, INC. (FLORIDA CORPORATION), DBA SLONIM INTERNATIONAL, INC.,
12864 N.W. SOUTH RIVER DRIVE
MEDLEY, FL 33178

FOR: SOUND ABSORBING FLOORING UNDERLAYMENT, IN CLASS 17 (U.S. CLS. 1, 5, 12, 13, 35 AND 50).

FIRST USE 9-27-2007; IN COMMERCE 9-27-2007.

FOR: FLOORING UNDERLAYMENTS, IN CLASS 19 (U.S. CLS. 1, 12, 33 AND 50).

FIRST USE 9-27-2007; IN COMMERCE 9-27-2007.

THE MARK CONSISTS OF STANDARD CHARACTERS WITHOUT CLAIM TO ANY PARTICULAR FONT, STYLE, SIZE, OR COLOR.

SN 77-273,063, FILED 9-6-2007.

ANDREA K. NADELMAN, EXAMINING ATTORNEY

Int. Cl.: 20

Prior U.S. Cls.: 2, 13, 22, 25, 32, and 50

United States Patent and Trademark Office

Reg. No. 3,486,056

Registered Aug. 12, 2008

**TRADEMARK
PRINCIPAL REGISTER**



ARK INNOVATIONS, LLC (CONNECTICUT LTD
LIAB CO)
4A FARMINGTON CHASE CRESCENT
FARMINGTON, CT 06032

FOR: HAND MIRRORS, IN CLASS 20 (U.S. CLS. 2,
13, 22, 25, 32 AND 50).

FIRST USE 12-10-2007; IN COMMERCE 12-10-2007.

THE COLOR(S) BLUE, GREEN, GREY AND
WHITE IS/ARE CLAIMED AS A FEATURE OF
THE MARK.

THE WORDS "MIRROR" AND "ROUND" ARE IN
THE COLOR BLUE. THE WORD "GO" IS IN THE
COLOR GREEN. ABOVE THE WORD "GO" ARE
FOUR CONNECTED MIRRORS FORMING A SEMI-
CIRCLE AROUND THE TOP OF THE WORD "GO".
THE MIRRORS ARE OUTLINED IN GREY AND
WHITE IN THE MIDDLE. THE BACKGROUND OF
THE MARK IS TRANSPARENT.

SN 77-273,824, FILED 9-7-2007.

TOBY BULLOFF, EXAMINING ATTORNEY

Int. Cl.: 5

Prior U.S. Cls.: 6, 18, 44, 46, 51, and 52

Reg. No. 3,486,057

United States Patent and Trademark Office

Registered Aug. 12, 2008

**TRADEMARK
PRINCIPAL REGISTER**

HYPER-SAL

PRE HOLDING, INC. (VIRGINIA CORPORATION)
2941 OAK LAKE BOULEVARD
MIDLOTHIAN, VA 23112

THE MARK CONSISTS OF STANDARD CHARACTERS WITHOUT CLAIM TO ANY PARTICULAR FONT, STYLE, SIZE, OR COLOR.

FOR: PHARMACEUTICAL PREPARATIONS USED IN THE TREATMENT OF RESPIRATORY ILLNESSES AND DISORDERS, IN CLASS 5 (U.S. CLS. 6, 18, 44, 46, 51 AND 52).

SN 77-276,814, FILED 9-11-2007.

FIRST USE 8-31-2007; IN COMMERCE 8-31-2007.

KYLE PEETE, EXAMINING ATTORNEY

Int. Cl.: 7

Prior U.S. Cls.: 13, 19, 21, 23, 31, 34, and 35

Reg. No. 3,486,058

United States Patent and Trademark Office

Registered Aug. 12, 2008

**TRADEMARK
PRINCIPAL REGISTER**

BIG HAWG

MILWAUKEE ELECTRIC TOOL CORPORATION
(DELAWARE CORPORATION)
ATTN: DYANN KOSTELLO
13135 WEST LISBON ROAD
BROOKFIELD, WI 53005

FOR: BITS FOR POWER DRILLS; WOOD BORING
BITS FOR POWER DRILLS, NAMELY, HOLE CUT-
TERS, HOLE SAWS, SELF-FEED BITS, AND DRILL
BITS, IN CLASS 7 (U.S. CLS. 13, 19, 21, 23, 31, 34 AND
35).

FIRST USE 11-4-2007; IN COMMERCE 3-17-2008.

THE MARK CONSISTS OF STANDARD CHAR-
ACTERS WITHOUT CLAIM TO ANY PARTICULAR
FONT, STYLE, SIZE, OR COLOR.

OWNER OF U.S. REG. NOS. 1,285,816, 1,504,604,
AND 2,743,974.

SN 77-278,098, FILED 9-12-2007.

HEATHER THOMPSON, EXAMINING ATTORNEY

Int. Cl.: 16

Prior U.S. Cls.: 2, 5, 22, 23, 29, 37, 38, and 50

Reg. No. 3,486,059

United States Patent and Trademark Office

Registered Aug. 12, 2008

**TRADEMARK
PRINCIPAL REGISTER**

füdoos Boards

EAT! DRINK! MOVE! THINK!, LLC (IOWA LTD
LIAB CO)
207 NORTH CHESTNUT ST.
GLENWOOD, IA 51534

FOR: SET OF DRY ERASE WRITING BOARDS
FEATURING MAGNETS FOR PLACEMENT THAT
RECORDS MEALS AND ACTIVITIES FOR FAMIL-
IES, IN CLASS 16 (U.S. CLS. 2, 5, 22, 23, 29, 37, 38 AND
50).

FIRST USE 5-1-2008; IN COMMERCE 5-1-2008.

THE MARK CONSISTS OF STANDARD CHAR-
ACTERS WITHOUT CLAIM TO ANY PARTICULAR
FONT, STYLE, SIZE, OR COLOR.

NO CLAIM IS MADE TO THE EXCLUSIVE
RIGHT TO USE "BOARDS", APART FROM THE
MARK AS SHOWN.

SN 77-279,656, FILED 9-14-2007.

KYLE PEETE, EXAMINING ATTORNEY

Int. Cl.: 25

Prior U.S. Cls.: 22 and 39

United States Patent and Trademark Office

Reg. No. 3,486,060

Registered Aug. 12, 2008

**TRADEMARK
PRINCIPAL REGISTER**

ACQUISITIONS

LESSER, MARK (UNITED STATES INDIVIDUAL)
1360 EAST 17TH STREET
LOS ANGELES, CA 90021

FOR: BLOUSES; CAPS; COATS; DENIM JACKETS;
DENIMS; DRESSES; JACKETS; JEANS; PANTS;
SCARVES; SHIRTS; SKORTS; SHORTS; SKIRTS;
SWEATERS; T-SHIRTS; VESTS, IN CLASS 25 (U.S.
CLS. 22 AND 39).

FIRST USE 4-1-2008; IN COMMERCE 4-15-2008.

THE MARK CONSISTS OF STANDARD CHARACTERS WITHOUT CLAIM TO ANY PARTICULAR FONT, STYLE, SIZE, OR COLOR.

SN 77-280,266, FILED 9-14-2007.

KATHLEEN M. VANSTON, EXAMINING ATTORNEY

Int. Cls.: 4 and 29

Prior U.S. Cls.: 1, 6, 15, and 46

United States Patent and Trademark Office

Reg. No. 3,486,061

Registered Aug. 12, 2008

**TRADEMARK
PRINCIPAL REGISTER**

B-TANE

AMERISTAR, LLC (PENNSYLVANIA LTD LIAB
CO)
1667 PENNS CROSSING
ALLENTOWN, PA 18104

FOR: FOSSIL FUEL SUBSTITUTE, NAMELY, BIO-
FUELS, DERIVED FROM VEGETABLE OILS, IN
CLASS 4 (U.S. CLS. 1, 6 AND 15).

FIRST USE 10-1-2007; IN COMMERCE 10-1-2007.

FOR: RECYCLED VEGETABLE OIL MADE
FROM PLANTS, NAMELY, SOY BEANS, CORN,
CANOLA, COCONUT, PALM, COTTONSEED, LIN-
SEED, OLIVE, PEANUT, SESAME, AND SUNFLOW-
ER, TUNG OIL, SARDINE OIL, CASTOR OIL,

MUTTON TALLOW, BEEF TALLOW, RAPESEED
OIL, SESAME OIL, SAFFLOWER, HIGH-OLEIC SAF-
FLOWER, CRAMBE AND BABASSU, IN CLASS 29
(U.S. CL. 46).

FIRST USE 10-1-2007; IN COMMERCE 10-1-2007.

THE MARK CONSISTS OF STANDARD CHAR-
ACTERS WITHOUT CLAIM TO ANY PARTICULAR
FONT, STYLE, SIZE, OR COLOR.

SN 77-280,719, FILED 9-17-2007.

SHAUNIA CARLYLE, EXAMINING ATTORNEY

Int. Cl.: 31

Prior U.S. Cls.: 1 and 46

United States Patent and Trademark Office

Reg. No. 3,486,062

Registered Aug. 12, 2008

**TRADEMARK
PRINCIPAL REGISTER**

CATATONIC

WENDY BUDA (UNITED STATES INDIVIDUAL)
156 WEST LIBERTY STREET
PLYMOUTH, MI 48170

FOR: CATNIP, IN CLASS 31 (U.S. CLS. 1 AND 46).

FIRST USE 11-20-2007; IN COMMERCE 11-20-2007.

THE MARK CONSISTS OF STANDARD CHARACTERS WITHOUT CLAIM TO ANY PARTICULAR FONT, STYLE, SIZE, OR COLOR.

SN 77-281,595, FILED 9-17-2007.

JACQUELINE A. LAVINE, EXAMINING ATTORNEY

Int. Cls.: 41 and 43

Prior U.S. Cls.: 100, 101, and 107

United States Patent and Trademark Office

Reg. No. 3,486,063

Registered Aug. 12, 2008

**SERVICE MARK
PRINCIPAL REGISTER**

CINEBISTRO

COBB CINEBISTRO, LLC (ALABAMA LTD LIAB
CO)
SUITE 640
2100 A SOUTHBRIDGE PARKWAY
BIRMINGHAM, AL 352130310

FOR: CINEMA THEATERS; MOVIE THEATERS,
IN CLASS 41 (U.S. CLS. 100, 101 AND 107).

FIRST USE 5-26-2008; IN COMMERCE 5-26-2008.

FOR: BAR SERVICES; RESTAURANT SERVICES,
IN CLASS 43 (U.S. CLS. 100 AND 101).

FIRST USE 5-26-2008; IN COMMERCE 5-26-2008.

THE MARK CONSISTS OF STANDARD CHAR-
ACTERS WITHOUT CLAIM TO ANY PARTICULAR
FONT, STYLE, SIZE, OR COLOR.

SN 77-283,536, FILED 9-19-2007.

STEVEN PEREZ, EXAMINING ATTORNEY

Int. Cl.: 41

Prior U.S. Cls.: 100, 101, and 107

United States Patent and Trademark Office

Reg. No. 3,486,064

Registered Aug. 12, 2008

**SERVICE MARK
PRINCIPAL REGISTER**

SPEAKERPOINT

NATIONAL SPEAKERS BUREAU, INC. (ILLINOIS CORPORATION), DBA SPEAKERPOINT, SUITE 102
14047 WEST PETRONELLA DRIVE
LIBERTYVILLE, IL 60048

FOR: PROVIDING EDUCATIONAL AND ENTERTAINMENT SERVICES, NAMELY, ARRANGING FOR SPEAKERS, LECTURERS, AND CELEBRITIES IN A WIDE ARRAY OF EDUCATIONAL, ENTERTAINING AND MOTIVATIONAL SUBJECTS FOR CORPORATE AND TRADE MEETINGS, CONFERENCES, CONVENTIONS, BANQUETS, AND EDU-

CATIONAL PROGRAMS AND FUNCTIONS, IN CLASS 41 (U.S. CLS. 100, 101 AND 107).

FIRST USE 3-28-2008; IN COMMERCE 3-28-2008.

THE MARK CONSISTS OF STANDARD CHARACTERS WITHOUT CLAIM TO ANY PARTICULAR FONT, STYLE, SIZE, OR COLOR.

SN 77-283,545, FILED 9-19-2007.

STEVEN PEREZ, EXAMINING ATTORNEY

Int. Cl.: 41

Prior U.S. Cls.: 100, 101, and 107

United States Patent and Trademark Office

Reg. No. 3,486,065

Registered Aug. 12, 2008

**SERVICE MARK
PRINCIPAL REGISTER**

Think, Love, Grow

ST. STEPHEN'S EPISCOPAL DAY SCHOOL
(FLORIDA EDUCATIONAL INSTITUTION)
3439 MAIN HIGHWAY
COCONUT GROVE, FL 33133

THE MARK CONSISTS OF STANDARD CHAR-
ACTERS WITHOUT CLAIM TO ANY PARTICULAR
FONT, STYLE, SIZE, OR COLOR.

FOR: EDUCATIONAL SERVICES, NAMELY,
PROVIDING COURSES OF INSTRUCTION AT
THE PRIMARY LEVEL, IN CLASS 41 (U.S. CLS.
100, 101 AND 107).

SN 77-287,066, FILED 9-24-2007.

FIRST USE 9-1-2007; IN COMMERCE 6-10-2008.

KELLY BOULTON, EXAMINING ATTORNEY

Int. Cl.: 36

Prior U.S. Cls.: 100, 101, and 102

United States Patent and Trademark Office

Reg. No. 3,486,066

Registered Aug. 12, 2008

**SERVICE MARK
PRINCIPAL REGISTER**

DRI CAPITAL

DRI CAPITAL INC. (CANADA CORPORATION)
22 ST. CLAIR AVENUE EAST, SUITE 200
TORONTO, ONTARIO, CANADA M4T 2S5

FOR: INVESTMENT MANAGEMENT SERVICES
IN THE FIELD OF HEALTHCARE, IN CLASS 36
(U.S. CLS. 100, 101 AND 102).

FIRST USE 10-4-2007; IN COMMERCE 10-4-2007.

THE MARK CONSISTS OF STANDARD CHAR-
ACTERS WITHOUT CLAIM TO ANY PARTICULAR
FONT, STYLE, SIZE, OR COLOR.

NO CLAIM IS MADE TO THE EXCLUSIVE
RIGHT TO USE "CAPITAL", APART FROM THE
MARK AS SHOWN.

THE WORDING "DRI" HAS NO MEANING IN A
FOREIGN LANGUAGE.

SN 77-287,306, FILED 9-24-2007.

BILL DAWE, EXAMINING ATTORNEY

Int. Cl.: 35

Prior U.S. Cls.: 100, 101, and 102

United States Patent and Trademark Office

Reg. No. 3,486,067

Registered Aug. 12, 2008

**SERVICE MARK
PRINCIPAL REGISTER**

**THE WINE CELLAR AT FARM
FRESH**

FF ACQUISITION, L.L.C. (VIRGINIA LTD LIAB
CO)
11840 VALLEY VIEW ROAD
EDEN PRAIRIE, MN 55344

FOR: RETAIL STORE SERVICES FEATURING
WINE AND BEER, IN CLASS 35 (U.S. CLS. 100, 101
AND 102).

FIRST USE 1-2-2008; IN COMMERCE 1-2-2008.

THE MARK CONSISTS OF STANDARD CHAR-
ACTERS WITHOUT CLAIM TO ANY PARTICULAR
FONT, STYLE, SIZE, OR COLOR.

OWNER OF U.S. REG. NOS. 1,544,928, 2,700,060,
AND OTHERS.

SN 77-288,513, FILED 9-25-2007.

ANNE E. GUSTASON, EXAMINING ATTORNEY

Int. Cl.: 25

Prior U.S. Cls.: 22 and 39

United States Patent and Trademark Office

Reg. No. 3,486,068

Registered Aug. 12, 2008

**TRADEMARK
PRINCIPAL REGISTER**



AURI DESIGN GROUP, INC. (CALIFORNIA CORPORATION)
2545 IRIS WAY
LAGUNA BEACH, CA 926514014

THE MARK CONSISTS OF A STYLIZED LETTER "A".

FOR: FOOTWEAR AND CLOTHING, NAMELY, HATS AND SHIRTS, IN CLASS 25 (U.S. CLS. 22 AND 39).

SN 77-290,994, FILED 9-27-2007.

FIRST USE 5-22-2008; IN COMMERCE 5-22-2008.

KAREN SEVERSON, EXAMINING ATTORNEY

Int. Cl.: 25

Prior U.S. Cls.: 22 and 39

United States Patent and Trademark Office

Reg. No. 3,486,069

Registered Aug. 12, 2008

**TRADEMARK
PRINCIPAL REGISTER**

Bibblesbibs

FORD, SANDRA A (UNITED STATES INDIVIDUAL)
66 MONMOUTH BLVD.
OCEANPORT, NJ 07757

FOR: BABY BIBS NOT OF PAPER; CHILDREN'S AND INFANTS' CLOTH BIBS; CHILDREN'S CLOTH EATING BIBS; CLOTH BIBS; CLOTH BIBS FOR ADULT DINERS; CLOTH BIBS FOR USE BY SENIOR CITIZENS OR PHYSICALLY- OR MENTALLY-CHALLENGED PERSONS, IN CLASS 25 (U.S. CLS. 22 AND 39).

FIRST USE 10-1-2007; IN COMMERCE 12-1-2007.

THE MARK CONSISTS OF STANDARD CHARACTERS WITHOUT CLAIM TO ANY PARTICULAR FONT, STYLE, SIZE, OR COLOR.

SN 77-292,830, FILED 10-1-2007.

JENNY PARK, EXAMINING ATTORNEY

Int. Cl.: 41

Prior U.S. Cls.: 100, 101, and 107

United States Patent and Trademark Office

Reg. No. 3,486,070

Registered Aug. 12, 2008

**SERVICE MARK
PRINCIPAL REGISTER**

Medicine 2.0

EYSENBACH, GUNTHER (CANADA INDIVIDUAL)
59 WINNERS CIRCLE
TORONTO, CANADA M4L3Y7

FOR: ARRANGING OF EXHIBITIONS, SEMINARS AND CONFERENCES; EDUCATIONAL SERVICES, NAMELY, CONDUCTING CONFERENCES, WORKSHOPS, SEMINARS, EXHIBITIONS, COURSES IN THE FIELD OF MEDICINE AND ICT (INFORMATION AND COMMUNICATION TECHNOLOGY) AND DISTRIBUTION OF COURSE MATERIAL IN CONNECTION THEREWITH; ORGANISATION OF CONFERENCES AND SYMPOSIA IN THE FIELD OF MEDICAL SCIENCE; ELECTRONIC PUBLISHING SERVICES, NAMELY, PUBLICATION OF TEXT AND GRAPHIC WORKS OF OTHERS ON CD, DVD, ON-LINE FEATURING MATERIAL RELEVANT TO HEALTH AND HEALTH CARE; ON-LINE PUBLICATION OF BOOKS, OF MAGAZINES, OF JOURNALS, OF CON-

ERENCE PROCEEDINGS, OF NEWSPAPERS, OF PERIODICALS, OF CATALOGS, OF BROCHURES; PUBLICATION OF BOOKS, OF MAGAZINES, OF JOURNALS, OF NEWSPAPERS, OF PERIODICALS, OF CATALOGS, OF BROCHURES, IN CLASS 41 (U.S. CLS. 100, 101 AND 107).

FIRST USE 11-24-2007; IN COMMERCE 11-24-2007.

THE MARK CONSISTS OF STANDARD CHARACTERS WITHOUT CLAIM TO ANY PARTICULAR FONT, STYLE, SIZE, OR COLOR.

NO CLAIM IS MADE TO THE EXCLUSIVE RIGHT TO USE "MEDICINE", APART FROM THE MARK AS SHOWN.

SN 77-292,954, FILED 10-1-2007.

DAWN HAN, EXAMINING ATTORNEY

Int. Cl.: 9

Prior U.S. Cls.: 21, 23, 26, 36, and 38

Reg. No. 3,486,071

United States Patent and Trademark Office

Registered Aug. 12, 2008

**TRADEMARK
PRINCIPAL REGISTER**

ENFORCER

ESRMCO, INC. (DELAWARE CORPORATION)
2366 BERNVILLE ROAD
READING, PA 19605

THE MARK CONSISTS OF STANDARD CHAR-
ACTERS WITHOUT CLAIM TO ANY PARTICULAR
FONT, STYLE, SIZE, OR COLOR.

FOR: BATTERY CHARGERS, IN CLASS 9 (U.S.
CLS. 21, 23, 26, 36 AND 38).

SN 77-293,094, FILED 10-1-2007.

FIRST USE 3-31-2008; IN COMMERCE 3-31-2008.

PAUL E. FAHRENKOPF, EXAMINING ATTORNEY

Int. Cl.: 28

Prior U.S. Cls.: 22, 23, 38, and 50

Reg. No. 3,486,072

United States Patent and Trademark Office

Registered Aug. 12, 2008

**TRADEMARK
PRINCIPAL REGISTER**

D66

KARSTEN MANUFACTURING CORPORATION
(ARIZONA CORPORATION)
2201 WEST DESERT COVE
PHOENIX, AZ 85029

FOR: GOLF CLUBS, IN CLASS 28 (U.S. CLS. 22, 23,
38 AND 50).

FIRST USE 4-1-2008; IN COMMERCE 4-1-2008.

THE MARK CONSISTS OF STANDARD CHAR-
ACTERS WITHOUT CLAIM TO ANY PARTICULAR
FONT, STYLE, SIZE, OR COLOR.

SN 77-293,223, FILED 10-1-2007.

JANICE L. MCMORROW, EXAMINING ATTOR-
NEY

Int. Cl.: 11

Prior U.S. Cls.: 13, 21, 23, 31, and 34

Reg. No. 3,486,073

United States Patent and Trademark Office

Registered Aug. 12, 2008

**TRADEMARK
PRINCIPAL REGISTER**



CECILWARE CORPORATION (DELAWARE CORPORATION)
43-05 20TH AVENUE
LONG ISLAND CITY, NY 11105

THE MARK CONSISTS OF THREE ROLLERS WITHIN THE STYLIZED LETTER "C" AND THE STYLIZED WORDS "ROLLERWARE".

FOR: ELECTRIC GRILLS, IN CLASS 11 (U.S. CLS. 13, 21, 23, 31 AND 34).

SN 77-293,709, FILED 10-2-2007.

FIRST USE 5-1-2007; IN COMMERCE 5-1-2007.

DAVID MILLER, EXAMINING ATTORNEY

Int. Cls.: 9 and 41

Prior U.S. Cls.: 21, 23, 26, 36, 38, 100, 101, and 107

United States Patent and Trademark Office

Reg. No. 3,486,074

Registered Aug. 12, 2008

**TRADEMARK
SERVICE MARK
PRINCIPAL REGISTER**

Revyou

GRACE RANDOLPH (UNITED STATES INDIVIDUAL)
APT 3K
106 CENTRAL PARK SOUTH
NEW YORK, NY 10019

FOR: DOWNLOADABLE MOTION PICTURES AND TV SHOWS ABOUT MOVIES AND TELEVISION AND AUDIENCE REACTIONS; DOWNLOADABLE MULTIMEDIA FILE CONTAINING ARTWORK, TEXT, AUDIO, VIDEO, GAMES, AND INTERNET WEB LINKS RELATING TO MOVIES AND TELEVISION AND AUDIENCE REACTIONS; DOWNLOADABLE VIDEO SEGMENTS FEATURING HOSTED INTERVIEWS AND INTRODUCTIONS TO MOVIES VIA THE INTERNET AND WIRELESS DEVICES, IN CLASS 9 (U.S. CLS. 21, 23, 26, 36 AND 38).

FIRST USE 9-7-2007; IN COMMERCE 9-7-2007.

FOR: ENTERTAINMENT IN THE NATURE OF AN ON-GOING SPECIAL VARIETY, NEWS, MUSIC OR COMEDY SHOW FEATURING INTERVIEWS AND REVIEWS OF MOVIES AND TELEVISION BROADCAST OVER TELEVISION, SATELLITE, AUDIO, AND VIDEO MEDIA, IN CLASS 41 (U.S. CLS. 100, 101 AND 107).

FIRST USE 9-10-2007; IN COMMERCE 9-10-2007.

THE MARK CONSISTS OF STANDARD CHARACTERS WITHOUT CLAIM TO ANY PARTICULAR FONT, STYLE, SIZE, OR COLOR.

SN 77-294,735, FILED 10-3-2007.

CHRISTINA SOBRAL, EXAMINING ATTORNEY

Int. Cls.: 16 and 25

Prior U.S. Cls.: 2, 5, 22, 23, 29, 37, 38, 39, and 50

United States Patent and Trademark Office

Reg. No. 3,486,075

Registered Aug. 12, 2008

**TRADEMARK
PRINCIPAL REGISTER**



BACANI, SHARON L. (PHILIPPINES INDIVIDUAL)
1671 OBSERVATION WAY
ANTIOCH, CA 94531

FOR: STICKERS; POSTERS; PAPER HANG TAGS,
IN CLASS 16 (U.S. CLS. 2, 5, 22, 23, 29, 37, 38 AND 50).

FIRST USE 6-15-2008; IN COMMERCE 6-15-2008.

FOR: SHIRTS; HATS; PANTS; JACKETS; UNDERWEAR;
SWEATERS; BELTS; SWEAT BANDS; HEADBANDS
AGAINST SWEATING, IN CLASS 25 (U.S. CLS. 22 AND 39).

FIRST USE 6-15-2008; IN COMMERCE 6-15-2008.

THE MARK CONSISTS OF A STYLIZED HEAD
LOCATED ABOVE TWO STYLIZED ARMS IN A
CROSSED POSITION, WHEREIN THE PHRASE
"BASTARD & FRIENDS" IS LOCATED BELOW
THE STYLIZED ARMS.

SN 77-297,067, FILED 10-5-2007.

ALEXANDER L. POWERS, EXAMINING ATTORNEY

Int. Cl.: 28

Prior U.S. Cls.: 22, 23, 38, and 50

Reg. No. 3,486,076

United States Patent and Trademark Office

Registered Aug. 12, 2008

**TRADEMARK
PRINCIPAL REGISTER**

Electra-Pole

CE LICENSING, LLC (CALIFORNIA LTD LIAB
CO)
SUITE 900 ATTN: MARIE AMBROSINO
1888 CENTURY PARK EAST
LOS ANGELES, CA 900671735

THE MARK CONSISTS OF STANDARD CHAR-
ACTERS WITHOUT CLAIM TO ANY PARTICULAR
FONT, STYLE, SIZE, OR COLOR.

FOR: PORTABLE SUPPORT STRUCTURES FOR
DANCE AND OTHER EXERCISES, IN CLASS 28
(U.S. CLS. 22, 23, 38 AND 50).

SN 77-297,319, FILED 10-5-2007.

FIRST USE 1-1-2008; IN COMMERCE 1-1-2008.

DAVID MILLER, EXAMINING ATTORNEY

Int. Cl.: 38

Prior U.S. Cls.: 100, 101, and 104

United States Patent and Trademark Office

Reg. No. 3,486,077

Registered Aug. 12, 2008

**SERVICE MARK
PRINCIPAL REGISTER**

NOT REALITY. ACTUALITY.

COURTROOM TELEVISION NETWORK LLC
(NEW YORK LTD LIAB CO)
600 THIRD AVENUE
NEW YORK, NY 10016

FOR: TELEVISION BROADCASTING SERVICES
VIA CABLE, SATELLITE, A GLOBAL COMPUTER
NETWORK, AND OTHER MEANS; WIRELESS
COMMUNICATIONS, NAMELY, TRANSMISSION
OF TEXT, DATA, AUDIO, VIDEO AND GRAPHICS
TO MOBILE TELEPHONES AND WIRELESS DEVI-
CES; STREAMING OF AUDIO AND VIDEO MATE-
RIALS VIA THE INTERNET; PROVIDING
STREAMING OF AUDIO AND VIDEO MATERIAL

IN THE NATURE OF ENTERTAINMENT AND
EDITORIAL CONTENT AND INFORMATION, IN
CLASS 38 (U.S. CLS. 100, 101 AND 104).

FIRST USE 1-1-2008; IN COMMERCE 1-1-2008.

THE MARK CONSISTS OF STANDARD CHAR-
ACTERS WITHOUT CLAIM TO ANY PARTICULAR
FONT, STYLE, SIZE, OR COLOR.

SN 77-298,300, FILED 10-8-2007.

ALLISON SCHRODY, EXAMINING ATTORNEY

Int. Cl.: 19

Prior U.S. Cls.: 1, 12, 33, and 50

United States Patent and Trademark Office

Reg. No. 3,486,078

Registered Aug. 12, 2008

**TRADEMARK
PRINCIPAL REGISTER**

ROSS 150 ROOF VENT

ROSS MANUFACTURING, LLC (TEXAS LTD
LIAB CO)
155 SPIRE LN.
NEW BRAUNFELS, TX 78132

FOR: NON-METAL ROOF VENTS FOR VENTI-
LATION IN RESIDENTIAL AND COMMERCIAL
BUILDINGS, IN CLASS 19 (U.S. CLS. 1, 12, 33 AND
50).

FIRST USE 11-1-2007; IN COMMERCE 11-1-2007.

THE MARK CONSISTS OF STANDARD CHAR-
ACTERS WITHOUT CLAIM TO ANY PARTICULAR
FONT, STYLE, SIZE, OR COLOR.

NO CLAIM IS MADE TO THE EXCLUSIVE
RIGHT TO USE "ROOF VENT", APART FROM
THE MARK AS SHOWN.

SN 77-298,696, FILED 10-8-2007.

PAULA MAHONEY, EXAMINING ATTORNEY

Int. Cl.: 12

Prior U.S. Cls.: 19, 21, 23, 31, 35, and 44

Reg. No. 3,486,079

United States Patent and Trademark Office

Registered Aug. 12, 2008

**TRADEMARK
PRINCIPAL REGISTER**

ASSAULT

POLARIS INDUSTRIES INC. (DELAWARE CORPORATION)
2100 HIGHWAY 55
MEDINA, MN 553409770

THE MARK CONSISTS OF STANDARD CHARACTERS WITHOUT CLAIM TO ANY PARTICULAR FONT, STYLE, SIZE, OR COLOR.

FOR: SNOWMOBILES AND STRUCTURAL PARTS THEREFOR, IN CLASS 12 (U.S. CLS. 19, 21, 23, 31, 35 AND 44).

SN 77-299,767, FILED 10-9-2007.

FIRST USE 2-16-2008; IN COMMERCE 2-16-2008.

KATHERINE M. DUBRAY, EXAMINING ATTORNEY

Int. Cl.: 11

Prior U.S. Cls.: 13, 21, 23, 31, and 34

Reg. No. 3,486,080

United States Patent and Trademark Office

Registered Aug. 12, 2008

**TRADEMARK
PRINCIPAL REGISTER**

FINE T BY IQ INNOVATIONS

MEYER INTELLECTUAL PROPERTIES LIMITED
(BR.VIRGIN ISLANDS CORPORATION)
382 KWUN TONG ROAD
KOWLOON, HONGKONG, CHINA

THE MARK CONSISTS OF STANDARD CHAR-
ACTERS WITHOUT CLAIM TO ANY PARTICULAR
FONT, STYLE, SIZE, OR COLOR.

FOR: ELECTRIC TEA MAKERS, IN CLASS 11
(U.S. CLS. 13, 21, 23, 31 AND 34).

SN 77-301,100, FILED 10-10-2007.

FIRST USE 3-31-2008; IN COMMERCE 3-31-2008.

BILL DAWE, EXAMINING ATTORNEY

Int. Cl.: 10

Prior U.S. Cls.: 26, 39, and 44

Reg. No. 3,486,081

United States Patent and Trademark Office

Registered Aug. 12, 2008

**TRADEMARK
PRINCIPAL REGISTER**

EHRDIRECT

PACESETTER, INC. (DELAWARE CORPORATION), DBA , ST. JUDE MEDICAL CARDIAC RHYTHM MANAGEMENT DIVISION, 15900 VALLEY VIEW COURT SYLMAR, CA 91342

FOR: MEDICAL DEVICE SYSTEM, NAMELY, PATIENT DATA TRANSFER FEATURE OF IMPLANTABLE CARDIOVERTER DEFIBRILLATORS AND IMPLANTABLE CARDIAC PULSE GENERATORS, AND MONITORING DEVICE USED THEREFOR, VIA A COMPUTER NETWORK, IN CLASS 10 (U.S. CLS. 26, 39 AND 44).

FIRST USE 5-1-2008; IN COMMERCE 5-1-2008.

THE MARK CONSISTS OF STANDARD CHARACTERS WITHOUT CLAIM TO ANY PARTICULAR FONT, STYLE, SIZE, OR COLOR.

SN 77-301,493, FILED 10-11-2007.

PAUL E. FAHRENKOPF, EXAMINING ATTORNEY

Int. Cl.: 25

Prior U.S. Cls.: 22 and 39

United States Patent and Trademark Office

Reg. No. 3,486,082

Registered Aug. 12, 2008

**TRADEMARK
PRINCIPAL REGISTER**

FIFTEEN TWENTY

KAREN KANE, INC. (CALIFORNIA CORPORATION)
2275 EAST 37TH STREET
LOS ANGELES, CA 90058

FOR: CLOTHES, NAMELY, BLOUSES, BLOUSON, JACKETS, CAMISOLES, SWEATERS, COATS, DRESSES, SHAWLS, SHIRTS, SCARVES, AND TANK-TOPS, IN CLASS 25 (U.S. CLS. 22 AND 39).

FIRST USE 2-26-2008; IN COMMERCE 2-26-2008.

THE MARK CONSISTS OF STANDARD CHARACTERS WITHOUT CLAIM TO ANY PARTICULAR FONT, STYLE, SIZE, OR COLOR.

SN 77-304,203, FILED 10-15-2007.

RICHARD A. STRASER, EXAMINING ATTORNEY

Int. Cl.: 32

Prior U.S. Cls.: 45, 46, and 48

United States Patent and Trademark Office

Reg. No. 3,486,083

Registered Aug. 12, 2008

**TRADEMARK
PRINCIPAL REGISTER**

QUIET STORM

STOKELY-VAN CAMP, INC. (INDIANA COR-
PORATION)
SUITE 11-10
555 WEST MONROE STREET
CHICAGO, IL 60510

THE MARK CONSISTS OF STANDARD CHAR-
ACTERS WITHOUT CLAIM TO ANY PARTICULAR
FONT, STYLE, SIZE, OR COLOR.

FOR: NON-CARBONATED FRUIT FLAVORED
SPORTS DRINKS, IN CLASS 32 (U.S. CLS. 45, 46 AND
48).

SN 77-304,259, FILED 10-15-2007.

FIRST USE 2-8-2008; IN COMMERCE 2-8-2008.

KAREN SEVERSON, EXAMINING ATTORNEY

Int. Cl.: 32

Prior U.S. Cls.: 45, 46, and 48

United States Patent and Trademark Office

Reg. No. 3,486,084

Registered Aug. 12, 2008

**TRADEMARK
PRINCIPAL REGISTER**

COOL FUSION

STOKELY-VAN CAMP, INC. (INDIANA COR-
PORATION)
SUITE 11-10
555 WEST MONROE STREET
CHICAGO, IL 60061

THE MARK CONSISTS OF STANDARD CHAR-
ACTERS WITHOUT CLAIM TO ANY PARTICULAR
FONT, STYLE, SIZE, OR COLOR.

FOR: NON-CARBONATED FRUIT FLAVORED
SPORTS DRINKS, IN CLASS 32 (U.S. CLS. 45, 46 AND
48).

SN 77-304,405, FILED 10-15-2007.

FIRST USE 2-8-2008; IN COMMERCE 2-8-2008.

KAREN SEVERSON, EXAMINING ATTORNEY

Int. Cl.: 41

Prior U.S. Cls.: 100, 101, and 107

United States Patent and Trademark Office

Reg. No. 3,486,085

Registered Aug. 12, 2008

**SERVICE MARK
PRINCIPAL REGISTER**



OPERATION BASS, INC (KENTUCKY CORPORATION)
30 GAMBLE LANE
BENTON, KY 42025

FOR: ENTERTAINMENT SERVICES IN THE NATURE OF FANTASY SPORT LEAGUE, IN CLASS 41 (U.S. CLS. 100, 101 AND 107).

FIRST USE 12-21-2007; IN COMMERCE 12-21-2007.

OWNER OF U.S. REG. NOS. 2,452,208, 2,497,160, AND OTHERS.

NO CLAIM IS MADE TO THE EXCLUSIVE RIGHT TO USE "FANTASY FISHING", APART FROM THE MARK AS SHOWN.

THE COLOR(S) RED, BLACK, WHITE AND GOLD IS/ARE CLAIMED AS A FEATURE OF THE MARK.

THE MARK CONSISTS OF A RED OVAL WITH A SMALLER BLACK OVAL AT THE TOP WHICH IS SLIGHTLY OFF CENTER WITH THE LETTERS "FLW" IN GOLD INSIDE IT WITH THE WORD "FANTASY" IN WHITE WITH A BLACK OUTLINE BELOW THE SMALLER BLACK OVAL AND THE WORD "FISHING" IN WHITE WITH A BLACK OUTLINE BELOW THAT AND A GOLD HOOK THAT STARTS AT THE TOP OF THE SMALLER OVAL AND GOES ALONG THE LEFT SIDE OF THE LARGER OVAL AND FINISHES THE "F" ON THE WORD "FISHING" WITH A GOLD BANNER WITH BLACK OUTLINE ACROSS THE BOTTOM. THE OVALS, BANNER, AND HOOK ALL HAVE A BLACK OUTLINE.

SN 77-305,786, FILED 10-17-2007.

KAPIL BHANOT, EXAMINING ATTORNEY

Int. Cl.: 14

Prior U.S. Cls.: 2, 27, 28, and 50

United States Patent and Trademark Office

Reg. No. 3,486,086

Registered Aug. 12, 2008

**TRADEMARK
PRINCIPAL REGISTER**



SACKOS, DIANE M. (UNITED STATES INDIVIDUAL), DBA COFFEY, DIANE M.,
3776 PUTTER DRIVE
BONITA, CA 91902

FOR: JEWELRY ORGANIZERS, IN CLASS 14 (U.S. CLS. 2, 27, 28 AND 50).

FIRST USE 10-21-2007; IN COMMERCE 10-21-2007.

NO CLAIM IS MADE TO THE EXCLUSIVE RIGHT TO USE "MOMI", APART FROM THE MARK AS SHOWN.

THE COLOR(S) BLUE, GRAY, DARK BLUE, WHITE IS/ARE CLAIMED AS A FEATURE OF THE MARK.

THE MARK CONSISTS OF WIDE LATIN LETTER FONT/STRONG IN DARK BLUE "MYMOMI" BLOWING PALM TREE SHADOWED INTERIOR GREY/WHITE-EXTERIOR EDGES BLUE GLOW FINISH. THE COLOR WHITE APPEARING IN THE BACKGROUND IS NOT PART OF THE MARK.

THE ENGLISH TRANSLATION OF "MOMI" IS "JEWELRY".

SN 77-309,387, FILED 10-21-2007.

JOHN HWANG, EXAMINING ATTORNEY

Int. Cl.: 8

Prior U.S. Cls.: 23, 28, and 44

Reg. No. 3,486,087

United States Patent and Trademark Office

Registered Aug. 12, 2008

TRADEMARK
PRINCIPAL REGISTER



DEXTER-RUSSELL, INC. (MASSACHUSETTS CORPORATION)
44 RIVER STREET
SOUTHBRIDGE, MA 01550

FOR: BONING KNIVES, SLITTING KNIVES, ANGLED KNIVES, POULTRY KNIVES, SKINNING KNIVES, PARING KNIVES, STEAK KNIVES, FILLETING KNIVES, COOK'S KNIVES, BREAD KNIVES, SANDWICH KNIVES, BUTCHER KNIVES, FISH SPLITTERS, CHUCK KNIVES, CHEESE KNIVES, CLAM KNIVES, OYSTER KNIVES, SCALLOP KNIVES, MANUALLY-OPERATED SLICING KNIVES, PIZZA SLICERS AND CHEESE SLICERS, UTILITY KNIVES, PIE KNIVES, VEGETABLE AND PRODUCE KNIVES, RIBBING KNIVES, TRIMMING KNIVES, HEADING KNIVES, SANDWICH SPREA-

DERS WITH A SERRATED CUTTING EDGE AND SLICER KNIVES, IN CLASS 8 (U.S. CLS. 23, 28 AND 44).

FIRST USE 4-1-2008; IN COMMERCE 4-1-2008.

OWNER OF U.S. REG. NOS. 1,937,870, 2,639,303, AND OTHERS.

NO CLAIM IS MADE TO THE EXCLUSIVE RIGHT TO USE "EDGE OR SINCE 1818", APART FROM THE MARK AS SHOWN.

SN 77-310,114, FILED 10-22-2007.

MARY MUNSON, EXAMINING ATTORNEY

Int. Cl.: 21

Prior U.S. Cls.: 2, 13, 23, 29, 30, 33, 40, and 50

Reg. No. 3,486,088

United States Patent and Trademark Office

Registered Aug. 12, 2008

**TRADEMARK
PRINCIPAL REGISTER**



DEXTER-RUSSELL, INC. (MASSACHUSETTS
CORPORATION)
44 RIVER STREET
SOUTHBRIDGE, MA 01550

OWNER OF U.S. REG. NOS. 1,937,870, 2,426,473,
AND 2,639,303.

FOR: KITCHEN UTENSILS, NAMELY, PIZZA
SERVERS, TURNERS, SPATULAS, GRILL AND
PAN SCRAPERS, DOUGH CUTTERS AND DOUGH
SCRAPERS, COOKING FORKS, FOR COMMERCIAL AND PROFESSIONAL USE, IN CLASS 21
(U.S. CLS. 2, 13, 23, 29, 30, 33, 40 AND 50).

NO CLAIM IS MADE TO THE EXCLUSIVE
RIGHT TO USE "EDGE OR SINCE 1818", APART
FROM THE MARK AS SHOWN.

SN 77-310,132, FILED 10-22-2007.

FIRST USE 4-1-2008; IN COMMERCE 4-1-2008.

MARY MUNSON, EXAMINING ATTORNEY

Int. Cl.: 18

Prior U.S. Cls.: 1, 2, 3, 22, and 41

United States Patent and Trademark Office

Reg. No. 3,486,089

Registered Aug. 12, 2008

**TRADEMARK
PRINCIPAL REGISTER**

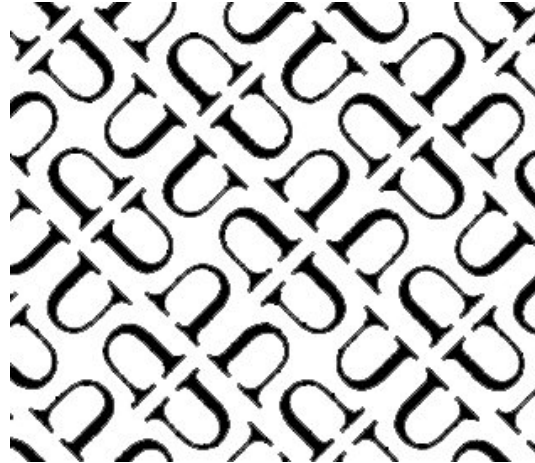

YH FOREVER INC (CALIFORNIA CORPORATION)
109 E 11TH ST
LOS ANGELES, CA 90015

THE MARK CONSISTS OF LETTER "U" IN DIFFERNT DIRECTIONS.

FOR: HANDBAGS; WALLET; LUGGAGE, IN CLASS 18 (U.S. CLS. 1, 2, 3, 22 AND 41).

SN 77-310,370, FILED 10-22-2007.

FIRST USE 5-5-2008; IN COMMERCE 5-5-2008.

MIDGE BUTLER, EXAMINING ATTORNEY

Int. Cl.: 36

Prior U.S. Cls.: 100, 101, and 102

United States Patent and Trademark Office

Reg. No. 3,486,090

Registered Aug. 12, 2008

**SERVICE MARK
PRINCIPAL REGISTER**

YOU PERFORM, WE PERFECT

THE PRESTON GROUP, LLC (TEXAS LTD LIAB
CO)
2123 PALM CASTLE DRIVE
LEAGUE CITY, TX 77573

THE MARK CONSISTS OF STANDARD CHAR-
ACTERS WITHOUT CLAIM TO ANY PARTICULAR
FONT, STYLE, SIZE, OR COLOR.

FOR: BANKING CONSULTATION, IN CLASS 36
(U.S. CLS. 100, 101 AND 102).

SN 77-311,081, FILED 10-23-2007.

FIRST USE 9-30-2007; IN COMMERCE 10-28-2007.

BILL DAWE, EXAMINING ATTORNEY

Int. Cl.: 21

Prior U.S. Cls.: 2, 13, 23, 29, 30, 33, 40, and 50

United States Patent and Trademark Office

Reg. No. 3,486,091

Registered Aug. 12, 2008

**TRADEMARK
PRINCIPAL REGISTER**

SIMPLE PLEASURES

THE PROCTER & GAMBLE COMPANY (OHIO
CORPORATION)
1 P&G PLAZA
CINCINNATI, OH 45202

FOR: LINT ROLLERS, IN CLASS 21 (U.S. CLS. 2,
13, 23, 29, 30, 33, 40 AND 50).

FIRST USE 6-21-2007; IN COMMERCE 6-21-2007.

THE MARK CONSISTS OF STANDARD CHAR-
ACTERS WITHOUT CLAIM TO ANY PARTICULAR
FONT, STYLE, SIZE, OR COLOR.

OWNER OF U.S. REG. NOS. 3,104,027, 3,197,684,
AND 3,197,685.

SN 77-316,082, FILED 10-29-2007.

PAULA MAHONEY, EXAMINING ATTORNEY

Int. Cl.: 5

Prior U.S. Cls.: 6, 18, 44, 46, 51, and 52

Reg. No. 3,486,092

United States Patent and Trademark Office

Registered Aug. 12, 2008

**TRADEMARK
PRINCIPAL REGISTER**

SANEK

LITTLE RAPIDS CORPORATION (WISCONSIN
CORPORATION)
2273 LARSEN ROAD, P.O. BOX 19100
GREEN BAY, WI 543079100

FOR: PRE-MOISTENED HARD SURFACE SANI-
TIZING DISINFECTANT WIPES AND PRE-MOIS-
TENED HAND SANITIZING DISINFECTANT
WIPES, IN CLASS 5 (U.S. CLS. 6, 18, 44, 46, 51 AND 52).

FIRST USE 6-1-2008; IN COMMERCE 6-1-2008.

THE MARK CONSISTS OF STANDARD CHAR-
ACTERS WITHOUT CLAIM TO ANY PARTICULAR
FONT, STYLE, SIZE, OR COLOR.

OWNER OF U.S. REG. NOS. 195,109 AND 654,474.

SN 77-320,465, FILED 11-2-2007.

DAVID MILLER, EXAMINING ATTORNEY

Int. Cl.: 32

Prior U.S. Cls.: 45, 46, and 48

Reg. No. 3,486,093

United States Patent and Trademark Office

Registered Aug. 12, 2008

**TRADEMARK
PRINCIPAL REGISTER**

TASTE MONTANA!

MISSOULA BREWING COMPANY, LLC (MONTANA LTD LIAB CO)
PO BOX 8235
MISSOULA, MT 59807

THE MARK CONSISTS OF STANDARD CHARACTERS WITHOUT CLAIM TO ANY PARTICULAR FONT, STYLE, SIZE, OR COLOR.

FOR: BEER; ALE, IN CLASS 32 (U.S. CLS. 45, 46 AND 48).

SN 77-322,916, FILED 11-6-2007.

FIRST USE 6-20-2008; IN COMMERCE 6-20-2008.

KHANH LE, EXAMINING ATTORNEY

Int. Cls.: 25 and 35

Prior U.S. Cls.: 22, 39, 100, 101, and 102

United States Patent and Trademark Office

Reg. No. 3,486,094

Registered Aug. 12, 2008

**TRADEMARK
SERVICE MARK
PRINCIPAL REGISTER**



POINT6 LLC (COLORADO LTD LIAB CO)
28630 YELLOW JACKET DRIVE
STEAMBOAT SPRINGS, CO 80487

FOR: CLOTHING, NAMELY, SHIRTS, PANTS, T-SHIRTS, SHORTS, SWEATERS, SWEATSHIRTS, UNDERGARMENTS, UNDERSHIRTS, THERMAL UNDERWEAR, NECK GAITERS, HEADWEAR, BEANIES, CAPS, BASEBALL CAPS, SKI HATS, GLOVES, SCARVES, SOCKS, ATHLETIC SHIRTS, ATHLETIC PANTS, ATHLETIC SHORTS, JOGGING SUITS, SWEAT SUITS, AND FOOTWEAR, IN CLASS 25 (U.S. CLS. 22 AND 39).

FIRST USE 5-1-2008; IN COMMERCE 6-9-2008.

FOR: RETAIL APPAREL STORES AND ON-LINE RETAIL STORE SERVICES FEATURING APPAREL, IN CLASS 35 (U.S. CLS. 100, 101 AND 102).

FIRST USE 6-9-2008; IN COMMERCE 6-9-2008.

THE MARK CONSISTS OF A LOGO INCORPORATING A STYLIZED NUMBER SIX.

SN 77-322,933, FILED 11-6-2007.

CYNTHIA SLOAN, EXAMINING ATTORNEY

Int. Cls.: 9 and 42

Prior U.S. Cls.: 21, 23, 26, 36, 38, 100, and 101

Reg. No. 3,486,095

United States Patent and Trademark Office

Registered Aug. 12, 2008

**TRADEMARK
SERVICE MARK
PRINCIPAL REGISTER**

VIPRION

F5 NETWORKS, INC. (WASHINGTON CORPORATION)
401 ELLIOTT AVENUE WEST
SEATTLE, WA 98119

FOR: COMPUTER NETWORKING HARDWARE; COMPUTER SOFTWARE FOR USE IN ENHANCING, OPTIMIZING, SECURING, ACCELERATING, MONITORING, AND MANAGING COMPUTER NETWORK TRAFFIC AND APPLICATIONS COMMUNICATING ACROSS NETWORKS, IN CLASS 9 (U.S. CLS. 21, 23, 26, 36 AND 38).

FIRST USE 1-23-2008; IN COMMERCE 1-23-2008.

FOR: COMPUTER NETWORK CONSULTING SERVICES, IN CLASS 42 (U.S. CLS. 100 AND 101).

FIRST USE 1-23-2008; IN COMMERCE 1-23-2008.

THE MARK CONSISTS OF STANDARD CHARACTERS WITHOUT CLAIM TO ANY PARTICULAR FONT, STYLE, SIZE, OR COLOR.

SN 77-325,763, FILED 11-9-2007.

KELLY BOULTON, EXAMINING ATTORNEY

Int. Cl.: 16

Prior U.S. Cls.: 2, 5, 22, 23, 29, 37, 38, and 50

Reg. No. 3,486,096

United States Patent and Trademark Office

Registered Aug. 12, 2008

**TRADEMARK
PRINCIPAL REGISTER**

QUEEN OF COLOR

LISA FRANK, INC. (ARIZONA CORPORATION)
6760 S. LISA FRANK AVE.
TUSCON, AZ 85706

FIRST USE 3-28-2008; IN COMMERCE 3-28-2008.

FOR: PRINTED ITEMS, NAMELY, STATIONERY-TYPE PORTFOLIOS, NOTEBOOKS, FOLDERS, BINDERS, WRITING TABLETS, MEMO PADS, STATIONERY, ORGANIZERS FOR STATIONERY AND PERSONAL ORGANIZERS, JOURNALS AND DIARIES, IN CLASS 16 (U.S. CLS. 2, 5, 22, 23, 29, 37, 38 AND 50).

THE MARK CONSISTS OF STANDARD CHARACTERS WITHOUT CLAIM TO ANY PARTICULAR FONT, STYLE, SIZE, OR COLOR.

SN 77-327,243, FILED 11-12-2007.

WENDY GOODMAN, EXAMINING ATTORNEY

Int. Cl.: 16

Prior U.S. Cls.: 2, 5, 22, 23, 29, 37, 38, and 50

Reg. No. 3,486,097

United States Patent and Trademark Office

Registered Aug. 12, 2008

**TRADEMARK
PRINCIPAL REGISTER**

SPARKLY

LISA FRANK, INC. (ARIZONA CORPORATION)
6760 S. LISA FRANK AVE.
TUSCON, AZ 85706

THE MARK CONSISTS OF STANDARD CHAR-
ACTERS WITHOUT CLAIM TO ANY PARTICULAR
FONT, STYLE, SIZE, OR COLOR.

FOR: PENS, IN CLASS 16 (U.S. CLS. 2, 5, 22, 23, 29,
37, 38 AND 50).

SN 77-329,491, FILED 11-14-2007.

FIRST USE 6-18-2008; IN COMMERCE 6-18-2008.

WENDY GOODMAN, EXAMINING ATTORNEY

Int. Cl.: 36

Prior U.S. Cls.: 100, 101, and 102

United States Patent and Trademark Office

Reg. No. 3,486,098

Registered Aug. 12, 2008

**SERVICE MARK
PRINCIPAL REGISTER**

CITIMARKETS

CITIGROUP INC. (DELAWARE CORPORATION)
399 PARK AVENUE
NEW YORK, NY 10043

FOR: FINANCIAL RESEARCH; FINANCIAL ANALYSIS AND CONSULTING; FINANCIAL INFORMATION; AND PROVIDING TRADING SERVICES BY ELECTRONIC MEANS, NAMELY, A TRADING PLATFORM FOR PLACING AND EXECUTING ORDERS TO BUY AND SELL SECURITIES, FUTURES, OPTIONS, FOREIGN EXCHANGE AND OTHER FINANCIAL PRODUCTS, IN CLASS 36 (U.S. CLS. 100, 101 AND 102).

FIRST USE 3-20-2008; IN COMMERCE 3-20-2008.

THE MARK CONSISTS OF STANDARD CHARACTERS WITHOUT CLAIM TO ANY PARTICULAR FONT, STYLE, SIZE, OR COLOR.

OWNER OF U.S. REG. NOS. 1,181,467, 2,801,076, AND OTHERS.

SN 77-334,076, FILED 11-20-2007.

KYLE PEETE, EXAMINING ATTORNEY

Int. Cl.: 25

Prior U.S. Cls.: 22 and 39

United States Patent and Trademark Office

Reg. No. 3,486,099

Registered Aug. 12, 2008

**TRADEMARK
PRINCIPAL REGISTER**

DISPOSACAPE

LITTLE RAPIDS CORPORATION (WISCONSIN
CORPORATION)
2273 LARSEN ROAD, P.O. BOX 19100
GREEN BAY, WI 543079100

THE MARK CONSISTS OF STANDARD CHAR-
ACTERS WITHOUT CLAIM TO ANY PARTICULAR
FONT, STYLE, SIZE, OR COLOR.

FOR: DISPOSABLE CAPES FOR USE IN BEAUTY
SALONS AND SPAS, IN CLASS 25 (U.S. CLS. 22 AND
39).

SN 77-340,131, FILED 11-29-2007.

FIRST USE 6-1-2008; IN COMMERCE 6-1-2008.

DAVID MILLER, EXAMINING ATTORNEY

Int. Cl.: 4

Prior U.S. Cls.: 1, 6, and 15

United States Patent and Trademark Office

Reg. No. 3,486,100

Registered Aug. 12, 2008

**TRADEMARK
PRINCIPAL REGISTER**

BELLA LUZ

LANCASTER COLONY CORPORATION (OHIO
CORPORATION)

37 WEST BROAD STREET

COLUMBUS, OH 432154177

FOR: CANDLES AND SCENTED WAX MELT
TARTS, IN CLASS 4 (U.S. CLS. 1, 6 AND 15).

FIRST USE 2-17-2007; IN COMMERCE 2-17-2007.

THE MARK CONSISTS OF STANDARD CHAR-
ACTERS WITHOUT CLAIM TO ANY PARTICULAR
FONT, STYLE, SIZE, OR COLOR.

THE FOREIGN WORDING IN THE MARK
TRANSLATES INTO ENGLISH AS "BEAUTIFUL
LIGHT"

SN 77-975,016, FILED 10-3-2006.

ELLEN PERKINS, EXAMINING ATTORNEY

Int. Cl.: 43

Prior U.S. Cls.: 100 and 101

United States Patent and Trademark Office

Reg. No. 3,486,101

Registered Aug. 12, 2008

**SERVICE MARK
PRINCIPAL REGISTER**

**WOLFGANG'S STEAKHOUSE BY
WOLFGANG ZWIENER**

ZWIENER, WOLFGANG (UNITED STATES IN-
DIVIDUAL)
WOLFGANG'S STEAKHOUSE
409 GREENWICH STREET
NEW YORK, NY 10013

FOR: RESTAURANT SERVICES; RESTAURANTS
FEATURING HOME AND OFFICE DELIVERY;
CARRY-OUT AND TAKE-OUT RESTAURANT SER-
VICES, IN CLASS 43 (U.S. CLS. 100 AND 101).

FIRST USE 5-1-2008; IN COMMERCE 5-1-2008.

THE MARK CONSISTS OF STANDARD CHAR-
ACTERS WITHOUT CLAIM TO ANY PARTICULAR
FONT, STYLE, SIZE, OR COLOR.

NO CLAIM IS MADE TO THE EXCLUSIVE
RIGHT TO USE "STEAKHOUSE", APART FROM
THE MARK AS SHOWN.

SN 77-975,080, FILED 4-12-2007.

MARK PILARO, EXAMINING ATTORNEY

Int. Cls.: 16, 19, and 35

**Prior U.S. Cls.: 1, 2, 5, 12, 22, 23, 29, 33, 37, 38, 50,
100, 101, and 102**

Reg. No. 3,486,102

United States Patent and Trademark Office

Registered Aug. 12, 2008

**TRADEMARK
SERVICE MARK
PRINCIPAL REGISTER**

AVALIS

LYLES CAROLINA HERITAGE CORP. (COLOR-
ADO CORPORATION)
301C SMOKEY STREET
FORT COLLINS, CO 80525

FOR: DIRECTORIES OF DESTINATION AREAS,
NAMELY, BUILDINGS, FACILITIES, AND CAMPU-
SES, IN CLASS 16 (U.S. CLS. 2, 5, 22, 23, 29, 37, 38 AND
50).

FIRST USE 5-5-2007; IN COMMERCE 5-20-2007.

FOR: NON-LUMINOUS, NON-MECHANICAL
SIGNS NOT OF METAL, IN CLASS 19 (U.S. CLS. 1,
12, 33 AND 50).

FIRST USE 5-5-2007; IN COMMERCE 5-20-2007.

FOR: BUSINESS MANAGEMENT AND BUSINESS
CONSULTING SERVICES IN THE FIELD OF NAVI-
GATION SYSTEMS IN AND ABOUT BUILDINGS,
FACILITIES, AND CAMPUSES, IN CLASS 35 (U.S.
CLS. 100, 101 AND 102).

FIRST USE 5-5-2007; IN COMMERCE 5-20-2007.

THE MARK CONSISTS OF STANDARD CHAR-
ACTERS WITHOUT CLAIM TO ANY PARTICULAR
FONT, STYLE, SIZE, OR COLOR.

SN 77-975,378, FILED 4-3-2007.

STEVEN JACKSON, EXAMINING ATTORNEY

Int. Cls.: 6, 9, 14, 16, and 18

**Prior U.S. Cls.: 1, 2, 3, 5, 12, 13, 14, 21, 22, 23, 25, 26,
27, 28, 29, 36, 37, 38, 41, and 50**

Reg. No. 3,486,103

United States Patent and Trademark Office

Registered Aug. 12, 2008

**TRADEMARK
PRINCIPAL REGISTER**

UTAH
LIFE ELEVATED

UTAH DIVISION OF TRAVEL DEVELOPMENT
(UTAH STATE AGENCY)
300 N. STATE ST. COUNCIL HALL/CAPITOL H.
SALT LAKE CITY, UT 84114

FOR: METAL LICENSE PLATES, IN CLASS 6 (U.S.
CLS. 2, 12, 13, 14, 23, 25 AND 50).

FIRST USE 11-19-2007; IN COMMERCE 11-19-2007.

FOR: DECORATIVE REFRIGERATOR MAG-
NETS, REFRIGERATOR MAGNETS, MOUSE PADS,
IN CLASS 9 (U.S. CLS. 21, 23, 26, 36 AND 38).

FIRST USE 1-15-2008; IN COMMERCE 1-15-2008.

FOR: LAPEL PINS, ORNAMENTAL LAPEL PINS,
IN CLASS 14 (U.S. CLS. 2, 27, 28 AND 50).

FIRST USE 7-31-2007; IN COMMERCE 7-31-2007.

FOR: BALL POINT PENS, GEL ROLLER PENS,
NOTE PADS, BUMPER STICKERS, CALENDARS,
DESK CALENDARS, PRINTED CALENDARS,

WALL CALENDARS, IN CLASS 16 (U.S. CLS. 2, 5,
22, 23, 29, 37, 38 AND 50).

FIRST USE 4-30-2006; IN COMMERCE 4-30-2006.

FOR: BACKPACKS, LUGGAGE TAGS, IN CLASS
18 (U.S. CLS. 1, 2, 3, 22 AND 41).

FIRST USE 4-30-2006; IN COMMERCE 4-30-2006.

NO CLAIM IS MADE TO THE EXCLUSIVE
RIGHT TO USE "UTAH", APART FROM THE
MARK AS SHOWN.

THE MARK CONSISTS OF THE WORDS "LIFE
ELEVATED" LOCATED BELOW THE WORD
"UTAH", WHICH IS WRITTEN IN STYLIZED
CHARACTERS.

SN 77-975,536, FILED 3-29-2007.

MICHAEL LEWIS, EXAMINING ATTORNEY

Int. Cl.: 3

Prior U.S. Cls.: 1, 4, 6, 50, 51, and 52

Reg. No. 3,486,104

United States Patent and Trademark Office

Registered Aug. 12, 2008

**TRADEMARK
PRINCIPAL REGISTER**

SHINE BURST

LABORATOIRE GARNIER & CIE (FRANCE SOCIETE EN NOM COLLECTIF)
281, RUE SAINT HONORE
PARIS, FRANCE 75008

THE MARK CONSISTS OF STANDARD CHARACTERS WITHOUT CLAIM TO ANY PARTICULAR FONT, STYLE, SIZE, OR COLOR.

FOR: SHAMPOOS, IN CLASS 3 (U.S. CLS. 1, 4, 6, 50, 51 AND 52).

SN 77-975,616, FILED 7-17-2007.

FIRST USE 12-1-2007; IN COMMERCE 12-1-2007.

SHARON MEIER, EXAMINING ATTORNEY

Int. Cl.: 16

Prior U.S. Cls.: 2, 5, 22, 23, 29, 37, 38, and 50

Reg. No. 3,486,105

United States Patent and Trademark Office

Registered Aug. 12, 2008

**TRADEMARK
PRINCIPAL REGISTER**



SELLARS ABSORBENT MATERIALS, INC. (WIS-
CONSIN CORPORATION)
6540 NORTH INDUSTRIAL ROAD
MILWAUKEE, WI 53223

THE MARK CONSISTS OF A HAND HOLDING
THE TERM "BIG GRIP".

FOR: PAPER TOWELS COMPRISED OF WOOD
PULP AND BINDING AGENTS, IN CLASS 16 (U.S.
CLS. 2, 5, 22, 23, 29, 37, 38 AND 50).

SN 77-975,647, FILED 12-6-2006.

FIRST USE 6-12-2007; IN COMMERCE 6-12-2007.

CAROLYN GRAY, EXAMINING ATTORNEY

Int. Cl.: 25

Prior U.S. Cls.: 22 and 39

United States Patent and Trademark Office

Reg. No. 3,486,106

Registered Aug. 12, 2008

**TRADEMARK
PRINCIPAL REGISTER**

Gratitude Attitude

SWARTZ, JUDY B. (UNITED STATES INDIVIDUAL)
705 HUNTLEY DRIVE
WEST HOLLYWOOD, CA 90069

THE MARK CONSISTS OF STANDARD CHARACTERS WITHOUT CLAIM TO ANY PARTICULAR FONT, STYLE, SIZE, OR COLOR.

FOR: CLOTHING, NAMELY, T-SHIRTS, IN CLASS 25 (U.S. CLS. 22 AND 39).

SN 77-975,654, FILED 12-19-2006.

FIRST USE 5-30-2008; IN COMMERCE 5-30-2008.

KIMBERLY PERRY, EXAMINING ATTORNEY

Int. Cl.: 28

Prior U.S. Cls.: 22, 23, 38, and 50

United States Patent and Trademark Office

Reg. No. 3,486,107

Registered Aug. 12, 2008

**TRADEMARK
PRINCIPAL REGISTER**

IRIDESSA

DISNEY ENTERPRISES, INC. (DELAWARE CORPORATION)
500 SOUTH BUENA VISTA STREET
BURBANK, CA 91521

THE MARK CONSISTS OF STANDARD CHARACTERS WITHOUT CLAIM TO ANY PARTICULAR FONT, STYLE, SIZE, OR COLOR.

FOR: ACTION FIGURES AND ACCESSORIES THEREFORE; DOLLS; TOY FIGURES; TOY ACTION FIGURES, IN CLASS 28 (U.S. CLS. 22, 23, 38 AND 50).

SN 77-975,659, FILED 3-26-2007.

FIRST USE 6-4-2008; IN COMMERCE 6-4-2008.

EMILY CARLSEN, EXAMINING ATTORNEY

Int. Cl.: 5

Prior U.S. Cls.: 6, 18, 44, 46, 51, and 52

Reg. No. 3,486,108

United States Patent and Trademark Office

Registered Aug. 12, 2008

**TRADEMARK
PRINCIPAL REGISTER**

FRUIT EXPLOSION

S. C. JOHNSON & SON, INC. (WISCONSIN CORPORATION)

1525 HOWE STREET

RACINE, WI 53403

FOR: AIR FRESHENERS, IN CLASS 5 (U.S. CLS. 6, 18, 44, 46, 51 AND 52).

FIRST USE 11-1-2007; IN COMMERCE 11-1-2007.

THE MARK CONSISTS OF STANDARD CHARACTERS WITHOUT CLAIM TO ANY PARTICULAR FONT, STYLE, SIZE, OR COLOR.

NO CLAIM IS MADE TO THE EXCLUSIVE RIGHT TO USE "FRUIT", APART FROM THE MARK AS SHOWN.

SN 77-975,674, FILED 1-29-2007.

LESLEY LAMOTHE, EXAMINING ATTORNEY

Int. Cl.: 30

Prior U.S. Cl.: 46

United States Patent and Trademark Office

Reg. No. 3,486,109

Registered Aug. 12, 2008

**TRADEMARK
PRINCIPAL REGISTER**



MAYBERRY ENTERPRISES (CALIFORNIA
JOINT VENTURE)
C/O ONE WILLIAM MORRIS PLACE
BEVERLY HILLS, CA 90212

FOR: WHEAT-BASED SNACK FOODS, CORN-
BASED SNACK FOODS, AND MIXES FOR BAKERY
GOODS, IN CLASS 30 (U.S. CL. 46).

FIRST USE 10-1-2007; IN COMMERCE 10-1-2007.

THE MARK CONSISTS OF THE WORDS "MAY-
BERRY'S FINEST" ACCOMPANIED BY A STAR-
SHAPED BADGE DESIGN WHICH BEARS THE
WORDS "SHERIFF MAYBERRY".

SN 77-975,683, FILED 3-15-2007.

PAM WILLIS, EXAMINING ATTORNEY

Int. Cl.: 28

Prior U.S. Cls.: 22, 23, 38, and 50

United States Patent and Trademark Office

Reg. No. 3,486,110

Registered Aug. 12, 2008

**TRADEMARK
PRINCIPAL REGISTER**

HAPPY BEARTHDAY

BUILD-A-BEAR RETAIL MANAGEMENT, INC.
(DELAWARE CORPORATION)
1954 INNERBELT BUSINESS CENTER DRIVE
ST. LOUIS, MO 631145760

FIRST USE 0-0-2000; IN COMMERCE 0-0-2000.

SN 78-086,736, FILED 10-3-2001.

FOR: STUFFED AND PLUSH TOY ANIMALS, IN
CLASS 28 (U.S. CLS. 22, 23, 38 AND 50).

KATHRYN COWARD, EXAMINING ATTORNEY

Int. Cl.: 35

Prior U.S. Cls.: 100, 101, and 102

United States Patent and Trademark Office

Reg. No. 3,486,111

Registered Aug. 12, 2008

**SERVICE MARK
PRINCIPAL REGISTER**

WINDOW SOLUTIONS

BLINDS TO GO (U.S.) INC. (DELAWARE CORPORATION)
70 WOOD AVE., 1ST FLOOR
ISELIN, NJ 088301526

NO CLAIM IS MADE TO THE EXCLUSIVE RIGHT TO USE "WINDOW", APART FROM THE MARK AS SHOWN.

FOR: RETAIL STORE SERVICES IN THE FIELD OF WINDOW COVERINGS, IN CLASS 35 (U.S. CLS. 100, 101 AND 102).

SN 78-147,776, FILED 7-26-2002.

FIRST USE 12-13-2007; IN COMMERCE 12-13-2007.

HOWARD SMIGA, EXAMINING ATTORNEY

Int. Cl.: 9

Prior U.S. Cls.: 21, 23, 26, 36, and 38

United States Patent and Trademark Office

Reg. No. 3,486,112

Registered Aug. 12, 2008

TRADEMARK
PRINCIPAL REGISTER

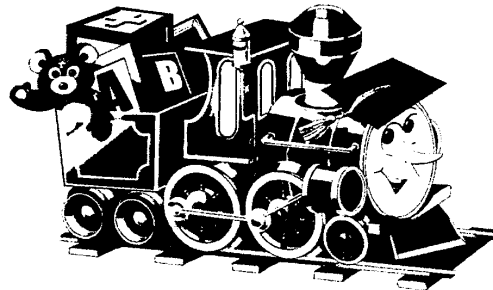

Teaching-Engine

PAYNE, CHRISTOPHER PHILIP (UNITED STATES INDIVIDUAL)
8 ARUM RD.
MILNERTON, W. CAPE, SOUTH AFRICA 7441

FOR: COMPUTER SOFTWARE FOR CREATING INTERACTIVE MULTIMEDIA EDUCATIONAL LESSONS AND FOR USING SAID LESSONS, IN CLASS 9 (U.S. CLS. 21, 23, 26, 36 AND 38).

FIRST USE 9-15-2002; IN COMMERCE 5-3-2008.

SN 78-164,214, FILED 9-15-2002.

HOWARD SMIGA, EXAMINING ATTORNEY

Int. Cl.: 9

Prior U.S. Cls.: 21, 23, 26, 36, and 38

Reg. No. 3,486,113

United States Patent and Trademark Office

Registered Aug. 12, 2008

**TRADEMARK
PRINCIPAL REGISTER**

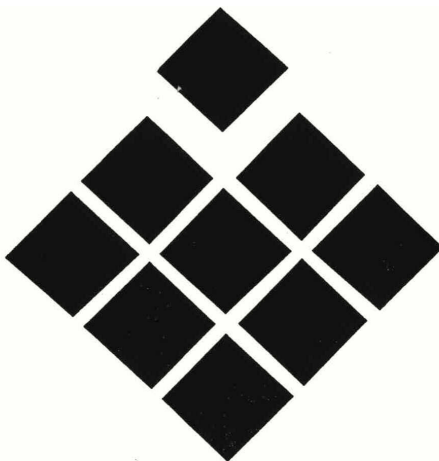

MICRONAS SEMICONDUCTOR HOLDING AG
(SWITZERLAND CORPORATION)
TECHNOPARKSTRASSE 1
8005 ZURICH, SWITZERLAND

FOR: ELECTRIC AND ELECTRONIC COMPONENTS AND CONSTRUCTION ELEMENTS, NAMELY, HYBRID CIRCUITS AND HYBRID SEMICONDUCTOR EQUIPMENT CONSISTING OF ANALOG AND DIGITAL CIRCUITS; SEMICONDUCTORS; SEMICONDUCTOR COMPONENTS, NAMELY, MEMORIES, SENSORS, INTEGRATED CIRCUITS; LARGE-SCALE INTEGRATED CIRCUITS, NAMELY FOR AUTOMOBILE INSTRUMENTATION AND INSTRUMENT PANEL ELECTRONICS; COMPONENTS FOR ENTERTAINMENT ELECTRONICS, MULTIMEDIA ELECTRONICS, INSTRUMENT PANELS, INSTRUMENTS, SEMI-CONDUCTORS AND ANALOG AND DIGITAL MOBILE TELEPHONES, NAMELY, INTEGRATED CIRCUITS, MULTI-CHIP ARRANGEMENT, NAMELY, MULTIPLE COMPUTER CHIPS INSIDE A SINGLE PACKAGE OR DIRECTLY BONDED ONTO A SMALL BOARD AND SENSORS; HYBRID CIRCUITS; SIGNAL PROCESSORS, NAMELY, FOR

DIGITAL SIGNAL PROCESSING; DIGITAL MODULATORS AND DEMODULATORS FOR TELEVISION, RADIO AND WIRELESS CONNECTIVITY, CYPHER, DECYPHER AND RIGHTS MANAGEMENT APPARATUS, NAMELY, FOR MEDIA APPLICATIONS, VIDEO, STILL IMAGE, AUDIO AND MULTIMEDIA ENCODERS AND DECODERS, NAMELY, FOR TELEVISION SETS AND VIDEO OR AUDIO APPARATUS AND SET TOP BOXES; SILICON BASED SENSORS, NAMELY, MAGNETIC FIELD SENSORS, NAMELY, FOR AUTOMOTIVE APPLICATIONS; SILICON BASED COMPOUND SENSORS, NAMELY, SILICON-BASED OPTICAL SENSORS; COMPUTER SOFTWARE, NAMELY, SOFTWARE USED TO OPERATE DIGITAL VIDEO AND AUDIO PLAYERS, SOFTWARE APPLICATION KITS, NAMELY, SOFTWARE USED FOR ENTERTAINMENT AND MULTIMEDIA APPARATUS, IN CLASS 9 (U.S. CLS. 21, 23, 26, 36 AND 38).

FIRST USE 3-0-2001; IN COMMERCE 3-0-2001.

SN 78-188,633, FILED 11-25-2002.

MICHELE SWAIN, EXAMINING ATTORNEY

Int. Cls.: 7 and 9

Prior U.S. Cls.: 13, 19, 21, 23, 26, 31, 34, 35, 36, and 38

Reg. No. 3,486,114

United States Patent and Trademark Office

Registered Aug. 12, 2008

**TRADEMARK
PRINCIPAL REGISTER**

VERIFIER

WECO OPTIK GMBH (FED REP GERMANY CORPORATION)
JAGERSTRAFFE 58
DUSSELDORF, FED REP GERMANY D-40231

FOR: ELECTRICAL, OPTICAL, MEASURING AND SIGNALING APPARATUS, INSTRUMENTS AND SYSTEMS ALL FOR MACHINING, CUTTING, MILLING, GRINDING, DRILLING BEVELING, GROOVING, POLISHER OR CLEANING OF THE EDGE AND/OR THE OPTICAL SURFACES OF OPHTHALMIC LENSES MADE OF GLASS OR PLASTIC, NAMELY, LENS EDGING, TRACING AND BLOCKING MACHINES; COMPUTERIZED SCIENTIFIC SYSTEMS FOR USE IN CONNECTION WITH THE AFORESAID APPARATUS, INSTRUMENTS, NAMELY, COMPUTER CONTROLLED LENS EDGING, TRACING AND BLOCKING MACHINES; MECHANICAL, OPTICAL, ELECTRICAL AND COMPUTERIZED LENS DECENTERING AND BLOCKING APPARATUS, NAMELY, LENS BLOCKING MEACHINES; BLOCK PADS AND BLOCK ADAPTERS BEING PARTS OF OPTICAL APPARATUS AND INSTRUMENTS, NAMELY, BLOCKING PADS AND ADACPTERS FOR USE IN BLOCKING MACHINES; TENSION RINGS MADE OF METAL OR PLASTIC FOR USE IN CONNECTION WITH OPTICAL APPARATUS AND INSTRUMENTS,

NAMELY, TENSION RINGS FOR USE IN LENS EDGING, TRACING AND BLOCKING MACHINES; TRACERS AND TRACER MACHINE SYSTEMS, NAMELY, COMPUTERIZED MARCHINES FOR TRACING THE DIMENSIONS OF A SPECTACLE FRAME, A TEMPLATE OR A PATTERN OR AN OPHTHALMIC LENS, IN CLASS 7 (U.S. CLS. 13, 19, 21, 23, 31, 34 AND 35).

FIRST USE 8-1-2007; IN COMMERCE 8-1-2007.

FOR: COMPUTER SOFTWARE USED TO MONITOR AND CONTROL THE PERFORMANCE, OPERATION, SAFETY; QUALITY AND ACCURACY OF LENS EDGING, TRACING AND BLOCKING MACHINES IN THE OPTICAL SUPPLY FIELD, IN CLASS 9 (U.S. CLS. 21, 23, 26, 36 AND 38).

FIRST USE 8-1-2007; IN COMMERCE 8-1-2007.

THE MARK CONSISTS OF STANDARD CHARACTERS WITHOUT CLAIM TO ANY PARTICULAR FONT, STYLE, SIZE, OR COLOR.

SN 78-202,662, FILED 1-13-2003.

ESTHER A. BORSUK, EXAMINING ATTORNEY

Int. Cls.: 9 and 15

Prior U.S. Cls.: 2, 21, 23, 26, 36, and 38

United States Patent and Trademark Office

Reg. No. 3,486,115

Registered Aug. 12, 2008

**TRADEMARK
PRINCIPAL REGISTER**

OPENSYNTH

OPEN LABS, INC. (TEXAS CORPORATION)
4020 S. INDUSTRIAL DR. SUITE 100
AUSTIN, TX 78744

FOR: ELECTRONIC MUSICAL EQUIPMENT,
NAMELY, ELECTRONIC TONE GENERATORS
AND ELECTRONIC MUSIC SEQUENCERS AND
RECORDERS, IN CLASS 9 (U.S. CLS. 21, 23, 26, 36
AND 38).

FIRST USE 2-1-2004; IN COMMERCE 2-1-2004.

FOR: ELECTRONIC PERFORMANCE INSTRU-
MENTS, NAMELY, ELECTRONIC MUSICAL KEY-

BOARDS AND ELECTRONIC MUSICAL
SYNTHESIZERS, IN CLASS 15 (U.S. CLS. 2, 21 AND
36).

FIRST USE 2-1-2004; IN COMMERCE 2-1-2004.

THE MARK CONSISTS OF STANDARD CHAR-
ACTERS WITHOUT CLAIM TO ANY PARTICULAR
FONT, STYLE, SIZE, OR COLOR.

SN 78-203,029, FILED 1-14-2003.

CORY BOONE, EXAMINING ATTORNEY

Int. Cl.: 29

Prior U.S. Cl.: 46

United States Patent and Trademark Office

Reg. No. 3,486,116

Registered Aug. 12, 2008

**TRADEMARK
PRINCIPAL REGISTER**

SHANGHAI NOODLE HOUSE

SIMPLY ASIA FOODS, LLC (DELAWARE LTD
LIAB CO)
18 LOVETON CIRCLE
SPARKS, MD 211526000

NO CLAIM IS MADE TO THE EXCLUSIVE
RIGHT TO USE "SHANGHAI NOODLE", APART
FROM THE MARK AS SHOWN.

FOR: SOUPS, IN CLASS 29 (U.S. CL. 46).

SN 78-204,783, FILED 1-17-2003.

FIRST USE 12-19-2005; IN COMMERCE 5-22-2008.

HOWARD SMIGA, EXAMINING ATTORNEY

Int. Cl.: 21

Prior U.S. Cls.: 2, 13, 23, 29, 30, 33, 40, and 50

Reg. No. 3,486,117

United States Patent and Trademark Office

Registered Aug. 12, 2008

**TRADEMARK
PRINCIPAL REGISTER**

PRO-CLAD

CLAD HOLDINGS CORP. (DELAWARE CORPORATION)
424 MORGANZA ROAD
CANONSBURG, PA 15317

FOR: BAKEWARE; AND COOKWARE, NAMELY, FRY PANS, SAUCE PANS, SAUCIERS, TAPERED PANS FOR CONCENTRATING LIQUIDS, SAUTE PANS, STOCK POTS, CASSEROLES, PASTA COOKING POTS AND COLANDER INSERTS, GRILLE PANS, GRIDDLE PANS, BRAISER PANS, ROASTER PANS, RACK INSERTS FOR ROASTER PANS, STIR FRY PANS, CHEF'S PANS, PAELLA PANS, OMELETTE PANS, AU GRATIN PANS, BUTTER WARMERS, AND LIDS FOR ALL OF THE ABOVE, TEA KETTLES, MIXING BOWLS, COLANDERS, DOUBLE BOILER INSERTS AND STEAMER INSERTS,

AND COOKWARE AND KITCHEN WARE TOOLS, NAMELY, SLOTTED AND SOLID COOKING SPOONS, LADLES, SPATULAS, WHISKS, GRAVY, SAUCE AND GREASE SKIMMERS, TURNERS, TOOL CADDYS, TONGS, AND HANGING RACKS , IN CLASS 21 (U.S. CLS. 2, 13, 23, 29, 30, 33, 40 AND 50).

FIRST USE 9-0-2007; IN COMMERCE 9-0-2007.

OWNER OF U.S. REG. NOS. 2,222,428, 2,585,922, AND OTHERS.

SN 78-232,836, FILED 4-2-2003.

KELLEY WELLS, EXAMINING ATTORNEY

Int. Cl.: 9

Prior U.S. Cls.: 21, 23, 26, 36, and 38

United States Patent and Trademark Office

Reg. No. 3,486,118

Registered Aug. 12, 2008

**TRADEMARK
PRINCIPAL REGISTER**

SYMON ENTERPRISE SERVER

SYMON COMMUNICATIONS, INC. (TEXAS CORPORATION)
500 NORTH CENTRAL EXPRESSWAY, SUITE 175
PLANO, TX 75074

FOR: COMPUTER SOFTWARE THAT ALLOWS AN ORGANIZATION TO COLLECT INFORMATION AND DATA FROM OTHER APPLICATION SOURCES, TRANSFORM AND INTEGRATE INCOMPATIBLE APPLICATION INFORMATION AND DATA AND CREATE REAL-TIME AND HISTORICAL INFORMATION AND DATA THAT CAN BE COMMUNICATED TO OTHERS AND VIEWED IN DIFFERENT FORMATS AND VISUAL DISPLAYS; USER TRAINING MANUALS AND INSTALLATION GUIDES SOLD AS A UNIT

THEREWITH, IN CLASS 9 (U.S. CLS. 21, 23, 26, 36 AND 38).

FIRST USE 7-15-2004; IN COMMERCE 7-15-2004.

OWNER OF U.S. REG. NOS. 2,912,745, 2,918,295, AND 3,094,942.

NO CLAIM IS MADE TO THE EXCLUSIVE RIGHT TO USE "ENTERPRISE SERVER" , APART FROM THE MARK AS SHOWN.

SN 78-241,591, FILED 4-24-2003.

DORITT L. CARROLL, EXAMINING ATTORNEY

Int. Cl.: 35

Prior U.S. Cls.: 100, 101, and 102

United States Patent and Trademark Office

Reg. No. 3,486,119

Registered Aug. 12, 2008

**SERVICE MARK
PRINCIPAL REGISTER**



JAFER LIMITED (BERMUDA CORPORATION)
CLARENDON HOUSE
2 CHURCH STREET
HAMILTON, BERMUDA HM12

FOR: HOUSE MARK FOR USE IN CONNECTION
WITH ONLINE RETAIL STORE SERVICES IN THE
FIELD OF COSMETICS, MAKEUP, PERFUMES,
AND BEAUTY AND HYGIENIC CARE PRODUCTS
AND PROMOTING THE GOODS AND SERVICES
OF OTHERS THROUGH PRINTED PROMOTIONAL

MATERIALS, IN CLASS 35 (U.S. CLS. 100, 101 AND
102).

FIRST USE 7-31-2003; IN COMMERCE 4-30-2004.

THE MARK CONSISTS OF AN ORANGE
SQUARE WITH A RED SLASH.

SN 78-250,223, FILED 5-15-2003.

YONG KIM, EXAMINING ATTORNEY

Int. Cl.: 6

Prior U.S. Cls.: 2, 12, 13, 14, 23, 25, and 50

Reg. No. 3,486,120

United States Patent and Trademark Office

Registered Aug. 12, 2008

**TRADEMARK
PRINCIPAL REGISTER**

MAX A LOK

ANGLO OPERATIONS LIMITED (SOUTH AFRICA CORPORATION), TA SCAW METALS GROUP,
44 MAIN STREET
JOHANNESBURG, GAUTENG PROVINCE, SOUTH AFRICA

CHAINS, HOOKS AND COUPLINGS , IN CLASS 6
(U.S. CLS. 2, 12, 13, 14, 23, 25 AND 50).

FIRST USE 6-0-2005; IN COMMERCE 6-0-2005.

SN 78-250,467, FILED 5-15-2003.

FOR: METAL CHAINS, AND ACCESSORIES FOR LIFTING EQUIPMENT, NAMELY, METAL

HOWARD SMIGA, EXAMINING ATTORNEY

Int. Cl.: 5

Prior U.S. Cls.: 6, 18, 44, 46, 51, and 52

Reg. No. 3,486,121

United States Patent and Trademark Office

Registered Aug. 12, 2008

**TRADEMARK
PRINCIPAL REGISTER**

BETAVITE

APICAL PHARMACEUTICAL CORPORATION
(FLORIDA CORPORATION)
701 E. COMMERCIAL BLVD. SUITE 200
FT. LAUDERDALE, FL 33334

FIRST USE 2-2-2007; IN COMMERCE 2-2-2007.

SN 78-265,100, FILED 6-20-2003.

FOR: ELECTROLYTE NUTRITIONAL SUPPLEMENT FOR VETERINARY USE, IN CLASS 5 (U.S. CLS. 6, 18, 44, 46, 51 AND 52).

JASON BLAIR, EXAMINING ATTORNEY

Int. Cls.: 9 and 36

Prior U.S. Cls.: 21, 23, 26, 36, 38, 100, 101, and 102

United States Patent and Trademark Office

Reg. No. 3,486,122

Registered Aug. 12, 2008

**TRADEMARK
SERVICE MARK
PRINCIPAL REGISTER**

PPM

PREFERRED PHYSICIANS MEDICAL RISK RETENTION GROUP, INC. (MISSOURI CORPORATION)

9000 WEST 67TH STREET
SHAWNEE MISSION, KS 662023656

FOR: COMPUTER SOFTWARE PROGRAM FOR PHYSICIAN PRACTICE MANAGEMENT, NAMELY, BILLING, MANAGEMENT OF ACCOUNTS, TRACKING OF MANAGED CARE, GENERATING REPORTS AND SUMMARIES, GENERATING FOLLOW-UP LETTERS AND INVOICES, TRANSMISSION OF CLAIM INFORMATION, PRODUCTIVITY ANALYSIS, AND HISTORY AND DATA ARCHIVING, IN CLASS 9 (U.S. CLS. 21, 23, 26, 36 AND 38).

FIRST USE 5-9-2008; IN COMMERCE 5-9-2008.

FOR: INSURANCE UNDERWRITING IN THE FIELD OF PROFESSIONAL LIABILITY FOR ANESTHESIOLOGISTS, IN CLASS 36 (U.S. CLS. 100, 101 AND 102).

FIRST USE 0-0-2003; IN COMMERCE 10-0-2007.

SN 78-266,914, FILED 6-25-2003.

HOWARD B. LEVINE, EXAMINING ATTORNEY

Int. Cl.: 29

Prior U.S. Cl.: 46

United States Patent and Trademark Office

Reg. No. 3,486,123

Registered Aug. 12, 2008

**TRADEMARK
PRINCIPAL REGISTER**

BETAPOL

LIPID NUTRITION B.V. (NETHERLANDS CORPORATION)
HOGEWEG 1
1521 AZ WORMERVEER, NETHERLANDS

OWNER OF BENELUX REG. NO. 498498, DATED
10-15-1991, EXPIRES 10-15-2011.

FOR: EDIBLE OILS AND FATS, IN CLASS 29 (U.S.
CL. 46).

SN 78-312,339, FILED 10-10-2003.

FIRST USE 8-1-2003; IN COMMERCE 8-7-2003.

CAROLYN GRAY, EXAMINING ATTORNEY

Int. Cl.: 18

Prior U.S. Cls.: 1, 2, 3, 22, and 41

United States Patent and Trademark Office

Reg. No. 3,486,124

Registered Aug. 12, 2008

**TRADEMARK
PRINCIPAL REGISTER**

WALT DISNEY WORLD

DISNEY ENTERPRISES, INC. (DELAWARE CORPORATION)
500 SOUTH BUENA VISTA STREET
BURBANK, CA 91521

FOR: ATHLETIC BAGS, ALL-PURPOSE ATHLETIC BAGS, BOOK BAGS, DUFFEL BAGS, GYM BAGS, TEXTILE SHOPPING BAGS, IN CLASS 18 (U.S. CLS. 1, 2, 3, 22 AND 41).

FIRST USE 12-0-1991; IN COMMERCE 12-0-1991.

OWNER OF U.S. REG. NOS. 980,995, 1,189,727, AND 2,189,177.

THE NAME IN THE MARK DOES NOT IDENTIFY A PARTICULAR LIVING INDIVIDUAL.

SN 78-316,590, FILED 10-21-2003.

PAUL F. GAST, EXAMINING ATTORNEY

Int. Cls.: 9, 16, and 28

Prior U.S. Cls.: 2, 5, 21, 22, 23, 26, 29, 36, 37, 38, and 50

Reg. No. 3,486,125

United States Patent and Trademark Office

Registered Aug. 12, 2008

**TRADEMARK
PRINCIPAL REGISTER**

OMNIBOT

PMT CORPORATION (MINNESOTA CORPORATION)
1500 PARK ROAD
CHANHASSEN, MN 55317

FOR: ELECTRICAL AND SCIENTIFIC APPARATUS, NAMELY, DECORATIVE REFRIGERATOR MAGNETS; SUNGLASSES; COMPUTER SOFTWARE FEATURING MUSIC VIDEOS, INFORMATION TRIVIA GAMES AND ANIMATED STORIES FOR CHILDREN AND ADULTS; EDUCATIONAL SOFTWARE FEATURING INSTRUCTION IN MATH, READING AND SCIENCE; PRE-RECORDED AUDIO AND VIDEO CASSETTES, COMPACT DISCS, MOTION PICTURE FILMS, AND LASER VIDEO DISCS ALL FEATURING FAMILY MUSIC, STORIES, AND ENTERTAINMENT, IN CLASS 9 (U.S. CLS. 21, 23, 26, 36 AND 38).

FIRST USE 5-12-2008; IN COMMERCE 5-12-2008.

FOR: PAPER GOODS AND PRINTED MATTER, NAMELY, GENERAL-PURPOSE PAPER BAGS; GREETING CARDS; DESK ACCESSORIES, NAMELY, DESK PADS; CALENDARS, STATIONERY, GIFT WRAPPING PAPER; PAPER PARTY SUPPLIES, NAMELY, HATS, CUPS BOWLS, PARTY DECORATIONS, AND NAPKINS; STICKERS, ADDRESS BOOKS; AND BOOKS AND MAGAZINES

FEATURING STORIES, GAMES AND ACTIVITIES, IN CLASS 16 (U.S. CLS. 2, 5, 22, 23, 29, 37, 38 AND 50).

FIRST USE 5-12-2008; IN COMMERCE 5-12-2008.

FOR: TOYS AND SPORTING GOODS, NAMELY, PLUSH TOYS, COLLECTIBLE TOY FIGURES, ACTION FIGURES AND ACCESSORIES THEREFORE, CARD GAMES, BOARD GAMES, DOLLS, PUZZLES, GOLF BALLS, GOLF GLOVES, GOLF BALL MARKERS, TENNIS BALLS, BOWS AND ARROWS, AND BADMINTON SETS, BALLOONS, CHILDREN'S PLAY COSMETICS, KITES, SOFT SCULPTURE TOYS, STUFFED TOYS, WIND-UP TOYS AND PLAYING CARDS, IN CLASS 28 (U.S. CLS. 22, 23, 38 AND 50).

FIRST USE 5-12-2008; IN COMMERCE 5-12-2008.

THE MARK CONSISTS OF STANDARD CHARACTERS WITHOUT CLAIM TO ANY PARTICULAR FONT, STYLE, SIZE, OR COLOR.

OWNER OF U.S. REG. NO. 2,583,395.

SN 78-324,169, FILED 11-6-2003.

JEFF DEFORD, EXAMINING ATTORNEY

Int. Cl.: 9

Prior U.S. Cls.: 21, 23, 26, 36, and 38

Reg. No. 3,486,126

United States Patent and Trademark Office

Registered Aug. 12, 2008

**TRADEMARK
PRINCIPAL REGISTER**

FastPlay Bingo

MIAMI TRIBE OF OKLAHOMA BUSINESS DEVELOPMENT AUTHORITY (UNITED STATES FEDERALLY RECOGNIZED INDIAN TRIBE)
3410 P STREET NW
MIAMI, OK 74354

FOR: GAMING MACHINES, NAMELY, BINGO-RELATED GAMES AND SLOT MACHINES AND SOFTWARE THAT RUNS THEREON, IN CLASS 9 (U.S. CLS. 21, 23, 26, 36 AND 38).

FIRST USE 5-28-2008; IN COMMERCE 5-28-2008.

THE MARK CONSISTS OF STANDARD CHARACTERS WITHOUT CLAIM TO ANY PARTICULAR FONT, STYLE, SIZE, OR COLOR.

NO CLAIM IS MADE TO THE EXCLUSIVE RIGHT TO USE "BINGO", APART FROM THE MARK AS SHOWN.

SN 78-324,760, FILED 11-7-2003.

PATRICIA EVANKO, EXAMINING ATTORNEY

Int. Cls.: 5 and 42

Prior U.S. Cls.: 6, 18, 44, 46, 51, 52, 100, and 101

United States Patent and Trademark Office

Reg. No. 3,486,127

Registered Aug. 12, 2008

**TRADEMARK
SERVICE MARK
PRINCIPAL REGISTER**

NEOTROPIX

NEOTROPIX, INC. (DELAWARE CORPORATION)
7461 ROSEWOOD MANNER LANE
GAITHERSBURG, MD 20882

FOR: PHARMACEUTICAL AND BIOLOGICAL PREPARATIONS FOR USE IN THE TREATMENT OF CANCER, IN CLASS 5 (U.S. CLS. 6, 18, 44, 46, 51 AND 52).

FIRST USE 5-8-2006; IN COMMERCE 5-8-2006.

FOR: PHARMACEUTICAL AND BIOTECHNOLOGICAL RESEARCH AND DEVELOPMENT SERVICES, IN CLASS 42 (U.S. CLS. 100 AND 101).

FIRST USE 6-30-2004; IN COMMERCE 6-30-2004.

THE MARK CONSISTS OF STANDARD CHARACTERS WITHOUT CLAIM TO ANY PARTICULAR FONT, STYLE, SIZE, OR COLOR.

SN 78-327,103, FILED 11-12-2003.

WON TEAK OH, EXAMINING ATTORNEY

Int. Cl.: 40

Prior U.S. Cls.: 100, 103, and 106

United States Patent and Trademark Office

Reg. No. 3,486,128

Registered Aug. 12, 2008

**SERVICE MARK
PRINCIPAL REGISTER**

**ADVANCING FORMULAS
FOR LIFE**

CHEVRON PHILLIPS CHEMICAL COMPANY LP
(DELAWARE LIMITED PARTNERSHIP)
10001 SIX PINES DRIVE
THE WOODLANDS, TX 77380

FOR: CUSTOM MANUFACTURE OF POLYMER
AND RESIN-BASED PACKAGING FOR USE IN
OXYGEN SENSITIVE APPLICATIONS; CUSTOM
MANUFACTURE OF CHEMICALS AND CHEMI-
CAL FORMULATIONS, IN CLASS 40 (U.S. CLS. 100,
103 AND 106).

FIRST USE 12-1-2005; IN COMMERCE 12-1-2005.

THE MARK CONSISTS OF STANDARD CHAR-
ACTERS WITHOUT CLAIM TO ANY PARTICULAR
FONT, STYLE, SIZE, OR COLOR.

SN 78-330,379, FILED 11-19-2003.

BARNEY CHARLON, EXAMINING ATTORNEY

Int. Cls.: 9 and 41

Prior U.S. Cls.: 21, 23, 26, 36, 38, 100, 101, and 107

United States Patent and Trademark Office

Reg. No. 3,486,129

Registered Aug. 12, 2008

**TRADEMARK
SERVICE MARK
PRINCIPAL REGISTER**

Bridget

GRAF, BARBARA B. (UNITED STATES INDIVIDUAL)
740 RUSHVILLE STREET
LA JOLLA, CA 92037

FOR: COMPACT DISCS FEATURING MUSICAL RECORDINGS, IN CLASS 9 (U.S. CLS. 21, 23, 26, 36 AND 38).

FIRST USE 4-0-2004; IN COMMERCE 4-0-2004.

FOR: ENTERTAINMENT SERVICES, NAMELY, PROVIDING A WEB SITE FEATURING MUSICAL PERFORMANCES, MUSICAL VIDEOS, RELATED FILM CLIPS, PHOTOGRAPHS, AND OTHER MULTIMEDIA MATERIALS, IN CLASS 41 (U.S. CLS. 100, 101 AND 107).

FIRST USE 4-0-2004; IN COMMERCE 4-0-2004.

THE MARK CONSISTS OF STANDARD CHARACTERS WITHOUT CLAIM TO ANY PARTICULAR FONT, STYLE, SIZE, OR COLOR.

NO CLAIM IS MADE TO THE EXCLUSIVE RIGHT TO USE "BRIDGET", APART FROM THE MARK AS SHOWN.

SN 78-331,042, FILED 11-20-2003.

ROBERT C. CLARK JR., EXAMINING ATTORNEY

Int. Cl.: 25

Prior U.S. Cls.: 22 and 39

United States Patent and Trademark Office

Reg. No. 3,486,130

Registered Aug. 12, 2008

**TRADEMARK
PRINCIPAL REGISTER**

COR VERUS

GHAILIAN, CHARLIE (UNITED STATES INDIVIDUAL)
C/O OURFALIAN & OURFALIAN 205 E BROADWAY
GLENDALE, CA 91205

FOR: CLOTHING, NAMELY, JEANS, PANTS, SKIRTS, T-SHIRTS, DRESSES; CASUAL WEAR, NAMELY, PANTS, SHORT PANTS, SHIRTS AND SANDALS; SPORTSWEAR, NAMELY, SPORTS COATS, SPORTS SHIRTS AND POLO SHIRTS; DRESS WEAR, NAMELY, EVENING GOWNS; DRESSES FOR BOYS, GIRLS, JUNIORS, MEN, WOMEN, YOUNG MEN, YOUNG WOMEN; ACCES-

SORIES, NAMELY, TIES AND SCARVES; AND SHOES, IN CLASS 25 (U.S. CLS. 22 AND 39).

FIRST USE 12-1-2004; IN COMMERCE 12-1-2004.

THE MARK CONSISTS OF STANDARD CHARACTERS WITHOUT CLAIM TO ANY PARTICULAR FONT, STYLE, SIZE, OR COLOR.

SN 78-332,596, FILED 11-24-2003.

DOUGLAS LEE, EXAMINING ATTORNEY

Int. Cl.: 25

Prior U.S. Cls.: 22 and 39

United States Patent and Trademark Office

Reg. No. 3,486,131

Registered Aug. 12, 2008

**TRADEMARK
PRINCIPAL REGISTER**

**BEGIN....BY NIKI
TAYLOR**

BEGIN ENTERPRISES, INC. (DELAWARE COR-
PORATION)

15 EAST NORTH STREET

DOVER, DE 19901

FOR: CLOTHING, NAMELY, T-SHIRTS, IN
CLASS 25 (U.S. CLS. 22 AND 39).

FIRST USE 6-9-2006; IN COMMERCE 6-9-2006.

THE MARK CONSISTS OF STANDARD CHAR-
ACTERS WITHOUT CLAIM TO ANY PARTICULAR
FONT, STYLE, SIZE, OR COLOR.

THE NAME "NICOLE TAYLOR" A.K.A. "NIKI
TAYLOR" IDENTIFIES A LIVING INDIVIDUAL
WHOSE CONSENT IS OF RECORD.

SN 78-343,328, FILED 12-19-2003.

JOHN HWANG, EXAMINING ATTORNEY

Int. Cl.: 35

Prior U.S. Cls.: 100, 101, and 102

United States Patent and Trademark Office

Reg. No. 3,486,132

Registered Aug. 12, 2008

**SERVICE MARK
PRINCIPAL REGISTER**



FOSSIL, INC. (DELAWARE CORPORATION)
2280 N. GREENVILLE AVENUE
RICHARDSON, TX 75082

FOR: ONLINE RETAIL STORE SERVICES FEATURING SUNGLASSES AND WATCHES, IN CLASS 35 (U.S. CLS. 100, 101 AND 102).

FIRST USE 9-0-2006; IN COMMERCE 9-0-2006.

OWNER OF U.S. REG. NOS. 2,129,527, 2,129,528, AND 2,715,932.

THE COLOR(S) RED AND WHITE IS/ARE CLAIMED AS A FEATURE OF THE MARK.

THE MARK CONSISTS OF A RED CIRCLE AND IN THE INSIDE OF THE CIRCLE IS THE LETTER "M" AND BELOW THE LETTER "M" IS THE LETTER "W", BOTH LETTERS BEING IN WHITE.

SN 78-343,571, FILED 12-19-2003.

KATHLEEN M. VANSTON, EXAMINING ATTORNEY

Int. Cl.: 28

Prior U.S. Cls.: 22, 23, 38, and 50

United States Patent and Trademark Office

Reg. No. 3,486,133

Registered Aug. 12, 2008

**TRADEMARK
PRINCIPAL REGISTER**

Normal, Texas

HUMAN HEAD STUDIOS, INC. (WISCONSIN CORPORATION)
1741 COMMERCIAL AVENUE, SUITE 200
MADISON, WI 53704

FOR: EQUIPMENT NAMELY, RULES OF PLAY, BACKGROUND INFORMATION, QUESTION AND ANSWER CARDS, CARD BOXES AND SCORING SHEETS, SOLD AS A UNIT FOR PLAYING A PENCIL AND PAPER FANTASY GAME, IN CLASS 28 (U.S. CLS. 22, 23, 38 AND 50).

FIRST USE 1-1-2005; IN COMMERCE 1-1-2005.

THE MARK CONSISTS OF STANDARD CHARACTERS WITHOUT CLAIM TO ANY PARTICULAR FONT, STYLE, SIZE, OR COLOR.

NO CLAIM IS MADE TO THE EXCLUSIVE RIGHT TO USE "TEXAS", APART FROM THE MARK AS SHOWN.

SN 78-343,659, FILED 12-19-2003.

ELLEN PERKINS, EXAMINING ATTORNEY

Int. Cl.: 16

Prior U.S. Cls.: 2, 5, 22, 23, 29, 37, 38, and 50

United States Patent and Trademark Office

Reg. No. 3,486,134

Registered Aug. 12, 2008

**TRADEMARK
PRINCIPAL REGISTER**

POPTOOS

SAMARIA, LANCE (UNITED STATES INDIVIDUAL)
150 WEST 225 ST., APT. # 25G
BRONX, NY 10463

FOR: ADHESIVE TEMPORARY TATTOOS THAT ARE USED TO PROMOTE THE MARKETABILITY OF FAMOUS POP STARS AND POP ACTS FROM THE MUSIC INDUSTRY , IN CLASS 16 (U.S. CLS. 2, 5, 22, 23, 29, 37, 38 AND 50).

FIRST USE 1-1-2004; IN COMMERCE 6-14-2004.

THE MARK CONSISTS OF STANDARD CHARACTERS WITHOUT CLAIM TO ANY PARTICULAR FONT, STYLE, SIZE, OR COLOR.

SN 78-347,237, FILED 1-1-2004.

KATHY DE JONGE, EXAMINING ATTORNEY

Int. Cl.: 16

Prior U.S. Cls.: 2, 5, 22, 23, 29, 37, 38, and 50

United States Patent and Trademark Office

Reg. No. 3,486,135

Registered Aug. 12, 2008

**TRADEMARK
PRINCIPAL REGISTER**

SPORTTOOS

SAMARIA, LANCE (UNITED STATES INDIVIDUAL)
150 WEST 225 ST., APT. #25G
BRONX, NY 10463

FOR: ADHESIVE TEMPORARY TATTOOS THAT ARE USED TO PROMOTE AND HELP ENHANCE THE MARKETABILITY OF FAMOUS ATHLETES AND OTHER FIGURES INSIDE THE SPORTS WORLD, IN CLASS 16 (U.S. CLS. 2, 5, 22, 23, 29, 37, 38 AND 50).

FIRST USE 1-1-2004; IN COMMERCE 6-14-2004.

THE MARK CONSISTS OF STANDARD CHARACTERS WITHOUT CLAIM TO ANY PARTICULAR FONT, STYLE, SIZE, OR COLOR.

SN 78-347,240, FILED 1-1-2004.

KATHY DE JONGE, EXAMINING ATTORNEY

Int. Cls.: 20 and 24

Prior U.S. Cls.: 2, 13, 22, 25, 32, 42, and 50

United States Patent and Trademark Office

Reg. No. 3,486,136

Registered Aug. 12, 2008

**TRADEMARK
PRINCIPAL REGISTER**

COVET

COVET, INC. (MICHIGAN CORPORATION)
3850 29TH STREET, S.E.
GRAND RAPIDS, MI 49512

FOR: PILLOWS, IN CLASS 20 (U.S. CLS. 2, 13, 22,
25, 32 AND 50).

FIRST USE 8-7-2002; IN COMMERCE 8-7-2002.

FOR: BEDDING AND BED COVERINGS, NAME-
LY, DUVETS, PILLOW SHAMS, AND BED SKIRTS;
AND FABRICS FOR UPHOLSTERY, CURTAINS,

DRAPERIES, BEDDING, AND BED COVERINGS, IN
CLASS 24 (U.S. CLS. 42 AND 50).

FIRST USE 3-6-2003; IN COMMERCE 3-6-2003.

THE MARK CONSISTS OF STANDARD CHAR-
ACTERS WITHOUT CLAIM TO ANY PARTICULAR
FONT, STYLE, SIZE, OR COLOR.

SN 78-355,801, FILED 1-22-2004.

MICHAEL ENGEL, EXAMINING ATTORNEY

Int. Cl.: 1

Prior U.S. Cls.: 1, 5, 6, 10, 26, and 46

Reg. No. 3,486,137

United States Patent and Trademark Office

Registered Aug. 12, 2008

**TRADEMARK
PRINCIPAL REGISTER**

LIQUIBOR

U.S. BORAX INC. (DELAWARE CORPORATION)
8051 E. MAPLEWOOD AVE., BLDG. 4
ATT. MANAGER, INTELLECTUAL PROPERTY
GREENWOOD VILLAGE, CO 80111

FIRST USE 4-25-2008; IN COMMERCE 4-25-2008.

THE MARK CONSISTS OF STANDARD CHARACTERS WITHOUT CLAIM TO ANY PARTICULAR FONT, STYLE, SIZE, OR COLOR.

FOR: BORON COMPOSITIONS FOR GENERAL INDUSTRIAL USE; FIRE RETARDANT CHEMICALS FOR GENERAL INDUSTRIAL USE; CHEMICALS FOR USE IN THE TREATMENT OF PAPER AND CELLULOSE-BASED PRODUCTS, IN CLASS 1 (U.S. CLS. 1, 5, 6, 10, 26 AND 46).

SN 78-356,947, FILED 1-23-2004.

ZACHARY BELLO, EXAMINING ATTORNEY

Int. Cls.: 25 and 28

Prior U.S. Cls.: 22, 23, 38, 39, and 50

United States Patent and Trademark Office

Reg. No. 3,486,138

Registered Aug. 12, 2008

**TRADEMARK
PRINCIPAL REGISTER**

**JACK LONDON
SURFBOARDS**

HENDERSON, KIM W (UNITED STATES INDIVIDUAL)
1513 LYNN COURT
SANTA ROSA, CA 95405

FOR: CLOTHING, NAMELY, FOOTWEAR, BEACHWEAR, SWIMWEAR, SHIRTS, T-SHIRTS, JACKETS, SHORTS, SWEAT PANTS, TROUSERS, TANK TOPS, SWEAT SHIRTS AND UNDERWEAR; HEADGEAR, NAMELY, CAPS AND HATS, IN CLASS 25 (U.S. CLS. 22 AND 39).

FIRST USE 8-24-2004; IN COMMERCE 9-27-2007.

FOR: SURFBOARDS, IN CLASS 28 (U.S. CLS. 22, 23, 38 AND 50).

FIRST USE 8-24-2004; IN COMMERCE 9-27-2007.

THE MARK CONSISTS OF STANDARD CHARACTERS WITHOUT CLAIM TO ANY PARTICULAR FONT, STYLE, SIZE, OR COLOR.

NO CLAIM IS MADE TO THE EXCLUSIVE RIGHT TO USE "SURFBOARDS", APART FROM THE MARK AS SHOWN.

THE NAME "JACK LONDON" DOES NOT IDENTIFY A PARTICULAR LIVING INDIVIDUAL.

SN 78-362,310, FILED 2-4-2004.

DAVID MURRAY, EXAMINING ATTORNEY

Int. Cls.: 9 and 16

Prior U.S. Cls.: 2, 5, 21, 22, 23, 26, 29, 36, 37, 38, and 50

Reg. No. 3,486,139

United States Patent and Trademark Office

Registered Aug. 12, 2008

TRADEMARK
PRINCIPAL REGISTER



EVEREST, MARK A. (UNITED STATES INDIVIDUAL)
4309 LINGLESTOWN ROAD
HARRISBURG, PA 17112

FOR: PRERECORDED AUDIO TAPES, COMPACT DISCS AND PRERECORDED VIDEO TAPES FEATURING PERSONAL IMPROVEMENT, EXERCISE PROGRAMS AND NUTRITION ADVICE, IN CLASS 9 (U.S. CLS. 21, 23, 26, 36 AND 38).

FIRST USE 6-25-2003; IN COMMERCE 6-25-2003.

FOR: PRINTED PUBLICATIONS AND MATERIALS, NAMELY, BOOKS, MAGAZINES, PAMPHLETS, BROCHURES, BULLETINS, NEWSLETTERS, CALENDARS, WORKBOOKS, RECIPE CARDS AND FOOD CHARTS, ALL IN THE FIELDS OF HEALTH, NUTRITION, WEIGHT LOSS, WEIGHT CONTROL,

COOKING, RECIPES AND SELF-IMPROVEMENT THROUGH THE ADOPTION OF HEALTHY LIFESTYLES, IN CLASS 16 (U.S. CLS. 2, 5, 22, 23, 29, 37, 38 AND 50).

FIRST USE 6-25-2003; IN COMMERCE 6-25-2003.

NO CLAIM IS MADE TO THE EXCLUSIVE RIGHT TO USE "ATHLETICS", APART FROM THE MARK AS SHOWN.

THE MARK CONSISTS OF STYLIZED HUMAN FIGURE CARRYING OBJECT STEPPING INTO THE LETTER "O" OF THE WORD "OCCUPATIONAL".

SN 78-365,422, FILED 2-10-2004.

YONG KIM, EXAMINING ATTORNEY

Int. Cl.: 5

Prior U.S. Cls.: 6, 18, 44, 46, 51, and 52

Reg. No. 3,486,140

United States Patent and Trademark Office

Registered Aug. 12, 2008

**TRADEMARK
PRINCIPAL REGISTER**

THERACYSYSTEM

SANOFI PASTEUR LIMITED/SANOFI PASTEUR
LIMITEE (CANADA CORPORATION)
1755 STEELES AVENUE WEST
TORONTO, ONTARIO, CANADA M2R 3T4

FOR: DELIVERY SYSTEM COMPRISED PRI-
MARILY OF AN IMMUNOTHERAPEUTIC AGENT,
A DILUENT, A VEHICLE, A VIAL-VENTING DE-
VICE AND INSTILLATION SPIKE, IN CLASS 5 (U.S.
CLS. 6, 18, 44, 46, 51 AND 52).

FIRST USE 4-0-2004; IN COMMERCE 4-0-2004.

THE MARK CONSISTS OF STANDARD CHAR-
ACTERS WITHOUT CLAIM TO ANY PARTICULAR
FONT, STYLE, SIZE, OR COLOR.

OWNER OF U.S. REG. NO. 1,692,357.

SN 78-373,761, FILED 2-25-2004.

JOHN DALIER, EXAMINING ATTORNEY

Int. Cl.: 33

Prior U.S. Cls.: 47 and 49

United States Patent and Trademark Office

Reg. No. 3,486,141

Registered Aug. 12, 2008

**TRADEMARK
PRINCIPAL REGISTER**

PLONK

WILSON, MICHAEL F. (UNITED STATES INDIVIDUAL)
786 N 15TH AVE
BOZEMAN, MT 59715

THE MARK CONSISTS OF STANDARD CHARACTERS WITHOUT CLAIM TO ANY PARTICULAR FONT, STYLE, SIZE, OR COLOR.

FOR: WINE, IN CLASS 33 (U.S. CLS. 47 AND 49).

SN 78-379,862, FILED 3-6-2004.

FIRST USE 6-10-2008; IN COMMERCE 6-10-2008.

ANDREA BUTLER, EXAMINING ATTORNEY

Int. Cl.: 9

Prior U.S. Cls.: 21, 23, 26, 36, and 38

United States Patent and Trademark Office

Reg. No. 3,486,142

Registered Aug. 12, 2008

**TRADEMARK
PRINCIPAL REGISTER**

capturEye

FIL, DUSAN (CANADA INDIVIDUAL)
50 WICKSTEAD CRT.
BRAMPTON, CANADA L6R 1N8

FOR: SET OF DIGITAL ELECTRONIC VIDEO/
AUDIO RECORDING PRODUCTS/SYSTEMS,
NAMELY, SMALL COMPUTER-CONTROLLED
PORTABLE DIGITAL VIDEO CAMERAS USED IN
MOBILE APPLICATIONS, IN CLASS 9 (U.S. CLS. 21,
23, 26, 36 AND 38).

FIRST USE 3-17-2008; IN COMMERCE 5-27-2008.

THE MARK CONSISTS OF STANDARD CHAR-
ACTERS WITHOUT CLAIM TO ANY PARTICULAR
FONT, STYLE, SIZE, OR COLOR.

SN 78-379,876, FILED 3-7-2004.

TERESA M. RUPP, EXAMINING ATTORNEY

Int. Cl.: 25

Prior U.S. Cls.: 22 and 39

United States Patent and Trademark Office

Reg. No. 3,486,143

Registered Aug. 12, 2008

**TRADEMARK
PRINCIPAL REGISTER**

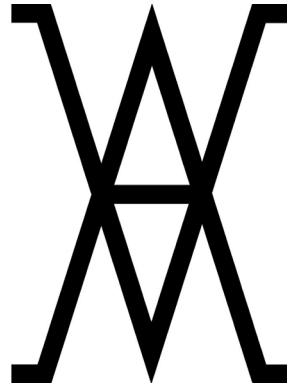

ALINA GROUP, INC. (TEXAS CORPORATION)
3333 RAUCH STREET
HOUSTON, TX 77029

THE MARK CONSISTS OF TWO INTERLOCK-
ING "A'S".

FOR: BELTS FOR CLOTHING, SCARVES, IN
CLASS 25 (U.S. CLS. 22 AND 39).

SN 78-381,791, FILED 3-10-2004.

FIRST USE 6-9-2008; IN COMMERCE 6-9-2008.

BRENDAN REGAN, EXAMINING ATTORNEY

Int. Cl.: 25

Prior U.S. Cls.: 22 and 39

United States Patent and Trademark Office

Reg. No. 3,486,144

Registered Aug. 12, 2008

**TRADEMARK
PRINCIPAL REGISTER**

ALINA

ALINA GROUP, INC. (TEXAS CORPORATION)
3333 RAUCH STREET
HOUSTON, TX 77029

THE MARK CONSISTS OF STANDARD CHAR-
ACTERS WITHOUT CLAIM TO ANY PARTICULAR
FONT, STYLE, SIZE, OR COLOR.

FOR: SCARVES, IN CLASS 25 (U.S. CLS. 22 AND
39).

SN 78-381,803, FILED 3-10-2004.

FIRST USE 6-9-2008; IN COMMERCE 6-9-2008.

BRENDAN REGAN, EXAMINING ATTORNEY

Int. Cl.: 35

Prior U.S. Cls.: 100, 101, and 102

United States Patent and Trademark Office

Reg. No. 3,486,145

Registered Aug. 12, 2008

**SERVICE MARK
PRINCIPAL REGISTER**

EARTHVISA

EARTHVISA LLC (DELAWARE LTD LIAB CO)
SUITE 1600
888 SW FIFTH AVENUE
PORTLAND, OR 97204

FOR: PROVIDING ONLINE INFORMATION IN
THE FIELD OF EMPLOYMENT, IN CLASS 35 (U.S.
CLS. 100, 101 AND 102).

FIRST USE 3-29-2008; IN COMMERCE 3-29-2008.

THE MARK CONSISTS OF STANDARD CHAR-
ACTERS WITHOUT CLAIM TO ANY PARTICULAR
FONT, STYLE, SIZE, OR COLOR.

NO CLAIM IS MADE TO THE EXCLUSIVE
RIGHT TO USE "VISA", APART FROM THE MARK
AS SHOWN.

SN 78-390,256, FILED 3-24-2004.

MIDGE BUTLER, EXAMINING ATTORNEY

Int. Cl.: 19

Prior U.S. Cls.: 1, 12, 33, and 50

United States Patent and Trademark Office

Reg. No. 3,486,146

Registered Aug. 12, 2008

**TRADEMARK
PRINCIPAL REGISTER**

SOILLOCK

PAVE TECH, INC. (MINNESOTA CORPORATION)
PO BOX 576
15354 FLAG AVENUE SOUTH
PRIOR LAKE, MN 55372

FOR: MATERIALS, NAMELY PSYLLIUM POWDER, WHICH PROVIDE A BINDING AGENT FOR SOILS AND EARTH-LIKE MATERIALS, IN CLASS 19 (U.S. CLS. 1, 12, 33 AND 50).

FIRST USE 5-9-2008; IN COMMERCE 5-9-2008.

THE MARK CONSISTS OF STANDARD CHARACTERS WITHOUT CLAIM TO ANY PARTICULAR FONT, STYLE, SIZE, OR COLOR.

SN 78-393,823, FILED 3-31-2004.

JOHN DALIER, EXAMINING ATTORNEY

Int. Cl.: 19

Prior U.S. Cls.: 1, 12, 33, and 50

United States Patent and Trademark Office

Reg. No. 3,486,147

Registered Aug. 12, 2008

**TRADEMARK
PRINCIPAL REGISTER**

ROCKLOCK

PAVE TECH, INC. (MINNESOTA CORPORATION)
PO BOX 576
15354 FLAG AVENUE SOUTH
PRIOR LAKE, MN 55372

FOR: MATERIALS, NAMELY, PSYLLIUM POWDER, WHICH PROVIDE A BINDING AGENT FOR GRAVEL AND/OR AGGREGATE-LIKE MATERIALS, IN CLASS 19 (U.S. CLS. 1, 12, 33 AND 50).

FIRST USE 5-9-2008; IN COMMERCE 5-9-2008.

THE MARK CONSISTS OF STANDARD CHARACTERS WITHOUT CLAIM TO ANY PARTICULAR FONT, STYLE, SIZE, OR COLOR.

SN 78-393,853, FILED 3-31-2004.

JOHN DALIER, EXAMINING ATTORNEY

Int. Cl.: 25

Prior U.S. Cls.: 22 and 39

United States Patent and Trademark Office

Reg. No. 3,486,148

Registered Aug. 12, 2008

**TRADEMARK
PRINCIPAL REGISTER**

Heaven Can Wait

WATT, TAMARA (UNITED STATES INDIVIDUAL)
2101 LEEWARD LANE
NEWPORT BEACH, CA 92660

FOR: CLOTHING, NAMELY, BASEBALL HATS, CAPS, SHIRTS, T-SHIRTS, SWEATSHIRTS AND JACKETS, IN CLASS 25 (U.S. CLS. 22 AND 39).

FIRST USE 8-11-2004; IN COMMERCE 6-14-2008.

THE MARK CONSISTS OF STANDARD CHARACTERS WITHOUT CLAIM TO ANY PARTICULAR FONT, STYLE, SIZE, OR COLOR.

SN 78-396,295, FILED 4-5-2004.

MICHAEL KEATING, EXAMINING ATTORNEY

Int. Cls.: 9, 12, and 25

Prior U.S. Cls.: 19, 21, 22, 23, 26, 31, 35, 36, 38, 39, and 44

Reg. No. 3,486,149

United States Patent and Trademark Office

Registered Aug. 12, 2008

**TRADEMARK
PRINCIPAL REGISTER**



LIFE STYLE METAL CO., LTD. (TAIWAN CORPORATION)
9F-A, NO.681, SEC.2, CHUNG SHAN RD.
CHANGHUA, TAIWAN

FOR: ALL-TERRAIN VEHICLE RIDER SAFETY AND PROTECTIVE CLOTHING AND EQUIPMENT, NAMELY, EYEGASSES, GOGGLES, HELMETS, BODY ARMORS, BODY PROTECTORS, SUITS, PROTECTIVE FACE MASKS, GLOVES, IN CLASS 9 (U.S. CLS. 21, 23, 26, 36 AND 38).

FIRST USE 3-29-2004; IN COMMERCE 2-0-2007.

FOR: ALL-TERRAIN VEHICLES AND STRUCTURAL PARTS THEREOF, MOTORCYCLES AND STRUCTURAL PARTS THEREOF, IN CLASS 12 (U.S. CLS. 19, 21, 23, 31, 35 AND 44).

FIRST USE 3-29-2004; IN COMMERCE 2-0-2007.

FOR: CLOTHING, NAMELY, JERSEYS, COATS, EAR MUFFS, JACKETS, GLOVES, HATS, JEANS, PANTS, RAINWEAR, SHIRTS, SHORTS, SOCKS,

SPORT COATS, SPORT SHIRTS, SUITS, BELTS, VESTS, SHOES, BOOTS, IN CLASS 25 (U.S. CLS. 22 AND 39).

FIRST USE 3-29-2004; IN COMMERCE 2-0-2007.

NO CLAIM IS MADE TO THE EXCLUSIVE RIGHT TO USE "MX", APART FROM THE MARK AS SHOWN.

THE COLOR(S) RED IS/ARE CLAIMED AS A FEATURE OF THE MARK.

THE MARK CONSISTS OF A RED WOLF-LIKE ANIMAL WITH THE STYLIZED WORDING "MX FORCE" WRITTEN BENEATH IT.

SN 78-398,132, FILED 4-7-2004.

WON TEAK OH, EXAMINING ATTORNEY

Int. Cl.: 15

Prior U.S. Cls.: 2, 21, and 36

United States Patent and Trademark Office

Reg. No. 3,486,150

Registered Aug. 12, 2008

**TRADEMARK
PRINCIPAL REGISTER**

ROCKINGHAM

PEAVEY ELECTRONICS CORPORATION (DELA-
WARE CORPORATION)
ATTN: LEGAL DEPT.
5022 HARTLEY PEAVEY DRIVE
MERIDIAN, MS 39305

THE MARK CONSISTS OF STANDARD CHAR-
ACTERS WITHOUT CLAIM TO ANY PARTICULAR
FONT, STYLE, SIZE, OR COLOR.

FOR: STRINGED MUSICAL INSTRUMENTS,
NAMELY, GUITARS, IN CLASS 15 (U.S. CLS. 2, 21
AND 36).

SN 78-399,592, FILED 4-9-2004.

FIRST USE 3-18-2004; IN COMMERCE 4-2-2008.

BRIAN PINO, EXAMINING ATTORNEY

Int. Cls.: 9 and 38

Prior U.S. Cls.: 21, 23, 26, 36, 38, 100, 101, and 104

United States Patent and Trademark Office

Reg. No. 3,486,151

Registered Aug. 12, 2008

**TRADEMARK
SERVICE MARK
PRINCIPAL REGISTER**

MEETINGPLACE

CISCO TECHNOLOGY, INC. (CALIFORNIA CORPORATION)
170 WEST TASMAN DRIVE
SAN JOSE, CA 95134

FOR: COMPUTER HARDWARE AND SOFTWARE FOR USE IN VOICE, VIDEO, AND WEB CONFERENCING; COMPUTER HARDWARE AND SOFTWARE FOR USE IN PROVIDING REAL-TIME, MULTIMEDIA, MULTIPARTY COMMUNICATIONS OVER COMPUTER NETWORKS; VOICE AND CALL PROCESSING SYSTEMS COMPRISED OF TELECOMMUNICATIONS AND COMPUTER HARDWARE AND SOFTWARE USED FOR CALL PROCESSING; VIDEO CONFERENCE SYSTEMS COMPRISED OF TELECOMMUNICATIONS AND COMPUTER HARDWARE AND SOFTWARE USED IN VIDEO CONFERENCING; COMPUTER HARDWARE AND SOFTWARE FOR USE IN DOCUMENT COLLABORATION, NAMELY, FOR PROVIDING REAL-TIME, MULTIPARTY ACCESS TO THE SAME DOCUMENTS; COMPUTER HARDWARE AND

SOFTWARE FOR USE IN ELECTRONIC MESSAGING, IN CLASS 9 (U.S. CLS. 21, 23, 26, 36 AND 38).

FIRST USE 8-1-1994; IN COMMERCE 9-1-1994.

FOR: PROVIDING TELEPHONE CONFERENCING SERVICES; PROVIDING TELECOMMUNICATIONS SERVICES, NAMELY, WEB CONFERENCING SERVICES, IN CLASS 38 (U.S. CLS. 100, 101 AND 104).

FIRST USE 1-0-2002; IN COMMERCE 1-0-2002.

THE MARK CONSISTS OF STANDARD CHARACTERS WITHOUT CLAIM TO ANY PARTICULAR FONT, STYLE, SIZE, OR COLOR.

SN 78-405,252, FILED 4-20-2004.

WENDY GOODMAN, EXAMINING ATTORNEY

Int. Cl.: 4

Prior U.S. Cls.: 1, 6, and 15

United States Patent and Trademark Office

Reg. No. 3,486,152

Registered Aug. 12, 2008

**TRADEMARK
PRINCIPAL REGISTER**

MANDLE CANDLE

JOSEPH ENTERPRISES, INC. (CALIFORNIA CORPORATION)

425 CALIFORNIA STREET, SUITE 300

SAN FRANCISCO, CA 94104

FOR: CANDLES, IN CLASS 4 (U.S. CLS. 1, 6 AND 15).

FIRST USE 11-15-2007; IN COMMERCE 5-15-2008.

THE MARK CONSISTS OF STANDARD CHARACTERS WITHOUT CLAIM TO ANY PARTICULAR FONT, STYLE, SIZE, OR COLOR.

NO CLAIM IS MADE TO THE EXCLUSIVE RIGHT TO USE "CANDLE", APART FROM THE MARK AS SHOWN.

SN 78-413,747, FILED 5-5-2004.

JOHN DALIER, EXAMINING ATTORNEY

Int. Cl.: 3

Prior U.S. Cls.: 1, 4, 6, 50, 51, and 52

Reg. No. 3,486,153

United States Patent and Trademark Office

Registered Aug. 12, 2008

**TRADEMARK
PRINCIPAL REGISTER**

SONICSCRUBBER

PN, LLC (COLORADO LTD LIAB CO)
1220 W JACK D DRIVE, SUITE 4
LAYTON, UT 84041

THE MARK CONSISTS OF STANDARD CHAR-
ACTERS WITHOUT CLAIM TO ANY PARTICULAR
FONT, STYLE, SIZE, OR COLOR.

FOR: ALL PURPOSE CLEANING PREPARA-
TIONS, IN CLASS 3 (U.S. CLS. 1, 4, 6, 50, 51 AND 52).

SN 78-415,286, FILED 5-7-2004.

FIRST USE 6-27-2008; IN COMMERCE 6-27-2008.

RICHARD A. STRASER, EXAMINING ATTORNEY

Int. Cl.: 3

Prior U.S. Cls.: 1, 4, 6, 50, 51, and 52

Reg. No. 3,486,154

United States Patent and Trademark Office

Registered Aug. 12, 2008

**TRADEMARK
PRINCIPAL REGISTER**

**SONICSCRUBBER
GELPASTE**

PN, LLC (COLORADO LTD LIAB CO)
1220 W JACK D DRIVE, SUITE 4
LAYTON, UT 84041

FOR: ALL PURPOSE CLEANING PREPARA-
TIONS, IN CLASS 3 (U.S. CLS. 1, 4, 6, 50, 51 AND 52).

FIRST USE 6-27-2008; IN COMMERCE 6-27-2008.

THE MARK CONSISTS OF STANDARD CHAR-
ACTERS WITHOUT CLAIM TO ANY PARTICULAR
FONT, STYLE, SIZE, OR COLOR.

NO CLAIM IS MADE TO THE EXCLUSIVE
RIGHT TO USE "GELPASTE", APART FROM THE
MARK AS SHOWN.

SN 78-415,296, FILED 5-7-2004.

RICHARD A. STRASER, EXAMINING ATTORNEY

Int. Cl.: 35

Prior U.S. Cls.: 100, 101, and 102

United States Patent and Trademark Office

Reg. No. 3,486,155

Registered Aug. 12, 2008

**SERVICE MARK
PRINCIPAL REGISTER**

PRESS HERE

PRESS HERE INC. (NEW YORK CORPORATION)
9111 SUNSET BLVD., ATTN: K. PALS
LOS ANGELES, CA 90069

FOR: PUBLIC RELATIONS SERVICES, MARKET
RESEARCH SERVICES, MARKET ANALYSIS SER-
VICES, IN CLASS 35 (U.S. CLS. 100, 101 AND 102).

FIRST USE 2-16-2004; IN COMMERCE 3-7-2004.

THE MARK CONSISTS OF STANDARD CHAR-
ACTERS WITHOUT CLAIM TO ANY PARTICULAR
FONT, STYLE, SIZE, OR COLOR.

SN 78-418,472, FILED 5-13-2004.

WENDY GOODMAN, EXAMINING ATTORNEY

Int. Cl.: 33

Prior U.S. Cls.: 47 and 49

United States Patent and Trademark Office

Reg. No. 3,486,156

Registered Aug. 12, 2008

**TRADEMARK
PRINCIPAL REGISTER**

CLOS DES ANDES

POESIA S.A. (ARGENTINA SOCIEDAD ANONIMA)
ESPEJO ESTE 1591 RUSSELL (5517) MAIPU
MENDOZA, ARGENTINA

FOR: WINES, IN CLASS 33 (U.S. CLS. 47 AND 49).

FIRST USE 10-31-2004; IN COMMERCE 11-8-2004.

THE MARK CONSISTS OF STANDARD CHARACTERS WITHOUT CLAIM TO ANY PARTICULAR FONT, STYLE, SIZE, OR COLOR.

NO CLAIM IS MADE TO THE EXCLUSIVE RIGHT TO USE "CLOS", APART FROM THE MARK AS SHOWN.

THE ENGLISH TRANSLATION OF THE WORD "CLOS DES ANDES" IN THE MARK IS "ENCLOSED VINEYARD OF THE ANDES".

SN 78-422,869, FILED 5-21-2004.

JOHN HWANG, EXAMINING ATTORNEY

Int. Cl.: 6

Prior U.S. Cls.: 2, 12, 13, 14, 23, 25, and 50

United States Patent and Trademark Office

Reg. No. 3,486,157

Registered Aug. 12, 2008

**TRADEMARK
PRINCIPAL REGISTER**

GATEHOUSE

LF, LLC (DELAWARE LTD LIAB CO)
2601 ANNAND DRIVE, SUITE 17
WILMINGTON, DE 19808

THE MARK CONSISTS OF STANDARD CHAR-
ACTERS WITHOUT CLAIM TO ANY PARTICULAR
FONT, STYLE, SIZE, OR COLOR.

FOR: METAL HOUSE NUMBERS, IN CLASS 6
(U.S. CLS. 2, 12, 13, 14, 23, 25 AND 50).

SN 78-427,797, FILED 6-1-2004.

FIRST USE 12-0-2004; IN COMMERCE 12-0-2004.

ZACHARY BELLO, EXAMINING ATTORNEY

Int. Cl.: 33

Prior U.S. Cls.: 47 and 49

United States Patent and Trademark Office

Reg. No. 3,486,158

Registered Aug. 12, 2008

**TRADEMARK
PRINCIPAL REGISTER**

**CHATEAU DES
KARANTES S/MER**

SCEA DOMAINE DES KARANTES (FRANCE
COMPANY)
KARANTES LE HAUT
NARBONNE PLAGE, FRANCE 11100

FOR: WINES, IN CLASS 33 (U.S. CLS. 47 AND 49).

FIRST USE 8-16-2004; IN COMMERCE 8-16-2004.

THE MARK CONSISTS OF STANDARD CHAR-
ACTERS WITHOUT CLAIM TO ANY PARTICULAR
FONT, STYLE, SIZE, OR COLOR.

NO CLAIM IS MADE TO THE EXCLUSIVE
RIGHT TO USE "CHATEAU", APART FROM THE
MARK AS SHOWN.

SN 78-429,329, FILED 6-3-2004.

PATRICIA EVANKO, EXAMINING ATTORNEY

Int. Cls.: 11 and 22

Prior U.S. Cls.: 1, 2, 7, 13, 19, 21, 22, 23, 31, 34, 42, and 50

Reg. No. 3,486,159

United States Patent and Trademark Office

Registered Aug. 12, 2008

**TRADEMARK
PRINCIPAL REGISTER**



HAPPICH FAHRZEUG-UND INDUSTRIETEILE
GMBH (FED REP GERMANY CORPORATION)
KONSUMSTRAFFE-45
WUPPERTAL, FED REP GERMANY 42285

FOR: READING LIGHT INSERTS, NAMELY,
VEHICLE INTERIOR LIGHTS, IN CLASS 11 (U.S.
CLS. 13, 21, 23, 31 AND 34).

FIRST USE 7-3-2003; IN COMMERCE 7-3-2003.

FOR: SEAT NETS FOR VEHICLES AND OTHER
INSTALLATIONS, NETTINGS FOR USE IN VEHI-

CLES AND IN DOMESTIC AND INDUSTRIAL
INSTALLATIONS, IN CLASS 22 (U.S. CLS. 1, 2, 7, 19,
22, 42 AND 50).

FIRST USE 7-3-2003; IN COMMERCE 7-3-2003.

OWNER OF U.S. REG. NO. 1,244,901.

SN 78-432,419, FILED 6-9-2004.

MARK SPARACINO, EXAMINING ATTORNEY

Int. Cl.: 35

Prior U.S. Cls.: 100, 101, and 102

Reg. No. 3,486,160

United States Patent and Trademark Office

Registered Aug. 12, 2008

**SERVICE MARK
PRINCIPAL REGISTER**

LEE

THE H. D. LEE COMPANY, INC (DELAWARE CORPORATION)
3411 SILVERSIDE RD.
WILMINGTON, DE 19810

FOR: ON-LINE RETAIL STORE SERVICES IN THE FIELD OF APPAREL; PROVIDING CONSUMER PRODUCT INFORMATION VIA THE INTERNET, IN CLASS 35 (U.S. CLS. 100, 101 AND 102).

FIRST USE 11-9-2000; IN COMMERCE 11-9-2000.

THE MARK CONSISTS OF STANDARD CHARACTERS WITHOUT CLAIM TO ANY PARTICULAR FONT, STYLE, SIZE, OR COLOR.

OWNER OF U.S. REG. NOS. 255,018, 430,729, AND OTHERS.

SN 78-439,821, FILED 6-23-2004.

GEORGE LORENZO, EXAMINING ATTORNEY

Int. Cl.: 9

Prior U.S. Cls.: 21, 23, 26, 36, and 38

United States Patent and Trademark Office

Reg. No. 3,486,161

Registered Aug. 12, 2008

**TRADEMARK
PRINCIPAL REGISTER**

STYLUS VERVE

OLYMPUS CORPORATION (JAPAN JOINT
STOCK COMPANY)
43-2, HATAGAYA 2-CHOME SHIBUYA-KU
TOKYO, JAPAN

FOR: PHOTOGRAPHIC CAMERAS; DIGITAL
CAMERAS, INTERCHANGEABLE LENSES FOR
DIGITAL CAMERAS AND PARTS AND ACCESSOR-
IES, NAMELY, LENS CAPS, LENS HOODS, FLA-
SHES, REMOTE CONTROLS, EXTENSION LENSES,
BATTERIES, BATTERY CHARGERS, AC ADAP-
TERS, CAMERA CASES, MEMORY CARDS, TRI-
PODS, LENS FILTERS, CAMERA STRAPS AND
WATERPROOF PROTECTORS FOR CAMERAS; OP-
TICAL LENSES; IMAGE PRINTERS; DATA PRO-

JECTORS, IN CLASS 9 (U.S. CLS. 21, 23, 26, 36 AND
38).

FIRST USE 9-3-2004; IN COMMERCE 9-3-2004.

THE MARK CONSISTS OF STANDARD CHAR-
ACTERS WITHOUT CLAIM TO ANY PARTICULAR
FONT, STYLE, SIZE, OR COLOR.

OWNER OF U.S. REG. NOS. 1,695,267, 2,255,932,
AND OTHERS.

SN 78-445,364, FILED 7-2-2004.

JASON BLAIR, EXAMINING ATTORNEY

Int. Cl.: 21

Prior U.S. Cls.: 2, 13, 23, 29, 30, 33, 40, and 50

Reg. No. 3,486,162

United States Patent and Trademark Office

Registered Aug. 12, 2008

**TRADEMARK
PRINCIPAL REGISTER**

IT'S A CHICK THING

TERRY, EMILY M. (UNITED STATES INDIVIDUAL)
45 CLARENCE STREET
BROOKLINE, MA 02446 AND
BEANLAND, AME M. (UNITED STATES INDIVIDUAL)
638 ABBIE STREET
PLEASANTON, CA 94566

FIRST USE 11-18-2006; IN COMMERCE 4-2-2007.

THE MARK CONSISTS OF STANDARD CHARACTERS WITHOUT CLAIM TO ANY PARTICULAR FONT, STYLE, SIZE, OR COLOR.

FOR: HOUSEWARES, NAMELY, PLATES, CUPS, BOWLS, SERVING BOWLS AND SERVING DISHES; BEVERAGE GLASSWARE, IN CLASS 21 (U.S. CLS. 2, 13, 23, 29, 30, 33, 40 AND 50).

SN 78-448,725, FILED 7-9-2004.

YONG KIM, EXAMINING ATTORNEY

Int. Cl.: 41

Prior U.S. Cls.: 100, 101, and 107

United States Patent and Trademark Office

Reg. No. 3,486,163

Registered Aug. 12, 2008

**SERVICE MARK
PRINCIPAL REGISTER**

**BEACH COUNTRY
BLUES**

SCHEXNAILDER, E. PAUL (UNITED STATES
INDIVIDUAL)
7801 ESCALA DR.
AUSTIN, TX 78735

FOR: PRESENTATION OF MUSICAL PERFOR-
MANCE, IN CLASS 41 (U.S. CLS. 100, 101 AND 107).

FIRST USE 4-19-2008; IN COMMERCE 4-19-2008.

THE MARK CONSISTS OF STANDARD CHAR-
ACTERS WITHOUT CLAIM TO ANY PARTICULAR
FONT, STYLE, SIZE, OR COLOR.

NO CLAIM IS MADE TO THE EXCLUSIVE
RIGHT TO USE "BLUES", APART FROM THE
MARK AS SHOWN.

SN 78-460,144, FILED 8-1-2004.

HOWARD SMIGA, EXAMINING ATTORNEY

Int. Cl.: 9

Prior U.S. Cls.: 21, 23, 26, 36, and 38

United States Patent and Trademark Office

Reg. No. 3,486,164

Registered Aug. 12, 2008

**TRADEMARK
PRINCIPAL REGISTER**

PURSUITRAK

AUDIOVOX ELECTRONICS CORPORATION
(DELAWARE CORPORATION)
150 MARCUS BLVD.
P.O. BOX 1800
HAUPPAUGE, NY 117881800

FOR: GLOBAL POSITIONING SYSTEM (GPS)
FOR VEHICLE TRACKING, THEFT RECOVERY
AND CONVENIENCE SYSTEM PERMITTING USER
TO TRACK, LOCATE AND ACTIVATE SELECT
AUTO SECURITY AND REMOTE START FEAT-
URES VIA THE INTERNET OR TOUCH-TONE

TELEPHONE, IN CLASS 9 (U.S. CLS. 21, 23, 26, 36
AND 38).

FIRST USE 7-0-2007; IN COMMERCE 7-0-2007.

THE MARK CONSISTS OF STANDARD CHAR-
ACTERS WITHOUT CLAIM TO ANY PARTICULAR
FONT, STYLE, SIZE, OR COLOR.

SN 78-471,019, FILED 8-20-2004.

JEFF DEFORD, EXAMINING ATTORNEY

Int. Cl.: 41

Prior U.S. Cls.: 100, 101, and 107

United States Patent and Trademark Office

Reg. No. 3,486,165

Registered Aug. 12, 2008

**SERVICE MARK
PRINCIPAL REGISTER**

TRUE GIRL

MILLER, VALARIE A. (UNITED STATES INDIVIDUAL)
5420 WHITEHURST ARCH
VIRGINIA BEACH, VA 23464

FOR: PROVIDING ONLINE NON-DOWNLOADABLE BOOKS, MAGAZINES, JOURNALS, CATALOGS AND BROCHURES FOR GENERAL INTEREST AMONG GIRLS AND YOUNG WOMEN, IN CLASS 41 (U.S. CLS. 100, 101 AND 107).

FIRST USE 8-22-2007; IN COMMERCE 8-22-2007.

THE MARK CONSISTS OF STANDARD CHARACTERS WITHOUT CLAIM TO ANY PARTICULAR FONT, STYLE, SIZE, OR COLOR.

NO CLAIM IS MADE TO THE EXCLUSIVE RIGHT TO USE "GIRL", APART FROM THE MARK AS SHOWN.

SN 78-479,900, FILED 9-8-2004.

JASON BLAIR, EXAMINING ATTORNEY

Int. Cl.: 9

Prior U.S. Cls.: 21, 23, 26, 36, and 38

United States Patent and Trademark Office

Reg. No. 3,486,166

Registered Aug. 12, 2008

**TRADEMARK
PRINCIPAL REGISTER**

WEB-911

QUINSTAR CORPORATION (TEXAS CORPORATION), DBA (SPECTER INSTRUMENTS),
4020 SOUTH INDUSTRIAL DRIVE, SUITE 120
AUSTIN, TX 78744

FOR: COMPUTER APPLICATION PROGRAMS
FOR PROVIDING NOTIFICATION OF EXCEPTIONS OR OUT-OF-TOLERANCE CONDITIONS IN
THE APPLICATION OPERATION ENVIRONMENT,
IN CLASS 9 (U.S. CLS. 21, 23, 26, 36 AND 38).

FIRST USE 5-0-2008; IN COMMERCE 5-0-2008.

THE MARK CONSISTS OF STANDARD CHARACTERS WITHOUT CLAIM TO ANY PARTICULAR FONT, STYLE, SIZE, OR COLOR.

OWNER OF U.S. REG. NO. 1,879,144.

SN 78-492,128, FILED 9-30-2004.

ANGELA M. MICHELI, EXAMINING ATTORNEY

Int. Cl.: 5

Prior U.S. Cls.: 6, 18, 44, 46, 51, and 52

Reg. No. 3,486,167

United States Patent and Trademark Office

Registered Aug. 12, 2008

**TRADEMARK
PRINCIPAL REGISTER**

CLEAR-ATADINE

HARVARD DRUG GROUP, LLC (MICHIGAN
CORPORATION)
31778 ENTERPRISE
LIVONIA, MI 48150

THE MARK CONSISTS OF STANDARD CHAR-
ACTERS WITHOUT CLAIM TO ANY PARTICULAR
FONT, STYLE, SIZE, OR COLOR.

FOR: ANTIHISTAMINES, IN CLASS 5 (U.S. CLS. 6,
18, 44, 46, 51 AND 52).

SN 78-494,728, FILED 10-5-2004.

FIRST USE 12-0-2004; IN COMMERCE 12-0-2004.

STEVEN PEREZ, EXAMINING ATTORNEY

Int. Cl.: 41

Prior U.S. Cls.: 100, 101, and 107

Reg. No. 3,486,168

United States Patent and Trademark Office

Registered Aug. 12, 2008

**SERVICE MARK
PRINCIPAL REGISTER**

**The Inner Health
Club**

SMITH, MELANIE (UNITED STATES INDIVIDUAL)
22 TIMBER KNOLL DRIVE
WASHINGTON CROSSING, PA 18977

FOR: HEALTH CLUB SERVICES, NAMELY, PROVIDING INSTRUCTION AND EQUIPMENT IN THE FIELD OF PHYSICAL EXERCISE, IN CLASS 41 (U.S. CLS. 100, 101 AND 107).

FIRST USE 11-30-2004; IN COMMERCE 11-30-2004.

THE MARK CONSISTS OF STANDARD CHARACTERS WITHOUT CLAIM TO ANY PARTICULAR FONT, STYLE, SIZE, OR COLOR.

NO CLAIM IS MADE TO THE EXCLUSIVE RIGHT TO USE "HEALTH CLUB", APART FROM THE MARK AS SHOWN.

SN 78-502,698, FILED 10-20-2004.

HANNO RITTNER, EXAMINING ATTORNEY

Int. Cl.: 28

Prior U.S. Cls.: 22, 23, 38, and 50

United States Patent and Trademark Office

Reg. No. 3,486,169

Registered Aug. 12, 2008

**TRADEMARK
PRINCIPAL REGISTER**

Pilates Power Gym

KASWIT, INC. (CALIFORNIA CORPORATION)
78-140 CALLE TAMPICO
LA QUINTA, CA 92253

FOR: EXERCISE EQUIPMENT, NAMELY, AN
ADJUSTABLE SLIDING BED WITH VARIABLE
RESISTANCE BANDS, IN CLASS 28 (U.S. CLS. 22,
23, 38 AND 50).

FIRST USE 1-16-2007; IN COMMERCE 1-16-2007.

THE MARK CONSISTS OF STANDARD CHAR-
ACTERS WITHOUT CLAIM TO ANY PARTICULAR
FONT, STYLE, SIZE, OR COLOR.

NO CLAIM IS MADE TO THE EXCLUSIVE
RIGHT TO USE "PILATES" AND "GYM", APART
FROM THE MARK AS SHOWN.

SN 78-503,133, FILED 10-20-2004.

WENDY GOODMAN, EXAMINING ATTORNEY

Int. Cl.: 25

Prior U.S. Cls.: 22 and 39

United States Patent and Trademark Office

Reg. No. 3,486,170

Registered Aug. 12, 2008

**TRADEMARK
PRINCIPAL REGISTER**

ZUP

HEAD ZUP ENTERTAINMENT L.L.C. (WASHINGTON LTD LIAB CO)
2129 130TH PLACE SE
BELLEVUE, WA 98005

FOR: MEN'S, WOMEN'S, AND CHILDREN'S CLOTHING, AND HEADWEAR, NAMELY, T-SHIRTS, SPORT SHIRTS, POLO SHIRTS, CASUAL TOPS WITH LONG AND SHORT SLEEVES, BODY-SUITS, SWEAT SHIRTS, HOODED TOPS, LEISURE WEAR, EXERCISE WEAR, APRONS, BIBS, INFANT WEAR, UNDERGARMENTS, HEADBANDS, HATS,

VISORS, AND CAPS, IN CLASS 25 (U.S. CLS. 22 AND 39).

FIRST USE 10-21-2004; IN COMMERCE 5-10-2005.

THE MARK CONSISTS OF STANDARD CHARACTERS WITHOUT CLAIM TO ANY PARTICULAR FONT, STYLE, SIZE, OR COLOR.

SN 78-503,770, FILED 10-21-2004.

JOHN HWANG, EXAMINING ATTORNEY

Int. Cl.: 9

Prior U.S. Cls.: 21, 23, 26, 36, and 38

Reg. No. 3,486,171

United States Patent and Trademark Office

Registered Aug. 12, 2008

**TRADEMARK
PRINCIPAL REGISTER**

StoBLs

STORY BASED LEARNING OBJECTS

TATA INDUSTRIES LIMITED (INDIA COMPANY)
BOMBAY HOUSE, 24 HOMI MODI STREET
MUMBAI-400 001
MAHARASHTRA, INDIA

FOR: TEACHING APPARATUS FOR USE IN STORY BASED LEARNING, NAMELY, COMPUTERS, COMPUTER PERIPHERALS; APPARATUS FOR RECORDING, TRANSMISSION OR REPRODUCTION OF TEXTS, SOUND AND IMAGES FOR USE IN STORY BASED LEARNING, NAMELY, COMPUTERS, COMPUTER PERIPHERALS, AUDIO SPEAKERS, VIDEO SCREENS, PROJECTION SCREENS, LCD PROJECTORS, DIGITAL AUDIO AND VIDEO RECORDERS AND TRANSMITTERS INCLUDING MOBILE, CELLULAR, WIRELESS AND CDMA PHONES; COMPUTER SOFTWARE, NAMELY, CUSTOMIZABLE EDUCATIONAL PLATFORMS FOR USE IN STORY BASED LEARNING; COMPUTER SOFTWARE AND PRERECORDED

MAGNETIC DATA CARRIERS, CDS, DVDS, CD-ROMS AND COMPUTER AND LASER DISCS FEATURING STORY BASED LEARNING PROGRAMS AND EDUCATIONAL MATERIALS IN A VARIETY OF FIELDS FOR K-12, CONTINUING, UNDERGRADUATE AND GRADUATE EDUCATION, AND CORPORATE, PROFESSIONAL AND GOVERNMENT TRAINING, IN CLASS 9 (U.S. CLS. 21, 23, 26, 36 AND 38).

FIRST USE 12-30-2004; IN COMMERCE 3-8-2006.

NO CLAIM IS MADE TO THE EXCLUSIVE RIGHT TO USE "STORY BASED LEARNING OBJECTS", APART FROM THE MARK AS SHOWN.

SN 78-506,736, FILED 10-27-2004.

ALICE SUE CARRUTHERS, EXAMINING ATTORNEY

Int. Cls.: 9 and 42

Prior U.S. Cls.: 21, 23, 26, 36, 38, 100, and 101

United States Patent and Trademark Office

Reg. No. 3,486,172

Registered Aug. 12, 2008

**TRADEMARK
SERVICE MARK
PRINCIPAL REGISTER**



ELECTRIC PAPER GESELLSCHAFT FÜR SOFTWARELÖSUNGEN MBH (FED REP GERMANY CORPORATION)
KONRAD-ZUSE-ALLEE 13
21337 LÜNEBURG, FED REP GERMANY

FOR: (BASED ON USE IN COMMERCE) COMPUTER SOFTWARE FOR EVALUATING EDUCATION AND EDUCATORS; (BASED ON USE IN COMMERCE AND BASED ON 44(E)) DATA PROCESSING EQUIPMENT, NAMELY, DATA PROCESSORS, IN CLASS 9 (U.S. CLS. 21, 23, 26, 36 AND 38).

FIRST USE 10-1-2004; IN COMMERCE 10-1-2004.

FOR: (BASED ON 44(E)) SCIENTIFIC AND TECHNOLOGICAL SERVICES, NAMELY, INDUSTRIAL ANALYSIS AND RESEARCH SERVICES, IN CLASS 42 (U.S. CLS. 100 AND 101).

OWNER OF FED REP GERMANY REG. NO. 30365005, DATED 2-23-2004, EXPIRES 12-31-2013.

THE COLOR(S) BLUE, YELLOW AND WHITE IS/ARE CLAIMED AS A FEATURE OF THE MARK.

THE COLOR BLUE APPEARS ON THE LETTERS AND THE OUTLINE OF THE SQUARE BOX. THE INSIDE OF THE SQUARE IS YELLOW. A WHITE CHECK MARK APPEARS IN THE SQUARE. THREE LINES APPEAR IN YELLOW TO THE RIGHT OF THE SQUARE.

SN 78-507,602, FILED 10-28-2004.

KAREN SEVERSON, EXAMINING ATTORNEY

Int. Cl.: 33

Prior U.S. Cls.: 47 and 49

United States Patent and Trademark Office

Reg. No. 3,486,173

Registered Aug. 12, 2008

**TRADEMARK
PRINCIPAL REGISTER**



SLASKA WYTWORNIA WODEK GATUNKOWYCH "POLMOS" S.A. (POLAND CORPORATION)
UL. KARPACKA 11
BIELSKO-BIALA, POLAND 43-316

FOR: ALCOHOLIC BEVERAGES, NAMELY, VODKA, IN CLASS 33 (U.S. CLS. 47 AND 49).

FIRST USE 12-3-2004; IN COMMERCE 12-3-2004.

THE MARK CONSISTS OF THE STYLIZED WORDS "ZLOTY KLOS" IN AN OVAL WITHIN A MISCELLANEOUS DESIGN.

THE ENGLISH TRANSLATION OF THE WORD "ZLOTY KLOS" IN THE MARK IS "GOLDEN EAR".

SN 78-508,116, FILED 10-29-2004.

ESTHER A. BORSUK, EXAMINING ATTORNEY

Int. Cl.: 41

Prior U.S. Cls.: 100, 101, and 107

United States Patent and Trademark Office

Reg. No. 3,486,174

Registered Aug. 12, 2008

**SERVICE MARK
PRINCIPAL REGISTER**

**TRIVIAL PURSUIT
LIVE**

HASBRO, INC. (RHODE ISLAND CORPORATION)
1027 NEWPORT AVENUE
PAWTUCKET, RI 02862

FOR: ENTERTAINMENT SERVICES, NAMELY, PROVIDING AN ON-LINE COMPUTER TRIVIA GAME; ENTERTAINMENT SERVICES, NAMELY, CONDUCTING TRIVIA GAME CONTESTS, IN CLASS 41 (U.S. CLS. 100, 101 AND 107).

FIRST USE 9-1-2007; IN COMMERCE 9-1-2007.

THE MARK CONSISTS OF STANDARD CHARACTERS WITHOUT CLAIM TO ANY PARTICULAR FONT, STYLE, SIZE, OR COLOR.

OWNER OF U.S. REG. NOS. 2,093,679, 2,758,701, AND OTHERS.

NO CLAIM IS MADE TO THE EXCLUSIVE RIGHT TO USE "LIVE", APART FROM THE MARK AS SHOWN.

SN 78-508,196, FILED 10-29-2004.

CHRISIE B. KING, EXAMINING ATTORNEY

Int. Cl.: 10

Prior U.S. Cls.: 26, 39, and 44

United States Patent and Trademark Office

Reg. No. 3,486,175

Registered Aug. 12, 2008

**TRADEMARK
PRINCIPAL REGISTER**

ACUPOINT

HUMAN TOUCH, LLC (DELAWARE LTD LIAB
CO)
3030 WALNUT AVENUE
LONG BEACH, CA 90807

THE MARK CONSISTS OF STANDARD CHAR-
ACTERS WITHOUT CLAIM TO ANY PARTICULAR
FONT, STYLE, SIZE, OR COLOR.

FOR: MASSAGE CHAIRS, IN CLASS 10 (U.S. CLS.
26, 39 AND 44).

SN 78-508,696, FILED 10-29-2004.

FIRST USE 6-0-2005; IN COMMERCE 6-0-2005.

KELLEY WELLS, EXAMINING ATTORNEY

Int. Cl.: 7

Prior U.S. Cls.: 13, 19, 21, 23, 31, 34, and 35

Reg. No. 3,486,176

United States Patent and Trademark Office

Registered Aug. 12, 2008

**TRADEMARK
PRINCIPAL REGISTER**

XTREME SERIES

ENIDINE INCORPORATED (DELAWARE CORPORATION)
7 CENTRE DRIVE
ORCHARD PARK, NY 14127

FOR: INDUSTRIAL HYDRAULIC SHOCK ABSORBERS FOR MACHINES, IN CLASS 7 (U.S. CLS. 13, 19, 21, 23, 31, 34 AND 35).

FIRST USE 6-25-2008; IN COMMERCE 6-25-2008.

THE MARK CONSISTS OF STANDARD CHARACTERS WITHOUT CLAIM TO ANY PARTICULAR FONT, STYLE, SIZE, OR COLOR.

NO CLAIM IS MADE TO THE EXCLUSIVE RIGHT TO USE "SERIES", APART FROM THE MARK AS SHOWN.

SN 78-511,279, FILED 11-4-2004.

CARRIE GENOVESE, EXAMINING ATTORNEY

Int. Cl.: 16

Prior U.S. Cls.: 2, 5, 22, 23, 29, 37, 38, and 50

Reg. No. 3,486,177

United States Patent and Trademark Office

Registered Aug. 12, 2008

**TRADEMARK
PRINCIPAL REGISTER**

ADFLEX

INTERFACE SOLUTIONS, INC. (PENNSYLVANIA CORPORATION)
216 WOHLSEN WAY
LANCASTER, PA 17603

FOR: FLEXIBLE SPECIALTY PAPER CONTAINING LATEX, IN CLASS 16 (U.S. CLS. 2, 5, 22, 23, 29, 37, 38 AND 50).

FIRST USE 3-0-2005; IN COMMERCE 3-0-2005.

THE MARK CONSISTS OF STANDARD CHARACTERS WITHOUT CLAIM TO ANY PARTICULAR FONT, STYLE, SIZE, OR COLOR.

SN 78-514,298, FILED 11-10-2004.

KATHLEEN M. VANSTON, EXAMINING ATTORNEY

Int. Cl.: 43

Prior U.S. Cls.: 100 and 101

United States Patent and Trademark Office

Reg. No. 3,486,178

Registered Aug. 12, 2008

**SERVICE MARK
PRINCIPAL REGISTER**



BARCELÓ CORPORACIÓN EMPRESARIAL, S.A.
(SPAIN CORPORATION)
C/JOSE ROVER MOTTA 27 07006
PALAM DE MALLORCA, SPAIN

FOR: HOTEL, RESTAURANT, CATERING, BAR AND LOUNGE SERVICES; PROVIDING FACILITIES FOR MEETINGS, CONFERENCES AND EXHIBITIONS; PROVIDING TRAVEL LODGING INFORMATION SERVICES AND TRAVEL LODGING BOOKING AGENCY SERVICES FOR TRAVELERS; PROVIDING INFORMATION IN THE FIELD OF HOSPITALITY VIA THE INTERNET, IN CLASS 43 (U.S. CLS. 100 AND 101).

FIRST USE 11-30-1992; IN COMMERCE 11-30-2004.

OWNER OF U.S. REG. NOS. 2,557,091, 2,596,874, AND 2,600,153.

NO CLAIM IS MADE TO THE EXCLUSIVE RIGHT TO USE "HOTELS & RESORTS", APART FROM THE MARK AS SHOWN.

THE COLOR(S) BLUE AND WHITE IS/ARE CLAIMED AS A FEATURE OF THE MARK.

THE MARK CONSISTS OF A BLUE BOX WITH THE WORDING "BARCELÓ HOTELS & RESORTS" IN WHITE INSIDE THE BOX.

SEC. 2(F).

SN 78-515,474, FILED 11-11-2004.

NELSON SNYDER, EXAMINING ATTORNEY

Int. Cl.: 25

Prior U.S. Cls.: 22 and 39

United States Patent and Trademark Office

Reg. No. 3,486,179

Registered Aug. 12, 2008

**TRADEMARK
PRINCIPAL REGISTER**

**THE MAGIC SLEEP
SUIT**

BABY MERLIN, LLC (PENNSYLVANIA LTD
LIAB CO)

128 HEATHER HILL DRIVE

DOWNTOWN, PA 19335

FOR: INFANT SLEEPWEAR, IN CLASS 25 (U.S.
CLS. 22 AND 39).

FIRST USE 11-22-2004; IN COMMERCE 5-13-2008.

THE MARK CONSISTS OF STANDARD CHAR-
ACTERS WITHOUT CLAIM TO ANY PARTICULAR
FONT, STYLE, SIZE, OR COLOR.

NO CLAIM IS MADE TO THE EXCLUSIVE
RIGHT TO USE "SLEEP SUIT", APART FROM THE
MARK AS SHOWN.

SN 78-517,147, FILED 11-15-2004.

STEVEN PEREZ, EXAMINING ATTORNEY

Int. Cls.: 35 and 42

Prior U.S. Cls.: 100, 101, and 102

United States Patent and Trademark Office

Reg. No. 3,486,180

Registered Aug. 12, 2008

**SERVICE MARK
PRINCIPAL REGISTER**

SPONSOR SELECT

AWS CONVERGENCE TECHNOLOGIES, INC.
(DELAWARE CORPORATION)
12410 MILESTONE CENTER DRIVE
GERMANTOWN, MD 20876

FOR: DISSEMINATION OF ADVERTISING MATTER; ADVERTISING AND MARKETING; PROMOTING THE GOODS AND SERVICES OF OTHERS BY ARRANGING FOR SPONSORS TO AFFILIATE THEIR GOODS AND SERVICES WITH INFORMATION AND ENTERTAINMENT CONTENT PROVIDERS; BUSINESS SERVICES, NAMELY, PROVIDING COMPUTER DATABASES REGARDING THE PURCHASE AND SALE OF A WIDE VARIETY OF PRODUCT AND SERVICES OF OTHERS, IN CLASS 35 (U.S. CLS. 100, 101 AND 102).

FIRST USE 2-0-2002; IN COMMERCE 2-0-2002.

FOR: COMPUTER SERVICES, NAMELY, ACTING AS AN APPLICATION SERVICE PROVIDER IN THE FIELD OF KNOWLEDGE MANAGEMENT TO HOST COMPUTER APPLICATION SOFTWARE FOR SEARCHING AND RETRIEVING INFORMA-

TION FROM DATABASES AND COMPUTER NETWORKS; PROVIDING ON-LINE NON-DOWNLOADABLE SOFTWARE FOR THE PRESENTATION OF PROMOTIONAL OR ADVERTISING OPTIONS FOR USERS TO DECIDE UPON, IN CLASS 42 (U.S. CLS. 100 AND 101).

FIRST USE 2-0-2002; IN COMMERCE 2-0-2002.

THE MARK CONSISTS OF STANDARD CHARACTERS WITHOUT CLAIM TO ANY PARTICULAR FONT, STYLE, SIZE, OR COLOR.

OWNER OF U.S. REG. NO. 2,799,186.

NO CLAIM IS MADE TO THE EXCLUSIVE RIGHT TO USE "SPONSOR", APART FROM THE MARK AS SHOWN.

SN 78-517,150, FILED 11-15-2004.

JANICE L. MCMORROW, EXAMINING ATTORNEY

Int. Cl.: 9

Prior U.S. Cls.: 21, 23, 26, 36, and 38

Reg. No. 3,486,181

United States Patent and Trademark Office

Registered Aug. 12, 2008

**TRADEMARK
PRINCIPAL REGISTER**



VISIONMOS INTERNATIONAL, INC. (ARIZONA CORPORATION)
4500 SOUTH LAKESHORE DRIVE, SUITE 340
TEMPE, AZ 85282

FOR: COMPUTER HARDWARE; PRINTED CIRCUIT BOARDS; ELECTRONIC CIRCUIT BOARDS; COMPUTER CHIPSETS, NAMELY, FOR USE IN MULTIMEDIA DEVICES AND DIGITAL CAMERAS; COMPUTER PERIPHERALS; COMPUTER FIRMWARE, NAMELY, COMPUTER UTILITY SOFTWARE AND OTHER COMPUTER SOFTWARE USED TO MAINTAIN AND OPERATE COMPUTER SYSTEMS ALL STORED IN A COMPUTER'S READ-ONLY MEMORY (ROM) OR ELSEWHERE IN THE COMPUTER'S CIRCUITRY, AND OPERATING SYSTEM SOFTWARE; COMPUTER FIRMWARE FOR

OPERATING AND MAINTAINING COMPUTER SYSTEMS, DIGITAL CAMERAS, DIGITAL VIDEO CAMERAS, PERSONAL MEDIA PLAYERS, PERSONAL RECORDING DEVICES, CELLULAR TELEPHONES, PDAS, AND COMPUTER PERIPHERAL DEVICES; ALL THE FOREGOING SOLD WITH OR WITHOUT USER MANUALS FOR USE THEREWITH AND PARTS THEREFORE, IN CLASS 9 (U.S. CLS. 21, 23, 26, 36 AND 38).

FIRST USE 3-0-2007; IN COMMERCE 3-0-2007.

SN 78-517,308, FILED 11-15-2004.

JEAN IM, EXAMINING ATTORNEY

Int. Cl.: 5

Prior U.S. Cls.: 6, 18, 44, 46, 51, and 52

United States Patent and Trademark Office

Reg. No. 3,486,182

Registered Aug. 12, 2008

**TRADEMARK
PRINCIPAL REGISTER**

ECHELON

FMC CORPORATION (DELAWARE CORPORATION)
1735 MARKET STREET
PHILADELPHIA, PA 19103

THE MARK CONSISTS OF STANDARD CHARACTERS WITHOUT CLAIM TO ANY PARTICULAR FONT, STYLE, SIZE, OR COLOR.

FOR: HERBICIDES FOR COMMERCIAL, INDUSTRIAL AND DOMESTIC USE, IN CLASS 5 (U.S. CLS. 6, 18, 44, 46, 51 AND 52).

SN 78-519,447, FILED 11-18-2004.

FIRST USE 9-19-2007; IN COMMERCE 9-19-2007.

ELLEN B. AWRICH, EXAMINING ATTORNEY

Int. Cl.: 9

Prior U.S. Cls.: 21, 23, 26, 36, and 38

United States Patent and Trademark Office

Reg. No. 3,486,183

Registered Aug. 12, 2008

**TRADEMARK
PRINCIPAL REGISTER**

BOSTON TEA PARTY

IGT (NEVADA CORPORATION)
9295 PROTOTYPE DRIVE
RENO, NV 895218986

FOR: GAMING MACHINES, NAMELY, DEVICES
WHICH ACCEPT A WAGER, IN CLASS 9 (U.S. CLS.
21, 23, 26, 36 AND 38).

FIRST USE 9-28-2007; IN COMMERCE 11-5-2007.

THE MARK CONSISTS OF STANDARD CHAR-
ACTERS WITHOUT CLAIM TO ANY PARTICULAR
FONT, STYLE, SIZE, OR COLOR.

OWNER OF U.S. REG. NOS. 2,466,283, 2,813,419,
AND OTHERS.

SN 78-522,276, FILED 11-23-2004.

JUSTINE D. PARKER, EXAMINING ATTORNEY

Int. Cl.: 3

Prior U.S. Cls.: 1, 4, 6, 50, 51, and 52

Reg. No. 3,486,184

United States Patent and Trademark Office

Registered Aug. 12, 2008

**TRADEMARK
PRINCIPAL REGISTER**

HELENA

JURAK HOLDINGS LIMITED (NEVADA CORPORATION)
SUITE C
1181 GRIER DRIVE
LAS VEGAS, NV 89119

FOR: NON-MEDICATED SKIN CARE PREPARATION AND HAIR CARE PREPARATION, IN CLASS 3 (U.S. CLS. 1, 4, 6, 50, 51 AND 52).

FIRST USE 12-1-2003; IN COMMERCE 12-1-2003.

THE MARK CONSISTS OF STANDARD CHARACTERS WITHOUT CLAIM TO ANY PARTICULAR FONT, STYLE, SIZE, OR COLOR.

THE NAME(S), PORTRAIT(S), AND/OR SIGNATURE(S) SHOWN IN THE MARK DOES NOT IDENTIFY A PARTICULAR LIVING INDIVIDUAL.

SN 78-523,794, FILED 11-29-2004.

KRISTINA MORRIS, EXAMINING ATTORNEY

Int. Cl.: 32

Prior U.S. Cls.: 45, 46, and 48

Reg. No. 3,486,185

United States Patent and Trademark Office

Registered Aug. 12, 2008

**TRADEMARK
PRINCIPAL REGISTER**

PURELY REFRESHING

DS WATERS OF AMERICA, LP (DELAWARE
PARTNERSHIP)
5660 NEW NORTHSIDE DRIVE, SUITE 500
ATLANTA, GA 30328

THE MARK CONSISTS OF STANDARD CHAR-
ACTERS WITHOUT CLAIM TO ANY PARTICULAR
FONT, STYLE, SIZE, OR COLOR.

FOR: BOTTLED WATER PRODUCTS, NAMELY,
SPRING WATER AND DISTILLED WATER, IN
CLASS 32 (U.S. CLS. 45, 46 AND 48).

SN 78-525,533, FILED 12-1-2004.

FIRST USE 2-1-2005; IN COMMERCE 2-1-2005.

PAUL CROWLEY, EXAMINING ATTORNEY

Int. Cl.: 9

Prior U.S. Cls.: 21, 23, 26, 36, and 38

Reg. No. 3,486,186

United States Patent and Trademark Office

Registered Aug. 12, 2008

**TRADEMARK
PRINCIPAL REGISTER**

**ANALYZE WITH
INTEGRITY**

PROGRESSION, INC. (DELAWARE CORPORATION)
15 FOUNDATION AVENUE
HAVERHILL, MA 01835

FOR: INDUSTRIAL ANALYZERS FOR ANALYZING MINERALS AND RESINS, AND LASERS FOR MEASURING PURPOSES, IN CLASS 9 (U.S. CLS. 21, 23, 26, 36 AND 38).

FIRST USE 3-23-2005; IN COMMERCE 3-23-2005.

THE MARK CONSISTS OF STANDARD CHARACTERS WITHOUT CLAIM TO ANY PARTICULAR FONT, STYLE, SIZE, OR COLOR.

NO CLAIM IS MADE TO THE EXCLUSIVE RIGHT TO USE "ANALYZE", APART FROM THE MARK AS SHOWN.

SN 78-526,587, FILED 12-3-2004.

BARBARA GAYNOR, EXAMINING ATTORNEY

Int. Cl.: 32

Prior U.S. Cls.: 45, 46, and 48

Reg. No. 3,486,187

United States Patent and Trademark Office

Registered Aug. 12, 2008

**TRADEMARK
PRINCIPAL REGISTER**

DUFF

TWENTIETH CENTURY FOX FILM CORPORATION (DELAWARE CORPORATION)
10201 WEST PICO BOULEVARD
LOS ANGELES, CA 90035

THE MARK CONSISTS OF STANDARD CHARACTERS WITHOUT CLAIM TO ANY PARTICULAR FONT, STYLE, SIZE, OR COLOR.

FOR: CARBONATED SOFT DRINKS, IN CLASS 32 (U.S. CLS. 45, 46 AND 48).

SN 78-527,050, FILED 12-3-2004.

FIRST USE 8-30-2007; IN COMMERCE 8-30-2007.

ALLISON SCHRODY, EXAMINING ATTORNEY

Int. Cl.: 9

Prior U.S. Cls.: 21, 23, 26, 36, and 38

Reg. No. 3,486,188

United States Patent and Trademark Office

Registered Aug. 12, 2008

**TRADEMARK
PRINCIPAL REGISTER**

FAHRENHEIT

CABOT SAFETY INTERMEDIATE CORPORATION (DELAWARE CORPORATION)
650 DAWSON DRIVE
NEWARK, DE 19713

THE MARK CONSISTS OF STANDARD CHARACTERS WITHOUT CLAIM TO ANY PARTICULAR FONT, STYLE, SIZE, OR COLOR.

FOR: PROTECTIVE EYEWEAR, IN CLASS 9 (U.S. CLS. 21, 23, 26, 36 AND 38).

SN 78-527,613, FILED 12-6-2004.

FIRST USE 3-0-2007; IN COMMERCE 3-0-2007.

KAREN BRACEY, EXAMINING ATTORNEY

Int. Cl.: 11

Prior U.S. Cls.: 13, 21, 23, 31, and 34

Reg. No. 3,486,189

United States Patent and Trademark Office

Registered Aug. 12, 2008

TRADEMARK
PRINCIPAL REGISTER



O'BRIEN, IRIS (UNITED STATES INDIVIDUAL)
8005 CASTLEHILL RD
BIRMINGHAM, AL 35242

FOR: OUTDOOR RESIDENTIAL AND COMMERCIAL COOKING OVENS, WOOD, GAS AND CHARCOAL FIRED COOKING GRILLS AND FIREPLACES, IN CLASS 11 (U.S. CLS. 13, 21, 23, 31 AND 34).

FIRST USE 8-6-2007; IN COMMERCE 8-6-2007.

NO CLAIM IS MADE TO THE EXCLUSIVE RIGHT TO USE "TUSCAN OVENS", APART FROM THE MARK AS SHOWN.

THE MARK CONSISTS OF FRONT VIEW OF AN OUTDOOR OVEN WITH FIRE INSIDE AND WORDS "TUSCAN OVENS".

SN 78-532,808, FILED 12-15-2004.

KATHY DE JONGE, EXAMINING ATTORNEY

Int. Cl.: 35

Prior U.S. Cls.: 100, 101, and 102

United States Patent and Trademark Office

Reg. No. 3,486,190

Registered Aug. 12, 2008

**SERVICE MARK
PRINCIPAL REGISTER**



CPS OPTICAL, INC. (NEW YORK CORPORATION)
11 HANOVER SQUARE, 8TH FLOOR
NEW YORK, NY 10005

FOR: COOPERATIVE ADVERTISING AND MARKETING SERVICES FOR OPTOMETRISTS BY WAY OF SOLICITATION, CUSTOMER SERVICES AND PROVIDING MARKETING INFORMATION VIA WEBSITES ON A GLOBAL COMPUTER NETWORK AND THROUGH PUBLIC COMMUNICATION MEANS, AND ADMINISTRATION, BILLING AND RECONCILIATION OF ACCOUNTS ON BEHALF OF OTHERS, IN CLASS 35 (U.S. CLS. 100, 101 AND 102).

FIRST USE 1-1-2004; IN COMMERCE 1-1-2004.

THE COLOR(S) WHITE, LIGHT BLUE AND NAVY IS/ARE CLAIMED AS A FEATURE OF THE MARK.

THE COLOR NAVY APPEARS IN THE WORDING "CPS" AND THE DESIGN OF THE SQUARE, THE COLOR LIGHT BLUE APPEARS IN DESIGN OF THE EYEBROW AND THE WORDING "OPTICAL", AND THE COLOR WHITE APPEARS IN THE DESIGN OF THE EYEGGLASS FRAME.

SN 78-533,003, FILED 12-15-2004.

KAREN BRACEY, EXAMINING ATTORNEY

Int. Cl.: 16

Prior U.S. Cls.: 2, 5, 22, 23, 29, 37, 38, and 50

Reg. No. 3,486,191

United States Patent and Trademark Office

Registered Aug. 12, 2008

**TRADEMARK
PRINCIPAL REGISTER**

TISSUETTE

RAPALA, GREGG R. (UNITED STATES INDIVIDUAL)
7 N. WILSHIRE LANE
ARLINGTON HEIGHTS, IL 60004

THE MARK CONSISTS OF STANDARD CHARACTERS WITHOUT CLAIM TO ANY PARTICULAR FONT, STYLE, SIZE, OR COLOR.

FOR: FACIAL TISSUE IN A SMALL PACKET, IN CLASS 16 (U.S. CLS. 2, 5, 22, 23, 29, 37, 38 AND 50).

SN 78-533,342, FILED 12-15-2004.

FIRST USE 6-10-2008; IN COMMERCE 6-10-2008.

WON TEAK OH, EXAMINING ATTORNEY

Int. Cls.: 16, 25, and 41

**Prior U.S. Cls.: 2, 5, 22, 23, 29, 37, 38, 39, 50, 100, 101,
and 107**

Reg. No. 3,486,192

United States Patent and Trademark Office

Registered Aug. 12, 2008

**TRADEMARK
SERVICE MARK
PRINCIPAL REGISTER**

Livin It

LUIS PALAU EVANGELISTIC ASSOCIATION
(OREGON CORPORATION)
PO BOX 1173
PORTLAND, OR 97207

FOR: EVENT PRODUCTION MATERIAL, NAME-
LY, PROGRAMS, BROCHURES ABOUT COMMU-
NITY CULTURAL EVENTS, FLYERS FEATURING
INFORMATION ABOUT COMMUNITY CULTUR-
AL EVENTS, STICKERS, PRINTED TICKETS, PENS
AND PENCILS, LETTERHEAD PAPER, STATION-
ERY, AND ENVELOPES, IN CLASS 16 (U.S. CLS. 2, 5,
22, 23, 29, 37, 38 AND 50).

FIRST USE 1-14-2003; IN COMMERCE 9-15-2003.

FOR: CLOTHING, NAMELY, T-SHIRTS, SWEAT-
SHIRTS, POLOS, TANK TOPS, KNIT SHIRTS, JER-
SEYS, JACKETS, HEAD BANDS, WRIST BANDS,
SHORTS, VISORS, AND HATS, IN CLASS 25 (U.S.
CLS. 22 AND 39).

FIRST USE 2-24-2006; IN COMMERCE 2-24-2006.

FOR: ENTERTAINMENT SERVICES, NAMELY,
STAGING AND ORGANIZING COMMUNITY CUL-
TURAL EVENTS; PRODUCTION OF RADIO AND
TELEVISION PROGRAMS; PRODUCTION OF DOC-
UMENTARY MOVIES, IN CLASS 41 (U.S. CLS. 100,
101 AND 107).

FIRST USE 2-24-2006; IN COMMERCE 2-24-2006.

THE MARK CONSISTS OF STANDARD CHAR-
ACTERS WITHOUT CLAIM TO ANY PARTICULAR
FONT, STYLE, SIZE, OR COLOR.

SN 78-534,483, FILED 12-17-2004.

COLLEEN KEARNEY, EXAMINING ATTORNEY

Int. Cl.: 25

Prior U.S. Cls.: 22 and 39

United States Patent and Trademark Office

Reg. No. 3,486,193

Registered Aug. 12, 2008

**TRADEMARK
PRINCIPAL REGISTER**

TECHUV

GANDER MOUNTAIN COMPANY (MINNESOTA
CORPORATION)
180 EAST FIFTH STREET
SUITE 1300
ST. PAUL, MN 55101

FOR: CLOTHING, NAMELY, COATS, JACKETS,
PARKAS, OVERALLS, PANTS, SHIRTS; RAIN-
WEAR; HEADWEAR, IN CLASS 25 (U.S. CLS. 22
AND 39).

FIRST USE 1-0-2008; IN COMMERCE 1-0-2008.

THE MARK CONSISTS OF STANDARD CHAR-
ACTERS WITHOUT CLAIM TO ANY PARTICULAR
FONT, STYLE, SIZE, OR COLOR.

SN 78-536,601, FILED 12-21-2004.

KATHRYN COWARD, EXAMINING ATTORNEY

Int. Cl.: 16

Prior U.S. Cls.: 2, 5, 22, 23, 29, 37, 38, and 50

Reg. No. 3,486,194

United States Patent and Trademark Office

Registered Aug. 12, 2008

**TRADEMARK
PRINCIPAL REGISTER**

VISIONFUND

WORLD VISION INTERNATIONAL (CALIFORNIA CORPORATION)
800 WEST CHESTNUT AVENUE
MONROVIA, CA 910163198

FIRST USE 11-1-2006; IN COMMERCE 11-1-2006.

FOR: PUBLICATIONS AND PRINTED MATTER, NAMELY, BROCHURES, NEWSLETTERS, PERIODIC REPORTS, PAMPHLETS, MAGAZINES AND NEWS BRIEFS FEATURING ECONOMIC DEVELOPMENT, MICRO-ENTERPRISE AND OTHER FINANCE SERVICES AND CHARITABLE AND HUMANITARIAN ISSUES; AND PHOTOGRAPHS, IN CLASS 16 (U.S. CLS. 2, 5, 22, 23, 29, 37, 38 AND 50).

THE MARK CONSISTS OF STANDARD CHARACTERS WITHOUT CLAIM TO ANY PARTICULAR FONT, STYLE, SIZE, OR COLOR.

SN 78-537,044, FILED 12-22-2004.

JOHN DALIER, EXAMINING ATTORNEY

Int. Cls.: 25 and 41

Prior U.S. Cls.: 22, 39, 100, 101, and 107

Reg. No. 3,486,195

United States Patent and Trademark Office

Registered Aug. 12, 2008

**TRADEMARK
SERVICE MARK
PRINCIPAL REGISTER**

CINCINNATI KINGS

RIVER CITY SOCCER HOLDING, LLC (OHIO
LTD LIAB CO)
1018 TOWN DRIVE
WILDER, KY 41076

FOR: MEN'S, WOMEN'S, AND CHILDREN'S ARTICLES OF CLOTHING, NAMELY, T-SHIRTS, SHIRTS, SWEAT SHIRTS, SWEAT PANTS, JACKETS AND HATS ALL SOLD OR DISTRIBUTED IN CONNECTION WITH A PROFESSIONAL SOCCER TEAM, IN CLASS 25 (U.S. CLS. 22 AND 39).

FIRST USE 4-30-2005; IN COMMERCE 4-30-2005.

FOR: EDUCATIONAL AND ENTERTAINMENT SERVICES, NAMELY, IN THE FORM OF PROFESSIONAL SOCCER GAMES AND EXHIBITIONS; PROVIDING SPORTS AND SPORTS RELATED ENTERTAINMENT INFORMATION VIA A GLOBAL COMPUTER NETWORK OR A COMMERCIAL TRANSMISSION FEATURING INFORMATION IN THE FIELDS OF SPORTS AND SPORTS RELATED ENTERTAINMENT; ORGANIZING AND ARRANGING SPORTING COMPETITIONS AND SPORTING EVENTS RELATED THERETO; FAN CLUB SERVICES; EDUCATIONAL SERVICES, NAMELY, PROVIDING CLASSES AND SEMINARS IN THE FIELD OF PHYSICAL EDUCATION AND THE SPORT OF SOCCER; ENTERTAINMENT SERVICES, NAMELY, MUSICAL AND DANCE PERFORMANCES PROVIDED DURING INTERVALS AT SPORTS EVENTS; PRODUCTION OF RADIO AND TELEVISION PRO-

GRAMS; LIVE SHOWS FEATURING SOCCER GAMES, EXHIBITIONS, COMPETITIONS AND MUSICAL, COMEDY, AND DANCE PERFORMANCES; ENTERTAINMENT IN THE NATURE OF PERFORMANCES AND PUBLIC APPEARANCES BY A TEAM MASCOT FOR A PROFESSIONAL SOCCER TEAM, BOTH LIVE AND VIA BROADCAST OVER TELEVISION, CABLE, SATELLITE, AND ON-LINE VIA THE INTERNET; ARRANGING AND CONDUCTING FESTIVALS AND CELEBRATIONS FOR SUPPORTERS OF A PROFESSIONAL SOCCER TEAM; AND CONDUCTING COMPETITIONS AND SWEEPSTAKES IN THE FIELD OF SOCCER AND SPORTS IN WHICH PARTICIPANTS ARE AWARDED PRIZES, IN CLASS 41 (U.S. CLS. 100, 101 AND 107).

FIRST USE 4-30-2005; IN COMMERCE 4-30-2005.

THE MARK CONSISTS OF STANDARD CHARACTERS WITHOUT CLAIM TO ANY PARTICULAR FONT, STYLE, SIZE, OR COLOR.

NO CLAIM IS MADE TO THE EXCLUSIVE RIGHT TO USE "CINCINNATI", APART FROM THE MARK AS SHOWN.

SN 78-537,473, FILED 12-22-2004.

G. MAYERSCHOFF, EXAMINING ATTORNEY

Int. Cl.: 30

Prior U.S. Cl.: 46

United States Patent and Trademark Office

Reg. No. 3,486,196

Registered Aug. 12, 2008

**TRADEMARK
PRINCIPAL REGISTER**

DuraGrain.com

MAHER, ZACKY (UNITED STATES INDIVIDUAL)
P.O.BOX 8433
EMERYVILLE, CA 946620433

THE MARK CONSISTS OF STANDARD CHARACTERS WITHOUT CLAIM TO ANY PARTICULAR FONT, STYLE, SIZE, OR COLOR.

FOR: BAKERY PRODUCTS NAMELY BREAD, FROZEN PIZZA, AND BREAD MIXES, TEA, RICE AND SPICES, IN CLASS 30 (U.S. CL. 46).

SN 78-539,876, FILED 12-29-2004.

FIRST USE 2-5-2005; IN COMMERCE 12-11-2007.

JASON TURNER, EXAMINING ATTORNEY

Int. Cl.: 37

Prior U.S. Cls.: 100, 103, and 106

United States Patent and Trademark Office

Reg. No. 3,486,197

Registered Aug. 12, 2008

**SERVICE MARK
PRINCIPAL REGISTER**



STORAGE TECHNOLOGIES INTERNATIONAL,
INC. (PENNSYLVANIA CORPORATION)
350 VISTA PARK DRIVE
PITTSBURGH, PA 15205

THE COLOR WHITE APPEARS IN THE LETTER
"S" WHICH IS PRESENTED ON A SQUARE RED
BACKGROUND TO THE LEFT AND "TECH" IN
BLACK LETTERING ON THE RIGHT.

FOR: INSTALLATION OF STORAGE SYSTEMS
AND RELATED EQUIPMENT, NAMELY, MEZZA-
NINES, INDUSTRIAL CABINET SYSTEMS AND
RACKING, IN CLASS 37 (U.S. CLS. 100, 103 AND 106).

SN 78-542,935, FILED 1-6-2005.

FIRST USE 1-1-2006; IN COMMERCE 1-1-2006.

THE COLOR(S) RED, BLACK AND WHITE IS/
ARE CLAIMED AS A FEATURE OF THE MARK.

TRACY WHITTAKER-BROWN, EXAMINING AT-
TORNEY

Int. Cls.: 25 and 41

Prior U.S. Cls.: 22, 39, 100, 101, and 107

Reg. No. 3,486,198

United States Patent and Trademark Office

Registered Aug. 12, 2008

TRADEMARK
SERVICE MARK
PRINCIPAL REGISTER



RIVER CITY SOCCER HOLDING, LLC (OHIO
LTD LIAB CO)
1018 TOWN DRIVE
WILDER, KY 41076

FOR: MEN'S, WOMEN'S, AND CHILDREN'S
CLOTHING, NAMELY, T-SHIRTS, SHIRTS, SWEAT
SUITS, SWEAT PANTS, JACKETS, AND HATS ALL
SOLD OR DISTRIBUTED IN CONNECTION WITH A
PROFESSIONAL SOCCER TEAM, IN CLASS 25 (U.S.
CLS. 22 AND 39).

FIRST USE 4-30-2005; IN COMMERCE 4-30-2005.

FOR: EDUCATIONAL AND ENTERTAINMENT
SERVICES, NAMELY, IN THE FORM OF PROFES-
SIONAL SOCCER GAMES AND EXHIBITIONS;
PROVIDING SPORTS AND SPORTS RELATED EN-
TERTAINMENT INFORMATION VIA A GLOBAL
COMPUTER NETWORK OR A COMMERCIAL
TRANSMISSION FEATURING INFORMATION IN
THE FIELDS OF SPORTS AND SPORTS RELATED
ENTERTAINMENT; ORGANIZING AND ARRAN-
GING SPORTING COMPETITIONS AND SPORTING
EVENTS RELATED THERETO; FAN CLUB SERVI-
CES; EDUCATIONAL SERVICES, NAMELY, PRO-
VIDING CLASSES AND SEMINARS IN THE FIELD
OF PHYSICAL EDUCATION AND THE SPORT OF
SOCCER; ENTERTAINMENT SERVICES, NAMELY,
MUSICAL AND DANCE PERFORMANCES PROVI-
DED DURING INTERVALS AT SPORTS EVENTS;

PRODUCTION OF RADIO AND TELEVISION PRO-
GRAMS; LIVE SHOWS FEATURING SOCCER
GAMES, EXHIBITIONS, COMPETITIONS AND MU-
SICAL, COMEDY, AND DANCE PERFORMANCES;
ENTERTAINMENT SERVICES IN THE NATURE OF
PERFORMANCES AND PUBLIC APPEARANCES
BY A TEAM MASCOT FOR A PROFESSIONAL
SOCCER TEAM, BOTH LIVE AND VIA BROAD-
CAST OVER TELEVISION, CABLE, SATELLITE,
AND ON-LINE VIA THE INTERNET; ARRANGING
AND CONDUCTING FESTIVALS AND CELEBRA-
TIONS FOR SUPPORTERS OF A PROFESSIONAL
SOCCER TEAM; AND CONDUCTING COMPETI-
TIONS AND SWEEPSTAKES IN THE FIELD OF
SOCCER AND SPORTS IN WHICH PARTICIPANTS
ARE AWARDED PRIZES, IN CLASS 41 (U.S. CLS.
100, 101 AND 107).

FIRST USE 4-30-2005; IN COMMERCE 4-30-2005.

NO CLAIM IS MADE TO THE EXCLUSIVE
RIGHT TO USE "CINCINNATI", APART FROM
THE MARK AS SHOWN.

THE MARK CONSISTS OF, IN PART, A ROAR-
ING LION DRIBBLING A SOCCER BALL.

SN 78-543,243, FILED 1-6-2005.

G. MAYERSCHOFF, EXAMINING ATTORNEY

Int. Cl.: 35

Prior U.S. Cls.: 100, 101, and 102

United States Patent and Trademark Office

Reg. No. 3,486,199

Registered Aug. 12, 2008

**SERVICE MARK
PRINCIPAL REGISTER**

COMBLU

COMMUNICATIONS BLUEPRINTS, L.L.C. (DE-
LAWARE LTD LIAB CO), DBA COMBLU,
875 NORTH MICHIGAN AVENUE
CHICAGO, IL 60611

FOR: BUSINESS MARKETING CONSULTATION
SERVICES IN THE FIELD OF MARKETING METH-
ODOLOGY, NAMELY, ASSESSMENT OF CUSTO-
MER LOYALTY, EMPLOYEE ENGAGEMENT,
DATABASE MARKETING, SOCIAL NETWORKING
AND GRASS ROOTS WORD OF MOUTH MARKET-
ING, IN CLASS 35 (U.S. CLS. 100, 101 AND 102).

FIRST USE 6-0-1994; IN COMMERCE 6-0-1994.

THE MARK CONSISTS OF STANDARD CHAR-
ACTERS WITHOUT CLAIM TO ANY PARTICULAR
FONT, STYLE, SIZE, OR COLOR.

SN 78-543,814, FILED 1-7-2005.

MICHAEL LEWIS, EXAMINING ATTORNEY

Int. Cl.: 42

Prior U.S. Cls.: 100 and 101

United States Patent and Trademark Office

Reg. No. 3,486,200

Registered Aug. 12, 2008

**SERVICE MARK
PRINCIPAL REGISTER**

LASERUT

PAR SYSTEMS, INC. (DELAWARE CORPORATION)
899 HIGHWAY 96 WEST
SHOREVIEW, MN 55126

THE MARK CONSISTS OF STANDARD CHARACTERS WITHOUT CLAIM TO ANY PARTICULAR FONT, STYLE, SIZE, OR COLOR.

FOR: MATERIALS TESTING AND EVALUATION; TECHNOLOGY SUPERVISION AND INSPECTION IN THE FIELD OF PRODUCT QUALITY CONTROL, IN CLASS 42 (U.S. CLS. 100 AND 101).

SN 78-551,796, FILED 1-21-2005.

FIRST USE 12-19-2007; IN COMMERCE 12-19-2007.

JOHN WILKE, EXAMINING ATTORNEY

Int. Cl.: 41

Prior U.S. Cls.: 100, 101, and 107

Reg. No. 3,486,201

United States Patent and Trademark Office

Registered Aug. 12, 2008

**SERVICE MARK
PRINCIPAL REGISTER**

**WALK THE WATER'S
EDGE**

DETROIT RIVERFRONT CONSERVANCY, INC.
(MICHIGAN CORPORATION)
MAIL CODE 482-B13-004
200 RENAISSANCE CENTER, 13TH FLOOR
DETROIT, MI 48265

THE MARK CONSISTS OF STANDARD CHAR-
ACTERS WITHOUT CLAIM TO ANY PARTICULAR
FONT, STYLE, SIZE, OR COLOR.

FOR: RECREATIONAL PARK SERVICES, IN
CLASS 41 (U.S. CLS. 100, 101 AND 107).

SN 78-556,661, FILED 1-31-2005.

FIRST USE 6-1-2008; IN COMMERCE 6-1-2008.

JEFFERY COWARD, EXAMINING ATTORNEY

Int. Cls.: 35, 36, 37, and 42

Prior U.S. Cls.: 100, 101, 102, 103, and 106

United States Patent and Trademark Office

Reg. No. 3,486,202

Registered Aug. 12, 2008

**SERVICE MARK
PRINCIPAL REGISTER**

**BIOMEDICAL
ACCELERATOR**

ALEXANDRIA REAL ESTATE EQUITIES, INC.
(MARYLAND CORPORATION)
385 E. COLORADO BLVD., SUITE 299
PASADENA, CA 91101

FOR: BUSINESS DEVELOPMENT SERVICES, NAMELY, PROVIDING START-UP SUPPORT FOR THE BUSINESSES OF OTHERS; BUSINESS MANAGEMENT AND CONSULTATION; BUSINESS INCUBATOR SERVICES, NAMELY, BUSINESS MANAGEMENT AND BUSINESS DEVELOPMENT SERVICES IN THE FORM OF START-UP SUPPORT FOR THE BUSINESSES OF OTHERS; RENTAL AND LEASING OF OFFICE MACHINERY AND EQUIPMENT, IN CLASS 35 (U.S. CLS. 100, 101 AND 102).

FIRST USE 5-0-2005; IN COMMERCE 5-0-2005.

FOR: FINANCIAL SERVICES, NAMELY, FINANCIAL CONSULTATION, FINANCIAL ANALYSIS, FINANCIAL PLANNING, FINANCIAL MANAGEMENT, PROVIDING DEBT AND EQUITY CAPITAL, AND TANGIBLE AND INTANGIBLE ASSET FINANCING; BUSINESS INCUBATOR SERVICES, NAMELY, PROVIDING EQUITY AND DEBT FINANCING TO EMERGING AND START-UP COMPANIES; REAL ESTATE SERVICES, NAMELY, REAL ESTATE BROKERAGE, ACQUISITION, RENTAL, LEASING, AND MANAGEMENT, IN CLASS 36 (U.S. CLS. 100, 101 AND 102).

FIRST USE 5-0-2005; IN COMMERCE 5-0-2005.

FOR: REAL ESTATE DEVELOPMENT; BUILDING CONSTRUCTION AND REPAIR; MAINTENANCE AND REPAIR OF BUILDINGS, ELECTRICAL SYSTEMS, HEATING AND AIR CONDITIONING SYSTEMS AND PLUMBING SYSTEMS, ALL IN THE FIELD OF REAL ESTATE, IN CLASS 37 (U.S. CLS. 100, 103 AND 106).

FIRST USE 5-0-2005; IN COMMERCE 5-0-2005.

FOR: ARCHITECTURAL DESIGN; ENGINEERING; RENTAL AND LEASING OF COMPUTERS, IN CLASS 42 (U.S. CLS. 100 AND 101).

FIRST USE 5-0-2005; IN COMMERCE 5-0-2005.

THE MARK CONSISTS OF STANDARD CHARACTERS WITHOUT CLAIM TO ANY PARTICULAR FONT, STYLE, SIZE, OR COLOR.

NO CLAIM IS MADE TO THE EXCLUSIVE RIGHT TO USE "BIOMEDICAL", APART FROM THE MARK AS SHOWN.

SN 78-557,642, FILED 2-1-2005.

YONG KIM, EXAMINING ATTORNEY

Int. Cl.: 35

Prior U.S. Cls.: 100, 101, and 102

United States Patent and Trademark Office

Reg. No. 3,486,203

Registered Aug. 12, 2008

**SERVICE MARK
PRINCIPAL REGISTER**

SURF TOWN USA

SURF TOWN USA, LLC (GEORGIA LTD LIAB
CO)
5182 BROOK HOLLOW PARKWAY
NORCROSS, GA 30071

FOR: RETAIL STORE SERVICES FEATURING
WATER AND BEACH CLOTHING AND SPORTS-
WEAR, FOOTWEAR, BEACH ACCESSORIES, SURF-
BOARDS, WAVE BOARDS, TOWELS, BEACH
TOTES AND BAGS, IN CLASS 35 (U.S. CLS. 100, 101
AND 102).

FIRST USE 4-0-2005; IN COMMERCE 4-0-2005.

THE MARK CONSISTS OF STANDARD CHAR-
ACTERS WITHOUT CLAIM TO ANY PARTICULAR
FONT, STYLE, SIZE, OR COLOR.

NO CLAIM IS MADE TO THE EXCLUSIVE
RIGHT TO USE "USA", APART FROM THE MARK
AS SHOWN.

SN 78-558,623, FILED 2-2-2005.

YONG KIM, EXAMINING ATTORNEY

Int. Cls.: 35, 36, 37, and 42

Prior U.S. Cls.: 100, 101, 102, 103, and 106

United States Patent and Trademark Office

Reg. No. 3,486,204

Registered Aug. 12, 2008

**SERVICE MARK
PRINCIPAL REGISTER**

ORTHO ACCELERATOR

ALEXANDRIA REAL ESTATE EQUITIES, INC.
(MARYLAND CORPORATION)
385 E COLORADO BLVD., SUITE 299
PASADENA, CA 91101

FOR: BUSINESS DEVELOPMENT SERVICES, NAMELY, PROVIDING START-UP SUPPORT FOR THE BUSINESSES OF OTHERS; BUSINESS MANAGEMENT AND CONSULTATION; BUSINESS INCUBATOR SERVICES, NAMELY, BUSINESS MANAGEMENT AND BUSINESS DEVELOPMENT SERVICES IN THE FORM OF START-UP SUPPORT FOR THE BUSINESSES OF OTHERS; RENTAL AND LEASING OF OFFICE MACHINERY AND EQUIPMENT, IN CLASS 35 (U.S. CLS. 100, 101 AND 102).

FIRST USE 5-0-2005; IN COMMERCE 5-0-2005.

FOR: FINANCIAL SERVICES, NAMELY, FINANCIAL CONSULTATION, FINANCIAL ANALYSIS, FINANCIAL PLANNING, FINANCIAL MANAGEMENT, PROVIDING DEBT AND EQUITY CAPITAL, AND TANGIBLE AND INTANGIBLE ASSET FINANCING; BUSINESS INCUBATOR SERVICES, NAMELY, PROVIDING EQUITY AND DEBT FINANCING TO EMERGING AND START-UP COMPANIES; REAL ESTATE SERVICES, NAMELY, REAL ESTATE BROKERAGE, ACQUISITION, REN-

TAL, LEASING, AND MANAGEMENT, IN CLASS 36 (U.S. CLS. 100, 101 AND 102).

FIRST USE 5-0-2005; IN COMMERCE 5-0-2005.

FOR: REAL ESTATE DEVELOPMENT; BUILDING CONSTRUCTION AND REPAIR; MAINTENANCE AND REPAIR OF BUILDINGS, ELECTRICAL SYSTEMS, HEATING AND AIR CONDITIONING SYSTEMS AND PLUMBING SYSTEMS, ALL IN THE FIELD OF REAL ESTATE, IN CLASS 37 (U.S. CLS. 100, 103 AND 106).

FIRST USE 5-0-2005; IN COMMERCE 5-0-2005.

FOR: ARCHITECTURAL DESIGN; ENGINEERING; RENTAL AND LEASING OF COMPUTERS, IN CLASS 42 (U.S. CLS. 100 AND 101).

FIRST USE 5-0-2005; IN COMMERCE 5-0-2005.

THE MARK CONSISTS OF STANDARD CHARACTERS WITHOUT CLAIM TO ANY PARTICULAR FONT, STYLE, SIZE, OR COLOR.

SN 78-561,831, FILED 2-7-2005.

YONG KIM, EXAMINING ATTORNEY

Int. Cl.: 20

Prior U.S. Cls.: 2, 13, 22, 25, 32, and 50

United States Patent and Trademark Office

Reg. No. 3,486,205

Registered Aug. 12, 2008

**TRADEMARK
PRINCIPAL REGISTER**

**NOTIONS OF THE
HEART**

KILLIP, KATHLEEN D. (UNITED STATES INDIVIDUAL)
5100 LEE'S SUMMIT ROAD
KANSAS CITY, MO 64136

THE MARK CONSISTS OF STANDARD CHARACTERS WITHOUT CLAIM TO ANY PARTICULAR FONT, STYLE, SIZE, OR COLOR.

FOR: COLD CAST RESIN AND FABRIC FIGURINES; ORNAMENTS OF COLD CAST RESIN AND FABRIC, IN CLASS 20 (U.S. CLS. 2, 13, 22, 25, 32 AND 50).

SN 78-562,627, FILED 2-8-2005.

FIRST USE 11-30-2006; IN COMMERCE 11-30-2006.

BRIAN PINO, EXAMINING ATTORNEY

Int. Cl.: 16

Prior U.S. Cls.: 2, 5, 22, 23, 29, 37, 38, and 50

Reg. No. 3,486,206

United States Patent and Trademark Office

Registered Aug. 12, 2008

**TRADEMARK
PRINCIPAL REGISTER**

CULTIVATED CAVEMAN

KNUCKLEDRAGGERS, LLC (COLORADO LTD
LIAB CO)
1549 COOK STREET
DENVER, CO 80206

FIRST USE 5-30-2008; IN COMMERCE 5-30-2008.

FOR: SERIES OF NON-FICTION BOOKS IN THE
FIELDS OF COOKBOOKS, HEALTH, NUTRITION
AND FITNESS, PERSONAL ENRICHMENT AND
SELF-IMPROVEMENT, HUMOR, AND PARENT-
ING, IN CLASS 16 (U.S. CLS. 2, 5, 22, 23, 29, 37, 38
AND 50).

THE MARK CONSISTS OF STANDARD CHAR-
ACTERS WITHOUT CLAIM TO ANY PARTICULAR
FONT, STYLE, SIZE, OR COLOR.

SN 78-565,412, FILED 2-11-2005.

JASON TURNER, EXAMINING ATTORNEY

Int. Cl.: 25

Prior U.S. Cls.: 22 and 39

United States Patent and Trademark Office

Reg. No. 3,486,207

Registered Aug. 12, 2008

**TRADEMARK
PRINCIPAL REGISTER**

VECTRIX

VECTRIX CORPORATION (DELAWARE CORPORATION)
76 HAMMARLUND WAY
TECH III PLAZA, SUITE 250
MIDDLETOWN, RI 02842

FOR: CLOTHING, NAMELY, GLOVES, SHIRTS, JACKETS, VESTS, HATS, IN CLASS 25 (U.S. CLS. 22 AND 39).

FIRST USE 9-14-2007; IN COMMERCE 10-2-2007.

THE MARK CONSISTS OF STANDARD CHARACTERS WITHOUT CLAIM TO ANY PARTICULAR FONT, STYLE, SIZE, OR COLOR.

SN 78-572,585, FILED 2-22-2005.

CHRISTOPHER BUONGIORNO, EXAMINING ATTORNEY

Int. Cl.: 42

Prior U.S. Cls.: 100 and 101

United States Patent and Trademark Office

Reg. No. 3,486,208

Registered Aug. 12, 2008

**SERVICE MARK
PRINCIPAL REGISTER**

**MEDIO MARKUP
LANGUAGE**

MEDIO SYSTEMS, INC. (DELAWARE CORPORATION)
701 PIKE STREET, SUITE 1500
SEATTLE, WA 98101

FOR: DATA MINING, NAMELY, EXTRACTION AND RETRIEVAL OF INFORMATION BY MEANS OF GLOBAL COMPUTER NETWORKS AND WIRELESS NETWORKS; CREATING INDEXES OF INFORMATION, INDEXES OF WEBSITES AND INDEXES OF OTHER INFORMATION SOURCES IN CONNECTION WITH GLOBAL COMPUTER NETWORKS AND WIRELESS NETWORKS; PROVIDING SPECIFIC INFORMATION AS REQUESTED BY CUSTOMERS VIA MOBILE HANDSETS FROM SEARCHABLE INDEXES AND DATABASES OF INFORMATION, INCLUDING TEXT, ELECTRONIC DOCUMENTS, DATABASES, GRAPHICS AND AUDIO VISUAL INFORMATION; PROVIDING CUSTOMIZED WEB PAGES FEATURING USER-REQUESTED INFORMATION, WHICH INCLUDES

INFORMATION STORED IN THE INFORMATION INDEX AND LINKS TO OTHER WEB SITES , IN CLASS 42 (U.S. CLS. 100 AND 101).

FIRST USE 2-13-2006; IN COMMERCE 2-13-2006.

THE MARK CONSISTS OF STANDARD CHARACTERS WITHOUT CLAIM TO ANY PARTICULAR FONT, STYLE, SIZE, OR COLOR.

NO CLAIM IS MADE TO THE EXCLUSIVE RIGHT TO USE "MARKUP LANGUAGE", APART FROM THE MARK AS SHOWN.

THE FOREIGN WORDING IN THE MARK TRANSLATES INTO ENGLISH AS MEANS.

SN 78-584,035, FILED 3-9-2005.

PAULA MAHONEY, EXAMINING ATTORNEY

Int. Cl.: 9

Prior U.S. Cls.: 21, 23, 26, 36, and 38

Reg. No. 3,486,209

United States Patent and Trademark Office

Registered Aug. 12, 2008

**TRADEMARK
PRINCIPAL REGISTER**

EMASK

TOPPAN PHOTOMASKS, INC. (DELAWARE
CORPORATION)
131 OLD SETTLERS BLVD.
ROUND ROCK, TX 78664

FOR: FACTORY AUTOMATION SOFTWARE,
NAMELY, SOFTWARE TO INTEGRATE PHOTO-
MASK MANUFACTURING MACHINE OPERA-
TIONS, TRACK PROBLEMS AND GENERATE
PRODUCTION REPORTS, IN CLASS 9 (U.S. CLS.
21, 23, 26, 36 AND 38).

FIRST USE 1-1-2000; IN COMMERCE 10-1-2004.

THE MARK CONSISTS OF STANDARD CHAR-
ACTERS WITHOUT CLAIM TO ANY PARTICULAR
FONT, STYLE, SIZE, OR COLOR.

SN 78-587,668, FILED 3-15-2005.

PAUL E. FAHRENKOPF, EXAMINING ATTORNEY

Int. Cl.: 12

Prior U.S. Cls.: 19, 21, 23, 31, 35, and 44

Reg. No. 3,486,210

United States Patent and Trademark Office

Registered Aug. 12, 2008

**TRADEMARK
PRINCIPAL REGISTER**

The word "ZING" is displayed in a large, bold, black serif font. The letters are closely spaced and centered horizontally. The background is a light gray with a subtle grid pattern.

KONA USA, INC. (WASHINGTON CORPORATION)

2455 SALASHAN

FERNDALE, WA 98248

FOR: BICYCLES, PARTS AND ACCESSORIES THEREFOR, IN CLASS 12 (U.S. CLS. 19, 21, 23, 31, 35 AND 44).

FIRST USE 8-31-2005; IN COMMERCE 8-31-2005.

THE MARK CONSISTS OF STANDARD CHARACTERS WITHOUT CLAIM TO ANY PARTICULAR FONT, STYLE, SIZE, OR COLOR.

PRIORITY CLAIMED UNDER SEC. 44(D) ON CANADA APPLICATION NO. 1250474, FILED 3-14-2005, REG. NO. TMA691483, DATED 7-6-2007, EXPIRES 7-6-2022.

SN 78-588,087, FILED 3-16-2005.

KIMBERLY PERRY, EXAMINING ATTORNEY

Int. Cl.: 11

Prior U.S. Cls.: 13, 21, 23, 31, and 34

United States Patent and Trademark Office

Reg. No. 3,486,211

Registered Aug. 12, 2008

**TRADEMARK
PRINCIPAL REGISTER**

DRYSTILL

FIELDING CHEMICAL TECHNOLOGIES INC.
(CANADA CORPORATION)
3549 MAVIS RD.
MISSISSAUGA, ONTARIO, CANADA L5C 1T7

FOR: CHEMICAL PROCESS EQUIPMENT,
NAMELY, PERVAPORATION SEPARATORS AND
MEMBRANE MODULES FOR PERVAPORATION
SEPARATORS, IN CLASS 11 (U.S. CLS. 13, 21, 23, 31
AND 34).

FIRST USE 3-14-2008; IN COMMERCE 3-14-2008.

THE MARK CONSISTS OF STANDARD CHAR-
ACTERS WITHOUT CLAIM TO ANY PARTICULAR
FONT, STYLE, SIZE, OR COLOR.

SN 78-588,761, FILED 3-16-2005.

MIDGE BUTLER, EXAMINING ATTORNEY

Int. Cl.: 43

Prior U.S. Cls.: 100 and 101

United States Patent and Trademark Office

Reg. No. 3,486,212

Registered Aug. 12, 2008

**SERVICE MARK
PRINCIPAL REGISTER**

**JOEY'S**
SEAFOOD & GRILL

JOEY'S ONLY FRANCHISING LTD. (CANADA
CORPORATION)

514 - 42ND AVENUE, SE

CALGARY, CANADA T2G 1Y6

FOR: RESTAURANT SERVICES, IN CLASS 43
(U.S. CLS. 100 AND 101).

FIRST USE 4-25-2005; IN COMMERCE 4-25-2005.

OWNER OF U.S. REG. NOS. 2,012,356, 2,113,247,
AND 2,638,685.

NO CLAIM IS MADE TO THE EXCLUSIVE
RIGHT TO USE "SEAFOOD & GRILL", APART
FROM THE MARK AS SHOWN.

SN 78-590,636, FILED 3-18-2005.

ELISSA GARBER KON, EXAMINING ATTORNEY

Int. Cl.: 41

Prior U.S. Cls.: 100, 101, and 107

United States Patent and Trademark Office

Reg. No. 3,486,213

Registered Aug. 12, 2008

**SERVICE MARK
PRINCIPAL REGISTER**

A-LIST AWARDS

ROSENHAUS, STEVEN (UNITED STATES INDIVIDUAL)
SUITE 20C
212 EAST 47 STREET
NEW YORK, NY 10017

FOR: ENTERTAINMENT SERVICES IN THE NATURE OF AN AWARD CEREMONY HONORING ACHIEVEMENTS IN THE FIELD OF WOMEN'S ACHIEVEMENTS, IN CLASS 41 (U.S. CLS. 100, 101 AND 107).

FIRST USE 6-12-2008; IN COMMERCE 6-12-2008.

THE MARK CONSISTS OF STANDARD CHARACTERS WITHOUT CLAIM TO ANY PARTICULAR FONT, STYLE, SIZE, OR COLOR.

NO CLAIM IS MADE TO THE EXCLUSIVE RIGHT TO USE "AWARDS", APART FROM THE MARK AS SHOWN.

SN 78-591,229, FILED 3-21-2005.

SHAUNIA CARLYLE, EXAMINING ATTORNEY

Int. Cls.: 10, 17, and 31

Prior U.S. Cls.: 1, 5, 12, 13, 26, 35, 39, 44, 46, and 50

United States Patent and Trademark Office

Reg. No. 3,486,214

Registered Aug. 12, 2008

**TRADEMARK
PRINCIPAL REGISTER**



THE LAMINITIS CLINIC

EUSTACE, ROBERT (UNITED KINGDOM INDIVIDUAL)
MEAD HOUSE FARM, DAUNTSEY, CHIPPENHAM
WILTSHIRE, UNITED KINGDOM SN15 4JA

FOR: VETERINARY APPARATUS AND INSTRUMENTS, NAMELY, INJECTION SYRINGES AND INJECTION SYRINGE GUNS, BLOOD PUMPS, ROTARY BLOOD PUMPS, HEART PUMPS, VENTRICULAR ASSIST DEVICES; PARTS AND ACCESSORIES FOR HEART PUMPS AND VENTRICULAR ASSIST DEVICES COMPRISING BLOOD PUMPS, BELTS, BRACES; ORTHOPEDIC ARTICLES FOR ANIMALS, NAMELY, ORTHOPEDIC FOOTWEAR, JOINT IMPLANTS, SOLES, FROG SUPPORTS, LEG BANDAGES, LEG AND JOINT SUPPORTS; PLASTIC PACKING FOR MEDICAL PURPOSES, NAMELY, FOR USE IN SUPPORTING AND BRACING INJURED OR DAMAGED JOINTS, IN CLASS 10 (U.S. CLS. 26, 39 AND 44).

FIRST USE 4-5-2005; IN COMMERCE 4-5-2005.

FOR: PLASTIC HORSE SHOE KITS; PLASTICS USED IN PACKAGING, NAMELY, PACKAGING

MATERIAL FOR FORMING SEALS, PACKING PADDING OF PLASTIC FOR SHIPPING CONTAINERS, IN CLASS 17 (U.S. CLS. 1, 5, 12, 13, 35 AND 50).

FIRST USE 4-5-2005; IN COMMERCE 4-5-2005.

FOR: ANIMAL FOODSTUFFS, NAMELY, SEED MIXTURES, FORAGE FEEDS AND HERBAL FEEDS, IN CLASS 31 (U.S. CLS. 1 AND 46).

FIRST USE 5-0-2005; IN COMMERCE 5-0-2005.

THE PORTION OF THE MARK COMPRISED OF A CROSS DESIGN IS NOT DISPLAYED IN THE COLOR RED OR A COLORABLE IMITATION THEREOF; AND IS NOT USED AND WILL NOT BE USED IN THE COLOR RED OR A COLORABLE IMITATION THEREOF.

SN 78-592,660, FILED 3-22-2005.

HOWARD SMIGA, EXAMINING ATTORNEY

Int. Cl.: 9

Prior U.S. Cls.: 21, 23, 26, 36, and 38

Reg. No. 3,486,215

United States Patent and Trademark Office

Registered Aug. 12, 2008

**TRADEMARK
PRINCIPAL REGISTER**



GENERAL ATOMICS (CALIFORNIA CORPORATION)
3550 GENERAL ATOMICS COURT
SAN DIEGO, CA 92121

NO CLAIM IS MADE TO THE EXCLUSIVE RIGHT TO USE "WIDEBAND", APART FROM THE MARK AS SHOWN.

FOR: ELECTRONIC INTERFACE DEVICES, NAMELY, HIGH DATA RATE, RADIO-ON-A CHIP DEVICES FOR USE IN WIRELESS THROUGHPUT SYSTEMS, IN CLASS 9 (U.S. CLS. 21, 23, 26, 36 AND 38).

SN 78-593,246, FILED 3-23-2005.

FIRST USE 1-7-2008; IN COMMERCE 1-7-2008.

KARANENDRA S. CHHINA, EXAMINING ATTORNEY

Int. Cl.: 3

Prior U.S. Cls.: 1, 4, 6, 50, 51, and 52

United States Patent and Trademark Office

Reg. No. 3,486,216

Registered Aug. 12, 2008

**TRADEMARK
PRINCIPAL REGISTER**

ADDICTED TO LOVE

DESIGNER SKIN, L.L.C. (ARIZONA LTD LIAB
CO)
6270 CORPORATE DRIVE
INDIANAPOLIS, IN 46278

FIRST USE 11-1-2005; IN COMMERCE 11-1-2005.

FOR: TANNING PREPARATIONS, NAMELY,
MOISTURIZERS, BRONZERS, INDOOR TANNING
PREPARATIONS, SELF-TANNING LOTIONS AND
SPRAYS, SUNLESS TANNING LOTIONS AND
SPRAYS, AND LOTIONS TO ACCELERATE, EX-
TEND, AND/OR ENHANCE TANS FOR SALE IN
INDOOR TANNING SALONS, IN CLASS 3 (U.S. CLS.
1, 4, 6, 50, 51 AND 52).

THE MARK CONSISTS OF STANDARD CHAR-
ACTERS WITHOUT CLAIM TO ANY PARTICULAR
FONT, STYLE, SIZE, OR COLOR.

SN 78-593,509, FILED 3-23-2005.

RAUL CORDOVA, EXAMINING ATTORNEY

Int. Cls.: 18 and 25

Prior U.S. Cls.: 1, 2, 3, 22, 39, and 41

United States Patent and Trademark Office

Reg. No. 3,486,217

Registered Aug. 12, 2008

TRADEMARK
PRINCIPAL REGISTER



SUPER RIFLE S.P.A. (ITALY SOCIETA PER AZIONI)
VIALE G. MATTEOTTI 2B/2C
50031 BARBERINO DI MUGELLO (FIRENZE), ITALY

FOR: BAGS FOR MEN AND WOMEN, NAMELY, HAND BAGS, SHOULDER BAGS; SMALL LEATHER GOODS, NAMELY, WALLETS, LEATHER KEY CHAINS, IN CLASS 18 (U.S. CLS. 1, 2, 3, 22 AND 41).

FIRST USE 3-0-2005; IN COMMERCE 4-0-2005.

FOR: READY-MADE CLOTHING ARTICLES FOR MEN, WOMEN AND CHILDREN, NAMELY,

TROUSERS, COATS, JACKETS, OVERCOATS, WORKING CLOTHES, SPORTS AND CASUAL CLOTHES, NAMELY, OVERALLS, SHIRTS, T-SHIRTS, SWEATERS, PULLOVERS, SWEATSHIRTS, SWEATPANTS, SWEATSUITS; BELTS, IN CLASS 25 (U.S. CLS. 22 AND 39).

FIRST USE 3-0-2005; IN COMMERCE 4-0-2005.

OWNER OF U.S. REG. NO. 1,173,381.

SN 78-604,029, FILED 4-7-2005.

ELISSA GARBER KON, EXAMINING ATTORNEY

Int. Cl.: 16

Prior U.S. Cls.: 2, 5, 22, 23, 29, 37, 38, and 50

Reg. No. 3,486,218

United States Patent and Trademark Office

Registered Aug. 12, 2008

**TRADEMARK
PRINCIPAL REGISTER**

SNAPPY NAPKINS

LEIGH, SUSAN (UNITED STATES INDIVIDUAL)
1153 WHITING STREET
MEMPHIS, TN 38117

OWNER OF U.S. REG. NO. 2,353,938.

FOR: PAPER NAPKINS, IN CLASS 16 (U.S. CLS. 2,
5, 22, 23, 29, 37, 38 AND 50).

NO CLAIM IS MADE TO THE EXCLUSIVE
RIGHT TO USE "NAPKINS", APART FROM THE
MARK AS SHOWN.

FIRST USE 5-5-2008; IN COMMERCE 6-3-2008.

SN 78-609,189, FILED 4-14-2005.

THE MARK CONSISTS OF STANDARD CHAR-
ACTERS WITHOUT CLAIM TO ANY PARTICULAR
FONT, STYLE, SIZE, OR COLOR.

CAROLYN GRAY, EXAMINING ATTORNEY

Int. Cls.: 5 and 10

Prior U.S. Cls.: 6, 18, 26, 39, 44, 46, 51, and 52

United States Patent and Trademark Office

Reg. No. 3,486,219

Registered Aug. 12, 2008

**TRADEMARK
PRINCIPAL REGISTER**

CareSens

I-SENS, INC. (REPUBLIC OF KOREA CORPORATION)
465-6, WOLGYE 4-DONG
SEOUL, NOWON-GU, REPUBLIC OF KOREA 139-845

FOR: MEDICAL DIAGNOSTIC TEST STRIPS FOR USE IN MEASURING BLOOD GLUCOSE LEVELS, IN CLASS 5 (U.S. CLS. 6, 18, 44, 46, 51 AND 52).

FIRST USE 5-28-2008; IN COMMERCE 5-28-2008.

FOR: DEVICES FOR MEASURING BLOOD GLUCOSE; MEDICAL ELECTRODES; CARDIAC, CRYO-SURGICAL, URETHRA, PHYSIOLOGICAL FLUID, BREATH, MOUTH, STOMACH, INTESTINE,

LARGE INTESTINE AND ESOPHAGEAL PROBES; APPARATUS FOR BLOOD ANALYSIS AND FOR COUNTING BLOOD CELLS; MOBILE X-RAY CT+F25 SCANNERS; LANCETS, IN CLASS 10 (U.S. CLS. 26, 39 AND 44).

FIRST USE 5-28-2008; IN COMMERCE 5-28-2008.

THE MARK CONSISTS OF STANDARD CHARACTERS WITHOUT CLAIM TO ANY PARTICULAR FONT, STYLE, SIZE, OR COLOR.

SN 78-615,654, FILED 4-25-2005.

LINDA MICKLEBURGH, EXAMINING ATTORNEY

Int. Cl.: 36

Prior U.S. Cls.: 100, 101, and 102

United States Patent and Trademark Office

Reg. No. 3,486,220

Registered Aug. 12, 2008

**SERVICE MARK
PRINCIPAL REGISTER**

ALLFOURYEARS

EDUCAP INC. (MARYLAND CORPORATION)
1676 INTERNATIONAL DR, SUITE 501
MCLEAN, VA 22102

FOR: EDUCATIONAL LOAN SERVICES; FINANCING OF GOODS AND SERVICES RELATED TO EDUCATION; RESEARCH IN THE AREA OF FINANCIAL RESOURCES FOR KINDERGARTEN THROUGH GRADE 12, COLLEGE, UNIVERSITY AND ADULT EDUCATION; COLLEGE SAVING PLANS; PROVIDING SCHOLARSHIPS FOR EDUCATION; MANAGEMENT OF CORPORATE FINANCIAL RESOURCES FOR USE IN EDUCATION, TRAINING AND RECRUITMENT;

AND ADMINISTRATION AND OPERATION OF A LINE OF CREDIT FOR USE IN FINANCING EDUCATION AND EDUCATION-RELATED EXPENSES, IN CLASS 36 (U.S. CLS. 100, 101 AND 102).

FIRST USE 6-14-2007; IN COMMERCE 6-14-2007.

THE MARK CONSISTS OF STANDARD CHARACTERS WITHOUT CLAIM TO ANY PARTICULAR FONT, STYLE, SIZE, OR COLOR.

SN 78-624,122, FILED 5-5-2005.

JOHN DALIER, EXAMINING ATTORNEY

Int. Cl.: 9

Prior U.S. Cls.: 21, 23, 26, 36, and 38

Reg. No. 3,486,221

United States Patent and Trademark Office

Registered Aug. 12, 2008

**TRADEMARK
PRINCIPAL REGISTER**

LASERUT

PAR SYSTEMS, INC. (DELAWARE CORPORATION)
899 HIGHWAY 96 WEST
SHOREVIEW, MN 55126

FOR: COMPUTER HARDWARE, COMPUTER SOFTWARE AND INSTRUMENTATION FOR USE IN THE FIELD OF MATERIALS TESTING, PRODUCT TESTING AND MANUFACTURING QUALITY CONTROL; IMAGING APPARATUS FOR LASER-BASED ULTRASOUND NON-DESTRUCTIVE TESTING FOR THE PURPOSE OF QUALITY CONTROL AND INSPECTION OF MATERIALS AND STRUCTURES DURING THEIR USE OR MANUFACTURE; ANALYTICAL EQUIPMENT PRIMARILY COMPRISING LASERS, INTERFEROMETERS, OPTICAL FILTERS, ULTRASOUND RECEIVERS, COMPUTER HARDWARE AND COMPUTER SOFTWARE FOR TESTING, DETECTING,

MEASURING, AND EVALUATING MATERIALS, PRODUCTS AND MANUFACTURING QUALITY CONTROL; COMPUTER SOFTWARE FOR INTERPRETING, EVALUATING, AND VISUALIZING DATA IN THE FIELD OF MATERIALS TESTING, PRODUCT TESTING AND MANUFACTURING QUALITY CONTROL, IN CLASS 9 (U.S. CLS. 21, 23, 26, 36 AND 38).

FIRST USE 12-19-2007; IN COMMERCE 12-19-2007.

THE MARK CONSISTS OF STANDARD CHARACTERS WITHOUT CLAIM TO ANY PARTICULAR FONT, STYLE, SIZE, OR COLOR.

SN 78-624,407, FILED 5-6-2005.

JOHN WILKE, EXAMINING ATTORNEY

Int. Cl.: 16

Prior U.S. Cls.: 2, 5, 22, 23, 29, 37, 38, and 50

Reg. No. 3,486,222

United States Patent and Trademark Office

Registered Aug. 12, 2008

**TRADEMARK
PRINCIPAL REGISTER**

POPULAR LIBRARY

HACHETTE BOOK GROUP USA, INC. (DELA-
WARE CORPORATION)
237 PARK AVENUE
NEW YORK, NY 10017

OWNER OF U.S. REG. NO. 1,340,662.

FOR: FICTION AND NON-FICTION BOOKS ON A
VARIETY OF TOPICS, IN CLASS 16 (U.S. CLS. 2, 5, 22,
23, 29, 37, 38 AND 50).

NO CLAIM IS MADE TO THE EXCLUSIVE
RIGHT TO USE "LIBRARY", APART FROM THE
MARK AS SHOWN.

FIRST USE 5-1-2008; IN COMMERCE 5-1-2008.

SN 78-629,839, FILED 5-13-2005.

THE MARK CONSISTS OF STANDARD CHAR-
ACTERS WITHOUT CLAIM TO ANY PARTICULAR
FONT, STYLE, SIZE, OR COLOR.

JOHN DALIER, EXAMINING ATTORNEY

Int. Cls.: 25 and 28

Prior U.S. Cls.: 22, 23, 38, 39, and 50

United States Patent and Trademark Office

Reg. No. 3,486,223

Registered Aug. 12, 2008

**TRADEMARK
PRINCIPAL REGISTER**

IMMORTAL EYES GAMES

WINNING MOVES, INC. (MASSACHUSETTS
CORPORATION)
SUITE 102
100 CONIFER HILL DRIVE
DANVERS, MA 01923

FOR: CLOTHING, NAMELY, SHIRTS, IN CLASS
25 (U.S. CLS. 22 AND 39).

FIRST USE 3-11-2006; IN COMMERCE 3-11-2006.

FOR: BOARD GAMES, STRATEGY GAMES, IN
CLASS 28 (U.S. CLS. 22, 23, 38 AND 50).

FIRST USE 3-11-2006; IN COMMERCE 3-11-2006.

THE MARK CONSISTS OF STANDARD CHAR-
ACTERS WITHOUT CLAIM TO ANY PARTICULAR
FONT, STYLE, SIZE, OR COLOR.

NO CLAIM IS MADE TO THE EXCLUSIVE
RIGHT TO USE "GAMES", APART FROM THE
MARK AS SHOWN.

SN 78-633,842, FILED 5-20-2005.

SARA THOMAS, EXAMINING ATTORNEY

Int. Cls.: 21 and 25

Prior U.S. Cls.: 2, 13, 22, 23, 29, 30, 33, 39, 40, and 50

United States Patent and Trademark Office

Reg. No. 3,486,224

Registered Aug. 12, 2008

**TRADEMARK
PRINCIPAL REGISTER**



CROCE, PASQUALE W., JR. (UNITED STATES
INDIVIDUAL)
835 MT. MORO ROAD
VILLANOVA, PA 19085

FOR: BEVERAGE GLASSWARE, IN CLASS 21
(U.S. CLS. 2, 13, 23, 29, 30, 33, 40 AND 50).

FIRST USE 2-0-2007; IN COMMERCE 2-0-2007.

FOR: CLOTHING FOR MEN, WOMEN AND
CHILDREN, NAMELY, SHIRTS, T-SHIRTS, SWEAT-

SHIRTS, HATS, AND CAPS, IN CLASS 25 (U.S. CLS.
22 AND 39).

FIRST USE 2-0-2007; IN COMMERCE 2-0-2007.

THE MARK CONSISTS OF A SKULL AND
CROSSBONES.

SN 78-634,392, FILED 5-20-2005.

REBECCA GILBERT, EXAMINING ATTORNEY

Int. Cls.: 9 and 11

Prior U.S. Cls.: 13, 21, 23, 26, 31, 34, 36, and 38

United States Patent and Trademark Office

Reg. No. 3,486,225

Registered Aug. 12, 2008

**TRADEMARK
PRINCIPAL REGISTER**

EZ UP

EMERALD INNOVATIONS L.L.C. (OHIO LTD
LIAB CO)
2200 OVERLOOK ROAD
CLEVELAND, OH 44106

FOR: ELECTRICAL LIGHT PROJECTORS,
NAMELY, A PICTURE PROJECTOR THAT PRO-
JECTS ILLUMINATED IMAGES ON SURFACES
AND COMPONENT PARTS THEREFORE, NAME-
LY, LENSES, AND IMAGE MEDIA IN THE FORM
OF TRANSLUCENT IMAGE SLIDES, NAMELY,
PHOTOGRAPHIC SLIDE TRANSPARENCIES, IN
CLASS 9 (U.S. CLS. 21, 23, 26, 36 AND 38).

FIRST USE 2-1-2007; IN COMMERCE 2-1-2007.

FOR: LIGHTED OUTDOOR SCULPTURES; LIGH-
TED WIRE FRAME STATUES; AND COMPONENT
PARTS FOR ELECTRICAL LIGHT PROJECTORS,
NAMELY, LIGHT BULBS, IN CLASS 11 (U.S. CLS. 13,
21, 23, 31 AND 34).

FIRST USE 2-1-2007; IN COMMERCE 2-1-2007.

THE MARK CONSISTS OF STANDARD CHAR-
ACTERS WITHOUT CLAIM TO ANY PARTICULAR
FONT, STYLE, SIZE, OR COLOR.

SN 78-635,903, FILED 5-24-2005.

RAMONA ORTIGA, EXAMINING ATTORNEY

Int. Cl.: 21

Prior U.S. Cls.: 2, 13, 23, 29, 30, 33, 40, and 50

United States Patent and Trademark Office

Reg. No. 3,486,226

Registered Aug. 12, 2008

TRADEMARK
PRINCIPAL REGISTER



DAVIS, DEJUR (UNITED STATES INDIVIDUAL)
264 S. LACIENEGA BOULEVARD, SUITE 1153
BEVERLY HILLS, CA 92011 AND
MCDONALD, SAMUEL (UNITED STATES INDIVIDUAL)
264 S. LACIENEGA BOULEVARD, SUITE 1153
BEVERLY HILLS, CA 92011

FOR: LOCKABLE TOTE CONTAINER FOR INDIVIDUAL MEALS AND SNACKS, IN CLASS 21 (U.S. CLS. 2, 13, 23, 29, 30, 33, 40 AND 50).

FIRST USE 6-2-2008; IN COMMERCE 6-2-2008.

NO CLAIM IS MADE TO THE EXCLUSIVE RIGHT TO USE "ORIGINAL LUNCH", APART FROM THE MARK AS SHOWN.

SN 78-635,989, FILED 5-24-2005.

PAUL CROWLEY, EXAMINING ATTORNEY

Int. Cl.: 9

Prior U.S. Cls.: 21, 23, 26, 36, and 38

Reg. No. 3,486,227

United States Patent and Trademark Office

Registered Aug. 12, 2008

**TRADEMARK
PRINCIPAL REGISTER**

NETWORKFX

SEABURN, SCOTT KELLY (UNITED STATES
INDIVIDUAL)
P.O. BOX 893459
MILILANI, HI 96789

THE MARK CONSISTS OF STANDARD CHAR-
ACTERS WITHOUT CLAIM TO ANY PARTICULAR
FONT, STYLE, SIZE, OR COLOR.

FOR: COMPUTER HARDWARE FOR NETWORK
IMPAIRMENT EMULATION; AND COMPUTER
SOFTWARE FOR NETWORK IMPAIRMENT EMU-
LATION, IN CLASS 9 (U.S. CLS. 21, 23, 26, 36 AND 38).

SN 78-638,468, FILED 5-26-2005.

FIRST USE 11-30-2007; IN COMMERCE 11-30-2007.

MICHELLE DUBOIS, EXAMINING ATTORNEY

Int. Cl.: 38

Prior U.S. Cls.: 100, 101, and 104

United States Patent and Trademark Office

Reg. No. 3,486,228

Registered Aug. 12, 2008

**SERVICE MARK
PRINCIPAL REGISTER**



NEDELCO, INC. (NEBRASKA CORPORATION)
1001 12TH STREET
AURORA, NE 68818

FOR: COMMUNICATION SERVICES, NAMELY, PROVIDING TELEPHONE COMMUNICATION SERVICES VIA THE INTERNET AND VIA TELEPHONE, FOR INDIVIDUALS WHO ARE DEAF, HARD OF HEARING OR SPEECH IMPAIRED; TELECOMMUNICATIONS RELAY SERVICES, NAMELY, PROVIDING TEXT TO VOICE RELAY AND TRANSLATION SERVICES TO FACILITATE TELEPHONE CONVERSATIONS BETWEEN INDIVIDUALS WHO ARE DEAF, HARD OF HEARING, SPEECH IMPAIRED AND HEARING IMPAIRED; CAPTIONED TELEPHONE SERVICES FOR INDIVIDUALS WHO ARE DEAF, HARD OF HEARING OR SPEECH IMPAIRED, IN CLASS 38 (U.S. CLS. 100, 101 AND 104).

VIDUALS WHO ARE DEAF, HARD OF HEARING, SPEECH IMPAIRED AND HEARING IMPAIRED; CAPTIONED TELEPHONE SERVICES FOR INDIVIDUALS WHO ARE DEAF, HARD OF HEARING OR SPEECH IMPAIRED, IN CLASS 38 (U.S. CLS. 100, 101 AND 104).

FIRST USE 4-10-2006; IN COMMERCE 4-10-2006.

SN 78-638,940, FILED 5-27-2005.

PAUL CROWLEY, EXAMINING ATTORNEY

Int. Cls.: 36 and 37

Prior U.S. Cls.: 100, 101, 102, 103, and 106

United States Patent and Trademark Office

Reg. No. 3,486,229

Registered Aug. 12, 2008

**SERVICE MARK
PRINCIPAL REGISTER**

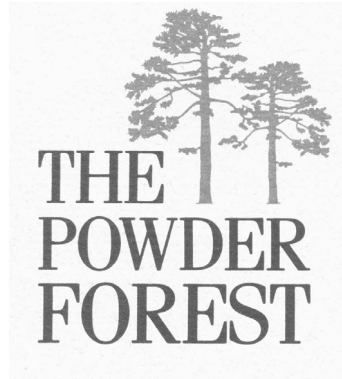

ENSIGN-BICKFORD REALTY CORPORATION
(CONNECTICUT CORPORATION)
75 WEST STREET
SIMSBURY, CT 060700711

FOR: REAL ESTATE MANAGEMENT; LEASING
OF REAL ESTATE AND REAL ESTATE BROKER-
AGE, IN CLASS 36 (U.S. CLS. 100, 101 AND 102).

FIRST USE 8-1-2005; IN COMMERCE 8-1-2005.

FOR: REAL ESTATE DEVELOPMENT; BUILD-
ING CONSTRUCTION, IN CLASS 37 (U.S. CLS. 100,
103 AND 106).

FIRST USE 8-1-2005; IN COMMERCE 8-1-2005.

OWNER OF U.S. REG. NO. 1,314,997.

SN 78-643,396, FILED 6-3-2005.

JASON TURNER, EXAMINING ATTORNEY

Int. Cl.: 44

Prior U.S. Cls.: 100 and 101

United States Patent and Trademark Office

Reg. No. 3,486,230

Registered Aug. 12, 2008

**SERVICE MARK
PRINCIPAL REGISTER**

BRINGING UP GEEKS

HICKS, MARYBETH (UNITED STATES INDIVIDUAL)
6410 RIDGEPOND PLACE
EAST LANSING, MI 48823

FOR: PROVIDING A WEBSITE FEATURING INFORMATION, INCLUDING PROVIDING ADVICE, IN THE FIELD OF CHILDREN'S PHYSICAL AND PSYCHOLOGICAL DEVELOPMENT, NAMELY, PROVIDING INFORMATION ON THE TOPICS OF RAISING HEALTHY, WELL-BEHAVED, AND SUCCESSFUL CHILDREN, CHILD DEVELOPMENT, CHILDREN'S BEHAVIOR, WELL-CHILD CARE,

AND CHILD DISCIPLINE, IN CLASS 44 (U.S. CLS. 100 AND 101).

FIRST USE 6-11-2008; IN COMMERCE 6-11-2008.

THE MARK CONSISTS OF STANDARD CHARACTERS WITHOUT CLAIM TO ANY PARTICULAR FONT, STYLE, SIZE, OR COLOR.

SN 78-643,405, FILED 6-3-2005.

DAVID MILLER, EXAMINING ATTORNEY

Int. Cl.: 9

Prior U.S. Cls.: 21, 23, 26, 36, and 38

Reg. No. 3,486,231

United States Patent and Trademark Office

Registered Aug. 12, 2008

**TRADEMARK
PRINCIPAL REGISTER**

BRILLIANT BET

FLEETWOOD MANUFACTURING, INC. (MONTANA CORPORATION)
200 REGAL STREET
BILLINGS, MT 59101

FOR: GAMING EQUIPMENT, NAMELY, GAMING MACHINES WITH OR WITH VIDEO OUTPUT, IN CLASS 9 (U.S. CLS. 21, 23, 26, 36 AND 38).

FIRST USE 4-7-2008; IN COMMERCE 4-7-2008.

THE MARK CONSISTS OF STANDARD CHARACTERS WITHOUT CLAIM TO ANY PARTICULAR FONT, STYLE, SIZE, OR COLOR.

NO CLAIM IS MADE TO THE EXCLUSIVE RIGHT TO USE "BET", APART FROM THE MARK AS SHOWN.

SN 78-643,556, FILED 6-3-2005.

JASON TURNER, EXAMINING ATTORNEY

Int. Cls.: 36 and 42

Prior U.S. Cls.: 100, 101, and 102

United States Patent and Trademark Office

Reg. No. 3,486,232

Registered Aug. 12, 2008

**SERVICE MARK
PRINCIPAL REGISTER**

CHOATE HALL & STEWART

CHOATE, HALL & STEWART LLP (MASSACHU-
SETTS LIMITED PARTNERSHIP)
TWO INTERNATIONAL PLACE
BOSTON, MA 02110

FOR: FINANCIAL SERVICES, NAMELY, ES-
TATE, CHARITABLE TAX AND FINANCIAL PLAN-
NING, IN CLASS 36 (U.S. CLS. 100, 101 AND 102).

FIRST USE 8-1-2005; IN COMMERCE 8-1-2005.

FOR: LEGAL SERVICES; PROVISION OF INFOR-
MATION IN THE FIELD OF LAW, IN CLASS 42 (U.S.
CLS. 100 AND 101).

FIRST USE 9-1-1904; IN COMMERCE 9-1-1904.

THE MARK CONSISTS OF STANDARD CHAR-
ACTERS WITHOUT CLAIM TO ANY PARTICULAR
FONT, STYLE, SIZE, OR COLOR.

SN 78-644,071, FILED 6-6-2005.

SHARON MEIER, EXAMINING ATTORNEY

Int. Cl.: 16

Prior U.S. Cls.: 2, 5, 22, 23, 29, 37, 38, and 50

Reg. No. 3,486,233

United States Patent and Trademark Office

Registered Aug. 12, 2008

**TRADEMARK
PRINCIPAL REGISTER**

CHOATE HALL & STEWART

CHOATE, HALL & STEWART LLP (MASSACHU-
SETTS LIMITED PARTNERSHIP)
TWO INTERNATIONAL PLACE
BOSTON, MA 02110

THE MARK CONSISTS OF STANDARD CHAR-
ACTERS WITHOUT CLAIM TO ANY PARTICULAR
FONT, STYLE, SIZE, OR COLOR.

FOR: PRINTED MATERIALS, NAMELY BRO-
CHURES, NEWSLETTERS, AND MEMORANDA IN
THE FIELD OF LAW, IN CLASS 16 (U.S. CLS. 2, 5, 22,
23, 29, 37, 38 AND 50).

SN 78-644,224, FILED 6-6-2005.

FIRST USE 8-1-2005; IN COMMERCE 8-1-2005.

SHARON MEIER, EXAMINING ATTORNEY

Int. Cls.: 21, 26, and 28

**Prior U.S. Cls.: 2, 13, 22, 23, 29, 30, 33, 37, 38, 39, 40,
42, and 50**

Reg. No. 3,486,234

United States Patent and Trademark Office

Registered Aug. 12, 2008

**TRADEMARK
PRINCIPAL REGISTER**

MEMBER'S SELECTION

PRICESMART, INC. (DELAWARE CORPORATION)
9740 SCRANTON ROAD
SAN DIEGO, CA 92121

FOR: HOLIDAY ORNAMENTS OF PORCELAIN,
CERAMIC, CHINA, CRYSTAL, GLASS AND TER-
RACOTTA, IN CLASS 21 (U.S. CLS. 2, 13, 23, 29, 30, 33,
40 AND 50).

FIRST USE 8-3-2005; IN COMMERCE 8-3-2005.

FOR: ORNAMENTAL RIBBONS AND BOWS
MADE OF TEXTILES; RIBBONS FOR GIFT-WRAP-
PING, IN CLASS 26 (U.S. CLS. 37, 39, 40, 42 AND 50).

FIRST USE 7-19-2005; IN COMMERCE 7-19-2005.

FOR: CHRISTMAS TREE ORNAMENTS; CHRIST-
MAS TREE DECORATIONS; CHRISTMAS STOCK-
INGS; ARTIFICIAL CHRISTMAS TREES, IN CLASS
28 (U.S. CLS. 22, 23, 38 AND 50).

FIRST USE 9-6-2005; IN COMMERCE 9-6-2005.

THE MARK CONSISTS OF STANDARD CHAR-
ACTERS WITHOUT CLAIM TO ANY PARTICULAR
FONT, STYLE, SIZE, OR COLOR.

SN 78-644,722, FILED 6-6-2005.

JUDITH HELFMAN, EXAMINING ATTORNEY

Int. Cl.: 3

Prior U.S. Cls.: 1, 4, 6, 50, 51, and 52

United States Patent and Trademark Office

Reg. No. 3,486,235

Registered Aug. 12, 2008

**TRADEMARK
PRINCIPAL REGISTER**

BRIGHT RINSE

ECOLAB INC. (DELAWARE CORPORATION)

ESC-7 370 WABASHA STREET N

ST. PAUL, MN 55102

FOR: FLOOR CLEANERS, IN CLASS 3 (U.S. CLS.
1, 4, 6, 50, 51 AND 52).

FIRST USE 11-21-2005; IN COMMERCE 11-21-2005.

THE MARK CONSISTS OF STANDARD CHAR-
ACTERS WITHOUT CLAIM TO ANY PARTICULAR
FONT, STYLE, SIZE, OR COLOR.

NO CLAIM IS MADE TO THE EXCLUSIVE
RIGHT TO USE "BRIGHT", APART FROM THE
MARK AS SHOWN.

SN 78-645,168, FILED 6-7-2005.

INGA ERVIN, EXAMINING ATTORNEY

Int. Cls.: 16 and 41

Prior U.S. Cls.: 2, 5, 22, 23, 29, 37, 38, 50, 100, 101, and 107

Reg. No. 3,486,236

United States Patent and Trademark Office

Registered Aug. 12, 2008

**TRADEMARK
SERVICE MARK
PRINCIPAL REGISTER**

ACTUALITY

TEAM FORT COLLINS (COLORADO CORPORATION)
P.O. BOX 1808
FORT COLLINS, CO 80522

FOR: NEWSLETTERS AND PRINTED INSTRUCTIONAL, EDUCATIONAL, AND TEACHING MATERIALS IN THE FIELD OF DRUG AND ALCOHOL PREVENTION, IN CLASS 16 (U.S. CLS. 2, 5, 22, 23, 29, 37, 38 AND 50).

FIRST USE 10-5-2005; IN COMMERCE 10-5-2005.

FOR: EDUCATIONAL SERVICES, NAMELY, CONDUCTING WORKSHOPS IN THE FIELD OF DRUG AND ALCOHOL PREVENTION AND DISTRIBUTING COURSE MATERIALS IN CONNEC-

TION THEREWITH; CONSULTING AND TRAINING IN THE IMPLEMENTATION AND EVALUATION OF EDUCATIONAL PROGRAMS IN THE FIELD OF DRUG AND ALCOHOL PREVENTION, IN CLASS 41 (U.S. CLS. 100, 101 AND 107).

FIRST USE 2-28-2005; IN COMMERCE 2-28-2005.

THE MARK CONSISTS OF STANDARD CHARACTERS WITHOUT CLAIM TO ANY PARTICULAR FONT, STYLE, SIZE, OR COLOR.

SN 78-646,631, FILED 6-8-2005.

H. M. FISHER, EXAMINING ATTORNEY

Int. Cls.: 2 and 9

Prior U.S. Cls.: 6, 11, 16, 21, 23, 26, 36, and 38

United States Patent and Trademark Office

Reg. No. 3,486,237

Registered Aug. 12, 2008

**TRADEMARK
PRINCIPAL REGISTER**

CROMAPRINT

E. I. DU PONT DE NEMOURS AND COMPANY
(DELAWARE CORPORATION)
TRADEMARK & COPYRIGHT GROUP
1007 MARKET STREET
WILMINGTON, DE 19898

FOR: INK FOR USE IN WIDE FORMAT PRINTERS, IN CLASS 2 (U.S. CLS. 6, 11 AND 16).

FIRST USE 5-31-2007; IN COMMERCE 5-31-2007.

FOR: WIDE FORMAT PRINTERS, IN CLASS 9 (U.S. CLS. 21, 23, 26, 36 AND 38).

FIRST USE 5-31-2007; IN COMMERCE 5-31-2007.

THE MARK CONSISTS OF STANDARD CHARACTERS WITHOUT CLAIM TO ANY PARTICULAR FONT, STYLE, SIZE, OR COLOR.

SN 78-647,216, FILED 6-9-2005.

H. M. FISHER, EXAMINING ATTORNEY

Int. Cl.: 43

Prior U.S. Cls.: 100 and 101

United States Patent and Trademark Office

Reg. No. 3,486,238

Registered Aug. 12, 2008

**SERVICE MARK
PRINCIPAL REGISTER**

TOY STORE PIZZA

RAYNALDO GARZA (UNITED STATES INDIVIDUAL)
SUITE 475
14 MONARCH BAY PLAZA
MONARCH BEACH, CA 92629

FOR: RESTAURANT AND TAKE-OUT RESTAURANT SERVICES, NAMELY, PIZZA, SANDWICHES, A SALAD BAR AND SOFT DRINKS, IN CLASS 43 (U.S. CLS. 100 AND 101).

FIRST USE 2-17-2000; IN COMMERCE 1-5-2008.

THE MARK CONSISTS OF STANDARD CHARACTERS WITHOUT CLAIM TO ANY PARTICULAR FONT, STYLE, SIZE, OR COLOR.

NO CLAIM IS MADE TO THE EXCLUSIVE RIGHT TO USE "PIZZA", APART FROM THE MARK AS SHOWN.

SN 78-648,723, FILED 6-10-2005.

SHARON MEIER, EXAMINING ATTORNEY

Int. Cl.: 37

Prior U.S. Cls.: 100, 103, and 106

United States Patent and Trademark Office

Reg. No. 3,486,239

Registered Aug. 12, 2008

**SERVICE MARK
PRINCIPAL REGISTER**

Cornell Steamboat Company

IANNUCCI, ROBERT T. (UNITED STATES INDIVIDUAL)
4TH FLOOR
325 GOLD STREET
BROOKLYN, NY 11201 AND
EWERS, SONIA O. (UNITED STATES INDIVIDUAL)
4TH FLOOR
325 GOLD STREET
BROOKLYN, NY 11201

THE MARK CONSISTS OF STANDARD CHARACTERS WITHOUT CLAIM TO ANY PARTICULAR FONT, STYLE, SIZE, OR COLOR.

NO CLAIM IS MADE TO THE EXCLUSIVE RIGHT TO USE "STEAMBOAT COMPANY", APART FROM THE MARK AS SHOWN.

FOR: REPAIR OR MAINTENANCE OF VESSELS,
IN CLASS 37 (U.S. CLS. 100, 103 AND 106).

SN 78-649,360, FILED 6-13-2005.

FIRST USE 1-15-2008; IN COMMERCE 1-15-2008.

KYLE PEETE, EXAMINING ATTORNEY

Int. Cls.: 9 and 35

Prior U.S. Cls.: 21, 23, 26, 36, 38, 100, 101, and 102

United States Patent and Trademark Office

Reg. No. 3,486,240

Registered Aug. 12, 2008

**TRADEMARK
SERVICE MARK
PRINCIPAL REGISTER**

TENVERA

TENVERA, INC. (DELAWARE CORPORATION)
274 MALLORY STATION ROAD
FRANKLIN, TN 37067

FOR: FIBER OPTIC AND OPTO-ELECTRONIC EQUIPMENT FOR USE IN THE FIELD OF TELECOMMUNICATIONS, NAMELY, FIBER OPTIC CABLE, CONNECTORS, COUPLERS, ENCLOSURES, NAMELY, POWER SOURCES; FIBER OPTIC COMMUNICATION APPARATUS IN THE NATURE OF FIBER OPTICS, ULTRAVIOLET FIBER RECOATING APPARATUS; FIBER OPTIC SENSORS, NAMELY, TEMPERATURE, PRESSURE, SMOKE, ACCELERATION, TACHOMETERS AND HYDROPHONE SENSORS; ACTIVE AND PASSIVE FIBER OPTIC PRODUCTS, IN CLASS 9 (U.S. CLS. 21, 23, 26, 36 AND 38).

FIRST USE 0-0-2006; IN COMMERCE 0-0-2006.

FOR: BUSINESS CONSULTING SERVICES IN THE FIELDS OF FIBER OPTIC AND OPTO-ELECTRONIC EQUIPMENT FOR USE IN THE FIELD OF TELECOMMUNICATIONS, IN CLASS 35 (U.S. CLS. 100, 101 AND 102).

FIRST USE 0-0-2006; IN COMMERCE 0-0-2006.

THE MARK CONSISTS OF STANDARD CHARACTERS WITHOUT CLAIM TO ANY PARTICULAR FONT, STYLE, SIZE, OR COLOR.

SN 78-649,627, FILED 6-13-2005.

ESTHER BELENKER, EXAMINING ATTORNEY

Int. Cl.: 9

Prior U.S. Cls.: 21, 23, 26, 36, and 38

Reg. No. 3,486,241

United States Patent and Trademark Office

Registered Aug. 12, 2008

**TRADEMARK
PRINCIPAL REGISTER**

XENOMAX

XENOSEP TECHNOLOGIES LLC (NEW JERSEY
LIMITED LIABILITY CORPORATION)
508 MAIN STREET
BOONTON, NJ 07005

FOR: EQUIPMENT, APPARATUS AND INSTRUMENTS, NAMELY, CHROMATOGRAPHIC COLUMNS AND CHROMATOGRAPHIC PLATES AND SINGLE USE/DISPOSABLE FILTRATION AND SOLID-PHASE EXTRACTION COLUMNS, CARTRIDGES, SYRINGE-DRIVEN FILTERS, VACUUM FILTERS, PIPETTE FILTERS AND DISK FILTERS, ALL USED IN CONNECTION WITH THE SEPARATION OF CHEMICAL OR MOLECULAR SUBSTANCES OR COMPONENTS FROM ONE ANOTHER, IN

LABORATORY AND RESEARCH FACILITIES OR IN CONNECTION WITH A MANUFACTURING PROCESS, IN CLASS 9 (U.S. CLS. 21, 23, 26, 36 AND 38).

FIRST USE 4-11-2007; IN COMMERCE 4-11-2007.

THE MARK CONSISTS OF STANDARD CHARACTERS WITHOUT CLAIM TO ANY PARTICULAR FONT, STYLE, SIZE, OR COLOR.

SN 78-650,344, FILED 6-14-2005.

BRENDAN REGAN, EXAMINING ATTORNEY

Int. Cl.: 3

Prior U.S. Cls.: 1, 4, 6, 50, 51, and 52

United States Patent and Trademark Office

Reg. No. 3,486,242

Registered Aug. 12, 2008

TRADEMARK
PRINCIPAL REGISTER



R.D.K. RESOURCES, LLC (NEW YORK LIMITED LIABILITY COMPANY)
23 FLAMINGO ROAD
EAST HILLS, NY 115762701

FOR: LIQUID SOLUTIONS, NAMELY, DISINFECTANT SOAPS, INDUSTRIAL SOAP, LIQUID SOAP, GENERAL PURPOSE CLEANING, POLISHING AND ABRASIVE LIQUIDS AND POWDERS, DEGREASING PREPARATIONS FOR COMMERCIAL AND INDUSTRIAL FACILITIES, FLOOR BUFFING COMPOUND, FLOOR FINISHING PREPARATION, AND FLOOR STRIPPING/CLEANING PREPARATION, ALL DELIVERED BY SPRAY BOTTLES, AEROSOL SPRAY DISPENSERS, AEROSOL PROPELLED CANS AND LIQUID DISPENSERS FOR CLEANING, DISINFECTING, DEGREASING AND SANITIZING IN COMMERCIAL AND INDUSTRIAL FACILITIES; DISINFECTANTS AND SANITIZERS, NAMELY, DISINFECTANT SOAPS, INDUSTRIAL SOAP, LIQUID SOAP, GENERAL PURPOSE CLEANING, POLISHING AND ABRASIVE LIQUIDS AND POWDERS, FLOOR BUFFING COMPOUND, FLOOR FINISHING PREPARATION AND FLOOR STRIPPING/CLEANING PREPARATION, ALL IN LIQUID, SOLID OR POWDER FORM USED IN COMMERCIAL AND INDUSTRIAL APPLICATIONS, NAMELY, INSTITUTIONAL WAREWASHING FOR KITCHENS, COMMERCIAL LAUNDRIES, WATER SUPPLY TREATMENT AT A COMMERCIAL OR INDUSTRIAL FACILITY, BOILER TREATMENT AND CLEANING APPLICATION, FLOOR COATINGS, SPRAY BUFFS FLOOR RESTORERS,

FLOOR MAINTAINERS, STRIPPERS, NAMELY, FLOOR COATING REMOVERS, FOR ALL SURFACES OF CARPET, FLOOR AND WALLS; AND PERSONAL CARE PRODUCTS, NAMELY, HAND, HAIR AND BODY SHAMPOO, HAIR AND SKIN CONDITIONERS AND SOAP, IN CLASS 3 (U.S. CLS. 1, 4, 6, 50, 51 AND 52).

FIRST USE 7-0-2005; IN COMMERCE 7-0-2005.

NO CLAIM IS MADE TO THE EXCLUSIVE RIGHT TO USE THE PICTORIAL REPRESENTATION OF THE RECYCLING SYMBOL AND THE CONTINENTS OF NORTH AND SOUTH AMERICA, APART FROM THE MARK AS SHOWN.

THE COLOR(S) GREEN, WHITE, YELLOW, BROWN AND BLUE IS/ARE CLAIMED AS A FEATURE OF THE MARK.

THE MARK CONSISTS OF THE WORDING "ENVIRO-BRANDS" APPEARING OVER A CIRCULAR BAND WITH AN ARROW ON ONE END ON WHICH THE WORDING "ENVIRONMENTALLY RESPECTFUL, RESPONSIVE & RESOURCEFUL" APPEAR. THE CIRCULAR BAND APPEARS AROUND A CIRCULAR GLOBE DESIGN ON WHICH APPEARS A DESIGN OF THE CONTINENT OF AMERICA, A PINE TREE AND THE RECYCLING SYMBOL. THE COLOR GREEN APPEARS IN THE WORDING "ENVIRO-BRANDS" AND IN THE DESIGN OF THE CIRCULAR BAND WITH AN ARROW ON ONE

END, THE PINE TREE AND IN THE CONTINENT OF AMERICA. THE COLOR WHITE APPEARS IN THE WORDING "ENVIRONMENTALLY RESPECTFUL, RESPONSIVE & RESOURCEFUL," IN THE DESIGN OF THE CIRCULAR GLOBE AND AS AN OUTLINE FOR THE DESIGN OF THE PINE TREE AND THE RECYCLING SYMBOL. THE COLOR YELLOW APPEARS IN THE DESIGN OF THE CONTINENT OF AMERICA. THE COLOR BROWN

APPEARS IN THE DESIGNS FOR THE CONTINENT OF AMERICA AND THE PINE TREE. THE COLOR BLUE APPEARS AS THE BACKGROUND COLOR FOR THE CIRCULAR GLOBE DESIGN.

SN 78-652,351, FILED 6-16-2005.

AMY MCMENAMIN, EXAMINING ATTORNEY

Int. Cl.: 5

Prior U.S. Cls.: 6, 18, 44, 46, 51, and 52

United States Patent and Trademark Office

Reg. No. 3,486,243

Registered Aug. 12, 2008

**TRADEMARK
PRINCIPAL REGISTER**

MACAMG

MACSTEEL SERVICE CENTERS USA, INC. (DE-
LAWARE CORPORATION)
555 STATE ROAD
BENSALEM, PA 19020

FOR: ANTIMICROBIAL COATINGS AND SUR-
FACE TREATMENTS COMPOSED OF EPOXY AND
MODIFIED EPOXY, POLYESTER AND MODIFIED
POLYESTER, ACRYLIC AND MODIFIED ACRYL-
IC, POLYVINYL FLUORIDE (PVDF) AND MODI-
FIED POLYVINYL FLUORIDE OR PLASTISOL
BASED POLYVINYL FLUORIDE, AS APPLIED TO
GALVANIZED STEEL, COLD ROLLED STEEL,
ALUMINIZED STEEL, GALVALUME, STAINLESS
STEEL AND ALUMINUM SURFACES THAT IS

CUSTOM FORMULATED TO MEET COLOR, FAB-
RICATION, AND PERFORMANCE CRITERIA, IN
CLASS 5 (U.S. CLS. 6, 18, 44, 46, 51 AND 52).

FIRST USE 8-0-2006; IN COMMERCE 8-0-2006.

THE MARK CONSISTS OF STANDARD CHAR-
ACTERS WITHOUT CLAIM TO ANY PARTICULAR
FONT, STYLE, SIZE, OR COLOR.

SN 78-652,390, FILED 6-16-2005.

JOHN DALIER, EXAMINING ATTORNEY

Int. Cl.: 28

Prior U.S. Cls.: 22, 23, 38, and 50

Reg. No. 3,486,244

United States Patent and Trademark Office

Registered Aug. 12, 2008

**TRADEMARK
PRINCIPAL REGISTER**

PRO SPORT

OUR NATION'S BEST SPORTS (TEXAS CORPORATION)
4216 HAHN BOULEVARD
FORT WORTH, TX 76117

FOR: SPORTS EQUIPMENT, NAMELY, BASEBALLS, SOFTBALLS, BASEBALL GLOVES, BASEBALL BATTING TEES, BASEBALL BASES, BASEBALL BAT CASES, BASEBALL PITCHING SCREENS; FOOTBALLS; PROTECTIVE PADDING FOR USE IN SPORTS ACTIVITIES, NAMELY, SHOULDER, HIP AND THIGH PADS FOR USE IN FOOTBALL, IN CLASS 28 (U.S. CLS. 22, 23, 38 AND 50).

FIRST USE 6-0-1998; IN COMMERCE 6-0-1998.

THE MARK CONSISTS OF STANDARD CHARACTERS WITHOUT CLAIM TO ANY PARTICULAR FONT, STYLE, SIZE, OR COLOR.

NO CLAIM IS MADE TO THE EXCLUSIVE RIGHT TO USE "SPORT", APART FROM THE MARK AS SHOWN.

SN 78-654,154, FILED 6-20-2005.

MICHAEL LEWIS, EXAMINING ATTORNEY

Int. Cl.: 12

Prior U.S. Cls.: 19, 21, 23, 31, 35, and 44

Reg. No. 3,486,245

United States Patent and Trademark Office

Registered Aug. 12, 2008

**TRADEMARK
PRINCIPAL REGISTER**

MANITO

TOTAL KIDS CORP. (REPUBLIC OF KOREA
CORPORATION)
586-12 JANGHANG-DONG ILSAN-GU GOYANG-SI
GYEONGGI-DO, REPUBLIC OF KOREA

FOR: BABY CARRIAGE AND STROLLER AC-
CESSORIES, NAMELY, CANOPIES, COVERS AND
SUN VISORS; BABY CARRIAGE AND STROLLER
PARTS, NAMELY, SEATS AND STRAPS FOR
HOLDING GOODS, IN CLASS 12 (U.S. CLS. 19, 21,
23, 31, 35 AND 44).

FIRST USE 11-0-2000; IN COMMERCE 3-0-2008.

THE MARK CONSISTS OF STANDARD CHAR-
ACTERS WITHOUT CLAIM TO ANY PARTICULAR
FONT, STYLE, SIZE, OR COLOR.

THE ENGLISH TRANSLATION OF THE WORD
"MANITO" IN THE MARK IS THE POWER THAT
PERMEATES ALL THINGS, PAL OR BUDDY, OR
LITTLE HAND.

SN 78-655,098, FILED 6-21-2005.

SARA THOMAS, EXAMINING ATTORNEY

Int. Cl.: 44

Prior U.S. Cls.: 100 and 101

United States Patent and Trademark Office

Reg. No. 3,486,246

Registered Aug. 12, 2008

**SERVICE MARK
PRINCIPAL REGISTER**

MEDANGEL

ISPRIT MANAGEMENT LLC (INDIANA LTD
LIAB CO)
P.O. BOX 4564
CARMEL, IN 46082

THE MARK CONSISTS OF STANDARD CHAR-
ACTERS WITHOUT CLAIM TO ANY PARTICULAR
FONT, STYLE, SIZE, OR COLOR.

FOR: PROVIDING MEDICAL INFORMATION TO
CONSUMERS VIA AN ON-LINE COMPUTER NET-
WORK, IN CLASS 44 (U.S. CLS. 100 AND 101).

SN 78-655,934, FILED 6-22-2005.

FIRST USE 5-22-2008; IN COMMERCE 5-22-2008.

JOHN DALIER, EXAMINING ATTORNEY

Int. Cl.: 3

Prior U.S. Cls.: 1, 4, 6, 50, 51, and 52

Reg. No. 3,486,247

United States Patent and Trademark Office

Registered Aug. 12, 2008

**TRADEMARK
PRINCIPAL REGISTER**

POWER SHAVE

MCKENZIE, THERMAN (UNITED STATES IN-
DIVIDUAL)

PO BOX 831981

STONE MOUNTAIN, GA 30083

FOR: AFTERSHAVE LOTION, IN CLASS 3 (U.S.
CLS. 1, 4, 6, 50, 51 AND 52).

FIRST USE 1-15-2008; IN COMMERCE 1-15-2008.

THE MARK CONSISTS OF STANDARD CHAR-
ACTERS WITHOUT CLAIM TO ANY PARTICULAR
FONT, STYLE, SIZE, OR COLOR.

NO CLAIM IS MADE TO THE EXCLUSIVE
RIGHT TO USE "SHAVE", APART FROM THE
MARK AS SHOWN.

SN 78-656,204, FILED 6-22-2005.

AMY MCMENAMIN, EXAMINING ATTORNEY

Int. Cl.: 44

Prior U.S. Cls.: 100 and 101

United States Patent and Trademark Office

Reg. No. 3,486,248

Registered Aug. 12, 2008

**SERVICE MARK
PRINCIPAL REGISTER**



PFIZER INC. (DELAWARE CORPORATION)
235 EAST 42ND STREET
NEW YORK, NY 10017

FOR: PROVISION OF HEALTH CARE SERVICES,
NAMELY, PROVIDING INFORMATION TO DOC-
TORS AND PATIENTS REGARDING WOMEN'S
HEALTH ISSUES, IN CLASS 44 (U.S. CLS. 100 AND
101).

FIRST USE 11-30-2007; IN COMMERCE 11-30-2007.

OWNER OF U.S. REG. NOS. 501,762, 626,088, AND
2,448,821.

THE COLOR(S) APPLICANT CLAIMS THE COL-
ORS PINK AND BLUE IS/ARE CLAIMED AS A
FEATURE OF THE MARK.

THE MARK CONSISTS OF THE WORD "HER" IN
PINK AND STYLIZED AND THE WORD PFIZER IN
BLUE.

SN 78-661,514, FILED 6-30-2005.

JEFF DEFORD, EXAMINING ATTORNEY

Int. Cls.: 14, 18, 25, and 35

**Prior U.S. Cls.: 1, 2, 3, 22, 27, 28, 39, 41, 50, 100, 101,
and 102**

Reg. No. 3,486,249

United States Patent and Trademark Office

Registered Aug. 12, 2008

**TRADEMARK
SERVICE MARK
PRINCIPAL REGISTER**



THE NEIMAN MARCUS GROUP, INC. (DELA-
WARE CORPORATION)
1618 MAIN STREET
DALLAS, TX 75201

FOR: WOMEN'S ACCESSORIES, NAMELY, JEW-
ELRY AND WATCHES, IN CLASS 14 (U.S. CLS. 2, 27,
28 AND 50).

FIRST USE 6-1-2008; IN COMMERCE 6-1-2008.

FOR: HANDBAGS; WOMEN'S ACCESSORIES,
NAMELY, TOTE BAGS, WALLETS AND COSMETIC
CASES SOLD EMPTY, IN CLASS 18 (U.S. CLS. 1, 2, 3,
22 AND 41).

FIRST USE 6-1-2008; IN COMMERCE 6-1-2008.

FOR: WOMEN'S APPAREL, NAMELY, SKIRTS,
PANTS, SHORTS, SHIRTS, KNIT TOPS, DRESSES,
SWEATERS, HATS, GLOVES, SCARVES, BELTS,
JACKETS, COATS, SLEEPWEAR, SWIMWEAR; IN-

TIMATE APPAREL, NAMELY, UNDERWEAR,
BRAS, NIGHTGOWNS; FOOTWEAR, IN CLASS 25
(U.S. CLS. 22 AND 39).

FIRST USE 6-1-2008; IN COMMERCE 6-1-2008.

FOR: RETAIL STORE SERVICES AND ON-LINE
RETAIL STORE SERVICES SPECIALIZING IN WO-
MEN'S APPAREL AND ACCESSORIES, IN CLASS 35
(U.S. CLS. 100, 101 AND 102).

FIRST USE 6-1-2008; IN COMMERCE 6-1-2008.

THE MARK CONSISTS OF A STYLIZED, CON-
TIGUOUS REPRESENTATION OF THE NUMBER/
LETTER COMBINATION "5F".

SN 78-661,805, FILED 6-30-2005.

CYNTHIA SLOAN, EXAMINING ATTORNEY

Int. Cl.: 13

Prior U.S. Cls.: 2 and 9

United States Patent and Trademark Office

Reg. No. 3,486,250

Registered Aug. 12, 2008

**TRADEMARK
PRINCIPAL REGISTER**

COSMIC SMASH

INGRAM ENTERPRISES, INC. (MISSOURI CORPORATION)
3010 N. INGRAM DR.
SPRINGFIELD, MO 65803

THE MARK CONSISTS OF STANDARD CHARACTERS WITHOUT CLAIM TO ANY PARTICULAR FONT, STYLE, SIZE, OR COLOR.

FOR: FIREWORKS, IN CLASS 13 (U.S. CLS. 2 AND 9).

SN 78-663,493, FILED 7-5-2005.

FIRST USE 4-30-2008; IN COMMERCE 4-30-2008.

GEORGE LORENZO, EXAMINING ATTORNEY

Int. Cl.: 35

Prior U.S. Cls.: 100, 101, and 102

United States Patent and Trademark Office

Reg. No. 3,486,251

Registered Aug. 12, 2008

**SERVICE MARK
PRINCIPAL REGISTER**

**PRESCRIPTION FOR CLEANER
WATER**

FORLINI, MICHAEL VITO (UNITED STATES
INDIVIDUAL)
606 COVENTRY ROAD
TOWSON, MD 21286

FOR: PROMOTING PUBLIC AWARENESS OF
THE NEED TO PROPERLY DISPOSE OF UNUSED
OR UNWANTED OR EXPIRED PHARMACEUTI-
CAL OR OVER-THE-COUNTER MEDICINES, IN
CLASS 35 (U.S. CLS. 100, 101 AND 102).

FIRST USE 6-30-2008; IN COMMERCE 6-30-2008.

THE MARK CONSISTS OF STANDARD CHAR-
ACTERS WITHOUT CLAIM TO ANY PARTICULAR
FONT, STYLE, SIZE, OR COLOR.

SN 78-663,776, FILED 7-5-2005.

STEVEN R. FOSTER, EXAMINING ATTORNEY

Int. Cls.: 11, 16, and 20

**Prior U.S. Cls.: 2, 5, 13, 21, 22, 23, 25, 29, 31, 32, 34,
37, 38, and 50**

Reg. No. 3,486,252

United States Patent and Trademark Office

Registered Aug. 12, 2008

**TRADEMARK
PRINCIPAL REGISTER**

POSHLIVING

POSHTOTS, INC. (VIRGINIA INC. ASSOCIATION), AKA POSH BABY, INC.,
717 17TH STREET, SUITE 1300
DENVER, CO 80202

FOR: ELECTRIC LIGHTING FIXTURES, LIGHTING FIXTURES, SCONCES, LAMPS, TABLE LAMPS, FLOOR LAMPS, LIGHTING DEVICES FOR SHOWCASES, LAMPS FOR OUTDOOR USE, IN CLASS 11 (U.S. CLS. 13, 21, 23, 31 AND 34).

FIRST USE 7-9-2005; IN COMMERCE 7-9-2005.

FOR: PAINTINGS, CHALK BOARDS AND MEMO BOARDS FOR HOME USE, BRAG BOOKS, PHOTO ALBUMS, ALBUMS FOR PHOTOGRAPHS, EVENT ALBUMS, MEMORY BOOKS; CARDBOARD STORAGE BOXES, IN CLASS 16 (U.S. CLS. 2, 5, 22, 23, 29, 37, 38 AND 50).

FIRST USE 7-9-2005; IN COMMERCE 7-9-2005.

FOR: FURNITURE, NAMELY, ARMOIRES, BEDSIDE TABLES, BLANKET CHESTS, CRIBS, BEDROOM FURNITURE, CABINETS, DRESSERS, LIVING ROOM FURNITURE, TABLES, CHAIRS, ROCKING CHAIRS, BOOKSHELVES, BEDS, BED FRAMES, HEADBOARDS, NIGHT STANDS, STORAGE BENCH, TRUNDLE BEDS, GLIDING ROCKING CHAIRS, FOOTSTOOLS, STEP STOOLS, TABLE

AND CHAIR SETS, BOOKCASES, DESKS, BATHROOM VANITIES, SEATS, ARMCHAIRS, CHEST OF DRAWERS, CREDENZAS, HAND-HELD MIRRORS, NON-METAL HOOKS, DOORKNOBS AND DRAWER KNOBS OF WOOD AND PLASTIC, PAPER PHOTO FRAMES, PICTURE FRAMES, BATH PILLOWS, PILLOWS, ACCENT TABLES AND NON-METAL CHESTS, MEDIA STORAGE UNITS, BENCHES AND OTTOMANS, COCKTAIL TABLES, CURIO CABINETS, OFFICE CHAIRS, OFFICE DESKS AND PLASTIC AND WOODEN STORAGE BOXES, DINING CHAIRS, DINING TABLES, SOFAS, MIRRORS, MIRRORS AS FURNITURE, SHELVES, DISPLAY SHELVES, MAGAZINE RACKS, BEDS FOR HOUSEHOLD PETS, OUTDOOR FURNITURE, DAYBEDS, PHOTOGRAPH FRAMES; POT RACKS, IN CLASS 20 (U.S. CLS. 2, 13, 22, 25, 32 AND 50).

FIRST USE 7-9-2005; IN COMMERCE 7-9-2005.

THE MARK CONSISTS OF STANDARD CHARACTERS WITHOUT CLAIM TO ANY PARTICULAR FONT, STYLE, SIZE, OR COLOR.

SN 78-665,819, FILED 7-7-2005.

MATTHEW PAPPAS, EXAMINING ATTORNEY

Int. Cl.: 41

Prior U.S. Cls.: 100, 101, and 107

United States Patent and Trademark Office

Reg. No. 3,486,253

Registered Aug. 12, 2008

**SERVICE MARK
PRINCIPAL REGISTER**

THE ROAD SAGE

S.J. WOOD, INC. (TEXAS CORPORATION)
SUITE 200
17721 ROGERS RANCH PARKWAY
SAN ANTONIO, TX 78258

FOR: EDUCATIONAL AND ENTERTAINMENT SERVICES, NAMELY, PROVIDING AN ONGOING SYNDICATED PROGRAM FEATURING DRIVING SAFETY TIPS AND HOW TO PREVENT AND RESPOND TO ROAD RAGE, RENDERED THROUGH THE MEDIUMS OF RADIO, TELEVISION, THE INTERNET, AND SPECIAL APPEARAN-

CES AT LOCAL EVENTS, IN CLASS 41 (U.S. CLS. 100, 101 AND 107).

FIRST USE 12-0-2006; IN COMMERCE 12-0-2006.

THE MARK CONSISTS OF STANDARD CHARACTERS WITHOUT CLAIM TO ANY PARTICULAR FONT, STYLE, SIZE, OR COLOR.

SN 78-666,541, FILED 7-8-2005.

ALICE BENMAMAN, EXAMINING ATTORNEY

Int. Cl.: 21

Prior U.S. Cls.: 2, 13, 23, 29, 30, 33, 40, and 50

Reg. No. 3,486,254

United States Patent and Trademark Office

Registered Aug. 12, 2008

**TRADEMARK
PRINCIPAL REGISTER**

BEN 10

THE CARTOON NETWORK, INC. (DELAWARE
CORPORATION)
C/O TURNER BROADCASTING SYSTEM, INC.
ONE CNN CENTER
ATLANTA, GA 303032762

THE MARK CONSISTS OF STANDARD CHAR-
ACTERS WITHOUT CLAIM TO ANY PARTICULAR
FONT, STYLE, SIZE, OR COLOR.

FOR: DINNERWARE, NAMELY, PAPER PLATES
AND PAPER CUPS, IN CLASS 21 (U.S. CLS. 2, 13, 23,
29, 30, 33, 40 AND 50).

SN 78-667,370, FILED 7-11-2005.

FIRST USE 1-7-2007; IN COMMERCE 1-7-2008.

LESLEY LAMOTHE, EXAMINING ATTORNEY

Int. Cl.: 5

Prior U.S. Cls.: 6, 18, 44, 46, 51, and 52

United States Patent and Trademark Office

Reg. No. 3,486,255

Registered Aug. 12, 2008

**TRADEMARK
PRINCIPAL REGISTER**

Aromalert

KASPAN, STEPHEN P. (UNITED STATES INDIVIDUAL)
9937 DORIAN
PLYMOUTH, MI 48170

THE MARK CONSISTS OF STANDARD CHARACTERS WITHOUT CLAIM TO ANY PARTICULAR FONT, STYLE, SIZE, OR COLOR.

FOR: AIR FRESHENER, IN CLASS 5 (U.S. CLS. 6, 18, 44, 46, 51 AND 52).

SN 78-667,476, FILED 7-11-2005.

FIRST USE 10-5-2005; IN COMMERCE 10-8-2007.

DEBRA LEE, EXAMINING ATTORNEY

Int. Cls.: 35 and 42

Prior U.S. Cls.: 100, 101, and 102

United States Patent and Trademark Office

Reg. No. 3,486,256

Registered Aug. 12, 2008

**SERVICE MARK
PRINCIPAL REGISTER**

SOURCEASIA

JONATHAN MANUFACTURING CORPORATION (DELAWARE CORPORATION)
410 EXCHANGE STE 200
IRVINE, CA 92602

FOR: BUSINESS MANAGEMENT AND CONSULTING SERVICES, INCLUDING, PROJECT SCOPING, TOOLING/MACHINERY PROCUREMENT, PRODUCTION MANAGEMENT, LOGISTICS MANAGEMENT, COST REDUCTION ANALYSIS, AND IDENTIFICATION OF SUPPLIERS, IN CLASS 35 (U.S. CLS. 100, 101 AND 102).

FIRST USE 6-17-2005; IN COMMERCE 6-17-2005.

FOR: QUALITY CONTROL FOR OTHERS; ENGINEERING; ENGINEERING COORDINATION; CONSULTATION WITH RESPECT TO DESIGN OF NEW PRODUCTS, IN CLASS 42 (U.S. CLS. 100 AND 101).

FIRST USE 6-17-2005; IN COMMERCE 6-17-2005.

THE MARK CONSISTS OF STANDARD CHARACTERS WITHOUT CLAIM TO ANY PARTICULAR FONT, STYLE, SIZE, OR COLOR.

SN 78-671,436, FILED 7-15-2005.

DOMINIC FATHY, EXAMINING ATTORNEY

Int. Cl.: 16

Prior U.S. Cls.: 2, 5, 22, 23, 29, 37, 38, and 50

United States Patent and Trademark Office

Reg. No. 3,486,257

Registered Aug. 12, 2008

**TRADEMARK
PRINCIPAL REGISTER**

CALMING THE STORM

PFIZER INC. (DELAWARE CORPORATION)
235 EAST 42ND STREET
NEW YORK, NY 10017

FOR: PRINTED MATERIALS, NAMELY, BOOK-
LETS, PAMPHLETS, LEAFLETS, DISPLAYS AND
POSTERS ON THE TOPIC OF PAIN AND THE
TREATMENT THEREOF, IN CLASS 16 (U.S. CLS. 2,
5, 22, 23, 29, 37, 38 AND 50).

FIRST USE 3-20-2007; IN COMMERCE 3-20-2007.

THE MARK CONSISTS OF STANDARD CHAR-
ACTERS WITHOUT CLAIM TO ANY PARTICULAR
FONT, STYLE, SIZE, OR COLOR.

SN 78-674,228, FILED 7-20-2005.

DANIEL BRODY, EXAMINING ATTORNEY

Int. Cls.: 3 and 4

Prior U.S. Cls.: 1, 4, 6, 15, 50, 51, and 52

United States Patent and Trademark Office

Reg. No. 3,486,258

Registered Aug. 12, 2008

**TRADEMARK
PRINCIPAL REGISTER**

MACLAREN

ARMON LIMITED (ANTIGUA & BARBUDA
CORPORATION)
P.O. BOX 3330
9 RUE VERDAINE
GENEVA 3, SWITZERLAND 1211

FOR: COSMETICS; PERFUMERY; NON-MEDICATED TOILETRIES; BATH MILK FOR THE PURPOSE OF CALMING, NON-MEDICATED PROTECTING NAPPY CHANGE CREAM, NAMELY, NON-MEDICATED DIAPER RASH OINTMENTS AND LOTIONS; DUSTING POWDER FOR ABSORBING, BABY SOAP FOR SOOTHING, MASSAGE OIL FOR BABIES; BODY MASSAGE OIL FOR PREGNANT WOMEN FOR THE PURPOSE OF CONNECTING MOTHER AND BABY; BATH MILK FOR THE PURPOSE OF NURTURING; NON-MEDICATED SHOWER AND BATH ELIXIR, NAMELY, BATH SALTS, BUBBLE BATH, SHOWER GEL AND BATH FOAM FOR THE PURPOSE OF PURIFYING; NON-MEDICATED CREAM FOR APPLICATION TO THE ABDOMEN; FACIAL SPRITZER FOR THE PURPOSE OF BALANCING; NON-MEDICATED

LEG LOTION FOR THE PURPOSE OF HEALING; SCENTED ROOM SPRAY FOR COMFORTING, IN CLASS 3 (U.S. CLS. 1, 4, 6, 50, 51 AND 52).

FIRST USE 1-1-2005; IN COMMERCE 1-1-2005.

FOR: CANDLES; SCENTED CANDLES; WICKS FOR OIL LAMPS AND CANDLES, IN CLASS 4 (U.S. CLS. 1, 6 AND 15).

FIRST USE 1-1-2005; IN COMMERCE 1-1-2005.

THE MARK CONSISTS OF STANDARD CHARACTERS WITHOUT CLAIM TO ANY PARTICULAR FONT, STYLE, SIZE, OR COLOR.

SEC. 2(F).

SN 78-681,262, FILED 7-29-2005.

JANET LEE, EXAMINING ATTORNEY

Int. Cl.: 3

Prior U.S. Cls.: 1, 4, 6, 50, 51, and 52

Reg. No. 3,486,259

United States Patent and Trademark Office

Registered Aug. 12, 2008

**TRADEMARK
PRINCIPAL REGISTER**

Syner-G Skincare

WANER, JANE E (UNITED STATES INDIVIDUAL)
1515 BOWMAN RD., SUITE D
LITTLE ROCK, AR 72211

FOR: NON-MEDICATED SKINCARE PREPARATIONS AND COSMETICS FOR PERSONAL HOME USE, IN CLASS 3 (U.S. CLS. 1, 4, 6, 50, 51 AND 52).

FIRST USE 4-0-2006; IN COMMERCE 4-0-2006.

THE MARK CONSISTS OF STANDARD CHARACTERS WITHOUT CLAIM TO ANY PARTICULAR FONT, STYLE, SIZE, OR COLOR.

NO CLAIM IS MADE TO THE EXCLUSIVE RIGHT TO USE "SKINCARE", APART FROM THE MARK AS SHOWN.

SN 78-684,385, FILED 8-3-2005.

DAVID HOFFMAN, EXAMINING ATTORNEY

Int. Cl.: 35

Prior U.S. Cls.: 100, 101, and 102

United States Patent and Trademark Office

Reg. No. 3,486,260

Registered Aug. 12, 2008

**SERVICE MARK
PRINCIPAL REGISTER**

TAPESTRY

DOMESTICATIONS, LLC (DELAWARE LTD
LIAB CO)
1500 HARBOR BLVD.
WEEHAWKEN, NJ 07086

FOR: MAIL ORDER CATALOG SERVICES FEATURING NOVELTY AND GIFT ITEMS; ON-LINE RETAIL STORE SERVICES FEATURING NOVELTY AND GIFT ITEMS, IN CLASS 35 (U.S. CLS. 100, 101 AND 102).

FIRST USE 6-24-2008; IN COMMERCE 6-24-2008.

THE MARK CONSISTS OF STANDARD CHARACTERS WITHOUT CLAIM TO ANY PARTICULAR FONT, STYLE, SIZE, OR COLOR.

OWNER OF U.S. REG. NO. 1,394,017.

SN 78-685,708, FILED 8-4-2005.

DAVID C. REIHNER, EXAMINING ATTORNEY

Int. Cl.: 3

Prior U.S. Cls.: 1, 4, 6, 50, 51, and 52

Reg. No. 3,486,261

United States Patent and Trademark Office

Registered Aug. 12, 2008

**TRADEMARK
PRINCIPAL REGISTER**

AM I DREAMING

ZADANOFF, SHARON Z. (UNITED STATES IN-
DIVIDUAL)
19021 BISCAYNE BLVD
AVENTURA, FL 33180

THE MARK CONSISTS OF STANDARD CHAR-
ACTERS WITHOUT CLAIM TO ANY PARTICULAR
FONT, STYLE, SIZE, OR COLOR.

FOR: PERFUMERY AND ESSENTIAL OILS TO
BE USED IN AROMATHERAPY OILS, IN CLASS 3
(U.S. CLS. 1, 4, 6, 50, 51 AND 52).

SN 78-685,795, FILED 8-4-2005.

FIRST USE 8-7-2007; IN COMMERCE 8-7-2007.

ZHALEH DELANEY, EXAMINING ATTORNEY

Int. Cl.: 9

Prior U.S. Cls.: 21, 23, 26, 36, and 38

Reg. No. 3,486,262

United States Patent and Trademark Office

Registered Aug. 12, 2008

**TRADEMARK
PRINCIPAL REGISTER**

VIZIA

LEVITON MANUFACTURING CO., INC. (DELA-
WARE CORPORATION)
59-25 LITTLE NECK PARKWAY
LITTLE NECK, NY 11362

FOR: DIMMER SWITCHES AND LIGHTING
CONTROLS, IN CLASS 9 (U.S. CLS. 21, 23, 26, 36
AND 38).

FIRST USE 4-28-2006; IN COMMERCE 4-28-2006.

THE MARK CONSISTS OF STANDARD CHAR-
ACTERS WITHOUT CLAIM TO ANY PARTICULAR
FONT, STYLE, SIZE, OR COLOR.

THE TERM "VIZIA" HAS NO MEANING IN A
FOREIGN LANGUAGE.

SN 78-689,580, FILED 8-10-2005.

ESTHER A. BORSUK, EXAMINING ATTORNEY

Int. Cl.: 16

Prior U.S. Cls.: 2, 5, 22, 23, 29, 37, 38, and 50

Reg. No. 3,486,263

United States Patent and Trademark Office

Registered Aug. 12, 2008

**TRADEMARK
PRINCIPAL REGISTER**

Blessue

KELMAN, DANA (UNITED STATES INDIVIDUAL)
15190 PRESTONWOOD BLVD #637
DALLAS, TX 75248

THE MARK CONSISTS OF STANDARD CHARACTERS WITHOUT CLAIM TO ANY PARTICULAR FONT, STYLE, SIZE, OR COLOR.

FOR: FACIAL TISSUE, IN CLASS 16 (U.S. CLS. 2, 5, 22, 23, 29, 37, 38 AND 50).

SN 78-692,427, FILED 8-15-2005.

FIRST USE 5-23-2008; IN COMMERCE 5-23-2008.

ZHALEH DELANEY, EXAMINING ATTORNEY

Int. Cl.: 5

Prior U.S. Cls.: 6, 18, 44, 46, 51, and 52

Reg. No. 3,486,264

United States Patent and Trademark Office

Registered Aug. 12, 2008

**TRADEMARK
PRINCIPAL REGISTER**

JOLT

GREAT EARTH COMPANIES, INC. (DELAWARE
CORPORATION)
200 ADAMS BOULEVARD
FARMINGDALE, NY 11735

FOR: DIETARY FOOD SUPPLEMENTS; DIET-
ARY SUPPLEMENTS, IN CLASS 5 (U.S. CLS. 6, 18,
44, 46, 51 AND 52).

FIRST USE 5-0-2000; IN COMMERCE 5-0-2000.

THE MARK CONSISTS OF STANDARD CHAR-
ACTERS WITHOUT CLAIM TO ANY PARTICULAR
FONT, STYLE, SIZE, OR COLOR.

OWNER OF U.S. REG. NO. 2,553,741.

SN 78-693,593, FILED 8-16-2005.

DAVID COLLIER, EXAMINING ATTORNEY

Int. Cl.: 25

Prior U.S. Cls.: 22 and 39

United States Patent and Trademark Office

Reg. No. 3,486,265

Registered Aug. 12, 2008

**TRADEMARK
PRINCIPAL REGISTER**

Rock Anthem

PROVIDENCE INDUSTRIES, INC. (CALIFORNIA
CORPORATION)
7300 SOMERSET BOULEVARD
PARAMOUNT, CA 90723

FOR: CLOTHING, NAMELY, T-SHIRTS, POLO
SHIRTS, KNIT SHIRT, DRESS SHIRTS, SWEAT-
SHIRTS, SWEATERS, JACKETS, AND PANTS, IN
CLASS 25 (U.S. CLS. 22 AND 39).

FIRST USE 11-1-2006; IN COMMERCE 11-1-2006.

THE MARK CONSISTS OF STANDARD CHAR-
ACTERS WITHOUT CLAIM TO ANY PARTICULAR
FONT, STYLE, SIZE, OR COLOR.

SN 78-696,766, FILED 8-19-2005.

JOHN SCHUYLER YARD, EXAMINING ATTOR-
NEY

Int. Cls.: 14 and 35

Prior U.S. Cls.: 2, 27, 28, 50, 100, 101, and 102

United States Patent and Trademark Office

Reg. No. 3,486,266

Registered Aug. 12, 2008

**TRADEMARK
SERVICE MARK
PRINCIPAL REGISTER**

FREEZE JEWELRY

A.V. JEWELRY EXPORT & IMPORT LTD. (NEW
YORK CORPORATION)

62 WEST 47TH STREET

NEW YORK, NY 10036

FOR: COSTUME JEWELRY, JEWELRY MADE OF GOLD, SILVER, PLATINUM, TITANIUM, STAINLESS STEEL AND PRECIOUS AND SEMI-PRECIOUS STONES; CLOCKS, STOP WATCHES AND WATCH BRACELETS, ITEMS COATED WITH PRECIOUS METAL OR THEIR ALLOYS, NAMELY, LETTER OPENERS, CANDLESTICKS, DECORATIVE BOXES, JEWELRY BOXES, CIGARETTE LIGHTERS AND MONEY CLIPS, IN CLASS 14 (U.S. CLS. 2, 27, 28 AND 50).

FIRST USE 3-0-2008; IN COMMERCE 3-0-2008.

FOR: RETAIL STORE SERVICES FEATURING COSTUME JEWELRY, JEWELRY, PRECIOUS AND SEMI-PRECIOUS STONES AND GIFTWARE, IN CLASS 35 (U.S. CLS. 100, 101 AND 102).

FIRST USE 3-0-2008; IN COMMERCE 3-0-2008.

THE MARK CONSISTS OF STANDARD CHARACTERS WITHOUT CLAIM TO ANY PARTICULAR FONT, STYLE, SIZE, OR COLOR.

NO CLAIM IS MADE TO THE EXCLUSIVE RIGHT TO USE "JEWELRY", APART FROM THE MARK AS SHOWN.

SN 78-697,798, FILED 8-22-2005.

JEFF DEFORD, EXAMINING ATTORNEY

Int. Cl.: 19

Prior U.S. Cls.: 1, 12, 33, and 50

United States Patent and Trademark Office

Reg. No. 3,486,267

Registered Aug. 12, 2008

**TRADEMARK
PRINCIPAL REGISTER**

STONE PRINTS

ANCHOR WALL SYSTEMS, INC. (MINNESOTA
CORPORATION)
5959 BAKER ROAD, SUITE 390
MINNETONKA, MN 553455996

FOR: CONCRETE LANDSCAPE PRODUCTS,
NAMELY, RETAINING WALL BLOCKS, FREE
STANDING WALL BLOCKS, PAVERS, SLABS,
EDGERS; ARCHITECTURAL CONCRETE MASON-
RY UNITS, NAMELY, BLOCKS, BRICKS, AND
VENEERS, IN CLASS 19 (U.S. CLS. 1, 12, 33 AND 50).

FIRST USE 5-30-2008; IN COMMERCE 6-5-2008.

THE MARK CONSISTS OF STANDARD CHAR-
ACTERS WITHOUT CLAIM TO ANY PARTICULAR
FONT, STYLE, SIZE, OR COLOR.

SN 78-704,402, FILED 8-31-2005.

KELLEY WELLS, EXAMINING ATTORNEY

Int. Cls.: 39, 40, and 42

Prior U.S. Cls.: 100, 101, 103, 105, and 106

Reg. No. 3,486,268

United States Patent and Trademark Office

Registered Aug. 12, 2008

**SERVICE MARK
PRINCIPAL REGISTER**



UNITED LAUNCH ALLIANCE LLC (COLORADO
LTD LIAB CO)
9100 EAST MINERAL CIRCLE
CENTENNIAL, CO 80112

FOR: LAUNCH AND PLACEMENT IN PRESCRIBED ORBIT OF SATELLITES OF OTHERS, IN CLASS 39 (U.S. CLS. 100 AND 105).

FIRST USE 6-17-2007; IN COMMERCE 6-17-2007.

FOR: CUSTOM MANUFACTURE FOR OTHERS OF SATELLITE LAUNCH VEHICLES, IN CLASS 40 (U.S. CLS. 100, 103 AND 106).

FIRST USE 6-17-2007; IN COMMERCE 6-17-2007.

FOR: ENGINEERING AND DESIGN SERVICES FOR OTHERS IN THE FIELD OF SATELLITE LAUNCH VEHICLES, IN CLASS 42 (U.S. CLS. 100 AND 101).

FIRST USE 6-17-2007; IN COMMERCE 6-17-2007.

NO CLAIM IS MADE TO THE EXCLUSIVE RIGHT TO USE "LAUNCH ALLIANCE", APART FROM THE MARK AS SHOWN.

THE MARK CONSISTS OF THE LETTERS "ULA" WITH A STYLIZED ROCKET AND ITS EXHAUST TRAIL ARCING THROUGH THE LEFT SIDE OF THE "A" IN "ULA". ALL WORDS, LETTERS AND DESIGN ELEMENTS IN THE MARK ARE SHOWN IN LIGHTER COLOR, AGAINST A DARKER RECTANGULAR BACKGROUND. THE LETTERS "ULA" ARE SEPARATED BY AN HORIZONTAL ARC OVER THE WORDS "UNITED LAUNCH ALLIANCE".

SN 78-706,400, FILED 9-2-2005.

EUGENIA MARTIN, EXAMINING ATTORNEY

Int. Cl.: 19

Prior U.S. Cls.: 1, 12, 33, and 50

United States Patent and Trademark Office

Reg. No. 3,486,269

Registered Aug. 12, 2008

**TRADEMARK
PRINCIPAL REGISTER**

MACMAT-AR

EMI CORP. OF MINNESOTA (MINNESOTA CORPORATION)
P.O. BOX 14257
ST. PAUL, MN 55114

THE MARK CONSISTS OF STANDARD CHARACTERS WITHOUT CLAIM TO ANY PARTICULAR FONT, STYLE, SIZE, OR COLOR.

FOR: RUBBER AND LATEX BASED LIQUID ASPHALT COMPOSITION FOR PAVEMENT MAINTENANCE, IN CLASS 19 (U.S. CLS. 1, 12, 33 AND 50).

SN 78-706,485, FILED 9-2-2005.

FIRST USE 5-8-2008; IN COMMERCE 5-8-2008.

INGRID C. EULIN, EXAMINING ATTORNEY

Int. Cl.: 21

Prior U.S. Cls.: 2, 13, 23, 29, 30, 33, 40, and 50

Reg. No. 3,486,270

United States Patent and Trademark Office

Registered Aug. 12, 2008

**TRADEMARK
PRINCIPAL REGISTER**



WATKINS GLEN INTERNATIONAL, INC. (DE-
LAWARE CORPORATION)
KAREN B. LEETZOW
1801 W. INTERNATIONAL SPEEDWAY BLVD.
DAYTONA BEACH, FL 32114

FOR: HOUSEWARES AND GLASS PRODUCTS,
NAMELY, MUGS, SHOT GLASSES, DRINKING
GLASSES, SALT AND PEPPER SHAKERS, DECAN-
TERS, PORTABLE COOLERS, INSULATING
SLEEVE HOLDERS FOR BEVERAGE CANS, AND

PLASTIC SPORT BOTTLES SOLD EMPTY, IN CLASS
21 (U.S. CLS. 2, 13, 23, 29, 30, 33, 40 AND 50).

FIRST USE 6-1-2006; IN COMMERCE 6-1-2006.

OWNER OF U.S. REG. NOS. 1,366,768, 1,862,034,
AND OTHERS.

SN 78-711,642, FILED 9-13-2005.

MARY BOAGNI, EXAMINING ATTORNEY

Int. Cl.: 25

Prior U.S. Cls.: 22 and 39

United States Patent and Trademark Office

Reg. No. 3,486,271

Registered Aug. 12, 2008

**TRADEMARK
PRINCIPAL REGISTER**



WATKINS GLEN INTERNATIONAL, INC. (DE-
LAWARE CORPORATION)
KAREN B. LEETZOW
1801 W. INTERNATIONAL SPEEDWAY BLVD.
DAYTONA BEACH, FL 32114

FIRST USE 6-1-2006; IN COMMERCE 6-1-2006.

OWNER OF U.S. REG. NOS. 1,366,768, 1,862,034,
AND OTHERS.

FOR: CLOTHING, NAMELY, T-SHIRTS, COL-
LARED SHIRTS, SPORT SHIRTS, SWEATSHIRTS,
SLEEVELESS TANK TOPS, JACKETS, SWEATERS,
CAPS, HATS, SUN VISORS, SHORTS, PANTS,
SHOES, SOCKS, BELTS, BANDANAS, AND HEAD-
BANDS, IN CLASS 25 (U.S. CLS. 22 AND 39).

SN 78-711,644, FILED 9-13-2005.

MARY BOAGNI, EXAMINING ATTORNEY

Int. Cl.: 28

Prior U.S. Cls.: 22, 23, 38, and 50

Reg. No. 3,486,272

United States Patent and Trademark Office

Registered Aug. 12, 2008

**TRADEMARK
PRINCIPAL REGISTER**



WATKINS GLEN INTERNATIONAL, INC. (DE-
LAWARE CORPORATION)
KAREN B. LEETZOW
1801 W. INTERNATIONAL SPEEDWAY BLVD.
DAYTONA BEACH, FL 32114

FIRST USE 6-1-2006; IN COMMERCE 6-1-2006.

OWNER OF U.S. REG. NOS. 1,366,768, 1,862,034,
AND OTHERS.

FOR: TOYS AND PLAYTHINGS, NAMELY, DIE
CAST AND PLASTIC MINIATURE CARS AND
STUFFED TOY ANIMALS , IN CLASS 28 (U.S. CLS.
22, 23, 38 AND 50).

SN 78-711,647, FILED 9-13-2005.

MARY BOAGNI, EXAMINING ATTORNEY

Int. Cl.: 9

Prior U.S. Cls.: 21, 23, 26, 36, and 38

Reg. No. 3,486,273

United States Patent and Trademark Office

Registered Aug. 12, 2008

**TRADEMARK
PRINCIPAL REGISTER**

RESPONDER

CRITICAL RESPONSE SYSTEMS, INC. (NEVADA CORPORATION)
SUITE 370
1760 OAKBROOK DR
NORCROSS, GA 30093

FOR: PAGERS FOR GROUP ALERTING IN EMERGENCY SITUATIONS SOLD TO MUNICIPALITIES, HOSPITALS, AND EMERGENCY MEDICAL ASSISTANCE PROVIDERS; RADIO PAGERS FOR GROUP ALERTING IN EMERGENCY SITUATIONS SOLD TO MUNICIPALITIES, HOSPITALS, AND

EMERGENCY MEDICAL ASSISTANCE PROVIDERS, IN CLASS 9 (U.S. CLS. 21, 23, 26, 36 AND 38).

FIRST USE 1-25-2005; IN COMMERCE 10-17-2005.

THE MARK CONSISTS OF STANDARD CHARACTERS WITHOUT CLAIM TO ANY PARTICULAR FONT, STYLE, SIZE, OR COLOR.

SN 78-711,790, FILED 9-13-2005.

SUSAN LESLIE DUBOIS, EXAMINING ATTORNEY

Int. Cls.: 28 and 41

Prior U.S. Cls.: 22, 23, 38, 50, 100, 101, and 107

United States Patent and Trademark Office

Reg. No. 3,486,274

Registered Aug. 12, 2008

**TRADEMARK
SERVICE MARK
PRINCIPAL REGISTER**



HOBBY TOWN UNLIMITED, INC. (NEBRASKA CORPORATION)
6301 SOUTH 58TH STREET
LINCOLN, NE 68516

FOR: PLUSH AND STUFFED TOY ANIMALS AND ACCESSORIES THEREFOR, IN CLASS 28 (U.S. CLS. 22, 23, 38 AND 50).

FIRST USE 9-0-2005; IN COMMERCE 8-0-2006.

FOR: ENTERTAINMENT SERVICES IN THE NATURE OF PARTIES FOR CREATING PLUSH

AND STUFFED TOY ANIMALS, IN CLASS 41 (U.S. CLS. 100, 101 AND 107).

FIRST USE 9-0-2005; IN COMMERCE 8-0-2006.

NO CLAIM IS MADE TO THE EXCLUSIVE RIGHT TO USE "ANIMAL", APART FROM THE MARK AS SHOWN.

SN 78-714,066, FILED 9-15-2005.

DAVID MILLER, EXAMINING ATTORNEY

Int. Cl.: 16

Prior U.S. Cls.: 2, 5, 22, 23, 29, 37, 38, and 50

United States Patent and Trademark Office

Reg. No. 3,486,275

Registered Aug. 12, 2008

**TRADEMARK
PRINCIPAL REGISTER**

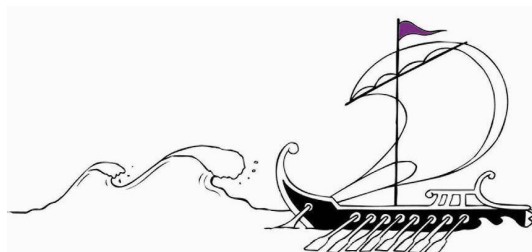

TELLMEOMUSE LLC (NEW YORK LTD LIAB
CO)

#5B

88 CHARLES STREET
NEW YORK, NY 10014

FOR: PAPER AND PRINTED MATERIALS,
NAMELY, GREETING CARDS; PAPER AND PRIN-
TED MATERIALS NAMELY JOURNALS, BOOK-
MARKS, IN CLASS 16 (U.S. CLS. 2, 5, 22, 23, 29, 37, 38
AND 50).

FIRST USE 8-27-2005; IN COMMERCE 8-27-2005.

THE COLOR(S) BLACK, WHITE AND PURPLE IS/
ARE CLAIMED AS A FEATURE OF THE MARK.

THE MARK CONSISTS OF A SHIP, OUTLINED IN
BLACK, AND WITH A BLACK BODY, WITH WHITE
DETAILING AND WHITE OARS STICKING OUT
OF THE SIDE. THERE IS A WHITE SAIL, OUT-
LINED IN BLACK, TIED TO THE MAST AND
LOOKING AS IF BLOWN TO THE RIGHT BY THE
WIND. AT THE TOP OF THE MAST IS A PURPLE
TRIANGULAR FLAG. THE SHIP IS IN A BODY OF
WHITE WATER, OUTLINED IN BLACK, WITH
TWO LARGE WAVES TO ITS LEFT, AND TWO
SMALLER WAVES ALONG ITS BOTTOM RIGHT
HAND SIDE.

SN 78-718,166, FILED 9-22-2005.

LYDIA BELZER, EXAMINING ATTORNEY

Int. Cls.: 6 and 19

Prior U.S. Cls.: 1, 2, 12, 13, 14, 23, 25, 33, and 50

United States Patent and Trademark Office

Reg. No. 3,486,276

Registered Aug. 12, 2008

**TRADEMARK
PRINCIPAL REGISTER**

TGP AMERICA

J.R. FOUR LTD. (WASHINGTON CORPORATION), DBA TECHNICAL GLASS PRODUCTS, 600 6TH STREET SOUTH KIRKLAND, WA 98033

FOR: METAL BUILDING FRAMES, STEEL BUILDING FRAMES, ALUMINUM BUILDING FRAMES, METAL DOORS, FIRE-RATED WINDOW AND DOOR FRAMES MADE OF METAL, IN CLASS 6 (U.S. CLS. 2, 12, 13, 14, 23, 25 AND 50).

FIRST USE 9-17-2007; IN COMMERCE 9-17-2007.

FOR: ARCHITECTURAL GLASS, NAMELY, STRUCTURAL GLASS, DECORATIVE GLASS, FIRE-RATED GLASS, IMPACT SAFETY-RATED GLASS, BULLET-RESISTANT GLASS, SECURITY GLASS, WIRED GLASS, SIDELIGHTS, WINDOWS, TRANSOMS; FRAMING MATERIALS, NAMELY, WOOD DOOR FRAMES, WOOD WINDOW FRAMES, FIRE-RATED WINDOW AND DOOR FRAMES MADE OF WOOD, IMMOVABLE WALL PARTITIONS; BUILDING MATERIALS, NAMELY,

MILLWORK FOR DOORS, MILLWORK FOR WINDOWS, NON-METAL DOORS; BUILDING SURFACING MATERIALS, NAMELY, CERAMIC WALL CLADDING, NON-METAL WALL CLADDING, SYNTHETIC WALL CLADDING, CERAMIC COUNTERTOPS, CERAMIC FLOORING, IN CLASS 19 (U.S. CLS. 1, 12, 33 AND 50).

FIRST USE 9-17-2007; IN COMMERCE 9-17-2007.

THE MARK CONSISTS OF STANDARD CHARACTERS WITHOUT CLAIM TO ANY PARTICULAR FONT, STYLE, SIZE, OR COLOR.

NO CLAIM IS MADE TO THE EXCLUSIVE RIGHT TO USE "AMERICA", APART FROM THE MARK AS SHOWN.

SN 78-718,795, FILED 9-22-2005.

MICHAEL LEWIS, EXAMINING ATTORNEY

Int. Cl.: 30

Prior U.S. Cl.: 46

United States Patent and Trademark Office

Reg. No. 3,486,277

Registered Aug. 12, 2008

**TRADEMARK
PRINCIPAL REGISTER**

KASHI MIGHTY BITES

KASHI COMPANY (CALIFORNIA CORPORATION)
4275 EXECUTIVE SQUARE, SUITE 500
LA JOLLA, CA 92037

FOR: PROCESSED CEREAL-DERIVED FOOD PRODUCT TO BE USED AS A BREAKFAST CEREAL, SNACK FOOD, OR INGREDIENT FOR MAKING FOOD; READY-TO-EAT CEREAL; GRAIN BASED SNACK FOODS; READY-TO-EAT OAT BASED SNACK FOOD; PROCESSED CEREALS; EXCLUDING CANDY, IN CLASS 30 (U.S. CL. 46).

FIRST USE 2-28-2005; IN COMMERCE 5-13-2005.

THE MARK CONSISTS OF STANDARD CHARACTERS WITHOUT CLAIM TO ANY PARTICULAR FONT, STYLE, SIZE, OR COLOR.

OWNER OF U.S. REG. NOS. 1,366,934, 2,273,746, AND OTHERS.

NO CLAIM IS MADE TO THE EXCLUSIVE RIGHT TO USE "BITES", APART FROM THE MARK AS SHOWN.

SN 78-719,203, FILED 9-23-2005.

DAVID HOFFMAN, EXAMINING ATTORNEY

Int. Cl.: 3

Prior U.S. Cls.: 1, 4, 6, 50, 51, and 52

Reg. No. 3,486,278

United States Patent and Trademark Office

Registered Aug. 12, 2008

**TRADEMARK
PRINCIPAL REGISTER**

C-FIRM

DERMA PRO INC. (NEVADA CORPORATION)
28324 CONSTELLATION RD.
VALENCIA, CA 91355

FOR: SKIN CARE MASKS, LOTIONS, CLEANSERS, CREAMS, MOISTURIZERS, SCRUBS, GELS, AND MAKE-UP REMOVER, IN CLASS 3 (U.S. CLS. 1, 4, 6, 50, 51 AND 52).

FIRST USE 9-27-2005; IN COMMERCE 9-27-2005.

THE MARK CONSISTS OF STANDARD CHARACTERS WITHOUT CLAIM TO ANY PARTICULAR FONT, STYLE, SIZE, OR COLOR.

NO CLAIM IS MADE TO THE EXCLUSIVE RIGHT TO USE "FIRM", APART FROM THE MARK AS SHOWN.

SN 78-720,025, FILED 9-24-2005.

JULIE GUTTADAURO, EXAMINING ATTORNEY

Int. Cl.: 35

Prior U.S. Cls.: 100, 101, and 102

United States Patent and Trademark Office

Reg. No. 3,486,279

Registered Aug. 12, 2008

**SERVICE MARK
PRINCIPAL REGISTER**

THINGS COOKS LOVE

SUR LA TABLE, INC. (WASHINGTON CORPORATION)
SUITE 486
5701 SIXTH AVENUE SOUTH
SEATTLE, WA 98108

FOR: RETAIL STORE SERVICES, MAIL ORDER CATALOG SERVICES, AND INTERNET CATALOG SERVICES, FEATURING FOODS, CUTLERY, KITCHEN GADGETS, KITCHEN APPLIANCES, KITCHEN UTENSILS, KITCHENWARE, DINNERWARE, TABLEWARE, COOKWARE, BAKEWARE, GIFTWARE, GLASSWARE, FLATWARE, BARWARE, HOUSEWARES, TABLE LINENS, KITCHEN TOWELS, VASES, STORAGE CONTAINERS, SOAPS

AND CLEANING PRODUCTS, COOKBOOKS, AND HOUSEHOLD FURNISHINGS, IN CLASS 35 (U.S. CLS. 100, 101 AND 102).

FIRST USE 9-5-2007; IN COMMERCE 9-5-2007.

THE MARK CONSISTS OF STANDARD CHARACTERS WITHOUT CLAIM TO ANY PARTICULAR FONT, STYLE, SIZE, OR COLOR.

SN 78-722,456, FILED 9-28-2005.

RICHARD A. STRASER, EXAMINING ATTORNEY

Int. Cl.: 18

Prior U.S. Cls.: 1, 2, 3, 22, and 41

United States Patent and Trademark Office

Reg. No. 3,486,280

Registered Aug. 12, 2008

**TRADEMARK
PRINCIPAL REGISTER**



THE BASEBALL CLUB OF SEATTLE, L.P. (WA-
SHINGTON LIMITED PARTNERSHIP)
SAFECO FIELD
1250 FIRST AVENUE SOUTH
SEATTLE, WA 98134

FOR: ATHLETIC BAGS, OVERNIGHT BAGS,
BACKPACKS, DUFFEL BAGS, KNAPSACKS, AT-
TACHÉ CASES, BRIEFCASES, PURSES, HAND-
BAGS, WALLETS, BILLFOLDS, FANNY PACKS,
WAIST PACKS, COSMETIC CASES SOLD EMPTY,
TOILETRY CASES SOLD EMPTY, BUSINESS CARD

CASES, LUGGAGE, LUGGAGE TAGS, SUITCASES,
IN CLASS 18 (U.S. CLS. 1, 2, 3, 22 AND 41).

FIRST USE 1-0-2005; IN COMMERCE 1-0-2005.

OWNER OF U.S. REG. NOS. 2,007,273, 2,573,322,
AND OTHERS.

SN 78-724,960, FILED 10-3-2005.

PAUL F. GAST, EXAMINING ATTORNEY

Int. Cl.: 9

Prior U.S. Cls.: 21, 23, 26, 36, and 38

Reg. No. 3,486,281

United States Patent and Trademark Office

Registered Aug. 12, 2008

**TRADEMARK
PRINCIPAL REGISTER**

MELODIS

MELODIS CORPORATION (DELAWARE CORPORATION)
440 N. WOLFE ROAD
SUNNYVALE, CA 94085

THE MARK CONSISTS OF STANDARD CHARACTERS WITHOUT CLAIM TO ANY PARTICULAR FONT, STYLE, SIZE, OR COLOR.

FOR: COMPUTER SEARCH ENGINE SOFTWARE, IN CLASS 9 (U.S. CLS. 21, 23, 26, 36 AND 38).

SN 78-725,701, FILED 10-3-2005.

FIRST USE 1-1-2006; IN COMMERCE 1-1-2006.

DANNEAN HETZEL, EXAMINING ATTORNEY

Int. Cl.: 9

Prior U.S. Cls.: 21, 23, 26, 36, and 38

Reg. No. 3,486,282

United States Patent and Trademark Office

Registered Aug. 12, 2008

**TRADEMARK
PRINCIPAL REGISTER**

S3 GRAPHICS ON BOARD

S3 GRAPHICS CO., LTD. (CAYMAN ISLANDS CORPORATION)

ATTN: JONATHAN CHANG, OFFICER

4TH FLOOR, ZEPHYR HOUSE 122 MARY STREET
PO BOX 709 GT PO BOX 709 GT

GEORGE TOWN, CAYMAN ISLANDS

FOR: COMPUTER HARDWARE, NAMELY, SEMICONDUCTORS, MICROPROCESSORS, INTEGRATED CIRCUITS, PRINTED CIRCUIT BOARD LEVEL PRODUCTS, NAMELY, GRAPHICS ACCELERATOR COMPUTER CHIPS AND RELATED OPERATION SOFTWARE, COMPUTER GRAPHIC CARDS, COMPUTER CHIPS, COMPUTER CHIPSETS, HANDHELD COMPUTING DEVICES AND WIRELESS COMMUNICATIONS DEVICES, NAMELY, CELLULAR HANDSETS, TABLET COMPUTERS, LCD DISPLAYS, DIGITAL VIDEO RECORDERS AND PLAYERS, ELECTRONIC NOTEPADS AND ASSOCIATED COMPUTER SUPPORT AND HARDWARE FOR OPERATING SAME; COMPUTER PROGRAMS FOR MODEMS, PERSONAL DIGITAL ASSISTANT PDA DEVICES PROCESSORS, NAMELY, HANDHELD DIGITAL DEVICES HAVING PROGRAMMABLE CAPACITY AND CAPACITY TO COMMUNICATE BY ELECTRONIC, DIGITAL, MICROWAVE, BROADBAND, ANALOG, RADIO, AND SATELLITE USING VOICE, GRAPHICS, VIDEO, DATA, SENSORY, INFRARED, ULTRAVIOLET, AND LASER AUDIO TRANSMISSIONS IN THE NATURE OF ELECTRONIC PERSONAL ORGANIZERS, MOBILE PHONES, SMART PHONES, PORTABLE AND POCKET-SIZE PERSONAL COMPUTERS, PALMTOP COMPUTERS IN THE NATURE OF ELECTRONIC PERSONAL ORGANIZERS, PERSONAL NAVIGATIONAL GLOBAL POSITIONING SYSTEMS (GPS), HANDHELD AND PORTABLE MULTIMEDIA PLAYERS, SMART COMPUTERS HAVING CONTEXT, USER AND LOCATION AWARENESS AND WHICH MAY BE OUTFITTED AND ADAPTABLE WITH MODEM, MEMORY, PC MCIA SLOTS, DISK DRIVES, KEY-

BOARD, AND MONITOR, MOBILE DIGITAL DEVICES WITH COMPUTER NOTEBOOK FUNCTIONALITY AND CONNECTIVITY IN A HANDHELD PORTABLE MICRO-SIZED FORM AND WHICH MAY BE ADAPTABLE AND FITTED WITH MODEM, MEMORY, PC MCIA SLOTS, DISK DRIVES, KEYBOARD, AND MONITOR IN THE NATURE OF ELECTRONIC PERSONAL ORGANIZERS, MOBILE PHONES, SMART PHONES, PORTABLE AND POCKET-SIZE PERSONAL COMPUTERS, PALMTOP COMPUTERS IN THE NATURE OF ELECTRONIC PERSONAL ORGANIZERS, PERSONAL NAVIGATIONAL GLOBAL POSITIONING SYSTEMS (GPS), HANDHELD MULTIMEDIA PLAYERS, SMART COMPUTERS HAVING CONTEXT, USER AND LOCATION AWARENESS AND WHICH MAY BE OUTFITTED AND ADAPTABLE WITH MODEM, MEMORY, PC MCIA SLOTS, DISK DRIVES, KEYBOARD, AND MONITOR, WIRELESS DIGITAL DEVICES IN THE NATURE OF MOBILE AND HANDHELD PHONES, HANDS-FREE PHONES, HANDHELD MULTIMEDIA PLAYERS, ELECTRONIC PERSONAL ORGANIZERS, ELECTRONIC PERSONAL INFORMATION MANAGEMENT ORGANIZERS, PORTABLE AND POCKET-SIZE PERSONAL COMPUTERS, PALMTOP COMPUTERS IN THE NATURE OF ELECTRONIC PERSONAL ORGANIZERS, SMART COMPUTERS HAVING CONTEXT, USER AND LOCATION AWARENESS AND WHICH MAY BE OUTFITTED AND ADAPTABLE WITH MODEM, MEMORY; PC MCIA SLOTS, DISK DRIVES, KEYBOARD, MONITOR, POCKET PRINTER, POCKET CAMERA, AND POCKET VIDEO CAMERA, REMOTE DEVICES IN THE NATURE OF PORTABLE MICRO SIZED COMPUTERS WITH NOTEBOOK FUNCTIONALITY FOR THE MOBILE ENTERPRISE HAVING CAPABILITIES OF REMOTE DESKTOP, REMOTE E-MAIL AND TRANSPARENCY ACCESS TO DATA, PORTABLE PERSONAL NAVIGATIONAL GLOBAL POSITIONING SYSTEMS (GPS), SMART COMPUTERS HAVING CONTEXT, USER

AND LOCATION AWARENESS AND WITH INTEGRATED MULTIDIMENSIONAL DATA, SOUND, VIDEO AND GRAPHICS, PORTABLE MULTIMEDIA PLAYER, PUBLIC KIOSKS IN THE NATURE OF COMPUTER TERMINALS, AND PORTABLE COMPUTER TERMINALS BOTH ALLOWING DIAL-UP CONNECTIVITY AND PERSONAL COMPUTER ACCESS, COMMUNICATION DEVICES HAVING CAPACITY FOR ACQUISITION, MULTIPLEXING, TRANSMISSION, ENCODING, COMPRESSION, FILTERING, TRANSFORMING, DECOMPRESSION, DECODING, DEMULTIPLEXING AND RECEPTION OF COMMUNICATIONS DATA IN THE NATURE OF SMART PHONES, PORTABLE COMPUTERS, PORTABLE INTERACTIVE LEARNING COMPUTERS, ELECTRONIC ORGANIZERS, AND VOICE-OVER SOFTWARE FOR TRANSMITTING AND RECEIVING COMMUNICATION SIGNALS, GAMES AND OTHER DATA, PARTS AND COMPONENTS THEREOF AND ACCESSORIES THEREFOR; INTEGRATED CIRCUITS CONTAINING CHIPSETS FOR SPREAD SPEC-

TRUM MODULATION AND DEMODULATION, ERROR CORRECTION ENCODING AND DECODING, VOICE CODING AND PREPROGRAMMED MEMORIES CONTAINING PROCESSOR INSTRUCTIONS AND COMPUTER MANUALS SOLD AS A UNIT, IN CLASS 9 (U.S. CLS. 21, 23, 26, 36 AND 38).

FIRST USE 2-1-2007; IN COMMERCE 6-1-2007.

THE MARK CONSISTS OF STANDARD CHARACTERS WITHOUT CLAIM TO ANY PARTICULAR FONT, STYLE, SIZE, OR COLOR.

OWNER OF U.S. REG. NO. 2,312,179.

NO CLAIM IS MADE TO THE EXCLUSIVE RIGHT TO USE "GRAPHICS", APART FROM THE MARK AS SHOWN.

SN 78-727,424, FILED 10-5-2005.

RAUL CORDOVA, EXAMINING ATTORNEY

Int. Cl.: 35

Prior U.S. Cls.: 100, 101, and 102

United States Patent and Trademark Office

Reg. No. 3,486,283

Registered Aug. 12, 2008

**SERVICE MARK
PRINCIPAL REGISTER**

ORIDIAN

ONLINE MEDIA SOLUTIONS LTD. (ISRAEL
CORPORATION)
3 SPIR STREET
HERZELIA, ISRAEL

THE MARK CONSISTS OF STANDARD CHAR-
ACTERS WITHOUT CLAIM TO ANY PARTICULAR
FONT, STYLE, SIZE, OR COLOR.

FOR: DISSEMINATION OF ADVERTISING FOR
OTHERS, BOTH ONLINE AND OFF-LINE; RENTAL
AND PROVISION OF ADVERTISING SPACE, IN
CLASS 35 (U.S. CLS. 100, 101 AND 102).

SN 78-727,540, FILED 10-6-2005.

FIRST USE 5-30-2005; IN COMMERCE 5-30-2005.

DAVID HOFFMAN, EXAMINING ATTORNEY

Int. Cls.: 5 and 32

Prior U.S. Cls.: 6, 18, 44, 45, 46, 48, 51, and 52

United States Patent and Trademark Office

Reg. No. 3,486,284

Registered Aug. 12, 2008

**TRADEMARK
PRINCIPAL REGISTER**

由内至外, 散發健康神采

CEREBOS PACIFIC LIMITED (SINGAPORE CORPORATION)
400 ORCHARD ROAD #11-12, ORCHARD TOWERS
SINGAPORE 238875, SINGAPORE

FOR: NUTRITIONAL DRINKS CONTAINING
EDIBLE BIRD'S NESTS, IN CLASS 5 (U.S. CLS. 6,
18, 44, 46, 51 AND 52).

FIRST USE 10-1-2005; IN COMMERCE 10-1-2005.

FOR: NON-CARBONATED DRINKS CONTAINING
EDIBLE BIRD'S NESTS, IN CLASS 32 (U.S. CLS.
45, 46 AND 48).

FIRST USE 10-1-2005; IN COMMERCE 10-1-2005.

THE FOREIGN WORDING IN THE MARK
TRANSLATES INTO ENGLISH AS "GLOWING
WITH HEALTH AND SPIRIT INSIDE AND OUT".

THE NON-LATIN CHARACTER(S) IN THE
MARK TRANSLITERATES INTO "YOU NEI ZHI
WAI, SAN FA JIAN KANG SHEN CAI" , AND THIS
MEANS "GLOWING WITH HEALTH AND SPIRIT
INSIDE AND OUT" IN ENGLISH.

SN 78-728,221, FILED 10-6-2005.

KOURTNEE HODGES, EXAMINING ATTORNEY

Int. Cl.: 9

Prior U.S. Cls.: 21, 23, 26, 36, and 38

Reg. No. 3,486,285

United States Patent and Trademark Office

Registered Aug. 12, 2008

**TRADEMARK
PRINCIPAL REGISTER**

F4W

F4W, INC. (FLORIDA CORPORATION)
SUITE 100
103 COMMERCE STREET
LAKE MARY, FL 32746

FIRST USE 9-30-2005; IN COMMERCE 9-30-2005.

FOR: SOFTWARE FOR VOICE, VIDEO, CHAT
AND TEXT COMMUNICATIONS OVER A WIRE-
LESS NETWORK, IN CLASS 9 (U.S. CLS. 21, 23, 26, 36
AND 38).

THE MARK CONSISTS OF STANDARD CHAR-
ACTERS WITHOUT CLAIM TO ANY PARTICULAR
FONT, STYLE, SIZE, OR COLOR.

SN 78-729,970, FILED 10-10-2005.

MATTHEW PAPPAS, EXAMINING ATTORNEY

Int. Cl.: 28

Prior U.S. Cls.: 22, 23, 38, and 50

United States Patent and Trademark Office

Reg. No. 3,486,286

Registered Aug. 12, 2008

**TRADEMARK
PRINCIPAL REGISTER**

PERFORMANCE DESIGN

PERFORMANCE DESIGN, INC. (UTAH CORPORATION)
FREEPORT CENTER BUILDING G-6
P.O. BOX 16051
CLEARFIELD, UT 84016

FOR: PLAYGROUND EQUIPMENT, NAMELY, SWINGS, SWING SETS, SLIDES, JUNGLE GYMS, CLIMBING STRUCTURES, SANDBOXES, TREE HOUSES, MONKEY BARS, ACTIVITY WALLS, DECKS AND ENCLOSURES, PLAY PICNIC TABLES, BRIDGES AND ATTACHED RUNG LAD-

DERS; EXCLUDING TOY PARACHUTES, IN CLASS 28 (U.S. CLS. 22, 23, 38 AND 50).

FIRST USE 2-0-2007; IN COMMERCE 2-0-2007.

THE MARK CONSISTS OF STANDARD CHARACTERS WITHOUT CLAIM TO ANY PARTICULAR FONT, STYLE, SIZE, OR COLOR.

SN 78-730,174, FILED 10-10-2005.

CAROLYN CATALDO, EXAMINING ATTORNEY

Int. Cl.: 11

Prior U.S. Cls.: 13, 21, 23, 31, and 34

Reg. No. 3,486,287

United States Patent and Trademark Office

Registered Aug. 12, 2008

**TRADEMARK
PRINCIPAL REGISTER**

**THE ULTIMATE GREEN
CLEANING MACHINE**

PUMPTEC INC. (MINNESOTA CORPORATION)
700 MCKINLEY STREET NW
ANOKA ENTERPRISE PARK
ANOKA, MN 55303

FIRST USE 8-24-2007; IN COMMERCE 8-24-2007.

FOR: WATER TREATMENT AND CONDITIONING UNITS, NAMELY, REVERSE OSMOSIS PRODUCTS FOR DOMESTIC, COMMERCIAL, AND INDUSTRIAL USE; REVERSE OSMOSIS SYSTEMS, NAMELY, CLEANING DEVICES FOR PRODUCING PURE WATER IN DOMESTIC, COMMERCIAL, AND INDUSTRIAL APPLICATIONS, IN CLASS 11 (U.S. CLS. 13, 21, 23, 31 AND 34).

THE MARK CONSISTS OF STANDARD CHARACTERS WITHOUT CLAIM TO ANY PARTICULAR FONT, STYLE, SIZE, OR COLOR.

SN 78-731,822, FILED 10-12-2005.

KARANENDRA S. CHHINA, EXAMINING ATTORNEY

Int. Cls.: 9 and 37

Prior U.S. Cls.: 21, 23, 26, 36, 38, 100, 103, and 106

United States Patent and Trademark Office

Reg. No. 3,486,288

Registered Aug. 12, 2008

**TRADEMARK
SERVICE MARK
PRINCIPAL REGISTER**

TEXIO

TEXIO CORPORATION (JAPAN CORPORATION)
1850-1, TSURUMA, MACHIDA-SHI
TOKYO, JAPAN

FOR: ELECTRIC RESISTORS; POWER SUPPLIES;
ELECTRIC OR MAGNETIC METERS AND TESTERS,
NAMELY, OSCILLOSCOPES, AMMETERS,
VOLTMETERS; ELECTRIC WIRES AND CABLES;
INTERFACE CARD FOR DATA PROCESSING
EQUIPMENT IN THE FORM OF PRINTED CIR-
CUITS, IN CLASS 9 (U.S. CLS. 21, 23, 26, 36 AND 38).

FIRST USE 2-22-2006; IN COMMERCE 2-19-2008.

FOR: REPAIR OR MAINTENANCE OF ELEC-
TRIC OR MAGNETIC METERS AND TESTERS,
NAMELY, OSCILLOSCOPES, AMMETERS, VOLT-
METERS; REPAIR OR MAINTENANCE OF POWER

DISTRIBUTION OR CONTROL MACHINES AND
APPARATUS, NAMELY, ELECTRIC RESISTORS,
POWER SUPPLIES, IN CLASS 37 (U.S. CLS. 100, 103
AND 106).

FIRST USE 2-22-2006; IN COMMERCE 11-13-2007.

PRIORITY CLAIMED UNDER SEC. 44(D) ON
JAPAN APPLICATION NO. 2005-34099, FILED 4-15-
2005, REG. NO. 4921049, DATED 1-13-2006, EXPIRES
1-13-2016.

THE MARK "TEXIO" HAS NO MEANING IN A
FOREIGN LANGUAGE.

SN 78-732,409, FILED 10-13-2005.

KHANH LE, EXAMINING ATTORNEY

Int. Cls.: 35, 36, and 41

Prior U.S. Cls.: 100, 101, 102, and 107

United States Patent and Trademark Office

Reg. No. 3,486,289

Registered Aug. 12, 2008

**SERVICE MARK
PRINCIPAL REGISTER**

ON YOUR MONEY

ON YOUR MONEY MEDIA LLC (WISCONSIN
LTD LIAB CO)
3311 EVERGREEN LANE
EAU CLAIRE, WI 54701

FOR: PROVIDING CONSUMER INFORMATION IN THE FIELD OF ECONOMICS, BUSINESS, PERSONAL FINANCE, INVESTMENTS, FINANCIAL PLANNING, ESTATE PLANNING; PROVIDING CONSUMER PRODUCT INFORMATION VIA THE INTERNET; PROVIDING AN ON-LINE DATABASE IN THE FIELDS OF ECONOMICS AND BUSINESS; PROVIDING INFORMATION IN THE FIELDS OF ECONOMICS AND BUSINESS VIA A WEBSITE; PROVIDING BUSINESS INFORMATION VIA THE INTERNET AND VIA MOBILE COMMUNICATION DEVICES, IN CLASS 35 (U.S. CLS. 100, 101 AND 102).

FIRST USE 10-1-2003; IN COMMERCE 10-1-2003.

FOR: PROVIDING AN ON-LINE COMPUTER DATABASE IN THE FIELDS OF FINANCE, INVESTMENTS, ESTATE PLANNING; PROVIDING INFORMATION IN THE FIELDS OF FINANCE, INVESTMENTS, ESTATE PLANNING VIA A WEBSITE; PROVIDING FINANCIAL INFORMATION VIA THE INTERNET AND VIA MOBILE COMMUNICATION DEVICES, IN CLASS 36 (U.S. CLS. 100, 101 AND 102).

FIRST USE 10-1-2003; IN COMMERCE 10-1-2003.

FOR: EDUCATIONAL AND ENTERTAINMENT SERVICES, NAMELY, RADIO PROGRAMS, RADIO TALK SHOWS, RADIO CALL-IN TALK SHOWS FEATURING PERFORMANCES BY A RADIO PERSONALITY; PROVIDING AN ON-LINE COMPUTER DATABASE IN THE FIELD OF EDUCATION STRATEGIES AND TECHNIQUES; PROVIDING INFORMATION IN THE FIELD OF EDUCATION STRATEGIES AND TECHNIQUES VIA THE INTERNET; PROVIDING NEWS IN THE NATURE OF CURRENT EVENT REPORTING VIA THE INTERNET AND VIA MOBILE COMMUNICATION DEVICES, IN CLASS 41 (U.S. CLS. 100, 101 AND 107).

FIRST USE 10-1-2003; IN COMMERCE 10-1-2003.

THE MARK CONSISTS OF STANDARD CHARACTERS WITHOUT CLAIM TO ANY PARTICULAR FONT, STYLE, SIZE, OR COLOR.

SN 78-733,976, FILED 10-15-2005.

SUNG IN, EXAMINING ATTORNEY

Int. Cls.: 35 and 42

Prior U.S. Cls.: 100, 101, and 102

United States Patent and Trademark Office

Reg. No. 3,486,290

Registered Aug. 12, 2008

**SERVICE MARK
PRINCIPAL REGISTER**

Weapon of Mass Distribution

EPRINTWERX INTERNATIONAL LLC (ARIZONA LTD LIAB CO)
7682 E CAMPO BELLO DRIVE
SCOTTSDALE, AZ 85255

FOR: DIRECT MAIL ADVERTISING; DISSEMINATION OF ADVERTISING FOR OTHERS VIA AN ONLINE COMMUNICATIONS NETWORK ON THE INTERNET; DISSEMINATION OF ADVERTISING FOR OTHERS VIA THE INTERNET; MAILING LIST PREPARATION; MARKET MANIPULATION, RESEARCH AND ANALYSIS, WHETHER OR NOT VIA THE INTERNET; PROVIDING BUSINESS INFORMATION, ALSO VIA INTERNET, THE CABLE NETWORK OR OTHER FORMS OF DATA TRANSFER; PROVIDING CONSUMER PRODUCT INFORMATION VIA THE INTERNET, IN CLASS 35 (U.S. CLS. 100, 101 AND 102).

FIRST USE 11-1-2005; IN COMMERCE 11-1-2005.

FOR: DESIGN, CREATION, HOSTING AND MAINTENANCE OF INTERNET SITES FOR THIRD PARTIES; HOSTING OF DIGITAL CONTENT ON THE INTERNET; PROVIDING SPECIFIC INFORMATION AS REQUESTED BY CUSTOMERS VIA THE INTERNET, IN CLASS 42 (U.S. CLS. 100 AND 101).

FIRST USE 11-1-2005; IN COMMERCE 11-1-2005.

THE MARK CONSISTS OF STANDARD CHARACTERS WITHOUT CLAIM TO ANY PARTICULAR FONT, STYLE, SIZE, OR COLOR.

NO CLAIM IS MADE TO THE EXCLUSIVE RIGHT TO USE "MASS DISTRIBUTION", APART FROM THE MARK AS SHOWN.

SN 78-734,021, FILED 10-15-2005.

JEFF DEFORD, EXAMINING ATTORNEY

Int. Cl.: 9

Prior U.S. Cls.: 21, 23, 26, 36, and 38

Reg. No. 3,486,291

United States Patent and Trademark Office

Registered Aug. 12, 2008

**TRADEMARK
PRINCIPAL REGISTER**



CORPORACION DELCOP C.A. (VENEZUELA
CORPORATION)
CALLE LAS VEGAS, EDIF. DELCOP
ZONA INDUSTRIAL LA TRINIDAD, CARACAS,
VENEZUELA

FOR: PHOTOCOPY MACHINES, IN CLASS 9 (U.S.
CLS. 21, 23, 26, 36 AND 38).

FIRST USE 4-11-2008; IN COMMERCE 4-11-2008.

THE MARK CONSISTS OF THE WORD "DEL-
COP" IN A STYLIZED OVAL.

SN 78-739,589, FILED 10-25-2005.

JENNIFER VASQUEZ, EXAMINING ATTORNEY

Int. Cl.: 35

Prior U.S. Cls.: 100, 101, and 102

United States Patent and Trademark Office

Reg. No. 3,486,292

Registered Aug. 12, 2008

**SERVICE MARK
PRINCIPAL REGISTER**

America's Hometown Parade

THOMSON, STEPHEN P. (UNITED STATES IN-
DIVIDUAL)
5450 WEST JEFFERSON AVENUE
DETROIT, MI 48209

FOR: ADVERTISING AND PROMOTION SERVI-
CES AND RELATED CONSULTING; ADVERTIS-
ING, INCLUDING PROMOTION OF PRODUCTS
AND SERVICES OF THIRD PARTIES THROUGH
SPONSORING ARRANGEMENTS AND LICENCE
AGREEMENTS RELATING TO INTERNATIONAL
SPORTS' EVENTS; ADVERTISING, MARKETING
AND PROMOTION SERVICES; ARRANGING AND
CONDUCTING MARKETING PROMOTIONAL
EVENTS FOR OTHERS, IN CLASS 35 (U.S. CLS. 100,
101 AND 102).

FIRST USE 1-1-2005; IN COMMERCE 1-1-2005.

THE MARK CONSISTS OF STANDARD CHAR-
ACTERS WITHOUT CLAIM TO ANY PARTICULAR
FONT, STYLE, SIZE, OR COLOR.

NO CLAIM IS MADE TO THE EXCLUSIVE
RIGHT TO USE "AMERICA'S" AND "PARADE",
APART FROM THE MARK AS SHOWN.

SN 78-746,051, FILED 11-3-2005.

PAUL E. FAHRENKOPF, EXAMINING ATTORNEY

Int. Cl.: 4

Prior U.S. Cls.: 1, 6, and 15

United States Patent and Trademark Office

Reg. No. 3,486,293

Registered Aug. 12, 2008

TRADEMARK
PRINCIPAL REGISTER

TVT 24-7

NRG RESOURCES INC. (NEVADA CORPORATION)
18301 VON KARMAN AVENUE
SUITE 1050
IRVINE, CA 92612

FOR: LUBRICANTS, NAMELY, ALL PURPOSE LUBRICANTS; AUTOMOBILE LUBRICANTS; AUTOMOTIVE LUBRICANTS; INDUSTRIAL LUBRICANTS; DRILLING LUBRICANTS; LUBRICANTS FOR AIRCRAFT ENGINES; LUBRICANTS FOR INDUSTRIAL MACHINERY; OILS, NAMELY, ALL PURPOSE PENETRATING OIL; BASE OILS; CUTTING OILS; ENGINE OILS; FUEL OIL; GEAR OILS; GUN BARREL OIL; HARDENED OILS WHICH ARE HYDROGENATED OILS FOR INDUSTRIAL USE; HEAT TRANSFER OILS; HEAVY OILS; HYDRAULIC OILS; INDUSTRIAL OILS; LUBRICATING OILS WHICH ARE INDUSTRIAL LUBRICANTS; MOTOR OIL; PENETRATING OIL; MINERAL OILS AND GREASES FOR INDUSTRIAL PURPOSES WHICH ARE NOT FOR FUEL; NON-MINERAL OILS AND GREASES FOR INDUSTRIAL PURPOSES WHICH ARE NOT FOR FUEL; MINERAL OIL FOR USE IN THE MANUFACTURE OF METAL CUTTING FLUIDS; LUBRICATING OIL FOR MOTOR VEHI-

CLE ENGINES; CUTTING OIL FOR INDUSTRIAL METAL WORKING; GREASES, NAMELY, AUTOMOTIVE GREASES; GENERAL PURPOSE GREASES; GREASES FOR MACHINES; INDUSTRIAL GREASES; LUBRICATION GREASE FOR VEHICLES; ADDITIVES, NAMELY, NON-CHEMICAL ADDITIVES FOR OILS AND FUELS; NON-CHEMICAL MOTOR OIL ADDITIVES; NON-CHEMICAL ENGINE TREATMENTS AND ADDITIVES FOR ENGINE OILS, GASOLINE AND DIESEL FUELS, TRANSMISSION FLUIDS AND COOLING SYSTEMS; CUTTING FLUIDS; FUELS, NAMELY, FUEL FOR MOTOR VEHICLES, NAMELY, DIESEL; FUEL FROM CRUDE OIL, IN CLASS 4 (U.S. CLS. 1, 6 AND 15).

FIRST USE 6-0-2005; IN COMMERCE 6-0-2005.

THE MARK CONSISTS OF STANDARD CHARACTERS WITHOUT CLAIM TO ANY PARTICULAR FONT, STYLE, SIZE, OR COLOR.

SN 78-747,789, FILED 11-4-2005.

JIM RINGLE, EXAMINING ATTORNEY

Int. Cls.: 16 and 25

Prior U.S. Cls.: 2, 5, 22, 23, 29, 37, 38, 39, and 50

United States Patent and Trademark Office

Reg. No. 3,486,294

Registered Aug. 12, 2008

**TRADEMARK
PRINCIPAL REGISTER**

BARK OFF!!

DXR DAWG EXTREME REVOLUTION, INC.
(ARIZONA CORPORATION)
17719 E. BROOKS FARM RD.
GILBERT, AZ 85297

FOR: DECALS, IN CLASS 16 (U.S. CLS. 2, 5, 22, 23,
29, 37, 38 AND 50).

FIRST USE 10-9-2007; IN COMMERCE 10-9-2007.

FOR: CLOTHING, NAMELY, CAPS, SHIRTS,
LONG SLEEVE PULL OVER SHIRTS, STOCKING
CAPS, MUSCLE SHIRTS, SWEAT PANTS, SWEAT-
SHIRTS, JACKETS, WIND RESISTANT JACKETS;
SHOES; JOGGING OUTFITS; CLOTHING FOR SKA-
TER AND SKIERS, NAMELY, GLOVES, HATS,

THERMAL UNDERWEAR, UNDERGARMENTS,
MITTENS, BOOTS, OVERALLS AND CLOTHING
FOR FIGHTERS, NAMELY, SHORTS, TANK TOPS,
SOCKS, AND HEADBANDS, IN CLASS 25 (U.S. CLS.
22 AND 39).

FIRST USE 10-31-2006; IN COMMERCE 10-31-2006.

THE MARK CONSISTS OF STANDARD CHAR-
ACTERS WITHOUT CLAIM TO ANY PARTICULAR
FONT, STYLE, SIZE, OR COLOR.

SN 78-748,799, FILED 11-7-2005.

KATHY DE JONGE, EXAMINING ATTORNEY

Int. Cl.: 9

Prior U.S. Cls.: 21, 23, 26, 36, and 38

United States Patent and Trademark Office

Reg. No. 3,486,295

Registered Aug. 12, 2008

**TRADEMARK
PRINCIPAL REGISTER**

DUNGEON RUNNERS

NCSOFT CORPORATION (REPUBLIC OF KOREA CORPORATION)
157-33 OKSAN BUILDING
SAMSUNG-DONG GANGNAM-GU
SEOUL, REPUBLIC OF KOREA 135090

FOR: COMPUTER GAME SOFTWARE; INTERACTIVE MULTIMEDIA COMPUTER GAME PROGRAMS; DOWNLOADABLE ELECTRONIC PUBLICATIONS IN THE NATURE OF NEWSLETTERS AND MAGAZINES IN THE FIELD OF COMPUTER GAMES, IN CLASS 9 (U.S. CLS. 21, 23, 26, 36 AND 38).

FIRST USE 3-0-2006; IN COMMERCE 3-0-2006.

THE MARK CONSISTS OF STANDARD CHARACTERS WITHOUT CLAIM TO ANY PARTICULAR FONT, STYLE, SIZE, OR COLOR.

SN 78-751,580, FILED 11-10-2005.

SEAN CROWLEY, EXAMINING ATTORNEY

Int. Cl.: 3

Prior U.S. Cls.: 1, 4, 6, 50, 51, and 52

Reg. No. 3,486,296

United States Patent and Trademark Office

Registered Aug. 12, 2008

**TRADEMARK
PRINCIPAL REGISTER**

HPA

BARTON MINES COMPANY, LLC (NEW YORK
LTD LIAB CO)
1557 STATE ROUTE 9
LAKE GEORGE, NY 12845

THE MARK CONSISTS OF STANDARD CHAR-
ACTERS WITHOUT CLAIM TO ANY PARTICULAR
FONT, STYLE, SIZE, OR COLOR.

FOR: WATERJET ABRASIVES, NAMELY, GAR-
NET ABRASIVE GRAINS AND POWDERS FOR USE
IN WATERJET CUTTING MACHINES, IN CLASS 3
(U.S. CLS. 1, 4, 6, 50, 51 AND 52).

SN 78-754,702, FILED 11-15-2005.

FIRST USE 7-1-1992; IN COMMERCE 7-1-1992.

CAROLYN GRAY, EXAMINING ATTORNEY

Int. Cls.: 14, 16, 21, 25, 26, and 41

Prior U.S. Cls.: 2, 5, 13, 22, 23, 27, 28, 29, 30, 33, 37, 38, 39, 40, 42, 50, 100, 101, and 107

Reg. No. 3,486,297

United States Patent and Trademark Office

Registered Aug. 12, 2008

**TRADEMARK
SERVICE MARK
PRINCIPAL REGISTER**

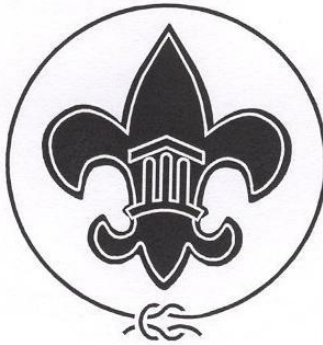

BOY SCOUTS OF AMERICA (UNITED STATES CORPORATION)
1325 WEST WALNUT HILL LANE
P.O. BOX 152079
IRVING, TX 750152079

FIRST USE 1-24-2006; IN COMMERCE 1-24-2006.

FOR: CLOTH PATCHES FOR CLOTHING, IN CLASS 26 (U.S. CLS. 37, 39, 40, 42 AND 50).

FIRST USE 1-8-2006; IN COMMERCE 1-8-2006.

FOR: JEWELRY, IN CLASS 14 (U.S. CLS. 2, 27, 28 AND 50).

FOR: MUSEUM SERVICES FEATURING THE HISTORY OF A SCOUTING ORGANIZATION; MUSEUM SERVICES PROVIDED VIA THE INTERNET FEATURING THE HISTORY OF A SCOUTING ORGANIZATION, IN CLASS 41 (U.S. CLS. 100, 101 AND 107).

FIRST USE 10-0-2005; IN COMMERCE 10-0-2005.

FIRST USE 1-13-2006; IN COMMERCE 1-13-2006.

FOR: PRINTED MATTER, NAMELY, STATIONERY, NOTE CARDS, NOTE PADS, BROCHURES FEATURING INFORMATION ABOUT MUSEUM SERVICES, SPECIAL EVENTS AND EXHIBITS; PENS AND PENCILS, IN CLASS 16 (U.S. CLS. 2, 5, 22, 23, 29, 37, 38 AND 50).

OWNER OF U.S. REG. NOS. 1,209,322, 1,796,124, AND OTHERS.

FIRST USE 1-29-2006; IN COMMERCE 1-29-2006.

FOR: MUGS, BEVERAGE GLASSWARE AND PLASTIC WATER BOTTLES SOLD EMPTY, IN CLASS 21 (U.S. CLS. 2, 13, 23, 29, 30, 33, 40 AND 50).

THE MARK CONSISTS OF A FLEUR DE LIS WITH PILLARS IN THE MIDDLE SURROUNDED BY A CIRCLE WITH A KNOT AT THE BOTTOM.

FIRST USE 3-29-2006; IN COMMERCE 3-29-2006.

FOR: CLOTHING, NAMELY, T-SHIRTS, POLO SHIRTS, JACKETS, HATS, CAPS AND NECKERCHIEFS; UNIFORMS FOR VOLUNTEER AND STAFF MEMBERS, IN CLASS 25 (U.S. CLS. 22 AND 39).

SN 78-755,959, FILED 11-17-2005.

DANIEL BRODY, EXAMINING ATTORNEY

Int. Cl.: 1

Prior U.S. Cls.: 1, 5, 6, 10, 26, and 46

Reg. No. 3,486,298

United States Patent and Trademark Office

Registered Aug. 12, 2008

**TRADEMARK
PRINCIPAL REGISTER**

SENTRY

CRITERION CATALYSTS & TECHNOLOGIES,
L.P. (DELAWARE LIMITED PARTNERSHIP)
TWO GREENSPOINT PLAZA SUITE 1000
16825 NORTHCHASE
HOUSTON, TX 77060

THE MARK CONSISTS OF STANDARD CHAR-
ACTERS WITHOUT CLAIM TO ANY PARTICULAR
FONT, STYLE, SIZE, OR COLOR.

FOR: CATALYSTS FOR USE IN THE OIL PRO-
CESSING INDUSTRY, IN CLASS 1 (U.S. CLS. 1, 5, 6,
10, 26 AND 46).

SN 78-756,286, FILED 11-17-2005.

FIRST USE 3-1-2006; IN COMMERCE 3-1-2006.

MYRIAH HABEEB, EXAMINING ATTORNEY

Int. Cl.: 40

Prior U.S. Cls.: 100, 103, and 106

United States Patent and Trademark Office

Reg. No. 3,486,299

Registered Aug. 12, 2008

**SERVICE MARK
PRINCIPAL REGISTER**

FLASHSTAK

ENTORIAN TECHNOLOGIES L.P. (TEXAS LIMITED PARTNERSHIP)
8900 SHOAL CREEK , SUITE 125
AUSTIN, TX 78757

THE MARK CONSISTS OF STANDARD CHARACTERS WITHOUT CLAIM TO ANY PARTICULAR FONT, STYLE, SIZE, OR COLOR.

FOR: MANUFACTURE OF INTEGRATED CIRCUIT MODULES TO THE ORDER AND SPECIFICATION OF OTHERS, IN CLASS 40 (U.S. CLS. 100, 103 AND 106).

SN 78-758,658, FILED 11-21-2005.

FIRST USE 12-31-2007; IN COMMERCE 12-31-2007.

AMY MCMENAMIN, EXAMINING ATTORNEY

Int. Cls.: 35 and 41

Prior U.S. Cls.: 100, 101, 102, and 107

United States Patent and Trademark Office

Reg. No. 3,486,300

Registered Aug. 12, 2008

**SERVICE MARK
PRINCIPAL REGISTER**

**INFRASTRUCTURE MANAGEMENT
WORLD IT STRATEGIES FOR THE
DYNAMIC ENTERPRISE**

INTERNATIONAL DATA GROUP, INC. (MASSACHUSETTS CORPORATION)
5 SPEEN STREET
FRAMINGHAM, MA 01701

FOR: ARRANGING AND CONDUCTING TRADE SHOWS, EXPOSITIONS, EXHIBITIONS, AND BUSINESS CONFERENCES IN THE FIELDS OF COMPUTERS, COMPUTER SOFTWARE, ONLINE SERVICES, HIGH TECHNOLOGY, COMMUNICATIONS, INFORMATION TECHNOLOGY AND INFORMATION SERVICES, IN CLASS 35 (U.S. CLS. 100, 101 AND 102).

FIRST USE 3-3-2006; IN COMMERCE 9-11-2006.

FOR: ARRANGING AND CONDUCTING SEMINARS IN THE FIELDS OF COMPUTERS, COMPUTER SOFTWARE, ONLINE SERVICES, HIGH TECHNOLOGY, COMMUNICATIONS, INFORMA-

TION TECHNOLOGY AND INFORMATION SERVICES, IN CLASS 41 (U.S. CLS. 100, 101 AND 107).

FIRST USE 3-3-2006; IN COMMERCE 9-11-2006.

THE MARK CONSISTS OF STANDARD CHARACTERS WITHOUT CLAIM TO ANY PARTICULAR FONT, STYLE, SIZE, OR COLOR.

OWNER OF U.S. REG. NOS. 2,658,857, 2,810,526, AND OTHERS.

NO CLAIM IS MADE TO THE EXCLUSIVE RIGHT TO USE "INFRASTRUCTURE MANAGEMENT", APART FROM THE MARK AS SHOWN.

SN 78-761,335, FILED 11-28-2005.

LINDA ESTRADA, EXAMINING ATTORNEY

Int. Cl.: 28

Prior U.S. Cls.: 22, 23, 38, and 50

Reg. No. 3,486,301

United States Patent and Trademark Office

Registered Aug. 12, 2008

**TRADEMARK
PRINCIPAL REGISTER**

PURE MOTION

PURE MOTION, INC. (TEXAS CORPORATION)
15010 NORTH 78TH WAY
SUITE 202
SCOTTSDALE, AZ 85260

FIRST USE 1-26-2007; IN COMMERCE 1-26-2007.

FOR: GOLF TRAINING AIDS, NAMELY, DEVICES FOR MONITORING AND IMPROVING REPETITIVE MOVEMENTS; GOLF PRACTICE AIDS, NAMELY, INSTRUCTIONAL DEVICES FOR MONITORING AND IMPROVING PUTTING STROKE AND GOLF SWING, IN CLASS 28 (U.S. CLS. 22, 23, 38 AND 50).

THE MARK CONSISTS OF STANDARD CHARACTERS WITHOUT CLAIM TO ANY PARTICULAR FONT, STYLE, SIZE, OR COLOR.

SN 78-762,854, FILED 11-29-2005.

ALICE SUE CARRUTHERS, EXAMINING ATTORNEY

Int. Cl.: 16

Prior U.S. Cls.: 2, 5, 22, 23, 29, 37, 38, and 50

Reg. No. 3,486,302

United States Patent and Trademark Office

Registered Aug. 12, 2008

**TRADEMARK
PRINCIPAL REGISTER**

AMM

AMERICAN METAL MARKET LLC (MASSACHUSETTS CORPORATION)
19TH FLOOR
220 FIFTH AVENUE
NEW YORK, NY 10001

FOR: PRINTED PUBLICATIONS, NAMELY, BOOKS, MAGAZINES, NEWSLETTERS, MANUALS, GUIDES AND BROCHURES IN THE FIELDS OF METALLURGY, THE METALS BUSINESS AND METALS INDUSTRIES, IN CLASS 16 (U.S. CLS. 2, 5, 22, 23, 29, 37, 38 AND 50).

FIRST USE 2-7-2000; IN COMMERCE 2-7-2000.

THE MARK CONSISTS OF STANDARD CHARACTERS WITHOUT CLAIM TO ANY PARTICULAR FONT, STYLE, SIZE, OR COLOR.

OWNER OF U.S. REG. NOS. 2,288,871 AND 2,431,586.

SN 78-763,357, FILED 11-30-2005.

WARREN L. OLANDRIA, EXAMINING ATTORNEY

Int. Cl.: 37

Prior U.S. Cls.: 100, 103, and 106

United States Patent and Trademark Office

Reg. No. 3,486,303

Registered Aug. 12, 2008

**SERVICE MARK
PRINCIPAL REGISTER**

**THE DESIGN-MATERIALS-BUILD
SOLUTION**

TENNESSEE TIMBERFRAME, INC. (TENNESSEE
CORPORATION)
2537 DECATUR PIKE
ATHENS, TN 37303

FOR: RESIDENTIAL CONSTRUCTION SERVICES
IN THE FIELD OF HOMES AND OTHER STRUC-
TURES CONSTRUCTED OF LOG, TIMBER FRAME
AND OTHER NATURAL BUILDING MATERIALS,
NAMELY, STONE AND ROCK, IN CLASS 37 (U.S.
CLS. 100, 103 AND 106).

FIRST USE 6-1-2006; IN COMMERCE 6-1-2006.

THE MARK CONSISTS OF STANDARD CHAR-
ACTERS WITHOUT CLAIM TO ANY PARTICULAR
FONT, STYLE, SIZE, OR COLOR.

NO CLAIM IS MADE TO THE EXCLUSIVE
RIGHT TO USE "SOLUTION", APART FROM THE
MARK AS SHOWN.

SN 78-764,199, FILED 12-1-2005.

LESLEY LAMOTHE, EXAMINING ATTORNEY

Int. Cl.: 9

Prior U.S. Cls.: 21, 23, 26, 36, and 38

Reg. No. 3,486,304

United States Patent and Trademark Office

Registered Aug. 12, 2008

TRADEMARK
PRINCIPAL REGISTER

Audio 2 Go

ASAHI KASEI EMD CORPORATION (JAPAN CORPORATION)
23-7, NISHI-SHINJUKU 1-CHOME,
SHINJUKU-KU
TOKYO, JAPAN

FOR: ELECTRONIC COMPONENTS, NAMELY, SEMICONDUCTOR DEVICES, STRUCTURED SEMICONDUCTOR WAFERS, SEMICONDUCTOR INTEGRATED CIRCUIT, CAPACITORS, ELECTRIC RESISTORS, ELECTRICAL INDUCTORS, INTEGRATED CIRCUIT MODULES, PRINTED CIRCUIT BOARDS, AND DISC STORAGE CONTAINERS FOR VIDEO/AUDIO DATA/SIGNAL PROCESSING APPARATUS OR INSTRUMENTS; CHIPS, NAMELY, INTEGRATED CIRCUIT CHIPS FOR SIGNAL FORM CONVERTING SUCH AS DIGITAL-TO-ANALOG CONVERTER OR ANALOG-TO-DIGITAL CONVERTER, COMPUTER CHIPS, SEMICONDUCTOR CHIPS, MICRO-MACHINE SILICON CHIPS, MICROPROCESSOR SILICON CHIPS, ANALOG SIGNAL PROCESSOR (ASP) SILICON CHIPS, AND DIGITAL SIGNAL PROCESSOR (DSP) SILICON CHIPS USED FOR VIDEO/AUDIO DATA/SIGNAL PROCESSING APPARATUS OR INSTRUMENTS; LARGE SCALE INTEGRATED (LSI) CIRCUIT, NAMELY, SINGLE CHIP AND MULTI-CHIP MODULE (MCM) INTEGRATED CIRCUITS FEATURING VIDEO/AUDIO SIGNAL/DATA PROCESSING; CALCULATING MACHINES, NAMELY, ELECTRIC CALCULATORS FEATURING LIBRARY COLLECTIONS, DICTIONARIES, LANGUAGE TRANSLATORS, MANUALS, OR NAVIGATIONS; DATA PROCESSING MACHINE OR EQUIPMENT AND THEIR COMPONENTS, NAMELY, PERSONAL COMPUTERS, DESKTOP COMPUTERS, LAPTOP COMPUTERS, HAND-HELD COMPUTERS, POCKET PERSONAL COMPUTER, PERSONAL DIGITAL ASSISTANTS (PDA), AND MULTI-MEDIA DATA PROCESSORS FEATURING AUDIO/VIDEO DATA/SIGNAL PROCESSING, SOFTWARE PROGRAMS TO OPERATE SINGLE CHIP (LSI) OR MULTI-CHIP

MODULE (MCM) FEATURING VIDEO/AUDIO PROCESSING; ELECTRICAL COMMUNICATION APPARATUS AND INSTRUMENTS, NAMELY, TELEPHONES, VIDEO TELEPHONES, INTERNET PROTOCOL (IP) TELEPHONES, SWITCHES OF TELEPHONE, MOBILE TELEPHONES, PERSONAL DIGITAL ASSISTANT (PDA) PHONES, WALKIE-TALKIES; RADIO PAGERS, PERSONAL GLOBAL POSITIONING SYSTEMS (GPS) FOR MAPPING, TRACKING AND DETERMINING LOCATIONS, DISTANCES, DIRECTIONS AND ROUTES; GLOBAL POSITIONING SYSTEMS FOR GLOBAL POSITIONING VIA SATELLITE; SATELLITE NAVIGATIONAL SYSTEMS, NAMELY, GLOBAL POSITIONING SYSTEMS AND SATELLITE RADIO LOCALIZATION SYSTEMS FOR FINDING DIRECTIONS OR PLACES FOR VEHICLES, VEHICLE OPERATORS, AND PEDESTRIANS; CHIPS, NAMELY, INTEGRATED CIRCUITS FOR GLOBAL POSITIONING VIA SATELLITE; SEMICONDUCTORS FOR GLOBAL POSITIONING VIA SATELLITE; CENTRAL PROCESSING UNITS FOR GLOBAL POSITIONING VIA SATELLITE; DATA PROCESSORS AND COMPUTERS FOR GLOBAL POSITIONING VIA SATELLITE; AND COMPUTER SOFTWARE FOR GLOBAL POSITIONING VIA SATELLITE, VOICE TRANSCIEVERS, FACSIMILE MACHINES, IN CLASS 9 (U.S. CLS. 21, 23, 26, 36 AND 38).

FIRST USE 3-24-2006; IN COMMERCE 6-1-2006.

THE MARK CONSISTS OF STANDARD CHARACTERS WITHOUT CLAIM TO ANY PARTICULAR FONT, STYLE, SIZE, OR COLOR.

NO CLAIM IS MADE TO THE EXCLUSIVE RIGHT TO USE "AUDIO" , APART FROM THE MARK AS SHOWN.

SN 78-764,249, FILED 12-1-2005.

DAWN HAN, EXAMINING ATTORNEY

Int. Cl.: 9

Prior U.S. Cls.: 21, 23, 26, 36, and 38

Reg. No. 3,486,305

United States Patent and Trademark Office

Registered Aug. 12, 2008

**TRADEMARK
PRINCIPAL REGISTER**

Audio 4 Pro

ASAHI KASEI EMD CORPORATION (JAPAN CORPORATION)
23-7, NISHI-SHINJUKU 1-CHOME
SHINJUKU-KU
TOKYO, JAPAN

FOR: ELECTRONIC COMPONENTS, NAMELY, SEMICONDUCTOR DEVICES, STRUCTURED SEMICONDUCTOR WAFERS, SEMICONDUCTOR INTEGRATED CIRCUIT, CAPACITORS, ELECTRIC RESISTORS, ELECTRICAL INDUCTORS, INTEGRATED CIRCUIT MODULES, PRINTED CIRCUIT BOARDS, AND DISC STORAGE CONTAINERS FOR VIDEO/AUDIO DATA/SIGNAL PROCESSING APPARATUS OR INSTRUMENTS; CHIPS, NAMELY, INTEGRATED CIRCUIT CHIPS FOR SIGNAL FORM CONVERTING SUCH AS DIGITAL-TO-ANALOG CONVERTER OR ANALOG-TO-DIGITAL CONVERTER, COMPUTER CHIPS, SEMICONDUCTOR CHIPS, MICRO-MACHINE SILICON CHIPS, MICROPROCESSOR SILICON CHIPS, ANALOG SIGNAL PROCESSOR (ASP) SILICON CHIPS, AND DIGITAL SIGNAL PROCESSOR (DSP) SILICON CHIPS USED FOR VIDEO/AUDIO DATA/SIGNAL PROCESSING APPARATUS OR INSTRUMENTS; LARGE SCALE INTEGRATED (LSI) CIRCUIT, NAMELY, SINGLE CHIP AND MULTI-CHIP MODULE (MCM) INTEGRATED CIRCUITS FEATURING VIDEO/AUDIO SIGNAL/DATA PROCESSING; CALCULATING MACHINES, NAMELY, ELECTRIC CALCULATORS FEATURING LIBRARY COLLECTIONS, DICTIONARIES, LANGUAGE TRANSLATORS, MANUALS, OR NAVIGATIONS; DATA PROCESSING MACHINE OR EQUIPMENT AND THEIR COMPONENTS, NAMELY, PERSONAL COMPUTERS, DESKTOP COMPUTERS, LAPTOP COMPUTERS, HAND-HELD COMPUTERS, POCKET PERSONAL COMPUTER, PERSONAL DIGITAL ASSISTANTS (PDA), AND MULTI-MEDIA DATA PROCESSORS FEATURING AUDIO/VIDEO DATA/SIGNAL PROCESSING, SOFTWARE PROGRAMS TO OPERATE SINGLE CHIP (LSI) OR MULTI-CHIP

MODULE (MCM) FEATURING VIDEO/AUDIO PROCESSING; ELECTRICAL COMMUNICATION APPARATUS AND INSTRUMENTS, NAMELY, TELEPHONES, VIDEO TELEPHONES, INTERNET PROTOCOL (IP) TELEPHONES, SWITCHES OF TELEPHONE, MOBILE TELEPHONES, PERSONAL DIGITAL ASSISTANT (PDA) PHONES, WALKIE-TALKIES; RADIO PAGERS, PERSONAL GLOBAL POSITIONING SYSTEMS (GPS) FOR MAPPING, TRACKING AND DETERMINING LOCATIONS, DISTANCES, DIRECTIONS AND ROUTES; GLOBAL POSITIONING SYSTEMS FOR GLOBAL POSITIONING VIA SATELLITE; SATELLITE NAVIGATIONAL SYSTEMS, NAMELY, GLOBAL POSITIONING SYSTEMS AND SATELLITE RADIO LOCALIZATION SYSTEMS FOR FINDING DIRECTIONS OR PLACES FOR VEHICLES, VEHICLE OPERATORS, AND PEDESTRIANS; CHIPS, NAMELY, INTEGRATED CIRCUITS FOR GLOBAL POSITIONING VIA SATELLITE; SEMICONDUCTORS FOR GLOBAL POSITIONING VIA SATELLITE; CENTRAL PROCESSING UNITS FOR GLOBAL POSITIONING VIA SATELLITE; DATA PROCESSORS AND COMPUTERS FOR GLOBAL POSITIONING VIA SATELLITE; AND COMPUTER SOFTWARE FOR GLOBAL POSITIONING VIA SATELLITE, VOICE RECEIVERS, FACSIMILE MACHINES, IN CLASS 9 (U.S. CLS. 21, 23, 26, 36 AND 38).

FIRST USE 3-24-2006; IN COMMERCE 6-1-2006.

THE MARK CONSISTS OF STANDARD CHARACTERS WITHOUT CLAIM TO ANY PARTICULAR FONT, STYLE, SIZE, OR COLOR.

NO CLAIM IS MADE TO THE EXCLUSIVE RIGHT TO USE "AUDIO" , APART FROM THE MARK AS SHOWN.

SN 78-764,251, FILED 12-1-2005.

DAWN HAN, EXAMINING ATTORNEY

Int. Cl.: 37

Prior U.S. Cls.: 100, 103, and 106

United States Patent and Trademark Office

Reg. No. 3,486,306

Registered Aug. 12, 2008

**SERVICE MARK
PRINCIPAL REGISTER**

TRUE PANEL COMPANY

YANKEE BARN HOMES, INC. (NEW HAMP-
SHIRE CORPORATION)
131 YANKEE BARN ROAD
GRANTHAM, NH 03753

FOR: CONSTRUCTION SERVICES, NAMELY,
PLANNING, LAYING OUT AND CUSTOM CON-
STRUCTION OF WOOD FRAMED WALL AND
ROOF PANELS, IN CLASS 37 (U.S. CLS. 100, 103
AND 106).

FIRST USE 3-21-2008; IN COMMERCE 3-21-2008.

THE MARK CONSISTS OF STANDARD CHAR-
ACTERS WITHOUT CLAIM TO ANY PARTICULAR
FONT, STYLE, SIZE, OR COLOR.

NO CLAIM IS MADE TO THE EXCLUSIVE
RIGHT TO USE "PANEL COMPANY", APART
FROM THE MARK AS SHOWN.

SN 78-764,349, FILED 12-1-2005.

MYRIAH HABEEB, EXAMINING ATTORNEY

Int. Cl.: 1

Prior U.S. Cls.: 1, 5, 6, 10, 26, and 46

Reg. No. 3,486,307

United States Patent and Trademark Office

Registered Aug. 12, 2008

**TRADEMARK
PRINCIPAL REGISTER**



BRENNAN, RORY E. (UNITED STATES INDIVIDUAL)
75 SOUTHERN AVENUE
BRATTLEBORO, VT 05301

FOR: ADHESIVES FOR USE IN THE CONSTRUCTION INDUSTRY, IN THE BUILDING CONSTRUCTION INDUSTRY, IN THE INDUSTRY SPECIALIZING IN CONSTRUCTION IN CONNECTION WITH BUILDING MAINTENANCE AND REPAIR; IN THE INDUSTRY SPECIALIZING IN CONSTRUCTION IN CONNECTION WITH BUILDING RENOVATION, AND IN THE INDUSTRY

SPECIALIZING IN CONSTRUCTION IN CONNECTION WITH HOME IMPROVEMENT, IN CLASS 1 (U.S. CLS. 1, 5, 6, 10, 26 AND 46).

FIRST USE 6-12-2005; IN COMMERCE 2-1-2006.

THE MARK CONSISTS OF A FANCIFUL DESIGN OF A HUMAN BEING.

SN 78-765,066, FILED 12-1-2005.

NANCY CLARKE, EXAMINING ATTORNEY

Int. Cl.: 41

Prior U.S. Cls.: 100, 101, and 107

United States Patent and Trademark Office

Reg. No. 3,486,308

Registered Aug. 12, 2008

**SERVICE MARK
PRINCIPAL REGISTER**

PEAKPREP

DEWEES, PAUL (UNITED STATES INDIVIDUAL)
12905 S. 71 HIGHWAY #121
GRANDVIEW, MO 64030

THE MARK CONSISTS OF STANDARD CHARACTERS WITHOUT CLAIM TO ANY PARTICULAR FONT, STYLE, SIZE, OR COLOR.

FOR: EDUCATIONAL SERVICES, NAMELY, CONDUCTING CLASSES IN THE FIELD OF AUCTIONEERING, IN CLASS 41 (U.S. CLS. 100, 101 AND 107).

SN 78-766,875, FILED 12-5-2005.

FIRST USE 5-23-2008; IN COMMERCE 5-23-2008.

CAROLYN GRAY, EXAMINING ATTORNEY

Int. Cl.: 9

Prior U.S. Cls.: 21, 23, 26, 36, and 38

Reg. No. 3,486,309

United States Patent and Trademark Office

Registered Aug. 12, 2008

**TRADEMARK
PRINCIPAL REGISTER**

RESPONSE WORKS

HNTB HOLDINGS LTD (DELAWARE CORPORATION)
715 KIRK DRIVE
KANAS CITY, MO 64105

FOR: COMPUTER SOFTWARE FOR TRACKING, MINING, AND MANAGING PUBLIC COMMENTS REGARDING CAPITAL IMPROVEMENT AND CIVIL PROJECTS, IN CLASS 9 (U.S. CLS. 21, 23, 26, 36 AND 38).

FIRST USE 9-28-2004; IN COMMERCE 9-28-2004.

THE MARK CONSISTS OF STANDARD CHARACTERS WITHOUT CLAIM TO ANY PARTICULAR FONT, STYLE, SIZE, OR COLOR.

SN 78-767,329, FILED 12-6-2005.

LESLEY LAMOTHE, EXAMINING ATTORNEY

Int. Cl.: 10

Prior U.S. Cls.: 26, 39, and 44

United States Patent and Trademark Office

Reg. No. 3,486,310

Registered Aug. 12, 2008

**TRADEMARK
PRINCIPAL REGISTER**

Nerve Avoidance Leader

NUVASIVE, INC. (DELAWARE CORPORATION)
4545 TOWNE CENTRE COURT
SAN DIEGO, CA 92121

FIRST USE 1-18-2006; IN COMMERCE 1-18-2006.

FOR: MEDICAL DEVICES, NAMELY, RETRACTORS, OBTURATORS, CANNULAE, K-WIRES AND APPARATUSES FOR GUIDANCE OF SURGICAL INSTRUMENTS ALL FOR USE IN TREATMENT OF THE SPINE; NERVE SURVEILLANCE SYSTEMS COMPRISING CANNULAE, OBTURATORS, ELECTRODES, SENSORS, MONITORS, CABLING, AND COMPUTER HARDWARE AND DEDICATED APPLICATION COMPUTER SOFTWARE FOR USE THEREWITH ALL FOR USE IN TREATMENT OF THE SPINE, IN CLASS 10 (U.S. CLS. 26, 39 AND 44).

THE MARK CONSISTS OF STANDARD CHARACTERS WITHOUT CLAIM TO ANY PARTICULAR FONT, STYLE, SIZE, OR COLOR.

NO CLAIM IS MADE TO THE EXCLUSIVE RIGHT TO USE "NERVE AVOIDANCE", APART FROM THE MARK AS SHOWN.

SN 78-767,656, FILED 12-6-2005.

JEFF DEFORD, EXAMINING ATTORNEY

Int. Cl.: 11

Prior U.S. Cls.: 13, 21, 23, 31, and 34

United States Patent and Trademark Office

Reg. No. 3,486,311

Registered Aug. 12, 2008

TRADEMARK
PRINCIPAL REGISTER



QUANICS, INC. (KENTUCKY CORPORATION)
6244 OLD LAGRANGE ROAD
CRESTWOOD, KY 40014

FOR: WASTEWATER TREATMENT SYSTEMS FOR DOMESTIC, COMMERCIAL, AND INDUSTRIAL USE COMPRISED OF (1) WATER FILTERING UNITS CONTAINING INTEGRATED RISERS, LIDS, BASINS, ADAPTERS, RECIRCULATION DEVICES, CHLORINATORS, FIXED FILM FILTERING MEDIA, FIXED FILM TREATMENT MEDIA, AIR COMPRESSORS, VALVES, GROMMETS, ALARMS, SWITCHES, DISTRIBUTION BOXES, SIPHONS AND PUMP VAULTS FOR USE IN CONNECTION WITH SEPTIC TANKS, ONSITE WASTEWATER SYSTEMS AND EFFLUENT DISCHARGE SYSTEMS; (2) EFFLUENT DISCHARGE SYSTEMS COMPRISED OF INTEGRATED RISERS, LIDS, BASINS, ADAPTERS, RECIRCULATION DEVICES, CHLORINATORS, FIXED FILM TREATMENT MEDIA, FIXED FILM FILTERING MEDIA, AIR COMPRESSORS, VALVES, GROMMETS, ALARMS, SWITCHES, DISTRIBUTION BOXES, SIPHONS, PUMP VAULTS, SELF-CONTAINED WASTEWATER FILTER UNITS, PVC PLASTIC PIPING, AND FILTERING MEDIA COMPRISED OF FOAM OR COIR MEDIA; (3) WASTEWATER FILTERS; (4) FILTERED PUMP VAULTS; (5) EFFLUENT FLOW DIVIDERS; AND (6) EFFLUENT FLOW DIRECTORS; SELF-CONTAINED WASTEWATER FILTER UNITS FOR USE IN CONNECTION WITH SEPTIC TANKS, ONSITE WASTEWATER SYSTEMS AND EFFLUENT DISCHARGE SYSTEMS; CASES MADE OF PLASTIC FOR WASTEWATER FILTERS; FILTERING MEDIA

COMPOSED OF FOAM OR COIR MEDIA FOR USE IN CONNECTION WITH SEPTIC TANKS, ONSITE WASTEWATER SYSTEMS AND EFFLUENT DISCHARGE SYSTEMS; AND WATER FILTERS FOR REMOVING SOLIDS FROM SEPTIC TANK DRAIN FIELDS, IN CLASS 11 (U.S. CLS. 13, 21, 23, 31 AND 34).

FIRST USE 2-28-2006; IN COMMERCE 2-28-2006.

NO CLAIM IS MADE TO THE EXCLUSIVE RIGHT TO USE "ENGINEERING WATER SOLUTIONS", APART FROM THE MARK AS SHOWN.

THE COLOR(S) BLACK, WHITE, NAVY BLUE AND LIGHT BLUE/GRAY IS/ARE CLAIMED AS A FEATURE OF THE MARK.

THE MARK CONSISTS OF THE COLOR BLACK APPEARING AS THE WORD PORTION OF THE MARK "QUANICS." THE COLOR WHITE APPEARS AS THE OUTLINE TO THE WORD PORTION "QUANICS" AND ALSO APPEARS AS THE WORD PORTION "ENGINEERING WATER SOLUTIONS." THE COLOR NAVY BLUE APPEARS AS A RECTANGULAR BAR WHICH CONTAINS THE WORD PORTION "ENGINEERING WATER SOLUTIONS." THE COLOR LIGHT BLUE/GRAY APPEARS AS AN ARROW DESIGN ABOVE THE WORD PORTION "QUANICS."

SN 78-769,241, FILED 12-8-2005.

ALYSSA PALADINO, EXAMINING ATTORNEY

Int. Cls.: 29 and 30

Prior U.S. Cl.: 46

United States Patent and Trademark Office

Reg. No. 3,486,312

Registered Aug. 12, 2008

**TRADEMARK
PRINCIPAL REGISTER**

agrimontana

AZIENDA AGRIMONTANA S.P.A (ITALY JOINT
STOCK COMPANY)
LOCALITA PONTE DELLA SALE
12011 BORGO SAN DALMAZZO
CUNEO, ITALY

FOR: CANDIED FRUITS, CANDIED FRUIT
WITH SYRUP OR LIQUOR, FRUIT PRESERVES,
FRUIT JELLIES, JAMS, MARRONS CREAMS,
CHESTNUT BASED CREAM; DRIED FRUITS,
FRUIT PUREES, IN CLASS 29 (U.S. CL. 46).

FIRST USE 0-0-1972; IN COMMERCE 0-0-1980.

FOR: CANDY, NAMELY MARRONS GLACES,
MARRONS GLACES WITH SYRUP, HONEYS; CHO-
COLATES, CHOCOLATES FILLED WITH FLA-
VORED CREAMS, ALIMENTARY PASTES FOR
MAKING ICE CREAMS, PANETONNE, IN CLASS
30 (U.S. CL. 46).

FIRST USE 0-0-1972; IN COMMERCE 0-0-1980.

SN 78-769,322, FILED 12-8-2005.

INGA ERVIN, EXAMINING ATTORNEY

Int. Cl.: 33

Prior U.S. Cls.: 47 and 49

United States Patent and Trademark Office

Reg. No. 3,486,313

Registered Aug. 12, 2008

**TRADEMARK
PRINCIPAL REGISTER**

ARDMORE

BEAM GLOBAL UK LIMITED (UNITED KING-
DOM CORPORATION)
PREWETTS MILL, WORTHING ROAD
HORSHAM, WEST SUSSEX, UNITED KINGDOM
RH12 1ST

FOR: ALCOHOLIC BEVERAGES, NAMELY,
WHISKEY, IN CLASS 33 (U.S. CLS. 47 AND 49).

FIRST USE 2-1-2008; IN COMMERCE 2-5-2008.

THE MARK CONSISTS OF STANDARD CHAR-
ACTERS WITHOUT CLAIM TO ANY PARTICULAR
FONT, STYLE, SIZE, OR COLOR.

SN 78-769,367, FILED 12-8-2005.

AMEETA JORDAN, EXAMINING ATTORNEY

Int. Cl.: 9

Prior U.S. Cls.: 21, 23, 26, 36, and 38

United States Patent and Trademark Office

Reg. No. 3,486,314

Registered Aug. 12, 2008

**TRADEMARK
PRINCIPAL REGISTER**

SIGNATURE BRIDGE SUITE

HNTB HOLDINGS LTD (DELAWARE CORPORATION)
715 KIRK DRIVE
KANAS CITY, MO 64105

FOR: COMPUTER SOFTWARE FOR USE BY ENGINEERS AND ARCHITECTURAL DESIGNERS THAT FACILITATES THE DESIGN AND ANALYSIS OF STRUCTURES, IN CLASS 9 (U.S. CLS. 21, 23, 26, 36 AND 38).

FIRST USE 2-4-2005; IN COMMERCE 4-14-2005.

THE MARK CONSISTS OF STANDARD CHARACTERS WITHOUT CLAIM TO ANY PARTICULAR FONT, STYLE, SIZE, OR COLOR.

NO CLAIM IS MADE TO THE EXCLUSIVE RIGHT TO USE "BRIDGE SUITE", APART FROM THE MARK AS SHOWN.

SN 78-769,912, FILED 12-9-2005.

LESLEY LAMOTHE, EXAMINING ATTORNEY

Int. Cls.: 35 and 36

Prior U.S. Cls.: 100, 101, and 102

United States Patent and Trademark Office

Reg. No. 3,486,315

Registered Aug. 12, 2008

**SERVICE MARK
PRINCIPAL REGISTER**

BREATHE CALIFORNIA

BREATHE CALIFORNIA INTELLECTUAL PROP-
ERTY TRUST (CALIFORNIA TRUST)
909 12TH STREET
SACRAMENTO, CA 95814

FOR: ASSOCIATION SERVICES, NAMELY, PRO-
MOTING THE INTERESTS OF THE PUBLIC
THROUGH PROMOTING PUBLIC AWARENESS
OF THE DETECTION AND PREVENTION OF
LUNG AND RESPIRATORY DISEASES; PROMOT-
ING PUBLIC AWARENESS OF LUNG HEALTH
ISSUES, IN CLASS 35 (U.S. CLS. 100, 101 AND 102).

FIRST USE 2-1-2006; IN COMMERCE 2-1-2006.

FOR: CHARITABLE SERVICES, NAMELY, PRO-
VIDING FUNDING FOR RESEARCH IN LUNG
HEALTH, IN CLASS 36 (U.S. CLS. 100, 101 AND 102).

FIRST USE 2-1-2006; IN COMMERCE 2-1-2006.

THE MARK CONSISTS OF STANDARD CHAR-
ACTERS WITHOUT CLAIM TO ANY PARTICULAR
FONT, STYLE, SIZE, OR COLOR.

NO CLAIM IS MADE TO THE EXCLUSIVE
RIGHT TO USE "CALIFORNIA", APART FROM
THE MARK AS SHOWN.

SN 78-770,254, FILED 12-9-2005.

BONNIE LUKEN, EXAMINING ATTORNEY

Int. Cl.: 39

Prior U.S. Cls.: 100 and 105

United States Patent and Trademark Office

Reg. No. 3,486,316

Registered Aug. 12, 2008

SERVICE MARK
PRINCIPAL REGISTER



LARRY WALLACE ENGINES, LLC (NORTH
CAROLINA LTD LIAB CO)
11169 HICKERY RIDGE ROAD
HARRISBURG, NC 28075

FOR: LEASING OF SELF-STORAGE FACILITIES,
IN CLASS 39 (U.S. CLS. 100 AND 105).

FIRST USE 6-1-2007; IN COMMERCE 6-1-2007.

THE MARK CONSISTS OF THE STYLIZED
WORDING "CLUTTER BUSTERS" HAVING THE

WORD "CLUTTER" APPEARING ABOVE THE
WORD "BUSTERS" WITH THE WORD "BUSTERS"
ENCLOSED WITHIN A RECTANGLE AND HAV-
ING THE STYLIZED GRAPHIC REPRESENTATION
OF A BUILDING APPEARING BEFORE THE "C" IN
"CLUTTER".

SN 78-770,516, FILED 12-9-2005.

SHARON MEIER, EXAMINING ATTORNEY

Int. Cl.: 35

Prior U.S. Cls.: 100, 101, and 102

United States Patent and Trademark Office

Reg. No. 3,486,317

Registered Aug. 12, 2008

**SERVICE MARK
PRINCIPAL REGISTER**



THIRD & WALL ART GROUP, LLC (WASHINGTON LIMITED LIABILITY CORPORATION)
2607 SECOND AVENUE
SUITE 300
SEATTLE, WA 98121

FOR: LICENSING OF WORKS OF ART AND PRINTED ART REPRODUCTIONS; DISTRIBUTORSHIP SERVICES IN THE FIELD OF WORKS OF ART

AND PRINTED ART REPRODUCTIONS, IN CLASS 35 (U.S. CLS. 100, 101 AND 102).

FIRST USE 12-0-2005; IN COMMERCE 12-0-2005.

SN 78-773,069, FILED 12-14-2005.

CAROLYN GRAY, EXAMINING ATTORNEY

Int. Cl.: 16

Prior U.S. Cls.: 2, 5, 22, 23, 29, 37, 38, and 50

United States Patent and Trademark Office

Reg. No. 3,486,318

Registered Aug. 12, 2008

**TRADEMARK
PRINCIPAL REGISTER**



GARCIA-MARQUEZ, FERNANDA (VENEZUELA
INDIVIDUAL)
AVENIDA PRINCIPAL DEL BOSQUE
EDIFICIO PICHINCHA, PISO 1, OFICINA 11URBA-
NIZACIÓN EL BOSQUE, CHACAO
URBANIZACIÓN EL BOSQUE, CHACAO
CARACAS, VENEZUELA

FOR: MAGAZINES FEATURING MUSIC, ARTS,
ENTERTAINMENT, SHOWBUSINESS STORIES,
GOSSIP AND INTERVIEWS AND POLITICS, IN
CLASS 16 (U.S. CLS. 2, 5, 22, 23, 29, 37, 38 AND 50).

FIRST USE 11-7-2001; IN COMMERCE 3-1-2007.

THE APPLICANT CLAIMS COLOR AS A FEAT-
URE OF THE MARK, NAMELY, BLUE.

THE MARK CONSISTS OF THE WORDS "SALA
DE ESPERA" IN STYLIZED BLUE LETTERS. ALL
OF THE LETTERS ARE CAPITAL LETTERS EX-
CEPT THE PREPOSITION "DE" WHICH IS IN LOW-
ER CASE LETTERS. THE LETTER "S" IN THE
WORD "SALA" AND THE FIRST LETTER "E" IN
THE WORD "ESPERA" HAVE A SLIGHTLY LIGHT-
ER BLUE COLOR THAN THE REST OF THE
LETTERS AND ARE SLIGHTLY BIGGER THAN
THE REST OF THE LETTERS.

THE FOREIGN WORDING IN THE MARK
TRANSLATES INTO ENGLISH AS "WAITING
ROOM"

SN 78-775,596, FILED 12-17-2005.

DAVID YONTEF, EXAMINING ATTORNEY

Int. Cls.: 10 and 35

Prior U.S. Cls.: 26, 39, 44, 100, 101, and 102

United States Patent and Trademark Office

Reg. No. 3,486,319

Registered Aug. 12, 2008

TRADEMARK
SERVICE MARK
PRINCIPAL REGISTER

Satiabes

URIAL MEDIA CORP. (CANADA CORPORATION)
UNIT #8
2759 LANCASTER
OTTAWA, CANADA K1B4V8

FOR: ADULT SEXUAL AIDS, NAMELY, ARTIFICIAL PENISES, PENIS ENLARGERS, VIBRATORS, BENWA BALLS, ARTIFICIAL VAGINAS, IN CLASS 10 (U.S. CLS. 26, 39 AND 44).

FIRST USE 4-1-2007; IN COMMERCE 6-13-2008.

FOR: RETAIL STORE SERVICES FEATURING ADULT SEXUAL AIDS, MAIL ORDER SERVICES FEATURING ADULT SEXUAL AIDS, AND ON-LINE RETAIL STORE SERVICES FEATURING

ADULT SEXUAL AIDS, IN CLASS 35 (U.S. CLS. 100, 101 AND 102).

FIRST USE 4-1-2007; IN COMMERCE 6-13-2008.

THE COLOR(S) RED IS/ARE CLAIMED AS A FEATURE OF THE MARK.

THE COLOR RED APPEARS ALL OVER THE MARK.

SN 78-776,635, FILED 12-19-2005.

DOMINIC FATHY, EXAMINING ATTORNEY

Int. Cl.: 3

Prior U.S. Cls.: 1, 4, 6, 50, 51, and 52

United States Patent and Trademark Office

Reg. No. 3,486,320

Registered Aug. 12, 2008

**TRADEMARK
PRINCIPAL REGISTER**

**FLORATTA IN ROSE O
BOTICÁRIO**

BOTICA COMERCIAL FARMACEUTICA S.A.
(BRAZIL CORPORATION)
AV. RUI BARBOSA, 3450
AFONSO PENA
SAO JOSE DOS PINHAIS, PARANA, BRAZIL
83065260

FOR: PERFUMERY, COSMETICS, AND SOAPS,
IN CLASS 3 (U.S. CLS. 1, 4, 6, 50, 51 AND 52).

FIRST USE 3-29-2006; IN COMMERCE 3-29-2006.

THE MARK CONSISTS OF STANDARD CHAR-
ACTERS WITHOUT CLAIM TO ANY PARTICULAR
FONT, STYLE, SIZE, OR COLOR.

OWNER OF U.S. REG. NOS. 2,808,076, 2,976,693,
AND OTHERS.

NO CLAIM IS MADE TO THE EXCLUSIVE
RIGHT TO USE "ROSE", APART FROM THE MARK
AS SHOWN.

THE FOREIGN WORDING IN THE MARK
TRANSLATES INTO ENGLISH AS "THE PHARMA-
CIST"

SN 78-778,379, FILED 12-21-2005.

RUDY R. SINGLETON, EXAMINING ATTORNEY

Int. Cl.: 12

Prior U.S. Cls.: 19, 21, 23, 31, 35, and 44

Reg. No. 3,486,321

United States Patent and Trademark Office

Registered Aug. 12, 2008

**TRADEMARK
PRINCIPAL REGISTER**



**Tomasetto
Achille**

DISTRIBUIDORA SHOPPING S.R.L. (ARGENTINA
SOCIEDAD DE RESPONSABILIDAD LIM-
ITADA)
JOSE INGENIEROS 2250
BECCAR, ARGENTINA

FOR: CONVERSION AND INSTALLATION KIT
COMPRISED OF GAS TANKS, VALVES, PIPES,
INJECTORS, WIRES, GAS FILTERS AND SENSORS,
TO BE INSTALLED ON VEHICLES WITH THE
PURPOSE OF ALLOWING THEM TO RUN ON

LIQUID PETROLEUM GAS, AND/OR ON COM-
PRESSED NATURAL GAS, IN CLASS 12 (U.S. CLS.
19, 21, 23, 31, 35 AND 44).

FIRST USE 12-31-1998; IN COMMERCE 1-13-2006.

SN 78-778,824, FILED 12-21-2005.

INGRID C. EULIN, EXAMINING ATTORNEY

Int. Cl.: 12

Prior U.S. Cls.: 19, 21, 23, 31, 35, and 44

Reg. No. 3,486,322

United States Patent and Trademark Office

Registered Aug. 12, 2008

**TRADEMARK
PRINCIPAL REGISTER**

XRAY

XRAY CARS (CALIFORNIA SOLE PROPRIETOR-
SHIP)
3857 PELL PLACE #301
SAN DIEGO, CA 92130

FOR: MOTOR VEHICLES, NAMELY, AUTOMO-
BILES, TRUCKS, VANS, AND SPORT UTILITY
VEHICLES AND THEIR STRUCTURAL PARTS
AND ENGINES, IN CLASS 12 (U.S. CLS. 19, 21, 23,
31, 35 AND 44).

FIRST USE 12-21-2005; IN COMMERCE 12-15-2007.

THE MARK CONSISTS OF STANDARD CHAR-
ACTERS WITHOUT CLAIM TO ANY PARTICULAR
FONT, STYLE, SIZE, OR COLOR.

SN 78-780,346, FILED 12-23-2005.

PAUL CROWLEY, EXAMINING ATTORNEY

Int. Cl.: 41

Prior U.S. Cls.: 100, 101, and 107

United States Patent and Trademark Office

Reg. No. 3,486,323

Registered Aug. 12, 2008

**SERVICE MARK
PRINCIPAL REGISTER**

Gremlist

MUSICGREMLIN, INC. (NEW YORK CORPORATION)
SUITE 207
594 BROADWAY
NEW YORK, NY 10012

FOR: ENTERTAINMENT SERVICES, NAMELY,
PROVIDING PRERECORDED MUSIC, INFORMATION
ABOUT MUSIC AND COMMENTARY
ABOUT MUSIC ALL VIA A WIRELESS NETWORK,
IN CLASS 41 (U.S. CLS. 100, 101 AND 107).

FIRST USE 6-14-2006; IN COMMERCE 6-14-2006.

THE MARK CONSISTS OF STANDARD CHARACTERS WITHOUT CLAIM TO ANY PARTICULAR FONT, STYLE, SIZE, OR COLOR.

SN 78-781,257, FILED 12-27-2005.

CARRIE GENOVESE, EXAMINING ATTORNEY

Int. Cl.: 5

Prior U.S. Cls.: 6, 18, 44, 46, 51, and 52

Reg. No. 3,486,324

United States Patent and Trademark Office

Registered Aug. 12, 2008

**TRADEMARK
PRINCIPAL REGISTER**

DECA-BOL

FIZOGEN PRECISION TECHNOLOGIES, INC.
(FLORIDA CORPORATION)
3133 FORTUNE WAY #4
WELLINGTON, FL 33414

THE MARK CONSISTS OF STANDARD CHAR-
ACTERS WITHOUT CLAIM TO ANY PARTICULAR
FONT, STYLE, SIZE, OR COLOR.

FOR: DIETARY FOOD SUPPLEMENTS, IN CLASS
5 (U.S. CLS. 6, 18, 44, 46, 51 AND 52).

SN 78-792,114, FILED 1-16-2006.

FIRST USE 11-30-2007; IN COMMERCE 11-30-2007.

SALLY SHIH, EXAMINING ATTORNEY

Int. Cl.: 5

Prior U.S. Cls.: 6, 18, 44, 46, 51, and 52

Reg. No. 3,486,325

United States Patent and Trademark Office

Registered Aug. 12, 2008

**TRADEMARK
PRINCIPAL REGISTER**

STANAZOL-V

FIZOGEN PRECISION TECHNOLOGIES, INC.
(FLORIDA CORPORATION)
3133 FORTUNE WAY #4
WELLINGTON, FL 33414

THE MARK CONSISTS OF STANDARD CHAR-
ACTERS WITHOUT CLAIM TO ANY PARTICULAR
FONT, STYLE, SIZE, OR COLOR.

FOR: DIETARY FOOD SUPPLEMENTS, IN CLASS
5 (U.S. CLS. 6, 18, 44, 46, 51 AND 52).

SN 78-792,117, FILED 1-16-2006.

FIRST USE 11-30-2007; IN COMMERCE 11-30-2007.

SALLY SHIH, EXAMINING ATTORNEY

Int. Cl.: 10

Prior U.S. Cls.: 26, 39, and 44

United States Patent and Trademark Office

Reg. No. 3,486,326

Registered Aug. 12, 2008

**TRADEMARK
PRINCIPAL REGISTER**

Sonqmark

MEDICAL PRODUCTS MANUFACTURING, INC.
(MINNESOTA CORPORATION)
SUITE 16E
10740 LYNDAL AVENUE S
BLOOMINGTON, MN 55420

FOR: RADIOLOGICAL APPARATUS FOR MEDICAL PURPOSES, IN CLASS 10 (U.S. CLS. 26, 39 AND 44).

FIRST USE 10-12-2006; IN COMMERCE 10-12-2006.

THE COLOR(S) BLUE IS/ARE CLAIMED AS A FEATURE OF THE MARK.

THE MARK CONSISTS OF THE WORD "SONOMARK". THE SECOND "O" HAS TWO VERTICAL LINES EXTENDING DOWN FROM EACH SIDE OF THE "O" TO CREATE THE APPEARANCE OF THE "O" AS THE TOP END OF A THREE-DIMENSIONAL CYLINDER.

SN 78-792,138, FILED 1-16-2006.

BRENDAN REGAN, EXAMINING ATTORNEY

Int. Cl.: 42

Prior U.S. Cls.: 100 and 101

United States Patent and Trademark Office

Reg. No. 3,486,327

Registered Aug. 12, 2008

**SERVICE MARK
PRINCIPAL REGISTER**

ESTOREWARE

ESTOREWARE, INC. (ILLINOIS CORPORATION)
1850 DEKALB AVENUE
SYCAMORE, IL 60178

FOR: COMPUTER SERVICES, NAMELY, DESIGN, CREATION, HOSTING AND MAINTENANCE OF WEB PAGES FOR OTHERS; PROVIDING ON-LINE NON-DOWNLOADABLE SOFTWARE THAT ENABLES USERS TO SELL THEIR PRODUCTS OR SERVICES ON-LINE, IN CLASS 42 (U.S. CLS. 100 AND 101).

FIRST USE 3-31-2006; IN COMMERCE 3-31-2006.

THE MARK CONSISTS OF STANDARD CHARACTERS WITHOUT CLAIM TO ANY PARTICULAR FONT, STYLE, SIZE, OR COLOR.

SN 78-792,584, FILED 1-16-2006.

DAVID MILLER, EXAMINING ATTORNEY

Int. Cls.: 35 and 36

Prior U.S. Cls.: 100, 101, and 102

United States Patent and Trademark Office

Reg. No. 3,486,328

Registered Aug. 12, 2008

**SERVICE MARK
PRINCIPAL REGISTER**

IFUND

IFUEL, LLC (WYOMING LTD LIAB CO)
1610 ALLRED ROAD
AFTON, WY 83110

FOR: PROMOTING THE GOODS AND SERVICES OF OTHERS THROUGH THE DISTRIBUTION OF PRE-PAYMENT AND POINT-OF-SALE PAYMENT ACCOUNTS, IN CLASS 35 (U.S. CLS. 100, 101 AND 102).

FIRST USE 4-11-2008; IN COMMERCE 4-11-2008.

FOR: ISSUING PRE-PAYMENT AND POINT-OF-SALE PAYMENT ACCOUNTS, IN CLASS 36 (U.S. CLS. 100, 101 AND 102).

FIRST USE 4-11-2008; IN COMMERCE 4-11-2008.

THE MARK CONSISTS OF STANDARD CHARACTERS WITHOUT CLAIM TO ANY PARTICULAR FONT, STYLE, SIZE, OR COLOR.

SN 78-793,438, FILED 1-17-2006.

DAVID MILLER, EXAMINING ATTORNEY

Int. Cl.: 41

Prior U.S. Cls.: 100, 101, and 107

United States Patent and Trademark Office

Reg. No. 3,486,329

Registered Aug. 12, 2008

**SERVICE MARK
PRINCIPAL REGISTER**



FRANK SKI KIDS FOUNDATION, INC. (GEORGIA NON-PROFIT CORPORATION)
8275 JETT FERRY ROAD
DUNWOODY, GA 30350

FOR: ENTERTAINMENT SERVICES, NAMELY, ORGANIZING FOOTBALL GAMES FOR CHARITABLE PURPOSES, IN CLASS 41 (U.S. CLS. 100, 101 AND 107).

FIRST USE 12-1-2005; IN COMMERCE 12-1-2005.

NO CLAIM IS MADE TO THE EXCLUSIVE RIGHT TO USE "YOUTH BOWL" AND "KIDS FOUNDATION", APART FROM THE MARK AS SHOWN.

THE NAME "FRANK SKI" IDENTIFIES A LIVING INDIVIDUAL WHOSE CONSENT IS OF RECORD.

SN 78-793,795, FILED 1-18-2006.

DEBRA LEE, EXAMINING ATTORNEY

Int. Cl.: 9

Prior U.S. Cls.: 21, 23, 26, 36, and 38

Reg. No. 3,486,330

United States Patent and Trademark Office

Registered Aug. 12, 2008

**TRADEMARK
PRINCIPAL REGISTER**

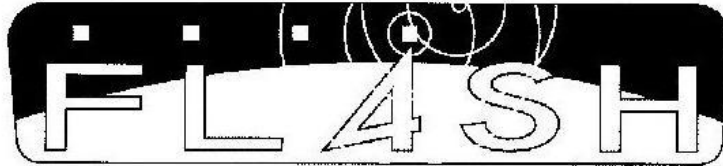

ABLENET, INC. (MINNESOTA CORPORATION)
2808 FAIRVIEW AVENUE N.
ROSEVILLE, MN 55113

LEARNING AND COMMUNICATION, IN CLASS 9
(U.S. CLS. 21, 23, 26, 36 AND 38).

FIRST USE 3-0-2006; IN COMMERCE 12-0-2006.

FOR: INTERACTIVE ELECTRONIC DEVICE IN-
CLUDING AN AUDIO SPEAKER FOR USE BY
PERSONS WITH DISABILITIES TO ASSIST WITH

SN 78-794,653, FILED 1-19-2006.

REBECCA EISINGER, EXAMINING ATTORNEY

Int. Cl.: 28

Prior U.S. Cls.: 22, 23, 38, and 50

Reg. No. 3,486,331

United States Patent and Trademark Office

Registered Aug. 12, 2008

**TRADEMARK
PRINCIPAL REGISTER**

TREEVERS

TUCKER, EDWARD (UNITED STATES INDIVIDUAL)
764 LAVENDER COURT
SAN MARCOS, CA 92069

THE MARK CONSISTS OF STANDARD CHARACTERS WITHOUT CLAIM TO ANY PARTICULAR FONT, STYLE, SIZE, OR COLOR.

FOR: DOG TOYS, IN CLASS 28 (U.S. CLS. 22, 23, 38 AND 50).

SN 78-796,343, FILED 1-20-2006.

FIRST USE 1-1-2006; IN COMMERCE 1-1-2006.

MARGERY A. TIERNEY, EXAMINING ATTORNEY

Int. Cl.: 9

Prior U.S. Cls.: 21, 23, 26, 36, and 38

Reg. No. 3,486,332

United States Patent and Trademark Office

Registered Aug. 12, 2008

**TRADEMARK
PRINCIPAL REGISTER**

GUESTLINK

COMMUNICATIONS INTEGRATORS, INC. (ARIZONA CORPORATION)
SUITE 105
2625 S. WILSON STREET
TEMPE, AZ 85282

FOR: CONNECTIVITY HARDWARE FOR VIDEO, COMMUNICATIONS, DATA NETWORKING AND POWER DISTRIBUTION, NAMELY, MODULAR DEVICES FOR PROVIDING CONNECTIVITY BETWEEN A MONITOR AND A COMPUTER AND INCLUDING VIDEO, VOICE, AND DATA COMMUNICATION CONNECTIONS AND POWER CONNECTIONS, FOR USE BY GENERAL AND

INTERIOR COMMERCIAL CONSTRUCTION CONTRACTORS AND SUB CONTRACTORS, IN CLASS 9 (U.S. CLS. 21, 23, 26, 36 AND 38).

FIRST USE 4-30-2006; IN COMMERCE 4-30-2006.

THE MARK CONSISTS OF STANDARD CHARACTERS WITHOUT CLAIM TO ANY PARTICULAR FONT, STYLE, SIZE, OR COLOR.

SN 78-797,822, FILED 1-24-2006.

ELISSA GARBER KON, EXAMINING ATTORNEY

Int. Cl.: 3

Prior U.S. Cls.: 1, 4, 6, 50, 51, and 52

Reg. No. 3,486,333

United States Patent and Trademark Office

Registered Aug. 12, 2008

**TRADEMARK
PRINCIPAL REGISTER**

TOUGH LOVE

BATH & BODY WORKS BRAND MANAGEMENT, INC. (DELAWARE CORPORATION)
7 LIMITED PARKWAY EAST
REYNOLDSBURG, OH 43068

THE MARK CONSISTS OF STANDARD CHARACTERS WITHOUT CLAIM TO ANY PARTICULAR FONT, STYLE, SIZE, OR COLOR.

FOR: PERSONAL CARE PRODUCTS, NAMELY, FOOT LOTION AND FOOT CREAM, IN CLASS 3 (U.S. CLS. 1, 4, 6, 50, 51 AND 52).

SN 78-798,188, FILED 1-24-2006.

FIRST USE 5-31-2006; IN COMMERCE 5-31-2006.

DOMINIC FATHY, EXAMINING ATTORNEY

Int. Cls.: 22 and 26

Prior U.S. Cls.: 1, 2, 7, 19, 22, 37, 39, 40, 42, and 50

United States Patent and Trademark Office

Reg. No. 3,486,334

Registered Aug. 12, 2008

**TRADEMARK
PRINCIPAL REGISTER**

SMH

RUAN CO., LTD. (JAPAN CORPORATION)
1-300-5 NISHIKATAKAI-MACHI
MAEBASHI-SHI, JAPAN

FOR: CUT RAYON, POLYESTER, CARBON, AND
OTHER ARTIFICIAL MATERIAL FIBER, AND
WOOL, SILK, AND OTHER NATURAL MATERIAL
FIBER, FOR USE AS ARTIFICIAL HAIR, IN CLASS
22 (U.S. CLS. 1, 2, 7, 19, 22, 42 AND 50).

FIRST USE 5-13-2008; IN COMMERCE 5-13-2008.

FOR: ARTIFICIAL HAIR FOR CONCEALING
PURPOSES, TO SPRINKLE OVER THIN HAIR, OR

TO BE USED AS A HAIRPIECE, MADE OF CUT
FIBER, IN CLASS 26 (U.S. CLS. 37, 39, 40, 42 AND 50).

FIRST USE 5-13-2008; IN COMMERCE 5-13-2008.

THE MARK CONSISTS OF STANDARD CHAR-
ACTERS WITHOUT CLAIM TO ANY PARTICULAR
FONT, STYLE, SIZE, OR COLOR.

SN 78-800,689, FILED 1-27-2006.

KOURTNEE HODGES, EXAMINING ATTORNEY

Int. Cl.: 18

Prior U.S. Cls.: 1, 2, 3, 22, and 41

United States Patent and Trademark Office

Reg. No. 3,486,335

Registered Aug. 12, 2008

**TRADEMARK
PRINCIPAL REGISTER**

SUN VALLEY

SINCLAIR FINANCE COMPANY (WYOMING CORPORATION)
550 EAST SOUTH TEMPLE
P.O. BOX 30825
SALT LAKE CITY, UT 841300825

FOR: ALL-PURPOSE SPORT, ATHLETIC AND CARRYING BAGS; BACKPACKS, DAYPACKS, FANNY PACKS, KNAPSACKS AND RUCKSACKS; BOOK BAGS; TRAVEL BAGS; TOTE BAGS; BUSINESS AND CREDIT CARD CASES; PURSES, CHANGE PURSES, KEY CASES; LEATHER KEY CHAINS; GOLF UMBRELLAS; LEATHER WALLETS AND BILLFOLDS, IN CLASS 18 (U.S. CLS. 1, 2, 3, 22 AND 41).

FIRST USE 4-0-2008; IN COMMERCE 4-0-2008.

THE MARK CONSISTS OF STANDARD CHARACTERS WITHOUT CLAIM TO ANY PARTICULAR FONT, STYLE, SIZE, OR COLOR.

OWNER OF U.S. REG. NOS. 2,815,676, 2,865,450, AND OTHERS.

SN 78-801,486, FILED 1-27-2006.

GISELLE AGOSTO, EXAMINING ATTORNEY

Int. Cl.: 36

Prior U.S. Cls.: 100, 101, and 102

United States Patent and Trademark Office

Reg. No. 3,486,336

Registered Aug. 12, 2008

**SERVICE MARK
PRINCIPAL REGISTER**

Growing Great Kids

KIDSPEACE CORPORATION (PENNSYLVANIA
CORPORATION)
5300 KIDSPEACE DRIVE
OREFIELD, PA 18069

THE MARK CONSISTS OF STANDARD CHAR-
ACTERS WITHOUT CLAIM TO ANY PARTICULAR
FONT, STYLE, SIZE, OR COLOR.

FOR: FUNDRAISING TO PROMOTE THE HEAL-
ING OF EMOTIONALLY DISTRESSED CHILDREN,
IN CLASS 36 (U.S. CLS. 100, 101 AND 102).

SN 78-808,931, FILED 2-7-2006.

FIRST USE 6-0-1994; IN COMMERCE 6-0-1994.

AMY GEARIN, EXAMINING ATTORNEY

Int. Cl.: 33

Prior U.S. Cls.: 47 and 49

United States Patent and Trademark Office

Reg. No. 3,486,337

Registered Aug. 12, 2008

**TRADEMARK
PRINCIPAL REGISTER**

AGAVE LOCO

AGAVE LOCO, LLC (ILLINOIS LTD LIAB CO)
851 WEST GUNNISON, SUITE K
CHICAGO, IL 60640

FOR: ALCOHOLIC BEVERAGES, NAMELY, TE-
QUILA MADE FROM AGAVE ORIGINATING IN
MEXICO, IN CLASS 33 (U.S. CLS. 47 AND 49).

FIRST USE 6-18-2008; IN COMMERCE 6-18-2008.

THE MARK CONSISTS OF STANDARD CHAR-
ACTERS WITHOUT CLAIM TO ANY PARTICULAR
FONT, STYLE, SIZE, OR COLOR.

NO CLAIM IS MADE TO THE EXCLUSIVE
RIGHT TO USE "AGAVE", APART FROM THE
MARK AS SHOWN.

SN 78-809,535, FILED 2-7-2006.

CORY BOONE, EXAMINING ATTORNEY

Int. Cl.: 35

Prior U.S. Cls.: 100, 101, and 102

United States Patent and Trademark Office

Reg. No. 3,486,338

Registered Aug. 12, 2008

**SERVICE MARK
PRINCIPAL REGISTER**

BUY RIGHT SELL RIGHT

BUY RIGHT SELL RIGHT, INC. (UTAH CORPORATION)
910 S. CUMBERLAND WAY
ALPINE, UT 84004

THE MARK CONSISTS OF STANDARD CHARACTERS WITHOUT CLAIM TO ANY PARTICULAR FONT, STYLE, SIZE, OR COLOR.

FOR: REAL ESTATE SALES MANAGEMENT, IN CLASS 35 (U.S. CLS. 100, 101 AND 102).

SN 78-811,633, FILED 2-9-2006.

FIRST USE 2-1-2005; IN COMMERCE 5-1-2006.

ELLEN PERKINS, EXAMINING ATTORNEY

Int. Cl.: 25

Prior U.S. Cls.: 22 and 39

United States Patent and Trademark Office

Reg. No. 3,486,339

Registered Aug. 12, 2008

**TRADEMARK
PRINCIPAL REGISTER**

DRYSTAT

ARCOS S.P.A. (ITALY JOINT STOCK COMPANY)
VIA DELL'ARTIGIANATO 47
25039 TRAVAGLIATO (BRESCIA), ITALY

THE MARK CONSISTS OF STANDARD CHAR-
ACTERS WITHOUT CLAIM TO ANY PARTICULAR
FONT, STYLE, SIZE, OR COLOR.

FOR: SOCKS; TIGHTS; UNDERSHIRTS; PAN-
TIES; SHORTS; BODICES; SUITS, NAMELY, TRACK
SUITS, BATHING SUITS, AND JOGGING SUITS, IN
CLASS 25 (U.S. CLS. 22 AND 39).

SN 78-814,114, FILED 2-14-2006.

FIRST USE 1-0-2007; IN COMMERCE 1-0-2007.

MARCIE MILONE, EXAMINING ATTORNEY

Int. Cls.: 1, 7, and 11

Prior U.S. Cls.: 1, 5, 6, 10, 13, 19, 21, 23, 26, 31, 34, 35,
and 46

Reg. No. 3,486,340

United States Patent and Trademark Office

Registered Aug. 12, 2008

TRADEMARK
PRINCIPAL REGISTER

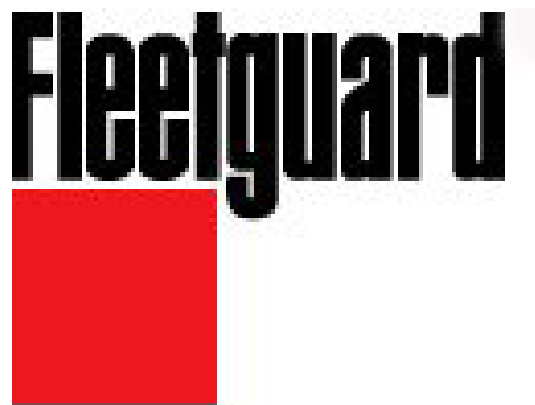

FLEETGUARD, INC. (INDIANA CORPORATION)
500 JACKSON STREET
COLUMBUS, IN 47201

FOR: COOLANTS FOR VEHICLE ENGINES, IN
CLASS 1 (U.S. CLS. 1, 5, 6, 10, 26 AND 46).

FIRST USE 12-31-1985; IN COMMERCE 12-31-1985.

FOR: OIL FILTERS; OIL, GASOLINE, DIESEL
FUEL AND AIR FILTERS FOR MOTORS AND
ENGINES; FUEL FILTERS AND STRUCTURAL
PARTS THEREOF; AIR AND OIL FILTERS AND
STRUCTURAL PARTS THEREOF; AIR AND OIL
FILTERS FOR MECHANICAL PURPOSES; HY-
DRAULIC FLUID FILTERS FOR MECHANICAL
PURPOSES; OIL, GASOLINE, AIR AND FUEL FIL-
TERS FOR MOTORS AND ENGINES OF LAND
AND MARINE VEHICLES; CANISTERS AND
HOUSING FOR ALL THE FOREGOING FILTERS,
HEAVY DUTY STARTERS; HEAVY DUTY STAR-
TERS FOR ENGINES AND MOTORS, IN CLASS 7
(U.S. CLS. 13, 19, 21, 23, 31, 34 AND 35).

FIRST USE 12-31-1968; IN COMMERCE 12-31-1968.

FOR: AIR FILTERS FOR THE REDUCTION OF
EMISSIONS IN INDUSTRIAL INSTALLATIONS;
BATTERY WARMING BLANKETS; HEATERS FOR
WARMING COOLANTS; HEATERS FOR WARM-
ING OIL; HEATERS FOR WARMING DIESEL FUEL,
IN CLASS 11 (U.S. CLS. 13, 21, 23, 31 AND 34).

FIRST USE 12-31-1997; IN COMMERCE 12-31-1997.

THE COLOR(S) RED AND BLACK IS/ARE
CLAIMED AS A FEATURE OF THE MARK.

THE COLOR RED APPEARS IN THE DESIGN OF
A SQUARE AND THE LETTERS "FLEETGUARD"
APPEAR IN BLACK.

THE MARK CONSISTS OF THE DEVICE OF A
SQUARE AND THE LITERAL ELEMENT "FLEET-
GUARD".

SN 78-814,818, FILED 2-14-2006.

CAROLYN GRAY, EXAMINING ATTORNEY

Int. Cl.: 10

Prior U.S. Cls.: 26, 39, and 44

Reg. No. 3,486,341

United States Patent and Trademark Office

Registered Aug. 12, 2008

**TRADEMARK
PRINCIPAL REGISTER**

TF-I

MASIMO CORPORATION (DELAWARE CORPORATION)
40 PARKER
IRVINE, CA 92618

THE MARK CONSISTS OF STANDARD CHARACTERS WITHOUT CLAIM TO ANY PARTICULAR FONT, STYLE, SIZE, OR COLOR.

FOR: MEDICAL DEVICES, NAMELY, PATIENT SENSORS FOR MONITORING AND MEASURING BLOOD PROPERTIES AND RESPIRATORY EVENTS, IN CLASS 10 (U.S. CLS. 26, 39 AND 44).

SN 78-815,771, FILED 2-15-2006.

FIRST USE 9-8-2004; IN COMMERCE 9-8-2004.

TEJBIR SINGH, EXAMINING ATTORNEY

Int. Cl.: 35

Prior U.S. Cls.: 100, 101, and 102

United States Patent and Trademark Office

Reg. No. 3,486,342

Registered Aug. 12, 2008

**SERVICE MARK
PRINCIPAL REGISTER**

Two Guys

GAROFALO, DAVID (UNITED STATES INDIVIDUAL)
16 LANTERN LANE
LONDONDERRY, NH 03053

THE MARK CONSISTS OF STANDARD CHARACTERS WITHOUT CLAIM TO ANY PARTICULAR FONT, STYLE, SIZE, OR COLOR.

FOR: MAIL ORDER SERVICES AND RETAIL STORE SERVICES FEATURING CIGARS AND CIGAR SUPPLIES, IN CLASS 35 (U.S. CLS. 100, 101 AND 102).

SN 78-816,331, FILED 2-16-2006.

FIRST USE 11-1-1985; IN COMMERCE 11-1-1985.

KAREN K. BUSH, EXAMINING ATTORNEY

Int. Cls.: 35 and 41

Prior U.S. Cls.: 100, 101, 102, and 107

United States Patent and Trademark Office

Reg. No. 3,486,343

Registered Aug. 12, 2008

**SERVICE MARK
PRINCIPAL REGISTER**

HARMONY

HARMONY, LLC (COLORADO LTD LIAB CO)
6432 GRAND TREE BLVD.
TIMNATH, CO 80547

FOR: RETAIL STORE SERVICES FEATURING GOLF EQUIPMENT AND APPAREL, TENNIS AND FITNESS APPAREL; HOME OWNERS ASSOCIATION SERVICES, NAMELY, MANAGING HOMEOWNERS ASSOCIATION OPEN SPACES, AND PROMOTING ISSUES RELATED TO THE PEACE, HEALTH, COMFORT, SAFETY AND GENERAL WELFARE OF ASSOCIATION MEMBERS, IN CLASS 35 (U.S. CLS. 100, 101 AND 102).

FIRST USE 5-2-2006; IN COMMERCE 2-25-2008.

FOR: PROVIDING GOLF CLUB SERVICES AND FACILITIES NAMELY, GOLF COURSES AND GOLF INSTRUCTION; RENTAL OF GOLF EQUIPMENT; PROVIDING FACILITIES FOR RECREATION ACTIVITIES; ENTERTAINMENT, NAMELY, PROVIDING GOLF TOURNAMENTS, IN CLASS 41 (U.S. CLS. 100, 101 AND 107).

FIRST USE 7-28-2006; IN COMMERCE 2-25-2008.

THE MARK CONSISTS OF STANDARD CHARACTERS WITHOUT CLAIM TO ANY PARTICULAR FONT, STYLE, SIZE, OR COLOR.

SN 78-816,369, FILED 2-16-2006.

MICHAEL LEWIS, EXAMINING ATTORNEY

Int. Cl.: 41

Prior U.S. Cls.: 100, 101, and 107

United States Patent and Trademark Office

Reg. No. 3,486,344

Registered Aug. 12, 2008

**SERVICE MARK
PRINCIPAL REGISTER**

Lady Di on Wine

DENHAM, DIANE, C (UNITED STATES INDIVIDUAL)
2870 MONTICELLO RD
NAPA, CA 94558

FOR: DEVELOPMENT AND DISSEMINATION OF EDUCATIONAL MATERIALS OF OTHERS IN THE FIELD OF WINE, IN CLASS 41 (U.S. CLS. 100, 101 AND 107).

FIRST USE 2-3-2006; IN COMMERCE 2-3-2006.

THE MARK CONSISTS OF STANDARD CHARACTERS WITHOUT CLAIM TO ANY PARTICULAR FONT, STYLE, SIZE, OR COLOR.

NO CLAIM IS MADE TO THE EXCLUSIVE RIGHT TO USE "WINE", APART FROM THE MARK AS SHOWN.

THE NAME IN THE MARK IDENTIFIES A LIVING INDIVIDUAL WHOSE CONSENT IS OF RECORD.

SN 78-816,428, FILED 2-16-2006.

PAUL F. GAST, EXAMINING ATTORNEY

Int. Cl.: 9

Prior U.S. Cls.: 21, 23, 26, 36, and 38

Reg. No. 3,486,345

United States Patent and Trademark Office

Registered Aug. 12, 2008

**TRADEMARK
PRINCIPAL REGISTER**

GOLD MAKER

ARISTOCRAT TECHNOLOGIES AUSTRALIA
PTY LTD (AUSTRALIA LTD LIAB CO)
71 LONGUEVILLE ROAD
LANE COVE, NEW SOUTH WALES, AUSTRALIA
2066

FOR: GAMING DEVICES, NAMELY, GAMING
MACHINES AND COMPUTER SOFTWARE USED
THEREWITH TO ENABLE THE GAMING MA-
CHINE TO RUN, IN CLASS 9 (U.S. CLS. 21, 23, 26,
36 AND 38).

FIRST USE 5-10-2005; IN COMMERCE 5-10-2005.

THE MARK CONSISTS OF STANDARD CHAR-
ACTERS WITHOUT CLAIM TO ANY PARTICULAR
FONT, STYLE, SIZE, OR COLOR.

SN 78-816,912, FILED 2-16-2006.

JOHN DWYER, EXAMINING ATTORNEY

Int. Cl.: 28

Prior U.S. Cls.: 22, 23, 38, and 50

Reg. No. 3,486,346

United States Patent and Trademark Office

Registered Aug. 12, 2008

**TRADEMARK
PRINCIPAL REGISTER**

FORCE TECHNOLOGY

ROCKBATS, LLC (WISCONSIN LTD LIAB CO)
5286 SANDY BEACH SOUTH
BELGIUM, WI 53004

FOR: BASEBALL BATS AND SOFTBALL BATS,
IN CLASS 28 (U.S. CLS. 22, 23, 38 AND 50).

FIRST USE 1-15-2008; IN COMMERCE 1-15-2008.

THE MARK CONSISTS OF STANDARD CHAR-
ACTERS WITHOUT CLAIM TO ANY PARTICULAR
FONT, STYLE, SIZE, OR COLOR.

NO CLAIM IS MADE TO THE EXCLUSIVE
RIGHT TO USE "TECHNOLOGY", APART FROM
THE MARK AS SHOWN.

SN 78-818,596, FILED 2-19-2006.

MIDGE BUTLER, EXAMINING ATTORNEY

Int. Cl.: 9

Prior U.S. Cls.: 21, 23, 26, 36, and 38

Reg. No. 3,486,347

United States Patent and Trademark Office

Registered Aug. 12, 2008

**TRADEMARK
PRINCIPAL REGISTER**

S2

STYLEMARK, INC. (FLORIDA CORPORATION)
2 SUNSHINE BLVD
ORMOND BEACH, FL 32174

FIRST USE 6-19-2008; IN COMMERCE 6-19-2008.

FOR: SUNGLASSES, EYEGLASS FRAMES, EYEGLASS CASES AND EYEGLASS ACCESSORIES, NAMELY, STRAPS, NECK CORDS, HEAD STRAPS WHICH RESTRAIN EYEWEAR FROM MOVEMENT ON A WEARER, NOSE PADS AND EAR PADS, IN CLASS 9 (U.S. CLS. 21, 23, 26, 36 AND 38).

THE MARK CONSISTS OF STANDARD CHARACTERS WITHOUT CLAIM TO ANY PARTICULAR FONT, STYLE, SIZE, OR COLOR.

SN 78-818,711, FILED 2-20-2006.

INGRID C. EULIN, EXAMINING ATTORNEY

Int. Cl.: 25

Prior U.S. Cls.: 22 and 39

United States Patent and Trademark Office

Reg. No. 3,486,348

Registered Aug. 12, 2008

**TRADEMARK
PRINCIPAL REGISTER**

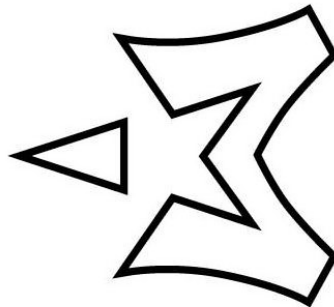

4004 INCORPORATED (PENNSYLVANIA CORPORATION)
12 HARBOR PARK DRIVE
PORT WASHINGTON, NY 11050

FOR: FOOTWEAR EXCLUDING ORTHOPEDIC FOOTWEAR, JACKETS, JEANS, HEADWEAR, SWEATERS, SWEATSHIRTS, PANTS, SHORTS, SHIRTS, TRACKSUITS, UNDERGARMENTS, IN CLASS 25 (U.S. CLS. 22 AND 39).

FIRST USE 8-17-2006; IN COMMERCE 8-17-2006.

THE MARK CONSISTS OF A STYLIZED NUMBER "3" WITH A TRIANGLE TO THE IMMEDIATE RIGHT OF THE NUMBER THAT TOGETHER FORM THE OPTICAL ILLUSION OF A FIVE-POINTED STAR.

SN 78-818,728, FILED 2-20-2006.

MICHAEL ENGEL, EXAMINING ATTORNEY

Int. Cl.: 9

Prior U.S. Cls.: 21, 23, 26, 36, and 38

Reg. No. 3,486,349

United States Patent and Trademark Office

Registered Aug. 12, 2008

**TRADEMARK
PRINCIPAL REGISTER**

ShareCast

WARDEN, DAVID M. (UNITED STATES INDIVIDUAL)
411 MOUNTAIN LAUREL DR.
CEDAR PARK, TX 78613

FOR: COMMUNICATIONS SOFTWARE FOR CONNECTING MULTIPLE COMPUTERS TO A SHARED DATA STREAM; COMPUTER SOFTWARE DEVELOPMENT TOOLS; COMPUTER SOFTWARE FOR ADMINISTRATION OF COMPUTER LOCAL AREA NETWORKS; COMPUTER SOFTWARE FOR COMMUNICATING WITH USERS OF HAND-HELD COMPUTERS; COMPUTER SOFTWARE FOR ENCRYPTION; COMPUTER SOFTWARE FOR WIRELESS CONTENT DELIVERY; COMPUTER SOFTWARE FOR COLLABORATIVE NETWORKED INTERACTIONS, NAMELY, SOFTWARE WHICH

ALLOWS SEVERAL USERS EACH USING THEIR OWN COMPUTER TO SHARE THE SAME DATA IN REAL TIME; LAN (LOCAL AREA NETWORK) OPERATING SOFTWARE; WAN (WIDE AREA NETWORK) OPERATING SOFTWARE, IN CLASS 9 (U.S. CLS. 21, 23, 26, 36 AND 38).

FIRST USE 5-10-2006; IN COMMERCE 5-10-2007.

THE MARK CONSISTS OF STANDARD CHARACTERS WITHOUT CLAIM TO ANY PARTICULAR FONT, STYLE, SIZE, OR COLOR.

SN 78-818,784, FILED 2-20-2006.

JANICE KIM, EXAMINING ATTORNEY

Int. Cl.: 1

Prior U.S. Cls.: 1, 5, 6, 10, 26, and 46

Reg. No. 3,486,350

United States Patent and Trademark Office

Registered Aug. 12, 2008

**TRADEMARK
PRINCIPAL REGISTER**

TERATRAP

CRYSTAPHASE INTERNATIONAL, INC, (TEXAS
CORPORATION)
16945 NORTHCHASE DRIVE
HOUSTON, TX 77060

THE MARK CONSISTS OF STANDARD CHAR-
ACTERS WITHOUT CLAIM TO ANY PARTICULAR
FONT, STYLE, SIZE, OR COLOR.

FOR: CERAMIC PIECES FOR FILTERING AND
PROVIDING LIQUID DISTRIBUTION IN CHEMI-
CAL PROCESSES, IN CLASS 1 (U.S. CLS. 1, 5, 6, 10, 26
AND 46).

SN 78-819,125, FILED 2-20-2006.

FIRST USE 5-15-2007; IN COMMERCE 5-15-2007.

SUSAN LESLIE DUBOIS, EXAMINING ATTORNEY

Int. Cls.: 20 and 24

Prior U.S. Cls.: 2, 13, 22, 25, 32, 42, and 50

United States Patent and Trademark Office

Reg. No. 3,486,351

Registered Aug. 12, 2008

**TRADEMARK
PRINCIPAL REGISTER**

THERA P

FKA DISTRIBUTING CO. (MICHIGAN CORPORATION), DBA HOMEDICS, INC.,
3000 PONTIAC TRAIL
COMMERCE TOWNSHIP, MI 48390

FOR: PILLOWS AND CUSHIONS; MATTRESSES;
MATTRESS TOPPERS; MATTRESS CUSHIONS, IN
CLASS 20 (U.S. CLS. 2, 13, 22, 25, 32 AND 50).

FIRST USE 6-0-2006; IN COMMERCE 6-0-2006.

FOR: PILLOW ACCESSORIES, NAMELY, CASES,
COVERS, SLIPS; MATTRESS PADS; MATTRESS
COVERS, IN CLASS 24 (U.S. CLS. 42 AND 50).

FIRST USE 6-0-2006; IN COMMERCE 6-0-2006.

THE MARK CONSISTS OF STANDARD CHARACTERS WITHOUT CLAIM TO ANY PARTICULAR FONT, STYLE, SIZE, OR COLOR.

OWNER OF U.S. REG. NOS. 2,424,906 AND 2,424,907.

SN 78-819,632, FILED 2-21-2006.

ALLISON SCHRODY, EXAMINING ATTORNEY

Int. Cls.: 1, 3, 11, 14, 20, 21, 28, 29, and 30

Prior U.S. Cls.: 1, 2, 4, 5, 6, 10, 13, 21, 22, 23, 25, 26, 27, 28, 29, 30, 31, 32, 33, 34, 38, 40, 46, 50, 51, and 52

Reg. No. 3,486,352

United States Patent and Trademark Office

Registered Aug. 12, 2008

**TRADEMARK
PRINCIPAL REGISTER**

ROMA

VISTAR CORPORATION (COLORADO CORPORATION)
12650 ARAPHOE ROAD
CENTENNIAL, CO 80112

FOR: ARTIFICIAL SWEETENER, IN CLASS 1 (U.S. CLS. 1, 5, 6, 10, 26 AND 46).

FIRST USE 12-3-1988; IN COMMERCE 12-3-1988.

FOR: DEGREASER SOAP; HAND SOAP; LAUNDRY BLEACH FOR FOODSERVICE USE AND FLOOR CLEANER, IN CLASS 3 (U.S. CLS. 1, 4, 6, 50, 51 AND 52).

FIRST USE 6-11-1986; IN COMMERCE 6-11-1986.

FOR: CHARCOAL LIGHTERS PRIMARILY FOR LIGHTING GRILLS, STOVES AND CANDLES, IN CLASS 11 (U.S. CLS. 13, 21, 23, 31 AND 34).

FIRST USE 5-1-2002; IN COMMERCE 5-1-2002.

FOR: CLOCKS, IN CLASS 14 (U.S. CLS. 2, 27, 28 AND 50).

FIRST USE 3-1-1995; IN COMMERCE 3-1-1995.

FOR: DRINKING STRAWS, IN CLASS 20 (U.S. CLS. 2, 13, 22, 25, 32 AND 50).

FIRST USE 1-15-1988; IN COMMERCE 1-15-1988.

FOR: DINNERWARE, NAMELY, CUPS AND SAUCERS AND WINE PITCHERS FOR FOODSERVICE USE, IN CLASS 21 (U.S. CLS. 2, 13, 23, 29, 30, 33, 40 AND 50).

FIRST USE 12-1-1997; IN COMMERCE 12-1-1997.

FOR: TOY TRUCKS, IN CLASS 28 (U.S. CLS. 22, 23, 38 AND 50).

FIRST USE 12-1-2001; IN COMMERCE 12-1-2001.

FOR: SOUPS, NAMELY, ITALIAN WEDDING, BROCCOLI AND CHEESE, MINISTRONE, CHILI, CHICKEN NOODLE, BOSTON CLAM CHOWDER AND TUSCAN VEGETABLE, ALL FOR FOOD SERVICE USE. NUTS, NAMELY, PIGNOLIA NUTS, IN CLASS 29 (U.S. CL. 46).

FIRST USE 6-15-1994; IN COMMERCE 6-15-1994.

FOR: PIES NAMELY KEY LIME; COOKIES; CAKES; PIZZA CRUST; AND DESSERTS NAMELY TIRAMISU ALL FOR FOODSERVICE USE, IN CLASS 30 (U.S. CL. 46).

FIRST USE 11-20-1990; IN COMMERCE 11-20-1990.

THE MARK CONSISTS OF STANDARD CHARACTERS WITHOUT CLAIM TO ANY PARTICULAR FONT, STYLE, SIZE, OR COLOR.

OWNER OF U.S. REG. NOS. 1,178,076, 1,194,795, AND OTHERS.

THE FOREIGN WORDING IN THE MARK TRANSLATES INTO ENGLISH AS "ROME".

SEC. 2(F).

THE 2(F) CLAIM IS RESTRICTED TO CLASS(ES) 14, 21 AND 28.

SN 78-819,764, FILED 2-21-2006.

COURTNEY MCCORMICK, EXAMINING ATTOR-
NEY

Int. Cl.: 41

Prior U.S. Cls.: 100, 101, and 107

United States Patent and Trademark Office

Reg. No. 3,486,353

Registered Aug. 12, 2008

**SERVICE MARK
PRINCIPAL REGISTER**

Up-Right

DAVE GESLAK AND SUZANNE GRAY (ILLINOIS PARTNERSHIP)
7938 S. MADISON STREET
BURR RIDGE, IL 60527

THE MARK CONSISTS OF STANDARD CHARACTERS WITHOUT CLAIM TO ANY PARTICULAR FONT, STYLE, SIZE, OR COLOR.

FOR: PHYSICAL FITNESS AND BODY MOVEMENT INSTRUCTION, IN CLASS 41 (U.S. CLS. 100, 101 AND 107).

SN 78-819,909, FILED 2-21-2006.

FIRST USE 1-16-2005; IN COMMERCE 4-20-2005.

RICHARD WHITE, EXAMINING ATTORNEY

Int. Cl.: 45

Prior U.S. Cls.: 100 and 101

United States Patent and Trademark Office

Reg. No. 3,486,354

Registered Aug. 12, 2008

SERVICE MARK
PRINCIPAL REGISTER



HARDY, ELBERT EARL (UNITED STATES INDIVIDUAL)
1316 NANCESOWEE AVENUE
SEBRING, FL 33870

FOR: PROVIDING A WEBSITE WITH INFORMATION ABOUT MINISTRIES, IN CLASS 45 (U.S. CLS. 100 AND 101).

FIRST USE 3-8-2006; IN COMMERCE 8-26-2006.

THE COLOR(S) BLACK, WHITE, GRAY, BLUE AND RED IS/ARE CLAIMED AS A FEATURE OF THE MARK.

THE COLOR BLACK APPEARS IN THE WORDING AND DESIGN. THE COLOR WHITE APPEARS

IN THE LAMB. THE COLORS GRAY AND RED APPEAR IN THE CAMERA. THE COLOR BLUE APPEARS IN THE MONITOR/TELEVISION SCREEN.

THE MARK CONSISTS OF A LAMB PEERING THROUGH A CAMERA LENS MOUNTED ON A TRIPOD WITH A WIRE LEADING TO A TV MONITOR WITH THE WORDS "WHERE MINISTRIES COME ALIVE 24-7-365" UNDERNEATH.

SN 78-820,997, FILED 2-22-2006.

ANNE MADDEN, EXAMINING ATTORNEY

Int. Cl.: 12

Prior U.S. Cls.: 19, 21, 23, 31, 35, and 44

Reg. No. 3,486,355

United States Patent and Trademark Office

Registered Aug. 12, 2008

**TRADEMARK
PRINCIPAL REGISTER**

MOTOGEAR

CLASSIC ACCESSORIES, INC. (WASHINGTON CORPORATION)
22640 68TH AVENUE SOUTH
KENT, WA 98032

FOR: ACCESSORIES FOR MOTORIZED VEHICLES, NAMELY, FITTED COVERS FOR VEHICLES, CARGO PACKS, CARGO BAGS, CARGO ORGANIZERS, NAMELY, BAGS, PACKS, RACKS, RACK STORAGE CONTAINERS FOR MOTORIZED VEHICLES, STORAGE CONTAINERS FOR MOTORIZED VEHICLES, STORAGE CASES FOR MOTORIZED VEHICLES; ACCESSORIES FOR MOTORIZED VEHICLES, NAMELY, BAGS, PACKS, RACKS, RACK STORAGE CONTAINERS FOR MOTORIZED VEHICLES, STORAGE CONTAINERS FOR MOTORIZED

VEHICLES, STORAGE CASES FOR MOTORIZED VEHICLES; MOTORCYCLE FITTED COVERS, POWER EQUIPMENT FITTED COVERS FOR VEHICLES, IN CLASS 12 (U.S. CLS. 19, 21, 23, 31, 35 AND 44).

FIRST USE 4-0-2007; IN COMMERCE 4-0-2007.

THE MARK CONSISTS OF STANDARD CHARACTERS WITHOUT CLAIM TO ANY PARTICULAR FONT, STYLE, SIZE, OR COLOR.

SN 78-821,047, FILED 2-22-2006.

MICHAEL LEWIS, EXAMINING ATTORNEY

Int. Cl.: 7

Prior U.S. Cls.: 13, 19, 21, 23, 31, 34, and 35

Reg. No. 3,486,356

United States Patent and Trademark Office

Registered Aug. 12, 2008

**TRADEMARK
PRINCIPAL REGISTER**

POWERBLEND 500

CONAIR CORPORATION (DELAWARE CORPORATION)
ONE CUMMINGS POINT ROAD
STAMFORD, CT 06902

FOR: ELECTRIC KITCHEN APPLIANCES, NAMELY, BLENDERS WITH FOOD PROCESSOR ATTACHMENTS, IN CLASS 7 (U.S. CLS. 13, 19, 21, 23, 31, 34 AND 35).

FIRST USE 8-0-2006; IN COMMERCE 8-0-2006.

THE MARK CONSISTS OF STANDARD CHARACTERS WITHOUT CLAIM TO ANY PARTICULAR FONT, STYLE, SIZE, OR COLOR.

NO CLAIM IS MADE TO THE EXCLUSIVE RIGHT TO USE "500", APART FROM THE MARK AS SHOWN.

SN 78-821,955, FILED 2-23-2006.

PAUL E. FAHRENKOPF, EXAMINING ATTORNEY

Int. Cl.: 11

Prior U.S. Cls.: 13, 21, 23, 31, and 34

United States Patent and Trademark Office

Reg. No. 3,486,357

Registered Aug. 12, 2008

**TRADEMARK
PRINCIPAL REGISTER**

RATTAN

AS IP HOLDCO, LLC (DELAWARE LTD LIAB
CO)
1 CENTENNIAL AVENUE
PISCATAWAY, NJ 08855

THE MARK CONSISTS OF STANDARD CHAR-
ACTERS WITHOUT CLAIM TO ANY PARTICULAR
FONT, STYLE, SIZE, OR COLOR.

FOR: LAVATORIES, IN CLASS 11 (U.S. CLS. 13, 21,
23, 31 AND 34).

SN 78-822,571, FILED 2-24-2006.

FIRST USE 4-30-2007; IN COMMERCE 4-30-2007.

LAURA KOVALSKY, EXAMINING ATTORNEY

Int. Cls.: 39 and 43

Prior U.S. Cls.: 100, 101, and 105

United States Patent and Trademark Office

Reg. No. 3,486,358

Registered Aug. 12, 2008

**SERVICE MARK
PRINCIPAL REGISTER**

I-TO-I

I-TO-I INTERNATIONAL PROJECTS LIMITED
(UNITED KINGDOM LIMITED COMPANY)
WOODSIDE HOUSE, 261 LOW LANE
LEEDS, WEST YORKSHIRE, UNITED KINGDOM
LS18 5NY

FOR: ARRANGING OF TRAVEL; ARRANGING
OF WORKING HOLIDAYS AND WORKING
TOURS; ARRANGING OF HOLIDAY TOURS , IN
CLASS 39 (U.S. CLS. 100 AND 105).

FIRST USE 4-30-2003; IN COMMERCE 4-30-2003.

FOR: ACCOMMODATION SERVICES, NAMELY,
ARRANGING, BOOKING AND RESERVATION OF
ACCOMMODATION; HOTEL SERVICES; HOLIDAY
ACCOMMODATION SERVICES, NAMELY, BOOK-
ING AND RESERVATION OF ACCOMMODATION
WORLDWIDE; CATERING SERVICES; CAFETERIA
SERVICES; FOOD TAKEAWAY SERVICES; PRE-
PARATION OF FOOD, MEALS AND BEVERAGES

FOR THE CONSUMPTION ON OR OFF THE PRE-
MISES; PROVISION OF FOOD AND DRINK FOR
GUESTS, IN CLASS 43 (U.S. CLS. 100 AND 101).

FIRST USE 4-30-2003; IN COMMERCE 4-30-2003.

THE MARK CONSISTS OF STANDARD CHAR-
ACTERS WITHOUT CLAIM TO ANY PARTICULAR
FONT, STYLE, SIZE, OR COLOR.

PRIORITY CLAIMED UNDER SEC. 44(D) ON
ERPNTY CMNTY TM OFC APPLICATION NO.
004850269, FILED 1-20-2006.

OWNER OF U.S. REG. NO. 2,823,009.

SN 78-823,077, FILED 2-24-2006.

SHANNON TWOHIG, EXAMINING ATTORNEY

Int. Cls.: 39 and 43

Prior U.S. Cls.: 100, 101, and 105

United States Patent and Trademark Office

Reg. No. 3,486,359

Registered Aug. 12, 2008

**SERVICE MARK
PRINCIPAL REGISTER**



I-TO-I INTERNATIONAL PROJECTS LIMITED
(UNITED KINGDOM LIMITED COMPANY)
WOODSIDE HOUSE, 261 LOW LANE
LEEDS, WEST YORKSHIRE, UNITED KINGDOM
LS18 5NY

FOR: ARRANGING OF TRAVEL; ARRANGING
OF WORKING HOLIDAYS AND WORKING
TOURS; ARRANGING OF HOLIDAY TOURS , IN
CLASS 39 (U.S. CLS. 100 AND 105).

FIRST USE 4-30-2003; IN COMMERCE 4-30-2003.

FOR: ACCOMMODATION SERVICES, NAMELY,
ARRANGING, BOOKING AND RESERVATION OF
ACCOMMODATION; HOTEL SERVICES; HOLIDAY
ACCOMMODATION SERVICES, NAMELY, BOOK-
ING AND RESERVATION OF ACCOMMODATION

WORLDWIDE; CATERING SERVICES; CAFETERIA
SERVICES; FOOD TAKEAWAY SERVICES; PRE-
PARATION OF FOOD, MEALS AND BEVERAGES
FOR THE CONSUMPTION ON OR OFF THE PRE-
MISES; PROVISION OF FOOD AND DRINK FOR
GUESTS, IN CLASS 43 (U.S. CLS. 100 AND 101).

FIRST USE 4-30-2003; IN COMMERCE 4-30-2003.

OWNER OF U.S. REG. NO. 2,916,672.

THE MARK CONSISTS OF A STYLIZED HAND
LOGO AND THE LETTERS "I-TO-I".

SN 78-823,084, FILED 2-24-2006.

SHANNON TWOHIG, EXAMINING ATTORNEY

Int. Cl.: 43

Prior U.S. Cls.: 100 and 101

United States Patent and Trademark Office

Reg. No. 3,486,360

Registered Aug. 12, 2008

**SERVICE MARK
PRINCIPAL REGISTER**



PICK UP STIX, INC. (CALIFORNIA CORPORATION)
1330 CALLE AVANZADO
SAN CLEMENTE, CA 92673

FOR: RESTAURANT SERVICES, TAKE-OUT FOOD SERVICES, AND CATERING SERVICES, IN CLASS 43 (U.S. CLS. 100 AND 101).

FIRST USE 1-1-2006; IN COMMERCE 1-1-2006.

OWNER OF U.S. REG. NOS. 1,719,646, 3,001,120, AND OTHERS.

NO CLAIM IS MADE TO THE EXCLUSIVE RIGHT TO USE "FRESH ASIAN FLAVORS", APART FROM THE MARK AS SHOWN.

THE MARK CONSISTS OF A TAKE-OUT FOOD PACKAGE/BOX WITH CHOPSTICKS IN A CIRCLE AND STYLIZED LETTERING.

SN 78-823,123, FILED 2-24-2006.

MARY CRAWFORD, EXAMINING ATTORNEY

Int. Cl.: 20

Prior U.S. Cls.: 2, 13, 22, 25, 32, and 50

Reg. No. 3,486,361

United States Patent and Trademark Office

Registered Aug. 12, 2008

**TRADEMARK
PRINCIPAL REGISTER**

STRIKING LINE

BRUNSWICK BOWLING & BILLIARDS COR-
PORATION (DELAWARE CORPORATION)
1 N. FIELD COURT
LAKE FOREST, IL 60045

FOR: FURNITURE, NAMELY, COUCHES, OTTO-
MANS, MODULAR WALL UNITS, COFFEE AND
SOFA TABLES AND BAR CHAIRS, IN CLASS 20
(U.S. CLS. 2, 13, 22, 25, 32 AND 50).

FIRST USE 7-21-2005; IN COMMERCE 7-21-2005.

THE MARK CONSISTS OF STANDARD CHAR-
ACTERS WITHOUT CLAIM TO ANY PARTICULAR
FONT, STYLE, SIZE, OR COLOR.

NO CLAIM IS MADE TO THE EXCLUSIVE
RIGHT TO USE "LINE", APART FROM THE MARK
AS SHOWN.

SN 78-824,161, FILED 2-27-2006.

AMY ALFIERI, EXAMINING ATTORNEY

Int. Cl.: 5

Prior U.S. Cls.: 6, 18, 44, 46, 51, and 52

United States Patent and Trademark Office

Reg. No. 3,486,362

Registered Aug. 12, 2008

**TRADEMARK
PRINCIPAL REGISTER**

BLINK GELTEARS

ADVANCED MEDICAL OPTICS, INC. (DELA-
WARE CORPORATION)

SA-3D

1700 E. ST. ANDREW PLACE, P.O. BOX 25162
SANTA ANA, CA 927995162

FOR: OPHTHALMIC FORMULATIONS, EYE
CARE TREATMENTS AND PREPARATIONS,
NAMELY, EYE DROPS; OPHTHALMIC LUBRI-
CANT EYEDROPS; CONTACT LENS CARE PRE-
PARATIONS, NAMELY, SOLUTIONS AND
TABLETS FOR DISINFECTING, CLEANING, WET-
TING, CUSHIONING, SOAKING, STORING AND/
OR RINSING CONTACT LENSES AND EYEDROPS
AND FOR THE TREATMENT OF DRY EYE AND
OCULAR IRRITATION, IN CLASS 5 (U.S. CLS. 6, 18,
44, 46, 51 AND 52).

FIRST USE 4-25-2008; IN COMMERCE 4-25-2008.

THE MARK CONSISTS OF STANDARD CHAR-
ACTERS WITHOUT CLAIM TO ANY PARTICULAR
FONT, STYLE, SIZE, OR COLOR.

OWNER OF U.S. REG. NOS. 1,613,501 AND
3,272,572.

NO CLAIM IS MADE TO THE EXCLUSIVE
RIGHT TO USE "GELTEARS", APART FROM THE
MARK AS SHOWN.

SN 78-824,375, FILED 2-27-2006.

ESTHER BELENKER, EXAMINING ATTORNEY

Int. Cls.: 35, 39, and 43

Prior U.S. Cls.: 100, 101, 102, and 105

United States Patent and Trademark Office

Reg. No. 3,486,363

Registered Aug. 12, 2008

**SERVICE MARK
PRINCIPAL REGISTER**

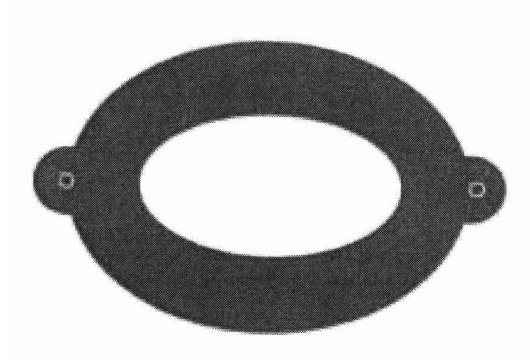

BOSTON MARKET CORPORATION (DELA-
WARE CORPORATION)
14103 DENVER WEST PARKWAY
GOLDEN, CO 80401

FOR: FOOD KIOSK SERVICES, IN CLASS 35 (U.S.
CLS. 100, 101 AND 102).

FIRST USE 4-1-2005; IN COMMERCE 4-1-2005.

FOR: FOOD DELIVERY SERVICES, IN CLASS 39
(U.S. CLS. 100 AND 105).

FIRST USE 3-1-2006; IN COMMERCE 3-1-2006.

FOR: RESTAURANT SERVICES, CARRY OUT
RESTAURANT SERVICES AND CATERING SERVI-
CES, IN CLASS 43 (U.S. CLS. 100 AND 101).

FIRST USE 3-0-2006; IN COMMERCE 3-0-2006.

SN 78-825,026, FILED 2-28-2006.

JEFF DEFORD, EXAMINING ATTORNEY

Int. Cls.: 9 and 42

Prior U.S. Cls.: 21, 23, 26, 36, 38, 100, and 101

United States Patent and Trademark Office

Reg. No. 3,486,364

Registered Aug. 12, 2008

**TRADEMARK
SERVICE MARK
PRINCIPAL REGISTER**

ORIGAMI

INDUSTRIAL ORIGAMI, INC. (DELAWARE CORPORATION)
487 BRYANT STREET
SAN FRANCISCO, CA 94107

FOR: COMPUTER SOFTWARE AND COMPUTER AIDED DESIGN SOFTWARE FOR USE IN THE PERFORATION, CUTTING AND FOLDING OF METALS, PLASTICS AND LAMINATES, IN CLASS 9 (U.S. CLS. 21, 23, 26, 36 AND 38).

FIRST USE 11-0-2004; IN COMMERCE 11-0-2004.

FOR: ENGINEERING; CONSULTATION IN THE FIELD OF INDUSTRIAL DESIGN AND COMPUTER

AIDED DESIGN; LICENSING OF INTELLECTUAL PROPERTY, IN CLASS 42 (U.S. CLS. 100 AND 101).

FIRST USE 2-0-2006; IN COMMERCE 2-0-2006.

THE MARK CONSISTS OF STANDARD CHARACTERS WITHOUT CLAIM TO ANY PARTICULAR FONT, STYLE, SIZE, OR COLOR.

OWNER OF U.S. REG. NO. 3,042,574.

SN 78-825,277, FILED 2-28-2006.

SONYA STEPHENS, EXAMINING ATTORNEY

Int. Cl.: 43

Prior U.S. Cls.: 100 and 101

United States Patent and Trademark Office

Reg. No. 3,486,365

Registered Aug. 12, 2008

**SERVICE MARK
PRINCIPAL REGISTER**

PICK UP STIX
FRESH ASIAN FLAVORS

PICK UP STIX, INC. (CALIFORNIA CORPORATION)
1330 CALLE AVANZADO
SAN CLEMENTE, CA 92673

FOR: RESTAURANT SERVICES, TAKE-OUT
FOOD SERVICES, AND CATERING SERVICES, IN
CLASS 43 (U.S. CLS. 100 AND 101).

FIRST USE 2-1-2006; IN COMMERCE 11-7-2006.

OWNER OF U.S. REG. NOS. 1,719,646, 3,001,120,
AND OTHERS.

NO CLAIM IS MADE TO THE EXCLUSIVE
RIGHT TO USE "FRESH ASIAN FLAVORS", APART
FROM THE MARK AS SHOWN.

SN 78-825,463, FILED 2-28-2006.

MARY CRAWFORD, EXAMINING ATTORNEY

Int. Cl.: 9

Prior U.S. Cls.: 21, 23, 26, 36, and 38

United States Patent and Trademark Office

Reg. No. 3,486,366

Registered Aug. 12, 2008

**TRADEMARK
PRINCIPAL REGISTER**

CUECARD

GROUP DCA (NEW JERSEY CORPORATION)
98 PARK STREET
MONTCLAIR, NJ 07042

FOR: CD ROM DISKS FEATURING INFORMATION ABOUT PHARMACEUTICAL PRODUCTS SOLD TO THE HEALTHCARE INDUSTRY FOR USE IN MARKETING PHARMACEUTICAL PRODUCTS, IN CLASS 9 (U.S. CLS. 21, 23, 26, 36 AND 38).

FIRST USE 7-0-2006; IN COMMERCE 7-0-2006.

THE MARK CONSISTS OF STANDARD CHARACTERS WITHOUT CLAIM TO ANY PARTICULAR FONT, STYLE, SIZE, OR COLOR.

SN 78-826,562, FILED 3-1-2006.

SHARON MEIER, EXAMINING ATTORNEY

Int. Cl.: 41

Prior U.S. Cls.: 100, 101, and 107

United States Patent and Trademark Office

Reg. No. 3,486,367

Registered Aug. 12, 2008

**SERVICE MARK
PRINCIPAL REGISTER**



ATLANTA FIGHT CLUBS, LLC (GEORGIA CORPORATION)
5959 ROSWELL ROAD
ATLANTA, GA 30342

FOR: PROVIDING FITNESS AND HEALTH CLUB SERVICES AND FACILITIES; PROVIDING GROUP, PERSONAL AND PROFESSIONAL FITNESS TRAINING IN THE AREAS OF MIXED MARTIAL ARTS, KICKBOXING, MUAY THAI, JIU JITSU, AND WRESTLING; ORGANIZING AND CONDUCTING CONTESTS, DEMONSTRATIONS AND OTHER PUBLIC EVENTS THAT FEATURE MIXED MARTIAL ARTS, KICKBOXING, MUAY THAI, JIU JITSU, AND WRESTLING, IN CLASS 41 (U.S. CLS. 100, 101 AND 107).

FIRST USE 9-15-2005; IN COMMERCE 9-15-2005.

THE COLOR(S) RED, BLACK AND WHITE IS/ARE CLAIMED AS A FEATURE OF THE MARK.

THE COLOR RED APPEARS IN THE KNUCKLES OF THE GLOVES AND AS THE COLOR OF THE ADJACENT LETTERS "UP" IN THE WORD "KNUCKLEUP". THE COLOR BLACK APPEARS IN THE FINGERTIPS AND THUMBS OF THE GLOVES, AS THE OUTLINE OF THE WORD "KNUCKLEUP" AND AS THE COLOR OF THE DOMAIN NAME "KNUCKLEUPFITNESS.COM". THE COLOR WHITE APPEARS AS THE COLOR OF THE ADJACENT LETTERS "KNUCKLE" IN THE WORD "KNUCKLEUP".

SN 78-826,613, FILED 3-1-2006.

DAVID H. STINE, EXAMINING ATTORNEY

Int. Cl.: 5

Prior U.S. Cls.: 6, 18, 44, 46, 51, and 52

Reg. No. 3,486,368

United States Patent and Trademark Office

Registered Aug. 12, 2008

**TRADEMARK
PRINCIPAL REGISTER**

CARAPASTE

MCGRATH, PATRICK D. (UNITED STATES IN-
DIVIDUAL)
1471 GREYSTONE DRIVE
GURNEE, IL 60031

THE MARK CONSISTS OF STANDARD CHAR-
ACTERS WITHOUT CLAIM TO ANY PARTICULAR
FONT, STYLE, SIZE, OR COLOR.

FOR: WOUND DRESSINGS, IN CLASS 5 (U.S. CLS.
6, 18, 44, 46, 51 AND 52).

SN 78-828,094, FILED 3-2-2006.

FIRST USE 7-9-2007; IN COMMERCE 2-15-2008.

MATTHEW PAPPAS, EXAMINING ATTORNEY

Int. Cls.: 9 and 25

Prior U.S. Cls.: 21, 22, 23, 26, 36, 38, and 39

United States Patent and Trademark Office

Reg. No. 3,486,369

Registered Aug. 12, 2008

**TRADEMARK
PRINCIPAL REGISTER**

VoodooScrew

HAMERNIK, SERGIO (UNITED STATES INDIVIDUAL)
SUITE 201
1650 LUCERNE C/O SULLIVAN LAW OFFICES
MINDEN, NV 89423

FOR: HIGH-END AUDIO TRANSFORMERS, IN CLASS 9 (U.S. CLS. 21, 23, 26, 36 AND 38).

FIRST USE 2-1-2005; IN COMMERCE 3-14-2005.

FOR: APPAREL, NAMELY, SHIRTS, JACKETS, CAPS AND HATS, IN CLASS 25 (U.S. CLS. 22 AND 39).

FIRST USE 2-1-2005; IN COMMERCE 3-14-2005.

THE MARK CONSISTS OF STANDARD CHARACTERS WITHOUT CLAIM TO ANY PARTICULAR FONT, STYLE, SIZE, OR COLOR.

SN 78-830,372, FILED 3-6-2006.

ROBERT STRUCK, EXAMINING ATTORNEY

Int. Cls.: 9 and 25

Prior U.S. Cls.: 21, 22, 23, 26, 36, 38, and 39

United States Patent and Trademark Office

Reg. No. 3,486,370

Registered Aug. 12, 2008

**TRADEMARK
PRINCIPAL REGISTER**

ToneClone

HAMERNIK, SERGIO (UNITED STATES INDIVIDUAL)
SUITE 201
1650 LUCERNE C/O SULLIVAN LAW OFFICES
MINDEN, NV 89423

FOR: HIGH-END AUDIO TRANSFORMERS, IN CLASS 9 (U.S. CLS. 21, 23, 26, 36 AND 38).

FIRST USE 1-25-2000; IN COMMERCE 3-14-2005.

FOR: APPAREL, NAMELY, SHIRTS, JACKETS, HATS AND CAPS, IN CLASS 25 (U.S. CLS. 22 AND 39).

FIRST USE 1-25-2000; IN COMMERCE 3-14-2005.

THE MARK CONSISTS OF STANDARD CHARACTERS WITHOUT CLAIM TO ANY PARTICULAR FONT, STYLE, SIZE, OR COLOR.

SN 78-830,397, FILED 3-6-2006.

ROBERT STRUCK, EXAMINING ATTORNEY

Int. Cl.: 35

Prior U.S. Cls.: 100, 101, and 102

United States Patent and Trademark Office

Reg. No. 3,486,371

Registered Aug. 12, 2008

**SERVICE MARK
PRINCIPAL REGISTER**

Poison Dagger

BACIGALUPO, CINDY (UNITED STATES INDIVIDUAL)
125 NANTUCKET LANE
ALISO VIEJO, CA 92656

FOR: RETAIL STORE FEATURING CLOTHING, SHOES, PURSES, HANDBAGS, JEWELRY, AND HOME DECOR, NAMELY, KITCHENWARE AND HOME DECORATIONS, IN CLASS 35 (U.S. CLS. 100, 101 AND 102).

FIRST USE 6-2-2006; IN COMMERCE 6-2-2006.

THE MARK CONSISTS OF STANDARD CHARACTERS WITHOUT CLAIM TO ANY PARTICULAR FONT, STYLE, SIZE, OR COLOR.

SN 78-830,505, FILED 3-6-2006.

MATTHEW PAPPAS, EXAMINING ATTORNEY

Int. Cls.: 12, 22, and 27

Prior U.S. Cls.: 1, 2, 7, 19, 20, 21, 22, 23, 31, 35, 37, 42, 44, and 50

Reg. No. 3,486,372

United States Patent and Trademark Office

Registered Aug. 12, 2008

**TRADEMARK
PRINCIPAL REGISTER**



UNITED AUTO PRODUCTS, INC. (TEXAS CORPORATION)
9630 CLARAWOOD DR., STE D-02
HOUSTON, TX 77036

FIRST USE 5-0-2006; IN COMMERCE 10-14-2006.

FOR: VEHICLE PARTS, NAMELY, SEMI-FITTED COVER FOR VEHICLES, FITTED COVERS FOR AUTOMOBILES AND MOTORCYCLES, FITTED AND SEMI-FITTED PERSONAL JET BOAT COVERS, AND FITTED AND SEMI-FITTED BOAT COVERS, IN CLASS 12 (U.S. CLS. 19, 21, 23, 31, 35 AND 44).

THE COLOR(S) RED, WHITE AND BLUE IS/ARE CLAIMED AS A FEATURE OF THE MARK.

FIRST USE 4-5-2006; IN COMMERCE 4-5-2006.

FOR: UNFITTED VEHICLE COVERS, UNFITTED CAR COVERS, UNFITTED BOAT COVERS, UNFITTED PERSONAL JET BOAT COVERS, AWNINGS, AWNINGS OF FABRIC, AND PROTECTIVE LINERS FOR THE CARGO AREA OF VEHICLES, IN CLASS 22 (U.S. CLS. 1, 2, 7, 19, 22, 42 AND 50).

THE MARK CONSISTS OF STYLIZED LETTERS "UAUTO" WHEREIN THE LETTER "U", THE LARGER PORTION OF THE LETTER "A", THE LINE DISSECTING THE INITIAL CIRCLE DESIGN AND THE STAR DESIGN ARE PRESENTED IN THE COLOR WHITE; THE SMALLER PORTION OF THE LETTER "A", THE LETTERS "UTO" AND THE RIGHT-SIDE PORTION OF THE INITIAL CIRCLE DESIGN ARE PRESENTED IN THE COLOR RED; AND LEFT-SIDE PORTION OF THE INITIAL CIRCLE DESIGN IS PRESENTED IN THE COLOR BLUE.

FIRST USE 2-0-2006; IN COMMERCE 4-5-2006.

FOR: CARPETS FOR AUTOMOBILES, AND FLOOR MATS FOR VEHICLES, IN CLASS 27 (U.S. CLS. 19, 20, 37, 42 AND 50).

SN 78-831,154, FILED 3-7-2006.

VERNA BETH RIRIE, EXAMINING ATTORNEY

Int. Cl.: 25

Prior U.S. Cls.: 22 and 39

United States Patent and Trademark Office

Reg. No. 3,486,373

Registered Aug. 12, 2008

TRADEMARK
PRINCIPAL REGISTER



SPORTIQE, LLC (ARIZONA LTD LIAB CO)
1575 W. UNIVERSITY DR., SUITE 107
TEMPE, AZ 85281

FOR: CAPS; GOLF SHIRTS; HATS; HEADWEAR;
JACKETS; KNIT SHIRTS; POLO SHIRTS; PULL-
OVERS; SHORT-SLEEVED OR LONG-SLEEVED T-
SHIRTS; SHORT-SLEEVED SHIRTS; SPORT SHIRTS;
SWEAT SHIRTS; SWEATERS; T-SHIRTS, IN CLASS
25 (U.S. CLS. 22 AND 39).

FIRST USE 11-30-2007; IN COMMERCE 11-30-2007.

NO CLAIM IS MADE TO THE EXCLUSIVE
RIGHT TO USE "APPAREL CO.", APART FROM
THE MARK AS SHOWN.

THE COLOR(S) RED AND WHITE IS/ARE
CLAIMED AS A FEATURE OF THE MARK.

THE MARK CONSISTS OF AN IMAGE OF A
BUFFALO AND THREE STARS CONTAINED
WITHIN A CIRCLE, AND THE WORDS "SPORTIQE
APPAREL CO. REINVENTING THE CLASSICS" IN-
SIDE THE CIRCLE. THE COLOR WHITE APPEARS
AS BACKGROUND IN THE MARK. THE COLOR
RED APPEARS IN THE ELEMENTS OF THE MARK,
NAMELY THE WORDS "SPORTIQE APPAREL CO.",
THE WORDS "REINVENTING THE CLASSICS",
THE IMAGE OF THE BUFFALO, THE THREE
STARS INSIDE THE CIRCLE AND THE OUTLINE
OF THE CIRCLE.

SN 78-832,087, FILED 3-8-2006.

DAWN FELDMAN, EXAMINING ATTORNEY

Int. Cl.: 28

Prior U.S. Cls.: 22, 23, 38, and 50

United States Patent and Trademark Office

Reg. No. 3,486,374

Registered Aug. 12, 2008

**TRADEMARK
PRINCIPAL REGISTER**

Full House

FULL HOUSE BRANDS LLC (OHIO LTD LIAB
CO)
5147 KENNEDY AVE
CINCINNATI, OH 45213

FOR: PLAYING CARDS, POKER CHIPS; AND
RELATED POKER AND GAMING SUPPLIES,
NAMELY, EQUIPMENT SOLD AS A UNIT FOR
PLAYING CARD GAMES, IN CLASS 28 (U.S. CLS. 22,
23, 38 AND 50).

FIRST USE 10-1-2007; IN COMMERCE 10-1-2007.

THE MARK CONSISTS OF STANDARD CHAR-
ACTERS WITHOUT CLAIM TO ANY PARTICULAR
FONT, STYLE, SIZE, OR COLOR.

SN 78-832,135, FILED 3-8-2006.

MARCIE MILONE, EXAMINING ATTORNEY

Int. Cl.: 42

Prior U.S. Cls.: 100 and 101

United States Patent and Trademark Office

Reg. No. 3,486,375

Registered Aug. 12, 2008

**SERVICE MARK
PRINCIPAL REGISTER**



NATIONWIDE TITLE CLEARING, INC (FLORIDA CORPORATION)

2100 ALTERNATE US 19 NORTH

PALM HARBOR, FL 34683

FOR: PUBLIC DOCUMENT RETRIEVAL, IN CLASS 42 (U.S. CLS. 100 AND 101).

FIRST USE 3-17-2006; IN COMMERCE 3-17-2006.

NO CLAIM IS MADE TO THE EXCLUSIVE RIGHT TO USE "EXPRESS RETRIEVAL", APART FROM THE MARK AS SHOWN.

THE MARK CONSISTS OF THE WORDS "EXPRESS RETRIEVAL" WITH A HUMANOID STICK FIGURE AND A DOCUMENT.

SN 78-834,267, FILED 3-10-2006.

LESLEY LAMOTHE, EXAMINING ATTORNEY

Int. Cl.: 7

Prior U.S. Cls.: 13, 19, 21, 23, 31, 34, and 35

Reg. No. 3,486,376

United States Patent and Trademark Office

Registered Aug. 12, 2008

**TRADEMARK
PRINCIPAL REGISTER**



SAMANA MEM, LLC (DELAWARE LTD LIAB
CO)
1390 S. DIXIE HWY, STE 2113
CORAL GABLES, FL 33146

FOR: RADIATORS FOR VEHICLES; VEHICLE
ENGINE PARTS, NAMELY, OIL COOLERS, HEA-
TER CORES, AND CONDENSERS, IN CLASS 7 (U.S.
CLS. 13, 19, 21, 23, 31, 34 AND 35).

THE MARK CONSISTS OF STYLIZED LETTERS
SPELLING "TECHRAD" CENTERED UNDER A
GRAPHIC DESIGN CONSISTING OF A SPHERE
POSITIONED BENEATH TWO INTERSECTING
SWOOSHES.

SN 78-836,005, FILED 3-13-2006.

FIRST USE 11-14-2007; IN COMMERCE 11-14-2007.

SHANNON TWOHIG, EXAMINING ATTORNEY

Int. Cls.: 7 and 9

Prior U.S. Cls.: 13, 19, 21, 23, 26, 31, 34, 35, 36, and 38

United States Patent and Trademark Office

Reg. No. 3,486,377

Registered Aug. 12, 2008

**TRADEMARK
PRINCIPAL REGISTER**

PERFECTPOSITION

COLE-PARMER INSTRUMENT COMPANY (IL-
LINOIS CORPORATION)
28W092 COMMERCIAL AVENUE
BARRINGTON, IL 60010

FOR: ELECTRIC, PNEUMATIC, AND PERISTAL-
TIC PUMPS AND TUBING THEREFOR FOR IN-
DUSTRIAL USE, IN CLASS 7 (U.S. CLS. 13, 19, 21, 23,
31, 34 AND 35).

FIRST USE 10-0-2006; IN COMMERCE 10-0-2006.

FOR: ELECTRIC, PNEUMATIC, PERISTALTIC,
AND METERING PUMPS AND TUBING THERE-

FOR FOR LABORATORY USE; METERING PUMPS
AND TUBING THEREFOR FOR INDUSTRIAL USE,
IN CLASS 9 (U.S. CLS. 21, 23, 26, 36 AND 38).

FIRST USE 10-0-2006; IN COMMERCE 10-0-2006.

THE MARK CONSISTS OF STANDARD CHAR-
ACTERS WITHOUT CLAIM TO ANY PARTICULAR
FONT, STYLE, SIZE, OR COLOR.

SN 78-836,735, FILED 3-14-2006.

ROBERT STRUCK, EXAMINING ATTORNEY

Int. Cl.: 9

Prior U.S. Cls.: 21, 23, 26, 36, and 38

United States Patent and Trademark Office

Reg. No. 3,486,378

Registered Aug. 12, 2008

**TRADEMARK
PRINCIPAL REGISTER**

GAME POINT

VIVA OPTIQUE, INC. (NEW JERSEY CORPORATION)
3140 ROUTE 22 WEST
SOMERVILLE, NJ 08876

FOR: EYEGASSES AND SUNGLASSES;
FRAMES FOR EYEGASSES AND SUNGLASSES;
LENSES AND CASES FOR EYEGASSES AND
SUNGLASSES; COMPONENT PARTS FOR EYE-
GLASSES AND SUNGLASSES, IN CLASS 9 (U.S.
CLS. 21, 23, 26, 36 AND 38).

FIRST USE 7-30-2006; IN COMMERCE 7-30-2006.

THE MARK CONSISTS OF STANDARD CHAR-
ACTERS WITHOUT CLAIM TO ANY PARTICULAR
FONT, STYLE, SIZE, OR COLOR.

SN 78-842,601, FILED 3-21-2006.

GINA HAYES, EXAMINING ATTORNEY

Int. Cl.: 24

Prior U.S. Cls.: 42 and 50

United States Patent and Trademark Office

Reg. No. 3,486,379

Registered Aug. 12, 2008

**TRADEMARK
PRINCIPAL REGISTER**

EAVEX

JANSPORT APPAREL CORP. (DELAWARE CORPORATION)
3411 SILVERSIDE ROAD
WILMINGTON, DE 19810

FOR: FABRIC FOR USE IN THE MANUFACTURE OF ALL PURPOSE SPORTING BAGS, ALL PURPOSE CARRYING BAGS, SOFT LUGGAGE, LUGGAGE CASES, BACKPACKS, DAYPACKS, FANNY PACKS, FRAME BACKPACKS, KNAPSACKS, BOOK BAGS FOR TRAVELING, TOTE BAGS, DUFFEL BAGS, HANDBAGS, GARMENT

BAGS FOR TRAVELING, CLOTHING BAGS FOR TRAVELING, IN CLASS 24 (U.S. CLS. 42 AND 50).

FIRST USE 6-22-2007; IN COMMERCE 6-22-2007.

THE MARK CONSISTS OF STANDARD CHARACTERS WITHOUT CLAIM TO ANY PARTICULAR FONT, STYLE, SIZE, OR COLOR.

SN 78-843,938, FILED 3-23-2006.

LINDA ORNDORFF, EXAMINING ATTORNEY

Int. Cl.: 30

Prior U.S. Cl.: 46

United States Patent and Trademark Office

Reg. No. 3,486,380

Registered Aug. 12, 2008

TRADEMARK
PRINCIPAL REGISTER



UNI-PAK FUNDRAISING SUPPLY & DISTRIBUTION LLC (WISCONSIN LTD LIAB CO)
6940 INDUSTRIAL LOOP
GREENDALE, WI 53129

FOR: PIZZA, IN CLASS 30 (U.S. CL. 46).

FIRST USE 11-15-2007; IN COMMERCE 11-15-2007.

NO CLAIM IS MADE TO THE EXCLUSIVE RIGHT TO USE "MICROWAVEABLE" AND "FRENCH BREAD PIZZA", APART FROM THE MARK AS SHOWN.

THE COLOR(S) GREEN, WHITE AND RED IS/ARE CLAIMED AS A FEATURE OF THE MARK.

THE MARK CONSISTS OF THE WORDING, "MICROWAVEABLE ZIA'S FRENCH BREAD PIZZA". "MICROWAVEABLE" IS IN GREEN LETTERS AT THE TOP RIGHT OF THE MARK WITH FIVE

GREEN SQUIGGLY LINES ON EACH SIDE OF "MICROWAVEABLE". "ZIA'S" IS IN GREEN LETTERS WITH A WHITE BORDER ENCASING THE GREEN LETTERS AND A RED BORDER ENCASING THE WHITE BORDERING. "FRENCH BREAD PIZZA" IS IN RED LETTERS WITH A WHITE BORDER ENCASING THE RED LETTERS AND A GREEN BORDER ENCASING THE WHITE BORDERING. AT THE BOTTOM OF THE MARK IS A BAR SECTIONED INTO THREE PARTS, WITH THE LEFT THE COLOR OF GREEN, THE MIDDLE THE COLOR OF WHITE, AND THE RIGHT THE COLOR OF RED.

THE FOREIGN WORDING IN THE MARK TRANSLATES INTO ENGLISH AS AUNT.

SN 78-845,115, FILED 3-24-2006.

CHARISMA HAMPTON, EXAMINING ATTORNEY

Int. Cl.: 41

Prior U.S. Cls.: 100, 101, and 107

United States Patent and Trademark Office

Reg. No. 3,486,381

Registered Aug. 12, 2008

**SERVICE MARK
PRINCIPAL REGISTER**

PREPARE BEAR

DELOSSO, MARTHA (UNITED STATES INDIVIDUAL)
425 WEST THIRD AVENUE
RUNNEMEDE, NJ 08078

THE MARK CONSISTS OF STANDARD CHARACTERS WITHOUT CLAIM TO ANY PARTICULAR FONT, STYLE, SIZE, OR COLOR.

FOR: CONDUCTING WORKSHOPS AND SEMINARS IN THE FIELD OF EMERGENCY PREPAREDNESS, IN CLASS 41 (U.S. CLS. 100, 101 AND 107).

SN 78-846,863, FILED 3-27-2006.

FIRST USE 6-29-2008; IN COMMERCE 6-29-2008.

LINDA LAVACHE, EXAMINING ATTORNEY

Int. Cl.: 17

Prior U.S. Cls.: 1, 5, 12, 13, 35, and 50

Reg. No. 3,486,382

United States Patent and Trademark Office

Registered Aug. 12, 2008

TRADEMARK
PRINCIPAL REGISTER



OPTIMUM INTERNATIONAL (H.K.) LIMITED
(HONG KONG LTD LIAB CO)
ROOM V, 1/F, VALIANT INDUSTRIAL CENTRE
2-12 AU PUI WAN STREET, FO TAN, SHATIN
NEW TERRITORIES, HONG KONG

FOR: RUBBER RAW OR SEMI-WORKED; NATURAL RUBBER; SYNTHETIC RUBBER; ACRYLIC RUBBER; CHLORINATED RUBBER; CRUDE RUBBER; ELECTRICAL INSULATING RUBBER PRODUCTS; FLUORO RUBBER; FOAM RUBBER; HYDROCHLORINATED RUBBER; ISOBUTYLENE-ISOPRENE RUBBER; NITRILE RUBBER; POLYSULFIDE RUBBER; RECLAIMED RUBBER; RUBBER DERIVATIVES; SILICONE RUBBER; NEOPRENE, NEOPRENE SHEETS AND LAMINATED NEOPRENE SHEETS FOR FURTHER USE IN INDUSTRIAL MANUFACTURE; SEALING PLUGS MADE PRIMARILY FROM RUBBER; STUFFING OF RUBBER; NON-METAL GASKETS FOR USE IN AUTOMOBILES, MACHINES AND TOYS; WASHERS OF RUBBER OR VULCANIZED FIBER; PLASTIC IN BARS, BLOCKS, PELLETS, RODS, SHEETS AND TUBES FOR GENERAL INDUSTRIAL USE;

PLASTIC IN EXTRUDED FORM FOR GENERAL INDUSTRIAL USE; PLASTICS IN THE FORM OF SHEETS, FILMS, BLOCKS, RODS AND TUBES; SYNTHETIC PLASTIC AS SEMI-FINISHED PRODUCTS IN FORM OF FOILS, PLATES, RODS, PROFILES, HOSES, TUBES, BLOCKS; STUFFING OF PLASTIC, IN CLASS 17 (U.S. CLS. 1, 5, 12, 13, 35 AND 50).

FIRST USE 4-1-2006; IN COMMERCE 5-5-2006.

NO CLAIM IS MADE TO THE EXCLUSIVE RIGHT TO USE "GROUP" , APART FROM THE MARK AS SHOWN.

THE MARK CONSISTS OF AN OVAL ENCLOSING THE WORD "OPTIMUM" WITH THE LETTER THE "I" STYLIZED TO THE SHAPE OF WAVES, AND THE WORD "GROUP" OUTSIDE THE OVAL.

SN 78-847,365, FILED 3-27-2006.

GINA HAYES, EXAMINING ATTORNEY

Int. Cl.: 11

Prior U.S. Cls.: 13, 21, 23, 31, and 34

Reg. No. 3,486,383

United States Patent and Trademark Office

Registered Aug. 12, 2008

**TRADEMARK
PRINCIPAL REGISTER**

PO

TOTO USA, INC. (DELAWARE CORPORATION)
1150 SOUTHERN ROAD
MORROW, GA 30260

THE MARK CONSISTS OF STANDARD CHAR-
ACTERS WITHOUT CLAIM TO ANY PARTICULAR
FONT, STYLE, SIZE, OR COLOR.

FOR: PLUMBING FIXTURES, NAMELY, TOI-
LETS, BIDETS, BATHTUBS, SHOWERS, SINKS,
FAUCETS, IN CLASS 11 (U.S. CLS. 13, 21, 23, 31
AND 34).

SN 78-849,292, FILED 3-29-2006.

FIRST USE 3-5-2008; IN COMMERCE 3-5-2008.

SHARON MEIER, EXAMINING ATTORNEY

Int. Cl.: 9

Prior U.S. Cls.: 21, 23, 26, 36, and 38

Reg. No. 3,486,384

United States Patent and Trademark Office

Registered Aug. 12, 2008

**TRADEMARK
PRINCIPAL REGISTER**



SPECTRUM K12 SCHOOL SOLUTIONS, INC.
(DELAWARE CORPORATION)
901 DULANEY VALLEY ROAD, SUITE 800
TOWSON, MD 21204

FIRST USE 4-0-2006; IN COMMERCE 4-0-2006.

FOR: SOFTWARE FOR TRACKING AND MONITORING COMPLIANCE WITH EDUCATIONAL AND EDUCATION RELATED REQUIREMENTS, AND FOR TRACKING AND MONITORING EDUCATIONAL AND EDUCATION RELATED SERVICES PROVIDED TO STUDENTS, IN CLASS 9 (U.S. CLS. 21, 23, 26, 36 AND 38).

NO CLAIM IS MADE TO THE EXCLUSIVE RIGHT TO USE "K12 SCHOOL", APART FROM THE MARK AS SHOWN.

SN 78-850,304, FILED 3-30-2006.

BARNEY CHARLON, EXAMINING ATTORNEY

Int. Cl.: 9

Prior U.S. Cls.: 21, 23, 26, 36, and 38

Reg. No. 3,486,385

United States Patent and Trademark Office

Registered Aug. 12, 2008

**TRADEMARK
PRINCIPAL REGISTER**

ZIGBEE

ZIGBEE ALLIANCE (CALIFORNIA CORPORATION)
2400 CAMINO RAMON, SUITE 375
SAN RAMON, CA 94583

FOR: ELECTRONIC AND COMPUTER DEVICES ENABLED FOR WIRELESS COMMUNICATION, NAMELY, COMPUTERS; COMPUTER MICE; VIDEO CONFERENCE EQUIPMENT, NAMELY, VIDEO MONITORS, MICROPHONES, AUDIO SPEAKERS, AND CAMERAS; REMOTE CONTROLS FOR RADIOS, TELEVISIONS, STEREOs, LIGHTS, VIDEO CASSETTE RECORDERS, DVD MACHINES, AND ELECTRONIC DOOR OPENERS; COMPONENTS TOGETHER WITH ACCESSORIES AND PARTS IN THE CONSUMER ELECTRONICS AREA, NAMELY, TELEVISIONS, RADIOS, STEREOs, PERSONAL DIGITAL ASSISTANTS, VIDEO CASSETTE RECORDERS, DVD MACHINES AND REMOTE CONTROLS FOR THE AFOREMENTIONED ITEMS; VIDEO GAMING EQUIPMENT, NAMELY, JOYSTICKS, INTERACTIVE REMOTE CONTROL UNITS, VIDEO GAME MACHINES FOR USE WITH TELEVISIONS AND COMPUTERS, AND MONITORS; ANTI-INTRUSION SECURITY SYSTEMS COMPRISED OF SECURITY ALARMS, ANTI-INTRUSION ALARMS, INTRUSION DETECTORS, PERSONAL SECURITY ALARMS, AND ELECTRONIC MOTION SENSITIVE SWITCHES; ELECTRICAL AND HEATING SYSTEMS COMPRISED OF CONTROLLERS, THERMOSTATS, AND ELECTRICAL RESISTANCE HEATING WIRES; GLASS BREAKAGE MONITORING SENSORS; WIRELESS KEYPADS; CHILD MONITORING SYSTEMS COMPRISED OF VIDEO CAMERAS, AND AUDIO SPEAKERS; SMOKE AND FIRE DETECTORS; FIRE

ALARMS; ALARM STATIONS COMPRISED OF FIRE ALARMS AND REMOTE CONTROLS FOR FIRE ALARMS; PERSONAL TRANSPONDERS; GARAGE DOOR OPENERS; VOICE CONTROL SYSTEMS COMPRISED OF VOICE SENSORS AND VOICE RECOGNITION SOFTWARE; INTEROPERABLE ELECTRONIC AND COMPUTER DEVICES ENABLED FOR WIRELESS COMMUNICATION; ELECTRONIC AND COMPUTER DEVICES ENABLED VIA INTEROPERABILITY STANDARDS FOR WIRELESS COMMUNICATION; DEVICES FOR ENABLING ELECTRONIC AND COMPUTER DEVICES FOR WIRELESS COMMUNICATION, NAMELY, SINGLE-CHANNEL RADIO COMMUNICATION MACHINES AND APPARATUS FOR FIXED STATIONS, RADIO TRANSMITTERS, RADIO RECEIVERS, WIRELESS ACCESS POINT (WAP) DEVICES, ANTENNAS, GATEWAY ROUTERS IN THE NATURE OF COMPUTER CONTROL HARDWARE, AND MODEMS, IN CLASS 9 (U.S. CLS. 21, 23, 26, 36 AND 38).

FIRST USE 3-22-2008; IN COMMERCE 3-22-2008.

THE MARK CONSISTS OF STANDARD CHARACTERS WITHOUT CLAIM TO ANY PARTICULAR FONT, STYLE, SIZE, OR COLOR.

OWNER OF U.S. REG. NOS. 2,938,499 AND 2,938,500.

SN 78-850,926, FILED 3-31-2006.

SUNG I N, EXAMINING ATTORNEY

Int. Cl.: 29

Prior U.S. Cl.: 46

United States Patent and Trademark Office

Reg. No. 3,486,386

Registered Aug. 12, 2008

**TRADEMARK
PRINCIPAL REGISTER**

CASTILE

NOVA CHEESE, INC. (CANADA CORPORATION)
425 RICHARDSON ROAD
ORANGEVILLE, ONTARIO, CANADA L9W 4Z4

THE MARK CONSISTS OF STANDARD CHAR-
ACTERS WITHOUT CLAIM TO ANY PARTICULAR
FONT, STYLE, SIZE, OR COLOR.

FOR: GOAT CHEESE, IN CLASS 29 (U.S. CL. 46).

SN 78-851,225, FILED 3-31-2006.

FIRST USE 11-30-2006; IN COMMERCE 11-30-2006.

KRISTINA MORRIS, EXAMINING ATTORNEY

Int. Cl.: 30

Prior U.S. Cl.: 46

United States Patent and Trademark Office

Reg. No. 3,486,387

Registered Aug. 12, 2008

**TRADEMARK
PRINCIPAL REGISTER**

CUISINART

CONAIR CORPORATION (DELAWARE CORPORATION)
ONE CUMMINGS POINT ROAD
STAMFORD, CT 06902

FOR: CAFFEINE-FREE COFFEE; COFFEE; COFFEE BEANS; COFFEE PODS; GROUND COFFEE BEANS; INSTANT COFFEE; ROASTED COFFEE BEANS; SUGAR-COATED COFFEE BEANS, IN CLASS 30 (U.S. CL. 46).

FIRST USE 5-1-2008; IN COMMERCE 5-1-2008.

THE MARK CONSISTS OF STANDARD CHARACTERS WITHOUT CLAIM TO ANY PARTICULAR FONT, STYLE, SIZE, OR COLOR.

OWNER OF U.S. REG. NOS. 1,048,883, 2,925,947, AND OTHERS.

SN 78-853,662, FILED 4-4-2006.

JOHN DWYER, EXAMINING ATTORNEY

Int. Cl.: 11

Prior U.S. Cls.: 13, 21, 23, 31, and 34

Reg. No. 3,486,388

United States Patent and Trademark Office

Registered Aug. 12, 2008

**TRADEMARK
PRINCIPAL REGISTER**

ALLEGRO

HANSGROHE, INC. (GEORGIA CORPORATION)
1490 BLUEGRASS LAKES PKWY
ALPHARETTA, GA 303093424

FOR: PLUMBING FIXTURES, NAMELY, KITCHEN FAUCETS AND KITCHEN FAUCETS WITH PULL-OUT SPRAYER, IN CLASS 11 (U.S. CLS. 13, 21, 23, 31 AND 34).

FIRST USE 6-30-2006; IN COMMERCE 6-30-2006.

THE MARK CONSISTS OF STANDARD CHARACTERS WITHOUT CLAIM TO ANY PARTICULAR FONT, STYLE, SIZE, OR COLOR.

OWNER OF U.S. REG. NO. 1,796,258.

SN 78-854,136, FILED 4-5-2006.

KATHERINE CONNOLLY, EXAMINING ATTORNEY

Int. Cls.: 9 and 42

Prior U.S. Cls.: 21, 23, 26, 36, 38, 100, and 101

United States Patent and Trademark Office

Reg. No. 3,486,389

Registered Aug. 12, 2008

**TRADEMARK
SERVICE MARK
PRINCIPAL REGISTER**



**CLINICAL
LOOKING
GLASS**

MONTEFIORE MEDICAL CENTER (NEW YORK
NON-PROFIT CORPORATION)
111 EAST 210 STREET
BRONX, NY 10467

FOR: COMPUTER SOFTWARE IN THE FIELD OF HEALTH CARE TO ALLOW USERS TO TRACK PATIENT CARE AND PROGRESS AND THE PROCESSES AND EFFICIENCY OF A HEALTH CARE SYSTEM THROUGH ALL STAGES OF MEDICAL TREATMENTS, HOSPITAL VISITS, LABORATORY SERVICES, REHABILITATION AND ANY OTHERS ASPECT OF THE CONTINUUM OF CARE AND TO PROVIDE DATA AND STATISTICS IN CONNECTION WITH MEDICAL TREATMENT AND HEALTH CARE REGARDING PATIENTS, PATIENT DIAGNOSIS, PATIENT DEMOGRAPHICS, FACILITY/CARE CENTERS AND MANAGED HEALTH CARE PROGRAMS, IN CLASS 9 (U.S. CLS. 21, 23, 26, 36 AND 38).

FIRST USE 5-19-2006; IN COMMERCE 6-5-2008.

FOR: PROVIDING TEMPORARY ONLINE USE OF NON-DOWNLOADABLE SOFTWARE IN THE FIELD OF HEALTH CARE TO ALLOW USERS TO

TRACK PATIENT CARE AND PROGRESS AND THE PROCESSES AND EFFICIENCY OF A HEALTH CARE SYSTEM THROUGH ALL STAGES OF MEDICAL TREATMENTS, HOSPITAL VISITS, LABORATORY SERVICES, REHABILITATION AND ANY OTHER ASPECT OF THE CONTINUUM OF CARE AND TO PROVIDE DATA AND STATISTICS IN CONNECTION WITH MEDICAL TREATMENT AND HEALTH CARE REGARDING PATIENTS, PATIENT DIAGNOSIS, PATIENT DEMOGRAPHICS, FACILITY/CARE CENTERS AND MANAGED HEALTH CARE PROGRAMS, IN CLASS 42 (U.S. CLS. 100 AND 101).

FIRST USE 1-16-2007; IN COMMERCE 1-16-2007.

OWNER OF U.S. REG. NO. 2,954,894.

NO CLAIM IS MADE TO THE EXCLUSIVE RIGHT TO USE "CLINICAL", APART FROM THE MARK AS SHOWN.

SN 78-854,896, FILED 4-5-2006.

CARRIE GENOVESE, EXAMINING ATTORNEY

Int. Cl.: 36

Prior U.S. Cls.: 100, 101, and 102

United States Patent and Trademark Office

Reg. No. 3,486,390

Registered Aug. 12, 2008

**SERVICE MARK
PRINCIPAL REGISTER**

CLEARBRIDGE ADVISORS

LEGG MASON, INC. (MARYLAND CORPORATION)
100 LIGHT STREET
BALTIMORE, MD 21202

FOR: FINANCIAL SERVICES, NAMELY, ASSET,
INVESTMENT AND PORTFOLIO MANAGEMENT
SERVICES, IN CLASS 36 (U.S. CLS. 100, 101 AND 102).

FIRST USE 5-2-2006; IN COMMERCE 5-2-2006.

THE MARK CONSISTS OF STANDARD CHARACTERS WITHOUT CLAIM TO ANY PARTICULAR FONT, STYLE, SIZE, OR COLOR.

NO CLAIM IS MADE TO THE EXCLUSIVE RIGHT TO USE "ADVISORS", APART FROM THE MARK AS SHOWN.

SN 78-855,723, FILED 4-6-2006.

CAROLYN GRAY, EXAMINING ATTORNEY

Int. Cl.: 19

Prior U.S. Cls.: 1, 12, 33, and 50

United States Patent and Trademark Office

Reg. No. 3,486,391

Registered Aug. 12, 2008

**TRADEMARK
PRINCIPAL REGISTER**

ComfortGuard

TIN INC. (DELAWARE CORPORATION)
3N
1300 SOUTH MOPAC EXPRESSWAY
AUSTIN, TX 78746

THE MARK CONSISTS OF STANDARD CHAR-
ACTERS WITHOUT CLAIM TO ANY PARTICULAR
FONT, STYLE, SIZE, OR COLOR.

FOR: DRYWALL; MOLD RESISTANT DRY-
WALL, IN CLASS 19 (U.S. CLS. 1, 12, 33 AND 50).

SN 78-856,024, FILED 4-6-2006.

FIRST USE 8-8-2007; IN COMMERCE 8-8-2007.

DEIRDRE ROBERTSON, EXAMINING ATTORNEY

Int. Cls.: 42 and 44

Prior U.S. Cls.: 100 and 101

United States Patent and Trademark Office

Reg. No. 3,486,392

Registered Aug. 12, 2008

**SERVICE MARK
PRINCIPAL REGISTER**

SMILE POWER

CONNOLLY, DR. JOSEPH (UNITED STATES INDIVIDUAL)

1355 MIDDLETOWN AVENUE
NORTHFORD, CT 06472 AND

SOCARRAS, DR. EFRAIN (UNITED STATES INDIVIDUAL)

1355 MIDDLETOWN AVENUE
NORTHFORD, CT 06472

FOR: DENTAL CARE SERVICES, IN CLASS 42
(U.S. CLS. 100 AND 101).

FIRST USE 1-1-2006; IN COMMERCE 1-1-2007.

FOR: DENTISTRY, IN CLASS 44 (U.S. CLS. 100
AND 101).

FIRST USE 1-1-2006; IN COMMERCE 1-1-2007.

THE MARK CONSISTS OF STANDARD CHARACTERS WITHOUT CLAIM TO ANY PARTICULAR FONT, STYLE, SIZE, OR COLOR.

SN 78-857,825, FILED 4-10-2006.

SHARON MEIER, EXAMINING ATTORNEY

Int. Cl.: 35

Prior U.S. Cls.: 100, 101, and 102

United States Patent and Trademark Office

Reg. No. 3,486,393

Registered Aug. 12, 2008

**SERVICE MARK
PRINCIPAL REGISTER**

LENDING DIRECT

LENDINGDIRECT.COM, INC. (NORTH DAKOTA
CORPORATION)

3001 EXPRESSWAT DRIVE NORTH

ISLANDIA, NY 11722

FOR: FINANCIAL REFERRAL SERVICE, IN
CLASS 35 (U.S. CLS. 100, 101 AND 102).

FIRST USE 2-25-2004; IN COMMERCE 2-25-2004.

THE MARK CONSISTS OF STANDARD CHAR-
ACTERS WITHOUT CLAIM TO ANY PARTICULAR
FONT, STYLE, SIZE, OR COLOR.

NO CLAIM IS MADE TO THE EXCLUSIVE
RIGHT TO USE "LENDING", APART FROM THE
MARK AS SHOWN.

SN 78-858,006, FILED 4-10-2006.

JEFF DEFORD, EXAMINING ATTORNEY

Int. Cl.: 5

Prior U.S. Cls.: 6, 18, 44, 46, 51, and 52

United States Patent and Trademark Office

Reg. No. 3,486,394

Registered Aug. 12, 2008

**TRADEMARK
PRINCIPAL REGISTER**

MI ANGELITO DIENTECITOS

KRAMER LABORATORIES, INC. (FLORIDA CORPORATION)
8778 S.W. EIGHTH STREET
MIAMI, FL 33174

FOR: HERBAL PREPARATION FOR THE RELIEF OF TEETHING PAINS AND TOOTHACHES, IN CLASS 5 (U.S. CLS. 6, 18, 44, 46, 51 AND 52).

FIRST USE 12-1-2007; IN COMMERCE 1-31-2008.

THE MARK CONSISTS OF STANDARD CHARACTERS WITHOUT CLAIM TO ANY PARTICULAR FONT, STYLE, SIZE, OR COLOR.

NO CLAIM IS MADE TO THE EXCLUSIVE RIGHT TO USE "DIENTECITOS", APART FROM THE MARK AS SHOWN.

THE FOREIGN WORDING IN THE MARK TRANSLATES INTO ENGLISH AS – (A) MI ANGELITO MEANS "MY LITTLE ANGEL" AND (B) DIENTECITOS MEANS "LITTLE TEETH".

SN 78-858,564, FILED 4-11-2006.

ALICE BENMAMAN, EXAMINING ATTORNEY

Int. Cl.: 30

Prior U.S. Cl.: 46

United States Patent and Trademark Office

Reg. No. 3,486,395

Registered Aug. 12, 2008

**TRADEMARK
PRINCIPAL REGISTER**

R.T. FRENCH

RECKITT BENCKISER INC. (DELAWARE CORPORATION)
399 INTERPACE PARKWAY
PARSIPPANY, NJ 07054

FOR: MUSTARD, SPICES, EXTRACT USED AS FOOD FLAVOURING (NOT ESSENTIAL OILS) AND FOOD FLAVOURINGS (NOT ESSENTIAL OILS), IN CLASS 30 (U.S. CL. 46).

FIRST USE 6-28-2006; IN COMMERCE 6-28-2006.

THE MARK CONSISTS OF STANDARD CHARACTERS WITHOUT CLAIM TO ANY PARTICULAR FONT, STYLE, SIZE, OR COLOR.

THE NAME(S), PORTRAIT(S), AND/OR SIGNATURE(S) SHOWN IN THE MARK DOES NOT IDENTIFY A PARTICULAR LIVING INDIVIDUAL.

SN 78-858,581, FILED 4-11-2006.

JEFF DEFORD, EXAMINING ATTORNEY

Int. Cl.: 24

Prior U.S. Cls.: 42 and 50

United States Patent and Trademark Office

Reg. No. 3,486,396

Registered Aug. 12, 2008

**TRADEMARK
PRINCIPAL REGISTER**

Haight Street

EPOCH TRADE, LLC. (CALIFORNIA LTD LIAB
CO)
1050 HAYNE ROAD
HILLSBOROUGH, CA 94010

THE MARK CONSISTS OF STANDARD CHAR-
ACTERS WITHOUT CLAIM TO ANY PARTICULAR
FONT, STYLE, SIZE, OR COLOR.

FOR: HOME TEXTILE PRODUCTS, NAMELY,
COMFORTERS, BED BLANKETS, FABRIC WIN-
DOW COVERINGS, NAMELY, CURTAINS AND
DRAPERIES, IN CLASS 24 (U.S. CLS. 42 AND 50).

SN 78-860,242, FILED 4-12-2006.

FIRST USE 11-21-2006; IN COMMERCE 11-21-2006.

JENNY PARK, EXAMINING ATTORNEY

Int. Cls.: 36 and 41

Prior U.S. Cls.: 100, 101, 102, and 107

United States Patent and Trademark Office

Reg. No. 3,486,397

Registered Aug. 12, 2008

**SERVICE MARK
PRINCIPAL REGISTER**

dwell

DWELL LLC (DELAWARE LTD LIAB CO)
40 GOLD STREET
SAN FRANCISCO, CA 94133

FOR: FINANCIAL SPONSORSHIP OF EXHIBITIONS, SEMINARS, AND CONFERENCES IN THE FIELD OF MODERN DESIGN, IN CLASS 36 (U.S. CLS. 100, 101 AND 102).

FIRST USE 2-1-2007; IN COMMERCE 2-1-2007.

FOR: ARRANGING OF EXHIBITIONS, SEMINARS, AND CONFERENCES IN THE FIELD OF MODERN DESIGN, IN CLASS 41 (U.S. CLS. 100, 101 AND 107).

FIRST USE 2-1-2007; IN COMMERCE 2-1-2007.

THE MARK CONSISTS OF STANDARD CHARACTERS WITHOUT CLAIM TO ANY PARTICULAR FONT, STYLE, SIZE, OR COLOR.

OWNER OF U.S. REG. NOS. 2,452,089 AND 3,016,045.

SN 78-860,261, FILED 4-12-2006.

CAROLYN GRAY, EXAMINING ATTORNEY

Int. Cl.: 3

Prior U.S. Cls.: 1, 4, 6, 50, 51, and 52

Reg. No. 3,486,398

United States Patent and Trademark Office

Registered Aug. 12, 2008

**TRADEMARK
PRINCIPAL REGISTER**

HPX

BARTON MINES COMPANY, LLC (NEW YORK
LTD LIAB CO)
1557 STATE ROUTE 9
LAKE GEORGE, NY 12845

THE MARK CONSISTS OF STANDARD CHAR-
ACTERS WITHOUT CLAIM TO ANY PARTICULAR
FONT, STYLE, SIZE, OR COLOR.

FOR: WATERJET ABRASIVES, NAMELY, GAR-
NET ABRASIVE GRAINS AND POWDERS FOR USE
IN WATERJET CUTTING MACHINES, IN CLASS 3
(U.S. CLS. 1, 4, 6, 50, 51 AND 52).

SN 78-863,406, FILED 4-18-2006.

FIRST USE 7-1-1992; IN COMMERCE 7-1-1992.

CAROLYN GRAY, EXAMINING ATTORNEY

Int. Cl.: 36

Prior U.S. Cls.: 100, 101, and 102

United States Patent and Trademark Office

Reg. No. 3,486,399

Registered Aug. 12, 2008

**SERVICE MARK
PRINCIPAL REGISTER**

BLOCK HUNTER

BLOOMBERG L.P. (DELAWARE LIMITED PART-
NERSHIP)
731 LEXINGTON AVENUE
NEW YORK, NY 10022

FOR: FINANCIAL SERVICES IN THE NATURE
OF PROVIDING AN ALGORITHMIC TRADING
STRATEGY, IN CLASS 36 (U.S. CLS. 100, 101 AND
102).

FIRST USE 4-4-2006; IN COMMERCE 4-4-2006.

THE MARK CONSISTS OF STANDARD CHAR-
ACTERS WITHOUT CLAIM TO ANY PARTICULAR
FONT, STYLE, SIZE, OR COLOR.

NO CLAIM IS MADE TO THE EXCLUSIVE
RIGHT TO USE "BLOCK", APART FROM THE
MARK AS SHOWN.

SN 78-865,098, FILED 4-19-2006.

JOHN DALIER, EXAMINING ATTORNEY

Int. Cl.: 36

Prior U.S. Cls.: 100, 101, and 102

United States Patent and Trademark Office

Reg. No. 3,486,400

Registered Aug. 12, 2008

**SERVICE MARK
PRINCIPAL REGISTER**

**STERLING TRUCKS
COMPLETELEASE**

DAIMLER TRUCKS NORTH AMERICA LLC
(DELAWARE LTD LIAB CO)
4747 N. CHANNEL AVENUE
PORTLAND, OR 97217

FOR: VEHICLE FINANCING SERVICES, IN
CLASS 36 (U.S. CLS. 100, 101 AND 102).

FIRST USE 6-25-2008; IN COMMERCE 6-25-2008.

THE MARK CONSISTS OF STANDARD CHAR-
ACTERS WITHOUT CLAIM TO ANY PARTICULAR
FONT, STYLE, SIZE, OR COLOR.

OWNER OF U.S. REG. NO. 2,282,569.

NO CLAIM IS MADE TO THE EXCLUSIVE
RIGHT TO USE "TRUCKS", APART FROM THE
MARK AS SHOWN.

SN 78-865,159, FILED 4-19-2006.

JOHN GARTNER, EXAMINING ATTORNEY

Int. Cl.: 9

Prior U.S. Cls.: 21, 23, 26, 36, and 38

United States Patent and Trademark Office

Reg. No. 3,486,401

Registered Aug. 12, 2008

**TRADEMARK
PRINCIPAL REGISTER**

PIXELNET

JUPITER SYSTEMS (CALIFORNIA CORPORATION)
3073 TEAGARDEN STREET
SAN LEANDRO, CA 94577

FOR: DIGITAL NETWORK SYSTEM CONSISTING OF COMPUTER HARDWARE AND COMPUTER SOFTWARE, USED FOR TRANSMITTING DIGITIZED COMPUTER AND VIDEO IMAGES AND IMAGE STREAMS FROM ONE OR MORE SOURCE DEVICES TO ONE OR MORE DESTINATION DEVICES, IN CLASS 9 (U.S. CLS. 21, 23, 26, 36 AND 38).

FIRST USE 6-18-2007; IN COMMERCE 6-18-2007.

THE MARK CONSISTS OF STANDARD CHARACTERS WITHOUT CLAIM TO ANY PARTICULAR FONT, STYLE, SIZE, OR COLOR.

SN 78-866,267, FILED 4-20-2006.

JASON TURNER, EXAMINING ATTORNEY

Int. Cl.: 25

Prior U.S. Cls.: 22 and 39

United States Patent and Trademark Office

Reg. No. 3,486,402

Registered Aug. 12, 2008

TRADEMARK
PRINCIPAL REGISTER



JOHNSON, ANTHONY G (UNITED STATES IN-
DIVIDUAL)
4660 NATOMAS BLVD #120-54
SACRAMENTO, CA 95835

FIRST USE 12-1-2007; IN COMMERCE 12-1-2007.

SN 78-866,354, FILED 4-20-2006.

FOR: CLOTHING, NAMELY, COATS, HATS,
SHIRTS, PANTS, AND TANK TOPS, IN CLASS 25
(U.S. CLS. 22 AND 39).

KAREN BRACEY, EXAMINING ATTORNEY

Int. Cl.: 16

Prior U.S. Cls.: 2, 5, 22, 23, 29, 37, 38, and 50

Reg. No. 3,486,403

United States Patent and Trademark Office

Registered Aug. 12, 2008

**TRADEMARK
PRINCIPAL REGISTER**

METALCALYPSE

THE CARTOON NETWORK, INC. (DELAWARE
CORPORATION)
C/O TURNER BROADCASTING SYSTEM
ONE CNN CENTER, 13 NORTH
ATLANTA, GA 30303

THE MARK CONSISTS OF STANDARD CHAR-
ACTERS WITHOUT CLAIM TO ANY PARTICULAR
FONT, STYLE, SIZE, OR COLOR.

FOR: POSTERS, IN CLASS 16 (U.S. CLS. 2, 5, 22, 23,
29, 37, 38 AND 50).

SN 78-866,676, FILED 4-21-2006.

FIRST USE 5-15-2008; IN COMMERCE 5-15-2008.

ZHALEH DELANEY, EXAMINING ATTORNEY

Int. Cls.: 35, 36, 39, and 43

Prior U.S. Cls.: 100, 101, 102, and 105

United States Patent and Trademark Office

Reg. No. 3,486,404

Registered Aug. 12, 2008

**SERVICE MARK
PRINCIPAL REGISTER**

iMix

ACTIVA MANAGEMENT SERVICES, LLC (MICHIGAN LTD LIAB CO)
ATTENTION: ALLAN D. ENGEL
2905 LUCERNE, SE
GRAND RAPIDS, MI 49546

FOR: BUSINESS SERVICES, NAMELY, REGISTERING, SCREENING, CREDENTIALING, AND ORGANIZING THIRD-PARTY VENDORS, SUPPLIERS, AND CONTRACTORS, AND DOCUMENTATION AND INFORMATION ON BEHALF OF OTHERS, IN CLASS 35 (U.S. CLS. 100, 101 AND 102).

FIRST USE 6-18-2008; IN COMMERCE 6-18-2008.

FOR: INSURANCE AGENCY AND BROKERAGE, IN CLASS 36 (U.S. CLS. 100, 101 AND 102).

FIRST USE 6-18-2008; IN COMMERCE 6-18-2008.

FOR: TRAVEL AGENCY SERVICES, NAMELY, MAKING RESERVATIONS AND BOOKINGS FOR

TRANSPORTATION, IN CLASS 39 (U.S. CLS. 100 AND 105).

FIRST USE 6-18-2008; IN COMMERCE 6-18-2008.

FOR: TRAVEL AGENCY SERVICES, NAMELY, MAKING RESERVATIONS AND BOOKING FOR TEMPORARY LODGING, IN CLASS 43 (U.S. CLS. 100 AND 101).

FIRST USE 6-18-2008; IN COMMERCE 6-18-2008.

THE MARK CONSISTS OF STANDARD CHARACTERS WITHOUT CLAIM TO ANY PARTICULAR FONT, STYLE, SIZE, OR COLOR.

SN 78-867,891, FILED 4-24-2006.

ZACHARY BELLO, EXAMINING ATTORNEY

Int. Cl.: 37

Prior U.S. Cls.: 100, 103, and 106

United States Patent and Trademark Office

Reg. No. 3,486,405

Registered Aug. 12, 2008

**SERVICE MARK
PRINCIPAL REGISTER**

Lube Max

CHAMBERLAIN OIL CO., INC. (MINNESOTA
CORPORATION)
112 GRACE AVENUE
P.O. BOX 278
CLONTARF, MN 56226

FOR: SERVICING OF MOTOR VEHICLES,
NAMELY, REPLACEMENT OF TRANSMISSION
OILS, MOTOR OILS AND GEAR OILS, MAINTAIN-
ING PROPER FLUID LEVELS FOR BRAKES, RA-
DIATORS, POWER STEERING AND WINDSHIELD
DETERGENT RESERVOIR, CHECKING TIRE
PRESSURES, AND LUBRICATION SERVICES, IN
CLASS 37 (U.S. CLS. 100, 103 AND 106).

FIRST USE 6-6-2008; IN COMMERCE 6-6-2008.

THE MARK CONSISTS OF STANDARD CHAR-
ACTERS WITHOUT CLAIM TO ANY PARTICULAR
FONT, STYLE, SIZE, OR COLOR.

NO CLAIM IS MADE TO THE EXCLUSIVE
RIGHT TO USE "LUBE", APART FROM THE MARK
AS SHOWN.

SN 78-868,764, FILED 4-25-2006.

AMY HELLA, EXAMINING ATTORNEY

Int. Cl.: 36

Prior U.S. Cls.: 100, 101, and 102

United States Patent and Trademark Office

Reg. No. 3,486,406

Registered Aug. 12, 2008

**SERVICE MARK
PRINCIPAL REGISTER**

PROMONTORY ASSET FINANCE
COMPANY

PROMONTORY MARK, LLC (DELAWARE LIMITED LIABILITY COMPANY)
SUITE 617
1201 PENNSYLVANIA AVENUE, N.W.
WASHINGTON, DC 20004

FOR: FINANCIAL MANAGEMENT AND INVESTMENT BANKING SERVICES; FUNDING OF INVESTMENTS BY ISSUING SHARES, COMMERCIAL PAPER, CAPITAL NOTES, MEDIUM TERM NOTES AND OTHER DEBT SECURITIES; FINANCIAL SERVICES, NAMELY, STRUCTURING, ORIGINATION, FUNDING AND ADMINISTRATION OF CREDIT FACILITIES AND INVESTMENT VEHICLES FOR OTHERS AND ADVISORY SERVICES RELATING THERETO, IN CLASS 36 (U.S. CLS. 100, 101 AND 102).

FIRST USE 3-22-2004; IN COMMERCE 3-22-2004.

THE MARK CONSISTS OF STANDARD CHARACTERS WITHOUT CLAIM TO ANY PARTICULAR FONT, STYLE, SIZE, OR COLOR.

NO CLAIM IS MADE TO THE EXCLUSIVE RIGHT TO USE "ASSET FINANCE COMPANY" , APART FROM THE MARK AS SHOWN.

SN 78-869,116, FILED 4-25-2006.

SKYE YOUNG, EXAMINING ATTORNEY

Int. Cl.: 41

Prior U.S. Cls.: 100, 101, and 107

United States Patent and Trademark Office

Reg. No. 3,486,407

Registered Aug. 12, 2008

**SERVICE MARK
PRINCIPAL REGISTER**

BASE ENTERTAINMENT

BZ CLARITY HOLDINGS, LLC (DELAWARE
LTD LIAB CO)
SUITE 1050
2000 WEST LOOP SOUTH
HOUSTON, TX 77027

FOR: PRODUCTION OF LIVE ENTERTAINMENT
SHOWS, IN CLASS 41 (U.S. CLS. 100, 101 AND 107).

FIRST USE 4-27-2006; IN COMMERCE 4-27-2006.

THE MARK CONSISTS OF STANDARD CHAR-
ACTERS WITHOUT CLAIM TO ANY PARTICULAR
FONT, STYLE, SIZE, OR COLOR.

NO CLAIM IS MADE TO THE EXCLUSIVE
RIGHT TO USE "ENTERTAINMENT", APART
FROM THE MARK AS SHOWN.

SN 78-873,667, FILED 5-1-2006.

PAULA MAHONEY, EXAMINING ATTORNEY

Int. Cl.: 28

Prior U.S. Cls.: 22, 23, 38, and 50

United States Patent and Trademark Office

Reg. No. 3,486,408

Registered Aug. 12, 2008

**TRADEMARK
PRINCIPAL REGISTER**

FREEDOM ARMS

NAUTILUS, INC. (WASHINGTON CORPORATION)
16400 SE NAUTILUS DRIVE
VANCOUVER, WA 98683

FOR: EXERCISE MACHINES; MANUALLY-OPERATED EXERCISE EQUIPMENT, IN CLASS 28 (U.S. CLS. 22, 23, 38 AND 50).

FIRST USE 7-0-2005; IN COMMERCE 10-0-2005.

THE MARK CONSISTS OF STANDARD CHARACTERS WITHOUT CLAIM TO ANY PARTICULAR FONT, STYLE, SIZE, OR COLOR.

NO CLAIM IS MADE TO THE EXCLUSIVE RIGHT TO USE "ARMS", APART FROM THE MARK AS SHOWN.

SN 78-875,103, FILED 5-3-2006.

ANDREA SAUNDERS, EXAMINING ATTORNEY

Int. Cl.: 28

Prior U.S. Cls.: 22, 23, 38, and 50

United States Patent and Trademark Office

Reg. No. 3,486,409

Registered Aug. 12, 2008

**TRADEMARK
PRINCIPAL REGISTER**

TRUE HEROES

GEOFFREY, LLC (DELAWARE LTD LIAB CO)
ONE GEOFFREY WAY
WAYNE, NJ 07470

FOR: TOYS, GAMES AND PLAYTHINGS, NAME-
LY, TOY ACTION FIGURES, TOY FIGURES AND
ACCESSORIES THEREFOR; TOY VEHICLES AND
ACCESSORIES THEREFOR; TOY TANKS, TOY
PLANES, TOY HELICOPTERS, TOY UTILITY VEHI-
CLES, TOY BOATS AND TOY MOTORCYCLES;
TOY PLAY SETS FOR USE WITH ACTION FIG-
URES, NAMELY, MILITARY, PIRATE AND
KNIGHT THEMED PLAY SETS, TOY VEHICLE
AND ACCESSORIES THEREFORE AND PLAY SETS
FOR TOY VEHICLES AND ACTION FIGURES SOLD
TOGETHER AS A UNIT; TOY ACCESSORIES,

NAMELY, PLASTIC FIGURES, BUILDINGS, TREES,
ROCKS AND TOY WEAPONS; AND PLAY MATS
FOR USE WITH TOY VEHICLES, TOY FIGURES,
TOY ACTION FIGURES AND ACCESSORIES
THEREFOR, IN CLASS 28 (U.S. CLS. 22, 23, 38 AND
50).

FIRST USE 2-28-2008; IN COMMERCE 2-28-2008.

THE MARK CONSISTS OF STANDARD CHAR-
ACTERS WITHOUT CLAIM TO ANY PARTICULAR
FONT, STYLE, SIZE, OR COLOR.

SN 78-875,497, FILED 5-3-2006.

COLLEEN KEARNEY, EXAMINING ATTORNEY

Int. Cl.: 28

Prior U.S. Cls.: 22, 23, 38, and 50

United States Patent and Trademark Office

Reg. No. 3,486,410

Registered Aug. 12, 2008

**TRADEMARK
PRINCIPAL REGISTER**

V.I.E.W. SYSTEM

VIRTUAL INTERACTIVE ENTERTAINMENT WINDOW

TECHNO SOURCE (HONG KONG CORPORATION)

4/F, TOWER II, SILVERCORD, 30 CANTON RD
KOWLOON, HONG KONG

FOR: HANDHELD UNITS FOR PLAYING ELECTRONIC GAMES, IN CLASS 28 (U.S. CLS. 22, 23, 38 AND 50).

FIRST USE 2-12-2006; IN COMMERCE 8-1-2006.

THE MARK CONSISTS OF STANDARD CHARACTERS WITHOUT CLAIM TO ANY PARTICULAR FONT, STYLE, SIZE, OR COLOR.

NO CLAIM IS MADE TO THE EXCLUSIVE RIGHT TO USE "SYSTEM" AND "VIRTUAL INTERACTIVE ENTERTAINMENT WINDOW", APART FROM THE MARK AS SHOWN.

SN 78-876,343, FILED 5-4-2006.

SETH A. RAPPAPORT, EXAMINING ATTORNEY

Int. Cl.: 4

Prior U.S. Cls.: 1, 6, and 15

United States Patent and Trademark Office

Reg. No. 3,486,411

Registered Aug. 12, 2008

**TRADEMARK
PRINCIPAL REGISTER**

PURE SEAL

HEARTHMARK, LLC (CANADA CORPORATION)
14611 COMMERCE DRIVE
DALEVILLE, IN 47334

THE MARK CONSISTS OF STANDARD CHARACTERS WITHOUT CLAIM TO ANY PARTICULAR FONT, STYLE, SIZE, OR COLOR.

FOR: WAX USED IN CANNING AND MAKING CANDLES, IN CLASS 4 (U.S. CLS. 1, 6 AND 15).

SN 78-876,506, FILED 5-4-2006.

FIRST USE 5-31-2007; IN COMMERCE 5-31-2007.

DAWN HAN, EXAMINING ATTORNEY

Int. Cl.: 30

Prior U.S. Cl.: 46

United States Patent and Trademark Office

Reg. No. 3,486,412

Registered Aug. 12, 2008

**TRADEMARK
PRINCIPAL REGISTER**

JAVA JULEP

CONSUMERS CHOICE COFFEE, INC. (KEN-
TUCKY CORPORATION)
1118 QUALITY CHOICE PLACE
LOUISVILLE, KY 40210

FOR: PREPARED COFFEE AND COFFEE-BASED
BEVERAGES BUT NOT FEATURING SWEET SYR-
UP, IN CLASS 30 (U.S. CL. 46).

FIRST USE 6-24-2008; IN COMMERCE 6-24-2008.

THE MARK CONSISTS OF STANDARD CHAR-
ACTERS WITHOUT CLAIM TO ANY PARTICULAR
FONT, STYLE, SIZE, OR COLOR.

NO CLAIM IS MADE TO THE EXCLUSIVE
RIGHT TO USE JAVA, APART FROM THE MARK
AS SHOWN.

SN 78-877,314, FILED 5-5-2006.

G. MAYERSCHOFF, EXAMINING ATTORNEY

Int. Cls.: 16 and 28

Prior U.S. Cls.: 2, 5, 22, 23, 29, 37, 38, and 50

United States Patent and Trademark Office

Reg. No. 3,486,413

Registered Aug. 12, 2008

**TRADEMARK
PRINCIPAL REGISTER**



DERRICK, PATRICIA, A (UNITED STATES INDIVIDUAL)
4186 MELODIA SONGO COURT
LAS VEGAS, NV 89135

FOR: CHILDREN'S BOOKS, IN CLASS 16 (U.S. CLS. 2, 5, 22, 23, 29, 37, 38 AND 50).

FIRST USE 1-3-2008; IN COMMERCE 1-3-2008.

FOR: STUFFED TOY ANIMALS, IN CLASS 28 (U.S. CLS. 22, 23, 38 AND 50).

FIRST USE 1-3-2008; IN COMMERCE 1-3-2008.

THE COLOR(S) LIGHT BROWN, MEDIUM BROWN AND DARK BROWN IS/ARE CLAIMED AS A FEATURE OF THE MARK.

THE MARK CONSISTS OF THE WORDING "ANIMALATIONS". THE FIRST LETTER "A" IN "ANIMALATIONS" IS A THREE-DIMENSIONAL LETTER TILTED TO REPRESENT AN ANIMAL WALKING, HAS MEDIUM BROWN SHADOWS AND FOUR DARK BROWN LINES EXTENDING FROM ITS "FEET." ALL OF THE LETTERS HAVE A DARK BROWN BORDER AND CONTAIN LIGHT AND DARK BROWN SPOTS REPRESENTING A LEOPARD SKIN.

SN 78-882,245, FILED 5-12-2006.

TOBY BULLOFF, EXAMINING ATTORNEY

Int. Cls.: 7 and 9

Prior U.S. Cls.: 13, 19, 21, 23, 26, 31, 34, 35, 36, and 38

Reg. No. 3,486,414

United States Patent and Trademark Office

Registered Aug. 12, 2008

**TRADEMARK
PRINCIPAL REGISTER**

AZURA ENERGY SYSTEMS

AZURA ENERGY SYSTEMS, INC. (DELAWARE CORPORATION)
2800 POST OAK BLVD., SUITE 5230
HOUSTON, TX 77056

FOR: REPLACEMENT PARTS FOR OIL-WELL PUMPING MACHINES, NAMELY, VALVES, CASING HANGERS, CASING HEADS, TUBING HEADS, TUBING HANGERS, COILED TUBING CONNECTORS, CHOKES, AND FLANGE PROTECTORS; REMOTE UNDERWATER OIL WELL PUMPING MACHINE COMPLETION SYSTEMS COMPRISED OF WELLHEADS, REMOTE FLOWLINE COILED TUBING CONNECTORS, REMOTE COILED TUBING CONNECTORS AND OILFIELD EQUIPMENT IN THE NATURE OF CHRISTMAS TREES COMPRISED OF PRESSURE GAUGES AND SAFETY VALVES FOR FLOW SHUTOFF IN OIL WELL CONSTRUCTION, IN CLASS 7 (U.S. CLS. 13, 19, 21, 23, 31, 34 AND 35).

FIRST USE 1-1-2008; IN COMMERCE 1-1-2008.

FOR: OILFIELD EQUIPMENT, NAMELY, CONTROL VALVES AND FLOW REGULATORS FOR REGULATING THE FLOW OF LIQUID PETROLEUM; OILFIELD EQUIPMENT IN THE NATURE OF CHRISTMAS TREES COMPRISED OF PRESSURE GAUGES AND SAFETY VALVES FOR FLOW SHUTOFF IN OIL WELL CONSTRUCTION, IN CLASS 9 (U.S. CLS. 21, 23, 26, 36 AND 38).

FIRST USE 1-1-2008; IN COMMERCE 1-1-2008.

THE MARK CONSISTS OF STANDARD CHARACTERS WITHOUT CLAIM TO ANY PARTICULAR FONT, STYLE, SIZE, OR COLOR.

NO CLAIM IS MADE TO THE EXCLUSIVE RIGHT TO USE "ENERGY SYSTEMS" , APART FROM THE MARK AS SHOWN.

SN 78-882,751, FILED 5-12-2006.

NELSON SNYDER, EXAMINING ATTORNEY

Int. Cl.: 12

Prior U.S. Cls.: 19, 21, 23, 31, 35, and 44

United States Patent and Trademark Office

Reg. No. 3,486,415

Registered Aug. 12, 2008

**TRADEMARK
PRINCIPAL REGISTER**

EXPRESS FLOOR

WESTERN TRAILER CO. (IDAHO CORPORATION)
6701 BUSINESS WAY
BOISE, ID 83716

FOR: BULK COMMODITY AND FREIGHT TRAILERS, IN CLASS 12 (U.S. CLS. 19, 21, 23, 31, 35 AND 44).

FIRST USE 5-9-2008; IN COMMERCE 5-9-2008.

THE MARK CONSISTS OF STANDARD CHARACTERS WITHOUT CLAIM TO ANY PARTICULAR FONT, STYLE, SIZE, OR COLOR.

OWNER OF U.S. REG. NO. 2,270,472.

NO CLAIM IS MADE TO THE EXCLUSIVE RIGHT TO USE "FLOOR", APART FROM THE MARK AS SHOWN.

SN 78-883,849, FILED 5-15-2006.

JANICE L. MCMORROW, EXAMINING ATTORNEY

Int. Cl.: 4

Prior U.S. Cls.: 1, 6, and 15

United States Patent and Trademark Office

Reg. No. 3,486,416

Registered Aug. 12, 2008

**TRADEMARK
PRINCIPAL REGISTER**

BIOMAX

METRO FUEL OIL CORP. (NEW YORK COR-
PORATION)
500 KINGSLAND AVENUE
BROOKLYN, NY 11222

THE MARK CONSISTS OF STANDARD CHAR-
ACTERS WITHOUT CLAIM TO ANY PARTICULAR
FONT, STYLE, SIZE, OR COLOR.

FOR: FUEL FOR HEATING SYSTEMS AND FUEL
FOR MOTOR VEHICLES, IN CLASS 4 (U.S. CLS. 1, 6
AND 15).

SN 78-883,933, FILED 5-15-2006.

FIRST USE 5-1-2006; IN COMMERCE 5-1-2006.

ELLEN PERKINS, EXAMINING ATTORNEY

Int. Cls.: 9 and 36

Prior U.S. Cls.: 21, 23, 26, 36, 38, 100, 101, and 102

United States Patent and Trademark Office

Reg. No. 3,486,417

Registered Aug. 12, 2008

**TRADEMARK
SERVICE MARK
PRINCIPAL REGISTER**

SNAPSHOT

HSBC FINANCE CORPORATION (DELAWARE CORPORATION)
26525 N. RIVERWOODS BOULEVARD
METTAWA, IL 60045

FOR: MAGNETICALLY ENCODED CARDS AND CARDS CONTAINING AN INTEGRATED CIRCUIT CHIP CONTAINING SOFTWARE USED FOR THE PURPOSE OF CONDUCTING FINANCIAL TRANSACTIONS, IN CLASS 9 (U.S. CLS. 21, 23, 26, 36 AND 38).

FIRST USE 6-30-2006; IN COMMERCE 6-30-2006.

FOR: FINANCIAL SERVICES, NAMELY, CREDIT CARD SERVICES, CHARGE CARD SERVICES, DEB-

IT CARD SERVICES AND PRE-PAID CARD SERVICES OFFERED THROUGH CARDS WITH STORED VALUE, IN CLASS 36 (U.S. CLS. 100, 101 AND 102).

FIRST USE 6-30-2006; IN COMMERCE 6-30-2006.

THE MARK CONSISTS OF STANDARD CHARACTERS WITHOUT CLAIM TO ANY PARTICULAR FONT, STYLE, SIZE, OR COLOR.

SN 78-887,246, FILED 5-18-2006.

ANNE MADDEN, EXAMINING ATTORNEY

Int. Cl.: 1

Prior U.S. Cls.: 1, 5, 6, 10, 26, and 46

Reg. No. 3,486,418

United States Patent and Trademark Office

Registered Aug. 12, 2008

**TRADEMARK
PRINCIPAL REGISTER**

EPIMAX

OSTERMAN & COMPANY (CONNECTICUT CORPORATION)
726 SOUTH MAIN STREET
CHESHIRE, CT 06410

FOR: ENGINEERING THERMOPLASTIC RAW MATERIALS OF CERTIFIED PRIME VIRGIN RESIN, NAMELY, PC (POLYCARBONATE), GF-PC (GLASS FIBER REINFORCED POLYCARBONATE), ABS (ACRYLONITRILE BUTADIENE STYRENE TERPOLYMER), GF-ABS (GLASS FIBER REINFORCED ABS), PET (POLYETHYLENE TEREPHTHALATE), GF-PET (GLASS FIBER REINFORCED POLYETHYLENE TEREPHTHALATE), PBT (POLYBUTYLENE TEREPHTHALATE), GF-PBT (GLASS FIBER REINFORCED POLYBUTYLENE TEREPHTHALATE), NYLON 6, NYLON 6/6, GF-NYLON (GLASS FIBER REINFORCED NYLON), HIPS (HIGH IMPACT POLYSTYRENE), PS (POLYSTYRENE), GF-PS (GLASS FIBER REINFORCED POLYSTYRENE), PC/ABS ALLOY, PC/PET ALLOY, GF-PC/PET

(GLASS FIBER REINFORCED PC/PET), PC/PBT ALLOY, GF-PC/PBT (GLASS FIBER REINFORCED PC/PBT), PC/POLYESTER ALLOY, GF-PC/POLYESTER (GLASS FIBER REINFORCED PC/POLYESTER), ACETAL, ACRYLIC, SAN (STYRENE ACRYLONITRILE), ASA (ACRYLONITRILE STYRENE ACRYLATE), PPS (POLYPHENYLENE SULFIDE), PPO (POLYPHENYLENE OXIDE) FOR STRUCTURAL USE, IN CLASS 1 (U.S. CLS. 1, 5, 6, 10, 26 AND 46).

FIRST USE 2-19-2006; IN COMMERCE 3-24-2006.

THE MARK CONSISTS OF STANDARD CHARACTERS WITHOUT CLAIM TO ANY PARTICULAR FONT, STYLE, SIZE, OR COLOR.

SN 78-888,454, FILED 5-20-2006.

JASON BLAIR, EXAMINING ATTORNEY

Int. Cl.: 28

Prior U.S. Cls.: 22, 23, 38, and 50

Reg. No. 3,486,419

United States Patent and Trademark Office

Registered Aug. 12, 2008

**TRADEMARK
PRINCIPAL REGISTER**

Scramblers 10

OSAYI MICHAEL ORIABURE (NIGERIA INDIVIDUAL)
4816 RUM STREET
KELLER, TX 76248

THE MARK CONSISTS OF STANDARD CHARACTERS WITHOUT CLAIM TO ANY PARTICULAR FONT, STYLE, SIZE, OR COLOR.

FOR: BOARD GAMES; CARD GAMES; DICE GAMES; ELECTRONIC EDUCATIONAL GAME MACHINES FOR CHILDREN, IN CLASS 28 (U.S. CLS. 22, 23, 38 AND 50).

SN 78-888,896, FILED 5-22-2006.

FIRST USE 2-26-1986; IN COMMERCE 4-1-2008.

DOMINIC FATHY, EXAMINING ATTORNEY

Int. Cl.: 25

Prior U.S. Cls.: 22 and 39

United States Patent and Trademark Office

Reg. No. 3,486,420

Registered Aug. 12, 2008

**TRADEMARK
PRINCIPAL REGISTER**

CINZIA CLARA

BONTA IMPORTS LLC (NEVADA LTD LIAB CO)
519 8TH AVENUE, 17TH FLOOR
NEW YORK, NY 10018

FOR: CLOTHING, NAMELY, HATS, GLOVES,
SCARVES, SETS COMPRISED OF HATS, GLOVES
AND SCARVES, SWEATERS AND OUTERWEAR,
NAMELY, COATS, OVERCOATS, JACKETS, LEA-
THER JACKETS AND TRENCH COATS , IN CLASS
25 (U.S. CLS. 22 AND 39).

FIRST USE 9-0-2006; IN COMMERCE 9-0-2006.

THE MARK CONSISTS OF STANDARD CHAR-
ACTERS WITHOUT CLAIM TO ANY PARTICULAR
FONT, STYLE, SIZE, OR COLOR.

THE NAME CINZIA CLARA DOES NOT IDENTI-
FY A LIVING INDIVIDUAL.

SN 78-889,151, FILED 5-22-2006.

DEBRA LEE, EXAMINING ATTORNEY

Int. Cl.: 11

Prior U.S. Cls.: 13, 21, 23, 31, and 34

Reg. No. 3,486,421

United States Patent and Trademark Office

Registered Aug. 12, 2008

**TRADEMARK
PRINCIPAL REGISTER**

IMAS

ASHBROOK SIMON-HARTLEY OPERATIONS,
LP (TEXAS LIMITED PARTNERSHIP)
11600 EAST HARDY STREET
HOUSTON, TX 770931098

FIRST USE 9-1-2005; IN COMMERCE 9-1-2005.

FOR: WATER PURIFICATION INSTALLATIONS
FOR REMOVING ORGANIC POLLUTANTS, NI-
TROGEN, PHOSPHOROUS, AND COLIFORM BAC-
TERIA AND OTHER MICROORGANISMS FROM
RESIDENTIAL, MUNICIPAL, AND INDUSTRIAL
WASTEWATER, IN CLASS 11 (U.S. CLS. 13, 21, 23,
31 AND 34).

THE MARK CONSISTS OF STANDARD CHAR-
ACTERS WITHOUT CLAIM TO ANY PARTICULAR
FONT, STYLE, SIZE, OR COLOR.

SN 78-891,246, FILED 5-24-2006.

DAVID YONTEF, EXAMINING ATTORNEY

Int. Cl.: 5

Prior U.S. Cls.: 6, 18, 44, 46, 51, and 52

Reg. No. 3,486,422

United States Patent and Trademark Office

Registered Aug. 12, 2008

**TRADEMARK
PRINCIPAL REGISTER**

BREAK-UP

UNITED PHOSPHORUS, INC. (DELAWARE CORPORATION)
SUITE 402
630 FREEDOM BUSINESS CENTER
PENNSYLVANIA, PA 19406

THE MARK CONSISTS OF STANDARD CHARACTERS WITHOUT CLAIM TO ANY PARTICULAR FONT, STYLE, SIZE, OR COLOR.

FOR: AGRICULTURAL HERBICIDE, IN CLASS 5 (U.S. CLS. 6, 18, 44, 46, 51 AND 52).

SN 78-891,442, FILED 5-24-2006.

FIRST USE 3-10-2008; IN COMMERCE 3-10-2008.

ALICE BENMAMAN, EXAMINING ATTORNEY

Int. Cl.: 36

Prior U.S. Cls.: 100, 101, and 102

United States Patent and Trademark Office

Reg. No. 3,486,423

Registered Aug. 12, 2008

**SERVICE MARK
PRINCIPAL REGISTER**

VEDANTA CAPITAL

VEDANTA CAPITAL LLC (DELAWARE LTD
LIAB CO)
540 MADISON AVENUE
34TH FLOOR
NEW YORK, NY 10022

FOR: INVESTMENT MANAGEMENT, INVEST-
MENT OF PRIVATE EQUITY FUNDS FOR OTHERS
AND PRIVATE EQUITY FUND MANAGEMENT,
INVESTMENT OF VENTURE CAPITAL FUNDS
FOR OTHERS AND VENTURE CAPITAL FUND
MANAGEMENT, IN CLASS 36 (U.S. CLS. 100, 101
AND 102).

FIRST USE 5-0-2006; IN COMMERCE 5-0-2006.

THE MARK CONSISTS OF STANDARD CHAR-
ACTERS WITHOUT CLAIM TO ANY PARTICULAR
FONT, STYLE, SIZE, OR COLOR.

NO CLAIM IS MADE TO THE EXCLUSIVE
RIGHT TO USE "CAPITAL", APART FROM THE
MARK AS SHOWN.

THE FOREIGN WORDING IN THE MARK
TRANSLATES INTO ENGLISH AS CULMINATION
OF KNOWLEDGE.

SN 78-893,094, FILED 5-25-2006.

RICHARD WHITE, EXAMINING ATTORNEY

Int. Cl.: 35

Prior U.S. Cls.: 100, 101, and 102

United States Patent and Trademark Office

Reg. No. 3,486,424

Registered Aug. 12, 2008

**SERVICE MARK
PRINCIPAL REGISTER**

WEST BUSINESS SERVICES

WEST CORPORATION (DELAWARE CORPORATION)
11808 MIRACLE HILLS DRIVE
OMAHA, NE 68154

FOR: TELEMARKETING SERVICES; BUSINESS MANAGEMENT CONSULTING WITH RELATION TO STRATEGY, MARKETING, PRODUCTION, PERSONNEL, AND RETAIL AND WHOLESALE MATTERS; OPERATION OF TELEPHONE BUSINESS CENTERS FOR OTHERS; TELEPHONE ANSWERING SERVICES; GENERAL BUSINESS NETWORKING REFERRAL SERVICES, NAMELY, PROMOTING THE GOODS AND SERVICES OF OTHERS BY PASSING LEADS AND REFERRALS AMONG OTHERS, IN CLASS 35 (U.S. CLS. 100, 101 AND 102).

FIRST USE 1-31-2005; IN COMMERCE 1-31-2005.

THE MARK CONSISTS OF STANDARD CHARACTERS WITHOUT CLAIM TO ANY PARTICULAR FONT, STYLE, SIZE, OR COLOR.

OWNER OF U.S. REG. NO. 2,817,892.

NO CLAIM IS MADE TO THE EXCLUSIVE RIGHT TO USE "BUSINESS SERVICES", APART FROM THE MARK AS SHOWN.

SN 78-894,001, FILED 5-26-2006.

WANDA KAY PRICE, EXAMINING ATTORNEY

Int. Cls.: 9 and 35

Prior U.S. Cls.: 21, 23, 26, 36, 38, 100, 101, and 102

United States Patent and Trademark Office

Reg. No. 3,486,425

Registered Aug. 12, 2008

**TRADEMARK
SERVICE MARK
PRINCIPAL REGISTER**

COMMUNICATING AT LIFE SPEED

WIRELESS RONIN TECHNOLOGIES INC. (MINNESOTA CORPORATION)
5929 BAKER ROAD, SUITE 475
BAKER TECHNOLOGY NORTH PLAZA
MINNEAPOLIS, MN 55345

FOR: COMPUTER HARDWARE FOR DIGITAL SIGNAGE; AND SOFTWARE FOR CREATING DIGITAL ADVERTISING AND OPERATING DIGITAL SIGNS, IN CLASS 9 (U.S. CLS. 21, 23, 26, 36 AND 38).

FIRST USE 0-0-2006; IN COMMERCE 0-0-2006.

FOR: ADVERTISING, MARKETING, AND PROMOTION SERVICES; DESIGN OF ADVERTISING MATERIALS; CREATING AND UPDATING AD-

VERTISING MATERIAL; ADVERTISING CONSULTATION; PREPARATION OF CUSTOM OR NON-CUSTOM ADVERTISING FOR BUSINESSES FOR DISSEMINATION VIA DIGITAL SIGNAGE, IN CLASS 35 (U.S. CLS. 100, 101 AND 102).

FIRST USE 5-30-2006; IN COMMERCE 5-30-2006.

THE MARK CONSISTS OF STANDARD CHARACTERS WITHOUT CLAIM TO ANY PARTICULAR FONT, STYLE, SIZE, OR COLOR.

SN 78-894,647, FILED 5-26-2006.

BRIAN PINO, EXAMINING ATTORNEY

Int. Cl.: 36

Prior U.S. Cls.: 100, 101, and 102

United States Patent and Trademark Office

Reg. No. 3,486,426

Registered Aug. 12, 2008

**SERVICE MARK
PRINCIPAL REGISTER**

PLAYA HOTELS & RESORTS

PLAYA HOTELS & RESORTS, S.L. (SPAIN LIMITED COMPANY)
C/O BARCELO CRESTLINE CORPORATION
8405 GREENSBORO DRIVE, SUITE 500
MCLEAN, VA 22102

FOR: REAL ESTATE INVESTMENT FUND, IN CLASS 36 (U.S. CLS. 100, 101 AND 102).

FIRST USE 5-8-2006; IN COMMERCE 5-8-2006.

THE MARK CONSISTS OF STANDARD CHARACTERS WITHOUT CLAIM TO ANY PARTICULAR FONT, STYLE, SIZE, OR COLOR.

NO CLAIM IS MADE TO THE EXCLUSIVE RIGHT TO USE "HOTELS & RESORTS", APART FROM THE MARK AS SHOWN.

THE ENGLISH TRANSLATION OF THE SPANISH WORD "PLAYA" IN THE MARK IS "BEACH".

SN 78-895,382, FILED 5-30-2006.

DANIEL BRODY, EXAMINING ATTORNEY

Int. Cls.: 16 and 44

Prior U.S. Cls.: 2, 5, 22, 23, 29, 37, 38, 50, 100, and 101

United States Patent and Trademark Office

Reg. No. 3,486,427

Registered Aug. 12, 2008

**TRADEMARK
SERVICE MARK
PRINCIPAL REGISTER**

GETQUIT

PFIZER INC. (DELAWARE CORPORATION)
235 EAST 42ND STREET
NEW YORK, NY 10017

FOR: PRINTED MATERIALS, NAMELY, BOOK-
LETS, BROCHURES AND PAMPHLETS RELATED
TO SMOKING AND SMOKING CESSATION, IN
CLASS 16 (U.S. CLS. 2, 5, 22, 23, 29, 37, 38 AND 50).

FIRST USE 7-31-2006; IN COMMERCE 7-31-2006.

FOR: MEDICAL INFORMATION SERVICES,
NAMELY, PROVIDING INFORMATION RELATED
TO SMOKING AND SMOKING CESSATION; ON-
LINE INFORMATION SERVICES, NAMELY, PRO-
VIDING INFORMATION RELATED TO SMOKING

AND SMOKING CESSATION; MEDICAL SERVICES,
NAMELY, PROVIDING A BEHAVIOR MODIFICA-
TION PROGRAM AND PERSONALIZED SUPPORT
PLAN RELATED TO SMOKING CESSATION, IN
CLASS 44 (U.S. CLS. 100 AND 101).

FIRST USE 7-31-2006; IN COMMERCE 7-31-2006.

THE MARK CONSISTS OF STANDARD CHAR-
ACTERS WITHOUT CLAIM TO ANY PARTICULAR
FONT, STYLE, SIZE, OR COLOR.

SN 78-895,653, FILED 5-30-2006.

JOHN HWANG, EXAMINING ATTORNEY

Int. Cl.: 1

Prior U.S. Cls.: 1, 5, 6, 10, 26, and 46

Reg. No. 3,486,428

United States Patent and Trademark Office

Registered Aug. 12, 2008

**TRADEMARK
PRINCIPAL REGISTER**

MultiPlex

DUNE SPECIALTY PRODUCTS, LLC (ARIZONA
LTD LIAB CO)
P.O. BOX 967
IMPERIAL, CA 92251

THE MARK CONSISTS OF STANDARD CHAR-
ACTERS WITHOUT CLAIM TO ANY PARTICULAR
FONT, STYLE, SIZE, OR COLOR.

FOR: FERTILIZER, IN CLASS 1 (U.S. CLS. 1, 5, 6,
10, 26 AND 46).

SN 78-896,737, FILED 5-31-2006.

FIRST USE 3-1-2005; IN COMMERCE 3-1-2005.

KRISTINA MORRIS, EXAMINING ATTORNEY

Int. Cl.: 41

Prior U.S. Cls.: 100, 101, and 107

United States Patent and Trademark Office

Reg. No. 3,486,429

Registered Aug. 12, 2008

**SERVICE MARK
PRINCIPAL REGISTER**

JUNGLE JAVA

JUNGLE JAVA, INC. (MICHIGAN CORPORATION)
6481 CANTON CENTER ROAD
CANTON, MI 48187

FOR: CHILDREN'S ENTERTAINMENT AND AMUSEMENT CENTERS, NAMELY, INTERACTIVE PLAY AREAS LOCATED IN RESTAURANTS, IN CLASS 41 (U.S. CLS. 100, 101 AND 107).

FIRST USE 12-0-2003; IN COMMERCE 12-0-2003.

THE MARK CONSISTS OF STANDARD CHARACTERS WITHOUT CLAIM TO ANY PARTICULAR FONT, STYLE, SIZE, OR COLOR.

NO CLAIM IS MADE TO THE EXCLUSIVE RIGHT TO USE "JAVA", APART FROM THE MARK AS SHOWN.

SN 78-897,197, FILED 5-31-2006.

COURTNEY MCCORMICK, EXAMINING ATTORNEY

Int. Cl.: 9

Prior U.S. Cls.: 21, 23, 26, 36, and 38

United States Patent and Trademark Office

Reg. No. 3,486,430

Registered Aug. 12, 2008

**TRADEMARK
PRINCIPAL REGISTER**

dwellingLIVE

DWELLINGLIVE, INC. (CALIFORNIA CORPORATION)
SUITE 104
3183-F AIRWAY AVENUE
COSTA MESA, CA 92626

FOR: COMPUTER PROGRAMS FOR HOME OWNERS AND HOME OWNER ASSOCIATIONS TO ACCESS INFORMATION VIA THE INTERNET REGARDING THEIR HOMES; COMPUTER SOFTWARE FOR ACCESSING INFORMATION DIRECTORIES THAT MAY BE DOWNLOADED FROM THE GLOBAL COMPUTER NETWORK; COMPUTER SOFTWARE FOR COMPUTER SYSTEM AND APPLICATION DEVELOPMENT, DEPLOYMENT

AND MANAGEMENT, IN CLASS 9 (U.S. CLS. 21, 23, 26, 36 AND 38).

FIRST USE 7-18-2006; IN COMMERCE 7-18-2006.

THE MARK CONSISTS OF STANDARD CHARACTERS WITHOUT CLAIM TO ANY PARTICULAR FONT, STYLE, SIZE, OR COLOR.

THE WORDING "LIVE" HAS NO MEANING IN A FOREIGN LANGUAGE.

SN 78-898,064, FILED 6-1-2006.

PATRICIA EVANKO, EXAMINING ATTORNEY

Int. Cls.: 29 and 30

Prior U.S. Cl.: 46

United States Patent and Trademark Office

Reg. No. 3,486,431

Registered Aug. 12, 2008

TRADEMARK
PRINCIPAL REGISTER

MIMICCREME

JARRETT, ROSE ANNE (UNITED STATES INDIVIDUAL)
9 NINEBARK LANE
OXFORD, NJ 07863

FOR: NON-DAIRY, NON-SOY FOODS AND INGREDIENTS, NAMELY, WHIPPED TOPPING, SOUP BASE, CREAM SUBSTITUTE AS BASE FOR CHEESE, CANDY, AND YOGURT; NON-SOY DAIRY SUBSTITUTE COMPRISED PRIMARILY OF ALMONDS, CASHEWS, WATER, SUGAR AND BAKING SODA USED AS AN INGREDIENT OF FOODS, IN CLASS 29 (U.S. CL. 46).

FIRST USE 5-3-2007; IN COMMERCE 5-19-2007.

FOR: NON-DAIRY ICE CREAM MIX; NON-SOY DAIRY SUBSTITUTE COMPRISED PRIMARILY OF

ALMONDS, CASHEWS, WATER, SUGAR AND BAKING SODA SOLD AS AN INGREDIENT OF MIXES FOR BAKERY GOODS, FROZEN CONFECTIONS, BAKING MIX, CAKE MIX, PANCAKE MIX, MUFFIN MIX, COOKIE MIX AND SHAKE MIX; NON-DAIRY, NON-SOY FOOD PRODUCTS, NAMELY, GRAVY BASE, IN CLASS 30 (U.S. CL. 46).

FIRST USE 5-3-2007; IN COMMERCE 5-19-2007.

THE MARK CONSISTS OF STANDARD CHARACTERS WITHOUT CLAIM TO ANY PARTICULAR FONT, STYLE, SIZE, OR COLOR.

SN 78-898,330, FILED 6-1-2006.

WENDY GOODMAN, EXAMINING ATTORNEY

Int. Cl.: 35

Prior U.S. Cls.: 100, 101, and 102

United States Patent and Trademark Office

Reg. No. 3,486,432

Registered Aug. 12, 2008

**SERVICE MARK
PRINCIPAL REGISTER**

ELYSIUM3

ELYSIUM3 SPRL (BELGIUM PRIVATE LIMITED
LIABILITY COMPANY)
AVENUE DE LA TENDRAIE, 18
1421 OPHAIN-BSI, BELGIUM

THE MARK CONSISTS OF STANDARD CHAR-
ACTERS WITHOUT CLAIM TO ANY PARTICULAR
FONT, STYLE, SIZE, OR COLOR.

FOR: ADVERTISING, MARKETING AND PRO-
MOTION SERVICES, IN CLASS 35 (U.S. CLS. 100, 101
AND 102).

SN 78-898,358, FILED 6-1-2006.

FIRST USE 3-1-2003; IN COMMERCE 3-1-2003.

BERYL GARDNER, EXAMINING ATTORNEY

Int. Cls.: 29 and 30

Prior U.S. Cl.: 46

United States Patent and Trademark Office

Reg. No. 3,486,433

Registered Aug. 12, 2008

**TRADEMARK
PRINCIPAL REGISTER**



JARRETT, ROSE ANNE (UNITED STATES INDIVIDUAL)
9 NINEBARK LANE
OXFORD, NJ 07863

FOR: NON-DAIRY, NON-SOY FOODS AND INGREDIENTS, NAMELY, WHIPPED TOPPING, SOUP BASE, CREAM SUBSTITUTE AS BASE FOR CHEESE, CANDY, AND YOGURT; NON-SOY DAIRY SUBSTITUTE COMPRISED PRIMARILY OF ALMONDS, CASHEWS, WATER, SUGAR AND BAKING SODA USED AS AN INGREDIENT OF FOODS, IN CLASS 29 (U.S. CL. 46).

FIRST USE 5-3-2007; IN COMMERCE 5-19-2007.

FOR: NON-DAIRY ICE CREAM MIX; NON-SOY DAIRY SUBSTITUTE COMPRISED PRIMARILY OF ALMONDS, CASHEWS, WATER, SUGAR AND BAKING SODA SOLD AS AN INGREDIENT OF MIXES FOR BAKERY GOODS, FROZEN CONFECTIONS, BAKING MIX, CAKE MIX, PANCAKE MIX, MUFFIN MIX, COOKIE MIX AND SHAKE MIX; NON-DAIRY, NON-SOY FOOD PRODUCTS, NAMELY, GRAVY BASE, IN CLASS 30 (U.S. CL. 46).

FIRST USE 5-3-2007; IN COMMERCE 5-19-2007.

SN 78-898,816, FILED 6-2-2006.

WENDY GOODMAN, EXAMINING ATTORNEY

Int. Cl.: 5

Prior U.S. Cls.: 6, 18, 44, 46, 51, and 52

Reg. No. 3,486,434

United States Patent and Trademark Office

Registered Aug. 12, 2008

**TRADEMARK
PRINCIPAL REGISTER**

Worksite Hydration

SUTTER BUTTES NUTRITION INC (CALIFORNIA CORPORATION)

4724 ARNOLD AVE

MCCLELLAN, CA 95652

FOR: NUTRITIONALLY FORTIFIED WATER, IN CLASS 5 (U.S. CLS. 6, 18, 44, 46, 51 AND 52).

FIRST USE 4-19-2006; IN COMMERCE 5-26-2008.

THE MARK CONSISTS OF STANDARD CHARACTERS WITHOUT CLAIM TO ANY PARTICULAR FONT, STYLE, SIZE, OR COLOR.

NO CLAIM IS MADE TO THE EXCLUSIVE RIGHT TO USE "HYDRATION", APART FROM THE MARK AS SHOWN.

SN 78-899,703, FILED 6-2-2006.

SHANNON TWOHIG, EXAMINING ATTORNEY

Int. Cls.: 9, 18, and 25

Prior U.S. Cls.: 1, 2, 3, 21, 22, 23, 26, 36, 38, 39, and 41

United States Patent and Trademark Office

Reg. No. 3,486,435

Registered Aug. 12, 2008

**TRADEMARK
PRINCIPAL REGISTER**

PARAJUMPERS

MAXROSS & PARTNERS LLC (DELAWARE LTD
LIAB CO)
GREYSTONE MANOR, 25
LEWES, DE 19958

FOR: EYEGLASSES, SUNGLASSES, FRAMES
AND CASES FOR EYEGLASSES AND SUNGLAS-
SES, IN CLASS 9 (U.S. CLS. 21, 23, 26, 36 AND 38).

FIRST USE 0-0-2006; IN COMMERCE 0-0-2006.

FOR: SUITCASES, TRAVELING BAGS, ALL PUR-
POSE CARRYING BAGS; UMBRELLAS; WALLETS,
PURSES, IN CLASS 18 (U.S. CLS. 1, 2, 3, 22 AND 41).

FIRST USE 0-0-2006; IN COMMERCE 0-0-2006.

FOR: FOOTWEAR, NAMELY, SHOES, BOOTS;
BELTS, IN CLASS 25 (U.S. CLS. 22 AND 39).

FIRST USE 0-0-2006; IN COMMERCE 0-0-2006.

THE MARK CONSISTS OF STANDARD CHAR-
ACTERS WITHOUT CLAIM TO ANY PARTICULAR
FONT, STYLE, SIZE, OR COLOR.

SN 78-900,984, FILED 6-5-2006.

ELLEN B. AWRICH, EXAMINING ATTORNEY

Int. Cl.: 43

Prior U.S. Cls.: 100 and 101

United States Patent and Trademark Office

Reg. No. 3,486,436

Registered Aug. 12, 2008

SERVICE MARK
PRINCIPAL REGISTER



MONTUFAR, ELISEO FERNÁNDEZ (MEXICO
INDIVIDUAL)
COL. CAMPESTRE, MÉRIDA
CALLE 15 NO. 253 POR 36 Y 38
YUCATÁN, C.P. 97100, MEXICO

FOR: SERVING OF FOOD AND DRINK/BEVERA-
GES, IN CLASS 43 (U.S. CLS. 100 AND 101).

FIRST USE 6-1-2007; IN COMMERCE 6-1-2007.

THE COLOR(S) RED, DARK GREEN, LIGHT
GREEN, YELLOW, BLACK AND WHITE IS/ARE
CLAIMED AS A FEATURE OF THE MARK.

THE COLOR RED APPEARS IN THE WORDING
PICA, THE PEPPER DESIGN, AND IN THE OUT-
LINE OF THE WORDING EL SANO ANTOJO. THE
COLOR GREEN APPEARS IN VARIOUS SHADES IN
THE WORD LIMON, THE LIME DESIGN AND IN
THE SHADING OF THE JUICE SQUIRTING FROM
THE LIME. THE COLOR YELLOW APPEARS IN
THE ZIGZAG BACKGROUND DESIGN AND IN
THE JUICE SQUIRTING FROM THE LIME. THE

COLOR BLACK APPEARS IN THE LINING OF THE
WORDING AND DESIGN TO GIVE THEM A THREE
DIMENSIONAL APPEARANCE. THE COLOR
WHITE APPEARS IN THE WORDING EL SANO
ANTOJO, IN THE SHADING OF THE PEPPER AND
IN THE LINES ON THE LIME

THE MARK CONSISTS OF THE WORDS "PICA
LIMON EL SANO ANTOJO" ON A YELLOW ZIG-
ZAG BACKGROUND, WITH A PEPPER USED IN-
STEAD OF THE LETTER "I" IN "PICA" (ENTIRE
WORD IS IN RED) AND A LEMON SLICE USED
INSTEAD OF THE LETTER "O" IN "LIMON" (EN-
TIRE WORD IS IN GREEN). THE WORDS "EL SANO
ANTOJO" HAVE A RED BORDER.

THE FOREIGN WORDING IN THE MARK
TRANSLATES INTO ENGLISH AS "SPICY LEMON
HEALTHY CRAVING"

SN 78-901,771, FILED 6-6-2006.

JENNIFER MARTIN, EXAMINING ATTORNEY

Int. Cl.: 42

Prior U.S. Cls.: 100 and 101

United States Patent and Trademark Office

Reg. No. 3,486,437

Registered Aug. 12, 2008

**SERVICE MARK
PRINCIPAL REGISTER**

TRAILFIRE

TRAILFIRE INC. (WASHINGTON CORPORATION)
101 YESLER WAY
SUITE 207
SEATTLE, WA 98104

FOR: COMPUTER SERVICES, NAMELY, IMPLEMENTING, HOSTING AND MAINTAINING DIGITAL CONTENT AND SOFTWARE APPLICATIONS FOR OTHERS ON THE INTERNET; APPLICATION SERVICE PROVIDER (ASP), NAMELY, HOSTING COMPUTER SOFTWARE APPLICATIONS OF OTHERS; PROVIDING CUSTOMIZED ON-LINE WEB PAGES FEATURING USER-DEFINED INFORMATION, WHICH INCLUDES SEARCH ENGINES AND ON-LINE WEB LINKS TO OTHER WEBSITES USED TO CREATE, ORGANIZE, STORE AND SHARE

ANNOTATED NAVIGATION PATHS ACROSS WEB PAGES WITH NOTES, COMMENTS, USER RATINGS, EMBEDDED CONTENT, APPLICATIONS, BOOK-MARKED WEB PAGES, TAGGED WEB PAGES, CLIPPED CONTENT FROM WEB PAGES AND BLOGS, IN CLASS 42 (U.S. CLS. 100 AND 101).

FIRST USE 9-0-2006; IN COMMERCE 9-0-2006.

THE MARK CONSISTS OF STANDARD CHARACTERS WITHOUT CLAIM TO ANY PARTICULAR FONT, STYLE, SIZE, OR COLOR.

SN 78-902,236, FILED 6-6-2006.

WENDY GOODMAN, EXAMINING ATTORNEY

Int. Cl.: 9

Prior U.S. Cls.: 21, 23, 26, 36, and 38

United States Patent and Trademark Office

Reg. No. 3,486,438

Registered Aug. 12, 2008

**TRADEMARK
PRINCIPAL REGISTER**

CLEAN REMOTE

NOSO CONTROL, LLC (FLORIDA LTD LIAB CO)
12914 DUPONT CIRCLE
TAMPA, FL 33626

FOR: REMOTE CONTROLS FOR TELEVISIONS,
IN CLASS 9 (U.S. CLS. 21, 23, 26, 36 AND 38).

FIRST USE 3-12-2008; IN COMMERCE 3-12-2008.

THE MARK CONSISTS OF STANDARD CHARACTERS WITHOUT CLAIM TO ANY PARTICULAR FONT, STYLE, SIZE, OR COLOR.

NO CLAIM IS MADE TO THE EXCLUSIVE RIGHT TO USE "REMOTE", APART FROM THE MARK AS SHOWN.

SN 78-902,399, FILED 6-7-2006.

RICHARD WHITE, EXAMINING ATTORNEY

Int. Cl.: 3

Prior U.S. Cls.: 1, 4, 6, 50, 51, and 52

United States Patent and Trademark Office

Reg. No. 3,486,439

Registered Aug. 12, 2008

**TRADEMARK
PRINCIPAL REGISTER**

SNAP SHOTS

CONAIR CORPORATION (DELAWARE CORPORATION)
ONE CUMMINGS POINT ROAD
STAMFORD, CT 06902

FOR: HAIR CARE LOTIONS; HAIR CARE PREPARATIONS; HAIR COLOR; HAIR COLORING PREPARATIONS; HAIR CONDITIONERS; HAIR DYES; HAIR GELS; HAIR MOUSSES; HAIR POMADES; HAIR SHAMPOO; HAIR STYLING GEL; HAIR STYLING SPRAY, IN CLASS 3 (U.S. CLS. 1, 4, 6, 50, 51 AND 52).

FIRST USE 9-1-2006; IN COMMERCE 9-1-2006.

THE MARK CONSISTS OF STANDARD CHARACTERS WITHOUT CLAIM TO ANY PARTICULAR FONT, STYLE, SIZE, OR COLOR.

SN 78-902,548, FILED 6-7-2006.

BRIAN PINO, EXAMINING ATTORNEY

Int. Cls.: 16 and 44

Prior U.S. Cls.: 2, 5, 22, 23, 29, 37, 38, 50, 100, and 101

United States Patent and Trademark Office

Reg. No. 3,486,440

Registered Aug. 12, 2008

**TRADEMARK
SERVICE MARK
PRINCIPAL REGISTER**



PFIZER INC. (DELAWARE CORPORATION)
235 EAST 42ND STREET
NEW YORK, NY 10017

FOR: PRINTED MATERIALS, NAMELY, BOOK-
LETS, BROCHURES AND PAMPHLETS RELATED
TO SMOKING AND SMOKING CESSATION, IN
CLASS 16 (U.S. CLS. 2, 5, 22, 23, 29, 37, 38 AND 50).

FIRST USE 7-31-2006; IN COMMERCE 7-31-2006.

FOR: MEDICAL INFORMATION SERVICES,
NAMELY, PROVIDING INFORMATION RELATED
TO SMOKING AND SMOKING CESSATION; ON-

LINE INFORMATION SERVICES, NAMELY, PRO-
VIDING INFORMATION RELATED TO SMOKING
AND SMOKING CESSATION; MEDICAL SERVICES,
NAMELY, PROVIDING A BEHAVIOR MODIFICA-
TION PROGRAM AND PERSONALIZED SUPPORT
PLAN RELATED TO SMOKING CESSATION, IN
CLASS 44 (U.S. CLS. 100 AND 101).

FIRST USE 7-31-2006; IN COMMERCE 7-31-2006.

SN 78-902,787, FILED 6-7-2006.

JOHN HWANG, EXAMINING ATTORNEY

Int. Cl.: 10

Prior U.S. Cls.: 26, 39, and 44

United States Patent and Trademark Office

Reg. No. 3,486,441

Registered Aug. 12, 2008

**TRADEMARK
PRINCIPAL REGISTER**

AB ORTHO, LLC

AB ORTHO, LLC (MINNESOTA LTD LIAB CO)
SUITE 470
5929 BAKER ROAD
MINNETONKA, MN 55345

NO CLAIM IS MADE TO THE EXCLUSIVE
RIGHT TO USE "LLC" , APART FROM THE MARK
AS SHOWN.

FOR: ORTHOPEDIC SUPPORT BANDAGES, IN
CLASS 10 (U.S. CLS. 26, 39 AND 44).

SN 78-903,663, FILED 6-8-2006.

FIRST USE 4-28-2006; IN COMMERCE 4-13-2007.

RAMONA ORTIGA, EXAMINING ATTORNEY

Int. Cl.: 41

Prior U.S. Cls.: 100, 101, and 107

Reg. No. 3,486,442

United States Patent and Trademark Office

Registered Aug. 12, 2008

**SERVICE MARK
PRINCIPAL REGISTER**



BIOLA UNIVERSITY, INC. (CALIFORNIA CORPORATION)
13800 BIOLA AVENUE
LA MIRADA, CA 906390001

FOR: EDUCATIONAL SERVICES, NAMELY, PROVIDING COURSES OF INSTRUCTION AT THE UNDERGRADUATE, GRADUATE AND POST-GRADUATE LEVELS AND DISTRIBUTING COURSE MATERIALS IN CONNECTION THEREWITH; DEVELOPING AND PROVIDING SEMINARS, CONFERENCES, WORKSHOPS AND LECTURES IN THE FIELDS OF ANTHROPOLOGY, ART, BIBLICAL STUDIES, BIOCHEMISTRY, BIOLOGICAL SCIENCE, BUSINESS ADMINISTRATION, CHRISTIAN EDUCATION, COMMUNICATIONS, COMPUTER SCIENCE, EDUCATION, FOREIGN LANGUAGES, LIBERAL ARTS, ENGLISH, TELEVISION, FILM, RADIO, HISTORY, HUMAN BIOLOGY, HUMANITIES, INTERCULTURAL STUDIES, JOURNALISM, KINESIOLOGY, LINGUISTICS, MATHEMATICS, MUSIC, NURSING, ORGANIZATIONAL LEADERSHIP, PHILOSOPHY,

PHYSICAL EDUCATION, PHYSICAL SCIENCE, PSYCHOLOGY, RELIGION, SOCIAL SCIENCE, SOCIOLOGY, AND THEOLOGY; CONDUCTING DISTANCE LEARNING INSTRUCTION AT THE UNDERGRADUATE, GRADUATE AND POST-GRADUATE LEVELS; ENTERTAINMENT SERVICES, NAMELY, ARRANGING AND CONDUCTING ATHLETIC AND SPORTS EVENTS AND COMPETITIONS, MUSICALS, THEATRICALS, PUBLIC SPEAKERS, AND VISUAL, LITERARY AND PERFORMING ARTS PRESENTATIONS; RECREATIONAL SERVICES IN THE NATURE OF PROVIDING SWIMMING POOLS, TENNIS COURTS, AND WEIGHT TRAINING FACILITIES, IN CLASS 41 (U.S. CLS. 100, 101 AND 107).

FIRST USE 7-1-1995; IN COMMERCE 7-1-1995.

SN 78-904,046, FILED 6-8-2006.

MICHAEL WEBSTER, EXAMINING ATTORNEY

Int. Cl.: 3

Prior U.S. Cls.: 1, 4, 6, 50, 51, and 52

United States Patent and Trademark Office

Reg. No. 3,486,443

Registered Aug. 12, 2008

**TRADEMARK
PRINCIPAL REGISTER**

POLO DOUBLE BLACK

PRL USA HOLDINGS, INC. (DELAWARE CORPORATION)
SUITE 201 103 FOULK ROAD
WILMINGTON, DE 19803

FOR: AFTER SHAVE GEL, PERSONAL DEODORANT, HAIR AND BODY WASH, IN CLASS 3 (U.S. CLS. 1, 4, 6, 50, 51 AND 52).

FIRST USE 9-1-2006; IN COMMERCE 9-1-2006.

THE MARK CONSISTS OF STANDARD CHARACTERS WITHOUT CLAIM TO ANY PARTICULAR FONT, STYLE, SIZE, OR COLOR.

OWNER OF U.S. REG. NOS. 1,532,557, 2,854,769, AND OTHERS.

SN 78-906,163, FILED 6-12-2006.

JANICE L. MCMORROW, EXAMINING ATTORNEY

Int. Cl.: 11

Prior U.S. Cls.: 13, 21, 23, 31, and 34

United States Patent and Trademark Office

Reg. No. 3,486,444

Registered Aug. 12, 2008

TRADEMARK
PRINCIPAL REGISTER



LIANG, YONGCHEN (CHINA INDIVIDUAL)
13, XIXIN XINCUN, XIHUACUN, SHIKEN, NANH
FOSHANSHI, CHINA

FOR: FAUCETS; BATH TUBS; TOILET BOWLS;
WASHING COPPERS AS PART OF SANITARY IN-
STALLATIONS; SINKS; DISINFECTANT DISTRIBUTORS
FOR TOILETS, SHOWERS, SHOWER
CUBICLES; WASH-HAND BOWLS AS PART OF
SANITARY INSTALLATIONS; SPA BATHS IN THE
NATURE OF HEATED POOLS; TOILET SEATS;
WATER CLOSETS, SANITATION FIXTURES,
NAMELY, URINALS, FAUCETS FOR PIPES, IN
CLASS 11 (U.S. CLS. 13, 21, 23, 31 AND 34).

FIRST USE 1-18-2000; IN COMMERCE 10-2-2002.

THE MARK CONSISTS OF A CRANE, ENGLISH
LETTERS "VIRGO" AND TWO CHINESE CHARAC-
TERS.

THE FOREIGN WORDING IN THE MARK
TRANSLATES INTO ENGLISH AS NO SPECIFIC
MEANINGS.

THE NON-LATIN CHARACTER(S) IN THE
MARK TRANSLITERATES INTO "WEIOU", AND
THIS MEANS NO SPECIFIC MEANINGS IN ENG-
LISH.

SN 78-906,351, FILED 6-12-2006.

JEFF DEFORD, EXAMINING ATTORNEY

Int. Cls.: 9, 16, and 18

Prior U.S. Cls.: 1, 2, 3, 5, 21, 22, 23, 26, 29, 36, 37, 38, 41, and 50

Reg. No. 3,486,445

United States Patent and Trademark Office

Registered Aug. 12, 2008

**TRADEMARK
PRINCIPAL REGISTER**

TON

IVERSEN, ALFRED A. (UNITED STATES INDIVIDUAL)
1500 PARK ROAD
CHANHASSEN, MN 55317

FOR: ELECTRICAL AND SCIENTIFIC APPARATUS, NAMELY, PRERECORDED AUDIO AND VIDEO CASSETTES, COMPACT DISC SAND LASER VIDEO DISCS FEATURING MOTION PICTURE FILMS, MUSIC, CHILDREN'S STORIES AND ENTERTAINMENT NEWS; DECORATIVE REFRIGERATOR MAGNETS; SUNGLASSES; PRERECORDED CD-ROMS AND DVDS FEATURING MUSIC VIDEOS, INFORMATIONAL TRIVIA GAMES, ANIMATED STORIES FOR CHILDREN AND ADULTS AND INSTRUCTION IN MATH, READING AND SCIENCE, IN CLASS 9 (U.S. CLS. 21, 23, 26, 36 AND 38).

FIRST USE 5-12-2008; IN COMMERCE 5-12-2008.

FOR: PAPER GOODS AND PRINTED MATTER, NAMELY, GENERAL-PURPOSE PAPER BAGS; GREETING CARDS; DESK ACCESSORIES, NAMELY, DESK PADS; CALENDARS, STATIONERY,

GIFT WRAPPING PAPER; PAPER PARTY DECORATIONS, NAMELY, PAPER HATS AND PAPER NAPKINS; STICKERS, ADDRESS BOOKS; AND BOOKS AND MAGAZINES FEATURING CHILDREN'S STORIES, GAMES AND ACTIVITY BOOKS, IN CLASS 16 (U.S. CLS. 2, 5, 22, 23, 29, 37, 38 AND 50).

FIRST USE 5-12-2008; IN COMMERCE 5-12-2008.

FOR: EQUESTRIAN RIDING EQUIPMENT, NAMELY, SADDLES, PADS FOR HORSE SADDLES, HORSE BLANKETS, HORSE BRIDLES AND HORSE HALTERS, IN CLASS 18 (U.S. CLS. 1, 2, 3, 22 AND 41).

FIRST USE 5-12-2008; IN COMMERCE 5-12-2008.

THE MARK CONSISTS OF STANDARD CHARACTERS WITHOUT CLAIM TO ANY PARTICULAR FONT, STYLE, SIZE, OR COLOR.

SN 78-908,097, FILED 6-14-2006.

KELLY CHOE, EXAMINING ATTORNEY

Int. Cl.: 30

Prior U.S. Cl.: 46

United States Patent and Trademark Office

Reg. No. 3,486,446

Registered Aug. 12, 2008

TRADEMARK
PRINCIPAL REGISTER



BIEBER, ERIC BRUCE (UNITED STATES INDIVIDUAL)
3501 26TH PL WEST #221
SEATTLE, WA 98199

FOR: BAGS OF COFFEE SOLD ONLINE ON THE INTERNET, IN CLASS 30 (U.S. CL. 46).

FIRST USE 1-7-2008; IN COMMERCE 1-2-2008.

NO CLAIM IS MADE TO THE EXCLUSIVE RIGHT TO USE "COFFEE" , APART FROM THE MARK AS SHOWN.

THE MARK CONSISTS OF A MAN SITTING AT A DESK WITH HIS EYES BULGING OUT, HOLDING A CUP OF COFFEE AND THE STYLIZED TEXT "DESK PILOT COFFEE BREAK THE GROUND BARRIER".

SN 78-912,747, FILED 6-20-2006.

JANICE L. MCMORROW, EXAMINING ATTORNEY

Int. Cl.: 5

Prior U.S. Cls.: 6, 18, 44, 46, 51, and 52

Reg. No. 3,486,447

United States Patent and Trademark Office

Registered Aug. 12, 2008

**TRADEMARK
PRINCIPAL REGISTER**

PLAGATOX

ISIS INVESTMENTS, INC. (FLORIDA CORPORATION)
8333 N.W. 68 STREET
MIAMI, FL 33166

THE MARK CONSISTS OF STANDARD CHARACTERS WITHOUT CLAIM TO ANY PARTICULAR FONT, STYLE, SIZE, OR COLOR.

FOR: INSECTICIDES, IN CLASS 5 (U.S. CLS. 6, 18, 44, 46, 51 AND 52).

SN 78-913,155, FILED 6-21-2006.

FIRST USE 4-25-1963; IN COMMERCE 11-15-2007.

ESTHER A. BORSUK, EXAMINING ATTORNEY

Int. Cl.: 21

Prior U.S. Cls.: 2, 13, 23, 29, 30, 33, 40, and 50

Reg. No. 3,486,448

United States Patent and Trademark Office

Registered Aug. 12, 2008

**TRADEMARK
PRINCIPAL REGISTER**

YAMAZAKI

YAMAZAKI TABLEWARE INCORPORATED
(NEW YORK CORPORATION)
105 MAIN STREET
HACKENSACK, NJ 07601

FOR: SERVING WARE FOR SERVING FOOD; BOWLS; CANDLESTICKS NOT OF PRECIOUS METAL; CANDLEHOLDERS NOT OF PRECIOUS METAL; SALT AND PEPPER SHAKERS; SUSHI SETS COMPRISED OF CHOPSTICKS, CHOPSTICK HOLDERS, SOY SAUCE DISHES, SUSHI BOARDS AND SUSHI TRAYS; SERVING TRAYS NOT OF PRECIOUS METAL; COASTERS NOT OF PAPER AND NOT BEING TABLE LINEN; COOLERS FOR WINE; PORTABLE BOTTLED BEVERAGE COOLERS; CHEESE AND FOOD BOARDS; BUCKETS FOR HOLDING ICE; CANDLE HOLDERS; TEA LIGHT CANDLE HOLDERS, AND GIFT SETS OF SUCH ITEMS, IN CLASS 21 (U.S. CLS. 2, 13, 23, 29, 30, 33, 40 AND 50).

FIRST USE 4-1-2003; IN COMMERCE 4-1-2003.

THE MARK CONSISTS OF STANDARD CHARACTERS WITHOUT CLAIM TO ANY PARTICULAR FONT, STYLE, SIZE, OR COLOR.

THE NAME ETSUJI "YAMAZAKI" IDENTIFIES A LIVING INDIVIDUAL WHOSE CONSENT IS OF RECORD.

SEC. 2(F).

SN 78-915,192, FILED 6-23-2006.

ZHALEH DELANEY, EXAMINING ATTORNEY

Int. Cl.: 41

Prior U.S. Cls.: 100, 101, and 107

Reg. No. 3,486,449

United States Patent and Trademark Office

Registered Aug. 12, 2008

**SERVICE MARK
PRINCIPAL REGISTER**

BLUR

MANDEVILLE, WILLIAM (UNITED STATES INDIVIDUAL)
11040 E. MISSION LANE
SCOTTSDALE, AZ 85259

FOR: PROVIDING NON-DOWNLOADABLE ONLINE PUBLICATIONS IN THE NATURE OF A MAGAZINE CONCERNING MULTICULTURAL FAMILY AND COMMUNITY ISSUES; ENTERTAINMENT, NAMELY, PROVIDING DEVELOPMENT, ORGANIZATION, AND PRODUCTION OF FAMILY AND CULTURAL EVENTS AND ACTIVITIES; ORGANIZING AND HOLDING OF CONFERENCES, COLLOQUIUMS, CONVENTIONS, SEMINARS, AND SYMPOSIUMS CONCERNING MULTICULTURAL FAMILIES AND COMMUNITIES; ORGA-

NIZING AND HOLDING OF MULTICULTURAL FAMILY AND COMMUNITY EXHIBITIONS AND EVENTS FOR CULTURAL OR EDUCATIONAL PURPOSES, IN CLASS 41 (U.S. CLS. 100, 101 AND 107).

FIRST USE 5-19-2008; IN COMMERCE 5-19-2008.

THE MARK CONSISTS OF STANDARD CHARACTERS WITHOUT CLAIM TO ANY PARTICULAR FONT, STYLE, SIZE, OR COLOR.

SN 78-915,411, FILED 6-23-2006.

CORY BOONE, EXAMINING ATTORNEY

Int. Cl.: 9

Prior U.S. Cls.: 21, 23, 26, 36, and 38

United States Patent and Trademark Office

Reg. No. 3,486,450

Registered Aug. 12, 2008

TRADEMARK
PRINCIPAL REGISTER

Kensington

ACCO BRANDS CORPORATION (DELAWARE CORPORATION)
300 TOWER PARKWAY
LINCOLNSHIRE, IL 60096

FOR: COMPUTER CABLES FEATURING LOCKS AND KEYS FOR SECURING COMPUTERS AND COMPUTER ACCESSORIES; COMPUTER ACCESSORIES, NAMELY, MICE, TRACKBALLS, KEYBOARDS, KEYPADS, KEYBOARD PLATFORMS, AND WIRELESS DESKTOP COMPUTER DOCKING STATIONS; CARRYING CASES FOR DIGITAL MUSIC PLAYERS; PRESENTATION REMOTE CONTROLS FOR COMPUTERS AND PORTABLE DIGITAL MUSIC PLAYER; COMPUTER SECURITY HARDWARE, NAMELY, ALARMS AND KEYS FOR USE WITH COMPUTERS, COMPUTER PERIPHERALS, AND COMPUTER ACCESSORIES; SOFTWARE AND FIRMWARE IN THE FIELD OF COMPUTER SECURITY FOR THE PROTECTION OF DATA; POWER CONTROLLERS; SURGE PROTECTORS; ADAPTERS, NAMELY, POWER ADAPTERS FOR USE WITH PORTABLE ELECTRONIC DEVICES; POWER CONTROL CENTERS, NAMELY, POWER SWITCHES; POWER INVERTERS FOR USE WITH COMPUTERS; COMPUTER PERIPHERALS; PORTABLE DIGITAL MUSIC PLAYERS; CELLULAR TELEPHONES; USB HARDWARE, NAMELY, ADAPTERS AND HUBS; COMPUTER HARDWARE, NAMELY, WIRELESS NETWORK LOCATORS;

COMPUTER HARDWARE, NAMELY, PORT REPLICATORS; PHONE ADAPTERS; MODEM CORDS; ETHERNET CORDS; COMPUTER DOCKING STATIONS; COMPUTER HARDWARE, NAMELY, MEMORY CARD READERS; HEADPHONES; AUDIO SPEAKERS; CALCULATORS; COMPUTER STANDS SPECIALLY DESIGNED FOR HOLDING A MONITOR; COMPUTER STANDS SPECIALLY DESIGNED FOR HOLDING A LAPTOP COMPUTER; MOUNTING RACKS FOR COMPUTER MONITORS AND LAPTOP COMPUTERS; WRIST RESTS AND SUPPORTS FOR COMPUTER MOUSE USERS; COMPUTER PERIPHERALS, NAMELY, LIGHTING AND FANS FOR COMPUTERS; COMPUTER PERIPHERALS; COMPUTER SCREEN FILTERS, IN CLASS 9 (U.S. CLS. 21, 23, 26, 36 AND 38).

FIRST USE 3-19-1982; IN COMMERCE 3-19-1982.

THE MARK CONSISTS OF STANDARD CHARACTERS WITHOUT CLAIM TO ANY PARTICULAR FONT, STYLE, SIZE, OR COLOR.

OWNER OF U.S. REG. NOS. 1,317,818, 1,565,648, AND 2,015,468.

SN 78-916,587, FILED 6-26-2006.

DAVID YONTEF, EXAMINING ATTORNEY

Int. Cl.: 29

Prior U.S. Cl.: 46

United States Patent and Trademark Office

Reg. No. 3,486,451

Registered Aug. 12, 2008

TRADEMARK
PRINCIPAL REGISTER



TECHNOLOGIE BIOLACTIS INC. (CANADA CORPORATION)
2152, CHEMIN ST-JOSEPH
P.O. BOX 1091
LA BAIE, CANADA

FOR: YOGURT, IN CLASS 29 (U.S. CL. 46).

FIRST USE 11-23-2006; IN COMMERCE 11-23-2006.

NO CLAIM IS MADE TO THE EXCLUSIVE RIGHT TO USE "HELPS IMPROVE NATURAL MANAGEMENT OF FAT" AND THE FRENCH TRANSLATION "AIDE À AMÉLIORER LA GESTION NATURELLE DES GRAS", APART FROM THE MARK AS SHOWN.

THE COLOR(S) RED, WHITE AND PURPLE IS/ARE CLAIMED AS A FEATURE OF THE MARK.

THE COLORS RED, WHITE AND PURPLE APPEAR IN THE MARK, SPECIFICALLY, THE PERSON DESIGN IS RED, THE FLOWER DESIGN IS WHITE WITH A PURPLE OUTLINE CONTAINING A RED HEART, THE WORDING IN THE MARK IS PURPLE AND THE OVAL BACKGROUND IS PURPLE HAVING A WHITE LIGHTBURST.

THE ENGLISH TRANSLATION OF THE FRENCH WORDING "AIDE À AMÉLIORER LA GESTION NATURELLE DES GRAS" IS "HELPS IMPROVE NATURAL MANAGEMENT OF FAT".

SN 78-916,634, FILED 6-26-2006.

DOMINIC FATHY, EXAMINING ATTORNEY

Int. Cls.: 2, 5, and 19

**Prior U.S. Cls.: 1, 6, 11, 12, 16, 18, 33, 44, 46, 50, 51,
and 52**

Reg. No. 3,486,452

United States Patent and Trademark Office

Registered Aug. 12, 2008

**TRADEMARK
PRINCIPAL REGISTER**

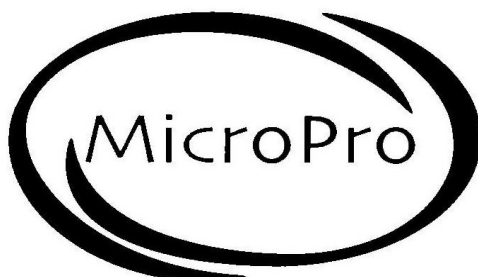

OSMOSE, INC. (NEW YORK CORPORATION)
980 ELLICOTT STREET
BUFFALO, NY 14209

FOR: PRESERVATIVES USED IN THE TREAT-
MENT OF WOOD AND CELLULOSIC MATERIALS,
IN CLASS 2 (U.S. CLS. 6, 11 AND 16).

FIRST USE 6-0-2006; IN COMMERCE 6-0-2006.

FOR: FUNGICIDES FOR USE IN/ON WOOD AND
LUMBER, IN CLASS 5 (U.S. CLS. 6, 18, 44, 46, 51 AND
52).

FIRST USE 6-0-2006; IN COMMERCE 6-0-2006.

FOR: TREATED WOOD AND LUMBER, IN
CLASS 19 (U.S. CLS. 1, 12, 33 AND 50).

FIRST USE 6-0-2006; IN COMMERCE 6-0-2006.

SN 78-917,094, FILED 6-26-2006.

REBECCA GILBERT, EXAMINING ATTORNEY

Int. Cls.: 9 and 41

Prior U.S. Cls.: 21, 23, 26, 36, 38, 100, 101, and 107

United States Patent and Trademark Office

Reg. No. 3,486,453

Registered Aug. 12, 2008

**TRADEMARK
SERVICE MARK
PRINCIPAL REGISTER**

SCHOOLED

OMX, INC. (NEVADA CORPORATION)
150 PIERCE ROAD
ITASCA, IL 60143

FOR: DVD FEATURING A REALITY TELEVISION PROGRAM FOR PROMOTION OF GOING TO SCHOOL, IN CLASS 9 (U.S. CLS. 21, 23, 26, 36 AND 38).

FIRST USE 9-0-2006; IN COMMERCE 9-0-2006.

FOR: PRODUCTION OF A REALITY CABLE TELEVISION PROGRAM FOR PROMOTION OF

GOING TO SCHOOL, IN CLASS 41 (U.S. CLS. 100, 101 AND 107).

FIRST USE 9-0-2006; IN COMMERCE 9-0-2006.

THE MARK CONSISTS OF STANDARD CHARACTERS WITHOUT CLAIM TO ANY PARTICULAR FONT, STYLE, SIZE, OR COLOR.

SN 78-917,257, FILED 6-26-2006.

FRANK LATTUCA, EXAMINING ATTORNEY

Int. Cls.: 9, 16, 17, 20, 22, 26, 35, and 40

Prior U.S. Cls.: 1, 2, 5, 7, 12, 13, 19, 21, 22, 23, 25, 26, 29, 32, 35, 36, 37, 38, 39, 40, 42, 50, 100, 101, 102, 103, and 106

Reg. No. 3,486,454

United States Patent and Trademark Office

Registered Aug. 12, 2008

**TRADEMARK
SERVICE MARK
PRINCIPAL REGISTER**

MAKE THE CONNECTION

FASTENATION, INC. (NEW JERSEY CORPORATION)
UNIT #2
120 BRIGHTON ROAD
CLIFTON, NJ 07012

FOR: STRUCTURAL PARTS OF CD AND DVD CASES, NAMELY, CD AND DVD HUBS, IN CLASS 9 (U.S. CLS. 21, 23, 26, 36 AND 38).

FIRST USE 3-0-2008; IN COMMERCE 3-0-2008.

FOR: ADHESIVE COINS USED TO AFFIX TWO SURFACES TOGETHER FOR STATIONERY PURPOSES, NAMELY, POSTERS, DISPLAYS, DIRECT MAIL AND PRESENTATION FOLDERS, IN CLASS 16 (U.S. CLS. 2, 5, 22, 23, 29, 37, 38 AND 50).

FIRST USE 3-0-2008; IN COMMERCE 3-0-2008.

FOR: FASTENING PRODUCTS, NAMELY, FOAM BACKED ADHESIVE TAPES AND PRESSURE SENSITIVE TAPES FOR INDUSTRIAL OR COMMERCIAL USE, ADHESIVE COINS USED TO AFFIX TWO SURFACES TOGETHER FOR INDUSTRIAL OR COMMERCIAL USES; SEMI-FINISHED SHEET FOAM SPACER BLOCKS USED TO CREATE POP OUT OR 3D EFFECTS ON SIGNAGE; SEMI-FINISHED ROLL CD-DVD FOAM DOTS USED FOR MOUNTING CD'S OR DVD'S ON ADVERTISING PIECES; ADHESIVE FILMS FOR INDUSTRIAL USE, ADHESIVE SPRAYS FOR INDUSTRIAL USE, ADHESIVE DOTS FOR INDUSTRIAL OR COMMERCIAL PURPOSES, AND KITS COMPRISED OF FASTENING PRODUCTS, CONSISTING PRIMARILY OF ADHESIVE DOTS FOR INDUSTRIAL OR COMMERCIAL PURPOSES, PRESSURE SENSITIVE ADHESIVE TAPE, ADHESIVE COINS, AND ALSO

INCLUDING HOOK AND LOOP FASTENING TAPE, HOOK AND LOOP COINS, CLOTHES HANGER STRAPS AND CABLE HANGERS, IN CLASS 17 (U.S. CLS. 1, 5, 12, 13, 35 AND 50).

FIRST USE 3-0-2008; IN COMMERCE 3-0-2008.

FOR: NON-METAL TABLE SKIRTING CLIPS, NON-METAL TABLE CLOTH CLIPS AND CAR CLOTHES HANGERS; FINISHED FOAM SPACER BLOCKS USED TO CREATE POP OUT OR 3D EFFECTS ON SIGNAGE; FINISHED CD-DVD FOAM DOTS USED FOR MOUNTING CD'S OR DVD'S ON ADVERTISING PIECES; MOLDED RUBBER BUMPERS AND MOLDED RUBBER FEET USED AS NON-SKID FRICTION DEVICES WHICH ACT AS PADS, CUSHIONS OR SHOCK ABSORBERS FOR CHAIR LEGS, DOORS, DRAWERS OR LIDS TO PREVENT SCRATCHES, NICKS, DENTS OR SQUEAKS, IN CLASS 20 (U.S. CLS. 2, 13, 22, 25, 32 AND 50).

FIRST USE 3-0-2008; IN COMMERCE 3-0-2008.

FOR: DIE CUT STRAPS FOR SECURING BUNDLES, CORD STRAPS FOR SECURING BUNDLES, CABLE TIES AND CABLE HANGERS FOR FASTENING AND SECURING OBJECTS SUCH AS BUNDLES OF WIRE, TUBES, PACKAGES, CORRUGATED MATERIALS, AND FABRICS, IN CLASS 22 (U.S. CLS. 1, 2, 7, 19, 22, 42 AND 50).

FIRST USE 3-0-2008; IN COMMERCE 3-0-2008.

FOR: HOOK AND LOOP FASTENING TAPE, PRESSURE SENSITIVE HOOK AND LOOP FASTENERS, SEW-ON FASTENERS, RECLOSABLE FASTENERS, BUCKLES AND ELASTIC LOOPS FOR

CLOTHING, IN CLASS 26 (U.S. CLS. 37, 39, 40, 42 AND 50).

FIRST USE 3-0-2008; IN COMMERCE 3-0-2008.

FOR: DISTRIBUTORSHIP SERVICES IN THE FIELD OF FASTENING PRODUCTS, NAMELY, FOAM BACKED ADHESIVE TAPES, PRESSURE SENSITIVE TAPES, ADHESIVE CIRCLES, FRAMING SUPPLIES, NAMELY, CORNER CHEVRONS, FOAM SPACER BLOCKS, MAGNETIC STRIPS WITH ADHESIVE BACKING, FOAM DOTS, GLUE DOTS, CD-DVD HUBS, ADHESIVE FILMS, ADHESIVE SPRAYS, HOOK AND LOOP FASTENING TAPE, TABLE SKIRTING CLIPS, TABLE CLOTH CLIPS, MOLDED BUMPERS, MOLDED FEET, CAR CLOTHES HANGERS, HOOK AND LOOP FASTENERS, SEW-ON FASTENERS, CABLE HANGERS, DIE CUT STRAPS, CORD STRAPS, CABLE TIES, ELASTIC LOOPS, INJECTION MOLDED FASTENERS, RECLOSABLE FASTENERS, BUCKLES AND KITS CONTAINING FASTENING PRODUCTS; PACKA-

GING OF FASTENING PRODUCTS TO THE ORDER AND SPECIFICATION OF OTHERS, IN CLASS 35 (U.S. CLS. 100, 101 AND 102).

FIRST USE 12-0-2006; IN COMMERCE 12-0-2006.

FOR: MANUFACTURING SERVICES, NAMELY, FABRICATION OF FASTENERS FOR OTHERS; ASSEMBLY OF FASTENING PRODUCTS FOR OTHERS; CUSTOM FABRICATION OF FASTENERS TO MEET CUSTOMERS SPECIFICATIONS, IN CLASS 40 (U.S. CLS. 100, 103 AND 106).

FIRST USE 12-0-2006; IN COMMERCE 12-0-2006.

THE MARK CONSISTS OF STANDARD CHARACTERS WITHOUT CLAIM TO ANY PARTICULAR FONT, STYLE, SIZE, OR COLOR.

SN 78-917,603, FILED 6-27-2006.

LYDIA BELZER, EXAMINING ATTORNEY

Int. Cl.: 12

Prior U.S. Cls.: 19, 21, 23, 31, 35, and 44

Reg. No. 3,486,455

United States Patent and Trademark Office

Registered Aug. 12, 2008

**TRADEMARK
PRINCIPAL REGISTER**



CACTUS CORPORATION CO., LTD. (JAPAN
CORPORATION)
3-37-1 NONOUE, HABIKINO
OSAKA, JAPAN

THE NAME G GARSON DOES NOT IDENTIFY A
LIVING INDIVIDUAL.

FOR: STRUCTURAL PARTS FOR AUTOMO-
BILES, IN CLASS 12 (U.S. CLS. 19, 21, 23, 31, 35 AND
44).

SN 78-918,305, FILED 6-27-2006.

FIRST USE 1-1-2003; IN COMMERCE 7-31-2007.

SIMON TENG, EXAMINING ATTORNEY

Int. Cl.: 15

Prior U.S. Cls.: 2, 21, and 36

United States Patent and Trademark Office

Reg. No. 3,486,456

Registered Aug. 12, 2008

**TRADEMARK
PRINCIPAL REGISTER**

Less Tall

FRANK D. PINE (MASSACHUSETTS SOLE PROPRIETORSHIP)
20 FLINT ROAD
CONCORD, MA 01742

THE MARK CONSISTS OF STANDARD CHARACTERS WITHOUT CLAIM TO ANY PARTICULAR FONT, STYLE, SIZE, OR COLOR.

FOR: GUITARS, IN CLASS 15 (U.S. CLS. 2, 21 AND 36).

SN 78-918,422, FILED 6-28-2006.

FIRST USE 7-1-2006; IN COMMERCE 7-1-2006.

AMY MCMENAMIN, EXAMINING ATTORNEY

Int. Cl.: 9

Prior U.S. Cls.: 21, 23, 26, 36, and 38

United States Patent and Trademark Office

Reg. No. 3,486,457

Registered Aug. 12, 2008

**TRADEMARK
PRINCIPAL REGISTER**

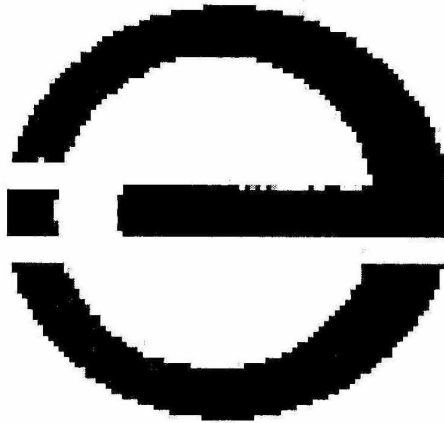

ETECH SOFTWARE LLC (DELAWARE CORPORATION)
5720 MADRID LANE
LONG BEACH, CA 90814

FOR: COMPUTER SOFTWARE FOR USE BY THE HEALTHCARE INDUSTRY FOR TIME MANAGEMENT, INFORMATION RESOURCE, AND STORAGE OF MULTIMEDIA AND HEALTH RECORDS, IN CLASS 9 (U.S. CLS. 21, 23, 26, 36 AND 38).

FIRST USE 2-17-2006; IN COMMERCE 2-17-2006.

THE MARK CONSISTS OF A STYLIZED LETTER "E".

SN 78-918,499, FILED 6-28-2006.

HOWARD SMIGA, EXAMINING ATTORNEY

Int. Cls.: 35, 36, and 38

Prior U.S. Cls.: 100, 101, 102, and 104

United States Patent and Trademark Office

Reg. No. 3,486,458

Registered Aug. 12, 2008

**SERVICE MARK
PRINCIPAL REGISTER**

CMPS EXCHANGE

CMPS INSTITUTE, LLC (MICHIGAN LTD LIAB
CO)
3017 WALNUT RIDGE DR.
ANN ARBOR, MI 48103

FOR: PROVIDING A WEB SITE AT WHICH
USERS EXCHANGE INFORMATION REGARDING
BUSINESS, BUSINESS MANAGEMENT, BUSINESS
PLANNING, TAX AND TAXATION PLANNING;
PROVIDING A WEB SITE AT WHICH USERS RE-
CEIVE INFORMATION REGARDING BUSINESS,
BUSINESS MANAGEMENT, BUSINESS PLANNING,
TAX AND TAXATION PLANNING, IN CLASS 35
(U.S. CLS. 100, 101 AND 102).

FIRST USE 5-28-2006; IN COMMERCE 5-28-2006.

FOR: PROVIDING A WEB SITE AT WHICH
USERS EXCHANGE INFORMATION REGARDING
REAL ESTATE EQUITY MANAGEMENT, AND
FINANCIAL PLANNING; PROVIDING A WEB SITE
AT WHICH USERS RECEIVE INFORMATION RE-
GARDING REAL ESTATE INVESTMENTS, MORT-
GAGE PLANNING, REAL ESTATE EQUITY
MANAGEMENT, AND FINANCIAL PLANNING,
IN CLASS 36 (U.S. CLS. 100, 101 AND 102).

FIRST USE 5-28-2006; IN COMMERCE 5-28-2006.

FOR: PROVIDING ON-LINE CHAT ROOMS FOR
TRANSMISSION OF MESSAGES AMONG COMPU-
TER USERS CONCERNING BUSINESS, BUSINESS
MANAGEMENT, BUSINESS PLANNING, TAX AND
TAXATION PLANNING, REAL ESTATE INVEST-
MENTS, MORTGAGE PLANNING, REAL ESTATE
EQUITY MANAGEMENT, AND FINANCIAL PLAN-
NING, IN CLASS 38 (U.S. CLS. 100, 101 AND 104).

FIRST USE 5-28-2006; IN COMMERCE 5-28-2006.

THE MARK CONSISTS OF STANDARD CHAR-
ACTERS WITHOUT CLAIM TO ANY PARTICULAR
FONT, STYLE, SIZE, OR COLOR.

NO CLAIM IS MADE TO THE EXCLUSIVE
RIGHT TO USE "EXCHANGE", APART FROM
THE MARK AS SHOWN.

SN 78-919,073, FILED 6-28-2006.

HENRY S. ZAK, EXAMINING ATTORNEY

Int. Cl.: 9

Prior U.S. Cls.: 21, 23, 26, 36, and 38

Reg. No. 3,486,459

United States Patent and Trademark Office

Registered Aug. 12, 2008

**TRADEMARK
PRINCIPAL REGISTER**

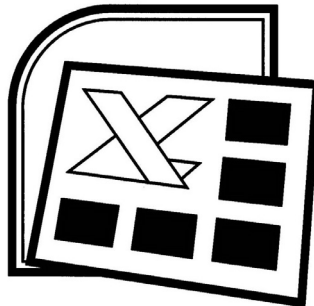

MICROSOFT CORPORATION (WASHINGTON CORPORATION)
ONE MICROSOFT WAY
REDMOND, WA 980526399

FIRST USE 11-21-2006; IN COMMERCE 11-21-2006.

FOR: COMPUTER SOFTWARE, NAMELY, SPREADSHEET SOFTWARE; AND COMPUTER PROGRAMS FOR CREATING CHARTS AND GRAPHS FROM ELECTRONIC SPREADSHEETS, IN CLASS 9 (U.S. CLS. 21, 23, 26, 36 AND 38).

OWNER OF U.S. REG. NOS. 1,626,863 AND 3,139,017.

SN 78-919,388, FILED 6-28-2006.

SUNG IN, EXAMINING ATTORNEY

Int. Cl.: 21

Prior U.S. Cls.: 2, 13, 23, 29, 30, 33, 40, and 50

United States Patent and Trademark Office

Reg. No. 3,486,460

Registered Aug. 12, 2008

TRADEMARK
PRINCIPAL REGISTER

Front of The House

FOH, INC. (FLORIDA CORPORATION)
9315 PARK DR.
MIAMI SHORES, FL 33138

FOR: BAKING DISHES; BASKETS OF RATTAN; BATH ACCESSORIES, NAMELY, CUP HOLDERS; BEVERAGE GLASSWARE; BEVERAGWARE; BOWLS; BUCKETS; BUCKETS OF WOVEN FABRIC; BUTLERS' TRAYS; BUTTER DISHES; BUTTER-DISH AND CHEESE-DISH COVERS; CAKE STANDS; CANDLE HOLDERS NOT OF PRECIOUS METAL; CARAFES; CARVER RESTS; CERAMIC TISSUE BOX COVERS; CHAMPAGNE BUCKETS; CHEESE COVERS; CHOPSTICK CASES; CHOPSTICKS; COASTERS NOT OF PAPER AND NOT BEING TABLE LINEN; COCKTAIL PICKS; COCKTAIL SHAKERS; COFFEE CUPS; COFFEE POTS NOT OF PRECIOUS METAL; COFFEE SERVICES NOT OF PRECIOUS METAL; COFFEE STIRRERS; CONTAINERS FOR HOUSEHOLD OR KITCHEN USE; CONTAINERS FOR ICE; COOLERS FOR WINE; COOLING BUCKETS FOR WINE; COTTON BALL DISPENSERS; CREAMER PITCHERS; CRUET STANDS FOR OIL OR VINEGAR NOT OF PRECIOUS METAL; CRUET STANDS NOT OF PRECIOUS METAL; CRUETS NOT OF PRECIOUS METAL; CUPS; DECANTERS; DECORATIVE GLASS; DECORATIVE PLATES; DINNERWARE; DINNERWARE, NAMELY, PLATES, UTENSILS, NAMELY, SERVING SPOONS AND SERVING FORKS, BOWLS; DISH COVERS; DISHES; DISHES AND PLATES; DISPENSERS FOR LIQUID SOAP; DISPENSERS FOR PAPER TOWELS; DRINKING CUPS; DRINKING GLASSES; DRINKING STEINS; DRINKING VESSELS; EARTHENWARE BASINS; EARTHENWARE MUGS; EGG CUPS; EGG CUPS; FINGER BOWLS; FLOWER BASKETS; FLOWER BOWLS; FLOWER VASES AND BOWL; FRUIT BOWLS; FRUIT BOWLS OF GLASS; GLASS BEVERAGWARE; GLASS BOWLS; GLASS BOXES; GLASS CARAFES; GLASS DISHES; GLASS MUGS; GOBLET; GRAVY BOATS; HAND-OPERATED COFFEE

GRINDERS AND PEPPER MILLS; HOLDERS FOR FLOWERS AND PLANTS; HOLDERS FOR TOILET PAPER; HOUSEHOLD UTENSILS, NAMELY, SERVING PIECES, NAMELY, SERVING SPOONS AND SERVING FORKS; HOUSEHOLD UTENSILS, NAMELY, SPATULAS; HOUSEHOLD UTENSILS, NAMELY, TURNERS; ICE BUCKETS; ICE PAILS; JAPANESE RICE BOWLS NOT OF PRECIOUS METAL (CHAWAN); JAPANESE STYLE EARTHENWARE MORTARS (SURIBACHI); JAPANESE STYLE PERSONAL DINING TRAYS OR STANDS (ZEN); JAPANESE STYLE SOUP SERVING BOWLS (WAN); JAPANESE STYLE TEA-SERVING POTS (KYUSU); JAPANESE STYLE WOODEN PESTLES (SURIKOGI); KITCHEN LADLES; KNIFE RESTS; LADLES, FOR KITCHEN USE; LEATHER COASTERS; MEAL TRAYS; MUG TREES; MUGS; NAPKIN HOLDERS; NAPKIN HOLDERS AND NAPKIN RINGS NOT OF PRECIOUS METAL; NAPKIN RINGS NOT OF PRECIOUS METALS; NON-ELECTRIC COFFEE POTS NOT OF PRECIOUS METAL; NON-ELECTRIC COFFEE SERVERS NOT OF PRECIOUS METAL; NON-ELECTRIC KITCHEN CONTAINERS NOT MADE OF PRECIOUS METAL; NON-METAL OIL CANS SOLD EMPTY; PEPPER GRINDERS; PEPPER MILLS; PEPPER MILLS; PEPPER POTS, SUGAR BOWLS AND SALT SHAKERS; PITCHERS; PLASTIC BUCKETS; PLASTIC COASTERS; PLASTIC CUPS; PLASTIC PLATES; PLATES; PLATES FOR HORS D'OEUVRE; PORCELAIN MUGS; PORTABLE PLASTIC CONTAINERS FOR STORING HOUSEHOLD AND KITCHEN GOODS; SAKE CUPS; SAKE SERVING BOTTLES (TOKKURI); SALAD BOWLS; SALAD BOWLS; SALT AND PEPPER MILLS; SALT AND PEPPER SHAKERS; SALT SHAKERS; SAUCEBOATS NOT OF PRECIOUS METALS; SAUCERS; SAUCERS NOT OF PRECIOUS METALS; SERVIETTE HOLDERS; SERVIETTE RINGS NOT OF PRECIOUS METAL; SERVING BOWLS (HACHI); SERVING DISHES; SERVING FORKS; SERVING LADLES; SERVING PLATTERS; SERVING PLATTERS NOT OF PRE-

CIOUS METAL; SERVING SPOONS; SERVING TONGS; SERVING TRAYS NOT OF PRECIOUS METAL; SERVINGWARE FOR SERVING FOOD; SHALLOW BOWLS; SHAVING BRUSH HOLDERS; SHAVING BRUSH STANDS; SHOT GLASSES; SLOTTED SPOONS; SOAP BOXES; SOAP CONTAINERS; SOAP DISHES; SOAP DISPENSERS; SOAP HOLDERS; SOAP HOLDERS AND BOXES; SOUP TUREENS; SPECKLED GLASS; SPONGE HOLDERS; STEMWARE; SUGAR BASINS; SWIZZLE STICKS; SYRUP JUGS; TEA CADDIES; TEA POTS NOT OF PRECIOUS METAL; TEA SERVICES NOT OF PRECIOUS METAL; TEA SETS; TEACUPS (YUNOMI); TOILET BRUSH HOLDERS; TOILET BRUSHES; TOILET PAPER DISPENSERS; TOILET PAPER HOLDERS; TOILET TISSUE HOLDERS; TOOTHPICK HOLDERS; TOOTHPICK HOLDERS; TOOTH-

PICKS; TOWEL HOLDERS; TRASH CANS; TRASH CONTAINERS FOR HOUSEHOLD USE; TRAYS; VASES; VINEGAR CRUETS; WASTE BASKETS; WASTEPAPER BASKETS; WINE BOTTLE CRADLES; WINE BUCKETS; WINE COOLING PAILS, IN CLASS 21 (U.S. CLS. 2, 13, 23, 29, 30, 33, 40 AND 50).

FIRST USE 1-1-2007; IN COMMERCE 1-1-2007.

THE MARK CONSISTS OF STANDARD CHARACTERS WITHOUT CLAIM TO ANY PARTICULAR FONT, STYLE, SIZE, OR COLOR.

SN 78-919,423, FILED 6-28-2006.

ALICE BENMAMAN, EXAMINING ATTORNEY

Int. Cl.: 30

Prior U.S. Cl.: 46

United States Patent and Trademark Office

Reg. No. 3,486,461

Registered Aug. 12, 2008

**TRADEMARK
PRINCIPAL REGISTER**



DAD'S GOURMET, LLC (MARYLAND LTD LIAB
CO)
15711 HUGHES ROAD
P.O. BOX 528
POOLESVILLE, MD 20837

NO CLAIM IS MADE TO THE EXCLUSIVE
RIGHT TO USE "OLIVE" , APART FROM THE
MARK AS SHOWN.

FOR: SALAD SAUCES AND DRESSINGS, IN
CLASS 30 (U.S. CL. 46).

SN 78-919,430, FILED 6-28-2006.

FIRST USE 5-6-2006; IN COMMERCE 11-1-2006.

DORITT L. CARROLL, EXAMINING ATTORNEY

Int. Cl.: 28

Prior U.S. Cls.: 22, 23, 38, and 50

United States Patent and Trademark Office

Reg. No. 3,486,462

Registered Aug. 12, 2008

**TRADEMARK
PRINCIPAL REGISTER**

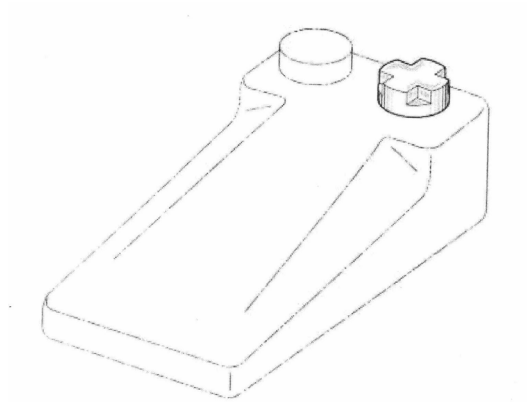

CONNECTOR SET LIMITED PARTNERSHIP (DE-
LAWARE LIMITED PARTNERSHIP)
2990 BERGEY ROAD
HATFIELD, PA 19440

FOR: MULTI-PART CONSTRUCTION TOYS AND
CONSTRUCTION TOY BLOCKS, IN CLASS 28 (U.S.
CLS. 22, 23, 38 AND 50).

FIRST USE 10-23-2006; IN COMMERCE 10-23-2006.

THE MARK CONSISTS OF A THREE-DIMEN-
SIONAL CROSS SHAPE ON A THREE-DIMENSION-
AL CYLINDRICAL SHAPE.

SN 78-920,045, FILED 6-29-2006.

AMOS T. MATTHEWS, JR., EXAMINING ATTOR-
NEY

Int. Cl.: 9

Prior U.S. Cls.: 21, 23, 26, 36, and 38

Reg. No. 3,486,463

United States Patent and Trademark Office

Registered Aug. 12, 2008

**TRADEMARK
PRINCIPAL REGISTER**



LUCRE

LUCRE COMPANIES, LLC (CALIFORNIA LTD
LIAB CO)
29882 TOP OF THE WORLD DRIVE
LAGUNA BEACH, CA 92651

FOR: COMPUTER SOFTWARE, NAMELY, ANA-
LYTICAL SOFTWARE FOR THE DUE DILIGENCE
REVIEW OF LOANS IN THE MORTGAGE AND
FINANCIAL INDUSTRY , IN CLASS 9 (U.S. CLS. 21,
23, 26, 36 AND 38).

FIRST USE 6-24-2008; IN COMMERCE 6-24-2008.

THE COLOR(S) RED, WHITE AND BLACK IS/
ARE CLAIMED AS A FEATURE OF THE MARK.

THE MARK CONSISTS OF A RED BOX SHAPE
WITH WHITE CUT OUTS ABOVE THE BLACK
WORDING "LUCRE".

THE WORDING "LUCRE" HAS NO MEANING IN
A FOREIGN LANGUAGE.

SN 78-920,152, FILED 6-29-2006.

WILLIAM BRECKENFELD, EXAMINING ATTOR-
NEY

Int. Cl.: 9

Prior U.S. Cls.: 21, 23, 26, 36, and 38

Reg. No. 3,486,464

United States Patent and Trademark Office

Registered Aug. 12, 2008

**TRADEMARK
PRINCIPAL REGISTER**



MICROSOFT CORPORATION (WASHINGTON CORPORATION)
ONE MICROSOFT WAY
REDMOND, WA 980526399

FOR: COMPUTER SOFTWARE FOR USE IN NOTE-TAKING, NAMELY, COMPUTER SOFTWARE FOR RECORDING, ORGANIZING, EDITING AND TRANSMITTING AUDIO AND VISUAL INFORMATION AND IMAGES IN ELECTRONIC FORM; COMPUTER SOFTWARE FOR VIEWING AND EDITING MEETING AGENDAS AND TO-DO LISTS; COMPUTER SOFTWARE FOR REMINDING USERS OF DATES AND EVENTS; COMPUTER SOFTWARE FOR ACCESSING SHARED DOCUMENTS OR SHARED ELECTRONIC NOTES; COM-

PUTER SOFTWARE FOR USE IN ACCESSING AND TRANSMITTING INFORMATION TO COMPUTER NETWORKS, NAMELY, COMPUTER SOFTWARE FOR E-MAILING NOTES AND PUBLISHING NOTES ON COMPUTER NETWORKS; AND COMPUTER PERIPHERALS, NAMELY, ELECTRONIC PENS FOR INPUTTING HANDWRITTEN DATA INTO A COMPUTER, IN CLASS 9 (U.S. CLS. 21, 23, 26, 36 AND 38).

FIRST USE 11-21-2006; IN COMMERCE 11-21-2006.

SN 78-920,162, FILED 6-29-2006.

SUNG IN, EXAMINING ATTORNEY

Int. Cl.: 35

Prior U.S. Cls.: 100, 101, and 102

United States Patent and Trademark Office

Reg. No. 3,486,465

Registered Aug. 12, 2008

**SERVICE MARK
PRINCIPAL REGISTER**

Vermont Sunshine

THE VERMONT SUNSHINE SOCIETY, INC.
(VERMONT CORPORATION)
225 PLATEAU ACRES
BRADFORD, VT 05033

THE MARK CONSISTS OF STANDARD CHAR-
ACTERS WITHOUT CLAIM TO ANY PARTICULAR
FONT, STYLE, SIZE, OR COLOR.

FOR: CHARITABLE SERVICES, NAMELY, OR-
GANIZING AND CONDUCTING VOLUNTEER
PROGRAMS AND COMMUNITY SERVICE PRO-
JECTS, IN CLASS 35 (U.S. CLS. 100, 101 AND 102).

SN 78-922,204, FILED 7-4-2006.

FIRST USE 5-15-1995; IN COMMERCE 5-15-1998.

DEZMONA MIZELLE, EXAMINING ATTORNEY

Int. Cl.: 32

Prior U.S. Cls.: 45, 46, and 48

United States Patent and Trademark Office

Reg. No. 3,486,466

Registered Aug. 12, 2008

**TRADEMARK
PRINCIPAL REGISTER**

CAPITAN JARRY

JARRITOS, INC. (DELAWARE CORPORATION)

SUITE 300

500 WEST OVERLAND

EL PASO, TX 79901

FOR: FRUIT FLAVORED SOFT DRINKS; FRUIT-
FLAVORED BEVERAGES; PREPARATIONS FOR
MAKING FRUIT FLAVORED BEVERAGES; SOFT
DRINKS, IN CLASS 32 (U.S. CLS. 45, 46 AND 48).

FIRST USE 10-11-2006; IN COMMERCE 10-11-2006.

THE MARK CONSISTS OF STANDARD CHAR-
ACTERS WITHOUT CLAIM TO ANY PARTICULAR
FONT, STYLE, SIZE, OR COLOR.

THE NAME(S), PORTRAIT(S), AND/OR SIGNA-
TURE(S) SHOWN IN THE MARK DOES NOT IDEN-
TIFY A PARTICULAR LIVING INDIVIDUAL.

THE FOREIGN WORDING IN THE MARK
TRANSLATES INTO ENGLISH AS CAPTAIN.

SN 78-922,829, FILED 7-5-2006.

TIMOTHY FINNEGAN, EXAMINING ATTORNEY

Int. Cl.: 25

Prior U.S. Cls.: 22 and 39

United States Patent and Trademark Office

Reg. No. 3,486,467

Registered Aug. 12, 2008

**TRADEMARK
PRINCIPAL REGISTER**



GREEN SHIRT, INC. (CALIFORNIA CORPORATION)
58390 BONANZA DRIVE
YUCCA VALLEY, CA 92284

THE MARK CONSISTS OF THE LETTER "G"
ENCASED IN A LEAF DESIGN.

FOR: CLOTHING, NAMELY, SHIRTS, JACKETS,
AND DRESSES, IN CLASS 25 (U.S. CLS. 22 AND 39).

SN 78-923,081, FILED 7-5-2006.

FIRST USE 4-0-2008; IN COMMERCE 4-0-2008.

GEORGE LORENZO, EXAMINING ATTORNEY

Int. Cl.: 7

Prior U.S. Cls.: 13, 19, 21, 23, 31, 34, and 35

Reg. No. 3,486,468

United States Patent and Trademark Office

Registered Aug. 12, 2008

**TRADEMARK
PRINCIPAL REGISTER**

COMPUCARVE

SEARS BRANDS, LLC (ILLINOIS LTD LIAB CO)
3333 BEVERLY ROAD
HOFFMAN ESTATES, IL 60179

THE MARK CONSISTS OF STANDARD CHAR-
ACTERS WITHOUT CLAIM TO ANY PARTICULAR
FONT, STYLE, SIZE, OR COLOR.

FOR: WOODWORKING MACHINE FOR CAR-
VING PLASTICS AND WOOD, IN CLASS 7 (U.S. CLS.
13, 19, 21, 23, 31, 34 AND 35).

SN 78-927,452, FILED 7-12-2006.

FIRST USE 11-0-2006; IN COMMERCE 11-0-2006.

KOURTNEE HODGES, EXAMINING ATTORNEY

Int. Cl.: 38

Prior U.S. Cls.: 100, 101, and 104

United States Patent and Trademark Office

Reg. No. 3,486,469

Registered Aug. 12, 2008

**SERVICE MARK
PRINCIPAL REGISTER**

KORE TELEMATICS

KORE WIRELESS GROUP INC. (DELAWARE
CORPORATION)

#500

12801 WORLDGATE DRIVE
HERNDON, VA 20170

FOR: PROVISION OF WIRELESS COMMUNICA-
TIONS SERVICES, EXCLUDING RETAIL CELLU-
LAR TELEPHONE SERVICES, FOR USE IN
TELEMETRY AND TELEMATICS APPLICATIONS
FOR USE IN VEHICLE LOCATION AND TRACK-
ING, POINT OF SALE AND VENDING, ASSET
TRACKING, PERSONAL SECURITY, HEALTH-
CARE, ENERGY MANAGEMENT, ENVIRONMEN-
TAL SERVICES, AND INDUSTRIAL MONITORING,
IN CLASS 38 (U.S. CLS. 100, 101 AND 104).

FIRST USE 9-9-2006; IN COMMERCE 9-9-2006.

THE MARK CONSISTS OF STANDARD CHAR-
ACTERS WITHOUT CLAIM TO ANY PARTICULAR
FONT, STYLE, SIZE, OR COLOR.

NO CLAIM IS MADE TO THE EXCLUSIVE
RIGHT TO USE "TELEMATICS", APART FROM
THE MARK AS SHOWN.

SN 78-927,853, FILED 7-12-2006.

LINDA POWELL, EXAMINING ATTORNEY

Int. Cl.: 25

Prior U.S. Cls.: 22 and 39

United States Patent and Trademark Office

Reg. No. 3,486,470

Registered Aug. 12, 2008

**TRADEMARK
PRINCIPAL REGISTER**

SWEET TOUCH

SHANTOU WINWOLF IND. LTD. (CHINA CORPORATION)
MAO GUANG INDUSTRY AREA, GURAO TOWN
CHAOYANG DISTRICT, SHANTOU CITY
GUANGDONG PROVINCE, CHINA

FOR: CLOTHING, NAMELY, SHIRTS, TOPS, JACKETS, TROUSERS, DRESSES; UNDERWEAR; UNDERPANTS; PERSPIRATION ABSORBENT UNDERWEAR CLOTHING; PETTICOATS; SINGLET; PAJAMAS; BRASSIERES; SWIMSUITS; LINGERIE ACCESSORY, NAMELY, BRA PADS FOR AESTHETIC PURPOSES; FOOTWEAR; HEADGEAR, NAME-

LY, HATS, CAPS; HOSIERY, IN CLASS 25 (U.S. CLS. 22 AND 39).

FIRST USE 8-16-2005; IN COMMERCE 11-6-2005.

THE MARK CONSISTS OF STANDARD CHARACTERS WITHOUT CLAIM TO ANY PARTICULAR FONT, STYLE, SIZE, OR COLOR.

SN 78-928,371, FILED 7-12-2006.

KARANENDRA S. CHHINA, EXAMINING ATTORNEY

Int. Cl.: 5

Prior U.S. Cls.: 6, 18, 44, 46, 51, and 52

United States Patent and Trademark Office

Reg. No. 3,486,471

Registered Aug. 12, 2008

**TRADEMARK
PRINCIPAL REGISTER**



TERBOL INC. (FLORIDA CORPORATION)
11132 NW 73 ST
DORAL, FL 33178

FOR: DIETARY AND NUTRITIONAL SUPPLEMENTS, IN CLASS 5 (U.S. CLS. 6, 18, 44, 46, 51 AND 52).

FIRST USE 2-28-2003; IN COMMERCE 1-29-2007.

NO CLAIM IS MADE TO THE EXCLUSIVE RIGHT TO USE "NUTRACEUTICALS", APART FROM THE MARK AS SHOWN.

THE COLOR(S) GREEN AND BLACK IS/ARE CLAIMED AS A FEATURE OF THE MARK.

THE MARK CONSISTS OF A MAPLE LEAF OVER THE WORDING "TERBONOVA NUTRACEUTICALS". THE COLOR GREEN APPEARS IN THE MAPLE LEAF AND THE COLOR BLACK APPEARS IN THE WORDING "TERBONOVA NUTRACEUTICALS".

SN 78-928,508, FILED 7-13-2006.

CHRISTINE COOPER, EXAMINING ATTORNEY

Int. Cl.: 25

Prior U.S. Cls.: 22 and 39

United States Patent and Trademark Office

Reg. No. 3,486,472

Registered Aug. 12, 2008

**TRADEMARK
PRINCIPAL REGISTER**

GSU CLOTHING COMPANY

STRETCH-O-RAMA, INC. (NEW YORK CORPORATION)
100 WEST 33RD STREET
NEW YORK, NY 10001

FOR: CHILDREN'S SCHOOL UNIFORMS, PANTS, JEANS, SHORTS, SHIRTS, SWEATERS, VESTS, JACKETS, OVERALLS, SWIMSUITS, SOCKS, SLIPPER SOCKS, UNDERWEAR, BLOUSES, SKIRTS, DRESSES, TIGHTS, HATS, SCARVES, GLOVES, FOOTWEAR, AND INFANTWEAR, IN CLASS 25 (U.S. CLS. 22 AND 39).

FIRST USE 6-1-2005; IN COMMERCE 6-1-2005.

THE MARK CONSISTS OF STANDARD CHARACTERS WITHOUT CLAIM TO ANY PARTICULAR FONT, STYLE, SIZE, OR COLOR.

OWNER OF U.S. REG. NO. 2,051,672.

NO CLAIM IS MADE TO THE EXCLUSIVE RIGHT TO USE "CLOTHING COMPANY", APART FROM THE MARK AS SHOWN.

SN 78-929,033, FILED 7-13-2006.

LINDA E. BLOHM, EXAMINING ATTORNEY

Int. Cls.: 17 and 23

Prior U.S. Cls.: 1, 5, 12, 13, 35, 43, and 50

Reg. No. 3,486,473

United States Patent and Trademark Office

Registered Aug. 12, 2008

**TRADEMARK
PRINCIPAL REGISTER**

NEXART

HIMO, INC. (REPUBLIC OF KOREA CORPORATION)
1364-11, SEOCHO-DONG, SEOCHO-GU
SEOUL, REPUBLIC OF KOREA

FOR: VULCANIZED FIBER NOT FOR USE IN TEXTILE; ARAMID FIBER FOR USE IN THE MANUFACTURE OF WIGGERY, IN THE FORM OF WIGS, TOUPEES, FALSE HAIR, AND NOT FOR USE IN TEXTILES; ARTIFICIAL WOOL FOR USE IN THE MANUFACTURE OF WIGGERY, IN THE FORM OF WIGS, TOUPEES, FALSE HAIR, AND NOT FOR USE IN TEXTILES, PLASTIC FIBER FOR USE IN THE MANUFACTURE OF WIGGERY, IN THE FORM OF WIGS, TOUPEES, FALSE HAIR, AND NOT FOR USE IN TEXTILES, THREADS OF RUBBER NOT FOR USE IN TEXTILE; COVERED RUBBER THREAD AND YARN NOT FOR USE IN TEXTILE; SEMI-SYNTHETIC FIBER FOR USE IN THE MANUFACTURE OF WIGGERY, IN FORM OF WIGS, NOT FOR USE IN TEXTILE , IN CLASS 17 (U.S. CLS. 1, 5, 12, 13, 35 AND 50).

FIRST USE 3-22-2007; IN COMMERCE 3-22-2007.

FOR: REGENERATED FIBER FOR USE IN THE MANUFACTURE OF WIGGERY, IN THE FORM OF

WIGS, TOUPEES, FALSE HAIR, AND NOT FOR USE IN TEXTILES; SEMI-SYNTHETIC FIBER THREAD AND YARN FOR USE IN THE MANUFACTURE OF WIGGERY, IN THE FORM OF WIGS, TOUPEES, FALSE HAIR, AND NOT FOR USE IN TEXTILES; ELASTIC YARN FOR USE IN THE MANUFACTURE OF WIGGERY, IN THE FORM OF WIGS, TOUPEES, FALSE HAIR, AND NOT FOR USE IN TEXTILES; THREAD OF PLASTIC MATERIALS FOR USE IN THE MANUFACTURE OF WIGGERY, IN THE FORM OF WIGS, TOUPEES, FALSE HAIR, AND NOT FOR USE IN TEXTILES; SYNTHETIC FIBER THREAD AND YARN IN THE MANUFACTURE OF WIGGERY, IN THE FORM OF WIGS, TOUPEES, FALSE HAIR, AND NOT FOR USE IN TEXTILES, IN CLASS 23 (U.S. CL. 43).

FIRST USE 3-22-2007; IN COMMERCE 3-22-2007.

THE MARK CONSISTS OF STANDARD CHARACTERS WITHOUT CLAIM TO ANY PARTICULAR FONT, STYLE, SIZE, OR COLOR.

SN 78-929,233, FILED 7-13-2006.

BENJAMIN OKEKE, EXAMINING ATTORNEY

Int. Cl.: 19

Prior U.S. Cls.: 1, 12, 33, and 50

United States Patent and Trademark Office

Reg. No. 3,486,474

Registered Aug. 12, 2008

**TRADEMARK
PRINCIPAL REGISTER**



STRUCTURAL SCIENCE COMPOSITES, LTD.
(UNITED KINGDOM CORPORATION)
18 TEMPLAND PARK, ALLITHWAITE
GRANGE-OVER-SANDS, UNITED KINGDOM LA11
7QS

FOR: NON-METALLIC BUILDING AND FLOOR-
ING PANELS AND COVERS COMPOSED OF FI-
BERGLASS IN A MATRIX RESIN FOR PUBLIC
UTILITY ACCESS CHAMBERS; NON-METALLIC
MAN-HOLE AND ACCESS CHAMBER COVERS
COMPOSED OF FIBERGLASS IN A MATRIX RESIN
FOR PUBLIC UTILITY ACCESS CHAMBERS; COM-
POSITE BUILDING AND FLOORING PANELS
COMPOSED OF FIBERGLASS IN A MATRIX RESIN

FOR PUBLIC UTILITY ACCESS CHAMBERS; COM-
POSITE MAN-HOLE AND ACCESS CHAMBER COV-
ERS COMPOSED OF FIBERGLASS IN A MATRIX
RESIN FOR PUBLIC UTILITY ACCESS CHAMBERS;
STRUCTURAL FRAMES AND PARTS AND FIT-
TINGS FOR AFORESAID GOODS, ALL SOLD AS A
UNIT, IN CLASS 19 (U.S. CLS. 1, 12, 33 AND 50).

FIRST USE 8-0-2006; IN COMMERCE 8-0-2006.

SN 78-929,254, FILED 7-13-2006.

LYDIA BELZER, EXAMINING ATTORNEY

Int. Cl.: 16

Prior U.S. Cls.: 2, 5, 22, 23, 29, 37, 38, and 50

United States Patent and Trademark Office

Reg. No. 3,486,475

Registered Aug. 12, 2008

TRADEMARK
PRINCIPAL REGISTER



THAYER, STEPHEN (UNITED STATES INDIVIDUAL), DBA MYVITALFILES,
1693 PARTRIDGE DRIVE
SAN LUIS OBISPO, CA 93405 AND
THAYER, PEGGY (UNITED STATES INDIVIDUAL),
DBA MYVITALFILES,
1693 PARTRIDGE DRIVE
SAN LUIS OBISPO, CA 93405

FOR: FINANCIAL, LEGAL, HOME, AND PERSONAL DOCUMENT ORGANIZATION SYSTEM COMPRISED OF PRE-LABELED AND PRE-SORTED COLOR-CODED FILE FOLDERS, BLANK FORMS AND CHARTS CONTAINING PRE-PRINTED INFORMATION AND PROVISIONS FOR RECORDING ADDITIONAL INFORMATION, AND WRITTEN INSTRUCTIONAL MATERIALS IN THE AREA OF FINANCIAL, LEGAL, HOME, AND PERSONAL DOCUMENT ORGANIZATION, MANAGE-

MENT, AND RETENTION, IN CLASS 16 (U.S. CLS. 2, 5, 22, 23, 29, 37, 38 AND 50).

FIRST USE 4-5-2008; IN COMMERCE 4-5-2008.

NO CLAIM IS MADE TO THE EXCLUSIVE RIGHT TO USE "MY VITAL FILES", APART FROM THE MARK AS SHOWN.

THE MARK CONSISTS OF THE WORDS "MYVITALFILES SMART & STYLISH SOLUTIONS", ALONG WITH A STYLIZED DEPICTION OF THREE PIECES OF PAPER OVER THE 'V' IN "VITAL".

SN 78-929,317, FILED 7-13-2006.

CORY BOONE, EXAMINING ATTORNEY

Int. Cls.: 6 and 35

Prior U.S. Cls.: 2, 12, 13, 14, 23, 25, 50, 100, 101, and 102

Reg. No. 3,486,476

United States Patent and Trademark Office

Registered Aug. 12, 2008

**TRADEMARK
SERVICE MARK
PRINCIPAL REGISTER**



FOX POOL CORPORATION (PENNSYLVANIA CORPORATION)
P.O. BOX 549
YORK, PA 17405

FOR: IN-GROUND, ON-GROUND AND ABOVE-GROUND VINYL-LINED METAL SWIMMING POOLS AND RAILS, LADDERS, STAIRS, DIVING BOARDS AND COVERS FOR THE SAME, IN CLASS 6 (U.S. CLS. 2, 12, 13, 14, 23, 25 AND 50).

FIRST USE 1-0-2007; IN COMMERCE 1-0-2007.

FOR: RETAIL STORE SERVICES FEATURING SWIMMING POOLS, IN CLASS 35 (U.S. CLS. 100, 101 AND 102).

FIRST USE 1-0-2007; IN COMMERCE 1-0-2007.

OWNER OF U.S. REG. NOS. 954,839, 1,106,117, AND 1,106,118.

SN 78-929,567, FILED 7-14-2006.

PAULA MAHONEY, EXAMINING ATTORNEY

Int. Cl.: 38

Prior U.S. Cls.: 100, 101, and 104

United States Patent and Trademark Office

Reg. No. 3,486,477

Registered Aug. 12, 2008

**SERVICE MARK
PRINCIPAL REGISTER**

MIND MEDIA INDEPENDENCE

INDEPENDENCE PUBLIC MEDIA OF PHILADELPHIA, INC. (PENNSYLVANIA NON-PROFIT CORPORATION)
8200 RIDGE AVENUE
PHILADELPHIA, PA 19128

FOR: TELEVISION BROADCASTING; CABLE TELEVISION BROADCASTING; SATELLITE TELEVISION BROADCASTING, IN CLASS 38 (U.S. CLS. 100, 101 AND 104).

FIRST USE 5-15-2008; IN COMMERCE 5-15-2008.

THE MARK CONSISTS OF STANDARD CHARACTERS WITHOUT CLAIM TO ANY PARTICULAR FONT, STYLE, SIZE, OR COLOR.

NO CLAIM IS MADE TO THE EXCLUSIVE RIGHT TO USE "MEDIA", APART FROM THE MARK AS SHOWN.

SN 78-929,711, FILED 7-14-2006.

SHARON MEIER, EXAMINING ATTORNEY

Int. Cl.: 38

Prior U.S. Cls.: 100, 101, and 104

United States Patent and Trademark Office

Reg. No. 3,486,478

Registered Aug. 12, 2008

**SERVICE MARK
PRINCIPAL REGISTER**

HOT TALK

AIR GAMES WIRELESS INC. (CANADA CORPORATION)
SUITE 706 1155 ROBSON STREET
VANCOUVER, CANADA V6E 1B5

FOR: PROVIDING ACCESS TO WIRELESS TELECOMMUNICATIONS NETWORKS SO THAT USERS CAN PLACE PERSONAL ADVERTISEMENTS ON WEBSITES AND VIEW RESPONSES TO SUCH ADVERTISEMENTS; COMMUNICATION SERVICES, NAMELY, ELECTRONIC TRANSMISSION OF DATA AMONG USERS OF TELEPHONES, PERSONAL

DIGITAL ASSISTANTS, AND COMPUTERS, IN CLASS 38 (U.S. CLS. 100, 101 AND 104).

FIRST USE 3-1-2006; IN COMMERCE 3-1-2006.

THE MARK CONSISTS OF STANDARD CHARACTERS WITHOUT CLAIM TO ANY PARTICULAR FONT, STYLE, SIZE, OR COLOR.

SN 78-929,723, FILED 7-14-2006.

SHARON MEIER, EXAMINING ATTORNEY

Int. Cl.: 7

Prior U.S. Cls.: 13, 19, 21, 23, 31, 34, and 35

Reg. No. 3,486,479

United States Patent and Trademark Office

Registered Aug. 12, 2008

**TRADEMARK
PRINCIPAL REGISTER**

REACTIV

POSITORK DISTRIBUTING, INC. (DELAWARE
CORPORATION)
SUITE 2211
4850 TASSAJARA ROAD
DUBLIN, CA 94568

FOR: ALTERNATORS FOR LAND VEHICLES
AND COMPONENTS THEREOF, NAMELY, BRU-
SHES, PULLEYS, ENGINE BEARINGS, DISTRIBUTOR
ROTORS AND STATORS , IN CLASS 7 (U.S.
CLS. 13, 19, 21, 23, 31, 34 AND 35).

FIRST USE 10-1-2006; IN COMMERCE 10-1-2006.

THE MARK CONSISTS OF STANDARD CHAR-
ACTERS WITHOUT CLAIM TO ANY PARTICULAR
FONT, STYLE, SIZE, OR COLOR.

SN 78-929,937, FILED 7-14-2006.

SHANNON TWOHIG, EXAMINING ATTORNEY

Int. Cl.: 35

Prior U.S. Cls.: 100, 101, and 102

United States Patent and Trademark Office

Reg. No. 3,486,480

Registered Aug. 12, 2008

SERVICE MARK
PRINCIPAL REGISTER



TRANSPORTATION INSIGHT LLC (NORTH
CAROLINA LTD LIAB CO)
328 1ST AVENUE NW
HICKORY, NC 28601

FOR: INFORMATION MANAGEMENT SERVICES, NAMELY, PROVIDING SHIPMENT PRICING INFORMATION, SHIPMENT PROCESSING, PREPARING SHIPPING DOCUMENTS AND INVOICES, TRACKING SHIPMENTS OF PACKAGES AND FREIGHT OVER COMPUTER NETWORKS, TRACKING PAYMENTS OF SHIPPING INVOICES, PROVIDING REPORTS OF SHIPPING ACTIVITIES, IN CLASS 35 (U.S. CLS. 100, 101 AND 102).

FIRST USE 11-6-2007; IN COMMERCE 11-6-2007.

OWNER OF U.S. REG. NO. 2,965,006.

NO CLAIM IS MADE TO THE EXCLUSIVE RIGHT TO USE "ONLINE", APART FROM THE MARK AS SHOWN.

SN 78-929,949, FILED 7-14-2006.

CHRISIE B. KING, EXAMINING ATTORNEY

Int. Cl.: 35

Prior U.S. Cls.: 100, 101, and 102

United States Patent and Trademark Office

Reg. No. 3,486,481

Registered Aug. 12, 2008

**SERVICE MARK
PRINCIPAL REGISTER**

INSIGHT RATER

TRANSPORTATION INSIGHT LLC (NORTH
CAROLINA LTD LIAB CO)
328 1ST AVENUE NW
HICKORY, NC 28601

FOR: INFORMATION MANAGEMENT SERVI-
CES, NAMELY, PROVIDING SHIPMENT PRICING
INFORMATION IN THE FIELD OF FREIGHT
TRANSPORTATION, IN CLASS 35 (U.S. CLS. 100,
101 AND 102).

FIRST USE 1-29-2007; IN COMMERCE 1-29-2007.

THE MARK CONSISTS OF STANDARD CHAR-
ACTERS WITHOUT CLAIM TO ANY PARTICULAR
FONT, STYLE, SIZE, OR COLOR.

OWNER OF U.S. REG. NO. 2,965,006.

NO CLAIM IS MADE TO THE EXCLUSIVE
RIGHT TO USE "RATER", APART FROM THE
MARK AS SHOWN.

SN 78-929,959, FILED 7-14-2006.

CHRISIE B. KING, EXAMINING ATTORNEY

Int. Cl.: 35

Prior U.S. Cls.: 100, 101, and 102

United States Patent and Trademark Office

Reg. No. 3,486,482

Registered Aug. 12, 2008

**SERVICE MARK
PRINCIPAL REGISTER**

INSIGHT TRACKER

TRANSPORTATION INSIGHT LLC (NORTH
CAROLINA LTD LIAB CO)
328 1ST AVENUE NW
HICKORY, NC 28601

FOR: INFORMATION MANAGEMENT SERVI-
CES, NAMELY, SHIPMENT PROCESSING, TRACK-
ING SHIPMENTS OF PACKAGES AND FREIGHT
OVER COMPUTER NETWORKS, IN CLASS 35 (U.S.
CLS. 100, 101 AND 102).

FIRST USE 1-29-2007; IN COMMERCE 1-29-2007.

THE MARK CONSISTS OF STANDARD CHAR-
ACTERS WITHOUT CLAIM TO ANY PARTICULAR
FONT, STYLE, SIZE, OR COLOR.

OWNER OF U.S. REG. NO. 2,965,006.

NO CLAIM IS MADE TO THE EXCLUSIVE
RIGHT TO USE "TRACKER", APART FROM THE
MARK AS SHOWN.

SN 78-929,961, FILED 7-14-2006.

CHRISIE B. KING, EXAMINING ATTORNEY

Int. Cl.: 35

Prior U.S. Cls.: 100, 101, and 102

United States Patent and Trademark Office

Reg. No. 3,486,483

Registered Aug. 12, 2008

**SERVICE MARK
PRINCIPAL REGISTER**

INSIGHT FORMS

TRANSPORTATION INSIGHT LLC (NORTH
CAROLINA LTD LIAB CO)

328 1ST AVENUE NW

HICKORY, NC 28601

FOR: INFORMATION MANAGEMENT SERVI-
CES, NAMELY, PREPARING SHIPPING DOCU-
MENTS AND INVOICES, IN CLASS 35 (U.S. CLS.
100, 101 AND 102).

FIRST USE 10-25-2007; IN COMMERCE 10-25-2007.

THE MARK CONSISTS OF STANDARD CHAR-
ACTERS WITHOUT CLAIM TO ANY PARTICULAR
FONT, STYLE, SIZE, OR COLOR.

OWNER OF U.S. REG. NO. 2,965,006.

NO CLAIM IS MADE TO THE EXCLUSIVE
RIGHT TO USE "FORMS", APART FROM THE
MARK AS SHOWN.

SN 78-929,966, FILED 7-14-2006.

CHRISIE B. KING, EXAMINING ATTORNEY

Int. Cl.: 35

Prior U.S. Cls.: 100, 101, and 102

United States Patent and Trademark Office

Reg. No. 3,486,484

Registered Aug. 12, 2008

**SERVICE MARK
PRINCIPAL REGISTER**

INSIGHT PAYER

TRANSPORTATION INSIGHT LLC (NORTH
CAROLINA LTD LIAB CO)

328 1ST AVENUE NW

HICKORY, NC 28601

FOR: INFORMATION MANAGEMENT SERVICES, NAMELY, TRACKING PAYMENTS OF SHIPPING INVOICES, IN CLASS 35 (U.S. CLS. 100, 101 AND 102).

FIRST USE 1-29-2007; IN COMMERCE 1-29-2007.

THE MARK CONSISTS OF STANDARD CHARACTERS WITHOUT CLAIM TO ANY PARTICULAR FONT, STYLE, SIZE, OR COLOR.

OWNER OF U.S. REG. NO. 2,965,006.

NO CLAIM IS MADE TO THE EXCLUSIVE RIGHT TO USE "PAYER", APART FROM THE MARK AS SHOWN.

SN 78-929,971, FILED 7-14-2006.

CHRISIE B. KING, EXAMINING ATTORNEY

Int. Cl.: 35

Prior U.S. Cls.: 100, 101, and 102

United States Patent and Trademark Office

Reg. No. 3,486,485

Registered Aug. 12, 2008

SERVICE MARK
PRINCIPAL REGISTER

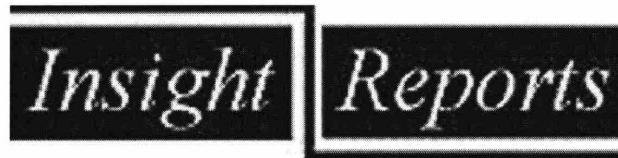

TRANSPORTATION INSIGHT LLC (NORTH
CAROLINA LTD LIAB CO)
328 1ST AVENUE NW
HICKORY, NC 28601

FOR: INFORMATION MANAGEMENT SERVI-
CES, NAMELY, SHIPMENT PROCESSING, PROVID-
ING REPORTS OF SHIPPING ACTIVITIES, IN
CLASS 35 (U.S. CLS. 100, 101 AND 102).

FIRST USE 10-25-2007; IN COMMERCE 10-25-2007.

OWNER OF U.S. REG. NO. 2,965,006.

NO CLAIM IS MADE TO THE EXCLUSIVE
RIGHT TO USE "REPORTS", APART FROM THE
MARK AS SHOWN.

SN 78-929,977, FILED 7-14-2006.

CHRISIE B. KING, EXAMINING ATTORNEY

Int. Cl.: 35

Prior U.S. Cls.: 100, 101, and 102

United States Patent and Trademark Office

Reg. No. 3,486,486

Registered Aug. 12, 2008

**SERVICE MARK
PRINCIPAL REGISTER**

INSIGHT BOL

TRANSPORTATION INSIGHT LLC (NORTH
CAROLINA LTD LIAB CO)

328 1ST AVENUE NW

HICKORY, NC 28601

FOR: INFORMATION MANAGEMENT SERVICES, NAMELY, PREPARING SHIPPING DOCUMENTS AND INVOICES, IN CLASS 35 (U.S. CLS. 100, 101 AND 102).

FIRST USE 1-29-2007; IN COMMERCE 1-29-2007.

THE MARK CONSISTS OF STANDARD CHARACTERS WITHOUT CLAIM TO ANY PARTICULAR FONT, STYLE, SIZE, OR COLOR.

OWNER OF U.S. REG. NO. 2,965,006.

NO CLAIM IS MADE TO THE EXCLUSIVE RIGHT TO USE "BOL", APART FROM THE MARK AS SHOWN.

SN 78-929,982, FILED 7-14-2006.

CHRISIE B. KING, EXAMINING ATTORNEY

Int. Cl.: 16

Prior U.S. Cls.: 2, 5, 22, 23, 29, 37, 38, and 50

Reg. No. 3,486,487

United States Patent and Trademark Office

Registered Aug. 12, 2008

**TRADEMARK
PRINCIPAL REGISTER**

VPAGE

REED ELSEVIER PROPERTIES INC. (DELA-
WARE CORPORATION)
1105 NORTH MARKET STREET, 5TH FLOOR
WILMINGTON, DE 19801

THE MARK CONSISTS OF STANDARD CHAR-
ACTERS WITHOUT CLAIM TO ANY PARTICULAR
FONT, STYLE, SIZE, OR COLOR.

FOR: PRINTED PUBLICATIONS, NAMELY, MA-
GAZINES AND MAGAZINE SECTIONS IN THE
FIELD OF ENTERTAINMENT, IN CLASS 16 (U.S.
CLS. 2, 5, 22, 23, 29, 37, 38 AND 50).

SN 78-930,669, FILED 7-17-2006.

FIRST USE 2-28-1997; IN COMMERCE 2-28-1997.

DARRYL SPRUILL, EXAMINING ATTORNEY

Int. Cl.: 28

Prior U.S. Cls.: 22, 23, 38, and 50

United States Patent and Trademark Office

Reg. No. 3,486,488

Registered Aug. 12, 2008

**TRADEMARK
PRINCIPAL REGISTER**

SPARC!

HORIZON HOBBY, INC. (DELAWARE CORPORATION)
4105 FIELDSTONE ROAD
CHAMPAIGN, IL 61822

THE MARK CONSISTS OF STANDARD CHARACTERS WITHOUT CLAIM TO ANY PARTICULAR FONT, STYLE, SIZE, OR COLOR.

FOR: REMOTE CONTROLLED HOBBY MODEL VEHICLES AND AIRCRAFT, IN CLASS 28 (U.S. CLS. 22, 23, 38 AND 50).

SN 78-931,607, FILED 7-18-2006.

FIRST USE 12-1-2006; IN COMMERCE 12-1-2006.

KOURTNEE HODGES, EXAMINING ATTORNEY

Int. Cls.: 35 and 36

Prior U.S. Cls.: 100, 101, and 102

United States Patent and Trademark Office

Reg. No. 3,486,489

Registered Aug. 12, 2008

**SERVICE MARK
PRINCIPAL REGISTER**

LENDERCITY

FIDELITY MORTGAGE GROUP, INCORPORATED (MISSOURI CORPORATION)
SUITE 150
13515 BARRETT PARKWAY DRIVE
ST. LOUIS, MO 63021

FOR: MATCHING BORROWERS WITH POTENTIAL LENDERS IN THE FIELD OF CONSUMER AND MORTGAGE LENDING, IN CLASS 35 (U.S. CLS. 100, 101 AND 102).

FIRST USE 1-31-1999; IN COMMERCE 1-31-1999.

FOR: MORTGAGE BANKING SERVICES, NAME-
LY, ORIGINATION, ACQUISITION, SERVICING,

SECURITIZATION AND BROKERAGE OF MORTGAGE LOANS; MORTGAGE PROCUREMENT FOR OTHERS, IN CLASS 36 (U.S. CLS. 100, 101 AND 102).

FIRST USE 1-31-1999; IN COMMERCE 1-31-1999.

THE MARK CONSISTS OF STANDARD CHARACTERS WITHOUT CLAIM TO ANY PARTICULAR FONT, STYLE, SIZE, OR COLOR.

SN 78-931,943, FILED 7-18-2006.

LYDIA BELZER, EXAMINING ATTORNEY

Int. Cl.: 36

Prior U.S. Cls.: 100, 101, and 102

United States Patent and Trademark Office

Reg. No. 3,486,490

Registered Aug. 12, 2008

**SERVICE MARK
PRINCIPAL REGISTER**

CROWE ESOP ADVANTAGE

CROWE GROUP LLP (INDIANA LIMITED LIABILITY PARTNERSHIP)
330 JEFFERSON BOULEVARD
SOUTH BEND, IN 46601

FOR: PROVIDING INFORMATION RELATING TO EMPLOYEES' BENEFIT ACCOUNTS, NAMELY, PARTICIPANT RECORDS, PLAN DOCUMENTS AND EDUCATIONAL AND PROMOTIONAL TOOLS, VIA THE INTERNET, IN CLASS 36 (U.S. CLS. 100, 101 AND 102).

FIRST USE 4-30-2008; IN COMMERCE 4-30-2008.

THE MARK CONSISTS OF STANDARD CHARACTERS WITHOUT CLAIM TO ANY PARTICULAR FONT, STYLE, SIZE, OR COLOR.

OWNER OF U.S. REG. NOS. 2,599,810 AND 2,772,731.

NO CLAIM IS MADE TO THE EXCLUSIVE RIGHT TO USE "ESOP", APART FROM THE MARK AS SHOWN.

SN 78-933,925, FILED 7-20-2006.

MICHAEL LEWIS, EXAMINING ATTORNEY

Int. Cl.: 9

Prior U.S. Cls.: 21, 23, 26, 36, and 38

Reg. No. 3,486,491

United States Patent and Trademark Office

Registered Aug. 12, 2008

**TRADEMARK
PRINCIPAL REGISTER**

adfotain

IADEA CORPORATION (TAIWAN CORPORATION)
5F, NO. 165, SEC.2 SINHAI ROAD
DA-AN DISTRICT
TAIPEI 106, TAIWAN

FOR: ELECTRONIC ADVERTISING SYSTEM COMPRISED OF VIDEO CAMERAS, VIDEO DISC PLAYERS, VIDEO PROJECTORS AND VIDEO MONITORS; SOFTWARE FOR USE IN THE ADVERTISING INDUSTRY FOR MANAGEMENT OF DIGITAL SIGNAGE CONTENT; ELECTRONIC KIOSK CONSISTING OF VIDEO MONITOR AND ELECTRIC SIGNS; DIGITAL VIDEO DISC PLAYER; APPARATUS FOR TRANSMISSION OF COMMUNICATION; APPARATUS FOR TRANSMITTING AND REPRODUCING SOUND OR IMAGES; AUDIO-VIDEO RECEIVERS; COMPUTER HARDWARE; COM-

PUTER SOFTWARE FOR VIDEO PROCESSING; COMPUTER SOFTWARE FOR THE WIRELESS DELIVERY OF AUDIO AND VIDEO CONTENT, CONTENT SOFTWARE FOR THE DELIVERY OF AUDIO AND VIDEO CONTENT BY MEANS OF ELECTRONIC OR OPTICAL NETWORKS, IN CLASS 9 (U.S. CLS. 21, 23, 26, 36 AND 38).

FIRST USE 7-1-2007; IN COMMERCE 4-20-2008.

THE MARK CONSISTS OF STANDARD CHARACTERS WITHOUT CLAIM TO ANY PARTICULAR FONT, STYLE, SIZE, OR COLOR.

SN 78-934,417, FILED 7-21-2006.

SHARON MEIER, EXAMINING ATTORNEY

Int. Cl.: 36

Prior U.S. Cls.: 100, 101, and 102

United States Patent and Trademark Office

Reg. No. 3,486,492

Registered Aug. 12, 2008

**SERVICE MARK
PRINCIPAL REGISTER**

UBIDLASIK

KISSINGER, JEFFREY (UNITED STATES INDIVIDUAL)
8252 DARROW ROAD, UNIT J
TWINSBURG, OH 44087

THE MARK CONSISTS OF STANDARD CHARACTERS WITHOUT CLAIM TO ANY PARTICULAR FONT, STYLE, SIZE, OR COLOR.

FOR: BROKERING LASER SURGERY SERVICES,
IN CLASS 36 (U.S. CLS. 100, 101 AND 102).

SN 78-934,838, FILED 7-21-2006.

FIRST USE 10-9-2006; IN COMMERCE 10-9-2006.

PRISCILLA MILTON, EXAMINING ATTORNEY

Int. Cl.: 43

Prior U.S. Cls.: 100 and 101

United States Patent and Trademark Office

Reg. No. 3,486,493

Registered Aug. 12, 2008

**SERVICE MARK
PRINCIPAL REGISTER**

D CUPS

LOWTHER, RICHARD JOSEPH (UNITED
STATES INDIVIDUAL)
P.O. BOX 794703
DALLAS, TX 75379

THE MARK CONSISTS OF STANDARD CHAR-
ACTERS WITHOUT CLAIM TO ANY PARTICULAR
FONT, STYLE, SIZE, OR COLOR.

FOR: COFFEE SHOPS; COFFEE-HOUSE AND
SNACK-BAR SERVICES, IN CLASS 43 (U.S. CLS.
100 AND 101).

SN 78-934,903, FILED 7-21-2006.

FIRST USE 6-1-2008; IN COMMERCE 6-1-2008.

EMILY CARLSEN, EXAMINING ATTORNEY

Int. Cl.: 5

Prior U.S. Cls.: 6, 18, 44, 46, 51, and 52

Reg. No. 3,486,494

United States Patent and Trademark Office

Registered Aug. 12, 2008

**TRADEMARK
PRINCIPAL REGISTER**

VITASYSTEMS

TATE & LYLE CUSTOM INGREDIENTS, INC.
(ILLINOIS CORPORATION)
1631 SOUTH PRAIRIE DRIVE
SYCAMORE, IL 60178

FOR: CUSTOMIZED BLENDS OF FOOD ADDITIVES FOR NUTRITIONAL PURPOSES CONSISTING OF VITAMINS, MINERALS, NUTRACEUTICALS, FIBER FOR USE IN FOOD PRODUCTS; HERBAL EXTRACTS AND FOOD FLAVORINGS IN THE NATURE OF ESSENTIAL OILS ALL SOLD AS INGREDIENTS IN FOOD ADDITIVES

FOR NUTRITIONAL PURPOSES, IN CLASS 5 (U.S. CLS. 6, 18, 44, 46, 51 AND 52).

FIRST USE 4-14-2004; IN COMMERCE 4-14-2004.

THE MARK CONSISTS OF STANDARD CHARACTERS WITHOUT CLAIM TO ANY PARTICULAR FONT, STYLE, SIZE, OR COLOR.

SN 78-936,258, FILED 7-24-2006.

LINDA ESTRADA, EXAMINING ATTORNEY

Int. Cl.: 6

Prior U.S. Cls.: 2, 12, 13, 14, 23, 25, and 50

Reg. No. 3,486,495

United States Patent and Trademark Office

Registered Aug. 12, 2008

**TRADEMARK
PRINCIPAL REGISTER**

SST ACCESS SYSTEM

CROWN INDUSTRIES, INC. (MINNESOTA CORPORATION)
P.O. BOX 15
135 MCLEOD AVENUE SOUTH
PLATO, MN 553705409

FOR: RESIDENTIAL AND COMMERCIAL DOORS MADE OF PRIMARILY METAL; DOOR FRAMES, CASING, PANELS, ROLLERS, AND HINGES MADE PRIMARILY OF METAL; GARAGE DOORS MADE PRIMARILY OF METAL; BI-FOLD DOORS MADE PRIMARILY OF METAL, IN CLASS 6 (U.S. CLS. 2, 12, 13, 14, 23, 25 AND 50).

FIRST USE 7-24-2006; IN COMMERCE 7-24-2006.

THE MARK CONSISTS OF STANDARD CHARACTERS WITHOUT CLAIM TO ANY PARTICULAR FONT, STYLE, SIZE, OR COLOR.

NO CLAIM IS MADE TO THE EXCLUSIVE RIGHT TO USE "ACCESS SYSTEM", APART FROM THE MARK AS SHOWN.

SN 78-936,862, FILED 7-25-2006.

CORY BOONE, EXAMINING ATTORNEY

Int. Cl.: 6

Prior U.S. Cls.: 2, 12, 13, 14, 23, 25, and 50

United States Patent and Trademark Office

Reg. No. 3,486,496

Registered Aug. 12, 2008

**TRADEMARK
PRINCIPAL REGISTER**



CROWN INDUSTRIES, INC. (MINNESOTA CORPORATION)
P.O. BOX 15
135 MCLEOD AVENUE SOUTH
PLATO, MN 553705409

FIRST USE 7-24-2006; IN COMMERCE 7-24-2006.

FOR: RESIDENTIAL AND COMMERCIAL DOORS MADE OF PRIMARILY METAL; DOOR FRAMES, CASING, PANELS, ROLLERS, AND HINGES MADE PRIMARILY OF METAL; GARAGE DOORS MADE PRIMARILY OF METAL; BI-FOLD DOORS MADE PRIMARILY OF METAL, IN CLASS 6 (U.S. CLS. 2, 12, 13, 14, 23, 25 AND 50).

NO CLAIM IS MADE TO THE EXCLUSIVE RIGHT TO USE "ACCESS SYSTEM", APART FROM THE MARK AS SHOWN.

SN 78-936,867, FILED 7-25-2006.

CORY BOONE, EXAMINING ATTORNEY

Int. Cl.: 16

Prior U.S. Cls.: 2, 5, 22, 23, 29, 37, 38, and 50

United States Patent and Trademark Office

Reg. No. 3,486,497

Registered Aug. 12, 2008

**TRADEMARK
PRINCIPAL REGISTER**

Romeo's World

BLACK DOG BOOKS LLC (NEW YORK LTD
LIAB CO)
2660 PINE GROVE ROAD
SKANEATELES, NY 13152

THE MARK CONSISTS OF STANDARD CHAR-
ACTERS WITHOUT CLAIM TO ANY PARTICULAR
FONT, STYLE, SIZE, OR COLOR.

FOR: CHILDREN'S BOOKS, IN CLASS 16 (U.S.
CLS. 2, 5, 22, 23, 29, 37, 38 AND 50).

SN 78-937,780, FILED 7-26-2006.

FIRST USE 2-1-2007; IN COMMERCE 2-1-2007.

JEFF DEFORD, EXAMINING ATTORNEY

Int. Cl.: 18

Prior U.S. Cls.: 1, 2, 3, 22, and 41

United States Patent and Trademark Office

Reg. No. 3,486,498

Registered Aug. 12, 2008

**TRADEMARK
PRINCIPAL REGISTER**

CHAT CHAT

SHIH ACCESSORIES, INC. (CALIFORNIA CORPORATION)
369 SOUTH DOHENY DRIVE, #289
BEVERLY HILLS, CA 90211

THE MARK CONSISTS OF STANDARD CHARACTERS WITHOUT CLAIM TO ANY PARTICULAR FONT, STYLE, SIZE, OR COLOR.

FOR: HANDBAGS, IN CLASS 18 (U.S. CLS. 1, 2, 3, 22 AND 41).

SN 78-938,396, FILED 7-26-2006.

FIRST USE 6-20-2008; IN COMMERCE 6-20-2008.

ELLEN PERKINS, EXAMINING ATTORNEY

Int. Cl.: 18

Prior U.S. Cls.: 1, 2, 3, 22, and 41

United States Patent and Trademark Office

Reg. No. 3,486,499

Registered Aug. 12, 2008

**TRADEMARK
PRINCIPAL REGISTER**

RABEANCO

SHIH ACCESSORIES, INC. (CALIFORNIA CORPORATION)
369 SOUTH DOHENY DRIVE, #289
BEVERLY HILLS, CA 90211

THE MARK CONSISTS OF STANDARD CHARACTERS WITHOUT CLAIM TO ANY PARTICULAR FONT, STYLE, SIZE, OR COLOR.

FOR: HANDBAGS, IN CLASS 18 (U.S. CLS. 1, 2, 3, 22 AND 41).

SN 78-938,418, FILED 7-26-2006.

FIRST USE 6-20-2008; IN COMMERCE 6-20-2008.

ELLEN PERKINS, EXAMINING ATTORNEY

Int. Cl.: 36

Prior U.S. Cls.: 100, 101, and 102

United States Patent and Trademark Office

Reg. No. 3,486,500

Registered Aug. 12, 2008

**SERVICE MARK
PRINCIPAL REGISTER**

INNOVATIVE BUSINESS GROUP

GALLO, THOMAS S. (UNITED STATES INDIVIDUAL)

250 MIDWAY AVENUE

FANWOOD, NJ 07023

FOR: BUSINESS BROKERAGE, IN CLASS 36 (U.S. CLS. 100, 101 AND 102).

FIRST USE 6-15-2007; IN COMMERCE 6-15-2007.

THE MARK CONSISTS OF STANDARD CHARACTERS WITHOUT CLAIM TO ANY PARTICULAR FONT, STYLE, SIZE, OR COLOR.

NO CLAIM IS MADE TO THE EXCLUSIVE RIGHT TO USE "BUSINESS GROUP", APART FROM THE MARK AS SHOWN.

SN 78-939,111, FILED 7-27-2006.

DAVID TAYLOR, EXAMINING ATTORNEY

Int. Cl.: 28

Prior U.S. Cls.: 22, 23, 38, and 50

United States Patent and Trademark Office

Reg. No. 3,486,501

Registered Aug. 12, 2008

**TRADEMARK
PRINCIPAL REGISTER**

DEER CRAVIN'

NEWMAN, MATTHEW (UNITED STATES INDIVIDUAL)
2261 MORGANZA HIGHWAY
NEW ROADS, LA 70760

FOR: WILDLIFE ATTRACTANT, NAMELY, FLAVORED AND SCENTED ANIMAL ATTRACTANT, IN CLASS 28 (U.S. CLS. 22, 23, 38 AND 50).

FIRST USE 1-15-2007; IN COMMERCE 1-15-2007.

THE MARK CONSISTS OF STANDARD CHARACTERS WITHOUT CLAIM TO ANY PARTICULAR FONT, STYLE, SIZE, OR COLOR.

NO CLAIM IS MADE TO THE EXCLUSIVE RIGHT TO USE "DEER", APART FROM THE MARK AS SHOWN.

SN 78-939,325, FILED 7-27-2006.

JUSTINE D. PARKER, EXAMINING ATTORNEY

Int. Cl.: 25

Prior U.S. Cls.: 22 and 39

United States Patent and Trademark Office

Reg. No. 3,486,502

Registered Aug. 12, 2008

**TRADEMARK
PRINCIPAL REGISTER**

My Cherry Girl

CHRISTINA ANNE VIDOVICH (MARYLAND
SOLE PROPRIETORSHIP)
519 TSCHIFFELY SQUARE ROAD
GAITHERSBURG, MD 20878

THE MARK CONSISTS OF STANDARD CHAR-
ACTERS WITHOUT CLAIM TO ANY PARTICULAR
FONT, STYLE, SIZE, OR COLOR.

FOR: HOSIERY; PANTIES; PANTS; SHIRTS;
SHOES; SHORTS; SKIRTS AND DRESSES; SWIM
WEAR FOR GENTLEMEN AND LADIES; UNDER-
GARMENTS, IN CLASS 25 (U.S. CLS. 22 AND 39).

SN 78-941,025, FILED 7-31-2006.

FIRST USE 9-27-2007; IN COMMERCE 2-8-2008.

BILL DAWE, EXAMINING ATTORNEY

Int. Cl.: 25

Prior U.S. Cls.: 22 and 39

United States Patent and Trademark Office

Reg. No. 3,486,503

Registered Aug. 12, 2008

**TRADEMARK
PRINCIPAL REGISTER**

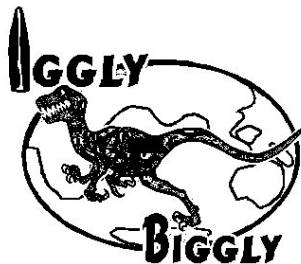

MIDDLETON, LISA (UNITED STATES INDIVIDUAL)
111 PICKWICK LAKE DRIVE
SHEFFIELD, AL 35660

THE MARK CONSISTS OF A DINOSAUR, GLOBE OF THE WORLD, AND STYLIZED TEXT OF THE WORDING "IGGLY BIGGLY".

FOR: FOOTWEAR, IN CLASS 25 (U.S. CLS. 22 AND 39).

SN 78-941,044, FILED 7-31-2006.

FIRST USE 8-1-2006; IN COMMERCE 8-1-2006.

MARLENE BELL, EXAMINING ATTORNEY

Int. Cl.: 35

Prior U.S. Cls.: 100, 101, and 102

United States Patent and Trademark Office

Reg. No. 3,486,504

Registered Aug. 12, 2008

**SERVICE MARK
PRINCIPAL REGISTER**



SOL ATLANTIC BIODIESEL LLC (FLORIDA LTD
LIAB CO)
1841 SW 164TH AVE
MIRAMAR, FL 33027

FOR: DISTRIBUTORSHIPS IN THE FIELD OF
BIODIESEL, IN CLASS 35 (U.S. CLS. 100, 101 AND
102).

FIRST USE 2-1-2006; IN COMMERCE 2-1-2006.

NO CLAIM IS MADE TO THE EXCLUSIVE
RIGHT TO USE "BIODIESEL", APART FROM THE
MARK AS SHOWN.

THE MARK CONSISTS OF A EIGHT-PETALED
FLOWER LAYED ON TOP OF A SMALLER FLOW-
ER AND NEXT TO THAT THE STYLIZED TEXT OF
THE WORDING "SOL ATLANTIC BIODIESEL".

THE ENGLISH TRANSLATION OF THE WORD
"SOL" IN THE MARK IS "SUN".

SN 78-941,746, FILED 7-31-2006.

ASMAT KHAN, EXAMINING ATTORNEY

Int. Cls.: 35 and 41

Prior U.S. Cls.: 100, 101, 102, and 107

United States Patent and Trademark Office

Reg. No. 3,486,505

Registered Aug. 12, 2008

**SERVICE MARK
PRINCIPAL REGISTER**

New York Titans

NEW YORK EMPIRE LACROSSE, LLC. (NEW YORK CORPORATION)
420 LEXINGTON AVE, SUITE 1639
NEW YORK, NY 10170

FOR: PROMOTING SPORTS COMPETITIONS OF OTHERS, NAMELY, A PROFESSIONAL LACROSSE TEAM, IN CLASS 35 (U.S. CLS. 100, 101 AND 102).

FIRST USE 1-6-2007; IN COMMERCE 1-6-2007.

FOR: ENTERTAINMENT SERVICES, NAMELY, ORGANIZING AND CONDUCTING OF COMPETITIONS FOR PROFESSIONAL LACROSSE GAMES BEFORE LIVE AUDIENCES AND ON TELEVISION AND RADIO; ORGANIZING AND CONDUCTING ENTERTAINMENT EXHIBITIONS FOR PROFESSIONAL LACROSSE GAMES BEFORE LIVE AUDIENCES AND ON TELEVISION AND RADIO; ORGANIZING AND CONDUCTING PROFESSIONAL LACROSSE TEAM SPORTS CAMPS; ORGANIZ-

ING AND CONDUCTING SPORTS CLINICS IN THE FIELD OF PROFESSIONAL LACROSSE; ENTERTAINMENT AND SPORTS ACTIVITIES, NAMELY, PROFESSIONAL LACROSSE MATCHES, IN CLASS 41 (U.S. CLS. 100, 101 AND 107).

FIRST USE 1-6-2007; IN COMMERCE 1-6-2007.

THE MARK CONSISTS OF STANDARD CHARACTERS WITHOUT CLAIM TO ANY PARTICULAR FONT, STYLE, SIZE, OR COLOR.

NO CLAIM IS MADE TO THE EXCLUSIVE RIGHT TO USE "NEW YORK", APART FROM THE MARK AS SHOWN.

SN 78-942,467, FILED 8-1-2006.

WANDA KAY PRICE, EXAMINING ATTORNEY

Int. Cl.: 28

Prior U.S. Cls.: 22, 23, 38, and 50

Reg. No. 3,486,506

United States Patent and Trademark Office

Registered Aug. 12, 2008

**TRADEMARK
PRINCIPAL REGISTER**

R/C MADE EASY

MATTEL, INC. (DELAWARE CORPORATION)
MAIL STOP M1-1518
333 CONTINENTAL BOULEVARD
EL SEGUNDO, CA 90245

FOR: TOYS, GAMES AND PLAYTHINGS, NAME-
LY, RADIO-CONTROLLED TOY VEHICLES, TOY
VEHICLES, TOY PLANES, AND ACCESSORIES FOR
ALL OF THE FOREGOING , IN CLASS 28 (U.S. CLS.
22, 23, 38 AND 50).

FIRST USE 5-15-2008; IN COMMERCE 5-15-2008.

THE MARK CONSISTS OF STANDARD CHAR-
ACTERS WITHOUT CLAIM TO ANY PARTICULAR
FONT, STYLE, SIZE, OR COLOR.

NO CLAIM IS MADE TO THE EXCLUSIVE
RIGHT TO USE "R/C", APART FROM THE MARK
AS SHOWN.

SN 78-942,615, FILED 8-1-2006.

KOURTNEE HODGES, EXAMINING ATTORNEY

Int. Cl.: 7

Prior U.S. Cls.: 13, 19, 21, 23, 31, 34, and 35

Reg. No. 3,486,507

United States Patent and Trademark Office

Registered Aug. 12, 2008

**TRADEMARK
PRINCIPAL REGISTER**



KABUSHIKI KAISHA KOBE SEIKO SHO (JAPAN CORPORATION), TA KOBE STEEL, LTD.,
10-26, WAKINOHAMA-CHO 2-CHOME, CHUO-KU
KOBE-SHI, HYOGO, JAPAN 651-8585

FOR: UNBALANCED MAGNETRON SPUTTERING EQUIPMENT, NAMELY, A VACUUM EVAPORATOR AND DEPOSITOR PRODUCING THIN FILMS AND COATING, SUCH AS AMORPHOUS CARBON FILM, ON THE SURFACE OF WORK-

PIECE, IN CLASS 7 (U.S. CLS. 13, 19, 21, 23, 31, 34 AND 35).

FIRST USE 1-24-2008; IN COMMERCE 1-24-2008.

SN 78-943,157, FILED 8-2-2006.

ANNE FARRELL, EXAMINING ATTORNEY

Int. Cls.: 1, 3, and 5

Prior U.S. Cls.: 1, 4, 5, 6, 10, 18, 26, 44, 46, 50, 51, and 52

Reg. No. 3,486,508

United States Patent and Trademark Office

Registered Aug. 12, 2008

**TRADEMARK
PRINCIPAL REGISTER**

LONGEVICELL

SOCIETE INDUSTRIELLE LIMOUSINE D'APPLI-
CATION BIOLOGIQUE (SILAB) (FRANCE SO-
CIE TE ANOYNYME)
MADRIAS
OBJAT, FRANCE F19130

FOR: PRIMARY MATERIALS ADAPTED FOR
THE PRODUCTION OF COSMETIC PREPARA-
TIONS, NAMELY, RAW MATERIALS, ADDITIVES
AND ACTIVE MATERIALS BASED ON CONCEN-
TRATES OF CONCENTRATED NATURAL SUB-
STANCES AND HIGHLY CONCENTRATED
NATURAL SUBSTANCES, NAMELY, PURIFIED
EXTRACTS FROM MYRTLE; ENZYMATIC PRE-
PARATIONS AND ENZYMES ADAPTED FOR THE
PRODUCTION OF COSMETIC PREPARATIONS, IN
CLASS 1 (U.S. CLS. 1, 5, 6, 10, 26 AND 46).

FIRST USE 3-0-2006; IN COMMERCE 3-0-2006.

FOR: COSMETICS; COSMETIC ARTICLES,
NAMELY, COSMETIC PRODUCTS FOR THE CARE
OF THE SKIN AND FOR BEAUTY, NAMELY, ANTI-
AGING PREPARATIONS IN THE NATURE OF
MILKS, CREAMS, LOTIONS, OILS, AND POWDERS;
BRONZING PRODUCTS AND FOR SOLAR PRO-
TECTION FOR COSMETIC USE, NAMELY, SUNSC-
REENS AND SUNLESS TANNING BRONZERS IN
THE NATURE OF MILKS, CREAMS, GELS, OILS
AND LOTIONS AND POWDERS; HAIR PRODUCTS,

NAMELY, SHAMPOOS AND CONDITIONS, AND
GELS, CREAMS, LOTIONS, SPRAYS AND OILS FOR
USE IN STYLING HAIR AND IN REPAIRING
DAMAGED HAIR; COSMETIC BODY DEODOR-
ANTS, IN CLASS 3 (U.S. CLS. 1, 4, 6, 50, 51 AND 52).

FIRST USE 3-0-2006; IN COMMERCE 3-0-2006.

FOR: DERMATOLOGICAL PRODUCTS, NAME-
LY, PRODUCTS ABLE TO INCREASE CELLULAR
LONGEVITY AND DELAY CELLULAR SENES-
CENCE, IN CLASS 5 (U.S. CLS. 6, 18, 44, 46, 51 AND
52).

FIRST USE 3-0-2006; IN COMMERCE 3-0-2006.

THE MARK CONSISTS OF STANDARD CHAR-
ACTERS WITHOUT CLAIM TO ANY PARTICULAR
FONT, STYLE, SIZE, OR COLOR.

PRIORITY CLAIMED UNDER SEC. 44(D) ON
ERPNTY TM OFC APPLICATION NO.
004879227, FILED 2-3-2006, REG. NO. 004879227,
DATED 3-5-2007, EXPIRES 2-3-2016.

SN 78-943,243, FILED 8-2-2006.

JANICE L. MCMORROW, EXAMINING ATTOR-
NEY

Int. Cls.: 1, 6, 21, 29, and 30

Prior U.S. Cls.: 1, 2, 5, 6, 10, 12, 13, 14, 23, 25, 26, 29, 30, 33, 40, 46, and 50

Reg. No. 3,486,509

United States Patent and Trademark Office

Registered Aug. 12, 2008

**TRADEMARK
PRINCIPAL REGISTER**

CAPTURE FRESHNESS

HEARTHMARK, LLC (DELAWARE LTD LIAB
CO)
14611 COMMERCE DRIVE
DALEVILLE, IN 47334

FOR: ASCORBIC ACID AND CITRIC ACID PRE-
PARATIONS FOR USE IN PRESERVING THE COL-
OR AND FLAVOR OF FRUITS AND VEGETABLES,
IN CLASS 1 (U.S. CLS. 1, 5, 6, 10, 26 AND 46).

FIRST USE 2-28-2007; IN COMMERCE 2-28-2007.

FOR: METAL LIDS AND CAPS FOR HOME
CANNING JARS AND CONTAINERS, IN CLASS 6
(U.S. CLS. 2, 12, 13, 14, 23, 25 AND 50).

FIRST USE 2-28-2007; IN COMMERCE 2-28-2007.

FOR: GLASS HOME CANNING JARS AND CON-
TAINERS; HOME CANNING UTENSILS, NAMELY,
FUNNELS, SPATULAS, LID LIFTERS; PLASTIC
STORAGE CONTAINERS FOR DOMESTIC USE;
PLASTIC FREEZER STORAGE CONTAINERS FOR
DOMESTIC USE, IN CLASS 21 (U.S. CLS. 2, 13, 23, 29,
30, 33, 40 AND 50).

FIRST USE 2-28-2008; IN COMMERCE 2-28-2008.

FOR: FRUIT PECTIN; HOME CANNING INGRE-
DIENTS, NAMELY, DEHYDRATED VEGETABLES,
FOR TOMATO-BASED SAUCES AND CONDI-
MENTS, NAMELY, PIZZA SAUCE, SPAGHETTI
SAUCE, SALSA AND SAUCE MIXES, IN CLASS 29
(U.S. CL. 46).

FIRST USE 2-28-2007; IN COMMERCE 2-28-2007.

FOR: HOME CANNING INGREDIENTS, NAME-
LY, SALT, SUGAR, GARLIC POWDER, NATURAL
FLAVORINGS, AND ARTIFICIAL FLAVORINGS
FOR SALSA MIXES; HOME CANNING AND PICK-
LING SALT, IN CLASS 30 (U.S. CL. 46).

FIRST USE 2-28-2007; IN COMMERCE 2-28-2007.

THE MARK CONSISTS OF STANDARD CHAR-
ACTERS WITHOUT CLAIM TO ANY PARTICULAR
FONT, STYLE, SIZE, OR COLOR.

SN 78-944,940, FILED 8-4-2006.

SETH A. RAPPAPORT, EXAMINING ATTORNEY

Int. Cl.: 35

Prior U.S. Cls.: 100, 101, and 102

United States Patent and Trademark Office

Reg. No. 3,486,510

Registered Aug. 12, 2008

**SERVICE MARK
PRINCIPAL REGISTER**

SEEVAST

SEEVAST CORP. (DELAWARE CORPORATION)
2390 NORTH FOREST ROAD
SUITE 10
GETZVILLE, NY 14068

FOR: ONLINE ADVERTISING AND MARKET-
ING SERVICES IN THE NATURE OF PROVIDING
TARGETED SPONSORED LINKS TO ADVERTISER
WEBSITES, IN CLASS 35 (U.S. CLS. 100, 101 AND 102).

FIRST USE 6-16-2006; IN COMMERCE 8-7-2006.

THE MARK CONSISTS OF STANDARD CHAR-
ACTERS WITHOUT CLAIM TO ANY PARTICULAR
FONT, STYLE, SIZE, OR COLOR.

SN 78-945,252, FILED 8-4-2006.

REGINA DRUMMOND, EXAMINING ATTORNEY

Int. Cl.: 35

Prior U.S. Cls.: 100, 101, and 102

United States Patent and Trademark Office

Reg. No. 3,486,511

Registered Aug. 12, 2008

**SERVICE MARK
PRINCIPAL REGISTER**

CONVEYOR

CONVEYOR, LLC (CALIFORNIA LTD LIAB CO)
420 BROADWAY
SANTA MONICA, CA 90402

THE MARK CONSISTS OF STANDARD CHAR-
ACTERS WITHOUT CLAIM TO ANY PARTICULAR
FONT, STYLE, SIZE, OR COLOR.

FOR: RETAIL STORE SERVICES IN THE FIELD
OF APPAREL, FOOTWEAR AND ACCESSORIES, IN
CLASS 35 (U.S. CLS. 100, 101 AND 102).

SN 78-945,494, FILED 8-4-2006.

FIRST USE 2-0-2005; IN COMMERCE 1-0-2006.

ANNE FARRELL, EXAMINING ATTORNEY

Int. Cl.: 36

Prior U.S. Cls.: 100, 101, and 102

United States Patent and Trademark Office

Reg. No. 3,486,512

Registered Aug. 12, 2008

**SERVICE MARK
PRINCIPAL REGISTER**

MONEYTREE LENDING

MONEYTREE, INC. (WASHINGTON CORPORATION)
6720 FORT DENT WAY, SUITE 230
SEATTLE, WA 98188

OWNER OF U.S. REG. NOS. 2,790,324, 3,056,563,
AND OTHERS.

FOR: FINANCIAL SERVICES, NAMELY, CONSUMER LENDING SERVICES, IN CLASS 36 (U.S. CLS. 100, 101 AND 102).

NO CLAIM IS MADE TO THE EXCLUSIVE RIGHT TO USE "LENDING", APART FROM THE MARK AS SHOWN.

FIRST USE 6-16-2008; IN COMMERCE 6-16-2008.

SN 78-946,222, FILED 8-7-2006.

THE MARK CONSISTS OF STANDARD CHARACTERS WITHOUT CLAIM TO ANY PARTICULAR FONT, STYLE, SIZE, OR COLOR.

AMY HELLA, EXAMINING ATTORNEY

Int. Cl.: 9

Prior U.S. Cls.: 21, 23, 26, 36, and 38

Reg. No. 3,486,513

United States Patent and Trademark Office

Registered Aug. 12, 2008

**TRADEMARK
PRINCIPAL REGISTER**

VERITI

APPLERA CORPORATION (DELAWARE CORPORATION)
850 LINCOLN CENTRE DRIVE
FOSTER CITY, CA 94404

THE MARK CONSISTS OF STANDARD CHARACTERS WITHOUT CLAIM TO ANY PARTICULAR FONT, STYLE, SIZE, OR COLOR.

FOR: LABORATORY EQUIPMENT FOR SCIENTIFIC AND RESEARCH USE, NAMELY, THERMAL CYCLER, IN CLASS 9 (U.S. CLS. 21, 23, 26, 36 AND 38).

SN 78-946,610, FILED 8-7-2006.

FIRST USE 3-13-2007; IN COMMERCE 3-13-2007.

TINA KUAN, EXAMINING ATTORNEY

Int. Cl.: 36

Prior U.S. Cls.: 100, 101, and 102

United States Patent and Trademark Office

Reg. No. 3,486,514

Registered Aug. 12, 2008

**SERVICE MARK
PRINCIPAL REGISTER**



iCents

M. SIMOES DESENVOLVIMENTO EMPRESARIAL S/C LTDA (BRAZIL LIMITED COMPANY)
R VISCONDE DE PIRAJA 357 / 401 - IPANEMA
RIO DE JANEIRO, BRAZIL 22410001

FOR: ELECTRONIC PAYMENT, NAMELY, ELECTRONIC PROCESSING OF PAYMENT DATA TO FACILITATE AND CONTROL THE SALE, PURCHASE, DELIVERY AND ACCESS OF ONLINE CONTENT AND SERVICES; ELECTRONIC PROCESSING OF PREPAID CARD TRANSACTIONS, IN CLASS 36 (U.S. CLS. 100, 101 AND 102).

FIRST USE 1-15-1997; IN COMMERCE 1-15-1997.

THE MARK CONSISTS OF WORDS IN STYLIZED FORM; DRAWING REPRESENTING A COIN, WITH A CENT SYMBOL INSIDE.

SN 78-946,803, FILED 8-7-2006.

DOMINIC J. FERRAIUOLO, EXAMINING ATTORNEY

Int. Cl.: 16

Prior U.S. Cls.: 2, 5, 22, 23, 29, 37, 38, and 50

United States Patent and Trademark Office

Reg. No. 3,486,515

Registered Aug. 12, 2008

**TRADEMARK
PRINCIPAL REGISTER**

**LITTLE HOUSE BY ANNETTE
TATUM**

HOUSE COLLECTIONS, INC. (CALIFORNIA
CORPORATION)
2880 COLORADO AVENUE
SANTA MONICA, CA 90404

FOR: PRINTED MATTER, NAMELY, STATION-
ERY, ENVELOPES, POSTERS, PRINTED PAPER
PLACE MATS AND NAPKINS, POSTCARDS, PAPER
TABLE COVERINGS, CALENDARS, SCRAP BOOKS,
GREETING CARDS, ART PRINTS, PAPER BAGS,
DESK PADS, BLOTTER PADS, NOTE PADS, PAPER
PADS, DAILY PLANNERS, APPOINTMENT BOOKS,
POCKET SECRETARY BOOKLETS, WRITING PA-
PER, AND PHOTO ALBUMS FOR CHILDREN, IN
CLASS 16 (U.S. CLS. 2, 5, 22, 23, 29, 37, 38 AND 50).

FIRST USE 5-10-2008; IN COMMERCE 5-10-2008.

THE MARK CONSISTS OF STANDARD CHAR-
ACTERS WITHOUT CLAIM TO ANY PARTICULAR
FONT, STYLE, SIZE, OR COLOR.

NO CLAIM IS MADE TO THE EXCLUSIVE
RIGHT TO USE "HOUSE", APART FROM THE
MARK AS SHOWN.

THE NAME(S), PORTRAIT(S), AND/OR SIGNA-
TURE(S) SHOWN IN THE MARK IDENTIFIES
"ANNETTE TATUM", WHOSE CONSENT(S) TO
REGISTER IS SUBMITTED.

SN 78-947,366, FILED 8-8-2006.

FRANK LATTUCA, EXAMINING ATTORNEY

Int. Cl.: 16

Prior U.S. Cls.: 2, 5, 22, 23, 29, 37, 38, and 50

Reg. No. 3,486,516

United States Patent and Trademark Office

Registered Aug. 12, 2008

**TRADEMARK
PRINCIPAL REGISTER**

HOUSE BY ANNETTE TATUM

HOUSE COLLECTIONS, INC. (CALIFORNIA CORPORATION)
2880 COLORADO AVENUE
SANTA MONICA, CA 90404

FOR: PRINTED MATTER, NAMELY, STATIONERY, ENVELOPES, POSTERS, PRINTED PAPER PLACE MATS AND NAPKINS, POSTCARDS, PAPER TABLE COVERINGS, CALENDARS, SCRAP BOOKS, GREETING CARDS, ART PRINTS, PAPER BAGS, DESK PADS, BLOTTER PADS, NOTE PADS, PAPER PADS, DAILY PLANNERS, APPOINTMENT BOOKS, POCKET SECRETARY BOOKLETS, WRITING PAPER, AND PHOTO ALBUMS, IN CLASS 16 (U.S. CLS. 2, 5, 22, 23, 29, 37, 38 AND 50).

FIRST USE 11-1-2007; IN COMMERCE 11-1-2007.

THE MARK CONSISTS OF STANDARD CHARACTERS WITHOUT CLAIM TO ANY PARTICULAR FONT, STYLE, SIZE, OR COLOR.

NO CLAIM IS MADE TO THE EXCLUSIVE RIGHT TO USE "HOUSE", APART FROM THE MARK AS SHOWN.

THE NAME(S), PORTRAIT(S), AND/OR SIGNATURE(S) SHOWN IN THE MARK IDENTIFIES "ANNETTE TATUM", WHOSE CONSENT(S) TO REGISTER IS SUBMITTED.

SN 78-947,371, FILED 8-8-2006.

FRANK LATTUCA, EXAMINING ATTORNEY

Int. Cl.: 31

Prior U.S. Cls.: 1 and 46

United States Patent and Trademark Office

Reg. No. 3,486,517

Registered Aug. 12, 2008

**TRADEMARK
PRINCIPAL REGISTER**

SENIOR SUPPER

ANDERSON, HARLAN R. (UNITED STATES IN-
DIVIDUAL)
2379 QUIMBY AVENUE S.W.
COKATO, MN 55321

FOR: FOOD FOR HORSES, NAMELY, ALFALFA
BASED NUTRITIONAL FEED FOR MATURE
HORSES, IN CLASS 31 (U.S. CLS. 1 AND 46).

FIRST USE 3-1-2008; IN COMMERCE 3-1-2008.

THE MARK CONSISTS OF STANDARD CHAR-
ACTERS WITHOUT CLAIM TO ANY PARTICULAR
FONT, STYLE, SIZE, OR COLOR.

NO CLAIM IS MADE TO THE EXCLUSIVE
RIGHT TO USE "SENIOR", APART FROM THE
MARK AS SHOWN.

SN 78-948,418, FILED 8-9-2006.

JULIE GUTTADAURO, EXAMINING ATTORNEY

Int. Cls.: 16, 35, 41, and 44

Prior U.S. Cls.: 2, 5, 22, 23, 29, 37, 38, 50, 100, 101, 102, and 107

Reg. No. 3,486,518

United States Patent and Trademark Office

Registered Aug. 12, 2008

**TRADEMARK
SERVICE MARK
PRINCIPAL REGISTER**

MARATHON HEALTH

MARATHON HEALTH INC. (DELAWARE CORPORATION)
354 MOUNTAIN VIEW DRIVE
SUITE 300
COLCHESTER, VT 05446

FOR: PRINTED HEALTH PROMOTION MATERIAL, NAMELY, NEWSLETTERS, BROCHURES, HANDOUTS, POSTERS, AND BOOKLETS, IN CLASS 16 (U.S. CLS. 2, 5, 22, 23, 29, 37, 38 AND 50).

FIRST USE 2-1-2007; IN COMMERCE 2-1-2007.

FOR: BUSINESS MANAGEMENT, NAMELY, THE MANAGEMENT OF EMPLOYEE HEALTH AND WELLNESS PROGRAMS FOR OTHERS, IN CLASS 35 (U.S. CLS. 100, 101 AND 102).

FIRST USE 2-1-2007; IN COMMERCE 2-1-2007.

FOR: PERSONAL COACHING SERVICES IN THE FIELD OF HEALTH, WELLNESS, AND LIFESTYLE; CONDUCTING WELLNESS AND PREVENTIVE CARE EDUCATION AND TRAINING PROGRAMS THROUGH IN PERSON SEMINARS AND CLASSES, ONLINE PROGRAMS, AND VIDEO CONFERENCING, IN CLASS 41 (U.S. CLS. 100, 101 AND 107).

FIRST USE 2-1-2007; IN COMMERCE 2-1-2007.

FOR: HEALTH CARE SERVICES, NAMELY, CONDUCTING EMPLOYEE HEALTH AND WELLNESS PROGRAMS FOR OTHERS, NAMELY, INDIVIDUAL HEALTH RISK ASSESSMENTS, INDIVIDUAL HEALTH RISK REDUCTION PROGRAMS, COUNSELING IN THE FIELDS OF NUTRITION, HEALTH, WELLNESS, AND DISEASE MANAGEMENT; PROVIDING HEALTH INFORMATION VIA THE INTERNET IN THE FIELD OF EMPLOYEE HEALTH AND WELLNESS PROGRAMS, IN CLASS 44 (U.S. CLS. 100 AND 101).

FIRST USE 2-1-2007; IN COMMERCE 2-1-2007.

THE MARK CONSISTS OF STANDARD CHARACTERS WITHOUT CLAIM TO ANY PARTICULAR FONT, STYLE, SIZE, OR COLOR.

NO CLAIM IS MADE TO THE EXCLUSIVE RIGHT TO USE "HEALTH", APART FROM THE MARK AS SHOWN.

SN 78-948,821, FILED 8-9-2006.

JENNIFER VASQUEZ, EXAMINING ATTORNEY

Int. Cl.: 29

Prior U.S. Cl.: 46

United States Patent and Trademark Office

Reg. No. 3,486,519

Registered Aug. 12, 2008

**TRADEMARK
PRINCIPAL REGISTER**



CHOICE CUTS, LLC (NEW MEXICO LTD LIAB
CO)
C/O FOREST TRUST
P.O. BOX 487
SANTA FE, NM 875040487

FOR: MEAT AND MEAT PRODUCTS, NAMELY,
PROCESSED MEAT; PACKAGED BEEF FOR WA-
GYU CATTLE, IN CLASS 29 (U.S. CL. 46).

FIRST USE 2-4-2008; IN COMMERCE 2-4-2008.

NO CLAIM IS MADE TO THE EXCLUSIVE
RIGHT TO USE "CERTIFIED 100%", "WAGYU
BEEF" AND THE PICTORIAL REPRESENTATION
OF THE STEER, APART FROM THE MARK AS
SHOWN.

SN 78-948,970, FILED 8-9-2006.

MARK PILARO, EXAMINING ATTORNEY

Int. Cl.: 9

Prior U.S. Cls.: 21, 23, 26, 36, and 38

Reg. No. 3,486,520

United States Patent and Trademark Office

Registered Aug. 12, 2008

**TRADEMARK
PRINCIPAL REGISTER**

LIFETRONS

GMCS PRODUCTS LIMITED (HONG KONG CORPORATION)
704 KAI TAK COMMERCIAL BUILDING
66-72 STANLEY STREET
CENTRAL, HONG KONG

FOR: TELEPHONES, USB TELEPHONES, CORDLESS TELEPHONES; MULTI-MEDIA APPARATUS, NAMELY, MP3 PLAYERS AND CD PLAYERS; COMPUTER PERIPHERALS, NAMELY, USB DEVICES; ACCESSORIES OF APPARATUS FOR SHORT-RANGE TRANSMISSION OF DIGITAL VOICE AND DATA THAT SUPPORTS POINT-TO-POINT AND MULTI-POINT APPLICATIONS, NAMELY, COMPONENT PARTS FOR DIGITAL TRANSMITTERS; RECHARGEABLE BATTERIES; BATTERIES; BAT-

TERIES FOR CHARGING ELECTRIC AND ELECTRONIC APPLIANCES; BATTERIES FOR CHARGING RECHARGEABLE BATTERIES; BATTERY CHARGERS; CHARGERS FOR BATTERIES; GALVANIC BATTERIES; GRIDS FOR BATTERIES, NAMELY, EXTERNAL BATTERIES; HIGH TENSION BATTERIES; SOLAR BATTERIES; BATTERY BOXES; AND BATTERY JARS, IN CLASS 9 (U.S. CLS. 21, 23, 26, 36 AND 38).

FIRST USE 1-1-2006; IN COMMERCE 1-1-2006.

SN 78-949,071, FILED 8-10-2006.

JASON BLAIR, EXAMINING ATTORNEY

Int. Cl.: 33

Prior U.S. Cls.: 47 and 49

United States Patent and Trademark Office

Reg. No. 3,486,521

Registered Aug. 12, 2008

**TRADEMARK
PRINCIPAL REGISTER**

HIGH SANDS

JACKSON WINE ESTATES INTERNATIONAL
LIMITED (IRELAND CORPORATION)
CHERRYWOOD BUSINESS PARK, BUILDING D
LOUGHLINSTOWN, COUNTY DUBLIN, IRELAND

FOR: WINE, IN CLASS 33 (U.S. CLS. 47 AND 49).

FIRST USE 1-1-2008; IN COMMERCE 1-1-2008.

THE MARK CONSISTS OF STANDARD CHAR-
ACTERS WITHOUT CLAIM TO ANY PARTICULAR
FONT, STYLE, SIZE, OR COLOR.

SN 78-949,224, FILED 8-10-2006.

BRIAN NEVILLE, EXAMINING ATTORNEY

Int. Cl.: 25

Prior U.S. Cls.: 22 and 39

United States Patent and Trademark Office

Reg. No. 3,486,522

Registered Aug. 12, 2008

**TRADEMARK
PRINCIPAL REGISTER**

JULIE'S CLOSET

UNO CLOTHING, INC. (CALIFORNIA CORPORATION)
2726 FRUITLAND AVENUE
VERNON, CA 90058

FOR: CLOTHING, NAMELY, SHIRTS, SOCKS, TOPS, SKIRTS, DRESSES, PANTS, LEGGINGS, STOCKINGS, HOSIERY, CAPS, HATS, SLACKS, JACKETS, GLOVES, AND SHOES, IN CLASS 25 (U.S. CLS. 22 AND 39).

FIRST USE 10-1-2004; IN COMMERCE 10-1-2004.

THE MARK CONSISTS OF STANDARD CHARACTERS WITHOUT CLAIM TO ANY PARTICULAR FONT, STYLE, SIZE, OR COLOR.

SN 78-949,386, FILED 8-10-2006.

LAURIE KAUFMAN, EXAMINING ATTORNEY

Int. Cl.: 3

Prior U.S. Cls.: 1, 4, 6, 50, 51, and 52

Reg. No. 3,486,523

United States Patent and Trademark Office

Registered Aug. 12, 2008

**TRADEMARK
PRINCIPAL REGISTER**

Dream All-In-One
Foundation

MBL/TIGI PRODUCTS, LP (TEXAS LIMITED
PARTNERSHIP)
2311 MIDWAY ROAD
CARROLLTON, TX 75006

FOR: COSMETICS, IN CLASS 3 (U.S. CLS. 1, 4, 6, 50,
51 AND 52).

FIRST USE 7-0-2006; IN COMMERCE 7-0-2006.

NO CLAIM IS MADE TO THE EXCLUSIVE
RIGHT TO USE "ALL-IN-ONE FOUNDATION",
APART FROM THE MARK AS SHOWN.

THE MARK CONSISTS OF THE WORD "DREAM"
AND THE WORDS "ALL-IN-ONE FOUNDATION".

SN 78-949,552, FILED 8-10-2006.

VERNA BETH RIRIE, EXAMINING ATTORNEY

Int. Cls.: 42, 44, and 45

Prior U.S. Cls.: 100 and 101

United States Patent and Trademark Office

Reg. No. 3,486,524

Registered Aug. 12, 2008

**SERVICE MARK
PRINCIPAL REGISTER**



RENOWN HEALTH (NEVADA CORPORATION)
77 PRINGLE WAY
RENO, NV 89502

FOR: MEDICAL RESEARCH SERVICES, MEDICAL LABORATORIES AND NEUROSCIENCE RESEARCH SERVICES, CLINICAL TRIAL SERVICES, IN CLASS 42 (U.S. CLS. 100 AND 101).

FIRST USE 9-21-2006; IN COMMERCE 9-21-2006.

FOR: HOSPITAL; MEDICAL SERVICES; INPATIENT AND OUTPATIENT DIAGNOSTIC IMAGING SERVICES; ACUTE INPATIENT AND OUTPATIENT REHABILITATION SERVICES; MENTAL REHABILITATION SERVICES; COMPLETE HEALTH CARE ORGANIZATION NAMELY, CANCER DIAGNOSTIC AND TREATMENT SERVICES, DIAGNOSIS AND TREATMENT OF HEART DISEASE, CARDIAC SURGERY SERVICES, ORTHOPEDIC SURGERY SERVICES, HEALTH AND WELLNESS PROGRAMS, HOME HEALTH CARE SERVICES, MENTAL HEALTH AND SUBSTANCE ABUSE TREATMENT; PSYCHIATRIC CONSULTATIONS, NAMELY MEDICATION MANAGEMENT, PSY-

CHOLOGICAL TESTING, PSYCHOLOGICAL THERAPY AND COUNSELING; PEDIATRIC MEDICAL SERVICES; PHYSICAL, OCCUPATIONAL AND SPEECH REHABILITATION AND THERAPY SERVICES; MEDICAL COUNSELING SERVICES, IN CLASS 44 (U.S. CLS. 100 AND 101).

FIRST USE 9-21-2006; IN COMMERCE 9-21-2006.

FOR: PROVIDING PERSONAL SUPPORT SERVICES FOR FAMILIES OF PATIENTS WITH LIFE THREATENING DISORDERS, NAMELY, COMPANIONSHIP, HELP WITH MEDICAL FORMS, COUNSELING AND EMOTIONAL SUPPORT, IN CLASS 45 (U.S. CLS. 100 AND 101).

FIRST USE 9-21-2006; IN COMMERCE 9-21-2006.

THE MARK CONSISTS OF DESIGN OF 4 CURVED LINES FORMING A SEMI-CIRCLE AROUND THE WORD RENOWN.

SN 78-949,723, FILED 8-10-2006.

DORITT L. CARROLL, EXAMINING ATTORNEY

Int. Cl.: 9

Prior U.S. Cls.: 21, 23, 26, 36, and 38

Reg. No. 3,486,525

United States Patent and Trademark Office

Registered Aug. 12, 2008

**TRADEMARK
PRINCIPAL REGISTER**

OPUS

HONEYWELL INTERNATIONAL INC. (DELA-
WARE CORPORATION)
101 COLUMBIA ROAD
MORRISTOWN, NJ 07962

GAS, WATER AND REFRIGERATION FOR USE BY
THE BUILDING AUTOMATION AND ENERGY
SERVICES MARKETS, IN CLASS 9 (U.S. CLS. 21, 23,
26, 36 AND 38).

FOR: COMPUTER SOFTWARE FOR USE IN IN-
TEGRATING AND MANAGING MULTI-VENDOR
CONTROL DEVICES, NAMELY, POWER METERS,
HVAC EQUIPMENT CONTROLLERS, ELECTRICAL
EQUIPMENT CONTROLLERS, GAS AND WATER
METERS, REFRIGERATION EQUIPMENT CON-
TROLLERS AND DEVICES THROUGH THE INTER-
NET IN ORDER TO CONTROL AND COORDINATE
BUILDING MANAGEMENT AND ENERGY MAN-
AGEMENT FUNCTIONS, NAMELY, LIGHTING,
HEATING, VENTILATION, AIR CONDITIONING,

FIRST USE 7-31-2007; IN COMMERCE 7-31-2007.

THE MARK CONSISTS OF STANDARD CHAR-
ACTERS WITHOUT CLAIM TO ANY PARTICULAR
FONT, STYLE, SIZE, OR COLOR.

SN 78-950,910, FILED 8-12-2006.

KAREN BRACEY, EXAMINING ATTORNEY

Int. Cl.: 18

Prior U.S. Cls.: 1, 2, 3, 22, and 41

Reg. No. 3,486,526

United States Patent and Trademark Office

Registered Aug. 12, 2008

**TRADEMARK
PRINCIPAL REGISTER**

ZENDA

BRANAA, MARCEL (URUGUAY INDIVIDUAL)
JOSÉ LLUPES 4949
MONTEVIDEO, URUGUAY

THE MARK CONSISTS OF STANDARD CHAR-
ACTERS WITHOUT CLAIM TO ANY PARTICULAR
FONT, STYLE, SIZE, OR COLOR.

FOR: LEATHER AND IMITATION LEATHER
USED IN FURNITURE UPHOLSTERY AS WELL
AS IN CARS' INTERIOR AND UPHOLSTERY, IN
CLASS 18 (U.S. CLS. 1, 2, 3, 22 AND 41).

SN 78-950,989, FILED 8-13-2006.

FIRST USE 10-17-2006; IN COMMERCE 10-17-2006.

CHRISTINE COOPER, EXAMINING ATTORNEY

Int. Cl.: 9

Prior U.S. Cls.: 21, 23, 26, 36, and 38

Reg. No. 3,486,527

United States Patent and Trademark Office

Registered Aug. 12, 2008

**TRADEMARK
PRINCIPAL REGISTER**

FLEXPROBE

AHURA CORPORATION (DELAWARE CORPORATION)
46 JONSPIN ROAD
WILMINGTON, MA 01887

FOR: A REMOTE SENSOR HEAD FOR USE WITH A PORTABLE SPECTROSCOPE FOR DETECTING AND IDENTIFYING BIOLOGICAL AND CHEMICAL SUBSTANCES, IN CLASS 9 (U.S. CLS. 21, 23, 26, 36 AND 38).

FIRST USE 11-1-2006; IN COMMERCE 11-1-2006.

THE MARK CONSISTS OF STANDARD CHARACTERS WITHOUT CLAIM TO ANY PARTICULAR FONT, STYLE, SIZE, OR COLOR.

SN 78-951,154, FILED 8-14-2006.

REBECCA EISINGER, EXAMINING ATTORNEY

Int. Cl.: 8

Prior U.S. Cls.: 23, 28, and 44

Reg. No. 3,486,528

United States Patent and Trademark Office

Registered Aug. 12, 2008

**TRADEMARK
PRINCIPAL REGISTER**

KITCHEN KING PRO

ONTEL PRODUCTS CORPORATION (NEW JERSEY CORPORATION)
21 LAW DRIVE
FAIRFIELD, NJ 07004

FOR: HAND-OPERATED FOOD CHOPPER;
HAND-OPERATED FOOD PROCESSOR, IN CLASS
8 (U.S. CLS. 23, 28 AND 44).

FIRST USE 4-7-2008; IN COMMERCE 4-7-2008.

THE MARK CONSISTS OF STANDARD CHARACTERS WITHOUT CLAIM TO ANY PARTICULAR FONT, STYLE, SIZE, OR COLOR.

NO CLAIM IS MADE TO THE EXCLUSIVE RIGHT TO USE "KITCHEN OR PRO", APART FROM THE MARK AS SHOWN.

SN 78-952,225, FILED 8-15-2006.

BRENDAN REGAN, EXAMINING ATTORNEY

Int. Cl.: 9

Prior U.S. Cls.: 21, 23, 26, 36, and 38

United States Patent and Trademark Office

Reg. No. 3,486,529

Registered Aug. 12, 2008

**TRADEMARK
PRINCIPAL REGISTER**

CABLE UP

FULL COMPASS SYSTEMS, LTD. (WISCONSIN CORPORATION)
8001 TERRACE AVENUE
MIDDLETON, WI 53562

OWNER OF U.S. REG. NO. 2,275,361.

FOR: ELECTRICAL CABLES AND ADAPTERS FOR USE WITH AUDIO AND RECORDING PRODUCTS, IN CLASS 9 (U.S. CLS. 21, 23, 26, 36 AND 38).

NO CLAIM IS MADE TO THE EXCLUSIVE RIGHT TO USE "CABLE", APART FROM THE MARK AS SHOWN.

FIRST USE 5-0-2008; IN COMMERCE 5-0-2008.

SN 78-953,415, FILED 8-16-2006.

THE MARK CONSISTS OF STANDARD CHARACTERS WITHOUT CLAIM TO ANY PARTICULAR FONT, STYLE, SIZE, OR COLOR.

DORITT L. CARROLL, EXAMINING ATTORNEY

Int. Cl.: 18

Prior U.S. Cls.: 1, 2, 3, 22, and 41

United States Patent and Trademark Office

Reg. No. 3,486,530

Registered Aug. 12, 2008

TRADEMARK
PRINCIPAL REGISTER



UNIVERSAL MODELS LIMITED (HONG KONG CORPORATION)
603-609 CASTLE PEAK ROAD, TSUEN WAN
FLAT B1, 10TH FL, KONG NAM INDUSTRIAL BLDG
NEW TERRITORIES, HONG KONG

FOR: CLOTHING FOR DOMESTIC PETS; COLLARS FOR PETS; LEATHER CHEWS AND BITS FOR PETS; ANIMAL LEASHES; DOG COLLARS; RAW-HIDE CHEWS FOR PETS; HARNESSSES FOR PETS; ANIMAL COLLARS, NAMELY, LEADS FOR PETS; PET CARRIER BAGS, IN CLASS 18 (U.S. CLS. 1, 2, 3, 22 AND 41).

FIRST USE 6-5-2008; IN COMMERCE 6-5-2008.

THE MARK CONSISTS OF THE WORDS "COOKIE ALAMODE" SURROUNDED BY THE SHAPE OF A DOG BONE, WITH THE OUTLINE BROKEN INTERMITTENTLY.

SN 78-953,703, FILED 8-16-2006.

DOMINIC FATHY, EXAMINING ATTORNEY

Int. Cls.: 3, 4, 6, 7, 8, 11, 21, 24, 26, 27, 28, and 31

Prior U.S. Cls.: 1, 2, 4, 6, 12, 13, 14, 15, 19, 20, 21, 22, 23, 25, 28, 29, 30, 31, 33, 34, 35, 37, 38, 39, 40, 42, 44, 46, 50, 51, and 52

Reg. No. 3,486,531

United States Patent and Trademark Office

Registered Aug. 12, 2008

**TRADEMARK
PRINCIPAL REGISTER**



THE GREAT ATLANTIC & PACIFIC TEA COMPANY, INC. (MARYLAND CORPORATION)
2 PARAGON DRIVE
MONTVALE, NJ 07645

FOR: POTPOURRI; HOME FRAGRANCE INFUSER, NAMELY, FRAGRANCE EMITTING RECEPTACLES FOR ROOM FRAGRANCES; BATH OILS; BATH MILKS; BATH POWDER; BATH SALTS, IN CLASS 3 (U.S. CLS. 1, 4, 6, 50, 51 AND 52).

FIRST USE 9-30-2006; IN COMMERCE 9-30-2006.

FOR: CANDLES, IN CLASS 4 (U.S. CLS. 1, 6 AND 15).

FIRST USE 9-30-2006; IN COMMERCE 9-30-2006.

FOR: DECORATIVE TINS MADE OF METAL, IN CLASS 6 (U.S. CLS. 2, 12, 13, 14, 23, 25 AND 50).

FIRST USE 9-30-2006; IN COMMERCE 9-30-2006.

FOR: ELECTRIC COFFEE BEAN GRINDERS; ELECTRIC FOOD BLENDERS; ELECTRIC CAN OPENERS; ELECTRIC JUICERS, IN CLASS 7 (U.S. CLS. 13, 19, 21, 23, 31, 34 AND 35).

FIRST USE 9-30-2006; IN COMMERCE 9-30-2006.

FOR: HAND TOOLS, NAMELY, NON-ELECTRIC FRUIT AND VEGETABLE PEELERS, APPLE CORERS, PIZZA WHEEL CUTTERS, CHEESE PLANES, GRAPEFRUIT TRIMMERS; NON-ELECTRIC

KITCHEN KNIVES; ZESTERS; EGG SLICERS; MEAT TENDERIZERS, NAMELY, A PRONGED INSTRUMENT FOR POUNDING MEAT; SEAFOOD CRACKERS NOT MADE OF PRECIOUS METAL; ICE SCRAPERS; NON-ELECTRIC GARDEN TOOLS, NAMELY, SPADES, TILLERS, TROWELS; NON-ELECTRIC CAN OPENERS, IN CLASS 8 (U.S. CLS. 23, 28 AND 44).

FIRST USE 9-30-2006; IN COMMERCE 9-30-2006.

FOR: ELECTRIC COFFEE MAKERS; ELECTRIC COFFEE PERCOLATORS; HOT PLATES; ELECTRIC KETTLES; OUTDOOR LIGHTED CHRISTMAS ORNAMENTS; ELECTRIC LIGHTS FOR CHRISTMAS TREES; CHOCOLATE FOUNTAINS, IN CLASS 11 (U.S. CLS. 13, 21, 23, 31 AND 34).

FIRST USE 9-30-2006; IN COMMERCE 9-30-2006.

FOR: CUTTING BOARDS; PIE SERVERS; JAR OPENERS, ICE CREAM SCOOPS; BOTTLE OPENERS; GARLIC PRESSES; TURNERS; SPATULAS; COOKING SPOONS; COOKING FORKS; POTATO MASHERS; WHISKS; BASTING BRUSHES, BAGEL HOLDERS NOT BEING SLICERS; COFFEE SCOOPS; CORKSCREWS; CORN COB HOLDERS; MELON BALLERS; PEPPER MILLS; SALT SHAKERS; COOKING STRAINERS; TURKEY BASTERS; BARBECUE UTENSILS, NAMELY, FORKS, TONGS AND SPATULAS; NON-ELECTRIC COFFEE GRINDERS; ICE BUCKETS; COOLERS FOR WINE; NAPKIN HOLDERS; CANDLE HOLDERS NOT OF PRECIOUS ME-

TAL; PLATES; COOKERY MOLDS; NAPKIN RINGS NOT OF PRECIOUS METAL; PET FEEDING DISHES; WINE GLASSES; CERAMIC SCULPTURES; VASES; BOWLS; TEA POTS NOT OF PRECIOUS METAL; METAL BUCKETS; SALAD SERVING TONGS; WASH BASINS; SALAD SERVING TONGS; ELECTRIC TOOTH BRUSHES; SOAP DISHES; TOOTH BRUSH HOLDERS; TOWEL RACKS; TOILET PAPER HOLDERS; SHOWER CADDIES AND CERAMIC TISSUE BOX COVERS; GARDEN SUPPLIES, NAMELY, HOSE NOZZLES, COOKING GRATERS, IN CLASS 21 (U.S. CLS. 2, 13, 23, 29, 30, 33, 40 AND 50).

FIRST USE 9-30-2006; IN COMMERCE 9-30-2006.

FOR: BED SHEETS; TOWELS; BED AND BATH LINEN; PILLOWCASES; BED BLANKETS; CLOTH NAPKINS; CLOTH PLACEMATS; PET BLANKETS; TABLE CLOTHS NOT MADE OF PAPER; FABRIC TABLE RUNNERS; BATH MITTS AND OVEN MITTS, IN CLASS 24 (U.S. CLS. 42 AND 50).

FIRST USE 9-30-2006; IN COMMERCE 9-30-2006.

FOR: RIBBONS; ARTIFICIAL GARLAND AND ARTIFICIAL WREATHS, IN CLASS 26 (U.S. CLS. 37, 39, 40, 42 AND 50).

FIRST USE 9-30-2006; IN COMMERCE 9-30-2006.

FOR: DOORMATS, IN CLASS 27 (U.S. CLS. 19, 20, 37, 42 AND 50).

FIRST USE 9-30-2006; IN COMMERCE 9-30-2006.

FOR: STUFFED TOYS; CHRISTMAS STOCKINGS; TREE SKIRTS; TREE STANDS; CHRISTMAS TREE ORNAMENTS; WOODEN DECORATIVE SLEDS, IN CLASS 28 (U.S. CLS. 22, 23, 38 AND 50).

FIRST USE 9-30-2006; IN COMMERCE 9-30-2006.

FOR: PINE CONES; LIVE TREES; EDIBLE PET TREATS; DRIED FLOWER WREATHS, IN CLASS 31 (U.S. CLS. 1 AND 46).

FIRST USE 9-30-2006; IN COMMERCE 9-30-2006.

SN 78-953,732, FILED 8-16-2006.

TIMOTHY FINNEGAN, EXAMINING ATTORNEY

Int. Cls.: 36 and 41

Prior U.S. Cls.: 100, 101, 102, and 107

United States Patent and Trademark Office

Reg. No. 3,486,532

Registered Aug. 12, 2008

**SERVICE MARK
PRINCIPAL REGISTER**

RIGHT CYCLE INVESTING

EVERGREEN CAPITAL MANAGEMENT, L.L.C.
(WASHINGTON LTD LIAB CO)
500 - 108TH AVE NE, STE 720
BELLEVUE, WA 98004

FOR: FINANCIAL ANALYSIS AND CONSULTATION; INVESTMENT ADVISORY SERVICES; INVESTMENT BY ELECTRONIC MEANS; INVESTMENT CONSULTATION , IN CLASS 36 (U.S. CLS. 100, 101 AND 102).

FIRST USE 5-0-2006; IN COMMERCE 5-0-2006.

FOR: EDUCATIONAL SERVICES, NAMELY, CONDUCTING SPEECHES AND LECTURES IN THE FIELD OF FINANCIAL INVESTING AND DISTRIBUTION OF COURSE MATERIAL IN CON-

NECTION THEREWITH, IN CLASS 41 (U.S. CLS. 100, 101 AND 107).

FIRST USE 4-0-2006; IN COMMERCE 5-0-2006.

THE MARK CONSISTS OF STANDARD CHARACTERS WITHOUT CLAIM TO ANY PARTICULAR FONT, STYLE, SIZE, OR COLOR.

NO CLAIM IS MADE TO THE EXCLUSIVE RIGHT TO USE "CYCLE INVESTING", APART FROM THE MARK AS SHOWN.

SN 78-953,915, FILED 8-16-2006.

ROBERT LAVACHE, EXAMINING ATTORNEY

Int. Cl.: 11

Prior U.S. Cls.: 13, 21, 23, 31, and 34

United States Patent and Trademark Office

Reg. No. 3,486,533

Registered Aug. 12, 2008

**TRADEMARK
PRINCIPAL REGISTER**

Creating the Great Indoors

NOVELAIRE TECHNOLOGIES, LLC (GEORGIA
LTD LIAB CO)
370 WATERS BEND WAY
ALPHARETTA, GA 30022

FOR: AIR CONDITIONING UNITS, NAMELY,
DEHUMIDIFIERS AND COMPONENT PARTS
THEREOF, IN CLASS 11 (U.S. CLS. 13, 21, 23, 31
AND 34).

FIRST USE 5-23-2008; IN COMMERCE 5-23-2008.

THE MARK CONSISTS OF STANDARD CHAR-
ACTERS WITHOUT CLAIM TO ANY PARTICULAR
FONT, STYLE, SIZE, OR COLOR.

SN 78-954,390, FILED 8-17-2006.

STEVEN PEREZ, EXAMINING ATTORNEY

Int. Cl.: 11

Prior U.S. Cls.: 13, 21, 23, 31, and 34

United States Patent and Trademark Office

Reg. No. 3,486,534

Registered Aug. 12, 2008

**TRADEMARK
PRINCIPAL REGISTER**

NOVELAIRE

NOVELAIRE TECHNOLOGIES, LLC (GEORGIA
LTD LIAB CO)
370 WATERS BEND WAY
ALPHARETTA, GA 30022

THE MARK CONSISTS OF STANDARD CHAR-
ACTERS WITHOUT CLAIM TO ANY PARTICULAR
FONT, STYLE, SIZE, OR COLOR.

FOR: AIR CONDITIONING UNITS, NAMELY,
DEHUMIDIFIERS AND COMPONENT PARTS
THEREOF, IN CLASS 11 (U.S. CLS. 13, 21, 23, 31
AND 34).

SN 78-954,474, FILED 8-17-2006.

FIRST USE 5-23-2008; IN COMMERCE 5-23-2008.

STEVEN PEREZ, EXAMINING ATTORNEY

Int. Cl.: 44

Prior U.S. Cls.: 100 and 101

United States Patent and Trademark Office

Reg. No. 3,486,535

Registered Aug. 12, 2008

**SERVICE MARK
PRINCIPAL REGISTER**

HELP

REDLABS U.S.A., INC. (NEVADA CORPORATION)
6600 NORTH WINGFIELD PKWY.
SPARKS, NV 89436

FOR: PROVIDING AND CONDUCTING A DIAGNOSTIC MEDICAL TEST THAT MEASURES IMMUNE SENSITIVITY TO METALS, IN CLASS 44 (U.S. CLS. 100 AND 101).

FIRST USE 3-1-2007; IN COMMERCE 3-1-2007.

THE MARK CONSISTS OF STANDARD CHARACTERS WITHOUT CLAIM TO ANY PARTICULAR FONT, STYLE, SIZE, OR COLOR.

SN 78-954,777, FILED 8-17-2006.

G. MAYERSCHOFF, EXAMINING ATTORNEY

Int. Cls.: 16, 41, and 42

Prior U.S. Cls.: 2, 5, 22, 23, 29, 37, 38, 50, 100, 101, and 107

Reg. No. 3,486,536

United States Patent and Trademark Office

Registered Aug. 12, 2008

**TRADEMARK
SERVICE MARK
PRINCIPAL REGISTER**

QUALITYCORE

ACT, INC. (IOWA CORPORATION)
P.O. BOX 168
IOWA CITY, IA 522430168

FOR: PRINTED MATTER, NAMELY, TESTS, TEST BOOKLETS, AND PRINTED SUPPORT MATERIALS IN THE FORM OF DIRECTIONS FOR TEST ADMINISTRATION, TEST GUIDES, TEST SCORE REPORTS, TEST ANSWER SHEETS, AND TEST ANSWER KEYS USED IN CONJUNCTION WITH STANDARDIZED TESTS; PRINTED TEACHING MATERIALS IN THE FIELD OF EDUCATIONAL TESTING, IN CLASS 16 (U.S. CLS. 2, 5, 22, 23, 29, 37, 38 AND 50).

FIRST USE 8-14-2007; IN COMMERCE 8-14-2007.

FOR: EDUCATIONAL SERVICES, NAMELY, PERFORMING RESEARCH, AND PROVIDING CONTINUING TEACHER TRAINING AND DEVELOPMENT AND DISTRIBUTING COURSE MATERIAL THEREWITH; EDUCATIONAL TESTING

SERVICES, NAMELY, ANALYZING AND REPORTING STANDARDIZED TEST SCORES FOR OTHERS, AND PREPARING, ADMINISTERING, AND SCORING STANDARDIZED TESTS, IN CLASS 41 (U.S. CLS. 100, 101 AND 107).

FIRST USE 1-1-2007; IN COMMERCE 1-1-2007.

FOR: PROVIDING TEMPORARY USE OF ONLINE SOFTWARE FOR EDUCATIONAL TESTING, IN CLASS 42 (U.S. CLS. 100 AND 101).

FIRST USE 12-10-2007; IN COMMERCE 12-10-2007.

THE MARK CONSISTS OF STANDARD CHARACTERS WITHOUT CLAIM TO ANY PARTICULAR FONT, STYLE, SIZE, OR COLOR.

SN 78-955,220, FILED 8-18-2006.

DEIRDRE ROBERTSON, EXAMINING ATTORNEY

Int. Cl.: 11

Prior U.S. Cls.: 13, 21, 23, 31, and 34

United States Patent and Trademark Office

Reg. No. 3,486,537

Registered Aug. 12, 2008

**TRADEMARK
PRINCIPAL REGISTER**

**BUILT FOR YOU. BUILT TO
LAST.**

GLEN ELECTRIC HOLDINGS GMBH (FED REP
GERMANY LTD LIAB CO)
OTTO BERGNER STRASSE 28
D-96515 SONNEBERG, FED REP GERMANY

THE MARK CONSISTS OF STANDARD CHAR-
ACTERS WITHOUT CLAIM TO ANY PARTICULAR
FONT, STYLE, SIZE, OR COLOR.

FOR: CLOSED LOOP INDUSTRIAL LIQUID
COOLING UNITS, WATER CHILLERS AND HEAT
EXCHANGERS, IN CLASS 11 (U.S. CLS. 13, 21, 23, 31
AND 34).

SN 78-955,504, FILED 8-18-2006.

FIRST USE 7-0-2006; IN COMMERCE 7-0-2006.

ANNE MADDEN, EXAMINING ATTORNEY

Int. Cl.: 41

Prior U.S. Cls.: 100, 101, and 107

United States Patent and Trademark Office

Reg. No. 3,486,538

Registered Aug. 12, 2008

**SERVICE MARK
PRINCIPAL REGISTER**

TELEMERSION

TRASK INDUSTRIES, LLC (FLORIDA LTD LIAB
CO)
1900 NORTH GOODMAN ROAD
KISSIMMEE, FL 34747

FOR: ENTERTAINMENT SERVICES, NAMELY,
FANTASY ENACTMENTS WHERE PARTICIPANTS
RE-ENACT CONDITIONS, SITUATIONS, OR
EVENTS SEEN ON TELEVISION FROM THEIR
OWN POINT OF VIEW, IN CLASS 41 (U.S. CLS. 100,
101 AND 107).

FIRST USE 8-18-2006; IN COMMERCE 3-17-2008.

THE MARK CONSISTS OF STANDARD CHAR-
ACTERS WITHOUT CLAIM TO ANY PARTICULAR
FONT, STYLE, SIZE, OR COLOR.

SN 78-955,807, FILED 8-18-2006.

TINA BROWN, EXAMINING ATTORNEY

Int. Cl.: 9

Prior U.S. Cls.: 21, 23, 26, 36, and 38

United States Patent and Trademark Office

Reg. No. 3,486,539

Registered Aug. 12, 2008

**TRADEMARK
PRINCIPAL REGISTER**



WARPATH RECORDS INC. (VIRGINIA CORPORATION)
UNIT K
7526 COXTON COURT
ALEXANDRIA, VA 22306

FOR: PHONOGRAPH RECORDS FEATURING MUSIC INCLUDING PRERECORDED VOCAL AND INSTRUMENTAL, IN CLASS 9 (U.S. CLS. 21, 23, 26, 36 AND 38).

FIRST USE 9-19-2006; IN COMMERCE 8-17-2007.

NO CLAIM IS MADE TO THE EXCLUSIVE RIGHT TO USE "RECORDS", APART FROM THE MARK AS SHOWN.

THE COLOR(S) RED, YELLOW, BLACK AND WHITE IS/ARE CLAIMED AS A FEATURE OF THE MARK.

THE MARK CONSISTS OF STYLIZED RED LETTERS BORDERED IN WHITE ABOVE A YELLOW, RED, AND BLACK SKY, ALL ABOVE BLACK MOUNTAINS.

SN 78-956,040, FILED 8-20-2006.

KATHERINE CONNOLLY, EXAMINING ATTORNEY

Int. Cl.: 9

Prior U.S. Cls.: 21, 23, 26, 36, and 38

Reg. No. 3,486,540

United States Patent and Trademark Office

Registered Aug. 12, 2008

**TRADEMARK
PRINCIPAL REGISTER**

HAZARDAVERT

FREDERICK MINING CONTROLS, LLC (ALABAMA LIMITED LIABILITY CORPORATION)
1769B JEFF ROAD
HUNTSVILLE, AL 35806

FIRST USE 3-16-2007; IN COMMERCE 3-16-2007.

FOR: SAFETY SYSTEM PRIMARILY COMPOSED OF COMPUTER SOFTWARE, MAGNETIC ALARM, MAGNETIC TRACKING TAGS AND AN ELECTROMAGNETIC GENERATOR FOR USE WITH TRUCKS, GRADERS, ROLLERS, FORKLIFTS AND OTHER MOTOR VEHICLES, IN CLASS 9 (U.S. CLS. 21, 23, 26, 36 AND 38).

THE MARK CONSISTS OF STANDARD CHARACTERS WITHOUT CLAIM TO ANY PARTICULAR FONT, STYLE, SIZE, OR COLOR.

SN 78-956,735, FILED 8-21-2006.

BERYL GARDNER, EXAMINING ATTORNEY

Int. Cl.: 9

Prior U.S. Cls.: 21, 23, 26, 36, and 38

Reg. No. 3,486,541

United States Patent and Trademark Office

Registered Aug. 12, 2008

**TRADEMARK
PRINCIPAL REGISTER**

Frankencash

GLOBAL GAMING GROUP (NEVADA CORPORATION)
3035 E PATRICK LANE SUITE 14
LAS VEGAS, NV 89120

THE MARK CONSISTS OF STANDARD CHARACTERS WITHOUT CLAIM TO ANY PARTICULAR FONT, STYLE, SIZE, OR COLOR.

FOR: GAMING EQUIPMENT, NAMELY, SLOT MACHINES WITH OR WITHOUT VIDEO OUTPUT, IN CLASS 9 (U.S. CLS. 21, 23, 26, 36 AND 38).

SN 78-956,770, FILED 8-21-2006.

FIRST USE 12-5-2005; IN COMMERCE 12-5-2005.

DAVID MURRAY, EXAMINING ATTORNEY

Int. Cls.: 35, 39, 41, and 42

Prior U.S. Cls.: 100, 101, 102, 105, and 107

United States Patent and Trademark Office

Reg. No. 3,486,542

Registered Aug. 12, 2008

**SERVICE MARK
PRINCIPAL REGISTER**

ALLPHASE CLINICAL RESEARCH

ALLPHASE CLINICAL RESEARCH (US), INC.
(DELAWARE CORPORATION)
SUITE 400
2711 CENTERVILLE ROAD
WILMINGTON, DE 19808

FOR: PRE-CLINICAL TO PHASE FOUR CLINICAL TRIAL MANAGEMENT SERVICES, NAMELY, PRE-STUDY DOCUMENT COLLECTION AND REVIEW, SITE SELECTION, VISITS AND AUDITS, SITE COMPLIANCE, PROJECT TRACKING AND MONITORING REPORTS, NEGOTIATION AND ADMINISTRATION OF INVESTIGATOR GRANTS, LABELING, PACKAGING, DISTRIBUTION, COORDINATION AND TRACKING OF CLINICAL TRIAL PRODUCTS AND MATERIALS, REGULATORY DOCUMENT PROCESSING, CENTRAL LABORATORY SELECTION AND COORDINATION; PRE-CLINICAL TO PHASE FOUR CLINICAL TRIAL MANAGEMENT SERVICES, NAMELY, MANAGING SITE AND STUDY-SPECIFIC SUBJECT RECRUITMENT STRATEGIES AND PROGRAMS IN THE NATURE OF CONTINGENCY STRATEGIES AND SOLUTIONS TO ADDRESS SPECIFIC PROJECT CHALLENGES; PRE-CLINICAL TO PHASE FOUR CLINICAL TRIAL MANAGEMENT SERVICES, NAMELY, MANAGING THE DEVELOPMENT OF ALL STUDY RELATED DOCUMENTS AND MATERIALS IN THE NATURE OF STUDY PROTOCOLS, AMENDMENTS, PAPER AND ELECTRONIC CASE REPORT FORMS, INFORMED CONSENT FORMS, DIARY CARDS, SAFETY NARRATIVES, PRESENTATION POSTERS, TECHNICAL BRIEFS AND TRAINING MANUALS; PRE-CLINICAL TO PHASE FOUR CLINICAL TRIAL MANAGEMENT SERVICES, NAMELY, MANAGING ALL ASPECTS OF STUDY, DRUG RECONCILIATION, AND INVENTORY AND DISTRIBUTION REPORTS, MANAGING ALL ASPECTS OF CLINICAL TRIALS, NAMELY, MANAGING INVESTIGATORS, TECHNICIANS, AND PARTICIPANTS, ETHICAL REVIEWS, INVESTIGATOR MEETINGS, DATABASES,

STATISTICAL ANALYSES AND REPORTING, RANDOMIZATION LOGISTICS, MEDICAL WRITING SERVICES, RECRUITMENT OF INVESTIGATORS, TECHNICIANS AND PARTICIPANTS; PROVIDING DATA MANAGEMENT SERVICES IN THE MEDICAL, PHARMACEUTICAL AND BIOTECHNOLOGICAL FIELD, IN CLASS 35 (U.S. CLS. 100, 101 AND 102).

FIRST USE 1-2-2001; IN COMMERCE 8-0-2003.

FOR: CLINICAL SUPPLY STORAGE IN THE FIELD OF CLINICAL AND MEDICAL SUPPLIES, IN CLASS 39 (U.S. CLS. 100 AND 105).

FIRST USE 9-9-2004; IN COMMERCE 9-9-2004.

FOR: PROVIDING TRAINING IN THE FIELD OF CLINICAL TRIALS AND CLINICAL TRIAL MANAGEMENT FOR THE PHARMACEUTICAL AND BIOTECHNOLOGICAL INDUSTRIES, IN CLASS 41 (U.S. CLS. 100, 101 AND 107).

FIRST USE 8-2-2006; IN COMMERCE 8-2-2006.

FOR: MEDICAL AND SCIENTIFIC RESEARCH CONSULTING REGARDING PRE-CLINICAL TO PHASE FOUR CLINICAL TRIALS; REGULATORY AFFAIRS, NAMELY, REVIEWING STANDARDS AND PRACTICES TO ASSURE COMPLIANCE WITH CLINICAL TRIAL LAWS AND REGULATIONS; PROVIDING QUALITY ASSURANCE SERVICES IN THE PHARMACEUTICAL AND BIOTECHNOLOGICAL INDUSTRIES, IN CLASS 42 (U.S. CLS. 100 AND 101).

FIRST USE 1-5-2001; IN COMMERCE 4-0-2003.

THE MARK CONSISTS OF STANDARD CHARACTERS WITHOUT CLAIM TO ANY PARTICULAR FONT, STYLE, SIZE, OR COLOR.

NO CLAIM IS MADE TO THE EXCLUSIVE
RIGHT TO USE "CLINICAL RESEARCH", APART
FROM THE MARK AS SHOWN.

SN 78-957,448, FILED 8-22-2006.

BRIAN PINO, EXAMINING ATTORNEY

Int. Cls.: 35, 39, 41, and 42

Prior U.S. Cls.: 100, 101, 102, 105, and 107

United States Patent and Trademark Office

Reg. No. 3,486,543

Registered Aug. 12, 2008

SERVICE MARK
PRINCIPAL REGISTER



ALLPHASE
CLINICAL RESEARCH

ALLPHASE CLINICAL RESEARCH (US), INC.
(DELAWARE CORPORATION)
SUITE 400
2711 CENTERVILLE ROAD
WILMINGTON, DE 19808

FOR: PRE-CLINICAL TO PHASE FOUR CLINICAL TRIAL MANAGEMENT SERVICES, NAMELY, PRE-STUDY DOCUMENT COLLECTION AND REVIEW, SITE SELECTION, VISITS AND AUDITS, SITE COMPLIANCE, PROJECT TRACKING AND MONITORING REPORTS, NEGOTIATION AND ADMINISTRATION OF INVESTIGATOR GRANTS, LABELING, PACKAGING, DISTRIBUTION, COORDINATION AND TRACKING OF CLINICAL TRIAL PRODUCTS AND MATERIALS, REGULATORY DOCUMENT PROCESSING, CENTRAL LABORATORY SELECTION AND COORDINATION; PRE-CLINICAL TO PHASE FOUR CLINICAL TRIAL MANAGEMENT SERVICES, NAMELY, MANAGING SITE AND STUDY-SPECIFIC SUBJECT RECRUITMENT STRATEGIES AND PROGRAMS IN THE NATURE OF CONTINGENCY STRATEGIES AND SOLUTIONS TO ADDRESS SPECIFIC PROJECT CHALLENGES; PRE-CLINICAL TO PHASE FOUR CLINICAL TRIAL MANAGEMENT SERVICES, NAMELY, MANAGING THE DEVELOPMENT OF ALL STUDY RELATED DOCUMENTS AND MATERIALS IN THE NATURE OF STUDY PROTOCOLS, AMENDMENTS, PAPER AND ELECTRONIC CASE REPORT FORMS, INFORMED CONSENT FORMS, DIARY CARDS, SAFETY NARRATIVES, PRESENTATION POSTERS, TECHNICAL BRIEFS AND TRAINING MANUALS; PRE-CLINICAL TO PHASE FOUR CLINICAL TRIAL MANAGEMENT

SERVICES, NAMELY, MANAGING ALL ASPECTS OF STUDY, DRUG RECONCILIATION, AND INVENTORY AND DISTRIBUTION REPORTS, MANAGING ALL ASPECTS OF CLINICAL TRIALS, NAMELY, MANAGING INVESTIGATORS, TECHNICIANS, AND PARTICIPANTS, ETHICAL REVIEWS, INVESTIGATOR MEETINGS, DATABASES, STATISTICAL ANALYSES AND REPORTING, RANDOMIZATION LOGISTICS, MEDICAL WRITING SERVICES, RECRUITMENT OF INVESTIGATORS, TECHNICIANS AND PARTICIPANTS; PROVIDING DATA MANAGEMENT SERVICES IN THE MEDICAL, PHARMACEUTICAL AND BIOTECHNOLOGICAL FIELD, IN CLASS 35 (U.S. CLS. 100, 101 AND 102).

FIRST USE 1-5-2001; IN COMMERCE 4-0-2003.

FOR: CLINICAL SUPPLY STORAGE IN THE FIELD OF CLINICAL AND MEDICAL SUPPLIES, IN CLASS 39 (U.S. CLS. 100 AND 105).

FIRST USE 9-9-2004; IN COMMERCE 9-9-2004.

FOR: PROVIDING TRAINING IN THE FIELD OF CLINICAL TRIALS AND CLINICAL TRIAL MANAGEMENT FOR THE PHARMACEUTICAL AND BIOTECHNOLOGICAL INDUSTRIES, IN CLASS 41 (U.S. CLS. 100, 101 AND 107).

FIRST USE 8-2-2006; IN COMMERCE 8-2-2006.

FOR: MEDICAL AND SCIENTIFIC RESEARCH CONSULTING REGARDING PRE-CLINICAL TO PHASE FOUR CLINICAL TRIALS; REGULATORY

AFFAIRS, NAMELY, REVIEWING STANDARDS AND PRACTICES TO ASSURE COMPLIANCE WITH CLINICAL TRIAL LAWS AND REGULATIONS; PROVIDING QUALITY ASSURANCE SERVICES IN THE PHARMACEUTICAL AND BIOTECHNOLOGICAL INDUSTRIES, IN CLASS 42 (U.S. CLS. 100 AND 101).

FIRST USE 1-5-2001; IN COMMERCE 4-0-2003.

NO CLAIM IS MADE TO THE EXCLUSIVE RIGHT TO USE "CLINICAL RESEARCH", APART FROM THE MARK AS SHOWN.

THE MARK CONSISTS OF A STYLIZED LEAF ABOVE THE WORD "ALLPHASE CLINICAL RESEARCH".

SN 78-957,550, FILED 8-22-2006.

BRIAN PINO, EXAMINING ATTORNEY

Int. Cl.: 41

Prior U.S. Cls.: 100, 101, and 107

Reg. No. 3,486,544

United States Patent and Trademark Office

Registered Aug. 12, 2008

**SERVICE MARK
PRINCIPAL REGISTER**

The Executive Producer

THE EXECUTIVE PRODUCER, LLC (DELA-
WARE LTD LIAB CO)
345 BOULEVARD
NEW MILFORD, NJ 07646

THE MARK CONSISTS OF STANDARD CHAR-
ACTERS WITHOUT CLAIM TO ANY PARTICULAR
FONT, STYLE, SIZE, OR COLOR.

FOR: ENTERTAINMENT IN THE NATURE OF
ON-GOING TELEVISION PROGRAMS IN THE
FIELD OF REALITY BASED MUSIC TELEVISION,
IN CLASS 41 (U.S. CLS. 100, 101 AND 107).

SN 78-958,382, FILED 8-23-2006.

FIRST USE 1-1-2008; IN COMMERCE 1-1-2008.

DAWN FELDMAN, EXAMINING ATTORNEY

Int. Cls.: 36, 39, and 42

Prior U.S. Cls.: 100, 101, 102, and 105

United States Patent and Trademark Office

Reg. No. 3,486,545

Registered Aug. 12, 2008

**SERVICE MARK
PRINCIPAL REGISTER**

zonder

VACATION RENTALS ONLINE, INC. (DELAWARE CORPORATION)
552 E. TECHNOLOGY AVE., BLD. C STE. 2300
OREM, UT 84097

FOR: REAL ESTATE SERVICES, NAMELY, RENTAL OF VACATION HOMES, CONDOMINIUMS, CABINS, AND VILLAS VIA A GLOBAL COMPUTER NETWORK, IN CLASS 36 (U.S. CLS. 100, 101 AND 102).

FIRST USE 7-6-2006; IN COMMERCE 7-6-2006.

FOR: TRAVEL AGENCY SERVICES, NAMELY, MAKING RESERVATIONS AND BOOKINGS FOR TRANSPORTATION VIA A GLOBAL COMPUTER NETWORK, IN CLASS 39 (U.S. CLS. 100 AND 105).

FIRST USE 6-23-2008; IN COMMERCE 6-23-2008.

FOR: TRAVEL AGENCY SERVICES, NAMELY, MAKING RESERVATIONS AND BOOKINGS FOR LODGING VIA A GLOBAL COMPUTER NETWORK, IN CLASS 42 (U.S. CLS. 100 AND 101).

FIRST USE 7-6-2006; IN COMMERCE 7-6-2006.

THE MARK CONSISTS OF STANDARD CHARACTERS WITHOUT CLAIM TO ANY PARTICULAR FONT, STYLE, SIZE, OR COLOR.

THE FOREIGN WORDING IN THE MARK TRANSLATES INTO ENGLISH AS WITHOUT OR OUTDOORS.

SN 78-960,008, FILED 8-24-2006.

PAUL F. GAST, EXAMINING ATTORNEY

Int. Cl.: 28

Prior U.S. Cls.: 22, 23, 38, and 50

United States Patent and Trademark Office

Reg. No. 3,486,546

Registered Aug. 12, 2008

**TRADEMARK
PRINCIPAL REGISTER**

SMART WHEEL!

AMERICA'S DRIVE-IN HOLDING INC. (KANSAS
CORPORATION)

3500 NORTH ROCK ROAD

BUILDING 1100

WICHITA, KS 67226

FOR: PUZZLES, NAMELY, MANIPULATIVE
EDUCATIONAL THREE DIMENSIONAL PUZZLES,
IN CLASS 28 (U.S. CLS. 22, 23, 38 AND 50).

FIRST USE 10-1-2006; IN COMMERCE 10-1-2006.

THE MARK CONSISTS OF STANDARD CHAR-
ACTERS WITHOUT CLAIM TO ANY PARTICULAR
FONT, STYLE, SIZE, OR COLOR.

OWNER OF U.S. REG. NO. 2,806,566.

NO CLAIM IS MADE TO THE EXCLUSIVE
RIGHT TO USE "WHEEL", APART FROM THE
MARK AS SHOWN.

SN 78-961,936, FILED 8-28-2006.

MICHAEL LITZAU, EXAMINING ATTORNEY

Int. Cl.: 35

Prior U.S. Cls.: 100, 101, and 102

United States Patent and Trademark Office

Reg. No. 3,486,547

Registered Aug. 12, 2008

**SERVICE MARK
PRINCIPAL REGISTER**

BOURBON & CANAL

ENTERTAINMENT ADVISORS, LLC (INDIANA
LTD LIAB CO)
SUITE 42
5276 WEST STATE ROAD
BRAZIL, IN 47834

FOR: RETAIL STORE SERVICES, MAIL ORDER
CATALOG SERVICES, AND COMPUTERIZED ON-
LINE ORDERING SERVICES ALL IN THE FIELD
OF LIQUOR, BEER, WINE, AND ACCESSORIES
FOR SUCH GOODS, IN CLASS 35 (U.S. CLS. 100,
101 AND 102).

FIRST USE 11-7-2006; IN COMMERCE 11-7-2006.

THE MARK CONSISTS OF STANDARD CHAR-
ACTERS WITHOUT CLAIM TO ANY PARTICULAR
FONT, STYLE, SIZE, OR COLOR.

SN 78-962,008, FILED 8-28-2006.

CHRISTINE COOPER, EXAMINING ATTORNEY

Int. Cls.: 29 and 30

Prior U.S. Cl.: 46

United States Patent and Trademark Office

Reg. No. 3,486,548

Registered Aug. 12, 2008

**TRADEMARK
PRINCIPAL REGISTER**

Tahoe Dream Vanilla Bean

TCIP, LLC (WYOMING LTD LIAB CO)
60 EAST SIMPSON AVE.
JACKSON, WY 83001

FOR: DAIRY AND NON-DAIRY WHIPPED TOP-
PINGS; DAIRY BASED BEVERAGES; DAIRY-
BASED FOOD BEVERAGES; TOPPINGS FOR ICE
CREAM IN THE NATURE OF FRUIT TOPPING,
NUT TOPPING AND PEANUT BUTTER TOPPING ,
IN CLASS 29 (U.S. CL. 46).

FIRST USE 8-1-2007; IN COMMERCE 8-1-2007.

FOR: ICE CREAM; ICE MILK; CONFECTIONERY
ICES, NAMELY, FROZEN YOGURT; FROZEN CON-
FECTIONS; SORBET; SHERBET; TOPPINGS FOR
ICE CREAM IN THE NATURE OF CHOCOLATE
TOPPINGS, FUDGE TOPPINGS, CARAMEL TOP-

PINGS, MARSHMALLOW TOPPING, BUTTERS-
COTCH TOPPING, CANDY TOPPINGS AND
CANDY SPRINKLE TOPPING, IN CLASS 30 (U.S.
CL. 46).

FIRST USE 8-1-2007; IN COMMERCE 8-1-2007.

THE MARK CONSISTS OF STANDARD CHAR-
ACTERS WITHOUT CLAIM TO ANY PARTICULAR
FONT, STYLE, SIZE, OR COLOR.

NO CLAIM IS MADE TO THE EXCLUSIVE
RIGHT TO USE "VANILLA BEAN", APART FROM
THE MARK AS SHOWN.

SN 78-962,951, FILED 8-29-2006.

MICHAEL LEWIS, EXAMINING ATTORNEY

Int. Cl.: 12

Prior U.S. Cls.: 19, 21, 23, 31, 35, and 44

Reg. No. 3,486,549

United States Patent and Trademark Office

Registered Aug. 12, 2008

**TRADEMARK
PRINCIPAL REGISTER**

KRAMER RACK+

KRAMER, JERRY D. (UNITED STATES INDIVIDUAL)
3882 THE ASCENT NE
ATLANTA, GA 30319

THE MARK CONSISTS OF STANDARD CHARACTERS WITHOUT CLAIM TO ANY PARTICULAR FONT, STYLE, SIZE, OR COLOR.

FOR: ACCESSORY FOR MOTOR VEHICLE, NAMELY, UTILITY RACK; UTILITY RACK FOR PICKUP TRUCKS, IN CLASS 12 (U.S. CLS. 19, 21, 23, 31, 35 AND 44).

SN 78-962,976, FILED 8-29-2006.

FIRST USE 7-0-2007; IN COMMERCE 7-0-2007.

JAMES MACFARLANE, EXAMINING ATTORNEY

Int. Cls.: 29 and 30

Prior U.S. Cl.: 46

United States Patent and Trademark Office

Reg. No. 3,486,550

Registered Aug. 12, 2008

**TRADEMARK
PRINCIPAL REGISTER**

Tahoe Tessy Mudpie Messy

TCIP, LLC (WYOMING LTD LIAB CO)
60 EAST SIMPSON AVE.
JACKSON, WY 83001

FOR: DAIRY AND NON-DAIRY WHIPPED TOP-
PINGS; DAIRY BASED BEVERAGES; DAIRY-
BASED FOOD BEVERAGES; TOPPINGS FOR ICE
CREAM IN THE NATURE OF FRUIT TOPPING,
NUT TOPPING AND PEANUT BUTTER TOPPING ,
IN CLASS 29 (U.S. CL. 46).

FIRST USE 8-1-2007; IN COMMERCE 8-1-2007.

FOR: ICE CREAM; ICE MILK; CONFECTIONERY
ICES, NAMELY, FROZEN YOGURT; FROZEN CON-
FECTIONS; SORBET; SHERBET; TOPPINGS FOR
ICE CREAM IN THE NATURE OF CHOCOLATE
TOPPINGS, FUDGE TOPPINGS, CARAMEL TOP-

PINGS, MARSHMALLOW TOPPING, BUTTERS-
COTCH TOPPING, CANDY TOPPINGS AND
CANDY SPRINKLE TOPPING, IN CLASS 30 (U.S.
CL. 46).

FIRST USE 8-1-2007; IN COMMERCE 8-1-2007.

THE MARK CONSISTS OF STANDARD CHAR-
ACTERS WITHOUT CLAIM TO ANY PARTICULAR
FONT, STYLE, SIZE, OR COLOR.

NO CLAIM IS MADE TO THE EXCLUSIVE
RIGHT TO USE "MUD PIE", APART FROM THE
MARK AS SHOWN.

SN 78-962,978, FILED 8-29-2006.

MICHAEL LEWIS, EXAMINING ATTORNEY

Int. Cls.: 29 and 30

Prior U.S. Cl.: 46

United States Patent and Trademark Office

Reg. No. 3,486,551

Registered Aug. 12, 2008

**TRADEMARK
PRINCIPAL REGISTER**

**Tahoe Pistachio Grizzly
Mustachio**

TCIP, LLC (WYOMING LTD LIAB CO)
60 EAST SIMPSON AVE.
JACKSON, WY 83001

FOR: DAIRY AND NON-DAIRY WHIPPED TOP-
PINGS; DAIRY BASED BEVERAGES; DAIRY-
BASED FOOD BEVERAGES; TOPPINGS FOR ICE
CREAM IN THE NATURE OF FRUIT TOPPING,
NUT TOPPING AND PEANUT BUTTER TOPPING ,
IN CLASS 29 (U.S. CL. 46).

FIRST USE 8-1-2007; IN COMMERCE 8-1-2007.

FOR: ICE CREAM; ICE MILK; CONFECTIONERY
ICES, NAMELY, FROZEN YOGURT; FROZEN CON-
FECTIONS; SORBET; SHERBET; TOPPINGS FOR
ICE CREAM IN THE NATURE OF CHOCOLATE
TOPPINGS, FUDGE TOPPINGS, CARAMEL TOP-

PINGS, MARSHMALLOW TOPPING, BUTTERS-
COTCH TOPPING, CANDY TOPPINGS AND
CANDY SPRINKLE TOPPING, IN CLASS 30 (U.S.
CL. 46).

FIRST USE 8-1-2007; IN COMMERCE 8-1-2007.

THE MARK CONSISTS OF STANDARD CHAR-
ACTERS WITHOUT CLAIM TO ANY PARTICULAR
FONT, STYLE, SIZE, OR COLOR.

NO CLAIM IS MADE TO THE EXCLUSIVE
RIGHT TO USE "PISTACHIO", APART FROM THE
MARK AS SHOWN.

SN 78-962,986, FILED 8-29-2006.

MICHAEL LEWIS, EXAMINING ATTORNEY

Int. Cl.: 35

Prior U.S. Cls.: 100, 101, and 102

United States Patent and Trademark Office

Reg. No. 3,486,552

Registered Aug. 12, 2008

**SERVICE MARK
PRINCIPAL REGISTER**

MONDAY MORNING REPLAY

PREMIERE RADIO NETWORKS, INC. (DELA-
WARE CORPORATION)
200 EAST BASSE ROAD
SAN ANTONIO, TX 78209

FOR: PROVIDING ONLINE BUSINESS INFOR-
MATION AND BUSINESS RELATED NEWS IN THE
FIELD OF RADIO BROADCASTING PROGRAM-
MING, DIRECTED TO THE BROADCAST INDUS-
TRY , IN CLASS 35 (U.S. CLS. 100, 101 AND 102).

FIRST USE 1-18-1988; IN COMMERCE 1-18-1988.

THE MARK CONSISTS OF STANDARD CHAR-
ACTERS WITHOUT CLAIM TO ANY PARTICULAR
FONT, STYLE, SIZE, OR COLOR.

SN 78-962,988, FILED 8-29-2006.

JIM RINGLE, EXAMINING ATTORNEY

Int. Cls.: 29 and 30

Prior U.S. Cl.: 46

United States Patent and Trademark Office

Reg. No. 3,486,553

Registered Aug. 12, 2008

**TRADEMARK
PRINCIPAL REGISTER**

Tahoe Coffee Crunchy Toffee

TCIP, LLC (WYOMING LTD LIAB CO)
60 EAST SIMPSON AVE.
JACKSON, WY 83001

FOR: DAIRY AND NON-DAIRY WHIPPED TOP-
PINGS; DAIRY BASED BEVERAGES; DAIRY-
BASED FOOD BEVERAGES; TOPPINGS FOR ICE
CREAM IN THE NATURE OF FRUIT TOPPING,
NUT TOPPING AND PEANUT BUTTER TOPPING ,
IN CLASS 29 (U.S. CL. 46).

FIRST USE 8-1-2007; IN COMMERCE 8-1-2007.

FOR: ICE CREAM; ICE MILK; CONFECTIONERY
ICES, NAMELY, FROZEN YOGURT; FROZEN CON-
FECTIONS; SORBET; SHERBET; TOPPINGS FOR
ICE CREAM IN THE NATURE OF CHOCOLATE
TOPPINGS, FUDGE TOPPINGS, CARAMEL TOP-

PINGS, MARSHMALLOW TOPPING, BUTTERS-
COTCH TOPPING, CANDY TOPPINGS AND
CANDY SPRINKLE TOPPING, IN CLASS 30 (U.S.
CL. 46).

FIRST USE 8-1-2007; IN COMMERCE 8-1-2007.

THE MARK CONSISTS OF STANDARD CHAR-
ACTERS WITHOUT CLAIM TO ANY PARTICULAR
FONT, STYLE, SIZE, OR COLOR.

NO CLAIM IS MADE TO THE EXCLUSIVE
RIGHT TO USE "COFFEE CRUNCHY TOFFEE",
APART FROM THE MARK AS SHOWN.

SN 78-962,993, FILED 8-29-2006.

MICHAEL LEWIS, EXAMINING ATTORNEY

Int. Cls.: 29 and 30

Prior U.S. Cl.: 46

United States Patent and Trademark Office

Reg. No. 3,486,554

Registered Aug. 12, 2008

**TRADEMARK
PRINCIPAL REGISTER**

**TAHOE CRUNCH PEANUT
BUTTER MUNCH**

TCIP, LLC (WYOMING LTD LIAB CO)
60 EAST SIMPSON AVE.
JACKSON, WY 83001

FOR: DAIRY AND NON-DAIRY WHIPPED TOP-
PINGS; DAIRY BASED BEVERAGES; DAIRY-
BASED FOOD BEVERAGES; TOPPINGS FOR ICE
CREAM IN THE NATURE OF FRUIT TOPPING,
NUT TOPPING AND PEANUT BUTTER TOPPING ,
IN CLASS 29 (U.S. CL. 46).

FIRST USE 8-1-2007; IN COMMERCE 8-1-2007.

FOR: ICE CREAM; ICE MILK; CONFECTIONERY
ICES, NAMELY, FROZEN YOGURT; FROZEN CON-
FECTIONS; SORBET; SHERBET; TOPPINGS FOR
ICE CREAM IN THE NATURE OF CHOCOLATE
TOPPINGS, FUDGE TOPPINGS, CARAMEL TOP-

PINGS, MARSHMALLOW TOPPING, BUTTERS-
COTCH TOPPING, CANDY TOPPINGS AND
CANDY SPRINKLE TOPPING, IN CLASS 30 (U.S.
CL. 46).

FIRST USE 8-1-2007; IN COMMERCE 8-1-2007.

THE MARK CONSISTS OF STANDARD CHAR-
ACTERS WITHOUT CLAIM TO ANY PARTICULAR
FONT, STYLE, SIZE, OR COLOR.

NO CLAIM IS MADE TO THE EXCLUSIVE
RIGHT TO USE "CRUNCH PEANUT BUTTER",
APART FROM THE MARK AS SHOWN.

SN 78-963,004, FILED 8-29-2006.

MICHAEL LEWIS, EXAMINING ATTORNEY

Int. Cl.: 36

Prior U.S. Cls.: 100, 101, and 102

United States Patent and Trademark Office

Reg. No. 3,486,555

Registered Aug. 12, 2008

**SERVICE MARK
PRINCIPAL REGISTER**

Commercial*EDGE*

UTICA MUTUAL INSURANCE COMPANY, DBA
UTICA NATIONAL INSURANCE GROUP
(NEW YORK CORPORATION)
180 GENESEE STREET
NEW HARTFORD, NY 13413

NO CLAIM IS MADE TO THE EXCLUSIVE
RIGHT TO USE "COMMERCIAL", APART FROM
THE MARK AS SHOWN.

FOR: PROPERTY AND CASUALTY INSURANCE
UNDERWRITING SERVICES, IN CLASS 36 (U.S.
CLS. 100, 101 AND 102).

SN 78-963,468, FILED 8-30-2006.

FIRST USE 12-0-2006; IN COMMERCE 12-0-2006.

DORITT L. CARROLL, EXAMINING ATTORNEY

Int. Cl.: 35

Prior U.S. Cls.: 100, 101, and 102

United States Patent and Trademark Office

Reg. No. 3,486,556

Registered Aug. 12, 2008

**SERVICE MARK
PRINCIPAL REGISTER**

PURE POWER

AMEREN CORPORATION (MISSOURI CORPORATION)
ONE AMEREN PLAZA, 1901 CHOUTEAU AVENUE
ST. LOUIS, MO 63166

FOR: PROMOTING PUBLIC AWARENESS OF THE NEED FOR RENEWABLE ENERGY AND CLEAN ENERGY TECHNOLOGIES AND PROMOTING THE INTERESTS OF RENEWABLE ENERGY TECHNOLOGY DEVELOPERS, NAMELY, ADMINISTERING A PROGRAM PURSUANT TO WHICH RESIDENTIAL AND NON-RESIDENTIAL ELECTRIC UTILITY CUSTOMERS CONTRIBUTE FUNDS WHICH UTILITY COMPANY USES TO PURCHASE RENEWABLE ENERGY CREDITS TO PROMOTE DEVELOPMENT OF RENEWABLE ENERGY TECH-

NOLOGIES, IN CLASS 35 (U.S. CLS. 100, 101 AND 102).

FIRST USE 10-1-2007; IN COMMERCE 10-1-2007.

THE MARK CONSISTS OF STANDARD CHARACTERS WITHOUT CLAIM TO ANY PARTICULAR FONT, STYLE, SIZE, OR COLOR.

NO CLAIM IS MADE TO THE EXCLUSIVE RIGHT TO USE "POWER", APART FROM THE MARK AS SHOWN.

SN 78-964,121, FILED 8-30-2006.

JOHN DALIER, EXAMINING ATTORNEY

Int. Cl.: 35

Prior U.S. Cls.: 100, 101, and 102

United States Patent and Trademark Office

Reg. No. 3,486,557

Registered Aug. 12, 2008

**SERVICE MARK
PRINCIPAL REGISTER**

EVERYDAY GROCERY SAVINGS

AFFINION BENEFITS GROUP, INC. (DELA-
WARE CORPORATION)
400 DUKE DRIVE
FRANKLIN, TN 37067

FOR: ADMINISTRATION OF A DISCOUNT PRO-
GRAM FOR ENABLING PARTICIPANTS TO OB-
TAIN DISCOUNTS ON GOODS AND SERVICES,
NAMELY, GROCERIES AND OTHER MERCHAN-
DISE THROUGH USE OF A DISCOUNT MEMBER-
SHIP PROGRAM, AND PROVIDING IN
CONNECTION THEREWITH AN ON-LINE DIRE-
CTORY OF INFORMATION ABOUT THE PROGRAM
AND PARTICIPATING BUSINESSES; PROVIDING
ALL OF THE FOREGOING SERVICES ELECTRO-
NICALLY BY MEANS OF THE INTERNET, IN
CLASS 35 (U.S. CLS. 100, 101 AND 102).

FIRST USE 1-1-2007; IN COMMERCE 1-1-2007.

THE MARK CONSISTS OF STANDARD CHAR-
ACTERS WITHOUT CLAIM TO ANY PARTICULAR
FONT, STYLE, SIZE, OR COLOR.

NO CLAIM IS MADE TO THE EXCLUSIVE
RIGHT TO USE "GROCERY SAVINGS" , APART
FROM THE MARK AS SHOWN.

SN 78-964,163, FILED 8-30-2006.

JOHN DALIER, EXAMINING ATTORNEY

Int. Cl.: 19

Prior U.S. Cls.: 1, 12, 33, and 50

United States Patent and Trademark Office

Reg. No. 3,486,558

Registered Aug. 12, 2008

**TRADEMARK
PRINCIPAL REGISTER**

ENSEMBLE

NORTHSTAR CERAMIC TRADING, LLC (TEXAS
LTD LIAB CO)
14500 E. BELTWOOD PARKWAY
DALLAS, TX 75244

THE MARK CONSISTS OF STANDARD CHAR-
ACTERS WITHOUT CLAIM TO ANY PARTICULAR
FONT, STYLE, SIZE, OR COLOR.

FOR: CERAMIC AND GLASS TILES, IN CLASS 19
(U.S. CLS. 1, 12, 33 AND 50).

SN 78-964,200, FILED 8-30-2006.

FIRST USE 4-7-2008; IN COMMERCE 4-7-2008.

JULIE WATSON, EXAMINING ATTORNEY

Int. Cl.: 35

Prior U.S. Cls.: 100, 101, and 102

United States Patent and Trademark Office

Reg. No. 3,486,559

Registered Aug. 12, 2008

**SERVICE MARK
PRINCIPAL REGISTER**

FIVE RIVERS

FIVE RIVERS, INC. (IDAHO CORPORATION)
2285 WARM SPRINGS AVENUE
BOISE, ID 83712

FOR: RETAIL STORE SERVICES FEATURING HOUSEWARES, INDOOR AND OUTDOOR LAMPS AND LIGHTING FIXTURES, INDOOR AND OUTDOOR FURNITURE AND ACCESSORIES, TEXTILES AND PILLOWS, CURTAINS AND WINDOW COVERINGS, BEDDING, LINENS, TOWELS, DINING AND KITCHEN GOODS AND UTENSILS, BATH GOODS AND ACCESSORIES, DECORATIVE HOME FURNISHINGS AND ACCESSORIES, PICTURE FRAMES, MIRRORS, STAINED GLASS, ART AND CREATIVE ITEMS, CANDLES AND POTPOURRI AND ACCESSORIES, COMPUTER SOFTWARE, BOOKS, CDS, DVDS, TOYS, GAMES, OFFICE SUPPLIES, GREETING CARDS, WRAPPING PAPER AND GIFT BAGS AND RIBBONS, SPICES, SNACK FOODS, FOOD, BEVERAGES, COSMETICS, BEAUTY PRODUCTS AND ACCESSORIES, SHOES, HANDBAGS, SMALL LEATHER ACCESSORIES, CLOTHING AND ACCESSORIES, JEWELRY, GARDENING TOOLS AND ACCESSORIES, HARDWARE AND WIDE RANGE OF CONSU-

MER ELECTRONIC GOODS AND PRODUCTS; ONLINE RETAIL SERVICES FEATURING HOUSEWARES, INDOOR AND OUTDOOR LAMPS AND LIGHTING FIXTURES, INDOOR AND OUTDOOR FURNITURE AND ACCESSORIES, DINING AND KITCHEN GOODS AND UTENSILS, BATH GOODS AND ACCESSORIES, DECORATIVE HOME FURNISHINGS AND ACCESSORIES, MIRRORS, STAINED GLASS, ART AND CREATIVE ITEMS, COMPUTER SOFTWARE, CDS, DVDS, CLOTHING AND ACCESSORIES, JEWELRY, HARDWARE AND WIDE RANGE OF CONSUMER ELECTRONIC GOODS AND PRODUCTS, IN CLASS 35 (U.S. CLS. 100, 101 AND 102).

FIRST USE 6-29-1996; IN COMMERCE 6-29-1996.

THE MARK CONSISTS OF STANDARD CHARACTERS WITHOUT CLAIM TO ANY PARTICULAR FONT, STYLE, SIZE, OR COLOR.

SN 78-964,276, FILED 8-30-2006.

JIM RINGLE, EXAMINING ATTORNEY

Int. Cl.: 44

Prior U.S. Cls.: 100 and 101

United States Patent and Trademark Office

Reg. No. 3,486,560

Registered Aug. 12, 2008

**SERVICE MARK
PRINCIPAL REGISTER**

FIVE RIVERS

FIVE RIVERS, INC. (IDAHO CORPORATION)
2285 WARM SPRINGS AVENUE
BOISE, ID 83712

THE MARK CONSISTS OF STANDARD CHAR-
ACTERS WITHOUT CLAIM TO ANY PARTICULAR
FONT, STYLE, SIZE, OR COLOR.

FOR: LANDSCAPE GARDENING, CONSULTA-
TION AND DESIGN SERVICES, IN CLASS 44 (U.S.
CLS. 100 AND 101).

SN 78-964,301, FILED 8-30-2006.

FIRST USE 7-22-2004; IN COMMERCE 7-22-2004.

JIM RINGLE, EXAMINING ATTORNEY

Int. Cl.: 43

Prior U.S. Cls.: 100 and 101

United States Patent and Trademark Office

Reg. No. 3,486,561

Registered Aug. 12, 2008

**SERVICE MARK
PRINCIPAL REGISTER**

InterContinental

INTER-CONTINENTAL HOTELS CORPORATION
(DELAWARE CORPORATION)
SUITE 100
THREE RAVINIA DRIVE
ATLANTA, GA 30346

FOR: HOTEL SERVICES TO CONDOMINIUM
APARTMENTS IN HOTELS, IN CLASS 43 (U.S.
CLS. 100 AND 101).

FIRST USE 5-0-2007; IN COMMERCE 5-0-2007.

THE MARK CONSISTS OF STANDARD CHAR-
ACTERS WITHOUT CLAIM TO ANY PARTICULAR
FONT, STYLE, SIZE, OR COLOR.

OWNER OF U.S. REG. NOS. 890,271 AND 1,635,689.

SN 78-964,986, FILED 8-31-2006.

MELISSA VALLILLO, EXAMINING ATTORNEY

Int. Cl.: 25

Prior U.S. Cls.: 22 and 39

United States Patent and Trademark Office

Reg. No. 3,486,562

Registered Aug. 12, 2008

**TRADEMARK
PRINCIPAL REGISTER**

WOOD ISLAND

100MC, LLC (CALIFORNIA LTD LIAB CO)
SUITE B
12 E. SIR FRANCIS DRAKE BLVD.
LARKSPUR, CA 94939

FIRST USE 2-15-2008; IN COMMERCE 2-15-2008.

FOR: CLOTHING, NAMELY, MEN'S, WOMEN'S
AND CHILDREN'S CASUAL AND DRESS CLOTH-
ING, NAMELY, DRESS AND CASUAL SHIRTS,
PANTS, SHORTS, JACKETS, UNDERWEAR, TOPS,
FOOTWEAR AND HEADWEAR , IN CLASS 25 (U.S.
CLS. 22 AND 39).

THE MARK CONSISTS OF STANDARD CHAR-
ACTERS WITHOUT CLAIM TO ANY PARTICULAR
FONT, STYLE, SIZE, OR COLOR.

SN 78-965,067, FILED 8-31-2006.

JOHN DALIER, EXAMINING ATTORNEY

Int. Cl.: 25

Prior U.S. Cls.: 22 and 39

United States Patent and Trademark Office

Reg. No. 3,486,563

Registered Aug. 12, 2008

**TRADEMARK
PRINCIPAL REGISTER**

LIKE IT OR NOT

6227040 CANADA INC. (CANADA CORPORATION)
603 HYMAN DR, DOLLARD-DES-ORMEAUX
MONTREAL, CANADA H9B 2G7

FOR: MEN'S AND WOMEN'S CLOTHING AND ACCESSORIES, NAMELY, BELTS, BLAZERS, BOMBER JACKETS, BRASSIERES, CAMISOLES, COATS, GLOVES, G-STRINGS, HATS, HEAD BANDS, JACKETS, JEANS, KNIT TOPS, LINGERIE, PAJAMAS, PANTIES, PANTS, POLO SHIRTS, RUNNING SHOES, SANDALS, SCARVES, SHIRTS, SHOES, SHORTS, SKIRTS, SLIPPERS, SOCKS, SWEAT PANTS, SWEAT SHIRTS, SWEAT SUITS, SWEATERS, SWIMSUITS, THONGS, TOPS, TRACK SUITS,

T-SHIRTS, TURTLE NECKS, UNDERSHIRTS, UNDERWEAR, VESTS, WIND-JACKETS, IN CLASS 25 (U.S. CLS. 22 AND 39).

FIRST USE 2-20-2005; IN COMMERCE 4-9-2008.

THE MARK CONSISTS OF STANDARD CHARACTERS WITHOUT CLAIM TO ANY PARTICULAR FONT, STYLE, SIZE, OR COLOR.

SN 78-966,440, FILED 9-1-2006.

IRA J. GOODSaid, EXAMINING ATTORNEY

Int. Cl.: 27

Prior U.S. Cls.: 19, 20, 37, 42, and 50

United States Patent and Trademark Office

Reg. No. 3,486,564

Registered Aug. 12, 2008

**TRADEMARK
PRINCIPAL REGISTER**

**CHESAPEAKE'S CRAZY ABOUT
KIDS**

CHESAPEAKE WALLCOVERINGS CORPORATION (MARYLAND CORPORATION)
16900 SCIENCE DRIVE
SUITE 200
BOWIE, MD 20715

FOR: WALLCOVERINGS, IN CLASS 27 (U.S. CLS. 19, 20, 37, 42 AND 50).

FIRST USE 12-0-2006; IN COMMERCE 12-0-2006.

THE MARK CONSISTS OF STANDARD CHARACTERS WITHOUT CLAIM TO ANY PARTICULAR FONT, STYLE, SIZE, OR COLOR.

OWNER OF U.S. REG. NOS. 2,163,812 AND 2,169,364.

SN 78-967,848, FILED 9-6-2006.

ANDREA HACK, EXAMINING ATTORNEY

Int. Cls.: 9 and 38

Prior U.S. Cls.: 21, 23, 26, 36, 38, 100, 101, and 104

United States Patent and Trademark Office

Reg. No. 3,486,565

Registered Aug. 12, 2008

**TRADEMARK
SERVICE MARK
PRINCIPAL REGISTER**

SIMPLE. SECURE. MOBILITY.

FIBERLINK COMMUNICATIONS CORPORATION
(PENNSYLVANIA CORPORATION)
BUILDING 18
1787 SENTRY PARKWAY WEST
BLUEBELL, PA 19422

FOR: COMPUTER SOFTWARE FOR PROVIDING MANAGED REMOTE ACCESS SERVICES, NAMELY, FOR PROVIDING SECURE, GENERAL PURPOSE CONNECTIVITY SO THAT A VARIETY OF COMPUTER SOFTWARE APPLICATIONS AND COMPUTER NETWORK-BASED SERVICES, FILE SHARING SERVICES, E-MAIL SERVICES, AND INTRANET SERVICES CAN BE SECURELY ACCESSED BY A USER CONNECTING REMOTELY TO THE ENTERPRISE LOCAL AREA NETWORK (LAN), IN CLASS 9 (U.S. CLS. 21, 23, 26, 36 AND 38).

FIRST USE 8-0-2006; IN COMMERCE 8-0-2006.

FOR: PROVIDING MANAGED REMOTE ACCESS SERVICES, NAMELY PROVIDING SECURE, GENERAL-PURPOSE CONNECTIVITY SO THAT COMPUTER SOFTWARE APPLICATIONS AND COMPUTER NETWORK-BASED SERVICES, FILE SHARING SERVICES, E-MAIL SERVICES, AND INTRANET SERVICES CAN BE SECURELY ACCESSED BY A USER CONNECTING REMOTELY TO THE ENTERPRISE LOCAL AREA NETWORK (LAN), IN CLASS 38 (U.S. CLS. 100, 101 AND 104).

FIRST USE 8-0-2006; IN COMMERCE 8-0-2006.

THE MARK CONSISTS OF STANDARD CHARACTERS WITHOUT CLAIM TO ANY PARTICULAR FONT, STYLE, SIZE, OR COLOR.

SN 78-967,866, FILED 9-6-2006.

EDWARD NELSON, EXAMINING ATTORNEY

Int. Cl.: 28

Prior U.S. Cls.: 22, 23, 38, and 50

Reg. No. 3,486,566

United States Patent and Trademark Office

Registered Aug. 12, 2008

**TRADEMARK
PRINCIPAL REGISTER**

POWER SQUADRON

MATTEL, INC. (DELAWARE CORPORATION)
MAIL STOP M1-1518
333 CONTINENTAL BOULEVARD
EL SEGUNDO, CA 90245

FIRST USE 8-22-2007; IN COMMERCE 8-22-2007.

FOR: TOYS, GAMES AND PLAYTHINGS, NAME-
LY, TOY VEHICLES, TOY AIRPLANES, AND AC-
CESSORIES FOR ALL OF THE FOREGOING, IN
CLASS 28 (U.S. CLS. 22, 23, 38 AND 50).

THE MARK CONSISTS OF STANDARD CHAR-
ACTERS WITHOUT CLAIM TO ANY PARTICULAR
FONT, STYLE, SIZE, OR COLOR.

SN 78-967,991, FILED 9-6-2006.

SUNG IN, EXAMINING ATTORNEY

Int. Cl.: 16

Prior U.S. Cls.: 2, 5, 22, 23, 29, 37, 38, and 50

United States Patent and Trademark Office

Reg. No. 3,486,567

Registered Aug. 12, 2008

**TRADEMARK
PRINCIPAL REGISTER**

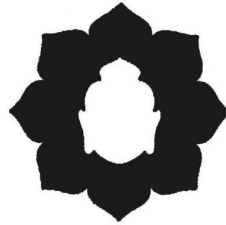

wink;)ng buddha

LORA, NINA C. (UNITED STATES INDIVIDUAL)
10 EAST 29TH STREET, SUITE 36D
NEW YORK, NY 10016

THE MARK CONSISTS OF STYLIZED LETTER-
ING OF THE WORDING WINKING BUDDHA
WITH A DESIGN ABOVE THE MARK.

FOR: PAPER GOODS NAMELY, GREETING
CARDS, IN CLASS 16 (U.S. CLS. 2, 5, 22, 23, 29, 37,
38 AND 50).

SN 78-968,102, FILED 9-6-2006.

FIRST USE 1-0-2008; IN COMMERCE 1-0-2008.

ANDREA BUTLER, EXAMINING ATTORNEY

Int. Cl.: 36

Prior U.S. Cls.: 100, 101, and 102

United States Patent and Trademark Office

Reg. No. 3,486,568

Registered Aug. 12, 2008

**SERVICE MARK
PRINCIPAL REGISTER**



LARGE SPUR, INC. (DELAWARE CORPORATION)
7392 W. PARAISO DRIVE
GLENDALE, AZ 85310

FOR: BANKING SERVICES; FINANCIAL MANAGEMENT AND CONSULTATION SERVICES; CASH MANAGEMENT SERVICES; MONEY LENDING SERVICES; COMMERCIAL LENDING SERVICES, NAMELY, WORKING CAPITAL LINES OF CREDIT, OWNER-OCCUPIED REAL ESTATE FINANCING, INVESTOR REAL ESTATE LOANS, CONSTRUCTION LOANS, AND UNSECURED NOTES; MORTGAGE LENDING SERVICES; PERSONAL LENDING SERVICES, NAMELY, CONSUMER LOANS AND LINES OF CREDIT, RESIDENTIAL CONSTRUCTION LOANS, HOME EQUITY LOANS, VEHICLE LOANS, BOAT LOANS AND UNSECURED NOTES; AND COMMERCIAL

REAL ESTATE LENDING SERVICES, IN CLASS 36 (U.S. CLS. 100, 101 AND 102).

FIRST USE 11-0-2006; IN COMMERCE 6-0-2007.

NO CLAIM IS MADE TO THE EXCLUSIVE RIGHT TO USE "BANK 1440" AND "FOURTEEN FORTY", APART FROM THE MARK AS SHOWN.

THE MARK CONSISTS OF A STYLIZED SUN-DIAL DESIGN CENTERED ABOVE THE WORDS "BANK 1440" WHICH ARE ABOVE THE WORDS "FOURTEEN FORTY".

SN 78-970,199, FILED 9-8-2006.

CAROLYN GRAY, EXAMINING ATTORNEY

Int. Cl.: 9

Prior U.S. Cls.: 21, 23, 26, 36, and 38

United States Patent and Trademark Office

Reg. No. 3,486,569

Registered Aug. 12, 2008

**TRADEMARK
PRINCIPAL REGISTER**

LUNAR KNIGHTS

KONAMI DIGITAL ENTERTAINMENT CO.,
LTD. (JAPAN CORPORATION)
9-7-2 AKASAKA, MINATO-KU
TOKYO, JAPAN

FOR: VIDEO GAME SOFTWARE; VIDEO GAME PROGRAMS; COMPUTER GAME PROGRAMS; ELECTRONIC GAME PROGRAMS; ELECTRONIC GAME CD-ROMS; ELECTRONIC GAME DIGITAL VERSATILE DISC-ROMS; CARTRIDGES AND CASSETTES FOR USE WITH HAND-HELD VIDEO GAME MACHINE; CIRCUIT BOARDS CONTAINING GAME PROGRAMS FOR USE WITH HAND-HELD VIDEO GAME MACHINE; VIDEO OUTPUT GAME MACHINES FOR USE WITH TELEVISIONS; DOWNLOADABLE ELECTRONIC GAME SOFT-

WARE, DOWNLOADABLE COMPUTER GAME SOFTWARE AND DOWNLOADABLE VIDEO GAME SOFTWARE; DOWNLOADABLE ELECTRONIC PUBLICATIONS, NAMELY, DIGITAL COMIC BOOKS, IN CLASS 9 (U.S. CLS. 21, 23, 26, 36 AND 38).

FIRST USE 2-6-2007; IN COMMERCE 2-6-2007.

THE MARK CONSISTS OF STANDARD CHARACTERS WITHOUT CLAIM TO ANY PARTICULAR FONT, STYLE, SIZE, OR COLOR.

SN 78-970,248, FILED 9-8-2006.

CARRIE GENOVESE, EXAMINING ATTORNEY

Int. Cl.: 35

Prior U.S. Cls.: 100, 101, and 102

United States Patent and Trademark Office

Reg. No. 3,486,570

Registered Aug. 12, 2008

**SERVICE MARK
PRINCIPAL REGISTER**

DESTINATION SAVINGS

AFFINION BENEFITS GROUP, INC. (DELA-
WARE CORPORATION)
400 DUKE DRIVE
FRANKLIN, TN 37067

FOR: ADMINISTERING A CONSUMER BENEFIT
PROGRAM WHICH ENTITLES MEMBERS TO DIS-
COUNTS, REBATES AND BONUSES IN CONNEC-
TION WITH TRAVEL, IN CLASS 35 (U.S. CLS. 100,
101 AND 102).

FIRST USE 1-1-2007; IN COMMERCE 1-1-2007.

THE MARK CONSISTS OF STANDARD CHAR-
ACTERS WITHOUT CLAIM TO ANY PARTICULAR
FONT, STYLE, SIZE, OR COLOR.

NO CLAIM IS MADE TO THE EXCLUSIVE
RIGHT TO USE "SAVINGS", APART FROM THE
MARK AS SHOWN.

SN 78-970,415, FILED 9-8-2006.

JOHN DALIER, EXAMINING ATTORNEY

Int. Cls.: 30 and 43

Prior U.S. Cls.: 46, 100, and 101

United States Patent and Trademark Office

Reg. No. 3,486,571

Registered Aug. 12, 2008

**TRADEMARK
SERVICE MARK
PRINCIPAL REGISTER**



BAG O' BURGERS RESTAURANT GROUP, LLC
(CALIFORNIA LTD LIAB CO)
SUITE 428
12021 WILSHIRE BLVD.
LOS ANGELES, CA 90025

FOR: HAMBURGER SANDWICHES, IN CLASS 30
(U.S. CL. 46).

FIRST USE 5-16-2005; IN COMMERCE 5-16-2005.

FOR: FAST FOOD AND NON-STOP RESTAURANT SERVICES; FAST-FOOD RESTAURANTS, IN CLASS 43 (U.S. CLS. 100 AND 101).

FIRST USE 5-16-2005; IN COMMERCE 5-16-2005.

NO CLAIM IS MADE TO THE EXCLUSIVE RIGHT TO USE "BAG O' BURGERS", APART FROM THE MARK AS SHOWN.

THE COLOR(S) RED AND WHITE IS/ARE CLAIMED AS A FEATURE OF THE MARK.

THE MARK CONSISTS OF A RED CIRCLE WITH THE LITERAL ELEMENT "BAG O' BURGERS" IN WHITE LETTERS.

SN 78-970,603, FILED 9-8-2006.

DEZMONA MIZELLE, EXAMINING ATTORNEY

Int. Cl.: 44

Prior U.S. Cls.: 100 and 101

United States Patent and Trademark Office

Reg. No. 3,486,572

Registered Aug. 12, 2008

**SERVICE MARK
PRINCIPAL REGISTER**



MIRROR SHOW MANAGEMENT INC. (NEW YORK CORPORATION)
439 CENTRAL AVENUE
ROCHESTER, NY 14604

FOR: CONDUCTING EMPLOYEE WELLNESS PROGRAMS, IN CLASS 44 (U.S. CLS. 100 AND 101).

FIRST USE 3-0-2007; IN COMMERCE 3-0-2007.

NO CLAIM IS MADE TO THE EXCLUSIVE RIGHT TO USE "HEALTH & WELLNESS PROGRAM", APART FROM THE MARK AS SHOWN.

THE COLOR(S) WHITE, BLACK, TAN AND BLUE IS/ARE CLAIMED AS A FEATURE OF THE MARK.

THE MARK CONSIST OF THE WORDING "LIVE GREAT HEALTH & WELLNESS PROGRAM" WRITTEN IN WHITE OVER A TAN SQUARE AND BLUE RECTANGLE. A BLACK DOTTED LINE IS FEATURED OVER THE TOP AND RIGHT HAND SIDE OF THE MARK.

SN 78-971,473, FILED 9-11-2006.

KYLE PEETE, EXAMINING ATTORNEY

Int. Cl.: 16

Prior U.S. Cls.: 2, 5, 22, 23, 29, 37, 38, and 50

Reg. No. 3,486,573

United States Patent and Trademark Office

Registered Aug. 12, 2008

**TRADEMARK
PRINCIPAL REGISTER**

SIMPLYSTRIPED

MEADWESTVACO CORPORATION (DELAWARE
CORPORATION)
MEADWESTVACO CORPORATE CENTER
11013 WEST BROAD STREET
GLEN ALLEN, VA 23060

THE MARK CONSISTS OF STANDARD CHAR-
ACTERS WITHOUT CLAIM TO ANY PARTICULAR
FONT, STYLE, SIZE, OR COLOR.

FOR: NOTEBOOKS, FILE FOLDERS, BINDERS,
IN CLASS 16 (U.S. CLS. 2, 5, 22, 23, 29, 37, 38 AND 50).

SN 78-971,996, FILED 9-12-2006.

FIRST USE 9-18-2006; IN COMMERCE 9-18-2006.

BRENDAN REGAN, EXAMINING ATTORNEY

Int. Cl.: 33

Prior U.S. Cls.: 47 and 49

United States Patent and Trademark Office

Reg. No. 3,486,574

Registered Aug. 12, 2008

**TRADEMARK
PRINCIPAL REGISTER**



CC DISTRIBUTION, LLC (FLORIDA LTD LIAB
CO)
94500 OVERSEAS HIGHWAY
KEY LARGO, FL 33037

FIRST USE 3-6-2006; IN COMMERCE 10-2-2006.

SN 78-972,334, FILED 9-12-2006.

FOR: DISTILLED SPIRITS, IN CLASS 33 (U.S. CLS.
47 AND 49).

JEFF DEFORD, EXAMINING ATTORNEY

Int. Cls.: 35, 36, and 43

Prior U.S. Cls.: 100, 101, and 102

United States Patent and Trademark Office

Reg. No. 3,486,575

Registered Aug. 12, 2008

**SERVICE MARK
PRINCIPAL REGISTER**

WORK WITHOUT BOUNDARIES

REGUS MANAGEMENT LIMITED (UNITED KINGDOM COMPANY)
3000 HILLSWOOD DRIVE, CHERTSEY
SURREY, UNITED KINGDOM KT16 0RS

FOR: RENTAL OF OFFICE MACHINES AND EQUIPMENT; COMPUTERIZED OFFICE MANAGEMENT SERVICES; MANAGEMENT ON BEHALF OF INDUSTRIAL AND COMMERCIAL ENTERPRISES IN TERMS OF SUPPLYING THEM WITH OFFICE REQUISITES; BUSINESS MANAGEMENT CONSULTATION IN THE FIELD OF PROVIDING SERVICED AND MANAGED EXECUTIVE SUITES; PROVIDING OFFICE FUNCTIONS; BUSINESS ADMINISTRATION FOR MANAGED OFFICES; SECRETARIAL SERVICES; PHOTOCOPYING; TELEPHONE ANSWERING, TYPING, WORD PROCESSING AND SHORT HAND SECRETARIAL SERVICES; CLERICAL SERVICES; DOCUMENT REPRODUCTION SERVICES; PERSONNEL PLACEMENT AND RECRUITMENT SERVICES; RENTAL OF DATA PROCESSING EQUIPMENT, IN CLASS 35 (U.S. CLS. 100, 101 AND 102).

FIRST USE 12-31-2006; IN COMMERCE 12-31-2006.

FOR: MANAGEMENT, BROKERAGE, LEASING AND APPRAISAL OF REAL ESTATE; REAL ES-

TATE MANAGEMENT; RENTAL, BROKERAGE, LEASING AND MANAGEMENT OF COMMERCIAL PROPERTY, OFFICES AND OFFICE SPACE; RENTAL OF OFFICE SPACE; LEASING OF REAL ESTATE; LEASING OF REAL PROPERTY; REAL ESTATE PROCUREMENT FOR OTHERS; AND REAL ESTATE INVESTMENT SERVICES, IN CLASS 36 (U.S. CLS. 100, 101 AND 102).

FIRST USE 12-31-2006; IN COMMERCE 12-31-2006.

FOR: PROVISION OF FACILITIES FOR MEETINGS, CONFERENCES, SEMINARS AND EXHIBITIONS; PROVIDING TEMPORARY ACCOMMODATIONS; RENTAL OF OFFICE FURNITURE, IN CLASS 43 (U.S. CLS. 100 AND 101).

FIRST USE 12-31-2006; IN COMMERCE 12-31-2006.

THE MARK CONSISTS OF STANDARD CHARACTERS WITHOUT CLAIM TO ANY PARTICULAR FONT, STYLE, SIZE, OR COLOR.

SN 78-972,806, FILED 9-12-2006.

BERYL GARDNER, EXAMINING ATTORNEY

Int. Cl.: 41

Prior U.S. Cls.: 100, 101, and 107

United States Patent and Trademark Office

Reg. No. 3,486,576

Registered Aug. 12, 2008

**SERVICE MARK
PRINCIPAL REGISTER**

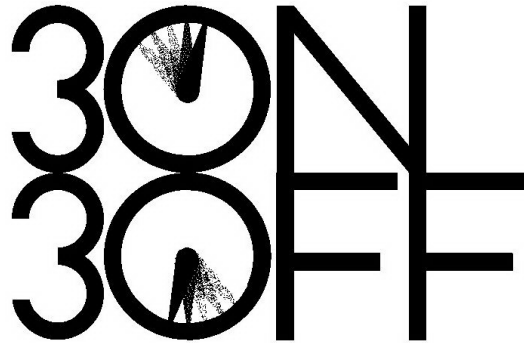

TRAIN WITH RON (ILLINOIS CORPORATION)
3815 N. DAMEN #1
CHICAGO, IL 60618

FIRST USE 7-23-2004; IN COMMERCE 7-23-2004.

FOR: PHYSICAL FITNESS CONSULTATION;
PHYSICAL FITNESS INSTRUCTION; TRAINING
SERVICES IN THE FIELD OF PHYSICAL FITNESS,
IN CLASS 41 (U.S. CLS. 100, 101 AND 107).

SN 78-973,241, FILED 9-13-2006.

ROBERT LAVACHE, EXAMINING ATTORNEY

Int. Cl.: 6

Prior U.S. Cls.: 2, 12, 13, 14, 23, 25, and 50

Reg. No. 3,486,577

United States Patent and Trademark Office

Registered Aug. 12, 2008

**TRADEMARK
PRINCIPAL REGISTER**

ADJUST-A-HINGE

ADAMS RITE MANUFACTURING CO. (CALI-
FORNIA CORPORATION)
260 SANTA FE STREET
POMONA, CA 91767

THE MARK CONSISTS OF STANDARD CHAR-
ACTERS WITHOUT CLAIM TO ANY PARTICULAR
FONT, STYLE, SIZE, OR COLOR.

FOR: METAL HINGES, IN CLASS 6 (U.S. CLS. 2,
12, 13, 14, 23, 25 AND 50).

SN 78-973,326, FILED 9-13-2006.

FIRST USE 12-20-1993; IN COMMERCE 12-20-1993.

CHARLOTTE CORWIN, EXAMINING ATTORNEY

Int. Cl.: 28

Prior U.S. Cls.: 22, 23, 38, and 50

Reg. No. 3,486,578

United States Patent and Trademark Office

Registered Aug. 12, 2008

**TRADEMARK
PRINCIPAL REGISTER**

CRASHERS

MATTEL, INC. (DELAWARE CORPORATION)
MAIL STOP M1-1518
333 CONTINENTAL BOULEVARD
EL SEGUNDO, CA 90245

FIRST USE 7-1-2008; IN COMMERCE 7-1-2008.

FOR: TOYS, GAMES AND PLAYTHINGS, NAME-
LY, TOY VEHICLES, TOY VEHICLE PLAYSETS,
TOY VEHICLE TRACK SETS, AND ACCESSORIES
FOR ALL OF THE FOREGOING , IN CLASS 28 (U.S.
CLS. 22, 23, 38 AND 50).

THE MARK CONSISTS OF STANDARD CHAR-
ACTERS WITHOUT CLAIM TO ANY PARTICULAR
FONT, STYLE, SIZE, OR COLOR.

SN 78-974,306, FILED 9-14-2006.

KATHY DE JONGE, EXAMINING ATTORNEY

Int. Cl.: 3

Prior U.S. Cls.: 1, 4, 6, 50, 51, and 52

United States Patent and Trademark Office

Reg. No. 3,486,579

Registered Aug. 12, 2008

**TRADEMARK
PRINCIPAL REGISTER**

Your Skin's Soulmate

WESSON, PAUL J. (UNITED STATES INDIVIDUAL)
10113 MARGUEx DRIVE
ORLANDO, FL 32825

FOR: SKIN AND BODY CARE PRODUCTS, NAMELY, MOISTURIZERS, CLEANSERS, TONERS, SCRUBS, EXFOLIATES, FACIAL MASKS, CREAMS, SUNSCREEN PREPARATIONS, BATH GEL, SHOWER GELS, HAIR SHAMPOO, HAIR CONDITIONER, SHAVING CREAM, SHAVING GEL, PRE-SHAVING PREPARATIONS, AND LIP BALM, IN CLASS 3 (U.S. CLS. 1, 4, 6, 50, 51 AND 52).

FIRST USE 9-28-2006; IN COMMERCE 9-28-2006.

THE MARK CONSISTS OF STANDARD CHARACTERS WITHOUT CLAIM TO ANY PARTICULAR FONT, STYLE, SIZE, OR COLOR.

SN 78-974,377, FILED 9-14-2006.

CARYN GLASSER, EXAMINING ATTORNEY

Int. Cl.: 25

Prior U.S. Cls.: 22 and 39

United States Patent and Trademark Office

Reg. No. 3,486,580

Registered Aug. 12, 2008

**TRADEMARK
PRINCIPAL REGISTER**



4004 INCORPORATED (PENNSYLVANIA CORPORATION)
12 HARBOR PARK DRIVE
PORT WASHINGTON, NY 11050

FIRST USE 6-17-2007; IN COMMERCE 7-10-2007.

SN 78-974,407, FILED 9-14-2006.

FOR: JACKETS, HEADWEAR, PANTS, SHORTS, SHIRTS, AND WINDSHIRTS, IN CLASS 25 (U.S. CLS. 22 AND 39).

WON TEAK OH, EXAMINING ATTORNEY

Int. Cl.: 25

Prior U.S. Cls.: 22 and 39

United States Patent and Trademark Office

Reg. No. 3,486,581

Registered Aug. 12, 2008

**TRADEMARK
PRINCIPAL REGISTER**



4004 INCORPORATED (PENNSYLVANIA CORPORATION)
12 HARBOR PARK DRIVE
PORT WASHINGTON, NY 11050

FIRST USE 6-17-2007; IN COMMERCE 7-10-2007.

SN 78-974,412, FILED 9-14-2006.

FOR: JACKETS, HEADWEAR, PANTS, SHORTS, SHIRTS, AND WINDSHIRTS, IN CLASS 25 (U.S. CLS. 22 AND 39).

WON TEAK OH, EXAMINING ATTORNEY

Int. Cl.: 35

Prior U.S. Cls.: 100, 101, and 102

United States Patent and Trademark Office

Reg. No. 3,486,582

Registered Aug. 12, 2008

**SERVICE MARK
PRINCIPAL REGISTER**

HORIZON

HORIZON CHRISTIAN FELLOWSHIP (CALIFORNIA CORPORATION)
5331 MT. ALIFAN DRIVE
SAN DIEGO, CA 92111

THE MARK CONSISTS OF STANDARD CHARACTERS WITHOUT CLAIM TO ANY PARTICULAR FONT, STYLE, SIZE, OR COLOR.

FOR: CHARITABLE SERVICES, NAMELY, ORGANIZING AND CONDUCTING VOLUNTEER PROGRAMS AND COMMUNITY SERVICE PROJECTS, IN CLASS 35 (U.S. CLS. 100, 101 AND 102).

SN 78-974,865, FILED 9-14-2006.

FIRST USE 12-31-1978; IN COMMERCE 12-31-1978.

JOHN DALIER, EXAMINING ATTORNEY

Int. Cl.: 36

Prior U.S. Cls.: 100, 101, and 102

United States Patent and Trademark Office

Reg. No. 3,486,583

Registered Aug. 12, 2008

**SERVICE MARK
PRINCIPAL REGISTER**

HORIZON

HORIZON CHRISTIAN FELLOWSHIP (CALI-
FORNIA CORPORATION)
5331 MT. ALIFAN DRIVE
SAN DIEGO, CA 92111

THE MARK CONSISTS OF STANDARD CHAR-
ACTERS WITHOUT CLAIM TO ANY PARTICULAR
FONT, STYLE, SIZE, OR COLOR.

FOR: ACCEPTING AND ADMINISTERING
MONETARY CHARITABLE CONTRIBUTIONS, IN
CLASS 36 (U.S. CLS. 100, 101 AND 102).

SN 78-974,878, FILED 9-14-2006.

FIRST USE 12-31-1978; IN COMMERCE 12-31-1978.

JOHN DALIER, EXAMINING ATTORNEY

Int. Cl.: 43

Prior U.S. Cls.: 100 and 101

United States Patent and Trademark Office

Reg. No. 3,486,584

Registered Aug. 12, 2008

**SERVICE MARK
PRINCIPAL REGISTER**

HORIZON

HORIZON CHRISTIAN FELLOWSHIP (CALIFORNIA CORPORATION)
5331 MT. ALIFAN DRIVE
SAN DIEGO, CA 92111

FOR: CHARITABLE SERVICES, NAMELY, PROVIDING RELIEF AND SUPPORT TO VICTIMS OF DISASTERS BY PROVIDING FOOD AND TEMPORARY HOUSING SHELTERS AND INFORMATION AND CONSULTATION RELATED THERETO, IN CLASS 43 (U.S. CLS. 100 AND 101).

FIRST USE 12-31-1978; IN COMMERCE 12-31-1978.

THE MARK CONSISTS OF STANDARD CHARACTERS WITHOUT CLAIM TO ANY PARTICULAR FONT, STYLE, SIZE, OR COLOR.

SN 78-974,897, FILED 9-14-2006.

JOHN DALIER, EXAMINING ATTORNEY

Int. Cl.: 45

Prior U.S. Cls.: 100 and 101

United States Patent and Trademark Office

Reg. No. 3,486,585

Registered Aug. 12, 2008

**SERVICE MARK
PRINCIPAL REGISTER**

HORIZON

HORIZON CHRISTIAN FELLOWSHIP (CALIFORNIA CORPORATION)
5331 MT. ALIFAN DRIVE
SAN DIEGO, CA 92111

FOR: EVANGELISTIC AND MINISTERIAL SERVICES; COUNSELING SERVICES IN THE FIELD OF CHRISTIAN CONDUCT IN PERSONAL RELATIONSHIPS; MINISTERIAL SERVICES, NAMELY HOLDING SPIRITUAL RETREATS TO ASSIST RELIGIOUS LEADERS, BOTH CLERGY AND LAY, TO DEVELOP AND ENHANCE THEIR SPIRITUAL LIVES; AND CHARITABLE SERVICES, NAMELY, ORGANIZING YOUTH GROUPS TO UNDERTAKE PROJECTS TO BENEFIT THE NEEDY AND THE

COMMUNITY TO ENCOURAGE LEADERSHIP, CHARACTER, COMPASSION, AND GOOD CITIZENSHIP, IN CLASS 45 (U.S. CLS. 100 AND 101).

FIRST USE 12-31-1978; IN COMMERCE 12-31-1978.

THE MARK CONSISTS OF STANDARD CHARACTERS WITHOUT CLAIM TO ANY PARTICULAR FONT, STYLE, SIZE, OR COLOR.

SN 78-974,907, FILED 9-14-2006.

JOHN DALIER, EXAMINING ATTORNEY

Int. Cls.: 16 and 41

Prior U.S. Cls.: 2, 5, 22, 23, 29, 37, 38, 50, 100, 101, and 107

Reg. No. 3,486,586

United States Patent and Trademark Office

Registered Aug. 12, 2008

TRADEMARK
SERVICE MARK
PRINCIPAL REGISTER

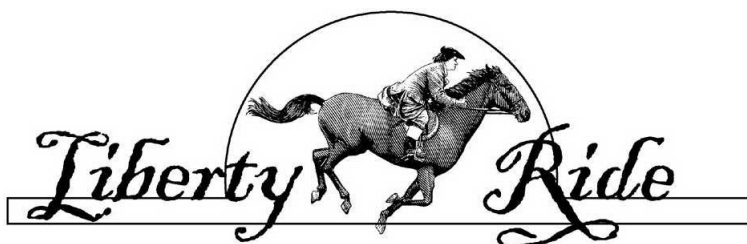

TOWN OF LEXINGTON (MASSACHUSETTS MUNICIPAL CORPORATION)
1625 MASSACHUSETTS AVENUE
LEXINGTON, MA 02420

FIRST USE 7-1-2002; IN COMMERCE 7-1-2002.

FOR: PRINTED MATTER, NAMELY, POSTCARDS, IN CLASS 16 (U.S. CLS. 2, 5, 22, 23, 29, 37, 38 AND 50).

THE MARK CONSISTS OF A MAN WEARING COLONIAL PERIOD CLOTHING RIDING A HORSE AND THE WORDS "LIBERTY RIDE".

FIRST USE 6-5-2008; IN COMMERCE 6-5-2008.

SN 78-975,846, FILED 11-21-2003.

FOR: PROVIDING EDUCATIONAL INFORMATION IN THE FIELD OF HISTORY, IN CLASS 41 (U.S. CLS. 100, 101 AND 107).

DAWN HAN, EXAMINING ATTORNEY

Int. Cls.: 16 and 41

Prior U.S. Cls.: 2, 5, 22, 23, 29, 37, 38, 50, 100, 101, and 107

Reg. No. 3,486,587

United States Patent and Trademark Office

Registered Aug. 12, 2008

**TRADEMARK
SERVICE MARK
PRINCIPAL REGISTER**

OUTWARD

KONICA MINOLTA BUSINESS TECHNOLOGIES,
INC. (JAPAN CORPORATION)
1-6-1 MARUNOUCHI, CHIYODA-KU
TOKYO, JAPAN 100-0005

FOR: EDUCATIONAL MANUALS IN THE FIELD OF INSTALLATION, MAINTENANCE AND REPAIR OF BUSINESS MACHINES AND COMPUTER OPERATION SOFTWARE FOR BUSINESS MACHINES, IN CLASS 16 (U.S. CLS. 2, 5, 22, 23, 29, 37, 38 AND 50).

FIRST USE 9-1-2005; IN COMMERCE 9-1-2005.

FOR: EDUCATION AND TRAINING SERVICES, NAMELY, PROVIDING COURSES OF INSTRUCTION IN THE FIELD OF INSTALLATION, MAINTENANCE AND REPAIR OF COPIERS, PRINTERS,

FACSIMILE MACHINES, SCANNERS AND MULTI-FUNCTIONAL MACHINES WHICH PERFORM SOME OR ALL OF THE ABOVE-MENTIONED FUNCTIONS IN ONE UNIT, AND COMPUTER OPERATION SOFTWARE FOR THE ABOVE-MENTIONED MACHINES, IN CLASS 41 (U.S. CLS. 100, 101 AND 107).

FIRST USE 9-1-2005; IN COMMERCE 9-1-2005.

THE MARK CONSISTS OF STANDARD CHARACTERS WITHOUT CLAIM TO ANY PARTICULAR FONT, STYLE, SIZE, OR COLOR.

SN 78-979,431, FILED 10-13-2005.

REBECCA SMITH, EXAMINING ATTORNEY

Int. Cls.: 9 and 16

Prior U.S. Cls.: 2, 5, 21, 22, 23, 26, 29, 36, 37, 38, and 50

Reg. No. 3,486,588

United States Patent and Trademark Office

Registered Aug. 12, 2008

**TRADEMARK
PRINCIPAL REGISTER**

2KSPORTS

TAKE-TWO INTERACTIVE SOFTWARE, INC.
(DELAWARE CORPORATION)
622 BROADWAY
NEW YORK, NY 10012

FOR: COMPUTER GAME PROGRAMS AND SOFTWARE AND COMPUTER GAME CARTRIDGES, IN CLASS 9 (U.S. CLS. 21, 23, 26, 36 AND 38).

FIRST USE 2-28-2005; IN COMMERCE 2-28-2005.

FOR: PRINTED MATTER, NAMELY, BOOKS, PAMPHLETS, MAGAZINES AND PERIODICALS IN THE FIELD OF VIDEO GAMES; CALENDARS;

POSTERS; PICTURES; AND PHOTOGRAPHS, IN CLASS 16 (U.S. CLS. 2, 5, 22, 23, 29, 37, 38 AND 50).

FIRST USE 2-28-2005; IN COMMERCE 2-28-2005.

THE MARK CONSISTS OF STANDARD CHARACTERS WITHOUT CLAIM TO ANY PARTICULAR FONT, STYLE, SIZE, OR COLOR.

SN 78-979,573, FILED 10-21-2004.

WON TEAK OH, EXAMINING ATTORNEY

Int. Cls.: 9 and 16

Prior U.S. Cls.: 2, 5, 21, 22, 23, 26, 29, 36, 37, 38, and 50

Reg. No. 3,486,589

United States Patent and Trademark Office

Registered Aug. 12, 2008

**TRADEMARK
PRINCIPAL REGISTER**



TAKE-TWO INTERACTIVE SOFTWARE, INC.
(DELAWARE CORPORATION)
622 BROADWAY
NEW YORK, NY 10012

FOR: COMPUTER GAME PROGRAMS AND
SOFTWARE AND COMPUTER GAME CARTRID-
GES, IN CLASS 9 (U.S. CLS. 21, 23, 26, 36 AND 38).

FIRST USE 2-28-2005; IN COMMERCE 2-28-2005.

FOR: PRINTED MATTER, NAMELY, BOOKS,
PAMPHLETS, MAGAZINES AND PERIODICALS
IN THE FIELD OF VIDEO GAMES; CALENDARS;

POSTERS; PICTURES; AND PHOTOGRAPHS, IN
CLASS 16 (U.S. CLS. 2, 5, 22, 23, 29, 37, 38 AND 50).

FIRST USE 2-28-2005; IN COMMERCE 2-28-2005.

NO CLAIM IS MADE TO THE EXCLUSIVE
RIGHT TO USE "SPORTS", APART FROM THE
MARK AS SHOWN.

SN 78-979,625, FILED 1-31-2005.

WON TEAK OH, EXAMINING ATTORNEY

Int. Cl.: 18

Prior U.S. Cls.: 1, 2, 3, 22, and 41

Reg. No. 3,486,590

United States Patent and Trademark Office

Registered Aug. 12, 2008

**TRADEMARK
PRINCIPAL REGISTER**

KELA CI'

KELA CI INC. (CALIFORNIA CORPORATION)
14006 VENTURA BLVD.
SHERMAN OAKS, CA 91423

FOR: MENS AND WOMENS HANDBAGS, PURSES, SHOE BAGS FOR TRAVEL AND TRAVELLING BAGS, IN CLASS 18 (U.S. CLS. 1, 2, 3, 22 AND 41).

FIRST USE 1-10-2006; IN COMMERCE 1-10-2006.

THE MARK CONSISTS OF STANDARD CHARACTERS WITHOUT CLAIM TO ANY PARTICULAR FONT, STYLE, SIZE, OR COLOR.

THE FOREIGN WORDING IN THE MARK TRANSLATES INTO ENGLISH AS SUGGESTING STYLE OR CLASS.

SN 78-979,782, FILED 5-11-2004.

HOWARD SMIGA, EXAMINING ATTORNEY

Int. Cls.: 14, 18, 25, and 35

**Prior U.S. Cls.: 1, 2, 3, 22, 27, 28, 39, 41, 50, 100, 101,
and 102**

Reg. No. 3,486,591

United States Patent and Trademark Office

Registered Aug. 12, 2008

**TRADEMARK
SERVICE MARK
PRINCIPAL REGISTER**

AERIE

RETAIL ROYALTY COMPANY (NEVADA CORPORATION)
101 CONVENTION CENTER DRIVE
LAS VEGAS, NV 89109

FOR: JEWELRY, NAMELY, JEWELRY, IN CLASS 14 (U.S. CLS. 2, 27, 28 AND 50).

FIRST USE 7-0-2007; IN COMMERCE 7-0-2007.

FOR: GYM BAGS, TOTE BAGS, AND TOILETRY CASES SOLD EMPTY, IN CLASS 18 (U.S. CLS. 1, 2, 3, 22 AND 41).

FIRST USE 10-0-2006; IN COMMERCE 10-0-2006.

FOR: CLOTHING, AND CLOTHING ACCESSORIES, NAMELY, BELTS, BOTTOMS, GYM SUITS, TOPS, LINGERIE, LOUNGEWEAR, PANTS, ROBES, SCARVES, SHIRTS, SHORTS, SKIRTS, SLEEP WEAR, SLIPPERS, SWEATERS, UNDERWEAR, FOOTWEAR, SOCKS, NAMELY, SHOES, SANDALS, HEADWEAR, NAMELY, HEADBANDS, HATS, SWEATBANDS, IN CLASS 25 (U.S. CLS. 22 AND 39).

FIRST USE 9-6-2006; IN COMMERCE 9-6-2006.

FOR: RETAIL STORE SERVICES, MAIL ORDER SERVICES, CATALOG ORDERING SERVICES, AND ELECTRONIC RETAIL STORE SERVICES USING A GLOBAL COMPUTER AND/OR COMMUNICATIONS NETWORK, ALL IN THE FIELD OF WEARING APPAREL, CLOTHING, CLOTHING ACCESSORIES, FOOTWEAR, HEADWEAR, ATHLETIC BAGS, PURSES, COSMETICS, PERSONAL CARE PRODUCTS, CANDLES, AND JEWELRY, IN CLASS 35 (U.S. CLS. 100, 101 AND 102).

FIRST USE 9-6-2006; IN COMMERCE 9-6-2006.

THE MARK CONSISTS OF STANDARD CHARACTERS WITHOUT CLAIM TO ANY PARTICULAR FONT, STYLE, SIZE, OR COLOR.

SN 78-980,065, FILED 8-19-2005.

ALICE BENMAMAN, EXAMINING ATTORNEY

Int. Cls.: 9, 16, and 41

**Prior U.S. Cls.: 2, 5, 21, 22, 23, 26, 29, 36, 37, 38, 50,
100, 101, and 107**

Reg. No. 3,486,592

United States Patent and Trademark Office

Registered Aug. 12, 2008

**TRADEMARK
SERVICE MARK
PRINCIPAL REGISTER**

TRAITOR DACHSHUND

TRAITOR DACHSHUND, LLC (NEW YORK LTD
LIAB CO)
176 BROADWAY
APT. 11A
NEW YORK, NY 10038

FOR: MAGNETS, IN CLASS 9 (U.S. CLS. 21, 23, 26,
36 AND 38).

FIRST USE 5-18-2007; IN COMMERCE 5-18-2007.

FOR: BOOKLETS IN THE FIELD OF FICTION
AND NON-FICTION BOOKS; BOOKMARKS; CHIL-
DREN'S STORY BOOKS; CHILDREN'S BOOKS;
NOVELS; POSTCARD; CHILDREN'S ACTIVITY
BOOKS; PICTURE BOOKS, IN CLASS 16 (U.S. CLS.
2, 5, 22, 23, 29, 37, 38 AND 50).

FIRST USE 11-0-2003; IN COMMERCE 9-0-2004.

FOR: PUBLICATION OF BOOKS; PROVIDING
ONLINE INFORMATION ABOUT BOOKS; ELEC-
TRONIC PUBLISHING SERVICES, NAMELY, PUB-
LICATION OF TEXT AND GRAPHIC WORKS OF
OTHERS ONLINE FEATURING WORKS OF FIC-
TION AND NON-FICTION , IN CLASS 41 (U.S. CLS.
100, 101 AND 107).

FIRST USE 12-1-2003; IN COMMERCE 12-1-2003.

THE MARK CONSISTS OF STANDARD CHAR-
ACTERS WITHOUT CLAIM TO ANY PARTICULAR
FONT, STYLE, SIZE, OR COLOR.

SN 78-980,078, FILED 5-6-2005.

MICHAEL LEWIS, EXAMINING ATTORNEY

Int. Cl.: 35

Prior U.S. Cls.: 100, 101, and 102

United States Patent and Trademark Office

Reg. No. 3,486,593

Registered Aug. 12, 2008

**SERVICE MARK
PRINCIPAL REGISTER**



BOBBY MOSCOW, LLC (MICHIGAN LTD LIAB
CO)
8800 ALLEN ROAD
CLARKSTON, MI 48348

FOR: COMPUTERIZED ON-LINE RETAIL STORE
SERVICES IN THE FIELD OF CLOTHING AND
APPAREL; ON-LINE RETAIL STORE SERVICES
FEATURING CLOTHING AND APPAREL, IN
CLASS 35 (U.S. CLS. 100, 101 AND 102).

FIRST USE 1-0-2003; IN COMMERCE 1-0-2003.

OWNER OF U.S. REG. NO. 2,912,784.

THE MARK CONSISTS OF AN ENCIRCLED
SILHOUETTE OF A PERSON WITH A TOOL AND
THE WORDS "MADE IN" AND "DETROIT".

SEC. 2(F) AS TO "MADE IN DETROIT".

SN 78-980,302, FILED 8-15-2005.

MICHAEL LEWIS, EXAMINING ATTORNEY

Int. Cl.: 18

Prior U.S. Cls.: 1, 2, 3, 22, and 41

United States Patent and Trademark Office

Reg. No. 3,486,594

Registered Aug. 12, 2008

**TRADEMARK
PRINCIPAL REGISTER**

BOPPY

THE BOPPY COMPANY (COLORADO COR-
PORATION)
560 GOLDEN RIDGE ROAD, SUITE 150
GOLDEN, CO 80401

OWNER OF U.S. REG. NO. 1,919,783.

FOR: BABY CARRIERS WORN ON THE BODY,
IN CLASS 18 (U.S. CLS. 1, 2, 3, 22 AND 41).

SN 78-980,340, FILED 10-30-2003.

FIRST USE 11-10-2007; IN COMMERCE 11-10-2007.

CAROLYN CATALDO, EXAMINING ATTORNEY

Int. Cls.: 5, 16, 29, 30, and 32

Prior U.S. Cls.: 2, 5, 6, 18, 22, 23, 29, 37, 38, 44, 45, 46, 48, 50, 51, and 52

Reg. No. 3,486,595

United States Patent and Trademark Office

Registered Aug. 12, 2008

**TRADEMARK
PRINCIPAL REGISTER**

LIFE'S DHA

MARTEK BIOSCIENCES CORPORATION (DELAWARE CORPORATION)
6480 DOBBIN ROAD
COLUMBIA, MD 21045

FOR: NUTRITIONAL SUPPLEMENTS; DIETARY SUPPLEMENTS; FOOD FOR BABIES; NUTRITIONAL FOOD BARS FOR MEAL REPLACEMENT AND FOR MEDICINAL PURPOSES, NAMELY, DIETETIC BARS, DIABETIC BARS, HIGH PROTEIN BARS, ENERGY BARS, LOW GLYCEMIC BARS AND LOW CARBOHYDRATE BARS; FOODS FOR MEDICALLY RESTRICTED DIETS; NUTRITIONALLY FORTIFIED BEVERAGES; FOODS FOR RESTRICTED DIETS AND FOR WEIGHT REDUCTION, IN CLASS 5 (U.S. CLS. 6, 18, 44, 46, 51 AND 52).

FIRST USE 9-0-2007; IN COMMERCE 9-0-2007.

FOR: PRINTED GUIDES CONTAINING INFORMATION ABOUT THE BENEFITS OF DHA AND OMEGA-3 FATTY ACIDS; PRINTED INSTRUCTIONAL AND EDUCATIONAL MATERIALS CONTAINING INFORMATION ABOUT THE BENEFITS OF DHA AND OMEGA-3 FATTY ACIDS; INFORMATIONAL FLYERS ABOUT THE BENEFITS OF DHA, IN CLASS 16 (U.S. CLS. 2, 5, 22, 23, 29, 37, 38 AND 50).

FIRST USE 1-0-2007; IN COMMERCE 1-0-2007.

FOR: EGGS; DAIRY PRODUCTS EXCLUDING ICE CREAM, ICE MILK AND FROZEN YOGURT; DAIRY-BASED BEVERAGES; SOY-BASED FOOD BEVERAGES USED AS A MILK SUBSTITUTE; DAIRY ANALOGUES, NAMELY, SOY MILK, FLA-

VORED SOY MILK; FLAVORED DAIRY ANALOGUE DRINKS IN THE NATURE OF DAIRY FOOD BEVERAGES; FLAVORED MILK-BASED DRINKS; YOGURT BASED BEVERAGES; YOGURT; EGG SUBSTITUTES; PREPARED ENTREES CONSISTING PRIMARILY OF VEGETABLES, IN CLASS 29 (U.S. CL. 46).

FIRST USE 6-0-2007; IN COMMERCE 6-0-2007.

FOR: CEREAL PRODUCTS, NAMELY, CEREAL-BASED SNACK FOOD AND READY TO EAT CEREAL-DERIVED FOOD BARS; PREPARED ENTREES CONSISTING PRIMARILY OF RICE, IN CLASS 30 (U.S. CL. 46).

FIRST USE 3-0-2007; IN COMMERCE 3-0-2007.

FOR: BEVERAGES, NAMELY, FRUIT JUICES; SOFT DRINKS, IN CLASS 32 (U.S. CLS. 45, 46 AND 48).

FIRST USE 10-0-2007; IN COMMERCE 10-0-2007.

THE MARK CONSISTS OF STANDARD CHARACTERS WITHOUT CLAIM TO ANY PARTICULAR FONT, STYLE, SIZE, OR COLOR.

NO CLAIM IS MADE TO THE EXCLUSIVE RIGHT TO USE "DHA", APART FROM THE MARK AS SHOWN.

SN 78-980,348, FILED 7-31-2006.

CARYN GLASSER, EXAMINING ATTORNEY

Int. Cl.: 5

Prior U.S. Cls.: 6, 18, 44, 46, 51, and 52

Reg. No. 3,486,596

United States Patent and Trademark Office

Registered Aug. 12, 2008

**TRADEMARK
PRINCIPAL REGISTER**



ARYSTA LIFESCIENCE CORPORATION (JAPAN
CORPORATION)

8-1, AKASHI-CHO, CHUO-KO
TOKYO, JAPAN 104 6591

FOR: HERBICIDES, INSECTICIDES, PESTICIDES
AND FUNGICIDES FOR USE IN AGRICULTURE,

HORTICULTURE AND HOME AND GARDEN, IN
CLASS 5 (U.S. CLS. 6, 18, 44, 46, 51 AND 52).

FIRST USE 3-1-2007; IN COMMERCE 3-1-2007.

SN 78-980,375, FILED 5-27-2005.

SUNG IN, EXAMINING ATTORNEY

Int. Cl.: 31

Prior U.S. Cls.: 1 and 46

United States Patent and Trademark Office

Reg. No. 3,486,597

Registered Aug. 12, 2008

**TRADEMARK
PRINCIPAL REGISTER**

PREEN

LEBANON SEABOARD CORPORATION (PENNSYLVANIA CORPORATION)
1600 E. CUMBERLAND ST.
LEBANON, PA 17042

FOR: COMBINATION WOOD MULCH AND HERBICIDES, IN CLASS 31 (U.S. CLS. 1 AND 46).

FIRST USE 12-31-2007; IN COMMERCE 12-31-2007.

THE MARK CONSISTS OF STANDARD CHARACTERS WITHOUT CLAIM TO ANY PARTICULAR FONT, STYLE, SIZE, OR COLOR.

OWNER OF U.S. REG. NOS. 828,096, 1,475,555, AND 3,042,789.

SN 78-980,385, FILED 2-14-2006.

ANTHONY RINKER, EXAMINING ATTORNEY

Int. Cl.: 3

Prior U.S. Cls.: 1, 4, 6, 50, 51, and 52

Reg. No. 3,486,598

United States Patent and Trademark Office

Registered Aug. 12, 2008

**TRADEMARK
PRINCIPAL REGISTER**

MICRO-ACTIVE

SMITHKLINE BEECHAM CORPORATION
(PENNSYLVANIA CORPORATION)
ONE FRANKLIN PLAZA
PHILADELPHIA, PA 19102

THE MARK CONSISTS OF STANDARD CHAR-
ACTERS WITHOUT CLAIM TO ANY PARTICULAR
FONT, STYLE, SIZE, OR COLOR.

FOR: ORAL CARE PREPARATIONS, NAMELY,
DENTIFRICES, IN CLASS 3 (U.S. CLS. 1, 4, 6, 50, 51
AND 52).

SN 78-980,391, FILED 1-10-2005.

FIRST USE 3-29-2003; IN COMMERCE 3-29-2003.

WENDY GOODMAN, EXAMINING ATTORNEY

Int. Cl.: 30

Prior U.S. Cl.: 46

United States Patent and Trademark Office

Reg. No. 3,486,599

Registered Aug. 12, 2008

**TRADEMARK
PRINCIPAL REGISTER**

DIVINE

DIVINE CHOCOLATE LIMITED (UNITED KING-
DOM CORPORATION)
4 GAINSFORD STREET
LONDON, UNITED KINGDOM SE1 2NE

FOR: COCOA, COCOA PRODUCTS, NAMELY,
POWDERED COCOA, CANDY WITH COCOA; CHO-
COLATE; CHOCOLATES; NON-MEDICATED CON-
FECTIONERY, NAMELY, CANDIES, CANDY BARS;
SNACK FOODS, NAMELY, CHOCOLATE BARS
AND CHOCOLATE CANDIES; FILLED CHOCO-
LATE; MILK CHOCOLATE; AND EXCLUDING

BAKERY GOODS, BAKED GOODS, BAKERY DES-
SERTS AND COOKIES, IN CLASS 30 (U.S. CL. 46).

FIRST USE 11-0-1998; IN COMMERCE 11-0-1999.

THE MARK CONSISTS OF STANDARD CHAR-
ACTERS WITHOUT CLAIM TO ANY PARTICULAR
FONT, STYLE, SIZE, OR COLOR.

SN 78-980,401, FILED 6-27-2005.

DAVID HOFFMAN, EXAMINING ATTORNEY

Int. Cl.: 5

Prior U.S. Cls.: 6, 18, 44, 46, 51, and 52

Reg. No. 3,486,600

United States Patent and Trademark Office

Registered Aug. 12, 2008

**TRADEMARK
PRINCIPAL REGISTER**



FX LIFE SCIENCES INTERNATIONAL GMBH
(SWITZERLAND CORPORATION)
BAARERSTRASSE 135
6301 ZUG, SWITZERLAND

FIRST USE 7-18-2006; IN COMMERCE 7-18-2006.

FOR: ALL NATURAL HEALTH FOOD SUPPLEMENTS, NAMELY, HEALTH SUPPLEMENTS FROM HERBAL SOURCES WHICH ARE IN THE FORM OF GROUND OR DRY PRODUCT, IN SOLUTION OR AS AN EXTRACT OF HERBAL SOURCES, IN CLASS 5 (U.S. CLS. 6, 18, 44, 46, 51 AND 52).

NO CLAIM IS MADE TO THE EXCLUSIVE RIGHT TO USE "CERTIFIED", APART FROM THE MARK AS SHOWN.

SN 78-980,412, FILED 9-30-2004.

DAWN HAN, EXAMINING ATTORNEY

Int. Cl.: 9

Prior U.S. Cls.: 21, 23, 26, 36, and 38

Reg. No. 3,486,601

United States Patent and Trademark Office

Registered Aug. 12, 2008

**TRADEMARK
PRINCIPAL REGISTER**

CITIZEN
Micro HumanTech

CITIZEN HOLDINGS KABUSHIKI KAISHA (JAPAN CORPORATION), TA CITIZEN HOLDINGS CO., LTD.,
1-12, 6-CHOME TANASHI-CHO
NISHI-TOKYO-SHI
TOKYO 188-8511, JAPAN

OWNER OF U.S. REG. NOS. 1,532,745, 1,847,178,
AND OTHERS.

NO CLAIM IS MADE TO THE EXCLUSIVE
RIGHT TO USE "MICRO", APART FROM THE
MARK AS SHOWN.

FOR: PRINTERS FOR COMPUTERS, IN CLASS 9
(U.S. CLS. 21, 23, 26, 36 AND 38).

SN 78-980,425, FILED 8-3-2005.

FIRST USE 10-0-2005; IN COMMERCE 10-0-2005.

JEFF DEFORD, EXAMINING ATTORNEY

Int. Cls.: 9 and 11

Prior U.S. Cls.: 13, 21, 23, 26, 31, 34, 36, and 38

United States Patent and Trademark Office

Reg. No. 3,486,602

Registered Aug. 12, 2008

**TRADEMARK
PRINCIPAL REGISTER**

SHARP

SHARP KABUSHIKI KAISHA (JAPAN CORPORATION), TA SHARP CORPORATION, 22-22, NAGAIKE-CHO, ABENO-KU OSAKA, JAPAN 545-8522

FOR: DVD PLAYERS AND RECORDERS, PORTABLE TELEPHONES, CELLULAR PHONES, ELECTRONIC DICTIONARIES, PERSONAL DIGITAL ASSISTANTS, PROJECTORS, IN CLASS 9 (U.S. CLS. 21, 23, 26, 36 AND 38).

FIRST USE 11-0-1994; IN COMMERCE 11-0-1994.

FOR: AIR PURIFIERS, RANGE HOODS, RANGES, COOKING APPLIANCES CONSISTING OF A COOK TOP HAVING RADIANT ELECTRIC HEATERS, A MICROWAVE OVEN AND AN ELECTRO-

NIC OVEN, IN CLASS 11 (U.S. CLS. 13, 21, 23, 31 AND 34).

FIRST USE 7-0-2003; IN COMMERCE 7-0-2003.

THE MARK CONSISTS OF STANDARD CHARACTERS WITHOUT CLAIM TO ANY PARTICULAR FONT, STYLE, SIZE, OR COLOR.

OWNER OF U.S. REG. NOS. 842,768, 1,093,113, AND OTHERS.

SN 78-980,441, FILED 6-16-2006.

INGRID C. EULIN, EXAMINING ATTORNEY

Int. Cl.: 25

Prior U.S. Cls.: 22 and 39

United States Patent and Trademark Office

Reg. No. 3,486,603

Registered Aug. 12, 2008

**TRADEMARK
PRINCIPAL REGISTER**

CALIFORNIA ANGELS

ANGELS BASEBALL LP (CALIFORNIA LIMITED
PARTNERSHIP)
2000 GENE AUTRY WAY
ANAHEIM, CA 92806

FOR: CLOTHING, NAMELY, CAPS, HATS,
SHIRTS, T-SHIRTS, BASEBALL UNIFORMS, JER-
SEYS, IN CLASS 25 (U.S. CLS. 22 AND 39).

FIRST USE 0-0-1980; IN COMMERCE 0-0-1980.

THE MARK CONSISTS OF STANDARD CHAR-
ACTERS WITHOUT CLAIM TO ANY PARTICULAR
FONT, STYLE, SIZE, OR COLOR.

NO CLAIM IS MADE TO THE EXCLUSIVE
RIGHT TO USE "CALIFORNIA", APART FROM
THE MARK AS SHOWN.

SN 78-980,442, FILED 3-8-2006.

DAVID H. STINE, EXAMINING ATTORNEY

Int. Cl.: 16

Prior U.S. Cls.: 2, 5, 22, 23, 29, 37, 38, and 50

Reg. No. 3,486,604

United States Patent and Trademark Office

Registered Aug. 12, 2008

**TRADEMARK
PRINCIPAL REGISTER**

Jolie-Marie

LISA FRANK, INC. (ARIZONA CORPORATION)
6760 S. LISA FRANK AVE.
TUCSON, AZ 85706

THE NAME SHOWN IN THE MARK DOES NOT
IDENTIFY A PARTICULAR LIVING INDIVIDUAL.

FOR: COLORING AND ACTIVITY BOOKS FOR
CHILDREN, IN CLASS 16 (U.S. CLS. 2, 5, 22, 23, 29, 37,
38 AND 50).

THE ENGLISH TRANSLATION OF "JOLIE" IS
PRETTY.

FIRST USE 9-30-2006; IN COMMERCE 9-30-2006.

SN 78-980,444, FILED 1-23-2006.

THE MARK CONSISTS OF STANDARD CHAR-
ACTERS WITHOUT CLAIM TO ANY PARTICULAR
FONT, STYLE, SIZE, OR COLOR.

DAVID MURRAY, EXAMINING ATTORNEY

Int. Cls.: 9 and 16

Prior U.S. Cls.: 2, 5, 21, 22, 23, 26, 29, 36, 37, 38, and 50

United States Patent and Trademark Office

Reg. No. 3,486,605

Registered Aug. 12, 2008

**TRADEMARK
SUPPLEMENTAL REGISTER**

TRADUCCION EN LENGUAJE ACTUAL

UNITED BIBLE SOCIETIES, INC. (FLORIDA CORPORATION)
1989 N.W. 88TH COURT
MIAMI, FL 33172

FOR: PRE-RECORDED VIDEOS, AUDIOS, CD-ROM AND COMPACT DISCS FEATURING RELIGIOUS SERMONS AND BIBLICAL SCRIPTURES, IN CLASS 9 (U.S. CLS. 21, 23, 26, 36 AND 38).

FIRST USE 5-0-2003; IN COMMERCE 5-0-2003.

FOR: PRINTED BOOKS FEATURING BIBLICAL TEXTS AND TEACHINGS; PRINTED BIBLES AND SEPARATE PORTIONS THEREOF, NAMELY, NEW TESTAMENT, IN CLASS 16 (U.S. CLS. 2, 5, 22, 23, 29, 37, 38 AND 50).

FIRST USE 5-0-2003; IN COMMERCE 5-0-2003.

THE MARK CONSISTS OF STANDARD CHARACTERS WITHOUT CLAIM TO ANY PARTICULAR FONT, STYLE, SIZE, OR COLOR.

THE ENGLISH TRANSLATION OF "TRADUCCION EN LENGUAJE ACTUAL" IS TRANSLATION IN CURRENT LANGUAGE.

SER. NO. 76-580,181, FILED P.R. 3-8-2004; AM. S.R. 6-9-2008.

TRACY WHITTAKER-BROWN, EXAMINING ATTORNEY

Int. Cl.: 16

Prior U.S. Cls.: 2, 5, 22, 23, 29, 37, 38, and 50

United States Patent and Trademark Office

Reg. No. 3,486,606

Registered Aug. 12, 2008

**TRADEMARK
SUPPLEMENTAL REGISTER**

SACRED SONGS OF THE CHURCH

PSALLO PUBLICATIONS, LLC (GEORGIA LTD
LIAB CO)

3642 PEACHTREE ROAD, NE

ATLANTA, GA 30319

FOR: PUBLICATIONS, NAMELY, SONG BOOKS,
IN CLASS 16 (U.S. CLS. 2, 5, 22, 23, 29, 37, 38 AND 50).

FIRST USE 3-1-2006; IN COMMERCE 3-1-2006.

THE MARK CONSISTS OF STANDARD CHAR-
ACTERS WITHOUT CLAIM TO ANY PARTICULAR
FONT, STYLE, SIZE, OR COLOR.

NO CLAIM IS MADE TO THE EXCLUSIVE
RIGHT TO USE "SONGS", APART FROM THE
MARK AS SHOWN.

SER. NO. 76-659,148, FILED P.R. 4-24-2006; AM. S.R.
6-10-2008.

MYRIAH HABEEB, EXAMINING ATTORNEY

Int. Cl.: 35

Prior U.S. Cls.: 100, 101, and 102

United States Patent and Trademark Office

Reg. No. 3,486,607

Registered Aug. 12, 2008

**SERVICE MARK
SUPPLEMENTAL REGISTER**

1-800-THE CASH

CORPORATE IMAGE MARKETING, INC. (CALIFORNIA CORPORATION)
416 AVIATION BOULEVARD, SUITE A
SANTA ROSA, CA 95403

FOR: ADVERTISING, MARKETING, AND PROMOTION SERVICES FOR OTHERS, NAMELY, MARKETING THE SERVICES OF LENDERS WHO PROVIDE LOANS TO BORROWERS WITH POOR CREDIT REQUIRING SPECIAL FINANCING, WITH THE LOANS BEING USED FOR PERSONAL FUNDS, PAYCHECK LOANS, SHORT TERM LOANS, AUTOMOBILE LOANS, AND SPECIAL FINANCE HOME LOANS, AS WELL AS MARKETING THE SERVICES OF BUYERS OFFERING TO

PAY CASH FOR PEOPLE SELLING THEIR HOMES, CARS OR OTHER PERSONAL ITEMS, IN CLASS 35 (U.S. CLS. 100, 101 AND 102).

FIRST USE 1-2-2007; IN COMMERCE 1-2-2007.

THE MARK CONSISTS OF STANDARD CHARACTERS WITHOUT CLAIM TO ANY PARTICULAR FONT, STYLE, SIZE, OR COLOR.

SER. NO. 76-660,231, FILED P.R. 5-18-2006; AM. S.R. 4-10-2007.

KRISTIN DAHLING, EXAMINING ATTORNEY

Int. Cl.: 25

Prior U.S. Cls.: 22 and 39

United States Patent and Trademark Office

Reg. No. 3,486,608

Registered Aug. 12, 2008

**TRADEMARK
SUPPLEMENTAL REGISTER**

**GOD INVENTED WIVES
BECAUSE A MAN WOULD NOT
LAST HALF A DAY DOING
WHAT SHE DOES**

CARRATURO, JOHN (UNITED STATES INDIVIDUAL)
86 TOKEN ST.
STATEN ISLAND, NY 10312

FOR: T-SHIRTS, IN CLASS 25 (U.S. CLS. 22 AND 39).

FIRST USE 3-24-2008; IN COMMERCE 3-24-2008.

THE MARK CONSISTS OF STANDARD CHARACTERS WITHOUT CLAIM TO ANY PARTICULAR FONT, STYLE, SIZE, OR COLOR.

SER. NO. 76-663,425, FILED P.R. 7-24-2006; AM. S.R. 7-8-2008.

KATHERINE CONNOLLY, EXAMINING ATTORNEY

Int. Cl.: 35

Prior U.S. Cls.: 100, 101, and 102

United States Patent and Trademark Office

Reg. No. 3,486,609

Registered Aug. 12, 2008

**SERVICE MARK
SUPPLEMENTAL REGISTER**

CPA METRICS

REVSHARE CORPORATION (NEVADA CORPORATION)
32836 WOLF STORE ROAD, SUITE A
TEMECULA, CA 925928274

THE MARK CONSISTS OF STANDARD CHARACTERS WITHOUT CLAIM TO ANY PARTICULAR FONT, STYLE, SIZE, OR COLOR.

FOR: BUSINESS MARKETING CONSULTING SERVICES, NAMELY, TRACKING, MEASURING, AND REPORTING ADVERTISING EFFECTIVENESS, IN CLASS 35 (U.S. CLS. 100, 101 AND 102).

SER. NO. 76-680,841, FILED P.R. 8-20-2007; AM. S.R. 6-12-2008.

FIRST USE 3-0-2007; IN COMMERCE 3-0-2007.

AMY MCMENAMIN, EXAMINING ATTORNEY

Int. Cl.: 35

Prior U.S. Cls.: 100, 101, and 102

United States Patent and Trademark Office

Reg. No. 3,486,610

Registered Aug. 12, 2008

**SERVICE MARK
SUPPLEMENTAL REGISTER**

KIDS RESTAURANT WEEK

ADVANCE MAGAZINE PUBLISHERS INC. (NEW
YORK CORPORATION)
FOUR TIMES SQUARE
NEW YORK, NY 10036

FOR: PROMOTIONAL SERVICES, NAMELY,
PROMOTING THE RESTAURANT SERVICES OF
OTHERS; PROMOTING THE PARTIES AND SPE-
CIAL EVENTS OF OTHERS , IN CLASS 35 (U.S. CLS.
100, 101 AND 102).

FIRST USE 6-21-2008; IN COMMERCE 6-21-2008.

NO CLAIM IS MADE TO THE EXCLUSIVE
RIGHT TO USE "RESTAURANT WEEK", APART
FROM THE MARK AS SHOWN.

SER. NO. 76-683,009, FILED P.R. 10-16-2007; AM.
S.R. 7-8-2008.

HEATHER SAPP, EXAMINING ATTORNEY

Int. Cl.: 3

Prior U.S. Cls.: 1, 4, 6, 50, 51, and 52

United States Patent and Trademark Office

Reg. No. 3,486,611

Registered Aug. 12, 2008

**TRADEMARK
SUPPLEMENTAL REGISTER**

FULL BODY TEXTURIZER

L'OREAL USA CREATIVE, INC. (DELAWARE
CORPORATION)

575 FIFTH AVENUE

NEW YORK, NY 10017

FOR: HAIR STYLING PREPARATION, IN CLASS
3 (U.S. CLS. 1, 4, 6, 50, 51 AND 52).

FIRST USE 4-15-2007; IN COMMERCE 4-15-2007.

THE MARK CONSISTS OF STANDARD CHAR-
ACTERS WITHOUT CLAIM TO ANY PARTICULAR
FONT, STYLE, SIZE, OR COLOR.

NO CLAIM IS MADE TO THE EXCLUSIVE
RIGHT TO USE "TEXTURIZER", APART FROM
THE MARK AS SHOWN.

SER. NO. 77-007,855, FILED P.R. 9-26-2006; AM. S.R.
4-26-2007.

KATHRYN COWARD, EXAMINING ATTORNEY

Int. Cl.: 40

Prior U.S. Cls.: 100, 103, and 106

United States Patent and Trademark Office

Reg. No. 3,486,612

Registered Aug. 12, 2008

**SERVICE MARK
SUPPLEMENTAL REGISTER**

G.A.L.T.

SONOMA CIRCUITS, INC. (DELAWARE CORPORATION)
76 HARDY DRIVE
SPARKS, NV 89431

FOR: CUSTOM MANUFACTURE OF LED ILLUMINATION DEVICES FOR USE WITH VEHICLES, HIGHWAYS, HOMES, AIRPORTS, TRAFFIC SIGNALS, MARINAS AND BOATS, AND INDUSTRIAL APPLICATIONS, IN CLASS 40 (U.S. CLS. 100, 103 AND 106).

FIRST USE 5-1-2008; IN COMMERCE 5-1-2008.

THE MARK CONSISTS OF STANDARD CHARACTERS WITHOUT CLAIM TO ANY PARTICULAR FONT, STYLE, SIZE, OR COLOR.

SER. NO. 77-022,810, FILED P.R. 10-17-2006; AM. S.R. 6-10-2008.

DAVID HOFFMAN, EXAMINING ATTORNEY

Int. Cl.: 41

Prior U.S. Cls.: 100, 101, and 107

United States Patent and Trademark Office

Reg. No. 3,486,613

Registered Aug. 12, 2008

**SERVICE MARK
SUPPLEMENTAL REGISTER**

SOUTH ASIAN HEART CENTER

SOUTH ASIAN HEART CENTER AT EL CAMINO
HOSPITAL (CALIFORNIA CORPORATION)
PO BOX 7025, PARG 21
2500 GRANT ROAD
MOUNTAIN VIEW, CA 94039

FOR: EDUCATIONAL SERVICES AND EDUCATIONAL RESEARCH SERVICES, NAMELY, PROVIDING CONTINUING MEDICAL EDUCATION PROGRAMS , IN CLASS 41 (U.S. CLS. 100, 101 AND 107).

FIRST USE 3-0-2005; IN COMMERCE 8-0-2005.

THE MARK CONSISTS OF STANDARD CHARACTERS WITHOUT CLAIM TO ANY PARTICULAR FONT, STYLE, SIZE, OR COLOR.

NO CLAIM IS MADE TO THE EXCLUSIVE RIGHT TO USE "HEART CENTER", APART FROM THE MARK AS SHOWN.

SER. NO. 77-045,213, FILED P.R. 11-16-2006; AM. S.R. 9-28-2007.

INGRID C. EULIN, EXAMINING ATTORNEY

Int. Cl.: 20

Prior U.S. Cls.: 2, 13, 22, 25, 32, and 50

United States Patent and Trademark Office

Reg. No. 3,486,614

Registered Aug. 12, 2008

**TRADEMARK
SUPPLEMENTAL REGISTER**

Zona Cucina

WELLBORN HOLDINGS, INC. (ALABAMA CORPORATION)
38669 HIGHWAY 77
ASHLAND, AL 36251

FOR: FURNITURE, NAMELY, CABINETS, DRAWERS, CUPBOARDS AND SHELVES; ORGANIZATIONAL DIVIDERS AND ACCESSORIES, NAMELY, PLATE RACKS, BOTTLE STORAGE RACKS, DRAWER ORGANIZERS FOR UTENSILS AND CUTLERY, DEEP DRAWER DIVIDERS, PULL OUT SWING PANTRY UNITS, AND INTERIOR ROLL OUT DRAWERS, EACH SOLD AS A UNIT WITH CABINETS, DRAWERS, CUPBOARDS OR SHELVES; AND KITCHEN CABINETS, NAMELY, APPLIANCE END PANELS, AND APPLIANCE FRONT PANELS; AND CABINET UNITS FOR APPLIANCES, NAMELY, COOKTOPS, OVENS, REFRIGERATORS, COFFEE SYSTEMS, AND MICROWAVES, IN CLASS 20 (U.S. CLS. 2, 13, 22, 25, 32 AND 50).

FIRST USE 6-0-2006; IN COMMERCE 6-0-2006.

THE MARK CONSISTS OF STANDARD CHARACTERS WITHOUT CLAIM TO ANY PARTICULAR FONT, STYLE, SIZE, OR COLOR.

NO CLAIM IS MADE TO THE EXCLUSIVE RIGHT TO USE "CUCINA", APART FROM THE MARK AS SHOWN.

THE FOREIGN WORDING IN THE MARK TRANSLATES INTO ENGLISH AS "KITCHEN SPACE".

SER. NO. 77-070,397, FILED P.R. 12-22-2006; AM. S.R. 6-20-2008.

JIM RINGLE, EXAMINING ATTORNEY

Int. Cls.: 38 and 41

Prior U.S. Cls.: 100, 101, 104, and 107

United States Patent and Trademark Office

Reg. No. 3,486,615

Registered Aug. 12, 2008

**SERVICE MARK
SUPPLEMENTAL REGISTER**

IN THEATRES

TOTALLY HOLLYWOOD TV, LLC (DELAWARE
LTD LIAB CO)
SUITE 221A
2255 GLADES ROAD
BOCA RATON, FL 33431

FOR: CABLE TELEVISION NETWORK BROAD-
CASTING SERVICES, IN CLASS 38 (U.S. CLS. 100, 101
AND 104).

FIRST USE 11-26-2007; IN COMMERCE 11-26-2007.

FOR: CABLE TELEVISION PROGRAMMING
SERVICES; ENTERTAINMENT PROGRAMMING,
NAMELY, ENTERTAINMENT IN THE NATURE

OF ON-GOING TELEVISION PROGRAMS IN THE
FIELD OF MOVIES PROVIDED THROUGH A
CABLE TELEVISION NETWORK, IN CLASS 41
(U.S. CLS. 100, 101 AND 107).

FIRST USE 11-26-2007; IN COMMERCE 11-26-2007.

THE MARK CONSISTS OF STANDARD CHAR-
ACTERS WITHOUT CLAIM TO ANY PARTICULAR
FONT, STYLE, SIZE, OR COLOR.

SER. NO. 77-095,398, FILED P.R. 1-31-2007; AM. S.R.
11-27-2007.

ALLISON SCHRODY, EXAMINING ATTORNEY

Int. Cl.: 21

Prior U.S. Cls.: 2, 13, 23, 29, 30, 33, 40, and 50

United States Patent and Trademark Office

Reg. No. 3,486,616

Registered Aug. 12, 2008

**TRADEMARK
SUPPLEMENTAL REGISTER**

CARPET BROOM

CASABELLA HOLDINGS LLC (DELAWARE LTD
LIAB CO)

400 CORPORATE DRIVE

BLAUVELT, NY 10913

FOR: NON-ELECTRIC CARPET SWEEPERS, IN
CLASS 21 (U.S. CLS. 2, 13, 23, 29, 30, 33, 40 AND 50).

FIRST USE 6-30-2007; IN COMMERCE 6-30-2007.

THE MARK CONSISTS OF STANDARD CHAR-
ACTERS WITHOUT CLAIM TO ANY PARTICULAR
FONT, STYLE, SIZE, OR COLOR.

NO CLAIM IS MADE TO THE EXCLUSIVE
RIGHT TO USE "CARPET", APART FROM THE
MARK AS SHOWN.

SER. NO. 77-096,330, FILED P.R. 1-31-2007; AM. S.R.
6-13-2008.

KAREN SEVERSON, EXAMINING ATTORNEY

Int. Cl.: 11

Prior U.S. Cls.: 13, 21, 23, 31, and 34

United States Patent and Trademark Office

Reg. No. 3,486,617

Registered Aug. 12, 2008

**TRADEMARK
SUPPLEMENTAL REGISTER**

THE REGULATOR

CONSERVATION TECHNOLOGY, LLC (ILLI-
NOIS LTD LIAB CO)
2783 SHERMER ROAD
NORTHBROOK, IL 60062

FOR: ELECTRIC TRACK LIGHTING UNITS, IN
CLASS 11 (U.S. CLS. 13, 21, 23, 31 AND 34).

FIRST USE 10-15-2005; IN COMMERCE 10-15-2005.

THE MARK CONSISTS OF STANDARD CHAR-
ACTERS WITHOUT CLAIM TO ANY PARTICULAR
FONT, STYLE, SIZE, OR COLOR.

SER. NO. 77-096,959, FILED P.R. 2-1-2007; AM. S.R.
11-20-2007.

BILL DAWE, EXAMINING ATTORNEY

Int. Cls.: 35 and 43

Prior U.S. Cls.: 100, 101, and 102

United States Patent and Trademark Office

Reg. No. 3,486,618

Registered Aug. 12, 2008

**SERVICE MARK
SUPPLEMENTAL REGISTER**

THE COMMONS AT MARCO ISLAND

DISCOVERY COMMUNITIES (FLORIDA CORPORATION)
3301 BONITA BEACH ROAD, SUITE 101
BONITA SPRINGS, FL 34134

FOR: OPERATION OF SENIOR HOUSING FACILITIES FOR OTHERS, NAMELY, PROVIDING MANAGEMENT SERVICES OF SENIOR HOUSING FACILITIES FOR OTHERS, IN CLASS 35 (U.S. CLS. 100, 101 AND 102).

FIRST USE 7-26-2007; IN COMMERCE 7-26-2007.

FOR: PROVIDING SENIOR HOUSING FACILITIES FOR PROVIDING SERVICES TO THE ELDER-

LY, NAMELY, PROVIDING ASSISTED LIVING AND INDEPENDENT LIVING, IN CLASS 43 (U.S. CLS. 100 AND 101).

FIRST USE 7-26-2007; IN COMMERCE 7-26-2007.

THE MARK CONSISTS OF STANDARD CHARACTERS WITHOUT CLAIM TO ANY PARTICULAR FONT, STYLE, SIZE, OR COLOR.

SER. NO. 77-101,691, FILED P.R. 2-7-2007; AM. S.R. 11-30-2007.

RON FAIRBANKS, EXAMINING ATTORNEY

Int. Cl.: 6

Prior U.S. Cls.: 2, 12, 13, 14, 23, 25, and 50

United States Patent and Trademark Office

Reg. No. 3,486,619

Registered Aug. 12, 2008

**TRADEMARK
SUPPLEMENTAL REGISTER**

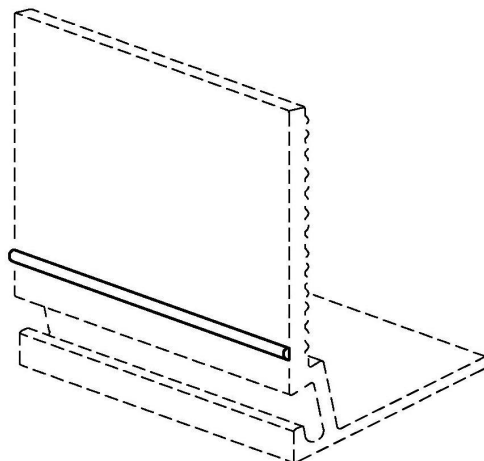

EAGLE METAL DISTRIBUTORS, INC. (FLORIDA CORPORATION)
603-B WEST LANDSTREET ROAD
ORLANDO, FL 32824

FOR: METAL BEAMS, NAMELY, EXTRUDED ALUMINUM ALLOY BEAMS USED IN CONSTRUCTING SCREENED ENCLOSURES, IN CLASS 6 (U.S. CLS. 2, 12, 13, 14, 23, 25 AND 50).

FIRST USE 4-4-2007; IN COMMERCE 4-4-2007.

THE MARK CONSISTS OF RAISED BED EXTENDING LENGTHWISE OF AN ALUMINUM EXTRUSION AND HAVING A SEMICIRCLE APPEARANCE IN CROSS-SECTION.

SER. NO. 77-111,541, FILED P.R. 2-20-2007; AM. S.R. 6-12-2008.

ALEXANDER L. POWERS, EXAMINING ATTORNEY

Int. Cl.: 33

Prior U.S. Cls.: 47 and 49

United States Patent and Trademark Office

Reg. No. 3,486,620

Registered Aug. 12, 2008

**TRADEMARK
SUPPLEMENTAL REGISTER**

GREEN APPLE

ARROWHEAD WINE CELLARS, INC. (PENNSYLVANIA CORPORATION)
12073 EAST MAIN ROAD
NORTH EAST, PA 16428

FOR: SPECIALTY WINE FOR ST. PATRICK'S DAY HOLIDAY EXCLUSIVE OF ANY WINE CONTAINING "GREEN APPLE" FLAVOR, IN CLASS 33 (U.S. CLS. 47 AND 49).

FIRST USE 3-10-2003; IN COMMERCE 3-31-2003.

THE MARK CONSISTS OF STANDARD CHARACTERS WITHOUT CLAIM TO ANY PARTICULAR FONT, STYLE, SIZE, OR COLOR.

NO CLAIM IS MADE TO THE EXCLUSIVE RIGHT TO USE "APPLE", APART FROM THE MARK AS SHOWN.

SER. NO. 77-112,190, FILED 2-21-2007.

PAUL F. GAST, EXAMINING ATTORNEY

Int. Cl.: 16

Prior U.S. Cls.: 2, 5, 22, 23, 29, 37, 38, and 50

United States Patent and Trademark Office

Reg. No. 3,486,621

Registered Aug. 12, 2008

**TRADEMARK
SUPPLEMENTAL REGISTER**

Grand Complications

TOURBILLON INTERNATIONAL LLC (NEW
YORK LTD LIAB CO)
11 WEST 25TH STREET, 8TH FLOOR
NEW YORK, NY 10010

THE MARK CONSISTS OF STANDARD CHAR-
ACTERS WITHOUT CLAIM TO ANY PARTICULAR
FONT, STYLE, SIZE, OR COLOR.

FOR: SERIES OF BOOKS ABOUT WATCHES, IN
CLASS 16 (U.S. CLS. 2, 5, 22, 23, 29, 37, 38 AND 50).

SER. NO. 77-123,601, FILED 3-6-2007.

FIRST USE 3-31-2005; IN COMMERCE 3-31-2005.

KATHERINE CHANG, EXAMINING ATTORNEY

Int. Cl.: 41

Prior U.S. Cls.: 100, 101, and 107

United States Patent and Trademark Office

Reg. No. 3,486,622

Registered Aug. 12, 2008

**SERVICE MARK
SUPPLEMENTAL REGISTER**

**THE NATURAL HEALTH
DICTIONARY**

ASK DR. MAO, LLC (DELAWARE LTD LIAB CO)
APT 6F
401 EAST 88TH STREET
NEW YORK, NY 10128

FOR: PROVIDING INFORMATION IN THE FORMAT OF A NON-DOWNLOADABLE ONLINE DICTIONARY IN THE FIELDS OF HEALTH, MEDICINE, AND LONGEVITY AS IT RELATES TO HEALTH, IN CLASS 41 (U.S. CLS. 100, 101 AND 107).

FIRST USE 5-20-2008; IN COMMERCE 5-20-2008.

THE MARK CONSISTS OF STANDARD CHARACTERS WITHOUT CLAIM TO ANY PARTICULAR FONT, STYLE, SIZE, OR COLOR.

OWNER OF U.S. REG. NO. 3,216,676.

NO CLAIM IS MADE TO THE EXCLUSIVE RIGHT TO USE "DICTIONARY", APART FROM THE MARK AS SHOWN.

SER. NO. 77-138,158, FILED P.R. 3-22-2007; AM. S.R. 5-29-2008.

MAUREEN DALL, EXAMINING ATTORNEY

Int. Cl.: 37

Prior U.S. Cls.: 100, 103, and 106

United States Patent and Trademark Office

Reg. No. 3,486,623

Registered Aug. 12, 2008

**SERVICE MARK
SUPPLEMENTAL REGISTER**

PORTS AMERICA

PORTS AMERICA, INC. (DELAWARE CORPORATION)
99 WOOD AVENUE SOUTH
ISELIN, NJ 08830

FOR: MAINTENANCE AND REPAIR OF EQUIPMENT, NAMELY, MARINE CONTAINERS, CONTAINER HANDLING EQUIPMENT AND ROAD CHASSIS, IN CLASS 37 (U.S. CLS. 100, 103 AND 106).

FIRST USE 3-16-2007; IN COMMERCE 3-16-2007.

THE MARK CONSISTS OF STANDARD CHARACTERS WITHOUT CLAIM TO ANY PARTICULAR FONT, STYLE, SIZE, OR COLOR.

SER. NO. 77-153,397, FILED P.R. 4-10-2007; AM. S.R. 7-7-2008.

DORITT L. CARROLL, EXAMINING ATTORNEY

Int. Cl.: 39

Prior U.S. Cls.: 100 and 105

United States Patent and Trademark Office

Reg. No. 3,486,624

Registered Aug. 12, 2008

**SERVICE MARK
SUPPLEMENTAL REGISTER**

PORTS AMERICA

PORTS AMERICA, INC. (DELAWARE CORPORATION)
99 WOOD AVENUE SOUTH
ISELIN, NJ 08830

FOR: OPERATING MARINE TERMINALS FOR CARGO AND PASSENGERS; PROVIDING SPECIALIZED CONTAINER, BREAK-BULK AND GENERAL CARGO HANDLING SERVICES; AND PROVIDING STEVEDORING SERVICES FOR CARGO AND PASSENGER VESSELS, IN CLASS 39 (U.S. CLS. 100 AND 105).

FIRST USE 3-16-2007; IN COMMERCE 3-16-2007.

THE MARK CONSISTS OF STANDARD CHARACTERS WITHOUT CLAIM TO ANY PARTICULAR FONT, STYLE, SIZE, OR COLOR.

SER. NO. 77-153,407, FILED P.R. 4-10-2007; AM. S.R. 7-7-2008.

DORITT L. CARROLL, EXAMINING ATTORNEY

Int. Cl.: 36

Prior U.S. Cls.: 100, 101, and 102

United States Patent and Trademark Office

Reg. No. 3,486,625

Registered Aug. 12, 2008

**SERVICE MARK
SUPPLEMENTAL REGISTER**

UNITED STATES GASOLINE FUND

UNITED STATES COMMODITY FUNDS, LLC
(DELAWARE LTD LIAB CO)
1320 BAY HARBOR PARKWAY SUITE 145
ALAMEDA, CA 94502

FOR: FUND INVESTMENT SERVICES IN THE
FIELD OF GASOLINE FUTURES CONTRACTS,
CASH-SETTLED OPTIONS ON GASOLINE FU-
TURES CONTRACTS, FORWARD CONTRACTS
FOR GASOLINE, OVER-THE-COUNTER TRANS-
ACTIONS BASED ON THE PRICE OF GASOLINE,
AND INDICES BASED ON THE FOREGOING, IN
CLASS 36 (U.S. CLS. 100, 101 AND 102).

FIRST USE 2-22-2008; IN COMMERCE 2-22-2008.

THE MARK CONSISTS OF STANDARD CHAR-
ACTERS WITHOUT CLAIM TO ANY PARTICULAR
FONT, STYLE, SIZE, OR COLOR.

NO CLAIM IS MADE TO THE EXCLUSIVE
RIGHT TO USE "GASOLINE FUND", APART FROM
THE MARK AS SHOWN.

SER. NO. 77-159,182, FILED P.R. 4-18-2007; AM. S.R.
7-3-2008.

CHRISTOPHER BUONGIORNO, EXAMINING AT-
TORNEY

Int. Cl.: 41

Prior U.S. Cls.: 100, 101, and 107

United States Patent and Trademark Office

Reg. No. 3,486,626

Registered Aug. 12, 2008

**SERVICE MARK
SUPPLEMENTAL REGISTER**

AUSSIE MILLIONS

CROWN MELBOURNE LIMITED (AUSTRALIA
CORPORATION)
8 WHITEMAN STREET
SOUTHBANK, MELBOURNE, VICTORIA, AUSTRALIA 3006

FOR: CASINO SERVICES, CONDUCTING CASINO AND GAMING CONTESTS AND TOURNAMENTS, AND PROVIDING ONLINE INFORMATION IN THE FIELDS OF CASINOS AND GAMING, IN CLASS 41 (U.S. CLS. 100, 101 AND 107).

FIRST USE 7-31-2005; IN COMMERCE 7-31-2005.

THE MARK CONSISTS OF STANDARD CHARACTERS WITHOUT CLAIM TO ANY PARTICULAR FONT, STYLE, SIZE, OR COLOR.

SER. NO. 77-181,733, FILED P.R. 5-15-2007; AM. S.R. 6-18-2008.

GEORGIA CARTY, EXAMINING ATTORNEY

Int. Cl.: 42

Prior U.S. Cls.: 100 and 101

United States Patent and Trademark Office

Reg. No. 3,486,627

Registered Aug. 12, 2008

**SERVICE MARK
SUPPLEMENTAL REGISTER**

EXPERTNEGOTIATOR

EXPERTNEGOTIATOR LLC (ARIZONA LTD
LIAB CO)
6242 EAST SHANGRI LA ROAD
SCOTTSDALE, AZ 85254

FOR: PROVIDING ONLINE NONDOWNLOAD-
ABLE SOFTWARE FOR NEGOTIATION PLAN-
NING AND MANAGEMENT, IN CLASS 42 (U.S.
CLS. 100 AND 101).

FIRST USE 7-19-2007; IN COMMERCE 7-19-2007.

THE MARK CONSISTS OF STANDARD CHAR-
ACTERS WITHOUT CLAIM TO ANY PARTICULAR
FONT, STYLE, SIZE, OR COLOR.

SER. NO. 77-185,103, FILED P.R. 5-18-2007; AM. S.R.
4-21-2008.

HOWARD SMIGA, EXAMINING ATTORNEY

Int. Cls.: 9 and 42

Prior U.S. Cls.: 21, 23, 26, 36, 38, 100, and 101

Reg. No. 3,486,628

United States Patent and Trademark Office

Registered Aug. 12, 2008

**TRADEMARK
SERVICE MARK
SUPPLEMENTAL REGISTER**

THE CHARGE-TRANSFER COMPANY

QRG LIMITED (ENGLAND PRIVATE LIMITED
COMPANY)
10 ROMSEY ROAD
EASTLEIGH, ENGLAND SO509AL

FOR: CAPACITIVE TOUCH SENSING PRODUCTS FOR SWITCHING AND CONTROLLING MEDICAL, AUTOMOTIVE, INDUSTRIAL, APPLIANCE, AND CONSUMER ELECTRONICS DEVICES, NAMELY, TOUCH SENSOR CONTROLS AND COMPONENTS, IN THE NATURE OF CAPACITIVE SENSOR INTEGRATED CIRCUITS, ELECTRONIC INTEGRATED CIRCUIT CHIPS, TOUCH SENSOR INTEGRATED CIRCUITS, TOUCH BUTTON INTEGRATED CIRCUIT CHIPS, TOUCH SCREEN INTEGRATED CIRCUIT CHIPS, TOUCH SCREEN INTEGRATED CIRCUIT ELEMENTS, NAMELY, TOUCH SCREEN CONDUCTIVE FILMS, TOUCH WHEEL AND ROTARY SCROLLING INTEGRATED CIRCUIT CHIPS, AND TOUCH LINEAR AND ROTARY SLIDER INTEGRATED CIRCUIT CHIPS, IN CLASS 9 (U.S. CLS. 21, 23, 26, 36 AND 38).

FOR: RESEARCH AND DEVELOPMENT CONSULTANCY SERVICES IN THE FIELD OF TOUCH SENSING PRODUCTS FOR SWITCHING AND CONTROL APPLICATIONS; COMPUTER SOFTWARE DEVELOPMENT AND DESIGN AND COMPUTER SOFTWARE TECHNICAL SUPPORT, NAMELY, DE-

VELOPING, CUSTOMIZING AND TROUBLESHOOTING OF COMPUTER HARDWARE AND SOFTWARE, IN THE FIELD OF TOUCH SENSING PRODUCTS FOR SWITCHING AND CONTROL APPLICATIONS; COMPUTER HARDWARE DESIGN, NAMELY, TOUCH SENSING COMPUTER CHIPS AND TOUCH SCREEN DESIGN, DEVELOPED AND CUSTOMIZED TO CUSTOMER NEEDS AND SPECIFICATIONS, IN CLASS 42 (U.S. CLS. 100 AND 101).

THE MARK CONSISTS OF STANDARD CHARACTERS WITHOUT CLAIM TO ANY PARTICULAR FONT, STYLE, SIZE, OR COLOR.

PRIORITY CLAIMED UNDER SEC. 44(D) ON ERPN CMNTY TM OFC APPLICATION NO. 5606066, FILED 12-22-2006, REG. NO. 005606066, DATED 12-13-2007, EXPIRES 12-13-2017.

NO CLAIM IS MADE TO THE EXCLUSIVE RIGHT TO USE "COMPANY", APART FROM THE MARK AS SHOWN.

SER. NO. 77-200,449, FILED P.R. 6-7-2007; AM. S.R. 3-21-2008.

MARK PILARO, EXAMINING ATTORNEY

Int. Cl.: 5

Prior U.S. Cls.: 6, 18, 44, 46, 51, and 52

United States Patent and Trademark Office

Reg. No. 3,486,629

Registered Aug. 12, 2008

**TRADEMARK
SUPPLEMENTAL REGISTER**

DIABETES ESSENTIALS

NUTRITION 21, INC. (NEW YORK CORPORATION)

4 MANHATTANVILLE ROAD

PURCHASE, NY 105772197

FOR: DIETARY AND NUTRITIONAL SUPPLEMENTS, IN CLASS 5 (U.S. CLS. 6, 18, 44, 46, 51 AND 52).

FIRST USE 8-14-2007; IN COMMERCE 8-14-2007.

THE MARK CONSISTS OF STANDARD CHARACTERS WITHOUT CLAIM TO ANY PARTICULAR FONT, STYLE, SIZE, OR COLOR.

NO CLAIM IS MADE TO THE EXCLUSIVE RIGHT TO USE "DIABETES", APART FROM THE MARK AS SHOWN.

SER. NO. 77-201,037, FILED P.R. 6-8-2007; AM. S.R. 6-25-2008.

GINA FINK, EXAMINING ATTORNEY

Int. Cl.: 16

Prior U.S. Cls.: 2, 5, 22, 23, 29, 37, 38, and 50

Reg. No. 3,486,630

United States Patent and Trademark Office

Registered Aug. 12, 2008

**TRADEMARK
SUPPLEMENTAL REGISTER**

The Local Foods Wheel

PRENTICE, JESSICA (UNITED STATES INDIVIDUAL)

5706 VAN FLEET AVENUE
RICHMOND, CA 94804 AND

GOSSELIN, MAGGIE (UNITED STATES INDIVIDUAL)

125 SANCHEZ STREET, #23
SAN FRANCISCO, CA 94114 AND

KLEIN, SARAH ELIZABETH (UNITED STATES INDIVIDUAL)

5252 BOYD AVENUE
OAKLAND, CA 94618

FOR: EDUCATIONAL PUBLICATIONS, NAME-
LY, EDUCATIONAL LEARNING CARDS, FLASH
CARDS, ACTIVITY CARDS, WORKBOOKS, TEXT-
BOOKS, ACTIVITY BOOKS, STORY BOOKS, PUZ-

ZLE BOOKS, PUZZLES, TEACHER GUIDES,
MANUALS, POSTERS, EDUCATIONAL CARD
GAMES AND EDUCATIONAL BOOKLETS IN THE
FIELD OF SUSTAINABLE AGRICULTURE; POS-
TERS; POSTERS MADE OF PAPER, IN CLASS 16
(U.S. CLS. 2, 5, 22, 23, 29, 37, 38 AND 50).

FIRST USE 6-1-2006; IN COMMERCE 6-1-2006.

THE MARK CONSISTS OF STANDARD CHAR-
ACTERS WITHOUT CLAIM TO ANY PARTICULAR
FONT, STYLE, SIZE, OR COLOR.

SER. NO. 77-209,816, FILED P.R. 6-19-2007; AM. S.R.
7-1-2008.

PETER B. BROMAGHIM, EXAMINING ATTORNEY

Int. Cl.: 25

Prior U.S. Cls.: 22 and 39

United States Patent and Trademark Office

Reg. No. 3,486,631

Registered Aug. 12, 2008

**TRADEMARK
SUPPLEMENTAL REGISTER**



DOUG REASER (UNITED STATES INDIVIDUAL)
1542 E. SPRUCE
OLATHE, KS 66061

FOR: T-SHIRTS, IN CLASS 25 (U.S. CLS. 22 AND 39).

FIRST USE 7-15-2006; IN COMMERCE 7-15-2006.

OWNER OF U.S. REG. NO. 3,361,138.

THE STIPPLING IS A FEATURE OF THE MARK AND DOES NOT INDICATE COLOR.

THE MARK CONSISTS OF A STYLIZED EYES DESIGN.

SER. NO. 77-215,801, FILED 6-26-2007.

GEORGIA CARTY, EXAMINING ATTORNEY

Int. Cl.: 39

Prior U.S. Cls.: 100 and 105

United States Patent and Trademark Office

Reg. No. 3,486,632

Registered Aug. 12, 2008

**SERVICE MARK
SUPPLEMENTAL REGISTER**

RES-Q-JETS

MED JETS NOW, L.L.C. (MICHIGAN LTD LIAB
CO)
5605 PORTAGE ROAD
KALAMAZOO, MI 49002

THE MARK CONSISTS OF STANDARD CHAR-
ACTERS WITHOUT CLAIM TO ANY PARTICULAR
FONT, STYLE, SIZE, OR COLOR.

FOR: AIRLINE TRANSPORTATION SERVICES;
AMBULANCE TRANSPORT, IN CLASS 39 (U.S. CLS.
100 AND 105).

SER. NO. 77-217,943, FILED P.R. 6-28-2007; AM. S.R.
6-27-2008.

FIRST USE 5-1-2007; IN COMMERCE 5-1-2007.

MICHAEL LEWIS, EXAMINING ATTORNEY

Int. Cl.: 42

Prior U.S. Cls.: 100 and 101

United States Patent and Trademark Office

Reg. No. 3,486,633

Registered Aug. 12, 2008

**SERVICE MARK
SUPPLEMENTAL REGISTER**

Digital Wish

CHIRTEA, HEATHER L. (UNITED STATES IN-
DIVIDUAL)
3336 SUNDERLAND HILL ROAD
SUNDERLAND, VT 05250

FOR: COMPUTER SERVICES, NAMELY, HOST-
ING AND MAINTAINING AN ONLINE WEBSITE
FOR OTHERS TO VIEW WANT LISTS OF EDUCA-
TIONAL INSTITUTES AND MAKE CHARITABLE
DONATIONS TO THOSE EDUCATIONAL INSTI-
TUTES, IN CLASS 42 (U.S. CLS. 100 AND 101).

FIRST USE 6-22-2007; IN COMMERCE 6-24-2007.

THE MARK CONSISTS OF STANDARD CHAR-
ACTERS WITHOUT CLAIM TO ANY PARTICULAR
FONT, STYLE, SIZE, OR COLOR.

SER. NO. 77-221,444, FILED P.R. 7-3-2007; AM. S.R.
4-3-2008.

EUGENIA MARTIN, EXAMINING ATTORNEY

Int. Cl.: 16

Prior U.S. Cls.: 2, 5, 22, 23, 29, 37, 38, and 50

United States Patent and Trademark Office

Reg. No. 3,486,634

Registered Aug. 12, 2008

**TRADEMARK
SUPPLEMENTAL REGISTER**

MATRIMONIO

MATRIMONIO (NEW YORK PARTNERSHIP)
85 STEVENSON BLVD.
AMHERST, NY 14226

FOR: STATIONERY, IN CLASS 16 (U.S. CLS. 2, 5,
22, 23, 29, 37, 38 AND 50).

FIRST USE 1-0-2008; IN COMMERCE 1-0-2008.

THE MARK CONSISTS OF STANDARD CHAR-
ACTERS WITHOUT CLAIM TO ANY PARTICULAR
FONT, STYLE, SIZE, OR COLOR.

THE ENGLISH TRANSLATION OF "MATRIMO-
NIO" IS MARRIAGE.

SER. NO. 77-225,619, FILED P.R. 7-10-2007; AM. S.R.
6-19-2008.

MATTHEW PAPPAS, EXAMINING ATTORNEY

Int. Cls.: 39 and 42

Prior U.S. Cls.: 100, 101, and 105

United States Patent and Trademark Office

Reg. No. 3,486,635

Registered Aug. 12, 2008

**SERVICE MARK
SUPPLEMENTAL REGISTER**

95 EXPRESS

FLORIDA DEPARTMENT OF TRANSPORTATION (FLORIDA STATE AGENCY)
605 SUWANNEE STREET
TALLAHASSEE, FL 323990450

FOR: MANAGEMENT OF VEHICULAR TRAFFIC FLOW THROUGH ADVANCED COMMUNICATIONS NETWORK AND TECHNOLOGY, IN CLASS 39 (U.S. CLS. 100 AND 105).

FIRST USE 4-17-2007; IN COMMERCE 4-17-2007.

FOR: DESIGN AND ENGINEERING SERVICES IN THE FIELD OF TRAFFIC MANAGEMENT AND CONTROL, NAMELY, TRAFFIC AND PUBLIC

TRANSIT REROUTING, TOLLING AND INFORMATION AND COMMUNICATION NETWORKS, IN CLASS 42 (U.S. CLS. 100 AND 101).

FIRST USE 4-17-2007; IN COMMERCE 4-17-2007.

THE MARK CONSISTS OF STANDARD CHARACTERS WITHOUT CLAIM TO ANY PARTICULAR FONT, STYLE, SIZE, OR COLOR.

SER. NO. 77-226,797, FILED P.R. 7-11-2007; AM. S.R. 6-23-2008.

KAREN K. BUSH, EXAMINING ATTORNEY

Int. Cl.: 25

Prior U.S. Cls.: 22 and 39

United States Patent and Trademark Office

Reg. No. 3,486,636

Registered Aug. 12, 2008

**TRADEMARK
SUPPLEMENTAL REGISTER**

ST. LOUIS FOOTBALL

ST. LOUIS RAMS PARTNERSHIP (DELAWARE
PARTNERSHIP)
ONE RAMS WAY
EARTH CITY, MO 63045

THE MARK CONSISTS OF STANDARD CHAR-
ACTERS WITHOUT CLAIM TO ANY PARTICULAR
FONT, STYLE, SIZE, OR COLOR.

FOR: SHIRTS; PANTS; JACKETS, IN CLASS 25
(U.S. CLS. 22 AND 39).

SER. NO. 77-226,978, FILED P.R. 7-11-2007; AM. S.R.
6-23-2008.

FIRST USE 6-4-2007; IN COMMERCE 11-27-2007.

KAREN K. BUSH, EXAMINING ATTORNEY

Int. Cl.: 35

Prior U.S. Cls.: 100, 101, and 102

United States Patent and Trademark Office

Reg. No. 3,486,637

Registered Aug. 12, 2008

**SERVICE MARK
SUPPLEMENTAL REGISTER**

DIDXchange

SUPER TECHNOLOGIES, INC. (DELAWARE
CORPORATION)
6005 KEATING ROAD
PENSACOLA, FL 32504

FOR: OPERATING AN ON-LINE WHOLESALE
MARKETPLACE FOR BUYERS AND SELLERS OF
TELEPHONE NUMBERS FEATURING DID (DI-
RECT INWARD DIALING) TELEPHONE NUM-
BERS, IN CLASS 35 (U.S. CLS. 100, 101 AND 102).

FIRST USE 8-1-2005; IN COMMERCE 8-1-2005.

THE MARK CONSISTS OF STANDARD CHAR-
ACTERS WITHOUT CLAIM TO ANY PARTICULAR
FONT, STYLE, SIZE, OR COLOR.

SER. NO. 77-231,775, FILED P.R. 7-17-2007; AM. S.R.
6-20-2008.

BRIAN PINO, EXAMINING ATTORNEY

Int. Cl.: 25

Prior U.S. Cls.: 22 and 39

United States Patent and Trademark Office

Reg. No. 3,486,638

Registered Aug. 12, 2008

**TRADEMARK
SUPPLEMENTAL REGISTER**

NATURALS

HOLT HOSIERY MILLS, INCORPORATED
(NORTH CAROLINA CORPORATION)
P.O. BOX 1757
BURLINGTON, NC 27216

THE MARK CONSISTS OF STANDARD CHARACTERS WITHOUT CLAIM TO ANY PARTICULAR FONT, STYLE, SIZE, OR COLOR.

FOR: HOSIERY; SOCKS; SOCKS AND STOCKINGS ALL MADE IN WHOLE OR IN SIGNIFICANT PART OF NATURAL FIBERS, IN CLASS 25 (U.S. CLS. 22 AND 39).

SER. NO. 77-245,033, FILED P.R. 8-2-2007; AM. S.R. 6-30-2008.

FIRST USE 4-1-2008; IN COMMERCE 4-1-2008.

LINDA E. BLOHM, EXAMINING ATTORNEY

Int. Cls.: 35 and 41

Prior U.S. Cls.: 100, 101, 102, and 107

United States Patent and Trademark Office

Reg. No. 3,486,639

Registered Aug. 12, 2008

**SERVICE MARK
SUPPLEMENTAL REGISTER**

WEST COAST GREEN

WEST COAST GREEN LLC (CALIFORNIA LTD
LIAB CO)
316 MILLER AVENUE, SUITE H
MILL VALLEY, CA 94941

FOR: ARRANGING AND CONDUCTING TRADE
SHOWS IN THE FIELD OF GREEN BUILDING, IN
CLASS 35 (U.S. CLS. 100, 101 AND 102).

FIRST USE 7-16-2005; IN COMMERCE 7-16-2005.

FOR: ARRANGING AND CONDUCTING EDU-
CATIONAL CONFERENCES, IN CLASS 41 (U.S. CLS.
100, 101 AND 107).

FIRST USE 7-16-2005; IN COMMERCE 7-16-2005.

THE MARK CONSISTS OF STANDARD CHAR-
ACTERS WITHOUT CLAIM TO ANY PARTICULAR
FONT, STYLE, SIZE, OR COLOR.

SER. NO. 77-250,675, FILED P.R. 8-8-2007; AM. S.R.
7-2-2008.

JAY FLOWERS, EXAMINING ATTORNEY

Int. Cls.: 38 and 41

Prior U.S. Cls.: 100, 101, 104, and 107

United States Patent and Trademark Office

Reg. No. 3,486,640

Registered Aug. 12, 2008

**SERVICE MARK
SUPPLEMENTAL REGISTER**

THE OHIO CHANNEL

IDEASTREAM (OHIO NON-PROFIT CORPORATION)
1375 EUCLID AVENUE
CLEVELAND, OH 441151835

FOR: MULTIMEDIA BROADCASTING, NAME-
LY, RADIO, TELEVISION, INTERNET, BROAD-
BAND, CABLE, AND SATELLITE
BROADCASTING OF AUDIO, IMAGE, TEXT, AND
VIDEO PROGRAMMING, IN CLASS 38 (U.S. CLS.
100, 101 AND 104).

FIRST USE 1-0-2004; IN COMMERCE 1-0-2004.

FOR: PRODUCTION AND DISTRIBUTION SER-
VICES FOR RADIO, TELEVISION, INTERNET,
BROADBAND, CABLE, AND SATELLITE PRO-

GRAMMING FOR OTHERS, IN CLASS 41 (U.S.
CLS. 100, 101 AND 107).

FIRST USE 1-0-2004; IN COMMERCE 1-0-2004.

THE MARK CONSISTS OF STANDARD CHAR-
ACTERS WITHOUT CLAIM TO ANY PARTICULAR
FONT, STYLE, SIZE, OR COLOR.

NO CLAIM IS MADE TO THE EXCLUSIVE
RIGHT TO USE "CHANNEL", APART FROM THE
MARK AS SHOWN.

SER. NO. 77-257,855, FILED P.R. 8-17-2007; AM. S.R.
7-1-2008.

PAUL F. GAST, EXAMINING ATTORNEY

Int. Cl.: 16

Prior U.S. Cls.: 2, 5, 22, 23, 29, 37, 38, and 50

United States Patent and Trademark Office

Reg. No. 3,486,641

Registered Aug. 12, 2008

**TRADEMARK
SUPPLEMENTAL REGISTER**



THUNDERBIRD GLOBAL ENTERPRISES, LLC
(GEORGIA LTD LIAB CO)
1220 REGENCY DRIVE, NW
ATLANTA, GA 30327

FOR: BIODEGRADABLE GENERAL PURPOSE STORAGE BAGS, NAMELY, PLASTIC BAGS, RE-CLOSABLE PLASTIC BAGS, AND ZIPPERED PLASTIC BAGS, IN CLASS 16 (U.S. CLS. 2, 5, 22, 23, 29, 37, 38 AND 50).

FIRST USE 9-0-2007; IN COMMERCE 9-0-2007.

THE MARK CONSISTS OF THREE HORIZONTAL LINES OF EQUAL WIDTH EXTENDING ACROSS A PLASTIC BAG NEAR THE BOTTOM OF THE BAG. THE LINES COMPLETELY ENCIRCLE THE BAG. THE DASHED OUTLINE OF THE PLASTIC BAG SHOWN IN THE DRAWING IS FOR POSITIONING ONLY AND DOES NOT COMPRISE A FEATURE OF THE MARK.

SER. NO. 77-260,433, FILED P.R. 8-21-2007; AM. S.R. 6-30-2008.

CARYN GLASSER, EXAMINING ATTORNEY

Int. Cl.: 10

Prior U.S. Cls.: 26, 39, and 44

United States Patent and Trademark Office

Reg. No. 3,486,642

Registered Aug. 12, 2008

**TRADEMARK
SUPPLEMENTAL REGISTER**

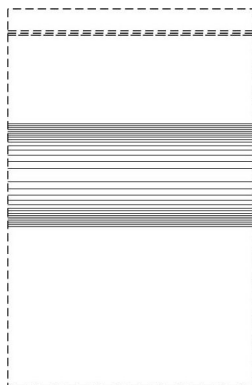

THUNDERBIRD GLOBAL ENTERPRISES, LLC
(GEORGIA LTD LIAB CO)
1220 REGENCY DRIVE, NW
ATLANTA, GA 30327

FOR: PLASTIC BAGS FOR MEDICAL SPECIMENS, NAMELY, TAMPER-PROOF PLASTIC SPECIMEN BAGS, RECLOSABLE PLASTIC SPECIMEN BAGS, AND ZIPPERED PLASTIC SPECIMEN BAGS, IN CLASS 10 (U.S. CLS. 26, 39 AND 44).

FIRST USE 2-0-2007; IN COMMERCE 2-0-2007.

THE MARK CONSISTS OF A SERIES OF HORIZONTAL LINES EXTENDING ACROSS THE MID-SECTION OF A PLASTIC BAG. THE DASHED OUTLINE OF THE PLASTIC BAG SHOWN IN THE DRAWING IS FOR POSITIONING ONLY AND DOES NOT COMPRISE A FEATURE OF THE MARK. NO CLAIM IS MADE TO A SPECIFIC COLOR.

SER. NO. 77-260,806, FILED P.R. 8-21-2007; AM. S.R. 6-30-2008.

CARYN GLASSER, EXAMINING ATTORNEY

Int. Cls.: 35, 36, 38, and 45

Prior U.S. Cls.: 100, 101, 102, and 104

United States Patent and Trademark Office

Reg. No. 3,486,643

Registered Aug. 12, 2008

**SERVICE MARK
SUPPLEMENTAL REGISTER**

ABANTE

LOCKTON, INC. (MISSOURI CORPORATION),
DBA LOCKTON COMPANIES, INC.,
SUITE 900
444 WEST 47TH STREET
KANSAS CITY, MO 64112

FOR: HUMAN RESOURCES CONSULTATION;
EMPLOYEE BENEFIT PLAN ACCOUNT AUDITING
SERVICES; CONDUCTING BUSINESS RESEARCH
AND SURVEYS FOR HUMAN RESOURCES AND
EMPLOYEE BENEFITS PURPOSES, IN CLASS 35
(U.S. CLS. 100, 101 AND 102).

FIRST USE 7-1-2004; IN COMMERCE 7-1-2004.

FOR: EMPLOYEE BENEFITS CONSULTATION,
NAMELY, FINANCIAL ANALYSIS OF EMPLOYEE
BENEFIT PLANS; FINANCIAL ADMINISTRATION
OF EMPLOYEE BENEFIT PLANS; PROVIDING FI-
NANCIAL INFORMATION, NAMELY, FINANCIAL
DATA REPORTING IN THE FIELD OF EMPLOYEE
BENEFIT PLANS; AND FINANCIAL ANALYSIS,
NAMELY, BENCHMARKING IN THE NATURE
OF MEASURING THE FINANCIAL PERFOR-
MANCE OF EMPLOYEE BENEFIT PLANS, IN
CLASS 36 (U.S. CLS. 100, 101 AND 102).

FIRST USE 7-1-2004; IN COMMERCE 7-1-2004.

FOR: ELECTRONIC DATA TRANSMISSION FOR
HUMAN RESOURCES AND EMPLOYEE BENEFIT
PROFESSIONALS AND EMPLOYERS, IN CLASS 38
(U.S. CLS. 100, 101 AND 104).

FIRST USE 7-1-2004; IN COMMERCE 7-1-2004.

FOR: COMPLIANCE SERVICES, NAMELY, RE-
VIEWING STANDARDS AND PRACTICES TO AS-
SURE COMPLIANCE WITH EMPLOYEE BENEFIT
LAWS AND REGULATIONS, IN CLASS 45 (U.S. CLS.
100 AND 101).

FIRST USE 7-1-2004; IN COMMERCE 7-1-2004.

THE MARK CONSISTS OF STANDARD CHAR-
ACTERS WITHOUT CLAIM TO ANY PARTICULAR
FONT, STYLE, SIZE, OR COLOR.

SER. NO. 77-263,567, FILED P.R. 8-24-2007; AM. S.R.
5-22-2008.

STEVEN PEREZ, EXAMINING ATTORNEY

Int. Cl.: 32

Prior U.S. Cls.: 45, 46, and 48

Reg. No. 3,486,644

United States Patent and Trademark Office

Registered Aug. 12, 2008

**TRADEMARK
SUPPLEMENTAL REGISTER**

SOUTHERN PECAN THE
ORIGINAL PECAN NUT BROWN
ALE

LAZY MAGNOLIA BREWING COMPANY, LLC
(MISSISSIPPI LTD LIAB CO)
7030 ROSCOE TURNER ROAD
KILN, MS 39556

NO CLAIM IS MADE TO THE EXCLUSIVE
RIGHT TO USE "BROWN ALE", APART FROM
THE MARK AS SHOWN.

FOR: BEER, IN CLASS 32 (U.S. CLS. 45, 46 AND 48).

FIRST USE 3-10-2005; IN COMMERCE 3-10-2005.

SER. NO. 77-265,023, FILED P.R. 8-27-2007; AM. S.R.
6-3-2008.

THE MARK CONSISTS OF STANDARD CHAR-
ACTERS WITHOUT CLAIM TO ANY PARTICULAR
FONT, STYLE, SIZE, OR COLOR.

BERYL GARDNER, EXAMINING ATTORNEY

Int. Cl.: 41

Prior U.S. Cls.: 100, 101, and 107

United States Patent and Trademark Office

Reg. No. 3,486,645

Registered Aug. 12, 2008

**SERVICE MARK
SUPPLEMENTAL REGISTER**

FLYING SENSORS

FLYING SENSORS, LLC (UTAH LTD LIAB CO)
3507 SOUTH HUNTINGTON DRIVE
BOUNTIFUL, UT 84010

FOR: PHOTOGRAPHY SERVICES USING UN-
MANNED AERIAL VEHICLES, IN CLASS 41 (U.S.
CLS. 100, 101 AND 107).

FIRST USE 2-28-2006; IN COMMERCE 2-28-2006.

THE MARK CONSISTS OF STANDARD CHAR-
ACTERS WITHOUT CLAIM TO ANY PARTICULAR
FONT, STYLE, SIZE, OR COLOR.

SER. NO. 77-266,841, FILED P.R. 8-29-2007; AM. S.R.
6-12-2008.

MICHAEL LEWIS, EXAMINING ATTORNEY

Int. Cl.: 16

Prior U.S. Cls.: 2, 5, 22, 23, 29, 37, 38, and 50

Reg. No. 3,486,646

United States Patent and Trademark Office

Registered Aug. 12, 2008

**TRADEMARK
SUPPLEMENTAL REGISTER**

THE TAXICAB.COM

BOWMAN, TOUJA A. (UNITED STATES INDIVIDUAL)
2921 14TH STREET, N.E.
WASHINGTON, DC 200172922

THE MARK CONSISTS OF STANDARD CHARACTERS WITHOUT CLAIM TO ANY PARTICULAR FONT, STYLE, SIZE, OR COLOR.

FOR: MAGAZINES FEATURING THE TAXICAB INDUSTRY, IN CLASS 16 (U.S. CLS. 2, 5, 22, 23, 29, 37, 38 AND 50).

SER. NO. 77-270,531, FILED P.R. 9-4-2007; AM. S.R. 6-10-2008.

FIRST USE 4-22-2008; IN COMMERCE 4-22-2008.

KATHERINE CHANG, EXAMINING ATTORNEY

Int. Cl.: 41

Prior U.S. Cls.: 100, 101, and 107

United States Patent and Trademark Office

Reg. No. 3,486,647

Registered Aug. 12, 2008

**SERVICE MARK
SUPPLEMENTAL REGISTER**

Enduro-Strength Training

PROW, TRACY (UNITED STATES INDIVIDUAL)
8599 W. ATHENS
PEORIA, AZ 85382 AND
EGHERMAN, MONTE (UNITED STATES INDIVIDUAL)
1298 N. 390TH AVE.
PAYSON, IL 62360

FOR: PHYSICAL FITNESS CONSULTATION AND
INSTRUCTION, IN CLASS 41 (U.S. CLS. 100, 101 AND
107).

FIRST USE 8-1-2007; IN COMMERCE 8-1-2007.

THE MARK CONSISTS OF STANDARD CHARACTERS WITHOUT CLAIM TO ANY PARTICULAR FONT, STYLE, SIZE, OR COLOR.

NO CLAIM IS MADE TO THE EXCLUSIVE RIGHT TO USE "TRAINING", APART FROM THE MARK AS SHOWN.

SER. NO. 77-274,900, FILED 9-8-2007.

AHSEN KHAN, EXAMINING ATTORNEY

Int. Cl.: 35

Prior U.S. Cls.: 100, 101, and 102

United States Patent and Trademark Office

Reg. No. 3,486,648

Registered Aug. 12, 2008

**SERVICE MARK
SUPPLEMENTAL REGISTER**

MIX&BURN

MIX & BURN LLC (DELAWARE LTD LIAB CO)
SUITE 615
287 EAST 6TH STREET
ST. PAUL, MN 55101

THE MARK CONSISTS OF STANDARD CHAR-
ACTERS WITHOUT CLAIM TO ANY PARTICULAR
FONT, STYLE, SIZE, OR COLOR.

FOR: RETAIL STORE SERVICES, FEATURING
CUSTOM COMPILATION OF DOWNLOADABLE
PRERECORDED MUSIC ON CDS, IN CLASS 35
(U.S. CLS. 100, 101 AND 102).

SER. NO. 77-277,475, FILED P.R. 9-12-2007; AM. S.R.
6-27-2008.

FIRST USE 8-20-2004; IN COMMERCE 8-20-2004.

DAVID COLLIER, EXAMINING ATTORNEY

Int. Cl.: 36

Prior U.S. Cls.: 100, 101, and 102

United States Patent and Trademark Office

Reg. No. 3,486,649

Registered Aug. 12, 2008

**SERVICE MARK
SUPPLEMENTAL REGISTER**

PENSION RISK SOLUTIONS

HARTFORD FIRE INSURANCE COMPANY
(CONNECTICUT CORPORATION)
LAW DEPT.-TECHNOLOGY/IP UNIT-HO1-09
ONE HARTFORD PLAZA
HARTFORD, CT 06155

FOR: INVESTMENT SERVICES, NAMELY, ASSET
AND LIABILITY MANAGEMENT SERVICES AND
ISSUANCE AND DISTRIBUTION OF GROUP AN-
NUITIES USED TO HELP RETIREMENT PLAN
SPONSORS MANAGE PENSION PLAN RISKS, IN
CLASS 36 (U.S. CLS. 100, 101 AND 102).

FIRST USE 9-30-2007; IN COMMERCE 9-30-2007.

THE MARK CONSISTS OF STANDARD CHAR-
ACTERS WITHOUT CLAIM TO ANY PARTICULAR
FONT, STYLE, SIZE, OR COLOR.

SER. NO. 77-278,535, FILED P.R. 9-13-2007; AM. S.R.
6-16-2008.

BRENDAN REGAN, EXAMINING ATTORNEY

Int. Cl.: 39

Prior U.S. Cls.: 100 and 105

United States Patent and Trademark Office

Reg. No. 3,486,650

Registered Aug. 12, 2008

**SERVICE MARK
SUPPLEMENTAL REGISTER**



STAR TRAVEL SERVICES INC. (INDIANA CORPORATION)
1025 ACUFF ROAD, 4TH FLOOR
BLOOMINGTON, IN 47404

FOR: COORDINATING TRAVEL ARRANGEMENTS FOR INDIVIDUALS AND FOR GROUPS, IN CLASS 39 (U.S. CLS. 100 AND 105).

FIRST USE 11-0-2005; IN COMMERCE 11-0-2005.

THE MARK CONSISTS OF THE TERM "EDUCATIONAL DESTINATIONS" IN A STYLIZED FORMAT.

SER. NO. 77-279,321, FILED P.R. 9-13-2007; AM. S.R. 6-17-2008.

ESTHER A. BORSUK, EXAMINING ATTORNEY

Int. Cl.: 41

Prior U.S. Cls.: 100, 101, and 107

United States Patent and Trademark Office

Reg. No. 3,486,651

Registered Aug. 12, 2008

**SERVICE MARK
SUPPLEMENTAL REGISTER**

MYO-NEURO RELEASE TECHNIQUE

MARY ELLEN DISCALA (UNITED STATES INDIVIDUAL)
8196 TRANQUIL DRIVE
SPRING HILL, FL 34606 AND
EILEEN A. TENNYSON (UNITED STATES INDIVIDUAL)
8196 TRANQUIL DRIVE
SPRING HILL, FL 34606

FOR: INSTRUCTIONAL COURSES, SEMINARS AND WORKSHOPS IN THE FIELD OF MASSAGE THERAPY AND BIOMECHANIC APPLICATION, IN CLASS 41 (U.S. CLS. 100, 101 AND 107).

FIRST USE 3-0-2002; IN COMMERCE 2-0-2003.

THE MARK CONSISTS OF STANDARD CHARACTERS WITHOUT CLAIM TO ANY PARTICULAR FONT, STYLE, SIZE, OR COLOR.

NO CLAIM IS MADE TO THE EXCLUSIVE RIGHT TO USE "TECHNIQUE", APART FROM THE MARK AS SHOWN.

SER. NO. 77-280,006, FILED P.R. 9-14-2007; AM. S.R. 6-26-2008.

ZHALEH DELANEY, EXAMINING ATTORNEY

Int. Cl.: 41

Prior U.S. Cls.: 100, 101, and 107

United States Patent and Trademark Office

Reg. No. 3,486,652

Registered Aug. 12, 2008

**SERVICE MARK
SUPPLEMENTAL REGISTER**

THE GAMERS BANK

GOLDEN SHADOW PICTURES (CALIFORNIA CORPORATION)
121 NE 46TH STREET
MIAMI, FL 33137

FOR: OPERATING AND MAINTAINING AN ON-LINE VIRTUAL WORLD FOR ENTERTAINMENT PURPOSES, NAMELY, PROVIDING ONLINE COMPUTER GAMES AND ENTERTAINMENT CONTENT, AND PROVIDING A VIRTUAL ECONOMY AND A VIRTUAL CURRENCY FOR TRANSACTION OF VIRTUAL COMMERCE FOR GAME PLAYING, IN CLASS 41 (U.S. CLS. 100, 101 AND 107).

FIRST USE 10-9-2007; IN COMMERCE 10-9-2007.

THE MARK CONSISTS OF STANDARD CHARACTERS WITHOUT CLAIM TO ANY PARTICULAR FONT, STYLE, SIZE, OR COLOR.

SER. NO. 77-287,603, FILED P.R. 9-24-2007; AM. S.R. 6-10-2008.

VIVIAN MICZNIK FIRST, EXAMINING ATTORNEY

Int. Cl.: 41

Prior U.S. Cls.: 100, 101, and 107

United States Patent and Trademark Office

Reg. No. 3,486,653

Registered Aug. 12, 2008

**SERVICE MARK
SUPPLEMENTAL REGISTER**

Mobility U

MOVERO TECHNOLOGY, INC. (DELAWARE
CORPORATION)
SUITE 700
1905B KRAMER LANE
AUSTIN, TX 78758

FOR: EDUCATION SERVICES AND EVENTS,
NAMELY, PROVIDING LIVE, WEB COURSES,
SEMINAR AND EDUCATIONAL COURSES IN
THE FIELD OF MANAGING MOBILE DEVICES IN
AN ENTERPRISE ENVIRONMENT AND IN BUILD-
ING COST-EFFECTIVE PLANS FOR DEPLOYMENT
AND ONGOING MANAGEMENT OF MOBILE DE-
VICES, IN CLASS 41 (U.S. CLS. 100, 101 AND 107).

FIRST USE 7-20-2007; IN COMMERCE 8-20-2007.

THE MARK CONSISTS OF STANDARD CHAR-
ACTERS WITHOUT CLAIM TO ANY PARTICULAR
FONT, STYLE, SIZE, OR COLOR.

NO CLAIM IS MADE TO THE EXCLUSIVE
RIGHT TO USE "U", APART FROM THE MARK
AS SHOWN.

SER. NO. 77-287,768, FILED P.R. 9-25-2007; AM. S.R.
6-30-2008.

INGRID C. EULIN, EXAMINING ATTORNEY

Int. Cls.: 35 and 42

Prior U.S. Cls.: 100, 101, and 102

United States Patent and Trademark Office

Reg. No. 3,486,654

Registered Aug. 12, 2008

**SERVICE MARK
SUPPLEMENTAL REGISTER**

eLifeCare Solutions

ELIFECARE ENTERPRISES (GEORGIA CORPORATION)
SUITE 250
3780 MANSELL ROAD
ALPHARETTA, GA 30022

FOR: MANAGEMENT AND BUSINESS CONSULTING SERVICES IN THE FIELD OF HEALTHCARE, IN CLASS 35 (U.S. CLS. 100, 101 AND 102).

FIRST USE 6-27-2005; IN COMMERCE 6-27-2005.

FOR: (BASED ON USE IN COMMERCE) COMPUTER SOFTWARE DEVELOPMENT; CONSULTING SERVICES IN THE FIELD OF DESIGN, SELECTION,

IMPLEMENTATION AND USE OF COMPUTER HARDWARE AND SOFTWARE SYSTEMS FOR OTHERS, IN CLASS 42 (U.S. CLS. 100 AND 101).

FIRST USE 6-27-2005; IN COMMERCE 6-27-2005.

THE MARK CONSISTS OF STANDARD CHARACTERS WITHOUT CLAIM TO ANY PARTICULAR FONT, STYLE, SIZE, OR COLOR.

SER. NO. 77-292,592, FILED P.R. 10-1-2007; AM. S.R. 6-23-2008.

MIDGE BUTLER, EXAMINING ATTORNEY

Int. Cls.: 9, 16, 39, and 41

**Prior U.S. Cls.: 2, 5, 21, 22, 23, 26, 29, 36, 37, 38, 50,
100, 101, 105, and 107**

Reg. No. 3,486,655

United States Patent and Trademark Office

Registered Aug. 12, 2008

**TRADEMARK
SERVICE MARK
SUPPLEMENTAL REGISTER**

TRANSPORT QUALITY ASSURANCE

NATIONAL PORK BOARD (IOWA BOARD ESTABLISHED UNDER FEDERAL STATUTE OF THE UNITED STATES)

1776 N.W. 114TH STREET
CLIVE, IA 50325

FOR: PRE-RECORDED CDS AND DVDS FEATURING INFORMATION ABOUT PROPER HANDLING, LOADING AND TRANSPORTING OF LIVESTOCK, IN CLASS 9 (U.S. CLS. 21, 23, 26, 36 AND 38).

FIRST USE 2-1-2008; IN COMMERCE 2-1-2008.

FOR: PRINTED MATERIALS, NAMELY, BROCHURES CONTAINING INFORMATION ABOUT PROPER HANDLING, LOADING AND TRANSPORTING OF LIVESTOCK, IN CLASS 16 (U.S. CLS. 2, 5, 22, 23, 29, 37, 38 AND 50).

FIRST USE 2-1-2008; IN COMMERCE 2-1-2008.

FOR: PROVIDING A WEBSITE FEATURING INFORMATION ABOUT PROPER HANDLING, LOADING AND TRANSPORTING OF LIVESTOCK, IN CLASS 39 (U.S. CLS. 100 AND 105).

FIRST USE 2-1-2008; IN COMMERCE 2-1-2008.

FOR: EDUCATIONAL SERVICES, NAMELY, CONDUCTING SEMINARS, CONFERENCES AND WORKSHOPS FOR TRUCKERS IN THE FIELD OF PROPER HANDLING, LOADING AND TRANSPORTING OF LIVESTOCK, IN CLASS 41 (U.S. CLS. 100, 101 AND 107).

FIRST USE 2-1-2008; IN COMMERCE 2-1-2008.

THE MARK CONSISTS OF STANDARD CHARACTERS WITHOUT CLAIM TO ANY PARTICULAR FONT, STYLE, SIZE, OR COLOR.

OWNER OF U.S. REG. NOS. 2,167,749, 2,982,481, AND OTHERS.

SER. NO. 77-293,808, FILED P.R. 10-2-2007; AM. S.R. 7-1-2008.

CYNTHIA SLOAN, EXAMINING ATTORNEY

Int. Cl.: 21

Prior U.S. Cls.: 2, 13, 23, 29, 30, 33, 40, and 50

United States Patent and Trademark Office

Reg. No. 3,486,656

Registered Aug. 12, 2008

**TRADEMARK
SUPPLEMENTAL REGISTER**

SENSOR BRUSH

FARIBORZ RAHBAR-DEHGHAN (CANADA IN-
DIVIDUAL)
9520-174 STREET NW UNIT 48
EDMONTON, CANADA T5T5Z3

FOR: HAND-HELD CLEANING BRUSH FOR USE
IN CLEANING DIGITAL CAMERA SENSORS, IN
CLASS 21 (U.S. CLS. 2, 13, 23, 29, 30, 33, 40 AND 50).

FIRST USE 4-4-2004; IN COMMERCE 4-4-2004.

THE MARK CONSISTS OF STANDARD CHAR-
ACTERS WITHOUT CLAIM TO ANY PARTICULAR
FONT, STYLE, SIZE, OR COLOR.

NO CLAIM IS MADE TO THE EXCLUSIVE
RIGHT TO USE "BRUSH", APART FROM THE
MARK AS SHOWN.

SER. NO. 77-293,990, FILED 10-2-2007.

JAY FLOWERS, EXAMINING ATTORNEY

Int. Cl.: 41

Prior U.S. Cls.: 100, 101, and 107

United States Patent and Trademark Office

Reg. No. 3,486,657

Registered Aug. 12, 2008

**SERVICE MARK
SUPPLEMENTAL REGISTER**

NEW JOURNALIST

CENTER FOR INDEPENDENT MEDIA, THE
(D.C. NON-PROFIT CORPORATION)
2040 S STREET NW
WASHINGTON, DC 20009

FOR: FELLOWSHIP PROGRAMS, NAMELY,
MENTORING, LIVE SEMINARS AND ONLINE
SEMINARS IN THE FIELD OF ONLINE BLOGGING
FOR THE PURPOSE OF FOSTERING THE PRO-
DUCTION OF ORIGINAL NEWS AND INFORMA-
TION VIA PARTICIPANTS' ONLINE BLOGS AND
ON A NETWORK OF NEWS WEBSITES, IN CLASS 41
(U.S. CLS. 100, 101 AND 107).

FIRST USE 5-1-2006; IN COMMERCE 5-1-2006.

THE MARK CONSISTS OF STANDARD CHAR-
ACTERS WITHOUT CLAIM TO ANY PARTICULAR
FONT, STYLE, SIZE, OR COLOR.

SER. NO. 77-294,881, FILED P.R. 10-3-2007; AM. S.R.
6-26-2008.

SUSAN STIGLITZ, EXAMINING ATTORNEY

Int. Cl.: 41

Prior U.S. Cls.: 100, 101, and 107

United States Patent and Trademark Office

Reg. No. 3,486,658

Registered Aug. 12, 2008

**SERVICE MARK
SUPPLEMENTAL REGISTER**

**THE CENTER FOR INDEPENDENT
MEDIA**

CENTER FOR INDEPENDENT MEDIA, THE
(D.C. NON-PROFIT CORPORATION)
2040 S STREET NW
WASHINGTON, DC 20009

FOR: PROVIDING TRAINING IN THE FIELDS
OF ONLINE BLOGGING AND JOURNALISM TO
ONLINE BLOGGERS AND JOURNALISTS, AND
OPERATING A NETWORK OF NEWS GATHERING
AND REPORTING WEB SITES, FOR THE PURPOSE
OF FOSTERING IDEOLOGICAL DIVERSITY IN
THE MEDIA, IN CLASS 41 (U.S. CLS. 100, 101 AND
107).

FIRST USE 5-1-2006; IN COMMERCE 5-1-2006.

THE MARK CONSISTS OF STANDARD CHAR-
ACTERS WITHOUT CLAIM TO ANY PARTICULAR
FONT, STYLE, SIZE, OR COLOR.

NO CLAIM IS MADE TO THE EXCLUSIVE
RIGHT TO USE "CENTER", APART FROM THE
MARK AS SHOWN.

SER. NO. 77-294,896, FILED P.R. 10-3-2007; AM. S.R.
6-26-2008.

SUSAN STIGLITZ, EXAMINING ATTORNEY

Int. Cls.: 9 and 35

Prior U.S. Cls.: 21, 23, 26, 36, 38, 100, 101, and 102

United States Patent and Trademark Office

Reg. No. 3,486,659

Registered Aug. 12, 2008

**TRADEMARK
SERVICE MARK
SUPPLEMENTAL REGISTER**

LED WORKPLACE

CREE, INC. (NORTH CAROLINA CORPORATION)
4600 SILICON DRIVE
DURHAM, NC 27703

FOR: OPTOELECTRONIC DEVICES, NAMELY, LIGHT EMITTING DIODES FOR ILLUMINATION, IN CLASS 9 (U.S. CLS. 21, 23, 26, 36 AND 38).

FIRST USE 11-1-2007; IN COMMERCE 11-1-2007.

FOR: ADVERTISING, MARKETING, AND PROMOTING THE USE OF OPTOELECTRONIC DEVICES, NAMELY, LIGHT EMITTING DIODES FOR ILLUMINATION FOR OTHERS; PROMOTING THE PUBLIC AWARENESS OF THE USE OF OPTOELECTRONIC DEVICES, NAMELY, LIGHT EMITTING

DIODES FOR ILLUMINATION, IN CLASS 35 (U.S. CLS. 100, 101 AND 102).

FIRST USE 11-1-2007; IN COMMERCE 11-1-2007.

THE MARK CONSISTS OF STANDARD CHARACTERS WITHOUT CLAIM TO ANY PARTICULAR FONT, STYLE, SIZE, OR COLOR.

NO CLAIM IS MADE TO THE EXCLUSIVE RIGHT TO USE "LED", APART FROM THE MARK AS SHOWN.

SER. NO. 77-298,479, FILED P.R. 10-8-2007; AM. S.R. 7-2-2008.

SUSAN LESLIE DUBOIS, EXAMINING ATTORNEY

Int. Cl.: 41

Prior U.S. Cls.: 100, 101, and 107

United States Patent and Trademark Office

Reg. No. 3,486,660

Registered Aug. 12, 2008

**SERVICE MARK
SUPPLEMENTAL REGISTER**

LOCAL GUIDES. WORLDWIDE.

MORRIS VISITOR PUBLICATIONS, LLC (GEOR-
GIA LTD LIAB CO)
725 BROAD STREET
AUGUSTA, GA 30901

FOR: ONLINE PUBLICATION OF GUIDE BOOKS
FEATURING VISITOR INFORMATION IN THE
FIELDS OF SHOPPING, DINING, ENTERTAIN-
MENT, ATTRACTIONS, LANDMARKS, RECREA-
TION, HOTELS AND TRANSPORTATION, IN
CLASS 41 (U.S. CLS. 100, 101 AND 107).

FIRST USE 4-2-2007; IN COMMERCE 9-26-2007.

THE MARK CONSISTS OF STANDARD CHAR-
ACTERS WITHOUT CLAIM TO ANY PARTICULAR
FONT, STYLE, SIZE, OR COLOR.

NO CLAIM IS MADE TO THE EXCLUSIVE
RIGHT TO USE "GUIDES", APART FROM THE
MARK AS SHOWN.

SER. NO. 77-299,065, FILED P.R. 10-9-2007; AM. S.R.
7-8-2008.

JORDAN BAKER, EXAMINING ATTORNEY

Int. Cl.: 8

Prior U.S. Cls.: 23, 28, and 44

United States Patent and Trademark Office

Reg. No. 3,486,661

Registered Aug. 12, 2008

**TRADEMARK
SUPPLEMENTAL REGISTER**



ACME UNITED CORPORATION (CONNECTI-
CUT CORPORATION)
60 ROUND HILL RD
FAIRFIELD, CT 06824

FOR: SCISSORS, IN CLASS 8 (U.S. CLS. 23, 28 AND
44).

FIRST USE 9-15-2006; IN COMMERCE 9-15-2006.

THE COLOR(S) BLACK, WHITE, GRAY, LIGHT
GRAY, DARK GRAY AND BEIGE IS/ARE
CLAIMED AS A FEATURE OF THE MARK.

THE MARK CONSISTS OF THE CONFIGURA-
TION OF A SCISSORS DESIGN WITH AN ELE-

PHANT HEAD ABOVE THE SCISSOR BLADES. THE
HEAD APPEARS LIGHT GRAY WITH A BLACK
MOUTH AND EYEBROWS, WHITE TUSKS, BEIGE
AND GRAY EARS AND BLACK AND WHITE EYES.
THE HANDLES ARE LIGHT GRAY WITH FEET ON
THEM. THE FEET HAVE WHITE LINES TO INDI-
CATE TOES. A DARK GRAY TAIL IS LOCATED ON
THE LEFT HANDLE. THE RIGHT SCISSOR BLADE
HAS A DARK GRAY AND LIGHT GRAY DESIGN
AND THE LEFT SCISSOR BLADE IS GRAY.

SER. NO. 77-300,538, FILED P.R. 10-10-2007; AM.
S.R. 6-19-2008.

DANIEL BRODY, EXAMINING ATTORNEY

Int. Cl.: 18

Prior U.S. Cls.: 1, 2, 3, 22, and 41

United States Patent and Trademark Office

Reg. No. 3,486,662

Registered Aug. 12, 2008

**TRADEMARK
SUPPLEMENTAL REGISTER**

The Whip Clip

DOS EQUINE LLC (MICHIGAN LTD LIAB CO)
3103 CORONATION COURT
BYRON CENTER, MI 49315

FOR: PERSONAL EQUESTRIAN WHIP HOLDER,
IN CLASS 18 (U.S. CLS. 1, 2, 3, 22 AND 41).

FIRST USE 1-5-2007; IN COMMERCE 3-17-2007.

THE MARK CONSISTS OF STANDARD CHAR-
ACTERS WITHOUT CLAIM TO ANY PARTICULAR
FONT, STYLE, SIZE, OR COLOR.

NO CLAIM IS MADE TO THE EXCLUSIVE
RIGHT TO USE "CLIP", APART FROM THE MARK
AS SHOWN.

SER. NO. 77-302,575, FILED P.R. 10-12-2007; AM.
S.R. 7-8-2008.

DANNEAN HETZEL, EXAMINING ATTORNEY

Int. Cl.: 41

Prior U.S. Cls.: 100, 101, and 107

United States Patent and Trademark Office

Reg. No. 3,486,663

Registered Aug. 12, 2008

**SERVICE MARK
SUPPLEMENTAL REGISTER**

CULINARY GETAWAYS

CULINARY GETAWAYS, LLC (CALIFORNIA
LTD LIAB CO)
77 CENTRAL AVENUE
SAUSALITO, CA 94965

FOR: PROVIDING CLASSES AND SEMINARS
RELATED TO COOKING AND THE APPRECIATION
OF FOOD AND WINE, IN CLASS 41 (U.S. CLS.
100, 101 AND 107).

FIRST USE 7-22-2005; IN COMMERCE 7-22-2005.

THE MARK CONSISTS OF STANDARD CHARACTERS
WITHOUT CLAIM TO ANY PARTICULAR
FONT, STYLE, SIZE, OR COLOR.

SER. NO. 77-302,903, FILED P.R. 10-12-2007; AM.
S.R. 7-1-2008.

DORITT L. CARROLL, EXAMINING ATTORNEY

Int. Cl.: 41

Prior U.S. Cls.: 100, 101, and 107

United States Patent and Trademark Office

Reg. No. 3,486,664

Registered Aug. 12, 2008

**SERVICE MARK
SUPPLEMENTAL REGISTER**

YOUTH MEDIA INTERNATIONAL

YOUTH RADIO, INC. (CALIFORNIA CORPORATION)
1701 BROADWAY
OAKLAND, CA 94612

FOR: EDUCATIONAL AND ENTERTAINMENT SERVICES, NAMELY, A CONTINUING PROGRAM ABOUT YOUTH, YOUTH-RELATED ISSUES, MUSIC, MEDIA AND THE ARTS ACCESSIBLE BY RADIO, TELEVISION, SATELLITE, AUDIO, VIDEO AND COMPUTER NETWORKS, IN CLASS 41 (U.S. CLS. 100, 101 AND 107).

FIRST USE 6-23-2008; IN COMMERCE 6-23-2008.

THE MARK CONSISTS OF STANDARD CHARACTERS WITHOUT CLAIM TO ANY PARTICULAR FONT, STYLE, SIZE, OR COLOR.

NO CLAIM IS MADE TO THE EXCLUSIVE RIGHT TO USE "MEDIA", APART FROM THE MARK AS SHOWN.

SER. NO. 77-303,423, FILED P.R. 10-12-2007; AM. S.R. 6-30-2008.

NATALIE POLZER, EXAMINING ATTORNEY

Int. Cls.: 35 and 43

Prior U.S. Cls.: 100, 101, and 102

United States Patent and Trademark Office

Reg. No. 3,486,665

Registered Aug. 12, 2008

**SERVICE MARK
SUPPLEMENTAL REGISTER**

BAR & BILLIARD ROOM

RAFFLES INTERNATIONAL LIMITED (SINGAPORE CORPORATION)
#10-00 RAFFLES CITY TOWER
250 NORTH BRIDGE ROAD
SINGAPORE, SINGAPORE 179101

FOR: BUSINESS MANAGEMENT OF FOOD OUTLETS AND BEVERAGE OUTLETS; BUSINESS MANAGEMENT CONSULTING SERVICES RELATING TO FOOD OUTLETS AND BEVERAGE OUTLETS; THE BRINGING TOGETHER, FOR THE BENEFIT OF OTHERS, OF A VARIETY OF GOODS, ENABLING CUSTOMERS TO CONVENIENTLY VIEW AND PURCHASE THOSE GOODS IN THE FIELD OF FOODS AND BEVERAGES; ADVISORY AND CONSULTING SERVICES RELATING TO ALL THE AFORESAID SERVICES, IN CLASS 35 (U.S. CLS. 100, 101 AND 102).

FOR: PROVIDING BANQUETING SERVICES AND FOOD AND BEVERAGE FACILITIES; CAFES, BAR SERVICES, COCKTAIL LOUNGES, RESTAURANTS, BISTRO, BRASSERIE AND COFFEE SHOPS AND SERVICES RELATED TO THE FOREGOING, NAMELY, PROVIDING OF FOOD AND DRINK;

FOOD PREPARATION SERVICES; CARRY-OUT AND TAKE-OUT RESTAURANT SERVICES; PROVISION OF FOOD AND DRINK CATERING SERVICES AT MEETINGS, CONFERENCES, CONVENTIONS, EXHIBITIONS AND SOCIAL FUNCTIONS; HOTEL CATERING SERVICES; CONSULTING SERVICES IN THE FIELD OF HOSPITALITY AND/OR CULINARY ARTS, IN CLASS 43 (U.S. CLS. 100 AND 101).

THE MARK CONSISTS OF STANDARD CHARACTERS WITHOUT CLAIM TO ANY PARTICULAR FONT, STYLE, SIZE, OR COLOR.

OWNER OF SINGAPORE REG. NO. T0718255I, DATED 5-9-2007, EXPIRES 5-9-2017.

NO CLAIM IS MADE TO THE EXCLUSIVE RIGHT TO USE "BAR", APART FROM THE MARK AS SHOWN.

SER. NO. 77-305,274, FILED P.R. 10-16-2007; AM. S.R. 5-30-2008.

JAY FLOWERS, EXAMINING ATTORNEY

Int. Cl.: 38

Prior U.S. Cls.: 100, 101, and 104

United States Patent and Trademark Office

Reg. No. 3,486,666

Registered Aug. 12, 2008

**SERVICE MARK
SUPPLEMENTAL REGISTER**

Online Consultation Account

INTERACTIVE TECHNOLOGIES, LLC (DELA-
WARE LTD LIAB CO)
1424 K STREET, NW, SUITE 620
WASHINGTON, DC 20005

FOR: ELECTRONIC TRANSMISSION OF DATA,
VOICE AND VIDEO OVER A TELECOMMUNICA-
TION OR COMPUTER NETWORK, NAMELY, PRO-
VIDING ELECTRONIC TRANSMISSION OF
CREDIT CARD TRANSACTION DATA AND ELEC-
TRONIC PAYMENT DATA, PROVIDING VOICE
OVER INTERNET PROTOCOL (VOIP) PEER-TO-
PEER COMMUNICATIONS, ELECTRONIC MESSA-
GING SERVICES, E-MAIL, TEXT MESSAGING, IN-
STANT MESSAGING, VIDEO MESSAGING,

TELECONFERENCING, VIDEO TELECONFEREN-
CING, TRANSMISSION OF STREAMED AUDIO-
VISUAL MATERIAL, IN CLASS 38 (U.S. CLS. 100, 101
AND 104).

FIRST USE 12-1-2006; IN COMMERCE 12-1-2006.

THE MARK CONSISTS OF STANDARD CHAR-
ACTERS WITHOUT CLAIM TO ANY PARTICULAR
FONT, STYLE, SIZE, OR COLOR.

SER. NO. 77-309,219, FILED P.R. 10-20-2007; AM.
S.R. 7-8-2008.

DEIRDRE ROBERTSON, EXAMINING ATTORNEY

Int. Cl.: 38

Prior U.S. Cls.: 100, 101, and 104

United States Patent and Trademark Office

Reg. No. 3,486,667

Registered Aug. 12, 2008

**SERVICE MARK
SUPPLEMENTAL REGISTER**

LIFESTYLE BUNDLES

TOLY DIGITAL NETWORKS, INC. (FLORIDA
CORPORATION)
4425 MILITARY TRAIL SUITE 209
JUPITER, FL 33458

FOR: TELECOMMUNICATION SERVICES,
NAMELY, LOCAL AND LONG DISTANCE TRANS-
MISSION OF VOICE, DATA, GRAPHICS AND VI-
DEO BY MEANS OF BROADBAND, COPPER AND
OPTICAL OR WIRELESS NETWORKS, IN CLASS 38
(U.S. CLS. 100, 101 AND 104).

FIRST USE 1-31-2007; IN COMMERCE 1-31-2007.

THE MARK CONSISTS OF STANDARD CHAR-
ACTERS WITHOUT CLAIM TO ANY PARTICULAR
FONT, STYLE, SIZE, OR COLOR.

NO CLAIM IS MADE TO THE EXCLUSIVE
RIGHT TO USE "BUNDLES", APART FROM THE
MARK AS SHOWN.

SER. NO. 77-310,573, FILED P.R. 10-23-2007; AM.
S.R. 6-23-2008.

SUSAN LESLIE DUBOIS, EXAMINING ATTORNEY

Int. Cl.: 25

Prior U.S. Cls.: 22 and 39

United States Patent and Trademark Office

Reg. No. 3,486,668

Registered Aug. 12, 2008

**TRADEMARK
SUPPLEMENTAL REGISTER**

CAMO TEENS

HUNTER'S EDGE, LLC (GEORGIA LTD LIAB
CO)
270 WHIGHAM DAIRY ROAD
BAINBRIDGE, GA 39817

FOR: WEARING APPAREL USING CAMOU-
FLAGE, NAMELY, SHIRTS, SWEATSHIRTS, JACK-
ETS, T-SHIRTS, JEANS, OVERALLS, AND COATS,
IN CLASS 25 (U.S. CLS. 22 AND 39).

FIRST USE 1-26-2008; IN COMMERCE 1-26-2008.

THE MARK CONSISTS OF STANDARD CHAR-
ACTERS WITHOUT CLAIM TO ANY PARTICULAR
FONT, STYLE, SIZE, OR COLOR.

SER. NO. 77-312,009, FILED P.R. 10-24-2007; AM.
S.R. 6-12-2008.

JACQUELINE A. LAVINE, EXAMINING ATTOR-
NEY

Int. Cl.: 9

Prior U.S. Cls.: 21, 23, 26, 36, and 38

Reg. No. 3,486,669

United States Patent and Trademark Office

Registered Aug. 12, 2008

**TRADEMARK
SUPPLEMENTAL REGISTER**

GRIDMONITOR

AUGUSTA SYSTEMS, INC. (WEST VIRGINIA CORPORATION)
3592 COLLINS FERRS RD, STE 200
MORGANTOWN, WV 26505

FOR: COMPUTING DEVICES CONTAINING EMBEDDED SOFTWARE TO PROCESS SENSOR DATA AND TRANSMIT SENSOR DATA IN THE FIELDS OF MONITORING, SECURITY, DEFENSE, AVIATION, ELECTRIC UTILITY APPLICATIONS, OIL AND GAS APPLICATIONS, WATER UTILITY APPLICATIONS, COMMUNICATIONS, INFORMATION TECHNOLOGY; COMPUTER SOFTWARE USED TO PROCESS SENSOR DATA AND TRANSMIT SENSOR DATA IN THE FIELDS OF MONITORING, SECURITY, DEFENSE, AVIATION, ELECTRIC UTI-

LITY APPLICATIONS, OIL AND GAS APPLICATIONS, WATER UTILITY APPLICATIONS, COMMUNICATIONS, INFORMATION PROCESSING, AND INFORMATION TECHNOLOGY, IN CLASS 9 (U.S. CLS. 21, 23, 26, 36 AND 38).

FIRST USE 8-1-2007; IN COMMERCE 11-8-2007.

THE MARK CONSISTS OF STANDARD CHARACTERS WITHOUT CLAIM TO ANY PARTICULAR FONT, STYLE, SIZE, OR COLOR.

SER. NO. 77-324,768, FILED P.R. 11-8-2007; AM. S.R. 5-23-2008.

MARIA-VICTORIA SUAREZ, EXAMINING ATTORNEY

Int. Cl.: 9

Prior U.S. Cls.: 21, 23, 26, 36, and 38

United States Patent and Trademark Office

Reg. No. 3,486,670

Registered Aug. 12, 2008

**TRADEMARK
SUPPLEMENTAL REGISTER**

PROTOTYPE COMPOSER

SERENA SOFTWARE, INC. (DELAWARE CORPORATION)
1900 SEAPORT BLVD., 2ND FLOOR
REDWOOD CITY, CA 940635587

FOR: DOWNLOADABLE SOFTWARE FOR CREATING, PLANNING, DEFINING, AND DESIGNING ENTERPRISE APPLICATIONS; DOWNLOADABLE SOFTWARE, NAMELY, SOFTWARE DEVELOPMENT TOOLS FOR THE CREATION OF APPLICATIONS AND CLIENT INTERFACES; DOWNLOADABLE SOFTWARE FOR USERS TO GRAPHICALLY REPRESENT REQUIREMENTS AND PROPOSED SOLUTIONS TO COMPUTER PROCESSES AND ACTIVITY FLOWS, COMPUTER

USER EXPERIENCES, AND SOLUTIONS TO BUSINESS LOGIC AND CONNECTION POINTS TO EXISTING COMPUTER SYSTEMS, IN CLASS 9 (U.S. CLS. 21, 23, 26, 36 AND 38).

FIRST USE 12-21-2007; IN COMMERCE 12-21-2007.

THE MARK CONSISTS OF STANDARD CHARACTERS WITHOUT CLAIM TO ANY PARTICULAR FONT, STYLE, SIZE, OR COLOR.

SER. NO. 77-326,441, FILED P.R. 11-9-2007; AM. S.R. 7-1-2008.

JACLYN KIDWELL, EXAMINING ATTORNEY

Int. Cl.: 36

Prior U.S. Cls.: 100, 101, and 102

United States Patent and Trademark Office

Reg. No. 3,486,671

Registered Aug. 12, 2008

**SERVICE MARK
SUPPLEMENTAL REGISTER**

3 IN 1 LISTING

BID4ASSETS, INC. (MARYLAND CORPORATION)
SUITE 1330
8757 GEORGIA AVENUE
SILVER SPRING, MD 20910

FOR: PROVIDING INFORMATION IN THE FIELD OF REAL ESTATE VIA THE INTERNET; PROVIDING REAL ESTATE LISTINGS AND REAL ESTATE INFORMATION VIA THE INTERNET , IN CLASS 36 (U.S. CLS. 100, 101 AND 102).

FIRST USE 11-21-2007; IN COMMERCE 11-21-2007.

THE MARK CONSISTS OF STANDARD CHARACTERS WITHOUT CLAIM TO ANY PARTICULAR FONT, STYLE, SIZE, OR COLOR.

SER. NO. 77-336,744, FILED P.R. 11-26-2007; AM. S.R. 7-10-2008.

TINA BROWN, EXAMINING ATTORNEY

Int. Cl.: 41

Prior U.S. Cls.: 100, 101, and 107

United States Patent and Trademark Office

Reg. No. 3,486,672

Registered Aug. 12, 2008

**SERVICE MARK
SUPPLEMENTAL REGISTER**

Training the Whole Horse

NATURAL HORSEMANSHIP CENTER OF OREGON, LLC (OREGON LTD LIAB CO), DBA "W" HOLISTIC HORSEMANSHIP,

26011 S MORGAN RD

ESTACADA, OR 97023

FOR: HORSE TRAINING, IN CLASS 41 (U.S. CLS. 100, 101 AND 107).

FIRST USE 11-30-2007; IN COMMERCE 11-30-2007.

THE MARK CONSISTS OF STANDARD CHARACTERS WITHOUT CLAIM TO ANY PARTICULAR FONT, STYLE, SIZE, OR COLOR.

NO CLAIM IS MADE TO THE EXCLUSIVE RIGHT TO USE "TRAINING", APART FROM THE MARK AS SHOWN.

SER. NO. 77-344,423, FILED P.R. 12-5-2007; AM. S.R. 5-28-2008.

PAUL MORENO, EXAMINING ATTORNEY

Int. Cl.: 36

Prior U.S. Cls.: 100, 101, and 102

United States Patent and Trademark Office

Reg. No. 3,486,673

Registered Aug. 12, 2008

**SERVICE MARK
SUPPLEMENTAL REGISTER**

RARE Properties

RARE PROPERTIES (WYOMING LTD LIAB CO)
PO BOX 1645
485 WEST BROADWAY JACKSON, WY 83001
WILSON, WY 83014

FOR: BUSINESS BROKERAGE, IN CLASS 36 (U.S.
CLS. 100, 101 AND 102).

FIRST USE 1-1-2007; IN COMMERCE 1-1-2007.

THE MARK CONSISTS OF STANDARD CHAR-
ACTERS WITHOUT CLAIM TO ANY PARTICULAR
FONT, STYLE, SIZE, OR COLOR.

SER. NO. 77-344,903, FILED P.R. 12-5-2007; AM. S.R.
7-1-2008.

ERNEST SHOSHO, EXAMINING ATTORNEY

Int. Cl.: 34

Prior U.S. Cls.: 2, 8, 9, and 17

United States Patent and Trademark Office

Reg. No. 3,486,674

Registered Aug. 12, 2008

**TRADEMARK
SUPPLEMENTAL REGISTER**

Cardenas Cigars

CARDENAS, ARMANDO (CUBA INDIVIDUAL),
DBA CARDENAS CIGARS,

2201 16TH ST

SACRAMENTO, CA 95818

FOR: CIGARS, IN CLASS 34 (U.S. CLS. 2, 8, 9 AND
17).

FIRST USE 4-28-2005; IN COMMERCE 4-28-2005.

THE MARK CONSISTS OF STANDARD CHAR-
ACTERS WITHOUT CLAIM TO ANY PARTICULAR
FONT, STYLE, SIZE, OR COLOR.

NO CLAIM IS MADE TO THE EXCLUSIVE
RIGHT TO USE "CIGARS", APART FROM THE
MARK AS SHOWN.

SER. NO. 77-345,618, FILED P.R. 12-6-2007; AM. S.R.
6-19-2008.

CURTIS FRENCH, EXAMINING ATTORNEY

Int. Cl.: 35

Prior U.S. Cls.: 100, 101, and 102

United States Patent and Trademark Office

Reg. No. 3,486,675

Registered Aug. 12, 2008

**SERVICE MARK
SUPPLEMENTAL REGISTER**

ROTHSCHILD & CO.

JM ROTHSCHILD CO. (IDAHO CORPORATION)
113 NORTH HIAWATHA DRIVE
HAILEY, ID 83333

FOR: ON-LINE RETAIL STORE SERVICES FEATURING A FULL LINE OF JEWELRY NOT INCLUDING WATCHES, IN CLASS 35 (U.S. CLS. 100, 101 AND 102).

FIRST USE 12-9-2007; IN COMMERCE 12-9-2007.

THE MARK CONSISTS OF STANDARD CHARACTERS WITHOUT CLAIM TO ANY PARTICULAR FONT, STYLE, SIZE, OR COLOR.

NO CLAIM IS MADE TO THE EXCLUSIVE RIGHT TO USE "& CO.", APART FROM THE MARK AS SHOWN.

SER. NO. 77-348,439, FILED P.R. 12-10-2007; AM. S.R. 7-2-2008.

RICHARD WHITE, EXAMINING ATTORNEY

Int. Cl.: 16

Prior U.S. Cls.: 2, 5, 22, 23, 29, 37, 38, and 50

Reg. No. 3,486,676

United States Patent and Trademark Office

Registered Aug. 12, 2008

**TRADEMARK
SUPPLEMENTAL REGISTER**

FLAVOR NUGGETS

KITCHEN TABLE COMMUNICATIONS, LLC
(WISCONSIN LTD LIAB CO)
19300 WEST JANACEK COURT
BROOKFIELD, WI 53045

THE MARK CONSISTS OF STANDARD CHARACTERS WITHOUT CLAIM TO ANY PARTICULAR FONT, STYLE, SIZE, OR COLOR.

FOR: COLUMN IN A PRINTED MAGAZINE IN THE FIELDS OF COOKING, BAKING, TRAVEL AND LIFESTYLE, IN CLASS 16 (U.S. CLS. 2, 5, 22, 23, 29, 37, 38 AND 50).

SER. NO. 77-349,274, FILED P.R. 12-11-2007; AM. S.R. 6-22-2008.

FIRST USE 10-20-2007; IN COMMERCE 10-20-2007.

DAVID C. REIHNER, EXAMINING ATTORNEY

Int. Cl.: 42

Prior U.S. Cls.: 100 and 101

United States Patent and Trademark Office

Reg. No. 3,486,677

Registered Aug. 12, 2008

SERVICE MARK
SUPPLEMENTAL REGISTER

ieduc

IEDUC, INC. (CALIFORNIA CORPORATION)
SUITE #2
1756 N GRAMERCY PL.
HOLLYWOOD, CA 90028

FOR: DESIGN, CREATION, HOSTING AND MAINTENANCE OF INTERNET SITES FOR THIRD PARTIES; DESIGN, CREATION, HOSTING, MAINTENANCE OF WEBSITES FOR OTHERS; DESIGNING AND DEVELOPING WEBPAGES ON THE INTERNET; DESIGNING WEBSITES FOR ADVERTISING PURPOSES; HOSTING AN ONLINE COMMUNITY WEBSITE FEATURING VIRTUAL SCHOOLS; HOSTING OF DIGITAL CONTENT ON THE INTERNET; HOSTING OF WEBSITES; ONLINE WEBSITE THAT ENABLES THE MANAGEMENT OF PRINT SYSTEMS OF OTHERS BY PROVIDING TECHNICAL MAINTENANCE AND PERFORMANCE REPORTS BASED ON DATA PROVIDED BY USERS; PROVIDING A WEBSITE FEATURING TECHNOLOGY THAT ENABLES COMPANIES AND ORGANIZATIONS TO ADMINISTER AND MANAGE EMPLOYEE INCENTIVE AWARD PROGRAMS AND TO PROMOTE EMPLOYEE

PRODUCTIVITY, PERFORMANCE, RECOGNITION AND MORALE; WEBSITE DEVELOPMENT FOR OTHERS; PROVIDING A WEBSITE THAT FEATURES INFORMATION ON COMPUTER TECHNOLOGY AND PROGRAMMING; PROVIDING A WEBSITE THAT GIVES COMPUTER USERS THE ABILITY TO UPLOAD, EXCHANGE AND SHARE PHOTOS, VIDEOS AND VIDEO LOGS; PROVIDING COMPUTER PROGRAMMING SERVICES TO CUSTOMERS THAT ENABLES THEM TO PROVIDE VIDEO AND AUDIO CONTENT ON THEIR WEBSITES, IN CLASS 42 (U.S. CLS. 100 AND 101).

FIRST USE 2-18-2000; IN COMMERCE 4-25-2007.

THE MARK CONSISTS OF STANDARD CHARACTERS WITHOUT CLAIM TO ANY PARTICULAR FONT, STYLE, SIZE, OR COLOR.

SER. NO. 77-350,777, FILED P.R. 12-13-2007; AM. S.R. 6-17-2008.

ROBIN MITTLER, EXAMINING ATTORNEY

Int. Cl.: 35

Prior U.S. Cls.: 100, 101, and 102

United States Patent and Trademark Office

Reg. No. 3,486,678

Registered Aug. 12, 2008

SERVICE MARK
SUPPLEMENTAL REGISTER

League
of American
Orchestras

AMERICAN SYMPHONY ORCHESTRA LEAGUE
(UNITED STATES CONGRESSIONALLY
CHARTERED NONPROFIT ORGANIZATION),
DBA LEAGUE OF AMERICAN ORCHESTRAS,
33 WEST 60TH STREET, 5TH FLOOR
NEW YORK, NY 100237905

FOR: ASSOCIATION SERVICES, NAMELY, PROMOTING THE INTERESTS OF ORCHESTRAS AND MUSICIANS AND PROMOTING PUBLIC AWARENESS IN THE FIELD OF ORCHESTRAS AND MUSIC; PROVIDING BUSINESS NETWORKING OPPORTUNITIES FOR ORCHESTRA MUSICIANS, CONDUCTORS, MANAGERS, BOARD MEMBERS, VOLUNTEERS, STAFF MEMBERS, OR BUSINESS PARTNERS; PROVIDING CAREER DEVELOPMENT INFORMATION IN THE FIELD OF MUSIC; BUSINESS NETWORKING SERVICES, IN CLASS 35 (U.S. CLS. 100, 101 AND 102).

FIRST USE 11-26-2007; IN COMMERCE 11-26-2007.

NO CLAIM IS MADE TO THE EXCLUSIVE RIGHT TO USE "LEAGUE" , APART FROM THE MARK AS SHOWN.

THE MARK CONSISTS OF THE WORDS "LEAGUE OF AMERICAN ORCHESTRAS" WITH THE "G" IN THE WORD "LEAGUE" AND "I" IN WORD "AMERICAN" FORMING A MUSICAL FERMATA.

SER. NO. 77-362,399, FILED P.R. 1-2-2008; AM. S.R. 7-9-2008.

WENDY JUN, EXAMINING ATTORNEY

Int. Cl.: 35

Prior U.S. Cls.: 100, 101, and 102

United States Patent and Trademark Office

Reg. No. 3,486,679

Registered Aug. 12, 2008

**SERVICE MARK
SUPPLEMENTAL REGISTER**

**LEAGUE OF AMERICAN
ORCHESTRAS**

AMERICAN SYMPHONY ORCHESTRA LEAGUE
(UNITED STATES CONGRESSIONALLY
CHARTERED NONPROFIT ORGANIZATION),
DBA LEAGUE OF AMERICAN ORCHESTRAS,
33 WEST 60TH STREET, 5TH FLOOR
NEW YORK, NY 100237905

FOR: ASSOCIATION SERVICES, NAMELY, PROMOTING THE INTERESTS OF ORCHESTRAS AND MUSICIANS AND PROMOTING PUBLIC AWARENESS IN THE FIELD OF ORCHESTRAS AND MUSIC; PROVIDING BUSINESS NETWORKING OPPORTUNITIES FOR ORCHESTRA MUSICIANS, CONDUCTORS, MANAGERS, BOARD MEMBERS, VOLUNTEERS, STAFF MEMBERS, OR BUSINESS PARTNERS; PROVIDING CAREER DEVELOPMENT INFORMATION IN THE FIELD OF MUSIC;

BUSINESS NETWORKING SERVICES, IN CLASS 35
(U.S. CLS. 100, 101 AND 102).

FIRST USE 11-26-2007; IN COMMERCE 11-26-2007.

THE MARK CONSISTS OF STANDARD CHARACTERS WITHOUT CLAIM TO ANY PARTICULAR FONT, STYLE, SIZE, OR COLOR.

NO CLAIM IS MADE TO THE EXCLUSIVE RIGHT TO USE "LEAGUE", APART FROM THE MARK AS SHOWN.

SER. NO. 77-362,526, FILED P.R. 1-2-2008; AM. S.R. 7-9-2008.

WENDY JUN, EXAMINING ATTORNEY

Int. Cl.: 35

Prior U.S. Cls.: 100, 101, and 102

United States Patent and Trademark Office

Reg. No. 3,486,680

Registered Aug. 12, 2008

**SERVICE MARK
SUPPLEMENTAL REGISTER**

**THE GREATEST BEERS OF THE
WORLD**

GRETZ BEVERAGE MONTCO, INC. (PENNSYLVANIA CORPORATION)

710 E. MAIN STREET

NORRISTOWN, PA 19401

FOR: WHOLESALE DISTRIBUTORSHIPS IN THE FIELD OF BEER, IN CLASS 35 (U.S. CLS. 100, 101 AND 102).

FIRST USE 11-0-2003; IN COMMERCE 11-0-2003.

THE MARK CONSISTS OF STANDARD CHARACTERS WITHOUT CLAIM TO ANY PARTICULAR FONT, STYLE, SIZE, OR COLOR.

NO CLAIM IS MADE TO THE EXCLUSIVE RIGHT TO USE "BEERS", APART FROM THE MARK AS SHOWN.

SER. NO. 77-378,665, FILED P.R. 1-23-2008; AM. S.R. 6-13-2008.

GENE MACIOL, EXAMINING ATTORNEY

Int. Cl.: 11

Prior U.S. Cls.: 13, 21, 23, 31, and 34

United States Patent and Trademark Office

Reg. No. 3,486,681

Registered Aug. 12, 2008

**TRADEMARK
SUPPLEMENTAL REGISTER**

SUTTON

CRAFTMADE INTERNATIONAL INC. (DELA-
WARE CORPORATION)
650 S. ROYAL LANE
COPPELL, TX 75019

FOR: CEILING FANS, IN CLASS 11 (U.S. CLS. 13,
21, 23, 31 AND 34).

FIRST USE 5-19-2008; IN COMMERCE 5-19-2008.

THE MARK CONSISTS OF STANDARD CHAR-
ACTERS WITHOUT CLAIM TO ANY PARTICULAR
FONT, STYLE, SIZE, OR COLOR.

SER. NO. 77-378,812, FILED P.R. 1-23-2008; AM. S.R.
6-3-2008.

WON TEAK OH, EXAMINING ATTORNEY

Int. Cl.: 9

Prior U.S. Cls.: 21, 23, 26, 36, and 38

United States Patent and Trademark Office

Reg. No. 3,486,682

Registered Aug. 12, 2008

**TRADEMARK
SUPPLEMENTAL REGISTER**

**AFRICAN AMERICAN HERITAGE
INSTITUTE**

TN MARKETING, L.L.C. (MASSACHUSETTS
LTD LIAB CO)
TWO CARLSON PARKWAY, SUITE 320
PLYMOUTH, MN 55447

FOR: VIDEO RECORDINGS FEATURING IN-
FORMATION ABOUT HISTORY, AFRICAN AMER-
ICANS AND RELATED SUBJECTS, IN CLASS 9 (U.S.
CLS. 21, 23, 26, 36 AND 38).

FIRST USE 8-30-2007; IN COMMERCE 8-30-2007.

THE MARK CONSISTS OF STANDARD CHAR-
ACTERS WITHOUT CLAIM TO ANY PARTICULAR
FONT, STYLE, SIZE, OR COLOR.

NO CLAIM IS MADE TO THE EXCLUSIVE
RIGHT TO USE "AFRICAN AMERICAN" AND
"INSTITUTE", APART FROM THE MARK AS
SHOWN.

SER. NO. 77-381,930, FILED P.R. 1-28-2008; AM. S.R.
6-26-2008.

WILLIAM ROSSMAN, EXAMINING ATTORNEY

Int. Cl.: 14

Prior U.S. Cls.: 2, 27, 28, and 50

United States Patent and Trademark Office

Reg. No. 3,486,683

Registered Aug. 12, 2008

**TRADEMARK
SUPPLEMENTAL REGISTER**

NASH

NASH DESIGNS, INC. (CALIFORNIA CORPORATION)
10966 ½ NATIONAL BOULEVARD
LOS ANGELES, CA 90064

FOR: JEWELRY, IN CLASS 14 (U.S. CLS. 2, 27, 28 AND 50).

FIRST USE 1-29-2007; IN COMMERCE 1-29-2007.

THE MARK CONSISTS OF STANDARD CHARACTERS WITHOUT CLAIM TO ANY PARTICULAR FONT, STYLE, SIZE, OR COLOR.

SER. NO. 77-384,852, FILED P.R. 1-30-2008; AM. S.R. 5-13-2008.

GEORGIA CARTY, EXAMINING ATTORNEY

Int. Cl.: 9

Prior U.S. Cls.: 21, 23, 26, 36, and 38

United States Patent and Trademark Office

Reg. No. 3,486,684

Registered Aug. 12, 2008

**TRADEMARK
SUPPLEMENTAL REGISTER**

Juris DOC Suite

JURIS DOC SUITE, LLC (MISSOURI LTD LIAB
CO)

#183

923 NE WOODS CHAPEL RD

LEE'S SUMMIT, MO 64064

FOR: SOFTWARE FOR PREPARATION OF LE-
GAL DOCUMENTS, CASE MANAGEMENT AND
IMPROVING PROFITABILITY AND EFFICIENCY
OF LAW OFFICES, IN CLASS 9 (U.S. CLS. 21, 23, 26,
36 AND 38).

FIRST USE 2-1-2008; IN COMMERCE 2-15-2008.

THE MARK CONSISTS OF STANDARD CHAR-
ACTERS WITHOUT CLAIM TO ANY PARTICULAR
FONT, STYLE, SIZE, OR COLOR.

SER. NO. 77-395,029, FILED P.R. 2-12-2008; AM. S.R.
7-1-2008.

COURTNEY MCCORMICK, EXAMINING ATTOR-
NEY

Int. Cl.: 36

Prior U.S. Cls.: 100, 101, and 102

United States Patent and Trademark Office

Reg. No. 3,486,685

Registered Aug. 12, 2008

**SERVICE MARK
SUPPLEMENTAL REGISTER**

ZHANG FINANCIAL

CHARLES C ZHANG & ASSOCIATES (MICHIGAN CORPORATION)

1302 W MILHAM AVENUE

PORTAGE, MI 49024

FOR: FINANCIAL PLANNING AND INVESTMENT ADVISORY SERVICES, IN CLASS 36 (U.S. CLS. 100, 101 AND 102).

FIRST USE 1-2-2008; IN COMMERCE 1-2-2008.

THE MARK CONSISTS OF STANDARD CHARACTERS WITHOUT CLAIM TO ANY PARTICULAR FONT, STYLE, SIZE, OR COLOR.

NO CLAIM IS MADE TO THE EXCLUSIVE RIGHT TO USE "FINANCIAL", APART FROM THE MARK AS SHOWN.

SER. NO. 77-395,282, FILED P.R. 2-12-2008; AM. S.R. 6-30-2008.

GEOFFREY FOSDICK, EXAMINING ATTORNEY

Int. Cl.: 17

Prior U.S. Cls.: 1, 5, 12, 13, 35, and 50

United States Patent and Trademark Office

Reg. No. 3,486,686

Registered Aug. 12, 2008

**TRADEMARK
SUPPLEMENTAL REGISTER**

BEND-&-SHAPE

NEW PENDULUM CORP. (DELAWARE COR-
PORATION)
STE. 1300
1105 NORTH MARKET ST.
WILMINGTON, DE 19801

FOR: CONFORMABLE ABSORBENT PADS AND
PADS IN ROLL FORM FOR THE CONTAINMENT
OF OIL-BASED CHEMICALS, OILS AND OTHER
LIQUIDS, IN CLASS 17 (U.S. CLS. 1, 5, 12, 13, 35 AND
50).

FIRST USE 1-8-2008; IN COMMERCE 1-8-2008.

THE MARK CONSISTS OF STANDARD CHAR-
ACTERS WITHOUT CLAIM TO ANY PARTICULAR
FONT, STYLE, SIZE, OR COLOR.

SER. NO. 77-397,264, FILED P.R. 2-14-2008; AM. S.R.
7-9-2008.

DEIRDRE ROBERTSON, EXAMINING ATTORNEY

Int. Cl.: 41

Prior U.S. Cls.: 100, 101, and 107

United States Patent and Trademark Office

Reg. No. 3,486,687

Registered Aug. 12, 2008

**SERVICE MARK
SUPPLEMENTAL REGISTER**

LAS VEGAS THE MUSICAL

/GARZA, RAYNALDO/ (UNITED STATES INDIVIDUAL)
14 MONARCH BAY PLAZA, SUITE 475
MONARCH BEACH, CA 92629

FOR: ENTERTAINMENT SERVICES, NAMELY, THE CONTINUING PRODUCTION AND EXHIBITION OF STAGE PLAYS AND MUSICAL SHOWS; ENTERTAINMENT SERVICES, NAMELY, CONDUCTING AN ANNUAL FESTIVAL FEATURING MUSICAL CONCERTS, THEATRICAL SHOWS, BEAUTY PAGEANTS, ARTS AND CRAFTS EXHIBITS, DANCING CONTESTS, GAMES AND FOOD, RAFFLES, GOLF, MARATHON RUNNING COMPETITIONS AND BICYCLE TOURNAMENTS; CASINOS; PROVIDING COSTUME AND MASQUERADE PARTIES; CONDUCTING POSTER, COSTUME, SINGING, DANCING AND COOKING CONTESTS; ENTERTAINMENT SERVICES, NAMELY, LIVE STAGE PERFORMANCES FEATURING MUSICAL CONCERTS, MAGIC SHOWS AND COMEDY ACTS; ENTERTAINMENT SERVICES, NAMELY, LIVE STAGE PERFORMANCES FEATURING MUSICAL CONCERTS, MAGIC SHOWS AND COMEDIC PERFORMANCES, RERECORDED FOR BOTH TELEVISION AND INTERNET VIEWING; ENTERTAINMENT IN THE NATURE OF AN ON-GOING TELEVISION VARIETY PROGRAM FEATURING MUSICAL CONCERTS, MAGIC SHOWS AND COMEDY ACTS; ENTERTAINMENT SERVI-

CES IN THE NATURE OF LIVE STAGE PERFORMANCES BY A FICTIONAL CHARACTER FOR USE AT RETAIL PROMOTIONS, CONVENTIONS AND CONFERENCES; ENTERTAINMENT SERVICES IN THE NATURE OF LIVE STAGE PERFORMANCES TRANSMITTED VIA SATELLITE OR GLOBAL COMPUTER NETWORKS AND PRESENTED BY WAY OF ON-GOING TELEVISION VARIETY SHOWS; PRODUCTION OF VIDEOTAPES, AUDIO-CASSETTES TAPES, MOTION PICTURE FILMS AND AUDIO AND VIDEO RECORDINGS FOR OTHERS; PRODUCTION AND DISTRIBUTION OF TELEVISION AND RADIO PROGRAMS TRANSMITTED VIA SATELLITE AND THE INTERNET, IN CLASS 41 (U.S. CLS. 100, 101 AND 107).

FIRST USE 7-11-2007; IN COMMERCE 12-23-2007.

THE MARK CONSISTS OF STANDARD CHARACTERS WITHOUT CLAIM TO ANY PARTICULAR FONT, STYLE, SIZE, OR COLOR.

NO CLAIM IS MADE TO THE EXCLUSIVE RIGHT TO USE "LAS VEGAS", APART FROM THE MARK AS SHOWN.

SER. NO. 77-399,029, FILED 2-16-2008.

CAROLYN GRAY, EXAMINING ATTORNEY

Int. Cl.: 36

Prior U.S. Cls.: 100, 101, and 102

United States Patent and Trademark Office

Reg. No. 3,486,688

Registered Aug. 12, 2008

**SERVICE MARK
SUPPLEMENTAL REGISTER**

LISTINGDOCS.COM

CENTRAL DOCUMENT SERVICES, LLC (MARY-
LAND LTD LIAB CO)
P.O. BOX 247
SMITHSBURG, MD 21783

FOR: PROVIDING A WEB SITE WHERE USERS
CAN POST REAL ESTATE LISTING INFORMA-
TION, IN CLASS 36 (U.S. CLS. 100, 101 AND 102).

FIRST USE 5-26-2006; IN COMMERCE 5-26-2006.

THE MARK CONSISTS OF STANDARD CHAR-
ACTERS WITHOUT CLAIM TO ANY PARTICULAR
FONT, STYLE, SIZE, OR COLOR.

SER. NO. 77-400,139, FILED P.R. 2-19-2008; AM. S.R.
6-4-2008.

FLORENTINA BLANDU, EXAMINING ATTORNEY

Int. Cls.: 16 and 44

Prior U.S. Cls.: 2, 5, 22, 23, 29, 37, 38, 50, 100, and 101

United States Patent and Trademark Office

Reg. No. 3,486,689

Registered Aug. 12, 2008

**TRADEMARK
SERVICE MARK
SUPPLEMENTAL REGISTER**

ORCHARDING

BOWTIE, INC. (CALIFORNIA CORPORATION)
3 BURROUGHS
IRVINE, CA 926182804

FOR: MAGAZINES IN THE FIELD OF GARDENING, FARMING, AGRICULTURE, HORTICULTURE AND ANIMALS, IN CLASS 16 (U.S. CLS. 2, 5, 22, 23, 29, 37, 38 AND 50).

FIRST USE 1-0-2008; IN COMMERCE 1-0-2008.

FOR: PROVIDING ONLINE INFORMATION REGARDING GARDENING, FARMING, AGRICUL-

TURE AND HORTICULTURE, IN CLASS 44 (U.S. CLS. 100 AND 101).

FIRST USE 2-1-2008; IN COMMERCE 2-1-2008.

THE MARK CONSISTS OF STANDARD CHARACTERS WITHOUT CLAIM TO ANY PARTICULAR FONT, STYLE, SIZE, OR COLOR.

SER. NO. 77-400,419, FILED P.R. 2-19-2008; AM. S.R. 6-23-2008.

MAYUR VAGHANI, EXAMINING ATTORNEY

Int. Cls.: 16 and 44

Prior U.S. Cls.: 2, 5, 22, 23, 29, 37, 38, 50, 100, and 101

Reg. No. 3,486,690

United States Patent and Trademark Office

Registered Aug. 12, 2008

**TRADEMARK
SERVICE MARK
SUPPLEMENTAL REGISTER**

AMERICAN PIT BULL TERRIERS

BOWTIE, INC. (CALIFORNIA CORPORATION)
3 BURROUGHS
IRVINE, CA 926182804

FOR: MAGAZINES FEATURING ANIMALS,
PETS AND FEATURES OF GENERAL INTEREST
TO ANIMAL AND PET OWNERS, IN CLASS 16 (U.S.
CLS. 2, 5, 22, 23, 29, 37, 38 AND 50).

FIRST USE 1-0-2008; IN COMMERCE 1-0-2008.

FOR: PROVIDING ON-LINE INFORMATION VIA
THE INTERNET IN THE FIELDS OF ANIMALS
AND PETS, RELATING TO BREEDING, SELEC-
TION OF THE ANIMALS AND PETS, CARE,

GROOMING, FEEDING AND NUTRITION, IN
CLASS 44 (U.S. CLS. 100 AND 101).

FIRST USE 2-14-2008; IN COMMERCE 2-14-2008.

THE MARK CONSISTS OF STANDARD CHAR-
ACTERS WITHOUT CLAIM TO ANY PARTICULAR
FONT, STYLE, SIZE, OR COLOR.

OWNER OF U.S. REG. NOS. 2,928,420, 3,236,617,
AND OTHERS.

SER. NO. 77-400,440, FILED P.R. 2-19-2008; AM. S.R.
6-23-2008.

MAYUR VAGHANI, EXAMINING ATTORNEY

Int. Cl.: 44

Prior U.S. Cls.: 100 and 101

United States Patent and Trademark Office

Reg. No. 3,486,691

Registered Aug. 12, 2008

**SERVICE MARK
SUPPLEMENTAL REGISTER**

Your Natural Delivery

NEW BORN PRODUCTIONS, LLC (NEW YORK
LTD LIAB CO)
P.O. BOX 1007
BRONX, NY 10473

FOR: PROVIDING MEDICAL INFORMATION;
PROVIDING MEDICAL INFORMATION, CONSULTANCY AND ADVISORY SERVICES; MEDICAL INFORMATION; MEDICAL SERVICES; PROVIDING AN INTERNET WEB SITE FOR MEDICAL PROFESSIONALS AND MEDICAL PATIENTS THAT ALLOWS FOR THE EXCHANGE OF INFORMATION FROM REMOTE LOCATIONS USING DEVICES THAT FEED INFORMATION TO THE WEB SITE THAT IS THEN PROCESSED AND CAN BE ACCESSED IN REAL-TIME BY USERS; MEDICAL ASSISTANCE CONSULTANCY PROVIDED BY DOCTORS AND OTHER SPECIALIZED MEDICAL

PERSONNEL; MEDICAL ASSISTANCE SERVICES; MEDICAL COUNSELING, IN CLASS 44 (U.S. CLS. 100 AND 101).

FIRST USE 10-8-2005; IN COMMERCE 10-8-2005.

THE MARK CONSISTS OF STANDARD CHARACTERS WITHOUT CLAIM TO ANY PARTICULAR FONT, STYLE, SIZE, OR COLOR.

THE WORDING "NATURAL DELIVERY" HAS NO MEANING IN A FOREIGN LANGUAGE.

SER. NO. 77-401,024, FILED P.R. 2-20-2008; AM. S.R. 7-6-2008.

ELLEN PERKINS, EXAMINING ATTORNEY

Int. Cl.: 41

Prior U.S. Cls.: 100, 101, and 107

United States Patent and Trademark Office

Reg. No. 3,486,692

Registered Aug. 12, 2008

**SERVICE MARK
SUPPLEMENTAL REGISTER**

DC INDIE Music Festival

GENTGES, DANIELLE E (UNITED STATES IN-
DIVIDUAL)
1523 NORTH GEORGE MASON DRIVE
ARLINGTON, VA 22205

FOR: CONDUCTING ENTERTAINMENT EXHI-
BITIONS IN THE NATURE OF VISUAL AND
AUDIO PERFORMANCES, ART, FILM, MUSIC,
TELEVISION, MUSIC, ENTERTAINMENT OR
SPORT , IN CLASS 41 (U.S. CLS. 100, 101 AND 107).

FIRST USE 2-8-2008; IN COMMERCE 2-8-2008.

THE MARK CONSISTS OF STANDARD CHAR-
ACTERS WITHOUT CLAIM TO ANY PARTICULAR
FONT, STYLE, SIZE, OR COLOR.

NO CLAIM IS MADE TO THE EXCLUSIVE
RIGHT TO USE "MUSIC FESTIVAL", APART FROM
THE MARK AS SHOWN.

SER. NO. 77-410,614, FILED P.R. 3-1-2008; AM. S.R.
7-7-2008.

ESTHER A. BORSUK, EXAMINING ATTORNEY

Int. Cl.: 35

Prior U.S. Cls.: 100, 101, and 102

United States Patent and Trademark Office

Reg. No. 3,486,693

Registered Aug. 12, 2008

**SERVICE MARK
SUPPLEMENTAL REGISTER**

SURVEY KNOWLEDGE

BANTHER CONSULTING CORPORATION
(FLORIDA CORPORATION)

1708 GULF BEACH BLVD.

TARPON SPRINGS, FL 34689

FOR: CONDUCTING BUSINESS RESEARCH
AND SURVEYS, IN CLASS 35 (U.S. CLS. 100, 101
AND 102).

FIRST USE 7-1-2007; IN COMMERCE 7-1-2007.

THE MARK CONSISTS OF STANDARD CHAR-
ACTERS WITHOUT CLAIM TO ANY PARTICULAR
FONT, STYLE, SIZE, OR COLOR.

NO CLAIM IS MADE TO THE EXCLUSIVE
RIGHT TO USE "SURVEY", APART FROM THE
MARK AS SHOWN.

SER. NO. 77-412,193, FILED P.R. 3-4-2008; AM. S.R.
6-25-2008.

ROBERT C. CLARK JR., EXAMINING ATTORNEY

Int. Cl.: 41

Prior U.S. Cls.: 100, 101, and 107

United States Patent and Trademark Office

Reg. No. 3,486,694

Registered Aug. 12, 2008

**SERVICE MARK
SUPPLEMENTAL REGISTER**

Spiritual Health Plan

SUN MOON STARS, INC. (GEORGIA CORPORATION)
2522 SKYLAND TRAIL
ATLANTA, GA 30319

FOR: EDUCATIONAL SERVICES, NAMELY, CONDUCTING SEMINARS AND WORKSHOPS, BOTH ONLINE AND IN-PERSON IN THE FIELD OF SPIRITUALITY AND HEALING AND DISTRIBUTION OF COURSE MATERIAL IN CONNECTION THEREWITH, IN CLASS 41 (U.S. CLS. 100, 101 AND 107).

FIRST USE 8-15-2004; IN COMMERCE 8-15-2004.

THE MARK CONSISTS OF STANDARD CHARACTERS WITHOUT CLAIM TO ANY PARTICULAR FONT, STYLE, SIZE, OR COLOR.

SER. NO. 77-414,749, FILED P.R. 3-6-2008; AM. S.R. 6-24-2008.

MIDGE BUTLER, EXAMINING ATTORNEY

Int. Cl.: 37

Prior U.S. Cls.: 100, 103, and 106

United States Patent and Trademark Office

Reg. No. 3,486,695

Registered Aug. 12, 2008

**SERVICE MARK
SUPPLEMENTAL REGISTER**

TENNESSEE LAND AND LAKES

TENNESSEE LAND AND LAKES, LLC (TENNESSEE LTD LIAB CO)

SUITE 600

406 UNION AVENUE

KNOXVILLE, TN 37902

FOR: REAL ESTATE DEVELOPMENT, IN CLASS 37 (U.S. CLS. 100, 103 AND 106).

FIRST USE 10-7-2005; IN COMMERCE 2-15-2006.

THE MARK CONSISTS OF STANDARD CHARACTERS WITHOUT CLAIM TO ANY PARTICULAR FONT, STYLE, SIZE, OR COLOR.

NO CLAIM IS MADE TO THE EXCLUSIVE RIGHT TO USE "LAND", APART FROM THE MARK AS SHOWN.

SER. NO. 77-415,456, FILED P.R. 3-6-2008; AM. S.R. 7-8-2008.

JIM RINGLE, EXAMINING ATTORNEY

Int. Cl.: 42

Prior U.S. Cls.: 100 and 101

United States Patent and Trademark Office

Reg. No. 3,486,696

Registered Aug. 12, 2008

**SERVICE MARK
SUPPLEMENTAL REGISTER**

**three-dimensional brand
management**

ROOZEE, WILLIAM (UNITED STATES INDIVIDUAL)
4113 LIBERTY COURT
FLOWER MOUND, TX 75028

FOR: CUSTOM DESIGN OF TRADE SHOW EXHIBITS, INTERIORS OF RETAIL STORES, AND KIOSKS, IN CLASS 42 (U.S. CLS. 100 AND 101).

FIRST USE 12-21-2007; IN COMMERCE 12-21-2007.

THE MARK CONSISTS OF STANDARD CHARACTERS WITHOUT CLAIM TO ANY PARTICULAR FONT, STYLE, SIZE, OR COLOR.

SER. NO. 77-417,082, FILED P.R. 3-9-2008; AM. S.R. 7-3-2008.

LANA PHAM, EXAMINING ATTORNEY

Int. Cl.: 41

Prior U.S. Cls.: 100, 101, and 107

United States Patent and Trademark Office

Reg. No. 3,486,697

Registered Aug. 12, 2008

**SERVICE MARK
SUPPLEMENTAL REGISTER**

QUALIFIED ETHICAL HACKER

SECURITY UNIVERSITY, LLC (CONNECTICUT
LTD LIAB CO)
109 WEED AVE
STAMFORD, CT 06902

FOR: EDUCATIONAL AND TRAINING SERVICES, NAMELY, SEMINARS AND CLASSES RELATING TO COMPUTER SECURITY SYSTEMS, POLICIES AND PROCEDURES AND HOW TO EVALUATE AND SOLVE COMPUTER SECURITY PROBLEMS, IN CLASS 41 (U.S. CLS. 100, 101 AND 107).

FIRST USE 1-1-2008; IN COMMERCE 1-1-2008.

THE MARK CONSISTS OF STANDARD CHARACTERS WITHOUT CLAIM TO ANY PARTICULAR FONT, STYLE, SIZE, OR COLOR.

OWNER OF U.S. REG. NO. 3,388,636.

SER. NO. 77-417,390, FILED P.R. 3-10-2008; AM. S.R. 6-27-2008.

STEPHEN AQUILA, EXAMINING ATTORNEY

Int. Cl.: 41

Prior U.S. Cls.: 100, 101, and 107

United States Patent and Trademark Office

Reg. No. 3,486,698

Registered Aug. 12, 2008

**SERVICE MARK
SUPPLEMENTAL REGISTER**

HAVA PARTNERS

LEGAL COMPLIANCE TRAINING, LLC (MARY-
LAND LTD LIAB CO)
2001 ROOKWOOD ROAD
SILVER SPRING, MD 20910

FOR: ONLINE TRAINING IN ELECTION LAW,
ELECTION MACHINERY AND ELECTION POLL
WORKING, IN CLASS 41 (U.S. CLS. 100, 101 AND
107).

FIRST USE 6-15-2003; IN COMMERCE 6-15-2003.

THE MARK CONSISTS OF STANDARD CHAR-
ACTERS WITHOUT CLAIM TO ANY PARTICULAR
FONT, STYLE, SIZE, OR COLOR.

SER. NO. 77-418,249, FILED P.R. 3-10-2008; AM. S.R.
7-9-2008.

CORY BOONE, EXAMINING ATTORNEY

Int. Cl.: 5

Prior U.S. Cls.: 6, 18, 44, 46, 51, and 52

Reg. No. 3,486,699

United States Patent and Trademark Office

Registered Aug. 12, 2008

TRADEMARK
SUPPLEMENTAL REGISTER

Germ
OFF

A.V.W. INC (FLORIDA CORPORATION), DBA
MAX PROFESSIONAL,
PO BOX 9962
FT LAUDERDALE, FL 33310

FOR: HAND SANITIZER AND DISINFECTING
PREPARATION WITH ANTI-BACTERIAL AND
ANTI-MICROBIAL PROPERTIES; GERMICIDES,
DEODORIZERS, AND SANITIZERS FOR BATH-
ROOMS AND TOILETS; ROOM DEODORIZERS;
PREPARATIONS FOR NEUTRALIZING ODORS
FOR USE ON HOUSEHOLD SURFACES; ALL PUR-
POSE DISINFECTANTS, NAMELY, GENERAL PUR-

POSE DISINFECTING CLEANERS, IN CLASS 5 (U.S.
CLS. 6, 18, 44, 46, 51 AND 52).

FIRST USE 5-18-2006; IN COMMERCE 8-5-2006.

THE MARK CONSISTS OF STANDARD CHAR-
ACTERS WITHOUT CLAIM TO ANY PARTICULAR
FONT, STYLE, SIZE, OR COLOR.

SER. NO. 77-418,465, FILED 3-11-2008.

LINDSEY RUBIN, EXAMINING ATTORNEY

Int. Cls.: 37 and 42

Prior U.S. Cls.: 100, 101, 103, and 106

United States Patent and Trademark Office

Reg. No. 3,486,700

Registered Aug. 12, 2008

**SERVICE MARK
SUPPLEMENTAL REGISTER**

LAPTOPFIX

A-1 BEST COMPUTER, INC. (WASHINGTON CORPORATION)

8057 LAKE CITY WAY

SEATTLE, WA 98115

FOR: COMPUTER HARDWARE INSTALLATION, MAINTENANCE AND REPAIR; UPGRADING COMPUTER HARDWARE, IN CLASS 37 (U.S. CLS. 100, 103 AND 106).

FIRST USE 8-29-2004; IN COMMERCE 11-0-2006.

FOR: COMPUTER SOFTWARE INSTALLATION, MAINTENANCE AND REPAIR, IN CLASS 42 (U.S. CLS. 100 AND 101).

FIRST USE 8-29-2004; IN COMMERCE 11-0-2006.

THE MARK CONSISTS OF STANDARD CHARACTERS WITHOUT CLAIM TO ANY PARTICULAR FONT, STYLE, SIZE, OR COLOR.

SER. NO. 77-420,949, FILED 3-13-2008.

KEVIN CORWIN, EXAMINING ATTORNEY

Int. Cl.: 35

Prior U.S. Cls.: 100, 101, and 102

United States Patent and Trademark Office

Reg. No. 3,486,701

Registered Aug. 12, 2008

**SERVICE MARK
SUPPLEMENTAL REGISTER**

LAPTOPFIX

A-1 BEST COMPUTER, INC. (WASHINGTON
CORPORATION)
8057 LAKE CITY WAY
SEATTLE, WA 98115

FOR: RETAIL STORE SERVICES AND ONLINE
RETAIL STORE SERVICES IN THE FIELD OF
COMPUTERS, COMPUTER PRODUCTS AND COM-
PUTER ACCESSORIES, IN CLASS 35 (U.S. CLS. 100,
101 AND 102).

FIRST USE 8-29-2004; IN COMMERCE 11-0-2006.

THE MARK CONSISTS OF STANDARD CHAR-
ACTERS WITHOUT CLAIM TO ANY PARTICULAR
FONT, STYLE, SIZE, OR COLOR.

SER. NO. 77-421,032, FILED 3-13-2008.

KEVIN CORWIN, EXAMINING ATTORNEY

Int. Cl.: 34

Prior U.S. Cls.: 2, 8, 9, and 17

United States Patent and Trademark Office

Reg. No. 3,486,702

Registered Aug. 12, 2008

**TRADEMARK
SUPPLEMENTAL REGISTER**

MONOCACY

DAVIDUS CIGARS, LTD. (MARYLAND CORPORATION)
4800 GREEN VALLEY ROAD
MONROVIA, MD 21770

FOR: TOBACCO PRODUCTS, NAMELY, CIGARS, CIGARILLOS, CIGARETTES, PIPE TOBACCO, SMOKING TOBACCO, SMOKELESS TOBACCO, AND CHEWING TOBACCO; SMOKING AND TOBACCO RELATED ACCESSORIES, NAMELY, TOBACCO PIPES, SMOKING PIPES, PIPE CLEANERS, CIGAR CUTTERS, NON-ELECTRIC CIGAR LIGHTERS, CIGARETTE LIGHTERS, CIGAR CASES, CIGARETTE CASES, CIGAR BOXES, CIGARETTE BOXES, HUMIDORS, CIGAR HUMIDIFIERS, PIPE

TAMPERS, ASHTRAYS, CIGAR HOLDERS, AND CIGARETTE HOLDERS; AND MATCHES, IN CLASS 34 (U.S. CLS. 2, 8, 9 AND 17).

FIRST USE 11-1-1996; IN COMMERCE 11-1-1996.

THE MARK CONSISTS OF STANDARD CHARACTERS WITHOUT CLAIM TO ANY PARTICULAR FONT, STYLE, SIZE, OR COLOR.

SER. NO. 77-421,806, FILED 3-14-2008.

JOHN DWYER, EXAMINING ATTORNEY

Int. Cl.: 34

Prior U.S. Cls.: 2, 8, 9, and 17

United States Patent and Trademark Office

Reg. No. 3,486,703

Registered Aug. 12, 2008

**TRADEMARK
SUPPLEMENTAL REGISTER**

ANTIETAM

DAVIDUS CIGARS, LTD. (MARYLAND CORPORATION)
4800 GREEN VALLEY ROAD
MONROVIA, MD 21770

THE MARK CONSISTS OF STANDARD CHARACTERS WITHOUT CLAIM TO ANY PARTICULAR FONT, STYLE, SIZE, OR COLOR.

FOR: CIGARS, IN CLASS 34 (U.S. CLS. 2, 8, 9 AND 17).

SER. NO. 77-423,174, FILED 3-16-2008.

FIRST USE 11-1-1996; IN COMMERCE 11-1-1996.

JOHN DWYER, EXAMINING ATTORNEY

Int. Cl.: 16

Prior U.S. Cls.: 2, 5, 22, 23, 29, 37, 38, and 50

United States Patent and Trademark Office

Reg. No. 3,486,704

Registered Aug. 12, 2008

**TRADEMARK
SUPPLEMENTAL REGISTER**

CALL MOM

AACH, BEVERLY WADE (UNITED STATES IN-
DIVIDUAL)
8146 INDIGO RIDGE TERRACE
UNIVERSITY PLACE, FL 34201

FOR: BOOKMARKS, IN CLASS 16 (U.S. CLS. 2, 5,
22, 23, 29, 37, 38 AND 50).

FIRST USE 9-20-2006; IN COMMERCE 9-20-2006.

THE MARK CONSISTS OF STANDARD CHAR-
ACTERS WITHOUT CLAIM TO ANY PARTICULAR
FONT, STYLE, SIZE, OR COLOR.

SER. NO. 77-424,694, FILED P.R. 3-18-2008; AM. S.R.
7-3-2008.

STEVEN R. FOSTER, EXAMINING ATTORNEY

Int. Cls.: 35 and 45

Prior U.S. Cls.: 100, 101, and 102

United States Patent and Trademark Office

Reg. No. 3,486,705

Registered Aug. 12, 2008

**SERVICE MARK
SUPPLEMENTAL REGISTER**

**NETWORK OF LAWYERS
MATCHING YOU WITH THE
RIGHT LAWYER**

LENFEST MEDIA GROUP, LLC (DELAWARE
LTD LIAB CO)

300 BARR HARBOR DRIVE, SUITE 705

WEST CONSHOHOCKEN, PA 19428

FOR: ATTORNEY REFERRAL SERVICES; AD-
VERTISING AND PROMOTING THE LEGAL SER-
VICES OF OTHERS, IN CLASS 35 (U.S. CLS. 100, 101
AND 102).

FIRST USE 10-31-2007; IN COMMERCE 10-31-2007.

FOR: PROVIDING NEWS AND INFORMATION
IN THE LEGAL FIELD VIA A GLOBAL COMPUTER
NETWORK, IN CLASS 45 (U.S. CLS. 100 AND 101).

FIRST USE 10-31-2007; IN COMMERCE 10-31-2007.

THE MARK CONSISTS OF STANDARD CHAR-
ACTERS WITHOUT CLAIM TO ANY PARTICULAR
FONT, STYLE, SIZE, OR COLOR.

SER. NO. 77-429,278, FILED 3-24-2008.

BENJAMIN ALLEN, EXAMINING ATTORNEY

Int. Cls.: 35 and 45

Prior U.S. Cls.: 100, 101, and 102

United States Patent and Trademark Office

Reg. No. 3,486,706

Registered Aug. 12, 2008

**SERVICE MARK
SUPPLEMENTAL REGISTER**

NETWORK OF LAWYERS

LENFEST MEDIA GROUP, LLC (DELAWARE
LTD LIAB CO)

300 BARR HARBOR DRIVE, SUITE 705

WEST CONSHOHOCKEN, PA 19428

FOR: ATTORNEY REFERRAL SERVICES; AD-
VERTISING AND PROMOTING THE LEGAL SER-
VICES OF OTHERS, IN CLASS 35 (U.S. CLS. 100, 101
AND 102).

FIRST USE 10-31-2007; IN COMMERCE 10-31-2007.

FOR: PROVIDING NEWS AND INFORMATION
IN THE LEGAL FIELD VIA A GLOBAL COMPUTER
NETWORK, IN CLASS 45 (U.S. CLS. 100 AND 101).

FIRST USE 10-31-2007; IN COMMERCE 10-31-2007.

THE MARK CONSISTS OF STANDARD CHAR-
ACTERS WITHOUT CLAIM TO ANY PARTICULAR
FONT, STYLE, SIZE, OR COLOR.

SER. NO. 77-429,282, FILED 3-24-2008.

BENJAMIN ALLEN, EXAMINING ATTORNEY

Int. Cls.: 35 and 45

Prior U.S. Cls.: 100, 101, and 102

United States Patent and Trademark Office

Reg. No. 3,486,707

Registered Aug. 12, 2008

**SERVICE MARK
SUPPLEMENTAL REGISTER**

**MATCHING YOU WITH THE
RIGHT LAWYER**

LENFEST MEDIA GROUP, LLC (DELAWARE
LTD LIAB CO)

300 BARR HARBOR DRIVE, SUITE 705

WEST CONSHOHOCKEN, PA 19428

FOR: ATTORNEY REFERRAL SERVICES; AD-
VERTISING AND PROMOTING THE LEGAL SER-
VICES OF OTHERS, IN CLASS 35 (U.S. CLS. 100, 101
AND 102).

FIRST USE 10-31-2007; IN COMMERCE 10-31-2007.

FOR: PROVIDING NEWS AND INFORMATION
IN THE LEGAL FIELD VIA A GLOBAL COMPUTER
NETWORK, IN CLASS 45 (U.S. CLS. 100 AND 101).

FIRST USE 10-31-2007; IN COMMERCE 10-31-2007.

THE MARK CONSISTS OF STANDARD CHAR-
ACTERS WITHOUT CLAIM TO ANY PARTICULAR
FONT, STYLE, SIZE, OR COLOR.

SER. NO. 77-429,284, FILED 3-24-2008.

BENJAMIN ALLEN, EXAMINING ATTORNEY

Int. Cl.: 41

Prior U.S. Cls.: 100, 101, and 107

United States Patent and Trademark Office

Reg. No. 3,486,708

Registered Aug. 12, 2008

**SERVICE MARK
SUPPLEMENTAL REGISTER**

WE TRACK STORMS

RAYCOM MEDIA, INC. (DELAWARE CORPORATION)
201 MONROE STREET, 20TH FLOOR
MONTGOMERY, AL 36104

FOR: ENTERTAINMENT SERVICES IN THE NATURE OF ON-GOING TELEVISION PROGRAMS IN THE FIELD OF WEATHER AND WEATHER REPORTING, IN CLASS 41 (U.S. CLS. 100, 101 AND 107).

FIRST USE 4-20-2005; IN COMMERCE 4-20-2005.

THE MARK CONSISTS OF STANDARD CHARACTERS WITHOUT CLAIM TO ANY PARTICULAR FONT, STYLE, SIZE, OR COLOR.

SER. NO. 77-429,633, FILED P.R. 3-24-2008; AM. S.R. 6-30-2008.

EMILY CHUO, EXAMINING ATTORNEY

Int. Cls.: 41 and 42

Prior U.S. Cls.: 100, 101, and 107

United States Patent and Trademark Office

Reg. No. 3,486,709

Registered Aug. 12, 2008

**SERVICE MARK
SUPPLEMENTAL REGISTER**

High Assurance Platform

NATIONAL SECURITY AGENCY (UNITED STATES AGENCY OF THE UNITED STATES GOVERNMENT)

ATTN: AGC IP&T, SUITE 6542
9800 SAVAGE ROAD
FT. MEADE, MD 207556542

FOR: ARRANGING OF SEMINARS, IN CLASS 41 (U.S. CLS. 100, 101 AND 107).

FIRST USE 9-4-2007; IN COMMERCE 3-27-2008.

FOR: DEVELOPMENT OF VOLUNTARY STANDARDS FOR HIGH ASSURANCE COMPUTERS, IN CLASS 42 (U.S. CLS. 100 AND 101).

FIRST USE 9-4-2007; IN COMMERCE 3-27-2008.

THE MARK CONSISTS OF STANDARD CHARACTERS WITHOUT CLAIM TO ANY PARTICULAR FONT, STYLE, SIZE, OR COLOR.

SER. NO. 77-432,827, FILED P.R. 3-27-2008; AM. S.R. 7-7-2008.

KAREN K. BUSH, EXAMINING ATTORNEY

Int. Cl.: 41

Prior U.S. Cls.: 100, 101, and 107

United States Patent and Trademark Office

Reg. No. 3,486,710

Registered Aug. 12, 2008

**SERVICE MARK
SUPPLEMENTAL REGISTER**



PIETRARIU, ADRIAN (UNITED STATES INDIVIDUAL)
1049 FOOTHILL BLVD.
LA CANADA, CA 91011

FOR: OUTDOOR PHYSICAL FITNESS INSTRUCTION AND PHYSICAL FITNESS CONDITIONING CLASSES, IN CLASS 41 (U.S. CLS. 100, 101 AND 107).

FIRST USE 7-11-2005; IN COMMERCE 7-11-2005.

THE MARK CONSISTS OF A BOX WITH THE TEXT "WEST COAST BOOT CAMP" INSIDE. FONT RESEMBLES A STAMP (I.E. A STAMP OF APPROVAL).

SER. NO. 77-437,374, FILED P.R. 4-1-2008; AM. S.R. 7-9-2008.

JANICE KIM, EXAMINING ATTORNEY

Int. Cl.: 9

Prior U.S. Cls.: 21, 23, 26, 36, and 38

United States Patent and Trademark Office

Reg. No. 3,486,711

Registered Aug. 12, 2008

**TRADEMARK
SUPPLEMENTAL REGISTER**

CHARTACCESS

CHART ACCESS, INC. (TEXAS CORPORATION)
SUITE 300
1010 LAMAR ST.
HOUSTON, TX 77002

FIRST USE 9-14-2007; IN COMMERCE 9-14-2007.

THE MARK CONSISTS OF STANDARD CHARACTERS WITHOUT CLAIM TO ANY PARTICULAR FONT, STYLE, SIZE, OR COLOR.

FOR: COMPUTER SOFTWARE FOR RECORD STORAGE AND RETRIEVAL; MULTIMEDIA SOFTWARE RECORDED ON CD-ROMS FEATURING DIGITAL IMAGES OF MEDICAL RECORDS, IN CLASS 9 (U.S. CLS. 21, 23, 26, 36 AND 38).

SER. NO. 77-975,667, FILED P.R. 6-22-2007; AM. S.R. 4-2-2008.

LAURA HAMMEL, EXAMINING ATTORNEY

Int. Cl.: 5

Prior U.S. Cls.: 6, 18, 44, 46, 51, and 52

United States Patent and Trademark Office

Reg. No. 3,486,712

Registered Aug. 12, 2008

**TRADEMARK
SUPPLEMENTAL REGISTER**

LUNG RX

LUNG RX, INC. (DELAWARE CORPORATION)
1077 HIGHWAY A1A
SATELLITE BEACH, FL 32937

NO CLAIM IS MADE TO THE EXCLUSIVE
RIGHT TO USE "RX", APART FROM THE MARK
AS SHOWN.

FOR: PHARMACEUTICAL PREPARATIONS FOR
CARDIOVASCULAR CONDITIONS, IN CLASS 5
(U.S. CLS. 6, 18, 44, 46, 51 AND 52).

SER. NO. 78-306,650, FILED P.R. 9-29-2003; AM. S.R.
2-9-2007.

FIRST USE 4-1-2004; IN COMMERCE 6-1-2004.

DAWN FELDMAN, EXAMINING ATTORNEY

Int. Cl.: 41

Prior U.S. Cls.: 100, 101, and 107

United States Patent and Trademark Office

Reg. No. 3,486,713

Registered Aug. 12, 2008

**SERVICE MARK
SUPPLEMENTAL REGISTER**

MIDWEST NATIONALS

NATIONAL HOT ROD ASSOCIATION (CALIFORNIA CORPORATION)

2035 FINANCIAL WAY

GLENDORA, CA 91741

FOR: ENTERTAINMENT SERVICES, NAMELY, THE PRODUCTION, SANCTIONING AND STAGING OF AUTOMOBILE RACES, EVENTS AND PROGRAMS, IN CLASS 41 (U.S. CLS. 100, 101 AND 107).

FIRST USE 6-30-2006; IN COMMERCE 6-30-2006.

THE MARK CONSISTS OF STANDARD CHARACTERS WITHOUT CLAIM TO ANY PARTICULAR FONT, STYLE, SIZE, OR COLOR.

OWNER OF U.S. REG. NOS. 1,293,349, 1,607,725, AND OTHERS.

NO CLAIM IS MADE TO THE EXCLUSIVE RIGHT TO USE "NATIONALS", APART FROM THE MARK AS SHOWN.

SER. NO. 78-789,366, FILED 1-11-2006.

BRIAN PINO, EXAMINING ATTORNEY

Int. Cl.: 44

Prior U.S. Cls.: 100 and 101

United States Patent and Trademark Office

Reg. No. 3,486,714

Registered Aug. 12, 2008

**SERVICE MARK
SUPPLEMENTAL REGISTER**

CELLOLOGY

DAVID HALL'S CENTER FOR CELLULAR
HEALTH, LLC (NEVADA LTD LIAB CO)
SUITE 27
2225 N. UNIVERSITY PARKWAY
PROVO, UT 84604

FOR: CUSTOMIZED WELLNESS PROGRAMS DI-
RECTING ACTIVITIES, DIET, BEHAVIOR, EXER-
CISE, AND LIFESTYLE CHANGES, IN CLASS 44
(U.S. CLS. 100 AND 101).

FIRST USE 5-19-2006; IN COMMERCE 5-19-2006.

THE MARK CONSISTS OF STANDARD CHAR-
ACTERS WITHOUT CLAIM TO ANY PARTICULAR
FONT, STYLE, SIZE, OR COLOR.

SER. NO. 78-888,054, FILED P.R. 5-19-2006; AM. S.R.
6-19-2008.

SANI KHOURI, EXAMINING ATTORNEY

Int. Cl.: 5

Prior U.S. Cls.: 6, 18, 44, 46, 51, and 52

United States Patent and Trademark Office

Reg. No. 3,486,715

Registered Aug. 12, 2008

**TRADEMARK
SUPPLEMENTAL REGISTER**

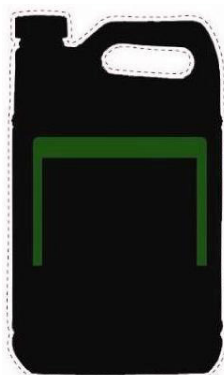

CENTRAL GARDEN & PET COMPANY (DELA-
WARE CORPORATION)

1340 TREAT BOULEVARD, SUITE 600

WALNUT CREEK, CA 94597

FOR: HERBICIDES, IN CLASS 5 (U.S. CLS. 6, 18, 44,
46, 51 AND 52).

FIRST USE 1-30-1986; IN COMMERCE 1-30-1986.

THE COLOR(S) BLACK AND GREEN IS/ARE
CLAIMED AS A FEATURE OF THE MARK.

THE MARK CONSISTS OF THE SHAPE, COLOR
AND LABEL OF A BLACK BOTTLE WITH TWO
GREEN VERTICAL LINES WHICH ARE PARALLEL
TO EACH OTHER AND ARE CONNECTED AT THE
TOP BY A HORIZONTAL GREEN LINE. THE
SHAPE OF THE BOTTLE INCLUDES A ROUND-
CORNERED RECTANGULAR HANDLE IN THE
UPPER RIGHT HAND CORNER AND A CAP IN
THE UPPER LEFT HAND CORNER. THE BOTTLE
IS THE PACKAGING FOR THE OWNER'S GOODS.

SER. NO. 78-892,024, FILED P.R. 5-24-2006; AM. S.R.
12-11-2007.

ROBERT C. CLARK JR., EXAMINING ATTORNEY

Int. Cl.: 16

Prior U.S. Cls.: 2, 5, 22, 23, 29, 37, 38, and 50

Reg. No. 3,486,716

United States Patent and Trademark Office

Registered Aug. 12, 2008

**TRADEMARK
SUPPLEMENTAL REGISTER**

BENTLEY

PRIVATE LABEL SALES & MARKETING GROUP
INC (NEW YORK CORPORATION)
PO BOX 234409
GREAT NECK, NY 11023

THE MARK CONSISTS OF STANDARD CHAR-
ACTERS WITHOUT CLAIM TO ANY PARTICULAR
FONT, STYLE, SIZE, OR COLOR.

FOR: CONSUMER AND INDUSTRIAL PAPER
PRODUCTS, NAMELY, FACIAL TISSUES, PAPER
TOWELS AND BATHROOM TISSUES, IN CLASS 16
(U.S. CLS. 2, 5, 22, 23, 29, 37, 38 AND 50).

SER. NO. 78-903,071, FILED P.R. 6-7-2006; AM. S.R.
11-28-2007.

FIRST USE 11-1-2007; IN COMMERCE 11-1-2007.

KATHERINE CONNOLLY, EXAMINING ATTOR-
NEY

Int. Cl.: 14

Prior U.S. Cls.: 2, 27, 28, and 50

United States Patent and Trademark Office

Reg. No. 3,486,717

Registered Aug. 12, 2008

**TRADEMARK
SUPPLEMENTAL REGISTER**

ENDS

ENDS PARTNERS, LLC (NEW YORK LTD LIAB
CO)
1180 AVENUE OF THE AMERICAS, STE. 1802
NEW YORK, NY 10036

FOR: REMOVABLE COVERS MADE OF PRE-
CIOUS METALS AND STONES THAT CAN BE
APPLIED TO THE TIP OF A LACE AS A FASHION
ACCESSORY; REMOVABLE COVERS MADE OF
PRECIOUS METALS AND STONES TO BE APPLIED
TO THE TIP OF A LACE OF A SHOE, JACKET,
SWEATER, SWEAT PANTS, PANTS, SHORTS,
BATHING TRUNKS/SUITS, AND ANY FASHION
ACCESSORY THAT HAS A LACE OR CORDING;
REMOVABLE COVERS MADE OF PRECIOUS ME-
TALS AND STONES TO BE APPLIED TO THE TIP

OF A LACE, WHICH LACE CAN THEN BE WORN
AS A NECKLACE, BELT, BRACELET, EARRING,
OR CAN ADORN HANDBAGS, DRESSES, PANTS,
SHIRTS AND ALL FORMS OF FASHION ACCES-
SORIES, IN CLASS 14 (U.S. CLS. 2, 27, 28 AND 50).

FIRST USE 10-31-2007; IN COMMERCE 10-31-2007.

THE MARK CONSISTS OF STANDARD CHAR-
ACTERS WITHOUT CLAIM TO ANY PARTICULAR
FONT, STYLE, SIZE, OR COLOR.

SER. NO. 78-937,692, FILED P.R. 7-26-2006; AM. S.R.
7-7-2008.

ANGELA M. MICHELI, EXAMINING ATTORNEY

Int. Cl.: 9

Prior U.S. Cls.: 21, 23, 26, 36, and 38

United States Patent and Trademark Office

Reg. No. 3,486,718

Registered Aug. 12, 2008

**TRADEMARK
SUPPLEMENTAL REGISTER**

BlinkerPaddle

TRAFFIC & PARKING CONTROL CO., INC.
(WISCONSIN CORPORATION)
800 WALL STREET
ELM GROVE, WI 53122

FOR: HAND-HELD ROAD SIGN THAT CONTAINS LIGHT EMITTING DIODE DISPLAYS; LIGHT EMITTING DIODE DISPLAYS; LUMINOUS OR MECHANICAL ROAD SIGNS; LUMINOUS SIGNS, IN CLASS 9 (U.S. CLS. 21, 23, 26, 36 AND 38).

FIRST USE 2-1-2001; IN COMMERCE 2-1-2001.

THE MARK CONSISTS OF STANDARD CHARACTERS WITHOUT CLAIM TO ANY PARTICULAR FONT, STYLE, SIZE, OR COLOR.

SER. NO. 78-959,178, FILED P.R. 8-24-2006; AM. S.R. 5-7-2008.

SUSAN RICHARDS, EXAMINING ATTORNEY

Int. Cl.: 3

Prior U.S. Cls.: 1, 4, 6, 50, 51, and 52

United States Patent and Trademark Office

Reg. No. 3,486,719

Registered Aug. 12, 2008

**TRADEMARK
SUPPLEMENTAL REGISTER**

Anti Bac 

KATE SOMERVILLE SKIN CARE, LLC (CON-
NECTICUT LTD LIAB CO)
8428 MELROSE PLACE, SUITES E&F
LOS ANGELES, CA 90069

FIRST USE 6-11-2007; IN COMMERCE 6-11-2007.

SER. NO. 78-967,367, FILED P.R. 9-5-2006; AM. S.R.
5-19-2008.

FOR: SKIN PREPARATIONS, NAMELY, CLEAR-
ING LOTIONS, IN CLASS 3 (U.S. CLS. 1, 4, 6, 50, 51
AND 52).

KAREN K. BUSH, EXAMINING ATTORNEY