

**Int. Cls.: 28 and 35**

**Prior U.S. Cls.: 22, 23, 38, 50, 100, 101 and 102**

**United States Patent and Trademark Office**

**Reg. No. 3,451,670**

**Registered June 24, 2008**

**TRADEMARK  
SERVICE MARK  
PRINCIPAL REGISTER**

**BEANIES**

TY, INC. (DELAWARE CORPORATION)  
807 BLACKHAWK  
WESTMONT, IL 60559

FIRST USE 9-0-1998; IN COMMERCE 9-0-1998.

FOR: PLUSH TOYS, IN CLASS 28 (U.S. CLS. 22, 23,  
38 AND 50).

OWNER OF U.S. REG. NOS. 2,250,152 AND  
2,255,891.

FIRST USE 9-0-1998; IN COMMERCE 9-0-1998.

SER. NO. 75-316,377, FILED 6-27-1997.

FOR: WHOLESALE ONLINE STORE SERVICES  
FEATURING PLUSH TOYS, IN CLASS 35 (U.S. CLS.  
100, 101 AND 102).

ANN E. SAPPENFIELD, EXAMINING ATTORNEY

**Int. Cls.: 5 and 30**

**Prior U.S. Cls.: 6, 18, 44, 46, 51 and 52**

**United States Patent and Trademark Office**

**Reg. No. 3,451,671**

**Registered June 24, 2008**

**TRADEMARK  
PRINCIPAL REGISTER**

**EVER WHITE**

GOULET, MARIE-KATERI (CANADA INDIVIDUAL)  
1260 CRESCENT STREET, SUITE 206  
MONTREAL, QUEBEC, CANADA H3G 2A9

FOR: MEDICATED CHEWING GUM, IN CLASS 5  
(U.S. CLS. 6, 18, 44, 46, 51 AND 52).

FOR: CONFECTIONERY, NAMELY, CHEWING  
GUM WITH AND WITHOUT SUGARS, IN CLASS 30  
(U.S. CL. 46).

PRIORITY CLAIMED UNDER SEC. 44(D) ON  
CANADA APPLICATION NO. 1007107, FILED 3-2-  
1999, REG. NO. TMA705029, DATED 1-18-2008, EX-  
PIRES 1-18-2023.

SER. NO. 75-659,346, FILED 3-16-1999.

KRISTIN DAHLING, EXAMINING ATTORNEY



Int. Cl.: 33

Prior U.S. Cls.: 47 and 49

United States Patent and Trademark Office

Reg. No. 3,451,672

Registered June 24, 2008

TRADEMARK  
PRINCIPAL REGISTER



GRIGORY IMPORTS, INC (OHIO CORPORATION)  
1221 WILMINGTON AVE.  
DAYTON, OH 45420

FOR: VODKA, IN CLASS 33 (U.S. CLS. 47 AND 49).

FIRST USE 6-1-2000; IN COMMERCE 6-1-2000.

NO CLAIM IS MADE TO THE EXCLUSIVE RIGHT TO USE "IMPORTED" AND "RUSSIAN VODKA", APART FROM THE MARK AS SHOWN.

THE MARK CONSISTS OF A FIELD IN WHICH IS SET A CLEAR WINDOW-LIKE FRAME. DIRECTLY BELOW THE FRAME ARE THE WORDS "MAD MONK", AND BELOW THAT, IN SMALLER TYPE,

ARE THE WORDS "RUSSIAN VODKA." THE WORD "IMPORTED" IS PRINTED TWICE ALONG THE TOP EDGES OF THE FRAME. A LARGE ROUND CIRCLE, IN WHICH THE LETTERS "GR" APPEAR, IS POSITIONED AT THE TOP OF THE FIELD. THROUGH THE WINDOW-LIKE FRAME, A STYLIZED ILLUSTRATION OF A MAN HOLDING A LIT CANDLE AND GOBLET CAN BE SEEN. THE DOTTED LINE IN THE DRAWING SHOWS THE OUTLINE OF THE CONTAINER TO WHICH THE MARK IS AFFIXED.

SER. NO. 75-897,278, FILED 1-18-2000.

DARRYL SPRUILL, EXAMINING ATTORNEY

**Int. Cl.: 35**

**Prior U.S. Cls.: 100, 101 and 102**

**United States Patent and Trademark Office**

**Reg. No. 3,451,673**

**Registered June 24, 2008**

**SERVICE MARK  
PRINCIPAL REGISTER**

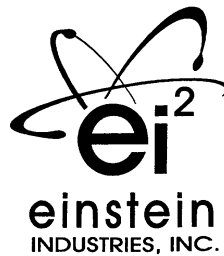

EINSTEIN MEDICAL, INC. (CALIFORNIA CORPORATION)  
5699 LA JOLLA BLVD.  
LA JOLLA, CA 92037

NO CLAIM IS MADE TO THE EXCLUSIVE RIGHT TO USE "INDUSTRIES, INC.", APART FROM THE MARK AS SHOWN.

FOR: BUSINESS MARKETING AND CONSULTING SERVICES PROVIDED OVER THE GLOBAL ON-LINE NETWORK, IN CLASS 35 (U.S. CLS. 100, 101 AND 102).

SER. NO. 76-041,565, FILED 5-5-2000.

FIRST USE 5-1-2000; IN COMMERCE 5-1-2000.

JENNIFER DIXON, EXAMINING ATTORNEY

**Int. Cl.: 11**

**Prior U.S. Cls.: 13, 21, 23, 31 and 34**

**United States Patent and Trademark Office**

**Reg. No. 3,451,674**

**Registered June 24, 2008**

**TRADEMARK  
PRINCIPAL REGISTER**

**PAGODA**

THE BRINKMANN CORPORATION (TEXAS  
CORPORATION)  
4215 MCEWEN ROAD  
DALLAS, TX 75244

FIRST USE 2-17-1998; IN COMMERCE 2-17-1998.

SER. NO. 76-265,187, FILED 5-29-2001.

FOR: ELECTRIC OUTDOOR LIGHTS, IN CLASS  
11 (U.S. CLS. 13, 21, 23, 31 AND 34).

RICHARD A. STRASER, EXAMINING ATTORNEY

**Int. Cl.: 41**

**Prior U.S. Cls.: 100, 101 and 107**

**United States Patent and Trademark Office**

**Reg. No. 3,451,675**

**Registered June 24, 2008**

**SERVICE MARK  
PRINCIPAL REGISTER**

**MOBICOM**

ASSOCIATION FOR COMPUTING MACHINERY,  
INC., THE (DELAWARE CORPORATION)  
1515 BROADWAY  
NEW YORK, NY 10036

MOBILE COMPUTING NETWORKS , IN CLASS 41  
(U.S. CLS. 100, 101 AND 107).

FIRST USE 9-26-1997; IN COMMERCE 9-26-1997.

FOR: EDUCATIONAL SERVICES IN THE NAT-  
URE OF A WORKSHOP IN THE FIELD OF CELLU-  
LAR SYSTEMS, WIRELESS CONNECTIVITY AND

SER. NO. 76-283,916, FILED 7-12-2001.

GINA FINK, EXAMINING ATTORNEY

**Int. Cls.: 9, 37 and 45**

**Prior U.S. Cls.: 21, 23, 26, 36, 38, 100, 101, 103 and 106**

**United States Patent and Trademark Office**

**Reg. No. 3,451,676**

**Registered June 24, 2008**

**TRADEMARK  
SERVICE MARK  
PRINCIPAL REGISTER**

**CHUBB SECURITY SERVICES**

CHUBB INTERNATIONAL HOLDINGS LIMITED  
(UNITED KINGDOM CORPORATION)  
PENTAGON HOUSE  
SIR FRANK WHITTLE ROAD  
DERBY, UNITED KINGDOM DE21 4XA

FOR: ELECTRONIC SECURITY PRODUCTS, NAMELY INTRUSION ALARM EQUIPMENT, INTRUSION AND FIRE MONITORING EQUIPMENT, INTRUDER DETECTION DEVICES, ACCESS CONTROL READERS AND SYSTEMS, CLOSED CIRCUIT VIDEO EQUIPMENT, ASSET AND VEHICLE TRACKING EQUIPMENT, PERSONAL PANIC AND LIFE SAFETY MONITORING EQUIPMENT AND COMPUTERS AND COMPUTER SOFTWARE TO MONITOR, CONTROL AND MANAGE ELECTRONIC SECURITY PRODUCTS, IN CLASS 9 (U.S. CLS. 21, 23, 26, 36 AND 38).

FOR: INSTALLATION OF ELECTRONIC SECURITY PRODUCTS, IN CLASS 37 (U.S. CLS. 100, 103 AND 106).

FOR: EMERGENCY RESPONSE AND MONITORING, SERVICING AND INSPECTION OF ELECTRONIC SECURITY PRODUCTS, AND SECURITY CONSULTATION, IN CLASS 45 (U.S. CLS. 100 AND 101).

PRIORITY CLAIMED UNDER SEC. 44(D) ON CANADA APPLICATION NO. 1119386, FILED 10-24-2001, REG. NO. TMA602,916, DATED 2-23-2004, EXPIRES 2-23-2019.

NO CLAIM IS MADE TO THE EXCLUSIVE RIGHT TO USE "SECURITY SERVICES", APART FROM THE MARK AS SHOWN.

SER. NO. 76-333,304, FILED 11-2-2001.

MICHAEL ENGEL, EXAMINING ATTORNEY

**Int. Cl.: 33**

**Prior U.S. Cls.: 47 and 49**

**United States Patent and Trademark Office**

**Reg. No. 3,451,677**

**Registered June 24, 2008**

**TRADEMARK  
PRINCIPAL REGISTER**

**SEVEN FLAGS**

P.C. KELDERS (PTY) LIMITED (SOUTH AFRICA  
CORPORATION)  
DE RUST ESTATE  
GRABOUW, 7160, SOUTH AFRICA

FOR: ALCOHOLIC BEVERAGES, NAMELY  
WINE; PREPARED WINE COCKTAILS, WINE  
COOLERS, WINE PUNCHES; SPIRITS DISTILLED  
FROM GRAPES AND LIQUEURS, IN CLASS 33 (U.S.  
CLS. 47 AND 49).

PRIORITY CLAIMED UNDER SEC. 44(D) ON  
SOUTH AFRICA APPLICATION NO. 2001/21332,  
FILED 12-14-2001, REG. NO. 2001/21332, DATED 12-  
14-2001, EXPIRES 12-14-2011.

SER. NO. 76-411,303, FILED 5-21-2002.

MARK T. MULLEN, EXAMINING ATTORNEY

**Int. Cl.: 3**

**Prior U.S. Cls.: 1, 4, 6, 50, 51 and 52**

**United States Patent and Trademark Office**

**Reg. No. 3,451,678**

**Registered June 24, 2008**

---

**TRADEMARK  
PRINCIPAL REGISTER**

**GLAM BRONZE**

L'OREAL (FRANCE SOCIETE ANONYME)  
14 RUE ROYALE  
PARIS, FRANCE

FOR: FOUNDATION MAKEUP, IN CLASS 3 (U.S.  
CLS. 1, 4, 6, 50, 51 AND 52).

PRIORITY CLAIMED UNDER SEC. 44(D) ON  
FRANCE APPLICATION NO. 02/3.165.226, FILED 5-

22-2002, REG. NO. 02/3.165.226, DATED 5-22-2002,  
EXPIRES 5-22-2012.

NO CLAIM IS MADE TO THE EXCLUSIVE  
RIGHT TO USE "BRONZE", APART FROM THE  
MARK AS SHOWN.

SER. NO. 76-415,765, FILED 6-4-2002.

CHRIS WELLS, EXAMINING ATTORNEY

**Int. Cl.: 3**

**Prior U.S. Cls.: 1, 4, 6, 50, 51 and 52**

**United States Patent and Trademark Office**

**Reg. No. 3,451,679**

**Registered June 24, 2008**

**TRADEMARK  
PRINCIPAL REGISTER**

**GLAM SHINE**

L'OREAL (FRANCE SOCIETE ANONYME)  
14, RUE ROYALE  
PARIS, FRANCE

FOR: LIPSTICKS, IN CLASS 3 (U.S. CLS. 1, 4, 6, 50,  
51 AND 52).

PRIORITY CLAIMED UNDER SEC. 44(D) ON  
FRANCE APPLICATION NO. 02/3.165.225, FILED 5-

22-2002, REG. NO. 02/3.165.225, DATED 5-22-2002,  
EXPIRES 5-22-2012.

NO CLAIM IS MADE TO THE EXCLUSIVE  
RIGHT TO USE "SHINE", APART FROM THE  
MARK AS SHOWN.

SER. NO. 76-415,767, FILED 6-4-2002.

CHRIS WELLS, EXAMINING ATTORNEY



**Int. Cl.: 7**

**Prior U.S. Cls.: 13, 19, 21, 23, 31, 34 and 35**

**United States Patent and Trademark Office**

**Reg. No. 3,451,680**

**Registered June 24, 2008**

**TRADEMARK  
PRINCIPAL REGISTER**

**PROCENTRIX**

GLADU TOOLS, G.P. (CANADA GENERAL  
PARTNERSHIP)  
2115 SAINT-CESAIRE STREET  
MARIEVILLE QC, CANADA J3M 1E5

PRIORITY CLAIMED UNDER SEC. 44(D) ON  
CANADA APPLICATION NO. 1142355, FILED 5-30-  
2002, REG. NO. TMA643147, DATED 6-28-2005, EX-  
PIRES 6-28-2015.

FOR: POWER-OPERATED MACHINE TOOLING  
PARTS, NAMELY, A CLAMPING AND POSITION-  
ING SYSTEM FOR USE WITH INSERT TOOLING  
COMPRISED OF CUTTING INSERT HOLDERS,  
METAL ABUTMENTS USED FOR HOLDING IN-  
SERT KNIVES ON THE CUTTERHEAD, IN CLASS 7  
(U.S. CLS. 13, 19, 21, 23, 31, 34 AND 35).

SER. NO. 76-424,370, FILED 6-21-2002.

HELEN BRYAN, EXAMINING ATTORNEY

**Int. Cl.: 12**

**Prior U.S. Cls.: 19, 21, 23, 31, 35 and 44**

**United States Patent and Trademark Office**

**Reg. No. 3,451,681**

**Registered June 24, 2008**

---

**TRADEMARK  
PRINCIPAL REGISTER**

**LEGEND BOATS**

LEGEND BOATS, LP (TEXAS PARTNERSHIP)  
107 FM 3059  
STREETMAN, TX 75859

FOR: FIBERGLASS RECREATIONAL POWER  
BOATS WHICH ARE LONGER THAN 18 FEET  
AND WHICH ARE NOT SAILBOATS, IN CLASS 12  
(U.S. CLS. 19, 21, 23, 31, 35 AND 44).

FIRST USE 6-1-2002; IN COMMERCE 6-1-2002.

NO CLAIM IS MADE TO THE EXCLUSIVE  
RIGHT TO USE "BOATS", APART FROM THE  
MARK AS SHOWN.

SER. NO. 76-453,516, FILED 9-27-2002.

KARANENDRA S. CHHINA, EXAMINING ATTOR-  
NEY

**Int. Cl.: 16**

**Prior U.S. Cls.: 2, 5, 22, 23, 29, 37, 38 and 50**

**United States Patent and Trademark Office**

**Reg. No. 3,451,682**

**Registered June 24, 2008**

---

**TRADEMARK  
PRINCIPAL REGISTER**

**HEAT**

NETWORK TELEPHONE SERVICES INC. (CALI-  
FORNIA CORPORATION)  
21135 ERWIN STREET  
WOODLAND HILLS, CA 91367

FIRST USE 6-0-1996; IN COMMERCE 6-0-1996.

SER. NO. 76-486,491, FILED 1-31-2003.

FOR: PUBLICATIONS AND MAILERS, NAMELY,  
A MAGAZINE DIRECTED TOWARD ADULT SUB-  
JECT MATTER, IN CLASS 16 (U.S. CLS. 2, 5, 22, 23, 29,  
37, 38 AND 50).

REBECCA GILBERT, EXAMINING ATTORNEY

**Int. Cl.: 41**

**Prior U.S. Cls.: 100, 101 and 107**

**United States Patent and Trademark Office**

**Reg. No. 3,451,683**

**Registered June 24, 2008**

**SERVICE MARK  
PRINCIPAL REGISTER**

**AMERICAN SUPERMODEL**

MAROTTA, STEVEN C. (UNITED STATES INDIVIDUAL)

2913 W. OSBORNE  
TAMPA, FL 33614 AND

HESS, BRYAN L. (UNITED STATES INDIVIDUAL)

2913 W. OSBORNE  
TAMPA, FL 33614 AND

SOBTZAK, BRYON (UNITED STATES INDIVIDUAL)

2913 W. OSBORNE  
TAMPA, FL 33614 AND

COHN, SHANE (UNITED STATES INDIVIDUAL)

2913 W. OSBORNE

TAMPA, FL 33614

FOR: ENTERTAINMENT, NAMELY, LIVE PERFORMANCES BY A MUSICAL BAND, IN CLASS 41 (U.S. CLS. 100, 101 AND 107).

FIRST USE 12-0-2000; IN COMMERCE 12-0-2000.

SER. NO. 76-497,521, FILED 3-10-2003.

KAREN K. BUSH, EXAMINING ATTORNEY

**Int. Cl.: 36**

**Prior U.S. Cls.: 100, 101 and 102**

**United States Patent and Trademark Office**

**Reg. No. 3,451,684**

**Registered June 24, 2008**

---

**SERVICE MARK  
PRINCIPAL REGISTER**

**JEFFERSON PILOT SMART COURSE**

JEFFERSON-PILOT CORPORATION (NORTH  
CAROLINA CORPORATION)  
100 N. GREENE STREET  
GREENSBORO, NC 27401

OWNER OF U.S. REG. NOS. 2,051,427, 2,320,131  
AND OTHERS.

FOR: LIFE INSURANCE UNDERWRITING AND  
ANNUITY UNDERWRITING SERVICES, IN CLASS  
36 (U.S. CLS. 100, 101 AND 102).

SER. NO. 76-515,857, FILED 5-21-2003.

FIRST USE 4-1-2003; IN COMMERCE 4-1-2003.

MICHAEL SOUDERS, EXAMINING ATTORNEY

**Int. Cl.: 5**

**Prior U.S. Cls.: 6, 18, 44, 46, 51 and 52**

**Reg. No. 3,451,685**

**United States Patent and Trademark Office**

**Registered June 24, 2008**

---

**TRADEMARK  
PRINCIPAL REGISTER**

**NYTRIC EFX**

ALL AMERICAN PHARMACEUTICAL & NAT-  
URAL FOODS CORP. (MONTANA CORPORA-  
TION)  
1831 MAIN STREET  
BILLINGS, MT 59105

NO CLAIM IS MADE TO THE EXCLUSIVE  
RIGHT TO USE "NYTRIC", APART FROM THE  
MARK AS SHOWN.

FOR: NUTRITIONAL SUPPLEMENT, IN CLASS 5  
(U.S. CLS. 6, 18, 44, 46, 51 AND 52).

SER. NO. 76-561,368, FILED 11-21-2003.

FIRST USE 1-2-2003; IN COMMERCE 1-2-2003.

CHERYL CLAYTON, EXAMINING ATTORNEY

**Int. Cl.: 9**

**Prior U.S. Cls.: 21, 23, 26, 36 and 38**

**Reg. No. 3,451,686**

**United States Patent and Trademark Office**

**Registered June 24, 2008**

**TRADEMARK  
PRINCIPAL REGISTER**



SECURITY LABS INC. (INDIANA CORPORATION)  
15540 HERRIMAN BLVD  
NOBLESVILLE, IN 46060

NO CLAIM IS MADE TO THE EXCLUSIVE  
RIGHT TO USE "PIXEL", APART FROM THE  
MARK AS SHOWN.

FOR: VIDEO SURVEILLANCE RECORDERS,  
MONITORS, CAMERAS, VIDEO PROCESSORS, IN  
CLASS 9 (U.S. CLS. 21, 23, 26, 36 AND 38).

SER. NO. 76-562,391, FILED 12-1-2003.

FIRST USE 11-7-2003; IN COMMERCE 11-7-2003.

SHARON MEIER, EXAMINING ATTORNEY

**Int. Cls.: 9, 16, 25, 28 and 41**

**Prior U.S. Cls.: 2, 5, 21, 22, 23, 26, 29, 36, 37, 38, 39,  
50, 100, 101 and 107**

**Reg. No. 3,451,687**

**United States Patent and Trademark Office**

**Registered June 24, 2008**

**TRADEMARK  
SERVICE MARK  
PRINCIPAL REGISTER**



COSMOS SOCCER CLUB, INC. (NEW YORK CORPORATION)  
89 MAIN STREET  
TAPPAN, NY 10983

FOR: BLANK VIDEO CASSETTES AND TAPES, DOWNLOADABLE VIDEO RECORDINGS FEATURING SOCCER, PRE-RECORDED VIDEO CASSETTES, VIDEO TAPES, CD'S, LASER DISKS AND DVD'S FEATURING SOCCER, IN CLASS 9 (U.S. CLS. 21, 23, 26, 36 AND 38).

FIRST USE 10-28-1976; IN COMMERCE 10-28-1976.

FOR: POSTERS, SCORE BOOKS, SCORE CARDS, MAGAZINES FEATURING SOCCER, SOUVENIR PROGRAMS CONCERNING SOCCER, CALENDARS, IN CLASS 16 (U.S. CLS. 2, 5, 22, 23, 29, 37, 38 AND 50).

FIRST USE 10-28-1976; IN COMMERCE 10-28-1976.

FOR: T-SHIRTS, JERSEYS, SWEATERS, PANTS, SWEATPANTS, HEADBANDS, WARM-UP SUITS, SOCKS, IN CLASS 25 (U.S. CLS. 22 AND 39).

FIRST USE 10-28-1976; IN COMMERCE 10-28-1976.

FOR: TOYS AND SPORTING GOODS, NAMELY, SOCCER BALLS, SOCCER BALL GOAL NETS, SOCCER BALL KNEE PADS, IN CLASS 28 (U.S. CLS. 22, 23, 38 AND 50).

FIRST USE 10-28-1976; IN COMMERCE 10-28-1976.

FOR: EDUCATION AND INSTRUCTION SERVICES, NAMELY, PROVIDING TRAINING AND INSTRUCTIONS RELATING TO SOCCER; CONDUCTING ENTERTAINMENT EXHIBITIONS IN THE NATURE OF PROFESSIONAL SOCCER EXHIBITIONS, IN CLASS 41 (U.S. CLS. 100, 101 AND 107).

FIRST USE 10-28-1976; IN COMMERCE 10-28-1976.

OWNER OF U.S. REG. NO. 1,099,005.

SER. NO. 76-571,129, FILED 1-20-2004.

YONG KIM, EXAMINING ATTORNEY



**Int. Cls.: 9, 14, 15, 16, 18, 20, 21, 22, 24, 25, 26, 27, 28, 32 and 41**

**Prior U.S. Cls.: 1, 2, 3, 5, 7, 13, 19, 20, 21, 22, 23, 25, 26, 27, 28, 29, 30, 32, 33, 36, 37, 38, 39, 40, 41, 42, 45, 46, 48, 50, 100, 101 and 107**

**Reg. No. 3,451,688**

**United States Patent and Trademark Office**

**Registered June 24, 2008**

**TRADEMARK  
SERVICE MARK  
PRINCIPAL REGISTER**

**YUKAGIR MAMMOTH**

SIRI C.V. (NETHERLANDS COMPANY)  
SIRIUSDREEF 22  
2132 WT HOOFDDORP  
THE NETHERLANDS, NETHERLANDS

FOR: PRERECORDED VIDEO AND AUDIO TAPES FEATURING DOCUMENTARIES AND ANIMATIONS; CD-ROMS FOR INSTRUCTIONAL AND EDUCATIONAL PURPOSES FEATURING INFORMATION ABOUT PRE-HISTORIC ANIMALS, IN CLASS 9 (U.S. CLS. 21, 23, 26, 36 AND 38).

FOR: PRECIOUS METALS AND THEIR ALLOYS; JEWELRY; WATCHES; CLOCKS; PRECIOUS STONES; HOROLOGICAL AND CHRONOMETRIC INSTRUMENTS, IN CLASS 14 (U.S. CLS. 2, 27, 28 AND 50).

FOR: MUSICAL INSTRUMENTS, IN CLASS 15 (U.S. CLS. 2, 21 AND 36).

FOR: PAPER; CARDBOARD; BOOKS, NAMELY, COMIC BOOKS, EDUCATIONAL BOOKS FEATURING INFORMATION ABOUT PRE-HISTORIC ANIMALS, PHOTOGRAPH BOOKS; PHOTOGRAPHS; STATIONERY; ADHESIVES FOR STATIONERY OR HOUSEHOLD PURPOSES; ARTISTS' MATERIALS, NAMELY, ARTS AND CRAFTS PAINTS; PAINT BRUSHES; OFFICE REQUISITES, NAMELY, PENS, PENCILS, ERASERS, MARKERS, HIGHLIGHTERS, DESK ORGANIZERS, IN CLASS 16 (U.S. CLS. 2, 5, 22, 23, 29, 37, 38 AND 50).

FOR: GOODS MADE OF LEATHER AND IMITATIONS OF LEATHER, NAMELY, PURSES, WALLETS, BRIEFCASES, BAGS, KEY CHAINS, KEY CASES; ANIMAL SKINS AND HIDES; LUGGAGE; LUGGAGE TRUNKS; TRAVELING BAGS; UMBRELLAS; PARASOLS; WALKING STICKS; WHIPS; HARNESS AND SADDLERY; GARMENT BAGS

FOR TRAVEL, IN CLASS 18 (U.S. CLS. 1, 2, 3, 22 AND 41).

FOR: NON-METAL AND NON-LEATHER KEY CHAINS; KEY HOLDERS, TELEPHONE STRAPS, AND STATUES ALL MADE OF IVORY, IN CLASS 20 (U.S. CLS. 2, 13, 22, 25, 32 AND 50).

FOR: HOUSEHOLD OR KITCHEN UTENSILS, NAMELY, MUGS, BEVERAGE GLASSWARE, PLATES, BOWLS, AND SAUCERS; CONTAINERS FOR HOUSEHOLD OR KITCHEN USE NOT OF PRECIOUS METAL; COMBS; SPONGES; UNWORKED OR SEMI-WORKED GLASS, IN CLASS 21 (U.S. CLS. 2, 13, 23, 29, 30, 33, 40 AND 50).

FOR: ROPES; STRING; TENTS; AWNINGS; TARPULINS; SAILS; SACKS AND BAGS, NAMELY, LAUNDRY BAGS, GARMENT BAGS FOR STORAGE, MULTI-PURPOSE CLOTH BAGS; PADDING AND STUFFING MATERIALS NOT OF RUBBER OR PLASTIC; RAW FIBROUS TEXTILE MATERIALS, IN CLASS 22 (U.S. CLS. 1, 2, 7, 19, 22, 42 AND 50).

FOR: TEXTILE GOODS, NAMELY, BED LINENS, TABLE LINENS, TOWELS, OVEN MITTS, HANDKERCHIEFS, IN CLASS 24 (U.S. CLS. 42 AND 50).

FOR: CLOTHING, NAMELY, SHIRTS, T-SHIRTS, SWEAT SHIRTS, PANTS, SHORTS, BELTS, SOCKS, SCARFS; FOOTWEAR; HEADGEAR, NAMELY, CAPS AND HATS, IN CLASS 25 (U.S. CLS. 22 AND 39).

FOR: LACE AND EMBROIDERY; RIBBONS AND BRAIDING; BUTTONS, NAMELY, NOVELTY BUTTONS AND BUTTONS FOR CLOTHING; HOOKS AND EYES; PINS AND NEEDLES; ARTIFICIAL FLOWERS, IN CLASS 26 (U.S. CLS. 37, 39, 40, 42 AND 50).

FOR: CARPETS, RUGS, MATS AND MATTING, LINOLEUM AND OTHER MATERIALS FOR COVERING EXISTING FLOORS; NON-TEXTILE WALL HANGINGS, IN CLASS 27 (U.S. CLS. 19, 20, 37, 42 AND 50).

FOR: GAMES AND PLAYTHINGS, NAMELY, BOARD GAMES, CARD GAMES, BALLS, SKATEBOARDS, TOY ANIMALS, ACTION FIGURES, SOFT TOYS, PLUSH ANIMAL TOYS, CONSTRUCTION PLAYTHINGS FOR CHILDREN, PUZZLES; STUFFED TOY ANIMALS; DOLLS; TOY MODEL ANIMALS; DECORATIONS FOR CHRISTMAS TREES; PLAYING CARDS, IN CLASS 28 (U.S. CLS. 22, 23, 38 AND 50).

FOR: BEERS; MINERAL AND AERATED WATERS; NON-ALCOHOLIC DRINKS, NAMELY, CARBONATED DRINKS, NON-CARBONATED SOFT DRINKS, NON-ALCOHOLIC BEVERAGES WITH TEA FLAVOR; FRUIT DRINKS; FRUIT JUICES; SYRUPS FOR BEVERAGES, IN CLASS 32 (U.S. CLS. 45, 46 AND 48).

FOR: EDUCATION AND ENTERTAINMENT SERVICES, NAMELY, ORGANIZING CULTURAL EVENTS, IN CLASS 41 (U.S. CLS. 100, 101 AND 107).

THE MARK CONSISTS OF STANDARD CHARACTERS WITHOUT CLAIM TO ANY PARTICULAR FONT, STYLE, SIZE, OR COLOR.

PRIORITY CLAIMED UNDER SEC. 44(D) ON ERPNTY CMNTY TM OFC APPLICATION NO. 003620986, FILED 1-20-2004, REG. NO. 003620986, DATED 4-26-2005, EXPIRES 1-20-2014.

OWNER OF ERPNTY CMNTY TM OFC REG. NO. 003829785, DATED 10-24-2005, EXPIRES 5-11-2014.

SER. NO. 76-579,184, FILED S.R. 3-4-2004 AM. P.R. 5-8-2006.

PATRICIA EVANKO, EXAMINING ATTORNEY

**Int. Cls.: 35, 36, 42 and 44**

**Prior U.S. Cls.: 100, 101 and 102**

**United States Patent and Trademark Office**

**Reg. No. 3,451,689**

**Registered June 24, 2008**

**SERVICE MARK  
PRINCIPAL REGISTER**

**ADVOCACY MULTIPLIER**

NOP WORLD LTD. (UNITED KINGDOM PRIVATE LIMITED COMPANY)

LUDGATE HOUSE

245 BLACKFRIARS ROAD

LONDON SE1 9UY, ENGLAND

FOR: CONSULTATION, RESEARCH, AND ANALYSIS IN THE FIELDS OF MARKETING, BUSINESS COMMUNICATIONS, PACKAGING DESIGN, BUSINESS, SALES, BRANDS AND BRAND IDENTITY, PUBLIC RELATIONS, DIRECT MARKETING, ADVERTISING, PROMOTIONS, FORECASTING, CONSUMER BEHAVIOR, AND OPINION POLLS, IN CLASS 35 (U.S. CLS. 100, 101 AND 102).

FOR: CONSULTATION, RESEARCH, AND ANALYSIS IN THE FIELDS OF FINANCIAL SERVICES, HEALTH INSURANCE, AND MEDICAID FINANCIAL AID PROGRAMS, IN CLASS 36 (U.S. CLS. 100, 101 AND 102).

FOR: RESEARCH, AND ANALYSIS IN THE FIELDS OF MEDICAID, HEALTHCARE, MEDICAL CARE, AND PHARMACEUTICALS, IN CLASS 42 (U.S. CLS. 100 AND 101).

FOR: CONSULTATION IN THE FIELDS OF HEALTHCARE, MEDICAL CARE, PHARMACEUTICALS, IN CLASS 44 (U.S. CLS. 100 AND 101).

THE MARK CONSISTS OF STANDARD CHARACTERS WITHOUT CLAIM TO ANY PARTICULAR FONT, STYLE, SIZE, OR COLOR.

PRIORITY CLAIMED UNDER SEC. 44(D) ON ERPN CMNTY TM OFC APPLICATION NO. 003797636, FILED 4-27-2004, REG. NO. 003797636, DATED 9-6-2005, EXPIRES 4-27-2014.

SER. NO. 76-592,521, FILED 5-17-2004.

JOHN DALIER, EXAMINING ATTORNEY

**Int. Cls.: 3 and 5**

**Prior U.S. Cls.: 1, 4, 6, 18, 44, 46, 50, 51 and 52**

**United States Patent and Trademark Office**

**Reg. No. 3,451,690**

**Registered June 24, 2008**

**TRADEMARK  
PRINCIPAL REGISTER**

**PERCUTA FEINE**

PIERRE FABRE MEDICAMENT (FRANCE SOCI-  
ÉTÉ ANONYME)  
45 PLACE ABEL GANCE  
92100 BOULOGNE, FRANCE

FOR: COSMETIC AND CLEANING PREPARA-  
TIONS; NAMELY, SKIN CREAMS, OILS, GELS,  
LOTIONS, AND MASSAGING CREAMS, OILS,  
GELS, AND LOTIONS , IN CLASS 3 (U.S. CLS. 1, 4,  
6, 50, 51 AND 52).

FOR: PREPARATION FOR THE SYMPTOMATIC  
TREATMENT OF LOCALIZED EXCESS FATTY  
SUBCUTANEOUS DEPOSITS, IN CLASS 5 (U.S.  
CLS. 6, 18, 44, 46, 51 AND 52).

THE MARK CONSISTS OF STANDARD CHAR-  
ACTERS WITHOUT CLAIM TO ANY PARTICULAR  
FONT, STYLE, SIZE, OR COLOR.

OWNER OF FRANCE REG. NO. 93484742, DATED  
9-21-1993, EXPIRES 9-21-2013.

OWNER OF FRANCE REG. NO. 1356929, DATED  
5-30-1986, EXPIRES 5-30-2016.

OWNER OF U.S. REG. NO. 1,300,130.

SER. NO. 76-619,914, FILED 11-9-2004.

PRISCILLA MILTON, EXAMINING ATTORNEY

Int. Cl.: 25

Prior U.S. Cls.: 22 and 39

United States Patent and Trademark Office

Reg. No. 3,451,691

Registered June 24, 2008

TRADEMARK  
PRINCIPAL REGISTER

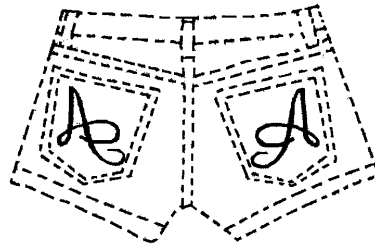

DENIM MANIA APPAREL, INC. (CALIFORNIA CORPORATION)

19715 E. HARRISON AVE.

CITY OF INDUSTRY, CA 91789

FOR: CLOTHING, NAMELY, JEANS, JACKETS, PANTS, SKIRTS, SHORTS, SWEATERS, SHIRTS, HATS, BELTS; FOOTWEAR, AND HEADWEAR, IN CLASS 25 (U.S. CLS. 22 AND 39).

FIRST USE 6-14-2004; IN COMMERCE 6-14-2004.

THE MARK CONSIST OF THE FOLLOWING, A AND A (STYLIZED), WHERE TWO STYLIZED LETTERS "A", ONE BEING A MIRROR IMAGE OF THE OTHER, ARE PLACED ON THE BACK POCKETS OF THE GOODS. THE DOTTED LINES IN THE DRAWING ARE NOT A FEATURE OF THE MARK AND ARE USED ONLY FOR ILLUSTRATING THE POSITION OF THE MARK ON THE GOODS.

SER. NO. 76-633,984, FILED 3-21-2005.

JAMES A. RAUEN, EXAMINING ATTORNEY

Int. Cl.: 12

Prior U.S. Cls.: 19, 21, 23, 31, 35 and 44

Reg. No. 3,451,692

United States Patent and Trademark Office

Registered June 24, 2008

TRADEMARK  
PRINCIPAL REGISTER



TESOR PLUS CORP. (TAIWAN CORPORATION)  
NO. 32, LANE 150, CHUNG HSING N. ST.  
SAN-CHUNG, TAIPEI, TAIWAN

FOR: ANTI-THEFT ALARMS FOR VEHICLES,  
REVERSING ALARMS FOR VEHICLES, TURN SIG-  
NALS FOR CARS, IN CLASS 12 (U.S. CLS. 19, 21, 23,  
31, 35 AND 44).

OWNER OF CHINA REG. NO. 1196251, DATED 2-  
16-2006, EXPIRES 2-15-2016.

THE NON-LATIN CHARACTERS IN THE MARK  
TRANSLITERATE TO "CHER INN YUEH" AND  
THIS MEANS "MUSIC CAR" IN ENGLISH.

SER. NO. 76-645,446, FILED 8-23-2005.

CHRIS DONINGER, EXAMINING ATTORNEY

Int. Cls.: 25, 27, 28, 30, 35, 36 and 41

Prior U.S. Cls.: 19, 20, 22, 23, 37, 38, 39, 42, 46, 50,  
100, 101, 102 and 107

Reg. No. 3,451,693

United States Patent and Trademark Office

Registered June 24, 2008

TRADEMARK  
SERVICE MARK  
PRINCIPAL REGISTER

# TIGERTURF

D-GENERATION, INC. (FLORIDA CORPORATION)

P. O. BOX 30

DAYTONA BEACH, FL 321150030

FOR: CLOTHING, NAMELY TEE SHIRTS, GOLF SHIRTS, JACKETS, HATS, SHORTS, SWEAT SHIRTS, APRONS, CLOTH BIBS, GLOVES, AND UNDERCLOTHES, IN CLASS 25 (U.S. CLS. 22 AND 39).

FIRST USE 7-16-1998; IN COMMERCE 7-16-1998.

FOR: RUBBER MATS; WRESTLING MATS; ARTIFICIAL TURF; PROTECTIVE FLOOR COVERINGS; GYMNASIAC MATS; CARPETING, IN CLASS 27 (U.S. CLS. 19, 20, 37, 42 AND 50).

FIRST USE 12-1-1998; IN COMMERCE 12-1-1998.

FOR: TOYS, NAMELY SKATE BOARDS, IN-LINE SKATES, RUBBER ACTION BALLS, ACTION FIGURES AND ACCESSORIES THEREFOR, ACTION TOYS, ELECTRIC ACTION TOYS, TOY AIRPLANES, STUFFED TOY ANIMALS, ARM GUARDS, SHIN GUARDS, KNEE GUARDS, WRIST GUARDS, ELBOW GUARDS, AND MOUTH GUARDS FOR ATHLETIC USE, BASEBALLS, BASKETBALLS, BOWLING BALLS, FOOTBALLS, VOLLEY BALLS, SOCCER BALLS, BEAN BAGS, SOFTBALL BATS, BASEBALL BATS, BODY BOARDS, SURF BOARDS, STAND ALONE VIDEO GAME OUTPUT MACHINES, BOARD GAMES, CARD GAMES, PINBALL TYPE GAMES, GOLF TEES, GOLF CLUBS, JIGSAW PUZZLES, KITES, SURFBOARD WAX, SURFBOARD LEASHES, VOLLEYBALL GAME PLAYING EQUIPMENT, AND YO-YOS, IN CLASS 28 (U.S. CLS. 22, 23, 38 AND 50).

FIRST USE 6-8-1999; IN COMMERCE 6-8-1999.

FOR: CANDY; CANDY BARS; CANDY MINTS; CANDY WITH CARAMEL; CANDY WITH COCOA; CHOCOLATE CANDIES; ICE CANDIES; PEPPERMINT CANDY; SUGARLESS CANDIES; CHEWING GUM; SUGARFREE CHEWING GUM; SUGARLESS CHEWING GUM, IN CLASS 30 (U.S. CL. 46).

FIRST USE 12-1-1998; IN COMMERCE 12-1-1998.

FOR: ADVERTISING AND COMMERCIAL INFORMATION SERVICES, VIA THE INTERNET; ADVERTISING VIA ELECTRONIC MEDIA AND SPECIFICALLY THE INTERNET; DISSEMINATION OF ADVERTISING FOR OTHERS VIA THE INTERNET; PROVIDING AND RENTAL OF ADVERTISING SPACE ON THE INTERNET; COMPUTERIZED ONLINE ORDERING FEATURING GENERAL MERCHANDISE AND GENERAL CONSUMER GOODS, IN CLASS 35 (U.S. CLS. 100, 101 AND 102).

FIRST USE 7-9-1999; IN COMMERCE 7-9-1999.

FOR: CHARITABLE FUND RAISING; ACCEPTING AND ADMINISTERING MONETARY CHARITABLE CONTRIBUTIONS; CREDIT CARD SERVICES, IN CLASS 36 (U.S. CLS. 100, 101 AND 102).

FIRST USE 7-9-1999; IN COMMERCE 7-9-1999.

FOR: CHARITABLE SERVICES, NAMELY AWARDS PROGRAM FOR MAJOR CORPORATIONS AND INDIVIDUALS WHO HAVE MADE SIGNIFICANT CHARITABLE CONTRIBUTIONS, IN CLASS 41 (U.S. CLS. 100, 101 AND 107).

FIRST USE 7-9-1999; IN COMMERCE 7-9-1999.

THE MARK CONSISTS OF STANDARD CHAR-  
ACTERS WITHOUT CLAIM TO ANY PARTICULAR  
FONT, STYLE, SIZE, OR COLOR.

SER. NO. 76-646,348, FILED 9-7-2005.

WILLIAM BRECKENFELD, EXAMINING ATTOR-  
NEY



**Int. Cls.: 6 and 7**

**Prior U.S. Cls.: 2, 12, 13, 14, 19, 21, 23, 25, 31, 34, 35  
and 50**

**Reg. No. 3,451,694**

**United States Patent and Trademark Office**

**Registered June 24, 2008**

**TRADEMARK  
PRINCIPAL REGISTER**

**JACPAC**

D & S PRODUCT SOLUTIONS INC. (CANADA  
CORPORATION)  
119 MAGILL STREET  
LIVELY, ONTARIO, CANADA P3Y 1K6

FOR: NAILS, METAL BRADS, IN CLASS 6 (U.S.  
CLS. 2, 12, 13, 14, 23, 25 AND 50).

FOR: POWER TOOLS, NAMELY, GAS CANIS-  
TER-OPERATED PNEUMATIC NAIL GUNS, IN  
CLASS 7 (U.S. CLS. 13, 19, 21, 23, 31, 34 AND 35).

THE MARK CONSISTS OF STANDARD CHAR-  
ACTERS WITHOUT CLAIM TO ANY PARTICULAR  
FONT, STYLE, SIZE, OR COLOR.

PRIORITY CLAIMED UNDER SEC. 44(D) ON  
CANADA APPLICATION NO. 1,255,530, FILED 4-27-  
2005, REG. NO. TMA666,644, DATED 6-28-2006, EX-  
PIRES 6-28-2021.

SER. NO. 76-647,947, FILED 10-4-2005.

ELLEN PERKINS, EXAMINING ATTORNEY

**Int. Cls.: 41, 43 and 44**

**Prior U.S. Cls.: 100, 101 and 107**

**United States Patent and Trademark Office**

**Reg. No. 3,451,695**

**Registered June 24, 2008**

**SERVICE MARK  
PRINCIPAL REGISTER**

**ERICKSON HEALTH**

ERICKSON RETIREMENT COMMUNITIES, LLC  
(MARYLAND LTD LIAB CO)  
701 MAIDEN CHOICE LANE  
BALTIMORE, MD 21228

FOR: FITNESS PROGRAMS AND FITNESS AC-  
TIVITIES FOR PEOPLE AGE 62 AND OLDER, IN  
CLASS 41 (U.S. CLS. 100, 101 AND 107).

FIRST USE 6-1-2004; IN COMMERCE 6-1-2004.

FOR: LIFE CARE RETIREMENT HOME SERVI-  
CES; PROVIDING ASSISTED LIVING FACILITIES  
FOR PEOPLE AGE 62 AND OLDER, IN CLASS 43  
(U.S. CLS. 100 AND 101).

FIRST USE 6-1-2004; IN COMMERCE 6-1-2004.

FOR: HEALTH AND WELLNESS PROGRAMS  
THAT PROVIDE COMPREHENSIVE MEDICAL  
CARE AND SUPPORT SERVICES, NAMELY, SKIL-  
LED NURSING SERVICES, HOME HEALTH CARE  
SERVICES AND EXTENDED MEDICAL SERVICES

FOR PEOPLE AGE 62 AND OLDER, IN CLASS 44  
(U.S. CLS. 100 AND 101).

FIRST USE 6-1-2004; IN COMMERCE 6-1-2004.

THE MARK CONSISTS OF STANDARD CHAR-  
ACTERS WITHOUT CLAIM TO ANY PARTICULAR  
FONT, STYLE, SIZE, OR COLOR.

OWNER OF U.S. REG. NOS. 2,532,802 AND  
2,545,345.

NO CLAIM IS MADE TO THE EXCLUSIVE  
RIGHT TO USE "HEALTH", APART FROM THE  
MARK AS SHOWN.

SEC. 2(F) AS TO "ERICKSON".

SER. NO. 76-652,668, FILED 12-23-2005.

KEVON CHISOLM, EXAMINING ATTORNEY

**Int. Cls.: 16, 39 and 43**

**Prior U.S. Cls.: 2, 5, 22, 23, 29, 37, 38, 50, 100, 101 and 105**

**Reg. No. 3,451,696**

**United States Patent and Trademark Office**

**Registered June 24, 2008**

**TRADEMARK  
SERVICE MARK  
PRINCIPAL REGISTER**

**TOUR EAST HOLIDAYS**

TOUR EAST HOLIDAYS (CANADA) INC. (CANADA CORPORATION)  
15 KERN ROAD  
TORONTO, ONTARIO, CANADA M3B 1S9

FOR: PRINTED MATERIALS, NAMELY, TRAVEL BROCHURES, TRAVEL FLYERS AND TRAVEL PAMPHLETS; PENS, IN CLASS 16 (U.S. CLS. 2, 5, 22, 23, 29, 37, 38 AND 50).

FOR: TRAVEL AGENCY SERVICES, NAMELY, MAKING RESERVATIONS AND BOOKINGS FOR TRANSPORTATION AND TOURS; ARRANGING TRAVEL TOURS; TRAVEL BOOKING AGENCY SERVICES; TRAVEL INFORMATION SERVICES; WHOLESALE TRAVEL AGENCY SERVICES, NAMELY, ASSEMBLING TOUR PACKAGES THAT COVER TRANSPORTATION, SIGHTSEEING, TOURS, MEALS AND TEMPORARY LODGINGS, IN CLASS 39 (U.S. CLS. 100 AND 105).

FOR: TRAVEL AGENCY SERVICES, NAMELY, MAKING RESERVATIONS AND BOOKINGS FOR TEMPORARY LODGING; WHOLESALE TRAVEL AGENCY SERVICES, NAMELY, MAKING RESERVATIONS AND BOOKINGS FOR TEMPORARY LODGINGS, IN CLASS 43 (U.S. CLS. 100 AND 101).

THE MARK CONSISTS OF STANDARD CHARACTERS WITHOUT CLAIM TO ANY PARTICULAR FONT, STYLE, SIZE, OR COLOR.

OWNER OF CANADA REG. NO. TMA625,409, DATED 11-15-2004, EXPIRES 11-15-2019.

NO CLAIM IS MADE TO THE EXCLUSIVE RIGHT TO USE "TOUR" AND "HOLIDAYS", APART FROM THE MARK AS SHOWN.

SER. NO. 76-657,501, FILED 3-29-2006.

ALLISON HOLTZ, EXAMINING ATTORNEY

**Int. Cl.: 9**

**Prior U.S. Cls.: 21, 23, 26, 36 and 38**

**United States Patent and Trademark Office**

**Reg. No. 3,451,697**

**Registered June 24, 2008**

**TRADEMARK  
PRINCIPAL REGISTER**

***SANDSTONE***

SANDSTONE (FLORIDA CORPORATION)  
P.O. BOX 1236  
HAINES CITY, FL 33845

FIRST USE 1-1-2005; IN COMMERCE 1-1-2005.

SER. NO. 76-659,080, FILED 4-26-2006.

FOR: CDS FEATURING MUSICAL RECORD-  
INGS, IN CLASS 9 (U.S. CLS. 21, 23, 26, 36 AND 38).

CAROLYN CATALDO, EXAMINING ATTORNEY

**Int. Cls.: 16, 25, 39 and 43**

**Prior U.S. Cls.: 2, 5, 22, 23, 29, 37, 38, 39, 50, 100, 101  
and 105**

**Reg. No. 3,451,698**

**United States Patent and Trademark Office**

**Registered June 24, 2008**

**TRADEMARK  
SERVICE MARK  
PRINCIPAL REGISTER**

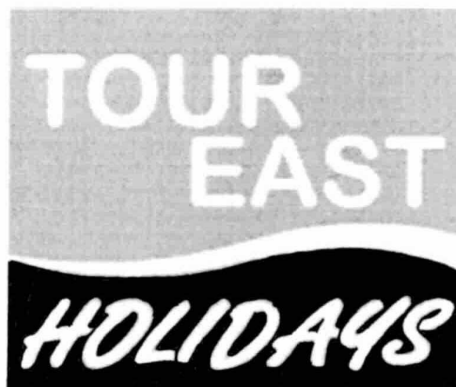

TOUR EAST HOLIDAYS (CANADA) INC. (CANADA CORPORATION)  
15 KERN ROAD  
TORONTO, ONTARIO, CANADA M3B 1S9

FOR: PRINTED MATERIALS, NAMELY, TRAVEL BROCHURES, TRAVEL FLYERS AND TRAVEL PAMPHLETS, PENS, IN CLASS 16 (U.S. CLS. 2, 5, 22, 23, 29, 37, 38 AND 50).

FOR: T-SHIRTS, IN CLASS 25 (U.S. CLS. 22 AND 39).

FOR: TRAVEL AGENCY SERVICES, NAMELY, MAKING RESERVATIONS AND BOOKINGS FOR TRANSPORTATION AND TOURS; ARRANGING TRAVEL TOURS; TRAVEL BOOKING AGENCY SERVICES; TRAVEL INFORMATION SERVICES; WHOLESALE TRAVEL AGENCY SERVICES, NAMELY, ASSEMBLING TOUR PACKAGES THAT COVER TRANSPORTATION, SIGHTSEEING,

TOURS, MEALS AND TEMPORARY LODGINGS, IN CLASS 39 (U.S. CLS. 100 AND 105).

FOR: TRAVEL AGENCY SERVICES, NAMELY, MAKING RESERVATIONS AND BOOKINGS FOR TEMPORARY LODGING; WHOLESALE TRAVEL AGENCY SERVICES, NAMELY, MAKING RESERVATIONS AND BOOKINGS FOR TEMPORARY LODGINGS, IN CLASS 43 (U.S. CLS. 100 AND 101).

OWNER OF CANADA REG. NO. TMA662789, DATED 4-19-2006, EXPIRES 4-19-2021.

NO CLAIM IS MADE TO THE EXCLUSIVE RIGHT TO USE "TOUR" AND "HOLIDAYS", APART FROM THE MARK AS SHOWN.

SER. NO. 76-659,285, FILED 4-28-2006.

ALLISON HOLTZ, EXAMINING ATTORNEY

Int. Cl.: 28

Prior U.S. Cls.: 22, 23, 38 and 50

Reg. No. 3,451,699

United States Patent and Trademark Office

Registered June 24, 2008

TRADEMARK  
PRINCIPAL REGISTER



LINCIR, MATT G. (UNITED STATES INDIVIDUAL)  
1417 W. 8TH STREET  
SAN PEDRO, CA 90732

FIRST USE 4-27-1979; IN COMMERCE 4-27-1979.

FOR: BALLET BARS, NAMELY, PORTABLE, WALL MOUNTED SUPPORT STRUCTURES FOR BAR WORK IN BALLET, IN CLASS 28 (U.S. CLS. 22, 23, 38 AND 50).

SER. NO. 76-659,924, FILED 5-5-2006.

JIM RINGLE, EXAMINING ATTORNEY

**Int. Cl.: 24**

**Prior U.S. Cls.: 42 and 50**

**United States Patent and Trademark Office**

**Reg. No. 3,451,700**

**Registered June 24, 2008**

**TRADEMARK  
PRINCIPAL REGISTER**



OHIO TABLE PAD COMPANY, INC. (OHIO CORPORATION)  
1270 FLAGSHIP DRIVE  
PERRYSBURG, OH 435529932

FOR: TABLE PADS, IN CLASS 24 (U.S. CLS. 42 AND 50).

FIRST USE 0-0-1923; IN COMMERCE 0-0-1923.

NO CLAIM IS MADE TO THE EXCLUSIVE RIGHT TO USE "TABLE PAD COMPANY" , APART FROM THE MARK AS SHOWN.

SEC. 2(F) AS TO "OHIO TABLE PAD COMPANY".

SER. NO. 76-661,856, FILED 6-20-2006.

TRACY CROSS, EXAMINING ATTORNEY

Int. Cl.: 34

Prior U.S. Cls.: 2, 8, 9 and 17

United States Patent and Trademark Office

Reg. No. 3,451,701

Registered June 24, 2008

TRADEMARK  
PRINCIPAL REGISTER

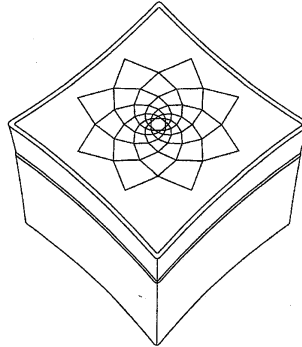

SWEDISH MATCH NORTH EUROPE AB (SWEDEN CORPORATION)  
118 85 STOCKHOLM, SWEDEN

FOR: SNUFF, IN CLASS 34 (U.S. CLS. 2, 8, 9 AND 17).

PRIORITY CLAIMED UNDER SEC. 44(D) ON ERPNTY CMNTY TM OFC APPLICATION NO.

CTM4892139, FILED 2-9-2006, REG. NO. 004892139, DATED 2-9-2006, EXPIRES 2-9-2016.

THE MARK CONSISTS OF A SQUARE BOX HAVING DESIGN ON THE COVER.

SER. NO. 76-663,177, FILED 7-17-2006.

ESTHER A. BORSUK, EXAMINING ATTORNEY



**Int. Cl.: 42**

**Prior U.S. Cls.: 100 and 101**

**United States Patent and Trademark Office**

**Reg. No. 3,451,702**

**Registered June 24, 2008**

**SERVICE MARK  
PRINCIPAL REGISTER**

# WiView

LCC INTERNATIONAL, INC. (DELAWARE CORPORATION)  
7925 JONES BRANCH DRIVE  
MC LEAN, VA 22102

FOR: PROVIDING ON-LINE NON-DOWNLOADABLE COMPUTER SOFTWARE, NAMELY, A WEB BASED APPLICATION THAT PREPARES BUSINESS CASES FOR THE DESIGN AND DEPLOYMENT OF WIRELESS TECHNOLOGY, IN CLASS 42 (U.S. CLS. 100 AND 101).

FIRST USE 7-1-2006; IN COMMERCE 7-1-2006.

THE MARK CONSISTS OF STANDARD CHARACTERS WITHOUT CLAIM TO ANY PARTICULAR FONT, STYLE, SIZE, OR COLOR.

SER. NO. 76-663,549, FILED 7-24-2006.

TRACY CROSS, EXAMINING ATTORNEY

**Int. Cl.: 25**

**Prior U.S. Cls.: 22 and 39**

**United States Patent and Trademark Office**

**Reg. No. 3,451,703**

**Registered June 24, 2008**

**TRADEMARK  
PRINCIPAL REGISTER**

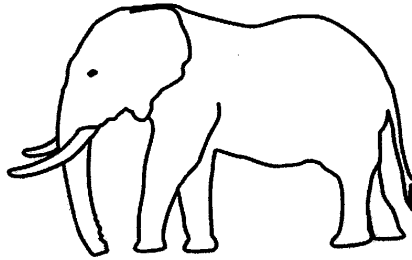

TOP POINT CORP. (CALIFORNIA CORPORATION)  
10175 E. RUSH STREET  
SOUTH EL MONTE, CA 91733

FIRST USE 7-1-2005; IN COMMERCE 7-1-2005.

SER. NO. 76-664,771, FILED 8-18-2006.

FOR: SHOES AND BOOTS INCLUDING MEN'S,  
WOMAN'S AND CHILDREN'S, IN CLASS 25 (U.S.  
CLS. 22 AND 39).

JAMES MACFARLANE, EXAMINING ATTORNEY

**Int. Cl.: 3**

**Prior U.S. Cls.: 1, 4, 6, 50, 51 and 52**

**Reg. No. 3,451,704**

**United States Patent and Trademark Office**

**Registered June 24, 2008**

---

**TRADEMARK  
PRINCIPAL REGISTER**

**POWERCON**

GETINGE USA, INC. (DELAWARE CORPORATION)  
1777 EAST HENRIETTA ROAD  
ROCHESTER, NY 146233133

THE MARK CONSISTS OF STANDARD CHARACTERS WITHOUT CLAIM TO ANY PARTICULAR FONT, STYLE, SIZE, OR COLOR.

FOR: DETERGENT FOR MEDICAL SUPPLIES, IN CLASS 3 (U.S. CLS. 1, 4, 6, 50, 51 AND 52).

SER. NO. 76-665,529, FILED 8-31-2006.

FIRST USE 10-0-2004; IN COMMERCE 5-0-2005.

JANICE KIM, EXAMINING ATTORNEY

**Int. Cls.: 29, 30, 35, 41 and 43**

**Prior U.S. Cls.: 46, 100, 101, 102 and 107**

**United States Patent and Trademark Office**

**Reg. No. 3,451,705**

**Registered June 24, 2008**

**TRADEMARK  
SERVICE MARK  
PRINCIPAL REGISTER**

**Di Bruno Bros.**

DB ASSOCIATES, INC. (PENNSYLVANIA CORPORATION), DBA DI BRUNO BROS.  
1730-32 CHESTNUT STREET  
PHILADELPHIA, PA 19103

FOR: EDIBLE OILS; CHEESE SPREADS; FRESH CHEESES; JAMS; FRESH AND DRY-CURED SAUSAGES, IN CLASS 29 (U.S. CL. 46).

FIRST USE 5-1-1939; IN COMMERCE 5-1-1939.

FOR: RAW PASTA, PASTA SAUCES, DRIED HERBS AND SPICES, FLAVORED VINEGARS; TORTILLA CHIPS; ICE CREAMS AND SORBETS; HONEY PRODUCTS, NAMELY, HONEY CONDIMENTS AND FLAVORED HONEY SPREADS; CHOCOLATES CANDIES, IN CLASS 30 (U.S. CL. 46).

FIRST USE 5-1-1939; IN COMMERCE 5-1-1939.

FOR: RETAIL STORE SERVICES FEATURING GOURMET FOODS, MAIL-ORDER SERVICES FEATURING FINE FOODS AND KITCHENWARE, IN CLASS 35 (U.S. CLS. 100, 101 AND 102).

FIRST USE 5-1-1939; IN COMMERCE 5-1-1939.

FOR: ENTERTAINMENT SERVICES, NAMELY, PROVIDING WINE AND FOOD TASTINGS, CULINARY AND PASTRY DEMONSTRATIONS, AND LECTURES AND PRESENTATIONS BY FOOD WRITERS. EDUCATIONAL SERVICES, NAMELY, PROVIDING COOKING CLASSES, IN CLASS 41 (U.S. CLS. 100, 101 AND 107).

FIRST USE 5-1-1939; IN COMMERCE 5-1-1939.

FOR: FOOD CATERING AND RESTAURANT SERVICES, IN CLASS 43 (U.S. CLS. 100 AND 101).

FIRST USE 5-1-1939; IN COMMERCE 5-1-1939.

THE MARK CONSISTS OF STANDARD CHARACTERS WITHOUT CLAIM TO ANY PARTICULAR FONT, STYLE, SIZE, OR COLOR.

SEC. 2(F).

SER. NO. 76-666,737, FILED 9-28-2006.

JILL C. ALT, EXAMINING ATTORNEY

**Int. Cl.: 19**

**Prior U.S. Cls.: 1, 12, 33 and 50**

**United States Patent and Trademark Office**

**Reg. No. 3,451,706**

**Registered June 24, 2008**

**TRADEMARK  
PRINCIPAL REGISTER**

**SUNRISE FLOATING DOCK SPECIALIST**

CAROBRESE, ROBERT A. (UNITED STATES IN-  
DIVIDUAL)  
P.O. BOX 128  
DAVIDSONVILLE, MD 21035

FOR: DOCKS, PRIMARILY MADE OF NON-ME-  
TALLIC MATERIALS, FOR TYPES OF AQUATIC  
AND MARINE VESSELS, NAMELY, FLOATING  
DOCKS FOR ALL TYPES OF WATERCRAFT, IN-  
CLUDING FLOATING DOCKS FOR PERSONAL  
WATERCRAFT, FLOATING DOCKS FOR KAYAKS,  
FLOATING DOCKS FOR CANOES, FLOATING  
DOCKS FOR SMALL BOATS. FLOATING DOCKS  
FOR LARGE BOATS, AND DOCK RAMPS FOR ALL  
TYPES OF FLOATING DOCKS, IN CLASS 19 (U.S.  
CLS. 1, 12, 33 AND 50).

FIRST USE 2-0-1998; IN COMMERCE 2-0-1998.

THE MARK CONSISTS OF STANDARD CHAR-  
ACTERS WITHOUT CLAIM TO ANY PARTICULAR  
FONT, STYLE, SIZE, OR COLOR.

NO CLAIM IS MADE TO THE EXCLUSIVE  
RIGHT TO USE "FLOATING DOCK SPECIALIST",  
APART FROM THE MARK AS SHOWN.

SER. NO. 76-667,107, FILED 10-6-2006.

MICHAEL WEBSTER, EXAMINING ATTORNEY

**Int. Cl.: 35**

**Prior U.S. Cls.: 100, 101 and 102**

**United States Patent and Trademark Office**

**Reg. No. 3,451,707**

**Registered June 24, 2008**

**SERVICE MARK  
PRINCIPAL REGISTER**

**I.A.A. ITALIAN AMERICAN ASSOCIATION  
OF MONMOUTH COUNTY**

CATANEO, STEVEN (UNITED STATES INDIVIDUAL)  
76 DEVON DRIVE  
MANALAPAN, NJ 07726

FOR: ASSOCIATION SERVICES, NAMELY, PROMOTING THE INTERESTS OF ITALIAN AMERICANS, IN CLASS 35 (U.S. CLS. 100, 101 AND 102).

FIRST USE 9-0-2004; IN COMMERCE 9-0-2004.

NO CLAIM IS MADE TO THE EXCLUSIVE RIGHT TO USE "ITALIAN AMERICAN ASSOCIATION OF MONMOUTH COUNTY", APART FROM THE MARK AS SHOWN.

SER. NO. 76-667,172, FILED 10-10-2006.

SHAUNIA CARLYLE, EXAMINING ATTORNEY

**Int. Cl.: 43**

**Prior U.S. Cls.: 100 and 101**

**United States Patent and Trademark Office**

**Reg. No. 3,451,708**

**Registered June 24, 2008**

**SERVICE MARK  
PRINCIPAL REGISTER**

**ARSAGA'S**

ARSAGA'S ENTERPRISES, INCORPORATED  
(ARKANSAS CORPORATION)

116 N. BLOCK STREET

FAYETTEVILLE, AR 72701

FOR: RESTAURANT AND COFFEE SHOP SERVICES, FEATURING COFFEE, TEA, AND COLD AND FROZEN DRINKS, IN CLASS 43 (U.S. CLS. 100 AND 101).

FIRST USE 11-2-1992; IN COMMERCE 11-2-1992.

THE MARK CONSISTS OF STANDARD CHARACTERS WITHOUT CLAIM TO ANY PARTICULAR FONT, STYLE, SIZE, OR COLOR.

"ARSAGA" IDENTIFIES A LIVING INDIVIDUAL WHOSE WRITTEN CONSENT IS ATTACHED HERETO.

SEC. 2(F).

SER. NO. 76-667,349, FILED 10-12-2006.

ARETHA SOMERVILLE, EXAMINING ATTORNEY

**Int. Cls.: 20 and 35**

**Prior U.S. Cls.: 2, 13, 22, 25, 32, 50, 100, 101 and 102**

**United States Patent and Trademark Office**

**Reg. No. 3,451,709**

**Registered June 24, 2008**

**TRADEMARK  
SERVICE MARK  
PRINCIPAL REGISTER**



BIG BOB'S FLOORING OUTLET OF AMERICA,  
INC. (MISSOURI CORPORATION)  
10,001 W. 75TH STREET  
SHAWNEE MISSION, KS 66204

THE COLOR(S) RED, WHITE AND BLUE IS/ARE  
CLAIMED AS A FEATURE OF THE MARK.

FOR: FURNITURE, IN CLASS 20 (U.S. CLS. 2, 13,  
22, 25, 32 AND 50).

FIRST USE 7-2-2005; IN COMMERCE 7-2-2005.

FOR: FRANCHISING, NAMELY, OFFERING  
TECHNICAL ASSISTANCE IN THE ESTABLISH-  
MENT AND OR OPERATION OF RETAIL STORES  
FOR THE SALES OF FURNITURE, IN CLASS 35  
(U.S. CLS. 100, 101 AND 102).

THE WORDS "BIG BOB'S" APPEAR IN RED  
WITHIN A RED BORDERED RECTANGLE ON  
WHITE BACKGROUND. THE WORD "FURNI-  
TURE" APPEARS IN BLUE WITHIN A BLUE REC-  
TANGLE ON WHITE BACKGROUND. THE WORD  
"OUTLET" APPEARS IN RED WITHIN A RED  
RECTANGLE ON WHITE BACKGROUND.

FIRST USE 7-2-2005; IN COMMERCE 7-2-2005.

SER. NO. 76-667,818, FILED 10-20-2006.

NO CLAIM IS MADE TO THE EXCLUSIVE  
RIGHT TO USE "FURNITURE OUTLET", APART  
FROM THE MARK AS SHOWN.

SCOTT BIBB, EXAMINING ATTORNEY



**Int. Cls.: 20 and 35**

**Prior U.S. Cls.: 2, 13, 22, 25, 32, 50, 100, 101 and 102**

**United States Patent and Trademark Office**

**Reg. No. 3,451,710**

**Registered June 24, 2008**

**TRADEMARK  
SERVICE MARK  
PRINCIPAL REGISTER**



BIG BOB'S FLOORING OUTLET OF AMERICA,  
INC. (MISSOURI CORPORATION)

10001 W. 75TH STREET

SHAWNEE MISSION, KS 66204

FOR: FURNITURE, NAMELY, MATTRESSES, IN  
CLASS 20 (U.S. CLS. 2, 13, 22, 25, 32 AND 50).

FIRST USE 7-2-2005; IN COMMERCE 7-2-2005.

FOR: FRANCHISING, NAMELY, TECHNICAL  
ASSISTANCE IN THE ESTABLISHMENT AND OR  
OPERATION OF RETAIL STORES FOR THE SALES  
OF MATTRESSES, IN CLASS 35 (U.S. CLS. 100, 101  
AND 102).

FIRST USE 7-2-2005; IN COMMERCE 7-2-2005.

NO CLAIM IS MADE TO THE EXCLUSIVE  
RIGHT TO USE "MATTRESS OUTLET", APART  
FROM THE MARK AS SHOWN.

THE COLOR(S) RED, WHITE, AND BLUE IS/ARE  
CLAIMED AS A FEATURE OF THE MARK.

THE WORDS "BIG BOB'S AND OUTLET" AP-  
PEAR IN BLUE WITHIN A BLUE BORDERED  
CIRCLE ON WHITE BACKGROUND. THE WORD  
"MATTRESS" APPEARS IN RED WITHIN A RED  
RECTANGLE ON WHITE BACKGROUND WITHIN  
THE BLUE BORDER CIRCLE AS SHOWN.

SER. NO. 76-667,819, FILED 10-20-2006.

SCOTT BIBB, EXAMINING ATTORNEY

**Int. Cl.: 20**

**Prior U.S. Cls.: 2, 13, 22, 25, 32 and 50**

**United States Patent and Trademark Office**

**Reg. No. 3,451,711**

**Registered June 24, 2008**

**TRADEMARK  
PRINCIPAL REGISTER**

**E-LIFT**

CASE SYSTEMS, INC. (NEW YORK CORPORATION)  
2700 JAMES SAVAGE ROAD  
MIDLAND, MI 48642

FOR: TABLES AND WORK SURFACES FOR  
LABORATORY WORKSTATIONS, IN CLASS 20  
(U.S. CLS. 2, 13, 22, 25, 32 AND 50).

FIRST USE 12-3-2001; IN COMMERCE 12-3-2001.

THE MARK CONSISTS OF STANDARD CHARACTERS WITHOUT CLAIM TO ANY PARTICULAR FONT, STYLE, SIZE, OR COLOR.

SEC. 2(F).

SER. NO. 76-668,473, FILED 11-3-2006.

EDWARD FENNESSY, EXAMINING ATTORNEY

**Int. Cl.: 36**

**Prior U.S. Cls.: 100, 101 and 102**

**United States Patent and Trademark Office**

**Reg. No. 3,451,712**

**Registered June 24, 2008**

**SERVICE MARK  
PRINCIPAL REGISTER**

**ROARING BROOK CAPITAL**

ROARING BROOK ADVISORS, LLC (DELA-  
WARE LTD LIAB CO)  
50 MAIN STREET  
WHITE PLAINS, NY 10606

FOR: FINANCIAL SERVICES IN THE FIELD OF  
INVESTMENT SECURITIES, IN CLASS 36 (U.S. CLS.  
100, 101 AND 102).

FIRST USE 10-10-2006; IN COMMERCE 10-10-2006.

THE MARK CONSISTS OF STANDARD CHAR-  
ACTERS WITHOUT CLAIM TO ANY PARTICULAR  
FONT, STYLE, SIZE, OR COLOR.

NO CLAIM IS MADE TO THE EXCLUSIVE  
RIGHT TO USE "CAPITAL", APART FROM THE  
MARK AS SHOWN.

SER. NO. 76-669,463, FILED 11-24-2006.

ALICIA COLLINS, EXAMINING ATTORNEY

**Int. Cl.: 6**

**Prior U.S. Cls.: 2, 12, 13, 14, 23, 25 and 50**

**Reg. No. 3,451,713**

**United States Patent and Trademark Office**

**Registered June 24, 2008**

**TRADEMARK  
PRINCIPAL REGISTER**



HERCULES INDUSTRIES, INC. (COLORADO CORPORATION)  
1310 WEST EVANS  
DENVER, CO 80223

SHEET METAL GRILLES, ALL FOR USE IN HEATING, COOLING, AND VENTILATION, IN CLASS 6 (U.S. CLS. 2, 12, 13, 14, 23, 25 AND 50).

FOR: HEATING AND AIR CONDITIONING ACCESSORIES FOR HEATERS, HEAT PUMPS, FURNACES, AIR CONDITIONERS AND EVAPORATIVE COOLERS, NAMELY, SHEET METAL PIPES, METAL PIPE FITTINGS, SHEET METAL DUCTS, METAL DUCT FITTINGS, SHEET METAL VENTS, AND

FIRST USE 1-1-1981; IN COMMERCE 1-1-1981.

SER. NO. 76-669,841, FILED 12-4-2006.

JOHN KELLY, EXAMINING ATTORNEY

**Int. Cl.: 41**

**Prior U.S. Cls.: 100, 101 and 107**

**United States Patent and Trademark Office**

**Reg. No. 3,451,714**

**Registered June 24, 2008**

**SERVICE MARK  
PRINCIPAL REGISTER**

# ADULT DOORWAY

D & E MEDIA, LLC (DELAWARE LTD LIAB CO)  
360 GLENWOOD AVE.  
EAST ORANGE, NJ 09017

FOR: ADULT ENTERTAINMENT SERVICES,  
NAMELY, PROVIDING AN ADULT ENTERTAIN-  
MENT WEBSITE FEATURING PHOTOGRAPHIC,  
AUDIO AND VIDEO PRESENTATIONS, IN CLASS  
41 (U.S. CLS. 100, 101 AND 107).

FIRST USE 2-23-2005; IN COMMERCE 2-23-2005.

THE MARK CONSISTS OF STANDARD CHAR-  
ACTERS WITHOUT CLAIM TO ANY PARTICULAR  
FONT, STYLE, SIZE, OR COLOR.

NO CLAIM IS MADE TO THE EXCLUSIVE  
RIGHT TO USE "ADULT", APART FROM THE  
MARK AS SHOWN.

SER. NO. 76-669,940, FILED 12-5-2006.

DAVID MURRAY, EXAMINING ATTORNEY

**Int. Cls.: 27 and 35**

**Prior U.S. Cls.: 19, 20, 37, 42, 50, 100, 101 and 102**

**United States Patent and Trademark Office**

**Reg. No. 3,451,715**

**Registered June 24, 2008**

**TRADEMARK  
SERVICE MARK  
PRINCIPAL REGISTER**



BIG BOB'S FLOORING OUTLET OF AMERICA,  
INC. (MISSOURI CORPORATION)  
10001 W. 75TH STREET  
SHAWNEE MISSION, KS 66204

FOR: CARPETS, RUGS, MATS AND MATTING,  
LINOLEUM AND OTHER MATERIALS FOR COV-  
ERING EXISTING FLOORS, NAMELY, FLOOR  
COVERINGS AND RESILIENT HARD SURFACE  
COVERING FOR FLOORS, IN CLASS 27 (U.S. CLS.  
19, 20, 37, 42 AND 50).

FIRST USE 10-15-2006; IN COMMERCE 10-15-2006.

FOR: FRANCHISING, NAMELY, OFFERING  
TECHNICAL ASSISTANCE IN THE ESTABLISH-  
MENT AND/OR OPERATION OF RETAIL STORES  
FOR SALES OF FLOOR COVERING, IN CLASS 35  
(U.S. CLS. 100, 101 AND 102).

FIRST USE 10-15-2006; IN COMMERCE 10-15-2006.

NO CLAIM IS MADE TO THE EXCLUSIVE  
RIGHT TO USE "SHOP AT HOME", APART FROM  
THE MARK AS SHOWN.

THE COLOR(S) RED, WHITE, AND BLUE IS/ARE  
CLAIMED AS A FEATURE OF THE MARK.

THE WORDS "BIG BOB'S" APPEAR IN BLUE,  
ABOVE THE OVERALL SHAPE OF A HOME WITH  
ROOF LINE AND CHIMNEY. THE HOME IS IN  
RED, WITH A BLUE OUTLINE. WITHIN THE  
HOME SHAPE IN WHITE ARE THE WORDS "SHOP  
AT HOME".

SER. NO. 76-670,189, FILED 12-11-2006.

SCOTT BIBB, EXAMINING ATTORNEY

**Int. Cls.: 35 and 41**

**Prior U.S. Cls.: 100, 101, 102 and 107**

**United States Patent and Trademark Office**

**Reg. No. 3,451,716**

**Registered June 24, 2008**

**SERVICE MARK  
PRINCIPAL REGISTER**

**IACVA**

NATIONAL ASSOCIATION OF CERTIFIED VALUATION ANALYSTS, INC. (UTAH CORPORATION)

1111 E. BRICKYARD RD., SUITE 200  
SALT LAKE CITY, UT 841065401

FOR: ASSOCIATION SERVICES, FOR CERTIFIED PUBLIC ACCOUNTANTS AND OTHERS IN ACCOUNTING IN THE INTERNATIONAL COMMUNITY, AND ANY PROFESSIONAL ADVISOR TO THE PUBLIC AND PRIVATE BUSINESS COMMUNITIES, NAMELY, PROMOTING PROFESSIONAL DEVELOPMENT, ADVANCING STANDARDS OF ETHICAL AND PROFESSIONAL PRACTICE, ENHANCING PUBLIC AWARENESS OF MEMBERS' SERVICES INTERNATIONALLY, AND PROMOTING WORKING RELATIONSHIPS WITH OTHER PROFESSIONAL ORGANIZATIONS, IN CLASS 35 (U.S. CLS. 100, 101 AND 102).

FIRST USE 6-1-2001; IN COMMERCE 6-1-2001.

FOR: EDUCATION AND TRAINING SERVICES, NAMELY, PROVIDING CERTIFICATION PROGRAMS AND COURSES OF INSTRUCTION IN THE FIELDS OF BUSINESS AND INTANGIBLE ASSET VALUATIONS, FINANCIAL FORENSICS, FINANCE, LITIGATION CONSULTING, EXPERT WITNESSING, MERGERS AND ACQUISITIONS, SUCCESSION PLANNING, FRAUD PREVENTION/DETECTION AND INVESTIGATION, AND BUSINESS PERFORMANCE CONSULTING, IN CLASS 41 (U.S. CLS. 100, 101 AND 107).

FIRST USE 6-1-2001; IN COMMERCE 6-1-2001.

THE MARK CONSISTS OF STANDARD CHARACTERS WITHOUT CLAIM TO ANY PARTICULAR FONT, STYLE, SIZE, OR COLOR.

SER. NO. 76-671,736, FILED 1-24-2007.

BENJAMIN OKEKE, EXAMINING ATTORNEY

**Int. Cl.: 1**

**Prior U.S. Cls.: 1, 5, 6, 10, 26 and 46**

**United States Patent and Trademark Office**

**Reg. No. 3,451,717**

**Registered June 24, 2008**

**TRADEMARK  
PRINCIPAL REGISTER**

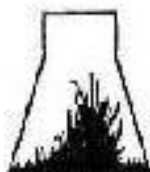

***Phyto*Technology Laboratories**

PHYTOTECHNOLOGY LABORATORIES, LLC,  
(KANSAS LTD LIAB CO)  
P. O. BOX 13481  
SHAWNEE MISSION, KS 662823481

FOR: CHEMICALS AND REAGENTS USED IN  
INDUSTRY, SCIENCE, AGRICULTURE, HORTI-  
CULTURE AND FORESTRY, NAMELY, CHEMI-  
CALS AND REAGENTS USED IN INDUSTRIAL,  
SCIENTIFIC, AGRICULTURAL, HORTICULTURAL  
AND FORESTRY-RELATED RESEARCH, IN CLASS  
1 (U.S. CLS. 1, 5, 6, 10, 26 AND 46).

FIRST USE 2-1-1998; IN COMMERCE 2-1-1998.

NO CLAIM IS MADE TO THE EXCLUSIVE  
RIGHT TO USE "PHYTOTECHNOLOGY LABORA-  
TORIES", APART FROM THE MARK AS SHOWN.

THE MARK CONSISTS OF A BEAKER IMAGE  
WITH A REPRESENTATIVE GROWTH OF A SPECI-  
MEN INSIDE OF IT, NEXT TO THE WORDS "PHY-  
TOTECHNOLOGY LABORATORIES", WITH THE  
WORD "PHYTO" ITALICIZED.

SER. NO. 76-671,878, FILED 1-26-2007.

JAMES STEIN, EXAMINING ATTORNEY



**Int. Cls.: 9 and 42**

**Prior U.S. Cls.: 21, 23, 26, 36, 38, 100 and 101**

**United States Patent and Trademark Office**

**Reg. No. 3,451,718**

**Registered June 24, 2008**

**TRADEMARK  
SERVICE MARK  
PRINCIPAL REGISTER**

**ARRS GOLDMINER**

AMERICAN ROENTGEN RAY SOCIETY (D.C.  
NOT-FOR-PROFIT ASSOCIATION)  
44211 SLATESTONE COURT  
LEESBURG, VA 20176

FOR: COMPUTER SOFTWARE FOR IMAGE  
SEARCHING, VISUAL SEARCH, VIDEO AND IM-  
AGE MONITORING AND CLASSIFICATION, COM-  
PUTER SEARCH ENGINE SOFTWARE;  
COMPUTER SOFTWARE FOR USE IN THE FIELD  
OF IMAGE AND VIDEO MANAGEMENT; COMPU-  
TER SOFTWARE FOR ORGANIZING AND VIEW-  
ING DIGITAL IMAGES, IN CLASS 9 (U.S. CLS. 21, 23,  
26, 36 AND 38).

FIRST USE 3-1-2006; IN COMMERCE 3-1-2006.

FOR: COMPUTER SERVICES, NAMELY, PRO-  
VIDING SEARCH ENGINES FOR OBTAINING  
DATA ON A GLOBAL COMPUTER NETWORK, IN  
CLASS 42 (U.S. CLS. 100 AND 101).

FIRST USE 3-1-2006; IN COMMERCE 3-1-2006.

THE MARK CONSISTS OF STANDARD CHAR-  
ACTERS WITHOUT CLAIM TO ANY PARTICULAR  
FONT, STYLE, SIZE, OR COLOR.

SER. NO. 76-672,695, FILED 2-13-2007.

TARAH HARDY, EXAMINING ATTORNEY

Int. Cls.: 9, 24 and 28

Prior U.S. Cls.: 21, 22, 23, 26, 36, 38, 42 and 50

United States Patent and Trademark Office

Reg. No. 3,451,719

Registered June 24, 2008

TRADEMARK  
PRINCIPAL REGISTER



MOOCOW LIMITED (UNITED KINGDOM CORPORATION)  
9-10 CHARLOTTE MEWS  
LONDON W1T 4EF, UNITED KINGDOM

FOR: PRE-RECORDED TAPES, LASER DISCS, CDS, DVDS FEATURING MUSIC, MOVIES, ANIMATION, AND GRAPHIC IMAGES, AND AUDIO RECORDED BOOKS; PRE-RECORDED TAPES, LASER DISCS, CDS, DVDS FEATURING DANCE AND FITNESS EXERCISES AND INSTRUCTION MANUALS DISTRIBUTED THEREWITH; COMPUTER GAME SOFTWARE; DOWNLOADABLE MUSIC FILES; DOWNLOADABLE MOTION PICTURE FILMS AND TELEVISION PROGRAMS; DOWNLOADABLE VIDEO RECORDINGS FEATURING DANCE AND FITNESS EXERCISES, IN CLASS 9 (U.S. CLS. 21, 23, 26, 36 AND 38).

FOR: TEXTILES AND TEXTILE GOODS, NAMELY, BLANKETS, SHEETS, PILLOW CASES, TABLECLOTHS, TOWELS, DUVET COVERS, AND CUSHION COVERS, IN CLASS 24 (U.S. CLS. 42 AND 50).

FOR: TOYS, GAMES AND PLAYTHINGS, NAMELY, A KIT COMPRISING A TEXTILE DUVET COVER OR A TEXTILE SHEET, RECORDED MUSIC IN THE FORM OF A CD OR RECORDED DVD FEATURING MUSIC AND ANIMATION, BATTERY OPERATED TOY MICROPHONE, GAME INSTRUCTION LEAFLET, IN CLASS 28 (U.S. CLS. 22, 23, 38 AND 50).

PRIORITY CLAIMED UNDER SEC. 44(D) ON ERPN CMNTY TM OFC APPLICATION NO. 005274791, FILED 8-24-2006, REG. NO. 005274791, DATED 8-30-2007, EXPIRES 8-24-2016.

NO CLAIM IS MADE TO THE EXCLUSIVE RIGHT TO USE "DUVET", APART FROM THE MARK AS SHOWN.

SER. NO. 76-672,844, FILED 2-20-2007.

DAWN FELDMAN, EXAMINING ATTORNEY

**Int. Cl.: 28**

**Prior U.S. Cls.: 22, 23, 38 and 50**

**Reg. No. 3,451,720**

**United States Patent and Trademark Office**

**Registered June 24, 2008**

**TRADEMARK  
PRINCIPAL REGISTER**

**TOMGIRL TOYS**

DONALD, TIFFANY (UNITED STATES INDIVIDUAL)  
C/O JOE D. GUERRIERO  
JOE D. GUERRIERO, LLC3030 AURORA AVENUE,  
SECOND FLOOR  
MONROE, LA 71201 AND  
BEALL, GENIE (UNITED STATES INDIVIDUAL)  
C/O JOE D. GUERRIERO  
JOE D. GUERRIERO, LLC3030 AURORA AVENUE,  
SECOND FLOOR  
MONROE, LA 71201

FIRST USE 9-25-2006; IN COMMERCE 9-25-2006.

NO CLAIM IS MADE TO THE EXCLUSIVE  
RIGHT TO USE "TOYS", APART FROM THE MARK  
AS SHOWN.

SER. NO. 76-673,100, FILED 2-21-2007.

FOR: TOYS, NAMELY, TOY VEHICLES, IN  
CLASS 28 (U.S. CLS. 22, 23, 38 AND 50).

DOMINIC J. FERRAIUOLO, EXAMINING ATTORNEY

**Int. Cl.: 41**

**Prior U.S. Cls.: 100, 101 and 107**

**United States Patent and Trademark Office**

**Reg. No. 3,451,721**

**Registered June 24, 2008**

**SERVICE MARK  
PRINCIPAL REGISTER**

**BRISTOW ACADEMY**

BRISTOW GROUP INC. (DELAWARE CORPORATION)  
2000 WEST SAM HOUSTON PARKWAY SOUTH  
SUITE 1700  
HOUSTON, TX 77042

FOR: FLIGHT TRAINING FOR AIRCRAFT AND HELICOPTER PILOTS; TRAINING FOR CIVIL AND MILITARY PERSONNEL IN THE FIELD OF AVIATION ENGINEERING; SEARCH AND RESCUE TRAINING; AND TRAINING OF OFFSHORE PERSONNEL IN THE FIELD OF OIL AND GAS PRODUCTION SERVICES, IN CLASS 41 (U.S. CLS. 100, 101 AND 107).

FIRST USE 4-15-2007; IN COMMERCE 4-15-2007.

OWNER OF U.S. REG. NO. 3,263,021.

NO CLAIM IS MADE TO THE EXCLUSIVE RIGHT TO USE "ACADEMY", APART FROM THE MARK AS SHOWN.

SEC. 2(F) AS TO "BRISTOW".

SER. NO. 76-673,333, FILED 2-28-2007.

LAURIE KAUFMAN, EXAMINING ATTORNEY

**Int. Cls.: 9 and 42**

**Prior U.S. Cls.: 21, 23, 26, 36, 38, 100 and 101**

**United States Patent and Trademark Office**

**Reg. No. 3,451,722**

**Registered June 24, 2008**

**TRADEMARK  
SERVICE MARK  
PRINCIPAL REGISTER**



FAT SPANIEL TECHNOLOGIES, INC. (CALIFORNIA CORPORATION)  
2 W. SANTA CLARA STREET, 5TH FLOOR  
SAN JOSE, CA 95113

FOR: SCIENTIFIC, CHECKING, PHOTOGRAPHIC AND MEASURING APPARATUS AND INSTRUMENTS, NAMELY, APPARATUS FOR ENERGY SYSTEM DATA MONITORING AND COLLECTING; APPARATUS FOR RECORDING, TRANSMISSION OR REPRODUCTION OF SOUND OR IMAGES, NAMELY, APPARATUS FOR RECORDING AND TRANSMITTING DISTRIBUTED ENERGY SYSTEM PERFORMANCE DATA; DATA PROCESSING EQUIPMENT AND COMPUTERS, NAMELY, DEVICES FOR TRANSPORTING AND AGGREGATING DISTRIBUTED ENERGY SYSTEM PERFORMANCE DATA, IN CLASS 9 (U.S. CLS. 21, 23, 26, 36 AND 38).

FIRST USE 9-15-2003; IN COMMERCE 9-15-2003.

FOR: SCIENTIFIC AND TECHNOLOGICAL SERVICES AND RESEARCH AND DESIGN THERETO,

NAMELY, MONITORING AND REPORTING DATA FOR DISTRIBUTED ENERGY SYSTEMS; DEVELOPMENT OF NEW DATA MONITORING AND COLLECTING TECHNOLOGIES IN THE FIELD OF ENERGY SYSTEM; DESIGN AND DEVELOPMENT OF COMPUTER HARDWARE AND SOFTWARE FOR ENERGY SYSTEM MEASURING, MONITORING AND REPORTING, IN CLASS 42 (U.S. CLS. 100 AND 101).

FIRST USE 9-15-2003; IN COMMERCE 9-15-2003.

THE COLOR(S) BLACK AND WHITE IS/ARE CLAIMED AS A FEATURE OF THE MARK.

THE COLOR WHITE APPEARS ON THE ENTIRE BODY OF THE DOG AND BLACK SPOTS APPEAR ON THE DOG'S HEAD AND BODY AND TAIL.

SER. NO. 76-673,828, FILED 3-9-2007.

ELIZABETH KAJUBI, EXAMINING ATTORNEY

**Int. Cls.: 9 and 42**

**Prior U.S. Cls.: 21, 23, 26, 36, 38, 100 and 101**

**United States Patent and Trademark Office**

**Reg. No. 3,451,723**

**Registered June 24, 2008**

**TRADEMARK  
SERVICE MARK  
PRINCIPAL REGISTER**

**FAT SPANIEL TECHNOLOGIES**

FAT SPANIEL TECHNOLOGIES, INC. (CALIFORNIA CORPORATION)  
2 W. SANTA CLARA STREET, 5TH FLOOR  
SAN JOSE, CA 95113

FOR: SCIENTIFIC, CHECKING, PHOTOGRAPHIC AND MEASURING APPARATUS AND INSTRUMENTS, NAMELY, APPARATUS FOR ENERGY SYSTEM DATA MONITORING AND COLLECTING; APPARATUS FOR RECORDING, TRANSMISSION OR REPRODUCTION OF SOUND OR IMAGES, NAMELY, APPARATUS FOR RECORDING AND TRANSMITTING DISTRIBUTED ENERGY SYSTEM PERFORMANCE DATA; DATA PROCESSING EQUIPMENT AND COMPUTERS, NAMELY, DEVICES FOR TRANSPORTING AND AGGREGATING DISTRIBUTED ENERGY SYSTEM PERFORMANCE DATA, IN CLASS 9 (U.S. CLS. 21, 23, 26, 36 AND 38).

FIRST USE 9-15-2003; IN COMMERCE 9-15-2003.

FOR: SCIENTIFIC AND TECHNOLOGICAL SERVICES AND RESEARCH AND DESIGN THERETO, NAMELY, MONITORING AND REPORTING DATA

FOR DISTRIBUTED ENERGY SYSTEMS; DEVELOPMENT OF NEW DATA MONITORING AND COLLECTING TECHNOLOGIES IN THE FIELD OF ENERGY SYSTEM; DESIGN AND DEVELOPMENT OF COMPUTER HARDWARE AND SOFTWARE FOR ENERGY SYSTEM MEASURING, MONITORING AND REPORTING, IN CLASS 42 (U.S. CLS. 100 AND 101).

FIRST USE 9-15-2003; IN COMMERCE 9-15-2003.

THE MARK CONSISTS OF STANDARD CHARACTERS WITHOUT CLAIM TO ANY PARTICULAR FONT, STYLE, SIZE, OR COLOR.

NO CLAIM IS MADE TO THE EXCLUSIVE RIGHT TO USE "TECHNOLOGIES", APART FROM THE MARK AS SHOWN.

SER. NO. 76-673,829, FILED 3-9-2007.

ELIZABETH KAJUBI, EXAMINING ATTORNEY

**Int. Cl.: 35**

**Prior U.S. Cls.: 100, 101 and 102**

**United States Patent and Trademark Office**

**Reg. No. 3,451,724**

**Registered June 24, 2008**

**SERVICE MARK  
PRINCIPAL REGISTER**

**ALL WEB LEADS**

ALL EXCLUSIVE LEADS, LTD. (TEXAS LIMITED PARTNERSHIP)  
9 KERN RAMBLE #A  
AUSTIN, TX 78722

THE MARK CONSISTS OF STANDARD CHARACTERS WITHOUT CLAIM TO ANY PARTICULAR FONT, STYLE, SIZE, OR COLOR.

FOR: PROVIDING SALES REFERRALS FOR INSURANCE AGENTS, IN CLASS 35 (U.S. CLS. 100, 101 AND 102).

SER. NO. 76-673,908, FILED 3-12-2007.

FIRST USE 12-1-2006; IN COMMERCE 12-1-2006.

PAM WILLIS, EXAMINING ATTORNEY

**Int. Cl.: 42**

**Prior U.S. Cls.: 100 and 101**

**United States Patent and Trademark Office**

**Reg. No. 3,451,725**

**Registered June 24, 2008**

**SERVICE MARK  
PRINCIPAL REGISTER**

**UNLEASH THE  
POWER OF  
TOGETHER**

TITAN CONSULTING LLP (TEXAS LIMITED  
LIABILITY PARTNERSHIP)  
3411 PRESTON RD, STE C-13, PMB 205  
FRISCO, TX 75034

FOR: CONSULTING SERVICES, NAMELY,  
TECHNOLOGY CONSULTING, NAMELY, SOFT-  
WARE CONSULTING FEATURING SOFTWARE  
SYSTEMS ANALYSIS, DEVELOPMENT AND IM-  
PLEMENTATION , IN CLASS 42 (U.S. CLS. 100 AND  
101).

FIRST USE 4-1-2006; IN COMMERCE 4-1-2006.

THE MARK CONSISTS OF STANDARD CHAR-  
ACTERS WITHOUT CLAIM TO ANY PARTICULAR  
FONT, STYLE, SIZE, OR COLOR.

SER. NO. 76-674,116, FILED 3-15-2007.

MARK RADEMACHER, EXAMINING ATTORNEY



**Int. Cl.: 9**

**Prior U.S. Cls.: 21, 23, 26, 36 and 38**

**Reg. No. 3,451,726**

**United States Patent and Trademark Office**

**Registered June 24, 2008**

**TRADEMARK  
PRINCIPAL REGISTER**

**ROAD SAFETY**

ROAD SAFETY INTERNATIONAL, INC. (CALI-  
FORNIA CORPORATION)  
3251 GRANDE VISTA DRIVE  
THOUSAND OAKS, CA 913201193

THE MARK CONSISTS OF STANDARD CHAR-  
ACTERS WITHOUT CLAIM TO ANY PARTICULAR  
FONT, STYLE, SIZE, OR COLOR.

FOR: COMPUTER SOFTWARE AND COMPUTER  
HARDWARE FOR USE IN MONITORING AND  
IMPROVING DRIVER PERFORMANCE, IN CLASS  
9 (U.S. CLS. 21, 23, 26, 36 AND 38).

SER. NO. 76-674,445, FILED 3-22-2007.

FIRST USE 10-29-1997; IN COMMERCE 10-29-1997.

JOHN DALIER, EXAMINING ATTORNEY

**Int. Cl.: 9**

**Prior U.S. Cls.: 21, 23, 26, 36 and 38**

**Reg. No. 3,451,727**

**United States Patent and Trademark Office**

**Registered June 24, 2008**

---

**TRADEMARK  
PRINCIPAL REGISTER**

**RS-2000 FLEET BLACK BOX**

ROAD SAFETY INTERNATIONAL, INC. (CALIFORNIA CORPORATION)  
3251 GRANDE VISTA DRIVE  
THOUSAND OAKS, CA 913201193

THE MARK CONSISTS OF STANDARD CHARACTERS WITHOUT CLAIM TO ANY PARTICULAR FONT, STYLE, SIZE, OR COLOR.

FOR: COMPUTER SOFTWARE AND COMPUTER HARDWARE FOR USE IN MONITORING AND IMPROVING DRIVER PERFORMANCE, PROVIDING DATABASE REPORTS IN CONNECTION WITH DRIVER PERFORMANCE, IN CLASS 9 (U.S. CLS. 21, 23, 26, 36 AND 38).

NO CLAIM IS MADE TO THE EXCLUSIVE RIGHT TO USE "FLEET BLACK BOX", APART FROM THE MARK AS SHOWN.

SER. NO. 76-674,448, FILED 3-22-2007.

FIRST USE 5-26-2005; IN COMMERCE 5-26-2005.

JOHN DALIER, EXAMINING ATTORNEY

**Int. Cl.: 9**

**Prior U.S. Cls.: 21, 23, 26, 36 and 38**

**Reg. No. 3,451,728**

**United States Patent and Trademark Office**

**Registered June 24, 2008**

**TRADEMARK  
PRINCIPAL REGISTER**

**RS-1000 TEEN BLACK BOX**

ROAD SAFETY INTERNATIONAL, INC. (CALI-  
FORNIA CORPORATION)  
3251 GRANDE VISTA DRIVE  
THOUSAND OAKS, CA 913201193

THE MARK CONSISTS OF STANDARD CHAR-  
ACTERS WITHOUT CLAIM TO ANY PARTICULAR  
FONT, STYLE, SIZE, OR COLOR.

FOR: COMPUTER SOFTWARE AND COMPUTER  
HARDWARE FOR USE IN MONITORING AND  
IMPROVING DRIVER PERFORMANCE, PROVID-  
ING DATABASE REPORTS IN CONNECTION WITH  
DRIVER PERFORMANCE, IN CLASS 9 (U.S. CLS. 21,  
23, 26, 36 AND 38).

SEC. 2(F).

SER. NO. 76-674,449, FILED 3-22-2007.

FIRST USE 7-5-2002; IN COMMERCE 7-5-2002.

JOHN DALIER, EXAMINING ATTORNEY

**Int. Cl.: 9**

**Prior U.S. Cls.: 21, 23, 26, 36 and 38**

**Reg. No. 3,451,729**

**United States Patent and Trademark Office**

**Registered June 24, 2008**

**TRADEMARK  
PRINCIPAL REGISTER**

**+** **EMTDOCS**

IT'S MUSIC, LLC (GEORGIA LTD LIAB CO)  
6100 LAKE FORREST DRIVE, SUITE 104  
ATLANTA, GA 30328

FOR: PORTABLE, COMPUTER- OR OPTIC-  
READABLE ELECTRONIC OR OPTICAL COMPU-  
TER DATA STORAGE DEVICES FOR ACCESSING  
AND STORING A PATIENT'S VITAL MEDICAL  
INFORMATION, MEDICAL PROVIDER CONTACT  
INFORMATION, LIVING WILL, HEALTHCARE  
POWER OF ATTORNEY, OTHER POWER OF AT-  
TORNEY INFORMATION, INSURANCE INFOR-

MATION, AND THE LIKE, IN CLASS 9 (U.S. CLS.  
21, 23, 26, 36 AND 38).

FIRST USE 7-8-2006; IN COMMERCE 7-0-2006.

NO CLAIM IS MADE TO THE EXCLUSIVE  
RIGHT TO USE THE GREEK CROSS DESIGN,  
APART FROM THE MARK AS SHOWN.

SER. NO. 76-674,970, FILED 4-3-2007.

JOHN GARTNER, EXAMINING ATTORNEY

**Int. Cl.: 7**

**Prior U.S. Cls.: 13, 19, 21, 23, 31, 34 and 35**

**Reg. No. 3,451,730**

**United States Patent and Trademark Office**

**Registered June 24, 2008**

**TRADEMARK  
PRINCIPAL REGISTER**

# PurePro

F.W. WEBB COMPANY (MASSACHUSETTS CORPORATION)  
160 MIDDLESEX TURNPIKE  
BEDFORD, MA 01730

FOR: OIL FILTERS FOR HEATING APPLIANCES, OIL FILTER CARTRIDGES, AND DEGREASERS FOR USE ON COOLING COILS, BOILER JACKETS, GARAGE FLOORS, ENGINES, MOTORS, WHITE WALLS, PRINTING PRESSES, INDUSTRIAL AND FARM MECHANICAL PARTS, TOOLS, MACHINERY, FUEL OIL RELATED COMPONENTS, REFRIGERATION PARTS AND HARD SURFACES, IN CLASS 7 (U.S. CLS. 13, 19, 21, 23, 31, 34 AND 35).

FIRST USE 1-31-2006; IN COMMERCE 1-31-2006.

THE MARK CONSISTS OF STANDARD CHARACTERS WITHOUT CLAIM TO ANY PARTICULAR FONT, STYLE, SIZE, OR COLOR.

OWNER OF U.S. REG. NO. 2,931,465.

SER. NO. 76-675,089, FILED 4-5-2007.

CAROLINE WOOD, EXAMINING ATTORNEY

**Int. Cl.: 11**

**Prior U.S. Cls.: 13, 21, 23, 31 and 34**

**United States Patent and Trademark Office**

**Reg. No. 3,451,731**

**Registered June 24, 2008**

**TRADEMARK  
PRINCIPAL REGISTER**



F.W. WEBB COMPANY (MASSACHUSETTS CORPORATION)  
160 MIDDLESEX TURNPIKE  
BEDFORD, MA 01730

FOR: PLUMBING PRODUCTS, FIXTURES AND FITTINGS FOR WATER SUPPLY, NAMELY, FAUCETS AND SHOWER VALVES; HOT WATER HEATERS AND BOILER TRIM KITS, COMPRISED OF AN EXPANSION TANK, BOILER FILL/BACKFLOW PREVENTER, AIR PURGER/AIR VENT AND CONNECTION FITTINGS, IN CLASS 11 (U.S. CLS. 13, 21, 23, 31 AND 34).

FIRST USE 1-25-2004; IN COMMERCE 1-25-2004.

OWNER OF U.S. REG. NO. 2,931,465.

THE COLOR(S) RED AND BLUE IS/ARE CLAIMED AS A FEATURE OF THE MARK.

THE MARK CONSISTS OF A RED ELLIPSE INSIDE OF WHICH IS THE WORD "PUREPRO" IN BLUE IN A STYLIZED FONT. THE COLORS RED AND BLUE APPEAR IN THE DESIGN OF THE MARK. THE COLOR RED APPEARS AS THE COLOR OF THE ELLIPSE. THE COLOR BLUE APPEARS AS THE COLOR OF THE LETTERS IN THE WORD "PUREPRO".

SER. NO. 76-675,095, FILED 4-5-2007.

CAROLINE WOOD, EXAMINING ATTORNEY

**Int. Cl.: 7**

**Prior U.S. Cls.: 13, 19, 21, 23, 31, 34 and 35**

**United States Patent and Trademark Office**

**Reg. No. 3,451,732**

**Registered June 24, 2008**

**TRADEMARK  
PRINCIPAL REGISTER**



F.W. WEBB COMPANY (MASSACHUSETTS CORPORATION)  
160 MIDDLESEX TURNPIKE  
BEDFORD, MA 01730

FOR: OIL FILTERS FOR HEATING APPLIANCES, OIL FILTER CARTRIDGES, AND DEGREASERS FOR USE ON COOLING COILS, BOILER JACKETS, GARAGE FLOORS, ENGINES, MOTORS, WHITE WALLS, PRINTING PRESSES, INDUSTRIAL AND FARM MECHANICAL PARTS, TOOLS, MACHINERY, FUEL OIL RELATED COMPONENTS, REFRIGERATION PARTS AND HARD SURFACES, IN CLASS 7 (U.S. CLS. 13, 19, 21, 23, 31, 34 AND 35).

FIRST USE 1-31-2006; IN COMMERCE 1-31-2006.

OWNER OF U.S. REG. NO. 2,931,465.

THE COLOR(S) RED AND BLUE IS/ARE CLAIMED AS A FEATURE OF THE MARK.

THE MARK CONSISTS OF A RED ELLIPSE INSIDE OF WHICH IS THE WORD "PUREPRO" IN BLUE IN A STYLIZED FONT. THE COLORS RED AND BLUE APPEAR IN THE DESIGN OF THE MARK. THE COLOR RED APPEARS AS THE COLOR OF THE ELLIPSE. THE COLOR BLUE APPEARS AS THE COLOR OF THE LETTERS IN THE WORD "PUREPRO".

SER. NO. 76-675,102, FILED 4-5-2007.

CAROLINE WOOD, EXAMINING ATTORNEY

**Int. Cl.: 11**

**Prior U.S. Cls.: 13, 21, 23, 31 and 34**

**United States Patent and Trademark Office**

**Reg. No. 3,451,733**

**Registered June 24, 2008**

**TRADEMARK  
PRINCIPAL REGISTER**

**PurePro**

F.W. WEBB COMPANY (MASSACHUSETTS CORPORATION)  
160 MIDDLESEX TURNPIKE  
BEDFORD, MA 01730

FOR: PLUMBING PRODUCTS, FIXTURES AND FITTINGS FOR WATER SUPPLY, NAMELY, FAUCETS AND SHOWER VALVES; HOT WATER HEATERS AND BOILER TRIM KITS, COMPRISED OF AN EXPANSION TANK, BOILER FILL/BACKFLOW PREVENTER, AIR PURGER/AIR VENT AND CONNECTION FITTINGS, IN CLASS 11 (U.S. CLS. 13, 21, 23, 31 AND 34).

FIRST USE 1-25-2004; IN COMMERCE 1-25-2004.

THE MARK CONSISTS OF STANDARD CHARACTERS WITHOUT CLAIM TO ANY PARTICULAR FONT, STYLE, SIZE, OR COLOR.

OWNER OF U.S. REG. NO. 2,931,465.

SER. NO. 76-675,103, FILED 4-5-2007.

CAROLINE WOOD, EXAMINING ATTORNEY



**Int. Cl.: 5**

**Prior U.S. Cls.: 6, 18, 44, 46, 51 and 52**

**Reg. No. 3,451,734**

**United States Patent and Trademark Office**

**Registered June 24, 2008**

**TRADEMARK  
PRINCIPAL REGISTER**

**CATT PLEX**

BLUEWATER CHEMGROUP, INC. (FLORIDA  
CORPORATION)  
3630 4TH AVENUE NE  
BRADENTON, FL 34208

FOR: HERBICIDE FOR AQUATIC, SHORELINE,  
LANDSCAPE AND AGRICULTURAL VEGETA-  
TION, IN CLASS 5 (U.S. CLS. 6, 18, 44, 46, 51 AND 52).

FIRST USE 2-15-2007; IN COMMERCE 2-15-2007.

THE MARK CONSISTS OF STANDARD CHAR-  
ACTERS WITHOUT CLAIM TO ANY PARTICULAR  
FONT, STYLE, SIZE, OR COLOR.

OWNER OF U.S. REG. NOS. 2,702,587, 2,702,590,  
AND 3,281,338.

SER. NO. 76-675,248, FILED 4-9-2007.

MICHAEL GAAFAR, EXAMINING ATTORNEY

**Int. Cl.: 9**

**Prior U.S. Cls.: 21, 23, 26, 36 and 38**

**Reg. No. 3,451,735**

**United States Patent and Trademark Office**

**Registered June 24, 2008**

---

**TRADEMARK  
PRINCIPAL REGISTER**

**ZZYZX**

JODAVI, INC. (CALIFORNIA CORPORATION)  
17316 EDWARDS ROAD, STE. 105  
CERRITOS, CA 90703

THE MARK CONSISTS OF STANDARD CHARACTERS WITHOUT CLAIM TO ANY PARTICULAR FONT, STYLE, SIZE, OR COLOR.

FOR: COAXIAL CABLES, CONNECTION CABLES AND ELECTRIC CABLES FOR USE WITH ALL TYPES OF MUSICAL INSTRUMENTS, IN CLASS 9 (U.S. CLS. 21, 23, 26, 36 AND 38).

SER. NO. 76-675,492, FILED 4-13-2007.

FIRST USE 11-1-2006; IN COMMERCE 11-1-2006.

MARY CRAWFORD, EXAMINING ATTORNEY

**Int. Cl.: 9**

**Prior U.S. Cls.: 21, 23, 26, 36 and 38**

**Reg. No. 3,451,736**

**United States Patent and Trademark Office**

**Registered June 24, 2008**

**TRADEMARK  
PRINCIPAL REGISTER**



CODESMITH TOOLS, LLC (TEXAS LTD LIAB  
CO)  
17950 PRESTON ROAD  
SUITE 310  
DALLAS, TX 75252

FIRST USE 11-1-2004; IN COMMERCE 11-1-2004.

NO CLAIM IS MADE TO THE EXCLUSIVE  
RIGHT TO USE "CODESMITH TOOLS", APART  
FROM THE MARK AS SHOWN.

FOR: COMPUTER SOFTWARE, NAMELY, SOFT-  
WARE DOWNLOADED TO ASSIST SOFTWARE  
DEVELOPERS IN THE GENERATION OF CODE  
FOR OTHER SOFTWARE PROJECTS AND PRO-  
GRAMS, IN CLASS 9 (U.S. CLS. 21, 23, 26, 36 AND 38).

SER. NO. 76-675,510, FILED 4-16-2007.

KAREN K. BUSH, EXAMINING ATTORNEY

**Int. Cl.: 35**

**Prior U.S. Cls.: 100, 101 and 102**

**United States Patent and Trademark Office**

**Reg. No. 3,451,737**

**Registered June 24, 2008**

**SERVICE MARK  
PRINCIPAL REGISTER**

**MISSYCOUPONS**

MISSYREVIEW INC (TEXAS CORPORATION)  
16238 HIGHWAY 620, SUITE F-124  
AUSTIN, TX 78717

FIRST USE 12-27-2004; IN COMMERCE 12-27-2004.

FOR: PROMOTING THE GOODS AND SERVICES OF OTHERS BY PROVIDING A WEBSITE FEATURING COUPONS, REBATES, PRICE-COMPARISON INFORMATION, PRODUCT REVIEWS, LINKS TO THE RETAIL WEBSITES OF OTHERS, AND DISCOUNT INFORMATION, IN CLASS 35 (U.S. CLS. 100, 101 AND 102).

THE MARK CONSISTS OF STANDARD CHARACTERS WITHOUT CLAIM TO ANY PARTICULAR FONT, STYLE, SIZE, OR COLOR.

SER. NO. 76-675,552, FILED 4-16-2007.

TARAH HARDY, EXAMINING ATTORNEY

**Int. Cl.: 37**

**Prior U.S. Cls.: 100, 103 and 106**

**United States Patent and Trademark Office**

**Reg. No. 3,451,738**

**Registered June 24, 2008**

**SERVICE MARK  
PRINCIPAL REGISTER**

**INDIANA FLOOR, INC.**

INDIANA FLOOR, INC. (VIRGINIA CORPORATION)  
8194 K & L TERMINAL ROAD  
LORTON, VA 22079

FOR: BUILDING CONSTRUCTION SERVICES AND BUILDING CONSTRUCTION CONSULTATION SERVICES THAT ADVISE BUILDERS, STORES AND INSTALLERS ON THE SELECTION AND INSTALLATION OF A VARIETY OF WOOD FLOORING PRODUCTS, NAMELY, HARDWOOD FLOORING, MOLDING, ADHESIVES, GLUES, SANDING AND INSTALLATION TOOLS, IN CLASS 37 (U.S. CLS. 100, 103 AND 106).

FIRST USE 12-31-1993; IN COMMERCE 12-31-1993.

THE MARK CONSISTS OF STANDARD CHARACTERS WITHOUT CLAIM TO ANY PARTICULAR FONT, STYLE, SIZE, OR COLOR.

NO CLAIM IS MADE TO THE EXCLUSIVE RIGHT TO USE "FLOOR, INC.", APART FROM THE MARK AS SHOWN.

SER. NO. 76-675,943, FILED 4-24-2007.

CHARLES L. JENKINS, EXAMINING ATTORNEY

**Int. Cl.: 42**

**Prior U.S. Cls.: 100 and 101**

**United States Patent and Trademark Office**

**Reg. No. 3,451,739**

**Registered June 24, 2008**

**SERVICE MARK  
PRINCIPAL REGISTER**

**THE WILD BUNCH INTERNATIONAL BALLOON TEAM**

MILLER, DAVID EARL (UNITED STATES INDIVIDUAL)  
P.O. BOX 40  
PORT ST. JOE, FL 32457

THE MARK CONSISTS OF STANDARD CHARACTERS WITHOUT CLAIM TO ANY PARTICULAR FONT, STYLE, SIZE, OR COLOR.

FOR: ENTERTAINMENT SERVICES, NAMELY, OFFERING HOT AIR BALLOON RIDES DURING WHICH CUSTOMERS ARE INFORMED OF THE NEED FOR PRESERVATION AND EFFICIENT USE OF NATURAL RESOURCES AND THE PROTECTION OF THE EARTH'S ENVIRONMENT, IN CLASS 42 (U.S. CLS. 100 AND 101).

NO CLAIM IS MADE TO THE EXCLUSIVE RIGHT TO USE "INTERNATIONAL BALLOON TEAM", APART FROM THE MARK AS SHOWN.

SER. NO. 76-676,004, FILED 4-26-2007.

FIRST USE 0-0-1988; IN COMMERCE 0-0-1988.

HENRY S. ZAK, EXAMINING ATTORNEY

**Int. Cl.: 32**

**Prior U.S. Cls.: 45, 46 and 48**

**Reg. No. 3,451,740**

**United States Patent and Trademark Office**

**Registered June 24, 2008**

---

**TRADEMARK  
PRINCIPAL REGISTER**

**IVY**

GUSTO FOOD INC. (NEW YORK CORPORATION)  
51-09 GRAND AVENUE  
MASPETH, NY 11378

THE MARK CONSISTS OF STANDARD CHARACTERS WITHOUT CLAIM TO ANY PARTICULAR FONT, STYLE, SIZE, OR COLOR.

FOR: NON-ALCOHOLIC BEVERAGES, NAMELY, FRUIT DRINKS, IN CLASS 32 (U.S. CLS. 45, 46 AND 48).

SER. NO. 76-676,104, FILED 4-27-2007.

FIRST USE 1-1-2007; IN COMMERCE 1-1-2007.

JULIE GUTTADAURO, EXAMINING ATTORNEY

**Int. Cl.: 30**

**Prior U.S. Cl.: 46**

**United States Patent and Trademark Office**

**Reg. No. 3,451,741**

**Registered June 24, 2008**

**TRADEMARK  
PRINCIPAL REGISTER**

The logo for "Spanish Latté" features a stylized, dark silhouette of a star or flower-like symbol positioned above the letter 'S' in "Spanish". The word "Spanish" is written in a bold, serif font, and "Latté" is written in a similar bold, serif font to its right. The entire logo is rendered in a dark, textured style.

URTH CAFFE CORPORATION (CALIFORNIA  
CORPORATION)  
1307 W. PICO BOULEVARD  
LOS ANGELES, CA 90015

NO CLAIM IS MADE TO THE EXCLUSIVE  
RIGHT TO USE "LATTE", APART FROM THE  
MARK AS SHOWN.

FOR: BEVERAGES MADE OF COFFEE; ESPRES-  
SO DRINKS; MENU ITEM SERVED AT A COFFEE  
CAFÉ, NAMELY, LATTES, IN CLASS 30 (U.S. CL. 46).

SER. NO. 76-676,133, FILED 4-26-2007.

FIRST USE 0-0-1997; IN COMMERCE 0-0-1997.

MARLENE BELL, EXAMINING ATTORNEY



**Int. Cl.: 44**

**Prior U.S. Cls.: 100 and 101**

**United States Patent and Trademark Office**

**Reg. No. 3,451,742**

**Registered June 24, 2008**

**SERVICE MARK  
PRINCIPAL REGISTER**



AFFILIATED VETERINARY SPECIALISTS, P.A.  
(FLORIDA CORPORATION)  
9905 SOUTH U.S. HIGHWAY 17-92  
MAITLAND, FL 32751

NO CLAIM IS MADE TO THE EXCLUSIVE  
RIGHT TO USE "AFFILIATED VETERINARY SPE-  
CIALISTS", APART FROM THE MARK AS SHOWN.

FOR: VETERINARY SERVICES, NAMELY, SUR-  
GERY, INTERNAL MEDICINE, NEUROLOGY,  
RADIOLOGY, ONCOLOGY AND DENTISTRY, IN  
CLASS 44 (U.S. CLS. 100 AND 101).

SER. NO. 76-676,162, FILED 4-30-2007.

FIRST USE 7-1-2004; IN COMMERCE 7-1-2004.

ANGELA GAW, EXAMINING ATTORNEY

**Int. Cl.: 37**

**Prior U.S. Cls.: 100, 103 and 106**

**United States Patent and Trademark Office**

**Reg. No. 3,451,743**

**Registered June 24, 2008**

**SERVICE MARK  
PRINCIPAL REGISTER**

**JUMO**

JUMO GMBH & CO. KG (FED REP GERMANY  
CORPORATION)

MOLTKESTRASSE 13 - 31

D-36039 FULDA, FED REP GERMANY

FOR: INSTALLATION OF ELECTRICAL SYS-  
TEMS, ELECTRO-MECHANICAL SYSTEMS, IN-  
DUSTRIAL MANUFACTURING EQUIPMENT  
AND AUTOMATED MACHINERY , IN CLASS 37  
(U.S. CLS. 100, 103 AND 106).

THE MARK CONSISTS OF STANDARD CHAR-  
ACTERS WITHOUT CLAIM TO ANY PARTICULAR  
FONT, STYLE, SIZE, OR COLOR.

OWNER OF FED REP GERMANY REG. NO.  
2032419, DATED 3-16-2003, EXPIRES 2-28-2011.

OWNER OF U.S. REG. NO. 1,807,116.

SER. NO. 76-676,204, FILED 4-30-2007.

SUSAN STIGLITZ, EXAMINING ATTORNEY

**Int. Cl.: 42**

**Prior U.S. Cls.: 100 and 101**

**United States Patent and Trademark Office**

**Reg. No. 3,451,744**

**Registered June 24, 2008**

**SERVICE MARK  
PRINCIPAL REGISTER**

**SIMPLYDIGI**

SIMPLYDIGI.COM INC (NEW MEXICO CORPORATION)  
9513 PERALTA NE  
ALBUQUERQUE, NM 87109

THE MARK CONSISTS OF STANDARD CHARACTERS WITHOUT CLAIM TO ANY PARTICULAR FONT, STYLE, SIZE, OR COLOR.

FOR: DEVELOPMENT OF COMPUTERIZED LEARNING MANAGEMENT SYSTEMS FOR OTHERS, IN CLASS 42 (U.S. CLS. 100 AND 101).

SER. NO. 76-676,269, FILED 4-30-2007.

FIRST USE 9-0-1998; IN COMMERCE 9-0-1999.

DAVID MURRAY, EXAMINING ATTORNEY

**Int. Cl.: 25**

**Prior U.S. Cls.: 22 and 39**

**United States Patent and Trademark Office**

**Reg. No. 3,451,745**

**Registered June 24, 2008**

**TRADEMARK  
PRINCIPAL REGISTER**

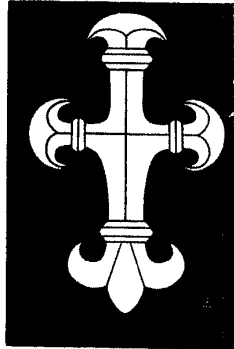

FUNKY UNIQUE CLOTHING (CALIFORNIA  
PARTNERSHIP)  
63 PICO PLAZA #255  
SAN CLEMENTE, CA 92672

FIRST USE 3-0-2002; IN COMMERCE 6-0-2003.

FOR: CLOTHING, NAMELY, FOOTWEAR,  
JEANS, SWEATPANTS, SWEAT SHIRTS, TEE  
SHIRTS, JACKETS, WRIST BANDS, HATS, CAPS,  
IN CLASS 25 (U.S. CLS. 22 AND 39).

SER. NO. 76-676,486, FILED 5-7-2007.

KAELIE KUNG, EXAMINING ATTORNEY

Int. Cl.: 25

Prior U.S. Cls.: 22 and 39

United States Patent and Trademark Office

Reg. No. 3,451,746

Registered June 24, 2008

TRADEMARK  
PRINCIPAL REGISTER

MADISON MICHELLE



KEMP, RUSSELL (UNITED STATES INDIVIDUAL)  
400 EAST 54TH STREET  
NEW YORK, NY 10022

FOR: WOMEN'S CLOTHING, NAMELY, DRESSES, JACKETS, SKIRTS, SUITS, PANTS, TOPS, BLOUSES, SHORTS AND LINGERIE, IN CLASS 25 (U.S. CLS. 22 AND 39).

FIRST USE 3-6-2006; IN COMMERCE 3-6-2006.

THE NAME "MADISON MICHELLE" DOES NOT IDENTIFY A LIVING INDIVIDUAL.

SER. NO. 76-676,520, FILED 5-7-2007.

ALLISON HOLTZ, EXAMINING ATTORNEY

Int. Cl.: 35

Prior U.S. Cls.: 100, 101 and 102

United States Patent and Trademark Office

Reg. No. 3,451,747

Registered June 24, 2008

**SERVICE MARK  
PRINCIPAL REGISTER**

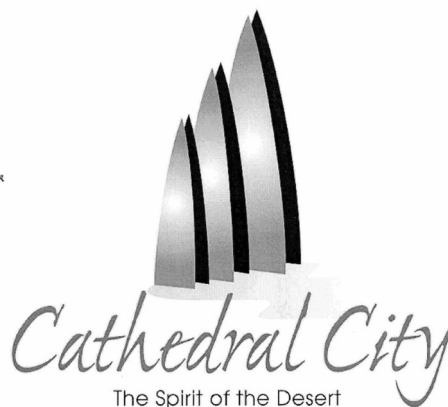

CITY OF CATHEDRAL CITY (CALIFORNIA  
MUNICIPAL CORPORATION)  
68700 AVEHIDA LALO GUERRERO  
CATHEDRAL CITY, CA 92234

FOR: ADVERTISING, MARKETING, AND PRO-  
MOTION SERVICES TO PROMOTE THE GOODS  
AND SERVICES OF OTHERS IN THE LOCAL BUSI-  
NESS COMMUNITY , IN CLASS 35 (U.S. CLS. 100, 101  
AND 102).

FIRST USE 10-0-2005; IN COMMERCE 10-0-2005.

NO CLAIM IS MADE TO THE EXCLUSIVE  
RIGHT TO USE "CATHEDRAL CITY", APART  
FROM THE MARK AS SHOWN.

THE MARK CONSISTS OF THREE TALL TRIAN-  
GLES, SLIGHTLY OVERLAPPING AND GROWING  
IN HEIGHT FROM LEFT TO RIGHT, WHICH  
REPRESENT MOUNTAIN CATHEDRALS. THE TRI-  
ANGLES HAVE A SHADOW ON THE RIGHT EDGE.  
THE WORDS "CATHEDRAL CITY" IN THE FONT  
OF EX PONTE SCRIPT ARE PLACED UNDER THE  
THREE TRIANGLES. THE WORDS "THE SPIRIT OF  
THE DESERT" IN THE FONT OF AVANTE GARDE  
ARE PLACED BELOW "CATHEDRAL CITY".

SER. NO. 76-676,871, FILED 5-15-2007.

DAVID H. STINE, EXAMINING ATTORNEY

Int. Cl.: 36

Prior U.S. Cls.: 100, 101 and 102

United States Patent and Trademark Office

Reg. No. 3,451,748

Registered June 24, 2008

**SERVICE MARK  
PRINCIPAL REGISTER**



GARRISS, GAIL A. (UNITED STATES INDIVIDUAL)  
2 FOUNTAIN DRIVE UNIT #3-F  
OCEAN CITY, MD 21842

FOR: REAL ESTATE SERVICES, NAMELY, REAL ESTATE AGENCY, BROKERAGE AND LISTING SERVICES, IN CLASS 36 (U.S. CLS. 100, 101 AND 102).

FIRST USE 3-31-2001; IN COMMERCE 3-31-2001.

NO CLAIM IS MADE TO THE EXCLUSIVE RIGHT TO USE "OCCONDO.COM" AND "OCEAN CITY E-REAL ESTATE" AND "OCEAN CITY, MARYLAND", APART FROM THE MARK AS SHOWN.

THE COLOR(S) BLUE, WHITE, GRAY, PINK, BLACK AND GOLD IS/ARE CLAIMED AS A FEATURE OF THE MARK.

THE MARK CONSISTS OF TWO TOWERS IN GRAY WITH A BRIDGE OR ARCH CONNECTING THEM WHICH IS IN BLUE; THE WORDING "BOARDWALK" IS IN GOLD, WHILE THE WORDING "OCEAN CITY, MARYLAND" IS IN BLUE; THE PEOPLE ON THE BRIDGE AND THE AMUSEMENT PARK RIDES ARE IN BLUE; THE SKY IS IN BLUE WITH WHITE AND PINK CLOUDS AND THE FLYING BIRD IS IN GRAY; THE WORDING "OCCONDO.COM YOUR OCEAN CITY E-REAL ESTATE CONNECTION" ARE IN BLACK.

SER. NO. 76-677,396, FILED 5-25-2007.

SUE LAWRENCE, EXAMINING ATTORNEY

**Int. Cls.: 36 and 37**

**Prior U.S. Cls.: 100, 101, 102, 103 and 106**

**United States Patent and Trademark Office**

**Reg. No. 3,451,749**

**Registered June 24, 2008**

**SERVICE MARK  
PRINCIPAL REGISTER**

**SEAWATCH**

SEAWATCH AT SUNSET HARBOR, INC.  
(NORTH CAROLINA CORPORATION)  
134 OCEAN BOULEVARD, WEST  
HOLDEN BEACH, NC 28462

FOR: REAL ESTATE MANAGEMENT AND  
LAND ACQUISITION, NAMELY, REAL ESTATE  
BROKERAGE, IN CLASS 36 (U.S. CLS. 100, 101  
AND 102).

FIRST USE 1-0-2005; IN COMMERCE 1-0-2005.

FOR: REAL ESTATE DEVELOPMENT, IN CLASS  
37 (U.S. CLS. 100, 103 AND 106).

FIRST USE 1-0-2005; IN COMMERCE 1-0-2005.

THE MARK CONSISTS OF STANDARD CHAR-  
ACTERS WITHOUT CLAIM TO ANY PARTICULAR  
FONT, STYLE, SIZE, OR COLOR.

SER. NO. 76-677,419, FILED 5-25-2007.

LINDA E. BLOHM, EXAMINING ATTORNEY



**Int. Cl.: 36**

**Prior U.S. Cls.: 100, 101 and 102**

**United States Patent and Trademark Office**

**Reg. No. 3,451,750**

**Registered June 24, 2008**

**SERVICE MARK  
PRINCIPAL REGISTER**

**THE MSA EXPERIENCE**

MAIN STREET AMERICA GROUP, INC. (FLOR-  
IDA CORPORATION)  
4601 TOUCHTON ROAD EAST, STE. 3400  
JACKSONVILLE, FL 322464486

FOR: PROPERTY AND CASUALTY INSURANCE  
UNDERWRITING SERVICES, IN CLASS 36 (U.S.  
CLS. 100, 101 AND 102).

FIRST USE 3-0-2004; IN COMMERCE 3-0-2004.

THE MARK CONSISTS OF STANDARD CHAR-  
ACTERS WITHOUT CLAIM TO ANY PARTICULAR  
FONT, STYLE, SIZE, OR COLOR.

OWNER OF U.S. REG. NO. 3,358,387.

SER. NO. 76-677,479, FILED 5-29-2007.

JESSICA A. POWERS, EXAMINING ATTORNEY

**Int. Cl.: 33**

**Prior U.S. Cls.: 47 and 49**

**United States Patent and Trademark Office**

**Reg. No. 3,451,751**

**Registered June 24, 2008**

**TRADEMARK  
PRINCIPAL REGISTER**

**FIVE SEVENTY FIVE**

GARGIULO VINEYARDS, LLC (CALIFORNIA  
LTD LIAB CO)  
575 OAKVILLE CROSSROAD  
NAPA, CA 94558

THE MARK CONSISTS OF STANDARD CHAR-  
ACTERS WITHOUT CLAIM TO ANY PARTICULAR  
FONT, STYLE, SIZE, OR COLOR.

FOR: WINE, IN CLASS 33 (U.S. CLS. 47 AND 49).

SER. NO. 76-677,539, FILED 5-29-2007.

FIRST USE 1-3-2001; IN COMMERCE 5-18-2007.

NICHOLAS ALTREE, EXAMINING ATTORNEY

Int. Cl.: 30

Prior U.S. Cl.: 46

United States Patent and Trademark Office

Reg. No. 3,451,752

Registered June 24, 2008

TRADEMARK  
PRINCIPAL REGISTER

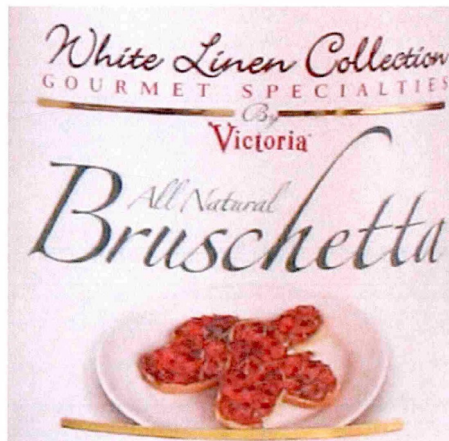

VICTORIA PACKING CORPORATION (NEW YORK CORPORATION)  
443 EAST 100TH STREET  
BROOKLYN, NY 11236

FOR: PASTA SAUCES, NAMELY, MARINARA SAUCE, VODKA SAUCE, SPICY VODKA SAUCE, FRADIAVOLO SAUCE, ROASTED GARLIC SAUCE, TOMATO BASIL SAUCE, PUTTANESCA SAUCE, MUSHROOMS SAUCE EGGPLANT SAUCE, ARTICHOKE SAUCE AND PESTO SAUCE; PASTA SAUCES WITH MEANT, NAMELY, CRUMBLLED SAUSAGE PASTA SAUCE, SAUSAGE SLICES SAUCE, BOLOGNESE SAUCE, MINI MEATBALLS SAUCE AND ROASTED WHITE CHICKEN SAUCE; ORGANIC PASTA SAUCE; COOKING SAUCES; PEPPER SAUCES; VINEGARS, NAMELY, BALSAMIC VINEGAR, RED WINE VINEGAR, PURE WHITE WINE VINEGAR AND DISTILLED VINEGAR; SALSAS; CAPERS; SALAD DRESSINGS; SPICES, NAMELY, BLACK PEPPER, CRUSHED RED PEPPER, BASIL, NUTMEG, BAY LEAVES, GARLIC, CHILI POWDER, CINNAMON, WHOLE CLOVES, CUMIN, CURRY POWDER, FENNEL SEEDS, ITALIAN SEASONING, OREGANO, PAPRIKA, PARSLEY, THYME, CHIVES AND LEMON PEPPER SEASONING, IN CLASS 30 (U.S. CL. 46).

FIRST USE 3-6-2006; IN COMMERCE 6-28-2006.

OWNER OF U.S. REG. NO. 1,149,967.

NO CLAIM IS MADE TO THE EXCLUSIVE RIGHT TO USE "COLLECTION", "GOURMET SPECIALTIES", "ALL NATURAL BRUSCHETTA" AND THE PICTORIAL REPRESENTATION OF THE BRUSCHETTA, APART FROM THE MARK AS SHOWN.

THE COLOR(S) OFF-WHITE, WHITE, RED, GREEN, BLACK, GOLD AND TAN IS/ARE CLAIMED AS A FEATURE OF THE MARK.

THE COLOR OFF-WHITE APPEARS IN THE BACKGROUND OF THE ENTIRE MARK, THE COLOR BLACK APPEARS IN THE STYLIZED WORDING "WHITE LINEN COLLECTION" AND THE STYLIZED WORD "BY", THE COLOR RED APPEARS IN THE WORDING "GOURMET SPECIALTIES" AND "VICTORIA", THE COLOR GOLD APPEARS IN THE TWO GOLD BANDS THAT APPEAR ON THE LABEL, THE COLOR GREEN APPEARS IN THE STYLIZED WORDING "ALL NATURAL BRUSCHETTA", THE COLOR WHITE APPEARS IN THE PICTORIAL REPRESENTATION OF THE PLATE AND THE COLORS RED AND TAN APPEAR IN THE PICTORIAL REPRESENTATION OF THE BRUSCHETTA.

SER. NO. 76-677,667, FILED 5-31-2007.

JAY FLOWERS, EXAMINING ATTORNEY

**Int. Cl.: 29**

**Prior U.S. Cl.: 46**

**United States Patent and Trademark Office**

**Reg. No. 3,451,753**

**Registered June 24, 2008**

**TRADEMARK  
PRINCIPAL REGISTER**

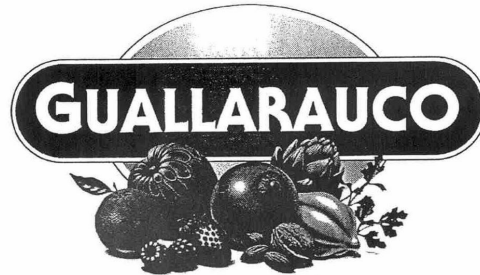

PIWONKA Z., ALBERTO (CHILE INDIVIDUAL)  
CARRETERA GENERAL SAN MARTIN KM. 16.5  
SITIO 19COLINA  
SANTIAGO, CHILE

AND PRESERVED VEGETABLES, IN CLASS 29 (U.S.  
CL. 46).

FIRST USE 11-18-2003; IN COMMERCE 11-18-2003.

FOR: FRUITS, NAMELY, PROCESSED, CANNED,  
FROZEN AND PRESERVED FRUITS; VEGETA-  
BLES, NAMELY, PROCESSED, CANNED, FROZEN

SER. NO. 76-677,680, FILED 6-1-2007.

CHERYL CLAYTON, EXAMINING ATTORNEY

**Int. Cls.: 35 and 39**

**Prior U.S. Cls.: 100, 101, 102 and 105**

**United States Patent and Trademark Office**

**Reg. No. 3,451,754**

**Registered June 24, 2008**

**SERVICE MARK  
PRINCIPAL REGISTER**



DEUTSCHE LUFTHANSA AG (FED REP GER-  
MANY CORPORATION)  
VON-GABLENZ-STRASSE 2-6  
50679 KÖLN, FED REP GERMANY

FOR: TRANSPORTATION LOGISTICS SERVICES,  
NAMELY, ARRANGING THE TRANSPORTATION  
OF GOODS FOR OTHERS AND PLANNING AND  
SCHEDULING SHIPMENTS FOR USERS OF AIR-  
CRAFT, IN CLASS 35 (U.S. CLS. 100, 101 AND 102).

FOR: AIR TRANSPORTATION SERVICES; AIR-  
LINE TRANSPORTATION CONSULTATION SERVI-  
CES, IN CLASS 39 (U.S. CLS. 100 AND 105).

PRIORITY CLAIMED UNDER SEC. 44(D) ON FED  
REP GERMANY APPLICATION NO. 30676213.7,  
FILED 12-13-2006, REG. NO. 30676213, DATED 12-  
31-2006, EXPIRES 12-31-2016.

NO CLAIM IS MADE TO THE EXCLUSIVE  
RIGHT TO USE "GLOBAL LOAD CONTROL",  
APART FROM THE MARK AS SHOWN.

THE COLOR(S) YELLOW, GREY AND LIGHT  
GREY IS/ARE CLAIMED AS A FEATURE OF THE  
MARK.

THE COLORS GRAY AND LIGHT GRAY AP-  
PEAR IN THE WORDING "GLOBAL" AND ON THE  
TOP OF THE SPHERE. THE COLOR YELLOW  
APPEARS IN THE WORDING "LOAD CONTROL"  
AND ON THE BOTTOM OF THE SPHERE.

SER. NO. 76-677,875, FILED 6-6-2007.

CHARLES L. JENKINS, EXAMINING ATTORNEY

**Int. Cl.: 39**

**Prior U.S. Cls.: 100 and 105**

**United States Patent and Trademark Office**

**Reg. No. 3,451,755**

**Registered June 24, 2008**

**SERVICE MARK  
PRINCIPAL REGISTER**



CAVALIER LOGISTICS MANAGEMENT II, INC.  
(NEW JERSEY CORPORATION)  
45085 OLD OX ROAD  
DULLES, VA 20166

NO CLAIM IS MADE TO THE EXCLUSIVE  
RIGHT TO USE "LOGISTICS", APART FROM THE  
MARK AS SHOWN.

FOR: FREIGHT FORWARDING SERVICES; STO-  
RAGE OF GOODS, IN CLASS 39 (U.S. CLS. 100 AND  
105).

SER. NO. 76-678,052, FILED 6-11-2007.

FIRST USE 0-0-1993; IN COMMERCE 0-0-1993.

LESLEY LAMOTHE, EXAMINING ATTORNEY

**Int. Cls.: 23 and 24**

**Prior U.S. Cls.: 42, 43 and 50**

**United States Patent and Trademark Office**

**Reg. No. 3,451,756**

**Registered June 24, 2008**

**TRADEMARK  
PRINCIPAL REGISTER**

**MICROSILVER**

MICROSILVER WEAR, INC. (DELAWARE CORPORATION)  
461 WATCHUNG AVE.  
WATCHUNG, NJ 07069

FOR: YARN, IN CLASS 23 (U.S. CL. 43).

FIRST USE 11-1-2007; IN COMMERCE 11-1-2007.

FOR: FABRICS FOR THE MANUFACTURE OF CLOTHING, IN CLASS 24 (U.S. CLS. 42 AND 50).

FIRST USE 11-1-2007; IN COMMERCE 11-1-2007.

THE MARK CONSISTS OF STANDARD CHARACTERS WITHOUT CLAIM TO ANY PARTICULAR FONT, STYLE, SIZE, OR COLOR.

SER. NO. 76-678,065, FILED 6-11-2007.

MATTHEW MCDOWELL, EXAMINING ATTORNEY

**Int. Cl.: 31**

**Prior U.S. Cls.: 1 and 46**

**United States Patent and Trademark Office**

**Reg. No. 3,451,757**

**Registered June 24, 2008**

**TRADEMARK  
PRINCIPAL REGISTER**

**ROOT PRODUCTION METHOD**

LOVELACE FARMS, INC. (MISSOURI GENERAL  
BUSINESS CORPORATION), DBA FORREST  
KEELING NURSERY  
HIGHWAY 79  
ELSBERRY, MO 63343

FOR: LIVE PLANTS, TREES AND BUSHES, IN  
CLASS 31 (U.S. CLS. 1 AND 46).

FIRST USE 6-0-1992; IN COMMERCE 6-0-1992.

THE MARK CONSISTS OF STANDARD CHAR-  
ACTERS WITHOUT CLAIM TO ANY PARTICULAR  
FONT, STYLE, SIZE, OR COLOR.

SEC. 2(F).

SER. NO. 76-678,216, FILED 6-14-2007.

JANET LEE, EXAMINING ATTORNEY



Int. Cl.: 36

Prior U.S. Cls.: 100, 101 and 102

United States Patent and Trademark Office

Reg. No. 3,451,758

Registered June 24, 2008

SERVICE MARK  
PRINCIPAL REGISTER

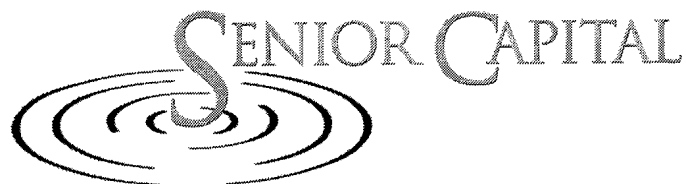

SENIOR CAPITAL INC. (DELAWARE CORPORATION)  
3030 LBJ FREEWAY, SUITE 1000  
DALLAS, TX 75234

FOR: LOAN FINANCING SERVICES SECURED BY LIFE INSURANCE; MONEY LENDING SERVICES; FINANCIAL SERVICES, NAMELY, FINANCIAL PLANNING SERVICES TO SENIOR CITIZENS, IN CLASS 36 (U.S. CLS. 100, 101 AND 102).

FIRST USE 4-25-2007; IN COMMERCE 5-15-2007.

NO CLAIM IS MADE TO THE EXCLUSIVE RIGHT TO USE "SENIOR CAPITAL", APART FROM THE MARK AS SHOWN.

THE MARK CONSISTS OF THE STYLIZED WORDS "SENIOR CAPITAL" WITH THE "S" IN "SENIOR" DIPPED INTO A CIRCULAR DESIGN DEPICTING RIPPLES.

SER. NO. 76-678,272, FILED 6-15-2007.

ELISSA GARBER KON, EXAMINING ATTORNEY

Int. Cl.: 43

Prior U.S. Cls.: 100 and 101

United States Patent and Trademark Office

Reg. No. 3,451,759

Registered June 24, 2008

SERVICE MARK  
PRINCIPAL REGISTER



DESSERT GALLERY HOLDINGS, LTD. (TEXAS  
LIMITED PARTNERSHIP)  
8813 KNIGHT ROAD  
HOUSTON, TX 77054

FOR: RESTAURANT SERVICES, IN CLASS 43  
(U.S. CLS. 100 AND 101).

FIRST USE 8-1-1995; IN COMMERCE 8-1-1995.

OWNER OF U.S. REG. NO. 2,080,833.

NO CLAIM IS MADE TO THE EXCLUSIVE  
RIGHT TO USE "DESSERT" AND "BAKERY &  
CAFÉ", APART FROM THE MARK AS SHOWN.

THE COLOR(S) RED, PURPLE AND YELLOW IS/  
ARE CLAIMED AS A FEATURE OF THE MARK.

THE MARK CONSISTS OF A STYLIZED STAR  
AND THE STYLIZED TEXT "DESSERT GALLERY  
BAKERY & CAFÉ". THE COLOR RED APPEARS IN  
THE OUTLINE OF THE STYLIZED STAR AND  
TEXT "DESSERT GALLERY" AND IN THE TEXT  
"BAKERY & CAFÉ", THE COLOR PURPLE AP-  
PEARS IN THE STYLIZED STAR, AND THE COLOR  
YELLOW APPEARS IN THE TEXT "DESSERT GAL-  
LERY", BEHIND THE TEXT "BAKERY & CAFÉ",  
AND IN SMALL LINES FLOATING INSIDE THE  
INTERIOR OF THE STYLIZED STAR.

SER. NO. 76-678,288, FILED 6-15-2007.

SHANNON TWOHIG, EXAMINING ATTORNEY

**Int. Cl.: 42**

**Prior U.S. Cls.: 100 and 101**

**United States Patent and Trademark Office**

**Reg. No. 3,451,760**

**Registered June 24, 2008**

**SERVICE MARK  
PRINCIPAL REGISTER**

**Bilcare**

BILCARE, INC. (DELAWARE CORPORATION)  
300 KIMBERTON ROAD  
PHOENIXVILLE, PA 19460

FOR: SCIENTIFIC RESEARCH, DEVELOPMENT  
AND TESTING OF CHEMICAL PRODUCTION  
METHODS, DESIGN OF PHARMACEUTICAL  
PACKAGING FOR OTHERS, CONSULTING SERVI-  
CES RELATING TO RESEARCH AND DEVELOP-  
MENT OF PHARMACEUTICAL PACKAGING,  
MEDICAL AND PHARMACEUTICAL RESEARCH,

LABORATORY RESEARCH IN THE FIELDS OF  
MEDICINE AND PHARMACEUTICALS, NEW PRO-  
DUCT DEVELOPMENT, QUALITY CONTROL FOR  
OTHERS, IN CLASS 42 (U.S. CLS. 100 AND 101).

FIRST USE 9-0-2003; IN COMMERCE 9-0-2003.

SER. NO. 76-678,483, FILED 6-20-2007.

H. M. FISHER, EXAMINING ATTORNEY

**Int. Cl.: 40**

**Prior U.S. Cls.: 100, 103 and 106**

**United States Patent and Trademark Office**

**Reg. No. 3,451,761**

**Registered June 24, 2008**

**SERVICE MARK  
PRINCIPAL REGISTER**

**Bilcare**

BILCARE, INC. (DELAWARE CORPORATION)  
300 KIMBERTON ROAD  
PHOENIXVILLE, PA 19460

FIRST USE 9-0-2003; IN COMMERCE 9-0-2003.

FOR: DESTRUCTION OF RETURNED MEDICINES AND PHARMACEUTICAL SUPPLIES FROM CLINICAL STUDIES, IN CLASS 40 (U.S. CLS. 100, 103 AND 106).

SER. NO. 76-678,484, FILED 6-20-2007.

H. M. FISHER, EXAMINING ATTORNEY

**Int. Cl.: 42**

**Prior U.S. Cls.: 100 and 101**

**United States Patent and Trademark Office**

**Reg. No. 3,451,762**

**Registered June 24, 2008**

**SERVICE MARK  
PRINCIPAL REGISTER**

**BILCARE**

BILCARE, INC. (DELAWARE CORPORATION)  
300 KIMBERTON ROAD  
PHOENIXVILLE, PA 19460

FOR: SCIENTIFIC RESEARCH, DEVELOPMENT AND TESTING OF CHEMICAL PRODUCTION METHODS, DESIGN OF PHARMACEUTICAL PACKAGING FOR OTHERS, CONSULTING SERVICES RELATING TO RESEARCH AND DEVELOPMENT OF PHARMACEUTICAL PACKAGING, MEDICAL AND PHARMACEUTICAL RESEARCH, LABORATORY RESEARCH IN THE FIELDS OF MEDICINE AND PHARMACEUTICALS, NEW PRO-

DUCT DEVELOPMENT, QUALITY CONTROL FOR OTHERS, IN CLASS 42 (U.S. CLS. 100 AND 101).

FIRST USE 9-0-2003; IN COMMERCE 9-0-2003.

THE MARK CONSISTS OF STANDARD CHARACTERS WITHOUT CLAIM TO ANY PARTICULAR FONT, STYLE, SIZE, OR COLOR.

SER. NO. 76-678,487, FILED 6-20-2007.

H. M. FISHER, EXAMINING ATTORNEY

Int. Cl.: 43

Prior U.S. Cls.: 100 and 101

United States Patent and Trademark Office

Reg. No. 3,451,763

Registered June 24, 2008

SERVICE MARK  
PRINCIPAL REGISTER



JWA, DOO HAENG (REPUBLIC OF KOREA INDIVIDUAL)  
326 N. WESTERN AVENUE, #259  
LOS ANGELES, CA 90004

FOR: RESTAURANT SERVICES SPECIALIZING IN KOREAN BEEF BRISKET SOUP, IN CLASS 43 (U.S. CLS. 100 AND 101).

FIRST USE 1-1-1993; IN COMMERCE 1-1-1993.

NO CLAIM IS MADE TO THE EXCLUSIVE RIGHT TO USE "SINCHON SULRUNTANG" AND "1960", APART FROM THE MARK AS SHOWN.

THE NAME AND PORTRAIT "BYUNG WOO LEE" IDENTIFIES A LIVING INDIVIDUAL WHOSE CONSENT IS OF RECORD.

THE COLOR(S) BROWN, WHITE, ORANGE AND BLUE IS/ARE CLAIMED AS A FEATURE OF THE MARK.

THE MARK CONSISTS OF THE COLOR BROWN APPEARS IN THE CIRCLE THAT ENCASES THE MARK AND AS THE HAIR COLOR AND GLASSES

OF THE WOMAN FEATURED IN THE PORTRAIT; THE COLOR BLUE APPEARS IN THE WOMAN'S TOP; THE COLOR ORANGE APPEARS AS THE WOMAN'S SKIN TONE; AND THE COLOR WHITE APPEARS IN THE KOREAN WORDING IN THE MARK AND IN THE WORDING "1960 SINCE SINCHON SULRUNTANG", AS WELL AS IN THE WOMAN'S TOP AND AS THE BACKGROUND COLOR TO THE INNER CIRCLE.

THE ENGLISH TRANSLATION OF THE FOREIGN WORDING IN THE MARK IS GRANDMOTHER BYUNG WOO LEE AND SINCHON KOREAN BEEF BRISKET SOUP.

THE KOREAN CHARACTERS THAT APPEAR INSIDE THE BROWN-COLORED BORDER TRANSLITERATE TO LEE BYUNG WOO HALMONI, WHICH MEANS GRANDMOTHER BYUNG WOO LEE IN ENGLISH.

SER. NO. 76-679,047, FILED 7-2-2007.

JORDAN BAKER, EXAMINING ATTORNEY

**Int. Cl.: 36**

**Prior U.S. Cls.: 100, 101 and 102**

**United States Patent and Trademark Office**

**Reg. No. 3,451,764**

**Registered June 24, 2008**

**SERVICE MARK  
PRINCIPAL REGISTER**

**XPRESSCHARTS**

OPTIONSPRESS HOLDINGS, INC. (DELAWARE CORPORATION)  
311 W. MONROE STREET, SUITE 1000  
CHICAGO, IL 60606

THE MARK CONSISTS OF STANDARD CHARACTERS WITHOUT CLAIM TO ANY PARTICULAR FONT, STYLE, SIZE, OR COLOR.

FOR: FINANCIAL SERVICES, NAMELY, SECURITIES AND COMMODITIES INVESTMENT SERVICES FOR OTHERS, IN CLASS 36 (U.S. CLS. 100, 101 AND 102).

SER. NO. 76-679,069, FILED 7-3-2007.

FIRST USE 2-5-2001; IN COMMERCE 2-5-2001.

ALLISON HOLTZ, EXAMINING ATTORNEY

**Int. Cl.: 42**

**Prior U.S. Cls.: 100 and 101**

**United States Patent and Trademark Office**

**Reg. No. 3,451,765**

**Registered June 24, 2008**

**SERVICE MARK  
PRINCIPAL REGISTER**

**XPRESS CHARTS**

OPTIONSPRESS HOLDINGS, INC. (DELAWARE CORPORATION)  
311 W. MONROE STREET, SUITE 1000  
CHICAGO, IL 60606

FOR: APPLICATION SERVICE PROVIDER (ASP) FEATURING SOFTWARE FOR USE IN TRADING SECURITIES AND COMMODITIES FOR FINANCIAL AND INVESTING SERVICES , IN CLASS 42 (U.S. CLS. 100 AND 101).

FIRST USE 2-5-2001; IN COMMERCE 2-5-2001.

THE MARK CONSISTS OF STANDARD CHARACTERS WITHOUT CLAIM TO ANY PARTICULAR FONT, STYLE, SIZE, OR COLOR.

NO CLAIM IS MADE TO THE EXCLUSIVE RIGHT TO USE "CHARTS", APART FROM THE MARK AS SHOWN.

SER. NO. 76-679,070, FILED 7-3-2007.

ALLISON HOLTZ, EXAMINING ATTORNEY



Int. Cl.: 29

Prior U.S. Cl.: 46

United States Patent and Trademark Office

Reg. No. 3,451,766

Registered June 24, 2008

TRADEMARK  
PRINCIPAL REGISTER

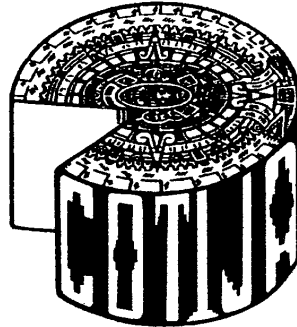

LOS ALTOS FOOD PRODUCTS, INC. (CALIFORNIA CORPORATION)  
15130 NELSON AVENUE  
CITY OF INDUSTRY, CA 91744

NO CLAIM IS MADE TO THE EXCLUSIVE RIGHT TO USE "COTIJA" , APART FROM THE MARK AS SHOWN.

FOR: CHEESE, IN CLASS 29 (U.S. CL. 46).

SER. NO. 76-679,183, FILED 7-6-2007.

FIRST USE 11-30-1980; IN COMMERCE 11-1-1981.

MELVIN AXILBUND, EXAMINING ATTORNEY

**Int. Cl.: 2**

**Prior U.S. Cls.: 6, 11 and 16**

**United States Patent and Trademark Office**

**Reg. No. 3,451,767**

**Registered June 24, 2008**

**TRADEMARK  
PRINCIPAL REGISTER**

# Pool Armor

CHICAGO TANK LINING SALES, INC. (ILLINOIS CORPORATION)  
2409 W MAIN STREET  
EVANSTON, IL 60202

OWNER OF U.S. REG. NO. 3,166,312.

FOR: COATINGS IN THE NATURE OF INDUSTRIAL SEALANTS FOR WATERPROOFING AND CORROSION PROTECTION FOR POOLS AND SPAS, IN CLASS 2 (U.S. CLS. 6, 11 AND 16).

NO CLAIM IS MADE TO THE EXCLUSIVE RIGHT TO USE "POOL", APART FROM THE MARK AS SHOWN.

FIRST USE 11-24-2004; IN COMMERCE 11-24-2004.

SER. NO. 76-679,437, FILED 7-12-2007.

THE MARK CONSISTS OF STANDARD CHARACTERS WITHOUT CLAIM TO ANY PARTICULAR FONT, STYLE, SIZE, OR COLOR.

CHRISTOPHER BUONGIORNO, EXAMINING ATTORNEY

**Int. Cl.: 11**

**Prior U.S. Cls.: 13, 21, 23, 31 and 34**

**United States Patent and Trademark Office**

**Reg. No. 3,451,768**

**Registered June 24, 2008**

**TRADEMARK  
PRINCIPAL REGISTER**

**MODULEFLEX**

ADVANCED DISTRIBUTOR PRODUCTS LLC  
(DELAWARE LTD LIAB CO)  
2100 LAKE PARK BLVD.  
RICHARDSON, TX 75080

THE MARK CONSISTS OF STANDARD CHAR-  
ACTERS WITHOUT CLAIM TO ANY PARTICULAR  
FONT, STYLE, SIZE, OR COLOR.

FOR: AIR BLOWERS AND CABINETS FOR USE  
IN RESIDENTIAL AIR CONDITIONING SYSTEMS,  
IN CLASS 11 (U.S. CLS. 13, 21, 23, 31 AND 34).

SER. NO. 76-679,472, FILED 7-13-2007.

FIRST USE 12-0-2006; IN COMMERCE 12-0-2006.

BARBARA BROWN, EXAMINING ATTORNEY

**Int. Cl.: 9**

**Prior U.S. Cls.: 21, 23, 26, 36 and 38**

**Reg. No. 3,451,769**

**United States Patent and Trademark Office**

**Registered June 24, 2008**

**TRADEMARK  
PRINCIPAL REGISTER**

**MATCHWARE**

MATCHWARE INC. (FLORIDA CORPORATION)  
311 SOUTH BREVARD AVE  
TAMPA, FL 33606

FOR: COMPUTER SOFTWARE AND DOWNLOADABLE COMPUTER SOFTWARE FOR ORGANIZING AND DIAGRAMMING DATA, NAMELY, MIND MAPS, TIMELINES, GANTT CHARTS, FLOW CHARTS, AND ORGANIGRAMS; COMPUTER SOFTWARE AND DOWNLOADABLE COMPUTER SOFTWARE FOR PROJECT PLANNING AND TIME MANAGEMENT; COMPUTER SOFTWARE AND DOWNLOADABLE COMPUTER SOFTWARE FOR INTEGRATION OF SOUND, IMAGES, TEXT, ANIMATIONS, AND VIDEO INTO AN INTERACTIVE DELIVERY FOR MULTIMEDIA APPLICATIONS,

PRESENTATIONS AND WEBSITES; COMPUTER SOFTWARE AND DOWNLOADABLE COMPUTER SOFTWARE FOR RECORDING A COMPUTER SCREEN WITH VOICE OVER AND CONVERTING THE RECORDINGS INTO VIDEO FILES, IN CLASS 9 (U.S. CLS. 21, 23, 26, 36 AND 38).

FIRST USE 1-1-1992; IN COMMERCE 1-1-1992.

THE MARK CONSISTS OF STANDARD CHARACTERS WITHOUT CLAIM TO ANY PARTICULAR FONT, STYLE, SIZE, OR COLOR.

SER. NO. 76-679,684, FILED 7-19-2007.

TASHIA BUNCH, EXAMINING ATTORNEY

**Int. Cl.: 44**

**Prior U.S. Cls.: 100 and 101**

**United States Patent and Trademark Office**

**Reg. No. 3,451,770**

**Registered June 24, 2008**

**SERVICE MARK  
PRINCIPAL REGISTER**



WILSON, JOHN R. (UNITED STATES INDIVIDUAL)  
928 N. MAPLETON AVE.  
OAK PARK, IL 60302

FOR: MEDICAL SERVICES, NAMELY, MEDICAL SERVICES IN THE FIELD OF NEUROLOGY, NEUROPHYSIOLOGY, AND SLEEP MEDICINE AND SLEEP DISORDERS, IN CLASS 44 (U.S. CLS. 100 AND 101).

FIRST USE 5-15-2005; IN COMMERCE 5-15-2005.

THE MARK CONSISTS OF AN OVAL DESIGN REPRESENTING A STYLIZED BRAIN AND APPROXIMATING THOUGHT BUBBLE OR BALLOON.

SER. NO. 76-679,697, FILED 7-19-2007.

RICHARD A. STRASER, EXAMINING ATTORNEY

**Int. Cl.: 9**

**Prior U.S. Cls.: 21, 23, 26, 36 and 38**

**Reg. No. 3,451,771**

**United States Patent and Trademark Office**

**Registered June 24, 2008**

**TRADEMARK  
PRINCIPAL REGISTER**

**UNIKA**

UNIKA ELECTRONIC CO., LTD. (TAIWAN COMPANY)  
6F., NO. 168, XINHU 2ND RD., NEI-HU  
TAIPEI, TAIWAN

FOR: APPARATUS FOR RECORDING, TRANSMITTING AND REPRODUCING SOUNDS AND IMAGES; KARAOKE PLAYERS, AUDIO SPEAKERS, LOUDSPEAKERS, AUDIO MIXER AND VIDEO MIXER, AMPLIFIER, ECHO SOUNDERS, STEREO EQUIPMENT FOR CARS, NAMELY, STEREOS, SPEAKERS, AMPLIFIERS, EQUALIZERS,

CROSSOVERS AND SPEAKER HOUSINGS; AUDIO SIGNAL PROCESSOR AND FREQUENCY SYNTHESIZER MODULES, IN CLASS 9 (U.S. CLS. 21, 23, 26, 36 AND 38).

FIRST USE 11-0-2003; IN COMMERCE 10-0-2005.

SER. NO. 76-679,751, FILED 2-8-2006.

JANICE KIM, EXAMINING ATTORNEY

**Int. Cls.: 35 and 36**

**Prior U.S. Cls.: 100, 101 and 102**

**United States Patent and Trademark Office**

**Reg. No. 3,451,772**

**Registered June 24, 2008**

**SERVICE MARK  
PRINCIPAL REGISTER**

  
**BancIntelligence.com**

BANCINTELLIGENCE.COM, INC. (GEORGIA CORPORATION)  
1301 HIGHTOWER TRAIL, SUITE 310  
ATLANTA, GA 30350

FOR: BUSINESS MANAGEMENT AND CONSULTATION PROVIDED TO FINANCIAL INSTITUTIONS BY MEANS OF A GLOBAL COMPUTER NETWORK, IN CLASS 35 (U.S. CLS. 100, 101 AND 102).

FIRST USE 8-1-2004; IN COMMERCE 8-1-2004.

FOR: FINANCIAL MANAGEMENT AND CONSULTATION PROVIDED TO FINANCIAL INSTITU-

TIONS BY MEANS OF A GLOBAL COMPUTER NETWORK, IN CLASS 36 (U.S. CLS. 100, 101 AND 102).

FIRST USE 8-1-2004; IN COMMERCE 8-1-2004.

OWNER OF U.S. REG. NOS. 2,577,864 AND 2,577,865.

SER. NO. 76-679,815, FILED 7-23-2007.

ANGELA GAW, EXAMINING ATTORNEY

**Int. Cls.: 32 and 33**

**Prior U.S. Cls.: 45, 46, 47, 48 and 49**

**United States Patent and Trademark Office**

**Reg. No. 3,451,773**

**Registered June 24, 2008**

**TRADEMARK  
PRINCIPAL REGISTER**

**THE CHALMATION**

WOW CAFE AND WINGERY (LOUISIANA LIMITED LIABILITY CORPORATION)  
109 NEW CAMELLIA BOULEVARD, SUITE 200  
COVINGTON, LA 70433

FOR: NON-ALCOHOLIC BEVERAGES, NAMELY, FRUIT COCKTAILS, IN CLASS 32 (U.S. CLS. 45, 46 AND 48).

FIRST USE 6-1-2006; IN COMMERCE 6-1-2006.

FOR: ALCOHOLIC BEVERAGES, NAMELY, PREPARED ALCOHOLIC COCKTAILS, IN CLASS 33 (U.S. CLS. 47 AND 49).

FIRST USE 6-1-2006; IN COMMERCE 6-1-2006.

THE MARK CONSISTS OF STANDARD CHARACTERS WITHOUT CLAIM TO ANY PARTICULAR FONT, STYLE, SIZE, OR COLOR.

SER. NO. 76-679,994, FILED 7-27-2007.

KIMBERLY FRYE, EXAMINING ATTORNEY



**Int. Cls.: 16 and 45**

**Prior U.S. Cls.: 2, 5, 22, 23, 29, 37, 38, 50, 100 and 101**

**United States Patent and Trademark Office**

**Reg. No. 3,451,774**

**Registered June 24, 2008**

**TRADEMARK  
SERVICE MARK  
PRINCIPAL REGISTER**

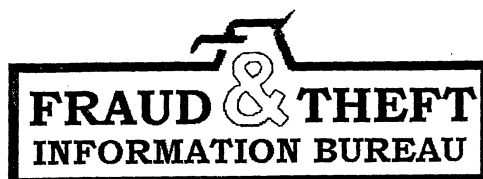

CHECKS BY PHONE, INC. (FLORIDA CORPORATION)  
11271 GOLFRIDGE LANE  
BOYNTON BEACH, FL 33437

FOR: PUBLICATIONS, NAMELY, MANUALS IN THE FIELD OF CREDIT CARD AND CHECK FRAUD CONTROL AND LOSS PREVENTION, IN CLASS 16 (U.S. CLS. 2, 5, 22, 23, 29, 37, 38 AND 50).

FIRST USE 6-0-1984; IN COMMERCE 6-0-1984.

FOR: CONSULTING AND INFORMATION SERVICES IN THE FIELD OF CREDIT CARD AND

CHECK FRAUD DETECTION AND LOSS PREVENTION, IN CLASS 45 (U.S. CLS. 100 AND 101).

FIRST USE 6-0-1984; IN COMMERCE 6-0-1984.

NO CLAIM IS MADE TO THE EXCLUSIVE RIGHT TO USE FRAUD & THEFT INFORMATION BUREAU, APART FROM THE MARK AS SHOWN.

SER. NO. 76-680,310, FILED 8-6-2007.

MICHELE SWAIN, EXAMINING ATTORNEY

**Int. Cl.: 19**

**Prior U.S. Cls.: 1, 12, 33 and 50**

**United States Patent and Trademark Office**

**Reg. No. 3,451,775**

**Registered June 24, 2008**

**TRADEMARK  
PRINCIPAL REGISTER**



HURD WINDOWS & DOORS, INC. (IOWA CORPORATION)  
575 SOUTH WHELEN AVENUE  
MEDFORD, WI 54451

FOR: BUILDING MATERIALS, NAMELY, NON-METAL WINDOWS AND NONMETAL PATIO DOORS, WOOD ENTRANCE DOORS AND SIDE-LIGHTS; AND WOOD WINDOWS AND PATIO DOORS WITH ALUMINUM STRIP SOLD AS INTEGRAL COMPONENT OF GOODS, IN CLASS 19 (U.S. CLS. 1, 12, 33 AND 50).

FIRST USE 2-0-2006; IN COMMERCE 2-0-2006.

OWNER OF U.S. REG. NOS. 2,068,703 AND 2,305,093.

THE DRAWING CONSISTS OF THE WORD "HURD" IN A STYLIZED FORMAT.

SEC. 2(F).

SER. NO. 76-680,320, FILED 8-6-2007.

ANGELA GAW, EXAMINING ATTORNEY

**Int. Cl.: 10**

**Prior U.S. Cls.: 26, 39 and 44**

**United States Patent and Trademark Office**

**Reg. No. 3,451,776**

**Registered June 24, 2008**

**TRADEMARK  
PRINCIPAL REGISTER**

**ATRIASEPT**

CARDIA, INC. (MINNESOTA CORPORATION)  
2900 LONE OAK PARKWAY  
EAGAN, MN 55121

THE MARK CONSISTS OF STANDARD CHAR-  
ACTERS WITHOUT CLAIM TO ANY PARTICULAR  
FONT, STYLE, SIZE, OR COLOR.

FOR: MEDICAL DEVICES, NAMELY, TRANSVE-  
NOUS CLOSURES FOR TREATMENT OF VASCU-  
LAR AND SEPTAL APERTURES, IN CLASS 10 (U.S.  
CLS. 26, 39 AND 44).

SER. NO. 76-680,390, FILED 8-6-2007.

FIRST USE 4-0-2006; IN COMMERCE 4-0-2006.

NAAKWAMA ANKRAH, EXAMINING ATTORNEY

**Int. Cls.: 16 and 41**

**Prior U.S. Cls.: 2, 5, 22, 23, 29, 37, 38, 50, 100, 101 and 107**

**Reg. No. 3,451,777**

**United States Patent and Trademark Office**

**Registered June 24, 2008**

**TRADEMARK  
SERVICE MARK  
PRINCIPAL REGISTER**

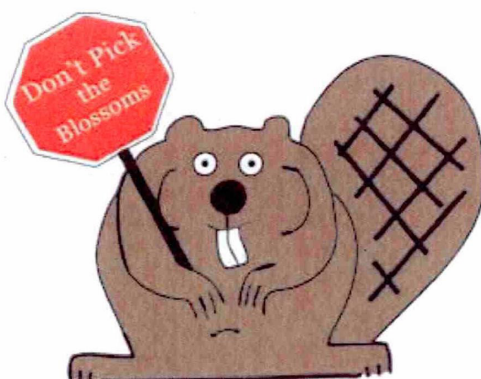

U.S. DEPARTMENT OF THE INTERIOR U.S.  
NATIONAL PARK SERVICE (UNITED  
STATES FEDERAL AGENCY)  
1849 C STREET, N.W., MS: 7308  
WASHINGTON, DC 20240

FOR: PRINTED PUBLICATIONS PROVIDED VIA  
RECREATIONAL AND EDUCATIONAL FACIL-  
ITIES, NAMELY, BROCHURES, PAMPHLETS AND  
MAPS FEATURING INFORMATION ABOUT THE  
VIEWING AND CARE OF THE CHERRY BLOSSOM  
TREES AND SURROUNDING GROUNDS, IN  
CLASS 16 (U.S. CLS. 2, 5, 22, 23, 29, 37, 38 AND 50).

FIRST USE 3-0-2007; IN COMMERCE 3-0-2007.

FOR: EDUCATIONAL AND RECREATIONAL  
SERVICES, NAMELY, PROVIDING INSTRUCTION  
IN THE VIEWING AND CARE OF THE CHERRY  
BLOSSOM TREES AND SURROUNDING  
GROUNDS, IN CLASS 41 (U.S. CLS. 100, 101 AND  
107).

FIRST USE 3-0-2007; IN COMMERCE 3-0-2007.

NO CLAIM IS MADE TO THE EXCLUSIVE  
RIGHT TO USE "DON'T PICK THE BLOSSOMS",  
APART FROM THE MARK AS SHOWN.

THE COLOR(S) RED, BROWN, BLACK, AND  
WHITE IS/ARE CLAIMED AS A FEATURE OF  
THE MARK.

THE MARK CONSISTS OF A BROWN STYLIZED  
BEAVER WITH WHITE TEETH AND A BLACK  
CRISSCROSS PATTERN ON ITS TAIL HOLDING A  
BLACK POLE OF WHICH IS MOUNTED AN OCTA-  
GONAL SIGN WITH THE WORDING "DON'T PICK  
THE BLOSSOMS" IN WHITE LETTERING ON A  
RED BACKGROUND WITH A WHITE BORDER.

SER. NO. 76-680,449, FILED 8-6-2007.

RON FAIRBANKS, EXAMINING ATTORNEY

Int. Cl.: 31

Prior U.S. Cls.: 1 and 46

**United States Patent and Trademark Office**

**Reg. No. 3,451,778**

Registered June 24, 2008

**TRADEMARK  
PRINCIPAL REGISTER**

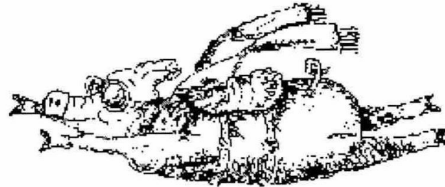

NEWSHAM GENETICS, LC (IOWA LTD LIAB  
CO)  
5058 GRAND RIDGE DRIVE, SUITE 200  
WEST DES MOINES, IA 502655754

THE STIPLING IS A FEATURE OF THE MARK.

FOR: LIVE HYBRID PIGS, IN CLASS 31 (U.S. CLS.  
1 AND 46).

SER. NO. 76-680,496, FILED 8-9-2007.

FIRST USE 6-6-1992; IN COMMERCE 7-6-1992.

AMY GEARIN, EXAMINING ATTORNEY

**Int. Cl.: 36**

**Prior U.S. Cls.: 100, 101 and 102**

**United States Patent and Trademark Office**

**Reg. No. 3,451,779**

**Registered June 24, 2008**

**SERVICE MARK  
PRINCIPAL REGISTER**

**THE SIMPLE CALCULATOR**

MORTGAGE BANKERS ASSOCIATION (ILLINOIS NOT-FOR-PROFIT CORPORATION)  
1919 PENNSYLVANIA AVENUE, N.W.  
WASHINGTON, DC 20006

FOR: PROVIDING ONLINE FINANCIAL CALCULATORS FOR THE ESTIMATION OF MONTHLY PAYMENTS FOR DIFFERENT TYPES OF MORTGAGE LOANS, IN CLASS 36 (U.S. CLS. 100, 101 AND 102).

FIRST USE 7-25-2007; IN COMMERCE 7-25-2007.

THE MARK CONSISTS OF STANDARD CHARACTERS WITHOUT CLAIM TO ANY PARTICULAR FONT, STYLE, SIZE, OR COLOR.

NO CLAIM IS MADE TO THE EXCLUSIVE RIGHT TO USE "CALCULATOR", APART FROM THE MARK AS SHOWN.

SER. NO. 76-680,542, FILED 8-9-2007.

EVELYN BRADLEY, EXAMINING ATTORNEY

**Int. Cl.: 41**

**Prior U.S. Cls.: 100, 101 and 107**

**United States Patent and Trademark Office**

**Reg. No. 3,451,780**

**Registered June 24, 2008**

**SERVICE MARK  
PRINCIPAL REGISTER**



THE TICKET COMPANY, INC. (TEXAS CORPORATION), DBA ONLINETICKETS.COM  
3772 RICHMOND AVENUE  
HOUSTON, TX 77046

FOR: TICKET AGENCY SERVICES IN THE FIELD OF ENTERTAINMENT EVENTS, SPORTING EVENTS, CONCERTS, AND THEATRE; TICKET AGENCY SERVICES RENDERED BY MEANS OF ELECTRONIC AND TELEPHONIC COMMUNICATIONS NETWORKS IN THE FIELDS OF ENTERTAINMENT EVENTS, SPORTING EVENTS, CONCERTS, AND THEATER, IN CLASS 41 (U.S. CLS. 100, 101 AND 107).

FIRST USE 6-1-2007; IN COMMERCE 6-1-2007.

NO CLAIM IS MADE TO THE EXCLUSIVE RIGHT TO USE "ONLINETICKETS.COM", APART FROM THE MARK AS SHOWN.

THE COLOR(S) BLUE AND ORANGE IS/ARE CLAIMED AS A FEATURE OF THE MARK.

THE MARK CONSISTS OF A STYLIZED TICKET AND THE STYLIZED TEXT "ONLINETICKETS.COM". THE COLOR BLUE APPEARS IN THE STYLIZED TICKET AND IN THE TEXT "ONLINE" AND ".COM". THE COLOR ORANGE APPEARS IN THE STYLIZED TICKET AND IN THE TEXT "TICKETS".

SER. NO. 76-680,563, FILED 8-10-2007.

BARBARA GAYNOR, EXAMINING ATTORNEY

Int. Cl.: 11

Prior U.S. Cls.: 13, 21, 23, 31 and 34

United States Patent and Trademark Office

Reg. No. 3,451,781

Registered June 24, 2008

TRADEMARK  
PRINCIPAL REGISTER



RACER SPORTING GOODS CO., LTD. (TAIWAN CORPORATION)

NO. 17, KUNG 6 ROAD

LINKOU 2ND INDUSTRIAL PARK

TAIPEI HSIEN, TAIWAN

FOR: FAR INFRARED HEATING PADS NOT FOR MEDICAL USE, IN CLASS 11 (U.S. CLS. 13, 21, 23, 31 AND 34).

FIRST USE 6-0-2007; IN COMMERCE 6-0-2007.

THE COLOR(S) BLACK, GREEN, YELLOW AND RED IS/ARE CLAIMED AS A FEATURE OF THE MARK.

THE COLOR BLACK APPEARS IN THE TEXT OF THE WORDING "PADONAN". THE COLOR RED APPEARS IN THE UPPER RIGHT OF THE TRIANGLE DESIGN ELEMENT AND GRADUALLY TRANSITIONS INTO THE YELLOW COLOR. THE COLOR YELLOW APPEARS IN THE LOWER PORTION OF THE TRIANGLE DESIGN AND IN THE UPPER PORTION OF THE CIRCULAR SECTION OF THE DESIGN ELEMENT. THE COLOR YELLOW GRADUALLY TRANSITIONS INTO THE COLOR GREEN. THE COLOR GREEN APPEARS IN THE LOWER HALF OF THE CIRCULAR PORTION OF THE DESIGN ELEMENT AND IN ITS STEM.

SER. NO. 76-680,764, FILED 8-16-2007.

ELI HELLMAN, EXAMINING ATTORNEY



**Int. Cl.: 29**

**Prior U.S. Cl.: 46**

**United States Patent and Trademark Office**

**Reg. No. 3,451,782**

**Registered June 24, 2008**

**TRADEMARK  
PRINCIPAL REGISTER**

**PELLA BOLOGNA**

MEAT SPECIALTIES, INC. (IOWA CORPORATION)  
715 FRANKLIN  
PELLA, IA 50219

NO CLAIM IS MADE TO THE EXCLUSIVE  
RIGHT TO USE "BOLOGNA", APART FROM THE  
MARK AS SHOWN.

FOR: PROCESSED MEAT, NAMELY, BOLOGNA,  
HOT DOGS AND SLICED MEATS, IN CLASS 29 (U.S.  
CL. 46).

SEC. 2(F).

FIRST USE 0-0-1868; IN COMMERCE 0-0-1868.

SER. NO. 76-680,860, FILED 8-20-2007.

THE MARK CONSISTS OF STANDARD CHAR-  
ACTERS WITHOUT CLAIM TO ANY PARTICULAR  
FONT, STYLE, SIZE, OR COLOR.

PAUL E. FAHRENKOPF, EXAMINING ATTORNEY

**Int. Cl.: 41**

**Prior U.S. Cls.: 100, 101 and 107**

**United States Patent and Trademark Office**

**Reg. No. 3,451,783**

**Registered June 24, 2008**

**SERVICE MARK  
PRINCIPAL REGISTER**

**GROWL ZONE**

ADVANCED SPORTS MARKETING, LTD. (OHIO  
LTD LIAB CO)  
1070 READING ROAD  
MASON, OH 45040

THE MARK CONSISTS OF STANDARD CHAR-  
ACTERS WITHOUT CLAIM TO ANY PARTICULAR  
FONT, STYLE, SIZE, OR COLOR.

FOR: PROVIDING A WEBSITE FEATURING IN-  
FORMATION IN THE FIELD OF SPORTS, IN CLASS  
41 (U.S. CLS. 100, 101 AND 107).

SER. NO. 76-680,951, FILED 8-20-2007.

FIRST USE 7-9-2007; IN COMMERCE 7-9-2007.

AMY GEARIN, EXAMINING ATTORNEY

**Int. Cl.: 14**

**Prior U.S. Cls.: 2, 27, 28 and 50**

**Reg. No. 3,451,784**

**United States Patent and Trademark Office**

**Registered June 24, 2008**

---

**TRADEMARK  
PRINCIPAL REGISTER**

**LUCKY FLIRTS**

RAMIREZ, FRANCESCA (UNITED STATES IN-  
DIVIDUAL)  
20 ISLAND AVENUE, #1103  
MIAMI BEACH, FL 33139

THE MARK CONSISTS OF STANDARD CHAR-  
ACTERS WITHOUT CLAIM TO ANY PARTICULAR  
FONT, STYLE, SIZE, OR COLOR.

FOR: JEWELRY FOR WOMEN AND MEN, IN  
CLASS 14 (U.S. CLS. 2, 27, 28 AND 50).

SER. NO. 76-681,159, FILED 8-27-2007.

FIRST USE 4-0-2007; IN COMMERCE 4-0-2007.

DOMINICK J. SALEMI, EXAMINING ATTORNEY

**Int. Cl.: 41**

**Prior U.S. Cls.: 100, 101 and 107**

**United States Patent and Trademark Office**

**Reg. No. 3,451,785**

**Registered June 24, 2008**

**SERVICE MARK  
PRINCIPAL REGISTER**

**LDNL**

EASTERDAY, VAN (UNITED STATES INDIVIDUAL)  
5438 HAUSSMAN PLACE  
WESTERVILLE, OH 43081

FOR: ENTERTAINMENT, NAMELY, LIVE PERFORMANCES BY A MUSICAL BAND, IN CLASS 41 (U.S. CLS. 100, 101 AND 107).

FIRST USE 1-1-2005; IN COMMERCE 1-1-2005.

THE MARK CONSISTS OF STANDARD CHARACTERS WITHOUT CLAIM TO ANY PARTICULAR FONT, STYLE, SIZE, OR COLOR.

SER. NO. 76-681,160, FILED 8-27-2007.

DOMINICK J. SALEMI, EXAMINING ATTORNEY

**Int. Cl.: 41**

**Prior U.S. Cls.: 100, 101 and 107**

**United States Patent and Trademark Office**

**Reg. No. 3,451,786**

**Registered June 24, 2008**

**SERVICE MARK  
PRINCIPAL REGISTER**

**GREENPRINT ENTERTAINMENT**

GREENPRINT ENTERTAINMENT, LLC (AR-  
KANSAS LTD LIAB CO)  
P. O. BOX 3313  
WEST HELENA, AR 72390

FOR: ENTERTAINMENT SERVICES, NAMELY,  
PRODUCTION OF MUSICAL SOUND RECORD-  
INGS, COMPACT DISCS, AND VIDEOS, ALL FEA-  
TURING MUSIC AND ENTERTAINMENT;  
ENTERTAINMENT SERVICES, NAMELY, PRO-  
DUCTION OF PERFORMANCES BY MUSICAL  
GROUPS AND MUSICAL ARTISTS; ENTERTAIN-  
MENT SERVICES, NAMELY, PRODUCTION OF  
LIVE PERFORMANCES BY MUSICAL GROUPS  
AND/OR ARTISTS; MUSIC PUBLISHING, IN CLASS  
41 (U.S. CLS. 100, 101 AND 107).

FIRST USE 8-16-2006; IN COMMERCE 4-20-2007.

THE MARK CONSISTS OF STANDARD CHAR-  
ACTERS WITHOUT CLAIM TO ANY PARTICULAR  
FONT, STYLE, SIZE, OR COLOR.

NO CLAIM IS MADE TO THE EXCLUSIVE  
RIGHT TO USE "ENTERTAINMENT", APART  
FROM THE MARK AS SHOWN.

SER. NO. 76-681,189, FILED 8-27-2007.

COLLEEN KEARNEY, EXAMINING ATTORNEY

**Int. Cl.: 38**

**Prior U.S. Cls.: 100, 101 and 104**

**United States Patent and Trademark Office**

**Reg. No. 3,451,787**

**Registered June 24, 2008**

**SERVICE MARK  
PRINCIPAL REGISTER**

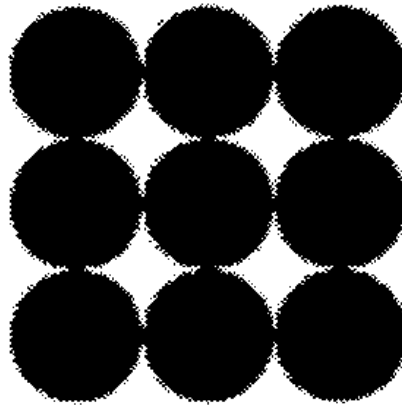

ONE PRODUCT PLACE LLC (OHIO LTD LIAB  
CO)  
375 NORTH FRONT STREET, SUITE 100  
COLUMBUS, OH 43215

FOR: BROADCASTING SERVICES THROUGH  
THE INTERNET, NAMELY, INTERACTIVE AUDIO,  
VIDEO, AND TEXT SERVICES, TELEVISION  
BROADCASTING, AND INTERACTIVE TELEVI-

SION TRANSMISSION SERVICES, IN CLASS 38  
(U.S. CLS. 100, 101 AND 104).

FIRST USE 4-1-2007; IN COMMERCE 4-1-2007.

SER. NO. 76-681,658, FILED 9-10-2007.

SEAN CROWLEY, EXAMINING ATTORNEY

Int. Cl.: 43

Prior U.S. Cls.: 100 and 101

United States Patent and Trademark Office

Reg. No. 3,451,788

Registered June 24, 2008

SERVICE MARK  
PRINCIPAL REGISTER



TACO TACO CAFÉ, INC. (TEXAS CORPORATION)  
145 E HILDEBRAND AVE  
SAN ANTONIO, TX 78212

FOR: RESTAURANT SERVICES AND CATERING SERVICES, IN CLASS 43 (U.S. CLS. 100 AND 101).

FIRST USE 9-0-1998; IN COMMERCE 9-0-1998.

NO CLAIM IS MADE TO THE EXCLUSIVE RIGHT TO USE "CAFÉ", APART FROM THE MARK AS SHOWN.

THE GREY IS FOR SHADING PURPOSES AND DOES NOT INDICATE COLOR.

THE MARK CONSISTS OF A TWO-DIMENSIONAL DESIGN AND WORDS.

SEC. 2(F).

SER. NO. 76-681,662, FILED 9-10-2007.

RICHARD WHITE, EXAMINING ATTORNEY

**Int. Cl.: 5**

**Prior U.S. Cls.: 6, 18, 44, 46, 51 and 52**

**Reg. No. 3,451,789**

**United States Patent and Trademark Office**

**Registered June 24, 2008**

**TRADEMARK  
PRINCIPAL REGISTER**

**DR. SMITH'S**

ESRUBAR, L.P. (TEXAS LIMITED PARTNER-  
SHIP)  
313 TOWN VUE  
SAN ANTONIO, TX 78213

OWNER OF U.S. REG. NOS. 1,990,055, 2,001,200,  
AND 3,177,738.

FOR: PHARMACEUTICAL OINTMENT USED  
FOR THE PREVENTION AND TREATMENT OF  
RASH AND DIAPER RASH, IN CLASS 5 (U.S. CLS. 6,  
18, 44, 46, 51 AND 52).

THE NAME "DR. SMITH'S" DOES NOT IDENTI-  
FY A LIVING INDIVIDUAL.

FIRST USE 2-0-1990; IN COMMERCE 2-0-1990.

SEC. 2(F).

THE MARK CONSISTS OF STANDARD CHAR-  
ACTERS WITHOUT CLAIM TO ANY PARTICULAR  
FONT, STYLE, SIZE, OR COLOR.

SER. NO. 76-681,663, FILED 9-10-2007.

RICHARD WHITE, EXAMINING ATTORNEY



**Int. Cl.: 35**

**Prior U.S. Cls.: 100, 101 and 102**

**United States Patent and Trademark Office**

**Reg. No. 3,451,790**

**Registered June 24, 2008**

**SERVICE MARK  
PRINCIPAL REGISTER**

**AJT SUPPLIES ONLINE**

AJT SUPPLIES, INC. (MASSACHUSETTS CORPORATION)  
4945 WASHINGTON ST.  
WEST ROXBURY, MA 02132

FOR: ONLINE RETAIL STORES SERVICES FEATURING LANDSCAPING AND HARDSCAPING MATERIALS, IN CLASS 35 (U.S. CLS. 100, 101 AND 102).

FIRST USE 8-30-2007; IN COMMERCE 8-30-2007.

THE MARK CONSISTS OF STANDARD CHARACTERS WITHOUT CLAIM TO ANY PARTICULAR FONT, STYLE, SIZE, OR COLOR.

NO CLAIM IS MADE TO THE EXCLUSIVE RIGHT TO USE "SUPPLIES ONLINE", APART FROM THE MARK AS SHOWN.

SER. NO. 76-681,680, FILED 9-10-2007.

LAURA HAMMEL, EXAMINING ATTORNEY

**Int. Cl.: 13**

**Prior U.S. Cls.: 2 and 9**

**United States Patent and Trademark Office**

**Reg. No. 3,451,791**

**Registered June 24, 2008**

**TRADEMARK  
PRINCIPAL REGISTER**

**UPLANDER**

STOEGER INDUSTRIES, INC. (MARYLAND  
CORPORATION)  
17603 INDIAN HEAD HIGHWAY  
ACCOKEEK, MD 20607

THE MARK CONSISTS OF STANDARD CHAR-  
ACTERS WITHOUT CLAIM TO ANY PARTICULAR  
FONT, STYLE, SIZE, OR COLOR.

FOR: FIREARMS, IN CLASS 13 (U.S. CLS. 2 AND  
9).

SER. NO. 76-681,879, FILED 9-14-2007.

FIRST USE 2-1-2001; IN COMMERCE 2-1-2001.

ESTHER BELENKER, EXAMINING ATTORNEY

**Int. Cl.: 39**

**Prior U.S. Cls.: 100 and 105**

**United States Patent and Trademark Office**

**Reg. No. 3,451,792**

**Registered June 24, 2008**

**SERVICE MARK  
PRINCIPAL REGISTER**



GULF ATLANTIC OPERATIONS, L.L.C. (TEXAS  
LTD LIAB CO)  
10333 RICHMOND AVE., SUITE 710  
HOUSTON, TX 77042

FOR: TRANSPORTATION AND STORAGE OF  
PETROLEUM PRODUCTS, NAMELY, ASPHALT,  
CRUDE, OIL, DIESEL, NAPHTHA, AND VACUUM  
GAS OIL, IN CLASS 39 (U.S. CLS. 100 AND 105).

FIRST USE 2-11-2007; IN COMMERCE 2-11-2007.

NO CLAIM IS MADE TO THE EXCLUSIVE  
RIGHT TO USE "OPERATIONS", APART FROM  
THE MARK AS SHOWN.

THE MARK CONSISTS OF THE TERM "GAO"  
HAVING FOUR CURVED LINES PASSING  
THROUGH THE TERM "GAO", AND THE WORDS  
"GULF ATLANTIC OPERATIONS" BELOW TERM  
"GAO".

SER. NO. 76-682,015, FILED 9-18-2007.

JENNIFER MARTIN, EXAMINING ATTORNEY

**Int. Cl.: 41**

**Prior U.S. Cls.: 100, 101 and 107**

**United States Patent and Trademark Office**

**Reg. No. 3,451,793**

**Registered June 24, 2008**

**SERVICE MARK  
PRINCIPAL REGISTER**

**THE SUICIDE KINGS**

DEMBOW, GEORGE F., III (UNITED STATES  
INDIVIDUAL)  
8814 N. 57TH STREET  
PARADISE VALLEY, AZ 85253

THE MARK CONSISTS OF STANDARD CHAR-  
ACTERS WITHOUT CLAIM TO ANY PARTICULAR  
FONT, STYLE, SIZE, OR COLOR.

FOR: ENTERTAINMENT SERVICES, NAMELY,  
LIVE PERFORMANCES BY A MUSICAL BAND, IN  
CLASS 41 (U.S. CLS. 100, 101 AND 107).

SER. NO. 76-682,223, FILED 9-24-2007.

FIRST USE 8-30-2007; IN COMMERCE 8-30-2007.

SUSAN RICHARDS, EXAMINING ATTORNEY

**Int. Cl.: 29**

**Prior U.S. Cl.: 46**

**United States Patent and Trademark Office**

**Reg. No. 3,451,794**

**Registered June 24, 2008**

**TRADEMARK  
PRINCIPAL REGISTER**

**RONDELE**

LACTALIS USA COMMERCIAL, INC. (DELA-  
WARE CORPORATION)

950 THIRD AVENUE, 22ND FLOOR

NEW YORK, NY 10022

FOR: CHEESE, IN CLASS 29 (U.S. CL. 46).

FIRST USE 1-21-1974; IN COMMERCE 1-21-1974.

THE MARK CONSISTS OF STANDARD CHAR-  
ACTERS WITHOUT CLAIM TO ANY PARTICULAR  
FONT, STYLE, SIZE, OR COLOR.

OWNER OF U.S. REG. NOS. 1,012,351 AND  
2,632,934.

SER. NO. 76-682,226, FILED 9-24-2007.

SUSAN RICHARDS, EXAMINING ATTORNEY

**Int. Cl.: 36**

**Prior U.S. Cls.: 100, 101 and 102**

**United States Patent and Trademark Office**

**Reg. No. 3,451,795**

**Registered June 24, 2008**

**SERVICE MARK  
PRINCIPAL REGISTER**



MARKETING PARTNERS, INC. (PENNSYLVANIA CORPORATION)  
6583 RUCH ROAD  
BETHLEHEM, PA 18017

FIRST USE 12-10-2004; IN COMMERCE 12-10-2004.

SER. NO. 76-682,284, FILED 9-25-2007.

FOR: FINANCIAL SERVICES, NAMELY, SAVINGS PROGRAMS FOR YOUTHS, IN CLASS 36 (U.S. CLS. 100, 101 AND 102).

CHRISTOPHER BUONGIORNO, EXAMINING ATTORNEY

**Int. Cl.: 35**

**Prior U.S. Cls.: 100, 101 and 102**

**United States Patent and Trademark Office**

**Reg. No. 3,451,796**

**Registered June 24, 2008**

**SERVICE MARK  
PRINCIPAL REGISTER**



MARKETING PARTNERS, INC. (PENNSYLVANIA CORPORATION)  
6583 RUCH ROAD  
BETHLEHEM, PA 18017

FOR: MARKETING CONSULTING, IN CLASS 35  
(U.S. CLS. 100, 101 AND 102).

FIRST USE 12-15-2003; IN COMMERCE 12-15-2003.

THE COLOR(S) BLUE IS/ARE CLAIMED AS A  
FEATURE OF THE MARK.

THE LETTERS "CU" ARE BLUE AND IN A BLUE  
CIRCLE PRECEDING THE BLUE WORDING  
"LEARNINGCENTER" UNDERLINED IN A BLUE  
UNDERLINE; THE WORDING "HELPFUL INFOR-  
MATION FROM YOUR CREDIT UNION" IS BLUE.

SER. NO. 76-682,285, FILED 9-25-2007.

CHRISTOPHER BUONGIORNO, EXAMINING AT-  
TORNEY

**Int. Cl.: 35**

**Prior U.S. Cls.: 100, 101 and 102**

**United States Patent and Trademark Office**

**Reg. No. 3,451,797**

**Registered June 24, 2008**

**SERVICE MARK  
PRINCIPAL REGISTER**



WORLD SUPREME INTERNATIONAL, LLC (NE-  
VADA LIMITED LIABILITY COMPANY)  
4833 FRUITLAND AVENUE  
VERNON, CA 90058

NO CLAIM IS MADE TO THE EXCLUSIVE  
RIGHT TO USE "WORLD SUPREME INT'L", APART  
FROM THE MARK AS SHOWN.

FOR: DISTRIBUTORSHIPS IN THE FIELDS OF  
PERSONAL CARE PRODUCTS AND FOOD, IN  
CLASS 35 (U.S. CLS. 100, 101 AND 102).

SER. NO. 76-682,580, FILED 10-4-2007.

FIRST USE 9-1-2007; IN COMMERCE 9-1-2007.

NAPOLEON SHARMA, EXAMINING ATTORNEY



**Int. Cl.: 15**

**Prior U.S. Cls.: 2, 21 and 36**

**United States Patent and Trademark Office**

**Reg. No. 3,451,798**

**Registered June 24, 2008**

**TRADEMARK  
PRINCIPAL REGISTER**

**DRUMCRAFT**

WESTHEIMER CORP. (ILLINOIS CORPORATION)  
3451 COMMERCIAL AVENUE  
NORTHBROOK, IL 60062

THE MARK CONSISTS OF STANDARD CHARACTERS WITHOUT CLAIM TO ANY PARTICULAR FONT, STYLE, SIZE, OR COLOR.

FOR: MUSICAL INSTRUMENTS, AND DRUM SETS, AND DRUM STANDS, IN CLASS 15 (U.S. CLS. 2, 21 AND 36).

SER. NO. 76-682,607, FILED 10-4-2007.

FIRST USE 9-19-2007; IN COMMERCE 9-19-2007.

BILL DAWE, EXAMINING ATTORNEY

**Int. Cls.: 10 and 14**

**Prior U.S. Cls.: 2, 26, 27, 28, 39, 44 and 50**

**United States Patent and Trademark Office**

**Reg. No. 3,451,799**

**Registered June 24, 2008**

**TRADEMARK  
PRINCIPAL REGISTER**

**‘KEEP IT UP!’**

SHEER DELIGHT, INC. (FLORIDA CORPORATION)  
7433 PELICAN DRIVE  
TAMPA, FL 33635

FOR: ADULT SEXUAL AIDS, NAMELY, AN ADJUSTABLE MEN’S DEVICE THAT COMPRISES A LOOP TO BE PLACED AROUND THE PENIS, IN CLASS 10 (U.S. CLS. 26, 39 AND 44).

FIRST USE 12-14-2004; IN COMMERCE 12-14-2004.

FOR: NON-PIERCING JEWELRY FOR MEN, NAMELY, A LOOP THAT ENCIRCLE THE PENIS

FOR ADORNMENT AND STIMULATION, IN CLASS 14 (U.S. CLS. 2, 27, 28 AND 50).

FIRST USE 12-14-2004; IN COMMERCE 12-14-2004.

THE MARK CONSISTS OF STANDARD CHARACTERS WITHOUT CLAIM TO ANY PARTICULAR FONT, STYLE, SIZE, OR COLOR.

SER. NO. 76-682,650, FILED 10-5-2007.

APRIL ROACH, EXAMINING ATTORNEY

**Int. Cl.: 37**

**Prior U.S. Cls.: 100, 103 and 106**

**United States Patent and Trademark Office**

**Reg. No. 3,451,800**

**Registered June 24, 2008**

**SERVICE MARK  
PRINCIPAL REGISTER**

**KING'S LIGHT**

TALISKER MOUNTAIN INCORPORATED  
(UTAH CORPORATION)  
900 MAIN ST., SUITE 6111  
PARK CITY, UT 84060

FOR: LAND AND REAL ESTATE DEVELOPMENT SERVICES IN CONNECTION WITH COMMERCIAL, RESIDENTIAL, AND RESORT PROPERTIES, IN CLASS 37 (U.S. CLS. 100, 103 AND 106).

FIRST USE 11-28-2006; IN COMMERCE 11-28-2006.

THE MARK CONSISTS OF STANDARD CHARACTERS WITHOUT CLAIM TO ANY PARTICULAR FONT, STYLE, SIZE, OR COLOR.

SER. NO. 76-682,707, FILED 10-9-2007.

SARA THOMAS, EXAMINING ATTORNEY

**Int. Cl.: 40**

**Prior U.S. Cls.: 100, 103 and 106**

**United States Patent and Trademark Office**

**Reg. No. 3,451,801**

**Registered June 24, 2008**

**SERVICE MARK  
PRINCIPAL REGISTER**

**WCQ**

WEST COAST QUARTZ CORPORATION (CALI-  
FORNIA CORPORATION)  
1000 CORPORATE WAY  
FREMONT, CA 94539

FOR: CUSTOM MANUFACTURE OF QUARTZ,  
SILICON AND CERAMIC PARTS FOR SEMICON-  
DUCTOR MANUFACTURING, SOLAR AND FLAT  
PANEL DISPLAY EQUIPMENT AND PARTS FOR  
WAFER PROCESSING EQUIPMENT, IN CLASS 40  
(U.S. CLS. 100, 103 AND 106).

FIRST USE 6-0-1989; IN COMMERCE 6-0-1989.

THE MARK CONSISTS OF STANDARD CHAR-  
ACTERS WITHOUT CLAIM TO ANY PARTICULAR  
FONT, STYLE, SIZE, OR COLOR.

SER. NO. 76-682,785, FILED 10-10-2007.

ANNE MADDEN, EXAMINING ATTORNEY

**Int. Cl.: 19**

**Prior U.S. Cls.: 1, 12, 33 and 50**

**United States Patent and Trademark Office**

**Reg. No. 3,451,802**

**Registered June 24, 2008**

**TRADEMARK  
PRINCIPAL REGISTER**

**GREENSTONE SLATE**

GREENSTONE SLATE CO., INC. (DELAWARE  
CORPORATION)  
P.O. BOX 134  
POULTNEY, VT 057640134

OWNER OF U.S. REG. NO. 2,188,615.

FOR: SLATE FOR ROOFS, IN CLASS 19 (U.S. CLS.  
1, 12, 33 AND 50).

NO CLAIM IS MADE TO THE EXCLUSIVE  
RIGHT TO USE "SLATE", APART FROM THE  
MARK AS SHOWN.

FIRST USE 11-0-1991; IN COMMERCE 11-0-1991.

SEC. 2(F).

THE MARK CONSISTS OF STANDARD CHAR-  
ACTERS WITHOUT CLAIM TO ANY PARTICULAR  
FONT, STYLE, SIZE, OR COLOR.

SER. NO. 76-683,080, FILED 10-18-2007.

ANGELA GAW, EXAMINING ATTORNEY

Int. Cls.: 35, 36 and 41

Prior U.S. Cls.: 100, 101, 102 and 107

United States Patent and Trademark Office

Reg. No. 3,451,803

Registered June 24, 2008

SERVICE MARK  
PRINCIPAL REGISTER



THE CRAZY HORSE MEMORIAL FOUNDATION  
(SOUTH DAKOTA NON-PROFIT CORPORATION)

AVENUE OF THE CHIEFS  
CRAZY HORSE, SD 577309506

FOR: CATALOG ORDERING SERVICES AND ELECTRONIC CATALOG SERVICES FEATURING GIFTWARE IN THE NATURE OF DECORATIVE PLATES, DECORATIVE MUGS, PAPER WEIGHTS, BOOKMARKS, TRAVEL MUGS AND WATER BOTTLES, ARTWORK AND SCULPTURES, DREAM CATCHERS, BOOKS AND AUDIOVISUAL MATERIALS, MUSIC-RELATED MATERIALS, CLOTHING, NAMELY, T-SHIRTS, SHIRTS, JACKETS, AND CAPS, BLANKETS, TOTE BAGS, DUFFLE BAGS, BEACH BAGS, AND BACKPACKS, WIND CHIMES, PEN SETS, MEMO CLIPS, MAGNETS, COLLECTOR COINS, BOOKS FEATURING A CARVED MOUNTAIN MONUMENT, NATIVE AMERICANS AND/OR THE BLACK HILLS, COOKBOOKS, POSTCARDS, AND CALENDARS, AUDIOVISUAL MATERIALS FEATURING A CARVED MOUNTAIN MONUMENT, NAMELY, DVDS, VIDEOTAPES, DIGITAL PHOTOGRAPHS, CDS, AND

AUDIOCASSETTES, IN CLASS 35 (U.S. CLS. 100, 101 AND 102).

FIRST USE 0-0-1999; IN COMMERCE 0-0-1999.

FOR: CHARITABLE FUND RAISING SERVICES FOR THE CREATION, CONSTRUCTION AND PRESERVATION OF A CARVED MOUNTAIN MONUMENT, IN CLASS 36 (U.S. CLS. 100, 101 AND 102).

FIRST USE 0-0-1999; IN COMMERCE 0-0-1999.

FOR: PROVIDING AN EDUCATIONAL AND CULTURAL EXHIBITION IN THE NATURE OF A CARVED MOUNTAIN MONUMENT, IN CLASS 41 (U.S. CLS. 100, 101 AND 107).

FIRST USE 0-0-1999; IN COMMERCE 0-0-1999.

OWNER OF U.S. REG. NOS. 2,382,778, 2,385,189, AND 2,508,515.

SER. NO. 76-683,099, FILED 10-18-2007.

WENDY JUN, EXAMINING ATTORNEY

**Int. Cl.: 16**

**Prior U.S. Cls.: 2, 5, 22, 23, 29, 37, 38 and 50**

**United States Patent and Trademark Office**

**Reg. No. 3,451,804**

**Registered June 24, 2008**

**TRADEMARK  
PRINCIPAL REGISTER**

**PURELY DELICIOUS**

THE RAW TABLE, LLC (TEXAS LTD LIAB CO)  
1720 SENDERO STREET  
RICHMOND, TX 77469

THE MARK CONSISTS OF STANDARD CHAR-  
ACTERS WITHOUT CLAIM TO ANY PARTICULAR  
FONT, STYLE, SIZE, OR COLOR.

FOR: MAGAZINE FEATURING RAW FOOD;  
RECIPE BOOKS; ANNUAL CALENDARS, IN CLASS  
16 (U.S. CLS. 2, 5, 22, 23, 29, 37, 38 AND 50).

SER. NO. 76-683,170, FILED 10-22-2007.

FIRST USE 1-0-2007; IN COMMERCE 1-0-2007.

WILLIAM ROSSMAN, EXAMINING ATTORNEY

Int. Cl.: 28

Prior U.S. Cls.: 22, 23, 38 and 50

United States Patent and Trademark Office

Reg. No. 3,451,805

Registered June 24, 2008

TRADEMARK  
PRINCIPAL REGISTER



KINDRED HANDS, LLC (IOWA LTD LIAB CO)  
1192 UPLAND AVENUE  
VAN METER, IA 50261

FIRST USE 8-15-2007; IN COMMERCE 8-15-2007.

SER. NO. 76-683,183, FILED 10-22-2007.

FOR: TOYS, NAMELY, PLUSH TOYS AND  
STUFFED TOYS, IN CLASS 28 (U.S. CLS. 22, 23, 38  
AND 50).

TERESA M. RUPP, EXAMINING ATTORNEY



Int. Cls.: 14 and 35

Prior U.S. Cls.: 2, 27, 28, 50, 100, 101 and 102

United States Patent and Trademark Office

Reg. No. 3,451,806

Registered June 24, 2008

TRADEMARK  
SERVICE MARK  
PRINCIPAL REGISTER



YOSEF, GUY (ISRAEL INDIVIDUAL)  
589 FIFTH AVENUE, SUITE 905  
NEW YORK, NY 100174220

FOR: JEWELRY; PRECIOUS GEMSTONES; PRECIOUS METALS AND THEIR ALLOYS; SEMIPRECIOUS GEMSTONES; DIAMONDS; CUT DIAMONDS; DIAMOND JEWELRY; RUBY; SAPPHIRE; TOPAZ; COSTUME JEWELRY; GEMSTONE JEWELRY; NECKLACES, CHOKERS, PENDANTS, ANKLE BRACELETS, BRACELETS OF PRECIOUS METAL, CHAINS, EARRINGS, EAR CLIPS, EAR STUDS, ORNAMENTAL PINS, BROOCHES, RINGS BEING JEWELRY, WEDDING BANDS, TOE RINGS, BODY JEWELRY, CUFF LINKS, IN CLASS 14 (U.S. CLS. 2, 27, 28 AND 50).

FIRST USE 7-1-1968; IN COMMERCE 8-1-1982.

FOR: WHOLESALE DISTRIBUTORSHIP FEATURING JEWELRY, GEMSTONES, DIAMONDS, RUBY, SAPPHIRE, TOPAZ, PRECIOUS METALS, SEMI-PRECIOUS GEMSTONES, COSTUME JEWELRY, IN CLASS 35 (U.S. CLS. 100, 101 AND 102).

FIRST USE 7-1-1968; IN COMMERCE 5-1-1998.

THE MARK CONSISTS OF THE WORD "OVADIA" IN STYLIZED LETTERS WITH A STYLIZED SIX-SPOKE STAR INSIDE THE "O" WITH LINES PROJECTING OUT FROM THE CENTER OF THE STAR AT ANGLES.

SER. NO. 76-683,196, FILED 10-22-2007.

ALICIA COLLINS, EXAMINING ATTORNEY

Int. Cl.: 45

Prior U.S. Cls.: 100 and 101

United States Patent and Trademark Office

Reg. No. 3,451,807

Registered June 24, 2008

**SERVICE MARK  
PRINCIPAL REGISTER**

IMHOFF &  
ASSOCIATES, PC  
CRIMINAL DEFENSE ATTORNEYS

IMHOFF, VINCENT M. (UNITED STATES INDIVIDUAL)  
2530 WILSHIRE BOULEVARD, 1ST FLOOR  
SANTA MONICA, CA 90403

FOR: LEGAL SERVICES, NAMELY, PROVIDING  
CRIMINAL DEFENSE LEGAL SERVICES, IN CLASS  
45 (U.S. CLS. 100 AND 101).

FIRST USE 9-0-2002; IN COMMERCE 9-5-2003.

NO CLAIM IS MADE TO THE EXCLUSIVE  
RIGHT TO USE "ASSOCIATES, PC" AND "CRIMINAL  
DEFENSE ATTORNEYS", APART FROM THE  
MARK AS SHOWN.

SER. NO. 76-683,235, FILED 10-23-2007.

JORDAN BAKER, EXAMINING ATTORNEY

**Int. Cl.: 10**

**Prior U.S. Cls.: 26, 39 and 44**

**United States Patent and Trademark Office**

**Reg. No. 3,451,808**

**Registered June 24, 2008**

**TRADEMARK  
PRINCIPAL REGISTER**

**BLACK LIGHT**

SHIN, THOMAS JB (UNITED STATES INDIVIDUAL)  
4030 W. 7TH STREET  
LOS ANGELES, CA 90005

THE MARK CONSISTS OF STANDARD CHARACTERS WITHOUT CLAIM TO ANY PARTICULAR FONT, STYLE, SIZE, OR COLOR.

FOR: CHAIRS, CHAIR CUSHIONS, MATTRESSES AND MATTRESS PADS WITH MASSAGING FEATURE TO PROMOTE RELAXATION FOR HEALTH PURPOSES, IN CLASS 10 (U.S. CLS. 26, 39 AND 44).

SER. NO. 76-683,236, FILED 10-23-2007.

FIRST USE 5-1-2006; IN COMMERCE 5-1-2006.

JENNIFER MARTIN, EXAMINING ATTORNEY

**Int. Cl.: 16**

**Prior U.S. Cls.: 2, 5, 22, 23, 29, 37, 38 and 50**

**Reg. No. 3,451,809**

**United States Patent and Trademark Office**

**Registered June 24, 2008**

**TRADEMARK  
PRINCIPAL REGISTER**

**VISTA**

IMPREMEDIA VISTA, LLC (DELAWARE LTD  
LIAB CO)  
C/O EL DIARIO LA PRENSA  
345 HUDSON STREET, 13TH FLOOR  
NEW YORK, NY 10014

FOR: MAGAZINE AND A MAGAZINE SUPPLE-  
MENT TO NEWSPAPER ALL PERTAINING TO  
ISSUES AND EVENTS OF INTEREST WITHIN THE  
HISPANIC-AMERICAN COMMUNITY, IN CLASS 16  
(U.S. CLS. 2, 5, 22, 23, 29, 37, 38 AND 50).

FIRST USE 9-0-1985; IN COMMERCE 9-0-1985.

THE MARK CONSISTS OF STANDARD CHAR-  
ACTERS WITHOUT CLAIM TO ANY PARTICULAR  
FONT, STYLE, SIZE, OR COLOR.

OWNER OF U.S. REG. NO. 2,631,205.

SER. NO. 76-683,237, FILED 10-23-2007.

KAREN BRACEY, EXAMINING ATTORNEY

**Int. Cls.: 16, 25 and 39**

**Prior U.S. Cls.: 2, 5, 22, 23, 29, 37, 38, 39, 50, 100 and 105**

**Reg. No. 3,451,810**

**United States Patent and Trademark Office**

**Registered June 24, 2008**

**TRADEMARK  
SERVICE MARK  
PRINCIPAL REGISTER**

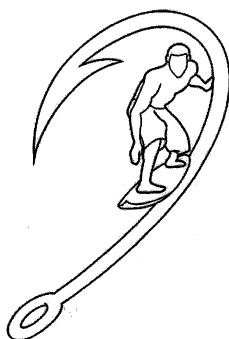

MOSS, LANCE BARNARD (UNITED STATES INDIVIDUAL)  
923 EAST CHOCTAWHATCHEE DRIVE  
NICEVILLE, FL 32578

FOR: DECALS CONTAINING LOGOS, IN CLASS 16 (U.S. CLS. 2, 5, 22, 23, 29, 37, 38 AND 50).

FIRST USE 6-15-2002; IN COMMERCE 6-15-2002.

FOR: CLOTHING CONTAINING LOGO CONSISTING OF HATS, VISORS, T-SHIRTS AND SHIRTS, WALK SHORTS, PANTS, SWEATSHIRTS AND JACKETS, RASHGUARDS, BOARDSHORTS, BAGGIES IN THE NATURE OF SURFING TRUNKS AND SWIM WEAR, IN CLASS 25 (U.S. CLS. 22 AND 39).

FIRST USE 6-15-2002; IN COMMERCE 6-15-2002.

FOR: ARRANGING OF TOURS FOR THE PURPOSE OF SURFING AND FISHING; CHARTERING OF BOAT AND VEHICLE FOR THE PURPOSE OF SURFING AND FISHING, IN CLASS 39 (U.S. CLS. 100 AND 105).

FIRST USE 6-15-2002; IN COMMERCE 6-15-2002.

SER. NO. 76-683,270, FILED 10-24-2007.

DANIEL BRODY, EXAMINING ATTORNEY

**Int. Cl.: 3**

**Prior U.S. Cls.: 1, 4, 6, 50, 51 and 52**

**Reg. No. 3,451,811**

**United States Patent and Trademark Office**

**Registered June 24, 2008**

**TRADEMARK  
PRINCIPAL REGISTER**

**QUO ANTE**

PARK, NAM HO (REPUBLIC OF KOREA INDIVIDUAL)  
5555 BURNING TREE DRIVE  
LA CANADA, CA 91011

FOR: NON-MEDICATED DOUCHE, IN CLASS 3  
(U.S. CLS. 1, 4, 6, 50, 51 AND 52).

FIRST USE 10-1-2007; IN COMMERCE 10-1-2007.

THE MARK CONSISTS OF STANDARD CHARACTERS WITHOUT CLAIM TO ANY PARTICULAR FONT, STYLE, SIZE, OR COLOR.

THE MARK CONSISTS OF: THE WORDS "QUO ANTE" IN LATIN WHICH MEANS "THE WAY THINGS WERE BEFORE" IN ENGLISH.

SER. NO. 76-683,273, FILED 10-25-2007.

INGRID C. EULIN, EXAMINING ATTORNEY

**Int. Cl.: 28**

**Prior U.S. Cls.: 22, 23, 38 and 50**

**United States Patent and Trademark Office**

**Reg. No. 3,451,812**

**Registered June 24, 2008**

**TRADEMARK  
PRINCIPAL REGISTER**

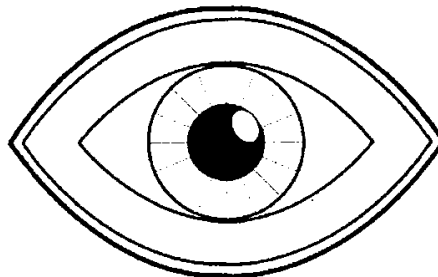

**eye know**

EYE KNOW (CANADA PARTNERSHIP)  
24 BELLEVUE AVENUE  
LONDON, ONTARIO, CANADA N6C 4A6

FIRST USE 10-11-2006; IN COMMERCE 10-11-2006.

OWNER OF U.S. REG. NO. 3,261,403.

FOR: CARD GAME, NAMELY, A GAME EMPLOYING CARDS BEARING IMAGES FOR THE PURPOSE OF RECOGNITION, IN CLASS 28 (U.S. CLS. 22, 23, 38 AND 50).

SER. NO. 76-683,283, FILED 10-24-2007.

CARYN GLASSER, EXAMINING ATTORNEY

**Int. Cl.: 41**

**Prior U.S. Cls.: 100, 101 and 107**

**United States Patent and Trademark Office**

**Reg. No. 3,451,813**

**Registered June 24, 2008**

**SERVICE MARK  
PRINCIPAL REGISTER**

**PHARMALOT**

NEWARK MORNING LEDGER CO (NEW JERSEY CORPORATION)  
STAR LEDGER PLAZA  
NEWARK, NJ 07102

THE MARK CONSISTS OF STANDARD CHARACTERS WITHOUT CLAIM TO ANY PARTICULAR FONT, STYLE, SIZE, OR COLOR.

FOR: ONLINE JOURNALS, NAMELY, BLOGS FEATURING INFORMATION ABOUT THE PHARMACEUTICAL INDUSTRY, IN CLASS 41 (U.S. CLS. 100, 101 AND 107).

SER. NO. 76-683,294, FILED 10-25-2007.

FIRST USE 1-19-2007; IN COMMERCE 1-19-2007.

GEOFFREY FOSDICK, EXAMINING ATTORNEY



**Int. Cl.: 45**

**Prior U.S. Cls.: 100 and 101**

**United States Patent and Trademark Office**

**Reg. No. 3,451,814**

**Registered June 24, 2008**

**SERVICE MARK  
PRINCIPAL REGISTER**

**PerfSpot.com**

PERFSPOT.COM, L.L.C. (ARIZONA LTD LIAB  
CO)  
1275 WEST WASHINGTON STREET  
SECOND FLOOR  
TEMPE, AZ 85281

THE MARK CONSISTS OF STANDARD CHAR-  
ACTERS WITHOUT CLAIM TO ANY PARTICULAR  
FONT, STYLE, SIZE, OR COLOR.

FOR: INTERNET-BASED DATING, INTRODUC-  
TION AND SOCIAL NETWORKING SERVICES, IN  
CLASS 45 (U.S. CLS. 100 AND 101).

SER. NO. 76-683,313, FILED 10-25-2007.

FIRST USE 8-1-2007; IN COMMERCE 8-1-2007.

ANNE MADDEN, EXAMINING ATTORNEY

Int. Cl.: 43

Prior U.S. Cls.: 100 and 101

United States Patent and Trademark Office

Reg. No. 3,451,815

Registered June 24, 2008

SERVICE MARK  
PRINCIPAL REGISTER



ISLANDS RESTAURANTS, L.P. (DELAWARE CORPORATION)  
SUITE 120  
5750 FLEET STREET  
CARLSBAD, CA 92008

FOR: RESTAURANT SERVICES, IN CLASS 43 (U.S. CLS. 100 AND 101).

FIRST USE 2-27-1997; IN COMMERCE 2-27-1997.

OWNER OF U.S. REG. NOS. 2,690,788, 3,066,080 AND OTHERS.

NO CLAIM IS MADE TO THE EXCLUSIVE RIGHT TO USE FINE BURGERS & DRINKS, APART FROM THE MARK AS SHOWN.

THE COLOR(S) YELLOW, ORANGE, RED, BLUE, TEAL, BROWN, BLUE-GREEN AND WHITE IS/ARE CLAIMED AS A FEATURE OF THE MARK.

THE MARK CONSISTS OF THE WORD "ISLANDS" IN UPPERCASE LETTERS THAT ARE YELLOW AND ORANGE, OUTLINED IN BLUE. A RED WAVE APPEARS BENEATH THE WORD. THE WORDS "FINE BURGERS & DRINKS" APPEAR IN LOWERCASE LETTERING BENEATH THE WAVE AND ARE IN THE COLOR BLUE. A SHORELINE WITH WAVES OUTLINED IN BLUE-GREEN IS BENEATH THE LOWERCASE WORDING. TWO PALM TREES WITH BROWN TRUNKS AND TEAL FOLIAGE APPEAR ON THE LEFT-HAND SIDE OF THE MARK. TWO BIRDS IN THE COLOR BLUE APPEAR OVER THE PALM TREES. THE COLOR WHITE APPEARS IN THE DEPICTION OF THE WAVES IN THE REPRESENTATION OF THE SHORE LINE, AND IN THE VEINS OF THE LEAVES OF THE PALM TREES.

SER. NO. 76-683,326, FILED 10-24-2007.

CARYN GLASSER, EXAMINING ATTORNEY

**Int. Cl.: 36**

**Prior U.S. Cls.: 100, 101 and 102**

**United States Patent and Trademark Office**

**Reg. No. 3,451,816**

**Registered June 24, 2008**

**SERVICE MARK  
PRINCIPAL REGISTER**

**CREDIT SYSTEMS DESIGN**

THE CREDIT BUREAU OF CONNECTICUT, INC.  
(CONNECTICUT CORPORATION)  
600 SAW MILL ROAD  
WEST HAVEN, CT 06516

FOR: PROVIDING CREDIT INFORMATION TO  
MORTGAGE LENDERS, IN CLASS 36 (U.S. CLS. 100,  
101 AND 102).

FIRST USE 9-8-1994; IN COMMERCE 9-8-1994.

THE MARK CONSISTS OF STANDARD CHAR-  
ACTERS WITHOUT CLAIM TO ANY PARTICULAR  
FONT, STYLE, SIZE, OR COLOR.

NO CLAIM IS MADE TO THE EXCLUSIVE  
RIGHT TO USE "CREDIT SYSTEMS", APART  
FROM THE MARK AS SHOWN.

SER. NO. 76-683,336, FILED 10-26-2007.

ERIN FALK, EXAMINING ATTORNEY

**Int. Cl.: 31**

**Prior U.S. Cls.: 1 and 46**

**United States Patent and Trademark Office**

**Reg. No. 3,451,817**

**Registered June 24, 2008**

---

**TRADEMARK  
PRINCIPAL REGISTER**

**ProBran**

QUALITY TECHNOLOGY INTERNATIONAL,  
INC. (DELAWARE CORPORATION)  
2250 POINT BOULEVARD, SUITE 322  
ELGIN, IL 60123

THE MARK CONSISTS OF STANDARD CHAR-  
ACTERS WITHOUT CLAIM TO ANY PARTICULAR  
FONT, STYLE, SIZE, OR COLOR.

FOR: FEED INGREDIENTS PRODUCED FROM  
CORN, IN CLASS 31 (U.S. CLS. 1 AND 46).

SER. NO. 76-683,350, FILED 10-26-2007.

FIRST USE 11-1-2004; IN COMMERCE 11-1-2004.

JILL C. ALT, EXAMINING ATTORNEY

**Int. Cl.: 32**

**Prior U.S. Cls.: 45, 46 and 48**

**United States Patent and Trademark Office**

**Reg. No. 3,451,818**

**Registered June 24, 2008**

**TRADEMARK  
PRINCIPAL REGISTER**

**THE BEER OF PARADISE**

SOUTH PACIFIC BREWERY LIMITED (PAPUA  
NEW GUINEA CORPORATION)  
P.O. BOX 6550 BOROKO  
NATIONAL CAPITAL DISTRICT  
PORT MORESBY, PAPUA NEW GUINEA

FOR: BEER, IN CLASS 32 (U.S. CLS. 45, 46 AND 48).

FIRST USE 9-0-1982; IN COMMERCE 3-18-1986.

THE MARK CONSISTS OF STANDARD CHAR-  
ACTERS WITHOUT CLAIM TO ANY PARTICULAR  
FONT, STYLE, SIZE, OR COLOR.

SER. NO. 76-683,379, FILED 10-26-2007.

DAVID H. STINE, EXAMINING ATTORNEY

Int. Cl.: 25

Prior U.S. Cls.: 22 and 39

United States Patent and Trademark Office

Reg. No. 3,451,819

Registered June 24, 2008

TRADEMARK  
PRINCIPAL REGISTER

*Shovelin Sunshine*

HARRINGTON, CLARICE (UNITED STATES IN-  
DIVIDUAL)  
500 PARAGON MILLS RD. M-12  
NASHVILLE, TN 37211

THE MARK CONSISTS OF STANDARD CHAR-  
ACTERS WITHOUT CLAIM TO ANY PARTICULAR  
FONT, STYLE, SIZE, OR COLOR.

FOR: TEE SHIRTS, BEACHWEAR, BASEBALL  
CAPS, SHOES, IN CLASS 25 (U.S. CLS. 22 AND 39).

SER. NO. 76-683,416, FILED 10-29-2007.

FIRST USE 10-16-2007; IN COMMERCE 10-22-2007.

MELVIN AXILBUND, EXAMINING ATTORNEY

**Int. Cl.: 35**

**Prior U.S. Cls.: 100, 101 and 102**

**United States Patent and Trademark Office**

**Reg. No. 3,451,820**

**Registered June 24, 2008**

**SERVICE MARK  
PRINCIPAL REGISTER**

**GRAVITYPEOPLE**

GRAVITY TECHNOLOGIES (CALIFORNIA CORPORATION)  
98 BATTERY STREET, SUITE 401  
SAN FRANCISCO, CA 94111

THE MARK CONSISTS OF STANDARD CHARACTERS WITHOUT CLAIM TO ANY PARTICULAR FONT, STYLE, SIZE, OR COLOR.

FOR: PERSONNEL PLACEMENT AND RECRUITMENT, IN CLASS 35 (U.S. CLS. 100, 101 AND 102).

SER. NO. 76-683,447, FILED 10-29-2007.

FIRST USE 2-0-2001; IN COMMERCE 2-0-2001.

DORITT L. CARROLL, EXAMINING ATTORNEY

**Int. Cl.: 35**

**Prior U.S. Cls.: 100, 101 and 102**

**United States Patent and Trademark Office**

**Reg. No. 3,451,821**

**Registered June 24, 2008**

**SERVICE MARK  
PRINCIPAL REGISTER**

**GRAVITY**

GRAVITY TECHNOLOGIES (CALIFORNIA CORPORATION)  
98 BATTERY STREET, SUITE 401  
SAN FRANCISCO, CA 94111

THE MARK CONSISTS OF STANDARD CHARACTERS WITHOUT CLAIM TO ANY PARTICULAR FONT, STYLE, SIZE, OR COLOR.

FOR: PERSONNEL PLACEMENT AND RECRUITMENT, IN CLASS 35 (U.S. CLS. 100, 101 AND 102).

SER. NO. 76-683,448, FILED 10-29-2007.

FIRST USE 3-0-1998; IN COMMERCE 3-0-1998.

DORITT L. CARROLL, EXAMINING ATTORNEY



**Int. Cl.: 42**

**Prior U.S. Cls.: 100 and 101**

**United States Patent and Trademark Office**

**Reg. No. 3,451,822**

**Registered June 24, 2008**

**SERVICE MARK  
PRINCIPAL REGISTER**

**GRAVITY**

GRAVITY TECHNOLOGIES (CALIFORNIA CORPORATION)  
98 BATTERY STREET, SUITE 401  
SAN FRANCISCO, CA 94111

FOR: PROVIDING TEMPORARY USE OF ON-LINE, NON-DOWNLOADABLE SOFTWARE FOR TRACKING EMPLOYEES, PERFORMANCE MANAGEMENT, TESTING EMPLOYEES, AND DATABASE MANAGEMENT, ALL IN THE FIELDS OF EMPLOYMENT HIRING, RECRUITING, PLACEMENT AND STAFFING, IN CLASS 42 (U.S. CLS. 100 AND 101).

FIRST USE 12-0-2005; IN COMMERCE 12-0-2005.

THE MARK CONSISTS OF STANDARD CHARACTERS WITHOUT CLAIM TO ANY PARTICULAR FONT, STYLE, SIZE, OR COLOR.

SER. NO. 76-683,449, FILED 10-29-2007.

DORITT L. CARROLL, EXAMINING ATTORNEY

Int. Cl.: 42

Prior U.S. Cls.: 100 and 101

**United States Patent and Trademark Office**

**Reg. No. 3,451,823**

Registered June 24, 2008

**SERVICE MARK  
PRINCIPAL REGISTER**

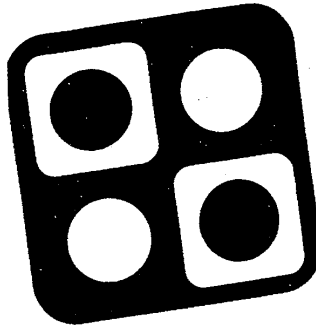

PRECISION DEVELOPMENT, INC. (IOWA CORPORATION)  
2929 WESTOWN PARKWAY, SUITE 100  
WEST DES MOINES, IA 50266

FOR: COMPUTER PROGRAMMING SERVICES  
FOR OTHERS AND CONSULTING IN THE FIELD  
OF DESIGN, SELECTION, IMPLEMENTATION

AND USE OF COMPUTER SOFTWARE SYSTEMS  
FOR OTHERS , IN CLASS 42 (U.S. CLS. 100 AND 101).

FIRST USE 1-15-2007; IN COMMERCE 1-15-2007.

SER. NO. 76-683,457, FILED 10-29-2007.

RUSS HERMAN, EXAMINING ATTORNEY

**Int. Cl.: 36**

**Prior U.S. Cls.: 100, 101 and 102**

**United States Patent and Trademark Office**

**Reg. No. 3,451,824**

**Registered June 24, 2008**

**SERVICE MARK  
PRINCIPAL REGISTER**

**DISCOVERING VALUE OFF THE BEATEN PATH**

RIVER ROAD ASSET MANAGEMENT, LLC (DE-  
LAWARE LTD LIAB CO)  
462 SOUTH FOURTH STREET, SUITE 1600  
LOUISVILLE, KY 40202

THE MARK CONSISTS OF STANDARD CHAR-  
ACTERS WITHOUT CLAIM TO ANY PARTICULAR  
FONT, STYLE, SIZE, OR COLOR.

FOR: FINANCIAL PORTFOLIO MANAGEMENT  
AND INVESTMENT ADVISORY SERVICES, IN  
CLASS 36 (U.S. CLS. 100, 101 AND 102).

SER. NO. 76-683,460, FILED 10-29-2007.

FIRST USE 4-1-2005; IN COMMERCE 4-1-2005.

RUSS HERMAN, EXAMINING ATTORNEY

Int. Cl.: 30

Prior U.S. Cl.: 46

United States Patent and Trademark Office

Reg. No. 3,451,825

Registered June 24, 2008

TRADEMARK  
PRINCIPAL REGISTER

MIREMBE  
KAWOMERA

THANKSGIVING COFFEE COMPANY (CALI-  
FORNIA CORPORATION)

PO BOX 1918

FORT BRAGG, CA 95437

FOR: COFFEE, IN CLASS 30 (U.S. CL. 46).

FIRST USE 7-15-2005; IN COMMERCE 7-15-2005.

THE MARK CONSISTS OF STANDARD CHAR-  
ACTERS WITHOUT CLAIM TO ANY PARTICULAR  
FONT, STYLE, SIZE, OR COLOR.

THE ENGLISH TRANSLATION OF MIREMBE  
KAWOMERA IS DELICIOUS PEACE.

SER. NO. 76-683,461, FILED 10-29-2007.

RUSS HERMAN, EXAMINING ATTORNEY

**Int. Cl.: 30**

**Prior U.S. Cl.: 46**

**United States Patent and Trademark Office**

**Reg. No. 3,451,826**

**Registered June 24, 2008**

**TRADEMARK  
PRINCIPAL REGISTER**

**THANKSGIVING COFFEE CO.**

THANKSGIVING COFFEE COMPANY (CALI-  
FORNIA CORPORATION)

PO BOX 1918

FORT BRAGG, CA 95437

FOR: COFFEE AND TEA, IN CLASS 30 (U.S. CL.  
46).

FIRST USE 8-5-1997; IN COMMERCE 8-5-1997.

THE MARK CONSISTS OF STANDARD CHAR-  
ACTERS WITHOUT CLAIM TO ANY PARTICULAR  
FONT, STYLE, SIZE, OR COLOR.

NO CLAIM IS MADE TO THE EXCLUSIVE  
RIGHT TO USE "COFFEE COMPANY", APART  
FROM THE MARK AS SHOWN.

SER. NO. 76-683,867, FILED 11-9-2007.

RUSS HERMAN, EXAMINING ATTORNEY

**Int. Cl.: 14**

**Prior U.S. Cls.: 2, 27, 28 and 50**

**United States Patent and Trademark Office**

**Reg. No. 3,451,827**

**Registered June 24, 2008**

**TRADEMARK  
PRINCIPAL REGISTER**

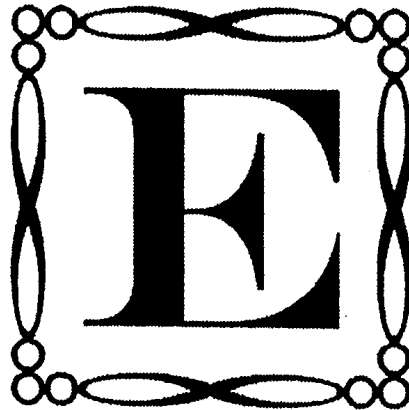

EUPHORIA FINE JEWELRY, LTD. (NEW YORK CORPORATION)  
21 WEST 46TH STREET  
NEW YORK, NY 10036

THE MARK CONSISTS OF THE LETTER "E"  
INSIDE AN ORNAMENTAL FRAMEWORK.

FOR: JEWELRY, IN CLASS 14 (U.S. CLS. 2, 27, 28 AND 50).

SER. NO. 76-683,983, FILED 11-13-2007.

FIRST USE 11-9-2007; IN COMMERCE 11-9-2007.

DAVID C. REIHNER, EXAMINING ATTORNEY

**Int. Cl.: 35**

**Prior U.S. Cls.: 100, 101 and 102**

**United States Patent and Trademark Office**

**Reg. No. 3,451,828**

**Registered June 24, 2008**

**SERVICE MARK  
PRINCIPAL REGISTER**

**SOCIETY FOR MARKETING PROFESSIONAL SERVICES**

SOCIETY FOR MARKETING PROFESSIONAL  
SERVICES (MISSOURI CORPORATION)  
99 CANAL CENTER PLAZA  
SUITE 330  
ALEXANDRIA, VA 22314

FOR: ASSOCIATION SERVICES, NAMELY, PRO-  
MOTING THE INTERESTS OF MARKETING AND  
BUSINESS DEVELOPMENT PROFESSIONALS, IN  
CLASS 35 (U.S. CLS. 100, 101 AND 102).

FIRST USE 0-0-1974; IN COMMERCE 0-0-1974.

THE MARK CONSISTS OF STANDARD CHAR-  
ACTERS WITHOUT CLAIM TO ANY PARTICULAR  
FONT, STYLE, SIZE, OR COLOR.

SEC. 2(F).

SER. NO. 76-684,476, FILED 11-29-2007.

LESLIE RICHARDS, EXAMINING ATTORNEY

**Int. Cl.: 3**

**Prior U.S. Cls.: 1, 4, 6, 50, 51 and 52**

**United States Patent and Trademark Office**

**Reg. No. 3,451,829**

**Registered June 24, 2008**

**TRADEMARK  
PRINCIPAL REGISTER**

**DRAGON SCALE**

WALGREEN CO. (ILLINOIS CORPORATION)  
200 WILMOT ROAD  
DEERFIELD, IL 60015

THE MARK CONSISTS OF STANDARD CHAR-  
ACTERS WITHOUT CLAIM TO ANY PARTICULAR  
FONT, STYLE, SIZE, OR COLOR.

FOR: BODY SHOWER GELS AND BODY SHOW-  
ER SCRUBS, IN CLASS 3 (U.S. CLS. 1, 4, 6, 50, 51 AND  
52).

SER. NO. 76-684,983, FILED 12-17-2007.

FIRST USE 5-4-2007; IN COMMERCE 5-4-2007.

KATHERINE CHANG, EXAMINING ATTORNEY



**Int. Cl.: 9**

**Prior U.S. Cls.: 21, 23, 26, 36 and 38**

**Reg. No. 3,451,830**

**United States Patent and Trademark Office**

**Registered June 24, 2008**

---

**TRADEMARK  
PRINCIPAL REGISTER**

# ELEMENTS

QUALITY VISION INTERNATIONAL, INC. (NEW  
YORK CORPORATION)  
850 HUDSON AVENUE  
ROCHESTER, NY 14621

FOR: METROLOGY SOFTWARE DESIGNED  
SPECIFICALLY FOR PRECISION MEASUREMENT  
AND INSPECTION OF ELECTRONIC COMPO-

NENTS AND ASSEMBLIES , IN CLASS 9 (U.S. CLS.  
21, 23, 26, 36 AND 38).

FIRST USE 1-22-2002; IN COMMERCE 1-22-2002.

SER. NO. 76-685,463, FILED 12-28-2007.

GINA HAYES, EXAMINING ATTORNEY

**Int. Cl.: 35**

**Prior U.S. Cls.: 100, 101 and 102**

**United States Patent and Trademark Office**

**Reg. No. 3,451,831**

**Registered June 24, 2008**

**SERVICE MARK  
PRINCIPAL REGISTER**



PREMIER INTERNET COMMUNICATIONS, INC.  
(NEW YORK CORPORATION)  
3 NORTHERN CONCOURSE  
NORTH SYRACUSE, NY 13212

FOR: MATCHING BORROWERS WITH POTENTIAL LENDERS IN THE FIELD OF CONSUMER AND MORTGAGE LENDING, IN CLASS 35 (U.S. CLS. 100, 101 AND 102).

FIRST USE 12-9-2003; IN COMMERCE 12-9-2003.

NO CLAIM IS MADE TO THE EXCLUSIVE RIGHT TO USE "XPRESS CREDIT", APART FROM THE MARK AS SHOWN.

THE COLOR(S) BLACK AND GREEN IS/ARE CLAIMED AS A FEATURE OF THE MARK.

THE MARK CONSISTS OF THE COLOR BLACK APPEARS IN THE WORD "XPRESS", THE COLOR GREEN APPEARS IN THE TOP LEFT HAND CORNER OF THE MARK, AND THE COLOR GREEN APPEARS IN THE WORD "CREDIT".

SER. NO. 77-000,196, FILED 9-15-2006.

INGA ERVIN, EXAMINING ATTORNEY

Int. Cl.: 25

Prior U.S. Cls.: 22 and 39

United States Patent and Trademark Office

Reg. No. 3,451,832

Registered June 24, 2008

TRADEMARK  
PRINCIPAL REGISTER



**REYME**  
EXPORT  
B O T A S

REYME EXPORT S.A. DE C.V. (MEXICO CORPORATION)  
SABINO #114 COL. VALLE DE LEÓN  
LEÓN, MEXICO 37140

FOR: WESTERN AND CASUAL FOOTWEAR, NAMELY, SHOES, SANDALS, SLIPPERS, BOOTS, ATHLETIC SHOES, BEACH SHOES, SNEAKERS, IN CLASS 25 (U.S. CLS. 22 AND 39).

FIRST USE 2-3-1999; IN COMMERCE 2-3-1999.

NO CLAIM IS MADE TO THE EXCLUSIVE RIGHT TO USE "EXPORT BOTAS", APART FROM THE MARK AS SHOWN.

THE ENGLISH TRANSLATION OF THE WORD "BOTAS" IN THE MARK IS "BOOTS".

SER. NO. 77-001,231, FILED 9-17-2006.

MARGARET POWER, EXAMINING ATTORNEY

**Int. Cls.: 9, 25, 28 and 41**

**Prior U.S. Cls.: 21, 22, 23, 26, 36, 38, 39, 50, 100, 101  
and 107**

**Reg. No. 3,451,833**

**United States Patent and Trademark Office**

**Registered June 24, 2008**

**TRADEMARK  
SERVICE MARK  
PRINCIPAL REGISTER**

# SUPERSET

SUPERSET TENNIS LIMITED (UNITED KINGDOM CORPORATION)  
168A CAMDEN STREET  
LONDON, UNITED KINGDOM NW19PT

FOR: COMPUTER GAME SOFTWARE; ELECTRONIC GAME SOFTWARE FOR TENNIS-RELATED GAMES; GAMING MACHINES ADAPTED FOR USE WITH TELEVISION RECEIVERS ONLY; VIDEO GAMING MACHINES ADAPTED FOR USE WITH TELEVISION RECEIVERS ONLY; ELECTRONIC GAME SOFTWARE FOR USE WITH TELEVISION RECEIVERS AND COMPUTERS; EQUIPMENT FOR GAMES ADAPTED FOR USE WITH TELEVISION RECEIVERS AND COMPUTERS, NAMELY, COMPUTER GAME EQUIPMENT CONTAINING MEMORY DEVICES, NAMELY, DISCS, COMPUTER GAME HARDWARE, COMPUTER GAME SOFTWARE, JOYSTICKS AND VIDEO GAME CONTROLLERS AND/OR CONSOLES; VISUAL RECORDINGS AND AUDIO VISUAL RECORDINGS FEATURING TENNIS INSTRUCTION, TENNIS TOURNAMENTS; PRERECORDED PROMOTIONAL VIDEOTAPES FEATURING TENNIS PLAYER INTERVIEWS AND AFTER PARTIES OF TENNIS TOURNAMENTS; SOUND RECORDINGS FEATURING TENNIS INSTRUCTION, TENNIS TOURNAMENTS, TENNIS PLAYER INTERVIEWS AND AFTER PARTIES OF TENNIS TOURNAMENTS; DOWNLOADABLE VISUAL RECORDINGS AND AUDIO VISUAL RECORDINGS FEATURING TENNIS INSTRUCTION, TENNIS TOURNAMENTS, PROMOTIONAL PRERECORDED VIDEOTAPES FEATURING TENNIS PLAYER INTERVIEWS AND AFTER PARTIES OF TENNIS TOURNAMENTS; DOWNLOADABLE SOUND RECORDINGS FEATURING TENNIS INSTRUCTION, TENNIS TOURNAMENTS, TENNIS PLAYER INTERVIEWS AND AFTER PARTIES OF TENNIS TOURNAMENTS; MULTIMEDIA SOFTWARE RECORDED ON CD-

ROM FEATURING TENNIS INSTRUCTION, TENNIS TOURNAMENTS, TENNIS PLAYER INTERVIEWS AND AFTER PARTIES OF TENNIS TOURNAMENTS; VIDEO GAME TAPE CASSETTES; VIDEO GAME SOFTWARE; SUNGLASSES AND SPECTACLES, IN CLASS 9 (U.S. CLS. 21, 23, 26, 36 AND 38).

FOR: CLOTHING, NAMELY, SHORTS, T-SHIRTS, TENNIS SKIRTS, TENNIS DRESSES, TENNIS WEAR, SHIRTS, TANK TOPS, PANTS, SWEATSHIRTS, SWEATPANTS, JACKETS, SWEATERS, WRISTBANDS, SOCKS; FOOTWEAR; HEADWEAR, IN CLASS 25 (U.S. CLS. 22 AND 39).

FOR: TOYS, GAMES AND PLAYTHINGS, NAMELY, PLUSH TOYS, STUFFED TOY ANIMALS, BATTERY OPERATED ACTION TOYS; GYMNASIIC APPARATUS; ATHLETIC SPORTING GOODS FOR SOCIAL AND TEAM GAMES, NAMELY, SPORT BALLS AND INFLATABLE SPORT BALLS, RACQUETS FOR TABLE TENNIS, SQUASH, BADMINTON AND RACQUETBALL, CASES FOR TENNIS BALLS, GUT FOR TENNIS RACKETS, GUTS FOR RACKETS FOR TENNIS OR BADMINTON, PLATFORM TENNIS BALLS, PLATFORM TENNIS NETS, PLATFORM TENNIS PADDLES, RACKET CASES FOR TENNIS OR BADMINTON, RACKETS FOR TENNIS OR BADMINTON, SAFETY PADDING FOR TENNIS UPRIGHTS, SOFT TENNIS BALLS, TENNIS BALL RETRIEVERS, TENNIS BALLS, TENNIS BALLS NOT BEING SOFT, TENNIS NETS, TENNIS NETS AND UPRIGHTS, TENNIS RACKET COVERS, TENNIS RACKET PRESSES, TENNIS RACKET STRINGS, TENNIS RACQUETS, TENNIS UPRIGHTS; COIN OPERATED VIDEO GAMES, IN CLASS 28 (U.S. CLS. 22, 23, 38 AND 50).

FOR: EDUCATION AND ENTERTAINMENT SERVICES, NAMELY, PROVIDING TRAINING AND CONDUCTING TOURNAMENTS IN THE FIELD OF TENNIS, CONDUCTING PARTIES AT TENNIS TOURNAMENTS, PROVIDING TENNIS COURT FACILITIES, PROVIDING TENNIS COURTS, RATING TENNIS PLAYERS AND TENNIS PROGRAMS BY ASSIGNING NUMERIC MEASURE, TENNIS INSTRUCTION; PROVIDING OF TRAINING IN THE FIELD OF TENNIS; ENTERTAINMENT, NAMELY, PRODUCTION OF SPORTING EVENT PROGRAMS TO BE BROADCAST OVER TELEVISION, RADIO, SATELLITE, AUDIO AND VIDEO MEDIA, TENNIS TOURNAMENTS; ORGANIZING COMMUNITY SPORTING AND CULTURAL EVENTS; ARRANGING AND CONDUCTING ATHLETIC COMPETITIONS; PROVIDING SPORTS AND RECREATION FACILITIES; TRAINING SERVICES IN THE FIELD OF TENNIS; PUBLICATION OF ELECTRONIC PUBLICATIONS IN THE NATURE OF BOOKS, MAGAZINES, JOURNALS AND PRINTED MATTER; PUBLISHING OF ELECTRONIC PUBLICATIONS; PUBLISHING OF BOOKS, MAGAZINES, BROCHURES, LEAFLETS; ENTERTAINMENT IN THE NATURE OF ONGOING TELEVISION AND RADIO PROGRAMS IN THE FIELD OF TENNIS EVENTS, TENNIS PLAYER INTERVIEWS AND AFTER PARTIES OF TENNIS

TOURNAMENTS; PRODUCTION OF RADIO AND TELEVISION PROGRAMS, SPORTING COMPETITIONS AND EVENTS; DISTRIBUTION OF RADIO AND TELEVISION PROGRAMS FOR OTHERS; RADIO AND TELEVISION PROGRAM SYNDICATION; ADVISING AND CONSULTING IN THE FIELD OF TENNIS AND TENNIS TOURNAMENTS; PROVIDING INFORMATION ABOUT TENNIS, TENNIS TOURNAMENTS AND OTHER RELATED ACTIVITIES IN THE FIELD OF TENNIS VIA WEBSITE ON A GLOBAL NETWORK, IN CLASS 41 (U.S. CLS. 100, 101 AND 107).

THE MARK CONSISTS OF STANDARD CHARACTERS WITHOUT CLAIM TO ANY PARTICULAR FONT, STYLE, SIZE, OR COLOR.

PRIORITY CLAIMED UNDER SEC. 44(D) ON ERPN CMNTY TM OFC APPLICATION NO. 5275268, FILED 8-24-2006, REG. NO. 5275268, DATED 8-17-2007, EXPIRES 8-24-2016.

OWNER OF U.S. REG. NO. 3,042,489.

SER. NO. 77-001,763, FILED 9-18-2006.

KAREN BRACEY, EXAMINING ATTORNEY

Int. Cls.: 30 and 43

Prior U.S. Cls.: 46, 100 and 101

United States Patent and Trademark Office

Reg. No. 3,451,834

Registered June 24, 2008

TRADEMARK  
SERVICE MARK  
PRINCIPAL REGISTER



MO GRIDDERS BBQ, INC. (NEW YORK CORPORATION)

565 HUNTS POINT AVENUE  
BRONX, NY 10474

FOR: BARBEQUE SAUCE, IN CLASS 30 (U.S. CL. 46).

FIRST USE 6-1-2006; IN COMMERCE 6-1-2006.

FOR: RESTAURANT SERVICES, NAMELY, SIT-DOWN AND CARRY-OUT SERVICES WITH MENU ITEMS IN THE NATURE OF BARBEQUED BEEF, PORK AND CHICKEN, IN CLASS 43 (U.S. CLS. 100 AND 101).

FIRST USE 6-1-2006; IN COMMERCE 6-1-2006.

NO CLAIM IS MADE TO THE EXCLUSIVE RIGHT TO USE "BBQ", APART FROM THE MARK AS SHOWN.

THE COLOR(S) DARK ORANGE, LIGHT ORANGE, YELLOW, LIGHT BLUE AND PEACH IS/ARE CLAIMED AS A FEATURE OF THE MARK.

THE MARK CONSISTS OF AN OVAL APPEARING WITH ITS OUTER HALF IN DARK ORANGE AND ITS INNER HALF IN LIGHT ORANGE. THE MARK FURTHER CONSISTS OF YELLOW LETTERING BORDERING THE TOP PORTION OF THE OVAL THAT READS "MOGRIDDER'S" AND OF YELLOW LETTERING BORDERING THE BOTTOM PORTION OF THE OVAL THAT READS "BBQ". WITHIN THE OVAL DESIGN APPEARS A DRAWING OF, FROM LEFT TO RIGHT, A STYLIZED HUMAN, A PIG AND A BULL. ONLY THE UPPER TORSO, HEAD AND FACE OF EACH ARE SHOWN, AND ALL APPEAR TO BE SMILING. THE HUMAN IS WEARING A LIGHT ORANGE HAT, HAS A LIGHT ORANGE PIPE IN HIS MOUTH AND IS WEARING LIGHT BLUE OVERALLS. THE SKIN OF THE HUMAN AND PIG APPEARS IN THE COLOR PEACH. THE TORSO AND HEAD OF THE BULL APPEAR IN THE COLORS DARK ORANGE, LIGHT ORANGE, AND PEACH. THE BLACK AND WHITE IN THE DRAWING REPRESENTS BACKGROUND, OUTLINING, SHADING, AND/OR TRANSPARENT AREAS AND IS NOT PART OF THE MARK.

SER. NO. 77-003,259, FILED 9-20-2006.

KEVIN CORWIN, EXAMINING ATTORNEY

**Int. Cl.: 6**

**Prior U.S. Cls.: 2, 12, 13, 14, 23, 25 and 50**

**Reg. No. 3,451,835**

**United States Patent and Trademark Office**

**Registered June 24, 2008**

**TRADEMARK  
PRINCIPAL REGISTER**

**DURA-RAMP**

**FORKLIFTRAMPS.COM INC. (CANADA CORPORATION)  
32915 MISSION WAY  
MISSION, CANADA V2V6E4**

**FOR: LOADING EQUIPMENT, NAMELY, METAL LOADING DOCKS, INCLUDING MECHANICAL, NON-MECHANICAL, ADJUSTABLE, MOBILE AND PORTABLE LOADING DOCKS ALL BEING OF METAL, METAL LOADING RAMPS, METAL LOADING DOCK BUMPERS, METAL LOADING DOCK RAILS; RESTRAINTS IN THE NATURE OF METAL CHAINS FOR SECURING EQUIPMENT, MACHINERY OR VEHICLES TO THE FACE OF A LOADING DOCK, RESTRAINTS IN THE NATURE OF**

**METAL CHAINS FOR SECURING LOADING DOCKS, YARD RAMPS, AND MOBILE YARD RAMPS, IN CLASS 6 (U.S. CLS. 2, 12, 13, 14, 23, 25 AND 50).**

**FIRST USE 3-31-2003; IN COMMERCE 3-31-2003.**

**THE MARK CONSISTS OF STANDARD CHARACTERS WITHOUT CLAIM TO ANY PARTICULAR FONT, STYLE, SIZE, OR COLOR.**

**SER. NO. 77-003,718, FILED 9-20-2006.**

**BRENDAN REGAN, EXAMINING ATTORNEY**

**Int. Cls.: 35 and 42**

**Prior U.S. Cls.: 100, 101 and 102**

**United States Patent and Trademark Office**

**Reg. No. 3,451,836**

**Registered June 24, 2008**

**SERVICE MARK  
PRINCIPAL REGISTER**

# Call Centers 24x7

PRUDENTIAL INFORMATION CORPORATION  
(WASHINGTON CORPORATION)  
SUITE 101  
116 W 8TH STREET  
PORT ANGELES, WA 98362

FOR: DEMONSTRATION OF GOODS AND SERVICES BY ELECTRONIC MEANS, ALSO FOR THE BENEFIT OF THE SO-CALLED TEleshopping AND HOMESHopping SERVICES; DIRECT MAIL ADVERTISING; MANAGEMENT OF TELEPHONE CALL CENTERS FOR OTHERS; OPERATION OF TELEPHONE CALL CENTERS FOR OTHERS; ORDER FULFILLMENT SERVICES; TELEPHONE ANSWERING SERVICE, IN CLASS 35 (U.S. CLS. 100, 101 AND 102).

FIRST USE 11-1-2002; IN COMMERCE 11-1-2002.

FOR: DESIGN OF HOMEPAGES AND WEBSITES, IN CLASS 42 (U.S. CLS. 100 AND 101).

FIRST USE 11-1-2002; IN COMMERCE 11-1-2002.

THE MARK CONSISTS OF STANDARD CHARACTERS WITHOUT CLAIM TO ANY PARTICULAR FONT, STYLE, SIZE, OR COLOR.

NO CLAIM IS MADE TO THE EXCLUSIVE RIGHT TO USE "CALL CENTERS", APART FROM THE MARK AS SHOWN.

SEC. 2(F).

SER. NO. 77-003,826, FILED 9-20-2006.

ELIZABETH KAJUBI, EXAMINING ATTORNEY



Int. Cl.: 41

Prior U.S. Cls.: 100, 101 and 107

United States Patent and Trademark Office

Reg. No. 3,451,837

Registered June 24, 2008

SERVICE MARK  
PRINCIPAL REGISTER



OGONTZ AVENUE REVITALIZATION CORPORATION (PENNSYLVANIA CORPORATION)

1536 HAINES STREET  
PHILADELPHIA, PA 19126

FOR: COMMUNITY FESTIVAL ACTIVITIES WITH ART, MUSIC, FLEA MARKET AND ENTERTAINMENT WITH LIVE MUSIC CONCERT, IN CLASS 41 (U.S. CLS. 100, 101 AND 107).

FIRST USE 3-3-2004; IN COMMERCE 3-3-2004.

NO CLAIM IS MADE TO THE EXCLUSIVE RIGHT TO USE "WEST OAK LANE" OR "JAZZ AND ARTS FESTIVAL", APART FROM THE MARK AS SHOWN.

THE COLOR(S) BLACK, BLUE, GREEN, PINK, RED, YELLOW, AND WHITE IS/ARE CLAIMED AS A FEATURE OF THE MARK.

THE COLOR BLACK APPEARS IN THE TWO HORIZONTAL LINES. THE COLOR BLUE APPEARS IN THE WORDS "WEST", "JAZZ", AND "LANE". THE GREEN APPEARS IN THE WORD "OAK". THE COLOR PINK APPEARS IN THE WORD "FESTIVAL". THE COLOR RED APPEARS IN THE WORD "ARTS" AND THE BACKGROUND ON WHICH THE WORDS "JAZZ AND ARTS FESTIVAL" APPEAR. THE COLOR YELLOW OUTLINES THE WORD "ARTS". THE COLOR WHITE APPEARS IN THE WORD "AND" AND IS THE BACKGROUND COLOR FOR ALL ELEMENTS OTHER THAN THE RED RECTANGLE.

SER. NO. 77-005,932, FILED 9-23-2006.

BRIAN PINO, EXAMINING ATTORNEY

**Int. Cls.: 6, 7, 12 and 37**

**Prior U.S. Cls.: 2, 12, 13, 14, 19, 21, 23, 25, 31, 34, 35,  
44, 50, 100, 103 and 106**

**Reg. No. 3,451,838**

**United States Patent and Trademark Office**

**Registered June 24, 2008**

**TRADEMARK  
SERVICE MARK  
PRINCIPAL REGISTER**

**MEGA**

MEGA CORP. (NEW MEXICO CORPORATION)  
700 OSUNA ROAD NE  
ALBUQUERQUE, NM 87113

FOR: METAL WATER TANKS AND TOWERS, IN  
CLASS 6 (U.S. CLS. 2, 12, 13, 14, 23, 25 AND 50).

FIRST USE 1-1-1983; IN COMMERCE 1-1-1983.

FOR: CONSTRUCTION AND MINING EQUIP-  
MENT, NAMELY, WATER PUMPS FOR CON-  
STRUCTION AND MINING AND MOTORS  
THEREFOR, POWER-OPERATED WATER SPRAY-  
ING SYSTEMS FOR DAMPENING THE GROUND  
COMPRISED OF NOZZLES, TUBING, VALVES,  
AND CONTROLS THEREFOR; COAL AND  
EARTH-MOVING MACHINERY IN THE NATURE  
OF SCRAPERS, IN CLASS 7 (U.S. CLS. 13, 19, 21, 23,  
31, 34 AND 35).

FIRST USE 1-1-1983; IN COMMERCE 1-1-1983.

FOR: CONSTRUCTION, MINING, AND FIRE-  
FIGHTING VEHICLES, NAMELY, TRUCKS FOR

HAULING EARTH AND COAL, TRAILERS FOR  
TRANSPORTING EQUIPMENT, AND WATER TAN-  
KER TRUCKS, IN CLASS 12 (U.S. CLS. 19, 21, 23, 31,  
35 AND 44).

FIRST USE 1-1-1983; IN COMMERCE 1-1-1983.

FOR: MINING AND CONSTRUCTION MACHIN-  
ERY REPAIR., IN CLASS 37 (U.S. CLS. 100, 103 AND  
106).

FIRST USE 1-1-1983; IN COMMERCE 1-1-1983.

THE MARK CONSISTS OF STANDARD CHAR-  
ACTERS WITHOUT CLAIM TO ANY PARTICULAR  
FONT, STYLE, SIZE, OR COLOR.

OWNER OF U.S. REG. NOS. 2,436,558 AND  
2,440,258.

SER. NO. 77-006,735, FILED 9-25-2006.

BARBARA GAYNOR, EXAMINING ATTORNEY

**Int. Cl.: 25**

**Prior U.S. Cls.: 22 and 39**

**United States Patent and Trademark Office**

**Reg. No. 3,451,839**

**Registered June 24, 2008**

**TRADEMARK  
PRINCIPAL REGISTER**



CHRISTAV LLC (FLORIDA LTD LIAB CO)  
7128 SW 47 ST 2ND FL  
MIAMI, FL 33155

THE NAME "MARIALEXANDRA" IDENTIFIES A  
LIVING INDIVIDUAL WHOSE CONSENT IS OF  
RECORD.

FOR: CLOTHING, NAMELY, BLOUSES, TOPS,  
SKIRTS, PANTS, EVENING GOWNS, COCKTAIL  
DRESSES, BRIDAL GOWNS AND SHOES, IN CLASS  
25 (U.S. CLS. 22 AND 39).

SER. NO. 77-006,819, FILED S.R. 9-25-2006 AM. P.R.  
8-1-2007.

FIRST USE 10-1-2004; IN COMMERCE 9-1-2005.

LINDA E. BLOHM, EXAMINING ATTORNEY

**Int. Cl.: 9**

**Prior U.S. Cls.: 21, 23, 26, 36 and 38**

**Reg. No. 3,451,840**

**United States Patent and Trademark Office**

**Registered June 24, 2008**

---

**TRADEMARK  
PRINCIPAL REGISTER**

**MEGASTAR**

ARISTOCRAT TECHNOLOGIES AUSTRALIA  
PTY LTD. (AUSTRALIA CORPORATION)  
71 LONGUEVILLE ROAD  
LANE COVE, NSW, AUSTRALIA 2066

OWNER OF AUSTRALIA REG. NO. 452541, DA-  
TED 9-23-1986, RENEWED AS REG. NO. 452541,  
DATED 9-23-2007, EXPIRES 9-23-2017.

FOR: GAMING MACHINES, IN CLASS 9 (U.S.  
CLS. 21, 23, 26, 36 AND 38).

SER. NO. 77-007,017, FILED 9-25-2006.

THE MARK CONSISTS OF STANDARD CHAR-  
ACTERS WITHOUT CLAIM TO ANY PARTICULAR  
FONT, STYLE, SIZE, OR COLOR.

DEZMONA MIZELLE, EXAMINING ATTORNEY

**Int. Cls.: 5, 29 and 30**

**Prior U.S. Cls.: 6, 18, 44, 46, 51 and 52**

**United States Patent and Trademark Office**

**Reg. No. 3,451,841**

**Registered June 24, 2008**

**TRADEMARK  
PRINCIPAL REGISTER**



TRUFFINI & REGGE' FARMACEUTICI S.R.L.  
(ITALY LTD LIAB CO)  
VIA OSLAVIA, 18  
MILAN, ITALY 20134

FOR: PHARMACEUTICAL PRODUCTS, NAME-  
LY, SLEEPING PILLS, SLEEPING COADJUTANTS,  
TRANQUILIZERS, ANTI-ANXIETY AND ANTI-  
PANIC SYRUPS, PILLS AND TABLETS; FOOD  
SUPPLEMENTS FOR MEDICAL PURPOSES, NAME-  
LY, MEDICATED ANTI-ANXIETY AND ANTI-PAN-  
IC CANDIES, JAMS, TOFFEES AND POWDERS;  
DIETETIC FOODS ADAPTED FOR MEDICAL USE,  
IN CLASS 5 (U.S. CLS. 6, 18, 44, 46, 51 AND 52).

FOR: CRYSTALLIZED FRUITS, FRUIT JELLIES,  
FRUIT JAM, WHIPPED CREAM, YOGURT, MILK,  
PREDOMINATING MILK BEVERAGES, POTATO  
CHIPS, POTATO CRISP, IN CLASS 29 (U.S. CL. 46).

FOR: BISCUITS, MALT BISCUITS, CAKES, CAN-  
DIES, CANDIES FOR FOOD CARAMELS, PRE-  
PARATION MADE FROM CEREALS, NAMELY,  
CEREAL-BASED SNACK FOODS, READY TO EAT  
CEREALS-DERIVED FOOD BARS, PROCESSED  
CEREALS, CHEWING GUMS NOT FOR MEDICAL

PURPOSES, CHOCOLATE FOR FOOD, CHOCO-  
LATE AND COCOA BASED BEVERAGES, CONFEC-  
TIONARY, NAMELY, CRYSTAL SUGAR PIECES  
AND PASTILLES, FONDANTS, COOKIES, CORN  
FLAKES, ICE CREAM, POWDER FOR ICE CREAM,  
CUSTARD, FROZEN YOGURT, FRUIT JELLIES  
FOR CONFECTIONARY, MARZIPAN, MINT FOR  
CONFECTIONARY, PANCAKES, PASTRIES, PRA-  
LINES, SUGAR, SWEETMEATS, NATURAL SWEET-  
MEATS, IN CLASS 30 (U.S. CL. 46).

PRIORITY CLAIMED UNDER SEC. 44(D) ON  
ITALY APPLICATION NO. MI2006C0036, FILED 4-  
4-2006, REG. NO. 1053189, DATED 6-25-2007, EX-  
PIRES 6-25-2017.

THE MARK CONSISTS OF THE WORD "QUIE-  
TOSAN" IN AN OVAL.

THE WORDING "QUIETOSAN" HAS NO MEAN-  
ING IN A FOREIGN LANGUAGE.

SER. NO. 77-010,218, FILED 9-29-2006.

MONIQUE MILLER, EXAMINING ATTORNEY

**Int. Cls.: 7 and 40**

**Prior U.S. Cls.: 13, 19, 21, 23, 31, 34, 35, 100, 103 and 106**

**Reg. No. 3,451,842**

**United States Patent and Trademark Office**

**Registered June 24, 2008**

**TRADEMARK  
SERVICE MARK  
PRINCIPAL REGISTER**

**TORR**

TORR CANADA INC. (CANADA COMPANY)  
1155, WELLINGTON  
MONTREAL, QUEBEC, CANADA H3C1V9

FOR: (BASED ON USE IN COMMERCE) (BASED ON 44(E)) MACHINES USED FOR ENVIRONMENTAL, COMMERCIAL AND INDUSTRIAL CLEAN-UP IN ORDER TO RECOVER OIL, GAS, HYDROCARBONS AND OTHER NON-AQUEOUS SUBSTANCES WHICH HAVE BEEN MIXED WITH AQUEOUS LIQUIDS OR WATER, AS USED IN THE OIL AND GAS INDUSTRY AND OTHER INDUSTRIAL APPLICATIONS, NAMELY, OIL SEPARATORS, OIL COALESCING MACHINES AND OIL DESORBING MACHINES, IN CLASS 7 (U.S. CLS. 13, 19, 21, 23, 31, 34 AND 35).

FIRST USE 3-19-2001; IN COMMERCE 5-16-2002.

FOR: (BASED ON 44(E)) LEASING OF EQUIPMENT FOR OIL AND OTHER ENVIRONMENTAL REMEDIATION AND RECOVERY APPLICATIONS, LEASING OF EQUIPMENT FOR CLEAN-UP, WATER TREATMENT, AND TREATMENT OF WATER PRODUCED BY THE OIL AND GAS INDUSTRY;

ENVIRONMENTAL REMEDIATION SERVICES PROVIDED TO OTHERS IN THE AREA OF ENVIRONMENTAL CLEAN-UP, OIL RECOVERY AND REMEDIATION AND WATER TREATMENT; ENVIRONMENTAL REMEDIATION CONSULTATION SERVICES IN THE FIELDS OF ENVIRONMENTAL CLEAN-UP, OIL RECOVERY AND REMEDIATION AND WATER TREATMENT, IN CLASS 40 (U.S. CLS. 100, 103 AND 106).

THE MARK CONSISTS OF STANDARD CHARACTERS WITHOUT CLAIM TO ANY PARTICULAR FONT, STYLE, SIZE, OR COLOR.

PRIORITY CLAIMED UNDER SEC. 44(D) ON CANADA APPLICATION NO. 1318116, FILED 9-27-2006, REG. NO. TMA696,677, DATED 9-18-2007, EXPIRES 9-18-2022.

OWNER OF U.S. REG. NO. 2,971,173.

SER. NO. 77-011,075, FILED 9-29-2006.

KAELIE KUNG, EXAMINING ATTORNEY

**Int. Cls.: 39 and 41**

**Prior U.S. Cls.: 100, 101, 105 and 107**

**United States Patent and Trademark Office**

**Reg. No. 3,451,843**

**Registered June 24, 2008**

**SERVICE MARK  
PRINCIPAL REGISTER**

# Air Cargo World

COMMONWEALTH BUSINESS MEDIA, INC.  
(DELAWARE CORPORATION)  
50 MILLSTONE ROAD  
400 WINDOR CORPORATE PARK  
EAST WINDSOR, NJ 08520

FOR: PROVIDING NEWS AND INFORMATION  
IN THE FIELDS OF AIR CARGO TRAFFIC INDUS-  
TRIES VIA THE INTERNET, IN CLASS 39 (U.S. CLS.  
100 AND 105).

FIRST USE 12-1-1996; IN COMMERCE 12-1-1996.

FOR: VOCATIONAL GUIDANCE IN THE FIELD  
OF THE IMPORT/EXPORT INDUSTRY VIA THE  
INTERNET, IN CLASS 41 (U.S. CLS. 100, 101 AND  
107).

FIRST USE 12-1-1996; IN COMMERCE 12-1-1996.

THE MARK CONSISTS OF STANDARD CHAR-  
ACTERS WITHOUT CLAIM TO ANY PARTICULAR  
FONT, STYLE, SIZE, OR COLOR.

NO CLAIM IS MADE TO THE EXCLUSIVE  
RIGHT TO USE "AIR CARGO", APART FROM  
THE MARK AS SHOWN.

SER. NO. 77-012,632, FILED 10-3-2006.

EMILY CARLSEN, EXAMINING ATTORNEY

**Int. Cl.: 41**

**Prior U.S. Cls.: 100, 101 and 107**

**United States Patent and Trademark Office**

**Reg. No. 3,451,844**

**Registered June 24, 2008**

**SERVICE MARK  
PRINCIPAL REGISTER**

**NEIGHBORHOOD EXCELLENCE  
LEADERSHIP PROGRAM**

BANK OF AMERICA CORPORATION (DELA-  
WARE CORPORATION)  
100 NORTH TRYON STREET  
CHARLOTTE, NC 28255

FOR: PHILANTHROPIC SERVICES, NAMELY,  
PROVIDING LEADERSHIP TRAINING PRO-  
GRAMS FOR COMMUNITY LEADERS, IN CLASS  
41 (U.S. CLS. 100, 101 AND 107).

FIRST USE 2-22-2005; IN COMMERCE 2-22-2005.

THE MARK CONSISTS OF STANDARD CHAR-  
ACTERS WITHOUT CLAIM TO ANY PARTICULAR  
FONT, STYLE, SIZE, OR COLOR.

NO CLAIM IS MADE TO THE EXCLUSIVE  
RIGHT TO USE "LEADERSHIP PROGRAM",  
APART FROM THE MARK AS SHOWN.

SER. NO. 77-013,242, FILED 10-4-2006.

ERNEST SHOSHO, EXAMINING ATTORNEY



**Int. Cl.: 9**

**Prior U.S. Cls.: 21, 23, 26, 36 and 38**

**Reg. No. 3,451,845**

**United States Patent and Trademark Office**

**Registered June 24, 2008**

---

**TRADEMARK  
PRINCIPAL REGISTER**

# ClassOne

OBJECTTEL INC. (TEXAS CORPORATION)  
5850 TOWN & COUNTRY BLVD. STE 40  
FRISCO, TX 75034

FIRST USE 10-1-2006; IN COMMERCE 10-1-2006.

FOR: COMMUNICATIONS SOFTWARE FOR  
CONNECTING OFF-THE-SHELF TELEPHONY  
AND CONVERGED COMMUNICATION NET-  
WORKS, AUTOMATIC CALL DISTRIBUTION,  
CONFERENCE, COMPUTER TELEPHONY AND  
CONTACT CENTERS, IN CLASS 9 (U.S. CLS. 21, 23,  
26, 36 AND 38).

THE MARK CONSISTS OF STANDARD CHAR-  
ACTERS WITHOUT CLAIM TO ANY PARTICULAR  
FONT, STYLE, SIZE, OR COLOR.

SER. NO. 77-014,194, FILED 10-4-2006.

SANI KHOURI, EXAMINING ATTORNEY

**Int. Cl.: 41**

**Prior U.S. Cls.: 100, 101 and 107**

**United States Patent and Trademark Office**

**Reg. No. 3,451,846**

**Registered June 24, 2008**

**SERVICE MARK  
PRINCIPAL REGISTER**



ALPINE PICTURES, INC (CALIFORNIA CORPORATION)  
3500 WEST MAGNOLIA BLVD  
BURBANK, CA 91505

FOR: PRODUCTION AND DISTRIBUTION OF INDEPENDENT MOTION PICTURES; PRODUCTION AND DISTRIBUTION OF MOTION PICTURES, IN CLASS 41 (U.S. CLS. 100, 101 AND 107).

FIRST USE 5-9-1995; IN COMMERCE 5-9-1995.

OWNER OF U.S. REG. NO. 3,367,630.

NO CLAIM IS MADE TO THE EXCLUSIVE RIGHT TO USE "PICTURES, INC.", APART FROM THE MARK AS SHOWN.

THE MARK CONSISTS OF SMALL STYLIZED OUTLINE INDICATING A MOUNTAIN WITH THE WORDS "ALPINE PICTURES, INC." BENEATH.

SER. NO. 77-014,829, FILED 10-5-2006.

ROSELLE HERRERA, EXAMINING ATTORNEY

**Int. Cl.: 35**

**Prior U.S. Cls.: 100, 101 and 102**

**United States Patent and Trademark Office**

**Reg. No. 3,451,847**

**Registered June 24, 2008**

**SERVICE MARK  
PRINCIPAL REGISTER**

**THE AMERICAN ACADEMY OF  
ORAL MEDICINE**

THE AMERICAN ACADEMY OF ORAL MEDICINE, INC. (NEW YORK NON-PROFIT CORPORATION)  
23607 HIGHWAY 99, SUITE 2-C  
EDMONDS, WA 98026

FOR: ASSOCIATION SERVICES, NAMELY, PROMOTING RESEARCH AND EDUCATION, TRAINING, PATIENT EDUCATION AND CLINICAL SERVICES, ADVANCEMENT AND HONORING OF THOSE IN THE FIELD OF ORAL MEDICINE, IN CLASS 35 (U.S. CLS. 100, 101 AND 102).

FIRST USE 7-0-1966; IN COMMERCE 7-0-1966.

THE MARK CONSISTS OF STANDARD CHARACTERS WITHOUT CLAIM TO ANY PARTICULAR FONT, STYLE, SIZE, OR COLOR.

NO CLAIM IS MADE TO THE EXCLUSIVE RIGHT TO USE "ACADEMY OF ORAL MEDICINE", APART FROM THE MARK AS SHOWN.

SEC. 2(F).

SER. NO. 77-015,408, FILED 10-6-2006.

HEATHER SAPP, EXAMINING ATTORNEY

**Int. Cl.: 35**

**Prior U.S. Cls.: 100, 101 and 102**

**United States Patent and Trademark Office**

**Reg. No. 3,451,848**

**Registered June 24, 2008**

**SERVICE MARK  
PRINCIPAL REGISTER**



IRENE MARIE, INC. (FLORIDA CORPORATION)  
728 OCEAN DRIVE  
MIAMI BEACH, FL 33139

FOR: MODELING AGENCY; TALENT AGENCY SERVICES, NAMELY, MANAGEMENT OF MODELS, HAIR AND MAKE-UP ARTISTS, PHOTOGRAPHERS, ACTORS, ATHLETES AND SPORTS PERSONALITIES, MUSIC ARTISTS AND ENTERTAINERS, AND OTHER PROMINENT PERSONALITIES, IN CLASS 35 (U.S. CLS. 100, 101 AND 102).

FIRST USE 1-1-1985; IN COMMERCE 1-1-1985.

THE MARK CONSISTS OF THE LETTER "I" OVER THE LETTER "M" SEPARATED BY A HORIZONTAL LINE ALL ENCLOSED WITHIN A CIRCLE.

SER. NO. 77-015,894, FILED 10-6-2006.

KIMBERLY FRYE, EXAMINING ATTORNEY

**Int. Cl.: 3**

**Prior U.S. Cls.: 1, 4, 6, 50, 51 and 52**

**Reg. No. 3,451,849**

**United States Patent and Trademark Office**

**Registered June 24, 2008**

**TRADEMARK  
PRINCIPAL REGISTER**

**FREEZE HOT REDUCE**

JCK WORLD TRADE, INC. (FLORIDA CORPORATION)

1440 JFK CSWY STE: 319 B

NORTH BAY VILLAGE, FL 33134

FOR: BODY CREAM, IN CLASS 3 (U.S. CLS. 1, 4, 6, 50, 51 AND 52).

FIRST USE 2-5-2006; IN COMMERCE 2-5-2006.

THE MARK CONSISTS OF STANDARD CHARACTERS WITHOUT CLAIM TO ANY PARTICULAR FONT, STYLE, SIZE, OR COLOR.

NO CLAIM IS MADE TO THE EXCLUSIVE RIGHT TO USE "HOT REDUCE", APART FROM THE MARK AS SHOWN.

SER. NO. 77-015,996, FILED 10-6-2006.

ODESSA BIBBINS, EXAMINING ATTORNEY

**Int. Cl.: 44**

**Prior U.S. Cls.: 100 and 101**

**United States Patent and Trademark Office**

**Reg. No. 3,451,850**

**Registered June 24, 2008**

**SERVICE MARK  
PRINCIPAL REGISTER**

**JEUNESSE  
'SPAS FOR LIFE'**

REM UNITED ASSOCIATES, INC (NEW YORK  
CORPORATION)  
21 GATEHOUSE ROAD  
BEDMINSTER, NJ 07921

FOR: HEALTH SPA SERVICES, NAMELY, COS-  
METIC BODY CARE SERVICES, IN CLASS 44 (U.S.  
CLS. 100 AND 101).

FIRST USE 10-2-2006; IN COMMERCE 10-2-2006.

THE MARK CONSISTS OF STANDARD CHAR-  
ACTERS WITHOUT CLAIM TO ANY PARTICULAR  
FONT, STYLE, SIZE, OR COLOR.

THE ENGLISH TRANSLATION OF THE WORD  
"JEUNESSE" IN THE MARK IS YOUTH.

SER. NO. 77-016,726, FILED 10-9-2006.

ROBIN CHOSID, EXAMINING ATTORNEY

**Int. Cls.: 9 and 10**

**Prior U.S. Cls.: 21, 23, 26, 36, 38, 39 and 44**

**United States Patent and Trademark Office**

**Reg. No. 3,451,851**

**Registered June 24, 2008**

**TRADEMARK  
PRINCIPAL REGISTER**

**CARESTAR**

DRÄGER MEDICAL AG & CO. KG (FED REP  
GERMANY CORPORATION)  
MOISLINGER ALLEE 53-55  
LÜBECK, FED REP GERMANY 23558

FOR: FILTERS FOR RESPIRATORY MASKS,  
NAMELY, BREATHING FILTERS, IN CLASS 9  
(U.S. CLS. 21, 23, 26, 36 AND 38).

FOR: MEDICAL INSTRUMENTS FOR USE IN  
ANESTHESIA AND RESPIRATION, NAMELY,  
BREATHING FILTERS FOR ANESTHESIA MA-  
CHINES, MEDICAL RESPIRATORS, AND MEDI-  
CAL VENTILATORS, IN CLASS 10 (U.S. CLS. 26, 39  
AND 44).

PRIORITY CLAIMED UNDER SEC. 44(D) ON  
ERPN CMNTY TM OFC APPLICATION NO.  
005363627, FILED 10-6-2006, REG. NO. 005363627,  
DATED 7-23-2007, EXPIRES 10-6-2016.

THE MARK CONSISTS OF THE WORD CARES-  
TAR.

SER. NO. 77-018,710, FILED 10-11-2006.

SHARON MEIER, EXAMINING ATTORNEY

**Int. Cls.: 16 and 41**

**Prior U.S. Cls.: 2, 5, 22, 23, 29, 37, 38, 50, 100, 101 and 107**

**Reg. No. 3,451,852**

**United States Patent and Trademark Office**

**Registered June 24, 2008**

**TRADEMARK  
SERVICE MARK  
PRINCIPAL REGISTER**

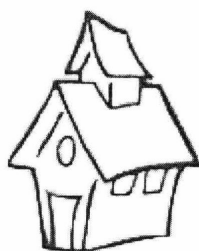

**School  
Solutions**

SCHOOL SOLUTIONS LLC (NEW JERSEY LTD  
LIAB CO)  
1812 FRONT STREET  
SCOTCH PLAINS, NJ 07076

FOR: PRINTED INSTRUCTIONAL, EDUCATIONAL AND TEACHING MATERIALS IN THE FIELD OF EDUCATION, NAMELY, CUSTOMIZED BOOKS, WORKBOOKS, TESTING MATERIALS, TEACHING AIDS, CURRICULUM MATERIALS AND STANDARD-ALIGNED TEACHING MATERIALS, IN CLASS 16 (U.S. CLS. 2, 5, 22, 23, 29, 37, 38 AND 50).

FIRST USE 8-1-2000; IN COMMERCE 8-1-2000.

FOR: PUBLISHING AND EDITING OF BOOKS, WORKBOOKS, TESTING MATERIALS, TEACHING AIDS AND OTHER PRINTED MATTER; ELECTRONIC PUBLISHING SERVICES, NAMELY, EDITING AND PUBLISHING OF TEXT AND GRAPHIC WORKS OF OTHERS ON CD-ROMS, DVDS AND OVER THE INTERNET IN THE FIELD OF EDUCA-

TION; PRODUCTION OF VIDEO DISCS AND CD-ROMS FOR OTHERS FEATURING EDUCATIONAL VIDEOS AND EDUCATIONAL INTERACTIVE TEXTBOOKS, IN CLASS 41 (U.S. CLS. 100, 101 AND 107).

FIRST USE 8-1-2000; IN COMMERCE 8-1-2000.

NO CLAIM IS MADE TO THE EXCLUSIVE RIGHT TO USE "SCHOOL SOLUTIONS", APART FROM THE MARK AS SHOWN.

THE MARK CONSISTS OF A SCHOOLHOUSE TO THE LEFT OF THE WORDING "SCHOOL SOLUTIONS". THE WORDING "SCHOOL" SITS ABOVE THE WORDING "SOLUTIONS".

SER. NO. 77-019,500, FILED 10-12-2006.

SETH A. RAPPAPORT, EXAMINING ATTORNEY



**Int. Cl.: 35**

**Prior U.S. Cls.: 100, 101 and 102**

**United States Patent and Trademark Office**

**Reg. No. 3,451,853**

**Registered June 24, 2008**

**SERVICE MARK  
PRINCIPAL REGISTER**

**WIND ENERGY WORKS**

AMERICAN WIND ENERGY ASSOCIATION,  
INC. (D.C. CORPORATION)  
1101 14TH STREET, N.W., 12TH FLOOR  
WASHINGTON, DC 20005

FOR: PROMOTING PUBLIC AWARENESS OF  
THE BENEFITS OF, AND NEED FOR, THE DEVEL-  
OPMENT AND USE OF WIND ENERGY AS A  
CLEAN AND RENEWABLE SOURCE OF ELECTRI-  
CITY, BY DISSEMINATING FACTS AND INFOR-  
MATION REGARDING WIND ENERGY  
THROUGHOUT THE UNITED STATES, IN CLASS  
35 (U.S. CLS. 100, 101 AND 102).

FIRST USE 7-6-2005; IN COMMERCE 7-6-2005.

THE MARK CONSISTS OF STANDARD CHAR-  
ACTERS WITHOUT CLAIM TO ANY PARTICULAR  
FONT, STYLE, SIZE, OR COLOR.

SER. NO. 77-020,888, FILED 10-13-2006.

JOHN WILKE, EXAMINING ATTORNEY

Int. Cl.: 39

Prior U.S. Cls.: 100 and 105

United States Patent and Trademark Office

Reg. No. 3,451,854

Registered June 24, 2008

SERVICE MARK  
PRINCIPAL REGISTER



**carhoppers**

CARHOPPERS CURBSIDE SERVICE, LLC (CALIFORNIA LTD LIAB CO)  
965 ROXBURY DR.  
PASADENA, CA 91104

FOR: RESTAURANT FOOD DELIVERY SERVICES, IN CLASS 39 (U.S. CLS. 100 AND 105).

FIRST USE 6-30-2006; IN COMMERCE 5-17-2007.

THE COLOR(S) BLACK, WHITE, AND RED IS/ARE CLAIMED AS A FEATURE OF THE MARK.

THE MARK CONSISTS OF A UNIFORMED WAITER WITH THE LEGS OF A RUNNER WEARING TENNIS SHOES, CARRYING A TRAY OF FOOD. THE IMAGE OF THE WAITER, IN A RUNNING POSE, IS BLACK AND WHITE AND IT IS LOCATED SLIGHTLY ABOVE THE WORD "CARHOPPERS"; THE WORD "CAR" IS BLACK AND THE WORD "HOPPERS" IS RED. THE BACKGROUND OF THE ENTIRE MARK IS WHITE".

SER. NO. 77-021,559, FILED 10-16-2006.

JIM RINGLE, EXAMINING ATTORNEY

**Int. Cl.: 10**

**Prior U.S. Cls.: 26, 39 and 44**

**United States Patent and Trademark Office**

**Reg. No. 3,451,855**

**Registered June 24, 2008**

**TRADEMARK  
PRINCIPAL REGISTER**

**CLEARVU**

CANNUFLOW, INC. (CALIFORNIA CORPORATION)  
1190 COLEMAN ROAD, SUITE 250  
SAN JOSE, CA 95710

FOR: SURGICAL INSTRUMENTS, NAMELY, ARTHROSCOPIC FLUID MANAGEMENT DEVICES FOR USE DURING ARTHROSCOPIC KNEE SURGERY; SURGICAL INSTRUMENTS FOR USE IN ARTHROSCOPIC KNEE SURGERY , IN CLASS 10 (U.S. CLS. 26, 39 AND 44).

FIRST USE 6-1-2003; IN COMMERCE 6-1-2003.

THE MARK CONSISTS OF STANDARD CHARACTERS WITHOUT CLAIM TO ANY PARTICULAR FONT, STYLE, SIZE, OR COLOR.

SER. NO. 77-021,798, FILED 10-16-2006.

ALLISON SCHRODY, EXAMINING ATTORNEY

**Int. Cls.: 9, 38 and 42**

**Prior U.S. Cls.: 21, 23, 26, 36, 38, 100, 101 and 104**

**United States Patent and Trademark Office**

**Reg. No. 3,451,856**

**Registered June 24, 2008**

**TRADEMARK  
SERVICE MARK  
PRINCIPAL REGISTER**

**getPlus**

WESSLING, OLIVER (UNITED STATES INDIVIDUAL)  
7181 ENCINA LANE  
BOCA RATON, FL 33433

FOR: COMPUTER SOFTWARE TO MANAGE ALL KINDS OF DOWNLOAD TRANSACTIONS, NAMELY, TO PAUSE AND RESUME DOWNLOADS, TO AUTOMATICALLY HANDLE FIREWALLS AND PROXY AUTHENTICATIONS, TO PERFORM AN INTEGRITY CHECK ON THE DOWNLOAD FILE, TO RELOAD INCREMENTAL PARTS OF THE SOFTWARE IN CASE OF DATA CORRUPTION, TO PERFORM SCHEDULED ON-DEMAND DOWNLOADS AND PROVIDE COMPLIMENTARY PRODUCTS, UPDATES OR ALTERNATIVE DOWNLOAD POSSIBILITIES BY AUTOMATICALLY READING OUT A MACHINE'S SPECIFICATION AND USER SECURITY RESTRICTIONS, TO PERFORM PARALLEL DOWNLOAD OF SEVERAL DOWNLOAD FILES VIA DOWNLOAD BASKET FUNCTIONALITY, TO SECURELY PROMPT CUSTOMER AUTHENTICATION AND PAYMENT INFORMATION PRIOR THE DOWNLOAD, TO AUTOMATICALLY INSTALL AND EXECUTE APPLICATIONS WITH COMMANDS ON THE CLIENT MACHINE AFTER DOWNLOAD, AND FOR CONTROLLED LAN ROLL-OUTS THROUGH REMOTE DISTRIBUTION, ALL OF THEM OPTIONALLY VIA SECURED COMMUNICATION, MULTI-SOURCING, AND BACKGROUND DOWNLOAD FOR USE IN DOWNLOAD MANAGEMENT AND SECURED LICENSE CONTROL IN THE FIELD OF ELECTRONIC DISTRIBUTION AND MANAGING OF DIGITAL GOODS, IN CLASS 9 (U.S. CLS. 21, 23, 26, 36 AND 38).

FIRST USE 4-1-2006; IN COMMERCE 4-1-2006.

FOR: PROVIDING ACCESS TO A COMPUTER NETWORK TO CONTROL DOWNLOAD TRANSACTIONS,

NAMELY, TO PAUSE AND RESUME THE INITIAL DOWNLOAD, TO PERFORM AN INTEGRITY CHECK ON THE DOWNLOAD FILE, TO RELOAD INCREMENTAL PARTS OF THE SOFTWARE IN CASE OF DATA CORRUPTION, TO PERFORM SCHEDULED ON-DEMAND DOWNLOADS AND PROVIDE COMPLIMENTARY PRODUCTS, UPDATES OR ALTERNATIVE DOWNLOAD POSSIBILITIES BY AUTOMATICALLY READING OUT A MACHINE'S SPECIFICATION AND USER SECURITY RESTRICTIONS, TO PERFORM PARALLEL DOWNLOAD OF SEVERAL DOWNLOAD FILES VIA DOWNLOAD BASKET FUNCTIONALITY, TO SECURELY PROMPT CUSTOMER AUTHENTICATION AND PAYMENT INFORMATION PRIOR THE DOWNLOAD, TO AUTOMATICALLY INSTALL ON-DEMAND AND EXECUTE APPLICATIONS WITH COMMANDS ON THE CLIENT MACHINE AFTER DOWNLOAD, AND FOR CONTROLLED LAN ROLL-OUTS THROUGH REMOTE DISTRIBUTION, ALL OF THEM OPTIONALLY VIA SECURED COMMUNICATION, MULTI-SOURCING, AND BACKGROUND DOWNLOAD FOR USE IN DOWNLOAD MANAGEMENT AND SECURED LICENSE CONTROL IN THE FIELD OF DIGITAL TRANSMISSION OF VOICE, DATA, IMAGES, SIGNALS, AND MESSAGES, IN CLASS 38 (U.S. CLS. 100, 101 AND 104).

FIRST USE 4-1-2006; IN COMMERCE 4-1-2006.

FOR: COMPUTER CONSULTATION, COMPUTER SOFTWARE CONSULTATION, AND COMPUTER SOFTWARE DEVELOPMENT IN THE FIELDS OF SECURED NETWORK DATA MANAGEMENT AND INSTALLATION, IN CLASS 42 (U.S. CLS. 100 AND 101).

FIRST USE 4-1-2006; IN COMMERCE 4-1-2006.

THE MARK CONSISTS OF STANDARD CHAR-  
ACTERS WITHOUT CLAIM TO ANY PARTICULAR  
FONT, STYLE, SIZE, OR COLOR.

OWNER OF UNITED KINGDOM REG. NO.  
005408349, DATED 2-4-2008, EXPIRES 2-4-2018.

SER. NO. 77-023,493, FILED 10-18-2006.

SHARON MEIER, EXAMINING ATTORNEY

**Int. Cl.: 28**

**Prior U.S. Cls.: 22, 23, 38 and 50**

**United States Patent and Trademark Office**

**Reg. No. 3,451,857**

**Registered June 24, 2008**

**TRADEMARK  
PRINCIPAL REGISTER**

**MinIum**

KYOSHO CORPORATION (JAPAN COMPANY)  
CHIYODA-KU  
1-9-3, HIRAKAWA-CHO  
TOKYO 102-0093, JAPAN

FOR: RADIO-CONTROLLED TOYS AND PARTS  
AND FITTINGS THEREFOR; RADIO TRANSMIT-  
TING SETS FOR RADIO-CONTROLLED TOYS;  
DOLLS; BILLIARD TABLES; DICE, TOYS FOR PETS;  
SKIS; SURF BOARDS; SKI WAX; FISHING RODS, IN  
CLASS 28 (U.S. CLS. 22, 23, 38 AND 50).

THE MARK CONSISTS OF STANDARD CHAR-  
ACTERS WITHOUT CLAIM TO ANY PARTICULAR  
FONT, STYLE, SIZE, OR COLOR.

OWNER OF JAPAN REG. NO. 5041067, DATED 4-  
13-2007, EXPIRES 4-13-2017.

SER. NO. 77-023,511, FILED 10-18-2006.

JULIE GUTTADAURO, EXAMINING ATTORNEY

**Int. Cls.: 7 and 40**

**Prior U.S. Cls.: 13, 19, 21, 23, 31, 34, 35, 100, 103 and 106**

**Reg. No. 3,451,858**

**United States Patent and Trademark Office**

**Registered June 24, 2008**

---

**TRADEMARK  
SERVICE MARK  
PRINCIPAL REGISTER**

**UNIQUECOAT**

UNIQUECOAT TECHNOLOGIES, LLC (VIRGINIA LTD LIAB CO)  
12700 STONEBRIAR LANE  
RICHMOND, VA 23233

FOR: POWDER COATING SPRAY GUNS, IN CLASS 7 (U.S. CLS. 13, 19, 21, 23, 31, 34 AND 35).

FIRST USE 6-29-2000; IN COMMERCE 6-29-2000.

FOR: APPLICATION OF PROTECTIVE COATINGS, IN CLASS 40 (U.S. CLS. 100, 103 AND 106).

FIRST USE 6-29-2000; IN COMMERCE 6-29-2000.

THE MARK CONSISTS OF STANDARD CHARACTERS WITHOUT CLAIM TO ANY PARTICULAR FONT, STYLE, SIZE, OR COLOR.

SER. NO. 77-024,461, FILED 10-18-2006.

KEVIN CORWIN, EXAMINING ATTORNEY

**Int. Cl.: 35**

**Prior U.S. Cls.: 100, 101 and 102**

**United States Patent and Trademark Office**

**Reg. No. 3,451,859**

**Registered June 24, 2008**

**SERVICE MARK  
PRINCIPAL REGISTER**

**DEWEATHERIZE**

PLANALYTICS, INC. (PENNSYLVANIA CORPORATION)  
1325 MORRIS DRIVE  
WAYNE, PA 19087

FOR: BUSINESS EVALUATION OF DATA, NAMELY, INTEGRATED DATA RELATED TO THE HISTORICAL CORRELATIONS OF WEATHER AND PRODUCTS SALES TO ENABLE BUSINESSES TO FORM THE BASIS OF PREDICTIVE MODELS, WHICH MODELS WILL EXTRAPOLATE THE EFFECTS OF WEATHER ON CONSUMERS TO ALLOW USERS TO CREATE WEATHER-EFFECTIVE MERCHANDISE PLANS AND ASSORTMENTS BY LOCATION, IN CLASS 35 (U.S. CLS. 100, 101 AND 102).

FIRST USE 6-1-1993; IN COMMERCE 6-1-1993.

THE MARK CONSISTS OF STANDARD CHARACTERS WITHOUT CLAIM TO ANY PARTICULAR FONT, STYLE, SIZE, OR COLOR.

SEC. 2(F).

SER. NO. 77-025,202, FILED 10-19-2006.

SHARON MEIER, EXAMINING ATTORNEY



**Int. Cl.: 10**

**Prior U.S. Cls.: 26, 39 and 44**

**United States Patent and Trademark Office**

**Reg. No. 3,451,860**

**Registered June 24, 2008**

**TRADEMARK  
PRINCIPAL REGISTER**

**EPR**

RESMED LIMITED (AUSTRALIA CORPORATION)  
1 ELIZABETH MACARTHUR DRIVE  
BELLA VISTA, NSW, AUSTRALIA 2153

FOR: MEDICAL APPARATUS, NAMELY, CONTINUOUS POSITIVE AIRWAY PRESSURE DEVICES DESIGNED TO TREAT SLEEP DISORDERED BREATHING, HUMIDIFIERS USED IN CONNECTION WITH CONTINUOUS POSITIVE AIRWAY PRESSURE MEDICAL DEVICES AND PARTS FOR ALL THE FOREGOING, IN CLASS 10 (U.S. CLS. 26, 39 AND 44).

THE MARK CONSISTS OF STANDARD CHARACTERS WITHOUT CLAIM TO ANY PARTICULAR FONT, STYLE, SIZE, OR COLOR.

PRIORITY CLAIMED UNDER SEC. 44(D) ON AUSTRALIA APPLICATION NO. 1135845, FILED 9-14-2006, REG. NO. 1135845, DATED 9-14-2006, EXPIRES 9-14-2016.

SER. NO. 77-025,997, FILED 10-20-2006.

CHERYL CLAYTON, EXAMINING ATTORNEY

**Int. Cl.: 41**

**Prior U.S. Cls.: 100, 101 and 107**

**United States Patent and Trademark Office**

**Reg. No. 3,451,861**

**Registered June 24, 2008**

**SERVICE MARK  
PRINCIPAL REGISTER**

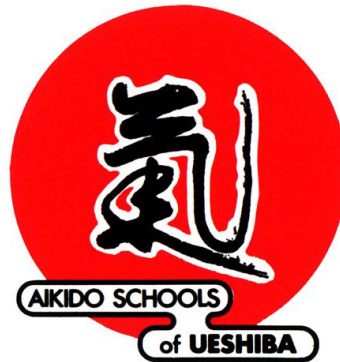

MITSUGI SAOTOME (UNITED STATES INDIVIDUAL)  
29165 SINGLETARY ROAD  
MYAKKA CITY, FL 34251

FOR: OPERATING OF MARTIAL ARTS SCHOOLS, IN CLASS 41 (U.S. CLS. 100, 101 AND 107).

FIRST USE 1-1-1986; IN COMMERCE 1-1-1986.

NO CLAIM IS MADE TO THE EXCLUSIVE RIGHT TO USE "AIKIDO SCHOOLS", APART FROM THE MARK AS SHOWN.

THE COLOR(S) RED, WHITE AND BLACK IS/ARE CLAIMED AS A FEATURE OF THE MARK.

THE MARK CONSISTS OF A RED CIRCLE WITH BLACK JAPANESE CHARACTER IN THE CENTER, BORDERED IN WHITE WITH AIKIDO SCHOOLS OF UESHIBA ON THE BOTTOM OF THE MARK SURRROUNDED BY A BLACK AND WHITE BORDER.

"THE NON-LATIN CHARACTER(S) IN THE MARK transliterates into DO , AND THIS MEANS WAY IN ENGLISH."

SER. NO. 77-026,534, FILED 10-21-2006.

SUSAN STIGLITZ, EXAMINING ATTORNEY

**Int. Cls.: 36 and 37**

**Prior U.S. Cls.: 100, 101, 102, 103 and 106**

**United States Patent and Trademark Office**

**Reg. No. 3,451,862**

**Registered June 24, 2008**

**SERVICE MARK  
PRINCIPAL REGISTER**

**ROAD TO REMARKABLE**

THE MACERICH PARTNERSHIP, L.P. (DELA-  
WARE LIMITED PARTNERSHIP)  
401 WILSHIRE BOULEVARD, SUITE 700  
SANTA MONICA, CA 90401

FOR: LEASING OF SHOPPING MALL SPACE  
AND PROVIDING ON-LINE LEASING INFORMA-  
TION IN CONNECTION THEREWITH; BUILDING  
MANAGEMENT OF SHOPPING CENTERS AND  
MALLS, IN CLASS 36 (U.S. CLS. 100, 101 AND 102).

FIRST USE 11-1-2006; IN COMMERCE 11-1-2006.

FOR: REAL ESTATE DEVELOPMENT AND REAL  
ESTATE REDEVELOPMENT OF SHOPPING CEN-

TERS, MIXED-DEVELOPMENTS AND MALLS;  
CUSTOM CONSTRUCTION AND RENOVATION  
OF BUILDINGS, IN CLASS 37 (U.S. CLS. 100, 103  
AND 106).

FIRST USE 11-1-2006; IN COMMERCE 11-1-2006.

THE MARK CONSISTS OF STANDARD CHAR-  
ACTERS WITHOUT CLAIM TO ANY PARTICULAR  
FONT, STYLE, SIZE, OR COLOR.

SER. NO. 77-027,350, FILED 10-23-2006.

TANYA AMOS, EXAMINING ATTORNEY

**Int. Cls.: 1, 3 and 5**

**Prior U.S. Cls.: 1, 4, 5, 6, 10, 18, 26, 44, 46, 50, 51 and 52**

**Reg. No. 3,451,863**

**United States Patent and Trademark Office**

**Registered June 24, 2008**

**TRADEMARK  
PRINCIPAL REGISTER**

# Clitofit

KOCHEM, HANS-GÜNTER (FED REP GERMAN-  
NY INDIVIDUAL)  
HEISINGER STRASSE 66  
D-45134 ESSEN-STADTVAL, FED REP GERMANY

FOR: CHEMICALS USED IN INDUSTRY, SCI-  
ENCE AND PHOTOGRAPHY; CHEMICALS FOR  
USE IN AGRICULTURE, HORTICULTURE AND  
FORESTRY, NAMELY, CHEMICAL PREPARA-  
TIONS FOR THE TREATMENT OF SEEDS, IN  
CLASS 1 (U.S. CLS. 1, 5, 6, 10, 26 AND 46).

FOR: BLEACHING PREPARATIONS FOR LAUN-  
DRY USE; COSMETIC SOAPS; PERFUMERY; ES-  
SENTIAL OILS; COSMETICS; HAIR LOTIONS;  
DENTIFRICES, IN CLASS 3 (U.S. CLS. 1, 4, 6, 50, 51  
AND 52).

FOR: PHARMACEUTICAL PREPARATIONS FOR  
THE TREATMENT OF FEMALE SEXUAL DIS-  
FUNCTIONS OR FEMALE SEXUAL DISORDERS;  
VETERINARY PREPARATIONS FOR THE TREAT-  
MENT OF FEMALE SEXUAL DISFUNCTIONS OR  
FEMALE SEXUAL DISORDERS; CHEMICAL PRE-

PARATIONS FOR SANITARY PURPOSES; DIETE-  
TIC FOODS ADAPTED FOR MEDICAL USE; FOOD  
FOR BABIES; MEDICAL PLASTERS; WOUND  
DRESSINGS; DENTAL AMALGAMS; DENTAL  
WAX; ALL PURPOSE DISINFECTANTS; PREPARA-  
TIONS FOR DESTROYING VERMIN; FUNGICIDES;  
HERBICIDES, IN CLASS 5 (U.S. CLS. 6, 18, 44, 46, 51  
AND 52).

THE MARK CONSISTS OF STANDARD CHAR-  
ACTERS WITHOUT CLAIM TO ANY PARTICULAR  
FONT, STYLE, SIZE, OR COLOR.

PRIORITY CLAIMED UNDER SEC. 44(D) ON  
ERPN CMNTY TM OFC APPLICATION NO.  
005057286, FILED 5-4-2006, REG. NO. 005057286,  
DATED 3-15-2007, EXPIRES 5-4-2016.

SER. NO. 77-027,689, FILED 10-24-2006.

KATHLEEN M. VANSTON, EXAMINING ATTOR-  
NEY

**Int. Cl.: 35**

**Prior U.S. Cls.: 100, 101 and 102**

**United States Patent and Trademark Office**

**Reg. No. 3,451,864**

**Registered June 24, 2008**

**SERVICE MARK  
PRINCIPAL REGISTER**

**carshq**

FORUM COMMUNICATIONS COMPANY  
(NORTH DAKOTA CORPORATION)  
101 5TH ST. N., P.O. BOX 2020  
FARGO, ND 581072020

THE MARK CONSISTS OF STANDARD CHAR-  
ACTERS WITHOUT CLAIM TO ANY PARTICULAR  
FONT, STYLE, SIZE, OR COLOR.

FOR: DISSEMINATION OF ADVERTISING OF  
CARS FOR OTHERS VIA THE INTERNET, IN  
CLASS 35 (U.S. CLS. 100, 101 AND 102).

SER. NO. 77-028,213, FILED 10-24-2006.

FIRST USE 8-0-2005; IN COMMERCE 8-0-2005.

MICHAEL WEBSTER, EXAMINING ATTORNEY

**Int. Cl.: 16**

**Prior U.S. Cls.: 2, 5, 22, 23, 29, 37, 38 and 50**

**United States Patent and Trademark Office**

**Reg. No. 3,451,865**

**Registered June 24, 2008**

**TRADEMARK  
PRINCIPAL REGISTER**

**EDGECUBE**

PEEL PLASTIC PRODUCTS LTD. (CANADA LIMITED COMPANY)

49 RUTHERFORD ROAD SOUTH, BRAMPTON

ONTARIO L6W 3J3, CANADA

FOR: PLASTIC BAGS FOR MERCHANDISE PACKAGING AND STORAGE; PLASTIC MERCHANDISE BAGS FOR STORAGE; GENERAL PURPOSE PLASTIC BAGS FOR STORAGE, IN CLASS 16 (U.S. CLS. 2, 5, 22, 23, 29, 37, 38 AND 50).

THE MARK CONSISTS OF STANDARD CHARACTERS WITHOUT CLAIM TO ANY PARTICULAR FONT, STYLE, SIZE, OR COLOR.

PRIORITY CLAIMED UNDER SEC. 44(D) ON CANADA APPLICATION NO. 1,299,270, FILED 4-26-2006, REG. NO. TMA694,836, DATED 8-27-2007, EXPIRES 8-27-2022.

SER. NO. 77-029,561, FILED 10-25-2006.

PATRICIA EVANKO, EXAMINING ATTORNEY

**Int. Cl.: 16**

**Prior U.S. Cls.: 2, 5, 22, 23, 29, 37, 38 and 50**

**Reg. No. 3,451,866**

**United States Patent and Trademark Office**

**Registered June 24, 2008**

**TRADEMARK  
PRINCIPAL REGISTER**

**FLEXIJUG**

PEEL PLASTIC PRODUCTS LTD. (CANADA LIMITED COMPANY)  
49 RUTHERFORD ROAD SOUTH, BRAMPTON  
ONTARIO L6W 3J3, CANADA

FOR: RE-SEALABLE PLASTIC BAGS FOR PACKAGING AND DISPENSING OF MERCHANDISE; RE-SEALABLE PLASTIC MERCHANDISE BAGS FOR STORAGE AND DISPENSING OF MERCHANDISE; RE-SEALABLE GENERAL PURPOSE PLASTIC BAGS FOR STORAGE AND DISPENSING OF MERCHANDISE, IN CLASS 16 (U.S. CLS. 2, 5, 22, 23, 29, 37, 38 AND 50).

THE MARK CONSISTS OF STANDARD CHARACTERS WITHOUT CLAIM TO ANY PARTICULAR FONT, STYLE, SIZE, OR COLOR.

PRIORITY CLAIMED UNDER SEC. 44(D) ON CANADA APPLICATION NO. 1299274, FILED 4-26-2006, REG. NO. TMA694,837, DATED 8-27-2007, EXPIRES 8-27-2022.

SER. NO. 77-029,574, FILED 10-25-2006.

PATRICIA EVANKO, EXAMINING ATTORNEY

**Int. Cl.: 16**

**Prior U.S. Cls.: 2, 5, 22, 23, 29, 37, 38 and 50**

**United States Patent and Trademark Office**

**Reg. No. 3,451,867**

**Registered June 24, 2008**

**TRADEMARK  
PRINCIPAL REGISTER**

**SLIDECUBE**

PEEL PLASTIC PRODUCTS LTD. (CANADA LIMITED COMPANY)  
49 RUTHERFORD ROAD SOUTH, BRAMPTON  
ONTARIO L6W 3J3, CANADA

FOR: RE-SEALABLE PLASTIC BAGS FOR MERCHANDISE PACKAGING AND STORAGE; RE-SEALABLE PLASTIC MERCHANDISE BAGS FOR STORAGE; GENERAL PURPOSE RE-SEALABLE PLASTIC BAGS FOR STORAGE, IN CLASS 16 (U.S. CLS. 2, 5, 22, 23, 29, 37, 38 AND 50).

THE MARK CONSISTS OF STANDARD CHARACTERS WITHOUT CLAIM TO ANY PARTICULAR FONT, STYLE, SIZE, OR COLOR.

PRIORITY CLAIMED UNDER SEC. 44(D) ON CANADA APPLICATION NO. 1299276, FILED 4-26-2006, REG. NO. TMA694,828, DATED 8-27-2007, EXPIRES 8-27-2022.

SER. NO. 77-029,586, FILED 10-25-2006.

PATRICIA EVANKO, EXAMINING ATTORNEY



**Int. Cl.: 16**

**Prior U.S. Cls.: 2, 5, 22, 23, 29, 37, 38 and 50**

**United States Patent and Trademark Office**

**Reg. No. 3,451,868**

**Registered June 24, 2008**

**TRADEMARK  
PRINCIPAL REGISTER**

**ZIPCUBE**

PEEL PLASTIC PRODUCTS LTD. (CANADA LIMITED COMPANY)  
49 RUTHERFORD ROAD SOUTH, BRAMPTON  
ONTARIO L6W 3J3, CANADA

FOR: RE-SEALABLE PLASTIC BAGS FOR MERCHANDISE PACKAGING AND STORAGE; RE-SEALABLE PLASTIC MERCHANDISE BAGS FOR STORAGE; GENERAL PURPOSE RE-SEALABLE PLASTIC BAGS FOR STORAGE, IN CLASS 16 (U.S. CLS. 2, 5, 22, 23, 29, 37, 38 AND 50).

THE MARK CONSISTS OF STANDARD CHARACTERS WITHOUT CLAIM TO ANY PARTICULAR FONT, STYLE, SIZE, OR COLOR.

PRIORITY CLAIMED UNDER SEC. 44(D) ON CANADA APPLICATION NO. 1299277, FILED 4-26-2006, REG. NO. TMA694,839, DATED 8-27-2007, EXPIRES 8-27-2022.

SER. NO. 77-029,590, FILED 10-25-2006.

PATRICIA EVANKO, EXAMINING ATTORNEY

**Int. Cl.: 36**

**Prior U.S. Cls.: 100, 101 and 102**

**United States Patent and Trademark Office**

**Reg. No. 3,451,869**

**Registered June 24, 2008**

**SERVICE MARK  
PRINCIPAL REGISTER**

**THAT'S THE POWER OF K**

K CAPITAL CORPORATION (MARYLAND CORPORATION)  
11407 CRONHILL DRIVE, SUITE N  
OWINGS MILLS, MD 21117

FOR: BANKING SERVICES; FINANCIAL SERVICES, NAMELY, FINANCIAL ANALYSIS AND CONSULTATION, FINANCIAL INFORMATION PROVIDED BY ELECTRONIC MEANS, FINANCIAL INFORMATION PROCESSING, FINANCIAL SERVICES IN THE FIELD OF MONEY LENDING, INVESTMENT FUND TRANSFER AND TRANSACTION SERVICES, IN CLASS 36 (U.S. CLS. 100, 101 AND 102).

FIRST USE 10-25-2006; IN COMMERCE 10-25-2006.

THE MARK CONSISTS OF STANDARD CHARACTERS WITHOUT CLAIM TO ANY PARTICULAR FONT, STYLE, SIZE, OR COLOR.

SER. NO. 77-030,185, FILED 10-26-2006.

TRACY WHITTAKER-BROWN, EXAMINING ATTORNEY

**Int. Cl.: 36**

**Prior U.S. Cls.: 100, 101 and 102**

**United States Patent and Trademark Office**

**Reg. No. 3,451,870**

**Registered June 24, 2008**

**SERVICE MARK  
PRINCIPAL REGISTER**

**THE POWER OF K**

K CAPITAL CORPORATION (MARYLAND CORPORATION)  
11407 CRONHILL DRIVE, SUITE N  
OWINGS MILLS, MD 21117

FOR: BANKING SERVICES; FINANCIAL SERVICES, NAMELY, FINANCIAL ANALYSIS AND CONSULTATION, FINANCIAL INFORMATION PROVIDED BY ELECTRONIC MEANS, FINANCIAL INFORMATION PROCESSING, FINANCIAL SERVICES IN THE FIELD OF MONEY LENDING, INVESTMENT FUND TRANSFER AND TRANSACTION SERVICES, IN CLASS 36 (U.S. CLS. 100, 101 AND 102).

FIRST USE 10-25-2006; IN COMMERCE 10-25-2006.

THE MARK CONSISTS OF STANDARD CHARACTERS WITHOUT CLAIM TO ANY PARTICULAR FONT, STYLE, SIZE, OR COLOR.

SER. NO. 77-031,129, FILED 10-27-2006.

TRACY WHITTAKER-BROWN, EXAMINING ATTORNEY

**Int. Cl.: 16**

**Prior U.S. Cls.: 2, 5, 22, 23, 29, 37, 38 and 50**

**Reg. No. 3,451,871**

**United States Patent and Trademark Office**

**Registered June 24, 2008**

**TRADEMARK  
PRINCIPAL REGISTER**

# First State Innovations

DELAWARE INNOVATION FUND (DELAWARE CORPORATION)  
THREE MILL ROAD, SUITE 201  
WILMINGTON, DE 19806

FOR: NEWSLETTERS IN THE FIELD OF VENTURE CAPITAL, ENTREPRENEURSHIP, EMERGING BUSINESS, TECHNOLOGY, SCIENCE, AND ECONOMIC DEVELOPMENT , IN CLASS 16 (U.S. CLS. 2, 5, 22, 23, 29, 37, 38 AND 50).

FIRST USE 9-15-1996; IN COMMERCE 9-15-1996.

THE MARK CONSISTS OF STANDARD CHARACTERS WITHOUT CLAIM TO ANY PARTICULAR FONT, STYLE, SIZE, OR COLOR.

NO CLAIM IS MADE TO THE EXCLUSIVE RIGHT TO USE "FIRST STATE", APART FROM THE MARK AS SHOWN.

SEC. 2(F).

SER. NO. 77-033,014, FILED 10-31-2006.

DEZMONA MIZELLE, EXAMINING ATTORNEY

**Int. Cls.: 37 and 44**

**Prior U.S. Cls.: 100, 101, 103 and 106**

**United States Patent and Trademark Office**

**Reg. No. 3,451,872**

**Registered June 24, 2008**

**SERVICE MARK  
PRINCIPAL REGISTER**



DELISLE, JOHN M. (UNITED STATES INDIVIDUAL)

PO BOX 124

GANSEVOORT, NY 12831

FOR: HARDSCAPING SERVICES; INSTALLATION AND MAINTENANCE OF IRRIGATION SYSTEMS; SNOW REMOVAL SERVICES, IN CLASS 37 (U.S. CLS. 100, 103 AND 106).

FIRST USE 1-1-1995; IN COMMERCE 1-1-1995.

FOR: GARDEN OR FLOWER BED CARE; GARDEN TREE PLANTING; LANDSCAPE GARDENING; LANDSCAPE GARDENING DESIGN FOR OTHERS, IN CLASS 44 (U.S. CLS. 100 AND 101).

FIRST USE 1-1-1995; IN COMMERCE 1-1-1995.

NO CLAIM IS MADE TO THE EXCLUSIVE RIGHT TO USE "GARDENS INC.", APART FROM THE MARK AS SHOWN.

THE COLOR(S) GREEN, YELLOW, BROWN, SILVER AND BLUE IS/ARE CLAIMED AS A FEATURE OF THE MARK.

THE COLOR BLUE APPEARS IN THE WORDS "GRASSHOPPER GARDENS INC.", THE COLOR GREEN APPEARS IN THE HEAD AND BODY OF A IMITATION OF A GRASSHOPPER, THE COLOR YELLOW APPEARS IN EACH HAND OF THE GRASS HOPPER, THE COLOR BROWN APPEARS IN THE HANDLE OF THE RAKE AND SPADE, THE COLOR SILVER APPEARS IN THE HEAD OF THE RAKE AND SPADE, AND THE COLOR LIGHT GREEN APPEARS IN THE LEAVES LOCATED BETWEEN THE RAKE AND THE GRASSHOPPER. THE COLORS BLACK AND WHITE CONSTITUTE BACKGROUND, OUTLINING, SHADING AND TRANSPARENT AREAS AND ARE NOT PART OF THE MARK.

SER. NO. 77-034,088, FILED 11-1-2006.

BARBARA GAYNOR, EXAMINING ATTORNEY

**Int. Cl.: 8**

**Prior U.S. Cls.: 23, 28 and 44**

**United States Patent and Trademark Office**

**Reg. No. 3,451,873**

**Registered June 24, 2008**

**TRADEMARK  
PRINCIPAL REGISTER**

**BAHCO**

KAPMAN AB (SWEDEN CORPORATION)  
C/O BAHCO AB, 811 81  
SANDVIKEN, SWEDEN

FOR: HAND-OPERATED TOOLS, NAMELY  
SAWS, BLADES FOR HAND SAWS, NIPPERS, PIN-  
CERS, PLIERS, WIRE CUTTERS, SCREWDRIVERS,  
WRENCHES, CHISELS, FILES, SCRAPERS, HAM-  
MERS, SECATEURS, SPANNERS , IN CLASS 8 (U.S.  
CLS. 23, 28 AND 44).

THE MARK CONSISTS OF STANDARD CHAR-  
ACTERS WITHOUT CLAIM TO ANY PARTICULAR  
FONT, STYLE, SIZE, OR COLOR.

OWNER OF ERPN CMNTY TM OFC REG. NO.  
003737822, DATED 5-11-2007, EXPIRES 4-2-2014.

OWNER OF U.S. REG. NO. 93,992.

SER. NO. 77-035,207, FILED 11-2-2006.

HEATHER BIDDULPH, EXAMINING ATTORNEY

**Int. Cls.: 1 and 4**

**Prior U.S. Cls.: 1, 5, 6, 10, 15, 26 and 46**

**United States Patent and Trademark Office**

**Reg. No. 3,451,874**

**Registered June 24, 2008**

**TRADEMARK  
PRINCIPAL REGISTER**

**NOVATECH**

DAIKIN INDUSTRIES, LTD. (JAPAN CORPORATION)

UMEDA CENTER BUILDING

4-12, NAKAZAKI-NISHI 2-CHOME, KITA-KU

OSAKA, JAPAN

FOR: WATER PROOFING AND OIL REPELLENT CHEMICAL COMPOSITIONS FOR ARTICLES OF LEATHER AND FABRIC FOR USE IN A LAUNDRY; FLUORINATED POWDER AND FLUORINATED POWDER DISPERSION FOR USE AS INGREDIENTS IN THE MANUFACTURE OF COSMETIC PREPARATIONS; WATER REPELLENT CHEMICAL AGENTS FOR COATING ARTICLES OF LEATHER AND FABRIC, IN CLASS 1 (U.S. CLS. 1, 5, 6, 10, 26 AND 46).

FOR: OIL REPELLENT AGENTS, NAMELY, ALL PURPOSE LUBRICANTS, IN CLASS 4 (U.S. CLS. 1, 6 AND 15).

THE MARK CONSISTS OF STANDARD CHARACTERS WITHOUT CLAIM TO ANY PARTICULAR FONT, STYLE, SIZE, OR COLOR.

OWNER OF JAPAN REG. NO. 4067708, DATED 10-9-1997, EXPIRES 10-9-2017.

OWNER OF U.S. REG. NOS. 2,429,204 AND 3,038,664.

SER. NO. 77-035,432, FILED 11-2-2006.

CHRISTOPHER BUONGIORNO, EXAMINING ATTORNEY

**Int. Cl.: 36**

**Prior U.S. Cls.: 100, 101 and 102**

**United States Patent and Trademark Office**

**Reg. No. 3,451,875**

**Registered June 24, 2008**

**SERVICE MARK  
PRINCIPAL REGISTER**

**SWAP 'TIL YOU DROP**

LEVENFELD PEARLSTEIN, LLC (ILLINOIS LTD  
LIAB CO)  
2 N. LASALLE STREET  
SUITE 1300  
CHICAGO, IL 60602

FOR: FACILITATING PROPERTY EXCHANGES  
UNDER SECTION 1031 OF THE INTERNAL REV-  
ENUE SERVICE CODE, NAMELY, MANAGING  
AND CONSULTING WITH RESPECT TO THE EX-  
CHANGE OF LIKE-KIND REAL ESTATE AND  
PERSONAL PROPERTY FOR INDIVIDUALS AND

LEGAL ENTITIES, IN CLASS 36 (U.S. CLS. 100, 101  
AND 102).

FIRST USE 3-19-1992; IN COMMERCE 3-19-1992.

THE MARK CONSISTS OF STANDARD CHAR-  
ACTERS WITHOUT CLAIM TO ANY PARTICULAR  
FONT, STYLE, SIZE, OR COLOR.

SER. NO. 77-036,506, FILED 11-3-2006.

LINDA MICKLEBURGH, EXAMINING ATTORNEY



**Int. Cl.: 43**

**Prior U.S. Cls.: 100 and 101**

**United States Patent and Trademark Office**

**Reg. No. 3,451,876**

**Registered June 24, 2008**

**SERVICE MARK  
PRINCIPAL REGISTER**

# The Drip Stop

THE DRIP STOP (CALIFORNIA PARTNERSHIP)  
409 S. SHIELDS DR.  
ANAHEIM, CA 92804

FOR: COFFEE SHOPS; COFFEE-HOUSE AND  
SNACK-BAR SERVICES, IN CLASS 43 (U.S. CLS.  
100 AND 101).

FIRST USE 7-9-2005; IN COMMERCE 7-9-2005.

THE MARK CONSISTS OF STANDARD CHAR-  
ACTERS WITHOUT CLAIM TO ANY PARTICULAR  
FONT, STYLE, SIZE, OR COLOR.

NO CLAIM IS MADE TO THE EXCLUSIVE  
RIGHT TO USE "DRIP", APART FROM THE MARK  
AS SHOWN.

SER. NO. 77-036,987, FILED 11-4-2006.

TARAH HARDY, EXAMINING ATTORNEY

**Int. Cl.: 5**

**Prior U.S. Cls.: 6, 18, 44, 46, 51 and 52**

**Reg. No. 3,451,877**

**United States Patent and Trademark Office**

**Registered June 24, 2008**

**TRADEMARK  
PRINCIPAL REGISTER**

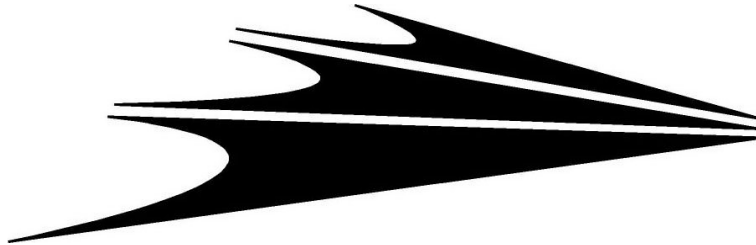

C. P. PHARMACEUTICALS C.V. (NETHER-  
LANDS LIMITED PARTNERSHIP)  
235 EAST 42ND STREET  
NEW YORK, NY 10017

OWNER OF U.S. REG. NO. 3,170,175.

FOR: PHARMACEUTICAL PREPARATIONS FOR  
THE TREATMENT OF ONCOLOGICAL DISEASES  
AND DISORDERS, IN CLASS 5 (U.S. CLS. 6, 18, 44, 46,  
51 AND 52).

THE MARK CONSISTS OF THREE ARROW-  
HEADS.

SER. NO. 77-038,147, FILED 11-7-2006.

FIRST USE 4-30-2006; IN COMMERCE 4-30-2006.

ALYSSA PALADINO, EXAMINING ATTORNEY

**Int. Cl.: 44**

**Prior U.S. Cls.: 100 and 101**

**United States Patent and Trademark Office**

**Reg. No. 3,451,878**

**Registered June 24, 2008**

**SERVICE MARK  
PRINCIPAL REGISTER**

**cosmeticsurg** • the science of beauty

RICARDO L. RODRIGUEZ, LLC (MARYLAND  
LTD LIAB CO)  
PAVILION WEST, SUITE 409  
6569 NORTH CHARLES STREET  
BALTIMORE, MD 21204

FOR: MEDICAL SERVICES, NAMELY, COSMET-  
IC AND PLASTIC SURGERY, IN CLASS 44 (U.S. CLS.  
100 AND 101).

FIRST USE 5-30-2005; IN COMMERCE 5-30-2005.

NO CLAIM IS MADE TO THE EXCLUSIVE  
RIGHT TO USE "COSMETICSURG", APART FROM  
THE MARK AS SHOWN.

THE COLOR(S) PINK, BLACK AND GRAY IS/  
ARE CLAIMED AS A FEATURE OF THE MARK.

THE MARK CONSISTS OF A ROUND GRAY DOT  
TO THE RIGHT OF THE TERM "COSMETICSURG"  
(IN LOWER CASE PINK LETTERS) AND TO THE  
LEFT OF THE PHRASE "THE SCIENCE OF BEAU-  
TY" IN LOWER CASE BLACK LETTERS.

SER. NO. 77-038,399, FILED 11-7-2006.

ELIZABETH HUGHITT, EXAMINING ATTORNEY

**Int. Cls.: 35, 37 and 42**

**Prior U.S. Cls.: 100, 101, 102, 103 and 106**

**United States Patent and Trademark Office**

**Reg. No. 3,451,879**

**Registered June 24, 2008**

**SERVICE MARK  
PRINCIPAL REGISTER**

**A LITTLE BIT OF SATELLITE  
GOES A LONG WAY**

GLOBECOMM SYSTEMS, INC. (DELAWARE  
CORPORATION)  
45 OSER AVENUE  
HAUPPAUGE, NY 11788

FOR: OPERATION AND ADMINISTRATION OF  
SATELLITE COMMUNICATIONS NETWORKS FOR  
OTHERS, IN CLASS 35 (U.S. CLS. 100, 101 AND 102).

FIRST USE 1-0-2006; IN COMMERCE 1-0-2006.

FOR: MAINTENANCE AND REPAIR OF SATEL-  
LITE COMMUNICATION SYSTEMS AND NET-  
WORKS, IN CLASS 37 (U.S. CLS. 100, 103 AND 106).

FIRST USE 1-0-2006; IN COMMERCE 1-0-2006.

FOR: SYSTEMS ENGINEERING AND DESIGN  
AND DEVELOPMENTS OF NETWORKS FOR FOR  
SATELLITE COMMUNICATIONS SYSTEMS; TECH-  
NICAL SUPPORT SERVICES, NAMELY, MONITOR-  
ING OF SATELLITE COMMUNICATIONS  
SYSTEMS AND NETWORKS, IN CLASS 42 (U.S.  
CLS. 100 AND 101).

FIRST USE 1-0-2006; IN COMMERCE 1-0-2006.

THE MARK CONSISTS OF STANDARD CHAR-  
ACTERS WITHOUT CLAIM TO ANY PARTICULAR  
FONT, STYLE, SIZE, OR COLOR.

SER. NO. 77-038,639, FILED 11-7-2006.

JENNIFER DIXON, EXAMINING ATTORNEY

**Int. Cl.: 25**

**Prior U.S. Cls.: 22 and 39**

**United States Patent and Trademark Office**

**Reg. No. 3,451,880**

**Registered June 24, 2008**

**TRADEMARK  
PRINCIPAL REGISTER**



ILLINOIS TOOL WORKS INC. (DELAWARE CORPORATION)  
3600 WEST LAKE AVENUE  
GLENVIEW, IL 600261215

FOR: CLOTHING, NAMELY, BEANIES, SHIRTS, JACKETS, PULLOVERS, AND SWEATSHIRTS; AND HEADWEAR, NAMELY, HATS AND CAPS; ALL OF THE FOREGOING TO EXCLUDE WESTERN STYLE CLOTHING AND HEADWEAR, IN CLASS 25 (U.S. CLS. 22 AND 39).

FIRST USE 4-0-1986; IN COMMERCE 4-0-1986.

THE MARK CONSISTS OF THREE LIGHT BARS INSIDE A DARK CIRCLE, FOLLOWED BY THE WORD, "MILLER", THE FIRST LETTER OF WHICH IS CAPITALIZED.

SER. NO. 77-038,940, FILED 11-7-2006.

EDWARD FENNESSY, EXAMINING ATTORNEY

**Int. Cls.: 37 and 45**

**Prior U.S. Cls.: 100, 101, 103 and 106**

**United States Patent and Trademark Office**

**Reg. No. 3,451,881**

**Registered June 24, 2008**

**SERVICE MARK  
PRINCIPAL REGISTER**

**INTEGRATED FIRE PROTECTION**

INTEGRATED FIRE PROTECTION INCORPORATED (GEORGIA CORPORATION)  
SUITE 17  
3715 NORTHCREST ROAD  
ATLANTA, GA 30340

FOR: FIRE ALARM INSTALLATION AND REPAIR; FIRE EXTINGUISHER RECHARGING SERVICES; INSTALLATION AND MAINTENANCE OF BURGLAR AND/OR FIRE ALARMS, IN CLASS 37 (U.S. CLS. 100, 103 AND 106).

FIRST USE 8-13-2002; IN COMMERCE 8-13-2002.

FOR: FIRE PREVENTION CONSULTATION, IN CLASS 45 (U.S. CLS. 100 AND 101).

FIRST USE 8-13-2002; IN COMMERCE 8-13-2002.

THE MARK CONSISTS OF STANDARD CHARACTERS WITHOUT CLAIM TO ANY PARTICULAR FONT, STYLE, SIZE, OR COLOR.

NO CLAIM IS MADE TO THE EXCLUSIVE RIGHT TO USE "FIRE PROTECTION", APART FROM THE MARK AS SHOWN.

SEC. 2(F).

SER. NO. 77-039,448, FILED 11-8-2006.

ALYSSA PALADINO, EXAMINING ATTORNEY

**Int. Cl.: 41**

**Prior U.S. Cls.: 100, 101 and 107**

**United States Patent and Trademark Office**

**Reg. No. 3,451,882**

**Registered June 24, 2008**

**SERVICE MARK  
PRINCIPAL REGISTER**

**DIVESTER**

AOL LLC (DELAWARE LTD LIAB CO)  
22000 AOL WAY  
DULLES, VA 20166

FOR: PROVIDING INFORMATION IN THE  
FIELD OF SPORTS VIA A GLOBAL COMPUTER  
NETWORK; ONLINE JOURNALS, NAMELY,  
BLOGS IN THE FIELDS OF SPORTS AND THE  
ADVENTURE TRAVEL INDUSTRY , IN CLASS 41  
(U.S. CLS. 100, 101 AND 107).

FIRST USE 5-1-2004; IN COMMERCE 5-1-2004.

THE MARK CONSISTS OF STANDARD CHAR-  
ACTERS WITHOUT CLAIM TO ANY PARTICULAR  
FONT, STYLE, SIZE, OR COLOR.

SER. NO. 77-039,553, FILED 11-8-2006.

TOBY BULLOFF, EXAMINING ATTORNEY

**Int. Cl.: 30**

**Prior U.S. Cl.: 46**

**United States Patent and Trademark Office**

**Reg. No. 3,451,883**

**Registered June 24, 2008**

**TRADEMARK  
PRINCIPAL REGISTER**

**SOPHIA'S**

MINOM, INC. (TEXAS CORPORATION)  
1623 NORTH SAN MARCOS  
SAN ANTONIO, TX 78201

FOR: FROZEN TORTILLA DOUGH; TAMALES;  
SALSA; SEASONINGS, SEASONING BLENDS, SPI-  
CES, AND SPICE BLENDS, IN CLASS 30 (U.S. CL. 46).

FIRST USE 6-6-2006; IN COMMERCE 6-6-2006.

THE MARK CONSISTS OF STANDARD CHAR-  
ACTERS WITHOUT CLAIM TO ANY PARTICULAR  
FONT, STYLE, SIZE, OR COLOR.

OWNER OF U.S. REG. NOS. 3,234,779 AND  
3,280,452.

SER. NO. 77-040,425, FILED 11-9-2006.

MARK PILARO, EXAMINING ATTORNEY



**Int. Cls.: 1 and 3**

**Prior U.S. Cls.: 1, 4, 5, 6, 10, 26, 46, 50, 51 and 52**

**United States Patent and Trademark Office**

**Reg. No. 3,451,884**

**Registered June 24, 2008**

**TRADEMARK  
PRINCIPAL REGISTER**

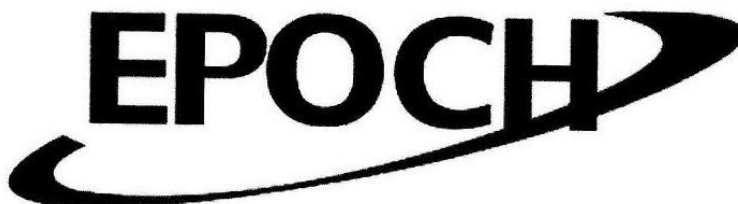

EPOCH MATERIAL CO., LTD. (TAIWAN LTD  
LIAB CO)  
LU-CHUH HSIANG  
NO. 2, LUKE 8TH RD, KAOHSIUNG SCIENCE PK  
KAOHSIUNG COUNTY, TAIWAN

FOR: CHEMICAL SOLUTIONS FOR USE IN THE  
MANUFACTURING AND PROCESSING OF SEMI-  
CONDUCTORS, NAMELY, PHOTORESIST STRIP-  
PER, BENOTRIAZOLE (BTA), AND L-PROLINE  
SOLUTION, IN CLASS 1 (U.S. CLS. 1, 5, 6, 10, 26  
AND 46).

FIRST USE 9-1-2006; IN COMMERCE 10-24-2006.

FOR: CHEMICAL MECHANICAL POLISHING  
(CMP) SLURRY AND CHEMICAL MECHANICAL  
PLANARIZATION (CMP) SLURRY FOR USE IN  
THE MANUFACTURING AND PROCESSING OF  
SEMICONDUCTORS IN THE OPTO-ELECTRONICS  
AND PHOTONICS INDUSTRIES; CHEMICAL ME-  
CHANICAL POLISHING SLURRY FOR LIQUID  
CRYSTAL DISPLAY (LCD), ORGANIC LIGHT  
EMITTING DIODES (O-LED), LIGHT EMITTING  
DIODE (LED), GLASS THINNING, AND HARD  
DISK; ABRASIVE COMPOUNDS FOR LAPPING  
AND POLISHING SEMICONDUCTORS, SILICON

WAFERS, GLASS AND METAL SURFACES; CLEA-  
NER FOR USE IN ELECTRONICS INDUSTRY; PAD  
CLEANING SOLUTION FOR USE IN THE MANU-  
FACTURING AND PROCESSING OF SEMICON-  
DUCTORS; POST-COPPER CHEMICAL  
MECHANICAL PLANARIZATION (CMP) CLEA-  
NING SOLUTION FOR USE IN THE MANUFACTUR-  
ING AND PROCESSING OF SEMICONDUCTORS;  
CLEANING SOLUTION FOR PROCESSING OF IN-  
TEGRATED CIRCUIT (IC) IN THE OPTO-ELECTRO-  
NICS AND PHOTONICS INDUSTRIES; POST-ASH  
CLEANING SOLUTION FOR USE IN THE MANU-  
FACTURING AND PROCESSING OF SEMICON-  
DUCTORS, IN CLASS 3 (U.S. CLS. 1, 4, 6, 50, 51  
AND 52).

FIRST USE 9-1-2006; IN COMMERCE 10-24-2006.

THE MARK CONSISTS OF THE WORD "EPOCH"  
IN CAPITAL LETTERS AND A CRESCENT SWISH  
IN THE BACKGROUND.

SER. NO. 77-041,032, FILED 11-9-2006.

KEVIN CORWIN, EXAMINING ATTORNEY

**Int. Cl.: 9**

**Prior U.S. Cls.: 21, 23, 26, 36 and 38**

**Reg. No. 3,451,885**

**United States Patent and Trademark Office**

**Registered June 24, 2008**

---

**TRADEMARK  
PRINCIPAL REGISTER**

**TORBAL**

FULCRUM INC. (NEW JERSEY CORPORATION)  
23 CAROL STREET  
CLIFTON, NJ 07014

THE MARK CONSISTS OF STANDARD CHARACTERS WITHOUT CLAIM TO ANY PARTICULAR FONT, STYLE, SIZE, OR COLOR.

FOR: WEIGHING EQUIPMENT, NAMELY, SCALES, BALANCES, AND MEASURING WEIGHTS, AND RELATED ACCESSORIES, NAMELY, BALANCE HOUSINGS AND COVERINGS, IN CLASS 9 (U.S. CLS. 21, 23, 26, 36 AND 38).

THE MARK HAS NO MEANING IN A FOREIGN LANGUAGE.

SER. NO. 77-041,250, FILED 11-10-2006.

FIRST USE 11-25-1960; IN COMMERCE 11-25-1960.

WENDY GOODMAN, EXAMINING ATTORNEY

**Int. Cl.: 16**

**Prior U.S. Cls.: 2, 5, 22, 23, 29, 37, 38 and 50**

**Reg. No. 3,451,886**

**United States Patent and Trademark Office**

**Registered June 24, 2008**

**TRADEMARK  
PRINCIPAL REGISTER**

**SMARTROLL**

JNJ INDUSTRIES, INC. (DELAWARE CORPORATION)  
290 BEAVER STREET  
FRANKLIN, MA 02038

FIRST USE 5-1-1994; IN COMMERCE 5-1-1994.

FOR: PAPER WIPING ROLLS MADE FROM NON-WOVEN, LINT FREE MATERIAL FOR USE IN CLEANING UNDER STENCILS AND SCREENS BETWEEN PRINTS IN AUTOMATIC IN-LINE SCREEN PRINTERS IN THE ELECTRONICS, COMPACT DISC, AND SCREEN PRINTING INDUSTRIES, IN CLASS 16 (U.S. CLS. 2, 5, 22, 23, 29, 37, 38 AND 50).

THE MARK CONSISTS OF STANDARD CHARACTERS WITHOUT CLAIM TO ANY PARTICULAR FONT, STYLE, SIZE, OR COLOR.

SER. NO. 77-042,846, FILED 11-13-2006.

CAROL SPILS, EXAMINING ATTORNEY

**Int. Cl.: 28**

**Prior U.S. Cls.: 22, 23, 38 and 50**

**United States Patent and Trademark Office**

**Reg. No. 3,451,887**

**Registered June 24, 2008**

**TRADEMARK  
PRINCIPAL REGISTER**

**ALPHABET ALLEY**

ALPHABET ALLEY KIDS LLC (TEXAS LTD LIAB  
CO)  
P.O. BOX 22105  
HOUSTON, TX 772272105

THE MARK CONSISTS OF STANDARD CHAR-  
ACTERS WITHOUT CLAIM TO ANY PARTICULAR  
FONT, STYLE, SIZE, OR COLOR.

FOR: TOY PUZZLES, BLOCKS, MEMORY  
GAMES AND MAGNETIC PLAYBOARDS, IN  
CLASS 28 (U.S. CLS. 22, 23, 38 AND 50).

SER. NO. 77-042,919, FILED 11-13-2006.

FIRST USE 10-1-2005; IN COMMERCE 10-1-2005.

HEATHER BIDDULPH, EXAMINING ATTORNEY

**Int. Cl.: 28**

**Prior U.S. Cls.: 22, 23, 38 and 50**

**Reg. No. 3,451,888**

**United States Patent and Trademark Office**

**Registered June 24, 2008**

---

**TRADEMARK  
PRINCIPAL REGISTER**



ALPHABET ALLEY KIDS LLC (TEXAS LTD LIAB  
CO)  
P.O. BOX 22105  
HOUSTON, TX 772272105

FIRST USE 10-1-2005; IN COMMERCE 10-1-2005.

SER. NO. 77-042,921, FILED 11-13-2006.

FOR: TOY PUZZLES, BLOCKS, MEMORY  
GAMES AND MAGNETIC PLAYBOARDS, IN  
CLASS 28 (U.S. CLS. 22, 23, 38 AND 50).

DAVID COLLIER, EXAMINING ATTORNEY

**Int. Cl.: 41**

**Prior U.S. Cls.: 100, 101 and 107**

**United States Patent and Trademark Office**

**Reg. No. 3,451,889**

**Registered June 24, 2008**

**SERVICE MARK  
PRINCIPAL REGISTER**

# VideosZ

BAYSHORE, LTD. (BARBADOS CORPORATION)  
HARBOUR INDUSTRIAL ESTATE  
SUITE 204, BUILDING #8  
ST. MICHAELS, BARBADOS

FOR: ENTERTAINMENT SERVICES OF AN EROTIC/SEXUAL NATURE, NAMELY, PROVIDING A WEBSITE FEATURING FILM CLIPS, PHOTOGRAPHS, AND OTHER MULTIMEDIA MATERIALS, WITH ACCESS LIMITED TO ADULT VIEWERS, EXCLUDING ANY USE OF THE MARK OTHER THAN IN MEDIA OR VENUES WHERE EROTIC AND ADULT-ORIENTED CONTENT IS

PROVIDED, IN CLASS 41 (U.S. CLS. 100, 101 AND 107).

FIRST USE 12-5-2002; IN COMMERCE 1-6-2004.

THE MARK CONSISTS OF STANDARD CHARACTERS WITHOUT CLAIM TO ANY PARTICULAR FONT, STYLE, SIZE, OR COLOR.

SEC. 2(F).

SER. NO. 77-043,552, FILED 11-14-2006.

ALLISON SCHRODY, EXAMINING ATTORNEY

**Int. Cls.: 35 and 39**

**Prior U.S. Cls.: 100, 101, 102 and 105**

**United States Patent and Trademark Office**

**Reg. No. 3,451,890**

**Registered June 24, 2008**

**SERVICE MARK  
PRINCIPAL REGISTER**



VITRAN CORPORATION (NEVADA CORPORATION)  
6500 EAST 30TH STREET  
INDIANAPOLIS, IN 46270

FOR: TRANSPORTATION LOGISTICS, NAMELY,  
ARRANGING TRANSPORTATION OF GOODS FOR  
OTHERS, IN CLASS 35 (U.S. CLS. 100, 101 AND 102).

FIRST USE 7-0-2004; IN COMMERCE 7-0-2004.

FOR: TRANSPORTATION SERVICES, NAMELY,  
FREIGHT TRANSPORT BY TRUCK, WAREHOUSE  
FREIGHT STORAGE, IN CLASS 39 (U.S. CLS. 100  
AND 105).

FIRST USE 7-0-2004; IN COMMERCE 7-0-2004.

NO CLAIM IS MADE TO THE EXCLUSIVE  
RIGHT TO USE "FREIGHT SYSTEM", APART  
FROM THE MARK AS SHOWN.

THE ENGLISH TRANSLATION OF THE WORD  
PJAX IN THE MARK IS SKIING-BOOT.

SER. NO. 77-045,023, FILED 11-15-2006.

SUSAN RICHARDS, EXAMINING ATTORNEY

Int. Cls.: 9, 16 and 41

Prior U.S. Cls.: 2, 5, 21, 22, 23, 26, 29, 36, 37, 38, 50,  
100, 101 and 107

Reg. No. 3,451,891

United States Patent and Trademark Office

Registered June 24, 2008

TRADEMARK  
SERVICE MARK  
PRINCIPAL REGISTER



KOOMZAAL CO., LTD. (REPUBLIC OF KOREA CORPORATION)  
7F SMAJUNG BLDG., 33-1 MAPO-DONG  
MAPO-GU, SEOUL, REPUBLIC OF KOREA 121-708

FOR: AUDIO TAPES FEATURING MUSIC, VIDEO TAPES FEATURING MUSIC, DOWNLOADABLE ELECTRONIC PUBLICATIONS, NAMELY, BOOK, MAGAZINE AND MANUALS FEATURING MUSIC, MUSIC RECORDED ON OPTICAL DISCS AND COMPUTER READABLE MEDIA, NAMELY, COMPACT DISCS (CDS) AND DIGITAL VIDEO DISCS (DVDS), DOWNLOADABLE MUSIC VIA THE INTERNET USING COMPUTER AND WIRELESS DEVICES, IN CLASS 9 (U.S. CLS. 21, 23, 26, 36 AND 38).

FOR: SONG BOOK, GREETING CARD, BOOKLETS IN THE FIELD OF MUSIC, PICTURE POSTCARD, COMIC BOOK, BOOKS IN THE FIELD OF MUSIC, CATALOGS IN THE FIELD OF MUSIC, PICTURE BOOKS, PAPER PICTURE CARDS FOR STUDYING MUSIC, PRINTED PERIODICALS IN THE FIELD OF MUSIC, PAMPHLETS IN THE FIELD OF MUSIC, THREE DIMENSIONAL MODELS FOR EDUCATIONAL PURPOSES, ENVELOPES, NOTEBOOK PAPER, PRINTED MUSIC BOOKS, WIREBOUND NOTEBOOKS, IN CLASS 16 (U.S. CLS. 2, 5, 22, 23, 29, 37, 38 AND 50).

FOR: INSTRUCTION IN THE FIELD OF MUSIC, EDUCATION SERVICES, NAMELY, PROVIDING

LIVE AND ON-LINE MUSIC CLASSES, SEMINARS AND WORKSHOPS, MULTIMEDIA PUBLISHING OF ELECTRONIC BOOKS AND JOURNALS; EDUCATIONAL SERVICES, NAMELY, DEVELOPING, ARRANGING, AND CONDUCTING EDUCATIONAL CONFERENCES AND PROGRAMS AND PROVIDING COURSES OF INSTRUCTION IN THE FIELD OF MUSIC, IN CLASS 41 (U.S. CLS. 100, 101 AND 107).

OWNER OF REPUBLIC OF KOREA REG. NO. 0018107, DATED 11-22-2006, EXPIRES 11-22-2016.

OWNER OF REPUBLIC OF KOREA REG. NO. 0720797, DATED 8-14-2007, EXPIRES 8-14-2017.

THE COLOR(S) GREEN, YELLOW, AND BLUE IS/ ARE CLAIMED AS A FEATURE OF THE MARK.

THE MARK CONSISTS OF SMILEY GREEN FACE WITH A YELLOW, GREEN, AND BLUE HEAD DRESS. THE COLORS GREEN APPEARS IN THE WORDS "DREAM A NEW WORLD KOOMZAAL".

SER. NO. 77-045,778, FILED 11-16-2006.

CHARLES L. JENKINS, EXAMINING ATTORNEY



**Int. Cls.: 35, 36, 39 and 42**

**Prior U.S. Cls.: 100, 101, 102 and 105**

**United States Patent and Trademark Office**

**Reg. No. 3,451,892**

**Registered June 24, 2008**

**SERVICE MARK  
PRINCIPAL REGISTER**



C.H. ROBINSON WORLDWIDE, INC. (DELA-  
WARE CORPORATION)  
8100 MITCHELL ROAD  
EDEN PRAIRIE, MN 55344

FOR: TRANSPORTATION LOGISTICS SERVICES, NAMELY, ARRANGING, PLANNING, MANAGING AND SCHEDULING THE TRANSPORTATION OF GOODS FOR OTHERS; PROCUREMENT, NAMELY THE PURCHASE OF AGRICULTURAL PRODUCE AND RELATED PRODUCTS; BUSINESS ANALYSIS, NAMELY ANALYZING DATA TO HELP RETAILERS MAXIMIZE SALES, EVALUATING SALES DATA AND USING THAT DATA TO DESIGN SALES STRATEGIES, GOALS AND OBJECTIVES, AND COORDINATION OF ANALYZED DATA MARKETING ACTIVITIES AND PROGRAMS; PROVIDING A WEB SITE WHERE CUSTOMERS AND SHIPPERS CAN ENTER AND UPDATE SHIPMENT INFORMATION, NAMELY, SHIPMENT PROCESSING, PREPARING SHIPPING DOCUMENTS AND INVOICES, AND TRACKING DOCUMENTS, PACKAGES AND FREIGHT, IN CLASS 35 (U.S. CLS. 100, 101 AND 102).

FIRST USE 11-3-1975; IN COMMERCE 11-3-1975.

FOR: BROKERAGE SERVICES IN THE FIELD OF AGRICULTURAL PRODUCE AND RELATED PRODUCTS, IN CLASS 36 (U.S. CLS. 100, 101 AND 102).

FIRST USE 11-3-1975; IN COMMERCE 11-3-1975.

FOR: SUPPLY CHAIN, LOGISTICS AND REVERSE LOGISTICS SERVICES, NAMELY, STORAGE, TRANSPORTATION AND DELIVERY OF DOCUMENTS, PACKAGES, RAW MATERIALS, AND OTHER FREIGHT FOR OTHERS BY AIR, RAIL, SHIP OR TRUCK; STORAGE, TRANSPORTATION, AND DELIVERY OF AGRICULTURAL PRODUCE AND RELATED PRODUCTS, IN CLASS 39 (U.S. CLS. 100 AND 105).

FIRST USE 11-3-1975; IN COMMERCE 11-3-1975.

FOR: ONLINE DOCUMENT RETRIEVAL SERVICES, IN CLASS 42 (U.S. CLS. 100 AND 101).

FIRST USE 11-3-1975; IN COMMERCE 11-3-1975.

OWNER OF U.S. REG. NO. 1,207,481.

THE MARK CONSISTS OF ARROWS FORMING A CIRCLE WITHIN A POLYGON

SER. NO. 77-045,878, FILED 11-16-2006.

LINDA E. BLOHM, EXAMINING ATTORNEY

**Int. Cls.: 5, 29 and 44**

**Prior U.S. Cls.: 6, 18, 44, 46, 51, 52, 100 and 101**

**United States Patent and Trademark Office**

**Reg. No. 3,451,893**

**Registered June 24, 2008**

**TRADEMARK  
SERVICE MARK  
PRINCIPAL REGISTER**



A2 CORPORATION LIMITED (NEW ZEALAND CORPORATION)  
LEVEL 5, 235 BROADWAY, NEWMARKET  
AUCKLAND, NEW ZEALAND

FOR: ANIMAL SEMEN; ANIMAL BREEDING MATERIALS, NAMELY, DNA, EMBRYOS AND OVUM; INFANT FOODS; MILK POWDER FOR INFANTS INCLUDING READY TO DRINK INFANT MILK POWDER, IN CLASS 5 (U.S. CLS. 6, 18, 44, 46, 51 AND 52).

FOR: MILK; MILK PRODUCTS, NAMELY, FULL CREAM, MILK POWDER, FULL CREAM MILK POWDER, SKIM MILK POWDER, YOGURT, YOGURT POWDER, BUTTERMILK POWDER, CASEIN; WHEY AND WHEY POWDER, BUTTER, CHEESE; MILK BEVERAGES, NAMELY, FLAVORED MILK, IN CLASS 29 (U.S. CL. 46).

FOR: VETERINARY SERVICES; ANIMAL BREEDING SERVICES; ANIMAL TESTING SERVICES FOR BREEDING PURPOSES, IN CLASS 44 (U.S. CLS. 100 AND 101).

PRIORITY CLAIMED UNDER SEC. 44(D) ON NEW ZEALAND APPLICATION NO. 754652, FILED 9-7-2006, REG. NO. 754652, DATED 9-7-2006, EXPIRES 9-7-2016.

OWNER OF U.S. REG. NO. 2,885,528.

SER. NO. 77-045,965, FILED 11-16-2006.

ANDREA HACK, EXAMINING ATTORNEY

**Int. Cl.: 12**

**Prior U.S. Cls.: 19, 21, 23, 31, 35 and 44**

**Reg. No. 3,451,894**

**United States Patent and Trademark Office**

**Registered June 24, 2008**

**TRADEMARK  
PRINCIPAL REGISTER**

**IT FITS**

CLOUD-RIDER DESIGNS LTD. (CANADA CORPORATION)  
1260 - 8TH AVENUE  
REGINA SASKATCHEWAN, CANADA S4R1C9

PRIORITY CLAIMED UNDER SEC. 44(D) ON CANADA APPLICATION NO. 1310028, FILED 7-21-2006, REG. NO. TMA690524, DATED 6-21-2007, EXPIRES 6-21-2022.

FOR: INSERTS FOR VEHICLE GRILLS, IN CLASS 12 (U.S. CLS. 19, 21, 23, 31, 35 AND 44).

SER. NO. 77-046,723, FILED 11-17-2006.

THE MARK CONSISTS OF STANDARD CHARACTERS WITHOUT CLAIM TO ANY PARTICULAR FONT, STYLE, SIZE, OR COLOR.

ASMAT KHAN, EXAMINING ATTORNEY

**Int. Cl.: 44**

**Prior U.S. Cls.: 100 and 101**

**United States Patent and Trademark Office**

**Reg. No. 3,451,895**

**Registered June 24, 2008**

**SERVICE MARK  
PRINCIPAL REGISTER**

**WILKINSON**

WILKINSON CORPORATION (WASHINGTON CORPORATION)  
402 E. YAKIMA AVENUE, 15TH FLOOR  
YAKIMA, WA 98901

FOR: HEALTH CARE SERVICES, NAMELY, PROVIDING CARE FOR PERSONS SUFFERING FROM ALZHEIMER'S DISEASE AND DEMENTIA, IN CLASS 44 (U.S. CLS. 100 AND 101).

FIRST USE 0-0-2002; IN COMMERCE 0-0-2002.

THE MARK CONSISTS OF STANDARD CHARACTERS WITHOUT CLAIM TO ANY PARTICULAR FONT, STYLE, SIZE, OR COLOR.

SEC. 2(F).

SER. NO. 77-046,881, FILED 11-17-2006.

DAWN FELDMAN, EXAMINING ATTORNEY

**Int. Cl.: 12**

**Prior U.S. Cls.: 19, 21, 23, 31, 35 and 44**

**Reg. No. 3,451,896**

**United States Patent and Trademark Office**

**Registered June 24, 2008**

---

**TRADEMARK  
PRINCIPAL REGISTER**

**XR 1200**

STORZ PERFORMANCE, INC (CALIFORNIA CORPORATION)  
239 SOUTH OLIVE STREET  
VENTURA, CA 93001

FOR: CUSTOM BUILT MOTORCYCLES AND STRUCTURAL PARTS THEREFORE, IN CLASS 12 (U.S. CLS. 19, 21, 23, 31, 35 AND 44).

FIRST USE 1-29-2005; IN COMMERCE 1-29-2005.

THE MARK CONSISTS OF STANDARD CHARACTERS WITHOUT CLAIM TO ANY PARTICULAR FONT, STYLE, SIZE, OR COLOR.

NO CLAIM IS MADE TO THE EXCLUSIVE RIGHT TO USE "1200", APART FROM THE MARK AS SHOWN.

SER. NO. 77-048,680, FILED 11-21-2006.

JASON ROTH, EXAMINING ATTORNEY

**Int. Cl.: 30**

**Prior U.S. Cl.: 46**

**United States Patent and Trademark Office**

**Reg. No. 3,451,897**

**Registered June 24, 2008**

**TRADEMARK  
PRINCIPAL REGISTER**

**AUTHENTIC FLAVORS OF THE  
WORLD**

GORDON FOOD SERVICE, INC. (MICHIGAN  
CORPORATION)  
333 FIFTIETH STREET  
GRAND RAPIDS, MI 49548

NO CLAIM IS MADE TO THE EXCLUSIVE  
RIGHT TO USE "FLAVORS", APART FROM THE  
MARK AS SHOWN.

FOR: SPICES AND SEASONINGS, IN CLASS 30  
(U.S. CL. 46).

SEC. 2(F).

FIRST USE 9-15-1998; IN COMMERCE 9-15-1998.

SER. NO. 77-048,806, FILED 11-21-2006.

THE MARK CONSISTS OF STANDARD CHAR-  
ACTERS WITHOUT CLAIM TO ANY PARTICULAR  
FONT, STYLE, SIZE, OR COLOR.

TIMOTHY FINNEGAN, EXAMINING ATTORNEY

**Int. Cls.: 16, 21, 25 and 42**

**Prior U.S. Cls.: 2, 5, 13, 22, 23, 29, 30, 33, 37, 38, 39,  
40, 50, 100 and 101**

**Reg. No. 3,451,898**

**United States Patent and Trademark Office**

**Registered June 24, 2008**

**TRADEMARK  
SERVICE MARK  
PRINCIPAL REGISTER**



WETLAND STUDIES AND SOLUTIONS, INC.  
(VIRGINIA CORPORATION)  
SUITE 100  
5300 WELLINGTON BRANCH DRIVE  
GAINESVILLE, VA 20155

FOR: PRINTED PUBLICATIONS, NAMELY, BROCHURES, BOOKLETS, AND PERIODICAL PUBLICATIONS IN THE FIELD OF ENVIRONMENTAL ASSESSMENT, COMPLIANCE AND PLANNING, PARTICULARLY AS RELATED TO LAND USE, LAND DEVELOPMENT, WATER QUALITY, NATURAL RESOURCES, AND CULTURAL RESOURCES, IN CLASS 16 (U.S. CLS. 2, 5, 22, 23, 29, 37, 38 AND 50).

FIRST USE 9-30-1993; IN COMMERCE 9-30-1993.

FOR: DRINK CONTAINERS, NAMELY, DRINKING GLASSES, CUPS, MUGS; INSULATING SLEEVE HOLDERS FOR BEVERAGE CONTAINERS, IN CLASS 21 (U.S. CLS. 2, 13, 23, 29, 30, 33, 40 AND 50).

FIRST USE 9-30-1993; IN COMMERCE 9-30-1993.

FOR: APPAREL, NAMELY, T-SHIRTS, SHIRTS, CAPS, VESTS, IN CLASS 25 (U.S. CLS. 22 AND 39).

FIRST USE 9-30-1993; IN COMMERCE 9-30-1993.

FOR: CONSULTING SERVICES IN THE FIELD OF ENVIRONMENTAL ASSESSMENT, COMPLIANCE AND PLANNING, PARTICULARLY AS RELATED TO LAND USE, LAND DEVELOPMENT, WATER QUALITY, NATURAL RESOURCES, AND CULTURAL RESOURCES, IN CLASS 42 (U.S. CLS. 100 AND 101).

FIRST USE 10-31-1991; IN COMMERCE 10-31-1991.

NO CLAIM IS MADE TO THE EXCLUSIVE RIGHT TO USE "WETLAND STUDIES AND SOLUTIONS, INC." IN INTERNATIONAL CLASSES 16 AND 42, AND "INC." IN INTERNATIONAL CLASSES 21 AND 25, APART FROM THE MARK AS SHOWN.

THE MARK CONSISTS OF AN OVAL WITH THE WORD "WETLAND" WITHIN IT, WAVY BROKEN LINES TO EACH SIDE OF THE OVAL AND THE WORDING "STUDIES AND SOLUTIONS, INC." BENEATH THE OVAL.

SER. NO. 77-049,628, FILED 11-22-2006.

SHAILA SETTLES, EXAMINING ATTORNEY

**Int. Cl.: 29**

**Prior U.S. Cl.: 46**

**United States Patent and Trademark Office**

**Reg. No. 3,451,899**

**Registered June 24, 2008**

**TRADEMARK  
PRINCIPAL REGISTER**

**Smoke & Fire**

YOUNG, MONA F (UNITED STATES INDIVIDUAL)  
120A KELLOGG ROAD  
SHEFFIELD, MA 01257

NO CLAIM IS MADE TO THE EXCLUSIVE RIGHT TO USE "SMOKE", APART FROM THE MARK AS SHOWN.

FOR: TOFU, IN CLASS 29 (U.S. CL. 46).

FIRST USE 11-1-1993; IN COMMERCE 7-7-1995.

SER. NO. 77-052,688, FILED 11-29-2006.

THE MARK CONSISTS OF STANDARD CHARACTERS WITHOUT CLAIM TO ANY PARTICULAR FONT, STYLE, SIZE, OR COLOR.

KRISTIN DAHLING, EXAMINING ATTORNEY



**Int. Cl.: 29**

**Prior U.S. Cl.: 46**

**United States Patent and Trademark Office**

**Reg. No. 3,451,900**

**Registered June 24, 2008**

**TRADEMARK  
PRINCIPAL REGISTER**

**Soy with Sizzle**

YOUNG, MONA F (UNITED STATES INDIVIDUAL)  
120A KELLOGG ROAD  
SHEFFIELD, MA 01257

NO CLAIM IS MADE TO THE EXCLUSIVE RIGHT TO USE "SOY", APART FROM THE MARK AS SHOWN.

FOR: TOFU, IN CLASS 29 (U.S. CL. 46).

FIRST USE 7-16-1998; IN COMMERCE 7-16-1998.

SER. NO. 77-052,722, FILED 11-29-2006.

THE MARK CONSISTS OF STANDARD CHARACTERS WITHOUT CLAIM TO ANY PARTICULAR FONT, STYLE, SIZE, OR COLOR.

KRISTIN DAHLING, EXAMINING ATTORNEY

**Int. Cl.: 30**

**Prior U.S. Cl.: 46**

**United States Patent and Trademark Office**

**Reg. No. 3,451,901**

**Registered June 24, 2008**

**TRADEMARK  
PRINCIPAL REGISTER**

# Killer Koffee

KROMER, LAWRENCE PAUL (UNITED STATES  
INDIVIDUAL)

4852 NORTH COAST HWY

NEWPORT, OR 97365

FOR: COFFEE PRODUCTS, NAMELY, COFFEE  
BEANS, IN CLASS 30 (U.S. CL. 46).

FIRST USE 1-3-1996; IN COMMERCE 1-3-1996.

THE MARK CONSISTS OF STANDARD CHAR-  
ACTERS WITHOUT CLAIM TO ANY PARTICULAR  
FONT, STYLE, SIZE, OR COLOR.

NO CLAIM IS MADE TO THE EXCLUSIVE  
RIGHT TO USE "COFFEE", APART FROM THE  
MARK AS SHOWN.

SER. NO. 77-053,571, FILED 11-29-2006.

DARRYL SPRUILL, EXAMINING ATTORNEY

**Int. Cls.: 35, 37, 39, 40 and 42**

**Prior U.S. Cls.: 100, 101, 102, 103, 105 and 106**

**United States Patent and Trademark Office**

**Reg. No. 3,451,902**

**Registered June 24, 2008**

**SERVICE MARK  
PRINCIPAL REGISTER**

**COVANTA**

COVANTA ENERGY CORPORATION (DELAWARE CORPORATION)  
40 LANE ROAD  
FAIRFIELD, NJ 07004

FOR: OPERATION OF A BUSINESS FOR OTHERS, NAMELY, MUNICIPAL, INDUSTRIAL AND COMMERCIAL WATER AND WASTE WATER TREATMENT SYSTEMS AND SLUDGE AND WASTE INCINERATION AND DISPOSAL FACILITIES; PROCUREMENT SERVICES, NAMELY, PURCHASING OF MUNICIPAL, INDUSTRIAL AND COMMERCIAL WATER AND WASTE WATER TREATMENT SYSTEMS AND SLUDGE AND WASTE INCINERATION AND DISPOSAL FACILITIES FOR OTHERS; OPERATION OF POWER PLANTS FOR OTHERS; BUSINESS MANAGEMENT OF SEWERAGE SYSTEMS, TREATMENT SYSTEMS AND WATER BILLING SYSTEMS FOR OTHERS; AND CONSULTATION RELATED TO THE FOREGOING, IN CLASS 35 (U.S. CLS. 100, 101 AND 102).

FIRST USE 0-0-2001; IN COMMERCE 0-0-2001.

FOR: WASTE DISPOSAL FOR OTHERS; MAINTENANCE OF MUNICIPAL, INDUSTRIAL, AND COMMERCIAL WATER AND WASTE WATER TREATMENT SYSTEMS, SLUDGE AND WASTE INCINERATION AND DISPOSAL FACILITIES, AND POWER PLANTS; CONSULTATION SERVICES RELATED TO CONSTRUCTION SERVICES, NAMELY, CONSTRUCTION OF MUNICIPAL, INDUSTRIAL AND COMMERCIAL WATER AND WASTE WATER TREATMENT SYSTEMS, SLUDGE AND WASTE INCINERATION AND WASTE DISPOSAL FACILITIES AND POWER PLANTS, IN CLASS 37 (U.S. CLS. 100, 103 AND 106).

FIRST USE 0-0-2001; IN COMMERCE 0-0-2001.

FOR: PUBLIC UTILITIES IN THE NATURE OF SUPPLYING WATER AND WATER DISTRIBUTION

AND DISTRIBUTION OF TREATED WATER, POWER, AND STEAM; UTILITY SERVICES IN THE NATURE OF ELECTRICITY DISTRIBUTION; UTILITY SERVICES, NAMELY, TRANSMISSION OF ELECTRICITY; OPERATION OF PIPELINES, NAMELY, TRANSMISSION OF STEAM THROUGH PIPELINES; CONSULTATION RELATED TO PUBLIC UTILITIES IN THE NATURE OF SUPPLYING WATER AND WATER DISTRIBUTION AND DISTRIBUTION OF TREATED WATER, POWER AND STEAM, IN CLASS 39 (U.S. CLS. 100 AND 105).

FIRST USE 0-0-2001; IN COMMERCE 0-0-2001.

FOR: GENERATION OF ELECTRICITY; GENERATION OF POWER; WATER TREATMENT; TREATMENT OF MUNICIPAL, INDUSTRIAL AND COMMERCIAL WATER AND WASTE WATER; SLUDGE AND WASTE INCINERATION; CONSULTATION RELATED TO GENERATION OF ELECTRICITY, GENERATION OF POWER, AND MUNICIPAL, INDUSTRIAL AND COMMERCIAL WATER AND WASTE WATER TREATMENT SERVICES, IN CLASS 40 (U.S. CLS. 100, 103 AND 106).

FIRST USE 0-0-2001; IN COMMERCE 0-0-2001.

FOR: ARCHITECTURAL DESIGN OF MUNICIPAL, INDUSTRIAL AND COMMERCIAL WATER AND WASTE WATER TREATMENT SYSTEMS, SLUDGE AND WASTE INCINERATION AND DISPOSAL FACILITIES, AND POWER PLANTS; CONSULTATION SERVICES RELATING TO ENGINEERING, NAMELY, DESIGN, ENGINEERING, AND DEVELOPMENT OF MUNICIPAL, INDUSTRIAL, AND COMMERCIAL WATER AND WASTE WATER TREATMENT SYSTEMS, SLUDGE AND WASTE INCINERATION AND DISPOSAL FACILITIES; AND DESIGN, ENGINEERING, AND DEVELOPMENT OF POWER PLANTS, IN CLASS 42 (U.S. CLS. 100 AND 101).

FIRST USE 0-0-2001; IN COMMERCE 0-0-2001.

OWNER OF U.S. REG. NO. 2,865,389.

THE MARK CONSISTS OF STANDARD CHARACTERS WITHOUT CLAIM TO ANY PARTICULAR FONT, STYLE, SIZE, OR COLOR.

SER. NO. 77-054,918, FILED 12-1-2006.

MORGAN WYNNE, EXAMINING ATTORNEY

**Int. Cl.: 45**

**Prior U.S. Cls.: 100 and 101**

**United States Patent and Trademark Office**

**Reg. No. 3,451,903**

**Registered June 24, 2008**

**SERVICE MARK  
PRINCIPAL REGISTER**

**A 24 HOUR A LOCKSMITH**

OLIVKOVICH, ADAM (ISRAEL INDIVIDUAL)

295 WEST 231 STREET

BRONX, NY 10463

FOR: LOCKSMITHING, NAMELY, OPENING OF  
LOCKS, IN CLASS 45 (U.S. CLS. 100 AND 101).

FIRST USE 12-1-2006; IN COMMERCE 12-1-2006.

THE MARK CONSISTS OF STANDARD CHAR-  
ACTERS WITHOUT CLAIM TO ANY PARTICULAR  
FONT, STYLE, SIZE, OR COLOR.

NO CLAIM IS MADE TO THE EXCLUSIVE  
RIGHT TO USE "24 HOUR" AND "LOCKSMITH",  
APART FROM THE MARK AS SHOWN.

SER. NO. 77-055,116, FILED 12-1-2006.

KALIE KUNG, EXAMINING ATTORNEY

**Int. Cl.: 25**

**Prior U.S. Cls.: 22 and 39**

**United States Patent and Trademark Office**

**Reg. No. 3,451,904**

**Registered June 24, 2008**

**TRADEMARK  
PRINCIPAL REGISTER**

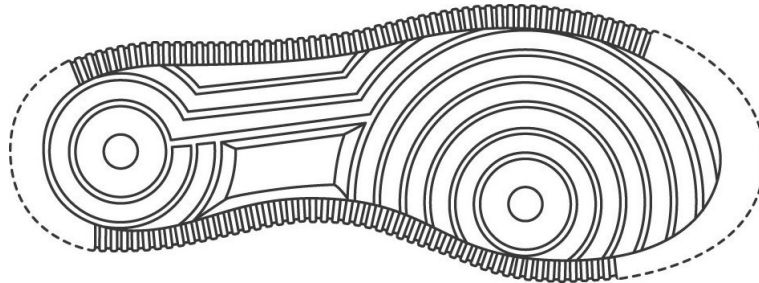

NIKE, INC. (OREGON CORPORATION)  
ONE BOWERMAN DRIVE  
BEAVERTON, OR 97005

LINES SHOW THE POSITION OF THE MARK ON  
THE GOODS AND ARE NOT CLAIMED AS A PART  
OF THE MARK.

FOR: FOOTWEAR, IN CLASS 25 (U.S. CLS. 22 AND  
39).

SEC. 2(F).

FIRST USE 10-28-1982; IN COMMERCE 10-28-1982.

SER. NO. 77-055,366, FILED 12-1-2006.

THE MARK CONSISTS OF THE DESIGN OF THE  
TREAD ON THE SOLE A SHOE. THE BROKEN

GEOFFREY FOSDICK, EXAMINING ATTORNEY

Int. Cl.: 25

Prior U.S. Cls.: 22 and 39

United States Patent and Trademark Office

Reg. No. 3,451,905

Registered June 24, 2008

TRADEMARK  
PRINCIPAL REGISTER

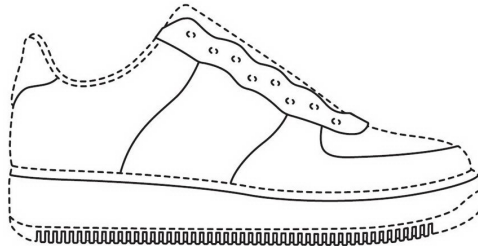

NIKE, INC. (OREGON CORPORATION)  
ONE BOWERMAN DRIVE  
BEAVERTON, OR 97005

FOR: FOOTWEAR, IN CLASS 25 (U.S. CLS. 22 AND 39).

FIRST USE 10-28-1982; IN COMMERCE 10-28-1982.

THE MARK CONSISTS OF THE DESIGN OF THE STITCHING ON THE EXTERIOR OF THE SHOE, THE DESIGN OF THE MATERIAL PANELS THAT FORM THE EXTERIOR BODY OF THE SHOE, THE DESIGN OF THE WAVY PANEL ON TOP OF THE

SHOE THAT ENCOMPASSES THE EYELETS FOR THE SHOE LACES, THE DESIGN OF THE VERTICAL RIDGE PATTERN ON THE SIDES OF THE SOLE OF THE SHOE, AND THE RELATIVE POSITION OF THESE ELEMENTS TO EACH OTHER. THE BROKEN LINES SHOW THE POSITION OF THE MARK AND ARE NOT CLAIMED AS PART OF THE MARK.

SEC. 2(F).

SER. NO. 77-055,375, FILED 12-1-2006.

GEOFFREY FOSDICK, EXAMINING ATTORNEY

Int. Cl.: 25

Prior U.S. Cls.: 22 and 39

United States Patent and Trademark Office

Reg. No. 3,451,906

Registered June 24, 2008

**TRADEMARK  
PRINCIPAL REGISTER**

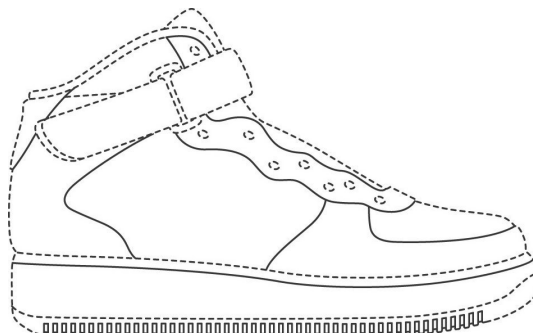

NIKE, INC. (OREGON CORPORATION)  
ONE BOWERMAN DRIVE  
BEAVERTON, OR 97005

FOR: FOOTWEAR, IN CLASS 25 (U.S. CLS. 22 AND 39).

FIRST USE 10-28-1982; IN COMMERCE 10-28-1982.

THE MARK CONSISTS OF THE DESIGN OF THE STITCHING ON THE EXTERIOR OF THE SHOE, THE DESIGN OF THE MATERIAL PANELS THAT FORM THE EXTERIOR BODY OF THE SHOE, THE DESIGN OF THE WAVY PANEL ON TOP OF THE

SHOE THAT ENCOMPASSES THE EYELETS FOR THE SHOE LACES, THE DESIGN OF THE VERTICAL RIDGE PATTERN ON THE SIDES OF THE SOLE OF THE SHOE, AND THE RELATIVE POSITION OF THESE ELEMENTS TO EACH OTHER. THE BROKEN LINES SHOW THE POSITION OF THE MARK AND ARE NOT CLAIMED AS PART OF THE MARK.

SEC. 2(F).

SER. NO. 77-055,385, FILED 12-1-2006.

GEOFFREY FOSDICK, EXAMINING ATTORNEY



Int. Cl.: 25

Prior U.S. Cls.: 22 and 39

United States Patent and Trademark Office

Reg. No. 3,451,907

Registered June 24, 2008

**TRADEMARK  
PRINCIPAL REGISTER**

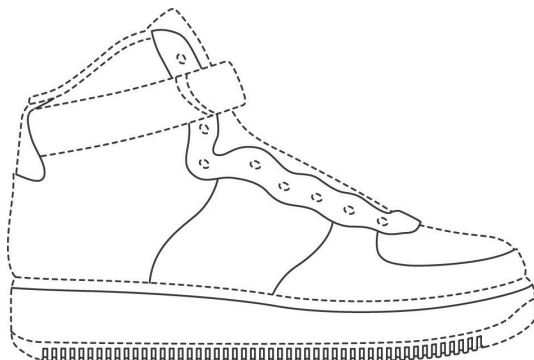

NIKE, INC. (OREGON CORPORATION)  
ONE BOWERMAN DRIVE  
BEAVERTON, OR 97005

FOR: FOOTWEAR, IN CLASS 25 (U.S. CLS. 22 AND 39).

FIRST USE 10-28-1982; IN COMMERCE 10-28-1982.

THE MARK CONSISTS OF THE DESIGN OF THE STITCHING ON THE EXTERIOR OF THE SHOE, THE DESIGN OF THE MATERIAL PANELS THAT FORM THE EXTERIOR BODY OF THE SHOE, THE DESIGN OF THE WAVY PANEL ON TOP OF THE

SHOE THAT ENCOMPASSES THE EYELETS FOR THE SHOE LACES, THE DESIGN OF THE VERTICAL RIDGE PATTERN ON THE SIDES OF THE SOLE OF THE SHOE, AND THE RELATIVE POSITION OF THESE ELEMENTS TO EACH OTHER. THE BROKEN LINES SHOW THE POSITION OF THE MARK AND ARE NOT CLAIMED AS PART OF THE MARK.

SEC. 2(F).

SER. NO. 77-055,394, FILED 12-1-2006.

GEOFFREY FOSDICK, EXAMINING ATTORNEY

**Int. Cl.: 38**

**Prior U.S. Cls.: 100, 101 and 104**

**United States Patent and Trademark Office**

**Reg. No. 3,451,908**

**Registered June 24, 2008**

**SERVICE MARK  
PRINCIPAL REGISTER**

**BLUESTREAK**

UNICAP, INC. (MAINE CORPORATION)  
P.O. BOX 165  
129 MAIN STREET  
UNITY, ME 04988

FOR: TELECOMMUNICATIONS SERVICES,  
NAMELY, LOCAL AND LONG DISTANCE TRANSMISSION OF DATA, VOICE, AND GRAPHICS, BY MEANS OF TELEPHONE, CABLE AND SATELLITE TRANSMISSIONS; PROVIDING MULTIPLE-USER ACCESS TO A GLOBAL COMPUTER INFORMA-

TION NETWORK, IN CLASS 38 (U.S. CLS. 100, 101 AND 104).

FIRST USE 11-1-2006; IN COMMERCE 11-1-2006.

THE MARK CONSISTS OF STANDARD CHARACTERS WITHOUT CLAIM TO ANY PARTICULAR FONT, STYLE, SIZE, OR COLOR.

SER. NO. 77-056,118, FILED 12-4-2006.

MARY CRAWFORD, EXAMINING ATTORNEY

**Int. Cl.: 41**

**Prior U.S. Cls.: 100, 101 and 107**

**Reg. No. 3,451,909**

**United States Patent and Trademark Office**

**Registered June 24, 2008**

---

**SERVICE MARK  
PRINCIPAL REGISTER**

**IFC GRIND HOUSE**

THE INDEPENDENT FILM CHANNEL LLC (DE-  
LAWARE LTD LIAB CO)  
200 JERICHO QUADRANGLE  
JERICHO, NY 11753

FOR: ENTERTAINMENT SERVICES, NAMELY,  
AN ON-GOING TELEVISION AND CABLE TELEVI-  
SION SERIES IN THE FIELDS OF HORROR AND  
DRAMA THAT FEATURES FILMS AND RELATED  
COMMENTARY ALL OF WHICH ARE COMMEM-  
ORATIVE OF THE INDEPENDENT FILM CHAN-  
NEL, IN CLASS 41 (U.S. CLS. 100, 101 AND 107).

FIRST USE 12-0-2006; IN COMMERCE 12-0-2006.

THE MARK CONSISTS OF STANDARD CHAR-  
ACTERS WITHOUT CLAIM TO ANY PARTICULAR  
FONT, STYLE, SIZE, OR COLOR.

OWNER OF U.S. REG. NOS. 2,923,508, 2,976,320  
AND OTHERS.

NO CLAIM IS MADE TO THE EXCLUSIVE  
RIGHT TO USE "GRIND HOUSE", APART FROM  
THE MARK AS SHOWN.

SER. NO. 77-056,570, FILED 12-4-2006.

SONYA STEPHENS, EXAMINING ATTORNEY

**Int. Cl.: 31**

**Prior U.S. Cls.: 1 and 46**

**United States Patent and Trademark Office**

**Reg. No. 3,451,910**

**Registered June 24, 2008**

**TRADEMARK  
PRINCIPAL REGISTER**

ROYAL HORTICULTURAL SOCIETY

THE ROYAL HORTICULTURAL SOCIETY (UNITED KINGDOM CORPORATION)  
80 VINCENT SQUARE  
LONDON, UNITED KINGDOM SW1P2PE

FOR: AGRICULTURAL GRAINS AND SEEDS FOR PLANTING; AGRICULTURAL AND HORTICULTURAL GOODS EXCLUDING CITRUS, NAMELY, BULBS FOR AGRICULTURAL AND HORTICULTURAL PURPOSES, LIVE BUSHES, SEED GERM FOR AGRICULTURAL AND HORTICULTURAL PURPOSES, FRESH HERBS, NATURAL TURF, LIVE SHRUBS AND LIVE TREES; SEEDS FOR AGRICULTURAL AND HORTICULTURAL PURPOSES; MALT FOR BREWING AND DISTILLING; LIVE ANIMALS; FRESH FRUITS AND VEGETABLES; NATURAL PLANTS AND FLOWERS;

AND FOODSTUFFS FOR ANIMALS, IN CLASS 31 (U.S. CLS. 1 AND 46).

THE MARK CONSISTS OF STANDARD CHARACTERS WITHOUT CLAIM TO ANY PARTICULAR FONT, STYLE, SIZE, OR COLOR.

OWNER OF ERPN CMNTY TM OFC REG. NO. 002643054, DATED 2-2-2006, EXPIRES 2-2-2016.

NO CLAIM IS MADE TO THE EXCLUSIVE RIGHT TO USE "HORTICULTURAL", APART FROM THE MARK AS SHOWN.

SER. NO. 77-056,626, FILED 12-4-2006.

DANNAN HETZEL, EXAMINING ATTORNEY

**Int. Cl.: 35**

**Prior U.S. Cls.: 100, 101 and 102**

**Reg. No. 3,451,911**

**United States Patent and Trademark Office**

**Registered June 24, 2008**

**SERVICE MARK  
PRINCIPAL REGISTER**



GRIND CENTRAL ENTERTAINMENT, LLC  
(MISSISSIPPI LTD LIAB CO)  
115 COUNTY ROAD 1082  
OXFORD, MS 38655

NO CLAIM IS MADE TO THE EXCLUSIVE  
RIGHT TO USE "ENTERTAINMENT", APART  
FROM THE MARK AS SHOWN.

FOR: ADVERTISING SERVICES, NAMELY, PRO-  
MOTING THE GOODS AND SERVICES OF THIRD  
PARTIES THROUGH SPONSORING ARRANGE-  
MENTS RELATING TO MUSICAL PERFORMAN-  
CES AND SIMILAR SPECIAL EVENTS, IN CLASS 35  
(U.S. CLS. 100, 101 AND 102).

THE MARK CONSISTS OF THE WORD "GRIND"  
AND THEN TWO BOLTS GRINDING TOGETHER  
WHICH HAVE MUSICAL NOTES COMING OUT  
BETWEEN THE TWO BOLTS AND THEN THE  
WORDS "CENTRAL ENTERTAINMENT".

SER. NO. 77-059,516, FILED 12-7-2006.

FIRST USE 6-9-2006; IN COMMERCE 6-9-2006.

KIMBERLY FRYE, EXAMINING ATTORNEY

**Int. Cl.: 40**

**Prior U.S. Cls.: 100, 103 and 106**

**United States Patent and Trademark Office**

**Reg. No. 3,451,912**

**Registered June 24, 2008**

**SERVICE MARK  
PRINCIPAL REGISTER**

**Store from a box**

APAD (CALIFORNIA LTD LIAB CO)  
2245 RINGWOOD AVE  
SAN JOSE, CA 95131

FOR: CUSTOM CONSTRUCTION OF FIXTURES  
FOR RETAIL STORES AND WAREHOUSES, IN  
CLASS 40 (U.S. CLS. 100, 103 AND 106).

FIRST USE 10-1-2006; IN COMMERCE 10-1-2006.

THE MARK CONSISTS OF STANDARD CHAR-  
ACTERS WITHOUT CLAIM TO ANY PARTICULAR  
FONT, STYLE, SIZE, OR COLOR.

NO CLAIM IS MADE TO THE EXCLUSIVE  
RIGHT TO USE "STORE", APART FROM THE  
MARK AS SHOWN.

SER. NO. 77-059,569, FILED 12-7-2006.

ANNE FARRELL, EXAMINING ATTORNEY

Int. Cl.: 3

Prior U.S. Cls.: 1, 4, 6, 50, 51 and 52

United States Patent and Trademark Office

Reg. No. 3,451,913

Registered June 24, 2008

TRADEMARK  
PRINCIPAL REGISTER

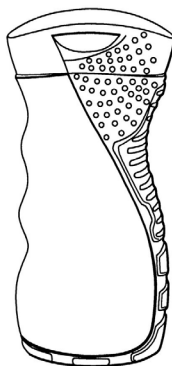

UNILEVER SUPPLY CHAIN, INC. (DELAWARE CORPORATION)  
1 JOHN STREET  
CLINTON, CT 06413

FOR: SHOWER GEL, IN CLASS 3 (U.S. CLS. 1, 4, 6, 50, 51 AND 52).

FIRST USE 6-3-2007; IN COMMERCE 6-3-2007.

THE MARK CONSISTS OF AN ARBITRARY DESIGN OF A BOTTLE HAVING TWO OPPOSED SIDES EACH WITH A GENERALIZED ASYMMETRIC HOUR-GLASS SHAPE WITH A FLATTENED BOTTOM AND CONVEX TOP, WITH EACH SIDE CONTAINING A PLURALITY OF SMALL MOGULS

ASYMMETRICALLY DISTRIBUTED ALONG THEIR UPPER PORTIONS. THE TWO OTHER OPPOSED SIDES OF THE BOTTLE HAVE GENERALIZED ELONGATED OBLONG SHAPE WITH SLIGHT CONVEX SIDES ALONG THE MAJOR AXIS, WITH ONE OBLONG SIDE CONTAINING AN OVERALL UNDULATING CURVILINEAR SHAPE AND THE OPPOSITE OBLONG SIDE CONTAINING A KNURLED SHAPE ON ITS LOWER END AND DISTORTED HYPERBOLIC SHAPE AT ITS UPPER END.

SER. NO. 77-060,176, FILED 12-8-2006.

MORGAN WYNNE, EXAMINING ATTORNEY

**Int. Cl.: 7**

**Prior U.S. Cls.: 13, 19, 21, 23, 31, 34 and 35**

**United States Patent and Trademark Office**

**Reg. No. 3,451,914**

**Registered June 24, 2008**

**TRADEMARK  
PRINCIPAL REGISTER**

**TROY PROFESSIONAL SHOP  
SERIES**

MAX TOOL LLC (CALIFORNIA LTD LIAB CO)  
1669 PUDDINGSTONE DR.  
LA VERNE, CA 91750

FOR: AUTOMOTIVE SHOP TOOLS, NAMELY,  
CRANES, HYDRAULIC JACKS, HYDRAULIC TIRE  
CHANGERS, SAND BLASTING APPARATUS IN  
THE NATURE OF CABINETS, HYDRAULIC SHOP  
PRESSES, AUTOMOTIVE FRAME STRAIGHTEN-  
ING MACHINES, OIL DRAIN PUMPS, AUTOMO-  
BILE OIL PANS, IN CLASS 7 (U.S. CLS. 13, 19, 21, 23,  
31, 34 AND 35).

FIRST USE 5-1-2002; IN COMMERCE 5-1-2002.

THE MARK CONSISTS OF STANDARD CHAR-  
ACTERS WITHOUT CLAIM TO ANY PARTICULAR  
FONT, STYLE, SIZE, OR COLOR.

NO CLAIM IS MADE TO THE EXCLUSIVE  
RIGHT TO USE "PROFESSIONAL SHOP SERIES",  
APART FROM THE MARK AS SHOWN.

SER. NO. 77-060,550, FILED 12-8-2006.

REBECCA EISINGER, EXAMINING ATTORNEY



**Int. Cl.: 41**

**Prior U.S. Cls.: 100, 101 and 107**

**United States Patent and Trademark Office**

**Reg. No. 3,451,915**

**Registered June 24, 2008**

**SERVICE MARK  
PRINCIPAL REGISTER**

**iGolf**

L1 TECHNOLOGIES, INC. (CALIFORNIA CORPORATION)  
10180 TELESIS COURT, SUITE 165  
ATTN: MR. DANA ROBINSON  
SAN DIEGO, CA 92121

FOR: PROVIDING GOLFING INFORMATION, NAMELY, AN ON-LINE SEARCHABLE DATABASE FEATURING DOWNLOADABLE DATA CHARACTERIZING FEATURES OF GOLF COURSES FOR USE BY HANDHELD DEVICES AND GPS-ENABLED DEVICES, DOWNLOADABLE DATA CHARACTERIZING LANDMARKS OF GOLF COURSES FOR USE BY HANDHELD LOCATION DEVICES TO DISPLAY DISTANCES FROM A GOLFER TO ONE

OR MORE OF THE LANDMARKS, AND DOWNLOADABLE DATA CHARACTERIZING GOLF SCORECARDS FOR USE BY HANDHELD DEVICES, IN CLASS 41 (U.S. CLS. 100, 101 AND 107).

FIRST USE 1-18-2006; IN COMMERCE 1-18-2006.

THE MARK CONSISTS OF STANDARD CHARACTERS WITHOUT CLAIM TO ANY PARTICULAR FONT, STYLE, SIZE, OR COLOR.

SER. NO. 77-060,765, FILED 12-9-2006.

JACLYN KIDWELL, EXAMINING ATTORNEY

Int. Cl.: 36

Prior U.S. Cls.: 100, 101 and 102

United States Patent and Trademark Office

Reg. No. 3,451,916

Registered June 24, 2008

SERVICE MARK  
PRINCIPAL REGISTER



REAL ESTATE BROKER DIRECT, INC. (MICHIGAN CORPORATION)  
18230 21 MILE ROAD  
MACOMB, MI 48044

FOR: APPRAISAL OF REAL ESTATE; ASSESSMENT AND MANAGEMENT OF REAL ESTATE; EVALUATION OF REAL PROPERTY; FINANCIAL INVESTMENT IN THE FIELD OF REAL ESTATE; FINANCIAL VALUATION OF PERSONAL PROPERTY AND REAL ESTATE; LAND ACQUISITION, NAMELY, REAL ESTATE BROKERAGE; LEASING OF REAL ESTATE; LEASING OF REAL PROPERTY; OPERATING MARKETPLACES FOR SELLERS OF GOODS AND/OR SERVICES; PROVIDING INFORMATION IN THE FIELD OF REAL ESTATE BY MEANS OF LINKING THE WEB SITE TO OTHER WEB SITES FEATURING REAL ESTATE INFORMATION; REAL ESTATE ACQUISITION SERVICES; REAL ESTATE AGENCIES; REAL ESTATE APPRAISAL; REAL ESTATE BROKERAGE; REAL ESTATE CONSULTANCY; REAL ESTATE CONSULTATION; REAL ESTATE EQUITY SHARING, NAMELY, MANAGING AND ARRANGING FOR CO-OWNERSHIP OF REAL ESTATE; REAL ESTATE ESCROW SERVICES; REAL ESTATE INVESTMENT; REAL ESTATE LISTING; REAL ESTATE MANAGEMENT; REAL ESTATE MANAGEMENT CONSULTATION; REAL ESTATE MULTIPLE LISTING SERVICES; REAL ESTATE PROCUREMENT FOR OTHERS; REAL ESTATE SERVICES, NAMELY, RENTAL OF VACATION HOMES, CONDOMINIUMS, CABINS, AND VILLAS USING PAY PER CLICK ADVERTIS-

ING ON A GLOBAL COMPUTER NETWORK; REAL ESTATE SYNDICATION; REAL ESTATE TIME-SHARING; REAL ESTATE TRUSTEE SERVICES; REAL ESTATE VALUATION SERVICES; REAL ESTATE VALUATIONS; VACATION REAL ESTATE TIME SHARE EXCHANGE SERVICES; VACATION REAL ESTATE TIME-SHARING; VACATION REAL ESTATE TIMESHARE SERVICES, IN CLASS 36 (U.S. CLS. 100, 101 AND 102).

FIRST USE 3-1-2006; IN COMMERCE 8-1-2006.

NO CLAIM IS MADE TO THE EXCLUSIVE RIGHT TO USE "BROKER DIRECT", APART FROM THE MARK AS SHOWN.

"THE COLOR(S) DARK BLUE, LIGHT BLUE, DARK GOLD AND LIGHT GOLD AND BLACK IS/ARE CLAIMED AS A FEATURE OF THE MARK."

THE MARK CONSISTS OF THE LETTERS RE STANDING IN GRADUATED GOLD COLOR SITUATED INSIDE A CIRCLE OUTLINED IN BLACK WITH A BLUE SKY AND HOUSE IMAGE IN THE BACKGROUND. BROKER DIRECT DISPLAYED IN A STYLISH GOLD VARIEGATED FONT, OUTLINED IN DARK BLUE.

SER. NO. 77-060,873, FILED 12-10-2006.

ELISSA GARBER KON, EXAMINING ATTORNEY

**Int. Cl.: 4**

**Prior U.S. Cls.: 1, 6 and 15**

**United States Patent and Trademark Office**

**Reg. No. 3,451,917**

**Registered June 24, 2008**

**TRADEMARK  
PRINCIPAL REGISTER**

**LUBRIPELLENT**

JIG-A-WORLD INC./JIG-A-MONDE INC. (CANADA CORPORATION)  
1100 RUE CONDE  
MONTREAL, QUEBEC, CANADA H3K 2E3

PRIORITY CLAIMED UNDER SEC. 44(D) ON CANADA APPLICATION NO. 1327566, FILED 12-8-2006, REG. NO. TMA703729, DATED 12-21-2007, EXPIRES 12-21-2022.

FOR: ALL PURPOSE LUBRICANTS, IN CLASS 4 (U.S. CLS. 1, 6 AND 15).

SER. NO. 77-063,237, FILED 12-13-2006.

THE MARK CONSISTS OF STANDARD CHARACTERS WITHOUT CLAIM TO ANY PARTICULAR FONT, STYLE, SIZE, OR COLOR.

REBECCA SMITH, EXAMINING ATTORNEY

**Int. Cl.: 35**

**Prior U.S. Cls.: 100, 101 and 102**

**United States Patent and Trademark Office**

**Reg. No. 3,451,918**

**Registered June 24, 2008**

**SERVICE MARK  
PRINCIPAL REGISTER**

**MYT-JET.COM**

U.S. GRAPHIC ARTS, INC. (ARIZONA CORPORATION)  
1901 E. 5TH ST.  
TEMPE, AZ 85281

THE MARK CONSISTS OF STANDARD CHARACTERS WITHOUT CLAIM TO ANY PARTICULAR FONT, STYLE, SIZE, OR COLOR.

FOR: ONLINE RETAIL STORE SERVICES FEATURING GARMENT AND TEXTILE PRINTING PRODUCTS, IN CLASS 35 (U.S. CLS. 100, 101 AND 102).

SER. NO. 77-063,256, FILED 12-13-2006.

FIRST USE 11-15-2006; IN COMMERCE 11-15-2006.

SETH A. RAPPAPORT, EXAMINING ATTORNEY

**Int. Cls.: 35, 42 and 45**

**Prior U.S. Cls.: 100, 101 and 102**

**United States Patent and Trademark Office**

**Reg. No. 3,451,919**

**Registered June 24, 2008**

**SERVICE MARK  
PRINCIPAL REGISTER**

**IT JUST MAKES YOU GIGGLE**

POPNOGGINS, LLC (FLORIDA LTD LIAB CO)  
11100 ASTRONAUT BLVD  
ORLANDO, FL 32837

FOR: BUSINESS SERVICES, NAMELY, DISTRIBUTORSHIPS IN THE FIELD OF HARDWARE, COMPUTER SOFTWARE AND ENTERTAINMENT SYSTEMS FOR CREATING CUSTOM DIGITAL VIDEO DISCS; RETAIL STORE SERVICES IN THE FIELD OF HARDWARE, COMPUTER SOFTWARE AND ENTERTAINMENT SYSTEMS FOR CREATING CUSTOM DIGITAL VIDEO DISCS, IN CLASS 35 (U.S. CLS. 100, 101 AND 102).

FIRST USE 11-0-2006; IN COMMERCE 11-0-2006.

FOR: RENTAL OF COMPUTERS AND SOFTWARE FOR CREATING CUSTOM DIGITAL DISCS, IN CLASS 42 (U.S. CLS. 100 AND 101).

FIRST USE 11-0-2006; IN COMMERCE 11-0-2006.

FOR: LICENSING OF COMPUTERS AND SOFTWARE FOR CREATING CUSTOM DIGITAL VIDEO DISCS, IN CLASS 45 (U.S. CLS. 100 AND 101).

FIRST USE 11-0-2006; IN COMMERCE 11-0-2006.

THE MARK CONSISTS OF STANDARD CHARACTERS WITHOUT CLAIM TO ANY PARTICULAR FONT, STYLE, SIZE, OR COLOR.

SER. NO. 77-066,435, FILED 12-18-2006.

MICHAEL ENGEL, EXAMINING ATTORNEY

Int. Cls.: 29 and 30

Prior U.S. Cl.: 46

United States Patent and Trademark Office

Reg. No. 3,451,920

Registered June 24, 2008

TRADEMARK  
PRINCIPAL REGISTER



PULMUONE WILDWOOD, INC. (IOWA CORPORATION)  
810 BLAKELY CIRCLE  
GRINNELL, IA 50112

FOR: PREPARED, READY-TO-EAT FOODS, NAMELY, BRAISED TOFU, BAKED TOFU, SMOKED TOFU, TOFU SALAD, SOY CHEESE, TEMPEH, HUMMUS, TOFU-VEGGIE PATTIES, SOY-BASED SOUR CREAM ALTERNATIVE, SOY-BASED YOGURT, VEGETARIAN HOT DOGS, VEGETARIAN DELI SLICES, VEGETARIAN GROUND MEAT SUBSTITUTE, PREPARED READY TO EAT FOODS NAMELY HEAT-AND-EAT TOFU-BASED VEGETARIAN MEALS CONSISTING PRIMARILY OF TOFU AND VEGETABLES, VEGETARIAN DIP, FLAVORED TOFU, VEGETARIAN SPREADS, IN CLASS 29 (U.S. CL. 46).

FIRST USE 11-24-2006; IN COMMERCE 11-24-2006.

FOR: PREPARED READY TO EAT FOODS, NAMELY, HEAT-AND-EAT TOFU-BASED VEGETARIAN MEALS CONSISTING PRIMARILY OF PASTA OR RICE; VEGETARIAN PESTO, VEGETARIAN PASTA SAUCE; TOFU PASTA (SHIRATAKI), VEGETARIAN SALAD DRESSINGS, IN CLASS 30 (U.S. CL. 46).

FIRST USE 11-24-2006; IN COMMERCE 11-24-2006.

OWNER OF U.S. REG. NO. 2,299,634.

THE MARK CONSISTS OF THE WORD "WILDWOOD" IN A FANCIFUL SCRIPT AND A DESIGN OF TWO LEAVES.

SER. NO. 77-068,550, FILED 12-20-2006.

ADA HAN, EXAMINING ATTORNEY

**Int. Cl.: 25**

**Prior U.S. Cls.: 22 and 39**

**United States Patent and Trademark Office**

**Reg. No. 3,451,921**

**Registered June 24, 2008**

**TRADEMARK  
PRINCIPAL REGISTER**

**CONCRETE JUNGLE**

J.PURE, INC. (NEW YORK CORPORATION)  
20 HILLPARK AVENUE, 2C  
GREAT NECK, NY 11021

FOR: CLOTHING, FOOTWEAR, AND HEADWEAR, NAMELY, T-SHIRTS, WOVEN SHIRTS, CASUAL TOPS WITH LONG AND SHORT SLEEVES, BODYSUITS, SWEATSHIRTS, SWEATERS, VESTS, BLAZERS, SUITS, JACKETS, COATS, ANORAKS, PARKAS, JEANS, PANTS, SLACKS, DRESSES, SKIRTS, SHORTS, OVERALLS, SOCKS, BELTS, GLOVES, MITTENS, ATHLETIC SHOES, SLIPPERS, SANDALS, THONGS, BOOTS, DRESS SHOES, SWIMWEAR, PAJAMAS, BOXERS, UNDERWEAR, LIN-

GERIE, PANTIES, UNDERSHIRTS, SKI WEAR, SNOWBOARD WEAR, SARONGS, BASEBALL CAPS, HATS, BEANIES, BANDANNAS, IN CLASS 25 (U.S. CLS. 22 AND 39).

FIRST USE 3-12-2007; IN COMMERCE 3-12-2007.

THE MARK CONSISTS OF STANDARD CHARACTERS WITHOUT CLAIM TO ANY PARTICULAR FONT, STYLE, SIZE, OR COLOR.

SER. NO. 77-070,035, FILED 12-21-2006.

STEVEN R. FINE, EXAMINING ATTORNEY

Int. Cl.: 9

Prior U.S. Cls.: 21, 23, 26, 36 and 38

United States Patent and Trademark Office

Reg. No. 3,451,922

Registered June 24, 2008

TRADEMARK  
PRINCIPAL REGISTER



VIRGINIA J. HOLMES (HAWAII SOLE PROPRIETORSHIP)  
189-102 GEORGE WASHINGTON CT.  
WAHIAWA, HI 96786

FOR: PROTECTIVE CLOTHING, NAMELY, MINIMITTENS FOR THE THUMB, INDEX AND MIDDLE FINGERS FOR HOLDING AND STOPPING A BRAID OF SYNTHETIC HAIR FROM UNRAVELING WHEN BURNED, AND FOR USE IN SHAPING THE BRAID, IN CLASS 9 (U.S. CLS. 21, 23, 26, 36 AND 38).

FIRST USE 11-5-2006; IN COMMERCE 11-5-2006.

THE MARK CONSISTS OF "STYLIZED LETTERS HOTTIPS."

SER. NO. 77-073,337, FILED 12-29-2006.

STEVEN R. FINE, EXAMINING ATTORNEY



**Int. Cl.: 36**

**Prior U.S. Cls.: 100, 101 and 102**

**United States Patent and Trademark Office**

**Reg. No. 3,451,923**

**Registered June 24, 2008**

**SERVICE MARK  
PRINCIPAL REGISTER**

**MONEY DIRECT**

SCOTTRADE, INC. (ARIZONA CORPORATION)  
12855 FLUSHING MEADOWS DRIVE  
ST. LOUIS, MO 63131

FOR: FINANCIAL SERVICES, NAMELY ELECTRONIC FUNDS TRANSFERS VIA AN AUTOMATED CLEARING HOUSE, AND PROVIDING ON-LINE STORED VALUE ACCOUNTS IN AN ELECTRONIC ENVIRONMENT; AND BROKAGE SERVICES, NAMELY DISCOUNT BROKERAGE SERVICES; AND ELECTRONIC FUNDS TRANSFER TO OR FROM ACCOUNTS OF CUSTOMERS OF A BROKERAGE FIRM, IN CLASS 36 (U.S. CLS. 100, 101 AND 102).

FIRST USE 10-5-2006; IN COMMERCE 10-5-2006.

THE MARK CONSISTS OF STANDARD CHARACTERS WITHOUT CLAIM TO ANY PARTICULAR FONT, STYLE, SIZE, OR COLOR.

NO CLAIM IS MADE TO THE EXCLUSIVE RIGHT TO USE "MONEY", APART FROM THE MARK AS SHOWN.

SER. NO. 77-073,600, FILED 12-29-2006.

STEPHANIE ALI, EXAMINING ATTORNEY

**Int. Cl.: 9**

**Prior U.S. Cls.: 21, 23, 26, 36 and 38**

**Reg. No. 3,451,924**

**United States Patent and Trademark Office**

**Registered June 24, 2008**

---

**TRADEMARK  
PRINCIPAL REGISTER**

**ARCOS**

SPECTRO ANALYTICAL INSTRUMENTS GMBH  
& CO. KG (FED REP GERMANY GMBH & CO.  
KG)  
BOSCHSTRASSE 10  
KLEVE, FED REP GERMANY D-47533

PRIORITY CLAIMED UNDER SEC. 44(D) ON  
ERPNTY TM OFC APPLICATION NO.  
005326566, FILED 9-6-2006, REG. NO. 005326566,  
DATED 9-3-2007, EXPIRES 9-6-2016.

FOR: SPECTROMETERS, IN CLASS 9 (U.S. CLS.  
21, 23, 26, 36 AND 38).

SER. NO. 77-073,723, FILED 12-29-2006.

THE MARK CONSISTS OF STANDARD CHAR-  
ACTERS WITHOUT CLAIM TO ANY PARTICULAR  
FONT, STYLE, SIZE, OR COLOR.

ODESSA BIBBINS, EXAMINING ATTORNEY

**Int. Cl.: 9**

**Prior U.S. Cls.: 21, 23, 26, 36 and 38**

**United States Patent and Trademark Office**

**Reg. No. 3,451,925**

**Registered June 24, 2008**

**TRADEMARK  
PRINCIPAL REGISTER**

**MaXess**

ELBIT SYSTEMS LTD. (ISRAEL COMPANY)  
ADVANCED TECHNOLOGY CENTRE, P.O. BOX 539  
HAIFA 31053, ISRAEL

FOR: COMMUNICATION APPARATUS FOR  
REAL-TIME DATA, AUDIO AND VIDEO TRANS-  
MISSION; COMPUTER SOFTWARE AND HARD-  
WARE PROVIDING ACCESS TO WIRELESS LOCAL  
AREA NETWORKS AND FOR ORGANIZING AND  
MANAGING SAID NETWORKS; PARTS AND FIT-  
TINGS FOR THE ABOVE PRODUCTS, IN CLASS 9  
(U.S. CLS. 21, 23, 26, 36 AND 38).

THE MARK CONSISTS OF STANDARD CHAR-  
ACTERS WITHOUT CLAIM TO ANY PARTICULAR  
FONT, STYLE, SIZE, OR COLOR.

OWNER OF ISRAEL REG. NO. 179660, DATED 8-3-  
2006, EXPIRES 3-31-2015.

SER. NO. 77-074,316, FILED 1-2-2007.

DEIRDRE ROBERTSON, EXAMINING ATTORNEY

**Int. Cl.: 33**

**Prior U.S. Cls.: 47 and 49**

**United States Patent and Trademark Office**

**Reg. No. 3,451,926**

**Registered June 24, 2008**

**TRADEMARK  
PRINCIPAL REGISTER**

## Micro-Winery Series

WINE ART COMPANY LTD. (CANADA CORPORATION)  
55 CLEGG RD.  
MARKHAM, CANADA L6G 1B9

PRIORITY CLAIMED UNDER SEC. 44(D) ON CANADA APPLICATION NO. 1329953, FILED 1-2-2007, REG. NO. TMA704175, DATED 1-8-2008, EXPIRES 1-8-2023.

FOR: HOME WINE-MAKING KITS CONTAINING SELECT INGREDIENTS FOR HOME WINE-MAKING, NAMELY, FRUIT JUICES AND CONCENTRATES, SANITIZING SOLUTION, YEASTS, CHEMICAL ADDITIVES AND DEXTROSE, IN CLASS 33 (U.S. CLS. 47 AND 49).

NO CLAIM IS MADE TO THE EXCLUSIVE RIGHT TO USE "SERIES", APART FROM THE MARK AS SHOWN.

FIRST USE 11-0-2006; IN COMMERCE 11-0-2006.

SER. NO. 77-074,574, FILED 1-2-2007.

THE MARK CONSISTS OF STANDARD CHARACTERS WITHOUT CLAIM TO ANY PARTICULAR FONT, STYLE, SIZE, OR COLOR.

ESTHER A. BORSUK, EXAMINING ATTORNEY

**Int. Cls.: 35 and 42**

**Prior U.S. Cls.: 100, 101 and 102**

**United States Patent and Trademark Office**

**Reg. No. 3,451,927**

**Registered June 24, 2008**

**SERVICE MARK  
PRINCIPAL REGISTER**



PRESENTATION STRATEGIES, INC. (NORTH  
CAROLINA CORPORATION)  
SUITE 220  
4021 STIRRUP CREEK DRIVE  
DURHAM, NC 27703

FOR: MANAGING ACTIVITIES ASSOCIATE WITH CLINICAL TRIAL STUDIES, NAMELY, MANAGING PATIENT DATA COLLECTION, STUDY COMPLIANCE STATISTICS, HIPAA COMPLIANCE, AND PROVIDING CUSTOMER ACCESS TO PATIENT DATA COLLECTED, STUDY COMPLIANCE STATISTICS AND INFORMATION RELATING TO HIPAA COMPLIANCE; TRACKING INFORMATION RELATING TO PRESENTATIONS, NAMELY, SALES INFORMATION IN THE MEDICAL FIELD, AND ANALYZING THE EFFECTIVE-

NESS OF PRESENTATIONS FOR OTHERS, IN CLASS 35 (U.S. CLS. 100, 101 AND 102).

FIRST USE 1-0-2006; IN COMMERCE 1-0-2006.

FOR: GRAPHIC DESIGN SERVICES, NAMELY, PREPARING PRINT AND DESIGN MATERIALS AND SCIENTIFIC POSTERS FOR OTHERS FOR USE IN SALES, ADVERTISING, MARKETING, TRADE SHOWS, CORPORATE EVENTS AND EXHIBITIONS, IN CLASS 42 (U.S. CLS. 100 AND 101).

FIRST USE 1-0-2006; IN COMMERCE 1-0-2006.

SER. NO. 77-074,955, FILED 1-3-2007.

SHANNON TWOHIG, EXAMINING ATTORNEY

**Int. Cls.: 19 and 37**

**Prior U.S. Cls.: 1, 12, 33, 50, 100, 103 and 106**

**Reg. No. 3,451,928**

**United States Patent and Trademark Office**

**Registered June 24, 2008**

**TRADEMARK  
SERVICE MARK  
PRINCIPAL REGISTER**

**HCH HandCrafted Homes**

HANDCRAFTED HOMES, L.L.C. (NORTH CAROLINA LTD LIAB CO)  
101 EASTERN MINERALS ROAD  
HENDERSON, NC 27537

FOR: MODULAR HOMES, IN CLASS 19 (U.S. CLS. 1, 12, 33 AND 50).

FIRST USE 5-1-1999; IN COMMERCE 5-1-1999.

FOR: OFF-SITE MODULAR HOUSING CONSTRUCTION SERVICES, IN CLASS 37 (U.S. CLS. 100, 103 AND 106).

FIRST USE 5-1-1999; IN COMMERCE 5-1-1999.

THE MARK CONSISTS OF STANDARD CHARACTERS WITHOUT CLAIM TO ANY PARTICULAR FONT, STYLE, SIZE, OR COLOR.

NO CLAIM IS MADE TO THE EXCLUSIVE RIGHT TO USE "HOMES", APART FROM THE MARK AS SHOWN.

SEC. 2(F) AS TO "HANDCRAFTED HOMES".

SER. NO. 77-075,110, FILED 1-3-2007.

LANA PHAM, EXAMINING ATTORNEY

**Int. Cls.: 19 and 37**

**Prior U.S. Cls.: 1, 12, 33, 50, 100, 103 and 106**

**United States Patent and Trademark Office**

**Reg. No. 3,451,929**

**Registered June 24, 2008**

**TRADEMARK  
SERVICE MARK  
PRINCIPAL REGISTER**



**HandCrafted Homes**

*A BETTER WAY TO BUILD*

HANDCRAFTED HOMES, L.L.C. (NORTH CAROLINA LTD LIAB CO)  
101 EASTERN MINERALS ROAD  
HENDERSON, NC 27537

FOR: MODULAR HOMES, IN CLASS 19 (U.S. CLS. 1, 12, 33 AND 50).

FIRST USE 4-1-2006; IN COMMERCE 4-1-2006.

FOR: OFF-SITE MODULAR HOUSING CONSTRUCTION SERVICES, IN CLASS 37 (U.S. CLS. 100, 103 AND 106).

FIRST USE 4-1-2006; IN COMMERCE 4-1-2006.

NO CLAIM IS MADE TO THE EXCLUSIVE RIGHT TO USE "HOMES", APART FROM THE MARK AS SHOWN.

THE COLOR(S) GREEN AND GOLD IS/ARE CLAIMED AS A FEATURE OF THE MARK.

THE MARK CONSISTS OF "HCH" IN THE COLOR GREEN WITH A GOLD OUTLINE. THE PHRASE "HANDCRAFTED HOMES" IS THE COLOR GREEN. THE PHRASE "A BETTER WAY TO BUILD" IS THE COLOR GOLD.

SEC. 2(F) AS TO "HANDCRAFTED HOMES".

SER. NO. 77-075,120, FILED 1-3-2007.

LANA PHAM, EXAMINING ATTORNEY

**Int. Cl.: 30**

**Prior U.S. Cl.: 46**

**United States Patent and Trademark Office**

**Reg. No. 3,451,930**

**Registered June 24, 2008**

**TRADEMARK  
PRINCIPAL REGISTER**



PEPPERS OF LOUISIANA, INC. (LOUISIANA CORPORATION)  
602 W. BRIDGE STREET  
ST. MARTINVILLE, LA 705820211

FOR: CHICKEN WING SAUCE; CONDIMENT, NAMELY, PEPPER SAUCE; HOT SAUCE; MARINADES; SAUCES; SOY SAUCE; STEAK SAUCE; STEAK SEASONING; TERIYAKI SAUCE; WORCESTERSHIRE SAUCE, IN CLASS 30 (U.S. CL. 46).

FIRST USE 2-28-2006; IN COMMERCE 2-28-2006.

OWNER OF U.S. REG. NOS. 3,311,163 AND 3,322,799.

NO CLAIM IS MADE TO THE EXCLUSIVE RIGHT TO USE "LOUISIANA SUPREME", APART FROM THE MARK AS SHOWN.

THE COLOR(S) YELLOW, BLACK, RED, WHITE AND GREEN IS/ARE CLAIMED AS A FEATURE OF THE MARK.

THE WORDING "LOUISIANA SUPREME" IS BLACK. THE PEPPER DESIGNS ARE RED, WHITE AND GREEN WITH BLACK OUTLINES. THE WORDING AND PEPPER DESIGNS APPEAR INSIDE A YELLOW QUADRILATERAL CARRIER DESIGN WITH A THIN BLACK OUTLINE.

SER. NO. 77-075,225, FILED 1-3-2007.

NELSON SNYDER, EXAMINING ATTORNEY



**Int. Cl.: 7**

**Prior U.S. Cls.: 13, 19, 21, 23, 31, 34 and 35**

**United States Patent and Trademark Office**

**Reg. No. 3,451,931**

**Registered June 24, 2008**

**TRADEMARK  
PRINCIPAL REGISTER**



AMERICAN RESCUE TECHNOLOGY, INC.  
(OHIO CORPORATION)  
2780 CULVER AVE.  
KETTERING, OH 45429

FIRST USE 4-0-2006; IN COMMERCE 4-0-2006.

FOR: RESCUE APPARATUSES, NAMELY, HY-  
DRAULIC EXCAVATORS AND HYDRAULIC CUT-  
TERS, IN CLASS 7 (U.S. CLS. 13, 19, 21, 23, 31, 34 AND  
35).

SER. NO. 77-079,039, FILED 1-9-2007.

JAMES MACFARLANE, EXAMINING ATTORNEY

**Int. Cls.: 37 and 40**

**Prior U.S. Cls.: 100, 103 and 106**

**United States Patent and Trademark Office**

**Reg. No. 3,451,932**

**Registered June 24, 2008**

**SERVICE MARK  
PRINCIPAL REGISTER**



ENERGY ANSWERS CORPORATION (NEW YORK CORPORATION)  
79 NORTH PEARL STREET  
ALBANY, NY 12207

FOR: COLLECTION CENTERS FOR COMBUSTIBLE WASTE, IN CLASS 37 (U.S. CLS. 100, 103 AND 106).

FIRST USE 1-1-1998; IN COMMERCE 1-1-1998.

FOR: WASTE MANAGEMENT SERVICES; GENERATION OF POWER AND ENERGY THROUGH THE COMBUSTION OF WASTE; RESOURCE RECOVERY, NAMELY, SORTING AND SEPARATING WASTE AND RECYCLABLE MATERIAL; WASTE PROCESSING AND TREATMENT; SLUDGE PROCESSING AND TREATMENT; RECOVERY OF ENERGY AND REUSABLE MATERIALS FROM WASTE, NAMELY, WASTE COMBUSTION AND

EXTRACTION OF REUSABLE MATERIALS FROM COMBUSTED WASTE; CONVERSION OF WASTE TO USABLE PRODUCTS, NAMELY, RECYCLING; WASTE TREATMENT, NAMELY, ASH PROCESSING AND TREATMENT; COMPOSTING; RECYCLING; RENEWABLE ENERGY GENERATION SERVICES; CONSULTING SERVICES IN THE FIELD OF WASTE COMBUSTION, RECYCLING AND MANAGEMENT, IN CLASS 40 (U.S. CLS. 100, 103 AND 106).

FIRST USE 1-1-1998; IN COMMERCE 1-1-1998.

THE MARK CONSISTS OF STYLIZED LETTERS ECO.

SER. NO. 77-080,013, FILED 1-10-2007.

JENNIFER MARTIN, EXAMINING ATTORNEY

**Int. Cls.: 9 and 16**

**Prior U.S. Cls.: 2, 5, 21, 22, 23, 26, 29, 36, 37, 38 and 50**

**Reg. No. 3,451,933**

**United States Patent and Trademark Office**

**Registered June 24, 2008**

**TRADEMARK  
PRINCIPAL REGISTER**

# BODYFLOW

LES MILLS INTERNATIONAL LIMITED (NEW ZEALAND LTD LIAB CO)  
L2 150 VICTORIA ST WEST  
AUCKLAND, NEW ZEALAND 1142

FOR: AUDIO AND VIDEO RECORDINGS FEATURING EXERCISE CLASSES AND INFORMATION ABOUT FITNESS AND HEALTH CLUB PROGRAMS; AUDIO-VISUAL RECORDINGS, NAMELY, PRE-RECORDED COMPACT DISCS, AUDIO AND VIDEO TAPES, DIGITAL VIDEO DISCS, AND CD-ROMS, ALL FEATURING EXERCISE CLASSES AND INFORMATION ABOUT FITNESS AND HEALTH CLUB PROGRAMS; PRE-RECORDED CDS AND DVDS FEATURING EXERCISE CLASSES AND INFORMATION ABOUT FITNESS AND HEALTH CLUB PROGRAMS; DOWNLOADABLE ELECTRONIC PUBLICATIONS IN THE NATURE OF TEACHING BOOKLETS AND TEACHING MANUALS IN THE FIELD OF HEALTH AND FITNESS, SUPPLIED ONLINE FROM DATABASES, FROM THE INTERNET, INTRANETS OR FROM EXTRANETS; DOWNLOADABLE MUSICAL SOUND RECORDINGS, IN CLASS 9 (U.S. CLS. 21, 23, 26, 36 AND 38).

FIRST USE 8-1-1999; IN COMMERCE 8-1-1999.

FOR: PRINTED MATTER, NAMELY, BOOKS, BOOKLETS, NEWSLETTERS, MAGAZINES, MANUALS, POSTERS AND POSTCARDS, ALL FEATURING INFORMATION ABOUT FITNESS AND HEALTH CLUB PROGRAMS; INSTRUCTIONAL AND TEACHING MATERIALS, NAMELY, BOOKS, BOOKLETS, NEWSLETTERS, MAGAZINES, MANUALS, POSTERS AND POSTCARDS, ALL FEATURING INFORMATION ABOUT FITNESS AND HEALTH CLUB PROGRAMS; CALENDARS, IN CLASS 16 (U.S. CLS. 2, 5, 22, 23, 29, 37, 38 AND 50).

FIRST USE 8-1-1999; IN COMMERCE 8-1-1999.

THE MARK CONSISTS OF STANDARD CHARACTERS WITHOUT CLAIM TO ANY PARTICULAR FONT, STYLE, SIZE, OR COLOR.

OWNER OF U.S. REG. NOS. 2,399,306, 2,414,664, AND 2,899,834.

SER. NO. 77-080,405, FILED 1-10-2007.

STEVEN R. FOSTER, EXAMINING ATTORNEY

**Int. Cls.: 9 and 41**

**Prior U.S. Cls.: 21, 23, 26, 36, 38, 100, 101 and 107**

**Reg. No. 3,451,934**

**United States Patent and Trademark Office**

**Registered June 24, 2008**

**TRADEMARK  
SERVICE MARK  
PRINCIPAL REGISTER**

**KALIKO**

SWAIN, JAMIR (UNITED STATES INDIVIDUAL)  
4118 37TH AVENUE NORTH  
ST. PETERSBURG, FL 33713

FOR: PRE-RECORDED CDS, VIDEO TAPES, LASER DISKS AND DVDS FEATURING MUSIC, IN CLASS 9 (U.S. CLS. 21, 23, 26, 36 AND 38).

FIRST USE 10-26-2006; IN COMMERCE 10-26-2006.

FOR: ENTERTAINMENT IN THE NATURE OF LIVE PERFORMANCES BY A RAP ARTIST, IN CLASS 41 (U.S. CLS. 100, 101 AND 107).

FIRST USE 12-25-2005; IN COMMERCE 12-25-2005.

THE MARK CONSISTS OF STANDARD CHARACTERS WITHOUT CLAIM TO ANY PARTICULAR FONT, STYLE, SIZE, OR COLOR.

THE NAME(S), PORTRAIT(S), AND/OR SIGNATURE(S) SHOWN IN THE MARK IDENTIFIES "KALIKO", WHOSE CONSENT(S) TO REGISTER IS SUBMITTED.

SER. NO. 77-080,860, FILED 1-11-2007.

ANTHONY RINKER, EXAMINING ATTORNEY

**Int. Cl.: 31**

**Prior U.S. Cls.: 1 and 46**

**United States Patent and Trademark Office**

**Reg. No. 3,451,935**

**Registered June 24, 2008**

**TRADEMARK  
PRINCIPAL REGISTER**

**HYDRO STRAW**

PELLETIZED STRAW, LLC (WASHINGTON LTD  
LIAB CO)  
3776 W 9000 N RD.  
MANTENO, IL 60950

NO CLAIM IS MADE TO THE EXCLUSIVE  
RIGHT TO USE "STRAW", APART FROM THE  
MARK AS SHOWN.

FOR: MULCH, IN CLASS 31 (U.S. CLS. 1 AND 46).

FIRST USE 3-10-2005; IN COMMERCE 3-10-2005.

SER. NO. 77-081,071, FILED 1-11-2007.

THE MARK CONSISTS OF STANDARD CHAR-  
ACTERS WITHOUT CLAIM TO ANY PARTICULAR  
FONT, STYLE, SIZE, OR COLOR.

BONNIE LUKEN, EXAMINING ATTORNEY

**Int. Cl.: 20**

**Prior U.S. Cls.: 2, 13, 22, 25, 32 and 50**

**United States Patent and Trademark Office**

**Reg. No. 3,451,936**

**Registered June 24, 2008**

**TRADEMARK  
PRINCIPAL REGISTER**

**MIGHTY**

SACRA, STEPHEN (UNITED STATES INDIVIDUAL)  
16515 S. 40TH STREET, SUITE 121  
PHOENIX, AZ 85048

THE MARK CONSISTS OF A STYLIZED WORD  
"MIGHTY".

FOR: DOG BEDS, IN CLASS 20 (U.S. CLS. 2, 13, 22,  
25, 32 AND 50).

SER. NO. 77-081,470, FILED 1-11-2007.

FIRST USE 10-24-2005; IN COMMERCE 5-20-2006.

CAROLINE WOOD, EXAMINING ATTORNEY

**Int. Cl.: 42**

**Prior U.S. Cls.: 100 and 101**

**United States Patent and Trademark Office**

**Reg. No. 3,451,937**

**Registered June 24, 2008**

**SERVICE MARK  
PRINCIPAL REGISTER**

# Fractional CTO

C' BAY TECHNOLOGIES, INC. (VIRGINIA CORPORATION)  
111 CYBERNETICS WAY, STE 220  
YORKTOWN, VA 23693

FOR: INFORMATION TECHNOLOGY MANAGED SERVICES, IN CLASS 42 (U.S. CLS. 100 AND 101).

FIRST USE 8-1-2006; IN COMMERCE 10-1-2006.

THE MARK CONSISTS OF STANDARD CHARACTERS WITHOUT CLAIM TO ANY PARTICULAR FONT, STYLE, SIZE, OR COLOR.

NO CLAIM IS MADE TO THE EXCLUSIVE RIGHT TO USE "CTO", APART FROM THE MARK AS SHOWN.

SER. NO. 77-082,531, FILED 1-13-2007.

REGINA DRUMMOND, EXAMINING ATTORNEY

Int. Cl.: 45

Prior U.S. Cls.: 100 and 101

United States Patent and Trademark Office

Reg. No. 3,451,938

Registered June 24, 2008

SERVICE MARK  
PRINCIPAL REGISTER



BLUSE-WARD, TRACIE (UNITED STATES INDIVIDUAL)  
ONE WINDY HILL COURT  
SUNFISH LAKE, MN 55077

FOR: PERSONAL LIFESTYLE CONSULTING SERVICES, IN CLASS 45 (U.S. CLS. 100 AND 101).

FIRST USE 11-1-2006; IN COMMERCE 1-1-2007.

THE COLOR(S) BLUE-GREEN, LIGHT GREY AND DARK GREY IS/ARE CLAIMED AS A FEATURE OF THE MARK.

THE MARK CONSISTS OF THE WORDING "CELEBRATIONS OF LIFE" WITH THE WORDING "PAST, PRESENT AND FUTURE" APPEARING BENEATH IT AND A HIGHLY STYLIZED DESIGN OF A JUMPING PERSON APPEARING ABOVE AND TO THE RIGHT OF THE WORD "LIFE". THE WORDS "CELEBRATION" AND "LIFE" ARE DARK GREY. THE WORD "OF" AND THE DESIGN ELEMENTS ARE BLUE-GREEN. THE WORDING "PAST, PRESENT AND FUTURE" IS LIGHT GREY.

SER. NO. 77-083,794, FILED 1-16-2007.

WENDY GOODMAN, EXAMINING ATTORNEY



**Int. Cl.: 35**

**Prior U.S. Cls.: 100, 101 and 102**

**United States Patent and Trademark Office**

**Reg. No. 3,451,939**

**Registered June 24, 2008**

**SERVICE MARK  
PRINCIPAL REGISTER**

**REELTAG**

FIREANTS PRODUCTION, INC. (NEW YORK  
CORPORATION)  
2ND FLOOR  
419 LAFAYETTE ST.  
NEW YORK, NY 10003

FOR: PRODUCTION OF VIDEOS FOR OTHERS,  
NAMELY, PRODUCTION OF MARKETING VI-  
DEOS AND VIDEO RESUMES, IN CLASS 35 (U.S.  
CLS. 100, 101 AND 102).

FIRST USE 6-14-2006; IN COMMERCE 6-14-2006.

THE MARK CONSISTS OF STANDARD CHAR-  
ACTERS WITHOUT CLAIM TO ANY PARTICULAR  
FONT, STYLE, SIZE, OR COLOR.

SER. NO. 77-083,814, FILED 1-16-2007.

WENDY GOODMAN, EXAMINING ATTORNEY

**Int. Cl.: 41**

**Prior U.S. Cls.: 100, 101 and 107**

**United States Patent and Trademark Office**

**Reg. No. 3,451,940**

**Registered June 24, 2008**

**SERVICE MARK  
PRINCIPAL REGISTER**

# Montana Rader

MONTANA RADER, LTD. (NEW YORK CORPORATION)  
417 EAST 57TH STREET  
NEW YORK, NY 10022

FOR: RENTAL OF VARIOUS PROPS FOR USE IN COMMERCIALS, ADVERTISEMENTS AND CATALOGUES, SUCH AS: MEN'S AND WOMEN'S COSTUMES AND DRESSES; MEN'S AND WOMEN'S SHOES PUMPS, LOAFERS, BOOTS, SANDALS AND OTHER FOOTWEAR; JEWELRY INCLUDING EARRINGS, NECKLACES, BRACELETS, RINGS AND WATCHES, IN CLASS 41 (U.S. CLS. 100, 101 AND 107).

FIRST USE 1-1-1995; IN COMMERCE 1-1-1995.

THE MARK CONSISTS OF STANDARD CHARACTERS WITHOUT CLAIM TO ANY PARTICULAR FONT, STYLE, SIZE, OR COLOR.

THE NAME "MONTANA RADER" IDENTIFIES A LIVING INDIVIDUAL WHOSE CONSENT IS OF RECORD.

SER. NO. 77-084,101, FILED 1-16-2007.

BRIAN NEVILLE, EXAMINING ATTORNEY

**Int. Cl.: 42**

**Prior U.S. Cls.: 100 and 101**

**United States Patent and Trademark Office**

**Reg. No. 3,451,941**

**Registered June 24, 2008**

**SERVICE MARK  
PRINCIPAL REGISTER**

**BETTER EDUCATIONAL  
DECISIONS START WITH  
BETTER INFORMATION**

VERSIFIT TECHNOLOGIES, LLC (WISCONSIN  
LTD LIAB CO)  
P.O. BOX 1012  
APPLETON, WI 549141012

FOR: DESIGN, DEVELOPMENT AND CUSTOMI-  
ZATION OF COMPUTER SOFTWARE AND SYS-  
TEMS, REMOTE AND ON-SITE SUPPORT,  
NAMELY, TROUBLESHOOTING AND CORREC-  
TION OF COMPUTER HARDWARE AND SOFT-  
WARE PROBLEMS, QUALITY ASSURANCE  
TESTING IN THE FIELD OF COMPUTER HARD-  
WARE AND SOFTWARE, COMPUTER PROJECT  
MANAGEMENT, DATA MIGRATION, SYSTEM  
ADMINISTRATION, NAMELY, MONITORING OF

NETWORK SYSTEMS, MULTI-SYSTEM INTEGRA-  
TION OF COMPUTER SYSTEMS AND NETWORKS,  
IN CLASS 42 (U.S. CLS. 100 AND 101).

FIRST USE 9-4-2006; IN COMMERCE 9-4-2006.

THE MARK CONSISTS OF STANDARD CHAR-  
ACTERS WITHOUT CLAIM TO ANY PARTICULAR  
FONT, STYLE, SIZE, OR COLOR.

SER. NO. 77-085,436, FILED 1-18-2007.

MICHAEL WIENER, EXAMINING ATTORNEY

**Int. Cls.: 3, 7 and 21**

**Prior U.S. Cls.: 1, 2, 4, 6, 13, 19, 21, 23, 29, 30, 31, 33,  
34, 35, 40, 50, 51 and 52**

**Reg. No. 3,451,942**

**United States Patent and Trademark Office**

**Registered June 24, 2008**

**TRADEMARK  
PRINCIPAL REGISTER**

**MARINE SHIELD**

RAYMARINE HOLDINGS LIMITED (UNITED  
KINGDOM CORPORATION)  
QUAY POINT, NORTHARBOUR ROAD  
PORTSMOUTH, UNITED KINGDOM PO63TD

FOR: ALL-PURPOSE CLEANING, POLISHING  
AND SCOURING PREPARATIONS FOR USE ON  
MARINE VESSELS, IN CLASS 3 (U.S. CLS. 1, 4, 6, 50,  
51 AND 52).

FOR: POLISHING BONNETS FOR MACHINES  
AND CONNECTORS, AND EXTENSIONS FOR THE  
AFORESAID GOODS FOR USE IN THE MARINE,  
YACHTING AND BOATING MARKETS, IN CLASS 7  
(U.S. CLS. 13, 19, 21, 23, 31, 34 AND 35).

FOR: CLEANING PADS AND CLOTHS; POLISH-  
ING PADS AND CLOTHS; CHAMOIS LEATHER,  
CHAMOIS PADS, AND CHAMOIS SPONGE MITTS  
ALL FOR CLEANING; CLEANING SPONGES; POL-  
ISHING BONNETS, NAMELY CLOTHS FOR POL-  
ISHING AND BUFFING MARINE VEHICLES BY  
HAND; DUSTERS; DUSTING BRUSHES, FLOOR  
BRUSHES, SCRAPING BRUSHES, SCRUBBING  
BRUSHES, WASHING BRUSHES AND SHIP SCRUB-  
BING BRUSHES AND CONNECTORS AND EXTEN-  
SIONS FOR ALL THE AFORESAID GOODS;

DISPENSER APPARATUS AND INSTRUMENTS,  
ALL FOR DISPENSING CLEANING AND WASH-  
ING PREPARATIONS; HOUSEHOLD GLOVES FOR  
CLEANING PURPOSES; DUSTBINS, DUSTPANS;  
ALL THE AFORESAID PRODUCTS FOR USE IN  
THE MARINE, YACHTING AND BOATING MAR-  
KETS, IN CLASS 21 (U.S. CLS. 2, 13, 23, 29, 30, 33, 40  
AND 50).

THE MARK CONSISTS OF STANDARD CHAR-  
ACTERS WITHOUT CLAIM TO ANY PARTICULAR  
FONT, STYLE, SIZE, OR COLOR.

PRIORITY CLAIMED UNDER SEC. 44(D) ON  
ERPN CMNTY TM OFC APPLICATION NO.  
005624523, FILED 1-18-2007, REG. NO. 005624523,  
DATED 12-11-2007, EXPIRES 1-18-2017.

NO CLAIM IS MADE TO THE EXCLUSIVE  
RIGHT TO USE "MARINE", APART FROM THE  
MARK AS SHOWN.

SER. NO. 77-085,999, FILED 1-18-2007.

ALYSSA PALADINO, EXAMINING ATTORNEY

**Int. Cl.: 20**

**Prior U.S. Cls.: 2, 13, 22, 25, 32 and 50**

**Reg. No. 3,451,943**

**United States Patent and Trademark Office**

**Registered June 24, 2008**

---

**TRADEMARK  
PRINCIPAL REGISTER**

*Bella*

LEGACY WINDOW COVERINGS, LLC (ARIZONA LTD LIAB CO)  
1620 WEST SUNRISE BLVD. #102  
GILBERT, AZ 85233

THE FOREIGN WORDING IN THE MARK  
TRANSLATES INTO ENGLISH AS BEAUTIFUL.

FOR: INTERIOR WINDOW COVERINGS, NAME-  
LY WOODEN WINDOW BLINDS, IN CLASS 20 (U.S.  
CLS. 2, 13, 22, 25, 32 AND 50).

SER. NO. 77-086,843, FILED 1-19-2007.

FIRST USE 5-5-2005; IN COMMERCE 5-5-2005.

NAPOLEON SHARMA, EXAMINING ATTORNEY

**Int. Cl.: 9**

**Prior U.S. Cls.: 21, 23, 26, 36 and 38**

**Reg. No. 3,451,944**

**United States Patent and Trademark Office**

**Registered June 24, 2008**

---

**TRADEMARK  
PRINCIPAL REGISTER**

# Mobilstar

COMPAMERICA (NEW JERSEY CORPORATION)  
6 COMMERCE DR, STE 2000  
CRANFORD, NJ 07016

THE MARK CONSISTS OF STANDARD CHAR-  
ACTERS WITHOUT CLAIM TO ANY PARTICULAR  
FONT, STYLE, SIZE, OR COLOR.

FOR: LAPTOP COMPUTERS AND NOTEBOOK  
COMPUTERS., IN CLASS 9 (U.S. CLS. 21, 23, 26, 36  
AND 38).

SER. NO. 77-087,310, FILED 1-20-2007.

FIRST USE 1-1-1986; IN COMMERCE 1-1-1992.

SIMON TENG, EXAMINING ATTORNEY

**Int. Cl.: 16**

**Prior U.S. Cls.: 2, 5, 22, 23, 29, 37, 38 and 50**

**United States Patent and Trademark Office**

**Reg. No. 3,451,945**

**Registered June 24, 2008**

**TRADEMARK  
PRINCIPAL REGISTER**

**pop packaging**

P.O.P. PACKAGING INC. (CANADA CORPORATION)  
1618 BLACKMORE COURT S.W.  
EDMONTON, CANADA T6W1J2

FOR: GENERAL PURPOSE PLASTIC BAGS; GROCERY BAGS; PLASTIC SHOPPING BAGS, IN CLASS 16 (U.S. CLS. 2, 5, 22, 23, 29, 37, 38 AND 50).

THE MARK CONSISTS OF STANDARD CHARACTERS WITHOUT CLAIM TO ANY PARTICULAR FONT, STYLE, SIZE, OR COLOR.

OWNER OF CANADA REG. NO. TMA649,043,  
DATED 9-27-2005, EXPIRES 9-27-2020.

NO CLAIM IS MADE TO THE EXCLUSIVE RIGHT TO USE "PACKAGING", APART FROM THE MARK AS SHOWN.

SER. NO. 77-089,372, FILED 1-23-2007.

KATHERINE CONNOLLY, EXAMINING ATTORNEY

**Int. Cl.: 28**

**Prior U.S. Cls.: 22, 23, 38 and 50**

**Reg. No. 3,451,946**

**United States Patent and Trademark Office**

**Registered June 24, 2008**

**TRADEMARK  
PRINCIPAL REGISTER**

**PURE FITNESS**

JAMZ FITNESS, INC. (FLORIDA CORPORATION)  
SUITE 12  
2257 VISTA PARKWAY  
WEST PALM BEACH, FL 33467

FOR: EXERCISE AND FITNESS EQUIPMENT, NAMELY, MANUALLY-OPERATED EXERCISE EQUIPMENT; EXERCISE MACHINES; GYMNASIUM-TYPE BODYBUILDING EXERCISE EQUIPMENT, NAMELY, WEIGHT LIFTING MACHINES, STATIONARY EXERCISE BIKES, EXERCISE BENCHES, WEIGHT LIFTING BENCHES AND BENCH ACCESSORIES, DUMB-BELL SETS; WEIGHTED EXERCISE BALLS, WEIGHT PLATES, BARBELLS, DUMB-BELLS, DUMB-BELL SHAFTS, IN CLASS 28 (U.S. CLS. 22, 23, 38 AND 50).

FIRST USE 1-5-2006; IN COMMERCE 3-1-2006.

THE MARK CONSISTS OF STANDARD CHARACTERS WITHOUT CLAIM TO ANY PARTICULAR FONT, STYLE, SIZE, OR COLOR.

NO CLAIM IS MADE TO THE EXCLUSIVE RIGHT TO USE "FITNESS", APART FROM THE MARK AS SHOWN.

SER. NO. 77-089,619, FILED 1-24-2007.

DAVID I, EXAMINING ATTORNEY



Int. Cl.: 19

Prior U.S. Cls.: 1, 12, 33 and 50

United States Patent and Trademark Office

Reg. No. 3,451,947

Registered June 24, 2008

TRADEMARK  
PRINCIPAL REGISTER



HERO FABRIDUCT INC (TENNESSEE CORPORATION)  
5344 RINGGOLD ROAD  
CHATTANOOGA, TN 37412

FOR: FABRIC DUCT WORK TO MOVE EITHER HEATED OR COOLED AIR IN A VENTILATION CAPACITY, IN CLASS 19 (U.S. CLS. 1, 12, 33 AND 50).

FIRST USE 11-1-1999; IN COMMERCE 11-1-1999.

THE COLOR(S) LIGHT PURPLE, DARK PURPLE, WHITE, AND BLUE IS/ARE CLAIMED AS A FEATURE OF THE MARK.

THE MARK CONSISTS OF THE WORD "HERO" IN BLUE, WITH THE WORDING "FABRIDUCT" IN DARK PURPLE AND WHITE IN THE CENTER, AND THE TERMS "SIMPLICITY QUALITY EFFICIENCY" IN DARK PURPLE. THE CIRCULAR BACKGROUND IS IN LIGHT PURPLE.

SER. NO. 77-090,098, FILED 1-24-2007.

PETER B. BROMAGHIM, EXAMINING ATTORNEY

**Int. Cl.: 25**

**Prior U.S. Cls.: 22 and 39**

**United States Patent and Trademark Office**

**Reg. No. 3,451,948**

**Registered June 24, 2008**

**TRADEMARK  
PRINCIPAL REGISTER**

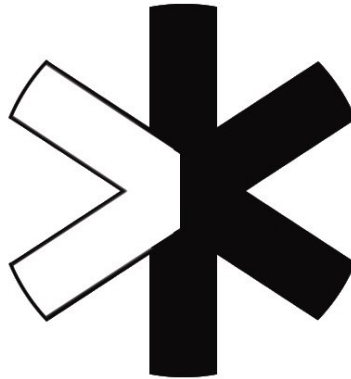

ARIZONA LAND SANCTUARY, LLC (ARIZONA  
LTD LIAB CO)  
7235 E. OVERLOOK DRIVE  
SCOTTSDALE, AZ 85255

THE MARK CONSISTS OF A HORIZONTAL X  
OVER A VERTICAL LINE; APPEARANCE IS A SIX  
POINTED STAR SHAPE.

FOR: CLOTHING, NAMELY, HATS, T-SHIRTS,  
SWEATSHIRTS, JACKETS, PANTS AND SPORTS  
BRAS, IN CLASS 25 (U.S. CLS. 22 AND 39).

SER. NO. 77-090,236, FILED 1-24-2007.

FIRST USE 12-3-2006; IN COMMERCE 12-3-2006.

SUNG IN, EXAMINING ATTORNEY

**Int. Cls.: 7 and 17**

**Prior U.S. Cls.: 1, 5, 12, 13, 19, 21, 23, 31, 34, 35 and 50**

**Reg. No. 3,451,949**

**United States Patent and Trademark Office**

**Registered June 24, 2008**

**TRADEMARK  
PRINCIPAL REGISTER**

**VULCO**

VULCO S.A. (CHILE CORPORATION)  
SAN JOSE 0815  
SAN BERNARDO, CHILE

FOR: MECHANICAL CONVEYOR BELTS AND MACHINE COUPLINGS THEREFOR; MACHINE BRAKE LININGS; AUTOMATIC NONMETALLIC LOOMS, IN CLASS 7 (U.S. CLS. 13, 19, 21, 23, 31, 34 AND 35).

FOR: RUBBER PRODUCTS, NAMELY, RUBBER ISOLATION BLOCKS, SEISMIC PADS, BUILDING MOUNTING PADS, EARTHQUAKE SHOCK ABSORBERS, MACHINE ISOLATION PADS, VIBRATION ABSORBING MOUNTING PADS, FOR INDUSTRIAL MACHINERY; RUBBER PLATES, SHEETS, STRIPS, STRINGS, PIPES, FLANGES, GASKETS AND SEALS FOR USE IN MINING, IN CLASS 17 (U.S. CLS. 1, 5, 12, 13, 35 AND 50).

THE MARK CONSISTS OF STANDARD CHARACTERS WITHOUT CLAIM TO ANY PARTICULAR FONT, STYLE, SIZE, OR COLOR.

OWNER OF CHILE REG. NO. 548.385, DATED 9-21-1999, EXPIRES 9-21-2009.

OWNER OF CHILE REG. NO. 548.384, DATED 9-21-1999, EXPIRES 9-21-2009.

THE WORDING VULCO HAS NO MEANING IN A FOREIGN LANGUAGE.

SER. NO. 77-090,982, FILED 1-25-2007.

LAURA KOVALSKY, EXAMINING ATTORNEY

Int. Cl.: 14

Prior U.S. Cls.: 2, 27, 28 and 50

United States Patent and Trademark Office

Reg. No. 3,451,950

Registered June 24, 2008

TRADEMARK  
PRINCIPAL REGISTER

*LACLOCHE FRÈRES*  
1875

LACLOCHE FRERES (FLORIDA LTD LIAB CO)  
1627 RIVERSIDE AVE.  
JACKSONVILLE, FL 32204

FOR: JEWELRY AND WATCHES, NAMELY, RINGS, BANDS, BRACELETS, NECKLACES, EARRINGS, PINS, BROACHES, PENDANTS, CHAINS, CUFFLINKS, WATCHES, WATCH BANDS, CLOCKS, BUCKLES OF PRECIOUS METALS FOR WATCHES, DIAMONDS AND PRECIOUS AND SEMI PRECIOUS GEMSTONES, BOXES OF PRECIOUS METALS, IN CLASS 14 (U.S. CLS. 2, 27, 28 AND 50).

FIRST USE 6-0-2006; IN COMMERCE 6-0-2006.

NO CLAIM IS MADE TO THE EXCLUSIVE RIGHT TO USE "FRÈRES" AND "1875", APART FROM THE MARK AS SHOWN.

THE ENGLISH TRANSLATION OF THE WORD FRÈRES IN THE MARK IS BROTHERS.

SER. NO. 77-091,140, FILED 1-25-2007.

ELI HELLMAN, EXAMINING ATTORNEY

**Int. Cls.: 35 and 41**

**Prior U.S. Cls.: 100, 101, 102 and 107**

**United States Patent and Trademark Office**

**Reg. No. 3,451,951**

**Registered June 24, 2008**

**SERVICE MARK  
PRINCIPAL REGISTER**

**ART CHICAGO**

MERCHANDISE MART PROPERTIES, INC. (DE-  
LAWARE CORPORATION)  
222 MERCHANDISE MART PLAZA  
SUITE 470  
CHICAGO, IL 60654

FOR: ORGANIZING AND CONDUCTING EXHI-  
BITIONS FOR ECONOMIC AND ADVERTISING  
PURPOSES IN THE FIELD OF ART, IN CLASS 35  
(U.S. CLS. 100, 101 AND 102).

FIRST USE 9-15-1993; IN COMMERCE 9-15-1993.

FOR: ORGANIZING AND CONDUCTING ART  
EXHIBITIONS, IN CLASS 41 (U.S. CLS. 100, 101 AND  
107).

FIRST USE 9-15-1993; IN COMMERCE 9-15-1993.

THE MARK CONSISTS OF STANDARD CHAR-  
ACTERS WITHOUT CLAIM TO ANY PARTICULAR  
FONT, STYLE, SIZE, OR COLOR.

SEC. 2(F).

SER. NO. 77-092,072, FILED 1-26-2007.

DAVID I, EXAMINING ATTORNEY

**Int. Cls.: 2 and 42**

**Prior U.S. Cls.: 6, 11, 16, 100 and 101**

**United States Patent and Trademark Office**

**Reg. No. 3,451,952**

**Registered June 24, 2008**

**TRADEMARK  
SERVICE MARK  
PRINCIPAL REGISTER**

**DONALD KAUFMAN COLOR**

KAUFMAN, DAHL, INC. (NEW YORK CORPORATION)  
336 WEST 37TH STREET  
NEW YORK, NY 10018

FOR: CUSTOM BLENDED INTERIOR PAINT, IN CLASS 2 (U.S. CLS. 6, 11 AND 16).

FIRST USE 1-1-1991; IN COMMERCE 1-1-1991.

FOR: DESIGNING CUSTOM ARCHITECTURAL PAINT COLOR, IN CLASS 42 (U.S. CLS. 100 AND 101).

FIRST USE 1-1-1987; IN COMMERCE 1-1-1987.

THE MARK CONSISTS OF STANDARD CHARACTERS WITHOUT CLAIM TO ANY PARTICULAR FONT, STYLE, SIZE, OR COLOR.

NO CLAIM IS MADE TO THE EXCLUSIVE RIGHT TO USE "COLOR", APART FROM THE MARK AS SHOWN.

THE NAME(S), PORTRAIT(S), AND/OR SIGNATURE(S) SHOWN IN THE MARK IDENTIFIES DONALD KAUFMAN, WHOSE CONSENT(S) TO REGISTER IS MADE OF RECORD.

SER. NO. 77-092,187, FILED 1-26-2007.

JULIE WATSON, EXAMINING ATTORNEY

**Int. Cl.: 28**

**Prior U.S. Cls.: 22, 23, 38 and 50**

**United States Patent and Trademark Office**

**Reg. No. 3,451,953**

**Registered June 24, 2008**

**TRADEMARK  
PRINCIPAL REGISTER**

**NURAY**

SCHLEICH GMBH (FED REP GERMANY GMBH)  
AM LIMES 69  
SCHWABISCH GMUND, FED REP GERMANY  
73527

FOR: TOYS, NAMELY, PLASTIC FIGURINES,  
PLASTIC ANIMALS AND FLEXIBLE FIGURINES,  
IN CLASS 28 (U.S. CLS. 22, 23, 38 AND 50).

THE MARK CONSISTS OF STANDARD CHAR-  
ACTERS WITHOUT CLAIM TO ANY PARTICULAR  
FONT, STYLE, SIZE, OR COLOR.

PRIORITY CLAIMED UNDER SEC. 44(D) ON  
ERPNTY TM OFC APPLICATION NO.  
005615257, FILED 1-15-2007, REG. NO. 005615257,  
DATED 11-14-2007, EXPIRES 1-15-2017.

SER. NO. 77-093,567, FILED 1-29-2007.

DAVID H. STINE, EXAMINING ATTORNEY

**Int. Cl.: 28**

**Prior U.S. Cls.: 22, 23, 38 and 50**

**United States Patent and Trademark Office**

**Reg. No. 3,451,954**

**Registered June 24, 2008**

**TRADEMARK  
PRINCIPAL REGISTER**

**SURAH**

SCHLEICH GMBH (FED REP GERMANY GMBH)  
AM LIMES 69  
SCHWABISCH GMUND, FED REP GERMANY  
73527

FOR: TOYS, NAMELY, PLASTIC FIGURINES,  
PLASTIC ANIMALS AND FLEXIBLE FIGURINES,  
IN CLASS 28 (U.S. CLS. 22, 23, 38 AND 50).

THE MARK CONSISTS OF STANDARD CHAR-  
ACTERS WITHOUT CLAIM TO ANY PARTICULAR  
FONT, STYLE, SIZE, OR COLOR.

PRIORITY CLAIMED UNDER SEC. 44(D) ON  
ERPNTY TM OFC APPLICATION NO.  
005615216, FILED 1-15-2007, REG. NO. 005615216,  
DATED 11-14-2007, EXPIRES 1-15-2017.

SER. NO. 77-093,581, FILED 1-29-2007.

DAVID H. STINE, EXAMINING ATTORNEY



**Int. Cl.: 28**

**Prior U.S. Cls.: 22, 23, 38 and 50**

**United States Patent and Trademark Office**

**Reg. No. 3,451,955**

**Registered June 24, 2008**

**TRADEMARK  
PRINCIPAL REGISTER**

**TURAG**

SCHLEICH GMBH (FED REP GERMANY GMBH)  
AM LIMES 69  
SCHWABISCH GMUND, FED REP GERMANY  
73527

FOR: TOYS, NAMELY, PLASTIC FIGURINES,  
PLASTIC ANIMALS AND FLEXIBLE FIGURINES,  
IN CLASS 28 (U.S. CLS. 22, 23, 38 AND 50).

THE MARK CONSISTS OF STANDARD CHAR-  
ACTERS WITHOUT CLAIM TO ANY PARTICULAR  
FONT, STYLE, SIZE, OR COLOR.

PRIORITY CLAIMED UNDER SEC. 44(D) ON  
ERPNTY TM OFC APPLICATION NO.  
005615191, FILED 1-15-2007, REG. NO. 005615191,  
DATED 11-26-2007, EXPIRES 1-15-2017.

SER. NO. 77-093,594, FILED 1-29-2007.

DAVID H. STINE, EXAMINING ATTORNEY

**Int. Cl.: 28**

**Prior U.S. Cls.: 22, 23, 38 and 50**

**United States Patent and Trademark Office**

**Reg. No. 3,451,956**

**Registered June 24, 2008**

**TRADEMARK  
PRINCIPAL REGISTER**

**FALAROY**

SCHLEICH GMBH (FED REP GERMANY GMBH)  
AM LIMES 69  
SCHWABISCH GMUND, FED REP GERMANY  
73527

FOR: TOYS, NAMELY, PLASTIC FIGURINES,  
PLASTIC ANIMALS AND FLEXIBLE FIGURINES,  
IN CLASS 28 (U.S. CLS. 22, 23, 38 AND 50).

THE MARK CONSISTS OF STANDARD CHAR-  
ACTERS WITHOUT CLAIM TO ANY PARTICULAR  
FONT, STYLE, SIZE, OR COLOR.

PRIORITY CLAIMED UNDER SEC. 44(D) ON  
ERPNTY TM OFC APPLICATION NO.  
005614797, FILED 1-15-2007, REG. NO. 005614797,  
DATED 11-14-2007, EXPIRES 1-15-2017.

SER. NO. 77-093,613, FILED 1-29-2007.

DAVID H. STINE, EXAMINING ATTORNEY

**Int. Cl.: 28**

**Prior U.S. Cls.: 22, 23, 38 and 50**

**United States Patent and Trademark Office**

**Reg. No. 3,451,957**

**Registered June 24, 2008**

**TRADEMARK  
PRINCIPAL REGISTER**

**FEYA**

SCHLEICH GMBH (FED REP GERMANY GMBH)  
AM LIMES 69  
SCHWABISCH GMUND, FED REP GERMANY  
73527

FOR: TOYS, NAMELY, PLASTIC FIGURINES,  
PLASTIC ANIMALS AND FLEXIBLE FIGURINES,  
IN CLASS 28 (U.S. CLS. 22, 23, 38 AND 50).

THE MARK CONSISTS OF STANDARD CHAR-  
ACTERS WITHOUT CLAIM TO ANY PARTICULAR  
FONT, STYLE, SIZE, OR COLOR.

PRIORITY CLAIMED UNDER SEC. 44(D) ON  
ERPNTY TM OFC APPLICATION NO.  
005614763, FILED 1-15-2007, REG. NO. 005614763,  
DATED 11-15-2007, EXPIRES 1-15-2017.

SER. NO. 77-093,641, FILED 1-29-2007.

DAVID H. STINE, EXAMINING ATTORNEY

**Int. Cl.: 41**

**Prior U.S. Cls.: 100, 101 and 107**

**Reg. No. 3,451,958**

**United States Patent and Trademark Office**

**Registered June 24, 2008**

**SERVICE MARK  
PRINCIPAL REGISTER**



NATIONAL HOCKEY LEAGUE (CANADA UN-  
INCORPORATED NOT-FOR-PROFIT ASSO-  
CIATION)  
1185 AVENUE OF THE AMERICAS  
NEW YORK, NY 10036

FOR: ENTERTAINMENT SERVICES, NAMELY,  
ICE HOCKEY EXHIBITIONS, IN CLASS 41 (U.S. CLS.  
100, 101 AND 107).

FIRST USE 1-0-2006; IN COMMERCE 1-0-2006.

OWNER OF U.S. REG. NOS. 883,569, 1,911,854 AND  
OTHERS.

NO CLAIM IS MADE TO THE EXCLUSIVE  
RIGHT TO USE "WESTERN CONFERENCE",  
APART FROM THE MARK AS SHOWN.

SER. NO. 77-093,911, FILED 1-29-2007.

HEATHER BIDDULPH, EXAMINING ATTORNEY

**Int. Cl.: 41**

**Prior U.S. Cls.: 100, 101 and 107**

**United States Patent and Trademark Office**

**Reg. No. 3,451,959**

**Registered June 24, 2008**

**SERVICE MARK  
PRINCIPAL REGISTER**



NATIONAL HOCKEY LEAGUE (CANADA UN-  
INCORPORATED NOT-FOR-PROFIT ASSO-  
CIATION)  
1185 AVENUE OF THE AMERICAS  
NEW YORK, NY 10036

FOR: ENTERTAINMENT SERVICES, NAMELY,  
ICE HOCKEY EXHIBITIONS, IN CLASS 41 (U.S. CLS.  
100, 101 AND 107).

FIRST USE 1-0-2006; IN COMMERCE 1-0-2006.

OWNER OF U.S. REG. NOS. 883,569, 1,991,855 AND  
OTHERS.

NO CLAIM IS MADE TO THE EXCLUSIVE  
RIGHT TO USE "EASTERN CONFERENCE",  
APART FROM THE MARK AS SHOWN.

SER. NO. 77-093,925, FILED 1-29-2007.

HEATHER BIDDULPH, EXAMINING ATTORNEY

**Int. Cls.: 16 and 35**

**Prior U.S. Cls.: 2, 5, 22, 23, 29, 37, 38, 50, 100, 101 and 102**

**Reg. No. 3,451,960**

**United States Patent and Trademark Office**

**Registered June 24, 2008**

**TRADEMARK  
SERVICE MARK  
PRINCIPAL REGISTER**

**SIMPLY INDOORS**

SEARS BRANDS, LLC (ILLINOIS LTD LIAB CO)  
3333 BEVERLY ROAD  
HOFFMAN ESTATES, IL 60179

FOR: CATALOGS IN THE FIELD OF DINNERWARE, GLASSWARE, FLATWARE, SERVERWARE, TABLE LINENS, KITCHEN LINENS, PICTURE FRAMES, CANDLES, DECORATIVE COLLECTIONS, PRE-MADE FLORAL/TREES, WALL ART, MIRRORS, LIGHTING, CONTAINERS/VASES, CLOCKS, COOKWARE, BAKEWARE, GADGETS, PANTRYWARE, CUTLERY, READY-TO-ASSEMBLE FURNITURE, MATTRESSES, LUGGAGE, SHEETS, COMFORTERS, PILLOWCASES, BLANKETS, PILLOWS, FEATHERBEDS, CURTAINS AND DRAPERIES, WINDOW HARDWARE, SLIPCOVERS, DECORATIVE PILLOWS, RUGS, TOWELS, BATH RUGS, BATH ACCESSORIES, THROWS, BEACH TOWELS AND VARIOUS STORAGE CONTAINERS, IN CLASS 16 (U.S. CLS. 2, 5, 22, 23, 29, 37, 38 AND 50).

FIRST USE 9-0-2006; IN COMMERCE 9-0-2006.

FOR: ELECTRONIC CATALOG SERVICES FEATURING DINNERWARE, GLASSWARE, FLATWARE, SERVERWARE, TABLE LINENS, KITCHEN

LINENS, PICTURE FRAMES, CANDLES, DECORATIVE COLLECTIONS, PRE-MADE FLORAL/TREES, WALL ART, MIRRORS, LIGHTING, CONTAINERS/VASES, CLOCKS, COOKWARE, BAKEWARE, GADGETS, PANTRYWARE, CUTLERY, READY-TO-ASSEMBLE FURNITURE, MATTRESSES, LUGGAGE, SHEETS, COMFORTERS, PILLOWCASES, BLANKETS, PILLOWS, FEATHERBEDS, CURTAINS AND DRAPERIES, WINDOW HARDWARE, SLIPCOVERS, DECORATIVE PILLOWS, RUGS, TOWELS, BATH RUGS, BATH ACCESSORIES, THROWS, BEACH TOWELS AND VARIOUS STORAGE CONTAINERS, IN CLASS 35 (U.S. CLS. 100, 101 AND 102).

FIRST USE 9-0-2006; IN COMMERCE 9-0-2006.

THE MARK CONSISTS OF STANDARD CHARACTERS WITHOUT CLAIM TO ANY PARTICULAR FONT, STYLE, SIZE, OR COLOR.

OWNER OF U.S. REG. NO. 3,123,600.

SER. NO. 77-093,929, FILED 1-29-2007.

AMY HELLA, EXAMINING ATTORNEY

**Int. Cls.: 3 and 44**

**Prior U.S. Cls.: 1, 4, 6, 50, 51, 52, 100 and 101**

**United States Patent and Trademark Office**

**Reg. No. 3,451,961**

**Registered June 24, 2008**

**TRADEMARK  
SERVICE MARK  
PRINCIPAL REGISTER**

# SKINTOLOGY

YEVGENY FREYLIKHMAN (UNITED STATES  
INDIVIDUAL)  
4 ALLEN DRIVE  
WOODCLIFF LAKE, NJ 07677

FOR: NON-MEDICATED SKIN CARE PREPARATIONS; COSMETICS; NAIL CARE PREPARATIONS; AND NON-MEDICATED SKIN CARE PRODUCTS, NAMELY, SKIN CREAMS, SKIN LOTIONS, SKIN GELS, SKIN TONERS, SKIN CLEANERS, SKIN PEELS, IN CLASS 3 (U.S. CLS. 1, 4, 6, 50, 51 AND 52).

FIRST USE 1-1-2004; IN COMMERCE 1-1-2004.

FOR: HEALTH SPA SERVICES, NAMELY, COSMETIC BODY CARE SERVICES; MEDICAL SERVICES, NAMELY, LASER HAIR REMOVAL SERVICES; NAIL CARE SALONS; HOMEOPATHIC MEDICAL SERVICES FEATURING SKIN TREATMENT, NAMELY, THE INJECTION OF DERMAL

FILLERS TO REDUCE THE APPEARANCE OF FACIAL FINE LINES; HEALTH SPA SERVICES FOR HEALTH AND WELLNESS OF THE BODY AND SPIRIT OFFERED AT A HEALTH RESORT; HEALTH SPA SERVICES FOR HEALTH AND WELLNESS OF THE MIND, BODY AND SPIRIT OFFERED IN OR FROM A REMOTE, MOBILE OR TEMPORARY ON-SITE LOCATION, IN CLASS 44 (U.S. CLS. 100 AND 101).

FIRST USE 1-1-2004; IN COMMERCE 1-1-2004.

THE MARK CONSISTS OF STANDARD CHARACTERS WITHOUT CLAIM TO ANY PARTICULAR FONT, STYLE, SIZE, OR COLOR.

SER. NO. 77-094,662, FILED 1-30-2007.

BARBARA A. GOLD, EXAMINING ATTORNEY

**Int. Cls.: 9 and 41**

**Prior U.S. Cls.: 21, 23, 26, 36, 38, 100, 101 and 107**

**United States Patent and Trademark Office**

**Reg. No. 3,451,962**

**Registered June 24, 2008**

**TRADEMARK  
SERVICE MARK  
PRINCIPAL REGISTER**

**oto**

HIBINO, KIKUHIKO (JAPAN INDIVIDUAL)  
APT. 1008-S  
1400 E. 55TH PLACE  
CHICAGO, IL 60637

FOR: AUDIO RECORDINGS FEATURING MUSIC; DOWNLOADABLE MP3 FILES, MP3 RECORDINGS, ONLINE DISCUSSION BOARDS, WEB CASTS, POD CASTS FEATURING MUSIC, AUDIO BOOKS AND NEWS BROADCASTS; DOWNLOADABLE MUSICAL SOUND RECORDINGS; DOWNLOADABLE RING TONES, GRAPHICS AND MUSIC VIA A GLOBAL COMPUTER NETWORK AND WIRELESS DEVICES; DOWNLOADABLE VIDEO RECORDINGS FEATURING MUSIC; MUSICAL SOUND RECORDINGS; MUSICAL VIDEO RECORDINGS; SOUND RECORDINGS FEATURING MUSIC; VIDEO RECORDINGS FEATURING MUSIC; VISUAL RECORDINGS AND AUDIO VISUAL RECORDINGS FEATURING MUSIC AND ANIMATION, IN CLASS 9 (U.S. CLS. 21, 23, 26, 36 AND 38).

FIRST USE 3-0-2002; IN COMMERCE 1-5-2007.

FOR: COMPOSITION OF MUSIC FOR OTHERS; ENTERTAINMENT IN THE NATURE OF VISUAL AND AUDIO PERFORMANCES, AND MUSICAL, VARIETY, NEWS AND COMEDY SHOWS; ENTERTAINMENT IN THE NATURE OF VISUAL AND AUDIO PERFORMANCES, NAMELY, MUSICAL BAND, ROCK GROUP, GYMNASTIC, DANCE, AND BALLET PERFORMANCES; ENTERTAINMENT, NAMELY, LIVE MUSIC CONCERTS; ENTERTAINMENT IN THE NATURE OF LIVE PERFORMANCES BY A MUSICAL GROUP; ENTERTAINMENT NAMELY, LIVE PERFORMANCES BY A MUSICAL BAND; ENTERTAINMENT SERVICES, NAMELY, AN ONLINE ACTIVITY WHERE

YOU CREATE YOUR OWN MUSIC VIDEOS; ENTERTAINMENT SERVICES, NAMELY, PROVIDING A WEB SITE FEATURING MUSICAL PERFORMANCES, MUSICAL VIDEOS, RELATED FILM CLIPS, PHOTOGRAPHS, AND OTHER MULTIMEDIA MATERIALS; ENTERTAINMENT SERVICES, NAMELY, PROVIDING ON-LINE REVIEWS OF MUSIC; ENTERTAINMENT SERVICES, NAMELY, PROVIDING PRERECORDED MUSIC, INFORMATION IN THE FIELD OF MUSIC, AND COMMENTARY AND ARTICLES ABOUT MUSIC, ALL ON-LINE VIA A GLOBAL COMPUTER NETWORK; ENTERTAINMENT, NAMELY LIVE MUSIC CONCERTS; ENTERTAINMENT, NAMELY, LIVE PERFORMANCES BY MUSICAL BANDS; INSTRUCTION IN THE FIELD OF MUSIC; MUSIC COMPOSITION AND TRANSCRIPTION FOR OTHERS; MUSIC COMPOSITION FOR OTHERS; MUSIC PRODUCTION SERVICES; MUSIC PUBLISHING SERVICES; MUSIC TRANSCRIPTION FOR OTHERS; PLANNING ARRANGEMENT OF SHOWING MOVIES, SHOWS, PLAYS OR MUSICAL PERFORMANCES; PRESENTATION OF MUSICAL PERFORMANCE; PRODUCTION OF SOUND AND MUSIC VIDEO RECORDINGS; PUBLICATION OF MUSICAL TEXTS; TEACHING IN THE FIELD OF MUSIC; THEATRICAL AND MUSICAL FLOOR SHOWS PROVIDED AT DISCOTHEQUES AND NIGHT-CLUBS, IN CLASS 41 (U.S. CLS. 100, 101 AND 107).

FIRST USE 3-0-2002; IN COMMERCE 1-5-2007.

THE MARK CONSISTS OF THE LETTERS OTO.

SER. NO. 77-096,389, FILED 2-1-2007.

MORGAN WYNNE, EXAMINING ATTORNEY



**Int. Cl.: 41**

**Prior U.S. Cls.: 100, 101 and 107**

**United States Patent and Trademark Office**

**Reg. No. 3,451,963**

**Registered June 24, 2008**

**SERVICE MARK  
PRINCIPAL REGISTER**

# MOGOPOP

MOGOPOP, INC. (DELAWARE CORPORATION)  
3384 ROBERTSON PLACE  
LOS ANGELES, CA 90034

FOR: ENTERTAINMENT AND EDUCATION SERVICES, NAMELY, PROVIDING A WEB SITE FEATURING MUSIC AND COMEDY PERFORMANCES, MUSICAL VIDEOS, FILM CLIPS, MULTIMEDIA INSTRUCTIONAL MATERIALS ON THE SUBJECTS OF LANGUAGES, MUSIC, MUSICAL INSTRUMENTS, PREPARATION OF FOOD AND DRINK, AND FEATURING GENERAL ACADEMIC K-12 AND COLLEGE STUDY GUIDES FOR TEACHERS AND STUDENTS, TRAVEL AND TOURISM

GUIDES, INTERACTIVE GAMES, SPORTS INFORMATION, AND OTHER GENERAL INTEREST MULTIMEDIA MATERIALS, IN CLASS 41 (U.S. CLS. 100, 101 AND 107).

FIRST USE 12-20-2006; IN COMMERCE 12-20-2006.

THE MARK CONSISTS OF STANDARD CHARACTERS WITHOUT CLAIM TO ANY PARTICULAR FONT, STYLE, SIZE, OR COLOR.

SER. NO. 77-097,786, FILED 2-2-2007.

TAMARA FRAZIER, EXAMINING ATTORNEY

**Int. Cl.: 20**

**Prior U.S. Cls.: 2, 13, 22, 25, 32 and 50**

**Reg. No. 3,451,964**

**United States Patent and Trademark Office**

**Registered June 24, 2008**

**TRADEMARK  
PRINCIPAL REGISTER**



LANGTRY, KEN G. (CANADA INDIVIDUAL)  
8575 EAST SAANICH ROAD  
NORTH SAANICH, CANADA V8L1G9

OWNER OF CANADA REG. NO. TMA697,055,  
DATED 9-21-2007, EXPIRES 9-21-2022.

FOR: NON-METAL SWIVEL FASTENING CLIPS  
FOR USE WITH TARPULINS, CLOTHS, POLY  
SHEETING, SHRINK WRAP AND OTHER FLEX-  
IBLE SHEET MATERIALS, IN CLASS 20 (U.S. CLS. 2,  
13, 22, 25, 32 AND 50).

NO CLAIM IS MADE TO THE EXCLUSIVE  
RIGHT TO USE "SWIVEL CLIP", APART FROM  
THE MARK AS SHOWN.

SER. NO. 77-098,013, FILED 3-8-2007.

FIRST USE 8-11-2006; IN COMMERCE 8-11-2006.

MICHAEL WEBSTER, EXAMINING ATTORNEY

**Int. Cls.: 9, 37 and 42**

**Prior U.S. Cls.: 21, 23, 26, 36, 38, 100, 101, 103 and 106**

**Reg. No. 3,451,965**

**United States Patent and Trademark Office**

**Registered June 24, 2008**

**TRADEMARK  
SERVICE MARK  
PRINCIPAL REGISTER**

# DICTAPHONE

DICTAPHONE CORPORATION (DELAWARE CORPORATION)  
ONE WAYSIDE ROAD  
BURLINGTON, MA 018034613

FOR: COMPUTER HARDWARE AND SOFTWARE FOR SPEECH RECOGNITION AND FOR APPLICATIONS INCORPORATING SPEECH RECOGNITION TECHNOLOGY; SOUND RECORDING AND REPRODUCING EQUIPMENT FOR THE CREATION, CONVERSION, MANIPULATION, TRANSLATION, STORAGE, MANAGEMENT, RECOGNITION, AND/OR THE TRANSFER OF DOCUMENTS, IMAGES, TEXT, VIDEO, SOUNDS, SPEECH AND DATA; COMPUTER SOFTWARE USED FOR ACCESSING A GLOBAL COMPUTER NETWORK FOR USE IN REMOTE COMMUNICATION EXCHANGE, SPEECH RECOGNITION, AND RECORD CODING; COMPUTER SOFTWARE APPLICATIONS FOR USE IN CONNECTION WITH DICTATION AND TRANSCRIPTION MACHINES; SPEECH AND ANALYSIS SOFTWARE USED IN A COMPUTER NETWORK; DIGITAL DICTATION AND TRANSCRIPTION UNITS; DIGITAL DICTATION MACHINES; ANALOG DICTATION MACHINES; DIGITAL TRANSCRIPTION MACHINES; ANALOG TRANSCRIPTION MACHINES; TAPE RECORDERS; DIGITAL AUDIO TAPE RECORDERS; AUDIO CASSETTE RECORDERS; CARRYING CASES FOR DICTATION MACHINES; DEVICES FOR HANDS-FREE USE OF DICTATION AND TRANSCRIPTION MACHINES; MICROPHONES; HEADPHONES; BLANK AUDIOCASSETTES; BLANK MINI AUDIO CASSETTES; BLANK MICRO AUDIO CASSETTES; TELEPHONES; TELEPHONE APPARATUS; TELEPHONE HEADSETS; TELEPHONE RECORDERS; POWER SUPPLY CONNECTORS AND ADAPTORS FOR USE WITH PORTABLE ELECTRONIC DEVICES; MAGNETIC TAPE ERASERS; USB, UNIVERSAL SERIAL BUS, MULTIMEDIA CARD READERS; RECHARGEABLE BATTERIES; FLASH

MEMORY CARDS; INSTRUCTIONAL MANUALS SOLD AS A UNIT THEREWITH FOR ALL OF THE PRECEDING GOODS, IN CLASS 9 (U.S. CLS. 21, 23, 26, 36 AND 38).

FIRST USE 9-3-1907; IN COMMERCE 9-3-1907.

FOR: MAINTENANCE SERVICES FOR OTHERS IN THE FIELDS OF COMPUTER HARDWARE AND SOUND RECORDING AND REPRODUCING EQUIPMENT, IN THE NATURE OF DICTATING MACHINES, TRANSCRIBING MACHINES, TELEPHONE RECORDING MACHINES, CONFERENCE RECORDING MACHINES, INVENTORY RECORDING MACHINES, AIRPORT COMMUNICATIONS RECORDING MACHINES, AND ACCESSORIES THEREOF, NAMELY, MICROPHONES, HEADSETS, HEADPHONES, LOUDSPEAKERS, AND CONTROL MECHANISMS; REPAIR SERVICES FOR OTHERS IN THE FIELDS OF COMPUTER HARDWARE AND SOUND RECORDING AND REPRODUCING EQUIPMENT, IN THE NATURE OF DICTATING MACHINES, TRANSCRIBING MACHINES, TELEPHONE RECORDING MACHINES, CONFERENCE RECORDING MACHINES, INVENTORY RECORDING MACHINES, AIRPORT COMMUNICATIONS RECORDING MACHINES, AND ACCESSORIES THEREOF, NAMELY, MICROPHONES, HEADSETS, HEADPHONES, LOUDSPEAKERS, AND CONTROL MECHANISMS; INSTALLATION SERVICES FOR OTHERS IN THE FIELDS OF COMPUTER HARDWARE AND SOUND RECORDING AND REPRODUCING EQUIPMENT, IN THE NATURE OF DICTATING MACHINES, TRANSCRIBING MACHINES, TELEPHONE RECORDING MACHINES, CONFERENCE RECORDING MACHINES, INVENTORY RECORDING MACHINES, AIRPORT COMMUNICATIONS RECORDING MACHINES, AND ACCESSORIES THEREOF, NAMELY, MICROPHONES, HEADSETS, HEADPHONES, LOUDSPEAKERS, AND CONTROL MECHANISMS; UPDATING

FOR OTHERS OF COMPUTER HARDWARE AND SOUND RECORDING AND REPRODUCING EQUIPMENT, IN THE NATURE OF DICTATING MACHINES, TRANSCRIBING MACHINES, TELEPHONE RECORDING MACHINES, CONFERENCE RECORDING MACHINES, INVENTORY RECORDING MACHINES, AIRPORT COMMUNICATIONS RECORDING MACHINES, AND ACCESSORIES THEREOF, NAMELY, MICROPHONES, HEADSETS, HEADPHONES, LOUDSPEAKERS, AND CONTROL MECHANISMS, IN CLASS 37 (U.S. CLS. 100, 103 AND 106).

FIRST USE 12-31-1923; IN COMMERCE 12-31-1923.

FOR: MAINTENANCE SERVICES FOR OTHERS IN THE FIELD OF COMPUTER SOFTWARE; REPAIR SERVICES FOR OTHERS IN THE FIELD OF COMPUTER SOFTWARE; CONSULTING SERVICES IN THE FIELDS OF COMPUTER SOFTWARE AND HARDWARE AND SOUND RECORDING AND REPRODUCING EQUIPMENT, IN THE NATURE OF DICTATING MACHINES, TRANSCRIBING MACHINES, TELEPHONE RECORDING MACHINES, CONFERENCE RECORDING MACHINES, INVENTORY RECORDING MACHINES, AIRPORT COMMUNICATIONS RECORDING MACHINES, AND ACCESSORIES THEREOF, NAMELY, MICROPHONES, HEADSETS, HEADPHONES, LOUDSPEAKERS, AND CONTROL MECHANISMS; DESIGN SERVICES FOR OTHERS IN THE FIELDS OF COMPUTER SOFTWARE AND HARDWARE AND SOUND RECORDING AND REPRODUCING EQUIPMENT, IN THE NATURE OF DICTATING MACHINES, TRANSCRIBING MACHINES, TELEPHONE RECORDING MACHINES, CONFERENCE RECORDING MACHINES, INVENTORY RECORDING MACHINES, AIRPORT COMMUNICATIONS RECORDING MACHINES, AND ACCESSORIES THEREOF, NAMELY, MICROPHONES, HEADSETS, HEADPHONES, LOUDSPEAKERS, AND CONTROL MECHANISMS; RESEARCH SERVICES FOR OTHERS IN THE FIELDS OF COMPUTER SOFTWARE

AND HARDWARE AND SOUND RECORDING AND REPRODUCING EQUIPMENT, IN THE NATURE OF DICTATING MACHINES, TRANSCRIBING MACHINES, TELEPHONE RECORDING MACHINES, CONFERENCE RECORDING MACHINES, INVENTORY RECORDING MACHINES, AIRPORT COMMUNICATIONS RECORDING MACHINES, AND ACCESSORIES THEREOF, NAMELY, MICROPHONES, HEADSETS, HEADPHONES, LOUDSPEAKERS, AND CONTROL MECHANISMS; DEVELOPMENT SERVICES FOR OTHERS IN THE FIELDS OF COMPUTER SOFTWARE AND HARDWARE AND SOUND RECORDING AND REPRODUCING EQUIPMENT, IN THE NATURE OF DICTATING MACHINES, TRANSCRIBING MACHINES, TELEPHONE RECORDING MACHINES, CONFERENCE RECORDING MACHINES, INVENTORY RECORDING MACHINES, AIRPORT COMMUNICATIONS RECORDING MACHINES, AND ACCESSORIES THEREOF, NAMELY, MICROPHONES, HEADSETS, HEADPHONES, LOUDSPEAKERS, AND CONTROL MECHANISMS; INSTALLATION SERVICES FOR OTHERS IN THE FIELD OF COMPUTER SOFTWARE; UPDATING SERVICES FOR OTHERS IN THE FIELD OF COMPUTER SOFTWARE; APPLICATION SERVICE PROVIDER (ASP) FEATURING DICTATION, TRANSCRIPTION, AND SPEECH RECOGNITION SOFTWARE, IN CLASS 42 (U.S. CLS. 100 AND 101).

FIRST USE 12-31-1923; IN COMMERCE 12-31-1923.

THE MARK CONSISTS OF STANDARD CHARACTERS WITHOUT CLAIM TO ANY PARTICULAR FONT, STYLE, SIZE, OR COLOR.

OWNER OF U.S. REG. NOS. 66,997, 639,275 AND OTHERS.

SER. NO. 77-098,384, FILED 2-2-2007.

TASHIA BUNCH, EXAMINING ATTORNEY

**Int. Cl.: 35**

**Prior U.S. Cls.: 100, 101 and 102**

**United States Patent and Trademark Office**

**Reg. No. 3,451,966**

**Registered June 24, 2008**

**SERVICE MARK  
PRINCIPAL REGISTER**

**VANILLA**

KELLER, WILLIAM SHANE (UNITED STATES  
INDIVIDUAL)  
29692 ELLENDALE DR.  
LAGUNA NIGUEL, CA 92677

THE MARK CONSISTS OF STANDARD CHAR-  
ACTERS WITHOUT CLAIM TO ANY PARTICULAR  
FONT, STYLE, SIZE, OR COLOR.

FOR: ACCOUNTING SERVICES, IN CLASS 35  
(U.S. CLS. 100, 101 AND 102).

SER. NO. 77-098,902, FILED 2-5-2007.

FIRST USE 12-0-2005; IN COMMERCE 12-0-2005.

LINDA MICKLEBURGH, EXAMINING ATTORNEY

**Int. Cl.: 9**

**Prior U.S. Cls.: 21, 23, 26, 36 and 38**

**Reg. No. 3,451,967**

**United States Patent and Trademark Office**

**Registered June 24, 2008**

**TRADEMARK  
PRINCIPAL REGISTER**

**SECURE SLEEVE**

IDENTITY STRONGHOLD, LLC (FLORIDA LTD  
LIAB CO)  
770 BUCKSKIN COURT  
ENGLEWOOD, FL 34223

FOR: RFID-BLOCKING AND ELECTROMAGNETICALLY OPAQUE HOLDERS FOR USE WITH PRODUCTS CONTAINING RADIO-FREQUENCY COMMUNICATION DEVICES, IN CLASS 9 (U.S. CLS. 21, 23, 26, 36 AND 38).

FIRST USE 6-1-2005; IN COMMERCE 8-1-2006.

THE MARK CONSISTS OF STANDARD CHARACTERS WITHOUT CLAIM TO ANY PARTICULAR FONT, STYLE, SIZE, OR COLOR.

NO CLAIM IS MADE TO THE EXCLUSIVE RIGHT TO USE "SLEEVE", APART FROM THE MARK AS SHOWN.

SER. NO. 77-099,927, FILED 2-6-2007.

MORGAN WYNNE, EXAMINING ATTORNEY

**Int. Cl.: 42**

**Prior U.S. Cls.: 100 and 101**

**United States Patent and Trademark Office**

**Reg. No. 3,451,968**

**Registered June 24, 2008**

**SERVICE MARK  
PRINCIPAL REGISTER**

**ABSORPTION SYSTEMS**

ABSORPTION SYSTEMS LP (PENNSYLVANIA  
LIMITED PARTNERSHIP)  
OAKLANDS CORPORATE CENTER  
440 CREAMERY WAY, SUITE 300  
EXTON, PA 19340

FOR: TESTING, ANALYSIS AND EVALUATION  
OF THE GOODS OF OTHERS IN THE FIELD OF  
PHARMACEUTICALS FOR THE PURPOSE OF CER-  
TIFICATION; CONVERSION OF TESTING DATA  
AND INFORMATION FOR OTHERS IN THE FIELD  
OF PHARMACEUTICALS FROM PHYSICAL TO  
ELECTRONIC MEDIA; DESIGN OF TESTS FOR  
NEW PRODUCT DEVELOPMENT IN THE FIELD  
OF PHARMACEUTICALS; CHEMICAL ANALYSIS;  
CHEMICAL LABORATORIES, IN CLASS 42 (U.S.  
CLS. 100 AND 101).

FIRST USE 1-30-1999; IN COMMERCE 1-30-1999.

THE MARK CONSISTS OF STANDARD CHAR-  
ACTERS WITHOUT CLAIM TO ANY PARTICULAR  
FONT, STYLE, SIZE, OR COLOR.

NO CLAIM IS MADE TO THE EXCLUSIVE  
RIGHT TO USE "SYSTEMS" , APART FROM THE  
MARK AS SHOWN.

SEC. 2(F).

SER. NO. 77-100,069, FILED 2-6-2007.

RENEE SERVANCE, EXAMINING ATTORNEY

**Int. Cl.: 25**

**Prior U.S. Cls.: 22 and 39**

**United States Patent and Trademark Office**

**Reg. No. 3,451,969**

**Registered June 24, 2008**

**TRADEMARK  
PRINCIPAL REGISTER**

**TEXPORT**

GOODSON, JAMES A. (UNITED STATES INDIVIDUAL)  
37 CAROLINA TRAIL  
MARSHFIELD, MA 02050

FOR: CHAPS, JACKETS, PANTS, GLOVES AND SUITS MADE FOR USE IN RIDING AND OPERATING MOTORCYCLES AND OTHER UNENCLOSED MOTORIZED VEHICLES, HAVING A HEAVY PROTECTIVE OUTER LAYER MADE OF ONE OR MORE OF THE FOLLOWING MATERIALS: LEATHER, NYLON AND 500 DENIER OR BETTER SYNTHETIC TEXTILE, AND INCORPORATING ONE OR MORE OF THE FOLLOWING TECHNICAL FEATURES: ABRASION-RESISTANT FABRIC,

BODY ARMOR, VENTILATION SYSTEMS AND REFLECTIVE SYSTEMS, IN CLASS 25 (U.S. CLS. 22 AND 39).

FIRST USE 6-6-2006; IN COMMERCE 6-6-2006.

THE MARK CONSISTS OF STANDARD CHARACTERS WITHOUT CLAIM TO ANY PARTICULAR FONT, STYLE, SIZE, OR COLOR.

SER. NO. 77-100,095, FILED 2-6-2007.

GRETTA YAO, EXAMINING ATTORNEY



**Int. Cl.: 7**

**Prior U.S. Cls.: 13, 19, 21, 23, 31, 34 and 35**

**Reg. No. 3,451,970**

**United States Patent and Trademark Office**

**Registered June 24, 2008**

---

**TRADEMARK  
PRINCIPAL REGISTER**

**PNEUMAG**

W.C. BRANHAM OF WISCONSIN, INC. (WIS-  
CONSIN CORPORATION)  
398 TROY STREET  
RIVER FALLS, WI 54022

FOR: MACHINE PARTS, NAMELY, PNEUMATI-  
CALLY ACTUATED RODLESS CYLINDERS, IN  
CLASS 7 (U.S. CLS. 13, 19, 21, 23, 31, 34 AND 35).

FIRST USE 8-1-2004; IN COMMERCE 8-1-2004.

THE MARK CONSISTS OF STANDARD CHAR-  
ACTERS WITHOUT CLAIM TO ANY PARTICULAR  
FONT, STYLE, SIZE, OR COLOR.

OWNER OF U.S. REG. NO. 1,996,522.

SER. NO. 77-100,568, FILED 2-6-2007.

AHSEN KHAN, EXAMINING ATTORNEY

**Int. Cl.: 7**

**Prior U.S. Cls.: 13, 19, 21, 23, 31, 34 and 35**

**Reg. No. 3,451,971**

**United States Patent and Trademark Office**

**Registered June 24, 2008**

---

**TRADEMARK  
PRINCIPAL REGISTER**

**MAGTEC**

W.C. BRANHAM OF WISCONSIN, INC. (WIS-  
CONSIN CORPORATION)  
398 TROY STREET  
RIVER FALLS, WI 54022

THE MARK CONSISTS OF STANDARD CHAR-  
ACTERS WITHOUT CLAIM TO ANY PARTICULAR  
FONT, STYLE, SIZE, OR COLOR.

FOR: MACHINE PARTS, NAMELY, PNEUMATI-  
CALLY ACTUATED RODLESS CYLINDERS, IN  
CLASS 7 (U.S. CLS. 13, 19, 21, 23, 31, 34 AND 35).

SER. NO. 77-100,590, FILED 2-6-2007.

FIRST USE 8-1-2004; IN COMMERCE 8-1-2004.

AHSEN KHAN, EXAMINING ATTORNEY

**Int. Cls.: 35, 38 and 41**

**Prior U.S. Cls.: 100, 101, 102, 104 and 107**

**United States Patent and Trademark Office**

**Reg. No. 3,451,972**

**Registered June 24, 2008**

**SERVICE MARK  
PRINCIPAL REGISTER**

# AUTOOBSERVER

EDMUNDS.COM, INC. (NEW YORK CORPORATION), DBA EDMUNDS INC.  
SUITE 400 SOUTH  
1620 26TH STREET  
SANTA MONICA, CA 90404

FOR: PROVIDING ONLINE INFORMATION ABOUT AUTOMOBILE INDUSTRY BUSINESS COMMENTARY AND ANALYSIS, TRADESHOW EVENTS, MARKETING EFFORTS, BUSINESS EXECUTIVES AND COMMERCIAL ANNOUNCEMENTS TO USERS VIA COMPUTER NETWORKS, PODCASTS, HANDHELD COMPUTER DEVICES AND PERSONAL DIGITAL ASSISTANT DEVICES, IN CLASS 35 (U.S. CLS. 100, 101 AND 102).

FIRST USE 1-29-2007; IN COMMERCE 1-29-2007.

FOR: PROVIDING ONLINE CHAT ROOMS AND ELECTRONIC TRANSMISSION OF MESSAGES AMONG USERS IN THE FIELD OF AUTOMOBILE INDUSTRY COMMENTARY, ANALYSIS, EVENTS, EXECUTIVES, MARKETING EFFORTS AND ANNOUNCEMENTS, IN CLASS 38 (U.S. CLS. 100, 101 AND 104).

FIRST USE 1-29-2007; IN COMMERCE 1-29-2007.

FOR: ON-LINE JOURNALS, NAMELY, BLOGS FEATURING AUTOMOBILE INDUSTRY COMMENTARY, ANALYSIS, EVENTS, EXECUTIVES, MARKETING EFFORTS AND ANNOUNCEMENTS; PROVIDING ONLINE INFORMATION ABOUT AUTOMOBILE INDUSTRY ENTERTAINMENT EVENTS AND CURRENT EVENT NEWS TO USERS VIA COMPUTER NETWORKS, PODCASTS, HANDHELD COMPUTER DEVICES AND PERSONAL DIGITAL ASSISTANT DEVICES, IN CLASS 41 (U.S. CLS. 100, 101 AND 107).

FIRST USE 1-29-2007; IN COMMERCE 1-29-2007.

THE MARK CONSISTS OF STANDARD CHARACTERS WITHOUT CLAIM TO ANY PARTICULAR FONT, STYLE, SIZE, OR COLOR.

SER. NO. 77-100,718, FILED 2-6-2007.

ALLISON SCHRODY, EXAMINING ATTORNEY

**Int. Cl.: 10**

**Prior U.S. Cls.: 26, 39 and 44**

**Reg. No. 3,451,973**

**United States Patent and Trademark Office**

**Registered June 24, 2008**

---

**TRADEMARK  
PRINCIPAL REGISTER**

**SportScan**

HD MEDICAL ELECTRONIC PRODUCTS INC.  
(TEXAS CORPORATION)  
5825 EDGEMOOR DRIVE  
HOUSTON, TX 77081

FIRST USE 2-23-2007; IN COMMERCE 2-23-2007.

THE MARK CONSISTS OF THE WORDING  
"SPORTSCAN" WITH A SOCCER BALL TAKING  
THE PLACE OF THE LETTER "O".

FOR: OXYGEN MONITORS, NAMELY, NON-  
PRESCRIPTION ELECTRONIC MEDICAL DEVICE  
FOR MEASURING AND DISPLAYING BLOOD  
OXYGEN SATURATION LEVELS AND THE HU-  
MAN PULSE, IN CLASS 10 (U.S. CLS. 26, 39 AND 44).

SER. NO. 77-101,067, FILED 2-7-2007.

HEATHER BIDDULPH, EXAMINING ATTORNEY

**Int. Cls.: 6, 14, 19, 20 and 21**

**Prior U.S. Cls.: 1, 2, 12, 13, 14, 22, 23, 25, 27, 28, 29,  
30, 32, 33, 40 and 50**

**Reg. No. 3,451,974**

**United States Patent and Trademark Office**

**Registered June 24, 2008**

**TRADEMARK  
PRINCIPAL REGISTER**

**BRILLIANT IMPRESSIONS**

GREENWOOD, INC. (ILLINOIS CORPORATION)  
3901 N. VERMILION STREET  
DANVILLE, IL 61834

FOR: PLAQUES MADE OF BRONZE AND ALUMINUM, IN CLASS 6 (U.S. CLS. 2, 12, 13, 14, 23, 25 AND 50).

FIRST USE 3-12-2006; IN COMMERCE 3-12-2006.

FOR: MEDALLIONS MADE OF BRONZE AND ALUMINUM, IN CLASS 14 (U.S. CLS. 2, 27, 28 AND 50).

FIRST USE 3-12-2006; IN COMMERCE 3-12-2006.

FOR: NON-LUMINOUS, NON-MECHANICAL SIGNS NOT OF METAL, IN CLASS 19 (U.S. CLS. 1, 12, 33 AND 50).

FIRST USE 3-12-2006; IN COMMERCE 3-12-2006.

FOR: FUNERARY URNS MADE OF BRONZE AND ALUMINUM, IN CLASS 20 (U.S. CLS. 2, 13, 22, 25, 32 AND 50).

FIRST USE 3-12-2006; IN COMMERCE 3-12-2006.

FOR: HOUSEHOLD URNS MADE OF BRONZE AND ALUMINUM, IN CLASS 21 (U.S. CLS. 2, 13, 23, 29, 30, 33, 40 AND 50).

FIRST USE 3-12-2006; IN COMMERCE 3-12-2006.

THE MARK CONSISTS OF STANDARD CHARACTERS WITHOUT CLAIM TO ANY PARTICULAR FONT, STYLE, SIZE, OR COLOR.

SER. NO. 77-101,874, FILED 2-7-2007.

YONG KIM, EXAMINING ATTORNEY

Int. Cl.: 25

Prior U.S. Cls.: 22 and 39

United States Patent and Trademark Office

Reg. No. 3,451,975

Registered June 24, 2008

TRADEMARK  
PRINCIPAL REGISTER



CAVENDER INVESTMENT PROPERTIES, LTD.  
(TEXAS LIMITED PARTNERSHIP)  
2019 WSW LOOP 323  
TYLER, TX 75701

FOR: HATS, IN CLASS 25 (U.S. CLS. 22 AND 39).

FIRST USE 11-22-2006; IN COMMERCE 11-22-2006.

NO CLAIM IS MADE TO THE EXCLUSIVE  
RIGHT TO USE "20X PREMIUM QUALITY HATS",  
APART FROM THE MARK AS SHOWN.

THE COLOR(S) GOLD, TAN AND BLACK IS/ARE  
CLAIMED AS A FEATURE OF THE MARK.

THE MARK CONSISTS OF A POCKET-SHAPED  
PATCH WITH A CENTER OF TAN OUTLINED  
WITH A GOLD BORDER SURROUNDED WITH A  
THIN BLACK AND A THIN TAN LINE. A TAN AND  
BLACK STAR SITS ON TOP OF THE PATCH SHAPE  
IMMEDIATELY ABOVE THE WORD "CAVEN-  
DER'S", WHICH IS GOLD WITH BLACK OUTLINE.  
THE WORDING "SOLID GOLD" AND "PREMIUM  
QUALITY HATS" ARE IN BLACK LETTERING.  
THE WORDING "20X" IS IN GOLD, OUTLINED IN  
BLACK AND FLANKED WITH TWO TAN AND  
BLACK STARS.

SER. NO. 77-102,313, FILED 2-8-2007.

CHRIS DONINGER, EXAMINING ATTORNEY

**Int. Cls.: 35 and 45**

**Prior U.S. Cls.: 100, 101 and 102**

**United States Patent and Trademark Office**

**Reg. No. 3,451,976**

**Registered June 24, 2008**

**SERVICE MARK  
PRINCIPAL REGISTER**

**NEUPART**

NEUPART A/S (DENMARK CORPORATION)  
HOLLANDSVEJ 12  
LYNGBY, DENMARK DK-2800

FOR: WHOLESALE DISTRIBUTORSHIPS FEATURING INFORMATION SECURITY SOFTWARE AND EDUCATIONAL SOFTWARE FEATURING INSTRUCTION IN INFORMATION SECURITY, IN CLASS 35 (U.S. CLS. 100, 101 AND 102).

FIRST USE 2-1-2002; IN COMMERCE 7-12-2004.

FOR: COMPUTER INFORMATION SECURITY SERVICES, NAMELY, CONSULTING IN THE FIELD OF PRIVACY AND SECURITY LAWS, REGULA-

TIONS AND REQUIREMENTS; COMPUTER INFORMATION SECURITY SERVICES, NAMELY, CONSULTING SERVICES IN THE FIELD OF MAINTAINING THE SECURITY AND INTEGRITY OF DATABASES, IN CLASS 45 (U.S. CLS. 100 AND 101).

FIRST USE 2-1-2002; IN COMMERCE 7-12-2004.

THE MARK CONSISTS OF STANDARD CHARACTERS WITHOUT CLAIM TO ANY PARTICULAR FONT, STYLE, SIZE, OR COLOR.

SER. NO. 77-103,362, FILED 2-9-2007.

MARK PILARO, EXAMINING ATTORNEY

Int. Cl.: 24

Prior U.S. Cls.: 42 and 50

**United States Patent and Trademark Office**

**Reg. No. 3,451,977**

Registered June 24, 2008

**TRADEMARK  
PRINCIPAL REGISTER**



MOTTON, DOREEN (UNITED STATES INDIVIDUAL)  
29 ROOSEVELT BLVD  
MASSAPEQUA, NY 11758

FOR: PILLOW CASES, IN CLASS 24 (U.S. CLS. 42 AND 50).

FIRST USE 6-1-2004; IN COMMERCE 6-1-2004.

THE NAME(S), PORTRAIT(S), AND/OR SIGNATURE(S) SHOWN IN THE MARK DOES NOT IDENTIFY A PARTICULAR LIVING INDIVIDUAL.

THE MARK CONSISTS OF THE WORDS NEERO & ANA WITH A STARBURST DESIGN ABOVE.

SER. NO. 77-103,496, FILED 2-9-2007.

JOHN KELLY, EXAMINING ATTORNEY



**Int. Cls.: 21, 25 and 41**

**Prior U.S. Cls.: 2, 13, 22, 23, 29, 30, 33, 39, 40, 50, 100,  
101 and 107**

**Reg. No. 3,451,978**

**United States Patent and Trademark Office**

**Registered June 24, 2008**

**TRADEMARK  
SERVICE MARK  
PRINCIPAL REGISTER**

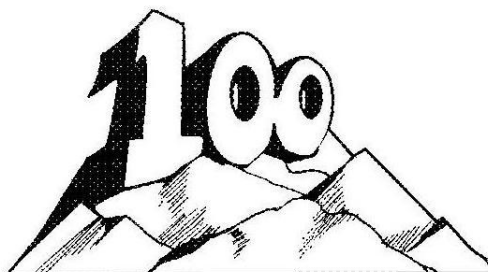

LEADVILLE TRAIL 100 INC. (COLORADO CORPORATION)  
213 HARRISON AVENUE  
LEADVILLE, CO 80461

FOR: MUGS, CUPS AND PLATES, IN CLASS 21 (U.S. CLS. 2, 13, 23, 29, 30, 33, 40 AND 50).

FIRST USE 9-18-1989; IN COMMERCE 9-18-1989.

FOR: SHIRTS, T-SHIRTS, GOLF SHIRTS, POLO SHIRTS, TANK TOPS, WARM-UP SUITS, SWEATSHIRTS, SWEATPANTS, SWEATSHORTS, SHORTS, COMPRESSION SHORTS, TRUNKS, JACKETS, REVERSIBLE JACKETS, COATS, RAINWEAR, SWEATERS, TURTLENECK SHIRTS AND SWEATERS, VESTS, FLEECE VESTS, RUNNER'S VEST WITH REFLECTIVE STRIPES AND ADJUSTABLE STRAPS, TIGHTS, BODY STOCKINGS, KNIT HOSIERY, BODYSUITS, LEOTARDS, UNITARDS, BRIEFS, UNDERWEAR, BRAS, SPORTS BRAS, SINGLETs, HATS, CAPS, HEADBANDS, GLOVES, SCARVES, LOUNGEWEAR, SLEEPWEAR, SOCKS,

SLIPPERS AND FOOTWEAR, IN CLASS 25 (U.S. CLS. 22 AND 39).

FIRST USE 9-18-1989; IN COMMERCE 9-18-1989.

FOR: ENTERTAINMENT SERVICES, NAMELY, PROMOTING, ORGANIZING, CONDUCTING AND STAGING ATHLETIC CONTESTS IN THE NATURE OF ATHLETIC BIKING AND RUNNING RACES, IN CLASS 41 (U.S. CLS. 100, 101 AND 107).

FIRST USE 9-18-1989; IN COMMERCE 9-18-1989.

NO CLAIM IS MADE TO THE EXCLUSIVE RIGHT TO USE "100", APART FROM THE MARK AS SHOWN.

THE MARK CONSISTS OF MOUNTAIN RANGE WITH THE NUMBER "100" ACROSS THE PEAK.

SER. NO. 77-104,204, FILED 2-9-2007.

CAROLYN CATALDO, EXAMINING ATTORNEY

**Int. Cl.: 41**

**Prior U.S. Cls.: 100, 101 and 107**

**United States Patent and Trademark Office**

**Reg. No. 3,451,979**

**Registered June 24, 2008**

**SERVICE MARK  
PRINCIPAL REGISTER**

**IMINDI**

MIND FUND LLC (NEVADA LTD LIAB CO)  
1-4 HIRATA-KITA MACHI  
ASHIYA CITY, HYOGO, JAPAN 659-0073

FIRST USE 1-0-2007; IN COMMERCE 1-0-2007.

FOR: PROVIDING INFORMATION FEATURING  
DIAGRAMS CONSISTING OF INTERRELATED  
WORDS AND IDEAS ARRANGED AROUND A  
CENTRAL KEY WORD FOR AIDING LEARNING  
AND THINKING PROCESS VIA THE INTERNET, IN  
CLASS 41 (U.S. CLS. 100, 101 AND 107).

THE MARK CONSISTS OF STANDARD CHAR-  
ACTERS WITHOUT CLAIM TO ANY PARTICULAR  
FONT, STYLE, SIZE, OR COLOR.

SER. NO. 77-104,304, FILED 2-9-2007.

SALLY SHIH, EXAMINING ATTORNEY

**Int. Cl.: 41**

**Prior U.S. Cls.: 100, 101 and 107**

**United States Patent and Trademark Office**

**Reg. No. 3,451,980**

**Registered June 24, 2008**

**SERVICE MARK  
PRINCIPAL REGISTER**

**COGITAMUS ERGO ERIMUS**

MIND FUND LLC (NEVADA LTD LIAB CO)  
1-4 HIRATA-KITA MACHI  
ASHIYA CITY, HYOGO, JAPAN 659-0073

FOR: PROVIDING INFORMATION FEATURING  
DIAGRAMS CONSISTING OF INTERRELATED  
WORDS AND IDEAS ARRANGED AROUND A  
CENTRAL KEY WORD FOR AIDING LEARNING  
AND THINKING PROCESS VIA THE INTERNET, IN  
CLASS 41 (U.S. CLS. 100, 101 AND 107).

FIRST USE 1-0-2007; IN COMMERCE 1-0-2007.

THE MARK CONSISTS OF STANDARD CHAR-  
ACTERS WITHOUT CLAIM TO ANY PARTICULAR  
FONT, STYLE, SIZE, OR COLOR.

THE FOREIGN WORDING IN THE MARK  
TRANSLATES INTO ENGLISH AS "WE THINK  
THEREFORE WE SHALL EXIST".

SER. NO. 77-104,311, FILED 2-9-2007.

SALLY SHIH, EXAMINING ATTORNEY

**Int. Cl.: 21**

**Prior U.S. Cls.: 2, 13, 23, 29, 30, 33, 40 and 50**

**United States Patent and Trademark Office**

**Reg. No. 3,451,981**

**Registered June 24, 2008**

**TRADEMARK  
PRINCIPAL REGISTER**



DR.FRESH, INC. (CALIFORNIA CORPORATION)  
6645 LA CABALLERO BLVD.  
BUENA PARK, CA 90620

FOR: DENTAL FLOSS; DENTAL FLOSS DISPENSERS; DENTAL TAPE; ELECTRIC TOOTHBRUSHES; MANUAL TOOTHBRUSHES; SYNTHETIC FIBERS FOR THE MANUFACTURE OF BRUSHES, NAMELY, TOOTHBRUSHES, HAIR BRUSHES AND CLEANING BRUSHES; TOOTHBRUSH CASES; TOOTHBRUSH HOLDERS; TOOTHBRUSHES, IN CLASS 21 (U.S. CLS. 2, 13, 23, 29, 30, 33, 40 AND 50).

FIRST USE 9-11-2006; IN COMMERCE 9-11-2006.

THE COLOR(S) GREEN, PURPLE, NAVY BLUE AND WHITE IS/ARE CLAIMED AS A FEATURE OF THE MARK.

THE MARK CONSISTS OF GREEN AND PURPLE IS THE BACKGROUND, NAVY BLUE AND WHITE ARE EMBEDDED IN THE WORDS.

SER. NO. 77-104,394, FILED 2-10-2007.

ANNE MADDEN, EXAMINING ATTORNEY

**Int. Cl.: 41**

**Prior U.S. Cls.: 100, 101 and 107**

**United States Patent and Trademark Office**

**Reg. No. 3,451,982**

**Registered June 24, 2008**

**SERVICE MARK  
PRINCIPAL REGISTER**



DANIEL E. LANTZ (UNITED STATES INDIVIDUAL)  
33 GREENTREE LANE  
MALVERN, PA 19355

FOR: ENTERTAINMENT SERVICES, NAMELY, AN ON-GOING TELEVISION ADVENTURE SERIES, PROVIDED THROUGH WEBCASTS, IN CLASS 41 (U.S. CLS. 100, 101 AND 107).

FIRST USE 2-9-2007; IN COMMERCE 2-9-2007.

THE COLOR(S) RED, BLACK AND WHITE IS/ARE CLAIMED AS A FEATURE OF THE MARK.

THE COLOR RED APPEARS IN THE BACKGROUND, WHILE THE COLOR BLACK APPEARS IN THE "NBS" AND THE COLOR WHITE APPEARS IN "NINJA BABES FROM SPACE".

SER. NO. 77-104,494, FILED 2-10-2007.

STEVEN R. FINE, EXAMINING ATTORNEY

**Int. Cl.: 9**

**Prior U.S. Cls.: 21, 23, 26, 36 and 38**

**Reg. No. 3,451,983**

**United States Patent and Trademark Office**

**Registered June 24, 2008**

---

**TRADEMARK  
PRINCIPAL REGISTER**

**SQLite**

HIPP, WYRICK & COMPANY, INC (GEORGIA CORPORATION)  
6200 MAPLE COVE LANE  
CHARLOTTE, NC 28269

THE MARK CONSISTS OF STANDARD CHARACTERS WITHOUT CLAIM TO ANY PARTICULAR FONT, STYLE, SIZE, OR COLOR.

FOR: DOWNLOADABLE COMPUTER SOFTWARE FOR CREATING SEARCHABLE DATABASES OF INFORMATION AND DATA, IN CLASS 9 (U.S. CLS. 21, 23, 26, 36 AND 38).

SER. NO. 77-104,711, FILED 2-12-2007.

FIRST USE 5-29-2000; IN COMMERCE 4-17-2002.

ELISSA GARBER KON, EXAMINING ATTORNEY

**Int. Cl.: 35**

**Prior U.S. Cls.: 100, 101 and 102**

**United States Patent and Trademark Office**

**Reg. No. 3,451,984**

**Registered June 24, 2008**

---

**SERVICE MARK  
PRINCIPAL REGISTER**

**ENTERPRISE YIELD**

BEACON PARTNERS INC (MASSACHUSETTS  
CORPORATION)  
SUITE 310  
97 LIBBEY PARKWAY  
WEYMOUTH, MA 02189

FOR: BUSINESS MANAGEMENT AND BUSINESS  
CONSULTING SERVICES IN THE FIELD OF  
HEALTHCARE, IN CLASS 35 (U.S. CLS. 100, 101  
AND 102).

FIRST USE 2-9-2007; IN COMMERCE 2-9-2007.

THE MARK CONSISTS OF STANDARD CHAR-  
ACTERS WITHOUT CLAIM TO ANY PARTICULAR  
FONT, STYLE, SIZE, OR COLOR.

SER. NO. 77-104,915, FILED 2-12-2007.

GEOFFREY FOSDICK, EXAMINING ATTORNEY

**Int. Cls.: 16 and 41**

**Prior U.S. Cls.: 2, 5, 22, 23, 29, 37, 38, 50, 100, 101 and 107**

**Reg. No. 3,451,985**

**United States Patent and Trademark Office**

**Registered June 24, 2008**

**TRADEMARK  
SERVICE MARK  
PRINCIPAL REGISTER**

**ZOMBIE PUMPKINS!**

WICKSTRAND, RYAN (UNITED STATES INDIVIDUAL)  
278 MAIN STREET #F119  
WEST HAVEN, CT 06516

FOR: STENCILS, IN CLASS 16 (U.S. CLS. 2, 5, 22, 23, 29, 37, 38 AND 50).

FIRST USE 9-19-2003; IN COMMERCE 9-19-2003.

FOR: ENTERTAINMENT SERVICES IN THE NATURE OF PROVIDING ONLINE INFORMATION IN THE FIELD OF HALLOWEEN TRADITIONS AND ACTIVITIES, IN CLASS 41 (U.S. CLS. 100, 101 AND 107).

FIRST USE 9-19-2003; IN COMMERCE 9-19-2003.

THE MARK CONSISTS OF STANDARD CHARACTERS WITHOUT CLAIM TO ANY PARTICULAR FONT, STYLE, SIZE, OR COLOR.

NO CLAIM IS MADE TO THE EXCLUSIVE RIGHT TO USE "PUMPKINS", APART FROM THE MARK AS SHOWN.

SER. NO. 77-105,041, FILED 2-12-2007.

RENEE SERVANCE, EXAMINING ATTORNEY



**Int. Cl.: 29**

**Prior U.S. Cl.: 46**

**United States Patent and Trademark Office**

**Reg. No. 3,451,986**

**Registered June 24, 2008**

**TRADEMARK  
PRINCIPAL REGISTER**

**TORTILLA TENDERS**

FERACO, RALPH (UNITED STATES INDIVIDUAL)  
7836 IONIO COURT  
NAPLES, FL 34114

FOR: BREADED MEATS, SEAFOOD, AND CHEESE; PROCESSED BREADED VEGETABLES, IN CLASS 29 (U.S. CL. 46).

FIRST USE 6-13-1997; IN COMMERCE 6-13-1997.

THE MARK CONSISTS OF STANDARD CHARACTERS WITHOUT CLAIM TO ANY PARTICULAR FONT, STYLE, SIZE, OR COLOR.

NO CLAIM IS MADE TO THE EXCLUSIVE RIGHT TO USE "TENDERS", APART FROM THE MARK AS SHOWN.

SER. NO. 77-106,388, FILED 2-13-2007.

ELIZABETH KAJUBI, EXAMINING ATTORNEY

**Int. Cl.: 30**

**Prior U.S. Cl.: 46**

**United States Patent and Trademark Office**

**Reg. No. 3,451,987**

**Registered June 24, 2008**

**TRADEMARK  
PRINCIPAL REGISTER**

**MAYOR SAM'S**

TIMES GRILL RESTAURANT GROUP, LLC  
(FLORIDA LTD LIAB CO)  
12148 MANDARIN ROAD  
JACKSONVILLE, FL 32223

THE NAME "MAYOR SAM'S" IDENTIFIES A  
LIVING INDIVIDUAL WHOSE CONSENT IS OF  
RECORD.

FOR: SANDWICHES, IN CLASS 30 (U.S. CL. 46).

FIRST USE 1-1-2004; IN COMMERCE 1-1-2004.

SER. NO. 77-107,404, FILED 2-14-2007.

THE MARK CONSISTS OF STANDARD CHAR-  
ACTERS WITHOUT CLAIM TO ANY PARTICULAR  
FONT, STYLE, SIZE, OR COLOR.

EDWARD NELSON, EXAMINING ATTORNEY

**Int. Cl.: 32**

**Prior U.S. Cls.: 45, 46 and 48**

**Reg. No. 3,451,988**

**United States Patent and Trademark Office**

**Registered June 24, 2008**

---

**TRADEMARK  
PRINCIPAL REGISTER**

**FANS THIRST FOR MORE**

THE COCA-COLA COMPANY (DELAWARE  
CORPORATION)  
ONE COCA-COLA PLAZA  
ATLANTA, GA 30313

THE MARK CONSISTS OF STANDARD CHAR-  
ACTERS WITHOUT CLAIM TO ANY PARTICULAR  
FONT, STYLE, SIZE, OR COLOR.

FOR: NON-ALCOHOLIC BEVERAGES, NAMELY,  
SOFT DRINKS, IN CLASS 32 (U.S. CLS. 45, 46 AND  
48).

SER. NO. 77-107,965, FILED 2-15-2007.

FIRST USE 8-15-2006; IN COMMERCE 8-15-2006.

ELLEN PERKINS, EXAMINING ATTORNEY

**Int. Cl.: 16**

**Prior U.S. Cls.: 2, 5, 22, 23, 29, 37, 38 and 50**

**Reg. No. 3,451,989**

**United States Patent and Trademark Office**

**Registered June 24, 2008**

**TRADEMARK  
PRINCIPAL REGISTER**



GOMEZ, JOE DENNIS (UNITED STATES INDIVIDUAL)  
909 ARMORY ROAD, PMB 509  
BARSTOW, CA 92311

FOR: SPORTS TRADING CARDS, IN CLASS 16  
(U.S. CLS. 2, 5, 22, 23, 29, 37, 38 AND 50).

FIRST USE 12-1-2006; IN COMMERCE 12-1-2006.

THE COLOR(S) RED, BLACK, AND WHITE IS/  
ARE CLAIMED AS A FEATURE OF THE MARK.

THE MARK CONSISTS OF THE COLOR RED WHICH APPEARS FILLED IN THE LETTER "X". THE COLOR BLACK APPEARS IN THE WORDING "GRADED" AND AS LINING TO THE LETTER "X". THE COLOR WHITE APPEARS AS LINING TO THE WORDING "GRADED".

SER. NO. 77-108,288, FILED 2-15-2007.

TIMOTHY FINNEGAN, EXAMINING ATTORNEY

Int. Cl.: 3

Prior U.S. Cls.: 1, 4, 6, 50, 51 and 52

United States Patent and Trademark Office

Reg. No. 3,451,990

Registered June 24, 2008

TRADEMARK  
PRINCIPAL REGISTER



PENNZOIL-QUAKER STATE COMPANY (DELAWARE CORPORATION)  
700 MILAM STREET  
HOUSTON, TX 77002

FOR: LIQUID PREPARATION FOR CLEANING, POLISHING AND SHINING METAL, VINYL, RUBBER OR PLASTIC, NAMELY, FOR WHEEL AND TIRES ON VEHICLES, IN CLASS 3 (U.S. CLS. 1, 4, 6, 50, 51 AND 52).

FIRST USE 1-1-2007; IN COMMERCE 1-1-2007.

OWNER OF U.S. REG. NO. 3,023,344.

THE COLOR(S) WHITE, RED, BLUE, GREEN, GRAY, SILVER AND BLACK IS/ARE CLAIMED AS A FEATURE OF THE MARK.

THE MARK CONSISTS OF THE WORDS "BLACK MAGIC" IN WHITE, BLUE, GREEN, GREEN AND

GREY FOR METALLIC EFFECT ENCASED IN AN ELLIPTICAL CIRCLE OF RED IN THE UPPER HALF AND BLACK IN THE BOTTOM HALF WITH A METALLIC BORDER CONSISTING OF WHITE, BLUE GREEN AND GREY. ADJACENT TO THE "BLACK MAGIC" DESIGN ARE THE WORDS "TITANIUM" IN WHITE, GRAY AND SILVER LETTERS FOR METALLIC EFFECT WITH A BLACK BORDER. THE FIRST TWO LETTERS OF "TITANIUM", ARE ENCASED IN A RED SLANTED RECTANGLE WITH A WHITE BORDER AND THE WORDS AND NUMBERS TI 22, THE SYMBOL FOR TITANIUM IN THE CHEMICAL PERIODIC TABLE. THE WORD "TITANIUM" IS ENCASED IN A RECTANGLE WITH A BLACK UPPER HALF, GREY/SILVER CORNERS ON THE BOTTOM HALF AND DARK GREY IN THE REMAINING SPACE..

SER. NO. 77-108,329, FILED 2-15-2007.

ALLISON HOLTZ, EXAMINING ATTORNEY

**Int. Cl.: 35**

**Prior U.S. Cls.: 100, 101 and 102**

**United States Patent and Trademark Office**

**Reg. No. 3,451,991**

**Registered June 24, 2008**

**SERVICE MARK  
PRINCIPAL REGISTER**

**PESTOP**

CONROY MANAGEMENT & ASSOCIATES, INC.  
(LOUISIANA CORPORATION)  
806 O'NEAL LANE  
BATON ROUGE, LA 70816

THE MARK CONSISTS OF STANDARD CHAR-  
ACTERS WITHOUT CLAIM TO ANY PARTICULAR  
FONT, STYLE, SIZE, OR COLOR.

FOR: RETAIL STORES FEATURING PEST CON-  
TROL PRODUCTS, IN CLASS 35 (U.S. CLS. 100, 101  
AND 102).

SER. NO. 77-109,104, FILED 2-16-2007.

FIRST USE 3-1-1997; IN COMMERCE 3-1-1997.

DORITT L. CARROLL, EXAMINING ATTORNEY

**Int. Cls.: 35, 41 and 43**

**Prior U.S. Cls.: 100, 101, 102 and 107**

**United States Patent and Trademark Office**

**Reg. No. 3,451,992**

**Registered June 24, 2008**

**SERVICE MARK  
PRINCIPAL REGISTER**

**TAMARACK**

WEST VIRGINIA PARKWAYS ECONOMIC DEVELOPMENT AND TOURISM AUTHORITY  
(WEST VIRGINIA STATE AGENCY)  
ONE TAMARACK PARK  
BECKLEY, WV 25801

FOR: ONLINE RETAIL STORE AND RETAIL STORE SERVICES FEATURING CLOTHING, CANDLES, LOTIONS, SOAPS, BOOKS, PRE-RECORDED VIDEOS, DVDS AND CDS; DESK ACCESSORIES, STATIONERY, PENS AND PENCILS, DECORATIVE GLASS, STEMWARE, KNIVES, BIRDHOUSES, ART AND SCULPTURES, FOOD PRODUCTS, SOUVENIRS, JEWELRY, CERAMICS, QUILTS, BASKETS, PILLOWS, MUSICAL INSTRUMENTS, PET ACCESSORIES AND TREATS, CHRISTMAS AND HOLIDAY DECORATIONS, TOYS, GAMES, AND DOLLS, WOODEN BOWLS AND KITCHEN ACCESSORIES AND UTENSILS; AND ART GALLERIES, IN CLASS 35 (U.S. CLS. 100, 101 AND 102).

FIRST USE 0-0-1996; IN COMMERCE 0-0-1996.

FOR: ENTERTAINMENT IN THE NATURE OF THEATER PRODUCTIONS; DINNER THEATERS,

MOVIE THEATERS; AND ENTERTAINMENT IN THE NATURE OF LIVE MUSICAL PERFORMANCES BY MUSICAL BANDS AND VOCALISTS, PERFORMANCE OF PLAYS, AND LIVE POETRY READINGS, IN CLASS 41 (U.S. CLS. 100, 101 AND 107).

FIRST USE 0-0-1996; IN COMMERCE 0-0-1996.

FOR: RESTAURANT AND CATERING SERVICES; PROVISION OF CONFERENCE, EXHIBITION, AND MEETING FACILITIES, IN CLASS 43 (U.S. CLS. 100 AND 101).

FIRST USE 0-0-1996; IN COMMERCE 0-0-1996.

THE MARK CONSISTS OF STANDARD CHARACTERS WITHOUT CLAIM TO ANY PARTICULAR FONT, STYLE, SIZE, OR COLOR.

SER. NO. 77-109,524, FILED 2-16-2007.

DOMINIC J. FERRAIUOLO, EXAMINING ATTORNEY

**Int. Cl.: 43**

**Prior U.S. Cls.: 100 and 101**

**United States Patent and Trademark Office**

**Reg. No. 3,451,993**

**Registered June 24, 2008**

**SERVICE MARK  
PRINCIPAL REGISTER**

**Buckhead Mountain Grill**

BUCKHEAD MANAGEMENT, INC. (KENTUCKY CORPORATION)  
106 BAUER AVENUE  
LOUISVILLE, KY 40207

FOR: RESTAURANT AND BAR SERVICES OFFERING CASUAL DINING IN A LODGE OR STEAK/CHOP HOUSE ATMOSPHERE WITH THE THEME OF THE RESTAURANT REVOLVING AROUND THE USE OF THE WORD 'BUCKHEAD' TO BRING TO MIND THE HEAD OF A MALE DEER, IN CLASS 43 (U.S. CLS. 100 AND 101).

FIRST USE 6-30-1997; IN COMMERCE 6-30-1997.

THE MARK CONSISTS OF STANDARD CHARACTERS WITHOUT CLAIM TO ANY PARTICULAR FONT, STYLE, SIZE, OR COLOR.

OWNER OF U.S. REG. NOS. 1,937,510, 3,199,128 AND OTHERS.

NO CLAIM IS MADE TO THE EXCLUSIVE RIGHT TO USE "GRILL", APART FROM THE MARK AS SHOWN.

SER. NO. 77-110,451, FILED 2-19-2007.

STEPHEN AQUILA, EXAMINING ATTORNEY



**Int. Cl.: 35**

**Prior U.S. Cls.: 100, 101 and 102**

**United States Patent and Trademark Office**

**Reg. No. 3,451,994**

**Registered June 24, 2008**

**SERVICE MARK  
PRINCIPAL REGISTER**

**GETAUTOAPPRAISE**

GETAUTOAPPRAISE, LLC (ARIZONA LTD LIAB  
CO)  
7900 EAST GREENWAY, SUITE 210  
SCOTTSDALE, AZ 85260

FOR: PROVIDING AN INTERNET-WEBSITE SER-  
VICE TO VEHICLE DEALERS TO GENERATE VE-  
HICLE SALES-LEADS FROM THE VEHICLE  
DEALER'S INTERNET-WEBSITE TRAFFIC; PRO-  
VIDING REAL-TIME PRICE QUOTES OF A CON-  
SUMER'S USED VEHICLE WHILE THE  
CONSUMER VISITS A VEHICLE DEALER WEBSITE  
OVER A GLOBAL COMPUTER NETWORK USING  
ON-LINE DATABASES FEATURING PRICING IN-

FORMATION, IN CLASS 35 (U.S. CLS. 100, 101 AND  
102).

FIRST USE 9-25-2005; IN COMMERCE 9-25-2005.

THE MARK CONSISTS OF STANDARD CHAR-  
ACTERS WITHOUT CLAIM TO ANY PARTICULAR  
FONT, STYLE, SIZE, OR COLOR.

SER. NO. 77-110,797, FILED 2-19-2007.

NATALIE POLZER, EXAMINING ATTORNEY

**Int. Cls.: 29, 30, 32, 35, 42 and 43**

**Prior U.S. Cls.: 45, 46, 48, 100, 101 and 102**

**Reg. No. 3,451,995**

**United States Patent and Trademark Office**

**Registered June 24, 2008**

**TRADEMARK  
SERVICE MARK  
PRINCIPAL REGISTER**

# TRIDUTCH

RENESSANCE VENTURES II B.V. (NETHERLANDS LTD LIAB CO)  
MUSEUMPLEIN 17  
AMSTERDAM, NETHERLANDS 1071DJ

FOR: MEAT, FISH, POULTRY AND GAME; PRESERVED, FROZEN, DRIED AND COOKED FRUITS AND VEGETABLES, PREPARED FOOD PRODUCTS COMPRISED OF ALL AFOREMENTIONED PRODUCTS, NAMELY, MEAT JELLIES, FISH FILLETS AND MARINATED POULTRY; MILK PRODUCTS AND OTHER DAIRY PRODUCTS EXCLUDING ICE CREAM, ICE MILK AND FROZEN YOGURT; EGGS, CHEESE, SOUPS AND SALADS EXCEPT MACARONI, RICE AND PASTA SALAD; SNACKS NOT INCLUDED IN OTHER CLASSES, NAMELY, SNACK MIX CONSISTING PRIMARILY OF PROCESSED FRUITS, PROCESSED NUTS AND/OR RAISINS; SMALL ROUND CROQUETTES MADE OF CHICKEN, MEAT AND FISH; CHIPS MADE OF POTATOES; MEAT EXTRACTS; JELLIES USED AS BREAD SPREADS, JAMS, COMPOTES; FRENCH FRIES; READY MADE MEALS NOT INCLUDED IN OTHER CLASSES, NAMELY, FROZEN, PREPARED AND PACKAGED MEALS CONSISTING PRIMARILY OF MEAT, FISH, POULTRY OR VEGETABLES; EDIBLE OILS AND FATS, IN CLASS 29 (U.S. CL. 46).

FOR: MEAT PIES, COFFEE, TEA, COCOA, SUGAR, RICE, TAPIOCA, SAGO, ARTIFICIAL COFFEE; FLOUR AND PREPARATIONS MADE FROM CEREALS, NAMELY, CEREAL-BASED SNACK FOOD, BREAD, PASTRY AND CONFECTIONERY, NAMELY, PASTILLES, CANDIES AND CHOCOLATES, COOKIES, CONSUMPTION ICE; HONEY, TREACLE; YEAST, BAKING-POWDER; SALT, MUSTARD; VINEGAR, SAUCES, NAMELY, BARBECUE SAUCES, CHEESE SAUCES AND CONDIMENTS, NAMELY, PEPPER SAUCES; SPICES, ICE; SNACKS NOT INCLUDED IN OTHER CLASSES, NAMELY, GRANOLA SNACKS AND SNACK MIX CONSISTING PRIMARILY OF CRACKERS, PRETZELS, CANDIED NUTS AND/OR POPPED POPCORN; READY MADE MEALS NOT INCLUDED IN OTHER CLAS-

SES, NAMELY, FROZEN, PREPARED AND PACKAGED MEALS CONSISTING PRIMARILY OF PASTA OR RICE; CHIPS MADE OF CEREAL TYPES, NAMELY, CEREAL BASED SNACK FOOD, AND CHIPS MADE OF CORN, MILK PRODUCTS AND OTHER DAIRY PRODUCTS, NAMELY, MILK SHAKES, IN CLASS 30 (U.S. CL. 46).

FOR: BEERS, MINERAL AND AERATED WATERS AND OTHER NON-ALCOHOLIC DRINKS, NAMELY, CARBONATED BEVERAGES; FRUIT DRINKS AND FRUIT JUICES; SYRUPS AND OTHER PREPARATIONS FOR MAKING BEVERAGES, NAMELY, FRUIT JUICE CONCENTRATES, IN CLASS 32 (U.S. CLS. 45, 46 AND 48).

FOR: PUBLICITY AND SALES PROMOTION; BUSINESS MANAGEMENT; BUSINESS ASSISTANCE AND ADVISORY SERVICES IN THE FIELD OF THE SET UP, THE EXPLOITATION AND MANAGEMENT OF HOTEL AND CATERING ESTABLISHMENTS IN THE NATURE OF RESTAURANTS; WHOLESALE TRADE DISTRIBUTORSHIPS AND RETAIL STORE SERVICES RELATED TO THE SALE OF FOOD AND NON FOOD PRODUCTS, NAMELY, HOUSEHOLD SUPPLIES; ADVISORY SERVICES IN THE FIELD OF BUSINESS ECONOMICS, BUSINESS ORGANIZATION, AND BUSINESS ADVISORY SERVICES, AMONG OTHERS, IN THE FIELD OF FOOD CONCEPTS; DEVELOPMENT OF BUSINESS STRATEGIES AND CONCEPTS FOR THE BENEFIT OF MARKETING; ADVISORY SERVICES IN THE FIELD OF MARKETING AND FRANCHISING, NAMELY, PROVIDED TO FRANCHISEES, IN CLASS 35 (U.S. CLS. 100, 101 AND 102).

FOR: ADVISORY SERVICES IN THE FIELD OF PRODUCT DEVELOPMENT; PRODUCT DEVELOPMENT; TECHNOLOGICAL DEVELOPMENT FOR OTHERS RELATING TO THE FOOD SECTOR, THE AFOREMENTIONED SERVICES ALSO RENDERED WITHIN THE FRAMEWORK OF FRANCHISING, NAMELY, PROVIDED TO FRANCHISEES, IN CLASS 42 (U.S. CLS. 100 AND 101).

FOR: SERVICES FOR PROVIDING FOOD AND DRINKS, NAMELY, PROVIDING SERVICES OF FAST FOOD RESTAURANTS, SNACK BARS, BARS, BISTROS, PUBS AND CANTEENS; CATERING SERVICES; HOTEL SERVICES AND SERVICES FOR RESERVATION OF TEMPORARY ACCOMMODATION; PROVIDING TEMPORARY LODGING ACCOMMODATIONS; THE AFOREMENTIONED SERVICES ALSO RENDERED WITHIN THE FRAMEWORK OF FRANCHISING, NAMELY, PROVIDED TO FRANCHISEES, IN CLASS 43 (U.S. CLS. 100 AND 101).

THE MARK CONSISTS OF STANDARD CHARACTERS WITHOUT CLAIM TO ANY PARTICULAR FONT, STYLE, SIZE, OR COLOR.

PRIORITY CLAIMED UNDER SEC. 44(D) ON BENELUX APPLICATION NO. 1128544, FILED 2-6-2007, REG. NO. 0817674, DATED 2-19-2007, EXPIRES 2-6-2017.

PRIORITY CLAIMED UNDER SEC. 44(D) ON BENELUX APPLICATION NO. 1128855, FILED 2-9-2007, REG. NO. 0817344, DATED 2-13-2007, EXPIRES 2-9-2017.

SER. NO. 77-111,536, FILED 2-20-2007.

TASHIA BUNCH, EXAMINING ATTORNEY

**Int. Cl.: 35**

**Prior U.S. Cls.: 100, 101 and 102**

**United States Patent and Trademark Office**

**Reg. No. 3,451,996**

**Registered June 24, 2008**

**SERVICE MARK  
PRINCIPAL REGISTER**



UPSCALE MAIL (MINNESOTA CORPORATION)  
6450 WHITE DOVE DRIVE  
EXCELSIOR, MN 55331

THE MARK CONSISTS OF AN OUTLINE OF A  
STAMP WITH "UPSCALE MAIL" IN THE MIDDLE.

FOR: DIRECT MAIL ADVERTISING, IN CLASS 35  
(U.S. CLS. 100, 101 AND 102).

SER. NO. 77-113,937, FILED 2-22-2007.

FIRST USE 2-19-2007; IN COMMERCE 2-21-2007.

JAMES GRIFFIN, EXAMINING ATTORNEY

**Int. Cl.: 9**

**Prior U.S. Cls.: 21, 23, 26, 36 and 38**

**Reg. No. 3,451,997**

**United States Patent and Trademark Office**

**Registered June 24, 2008**

**TRADEMARK  
PRINCIPAL REGISTER**

**THE WEIDT GROUP**

THE WEIDT GROUP, INC. (MINNESOTA CORPORATION)  
5800 BAKER ROAD  
MINNETONKA, MN 55345

FOR: COMPUTER SOFTWARE FOR USE IN BUSINESS PROCESS AUTOMATION, FOR ASSISTING IN THE DESIGN AND OPERATION OF BUILDINGS, AND FOR DEVELOPING STRATEGIES FOR OPERATING AND DESIGNING ENERGY EFFICIENT BUILDINGS, IN CLASS 9 (U.S. CLS. 21, 23, 26, 36 AND 38).

FIRST USE 1-0-1989; IN COMMERCE 1-0-1989.

THE MARK CONSISTS OF STANDARD CHARACTERS WITHOUT CLAIM TO ANY PARTICULAR FONT, STYLE, SIZE, OR COLOR.

NO CLAIM IS MADE TO THE EXCLUSIVE RIGHT TO USE "GROUP", APART FROM THE MARK AS SHOWN.

SEC. 2(F).

SER. NO. 77-114,260, FILED 2-23-2007.

CHRISIE B. KING, EXAMINING ATTORNEY

**Int. Cl.: 9**

**Prior U.S. Cls.: 21, 23, 26, 36 and 38**

**Reg. No. 3,451,998**

**United States Patent and Trademark Office**

**Registered June 24, 2008**

**TRADEMARK  
PRINCIPAL REGISTER**

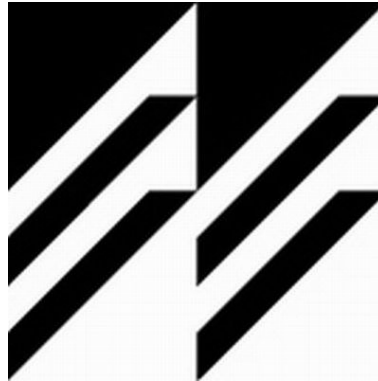

THE WEIDT GROUP, INC. (MINNESOTA CORPORATION)  
5800 BAKER ROAD  
MINNETONKA, MN 55345

FOR: COMPUTER SOFTWARE FOR USE IN BUSINESS PROCESS AUTOMATION, FOR ASSISTING IN THE DESIGN AND OPERATION OF BUILDINGS, AND FOR DEVELOPING STRATEGIES FOR OPERATING AND DESIGNING ENERGY EFFICIENT BUILDINGS, IN CLASS 9 (U.S. CLS. 21, 23, 26, 36 AND 38).

FIRST USE 1-0-1989; IN COMMERCE 1-0-1989.

THE MARK CONSISTS OF TWO 45-DEGREE TRIANGLES SIDE BY SIDE WITH TWO THIN TRAPEZOID SHAPED BARS UNDER EACH TRIANGLE.

SER. NO. 77-114,266, FILED 2-23-2007.

CHRISIE B. KING, EXAMINING ATTORNEY

**Int. Cls.: 35, 41 and 42**

**Prior U.S. Cls.: 100, 101, 102 and 107**

**United States Patent and Trademark Office**

**Reg. No. 3,451,999**

**Registered June 24, 2008**

**SERVICE MARK  
PRINCIPAL REGISTER**

# STUDIONORTH

STUDIO NORTH, INC. (ILLINOIS CORPORATION)  
1616 N GREEN BAY RD  
NORTH CHICAGO, IL 60064

FOR: MARKET RESEARCH SERVICES FOR OTHERS, NAMELY, CONDUCTING CONSUMER FOCUS GROUPS, SURVEYS, INTERVIEWS, DATA COLLECTION, AND ANALYSIS; BUSINESS CONSULTING SERVICES, NAMELY, ADVERTISING STRATEGY FOR ELECTRONIC, OUTDOOR, PRINT AND ONLINE MEDIA, BRAND POSITIONING AND CONCEPT DEVELOPMENT IN THE FIELD OF MARKETING, MULTIMEDIA PRESENTATION DEVELOPMENT OF ADVERTISING, NAMELY, DEVELOPMENT OF ADVERTISING CAMPAIGNS FOR TELEVISION, PRINT, CD-ROM, WEB DESIGN, FOR DISTRIBUTION VIA THE INTERNET, RADIO, TELEVISION, LIVE VENUES SUCH AS SALES MEETINGS, TRADE SHOWS AND INTERNAL CORPORATE COMMUNICATIONS, CORPORATE BRANDING AND CREATING AND IMPROVING CORPORATE BRANDING IDENTITY, PRODUCT MARKETING, ADVERTISING, DIRECT MARKETING, SALES PROMOTION, INTERNET MARKETING; DESIGN AND DEVELOPMENT OF ADVERTISING, MARKETING, AND PROMOTIONAL MATERIALS FOR OTHERS, INCLUDING PRINT, ONLINE, MULTIMEDIA, AND INTERACTIVE MATERIAL, IN CLASS 35 (U.S. CLS. 100, 101 AND 102).

FIRST USE 10-1-1984; IN COMMERCE 10-1-1984.

FOR: VIDEO PRODUCTION SERVICES, NAMELY, PRODUCTION AND EDITING OF SOUND AND MOTION VIDEO RECORDINGS, AND THE PRODUCTION OF EDUCATIONAL AND TRAINING VIDEOS, IN CLASS 41 (U.S. CLS. 100, 101 AND 107).

FIRST USE 10-1-1984; IN COMMERCE 10-1-1984.

FOR: WEB SITE DEVELOPMENT AND DESIGN, CREATION, AND MAINTENANCE OF INTERNET AND EXTRANET SITES FOR THIRD PARTIES; ART DESIGN, NAMELY, PRINT, MULTIMEDIA, ONLINE, VIDEO, AND COMPUTER GENERATED GRAPHIC ARTS DESIGN, AND PRINT AND COMPUTER GENERATED GRAPHIC ILLUSTRATION SERVICES, IN CLASS 42 (U.S. CLS. 100 AND 101).

FIRST USE 10-1-1984; IN COMMERCE 10-1-1984.

THE MARK CONSISTS OF STANDARD CHARACTERS WITHOUT CLAIM TO ANY PARTICULAR FONT, STYLE, SIZE, OR COLOR.

SER. NO. 77-114,270, FILED 2-23-2007.

WANDA KAY PRICE, EXAMINING ATTORNEY

**Int. Cls.: 30 and 35**

**Prior U.S. Cls.: 46, 100, 101 and 102**

**United States Patent and Trademark Office**

**Reg. No. 3,452,000**

**Registered June 24, 2008**

**TRADEMARK  
SERVICE MARK  
PRINCIPAL REGISTER**

**WHITTARD**

WHITTARD OF CHELSEA LIMITED (UNITED KINGDOM CORPORATION)  
UNION COURT, 22 UNION ROAD  
LONDON, ENGLAND SW46JQ

FOR: TEA, COCOA, COFFEE, COFFEE SUBSTITUTES, INSTANT TEA, TEA-BASED BEVERAGES, COCOA-BASED BEVERAGES, COFFEE-BASED BEVERAGES; CHOCOLATE; PRODUCTS CONTAINING CHOCOLATE, NAMELY, HOT DRINKING CHOCOLATE, CHOCOLATE-BASED BEVERAGES, CHOCOLATE FLAVORED COFFEE AND COFFEE BEANS, CHOCOLATE CAPPUCCINO, CHOCOLATE CHAI, CHOCOLATE FLAVORED TEA, CHOCOLATE FLAVORED BLACK TEA, CHOCOLATE HONEY BUSH TEA; CHOCOLATE AND CONFECTIONARY SPRINKLES AND TOPPINGS FOR HOT BEVERAGES, IN CLASS 30 (U.S. CL. 46).

FOR: RETAIL STORE SERVICES, ONLINE RETAIL STORE SERVICES AND MAIL ORDER CATALOGUE SERVICES IN THE FIELDS OF FOOD,

BEVERAGES, HOUSEHOLD ITEMS, TABLEWARE AND CROCKERY; PRODUCT AND SERVICE INFORMATION TO CUSTOMERS, IN CLASS 35 (U.S. CLS. 100, 101 AND 102).

THE MARK CONSISTS OF STANDARD CHARACTERS WITHOUT CLAIM TO ANY PARTICULAR FONT, STYLE, SIZE, OR COLOR.

OWNER OF ERPN CMNTY TM OFC REG. NO. 002023349, DATED 4-18-2002, EXPIRES 12-21-2010.

OWNER OF ERPN CMNTY TM OFC REG. NO. 000116160, DATED 7-6-1998, EXPIRES 4-1-2016.

OWNER OF U.S. REG. NO. 2,671,068.

SER. NO. 77-114,331, FILED 2-23-2007.

LAURA KOVALSKY, EXAMINING ATTORNEY



**Int. Cl.: 14**

**Prior U.S. Cls.: 2, 27, 28 and 50**

**Reg. No. 3,452,001**

**United States Patent and Trademark Office**

**Registered June 24, 2008**

**TRADEMARK  
PRINCIPAL REGISTER**



SWISS TIME CORPORATION (TEXAS CORPORATION)  
SUITE 225  
1617 W. OLEANDER STREET  
FORT WORTH, TX 76104

FOR: HOROLOGICAL AND CHRONOMETRIC INSTRUMENTS AND PARTS THEREOF, IN CLASS 14 (U.S. CLS. 2, 27, 28 AND 50).

FIRST USE 5-1-2007; IN COMMERCE 5-1-2007.

NO CLAIM IS MADE TO THE EXCLUSIVE RIGHT TO USE "H3 TACTICAL", APART FROM THE MARK AS SHOWN.

THE COLOR(S) ORANGE, BLACK AND WHITE IS/ARE CLAIMED AS A FEATURE OF THE MARK.

THE MARK CONSISTS OF A CIRCLE CIRCUMSCRIBED AROUND TWO PERPENDICULAR LINES THAT BISECT THE INSIDE OF THE CIRCLE BOTH HORIZONTALLY AND VERTICALLY TO CREATE AN IMAGE THAT IS COMMONLY KNOWN AS A GUN SIGHT. THE GUN SIGHT IS IN WHITE. THE WORD "H3" IS INTERPOSED WITHIN THE TOP TWO QUADRANTS OF THE CIRCLE, WHILE THE WORD "TACTICAL" IS INTERPOSED IN THE BOTTOM TWO QUADRANTS OF THE CIRCLE. THE COLOR WHITE APPEARS IN THE "H" AND THE COLOR ORANGE APPEARS IN THE "3" OF THE TERM "H3" WORDING. THE ENTIRE DESIGN APPEARS ON A BLACK BACKGROUND.

SER. NO. 77-114,897, FILED 2-23-2007.

ANDREA BUTLER, EXAMINING ATTORNEY

**Int. Cl.: 25**

**Prior U.S. Cls.: 22 and 39**

**United States Patent and Trademark Office**

**Reg. No. 3,452,002**

**Registered June 24, 2008**

**TRADEMARK  
PRINCIPAL REGISTER**



E4HATS.COM INC. (CALIFORNIA CORPORATION)  
701 S. HARBOR BLVD.  
FULLERTON, CA 92832

FOR: HATS, IN CLASS 25 (U.S. CLS. 22 AND 39).

FIRST USE 3-1-2002; IN COMMERCE 3-1-2002.

NO CLAIM IS MADE TO THE EXCLUSIVE RIGHT TO USE "HATS.COM", APART FROM THE MARK AS SHOWN.

THE COLOR(S) WHITE, BLACK, ORANGE AND GREEN IS/ARE CLAIMED AS A FEATURE OF THE MARK.

THE MARK CONSISTS OF THE PHRASE "E4" IN WHITE WITH A BLACK BORDER. THE COLOR BLACK APPEARS IN THE WORD "HATS". THE COLOR ORANGE APPEARS IN THE WORD ".COM". THE COLOR GREEN APPEARS IN THE BACK PORTION OF THE HAT DESIGN AND UNDERNEATH THE BILL AND THE REST OF THE HAT DESIGN IS IN WHITE WITH BLACK BORDER.

SER. NO. 77-115,287, FILED 2-23-2007.

ERNEST SHOSHO, EXAMINING ATTORNEY

**Int. Cl.: 42**

**Prior U.S. Cls.: 100 and 101**

**United States Patent and Trademark Office**

**Reg. No. 3,452,003**

**Registered June 24, 2008**

**SERVICE MARK  
PRINCIPAL REGISTER**



JAZZ PHARMACEUTICALS, INC. (DELAWARE CORPORATION)  
3180 PORTER DRIVE  
PALO ALTO, CA 94304

FOR: PROVIDING CUSTOMIZED ON-LINE WEB PAGES FEATURING USER-DEFINED INFORMATION, WHICH INCLUDES ON-LINE WEB LINKS TO OTHER WEB SITES; PROVIDING INFORMATION AT THE SPECIFIC REQUEST OF END-USERS BY MEANS OF TELEPHONE OR GLOBAL COMPUTER NETWORKS; SCIENTIFIC RESEARCH AND DEVELOPMENT; PHARMACEUTICAL DRUG DEVELOPMENT SERVICES; PHARMACEUTICAL RESEARCH AND DEVELOPMENT, IN CLASS 42 (U.S. CLS. 100 AND 101).

FIRST USE 5-19-2004; IN COMMERCE 5-19-2004.

OWNER OF U.S. REG. NO. 3,005,004.

NO CLAIM IS MADE TO THE EXCLUSIVE RIGHT TO USE "PHARMACEUTICALS", APART FROM THE MARK AS SHOWN.

THE COLOR(S) PURPLE, GOLD AND WHITE IS/ ARE CLAIMED AS A FEATURE OF THE MARK.

THE MARK CONSISTS OF THE WORDING JAZZ PHARMACEUTICALS IN THE COLOR PURPLE POSITIONED TO THE RIGHT OF A CIRCULAR LOGO WITH CONCENTRIC CIRCLES OF PURPLE AND WHITE CONTAINING A STYLIZED DEPICTION OF THE LETTERS JP IN THE COLOR WHITE WHICH VERTICALLY SPLITS THE CIRCLE SHOWING GOLD ON THE RIGHT PORTION AND PURPLE ON THE LEFT PORTION OF THE CIRCLE.

SER. NO. 77-115,376, FILED 2-23-2007.

EMILY CHUO, EXAMINING ATTORNEY

**Int. Cl.: 5**

**Prior U.S. Cls.: 6, 18, 44, 46, 51 and 52**

**Reg. No. 3,452,004**

**United States Patent and Trademark Office**

**Registered June 24, 2008**

**TRADEMARK  
PRINCIPAL REGISTER**

**SlimOrganex**

ALSHABAN PHARMA CO. (MARYLAND SOLE  
PROPRIETORSHIP)  
806 SEMINARY ROUNDTOP CT, # 3C  
LUTHERVILLE, MD 21093

FOR: MEDICATIONS AND FOOD SUPPLE-  
MENTS FOR WEIGHT LOSS AND FOR USE IN  
WEIGHT REDUCTION PROGRAMS; FOOD SUP-  
PLEMENTS FOR PROMOTING GENERAL GOOD  
HEALTH , IN CLASS 5 (U.S. CLS. 6, 18, 44, 46, 51 AND  
52).

FIRST USE 2-1-2007; IN COMMERCE 2-1-2007.

THE MARK CONSISTS OF STANDARD CHAR-  
ACTERS WITHOUT CLAIM TO ANY PARTICULAR  
FONT, STYLE, SIZE, OR COLOR.

SER. NO. 77-115,593, FILED 2-25-2007.

DAYNA BROWNE, EXAMINING ATTORNEY

**Int. Cl.: 5**

**Prior U.S. Cls.: 6, 18, 44, 46, 51 and 52**

**United States Patent and Trademark Office**

**Reg. No. 3,452,005**

**Registered June 24, 2008**

**TRADEMARK  
PRINCIPAL REGISTER**

**ACTIMEL**

COMPAGNIE GERVAIS DANONE (FRANCE  
JOINT STOCK COMPANY)  
17, BOULEVARD HAUSSMANN  
PARIS, FRANCE 75009

FOR: NUTRITIVE SUBSTANCES FOR MICRO-  
ORGANISMS FOR MEDICAL USE; VITAMIN PRE-  
PARATIONS; BABY FOOD, NAMELY, LACTEAL  
FLOURS, SOUPS, DEHYDRATED SOUPS, MILK,  
POWDERED MILK, STEWED FRUITS, VEGETABLE  
PUREES, DEHYDRATED VEGETABLE PUREES,  
FRUIT AND VEGETABLE JUICES, AND BABY  
CEREALS, IN CLASS 5 (U.S. CLS. 6, 18, 44, 46, 51  
AND 52).

THE MARK CONSISTS OF STANDARD CHAR-  
ACTERS WITHOUT CLAIM TO ANY PARTICULAR  
FONT, STYLE, SIZE, OR COLOR.

OWNER OF FRANCE REG. NO. 98763476, DATED  
12-9-1998, EXPIRES 12-9-2008.

SER. NO. 77-116,324, FILED 2-26-2007.

DAVID C. REIHNER, EXAMINING ATTORNEY

Int. Cls.: 35, 38, 41 and 42

Prior U.S. Cls.: 100, 101, 102, 104 and 107

Reg. No. 3,452,006

United States Patent and Trademark Office

Registered June 24, 2008

SERVICE MARK  
PRINCIPAL REGISTER



RATE MY ENTERPRISES, LLC (NEW JERSEY  
LTD LIAB CO)  
SUITE 305  
1139 EAST JERSEY STREET  
ELIZABETH, NJ 07201

USERS TO PARTICIPATE IN COMPETITIONS, GET  
FEEDBACK FROM THEIR PEERS, FORM VIRTUAL  
COMMUNITIES AND ENGAGE IN SOCIAL NET-  
WORKING, IN CLASS 42 (U.S. CLS. 100 AND 101).

FOR: CONDUCTING PUBLIC OPINION POLLS;  
PROVIDING A WEBSITE FEATURING RATINGS  
OF PHOTOGRAPHS OF OTHERS OF HUMAN BUT-  
TOCKS, IN CLASS 35 (U.S. CLS. 100, 101 AND 102).

FIRST USE 5-1-2005; IN COMMERCE 5-1-2005.

FIRST USE 5-1-2005; IN COMMERCE 5-1-2005.

FOR: PROVIDING ONLINE FORUMS FOR  
TRANSMISSION OF MESSAGES AMONG COMPU-  
TER USERS CONCERNING PHOTOGRAPHS OF  
HUMAN BUTTOCKS AND INDIVIDUALS' PHYSI-  
CAL APPEARANCE, IN CLASS 38 (U.S. CLS. 100, 101  
AND 104).

THE MARK CONSISTS OF THE WORDS "RATE  
MY" WITH THE LEFT SIDE "R" CONNECTED  
UNDERNEATH TO THE RIGHT SIDE Y BY A  
FLOWING CONNECTION RESEMBLING A W. IF  
W IS ROTATED 90 DEGREES COUNTERCLOCK-  
WISE, IT GIVES THE APPEARANCE OF THE FOR-  
MATION OF THE LETTER "B". BELOW THE "W"  
AND LYING SIDWAYS AND PARALLEL TO THE  
W ARE THE ELONGATED LETTERS "UTT",  
STRETCHING THE WIDTH OF THE "W". THE "R"  
AND "T" IN THE WORD "RATE" ARE IN CAPI-  
TALS. THE A AND E IN THE WORD "RATE" ARE  
IN LOWER CASE. BOTH THE M AND Y IN THE  
WORD "MY" ARE IN LOWER CASE. ALL LETTERS  
IN "RATE MY" ARE THE SAME HEIGHT. THE  
LETTERS "UTT" ARE ELONGATED FROM THE  
LEFT SIDE OF THE BORDER TO THE RIGHT SIDE.  
IF THE ENTIRE MARK WAS ROTATED 90 DE-  
GREES COUNTERCLOCKWISE, THE WORD  
"BUTT" BECOMES APPARENT. NEXT TO THE  
IMAGE ARE THE WORDS THE STANDARD IN  
RATING. .

FIRST USE 5-1-2005; IN COMMERCE 5-1-2005.

FOR: ENTERTAINMENT SERVICES, NAMELY,  
PROVIDING A WEBSITE FEATURING PHOTO-  
GRAPHIC PRESENTATIONS OF HUMAN BUT-  
TOCKS; ENTERTAINMENT SERVICES, NAMELY,  
ARRANGING AND CONDUCTING COMPETI-  
TIONS IN THE NATURE OF INDIVIDUALS PHYSI-  
CAL APPEARANCE, IN CLASS 41 (U.S. CLS. 100, 101  
AND 107).

FIRST USE 5-1-2005; IN COMMERCE 5-1-2005.

SER. NO. 77-116,544, FILED 2-26-2007.

FOR: COMPUTER SERVICES, NAMELY, CREAT-  
ING AN ONLINE COMMUNITY FOR REGISTERED

ALICE BENMAMAN, EXAMINING ATTORNEY

**Int. Cls.: 6, 7 and 8**

**Prior U.S. Cls.: 2, 12, 13, 14, 19, 21, 23, 25, 28, 31, 34,  
35, 44 and 50**

**Reg. No. 3,452,007**

**United States Patent and Trademark Office**

**Registered June 24, 2008**

**TRADEMARK  
PRINCIPAL REGISTER**



AMPLE SUPPLY COMPANY (ILLINOIS COR-  
PORATION)  
11914 OAK CREEK PARKWAY  
HUNTLEY, IL 60142

FOR: INDUSTRIAL FASTENERS, NAMELY, ME-  
TAL STAPLES, NAILS AND STITCHING WIRE, IN  
CLASS 6 (U.S. CLS. 2, 12, 13, 14, 23, 25 AND 50).

FIRST USE 1-31-2002; IN COMMERCE 1-31-2002.

FOR: INDUSTRIAL POWER FASTENING MA-  
CHINES, NAMELY, STAPLERS AND NAILERS, IN  
CLASS 7 (U.S. CLS. 13, 19, 21, 23, 31, 34 AND 35).

FIRST USE 1-31-2002; IN COMMERCE 1-31-2002.

FOR: MANUAL TOOLS, NAMELY, INDUSTRIAL  
STAPLERS AND NAILERS, IN CLASS 8 (U.S. CLS. 23,  
28 AND 44).

FIRST USE 1-31-2002; IN COMMERCE 1-31-2002.

THE MARK CONSISTS OF THE LETTERS ASC IN  
STYLIZED FORM WITH THE S BEING LARGER  
THAN THE EQUAL-SIZED A AND C ON EITHER  
SIDE OF THE LARGER S.

SER. NO. 77-116,558, FILED 2-26-2007.

MIDGE BUTLER, EXAMINING ATTORNEY

Int. Cl.: 41

Prior U.S. Cls.: 100, 101 and 107

United States Patent and Trademark Office

Reg. No. 3,452,008

Registered June 24, 2008

SERVICE MARK  
PRINCIPAL REGISTER



HOMEFONTUSA (UTAH LTD LIAB CO)  
2647 EAST GENTILE  
LAYTON, UT 84040

FOR: EDUCATION SERVICES, NAMELY, PROVIDING CLASSES, SEMINARS, AND WORKSHOPS IN THE FIELDS OF REAL ESTATE; TRAINING SERVICES IN THE FIELD OF REAL ESTATE, IN CLASS 41 (U.S. CLS. 100, 101 AND 107).

FIRST USE 9-1-2005; IN COMMERCE 9-1-2005.

NO CLAIM IS MADE TO THE EXCLUSIVE RIGHT TO USE "SHORT SALES FOR PROFIT", APART FROM THE MARK AS SHOWN.

THE MARK CONSISTS OF A DRAWING OF A HOUSE WITH ABSTRACT LINES THROUGH THE HOUSE, LETTERS "SHORT SALES" THE NUMBER "4" LARGER THAN THE LETTERS AND THE LETTERS "PROFIT" UNDERNEATH.

SER. NO. 77-117,054, FILED 2-27-2007.

KELLY BOULTON, EXAMINING ATTORNEY



**Int. Cl.: 41**

**Prior U.S. Cls.: 100, 101 and 107**

**United States Patent and Trademark Office**

**Reg. No. 3,452,009**

**Registered June 24, 2008**

**SERVICE MARK  
PRINCIPAL REGISTER**

**SIMULTANEOUS KICKOFF**

POP WARNER LITTLE SCHOLARS, INC. (PENN-  
SYLVANIA NON-PROFIT CORPORATION)  
SUITE C-100  
586 MIDDLETOWN BOULEVARD  
LANGHORNE, PA 19047

FOR: ORGANIZING AND CONDUCTING  
EVENTS RELATING TO YOUTH FOOTBALL, FLAG  
FOOTBALL, AND CHEERLEADING TEAMS TO  
PROMOTE SPORTSMANSHIP AND SCHOLARSHIP,  
IN CLASS 41 (U.S. CLS. 100, 101 AND 107).

FIRST USE 8-12-2005; IN COMMERCE 8-12-2005.

THE MARK CONSISTS OF STANDARD CHAR-  
ACTERS WITHOUT CLAIM TO ANY PARTICULAR  
FONT, STYLE, SIZE, OR COLOR.

SER. NO. 77-117,079, FILED 2-27-2007.

KELLY BOULTON, EXAMINING ATTORNEY

**Int. Cl.: 35**

**Prior U.S. Cls.: 100, 101 and 102**

**United States Patent and Trademark Office**

**Reg. No. 3,452,010**

**Registered June 24, 2008**

**SERVICE MARK  
PRINCIPAL REGISTER**



CONROY MANAGEMENT & ASSOCIATES, INC.  
(LOUISIANA CORPORATION)

806 O'NEAL LANE  
BATON ROUGE, LA 70816

FOR: RETAIL STORES FEATURING PEST CONTROL PRODUCTS, IN CLASS 35 (U.S. CLS. 100, 101 AND 102).

FIRST USE 3-1-1997; IN COMMERCE 3-1-1997.

THE MARK CONSISTS OF THE WORD "PESTOP" OVERLINED WITH ONE HORIZONTAL LINE AND UNDERLINED WITH ONE HORIZONTAL LINE, WITH THE LETTER "O" SHAPED AS AN OCTAGON WITH AN INSECT PLACED IN THE CENTER OF THE OCTAGON AND A DIAGONAL LINE FROM LEFT TO RIGHT.

SER. NO. 77-117,303, FILED 2-27-2007.

DORITT L. CARROLL, EXAMINING ATTORNEY

**Int. Cl.: 5**

**Prior U.S. Cls.: 6, 18, 44, 46, 51 and 52**

**Reg. No. 3,452,011**

**United States Patent and Trademark Office**

**Registered June 24, 2008**

**TRADEMARK  
PRINCIPAL REGISTER**



white

NOVUS NUTRITION, LLC (CALIFORNIA LTD  
LIAB CO)  
8740 VILLA LA JOLLA DRIVE, SUITE 16  
LA JOLLA, CA 92037

FOR: DIETARY AND NUTRITIONAL SUPPLE-  
MENTS; DIETARY FOOD SUPPLEMENTS; DIET-  
ARY SUPPLEMENTAL DRINKS; DIETARY  
SUPPLEMENTS; DIETARY SUPPLEMENTS FOR  
HUMAN CONSUMPTION; MEAL REPLACEMENT

AND DIETARY SUPPLEMENT DRINK MIXES;  
NUTRITIONAL SUPPLEMENTS, IN CLASS 5 (U.S.  
CLS. 6, 18, 44, 46, 51 AND 52).

FIRST USE 1-1-2007; IN COMMERCE 2-27-2007.

SER. NO. 77-117,447, FILED 2-27-2007.

REBECCA EISINGER, EXAMINING ATTORNEY

**Int. Cl.: 39**

**Prior U.S. Cls.: 100 and 105**

**United States Patent and Trademark Office**

**Reg. No. 3,452,012**

**Registered June 24, 2008**

**SERVICE MARK  
PRINCIPAL REGISTER**



THE KETCHAM GROUP (NEW YORK COR-  
PORATION)  
140 OLD NORTHPORT ROAD  
KINGS PARK, NY 11754

FOR: AGRICULTURAL SERVICES, NAMELY,  
TRUCKING AND SPECIALIZED TRUCK HAUL-  
ING, IN CLASS 39 (U.S. CLS. 100 AND 105).

FIRST USE 12-0-2006; IN COMMERCE 12-0-2006.

OWNER OF U.S. REG. NO. 3,280,988.

NO CLAIM IS MADE TO THE EXCLUSIVE  
RIGHT TO USE "GROUP", APART FROM THE  
MARK AS SHOWN.

SER. NO. 77-117,911, FILED 2-28-2007.

LINDSEY RUBIN, EXAMINING ATTORNEY

**Int. Cl.: 5**

**Prior U.S. Cls.: 6, 18, 44, 46, 51 and 52**

**Reg. No. 3,452,013**

**United States Patent and Trademark Office**

**Registered June 24, 2008**

**TRADEMARK  
PRINCIPAL REGISTER**

**VENGA**

BEVERAGE INNOVATIONS (INTERNATIONAL)  
LTD. (BAHAMAS LTD LIAB CO)  
SASSOON HOUSE, SHIRLEY & VICTORIA ST.  
NASSAU, NEW PROVIDENCE, BAHAMAS

FOR: VITAMIN FORTIFIED BEVERAGES, IN  
CLASS 5 (U.S. CLS. 6, 18, 44, 46, 51 AND 52).

THE MARK CONSISTS OF STANDARD CHAR-  
ACTERS WITHOUT CLAIM TO ANY PARTICULAR  
FONT, STYLE, SIZE, OR COLOR.

PRIORITY CLAIMED UNDER SEC. 44(D) ON FED  
REP GERMANY APPLICATION NO. 30712512233,  
FILED 2-23-2007, REG. NO. 30712512, DATED 5-29-  
2007, EXPIRES 2-28-2017.

THE TERM "VENGA" TRANSLATED FROM  
SPANISH TO ENGLISH AS COME.

SER. NO. 77-118,063, FILED 2-28-2007.

JAMES A. RAUEN, EXAMINING ATTORNEY

**Int. Cl.: 35**

**Prior U.S. Cls.: 100, 101 and 102**

**United States Patent and Trademark Office**

**Reg. No. 3,452,014**

**Registered June 24, 2008**

**SERVICE MARK  
PRINCIPAL REGISTER**



GIANT BRANDS, INC. (DELAWARE CORPORATION)  
NEMOURS BUILDING, SUITE 1410  
1007 ORANGE STREET  
WILMINGTON, DE 19801

FOR: PROMOTING PUBLIC AWARENESS OF THE NEED FOR HEALTH, NUTRITION AND WELLNESS, CONDUCTED BY MEANS OTHER THAN THE INTERNET, IN CLASS 35 (U.S. CLS. 100, 101 AND 102).

FIRST USE 10-0-2006; IN COMMERCE 10-0-2006.

OWNER OF U.S. REG. NOS. 2,829,025, 2,913,183 AND OTHERS.

NO CLAIM IS MADE TO THE EXCLUSIVE RIGHT TO USE "KID", APART FROM THE MARK AS SHOWN.

THE MARK CONSISTS OF THE WORDS "KID HEALTHY IDEAS". A SUNBURST DESIGN TAKES THE PLACE OF THE DOT OVER THE LETTER "I" IN "KID". "HEALTHY IDEAS" APPEARS BELOW THE WORD "KID" AND A HORIZONTAL LINE.

SEC. 2(F) AS TO "HEALTHY IDEAS".

SER. NO. 77-118,253, FILED 2-28-2007.

JAY BESCH, EXAMINING ATTORNEY

**Int. Cl.: 35**

**Prior U.S. Cls.: 100, 101 and 102**

**United States Patent and Trademark Office**

**Reg. No. 3,452,015**

**Registered June 24, 2008**

**SERVICE MARK  
PRINCIPAL REGISTER**



SEWING CENTER SUPPLY CO., INC. (OREGON CORPORATION)  
19018 NE PORTAL WAY  
PORTLAND, OR 97230

FOR: WHOLESALE DISTRIBUTORSHIP OF SEWING AND CRAFT SUPPLIES AND ACCESSORIES, SEWING CABINETS, CRAFT TABLES AND CABINETS; PROVIDING ADVERTISING FOR OTHERS OF RETAIL DISTRIBUTORSHIPS SELLING SEWING AND CRAFT SUPPLIES AND ACCESSORIES, SEWING CABINETS, CRAFT TABLES AND CABINETS, IN CLASS 35 (U.S. CLS. 100, 101 AND 102).

FIRST USE 12-0-2007; IN COMMERCE 12-0-2007.

NO CLAIM IS MADE TO THE EXCLUSIVE RIGHT TO USE "SEWING & CRAFT CLUB", APART FROM THE MARK AS SHOWN.

"THE COLOR(S) BLUE, WHITE, GOLD AND GRAY IS/ARE CLAIMED AS A FEATURE OF THE MARK."

THE MARK CONSISTS OF THE WORDS SEWING & CRAFT CLUB. THE COLOR BLUE APPEARS IN THE RECTANGULAR DESIGN WITHIN THE CARD SHAPE; THE COLOR GOLD APPEARS IN THE CROSS-STITCH DESIGN IN THE UPPER RIGHT CORNER OF THE BLUE RECTANGLE AND IN THE WORDING "SEWING & CRAFT CLUB"; THE COLOR WHITE APPEARS IN THE STYLIZED LETTERS "SCS" WITHIN THE BLUE RECTANGLE AND AS THE BACKGROUND OF THE MARK; AND THE COLOR GRAY APPEARS AS THE UNDERLINE FOR THE WORDING "SEWING & CRAFT" AND AS SHADING ON THE EDGES OF THE CARD DESIGN.

SER. NO. 77-118,395, FILED 2-28-2007.

KAREN BRACEY, EXAMINING ATTORNEY

**Int. Cl.: 10**

**Prior U.S. Cls.: 26, 39 and 44**

**United States Patent and Trademark Office**

**Reg. No. 3,452,016**

**Registered June 24, 2008**

**TRADEMARK  
PRINCIPAL REGISTER**

**EPOCA**

SYNTHES (U.S.A.) (PENNSYLVANIA PARTNER-  
SHIP)  
1302 WRIGHTS LANE EAST  
WEST CHESTER, PA 19380

THE MARK CONSISTS OF STANDARD CHAR-  
ACTERS WITHOUT CLAIM TO ANY PARTICULAR  
FONT, STYLE, SIZE, OR COLOR.

FOR: SURGICAL IMPLANTS, NAMELY,  
SHOULDER PROSTHESIS, IN CLASS 10 (U.S. CLS.  
26, 39 AND 44).

SER. NO. 77-118,597, FILED 2-28-2007.

FIRST USE 9-18-1997; IN COMMERCE 9-18-1997.

REBECCA SMITH, EXAMINING ATTORNEY



**Int. Cls.: 4, 11 and 21**

**Prior U.S. Cls.: 1, 2, 6, 13, 15, 21, 23, 29, 30, 31, 33, 34,  
40 and 50**

**Reg. No. 3,452,017**

**United States Patent and Trademark Office**

**Registered June 24, 2008**

**TRADEMARK  
PRINCIPAL REGISTER**

**INNOPOWER THE POWER OF  
INNOVATION**

INNOPOWER LTD. (CHINA CORPORATION)  
SHIQI, YINZHOU  
DONGYANG INDUSTRIAL ZONE  
NINGBO, CHINA

FOR: CANDLES, IN CLASS 4 (U.S. CLS. 1, 6 AND 15).

FIRST USE 11-8-2006; IN COMMERCE 11-8-2006.

FOR: BARBECUE GRILLS, CANDLE LAMPS, CANDLE LANTERNS, DECORATIVE WATER FOUNTAINS, DRINKING FOUNTAINS, ELECTRIC CANDLES, ELECTRIC PATIO HEATERS, ELECTRIC RADIANT HEATERS FOR HOUSEHOLD PURPOSES, FIREPLACES, GAS RANGES, GAS STOVES, KITCHEN SINKS, PORTABLE THERMO-ELECTRIC COOLING AND HEATING UNIT FOR FOOD AND BEVERAGES, GAS PATIO HEATERS,

PORTABLE ELECTRIC HEATERS, RANGE HOODS, AND WATER FOUNTAINS, IN CLASS 11 (U.S. CLS. 13, 21, 23, 31 AND 34).

FIRST USE 9-27-2005; IN COMMERCE 4-1-2006.

FOR: CANDLE HOLDERS, IN CLASS 21 (U.S. CLS. 2, 13, 23, 29, 30, 33, 40 AND 50).

FIRST USE 12-1-2006; IN COMMERCE 12-1-2006.

THE MARK CONSISTS OF STANDARD CHARACTERS WITHOUT CLAIM TO ANY PARTICULAR FONT, STYLE, SIZE, OR COLOR.

SER. NO. 77-119,036, FILED 2-28-2007.

COLLEEN KEARNEY, EXAMINING ATTORNEY

Int. Cl.: 25

Prior U.S. Cls.: 22 and 39

United States Patent and Trademark Office

Reg. No. 3,452,018

Registered June 24, 2008

TRADEMARK  
PRINCIPAL REGISTER



MYRTLE BEACH PELICANS LP (PENNSYLVANIA LIMITED PARTNERSHIP)  
1251 21ST AVE. N  
MYRTLE BEACH, SC 29577

FIRST USE 11-30-2006; IN COMMERCE 11-30-2006.

OWNER OF U.S. REG. NOS. 2,317,254 AND 2,471,929.

FOR: CLOTHING, NAMELY, ATHLETIC UNIFORMS, CAPS, GOLF SHIRTS, GYM SHORTS, HATS, JACKETS, JERSEYS, KNIT SHIRTS, POLO SHIRTS, PONCHOS, PULLOVERS, RAIN COATS, RAINWEAR, SWEATERS, SWEAT PANTS, SWEAT SHIRTS, SWEAT SUITS, SOCKS, SPORT SHIRTS, T-SHIRTS, TANK TOPS, TIES, VISORS, WIND RESISTANT JACKETS AND WRISTBANDS, IN CLASS 25 (U.S. CLS. 22 AND 39).

NO CLAIM IS MADE TO THE EXCLUSIVE RIGHT TO USE "MYRTLE BEACH", APART FROM THE MARK AS SHOWN.

SER. NO. 77-119,310, FILED 3-1-2007.

SHARON MEIER, EXAMINING ATTORNEY

**Int. Cl.: 9**

**Prior U.S. Cls.: 21, 23, 26, 36 and 38**

**Reg. No. 3,452,019**

**United States Patent and Trademark Office**

**Registered June 24, 2008**

**TRADEMARK  
PRINCIPAL REGISTER**

**SAN FRANCISCO 49ERS**

SAN FRANCISCO FORTY NINERS, LIMITED  
(CALIFORNIA LIMITED PARTNERSHIP)  
4949 CENTENNIAL BOULEVARD  
SANTA CLARA, CA 95054

FOR: FOOTBALL HELMETS, TELEPHONES,  
CELL PHONE COVERS, MAGNETICALLY ENCO-  
DED CREDIT CARDS, DECORATIVE MAGNETS,  
PRE-RECORDED DVD'S FEATURING THE SPORT  
OF FOOTBALL, COMPUTER GAME SOFTWARE,  
VIDEO GAME CARTRIDGES, COMPUTER MOUSE  
PADS AND SUNGLASSES, IN CLASS 9 (U.S. CLS. 21,  
23, 26, 36 AND 38).

FIRST USE 9-30-1983; IN COMMERCE 9-30-1983.

THE MARK CONSISTS OF STANDARD CHAR-  
ACTERS WITHOUT CLAIM TO ANY PARTICULAR  
FONT, STYLE, SIZE, OR COLOR.

OWNER OF U.S. REG. NOS. 829,949 AND 1,810,714.

NO CLAIM IS MADE TO THE EXCLUSIVE  
RIGHT TO USE "SAN FRANCISCO", APART FROM  
THE MARK AS SHOWN.

SER. NO. 77-119,378, FILED 3-1-2007.

MARIA-VICTORIA SUAREZ, EXAMINING ATTOR-  
NEY

**Int. Cl.: 42**

**Prior U.S. Cls.: 100 and 101**

**United States Patent and Trademark Office**

**Reg. No. 3,452,020**

**Registered June 24, 2008**

**SERVICE MARK  
PRINCIPAL REGISTER**

**ENTERDEV**

ENTERDEV, LLC (ILLINOIS LTD LIAB CO)  
1668 BLACKWELL LANE  
AURORA, IL 60504

FIRST USE 5-0-2002; IN COMMERCE 5-0-2002.

FOR: CUSTOM WEBSITE DESIGN; DESIGN,  
CREATION, HOSTING AND MAINTENANCE OF  
INTERNET SITES FOR THIRD PARTIES; DESIGN,  
CREATION, HOSTING, MAINTENANCE OF WEB-  
SITES FOR OTHERS; HOSTING OF DIGITAL CON-  
TENT ON THE INTERNET; GRAPHIC DESIGN  
SERVICES, IN CLASS 42 (U.S. CLS. 100 AND 101).

THE MARK CONSISTS OF STANDARD CHAR-  
ACTERS WITHOUT CLAIM TO ANY PARTICULAR  
FONT, STYLE, SIZE, OR COLOR.

SER. NO. 77-119,719, FILED 3-1-2007.

LOURDES AYALA, EXAMINING ATTORNEY

**Int. Cls.: 1, 3 and 5**

**Prior U.S. Cls.: 1, 4, 5, 6, 10, 18, 26, 44, 46, 50, 51 and 52**

**Reg. No. 3,452,021**

**United States Patent and Trademark Office**

**Registered June 24, 2008**

**TRADEMARK  
PRINCIPAL REGISTER**

# GLB Pool & Spa

ADVANTIS TECHNOLOGIES, INC. (DELAWARE CORPORATION)

1400 BLUEGRASS LAKES PARKWAY

ALPHARETTA, GA 30004

FOR: WATER PURIFYING AND TREATMENT CHEMICALS FOR SWIMMING POOLS, SPAS, HOT TUBS, AND BATHS, NAMELY, WATER CHLORINATING CHEMICALS; SLIME REMOVERS FOR WATER; BALANCERS FOR ADJUSTING AND BUFFERING PH, TOTAL ALKALINITY, AND HARDNESS OF WATER; CHLORINE SHOCK TREATMENTS FOR OXIDIZING WATER CONTAMINANTS; NON-CHLORINE SHOCK TREATMENTS FOR OXIDIZING WATER CONTAMINANTS; CLARIFIERS FOR AGGLOMERATING PARTICLES SUSPENDING IN WATER TO FACILITATE FILTERING, REACTING WITH ORGANIC CONTAMINANTS IN WATER, PREVENTING SCUM LINES, FILTER CLOGGING AND CLOUDINESS IN WATER, AND PREVENTING FLOATING AND DIVING INSECTS FROM GATHERING ON A WATER SURFACE; COAGULATING AGENTS FOR PRECIPITATING FLOATING DEBRIS AND UNFILTERABLE MATERIAL IN WATER; FOAM REDUCERS FOR WATER; STABILIZERS FOR STABILIZING CHLORINATED WATER AGAINST ATTACK BY SUNLIGHT; STAIN CONTROLLERS, NAMELY SEQUESTERING AGENTS FOR PREVENTING STAINING, SCALE, AND RUST IN WATER FROM DEPOSITING ON POOL EQUIPMENT, PIPES AND FITTINGS; TEST STRIPS FOR TESTING THE PH, ALKALINITY, CHLORINE OR BROMINE CONCENTRATION IN WATER; AND WATER TREATMENT AND TEST KITS COMPRISING WATER PURIFYING AND TREATMENT CHEMICALS FOR CONTROLLING AND TESTING THE PH, ALKALINITY, CHLORINE OR BROMINE IN WATER; AND TEST STRIPS FOR CONTROLLING AND TESTING THE PH, ALKALINITY, CHLORINE

OR BROMINE IN WATER, IN CLASS 1 (U.S. CLS. 1, 5, 6, 10, 26 AND 46).

FIRST USE 3-1-1999; IN COMMERCE 3-1-1999.

FOR: FRAGRANCES FOR WATER FOR USE IN SWIMMING POOLS, SPAS, HOT TUBS, AND BATHS; CLEANERS FOR SWIMMING POOLS, HOT TUBS, SPAS, AND BATHS, NAMELY, FILTER CLEANERS FOR REMOVING SCALE, RUST, COSMETICS, OILS, SCALE, AND OTHER MATERIALS FROM WATER FILTER CARTRIDGES AND SAND AND DIATOMITE FILTERS, SURFACE CLEANERS FOR REMOVING GRIME, GREASE, OILS, DIRT, STAINS, AND MINERAL SCALE FROM TILE, VINYL, CONCRETE, GUNITE, FIBERGLASS, ACRYLIC, AND METAL POOL, SPA, PATIO, AND OUTDOOR FURNITURE SURFACES, POLISHES FOR SPA SURFACES, AND CLEANERS FOR POOL AND SOLAR COVERS, IN CLASS 3 (U.S. CLS. 1, 4, 6, 50, 51 AND 52).

FIRST USE 3-1-1999; IN COMMERCE 3-1-1999.

FOR: SANITIZERS FOR WATER IN SWIMMING POOLS, SPAS, HOT TUBS, AND BATHS, NAMELY, WATER BROMINATING CHEMICALS; AND ALGAECIDES FOR SWIMMING POOLS, SPAS, HOT TUBS, AND BATHS, IN CLASS 5 (U.S. CLS. 6, 18, 44, 46, 51 AND 52).

FIRST USE 3-1-1999; IN COMMERCE 3-1-1999.

THE MARK CONSISTS OF STANDARD CHARACTERS WITHOUT CLAIM TO ANY PARTICULAR FONT, STYLE, SIZE, OR COLOR.

OWNER OF U.S. REG. NOS. 1,123,525, 1,632,823, AND 2,894,617.

NO CLAIM IS MADE TO THE EXCLUSIVE  
RIGHT TO USE "POOL & SPA", APART FROM  
THE MARK AS SHOWN.

SER. NO. 77-121,215, FILED 3-2-2007.

TINA L. SNAPP, EXAMINING ATTORNEY

**Int. Cl.: 12**

**Prior U.S. Cls.: 19, 21, 23, 31, 35 and 44**

**Reg. No. 3,452,022**

**United States Patent and Trademark Office**

**Registered June 24, 2008**

---

**TRADEMARK  
PRINCIPAL REGISTER**

**RIDE THE FUTURE**

ZAP (CALIFORNIA CORPORATION)  
501 FOURTH STREET  
SANTA ROSA, CA 95401

THE MARK CONSISTS OF STANDARD CHAR-  
ACTERS WITHOUT CLAIM TO ANY PARTICULAR  
FONT, STYLE, SIZE, OR COLOR.

FOR: ELECTRIC VEHICLES, NAMELY, CARS,  
TRUCKS, BIKES, SCOOTERS, AND ALL TERRAIN  
VEHICLES, IN CLASS 12 (U.S. CLS. 19, 21, 23, 31, 35  
AND 44).

SER. NO. 77-121,301, FILED 3-2-2007.

FIRST USE 7-13-2001; IN COMMERCE 7-13-2001.

PAUL F. GAST, EXAMINING ATTORNEY

**Int. Cl.: 42**

**Prior U.S. Cls.: 100 and 101**

**United States Patent and Trademark Office**

**Reg. No. 3,452,023**

**Registered June 24, 2008**

**SERVICE MARK  
PRINCIPAL REGISTER**

**WEATHERTECH INNOVATIONS**

GEL TECH SOLUTIONS, INC. (FLORIDA CORPORATION)  
SUITE 1  
1460 PARK LANE SOUTH  
JUPITER, FL 33458

FOR: NEW PRODUCT RESEARCH, DESIGN, AND DEVELOPMENT SERVICES IN THE FIELD OF POLYMER COMPOSITIONS FOR USE IN MODIFYING WEATHER, IN CLASS 42 (U.S. CLS. 100 AND 101).

FIRST USE 7-31-2006; IN COMMERCE 7-31-2006.

THE MARK CONSISTS OF STANDARD CHARACTERS WITHOUT CLAIM TO ANY PARTICULAR FONT, STYLE, SIZE, OR COLOR.

NO CLAIM IS MADE TO THE EXCLUSIVE RIGHT TO USE "WEATHER TECH", APART FROM THE MARK AS SHOWN.

SER. NO. 77-121,331, FILED 3-2-2007.

MAUREEN DALL, EXAMINING ATTORNEY



**Int. Cl.: 35**

**Prior U.S. Cls.: 100, 101 and 102**

**United States Patent and Trademark Office**

**Reg. No. 3,452,024**

**Registered June 24, 2008**

**SERVICE MARK  
PRINCIPAL REGISTER**



THE HENRY J. KAISER FAMILY FOUNDATION  
(CALIFORNIA CHARITABLE TRUST)  
2400 SAND HILL ROAD  
MENLO PARK, CA 94025

FIRST USE 2-13-2007; IN COMMERCE 3-5-2007.

FOR: PROMOTING PUBLIC AWARENESS BY  
FACILITATING A PARTNERSHIP OF CARIBBEAN  
MEDIA ENTITIES TO INFORM THE PUBLIC  
ABOUT HIV/AIDS WITH THE GOALS OF REDU-  
CING THE STIGMA FACING THOSE LIVING WITH  
THE DISEASE AND REDUCING ITS SPREAD, IN  
CLASS 35 (U.S. CLS. 100, 101 AND 102).

THE MARK CONSISTS OF THE STYLIZED  
WORDS "LOVE. PROTECT. RESPECT." BELOW  
THE STYLIZED WORDS "LIVE UP".

SER. NO. 77-122,215, FILED 3-5-2007.

MARILYN IZZI, EXAMINING ATTORNEY

**Int. Cl.: 35**

**Prior U.S. Cls.: 100, 101 and 102**

**United States Patent and Trademark Office**

**Reg. No. 3,452,025**

**Registered June 24, 2008**

**SERVICE MARK  
PRINCIPAL REGISTER**

**LIVE UP: Love. Protect.  
Respect.**

THE HENRY J. KAISER FAMILY FOUNDATION  
(CALIFORNIA CHARITABLE TRUST)  
2400 SAND HILL ROAD  
MENLO PARK, CA 94025

FOR: PROMOTING PUBLIC AWARENESS BY  
FACILITATING A PARTNERSHIP OF CARIBBEAN  
MEDIA ENTITIES TO INFORM THE PUBLIC  
ABOUT HIV/AIDS WITH THE GOALS OF REDU-  
CING THE STIGMA FACING THOSE LIVING WITH  
THE DISEASE AND REDUCING ITS SPREAD, IN  
CLASS 35 (U.S. CLS. 100, 101 AND 102).

FIRST USE 2-13-2007; IN COMMERCE 3-5-2007.

THE MARK CONSISTS OF STANDARD CHAR-  
ACTERS WITHOUT CLAIM TO ANY PARTICULAR  
FONT, STYLE, SIZE, OR COLOR.

SER. NO. 77-122,238, FILED 3-5-2007.

MARILYN IZZI, EXAMINING ATTORNEY

**Int. Cl.: 7**

**Prior U.S. Cls.: 13, 19, 21, 23, 31, 34 and 35**

**United States Patent and Trademark Office**

**Reg. No. 3,452,026**

**Registered June 24, 2008**

**TRADEMARK  
PRINCIPAL REGISTER**

**DDV**

WEATHERFORD/LAMB, INC. (DELAWARE  
CORPORATION)  
SUITE 600  
515 POST OAK BLVD.  
HOUSTON, TX 77027

FOR: FLUID POWER COMPONENT KIT FOR  
MACHINE CONTROL COMPRISING DOWNHOLE  
PUMPS AND DOWNHOLE VALVES; HYDRAULIC  
DOWNHOLE VALVE ACTUATORS; DOWNHOLE  
PUMP CONTROL VALVES; VALVES FOR DOWN-  
HOLE PUMPS, IN CLASS 7 (U.S. CLS. 13, 19, 21, 23, 31,  
34 AND 35).

FIRST USE 12-14-2006; IN COMMERCE 12-14-2006.

THE MARK CONSISTS OF STANDARD CHAR-  
ACTERS WITHOUT CLAIM TO ANY PARTICULAR  
FONT, STYLE, SIZE, OR COLOR.

SER. NO. 77-123,321, FILED 3-6-2007.

JACQUELINE A. LAVINE, EXAMINING ATTOR-  
NEY

**Int. Cl.: 9**

**Prior U.S. Cls.: 21, 23, 26, 36 and 38**

**Reg. No. 3,452,027**

**United States Patent and Trademark Office**

**Registered June 24, 2008**

---

**TRADEMARK  
PRINCIPAL REGISTER**

**STRIKE ZONE**

DELL INC. (DELAWARE CORPORATION)  
ONE DELL WAY  
ROUND ROCK, TX 78682

FIRST USE 3-1-2006; IN COMMERCE 3-1-2006.

FOR: FEATURE OF A COMPUTER LAPTOP,  
NAMELY, A SHOCK ABSORBING PROTECTION  
SYSTEM THAT ENHANCES THE DURABILITY OF  
THE HARDWARE, SOLD AS AN INTEGRAL COM-  
PONENT OF LAPTOP COMPUTERS , IN CLASS 9  
(U.S. CLS. 21, 23, 26, 36 AND 38).

THE MARK CONSISTS OF STANDARD CHAR-  
ACTERS WITHOUT CLAIM TO ANY PARTICULAR  
FONT, STYLE, SIZE, OR COLOR.

SER. NO. 77-123,724, FILED 3-6-2007.

JESSICA FATHY, EXAMINING ATTORNEY

**Int. Cl.: 37**

**Prior U.S. Cls.: 100, 103 and 106**

**Reg. No. 3,452,028**

**United States Patent and Trademark Office**

**Registered June 24, 2008**

**SERVICE MARK  
PRINCIPAL REGISTER**



HEITKAMP, INC. (DELAWARE CORPORATION)  
99 CALLENDAR ROAD  
WATERTOWN, CT 06795

AND INFRASTRUCTURE, IN CLASS 37 (U.S. CLS.  
100, 103 AND 106).

FOR: CONSTRUCTION SERVICES, NAMELY,  
CLEANING, MAINTENANCE, REPAIR, IMPROVE-  
MENT, RESTORATION AND CONSTRUCTION OF  
MUNICIPAL, COMMERCIAL, INDUSTRIAL AND  
RESIDENTIAL WATER DISTRIBUTION SYSTEMS

FIRST USE 1-19-1982; IN COMMERCE 5-0-1983.

SER. NO. 77-124,769, FILED 3-7-2007.

DAVID YONTEF, EXAMINING ATTORNEY

**Int. Cl.: 37**

**Prior U.S. Cls.: 100, 103 and 106**

**United States Patent and Trademark Office**

**Reg. No. 3,452,029**

**Registered June 24, 2008**

**SERVICE MARK  
PRINCIPAL REGISTER**



HEITKAMP, INC. (DELAWARE CORPORATION)  
99 CALLENDAR ROAD  
WATERTOWN, CT 06795

FOR: CONSTRUCTION SERVICES, NAMELY,  
CLEANING, MAINTENANCE, REPAIR, IMPROVE-  
MENT, RESTORATION AND CONSTRUCTION OF  
MUNICIPAL, COMMERCIAL, INDUSTRIAL AND  
RESIDENTIAL WASTEWATER AND STORM WA-

TER COLLECTION SYSTEMS AND INFRASTRUC-  
TURE, IN CLASS 37 (U.S. CLS. 100, 103 AND 106).

FIRST USE 10-30-1987; IN COMMERCE 10-30-1987.

OWNER OF U.S. REG. NO. 1,652,604.

SER. NO. 77-124,806, FILED 3-7-2007.

DAVID YONTEF, EXAMINING ATTORNEY

**Int. Cl.: 42**

**Prior U.S. Cls.: 100 and 101**

**United States Patent and Trademark Office**

**Reg. No. 3,452,030**

**Registered June 24, 2008**

**SERVICE MARK  
PRINCIPAL REGISTER**

**Ace Environmental, LLC**

ACE ENVIRONMENTAL, LLC (NEVADA LTD  
LIAB CO)  
7855 SPINDRIFT COVE STREET  
LAS VEGAS, NV 89113

FOR: ENGINEERING SERVICES FOR BUILDING  
AND PROPERTY CONDITION ASSESSMENT, FA-  
CILITY MANAGEMENT, REPAIR AND RESTORA-  
TION, BUILDING INSTRUMENTATION AND  
MONITORING, AND ENVIRONMENTAL CON-  
SULTING, IN CLASS 42 (U.S. CLS. 100 AND 101).

FIRST USE 4-27-2005; IN COMMERCE 4-27-2005.

THE MARK CONSISTS OF STANDARD CHAR-  
ACTERS WITHOUT CLAIM TO ANY PARTICULAR  
FONT, STYLE, SIZE, OR COLOR.

NO CLAIM IS MADE TO THE EXCLUSIVE  
RIGHT TO USE "ENVIRONMENTAL, LLC", APART  
FROM THE MARK AS SHOWN.

SER. NO. 77-125,041, FILED 3-7-2007.

MICHAEL WIENER, EXAMINING ATTORNEY

**Int. Cl.: 41**

**Prior U.S. Cls.: 100, 101 and 107**

**United States Patent and Trademark Office**

**Reg. No. 3,452,031**

**Registered June 24, 2008**

**SERVICE MARK  
PRINCIPAL REGISTER**

**GILMAN LACROSSE**

GILMAN LACROSSE, LLC (CONNECTICUT LTD  
LIAB CO)  
P.O. BOX 7321  
28 WILRIDGE ROAD  
WILTON, CT 06897

FOR: PERSONAL COACHING SERVICES IN THE  
FIELD OF LACROSSE, IN CLASS 41 (U.S. CLS. 100,  
101 AND 107).

FIRST USE 7-13-1995; IN COMMERCE 7-13-1995.

THE MARK CONSISTS OF STANDARD CHAR-  
ACTERS WITHOUT CLAIM TO ANY PARTICULAR  
FONT, STYLE, SIZE, OR COLOR.

NO CLAIM IS MADE TO THE EXCLUSIVE  
RIGHT TO USE "LACROSSE", APART FROM THE  
MARK AS SHOWN.

SER. NO. 77-125,144, FILED 3-7-2007.

DEIRDRE ROBERTSON, EXAMINING ATTORNEY



**Int. Cls.: 37 and 44**

**Prior U.S. Cls.: 100, 101, 103 and 106**

**United States Patent and Trademark Office**

**Reg. No. 3,452,032**

**Registered June 24, 2008**

**SERVICE MARK  
PRINCIPAL REGISTER**



PROSCAPES - LANDSCAPE DESIGN GROUP,  
INC. (TENNESSEE CORPORATION)  
921 SUWANNEE ROAD  
KNOXVILLE, TN 37923

FOR: INSTALLATION AND MAINTENANCE OF  
IRRIGATION SYSTEMS, IN CLASS 37 (U.S. CLS. 100,  
103 AND 106).

FIRST USE 2-25-2007; IN COMMERCE 2-25-2007.

FOR: LANDSCAPE GARDENING, IN CLASS 44  
(U.S. CLS. 100 AND 101).

FIRST USE 6-1-2000; IN COMMERCE 6-1-2000.

NO CLAIM IS MADE TO THE EXCLUSIVE  
RIGHT TO USE "LANDSCAPE DESIGN GROUP,  
INC.", APART FROM THE MARK AS SHOWN.

THE COLOR(S) RED AND BLACK IS/ARE  
CLAIMED AS A FEATURE OF THE MARK.

THE MARK CONSISTS OF THE WORD "PROSCAPES" IN BLACK, WRAPPED OVER THE TOP OF A RED HALF SUN. THE WORDS "LANDSCAPE DESIGN GROUP, INC." IN BLACK ARE LOCATED UNDERNEATH THE RED HALF SUN.

SER. NO. 77-125,375, FILED 3-8-2007.

JOHN SCHUYLER YARD, EXAMINING ATTORNEY

**Int. Cl.: 41**

**Prior U.S. Cls.: 100, 101 and 107**

**United States Patent and Trademark Office**

**Reg. No. 3,452,033**

**Registered June 24, 2008**

**SERVICE MARK  
PRINCIPAL REGISTER**

**BREAKFAST SERIALS**

BREAKFAST SERIALS, INC. (COLORADO CORPORATION)  
859 SOUTH YORK STREET  
DENVER, CO 80209

FOR: PUBLISHING SERVICES, NAMELY, THE PUBLICATION OF LITERATURE, NAMELY, SHORT STORIES, NOVELS AND NOVELLAS, OVER THE INTERNET IN SERIALIZED FORM AND THE PLACEMENT WITH NEWSPAPERS OF LITERATURE FOR PUBLICATION IN SERIALIZED FORM, IN CLASS 41 (U.S. CLS. 100, 101 AND 107).

FIRST USE 9-11-1997; IN COMMERCE 9-11-1997.

THE MARK CONSISTS OF STANDARD CHARACTERS WITHOUT CLAIM TO ANY PARTICULAR FONT, STYLE, SIZE, OR COLOR.

OWNER OF U.S. REG. NO. 2,651,060.

NO CLAIM IS MADE TO THE EXCLUSIVE RIGHT TO USE "SERIALS", APART FROM THE MARK AS SHOWN.

SER. NO. 77-125,677, FILED 3-8-2007.

SCOTT BIBB, EXAMINING ATTORNEY

**Int. Cls.: 9 and 16**

**Prior U.S. Cls.: 2, 5, 21, 22, 23, 26, 29, 36, 37, 38 and 50**

**United States Patent and Trademark Office**

**Reg. No. 3,452,034**

**Registered June 24, 2008**

**TRADEMARK  
PRINCIPAL REGISTER**

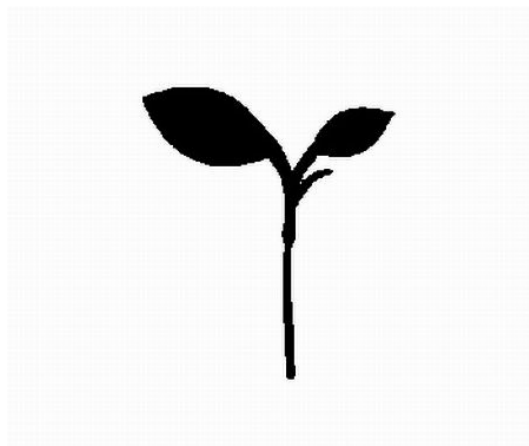

THE INSPIRATIONAL NETWORK, INC. (NORTH  
CAROLINA NON-PROFIT CORPORATION)  
SUITE 500  
7910 CRESCENT EXECUTIVE DRIVE  
CHARLOTTE, NC 28217

FOR: VIDEO TAPES AND DVDS FEATURING  
CHRISTIAN RELIGIOUS TOPICS, IN CLASS 9 (U.S.  
CLS. 21, 23, 26, 36 AND 38).

FIRST USE 5-0-2006; IN COMMERCE 5-0-2006.

FOR: PRINTED MATERIALS, NAMELY, WORK-  
BOOKS FEATURING CHRISTIAN RELIGIOUS TO-

PICS, IN CLASS 16 (U.S. CLS. 2, 5, 22, 23, 29, 37, 38  
AND 50).

FIRST USE 5-0-2006; IN COMMERCE 5-0-2006.

THE MARK CONSISTS OF BLACK AND WHITE  
IMAGE OF A SMALL GROWING PLANT WITH  
STALK AND LEAVES.

SER. NO. 77-125,756, FILED 3-8-2007.

KEVIN CORWIN, EXAMINING ATTORNEY

**Int. Cls.: 9 and 16**

**Prior U.S. Cls.: 2, 5, 21, 22, 23, 26, 29, 36, 37, 38 and 50**

**Reg. No. 3,452,035**

**United States Patent and Trademark Office**

**Registered June 24, 2008**

---

**TRADEMARK  
PRINCIPAL REGISTER**

**MICROCAPTIVATIONS**

THE INVESTOR RELATIONS GROUP, INC.  
(NEW YORK CORPORATION)  
3RD FLOOR  
11 STONE STREET  
NEW YORK, NY 10004

FOR: DOWNLOADABLE ELECTRONIC NEWS-  
LETTERS FOR MICROCAPITLIZATION AND  
SMALL CAPITALIZATION STOCKS , IN CLASS 9  
(U.S. CLS. 21, 23, 26, 36 AND 38).

FIRST USE 6-27-2006; IN COMMERCE 6-27-2006.

FOR: NEWSLETTERS FOR MICROCAPITLIZA-  
TION AND SMALL CAPITALIZATION STOCKS, IN  
CLASS 16 (U.S. CLS. 2, 5, 22, 23, 29, 37, 38 AND 50).

FIRST USE 6-27-2006; IN COMMERCE 6-27-2006.

THE MARK CONSISTS OF STANDARD CHAR-  
ACTERS WITHOUT CLAIM TO ANY PARTICULAR  
FONT, STYLE, SIZE, OR COLOR.

SER. NO. 77-125,958, FILED 3-8-2007.

ELIZABETH KAJUBI, EXAMINING ATTORNEY

**Int. Cl.: 35**

**Prior U.S. Cls.: 100, 101 and 102**

**United States Patent and Trademark Office**

**Reg. No. 3,452,036**

**Registered June 24, 2008**

**SERVICE MARK  
PRINCIPAL REGISTER**

**LUMINATIONS LIGHTNING  
STRIKE**

THE LUMINATIONS GROUP, LLC (NEW JERSEY LTD LIAB CO)  
9 KILMER DRIVE  
HILLSBOROUGH, NJ 08844

FOR: BUSINESS MARKETING SERVICES, NAMELY, MARKETING CONSULTATION AND BRAND CONSULTATION AND NEW PRODUCT IDEATION; CONSULTANCY REGARDING BUSINESS STRATEGIES AND PLANNING; CONFERENCE MARKETING AND INTERIM BUSINESS MARKETING SUPPORT; DIRECT-TO-CONSUMER MARKETING SERVICES AND DEVELOPMENT OF

ONLINE MARKETING STRATEGIES, IN CLASS 35 (U.S. CLS. 100, 101 AND 102).

FIRST USE 6-2-2004; IN COMMERCE 6-2-2004.

THE MARK CONSISTS OF STANDARD CHARACTERS WITHOUT CLAIM TO ANY PARTICULAR FONT, STYLE, SIZE, OR COLOR.

SER. NO. 77-126,398, FILED 3-9-2007.

PAULA MAHONEY, EXAMINING ATTORNEY

**Int. Cl.: 19**

**Prior U.S. Cls.: 1, 12, 33 and 50**

**United States Patent and Trademark Office**

**Reg. No. 3,452,037**

**Registered June 24, 2008**

**TRADEMARK  
PRINCIPAL REGISTER**

**AB CLASSIC**

ALLAN BLOCK CORPORATION (MINNESOTA  
CORPORATION)  
SUITE 100  
5300 EDINA INDUSTRIAL BOULEVARD  
EDINA, MN 55439

FOR: LANDSCAPING AND RETAINING WALL  
CONCRETE BLOCKS, IN CLASS 19 (U.S. CLS. 1, 12,  
33 AND 50).

FIRST USE 12-31-1998; IN COMMERCE 12-31-1998.

THE MARK CONSISTS OF STANDARD CHAR-  
ACTERS WITHOUT CLAIM TO ANY PARTICULAR  
FONT, STYLE, SIZE, OR COLOR.

OWNER OF U.S. REG. NOS. 1,741,318, 2,638,861  
AND OTHERS.

NO CLAIM IS MADE TO THE EXCLUSIVE  
RIGHT TO USE "CLASSIC", APART FROM THE  
MARK AS SHOWN.

SER. NO. 77-126,693, FILED 3-9-2007.

CAROL SPILS, EXAMINING ATTORNEY

**Int. Cl.: 44**

**Prior U.S. Cls.: 100 and 101**

**United States Patent and Trademark Office**

**Reg. No. 3,452,038**

**Registered June 24, 2008**

**SERVICE MARK  
PRINCIPAL REGISTER**



JAZZ PHARMACEUTICALS, INC. (DELAWARE CORPORATION)  
3180 PORTER DRIVE  
PALO ALTO, CA 94304

FOR: MEDICAL INFORMATION; PROVIDING MEDICAL INFORMATION; AND PROVIDING HEALTH CARE INFORMATION BY TELEPHONE AND THE INTERNET, IN CLASS 44 (U.S. CLS. 100 AND 101).

FIRST USE 8-11-2006; IN COMMERCE 8-11-2006.

OWNER OF U.S. REG. NO. 3,005,004.

THE COLOR(S) PURPLE, GOLD, AND WHITE IS/ ARE CLAIMED AS A FEATURE OF THE MARK.

THE MARK CONSISTS OF CONCENTRIC CIRCLES OF PURPLE AND WHITE CONTAINING A STYLIZED DEPICTION OF THE LETTERS "JP" IN THE COLOR WHITE WHICH VERTICALLY SPLITS THE CIRCLE SHOWING GOLD ON THE RIGHT PORTION AND PURPLE ON THE LEFT PORTION OF THE CIRCLE.

SER. NO. 77-126,898, FILED 3-9-2007.

JOHN DWYER, EXAMINING ATTORNEY

**Int. Cls.: 5, 29 and 30**

**Prior U.S. Cls.: 6, 18, 44, 46, 51 and 52**

**United States Patent and Trademark Office**

**Reg. No. 3,452,039**

**Registered June 24, 2008**

**TRADEMARK  
PRINCIPAL REGISTER**

**GO RAW**

FREELAND FOODS INC. (CALIFORNIA CORPORATION)  
2245 MORA DRIVE  
MOUNTAIN VIEW, CA 94040

FOR: MEAL REPLACEMENT BARS; NUTRITIONAL BARS FOR USE AS A MEAL REPLACEMENT ALL SOLD AT WHOLESALE, IN CLASS 5 (U.S. CLS. 6, 18, 44, 46, 51 AND 52).

FIRST USE 12-31-2003; IN COMMERCE 12-31-2003.

FOR: FRUIT-BASED SNACK FOODS; SNACK MIX CONSISTING PRIMARILY OF PROCESSED FRUITS, SEEDS AND NUTS; VEGETABLE-BASED SNACK FOODS ALL SOLD AT WHOLESALE, IN CLASS 29 (U.S. CL. 46).

FIRST USE 12-31-2003; IN COMMERCE 12-31-2003.

FOR: CHOCOLATE CANDIES, CHOCOLATE; GRANOLA SNACKS, GRANOLA-BASED SNACK

BARS, CEREAL-BASED SNACK FOODS, READY TO EAT CEREAL-DERIVED FOOD BARS; FLAX-BASED SNACK FOODS; FLAX-BASED SNACK BARS; GRAIN-BASED FOOD BARS ALSO CONTAINING GRAINS, FRUITS, NUTS AND SEEDS ALL SOLD AT WHOLESALE, IN CLASS 30 (U.S. CL. 46).

FIRST USE 12-31-2003; IN COMMERCE 12-31-2003.

THE MARK CONSISTS OF STANDARD CHARACTERS WITHOUT CLAIM TO ANY PARTICULAR FONT, STYLE, SIZE, OR COLOR.

NO CLAIM IS MADE TO THE EXCLUSIVE RIGHT TO USE "RAW", APART FROM THE MARK AS SHOWN.

SER. NO. 77-127,351, FILED 3-9-2007.

STEVEN PEREZ, EXAMINING ATTORNEY



**Int. Cls.: 35, 36 and 37**

**Prior U.S. Cls.: 100, 101, 102, 103 and 106**

**United States Patent and Trademark Office**

**Reg. No. 3,452,040**

**Registered June 24, 2008**

**SERVICE MARK  
PRINCIPAL REGISTER**

# BIODIRECT

BIODIRECT INC. (MASSACHUSETTS CORPORATION)  
305 CONSTITUTION DR.  
TAUNTON, MA 02780

FOR: ELECTRONIC CATALOG SERVICES AND TELEPHONE ORDER TAKING SERVICES FOR OTHERS FEATURING NEW AND PRE-OWNED LABORATORY EQUIPMENT; PROCUREMENT, NAMELY, PURCHASING LABORATORY EQUIPMENT FOR OTHERS; REMARKETING OF LABORATORY EQUIPMENT FOR OTHERS; BUSINESS RISK MANAGEMENT, IN CLASS 35 (U.S. CLS. 100, 101 AND 102).

FIRST USE 7-1-2002; IN COMMERCE 7-1-2002.

FOR: FINANCIAL RISK MANAGEMENT; INVESTMENT SERVICES, NAMELY, ASSET MANAGEMENT SERVICES; FISCAL VALUATION,

NAMELY, FAIR MARKET VALUATIONS AND ASSESSMENTS OF LABORATORY EQUIPMENT, IN CLASS 36 (U.S. CLS. 100, 101 AND 102).

FIRST USE 7-1-2002; IN COMMERCE 7-1-2002.

FOR: REPAIR AND MAINTENANCE OF LABORATORY EQUIPMENT, IN CLASS 37 (U.S. CLS. 100, 103 AND 106).

FIRST USE 7-1-2002; IN COMMERCE 7-1-2002.

THE MARK CONSISTS OF STANDARD CHARACTERS WITHOUT CLAIM TO ANY PARTICULAR FONT, STYLE, SIZE, OR COLOR.

SER. NO. 77-128,455, FILED 3-12-2007.

SHARON MEIER, EXAMINING ATTORNEY

**Int. Cl.: 19**

**Prior U.S. Cls.: 1, 12, 33 and 50**

**United States Patent and Trademark Office**

**Reg. No. 3,452,041**

**Registered June 24, 2008**

**TRADEMARK  
PRINCIPAL REGISTER**

**APPLIQUE'**

GREENWOOD, INC. (ILLINOIS CORPORATION)  
3901 N. VERMILION STREET  
DANVILLE, IL 61834

FOR: BURIAL VAULTS NOT MADE OF METAL  
AND INCLUDING OPTIONAL METAL INSERTS, IN  
CLASS 19 (U.S. CLS. 1, 12, 33 AND 50).

FIRST USE 10-21-2002; IN COMMERCE 10-21-2002.

THE MARK CONSISTS OF STANDARD CHAR-  
ACTERS WITHOUT CLAIM TO ANY PARTICULAR  
FONT, STYLE, SIZE, OR COLOR.

THE WORDING "APPLIQUE" HAS NO MEAN-  
ING IN A FOREIGN LANGUAGE.

SER. NO. 77-128,489, FILED 3-12-2007.

YONG KIM, EXAMINING ATTORNEY

Int. Cl.: 44

Prior U.S. Cls.: 100 and 101

United States Patent and Trademark Office

Reg. No. 3,452,042

Registered June 24, 2008

SERVICE MARK  
PRINCIPAL REGISTER



Skin • Self • Renewal

ALC OF LEHIGH VALLEY (PENNSYLVANIA  
CORPORATION)  
3067 JORDAN ROAD  
OREFIELD, PA 18069

FOR: HEALTH SPA SERVICES, NAMELY, COS-  
METIC BODY CARE SERVICES, IN CLASS 44 (U.S.  
CLS. 100 AND 101).

FIRST USE 5-1-2005; IN COMMERCE 10-5-2005.

NO CLAIM IS MADE TO THE EXCLUSIVE  
RIGHT TO USE "MEDICAL SPA SKIN", APART  
FROM THE MARK AS SHOWN.

THE COLOR(S) BLUE AND MAROON IS/ARE  
CLAIMED AS A FEATURE OF THE MARK.

THE COLOR BLUE APPEARS IN THE CIRCLE  
DESIGNS AND IN THE WORDING MEDICAL SPA,  
THE COLOR MAROON APPEARS IN THE TERMS  
GAZA, SKIN, SELF, RENEWAL.

"THE FOREIGN WORDING IN THE MARK  
TRANSLATES INTO ENGLISH AS ULTIMATE."

SER. NO. 77-128,603, FILED 3-12-2007.

AMOS T. MATTHEWS, JR., EXAMINING ATTOR-  
NEY

**Int. Cl.: 11**

**Prior U.S. Cls.: 13, 21, 23, 31 and 34**

**Reg. No. 3,452,043**

**United States Patent and Trademark Office**

**Registered June 24, 2008**

---

**TRADEMARK  
PRINCIPAL REGISTER**

**MODERUSTIC**

JAUNZEMIS, EDGAR EDWARD (UNITED STATES INDIVIDUAL)  
12952 COLONIAL DRIVE  
RANCHO CUCAMONGA, CA 91739

THE MARK CONSISTS OF STANDARD CHARACTERS WITHOUT CLAIM TO ANY PARTICULAR FONT, STYLE, SIZE, OR COLOR.

FOR: FIREPLACES AND FIRE PITS, IN CLASS 11 (U.S. CLS. 13, 21, 23, 31 AND 34).

SER. NO. 77-128,919, FILED 3-12-2007.

FIRST USE 4-0-1973; IN COMMERCE 4-0-2002.

DAYNA BROWNE, EXAMINING ATTORNEY

Int. Cl.: 35

Prior U.S. Cls.: 100, 101 and 102

United States Patent and Trademark Office

Reg. No. 3,452,044

Registered June 24, 2008

**SERVICE MARK  
PRINCIPAL REGISTER**



SERVICE LIGHTING AND ELECTRICAL SUPPLIES, INC. (TEXAS CORPORATION)  
124 GROSS ROAD, SUITE D  
MESQUITE, TX 75149

FOR: ON-LINE RETAIL STORE SERVICES FEATURING LIGHT BULBS, IN CLASS 35 (U.S. CLS. 100, 101 AND 102).

FIRST USE 9-22-2003; IN COMMERCE 9-22-2003.

THE MARK CONSISTS OF THE DESIGN OF A LIGHT BULB CONTAINING THE LETTER "S", A CALIPER/MEASURING DEVICE WITH THE LETTER "L", AND THE WORDS "1000BULBS.COM COMBINING ART AND SCIENCE THROUGH LIGHTING".

SER. NO. 77-129,226, FILED 3-13-2007.

SHAUNIA CARLYLE, EXAMINING ATTORNEY

**Int. Cl.: 9**

**Prior U.S. Cls.: 21, 23, 26, 36 and 38**

**Reg. No. 3,452,045**

**United States Patent and Trademark Office**

**Registered June 24, 2008**

---

**TRADEMARK  
PRINCIPAL REGISTER**

**VPDISK**

PROTEGRITY USA, INC. (DELAWARE CORPORATION)  
201 BROAD STREET  
STAMFORD, CT 06901

THE MARK CONSISTS OF STANDARD CHARACTERS WITHOUT CLAIM TO ANY PARTICULAR FONT, STYLE, SIZE, OR COLOR.

FOR: COMPUTER SOFTWARE AND RELATED INSTRUCTIONAL MANUALS, SOLD AS A UNIT, USED FOR ENCRYPTION AND DATA SECURITY IN FILE SYSTEMS, IN CLASS 9 (U.S. CLS. 21, 23, 26, 36 AND 38).

SEC. 2(F).

SER. NO. 77-129,684, FILED 3-13-2007.

FIRST USE 10-0-1998; IN COMMERCE 10-0-2000.

DAVID ELTON, EXAMINING ATTORNEY

**Int. Cl.: 42**

**Prior U.S. Cls.: 100 and 101**

**United States Patent and Trademark Office**

**Reg. No. 3,452,046**

**Registered June 24, 2008**

**SERVICE MARK  
PRINCIPAL REGISTER**



DIGITAL INFO SECURITY CO, INC (COLOR-  
ADO CORPORATION)  
11030 CIRCLE POINT ROAD, SUITE 100  
WESTMINSTER, CO 80020

FOR: APPLICATION SERVICE PROVIDER (ASP),  
NAMELY, HOSTING COMPUTER SOFTWARE AP-  
PLICATIONS OF OTHERS, IN CLASS 42 (U.S. CLS.  
100 AND 101).

FIRST USE 3-1-2005; IN COMMERCE 3-1-2005.

NO CLAIM IS MADE TO THE EXCLUSIVE  
RIGHT TO USE "DIGITAL INFO SECURITY COM-  
PANY", APART FROM THE MARK AS SHOWN.

THE COLOR(S) BLUE AND GREY IS/ARE  
CLAIMED AS A FEATURE OF THE MARK.

THE MARK CONSISTS OF A BLUE CIRCLE  
WITH CURVED GREY LINES/BARS RUNNING  
THROUGH CENTER; THE LINES HAVE A GRADI-  
ANT, SO THAT THEY START OUT GREY AT THE  
TOP AND FADE TO WHITE AT THE BOTTOM. THE  
CIRCLE IS SHADED IN BLUE. THE LETTERS  
"DISC" APPEAR TO THE RIGHT OF THE CIRCLE  
IN ALL CAPITAL LETTERS IN GREY. THE WORDS  
"DIGITAL INFO SECURITY COMPANY" APPEAR  
BELOW "DISC" AND ARE BLUE.

SER. NO. 77-129,788, FILED 3-13-2007.

ANNE MADDEN, EXAMINING ATTORNEY

**Int. Cl.: 35**

**Prior U.S. Cls.: 100, 101 and 102**

**United States Patent and Trademark Office**

**Reg. No. 3,452,047**

**Registered June 24, 2008**

**SERVICE MARK  
PRINCIPAL REGISTER**

**MR. CYNIC**

GAME ALMIGHTY, LLC (DELAWARE LTD  
LIAB CO)  
STE. 100  
23265 SOUTH POINTE DRIVE  
LAGUNA HILLS, CA 92653

FOR: PROVIDING CONSUMER PRODUCT INFORMATIONAL SERVICES PERTAINING TO VIDEO GAMES AND COMPUTER GAMES, COMPUTER TECHNOLOGY AND ENTERTAINMENT MEDIA, NAMELY, PRODUCT REVIEWS, PREVIEWS, ARTICLES AND EDITORIALS, IN CLASS 35 (U.S. CLS. 100, 101 AND 102).

FIRST USE 12-20-2006; IN COMMERCE 12-20-2006.

THE MARK CONSISTS OF STANDARD CHARACTERS WITHOUT CLAIM TO ANY PARTICULAR FONT, STYLE, SIZE, OR COLOR.

SER. NO. 77-129,908, FILED 3-13-2007.

REGINA DRUMMOND, EXAMINING ATTORNEY



Int. Cl.: 35

Prior U.S. Cls.: 100, 101 and 102

United States Patent and Trademark Office

Reg. No. 3,452,048

Registered June 24, 2008

SERVICE MARK  
PRINCIPAL REGISTER



The logo features the word "spherion" in a bold, lowercase, sans-serif font. Above the letter "i" is a vertical line with a horizontal bar at the top, resembling a stylized exclamation point or a crosshair. Below "spherion" are the words "Recruitment", "Process", and "Outsourcing" stacked vertically in a smaller, italicized serif font.

SPHERION ATLANTIC ENTERPRISES LLC (DE-  
LAWARE LTD LIAB CO)  
THE LAW DEPARTMENT  
2050 SPECTRUM BOULEVARD  
FORT LAUDERDALE, FL 33309

FOR: EMPLOYMENT HIRING, RECRUITING,  
PLACEMENT, STAFFING AND CAREER NET-  
WORKING SERVICES, IN CLASS 35 (U.S. CLS. 100,  
101 AND 102).

FIRST USE 1-1-2007; IN COMMERCE 1-1-2007.

OWNER OF U.S. REG. NOS. 2,497,002, 2,888,096  
AND OTHERS.

NO CLAIM IS MADE TO THE EXCLUSIVE  
RIGHT TO USE "RECRUITMENT PROCESS OUT-  
SOURCING", APART FROM THE MARK AS  
SHOWN.

SER. NO. 77-129,992, FILED 3-13-2007.

ELLEN PERKINS, EXAMINING ATTORNEY

Int. Cl.: 41

Prior U.S. Cls.: 100, 101 and 107

United States Patent and Trademark Office

Reg. No. 3,452,049

Registered June 24, 2008

SERVICE MARK  
PRINCIPAL REGISTER



SILVER SADDLE PRODUCTIONS, INC. (NEVADA CORPORATION)  
3027 WEST HIGHWAY 76, SUITE C1  
BRANSON, MO 65616

FOR: ENTERTAINMENT IN THE NATURE OF HORSE RIDING EXHIBITIONS, REENACTMENTS OF HISTORICAL EVENTS OF THE AMERICAN WEST AND EXHIBITIONS FEATURING DEPICTIONS OF LIFESTYLES AND PEOPLE OF THE AMERICAN WEST, IN CLASS 41 (U.S. CLS. 100, 101 AND 107).

FIRST USE 6-5-1996; IN COMMERCE 8-15-1996.

NO CLAIM IS MADE TO THE EXCLUSIVE RIGHT TO USE "GREAT AMERICAN WILD WEST SHOW SPECTACULAR", APART FROM THE MARK AS SHOWN.

THE COLOR(S) RED, WHITE, BLUE, YELLOW, GOLD, BLACK, WHITE, BROWN, TAN, SILVER, GRAY IS/ARE CLAIMED AS A FEATURE OF THE MARK.

THE MARK CONSISTS OF A COWBOY ON A HORSE IN THE MIDDLE OF THE STYLIZED WORDS "GREAT AMERICAN WILD WEST SHOW SPECTACULAR." THE HORSE IS OVER TWO STYLIZED DESIGNS OF THE AMERICAN FLAG, TWO STYLIZED SCROLLS AND BANNERS WITH STARS AND ROPE SURROUNDING THE MARK.

ADDITIONALLY, THREE STARS APPEAR TO THE RIGHT OF THE COWBOY AND THREE STARS APPEAR ON TOP OF THE COWBOY. THE COLOR RED APPEARS IN THE BANNERS, THE COWBOY'S SHIRT, IN ONE OF THE THREE STARS ABOVE THE COWBOY, IN ONE OF THE THREE STARS TO THE RIGHT OF THE COWBOY, IN THE COLLAR OF THE HORSE, THE DIAMONDS IN THE WORDING "WILD WEST SHOW" AND IN THE STRIPES ON THE AMERICAN FLAG. THE COLOR WHITE APPEARS IN THE WORDING "GREAT AMERICAN" AND "SPECTACULAR," IN THE HORSE, IN THE STRIPES ON THE AMERICAN FLAG, IN THE STARS CONTAINED ON THE BANNERS AND IN THE BACKGROUND OF THE MARK. THE COLOR BLUE APPEARS IN THE BANNERS, THE SCROLLS, TWO OF THE STARS ON TOP OF THE COWBOY, TWO OF THE STARS TO THE RIGHT OF THE COWBOY, IN THE AMERICAN FLAG DESIGN, AND ON THE COWBOY'S SADDLE. THE COLOR YELLOW APPEARS IN THE WORDING "WILD WEST SHOW." THE COLOR GOLD APPEARS IN THE BANNERS. THE COLOR BLACK APPEARS IN THE SHADING OF THE WORDING "GREAT AMERICAN" "WILD WEST SHOW" AND "SPECTACULAR," IN THE HORSE, IN THE COWBOY'S SHIRT, HAT AND PANTS, AND IN THE SHADOW OF THE BANNERS. THE COLOR TAN APPEARS IN THE ROPE, HORSE'S HOOVES AND COWBOY'S HAT AND GLOVES. THE COLOR BROWN APPEARS IN THE COWBOY'S SHOES. THE COLOR

SILVER APPEARS IN THE SCROLLS. THE COLOR  
GRAY APPEARS IN THE COWBOY'S CHAPS.

SER. NO. 77-130,100, FILED S.R. 3-13-2007 AM. P.R.  
2-26-2008.

STEPHEN AQUILA, EXAMINING ATTORNEY

**Int. Cl.: 33**

**Prior U.S. Cls.: 47 and 49**

**United States Patent and Trademark Office**

**Reg. No. 3,452,050**

**Registered June 24, 2008**

**TRADEMARK  
PRINCIPAL REGISTER**

**Coyote Canyon Winery**

COYOTE CANYON WINERY, LLC (WASHING-  
TON LTD LIAB CO)  
80 MCKINLEY SPRINGS RD  
PROSSER, WA 99350

FOR: GRAPE WINE; RED WINE; SWEET WINES;  
TABLE WINES; WHITE WINE; WINE; WINES, IN  
CLASS 33 (U.S. CLS. 47 AND 49).

FIRST USE 7-1-2005; IN COMMERCE 4-1-2006.

THE MARK CONSISTS OF STANDARD CHAR-  
ACTERS WITHOUT CLAIM TO ANY PARTICULAR  
FONT, STYLE, SIZE, OR COLOR.

NO CLAIM IS MADE TO THE EXCLUSIVE  
RIGHT TO USE "WINERY", APART FROM THE  
MARK AS SHOWN.

SER. NO. 77-130,284, FILED 3-13-2007.

JULIE GUTTADAURO, EXAMINING ATTORNEY

**Int. Cl.: 14**

**Prior U.S. Cls.: 2, 27, 28 and 50**

**United States Patent and Trademark Office**

**Reg. No. 3,452,051**

**Registered June 24, 2008**

**TRADEMARK  
PRINCIPAL REGISTER**

T H E *Ah* R I N G

DIVINE DIAMONDS, INC. (NEW YORK CORPORATION)  
230 EAST 44TH STREET  
NEW YORK, NY 10017

FOR: RINGS BEING JEWELRY, IN CLASS 14 (U.S. CLS. 2, 27, 28 AND 50).

FIRST USE 7-1-2001; IN COMMERCE 7-1-2001.

NO CLAIM IS MADE TO THE EXCLUSIVE RIGHT TO USE "RING", APART FROM THE MARK AS SHOWN.

THE MARK CONSISTS OF THE WORDS, "THE AH RING", IN WHICH THE WORD "AH" IS OF STYLIZED CHARACTERS AS SHOWN IN THE ATTACHMENT.

SER. NO. 77-130,353, FILED 3-13-2007.

MATTHEW EINSTEIN, EXAMINING ATTORNEY

**Int. Cl.: 25**

**Prior U.S. Cls.: 22 and 39**

**United States Patent and Trademark Office**

**Reg. No. 3,452,052**

**Registered June 24, 2008**

**TRADEMARK  
PRINCIPAL REGISTER**

**GIRL TALK**

TERRY K INC. (CALIFORNIA CORPORATION)  
#1  
9340 7TH STREET  
RANCHO CUCAMONGA, CA 91730

FOR: CLOTHING ITEMS, NAMELY, JACKETS,  
SWEATERS, SHORTS, SHIRTS, SWEATSHIRTS, T-  
SHIRTS, SWEAT PANTS, DRESSES, TANK TOPS,  
AND JEANS, IN CLASS 25 (U.S. CLS. 22 AND 39).

FIRST USE 1-30-2006; IN COMMERCE 1-30-2006.

THE MARK CONSISTS OF STANDARD CHAR-  
ACTERS WITHOUT CLAIM TO ANY PARTICULAR  
FONT, STYLE, SIZE, OR COLOR.

SER. NO. 77-130,647, FILED 3-14-2007.

CHARLOTTE CORWIN, EXAMINING ATTORNEY

**Int. Cl.: 29**

**Prior U.S. Cl.: 46**

**United States Patent and Trademark Office**

**Reg. No. 3,452,053**

**Registered June 24, 2008**

**TRADEMARK  
PRINCIPAL REGISTER**

**BEVERLY**

BOST DISTRIBUTING CO. (NORTH CAROLINA  
CORPORATION)  
PO BOX 447  
2205 BOONE TRAIL ROAD  
SANFORD, NC 27331

FOR: FOOD PRODUCTS, NAMELY, SAUSAGE  
SOLD IN RETAIL STORES, IN CLASS 29 (U.S. CL.  
46).

FIRST USE 4-1-1920; IN COMMERCE 4-1-1920.

THE MARK CONSISTS OF STANDARD CHAR-  
ACTERS WITHOUT CLAIM TO ANY PARTICULAR  
FONT, STYLE, SIZE, OR COLOR.

"THE NAME(S), PORTRAIT(S), AND/OR SIGNA-  
TURE(S) SHOWN IN THE MARK DOES NOT IDEN-  
TIFY A PARTICULAR LIVING INDIVIDUAL."

SER. NO. 77-130,736, FILED 3-14-2007.

STEPHEN AQUILA, EXAMINING ATTORNEY

**Int. Cl.: 32**

**Prior U.S. Cls.: 45, 46 and 48**

**United States Patent and Trademark Office**

**Reg. No. 3,452,054**

**Registered June 24, 2008**

**TRADEMARK  
PRINCIPAL REGISTER**

**GIVE YOURSELF A RAY'S**

HILL BREWING COMPANY, INC. (MISSOURI  
CORPORATION)  
1330 CRAIG RD.  
ST. LOUIS, MO 63146

FOR: BEER, IN CLASS 32 (U.S. CLS. 45, 46 AND 48).

FIRST USE 10-1-2004; IN COMMERCE 10-1-2004.

THE MARK CONSISTS OF STANDARD CHAR-  
ACTERS WITHOUT CLAIM TO ANY PARTICULAR  
FONT, STYLE, SIZE, OR COLOR.

OWNER OF U.S. REG. NO. 3,173,370.

"THE NAME(S), PORTRAIT(S), AND/OR SIGNA-  
TURE(S) SHOWN IN THE MARK IDENTIFIES RAY,  
WHOSE CONSENT(S) TO REGISTER IS SUBMIT-  
TED."

SER. NO. 77-130,761, FILED 3-14-2007.

TRICIA SONNEBORN, EXAMINING ATTORNEY



**Int. Cl.: 45**

**Prior U.S. Cls.: 100 and 101**

**United States Patent and Trademark Office**

**Reg. No. 3,452,055**

**Registered June 24, 2008**

**SERVICE MARK  
PRINCIPAL REGISTER**

**1-800-LAW EXPERTS**

PLATINUM WORLDWIDE, INC. (DELAWARE  
CORPORATION)  
P.O. BOX 297278  
BROOKLYN, NY 11229

FOR: LEGAL SERVICES, IN CLASS 45 (U.S. CLS.  
100 AND 101).

FIRST USE 1-4-2002; IN COMMERCE 1-4-2002.

THE MARK CONSISTS OF STANDARD CHAR-  
ACTERS WITHOUT CLAIM TO ANY PARTICULAR  
FONT, STYLE, SIZE, OR COLOR.

SEC. 2(F).

SER. NO. 77-130,787, FILED 3-14-2007.

REBECCA EISINGER, EXAMINING ATTORNEY

**Int. Cls.: 16 and 35**

**Prior U.S. Cls.: 2, 5, 22, 23, 29, 37, 38, 50, 100, 101 and 102**

**Reg. No. 3,452,056**

**United States Patent and Trademark Office**

**Registered June 24, 2008**

**TRADEMARK  
SERVICE MARK  
PRINCIPAL REGISTER**



VIBRATION ISOLATION AND SEISMIC CONTROL MANUFACTURERS ASSOCIATION (PENNSYLVANIA NON-PROFIT CORPORATION)

994 OLD EAGLE SCHOOL ROAD  
SUITE 1019  
WAYNE, PA 19087

FOR: PUBLICATIONS, NAMELY, PRINTED MANUALS RELATED TO SEISMIC EQUIPMENT, IN CLASS 16 (U.S. CLS. 2, 5, 22, 23, 29, 37, 38 AND 50).

FIRST USE 3-20-2000; IN COMMERCE 3-20-2000.

FOR: ASSOCIATION SERVICES, NAMELY, PROMOTING THE PROPER INSTALLATION OF SEIS-

MIC RESTRAINTS FOR MECHANICAL, ELECTRICAL AND PLUMBING EQUIPMENT, IN CLASS 35 (U.S. CLS. 100, 101 AND 102).

FIRST USE 3-25-1999; IN COMMERCE 3-25-1999.

NO CLAIM IS MADE TO THE EXCLUSIVE RIGHT TO USE "VIBRATION ISOLATION AND SEISMIC CONTROL MANUFACTURING ASSOCIATION", APART FROM THE MARK AS SHOWN.

SER. NO. 77-131,129, FILED 3-14-2007.

THOMAS MANOR, EXAMINING ATTORNEY

**Int. Cls.: 7 and 12**

**Prior U.S. Cls.: 13, 19, 21, 23, 31, 34, 35 and 44**

**Reg. No. 3,452,057**

**United States Patent and Trademark Office**

**Registered June 24, 2008**

**TRADEMARK  
PRINCIPAL REGISTER**

***NITRO-SPECIAL***

KARATA ENTERPRISES CO. (PENNSYLVANIA CORPORATION)  
3 RIVER ROAD  
CONSHOHOKEN, PA 19428

FOR: PARTS FOR AUTOMOBILE ENGINES, NAMELY, SUPERCHARGER PARTS IN THE NATURE OF INTAKE AND EXHAUST AIR FLOW VANE ASSEMBLY DEVICE FOR USE IN AN INTERNAL COMBUSTION ENGINE CONTAINING SPECIAL MANUFACTURED BILLET PLATES, BRACKETS, SHAFTS, ALIGNMENT SPACERS, BOLTS, NUTS, PULLEYS AND BELTS; PARTS OF MARINE ENGINES, NAMELY, SUPERCHARGER PARTS IN THE NATURE OF INTAKE AND EXHAUST AIR FLOW VANE ASSEMBLY DEVICE FOR USE IN AN INTERNAL COMBUSTION ENGINE CONTAINING SPECIAL MANUFACTURED BILLET PLATES, BRACKETS, SHAFTS, ALIGNMENT SPACERS, BOLTS, NUTS, PULLEYS AND BELTS; PARTS FOR LAND VEHICLE ENGINES, NAMELY, GEARS FOR ALTERNATORS, GEARS FOR ENGINE WATER PUMPS, GEARS FOR ENGINE OIL PUMPS, GEARS FOR ENGINE FUEL PUMPS, GEARS FOR ENGINE CAMSHAFTS; PARTS OF MARINE VEHICLE ENGINES, NAMELY, MARINE SUPERCHARGER PARTS COMPRISED OF ELECTRIC POWERED VARIABLE SPEED DRIVES FOR AIR INTAKE, IN CLASS 7 (U.S. CLS. 13, 19, 21, 23, 31, 34 AND 35).

FIRST USE 2-23-2007; IN COMMERCE 2-23-2007.

FOR: PARTS FOR LAND VEHICLE TRANSMISSIONS, NAMELY, ELECTRIC DRIVES, DRIVE BELTS, DRIVE GEARS, DRIVE SHAFTS, AND TRANSMISSION BELTS FOR ALL TYPES OF RACING AND STREET LAND VEHICLES; DRIVE GEARS, GEARS FOR VEHICLES; TRANSMISSION BELTS FOR LAND VEHICLES; MAGNETO DRIVE BELTS, DRIVE GEARS, AND DRIVE SHAFTS FOR LAND VEHICLES; MOTORCYCLE PRIMARY AND SECONDARY DRIVE BELTS; BELT DRIVE ASSEMBLIES FOR VEHICLE POWER TRANSMISSION COMPRISED PRIMARILY OF DRIVE BELTS, DRIVE GEARS, AND ELECTRIC DRIVES; CLUTCHES AND GEARS FOR LAND VEHICLE POWER TRANSMISSION; PARTS FOR AUTOMOBILE TRANSMISSIONS, NAMELY, AUTOMOBILE DRIVE BELT ASSEMBLIES COMPRISED PRIMARILY OF SPECIAL MANUFACTURED BILLET PLATES, PULLEYS AND DRIVE BELTS, AND CONTAINING BRACKETS, SHAFTS, ALIGNMENT SPACERS, BOLTS, AND NUTS, IN CLASS 12 (U.S. CLS. 19, 21, 23, 31, 35 AND 44).

FIRST USE 2-23-2007; IN COMMERCE 2-23-2007.

SER. NO. 77-131,848, FILED 3-15-2007.

JAY BESCH, EXAMINING ATTORNEY

**Int. Cl.: 38**

**Prior U.S. Cls.: 100, 101 and 104**

**United States Patent and Trademark Office**

**Reg. No. 3,452,058**

**Registered June 24, 2008**

**SERVICE MARK  
PRINCIPAL REGISTER**

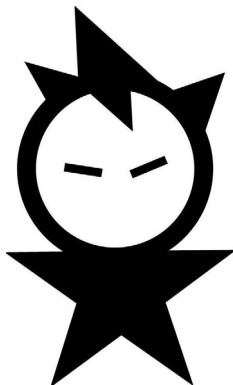

INTERCASTING CORPORATION (DELAWARE CORPORATION)  
SUITE 200  
4350 LA JOLLA VILLAGE DR.  
SAN DIEGO, CA 92122

FOR: INTERNET AND WIRELESS COMMUNICATION SERVICES, NAMELY, ALLOWING SUBSCRIBERS OF MOBILE TELEPHONES, PERSONAL DIGITAL ASSISTANTS, AND WIRELESS HANDHELD DEVICES TO CREATE NETWORKS CONTAINING PERSONALIZED CONTENT; ELECTRONIC TRANSMISSION OF DATA, TEXT, AND GRAPHICS TO MOBILE TELEPHONES, PER-

SONAL DIGITAL ASSISTANTS, AND WIRELESS DEVICES; AND ELECTRONIC MAIL SERVICES, IN CLASS 38 (U.S. CLS. 100, 101 AND 104).

FIRST USE 5-0-2005; IN COMMERCE 5-0-2005.

THE MARK CONSISTS OF A MAN WITH A BODY IN THE SHAPE OF A STAR.

SER. NO. 77-132,480, FILED 3-15-2007.

PETER B. BROMAGHIM, EXAMINING ATTORNEY

**Int. Cl.: 35**

**Prior U.S. Cls.: 100, 101 and 102**

**United States Patent and Trademark Office**

**Reg. No. 3,452,059**

**Registered June 24, 2008**

**SERVICE MARK  
PRINCIPAL REGISTER**

**STAR-PERFORMERS**

FIDELITY NATIONAL CARD SERVICES, INC.  
(FLORIDA CORPORATION)  
601 RIVERSIDE AVENUE  
JACKSONVILLE, FL 32204

THE MARK CONSISTS OF STANDARD CHARACTERS WITHOUT CLAIM TO ANY PARTICULAR FONT, STYLE, SIZE, OR COLOR.

FOR: CONDUCTING EMPLOYEE INCENTIVE REWARD PROGRAMS TO PROMOTE EMPLOYEE PERFORMANCE, IN CLASS 35 (U.S. CLS. 100, 101 AND 102).

SER. NO. 77-132,667, FILED 3-16-2007.

FIRST USE 2-28-2006; IN COMMERCE 2-28-2006.

BARBARA RUTLAND, EXAMINING ATTORNEY

**Int. Cl.: 45**

**Prior U.S. Cls.: 100 and 101**

**United States Patent and Trademark Office**

**Reg. No. 3,452,060**

**Registered June 24, 2008**

**SERVICE MARK  
PRINCIPAL REGISTER**

**BECK DISASTER RECOVERY,  
INC.**

BECK DISASTER RECOVERY, INC. (WASHING-  
TON CORPORATION)  
1001 FOURTH AVENUE, SUITE 2500  
SEATTLE, WA 981541004

FOR: PROVIDING CONSULTATION AND IN-  
FORMATION IN THE FIELD OF EMERGENCY  
AND NATURAL DISASTER RESPONSE FOR OTH-  
ERS, IN CLASS 45 (U.S. CLS. 100 AND 101).

FIRST USE 0-0-2006; IN COMMERCE 0-0-2006.

THE MARK CONSISTS OF STANDARD CHAR-  
ACTERS WITHOUT CLAIM TO ANY PARTICULAR  
FONT, STYLE, SIZE, OR COLOR.

NO CLAIM IS MADE TO THE EXCLUSIVE  
RIGHT TO USE "DISASTER RECOVERY, INC.",  
APART FROM THE MARK AS SHOWN.

SER. NO. 77-133,242, FILED 3-16-2007.

SIMON TENG, EXAMINING ATTORNEY

**Int. Cl.: 45**

**Prior U.S. Cls.: 100 and 101**

**United States Patent and Trademark Office**

**Reg. No. 3,452,061**

**Registered June 24, 2008**

**SERVICE MARK  
PRINCIPAL REGISTER**



BECK DISASTER RECOVERY, INC. (WASHINGTON CORPORATION)  
1001 FOURTH AVENUE, SUITE 2500  
SEATTLE, WA 981541004

NO CLAIM IS MADE TO THE EXCLUSIVE RIGHT TO USE "DISASTER RECOVERY, INC.", APART FROM THE MARK AS SHOWN.

FOR: PROVIDING CONSULTATION AND INFORMATION IN THE FIELD OF EMERGENCY AND NATURAL DISASTER RESPONSE FOR OTHERS, IN CLASS 45 (U.S. CLS. 100 AND 101).

SER. NO. 77-133,267, FILED 3-16-2007.

FIRST USE 0-0-2006; IN COMMERCE 0-0-2006.

KAREN K. BUSH, EXAMINING ATTORNEY

**Int. Cl.: 38**

**Prior U.S. Cls.: 100, 101 and 104**

**Reg. No. 3,452,062**

**United States Patent and Trademark Office**

**Registered June 24, 2008**

**SERVICE MARK  
PRINCIPAL REGISTER**

**PARENTCHECKIN**

ASPEN EDUCATION GROUP, INC. (CALIFORNIA CORPORATION)  
SUITE 300  
17777 CENTER COURT DRIVE  
CERRITOS, CA 90703

FOR: PROVIDING AN AUTOMATED MEANS OF COMMUNICATION VIA THE INTERNET BETWEEN ADULT PARENTS AND INSTITUTIONS SUCH AS EDUCATIONAL FACILITIES, TREATMENT PROGRAMS, WILDERNESS CAMPS AND RESIDENTIAL BOARDING SCHOOLS CONCERNING THE STATUS OF THEIR CHILDREN'S PRO-

GRESS IN SUCH FACILITIES, IN CLASS 38 (U.S. CLS. 100, 101 AND 104).

FIRST USE 3-0-2002; IN COMMERCE 3-0-2002.

THE MARK CONSISTS OF STANDARD CHARACTERS WITHOUT CLAIM TO ANY PARTICULAR FONT, STYLE, SIZE, OR COLOR.

SER. NO. 77-133,270, FILED 3-16-2007.

AMOS T. MATTHEWS, JR., EXAMINING ATTORNEY



**Int. Cls.: 9, 25 and 41**

**Prior U.S. Cls.: 21, 22, 23, 26, 36, 38, 39, 100, 101 and 107**

**Reg. No. 3,452,063**

**United States Patent and Trademark Office**

**Registered June 24, 2008**

**TRADEMARK  
SERVICE MARK  
PRINCIPAL REGISTER**

**DJ RAP**

SAVERIO, CHARISSA (ITALY INDIVIDUAL)  
3207A M STREET NW  
WASHINGTON, DC 20007

FOR: SERIES OF MUSICAL SOUND RECORDINGS, PRE-RECORDED COMPACT DISCS, AUDIO CASSETTES, DIGITAL VIDEO DISCS, PHONOGRAPH RECORDS AND DIGITAL AUDIO FILES FEATURING MUSIC, IN CLASS 9 (U.S. CLS. 21, 23, 26, 36 AND 38).

FIRST USE 6-30-1991; IN COMMERCE 6-30-1991.

FOR: CLOTHING, NAMELY, SHIRTS, PANTS, SHORTS, JACKETS, SWEATSHIRTS, SWEATERS, T-SHIRTS, HATS, SWIMWEAR, FOOTWEAR; AND HEADWEAR, IN CLASS 25 (U.S. CLS. 22 AND 39).

FIRST USE 1-23-1998; IN COMMERCE 1-23-1998.

FOR: ENTERTAINMENT SERVICES, NAMELY, LIVE PERFORMANCES BY A MUSICAL PERFORMER AND NAMELY THE PLAYING OF RECORDED MUSIC BY A DISC JOCKEY, IN CLASS 41 (U.S. CLS. 100, 101 AND 107).

FIRST USE 6-30-1991; IN COMMERCE 6-30-1991.

THE MARK CONSISTS OF STANDARD CHARACTERS WITHOUT CLAIM TO ANY PARTICULAR FONT, STYLE, SIZE, OR COLOR.

SEC. 2(F).

THE 2(F) CLAIM IS RESTRICTED TO CLASS(ES) 9 AND 41

SER. NO. 77-134,087, FILED 3-19-2007.

MONIQUE MILLER, EXAMINING ATTORNEY

**Int. Cl.: 30**

**Prior U.S. Cl.: 46**

**United States Patent and Trademark Office**

**Reg. No. 3,452,064**

**Registered June 24, 2008**

**TRADEMARK  
PRINCIPAL REGISTER**

**Hot Diggety's**

OLD VIENNA LLC (ILLINOIS LTD LIAB CO)  
345 S. OLD HIGHWAY 141  
FENTON, MO 63026

FOR: PUFFED CORN SNACKS, IN CLASS 30 (U.S.  
CL. 46).

FIRST USE 6-14-1999; IN COMMERCE 1-1-2000.

THE MARK CONSISTS OF STANDARD CHAR-  
ACTERS WITHOUT CLAIM TO ANY PARTICULAR  
FONT, STYLE, SIZE, OR COLOR.

SER. NO. 77-134,143, FILED 3-19-2007.

KATHERINE CONNOLLY, EXAMINING ATTOR-  
NEY

**Int. Cl.: 37**

**Prior U.S. Cls.: 100, 103 and 106**

**United States Patent and Trademark Office**

**Reg. No. 3,452,065**

**Registered June 24, 2008**

**SERVICE MARK  
PRINCIPAL REGISTER**

**PRINTFLEET**

PRINTFLEET INC. (CANADA CORPORATION)  
210 JAMES A BRENNAN ROAD  
GANANOQUE, CANADA K7G1N7

FOR: MAINTAINING AND SERVICING COMPUTER HARDWARE, NAMELY, SERVERS, FOR OTHERS; MAINTAINING AND SERVICING OF PRINTERS, COPIERS, FAX MACHINES AND MULTI-FUNCTION PERIPHERAL DEVICES FOR OTHERS, IN CLASS 37 (U.S. CLS. 100, 103 AND 106).

FIRST USE 11-30-2003; IN COMMERCE 11-30-2003.

THE MARK CONSISTS OF STANDARD CHARACTERS WITHOUT CLAIM TO ANY PARTICULAR FONT, STYLE, SIZE, OR COLOR.

SER. NO. 77-134,374, FILED 3-19-2007.

DOMINIC J. FERRAIUOLO, EXAMINING ATTORNEY

Int. Cl.: 5

Prior U.S. Cls.: 6, 18, 44, 46, 51 and 52

Reg. No. 3,452,066

United States Patent and Trademark Office

Registered June 24, 2008

TRADEMARK  
PRINCIPAL REGISTER



*Natural 3*  
body • mind • spirit

SUNBELL PRODUCTS, INC. (CALIFORNIA CORPORATION)  
204  
18740 VENTURA BLVD.  
TARZANA, CA 91356

FOR: HERBAL SUPPLEMENTS, IN CLASS 5 (U.S. CLS. 6, 18, 44, 46, 51 AND 52).

FIRST USE 9-1-2007; IN COMMERCE 9-10-2007.

THE COLOR(S) BLACK, WHITE, GRAY, GREEN, ORANGE, AND BLUE IS/ARE CLAIMED AS A FEATURE OF THE MARK.

THE MARK CONSISTS OF THE COLOR BLACK APPEARS IN THE WORDING "NATURAL 3", THE

COLOR GRAY APPEARS IN THE WORDING "BODY, MIND, SPIRIT", THE COLOR GREEN APPEARS IN THE FIRST BLOCK AS A BACKGROUND TO THE TREES, THE COLOR ORANGE APPEARS IN THE SECOND BLOCK AS A BACKGROUND TO THE SUNBURST, THE COLOR BLUE APPEARS IN THE THIRD BLOCK AS A BACKGROUND TO THE WATER DROPS, THE COLOR WHITE APPEARS IN THE IMAGES OF A TREE, SUNBURST, AND WATER DROP DESIGN FOUND WITHIN EACH OF THE THREE BLOCKS.

SER. NO. 77-135,967, FILED 3-20-2007.

DAVID TAYLOR, EXAMINING ATTORNEY

**Int. Cl.: 45**

**Prior U.S. Cls.: 100 and 101**

**United States Patent and Trademark Office**

**Reg. No. 3,452,067**

**Registered June 24, 2008**

**SERVICE MARK  
PRINCIPAL REGISTER**



EXECUTIVE RISK STRATEGIES, LLC D/B/A  
MINNESOTA PRIVACY CONSULTANTS  
(MINNESOTA LTD LIAB CO)

SUITE 101

17072 77TH AVE N

MAPLE GROVE, MN 55311

FOR: CONSULTATION IN THE FIELD OF PERSONAL DATA THEFT; PERSONAL SECURITY CONSULTATION; CONSULTING SERVICES IN THE FIELD OF MAINTAINING THE SECURITY AND INTEGRITY OF DATABASES; CONSULTING SERVICES IN THE FIELD OF PRIVACY AND SECURITY LAWS, REGULATIONS, AND REQUIREMENTS, IN CLASS 45 (U.S. CLS. 100 AND 101).

FIRST USE 1-22-2007; IN COMMERCE 1-22-2007.

NO CLAIM IS MADE TO THE EXCLUSIVE RIGHT TO USE "MINNESOTA PRIVACY CONSULTANTS", APART FROM THE MARK AS SHOWN.

THE COLOR(S) BLUE AND WHITE IS/ARE CLAIMED AS A FEATURE OF THE MARK.

THE MARK CONSISTS OF A STYLIZED VERSION OF "MPC" APPEARING ADJACENT TO THE WORDING "MINNESOTA PRIVACY CONSULTANTS". A VERTICAL WHITE LINE APPEARS BETWEEN "MPC" AND "MINNESOTA PRIVACY CONSULTANTS". THE LETTERING APPEARS IN WHITE ON A BLUE BACKGROUND.

SER. NO. 77-136,327, FILED 3-21-2007.

JENNIFER MARTIN, EXAMINING ATTORNEY

**Int. Cls.: 9, 37 and 42**

**Prior U.S. Cls.: 21, 23, 26, 36, 38, 100, 101, 103 and 106**

**United States Patent and Trademark Office**

**Reg. No. 3,452,068**

**Registered June 24, 2008**

**TRADEMARK  
SERVICE MARK  
PRINCIPAL REGISTER**



SICK AG (FED REP GERMANY CORPORATION)  
ERWIN-SICK-STRASSE 1  
D-79183 WALDKIRCH, FED REP GERMANY

FOR: OPTICAL, OPTO-ELECTRONIC, PHOTO-ELECTRIC SENSORS FOR SENSING LIGHT AND REFLECTED LIGHT BY OBJECTS, ACOUSTO-ELECTRIC AND ULTRASOUND SENSORS FOR SENSING ACOUSTIC WAVES; MAGNETIC, INDUCTIVE, CAPACITIVE SENSORS FOR SENSING THE PRESENCE OF OBJECTS; LIGHT BARRIERS, LIGHT SCANNERS, SAFETY LIGHT GRIDS AND LIGHT GRIDS FOR MEASURING OBJECT DIMENSIONS; COLOR SENSORS; ELECTRONIC AND/OR OPTICAL SENSORS FOR THE PURPOSE OF MEASURING THE POSITION OR LENGTH OR DISTANCE; ELECTRONIC POSITION ENCODER; ELECTRONIC INTERFACE MODULES FOR CONNECTING THE ABOVE MENTIONED SENSORS TO A CONTROL COMPUTER; INPUT/OUTPUT MODULES FOR CONNECTING THE ABOVE MENTIONED SENSORS TO A CONTROL COMPUTER; CAMERAS FOR AUTOMATIC ENGINEERING AND SAFETY ENGINEERING; CAMERAS; OPTICAL, OPTO-ELECTRONIC, PHOTOELECTRIC SENSORS FOR SENSING LIGHT AND REFLECTED LIGHT BY OBJECTS FOR THE PURPOSE OF SAFETY GUARDING AND MONITORING OF ROOMS, SPACES, POINTS OF DANGER OR DANGER ZONES; CAPACITIVE SENSORS FOR THE PURPOSE OF SAFETY GUARDING AND MONITORING OF ROOMS, SPACES, POINTS OF DANGER OR DANGER ZONES; SAFETY LIGHT CURTAINS; BARRIERS AND SCANNERS WORKING ON AN

ELECTRONIC BASIS AND IN THE FIELD OF INFRARED, VISIBLE OR ULTRAVIOLET RADIATION OR IN THE FIELD OF ULTRASOUND; SCANNERS WHICH OPERATE WITH A SCANNING BEAM FOR THE SCANNING OF SPECIFIC SURFACES AND/OR SPATIAL REGIONS; COMPUTER PROGRAMS FOR SENSOR OPERATION; ELECTRONIC SAFETY SWITCHES; ELECTRONIC SAFETY CONTROL SYSTEMS FOR INDUSTRIAL MACHINES; SAFETY RELAYS, SAFETY SWITCHING DEVICES, NAMELY, ELECTROMECHANICAL SAFETY SWITCHES, NON-CONTACT SAFETY SWITCHES, SINGLE-BEAM PHOTOELECTRIC SAFETY SWITCHES, ENABLING SWITCHES; ELECTRONIC DATA PROCESSING EQUIPMENT AND COMPUTER PROGRAMS FOR USE IN MEASURING AND CONTROL TECHNOLOGY IN THE FIELD OF SAFETY ENGINEERING, IN CLASS 9 (U.S. CLS. 21, 23, 26, 36 AND 38).

FOR: INSTALLATION, MAINTENANCE AND REPAIR OF ELECTRIC, OPTIC AND OPTO-ELECTRONIC APPLIANCE, IN CLASS 37 (U.S. CLS. 100, 103 AND 106).

FOR: DEVELOPMENT OF OPTICAL, ELECTRONIC, OPTO-ELECTRONIC, PHOTOELECTRIC, ACOUSTO-ELECTRIC, MAGNETIC, INDUCTIVE, CAPACITIVE, ULTRASOUND, MEASURING, SIGNALING APPARATUS AND SENSORS; PLANNING OF TECHNICAL SYSTEMS, NAMELY, SAFETY CONTROL SYSTEMS FOR INDUSTRIAL PLANTS, IN CLASS 42 (U.S. CLS. 100 AND 101).

PRIORITY CLAIMED UNDER SEC. 44(D) ON FED REP GERMANY APPLICATION NO. 30660099.4/0, FILED 9-29-2006, REG. NO. 30660099, DATED 1-8-2007, EXPIRES 9-29-2017.

NO CLAIM IS MADE TO THE EXCLUSIVE RIGHT TO USE "SAFETY", APART FROM THE MARK AS SHOWN.

THE COLOR(S) YELLOW, BLUE, AND GREY IS/ ARE CLAIMED AS A FEATURE OF THE MARK.

THE COLOR YELLOW APPEARS IN THE SHADED BACKGROUND, THE COLOR BLUE APPEARS ON THE WORDING AND ON THE SMALL MIDDLE SHADED SQUARES CREATING A PLUS SYMBOL, AND THE COLOR GREY APPEARS ON THE OUTER SMALL SQUARES.

SER. NO. 77-136,444, FILED 3-21-2007.

ANDREA SAUNDERS, EXAMINING ATTORNEY

**Int. Cl.: 5**

**Prior U.S. Cls.: 6, 18, 44, 46, 51 and 52**

**Reg. No. 3,452,069**

**United States Patent and Trademark Office**

**Registered June 24, 2008**

**TRADEMARK  
PRINCIPAL REGISTER**

**CLEAN CAR**

MOBLEY PRODUCTS, INC. D/B/A WONDER  
WAFERS INTERNATIONAL (TEXAS COR-  
PORATION)  
6418 WULIGER WAY  
FORT WORTH, TX 76180

FOR: AIR FRESHENERS, AIR FRESHENER WA-  
FERS, AIR FRESHENER CONCENTRATES, IN  
CLASS 5 (U.S. CLS. 6, 18, 44, 46, 51 AND 52).

FIRST USE 12-31-2000; IN COMMERCE 12-31-2000.

THE MARK CONSISTS OF STANDARD CHAR-  
ACTERS WITHOUT CLAIM TO ANY PARTICULAR  
FONT, STYLE, SIZE, OR COLOR.

NO CLAIM IS MADE TO THE EXCLUSIVE  
RIGHT TO USE "CAR", APART FROM THE MARK  
AS SHOWN.

SER. NO. 77-136,631, FILED 3-21-2007.

MARLENE BELL, EXAMINING ATTORNEY



**Int. Cl.: 42**

**Prior U.S. Cls.: 100 and 101**

**United States Patent and Trademark Office**

**Reg. No. 3,452,070**

**Registered June 24, 2008**

**SERVICE MARK  
PRINCIPAL REGISTER**

# POWERTRACK

APTARA, INC. (DELAWARE CORPORATION)  
SUITE 900  
3110 FAIRVIEW PARK DRIVE  
FALLS CHURCH, VA 22042

FOR: PROVIDING ONLINE NONDOWNLOADABLE SOFTWARE FOR USE IN MANAGING PUBLISHING PROJECTS; GRAPHIC ART DESIGN; COMPUTER SERVICES, NAMELY, DESIGNING, CREATING, IMPLEMENTING, AND MAINTAINING WEB SITES AND NETWORK PAGES FOR OTHERS; HOSTING THE WEB SITES OF OTHERS; DOCUMENT DATA TRANSFER AND DOCUMENT CONVERSION FROM ONE MEDIA TO ANOTHER; ANALOG TO DIGITAL IMAGE AND DOCUMENT

CONVERSION; CUSTOM GRAPHIC DESIGN SERVICES FOR THE PUBLISHING AND PRINTED MEDIA INDUSTRY, IN CLASS 42 (U.S. CLS. 100 AND 101).

FIRST USE 11-29-2004; IN COMMERCE 11-29-2004.

THE MARK CONSISTS OF STANDARD CHARACTERS WITHOUT CLAIM TO ANY PARTICULAR FONT, STYLE, SIZE, OR COLOR.

SER. NO. 77-136,932, FILED 3-21-2007.

MARILYN IZZI, EXAMINING ATTORNEY

**Int. Cl.: 42**

**Prior U.S. Cls.: 100 and 101**

**United States Patent and Trademark Office**

**Reg. No. 3,452,071**

**Registered June 24, 2008**

**SERVICE MARK  
PRINCIPAL REGISTER**

**POWERREVIEW**

APTARA, INC. (DELAWARE CORPORATION)  
SUITE 900  
3110 FAIRVIEW PARK DRIVE  
FALLS CHURCH, VA 22042

FOR: PROVIDING ONLINE NONDOWNLOADABLE SOFTWARE FOR USE IN MANAGING PUBLISHING PROJECTS; GRAPHIC ART DESIGN; COMPUTER SERVICES, NAMELY, DESIGNING, CREATING, IMPLEMENTING, AND MAINTAINING WEB SITES AND NETWORK PAGES FOR OTHERS; HOSTING THE WEB SITES OF OTHERS; DOCUMENT DATA TRANSFER AND DOCUMENT CONVERSION FROM ONE MEDIA TO ANOTHER; ANALOG TO DIGITAL IMAGE AND DOCUMENT

CONVERSION; CUSTOM GRAPHIC DESIGN SERVICES FOR THE PUBLISHING AND PRINTED MEDIA INDUSTRY, IN CLASS 42 (U.S. CLS. 100 AND 101).

FIRST USE 11-29-2004; IN COMMERCE 11-29-2004.

THE MARK CONSISTS OF STANDARD CHARACTERS WITHOUT CLAIM TO ANY PARTICULAR FONT, STYLE, SIZE, OR COLOR.

SER. NO. 77-136,938, FILED 3-21-2007.

MARILYN IZZI, EXAMINING ATTORNEY

**Int. Cl.: 35**

**Prior U.S. Cls.: 100, 101 and 102**

**United States Patent and Trademark Office**

**Reg. No. 3,452,072**

**Registered June 24, 2008**

**SERVICE MARK  
PRINCIPAL REGISTER**



MOTORCYCLE TRADE DESK LIMITED (UNITED KINGDOM CORPORATION)

PO BOX 131

HAROLD HILL

ROMFORD, ESSEX, UNITED KINGDOM RM39LZ

FOR: INFOMEDIARY SERVICES, NAMELY, FACILITATING TRANSACTIONS BETWEEN MOTORCYCLE BUYERS AND SELLERS THROUGH PROVIDING BUYERS WITH INFORMATION ABOUT MOTORCYCLES, SELLERS OF MOTORCYCLES, AND ESSENTIAL BUSINESS SERVICE PROVIDERS AVAILABLE TO THE MOTORCYCLE INDUSTRY, IN CLASS 35 (U.S. CLS. 100, 101 AND 102).

FIRST USE 10-16-2006; IN COMMERCE 10-16-2006.

PRIORITY CLAIMED UNDER SEC. 44(D) ON UNITED KINGDOM APPLICATION NO. 2436133, FILED 10-20-2006, REG. NO. 2436133, DATED 10-20-2006, EXPIRES 10-20-2016.

NO CLAIM IS MADE TO THE EXCLUSIVE RIGHT TO USE "MOTORCYCLE TRADEDESK.CO.UK", APART FROM THE MARK AS SHOWN.

THE COLOR(S) LIGHT BLUE, AQUA AND BLACK IS/ARE CLAIMED AS A FEATURE OF THE MARK.

THE MARK CONSISTS OF ONE BLACK ARROW POINTING RIGHT, COMPRISED OF THREE CIRCLES AND AN ARROWHEAD, ON TOP OF ONE BLUE ARROW POINTING LEFT, COMPRISED OF THREE CIRCLES AND AN ARROWHEAD, BOTH INSIDE A TWO PART CIRCLE, ONE PART BEING BLACK AND ONE PART BEING BLUE, AND, TO THE RIGHT OF THE CIRCLE, THE WORDS MOTORCYCLE IN BLACK ON TOP OF THE WORDS TRADE IN AQUA, DESK IN BLUE, AND .CO.UK IN WHITE SURROUNDED BY A BLUE OVAL.

SER. NO. 77-137,280, FILED 3-22-2007.

JOHN DALIER, EXAMINING ATTORNEY

**Int. Cl.: 9**

**Prior U.S. Cls.: 21, 23, 26, 36 and 38**

**Reg. No. 3,452,073**

**United States Patent and Trademark Office**

**Registered June 24, 2008**

**TRADEMARK  
PRINCIPAL REGISTER**

**TENO**

SUMITOMO ELECTRIC INDUSTRIES, LTD. (JAPAN CORPORATION)  
5-33 KITAHAMA 4-CHOME  
CHUO-KU  
OSAKA-SHI, OSAKA, JAPAN

FOR: COMPUTER SOFTWARE, NAMELY, PEER-TO-PEER FILE SHARING SOFTWARE AND DATA MANAGEMENT SOFTWARE USED FOR THE PURPOSE OF RECEIVING, TRANSMITTING, CREATING, STORING, RETRIEVING, SHARING, VIEWING, PREVIEWING, PRINTING, EDITING, ANNOTATING, ORGANIZING AND MANAGING INFORMATION, SITES, FILES, DOCUMENTS, SOUND RECORDINGS, PICTURES, MOVIES, MEDIA FILES AND OTHER RESOURCES ON COMPU-

TER NETWORKS AND IN COMPUTERS, IN CLASS 9 (U.S. CLS. 21, 23, 26, 36 AND 38).

THE MARK CONSISTS OF STANDARD CHARACTERS WITHOUT CLAIM TO ANY PARTICULAR FONT, STYLE, SIZE, OR COLOR.

PRIORITY CLAIMED UNDER SEC. 44(D) ON JAPAN APPLICATION NO. 2007-015585, FILED 2-23-2007, REG. NO. 5093673, DATED 11-22-2007, EXPIRES 11-22-2017.

SER. NO. 77-137,659, FILED 3-22-2007.

DAVID TOOLEY, EXAMINING ATTORNEY

**Int. Cl.: 11**

**Prior U.S. Cls.: 13, 21, 23, 31 and 34**

**Reg. No. 3,452,074**

**United States Patent and Trademark Office**

**Registered June 24, 2008**

---

**TRADEMARK  
PRINCIPAL REGISTER**



PURIFAN, INC. (KANSAS CORPORATION)  
224 E. DOUGLAS, SUITE 500  
WICHITA, KS 67202

FIRST USE 3-12-2003; IN COMMERCE 3-12-2003.

OWNER OF U.S. REG. NO. 2,483,366.

FOR: AIR FILTRATION UNITS FOR USE IN  
DOMESTIC AND INDUSTRIAL APPLICATIONS,  
IN CLASS 11 (U.S. CLS. 13, 21, 23, 31 AND 34).

SER. NO. 77-138,010, FILED 3-22-2007.

DAVID MURRAY, EXAMINING ATTORNEY

**Int. Cl.: 25**

**Prior U.S. Cls.: 22 and 39**

**United States Patent and Trademark Office**

**Reg. No. 3,452,075**

**Registered June 24, 2008**

**TRADEMARK  
PRINCIPAL REGISTER**

**PARTY! MY CRIB. 3:00A.M.**

REIN DESIGNS, INC. (COLORADO CORPORATION)  
SUITE I  
2400 CENTRAL AVENUE  
BOULDER, CO 80301

FOR: BABY BIBS NOT OF PAPER; BIB OVERALLS; BIBS NOT OF CLOTH OR PAPER; BODY SUITS; BOOTIES; CAPS; CHILDREN'S AND INFANTS' CLOTH BIBS; CLOTH BIBS; INFANT AND TODDLER ONE PIECE CLOTHING; INFANT DIAPER COVERS; INFANT SLEEPERS; INFANTS' SHOES AND BOOTS; INFANTS' TROUSERS; INFANTWEAR; JACKETS; JERSEYS; JUMPERS; KNITTED CAPS; LAYETTES; ONE PIECE GARMENT

FOR INFANTS AND TODDLERS; PAJAMAS; ROMPERS; SHORTS; SWADDLING CLOTHES; SWEAT SHIRTS; SWEAT SUITS; T-SHIRTS, IN CLASS 25 (U.S. CLS. 22 AND 39).

FIRST USE 7-1-1995; IN COMMERCE 7-1-1995.

THE MARK CONSISTS OF STANDARD CHARACTERS WITHOUT CLAIM TO ANY PARTICULAR FONT, STYLE, SIZE, OR COLOR.

SER. NO. 77-138,177, FILED 3-22-2007.

MICHAEL WIENER, EXAMINING ATTORNEY

**Int. Cl.: 41**

**Prior U.S. Cls.: 100, 101 and 107**

**United States Patent and Trademark Office**

**Reg. No. 3,452,076**

**Registered June 24, 2008**

**SERVICE MARK  
PRINCIPAL REGISTER**

**GLAMCAM**

E! ENTERTAINMENT TELEVISION, INC. (DELA-  
WARE CORPORATION)  
5750 WILSHIRE BLVD.  
LOS ANGELES, CA 90036

FOR: ENTERTAINMENT IN THE NATURE OF  
ON-GOING TELEVISION PROGRAMS IN THE  
FIELD OF CELEBRITIES AND AWARD SHOWS;  
ENTERTAINMENT IN THE NATURE OF NEWS  
REPORTING AND VIDEO COVERAGE OF LIVE  
EVENTS; ENTERTAINMENT SERVICES, NAMELY,  
PROVIDING A TELEVISION PROGRAM IN THE  
FIELD OF CELEBRITIES AND AWARD SHOWS VIA  
A GLOBAL COMPUTER NETWORK; OPERATION  
OF VIDEO EQUIPMENT FOR PRODUCTION OF

TELEVISION PROGRAMS; PRODUCTION OF VI-  
SUAL EFFECTS FOR TELEVISION, IN CLASS 41  
(U.S. CLS. 100, 101 AND 107).

FIRST USE 8-27-2006; IN COMMERCE 8-27-2006.

THE MARK CONSISTS OF STANDARD CHAR-  
ACTERS WITHOUT CLAIM TO ANY PARTICULAR  
FONT, STYLE, SIZE, OR COLOR.

SER. NO. 77-138,257, FILED 3-22-2007.

ROSELLE HERRERA, EXAMINING ATTORNEY

**Int. Cl.: 42**

**Prior U.S. Cls.: 100 and 101**

**United States Patent and Trademark Office**

**Reg. No. 3,452,077**

**Registered June 24, 2008**

**SERVICE MARK  
PRINCIPAL REGISTER**



OZLER, LEVENT (TURKEY INDIVIDUAL)  
DENIZ APT. 19 D:4 MALTEPE  
YALI MAH. 27 MAYIS SOK.  
ISTANBUL, TURKEY 34844

FOR: PROVIDING INFORMATION IN THE  
FIELDS OF DESIGN, NAMELY, PRODUCT DE-  
SIGN, GRAPHIC DESIGN, FASHION DESIGN, AR-  
CHITECTURE, DIGITAL DESIGN, INTERIOR  
DESIGN, PROVIDED VIA A GLOBAL COMPUTER  
NETWORK, IN CLASS 42 (U.S. CLS. 100 AND 101).

FIRST USE 1-19-2001; IN COMMERCE 5-16-2003.

NO CLAIM IS MADE TO THE EXCLUSIVE  
RIGHT TO USE "DESIGNER", APART FROM THE  
MARK AS SHOWN.

THE MARK CONSISTS OF A STYLIZED FISH,  
THE BODY OF WHICH LOOKS LIKE A HUMAN  
EYE, TO THE LEFT OF THE TERM DEXIGNER.

THE WORDING DEXIGNER HAS NO MEANING  
IN A FOREIGN LANGUAGE.

SER. NO. 77-138,351, FILED 3-22-2007.

MYRIAH HABEEB, EXAMINING ATTORNEY



**Int. Cl.: 35**

**Prior U.S. Cls.: 100, 101 and 102**

**United States Patent and Trademark Office**

**Reg. No. 3,452,078**

**Registered June 24, 2008**

---

**SERVICE MARK  
PRINCIPAL REGISTER**

**CAMP POLO**

PRL USA HOLDINGS, INC. (DELAWARE CORPORATION)  
103 FOULK ROAD  
WILMINGTON, DE 19803

FOR: RETAIL STORE SERVICES AND ONLINE  
RETAIL STORE SERVICES FEATURING CLOTHING  
AND FASHION ACCESSORIES, IN CLASS 35  
(U.S. CLS. 100, 101 AND 102).

FIRST USE 5-0-2005; IN COMMERCE 5-0-2005.

THE MARK CONSISTS OF STANDARD CHARACTERS WITHOUT CLAIM TO ANY PARTICULAR FONT, STYLE, SIZE, OR COLOR.

SER. NO. 77-138,617, FILED 3-23-2007.

SUSAN RICHARDS, EXAMINING ATTORNEY

**Int. Cl.: 40**

**Prior U.S. Cls.: 100, 103 and 106**

**United States Patent and Trademark Office**

**Reg. No. 3,452,079**

**Registered June 24, 2008**

**SERVICE MARK  
PRINCIPAL REGISTER**



MICROZYME TECHNOLOGIES LLC (FLORIDA  
LTD LIAB CO)  
SUITE C2302  
777 EAST ATLANTIC AVENUE  
DELRAY BEACH, FL 33483

FOR: MOLD REMEDIATION AND MOLD PRE-  
VENTION TREATMENT OF RESIDENTIAL AND  
COMMERCIAL BUILDINGS, IN CLASS 40 (U.S. CLS.  
100, 103 AND 106).

FIRST USE 7-1-2006; IN COMMERCE 7-1-2006.

NO CLAIM IS MADE TO THE EXCLUSIVE  
RIGHT TO USE "TECHNOLOGIES LLC", APART  
FROM THE MARK AS SHOWN.

THE MARK CONSISTS OF ORANGE CIRCLE  
WITH BROWN BORDER AND FOURTEEN SMAL-  
LER CIRCLES EMANATING FROM THE CENTER  
CIRCLE AND CIRCLES ARE ORANGE AND THE  
BORDERS ARE BROWN.

SER. NO. 77-138,665, FILED 3-23-2007.

MICHAEL ENGEL, EXAMINING ATTORNEY

**Int. Cls.: 9 and 42**

**Prior U.S. Cls.: 21, 23, 26, 36, 38, 100 and 101**

**United States Patent and Trademark Office**

**Reg. No. 3,452,080**

**Registered June 24, 2008**

**TRADEMARK  
SERVICE MARK  
PRINCIPAL REGISTER**

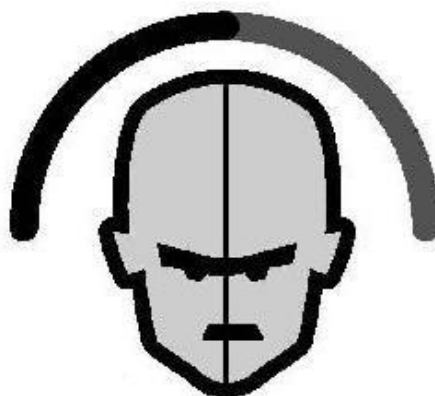

HOTHEAD SPORTS, LLC (GEORGIA LTD LIAB  
CO)  
SUITE A  
1942 BRANNAN ROAD  
MCDONOUGH, GA 30281

FOR: SPORTS HELMETS, NAMELY, FOOTBALL,  
HOCKEY, BASEBALL, BICYCLING, AND LA-  
CROSSE HELMETS; PROTECTIVE HELMETS;  
SAFETY HELMETS; INDUSTRIAL HELMETS;  
AND CONSTRUCTION HELMETS; CELLULAR  
PHONES; CIRCUIT BOARDS; COMMUNICATIONS  
SOFTWARE FOR CONNECTING WIRELESS COM-  
MUNICATION DEVICES; COMPUTER SOFTWARE  
FOR MONITORING PATIENT'S PHYSICAL AND  
BIOLOGICAL HEALTH BY MEASURING PA-  
TIENT'S TEMPERATURE, BLOOD PRESSURE,  
HEARTBEAT, BLOOD OXYGEN LEVEL, AND  
BLOOD PRESSURE; HANDHELD COMPUTERS;  
TEMPERATURE SENSORS; PERSONAL DIGITAL  
ASSISTANTS (PDA); PRESSURE SENSORS; ACCEL-  
ERATION SENSORS, IN CLASS 9 (U.S. CLS. 21, 23, 26,  
36 AND 38).

FIRST USE 1-6-2007; IN COMMERCE 1-6-2007.

FOR: CUSTOMIZATION OF COMPUTER HARD-  
WARE AND SOFTWARE; COMPUTER SOFTWARE  
DESIGN, COMPUTER PROGRAMMING, OR MAIN-  
TENANCE OF COMPUTER SOFTWARE; DESIGN,  
DEVELOPMENT AND IMPLEMENTATION OF  
SOFTWARE; DESIGNING OF MACHINES, APPA-  
RATUS, INSTRUMENTS OR SYSTEMS COMPOSED  
OF SUCH MACHINES, APPARATUS AND INSTRU-  
MENTS, IN CLASS 42 (U.S. CLS. 100 AND 101).

FIRST USE 1-6-2007; IN COMMERCE 1-6-2007.

THE MARK CONSISTS OF A STYLIZED POR-  
TRAIT BENEATH A SEMICIRCULAR LINE.

SER. NO. 77-138,952, FILED 3-23-2007.

DANNEAN HETZEL, EXAMINING ATTORNEY

**Int. Cls.: 35 and 36**

**Prior U.S. Cls.: 100, 101 and 102**

**United States Patent and Trademark Office**

**Reg. No. 3,452,081**

**Registered June 24, 2008**

**SERVICE MARK  
PRINCIPAL REGISTER**

**LEDRA CAPITAL**

LEDRA CAPITAL, LLC (DELAWARE LTD LIAB  
CO)  
7TH FLOOR  
1230 AVENUE OF THE AMERICAS  
NEW YORK, NY 10020

FOR: BUSINESS MANAGEMENT SERVICES, IN  
CLASS 35 (U.S. CLS. 100, 101 AND 102).

FIRST USE 11-1-2006; IN COMMERCE 11-1-2006.

FOR: VENTURE CAPITAL AND PRIVATE EQUI-  
TY SERVICES, NAMELY, PROVIDING TO COMPA-  
NIES FINANCING AND RELATED CONSULTING  
SERVICES, IN CLASS 36 (U.S. CLS. 100, 101 AND 102).

FIRST USE 11-1-2006; IN COMMERCE 11-1-2006.

THE MARK CONSISTS OF STANDARD CHAR-  
ACTERS WITHOUT CLAIM TO ANY PARTICULAR  
FONT, STYLE, SIZE, OR COLOR.

NO CLAIM IS MADE TO THE EXCLUSIVE  
RIGHT TO USE "CAPITAL", APART FROM THE  
MARK AS SHOWN.

SER. NO. 77-139,071, FILED 3-23-2007.

DAVID C. REIHNER, EXAMINING ATTORNEY

**Int. Cl.: 25**

**Prior U.S. Cls.: 22 and 39**

**United States Patent and Trademark Office**

**Reg. No. 3,452,082**

**Registered June 24, 2008**

**TRADEMARK  
PRINCIPAL REGISTER**

**BARE FOX**

TRIPLE S PRODUCTION, INC. (CALIFORNIA CORPORATION)  
1844 E. 27TH STREET  
VERNON, CA 90058

FOR: CLOTHING FOR MEN, WOMEN AND CHILDREN, NAMELY, ANORAKS, BANDANAS, BASEBALL CAPS, BATHING SUITS, BEACHWEAR, BELTS, BERETS, BIKINIS, BLAZERS, BLOUSES, BODYSUITS, BRAS, BRIEFS, CAMISOLES, CAPS, CAPES, CARDIGANS, COATS, COVERUPS, DINNER JACKETS, DRESSES, DRESS SHIRTS, FOOTWEAR, GLOVES, HALTERS, HATS, HEADWEAR, HEADBANDS, HOODS, HOSIERY, JACKETS, JEANS, JERSEYS, JUMPERS, JUMPSUITS, LEGGINGS, LEOTARDS, LINGERIE, MITTENS, MUFFLERS, NECKERCHIEFS, NIGHTGOWNS, OVERALLS, PAJAMAS, PANTIES, PANTS, PARKAS, PONCHOS, PULLOVERS, RAIN JACKETS, RAIN TROUSERS, RAINCOATS, RAINWEAR, ROBES, SCARVES, SHAWLS, SHIRTS, SHORTS, SHOULDER WRAPS, SKI JACKETS, SKI PANTS, SKIRTS, SLEEP-

WEAR, SMOCK TOPS, SOCKS, SPORTCOATS, SPORT SHIRTS, STOCKINGS, SUIT COATS, SUITS, SUSPENDERS, SWEATPANTS, SWEATSHIRTS, SWEATERS, SWIMWEAR, SWIMSUITS, TANK TOPS, TIES, TIGHTS, TOP COATS, TRACK SUITS, TROUSERS, TURTLENECKS, T-SHIRTS, TUXEDOS, UNDERSHIRTS, UNDERWEAR, VESTS, VISORS, WIND RESISTANT JACKETS, AND WRIST BANDS, IN CLASS 25 (U.S. CLS. 22 AND 39).

FIRST USE 2-2-1995; IN COMMERCE 2-2-1995.

THE MARK CONSISTS OF STANDARD CHARACTERS WITHOUT CLAIM TO ANY PARTICULAR FONT, STYLE, SIZE, OR COLOR.

OWNER OF U.S. REG. NO. 3,235,578.

SER. NO. 77-139,379, FILED 3-23-2007.

TARAH HARDY, EXAMINING ATTORNEY

**Int. Cls.: 35 and 41**

**Prior U.S. Cls.: 100, 101, 102 and 107**

**United States Patent and Trademark Office**

**Reg. No. 3,452,083**

**Registered June 24, 2008**

**SERVICE MARK  
PRINCIPAL REGISTER**

**PASSION FOR POSH**

MCMILLIN COMPANIES, LLC (DELAWARE  
LTD LIAB CO)  
P.O. BOX 85104  
SAN DIEGO, CA 921865104

FOR: PROMOTIONAL AND MARKETING SERVICES, NAMELY, PROMOTING AND MARKETING RESIDENTIAL AND COMMERCIAL REAL ESTATE DEVELOPMENTS AND COMMUNITIES, NAMELY, MASTER PLANNED COMMUNITIES, IN CLASS 35 (U.S. CLS. 100, 101 AND 102).

FIRST USE 1-30-2007; IN COMMERCE 1-30-2007.

FOR: ENTERTAINMENT SERVICES, NAMELY, EXHIBITIONS AND DEMONSTRATIONS DIRECTED TO POTENTIAL NEW BUYERS IN RESIDENTIAL AND COMMERCIAL REAL ESTATE

DEVELOPMENTS AND COMMUNITIES, NAMELY, MASTER PLANNED COMMUNITIES, IN THE NATURE OF LANDSCAPING AND GARDENING EXHIBITIONS AND DEMONSTRATIONS, CAR EXHIBITIONS, COOKING DEMONSTRATIONS AND WINE TASTING, IN CLASS 41 (U.S. CLS. 100, 101 AND 107).

FIRST USE 1-30-2007; IN COMMERCE 1-30-2007.

THE MARK CONSISTS OF STANDARD CHARACTERS WITHOUT CLAIM TO ANY PARTICULAR FONT, STYLE, SIZE, OR COLOR.

SER. NO. 77-139,482, FILED 3-23-2007.

RICHARD A. STRASER, EXAMINING ATTORNEY

**Int. Cl.: 16**

**Prior U.S. Cls.: 2, 5, 22, 23, 29, 37, 38 and 50**

**Reg. No. 3,452,084**

**United States Patent and Trademark Office**

**Registered June 24, 2008**

**TRADEMARK  
PRINCIPAL REGISTER**

# Ruler Korrall

PIERSON, JERRY (UNITED STATES INDIVIDUAL)  
ACC 412  
343 DIANA DR.  
ALAMO, TX 78516 AND  
PIERSON, MARY (UNITED STATES INDIVIDUAL)  
ACC 412  
343 DIANA DR.  
ALAMO, TX 78516

FOR: APPARTUS DESIGNED TO HOLD RULERS, MAT BOARDS FOR CUTTING, AND TOOLS PARTICULAR TO THE DESIGN INDUSTRY, NAMELY, ACRYLIC GRIDDED RULERS AND MATS USED FOR CUTTING AND MEASURING OF PIECED BLOCKS FOR QUILTING PATTERNS, IN CLASS 16 (U.S. CLS. 2, 5, 22, 23, 29, 37, 38 AND 50).

FIRST USE 8-1-2005; IN COMMERCE 8-1-2005.

THE MARK CONSISTS OF STANDARD CHARACTERS WITHOUT CLAIM TO ANY PARTICULAR FONT, STYLE, SIZE, OR COLOR.

NO CLAIM IS MADE TO THE EXCLUSIVE RIGHT TO USE "RULER", APART FROM THE MARK AS SHOWN.

SER. NO. 77-140,581, FILED 3-26-2007.

MARGARET POWER, EXAMINING ATTORNEY

**Int. Cls.: 35, 36, 41 and 45**

**Prior U.S. Cls.: 100, 101, 102 and 107**

**United States Patent and Trademark Office**

**Reg. No. 3,452,085**

**Registered June 24, 2008**

**SERVICE MARK  
PRINCIPAL REGISTER**

**WOMEN FOR WOMEN  
INTERNATIONAL**

WOMEN FOR WOMEN INTERNATIONAL (D.C.  
CHARITABLE, NON-PROFIT CORPORATION)  
SUITE 200  
4455 CONNECTICUT AVENUE, N.W.  
WASHINGTON, DC 20008

FOR: CATALOG ORDERING SERVICES FEATURING, JEWELRY, CLOTHING AND CRAFT ITEMS PRINCIPALLY MADE AND SOLD FOR THE BENEFIT OF WOMEN VICTIMS OF WAR AND CIVIL STRIFE; MAIL ORDER SERVICES FEATURING JEWELRY, CLOTHING AND CRAFT ITEMS PRINCIPALLY MADE AND SOLD FOR THE BENEFIT OF WOMEN VICTIMS OF WAR AND CIVIL STRIFE; ON-LINE RETAIL STORE SERVICES FEATURING JEWELRY, CLOTHING AND CRAFT ITEMS PRINCIPALLY MADE AND SOLD FOR THE BENEFIT OF WOMEN VICTIMS OF WAR AND CIVIL STRIFE, IN CLASS 35 (U.S. CLS. 100, 101 AND 102).

FIRST USE 2-1-2001; IN COMMERCE 2-1-2001.

FOR: CHARITABLE FUND RAISING SERVICES TO ASSIST WOMEN VICTIMS OF WAR AND CIVIL STRIFE; ESTABLISHING AND ADMINISTERING MONETARY CHARITABLE PROGRAMS TO PROVIDE INCOME-GENERATING SUPPORT AND MICRO CREDIT LOANS TO BENEFIT WOMEN VICTIMS OF WAR AND CIVIL STRIFE, IN CLASS 36 (U.S. CLS. 100, 101 AND 102).

FIRST USE 6-30-2003; IN COMMERCE 6-30-2003.

FOR: EDUCATIONAL SERVICES, NAMELY, ESTABLISHING AND CONDUCTING PROGRAMS IN HEALTH, WOMEN'S RIGHTS AND VOCATIONAL TRAINING FOR WOMEN VICTIMS OF WAR AND CIVIL STRIFE, IN CLASS 41 (U.S. CLS. 100, 101 AND 107).

FIRST USE 6-30-2003; IN COMMERCE 6-30-2003.

FOR: ORGANIZING SUPPORT GROUPS FEATURING AN INCREASED AWARENESS OF THE PLIGHT OF WOMEN VICTIMS OF WAR AND CIVIL STRIFE AND ONE-ON-ONE SUPPORTING RELATIONSHIPS BETWEEN WOMEN VICTIMS OF WAR AND CIVIL STRIFE AND WOMEN WHO PROVIDE EMOTIONAL SUPPORT, IN CLASS 45 (U.S. CLS. 100 AND 101).

FIRST USE 11-1-1999; IN COMMERCE 11-1-1999.

THE MARK CONSISTS OF STANDARD CHARACTERS WITHOUT CLAIM TO ANY PARTICULAR FONT, STYLE, SIZE, OR COLOR.

OWNER OF U.S. REG. NOS. 3,065,242, 3,190,967 AND OTHERS.

NO CLAIM IS MADE TO THE EXCLUSIVE RIGHT TO USE INTERNATIONAL, APART FROM THE MARK AS SHOWN.

SER. NO. 77-141,668, FILED 3-27-2007.

JULIE GUTTADAURO, EXAMINING ATTORNEY



**Int. Cl.: 15**

**Prior U.S. Cls.: 2, 21 and 36**

**United States Patent and Trademark Office**

**Reg. No. 3,452,086**

**Registered June 24, 2008**

**TRADEMARK  
PRINCIPAL REGISTER**

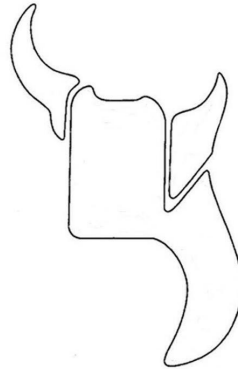

BURNS LONDON LTD. (UNITED KINGDOM CORPORATION)  
76 HURST LANE, EAST MOLESEY  
SURREY, UNITED KINGDOM KT89DY

FOR: STRINGED MUSICAL INSTRUMENTS, NAMELY, ACOUSTIC, ACOUSTIC/ELECTRIC AND ELECTRIC GUITARS AND ACOUSTIC, ACOUSTIC/ELECTRIC AND ELECTRIC BASSES, AND REPLACEMENT PARTS THEREFOR, IN CLASS 15 (U.S. CLS. 2, 21 AND 36).

FIRST USE 0-0-1963; IN COMMERCE 0-0-1964.

THE MARK CONSISTS OF A FANCIFUL CONFIGURATION OF A GUITAR PICKGUARD.

SEC. 2(F).

SER. NO. 77-141,718, FILED 3-27-2007.

CHRIS WELLS, EXAMINING ATTORNEY

**Int. Cl.: 45**

**Prior U.S. Cls.: 100 and 101**

**United States Patent and Trademark Office**

**Reg. No. 3,452,087**

**Registered June 24, 2008**

**SERVICE MARK  
PRINCIPAL REGISTER**

**VIVA**

VERIFX, INC. (CALIFORNIA CORPORATION)  
2233 E. EL SEGUNDO BOULEVARD  
EL SEGUNDO, CA 90245

FOR: COMPUTER VERIFICATION SERVICES,  
NAMELY, VERIFICATION OF A PERSON'S SIGNA-  
TURE AND VERIFICATION OF NOTARIZATION  
ON A DOCUMENT, AND VERIFICATION OF FIN-  
GERPRINTS, IN CLASS 45 (U.S. CLS. 100 AND 101).

FIRST USE 11-11-2006; IN COMMERCE 2-9-2007.

THE MARK CONSISTS OF STANDARD CHAR-  
ACTERS WITHOUT CLAIM TO ANY PARTICULAR  
FONT, STYLE, SIZE, OR COLOR.

SER. NO. 77-142,021, FILED 3-27-2007.

EDWARD NELSON, EXAMINING ATTORNEY

**Int. Cls.: 35 and 42**

**Prior U.S. Cls.: 100, 101 and 102**

**United States Patent and Trademark Office**

**Reg. No. 3,452,088**

**Registered June 24, 2008**

**SERVICE MARK  
PRINCIPAL REGISTER**

# Lucipa

LUCIPA INC. (CALIFORNIA CORPORATION)  
PO BOX 472226  
SAN FRANCISCO, CA 941472226

FOR: BUSINESS CONSULTING AND INFORMATION SERVICES; BUSINESS MANAGEMENT CONSULTANCY AND ADVISORY SERVICES; BUSINESS MANAGEMENT CONSULTING AND ADVISORY SERVICES, IN CLASS 35 (U.S. CLS. 100, 101 AND 102).

FIRST USE 11-0-2006; IN COMMERCE 11-0-2006.

FOR: COMPUTER NETWORK DESIGN AND COMPUTER SOFTWARE DESIGN FOR THE MANAGEMENT OF THE NETWORKS; CONSULTING SERVICES IN THE FIELD OF DESIGN, SELECTION, IMPLEMENTATION AND USE OF COMPUTER HARDWARE AND SOFTWARE SYSTEMS FOR

OTHERS; COMPUTER NETWORK DESIGN FOR OTHERS; DESIGN FOR OTHERS IN THE FIELD OF COMPUTER NETWORKS, SOFTWARE, AND ENGINEERING FOR THE MANAGEMENT OF THE NETWORKS; DESIGN AND DEVELOPMENT OF NETWORKS; DESIGN OF COMPUTER NETWORKS AND SOFTWARE FOR OTHERS FOR THE MANAGEMENT OF THE NETWORKS, IN CLASS 42 (U.S. CLS. 100 AND 101).

FIRST USE 11-0-2006; IN COMMERCE 11-0-2006.

THE MARK CONSISTS OF STANDARD CHARACTERS WITHOUT CLAIM TO ANY PARTICULAR FONT, STYLE, SIZE, OR COLOR.

SER. NO. 77-142,035, FILED 3-27-2007.

RONALD MCMORROW, EXAMINING ATTORNEY

**Int. Cl.: 3**

**Prior U.S. Cls.: 1, 4, 6, 50, 51 and 52**

**United States Patent and Trademark Office**

**Reg. No. 3,452,089**

**Registered June 24, 2008**

**TRADEMARK  
PRINCIPAL REGISTER**

**ROCK THE SOAP**

T. S. PINK CORP. (NEW YORK CORPORATION)  
139 PONY FARM ROAD  
ONEONTA, NY 13820

FOR: BAR SOAP, IN CLASS 3 (U.S. CLS. 1, 4, 6, 50,  
51 AND 52).

FIRST USE 1-7-1993; IN COMMERCE 9-4-1994.

THE MARK CONSISTS OF STANDARD CHAR-  
ACTERS WITHOUT CLAIM TO ANY PARTICULAR  
FONT, STYLE, SIZE, OR COLOR.

SER. NO. 77-142,216, FILED 3-28-2007.

LESLIE RICHARDS, EXAMINING ATTORNEY

**Int. Cl.: 43**

**Prior U.S. Cls.: 100 and 101**

**United States Patent and Trademark Office**

**Reg. No. 3,452,090**

**Registered June 24, 2008**

**SERVICE MARK  
PRINCIPAL REGISTER**

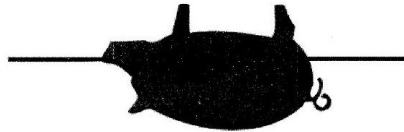

ADAMS, SR, ROBERT L (UNITED STATES IN-  
DIVIDUAL)  
2241 N WESTERN AVE  
CHICAGO, IL 60647

THE MARK CONSISTS OF SIDE VIEW SILHOU-  
ETTE OF UPSIDE DOWN PIG ON SKEWER.

FOR: RESTAURANT SERVICES, IN CLASS 43  
(U.S. CLS. 100 AND 101).

SER. NO. 77-142,242, FILED 3-28-2007.

FIRST USE 6-27-2003; IN COMMERCE 6-27-2003.

MICHAEL KEATING, EXAMINING ATTORNEY

**Int. Cl.: 42**

**Prior U.S. Cls.: 100 and 101**

**United States Patent and Trademark Office**

**Reg. No. 3,452,091**

**Registered June 24, 2008**

**SERVICE MARK  
PRINCIPAL REGISTER**



THERANOSTICS HEALTH, LLC (MARYLAND  
LTD LIAB CO)  
32 LISA DRIVE  
CHATHAM, NJ 079281036

FOR: MEDICAL AND SCIENTIFIC RESEARCH  
SERVICES IN THE FIELD OF DISEASE DIAGNOSIS,  
TREATMENT, AND MONITORING, IN CLASS 42  
(U.S. CLS. 100 AND 101).

FIRST USE 3-27-2007; IN COMMERCE 3-27-2007.

NO CLAIM IS MADE TO THE EXCLUSIVE  
RIGHT TO USE "THERANOSTICS HEALTH PART-  
NERS FOR PERSONALIZED MEDICINE", APART  
FROM THE MARK AS SHOWN.

THE COLOR(S) BLUE AND GREEN IS/ARE  
CLAIMED AS A FEATURE OF THE MARK.

THE MARK CONSISTS OF A BLUE STYLIZED  
HUMAN FIGURE ABOVE A GREEN AREA REPRE-  
SENTING A GRASS PATH. TO THE RIGHT OF THE  
HUMAN FIGURE IS THE WORDING "THERANOS-  
TICS HEALTH" WITH THE WORDING "PARTNERS  
FOR PERSONALIZED MEDICINE" UNDERNEATH  
"THERANOSTICS HEALTH" IN BLUE. THE DOT IN  
THE LETTER "I" IN "THERANOSTICS" IS GREEN.

SER. NO. 77-142,697, FILED 3-28-2007.

SUSAN RICHARDS, EXAMINING ATTORNEY

**Int. Cls.: 5 and 10**

**Prior U.S. Cls.: 6, 18, 26, 39, 44, 46, 51 and 52**

**United States Patent and Trademark Office**

**Reg. No. 3,452,092**

**Registered June 24, 2008**

**TRADEMARK  
PRINCIPAL REGISTER**

**NOVOLIZER**

MEDA PHARMA GMBH & CO. KG (FED REP  
GERMANY LIMITED LIABILITY PARTNER-  
SHIP)  
BENZSTRASSE 1  
BAD HOMBURG, FED REP GERMANY 61352

FOR: INHALERS FILLED WITH PHARMACEU-  
TICAL PREPARATIONS FOR THE TREATMENT  
OF RESPIRATORY DISEASES; PHARMACEUTI-  
CAL PREPARATIONS FOR THE TREATMENT OF  
RESPIRATORY DISEASES, IN CLASS 5 (U.S. CLS. 6,  
18, 44, 46, 51 AND 52).

FOR: INHALERS FOR THERAPEUTIC USE SOLD  
EMPTY, IN CLASS 10 (U.S. CLS. 26, 39 AND 44).

THE MARK CONSISTS OF STANDARD CHAR-  
ACTERS WITHOUT CLAIM TO ANY PARTICULAR  
FONT, STYLE, SIZE, OR COLOR.

OWNER OF FED REP GERMANY REG. NO.  
39804275, DATED 1-29-1998, RENEWED AS REG.  
NO. 39804275, DATED 1-31-2008, EXPIRES 1-31-2018.

OWNER OF FED REP GERMANY REG. NO.  
39908878, DATED 2-17-1999, EXPIRES 2-28-2009.

SER. NO. 77-143,315, FILED 3-29-2007.

BERYL GARDNER, EXAMINING ATTORNEY

**Int. Cl.: 35**

**Prior U.S. Cls.: 100, 101 and 102**

**United States Patent and Trademark Office**

**Reg. No. 3,452,093**

**Registered June 24, 2008**

**SERVICE MARK  
PRINCIPAL REGISTER**

**MARKETING STRUCTURES &  
COMMUNICATION**

MARKETING STRUCTURES & COMMUNICA-  
TION INC. (ILLINOIS CORPORATION)  
SUITE 1412  
875 N MICHIGAN AVENUE  
CHICAGO, IL 60611

FOR: ADVERTISING, MARKETING AND PRO-  
MOTION SERVICES, IN CLASS 35 (U.S. CLS. 100, 101  
AND 102).

FIRST USE 11-1-2000; IN COMMERCE 11-1-2000.

THE MARK CONSISTS OF STANDARD CHAR-  
ACTERS WITHOUT CLAIM TO ANY PARTICULAR  
FONT, STYLE, SIZE, OR COLOR.

NO CLAIM IS MADE TO THE EXCLUSIVE  
RIGHT TO USE "MARKETING", APART FROM  
THE MARK AS SHOWN.

SEC. 2(F).

SER. NO. 77-143,379, FILED 3-29-2007.

KAREN BRACEY, EXAMINING ATTORNEY



**Int. Cl.: 37**

**Prior U.S. Cls.: 100, 103 and 106**

**United States Patent and Trademark Office**

**Reg. No. 3,452,094**

**Registered June 24, 2008**

---

**SERVICE MARK  
PRINCIPAL REGISTER**

# Computer Clinic

TRANSCOMP, INC. (NORTH CAROLINA CORPORATION)  
742-A EAST CHATHAM STREET  
CARY, NC 27511

FOR: COMPUTER REPAIR SERVICES, IN CLASS  
37 (U.S. CLS. 100, 103 AND 106).

FIRST USE 2-0-1988; IN COMMERCE 2-0-1988.

THE MARK CONSISTS OF STANDARD CHARACTERS WITHOUT CLAIM TO ANY PARTICULAR FONT, STYLE, SIZE, OR COLOR.

SEC. 2(F).

SER. NO. 77-143,491, FILED 3-29-2007.

ROBERT STRUCK, EXAMINING ATTORNEY

**Int. Cl.: 30**

**Prior U.S. Cl.: 46**

**United States Patent and Trademark Office**

**Reg. No. 3,452,095**

**Registered June 24, 2008**

**TRADEMARK  
PRINCIPAL REGISTER**

**MEADOW SPRINGS**

LESAFFRE ET COMPAGNIE (FRANCE JOINT  
STOCK COMPANY)  
41, RUE ETIENNE MARCEL  
PARIS, FRANCE 75001

PRIORITY CLAIMED UNDER SEC. 44(D) ON  
FRANCE APPLICATION NO. 07/3490845, FILED 3-  
27-2007, REG. NO. 07/3490845, DATED 3-27-2007,  
EXPIRES 3-27-2017.

FOR: YEAST, IN CLASS 30 (U.S. CL. 46).

SER. NO. 77-143,623, FILED 3-29-2007.

THE MARK CONSISTS OF STANDARD CHAR-  
ACTERS WITHOUT CLAIM TO ANY PARTICULAR  
FONT, STYLE, SIZE, OR COLOR.

CHRISTINE COOPER, EXAMINING ATTORNEY

**Int. Cls.: 3, 14, 18, 25 and 35**

**Prior U.S. Cls.: 1, 2, 3, 4, 6, 22, 27, 28, 39, 41, 50, 51,  
52, 100, 101 and 102**

**Reg. No. 3,452,096**

**United States Patent and Trademark Office**

**Registered June 24, 2008**

**TRADEMARK  
SERVICE MARK  
PRINCIPAL REGISTER**



HUB DISTRIBUTING, INC. (DELAWARE CORPORATION)  
2501 GUASTI ROAD  
ONTARIO, CA 91761

FOR: FRAGRANCES FOR PERSONAL USE, COSMETICS AND NON-MEDICATED TOILETRIES, IN CLASS 3 (U.S. CLS. 1, 4, 6, 50, 51 AND 52).

FIRST USE 2-0-2002; IN COMMERCE 2-0-2002.

FOR: JEWELRY, IN CLASS 14 (U.S. CLS. 2, 27, 28 AND 50).

FIRST USE 2-0-2002; IN COMMERCE 2-0-2002.

FOR: BACKPACKS, TOTE BAGS AND HANDBAGS, IN CLASS 18 (U.S. CLS. 1, 2, 3, 22 AND 41).

FIRST USE 2-0-2002; IN COMMERCE 2-0-2002.

FOR: SHIRTS, T-SHIRTS, SWEATERS, TOPS, JACKETS, PANTS, BELTS, SHORTS, UNDERWEAR, SWIMWEAR, LINGERIE, HEADWEAR AND FOOTWEAR, IN CLASS 25 (U.S. CLS. 22 AND 39).

FIRST USE 2-0-2002; IN COMMERCE 2-0-2002.

FOR: RETAIL STORE SERVICES SPECIALIZING IN CLOTHING, FOOTWEAR AND ACCESSORIES, NAMELY, HANDBAGS, BACKPACKS AND TOTE BAGS, HAIR ORNAMENTS, SUNGLASSES, JEWELRY, FRAGRANCES AND COSMETICS, IN CLASS 35 (U.S. CLS. 100, 101 AND 102).

FIRST USE 12-0-1999; IN COMMERCE 12-0-1999.

SER. NO. 77-144,024, FILED 3-29-2007.

LOURDES AYALA, EXAMINING ATTORNEY

**Int. Cl.: 12**

**Prior U.S. Cls.: 19, 21, 23, 31, 35 and 44**

**United States Patent and Trademark Office**

**Reg. No. 3,452,097**

**Registered June 24, 2008**

**TRADEMARK  
PRINCIPAL REGISTER**

**DUNTOV LIGHTWEIGHT**

DUNTOV MOTOR COMPANY, LLC (TEXAS LTD  
LIAB CO)

13906-C DENTON DR.

FARMER'S BRANCH, TX 75234

FOR: RACING CARS, IN CLASS 12 (U.S. CLS. 19,  
21, 23, 31, 35 AND 44).

FIRST USE 4-1-2005; IN COMMERCE 4-1-2005.

THE MARK CONSISTS OF STANDARD CHAR-  
ACTERS WITHOUT CLAIM TO ANY PARTICULAR  
FONT, STYLE, SIZE, OR COLOR.

THE NAME(S), PORTRAIT(S), AND/OR SIGNA-  
TURE(S) SHOWN IN THE MARK DOES NOT IDEN-  
TIFY A PARTICULAR LIVING INDIVIDUAL.

SER. NO. 77-144,522, FILED 3-30-2007.

TINA L. SNAPP, EXAMINING ATTORNEY

**Int. Cl.: 6**

**Prior U.S. Cls.: 2, 12, 13, 14, 23, 25 and 50**

**Reg. No. 3,452,098**

**United States Patent and Trademark Office**

**Registered June 24, 2008**

---

**TRADEMARK  
PRINCIPAL REGISTER**

**DYN-O-LOC**

DURO DYNE CORPORATION (NEW YORK  
CORPORATION)  
81 SPENCE STREET  
BAY SHORE, NY 11706

FOR: A SYSTEM FOR STRUCTURALLY REIN-  
FORCING LENGTHS OF A DUCT CONDUIT, THE  
SYSTEM COMPRISING PRIMARILY METAL  
BOLTS, AND A PAIR OF METAL FRICTION-FIT  
THREADED INSERTS FOR THE ENDS OF AN  
INTERNAL REINFORCING TUBE OR PIPE, WHICH  
TUBE OR PIPE EXTENDS ACROSS THE INTERIOR

OF THE CONDUIT, IN CLASS 6 (U.S. CLS. 2, 12, 13,  
14, 23, 25 AND 50).

FIRST USE 2-28-2007; IN COMMERCE 2-28-2007.

THE MARK CONSISTS OF STANDARD CHAR-  
ACTERS WITHOUT CLAIM TO ANY PARTICULAR  
FONT, STYLE, SIZE, OR COLOR.

SER. NO. 77-144,672, FILED 3-30-2007.

TINA L. SNAPP, EXAMINING ATTORNEY

Int. Cl.: 12

Prior U.S. Cls.: 19, 21, 23, 31, 35 and 44

Reg. No. 3,452,099

United States Patent and Trademark Office

Registered June 24, 2008

TRADEMARK  
PRINCIPAL REGISTER

*Dunton*

LIGHTWEIGHT

DUNTOV MOTOR COMPANY, LLC (TEXAS LTD  
LIAB CO)  
13906-C DENTON DR.  
FARMER'S BRANCH, TX 75234

FOR: RACING CARS, IN CLASS 12 (U.S. CLS. 19,  
21, 23, 31, 35 AND 44).

FIRST USE 4-1-2005; IN COMMERCE 4-1-2005.

THE NAME "DUNTON" DOES NOT IDENTIFY A  
LIVING INDIVIDUAL.

THE MARK CONSISTS OF A CURSIVE "DUN-  
TOV" TERM, FURTHER COMPRISING THE  
"LIGHTWEIGHT" TERM LOCATED AT ITS LOWER  
RIGHT. THIS "LIGHTWEIGHT" TERM IS EN-  
CLOSED IN A BOX AND THE 'L' AND 'W' LETTERS  
ARE MORE PROMINENT THAN THE OTHER  
LETTERS COMPRISING THAT TERM.

SER. NO. 77-144,679, FILED 3-30-2007.

TINA L. SNAPP, EXAMINING ATTORNEY

**Int. Cls.: 35, 41 and 42**

**Prior U.S. Cls.: 100, 101, 102 and 107**

**United States Patent and Trademark Office**

**Reg. No. 3,452,100**

**Registered June 24, 2008**

**SERVICE MARK  
PRINCIPAL REGISTER**

**THE PEOPLE'S  
MEDIA  
COMPANY**

ASSOCIATED CONTENT INC. (DELAWARE CORPORATION)  
SUITE 250  
88 STEELE STREET  
DENVER, CO 80206

FOR: PROMOTING THE GOODS AND SERVICES OF OTHERS BY PREPARING AND CONTEXTUALLY PLACING TARGETED TEXT ADVERTISEMENTS IN ON-LINE CONTENT AND WEBSITES ON A GLOBAL COMPUTER NETWORK; DISSEMINATION OF ADVERTISING FOR OTHERS VIA AN ON-LINE ELECTRONIC COMMUNICATIONS NETWORK; ADVERTISING SERVICES, NAMELY, PROVIDING ADVERTISING SPACE ON TARGETED WEBSITES AND ON-LINE VIDEO, TEXT, AUDIO, AND IMAGES ON A GLOBAL COMPUTER NETWORK, IN CLASS 35 (U.S. CLS. 100, 101 AND 102).

FIRST USE 6-1-2006; IN COMMERCE 6-1-2006.

FOR: PUBLICATION SERVICES, NAMELY, PUBLICATION OF VIDEO, TEXT, AUDIO, AND IMAGES OF OTHERS VIA GLOBAL COMPUTER NETWORKS, IN CLASS 41 (U.S. CLS. 100, 101 AND 107).

FIRST USE 6-1-2006; IN COMMERCE 6-1-2006.

FOR: COMPUTER SERVICES, NAMELY, PROVIDING TEMPORARY USE OF ON-LINE, NON-DOWNLOADABLE SOFTWARE FOR USE BY MEMBER CONTRIBUTORS TO DEVELOP AND MANAGE PROPRIETARY CONTENT ON MULTIPLE TOPICS FOR PUBLICATION ON A GLOBAL COMPUTER NETWORK; HOSTING DIGITAL CONTENT FOR OTHERS ON THE INTERNET AND ACTING AS AN APPLICATION SERVICE PROVIDER FEATURING SOFTWARE TO FACILITATE ON-LINE CONTENT PUBLICATION FOR OTHERS ON A PRIVATE LABEL AND/OR CO-BRANDED BASIS, IN CLASS 42 (U.S. CLS. 100 AND 101).

FIRST USE 6-1-2006; IN COMMERCE 6-1-2006.

NO CLAIM IS MADE TO THE EXCLUSIVE RIGHT TO USE "MEDIA COMPANY", APART FROM THE MARK AS SHOWN.

THE MARK CONSISTS OF THE WORDS "THE PEOPLE'S MEDIA COMPANY" IN STYLIZED LETTERS.

SER. NO. 77-145,192, FILED 3-30-2007.

CARRIE GENOVESE, EXAMINING ATTORNEY

**Int. Cl.: 16**

**Prior U.S. Cls.: 2, 5, 22, 23, 29, 37, 38 and 50**

**United States Patent and Trademark Office**

**Reg. No. 3,452,101**

**Registered June 24, 2008**

**TRADEMARK  
PRINCIPAL REGISTER**

**AHEAD OF THE CURVE**

KYPHON, INC. (DELAWARE CORPORATION)  
1221 CROSSMAN AVENUE  
SUNNYVALE, CA 94089

THE MARK CONSISTS OF STANDARD CHAR-  
ACTERS WITHOUT CLAIM TO ANY PARTICULAR  
FONT, STYLE, SIZE, OR COLOR.

FOR: PRINTED INSTRUCTIONAL, EDUCATION-  
AL AND TEACHING MATERIALS IN THE FIELD  
OF MEDICINE, IN CLASS 16 (U.S. CLS. 2, 5, 22, 23, 29,  
37, 38 AND 50).

SER. NO. 77-145,257, FILED 3-30-2007.

FIRST USE 12-31-2002; IN COMMERCE 12-31-2002.

JENNIFER HETU, EXAMINING ATTORNEY



**Int. Cl.: 41**

**Prior U.S. Cls.: 100, 101 and 107**

**United States Patent and Trademark Office**

**Reg. No. 3,452,102**

**Registered June 24, 2008**

---

**SERVICE MARK  
PRINCIPAL REGISTER**

**AHEAD OF THE CURVE**

KYPHON, INC. (DELAWARE CORPORATION)  
1221 CROSSMAN AVENUE  
SUNNYVALE, CA 94089

FOR: EDUCATIONAL SERVICES, NAMELY,  
CONDUCTING CLASSES AND WORKSHOPS IN  
THE DIAGNOSIS AND TREATMENT OF ORTHO-  
PEDIC AND SPINAL CONDITIONS AND THE USE  
OF MEDICAL AND SURGICAL DEVICES FOR  
ORTHOPEDIC AUGMENTATION AND REPAIR  
AND WRITTEN MATERIALS DISTRIBUTED IN

CONNECTION THEREWITH, IN CLASS 41 (U.S.  
CLS. 100, 101 AND 107).

FIRST USE 10-28-2004; IN COMMERCE 10-28-2004.

THE MARK CONSISTS OF STANDARD CHAR-  
ACTERS WITHOUT CLAIM TO ANY PARTICULAR  
FONT, STYLE, SIZE, OR COLOR.

SER. NO. 77-145,272, FILED 3-30-2007.

JENNIFER HETU, EXAMINING ATTORNEY

**Int. Cl.: 45**

**Prior U.S. Cls.: 100 and 101**

**United States Patent and Trademark Office**

**Reg. No. 3,452,103**

**Registered June 24, 2008**

---

**SERVICE MARK  
PRINCIPAL REGISTER**

**Litilaw**

LEXBE LC (TEXAS LTD LIAB CO)  
3801 N. CAPITAL OF TX HWY E420/152  
AUSTIN, TX 78746

THE MARK CONSISTS OF STANDARD CHAR-  
ACTERS WITHOUT CLAIM TO ANY PARTICULAR  
FONT, STYLE, SIZE, OR COLOR.

FOR: LEGAL RESEARCH, IN CLASS 45 (U.S. CLS.  
100 AND 101).

SER. NO. 77-145,385, FILED 3-30-2007.

FIRST USE 3-1-2007; IN COMMERCE 3-1-2007.

MARK SPARACINO, EXAMINING ATTORNEY

**Int. Cl.: 16**

**Prior U.S. Cls.: 2, 5, 22, 23, 29, 37, 38 and 50**

**United States Patent and Trademark Office**

**Reg. No. 3,452,104**

**Registered June 24, 2008**

---

**TRADEMARK  
PRINCIPAL REGISTER**

**Auratone**

SMITH, BARBARA (UNITED STATES INDIVIDUAL)  
501 SANTA MONICA BLVD., #704  
SANTA MONICA, CA 90401

THE MARK CONSISTS OF STANDARD CHARACTERS WITHOUT CLAIM TO ANY PARTICULAR FONT, STYLE, SIZE, OR COLOR.

FOR: PRINTS IN THE NATURE OF PHOTOGRAPHS, IN CLASS 16 (U.S. CLS. 2, 5, 22, 23, 29, 37, 38 AND 50).

SER. NO. 77-145,631, FILED 3-31-2007.

FIRST USE 8-6-2004; IN COMMERCE 8-6-2004.

DAYNA BROWNE, EXAMINING ATTORNEY

**Int. Cl.: 35**

**Prior U.S. Cls.: 100, 101 and 102**

**United States Patent and Trademark Office**

**Reg. No. 3,452,105**

**Registered June 24, 2008**

**SERVICE MARK  
PRINCIPAL REGISTER**

**Pecan Pie Productions**

KEVIN LAKRITZ (CALIFORNIA LTD LIAB CO)  
3547 19TH STREET  
SAN FRANCISCO, CA 94110

FOR: ADVERTISING SERVICES, NAMELY, PROMOTING AND MARKETING THE GOODS AND SERVICES OF OTHERS THROUGH ALL PUBLIC COMMUNICATION MEANS, IN CLASS 35 (U.S. CLS. 100, 101 AND 102).

FIRST USE 9-7-2006; IN COMMERCE 9-15-2006.

THE MARK CONSISTS OF STANDARD CHARACTERS WITHOUT CLAIM TO ANY PARTICULAR FONT, STYLE, SIZE, OR COLOR.

NO CLAIM IS MADE TO THE EXCLUSIVE RIGHT TO USE "PRODUCTIONS", APART FROM THE MARK AS SHOWN.

SER. NO. 77-145,745, FILED 4-1-2007.

GINA HAYES, EXAMINING ATTORNEY

**Int. Cl.: 5**

**Prior U.S. Cls.: 6, 18, 44, 46, 51 and 52**

**United States Patent and Trademark Office**

**Reg. No. 3,452,106**

**Registered June 24, 2008**

**TRADEMARK  
PRINCIPAL REGISTER**

**LOOK FOR THE BUTTERFLY**

THAROS LABORATORIES, INC. (UTAH CORPORATION)  
BUILDING G #15-288  
274 S. 1300 EAST  
SALT LAKE CITY, UT 84106

THE MARK CONSISTS OF STANDARD CHARACTERS WITHOUT CLAIM TO ANY PARTICULAR FONT, STYLE, SIZE, OR COLOR.

FOR: DIETARY SUPPLEMENTS, IN CLASS 5 (U.S. CLS. 6, 18, 44, 46, 51 AND 52).

SER. NO. 77-145,863, FILED 4-2-2007.

FIRST USE 4-20-2004; IN COMMERCE 4-20-2004.

REBECCA EISINGER, EXAMINING ATTORNEY

**Int. Cls.: 16, 35, 36 and 41**

**Prior U.S. Cls.: 2, 5, 22, 23, 29, 37, 38, 50, 100, 101, 102  
and 107**

**Reg. No. 3,452,107**

**United States Patent and Trademark Office**

**Registered June 24, 2008**

**TRADEMARK  
SERVICE MARK  
PRINCIPAL REGISTER**

**NATIONAL CENTER FOR  
RESPONSIBLE GAMING**

NATIONAL CENTER FOR RESPONSIBLE GAMING (D.C. NON-PROFIT CORPORATION)  
1299 PENNSYLVANIA AVENUE, NW, SUITE 1175  
WASHINGTON, DC 20004

FOR: MONOGRAPHS IN THE FIELD OF PATHOLOGICAL AND YOUTH GAMBLING, IN CLASS 16 (U.S. CLS. 2, 5, 22, 23, 29, 37, 38 AND 50).

FIRST USE 7-0-2007; IN COMMERCE 7-0-2007.

FOR: PROMOTING PUBLIC AWARENESS OF ISSUES AND TRENDS RELATED TO PATHOLOGICAL AND YOUTH GAMBLING AND INDIVIDUAL AND ORGANIZATIONAL BEHAVIORS RELATED THERETO, IN CLASS 35 (U.S. CLS. 100, 101 AND 102).

FIRST USE 4-20-2001; IN COMMERCE 4-20-2001.

FOR: PROVIDING GRANTS TO RESEARCH INSTITUTIONS AND ORGANIZATIONS FOR RESEARCH IN THE SUBJECT OF PATHOLOGICAL GAMBLING, IN CLASS 36 (U.S. CLS. 100, 101 AND 102).

FIRST USE 4-20-2001; IN COMMERCE 4-20-2001.

FOR: PROVIDING EDUCATIONAL SERVICES, NAMELY, ORGANIZING AND PROVIDING CLASSES, SEMINARS, AND CONFERENCES IN THE FIELD OF PATHOLOGICAL AND YOUTH GAMBLING; PUBLISHING WRITTEN EDUCATIONAL MATERIALS REGARDING STUDIES, ISSUES, AND TRENDS RELATED TO PATHOLOGICAL AND YOUTH GAMBLING AND INDIVIDUAL AND ORGANIZATIONAL BEHAVIORS RELATED THERETO; AND PROVIDING RECOGNITION AND INCENTIVES BY THE WAY OF AWARDS TO DEMONSTRATE EXCELLENCE IN THE FIELD OF RESEARCH RELATED TO PATHOLOGICAL AND YOUTH GAMBLING, IN CLASS 41 (U.S. CLS. 100, 101 AND 107).

FIRST USE 4-20-2001; IN COMMERCE 4-20-2001.

THE MARK CONSISTS OF STANDARD CHARACTERS WITHOUT CLAIM TO ANY PARTICULAR FONT, STYLE, SIZE, OR COLOR.

SEC. 2(F).

SER. NO. 77-146,077, FILED 4-2-2007.

STEVEN JACKSON, EXAMINING ATTORNEY

**Int. Cl.: 28**

**Prior U.S. Cls.: 22, 23, 38 and 50**

**Reg. No. 3,452,108**

**United States Patent and Trademark Office**

**Registered June 24, 2008**

**TRADEMARK  
PRINCIPAL REGISTER**



ITBC INTERNATIONAL TRADE & BUSINESS  
CONSULTING LLC (CALIFORNIA LTD LIAB  
CO)  
1043 BRET KNOLL CT.  
SAN JOSE, CA 95120

FOR: TOY BUILDING BLOCKS, IN CLASS 28 (U.S.  
CLS. 22, 23, 38 AND 50).

FIRST USE 1-0-2002; IN COMMERCE 1-0-2002.

THE COLOR(S) BLUE, YELLOW, RED, GREEN,  
WHITE, AND BLACK IS/ARE CLAIMED AS A  
FEATURE OF THE MARK.

THE LETTERS IN THE MARK ARE DISPLAYED  
IN THE COLORS BLUE, YELLOW, RED, GREEN,  
BLUE, YELLOW, RED, AND GREEN, WHEN  
VIEWED FROM LEFT TO RIGHT. EACH LETTER  
HAS AN AREA OR AREAS OF WHITE IN THE  
UPPER PORTION OF THE LETTER. ALL LETTERS  
ARE TRIMMED IN BLACK.

THE ENGLISH TRANSLATION OF THE WORD  
"PLAYMAIS" IN THE MARK IS "PLAYCORN".

SER. NO. 77-146,147, FILED 4-2-2007.

STEVEN R. FOSTER, EXAMINING ATTORNEY

**Int. Cl.: 44**

**Prior U.S. Cls.: 100 and 101**

**United States Patent and Trademark Office**

**Reg. No. 3,452,109**

**Registered June 24, 2008**

**SERVICE MARK  
PRINCIPAL REGISTER**

**OHS Occupational Health  
Solutions**

FORTH WORTH OCCMED, L.L.C. (TEXAS LTD  
LIAB CO)

P.O. BOX 12089

FORTH WORTH, TX 76110

FOR: OCCUPATIONAL HEALTH CARE SERVI-  
CES, IN CLASS 44 (U.S. CLS. 100 AND 101).

FIRST USE 5-1-1995; IN COMMERCE 5-1-1997.

THE MARK CONSISTS OF STANDARD CHAR-  
ACTERS WITHOUT CLAIM TO ANY PARTICULAR  
FONT, STYLE, SIZE, OR COLOR.

NO CLAIM IS MADE TO THE EXCLUSIVE  
RIGHT TO USE "OCCUPATIONAL HEALTH SOLU-  
TIONS", APART FROM THE MARK AS SHOWN.

SER. NO. 77-146,247, FILED 4-2-2007.

ROBERT C. CLARK JR., EXAMINING ATTORNEY



**Int. Cls.: 16, 35, 36 and 41**

**Prior U.S. Cls.: 2, 5, 22, 23, 29, 37, 38, 50, 100, 101, 102  
and 107**

**Reg. No. 3,452,110**

**United States Patent and Trademark Office**

**Registered June 24, 2008**

**TRADEMARK  
SERVICE MARK  
PRINCIPAL REGISTER**

**NCRG**

NATIONAL CENTER FOR RESPONSIBLE GAM-  
ING (D.C. NON-PROFIT CORPORATION)  
1299 PENNSYLVANIA AVENUE, NW, SUITE 1175  
WASHINGTON, DC 20004

FOR: MONOGRAPHS IN THE FIELD OF PATHO-  
LOGICAL AND YOUTH GAMBLING , IN CLASS 16  
(U.S. CLS. 2, 5, 22, 23, 29, 37, 38 AND 50).

FIRST USE 7-0-2007; IN COMMERCE 7-0-2007.

FOR: PROMOTING PUBLIC AWARENESS OF  
ISSUES AND TRENDS RELATED TO PATHOLOGICAL  
AND YOUTH GAMBLING AND INDIVIDUAL  
AND ORGANIZATIONAL BEHAVIORS RELATED  
THERE TO, IN CLASS 35 (U.S. CLS. 100, 101 AND 102).

FIRST USE 4-20-2001; IN COMMERCE 4-20-2001.

FOR: PROVIDING GRANTS TO RESEARCH IN-  
STITUTIONS AND ORGANIZATIONS FOR RE-  
SEARCH IN THE SUBJECT OF PATHOLOGICAL  
GAMBLING, IN CLASS 36 (U.S. CLS. 100, 101 AND  
102).

FIRST USE 4-20-2001; IN COMMERCE 4-20-2001.

FOR: PROVIDING EDUCATIONAL SERVICES,  
NAMELY, ORGANIZING AND PROVIDING CLAS-  
SES, SEMINARS, AND CONFERENCES IN THE  
FIELD OF PATHOLOGICAL AND YOUTH GAM-  
BLING; PUBLISHING WRITTEN EDUCATIONAL  
MATERIALS REGARDING STUDIES, ISSUES, AND  
TRENDS RELATED TO PATHOLOGICAL AND  
YOUTH GAMBLING AND INDIVIDUAL AND OR-  
GANIZATIONAL BEHAVIORS RELATED THERE-  
TO; AND PROVIDING RECOGNITION AND  
INCENTIVES BY THE WAY OF AWARDS TO  
DEMONSTRATE EXCELLENCE IN THE FIELD OF  
RESEARCH RELATED TO PATHOLOGICAL AND  
YOUTH GAMBLING, IN CLASS 41 (U.S. CLS. 100, 101  
AND 107).

FIRST USE 4-20-2001; IN COMMERCE 4-20-2001.

THE MARK CONSISTS OF STANDARD CHAR-  
ACTERS WITHOUT CLAIM TO ANY PARTICULAR  
FONT, STYLE, SIZE, OR COLOR.

SER. NO. 77-146,295, FILED 4-2-2007.

STEVEN JACKSON, EXAMINING ATTORNEY

**Int. Cls.: 16, 35, 36 and 41**

**Prior U.S. Cls.: 2, 5, 22, 23, 29, 37, 38, 50, 100, 101, 102  
and 107**

**Reg. No. 3,452,111**

**United States Patent and Trademark Office**

**Registered June 24, 2008**

**TRADEMARK  
SERVICE MARK  
PRINCIPAL REGISTER**



NATIONAL CENTER FOR RESPONSIBLE GAM-  
ING (D.C. NON-PROFIT CORPORATION)  
1299 PENNSYLVANIA AVENUE, NW, SUITE 1175  
WASHINGTON, DC 20004

FOR: MONOGRAPHS IN THE FIELD OF PATHO-  
LOGICAL AND YOUTH GAMBLING , IN CLASS 16  
(U.S. CLS. 2, 5, 22, 23, 29, 37, 38 AND 50).

FIRST USE 7-0-2007; IN COMMERCE 7-0-2007.

FOR: PROMOTING PUBLIC AWARENESS OF  
ISSUES AND TRENDS RELATED TO PATHOLOGICAL  
AND YOUTH GAMBLING AND INDIVIDUAL  
AND ORGANIZATIONAL BEHAVIORS RELATED  
THERE TO, IN CLASS 35 (U.S. CLS. 100, 101 AND 102).

FIRST USE 3-9-2007; IN COMMERCE 3-9-2007.

FOR: PROVIDING GRANTS TO RESEARCH IN-  
STITUTIONS AND ORGANIZATIONS FOR RE-  
SEARCH IN THE SUBJECT OF PATHOLOGICAL  
GAMBLING, IN CLASS 36 (U.S. CLS. 100, 101 AND  
102).

FIRST USE 3-9-2007; IN COMMERCE 3-9-2007.

FOR: PROVIDING EDUCATIONAL SERVICES,  
NAMELY, ORGANIZING AND PROVIDING CLAS-  
SES, SEMINARS, AND CONFERENCES IN THE  
FIELD OF PATHOLOGICAL AND YOUTH GAM-  
BLING; PUBLISHING WRITTEN EDUCATIONAL  
MATERIALS REGARDING STUDIES, ISSUES, AND  
TRENDS RELATED TO PATHOLOGICAL AND  
YOUTH GAMBLING AND INDIVIDUAL AND OR-  
GANIZATIONAL BEHAVIORS RELATED THERE-  
TO; AND PROVIDING RECOGNITION AND  
INCENTIVES BY THE WAY OF AWARDS TO  
DEMONSTRATE EXCELLENCE IN THE FIELD OF  
RESEARCH RELATED TO PATHOLOGICAL AND  
YOUTH GAMBLING, IN CLASS 41 (U.S. CLS. 100, 101  
AND 107).

FIRST USE 3-9-2007; IN COMMERCE 3-9-2007.

THE MARK CONSISTS OF THE LETTERS "N C R  
G" ENCLOSED IN RECTANGLES, WHERE THE "R"  
APPEARS IN TWO PIECES TO SIMULATE A SLOT  
MACHINE IN MOTION.

SER. NO. 77-146,332, FILED 4-2-2007.

STEVEN JACKSON, EXAMINING ATTORNEY

**Int. Cl.: 36**

**Prior U.S. Cls.: 100, 101 and 102**

**United States Patent and Trademark Office**

**Reg. No. 3,452,112**

**Registered June 24, 2008**

**SERVICE MARK  
PRINCIPAL REGISTER**



FINANCIAL & PROFESSIONAL RISK SOLUTIONS, INC. (ILLINOIS CORPORATION)  
AON CENTER, LAW DEPARTMENT - 8TH FLOOR  
200 EAST RANDOLPH STREET  
CHICAGO, IL 60601

FOR: INSURANCE BROKERAGE AND BONDING SERVICES, ALL FOR BANKS INSURANCE COMPANIES, SECURITY FIRMS AND FINANCIAL

SERVICES RELATED COMPANIES, IN CLASS 36 (U.S. CLS. 100, 101 AND 102).

FIRST USE 1-1-2005; IN COMMERCE 1-1-2005.

OWNER OF U.S. REG. NO. 3,111,014.

SER. NO. 77-146,531, FILED 4-2-2007.

DORITT L. CARROLL, EXAMINING ATTORNEY

**Int. Cl.: 36**

**Prior U.S. Cls.: 100, 101 and 102**

**United States Patent and Trademark Office**

**Reg. No. 3,452,113**

**Registered June 24, 2008**

**SERVICE MARK  
PRINCIPAL REGISTER**

**SCARBOROUGH**

FINANCIAL & PROFESSIONAL RISK SOLUTIONS, INC. (ILLINOIS CORPORATION)  
AON CENTER, LAW DEPARTMENT - 8TH FLOOR  
200 EAST RANDOLPH STREET  
CHICAGO, IL 60601

FOR: INSURANCE BROKERAGE AND BONDING SERVICES, ALL FOR BANKS, INSURANCE COMPANIES, SECURITY FIRMS AND FINANCIAL SERVICES RELATED COMPANIES, IN CLASS 36 (U.S. CLS. 100, 101 AND 102).

FIRST USE 12-31-1919; IN COMMERCE 12-31-1919.

THE MARK CONSISTS OF STANDARD CHARACTERS WITHOUT CLAIM TO ANY PARTICULAR FONT, STYLE, SIZE, OR COLOR.

OWNER OF U.S. REG. NO. 3,111,014.

SER. NO. 77-146,537, FILED 4-2-2007.

DORITT L. CARROLL, EXAMINING ATTORNEY

**Int. Cl.: 16**

**Prior U.S. Cls.: 2, 5, 22, 23, 29, 37, 38 and 50**

**Reg. No. 3,452,114**

**United States Patent and Trademark Office**

**Registered June 24, 2008**

---

**TRADEMARK  
PRINCIPAL REGISTER**

# Awakened Art

OMOQUI, PATRICIA G. (UNITED STATES INDIVIDUAL)  
517 STANBRIDGE STREET  
NORRISTOWN, PA 19401

FOR: PRINTED ART REPRODUCTIONS; ART PRINTS; COLOR PRINTS; PHOTOGRAPHIC PRINTS; PHOTOGRAPHS; PICTORIAL PRINTS, IN CLASS 16 (U.S. CLS. 2, 5, 22, 23, 29, 37, 38 AND 50).

FIRST USE 2-2-2007; IN COMMERCE 2-4-2007.

THE MARK CONSISTS OF STANDARD CHARACTERS WITHOUT CLAIM TO ANY PARTICULAR FONT, STYLE, SIZE, OR COLOR.

NO CLAIM IS MADE TO THE EXCLUSIVE RIGHT TO USE "ART", APART FROM THE MARK AS SHOWN.

SER. NO. 77-146,996, FILED 4-3-2007.

KAREN K. BUSH, EXAMINING ATTORNEY

**Int. Cl.: 35**

**Prior U.S. Cls.: 100, 101 and 102**

**United States Patent and Trademark Office**

**Reg. No. 3,452,115**

**Registered June 24, 2008**

**SERVICE MARK  
PRINCIPAL REGISTER**



HOLLYWOOD CANDY, L.L.C. (NEBRASKA LTD  
LIAB CO)  
501 SOUTH 13TH STREET  
OMAHA, NE 68102

FOR: RETAIL STORE SERVICES FEATURING A  
WIDE VARIETY OF CONSUMER GOODS OF OTH-  
ERS, IN CLASS 35 (U.S. CLS. 100, 101 AND 102).

FIRST USE 4-1-2007; IN COMMERCE 4-1-2007.

NO CLAIM IS MADE TO THE EXCLUSIVE  
RIGHT TO USE "CANDY", APART FROM THE  
MARK AS SHOWN.

THE COLOR(S) YELLOW, BLUE, WHITE AND  
PINK IS/ARE CLAIMED AS A FEATURE OF THE  
MARK.

THE MARK CONSISTS OF THE WORDS "HOL-  
LYWOOD" IN BLUE WITH YELLOW SHADOWING  
AND "CANDY" IN YELLOW WITH WHITE HIGH-  
LIGHTS AND BLUE OUTLINING ACROSS A  
WHITE BANNER WITH PINK AND BLUE HORI-  
ZONTAL LINING; THIS ELEMENT IS PLACED  
ATOP A PINK THEATRE SCREEN DESIGN WITH  
YELLOW BORDER AND LIGHT PINK SPOT-  
LIGHTS SHINING UPWARD FROM A BLUE AND  
YELLOW FLOURISH DESIGN AT THE BOTTOM;  
THE UPPER PORTION OF THE MARK FEATURES  
THREE YELLOW STARS, A CENTRAL BLUE LOL-  
LIPOP DESIGN WITH WHITE SWIRL AND STICK  
AND TWO YELLOW LOLLIPOPS WITH WHITE  
SWIRLS AND STICKS.

SER. NO. 77-147,172, FILED 4-3-2007.

STEVEN PEREZ, EXAMINING ATTORNEY

**Int. Cl.: 14**

**Prior U.S. Cls.: 2, 27, 28 and 50**

**United States Patent and Trademark Office**

**Reg. No. 3,452,116**

**Registered June 24, 2008**

**TRADEMARK  
PRINCIPAL REGISTER**



PINKJULES, LLC (WISCONSIN LTD LIAB CO)  
3547 TOPPING ROAD  
MADISON, WI 53705

FOR: JEWELRY, IN CLASS 14 (U.S. CLS. 2, 27, 28  
AND 50).

FIRST USE 6-1-2006; IN COMMERCE 6-1-2006.

THE COLOR(S) PINK IS/ARE CLAIMED AS A  
FEATURE OF THE MARK.

THE MARK CONSISTS OF A PINK OUTLINE OF  
A BUTTERFLY WITH THE WORDS PINKJULES  
WRITTEN IN PINK DIAGONALLY WITHIN THE  
BUTTERFLY.

SER. NO. 77-147,550, FILED 4-3-2007.

FRANK LATTUCA, EXAMINING ATTORNEY

**Int. Cl.: 40**

**Prior U.S. Cls.: 100, 103 and 106**

**United States Patent and Trademark Office**

**Reg. No. 3,452,117**

**Registered June 24, 2008**

**SERVICE MARK  
PRINCIPAL REGISTER**

# LASER BLACK

EPNER TECHNOLOGY, INC. (NEW YORK CORPORATION)  
78 KINGSLAND AVENUE  
BROOKLYN, NY 11222

FOR: ELECTRO-COATING AND ELECTRO-PLATING OF METALLIC SUBSTRATES, PLASTIC, AND OTHER OPTICAL COMPONENT SURFACES WITH LOW-REFLECTIVE, THERMAL/OPTICAL ABSORPTION COATING; CUSTOM MANUFACTURE OF SPECIALLY ORDERED PRODUCTS WITH LOW-REFLECTIVE, THERMAL/OPTICAL ABSORPTION COATING APPLIED TO SURFACE, IN CLASS 40 (U.S. CLS. 100, 103 AND 106).

FIRST USE 1-1-1987; IN COMMERCE 1-1-1987.

THE MARK CONSISTS OF STANDARD CHARACTERS WITHOUT CLAIM TO ANY PARTICULAR FONT, STYLE, SIZE, OR COLOR.

OWNER OF U.S. REG. NO. 2,071,292.

NO CLAIM IS MADE TO THE EXCLUSIVE RIGHT TO USE "BLACK", APART FROM THE MARK AS SHOWN.

SER. NO. 77-147,876, FILED 4-3-2007.

SAMUEL E. SHARPER JR., EXAMINING ATTORNEY



Int. Cl.: 7

Prior U.S. Cls.: 13, 19, 21, 23, 31, 34 and 35

United States Patent and Trademark Office

Reg. No. 3,452,118

Registered June 24, 2008

TRADEMARK  
PRINCIPAL REGISTER



MULTISCAN TECHNOLOGIES, S.L. (SPAIN CORPORATION)  
POLÍG. INDUSTRIAL COTES BAIXES, C/E  
N. 12  
ALCOY (ALICANTE), SPAIN 03804

FOR: FRUIT SELECTION MACHINES, FRUIT SELECTION AND CALIBRATION MACHINES, FRUIT SELECTION AND PACKAGING MACHINES, IN CLASS 7 (U.S. CLS. 13, 19, 21, 23, 31, 34 AND 35).

OWNER OF ERPN CMNTY TM OFC REG. NO. 4680328, DATED 11-8-2006, EXPIRES 10-27-2015.

NO CLAIM IS MADE TO THE EXCLUSIVE RIGHT TO USE "SCAN TECHNOLOGIES", APART FROM THE MARK AS SHOWN.

THE COLOR(S) RED, WHITE, BLUE AND GRAY IS/ARE CLAIMED AS A FEATURE OF THE MARK.

THE MARK CONSISTS OF A BLUE SPHERE, CONTAINING FADING BLUE TO WHITE CONCENTRIC CIRCLES, WITH TWO BLUE CURVED LINES ABOVE AND BELOW IT. TO THE RIGHT OF THIS DESIGN ARE THE WORDS "MULTI" IN BLUE, ABOVE "SCAN" IN RED WITH GRAY OUTLINING, ABOVE "TECHNOLOGIES" IN GRAY.

SER. NO. 77-148,556, FILED 4-4-2007.

ELISSA GARBER KON, EXAMINING ATTORNEY

**Int. Cl.: 1**

**Prior U.S. Cls.: 1, 5, 6, 10, 26 and 46**

**United States Patent and Trademark Office**

**Reg. No. 3,452,119**

**Registered June 24, 2008**

**TRADEMARK  
PRINCIPAL REGISTER**

**INTEGRO**

INTEGRO, INC. (CALIFORNIA CORPORATION)  
P.O. BOX 156  
HELM, CA 93627

FOR: ORGANIC AND NON-ORGANIC CHEMICAL FERTILIZERS AND SOIL CONDITIONERS USED IN AGRICULTURE FOR COMMERCIAL SALES TO PERSONS ENGAGED IN FARMING BUSINESS, IN CLASS 1 (U.S. CLS. 1, 5, 6, 10, 26 AND 46).

FIRST USE 1-1-1992; IN COMMERCE 1-1-1992.

THE MARK CONSISTS OF STANDARD CHARACTERS WITHOUT CLAIM TO ANY PARTICULAR FONT, STYLE, SIZE, OR COLOR.

SER. NO. 77-148,595, FILED 4-4-2007.

BARBARA BROWN, EXAMINING ATTORNEY

**Int. Cl.: 25**

**Prior U.S. Cls.: 22 and 39**

**United States Patent and Trademark Office**

**Reg. No. 3,452,120**

**Registered June 24, 2008**

**TRADEMARK  
PRINCIPAL REGISTER**

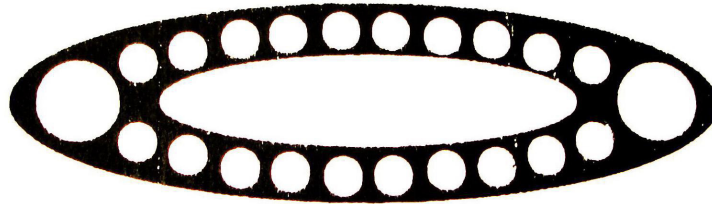

WANG, CHING YUN (TAIWAN INDIVIDUAL)  
939 COTTONWOOD WAY  
WALNUT, CA 91789

FIRST USE 8-21-2005; IN COMMERCE 8-21-2005.

SER. NO. 77-149,015, FILED 4-20-2007.

FOR: SHOES, IN CLASS 25 (U.S. CLS. 22 AND 39).

ROBIN MITTLER, EXAMINING ATTORNEY

**Int. Cl.: 41**

**Prior U.S. Cls.: 100, 101 and 107**

**United States Patent and Trademark Office**

**Reg. No. 3,452,121**

**Registered June 24, 2008**

**SERVICE MARK  
PRINCIPAL REGISTER**

**HOUSTON OAKS**

HOUSTON OAKS VENTURE, L.P. (TEXAS LIMITED PARTNERSHIP)  
SUITE 200  
8807 WEST SAM HOUSTON PARKWAY NORTH  
HOUSTON, TX 77040

FOR: GOLF CLUB SERVICES; COUNTRY CLUBS,  
IN CLASS 41 (U.S. CLS. 100, 101 AND 107).

FIRST USE 1-31-1998; IN COMMERCE 1-31-1998.

THE MARK CONSISTS OF STANDARD CHARACTERS WITHOUT CLAIM TO ANY PARTICULAR FONT, STYLE, SIZE, OR COLOR.

NO CLAIM IS MADE TO THE EXCLUSIVE RIGHT TO USE "HOUSTON", APART FROM THE MARK AS SHOWN.

SER. NO. 77-149,116, FILED 4-5-2007.

FRANK LATTUCA, EXAMINING ATTORNEY

**Int. Cl.: 11**

**Prior U.S. Cls.: 13, 21, 23, 31 and 34**

**Reg. No. 3,452,122**

**United States Patent and Trademark Office**

**Registered June 24, 2008**

---

**TRADEMARK  
PRINCIPAL REGISTER**

**GP**

SHARPER IMAGE CORPORATION (DELAWARE  
CORPORATION)  
SUITE 600  
350 THE EMBARCADERO  
SAN FRANCISCO, CA 94105

FOR: AIR PURIFIERS AND STRUCTURAL  
PARTS THEREFOR; AIR CLEANERS, NAMELY,  
AN ELECTRO-STATIC PRECIPITATOR WITH A  
UV LAMP FOR CLEANING AIR AND STRUCTUR-  
AL PARTS THEREFOR, IN CLASS 11 (U.S. CLS. 13,  
21, 23, 31 AND 34).

FIRST USE 1-0-2002; IN COMMERCE 1-0-2002.

THE MARK CONSISTS OF STANDARD CHAR-  
ACTERS WITHOUT CLAIM TO ANY PARTICULAR  
FONT, STYLE, SIZE, OR COLOR.

OWNER OF U.S. REG. NO. 2,703,083.

SER. NO. 77-149,524, FILED 4-5-2007.

DANNEAN HETZEL, EXAMINING ATTORNEY

**Int. Cl.: 9**

**Prior U.S. Cls.: 21, 23, 26, 36 and 38**

**Reg. No. 3,452,123**

**United States Patent and Trademark Office**

**Registered June 24, 2008**

---

**TRADEMARK  
PRINCIPAL REGISTER**

**TIP/IX**

INGLET BUSINESS SOLUTIONS INCORPORATED (CANADA CORPORATION)  
1156 OSBORNE POINT ROAD, P.O. BOX 227  
DWIGHT, CANADA P0A1H0

FOR: TRANSACTION PROCESSING SOFTWARE, NAMELY, INTERACTIVE DATABASE MANAGEMENT SOFTWARE INTEGRATED WITH SOFTWARE DEVELOPMENT TOOLS TO IMPROVE ON-LINE PERFORMANCE AND REDUCE ON-LINE APPLICATION DEVELOPMENT TIME BY INCREASING PROGRAMMER PRODUCTIVITY, IN CLASS 9 (U.S. CLS. 21, 23, 26, 36 AND 38).

FIRST USE 3-2-1990; IN COMMERCE 1-14-1991.

THE MARK CONSISTS OF STANDARD CHARACTERS WITHOUT CLAIM TO ANY PARTICULAR FONT, STYLE, SIZE, OR COLOR.

OWNER OF CANADA REG. NO. TMA421,363, DATED 12-24-1993, EXPIRES 12-24-2008.

SER. NO. 77-149,737, FILED 4-5-2007.

DAVID TOOLEY, EXAMINING ATTORNEY

**Int. Cl.: 44**

**Prior U.S. Cls.: 100 and 101**

**United States Patent and Trademark Office**

**Reg. No. 3,452,124**

**Registered June 24, 2008**

**SERVICE MARK  
PRINCIPAL REGISTER**

**AFB SENIOR SITE**

AMERICAN FOUNDATION FOR THE BLIND,  
INC. (NEW YORK CORPORATION)  
SUITE 300  
11 PENN PLAZA  
NEW YORK, NY 10001

FOR: PROVIDING ON-LINE INFORMATION  
ABOUT AGE - RELATED EYE DISEASES AND  
TREATMENTS, IN CLASS 44 (U.S. CLS. 100 AND  
101).

FIRST USE 3-13-2007; IN COMMERCE 3-13-2007.

THE MARK CONSISTS OF STANDARD CHAR-  
ACTERS WITHOUT CLAIM TO ANY PARTICULAR  
FONT, STYLE, SIZE, OR COLOR.

OWNER OF U.S. REG. NOS. 3,093,324 AND  
3,147,983.

SER. NO. 77-149,805, FILED 4-5-2007.

ESTHER BELENKER, EXAMINING ATTORNEY

**Int. Cls.: 35, 36, 41 and 44**

**Prior U.S. Cls.: 100, 101, 102 and 107**

**United States Patent and Trademark Office**

**Reg. No. 3,452,125**

**Registered June 24, 2008**

**SERVICE MARK  
PRINCIPAL REGISTER**

**ORBIS FLYING EYE HOSPITAL**

PROJECT ORBIS INTERNATIONAL, INC. (NEW YORK NON-PROFIT CORPORATION)  
520 8TH AVENUE, 11TH FLOOR  
NEW YORK, NY 100186507

FOR: PROMOTING PUBLIC AWARENESS REGARDING AVOIDANCE, DIAGNOSIS VISION IMPAIRMENT, IN CLASS 35 (U.S. CLS. 100, 101 AND 102).

FIRST USE 12-31-1982; IN COMMERCE 12-31-1982.

FOR: CHARITABLE FUNDRAISING, IN CLASS 36 (U.S. CLS. 100, 101 AND 102).

FIRST USE 12-31-1982; IN COMMERCE 12-31-1982.

FOR: PROVIDING MEDICAL TRAINING RELATING TO PREVENTION OF BLINDNESS AND RESTORATION OF SIGHT, IN CLASS 41 (U.S. CLS. 100, 101 AND 107).

FIRST USE 12-31-1982; IN COMMERCE 12-31-1982.

FOR: PROVIDING MEDICAL SERVICES AND MEDICAL INFORMATION RELATING TO PREVENTION OF BLINDNESS AND RESTORATION OF SIGHT, IN CLASS 44 (U.S. CLS. 100 AND 101).

FIRST USE 12-31-1982; IN COMMERCE 12-31-1982.

THE MARK CONSISTS OF STANDARD CHARACTERS WITHOUT CLAIM TO ANY PARTICULAR FONT, STYLE, SIZE, OR COLOR.

OWNER OF U.S. REG. NOS. 2,444,396, 2,444,397, AND 2,988,628.

NO CLAIM IS MADE TO THE EXCLUSIVE RIGHT TO USE "FLYING EYE HOSPITAL", APART FROM THE MARK AS SHOWN.

SER. NO. 77-149,824, FILED 4-5-2007.

MICHAEL KAZAZIAN, EXAMINING ATTORNEY



**Int. Cl.: 18**

**Prior U.S. Cls.: 1, 2, 3, 22 and 41**

**United States Patent and Trademark Office**

**Reg. No. 3,452,126**

**Registered June 24, 2008**

**TRADEMARK  
PRINCIPAL REGISTER**

**DOGO**

MORIENT INC (NEW YORK CORPORATION)  
SUITE 508  
44-02 11TH STREET  
LONG ISLAND CITY, NY 11101

THE MARK CONSISTS OF STANDARD CHAR-  
ACTERS WITHOUT CLAIM TO ANY PARTICULAR  
FONT, STYLE, SIZE, OR COLOR.

FOR: DOG CLOTHING, DOG APPAREL, DOG  
COLLARS, DOG LEASHES, DOG PARKAS, IN  
CLASS 18 (U.S. CLS. 1, 2, 3, 22 AND 41).

SER. NO. 77-150,120, FILED 4-5-2007.

FIRST USE 9-0-2004; IN COMMERCE 9-0-2004.

ELI HELLMAN, EXAMINING ATTORNEY

**Int. Cls.: 16 and 25**

**Prior U.S. Cls.: 2, 5, 22, 23, 29, 37, 38, 39 and 50**

**Reg. No. 3,452,127**

**United States Patent and Trademark Office**

**Registered June 24, 2008**

**TRADEMARK  
PRINCIPAL REGISTER**

**TNO**

SODINI, JIM (UNITED STATES INDIVIDUAL),  
DBA TNO ENTERPRISES  
P. O. BOX 1122  
6216 W. PALM AVENUE  
WINTON, CA 95388

NOT PRIMARILY FASHION APPAREL, IN CLASS  
25 (U.S. CLS. 22 AND 39).

FIRST USE 6-23-2005; IN COMMERCE 6-23-2005.

FOR: STICKERS, IN CLASS 16 (U.S. CLS. 2, 5, 22,  
23, 29, 37, 38 AND 50).

THE MARK CONSISTS OF STANDARD CHAR-  
ACTERS WITHOUT CLAIM TO ANY PARTICULAR  
FONT, STYLE, SIZE, OR COLOR.

FIRST USE 6-23-2005; IN COMMERCE 6-23-2005.

SER. NO. 77-150,198, FILED 4-5-2007.

FOR: CLOTHING, NAMELY T-SHIRTS, SWEAT-  
SHIRTS, AND CAPS AS NOVELTY APPAREL AND

CYNTHIA SLOAN, EXAMINING ATTORNEY

Int. Cl.: 44

Prior U.S. Cls.: 100 and 101

United States Patent and Trademark Office

Reg. No. 3,452,128

Registered June 24, 2008

**SERVICE MARK  
PRINCIPAL REGISTER**



CHUNG, HYUN MO (UNITED STATES INDIVIDUAL)

#270

4725 FIRST ST.

PLEASANTON, CA 94566

FOR: WEIGHT REDUCTION DIET PLANNING AND SUPERVISION SERVICES, IN CLASS 44 (U.S. CLS. 100 AND 101).

FIRST USE 3-1-2006; IN COMMERCE 3-1-2006.

NO CLAIM IS MADE TO THE EXCLUSIVE RIGHT TO USE "DETOX WEIGHT LOSS CENTER", APART FROM THE MARK AS SHOWN.

THE COLOR(S) LIME GREEN, DARK GREEN AND BLACK IS/ARE CLAIMED AS A FEATURE OF THE MARK.

THE MARK CONSISTS OF THE STYLIZED LETTERING "TAHARA" IN LIME GREEN COLOR, WITH DARK GREEN COLOR FOR A PUNCTUATION MARK SHAPED LIKE A LEAF, AND THE WORDING "DETOX WEIGHT LOSS CENTER" BELOW IN BLACK.

THE ENGLISH TRANSLATION OF THE WORD "TAHARA" IN THE MARK IS COUNTRY LIVING OR PURITY.

SER. NO. 77-150,242, FILED 4-5-2007.

DAVID TOOLEY, EXAMINING ATTORNEY

**Int. Cls.: 35 and 40**

**Prior U.S. Cls.: 100, 101, 102, 103 and 106**

**United States Patent and Trademark Office**

**Reg. No. 3,452,129**

**Registered June 24, 2008**

**SERVICE MARK  
PRINCIPAL REGISTER**



E BUSINESS INCENTIVES, INC. (MINNESOTA CORPORATION)

14940 28TH AVE. N.

PLYMOUTH, MN 55447

FOR: PROVIDING PROMOTIONAL AND MARKETING SERVICES BY MEANS OF PRINTED MATERIALS, IN CLASS 35 (U.S. CLS. 100, 101 AND 102).

FIRST USE 1-12-2007; IN COMMERCE 1-12-2007.

FOR: PRINTING SERVICES, IN CLASS 40 (U.S. CLS. 100, 103 AND 106).

FIRST USE 1-1-2007; IN COMMERCE 1-1-2007.

THE MARK CONSISTS OF A BLOCK WITH THE LETTERS "E" "B" "I" SUPERIMPOSED THEREON.

SER. NO. 77-150,383, FILED 4-6-2007.

BRIAN NEVILLE, EXAMINING ATTORNEY

**Int. Cls.: 35 and 36**

**Prior U.S. Cls.: 100, 101 and 102**

**United States Patent and Trademark Office**

**Reg. No. 3,452,130**

**Registered June 24, 2008**

**SERVICE MARK  
PRINCIPAL REGISTER**

**SKYWORKS**

SKYWORKS CAPITAL, LLC (DELAWARE LTD  
LIAB CO)  
4TH FLOOR  
283 GREENWICH AVENUE  
GREENWICH, CT 06830

FOR: CONSULTATION SERVICES IN THE  
FIELDS OF ACQUISITIONS AND MERGERS, IN  
CLASS 35 (U.S. CLS. 100, 101 AND 102).

FIRST USE 8-14-2002; IN COMMERCE 8-14-2002.

FOR: EVALUATION OF AIRCRAFT EQUIPMENT  
PORTFOLIOS; INVESTMENT BANKING SERVICES

AND ASSET-BASED FINANCING SERVICES,  
NAMELY, FACILITATING AND ARRANGING  
FOR THE FINANCING OF AIRCRAFT; CONSUL-  
TATION SERVICES IN THE FIELDS OF FINANCIAL  
RECONSTRUCTURING AND DEBT AND EQUITY  
OFFERINGS, IN CLASS 36 (U.S. CLS. 100, 101 AND  
102).

FIRST USE 8-14-2002; IN COMMERCE 8-14-2002.

SER. NO. 77-150,696, FILED 4-6-2007.

DEZMONA MIZELLE, EXAMINING ATTORNEY

Int. Cl.: 12

Prior U.S. Cls.: 19, 21, 23, 31, 35 and 44

Reg. No. 3,452,131

United States Patent and Trademark Office

Registered June 24, 2008

TRADEMARK  
PRINCIPAL REGISTER

*Scooter Superstore*

SCOOTER SUPERSTORE OF AMERICA, INC.  
(FLORIDA CORPORATION)  
2300 N 23RD AVE  
HOLLYWOOD, FL 33020

FOR: BRAKE DISCS FOR MOTORCYCLES; HUBS FOR MOTORCYCLE WHEELS; MOTORCYCLE ACCESSORIES, NAMELY, FRONT AND SIDE PLATES; MOTORCYCLE ACCESSORIES, NAMELY, GAS TANK AND RADIATOR SHROUDS; MOTORCYCLE AND AUTOMOBILE STRUCTURAL PARTS, NAMELY, SUMP GUARDS; MOTORCYCLE ENGINES; MOTORCYCLE GRIP TAPE; MOTORCYCLE KICKSTANDS; MOTORCYCLE PARTS, NAMELY, CHROMED SAFETY PADS; MOTORCYCLE PARTS, NAMELY, HEEL GUARDS; MOTORCYCLE SADDLEBAGS; MOTORCYCLE SIDECARS; MOTORCYCLE TRIKE CONVERSION KITS FOR CONVERTING A TWO-WHEELED MOTORCYCLE INTO A THREE-WHEELED MOTORCYCLE; MOTORCYCLES; MOTORCYCLES AND STRUCTURAL PARTS THEREFORE; MOTORCYCLES FOR MOTOCROSS; PANNIER BAGS FOR MOTORCYCLES; PARTS OF MOTORCYCLES, NAMELY, HANDLE BAR THROTTLES; PARTS OF MOTORCYCLES, NAMELY, BRAKE CABLES; PARTS OF MOTORCYCLES, NAMELY, BRAKE CALIPERS; PARTS OF MOTORCYCLES, NAMELY, BRAKE PEDALS; PARTS OF MOTORCYCLES, NAMELY, BRAKE ROTORS; PARTS OF MOTORCYCLES, NAMELY, CLUTCH CABLES; PARTS OF MOTORCYCLES, NAMELY, FORK BEARINGS

AND RACES; PARTS OF MOTORCYCLES, NAMELY, FORK DUST BOOTS; PARTS OF MOTORCYCLES, NAMELY, FORK SEALS; PARTS OF MOTORCYCLES, NAMELY, FRONT DASH PANELS; PARTS OF MOTORCYCLES, NAMELY, FRONT SPACERS; PARTS OF MOTORCYCLES, NAMELY, HANDLE BAR CONTROL LEVERS; PARTS OF MOTORCYCLES, NAMELY, HANDLE BAR DAMPERS; PARTS OF MOTORCYCLES, NAMELY, HANDLE BAR GRIPS; PARTS OF MOTORCYCLES, NAMELY, HANDLE BARS; PARTS OF MOTORCYCLES, NAMELY, HEADLIGHT MOUNTS; PARTS OF MOTORCYCLES, NAMELY, SHIFT LEVERS; PNEUMATIC TIRES AND INNER TUBES FOR MOTORCYCLES; STRUCTURAL PARTS FOR MOTORCYCLES, IN CLASS 12 (U.S. CLS. 19, 21, 23, 31, 35 AND 44).

FIRST USE 2-1-2007; IN COMMERCE 2-12-2007.

NO CLAIM IS MADE TO THE EXCLUSIVE RIGHT TO USE "SCOOTER SUPERSTORE", APART FROM THE MARK AS SHOWN.

THE MARK CONSISTS OF THE STYLIZED AND UNDERLINED WORDING "SCOOTER SUPERSTORE".

SER. NO. 77-150,986, FILED 4-6-2007.

ESTHER A. BORSUK, EXAMINING ATTORNEY

**Int. Cls.: 25 and 37**

**Prior U.S. Cls.: 22, 39, 100, 103 and 106**

**United States Patent and Trademark Office**

**Reg. No. 3,452,132**

**Registered June 24, 2008**

**TRADEMARK  
SERVICE MARK  
PRINCIPAL REGISTER**

# DIVA CUSTOMS

T SQUARED LLC (VIRGINIA LTD LIAB CO)  
640 9TH STREET  
VIRGINIA BEACH, VA 23451

FOR: MOTORCYCLE CLOTHING, NAMELY, LEATHER PANTS AND LEATHER JACKETS; CLOTHING, NAMELY, SHIRTS, COATS, GLOVES, PANTS, SHOES, T-SHIRTS, DRESSES, HATS, LEATHER PANTS, LEATHER JACKETS, JEAN JACKETS AND SWEATSHIRTS, IN CLASS 25 (U.S. CLS. 22 AND 39).

FIRST USE 9-19-2005; IN COMMERCE 9-19-2005.

FOR: MOTORCYCLE CUSTOMIZATION SERVICES, MOTORCYCLE BODY REPAIR AND FINISH-

ING FOR OTHERS, IN CLASS 37 (U.S. CLS. 100, 103 AND 106).

FIRST USE 9-19-2005; IN COMMERCE 9-19-2005.

THE MARK CONSISTS OF STANDARD CHARACTERS WITHOUT CLAIM TO ANY PARTICULAR FONT, STYLE, SIZE, OR COLOR.

NO CLAIM IS MADE TO THE EXCLUSIVE RIGHT TO USE "CUSTOMS" , APART FROM THE MARK AS SHOWN.

SER. NO. 77-151,172, FILED 4-6-2007.

AMEETA JORDAN, EXAMINING ATTORNEY

**Int. Cl.: 35**

**Prior U.S. Cls.: 100, 101 and 102**

**United States Patent and Trademark Office**

**Reg. No. 3,452,133**

**Registered June 24, 2008**

**SERVICE MARK  
PRINCIPAL REGISTER**

**THE CREATIVE EDGE IN  
COMMUNICATIONS**

MAYS & ASSOCIATES, INC. (MARYLAND CORPORATION)  
SUITE 103  
8726 TOWN & COUNTRY BOULEVARD  
ELLCOTT CITY, MD 21043

FOR: BUSINESS SERVICES, NAMELY, DEVELOPING STRATEGIES IN THE FIELDS OF MARKETING AND ADVERTISING; BUSINESS SERVICES, NAMELY, CREATING BRAND IDENTITY FOR OTHERS AND BRAND DEVELOPMENT IN THE FOR PROFIT, NOT FOR PROFIT AND GOVERN-

MENT SECTORS, IN CLASS 35 (U.S. CLS. 100, 101 AND 102).

FIRST USE 1-1-1992; IN COMMERCE 1-1-1992.

THE MARK CONSISTS OF STANDARD CHARACTERS WITHOUT CLAIM TO ANY PARTICULAR FONT, STYLE, SIZE, OR COLOR.

SER. NO. 77-151,627, FILED 4-9-2007.

MICHAEL WEBSTER, EXAMINING ATTORNEY



**Int. Cls.: 35, 42 and 45**

**Prior U.S. Cls.: 100, 101 and 102**

**United States Patent and Trademark Office**

**Reg. No. 3,452,134**

**Registered June 24, 2008**

**SERVICE MARK  
PRINCIPAL REGISTER**

**VERIS**

VERIS CONSULTING, LLC (VIRGINIA LTD LIAB  
CO)  
SUITE 300  
11710 PLAZA AMERICA DRIVE  
RESTON, VA 20190

FOR: BUSINESS CONSULTATION SERVICES IN  
THE FIELDS OF INSURANCE AND REINSUR-  
ANCE, ACCOUNTING, FORENSIC ACCOUNTING,  
INTERNAL AND EXTERNAL AUDITING, AC-  
TUARIAL FORENSICS, CORPORATE GOVERN-  
ANCE, SECURITIES LAW COMPLIANCE,  
ECONOMIC DAMAGES, BUSINESS LIQUIDATION,  
BANKRUPTCY AND INSOLVENCY, INDUSTRY  
RESEARCH AND SURVEYS, AND STATISTICAL  
INDUSTRY ANALYSIS, IN CLASS 35 (U.S. CLS. 100,  
101 AND 102).

FIRST USE 9-30-2000; IN COMMERCE 9-30-2000.

FOR: INFORMATION TECHNOLOGY CONSUL-  
TATION IN THE AREAS OF ACCOUNTING, FOR-  
ENSIC ACCOUNTING, LITIGATION SUPPORT

AND INFORMATION TECHNOLOGY ASSUR-  
ANCE, IN CLASS 42 (U.S. CLS. 100 AND 101).

FIRST USE 9-30-2000; IN COMMERCE 9-30-2000.

FOR: LITIGATION SUPPORT CONSULTATION;  
CONSULTATION SERVICES FEATURING SECUR-  
ITY LAWS, COMPLIANCE, REGULATIONS, AND  
REQUIREMENTS; REVIEWING STANDARDS AND  
PRACTICES TO ASSURE COMPLIANCE WITH IN-  
SURANCE LAWS AND REGULATIONS, IN CLASS  
45 (U.S. CLS. 100 AND 101).

FIRST USE 9-30-2000; IN COMMERCE 9-30-2000.

THE MARK CONSISTS OF STANDARD CHAR-  
ACTERS WITHOUT CLAIM TO ANY PARTICULAR  
FONT, STYLE, SIZE, OR COLOR.

SER. NO. 77-151,722, FILED 4-9-2007.

ZACHARY BELLO, EXAMINING ATTORNEY

**Int. Cls.: 6, 9, 16, 20 and 35**

**Prior U.S. Cls.: 2, 5, 12, 13, 14, 21, 22, 23, 25, 26, 29, 32, 36, 37, 38, 50, 100, 101 and 102**

**Reg. No. 3,452,135**

**United States Patent and Trademark Office**

**Registered June 24, 2008**

**TRADEMARK  
SERVICE MARK  
PRINCIPAL REGISTER**



W.A. KRAPP, INC. (DELAWARE CORPORATION)  
2031 O'NEILL ROAD  
MACEDON, NY 145028953

FOR: WALL PANELS OF METAL HAVING SMOOTH MAGNETIC WRITING SURFACES, IN CLASS 6 (U.S. CLS. 2, 12, 13, 14, 23, 25 AND 50).

FIRST USE 2-0-2005; IN COMMERCE 2-0-2005.

FOR: PLASTIC COVERED MAGNETS; DOUBLE SIDED MAGNETS; FLEXIBLE PLASTIC STRIP MAGNETS SOLD IN ROLL FORM FOR USE IN MOUNTING LABELS; MAGNETS HAVING PRINTED THERE ON INFORMATION OBSERVABLE WHEN THE MAGNETS ARE ATTACHED TO FERROMAGNETIC SURFACES, IN CLASS 9 (U.S. CLS. 21, 23, 26, 36 AND 38).

FIRST USE 2-0-2005; IN COMMERCE 2-0-2005.

FOR: MAGNETIC BOARDS AND PANELS AND SUPPORTING MOUNTING TRACKS THEREFORE AND UPON WHICH MARKERS MAY BE MAGNETICALLY ATTACHED FOR THE PURPOSE OF VISUALLY DISPLAYING INFORMATION; MAGNETIC BOARDS WITH WRITE-ON/WIPE-OFF SURFACES; WALL MOUNTABLE VISIBLE CARD FILES AND CARDS THEREFORE; TRANSPARENT, FLEXIBLE DOCUMENT SUPPORTING JACKETS WITH

MAGNETIZED MOUNTING STRIPS; MULTI-FACED VISUAL DISPLAY BOARD PANELS; FOLDING MAGNETIC SCHEDULING AND DISPLAY BOARDS; WALL MOUNTABLE BULLETIN AND DISPLAY BOARD PANELS; MAGNETIC WALL MOUNTABLE FILE HOLDERS; MAGNETIC BOARDS OR PANELS WITH GRID PRINTED FACE; TRANSPARENT BARS FOR GRIPPING DOCUMENT SHEETS ON VERTICAL SURFACES; TRANSPARENT DRY ERASE DISPLAY AND WRITING BOARD SYSTEMS MADE FOR WALL HUNG UNITS, FREE STANDING UNITS, AND PORTABLE UNITS; WALL MOUNTABLE AND FREESTANDING MEMORANDUM BOARDS; MAGNETIC WRITE ON-WIPE OFF BOARDS WITH PLAIN AND PRINTED WORKING SURFACES; ADHESIVE AND MAGNETIC CLAMPS FOR GRIPPING AND HOLDING PAPERS; PAPER SIGN OR LABEL MATERIAL USED AS SHELF AND DRAWER LABELS, BOX AND BIN LABELS, NAMEPLATES, SIGNS, MARKERS, EMBLEMS, SYMBOLS, AND IDENTIFICATION TAGS; ORGANIZATIONAL CHART KITS INCLUDING PAPER LABELS ARRANGED ON DISPLAY BOARDS TO FORM CHARTS, SCHEDULES, DIRECTORIES, ROSTERS; MAGNETIC AND NON-MAGNETIC SCHEDULING AND DISPLAY BOARDS WITH WRITE-ON AND WIPE-OFF SURFACES; WALL OR DESK TOP FILES HAVING HINGED MOUNTED TRANSPARENT JACKETS FOR HOLDING REFERENCE SHEETS; PRINTA-

BLE, PORCELAIN-LIKE WRITING SURFACES FOR USE WITH LIQUID CHALK PENS AND OTHER MARKERS; MAGNETIC BOARDS HAVING IMITATION WOOD GRAIN SURFACES; PHOTOGRAPHIC ALBUMS; MAGNETIC PRESENTATION BOARDS AND VISUAL DISPLAY PANELS FOR INFORMATIONAL USE; REMOVABLE LINE CHART TAPES - NAMELY, ADHESIVELY BACKED TAPES FOR SUBDIVIDING SCHEDULING BOARDS; OFFICE EQUIPMENT, NAMELY, SCHEDULING AND PLANNING BOARDS COMPOSED OF DISPLAY PANELS WITH ENDLESS TRANSPARENT WRITE-ON PLASTIC OVERLAYS MOVABLE ACROSS THE PANEL FACES; EDUCATIONAL KITS FOR PROMOTING SAFETY AWARENESS CONSISTING OF A MAGNETIC BOARD AND VARIOUSLY COLORED MAGNETS FOR FORMING A CROSS ON THE FACE OF THE BOARD; MAGNETIC WRITE-ON BOARDS WITH PALE GREY BAR LINES THEREON; GRAPHIC DISPLAY BOARD PANELS AND BRACKETS THEREFORE SOLD IN KIT FORM FOR MOUNTING THE BOARDS FOR SWINGING MOVEMENT ON WALL OR STANDS; OFFICE INVENTORY CONTROL KITS, COMPOSED OF REMOVABLE SYMBOLS, LETTERS AND NUMERALS, USED WITH CHARTS AND BOARDS; BULLETIN BOARDS WITH TRANSPARENT RETAINERS FOR HANGING DOCUMENTS ON THE BOARDS; SLIDING DISPLAY PANELS, NAMELY, MAGNETIC AND NON-MAGNETIC SCHEDULING AND DISPLAY BOARDS SLIDE-ABLE ON TRACKS; PERSONAL ORGANIZERS FEATURING DIE-CUT T-CARDS AND SLOTTED PANELS FOR RELEASING, HOLDING AND DISPLAYING THE CARDS; WALL PANELS, NAMELY, MAGNETIC AND WRITE-ON DISPLAY BOARDS; KITS PRINCIPALLY COMPOSED OF MAGNETIC BOARDS WITH SURFACES CAPABLE OF BEING WRITTEN UPON AND WIPED AWAY, PENS CONTAINING CHALK IN LIQUID FORM, ERASERS, AND MAGNETIC LETTERS AND NUMERALS; MAGNETIC PLANNING AND SCHEDULING CALENDAR KITS CONSISTING OF MAGNETIC CALENDAR YEAR

BOARDS, AND MAGNETIC LABELS AND MARKERS; MAGNETIC THUMB TACKS FOR SUPPORTING SMALL ARTICLES AGAINST STATIONARY SURFACES, IN CLASS 16 (U.S. CLS. 2, 5, 22, 23, 29, 37, 38 AND 50).

FIRST USE 2-0-2005; IN COMMERCE 2-0-2005.

FOR: PLASTIC LABELS; FURNITURE, NAMELY, PORTABLE AND FOLDING DISPLAY UNITS FEATURING TRANSPARENT PHOTO RETAINING EXHIBIT SLEEVES AND WALL-MOUNTABLE, FREE-STANDING, HINGED AND TRACK SLIDING PANELS; CABINETS FOR ENCLOSING SLIDING INFORMATION DISPLAY PANELS; TAMBOUR DOOR WALL CABINETS FOR MAGNETIC BOARDS OR PANELS; MULTI-SIDED ROTATABLE DISPLAY STAND WITH WRITE-ON, WIPE-OFF MAGNETIC SURFACES, IN CLASS 20 (U.S. CLS. 2, 13, 22, 25, 32 AND 50).

FIRST USE 2-0-2005; IN COMMERCE 2-0-2005.

FOR: MAIL ORDER CATALOG AND COMPUTERIZED ON-LINE RETAIL STORE SERVICES FEATURING BULLETIN AND DISPLAY BOARD SYSTEM KITS, MAGNETIC LABELS AND TAGS, MARKERS, AND ADHESIVELY AND MAGNETICALLY BACKED TAPES AND LABELS, LETTERS AND NUMBERS, AND VISIBLE DATA DISPLAY SYSTEMS, IN CLASS 35 (U.S. CLS. 100, 101 AND 102).

FIRST USE 3-0-2005; IN COMMERCE 3-0-2005.

OWNER OF U.S. REG. NOS. 903,983 AND 2,504,371.

NO CLAIM IS MADE TO THE EXCLUSIVE RIGHT TO USE "VISIBLE SYSTEMS", APART FROM THE MARK AS SHOWN.

SER. NO. 77-151,925, FILED 4-9-2007.

KELLY MCCOY, EXAMINING ATTORNEY

Int. Cl.: 30

Prior U.S. Cl.: 46

United States Patent and Trademark Office

Reg. No. 3,452,136

Registered June 24, 2008

TRADEMARK  
PRINCIPAL REGISTER



EVERYTHING PEPPERS, LLC (WASHINGTON  
LTD LIAB CO)  
SUITE 229  
3110 JUDSON STREET  
GIG HARBOR, WA 98335

THE MARK CONSISTS OF THE WORD "DAVIO-  
LA," UNDERLINED AND IN FANCY CURSIVE  
LOWERCASE FONT, EXCEPT FOR "D" AND "V,"  
WHICH ARE CAPITAL LETTERS.

FOR: PEPPER, SPICES, DRIED CHILI PEPPERS,  
AND SEASONINGS, IN CLASS 30 (U.S. CL. 46).

SER. NO. 77-152,299, FILED 4-9-2007.

FIRST USE 10-16-2006; IN COMMERCE 10-25-2006.

OWNER OF U.S. REG. NO. 3,272,946.

CHRISTOPHER BUONGIORNO, EXAMINING AT-  
TORNEY

**Int. Cl.: 16**

**Prior U.S. Cls.: 2, 5, 22, 23, 29, 37, 38 and 50**

**Reg. No. 3,452,137**

**United States Patent and Trademark Office**

**Registered June 24, 2008**

**TRADEMARK  
PRINCIPAL REGISTER**



JAZZ PHARMACEUTICALS, INC. (DELAWARE CORPORATION)  
3180 PORTER DRIVE  
PALO ALTO, CA 94304

FOR: PRINTED MATERIALS, NAMELY, PAMPHLETS, BROCHURES, BOOKLETS, AND MANUALS, CONCERNING MEDICINE; PRINTED MATERIALS, NAMELY, PAMPHLETS, BROCHURES, AND BOOKLETS, CONCERNING THE MEDICAL AND PHARMACEUTICAL FIELDS; MONOGRAPHS IN THE FIELD OF MEDICINE; PRINTED INSTRUCTIONAL, EDUCATIONAL, AND TEACHING MATERIALS IN THE FIELD OF MEDICINE; NOTE PADS; PENS; AND FOLDERS, IN CLASS 16 (U.S. CLS. 2, 5, 22, 23, 29, 37, 38 AND 50).

FIRST USE 2-0-2006; IN COMMERCE 2-0-2006.

OWNER OF U.S. REG. NOS. 3,005,004 AND 3,268,952.

NO CLAIM IS MADE TO THE EXCLUSIVE RIGHT TO USE "PHARMACEUTICALS", APART FROM THE MARK AS SHOWN.

THE COLOR(S) PURPLE, GOLD AND WHITE IS/ ARE CLAIMED AS A FEATURE OF THE MARK.

THE MARK CONSISTS OF THE WORDING "JAZZ PHARMACEUTICALS" IN THE COLOR PURPLE POSITIONED TO THE RIGHT OF A CIRCULAR LOGO WITH CONCENTRIC CIRCLES OF PURPLE AND WHITE CONTAINING A STYLIZED DEPICTION OF THE LETTERS "JP" IN THE COLOR WHITE WHICH VERTICALLY SPLITS THE CIRCLE SHOWING GOLD ON THE RIGHT PORTION AND PURPLE ON THE LEFT PORTION OF THE CIRCLE.

SER. NO. 77-152,428, FILED 4-9-2007.

SHANNON TWOHIG, EXAMINING ATTORNEY

**Int. Cl.: 6**

**Prior U.S. Cls.: 2, 12, 13, 14, 23, 25 and 50**

**Reg. No. 3,452,138**

**United States Patent and Trademark Office**

**Registered June 24, 2008**

---

**TRADEMARK  
PRINCIPAL REGISTER**

# Scapeguard

SHRUBGUARD, INC. (MICHIGAN CORPORATION)  
SUITE SG  
2905 HILTON  
FERNDALE, MI 48220

FIRST USE 12-1-2004; IN COMMERCE 12-1-2004.

THE MARK CONSISTS OF STANDARD CHARACTERS WITHOUT CLAIM TO ANY PARTICULAR FONT, STYLE, SIZE, OR COLOR.

FOR: METALLIC, HOUSELIKE, TUBULAR STRUCTURE USED TO HELP PREVENT DAMAGE TO SHRUBBERY AND OTHER LANDSCAPING CAUSED BY HARSH WEATHER CONDITIONS AND ANIMALS, IN CLASS 6 (U.S. CLS. 2, 12, 13, 14, 23, 25 AND 50).

SER. NO. 77-152,606, FILED 4-10-2007.

WILLIAM VERHOSEK, EXAMINING ATTORNEY

**Int. Cl.: 10**

**Prior U.S. Cls.: 26, 39 and 44**

**United States Patent and Trademark Office**

**Reg. No. 3,452,139**

**Registered June 24, 2008**

**TRADEMARK  
PRINCIPAL REGISTER**

**GREENBERG**

GREENBERG, I. MELBOURNE, M.D. (UNITED STATES INDIVIDUAL)  
62 THE HEMLOCKS, ROSLYN ESTATES  
LONG ISLAND, NY 115761804

FOR: SURGICAL EQUIPMENT, NAMELY, A UNIVERSAL RETRACTOR AND HANDREST, SOLD AS A UNIT, IN CLASS 10 (U.S. CLS. 26, 39 AND 44).

FIRST USE 3-7-1977; IN COMMERCE 3-7-1977.

THE MARK CONSISTS OF STANDARD CHARACTERS WITHOUT CLAIM TO ANY PARTICULAR FONT, STYLE, SIZE, OR COLOR.

SEC. 2(F).

SER. NO. 77-152,724, FILED 4-10-2007.

SUSAN STIGLITZ, EXAMINING ATTORNEY

**Int. Cl.: 30**

**Prior U.S. Cl.: 46**

**United States Patent and Trademark Office**

**Reg. No. 3,452,140**

**Registered June 24, 2008**

**TRADEMARK  
PRINCIPAL REGISTER**

**POULTRY PERFECT**

FIRE & FLAVOR GRILLING CO. (GEORGIA  
CORPORATION)  
328 COMMERCE BLVD.  
SUITE #8  
BOGART, GA 30622

FOR: BRINE MIXES, NAMELY, MIXTURES OF  
SALTS, SUGARS, AND SEASONINGS, IN CLASS 30  
(U.S. CL. 46).

FIRST USE 2-28-2007; IN COMMERCE 2-28-2007.

THE MARK CONSISTS OF STANDARD CHAR-  
ACTERS WITHOUT CLAIM TO ANY PARTICULAR  
FONT, STYLE, SIZE, OR COLOR.

NO CLAIM IS MADE TO THE EXCLUSIVE  
RIGHT TO USE "POULTRY", APART FROM THE  
MARK AS SHOWN.

SER. NO. 77-153,012, FILED 4-10-2007.

JAMES A. RAUEN, EXAMINING ATTORNEY



**Int. Cl.: 36**

**Prior U.S. Cls.: 100, 101 and 102**

**United States Patent and Trademark Office**

**Reg. No. 3,452,141**

**Registered June 24, 2008**

**SERVICE MARK  
PRINCIPAL REGISTER**

**CS&A AVIATION INSURANCE**

CHAPPELL, SMITH & ASSOCIATES, INC. (TEN-  
NESSEE CORPORATION)  
1006 MERYLINGER COURT  
FRANKLIN, TN 37067

FOR: INSURANCE AGENCY IN THE FIELDS OF  
AVIATION, AIRCRAFT, PROPERTY, CASUALTY,  
LIFE, DISABILITY, HEALTH, PERSONAL INSUR-  
ANCE AND COMMERCIAL INSURANCE; AND  
PERSONAL AND RETIREMENT INCOME PLAN-  
NING, IN CLASS 36 (U.S. CLS. 100, 101 AND 102).

FIRST USE 3-0-1996; IN COMMERCE 3-0-1996.

THE MARK CONSISTS OF STANDARD CHAR-  
ACTERS WITHOUT CLAIM TO ANY PARTICULAR  
FONT, STYLE, SIZE, OR COLOR.

NO CLAIM IS MADE TO THE EXCLUSIVE  
RIGHT TO USE "AVIATION INSURANCE", APART  
FROM THE MARK AS SHOWN.

SER. NO. 77-153,044, FILED 4-10-2007.

SUSAN LESLIE DUBOIS, EXAMINING ATTORNEY

**Int. Cls.: 35, 41, 42 and 45**

**Prior U.S. Cls.: 100, 101, 102 and 107**

**United States Patent and Trademark Office**

**Reg. No. 3,452,142**

**Registered June 24, 2008**

**SERVICE MARK  
PRINCIPAL REGISTER**



THE MODERN GROUP LTD. (TEXAS LTD LIAB  
CO)  
1655 LOUISIANA  
BEAUMONT, TX 77701

FOR: MAIL ORDER SERVICES FEATURING  
SAFETY EQUIPMENT FOR THE PETROCHEMICAL  
INDUSTRY, IN CLASS 35 (U.S. CLS. 100, 101  
AND 102).

FIRST USE 3-1-2007; IN COMMERCE 3-1-2007.

FOR: TRAINING IN THE USE OF SAFETY  
EQUIPMENT FOR THE PETROCHEMICAL INDUS-  
TRY, IN CLASS 41 (U.S. CLS. 100, 101 AND 107).

FIRST USE 3-1-2007; IN COMMERCE 3-1-2007.

FOR: TESTING, ANALYSIS AND EVALUATION  
OF SAFETY EQUIPMENT OF OTHERS FOR THE  
PURPOSE OF CERTIFICATION; CALIBRATION OF  
SAFETY EQUIPMENT FOR OTHERS, IN CLASS 42  
(U.S. CLS. 100 AND 101).

FIRST USE 3-1-2007; IN COMMERCE 3-1-2007.

FOR: RENTAL OF SAFETY EQUIPMENT FOR  
THE PETROCHEMICAL INDUSTRY, NAMELY,  
HARNESSES AND NETS FOR FALL PROTECTION,  
PERSONAL PROTECTION EQUIPMENT, EXPLO-  
SIVE PROOF LIGHTING, GAS DETECTION EQUIP-  
MENT AND EMERGENCY RESPONSE SUPPLIES,  
IN CLASS 45 (U.S. CLS. 100 AND 101).

FIRST USE 3-1-2007; IN COMMERCE 3-1-2007.

OWNER OF U.S. REG. NOS. 2,222,563, 2,227,817,  
AND 2,227,818.

NO CLAIM IS MADE TO THE EXCLUSIVE  
RIGHT TO USE "SAFETY", APART FROM THE  
MARK AS SHOWN.

THE MARK CONSISTS OF A TIGER BETWEEN  
THE WORDS "TIGER" AND "SAFETY".

SER. NO. 77-153,201, FILED 4-10-2007.

JULIE WATSON, EXAMINING ATTORNEY

**Int. Cl.: 36**

**Prior U.S. Cls.: 100, 101 and 102**

**United States Patent and Trademark Office**

**Reg. No. 3,452,143**

**Registered June 24, 2008**

**SERVICE MARK  
PRINCIPAL REGISTER**

**CHAPPELL, SMITH &  
ASSOCIATES, INC.**

CHAPPELL, SMITH & ASSOCIATES, INC. (TEN-  
NESSEE CORPORATION)  
1006 MERYLINGER COURT  
FRANKLIN, TN 37067

FOR: INSURANCE AGENCY IN THE FIELDS OF  
AVIATION, AIRCRAFT, PROPERTY, CASUALTY,  
LIFE, DISABILITY, HEALTH, PERSONAL INSUR-  
ANCE AND COMMERCIAL INSURANCE; AND  
PERSONAL AND RETIREMENT INCOME PLAN-  
NING, IN CLASS 36 (U.S. CLS. 100, 101 AND 102).

FIRST USE 11-0-1981; IN COMMERCE 11-0-1981.

THE MARK CONSISTS OF STANDARD CHAR-  
ACTERS WITHOUT CLAIM TO ANY PARTICULAR  
FONT, STYLE, SIZE, OR COLOR.

NO CLAIM IS MADE TO THE EXCLUSIVE  
RIGHT TO USE "& ASSOCIATES, INC.", APART  
FROM THE MARK AS SHOWN.

SER. NO. 77-153,209, FILED 4-10-2007.

SUSAN LESLIE DUBOIS, EXAMINING ATTORNEY

**Int. Cl.: 43**

**Prior U.S. Cls.: 100 and 101**

**United States Patent and Trademark Office**

**Reg. No. 3,452,144**

**Registered June 24, 2008**

**SERVICE MARK  
PRINCIPAL REGISTER**

**TAKE ME HEAT ME EAT ME**

LETTUCE ENTERTAIN YOU ENTERPRISES,  
INC. (ILLINOIS CORPORATION)  
5419 NORTH SHERIDAN ROAD  
CHICAGO, IL 60640

THE MARK CONSISTS OF STANDARD CHAR-  
ACTERS WITHOUT CLAIM TO ANY PARTICULAR  
FONT, STYLE, SIZE, OR COLOR.

FOR: TAKE-OUT RESTAURANT SERVICES; RES-  
TAURANT SERVICES, IN CLASS 43 (U.S. CLS. 100  
AND 101).

SER. NO. 77-153,250, FILED 4-10-2007.

FIRST USE 2-26-2007; IN COMMERCE 2-26-2007.

ANDREA BUTLER, EXAMINING ATTORNEY

Int. Cls.: 3, 5 and 30

Prior U.S. Cls.: 1, 4, 6, 18, 44, 46, 50, 51 and 52

United States Patent and Trademark Office

Reg. No. 3,452,145

Registered June 24, 2008

TRADEMARK  
PRINCIPAL REGISTER



EVANS-PETERSON, MARY (UNITED STATES  
INDIVIDUAL)  
10121 WOLF ROAD  
GRASS VALLEY, CA 95949

FOR: NON-MEDICATED SKIN CARE PREPARA-  
TIONS, IN CLASS 3 (U.S. CLS. 1, 4, 6, 50, 51 AND 52).

FIRST USE 1-1-1988; IN COMMERCE 1-1-1988.

FOR: HERBAL SUPPLEMENTS USED TO SUP-  
PORT LIVER FUNCTION AND INTERNAL META-  
BOLIC HEALTH, IN CLASS 5 (U.S. CLS. 6, 18, 44, 46,  
51 AND 52).

FIRST USE 1-1-1988; IN COMMERCE 1-1-1988.

FOR: PROCESSED HERBS, NAMELY, POW-  
DERED BLENDS, TINCTURE BLENDS, TEA  
BLENDS, IN CLASS 30 (U.S. CL. 46).

FIRST USE 1-1-1988; IN COMMERCE 1-1-1988.

NO CLAIM IS MADE TO THE EXCLUSIVE  
RIGHT TO USE "HERB", APART FROM THE MARK  
AS SHOWN.

THE MARK CONSISTS OF A FENCED OUT-  
DOOR BUILDING STRUCTURE WITH FRONT-  
FACING WINDOWS AND SURROUNDING FOLI-  
AGE, AN ENLARGED PARTIAL SUN-LIKE STRUC-  
TURE AS A BACKGROUND COMPONENT AND  
OVERARCHING BANNER-LIKE COMPONENT  
COMPRISING THE LITERAL ELEMENT OF THE  
TRADEMARK.

SER. NO. 77-153,286, FILED 4-10-2007.

GINA HAYES, EXAMINING ATTORNEY

**Int. Cl.: 35**

**Prior U.S. Cls.: 100, 101 and 102**

**United States Patent and Trademark Office**

**Reg. No. 3,452,146**

**Registered June 24, 2008**

**SERVICE MARK  
PRINCIPAL REGISTER**

**SOCIETY OF INDEPENDENT  
GASOLINE MARKETERS OF  
AMERICA**

SOCIETY OF INDEPENDENT GASOLINE MAR-  
KETERS OF AMERICA (MISSOURI COR-  
PORATION)  
SUITE 215  
11495 SUNSET HILLS ROAD  
RESTON, VA 20190

FOR: ASSOCIATION SERVICES, NAMELY, PRO-  
MOTING THE INTERESTS OF GASOLINE MAR-  
KETERS, IN CLASS 35 (U.S. CLS. 100, 101 AND 102).

FIRST USE 12-31-1961; IN COMMERCE 12-31-1961.

THE MARK CONSISTS OF STANDARD CHAR-  
ACTERS WITHOUT CLAIM TO ANY PARTICULAR  
FONT, STYLE, SIZE, OR COLOR.

OWNER OF U.S. REG. NO. 1,780,204.

SEC. 2(F).

SER. NO. 77-153,636, FILED 4-11-2007.

LESLIE RICHARDS, EXAMINING ATTORNEY

**Int. Cls.: 18 and 25**

**Prior U.S. Cls.: 1, 2, 3, 22, 39 and 41**

**United States Patent and Trademark Office**

**Reg. No. 3,452,147**

**Registered June 24, 2008**

**TRADEMARK  
PRINCIPAL REGISTER**



HEELS LLC (OHIO LTD LIAB CO)  
SUITE 144  
1933 EAST DUBLIN GRANVILLE ROAD  
COLUMBUS, OH 43229

FOR: HANDBAGS, IN CLASS 18 (U.S. CLS. 1, 2, 3,  
22 AND 41).

FIRST USE 1-5-2007; IN COMMERCE 1-5-2007.

FOR: BELTS; WOMEN'S SHOES, IN CLASS 25 (U.S.  
CLS. 22 AND 39).

FIRST USE 1-5-2007; IN COMMERCE 1-5-2007.

NO CLAIM IS MADE TO THE EXCLUSIVE  
RIGHT TO USE "HEELS" IN CLASS 25, APART  
FROM THE MARK AS SHOWN.

SER. NO. 77-153,996, FILED 4-11-2007.

KAREN K. BUSH, EXAMINING ATTORNEY

**Int. Cl.: 42**

**Prior U.S. Cls.: 100 and 101**

**United States Patent and Trademark Office**

**Reg. No. 3,452,148**

**Registered June 24, 2008**

**SERVICE MARK  
PRINCIPAL REGISTER**



RO-MAC LUMBER & SUPPLY, INC. (FLORIDA CORPORATION)  
610 E MAIN STREET  
LEESBURG, FL 34748

FOR: PROVIDING QUALITY ASSURANCE SERVICES IN THE FIELD OF BUILDING MATERIALS & SUPPLIES, IN CLASS 42 (U.S. CLS. 100 AND 101).

FIRST USE 1-18-2006; IN COMMERCE 1-18-2006.

NO CLAIM IS MADE TO THE EXCLUSIVE RIGHT TO USE "DOUBLE CHECK", APART FROM THE MARK AS SHOWN.

THE MARK CONSISTS OF A CIRCLE WITHIN A CIRCLE. IN BETWEEN THE INNER AND OUTER CIRCLE, AT THE TOP, IN CAPITALIZED LETTERING, "DOUBLE CHECK" AND IN BETWEEN THE INNER AND OUTER CIRCLE AT THE BOTTOM, IN CAPITALIZED LETTERING, "PROMISE". WITHIN THE INNER CIRCLE ARE TWO CHECK MARKS. THE BOTTOM CHECK MARK OVERRIDES THE INNER CIRCLE INTO THE OUTER CIRCLE.

SER. NO. 77-154,124, FILED 4-11-2007.

MORGAN WYNNE, EXAMINING ATTORNEY



**Int. Cls.: 9 and 41**

**Prior U.S. Cls.: 21, 23, 26, 36, 38, 100, 101 and 107**

**Reg. No. 3,452,149**

**United States Patent and Trademark Office**

**Registered June 24, 2008**

---

**TRADEMARK  
SERVICE MARK  
PRINCIPAL REGISTER**

**InSpirit**

INSPIRIT MEN'S CHORUS (TENNESSEE NON-PROFIT ORGANIZATION)

7452 SPLENDID VIEW DRIVE

OOLETEWAH, TN 37363

FOR: PRERECORDED AUDIO AND DIGITAL COMPACT DISCS FEATURING MUSIC BY A CHRISTIAN MALE CHORUS , IN CLASS 9 (U.S. CLS. 21, 23, 26, 36 AND 38).

FIRST USE 4-7-2007; IN COMMERCE 4-7-2007.

FOR: ENTERTAINMENT IN THE NATURE OF LIVE MUSIC CONCERTS BY A CHRISTIAN MALE CHORUS, IN CLASS 41 (U.S. CLS. 100, 101 AND 107).

FIRST USE 4-7-2007; IN COMMERCE 4-7-2007.

THE MARK CONSISTS OF STANDARD CHARACTERS WITHOUT CLAIM TO ANY PARTICULAR FONT, STYLE, SIZE, OR COLOR.

SER. NO. 77-154,574, FILED 4-11-2007.

MICHAEL TANNER, EXAMINING ATTORNEY

**Int. Cl.: 42**

**Prior U.S. Cls.: 100 and 101**

**United States Patent and Trademark Office**

**Reg. No. 3,452,150**

**Registered June 24, 2008**

**SERVICE MARK  
PRINCIPAL REGISTER**

**RENTMATTERS**

RENTMATTERS, INC. (WASHINGTON CORPORATION)  
SUITE 110  
10940 NE 33RD PLACE  
BELLEVUE, WA 98004

FOR: COMPUTER SOFTWARE DESIGN FOR OTHERS IN THE FIELD OF REAL ESTATE, NAME-  
LY, APARTMENT RENTAL, OPERATIONS, MAR-  
KETING AND MANAGEMENT SOFTWARE;  
COMPUTER SERVICES, NAMELY, HOSTING THE  
WEBSITES OF OTHERS ON A COMPUTER SERVER

FOR A GLOBAL COMPUTER NETWORK, IN CLASS  
42 (U.S. CLS. 100 AND 101).

FIRST USE 10-22-2005; IN COMMERCE 10-22-2005.

THE MARK CONSISTS OF STANDARD CHAR-  
ACTERS WITHOUT CLAIM TO ANY PARTICULAR  
FONT, STYLE, SIZE, OR COLOR.

SER. NO. 77-154,579, FILED 4-11-2007.

CURTIS FRENCH, EXAMINING ATTORNEY

**Int. Cl.: 5**

**Prior U.S. Cls.: 6, 18, 44, 46, 51 and 52**

**Reg. No. 3,452,151**

**United States Patent and Trademark Office**

**Registered June 24, 2008**

**TRADEMARK  
PRINCIPAL REGISTER**



SZM FORMULA NZ LIMITED (NEW ZEALAND CORPORATION)  
KUMEU PROFESSIONAL CENTRE  
2 SHAMROCK DRIVE, KUMEU  
AUCKLAND, NEW ZEALAND

FOR: DIETARY HERBAL SUPPLEMENTS, IN CLASS 5 (U.S. CLS. 6, 18, 44, 46, 51 AND 52).

PRIORITY CLAIMED UNDER SEC. 44(D) ON NEW ZEALAND APPLICATION NO. 757285, FILED 10-18-2006, REG. NO. 757285, DATED 10-18-2006, EXPIRES 10-18-2016.

NO CLAIM IS MADE TO THE EXCLUSIVE RIGHT TO USE "FORMULA", APART FROM THE MARK AS SHOWN.

THE MARK CONSISTS OF STYLIZED LETTERS "SZM FORMULA" AND DESIGN.

SER. NO. 77-154,901, FILED 4-12-2007.

LESLIE RICHARDS, EXAMINING ATTORNEY

**Int. Cl.: 41**

**Prior U.S. Cls.: 100, 101 and 107**

**United States Patent and Trademark Office**

**Reg. No. 3,452,152**

**Registered June 24, 2008**

**SERVICE MARK  
PRINCIPAL REGISTER**

**Citizens' Winning Hands**

CITIZENS' WINNING HANDS CORPORATION  
(VIRGINIA CORPORATION)  
P.O. BOX 1973  
LEESBURG, VA 20177

FOR: EDUCATIONAL SERVICES, NAMELY,  
PROVIDING A WEBSITE FEATURING ONLINE  
EDUCATION CONTENT REGARDING POLITICAL  
ISSUES, POLICY OPTIONS, DECISION-MAKING  
AND CONSENSUS-BUILDING, IN CLASS 41 (U.S.  
CLS. 100, 101 AND 107).

FIRST USE 7-27-2006; IN COMMERCE 7-27-2006.

THE MARK CONSISTS OF STANDARD CHAR-  
ACTERS WITHOUT CLAIM TO ANY PARTICULAR  
FONT, STYLE, SIZE, OR COLOR.

SER. NO. 77-154,972, FILED 4-12-2007.

ANGELA GAW, EXAMINING ATTORNEY

**Int. Cl.: 9**

**Prior U.S. Cls.: 21, 23, 26, 36 and 38**

**United States Patent and Trademark Office**

**Reg. No. 3,452,153**

**Registered June 24, 2008**

**TRADEMARK  
PRINCIPAL REGISTER**



**AISHI**

YIYANG ZIJIANG ELECTRON COMPONENTS  
CO., LTD (CHINA LTD LIAB CO)  
JINXIU ROAD  
YIYANG, CHINA

FOR: CONDENSERS; FOIL ELEMENTS, NAME-  
LY, CIRCUITS FOR HEATING OR ELECTRICAL  
CONDUCTION, IN CLASS 9 (U.S. CLS. 21, 23, 26, 36  
AND 38).

OWNER OF CHINA REG. NO. 3743248, DATED 7-  
14-2005, EXPIRES 7-13-2015.

THE MARK CONSISTS OF STYLIZED WORDING  
"AISHI".

SER. NO. 77-154,980, FILED 4-12-2007.

TOBY BULLOFF, EXAMINING ATTORNEY

**Int. Cl.: 37**

**Prior U.S. Cls.: 100, 103 and 106**

**United States Patent and Trademark Office**

**Reg. No. 3,452,154**

**Registered June 24, 2008**

---

**SERVICE MARK  
PRINCIPAL REGISTER**

**MASTER THE MESS**

GARAGE ENVY, INC. (CALIFORNIA CORPORATION)  
9455 CHIVERS AVENUE  
SUN VALLEY, CA 91352

THE MARK CONSISTS OF STANDARD CHARACTERS WITHOUT CLAIM TO ANY PARTICULAR FONT, STYLE, SIZE, OR COLOR.

FOR: INSTALLATION OF CUSTOM DESIGNED AND MANUFACTURED CLOSETS, GARAGE COMPONENTS, CABINETS AND FLOORS, IN CLASS 37 (U.S. CLS. 100, 103 AND 106).

SER. NO. 77-155,068, FILED 4-12-2007.

FIRST USE 12-31-2002; IN COMMERCE 1-1-2003.

JILL PRATER, EXAMINING ATTORNEY

**Int. Cl.: 41**

**Prior U.S. Cls.: 100, 101 and 107**

**United States Patent and Trademark Office**

**Reg. No. 3,452,155**

**Registered June 24, 2008**

**SERVICE MARK  
PRINCIPAL REGISTER**

**COLLEGE LINEBACKER HALL OF  
FAME**

DOWNTOWN ATHLETIC CLUB OF ORLANDO,  
INC. (FLORIDA CORPORATION)  
P.O. BOX 4062  
ORLANDO, FL 32802

FOR: RECOGNIZING AND HONORING OUT-  
STANDING COLLEGE FOOTBALL ATHLETES  
THROUGH THE ISSUANCE OF AWARDS AND  
TROPHIES, IN CLASS 41 (U.S. CLS. 100, 101 AND  
107).

FIRST USE 10-3-1996; IN COMMERCE 10-3-1996.

THE MARK CONSISTS OF STANDARD CHAR-  
ACTERS WITHOUT CLAIM TO ANY PARTICULAR  
FONT, STYLE, SIZE, OR COLOR.

NO CLAIM IS MADE TO THE EXCLUSIVE  
RIGHT TO USE "HALL OF FAME", APART FROM  
THE MARK AS SHOWN.

SEC. 2(F).

SER. NO. 77-155,083, FILED 4-12-2007.

DANNEAN HETZEL, EXAMINING ATTORNEY

**Int. Cl.: 35**

**Prior U.S. Cls.: 100, 101 and 102**

**United States Patent and Trademark Office**

**Reg. No. 3,452,156**

**Registered June 24, 2008**

**SERVICE MARK  
PRINCIPAL REGISTER**

**SAN FRANCISCO ART EXCHANGE**

SAN FRANCISCO ART EXCHANGE LLC (CALIFORNIA LTD LIAB CO)  
458 GEARY STREET  
SAN FRANCISCO, CA 94102

FOR: RETAIL STORE SERVICES AND ONLINE RETAIL STORE SERVICES, EACH FEATURING THE FOLLOWING GOODS, NAMELY, ARTWORK, PAINTINGS, DRAWINGS, SCULPTURES, PHOTOGRAPHS, ANIMATION, POSTERS, BOOKS AND OTHER PUBLISHED WORKS, CALENDARS, MAGAZINES, COMICS, MEMORABILIA, LIMITED AND OPEN EDITION PRINTS AND OBJETS D'ART, ARTIFACTS, COLLECTIBLES, ART OF AND ART BY FAMOUS PERSONS, DIGITAL IMAGES, RECORDED COMPACT DISCS, RECORDED DIGITAL VIDEO DISCS, FIXATIONS IN ANY FORM OF MEDIA OF IMAGERY DERIVED FROM POPULAR MEDIA OF ALL TYPES, INCLUDING PUBLIC AND NON-PUBLIC EVENTS, WHETHER INVOLVING

MUSIC OR NOT, IN CLASS 35 (U.S. CLS. 100, 101 AND 102).

FIRST USE 5-31-1983; IN COMMERCE 5-31-1983.

THE MARK CONSISTS OF STANDARD CHARACTERS WITHOUT CLAIM TO ANY PARTICULAR FONT, STYLE, SIZE, OR COLOR.

NO CLAIM IS MADE TO THE EXCLUSIVE RIGHT TO USE "ART EXCHANGE", APART FROM THE MARK AS SHOWN.

SEC. 2(F).

SER. NO. 77-155,162, FILED 4-12-2007.

MELVIN AXILBUND, EXAMINING ATTORNEY



**Int. Cl.: 35**

**Prior U.S. Cls.: 100, 101 and 102**

**United States Patent and Trademark Office**

**Reg. No. 3,452,157**

**Registered June 24, 2008**

**SERVICE MARK  
PRINCIPAL REGISTER**

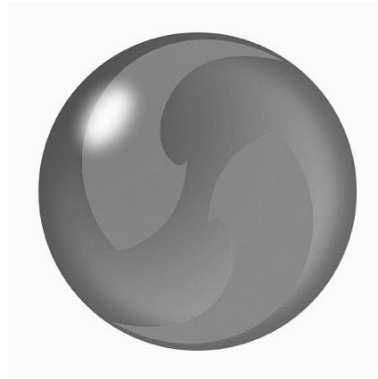

SAN FRANCISCO ART EXCHANGE LLC (CALIFORNIA LTD LIAB CO)  
458 GEARY STREET  
SAN FRANCISCO, CA 94102

FOR: RETAIL STORE SERVICES AND ONLINE RETAIL STORE SERVICES, EACH FEATURING THE FOLLOWING GOODS, NAMELY, ARTWORK, PAINTINGS, DRAWINGS, SCULPTURES, PHOTOGRAPHS, ANIMATION, POSTERS, BOOKS AND OTHER PUBLISHED WORKS, CALENDARS, MAGAZINES, COMICS, MEMORABILIA, LIMITED AND OPEN EDITION PRINTS AND OBJETS D'ART, ARTIFACTS, COLLECTIBLES, ART OF AND ART BY FAMOUS PERSONS, DIGITAL IMAGES, RECORDED COMPACT DISCS, RECORDED DIGITAL

VIDEO DISCS, FIXATIONS IN ANY FORM OF MEDIA OF IMAGERY DERIVED FROM POPULAR MEDIA OF ALL TYPES, INCLUDING PUBLIC AND NON-PUBLIC EVENTS, WHETHER INVOLVING MUSIC OR NOT, IN CLASS 35 (U.S. CLS. 100, 101 AND 102).

FIRST USE 4-30-2006; IN COMMERCE 4-30-2006.

THE MARK CONSISTS OF ROTATIONALLY SYMMETRIC SWIRLS INSIDE OF A CIRCLE.

SER. NO. 77-155,351, FILED 4-12-2007.

MELVIN AXILBUND, EXAMINING ATTORNEY

**Int. Cl.: 35**

**Prior U.S. Cls.: 100, 101 and 102**

**United States Patent and Trademark Office**

**Reg. No. 3,452,158**

**Registered June 24, 2008**

**SERVICE MARK  
PRINCIPAL REGISTER**

**GALLERY OF THE POPULAR  
IMAGE**

SAN FRANCISCO ART EXCHANGE LLC (CALI-  
FORNIA LTD LIAB CO)  
458 GEARY STREET  
SAN FRANCISCO, CA 94102

FOR: RETAIL STORE SERVICES AND ONLINE  
RETAIL STORE SERVICES, EACH FEATURING  
THE FOLLOWING GOODS, NAMELY, ARTWORK,  
PAINTINGS, DRAWINGS, SCULPTURES, PHOTO-  
GRAPHS, ANIMATION, POSTERS, BOOKS AND  
OTHER PUBLISHED WORKS, CALENDARS, MA-  
GAZINES, COMICS, MEMORABILIA, LIMITED  
AND OPEN EDITION PRINTS AND OBJETS D'ART,  
ARTIFACTS, COLLECTIBLES, ART OF AND ART  
BY FAMOUS PERSONS, DIGITAL IMAGES, RE-  
CORDED COMPACT DISCS, RECORDED DIGITAL  
VIDEO DISCS, FIXATIONS IN ANY FORM OF  
MEDIA OF IMAGERY DERIVED FROM POPULAR  
MEDIA OF ALL TYPES, INCLUDING PUBLIC AND

NON-PUBLIC EVENTS, WHETHER INVOLVING  
MUSIC OR NOT, IN CLASS 35 (U.S. CLS. 100, 101  
AND 102).

FIRST USE 4-30-2006; IN COMMERCE 4-30-2006.

THE MARK CONSISTS OF STANDARD CHAR-  
ACTERS WITHOUT CLAIM TO ANY PARTICULAR  
FONT, STYLE, SIZE, OR COLOR.

NO CLAIM IS MADE TO THE EXCLUSIVE  
RIGHT TO USE "GALLERY" AND "IMAGE",  
APART FROM THE MARK AS SHOWN.

SER. NO. 77-155,374, FILED 4-12-2007.

MELVIN AXILBUND, EXAMINING ATTORNEY

Int. Cl.: 9

Prior U.S. Cls.: 21, 23, 26, 36 and 38

Reg. No. 3,452,159

United States Patent and Trademark Office

Registered June 24, 2008

TRADEMARK  
PRINCIPAL REGISTER

christianaudio   
listen enjoy think grow

HOVEL AUDIO, INC. (CALIFORNIA CORPORATION)  
SUITE 106  
926 S. ANDREASEN DRIVE  
ESCONDIDO, CA 92029

FOR: AUDIO DIGITAL TAPES FEATURING PRE-RECORDED AUDIO CONTENT, NAMELY, RELIGION, THEOLOGY, THEATRICAL PERFORMANCES AND AUDIOBOOKS; DIGITAL MATERIALS, NAMELY, CDS, MP3CDS, DIGITAL DOWNLOADS, NAMELY, AUDIO FILES, MULTIMEDIA FILES FEATURING PRE-RECORDED AUDIO CONTENT, NAMELY, RELIGION, THEOLOGY, THEATRICAL PERFORMANCES AND AUDIOBOOKS; DIGITAL MEDIA, NAMELY, CDS, MP3CDS, DIGITAL DOWNLOADS, NAMELY AUDIO FILES, MULTIMEDIA FILE FEATURING PRE-RECORDED AUDIO CONTENT, NAMELY, RELIGION, THEOLOGY, THEATRICAL PERFORMANCES AND AUDIOBOOKS; PRERECORDED DIGITAL AUDIO TAPES FEATURING PRE-RECORDED AUDIO CONTENT, NAMELY, RELIGION, THEOLOGY, THEATRICAL PERFORMANCES AND AUDIOBOOKS; AUDIO DISCS FEATURING PRE-RECOR-

DED AUDIO CONTENT, NAMELY, MUSIC, RELIGION, THEOLOGY, THEATRICAL PERFORMANCES AND AUDIOBOOKS; DOWNLOADABLE MP3 FILES, MP3 RECORDINGS, ONLINE DISCUSSION BOARDS, WEB CASTS, POD CASTS FEATURING MUSIC, AUDIO BOOKS AND NEWS BROADCASTS; DOWNLOADABLE MUSICAL SOUND RECORDINGS; COMPACT DISCS FEATURING AUDIOBOOKS AND PRE-RECORDED AUDIO CONTENT, NAMELY, RELIGION, THEOLOGY, THEATRICAL PERFORMANCES; DOWNLOADABLE PRE-RECORDED AUDIO CONTENT, NAMELY, AUDIO FILES CONTAINING MUSIC, RELIGION, THEOLOGY, THEATRICAL PERFORMANCES AND AUDIOBOOKS VIA THE INTERNET AND WIRELESS DEVICES, IN CLASS 9 (U.S. CLS. 21, 23, 26, 36 AND 38).

FIRST USE 8-1-2004; IN COMMERCE 8-1-2004.

SER. NO. 77-155,533, FILED 4-12-2007.

MARY CRAWFORD, EXAMINING ATTORNEY

**Int. Cl.: 34**

**Prior U.S. Cls.: 2, 8, 9 and 17**

**United States Patent and Trademark Office**

**Reg. No. 3,452,160**

**Registered June 24, 2008**

**TRADEMARK  
PRINCIPAL REGISTER**

**CARLOS TORAÑO CASA TORAÑO**

C.A.T. TOBACCO CORPORATION (FLORIDA CORPORATION)  
7440 S.W. 50TH TERRACE, UNIT 106  
MIAMI, FL 33155

FOR: CIGARS, IN CLASS 34 (U.S. CLS. 2, 8, 9 AND 17).

FIRST USE 8-15-1997; IN COMMERCE 8-15-1997.

THE MARK CONSISTS OF STANDARD CHARACTERS WITHOUT CLAIM TO ANY PARTICULAR FONT, STYLE, SIZE, OR COLOR.

OWNER OF U.S. REG. NOS. 2,064,589, 3,127,301 AND OTHERS.

THE NAME "CARLOS TORAÑO" IDENTIFIES A LIVING INDIVIDUAL WHOSE CONSENT IS OF RECORD.

THE FOREIGN WORDING IN THE MARK TRANSLATES INTO ENGLISH AS "CASA TORANO" IS "HOUSE OF TORANO".

SER. NO. 77-156,016, FILED 4-13-2007.

JILL C. ALT, EXAMINING ATTORNEY

**Int. Cl.: 44**

**Prior U.S. Cls.: 100 and 101**

**United States Patent and Trademark Office**

**Reg. No. 3,452,161**

**Registered June 24, 2008**

**SERVICE MARK  
PRINCIPAL REGISTER**

**RXEOB**

RXEOB.COM, LLC (VIRGINIA CORPORATION)  
SUITE B  
406 WEST FRANKLIN STREET  
RICHMOND, VA 23220

FOR: PROVIDING HEALTH CARE INFORMATION IN THE NATURE OF PHARMACY BENEFITS INFORMATION TO CONSUMERS, IN CLASS 44 (U.S. CLS. 100 AND 101).

FIRST USE 3-18-2000; IN COMMERCE 5-24-2000.

THE MARK CONSISTS OF STANDARD CHARACTERS WITHOUT CLAIM TO ANY PARTICULAR FONT, STYLE, SIZE, OR COLOR.

OWNER OF U.S. REG. NO. 2,521,395.

SEC. 2(F).

SER. NO. 77-156,291, FILED 4-13-2007.

BERNICE MIDDLETON, EXAMINING ATTORNEY

**Int. Cl.: 25**

**Prior U.S. Cls.: 22 and 39**

**United States Patent and Trademark Office**

**Reg. No. 3,452,162**

**Registered June 24, 2008**

**TRADEMARK  
PRINCIPAL REGISTER**

**THE WAY TO A MAN'S HEART**

EAGLE CREST, INC. (FLORIDA CORPORATION)  
5353-1 RAMONA BOULEVARD  
JACKSONVILLE, FL 32205

FIRST USE 4-4-2007; IN COMMERCE 4-4-2007.

FOR: CLOTHING, NAMELY, HATS, SHIRTS,  
UNDERGARMENTS, SWIMSUITS, SWEATSHIRTS,  
SWEATERS, JACKETS, COATS, GLOVES, SCARVES,  
BELTS, HEADBANDS, WRISTBANDS, PANTS,  
SHORTS, SKIRTS, DRESSES, OVERALLS, SOCKS,  
STOCKINGS, AND LEGGINGS, IN CLASS 25 (U.S.  
CLS. 22 AND 39).

THE MARK CONSISTS OF STANDARD CHAR-  
ACTERS WITHOUT CLAIM TO ANY PARTICULAR  
FONT, STYLE, SIZE, OR COLOR.

SER. NO. 77-156,393, FILED 4-13-2007.

KAREN K. BUSH, EXAMINING ATTORNEY

**Int. Cl.: 25**

**Prior U.S. Cls.: 22 and 39**

**United States Patent and Trademark Office**

**Reg. No. 3,452,163**

**Registered June 24, 2008**

**TRADEMARK  
PRINCIPAL REGISTER**

**CAT SCRATCH FEVER**

EAGLE CREST, INC. (FLORIDA CORPORATION)  
5353-1 RAMONA BOULEVARD  
JACKSONVILLE, FL 32205

FOR: CLOTHING, NAMELY, HATS, SHIRTS,  
UNDERGARMENTS, SWIMSUITS, SWEATSHIRTS,  
SWEATERS, JACKETS, COATS, GLOVES, SCARVES,  
BELTS, HEADBANDS, WRISTBANDS, PANTS,  
SHORTS, SKIRTS, DRESSES, OVERALLS, SOCKS,  
STOCKINGS, AND LEGGINGS, IN CLASS 25 (U.S.  
CLS. 22 AND 39).

FIRST USE 4-4-2007; IN COMMERCE 4-4-2007.

THE MARK CONSISTS OF STANDARD CHAR-  
ACTERS WITHOUT CLAIM TO ANY PARTICULAR  
FONT, STYLE, SIZE, OR COLOR.

SER. NO. 77-156,447, FILED 4-13-2007.

KAREN K. BUSH, EXAMINING ATTORNEY

**Int. Cl.: 10**

**Prior U.S. Cls.: 26, 39 and 44**

**United States Patent and Trademark Office**

**Reg. No. 3,452,164**

**Registered June 24, 2008**

**TRADEMARK  
PRINCIPAL REGISTER**

**SNUGGLEBUG**

SNUGGLEBUG BABY (UTAH LTD LIAB CO)  
10717 S. MAUGHAN CIR.  
SOUTH JORDAN, UT 84095

FOR: PACIFIERS AND PACIFIER ACCESSORIES,  
NAMELY, PACIFIER RETENTION CLIPS FOR BA-  
BIES, IN CLASS 10 (U.S. CLS. 26, 39 AND 44).

FIRST USE 1-1-2005; IN COMMERCE 1-1-2005.

THE MARK CONSISTS OF STANDARD CHAR-  
ACTERS WITHOUT CLAIM TO ANY PARTICULAR  
FONT, STYLE, SIZE, OR COLOR.

SER. NO. 77-156,546, FILED 4-13-2007.

KATHERINE CONNOLLY, EXAMINING ATTOR-  
NEY



**Int. Cl.: 37**

**Prior U.S. Cls.: 100, 103 and 106**

**United States Patent and Trademark Office**

**Reg. No. 3,452,165**

**Registered June 24, 2008**

**SERVICE MARK  
PRINCIPAL REGISTER**

**SUPERIOR LIVING PRODUCTS**

SUPERIOR LIVING PRODUCTS, LLC (PENNSYLVANIA LTD LIAB CO)  
355 CIRCLE OF PROGRESS  
POTTSTOWN, PA 19464

FOR: INSTALLATION OF BATHTUBS, WALK-IN BATHTUBS, TOILETS, OVERSIZED TOILETS, SINKS, SHOWER ENCLOSURES, HANDICAPPED ACCESSIBLE TOILETS, HANDICAPPED ACCESSIBLE SHOWERS, BARRIER FREE SHOWERS, HANDICAPPED ACCESSIBLE BATHTUBS, HYDROTHERAPY TUBS, ELEVATORS, STAIR LIFTERS, BATH TUB LIFTERS, POOL AND SPA LIFTS, SAUNAS, STEAM ROOMS, BARRIER-FREE BATHING SYSTEMS, OXYGEN BARS, AROMATHERAPY BARS, IN CLASS 37 (U.S. CLS. 100, 103 AND 106).

FIRST USE 12-1-2005; IN COMMERCE 12-1-2005.

THE MARK CONSISTS OF STANDARD CHARACTERS WITHOUT CLAIM TO ANY PARTICULAR FONT, STYLE, SIZE, OR COLOR.

NO CLAIM IS MADE TO THE EXCLUSIVE RIGHT TO USE "SUPERIOR" OR "PRODUCTS" , APART FROM THE MARK AS SHOWN.

SER. NO. 77-156,602, FILED 4-13-2007.

JAMES A. RAUEN, EXAMINING ATTORNEY

**Int. Cl.: 35**

**Prior U.S. Cls.: 100, 101 and 102**

**United States Patent and Trademark Office**

**Reg. No. 3,452,166**

**Registered June 24, 2008**

**SERVICE MARK  
PRINCIPAL REGISTER**

**SUPERIOR LIVING PRODUCTS**

SUPERIOR LIVING PRODUCTS, LLC (PENNSYLVANIA LTD LIAB CO)  
355 CIRCLE OF PROGRESS  
POTTSTOWN, PA 19464

FOR: ON-LINE RETAIL STORE SERVICES FEATURING MOBILITY, SAFETY, AND ACCESSIBILITY AIDS FOR THE HOME, NAMELY, WALK-IN BATHTUBS, ADJUSTABLE BEDS, BATHLIFTERS, GRAB BARS, HEATING PADS, WHIRLPOOLS, SPAS, SAUNA AND STEAM ROOMS, MEDICAL ALERT SYSTEMS, AIR PURIFIERS, BARRIER FREE BATHING SYSTEMS, ELECTRIC WHEEL CHAIRS / SCOOTERS, DRY HYDROTHERAPY MASSAGE BEDS, MASSAGE CHAIRS, PERSONAL OXYGEN PRODUCTS I.E. OXYGENATED WATER DISPENSERS, PERSONAL OXYGEN MACHINES, WHEEL CHAIR RAMPS, AND ELEVATORS; RETAIL STORE SERVICES FEATURING MOBILITY, SAFETY, AND ACCESSIBILITY AIDS FOR THE HOME, NAMELY, WALK-IN BATHTUBS, ADJUSTABLE BEDS, BATHLIFTERS, GRAB BARS, HEATING PADS, WHIRLPOOLS, SPAS, SAUNA AND STEAM ROOMS, MEDICAL ALERT SYSTEMS, AIR

PURIFIERS, BARRIER FREE BATHING SYSTEMS, ELECTRIC WHEEL CHAIRS / SCOOTERS, DRY HYDROTHERAPY MASSAGE BEDS, MASSAGE CHAIRS, PERSONAL OXYGEN PRODUCTS I.E. OXYGENATED WATER DISPENSERS, PERSONAL OXYGEN MACHINES, WHEEL CHAIR RAMPS, AND ELEVATORS, IN CLASS 35 (U.S. CLS. 100, 101 AND 102).

FIRST USE 12-1-2005; IN COMMERCE 12-1-2005.

THE MARK CONSISTS OF STANDARD CHARACTERS WITHOUT CLAIM TO ANY PARTICULAR FONT, STYLE, SIZE, OR COLOR.

NO CLAIM IS MADE TO THE EXCLUSIVE RIGHT TO USE "SUPERIOR" OR "PRODUCTS", APART FROM THE MARK AS SHOWN.

SER. NO. 77-156,618, FILED 4-13-2007.

JAMES A. RAUEN, EXAMINING ATTORNEY

**Int. Cl.: 35**

**Prior U.S. Cls.: 100, 101 and 102**

**United States Patent and Trademark Office**

**Reg. No. 3,452,167**

**Registered June 24, 2008**

**SERVICE MARK  
PRINCIPAL REGISTER**

# Attitude Dancewear

RANGEL, CARLOS (UNITED STATES INDIVIDUAL)  
8790 NW 50 DRIVE  
CORAL SPRINGS, FL 33067

FOR: RETAIL STORE SERVICES FEATURING DANCE CLOTHING, DANCE SHOES, DANCE APPAREL AND DANCE ACCESSORIES, IN CLASS 35 (U.S. CLS. 100, 101 AND 102).

FIRST USE 6-1-2002; IN COMMERCE 8-1-2002.

THE MARK CONSISTS OF STANDARD CHARACTERS WITHOUT CLAIM TO ANY PARTICULAR FONT, STYLE, SIZE, OR COLOR.

NO CLAIM IS MADE TO THE EXCLUSIVE RIGHT TO USE "DANCEWEAR", APART FROM THE MARK AS SHOWN.

SER. NO. 77-157,084, FILED 4-15-2007.

TERESA M. RUPP, EXAMINING ATTORNEY

**Int. Cl.: 41**

**Prior U.S. Cls.: 100, 101 and 107**

**Reg. No. 3,452,168**

**United States Patent and Trademark Office**

**Registered June 24, 2008**

**SERVICE MARK  
PRINCIPAL REGISTER**



LORTON ARTS FOUNDATION, INC. (VIRGINIA CORPORATION)

9601 OX ROAD

LORTON, VA 22079

FOR: EDUCATION SERVICES, NAMELY, PROVIDING LECTURES, WORKSHOPS AND CLASSES IN THE FIELDS OF PERFORMING ARTS, ACTING, THEATER, FINE ARTS, PAINTING, CRAFTS; ENTERTAINMENT IN THE NATURE OF DANCE PERFORMANCES; ENTERTAINMENT IN THE NATURE OF THEATER PRODUCTIONS; ENTERTAINMENT, NAMELY, LIVE MUSIC CONCERTS; ART EXHIBITIONS; CONDUCTING WORKSHOPS AND SEMINARS IN PERFORMING ARTS AND FINE ART; ENTERTAINMENT, NAMELY, PRODUCTION OF THEATRICAL SHOWS AND MUSIC CONCERTS, IN CLASS 41 (U.S. CLS. 100, 101 AND 107).

FIRST USE 8-1-2006; IN COMMERCE 8-1-2006.

NO CLAIM IS MADE TO THE EXCLUSIVE RIGHT TO USE "ARTS CENTER AT LORTON", APART FROM THE MARK AS SHOWN.

THE COLOR(S) BLACK, PURPLE, WHITE AND YELLOW IS/ARE CLAIMED AS A FEATURE OF THE MARK.

THE MARK CONSISTS OF A YELLOW SUN OVER A WHITE TRIANGLE OVER A PURPLE BUILDING OVER A YELLOW LINE. THE WHITE TRIANGLE AT THE TOP OF THE MARK AND THE WHITE BORDER ON BOTH SIDES OF THE MARK CONSTITUTES BACKGROUND AREA AND IS NOT PART OF THE MARK. THE WORD "WORKHOUSE" IS IN THE COLOR BLACK ABOVE THE WORDS "ARTS CENTER AT LORTON" IN THE COLOR PURPLE.

SER. NO. 77-157,218, FILED 4-16-2007.

LOURDES AYALA, EXAMINING ATTORNEY

**Int. Cl.: 25**

**Prior U.S. Cls.: 22 and 39**

**United States Patent and Trademark Office**

**Reg. No. 3,452,169**

**Registered June 24, 2008**

**TRADEMARK  
PRINCIPAL REGISTER**

**LIL' SQUIRTZ**

LIL' SQUIRTZ CLOTHING COMPANY LLC (WA-  
SHINGTON LTD LIAB CO)  
303 NE 135TH STREET  
VANCOUVER, WA 98685

FOR: INFANT, TODDLER AND YOUTH CLOTH-  
ING, NAMELY, SHIRTS, PANTS, SKIRTS, HATS  
AND ONE-PIECE T-SHIRTS, IN CLASS 25 (U.S. CLS.  
22 AND 39).

FIRST USE 7-30-2006; IN COMMERCE 11-29-2006.

THE MARK CONSISTS OF STANDARD CHAR-  
ACTERS WITHOUT CLAIM TO ANY PARTICULAR  
FONT, STYLE, SIZE, OR COLOR.

SER. NO. 77-157,482, FILED 4-16-2007.

KATHLEEN M. VANSTON, EXAMINING ATTOR-  
NEY

Int. Cl.: 33

Prior U.S. Cls.: 47 and 49

United States Patent and Trademark Office

Reg. No. 3,452,170

Registered June 24, 2008

TRADEMARK  
PRINCIPAL REGISTER

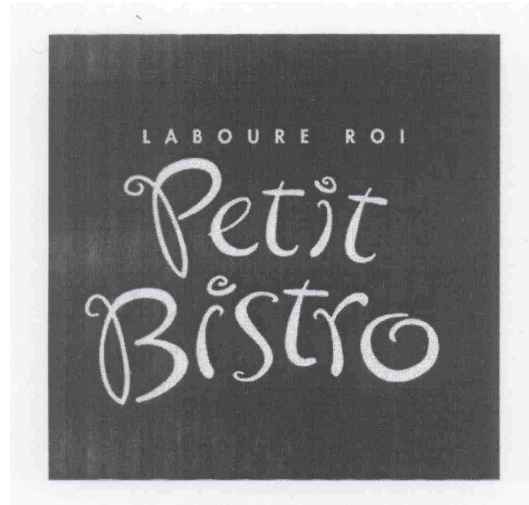

PALM BAY INTERNATIONAL, INC. (FLORIDA CORPORATION)  
48 HARBOR PARK DRIVE  
PORT WASHINGTON, NY 11050

FOR: ALCOHOLIC BEVERAGES, NAMELY, WINES, IN CLASS 33 (U.S. CLS. 47 AND 49).

FIRST USE 1-26-2006; IN COMMERCE 1-26-2006.

THE FOREIGN WORDS "PETIT BISTRO" IN THE MARK TRANSLATES INTO ENGLISH AS "SMALL CAFE." THE WORDING "LABOURE-ROI" DOES NOT HAVE A MEANING IN A FOREIGN LANGUAGE.

SER. NO. 77-157,625, FILED 4-16-2007.

ALEX KEAM, EXAMINING ATTORNEY

**Int. Cl.: 36**

**Prior U.S. Cls.: 100, 101 and 102**

**United States Patent and Trademark Office**

**Reg. No. 3,452,171**

**Registered June 24, 2008**

**SERVICE MARK  
PRINCIPAL REGISTER**

GET READY FOR THE FUTURE

JOHN SHREWSBURY (UNITED STATES INDIVIDUAL)  
SUITE 2  
612 WEST COMMERCE  
BRYANT, AR 72022

FOR: FINANCIAL PLANNING, NAMELY, THE CREATION OF PERSONALIZED STRATEGIES TO ACHIEVE FINANCIAL INDEPENDENCE, IN CLASS 36 (U.S. CLS. 100, 101 AND 102).

FIRST USE 1-1-2005; IN COMMERCE 7-13-2005.

THE MARK CONSISTS OF STANDARD CHARACTERS WITHOUT CLAIM TO ANY PARTICULAR FONT, STYLE, SIZE, OR COLOR.

SER. NO. 77-157,850, FILED 4-16-2007.

RICHARD A. STRASER, EXAMINING ATTORNEY

**Int. Cl.: 38**

**Prior U.S. Cls.: 100, 101 and 104**

**United States Patent and Trademark Office**

**Reg. No. 3,452,172**

**Registered June 24, 2008**

**SERVICE MARK  
PRINCIPAL REGISTER**

**TURCK CONNECT**

TURCK INC. (MINNESOTA CORPORATION)  
3000 CAMPUS DRIVE  
PLYMOUTH, MN 554412656

OWNER OF U.S. REG. NOS. 3,227,006 AND  
3,227,215.

FOR: WORKGROUP COMMUNICATION SERVICES IN THE NATURE OF PROVIDING ELECTRONIC TELECOMMUNICATION CONNECTIONS OVER COMPUTER NETWORKS FOR GROUPS OF COMPUTER USERS, IN CLASS 38 (U.S. CLS. 100, 101 AND 104).

NO CLAIM IS MADE TO THE EXCLUSIVE RIGHT TO USE "CONNECT", APART FROM THE MARK AS SHOWN.

FIRST USE 10-0-2000; IN COMMERCE 10-0-2000.

THE WORDING "TURCK" HAS NO MEANING IN A FOREIGN LANGUAGE.

THE MARK CONSISTS OF STANDARD CHARACTERS WITHOUT CLAIM TO ANY PARTICULAR FONT, STYLE, SIZE, OR COLOR.

SER. NO. 77-157,908, FILED 4-16-2007.

MAUREEN DALL, EXAMINING ATTORNEY



**Int. Cl.: 41**

**Prior U.S. Cls.: 100, 101 and 107**

**United States Patent and Trademark Office**

**Reg. No. 3,452,173**

**Registered June 24, 2008**

**SERVICE MARK  
PRINCIPAL REGISTER**

**STARCAST STUDIOS**

VERILOGIX, INC. (CALIFORNIA CORPORATION)  
23705 CRENSHAW BLVD, SUITE 101  
TORRANCE, CA 90505

FOR: VIDEO PRODUCTION SERVICES FOR CREATING INTERACTIVE E-LEARNING COURSES, WEB PRESENTATIONS OR WEBCASTS, TESTS AND SURVEYS FOR DATA COLLECTION, INTERNET ADVERTISING, AND FOR EDUCATIONAL TRAINING IN THE FIELDS OF MANUFACTURING, AEROSPACE, AUTOMOTIVE, HIGH TECH, RETAIL, FINANCIAL, INSURANCE, HEALTHCARE, GOVERNMENT, UTILITIES, TRANSPORTATION, AND SECURITY INDUSTRIES, IN CLASS 41 (U.S. CLS. 100, 101 AND 107).

FIRST USE 11-0-2006; IN COMMERCE 11-0-2006.

THE MARK CONSISTS OF STANDARD CHARACTERS WITHOUT CLAIM TO ANY PARTICULAR FONT, STYLE, SIZE, OR COLOR.

OWNER OF U.S. REG. NO. 2,918,840.

NO CLAIM IS MADE TO THE EXCLUSIVE RIGHT TO USE "STUDIOS" , APART FROM THE MARK AS SHOWN.

SER. NO. 77-157,957, FILED 4-16-2007.

CARYN GLASSER, EXAMINING ATTORNEY

**Int. Cls.: 35 and 38**

**Prior U.S. Cls.: 100, 101, 102 and 104**

**United States Patent and Trademark Office**

**Reg. No. 3,452,174**

**Registered June 24, 2008**

**SERVICE MARK  
PRINCIPAL REGISTER**

**SKC**

SKC COMMUNICATION PRODUCTS, INC.  
(KANSAS CORPORATION)  
8320 HEDGE LANE TERR.  
SHAWNEE MISSION, KS 66227

FOR: RETAIL DIRECT TO CUSTOMER AND ONLINE STORE SERVICES FEATURING TELECOMMUNICATION PRODUCTS, NAMELY, COMPUTER SOFTWARE FOR TELECONFERENCING AND VIDEO CONFERENCING, COMPUTER SOFTWARE FOR INTEGRATING, CONTROLLING, ENHANCING, SECURING, AND MANAGING VIDEO, VOICE AND DATA COMMUNICATIONS, COMPUTER HARDWARE, SPEAKERPHONES, TELECONFERENCING, VIDEO CONFERENCING AND ELECTRONIC CONFERENCING HARDWARE CONSULTING SERVICES REGARDING TELECOMMUNICATIONS, IN CLASS 35 (U.S. CLS. 100, 101 AND 102).

FIRST USE 12-31-1986; IN COMMERCE 12-31-1986.

FOR: TELECOMMUNICATIONS SERVICES, NAMELY, AUDIO TELECONFERENCING; NETWORK CONFERENCING SERVICES; PROVIDING FACILITIES AND EQUIPMENT FOR VIDEO CONFERENCING; PROVIDING TELEPHONE CONFERENCING SERVICES; VIDEO TELECONFERENCING; WEB CONFERENCING SERVICES, IN CLASS 38 (U.S. CLS. 100, 101 AND 104).

FIRST USE 12-31-1986; IN COMMERCE 12-31-1986.

THE MARK CONSISTS OF STANDARD CHARACTERS WITHOUT CLAIM TO ANY PARTICULAR FONT, STYLE, SIZE, OR COLOR.

SER. NO. 77-158,170, FILED 4-17-2007.

FRANK LATTUCA, EXAMINING ATTORNEY

**Int. Cl.: 9**

**Prior U.S. Cls.: 21, 23, 26, 36 and 38**

**Reg. No. 3,452,175**

**United States Patent and Trademark Office**

**Registered June 24, 2008**

**TRADEMARK  
PRINCIPAL REGISTER**

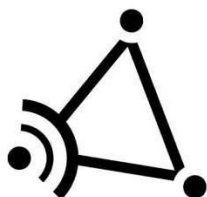

TELCHEMY, INC. (DELAWARE CORPORATION)  
SUITE 280  
2905 PREMIER PARKWAY  
DULUTH, GA 30097

FOR: COMMUNICATIONS SOFTWARE FOR  
MANAGING THE QUALITY OF SERVICE PROVIDED BY A MULTIMEDIA COMMUNICATION NETWORK AND COMMUNICATION NETWORK HARDWARE, NAMELY, COMPUTER NETWORK SERVERS AND ROUTERS; COMPUTER HARDWARE, IN CLASS 9 (U.S. CLS. 21, 23, 26, 36 AND 38).

THE MARK CONSISTS OF A GEOMETRIC DESIGN WITH AN OVERALL EQUILATERAL TRIANGULAR SHAPE, WITH SPHERES APPEARING ADJACENT TO EACH ANGLE, AND THE BOTTOM LEFT ANGLE INTERSECTED BY TWO CURVED LINES THAT APPEAR TO RADIATE FROM THE SPHERE ADJACENT TO THAT ANGLE.

SER. NO. 77-158,238, FILED 4-17-2007.

FIRST USE 0-0-2005; IN COMMERCE 0-0-2005.

KAELIE KUNG, EXAMINING ATTORNEY

**Int. Cl.: 14**

**Prior U.S. Cls.: 2, 27, 28 and 50**

**United States Patent and Trademark Office**

**Reg. No. 3,452,176**

**Registered June 24, 2008**

**TRADEMARK  
PRINCIPAL REGISTER**

**R. RAVEN**

MARKS, GAVIN (UNITED STATES INDIVIDUAL)  
835 N. CHURCH CT.  
ELMHURST, IL 60126

FOR: JEWELRY, NOT RELATED TO, PROVIDED FOR, OR USED ON OR IN CONNECTION WITH SPORTS, SPORTING EVENTS, OR SPORTS TEAMS, IN CLASS 14 (U.S. CLS. 2, 27, 28 AND 50).

FIRST USE 1-0-2007; IN COMMERCE 1-0-2007.

THE MARK CONSISTS OF STANDARD CHARACTERS WITHOUT CLAIM TO ANY PARTICULAR FONT, STYLE, SIZE, OR COLOR.

SER. NO. 77-158,416, FILED 4-17-2007.

ALICE SUE CARRUTHERS, EXAMINING ATTORNEY

**Int. Cl.: 41**

**Prior U.S. Cls.: 100, 101 and 107**

**United States Patent and Trademark Office**

**Reg. No. 3,452,177**

**Registered June 24, 2008**

**SERVICE MARK  
PRINCIPAL REGISTER**



RALLY AMERICA, INC. (MINNESOTA CORPORATION)  
SUITE 617  
8014 OLSON MEMORIAL HIGHWAY  
GOLDEN VALLEY, MN 55427

FOR: ORGANIZING, GOVERNING, OPERATING, SANCTIONING, AND PROMOTING AUTOMOBILE RACE EVENTS AND COMPETITIONS; PROVIDING EQUIPMENT RENTAL FOR TIMING AND MONITORING AUTOMOBILE RACE EVENTS AND COMPETITIONS, IN CLASS 41 (U.S. CLS. 100, 101 AND 107).

FIRST USE 12-14-2004; IN COMMERCE 12-14-2004.

NO CLAIM IS MADE TO THE EXCLUSIVE RIGHT TO USE "RALLY AMERICA", APART FROM THE MARK AS SHOWN.

THE MARK CONSISTS OF THE WORDS "RALLY AMERICA" WITH A BOOMERANG DESIGN BEGINNING AT THE SECOND "L" IN "RALLY", PIERCING THROUGH THE LETTER "R" IN "RALLY", AND ENDING BELOW THE LETTER "R" IN "AMERICA".

SER. NO. 77-158,509, FILED 4-17-2007.

JAMES STEIN, EXAMINING ATTORNEY

**Int. Cl.: 5**

**Prior U.S. Cls.: 6, 18, 44, 46, 51 and 52**

**Reg. No. 3,452,178**

**United States Patent and Trademark Office**

**Registered June 24, 2008**

---

**TRADEMARK  
PRINCIPAL REGISTER**

**SINOGRAFIN**

BRACCO DIAGNOSTICS INC. (DELAWARE  
CORPORATION)  
107 COLLEGE ROAD EAST  
PRINCETON, NJ 08540

FOR: CONTRAST MEDIUM FOR HYSTEROSAL-  
PINGOGRAPHY AND VISUALIZATION OF SINUS  
FISTULAS, IN CLASS 5 (U.S. CLS. 6, 18, 44, 46, 51 AND  
52).

FIRST USE 11-20-1956; IN COMMERCE 11-20-1956.

THE MARK CONSISTS OF STANDARD CHAR-  
ACTERS WITHOUT CLAIM TO ANY PARTICULAR  
FONT, STYLE, SIZE, OR COLOR.

OWNER OF U.S. REG. NOS. 618,899, 839,053 AND  
OTHERS.

SER. NO. 77-158,643, FILED 4-17-2007.

NICHOLAS ALTREE, EXAMINING ATTORNEY

**Int. Cl.: 11**

**Prior U.S. Cls.: 13, 21, 23, 31 and 34**

**United States Patent and Trademark Office**

**Reg. No. 3,452,179**

**Registered June 24, 2008**

**TRADEMARK  
PRINCIPAL REGISTER**



**POWERMARK**

SHANGHAI POWERMARK LIGHTING TECH-  
NOLOGY CO., LTD (CHINA CORPORATION)  
A-084, NO. 400, YINGYUAN ROAD  
JIADING DISTRICT  
SHANGHAI, CHINA

FOR: ELECTRIC LIGHTING FIXTURES; LIGHT  
DIFFUSERS; SAFETY LAMPS FOR UNDER-  
GROUND USE; LIGHTING TUBES; STREET  
LAMPS; SEARCHLIGHTS; AQUARIUM LIGHTS;

LIGHTS FOR VEHICLES, IN CLASS 11 (U.S. CLS.  
13, 21, 23, 31 AND 34).

FIRST USE 8-1-2006; IN COMMERCE 8-1-2006.

SER. NO. 77-159,096, FILED 4-17-2007.

STEPHEN AQUILA, EXAMINING ATTORNEY

**Int. Cl.: 36**

**Prior U.S. Cls.: 100, 101 and 102**

**United States Patent and Trademark Office**

**Reg. No. 3,452,180**

**Registered June 24, 2008**

**SERVICE MARK  
PRINCIPAL REGISTER**

**AMBUSH**

BANK OF AMERICA CORPORATION (DELA-  
WARE CORPORATION)  
100 NORTH TRYON STREET  
CHARLOTTE, NC 28255

FOR: FINANCIAL SERVICES IN THE NATURE  
OF PROVIDING A SECURITIES TRADING SYS-  
TEM; ELECTRONICALLY PROVIDING THE SER-  
VICES OF A SECURITIES TRADING BROKER;  
FINANCIAL SERVICES IN THE NATURE OF PRO-  
VIDING AN ALGORITHMIC TRADING STRAT-  
EGY; INFORMATION SERVICES RELATING TO  
FINANCE AND FINANCIAL NEWS, NAMELY,  
PROVIDING ANALYSES OF SECURITIES MAR-

KETS AND MODELS THAT OBJECTIVELY TRADE  
SECURITIES, IN CLASS 36 (U.S. CLS. 100, 101 AND  
102).

FIRST USE 1-24-2006; IN COMMERCE 1-24-2006.

THE MARK CONSISTS OF STANDARD CHAR-  
ACTERS WITHOUT CLAIM TO ANY PARTICULAR  
FONT, STYLE, SIZE, OR COLOR.

SER. NO. 77-159,401, FILED 4-18-2007.

TINA BROWN, EXAMINING ATTORNEY



**Int. Cl.: 36**

**Prior U.S. Cls.: 100, 101 and 102**

**United States Patent and Trademark Office**

**Reg. No. 3,452,181**

**Registered June 24, 2008**

**SERVICE MARK  
PRINCIPAL REGISTER**



NATIONAL SAFETY COUNCIL (UNITED STATES CHARTERED CORPORATION)  
1121 SPRING LAKE DRIVE  
ITASCA, IL 601433201

FOR: CHARITABLE FUND RAISING BY MEANS OF ORGANIZING AND CONDUCTING GOLF TOURNAMENTS, IN CLASS 36 (U.S. CLS. 100, 101 AND 102).

FIRST USE 6-0-2000; IN COMMERCE 8-7-2000.

OWNER OF U.S. REG. NOS. 1,930,643, 2,942,519 AND OTHERS.

NO CLAIM IS MADE TO THE EXCLUSIVE RIGHT TO USE "GOLF", APART FROM THE MARK AS SHOWN.

SEC. 2(F) AS TO "NATIONAL SAFETY COUNCIL".

SER. NO. 77-159,910, FILED 4-18-2007.

ODESSA BIBBINS, EXAMINING ATTORNEY

Int. Cl.: 28

Prior U.S. Cls.: 22, 23, 38 and 50

United States Patent and Trademark Office

Reg. No. 3,452,182

Registered June 24, 2008

TRADEMARK  
PRINCIPAL REGISTER



WANDERER'S CLUB, L.L.C (FLORIDA LTD  
LIAB CO)  
350 ROYAL PALM WAY, STE. 409  
PALM BEACH, FL 33480

FOR: DIVOT REPAIR TOOL FOR GOLFERS;  
FITTED HEAD COVERS FOR GOLF CLUBS; GOLF  
ACCESSORY POUCHES; GOLF BAG COVERS;  
GOLF BAG TAGS; GOLF BAGS; GOLF BALL MAR-  
KERS; GOLF BALL RETRIEVERS; GOLF BALL  
SLEEVES; GOLF BALLS; GOLF CLUB GRIPS; GOLF  
CLUB SHAFTS; GOLF CLUBS; GOLF FLAGS; GOLF  
GLOVES; GOLF PUTTER COVERS; GOLF TEES;  
GRIP TAPES FOR GOLF CLUBS; HAND GRIPS FOR  
GOLF CLUBS, IN CLASS 28 (U.S. CLS. 22, 23, 38 AND  
50).

FIRST USE 4-6-2007; IN COMMERCE 4-6-2007.

NO CLAIM IS MADE TO THE EXCLUSIVE  
RIGHT TO USE "WELLINGTON", APART FROM  
THE MARK AS SHOWN.

THE MARK CONSISTS OF A PICTURE OF A  
WALKING ELEPHANT INSIDE THE INNER CIR-  
CLE OF TWO CONCENTRIC CIRCLES, AND THE  
WORDS "THE WANDERERS CLUB WELLINGTON"  
IN BETWEEN THE TWO CONCENTRIC CIRCLES.

SER. NO. 77-159,932, FILED 4-18-2007.

SARA THOMAS, EXAMINING ATTORNEY

**Int. Cl.: 25**

**Prior U.S. Cls.: 22 and 39**

**United States Patent and Trademark Office**

**Reg. No. 3,452,183**

**Registered June 24, 2008**

**TRADEMARK  
PRINCIPAL REGISTER**

**Vanilla Crème**

ALLISON PLACE SHIRT CORP. (ALABAMA  
CORPORATION)  
2615 FRUITLAND AVE.  
VERNON, CA 90058

FOR: BLOUSES; BOOTS; CAPS; COATS; COVER-  
UPS; DRESSES; HATS; JACKETS; LINGERIE;  
PANTS; SWEAT PANTS; SANDALS; SCARVES;  
SHIRTS; SHOES; SHORTS; SKIRTS; SLEEPWEAR;  
SLIPPERS; SOCKS; SWEAT SHIRTS; SWEAT

SHORTS; SWEATERS; SWIM WEAR; T-SHIRTS;  
VESTS; VISORS, IN CLASS 25 (U.S. CLS. 22 AND 39).

FIRST USE 4-18-2007; IN COMMERCE 4-18-2007.

OWNER OF U.S. REG. NO. 2,838,279.

SER. NO. 77-160,063, FILED 4-18-2007.

MORGAN WYNNE, EXAMINING ATTORNEY

**Int. Cl.: 21**

**Prior U.S. Cls.: 2, 13, 23, 29, 30, 33, 40 and 50**

**Reg. No. 3,452,184**

**United States Patent and Trademark Office**

**Registered June 24, 2008**

---

**TRADEMARK  
PRINCIPAL REGISTER**

**"HANDS FREE" RECYCLING  
FUNNEL**

GEO PLASTICS (CALIFORNIA CORPORATION)  
2200 E. 52ND STREET  
LOS ANGELES, CA 90058

NO CLAIM IS MADE TO THE EXCLUSIVE  
RIGHT TO USE "FUNNEL", APART FROM THE  
MARK AS SHOWN.

FOR: FUNNELS, IN CLASS 21 (U.S. CLS. 2, 13, 23,  
29, 30, 33, 40 AND 50).

SEC. 2(F).

FIRST USE 1-31-1996; IN COMMERCE 1-31-1996.

SER. NO. 77-160,085, FILED 4-18-2007.

THE MARK CONSISTS OF STANDARD CHAR-  
ACTERS WITHOUT CLAIM TO ANY PARTICULAR  
FONT, STYLE, SIZE, OR COLOR.

SARA THOMAS, EXAMINING ATTORNEY

**Int. Cl.: 20**

**Prior U.S. Cls.: 2, 13, 22, 25, 32 and 50**

**United States Patent and Trademark Office**

**Reg. No. 3,452,185**

**Registered June 24, 2008**

**TRADEMARK  
PRINCIPAL REGISTER**

**DRAINER CONTAINER**

GEO PLASTICS (CALIFORNIA CORPORATION)  
2200 E. 52ND STREET  
LOS ANGELES, CA 90058

FOR: PLASTIC CONTAINER TO HOLD AND  
TRANSPORT MOTOR OIL, NAMELY, AN EN-  
CLOSED PLASTIC AUTOMOTIVE OIL CHANGE  
PAN, IN CLASS 20 (U.S. CLS. 2, 13, 22, 25, 32 AND 50).

FIRST USE 1-5-1993; IN COMMERCE 4-21-1993.

THE MARK CONSISTS OF STANDARD CHAR-  
ACTERS WITHOUT CLAIM TO ANY PARTICULAR  
FONT, STYLE, SIZE, OR COLOR.

NO CLAIM IS MADE TO THE EXCLUSIVE  
RIGHT TO USE "CONTAINER", APART FROM  
THE MARK AS SHOWN.

SEC. 2(F).

SER. NO. 77-160,087, FILED 4-18-2007.

SARA THOMAS, EXAMINING ATTORNEY

**Int. Cl.: 20**

**Prior U.S. Cls.: 2, 13, 22, 25, 32 and 50**

**United States Patent and Trademark Office**

**Reg. No. 3,452,186**

**Registered June 24, 2008**

**TRADEMARK  
PRINCIPAL REGISTER**

**EARTHART**

GOLD LEAF DESIGN GROUP, INC. (ILLINOIS  
CORPORATION)  
337 N. OAKLEY BLVD.  
CHICAGO, IL 60612

FOR: WORKS OF ART OF NATURALLY OCCUR-  
ING ELEMENTS AND NON-SYNTHETIC MATERI-  
ALS, NAMELY, WOOD, SEEDS, PORTIONS OF  
PLANTS, STEMS, LEAVES, PINE CONES, AND  
CACTI, IN CLASS 20 (U.S. CLS. 2, 13, 22, 25, 32 AND  
50).

FIRST USE 1-12-2007; IN COMMERCE 1-12-2007.

THE MARK CONSISTS OF STANDARD CHAR-  
ACTERS WITHOUT CLAIM TO ANY PARTICULAR  
FONT, STYLE, SIZE, OR COLOR.

SER. NO. 77-160,329, FILED 4-19-2007.

JILL C. ALT, EXAMINING ATTORNEY

**Int. Cls.: 40, 41 and 42**

**Prior U.S. Cls.: 100, 101, 103, 106 and 107**

**United States Patent and Trademark Office**

**Reg. No. 3,452,187**

**Registered June 24, 2008**

**SERVICE MARK  
PRINCIPAL REGISTER**

# IMEMORIES

IMEMORIES, LLC (ARIZONA LTD LIAB CO)  
9181 EAST BELL ROAD, SUITE 101  
SCOTTSDALE, AZ 85260

FOR: REMASTERING OF FILMS FROM ONE  
FORMAT TO ANOTHER; ELECTRONIC DIGITIZ-  
ING OF PHOTOGRAPHS INTO A COMPUTER  
READABLE MEDIA, IN CLASS 40 (U.S. CLS. 100,  
103 AND 106).

FIRST USE 5-10-1999; IN COMMERCE 5-10-1999.

FOR: PROVIDING A WEBSITE FEATURING ON-  
LINE VIEWING, SHARING AND EDITING OF  
DIGITAL VIDEO AND PHOTOGRAPHS, IN CLASS  
41 (U.S. CLS. 100, 101 AND 107).

FIRST USE 5-10-1999; IN COMMERCE 5-10-1999.

FOR: DIGITAL TRANSFER SERVICES FOR  
TRANSFERRING HOME VIDEOS AND FILM TO  
DVD AND THE INTERNET, IN CLASS 42 (U.S. CLS.  
100 AND 101).

FIRST USE 5-10-1999; IN COMMERCE 5-10-1999.

THE MARK CONSISTS OF STANDARD CHAR-  
ACTERS WITHOUT CLAIM TO ANY PARTICULAR  
FONT, STYLE, SIZE, OR COLOR.

SER. NO. 77-160,428, FILED 4-19-2007.

KYLE PEETE, EXAMINING ATTORNEY

**Int. Cl.: 41**

**Prior U.S. Cls.: 100, 101 and 107**

**United States Patent and Trademark Office**

**Reg. No. 3,452,188**

**Registered June 24, 2008**

**SERVICE MARK  
PRINCIPAL REGISTER**



LEARNING CENTERS OF CENTRAL FLORIDA,  
LLC (FLORIDA LTD LIAB CO)  
401 W. COLONIAL DRIVE  
ORLANDO, FL 32804

THE COLOR(S) ROYAL BLUE AND YELLOW IS/  
ARE CLAIMED AS A FEATURE OF THE MARK.

FOR: EDUCATIONAL SERVICES, NAMELY,  
PROVIDING TUTORING IN THE FIELD OF GEN-  
ERAL EDUCATION AT THE PRIMARY AND SEC-  
ONDARY EDUCATIONAL LEVELS , IN CLASS 41  
(U.S. CLS. 100, 101 AND 107).

THE MARK CONSISTS OF THE LITERAL ELE-  
MENT "TUTOR" "U" IN ROYAL BLUE WITH  
YELLOW BACKGROUND.

FIRST USE 4-0-2005; IN COMMERCE 9-0-2005.

SER. NO. 77-160,429, FILED 4-19-2007.

NO CLAIM IS MADE TO THE EXCLUSIVE  
RIGHT TO USE "TUTOR", APART FROM THE  
MARK AS SHOWN.

WILLIAM ROSSMAN, EXAMINING ATTORNEY



**Int. Cl.: 41**

**Prior U.S. Cls.: 100, 101 and 107**

**United States Patent and Trademark Office**

**Reg. No. 3,452,189**

**Registered June 24, 2008**

**SERVICE MARK  
PRINCIPAL REGISTER**

**TUTOR U**

LEARNING CENTERS OF CENTRAL FLORIDA,  
LLC (FLORIDA LTD LIAB CO)  
401 W. COLONIAL DRIVE  
ORLANDO, FL 32804

FOR: EDUCATIONAL SERVICES, NAMELY,  
PROVIDING TUTORING IN THE FIELD OF GEN-  
ERAL EDUCATION AT THE PRIMARY AND SEC-  
ONDARY EDUCATIONAL LEVELS , IN CLASS 41  
(U.S. CLS. 100, 101 AND 107).

FIRST USE 4-0-2005; IN COMMERCE 9-0-2005.

THE MARK CONSISTS OF STANDARD CHAR-  
ACTERS WITHOUT CLAIM TO ANY PARTICULAR  
FONT, STYLE, SIZE, OR COLOR.

NO CLAIM IS MADE TO THE EXCLUSIVE  
RIGHT TO USE "TUTOR", APART FROM THE  
MARK AS SHOWN.

SER. NO. 77-160,433, FILED 4-19-2007.

WILLIAM ROSSMAN, EXAMINING ATTORNEY

**Int. Cl.: 41**

**Prior U.S. Cls.: 100, 101 and 107**

**United States Patent and Trademark Office**

**Reg. No. 3,452,190**

**Registered June 24, 2008**

**SERVICE MARK  
PRINCIPAL REGISTER**



LEARNING CENTERS OF CENTRAL FLORIDA,  
LLC (FLORIDA LTD LIAB CO)  
401 W. COLONIAL DRIVE  
ORLANDO, FL 32804

FOR: EDUCATIONAL SERVICES, NAMELY,  
PROVIDING TUTORING IN THE FIELD OF GEN-  
ERAL EDUCATION AT THE PRIMARY AND SEC-  
ONDARY EDUCATIONAL LEVELS , IN CLASS 41  
(U.S. CLS. 100, 101 AND 107).

FIRST USE 4-0-2006; IN COMMERCE 4-0-2006.

NO CLAIM IS MADE TO THE EXCLUSIVE  
RIGHT TO USE "TUTOR", APART FROM THE  
MARK AS SHOWN.

THE COLOR(S) BLACK, WHITE, ROYAL BLUE,  
NAVY, YELLOW, RED, BROWN, LIGHT BROWN,  
PINK AND GRAY IS/ARE CLAIMED AS A FEAT-  
URE OF THE MARK.

THE MARK CONSISTS OF THE LITERAL ELE-  
MENT "A+" IN BLACK AND WHITE; THE LIT-  
ERAL ELEMENT "TUTOR U" IN ROYAL BLUE  
WITH A YELLOW BACKGROUND; THE DESIGN  
OF GIRL HAS BROWN HAIR WITH RED HAIR  
BANDS, LIGHT BROWN SKIN, WHITE T-SHIRT  
WITH ROYAL BLUE COLLAR, ROYAL BLUE  
PANTS, WHITE SHOES WITH RED SOLES; THE  
DESIGN OF BOY HAS RED HAT, PINK SKIN,  
WHITE T-SHIRT, NAVY PANTS, WHITE SHOES  
WITH GRAY SOLES, HOLDING A YELLOW BOOK  
WITH ROYAL BLUE STRIPE WITH BOTH CHIL-  
DREN STANDING ON A GREY SHADOW.

SER. NO. 77-160,438, FILED 4-19-2007.

WILLIAM ROSSMAN, EXAMINING ATTORNEY

**Int. Cl.: 41**

**Prior U.S. Cls.: 100, 101 and 107**

**United States Patent and Trademark Office**

**Reg. No. 3,452,191**

**Registered June 24, 2008**

**SERVICE MARK  
PRINCIPAL REGISTER**

**A+ TUTOR U**

LEARNING CENTERS OF CENTRAL FLORIDA,  
LLC (FLORIDA LTD LIAB CO)  
401 W. COLONIAL DRIVE  
ORLANDO, FL 32804

FOR: EDUCATIONAL SERVICES, NAMELY,  
PROVIDING TUTORING IN THE FIELD OF GEN-  
ERAL EDUCATION AT THE PRIMARY AND SEC-  
ONDARY EDUCATIONAL LEVELS , IN CLASS 41  
(U.S. CLS. 100, 101 AND 107).

FIRST USE 4-0-2006; IN COMMERCE 4-0-2006.

THE MARK CONSISTS OF STANDARD CHAR-  
ACTERS WITHOUT CLAIM TO ANY PARTICULAR  
FONT, STYLE, SIZE, OR COLOR.

NO CLAIM IS MADE TO THE EXCLUSIVE  
RIGHT TO USE "TUTOR", APART FROM THE  
MARK AS SHOWN.

SER. NO. 77-160,443, FILED 4-19-2007.

WILLIAM ROSSMAN, EXAMINING ATTORNEY

Int. Cl.: 41

Prior U.S. Cls.: 100, 101 and 107

United States Patent and Trademark Office

Reg. No. 3,452,192

Registered June 24, 2008

SERVICE MARK  
PRINCIPAL REGISTER



LEARNING CENTERS OF CENTRAL FLORIDA,  
LLC (FLORIDA LTD LIAB CO)  
401 W. COLONIAL DRIVE  
ORLANDO, FL 32804

FOR: EDUCATIONAL SERVICES, NAMELY,  
PROVIDING TUTORING IN THE FIELD OF GEN-  
ERAL EDUCATION AT THE PRIMARY AND SEC-  
ONDARY EDUCATIONAL LEVELS , IN CLASS 41  
(U.S. CLS. 100, 101 AND 107).

FIRST USE 4-0-2005; IN COMMERCE 9-0-2005.

NO CLAIM IS MADE TO THE EXCLUSIVE  
RIGHT TO USE "TUTOR", APART FROM THE  
MARK AS SHOWN.

THE COLOR(S) ROYAL BLUE AND YELLOW IS/  
ARE CLAIMED AS A FEATURE OF THE MARK.

THE MARK CONSISTS OF THE LITERAL ELE-  
MENT AND A GRADUATION CAP DESIGN THE  
LITERAL ELEMENT "TUTOR U" IN ROYAL BLUE  
WITH A YELLOW BORDER; THE LITERAL ELE-  
MENT "READING, MATH AND MORE!" IN ROYAL  
BLUE; AND A GRADUATION CAP DESIGN IN  
ROYAL BLUE AND WHITE.

SER. NO. 77-160,448, FILED 4-19-2007.

WILLIAM ROSSMAN, EXAMINING ATTORNEY

**Int. Cl.: 31**

**Prior U.S. Cls.: 1 and 46**

**United States Patent and Trademark Office**

**Reg. No. 3,452,193**

**Registered June 24, 2008**

---

**TRADEMARK  
PRINCIPAL REGISTER**

**FISHER**

FISHER RANCH CORPORATION (CALIFORNIA  
CORPORATION)  
10600 ICEPLANT ROAD  
BLYTHE, CA 92225

FOR: FRUITS, NAMELY, FRESH MELONS, IN  
CLASS 31 (U.S. CLS. 1 AND 46).

FIRST USE 11-1-1974; IN COMMERCE 11-1-1974.

THE MARK CONSISTS OF STANDARD CHAR-  
ACTERS WITHOUT CLAIM TO ANY PARTICULAR  
FONT, STYLE, SIZE, OR COLOR.

OWNER OF U.S. REG. NO. 1,061,467.

SEC. 2(F).

SER. NO. 77-160,551, FILED 4-19-2007.

ALEXANDER L. POWERS, EXAMINING ATTOR-  
NEY

**Int. Cl.: 41**

**Prior U.S. Cls.: 100, 101 and 107**

**United States Patent and Trademark Office**

**Reg. No. 3,452,194**

**Registered June 24, 2008**

**SERVICE MARK  
PRINCIPAL REGISTER**



KREVOY, BRADLEY R. (UNITED STATES INDIVIDUAL)  
2311 LA MESA DRIVE  
SANTA MONICA, CA 90402

FOR: MOTION PICTURE PRODUCTION AND DISTRIBUTION SERVICES, IN CLASS 41 (U.S. CLS. 100, 101 AND 107).

FIRST USE 1-1-1986; IN COMMERCE 1-1-1986.

NO CLAIM IS MADE TO THE EXCLUSIVE RIGHT TO USE "CORPORATION", APART FROM THE MARK AS SHOWN.

THE MARK CONSISTS OF A STRIP OF MOTION PICTURE FILM DISSOLVING INTO STARS ON THE LEFT AND THE SILHOUETTE OF A BALD EAGLE ON THE RIGHT, ABOVE THE LETTERING "MOTION PICTURE CORPORATION OF AMERICA".

SEC. 2(F) AS TO "MOTION PICTURE CORPORATION OF AMERICA".

SER. NO. 77-160,601, FILED 4-19-2007.

MARGERY A. TIERNEY, EXAMINING ATTORNEY

**Int. Cl.: 19**

**Prior U.S. Cls.: 1, 12, 33 and 50**

**United States Patent and Trademark Office**

**Reg. No. 3,452,195**

**Registered June 24, 2008**

**TRADEMARK  
PRINCIPAL REGISTER**

**AB YORK**

ALLAN BLOCK CORPORATION (MINNESOTA  
CORPORATION)  
SUITE 100  
5300 EDINA INDUSTRIAL BOULEVARD  
EDINA, MN 55439

FOR: LANDSCAPING AND RETAINING WALL  
BLOCKS, IN CLASS 19 (U.S. CLS. 1, 12, 33 AND 50).

FIRST USE 3-31-2004; IN COMMERCE 3-31-2004.

THE MARK CONSISTS OF STANDARD CHAR-  
ACTERS WITHOUT CLAIM TO ANY PARTICULAR  
FONT, STYLE, SIZE, OR COLOR.

OWNER OF U.S. REG. NOS. 1,741,318, 2,638,861  
AND OTHERS.

SER. NO. 77-160,750, FILED 4-19-2007.

CAROL SPILS, EXAMINING ATTORNEY

**Int. Cl.: 16**

**Prior U.S. Cls.: 2, 5, 22, 23, 29, 37, 38 and 50**

**United States Patent and Trademark Office**

**Reg. No. 3,452,196**

**Registered June 24, 2008**

**TRADEMARK  
PRINCIPAL REGISTER**

**PRO-LENE**

API INDUSTRIES, INC. (NEW JERSEY CORPORATION)  
2 GLENSHAW STREET  
ORANGEBURG, NY 10962

THE MARK CONSISTS OF STANDARD CHARACTERS WITHOUT CLAIM TO ANY PARTICULAR FONT, STYLE, SIZE, OR COLOR.

FOR: PLASTIC LINERS FOR TRASH RECEPTACLES, PLASTIC TRASH BAGS, IN CLASS 16 (U.S. CLS. 2, 5, 22, 23, 29, 37, 38 AND 50).

SER. NO. 77-160,761, FILED 4-19-2007.

FIRST USE 11-0-2000; IN COMMERCE 11-0-2000.

ESTHER BELENKER, EXAMINING ATTORNEY



**Int. Cl.: 35**

**Prior U.S. Cls.: 100, 101 and 102**

**United States Patent and Trademark Office**

**Reg. No. 3,452,197**

**Registered June 24, 2008**

**SERVICE MARK  
PRINCIPAL REGISTER**

**KC WEDDINGS BRIDAL  
SPECTACULAR**

MCCLATCHY U.S.A., INC. (DELAWARE COR-  
PORATION)  
2100 Q STREET  
SACRAMENTO, CA 95816

FOR: TRADE SHOW EXHIBITION IN THE FIELD  
OF WEDDINGS, IN CLASS 35 (U.S. CLS. 100, 101  
AND 102).

FIRST USE 1-24-1998; IN COMMERCE 1-24-1998.

THE MARK CONSISTS OF STANDARD CHAR-  
ACTERS WITHOUT CLAIM TO ANY PARTICULAR  
FONT, STYLE, SIZE, OR COLOR.

OWNER OF U.S. REG. NO. 2,398,782.

SEC. 2(F).

SER. NO. 77-160,788, FILED 4-19-2007.

DANIEL CAPSHAW, EXAMINING ATTORNEY

**Int. Cl.: 9**

**Prior U.S. Cls.: 21, 23, 26, 36 and 38**

**Reg. No. 3,452,198**

**United States Patent and Trademark Office**

**Registered June 24, 2008**

**TRADEMARK  
PRINCIPAL REGISTER**

**SLUGGO'S GOON MUSIC**

TROTТА, DAMON (UNITED STATES INDIVIDUAL)  
C/O SLUGGO'S GOON MUSIC, 9 PINE STREET  
EDISON, NJ 08817 AND  
VON BUELOW, JAMES (UNITED STATES INDIVIDUAL)  
C/O SLUGGO'S GOON MUSIC, 9 PINE STREET  
EDISON, NJ 08817

FOR: PRE-RECORDED CDS, VIDEOTAPES, LASER DISKS AND DVDS FEATURING MUSIC; DIGITAL MATERIALS, NAMELY, CDS, DVDS, DOWNLOADABLE AUDIO FILES, FEATURING MUSIC; DOWNLOADABLE RING TONES, GRAPHICS AND MUSIC VIA A GLOBAL COMPUTER NETWORK AND WIRELESS DEVICES, IN CLASS 9 (U.S. CLS. 21, 23, 26, 36 AND 38).

FIRST USE 9-0-2005; IN COMMERCE 9-0-2005.

THE MARK CONSISTS OF STANDARD CHARACTERS WITHOUT CLAIM TO ANY PARTICULAR FONT, STYLE, SIZE, OR COLOR.

NO CLAIM IS MADE TO THE EXCLUSIVE RIGHT TO USE "MUSIC", APART FROM THE MARK AS SHOWN.

SER. NO. 77-160,917, FILED 4-19-2007.

JENNY PARK, EXAMINING ATTORNEY

**Int. Cl.: 41**

**Prior U.S. Cls.: 100, 101 and 107**

**United States Patent and Trademark Office**

**Reg. No. 3,452,199**

**Registered June 24, 2008**

**SERVICE MARK  
PRINCIPAL REGISTER**

**A DEEPER SHADE OF GREEN**

WYLAND WORLDWIDE, LLC (CALIFORNIA  
LTD LIAB CO)  
5 COLUMBIA  
ALISO VIEJO, CA 92656

FOR: EDUCATION AND ENTERTAINMENT  
SERVICES, NAMELY, PROVIDING CLASSES, SEMI-  
NARS, WORKSHOPS, AND EDUCATIONAL PRO-  
GRAMS IN THE FIELD OF NATURE, BIOLOGY,  
AND MARINE LIFE, IN CLASS 41 (U.S. CLS. 100, 101  
AND 107).

FIRST USE 3-1-2007; IN COMMERCE 3-1-2007.

THE MARK CONSISTS OF STANDARD CHAR-  
ACTERS WITHOUT CLAIM TO ANY PARTICULAR  
FONT, STYLE, SIZE, OR COLOR.

SER. NO. 77-161,060, FILED 4-19-2007.

JENNIFER HETU, EXAMINING ATTORNEY

**Int. Cl.: 41**

**Prior U.S. Cls.: 100, 101 and 107**

**United States Patent and Trademark Office**

**Reg. No. 3,452,200**

**Registered June 24, 2008**

**SERVICE MARK  
PRINCIPAL REGISTER**

**CHUNG KING STUDIOS**

JOHN KING (UNITED STATES INDIVIDUAL)  
170 VARICK STREET  
C/O CHUNG KING STUDIOS  
NEW YORK, NY 100131221

FOR: RECORDING STUDIO SERVICES, IN  
CLASS 41 (U.S. CLS. 100, 101 AND 107).

FIRST USE 0-0-1986; IN COMMERCE 0-0-1986.

THE MARK CONSISTS OF STANDARD CHAR-  
ACTERS WITHOUT CLAIM TO ANY PARTICULAR  
FONT, STYLE, SIZE, OR COLOR.

OWNER OF U.S. REG. NO. 3,045,739.

NO CLAIM IS MADE TO THE EXCLUSIVE  
RIGHT TO USE "STUDIOS", APART FROM THE  
MARK AS SHOWN.

THE FOREIGN WORDING IN THE MARK  
TRANSLATES INTO ENGLISH AS PALACE OR  
SCHOOL.

SER. NO. 77-161,097, FILED 4-19-2007.

RICHARD A. STRASER, EXAMINING ATTORNEY

Int. Cl.: 16

Prior U.S. Cls.: 2, 5, 22, 23, 29, 37, 38 and 50

Reg. No. 3,452,201

United States Patent and Trademark Office

Registered June 24, 2008

TRADEMARK  
PRINCIPAL REGISTER



KINGDOM OF GOD HEADQUARTERS (CALI-  
FORNIA UNINC. ASSOCIATION)  
19503 SCOBEE AVENUE  
CARSON, CA 90746

NO CLAIM IS MADE TO THE EXCLUSIVE  
RIGHT TO USE 1974, APART FROM THE MARK  
AS SHOWN.

FOR: RELIGIOUS BOOKS, IN CLASS 16 (U.S. CLS.  
2, 5, 22, 23, 29, 37, 38 AND 50).

SER. NO. 77-161,365, FILED 4-20-2007.

FIRST USE 1-1-1974; IN COMMERCE 1-1-1974.

KYLE PEETE, EXAMINING ATTORNEY

**Int. Cl.: 16**

**Prior U.S. Cls.: 2, 5, 22, 23, 29, 37, 38 and 50**

**United States Patent and Trademark Office**

**Reg. No. 3,452,202**

**Registered June 24, 2008**

**TRADEMARK  
PRINCIPAL REGISTER**

# South Hills Record

WESTMINSTER HOLDINGS, INC. (PENNSYLVANIA CORPORATION)  
610 BEATTY ROAD  
MONROEVILLE, PA 15146

FOR: NEWSPAPERS FOR GENERAL CIRCULATION, IN CLASS 16 (U.S. CLS. 2, 5, 22, 23, 29, 37, 38 AND 50).

FIRST USE 3-14-1991; IN COMMERCE 3-14-1991.

THE MARK CONSISTS OF STANDARD CHARACTERS WITHOUT CLAIM TO ANY PARTICULAR FONT, STYLE, SIZE, OR COLOR.

SEC. 2(F).

SER. NO. 77-161,501, FILED 4-20-2007.

ANDREA SAUNDERS, EXAMINING ATTORNEY

**Int. Cl.: 29**

**Prior U.S. Cl.: 46**

**United States Patent and Trademark Office**

**Reg. No. 3,452,203**

**Registered June 24, 2008**

**TRADEMARK  
PRINCIPAL REGISTER**

**WEBBERS**

KERN FOOD DISTRIBUTING INC. (KENTUCKY  
CORPORATION)  
2711 WAGEL ROAD  
BROOKSVILLE, KY 41004

FOR: SAUSAGES; MEAT; PREPARED MEAT;  
PROCESSED MEAT; PROCESSED MEAT, NAMELY,  
SAUSAGE; SEASONED SAUSAGE, IN CLASS 29  
(U.S. CL. 46).

FIRST USE 12-31-1954; IN COMMERCE 12-31-1954.

THE MARK CONSISTS OF STANDARD CHAR-  
ACTERS WITHOUT CLAIM TO ANY PARTICULAR  
FONT, STYLE, SIZE, OR COLOR.

SEC. 2(F).

SER. NO. 77-161,516, FILED 4-20-2007.

TINA L. SNAPP, EXAMINING ATTORNEY

**Int. Cl.: 25**

**Prior U.S. Cls.: 22 and 39**

**United States Patent and Trademark Office**

**Reg. No. 3,452,204**

**Registered June 24, 2008**

**TRADEMARK  
PRINCIPAL REGISTER**



WRANGLER APPAREL CORP. (DELAWARE CORPORATION)  
3411 SILVERSIDE RD.  
WILMINGTON, DE 19810

FOR: BOYS, INFANTS AND TODDLERS SHIRTS,  
IN CLASS 25 (U.S. CLS. 22 AND 39).

FIRST USE 1-20-2006; IN COMMERCE 1-20-2006.

OWNER OF U.S. REG. NOS. 849,477, 2,998,129 AND OTHERS.

NO CLAIM IS MADE TO THE EXCLUSIVE RIGHT TO USE "JEANS CO. ESTABLISHED 1947", APART FROM THE MARK AS SHOWN.

THE MARK CONSISTS OF A RECTANGLE CONTAINING THE WORD "WRANGLER" IN BLOCK LETTERS. BELOW THE RECTANGLE ARE THE WORDS "JEANS CO. ESTABLISHED 1947" IN BLOCK LETTERING, WITH THE "O" UNDERLINED. THE BACKGROUND OF THE MARK IS SHADED AND CONTAINS SPOTS AND LINES RANDOMLY PLACED THROUGHOUT THE BACKGROUND, RESEMBLING THE TEXTURE AND APPEARANCE OF DENIM FABRIC.

SER. NO. 77-161,520, FILED 4-20-2007.

RENEE SERVANCE, EXAMINING ATTORNEY



**Int. Cl.: 16**

**Prior U.S. Cls.: 2, 5, 22, 23, 29, 37, 38 and 50**

**Reg. No. 3,452,205**

**United States Patent and Trademark Office**

**Registered June 24, 2008**

---

**TRADEMARK  
PRINCIPAL REGISTER**

**DUMPY**

DUMPY, LLC (NEW YORK LTD LIAB CO)  
2ND FLOOR, ATTN: STEVE SAUER  
C/O MEDIA FOUR, 8840 WILSHIRE BOULEVARD  
BEVERLY HILLS, CA 90211

THE MARK CONSISTS OF STANDARD CHAR-  
ACTERS WITHOUT CLAIM TO ANY PARTICULAR  
FONT, STYLE, SIZE, OR COLOR.

FOR: CHILDREN'S BOOKS, IN CLASS 16 (U.S.  
CLS. 2, 5, 22, 23, 29, 37, 38 AND 50).

SER. NO. 77-161,893, FILED 4-20-2007.

FIRST USE 9-30-2000; IN COMMERCE 9-30-2000.

MORGAN WYNNE, EXAMINING ATTORNEY

**Int. Cl.: 7**

**Prior U.S. Cls.: 13, 19, 21, 23, 31, 34 and 35**

**Reg. No. 3,452,206**

**United States Patent and Trademark Office**

**Registered June 24, 2008**

---

**TRADEMARK  
PRINCIPAL REGISTER**

**DROOL SHIELD**

UNITHERM INTERNATIONAL, INC. (TEXAS  
CORPORATION)  
711 JONES ST.  
LEWISVILLE, TX 75057

FOR: ACCESSORIES FOR INJECTION PLASTIC  
MOLDING MACHINES, NAMELY, A DISK WHICH  
FITS THE NOZZLE OF THE MOLDING MACHINE  
TO PREVENT EXCESS LIQUID PLASTIC FROM  
DAMAGING BLANKETS AND WIRING/HEATERS  
WITHIN THE MACHINE, IN CLASS 7 (U.S. CLS. 13,  
19, 21, 23, 31, 34 AND 35).

FIRST USE 3-1-2007; IN COMMERCE 3-1-2007.

THE MARK CONSISTS OF STANDARD CHAR-  
ACTERS WITHOUT CLAIM TO ANY PARTICULAR  
FONT, STYLE, SIZE, OR COLOR.

OWNER OF U.S. REG. NO. 2,193,083.

NO CLAIM IS MADE TO THE EXCLUSIVE  
RIGHT TO USE "SHIELD", APART FROM THE  
MARK AS SHOWN.

SER. NO. 77-161,957, FILED 4-20-2007.

DANIEL BRODY, EXAMINING ATTORNEY

**Int. Cl.: 35**

**Prior U.S. Cls.: 100, 101 and 102**

**United States Patent and Trademark Office**

**Reg. No. 3,452,207**

**Registered June 24, 2008**

**SERVICE MARK  
PRINCIPAL REGISTER**

**PARCELPOINT**

FIRST AMERICAN REAL ESTATE SOLUTIONS  
LLC (CALIFORNIA LTD LIAB CO)  
1 FIRST AMERICAN WAY  
WESTLAKE, TX 76262

FOR: PROVIDING PROPERTY LOCATION INFORMATION SERVICES TO OTHERS FOR BUSINESS PURPOSES THAT UTILIZE THE GEOGRAPHIC LOCATION OF A PARCEL IN THE ASSOCIATION WITH THE EXACT LATITUDE AND LONGITUDE AND ADDRESS FOR THAT PARCEL AND ITS GEOGRAPHIC CENTER, IN CLASS 35 (U.S. CLS. 100, 101 AND 102).

FIRST USE 4-17-2007; IN COMMERCE 4-17-2007.

THE MARK CONSISTS OF STANDARD CHARACTERS WITHOUT CLAIM TO ANY PARTICULAR FONT, STYLE, SIZE, OR COLOR.

SER. NO. 77-161,981, FILED 4-20-2007.

CAROLINE WOOD, EXAMINING ATTORNEY

Int. Cl.: 3

Prior U.S. Cls.: 1, 4, 6, 50, 51 and 52

United States Patent and Trademark Office

Reg. No. 3,452,208

Registered June 24, 2008

TRADEMARK  
PRINCIPAL REGISTER

Jan Marini Skin Research

JAN MARINI SKIN RESEARCH, INC. (CALIFORNIA CORPORATION)  
6951 VIA DEL ORO  
SAN JOSE, CA 95119

FOR: SKIN AND HAIR PREPARATIONS, NAME-  
LY, FACIAL MASKS, SKIN MOISTURIZING LO-  
TIONS, SKIN CLEANSERS, SUNSCREEN  
PREPARATIONS, DEAD-SKIN REMOVING GELS,  
MAKE-UP, SHAVING PREPARATIONS, AFTER-  
SHAVE LOTIONS, AND HAIR SHAMPOOS AND  
CONDITIONERS, IN CLASS 3 (U.S. CLS. 1, 4, 6, 50, 51  
AND 52).

FIRST USE 4-30-1998; IN COMMERCE 4-30-1998.

OWNER OF U.S. REG. NO. 2,517,499.

NO CLAIM IS MADE TO THE EXCLUSIVE  
RIGHT TO USE "SKIN RESEARCH", APART FROM  
THE MARK AS SHOWN.

THE NAME(S), PORTRAIT(S), AND/OR SIGNA-  
TURE(S) SHOWN IN THE MARK IDENTIFIES "JAN  
MARINI", WHOSE CONSENT(S) TO REGISTER IS  
SUBMITTED.

THE MARK CONSISTS OF THE STYLIZED  
WORDS "JAN MARINI SKIN RESEARCH" WITH  
THE STYLIZED LETTERS "JM" SET IN THE MID-  
DLE BACKGROUND OF THE WORDS "JAN MAR-  
INI SKIN RESEARCH".

SER. NO. 77-161,987, FILED 4-20-2007.

RICHARD A. STRASER, EXAMINING ATTORNEY

**Int. Cl.: 3**

**Prior U.S. Cls.: 1, 4, 6, 50, 51 and 52**

**United States Patent and Trademark Office**

**Reg. No. 3,452,209**

**Registered June 24, 2008**

**TRADEMARK  
PRINCIPAL REGISTER**

**MARY ELLEN'S SMELLY DOG  
(STINKY CAT!)**

MARY ELLEN PRODUCTS, INC. (MINNESOTA  
CORPORATION)  
9437 GARFIELD AVE. S.  
SUITE 110  
BLOOMINGTON, MN 55420

FOR: PET ODOR REMOVERS, IN CLASS 3 (U.S.  
CLS. 1, 4, 6, 50, 51 AND 52).

FIRST USE 8-11-2006; IN COMMERCE 8-11-2006.

THE MARK CONSISTS OF STANDARD CHAR-  
ACTERS WITHOUT CLAIM TO ANY PARTICULAR  
FONT, STYLE, SIZE, OR COLOR.

NO CLAIM IS MADE TO THE EXCLUSIVE  
RIGHT TO USE "DOG" AND "CAT", APART FROM  
THE MARK AS SHOWN.

MARY ELLEN DOES NOT IDENTIFY A LIVING  
INDIVIDUAL.

SER. NO. 77-162,051, FILED 4-20-2007.

TIMOTHY FINNEGAN, EXAMINING ATTORNEY

**Int. Cl.: 3**

**Prior U.S. Cls.: 1, 4, 6, 50, 51 and 52**

**Reg. No. 3,452,210**

**United States Patent and Trademark Office**

**Registered June 24, 2008**

**TRADEMARK  
PRINCIPAL REGISTER**



JAN MARINI SKIN RESEARCH, INC. (CALIFORNIA CORPORATION)  
6951 VIA DEL ORO  
SAN JOSE, CA 95119

THE NAME(S), PORTRAIT(S), AND/OR SIGNATURE(S) SHOWN IN THE MARK IDENTIFIES "JAN MARINI", WHOSE CONSENT(S) TO REGISTER IS SUBMITTED.

FOR: SKIN AND HAIR PREPARATIONS, NAMELY, FACIAL MASKS, SKIN MOISTURIZING LOTIONS, SKIN CLEANSERS, SUNSCREEN PREPARATIONS, DEAD-SKIN REMOVING GELS, MAKE-UP, SHAVING PREPARATIONS, AFTER-SHAVE LOTIONS, AND HAIR SHAMPOOS AND CONDITIONERS, IN CLASS 3 (U.S. CLS. 1, 4, 6, 50, 51 AND 52).

THE MARK CONSISTS OF IMAGE OF MARK SHOWN AS AN OPEN SQUARE WITH THE WORDS "JAN MARINI" ON THE TOP PART OF THE SQUARE AND THE WORDS "SKIN RESEARCH" BELOW THE SQUARE WITH THE STYLIZED LETTERS "JM" IN THE MIDDLE OF THE OPEN SQUARE.

FIRST USE 7-1-1994; IN COMMERCE 7-1-1994.

OWNER OF U.S. REG. NO. 2,517,499.

SER. NO. 77-162,279, FILED 4-20-2007.

NO CLAIM IS MADE TO THE EXCLUSIVE RIGHT TO USE "SKIN RESEARCH", APART FROM THE MARK AS SHOWN.

RICHARD A. STRASER, EXAMINING ATTORNEY

**Int. Cl.: 3**

**Prior U.S. Cls.: 1, 4, 6, 50, 51 and 52**

**United States Patent and Trademark Office**

**Reg. No. 3,452,211**

**Registered June 24, 2008**

**TRADEMARK  
PRINCIPAL REGISTER**

**Jan Marini Skin Research**

JAN MARINI SKIN RESEARCH, INC. (CALIFORNIA CORPORATION)  
6951 VIA DEL ORO  
SAN JOSE, CA 95119

FOR: SKIN AND HAIR PREPARATIONS, NAMELY, FACIAL MASKS, SKIN MOISTURIZING LOTIONS, SKIN CLEANSERS, SUNSCREEN PREPARATIONS, DEAD-SKIN REMOVING GELS, MAKE-UP, SHAVING PREPARATIONS, AFTER-SHAVE LOTIONS, AND HAIR SHAMPOOS AND CONDITIONERS, IN CLASS 3 (U.S. CLS. 1, 4, 6, 50, 51 AND 52).

FIRST USE 7-1-1994; IN COMMERCE 7-1-1994.

THE MARK CONSISTS OF STANDARD CHARACTERS WITHOUT CLAIM TO ANY PARTICULAR FONT, STYLE, SIZE, OR COLOR.

NO CLAIM IS MADE TO THE EXCLUSIVE RIGHT TO USE "SKIN RESEARCH", APART FROM THE MARK AS SHOWN.

THE NAME(S), PORTRAIT(S), AND/OR SIGNATURE(S) SHOWN IN THE MARK IDENTIFIES "JAN MARINI", WHOSE CONSENT(S) TO REGISTER IS SUBMITTED.

SER. NO. 77-162,312, FILED 4-20-2007.

RICHARD A. STRASER, EXAMINING ATTORNEY

**Int. Cl.: 3**

**Prior U.S. Cls.: 1, 4, 6, 50, 51 and 52**

**United States Patent and Trademark Office**

**Reg. No. 3,452,212**

**Registered June 24, 2008**

**TRADEMARK  
PRINCIPAL REGISTER**

# Jan Marini

JAN MARINI SKIN RESEARCH, INC. (CALIFORNIA CORPORATION)  
6951 VIA DEL ORO  
SAN JOSE, CA 95119

FOR: SKIN AND HAIR PREPARATIONS, NAME-  
LY, FACIAL MASKS, SKIN MOISTURIZING LO-  
TIONS, SKIN CLEANSERS, SUNSCREEN  
PREPARATIONS, DEAD-SKIN REMOVING GELS,  
MAKE-UP, SHAVING PREPARATIONS, AFTER-  
SHAVE LOTIONS, AND HAIR SHAMPOOS AND  
CONDITIONERS, IN CLASS 3 (U.S. CLS. 1, 4, 6, 50, 51  
AND 52).

FIRST USE 7-1-1994; IN COMMERCE 7-1-1994.

THE MARK CONSISTS OF STANDARD CHAR-  
ACTERS WITHOUT CLAIM TO ANY PARTICULAR  
FONT, STYLE, SIZE, OR COLOR.

OWNER OF U.S. REG. NO. 2,517,499.

"THE NAME(S), PORTRAIT(S), AND/OR SIGNA-  
TURE(S) SHOWN IN THE MARK IDENTIFIES JAN  
MARINI, WHOSE CONSENT(S) TO REGISTER IS  
SUBMITTED."

SER. NO. 77-162,324, FILED 4-20-2007.

RICHARD A. STRASER, EXAMINING ATTORNEY



**Int. Cl.: 25**

**Prior U.S. Cls.: 22 and 39**

**United States Patent and Trademark Office**

**Reg. No. 3,452,213**

**Registered June 24, 2008**

**TRADEMARK  
PRINCIPAL REGISTER**

**NSS**

AMERICAN SPORTING GOODS CORPORATION  
(DELAWARE CORPORATION)  
101 ENTERPRISE  
ALISO VIEJO, CA 92656

THE MARK CONSISTS OF STANDARD CHAR-  
ACTERS WITHOUT CLAIM TO ANY PARTICULAR  
FONT, STYLE, SIZE, OR COLOR.

FOR: CLOTHING, NAMELY, T-SHIRTS, SHIRTS,  
SWEATSHIRTS, AND HOODIES; SHOES; FOOT-  
WEAR, IN CLASS 25 (U.S. CLS. 22 AND 39).

SER. NO. 77-162,347, FILED 4-20-2007.

FIRST USE 8-0-1995; IN COMMERCE 8-0-1995.

BRIDGETT SMITH, EXAMINING ATTORNEY

**Int. Cls.: 16 and 21**

**Prior U.S. Cls.: 2, 5, 13, 22, 23, 29, 30, 33, 37, 38, 40  
and 50**

**Reg. No. 3,452,214**

**United States Patent and Trademark Office**

**Registered June 24, 2008**

**TRADEMARK  
PRINCIPAL REGISTER**

**Sorelle Antiques  
of Tomorrow**

HENDIAZAD, ANNOUSH (UNITED STATES IN-  
DIVIDUAL)  
23 SOUTHWOOD DR.  
MORRIS PLAINS, NJ 07950

FOR: FRAMED WALL PAINTINGS, IN CLASS 16  
(U.S. CLS. 2, 5, 22, 23, 29, 37, 38 AND 50).

FIRST USE 7-1-2004; IN COMMERCE 7-1-2004.

FOR: PORCELAIN AND CRYSTAL FIGURINES;  
PORCELAIN AND CRYSTAL DINNERWARE,  
NAMELY, VASES, BOWLS, CANDLESTICKS, IN  
CLASS 21 (U.S. CLS. 2, 13, 23, 29, 30, 33, 40 AND 50).

FIRST USE 7-1-2004; IN COMMERCE 7-1-2004.

THE MARK CONSISTS OF STANDARD CHAR-  
ACTERS WITHOUT CLAIM TO ANY PARTICULAR  
FONT, STYLE, SIZE, OR COLOR.

NO CLAIM IS MADE TO THE EXCLUSIVE  
RIGHT TO USE "ANTIQUES", APART FROM THE  
MARK AS SHOWN.

THE FOREIGN WORDING IN THE MARK  
TRANSLATES INTO ENGLISH AS SISTERS.

SER. NO. 77-162,370, FILED 4-20-2007.

ALICE BENMAMAN, EXAMINING ATTORNEY

**Int. Cl.: 42**

**Prior U.S. Cls.: 100 and 101**

**United States Patent and Trademark Office**

**Reg. No. 3,452,215**

**Registered June 24, 2008**

**SERVICE MARK  
PRINCIPAL REGISTER**

**GeoChemical Solutions**

PATRICK, DOREENA (UNITED STATES INDIVIDUAL)  
114 RIVER LANE BOX 368  
FORT PIERRE, SD 19454 AND  
WEGLEITNER, PAUL N. (UNITED STATES INDIVIDUAL)  
114 RIVER LANE BOX 368  
FORT PIERRE, SD 57532

FOR: GEOCHEMICAL EXPLORATION FOR THE OIL, GAS AND MINING INDUSTRIES, NAMELY, RARE EARTH ELEMENT (REE) AND TRACE ELEMENT (TE) ANALYSIS; PHARMACEUTICAL RESEARCH SERVICES, IN CLASS 42 (U.S. CLS. 100 AND 101).

FIRST USE 3-1-2003; IN COMMERCE 3-1-2005.

THE MARK CONSISTS OF STANDARD CHARACTERS WITHOUT CLAIM TO ANY PARTICULAR FONT, STYLE, SIZE, OR COLOR.

NO CLAIM IS MADE TO THE EXCLUSIVE RIGHT TO USE "GEOCHEMICAL", APART FROM THE MARK AS SHOWN.

SER. NO. 77-162,454, FILED 4-21-2007.

MICHAEL ENGEL, EXAMINING ATTORNEY

Int. Cl.: 35

Prior U.S. Cls.: 100, 101 and 102

United States Patent and Trademark Office

Reg. No. 3,452,216

Registered June 24, 2008

**SERVICE MARK  
PRINCIPAL REGISTER**



THE B FORCE LLC (DELAWARE LTD LIAB CO)  
115 E ROUMFORT ROAD, UNIT 4  
PHILADELPHIA, PA 19119

FOR: BUSINESS ADMINISTRATION CONSULTANCY; ADMINISTRATION OF BUSINESS PAYROLL FOR OTHERS; ADMINISTRATION, BILLING AND RECONCILIATION OF ACCOUNTS ON BEHALF OF OTHERS; ADMINISTRATIVE ACCOUNTING; ADMINISTRATIVE PROCESSING OF PURCHASE ORDERS; ADVISORY SERVICE FOR ORGANIZATIONAL ISSUES AND BUSINESS ADMINISTRATION, WITH AND WITHOUT THE HELP OF ELECTRONIC DATA BASES; BUSINESS ADMINISTRATION AND MANAGEMENT; BUSINESS ADMINISTRATION AND OFFICE WORK; BUSINESS OPERATION, BUSINESS ADMINISTRATION AND OFFICE FUNCTIONS, IN CLASS 35 (U.S. CLS. 100, 101 AND 102).

FIRST USE 11-11-2006; IN COMMERCE 1-14-2007.

THE COLOR(S) BROWN AND GOLD IS/ARE CLAIMED AS A FEATURE OF THE MARK.

THE MARK CONSISTS OF A FLYING BEE IN BROWN WITH A GOLD CAPE, GOLD MASK AND GOLD B EMBLEM ON CHEST. THE WORDING "THE B FORCE" IS IN BROWN COLOR, AND THE SLOGAN "SAVING SMALL BUSINESSES-ONE TASK AT A TIME!" IN GOLD COLOR. THE COLOR WHITE APPEARS AS BACKGROUND AND OUTLINING AND IS NOT PART OF THE MARK.

SER. NO. 77-162,553, FILED 4-22-2007.

WILLIAM VERHOSEK, EXAMINING ATTORNEY

**Int. Cl.: 44**

**Prior U.S. Cls.: 100 and 101**

**United States Patent and Trademark Office**

**Reg. No. 3,452,217**

**Registered June 24, 2008**

**SERVICE MARK  
PRINCIPAL REGISTER**

**TEETIME LAWN CARE**

TEE TIME LAWN CARE, INC. (ILLINOIS CORPORATION)

922 TALON DRIVE

O'FALLON, IL 62269

FOR: LAWN CARE, IN CLASS 44 (U.S. CLS. 100 AND 101).

FIRST USE 5-31-2005; IN COMMERCE 8-1-2005.

THE MARK CONSISTS OF STANDARD CHARACTERS WITHOUT CLAIM TO ANY PARTICULAR FONT, STYLE, SIZE, OR COLOR.

NO CLAIM IS MADE TO THE EXCLUSIVE RIGHT TO USE "LAWN CARE", APART FROM THE MARK AS SHOWN.

SER. NO. 77-162,572, FILED 4-22-2007.

TARAH HARDY, EXAMINING ATTORNEY

Int. Cl.: 29

Prior U.S. Cl.: 46

United States Patent and Trademark Office

Reg. No. 3,452,218

Registered June 24, 2008

TRADEMARK  
PRINCIPAL REGISTER



GOLDEN PHEASANT FOODS, LLC (WASHINGTON LTD LIAB CO)  
PARK 234, BUILDING B  
6931 SOUTH 234TH STREET  
KENT, WA 98032

FOR: ASIAN-STYLE FOOD PRODUCTS, NAME-  
LY, COOKING INGREDIENTS CONSISTING OF  
SOYBEAN OILS, CANOLA OILS, SESAME OILS,  
VEGETABLE OILS, BLENDED OILS; DRIED FOOD  
ITEMS CONSISTING OF FRUIT AND FRUIT  
MIXES, SOYBEANS; AND CANNED FOOD ITEMS  
CONSISTING OF FRUITS AND VEGETABLES, IN  
CLASS 29 (U.S. CL. 46).

FIRST USE 8-1-2004; IN COMMERCE 8-1-2004.

OWNER OF U.S. REG. NO. 2,603,439.

THE FOREIGN WORDING IN THE MARK  
TRANSLATES INTO ENGLISH AS "GOLDEN BEE  
PAVILION."

THE NON-LATIN CHARACTER IN THE MARK  
TRANSLITERATES INTO "JIN FENG GE," WHICH  
MEANS "GOLDEN BEE PAVILION" IN ENGLISH.

SER. NO. 77-163,059, FILED 4-23-2007.

ALICE SUE CARRUTHERS, EXAMINING ATTOR-  
NEY

**Int. Cl.: 25**

**Prior U.S. Cls.: 22 and 39**

**United States Patent and Trademark Office**

**Reg. No. 3,452,219**

**Registered June 24, 2008**

**TRADEMARK  
PRINCIPAL REGISTER**



KABUSHIKI KAISHA BANDAI (JAPAN CORPORATION)  
1-4-8 KOMAGATA  
TAITO-KU, JAPAN 111-8081

FOR: CLOTHING FOR MEN, WOMEN, BOYS, GIRLS, INFANTS, NAMELY, JACKETS, SWEATERS, PAJAMAS, PANTS, SPORT SHIRTS, POLO SHIRTS, UNDERSHIRTS, UNDERPANTS, DIAPERS, NAMELY, CLOTH DIAPERS, APRONS, SOCKS, CAPS, HATS, TIES, STOCKINGS, GLOVES, BOOTS, SHOES AND SANDALS, IN CLASS 25 (U.S. CLS. 22 AND 39).

OWNER OF JAPAN REG. NO. 2700864, DATED 12-22-1994, EXPIRES 12-22-2014.

OWNER OF U.S. REG. NOS. 1,716,040, 2,052,185 AND OTHERS.

THE ENGLISH TRANSLATION OF THE WORD "BANDAI" IN THE MARK IS "ETERNITY".

SER. NO. 77-163,074, FILED 4-23-2007.

WILLIAM VERHOSEK, EXAMINING ATTORNEY

**Int. Cls.: 37, 40 and 42**

**Prior U.S. Cls.: 100, 101, 103 and 106**

**United States Patent and Trademark Office**

**Reg. No. 3,452,220**

**Registered June 24, 2008**

**SERVICE MARK  
PRINCIPAL REGISTER**



TRUCUT INCORPORATED (OHIO CORPORATION)  
1145 ALLIED DRIVE  
SEBRING, OH 446720391

FOR: MAINTENANCE AND REPAIR OF METAL WORKING DIES AND DIE COMPONENTS, IN CLASS 37 (U.S. CLS. 100, 103 AND 106).

FIRST USE 6-28-2004; IN COMMERCE 6-28-2004.

FOR: MANUFACTURE OF ORIGINAL METAL PARTS AND REPLACEMENT METAL PARTS MADE TO ORDER AND/OR SPECIFICATION OF OTHERS, NAMELY, THE ORIGINAL EQUIPMENT MANUFACTURERS; CUSTOM MANUFACTURE OF TOOLS AND DIES MADE TO ORDER AND/OR SPECIFICATION OF OTHERS, NAMELY, THE ORIGINAL EQUIPMENT MANUFACTURERS; AND STAMPING INDUSTRIES MACHINE SHOP SERVICE, NAMELY, MACHINING PARTS FOR OTHERS, IN CLASS 40 (U.S. CLS. 100, 103 AND 106).

FIRST USE 6-28-2004; IN COMMERCE 6-28-2004.

FOR: ENGINEERING SERVICES IN THE FIELD OF DESIGNING TOOLS AND DIES FOR OTHERS IN THE METAL STAMPING INDUSTRY, IN CLASS 42 (U.S. CLS. 100 AND 101).

FIRST USE 6-28-2004; IN COMMERCE 6-28-2004.

OWNER OF U.S. REG. NOS. 2,495,524 AND 2,495,525.

THE MARK CONSISTS OF A STYLIZED WORLD GLOBE INSIDE A STYLIZED COG WHEEL.

SER. NO. 77-163,082, FILED 4-23-2007.

PAUL CROWLEY, EXAMINING ATTORNEY



Int. Cl.: 30

Prior U.S. Cl.: 46

United States Patent and Trademark Office

Reg. No. 3,452,221

Registered June 24, 2008

TRADEMARK  
PRINCIPAL REGISTER



GOLDEN PHEASANT FOODS, LLC (WASHINGTON LTD LIAB CO)  
PARK 234, BUILDING B  
6931 SOUTH 234TH STREET  
KENT, WA 98032

FOR: ASIAN-STYLE FOOD PRODUCTS, NAME-  
LY, NOODLES, SAUCES, VINEGARS, SPICES AND  
FOOD FLAVORINGS, SEASONINGS, EGG ROLLS,  
WONTONS, FLOUR, TEA, FORTUNE COOKIES,  
AND DRY RICE PRODUCTS CONSISTING OF RICE  
CAKES, CRACKERS, STARCHES, AND NOODLES,  
IN CLASS 30 (U.S. CL. 46).

FIRST USE 8-1-2004; IN COMMERCE 8-1-2004.

OWNER OF U.S. REG. NO. 2,603,439.

THE FOREIGN WORDING IN THE MARK  
TRANSLATES INTO ENGLISH AS "GOLDEN BEE  
PAVILION."

THE NON-LATIN CHARACTERS IN THE MARK  
TRANSLITERATES INTO "JING FENG GE," WHICH  
MEANS "GOLDEN BEE PAVILION" IN ENGLISH.

SER. NO. 77-163,116, FILED 4-23-2007.

ALICE SUE CARRUTHERS, EXAMINING ATTOR-  
NEY

**Int. Cl.: 30**

**Prior U.S. Cl.: 46**

**United States Patent and Trademark Office**

**Reg. No. 3,452,222**

**Registered June 24, 2008**

**TRADEMARK  
PRINCIPAL REGISTER**

**FROZEN DIAMONDS**

ARCTIC GLACIER VERNON INC. (CALIFORNIA  
CORPORATION)  
2970 EAST 50TH STREET  
VERNON, CA 90058

FOR: ICE MADE FROM WATER AND IN BLOCK,  
CRUSHED OR BROKEN FORM, IN CLASS 30 (U.S.  
CL. 46).

FIRST USE 6-0-1951; IN COMMERCE 6-0-1951.

THE MARK CONSISTS OF STANDARD CHAR-  
ACTERS WITHOUT CLAIM TO ANY PARTICULAR  
FONT, STYLE, SIZE, OR COLOR.

NO CLAIM IS MADE TO THE EXCLUSIVE  
RIGHT TO USE "FROZEN", APART FROM THE  
MARK AS SHOWN.

SER. NO. 77-163,297, FILED 4-23-2007.

INGA ERVIN, EXAMINING ATTORNEY

**Int. Cl.: 41**

**Prior U.S. Cls.: 100, 101 and 107**

**United States Patent and Trademark Office**

**Reg. No. 3,452,223**

**Registered June 24, 2008**

---

**SERVICE MARK  
PRINCIPAL REGISTER**

**MYSTERY BOY**

MATTEL, INC. (DELAWARE CORPORATION)  
M1-1518  
333 CONTINENTAL BLVD.  
EL SEGUNDO, CA 90245

THE MARK CONSISTS OF STANDARD CHAR-  
ACTERS WITHOUT CLAIM TO ANY PARTICULAR  
FONT, STYLE, SIZE, OR COLOR.

FOR: ENTERTAINMENT SERVICES, NAMELY,  
PROVIDING ONLINE GAMES, IN CLASS 41 (U.S.  
CLS. 100, 101 AND 107).

SER. NO. 77-163,852, FILED 4-24-2007.

FIRST USE 1-17-2008; IN COMMERCE 1-17-2008.

MATTHEW PAPPAS, EXAMINING ATTORNEY

**Int. Cl.: 41**

**Prior U.S. Cls.: 100, 101 and 107**

**United States Patent and Trademark Office**

**Reg. No. 3,452,224**

**Registered June 24, 2008**

**SERVICE MARK  
PRINCIPAL REGISTER**

**MONSTER BABY**

MATTEL, INC. (DELAWARE CORPORATION)  
M1-1518  
333 CONTINENTAL BLVD.  
EL SEGUNDO, CA 90245

FOR: ENTERTAINMENT SERVICES, NAMELY,  
PROVIDING ONLINE GAMES, IN CLASS 41 (U.S.  
CLS. 100, 101 AND 107).

FIRST USE 1-10-2008; IN COMMERCE 1-10-2008.

THE MARK CONSISTS OF STANDARD CHAR-  
ACTERS WITHOUT CLAIM TO ANY PARTICULAR  
FONT, STYLE, SIZE, OR COLOR.

NO CLAIM IS MADE TO THE EXCLUSIVE  
RIGHT TO USE "BABY", APART FROM THE MARK  
AS SHOWN.

SER. NO. 77-163,853, FILED 4-24-2007.

MATTHEW PAPPAS, EXAMINING ATTORNEY

**Int. Cl.: 36**

**Prior U.S. Cls.: 100, 101 and 102**

**United States Patent and Trademark Office**

**Reg. No. 3,452,225**

**Registered June 24, 2008**

**SERVICE MARK  
PRINCIPAL REGISTER**

**FIRETHORN**

FIRETHORN HOLDINGS, LLC (GEORGIA LTD  
LIAB CO)  
4 CONCOURSE PARKWAY NE, SUITE 475  
ATLANTA, GA 30328

THE MARK CONSISTS OF STANDARD CHAR-  
ACTERS WITHOUT CLAIM TO ANY PARTICULAR  
FONT, STYLE, SIZE, OR COLOR.

FOR: MOBILE BANKING AND BILL PAYMENT  
SERVICES FOR OTHERS, IN CLASS 36 (U.S. CLS.  
100, 101 AND 102).

SER. NO. 77-163,863, FILED 4-24-2007.

FIRST USE 2-0-2004; IN COMMERCE 6-0-2006.

PAUL F. GAST, EXAMINING ATTORNEY

**Int. Cl.: 36**

**Prior U.S. Cls.: 100, 101 and 102**

**United States Patent and Trademark Office**

**Reg. No. 3,452,226**

**Registered June 24, 2008**

**SERVICE MARK  
PRINCIPAL REGISTER**

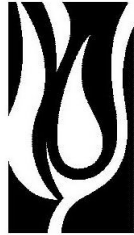

**FIRETHORN**

FIRETHORN HOLDINGS, LLC (GEORGIA LTD  
LIAB CO)  
4 CONCOURSE PARKWAY NE, SUITE 475  
ATLANTA, GA 30328

THE MARK CONSISTS OF A FIRE FLAME IN-  
SIDE A BOX WITH THE WORD "FIRETHORN"  
TYPEWRITTEN TO THE SIDE.

FOR: MOBILE BANKING AND BILL PAYMENT  
SERVICES FOR OTHERS, IN CLASS 36 (U.S. CLS.  
100, 101 AND 102).

SER. NO. 77-163,872, FILED 4-24-2007.

FIRST USE 2-0-2004; IN COMMERCE 6-0-2006.

PAUL F. GAST, EXAMINING ATTORNEY

**Int. Cl.: 25**

**Prior U.S. Cls.: 22 and 39**

**United States Patent and Trademark Office**

**Reg. No. 3,452,227**

**Registered June 24, 2008**

**TRADEMARK  
PRINCIPAL REGISTER**



DUAL JEANS LIMITED (AUSTRALIA COMPANY)  
LEVEL 6, 52 COLLINS STREET  
MELBOURNE VIC 3000, AUSTRALIA

THE MARK CONSISTS OF THE WORD "DUAL"  
ENCLOSED IN A RECTANGLE.

FOR: JEANS; SHIRTS; JACKETS; FOOTWEAR;  
HEADWEAR, IN CLASS 25 (U.S. CLS. 22 AND 39).

SER. NO. 77-164,158, FILED 4-24-2007.

OWNER OF AUSTRALIA REG. NO. 1016825,  
DATED 8-23-2004, EXPIRES 8-23-2014.

JASON LOTT, EXAMINING ATTORNEY

**Int. Cl.: 28**

**Prior U.S. Cls.: 22, 23, 38 and 50**

**Reg. No. 3,452,228**

**United States Patent and Trademark Office**

**Registered June 24, 2008**

---

**TRADEMARK  
PRINCIPAL REGISTER**



CHOKEPHAILBULKIT, KAMOL (THAILAND IN-  
DIVIDUAL)  
2357 FBT BUILDING, RANMKAMHAENG ROAD  
BANKAPI, THAILAND

FIRST USE 8-20-1993; IN COMMERCE 8-20-1993.

SER. NO. 77-164,205, FILED 4-24-2007.

FOR: FOOTBALL IN THE NATURE OF SOCCER  
BALLS, IN CLASS 28 (U.S. CLS. 22, 23, 38 AND 50).

WILLIAM VERHOSEK, EXAMINING ATTORNEY



**Int. Cl.: 35**

**Prior U.S. Cls.: 100, 101 and 102**

**United States Patent and Trademark Office**

**Reg. No. 3,452,229**

**Registered June 24, 2008**

**SERVICE MARK  
PRINCIPAL REGISTER**

**BE A VOICE FOR BABIES**

ZERO TO THREE (D.C. NON-PROFIT ORGANIZATION)  
SUITE 200  
2000 M STREET NW  
WASHINGTON, DC 20036

FOR: PUBLIC ADVOCACY TO PROMOTE AWARENESS OF THE HEALTHY DEVELOPMENT OF INFANTS AND TODDLERS, IN CLASS 35 (U.S. CLS. 100, 101 AND 102).

FIRST USE 11-3-2005; IN COMMERCE 11-3-2005.

THE MARK CONSISTS OF STANDARD CHARACTERS WITHOUT CLAIM TO ANY PARTICULAR FONT, STYLE, SIZE, OR COLOR.

SER. NO. 77-164,251, FILED 4-24-2007.

CAROLINE WOOD, EXAMINING ATTORNEY

**Int. Cl.: 9**

**Prior U.S. Cls.: 21, 23, 26, 36 and 38**

**Reg. No. 3,452,230**

**United States Patent and Trademark Office**

**Registered June 24, 2008**

**TRADEMARK  
PRINCIPAL REGISTER**

**BLOCKS PLAYER**

THE BLOCKS COMPANY, LLC (DELAWARE  
LTD LIAB CO)  
5370 NW 35TH TERRACE #113  
FT. LAUDERDALE, FL 33309

FOR: COMPUTER SOFTWARE FOR INFORMATION MANAGEMENT, DATA AND TEXT PROCESSING, DATA ANALYSIS AND REPORTING; COMPUTER SOFTWARE FOR CREATING, VIEWING, EDITING, AND SHARING CHARTS, NOTES, AND DATA; COMPUTER SOFTWARE FOR DEVELOPING OTHER COMPUTER SOFTWARE; AND COMPUTER SOFTWARE FOR ORGANIZING AND MANAGING OTHER SOFTWARE PROGRAMS, IN CLASS 9 (U.S. CLS. 21, 23, 26, 36 AND 38).

FIRST USE 4-5-2006; IN COMMERCE 5-1-2006.

THE MARK CONSISTS OF STANDARD CHARACTERS WITHOUT CLAIM TO ANY PARTICULAR FONT, STYLE, SIZE, OR COLOR.

NO CLAIM IS MADE TO THE EXCLUSIVE RIGHT TO USE "PLAYER", APART FROM THE MARK AS SHOWN.

SER. NO. 77-164,393, FILED 4-24-2007.

KAREN K. BUSH, EXAMINING ATTORNEY

Int. Cls.: 16 and 41

Prior U.S. Cls.: 2, 5, 22, 23, 29, 37, 38, 50, 100, 101 and 107

Reg. No. 3,452,231

United States Patent and Trademark Office

Registered June 24, 2008

TRADEMARK  
SERVICE MARK  
PRINCIPAL REGISTER



CHAT, CHEW & CHOCOLATE, LLC (ARIZONA LTD LIAB CO)  
4340 E. INDIAN SCHOOL ROAD, #21143  
PHOENIX, AZ 85018

FOR: EVENT PROGRAMS; BUMPER STICKERS; INVITATION CARDS; EDUCATIONAL BOOKS FEATURING TOPICS OF INTEREST TO WOMEN, NAMELY, LIFE BALANCE, INSPIRATION, SELF CARE, AND SELF ESTEEM; ANNOUNCEMENT CARDS; MOTIVATIONAL CARDS, IN CLASS 16 (U.S. CLS. 2, 5, 22, 23, 29, 37, 38 AND 50).

FIRST USE 11-25-2005; IN COMMERCE 12-5-2005.

FOR: SPECIAL EVENT PLANNING; MEETING AND SEMINAR ARRANGING; ENTERTAINMENT SERVICES, NAMELY, CONDUCTING PARTIES; EDUCATIONAL AND ENTERTAINMENT SERVICES, NAMELY, PROVIDING MOTIVATIONAL

AND EDUCATIONAL SPEAKERS, IN CLASS 41 (U.S. CLS. 100, 101 AND 107).

FIRST USE 11-25-2005; IN COMMERCE 11-25-2005.

THE COLOR(S) BROWN AND PINK IS/ARE CLAIMED AS A FEATURE OF THE MARK.

THE MARK CONSISTS OF THE WORDS "CHAT, CHEW & CHOCOLATE" IN STYLIZED BROWN, SURROUNDED BY PINK LIPS AND THREE PINK STARS, WITH THE WORDS "FUN FOR FABULOUS WOMEN!" IN STYLIZED PINK BELOW.

SER. NO. 77-164,553, FILED 4-24-2007.

JAY FLOWERS, EXAMINING ATTORNEY

**Int. Cl.: 33**

**Prior U.S. Cls.: 47 and 49**

**United States Patent and Trademark Office**

**Reg. No. 3,452,232**

**Registered June 24, 2008**

**TRADEMARK  
PRINCIPAL REGISTER**

**ABBHEY OF SAINT-HILAIRE**

JACK POUST & COMPANY, INC. (NEW YORK  
CORPORATION)  
SUITE 1505  
250 WEST 57TH STREET  
NEW YORK, NY 10107

FOR: WINES, IN CLASS 33 (U.S. CLS. 47 AND 49).

FIRST USE 10-0-2006; IN COMMERCE 10-0-2006.

THE MARK CONSISTS OF STANDARD CHAR-  
ACTERS WITHOUT CLAIM TO ANY PARTICULAR  
FONT, STYLE, SIZE, OR COLOR.

SEC. 2(F) AS TO "SAINT-HILAIRE".

SER. NO. 77-164,699, FILED 4-24-2007.

BRIAN CALLAGHAN, EXAMINING ATTORNEY

**Int. Cl.: 42**

**Prior U.S. Cls.: 100 and 101**

**United States Patent and Trademark Office**

**Reg. No. 3,452,233**

**Registered June 24, 2008**

**SERVICE MARK  
PRINCIPAL REGISTER**

schoolfusion

CENTRIFUGE SOLUTIONS LLC (COLORADO  
LTD LIAB CO)  
1600 DOWNING ST, STE 700  
DENVER, CO 80218

FOR: COMPUTER SERVICES, NAMELY, HOST-  
ING AND MAINTAINING AN ONLINE WEBSITE  
FOR OTHERS TO FACILITATE COMMUNICATION  
WITHIN SCHOOLS OR DISTRICTS, IN CLASS 42  
(U.S. CLS. 100 AND 101).

FIRST USE 3-1-2003; IN COMMERCE 3-1-2003.

THE COLOR(S) GRAY AND ORANGE IS/ARE  
CLAIMED AS A FEATURE OF THE MARK.

THE MARK CONSISTS OF THE WORDS  
"SCHOOLFUSION" IS ALL LOWER CASE,  
"SCHOOL" IN GRAY, "FUSION" IN ORANGE.

SER. NO. 77-165,013, FILED 4-25-2007.

DANIEL CAPSHAW, EXAMINING ATTORNEY

**Int. Cl.: 42**

**Prior U.S. Cls.: 100 and 101**

**United States Patent and Trademark Office**

**Reg. No. 3,452,234**

**Registered June 24, 2008**

**SERVICE MARK  
PRINCIPAL REGISTER**

officefusion

CENTRIFUGE SOLUTIONS LLC (COLORADO  
LTD LIAB CO)  
1600 DOWNING ST, STE 700  
DENVER, CO 80218

FOR: COMPUTER SERVICES, NAMELY, HOST-  
ING AND MAINTAINING AN ONLINE WEBSITE  
FOR OTHERS TO FACILITATE COMMUNICATION  
WITHIN OFFICES, IN CLASS 42 (U.S. CLS. 100 AND  
101).

FIRST USE 3-1-2003; IN COMMERCE 6-1-2003.

THE COLOR(S) GRAY AND RED IS/ARE  
CLAIMED AS A FEATURE OF THE MARK.

THE MARK CONSISTS OF THE WORDS "OF-  
FICE" IN GRAY, "FUSION" IN RED.

SER. NO. 77-165,055, FILED 4-25-2007.

DANIEL CAPSHAW, EXAMINING ATTORNEY

**Int. Cl.: 42**

**Prior U.S. Cls.: 100 and 101**

**United States Patent and Trademark Office**

**Reg. No. 3,452,235**

**Registered June 24, 2008**

**SERVICE MARK  
PRINCIPAL REGISTER**

**fusionCalendar**

CENTRIFUGE SOLUTIONS LLC (COLORADO  
LTD LIAB CO)  
1600 DOWNING ST  
DENVER, CO 80218

FOR: COMPUTER SERVICES, NAMELY, HOST-  
ING AND MAINTAINING AN ONLINE WEBSITE  
FOR OTHERS TO FACILITATE A CALENDARING  
PLATFORM, IN CLASS 42 (U.S. CLS. 100 AND 101).

FIRST USE 3-1-2003; IN COMMERCE 6-1-2003.

THE COLOR(S) GRAY AND GREEN IS/ARE  
CLAIMED AS A FEATURE OF THE MARK.

THE MARK CONSISTS OF "FUSION" IN GRAY,  
"CALENDAR" IN GREEN.

SER. NO. 77-165,085, FILED 4-25-2007.

DANIEL CAPSHAW, EXAMINING ATTORNEY

**Int. Cl.: 35**

**Prior U.S. Cls.: 100, 101 and 102**

**United States Patent and Trademark Office**

**Reg. No. 3,452,236**

**Registered June 24, 2008**

**SERVICE MARK  
PRINCIPAL REGISTER**



HORIZON SOLUTIONS, INC. (ARKANSAS CORPORATION)  
SUITE 2  
1913 N. WALTON BLVD.  
BENTONVILLE, AR 72712

FOR: ADVERTISING, MARKETING AND PROMOTION SERVICES; ADVICE IN THE FIELD OF BUSINESS MANAGEMENT AND MARKETING; BUSINESS CONSULTATION AND MANAGEMENT REGARDING MARKETING ACTIVITIES AND LAUNCHING OF NEW PRODUCTS; BUSINESS ADVISORY SERVICES, CONSULTANCY AND INFORMATION; MANAGEMENT AND BUSINESS CONSULTING SERVICES IN THE FIELD OF PRODUCT POSITIONING AND PLACEMENT FOR SALE TO LARGE RETAILERS; MARKETING CONSULTATION IN THE FIELD OF PRODUCT POSITIONING AND PLACEMENT; DEVELOPMENT OF ADVERTISING CAMPAIGNS FOR PRODUCTS TO BE SOLD TO RETAILERS, IN CLASS 35 (U.S. CLS. 100, 101 AND 102).

FIRST USE 2-2-2007; IN COMMERCE 2-2-2007.

NO CLAIM IS MADE TO THE EXCLUSIVE RIGHT TO USE "MARKETING SOLUTIONS, INC.", APART FROM THE MARK AS SHOWN.

THE COLOR(S) MAROON, YELLOW AND WHITE IS/ARE CLAIMED AS A FEATURE OF THE MARK.

THE WORD "HORIZON" IS MAROON, THE SUN IS YELLOW, AND THE WORDING "MARKETING SOLUTIONS, INC." IS WHITE.

SER. NO. 77-165,201, FILED 4-25-2007.

ALICE SUE CARRUTHERS, EXAMINING ATTORNEY



**Int. Cls.: 35, 36 and 41**

**Prior U.S. Cls.: 100, 101, 102 and 107**

**United States Patent and Trademark Office**

**Reg. No. 3,452,237**

**Registered June 24, 2008**

**SERVICE MARK  
PRINCIPAL REGISTER**

**MEDICAL ECONOMICS**

ADVANSTAR COMMUNICATIONS INC. (NEW YORK CORPORATION)  
131 WEST FIRST STREET  
DULUTH, MN 55802

FOR: PROVIDING A WEBSITE ON A GLOBAL COMPUTER NETWORK REGARDING PRACTICE MANAGEMENT AND PATIENT RELATIONS IN THE FIELD OF MEDICINE, PRIMARILY OF INTEREST TO PHYSICIANS IN PRIVATE, OFFICE-BASED PRACTICE, IN CLASS 35 (U.S. CLS. 100, 101 AND 102).

FIRST USE 0-0-1996; IN COMMERCE 0-0-1996.

FOR: PROVIDING A WEBSITE ON A GLOBAL COMPUTER NETWORK REGARDING PERSONAL FINANCE IN THE FIELD OF MEDICINE, PRIMARILY OF INTEREST TO PHYSICIANS IN PRIVATE, OFFICE-BASED PRACTICE, IN CLASS 36 (U.S. CLS. 100, 101 AND 102).

FIRST USE 0-0-1996; IN COMMERCE 0-0-1996.

FOR: ELECTRONIC PUBLICATION, NAMELY, AN ONLINE MAGAZINE IN THE FIELD OF MEDICINE, PRIMARILY OF INTEREST TO PHYSICIANS IN PRIVATE, OFFICE-BASED PRACTICE, FEATURING ARTICLES REGARDING PRACTICE MANAGEMENT, PERSONAL FINANCE AND PATIENT RELATIONS, IN CLASS 41 (U.S. CLS. 100, 101 AND 107).

FIRST USE 0-0-1996; IN COMMERCE 0-0-1996.

THE MARK CONSISTS OF STANDARD CHARACTERS WITHOUT CLAIM TO ANY PARTICULAR FONT, STYLE, SIZE, OR COLOR.

OWNER OF U.S. REG. NOS. 183,595 AND 1,242,071.

SEC. 2(F).

SER. NO. 77-165,369, FILED 4-25-2007.

DAYNA BROWNE, EXAMINING ATTORNEY

**Int. Cls.: 2 and 7**

**Prior U.S. Cls.: 6, 11, 13, 16, 19, 21, 23, 31, 34 and 35**

**United States Patent and Trademark Office**

**Reg. No. 3,452,238**

**Registered June 24, 2008**

**TRADEMARK  
PRINCIPAL REGISTER**

**AMERIMULCH**

CHROMASCAPE, INC. (OHIO CORPORATION)  
5549 CANAL ROAD  
VALLEY VIEW, OH 44125

FOR: COLORANTS FOR USE IN THE MANUFACTURE OF MULCH, IN CLASS 2 (U.S. CLS. 6, 11 AND 16).

FIRST USE 1-1-1993; IN COMMERCE 1-1-1993.

FOR: POWER OPERATED COLORING EQUIPMENT FOR USE IN COLORING LANDSCAPING

PRODUCTS AND PARTICULATE MATERIALS, IN CLASS 7 (U.S. CLS. 13, 19, 21, 23, 31, 34 AND 35).

FIRST USE 1-1-1993; IN COMMERCE 1-1-1993.

THE MARK CONSISTS OF STANDARD CHARACTERS WITHOUT CLAIM TO ANY PARTICULAR FONT, STYLE, SIZE, OR COLOR.

SER. NO. 77-165,498, FILED 4-25-2007.

DAVID MURRAY, EXAMINING ATTORNEY

**Int. Cl.: 35**

**Prior U.S. Cls.: 100, 101 and 102**

**United States Patent and Trademark Office**

**Reg. No. 3,452,239**

**Registered June 24, 2008**

**SERVICE MARK  
PRINCIPAL REGISTER**

**ONE.ORG**

ONE ACTION (D.C. NON-PROFIT CORPORATION)  
SUITE 601  
1400 EYE STREET, N.W.  
WASHINGTON, DC 20005

FOR: PROMOTING PUBLIC AWARENESS ABOUT THE GLOBAL AIDS EPIDEMIC AND POVERTY WORLDWIDE; PUBLIC ADVOCACY TO PROMOTE AWARENESS ABOUT THE GLOBAL AIDS EPIDEMIC AND POVERTY WORLDWIDE, IN CLASS 35 (U.S. CLS. 100, 101 AND 102).

FIRST USE 3-31-2005; IN COMMERCE 3-31-2005.

THE MARK CONSISTS OF STANDARD CHARACTERS WITHOUT CLAIM TO ANY PARTICULAR FONT, STYLE, SIZE, OR COLOR.

OWNER OF U.S. REG. NOS. 3,069,885, 3,069,886, AND 3,069,887.

SER. NO. 77-165,507, FILED 4-25-2007.

DAVID MURRAY, EXAMINING ATTORNEY

**Int. Cl.: 41**

**Prior U.S. Cls.: 100, 101 and 107**

**United States Patent and Trademark Office**

**Reg. No. 3,452,240**

**Registered June 24, 2008**

**SERVICE MARK  
PRINCIPAL REGISTER**

**THE INSTITUTE FOR FACIAL  
ESTHETICS**

INSTITUTE FOR FACIAL ESTHETICS (PENN-  
SYLVANIA NON-PROFIT CORPORATION)  
SUITE 201  
467 PENNSYLVANIA AVE.  
FORT WASHINGTON, PA 19034

FOR: EDUCATIONAL SERVICES, NAMELY,  
CONDUCTING COURSES OF INSTRUCTION,  
CLASSES, SEMINARS, WORKSHOPS, FORUMS  
AND SYMPOSIA ABOUT DENTAL EXAMINATION,  
DENTAL IMPLANTS AND DENTAL IMPLANT  
TREATMENTS FOR DENTAL PROFESSIONALS  
AND THE GENERAL PUBLIC, IN CLASS 41 (U.S.  
CLS. 100, 101 AND 107).

FIRST USE 3-4-1985; IN COMMERCE 3-4-1985.

THE MARK CONSISTS OF STANDARD CHAR-  
ACTERS WITHOUT CLAIM TO ANY PARTICULAR  
FONT, STYLE, SIZE, OR COLOR.

NO CLAIM IS MADE TO THE EXCLUSIVE  
RIGHT TO USE "INSTITUTE", APART FROM THE  
MARK AS SHOWN.

SEC. 2(F).

SER. NO. 77-165,540, FILED 4-25-2007.

DAWN FELDMAN, EXAMINING ATTORNEY

**Int. Cl.: 16**

**Prior U.S. Cls.: 2, 5, 22, 23, 29, 37, 38 and 50**

**Reg. No. 3,452,241**

**United States Patent and Trademark Office**

**Registered June 24, 2008**

**TRADEMARK  
PRINCIPAL REGISTER**

**INCLUDE FOOD**

LAPINSKY, JOYCE (UNITED STATES INDIVIDUAL)  
8001 HEMET PLACE  
LOS ANGELES, CA 90046

FOR: PRINTED MATTER, NAMELY, POSTERS, PRINTED PAPER SIGNS, PAPER BANNERS, PAPER TABLE CLOTHS, BUMPER STICKERS, STICKERS, DECALS, FOLDERS, NOTE PADS, STATIONERY AND POSTCARDS; BROCHURES AND PAMPHLETS DEALING WITH ENCOURAGING PEOPLE TO PLANT FOOD IN SUPPORT OF HEALTHIER EATING AND FEEDING THE HUNGRY; PENCILS, ERASERS AND PENS, IN CLASS 16 (U.S. CLS. 2, 5, 22, 23, 29, 37, 38 AND 50).

FIRST USE 7-24-2006; IN COMMERCE 10-6-2006.

THE MARK CONSISTS OF STANDARD CHARACTERS WITHOUT CLAIM TO ANY PARTICULAR FONT, STYLE, SIZE, OR COLOR.

NO CLAIM IS MADE TO THE EXCLUSIVE RIGHT TO USE "FOOD", APART FROM THE MARK AS SHOWN.

SER. NO. 77-165,665, FILED 4-25-2007.

RUSS HERMAN, EXAMINING ATTORNEY

**Int. Cl.: 35**

**Prior U.S. Cls.: 100, 101 and 102**

**United States Patent and Trademark Office**

**Reg. No. 3,452,242**

**Registered June 24, 2008**

**SERVICE MARK  
PRINCIPAL REGISTER**

**BEEHIVE**

THIRD WAVE RESEARCH GROUP, LTD. (WIS-  
CONSIN CORPORATION)  
305 SOUTH MAIN STREET  
VERONA, WI 53593

FOR: DATA ANALYSIS SERVICES, NAMELY,  
ANALYSIS OF CUSTOMER DATA FOR BUSINES-  
SES USING A DEMOGRAPHIC CLASSIFICATION  
AND SEGMENTATION SCHEME, FOR THE PUR-  
POSE OF IDENTIFYING TARGET MARKET OP-  
PORTUNITIES, IN CLASS 35 (U.S. CLS. 100, 101 AND  
102).

FIRST USE 1-3-2006; IN COMMERCE 1-3-2006.

THE MARK CONSISTS OF STANDARD CHAR-  
ACTERS WITHOUT CLAIM TO ANY PARTICULAR  
FONT, STYLE, SIZE, OR COLOR.

SER. NO. 77-165,667, FILED 4-25-2007.

BILL DAWE, EXAMINING ATTORNEY

**Int. Cl.: 35**

**Prior U.S. Cls.: 100, 101 and 102**

**United States Patent and Trademark Office**

**Reg. No. 3,452,243**

**Registered June 24, 2008**

**SERVICE MARK  
PRINCIPAL REGISTER**

# The Christian Life

NORTHRUP, PAUL G (UNITED STATES INDIVIDUAL)  
13664 CHERRY STREET  
THORNTON, CO 80602

THE MARK CONSISTS OF STANDARD CHARACTERS WITHOUT CLAIM TO ANY PARTICULAR FONT, STYLE, SIZE, OR COLOR.

FOR: BUSINESS MARKETING SERVICES, IN CLASS 35 (U.S. CLS. 100, 101 AND 102).

SER. NO. 77-165,678, FILED 4-25-2007.

FIRST USE 6-30-2003; IN COMMERCE 6-30-2003.

LINDA MICKLEBURGH, EXAMINING ATTORNEY

**Int. Cl.: 7**

**Prior U.S. Cls.: 13, 19, 21, 23, 31, 34 and 35**

**United States Patent and Trademark Office**

**Reg. No. 3,452,244**

**Registered June 24, 2008**

**TRADEMARK  
PRINCIPAL REGISTER**

**XPRESS**

K-TEC, INC. (UTAH CORPORATION)  
1206 SOUTH 1680 WEST  
OREM, UT 84058

THE MARK CONSISTS OF STANDARD CHARACTERS WITHOUT CLAIM TO ANY PARTICULAR FONT, STYLE, SIZE, OR COLOR.

FOR: ELECTRIC FOOD BLENDERS FOR USE IN THE FIELD OF FOOD AND DRINK PREPARATION, IN CLASS 7 (U.S. CLS. 13, 19, 21, 23, 31, 34 AND 35).

OWNER OF U.S. REG. NO. 2,901,989.

SER. NO. 77-165,771, FILED 4-25-2007.

FIRST USE 8-12-2004; IN COMMERCE 8-12-2004.

ROBERT C. CLARK JR., EXAMINING ATTORNEY



**Int. Cl.: 41**

**Prior U.S. Cls.: 100, 101 and 107**

**United States Patent and Trademark Office**

**Reg. No. 3,452,245**

**Registered June 24, 2008**

**SERVICE MARK  
PRINCIPAL REGISTER**

**Planners To The Rescue**

VIRTUAL MEETING STRATEGIES, INC (INDI-  
ANA CORPORATION)  
SUITE 350  
8424 WOODFIELD CROSSING BLVD  
INDIANAPOLIS, IN 46240

FOR: ARRANGING MEETINGS AND SEMINARS  
FOR OTHERS IN THE FIELDS OF BUSINESS AND  
HEALTHCARE, IN CLASS 41 (U.S. CLS. 100, 101 AND  
107).

FIRST USE 4-1-2007; IN COMMERCE 4-1-2007.

THE MARK CONSISTS OF STANDARD CHAR-  
ACTERS WITHOUT CLAIM TO ANY PARTICULAR  
FONT, STYLE, SIZE, OR COLOR.

SER. NO. 77-165,893, FILED 4-25-2007.

TIMOTHY FINNEGAN, EXAMINING ATTORNEY

**Int. Cl.: 17**

**Prior U.S. Cls.: 1, 5, 12, 13, 35 and 50**

**Reg. No. 3,452,246**

**United States Patent and Trademark Office**

**Registered June 24, 2008**

---

**TRADEMARK  
PRINCIPAL REGISTER**

**NOSWEAT**

NO SWEAT VALVE WRAPS, INC. (DELAWARE  
CORPORATION)  
68A ALBE DRIVE  
NEWARK, DE 19702

THE MARK CONSISTS OF STANDARD CHAR-  
ACTERS WITHOUT CLAIM TO ANY PARTICULAR  
FONT, STYLE, SIZE, OR COLOR.

FOR: NON-METAL FLEXIBLE WRAPS FOR COV-  
ERING INSULATED PIPES AND VALVES TO PRE-  
VENT MOISTURE AND CONDENSATION, IN  
CLASS 17 (U.S. CLS. 1, 5, 12, 13, 35 AND 50).

SER. NO. 77-166,194, FILED 4-26-2007.

FIRST USE 1-0-2006; IN COMMERCE 4-0-2006.

JANICE KIM, EXAMINING ATTORNEY

**Int. Cl.: 40**

**Prior U.S. Cls.: 100, 103 and 106**

**United States Patent and Trademark Office**

**Reg. No. 3,452,247**

**Registered June 24, 2008**

**SERVICE MARK  
PRINCIPAL REGISTER**

**OEM CONCEPTS**

MERIDIAN LIFE SCIENCE, INC. (MAINE CORPORATION)  
60 INDUSTRIAL PARK ROAD  
SACO, ME 04072

FOR: CUSTOM MANUFACTURING OF MONOCLONAL ANTIBODIES AND ASCITES ANTIBODIES FOR DIAGNOSTIC AND BIOPHARMACEUTICAL USE; PROCESSING AND PURIFYING MONOCLONAL ANTIBODIES AND ASCITES ANTIBODIES FOR USE BY OTHERS IN DIAGNOSTIC AND BIOPHARMACEUTICAL RESEARCH, IN CLASS 40 (U.S. CLS. 100, 103 AND 106).

FIRST USE 3-20-2007; IN COMMERCE 3-20-2007.

THE MARK CONSISTS OF STANDARD CHARACTERS WITHOUT CLAIM TO ANY PARTICULAR FONT, STYLE, SIZE, OR COLOR.

SER. NO. 77-166,335, FILED 4-26-2007.

RUSS HERMAN, EXAMINING ATTORNEY

**Int. Cl.: 40**

**Prior U.S. Cls.: 100, 103 and 106**

**United States Patent and Trademark Office**

**Reg. No. 3,452,248**

**Registered June 24, 2008**

**SERVICE MARK  
PRINCIPAL REGISTER**

**INNOVATIVE SOLUTIONS.  
TRUSTED PARTNER.**

MERIDIAN LIFE SCIENCE, INC. (MAINE CORPORATION)  
60 INDUSTRIAL PARK ROAD  
SACO, ME 04072

FOR: CUSTOM MANUFACTURING OF VACCINES, ANTIBODIES, ANTIGENS, PROTEINS AND OTHER BIOLOGICAL MATERIALS FOR MEDICAL DIAGNOSTIC, BIOPHARMACEUTICAL AND VETERINARY USE BY OTHERS , IN CLASS 40 (U.S. CLS. 100, 103 AND 106).

FIRST USE 3-20-2007; IN COMMERCE 3-20-2007.

THE MARK CONSISTS OF STANDARD CHARACTERS WITHOUT CLAIM TO ANY PARTICULAR FONT, STYLE, SIZE, OR COLOR.

SER. NO. 77-166,366, FILED 4-26-2007.

RUSS HERMAN, EXAMINING ATTORNEY

**Int. Cl.: 25**

**Prior U.S. Cls.: 22 and 39**

**United States Patent and Trademark Office**

**Reg. No. 3,452,249**

**Registered June 24, 2008**

**TRADEMARK  
PRINCIPAL REGISTER**



AMERICAN SPORTING GOODS CORPORATION  
(DELAWARE CORPORATION)  
101 ENTERPRISE  
ALISO VIEJO, CA 92656

FIRST USE 0-0-2002; IN COMMERCE 0-0-2002.

SER. NO. 77-166,490, FILED 4-26-2007.

FOR: SHOES; FOOTWEAR, IN CLASS 25 (U.S. CLS.  
22 AND 39).

BRIDGETT SMITH, EXAMINING ATTORNEY

**Int. Cl.: 40**

**Prior U.S. Cls.: 100, 103 and 106**

**United States Patent and Trademark Office**

**Reg. No. 3,452,250**

**Registered June 24, 2008**

**SERVICE MARK  
PRINCIPAL REGISTER**



MERIDIAN LIFE SCIENCE, INC. (MAINE CORPORATION)  
60 INDUSTRIAL PARK ROAD  
SACO, ME 04072

FOR: CUSTOM MANUFACTURING OF MONOCLONAL ANTIBODIES AND ASCITES ANTIBODIES FOR DIAGNOSTIC AND BIOPHARMACEUTICAL USE; PROCESSING AND PURIFYING MONOCLONAL ANTIBODIES AND ASCITES ANTIBODIES FOR USE BY OTHERS IN DIAGNOSTIC AND BIOPHARMACEUTICAL RESEARCH, IN CLASS 40 (U.S. CLS. 100, 103 AND 106).

FIRST USE 3-20-2007; IN COMMERCE 3-20-2007.

THE MARK CONSISTS OF TWO SPIRALED RIBBONS WITH SHADED TONE FOLLOWED BY THE UNDERLINED WORD "OEM" IN ALL CAPITAL LETTERS AND WITH THE WORD "CONCEPTS" UNDERNEATH IT.

SER. NO. 77-166,604, FILED 4-26-2007.

RUSS HERMAN, EXAMINING ATTORNEY

**Int. Cl.: 36**

**Prior U.S. Cls.: 100, 101 and 102**

**United States Patent and Trademark Office**

**Reg. No. 3,452,251**

**Registered June 24, 2008**

**SERVICE MARK  
PRINCIPAL REGISTER**

# Tropical Villa Realty

TROPICAL VILLA REALTY (HAWAII LTD LIAB  
CO)  
P.O. BOX 959, P.M.B. 747  
KIHEI, MAUI, HI 967530959

NO CLAIM IS MADE TO THE EXCLUSIVE  
RIGHT TO USE "REALTY", APART FROM THE  
MARK AS SHOWN.

FOR: REAL ESTATE PROCUREMENT FOR OTH-  
ERS, IN CLASS 36 (U.S. CLS. 100, 101 AND 102).

SEC. 2(F).

FIRST USE 1-9-2001; IN COMMERCE 1-9-2001.

SER. NO. 77-166,644, FILED 4-26-2007.

THE MARK CONSISTS OF STANDARD CHAR-  
ACTERS WITHOUT CLAIM TO ANY PARTICULAR  
FONT, STYLE, SIZE, OR COLOR.

RUSS HERMAN, EXAMINING ATTORNEY

**Int. Cl.: 9**

**Prior U.S. Cls.: 21, 23, 26, 36 and 38**

**United States Patent and Trademark Office**

**Reg. No. 3,452,252**

**Registered June 24, 2008**

**TRADEMARK  
PRINCIPAL REGISTER**

**THE COMMUNICATOR!**

DIALOGIC COMMUNICATIONS CORPORATION  
(TENNESSEE CORPORATION)  
730 COOL SPRINGS ROAD, SUITE 300  
FRANKLIN, TN 37067

FOR: COMPUTER SOFTWARE AND RELATED  
HARDWARE FOR USE BY PUBLIC AND PRIVATE  
ENTITIES FOR DELIVERY OF EMERGENCY NO-  
TIFICATIONS AND INFORMATION VIA TELE-  
PHONE, WIRELESS TELEPHONE, ELECTRONIC  
MESSAGING, GLOBAL COMPUTER NETWORK  
OR OTHER MEDIA DEVICES, IN CLASS 9 (U.S.  
CLS. 21, 23, 26, 36 AND 38).

FIRST USE 1-1-1994; IN COMMERCE 1-1-1994.

THE MARK CONSISTS OF STANDARD CHAR-  
ACTERS WITHOUT CLAIM TO ANY PARTICULAR  
FONT, STYLE, SIZE, OR COLOR.

SER. NO. 77-166,852, FILED 4-26-2007.

SALLY SHIH, EXAMINING ATTORNEY



**Int. Cl.: 9**

**Prior U.S. Cls.: 21, 23, 26, 36 and 38**

**United States Patent and Trademark Office**

**Reg. No. 3,452,253**

**Registered June 24, 2008**

**TRADEMARK  
PRINCIPAL REGISTER**



NIKON CORPORATION (JAPAN CORPORATION)  
2-3, MARUNOUCHI 3-CHOME, CHIYODA-KU  
TOKYO, JAPAN 100

THE MARK CONSISTS OF THE UPPER-CASE LETTER "D", THE NUMBER "40" AND THE LOWER-CASE LETTER "X".

FOR: DIGITAL CAMERAS, IN CLASS 9 (U.S. CLS. 21, 23, 26, 36 AND 38).

SER. NO. 77-167,328, FILED 4-27-2007.

FIRST USE 3-29-2007; IN COMMERCE 3-29-2007.

MONIQUE MILLER, EXAMINING ATTORNEY

**Int. Cl.: 45**

**Prior U.S. Cls.: 100 and 101**

**United States Patent and Trademark Office**

**Reg. No. 3,452,254**

**Registered June 24, 2008**

**SERVICE MARK  
PRINCIPAL REGISTER**

**CERTREC**

CRIMSON ENGINEERED SOLUTIONS (TEXAS  
LTD LIAB CO)  
4200 S. HULEN, SUITE 630  
FORT WORTH, TX 76109

FOR: COMPUTER SERVICES, NAMELY, PROVIDING ONLINE INTERACTIVE DATABASES FEATURING INFORMATION IN THE FIELD OF REGULATIONS GOVERNING ELECTRICAL POWER PLANTS, THE INSPECTION OF ELECTRICAL POWER PLANTS, AND REGULATORY COMPLIANCE ACTIVITIES RELATED THERETO, IN CLASS 45 (U.S. CLS. 100 AND 101).

FIRST USE 4-0-1998; IN COMMERCE 4-0-1998.

THE MARK CONSISTS OF STANDARD CHARACTERS WITHOUT CLAIM TO ANY PARTICULAR FONT, STYLE, SIZE, OR COLOR.

SER. NO. 77-167,365, FILED 4-27-2007.

ESTHER BELENKER, EXAMINING ATTORNEY

**Int. Cls.: 9 and 37**

**Prior U.S. Cls.: 21, 23, 26, 36, 38, 100, 103 and 106**

**United States Patent and Trademark Office**

**Reg. No. 3,452,255**

**Registered June 24, 2008**

**TRADEMARK  
SERVICE MARK  
PRINCIPAL REGISTER**

**AKEENA**

AKEENA SOLAR, INC. (DELAWARE CORPORATION)  
605 UNIVERSITY AVENUE  
LOS GATOS, CA 95032

FOR: RENEWABLE ENERGY SYSTEMS, NAME-  
LY, PHOTOVOLTAIC SYSTEMS COMPOSED OF  
PHOTOVOLTAIC SOLAR MODULES, BATTERIES,  
VOLTAGE REGULATORS, INVERTERS, RACKS,  
AND ELECTRIC CONTROLS; COMPUTER SOFT-  
WARE FOR PHOTOVOLTAIC SYSTEMS FOR EVAL-  
UATING ELECTRIC CONSUMPTION,  
DETERMINING SYSTEM SIZING, ESTIMATING  
ELECTRICAL OUTPUT, ESTIMATING CUSTOMER  
COSTS, AND ESTIMATING FINANCIAL LIFE CY-  
CLES SAVINGS, FOR USE BY CONSUMERS AND  
BUSINESSES, IN CLASS 9 (U.S. CLS. 21, 23, 26, 36  
AND 38).

FIRST USE 11-9-1995; IN COMMERCE 11-9-1995.

FOR: INSTALLATION OF RENEWABLE ENER-  
GY SYSTEMS, NAMELY, PHOTOVOLTAIC SYS-  
TEMS COMPOSED OF PHOTOVOLTAIC SOLAR  
MODULES, BATTERIES, VOLTAGE REGULATORS,  
INVERTERS, RACKS, AND ELECTRIC CONTROLS,  
IN CLASS 37 (U.S. CLS. 100, 103 AND 106).

FIRST USE 11-9-1995; IN COMMERCE 11-9-1995.

THE MARK CONSISTS OF STANDARD CHAR-  
ACTERS WITHOUT CLAIM TO ANY PARTICULAR  
FONT, STYLE, SIZE, OR COLOR.

OWNER OF U.S. REG. NO. 2,609,444.

SER. NO. 77-167,586, FILED 4-27-2007.

ERIN FALK, EXAMINING ATTORNEY

**Int. Cl.: 35**

**Prior U.S. Cls.: 100, 101 and 102**

**United States Patent and Trademark Office**

**Reg. No. 3,452,256**

**Registered June 24, 2008**

**SERVICE MARK  
PRINCIPAL REGISTER**

**I SEE YOU**

BEST BUDDIES INTERNATIONAL, INC. (FLOR-  
IDA CORPORATION)  
SUITE 2200  
100 SOUTHEAST SECOND STREET  
MIAMI, FL 33131

FOR: ASSOCIATION SERVICES, NAMELY, PRO-  
MOTING THE INTERESTS OF MENTALLY RETAR-  
DED PERSONS BY FOSTERING SOCIAL  
ACTIVITIES AND PERSONAL CONTACTS BE-  
TWEEN THEM AND PERSONS WHO ARE NOT  
MENTALLY RETARDED, IN CLASS 35 (U.S. CLS.  
100, 101 AND 102).

FIRST USE 12-1-2004; IN COMMERCE 12-1-2004.

THE MARK CONSISTS OF STANDARD CHAR-  
ACTERS WITHOUT CLAIM TO ANY PARTICULAR  
FONT, STYLE, SIZE, OR COLOR.

SER. NO. 77-167,652, FILED 4-27-2007.

ALEXANDER L. POWERS, EXAMINING ATTOR-  
NEY

**Int. Cls.: 35 and 42**

**Prior U.S. Cls.: 100, 101 and 102**

**United States Patent and Trademark Office**

**Reg. No. 3,452,257**

**Registered June 24, 2008**

**SERVICE MARK  
PRINCIPAL REGISTER**



EMTEC, INC. (NEW JERSEY CORPORATION)  
525 LINCOLN DRIVE WEST  
5 GREENTREE CENTER, SUITE 117  
MARLTON, NJ 08053

FOR: BUSINESS CONSULTING SERVICES IN THE FIELDS OF PROJECT MANAGEMENT, COMPUTER HARDWARE AND SOFTWARE MANAGEMENT, DATA STORAGE, DATA BACKUP AND DISASTER RECOVERY; BUSINESS PROCESS RE-ENGINEERING SERVICES; BUSINESS CONSULTING SERVICES IN THE FIELD OF PERFORMANCE MANAGEMENT SERVICES, IN CLASS 35 (U.S. CLS. 100, 101 AND 102).

FIRST USE 10-22-2006; IN COMMERCE 10-22-2006.

FOR: CONSULTATION SERVICES AND DESIGN SERVICES IN THE FIELDS OF SELECTION, IMPLEMENTATION, INTEGRATION, BACKUP, MANAGEMENT AND USE OF COMPUTER HARDWARE AND SOFTWARE, E-COMMERCE

SOFTWARE, AND ENTERPRISE ARCHITECTURE; CONSULTATION SERVICES AND DESIGN SERVICES IN THE FIELD OF CONFIGURATION OF COMPUTER SOFTWARE, IN CLASS 42 (U.S. CLS. 100 AND 101).

FIRST USE 10-22-2006; IN COMMERCE 10-22-2006.

OWNER OF U.S. REG. NOS. 2,581,456, 2,634,248, AND 2,634,249.

NO CLAIM IS MADE TO THE EXCLUSIVE RIGHT TO USE "AGILITY IN IT", APART FROM THE MARK AS SHOWN.

THE MARK CONSISTS OF THE WORDS "EMTEC AGILITY IN IT" IN SPECIAL LETTERING WITH 3 SQUARE APPEARING IN THE BACKGROUND.

SER. NO. 77-167,795, FILED 4-27-2007.

MICHAEL WIENER, EXAMINING ATTORNEY

**Int. Cl.: 26**

**Prior U.S. Cls.: 37, 39, 40, 42 and 50**

**Reg. No. 3,452,258**

**United States Patent and Trademark Office**

**Registered June 24, 2008**

**TRADEMARK  
PRINCIPAL REGISTER**



**DREAMWEAVER**

MODEL MODEL HAIR FASHION, INC. (NEW YORK CORPORATION)  
83 HARBOR ROAD  
PORT WASHINGTON, NY 11050

FOR: HAIR PRODUCTS, NAMELY HAIR EXTENSIONS, WIGS, HAIR PIECES, AND PONYTAILS, IN CLASS 26 (U.S. CLS. 37, 39, 40, 42 AND 50).

FIRST USE 11-0-2004; IN COMMERCE 11-0-2004.

OWNER OF U.S. REG. NO. 3,212,054.

THE COLOR(S) BLACK, WHITE, ORANGE AND SILVER IS/ARE CLAIMED AS A FEATURE OF THE MARK.

THE MARK CONSISTS OF THE DISTINCTIVE TRADEDRESS CHARACTERIZING THE FRONT

OF THE PACKAGING FOR THE APPLICANT'S GOODS. THE MARK HAS A BLACK UPPER PORTION, A WHITE LOWER PORTION AND A SLOPED SILVER STRIP LOCATED BETWEEN THE BLACK UPPER PORTION AND THE WHITE LOWER PORTION. THE WORD "MODEL" IS LOCATED AT THE TOP OF THE BLACK UPPER PORTION AND HAS THE COLOR ORANGE, WHILE THE WORD "MODEL" HAVING THE COLOR WHITE IS LOCATED BELOW THE WORD "MODEL" IN ORANGE. THE WORDS "MODEL" "MODEL" ARE ENCLOSED BY A RECTANGULAR BORDER HAVING THE COLOR SILVER. THE TERM "DREAMWEAVER" HAVING THE COLOR BLACK IS LOCATED IN THE LOWER RIGHT CORNER OF THE MARK.

SER. NO. 77-167,855, FILED 4-27-2007.

MICHAEL LEWIS, EXAMINING ATTORNEY

**Int. Cl.: 35**

**Prior U.S. Cls.: 100, 101 and 102**

**United States Patent and Trademark Office**

**Reg. No. 3,452,259**

**Registered June 24, 2008**

**SERVICE MARK  
PRINCIPAL REGISTER**

**BEDTIME! MATTRESS**

MATTRESS FIRM, INC. (DELAWARE CORPORATION)  
5815 GULF FREEWAY  
HOUSTON, TX 77023

FOR: RETAIL STORE SERVICES FEATURING  
FURNITURE AND SLEEP PRODUCTS, IN CLASS 35  
(U.S. CLS. 100, 101 AND 102).

FIRST USE 6-11-1992; IN COMMERCE 6-11-1992.

THE MARK CONSISTS OF STANDARD CHARACTERS WITHOUT CLAIM TO ANY PARTICULAR FONT, STYLE, SIZE, OR COLOR.

NO CLAIM IS MADE TO THE EXCLUSIVE RIGHT TO USE "MATTRESS", APART FROM THE MARK AS SHOWN.

SER. NO. 77-167,912, FILED 4-27-2007.

ANGELA M. MICHELI, EXAMINING ATTORNEY

**Int. Cls.: 16 and 35**

**Prior U.S. Cls.: 2, 5, 22, 23, 29, 37, 38, 50, 100, 101 and 102**

**Reg. No. 3,452,260**

**United States Patent and Trademark Office**

**Registered June 24, 2008**

**TRADEMARK  
SERVICE MARK  
PRINCIPAL REGISTER**



EDGE CONSULTING ASSOCIATES INC. (CANADA CORPORATION)  
C/O PROWSE CHOWNE LLP  
1300 - 10020 101A AVENUE  
EDMONTON, CANADA T5J3G2

FOR: BOOKS IN THE FIELD OF BUSINESS MANAGEMENT IN THE LEGAL PROFESSION; MAGAZINES FEATURING INFORMATION ABOUT BUSINESS MANAGEMENT IN THE LEGAL PROFESSION; BOOKLETS IN THE FIELD OF BUSINESS MANAGEMENT IN THE LEGAL PROFESSION, IN CLASS 16 (U.S. CLS. 2, 5, 22, 23, 29, 37, 38 AND 50).

FIRST USE 0-0-1986; IN COMMERCE 0-0-1986.

FOR: BUSINESS MANAGEMENT CONSULTATION FOR THE LEGAL PROFESSION, IN CLASS 35 (U.S. CLS. 100, 101 AND 102).

FIRST USE 0-0-1983; IN COMMERCE 0-0-1983.

THE MARK CONSISTS OF A STYLIZED COMPASS WITH THE WORD "EDGE".

SER. NO. 77-167,913, FILED 4-27-2007.

JENNIFER MARTIN, EXAMINING ATTORNEY



**Int. Cl.: 42**

**Prior U.S. Cls.: 100 and 101**

**United States Patent and Trademark Office**

**Reg. No. 3,452,261**

**Registered June 24, 2008**

**SERVICE MARK  
PRINCIPAL REGISTER**

**ECODESIGN**

ECODESIGN, INC. (MASSACHUSETTS CORPORATION)  
FLAGSHIP WHARF SUITE 506  
197 EIGHTH STREET  
CHARLESTOWN, MA 02129

FOR: ARCHITECTURAL DESIGN, URBAN PLANNING, ENGINEERING SERVICES, CONSULTING SERVICES IN THE FIELD OF ENVIRONMENTAL ASSESSMENT, COMPLIANCE AND PLANNING, IN CLASS 42 (U.S. CLS. 100 AND 101).

FIRST USE 12-31-1969; IN COMMERCE 12-31-1969.

THE MARK CONSISTS OF STANDARD CHARACTERS WITHOUT CLAIM TO ANY PARTICULAR FONT, STYLE, SIZE, OR COLOR.

SEC. 2(F).

SER. NO. 77-168,508, FILED 4-29-2007.

ADA HAN, EXAMINING ATTORNEY

**Int. Cls.: 35 and 36**

**Prior U.S. Cls.: 100, 101 and 102**

**United States Patent and Trademark Office**

**Reg. No. 3,452,262**

**Registered June 24, 2008**

**SERVICE MARK  
PRINCIPAL REGISTER**

**GLOBAL VICTORY FOUNDATION**

VIP PARTNERS, LLC (VIRGINIA LTD LIAB CO)  
7006 LITTLE RIVER TURNPIKE, SUITE L  
ANNANDALE, VA 22003

FOR: CHARITABLE SERVICES, NAMELY, ORGANIZING AND CONDUCTING VOLUNTEER PROGRAMS AND COMMUNITY SERVICE PROJECTS, IN CLASS 35 (U.S. CLS. 100, 101 AND 102).

FIRST USE 9-8-2006; IN COMMERCE 9-8-2006.

FOR: CHARITABLE SERVICES, NAMELY, PROVIDING EDUCATIONAL SCHOLARSHIPS AND GRANTS; CHARITABLE FUND RAISING, IN CLASS 36 (U.S. CLS. 100, 101 AND 102).

FIRST USE 9-8-2006; IN COMMERCE 9-8-2006.

THE MARK CONSISTS OF STANDARD CHARACTERS WITHOUT CLAIM TO ANY PARTICULAR FONT, STYLE, SIZE, OR COLOR.

NO CLAIM IS MADE TO THE EXCLUSIVE RIGHT TO USE "GLOBAL" AND "FOUNDATION", APART FROM THE MARK AS SHOWN.

SER. NO. 77-169,188, FILED 4-30-2007.

DAVID YONTEF, EXAMINING ATTORNEY

**Int. Cls.: 35 and 36**

**Prior U.S. Cls.: 100, 101 and 102**

**United States Patent and Trademark Office**

**Reg. No. 3,452,263**

**Registered June 24, 2008**

**SERVICE MARK  
PRINCIPAL REGISTER**

**GIRLS ON COURSE**

VIP PARTNERS, LLC (VIRGINIA LTD LIAB CO)  
7006 LITTLE RIVER TURNPIKE, SUITE L  
ANNANDALE, VA 22003

FOR: CHARITABLE SERVICES, NAMELY, ORGANIZING AND CONDUCTING VOLUNTEER PROGRAMS AND COMMUNITY SERVICE PROJECTS, IN CLASS 35 (U.S. CLS. 100, 101 AND 102).

FIRST USE 9-8-2006; IN COMMERCE 9-8-2006.

FOR: CHARITABLE SERVICES, NAMELY, PROVIDING EDUCATIONAL SCHOLARSHIPS AND GRANTS; CHARITABLE FUND RAISING, IN CLASS 36 (U.S. CLS. 100, 101 AND 102).

FIRST USE 9-8-2006; IN COMMERCE 9-8-2006.

THE MARK CONSISTS OF STANDARD CHARACTERS WITHOUT CLAIM TO ANY PARTICULAR FONT, STYLE, SIZE, OR COLOR.

NO CLAIM IS MADE TO THE EXCLUSIVE RIGHT TO USE "GIRLS", APART FROM THE MARK AS SHOWN.

SER. NO. 77-169,194, FILED 4-30-2007.

DAVID YONTEF, EXAMINING ATTORNEY

**Int. Cl.: 36**

**Prior U.S. Cls.: 100, 101 and 102**

**United States Patent and Trademark Office**

**Reg. No. 3,452,264**

**Registered June 24, 2008**

**SERVICE MARK  
PRINCIPAL REGISTER**

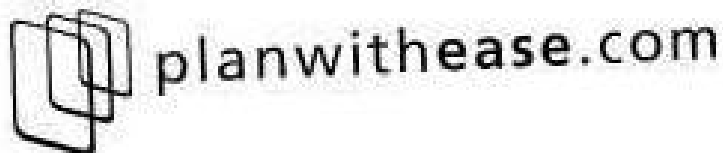

ING NORTH AMERICA INSURANCE CORPORATION (DELAWARE CORPORATION)  
5780 POWERS FERRY ROAD, N.W.  
ATLANTA, GA 30327

FOR: PROVIDING AN ON-LINE COMPUTER DATABASE IN THE FIELD OF EMPLOYEE BENEFIT PLAN ADMINISTRATION SERVICES, NAMELY, INVESTMENT ACCOUNT AGGREGATION, NAMELY, CONSOLIDATING THE ADMINISTRATION OF MULTIPLE INVESTMENT PROVIDERS IN A SINGLE RETIREMENT PLAN; RETIREMENT PLAN OVERSIGHT SERVICES TO EMPLOYERS, NAMELY, MONITORING PLAN CONTRIBUTION LIMITS AND PLAN DISBURSEMENTS TO EMPLOYEES; PROVIDING ON-LINE FINANCIAL CALCULATORS TO ASSIST EMPLOYEES IN

CALCULATING RETIREMENT PLAN BENEFITS; AND PROVIDING INFORMATION IN THE FIELD OF RETIREMENT PLANS VIA THE INTERNET, IN CLASS 36 (U.S. CLS. 100, 101 AND 102).

FIRST USE 10-0-2006; IN COMMERCE 10-0-2006.

THE MARK CONSISTS OF THE WORDS "PLAN-WITHEASE.COM" AND THREE RECTANGLES TO THE LEFT OF THE WORDS THAT HAVE A CONTINUALLY DECREASING PERIMETER.

SER. NO. 77-169,367, FILED 4-30-2007.

BILL DAWE, EXAMINING ATTORNEY

Int. Cl.: 35

Prior U.S. Cls.: 100, 101 and 102

United States Patent and Trademark Office

Reg. No. 3,452,265

Registered June 24, 2008

SERVICE MARK  
PRINCIPAL REGISTER



GREENBERG CASEWORK CO.INC. (ILLINOIS CORPORATION)

592 QUALITY LN.

SOUTH BELOIT, IL 61080

FOR: WHOLESALE DISTRIBUTORSHIPS FEATURING WOOD CABINETS, IN CLASS 35 (U.S. CLS. 100, 101 AND 102).

FIRST USE 5-1-2004; IN COMMERCE 5-1-2004.

NO CLAIM IS MADE TO THE EXCLUSIVE RIGHT TO USE "GARAGEGEAR", APART FROM THE MARK AS SHOWN.

THE MARK CONSISTS OF A TACKOMETER WITH THE GAGE INDICATOR IN THE WARNING AREA ATTACHED TO THE WORDS "REDLINE GARAGEGEAR".

SER. NO. 77-169,459, FILED 4-30-2007.

KEVON CHISOLM, EXAMINING ATTORNEY

**Int. Cl.: 28**

**Prior U.S. Cls.: 22, 23, 38 and 50**

**United States Patent and Trademark Office**

**Reg. No. 3,452,266**

**Registered June 24, 2008**

**TRADEMARK  
PRINCIPAL REGISTER**

**DIRTBIKE DOME**

MATTEL, INC. (DELAWARE CORPORATION)  
M1-1518  
333 CONTINENTAL BLVD.  
EL SEGUNDO, CA 90245

FOR: TOYS, GAMES AND PLAYTHINGS, NAME-  
LY, TOY FIGURE PLAYSETS AND ACCESSORIES  
THEREFOR, IN CLASS 28 (U.S. CLS. 22, 23, 38 AND  
50).

FIRST USE 12-13-2007; IN COMMERCE 12-13-2007.

THE MARK CONSISTS OF STANDARD CHAR-  
ACTERS WITHOUT CLAIM TO ANY PARTICULAR  
FONT, STYLE, SIZE, OR COLOR.

NO CLAIM IS MADE TO THE EXCLUSIVE  
RIGHT TO USE "DIRTBIKE", APART FROM THE  
MARK AS SHOWN.

SER. NO. 77-169,669, FILED 5-1-2007.

ELLEN BURNS, EXAMINING ATTORNEY

**Int. Cl.: 36**

**Prior U.S. Cls.: 100, 101 and 102**

**United States Patent and Trademark Office**

**Reg. No. 3,452,267**

**Registered June 24, 2008**

**SERVICE MARK  
PRINCIPAL REGISTER**

**RCG DIRECT**

ROSENTHAL COLLINS GROUP, LLC (ILLINOIS  
LTD LIAB CO)  
SUITE 400  
216 W. JACKSON BLVD.  
CHICAGO, IL 60606

FOR: BROKER SERVICES, NAMELY, STOCK  
EXCHANGE TRADING FLOOR BROKERAGE SER-  
VICES, ELECTRONIC TRADING SERVICES FOR  
THE BROKERAGE OF SECURITIES, FOREIGN EX-  
CHANGE TRADING SERVICES, COMMODITY FU-  
TURES TRADING SERVICES AND SECURITY  
BROKERAGE CLEARING SERVICES, IN CLASS 36  
(U.S. CLS. 100, 101 AND 102).

FIRST USE 9-22-1998; IN COMMERCE 9-22-1998.

THE MARK CONSISTS OF STANDARD CHAR-  
ACTERS WITHOUT CLAIM TO ANY PARTICULAR  
FONT, STYLE, SIZE, OR COLOR.

OWNER OF U.S. REG. NOS. 2,970,765, 2,970,767  
AND OTHERS.

NO CLAIM IS MADE TO THE EXCLUSIVE  
RIGHT TO USE "DIRECT", APART FROM THE  
MARK AS SHOWN.

SER. NO. 77-169,756, FILED 5-1-2007.

MICHAEL WIENER, EXAMINING ATTORNEY

**Int. Cls.: 42 and 44**

**Prior U.S. Cls.: 100 and 101**

**United States Patent and Trademark Office**

**Reg. No. 3,452,268**

**Registered June 24, 2008**

**SERVICE MARK  
PRINCIPAL REGISTER**

**DNA SOLUTIONS**

THE TRUSTEES OF THE THOMAS C. KUPIEC  
REVOCABLE TRUST (OKLAHOMA TRUST)  
840 RESEARCH PARKWAY, STE 546  
OKLAHOMA CITY, OK 73104

FOR: DNA TESTING FOR NON-MEDICAL USE,  
NAMELY, FOR DETERMINING PATERNITY, MA-  
TERNITY AND OTHER BIOLOGICAL FAMILY  
RELATIONSHIPS, IN CLASS 42 (U.S. CLS. 100 AND  
101).

FIRST USE 5-1-2000; IN COMMERCE 5-1-2000.

FOR: MEDICAL TESTING, NAMELY, DNA TEST-  
ING TO DETERMINE PRESENCE OF INHERITED  
MEDICAL CONDITIONS OR RISK FACTORS ARIS-

ING FROM BIOLOGICAL RELATIONSHIPS, IN  
CLASS 44 (U.S. CLS. 100 AND 101).

FIRST USE 5-1-2000; IN COMMERCE 5-1-2000.

THE MARK CONSISTS OF STANDARD CHAR-  
ACTERS WITHOUT CLAIM TO ANY PARTICULAR  
FONT, STYLE, SIZE, OR COLOR.

NO CLAIM IS MADE TO THE EXCLUSIVE  
RIGHT TO USE "DNA" , APART FROM THE MARK  
AS SHOWN.

SER. NO. 77-169,809, FILED 5-1-2007.

STEVEN PEREZ, EXAMINING ATTORNEY



**Int. Cl.: 9**

**Prior U.S. Cls.: 21, 23, 26, 36 and 38**

**Reg. No. 3,452,269**

**United States Patent and Trademark Office**

**Registered June 24, 2008**

**TRADEMARK  
PRINCIPAL REGISTER**



ENEWAVE ELECTRONIC (SOUTH CAROLINA  
LTD LIAB CO)  
19 BRECKENRIDGE CT  
GREENVILLE, SC 29615

FOR: PROFESSIONAL AUDIO AND VIDEO  
EQUIPMENT USED IN STAGE, STUDIO, BUSINESS  
AND PUBLIC CONSTRUCTIONS COMPRISING  
SIGNAL PROCESSORS, VIDEO IMAGE PROCES-  
SORS, LOUDSPEAKERS AND HIGH POWER AM-

PLIFIERS, IN CLASS 9 (U.S. CLS. 21, 23, 26, 36 AND  
38).

FIRST USE 3-15-2007; IN COMMERCE 3-15-2007.

SER. NO. 77-169,813, FILED 5-1-2007.

BARNEY CHARLON, EXAMINING ATTORNEY

**Int. Cl.: 41**

**Prior U.S. Cls.: 100, 101 and 107**

**Reg. No. 3,452,270**

**United States Patent and Trademark Office**

**Registered June 24, 2008**

---

**SERVICE MARK  
PRINCIPAL REGISTER**

OPPORTUNITY EVERYWHERE

TWENTIETH CENTURY FOX FILM CORPORATION (DELAWARE CORPORATION)  
10201 WEST PICO BOULEVARD  
LOS ANGELES, CA 90035

THE MARK CONSISTS OF STANDARD CHARACTERS WITHOUT CLAIM TO ANY PARTICULAR FONT, STYLE, SIZE, OR COLOR.

FOR: ENTERTAINMENT SERVICES IN THE NATURE OF DISTRIBUTION OF MOTION PICTURE FILMS AND TELEVISION PROGRAMS, IN CLASS 41 (U.S. CLS. 100, 101 AND 107).

SER. NO. 77-170,408, FILED 5-1-2007.

FIRST USE 7-17-2005; IN COMMERCE 7-17-2005.

ROSELLE HERRERA, EXAMINING ATTORNEY

**Int. Cl.: 11**

**Prior U.S. Cls.: 13, 21, 23, 31 and 34**

**United States Patent and Trademark Office**

**Reg. No. 3,452,271**

**Registered June 24, 2008**

**TRADEMARK  
PRINCIPAL REGISTER**

# Aqua Freshe

CUSTOMIZED ENVIRONMENTAL SYSTEMS,  
INC. (PENNSYLVANIA CORPORATION)  
3930 OLD WILLIAM PENN HWY.  
APT.302  
PITTSBURGH, PA 15235

FOR: WATER FILTRATION AND PURIFICATION UNITS FOR DOMESTIC, COMMERCIAL AND INDUSTRIAL USE, IN CLASS 11 (U.S. CLS. 13, 21, 23, 31 AND 34).

FIRST USE 2-23-1993; IN COMMERCE 2-23-1993.

THE MARK CONSISTS OF STANDARD CHARACTERS WITHOUT CLAIM TO ANY PARTICULAR FONT, STYLE, SIZE, OR COLOR.

NO CLAIM IS MADE TO THE EXCLUSIVE RIGHT TO USE "AQUA", APART FROM THE MARK AS SHOWN.

SER. NO. 77-170,436, FILED 5-1-2007.

KATHERINE CONNOLLY, EXAMINING ATTORNEY

**Int. Cl.: 41**

**Prior U.S. Cls.: 100, 101 and 107**

**United States Patent and Trademark Office**

**Reg. No. 3,452,272**

**Registered June 24, 2008**

**SERVICE MARK  
PRINCIPAL REGISTER**

**HAYDENETTES**

HAYDEN SYNCHRONIZED SKATING TEAMS  
(MASSACHUSETTS NON-PROFIT UNINCOR-  
PORATED ASSOCIATION)  
P.O. BOX 493H  
LEXINGTON, MA 02420

THE MARK CONSISTS OF STANDARD CHAR-  
ACTERS WITHOUT CLAIM TO ANY PARTICULAR  
FONT, STYLE, SIZE, OR COLOR.

FOR: ICE SKATING INSTRUCTION, IN CLASS 41  
(U.S. CLS. 100, 101 AND 107).

SER. NO. 77-170,496, FILED 5-1-2007.

FIRST USE 1-1-1980; IN COMMERCE 1-1-1980.

BERYL GARDNER, EXAMINING ATTORNEY

**Int. Cl.: 41**

**Prior U.S. Cls.: 100, 101 and 107**

**United States Patent and Trademark Office**

**Reg. No. 3,452,273**

**Registered June 24, 2008**

**SERVICE MARK  
PRINCIPAL REGISTER**

**ICE MATES**

HAYDEN SYNCHRONIZED SKATING TEAMS  
(MASSACHUSETTS NON-PROFIT UNINCORPORATED ASSOCIATION)

P.O. BOX 493  
LEXINGTON, MA 02420

FOR: ICE SKATING INSTRUCTION, IN CLASS 41  
(U.S. CLS. 100, 101 AND 107).

FIRST USE 1-1-1990; IN COMMERCE 1-1-1990.

THE MARK CONSISTS OF STANDARD CHARACTERS WITHOUT CLAIM TO ANY PARTICULAR FONT, STYLE, SIZE, OR COLOR.

NO CLAIM IS MADE TO THE EXCLUSIVE RIGHT TO USE "ICE", APART FROM THE MARK AS SHOWN.

SER. NO. 77-170,509, FILED 5-1-2007.

BERYL GARDNER, EXAMINING ATTORNEY

**Int. Cl.: 29**

**Prior U.S. Cl.: 46**

**United States Patent and Trademark Office**

**Reg. No. 3,452,274**

**Registered June 24, 2008**

**TRADEMARK  
PRINCIPAL REGISTER**

**SUNRICH**

SUNRICH LLC (MINNESOTA LTD LIAB CO)  
3824 SOUTHWEST 93RD STREET  
HOPE, MN 56046

FOR: SOY MILK, IN CLASS 29 (U.S. CL. 46).

FIRST USE 8-31-2005; IN COMMERCE 8-31-2005.

THE MARK CONSISTS OF STANDARD CHARACTERS WITHOUT CLAIM TO ANY PARTICULAR FONT, STYLE, SIZE, OR COLOR.

OWNER OF U.S. REG. NOS. 2,445,696 AND 2,869,627.

SER. NO. 77-171,058, FILED 5-2-2007.

LINDA POWELL, EXAMINING ATTORNEY

**Int. Cl.: 35**

**Prior U.S. Cls.: 100, 101 and 102**

**United States Patent and Trademark Office**

**Reg. No. 3,452,275**

**Registered June 24, 2008**

---

**SERVICE MARK  
PRINCIPAL REGISTER**

**PARTNER-CENTRIC**

PREFERRED HOME BUYERS NETWORK, INC.  
(MINNESOTA CORPORATION)  
28215 BOULDER CIRCLE  
EXCELSIOR, MN 55331

FOR: BUSINESS MARKETING CONSULTING  
SERVICES, IN CLASS 35 (U.S. CLS. 100, 101 AND 102).

FIRST USE 2-0-2003; IN COMMERCE 2-0-2003.

THE MARK CONSISTS OF STANDARD CHAR-  
ACTERS WITHOUT CLAIM TO ANY PARTICULAR  
FONT, STYLE, SIZE, OR COLOR.

NO CLAIM IS MADE TO THE EXCLUSIVE  
RIGHT TO USE "PARTNER", APART FROM THE  
MARK AS SHOWN.

SER. NO. 77-171,355, FILED 5-2-2007.

KATHERINE M. DUBRAY, EXAMINING ATTOR-  
NEY

**Int. Cl.: 41**

**Prior U.S. Cls.: 100, 101 and 107**

**United States Patent and Trademark Office**

**Reg. No. 3,452,276**

**Registered June 24, 2008**

**SERVICE MARK  
PRINCIPAL REGISTER**

**LOCOFEST**

DANIEL C HARTWELL (UNITED STATES INDIVIDUAL)  
17 FOURTH STREET  
WORCESTER, MA 01602

THE MARK CONSISTS OF STANDARD CHARACTERS WITHOUT CLAIM TO ANY PARTICULAR FONT, STYLE, SIZE, OR COLOR.

FOR: CONDUCTING ENTERTAINMENT EXHIBITIONS IN THE NATURE OF MUSIC AND ARTS FESTIVALS, IN CLASS 41 (U.S. CLS. 100, 101 AND 107).

SER. NO. 77-171,412, FILED 5-2-2007.

FIRST USE 3-22-2007; IN COMMERCE 3-22-2007.

KEVON CHISOLM, EXAMINING ATTORNEY



**Int. Cl.: 9**

**Prior U.S. Cls.: 21, 23, 26, 36 and 38**

**Reg. No. 3,452,277**

**United States Patent and Trademark Office**

**Registered June 24, 2008**

**TRADEMARK  
PRINCIPAL REGISTER**



TRUE AUTOMATION, INC. (TEXAS CORPORATION)  
2600 TECHNOLOGY DR, SUITE 900  
PLANO, TX 75074

FOR: COMPUTER SOFTWARE FOR THE APPRAISAL AND COLLECTION OF PROPERTY TAXES FOR USE BY GOVERNMENTAL ENTITIES, IN CLASS 9 (U.S. CLS. 21, 23, 26, 36 AND 38).

FIRST USE 0-0-2000; IN COMMERCE 0-0-2000.

THE MARK CONSISTS OF THE STYLIZED LETTERS "TA" SUPERIMPOSED OVER A SPHERE WITH TWO INTERLOCKING AND ORBITING CIRCLES.

SER. NO. 77-171,540, FILED 5-2-2007.

EMILY CHUO, EXAMINING ATTORNEY

**Int. Cl.: 9**

**Prior U.S. Cls.: 21, 23, 26, 36 and 38**

**Reg. No. 3,452,278**

**United States Patent and Trademark Office**

**Registered June 24, 2008**

---

**TRADEMARK  
PRINCIPAL REGISTER**

**PACS APPRAISAL**

TRUE AUTOMATION, INC. (TEXAS CORPORATION)  
2600 TECHNOLOGY DR, SUITE 900  
PLANO, TX 75074

FOR: COMPUTER SOFTWARE FOR THE APPRAISAL AND COLLECTION OF PROPERTY TAXES FOR USE BY GOVERNMENTAL ENTITIES, IN CLASS 9 (U.S. CLS. 21, 23, 26, 36 AND 38).

FIRST USE 0-0-1998; IN COMMERCE 0-0-1998.

THE MARK CONSISTS OF STANDARD CHARACTERS WITHOUT CLAIM TO ANY PARTICULAR FONT, STYLE, SIZE, OR COLOR.

NO CLAIM IS MADE TO THE EXCLUSIVE RIGHT TO USE "APPRAISAL", APART FROM THE MARK AS SHOWN.

SER. NO. 77-171,545, FILED 5-2-2007.

EMILY CHUO, EXAMINING ATTORNEY

**Int. Cl.: 16**

**Prior U.S. Cls.: 2, 5, 22, 23, 29, 37, 38 and 50**

**Reg. No. 3,452,279**

**United States Patent and Trademark Office**

**Registered June 24, 2008**

**TRADEMARK  
PRINCIPAL REGISTER**

# Maya Road

MAYA ROAD, LLC (TEXAS LTD LIAB CO)  
461 RIDGE MEADE DRIVE  
LEWISVILLE, TX 750678370

FOR: ALBUMS FOR STICKERS; BRAG BOOKS; EVENT ALBUMS; EVENTS ALBUMS; MEMORY BOOKS; PHOTOGRAPH ALBUM PAGES; PHOTOGRAPH ALBUMS; PHOTOGRAPHIC ALBUMS; SCRAPBOOK ALBUMS; STAMP ALBUMS; BINDERS; LOOSE LEAF BINDERS; THREE-RING BINDERS; BLANK JOURNAL BOOKS; EDUCATIONAL PUBLICATIONS, NAMELY, EDUCATIONAL LEARNING CARDS, FLASH CARDS, ACTIVITY CARDS, WORKBOOKS, TEXTBOOKS, ACTIVITY BOOKS, STORY BOOKS, PUZZLE BOOKS, PUZZLES, TEACHER GUIDES, MANUALS, POSTERS, EDUCATIONAL CARD GAMES AND EDUCATIONAL BOOKLETS IN THE FIELD OF SCRAPBOOKING AND OTHER PAPER CRAFTS; PROTECTIVE COVERS FOR SHEETS OR PAPER AND PAGES OF BOOKS AND THE LIKE; BOXES OF PAPER OR CARDBOARD; CARDBOARD BOXES; FIBERBOARD BOXES; PAPER BOXES; PAPER DISPLAY BOXES; PHOTO STORAGE BOXES; STATIONERY BOXES; CARDBOARD; CARDBOARD CONTAINERS; CARDBOARD HANG TAGS; PAPER AND CARDBOARD; PAPERBOARD; PICTURE MOUNTS OF CARDBOARD; PAPER CLIPS; PAPER CONTAINERS; PHOTO MOUNTING CORNERS; PHOTOGRAPH CORNERS; CRAFT PAPER; PICTURE FRAMING MAT BOARDS; INSTRUCTION SHEETS; PRINTED INSTRUCTIONAL, EDUCATIONAL, AND TEACHING MATERIALS IN THE FIELD OF

SCRAPBOOKING AND OTHER PAPER CRAFTS; ADHESIVE-BACKED LETTERS AND NUMBERS FOR USE IN MAKING SCRAPBOOK PAGES AND OTHER PAPER CRAFTS; PAPER LETTERS AND NUMBER FOR USE IN MAKING SCRAPBOOK PAGES AND OTHER PAPER CRAFTS; MANUALS IN THE FIELD OF SCRAPBOOKING AND OTHER PAPER CRAFTS; MOUNTS FOR STAMPS; PAPER PICTURE MOUNTS; PHOTOGRAPH MOUNTS; PHOTOGRAPHIC OR ART MOUNTS; PICTURE MOUNTS OF PAPER; ACID-RESISTANT PAPER; COASTERS MADE OF PAPER; PAPER; PAPER BOARD; PAPER DIE CUT SHAPES; PAPER HANG TAGS; PAPER RIBBONS; PAPER STATIONERY; PAPER TAGS; ALBUMS FOR PHOTOGRAPHS; PLASTIC PAGES FOR HOLDING SCRAPBOOK PAGES; SCRAPBOOK PAGES; SCRAPBOOKS; IMPRESSION STAMPS; INK STAMPS; MARKING STAMPS; RUBBER STAMP; RUBBER STAMPS; STICKERS; DRY TRANSFER CHARACTERS; RUB-ON TRANSFERS; STATIONERY, IN CLASS 16 (U.S. CLS. 2, 5, 22, 23, 29, 37, 38 AND 50).

FIRST USE 4-0-2003; IN COMMERCE 9-0-2003.

THE MARK CONSISTS OF STANDARD CHARACTERS WITHOUT CLAIM TO ANY PARTICULAR FONT, STYLE, SIZE, OR COLOR.

SER. NO. 77-171,589, FILED 5-3-2007.

JAMES STEIN, EXAMINING ATTORNEY

**Int. Cl.: 45**

**Prior U.S. Cls.: 100 and 101**

**United States Patent and Trademark Office**

**Reg. No. 3,452,280**

**Registered June 24, 2008**

**SERVICE MARK  
PRINCIPAL REGISTER**

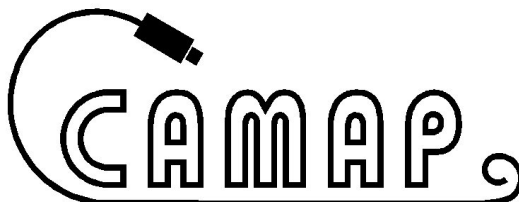

JOHN MCNAIR AND ASSOCIATES, INC. (VIR-  
GINIA CORPORATION)  
109 SOUTH WAYNE AVE  
WAYNESBORO, VA 22980

FOR: ON-LINE MONITORING, NAMELY, VIDEO  
MONITORING OF FACILITIES, VIEWABLE  
THROUGH A GLOBAL COMPUTER NETWORK,  
IN CLASS 45 (U.S. CLS. 100 AND 101).

FIRST USE 10-3-2005; IN COMMERCE 1-16-2006.

THE MARK CONSISTS OF THE WORD "CAMAP"  
IN ALL UPPER CASE LETTERS; A STYLIZED  
PICTURE OF A CAMERA IS HANGING OVER  
THE FIRST LETTER "A" ATTACHED TO A LINE  
THAT CURVES UP AND AROUND THE "C" AND  
THEN CONTINUES AROUND TO UNDERLINE  
THE WORD "CAMAP" AND ENDS JUST PAST  
THE LETTER "P" WITH A SMALL CURL.

SER. NO. 77-171,718, FILED 5-3-2007.

MICHAEL LEWIS, EXAMINING ATTORNEY

**Int. Cl.: 35**

**Prior U.S. Cls.: 100, 101 and 102**

**United States Patent and Trademark Office**

**Reg. No. 3,452,281**

**Registered June 24, 2008**

**SERVICE MARK  
PRINCIPAL REGISTER**

**AUTOMAX**

MAX AUTO MANAGEMENT, INC. (FLORIDA  
CORPORATION)  
2075 N. WICKHAM ROAD  
MELBOURNE, FL 32935

FOR: RETAIL STORE SERVICES FEATURING  
USED VEHICLES, AUTOMOBILES AND TRUCKS,  
IN CLASS 35 (U.S. CLS. 100, 101 AND 102).

FIRST USE 12-31-1995; IN COMMERCE 12-31-1995.

THE MARK CONSISTS OF THE WORD "AUTO-  
MAX" IN STYLIZED LETTERING.

SER. NO. 77-172,005, FILED 5-3-2007.

AMOS T. MATTHEWS, JR., EXAMINING ATTOR-  
NEY

Int. Cl.: 41

Prior U.S. Cls.: 100, 101 and 107

United States Patent and Trademark Office

Reg. No. 3,452,282

Registered June 24, 2008

SERVICE MARK  
PRINCIPAL REGISTER

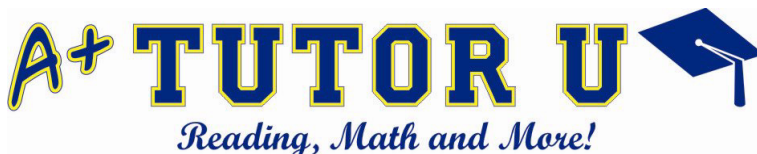

LEARNING CENTERS OF CENTRAL FLORIDA,  
LLC (FLORIDA LTD LIAB CO)  
401 W. COLONIAL DRIVE  
ORLANDO, FL 32804

FOR: EDUCATIONAL SERVICES, NAMELY,  
PROVIDING TUTORING IN THE FIELD OF GEN-  
ERAL EDUCATION AT THE PRIMARY AND SEC-  
ONDARY EDUCATIONAL LEVELS , IN CLASS 41  
(U.S. CLS. 100, 101 AND 107).

FIRST USE 4-0-2006; IN COMMERCE 4-0-2006.

THE COLOR(S) ROYAL BLUE, YELLOW AND  
WHITE IS/ARE CLAIMED AS A FEATURE OF THE  
MARK.

THE MARK CONSISTS OF THE LITERAL ELE-  
MENT "A+ TUTOR U" IN ROYAL BLUE WITH A  
YELLOW BORDER; THE LITERAL ELEMENT  
"READING, MATH AND MORE!" IN ROYAL BLUE;  
AND A GRADUATION CAP DESIGN IN ROYAL  
BLUE AND WHITE.

SER. NO. 77-172,178, FILED 5-3-2007.

WILLIAM ROSSMAN, EXAMINING ATTORNEY

**Int. Cl.: 35**

**Prior U.S. Cls.: 100, 101 and 102**

**United States Patent and Trademark Office**

**Reg. No. 3,452,283**

**Registered June 24, 2008**

**SERVICE MARK  
PRINCIPAL REGISTER**

**GET FRESH WITH EDIBLE  
ARRANGEMENTS!**

EDIBLE ARRANGEMENTS, LLC (CONNECTI-  
CUT LTD LIAB CO)  
95 BARNES ROAD  
WALLINGFORD, CT 064921800

FOR: RETAIL STORE SERVICES RELATING TO FRESH FRUIT AND FRESH CUT INTO FLOWER SHAPES AND ARRANGED IN CONTAINERS AS FLORAL DESIGNS, FRUIT SALADS, PROCESSED FRUITS, FRESH FRUIT CUT INTO FLOWER SHAPES AND COATED WITH CHOCOLATE, FRUIT JUICES, SMOOTHIES, FRUIT SMOOTHIES, VEGETABLE SMOOTHIES, ARRANGEMENTS MADE OF FRESH FRUIT; BUSINESS MANAGEMENT AND ASSISTANCE SERVICES; FRANCHISE SERVICES, NAMELY, OFFERING BUSINESS MANAGEMENT ASSISTANCE IN THE ESTABLISHMENT AND OPERATION OF RETAIL STORES; FRANCHISING, NAMELY, CONSULTATION AND ASSISTANCE IN

BUSINESS MANAGEMENT, ORGANIZATION AND PROMOTION; ADVICE, INFORMATION AND CONSULTANCY SERVICES RELATING TO ALL OF THE AFORESAID SERVICES, IN CLASS 35 (U.S. CLS. 100, 101 AND 102).

FIRST USE 2-4-2005; IN COMMERCE 2-4-2005.

THE MARK CONSISTS OF STANDARD CHARACTERS WITHOUT CLAIM TO ANY PARTICULAR FONT, STYLE, SIZE, OR COLOR.

OWNER OF U.S. REG. NOS. 2,545,999, 3,141,566 AND OTHERS.

SER. NO. 77-172,386, FILED 5-3-2007.

CAROLYN CATALDO, EXAMINING ATTORNEY

**Int. Cl.: 29**

**Prior U.S. Cl.: 46**

**United States Patent and Trademark Office**

**Reg. No. 3,452,284**

**Registered June 24, 2008**

**TRADEMARK  
PRINCIPAL REGISTER**

**SIMPLY DAISIES**

EDIBLE ARRANGEMENTS, LLC (CONNECTI-  
CUT LTD LIAB CO)  
95 BARNES ROAD  
WALLINGFORD, CT 064921800

FOR: FRESH FRUIT CUT INTO FLOWER  
SHAPES AND ARRANGED IN CONTAINERS AS  
FLORAL DESIGNS; PROCESSED FRUITS; AR-  
RANGEMENTS MADE OF FRESH PROCESSED  
FRUIT, IN CLASS 29 (U.S. CL. 46).

FIRST USE 3-26-2007; IN COMMERCE 3-26-2007.

THE MARK CONSISTS OF STANDARD CHAR-  
ACTERS WITHOUT CLAIM TO ANY PARTICULAR  
FONT, STYLE, SIZE, OR COLOR.

SER. NO. 77-172,429, FILED 5-3-2007.

CAROLYN CATALDO, EXAMINING ATTORNEY



**Int. Cl.: 9**

**Prior U.S. Cls.: 21, 23, 26, 36 and 38**

**Reg. No. 3,452,285**

**United States Patent and Trademark Office**

**Registered June 24, 2008**

---

**TRADEMARK  
PRINCIPAL REGISTER**

**PACS COLLECTIONS**

TRUE AUTOMATION, INC. (TEXAS CORPORATION)  
2600 TECHNOLOGY DR, SUITE 900  
PLANO, TX 75074

FOR: COMPUTER SOFTWARE FOR THE APPRAISAL AND COLLECTION OF PROPERTY TAXES FOR USE BY GOVERNMENTAL ENTITIES, IN CLASS 9 (U.S. CLS. 21, 23, 26, 36 AND 38).

FIRST USE 0-0-1998; IN COMMERCE 0-0-1998.

THE MARK CONSISTS OF STANDARD CHARACTERS WITHOUT CLAIM TO ANY PARTICULAR FONT, STYLE, SIZE, OR COLOR.

NO CLAIM IS MADE TO THE EXCLUSIVE RIGHT TO USE "COLLECTIONS", APART FROM THE MARK AS SHOWN.

SER. NO. 77-172,599, FILED 5-3-2007.

EMILY CHUO, EXAMINING ATTORNEY

**Int. Cl.: 5**

**Prior U.S. Cls.: 6, 18, 44, 46, 51 and 52**

**Reg. No. 3,452,286**

**United States Patent and Trademark Office**

**Registered June 24, 2008**

**TRADEMARK  
PRINCIPAL REGISTER**

**VIZENDO**

GLAXO GROUP LIMITED (UNITED KINGDOM CORPORATION)  
GLAXO WELLCOME HOUSE  
BERKELEY AVENUE  
GREENFORD, MIDDLESEX, UNITED KINGDOM UB60NN

FOR: PHARMACEUTICAL PREPARATIONS AND SUBSTANCES FOR THE TREATMENT OF INFECTIOUS DISEASES, BLOOD DISORDERS, PAIN, INFLAMMATION, SEPSIS, ALOPECIA AND OBESITY, AND FOR THE TREATMENT OF VIRAL, METABOLIC, ENDOCRINE, MUSCULOSKELETAL, CARDIOVASCULAR, CARDIOPULMONARY, GENITOURINARY, SEXUAL DYSFUNCTION, ONCOLOGICAL, HEPATOLOGICAL, OPHTHALMOLOGICAL, RESPIRATORY, NEUROLOGICAL, GASTROINTESTINAL, HORMONAL, DERMATOLOGICAL AND PSYCHIATRIC RELA-

TED DISEASES AND DISORDERS, AND FOR THE TREATMENT OF DAMAGED SKIN AND TISSUE; AND FOR VACCINES, IN CLASS 5 (U.S. CLS. 6, 18, 44, 46, 51 AND 52).

THE MARK CONSISTS OF STANDARD CHARACTERS WITHOUT CLAIM TO ANY PARTICULAR FONT, STYLE, SIZE, OR COLOR.

PRIORITY CLAIMED UNDER SEC. 44(D) ON UNITED KINGDOM APPLICATION NO. 2453406, FILED 4-23-2007, REG. NO. 2453406, DATED 4-23-2007, EXPIRES 4-23-2017.

SER. NO. 77-172,741, FILED 5-4-2007.

GEORGE LORENZO, EXAMINING ATTORNEY

**Int. Cl.: 9**

**Prior U.S. Cls.: 21, 23, 26, 36 and 38**

**United States Patent and Trademark Office**

**Reg. No. 3,452,287**

**Registered June 24, 2008**

**TRADEMARK  
PRINCIPAL REGISTER**

**LANTANA**

KABIZ, LLC (TEXAS LTD LIAB CO)  
P.O. BOX 3553  
MCKINNEY, TX 75070

FOR: SERIES OF MUSICAL SOUND RECORDINGS, IN CLASS 9 (U.S. CLS. 21, 23, 26, 36 AND 38).

FIRST USE 2-22-2005; IN COMMERCE 2-22-2005.

THE MARK CONSISTS OF STANDARD CHARACTERS WITHOUT CLAIM TO ANY PARTICULAR FONT, STYLE, SIZE, OR COLOR.

SER. NO. 77-172,868, FILED 5-4-2007.

ALICE SUE CARRUTHERS, EXAMINING ATTORNEY

Int. Cl.: 42

Prior U.S. Cls.: 100 and 101

United States Patent and Trademark Office

Reg. No. 3,452,288

Registered June 24, 2008

SERVICE MARK  
PRINCIPAL REGISTER

The logo for Designfruit is written in a highly stylized, cursive script. The letters are black and feature elegant flourishes, particularly at the beginning and end of the word. The 'D' has a large, decorative swirl that loops back under the 'e'.

DESIGNFRUIT, L.L.C. (MISSOURI LTD LIAB  
CO)  
600 W. COLLEGE, STE. 120  
SPRINGFIELD, MO 65806

FOR: STOCK IMAGE SERVICES, NAMELY,  
LEASING REPRODUCTION RIGHTS OF IMAGES,  
GRAPHIC DESIGNS, ILLUSTRATIONS AND PHO-  
TOGRAPHS TO OTHERS; PROVIDING INFORMA-  
TION ON DIGITAL IMAGE PROCESSING TOOLS,  
IN CLASS 42 (U.S. CLS. 100 AND 101).

FIRST USE 12-31-2006; IN COMMERCE 12-31-2006.

THE MARK CONSISTS OF THE LITERAL ELE-  
MENT DESIGN AND FRUIT CONJOINED IN STY-  
LIZED LETTERING.

SER. NO. 77-173,170, FILED 5-4-2007.

PAUL F. GAST, EXAMINING ATTORNEY

Int. Cl.: 41

Prior U.S. Cls.: 100, 101 and 107

United States Patent and Trademark Office

Reg. No. 3,452,289

Registered June 24, 2008

SERVICE MARK  
PRINCIPAL REGISTER



DR. VINCENT M. MCINTYRE (UNITED STATES INDIVIDUAL)

16349 NORTHWEST 57 AVENUE  
MIAMI LAKES, FL 33014 AND

DR. CONSTANCE M. MCINTYRE (UNITED STATES INDIVIDUAL)

16349 NORTHWEST 57 AVENUE  
MIAMI LAKES, FL 33014

FOR: DANCE INSTRUCTION AND TRAINING,  
IN CLASS 41 (U.S. CLS. 100, 101 AND 107).

FIRST USE 1-1-2000; IN COMMERCE 1-1-2000.

NO CLAIM IS MADE TO THE EXCLUSIVE RIGHT TO USE "DANCE" AND "NATIONAL LITURGICAL DANCE CONFERENCE", APART FROM THE MARK AS SHOWN.

THE COLOR(S) BLUE, YELLOW, WHITE, PINK, BLACK AND PEACH IS/ARE CLAIMED AS A FEATURE OF THE MARK.

THE MARK CONSISTS OF A BLUE CIRCLE WITH THE WORDS "CALLED 2 DANCE" APPEARING IN YELLOW AND THE WORDS "NATIONAL LITURGICAL DANCE CONFERENCE C2D" AND THE OUTLINE OF DOVES APPEARING IN WHITE, WITH THE IMAGE OF A DANCER WEARING A PINK DRESS, WITH BLACK HAIR AND PEACH COLORED SKIN, HOLDING A BLACK BOOK, APPEARING SUPERIMPOSED IN FRONT OF A BLUE SHADED GLOBE.

SER. NO. 77-173,187, FILED 5-4-2007.

KELLY MCCOY, EXAMINING ATTORNEY

**Int. Cl.: 41**

**Prior U.S. Cls.: 100, 101 and 107**

**United States Patent and Trademark Office**

**Reg. No. 3,452,290**

**Registered June 24, 2008**

---

**SERVICE MARK  
PRINCIPAL REGISTER**

**LANTANA**

KABIZ, LLC (TEXAS LTD LIAB CO)  
P.O. BOX 3553  
MCKINNEY, TX 75070

FOR: ENTERTAINMENT, NAMELY, LIVE PER-  
FORMANCES BY A MUSICAL GROUP, IN CLASS 41  
(U.S. CLS. 100, 101 AND 107).

FIRST USE 7-1-2004; IN COMMERCE 7-1-2004.

THE MARK CONSISTS OF STANDARD CHAR-  
ACTERS WITHOUT CLAIM TO ANY PARTICULAR  
FONT, STYLE, SIZE, OR COLOR.

SER. NO. 77-173,250, FILED 5-4-2007.

ALICE SUE CARRUTHERS, EXAMINING ATTOR-  
NEY

**Int. Cl.: 9**

**Prior U.S. Cls.: 21, 23, 26, 36 and 38**

**Reg. No. 3,452,291**

**United States Patent and Trademark Office**

**Registered June 24, 2008**

**TRADEMARK  
PRINCIPAL REGISTER**

# TurboVet

STRATIZON CORPORATION (DELAWARE CORPORATION)  
590 MEANS ST NW  
ATLANTA, GA 30318

FOR: COMPUTER SOFTWARE THAT PROVIDES REAL-TIME, INTEGRATED BUSINESS MANAGEMENT INTELLIGENCE BY COMBINING INFORMATION FROM VARIOUS DATABASES AND PRESENTING IT IN AN EASY-TO-UNDERSTAND USER INTERFACE, IN CLASS 9 (U.S. CLS. 21, 23, 26, 36 AND 38).

FIRST USE 11-13-2006; IN COMMERCE 4-20-2007.

THE MARK CONSISTS OF STANDARD CHARACTERS WITHOUT CLAIM TO ANY PARTICULAR FONT, STYLE, SIZE, OR COLOR.

NO CLAIM IS MADE TO THE EXCLUSIVE RIGHT TO USE "VET", APART FROM THE MARK AS SHOWN.

SER. NO. 77-173,820, FILED 5-6-2007.

JIM RINGLE, EXAMINING ATTORNEY

**Int. Cl.: 41**

**Prior U.S. Cls.: 100, 101 and 107**

**United States Patent and Trademark Office**

**Reg. No. 3,452,292**

**Registered June 24, 2008**

**SERVICE MARK  
PRINCIPAL REGISTER**

**TARGHEE INSTITUTE**

GRAND TARGHEE RESORT, LLC (DELAWARE  
LTD LIAB CO)  
P.O. BOX SKI  
ALTA, WY 83414

FOR: PROVIDING EDUCATIONAL SERVICES,  
NAMELY, CLASSES AND WORKSHOPS IN THE  
AREAS OF ARTS AND NATURAL SCIENCES, AND  
DISTRIBUTING LITERATURE IN RELATION  
THERE TO; ARRANGING AND CONDUCTING  
TOURS, CLASSES, PROGRAMS, WORKSHOPS,  
OVERNIGHT TRIPS, AND SEMINARS IN THE  
AREAS OF ARTS AND NATURAL SCIENCES, IN  
CLASS 41 (U.S. CLS. 100, 101 AND 107).

FIRST USE 1-31-1988; IN COMMERCE 1-31-1988.

THE MARK CONSISTS OF STANDARD CHAR-  
ACTERS WITHOUT CLAIM TO ANY PARTICULAR  
FONT, STYLE, SIZE, OR COLOR.

NO CLAIM IS MADE TO THE EXCLUSIVE  
RIGHT TO USE "INSTITUTE", APART FROM THE  
MARK AS SHOWN.

SER. NO. 77-173,830, FILED 5-6-2007.

FLORENTINA BLANDU, EXAMINING ATTORNEY



**Int. Cl.: 41**

**Prior U.S. Cls.: 100, 101 and 107**

**United States Patent and Trademark Office**

**Reg. No. 3,452,293**

**Registered June 24, 2008**

**SERVICE MARK  
PRINCIPAL REGISTER**



BODYBUILDING.COM, LLC (DELAWARE LTD  
LIAB CO)  
305 STEELHEAD WAY  
BOISE, ID 83704

FOR: PROVIDING PHYSICAL FITNESS INFOR-  
MATION VIA AN ONLINE WEBSITE, IN CLASS 41  
(U.S. CLS. 100, 101 AND 107).

FIRST USE 5-0-2000; IN COMMERCE 5-0-2000.

OWNER OF U.S. REG. NO. 3,164,763.

NO CLAIM IS MADE TO THE EXCLUSIVE  
RIGHT TO USE "TEENBODY BUILDING.COM",  
APART FROM THE MARK AS SHOWN.

SER. NO. 77-173,971, FILED 5-7-2007.

JULIE WATSON, EXAMINING ATTORNEY

**Int. Cl.: 19**

**Prior U.S. Cls.: 1, 12, 33 and 50**

**United States Patent and Trademark Office**

**Reg. No. 3,452,294**

**Registered June 24, 2008**

**TRADEMARK  
PRINCIPAL REGISTER**

**RESTORATION MILLWORK**

CERTAINEED CORPORATION (DELAWARE CORPORATION)  
750 E. SWEDESFORD ROAD  
VALLEY FORGE, PA 194820101

FOR: BUILDING MATERIALS, NAMELY, NON-METAL TRIM BOARDS, PROFILES AND PVC SHEETS, IN CLASS 19 (U.S. CLS. 1, 12, 33 AND 50).

FIRST USE 3-13-2006; IN COMMERCE 3-13-2006.

THE MARK CONSISTS OF STANDARD CHARACTERS WITHOUT CLAIM TO ANY PARTICULAR FONT, STYLE, SIZE, OR COLOR.

OWNER OF U.S. REG. NOS. 1,474,181 AND 1,476,870.

NO CLAIM IS MADE TO THE EXCLUSIVE RIGHT TO USE "MILLWORK", APART FROM THE MARK AS SHOWN.

SEC. 2(F) AS TO "RESTORATION".

SER. NO. 77-173,986, FILED 5-7-2007.

LOURDES AYALA, EXAMINING ATTORNEY

**Int. Cl.: 9**

**Prior U.S. Cls.: 21, 23, 26, 36 and 38**

**United States Patent and Trademark Office**

**Reg. No. 3,452,295**

**Registered June 24, 2008**

**TRADEMARK  
PRINCIPAL REGISTER**

# ADInstruments

ADINSTRUMENTS PTY. LTD. (AUSTRALIA  
CORPORATION)  
UNIT 13, 22 LEXINGTON DRIVE  
BELLA VISTA NSW, AUSTRALIA 2153

FOR: COMPUTER SOFTWARE AND HARD-  
WARE USED FOR DATA ACQUISITION, RE-  
SEARCH, ANALYSIS, AND TEACHING IN THE  
LIFE SCIENCES, IN CLASS 9 (U.S. CLS. 21, 23, 26, 36  
AND 38).

FIRST USE 10-0-1992; IN COMMERCE 10-0-1992.

THE MARK CONSISTS OF STANDARD CHAR-  
ACTERS WITHOUT CLAIM TO ANY PARTICULAR  
FONT, STYLE, SIZE, OR COLOR.

SEC. 2(F).

SER. NO. 77-173,997, FILED 5-7-2007.

JENNIFER VASQUEZ, EXAMINING ATTORNEY

**Int. Cls.: 16 and 20**

**Prior U.S. Cls.: 2, 5, 13, 22, 23, 25, 29, 32, 37, 38 and 50**

**United States Patent and Trademark Office**

**Reg. No. 3,452,296**

**Registered June 24, 2008**

**TRADEMARK  
PRINCIPAL REGISTER**

**CLAMP MAN**

ADAMS MFG. CORP. (PENNSYLVANIA CORPORATION)  
BOX 1  
PORTERSVILLE, PA 16051

FOR: NON-METAL, JAW-TYPE CLIPS FOR HOLDING PAPER, IN CLASS 16 (U.S. CLS. 2, 5, 22, 23, 29, 37, 38 AND 50).

FIRST USE 3-1-1996; IN COMMERCE 3-1-1996.

FOR: NON-METAL, JAW-TYPE CLIPS FOR CLOSING BAGS, IN CLASS 20 (U.S. CLS. 2, 13, 22, 25, 32 AND 50).

FIRST USE 3-1-1996; IN COMMERCE 3-1-1996.

THE MARK CONSISTS OF STANDARD CHARACTERS WITHOUT CLAIM TO ANY PARTICULAR FONT, STYLE, SIZE, OR COLOR.

OWNER OF U.S. REG. NOS. 1,804,273 AND 1,831,212.

NO CLAIM IS MADE TO THE EXCLUSIVE RIGHT TO USE "CLAMP", APART FROM THE MARK AS SHOWN.

SER. NO. 77-174,459, FILED 5-7-2007.

STEVEN R. FINE, EXAMINING ATTORNEY

**Int. Cls.: 3 and 5**

**Prior U.S. Cls.: 1, 4, 6, 18, 44, 46, 50, 51 and 52**

**United States Patent and Trademark Office**

**Reg. No. 3,452,297**

**Registered June 24, 2008**

**TRADEMARK  
PRINCIPAL REGISTER**

**CELLCLEAN**

SYSMEX CORPORATION (JAPAN CORPORATION)  
1-5-1, WAKINOHAMA-KAIGANDORI, CHUO-KU  
KOBE, HYOGO, JAPAN

FOR: DETERGENTS FOR MEDICAL APPARATUS AND INSTRUMENTS; CLEANING SOLUTIONS FOR MEDICAL APPARATUS AND INSTRUMENTS; CLEANING PREPARATIONS FOR MEDICAL APPARATUS AND INSTRUMENTS; CLEANSING SOLUTIONS FOR MEDICAL APPARATUS AND INSTRUMENTS; DETERGENTS, CLEANING SOLUTIONS, CLEANING PREPARATIONS AND CLEANSING SOLUTIONS ALL FOR LABORATORY APPARATUS AND INSTRUMENTS, IN CLASS 3 (U.S. CLS. 1, 4, 6, 50, 51 AND 52).

FIRST USE 9-30-1983; IN COMMERCE 9-30-1983.

FOR: DIAGNOSTIC REAGENTS AND DIAGNOSTIC PREPARATIONS FOR MEDICAL OR VETERINARY PURPOSES; CHEMICAL REAGENTS AND CHEMICAL PREPARATIONS FOR MEDICAL OR VETERINARY PURPOSES; REAGENTS AND DIAGNOSTIC PREPARATIONS USED FOR TESTING HEMATOLOGY; REAGENTS AND DIAGNOSTIC PREPARATIONS FOR BLOOD ANALYSIS, IN CLASS 5 (U.S. CLS. 6, 18, 44, 46, 51 AND 52).

FIRST USE 9-30-1983; IN COMMERCE 9-30-1983.

THE MARK CONSISTS OF STANDARD CHARACTERS WITHOUT CLAIM TO ANY PARTICULAR FONT, STYLE, SIZE, OR COLOR.

SER. NO. 77-174,542, FILED 5-7-2007.

KELLEY WELLS, EXAMINING ATTORNEY

Int. Cls.: 20 and 24

Prior U.S. Cls.: 2, 13, 22, 25, 32, 42 and 50

Reg. No. 3,452,298

United States Patent and Trademark Office

Registered June 24, 2008

TRADEMARK  
PRINCIPAL REGISTER



FREDMAN BROS. FURNITURE COMPANY,  
INC. (ILLINOIS CORPORATION)  
8226 LACKLAND  
ST. LOUIS, MO 63114

FOR: MATTRESSES, PILLOWS, ADJUSTABLE  
SOFA BEDS, ADJUSTABLE BEDS, BED RAILS,  
BED FRAMES, FURNITURE PARTS, NAMELY,  
CENTER SUPPORTS, LINK SPRINGS, POP-UP  
UNITS AND HARDWARE FOR ATTACHING A  
METAL BED FRAME TO A HEADBOARD SOLD  
AS A KIT, IN CLASS 20 (U.S. CLS. 2, 13, 22, 25, 32 AND  
50).

FIRST USE 8-31-2006; IN COMMERCE 8-31-2006.

FOR: MATTRESS PADS, IN CLASS 24 (U.S. CLS. 42  
AND 50).

FIRST USE 8-31-2006; IN COMMERCE 8-31-2006.

THE MARK CONSISTS OF A PARTIAL OUTLINE  
OF A BODY.

SER. NO. 77-174,740, FILED 5-7-2007.

THEODORE MCBRIDE, EXAMINING ATTORNEY

**Int. Cl.: 41**

**Prior U.S. Cls.: 100, 101 and 107**

**United States Patent and Trademark Office**

**Reg. No. 3,452,299**

**Registered June 24, 2008**

**SERVICE MARK  
PRINCIPAL REGISTER**



SCIENTIFIC DESIGN AND INFORMATION, INC.  
(CALIFORNIA CORPORATION)  
165 CERVANTES ROAD  
REDWOOD CITY, CA 94062

FOR: PUBLICATION OF ELECTRONIC MAGAZINES, IN CLASS 41 (U.S. CLS. 100, 101 AND 107).

FIRST USE 0-0-1997; IN COMMERCE 0-0-1997.

NO CLAIM IS MADE TO THE EXCLUSIVE RIGHT TO USE "HOME THEATER AND HIGH FIDELITY", APART FROM THE MARK AS SHOWN.

THE COLOR(S) THE COLORS RED, BLACK AND WHITE ARE CLAIMED AS A FEATURE OF THE

MARK. IS/ARE CLAIMED AS A FEATURE OF THE MARK.

THE MARK CONSISTS OF THE WORD "SECRETS" IS CONTAINED IN A RECTANGLE, BOTH OF WHICH ARE IN THE COLOR RED. THE WORDS "OF HOME THEATER AND HIGH FIDELITY" APPEAR IN THE COLOR WHITE AND ARE CONTAINED WITHIN A BLACK RECTANGLE.

SER. NO. 77-175,323, FILED 5-8-2007.

CAROLYN CATALDO, EXAMINING ATTORNEY

**Int. Cls.: 35, 38, 41 and 42**

**Prior U.S. Cls.: 100, 101, 102, 104 and 107**

**United States Patent and Trademark Office**

**Reg. No. 3,452,300**

**Registered June 24, 2008**

**SERVICE MARK  
PRINCIPAL REGISTER**

**POPSCI.COM**

BONNIER ACTIVE MEDIA, INC. (NEW YORK CORPORATION)  
460 N. ORLANDO AVE. SUITE 200  
WINTER PARK, FL 32789

FOR: PROVIDING INFORMATION VIA THE INTERNET, NAMELY, ARTICLES, PHOTOS, IMAGES, AUDIO, AND VIDEO IN THE FIELD OF INNOVATIVE PRODUCTS AND SERVICES, NAMELY, INFORMATION ON LAUNCHING OF NEW PRODUCTS BY OTHERS IN THE FIELDS OF CONSUMER, ENTERTAINMENT, MILITARY, AVIATION, SPACE, AUTOMOTIVE, ENERGY, ENVIRONMENT, AND INTERNET PRODUCTS; AND INFORMATION ON LAUNCHING OF NEW SERVICES OF OTHERS IN THE FIELDS OF CONSUMER, ENTERTAINMENT, MILITARY, AVIATION, SPACE, AUTOMOTIVE, ENERGY, ENVIRONMENT, AND INTERNET SERVICES, IN CLASS 35 (U.S. CLS. 100, 101 AND 102).

FIRST USE 11-30-1995; IN COMMERCE 11-30-1995.

FOR: PROVIDING WEB-BASED AUDIO BROADCAST VIA AN RSS FEED IN THE FIELD OF SCIENCE, TECHNOLOGY, MEDICINE, ARTS, POPULAR CULTURE, SPORTS AND INNOVATIVE PRODUCTS AND SERVICES, IN CLASS 38 (U.S. CLS. 100, 101 AND 104).

FIRST USE 5-8-2007; IN COMMERCE 5-8-2007.

FOR: PROVIDING INFORMATION, NAMELY, ARTICLES, PHOTOS, IMAGES, AUDIO, AND VI-

DEO IN THE FIELD OF ARTS, POPULAR CULTURE, AND SPORTS VIA THE INTERNET; PROVIDING AN INTERACTIVE ONLINE WEB JOURNAL IN THE NATURE OF A WEB BLOG IN THE FIELD OF SCIENCE, TECHNOLOGY, ARTS, POPULAR CULTURE, SPORTS AND INNOVATIVE PRODUCTS AND SERVICES, NAMELY, LAUNCHING OF NEW PRODUCTS; ENTERTAINMENT SERVICES, NAMELY, PROVIDING PODCASTS IN THE FIELD OF SCIENCE, TECHNOLOGY, MEDICINE, ARTS, POPULAR CULTURE, SPORTS AND INNOVATIVE PRODUCTS AND SERVICES, NAMELY, LAUNCHING OF NEW PRODUCTS, IN CLASS 41 (U.S. CLS. 100, 101 AND 107).

FIRST USE 11-30-1995; IN COMMERCE 11-30-1995.

FOR: PROVIDING INFORMATION IN THE FIELD OF SCIENCE AND TECHNOLOGY VIA THE INTERNET, IN CLASS 42 (U.S. CLS. 100 AND 101).

FIRST USE 11-30-1995; IN COMMERCE 11-30-1995.

THE MARK CONSISTS OF STANDARD CHARACTERS WITHOUT CLAIM TO ANY PARTICULAR FONT, STYLE, SIZE, OR COLOR.

SER. NO. 77-175,401, FILED 5-8-2007.

KELLY MCCOY, EXAMINING ATTORNEY



**Int. Cl.: 42**

**Prior U.S. Cls.: 100 and 101**

**United States Patent and Trademark Office**

**Reg. No. 3,452,301**

**Registered June 24, 2008**

**SERVICE MARK  
PRINCIPAL REGISTER**

# Productevo

PRODUCTEVO LLC (WASHINGTON LTD LIAB  
CO)  
PO BOX 2072  
ISSAQUAH, WA 980270092

FOR: APPLICATION SERVICE PROVIDER (ASP)  
FEATURING WORKFORCE PERFORMANCE  
MANAGEMENT SOFTWARE FOR USE BY INSTI-  
TUTIONS AND INDIVIDUALS IN EMPLOYEE PER-  
FORMANCE PLANS, PERFORMANCE  
ASSESSMENTS, COMPETENCY ASSESSMENTS,  
TASK MANAGEMENT, DATA ANALYSIS AND  
REPORTING IN THE FIELD OF WORKFORCE  
PERFORMANCE MANAGEMENT AND EVALUA-

TION OF PERSONNEL, IN CLASS 42 (U.S. CLS. 100  
AND 101).

FIRST USE 7-19-2006; IN COMMERCE 7-19-2006.

THE MARK CONSISTS OF STANDARD CHAR-  
ACTERS WITHOUT CLAIM TO ANY PARTICULAR  
FONT, STYLE, SIZE, OR COLOR.

SER. NO. 77-175,596, FILED 5-8-2007.

STEVEN PEREZ, EXAMINING ATTORNEY

**Int. Cl.: 6**

**Prior U.S. Cls.: 2, 12, 13, 14, 23, 25 and 50**

**Reg. No. 3,452,302**

**United States Patent and Trademark Office**

**Registered June 24, 2008**

**TRADEMARK  
PRINCIPAL REGISTER**

**5059**

MACLEAN POWER, L.L.C. (DELAWARE LTD  
LIAB CO)  
11411 ADDISON STREET  
FRANKLIN PARK, IL 60131

FOR: CONNECTORS AND POLE LINE HARD-  
WARE OF METAL, NAMELY, CABLE DEADEND  
DEVICES, COMPRISING A CABLE GRIP AND  
MEANS FOR ANCHORING THE GRIP TO A SUP-  
PORTING MEMBER, CABLE SPLICERS BEING  
CABLE CONNECTORS, TENSION SPLICE DEVICES  
FOR COMMUNICATIONS WIRES BEING CABLE  
CONNECTORS, DEADEND DEVICES FOR COM-  
MUNICATIONS WIRES, AND AUTOMATIC CABLE

CONNECTORS, IN CLASS 6 (U.S. CLS. 2, 12, 13, 14, 23,  
25 AND 50).

FIRST USE 12-31-1972; IN COMMERCE 12-31-1972.

THE MARK CONSISTS OF STANDARD CHAR-  
ACTERS WITHOUT CLAIM TO ANY PARTICULAR  
FONT, STYLE, SIZE, OR COLOR.

SEC. 2(F).

SER. NO. 77-176,032, FILED 5-8-2007.

LINDA POWELL, EXAMINING ATTORNEY

**Int. Cl.: 6**

**Prior U.S. Cls.: 2, 12, 13, 14, 23, 25 and 50**

**Reg. No. 3,452,303**

**United States Patent and Trademark Office**

**Registered June 24, 2008**

**TRADEMARK  
PRINCIPAL REGISTER**

**5058**

MACLEAN POWER, L.L.C. (DELAWARE LTD  
LIAB CO)  
11411 ADDISON STREET  
FRANKLIN PARK, IL 60131

FOR: CONNECTORS AND POLE LINE HARD-  
WARE OF METAL, NAMELY, CABLE DEADEND  
DEVICES, COMPRISING A CABLE GRIP AND  
MEANS FOR ANCHORING THE GRIP TO A SUP-  
PORTING MEMBER, CABLE SPLICERS BEING  
CABLE CONNECTORS, TENSION SPLICE DEVICES  
FOR COMMUNICATIONS WIRES BEING CABLE  
CONNECTORS, DEADEND DEVICES FOR COM-  
MUNICATIONS WIRES, AND AUTOMATIC CABLE

CONNECTORS, IN CLASS 6 (U.S. CLS. 2, 12, 13, 14, 23,  
25 AND 50).

FIRST USE 12-31-1972; IN COMMERCE 12-31-1972.

THE MARK CONSISTS OF STANDARD CHAR-  
ACTERS WITHOUT CLAIM TO ANY PARTICULAR  
FONT, STYLE, SIZE, OR COLOR.

SEC. 2(F).

SER. NO. 77-176,036, FILED 5-8-2007.

LINDA POWELL, EXAMINING ATTORNEY

**Int. Cls.: 8, 21 and 38**

**Prior U.S. Cls.: 2, 13, 23, 28, 29, 30, 33, 40, 44, 50, 100,  
101 and 104**

**Reg. No. 3,452,304**

**United States Patent and Trademark Office**

**Registered June 24, 2008**

**TRADEMARK  
SERVICE MARK  
PRINCIPAL REGISTER**

# FACELINER

LEBOVIC, IGOR (AUSTRIA INDIVIDUAL)  
DIESTERWEGGASSE 18/14  
WIEN, AUSTRIA A-1140

FOR: HAND TOOLS AND HAND OPERATED IMPLEMENTS, NAMELY, RAZORS, SHAVERS, AND BEARD TRIMMERS, BOTH ELECTRICAL AND NON-ELECTRICAL; RAZOR BLADES; RAZOR BLADE HOLDERS, IN CLASS 8 (U.S. CLS. 23, 28 AND 44).

FOR: TOILETRIES FOR BODY CARE, NAMELY, COMBS AND HAIR BRUSHES; SHAVING BRUSHES; SHAVING TEMPLATES, RULERS AND GUIDES FOR SHAPING BEARDS, IN CLASS 21 (U.S. CLS. 2, 13, 23, 29, 30, 33, 40 AND 50).

FOR: PROVIDING TELECOMMUNICATION CHANNELS FOR INTERNET AND TEleshopping SERVICES; PROVIDING INTERNET CHATROOMS;

PROVIDING ON-LINE FORUMS FOR TRANSMISSION OF MESSAGES AMONG COMPUTER USERS CONCERNING BEAUTY, COSMETICS, TOILETRIES, FASHION AND SPORTS AND PROVIDING ACCESS TO INTERNET PORTALS FOR WEB COMMUNITIES, IN CLASS 38 (U.S. CLS. 100, 101 AND 104).

THE MARK CONSISTS OF STANDARD CHARACTERS WITHOUT CLAIM TO ANY PARTICULAR FONT, STYLE, SIZE, OR COLOR.

PRIORITY CLAIMED UNDER SEC. 44(D) ON AUSTRIA APPLICATION NO. AM7543/2006, FILED 11-9-2006, REG. NO. 236241, DATED 1-2-2007, EXPIRES 1-31-2017.

SER. NO. 77-176,084, FILED 5-9-2007.

KALIE KUNG, EXAMINING ATTORNEY

**Int. Cls.: 35 and 42**

**Prior U.S. Cls.: 100, 101 and 102**

**United States Patent and Trademark Office**

**Reg. No. 3,452,305**

**Registered June 24, 2008**

**SERVICE MARK  
PRINCIPAL REGISTER**

**BUSCOMM**

BUSCOMM INCORPORATED (MISSOURI CORPORATION)  
11696 LILBURN PARK  
ST. LOUIS, MO 63146

FOR: DISTRIBUTORSHIP SERVICES IN THE FIELD OF VOICE, DATA, AND BUSINESS COMMUNICATION APPLICATIONS AND HARDWARE, IN CLASS 35 (U.S. CLS. 100, 101 AND 102).

FIRST USE 0-0-1972; IN COMMERCE 0-0-1972.

FOR: PROVIDING TECHNICAL SUPPORT AND TROUBLESHOOTING OF VOICE, DATA, AND

BUSINESS COMMUNICATION APPLICATIONS AND HARDWARE PROBLEMS, IN CLASS 42 (U.S. CLS. 100 AND 101).

FIRST USE 0-0-1972; IN COMMERCE 0-0-1972.

THE MARK CONSISTS OF STANDARD CHARACTERS WITHOUT CLAIM TO ANY PARTICULAR FONT, STYLE, SIZE, OR COLOR.

SER. NO. 77-176,211, FILED 5-9-2007.

ERNEST SHOSHO, EXAMINING ATTORNEY

**Int. Cl.: 9**

**Prior U.S. Cls.: 21, 23, 26, 36 and 38**

**Reg. No. 3,452,306**

**United States Patent and Trademark Office**

**Registered June 24, 2008**

**TRADEMARK  
PRINCIPAL REGISTER**



NIKON CORPORATION (JAPAN CORPORATION)  
2-3, MARUNOUCHI 3-CHOME, CHIYODA-KU  
TOKYO, JAPAN 100

FOR: DIGITAL CAMERAS, IN CLASS 9 (U.S. CLS. 21, 23, 26, 36 AND 38).

FIRST USE 12-1-2006; IN COMMERCE 12-1-2006.

PRIORITY CLAIMED UNDER SEC. 44(D) ON  
ERPNTY TM OFC APPLICATION NO.  
5,588,504, FILED 12-27-2006.

THE MARK CONSISTS OF THE UPPER-CASE LETTER "D" AND THE NUMBER "40".

THE WORDING "D40" HAS NO MEANING IN A FOREIGN LANGUAGE.

SER. NO. 77-176,439, FILED 5-9-2007.

MONIQUE MILLER, EXAMINING ATTORNEY

**Int. Cl.: 19**

**Prior U.S. Cls.: 1, 12, 33 and 50**

**United States Patent and Trademark Office**

**Reg. No. 3,452,307**

**Registered June 24, 2008**

**TRADEMARK  
PRINCIPAL REGISTER**

**California Custom Sheds**

AKINS, JEFF, J (UNITED STATES INDIVIDUAL)  
728 EL CAMINO REAL NORTH STE. I  
SALINAS, CA 93907 AND

AKINS, DANNA, L (UNITED STATES INDIVIDUAL)  
728 EL CAMINO REAL NORTH STE. I  
SALINAS, CA 93907

FOR: NON-METAL STORAGE SHEDS, IN CLASS  
19 (U.S. CLS. 1, 12, 33 AND 50).

FIRST USE 8-27-1985; IN COMMERCE 8-27-1985.

THE MARK CONSISTS OF STANDARD CHAR-  
ACTERS WITHOUT CLAIM TO ANY PARTICULAR  
FONT, STYLE, SIZE, OR COLOR.

NO CLAIM IS MADE TO THE EXCLUSIVE  
RIGHT TO USE "CUSTOM SHEDS", APART FROM  
THE MARK AS SHOWN.

SEC. 2(F) AS TO "CALIFORNIA".

SER. NO. 77-176,716, FILED 5-9-2007.

SHAILA SETTLES, EXAMINING ATTORNEY

**Int. Cl.: 7**

**Prior U.S. Cls.: 13, 19, 21, 23, 31, 34 and 35**

**United States Patent and Trademark Office**

**Reg. No. 3,452,308**

**Registered June 24, 2008**

**TRADEMARK  
PRINCIPAL REGISTER**



HARDINGE, INC. (NEW YORK CORPORATION)  
ONE HARDINGE DRIVE, P.O. BOX 1507  
ELMIRA, NY 14902

FOR: LATHES; MILLING MACHINES; COLLETS  
AND CHUCKS USED WITH LATHES AND MIL-  
LING MACHINES; GRINDING MACHINES FOR  
METALWORKING, MATERIALS PROCESSING,  
AND MATERIALS CUTTING; INDEXERS, NAME-  
LY, ROTARY TABLES, IN CLASS 7 (U.S. CLS. 13, 19,  
21, 23, 31, 34 AND 35).

FIRST USE 9-0-2004; IN COMMERCE 9-0-2004.

THE COLOR(S) BLUE AND WHITE IS/ARE  
CLAIMED AS A FEATURE OF THE MARK.

THE MARK CONSISTS OF A STYLIZED LETTER  
"H" DEPICTED IN BLUE WITH WHITE SEPARAT-  
ING THE TWO VERTICAL PORTIONS OF THE "H".

SER. NO. 77-177,367, FILED 5-10-2007.

STEVEN JACKSON, EXAMINING ATTORNEY



**Int. Cl.: 7**

**Prior U.S. Cls.: 13, 19, 21, 23, 31, 34 and 35**

**United States Patent and Trademark Office**

**Reg. No. 3,452,309**

**Registered June 24, 2008**

**TRADEMARK  
PRINCIPAL REGISTER**



HARDINGE, INC. (NEW YORK CORPORATION)  
ONE HARDINGE DRIVE, P.O. BOX 1507  
ELMIRA, NY 14902

FOR: LATHES; MILLING MACHINES; COLLETS  
AND CHUCKS USED WITH LATHES AND MIL-  
LING MACHINES; GRINDING MACHINES FOR  
METALWORKING, MATERIALS PROCESSING,  
AND MATERIALS CUTTING; INDEXERS, NAME-  
LY, ROTARY TABLES, IN CLASS 7 (U.S. CLS. 13, 19,  
21, 23, 31, 34 AND 35).

FIRST USE 9-0-2004; IN COMMERCE 9-0-2004.

OWNER OF U.S. REG. NOS. 672,452 AND 1,742,918.

NO CLAIM IS MADE TO THE EXCLUSIVE  
RIGHT TO USE "BRIDGEPORT", APART FROM  
THE MARK AS SHOWN.

THE COLOR(S) BLUE AND WHITE IS/ARE  
CLAIMED AS A FEATURE OF THE MARK.

THE MARK CONSISTS OF A STYLIZED LETTER  
"H" AND THE WORDING "BRIDGEPORT" DEPICTED  
IN BLUE WITH WHITE SEPARATING THE  
TWO VERTICAL PORTIONS OF THE "H" AND IN  
THE SPACES IN AND BETWEEN THE WORDING  
"BRIDGEPORT".

SER. NO. 77-177,370, FILED 5-10-2007.

STEVEN JACKSON, EXAMINING ATTORNEY

**Int. Cl.: 7**

**Prior U.S. Cls.: 13, 19, 21, 23, 31, 34 and 35**

**United States Patent and Trademark Office**

**Reg. No. 3,452,310**

**Registered June 24, 2008**

**TRADEMARK  
PRINCIPAL REGISTER**



HARDINGE, INC. (NEW YORK CORPORATION)  
ONE HARDINGE DRIVE, P.O. BOX 1507  
ELMIRA, NY 14902

FOR: LATHES; MILLING MACHINES; COLLETS  
AND CHUCKS USED WITH LATHES AND MIL-  
LING MACHINES; GRINDING MACHINES FOR  
METALWORKING, MATERIALS PROCESSING,  
AND MATERIALS CUTTING; INDEXERS, NAME-  
LY, ROTARY TABLES, IN CLASS 7 (U.S. CLS. 13, 19,  
21, 23, 31, 34 AND 35).

FIRST USE 9-0-2004; IN COMMERCE 9-0-2004.

OWNER OF U.S. REG. NOS. 514,077, 589,432, AND  
1,534,250.

THE COLOR(S) BLUE AND WHITE IS/ARE  
CLAIMED AS A FEATURE OF THE MARK.

THE MARK CONSISTS OF A STYLIZED LETTER  
"H" AND THE WORDING "HARDINGE" DEPICTED  
IN BLUE WITH WHITE SEPARATING THE TWO  
VERTICAL PORTIONS OF THE "H" AND IN THE  
SPACES IN AND BETWEEN THE WORDING  
"HARDINGE".

SER. NO. 77-177,375, FILED 5-10-2007.

STEVEN JACKSON, EXAMINING ATTORNEY

Int. Cl.: 30

Prior U.S. Cl.: 46

United States Patent and Trademark Office

Reg. No. 3,452,311

Registered June 24, 2008

TRADEMARK  
PRINCIPAL REGISTER

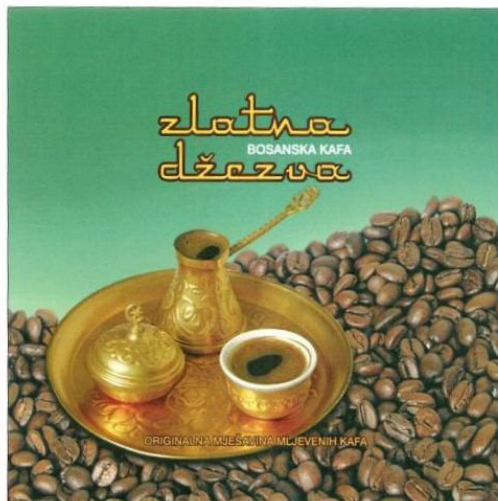

DD "VISPAK" PREHRAMBENA INDUSTRIJA  
P.O. VISOKO (BOSNIA & HERZEGOV COR-  
PORATION)  
OZRAKOVICI BB  
71300 VISOKO, BA, BOSNIA & HERZEGOV

FOR: COFFEE, IN CLASS 30 (U.S. CL. 46).

FIRST USE 3-29-2002; IN COMMERCE 3-29-2002.

NO CLAIM IS MADE TO THE EXCLUSIVE  
RIGHT TO USE "BOSANSKA Kafa ORIGINALNA  
MJESAVINA MLJEVENIH Kafa" AND THE RE-  
PRESENTATION OF THE COFFEE BEANS, APART  
FROM THE MARK AS SHOWN.

THE COLOR(S) GREEN, BROWN, GOLD, YEL-  
LOW AND WHITE IS/ARE CLAIMED AS A FEAT-  
URE OF THE MARK.

THE MARK CONSISTS OF A GREEN BACK-  
GROUND, BROWN COFFEE BEANS, GOLD SER-

VING TRAY WITH A GOLD COFFEE CUP WITH A  
WHITE RIM AND FILLED WITH BROWN COFFEE,  
A GOLD DISPENSER FILLED WITH BROWN COFFEE,  
A GOLD COVERED BOWL, THE WORDS  
ORIGINALNA MJESAVINA MLJEVENIH Kafa IN  
YELLOW OUTLINED WITH BROWN CENTERED  
NEAR THE BOTTOM OF THE WHOLE DRAWING,  
AND THE WORDS ZLATNA DŽEZVA BOSANSKA  
Kafa CENTERED NEAR THE TOP OF THE DRAW-  
ING, THE WORDS ZLATNA DŽEZVA BEING IN  
YELLOW OUTLINED IN BROWN, AND THE  
WORDS BOSANSKA Kafa BEING WHITE.

THE FOREIGN WORDING IN THE MARK  
TRANSLATES INTO ENGLISH AS GOLDEN COFFEE-  
POT BOSNIAN COFFEE ORIGINAL MIXTURE  
OF GROUND COFFEE.

SER. NO. 77-177,598, FILED 5-10-2007.

JOHN GARTNER, EXAMINING ATTORNEY

**Int. Cl.: 7**

**Prior U.S. Cls.: 13, 19, 21, 23, 31, 34 and 35**

**Reg. No. 3,452,312**

**United States Patent and Trademark Office**

**Registered June 24, 2008**

**TRADEMARK  
PRINCIPAL REGISTER**



HARDINGE, INC. (NEW YORK CORPORATION)  
ONE HARDINGE DRIVE, P.O. BOX 1507  
ELMIRA, NY 14902

THE COLOR(S) BLUE AND WHITE IS/ARE  
CLAIMED AS A FEATURE OF THE MARK.

FOR: LATHES; MILLING MACHINES; COLLETS  
AND CHUCKS USED WITH LATHES AND MIL-  
LING MACHINES; GRINDING MACHINES FOR  
METALWORKING, MATERIALS PROCESSING,  
AND MATERIALS CUTTING; INDEXERS, NAME-  
LY, ROTARY TABLES, IN CLASS 7 (U.S. CLS. 13, 19,  
21, 23, 31, 34 AND 35).

THE MARK CONSISTS OF THE LETTER "H"  
AND THE WORDING "TRIPET" DEPICTED IN  
BLUE WITH WHITE SEPARATING THE TWO VER-  
TICAL PORTIONS OF THE LETTER "H" AND THE  
WORDING "TRIPET".

SER. NO. 77-177,694, FILED 5-10-2007.

FIRST USE 9-0-2004; IN COMMERCE 9-0-2004.

STEVEN JACKSON, EXAMINING ATTORNEY

**Int. Cl.: 7**

**Prior U.S. Cls.: 13, 19, 21, 23, 31, 34 and 35**

**Reg. No. 3,452,313**

**United States Patent and Trademark Office**

**Registered June 24, 2008**

**TRADEMARK  
PRINCIPAL REGISTER**



HARDINGE, INC. (NEW YORK CORPORATION)  
ONE HARDINGE DRIVE, P.O. BOX 1507  
ELMIRA, NY 14902

THE COLOR(S) BLUE AND WHITE IS/ARE  
CLAIMED AS A FEATURE OF THE MARK.

FOR: LATHES; MILLING MACHINES; COLLETS  
AND CHUCKS USED WITH LATHES AND MIL-  
LING MACHINES; GRINDING MACHINES FOR  
METALWORKING, MATERIALS PROCESSING,  
AND MATERIALS CUTTING; INDEXERS, NAME-  
LY, ROTARY TABLES, IN CLASS 7 (U.S. CLS. 13, 19,  
21, 23, 31, 34 AND 35).

THE MARK CONSISTS OF THE LETTER "H"  
AND THE WORDING "KELLENBERGER" DEPIC-  
TED IN BLUE, WITH WHITE SEPARATING THE  
TWO VERTICAL PORTIONS OF THE LETTER "H"  
AND THE WORDING "KELLENBERGER".

FIRST USE 9-0-2004; IN COMMERCE 9-0-2004.

SER. NO. 77-177,729, FILED 5-10-2007.

OWNER OF U.S. REG. NO. 2,231,733.

STEVEN JACKSON, EXAMINING ATTORNEY

**Int. Cl.: 41**

**Prior U.S. Cls.: 100, 101 and 107**

**United States Patent and Trademark Office**

**Reg. No. 3,452,314**

**Registered June 24, 2008**

**SERVICE MARK  
PRINCIPAL REGISTER**

**HOMEWORK HELPLINE**

BIG Y FOODS, INC. (MASSACHUSETTS CORPORATION)  
2145 ROOSEVELT AVENUE  
SPRINGFIELD, MA 01102

FOR: EDUCATIONAL SERVICES, NAMELY, PROVIDING TUTORIAL SESSIONS VIA TELEPHONE AND THE INTERNET TO STUDENTS IN THE FIELDS OF READING, WRITING, SPELLING, LANGUAGE ARTS, FOREIGN LANGUAGES, MATH, SCIENCE AND TECHNOLOGY, SOCIAL SCIENCES, ARTS, HUMANITIES, AND HEALTH, IN CLASS 41 (U.S. CLS. 100, 101 AND 107).

FIRST USE 0-0-1993; IN COMMERCE 0-0-1993.

THE MARK CONSISTS OF STANDARD CHARACTERS WITHOUT CLAIM TO ANY PARTICULAR FONT, STYLE, SIZE, OR COLOR.

NO CLAIM IS MADE TO THE EXCLUSIVE RIGHT TO USE "HELPLINE", APART FROM THE MARK AS SHOWN.

SEC. 2(F).

SER. NO. 77-177,907, FILED 5-10-2007.

STEPHEN AQUILA, EXAMINING ATTORNEY

**Int. Cl.: 30**

**Prior U.S. Cl.: 46**

**United States Patent and Trademark Office**

**Reg. No. 3,452,315**

**Registered June 24, 2008**

**TRADEMARK  
PRINCIPAL REGISTER**



ADMINISTRADORA DE MARCAS, LICENCIAS  
Y DISEÑOS, S.A. DE C.V. (MEXICO COR-  
PORATION)

COLONIA MEZQUITAN COUNTRY  
PRIVADA SINALOA #1569 A  
GUADALAJARA, JALISCO, MEXICO C.P.44206

FOR: CANDY, CANDY, NAMELY, MARZIPAN,  
CHOCOLATES, CHEWING GUM, IN CLASS 30 (U.S.  
CL. 46).

FIRST USE 8-0-2003; IN COMMERCE 8-0-2003.

OWNER OF U.S. REG. NOS. 1,902,902 AND  
2,005,457.

THE COLOR(S) RED, YELLOW AND GREEN IS/  
ARE CLAIMED AS A FEATURE OF THE MARK.

THE MARK CONSISTS OF A RED ROSE WITH  
GREEN LEAVES, YELLOW BACKGROUND AND  
OUTLINED IN RED AND YELLOW WITH THE  
WORDING DE LA ROSA IN RED.

THE FOREIGN WORDING IN THE MARK  
TRANSLATES INTO ENGLISH AS OF THE ROSE.

SER. NO. 77-177,946, FILED 5-10-2007.

AMY HELLA, EXAMINING ATTORNEY

**Int. Cls.: 16, 29, 30 and 35**

**Prior U.S. Cls.: 2, 5, 22, 23, 29, 37, 38, 46, 50, 100, 101 and 102**

**United States Patent and Trademark Office**

**Reg. No. 3,452,316**

**Registered June 24, 2008**

**TRADEMARK  
SERVICE MARK  
PRINCIPAL REGISTER**



HBH LIMITED PARTNERSHIP (MICHIGAN LIMITED PARTNERSHIP)  
SUITE 200  
11935 MASON-MONTGOMERY ROAD  
CINCINNATI, OH 45249

FOR: GIFT CARDS; COUPONS, IN CLASS 16 (U.S. CLS. 2, 5, 22, 23, 29, 37, 38 AND 50).

FIRST USE 11-30-2006; IN COMMERCE 11-30-2006.

FOR: HAM; PORK; POULTRY; BEEF; AND PREPARED FOODS, NAMELY, SIDE DISHES AND CASSEROLES MAINLY CONSISTING OF VEGETABLES, POTATOES, BEANS OR FRUITS, IN CLASS 29 (U.S. CL. 46).

FIRST USE 11-30-2006; IN COMMERCE 11-30-2006.

FOR: CAKES; AND PREPARED FOODS, NAMELY, SIDE DISHES AND CASSEROLES MAINLY CONSISTING OF BREAD STUFFING, IN CLASS 30 (U.S. CL. 46).

FIRST USE 11-30-2006; IN COMMERCE 11-30-2006.

FOR: MAIL ORDER CATALOG SERVICES FEATURING PREPARED FOODS; RETAIL FOOD STORES, IN CLASS 35 (U.S. CLS. 100, 101 AND 102).

FIRST USE 11-30-2006; IN COMMERCE 11-30-2006.

OWNER OF U.S. REG. NOS. 2,024,543, 2,126,500 AND OTHERS.

NO CLAIM IS MADE TO THE EXCLUSIVE RIGHT TO USE "HAM" AND "COMPANY" AS TO CLASSES 29 AND 35, AND "COMPANY" AS TO CLASSES 16 AND 30, APART FROM THE MARK AS SHOWN.

SEC. 2(F) "HONEYBAKED" AS TO CLASSES 29 AND 35.

SER. NO. 77-178,488, FILED 5-11-2007.

HEATHER BIDDULPH, EXAMINING ATTORNEY



**Int. Cl.: 35**

**Prior U.S. Cls.: 100, 101 and 102**

**United States Patent and Trademark Office**

**Reg. No. 3,452,317**

**Registered June 24, 2008**

**SERVICE MARK  
PRINCIPAL REGISTER**

# EVENTVIEW

DENNIS GARBERG AND ASSOCIATES, INC.  
(KANSAS CORPORATION)  
SUITE 300  
10561 BARKLEY  
OVERLAND PARK, KS 66212

FIRST USE 12-21-2007; IN COMMERCE 12-21-2007.

THE MARK CONSISTS OF STANDARD CHARACTERS WITHOUT CLAIM TO ANY PARTICULAR FONT, STYLE, SIZE, OR COLOR.

FOR: ON-LINE TRACKING FOR OTHERS OF THE STATUS OF PREPARATION AND CONDUCT OF PROMOTIONAL PRESENTATIONS AT GEOGRAPHICALLY REMOTE LOCATIONS , IN CLASS 35 (U.S. CLS. 100, 101 AND 102).

SER. NO. 77-179,124, FILED 5-11-2007.

ROSELLE HERRERA, EXAMINING ATTORNEY

**Int. Cl.: 42**

**Prior U.S. Cls.: 100 and 101**

**United States Patent and Trademark Office**

**Reg. No. 3,452,318**

**Registered June 24, 2008**

---

**SERVICE MARK  
PRINCIPAL REGISTER**

**Let's Get Started**

EVENTURE 360 INC. (NORTH CAROLINA COR-  
PORATION)  
STUDIO 5  
163 BEACON STREET  
BOSTON, MA 02116

THE MARK CONSISTS OF STANDARD CHAR-  
ACTERS WITHOUT CLAIM TO ANY PARTICULAR  
FONT, STYLE, SIZE, OR COLOR.

FOR: INFORMATION TECHNOLOGY CONSUL-  
TATION, IN CLASS 42 (U.S. CLS. 100 AND 101).

SER. NO. 77-179,483, FILED 5-12-2007.

FIRST USE 1-1-2007; IN COMMERCE 1-1-2007.

GINA HAYES, EXAMINING ATTORNEY

**Int. Cl.: 42**

**Prior U.S. Cls.: 100 and 101**

**United States Patent and Trademark Office**

**Reg. No. 3,452,319**

**Registered June 24, 2008**

**SERVICE MARK  
PRINCIPAL REGISTER**

**IH EXPRESS**

THE INSURANCE HOUSE, INC. (GEORGIA  
CORPORATION)  
1904 LELAND DRIVE  
MARIETTA, GA 30067

FOR: PROVIDING ON-LINE NON-DOWNLOAD-  
ABLE SOFTWARE FOR USE IN DETERMINING  
INSURANCE RATINGS FOR COMMERCIAL AND  
PERSONAL LINES OF BUSINESS, IN CLASS 42 (U.S.  
CLS. 100 AND 101).

FIRST USE 5-1-2007; IN COMMERCE 5-1-2007.

THE MARK CONSISTS OF STANDARD CHAR-  
ACTERS WITHOUT CLAIM TO ANY PARTICULAR  
FONT, STYLE, SIZE, OR COLOR.

SER. NO. 77-179,790, FILED 5-14-2007.

PETER B. BROMAGHIM, EXAMINING ATTORNEY

**Int. Cl.: 38**

**Prior U.S. Cls.: 100, 101 and 104**

**United States Patent and Trademark Office**

**Reg. No. 3,452,320**

**Registered June 24, 2008**

**SERVICE MARK  
PRINCIPAL REGISTER**



DATAROSE IP LLC (COLORADO LTD LIAB CO)  
PO BOX 418  
BAILEY, CO 80421

FOR: ELECTRONIC DATA INTERCHANGE (EDI)  
SERVICES, IN CLASS 38 (U.S. CLS. 100, 101 AND 104).

FIRST USE 6-9-2005; IN COMMERCE 6-9-2005.

THE MARK CONSISTS OF A CLOCK-WISE ROTATING PINWHEEL POSITIONED CENTRALLY ABOVE THE "DATAROSE" LOGOTYPE WRITTEN IN THE ITC GARAMOND LIGHT CONDENSED FONT.

SER. NO. 77-179,799, FILED 5-14-2007.

JORDAN BAKER, EXAMINING ATTORNEY

**Int. Cls.: 9, 37 and 42**

**Prior U.S. Cls.: 21, 23, 26, 36, 38, 100, 101, 103 and 106**

**Reg. No. 3,452,321**

**United States Patent and Trademark Office**

**Registered June 24, 2008**

**TRADEMARK  
SERVICE MARK  
PRINCIPAL REGISTER**

# AIRSWEEPER

PENTURA LTD (UNITED KINGDOM CORPORATION)  
DIDDENHAM COURT, LAMBWOOD HILL, GRAZELEY  
READING, UNITED KINGDOM RG71JS

FOR: COMPUTER SOFTWARE FOR USE IN THE FIELD OF COMPUTER AND COMPUTER DATA SECURITY; COMPUTER, INTERNET AND NETWORK SECURITY SOFTWARE; INTRUSION, DETECTION AND CONTENT CHECKING SOFTWARE, NAMELY, ANTI-VIRUS COMPUTER SOFTWARE, ANTI-SPYWARE SOFTWARE, COMPUTER SOFTWARE FOR THE CREATION OF FIREWALLS; ENCRYPTION AND AUTHENTICATION SOFTWARE; SOFTWARE FOR MONITORING DATABASE SECURITY SYSTEMS AND SOFTWARE; SECURITY DEVICES FOR COMPUTER SOFTWARE AND HARDWARE, NAMELY THEFT ALARMS, PLASTIC CASE USED AS A SECURITY DEVICE FOR PROTECTING AND SECURING COMPACT DISCS AND OTHER MAGNETIC AND ELECTRONIC MEDIA FROM THEFT; SECURITY SURVEILLANCE APPARATUS USED IN RELATION TO COMPUTERS AND COMPUTER NETWORKS, NAMELY, ELECTRIC AND ELECTRONIC VIDEO SURVEILLANCE INSTALLATIONS, ANTI-SPYWARE SOFTWARE, IN CLASS 9 (U.S. CLS. 21, 23, 26, 36 AND 38).

FOR: INSTALLATION, MAINTENANCE AND REPAIR OF COMPUTER HARDWARE, IN CLASS 37 (U.S. CLS. 100, 103 AND 106).

FOR: ADVISORY, INFORMATION AND CONSULTANCY SERVICES IN THE FIELD OF INFORMATION TECHNOLOGY, COMPUTERS, COMPUTER SYSTEMS AND SOFTWARE; DESIGN, INSTALLATION, IMPLEMENTATION, MAINTENANCE, AND SUPPORT SERVICES IN THE NATURE OF REPAIR SERVICES IN CONNECTION

WITH COMPUTER SOFTWARE; DESIGN SERVICES IN CONNECTION WITH COMPUTER HARDWARE; COMPUTER PROJECT MANAGEMENT SERVICES IN THE FIELD OF INFORMATION SYSTEMS DESIGN, SPECIFICATION, IMPLEMENTATION AND MAINTENANCE; ADVISORY, INFORMATION AND CONSULTANCY SERVICES IN THE FIELDS OF COMPUTER HARDWARE AND SOFTWARE AND INTERNET SECURITY; PROFESSIONAL CONSULTANCY RELATING TO COMPUTER SECURITY; DATA SECURITY SERVICES, NAMELY, COMPUTER SECURITY SERVICES IN THE NATURE OF RESTRICTING ACCESS TO AND BY COMPUTER NETWORKS TO AND OF UNDESIRE WEB SITES, MEDIA AND INDIVIDUALS AND FACILITIES, COMPUTER SECURITY SERVICES IN THE NATURE OF HARD DRIVE ERASURE; SUPPORT SERVICES IN CONNECTION WITH COMPUTER HARDWARE AND SOFTWARE, NAMELY, TROUBLESHOOTING OF COMPUTER HARDWARE AND SOFTWARE PROBLEMS, TECHNOLOGY ADVICE PROVIDED TO INTERNET USERS BY MEANS OF A SUPPORT HOTLINE, TECHNICAL SUPPORT IN THE NATURE OF MONITORING OF NETWORK SYSTEMS; IMPLEMENTATION OF COMPUTER HARDWARE, IN CLASS 42 (U.S. CLS. 100 AND 101).

THE MARK CONSISTS OF STANDARD CHARACTERS WITHOUT CLAIM TO ANY PARTICULAR FONT, STYLE, SIZE, OR COLOR.

OWNER OF UNITED KINGDOM REG. NO. 2427851, DATED 1-26-2007, EXPIRES 7-20-2016.

SER. NO. 77-180,200, FILED 5-14-2007.

KATHERINE CONNOLLY, EXAMINING ATTORNEY

**Int. Cl.: 20**

**Prior U.S. Cls.: 2, 13, 22, 25, 32 and 50**

**United States Patent and Trademark Office**

**Reg. No. 3,452,322**

**Registered June 24, 2008**

**TRADEMARK  
PRINCIPAL REGISTER**

**ROSE GRIPBOX**

ROSE PLASTIC GMBH (FED REP GERMANY  
GMBH)

RUPOLZER STRASSE 53

HERGENSWEILER, FED REP GERMANY D-88138

FOR: PACKAGING CONTAINERS AND TUBES  
MANUFACTURED OF SYNTHETIC MATERIALS,  
NAMELY, PLASTIC, FOR COMMERCIAL USE AND  
THE PROTECTION OR WAREHOUSING OF PRO-  
DUCTS , IN CLASS 20 (U.S. CLS. 2, 13, 22, 25, 32 AND  
50).

THE MARK CONSISTS OF STANDARD CHAR-  
ACTERS WITHOUT CLAIM TO ANY PARTICULAR  
FONT, STYLE, SIZE, OR COLOR.

PRIORITY CLAIMED UNDER SEC. 44(D) ON FED  
REP GERMANY APPLICATION NO. 306716992,  
FILED 11-23-2006, REG. NO. 30671699, DATED 1-27-  
2007, EXPIRES 11-30-2016.

SER. NO. 77-180,208, FILED 5-14-2007.

SETH A. RAPPAPORT, EXAMINING ATTORNEY

**Int. Cl.: 14**

**Prior U.S. Cls.: 2, 27, 28 and 50**

**United States Patent and Trademark Office**

**Reg. No. 3,452,323**

**Registered June 24, 2008**

**TRADEMARK  
PRINCIPAL REGISTER**

**MAHLIA COLLECTION**

MAHLIA COLLECTION INC. (ARIZONA CORPORATION)

410 N. TOOLE AVENUE

TUCSON, AZ 85701

FOR: JEWELRY, IN CLASS 14 (U.S. CLS. 2, 27, 28 AND 50).

FIRST USE 11-0-2003; IN COMMERCE 11-0-2003.

THE MARK CONSISTS OF STANDARD CHARACTERS WITHOUT CLAIM TO ANY PARTICULAR FONT, STYLE, SIZE, OR COLOR.

NO CLAIM IS MADE TO THE EXCLUSIVE RIGHT TO USE "COLLECTION", APART FROM THE MARK AS SHOWN.

SER. NO. 77-180,275, FILED 5-14-2007.

JULIE WATSON, EXAMINING ATTORNEY

**Int. Cl.: 14**

**Prior U.S. Cls.: 2, 27, 28 and 50**

**Reg. No. 3,452,324**

**United States Patent and Trademark Office**

**Registered June 24, 2008**

---

**TRADEMARK  
PRINCIPAL REGISTER**



MAHLIA COLLECTION INC. (ARIZONA CORPORATION)  
410 N. TOOLE AVENUE  
TUCSON, AZ 85701

NO CLAIM IS MADE TO THE EXCLUSIVE  
RIGHT TO USE COLLECTION , APART FROM  
THE MARK AS SHOWN.

FOR: JEWELRY, IN CLASS 14 (U.S. CLS. 2, 27, 28  
AND 50).

SER. NO. 77-180,431, FILED 5-14-2007.

FIRST USE 10-0-2004; IN COMMERCE 10-0-2004.

JULIE WATSON, EXAMINING ATTORNEY



**Int. Cl.: 43**

**Prior U.S. Cls.: 100 and 101**

**United States Patent and Trademark Office**

**Reg. No. 3,452,325**

**Registered June 24, 2008**

**SERVICE MARK  
PRINCIPAL REGISTER**

**POSITANO COAST BY ALDO  
LAMBERTI**

ROMUALDO LAMBERTI (UNITED STATES IN-  
DIVIDUAL)  
6 REAR GROVE STREET  
CHERRY HILL, NJ 08002

THE MARK CONSISTS OF STANDARD CHAR-  
ACTERS WITHOUT CLAIM TO ANY PARTICULAR  
FONT, STYLE, SIZE, OR COLOR.

FOR: RESTAURANT SERVICES, IN CLASS 43  
(U.S. CLS. 100 AND 101).

SER. NO. 77-180,449, FILED 5-14-2007.

FIRST USE 1-17-2005; IN COMMERCE 1-17-2005.

TRICIA SONNEBORN, EXAMINING ATTORNEY

**Int. Cl.: 41**

**Prior U.S. Cls.: 100, 101 and 107**

**United States Patent and Trademark Office**

**Reg. No. 3,452,326**

**Registered June 24, 2008**

**SERVICE MARK  
PRINCIPAL REGISTER**

# ProFirstAid

PROCPR, LLC (MICHIGAN LTD LIAB CO)  
P.O. BOX 775  
ROCKFORD, MI 49341

FOR: EDUCATIONAL SERVICES, NAMELY,  
CONDUCTING CLASSES IN MEDICAL CARE IN  
PERSON AND OVER THE INTERNET FOR PRO-  
FESSIONAL RECERTIFICATION OF HEALTH-  
CARE PROFESSIONALS, IN CLASS 41 (U.S. CLS.  
100, 101 AND 107).

FIRST USE 2-27-2005; IN COMMERCE 2-27-2005.

THE MARK CONSISTS OF STANDARD CHAR-  
ACTERS WITHOUT CLAIM TO ANY PARTICULAR  
FONT, STYLE, SIZE, OR COLOR.

NO CLAIM IS MADE TO THE EXCLUSIVE  
RIGHT TO USE NO CLAIM IS MADE TO THE  
EXCLUSIVE RIGHT TO USE 'FIRST AID' APART  
FROM THE MARK AS SHOWN., APART FROM  
THE MARK AS SHOWN.

SER. NO. 77-180,542, FILED 5-14-2007.

CHERYL CLAYTON, EXAMINING ATTORNEY

**Int. Cl.: 9**

**Prior U.S. Cls.: 21, 23, 26, 36 and 38**

**Reg. No. 3,452,327**

**United States Patent and Trademark Office**

**Registered June 24, 2008**

**TRADEMARK  
PRINCIPAL REGISTER**

# TOSA

TOSA INTERNATIONAL INC. (TAIWAN CORPORATION)  
7F-4, NO. 21, SEC. 1, TUN HUA S. RD.  
TAIPEI CITY, TAIWAN

FOR: VIDEO GAME JOYSTICKS; COMPUTER GAME JOYSTICKS; CONNECTING ELECTRICAL CABLES; APPARATUS FOR VIDEO GAMES, NAMELY, GAME CONSOLES ADAPTED FOR USE WITH TELEVISION RECEIVERS; BAGS USED TO CARRY VIDEO GAME MACHINES; STANDS FOR ELECTRONIC GAME MACHINES; PROTECTIVE CARRYING BAGS SPECIFICALLY ADAPTED TO CARRY VIDEO GAME MACHINES; SHAPED JOYSTICK COVERS MADE OF SILICON; CHARGING APPLIANCES FOR RECHARGING EQUIPMENT;

WIRELESS SENSORS FOR USE IN PLAYING VIDEO GAMES; COVERS FOR VIDEO GAMES; VIDEO GAME INTERACTIVE HAND HELD REMOTE CONTROLS FOR PLAYING ELECTRONIC GAMES, IN CLASS 9 (U.S. CLS. 21, 23, 26, 36 AND 38).

FIRST USE 1-10-1997; IN COMMERCE 6-20-1997.

THE MARK CONSISTS OF THE LITERAL WORD: TOSA.

SER. NO. 77-180,886, FILED 5-15-2007.

INGA ERVIN, EXAMINING ATTORNEY

**Int. Cl.: 25**

**Prior U.S. Cls.: 22 and 39**

**United States Patent and Trademark Office**

**Reg. No. 3,452,328**

**Registered June 24, 2008**

**TRADEMARK  
PRINCIPAL REGISTER**



MANCINI, MICHAEL J (UNITED STATES INDIVIDUAL)  
373 MILLERS BRANCH DR.  
ST. MARYS, GA 31558

FOR: DECK-SHOES; HATS; POLO SHIRTS; SHIRTS; SHOES; T-SHIRTS, IN CLASS 25 (U.S. CLS. 22 AND 39).

FIRST USE 3-10-2007; IN COMMERCE 5-10-2007.

NO CLAIM IS MADE TO THE EXCLUSIVE RIGHT TO USE "WEAR", APART FROM THE MARK AS SHOWN.

THE COLOR(S) BLACK AND TURQUOISE IS/ ARE CLAIMED AS A FEATURE OF THE MARK.

THE COLOR BLACK APPEARS IN THE WORDING "ST MARYS RIVER WEAR", THE BIRD, AND STOOP AND THE COLOR TURQUOISE APPEARS IN THE DESIGN OF THE WATER WAVES AND MOON.

SER. NO. 77-180,899, FILED 5-15-2007.

LOURDES AYALA, EXAMINING ATTORNEY

**Int. Cl.: 43**

**Prior U.S. Cls.: 100 and 101**

**United States Patent and Trademark Office**

**Reg. No. 3,452,329**

**Registered June 24, 2008**

**SERVICE MARK  
PRINCIPAL REGISTER**

**LOUNGY LOUNGY**

BONEFISH GRILL, INC. (FLORIDA CORPORATION)  
5TH FLOOR  
2202 N. WESTSHORE BLVD.  
TAMPA, FL 33607

THE MARK CONSISTS OF STANDARD CHARACTERS WITHOUT CLAIM TO ANY PARTICULAR FONT, STYLE, SIZE, OR COLOR.

FOR: RESTAURANT AND BAR SERVICES, IN CLASS 43 (U.S. CLS. 100 AND 101).

SER. NO. 77-182,452, FILED 5-16-2007.

FIRST USE 6-3-2007; IN COMMERCE 6-3-2007.

JAY FLOWERS, EXAMINING ATTORNEY

Int. Cl.: 16

Prior U.S. Cls.: 2, 5, 22, 23, 29, 37, 38 and 50

United States Patent and Trademark Office

Reg. No. 3,452,330

Registered June 24, 2008

TRADEMARK  
PRINCIPAL REGISTER



KIDZ'N PUBLICATIONS, LLC (MAINE LTD  
LIAB CO)  
3 PARTRIDGE LANE  
SCARBOROUGH, ME 04074

FOR: NEWSLETTERS IN THE FIELD OF CHILDREN'S ACTIVITIES, IN CLASS 16 (U.S. CLS. 2, 5, 22, 23, 29, 37, 38 AND 50).

FIRST USE 5-1-2007; IN COMMERCE 5-1-2007.

NO CLAIM IS MADE TO THE EXCLUSIVE RIGHT TO USE "KIDS IN MAINE", APART FROM THE MARK AS SHOWN.

THE COLOR(S) BLUE, GREEN, YELLOW, RED, PURPLE IS/ARE CLAIMED AS A FEATURE OF THE MARK.

THE MARK CONSISTS OF BLUE LETTERS "KIDZ'N MAINE" WITH THE "I" IN "KIDZ" AND THE "I" IN "MAINE" DOTTED WITH CHILD'S HANDPRINTS. FINGERS ON HANDPRINTS ARE COLORED AS FOLLOWS: LITTLE FINGER IS PURPLE, RING FINGER IS YELLOW, MIDDLE FINGER IS BLUE, INDEX FINGER IS GREEN AND THUMB IS RED.

SER. NO. 77-182,475, FILED 5-16-2007.

ANNE E. GUSTASON, EXAMINING ATTORNEY

**Int. Cl.: 5**

**Prior U.S. Cls.: 6, 18, 44, 46, 51 and 52**

**United States Patent and Trademark Office**

**Reg. No. 3,452,331**

**Registered June 24, 2008**

**TRADEMARK  
PRINCIPAL REGISTER**



NHI, INC. (BR.VIRGIN ISLANDS BUSINESS  
COMPANY)  
C/O OVERSEAS MANAGEMENT COMPANY  
TRUST  
P.O. BOX 3152  
ROAD TOWN TORTOLA, BR.VIRGIN ISLANDS

FOR: DIETARY SUPPLEMENTS, IN CLASS 5 (U.S.  
CLS. 6, 18, 44, 46, 51 AND 52).

FIRST USE 9-28-2005; IN COMMERCE 11-1-2005.

THE MARK CONSISTS OF A PICTURE OF A  
LEAF WITH FOUR CHECKMARKS DESCENDING  
DOWN THROUGH THE UPPER PORTION OF THE  
LEAF IN DECREASING SIZE.

SER. NO. 77-182,480, FILED 5-16-2007.

BRIAN PINO, EXAMINING ATTORNEY

**Int. Cl.: 36**

**Prior U.S. Cls.: 100, 101 and 102**

**United States Patent and Trademark Office**

**Reg. No. 3,452,332**

**Registered June 24, 2008**

**SERVICE MARK  
PRINCIPAL REGISTER**

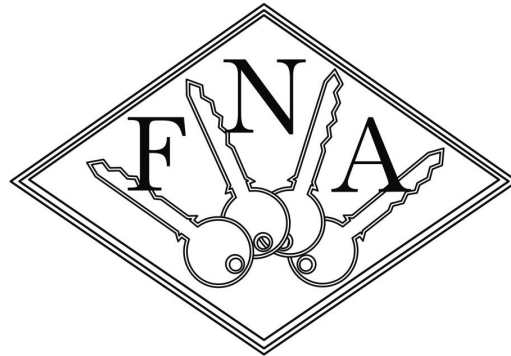

**FINANCIAL NETWORK  
OF AMERICA LTD.**

FINANCIAL NETWORK OF AMERICA LTD.  
(OHIO LTD LIAB CO)  
P.O. BOX 559  
2214 ENTERPRISE PARKWAY EAST  
TWINSBURG, OH 44087

FOR: FINANCIAL PLANNING, FINANCIAL  
PLANNING FOR RETIREMENT AND INVEST-  
MENT CONSULTATION IN THE FIELD OF INTE-  
GRATED ESTATE, TAX, BUSINESS  
MANAGEMENT AND INSURANCE, IN CLASS 36  
(U.S. CLS. 100, 101 AND 102).

FIRST USE 6-1-1994; IN COMMERCE 6-1-1994.

NO CLAIM IS MADE TO THE EXCLUSIVE  
RIGHT TO USE "LTD", APART FROM THE MARK  
AS SHOWN.

SEC. 2(F) AS TO "FINANCIAL NETWORK OF  
AMERICA".

SER. NO. 77-182,500, FILED 5-16-2007.

DAWN HAN, EXAMINING ATTORNEY



**Int. Cl.: 36**

**Prior U.S. Cls.: 100, 101 and 102**

**United States Patent and Trademark Office**

**Reg. No. 3,452,333**

**Registered June 24, 2008**

**SERVICE MARK  
PRINCIPAL REGISTER**

**“eXpress Account”**



FINANCIAL NETWORK OF AMERICA LTD.  
(OHIO LTD LIAB CO)  
P.O. BOX 559  
2214 ENTERPRISE PARKWAY EAST  
TWINSBURG, OH 44087

FOR: FINANCIAL PLANNING, FINANCIAL  
PLANNING FOR RETIREMENT AND INVEST-  
MENT CONSULTATION IN THE FIELD OF INTE-  
GRATED ESTATE, TAX, BUSINESS

MANAGEMENT AND INSURANCE, IN CLASS 36  
(U.S. CLS. 100, 101 AND 102).

FIRST USE 12-31-1998; IN COMMERCE 12-31-1998.

SEC. 2(F) AS TO "EXPRESS ACCOUNT".

SER. NO. 77-182,526, FILED 5-16-2007.

DAWN HAN, EXAMINING ATTORNEY

**Int. Cl.: 9**

**Prior U.S. Cls.: 21, 23, 26, 36 and 38**

**United States Patent and Trademark Office**

**Reg. No. 3,452,334**

**Registered June 24, 2008**

**TRADEMARK  
PRINCIPAL REGISTER**

**UNIPRO FOODSERVICE NETNEWS**

UNIPRO FOODSERVICE, INC. (DELAWARE CORPORATION)

2500 CUMBERLAND PARKWAY

ATLANTA, GA 30339

FOR: PROVIDING DOWNLOADABLE ELECTRONIC NEWSLETTERS PROVIDING INFORMATION ABOUT MARKETING SERVICES FROM FOOD SERVICE OPERATORS, IN CLASS 9 (U.S. CLS. 21, 23, 26, 36 AND 38).

FIRST USE 2-9-2007; IN COMMERCE 2-9-2007.

THE MARK CONSISTS OF STANDARD CHARACTERS WITHOUT CLAIM TO ANY PARTICULAR FONT, STYLE, SIZE, OR COLOR.

OWNER OF U.S. REG. NOS. 2,257,994, 2,257,995, AND 2,259,965.

NO CLAIM IS MADE TO THE EXCLUSIVE RIGHT TO USE "FOOD SERVICE NET NEWS", APART FROM THE MARK AS SHOWN.

SER. NO. 77-182,598, FILED 5-16-2007.

MELVIN AXILBUND, EXAMINING ATTORNEY

**Int. Cl.: 12**

**Prior U.S. Cls.: 19, 21, 23, 31, 35 and 44**

**Reg. No. 3,452,335**

**United States Patent and Trademark Office**

**Registered June 24, 2008**

**TRADEMARK  
PRINCIPAL REGISTER**

**BONANZA**

FERRAND, MICHAEL O. (UNITED STATES IN-  
DIVIDUAL)  
P.O. BOX 320211  
LOS GATOS, CA 95032

THE MARK CONSISTS OF STANDARD CHAR-  
ACTERS WITHOUT CLAIM TO ANY PARTICULAR  
FONT, STYLE, SIZE, OR COLOR.

FOR: MOTORIZED VEHICLES, NAMELY,  
CARTS, MINI-BIKES, MINI-MOTORCYCLES, AND  
FOUR-WHEEL ALL-TERRAIN VEHICLES, IN  
CLASS 12 (U.S. CLS. 19, 21, 23, 31, 35 AND 44).

SER. NO. 77-182,617, FILED 5-16-2007.

FIRST USE 1-31-1991; IN COMMERCE 1-31-1991.

REBECCA SMITH, EXAMINING ATTORNEY

**Int. Cl.: 36**

**Prior U.S. Cls.: 100, 101 and 102**

**United States Patent and Trademark Office**

**Reg. No. 3,452,336**

**Registered June 24, 2008**

**SERVICE MARK  
PRINCIPAL REGISTER**

**110REALTY.COM**

110REALTY LLC (MARYLAND LTD LIAB CO)  
38 VILLAGE SQUARE  
BALTIMORE, MD 21210

THE MARK CONSISTS OF STANDARD CHAR-  
ACTERS WITHOUT CLAIM TO ANY PARTICULAR  
FONT, STYLE, SIZE, OR COLOR.

FOR: REAL ESTATE AGENCY SERVICES;  
CHARITABLE FUNDRAISING SERVICES, IN  
CLASS 36 (U.S. CLS. 100, 101 AND 102).

SER. NO. 77-182,807, FILED 5-16-2007.

FIRST USE 8-1-2005; IN COMMERCE 8-1-2005.

PETER B. BROMAGHIM, EXAMINING ATTORNEY

**Int. Cl.: 21**

**Prior U.S. Cls.: 2, 13, 23, 29, 30, 33, 40 and 50**

**Reg. No. 3,452,337**

**United States Patent and Trademark Office**

**Registered June 24, 2008**

---

**TRADEMARK  
PRINCIPAL REGISTER**

**FLOSS & WIPE**

ALTEAN, INC. (NEW YORK CORPORATION)  
649 7TH AVENUE  
NEW HYDE PARK, NY 11040

NO CLAIM IS MADE TO THE EXCLUSIVE  
RIGHT TO USE "FLOSS", APART FROM THE  
MARK AS SHOWN.

FOR: DENTAL FLOSS, IN CLASS 21 (U.S. CLS. 2,  
13, 23, 29, 30, 33, 40 AND 50).

SER. NO. 77-183,526, FILED 5-17-2007.

FIRST USE 6-1-2005; IN COMMERCE 0-0-2006.

THE MARK CONSISTS OF STANDARD CHAR-  
ACTERS WITHOUT CLAIM TO ANY PARTICULAR  
FONT, STYLE, SIZE, OR COLOR.

WARREN L. OLANDRIA, EXAMINING ATTOR-  
NEY

**Int. Cl.: 28**

**Prior U.S. Cls.: 22, 23, 38 and 50**

**Reg. No. 3,452,338**

**United States Patent and Trademark Office**

**Registered June 24, 2008**

**TRADEMARK  
PRINCIPAL REGISTER**

**THREE MINUTE EGG**

THREE MINUTE EGG, INC. (NORTH CAROLINA CORPORATION)  
27 PARKWAY LOOP  
ASHEVILLE, NC 28803

FOR: EXERCISE EQUIPMENT, NAMELY, ABDOMINAL BOARDS; EXERCISE EQUIPMENT, NAMELY, CHEST PULLS; EXERCISE PLATFORMS; ELBOW PADS FOR ATHLETIC USE; HAND PADS FOR ATHLETIC USE; KNEE PADS FOR ATHLETIC USE; SHIN PADS FOR ATHLETIC USE; SHOULDER PADS FOR ATHLETIC USE; PADS FOR USE IN RESISTANCE TRAINING OF ALL MAJOR MUSCLE GROUPS, ATHLETICS, EXERCISING, GYMNASTICS, MARTIAL ARTS, AND YOGA; BOARDS USED IN THE PRACTICE OF WATER SPORTS; FLOATS FOR RECREATIONAL USE, NAMELY, IN WATER GAMES, EXERCISING, AND YOGA; SWIM BOARDS FOR RECREATIONAL USE; SWIM FLOATS FOR RECREATIONAL USE; SWIMMING AIDS, NAMELY, HAND PADDLES AND KNEE STABILIZERS; SWIMMING BOARDS; PORTABLE SUPPORT STRUCTURES FOR DANCE AND OTHER EXERCISES; STRESS RELIEF BALLS FOR HAND EXERCISE; WATER WING SWIM AIDS FOR RECREATIONAL USE; YOGA MATS; ACTION TARGET GAMES; ACTION-TYPE TARGET GAMES; AERO-DYNAMIC DISK FOR USE IN PLAYING CATCHING GAMES; BALLS FOR GAMES; EQUIPMENT FOR PLAYING A VERTICAL HOOP TARGET GAME; EQUIPMENT SOLD AS A UNIT FOR PLAYING ACTION TYPE TARGET GAMES; MANIPULATIVE GAMES; PADDLE BALL GAMES; PADDLES FOR USE IN PADDLE BALL GAMES; PARLOR GAMES; PARTY GAMES; RING GAMES; TARGET GAMES; TOYS, NAMELY, A DISK TO TOSS IN PLAYING A GAME WHEREIN OTHER

DISKS ARE FLIPPED AND COLLECTED; BOOMERANGS; KARATE TARGET PADS; TARGETS; DISC TOSS TOYS; TOSSING DISC TOYS; HANDBALLS; EXERCISE BALLS; FOOT BALLS; HAND BALLS; BEACH BALLS; PADDLE BALLS; PLAYGROUND BALLS; PUNCHING BALLS; RUBBER ACTION BALLS; RUBBER BALLS; SPORT BALLS; KARATE KICK PADS; KICK BOARD FLOTATION DEVICES FOR RECREATIONAL USE; BATH TOYS; BATHTUB TOYS; BABY MULTIPLE ACTIVITY TOYS; CHILDREN'S MULTIPLE ACTIVITY TOYS; CHILDREN'S MULTIPLE ACTIVITY TOYS SOLD AS A UNIT WITH PRINTED BOOKS; INFANT ACTION CRIB TOYS; INFANT DEVELOPMENT TOYS; INFANT TOYS; BLOCKING DUMMIES; TOY BUILDING BLOCKS; TOY CONSTRUCTION BLOCKS; STACKING TOYS; SQUEEZE TOYS; DOG TOYS; PET TOYS; SPORTS EQUIPMENT, NAMELY, LOWER BODY ALIGNMENT APPARATUS; MANUAL LEG EXERCISERS; MANUALLY-OPERATED EXERCISE EQUIPMENT; GYMNASTIC APPARATUS; WEIGHT LIFTING BENCHES AND BENCH ACCESSORIES; POOL CUSHIONS; PERSONAL EXERCISE MATS, IN CLASS 28 (U.S. CLS. 22, 23, 38 AND 50).

FIRST USE 10-16-2006; IN COMMERCE 1-16-2007.

THE MARK CONSISTS OF STANDARD CHARACTERS WITHOUT CLAIM TO ANY PARTICULAR FONT, STYLE, SIZE, OR COLOR.

SER. NO. 77-183,551, FILED 5-17-2007.

SHAUNIA CARLYLE, EXAMINING ATTORNEY

**Int. Cl.: 42**

**Prior U.S. Cls.: 100 and 101**

**United States Patent and Trademark Office**

**Reg. No. 3,452,339**

**Registered June 24, 2008**

**SERVICE MARK  
PRINCIPAL REGISTER**

**MIRAVISTA**

MIRABELLA TECHNOLOGIES, LLC (INDIANA  
LTD LIAB CO)  
4444 DECATUR BOULEVARD, SUITE 300  
INDIANAPOLIS, IN 46241

FOR: DIAGNOSTIC SERVICES IN THE FIELD OF  
INFECTIOUS DISEASES, IN CLASS 42 (U.S. CLS. 100  
AND 101).

FIRST USE 7-12-2005; IN COMMERCE 7-12-2005.

THE MARK CONSISTS OF STANDARD CHAR-  
ACTERS WITHOUT CLAIM TO ANY PARTICULAR  
FONT, STYLE, SIZE, OR COLOR.

THE ENGLISH TRANSLATION OF THE WORD  
"MIRAVISTA" IN THE MARK IS "SCOPE OF  
SIGHT".

SER. NO. 77-183,558, FILED 5-17-2007.

RON FAIRBANKS, EXAMINING ATTORNEY

**Int. Cl.: 26**

**Prior U.S. Cls.: 37, 39, 40, 42 and 50**

**Reg. No. 3,452,340**

**United States Patent and Trademark Office**

**Registered June 24, 2008**

**TRADEMARK  
PRINCIPAL REGISTER**

**MY BAG OF SECRETS**

CE SOIR LINGERIE CO., INC. (CALIFORNIA  
CORPORATION)  
2907 PALMA DRIVE  
VENTURA, CA 93003

FOR: KITS OF WOMEN'S ACCESSORY ITEMS  
CONSISTING PRIMARILY OF GARMENT STRAP  
FASTENERS, SHOULDER PADS, AND DRESS  
TAPE, ALSO WITH DISPOSABLE DRESS PROTEC-  
TORS IN THE NATURE OF UNDERARM PADS,  
NIPPLE BREAST COVERS AND BRA EXTENDERS,  
IN CLASS 26 (U.S. CLS. 37, 39, 40, 42 AND 50).

FIRST USE 5-8-2007; IN COMMERCE 5-8-2007.

THE MARK CONSISTS OF STANDARD CHAR-  
ACTERS WITHOUT CLAIM TO ANY PARTICULAR  
FONT, STYLE, SIZE, OR COLOR.

THE WORD "SWEETROCKING" HAS NO MEAN-  
ING IN ANY FOREIGN LANGUAGE.

SER. NO. 77-184,060, FILED 5-17-2007.

FRANK LATTUCA, EXAMINING ATTORNEY



**Int. Cl.: 36**

**Prior U.S. Cls.: 100, 101 and 102**

**United States Patent and Trademark Office**

**Reg. No. 3,452,341**

**Registered June 24, 2008**

**SERVICE MARK  
PRINCIPAL REGISTER**



FLAGSHIP CAPITAL PARTNERS, LLC (NORTH CAROLINA LTD LIAB CO)  
2701 COLTSGATE ROAD, SUITE 100  
CHARLOTTE, NC 28211

FOR: REAL ESTATE INVESTMENT, IN CLASS 36 (U.S. CLS. 100, 101 AND 102).

FIRST USE 5-17-2007; IN COMMERCE 5-17-2007.

NO CLAIM IS MADE TO THE EXCLUSIVE RIGHT TO USE "CAPITAL PARTNERS, LLC", APART FROM THE MARK AS SHOWN.

THE COLOR(S) CLAIMED AS A FEATURE OF THE MARK ARE SAILS IN BLUE AND BURGUN-

DY; WORDS IN BLUE IS/ARE CLAIMED AS A FEATURE OF THE MARK.

THE MARK CONSISTS OF THE WORDING FLAGSHIP CAPITAL PARTNERS, LLC AND DESIGN OF TWO SAILS, ONE IN FRONT OF THE OTHER, ALL ABOVE THE WORDING IN THE MARK.

SER. NO. 77-184,728, FILED 5-18-2007.

SAMUEL E. SHARPER JR., EXAMINING ATTORNEY

**Int. Cl.: 8**

**Prior U.S. Cls.: 23, 28 and 44**

**United States Patent and Trademark Office**

**Reg. No. 3,452,342**

**Registered June 24, 2008**

**TRADEMARK  
PRINCIPAL REGISTER**

# Honey-Do

BEZA, L.P. (TEXAS LIMITED PARTNERSHIP)  
1615 WEST 6TH STREET, SUITE A  
AUSTIN, TX 78703

FIRST USE 6-0-2004; IN COMMERCE 6-0-2004.

FOR: MULTI-FUNCTION HAND TOOL KITS  
COMPRISED OF HAND-HELD CUTTING TOOLS,  
KNIVES, HAMMERS, SAWS, FILES, BIT DRIVERS,  
PLIERS, SCREWDRIVERS, WIRE CUTTERS AND  
STRIPPERS, WRENCHES, SCISSORS AND BITS FOR  
HAND TOOLS, ALL SOLD IN A SPECIALLY DE-  
SIGNER CASE, IN CLASS 8 (U.S. CLS. 23, 28 AND 44).

THE MARK CONSISTS OF STANDARD CHAR-  
ACTERS WITHOUT CLAIM TO ANY PARTICULAR  
FONT, STYLE, SIZE, OR COLOR.

SER. NO. 77-185,043, FILED 5-18-2007.

JACQUELINE A. LAVINE, EXAMINING ATTOR-  
NEY

Int. Cl.: 38

Prior U.S. Cls.: 100, 101 and 104

United States Patent and Trademark Office

Reg. No. 3,452,343

Registered June 24, 2008

SERVICE MARK  
PRINCIPAL REGISTER



MIDWESTBOATPARTY, LLC (MISSOURI LTD  
LIAB CO)  
5408 BELL FLOWER COURT  
COLUMBIA, MO 65203

FOR: PROVIDING ON-LINE FORUMS FOR  
TRANSMISSION OF MESSAGES AMONG COMPU-  
TER USERS CONCERNING BOATING ACTIVITIES  
IN THE MIDWEST, IN CLASS 38 (U.S. CLS. 100, 101  
AND 104).

FIRST USE 12-5-2003; IN COMMERCE 12-5-2003.

NO CLAIM IS MADE TO THE EXCLUSIVE  
RIGHT TO USE "MIDWEST BOAT PARTY.COM",  
APART FROM THE MARK AS SHOWN.

THE MARK CONSISTS OF A STYLIZED LETTER-  
ING OF THE WEBSITE ADDRESS "MIDWEST-  
BOATPARTY.COM" NEXT TO THE OUTLINE OF  
A BIKINI CLAD FEMALE.

SER. NO. 77-185,147, FILED 5-18-2007.

JIM RINGLE, EXAMINING ATTORNEY

**Int. Cl.: 43**

**Prior U.S. Cls.: 100 and 101**

**United States Patent and Trademark Office**

**Reg. No. 3,452,344**

**Registered June 24, 2008**

**SERVICE MARK  
PRINCIPAL REGISTER**



K&J LTD. CO. LLC (CALIFORNIA LTD LIAB CO)  
#130  
280 TELLER ST.  
CORONA, CA 92879

NO CLAIM IS MADE TO THE EXCLUSIVE  
RIGHT TO USE "NAPA 29," "FOOD" AND "WINE",  
APART FROM THE MARK AS SHOWN.

FOR: RESTAURANT AND BAR SERVICES, IN  
CLASS 43 (U.S. CLS. 100 AND 101).

SER. NO. 77-185,271, FILED 5-18-2007.

FIRST USE 9-0-2002; IN COMMERCE 9-0-2002.

WENDY GOODMAN, EXAMINING ATTORNEY

**Int. Cl.: 44**

**Prior U.S. Cls.: 100 and 101**

**United States Patent and Trademark Office**

**Reg. No. 3,452,345**

**Registered June 24, 2008**

**SERVICE MARK  
PRINCIPAL REGISTER**



TEE TIME LAWN CARE, INC. (ILLINOIS CORPORATION)  
922 TALON DRIVE  
O'FALLON, IL 62269

NO CLAIM IS MADE TO THE EXCLUSIVE RIGHT TO USE "LAWN CARE" , APART FROM THE MARK AS SHOWN.

FOR: LAWN CARE SERVICES, IN CLASS 44 (U.S. CLS. 100 AND 101).

SER. NO. 77-185,356, FILED 5-19-2007.

FIRST USE 5-31-2005; IN COMMERCE 8-1-2005.

TARAH HARDY, EXAMINING ATTORNEY

**Int. Cl.: 35**

**Prior U.S. Cls.: 100, 101 and 102**

**United States Patent and Trademark Office**

**Reg. No. 3,452,346**

**Registered June 24, 2008**

**SERVICE MARK  
PRINCIPAL REGISTER**

**LIVE BETTER WELLNESS CLUB**

THE GREAT ATLANTIC & PACIFIC TEA COMPANY, INC. (MARYLAND CORPORATION)  
2 PARAGON DRIVE  
MONTVALE, NJ 07645

FOR: RETAIL STORE SERVICES IN THE FIELD OF PHARMACEUTICALS FEATURING A BONUS INCENTIVE PROGRAM FOR CUSTOMERS, IN CLASS 35 (U.S. CLS. 100, 101 AND 102).

FIRST USE 1-24-2007; IN COMMERCE 1-24-2007.

THE MARK CONSISTS OF STANDARD CHARACTERS WITHOUT CLAIM TO ANY PARTICULAR FONT, STYLE, SIZE, OR COLOR.

NO CLAIM IS MADE TO THE EXCLUSIVE RIGHT TO USE "WELLNESS CLUB", APART FROM THE MARK AS SHOWN.

SER. NO. 77-185,924, FILED 5-21-2007.

NORA BUCHANAN WILL, EXAMINING ATTORNEY

**Int. Cl.: 9**

**Prior U.S. Cls.: 21, 23, 26, 36 and 38**

**Reg. No. 3,452,347**

**United States Patent and Trademark Office**

**Registered June 24, 2008**

**TRADEMARK  
PRINCIPAL REGISTER**

**ORION**

THERMO ORION INC. (MASSACHUSETTS CORPORATION)  
166 CUMMINGS CENTER  
BEVERLY, MA 01915

FOR: EQUIPMENT FOR ELECTROCHEMICAL ANALYSIS, NAMELY, ELECTROCHEMICAL ELECTRODES FOR SENSING IONS IN SOLUTION AND ELECTRICAL METERS RESPONSIVE TO THE OUTPUT OF SUCH ELECTRODES , IN CLASS 9 (U.S. CLS. 21, 23, 26, 36 AND 38).

FIRST USE 5-1-2001, THE MARK WAS FIRST USED ANYWHERE IN A DIFFERENT FORM OTHER THAN THAT SOUGHT TO BE REGISTERED ON 06/10/1966.; IN COMMERCE

5-1-2001, THE MARK WAS FIRST USED IN COMMERCE IN A DIFFERENT FORM OTHER THAN THAT SOUGHT TO BE REGISTERED ON 06/10/1966..

THE MARK CONSISTS OF STANDARD CHARACTERS WITHOUT CLAIM TO ANY PARTICULAR FONT, STYLE, SIZE, OR COLOR.

OWNER OF U.S. REG. NOS. 1,090,769 AND 2,456,594.

SER. NO. 77-186,738, FILED 5-22-2007.

LINDA POWELL, EXAMINING ATTORNEY

**Int. Cl.: 28**

**Prior U.S. Cls.: 22, 23, 38 and 50**

**United States Patent and Trademark Office**

**Reg. No. 3,452,348**

**Registered June 24, 2008**

**TRADEMARK  
PRINCIPAL REGISTER**

**SAPPHIRE FROST**

MATTEL, INC. (DELAWARE CORPORATION)  
M1-1518  
333 CONTINENTAL BLVD.  
EL SEGUNDO, CA 90245

FOR: TOYS, GAMES AND PLAYTHINGS, NAME-  
LY, TOY VEHICLES, TOY FIGURES, AND ACCES-  
SORIES FOR ALL OF THE FOREGOING, IN CLASS  
28 (U.S. CLS. 22, 23, 38 AND 50).

FIRST USE 1-14-2008; IN COMMERCE 1-14-2008.

THE MARK CONSISTS OF STANDARD CHAR-  
ACTERS WITHOUT CLAIM TO ANY PARTICULAR  
FONT, STYLE, SIZE, OR COLOR.

OWNER OF U.S. REG. NOS. 2,532,082, 2,933,967,  
AND 2,968,120.

SER. NO. 77-187,059, FILED 5-22-2007.

MONIQUE MILLER, EXAMINING ATTORNEY



**Int. Cl.: 35**

**Prior U.S. Cls.: 100, 101 and 102**

**United States Patent and Trademark Office**

**Reg. No. 3,452,349**

**Registered June 24, 2008**

**SERVICE MARK  
PRINCIPAL REGISTER**

**HBM2**

PREFERRED HOME BUYERS NETWORK, INC.  
(MINNESOTA CORPORATION)

28215 BOULDER CIRCLE

EXCELSIOR, MN 55331

FOR: BUSINESS MARKETING CONSULTING  
SERVICES, IN CLASS 35 (U.S. CLS. 100, 101 AND 102).

FIRST USE 3-13-1998; IN COMMERCE 3-13-1998.

THE MARK CONSISTS OF STANDARD CHAR-  
ACTERS WITHOUT CLAIM TO ANY PARTICULAR  
FONT, STYLE, SIZE, OR COLOR.

OWNER OF U.S. REG. NOS. 2,840,410 AND  
2,843,247.

SER. NO. 77-187,083, FILED 5-22-2007.

KATHERINE M. DUBRAY, EXAMINING ATTOR-  
NEY

**Int. Cl.: 9**

**Prior U.S. Cls.: 21, 23, 26, 36 and 38**

**Reg. No. 3,452,350**

**United States Patent and Trademark Office**

**Registered June 24, 2008**

---

**TRADEMARK  
PRINCIPAL REGISTER**

**COUPE**

CELLCO PARTNERSHIP D/B/A VERIZON WIRE-  
LESS (DELAWARE PARTNERSHIP)  
ONE VERIZON WAY, VC52N058  
BASKING RIDGE, NJ 079201097

THE MARK CONSISTS OF STANDARD CHAR-  
ACTERS WITHOUT CLAIM TO ANY PARTICULAR  
FONT, STYLE, SIZE, OR COLOR.

FOR: CELL PHONES, IN CLASS 9 (U.S. CLS. 21, 23,  
26, 36 AND 38).

SER. NO. 77-187,095, FILED 5-22-2007.

FIRST USE 9-4-2007; IN COMMERCE 9-4-2007.

DOMINICK J. SALEMI, EXAMINING ATTORNEY

**Int. Cl.: 5**

**Prior U.S. Cls.: 6, 18, 44, 46, 51 and 52**

**Reg. No. 3,452,351**

**United States Patent and Trademark Office**

**Registered June 24, 2008**

**TRADEMARK  
PRINCIPAL REGISTER**

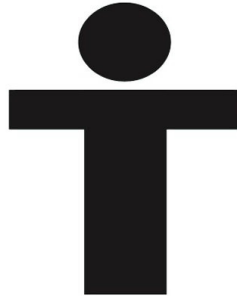

**intelligentFirstAid**

DLH, INC. (NEW JERSEY CORPORATION)  
SUITE 2  
42 BROAD STREET  
RED BANK, NJ 07701

FOR: FIRST AID KITS; FIRST AID KITS FOR  
DOMESTIC OR OTHER NON-PROFESSIONAL USE,  
IN CLASS 5 (U.S. CLS. 6, 18, 44, 46, 51 AND 52).

FIRST USE 1-1-2007; IN COMMERCE 1-1-2007.

NO CLAIM IS MADE TO THE EXCLUSIVE  
RIGHT TO USE FIRST AID, APART FROM THE  
MARK AS SHOWN.

THE MARK CONSISTS OF A STICK FIGURE  
MAN REPRESENTING A CROSS WITH A HEAD ON  
TOP TO SYMBOLIZE INTELLIGENT FIRST AID.

SER. NO. 77-187,343, FILED 5-22-2007.

ERNEST SHOSHO, EXAMINING ATTORNEY

**Int. Cl.: 30**

**Prior U.S. Cl.: 46**

**United States Patent and Trademark Office**

**Reg. No. 3,452,352**

**Registered June 24, 2008**

**TRADEMARK  
PRINCIPAL REGISTER**

**Cool Your Jets**

WISE-ACRE, INC. (MAINE CORPORATION)  
173 VARNUMVILLE RD  
BROOKSVILLE, ME 04617

THE MARK CONSISTS OF STANDARD CHAR-  
ACTERS WITHOUT CLAIM TO ANY PARTICULAR  
FONT, STYLE, SIZE, OR COLOR.

FOR: FROZEN CONFECTIONS, IN CLASS 30 (U.S.  
CL. 46).

SER. NO. 77-187,810, FILED 5-22-2007.

FIRST USE 10-26-2006; IN COMMERCE 10-26-2006.

DOMINICK J. SALEMI, EXAMINING ATTORNEY

**Int. Cl.: 44**

**Prior U.S. Cls.: 100 and 101**

**United States Patent and Trademark Office**

**Reg. No. 3,452,353**

**Registered June 24, 2008**

**SERVICE MARK  
PRINCIPAL REGISTER**

**Deep Tissue Intervention**

NEWMAN, JAMES DALE (UNITED STATES IN-  
DIVIDUAL)  
1515 PACIFIC AVE B-1  
EVERETT, WA 98201

NO CLAIM IS MADE TO THE EXCLUSIVE  
RIGHT TO USE "DEEP TISSUE", APART FROM  
THE MARK AS SHOWN.

FOR: MASSAGE, IN CLASS 44 (U.S. CLS. 100 AND  
101).

SER. NO. 77-187,828, FILED 5-23-2007.

FIRST USE 6-5-2006; IN COMMERCE 6-10-2006.

THE MARK CONSISTS OF STANDARD CHAR-  
ACTERS WITHOUT CLAIM TO ANY PARTICULAR  
FONT, STYLE, SIZE, OR COLOR.

JACQUELINE A. LAVINE, EXAMINING ATTOR-  
NEY

**Int. Cl.: 36**

**Prior U.S. Cls.: 100, 101 and 102**

**United States Patent and Trademark Office**

**Reg. No. 3,452,354**

**Registered June 24, 2008**

**SERVICE MARK  
PRINCIPAL REGISTER**

**TELL US YOUR STORY**

GREGORY FUNDING LLC (OREGON LTD LIAB  
CO)  
425 NW 10TH AVE #307  
PORTLAND, OR 97209

FOR: MORTGAGE LENDING; LEASE-PUR-  
CHASE LOANS; LEASE-PURCHASE FINANCING;  
LEASING OF REAL PROPERTY; FINANCIAL  
LOAN CONSULTATION; LOAN REFINANCING,  
IN CLASS 36 (U.S. CLS. 100, 101 AND 102).

FIRST USE 11-0-2005; IN COMMERCE 11-0-2005.

THE MARK CONSISTS OF STANDARD CHAR-  
ACTERS WITHOUT CLAIM TO ANY PARTICULAR  
FONT, STYLE, SIZE, OR COLOR.

SER. NO. 77-187,951, FILED 5-23-2007.

JAMES LOVELACE, EXAMINING ATTORNEY

**Int. Cl.: 35**

**Prior U.S. Cls.: 100, 101 and 102**

**United States Patent and Trademark Office**

**Reg. No. 3,452,355**

**Registered June 24, 2008**

**SERVICE MARK  
PRINCIPAL REGISTER**

**THE SAGEBRUSH SEA**

SALVO, MARK N. (UNITED STATES INDIVIDUAL)  
2224 W. PALOMINO DRIVE  
CHANDLER, AZ 85224

FOR: PUBLIC ADVOCACY TO PROMOTE AWARENESS OF ENVIRONMENTAL PROTECTION, IN CLASS 35 (U.S. CLS. 100, 101 AND 102).

FIRST USE 6-1-2001; IN COMMERCE 6-1-2001.

THE MARK CONSISTS OF STANDARD CHARACTERS WITHOUT CLAIM TO ANY PARTICULAR FONT, STYLE, SIZE, OR COLOR.

SEC. 2(F).

SER. NO. 77-187,991, FILED 5-23-2007.

ELLEN B. AWRICH, EXAMINING ATTORNEY

**Int. Cl.: 7**

**Prior U.S. Cls.: 13, 19, 21, 23, 31, 34 and 35**

**United States Patent and Trademark Office**

**Reg. No. 3,452,356**

**Registered June 24, 2008**

**TRADEMARK  
PRINCIPAL REGISTER**

**BIOLINE**

OCRIM S.P.A. (ITALY CORPORATION)  
VIA MASSAROTTI 76  
CREMONA, ITALY 26100

FOR: MILLING MACHINES, NAMELY, GRAIN MILLING MACHINES INCORPORATING APPARATUS FOR GRINDING, SIFTING, AND SEPARATING GRAINS; MILLING MACHINES, NAMELY, GRAIN MILLING MACHINES INCORPORATING APPARATUS FOR GRINDING, SIFTING, AND SEPARATING GRAINS FOR THE PRODUCTION OF FUELS, IN CLASS 7 (U.S. CLS. 13, 19, 21, 23, 31, 34 AND 35).

FIRST USE 11-30-2006; IN COMMERCE 11-30-2006.

THE MARK CONSISTS OF STANDARD CHARACTERS WITHOUT CLAIM TO ANY PARTICULAR FONT, STYLE, SIZE, OR COLOR.

THE WORDING "BIOLINE" HAS NO MEANING IN A FOREIGN LANGUAGE.

SER. NO. 77-188,023, FILED 5-23-2007.

KEVIN CORWIN, EXAMINING ATTORNEY



Int. Cl.: 35

Prior U.S. Cls.: 100, 101 and 102

United States Patent and Trademark Office

Reg. No. 3,452,357

Registered June 24, 2008

SERVICE MARK  
PRINCIPAL REGISTER



ANNEX BRANDS, INC. (CALIFORNIA CORPORATION)  
7580 METROPOLITAN DRIVE, SUITE 200  
SAN DIEGO, CA 92108

FOR: FRANCHISE SERVICES, NAMELY, OFFERING TECHNICAL AND BUSINESS MANAGEMENT ASSISTANCE IN THE ESTABLISHMENT AND OPERATION OF STORES PROVIDING POSTAL SERVICES, PRINTING, COPYING, SHIPPING, PACKAGING AND RELATED SUPPLIES AND SERVICES; INFORMATION MANAGEMENT SERVICES, NAMELY, SHIPMENT PROCESSING, PREPARING SHIPPING DOCUMENTS AND INVOICES, TRACKING DOCUMENTS, PACKAGES AND FREIGHT OVER COMPUTER NETWORKS, INTRANETS AND INTERNETS; PHOTOCOPYING SERVICES; DOCUMENT COPYING AND REPRODUCTION FOR OTHERS; RETAIL STORE SERVICES FEATURING A WIDE VARIETY OF OFFICE SUPPLIES; ONLINE RETAIL STORE SERVICES FEATURING A WIDE VARIETY OF OFFICE

SUPPLIES; MOVING AND RELOCATION SERVICES, NAMELY, PLANNING AND IMPLEMENTING MOVES OF HOMES AND OFFICES; TRANSPORTATION LOGISTICS SERVICES, NAMELY, ARRANGING THE TRANSPORTATION OF GOODS FOR OTHERS; ONLINE AUCTION SERVICES; ARRANGING AND CONDUCTION OF AUCTION SALES; AUCTION MANAGEMENT SERVICES PROVIDED TO OTHERS OVER AN ON-LINE WEB SITE ACCESSED THROUGH A GLOBAL COMPUTER NETWORK, IN CLASS 35 (U.S. CLS. 100, 101 AND 102).

FIRST USE 3-1-2005; IN COMMERCE 3-1-2005.

NO CLAIM IS MADE TO THE EXCLUSIVE RIGHT TO USE "MOVING" , APART FROM THE MARK AS SHOWN.

SER. NO. 77-188,040, FILED 5-23-2007.

TINA L. SNAPP, EXAMINING ATTORNEY

**Int. Cls.: 35 and 39**

**Prior U.S. Cls.: 100, 101, 102 and 105**

**United States Patent and Trademark Office**

**Reg. No. 3,452,358**

**Registered June 24, 2008**

**SERVICE MARK  
PRINCIPAL REGISTER**

# SPS AUCTIONS

ANNEX BRANDS, INC. (CALIFORNIA CORPORATION)  
7580 METROPOLITAN DRIVE, SUITE 200  
SAN DIEGO, CA 92108

FOR: FRANCHISE SERVICES, NAMELY, OFFERING TECHNICAL AND BUSINESS MANAGEMENT ASSISTANCE IN THE ESTABLISHMENT AND OPERATION OF STORES PROVIDING POSTAL SERVICES, PRINTING, COPYING, SHIPPING, PACKAGING AND RELATED SUPPLIES AND SERVICES; INFORMATION MANAGEMENT SERVICES, NAMELY, SHIPMENT PROCESSING, PREPARING SHIPPING DOCUMENTS AND INVOICES, TRACKING DOCUMENTS, PACKAGES AND FREIGHT OVER COMPUTER NETWORKS, INTRANETS AND INTERNETS; PHOTOCOPYING SERVICES; DOCUMENT COPYING AND REPRODUCTION FOR OTHERS; RETAIL STORE SERVICES FEATURING A WIDE VARIETY OF OFFICE SUPPLIES; ONLINE RETAIL STORE SERVICES FEATURING A WIDE VARIETY OF OFFICE SUPPLIES; MOVING AND RELOCATION SERVICES, NAMELY, PLANNING AND IMPLEMENTING MOVES OF HOMES AND OFFICES; TRANSPORTATION LOGISTICS SERVICES, NAMELY, ARRANGING THE TRANSPORTATION OF GOODS FOR OTHERS; ONLINE AUCTION SERVICES; ARRANGING AND CONDUCTION OF AUCTION SALES; AUCTION MANAGEMENT SERVICES PROVIDED TO OTHERS OVER AN ON-LINE WEB SITE ACCESS-

SED THROUGH A GLOBAL COMPUTER NETWORK; MAIL SERVICES, NAMELY, RECEIVING PACKAGES FOR OTHERS, IN CLASS 35 (U.S. CLS. 100, 101 AND 102).

FIRST USE 3-1-2005; IN COMMERCE 3-1-2005.

FOR: SHIPPING AND DELIVERY SERVICES, NAMELY, PICKUP, TRANSPORTATION, AND DELIVERY OF PACKAGES AND LETTERS BY VARIOUS MODES OF TRANSPORTATION; POSTAL SERVICES, NAMELY, PARCEL DELIVERY, PACKAGING ARTICLES FOR TRANSPORTATION, AND RENTAL OF MAIL BOXES, IN CLASS 39 (U.S. CLS. 100 AND 105).

FIRST USE 3-1-2005; IN COMMERCE 3-1-2005.

THE MARK CONSISTS OF STANDARD CHARACTERS WITHOUT CLAIM TO ANY PARTICULAR FONT, STYLE, SIZE, OR COLOR.

NO CLAIM IS MADE TO THE EXCLUSIVE RIGHT TO USE "AUCTIONS", APART FROM THE MARK AS SHOWN.

SER. NO. 77-188,075, FILED 5-23-2007.

TINA L. SNAPP, EXAMINING ATTORNEY

Int. Cl.: 30

Prior U.S. Cl.: 46

United States Patent and Trademark Office

Reg. No. 3,452,359

Registered June 24, 2008

TRADEMARK  
PRINCIPAL REGISTER



SAL & JUDY'S INC. (LOUISIANA CORPORATION)  
28389 HIGHWAY 190  
LACOMBE, LA 70445

FOR: SAUCES AND SALAD DRESSINGS OF PLANT ORIGIN PREPARED FOR CONSUMPTION, IN CLASS 30 (U.S. CL. 46).

FIRST USE 1-1-1986; IN COMMERCE 1-1-1986.

NO CLAIM IS MADE TO THE EXCLUSIVE RIGHT TO USE "CHEF" AND "ALL NATURAL CREOLE ITALIAN CUISINE", APART FROM THE MARK AS SHOWN.

THE NAME SAL IMPASTATO IDENTIFIES A PARTICULAR LIVING INDIVIDUAL WHOSE CONSENT IS OF RECORD.

THE COLOR(S) BLACK, WHITE, 1815 MAROON, 7401 CREAM AND 574 GREEN IS/ARE CLAIMED AS A FEATURE OF THE MARK.

THE MARK CONSISTS OF (I) FIVE STARS AT THE TOP, (II) THE WORDING CHEF SAL IMPASTATO'S ALL NATURAL CREOLE ITALIAN CUISINE, APPEARING IN THE MIDDLE AND BELOW THE STARS, (III) AND A RECTANGULAR SHAPE APPEARING AT THE BOTTOM, WHICH RECTANGULAR SHAPE HAS THE FOLLOWING COMPONENTS: (A) THE WORDING SAL & JUDY'S, STYLIZED IN SCRIPT FORMAT, IN THE CENTER OF THE MARK ALONG ITS FULL WIDTH, AND (B) A THREE STRIPE BORDER ALONG THE TOP AND BOTTOM. THE COLOR FEATURES OF THE MARK ARE FURTHER DESCRIBED AS FOLLOWS: (I) THE COLOR BLACK APPEARS AS THE BACKGROUND OF THE RECTANGULAR SHAPE, (II) THE COLOR WHITE APPEARS IN THE WORDING SAL & JUDY'S, (III) THE COLOR 1815 MAROON APPEARS AS THE FIRST BORDER AT THE TOP AND BOTTOM OF THE RECTANGULAR SHAPE, (IV) THE COLOR 7401 CREAM APPEARS AS THE SECOND BORDER FROM THE TOP AND BOTTOM OF THE RECTANGULAR SHAPE, (V) AND THE COLOR 574 GREEN APPEARS AS THE THIRD BORDER FROM THE TOP AND BOTTOM OF THE RECTANGULAR SHAPE.

SER. NO. 77-188,477, FILED 5-23-2007.

RONALD AIKENS, EXAMINING ATTORNEY

**Int. Cl.: 25**

**Prior U.S. Cls.: 22 and 39**

**United States Patent and Trademark Office**

**Reg. No. 3,452,360**

**Registered June 24, 2008**

**TRADEMARK  
PRINCIPAL REGISTER**

**FLORIDA GIRL**

EAGLE CREST, INC. (FLORIDA CORPORATION)  
5353-1 RAMONA BOULEVARD  
JACKSONVILLE, FL 32205

FOR: CLOTHING, NAMELY, HATS, SHIRTS,  
UNDERGARMENTS, SWIMSUITS, SWEATSHIRTS,  
SWEATERS, JACKETS, COATS, GLOVES, SCARVES,  
BELTS, HEADBANDS, WRISTBANDS, PANTS,  
SHORTS, SKIRTS, DRESSES, OVERALLS, SOCKS,  
STOCKINGS, AND LEGGINGS, IN CLASS 25 (U.S.  
CLS. 22 AND 39).

FIRST USE 4-4-2007; IN COMMERCE 4-4-2007.

THE MARK CONSISTS OF STANDARD CHAR-  
ACTERS WITHOUT CLAIM TO ANY PARTICULAR  
FONT, STYLE, SIZE, OR COLOR.

SER. NO. 77-188,563, FILED 5-23-2007.

KAREN K. BUSH, EXAMINING ATTORNEY

**Int. Cl.: 25**

**Prior U.S. Cls.: 22 and 39**

**United States Patent and Trademark Office**

**Reg. No. 3,452,361**

**Registered June 24, 2008**

**TRADEMARK  
PRINCIPAL REGISTER**

**TEXAS GIRL**

EAGLE CREST, INC. (FLORIDA CORPORATION)  
5353-1 RAMONA BOULEVARD  
JACKSONVILLE, FL 32205

FOR: CLOTHING, NAMELY, HATS, SHIRTS,  
UNDERGARMENTS, SWIMSUITS, SWEATSHIRTS,  
SWEATERS, JACKETS, COATS, GLOVES, SCARVES,  
BELTS, HEADBANDS, WRISTBANDS, PANTS,  
SHORTS, SKIRTS, DRESSES, OVERALLS, SOCKS,  
STOCKINGS, AND LEGGINGS, IN CLASS 25 (U.S.  
CLS. 22 AND 39).

FIRST USE 4-4-2007; IN COMMERCE 4-4-2007.

THE MARK CONSISTS OF STANDARD CHAR-  
ACTERS WITHOUT CLAIM TO ANY PARTICULAR  
FONT, STYLE, SIZE, OR COLOR.

SER. NO. 77-188,587, FILED 5-23-2007.

KAREN K. BUSH, EXAMINING ATTORNEY

**Int. Cl.: 39**

**Prior U.S. Cls.: 100 and 105**

**United States Patent and Trademark Office**

**Reg. No. 3,452,362**

**Registered June 24, 2008**

**SERVICE MARK  
PRINCIPAL REGISTER**

**SPACELOTTO**

SAMARRA, KENNETH (UNITED STATES INDIVIDUAL)  
1815 ROCHESTER ST  
LIMA, NY 14485

FOR: TRAVEL SERVICES, NAMELY, PROVIDING AIR TRANSPORTATION AND ORGANIZING AIR TRANSPORTATION TO SPACE AND SPACE-RELATED DESTINATIONS, INCLUDING ZERO-GRAVITY PARABOLIC FLIGHT , IN CLASS 39 (U.S. CLS. 100 AND 105).

FIRST USE 5-30-2002; IN COMMERCE 1-5-2008.

THE MARK CONSISTS OF STANDARD CHARACTERS WITHOUT CLAIM TO ANY PARTICULAR FONT, STYLE, SIZE, OR COLOR.

SER. NO. 77-188,643, FILED 5-23-2007.

KIMBERLY FRYE, EXAMINING ATTORNEY

**Int. Cl.: 43**

**Prior U.S. Cls.: 100 and 101**

**United States Patent and Trademark Office**

**Reg. No. 3,452,363**

**Registered June 24, 2008**

**SERVICE MARK  
PRINCIPAL REGISTER**

**JUICE STOP**

TDMM, INC. (NEBRASKA CORPORATION)

3802 NORTH 161ST AVENUE

OMAHA, NE 68116

FOR: RESTAURANT SERVICES, IN CLASS 43  
(U.S. CLS. 100 AND 101).

FIRST USE 2-28-1999; IN COMMERCE 2-28-1999.

THE MARK CONSISTS OF STANDARD CHAR-  
ACTERS WITHOUT CLAIM TO ANY PARTICULAR  
FONT, STYLE, SIZE, OR COLOR.

NO CLAIM IS MADE TO THE EXCLUSIVE  
RIGHT TO USE "JUICE", APART FROM THE MARK  
AS SHOWN.

SER. NO. 77-188,714, FILED 5-23-2007.

STEVEN PEREZ, EXAMINING ATTORNEY

**Int. Cl.: 36**

**Prior U.S. Cls.: 100, 101 and 102**

**United States Patent and Trademark Office**

**Reg. No. 3,452,364**

**Registered June 24, 2008**

**SERVICE MARK  
PRINCIPAL REGISTER**

**SMART PROFILE**

CLINICAL REFERENCE LABORATORY, INC.  
(KANSAS CORPORATION)  
8433 QUIVIRA ROAD  
LENEXA, KS 66215

FOR: INSURANCE RISK ASSESSMENT SERVICES, NAMELY, ASSESSING THE EFFECTIVENESS OF LABORATORY TESTING FOR INSURANCE APPLICANTS FOR THE PURPOSE OF EFFECTIVE RISK ASSESSMENT , IN CLASS 36 (U.S. CLS. 100, 101 AND 102).

FIRST USE 6-1-2007; IN COMMERCE 6-1-2007.

THE MARK CONSISTS OF STANDARD CHARACTERS WITHOUT CLAIM TO ANY PARTICULAR FONT, STYLE, SIZE, OR COLOR.

NO CLAIM IS MADE TO THE EXCLUSIVE RIGHT TO USE "PROFILE", APART FROM THE MARK AS SHOWN.

SER. NO. 77-188,810, FILED 5-23-2007.

AMY MCMENAMIN, EXAMINING ATTORNEY



Int. Cl.: 35

Prior U.S. Cls.: 100, 101 and 102

United States Patent and Trademark Office

Reg. No. 3,452,365

Registered June 24, 2008

SERVICE MARK  
PRINCIPAL REGISTER

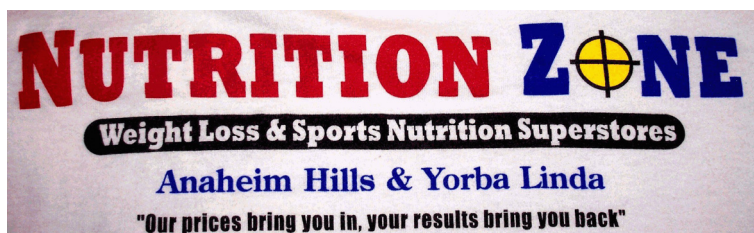

NUTRITION ZONE ANAHEIM HILL INC. (CALIFORNIA CORPORATION)  
23892 INNIS BROOKE LANE  
LAGUNA NIGUEL, CA 92677

FOR: RETAIL STORES FOR NUTRITIONAL AND DIETARY SUPPLEMENTS, IN CLASS 35 (U.S. CLS. 100, 101 AND 102).

FIRST USE 5-9-2000; IN COMMERCE 5-9-2000.

NO CLAIM IS MADE TO THE EXCLUSIVE RIGHT TO USE "NUTRITION" AND "WEIGHT LOSS & SPORTS NUTRITION SUPERSTORES", APART FROM THE MARK AS SHOWN.

THE COLOR(S) RED, BLUE, YELLOW, WHITE AND BLACK IS/ARE CLAIMED AS A FEATURE OF THE MARK.

THE MARK CONSISTS OF IN THE WORDS "NUTRITION ZONE", "NUTRITION" IS COLORED IN RED AND "ZONE" IS COLORED IN BLUE, EXCEPT THE LETTER "O" WHICH IS A YELLOW TARGET AND UNDERNEATH THE WORDS "NUTRITION ZONE", IN WHITE LETTERS OUTLINED IN A BLACK BUBBLE STATES THEIR SLOGAN "WEIGHT LOSS & SPORTS NUTRITION SUPERSTORES".

SER. NO. 77-188,968, FILED 5-23-2007.

FLORENTINA BLANDU, EXAMINING ATTORNEY

**Int. Cl.: 35**

**Prior U.S. Cls.: 100, 101 and 102**

**United States Patent and Trademark Office**

**Reg. No. 3,452,366**

**Registered June 24, 2008**

**SERVICE MARK  
PRINCIPAL REGISTER**

# Hassle Free Hiring

LABORWORKS, INC. (WASHINGTON CORPORATION)  
P O BOX 1755  
GIG HARBOR, WA 98335

FOR: EMPLOYMENT HIRING, RECRUITING, PLACEMENT, STAFFING AND CAREER NETWORKING SERVICES, IN CLASS 35 (U.S. CLS. 100, 101 AND 102).

FIRST USE 4-1-2007; IN COMMERCE 4-1-2007.

THE MARK CONSISTS OF STANDARD CHARACTERS WITHOUT CLAIM TO ANY PARTICULAR FONT, STYLE, SIZE, OR COLOR.

NO CLAIM IS MADE TO THE EXCLUSIVE RIGHT TO USE "HIRING", APART FROM THE MARK AS SHOWN.

SER. NO. 77-189,353, FILED 5-24-2007.

JAMES GRIFFIN, EXAMINING ATTORNEY

**Int. Cl.: 35**

**Prior U.S. Cls.: 100, 101 and 102**

**United States Patent and Trademark Office**

**Reg. No. 3,452,367**

**Registered June 24, 2008**

**SERVICE MARK  
PRINCIPAL REGISTER**



QUICKREWARDS NETWORK INC. (NEW YORK CORPORATION)  
2203 EAST 27TH STREET  
BROOKLYN, NY 11229

FOR: PROMOTING THE GOODS AND SERVICES OF OTHERS BY PROVIDING A WEBSITE FEATURING ONLINE ADVERTISING SPACE, MEMBER NEWSLETTERS, AND MEMBER LOYALTY INCENTIVES, IN CLASS 35 (U.S. CLS. 100, 101 AND 102).

FIRST USE 12-2-2002; IN COMMERCE 4-11-2007.

THE MARK CONSISTS OF AN ABSTRACT DESIGN IN THE FORM OF A CIRCLE WITH STYLIZED TEXT.

SER. NO. 77-190,057, FILED 5-24-2007.

STEVEN JACKSON, EXAMINING ATTORNEY

**Int. Cl.: 41**

**Prior U.S. Cls.: 100, 101 and 107**

**United States Patent and Trademark Office**

**Reg. No. 3,452,368**

**Registered June 24, 2008**

**SERVICE MARK  
PRINCIPAL REGISTER**

**PING**

DAVID M. ADLER, ESQ. & ASSOC. PC (ILLINOIS  
CORPORATION)  
161 N CLARK ST  
CHICAGO, IL 60601

THE MARK CONSISTS OF STANDARD CHAR-  
ACTERS WITHOUT CLAIM TO ANY PARTICULAR  
FONT, STYLE, SIZE, OR COLOR.

FOR: PROVIDING NEWSLETTERS IN THE  
FIELD OF LAW VIA E-MAIL, IN CLASS 41 (U.S.  
CLS. 100, 101 AND 107).

SER. NO. 77-190,314, FILED 5-25-2007.

FIRST USE 5-25-2007; IN COMMERCE 5-25-2007.

AISHA CLARKE, EXAMINING ATTORNEY

**Int. Cl.: 44**

**Prior U.S. Cls.: 100 and 101**

**United States Patent and Trademark Office**

**Reg. No. 3,452,369**

**Registered June 24, 2008**

**SERVICE MARK  
PRINCIPAL REGISTER**

**Spine. That's all we do.**

CENTER FOR ORTHOPAEDIC SPECIALTIES  
(TEXAS CORPORATION), DBA BRAZOS  
SPINE  
SUITE 255  
3201 UNIVERSITY DRIVE EAST  
BRYAN, TX 77802

FOR: SURGERY, IN CLASS 44 (U.S. CLS. 100 AND  
101).

FIRST USE 8-1-2006; IN COMMERCE 8-1-2006.

THE MARK CONSISTS OF STANDARD CHAR-  
ACTERS WITHOUT CLAIM TO ANY PARTICULAR  
FONT, STYLE, SIZE, OR COLOR.

NO CLAIM IS MADE TO THE EXCLUSIVE  
RIGHT TO USE "SPINE", APART FROM THE MARK  
AS SHOWN.

SER. NO. 77-191,086, FILED 5-25-2007.

ROBIN CHOSID, EXAMINING ATTORNEY

**Int. Cl.: 16**

**Prior U.S. Cls.: 2, 5, 22, 23, 29, 37, 38 and 50**

**United States Patent and Trademark Office**

**Reg. No. 3,452,370**

**Registered June 24, 2008**

**TRADEMARK  
PRINCIPAL REGISTER**

**Stay Positive Greetings**

STAY POSITIVE GROUP, LLC (OHIO LTD LIAB  
CO)

122 DEBBIE DRIVE

WESTERVILLE, OH 43081

FOR: GREETING CARDS, IN CLASS 16 (U.S. CLS.  
2, 5, 22, 23, 29, 37, 38 AND 50).

FIRST USE 4-7-2007; IN COMMERCE 7-14-2007.

THE MARK CONSISTS OF STANDARD CHAR-  
ACTERS WITHOUT CLAIM TO ANY PARTICULAR  
FONT, STYLE, SIZE, OR COLOR.

NO CLAIM IS MADE TO THE EXCLUSIVE  
RIGHT TO USE "GREETINGS", APART FROM  
THE MARK AS SHOWN.

SER. NO. 77-191,374, FILED 5-27-2007.

PAUL E. FAHRENKOPF, EXAMINING ATTORNEY

Int. Cl.: 9

Prior U.S. Cls.: 21, 23, 26, 36 and 38

Reg. No. 3,452,371

United States Patent and Trademark Office

Registered June 24, 2008

TRADEMARK  
PRINCIPAL REGISTER



SEAFARER INTERNATIONAL, LLC (CALIFORNIA LTD LIAB CO)  
24481 DARDANIA AVE  
MISSION VIEJO, CA 92691

FOR: AUDIO SPEAKERS; AUDIO EQUIPMENT FOR VEHICLES, NAMELY, STEREOS, SPEAKERS, AMPLIFIERS, EQUALIZERS, CROSSOVERS AND SPEAKER HOUSINGS; AUDIO SPEAKER ENCLOSURES; AUTOMATIC LIQUID-FLOW CONTROL MACHINES AND INSTRUMENTS; AUTOMATIC LIQUID-LEVEL CONTROL MACHINES AND INSTRUMENTS; AUTOMOTIVE MEASURING INSTRUMENTS, NAMELY, WATER TEMPERATURE GAUGES, AIR FUEL/RATIO GAUGES, BOOST GAUGES, VACUUM GAUGES AND EXHAUST GAS TEMPERATURE GAUGES; CARRYING CASES FOR RADIO PAGERS; COMMUNICATIONS HEADSETS FOR USE WITH COMMUNICATION RADIOS, INTERCOM SYSTEMS, OR OTHER COMMUNICATIONS NETWORK TRANSCIEVERS; DEVICES FOR WIRELESS RADIO TRANSMISSION; ELECTRIC AUDIO PLAYBACK UNITS WITH LIGHTS AND SPEAKERS; ELECTRIC NAVIGATIONAL INSTRUMENTS; INSTRUMENTS AND APPARATUS FOR CONTROLLING ELECTRIC CURRENT, NAMELY, ELECTRICAL CONTROLLERS FOR MAGNETIC BEARING CONTROL; INSTRUMENTS FOR DETECTING AND MEASURING TWO-DIMENSIONAL DISTRIBUTION OF FORCE AND PRESSURE; LOUD SPEAKER SYSTEMS; MARINE DEPTH FINDERS; MARINE RADIO COMMUNICATION MA-

CHINES AND APPARATUS; MOBILE RADIOS; PORTABLE RADIOS; PUBLIC-ADDRESS SYSTEMS AND INSTRUMENTS; RADIO AND TELEVISION AERIALS; RADIO RECEIVERS; RADIO RECEIVERS AND MONITORS FOR REPRODUCTION OF SOUND AND SIGNALS; RADIO SETS; RADIO TELEPHONES; RADIO TRANSMITTERS; RADIO TRANSMITTERS AND RECEIVERS FOR REMOTE CONTROLS, RADIO CONTROLS; RADIOS; RADIOS FOR VEHICLES; SATELLITE RADIOS; SPEAKER ENCLOSURES; TRANSMITTING AND RECEIVING APPARATUS FOR RADIO AND TELEVISION BROADCASTING AND FOR LONG-DISTANCE TRANSMISSION; TWO-WAY RADIOS; VEHICLE LOCATING, TRACKING AND SECURITY SYSTEM COMPRISED OF AN ANTENNA AND RADIO TRANSMITTER TO BE PLACED IN A VEHICLE; WAVE REFLECTORS FOR ACOUSTIC SPEAKERS, LIGHTING APPARATUS, AND AIR FLOW DEVICES, IN CLASS 9 (U.S. CLS. 21, 23, 26, 36 AND 38).

FIRST USE 1-4-2006; IN COMMERCE 3-3-2007.

NO CLAIM IS MADE TO THE EXCLUSIVE RIGHT TO USE "INTERNATIONAL", APART FROM THE MARK AS SHOWN.

SER. NO. 77-191,590, FILED 5-29-2007.

ELIZABETH KAJUBI, EXAMINING ATTORNEY

**Int. Cl.: 5**

**Prior U.S. Cls.: 6, 18, 44, 46, 51 and 52**

**Reg. No. 3,452,372**

**United States Patent and Trademark Office**

**Registered June 24, 2008**

**TRADEMARK  
PRINCIPAL REGISTER**

**JUROVE**

GLAXO GROUP LIMITED (ENGLAND CORPORATION)  
BERKELEY AVENUE  
GLAXO WELLCOME HOUSE  
GREENFORD, MIDDLESEX, ENGLAND UB60NN

FOR: PHARMACEUTICAL PREPARATIONS AND SUBSTANCES FOR THE TREATMENT OF INFECTIOUS DISEASES, BLOOD DISORDERS, PAIN, INFLAMMATION, SEPSIS, ALOPECIA AND OBESITY, AND FOR THE TREATMENT OF VIRAL, METABOLIC, ENDOCRINE, MUSCULOSKELETAL, CARDIOVASCULAR, CARDIOPULMONARY, GENITOURINARY, SEXUAL DYSFUNCTION, ONCOLOGICAL, HEPATOLOGICAL, OPHTHALMOLOGICAL, RESPIRATORY, NEUROLOGICAL, GASTROINTESTINAL, HORMONAL, DERMATOLOGICAL AND PSYCHIATRIC RELA-

TED DISEASES AND DISORDERS, AND FOR THE TREATMENT OF DAMAGED SKIN AND TISSUE; AND FOR VACCINES, IN CLASS 5 (U.S. CLS. 6, 18, 44, 46, 51 AND 52).

THE MARK CONSISTS OF STANDARD CHARACTERS WITHOUT CLAIM TO ANY PARTICULAR FONT, STYLE, SIZE, OR COLOR.

PRIORITY CLAIMED UNDER SEC. 44(D) ON UNITED KINGDOM APPLICATION NO. 2453640, FILED 4-25-2007, REG. NO. 2453640, DATED 4-25-2007, EXPIRES 4-25-2017.

SER. NO. 77-192,782, FILED 5-30-2007.

ANNE MADDEN, EXAMINING ATTORNEY



Int. Cl.: 42

Prior U.S. Cls.: 100 and 101

United States Patent and Trademark Office

Reg. No. 3,452,373

Registered June 24, 2008

SERVICE MARK  
PRINCIPAL REGISTER



MIRABELLA TECHNOLOGIES, LLC (INDIANA  
LTD LIAB CO)  
SUITE 300  
4444 DECATUR BLVD.  
INDIANAPOLIS, IN 46241

FOR: DIAGNOSTIC SERVICES IN THE FIELD OF  
INFECTIOUS DISEASES, IN CLASS 42 (U.S. CLS. 100  
AND 101).

FIRST USE 9-19-2003; IN COMMERCE 9-19-2003.

THE MARK CONSISTS OF A LOGO FORMED BY  
THE STYLIZED LETTERS "MIRAVISTA" BENEATH

A HORIZON FORMED BY A SUBSTANTIALLY  
HORIZONTAL CURVED LINE AND A PARTIAL  
CIRCLE ABOVE THE CURVED LINE.

THE ENGLISH TRANSLATION OF THE WORD  
"MIRAVISTA" IN THE MARK IS "SCOPE OF  
SIGHT".

SER. NO. 77-193,034, FILED 5-30-2007.

RON FAIRBANKS, EXAMINING ATTORNEY

**Int. Cl.: 35**

**Prior U.S. Cls.: 100, 101 and 102**

**United States Patent and Trademark Office**

**Reg. No. 3,452,374**

**Registered June 24, 2008**

---

**SERVICE MARK  
PRINCIPAL REGISTER**

**CHAINNOVATIONS**

GROSSMAN, IRVIN (UNITED STATES INDIVIDUAL)  
1180 AUSTIN GLEN DRIVE  
DUNWOODY, GA 30338

THE MARK CONSISTS OF STANDARD CHARACTERS WITHOUT CLAIM TO ANY PARTICULAR FONT, STYLE, SIZE, OR COLOR.

FOR: BUSINESS CONSULTING SERVICES IN THE FIELDS OF PROCUREMENT, LOGISTICS AND SERVICE CHAIN MANAGEMENT, IN CLASS 35 (U.S. CLS. 100, 101 AND 102).

SER. NO. 77-193,158, FILED 5-30-2007.

FIRST USE 12-3-2006; IN COMMERCE 12-3-2006.

WENDY GOODMAN, EXAMINING ATTORNEY

Int. Cl.: 17

Prior U.S. Cls.: 1, 5, 12, 13, 35 and 50

United States Patent and Trademark Office

Reg. No. 3,452,375

Registered June 24, 2008

TRADEMARK  
PRINCIPAL REGISTER



SIGNWAREHOUSE, INC. (TEXAS CORPORATION)  
2614 TEXOMA DRIVE  
DENISON, TX 75020

FOR: SIGNAGE SUPPLIES, NAMELY, ADHESIVE APPLICATION TAPE FOR INDUSTRIAL AND COMMERCIAL USE, IN CLASS 17 (U.S. CLS. 1, 5, 12, 13, 35 AND 50).

FIRST USE 1-1-2004; IN COMMERCE 1-1-2004.

THE COLOR(S) BROWN, GREEN, BLUE, RUST IS/ARE CLAIMED AS A FEATURE OF THE MARK.

THE MARK CONSISTS OF THE WORD "ENDURA" IN ROYAL BLUE AND YELLOW NEXT TO THE WORD "MASK" IN BLACK WITH A FLOURISH AFTER THE "A" ENDING IN THE WORD "MASK".

SER. NO. 77-193,225, FILED 5-30-2007.

ELLEN PERKINS, EXAMINING ATTORNEY

Int. Cl.: 28

Prior U.S. Cls.: 22, 23, 38 and 50

United States Patent and Trademark Office

Reg. No. 3,452,376

Registered June 24, 2008

TRADEMARK  
PRINCIPAL REGISTER



JLB STUDIOS, L.L.C. (KANSAS LTD LIAB CO)  
8413 W 144TH PLACE  
OVERLAND PARK, KS 66223

FOR: MINIATURE TOY FIGURES AND ACCESSORIES THEREFOR, IN CLASS 28 (U.S. CLS. 22, 23, 38 AND 50).

FIRST USE 3-10-2003; IN COMMERCE 3-10-2003.

NO CLAIM IS MADE TO THE EXCLUSIVE RIGHT TO USE "MINIATURES", APART FROM THE MARK AS SHOWN.

THE STIPPLING IS FOR SHADING PURPOSES ONLY.

THE MARK CONSISTS OF A LARGE LETTER "V" IN THE CENTER OF THE RING. THE WORDS "VICTORY FORCE" ARE ALSO CENTERED INSIDE THE RING OVERLAPPING THE LARGE LETTER "V". THE WORD "MINIATURES" IS CAPITALIZED, THE WORD IS FOLLOWING THE CURVE OF THE RING AND SITS ON THE RING.

SER. NO. 77-193,547, FILED 5-30-2007.

STEVEN PEREZ, EXAMINING ATTORNEY

Int. Cl.: 44

Prior U.S. Cls.: 100 and 101

United States Patent and Trademark Office

Reg. No. 3,452,377

Registered June 24, 2008

SERVICE MARK  
PRINCIPAL REGISTER



SURGEON'S MANAGEMENT, INC. (TEXAS  
CORPORATION)  
PO BOX 924587  
HOUSTON, TX 77292

NO CLAIM IS MADE TO THE EXCLUSIVE  
RIGHT TO USE "THE HAND CENTER", APART  
FROM THE MARK AS SHOWN.

FOR: MEDICAL, PHYSICAL REHABILITATION  
AND PHYSICAL THERAPY SERVICES, IN CLASS 44  
(U.S. CLS. 100 AND 101).

SER. NO. 77-194,133, FILED 5-31-2007.

FIRST USE 1-1-1990; IN COMMERCE 1-1-1990.

LESLEY LAMOTHE, EXAMINING ATTORNEY

**Int. Cl.: 44**

**Prior U.S. Cls.: 100 and 101**

**United States Patent and Trademark Office**

**Reg. No. 3,452,378**

**Registered June 24, 2008**

**SERVICE MARK  
PRINCIPAL REGISTER**



SURGEON'S MANAGEMENT, INC. (TEXAS CORPORATION)  
PO BOX 924587  
HOUSTON, TX 77292

FOR: MEDICAL, PHYSICAL REHABILITATION AND PHYSICAL THERAPY SERVICES, IN CLASS 44 (U.S. CLS. 100 AND 101).

FIRST USE 8-5-2005; IN COMMERCE 8-5-2005.

NO CLAIM IS MADE TO THE EXCLUSIVE RIGHT TO USE "THE HAND CENTER", "M.D."

AND "FOUNDER", APART FROM THE MARK AS SHOWN.

THE NAME MICHAEL G. BROWN IDENTIFIES A LIVING INDIVIDUAL WHOSE CONSENT IS OF RECORD.

SER. NO. 77-194,150, FILED 5-31-2007.

LESLEY LAMOTHE, EXAMINING ATTORNEY

**Int. Cl.: 35**

**Prior U.S. Cls.: 100, 101 and 102**

**United States Patent and Trademark Office**

**Reg. No. 3,452,379**

**Registered June 24, 2008**

**SERVICE MARK  
PRINCIPAL REGISTER**

**NORTH POINT**

ASBURY AUTOMOTIVE GROUP, INC. (DELA-  
WARE CORPORATION)  
37TH FLOOR  
622 THIRD AVENUE  
NEW YORK, NY 10017

FOR: AUTOMOBILE DEALERSHIPS, IN CLASS 35  
(U.S. CLS. 100, 101 AND 102).

FIRST USE 0-0-1987; IN COMMERCE 0-0-1987.

THE MARK CONSISTS OF STANDARD CHAR-  
ACTERS WITHOUT CLAIM TO ANY PARTICULAR  
FONT, STYLE, SIZE, OR COLOR.

SEC. 2(F).

SER. NO. 77-194,302, FILED 5-31-2007.

SAIMA MAKHDOOM, EXAMINING ATTORNEY

**Int. Cl.: 35**

**Prior U.S. Cls.: 100, 101 and 102**

**United States Patent and Trademark Office**

**Reg. No. 3,452,380**

**Registered June 24, 2008**

**SERVICE MARK  
PRINCIPAL REGISTER**

**TWO BY TWO FOR AIDS AND ART**

THE FOUNDATION FOR AIDS RESEARCH (AM-  
FAR) (NEW YORK NON-PROFIT CORPORA-  
TION)  
13TH FLOOR  
120 WALL STREET  
NEW YORK, NY 10005

FOR: ARRANGING AND CONDUCTING AUC-  
TIONS IN THE FIELD OF ART IN ORDER TO  
INCREASE AIDS AWARENESS AND RAISE MON-  
EY FOR AIDS RESEARCH AND EDUCATION, IN  
CLASS 35 (U.S. CLS. 100, 101 AND 102).

FIRST USE 1-1-2000; IN COMMERCE 1-1-2000.

THE MARK CONSISTS OF STANDARD CHAR-  
ACTERS WITHOUT CLAIM TO ANY PARTICULAR  
FONT, STYLE, SIZE, OR COLOR.

NO CLAIM IS MADE TO THE EXCLUSIVE  
RIGHT TO USE "FOR AIDS AND ART", APART  
FROM THE MARK AS SHOWN.

SER. NO. 77-194,487, FILED 5-31-2007.

KATHRYN COWARD, EXAMINING ATTORNEY



**Int. Cl.: 21**

**Prior U.S. Cls.: 2, 13, 23, 29, 30, 33, 40 and 50**

**Reg. No. 3,452,381**

**United States Patent and Trademark Office**

**Registered June 24, 2008**

**TRADEMARK  
PRINCIPAL REGISTER**



RL INDUSTRY COMPANY LIMITED (HONG  
KONG LTD LIAB CO)  
2F/B  
41 WANTONG LODGE KENNEDY RD WANCHAI  
HONG KONG, HONG KONG

FOR: COOKING POT SETS; CAKE MOLDS;  
COOKING POT LIDS; COOKING UTENSILS,  
NAMESLY, GRILLS; FRYING PANS; IRON POTS;  
KITCHEN UTENSILS, NAMESLY, SPATULAS, POT  
AND PAN SCRAPERS, ROLLING PINS, TURNERS,  
WHISKS; PORCELAIN WARE, STONE WARE AND  
POTTERY, NAMESLY, PLATES, BOWLS, DISHES,

POTS, TABLEWARE, JARS, AND JUGS, IN CLASS  
21 (U.S. CLS. 2, 13, 23, 29, 30, 33, 40 AND 50).

FIRST USE 4-20-2007; IN COMMERCE 4-20-2007.

THE MARK CONSISTS OF THE CREATED  
WORD "UNICO" AND A SEMI-OPEN ELLIPSE.

SER. NO. 77-195,066, FILED 6-1-2007.

JILL C. ALT, EXAMINING ATTORNEY

**Int. Cl.: 19**

**Prior U.S. Cls.: 1, 12, 33 and 50**

**United States Patent and Trademark Office**

**Reg. No. 3,452,382**

**Registered June 24, 2008**

**TRADEMARK  
PRINCIPAL REGISTER**

**JOLYKA**

VRSALOVIC, LYDIA (BOLIVIA INDIVIDUAL)  
ZONA EL PASO  
AVENIDA ELIAS MENESES S/N  
COCHABAMBA, BOLIVIA AND  
HERMSEN, KATRINA (FED REP GERMANY INDIVIDUAL)  
AM RIDDERSHOF 15  
KREFELD, FED REP GERMANY 47839

THE MARK CONSISTS OF STANDARD CHARACTERS WITHOUT CLAIM TO ANY PARTICULAR FONT, STYLE, SIZE, OR COLOR.

THE WORDING "JOLYKA" HAS NO MEANING IN A FOREIGN LANGUAGE.

FOR: PARQUET FLOORING OF WOOD, IN CLASS 19 (U.S. CLS. 1, 12, 33 AND 50).

SER. NO. 77-195,253, FILED 6-1-2007.

FIRST USE 4-30-1995; IN COMMERCE 4-30-1995.

MICHAEL KEATING, EXAMINING ATTORNEY

**Int. Cl.: 12**

**Prior U.S. Cls.: 19, 21, 23, 31, 35 and 44**

**Reg. No. 3,452,383**

**United States Patent and Trademark Office**

**Registered June 24, 2008**

---

**TRADEMARK  
PRINCIPAL REGISTER**

**TRAV-LER**

RADIO FLYER INC. (ILLINOIS CORPORATION)  
6515 WEST GRAND AVENUE  
CHICAGO, IL 60707

THE MARK CONSISTS OF STANDARD CHAR-  
ACTERS WITHOUT CLAIM TO ANY PARTICULAR  
FONT, STYLE, SIZE, OR COLOR.

FOR: WAGONS, IN CLASS 12 (U.S. CLS. 19, 21, 23,  
31, 35 AND 44).

SER. NO. 77-196,547, FILED 6-4-2007.

FIRST USE 2-15-1986; IN COMMERCE 2-15-1986.

TOBY BULLOFF, EXAMINING ATTORNEY

**Int. Cl.: 9**

**Prior U.S. Cls.: 21, 23, 26, 36 and 38**

**Reg. No. 3,452,384**

**United States Patent and Trademark Office**

**Registered June 24, 2008**

---

**TRADEMARK  
PRINCIPAL REGISTER**

**TELEVANTAGE**

VERTICAL COMMUNICATIONS, INC. (DELA-  
WARE CORPORATION)  
ONE MEMORIAL DRIVE  
CAMBRIDGE, MA 02142

FOR: PERSONAL COMPUTER BASED PBX SYS-  
TEM COMPRISING COMPUTER HARDWARE  
SOFTWARE TO ROUTE INCOMING AND OUT-  
GOING TELEPHONE CALLS, AND ALSO COM-  
PRISING VOICE MAIL AND VOICE MESSAGING  
CAPABILITIES, IN CLASS 9 (U.S. CLS. 21, 23, 26, 36  
AND 38).

FIRST USE 3-1-1998; IN COMMERCE 3-1-1998.

THE MARK CONSISTS OF STANDARD CHAR-  
ACTERS WITHOUT CLAIM TO ANY PARTICULAR  
FONT, STYLE, SIZE, OR COLOR.

SER. NO. 77-196,747, FILED 6-4-2007.

KEVON CHISOLM, EXAMINING ATTORNEY

**Int. Cl.: 36**

**Prior U.S. Cls.: 100, 101 and 102**

**United States Patent and Trademark Office**

**Reg. No. 3,452,385**

**Registered June 24, 2008**

**SERVICE MARK  
PRINCIPAL REGISTER**

**REFUND MANAGEMENT**

HIGHER ONE, INC. (DELAWARE CORPORATION)  
25 SCIENCE PARK  
NEW HAVEN, CT 06511

FOR: FINANCIAL SERVICES, NAMELY, ELECTRONIC FUNDS DISBURSEMENT ADMINISTRATION SERVICES, IN CLASS 36 (U.S. CLS. 100, 101 AND 102).

FIRST USE 12-31-2002; IN COMMERCE 1-31-2003.

THE MARK CONSISTS OF STANDARD CHARACTERS WITHOUT CLAIM TO ANY PARTICULAR FONT, STYLE, SIZE, OR COLOR.

SEC. 2(F).

SER. NO. 77-196,885, FILED 6-4-2007.

TRICIA SONNEBORN, EXAMINING ATTORNEY

**Int. Cl.: 42**

**Prior U.S. Cls.: 100 and 101**

**United States Patent and Trademark Office**

**Reg. No. 3,452,386**

**Registered June 24, 2008**

**SERVICE MARK  
PRINCIPAL REGISTER**

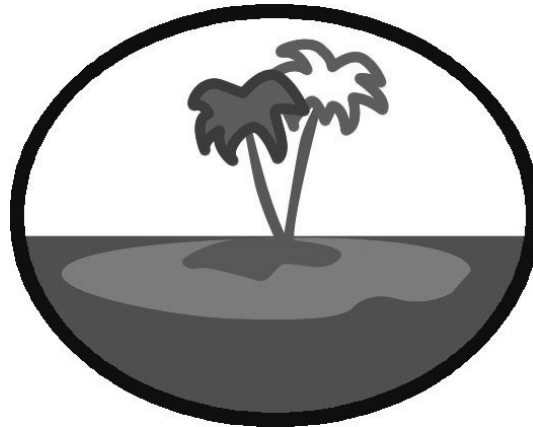

STUDY ISLAND, LLC (DELAWARE LTD LIAB  
CO)  
3400 CARLISLE STREET, SUITE 345  
DALLAS, TX 75204

FOR: PROVIDING TEMPORARY USE OF WEB-  
BASED, NON-DOWNLOADABLE SOFTWARE FOR  
K-12 TEACHERS AND STUDENTS FEATURING  
STATE-STANDARDS-BASED DIAGNOSTICS, IN-  
STRUCTION, PRACTICE, AND TEST PREPARA-  
TION FOR EACH CORE CURRICULUM SUBJECT

AREA IN THE K-12 EDUCATIONAL MARKET, IN  
CLASS 42 (U.S. CLS. 100 AND 101).

FIRST USE 9-30-2000; IN COMMERCE 9-30-2000.

THE MARK CONSISTS OF 2 PALM TREES ON AN  
ISLAND WITH SURROUNDING WATER.

SER. NO. 77-197,027, FILED 6-4-2007.

LAURA HAMMEL, EXAMINING ATTORNEY

**Int. Cl.: 5**

**Prior U.S. Cls.: 6, 18, 44, 46, 51 and 52**

**Reg. No. 3,452,387**

**United States Patent and Trademark Office**

**Registered June 24, 2008**

**TRADEMARK  
PRINCIPAL REGISTER**

**KOROMITE**

SANKYO AGRO COMPANY, LIMITED (JAPAN  
CORPORATION)

MINATO-KU

5-2, HIGASHI-SHIMBASHI 1-CHOME

TOKYO, JAPAN

FOR: PREPARATIONS FOR DESTROYING VER-  
MIN, FUNGICIDES FOR AGRICULTURAL, DO-  
MESTIC AND HORTICULTURAL USE,  
INSECTICIDES FOR AGRICULTURAL USE , IN  
CLASS 5 (U.S. CLS. 6, 18, 44, 46, 51 AND 52).

THE MARK CONSISTS OF STANDARD CHAR-  
ACTERS WITHOUT CLAIM TO ANY PARTICULAR  
FONT, STYLE, SIZE, OR COLOR.

OWNER OF JAPAN REG. NO. 3030367, DATED 3-  
31-1995, EXPIRES 3-31-2015.

"KOROMITE" HAS NO MEANING IN A FOR-  
EIGN LANGUAGE.

SER. NO. 77-198,061, FILED 6-5-2007.

STEPHANIE ALI, EXAMINING ATTORNEY

**Int. Cl.: 17**

**Prior U.S. Cls.: 1, 5, 12, 13, 35 and 50**

**Reg. No. 3,452,388**

**United States Patent and Trademark Office**

**Registered June 24, 2008**

**TRADEMARK  
PRINCIPAL REGISTER**

**DELTA-FL**

EWALD DÖRKEN AG (FED REP GERMANY  
JOINT STOCK COMPANY)  
WETTERSTRASSE 58  
D-58313 HERDECKE, FED REP GERMANY

THE MARK CONSISTS OF STANDARD CHAR-  
ACTERS WITHOUT CLAIM TO ANY PARTICULAR  
FONT, STYLE, SIZE, OR COLOR.

FOR: CONSTRUCTION MATERIALS, NAMELY,  
SHEETS OF PLASTIC MEMBRANE FOR USE IN  
CREATING AN AIR GAP BETWEEN FLOORING  
LAYERS, AND SHEETS OF PLASTIC MEMBRANE  
FOR USE AS PADDING TO PREVENT AIR AND  
WATER INFILTRATION, IN CLASS 17 (U.S. CLS. 1,  
5, 12, 13, 35 AND 50).

OWNER OF U.S. REG. NOS. 3,154,276 AND  
3,185,428.

SER. NO. 77-198,142, FILED 6-5-2007.

FIRST USE 1-0-1996; IN COMMERCE 3-21-1996.

SUSAN LESLIE DUBOIS, EXAMINING ATTORNEY



Int. Cl.: 30

Prior U.S. Cl.: 46

United States Patent and Trademark Office

Reg. No. 3,452,389

Registered June 24, 2008

TRADEMARK  
PRINCIPAL REGISTER



CHOCOLADEFABRIKEN LINDT & SPRÜNGLI  
AG (SWITZERLAND CORPORATION)  
SEESTRASSE 204  
KILCHBERG, SWITZERLAND 8802

FOR: CHOCOLATE, IN CLASS 30 (U.S. CL. 46).

FIRST USE 12-31-1996; IN COMMERCE 12-31-1996.

OWNER OF U.S. REG. NOS. 2,031,928, 3,127,059  
AND OTHERS.

THE MARK CONSISTS OF A THREE DIMEN-  
SIONAL BALL CONFIGURATION CONSISTING OF

A ROUND CENTER AND FANCIFUL TABS CON-  
TAINING LACE DESIGNS AT EACH END. AN  
OVAL DESIGN IS PRESENT ON THE ROUND  
CENTER OF THE CONFIGURATION CONTAIN-  
ING THE WORD "LINDT" AND LOGO SPATIALLY  
SEPARATED BY A SOLID LINE FROM THE WORD  
"LINDOR".

SER. NO. 77-198,831, FILED 6-6-2007.

THEODORE MCBRIDE, EXAMINING ATTORNEY

**Int. Cls.: 12, 37 and 42**

**Prior U.S. Cls.: 19, 21, 23, 31, 35, 44, 100, 101, 103 and 106**

**Reg. No. 3,452,390**

**United States Patent and Trademark Office**

**Registered June 24, 2008**

**TRADEMARK  
SERVICE MARK  
PRINCIPAL REGISTER**



NISSAN JIDOSHA KABUSHIKI KAISHA (JAPAN CORPORATION)  
NO.2 TAKARACHO, KANAGAWA-KU  
YOKOHAMA-SHI, KANAGAWA, JAPAN

FOR: AUTOMOBILES, WAGONS, TRUCKS, VEHICLE VANS, SPORT UTILITY VEHICLES, BUSES, RECREATIONAL VEHICLES, SPORT CARS, RACING CARS, LIGHT LORRIES, FORKLIFT TRUCKS, AND TOWING TRACTORS, AND STRUCTURAL PARTS AND FITTINGS THEREFOR, TRACTORS, ANTI-THEFT ALARMS FOR VEHICLES, ADHESIVE RUBBER PATCHES FOR REPAIRING TUBES OR TIRES, IN CLASS 12 (U.S. CLS. 19, 21, 23, 31, 35 AND 44).

FOR: REPAIR AND MAINTENANCE OF AUTOMOBILES AND THEIR PARTS; REPAIR, MAINTENANCE

OF VEHICLE WASHING INSTALLATIONS; RENTAL, LEASING OF VEHICLE WASHING INSTALLATIONS; VEHICLE CLEANING; VEHICLE POLISHING, IN CLASS 37 (U.S. CLS. 100, 103 AND 106).

FOR: INSPECTION OF AUTOMOBILE AND THEIR PARTS, IN CLASS 42 (U.S. CLS. 100 AND 101).

OWNER OF JAPAN REG. NO. 4349783, DATED 1-7-2000, EXPIRES 1-7-2010.

SER. NO. 77-198,860, FILED 6-6-2007.

COLLEEN KEARNEY, EXAMINING ATTORNEY

**Int. Cl.: 41**

**Prior U.S. Cls.: 100, 101 and 107**

**United States Patent and Trademark Office**

**Reg. No. 3,452,391**

**Registered June 24, 2008**

**SERVICE MARK  
PRINCIPAL REGISTER**

**BODY BITZ**

ATTITUDE2FOOD LLC (CALIFORNIA LTD LIAB  
CO)  
3 QUINCE COURT  
NOVATO, CA 94947

FOR: EDUCATIONAL SERVICES FOR CHILDREN IN THE FIELD OF HEALTH AND NUTRITION, VIA LECTURES AND SHARING OF KNOWLEDGE THROUGH THE WEBSITE, IN CLASS 41 (U.S. CLS. 100, 101 AND 107).

FIRST USE 9-1-2006; IN COMMERCE 9-1-2006.

THE MARK CONSISTS OF STANDARD CHARACTERS WITHOUT CLAIM TO ANY PARTICULAR FONT, STYLE, SIZE, OR COLOR.

SER. NO. 77-199,808, FILED 6-6-2007.

JAMES A. RAUEN, EXAMINING ATTORNEY

Int. Cl.: 41

Prior U.S. Cls.: 100, 101 and 107

United States Patent and Trademark Office

Reg. No. 3,452,392

Registered June 24, 2008

SERVICE MARK  
PRINCIPAL REGISTER



ALLAN GOLDIN (ILLINOIS SOLE PROPRIETOR-  
SHIP)  
1341 N. KENNELWOOD LANE  
RIVERWOODS, IL 60015

FOR: TEACHING IN THE FIELD OF SPEED  
READING, IN CLASS 41 (U.S. CLS. 100, 101 AND 107).

FIRST USE 6-1-2007; IN COMMERCE 6-5-2007.

NO CLAIM IS MADE TO THE EXCLUSIVE  
RIGHT TO USE "ADVANCED LEARNING", APART  
FROM THE MARK AS SHOWN.

THE MARK CONSISTS OF LINE ARTWORK  
FORMING TWO SPHERES OVER THE WORD "KI-  
NETIC" STACKED ON TOP OF THE WORDING  
"ADVANCED LEARNING".

SER. NO. 77-200,448, FILED 6-7-2007.

VERNA BETH RIRIE, EXAMINING ATTORNEY

**Int. Cls.: 7 and 11**

**Prior U.S. Cls.: 13, 19, 21, 23, 31, 34 and 35**

**United States Patent and Trademark Office**

**Reg. No. 3,452,393**

**Registered June 24, 2008**

**TRADEMARK  
PRINCIPAL REGISTER**



B&N, LLC (FLORIDA LTD LIAB CO)  
SUITE 800  
15712 SW 41 STREET  
FT. LAUDERDALE, FL 33331

FOR: ELECTRIC FOOD BLENDERS, ELECTRIC FOOD PROCESSORS, ELECTRIC JUICE EXTRACTORS; ALL FOR COMMERCIAL OR RESIDENTIAL USE, IN CLASS 7 (U.S. CLS. 13, 19, 21, 23, 31, 34 AND 35).

FIRST USE 8-1-2002; IN COMMERCE 8-1-2003.

FOR: MACHINES, APPARATUS AND APPLIANCES FOR COOKING, HEATING AND CHILLING AND PREPARING FOOD, NAMELY, ELECTRIC COFFEE MAKERS, ELECTRIC COFFEE PERCOLATORS, ELECTRIC GRANITA MACHINES, REFRIGERATED DRINK DISPENSING UNITS, FAUCETS, ELECTRIC SOUP COOKERS, ELECTRIC RICE COOKERS, INDUCTION COOKERS, ELECTRIC ICE MACHINES, REFRIGERATORS AND FREEZERS, ELECTRIC COOKING STOVES, BAKING OVENS; MICROWAVE COOKING OVENS; ALL FOR COMMERCIAL AND RESIDENTIAL USE, IN CLASS 11 (U.S. CLS. 13, 21, 23, 31 AND 34).

FIRST USE 8-1-2002; IN COMMERCE 8-1-2003.

THE COLOR(S) METALLIC BLUE, GRAY AND WHITE IS/ARE CLAIMED AS A FEATURE OF THE MARK.

THE MARK CONSISTS OF A SQUARE THAT IS METALLIC BLUE ON THE TOP HALF AND BECOMES GRAY ON THE BOTTOM HALF, WITH THE DESIGN OF WATER DROPLETS IN METALLIC BLUE COVERING THE SQUARE, AND THE WORDING "MAXXIMUM" TO THE RIGHT OF THE SQUARE IN METALLIC BLUE ON THE TOP HALF OF THE LETTERS, AND GRAY ON THE BOTTOM HALF OF THE LETTERS, WITH SPOTS OF WHITE IN THE MIDDLE OF THE LETTERS, ALL WITH THE EFFECT OF LIGHT REFLECTING OFF A METALLIC SURFACE.

SER. NO. 77-200,730, FILED 6-7-2007.

APRIL ROACH, EXAMINING ATTORNEY

**Int. Cl.: 28**

**Prior U.S. Cls.: 22, 23, 38 and 50**

**United States Patent and Trademark Office**

**Reg. No. 3,452,394**

**Registered June 24, 2008**

**TRADEMARK  
PRINCIPAL REGISTER**



DARTSLIVE CO., LTD. (JAPAN CORPORATION)  
2-12-14, HIGASHI-KOUJIYA  
OHTA-KU, TOKYO, JAPAN

FOR: ELECTRONIC DART GAMES; STAND  
ALONE VIDEO GAME MACHINES; ARCADE  
GAME MACHINES WITH BUILT-IN SCREENS;  
DART BOARDS; DART FLIGHTS; DART SHAFTS,  
IN CLASS 28 (U.S. CLS. 22, 23, 38 AND 50).

PRIORITY CLAIMED UNDER SEC. 44(D) ON  
JAPAN APPLICATION NO. 2007-053448, FILED 5-29-  
2007, REG. NO. 5107971, DATED 5-29-2007, EXPIRES  
5-29-2017.

SER. NO. 77-201,367, FILED 6-8-2007.

PETER B. BROMAGHIM, EXAMINING ATTORNEY

**Int. Cl.: 30**

**Prior U.S. Cl.: 46**

**United States Patent and Trademark Office**

**Reg. No. 3,452,395**

**Registered June 24, 2008**

**TRADEMARK  
PRINCIPAL REGISTER**

**TOSHIMI ON TAP**

SEA BREEZE FRUIT FLAVORS, INC. (NEW  
JERSEY CORPORATION)  
441 ROUTE 202  
TOWACO, NJ 07082

FOR: HOT AND COLD PREPARED GREEN TEA  
BASED BEVERAGES, IN CLASS 30 (U.S. CL. 46).

FIRST USE 3-0-2006; IN COMMERCE 3-0-2006.

THE MARK CONSISTS OF STANDARD CHAR-  
ACTERS WITHOUT CLAIM TO ANY PARTICULAR  
FONT, STYLE, SIZE, OR COLOR.

OWNER OF U.S. REG. NO. 3,277,575.

NO CLAIM IS MADE TO THE EXCLUSIVE  
RIGHT TO USE "ON TAP", APART FROM THE  
MARK AS SHOWN.

THE FOREIGN WORDING IN THE MARK  
TRANSLATES INTO ENGLISH AS "SMART" AND  
"BEAUTIFUL".

SER. NO. 77-201,720, FILED 6-8-2007.

ANDREA BUTLER, EXAMINING ATTORNEY

**Int. Cl.: 41**

**Prior U.S. Cls.: 100, 101 and 107**

**United States Patent and Trademark Office**

**Reg. No. 3,452,396**

**Registered June 24, 2008**

**SERVICE MARK  
PRINCIPAL REGISTER**

**HPT**

GALLAGHER, MONIQUE (UNITED STATES INDIVIDUAL)  
6965 EL CAMINO REAL, #105-178  
CARLSBAD, CA 90209

FOR: EDUCATION SERVICES, NAMELY, PROGRAMS TO ASSIST PARENTS OF STRONG WILLED CHILDREN, PARENT EMPOWERMENT TRAINING; EDUCATION SERVICES, NAMELY, WORKSHOPS, SEMINARS, ONLINE LEARNING PROGRAMS, PRIVATE BUSINESS AND PROFESSIONAL COACHING AND BUSINESS DEVELOPMENT TRAINING SERVICES, IN CLASS 41 (U.S. CLS. 100, 101 AND 107).

FIRST USE 5-15-2005; IN COMMERCE 5-15-2005.

THE MARK CONSISTS OF STANDARD CHARACTERS WITHOUT CLAIM TO ANY PARTICULAR FONT, STYLE, SIZE, OR COLOR.

THE WORDING "HPT" HAS NO MEANING IN A FOREIGN LANGUAGE.

SER. NO. 77-202,018, FILED 6-8-2007.

TINA BROWN, EXAMINING ATTORNEY



**Int. Cl.: 21**

**Prior U.S. Cls.: 2, 13, 23, 29, 30, 33, 40 and 50**

**United States Patent and Trademark Office**

**Reg. No. 3,452,397**

**Registered June 24, 2008**

**TRADEMARK  
PRINCIPAL REGISTER**

# Classicor Century 21

PATHWAY INVESTMENT CORP. (NEW JERSEY CORPORATION)  
401 NEW YORK AVENUE  
WYCKOFF, NJ 07481

FOR: POTS, PANS, NON-ELECTRIC GRILLS, NON-ELECTRIC FRYING PANS, BOWLS, SAUTE PANS, MULTI-USE POTS, CLAM POTS, WINDSOR PANS, LASAGNA PANS, PAELLA PANS, TEAKETTLES, GRIDDLES, STOCKPOTS, ROASTERS, SAUCEPANS, NON-ELECTRIC CHICKEN FRYERS, NON-ELECTRIC PRESSURE COOKERS, MIXING SPOONS, SERVING SPOONS, AND BASTING

SPOONS, IN CLASS 21 (U.S. CLS. 2, 13, 23, 29, 30, 33, 40 AND 50).

FIRST USE 6-5-2007; IN COMMERCE 10-11-2007.

THE MARK CONSISTS OF STANDARD CHARACTERS WITHOUT CLAIM TO ANY PARTICULAR FONT, STYLE, SIZE, OR COLOR.

SER. NO. 77-202,067, FILED 6-8-2007.

FLORENTINA BLANDU, EXAMINING ATTORNEY

**Int. Cl.: 25**

**Prior U.S. Cls.: 22 and 39**

**United States Patent and Trademark Office**

**Reg. No. 3,452,398**

**Registered June 24, 2008**

**TRADEMARK  
PRINCIPAL REGISTER**



SNUGGLY STEPS, LLC (VIRGINIA LTD LIAB  
CO)  
2801 JOHN MARSHALL DRIVE  
ARLINGTON, VA 22207

FOR: CHILDREN'S AND INFANTS' CLOTH BIBS;  
INFANT AND TODDLER ONE PIECE CLOTHING;  
ONE PIECE GARMENT FOR INFANTS AND TOD-  
DLERS; BABY BIBS NOT OF PAPER; CLOTH BIBS,  
IN CLASS 25 (U.S. CLS. 22 AND 39).

FIRST USE 5-21-2007; IN COMMERCE 5-21-2007.

NO CLAIM IS MADE TO THE EXCLUSIVE  
RIGHT TO USE "PLUSH BABY APPAREL", APART  
FROM THE MARK AS SHOWN.

THE COLOR(S) BLUE AND GREEN IS/ARE  
CLAIMED AS A FEATURE OF THE MARK.

THE MARK CONSISTS OF HAPPY BABY IN  
BLUE ON TOP OFF 3 ANIMAL PRINTS. ANIMAL  
PRINTS ARE FOR A DOG (BLUE), BUNNY (BLUE)  
& DUCK (GREEN) TO THE RIGHT OF THE BABY  
AND PRINTS ARE THE WORDS "SNUGGLY  
STEPS" UNDERNEATH "SNUGGLY STEPS" ARE  
THE WORDS "PLUSH BABY APPAREL".

SER. NO. 77-202,108, FILED 6-9-2007.

GIANCARLO CASTRO, EXAMINING ATTORNEY

Prior U.S. Cl.: 200

United States Patent and Trademark Office

Reg. No. 3,452,399

Registered June 24, 2008

COLLECTIVE MEMBERSHIP  
PRINCIPAL REGISTER



THE SOVEREIGN ORDER OF THE ORTHODOX  
KNIGHTS HOSPITALER OF SAINT JOHN OF  
JERUSALEM (NEW YORK NON-PROFIT COR-  
PORATION)

39 PARKWAY EAST  
MT. VERNON, NY 10552

FOR: INDICATING MEMBERSHIP IN AN INTER-  
NATIONAL ORGANIZATION OF BUSINESS AND  
PROFESSIONAL LEADERS UNITED WORLDWIDE  
IN ORDER TO PROVIDE EDUCATIONAL, CULT-  
URAL, PHILANTHROPIC AND HUMANITARIAN  
SERVICES, ENCOURAGE HIGH ETHICAL STAND-  
ARDS AND HELP BUILD GOODWILL AND  
PEACE THROUGHOUT THE WORLD, IN CLASS  
200 (U.S. CL. 200).

FIRST USE 4-20-1977; IN COMMERCE 4-20-1977.

THE MARK CONSISTS OF DOUBLE-HEADED  
EAGLE CREST WITH TALONS HOLDING SCEPTER

AND SPHERE, OVER INTERSECTING HORNS AND  
FLAGS, ENCIRCLED IN A BANNER HAVING  
RUSSIAN CHARACTERS THAT TRANSLATE TO  
SOVEREIGN ORDER OF ST. JOHN OF JERUSA-  
LEM.

THE FOREIGN WORDING IN THE MARK  
TRANSLATES INTO ENGLISH AS SOVEREIGN  
ORDER OF ST. JOHN OF JERUSALEM.

THE NON-LATIN CHARACTER(S) IN THE  
MARK TRANSLITERATES INTO JERJAVNYI OR-  
DEN SV. JOANNA IERUSSALIMSKAGO, AND THIS  
MEANS SOVEREIGN ORDER OF ST. JOHN OF  
JERUSALEM IN ENGLISH.

SER. NO. 77-202,387, FILED 6-11-2007.

ESTHER A. BORSUK, EXAMINING ATTORNEY

Int. Cl.: 43

Prior U.S. Cls.: 100 and 101

United States Patent and Trademark Office

Reg. No. 3,452,400

Registered June 24, 2008

SERVICE MARK  
PRINCIPAL REGISTER



TRES TACUACHES, LLC (DELAWARE LTD  
LIAB CO)  
225 SOUTH STATE STREET  
DOVER, DE 19901

FOR: CAFE-RESTAURANTS; CARRY-OUT RESTAURANTS; FAST FOOD AND NON-STOP RESTAURANT SERVICES; FAST-FOOD RESTAURANTS; FAST-FOOD RESTAURANTS AND SNACKBARS; RESTAURANTS; SELF SERVICE RESTAURANTS; SELF-SERVICE RESTAURANTS; TAKE-OUT RESTAURANT SERVICES, IN CLASS 43 (U.S. CLS. 100 AND 101).

FIRST USE 5-1-2006; IN COMMERCE 5-1-2006.

NO CLAIM IS MADE TO THE EXCLUSIVE RIGHT TO USE "AUTHENTIC MEXICAN RESTAURANT", APART FROM THE MARK AS SHOWN.

SER. NO. 77-202,795, FILED 6-11-2007.

ELI HELLMAN, EXAMINING ATTORNEY

**Int. Cl.: 16**

**Prior U.S. Cls.: 2, 5, 22, 23, 29, 37, 38 and 50**

**United States Patent and Trademark Office**

**Reg. No. 3,452,401**

**Registered June 24, 2008**

**TRADEMARK  
PRINCIPAL REGISTER**

**It's easy to change your  
stripes**

GREENZEBRA (CALIFORNIA LTD LIAB CO)  
2269 CHESTNUT STREET, #297  
SAN FRANCISCO, CA 94123

FOR: PRINTED PUBLICATIONS, NAMELY,  
PRINTED BROCHURES PROMOTING SUSTAIN-  
ABLE LIVING THROUGH INFORMATIVE ARTI-  
CLES AND DISCOUNTS AT LOCAL AND  
ENVIRONMENTALLY FRIENDLY BUSINESSES,  
IN CLASS 16 (U.S. CLS. 2, 5, 22, 23, 29, 37, 38 AND 50).

FIRST USE 3-1-2006; IN COMMERCE 3-1-2006.

THE MARK CONSISTS OF STANDARD CHAR-  
ACTERS WITHOUT CLAIM TO ANY PARTICULAR  
FONT, STYLE, SIZE, OR COLOR.

SER. NO. 77-203,030, FILED 6-11-2007.

MICHAEL TANNER, EXAMINING ATTORNEY

**Int. Cl.: 35**

**Prior U.S. Cls.: 100, 101 and 102**

**United States Patent and Trademark Office**

**Reg. No. 3,452,402**

**Registered June 24, 2008**

**SERVICE MARK  
PRINCIPAL REGISTER**



ALLIED SAFE & VAULT CO., INC. (WASHINGTON CORPORATION)  
425 W. SECOND AVENUE  
SPOKANE, WA 99204

THE COLOR(S) BLACK, WHITE AND RED IS/ARE CLAIMED AS A FEATURE OF THE MARK.

FOR: COMPUTERIZED ON-LINE RETAIL STORE SERVICES IN THE FIELD OF SAFES, WALL SAFES, FLOOR SAFES, FIRE SAFES, GUN SAFES, DATA MEDIA SAFES, DEPOSITORY SAFES, ELECTRONIC SAFES, ELECTRONIC LOCKS, COMBINATION LOCKS, KEY MANAGEMENT SYSTEMS, LAPTOP COMPUTER SAFES, VAULT DOORS, HOTEL SAFES, NARCOTIC SAFES, UNDERCOUNTER SAFES, IN CLASS 35 (U.S. CLS. 100, 101 AND 102).

THE COLORS BLACK AND WHITE APPEAR IN THE WORDING "SAFEANDVAULT", THE COLOR RED APPEARS IN THE WORDING "STORE.COM" AND THE COLOR BLACK APPEARS IN THE WORDING "ALL OVER THE WORLD IT'S A SAFE NAME".

FIRST USE 2-1-2007; IN COMMERCE 2-1-2007.

SER. NO. 77-203,301, FILED 6-11-2007.

NO CLAIM IS MADE TO THE EXCLUSIVE RIGHT TO USE "SAFEANDVAULTSTORE.COM", APART FROM THE MARK AS SHOWN.

DOMINIC J. FERRAIUOLO, EXAMINING ATTORNEY

**Int. Cl.: 11**

**Prior U.S. Cls.: 13, 21, 23, 31 and 34**

**Reg. No. 3,452,403**

**United States Patent and Trademark Office**

**Registered June 24, 2008**

---

**TRADEMARK  
PRINCIPAL REGISTER**

**WALLACE & TIERNAN**

SIEMENS WATER TECHNOLOGIES CORP.  
(MASSACHUSETTS CORPORATION)  
181 THORN HILL ROAD  
WARRENDALE, PA 15086

FOR: WATER PURIFYING APPARATUSES,  
NAMELY, ULTRAVIOLET DISINFECTION UNITS,  
CHLORINATORS AND DISINFECTION SYSTEMS;  
GRAVIMETRIC AND VOLUMETRIC DRY FLOW  
FEEDERS, LIME SLAKERS AND FLUORIDATORS  
FOR WASTEWATER TREATMENT, WATER PUR-  
IFICATION, AND CHEMICAL PROCESSES, IN  
CLASS 11 (U.S. CLS. 13, 21, 23, 31 AND 34).

FIRST USE 8-31-2002; IN COMMERCE 8-31-2002.

THE MARK CONSISTS OF STANDARD CHAR-  
ACTERS WITHOUT CLAIM TO ANY PARTICULAR  
FONT, STYLE, SIZE, OR COLOR.

OWNER OF U.S. REG. NO. 929,981.

SER. NO. 77-204,076, FILED 6-12-2007.

ERNEST SHOSHO, EXAMINING ATTORNEY

**Int. Cl.: 7**

**Prior U.S. Cls.: 13, 19, 21, 23, 31, 34 and 35**

**Reg. No. 3,452,404**

**United States Patent and Trademark Office**

**Registered June 24, 2008**

---

**TRADEMARK  
PRINCIPAL REGISTER**

**WALLACE & TIERNAN**

SIEMENS WATER TECHNOLOGIES CORP.  
(MASSACHUSETTS CORPORATION)  
181 THORN HILL ROAD  
WARRENDALE, PA 02142

THE MARK CONSISTS OF STANDARD CHAR-  
ACTERS WITHOUT CLAIM TO ANY PARTICULAR  
FONT, STYLE, SIZE, OR COLOR.

FOR: ELECTRIC PUMPS, WATER PUMPS, ME-  
TERING PUMPS, PERISTALTIC PUMPS, AND CHE-  
MICAL DOSING PUMPS ALL FOR USE IN WATER  
PURIFICATION, WASTEWATER TREATMENT  
AND CHEMICAL PROCESS TREATMENT, IN  
CLASS 7 (U.S. CLS. 13, 19, 21, 23, 31, 34 AND 35).

OWNER OF U.S. REG. NO. 929,981.

SER. NO. 77-204,116, FILED 6-12-2007.

FIRST USE 5-31-1989; IN COMMERCE 5-31-1989.

ERNEST SHOSHO, EXAMINING ATTORNEY



**Int. Cl.: 35**

**Prior U.S. Cls.: 100, 101 and 102**

**United States Patent and Trademark Office**

**Reg. No. 3,452,405**

**Registered June 24, 2008**

**SERVICE MARK  
PRINCIPAL REGISTER**

# Blue Bolt Marketing

BLUE BOLT MARKETING (CALIFORNIA CORPORATION)

251 CLORINDA AVENUE

SAN RAFAEL, CA 94901

FOR: BUSINESS MARKETING CONSULTING SERVICES, IN CLASS 35 (U.S. CLS. 100, 101 AND 102).

FIRST USE 1-27-2003; IN COMMERCE 9-16-2003.

THE MARK CONSISTS OF STANDARD CHARACTERS WITHOUT CLAIM TO ANY PARTICULAR FONT, STYLE, SIZE, OR COLOR.

NO CLAIM IS MADE TO THE EXCLUSIVE RIGHT TO USE "MARKETING", APART FROM THE MARK AS SHOWN.

SER. NO. 77-204,365, FILED 6-12-2007.

ALICE BENMAMAN, EXAMINING ATTORNEY

**Int. Cls.: 1, 29, 30 and 31**

**Prior U.S. Cls.: 1, 5, 6, 10, 26 and 46**

**United States Patent and Trademark Office**

**Reg. No. 3,452,406**

**Registered June 24, 2008**

**TRADEMARK  
PRINCIPAL REGISTER**

**EQUACIA**

CNI COLLOIDES NATURELS INTERNATIONAL  
(FRANCE SOCIETE ANONYME)  
129 CHEMIN DE CROISSET  
ROUEN, FRANCE 76000

FOR: CHEMICALS FOR USE IN INDUSTRY; FOOD PRESERVATIVE COMPOSITIONS, NAMELY, COLLOIDS; GUM ARABIC, GUM ACACIA, WHEAT FIBERS AND TRAGACANTH GUM, ALL USED AS STABILISERS FOR USE IN THE MANUFACTURE OF FOODS; STABILISERS FOR USE IN THE MANUFACTURE OF FOODS; GELATIN FOR INDUSTRIAL USE IN THE MANUFACTURE OF FOOD PRODUCTS; AGAR; CHEMICALS FOR USE IN THE FOOD INDUSTRY, IN CLASS 1 (U.S. CLS. 1, 5, 6, 10, 26 AND 46).

FOR: SEAWEED EXTRACTS FOR FOOD; ALGINATES FOR FOOD; UNFLAVORED AND UNSWEETENED GELATIN FOR FOOD, IN CLASS 29 (U.S. CL. 46).

FOR: THICKENING AGENTS FOR USE IN COOKING, NAMELY, COLLOIDS AND GUM ACA-

CIA; FOOD STARCH; STARCHY PRODUCTS FOR FOOD, NAMELY, STARCH SYRUP, STARCH-BASED BINDING AGENTS FOR ICE CREAM, AND STARCH-BASED THICKENERS FOR WHIPPED CREAM; THICKENING AGENTS FOR COOKING FOODSTUFFS, IN CLASS 30 (U.S. CL. 46).

FOR: UNPROCESSED WHEAT FIBERS FOR FOOD, IN CLASS 31 (U.S. CLS. 1 AND 46).

THE MARK CONSISTS OF STANDARD CHARACTERS WITHOUT CLAIM TO ANY PARTICULAR FONT, STYLE, SIZE, OR COLOR.

PRIORITY CLAIMED UNDER SEC. 44(D) ON FRANCE APPLICATION NO. 063471371, FILED 12-22-2006, REG. NO. 063471371, DATED 12-22-2006, EXPIRES 12-21-2016.

SER. NO. 77-204,899, FILED 6-13-2007.

JOHN GARTNER, EXAMINING ATTORNEY

**Int. Cl.: 25**

**Prior U.S. Cls.: 22 and 39**

**United States Patent and Trademark Office**

**Reg. No. 3,452,407**

**Registered June 24, 2008**

**TRADEMARK  
PRINCIPAL REGISTER**

**TENNESSEE GIRL**

EAGLE CREST, INC. (FLORIDA CORPORATION)  
5353-1 RAMONA BOULEVARD  
JACKSONVILLE, FL 32205

FIRST USE 4-4-2007; IN COMMERCE 4-4-2007.

FOR: CLOTHING, NAMELY, HATS, SHIRTS,  
UNDERGARMENTS, SWIMSUITS, SWEATSHIRTS,  
SWEATERS, JACKETS, COATS, GLOVES, SCARVES,  
BELTS, HEADBANDS, WRISTBANDS, PANTS,  
SHORTS, SKIRTS, DRESSES, OVERALLS, SOCKS,  
STOCKINGS, AND LEGGINGS, IN CLASS 25 (U.S.  
CLS. 22 AND 39).

THE MARK CONSISTS OF STANDARD CHAR-  
ACTERS WITHOUT CLAIM TO ANY PARTICULAR  
FONT, STYLE, SIZE, OR COLOR.

SER. NO. 77-204,927, FILED 6-13-2007.

KAREN K. BUSH, EXAMINING ATTORNEY

**Int. Cl.: 3**

**Prior U.S. Cls.: 1, 4, 6, 50, 51 and 52**

**Reg. No. 3,452,408**

**United States Patent and Trademark Office**

**Registered June 24, 2008**

**TRADEMARK  
PRINCIPAL REGISTER**

A large, bold, black letter 'M' is centered on the page. The letter has a slightly irregular, hand-drawn appearance with a small notch at the top of the right vertical stroke.

**AU MASCULIN | FOR MEN**

COSMÉTIQUES FRANCE-LAURE (1970) INC.  
(CANADA CORPORATION)  
11970 ALBERT-HUDON STREET  
MONTREAL-NORTH, CANADA H1G3K3

FOR: PERFUMERY PRODUCTS, NAMELY, PER-  
FUMES, EAU DE COLOGNE, EAU DE TOILETTE,  
EAU DE PARFUM; COSMETICS AND TREATMENT  
PRODUCTS, NAMELY, SKIN CREAMS, CLEANS-  
ING MILK FOR THE SKIN, IN CLASS 3 (U.S. CLS. 1,  
4, 6, 50, 51 AND 52).

OWNER OF CANADA REG. NO. 672418, DATED  
9-12-2006, EXPIRES 9-12-2021.

NO CLAIM IS MADE TO THE EXCLUSIVE  
RIGHT TO USE "MASCULIN" AND "MEN", APART  
FROM THE MARK AS SHOWN.

THE MARK CONSISTS OF THE LETTER "M"  
OVERHANGING THE WORDS "AU MASCULIN"  
AND "FOR MEN", THESE EXPRESSIONS BEING  
SEPARATED BY A VERTICAL LINE.

THE FOREIGN WORDING IN THE MARK  
TRANSLATES INTO ENGLISH AS FOR MEN.

SER. NO. 77-205,044, FILED 6-13-2007.

REGINA DRUMMOND, EXAMINING ATTORNEY

**Int. Cl.: 36**

**Prior U.S. Cls.: 100, 101 and 102**

**United States Patent and Trademark Office**

**Reg. No. 3,452,409**

**Registered June 24, 2008**

**SERVICE MARK  
PRINCIPAL REGISTER**



TOWNEBANK (VIRGINIA CORPORATION)  
5716 HIGH STREET  
PORTSMOUTH, VA 23703

FOR: BANKING SERVICES; RESIDENTIAL REAL ESTATE BROKERAGE SERVICES; INSURANCE BROKERAGE IN THE FIELD OF PROPERTY AND CASUALTY INSURANCE, GROUP HEALTH, DENTAL, VISION, LIFE, AND DISABILITY INSURANCE; ADMINISTRATION OF FLEXIBLE SPENDING SAVINGS ACCOUNTS; INVESTMENT BROKERAGE SERVICES; INVESTMENT ADVICE; ASSET MANAGEMENT SERVICES; MORTGAGE

LENDING SERVICES, IN CLASS 36 (U.S. CLS. 100, 101 AND 102).

FIRST USE 11-1-2004; IN COMMERCE 11-1-2004.

THE MARK CONSISTS OF THE LETTER "T" SURROUNDED ON THE BOTTOM BY A LAUREL DESIGN.

SER. NO. 77-205,319, FILED 6-13-2007.

ANDREA K. NADELMAN, EXAMINING ATTORNEY

**Int. Cl.: 36**

**Prior U.S. Cls.: 100, 101 and 102**

**United States Patent and Trademark Office**

**Reg. No. 3,452,410**

**Registered June 24, 2008**

**SERVICE MARK  
PRINCIPAL REGISTER**

**TOWNE INVESTMENT GROUP**

TOWNEBANK (VIRGINIA CORPORATION)  
5716 HIGH STREET  
PORTSMOUTH, VA 23703

FOR: INVESTMENT BROKERAGE SERVICES;  
INVESTMENT ADVICE, IN CLASS 36 (U.S. CLS.  
100, 101 AND 102).

FIRST USE 1-30-2004; IN COMMERCE 1-30-2004.

THE MARK CONSISTS OF STANDARD CHAR-  
ACTERS WITHOUT CLAIM TO ANY PARTICULAR  
FONT, STYLE, SIZE, OR COLOR.

NO CLAIM IS MADE TO THE EXCLUSIVE  
RIGHT TO USE "INVESTMENT GROUP", APART  
FROM THE MARK AS SHOWN.

SER. NO. 77-205,406, FILED 6-13-2007.

ANDREA K. NADELMAN, EXAMINING ATTOR-  
NEY

**Int. Cl.: 36**

**Prior U.S. Cls.: 100, 101 and 102**

**United States Patent and Trademark Office**

**Reg. No. 3,452,411**

**Registered June 24, 2008**

**SERVICE MARK  
PRINCIPAL REGISTER**

**TOWNE INSURANCE**

TOWNEBANK (VIRGINIA CORPORATION)  
5716 HIGH STREET  
PORTSMOUTH, VA 23703

FOR: INSURANCE BROKERAGE IN THE FIELD OF PROPERTY AND CASUALTY INSURANCE, GROUP HEALTH, DENTAL, VISION, LIFE, AND DISABILITY INSURANCE; ADMINISTRATION OF FLEXIBLE SPENDING SAVINGS ACCOUNTS , IN CLASS 36 (U.S. CLS. 100, 101 AND 102).

FIRST USE 5-1-2001; IN COMMERCE 5-1-2001.

THE MARK CONSISTS OF STANDARD CHARACTERS WITHOUT CLAIM TO ANY PARTICULAR FONT, STYLE, SIZE, OR COLOR.

NO CLAIM IS MADE TO THE EXCLUSIVE RIGHT TO USE "INSURANCE", APART FROM THE MARK AS SHOWN.

SER. NO. 77-205,422, FILED 6-13-2007.

ANDREA K. NADELMAN, EXAMINING ATTORNEY

**Int. Cl.: 37**

**Prior U.S. Cls.: 100, 103 and 106**

**United States Patent and Trademark Office**

**Reg. No. 3,452,412**

**Registered June 24, 2008**

**SERVICE MARK  
PRINCIPAL REGISTER**



AAMCO TRANSMISSIONS, INC. (PENNSYLVANIA CORPORATION)

SUITE 150

201 GIBRALTAR ROAD

HORSHAM, PA 19044

FOR: AUTOMOBILE REPAIR SERVICES; MAINTENANCE AND REPAIR SERVICES FOR MOTOR VEHICLES, MOTOR VEHICLE PARTS AND MOTOR VEHICLE ACCESSORIES , IN CLASS 37 (U.S. CLS. 100, 103 AND 106).

FIRST USE 6-30-2006; IN COMMERCE 6-30-2006.

OWNER OF U.S. REG. NOS. 851,209, 1,127,710 AND OTHERS.

NO CLAIM IS MADE TO THE EXCLUSIVE RIGHT TO USE "TRANSMISSIONS", APART FROM THE MARK AS SHOWN.

THE COLOR(S) RED, WHITE AND BLUE IS/ARE CLAIMED AS A FEATURE OF THE MARK.

THE MARK CONSISTS OF THE WORD "AAMCO" IN WHITE WITH BLUE SHADING AND THE WORD "TRANSMISSIONS" IN BLUE, BOTH ON TOP OF AN IRREGULAR-SHAPED BLUE AND WHITE OCTAGON, ALL OF WHICH IS CONTAINED IN AN IRREGULAR-SHAPED RED HEXAGON.

SER. NO. 77-205,438, FILED 6-13-2007.

CARRIE GENOVESE, EXAMINING ATTORNEY



**Int. Cl.: 37**

**Prior U.S. Cls.: 100, 103 and 106**

**United States Patent and Trademark Office**

**Reg. No. 3,452,413**

**Registered June 24, 2008**

**SERVICE MARK  
PRINCIPAL REGISTER**



AAMCO TRANSMISSIONS, INC. (PENNSYLVANIA CORPORATION)  
SUITE 150  
201 GIBRALTAR ROAD  
HORSHAM, PA 19044

FOR: AUTOMOBILE REPAIR SERVICES; MAINTENANCE AND REPAIR SERVICES FOR MOTOR VEHICLES, MOTOR VEHICLE PARTS AND MOTOR VEHICLE ACCESSORIES, IN CLASS 37 (U.S. CLS. 100, 103 AND 106).

FIRST USE 6-30-2006; IN COMMERCE 6-30-2006.

OWNER OF U.S. REG. NOS. 851,209, 1,127,710 AND OTHERS.

NO CLAIM IS MADE TO THE EXCLUSIVE RIGHT TO USE "TRANSMISSIONS", APART FROM THE MARK AS SHOWN.

THE MARK CONSISTS OF THE WORDS "AAMCO TRANSMISSIONS" ON TOP OF AN IRREGULAR-SHAPED OCTAGON, ALL OF WHICH IS CONTAINED WITHIN THE OUTLINE OF AN IRREGULAR-SHAPED HEXAGON.

SER. NO. 77-205,440, FILED 6-13-2007.

CARRIE GENOVESE, EXAMINING ATTORNEY

**Int. Cl.: 5**

**Prior U.S. Cls.: 6, 18, 44, 46, 51 and 52**

**United States Patent and Trademark Office**

**Reg. No. 3,452,414**

**Registered June 24, 2008**

**TRADEMARK  
PRINCIPAL REGISTER**

**BOR-RAM**

SOSTRAM CORPORATION (GEORGIA CORPORATION)  
300 COLONIAL CENTER PARKWAY  
ROSWELL, GA 30076

THE MARK CONSISTS OF STANDARD CHARACTERS WITHOUT CLAIM TO ANY PARTICULAR FONT, STYLE, SIZE, OR COLOR.

FOR: TERMITICIDES AND FUNGICIDES, IN CLASS 5 (U.S. CLS. 6, 18, 44, 46, 51 AND 52).

SER. NO. 77-205,802, FILED 6-14-2007.

FIRST USE 10-11-2007; IN COMMERCE 10-11-2007.

DAVID HOFFMAN, EXAMINING ATTORNEY

**Int. Cl.: 16**

**Prior U.S. Cls.: 2, 5, 22, 23, 29, 37, 38 and 50**

**Reg. No. 3,452,415**

**United States Patent and Trademark Office**

**Registered June 24, 2008**

**TRADEMARK  
PRINCIPAL REGISTER**

**TINY BIRD SONGS**

MCBRIDE, GLENN NELSON (UNITED STATES  
INDIVIDUAL)  
51 CHERVIL COMMON  
LAKE JACKSON, TX 77566 AND  
MCBRIDE, CHERIE NOWLIN (UNITED STATES  
INDIVIDUAL)  
51 CHERVIL COMMON  
LAKE JACKSON, TX 77566

FOR: BOOKS, CALENDARS, DAILY PLANNERS,  
STATIONERY, POSTERS, ART PRINTS, NOTE  
CARDS, GREETING CARDS AND CARTOONS IN  
THE FIELD OF ILLUSTRATED NATURE POEMS,  
IN CLASS 16 (U.S. CLS. 2, 5, 22, 23, 29, 37, 38 AND 50).

FIRST USE 7-17-2004; IN COMMERCE 7-17-2004.

THE MARK CONSISTS OF STANDARD CHAR-  
ACTERS WITHOUT CLAIM TO ANY PARTICULAR  
FONT, STYLE, SIZE, OR COLOR.

NO CLAIM IS MADE TO THE EXCLUSIVE  
RIGHT TO USE "BIRD", APART FROM THE MARK  
AS SHOWN.

SER. NO. 77-205,969, FILED 6-14-2007.

TASHIA BUNCH, EXAMINING ATTORNEY

**Int. Cl.: 9**

**Prior U.S. Cls.: 21, 23, 26, 36 and 38**

**Reg. No. 3,452,416**

**United States Patent and Trademark Office**

**Registered June 24, 2008**

**TRADEMARK  
PRINCIPAL REGISTER**



REVOLUTION EYEWEAR, INC. (CALIFORNIA CORPORATION)  
997 FLOWER GLEN STREET  
SIMI VALLEY, CA 93065

FOR: EYEGLOSS FRAMES, IN CLASS 9 (U.S. CLS. 21, 23, 26, 36 AND 38).

FIRST USE 3-14-1995; IN COMMERCE 3-14-1995.

OWNER OF U.S. REG. NOS. 2,666,675, 2,867,716 AND OTHERS.

NO CLAIM IS MADE TO THE EXCLUSIVE RIGHT TO USE "EYEWEAR", APART FROM THE MARK AS SHOWN.

SER. NO. 77-206,566, FILED 6-14-2007.

JULIE GUTTADAURO, EXAMINING ATTORNEY

Int. Cl.: 16

Prior U.S. Cls.: 2, 5, 22, 23, 29, 37, 38 and 50

United States Patent and Trademark Office

Reg. No. 3,452,417

Registered June 24, 2008

TRADEMARK  
PRINCIPAL REGISTER



KRISTIN DEWIT (UNITED STATES INDIVIDUAL)  
24861 TIGRIS LANE  
HEMET, CA 92544

FOR: MANUALS IN THE FIELD OF MATH, IN CLASS 16 (U.S. CLS. 2, 5, 22, 23, 29, 37, 38 AND 50).

FIRST USE 1-1-2001; IN COMMERCE 1-1-2006.

NO CLAIM IS MADE TO THE EXCLUSIVE RIGHT TO USE "MATH", APART FROM THE MARK AS SHOWN.

THE COLOR(S) BLACK, BLUE, GREEN, RED, AND ORANGE IS/ARE CLAIMED AS A FEATURE OF THE MARK.

THE MARK CONSISTS OF THE WORD "FACE" IN CAPITAL LETTERS; FOLLOWED BY "ING" IN SMALL LETTERS; THEN THERE IS A LOGO OF A SMILING FACE NEXT, FOLLOWED BY THE WORD, "MATH" IN CAPITAL LETTERS. THE CAPITAL LETTERS "F" AND "M" AND SMALL I ARE RED; THE CAPITAL LETTER "A"'S AND SMALL "N" ARE ORANGE, THE CAPITAL LETTERS "C" AND "T", AND SMALL LETTER G ARE BLUE, AND THE CAPITAL LETTERS "E" AND "H" ARE GREEN. THE INTERIOR WHITE WHICH APPEARS IN THE MARK IS NOT BEING USED AS COLOR IN THE MARK. THE WHITE COLOR CONSTITUTES ONLY THE BACKGROUND OR TRANSPARENT AREAS, AND IS NOT PART OF THE MARK.

SER. NO. 77-206,580, FILED 6-14-2007.

SETH A. RAPPAPORT, EXAMINING ATTORNEY

Int. Cl.: 45

Prior U.S. Cls.: 100 and 101

United States Patent and Trademark Office

Reg. No. 3,452,418

Registered June 24, 2008

**SERVICE MARK  
PRINCIPAL REGISTER**



GREGUS, MICHAL (UNITED STATES INDIVIDUAL)  
737 N LA JOLLA AVE  
LOS ANGELES, CA 90046

FOR: PERSONAL CONCIERGE SERVICES FOR OTHERS COMPRISING MAKING REQUESTED PERSONAL ARRANGEMENTS AND RESERVATIONS, RUNNING ERRANDS AND PROVIDING CUSTOMER SPECIFIC INFORMATION TO MEET INDIVIDUAL NEEDS, ALL RENDERED IN BUSINESS ESTABLISHMENTS, OFFICE BUILDINGS, HOTELS, RESIDENTIAL COMPLEXES AND HOMES, IN CLASS 45 (U.S. CLS. 100 AND 101).

FIRST USE 2-1-2007; IN COMMERCE 3-12-2007.

THE COLOR(S) ORANGE, BLACK AND WHITE IS/ARE CLAIMED AS A FEATURE OF THE MARK.

THE MARK CONSISTS OF A STYLIZED WHITE TEXT YOUR LITTLE HELPER INSIDE AN ORANGE RECTANGLE WITH OVAL EDGES. A STYLIZED BLACK TEXT UNDER THE RECTANGLE READS EVERYDAY ERRANDS, BIG PROJECTS... CONSIDER IT DONE.

SER. NO. 77-206,760, FILED 6-14-2007.

MONIQUE MILLER, EXAMINING ATTORNEY

**Int. Cls.: 9, 35, 36 and 45**

**Prior U.S. Cls.: 21, 23, 26, 36, 38, 100, 101 and 102**

**Reg. No. 3,452,419**

**United States Patent and Trademark Office**

**Registered June 24, 2008**

**TRADEMARK  
SERVICE MARK  
PRINCIPAL REGISTER**

# NAVIGANT

NAVIGANT INTERNATIONAL, INC. (DELAWARE CORPORATION)  
701 CARLSON PARKWAY  
MINNETONKA, MN 55305

FOR: COMPUTER PROGRAMS FOR USE IN THE ANALYSIS, COLLECTING, PROCESSING, ADMINISTERING AND AUDITING OF DATE, INFORMATION, METHODS, PROCEDURES, EVENTS AND PERFORMANCE IN THE POWER GENERATION INDUSTRY; AND INSTRUCTIONAL MANUALS AND OPERATING INSTRUCTIONS PACKAGED AS A UNIT HEREWITH; COMPUTER PROGRAMS FOR USE IN DATABASE MANAGEMENT, NAMELY, DATA WAREHOUSING, DATA EVALUATION, DATA PROCESSING, DATA ANALYZING, DATA CHARTING, DATA SCORING, DATA CHARACTERIZING, AND DATA MONITORING IN THE FIELD OF RESEARCH AND DEVELOPMENT MANAGEMENT, IN CLASS 9 (U.S. CLS. 21, 23, 26, 36 AND 38).

FIRST USE 6-14-1999; IN COMMERCE 6-14-1999.

FOR: BUSINESS CONSULTING SERVICES; BUSINESS MANAGEMENT CONSULTING SERVICES; BUSINESS MARKETING CONSULTING SERVICES; CONDUCTING MARKETING STUDIES AND MARKET ANALYSIS; CONDUCTING BUSINESS AND MARKET RESEARCH SURVEYS; BUSINESS RESEARCH, NAMELY, CONDUCTING FOCUS GROUP STUDIES; BUSINESS ACQUISITIONS AND MERGER CONSULTATION; ECONOMIC FORECASTING AND ANALYSIS; BUSINESS MANAGEMENT TRANSITION CONSULTING SERVICES; BUSINESS MANAGEMENT CONSULTING IN THE AREA OF INFORMATION TECHNOLOGY; BUSINESS MANAGEMENT CONSULTING IN THE AREA OF GOVERNMENTAL REGULATORY COMPLIANCE; CONSULTING SERVICES IN THE FIELD OF HEALTHCARE MANAGEMENT, NAMELY

CONSULTING SERVICES IN THE COST AND PAYMENT MANAGEMENT OF HEALTH CARE; BUSINESS CONSULTING SERVICES IN THE FIELD OF RESEARCH AND DEVELOPMENT, SCIENCE AND TECHNOLOGY, AND EDUCATIONAL PROGRAMS AND PORTFOLIOS; CONSULTING SERVICES IN THE FIELDS OF ENERGY EFFICIENCY, ENERGY USE MANAGEMENT AND ENERGY RESOURCE MANAGEMENT; BUSINESS ORGANIZATION REENGINEERING SERVICES, NAMELY, CONSULTATION FOR REDESIGNING OF A BUSINESS PROCESS THROUGH THE USE OF INFORMATION TECHNOLOGY; BUSINESS MANAGEMENT CONSULTING SERVICES IN THE AREA OF DISTRIBUTORS AND DISTRIBUTION CHAINS AND CHANNELS OF TRADE; BUSINESS MANAGEMENT CONSULTATION, NAMELY, CONSULTING FOR BUSINESSES WHO HAVE EXPERIENCED DISCONTINUATIONS OR INTERRUPTIONS IN TOP LEVEL MANAGEMENT; AND BUSINESS MANAGEMENT CONSULTING IN THE AREA OF INTENSIVE COMMERCIAL TRANSACTIONS IN A WIDE RANGE OF INDUSTRIES; CONSULTING SERVICES FOR HEALTHCARE PROVIDERS, HEALTHCARE PROFESSIONAL GROUPS AND HEALTHCARE PAYORS, NAMELY ASSISTING THESE ORGANIZATIONS IN IMPROVING THEIR OPERATIONAL AND STRATEGIC PERFORMANCE, IN CLASS 35 (U.S. CLS. 100, 101 AND 102).

FIRST USE 6-14-1999; IN COMMERCE 6-14-1999.

FOR: FINANCIAL MANAGEMENT SERVICES; FINANCIAL FORECASTING SERVICES; FINANCIAL VALUATION OF PERSONAL PROPERTY AND REAL ESTATE; FINANCIAL PORTFOLIO MANAGEMENT; INSURANCE CLAIMS PROCESSING; FINANCIAL RISK MANAGEMENT; PROVIDING ASSET MANAGEMENT STRATEGY; CONSULTING SERVICES FOR HEALTHCARE PROVIDERS, HEALTHCARE PROFESSIONAL

GROUPS AND HEALTHCARE PAYORS, NAMELY ASSISTING THESE ORGANIZATIONS IN IMPROVING THEIR FINANCIAL PERFORMANCE; INSURANCE SERVICES, NAMELY, CLAIM ADMINISTRATION AND VALUATION; INSURANCE COVERAGE ANALYSIS; ASSET ALLOCATION ANALYSIS; REPAIR COST EVALUATION AND ALLOCATION; INSURANCE RATE COMPUTING SERVICES AND CONSULTING IN REGARD TO THE FOREGOING, IN CLASS 36 (U.S. CLS. 100, 101 AND 102).

FIRST USE 6-14-1999; IN COMMERCE 6-14-1999.

FOR: INVESTIGATION SERVICES RELATED TO INSURANCE CLAIMS; REVIEWING STANDARDS AND PRACTICES TO ASSURE COMPLIANCE WITH ENVIRONMENTAL LAWS AND REGULATIONS; LITIGATION SUPPORT SERVICES; LITIGATION SUPPORT SERVICES IN THE FIELD OF BANKRUPTCY CLAIMS; LITIGATION SUPPORT SERVICES IN THE FIELD OF LITIGATION CLAIMS;

EXPERT WITNESS SERVICES IN THE FIELDS OF ANTITRUST, BANKRUPTCY, COMMERCIAL LITIGATION, INTELLECTUAL PROPERTY, CONSTRUCTION CLAIMS, INSURANCE CLAIMS AND ENVIRONMENTAL MATTERS; EXPERT REPORTS AND TESTIMONY IN THE FIELD OF DAMAGES, CLAIMS AND ASSET VALUATIONS; ALTERNATIVE DISPUTE RESOLUTION, IN CLASS 45 (U.S. CLS. 100 AND 101).

FIRST USE 6-14-1999; IN COMMERCE 6-14-1999.

THE MARK CONSISTS OF STANDARD CHARACTERS WITHOUT CLAIM TO ANY PARTICULAR FONT, STYLE, SIZE, OR COLOR.

OWNER OF U.S. REG. NO. 2,714,796.

SER. NO. 77-207,039, FILED 6-15-2007.

CAROLYN CATALDO, EXAMINING ATTORNEY



**Int. Cl.: 7**

**Prior U.S. Cls.: 13, 19, 21, 23, 31, 34 and 35**

**United States Patent and Trademark Office**

**Reg. No. 3,452,420**

**Registered June 24, 2008**

**TRADEMARK  
PRINCIPAL REGISTER**

**ERGO RAPIDO**

ELECTROLUX HOME CARE PRODUCTS, INC.  
(DELAWARE CORPORATION)  
20445 EMERALD PARKWAY SOUTHWEST  
SUITE 250  
CLEVELAND, OH 44135

FOR: VACUUM CLEANERS AND PARTS AND  
FITTINGS THEREFOR, NAMELY, HOSES, NOZ-  
ZLES, BRUSHES AND WANDS, IN CLASS 7 (U.S.  
CLS. 13, 19, 21, 23, 31, 34 AND 35).

THE MARK CONSISTS OF STANDARD CHAR-  
ACTERS WITHOUT CLAIM TO ANY PARTICULAR  
FONT, STYLE, SIZE, OR COLOR.

OWNER OF ERPN CMNTY TM OFC REG. NO.  
003167319, DATED 6-16-2004, EXPIRES 5-15-2013.

THE FOREIGN WORDING IN THE MARK  
TRANSLATES INTO ENGLISH AS RAPID.

SER. NO. 77-207,388, FILED 6-15-2007.

ALICE BENMAMAN, EXAMINING ATTORNEY

**Int. Cl.: 42**

**Prior U.S. Cls.: 100 and 101**

**United States Patent and Trademark Office**

**Reg. No. 3,452,421**

**Registered June 24, 2008**

**SERVICE MARK  
PRINCIPAL REGISTER**

**YOURMEMBERSHIP.COM**

YOURMEMBERSHIP.COM, INC. (FLORIDA  
CORPORATION)  
SUITE 300  
300 FIRST AVENUE SOUTH  
ST. PETERSBURG, FL 33701

FOR: COMPUTER SERVICES, NAMELY, DESIGN, DEVELOPMENT, HOSTING AND MAINTAINING ONLINE WEBSITES FOR THIRD PARTY ORGANIZATIONS, COMMUNITIES AND SIMILAR ENTITIES, IN CLASS 42 (U.S. CLS. 100 AND 101).

FIRST USE 1-31-2000; IN COMMERCE 1-31-2000.

THE MARK CONSISTS OF STANDARD CHARACTERS WITHOUT CLAIM TO ANY PARTICULAR FONT, STYLE, SIZE, OR COLOR.

SEC. 2(F).

SER. NO. 77-207,550, FILED 6-15-2007.

DAWN HAN, EXAMINING ATTORNEY

**Int. Cl.: 41**

**Prior U.S. Cls.: 100, 101 and 107**

**United States Patent and Trademark Office**

**Reg. No. 3,452,422**

**Registered June 24, 2008**

**SERVICE MARK  
PRINCIPAL REGISTER**

**RUBENFELD SYNERGY METHOD**

RUBENFELD CENTER, INC. (NEW YORK CORPORATION)  
104 BUSH STREET  
ASHLAND, OR 97520

FOR: EDUCATIONAL SERVICES, NAMELY, TRAINING PROGRAMS TO DEVELOP SELF-AWARENESS AND WELL-BEING; EDUCATIONAL SERVICES, NAMELY, CONDUCTING CLASSES, SEMINARS, WORKSHOPS, AND TRAINING PROGRAMS IN THE FIELDS OF SELF-AWARENESS AND PERSONAL AWARENESS, AND DISTRIBUTION OF COURSE MATERIAL IN CONNECTION THEREWITH; EDUCATIONAL SERVICES, NAMELY, DEVELOPING, ARRANGING, AND CONDUCTING EDUCATIONAL CONFERENCES AND PROGRAMS AND PROVIDING COURSES OF INSTRUCTION IN THE FIELD OF SELF-AWARENESS AND PERSONAL AWARENESS; CONDUCTING

WORKSHOPS AND SEMINARS IN SELF AWARENESS; CONDUCTING WORKSHOPS AND SEMINARS IN PERSONAL AWARENESS, IN CLASS 41 (U.S. CLS. 100, 101 AND 107).

FIRST USE 11-0-1982; IN COMMERCE 11-0-1982.

THE MARK CONSISTS OF STANDARD CHARACTERS WITHOUT CLAIM TO ANY PARTICULAR FONT, STYLE, SIZE, OR COLOR.

NO CLAIM IS MADE TO THE EXCLUSIVE RIGHT TO USE "METHOD", APART FROM THE MARK AS SHOWN.

SER. NO. 77-207,734, FILED 6-15-2007.

PAUL F. GAST, EXAMINING ATTORNEY

**Int. Cl.: 16**

**Prior U.S. Cls.: 2, 5, 22, 23, 29, 37, 38 and 50**

**Reg. No. 3,452,423**

**United States Patent and Trademark Office**

**Registered June 24, 2008**

**TRADEMARK  
PRINCIPAL REGISTER**



PALMER, PAMELA R. (TENNESSEE SOLE PROPRIETORSHIP)  
212 CHEEKWOOD CT  
FRANKLIN, TN 37069

THE MARK CONSISTS OF THE WORDS "MEMORY CLOTHES PLANNER" IN A CIRCULAR ARRAY TRISECTED BY ELEMENTS OF A STYLIZED CLOTHES HANGER.

FOR: PAPER HANG TAGS, IN CLASS 16 (U.S. CLS. 2, 5, 22, 23, 29, 37, 38 AND 50).

FIRST USE 2-21-2007; IN COMMERCE 2-21-2007.

SER. NO. 77-208,399, FILED 6-18-2007.

NO CLAIM IS MADE TO THE EXCLUSIVE RIGHT TO USE "CLOTHES", APART FROM THE MARK AS SHOWN.

SANDRA MANIOS, EXAMINING ATTORNEY

Int. Cl.: 25

Prior U.S. Cls.: 22 and 39

United States Patent and Trademark Office

Reg. No. 3,452,424

Registered June 24, 2008

TRADEMARK  
PRINCIPAL REGISTER



KENAN ENTERPRISES INTERNATIONAL INC.  
(CANADA CORPORATION)  
342 EAST KENT AVE. SOUTH, SUITE 104  
VANCOUVER, BRITISH COLUMBIA V5X 4N6

FOR: LINGERIE, SLEEPWEAR, LOUNGEWEAR,  
UNDERWEAR, ROBES, FOUNDATION GAR-  
MENTS, SHIRTS, BLOUSES, PANTS, JACKETS,  
JUMPSUITS, GOWNS AND COATS , IN CLASS 25  
(U.S. CLS. 22 AND 39).

FIRST USE 9-2-2006; IN COMMERCE 3-1-2007.

THE MARK CONSISTS OF THE LETTERS "NK"  
APPEAR FOLLOWED BY THE WORD "ROMANCE"  
IN A CURSIVE FONT.

SER. NO. 77-208,611, FILED 6-18-2007.

INGRID C. EULIN, EXAMINING ATTORNEY

Int. Cl.: 20

Prior U.S. Cls.: 2, 13, 22, 25, 32 and 50

Reg. No. 3,452,425

United States Patent and Trademark Office

Registered June 24, 2008

TRADEMARK  
PRINCIPAL REGISTER

TRADE SECRETS  
FOR THE HOME

FELLER MARK M. (UNITED STATES INDIVIDUAL)  
8615 SHERWOOD DRIVE  
WEST HOLLYWOOD, CA 90069 AND  
STELOFF ROBERT (UNITED STATES INDIVIDUAL)  
8615 SHERWOOD DRIVE  
WEST HOLLYWOOD, CA 90069

FOR: BEDROOM FURNITURE; BUMPER GUARDS FOR FURNITURE; CABINETS; CARPET COASTERS FOR PROTECTING FURNITURE LEGS; CAST STONE HOUSEHOLD AND GARDEN FURNITURE; COMPUTER FURNITURE; CUSHIONS; DINNER WAGONS; DOORS FOR FURNITURE; DRAFTING TABLES; ENTERTAINMENT CENTERS; FITTED FABRIC FURNITURE COVERS; FITTED FURNITURE COVER NOT OF FABRIC; FURNITURE; FURNITURE CHESTS; FURNITURE FOR CAMPING; FURNITURE FOR DISPLAYING GOODS; FURNITURE FOR HOUSE, OFFICE AND GARDEN; FURNITURE FRAMES; FURNITURE HARDWARE, NAMELY, DRAWER SLIDES; FURNITURE MADE FROM STEEL TUBING; FURNITURE MOLDINGS; FURNITURE PARTITIONS; FURNITURE PARTS; FURNITURE PARTS, NAMELY, TABLE TOPS, LEG TURNINGS; FURNITURE PARTS, NAMELY, COUNTERTOPS; FURNITURE, NAMELY, DISPLAY UNITS; FURNITURE, NAMELY, DRESSERS; FURNITURE, NAMELY, SALES AND DISPLAY COUNTERS; FURNITURE, NAMELY, WALL UNITS; FURNITURE, NAMELY, WARD-

ROBES; INDOOR WINDOW BLINDS; KITCHEN FURNITURE, NAMELY, READY TO ASSEMBLE MOBILE KITCHEN ISLANDS; LAWN FURNITURE; LIVING ROOM FURNITURE; MIRRORS; NON-METAL HANDLES FOR CLOSETS, DOORS, DRAWERS; OFFICE FURNITURE; OUTDOOR FURNITURE; PLASTIC FURNITURE FOR GARDENS; RECLINERS; SCREENS; SEATING FURNITURE; SEATS; STONE FURNITURE; TABLES; TOOL BOXES NOT OF METAL; TOWEL CLOSETS; TOY BOXES; WASHSTANDS, IN CLASS 20 (U.S. CLS. 2, 13, 22, 25, 32 AND 50).

FIRST USE 6-1-2004; IN COMMERCE 1-1-2005.

NO CLAIM IS MADE TO THE EXCLUSIVE RIGHT TO USE "HOME", APART FROM THE MARK AS SHOWN.

THE COLOR(S) BLACK AND RED IS/ARE CLAIMED AS A FEATURE OF THE MARK.

THE MARK CONSISTS OF "TRADE SECRETS" STYLIZED LETTERS BLACK OUTLINE AND RED INSIDE.

SER. NO. 77-209,182, FILED 6-19-2007.

WARREN L. OLANDRIA, EXAMINING ATTORNEY

**Int. Cls.: 9 and 10**

**Prior U.S. Cls.: 21, 23, 26, 36, 38, 39 and 44**

**United States Patent and Trademark Office**

**Reg. No. 3,452,426**

**Registered June 24, 2008**

**TRADEMARK  
PRINCIPAL REGISTER**

**WAVETEC**

WAVETEC VISION SYSTEMS, INC. (DELAWARE CORPORATION)

#170

66 ARGONAUT

ALISO VIEJO, CA 92656

FOR: COMPUTER SOFTWARE AND HARDWARE FOR USE IN TAKING, PROCESSING, RECORDING, STORING AND TRANSMITTING OPTICAL MEASUREMENTS; COMPUTER SOFTWARE AND HARDWARE FOR PERFORMING OPTICAL DIAGNOSTICS, IN CLASS 9 (U.S. CLS. 21, 23, 26, 36 AND 38).

FIRST USE 8-0-2006; IN COMMERCE 8-0-2006.

FOR: OPHTHALMIC AND OPTOMETRIC INSTRUMENTS FOR TAKING, PROCESSING, RE-

CORDING, STORING AND TRANSMITTING OPTICAL MEASUREMENTS AND PERFORMING DIAGNOSTIC TESTS; LASERS FOR OPHTHALMIC AND OPTOMETRIC USE, IN CLASS 10 (U.S. CLS. 26, 39 AND 44).

FIRST USE 8-0-2006; IN COMMERCE 8-0-2006.

THE MARK CONSISTS OF STANDARD CHARACTERS WITHOUT CLAIM TO ANY PARTICULAR FONT, STYLE, SIZE, OR COLOR.

SER. NO. 77-209,416, FILED 6-19-2007.

KRISTINA MORRIS, EXAMINING ATTORNEY

**Int. Cl.: 10**

**Prior U.S. Cls.: 26, 39 and 44**

**United States Patent and Trademark Office**

**Reg. No. 3,452,427**

**Registered June 24, 2008**

**TRADEMARK  
PRINCIPAL REGISTER**

**CRYOCYTE**

BAXTER INTERNATIONAL INC. (DELAWARE  
CORPORATION)  
LAW DEPARTMENT  
ONE BAXTER PARKWAY  
DEERFIELD, IL 60015

THE MARK CONSISTS OF STANDARD CHAR-  
ACTERS WITHOUT CLAIM TO ANY PARTICULAR  
FONT, STYLE, SIZE, OR COLOR.

FOR: CONTAINER FOR FREEZING AND STOR-  
ING OF BLOOD COMPONENTS, IN CLASS 10 (U.S.  
CLS. 26, 39 AND 44).

SER. NO. 77-209,594, FILED 6-19-2007.

FIRST USE 9-2-1970; IN COMMERCE 9-2-1970.

PAUL E. FAHRENKOPF, EXAMINING ATTORNEY



**Int. Cl.: 9**

**Prior U.S. Cls.: 21, 23, 26, 36 and 38**

**Reg. No. 3,452,428**

**United States Patent and Trademark Office**

**Registered June 24, 2008**

**TRADEMARK  
PRINCIPAL REGISTER**

**TIGRIS**

GEN-PROBE INCORPORATED (DELAWARE CORPORATION)  
10210 GENETIC CENTER DRIVE  
SAN DIEGO, CA 92121

FOR: COMPUTER SOFTWARE FOR THE OPERATION OF AN AUTOMATED IN VITRO DIAGNOSTIC SPECIMEN TEST ANALYZER; COMPUTER SOFTWARE FOR THE ORGANIZATION, ANALYSIS AND REPORTING OF IN VITRO DIAGNOSTIC SPECIMEN TEST DATA, NAMELY, DATA PROCESSING SOFTWARE; ELECTRONIC PUBLICATIONS, NAMELY, INSTRUMENT AND SOFTWARE MANUALS, AND QUICK REFERENCE GUIDES RECORDED ON COMPUTER MEDIA; AUTOMATED IN VITRO DIAGNOSTIC INSTRUMENT SYSTEM FOR THE ASSAY OF BIOLOGICAL SPECIMENS COM-

PRISED OF ASSAY PROCESSING UNIT, WORKSTATION CONTROL UNIT, AND POWER SUPPLY, AND PARTS THEREFOR, ALL FOR LABORATORY USE, IN CLASS 9 (U.S. CLS. 21, 23, 26, 36 AND 38).

FIRST USE 4-14-2003; IN COMMERCE 4-14-2003.

THE MARK CONSISTS OF STANDARD CHARACTERS WITHOUT CLAIM TO ANY PARTICULAR FONT, STYLE, SIZE, OR COLOR.

OWNER OF U.S. REG. NO. 2,780,355.

SER. NO. 77-209,729, FILED 6-19-2007.

ELIZABETH KAJUBI, EXAMINING ATTORNEY

**Int. Cls.: 9, 16, 38 and 41**

**Prior U.S. Cls.: 2, 5, 21, 22, 23, 26, 29, 36, 37, 38, 50,  
100, 101, 104 and 107**

**Reg. No. 3,452,429**

**United States Patent and Trademark Office**

**Registered June 24, 2008**

**TRADEMARK  
SERVICE MARK  
PRINCIPAL REGISTER**

**TOM HOPKINS**

TOM HOPKINS INTERNATIONAL, INC. (ARIZONA CORPORATION)  
7531 EAST SECOND STREET  
SCOTTSDALE, AZ 85251

FOR: PRE-RECORDED CDS, DVDS, AND CASSETTE TAPES IN THE FIELDS OF SALES TRAINING, PERSONAL MOTIVATION, GOAL SETTING AND ACHIEVEMENT, AND SELF ESTEEM; AND ELECTRONIC PUBLICATIONS, NAMELY, DOWNLOADABLE BOOKS, WORKBOOKS, AND MANUALS IN THE FIELDS OF SALES TRAINING, PERSONAL MOTIVATION, GOAL SETTING AND ACHIEVEMENT, AND SELF ESTEEM, AND ELECTRONIC WORKBOOKS AND MANUALS IN THE FIELDS OF SALES TRAINING, PERSONAL MOTIVATION, GOAL SETTING AND ACHIEVEMENT, AND SELF ESTEEM RECORDED ON COMPUTER MEDIA, IN CLASS 9 (U.S. CLS. 21, 23, 26, 36 AND 38).

FIRST USE 2-28-1976; IN COMMERCE 2-28-1976.

FOR: PRINTED PUBLICATIONS, NAMELY, BOOKS, WORKBOOKS, AND MANUALS IN THE FIELDS OF SALES TRAINING, PERSONAL MOTIVATION, GOAL SETTING AND ACHIEVEMENT, AND SELF ESTEEM, IN CLASS 16 (U.S. CLS. 2, 5, 22, 23, 29, 37, 38 AND 50).

FIRST USE 2-28-1976; IN COMMERCE 2-28-1976.

FOR: AUDIO AND VIDEO BROADCASTING SERVICES OVER THE INTERNET; AND STREAMING OF AUDIO AND VIDEO CONTENT ON THE INTERNET, IN CLASS 38 (U.S. CLS. 100, 101 AND 104).

FIRST USE 10-31-2006; IN COMMERCE 10-31-2006.

FOR: CONDUCTING SEMINARS IN THE FIELDS OF SALES TRAINING, MANAGEMENT TRAINING, PERSONAL MOTIVATION, GOAL SETTING AND ACHIEVEMENT, AND SELF ESTEEM, IN CLASS 41 (U.S. CLS. 100, 101 AND 107).

FIRST USE 2-28-1976; IN COMMERCE 2-28-1976.

THE MARK CONSISTS OF STANDARD CHARACTERS WITHOUT CLAIM TO ANY PARTICULAR FONT, STYLE, SIZE, OR COLOR.

THE NAME(S), PORTRAIT(S), AND/OR SIGNATURE(S) SHOWN IN THE MARK IDENTIFIES "THOMAS HOPKINS", WHOSE CONSENT(S) TO REGISTER IS SUBMITTED.

SER. NO. 77-209,885, FILED 6-19-2007.

ERIN FALK, EXAMINING ATTORNEY

**Int. Cl.: 28**

**Prior U.S. Cls.: 22, 23, 38 and 50**

**United States Patent and Trademark Office**

**Reg. No. 3,452,430**

**Registered June 24, 2008**

**TRADEMARK  
PRINCIPAL REGISTER**

**AGNES VON WEISS**

INTEGRITY TOYS, INC. (NEW JERSEY CORPORATION)  
100 CHESTNUT SPRINGS ROAD  
CHESAPEAKE CITY, MD 21915

FOR: DOLLS, IN CLASS 28 (U.S. CLS. 22, 23, 38 AND 50).

FIRST USE 10-31-2006; IN COMMERCE 10-31-2006.

THE MARK CONSISTS OF STANDARD CHARACTERS WITHOUT CLAIM TO ANY PARTICULAR FONT, STYLE, SIZE, OR COLOR.

THE NAME "AGNES VON WEISS" DOES NOT IDENTIFY A LIVING INDIVIDUAL.

SER. NO. 77-210,166, FILED 6-19-2007.

CHRISTINE COOPER, EXAMINING ATTORNEY

**Int. Cl.: 1**

**Prior U.S. Cls.: 1, 5, 6, 10, 26 and 46**

**Reg. No. 3,452,431**

**United States Patent and Trademark Office**

**Registered June 24, 2008**

**TRADEMARK  
PRINCIPAL REGISTER**

**FLORALIFE THE CARE AND  
HANDLING EXPERTS**

FLORALIFE, INC. (SOUTH CAROLINA COR-  
PORATION)  
SUITE 301  
2020 FRONT STREET  
CUYAHOGA FALLS, OH 44221

FOR: PREPARATIONS FOR MAINTAINING THE  
LIFE AND BEAUTY OF CUT FLOWERS; PREPARA-  
TIONS FOR THE HYDRATION AND PRE-TREAT-  
MENT OF FRESH CUT FLOWERS , IN CLASS 1 (U.S.  
CLS. 1, 5, 6, 10, 26 AND 46).

FIRST USE 1-1-1990; IN COMMERCE 1-1-1990.

THE MARK CONSISTS OF STANDARD CHAR-  
ACTERS WITHOUT CLAIM TO ANY PARTICULAR  
FONT, STYLE, SIZE, OR COLOR.

OWNER OF U.S. REG. NOS. 366,178, 2,009,496,  
AND 2,957,771.

SEC. 2(F) AS TO "THE CARE AND HANDLING  
EXPERTS".

SER. NO. 77-210,552, FILED 6-20-2007.

ALICE SUE CARRUTHERS, EXAMINING ATTOR-  
NEY

Int. Cl.: 5

Prior U.S. Cls.: 6, 18, 44, 46, 51 and 52

United States Patent and Trademark Office

Reg. No. 3,452,432

Registered June 24, 2008

TRADEMARK  
PRINCIPAL REGISTER

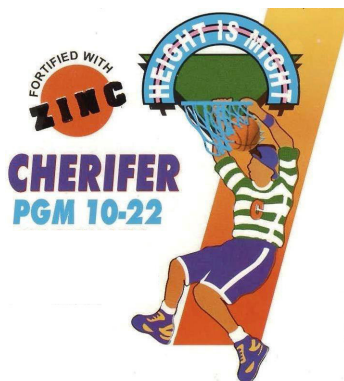

GRUPPO MEDICA, INCORPORATED (PHILIPPINES CORPORATION)  
INDUSTRYST.,MADRIGAL BUS.PK.AYALAALABANG  
16/F, THE PARAGON CORPORATE CENTRE  
MUNTINLUPA CITY, PHILIPPINES

FOR: VITAMINS; FOOD SUPPLEMENTS, IN CLASS 5 (U.S. CLS. 6, 18, 44, 46, 51 AND 52).

FIRST USE 6-30-1996; IN COMMERCE 10-31-2006.

NO CLAIM IS MADE TO THE EXCLUSIVE RIGHT TO USE "FORTIFIED WITH ZINC" AND "10-22", APART FROM THE MARK AS SHOWN.

THE COLOR(S) BLACK, WHITE, BLUE, ORANGE, PURPLE, BEIGE, TAN, GREEN, BROWN, LIGHT ORANGE, AND PINK IS/ARE CLAIMED AS A FEATURE OF THE MARK.

THE MARK CONSISTS OF THE WORD "CHERIFER" IN PURPLE, "PGM" AND "10-22" IN BLUE, "FORTIFIED WITH ZINC" IN BLACK WITH AN ORANGE CIRCLE UNDER "FORTIFIED WITH" AND BEHIND "ZINC", AND A DESIGN OF A BOY

WITH TAN SKIN, PURPLE SHORTS WITH A WHITE VERTICAL STRIPE ALONG THE SIDE AND BOTTOM TRIM, WHITE SOCKS, PURPLE SNEAKERS WITH BEIGE HEEL, ARCH AND LACE TRIM, A WHITE SHIRT WITH GREEN HORIZONTAL STRIPES WITH THE LETTER "C" IN ORANGE, A PURPLE CAP AND WRISTBAND ON THE LEFT WRIST, THE BOY HOLDING ON TO A BLUE BASKETBALL HOOP WITH A BLUE NET, WITH A BROWN BASKETBALL UNDER THE HOOP AS IF DUNKED THROUGH THE HOOP, WITH A GREEN TRIANGLE BEHIND THE HOOP WITH BLACK SHADING AT THE BOTTOM EDGES AS IF A SHADOW, WITH AN ARCH SUPERIMPOSED ON SAID TRIANGLE IN BLUE WITH A PINK STRIPE ALONG THE MIDDLE OF SAID ARCH, WITH THE WORDS "HEIGHT IS MIGHT" IN WHITE SUPERIMPOSED ON THE ARCH, WITH A TRAPEZOID DISPOSED BEHIND THE BOY AND THE TRIANGLE COLORED IN DARKER ORANGE AT THE BOTTOM PORTION AND LIGHTENING TO LIGHT ORANGE AT THE TOP PORTION.

SER. NO. 77-211,540, FILED 6-21-2007.

DANNAN HETZEL, EXAMINING ATTORNEY

Int. Cl.: 44

Prior U.S. Cls.: 100 and 101

United States Patent and Trademark Office

Reg. No. 3,452,433

Registered June 24, 2008

**SERVICE MARK  
PRINCIPAL REGISTER**



VIRTUAL HEALTH SYSTEMS CORPORATION  
(INDIANA CORPORATION)  
2ND FLOOR  
2 EAST MCCLAIN AVENUE  
SCOTTSBURG, IN 47170

FOR: PROVIDING A WEBSITE FEATURING  
HEALTH INFORMATION ACCESSIBLE BY MEDI-  
CAL PERSONNEL AND PATIENTS, IN CLASS 44  
(U.S. CLS. 100 AND 101).

FIRST USE 6-0-2006; IN COMMERCE 6-0-2006.

NO CLAIM IS MADE TO THE EXCLUSIVE  
RIGHT TO USE THE DESIGN OF A CADUCEUS,  
APART FROM THE MARK AS SHOWN.

THE MARK CONSISTS OF A CIRCLE WITH A  
BORDER FORMED WITH A TWO EARS OF  
WHEAT, THE LETTER "V", AND THE GREEK  
LETTER PSI FORMING A CADUCEUS.

SER. NO. 77-211,578, FILED 6-21-2007.

DAVID C. REIHNER, EXAMINING ATTORNEY

**Int. Cl.: 24**

**Prior U.S. Cls.: 42 and 50**

**United States Patent and Trademark Office**

**Reg. No. 3,452,434**

**Registered June 24, 2008**

**TRADEMARK  
PRINCIPAL REGISTER**

**SKYBANNER**

BRITTEN BILLBOARDS, INC. (MICHIGAN CORPORATION)  
2322 CASS ROAD  
TRAVERSE CITY, MI 49686

THE MARK CONSISTS OF STANDARD CHARACTERS WITHOUT CLAIM TO ANY PARTICULAR FONT, STYLE, SIZE, OR COLOR.

FOR: CLOTH BANNERS, IN CLASS 24 (U.S. CLS. 42 AND 50).

SER. NO. 77-212,042, FILED 6-21-2007.

FIRST USE 3-28-2006; IN COMMERCE 3-28-2006.

SUSAN LESLIE DUBOIS, EXAMINING ATTORNEY

**Int. Cls.: 25 and 28**

**Prior U.S. Cls.: 22, 23, 38, 39 and 50**

**United States Patent and Trademark Office**

**Reg. No. 3,452,435**

**Registered June 24, 2008**

**TRADEMARK  
PRINCIPAL REGISTER**



3N2 LLC (COLORADO LTD LIAB CO)  
3300 UNIVERSITY BOULEVARD, SUITE 218  
WINTER PARK, FL 32792

FOR: ATHLETIC FOOTWEAR AND APPAREL  
NAMELY, ATHLETIC SHOES, ATHLETIC UNI-  
FORMS, CAPS, SHIRTS, T-SHIRTS, HATS, POLO  
SHIRTS, SWEATSHIRTS, SWEATERS, VISORS , IN  
CLASS 25 (U.S. CLS. 22 AND 39).

FIRST USE 6-20-2007; IN COMMERCE 6-20-2007.

FOR: SPORT EQUIPMENT NAMELY, BASEBALL  
AND SOFTBALL BATS, GLOVES, BATTING

GLOVES, BASEBALLS AND SOFTBALLS, IN CLASS  
28 (U.S. CLS. 22, 23, 38 AND 50).

FIRST USE 6-20-2007; IN COMMERCE 6-20-2007.

OWNER OF U.S. REG. NO. 2,913,509.

THE MARK CONSISTS OF A STYLIZED NUM-  
BER "2" CONNECTED TO A STYLIZED TWO DI-  
MENSIONAL LETTER "N" AND CONNECTED TO A  
STYLIZED NUMBER "3".

SER. NO. 77-212,765, FILED 6-22-2007.

SHANNON TWOHIG, EXAMINING ATTORNEY



**Int. Cls.: 25 and 28**

**Prior U.S. Cls.: 22, 23, 38, 39 and 50**

**Reg. No. 3,452,436**

**United States Patent and Trademark Office**

**Registered June 24, 2008**

**TRADEMARK  
PRINCIPAL REGISTER**



3N2 LLC (COLORADO LTD LIAB CO)  
3300 UNIVERSITY BOULEVARD, SUITE 218  
WINTER PARK, FL 32792

FOR: ATHLETIC FOOTWEAR AND APPAREL  
NAMESLY, ATHLETIC SHOES, ATHLETIC UNI-  
FORMS, CAPS, SHIRTS, T-SHIRTS, HATS, POLO  
SHIRTS, SWEATSHIRTS, SWEATERS, VISORS , IN  
CLASS 25 (U.S. CLS. 22 AND 39).

FIRST USE 6-20-2007; IN COMMERCE 6-20-2007.

FOR: SPORT EQUIPMENT NAMESLY, BASEBALL  
AND SOFTBALL BATS, GLOVES, BATTING

GLOVES, BASEBALLS AND SOFTBALLS, IN CLASS  
28 (U.S. CLS. 22, 23, 38 AND 50).

FIRST USE 6-20-2007; IN COMMERCE 6-20-2007.

THE MARK CONSISTS OF AN UPSIDE DOWN  
TRIANGLE WITH CURVED SIDES AND AN IN-  
COMPLETE CORNER.

SER. NO. 77-212,777, FILED 6-22-2007.

SHANNON TWOHIG, EXAMINING ATTORNEY

**Int. Cl.: 41**

**Prior U.S. Cls.: 100, 101 and 107**

**United States Patent and Trademark Office**

**Reg. No. 3,452,437**

**Registered June 24, 2008**

**SERVICE MARK  
PRINCIPAL REGISTER**

**Making a positive impact  
in the gay community.  
Make yours.**

OUT IMPACT, INC. (NORTH CAROLINA COR-  
PORATION)  
222 MOHAWK TRAIL  
WILMINGTON, NC 28409

FOR: PROVIDING ONLINE INFORMATION IN  
THE FIELD OF ENTERTAINMENT AND CURRENT  
EVENTS RELATING TO THE GAY COMMUNITY,  
IN CLASS 41 (U.S. CLS. 100, 101 AND 107).

FIRST USE 6-6-2007; IN COMMERCE 6-6-2007.

THE MARK CONSISTS OF STANDARD CHAR-  
ACTERS WITHOUT CLAIM TO ANY PARTICULAR  
FONT, STYLE, SIZE, OR COLOR.

SER. NO. 77-212,844, FILED 6-22-2007.

DANIEL BRODY, EXAMINING ATTORNEY

Int. Cl.: 25

Prior U.S. Cls.: 22 and 39

United States Patent and Trademark Office

Reg. No. 3,452,438

Registered June 24, 2008

TRADEMARK  
PRINCIPAL REGISTER



LEBEDA'S INC. (NEW JERSEY CORPORATION)  
232 OLD SAND ROAD  
FAIRFIELD, NJ 070041500

FOR: MEN'S AND WOMEN'S COATS AND LEATHER BELTS, IN CLASS 25 (U.S. CLS. 22 AND 39).

FIRST USE 2-3-2005; IN COMMERCE 2-3-2005.

OWNER OF U.S. REG. NO. 3,219,755.

NO CLAIM IS MADE TO THE EXCLUSIVE RIGHT TO USE "DESIGNS", APART FROM THE MARK AS SHOWN.

THE COLOR(S) GRAY, YELLOW, BLACK, AND WHITE IS/ARE CLAIMED AS A FEATURE OF THE MARK.

THE WORDS "STAR" AND "DESIGNS" APPEAR IN BLACK WITH GRAY STRIPES AND GRAY AND BLACK OUTLINING; THE OUTER CIRCLE SHAPED DESIGN IS GRAY WITH BLACK OUTLINING AND BLACK STARS; THE LARGE STAR IS YELLOW WITH A WHITE CIRCLE INTERIOR CONTAINING BLACK STARS; THE INTERIOR OF THE OUTER CIRCLE SHAPED DESIGN IS WHITE

SER. NO. 77-213,169, FILED 6-22-2007.

JEAN IM, EXAMINING ATTORNEY

**Int. Cl.: 35**

**Prior U.S. Cls.: 100, 101 and 102**

**United States Patent and Trademark Office**

**Reg. No. 3,452,439**

**Registered June 24, 2008**

**SERVICE MARK  
PRINCIPAL REGISTER**

**SHIPITAPO**

MILITARY MAIL SOLUTIONS, LLC (VIRGINIA  
LTD LIAB CO)  
2007 N. 15TH STREET, SUITE 4  
ARLINGTON, VA 22201

THE MARK CONSISTS OF STANDARD CHAR-  
ACTERS WITHOUT CLAIM TO ANY PARTICULAR  
FONT, STYLE, SIZE, OR COLOR.

FOR: ARRANGING FOR PARCEL DELIVERY, IN  
CLASS 35 (U.S. CLS. 100, 101 AND 102).

SER. NO. 77-213,276, FILED 6-22-2007.

FIRST USE 10-16-2000; IN COMMERCE 10-16-2000.

SUSAN RICHARDS, EXAMINING ATTORNEY

**Int. Cl.: 35**

**Prior U.S. Cls.: 100, 101 and 102**

**United States Patent and Trademark Office**

**Reg. No. 3,452,440**

**Registered June 24, 2008**

**SERVICE MARK  
PRINCIPAL REGISTER**

SHOP ANYWHERE, SHIPITAPO

MILITARY MAIL SOLUTIONS, LLC (VIRGINIA  
LTD LIAB CO)  
2007 N. 15TH STREET, SUITE 4  
ARLINGTON, VA 22201

THE MARK CONSISTS OF STANDARD CHAR-  
ACTERS WITHOUT CLAIM TO ANY PARTICULAR  
FONT, STYLE, SIZE, OR COLOR.

FOR: ARRANGING FOR PARCEL DELIVERY, IN  
CLASS 35 (U.S. CLS. 100, 101 AND 102).

SER. NO. 77-213,306, FILED 6-22-2007.

FIRST USE 6-11-2007; IN COMMERCE 6-11-2007.

SUSAN RICHARDS, EXAMINING ATTORNEY

**Int. Cl.: 35**

**Prior U.S. Cls.: 100, 101 and 102**

**United States Patent and Trademark Office**

**Reg. No. 3,452,441**

**Registered June 24, 2008**

**SERVICE MARK  
PRINCIPAL REGISTER**



MILITARY MAIL SOLUTIONS, LLC (VIRGINIA  
LTD LIAB CO)  
2007 N. 15TH STREET, SUITE 4  
ARLINGTON, VA 22201

THE MARK CONSISTS OF LOGO DEPICTING  
STACKED BOXES IN A RIGHT TRIANGULAR  
DESIGN. THE MARK IS NOT IN COLOR.

FOR: ARRANGING FOR PARCEL DELIVERY, IN  
CLASS 35 (U.S. CLS. 100, 101 AND 102).

SER. NO. 77-213,308, FILED 6-22-2007.

FIRST USE 7-1-2005; IN COMMERCE 7-1-2005.

SUSAN RICHARDS, EXAMINING ATTORNEY

**Int. Cl.: 35**

**Prior U.S. Cls.: 100, 101 and 102**

**United States Patent and Trademark Office**

**Reg. No. 3,452,442**

**Registered June 24, 2008**

**SERVICE MARK  
PRINCIPAL REGISTER**



MILITARY MAIL SOLUTIONS, LLC (VIRGINIA  
LTD LIAB CO)  
2007 N. 15TH STREET, SUITE 4  
ARLINGTON, VA 22201

THE MARK CONSISTS OF A LOGO DEPICTING  
A RUNNING HUMAN FIGURE, WITH AN ARROW  
FOR ARMS, HOLDING A BOX. THE MARK IS NOT  
IN COLOR.

FOR: ARRANGING FOR PARCEL DELIVERY, IN  
CLASS 35 (U.S. CLS. 100, 101 AND 102).

SER. NO. 77-213,321, FILED 6-22-2007.

FIRST USE 7-1-2005; IN COMMERCE 7-1-2005.

SUSAN RICHARDS, EXAMINING ATTORNEY

**Int. Cl.: 41**

**Prior U.S. Cls.: 100, 101 and 107**

**United States Patent and Trademark Office**

**Reg. No. 3,452,443**

**Registered June 24, 2008**

**SERVICE MARK  
PRINCIPAL REGISTER**

**STUDENT PLACE**

EPALS, INC. (DELAWARE CORPORATION)  
13625-A DULLES TECHNOLOGY DRIVE  
HERNDON, VA 20171

FOR: PROVIDING EDUCATIONAL SERVICES, NAMELY, ORGANIZING AND CONDUCTING EDUCATIONAL PROGRAMS FEATURING PEN PAL, READING, WRITING, RESEARCH AND CRITICAL THINKING PROGRAMS, TEACHER TRAINING AND DEVELOPMENT, LITERACY DEVELOPMENT, STUDENT ASSESSMENT AND PROGRAM ASSESSMENT PROGRAMS VIA CLASSROOM INSTRUCTION AND VIA A GLOBAL COMMUNICATIONS NETWORK, IN CLASS 41 (U.S. CLS. 100, 101 AND 107).

FIRST USE 6-30-2004; IN COMMERCE 6-30-2004.

THE MARK CONSISTS OF STANDARD CHARACTERS WITHOUT CLAIM TO ANY PARTICULAR FONT, STYLE, SIZE, OR COLOR.

OWNER OF U.S. REG. NO. 3,233,941.

NO CLAIM IS MADE TO THE EXCLUSIVE RIGHT TO USE "STUDENT", APART FROM THE MARK AS SHOWN.

SER. NO. 77-213,448, FILED 6-22-2007.

LINDA M. KING, EXAMINING ATTORNEY



**Int. Cl.: 25**

**Prior U.S. Cls.: 22 and 39**

**United States Patent and Trademark Office**

**Reg. No. 3,452,444**

**Registered June 24, 2008**

**TRADEMARK  
PRINCIPAL REGISTER**

# Cowgirl Attitude

NEWCOMBE, PATRICIA G. (UNITED STATES  
INDIVIDUAL)  
12188 CENTRAL AVENUE #623  
CHINO, CA 91710

FOR: SHIRTS; BLOUSES; JACKETS; PANTS;  
SHORTS; DRESSES; NIGHTIES; PAJAMAS; VISORS;  
CAPS; HATS; SHOES; BOOTS; SOCKS, IN CLASS 25  
(U.S. CLS. 22 AND 39).

FIRST USE 10-1-2004; IN COMMERCE 12-7-2004.

THE MARK CONSISTS OF STANDARD CHAR-  
ACTERS WITHOUT CLAIM TO ANY PARTICULAR  
FONT, STYLE, SIZE, OR COLOR.

OWNER OF U.S. REG. NO. 3,146,737.

SER. NO. 77-213,897, FILED 6-23-2007.

ANDREA K. NADELMAN, EXAMINING ATTOR-  
NEY

**Int. Cl.: 3**

**Prior U.S. Cls.: 1, 4, 6, 50, 51 and 52**

**United States Patent and Trademark Office**

**Reg. No. 3,452,445**

**Registered June 24, 2008**

**TRADEMARK  
PRINCIPAL REGISTER**



*nurigene*

AVICENA GROUP, INC. (DELAWARE CORPORATION)  
228 HAMILTON AVENUE, 3RD FLOOR  
PALO ALTO, CA 94301

FOR: COSMETIC PREPARATIONS FOR BODY CARE, IN CLASS 3 (U.S. CLS. 1, 4, 6, 50, 51 AND 52).

FIRST USE 9-19-2007; IN COMMERCE 9-19-2007.

THE COLOR(S) BLACK, DARK GREEN, LIGHT GREEN, LIGHT PURPLE AND WHITE. IS/ARE CLAIMED AS A FEATURE OF THE MARK.

THE MARK CONSISTS OF THE WORD "NURIGENE" IN BLACK LETTERS BELOW A RECTANGULAR DESIGN THAT IS OUTLINED IN DARK GREEN ON TWO SIDES AND LIGHT GREEN ON TWO SIDES, THE INTERIOR OF THE RECTANGLE IS WHITE WITH LIGHT GREEN CIRCLES AND HEXAGONS WITHIN THE RECTANGLE THAT ARE DARK GREEN, LIGHT GREEN AND LIGHT PURPLE.

SER. NO. 77-214,949, FILED 6-25-2007.

CHRISTOPHER BUONGIORNO, EXAMINING ATTORNEY

**Int. Cl.: 17**

**Prior U.S. Cls.: 1, 5, 12, 13, 35 and 50**

**United States Patent and Trademark Office**

**Reg. No. 3,452,446**

**Registered June 24, 2008**

**TRADEMARK  
PRINCIPAL REGISTER**

**WET N STICK**

WET-N-STICK, LLC (NEW JERSEY LTD LIAB  
CO)  
120 ARLINGTON AVENUE  
BLOOMFIELD, NJ 07003

FOR: WALLBOARD JOINT TAPE, IN CLASS 17  
(U.S. CLS. 1, 5, 12, 13, 35 AND 50).

FIRST USE 7-1-2004; IN COMMERCE 7-1-2004.

THE MARK CONSISTS OF STANDARD CHAR-  
ACTERS WITHOUT CLAIM TO ANY PARTICULAR  
FONT, STYLE, SIZE, OR COLOR.

OWNER OF U.S. REG. NO. 3,111,021.

SER. NO. 77-215,158, FILED 6-25-2007.

CHRISTOPHER BUONGIORNO, EXAMINING AT-  
TORNEY

**Int. Cls.: 9, 40 and 42**

**Prior U.S. Cls.: 21, 23, 26, 36, 38, 100, 101, 103 and 106**

**Reg. No. 3,452,447**

**United States Patent and Trademark Office**

**Registered June 24, 2008**

**TRADEMARK  
SERVICE MARK  
PRINCIPAL REGISTER**

**SIGMA**

SIGMA PLASTIC SERVICES, INC. (ILLINOIS CORPORATION)  
SUITE 425  
10 N. MARTINGALE ROAD  
SCHAUMBURG, IL 60173

FOR: COMPUTER SOFTWARE USED FOR PROCESS ANALYSIS IN CONNECTION WITH PLASTIC TECHNOLOGIES, IN CLASS 9 (U.S. CLS. 21, 23, 26, 36 AND 38).

FIRST USE 1-1-2001; IN COMMERCE 1-1-2001.

FOR: CONSULTING SERVICES IN THE FIELD OF THE MANUFACTURE OF PLASTIC TECHNOLOGIES, IN CLASS 40 (U.S. CLS. 100, 103 AND 106).

FIRST USE 1-1-2001; IN COMMERCE 1-1-2001.

FOR: CONSULTING SERVICES IN THE FIELD OF DESIGN AND ENGINEERING OF PLASTIC TECHNOLOGIES, IN CLASS 42 (U.S. CLS. 100 AND 101).

FIRST USE 1-1-2001; IN COMMERCE 1-1-2001.

THE MARK CONSISTS OF STANDARD CHARACTERS WITHOUT CLAIM TO ANY PARTICULAR FONT, STYLE, SIZE, OR COLOR.

SER. NO. 77-215,447, FILED 6-26-2007.

PAM WILLIS, EXAMINING ATTORNEY

**Int. Cl.: 14**

**Prior U.S. Cls.: 2, 27, 28 and 50**

**United States Patent and Trademark Office**

**Reg. No. 3,452,448**

**Registered June 24, 2008**

**TRADEMARK  
PRINCIPAL REGISTER**

# NextDay Watches

NEXTDAY WATCHES (NEW JERSEY CORPORATION)  
140-D COMMERCE WAY  
TOTOWA, NJ 07512

FOR: JEWELRY WATCHES; WATCHES; WRIST WATCHES; DIVING WATCHES; WATCH BRACELETS, IN CLASS 14 (U.S. CLS. 2, 27, 28 AND 50).

FIRST USE 6-26-2007; IN COMMERCE 6-26-2007.

THE MARK CONSISTS OF STANDARD CHARACTERS WITHOUT CLAIM TO ANY PARTICULAR FONT, STYLE, SIZE, OR COLOR.

NO CLAIM IS MADE TO THE EXCLUSIVE RIGHT TO USE "WATCHES", APART FROM THE MARK AS SHOWN.

SER. NO. 77-215,627, FILED 6-26-2007.

SHANNON TWOHIG, EXAMINING ATTORNEY

**Int. Cl.: 42**

**Prior U.S. Cls.: 100 and 101**

**United States Patent and Trademark Office**

**Reg. No. 3,452,449**

**Registered June 24, 2008**

**SERVICE MARK  
PRINCIPAL REGISTER**

**FAMNET Telecommunications  
Network (FTN)**

HUMAN RESOURCES TECHNOLOGIES, INC.  
(VIRGINIA CORPORATION)  
SUITE 302B  
6416 GROVEDALE DRIVE  
ALEXANDRIA, VA 22310

FOR: COMPUTER SERVICE, NAMELY, ACTING AS AN APPLICATION SERVICE PROVIDER IN THE FIELD OF KNOWLEDGE MANAGEMENT TO HOST COMPUTER APPLICATION SOFTWARE FOR THE COLLECTION, EDITING, ORGANIZING, MODIFYING, BOOK MARKING, TRANSMISSION, STORAGE AND SHARING OF DATA AND INFORMATION, IN CLASS 42 (U.S. CLS. 100 AND 101).

FIRST USE 5-0-1989; IN COMMERCE 5-0-1989.

THE MARK CONSISTS OF STANDARD CHARACTERS WITHOUT CLAIM TO ANY PARTICULAR FONT, STYLE, SIZE, OR COLOR.

OWNER OF U.S. REG. NO. 2,191,863.

NO CLAIM IS MADE TO THE EXCLUSIVE RIGHT TO USE "TELECOMMUNICATIONS NETWORK", APART FROM THE MARK AS SHOWN.

SER. NO. 77-215,695, FILED 6-26-2007.

CAROLYN CATALDO, EXAMINING ATTORNEY

**Int. Cl.: 38**

**Prior U.S. Cls.: 100, 101 and 104**

**United States Patent and Trademark Office**

**Reg. No. 3,452,450**

**Registered June 24, 2008**

**SERVICE MARK  
PRINCIPAL REGISTER**

**FAMNET Secure  
Telecommunications Network  
(FSTN)**

HUMAN RESOURCES TECHNOLOGIES, INC.  
(VIRGINIA CORPORATION)  
SUITE 302B  
6416 GROVEDALE DRIVE  
ALEXANDRIA, VA 22310

FOR: PROVIDING MULTIPLE USE ACCESS TO GLOBAL COMPUTER INFORMATION NETWORKS FOR THE TRANSFER AND DISSEMINATION OF A WIDE RANGE OF INFORMATION; PROVIDING PRIVATE AND SECURE REAL TIME ELECTRONIC COMMUNICATION OVER A COMPUTER NETWORK, IN CLASS 38 (U.S. CLS. 100, 101 AND 104).

FIRST USE 5-0-1989; IN COMMERCE 5-0-1989.

THE MARK CONSISTS OF STANDARD CHARACTERS WITHOUT CLAIM TO ANY PARTICULAR FONT, STYLE, SIZE, OR COLOR.

OWNER OF U.S. REG. NO. 2,191,863.

NO CLAIM IS MADE TO THE EXCLUSIVE RIGHT TO USE "SECURE TELECOMMUNICATIONS NETWORK", APART FROM THE MARK AS SHOWN.

SER. NO. 77-215,819, FILED 6-26-2007.

EMILY CARLSEN, EXAMINING ATTORNEY

**Int. Cl.: 36**

**Prior U.S. Cls.: 100, 101 and 102**

**United States Patent and Trademark Office**

**Reg. No. 3,452,451**

**Registered June 24, 2008**

**SERVICE MARK  
PRINCIPAL REGISTER**

**REAVES**

W.H. REAVES & COMPANY (DELAWARE CORPORATION)  
10 EXCHANGE PLACE  
JERSEY CITY, NJ 07302

FOR: FINANCIAL SERVICES, NAMELY, FINANCIAL INVESTMENT SERVICES RELATING TO THE MANAGEMENT OF MUTUAL FUNDS, STOCKS, AND BONDS; ASSET MANAGEMENT SERVICES; INVESTMENT MANAGEMENT SERVICES AND INVESTMENT ADVISORY AND MUTUAL FUND SERVICES, NAMELY, MUTUAL FUND BROKERAGE, DISTRIBUTION AND INVESTMENT SERVICES; MANAGING FUNDS, STOCKS, BONDS, AND OTHER INVESTMENTS FOR INSTITUTIONS AND THE GENERAL PUBLIC; AND CONSULTING SER-

VICES RELATING TO THE SALE OF MUTUAL FUNDS, STOCKS, BONDS, AND OTHER INVESTMENTS TO INSTITUTIONS AND THE GENERAL PUBLIC, IN CLASS 36 (U.S. CLS. 100, 101 AND 102).

FIRST USE 0-0-1961; IN COMMERCE 0-0-1961.

THE MARK CONSISTS OF STANDARD CHARACTERS WITHOUT CLAIM TO ANY PARTICULAR FONT, STYLE, SIZE, OR COLOR.

SER. NO. 77-215,832, FILED 6-26-2007.

JACLYN KIDWELL, EXAMINING ATTORNEY



**Int. Cl.: 45**

**Prior U.S. Cls.: 100 and 101**

**United States Patent and Trademark Office**

**Reg. No. 3,452,452**

**Registered June 24, 2008**

**SERVICE MARK  
PRINCIPAL REGISTER**

**PEACE OF MIND PROGRAM**

CLARK, PERDUE, ARNOLD & SCOTT CO.,  
L.P.A. (OHIO CORPORATION)

471 EAST BROAD STREET, SUITE 1400

COLUMBUS, OH 43215

FOR: LEGAL SERVICES, IN CLASS 45 (U.S. CLS.  
100 AND 101).

FIRST USE 5-18-2007; IN COMMERCE 5-30-2007.

THE MARK CONSISTS OF STANDARD CHAR-  
ACTERS WITHOUT CLAIM TO ANY PARTICULAR  
FONT, STYLE, SIZE, OR COLOR.

NO CLAIM IS MADE TO THE EXCLUSIVE  
RIGHT TO USE "PROGRAM", APART FROM THE  
MARK AS SHOWN.

SER. NO. 77-216,457, FILED 6-27-2007.

KEVIN CORWIN, EXAMINING ATTORNEY

**Int. Cl.: 42**

**Prior U.S. Cls.: 100 and 101**

**United States Patent and Trademark Office**

**Reg. No. 3,452,453**

**Registered June 24, 2008**

**SERVICE MARK  
PRINCIPAL REGISTER**

# MASTER PLAN

BUSH INDUSTRIES, INC. (DELAWARE CORPORATION)  
ONE MASON DRIVE, P.O. BOX 460  
JAMESTOWN, NY 147020460

THE MARK CONSISTS OF STANDARD CHARACTERS WITHOUT CLAIM TO ANY PARTICULAR FONT, STYLE, SIZE, OR COLOR.

FOR: DESIGNING OFFICE SPACE FOR OTHERS USING AN INTERACTIVE GLOBAL COMPUTER NETWORK, IN CLASS 42 (U.S. CLS. 100 AND 101).

SER. NO. 77-216,584, FILED 6-27-2007.

FIRST USE 10-0-2005; IN COMMERCE 10-0-2005.

RICHARD A. STRASER, EXAMINING ATTORNEY

**Int. Cl.: 9**

**Prior U.S. Cls.: 21, 23, 26, 36 and 38**

**Reg. No. 3,452,454**

**United States Patent and Trademark Office**

**Registered June 24, 2008**

**TRADEMARK  
PRINCIPAL REGISTER**

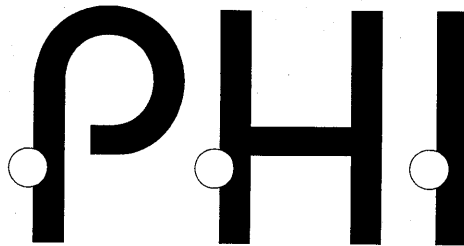

COMMERCIAL BARGAINS, INC. (WISCONSIN CORPORATION)  
820 SOUTH WATER STREET  
MILWAUKEE, WI 53204

THE MARK CONSISTS OF THE LETTERS "PHI" WITH THREE CIRCLES ONE THROUGH EACH LETTER.

FOR: ELECTRIC HAIR STRAIGHTENING IRONS AND ELECTRIC HAIR CURLING IRONS, IN CLASS 9 (U.S. CLS. 21, 23, 26, 36 AND 38).

SER. NO. 77-216,614, FILED 6-27-2007.

FIRST USE 3-3-2007; IN COMMERCE 3-3-2007.

SHAUNIA CARLYLE, EXAMINING ATTORNEY

**Int. Cl.: 41**

**Prior U.S. Cls.: 100, 101 and 107**

**United States Patent and Trademark Office**

**Reg. No. 3,452,455**

**Registered June 24, 2008**

**SERVICE MARK  
PRINCIPAL REGISTER**



HTE RESEARCH, INC. (CALIFORNIA CORPORATION)  
2493 ERIE TERRACE  
BELLINGHAM, WA 98229

FOR: PROVIDING A WEBSITE THAT FEATURES INFORMAL INSTRUCTION ON STARTUPS IN THE SEMICONDUCTOR INDUSTRY, IN CLASS 41 (U.S. CLS. 100, 101 AND 107).

FIRST USE 6-1-2006; IN COMMERCE 8-1-2006.

THE COLOR(S) RED, BLACK, AND GREY IS/ARE CLAIMED AS A FEATURE OF THE MARK.

THE MARK CONSISTS OF BLACK BOX SURROUNDED ON FOUR SIDES BY GREY DESIGN BORDER ELEMENTS; THE WORD "INSIDE" IS COLORED RED AND "CHIPS" IS GREY AND PARTIALLY INSIDE THE BLACK BOX. THE WORDING FOCUSED ON SEMICONDUCTOR INNOVATION AND VENTURES IS IN BLACK.

SER. NO. 77-217,289, FILED 6-27-2007.

TARAH HARDY, EXAMINING ATTORNEY

**Int. Cl.: 3**

**Prior U.S. Cls.: 1, 4, 6, 50, 51 and 52**

**Reg. No. 3,452,456**

**United States Patent and Trademark Office**

**Registered June 24, 2008**

**TRADEMARK  
PRINCIPAL REGISTER**

**ZIA ULTIMATES**

ZIA COSMETICS, INC. (CALIFORNIA CORPORATION)  
3515 EASTHAM DRIVE  
CULVER CITY, CA 90232

FOR: COSMETICS, SKIN CARE PRODUCTS AND FACIAL CARE PRODUCTS, NAMELY, SKIN MOISTURIZING, SOFTENING, CONDITIONING, SMOOTHING, CONTOURING, AND FIRING LOTIONS, CREAMS AND GELS; LOTIONS, CREAMS AND GELS TO SMOOTH WRINKLES AND DIMINISH THE APPEARANCE OF WRINKLES; SKIN TONERS; SKIN CLEANSERS; EYE CREAMS AND GELS; SUN BLOCK AND SUNSCREEN PREPARATIONS; FACIAL MASKS; SKIN EXFOLIANTS; SELF

SUN-TANNING CREAMS, IN CLASS 3 (U.S. CLS. 1, 4, 6, 50, 51 AND 52).

FIRST USE 0-0-1998; IN COMMERCE 0-0-1998.

THE MARK CONSISTS OF STANDARD CHARACTERS WITHOUT CLAIM TO ANY PARTICULAR FONT, STYLE, SIZE, OR COLOR.

OWNER OF U.S. REG. NO. 2,422,418.

SER. NO. 77-217,840, FILED 6-28-2007.

MATTHEW PAPPAS, EXAMINING ATTORNEY

**Int. Cl.: 5**

**Prior U.S. Cls.: 6, 18, 44, 46, 51 and 52**

**Reg. No. 3,452,457**

**United States Patent and Trademark Office**

**Registered June 24, 2008**

**TRADEMARK  
PRINCIPAL REGISTER**

**MINLEB**

TAKEDA PHARMACEUTICAL COMPANY LIMITED (JAPAN CORPORATION)  
1-1, DOSHOMACHI 4-CHOME  
CHUO-KU, OSAKA, JAPAN

PRIORITY CLAIMED UNDER SEC. 44(D) ON  
JAPAN APPLICATION NO. 2007-043193, FILED 4-27-  
2007, REG. NO. 5090712, DATED 11-9-2007, EXPIRES  
11-9-2017.

FOR: PHARMACEUTICAL PREPARATIONS FOR  
HUMAN USE FOR THE TREATMENT OF CARDI-  
OVASCULAR CONDITIONS AND DISEASES, IN  
CLASS 5 (U.S. CLS. 6, 18, 44, 46, 51 AND 52).

THE WORDING "MINLEB" HAS NO MEANING  
IN A FOREIGN LANGUAGE.

THE MARK CONSISTS OF STANDARD CHAR-  
ACTERS WITHOUT CLAIM TO ANY PARTICULAR  
FONT, STYLE, SIZE, OR COLOR.

SER. NO. 77-217,900, FILED 6-28-2007.

MATTHEW PAPPAS, EXAMINING ATTORNEY

**Int. Cl.: 5**

**Prior U.S. Cls.: 6, 18, 44, 46, 51 and 52**

**Reg. No. 3,452,458**

**United States Patent and Trademark Office**

**Registered June 24, 2008**

**TRADEMARK  
PRINCIPAL REGISTER**

**PIMRIO**

TAKEDA PHARMACEUTICAL COMPANY LIM-  
ITED (JAPAN CORPORATION)  
1-1, DOSHOMACHI 4-CHOME  
CHUO-KU, OSAKA, JAPAN

PRIORITY CLAIMED UNDER SEC. 44(D) ON  
JAPAN APPLICATION NO. 2007-043195, FILED 4-27-  
2007, REG. NO. 5090714, DATED 11-9-2007, EXPIRES  
11-9-2017.

FOR: PHARMACEUTICAL PREPARATIONS FOR  
HUMAN USE FOR THE TREATMENT OF CARDI-  
OVASCULAR CONDITIONS AND DISEASES, IN  
CLASS 5 (U.S. CLS. 6, 18, 44, 46, 51 AND 52).

SER. NO. 77-217,907, FILED 6-28-2007.

THE MARK CONSISTS OF STANDARD CHAR-  
ACTERS WITHOUT CLAIM TO ANY PARTICULAR  
FONT, STYLE, SIZE, OR COLOR.

MATTHEW PAPPAS, EXAMINING ATTORNEY

**Int. Cl.: 5**

**Prior U.S. Cls.: 6, 18, 44, 46, 51 and 52**

**Reg. No. 3,452,459**

**United States Patent and Trademark Office**

**Registered June 24, 2008**

**TRADEMARK  
PRINCIPAL REGISTER**

**ENRAP SAR**

TAKEDA PHARMACEUTICAL COMPANY LIMITED (JAPAN CORPORATION)  
1-1, DOSHOMACHI 4-CHOME  
CHUO-KU, OSAKA, JAPAN

PRIORITY CLAIMED UNDER SEC. 44(D) ON  
JAPAN APPLICATION NO. 2007-043198, FILED 4-27-  
2007, REG. NO. 5090717, DATED 11-9-2007, EXPIRES  
11-9-2017.

FOR: PHARMACEUTICAL PREPARATIONS FOR  
HUMAN USE FOR THE TREATMENT OF CARDI-  
OVASCULAR CONDITIONS AND DISEASES, IN  
CLASS 5 (U.S. CLS. 6, 18, 44, 46, 51 AND 52).

SER. NO. 77-217,916, FILED 6-28-2007.

THE MARK CONSISTS OF STANDARD CHAR-  
ACTERS WITHOUT CLAIM TO ANY PARTICULAR  
FONT, STYLE, SIZE, OR COLOR.

MATTHEW PAPPAS, EXAMINING ATTORNEY



**Int. Cl.: 5**

**Prior U.S. Cls.: 6, 18, 44, 46, 51 and 52**

**Reg. No. 3,452,460**

**United States Patent and Trademark Office**

**Registered June 24, 2008**

**TRADEMARK  
PRINCIPAL REGISTER**

**GLENTOTA**

TAKEDA PHARMACEUTICAL COMPANY LIM-  
ITED (JAPAN CORPORATION)  
1-1, DOSHOMACHI 4-CHOME  
CHUO-KU, OSAKA, JAPAN

PRIORITY CLAIMED UNDER SEC. 44(D) ON  
JAPAN APPLICATION NO. 2007-043199, FILED 4-27-  
2007, REG. NO. 5090718, DATED 11-9-2007, EXPIRES  
11-9-2017.

FOR: PHARMACEUTICAL PREPARATIONS FOR  
HUMAN USE FOR THE TREATMENT OF CARDI-  
OVASCULAR CONDITIONS AND DISEASES, IN  
CLASS 5 (U.S. CLS. 6, 18, 44, 46, 51 AND 52).

SER. NO. 77-217,928, FILED 6-28-2007.

THE MARK CONSISTS OF STANDARD CHAR-  
ACTERS WITHOUT CLAIM TO ANY PARTICULAR  
FONT, STYLE, SIZE, OR COLOR.

MATTHEW PAPPAS, EXAMINING ATTORNEY

**Int. Cl.: 3**

**Prior U.S. Cls.: 1, 4, 6, 50, 51 and 52**

**Reg. No. 3,452,461**

**United States Patent and Trademark Office**

**Registered June 24, 2008**

---

**TRADEMARK  
PRINCIPAL REGISTER**

**POWDER MADE EASY**

STONE SOAP COMPANY, INC. (MICHIGAN  
CORPORATION)  
2000 PONTIAC DRIVE  
SYLVAN LAKE, MI 48320

FOR: CONCENTRATED SOAP, DETERGENTS  
AND CLEANSERS USED IN THE PROFESSIONAL  
CAR WASH INDUSTRY, IN CLASS 3 (U.S. CLS. 1, 4,  
6, 50, 51 AND 52).

FIRST USE 3-19-2007; IN COMMERCE 3-19-2007.

THE MARK CONSISTS OF STANDARD CHAR-  
ACTERS WITHOUT CLAIM TO ANY PARTICULAR  
FONT, STYLE, SIZE, OR COLOR.

NO CLAIM IS MADE TO THE EXCLUSIVE  
RIGHT TO USE "POWDER", APART FROM THE  
MARK AS SHOWN.

SER. NO. 77-217,993, FILED 6-28-2007.

LINDSEY RUBIN, EXAMINING ATTORNEY

**Int. Cl.: 25**

**Prior U.S. Cls.: 22 and 39**

**United States Patent and Trademark Office**

**Reg. No. 3,452,462**

**Registered June 24, 2008**

**TRADEMARK  
PRINCIPAL REGISTER**

**Generation Tchín**

CHIN, TONY (UNITED STATES INDIVIDUAL)  
5 IVY COURT  
PERRINEVILLE, NJ 08535

THE MARK CONSISTS OF STANDARD CHAR-  
ACTERS WITHOUT CLAIM TO ANY PARTICULAR  
FONT, STYLE, SIZE, OR COLOR.

FOR: PANTS; SHORT-SLEEVED OR LONG-  
SLEEVED T-SHIRTS; TANK TOPS, IN CLASS 25  
(U.S. CLS. 22 AND 39).

SER. NO. 77-218,420, FILED 6-28-2007.

FIRST USE 1-1-2007; IN COMMERCE 1-1-2007.

DAVID ELTON, EXAMINING ATTORNEY

**Int. Cls.: 36 and 41**

**Prior U.S. Cls.: 100, 101, 102 and 107**

**United States Patent and Trademark Office**

**Reg. No. 3,452,463**

**Registered June 24, 2008**

**SERVICE MARK  
PRINCIPAL REGISTER**

**CHANGING DETROIT, ONE  
CHILD AT A TIME**

CORNERSTONE SCHOOLS ASSOCIATION (MI-  
CHIGAN NON-PROFIT CORPORATION)  
6861 NEVADA  
DETROIT, MI 48234

FOR: CHARITABLE FUNDRAISING SERVICES,  
NAMELY, RAISING FUNDS FOR A SCHOOL, IN  
CLASS 36 (U.S. CLS. 100, 101 AND 102).

FIRST USE 5-30-2007; IN COMMERCE 5-30-2007.

FOR: EDUCATIONAL SERVICES, NAMELY,  
PROVIDING COURSES OF INSTRUCTION AT

THE PRIMARY AND SECONDARY LEVEL (K-12),  
IN CLASS 41 (U.S. CLS. 100, 101 AND 107).

FIRST USE 5-30-2007; IN COMMERCE 5-30-2007.

THE MARK CONSISTS OF STANDARD CHAR-  
ACTERS WITHOUT CLAIM TO ANY PARTICULAR  
FONT, STYLE, SIZE, OR COLOR.

SER. NO. 77-218,792, FILED 6-29-2007.

MONIQUE MILLER, EXAMINING ATTORNEY

**Int. Cl.: 5**

**Prior U.S. Cls.: 6, 18, 44, 46, 51 and 52**

**United States Patent and Trademark Office**

**Reg. No. 3,452,464**

**Registered June 24, 2008**

**TRADEMARK  
PRINCIPAL REGISTER**

**SEPONIS**

TAKEDA PHARMACEUTICAL COMPANY LIM-  
ITED (JAPAN CORPORATION)  
1-1, DOSHOMACHI 4-CHOME  
CHUO-KU, OSAKA, JAPAN

FOR: PHARMACEUTICAL PREPARATIONS FOR  
HUMAN USE FOR THE TREATMENT OF SEVERE  
SEPSIS, IN CLASS 5 (U.S. CLS. 6, 18, 44, 46, 51 AND 52).

THE MARK CONSISTS OF STANDARD CHAR-  
ACTERS WITHOUT CLAIM TO ANY PARTICULAR  
FONT, STYLE, SIZE, OR COLOR.

OWNER OF JAPAN REG. NO. 5051309, DATED 6-  
1-2007, EXPIRES 6-1-2017.

THE TERM "SEPONIS" DOES NOT HAVE ANY  
SIGNIFICANCE.

SER. NO. 77-219,033, FILED 6-29-2007.

MATTHEW PAPPAS, EXAMINING ATTORNEY

**Int. Cl.: 5**

**Prior U.S. Cls.: 6, 18, 44, 46, 51 and 52**

**United States Patent and Trademark Office**

**Reg. No. 3,452,465**

**Registered June 24, 2008**

**TRADEMARK  
PRINCIPAL REGISTER**

**CADESEP**

TAKEDA PHARMACEUTICAL COMPANY LIM-  
ITED (JAPAN CORPORATION)  
1-1, DOSHOMACHI 4-CHOME  
CHUO-KU, OSAKA, JAPAN

FOR: PHARMACEUTICAL PREPARATIONS FOR  
HUMAN USE FOR THE TREATMENT OF SEVERE  
SEPSIS, IN CLASS 5 (U.S. CLS. 6, 18, 44, 46, 51 AND 52).

THE MARK CONSISTS OF STANDARD CHAR-  
ACTERS WITHOUT CLAIM TO ANY PARTICULAR  
FONT, STYLE, SIZE, OR COLOR.

OWNER OF JAPAN REG. NO. 5051310, DATED 6-  
1-2007, EXPIRES 6-1-2017.

THE TERM "CADESEP" DOES NOT HAVE ANY  
SIGNIFICANCE.

SER. NO. 77-219,053, FILED 6-29-2007.

MATTHEW PAPPAS, EXAMINING ATTORNEY

**Int. Cl.: 41**

**Prior U.S. Cls.: 100, 101 and 107**

**United States Patent and Trademark Office**

**Reg. No. 3,452,466**

**Registered June 24, 2008**

**SERVICE MARK  
PRINCIPAL REGISTER**

GRAND PARADISE WATERPARK

GRAND PARADISE WATER PARK, INC. (MISSISSIPPI CORPORATION)  
50 GRANDVIEW DRIVE  
COLLINS, MS 39428

FOR: ENTERTAINMENT SERVICES IN THE NATURE OF A WATER PARK, IN CLASS 41 (U.S. CLS. 100, 101 AND 107).

FIRST USE 5-5-2007; IN COMMERCE 5-5-2007.

THE MARK CONSISTS OF STANDARD CHARACTERS WITHOUT CLAIM TO ANY PARTICULAR FONT, STYLE, SIZE, OR COLOR.

NO CLAIM IS MADE TO THE EXCLUSIVE RIGHT TO USE "WATER PARK", APART FROM THE MARK AS SHOWN.

SER. NO. 77-220,412, FILED 7-2-2007.

INGA ERVIN, EXAMINING ATTORNEY

**Int. Cls.: 35 and 43**

**Prior U.S. Cls.: 100, 101 and 102**

**United States Patent and Trademark Office**

**Reg. No. 3,452,467**

**Registered June 24, 2008**

**SERVICE MARK  
PRINCIPAL REGISTER**



EMDECE GROUP S.A. (ARGENTINA CORPORATION)  
FLORIDA 935  
BUENOS AIRES, ARGENTINA C1005AAS

FOR: ADMINISTRATIVE HOTEL MANAGEMENT; BUSINESS MANAGEMENT OF HOTELS FOR OTHERS; HOTEL MANAGEMENT FOR OTHERS; MANAGEMENT OF HOTEL INCENTIVE PROGRAMS OF OTHERS; MANAGING AND OPERATING RESORT HOTELS AND BUSINESS CONFERENCE CENTERS OF OTHERS; PROVIDING HOTEL RATE COMPARISON INFORMATION, IN CLASS 35 (U.S. CLS. 100, 101 AND 102).

FIRST USE 5-20-2007; IN COMMERCE 5-20-2007.

FOR: HOTEL SERVICES; HOTEL SERVICES FOR PREFERRED CUSTOMERS; HOTEL, BAR AND

RESTAURANT SERVICES; HOTELS; MAKING HOTEL RESERVATIONS FOR OTHERS; PROVIDING ADVICE TO TOURISTS AND BUSINESS TRAVELERS ON HOTEL AND RESTAURANT DESTINATIONS; PROVIDING ON-LINE REVIEWS OF RESTAURANTS AND HOTELS; RESERVATION OF HOTEL ROOMS FOR TRAVELERS; RESORT HOTELS, IN CLASS 43 (U.S. CLS. 100 AND 101).

FIRST USE 5-20-2007; IN COMMERCE 5-20-2007.

NO CLAIM IS MADE TO THE EXCLUSIVE RIGHT TO USE "SMALL RESORTS & SPAS", APART FROM THE MARK AS SHOWN.

SER. NO. 77-221,158, FILED 7-3-2007.

DEIRDRE ROBERTSON, EXAMINING ATTORNEY



**Int. Cl.: 33**

**Prior U.S. Cls.: 47 and 49**

**United States Patent and Trademark Office**

**Reg. No. 3,452,468**

**Registered June 24, 2008**

---

**TRADEMARK  
PRINCIPAL REGISTER**

**KOHALA BAY**

CARRIAGE HOUSE IMPORTS LTD. (DELA-  
WARE CORPORATION)  
99 MORRIS AVENUE  
SPRINGFIELD, NJ 07081

THE MARK CONSISTS OF STANDARD CHAR-  
ACTERS WITHOUT CLAIM TO ANY PARTICULAR  
FONT, STYLE, SIZE, OR COLOR.

FOR: RUM, IN CLASS 33 (U.S. CLS. 47 AND 49).

SER. NO. 77-221,460, FILED 7-3-2007.

FIRST USE 6-24-2003; IN COMMERCE 6-24-2003.

EMILY CARLSEN, EXAMINING ATTORNEY

**Int. Cl.: 35**

**Prior U.S. Cls.: 100, 101 and 102**

**United States Patent and Trademark Office**

**Reg. No. 3,452,469**

**Registered June 24, 2008**

**SERVICE MARK  
PRINCIPAL REGISTER**

**THE BIG IDEA CO.**

LEN SILVERFINE PRODUCTIONS, INC. (VER-  
MONT CORPORATION)  
202 SOUTH STREET #1  
202 SOUTH STREET #1  
SAUSALITO, CA 94965

FOR: ADVERTISING AND PUBLICITY SERVI-  
CES; ADVERTISING AND PUBLICITY SERVICES,  
NAMELY, PROMOTING THE GOODS, SERVICES,  
BRAND IDENTITY AND COMMERCIAL INFOR-  
MATION AND NEWS OF THIRD PARTIES  
THROUGH PRINT, AUDIO, VIDEO, DIGITAL  
AND ON-LINE MEDIUM; ADVERTISING BY  
TRANSMISSION OF ON-LINE PUBLICITY FOR  
THIRD PARTIES THROUGH ELECTRONIC COM-  
MUNICATIONS NETWORKS; ADVERTISING SER-  
VICES, NAMELY, PROMOTING AND MARKETING  
THE GOODS AND SERVICES OF OTHERS  
THROUGH ALL PUBLIC COMMUNICATION

MEANS; ADVERTISING THROUGH ALL PUBLIC  
COMMUNICATION MEANS, IN CLASS 35 (U.S. CLS.  
100, 101 AND 102).

FIRST USE 4-26-1982; IN COMMERCE 4-26-1982.

THE MARK CONSISTS OF STANDARD CHAR-  
ACTERS WITHOUT CLAIM TO ANY PARTICULAR  
FONT, STYLE, SIZE, OR COLOR.

NO CLAIM IS MADE TO THE EXCLUSIVE  
RIGHT TO USE "CO.", APART FROM THE MARK  
AS SHOWN.

SER. NO. 77-221,508, FILED 7-3-2007.

TEJBIR SINGH, EXAMINING ATTORNEY

**Int. Cl.: 5**

**Prior U.S. Cls.: 6, 18, 44, 46, 51 and 52**

**Reg. No. 3,452,470**

**United States Patent and Trademark Office**

**Registered June 24, 2008**

**TRADEMARK  
PRINCIPAL REGISTER**

**ALFASIP**

ALFA WASSERMANN, INC. (DELAWARE CORPORATION)  
4 HENDERSON DRIVE  
WEST CALDWELL, NJ 07006

FIRST USE 6-30-2007; IN COMMERCE 6-30-2007.

FOR: SANITARY STERILIZING PREPARATIONS, DISINFECTANTS, SANITIZERS, VIRUCIDES, FUNGICIDES, ALGAECIDES, SLIMICIDES, AND ALL PURPOSE DEODORIZER PREPARATIONS FOR THE CLEANING OF MANUFACTURING, LABORATORY, AND MEDICAL INSTRUMENTATION AND EQUIPMENT, IN CLASS 5 (U.S. CLS. 6, 18, 44, 46, 51 AND 52).

THE MARK CONSISTS OF STANDARD CHARACTERS WITHOUT CLAIM TO ANY PARTICULAR FONT, STYLE, SIZE, OR COLOR.

SER. NO. 77-221,628, FILED 7-3-2007.

STEVEN JACKSON, EXAMINING ATTORNEY

Int. Cl.: 41

Prior U.S. Cls.: 100, 101 and 107

United States Patent and Trademark Office

Reg. No. 3,452,471

Registered June 24, 2008

SERVICE MARK  
PRINCIPAL REGISTER



ASSOCIATION OF HIMALAYAN YOGA MEDITATION SOCIETIES (MINNESOTA CORPORATION)  
631 UNIVERSITY AVENUE NE  
MINNEAPOLIS, MN 55413

FOR: EDUCATIONAL SERVICES, NAMELY, PROVIDING CLASSES AND SEMINARS IN THE FIELDS OF YOGA MEDITATION AND SPIRITUAL GUIDANCE, IN CLASS 41 (U.S. CLS. 100, 101 AND 107).

FIRST USE 9-11-2005; IN COMMERCE 9-11-2005.

NO CLAIM IS MADE TO THE EXCLUSIVE RIGHT TO USE "YOGA IS SAMADHI", APART FROM THE MARK AS SHOWN.

"THE FOREIGN WORDING IN THE MARK TRANSLATES INTO ENGLISH AS YOGA IS SAMADHI."

"THE NON-LATIN CHARACTER(S) IN THE MARK TRANSLITERATES INTO YOGAH SAMADHIH, AND THIS MEANS YOGA IS SAMADHI IN ENGLISH."

SER. NO. 77-221,949, FILED 7-3-2007.

STEVEN R. FINE, EXAMINING ATTORNEY

**Int. Cls.: 16 and 35**

**Prior U.S. Cls.: 2, 5, 22, 23, 29, 37, 38, 50, 100, 101 and 102**

**Reg. No. 3,452,472**

**United States Patent and Trademark Office**

**Registered June 24, 2008**

**TRADEMARK  
SERVICE MARK  
PRINCIPAL REGISTER**



THE BOOK OF GOOD DEALS (ALASKA LTD  
LIAB CO)  
SUITE 204  
1399 W. 34TH AVENUE  
ANCHORAGE, AK 99503

FOR: PRINTED ADVERTISING PERIODICALS IN  
THE NATURE OF BOOKS AND MAGAZINES CON-  
TAINING DISPLAY ADVERTISING AND REDEEM-  
ABLE COUPONS, IN CLASS 16 (U.S. CLS. 2, 5, 22, 23,  
29, 37, 38 AND 50).

FIRST USE 4-26-2006; IN COMMERCE 5-30-2006.

FOR: PUBLICATION OF ADVERTISING TEXTS  
IN THE NATURE OF MAGAZINES, BOOKS, AND

ELECTRONIC PUBLICATIONS FOR OTHERS, IN  
CLASS 35 (U.S. CLS. 100, 101 AND 102).

FIRST USE 4-26-2006; IN COMMERCE 5-30-2006.

THE MARK CONSISTS OF THE WORDS "THE  
BOOK OF" ON THE FIRST LINE WITH A DESIGN  
OF AN OPEN BOOK WITH DOLLARS SIGNS IN IT  
AND TWO DOLLARS SIGNS TO THE RIGHT OF IT,  
AND ON THE SECOND LINE THE WORDS "GOOD  
DEALS" WITH THE LETTER "S" COMPRISED OF A  
DOLLAR SIGN.

SER. NO. 77-221,957, FILED 7-3-2007.

STEPHEN AQUILA, EXAMINING ATTORNEY

**Int. Cl.: 31**

**Prior U.S. Cls.: 1 and 46**

**United States Patent and Trademark Office**

**Reg. No. 3,452,473**

**Registered June 24, 2008**

**TRADEMARK  
PRINCIPAL REGISTER**

AMERICA'S FAVORITE MUSHROOM

GIORGIFRED COMPANY (DELAWARE CORPORATION)  
NEMOURS BUILDING  
1007 ORANGE STREET, SUITE 1404  
WILMINGTON, DE 19801

FOR: FRESH MUSHROOMS, IN CLASS 31 (U.S. CLS. 1 AND 46).

FIRST USE 11-0-1995; IN COMMERCE 11-0-1995.

THE MARK CONSISTS OF STANDARD CHARACTERS WITHOUT CLAIM TO ANY PARTICULAR FONT, STYLE, SIZE, OR COLOR.

OWNER OF U.S. REG. NOS. 1,777,517 AND 2,520,064.

NO CLAIM IS MADE TO THE EXCLUSIVE RIGHT TO USE "MUSHROOM", APART FROM THE MARK AS SHOWN.

SEC. 2(F).

SER. NO. 77-223,155, FILED 7-6-2007.

KATINA MISTER, EXAMINING ATTORNEY

**Int. Cls.: 35 and 43**

**Prior U.S. Cls.: 100, 101 and 102**

**United States Patent and Trademark Office**

**Reg. No. 3,452,474**

**Registered June 24, 2008**

**SERVICE MARK  
PRINCIPAL REGISTER**



EMDECE GROUP S.A. (ARGENTINA CORPORATION)  
FLORIDA 935  
BUENOS AIRES, ARGENTINA C1005AAS

FOR: ADMINISTRATIVE HOTEL MANAGEMENT; BUSINESS MANAGEMENT OF HOTELS FOR OTHERS; HOTEL MANAGEMENT FOR OTHERS; MANAGEMENT OF HOTEL INCENTIVE PROGRAMS OF OTHERS; MANAGING AND OPERATING RESORT HOTELS AND BUSINESS CONFERENCE CENTERS OF OTHERS; PROVIDING HOTEL RATE COMPARISON INFORMATION, IN CLASS 35 (U.S. CLS. 100, 101 AND 102).

FIRST USE 5-20-2007; IN COMMERCE 5-20-2007.

FOR: HOTEL SERVICES; HOTEL SERVICES FOR PREFERRED CUSTOMERS; HOTEL, BAR AND

RESTAURANT SERVICES; HOTELS; MAKING HOTEL RESERVATIONS FOR OTHERS; PROVIDING ADVICE TO TOURISTS AND BUSINESS TRAVELERS ON HOTEL AND RESTAURANT DESTINATIONS; PROVIDING ON-LINE REVIEWS OF RESTAURANTS AND HOTELS; RESERVATION OF HOTEL ROOMS FOR TRAVELERS; RESORT HOTELS, IN CLASS 43 (U.S. CLS. 100 AND 101).

FIRST USE 5-20-2007; IN COMMERCE 5-20-2007.

NO CLAIM IS MADE TO THE EXCLUSIVE RIGHT TO USE "HOTELS & SPAS", APART FROM THE MARK AS SHOWN.

SER. NO. 77-223,178, FILED 7-6-2007.

DEIRDRE ROBERTSON, EXAMINING ATTORNEY

Int. Cl.: 30

Prior U.S. Cl.: 46

United States Patent and Trademark Office

Reg. No. 3,452,475

Registered June 24, 2008

TRADEMARK  
PRINCIPAL REGISTER



THE GIROD CORPORATION (DELAWARE CORPORATION)  
1105 N. MARKET STREET, SUITE 1300  
WILMINGTON, DE 19899

FOR: COFFEE AND CHICORY COMPOUND, IN CLASS 30 (U.S. CL. 46).

FIRST USE 1-1-1929; IN COMMERCE 1-1-1929.

OWNER OF U.S. REG. NOS. 734,620 AND 1,249,201.

NO CLAIM IS MADE TO THE EXCLUSIVE RIGHT TO USE "100% GOOD", APART FROM THE MARK AS SHOWN.

THE MARK CONSISTS OF AN OUTLINE OF A CUP AND SAUCER WITH THE WORDS "LUZIANNE 100% GOOD" INSIDE.

SER. NO. 77-223,256, FILED 7-6-2007.

JULIE WATSON, EXAMINING ATTORNEY



Int. Cls.: 35 and 45

Prior U.S. Cls.: 100, 101 and 102

United States Patent and Trademark Office

Reg. No. 3,452,476

Registered June 24, 2008

**SERVICE MARK  
PRINCIPAL REGISTER**



DAVID W. HOTTLE (UNITED STATES INDIVIDUAL)  
3520 CHASTAIN GLEN LANE  
MARIETTA, GA 30066

FOR: CLUB SERVICES, NAMELY, PROMOTING THE INTERESTS OF BEER ENTHUSIASTS, IN CLASS 35 (U.S. CLS. 100, 101 AND 102).

FIRST USE 7-1-2007; IN COMMERCE 7-1-2007.

FOR: ONLINE SOCIAL NETWORKING SERVICES, IN CLASS 45 (U.S. CLS. 100 AND 101).

FIRST USE 7-1-2007; IN COMMERCE 7-1-2007.

NO CLAIM IS MADE TO THE EXCLUSIVE RIGHT TO USE "AMERICAN BEER DRINKING CLUB" OR "BEERDRINKINGCLUB.COM", APART FROM THE MARK AS SHOWN.

THE COLOR(S) BLACK, WHITE, AMBER AND YELLOW IS/ARE CLAIMED AS A FEATURE OF THE MARK.

THE MARK CONSISTS OF A TILTED BEER GLASS FILLED WITH AMBER AND YELLOW BEER, WITH WHITE FOAM ON TOP AND BLACK SHADOWING ON THE SIDE. THE WORDS "AMERICAN BEER DRINKING CLUB" ARE SHOWN IN YELLOW WITH A BLACK OUTLINE IN A SEMI-CIRCLE OUT OF THE TOP OF THE GLASS. THE TERM "BEERDRINKINGCLUB.COM" IS SHOWN IN YELLOW LETTERS WITH A BLACK OUTLINE BELOW THE GLASS.

SEC. 2(F).

SER. NO. 77-224,261, FILED 7-8-2007.

SUSAN LESLIE DUBOIS, EXAMINING ATTORNEY

**Int. Cl.: 44**

**Prior U.S. Cls.: 100 and 101**

**United States Patent and Trademark Office**

**Reg. No. 3,452,477**

**Registered June 24, 2008**

**SERVICE MARK  
PRINCIPAL REGISTER**

**Simply FlawlessFaces**

HARRIS, DENISE A (UNITED STATES INDIVIDUAL)  
62 LOIS LANE  
MONROE, NY 10950

FOR: CONSULTATION SERVICES IN THE FIELD OF MAKEUP, NAMELY, ON-LINE MAKEUP CONSULTATION SERVICES AND IN-PERSON MAKEUP CONSULTATION AND APPLICATION SERVICES, IN CLASS 44 (U.S. CLS. 100 AND 101).

FIRST USE 5-1-2007; IN COMMERCE 5-1-2007.

THE MARK CONSISTS OF STANDARD CHARACTERS WITHOUT CLAIM TO ANY PARTICULAR FONT, STYLE, SIZE, OR COLOR.

SER. NO. 77-224,642, FILED 7-9-2007.

DAVID C. REIHNER, EXAMINING ATTORNEY

**Int. Cl.: 41**

**Prior U.S. Cls.: 100, 101 and 107**

**United States Patent and Trademark Office**

**Reg. No. 3,452,478**

**Registered June 24, 2008**

**SERVICE MARK  
PRINCIPAL REGISTER**

**SYNAVISTA**

DOWLING, MICHAEL, J (UNITED STATES INDIVIDUAL)  
308 STUART CT  
BERRYVILLE, VA 22611 AND  
BROWN, JAMES, M (UNITED STATES INDIVIDUAL)  
19554 HERNDON CT  
LEESBURG, VA 20175

FOR: ENTERTAINMENT IN THE NATURE OF AN ON-GOING SPECIAL VARIETY, NEWS, MUSIC OR COMEDY SHOW FEATURING LOCAL SUBJECT MATTER BROADCAST OVER TELEVISION,

SATELLITE, AUDIO, AND VIDEO MEDIA, IN CLASS 41 (U.S. CLS. 100, 101 AND 107).

FIRST USE 10-12-2005; IN COMMERCE 10-12-2005.

THE MARK CONSISTS OF STANDARD CHARACTERS WITHOUT CLAIM TO ANY PARTICULAR FONT, STYLE, SIZE, OR COLOR.

SER. NO. 77-224,817, FILED 7-9-2007.

MARK SPARACINO, EXAMINING ATTORNEY

**Int. Cl.: 16**

**Prior U.S. Cls.: 2, 5, 22, 23, 29, 37, 38 and 50**

**Reg. No. 3,452,479**

**United States Patent and Trademark Office**

**Registered June 24, 2008**

**TRADEMARK  
PRINCIPAL REGISTER**



PENNWELL CORPORATION (OKLAHOMA CORPORATION)  
1421 SOUTH SHERIDAN ROAD  
TULSA, OK 74112

NO CLAIM IS MADE TO THE EXCLUSIVE RIGHT TO USE "UTILITY PRODUCTS", APART FROM THE MARK AS SHOWN.

FOR: MAGAZINE RELATING TO THE TELECOMMUNICATIONS, CABLE TELEVISION AND UTILITIES INDUSTRIES, IN CLASS 16 (U.S. CLS. 2, 5, 22, 23, 29, 37, 38 AND 50).

SER. NO. 77-224,821, FILED 7-9-2007.

FIRST USE 5-18-2007; IN COMMERCE 5-18-2007.

MICHAEL WIENER, EXAMINING ATTORNEY

**Int. Cl.: 20**

**Prior U.S. Cls.: 2, 13, 22, 25, 32 and 50**

**Reg. No. 3,452,480**

**United States Patent and Trademark Office**

**Registered June 24, 2008**

**TRADEMARK  
PRINCIPAL REGISTER**

**ELFA EVERYWHERE**

ELFA INTERNATIONAL AB (SWEDEN LTD  
LIAB JT ST CO)  
ELFAGATAN 5  
59387 VASTERVIK, SWEDEN

FOR: SHELVES, DRAWERS AND GLIDING AND  
FIXED STORAGE RACKS ALL MADE FROM  
EPOXY COATED METAL; GLIDING AND FIXED  
STORAGE RACKS MADE FROM EPOXY COATED  
METAL AND WOOD; SHELVING MADE FROM  
EPOXY COATED METAL, WOOD VENEER AND  
LAMINATE, IN CLASS 20 (U.S. CLS. 2, 13, 22, 25, 32  
AND 50).

FIRST USE 12-24-2006; IN COMMERCE 12-24-2006.

THE MARK CONSISTS OF STANDARD CHAR-  
ACTERS WITHOUT CLAIM TO ANY PARTICULAR  
FONT, STYLE, SIZE, OR COLOR.

OWNER OF U.S. REG. NOS. 1,131,621 AND  
2,814,662.

SER. NO. 77-225,279, FILED 7-9-2007.

GEORGE LORENZO, EXAMINING ATTORNEY

**Int. Cl.: 36**

**Prior U.S. Cls.: 100, 101 and 102**

**United States Patent and Trademark Office**

**Reg. No. 3,452,481**

**Registered June 24, 2008**

**SERVICE MARK  
PRINCIPAL REGISTER**

**SMARTFOOTPRINTS**

SMART CAPITAL MANAGEMENT LLC (NEW  
YORK LTD LIAB CO)  
26 FRELEIGH PLACE  
COXSACKIE, NY 12051

THE MARK CONSISTS OF STANDARD CHAR-  
ACTERS WITHOUT CLAIM TO ANY PARTICULAR  
FONT, STYLE, SIZE, OR COLOR.

FOR: ESTATE PLANNING; FINANCIAL PLAN-  
NING, IN CLASS 36 (U.S. CLS. 100, 101 AND 102).

SER. NO. 77-225,576, FILED 7-10-2007.

FIRST USE 5-0-2007; IN COMMERCE 5-0-2007.

JACLYN KIDWELL, EXAMINING ATTORNEY

**Int. Cl.: 16**

**Prior U.S. Cls.: 2, 5, 22, 23, 29, 37, 38 and 50**

**United States Patent and Trademark Office**

**Reg. No. 3,452,482**

**Registered June 24, 2008**

**TRADEMARK  
PRINCIPAL REGISTER**

**BLUE DONKEY**

BLUE DONKEY, LLC (NEW YORK LTD LIAB  
CO)  
8 RIDGE ROAD  
STANHOPE, NJ 07874

THE MARK CONSISTS OF STANDARD CHAR-  
ACTERS WITHOUT CLAIM TO ANY PARTICULAR  
FONT, STYLE, SIZE, OR COLOR.

FOR: SERIES OF FICTION BOOKS; COLORING  
BOOKS; CHILDREN'S BOOKS; POSTCARDS, IN  
CLASS 16 (U.S. CLS. 2, 5, 22, 23, 29, 37, 38 AND 50).

SER. NO. 77-225,602, FILED 7-10-2007.

FIRST USE 2-0-2007; IN COMMERCE 2-0-2007.

TASHIA BUNCH, EXAMINING ATTORNEY

**Int. Cl.: 37**

**Prior U.S. Cls.: 100, 103 and 106**

**United States Patent and Trademark Office**

**Reg. No. 3,452,483**

**Registered June 24, 2008**

**SERVICE MARK  
PRINCIPAL REGISTER**



**CHARTER** Homes &  
Neighborhoods

CHARTER HOMES BUILDING COMPANY  
(PENNSYLVANIA CORPORATION)  
114 FOXSHIRE DRIVE  
LANCASTER, PA 17601

FOR: CONSTRUCTION SERVICES, NAMELY,  
PLANNING, LAYING OUT AND CUSTOM CON-  
STRUCTION OF RESIDENTIAL AND COMMER-  
CIAL COMMUNITIES; REAL ESTATE  
DEVELOPMENT , IN CLASS 37 (U.S. CLS. 100, 103  
AND 106).

FIRST USE 3-0-2006; IN COMMERCE 3-0-2006.

NO CLAIM IS MADE TO THE EXCLUSIVE  
RIGHT TO USE "HOMES & NEIGHBORHOODS",  
APART FROM THE MARK AS SHOWN.

THE MARK CONSISTS OF THE WORDS CHAR-  
TER HOMES & NEIGHBORHOODS AND A STY-  
LIZED WREATH DESIGN.

SER. NO. 77-225,934, FILED 7-10-2007.

CIMMERIAN COLEMAN, EXAMINING ATTOR-  
NEY



**Int. Cl.: 16**

**Prior U.S. Cls.: 2, 5, 22, 23, 29, 37, 38 and 50**

**Reg. No. 3,452,484**

**United States Patent and Trademark Office**

**Registered June 24, 2008**

**TRADEMARK  
PRINCIPAL REGISTER**

**360 Career Accelerator**

O'DONNELL, CATHERINE (UNITED STATES  
INDIVIDUAL)  
216 6TH STREET  
AVALON, NJ 08202

FOR: EDUCATIONAL PUBLICATIONS, NAME-  
LY, TRAINING MANUALS IN THE FIELD OF  
HUMAN RESOURCES AND MANAGEMENT DE-  
SIGNATED TO IMPROVE WORK PERFORMANCE, IN  
CLASS 16 (U.S. CLS. 2, 5, 22, 23, 29, 37, 38 AND 50).

FIRST USE 7-1-2007; IN COMMERCE 7-1-2007.

THE MARK CONSISTS OF STANDARD CHAR-  
ACTERS WITHOUT CLAIM TO ANY PARTICULAR  
FONT, STYLE, SIZE, OR COLOR.

NO CLAIM IS MADE TO THE EXCLUSIVE  
RIGHT TO USE "CAREER", APART FROM THE  
MARK AS SHOWN.

SER. NO. 77-226,122, FILED 7-10-2007.

STEVEN R. FINE, EXAMINING ATTORNEY

Int. Cls.: 35, 40 and 42

Prior U.S. Cls.: 100, 101, 102, 103 and 106

United States Patent and Trademark Office

Reg. No. 3,452,485

Registered June 24, 2008

SERVICE MARK  
PRINCIPAL REGISTER



INTEGRATED BAKERY RESOURCES, INC. (WASHINGTON CORPORATION)  
6405 ROSEWOOD STREET, SUITE C  
LAKE OSWEGO, OR 97035

FOR: PROVIDING BAKERIES WITH INFORMATION ABOUT PRODUCT MERCHANDISING, ADVERTISING, CONSUMER TRENDS AND MARKETING; PROVIDING BAKERIES WITH BUSINESS RESEARCH IN THE FIELD OF THE BAKING INDUSTRY; BAKING CONSULTATION SERVICES, NAMELY, PROVIDING BAKERIES WITH COMMERCIAL INFORMATION ABOUT INGREDIENTS USED BY BAKERIES, IN CLASS 35 (U.S. CLS. 100, 101 AND 102).

FIRST USE 4-23-2001; IN COMMERCE 4-23-2001.

FOR: BAKERY CONSULTATION SERVICES, NAMELY, PROVIDING BAKERIES WITH TECHNICAL INFORMATION ON BAKING TECHNIQUES USED IN THE BAKING INDUSTRY, IN CLASS 40 (U.S. CLS. 100, 103 AND 106).

FIRST USE 4-23-2001; IN COMMERCE 4-23-2001.

FOR: PROVIDING GRAPHIC DESIGN SERVICES FOR BAKERIES; PROVIDING BAKERIES WITH SCIENTIFIC RESEARCH IN THE FIELD OF THE

BAKING INDUSTRY, IN CLASS 42 (U.S. CLS. 100 AND 101).

FIRST USE 4-23-2001; IN COMMERCE 4-23-2001.

OWNER OF U.S. REG. NO. 2,583,929.

NO CLAIM IS MADE TO THE EXCLUSIVE RIGHT TO USE "BAKERY RESOURCES", APART FROM THE MARK AS SHOWN.

THE MARK CONSISTS OF A PLAIN LINE CIRCLE WITH THE LETTERS "IBR" AND "INTEGRATED BAKERY RESOURCES" AND TWO SOLID SMALLER CIRCLES DISPLAYED AROUND THE PERIMETER OF THE CIRCLE. INSIDE THE PLAIN LINE CIRCLE IS A PARTIALLY SHADED CONCENTRIC CIRCLE THAT DISPLAYS A DESIGN CONTAINING A SILHOUETTE OF A MALE AND A FEMALE HARVESTING WHEAT AND GRAINS. SHEATHS OF WHEAT ARE DISPLAYED IN THE DESIGN AND THE MALE SILHOUETTE IS WEARING A WIDE-BRIMMED HAT.

SEC. 2(F) "INTEGRATED".

SER. NO. 77-226,156, FILED 7-10-2007.

RENEE SERVANCE, EXAMINING ATTORNEY

**Int. Cls.: 35, 40 and 42**

**Prior U.S. Cls.: 100, 101, 102, 103 and 106**

**United States Patent and Trademark Office**

**Reg. No. 3,452,486**

**Registered June 24, 2008**

**SERVICE MARK  
PRINCIPAL REGISTER**

**INTEGRATED BAKERY RESOURCES**

INTEGRATED BAKERY RESOURCES, INC. (WASHINGTON CORPORATION)  
6405 ROSEWOOD STREET, SUITE C  
LAKE OSWEGO, OR 97035

FOR: PROVIDING BAKERIES WITH INFORMATION ABOUT PRODUCT MERCHANDISING, ADVERTISING, CONSUMER TRENDS AND MARKETING; PROVIDING BAKERIES WITH BUSINESS RESEARCH IN THE FIELD OF THE BAKING INDUSTRY; BAKING CONSULTATION SERVICES, NAMELY, PROVIDING BAKERIES WITH COMMERCIAL INFORMATION ABOUT INGREDIENTS USED BY BAKERIES, IN CLASS 35 (U.S. CLS. 100, 101 AND 102).

FIRST USE 4-23-2001; IN COMMERCE 4-23-2001.

FOR: BAKERY CONSULTATION SERVICES, NAMELY, PROVIDING BAKERIES WITH TECHNICAL INFORMATION ON BAKING TECHNIQUES USED IN THE BAKING INDUSTRY, IN CLASS 40 (U.S. CLS. 100, 103 AND 106).

FIRST USE 4-23-2001; IN COMMERCE 4-23-2001.

FOR: PROVIDING GRAPHIC DESIGN SERVICES FOR BAKERIES; PROVIDING BAKERIES WITH SCIENTIFIC RESEARCH IN THE FIELD OF THE BAKING INDUSTRY, IN CLASS 42 (U.S. CLS. 100 AND 101).

FIRST USE 4-23-2001; IN COMMERCE 4-23-2001.

THE MARK CONSISTS OF STANDARD CHARACTERS WITHOUT CLAIM TO ANY PARTICULAR FONT, STYLE, SIZE, OR COLOR.

OWNER OF U.S. REG. NO. 2,583,929.

NO CLAIM IS MADE TO THE EXCLUSIVE RIGHT TO USE "BAKERY RESOURCES", APART FROM THE MARK AS SHOWN.

SEC. 2(F).

SER. NO. 77-226,162, FILED 7-10-2007.

RENEE SERVANCE, EXAMINING ATTORNEY

**Int. Cl.: 9**

**Prior U.S. Cls.: 21, 23, 26, 36 and 38**

**Reg. No. 3,452,487**

**United States Patent and Trademark Office**

**Registered June 24, 2008**

---

**TRADEMARK  
PRINCIPAL REGISTER**

**XPT**

DRB SYSTEMS, INC. (OHIO CORPORATION)  
P.O. BOX 550  
UNIONTOWN, OH 44685

FOR USE IN SELLING CAR WASH SERVICES, IN  
CLASS 9 (U.S. CLS. 21, 23, 26, 36 AND 38).

FIRST USE 9-0-2003; IN COMMERCE 9-0-2003.

FOR: COMPUTER HARDWARE AND COMPU-  
TER SOFTWARE FOR CONTROLLING COMMER-  
CIAL CAR WASH SYSTEMS AND ACCEPTING  
CUSTOMER PAYMENTS FOR CAR WASH SERVI-  
CES; INTERACTIVE COMPUTER KIOSKS COM-  
PRISING COMPUTER HARDWARE, COMPUTER  
PERIPHERALS, AND COMPUTER SOFTWARE,

THE MARK CONSISTS OF STANDARD CHAR-  
ACTERS WITHOUT CLAIM TO ANY PARTICULAR  
FONT, STYLE, SIZE, OR COLOR.

SER. NO. 77-226,200, FILED 7-10-2007.

KEVIN CORWIN, EXAMINING ATTORNEY

**Int. Cl.: 38**

**Prior U.S. Cls.: 100, 101 and 104**

**United States Patent and Trademark Office**

**Reg. No. 3,452,488**

**Registered June 24, 2008**

**SERVICE MARK  
PRINCIPAL REGISTER**

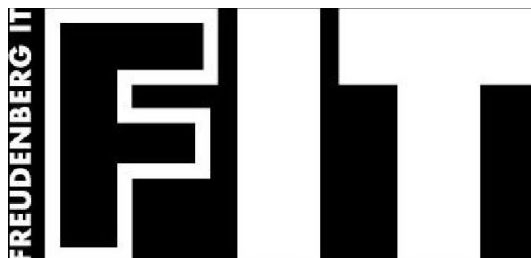

CARL FREUDENBERG KG (FED REP GERMA-  
NY KOMMANDITGESELLSCHAFT (KG))  
HOEHNERWEG 2-4  
WEINHEIM, FED REP GERMANY D-69469

OWNER OF U.S. REG. NO. 3,285,588.

FOR: CONSULTING IN THE FIELD OF TELE-  
COMMUNICATIONS TECHNOLOGY; PROVIDING  
ACCESS TO DATA OR DOCUMENTS STORED  
ELECTRONICALLY IN CENTRAL FILES FOR RE-  
MOTE CONSULTATION, IN CLASS 38 (U.S. CLS. 100,  
101 AND 104).

NO CLAIM IS MADE TO THE EXCLUSIVE  
RIGHT TO USE "IT", APART FROM THE MARK  
AS SHOWN.

SER. NO. 77-226,250, FILED 7-10-2007.

FIRST USE 4-1-2006; IN COMMERCE 4-1-2006.

DAVID TOOLEY, EXAMINING ATTORNEY

**Int. Cl.: 5**

**Prior U.S. Cls.: 6, 18, 44, 46, 51 and 52**

**Reg. No. 3,452,489**

**United States Patent and Trademark Office**

**Registered June 24, 2008**

**TRADEMARK  
PRINCIPAL REGISTER**

**DIATXZN**

PAMLAB, L.L.C. (LOUISIANA LTD LIAB CO)  
4099 HIGHWAY 190  
COVINGTON, LA 70433

FOR: MEDICAL FOODS FOR THE NUTRITIONAL REQUIREMENTS OF PATIENTS HAVING HYPERHOMOCYSTEINEMIA, CHRONIC KIDNEY DISEASE (CKD), END STAGE RENAL DISEASE (ESRD), AND DIALYSIS , IN CLASS 5 (U.S. CLS. 6, 18, 44, 46, 51 AND 52).

FIRST USE 6-24-2005; IN COMMERCE 6-24-2005.

THE MARK CONSISTS OF STANDARD CHARACTERS WITHOUT CLAIM TO ANY PARTICULAR FONT, STYLE, SIZE, OR COLOR.

"DIATXZN" HAS NO SIGNIFICANCE IN THE RELEVANT TRADE OR INDUSTRY OR AS APPLIED TO THE GOODS, OR ANY GEOGRAPHICAL SIGNIFICANCE, OR ANY MEANING IN A FOREIGN LANGUAGE.

SER. NO. 77-226,735, FILED 7-11-2007.

NAAKWAMA ANKRAH, EXAMINING ATTORNEY

**Int. Cl.: 16**

**Prior U.S. Cls.: 2, 5, 22, 23, 29, 37, 38 and 50**

**United States Patent and Trademark Office**

**Reg. No. 3,452,490**

**Registered June 24, 2008**

**TRADEMARK  
PRINCIPAL REGISTER**

**SUPERRABBI**

TAMIRAN, DAVID (UNITED STATES INDIVIDUAL)

#401

545 EIGHTH AVENUE  
NEW YORK, NY 10018

THE MARK CONSISTS OF STANDARD CHARACTERS WITHOUT CLAIM TO ANY PARTICULAR FONT, STYLE, SIZE, OR COLOR.

FOR: CALENDARS; GREETING CARDS; POSTCARDS; POSTERS, IN CLASS 16 (U.S. CLS. 2, 5, 22, 23, 29, 37, 38 AND 50).

SER. NO. 77-226,777, FILED 7-11-2007.

FIRST USE 10-11-1990; IN COMMERCE 7-24-1995.

LESLIE RICHARDS, EXAMINING ATTORNEY

**Int. Cls.: 29 and 30**

**Prior U.S. Cl.: 46**

**United States Patent and Trademark Office**

**Reg. No. 3,452,491**

**Registered June 24, 2008**

**TRADEMARK  
PRINCIPAL REGISTER**



LOG HOUSE FOODS, INC. (MINNESOTA CORPORATION)  
700 NORTH BERKSHIRE LANE  
PLYMOUTH, MN 55441

FOR: PROCESSED COCONUT, IN CLASS 29 (U.S. CL. 46).

FIRST USE 12-31-1948; IN COMMERCE 12-31-1950.

FOR: HARD BREADS, SNACK TOASTS, NAME-  
LY, CINNAMON TOAST, CINNAMON RAISIN  
TOAST; COOKIES, CONFECTIONERY COATINGS,  
NAMELY, ALMOND BARK, CHOCOLATE COAT-

ING, VANILLA COATING; AND CONFECTIONERY  
BAKING CHIPS, IN CLASS 30 (U.S. CL. 46).

FIRST USE 12-31-1946; IN COMMERCE 12-31-1950.

THE MARK CONSISTS OF WORDS LOG HOUSE  
FORMED WITH TREE LOGS UNDER DRAWING  
OF LOG CABIN WITH TREES.

SER. NO. 77-227,010, FILED 7-11-2007.

ALEX KEAM, EXAMINING ATTORNEY



**Int. Cl.: 35**

**Prior U.S. Cls.: 100, 101 and 102**

**United States Patent and Trademark Office**

**Reg. No. 3,452,492**

**Registered June 24, 2008**

**SERVICE MARK  
PRINCIPAL REGISTER**

**COMMITMENT TO QUALITY -  
THE CORNERSTONE OF OUR  
SUCCESS**

ROLLING ROCK BUILDING STONE, INC.  
(PENNSYLVANIA CORPORATION)  
40 ROLLING ROCK ROAD  
BOYERTOWN, PA 19512

THE MARK CONSISTS OF STANDARD CHAR-  
ACTERS WITHOUT CLAIM TO ANY PARTICULAR  
FONT, STYLE, SIZE, OR COLOR.

FOR: WHOLESALE DISTRIBUTORSHIPS FEATURING NATURAL BUILDING STONE PRODUCTS, IN CLASS 35 (U.S. CLS. 100, 101 AND 102).

SER. NO. 77-227,015, FILED 7-11-2007.

FIRST USE 6-15-1986; IN COMMERCE 6-15-1986.

JIM RINGLE, EXAMINING ATTORNEY

**Int. Cls.: 29 and 30**

**Prior U.S. Cl.: 46**

**United States Patent and Trademark Office**

**Reg. No. 3,452,493**

**Registered June 24, 2008**

**TRADEMARK  
PRINCIPAL REGISTER**

# LOG HOUSE

LOG HOUSE FOODS, INC. (MINNESOTA CORPORATION)  
80 SOUTH EIGHTH STREET, 4200 IDS CENTER  
MINNEAPOLIS, MN 55402

FOR: PROCESSED COCONUT, IN CLASS 29 (U.S. CL. 46).

FIRST USE 12-31-1948; IN COMMERCE 12-31-1950.

FOR: HARD BREADS, SNACK TOASTS, NAME-  
LY, CINNAMON TOAST, CINNAMON RAISIN  
TOAST; COOKIES, CONFECTIONERY COATINGS,  
NAMELY, ALMOND BARK, CHOCOLATE COAT-

ING, VANILLA COATING; AND CONFECTIONERY  
BAKING CHIPS, IN CLASS 30 (U.S. CL. 46).

FIRST USE 12-31-1948; IN COMMERCE 12-31-1950.

THE MARK CONSISTS OF STANDARD CHAR-  
ACTERS WITHOUT CLAIM TO ANY PARTICULAR  
FONT, STYLE, SIZE, OR COLOR.

SER. NO. 77-227,029, FILED 7-11-2007.

ALEX KEAM, EXAMINING ATTORNEY

**Int. Cl.: 35**

**Prior U.S. Cls.: 100, 101 and 102**

**United States Patent and Trademark Office**

**Reg. No. 3,452,494**

**Registered June 24, 2008**

**SERVICE MARK  
PRINCIPAL REGISTER**

**WORKING RANCH COWBOYS  
ASSOCIATION**

WORKING RANCH COWBOYS ASSOCIATION  
(TEXAS NON-PROFIT ASSOCIATION)  
2750 DUNIVEN CIRCLE  
AMARILLO, TX 79109

FOR: ASSOCIATION SERVICES, NAMELY, PROMOTING THE INTERESTS OF WORKING RANCH COWBOYS, IN CLASS 35 (U.S. CLS. 100, 101 AND 102).

FIRST USE 3-16-1995; IN COMMERCE 3-16-1995.

THE MARK CONSISTS OF STANDARD CHARACTERS WITHOUT CLAIM TO ANY PARTICULAR FONT, STYLE, SIZE, OR COLOR.

OWNER OF U.S. REG. NO. 3,274,474.

NO CLAIM IS MADE TO THE EXCLUSIVE RIGHT TO USE "ASSOCIATION", APART FROM THE MARK AS SHOWN.

SEC. 2(F).

SER. NO. 77-227,097, FILED 7-11-2007.

DAVID MURRAY, EXAMINING ATTORNEY

**Int. Cl.: 42**

**Prior U.S. Cls.: 100 and 101**

**United States Patent and Trademark Office**

**Reg. No. 3,452,495**

**Registered June 24, 2008**

**SERVICE MARK  
PRINCIPAL REGISTER**



PAYMENT SYSTEMS GROUP, INC. (MISSOURI CORPORATION)

5988 MID RIVERS MALL DR.

ST. CHARLES, MO 63304

FOR: COMPUTER SOFTWARE DEVELOPMENT,  
IN CLASS 42 (U.S. CLS. 100 AND 101).

FIRST USE 12-20-2006; IN COMMERCE 4-4-2007.

NO CLAIM IS MADE TO THE EXCLUSIVE RIGHT TO USE "PAYMENT SYSTEMS GROUP", APART FROM THE MARK AS SHOWN.

THE MARK CONSISTS OF UMBRELLA OVER THE LETTERS PSG WITH THE WORDS "PAYMENT SYSTEMS GROUP" UNDERNEATH.

SER. NO. 77-227,599, FILED 7-12-2007.

JAY FLOWERS, EXAMINING ATTORNEY

**Int. Cl.: 37**

**Prior U.S. Cls.: 100, 103 and 106**

**United States Patent and Trademark Office**

**Reg. No. 3,452,496**

**Registered June 24, 2008**

**SERVICE MARK  
PRINCIPAL REGISTER**

**Dr. Poolittle**

BENSON, BRIAN J (UNITED STATES INDIVIDUAL)  
4160 RAPTOR ROAD  
EAGAN, MN 55122

THE MARK CONSISTS OF STANDARD CHARACTERS WITHOUT CLAIM TO ANY PARTICULAR FONT, STYLE, SIZE, OR COLOR.

FOR: PET WASTE REMOVAL SERVICES, IN CLASS 37 (U.S. CLS. 100, 103 AND 106).

SER. NO. 77-227,630, FILED 7-12-2007.

FIRST USE 4-19-2005; IN COMMERCE 4-19-2005.

GIANCARLO CASTRO, EXAMINING ATTORNEY

**Int. Cl.: 6**

**Prior U.S. Cls.: 2, 12, 13, 14, 23, 25 and 50**

**United States Patent and Trademark Office**

**Reg. No. 3,452,497**

**Registered June 24, 2008**

**TRADEMARK  
PRINCIPAL REGISTER**

**knobappeal**

KNOBAPPEAL, LLC (GEORGIA LTD LIAB CO)  
1214 VILLA DRIVE NE  
ATLANTA, GA 30306

FOR: COMMON METAL DRAWER PULLS, IN  
CLASS 6 (U.S. CLS. 2, 12, 13, 14, 23, 25 AND 50).

FIRST USE 12-14-1999; IN COMMERCE 12-14-1999.

THE MARK CONSISTS OF STANDARD CHAR-  
ACTERS WITHOUT CLAIM TO ANY PARTICULAR  
FONT, STYLE, SIZE, OR COLOR.

OWNER OF U.S. REG. NO. 2,482,026.

SER. NO. 77-227,721, FILED 7-12-2007.

BARBARA A. GOLD, EXAMINING ATTORNEY

**Int. Cl.: 3**

**Prior U.S. Cls.: 1, 4, 6, 50, 51 and 52**

**United States Patent and Trademark Office**

**Reg. No. 3,452,498**

**Registered June 24, 2008**

---

**TRADEMARK  
PRINCIPAL REGISTER**

**PERFECT RESULTS**

FROMM INTERNATIONAL, INC. (ILLINOIS  
CORPORATION)  
1919 STANLEY STREET  
NORTHBROOK, IL 60062

FOR: HAIR COLOR, IN CLASS 3 (U.S. CLS. 1, 4, 6,  
50, 51 AND 52).

FIRST USE 6-1-2005; IN COMMERCE 6-1-2005.

THE MARK CONSISTS OF STANDARD CHAR-  
ACTERS WITHOUT CLAIM TO ANY PARTICULAR  
FONT, STYLE, SIZE, OR COLOR.

OWNER OF U.S. REG. NO. 2,908,071.

SER. NO. 77-227,806, FILED 7-12-2007.

CHARLES L. JENKINS, EXAMINING ATTORNEY

**Int. Cl.: 35**

**Prior U.S. Cls.: 100, 101 and 102**

**United States Patent and Trademark Office**

**Reg. No. 3,452,499**

**Registered June 24, 2008**

**SERVICE MARK  
PRINCIPAL REGISTER**

**WEBB Women Empowered by  
Business**

TES FRANCHISING LLC (CONNECTICUT LTD  
LIAB CO)  
BUILDING 2  
900 MAIN STREET SOUTH  
SOUTHURY, CT 06488

FOR: BUSINESS CONSULTING SERVICES FOR  
WOMEN IN THE FIELD OF BUSINESS AND FRAN-  
CHISE OWNERSHIP, IN CLASS 35 (U.S. CLS. 100, 101  
AND 102).

FIRST USE 3-1-2005; IN COMMERCE 3-1-2005.

THE MARK CONSISTS OF STANDARD CHAR-  
ACTERS WITHOUT CLAIM TO ANY PARTICULAR  
FONT, STYLE, SIZE, OR COLOR.

SER. NO. 77-227,835, FILED 7-12-2007.

KRISTINA MORRIS, EXAMINING ATTORNEY



**Int. Cl.: 36**

**Prior U.S. Cls.: 100, 101 and 102**

**United States Patent and Trademark Office**

**Reg. No. 3,452,500**

**Registered June 24, 2008**

**SERVICE MARK  
PRINCIPAL REGISTER**

**UNIFI Retirement Advantage  
Series**

AMERITAS HOLDING COMPANY (NEBRASKA  
CORPORATION)  
5900 O STREET  
LINCOLN, NE 68510

FOR: INSURANCE AND FINANCIAL SERVICES,  
NAMELY, ADMINISTRATION OF RETIREMENT  
PLANS, IN CLASS 36 (U.S. CLS. 100, 101 AND 102).

FIRST USE 8-4-2006; IN COMMERCE 8-7-2006.

THE MARK CONSISTS OF STANDARD CHAR-  
ACTERS WITHOUT CLAIM TO ANY PARTICULAR  
FONT, STYLE, SIZE, OR COLOR.

NO CLAIM IS MADE TO THE EXCLUSIVE  
RIGHT TO USE "RETIREMENT" OR "SERIES",  
APART FROM THE MARK AS SHOWN.

SER. NO. 77-227,836, FILED 7-12-2007.

HENRY S. ZAK, EXAMINING ATTORNEY

**Int. Cl.: 35**

**Prior U.S. Cls.: 100, 101 and 102**

**United States Patent and Trademark Office**

**Reg. No. 3,452,501**

**Registered June 24, 2008**

**SERVICE MARK  
PRINCIPAL REGISTER**

**Women Empowered by Business**

TES FRANCHISING LLC (CONNECTICUT LTD  
LIAB CO)  
BUILDING 2  
900 MAIN STREET SOUTH  
SOUTHURY, CT 06488

FOR: BUSINESS CONSULTING SERVICES FOR  
WOMEN IN THE FIELD OF BUSINESS AND FRAN-  
CHISE OWNERSHIP, IN CLASS 35 (U.S. CLS. 100, 101  
AND 102).

FIRST USE 3-1-2005; IN COMMERCE 3-1-2005.

THE MARK CONSISTS OF STANDARD CHAR-  
ACTERS WITHOUT CLAIM TO ANY PARTICULAR  
FONT, STYLE, SIZE, OR COLOR.

SER. NO. 77-227,852, FILED 7-12-2007.

KRISTINA MORRIS, EXAMINING ATTORNEY

**Int. Cl.: 42**

**Prior U.S. Cls.: 100 and 101**

**United States Patent and Trademark Office**

**Reg. No. 3,452,502**

**Registered June 24, 2008**

**SERVICE MARK  
PRINCIPAL REGISTER**

**vide☀share**

LIWERANT, GAD (MEXICO INDIVIDUAL)  
16 ESSEX ROAD  
CHESTNUT HILL, MA 02467

FOR: APPLICATION SERVICE PROVIDER IN THE NATURE OF A VIDEO COMMUNITY FEATURING SOFTWARE TO ENABLE UPLOADING, POSTING, OR DISPLAYING ELECTRONIC MEDIA OVER THE INTERNET , IN CLASS 42 (U.S. CLS. 100 AND 101).

FIRST USE 7-11-2007; IN COMMERCE 7-11-2007.

OWNER OF U.S. REG. NO. 2,529,418.

NO CLAIM IS MADE TO THE EXCLUSIVE RIGHT TO USE "VIDEOSHARE", APART FROM THE MARK AS SHOWN.

THE MARK CONSISTS OF THE WORD "VIDEO-SHARE," WITH A FANCIFUL "O" CONSISTING OF A CIRCLE OF "V"S TO FORM A "SUNBURST" DESIGN.

SER. NO. 77-228,300, FILED 7-12-2007.

SHARON MEIER, EXAMINING ATTORNEY

Int. Cl.: 41

Prior U.S. Cls.: 100, 101 and 107

United States Patent and Trademark Office

Reg. No. 3,452,503

Registered June 24, 2008

SERVICE MARK  
PRINCIPAL REGISTER



HIGH SPEED ENTERTAINMENT LLC (NEVADA  
LTD LIAB CO)  
2610 ELM AVE.  
LONG BEACH, CA 90806

FOR: MUSIC PRODUCTION SERVICES, IN  
CLASS 41 (U.S. CLS. 100, 101 AND 107).

FIRST USE 11-20-2003; IN COMMERCE 11-20-2003.

NO CLAIM IS MADE TO THE EXCLUSIVE  
RIGHT TO USE "ENTERTAINMENT", APART  
FROM THE MARK AS SHOWN.

THE MARK CONSISTS OF THE WORDS HIGH  
SPEED ENTERTAINMENT IN A STYLIZED TEXT  
WITH A CHROME CHAIN STEERING WHEEL AND  
RACING FLAGS IN THE MIDDLE OF IT.

SER. NO. 77-228,648, FILED 7-12-2007.

SANI KHOURI, EXAMINING ATTORNEY

**Int. Cl.: 25**

**Prior U.S. Cls.: 22 and 39**

**United States Patent and Trademark Office**

**Reg. No. 3,452,504**

**Registered June 24, 2008**

**TRADEMARK  
PRINCIPAL REGISTER**

**REAL DADS WEAR ORANGE**

SYRACUSE UNIVERSITY (NEW YORK EDUCATIONAL INSTITUTION)  
303 UNIVERSITY PLACE  
SYRACUSE, NY 132442020

FOR: SPORTS SHIRTS; SWEAT SHIRTS; T-SHIRTS; SPORT SHIRTS; SHIRTS; SHORT-SLEEVED OR LONG-SLEEVED T-SHIRTS; SLEEP SHIRTS; JERSEYS; TANK TOPS; JACKETS; COATS; PARKAS; SWEATERS; PANTS; SHORTS; SWEAT PANTS; SCARVES; HEADWEAR; SWEAT BANDS; CAPS; HATS; BOXER SHORTS, IN CLASS 25 (U.S. CLS. 22 AND 39).

FIRST USE 5-30-2003; IN COMMERCE 6-30-2003.

THE MARK CONSISTS OF STANDARD CHARACTERS WITHOUT CLAIM TO ANY PARTICULAR FONT, STYLE, SIZE, OR COLOR.

OWNER OF U.S. REG. NOS. 2,268,372, 2,929,720 AND OTHERS.

SER. NO. 77-228,809, FILED 7-13-2007.

LANA PHAM, EXAMINING ATTORNEY

**Int. Cl.: 25**

**Prior U.S. Cls.: 22 and 39**

**United States Patent and Trademark Office**

**Reg. No. 3,452,505**

**Registered June 24, 2008**

**TRADEMARK  
PRINCIPAL REGISTER**

**REAL MOMS WEAR ORANGE**

SYRACUSE UNIVERSITY (NEW YORK EDUCATIONAL INSTITUTION)  
303 UNIVERSITY PLACE  
SYRACUSE, NY 132442020

FOR: T-SHIRTS, IN CLASS 25 (U.S. CLS. 22 AND 39).

FIRST USE 5-30-2003; IN COMMERCE 6-30-2003.

THE MARK CONSISTS OF STANDARD CHARACTERS WITHOUT CLAIM TO ANY PARTICULAR FONT, STYLE, SIZE, OR COLOR.

OWNER OF U.S. REG. NOS. 2,268,372, 2,929,720 AND OTHERS.

SER. NO. 77-228,815, FILED 7-13-2007.

LANA PHAM, EXAMINING ATTORNEY

**Int. Cl.: 25**

**Prior U.S. Cls.: 22 and 39**

**United States Patent and Trademark Office**

**Reg. No. 3,452,506**

**Registered June 24, 2008**

**TRADEMARK  
PRINCIPAL REGISTER**

**REAL GRANDPARENTS WEAR  
ORANGE**

SYRACUSE UNIVERSITY (NEW YORK EDUCATIONAL INSTITUTION)  
303 UNIVERSITY PLACE  
SYRACUSE, NY 132442020

FOR: T-SHIRTS, IN CLASS 25 (U.S. CLS. 22 AND 39).

FIRST USE 5-30-2003; IN COMMERCE 6-30-2003.

THE MARK CONSISTS OF STANDARD CHARACTERS WITHOUT CLAIM TO ANY PARTICULAR FONT, STYLE, SIZE, OR COLOR.

OWNER OF U.S. REG. NOS. 2,268,372, 2,929,720 AND OTHERS.

SER. NO. 77-228,818, FILED 7-13-2007.

LANA PHAM, EXAMINING ATTORNEY

**Int. Cl.: 25**

**Prior U.S. Cls.: 22 and 39**

**United States Patent and Trademark Office**

**Reg. No. 3,452,507**

**Registered June 24, 2008**

**TRADEMARK  
PRINCIPAL REGISTER**

**REAL ALUMNI WEAR ORANGE**

SYRACUSE UNIVERSITY (NEW YORK EDUCATIONAL INSTITUTION)  
303 UNIVERSITY PLACE  
SYRACUSE, NY 132442020

FOR: T-SHIRTS, IN CLASS 25 (U.S. CLS. 22 AND 39).

FIRST USE 5-30-2003; IN COMMERCE 6-30-2003.

THE MARK CONSISTS OF STANDARD CHARACTERS WITHOUT CLAIM TO ANY PARTICULAR FONT, STYLE, SIZE, OR COLOR.

OWNER OF U.S. REG. NOS. 2,268,372, 2,929,720 AND OTHERS.

SER. NO. 77-228,823, FILED 7-13-2007.

LANA PHAM, EXAMINING ATTORNEY



**Int. Cl.: 25**

**Prior U.S. Cls.: 22 and 39**

**United States Patent and Trademark Office**

**Reg. No. 3,452,508**

**Registered June 24, 2008**

**TRADEMARK  
PRINCIPAL REGISTER**

**REAL GIRLS WEAR ORANGE**

SYRACUSE UNIVERSITY (NEW YORK EDUCATIONAL INSTITUTION)  
303 UNIVERSITY PLACE  
SYRACUSE, NY 132442020

FOR: T-SHIRTS, IN CLASS 25 (U.S. CLS. 22 AND 39).

FIRST USE 5-30-2003; IN COMMERCE 6-30-2003.

THE MARK CONSISTS OF STANDARD CHARACTERS WITHOUT CLAIM TO ANY PARTICULAR FONT, STYLE, SIZE, OR COLOR.

OWNER OF U.S. REG. NOS. 2,268,372, 2,929,720 AND OTHERS.

SER. NO. 77-228,824, FILED 7-13-2007.

LANA PHAM, EXAMINING ATTORNEY

**Int. Cl.: 25**

**Prior U.S. Cls.: 22 and 39**

**United States Patent and Trademark Office**

**Reg. No. 3,452,509**

**Registered June 24, 2008**

**TRADEMARK  
PRINCIPAL REGISTER**

**REAL BOYS WEAR ORANGE**

SYRACUSE UNIVERSITY (NEW YORK EDUCATIONAL INSTITUTION)  
303 UNIVERSITY PLACE  
SYRACUSE, NY 132442020

FOR: T-SHIRTS, IN CLASS 25 (U.S. CLS. 22 AND 39).

FIRST USE 5-30-2003; IN COMMERCE 6-30-2003.

THE MARK CONSISTS OF STANDARD CHARACTERS WITHOUT CLAIM TO ANY PARTICULAR FONT, STYLE, SIZE, OR COLOR.

OWNER OF U.S. REG. NOS. 2,268,372, 2,929,720 AND OTHERS.

SER. NO. 77-228,828, FILED 7-13-2007.

LANA PHAM, EXAMINING ATTORNEY

**Int. Cl.: 21**

**Prior U.S. Cls.: 2, 13, 23, 29, 30, 33, 40 and 50**

**Reg. No. 3,452,510**

**United States Patent and Trademark Office**

**Registered June 24, 2008**

**TRADEMARK  
PRINCIPAL REGISTER**



S. C. JOHNSON & SON, INC. (WISCONSIN CORPORATION)  
1525 HOWE STREET  
RACINE, WI 53403

OWNER OF U.S. REG. NOS. 628,506 AND 847,541.

FOR: DISPOSABLE INSECT TRAP, IN CLASS 21  
(U.S. CLS. 2, 13, 23, 29, 30, 33, 40 AND 50).

THE MARK CONSISTS OF "RAID" WITH A  
CHEVRON DESIGN AND LIGHTNING BOLT.

SER. NO. 77-229,021, FILED 7-13-2007.

FIRST USE 2-14-2007; IN COMMERCE 2-14-2007.

RON FAIRBANKS, EXAMINING ATTORNEY

**Int. Cl.: 41**

**Prior U.S. Cls.: 100, 101 and 107**

**United States Patent and Trademark Office**

**Reg. No. 3,452,511**

**Registered June 24, 2008**

**SERVICE MARK  
PRINCIPAL REGISTER**

# Romance in a Can

LANDMAN, ISABELLE (FRANCE INDIVIDUAL)  
8877 COLLINS AVE. #610  
MIAMI BEACH, FL 33141

FOR: PLANNING, MANAGING AND CONDUCTING AN INTERNATIONAL ROMANCE FILM FESTIVAL; AND PRODUCING EDUCATIONAL SERVICE, NAMELY, ARRANGING AN CONDUCTING SEMINARS AND WORKSHOPS IN THE FIELD OF INDEPENDENT FILMS; INFORMATION IN THE FIELD OF INDEPENDENT FILMS, IN CLASS 41 (U.S. CLS. 100, 101 AND 107).

FIRST USE 5-30-2006; IN COMMERCE 5-30-2006.

THE MARK CONSISTS OF STANDARD CHARACTERS WITHOUT CLAIM TO ANY PARTICULAR FONT, STYLE, SIZE, OR COLOR.

NO CLAIM IS MADE TO THE EXCLUSIVE RIGHT TO USE "ROMANCE", APART FROM THE MARK AS SHOWN.

SER. NO. 77-229,141, FILED 7-13-2007.

KELLY BOULTON, EXAMINING ATTORNEY

**Int. Cl.: 42**

**Prior U.S. Cls.: 100 and 101**

**United States Patent and Trademark Office**

**Reg. No. 3,452,512**

**Registered June 24, 2008**

**SERVICE MARK  
PRINCIPAL REGISTER**

**Techliant LLC  
Secure | Scale | Sustain**

TECHLIANT LLC (VIRGINIA LTD LIAB CO)  
9877 DOCHART SOUND LANE  
BRISTOW, VA 20136

FOR: INFORMATION TECHNOLOGY CONSULTATION, IN CLASS 42 (U.S. CLS. 100 AND 101).

FIRST USE 12-1-2003; IN COMMERCE 6-1-2007.

THE MARK CONSISTS OF STANDARD CHARACTERS WITHOUT CLAIM TO ANY PARTICULAR FONT, STYLE, SIZE, OR COLOR.

NO CLAIM IS MADE TO THE EXCLUSIVE RIGHT TO USE "LLC SECURE SCALE SUSTAIN", APART FROM THE MARK AS SHOWN.

SER. NO. 77-229,259, FILED 7-13-2007.

BILL DAWE, EXAMINING ATTORNEY

**Int. Cl.: 41**

**Prior U.S. Cls.: 100, 101 and 107**

**United States Patent and Trademark Office**

**Reg. No. 3,452,513**

**Registered June 24, 2008**

**SERVICE MARK  
PRINCIPAL REGISTER**

# Strictly Blues

TURNER, KAI (UNITED STATES INDIVIDUAL)  
2266 GRAY STREET  
EDGEWATER, CO 80214

FOR: PRODUCTION AND DISTRIBUTION OF  
RADIO PROGRAMS; RADIO ENTERTAINMENT  
PRODUCTION; RADIO PROGRAM SYNDICATION;  
PRODUCTION OF RADIO OR TELEVISION PRO-  
GRAMS, IN CLASS 41 (U.S. CLS. 100, 101 AND 107).

FIRST USE 6-6-1996; IN COMMERCE 6-6-1996.

THE MARK CONSISTS OF STANDARD CHAR-  
ACTERS WITHOUT CLAIM TO ANY PARTICULAR  
FONT, STYLE, SIZE, OR COLOR.

NO CLAIM IS MADE TO THE EXCLUSIVE  
RIGHT TO USE "BLUES", APART FROM THE  
MARK AS SHOWN.

SER. NO. 77-229,601, FILED 7-13-2007.

AMEETA JORDAN, EXAMINING ATTORNEY

**Int. Cl.: 25**

**Prior U.S. Cls.: 22 and 39**

**United States Patent and Trademark Office**

**Reg. No. 3,452,514**

**Registered June 24, 2008**

**TRADEMARK  
PRINCIPAL REGISTER**

**nôa-nôa**

CALÇADOS ASDURIAN LTDA. (BRAZIL LIMITED PARTNERSHIP)  
ITAIM BIBI  
RUA CAMPOS BICUDO, 98, 12º ANDAR  
SAO PAULO, BRAZIL 04536-010

FOR: FOOTWEAR; SHOES, TENNIS SHOES, SANDALS, SLIPPERS, BOOTS, CLOGS, IN CLASS 25 (U.S. CLS. 22 AND 39).

FIRST USE 12-10-1975; IN COMMERCE 6-1-2007.

THE MARK CONSISTS OF THE WORD NÔA NÔA IN STYLIZED LETTERS.

THE FOREIGN WORDING IN THE MARK TRANSLATES INTO ENGLISH AS FRAGRANCE.

SER. NO. 77-229,939, FILED 7-15-2007.

DAVID H. STINE, EXAMINING ATTORNEY

**Int. Cl.: 36**

**Prior U.S. Cls.: 100, 101 and 102**

**United States Patent and Trademark Office**

**Reg. No. 3,452,515**

**Registered June 24, 2008**

**SERVICE MARK  
PRINCIPAL REGISTER**

**THE PEOPLE IN YOUR FUTURE**

INTELLIDYN CORP. (FED REP GERMANY  
CORPORATION)  
175 DERBY STREET, UNIT 40  
HINGHAM, MA 02043

FIRST USE 2-15-2002; IN COMMERCE 2-15-2002.

FOR: CREDIT AND FINANCIAL CONSULTA-  
TION; CREDIT CONSULTATION; CREDIT RATING  
SERVICES; CREDIT REPORTING SERVICES;  
CREDIT RISK MANAGEMENT; EVALUATION OF  
CREDIT BUREAU DATA; EVALUATION OF THE  
CREDIT WORTHINESS OF COMPANIES AND PRI-  
VATE INDIVIDUALS, IN CLASS 36 (U.S. CLS. 100,  
101 AND 102).

THE MARK CONSISTS OF STANDARD CHAR-  
ACTERS WITHOUT CLAIM TO ANY PARTICULAR  
FONT, STYLE, SIZE, OR COLOR.

SER. NO. 77-230,150, FILED 7-16-2007.

JOHN DALIER, EXAMINING ATTORNEY



Int. Cl.: 25

Prior U.S. Cls.: 22 and 39

United States Patent and Trademark Office

Reg. No. 3,452,516

Registered June 24, 2008

TRADEMARK  
PRINCIPAL REGISTER

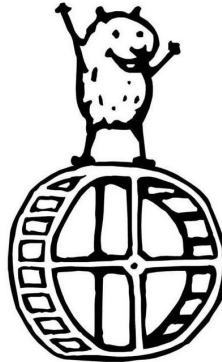

SCHALLERT, JON (UNITED STATES INDIVIDUAL)  
SUITE 100  
2117 EMERALD DRIVE  
LONGMONT, CO 80504 AND  
SCHALLERT, MARGARET (UNITED STATES INDIVIDUAL)  
SUITE 100  
2117 EMERALD DRIVE  
LONGMONT, CO 80504

FIRST USE 8-16-2005; IN COMMERCE 8-16-2005.

THE MARK CONSISTS OF A HAMSTER RUNNING WHEEL WITH A TRIUMPHANT HAMSTER STANDING ON TOP OF IT.

SER. NO. 77-230,293, FILED 7-16-2007.

FOR: SHORT-SLEEVED OR LONG-SLEEVED T-SHIRTS, IN CLASS 25 (U.S. CLS. 22 AND 39).

RENEE MCCRAY, EXAMINING ATTORNEY

Int. Cl.: 36

Prior U.S. Cls.: 100, 101 and 102

United States Patent and Trademark Office

Reg. No. 3,452,517

Registered June 24, 2008

SERVICE MARK  
PRINCIPAL REGISTER



MATTRESS FIRM, INC. (DELAWARE CORPORATION)

5815 GULF FREEWAY  
HOUSTON, TX 77023

FOR: CHARITABLE SERVICES, NAMELY FUNDRAISING SERVICES AND PROVIDING FINANCIAL SUPPORT FOR CHARITABLE PROGRAMS, IN CLASS 36 (U.S. CLS. 100, 101 AND 102).

FIRST USE 12-0-2004; IN COMMERCE 12-0-2004.

NO CLAIM IS MADE TO THE EXCLUSIVE RIGHT TO USE "FOUNDATION", APART FROM THE MARK AS SHOWN.

THE COLOR(S) RED, YELLOW, BLACK, GREEN, BLUE, BROWN, WHITE, GREY, PEACH, ORANGE, PURPLE, AND PINK IS/ARE CLAIMED AS A FEATURE OF THE MARK.

THE MARK CONSISTS OF MATTRESSFIRM IN RED AND A YELLOW AND BLACK SWOOSH DESIGN UNDERNEATH FIRM, ALL ABOVE FOUNDATION IN BLACK AND IMAGES OF SIX LITTLE CHILDREN, ONE WITH GREEN SHIRT AND BLUE PANTS AND SHOES, BROWN HAIR AND PEACH SKIN, ONE WITH BROWN SKIN AND BLACK HAIR, PURPLE SKIRT, PURPLE AND YELLOW TOP AND GREY SHOES, ONE WITH BLUE HAT, SHOES AND PANTS, PEACH SKIN AND ORANGE TOP, ONE WITH BROWN HAIR, PEACH SKIN, PINK TOP, RED OVERALLS AND BLACK SHOES, ONE WITH WHITE AND GREEN TOP, PEACH SKIN, YELLOW HAIR, GREEN SHORTS AND BLUE SHOES, AND ONE WITH BROWN HAIR AND SKIN, PURPLE SHIRT, BLUE PANTS AND GREY SHOES, ALL ABOVE THE PHRASE FOR A SAFE AND HEALTHY CHILDHOOD IN BLACK.

SER. NO. 77-230,919, FILED 7-16-2007.

ANGELA M. MICHELI, EXAMINING ATTORNEY

**Int. Cls.: 29 and 30**

**Prior U.S. Cl.: 46**

**United States Patent and Trademark Office**

**Reg. No. 3,452,518**

**Registered June 24, 2008**

**TRADEMARK  
PRINCIPAL REGISTER**

**REDUCED GUILT**

TRADER JOE'S COMPANY (CALIFORNIA CORPORATION)  
800 S. SHAMROCK AVENUE  
MONROVIA, CA 91016

FOR: POTATO-BASED SNACK FOODS, NAME-  
LY, POTATO CHIPS, IN CLASS 29 (U.S. CL. 46).

FIRST USE 1-24-2007; IN COMMERCE 1-24-2007.

FOR: WHEAT-BASED SNACK FOODS, NAME-  
LY, CRACKERS; PITA CHIPS, IN CLASS 30 (U.S. CL. 46).

FIRST USE 1-24-2007; IN COMMERCE 1-24-2007.

THE MARK CONSISTS OF STANDARD CHAR-  
ACTERS WITHOUT CLAIM TO ANY PARTICULAR  
FONT, STYLE, SIZE, OR COLOR.

SER. NO. 77-232,539, FILED 7-18-2007.

FRED MANDIR, EXAMINING ATTORNEY

**Int. Cl.: 36**

**Prior U.S. Cls.: 100, 101 and 102**

**United States Patent and Trademark Office**

**Reg. No. 3,452,519**

**Registered June 24, 2008**

**SERVICE MARK  
PRINCIPAL REGISTER**

# Rehmann Roadmap

THE REHMANN GROUP (MICHIGAN LTD LIAB  
CO)  
STE. 201  
5800 GRATIOT AVE.  
SAGINAW, MI 48638

THE MARK CONSISTS OF STANDARD CHAR-  
ACTERS WITHOUT CLAIM TO ANY PARTICULAR  
FONT, STYLE, SIZE, OR COLOR.

FOR: FINANCIAL CONSULTATION, IN CLASS 36  
(U.S. CLS. 100, 101 AND 102).

SER. NO. 77-232,563, FILED 7-18-2007.

FIRST USE 11-1-2006; IN COMMERCE 11-1-2006.

ZACHARY BELLO, EXAMINING ATTORNEY

**Int. Cl.: 41**

**Prior U.S. Cls.: 100, 101 and 107**

**United States Patent and Trademark Office**

**Reg. No. 3,452,520**

**Registered June 24, 2008**

---

**SERVICE MARK  
PRINCIPAL REGISTER**

**ATOMIC TRAINING**

ATOMIC LEARNING, INC. (MINNESOTA CORPORATION)

15088 22ND AVENUE NE

LITTLE FALLS, MN 56345

FOR: PROVIDING WEB-BASED SOFTWARE TRAINING AND THE DISTRIBUTION OF DIGITAL COURSE MATERIAL IN CONNECTION THEREWITH TO A DEFINED GROUP OF USERS, IN CLASS 41 (U.S. CLS. 100, 101 AND 107).

FIRST USE 6-29-2007; IN COMMERCE 6-29-2007.

THE MARK CONSISTS OF STANDARD CHARACTERS WITHOUT CLAIM TO ANY PARTICULAR FONT, STYLE, SIZE, OR COLOR.

OWNER OF U.S. REG. NOS. 2,943,745 AND 2,943,752.

NO CLAIM IS MADE TO THE EXCLUSIVE RIGHT TO USE "TRAINING", APART FROM THE MARK AS SHOWN.

SER. NO. 77-232,770, FILED 7-18-2007.

KRISTIN DAHLING, EXAMINING ATTORNEY

**Int. Cl.: 5**

**Prior U.S. Cls.: 6, 18, 44, 46, 51 and 52**

**United States Patent and Trademark Office**

**Reg. No. 3,452,521**

**Registered June 24, 2008**

**TRADEMARK  
PRINCIPAL REGISTER**



COUNTRY LIFE, LLC (NEW YORK LTD LIAB  
CO)  
180 VANDERBILT MOTOR PARKWAY  
HAUPPAUGE, NY 11788

FOR: DIETARY SUPPLEMENTS, IN CLASS 5 (U.S.  
CLS. 6, 18, 44, 46, 51 AND 52).

FIRST USE 5-1-2007; IN COMMERCE 5-1-2007.

NO CLAIM IS MADE TO THE EXCLUSIVE  
RIGHT TO USE "PH CONTROLLED", APART  
FROM THE MARK AS SHOWN.

THE COLOR(S) GREEN AND GOLD IS/ARE  
CLAIMED AS A FEATURE OF THE MARK.

THE MARK CONSISTS OF THE LETTERING  
"BUFFER-C" AND "PH CONTROLLED" IN GREEN,  
WITH THE WORDS "PH CONTROLLED" UNDER-  
SCORED IN GREEN AND WITH THE LETTER "C"  
IN "BUFFER-C" SURROUNDED BY A LARGER  
LETTER "C" IN GOLD.

SER. NO. 77-232,989, FILED 7-18-2007.

CHRISTINA SOBRAL, EXAMINING ATTORNEY

**Int. Cl.: 5**

**Prior U.S. Cls.: 6, 18, 44, 46, 51 and 52**

**Reg. No. 3,452,522**

**United States Patent and Trademark Office**

**Registered June 24, 2008**

**TRADEMARK  
PRINCIPAL REGISTER**

**CENTRILENE**

WEIGHT LOSS INNOVATIONS, LP (CALIFORNIA LIMITED PARTNERSHIP)  
SUITE 130  
5790 FLEET STREET  
CARLSBAD, CA 92008

FOR: NUTRITIONAL SUPPLEMENTS AND DIETARY SUPPLEMENTS, NAMELY, WEIGHT LOSS SUPPLEMENTS, VITAMIN SUPPLEMENTS, MINERAL SUPPLEMENTS, HERBAL SUPPLEMENTS, BOTANICAL SUPPLEMENTS, HOMEOPATHIC SUPPLEMENTS, NUTRACEUTICAL SUPPLEMENTS, NON-PRESCRIPTION HEALTH SUPPLEMENTS, FOOD SUPPLEMENTS, NUTRITIONAL

ADDITIVES FOR USE AS DIETARY SUPPLEMENTS AND ANY COMBINATION OF THE ABOVE, IN CLASS 5 (U.S. CLS. 6, 18, 44, 46, 51 AND 52).

FIRST USE 11-27-2006; IN COMMERCE 11-27-2006.

THE MARK CONSISTS OF STANDARD CHARACTERS WITHOUT CLAIM TO ANY PARTICULAR FONT, STYLE, SIZE, OR COLOR.

SER. NO. 77-233,894, FILED 7-19-2007.

MORGAN WYNNE, EXAMINING ATTORNEY

**Int. Cl.: 42**

**Prior U.S. Cls.: 100 and 101**

**United States Patent and Trademark Office**

**Reg. No. 3,452,523**

**Registered June 24, 2008**

**SERVICE MARK  
PRINCIPAL REGISTER**

**CONNECTIONS SYSTEM**

MARTHA STEWART LIVING OMNIMEDIA, INC.  
(DELAWARE CORPORATION)  
11 WEST 42ND STREET  
NEW YORK, NY 10036

FOR: INTERIOR DESIGN SERVICES; COLOR  
ANALYSIS FOR PURPOSES OF INTERIOR DESIGN,  
IN CLASS 42 (U.S. CLS. 100 AND 101).

FIRST USE 3-0-2007; IN COMMERCE 3-0-2007.

THE MARK CONSISTS OF STANDARD CHAR-  
ACTERS WITHOUT CLAIM TO ANY PARTICULAR  
FONT, STYLE, SIZE, OR COLOR.

NO CLAIM IS MADE TO THE EXCLUSIVE  
RIGHT TO USE "SYSTEM", APART FROM THE  
MARK AS SHOWN.

SER. NO. 77-233,908, FILED 7-19-2007.

FRANK LATTUCA, EXAMINING ATTORNEY



**Int. Cl.: 33**

**Prior U.S. Cls.: 47 and 49**

**United States Patent and Trademark Office**

**Reg. No. 3,452,524**

**Registered June 24, 2008**

**TRADEMARK  
PRINCIPAL REGISTER**

**UNTOUCHED, UNTAINTED,  
UNSPOILED.**

FINLANDIA VODKA WORLDWIDE LTD. (FIN-  
LAND CORPORATION)  
PORKKALANKATU 24  
HELSINKI, FINLAND 00180

FOR: DISTILLED SPIRITS, IN CLASS 33 (U.S. CLS.  
47 AND 49).

FIRST USE 5-1-2007; IN COMMERCE 5-1-2007.

THE MARK CONSISTS OF STANDARD CHAR-  
ACTERS WITHOUT CLAIM TO ANY PARTICULAR  
FONT, STYLE, SIZE, OR COLOR.

SER. NO. 77-233,953, FILED 7-19-2007.

WARREN L. OLANDRIA, EXAMINING ATTOR-  
NEY

**Int. Cl.: 37**

**Prior U.S. Cls.: 100, 103 and 106**

**United States Patent and Trademark Office**

**Reg. No. 3,452,525**

**Registered June 24, 2008**

**SERVICE MARK  
PRINCIPAL REGISTER**



24 HOUR ELECTRIC, INC (IDAHO CORPORATION)  
703 A STREET  
COEUR D' ALENE, ID 83814

FOR: ELECTRICAL CONTRACTOR SERVICES,  
IN CLASS 37 (U.S. CLS. 100, 103 AND 106).

FIRST USE 8-12-2002; IN COMMERCE 8-12-2002.

THE COLOR(S) RED, BLACK, WHITE, BLUE IS/  
ARE CLAIMED AS A FEATURE OF THE MARK.

THE MARK CONSISTS OF "24 HOUR" AT THE  
TOP IN BLUE AND AGAINST A WHITE BACK-

GROUND, AND "ELECTRIC" WRITTEN IN WHITE  
WITHIN A RED OBLONG CIRCLE. THE RED  
CIRCLE IS WITHIN A THIN WHITE BORDER  
AND A BLACK RECTANGULAR SHAPE, BELOW  
THE WORDS "24 HOUR". BOTH THE "24 HOUR"  
AND THE "ELECTRIC" ARE INSIDE OF A RED  
RECTANGULAR BORDER.

SEC. 2(F).

SER. NO. 77-233,975, FILED 7-19-2007.

DAVID TOOLEY, EXAMINING ATTORNEY

**Int. Cl.: 9**

**Prior U.S. Cls.: 21, 23, 26, 36 and 38**

**United States Patent and Trademark Office**

**Reg. No. 3,452,526**

**Registered June 24, 2008**

**TRADEMARK  
PRINCIPAL REGISTER**



CAO GROUP, INC. (UTAH CORPORATION)  
4628 W SKYHAWK DRIVE  
WEST JORDAN, UT 84084

FOR: LIGHT EMITTING DIODES (LEDS), IN  
CLASS 9 (U.S. CLS. 21, 23, 26, 36 AND 38).

FIRST USE 1-1-2006; IN COMMERCE 1-1-2006.

THE COLOR(S) WHITE, RED, RED-ORANGE,  
ORANGE, LIGHT ORANGE, YELLOW, YELLOW-  
GREEN, GREEN, CYAN, BLUE, INDIGO, PURPLE  
AND VIOLET IS/ARE CLAIMED AS A FEATURE OF  
THE MARK.

THE MARK CONSISTS OF A GENERALIZED  
BUTTRERFLY WITH A WHITE CENTER AND  
COLORED AS A SPECTRAL WHEEL WITH THE  
COLORS RED, RED-ORANGE, ORANGE, LIGHT  
ORANGE, YELLOW, YELLOW-GREEN, GREEN,  
CYAN, BLUE, INDIGO, PURPLE AND VIOLET  
PROGRESSING CLOCKWISE FROM THE TOP OF  
THE LOGO. THE WHITE COLOR EXTENDS OUT-  
WARD FROM THE CENTER IN WAVES, PROVID-  
ING DIFFERENT SHADES OF THE COLORS.

SER. NO. 77-234,030, FILED 7-19-2007.

ESTHER A. BORSUK, EXAMINING ATTORNEY

**Int. Cl.: 33**

**Prior U.S. Cls.: 47 and 49**

**United States Patent and Trademark Office**

**Reg. No. 3,452,527**

**Registered June 24, 2008**

**TRADEMARK  
PRINCIPAL REGISTER**

**ASHBRIDGE LANE**

MARGATE WINE AND SPIRIT COMPANY, LLC  
(NEW JERSEY LTD LIAB CO)  
3303 ATLANTIC AVENUE  
ATLANTIC CITY, NJ 08401

THE MARK CONSISTS OF STANDARD CHAR-  
ACTERS WITHOUT CLAIM TO ANY PARTICULAR  
FONT, STYLE, SIZE, OR COLOR.

FOR: WINES, IN CLASS 33 (U.S. CLS. 47 AND 49).

SER. NO. 77-234,214, FILED 7-19-2007.

FIRST USE 1-16-2004; IN COMMERCE 1-16-2004.

WENDY GOODMAN, EXAMINING ATTORNEY

**Int. Cl.: 41**

**Prior U.S. Cls.: 100, 101 and 107**

**United States Patent and Trademark Office**

**Reg. No. 3,452,528**

**Registered June 24, 2008**

**SERVICE MARK  
PRINCIPAL REGISTER**



CHANG CALDERON, MARIA (UNITED STATES  
INDIVIDUAL)  
2114 CRESTFIELD DR.  
SAN RAMON, CA 94582

NO CLAIM IS MADE TO THE EXCLUSIVE  
RIGHT TO USE "TALENT ID", APART FROM THE  
MARK AS SHOWN.

FOR: PROFESSIONAL COACHING SERVICES IN  
THE FIELD OF CORPORATE MANAGEMENT,  
NAMELY, COMPREHENSIVE TALENT ASSES-  
SMENT, PERFORMANCE COACHING AND STRA-  
TEGIC MANAGERIAL CAREER DEVELOPMENT,  
IN CLASS 41 (U.S. CLS. 100, 101 AND 107).

THE MARK CONSISTS OF 3 INDIVIDUALS WITH  
STYLIZED TEXT UNDERNEATH.

SER. NO. 77-234,236, FILED 7-19-2007.

FIRST USE 7-9-2007; IN COMMERCE 7-16-2007.

JILL C. ALT, EXAMINING ATTORNEY

**Int. Cl.: 41**

**Prior U.S. Cls.: 100, 101 and 107**

**United States Patent and Trademark Office**

**Reg. No. 3,452,529**

**Registered June 24, 2008**

---

**SERVICE MARK  
PRINCIPAL REGISTER**

**Mrs. Earth**

STAFFORD, MICHAEL R. (UNITED STATES IN-  
DIVIDUAL)  
P.O. BOX 723  
BRIDGEWATER, MA 02324

THE MARK CONSISTS OF STANDARD CHAR-  
ACTERS WITHOUT CLAIM TO ANY PARTICULAR  
FONT, STYLE, SIZE, OR COLOR.

FOR: ENTERTAINMENT IN THE NATURE OF  
BEAUTY PAGEANTS, IN CLASS 41 (U.S. CLS. 100,  
101 AND 107).

SER. NO. 77-234,413, FILED 7-20-2007.

FIRST USE 6-22-2007; IN COMMERCE 6-22-2007.

MIDGE BUTLER, EXAMINING ATTORNEY

**Int. Cl.: 42**

**Prior U.S. Cls.: 100 and 101**

**United States Patent and Trademark Office**

**Reg. No. 3,452,530**

**Registered June 24, 2008**

**SERVICE MARK  
PRINCIPAL REGISTER**

**CPCM**

BAKER HUGHES INCORPORATED (DELA-  
WARE CORPORATION)  
2929 ALLEN PARKWAY, SUITE 2100  
HOUSTON, TX 770192118

FOR: SERVICES COMPRISING OF MONITOR-  
ING AND REPORTING THE STATUS OF A PIPELI-  
NE'S CATHODIC PROTECTION SYSTEM USING  
AN IN-LINE INSPECTION TOOL (PIG) , IN CLASS 42  
(U.S. CLS. 100 AND 101).

FIRST USE 3-1-2007; IN COMMERCE 3-1-2007.

THE MARK CONSISTS OF STANDARD CHAR-  
ACTERS WITHOUT CLAIM TO ANY PARTICULAR  
FONT, STYLE, SIZE, OR COLOR.

SER. NO. 77-234,526, FILED 7-20-2007.

JACQUELINE A. LAVINE, EXAMINING ATTOR-  
NEY

Int. Cl.: 9

Prior U.S. Cls.: 21, 23, 26, 36 and 38

United States Patent and Trademark Office

Reg. No. 3,452,531

Registered June 24, 2008

TRADEMARK  
PRINCIPAL REGISTER



CHARLES A. RICHARDSON (UNITED STATES  
INDIVIDUAL)  
1938 BALTIMORE ANNAPOLIS BOULEVARD  
ANNAPOLIS, MD 214096248

FOR: PRE-RECORDED ELECTRONIC MEDIA,  
PHONOGRAPH RECORDS AND CDS FEATURING  
MUSIC, IN CLASS 9 (U.S. CLS. 21, 23, 26, 36 AND 38).

FIRST USE 1-1-1975; IN COMMERCE 1-1-1975.

NO CLAIM IS MADE TO THE EXCLUSIVE  
RIGHT TO USE "RECORDS", APART FROM THE  
MARK AS SHOWN.

THE MARK CONSISTS OF THE WORDS "RI-  
CHARDSON RECORDS" SHARING A STYLIZED  
"R".

SEC. 2(F).

SER. NO. 77-234,830, FILED 7-20-2007.

STEPHEN AQUILA, EXAMINING ATTORNEY



Int. Cl.: 41

Prior U.S. Cls.: 100, 101 and 107

United States Patent and Trademark Office

Reg. No. 3,452,532

Registered June 24, 2008

**SERVICE MARK  
PRINCIPAL REGISTER**



EDUCATIONAL SERVICES OF AMERICA (TENNESSEE CORPORATION)  
1321 MURFREESBORO PIKE, STE. 702  
NASHVILLE, TN 372172626

FOR: EDUCATING AT SENIOR HIGH SCHOOLS; ACADEMIC MENTORING SPECIAL EDUCATION AND AT-RISK STUDENTS AT THE ELEMENTARY THROUGH POST-SECONDARY SCHOOL LEVELS; EDUCATIONAL SERVICES, NAMELY, PROVIDING COURSES OF INSTRUCTION AT THE ELEMENTARY AND SECONDARY LEVEL AND DISTRIBUTION OF COURSE MATERIAL IN CONNECTION THEREWITH; ON-LINE EDUCATION CREDIT AND DEGREE EVALUATION AND COMPARISON SERVICES; PROVIDING COURSES OF INSTRUCTION AT THE PRE K THROUGH SECONDARY LEVEL; PROVIDING ACADEMIC MENTORING SERVICES AND PROGRAMS FOR AT-RISK STUDENTS AND POST-SECONDARY STUDENTS WITH SPECIAL NEEDS, IN CLASS 41 (U.S. CLS. 100, 101 AND 107).

FIRST USE 3-0-2006; IN COMMERCE 3-0-2006.

NO CLAIM IS MADE TO THE EXCLUSIVE RIGHT TO USE "EDUCATIONAL SERVICES OF AMERICA", APART FROM THE MARK AS SHOWN.

THE COLOR(S) RED, GREEN, BLUE, YELLOW, WHITE, AND BLACK IS/ARE CLAIMED AS A FEATURE OF THE MARK.

THE MARK CONSISTS OF A STYLIZED LETTER "E" IN WHITE INSIDE A RED COLOR BLOCK, A STYLIZED LETTER "S" IN WHITE INSIDE A GREEN COLOR BLOCK, A STYLIZED LETTER "A" IN WHITE INSIDE A BLUE COLOR BLOCK; A YELLOW PENCIL WITH A WHITE AND BLACK TIP COMING UP FROM BENEATH THE STYLIZED LETTER "A" IN WHITE; STYLIZED "EDUCATIONAL SERVICES OF AMERICA" WRITTEN IN BLACK BENEATH THE STYLIZED LETTERS "ESA".

SER. NO. 77-235,086, FILED 7-20-2007.

FLORENTINA BLANDU, EXAMINING ATTORNEY

**Int. Cl.: 30**

**Prior U.S. Cl.: 46**

**United States Patent and Trademark Office**

**Reg. No. 3,452,533**

**Registered June 24, 2008**

**TRADEMARK  
PRINCIPAL REGISTER**

**SWEET SHOTS**

SODEXHO OPERATIONS, LLC (DELAWARE  
LTD LIAB CO)  
9801 WASHINGTONIAN BOULEVARD  
GAITHERSBURG, MD 20878

FOR: DESSERTS CONSISTING OF MOUSSE  
SOLD AS A UNIT WITH VARIOUS OF THE FOL-  
LOWING ADDITIONAL INGREDIENTS – DICED  
CAKE, DICED PIE, COOKIE CRUMBS, MARSH-  
MALLOWS, FLAVORED SYRUPS, DESSERT SAU-  
CES, WHIPPED TOPPING, CHOPPED NUTS,  
PROCESSED FRUIT, FRESH FRUIT AND FRUIT  
PUREE, IN CLASS 30 (U.S. CL. 46).

FIRST USE 6-5-2006; IN COMMERCE 6-5-2006.

THE MARK CONSISTS OF STANDARD CHAR-  
ACTERS WITHOUT CLAIM TO ANY PARTICULAR  
FONT, STYLE, SIZE, OR COLOR.

NO CLAIM IS MADE TO THE EXCLUSIVE  
RIGHT TO USE "SWEET", APART FROM THE  
MARK AS SHOWN.

SER. NO. 77-235,380, FILED 7-21-2007.

LINDA POWELL, EXAMINING ATTORNEY

**Int. Cl.: 9**

**Prior U.S. Cls.: 21, 23, 26, 36 and 38**

**Reg. No. 3,452,534**

**United States Patent and Trademark Office**

**Registered June 24, 2008**

**TRADEMARK  
PRINCIPAL REGISTER**

# ReagentWorld

REAGENT WORLD, INC (DELAWARE CORPORATION)  
2192 DUPONT DRIVE, SUITE 214  
IRVINE, CA 92612

FOR: GLASSWARE FOR USE IN SCIENTIFIC LABORATORY IN BIOCHEMICAL, DIAGNOSTICS, AND CHEMICAL FIELDS, NAMELY, BEAKERS, FLASKS, GRADUATED CYLINDERS, BURETTES, FUNNELS, CONDENSERS; SCIENTIFIC INSTRUMENTS, EQUIPMENT, APPARATUS, AND ACCESSORIES FOR USE IN SCIENTIFIC LABORATORY IN BIOCHEMICAL, DIAGNOSTICS, AND CHEMICAL FIELDS, NAMELY, BALANCES, LAB JACKS, STIRRING HEATING PLATE, HOT PLATE, VACUUM PUMPS, INCUBATORS, OVENS; POLYETHYLENE AND OTHER PLASTICS PRODUCTS

FOR LABORATORY APPLICATIONS, NAMELY, PLASTIC BEAKERS AND FLASKS, RUBBER AND ELASTOMER CLOSURES, SEALS AND STOPPERS FOR LABORATORY BOTTLES, IN CLASS 9 (U.S. CLS. 21, 23, 26, 36 AND 38).

FIRST USE 1-1-2003; IN COMMERCE 3-13-2006.

THE MARK CONSISTS OF STANDARD CHARACTERS WITHOUT CLAIM TO ANY PARTICULAR FONT, STYLE, SIZE, OR COLOR.

SER. NO. 77-236,052, FILED 7-23-2007.

KEVIN DINALLO, EXAMINING ATTORNEY

**Int. Cl.: 41**

**Prior U.S. Cls.: 100, 101 and 107**

**United States Patent and Trademark Office**

**Reg. No. 3,452,535**

**Registered June 24, 2008**

**SERVICE MARK  
PRINCIPAL REGISTER**



EDUCATIONAL SERVICES OF AMERICA (TENNESSEE CORPORATION), DBA ESA  
SUITE 702  
1321 MURFREESBORO PIKE  
NASHVILLE, TN 372172626

FOR: PROVIDING COURSES OF INSTRUCTION AT THE PREK-12 LEVEL; ACADEMIC MENTORING SERVICES NAMELY, MENTORING AT RISK STUDENTS AND STUDENTS WITH SPECIAL NEEDS; ACADEMIC MENTORING SPECIAL EDUCATION AND AT-RISK STUDENTS AT THE ELEMENTARY THROUGH POST-SECONDARY SCHOOL LEVELS; ACADEMIC MENTORING SERVICES, NAMELY, PROVIDING COURSES OF INSTRUCTION AT THE PREK-12 LEVEL, IN CLASS 41 (U.S. CLS. 100, 101 AND 107).

FIRST USE 12-0-2006; IN COMMERCE 12-0-2006.

NO CLAIM IS MADE TO THE EXCLUSIVE RIGHT TO USE "SCHOOLS AND PROGRAMS", APART FROM THE MARK AS SHOWN.

THE COLOR(S) RED, GREEN, AND BLUE IS/ARE CLAIMED AS A FEATURE OF THE MARK.

THE MARK CONSISTS OF THE LETTER "E" IN RED, THE LETTER "S" IN GREEN, THE LETTER "A" IN BLUE ABOVE "EXCEPTIONAL SCHOOLS AND PROGRAMS" IN BLACK.

SER. NO. 77-236,334, FILED 7-23-2007.

FLORENTINA BLANDU, EXAMINING ATTORNEY

**Int. Cl.: 42**

**Prior U.S. Cls.: 100 and 101**

**United States Patent and Trademark Office**

**Reg. No. 3,452,536**

**Registered June 24, 2008**

**SERVICE MARK  
PRINCIPAL REGISTER**

**RADIUS RISK ASSESSMENT &  
DATA MANAGEMENT SYSTEM**

AMERICAN INTERNATIONAL GROUP, INC.  
(DELAWARE CORPORATION)  
70 PINE STREET  
NEW YORK, NY 10270

FOR: PROVIDING ON-LINE NON-DOWNLOAD-  
ABLE SOFTWARE FOR TRACKING AND REPORT-  
ING RISK ASSESSMENT INSPECTIONS RELATING  
TO HOMEOWNERS INSURANCE, IN CLASS 42 (U.S.  
CLS. 100 AND 101).

FIRST USE 7-16-2007; IN COMMERCE 7-16-2007.

THE MARK CONSISTS OF STANDARD CHAR-  
ACTERS WITHOUT CLAIM TO ANY PARTICULAR  
FONT, STYLE, SIZE, OR COLOR.

NO CLAIM IS MADE TO THE EXCLUSIVE  
RIGHT TO USE "RISK ASSESSMENT & DATA  
MANAGEMENT SYSTEM", APART FROM THE  
MARK AS SHOWN.

SER. NO. 77-236,417, FILED 7-23-2007.

ELLEN PERKINS, EXAMINING ATTORNEY

Int. Cl.: 41

Prior U.S. Cls.: 100, 101 and 107

United States Patent and Trademark Office

Reg. No. 3,452,537

Registered June 24, 2008

SERVICE MARK  
PRINCIPAL REGISTER



THE CULINARY LOFT, LLC (NEW YORK LTD  
LIAB CO)

#5A  
515 BROADWAY  
NEW YORK, NY 10012

FOR: ENTERTAINMENT SERVICES, NAMELY,  
PROVIDING/RENTING A SPECIALLY DESIGNED  
EVENT FACILITY FOR EVENTS, NAMELY, PHOTO  
SHOOTS, MEDIA PRODUCTIONS, SEMINARS,  
CORPORATE ENTERTAINMENT, WINE TASTING  
AND PARTIES, AND ARRANGING, CONDUCT-  
ING, PLANNING, COORDINATING AND HOSTING  
SPECIAL EVENTS, IN CLASS 41 (U.S. CLS. 100, 101  
AND 107).

FIRST USE 4-27-2007; IN COMMERCE 4-27-2007.

NO CLAIM IS MADE TO THE EXCLUSIVE  
RIGHT TO USE "LOFT", APART FROM THE MARK  
AS SHOWN.

SEC. 2(F) AS TO "CULINARY LOFT".

SER. NO. 77-237,310, FILED 7-24-2007.

SARA THOMAS, EXAMINING ATTORNEY

**Int. Cl.: 35**

**Prior U.S. Cls.: 100, 101 and 102**

**United States Patent and Trademark Office**

**Reg. No. 3,452,538**

**Registered June 24, 2008**

**SERVICE MARK  
PRINCIPAL REGISTER**

**URBAN BEAST**

URBAN BEAST-SEATTLE, LLC (WASHINGTON  
LTD LIAB CO), DBA URBAN BEAST  
217 YALE AVENUE NORTH  
SEATTLE, WA 98109

FOR: ON-LINE RETAIL STORE SERVICES FEATURING PET FOOD, PET SUPPLIES, PET TOYS AND PET ACCESSORIES; RETAIL STORE SERVICES FEATURING PET FOOD, PET SUPPLIES, PET TOYS AND PET ACCESSORIES, IN CLASS 35 (U.S. CLS. 100, 101 AND 102).

FIRST USE 2-15-2007; IN COMMERCE 2-15-2007.

THE MARK CONSISTS OF STANDARD CHARACTERS WITHOUT CLAIM TO ANY PARTICULAR FONT, STYLE, SIZE, OR COLOR.

SER. NO. 77-237,528, FILED 7-24-2007.

WILLIAM VERHOSEK, EXAMINING ATTORNEY

**Int. Cl.: 5**

**Prior U.S. Cls.: 6, 18, 44, 46, 51 and 52**

**Reg. No. 3,452,539**

**United States Patent and Trademark Office**

**Registered June 24, 2008**

---

**TRADEMARK  
PRINCIPAL REGISTER**

**NOVASOURCE**

TESSENDERLO KERLEY, INC. (DELAWARE  
CORPORATION)  
2255 N. 44TH STREET, SUITE 300  
PHOENIX, AZ 85008

THE MARK CONSISTS OF STANDARD CHAR-  
ACTERS WITHOUT CLAIM TO ANY PARTICULAR  
FONT, STYLE, SIZE, OR COLOR.

FOR: PESTICIDES; BIOCIDES, IN CLASS 5 (U.S.  
CLS. 6, 18, 44, 46, 51 AND 52).

SER. NO. 77-237,618, FILED 7-24-2007.

FIRST USE 6-0-2007; IN COMMERCE 6-0-2007.

KATHLEEN LORENZO, EXAMINING ATTORNEY



**Int. Cl.: 36**

**Prior U.S. Cls.: 100, 101 and 102**

**United States Patent and Trademark Office**

**Reg. No. 3,452,540**

**Registered June 24, 2008**

**SERVICE MARK  
PRINCIPAL REGISTER**

**MONEY BY DESIGN**

KADES-MARGOLIS CORPORATION (PENNSYLVANIA CORPORATION)  
998 OLD EAGLE SCHOOL RD.  
WAYNE, PA 19087

FOR: FINANCIAL ADMINISTRATION OF RETIREMENT PLANS; FINANCIAL PLANNING FOR RETIREMENT; INVESTMENT ADVISORY SERVICES; MUTUAL FUND INVESTMENT, IN CLASS 36 (U.S. CLS. 100, 101 AND 102).

FIRST USE 1-1-2001; IN COMMERCE 1-1-2001.

THE MARK CONSISTS OF STANDARD CHARACTERS WITHOUT CLAIM TO ANY PARTICULAR FONT, STYLE, SIZE, OR COLOR.

NO CLAIM IS MADE TO THE EXCLUSIVE RIGHT TO USE "MONEY", APART FROM THE MARK AS SHOWN.

SER. NO. 77-237,896, FILED 7-25-2007.

LINDA M. KING, EXAMINING ATTORNEY

**Int. Cl.: 35**

**Prior U.S. Cls.: 100, 101 and 102**

**United States Patent and Trademark Office**

**Reg. No. 3,452,541**

**Registered June 24, 2008**

**SERVICE MARK  
PRINCIPAL REGISTER**

**NSCP**

NATIONAL SOCIETY OF COMPLIANCE PROFESSIONALS (CONNECTICUT CORPORATION)  
22 KENT ROAD  
CORNWALL BRIDGE, CT 06754

FOR: ASSOCIATION SERVICES, NAMELY, PROMOTING THE INTERESTS OF SECURITIES COMPLIANCE PROFESSIONALS, IN CLASS 35 (U.S. CLS. 100, 101 AND 102).

FIRST USE 0-0-1987; IN COMMERCE 0-0-1987.

THE MARK CONSISTS OF STANDARD CHARACTERS WITHOUT CLAIM TO ANY PARTICULAR FONT, STYLE, SIZE, OR COLOR.

SER. NO. 77-238,523, FILED 7-25-2007.

DAVID H. STINE, EXAMINING ATTORNEY

**Int. Cl.: 35**

**Prior U.S. Cls.: 100, 101 and 102**

**United States Patent and Trademark Office**

**Reg. No. 3,452,542**

**Registered June 24, 2008**

**SERVICE MARK  
PRINCIPAL REGISTER**

**WE DO THE WORK. YOU GET  
THE CREDIT.**

FKM/RAS, LLP (TEXAS LTD LIAB LTD PART),  
DBA MITTON MEDIA  
846 MERRICK  
SUGAR LAND, TX 77478

FOR: ADVERTISING SERVICES, NAMELY, PERSONNEL RECRUITMENT ADVERTISING FOR OTHERS; BUSINESS SERVICES, NAMELY, BUSINESS PLANNING, BUSINESS MANAGEMENT; ADVERTISING AND BUSINESS SERVICES, NAMELY, SECURING AIRTIME ON ALL FORMS OF MEDIA COMMUNICATIONS STATIONS, SYSTEMS, NETWORKS, AND SERVICES FOR THE PURPOSE OF PROMOTING THE GOODS AND SERVICES OF OTHERS; ADVERTISING VIA ELECTRONIC MEDIA AND SPECIFICALLY THE INTERNET; PREPARATION AND REALIZATION OF MEDIA AND ADVERTISING PLANS AND CONCEPTS; MEDIA PLANNING, NAMELY, ADVISING THE CLIENT ON THE CORRECT TIMES AND STATIONS TO

ADVERTISE BASED ON MEDIA ANALYSIS OF THE MARKET FOR THAT MEDIA; EMPLOYMENT COUNSELING AND RECRUITING; CONSULTING FOR THE PROMOTION OF EMPLOYEE RETENTION; PERSONNEL PLACEMENT AND RECRUITMENT; JOB PLACEMENT; AND BUSINESS CONSULTATION, IN CLASS 35 (U.S. CLS. 100, 101 AND 102).

FIRST USE 9-15-2004; IN COMMERCE 9-15-2004.

THE MARK CONSISTS OF STANDARD CHARACTERS WITHOUT CLAIM TO ANY PARTICULAR FONT, STYLE, SIZE, OR COLOR.

SER. NO. 77-238,649, FILED 7-25-2007.

G. MAYERSCHOFF, EXAMINING ATTORNEY

**Int. Cl.: 7**

**Prior U.S. Cls.: 13, 19, 21, 23, 31, 34 and 35**

**United States Patent and Trademark Office**

**Reg. No. 3,452,543**

**Registered June 24, 2008**

**TRADEMARK  
PRINCIPAL REGISTER**

**BEAD BOOSTER**

GAITHER TOOL CO. (ILLINOIS CORPORATION)  
21 HAROLD COX DRIVE  
JACKSONVILLE, IL 62650

FOR: PNEUMATIC INFLATION MACHINE FOR  
SEATING AND INFLATING TIRES, IN CLASS 7  
(U.S. CLS. 13, 19, 21, 23, 31, 34 AND 35).

FIRST USE 7-1-1995; IN COMMERCE 12-7-1995.

THE MARK CONSISTS OF STANDARD CHAR-  
ACTERS WITHOUT CLAIM TO ANY PARTICULAR  
FONT, STYLE, SIZE, OR COLOR.

NO CLAIM IS MADE TO THE EXCLUSIVE  
RIGHT TO USE "BEAD", APART FROM THE MARK  
AS SHOWN.

SER. NO. 77-239,376, FILED 7-26-2007.

SUZANNE BLANE, EXAMINING ATTORNEY

**Int. Cl.: 35**

**Prior U.S. Cls.: 100, 101 and 102**

**United States Patent and Trademark Office**

**Reg. No. 3,452,544**

**Registered June 24, 2008**

**SERVICE MARK  
PRINCIPAL REGISTER**

**AUTOANYTHING**

BLUE RIBBON MOTORING, LLC (CALIFORNIA  
LTD LIAB CO), DBA AUTOANYTHING  
9210 SKY PARK COURT, SUITE 100  
SAN DIEGO, CA 92123

THE MARK CONSISTS OF STANDARD CHAR-  
ACTERS WITHOUT CLAIM TO ANY PARTICULAR  
FONT, STYLE, SIZE, OR COLOR.

FOR: ONLINE RETAIL STORE AND MAIL OR-  
DER SERVICES FEATURING AUTOMOTIVE  
PARTS, TOOLS AND ACCESSORIES, IN CLASS 35  
(U.S. CLS. 100, 101 AND 102).

SER. NO. 77-239,991, FILED 7-26-2007.

FIRST USE 11-15-1999; IN COMMERCE 11-15-1999.

PATRICIA EVANKO, EXAMINING ATTORNEY

**Int. Cls.: 16 and 41**

**Prior U.S. Cls.: 2, 5, 22, 23, 29, 37, 38, 50, 100, 101 and 107**

**Reg. No. 3,452,545**

**United States Patent and Trademark Office**

**Registered June 24, 2008**

**TRADEMARK  
SERVICE MARK  
PRINCIPAL REGISTER**

**THE JOURNAL OF THE TEXAS  
TROPHY HUNTERS**

TEXAS TROPHY HUNTERS ASSOCIATION, LTD.  
(TEXAS PARTNERSHIP)  
SUITE 1000  
8122 DATAPOINT DRIVE  
SAN ANTONIO, TX 78229

FOR: MAGAZINES FEATURING HUNTING, IN  
CLASS 16 (U.S. CLS. 2, 5, 22, 23, 29, 37, 38 AND 50).

FIRST USE 11-0-1987; IN COMMERCE 11-0-1987.

FOR: ENTERTAINMENT IN THE NATURE OF  
ON-GOING TELEVISION PROGRAMS IN THE  
FIELD OF HUNTING; PROVIDING ON-LINE PUB-  
LICATIONS IN THE NATURE OF MAGAZINES IN  
THE FIELD OF HUNTING, IN CLASS 41 (U.S. CLS.  
100, 101 AND 107).

FIRST USE 7-0-1998; IN COMMERCE 7-0-1998.

THE MARK CONSISTS OF STANDARD CHAR-  
ACTERS WITHOUT CLAIM TO ANY PARTICULAR  
FONT, STYLE, SIZE, OR COLOR.

OWNER OF U.S. REG. NOS. 3,240,896, 3,240,916,  
AND 3,264,526.

SEC. 2(F).

SER. NO. 77-240,352, FILED 7-27-2007.

ALEXANDER L. POWERS, EXAMINING ATTOR-  
NEY

**Int. Cls.: 16 and 41**

**Prior U.S. Cls.: 2, 5, 22, 23, 29, 37, 38, 50, 100, 101 and 107**

**Reg. No. 3,452,546**

**United States Patent and Trademark Office**

**Registered June 24, 2008**

**TRADEMARK  
SERVICE MARK  
PRINCIPAL REGISTER**



TEXAS TROPHY HUNTERS ASSOCIATION, LTD.  
(TEXAS PARTNERSHIP)  
SUITE 1000  
8122 DATAPOINT DRIVE  
SAN ANTONIO, TX 78229

FIRST USE 7-0-1998; IN COMMERCE 7-0-1998.

OWNER OF U.S. REG. NOS. 3,240,896, 3,240,916,  
AND 3,264,526.

FOR: MAGAZINES FEATURING HUNTING, IN  
CLASS 16 (U.S. CLS. 2, 5, 22, 23, 29, 37, 38 AND 50).

THE MARK CONSISTS OF THE WORDS "THE  
JOURNAL OF THE TEXAS TROPHY HUNTERS"  
SUPERIMPOSED OVER A MAP OF THE STATE OF  
TEXAS.

FIRST USE 11-0-1987; IN COMMERCE 11-0-1987.

SEC. 2(F).

FOR: PROVIDING ON-LINE PUBLICATIONS IN  
THE NATURE OF MAGAZINES IN THE FIELD OF  
HUNTING; ENTERTAINMENT IN THE NATURE  
OF ON-GOING TELEVISION PROGRAMS IN THE  
FIELD OF HUNTING, IN CLASS 41 (U.S. CLS. 100,  
101 AND 107).

SER. NO. 77-240,377, FILED 7-27-2007.

ALEXANDER L. POWERS, EXAMINING ATTOR-  
NEY

**Int. Cl.: 39**

**Prior U.S. Cls.: 100 and 105**

**United States Patent and Trademark Office**

**Reg. No. 3,452,547**

**Registered June 24, 2008**

**SERVICE MARK  
PRINCIPAL REGISTER**

**MARITIME-ONTARIO**

MARITIME-ONTARIO FREIGHT LINES LIMITED (CANADA CORPORATION)  
1 MARITIME-ONTARIO BLVD.  
BRAMPTON, CANADA L6S6G4

FOR: FREIGHT FORWARDING SERVICES; FREIGHT TRANSPORTATION BY TRUCK, TRAIN, BOAT AND AIR; FREIGHT BROKERAGE SERVICES, IN CLASS 39 (U.S. CLS. 100 AND 105).

FIRST USE 5-0-1985; IN COMMERCE 5-0-1985.

THE MARK CONSISTS OF STANDARD CHARACTERS WITHOUT CLAIM TO ANY PARTICULAR FONT, STYLE, SIZE, OR COLOR.

PRIORITY CLAIMED UNDER SEC. 44(D) ON CANADA APPLICATION NO. 1335995, FILED 2-19-2007, REG. NO. 704886, DATED 1-17-2008, EXPIRES 1-17-2023.

OWNER OF U.S. REG. NO. 2,337,194.

SER. NO. 77-240,669, FILED 7-27-2007.

BILL DAWE, EXAMINING ATTORNEY



**Int. Cl.: 42**

**Prior U.S. Cls.: 100 and 101**

**United States Patent and Trademark Office**

**Reg. No. 3,452,548**

**Registered June 24, 2008**

**SERVICE MARK  
PRINCIPAL REGISTER**

# Laba Design

MERIMSKY ALON (ISRAEL INDIVIDUAL)  
B.S.R TOWER 1  
2 BEN GURION ST.  
RAMAT GAN, ISRAEL 52573

FOR: COMMERCIAL ART DESIGN; CUSTOM DESIGN OF MEDICAL DEVICES, GADGETS, CONSUMER PRODUCTS AND PROMOTIONAL ITEMS FOR OTHERS; GRAPHIC ART DESIGN; GRAPHIC DESIGN SERVICES; INDUSTRIAL DESIGN; PACKAGING DESIGN FOR OTHERS, IN CLASS 42 (U.S. CLS. 100 AND 101).

FIRST USE 8-1-2003; IN COMMERCE 8-1-2003.

THE MARK CONSISTS OF STANDARD CHARACTERS WITHOUT CLAIM TO ANY PARTICULAR FONT, STYLE, SIZE, OR COLOR.

NO CLAIM IS MADE TO THE EXCLUSIVE RIGHT TO USE "DESIGN", APART FROM THE MARK AS SHOWN.

SER. NO. 77-241,421, FILED 7-29-2007.

GRETTA YAO, EXAMINING ATTORNEY

**Int. Cl.: 36**

**Prior U.S. Cls.: 100, 101 and 102**

**United States Patent and Trademark Office**

**Reg. No. 3,452,549**

**Registered June 24, 2008**

**SERVICE MARK  
PRINCIPAL REGISTER**



SPECTRUM BUSINESS SOLUTIONS, INC. (MICHIGAN CORPORATION), DBA SPECTRUM FINANCIAL SOLUTIONS, INC.  
4522 WILLOWVIEW COURT  
HOWELL, MI 48843

FOR: FINANCIAL PLANNING; INVESTMENT PLANNING; FINANCIAL RETIREMENT PLANNING; AND VENTURE CAPITAL ACQUISITION, NAMELY, PROVIDING FUNDING TO EMERGING AND START-UP COMPANIES, IN CLASS 36 (U.S. CLS. 100, 101 AND 102).

FIRST USE 1-1-2005; IN COMMERCE 1-1-2005.

THE COLOR(S) RED, ORANGE, YELLOW, GREEN, BLUE, VIOLET, BLACK AND WHITE IS/ ARE CLAIMED AS A FEATURE OF THE MARK.

THE MARK CONSISTS OF A RAINBOW INSIDE A STOCK TICKER. THE RAINBOW'S BANDS ARE RED, ORANGE, YELLOW, GREEN, BLUE, AND VIOLET GOING FROM TOP TO BOTTOM. THE COLOR BLACK APPEARS IN THE BASE OF THE TICKER MACHINE, IN THE SPOT ON THE UPPER LEFT OF THE RAINBOW, AND IN THE OUTLINE OF THE TICKER MACHINE AND TICKER TAPE. THE COLOR WHITE APPEARS IN THE TICKER TAPE, IN THE REFLECTION ON THE BASE OF THE TICKER MACHINE, AND IN THE BACKGROUND SURROUNDING THE RAINBOW.

SER. NO. 77-242,090, FILED 7-30-2007.

JASON BLAIR, EXAMINING ATTORNEY

**Int. Cls.: 9 and 42**

**Prior U.S. Cls.: 21, 23, 26, 36, 38, 100 and 101**

**United States Patent and Trademark Office**

**Reg. No. 3,452,550**

**Registered June 24, 2008**

**TRADEMARK  
SERVICE MARK  
PRINCIPAL REGISTER**

**SIMPLIFYING SOFTWARE  
DELIVERY**

VERSIONONE, INC. (DELAWARE CORPORATION)  
6220 SHILOH ROAD, SUITE 400  
ALPHARETTA, GA 30005

FOR: COMPUTER SOFTWARE FOR MANAGEMENT OF COMPUTER SOFTWARE DEVELOPMENT AND RELEASE BY OTHERS; COMPUTER SOFTWARE FOR MANAGEMENT OF COMPUTER SOFTWARE DEVELOPMENT AND RELEASE BY OTHERS THAT MAY BE DOWNLOADED FROM A GLOBAL COMPUTER NETWORK, IN CLASS 9 (U.S. CLS. 21, 23, 26, 36 AND 38).

FIRST USE 7-0-2004; IN COMMERCE 7-0-2004.

FOR: APPLICATION SERVICE PROVIDER (ASP) FEATURING SOFTWARE FOR USE IN THE MAN-

AGEMENT OF COMPUTER SOFTWARE DEVELOPMENT AND RELEASE BY OTHERS, IN CLASS 42 (U.S. CLS. 100 AND 101).

FIRST USE 7-0-2004; IN COMMERCE 7-0-2004.

THE MARK CONSISTS OF STANDARD CHARACTERS WITHOUT CLAIM TO ANY PARTICULAR FONT, STYLE, SIZE, OR COLOR.

NO CLAIM IS MADE TO THE EXCLUSIVE RIGHT TO USE "SOFTWARE DELIVERY", APART FROM THE MARK AS SHOWN.

SER. NO. 77-242,307, FILED 7-30-2007.

KATHY DE JONGE, EXAMINING ATTORNEY

**Int. Cl.: 16**

**Prior U.S. Cls.: 2, 5, 22, 23, 29, 37, 38 and 50**

**Reg. No. 3,452,551**

**United States Patent and Trademark Office**

**Registered June 24, 2008**

**TRADEMARK  
PRINCIPAL REGISTER**

## Powerful Connections

FINANCIAL AND PROFESSIONAL RISK SERVICES, INC. (ILLINOIS CORPORATION)  
AON CENTER - 8TH FLOOR LAW DEPARTMENT  
200 E. RANDOLPH STREET  
CHICAGO, IL 60601

FOR: PRINTED PUBLICATIONS, NAMELY, NEWSLETTERS IN THE FIELD OF INSURANCE THAT PROVIDE INSURANCE INFORMATION, INSURANCE BROKERAGE AND UNDERWRITING INFORMATION, AND SPECIALTY INSURANCE INFORMATION IN THE FIELDS OF PROFESSIONAL LIABILITY, MOTOR VEHICLE, WORKERS COMPENSATION, ENTERTAINMENT, SPECIAL EVENT, NON-PROFIT ORGANIZATIONS, TRAVEL, TRANSPORTATION, PREMIUM FUNDING, FLOOD, FINE ARTS, PROPERTY MANAGEMENT,

MORTGAGE, SPORTS, LIFE, MERGER AND ACQUISITION, CYBERSPACE LIABILITY, MEDICAL LIABILITY, FINANCIAL SERVICES, FIRE PROTECTION ENGINEERING, PROPERTY RISK, KIDNAP , IN CLASS 16 (U.S. CLS. 2, 5, 22, 23, 29, 37, 38 AND 50).

FIRST USE 4-24-2007; IN COMMERCE 4-24-2007.

THE MARK CONSISTS OF STANDARD CHARACTERS WITHOUT CLAIM TO ANY PARTICULAR FONT, STYLE, SIZE, OR COLOR.

SER. NO. 77-242,712, FILED 7-31-2007.

KATHRYN COWARD, EXAMINING ATTORNEY

**Int. Cl.: 25**

**Prior U.S. Cls.: 22 and 39**

**United States Patent and Trademark Office**

**Reg. No. 3,452,552**

**Registered June 24, 2008**

**TRADEMARK  
PRINCIPAL REGISTER**

# BellySock

BELLYSOCK LLC (WASHINGTON LTD LIAB  
CO)  
13875 SE 2ND ST  
BELLEVUE, WA 98005

FOR: MATERNITY LINGERIE; NURSING APPA-  
REL, NAMELY, BELLY COVER TO BE USED WHEN  
BREASTFEEDING, IN THE NATURE OF A TOP-  
LESS CAMISOLE WORN UNDER A SHIRT; TOPS;  
MATERNITY SLEEPWEAR , IN CLASS 25 (U.S. CLS.  
22 AND 39).

FIRST USE 1-31-2005; IN COMMERCE 3-31-2005.

THE MARK CONSISTS OF STANDARD CHAR-  
ACTERS WITHOUT CLAIM TO ANY PARTICULAR  
FONT, STYLE, SIZE, OR COLOR.

SER. NO. 77-243,771, FILED 7-31-2007.

LINDA E. BLOHM, EXAMINING ATTORNEY

Int. Cl.: 25

Prior U.S. Cls.: 22 and 39

United States Patent and Trademark Office

Reg. No. 3,452,553

Registered June 24, 2008

TRADEMARK  
PRINCIPAL REGISTER



BELLYSOCK LLC (WASHINGTON LTD LIAB  
CO)  
13875 SE 2ND ST  
BELLEVUE, WA 98005

FOR: MATERNITY LINGERIE; NURSING APPA-  
REL, NAMELY, BELLY COVER TO BE USED WHEN  
BREASTFEEDING, IN THE NATURE OF A TOP-  
LESS CAMISOLE WORN UNDER A SHIRT; TOPS;  
MATERNITY SLEEPWEAR, IN CLASS 25 (U.S. CLS.  
22 AND 39).

FIRST USE 1-31-2005; IN COMMERCE 3-31-2005.

THE COLOR(S) BROWN AND PINK IS/ARE  
CLAIMED AS A FEATURE OF THE MARK.

THE MARK CONSISTS OF STYLIZED LETTERS  
IN BROWN UNIQUE FONT. THE LETTER "B" OF  
"BELLYSOCK" IS DRESSED WITH PINK BAND  
AND HAS ARMS HOLDING BOTTOM OF "B" AS  
IF IT WERE A BELLY.

SER. NO. 77-243,802, FILED 8-1-2007.

LINDA E. BLOHM, EXAMINING ATTORNEY

Prior U.S. Cl.: B

United States Patent and Trademark Office

Reg. No. 3,452,554

Registered June 24, 2008

CERTIFICATION MARK  
PRINCIPAL REGISTER



AMERICAN INSTITUTE OF STEEL CONSTRUCTION, INC. (ILLINOIS CORPORATION)  
ONE EAST WACKER DRIVE, SUITE 700  
CHICAGO, IL 60601

FOR: STEEL FABRICATION, ERECTION, AND METAL BUILDING MANUFACTURING SERVICES, IN CLASS B (U.S. CL. B).

FIRST USE 1-0-2005; IN COMMERCE 1-0-2005.

OWNER OF U.S. REG. NO. 652,202.

THE MARK CONSISTS OF THE LETTERS AISC WITHIN THE LETTER Q WITHIN THE LETTER C.

THE CERTIFICATION MARK, AS USED BY PERSONS AUTHORIZED BY THE CERTIFIER, CERTIFIES THAT THE SERVICES PROVIDED ARE BEING PERFORMED BY PROFESSIONALS WHO ARE CERTIFIED AND WHO HAVE MET THE CERTIFIER'S STANDARDS OF KNOWLEDGE, EXPERIENCE AND COMPETENCY IN THE FIELD OF STEEL CONSTRUCTION.

SER. NO. 77-243,837, FILED 8-1-2007.

JUSTINE D. PARKER, EXAMINING ATTORNEY

**Int. Cl.: 42**

**Prior U.S. Cls.: 100 and 101**

**United States Patent and Trademark Office**

**Reg. No. 3,452,555**

**Registered June 24, 2008**

**SERVICE MARK  
PRINCIPAL REGISTER**



MISSION CRITICAL WIRELESS, LLC (DELA-  
WARE LTD LIAB CO)  
SUITE 100  
25 TRI-STATE INTERNATIONAL  
LINCOLNSHIRE, IL 60069

FOR: PROVIDING TECHNICAL CONSULTA-  
TION AND TECHNICAL SUPPORT SERVICES IN  
THE FIELDS OF SELECTION, IMPLEMENTATION  
AND USE OF WIRELESS TELECOMMUNICATIONS  
EQUIPMENT AND SOFTWARE BY OTHERS, IN  
CLASS 42 (U.S. CLS. 100 AND 101).

FIRST USE 9-1-2004; IN COMMERCE 9-1-2004.

NO CLAIM IS MADE TO THE EXCLUSIVE  
RIGHT TO USE "MISSION CRITICAL WIRELESS",  
APART FROM THE MARK AS SHOWN.

THE COLOR(S) RED AND BLACK IS/ARE  
CLAIMED AS A FEATURE OF THE MARK.

THE MARK CONSISTS OF A DESIGN ELEMENT  
CONSISTING OF A BLACK CURVING LINE INTER-  
SECTING A RED CURVING LINE LEADING TO A  
RED POINT, ADJACENT TO THE BLACK LETTERS  
"MCW" AND THE BLACK WORDS "MISSION CRI-  
TICAL WIRELESS".

SER. NO. 77-244,020, FILED 8-1-2007.

BONNIE LUKEN, EXAMINING ATTORNEY



**Int. Cl.: 7**

**Prior U.S. Cls.: 13, 19, 21, 23, 31, 34 and 35**

**United States Patent and Trademark Office**

**Reg. No. 3,452,556**

**Registered June 24, 2008**

**TRADEMARK  
PRINCIPAL REGISTER**

**UV CURED, INC...CURED AT THE  
SPEED OF LIGHT**

UV CURED, INC. (CALIFORNIA CORPORATION)  
717 SANTANA RD.  
NOVATO, CA 94945

FOR: ULTRAVIOLET LIGHT CURING MACHINE USED IN PRESERVING AND FINISHING HARDWOOD, CONCRETE, WELDED AND TILED VINYL, AND TERRAZZO FLOORING, IN CLASS 7 (U.S. CLS. 13, 19, 21, 23, 31, 34 AND 35).

FIRST USE 1-1-2003; IN COMMERCE 7-17-2003.

THE MARK CONSISTS OF STANDARD CHARACTERS WITHOUT CLAIM TO ANY PARTICULAR FONT, STYLE, SIZE, OR COLOR.

SER. NO. 77-244,025, FILED 8-1-2007.

CHRISTINA SOBRAL, EXAMINING ATTORNEY

Int. Cl.: 37

Prior U.S. Cls.: 100, 103 and 106

United States Patent and Trademark Office

Reg. No. 3,452,557

Registered June 24, 2008

**SERVICE MARK  
PRINCIPAL REGISTER**



G & S INSULATION, LLC (TEXAS LTD LIAB CO)  
7710-T CHERRY PARK DR. #303  
HOUSTON, TX 77095

FOR: INSTALLATION OF INSULATING MATERIALS, IN CLASS 37 (U.S. CLS. 100, 103 AND 106).

FIRST USE 1-1-2007; IN COMMERCE 1-1-2007.

NO CLAIM IS MADE TO THE EXCLUSIVE RIGHT TO USE "INSULATION", APART FROM THE MARK AS SHOWN.

THE MARK CONSISTS OF THE STYLIZED WORDING "G&S INSULATION" AND DESIGNS. THE LETTERS "G" AND "S" ARE FORMED FROM STYLIZED RENDERINGS OF PIPES AND JOINTS. THE SYMBOL "&" IS FORMED FROM A STYLIZED RENDERING OF A FLEXIBLE HOSE OR TUBE. THE WORD "INSULATION" APPEARS IN STYLIZED FORM AT THE BASE OF THE MARK, ENCLOSED WITHIN A RECTANGULAR BASE THAT DESCENDS FROM THE LETTERS.

SER. NO. 77-244,958, FILED 8-2-2007.

CORY BOONE, EXAMINING ATTORNEY

**Int. Cl.: 35**

**Prior U.S. Cls.: 100, 101 and 102**

**United States Patent and Trademark Office**

**Reg. No. 3,452,558**

**Registered June 24, 2008**

**SERVICE MARK  
PRINCIPAL REGISTER**

**VISAYA STYLE**

KILTHAU, JAMES (UNITED STATES INDIVIDUAL)

30359 N. MARIGOLD CIR.

CASTAIC, CA 91384

FOR: IMPORT AND EXPORT AGENCIES, IN CLASS 35 (U.S. CLS. 100, 101 AND 102).

FIRST USE 2-1-2004; IN COMMERCE 2-1-2004.

THE MARK CONSISTS OF STANDARD CHARACTERS WITHOUT CLAIM TO ANY PARTICULAR FONT, STYLE, SIZE, OR COLOR.

NO CLAIM IS MADE TO THE EXCLUSIVE RIGHT TO USE "VISAYA", APART FROM THE MARK AS SHOWN.

SER. NO. 77-245,214, FILED 8-2-2007.

LINDA ORNDORFF, EXAMINING ATTORNEY

**Int. Cl.: 14**

**Prior U.S. Cls.: 2, 27, 28 and 50**

**United States Patent and Trademark Office**

**Reg. No. 3,452,559**

**Registered June 24, 2008**

**TRADEMARK  
PRINCIPAL REGISTER**

# Voting Coin

CONDON, JOHN (UNITED STATES INDIVIDUAL)

17864 GLADVILLE AVE.

HOMEWOOD, IL 60430

FOR: COLLECTIBLE COINS; COMMEMORATIVE COINS, IN CLASS 14 (U.S. CLS. 2, 27, 28 AND 50).

FIRST USE 3-1-2004; IN COMMERCE 4-1-2004.

THE MARK CONSISTS OF STANDARD CHARACTERS WITHOUT CLAIM TO ANY PARTICULAR FONT, STYLE, SIZE, OR COLOR.

NO CLAIM IS MADE TO THE EXCLUSIVE RIGHT TO USE "COIN", APART FROM THE MARK AS SHOWN.

SER. NO. 77-245,279, FILED 8-2-2007.

REBECCA SMITH, EXAMINING ATTORNEY

**Int. Cl.: 10**

**Prior U.S. Cls.: 26, 39 and 44**

**United States Patent and Trademark Office**

**Reg. No. 3,452,560**

**Registered June 24, 2008**

**TRADEMARK  
PRINCIPAL REGISTER**

# MedShot

KOWA COMPANY, LTD. (JAPAN CORPORATION)  
NAKA-KU  
6-29, NISHIKI 3-CHOME  
NAGOYA, JAPAN

FOR: MEDICAL MACHINES AND APPARATUS, NAMELY, INTRAOCULAR PROSTHETIC LENSES FOR SURGICAL IMPLANTATION, AND INSERTERS OF INTRAOCULAR PROSTHETIC LENSES USED FOR SURGICAL IMPLANTATION, IN CLASS 10 (U.S. CLS. 26, 39 AND 44).

THE MARK CONSISTS OF STANDARD CHARACTERS WITHOUT CLAIM TO ANY PARTICULAR FONT, STYLE, SIZE, OR COLOR.

OWNER OF JAPAN REG. NO. 4379650, DATED 4-28-2000, EXPIRES 4-28-2010.

SER. NO. 77-245,479, FILED 8-2-2007.

MARK PILARO, EXAMINING ATTORNEY

**Int. Cl.: 44**

**Prior U.S. Cls.: 100 and 101**

**United States Patent and Trademark Office**

**Reg. No. 3,452,561**

**Registered June 24, 2008**

**SERVICE MARK  
PRINCIPAL REGISTER**

**World Mental Health Day**

WORLD FEDERATION FOR MENTAL HEALTH  
(D.C. CORPORATION)

SUITE 301

6564 LOISDALE COURT

SPRINGFIELD, VA 221501812

FOR: PROVIDING A WEBSITE FEATURING INFORMATION IN THE FIELD OF MENTAL HEALTH AND WELLNESS; PROVIDING HEALTH INFORMATION, IN CLASS 44 (U.S. CLS. 100 AND 101).

FIRST USE 9-1-1992; IN COMMERCE 9-1-1992.

THE MARK CONSISTS OF STANDARD CHARACTERS WITHOUT CLAIM TO ANY PARTICULAR FONT, STYLE, SIZE, OR COLOR.

NO CLAIM IS MADE TO THE EXCLUSIVE RIGHT TO USE "MENTAL HEALTH", APART FROM THE MARK AS SHOWN.

SEC. 2(F).

SER. NO. 77-245,634, FILED 8-2-2007.

AMOS T. MATTHEWS, JR., EXAMINING ATTORNEY

**Int. Cl.: 35**

**Prior U.S. Cls.: 100, 101 and 102**

**United States Patent and Trademark Office**

**Reg. No. 3,452,562**

**Registered June 24, 2008**

---

**SERVICE MARK  
PRINCIPAL REGISTER**

**APW**

ALLIANCE PARTS WAREHOUSE, LLC (ARKAN-  
SAS LTD LIAB CO)  
600 FIBER OPTIC DRIVE  
NORTH LITTLE ROCK, AR 72117

FOR: DISTRIBUTORSHIP SERVICES IN THE  
FIELD OF AUTOMOTIVE AFTERMARKET REPLA-  
CEMENT PARTS, SUPPLIES, ACCESSORIES, CHE-  
MICALS, TOOLS, AND EQUIPMENT , IN CLASS 35  
(U.S. CLS. 100, 101 AND 102).

FIRST USE 5-30-2000; IN COMMERCE 5-30-2000.

THE MARK CONSISTS OF STANDARD CHAR-  
ACTERS WITHOUT CLAIM TO ANY PARTICULAR  
FONT, STYLE, SIZE, OR COLOR.

SER. NO. 77-246,203, FILED 8-3-2007.

MYRIAH HABEEB, EXAMINING ATTORNEY

**Int. Cl.: 35**

**Prior U.S. Cls.: 100, 101 and 102**

**United States Patent and Trademark Office**

**Reg. No. 3,452,563**

**Registered June 24, 2008**

**SERVICE MARK  
PRINCIPAL REGISTER**



ALLIANCE PARTS WAREHOUSE, LLC (ARKAN-  
SAS LTD LIAB CO)  
600 FIBER OPTIC DRIVE  
NORTH LITTLE ROCK, AR 72117

FOR: DISTRIBUTORSHIP SERVICES IN THE  
FIELD OF AUTOMOTIVE AFTERMARKET REPLA-  
CEMENT PARTS, SUPPLIES, ACCESSORIES, CHE-  
MICALS, TOOLS, AND EQUIPMENT , IN CLASS 35  
(U.S. CLS. 100, 101 AND 102).

FIRST USE 9-15-2005; IN COMMERCE 9-15-2005.

NO CLAIM IS MADE TO THE EXCLUSIVE  
RIGHT TO USE "PARTS WAREHOUSE", APART  
FROM THE MARK AS SHOWN.

SER. NO. 77-246,209, FILED 8-3-2007.

MYRIAH HABEEB, EXAMINING ATTORNEY



**Int. Cl.: 11**

**Prior U.S. Cls.: 13, 21, 23, 31 and 34**

**United States Patent and Trademark Office**

**Reg. No. 3,452,564**

**Registered June 24, 2008**

**TRADEMARK  
PRINCIPAL REGISTER**

**Q**

WEBER-STEPHEN PRODUCTS CO. (ILLINOIS  
CORPORATION)  
200 E. DANIELS ROAD  
PALATINE, IL 60067

FOR: GRILLS, NAMELY, GAS GRILLS; REPLACEMENT AND REPAIR PARTS AND ACCESSORIES FOR GRILLS, NAMELY, BURNER TUBES, IGNITERS, GRILL GRATES, COOKING GRIDS, LID HANDLES, CONTROL KNOBS, GAS REGULATORS, GAS LINES, TEMPERATURE GAUGES, ROTISSERIES AND GRILL COVERS, IN CLASS 11 (U.S. CLS. 13, 21, 23, 31 AND 34).

FIRST USE 12-17-2002; IN COMMERCE 12-17-2002.

THE MARK CONSISTS OF STANDARD CHARACTERS WITHOUT CLAIM TO ANY PARTICULAR FONT, STYLE, SIZE, OR COLOR.

OWNER OF U.S. REG. NO. 3,064,060.

SER. NO. 77-246,258, FILED 8-3-2007.

ANDREW RHIM, EXAMINING ATTORNEY

**Int. Cl.: 42**

**Prior U.S. Cls.: 100 and 101**

**United States Patent and Trademark Office**

**Reg. No. 3,452,565**

**Registered June 24, 2008**

**SERVICE MARK  
PRINCIPAL REGISTER**

**Your Outsourced IT  
Solutions Partner**

FAYE, POLLACK & ASSOCIATES, INC. (CALIFORNIA CORPORATION)  
16000 VENTURA BOULEVARD  
SUITE 702  
ENCINO, CA 91436

FOR: COMPUTER SERVICES, NAMELY, COMPUTER PROJECT MANAGEMENT SERVICES; COMPUTER SERVICES, NAMELY, CONSULTING IN THE FIELD OF IMPLEMENTATION OF COMPUTER PROGRAMS FOR OTHERS FOR USE IN ACCOUNTING SYSTEMS; COMPUTER SERVICES, NAMELY, DESIGN OF CUSTOM COMPUTER PROGRAMS FOR OTHERS; COMPUTER SERVICES,

NAMELY, DESIGN AND DEVELOPMENT OF WEBSITES FOR OTHERS, IN CLASS 42 (U.S. CLS. 100 AND 101).

FIRST USE 7-30-2007; IN COMMERCE 7-30-2007.

THE MARK CONSISTS OF STANDARD CHARACTERS WITHOUT CLAIM TO ANY PARTICULAR FONT, STYLE, SIZE, OR COLOR.

SER. NO. 77-246,437, FILED 8-3-2007.

MICHAEL GAAFAR, EXAMINING ATTORNEY

**Int. Cls.: 9 and 42**

**Prior U.S. Cls.: 21, 23, 26, 36, 38, 100 and 101**

**United States Patent and Trademark Office**

**Reg. No. 3,452,566**

**Registered June 24, 2008**

**TRADEMARK  
SERVICE MARK  
PRINCIPAL REGISTER**

# AGENT LOGIC

AGENT LOGIC, INC. (DELAWARE CORPORATION)

1000 WILSON BOULEVARD, SUITE 2520

ARLINGTON, VA 22209

FOR: USER-DRIVEN COMPUTER SOFTWARE FOR MONITORING, DETECTING, AND INTERPRETING INPUTS FROM PEOPLE, DATA SOURCES AND ELECTRONIC DEVICES AND INITIATING AND HANDLING RESPONSIVE PROCESSES, ALERTS, NOTIFICATIONS, AND ACTIONS; COMPUTER SOFTWARE FOR USE IN BUSINESS INFORMATION INTELLIGENCE, INFORMATION MANAGEMENT AND AUGMENTATION, COLLECTIVE INTELLIGENCE, DATA ANALYSIS, DATA MINING, REPORTING, QUERYING AND DECISION SUPPORT RECORDING, AND PROCESS AND REPRODUCTION OF REAL-TIME DATA, IN CLASS 9 (U.S. CLS. 21, 23, 26, 36 AND 38).

FIRST USE 11-14-2003; IN COMMERCE 11-14-2003.

FOR: DESIGN AND DEVELOPMENT OF COMPUTER SOFTWARE FOR OTHERS USED FOR HIGH SPEED DATA BUSINESS AND OPERATIONAL INTELLIGENCE, TRANSACTION PROCESSING, DATA ANALYSIS, DATA WAREHOUSING AND DATABASE SYSTEMS; COMPUTER SOFTWARE CONSULTATION IN CONNECTION THEREWITH, IN CLASS 42 (U.S. CLS. 100 AND 101).

FIRST USE 11-14-2003; IN COMMERCE 11-14-2003.

THE MARK CONSISTS OF STANDARD CHARACTERS WITHOUT CLAIM TO ANY PARTICULAR FONT, STYLE, SIZE, OR COLOR.

NO CLAIM IS MADE TO THE EXCLUSIVE RIGHT TO USE "AGENT", APART FROM THE MARK AS SHOWN.

SER. NO. 77-246,473, FILED 8-3-2007.

ANDREA HACK, EXAMINING ATTORNEY

**Int. Cls.: 9 and 42**

**Prior U.S. Cls.: 21, 23, 26, 36, 38, 100 and 101**

**United States Patent and Trademark Office**

**Reg. No. 3,452,567**

**Registered June 24, 2008**

**TRADEMARK  
SERVICE MARK  
PRINCIPAL REGISTER**



AGENT LOGIC, INC. (DELAWARE CORPORATION)

1000 WILSON BOULEVARD, SUITE 2520  
ARLINGTON, VA 22209

FOR: USER-DRIVEN COMPUTER SOFTWARE FOR MONITORING, DETECTING, AND INTERPRETING INPUTS FROM PEOPLE, DATA SOURCES AND ELECTRONIC DEVICES AND INITIATING AND HANDLING RESPONSIVE PROCESSES, ALERTS, NOTIFICATIONS, AND ACTIONS; COMPUTER SOFTWARE FOR USE IN BUSINESS INFORMATION INTELLIGENCE, INFORMATION MANAGEMENT AND AUGMENTATION, COLLECTIVE INTELLIGENCE, DATA ANALYSIS, DATA MINING, REPORTING, QUERYING AND DECISION SUPPORT RECORDING, AND PROCESS AND REPRODUCTION OF REAL-TIME DATA, IN CLASS 9 (U.S. CLS. 21, 23, 26, 36 AND 38).

FIRST USE 11-14-2003; IN COMMERCE 11-14-2003.

FOR: DESIGN AND DEVELOPMENT OF COMPUTER SOFTWARE FOR OTHERS USED FOR HIGH SPEED DATA BUSINESS AND OPERATIONAL INTELLIGENCE, TRANSACTION PROCESSING, DATA ANALYSIS, DATA WAREHOUSING AND DATABASE SYSTEMS; COMPUTER SOFTWARE CONSULTATION IN CONNECTION THEREWITH, IN CLASS 42 (U.S. CLS. 100 AND 101).

FIRST USE 11-14-2003; IN COMMERCE 11-14-2003.

NO CLAIM IS MADE TO THE EXCLUSIVE RIGHT TO USE "AGENT", APART FROM THE MARK AS SHOWN.

THE MARK CONSISTS OF THE WORD "AGENT", A CIRCLE DESIGN IN THE MIDDLE, AND THE WORD "LOGIC".

SER. NO. 77-246,478, FILED 8-3-2007.

ANDREA HACK, EXAMINING ATTORNEY

**Int. Cl.: 35**

**Prior U.S. Cls.: 100, 101 and 102**

**United States Patent and Trademark Office**

**Reg. No. 3,452,568**

**Registered June 24, 2008**

**SERVICE MARK  
PRINCIPAL REGISTER**

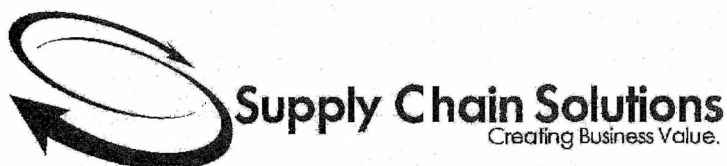

SUPPLY CHAIN SOLUTIONS, INC. (MICHIGAN CORPORATION)  
4607 44TH STREET, S.E.  
GRAND RAPIDS, MI 49512

FOR: BUSINESS MANAGEMENT SERVICES, NAMELY, MANAGING LOGISTICS, REVERSE LOGISTICS, SUPPLY CHAIN SERVICES, SUPPLY CHAIN VISIBILITY AND SYNCHRONIZATION, SUPPLY AND DEMAND FORECASTING AND PRODUCT DISTRIBUTION PROCESSES FOR OTHERS, IN CLASS 35 (U.S. CLS. 100, 101 AND 102).

FIRST USE 10-12-2003; IN COMMERCE 10-12-2003.

NO CLAIM IS MADE TO THE EXCLUSIVE RIGHT TO USE "SUPPLY CHAIN SOLUTIONS", APART FROM THE MARK AS SHOWN.

THE MARK CONSISTS OF A DESIGN OF TWO CONCENTRIC CURVED ARROWS AND THE WORDING "SUPPLY CHAIN SOLUTIONS CREATING BUSINESS VALUE".

SER. NO. 77-246,697, FILED 8-3-2007.

JOHN DALIER, EXAMINING ATTORNEY

**Int. Cls.: 40 and 44**

**Prior U.S. Cls.: 100, 101, 103 and 106**

**United States Patent and Trademark Office**

**Reg. No. 3,452,569**

**Registered June 24, 2008**

**SERVICE MARK  
PRINCIPAL REGISTER**



HUBBARD FEEDS, INC. (MINNESOTA CORPORATION)  
424 NORTH RIVERFRONT DRIVE  
MANKATO, MN 56002

FOR: CUSTOM MANUFACTURING SERVICES, NAMELY, CUSTOM FORMULATION AND BLENDING OF ANIMAL FEED FOR OTHERS, IN CLASS 40 (U.S. CLS. 100, 103 AND 106).

FIRST USE 4-1-1969; IN COMMERCE 4-1-1969.

FOR: LIVESTOCK NUTRITION CONSULTING SERVICES; CONSULTATION SERVICES PERTAIN-

ING TO ANIMAL FEEDS, IN CLASS 44 (U.S. CLS. 100 AND 101).

FIRST USE 4-1-1969; IN COMMERCE 4-1-1969.

THE MARK CONSISTS OF FOUR SHADED QUADRANTS FORMING A SQUARE CLOVER-LIKE SHAPE WITH THE LOWER RIGHT QUADRANT IN THE SHAPE OF AN "H".

SER. NO. 77-247,035, FILED 8-3-2007.

MARY MUNSON, EXAMINING ATTORNEY

**Int. Cls.: 40 and 44**

**Prior U.S. Cls.: 100, 101, 103 and 106**

**United States Patent and Trademark Office**

**Reg. No. 3,452,570**

**Registered June 24, 2008**

**SERVICE MARK  
PRINCIPAL REGISTER**

# HUBBARD

HUBBARD FEEDS, INC. (MINNESOTA CORPORATION)  
424 NORTH RIVERFRONT DRIVE  
MANKATO, MN 56002

FOR: CUSTOM MANUFACTURING SERVICES, NAMELY, CUSTOM FORMULATION AND BLENDING OF ANIMAL FEED FOR OTHERS, IN CLASS 40 (U.S. CLS. 100, 103 AND 106).

FIRST USE 4-1-1969; IN COMMERCE 4-1-1969.

FOR: LIVESTOCK NUTRITION CONSULTING SERVICES; CONSULTATION SERVICES PERTAINING TO ANIMAL FEEDS, IN CLASS 44 (U.S. CLS. 100 AND 101).

FIRST USE 4-1-1969; IN COMMERCE 4-1-1969.

THE MARK CONSISTS OF STANDARD CHARACTERS WITHOUT CLAIM TO ANY PARTICULAR FONT, STYLE, SIZE, OR COLOR.

OWNER OF U.S. REG. NOS. 621,407 AND 641,332.

SEC. 2(F).

SER. NO. 77-247,046, FILED 8-3-2007.

MARY MUNSON, EXAMINING ATTORNEY

**Int. Cl.: 42**

**Prior U.S. Cls.: 100 and 101**

**United States Patent and Trademark Office**

**Reg. No. 3,452,571**

**Registered June 24, 2008**

**SERVICE MARK  
PRINCIPAL REGISTER**

# Blingee

BA SOFTWARE LIMITED (CAYMAN ISLANDS  
CORPORATION)  
SOUTH CHURCH STREET  
PO BOX 309GT UGLAND HOUSE  
GEORGE TOWN, CAYMAN ISLANDS

FOR: COMPUTER SERVICES, NAMELY, HOST-  
ING AND MAINTAINING AN ONLINE WEBSITE  
FOR OTHERS TO STORE, ENHANCE AND SHARE  
DIGITAL PHOTOS, IN CLASS 42 (U.S. CLS. 100 AND  
101).

FIRST USE 1-1-2007; IN COMMERCE 1-1-2007.

THE MARK CONSISTS OF STANDARD CHAR-  
ACTERS WITHOUT CLAIM TO ANY PARTICULAR  
FONT, STYLE, SIZE, OR COLOR.

SER. NO. 77-247,699, FILED 8-6-2007.

MIDGE BUTLER, EXAMINING ATTORNEY



**Int. Cl.: 27**

**Prior U.S. Cls.: 19, 20, 37, 42 and 50**

**Reg. No. 3,452,572**

**United States Patent and Trademark Office**

**Registered June 24, 2008**

**TRADEMARK  
PRINCIPAL REGISTER**

**LOT 26 STUDIO**

LOT 26 STUDIO, LLC (CALIFORNIA LTD LIAB  
CO)  
277 CAROLINA STREET  
SAN FRANCISCO, CA 94103

THE MARK CONSISTS OF STANDARD CHAR-  
ACTERS WITHOUT CLAIM TO ANY PARTICULAR  
FONT, STYLE, SIZE, OR COLOR.

FOR: NON-TEXTILE WALL COVERINGS, IN  
CLASS 27 (U.S. CLS. 19, 20, 37, 42 AND 50).

SER. NO. 77-248,204, FILED 8-6-2007.

FIRST USE 7-2-2007; IN COMMERCE 7-2-2007.

SALLY SHIH, EXAMINING ATTORNEY

**Int. Cl.: 21**

**Prior U.S. Cls.: 2, 13, 23, 29, 30, 33, 40 and 50**

**Reg. No. 3,452,573**

**United States Patent and Trademark Office**

**Registered June 24, 2008**

---

**TRADEMARK  
PRINCIPAL REGISTER**

**MAKIN BACON**

A DE F LTD. (NORTH DAKOTA CORPORATION)  
425 HALL AVENUE  
WHITE BEAR LAKE, MN 55110

THE MARK CONSISTS OF STANDARD CHARACTERS WITHOUT CLAIM TO ANY PARTICULAR FONT, STYLE, SIZE, OR COLOR.

FOR: COOKWARE, NAMELY, COOKING TRAYS FOR USE WITH MICROWAVE OVENS, IN CLASS 21 (U.S. CLS. 2, 13, 23, 29, 30, 33, 40 AND 50).

SER. NO. 77-248,266, FILED 8-6-2007.

FIRST USE 10-19-1993; IN COMMERCE 10-19-1993.

BERYL GARDNER, EXAMINING ATTORNEY

**Int. Cl.: 16**

**Prior U.S. Cls.: 2, 5, 22, 23, 29, 37, 38 and 50**

**Reg. No. 3,452,574**

**United States Patent and Trademark Office**

**Registered June 24, 2008**

**TRADEMARK  
PRINCIPAL REGISTER**

**CAROLENE DE MESILLA**

HERBEL, CAROLENE C. (UNITED STATES INDIVIDUAL)  
1804 HALFMOON DRIVE  
LAS CRUCES, NM 88002

FOR: PRINTED MATTER, NAMELY, GRAPHIC ART REPRODUCTIONS, ART PICTURES, ART PRINTS, AND GREETING CARDS, IN CLASS 16 (U.S. CLS. 2, 5, 22, 23, 29, 37, 38 AND 50).

FIRST USE 1-1-1993; IN COMMERCE 1-1-1993.

THE MARK CONSISTS OF STANDARD CHARACTERS WITHOUT CLAIM TO ANY PARTICULAR FONT, STYLE, SIZE, OR COLOR.

NO CLAIM IS MADE TO THE EXCLUSIVE RIGHT TO USE "MESILLA", APART FROM THE MARK AS SHOWN.

THE NAME(S), PORTRAIT(S), AND/OR SIGNATURE(S) SHOWN IN THE MARK IDENTIFIES "CAROLENE DE MESILLA", WHOSE CONSENT(S) TO REGISTER IS SUBMITTED.

SER. NO. 77-248,322, FILED 8-6-2007.

JAMES STEIN, EXAMINING ATTORNEY

**Int. Cl.: 41**

**Prior U.S. Cls.: 100, 101 and 107**

**United States Patent and Trademark Office**

**Reg. No. 3,452,575**

**Registered June 24, 2008**

**SERVICE MARK  
PRINCIPAL REGISTER**

**WORLD CHAMPIONSHIP  
OFF-ROAD RACES**

WOLFHEAD SPORTSMEN CLUB, INC. (WIS-  
CONSIN CORPORATION)

BOX 101

CRANDON, WI 54520

FOR: ORGANIZING AND OPERATING ANNUAL  
RACING EVENTS FOR AUTOMOBILES, BUGGIES,  
AND MOTORCYCLES, IN CLASS 41 (U.S. CLS. 100,  
101 AND 107).

FIRST USE 5-31-1973; IN COMMERCE 5-31-1973.

THE MARK CONSISTS OF STANDARD CHAR-  
ACTERS WITHOUT CLAIM TO ANY PARTICULAR  
FONT, STYLE, SIZE, OR COLOR.

NO CLAIM IS MADE TO THE EXCLUSIVE  
RIGHT TO USE "OFF-ROAD RACES", APART  
FROM THE MARK AS SHOWN.

SEC. 2(F).

SER. NO. 77-248,374, FILED 8-6-2007.

BRIAN CALLAGHAN, EXAMINING ATTORNEY

**Int. Cl.: 10**

**Prior U.S. Cls.: 26, 39 and 44**

**United States Patent and Trademark Office**

**Reg. No. 3,452,576**

**Registered June 24, 2008**

**TRADEMARK  
PRINCIPAL REGISTER**



GF HEALTH PRODUCTS, INC (GEORGIA CORPORATION)  
2935 NORTHEAST PARKWAY  
ATLANTA, GA 30360

FOR: OXYGEN CONCENTRATORS FOR MEDICAL APPLICATIONS, IN CLASS 10 (U.S. CLS. 26, 39 AND 44).

FIRST USE 1-6-2006; IN COMMERCE 3-15-2006.

OWNER OF U.S. REG. NOS. 1,982,067 AND 2,003,945.

NO CLAIM IS MADE TO THE EXCLUSIVE RIGHT TO USE "O2 PREMIER", APART FROM THE MARK AS SHOWN.

THE NAME JOHN BUNN DOES NOT IDENTIFY A LIVING INDIVIDUAL.

THE COLOR(S) BLUE, GREY AND WHITE IS/ARE CLAIMED AS A FEATURE OF THE MARK.

THE MARK CONSISTS OF A STYLIZED "O2" IN SHADES OF BLUE WITH WHITE ON THE TOP. THE LETTER "2" AND APPEARS IN GRAYSCALE WITH THE TERM "JOHN BUNN" AND THE DIAMOND DESIGN IN BLUE.

SER. NO. 77-248,731, FILED 8-7-2007.

CAROLINE WOOD, EXAMINING ATTORNEY

**Int. Cl.: 9**

**Prior U.S. Cls.: 21, 23, 26, 36 and 38**

**Reg. No. 3,452,577**

**United States Patent and Trademark Office**

**Registered June 24, 2008**

---

**TRADEMARK  
PRINCIPAL REGISTER**

# Klacker

RATEC LLC (DELAWARE LTD LIAB CO)  
SUITE 501  
13000 AUTOMOBILE BLVD  
CLEARWATER, FL 33762

FIRST USE 0-0-1997; IN COMMERCE 0-0-1997.

THE MARK CONSISTS OF STANDARD CHARACTERS WITHOUT CLAIM TO ANY PARTICULAR FONT, STYLE, SIZE, OR COLOR.

FOR: MAGNET FOR USE IN ASSEMBLING WOOD OR METAL PRE-CAST MOLDS FOR CONCRETE POURING PROCESS, IN CLASS 9 (U.S. CLS. 21, 23, 26, 36 AND 38).

SER. NO. 77-248,751, FILED 8-7-2007.

ALICE BENMAMAN, EXAMINING ATTORNEY

**Int. Cl.: 41**

**Prior U.S. Cls.: 100, 101 and 107**

**United States Patent and Trademark Office**

**Reg. No. 3,452,578**

**Registered June 24, 2008**

**SERVICE MARK  
PRINCIPAL REGISTER**

**HEALTH AND WELFARE PLAN  
MANAGEMENT FOR MID-SIZED  
EMPLOYERS**

UAI TECHNOLOGY, INC. (DELAWARE CORPORATION)  
P.O. BOX 13628  
68 T.W. ALEXANDER DRIVE  
RESEARCH TRIANGLE PARK, NC 27709

FOR: ARRANGING AND CONDUCTING EDUCATIONAL CONFERENCES, WORKSHOPS, SEMINARS, AND CLASSES FOR INDIVIDUALS AND BUSINESSES IN THE FIELD OF MANAGEMENT AND ADMINISTRATION OF CORPORATE HEALTH AND BENEFIT PLANS, IN CLASS 41 (U.S. CLS. 100, 101 AND 107).

FIRST USE 6-1-1999; IN COMMERCE 6-1-1999.

THE MARK CONSISTS OF STANDARD CHARACTERS WITHOUT CLAIM TO ANY PARTICULAR FONT, STYLE, SIZE, OR COLOR.

SEC. 2(F).

SER. NO. 77-249,024, FILED 8-7-2007.

KAREN BRACEY, EXAMINING ATTORNEY

**Int. Cl.: 35**

**Prior U.S. Cls.: 100, 101 and 102**

**United States Patent and Trademark Office**

**Reg. No. 3,452,579**

**Registered June 24, 2008**

**SERVICE MARK  
PRINCIPAL REGISTER**

**BRANDACCESS**

ACCESS VG, LLC (UTAH LTD LIAB CO)  
1012 W. BEARDSLEY  
SALT LAKE CITY, UT 84119

FIRST USE 7-1-2007; IN COMMERCE 7-1-2007.

FOR: ADMINISTRATION OF A DISCOUNT COUPON PROGRAM FEATURING PREMIUM PRINTABLE COUPONS AND CERTIFICATES FOR THIRD PARTY ORGANIZATIONS FOR USE IN LOYALTY PROGRAMS, IN CLASS 35 (U.S. CLS. 100, 101 AND 102).

THE MARK CONSISTS OF STANDARD CHARACTERS WITHOUT CLAIM TO ANY PARTICULAR FONT, STYLE, SIZE, OR COLOR.

SER. NO. 77-249,042, FILED 8-7-2007.

ATTIYA MALIK, EXAMINING ATTORNEY



**Int. Cl.: 9**

**Prior U.S. Cls.: 21, 23, 26, 36 and 38**

**Reg. No. 3,452,580**

**United States Patent and Trademark Office**

**Registered June 24, 2008**

---

**TRADEMARK  
PRINCIPAL REGISTER**

# Paradigm

PERCEPTION RESEARCH SYSTEMS, INCORPORATED (NEW YORK CORPORATION)  
240-48 43RD AVENUE  
DOUGLASTON, NY 11363

FOR: COMPUTER SOFTWARE FOR CREATING AND PRESENTING EXPERIMENTS IN THE FIELD OF COGNITIVE NEUROSCIENCE AND PSYCHOLOGY RESEARCH, IN CLASS 9 (U.S. CLS. 21, 23, 26, 36 AND 38).

FIRST USE 1-1-2003; IN COMMERCE 1-3-2004.

THE MARK CONSISTS OF STANDARD CHARACTERS WITHOUT CLAIM TO ANY PARTICULAR FONT, STYLE, SIZE, OR COLOR.

SER. NO. 77-249,836, FILED 8-8-2007.

REBECCA SMITH, EXAMINING ATTORNEY

**Int. Cl.: 36**

**Prior U.S. Cls.: 100, 101 and 102**

**United States Patent and Trademark Office**

**Reg. No. 3,452,581**

**Registered June 24, 2008**

**SERVICE MARK  
PRINCIPAL REGISTER**

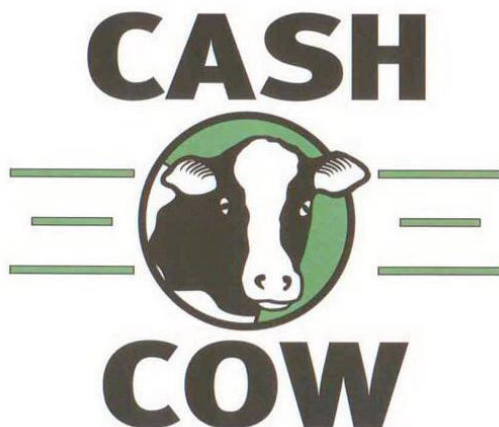

SOUTHERN FAST LOANS OF LOUISIANA, INC.  
(LOUISIANA CORPORATION)  
SUITE 406  
8601 DUNWOODY PLACE  
ATLANTA, GA 30350

FOR: FINANCIAL SERVICES, NAMELY, DEFERRED DEPOSIT TRANSACTIONS, IN CLASS 36 (U.S. CLS. 100, 101 AND 102).

FIRST USE 8-1-2007; IN COMMERCE 8-1-2007.

NO CLAIM IS MADE TO THE EXCLUSIVE RIGHT TO USE "CASH", APART FROM THE MARK AS SHOWN.

THE COLOR(S) GREEN, BLACK AND WHITE IS/ARE CLAIMED AS A FEATURE OF THE MARK.

THE COLOR BLACK APPEARS IN THE WORDING "CASH COW" AND THE COLOR GREEN APPEARS IN THE DESIGN OF THE COW AND THE LINES BETWEEN THE WORDS "CASH COW". ALSO, THE COLORS BLACK, WHITE AND GREEN APPEAR IN THE COW DESIGN.

SER. NO. 77-250,830, FILED 8-9-2007.

JAY FLOWERS, EXAMINING ATTORNEY

**Int. Cls.: 16 and 36**

**Prior U.S. Cls.: 2, 5, 22, 23, 29, 37, 38, 50, 100, 101 and 102**

**Reg. No. 3,452,582**

**United States Patent and Trademark Office**

**Registered June 24, 2008**

**TRADEMARK  
SERVICE MARK  
PRINCIPAL REGISTER**

**THE PROPERTY POET**

SUSAN M. YANNESSA (UNITED STATES INDIVIDUAL)  
309 FLORENCE AVENUE 628N  
JENKINTOWN, PA 19046

FOR: PRINTED PUBLICATIONS, NAMELY, PAMPHLETS AND PERIODIC NEWSLETTERS IN THE FIELD OF HOME OWNERSHIP, REAL ESTATE SALES AND ACQUISITIONS AND REAL ESTATE COUNSELING, IN CLASS 16 (U.S. CLS. 2, 5, 22, 23, 29, 37, 38 AND 50).

FIRST USE 3-1-2005; IN COMMERCE 3-1-2005.

FOR: PROVIDING REAL ESTATE AGENT SERVICES, PROVIDING REAL ESTATE COUNSELING AND REAL ESTATE CONSULTING SERVICES,

PROVIDING REAL ESTATE VALUATION SERVICES, IN CLASS 36 (U.S. CLS. 100, 101 AND 102).

FIRST USE 5-8-2006; IN COMMERCE 5-8-2006.

THE MARK CONSISTS OF STANDARD CHARACTERS WITHOUT CLAIM TO ANY PARTICULAR FONT, STYLE, SIZE, OR COLOR.

NO CLAIM IS MADE TO THE EXCLUSIVE RIGHT TO USE "PROPERTY", APART FROM THE MARK AS SHOWN.

SER. NO. 77-250,893, FILED 8-9-2007.

LINDA E. BLOHM, EXAMINING ATTORNEY

**Int. Cl.: 9**

**Prior U.S. Cls.: 21, 23, 26, 36 and 38**

**Reg. No. 3,452,583**

**United States Patent and Trademark Office**

**Registered June 24, 2008**

---

**TRADEMARK  
PRINCIPAL REGISTER**

# Tekram

TEKRAM USA INC. (CALIFORNIA CORPORATION)  
2861 SATURN STREET. UNIT B  
BREA, CA 92821

THE MARK CONSISTS OF STANDARD CHARACTERS WITHOUT CLAIM TO ANY PARTICULAR FONT, STYLE, SIZE, OR COLOR.

FOR: COMPUTER PERIPHERAL DEVICES, IN CLASS 9 (U.S. CLS. 21, 23, 26, 36 AND 38).

SER. NO. 77-251,770, FILED S.R. 8-9-2007 AM. P.R. 2-7-2008.

FIRST USE 1-1-2004; IN COMMERCE 1-1-2004.

MARY MUNSON, EXAMINING ATTORNEY

Int. Cl.: 35

Prior U.S. Cls.: 100, 101 and 102

United States Patent and Trademark Office

Reg. No. 3,452,584

Registered June 24, 2008

SERVICE MARK  
PRINCIPAL REGISTER



TIMOTHY JOEL GREEN II (UNITED STATES  
INDIVIDUAL)  
455 EAST OCEAN SUITE 902  
LONG BEACH, CA 90802

FOR: ADVERTISING, MARKETING AND PRO-  
MOTION SERVICES; ADVERTISING BY TRANS-  
MISSION OF ON-LINE PUBLICITY FOR THIRD  
PARTIES THROUGH ELECTRONIC COMMUNICA-  
TIONS NETWORKS; ADVERTISING VIA ELECTRO-  
NIC MEDIA AND SPECIFICALLY THE INTERNET;  
DISSEMINATION OF ADVERTISING FOR OTHERS  
VIA AN ON-LINE COMMUNICATIONS NETWORK  
ON THE INTERNET; ON-LINE ADVERTISING AND  
MARKETING SERVICES; PROMOTION, ADVER-  
TISING AND MARKETING OF ON-LINE WEB-  
SITES, IN CLASS 35 (U.S. CLS. 100, 101 AND 102).

FIRST USE 8-8-2007; IN COMMERCE 8-8-2007.

NO CLAIM IS MADE TO THE EXCLUSIVE  
RIGHT TO USE "ADS", APART FROM THE MARK  
AS SHOWN.

THE COLOR(S) GREEN AND BLACK IS/ARE  
CLAIMED AS A FEATURE OF THE MARK.

THE COLOR GREEN APPEARS IN THE FIRST  
TERM "GREEN" AND IN THE FINGERPRINT DE-  
SIGN; THE COLOR BLACK APPEARS IN THE  
WORDING "ADS GREEN IS SCREENED & CLEAN;"  
AND THE BACKGROUND IS TRANSPARENT.

SER. NO. 77-251,909, FILED 8-9-2007.

BILL DAWE, EXAMINING ATTORNEY

**Int. Cls.: 37 and 40**

**Prior U.S. Cls.: 100, 103 and 106**

**United States Patent and Trademark Office**

**Reg. No. 3,452,585**

**Registered June 24, 2008**

**SERVICE MARK  
PRINCIPAL REGISTER**



TRI-VALLEY CORPORATION (DELAWARE CORPORATION)  
SUITE 600  
4550 CALIFORNIA AVENUE  
BAKERSFIELD, CA 93309

FOR: GAS AND OIL WELL DRILLING, IN CLASS 37 (U.S. CLS. 100, 103 AND 106).

FIRST USE 4-0-2006; IN COMMERCE 4-0-2006.

FOR: OIL AND GAS PRODUCTION, IN CLASS 40 (U.S. CLS. 100, 103 AND 106).

FIRST USE 4-0-2006; IN COMMERCE 4-0-2006.

NO CLAIM IS MADE TO THE EXCLUSIVE RIGHT TO USE "PRODUCTION SERVICES, LLC", APART FROM THE MARK AS SHOWN.

THE MARK CONSISTS OF THE LITERAL ELEMENT AND A FANCIFUL DEPICTION OF MOUNTAINS, A VALLEY, LAYERS, A RESERVOIR AND A RIG IN A CIRCULAR DESIGN.

SER. NO. 77-252,368, FILED 8-10-2007.

LINDA M. KING, EXAMINING ATTORNEY

Int. Cl.: 37

Prior U.S. Cls.: 100, 103 and 106

United States Patent and Trademark Office

Reg. No. 3,452,586

Registered June 24, 2008

SERVICE MARK  
PRINCIPAL REGISTER



TRI-VALLEY CORPORATION (DELAWARE CORPORATION)  
SUITE 600  
4550 CALIFORNIA AVENUE  
BAKERSFIELD, CA 93309

FOR: GAS AND OIL WELL DRILLING, IN CLASS 37 (U.S. CLS. 100, 103 AND 106).

FIRST USE 1-0-2007; IN COMMERCE 1-0-2007.

NO CLAIM IS MADE TO THE EXCLUSIVE RIGHT TO USE "DRILLING COMPANY, LLC", APART FROM THE MARK AS SHOWN.

THE MARK CONSISTS OF THE LITERAL ELEMENT AND A FANCIFUL DEPICTION OF MOUNTAINS, A VALLEY, LAYERS, A RESERVOIR AND A RIG IN A CIRCULAR DESIGN.

SER. NO. 77-252,412, FILED 8-10-2007.

LINDA M. KING, EXAMINING ATTORNEY

**Int. Cl.: 45**

**Prior U.S. Cls.: 100 and 101**

**United States Patent and Trademark Office**

**Reg. No. 3,452,587**

**Registered June 24, 2008**

**SERVICE MARK  
PRINCIPAL REGISTER**

**WILL SANTA FIND ME?  
FOUNDATION**

THE "WILL SANTA FIND ME?" FOUNDATION,  
INC. (CONNECTICUT CORPORATION)  
13 WADSWORTH LANE  
WALLINGFORD, CT 06492

FOR: CHARITABLE SERVICES, NAMELY,  
GRANTING WISHES OF NEEDY, TERMINALLY  
OR CHRONICALLY ILL CHILDREN AND THEIR  
FAMILIES, AND OF VICTIMS OF DOMESTIC VIO-  
LENCE AND THEIR FAMILIES, IN CLASS 45 (U.S.  
CLS. 100 AND 101).

FIRST USE 0-0-1990; IN COMMERCE 0-0-2002.

THE MARK CONSISTS OF STANDARD CHAR-  
ACTERS WITHOUT CLAIM TO ANY PARTICULAR  
FONT, STYLE, SIZE, OR COLOR.

NO CLAIM IS MADE TO THE EXCLUSIVE  
RIGHT TO USE "FOUNDATION", APART FROM  
THE MARK AS SHOWN.

SER. NO. 77-252,534, FILED 8-10-2007.

TRACY CROSS, EXAMINING ATTORNEY



**Int. Cl.: 10**

**Prior U.S. Cls.: 26, 39 and 44**

**Reg. No. 3,452,588**

**United States Patent and Trademark Office**

**Registered June 24, 2008**

---

**TRADEMARK  
PRINCIPAL REGISTER**

**TUNNO TOTS**

BELLA TUNNO LLC (NORTH CAROLINA LTD  
LIAB CO), DBA BELLA TUNNO LLC  
7801 COMPTON COURT  
CHARLOTTE, NC 28270

FOR: PACIFIER CLIPS, IN CLASS 10 (U.S. CLS. 26,  
39 AND 44).

FIRST USE 2-1-2007; IN COMMERCE 8-6-2007.

NO CLAIM IS MADE TO THE EXCLUSIVE  
RIGHT TO USE "TOTS", APART FROM THE MARK  
AS SHOWN.

THE MARK CONSISTS OF "TUNNO TOTS" IS IN  
SERIF FONT WITH STYLIZED "O"S.

SER. NO. 77-252,744, FILED 8-10-2007.

SANDRA MANIOS, EXAMINING ATTORNEY

**Int. Cl.: 42**

**Prior U.S. Cls.: 100 and 101**

**United States Patent and Trademark Office**

**Reg. No. 3,452,589**

**Registered June 24, 2008**

**SERVICE MARK  
PRINCIPAL REGISTER**

**NETPRM**

AXONOM INC. (MINNESOTA CORPORATION)  
10860 NESBITT AVENUE S.  
BLOOMINGTON, MN 55437

FOR: PROVIDING ON-LINE NON-DOWNLOAD-ABLE COMPUTER SOFTWARE USED IN CONNECTION WITH AN INTEGRATED SUITE OF CALL CENTER, BUSINESS-TO-BUSINESS E-COMMERCE, KNOWLEDGE MANAGEMENT AND PARTNER RELATIONSHIP MODULES, FOR USE IN CONNECTION WITH ELECTRONIC AND DIRECT INTERACTIONS BETWEEN BUSINESSES, PARTNERS AND CUSTOMERS VIA WEB, EMAIL, PHONE AS RECORDED AND FACILITATED WITHIN SALES, TECHNICAL SERVICES, ADVANCED MARKETING, PRODUCT CONFIGURATION, CALL CENTER AREAS, AND PROVIDING ON-LINE NON-DOWN-

LOADABLE SUPPORTING COMPUTER PROGRAMS WHICH CONTROL ROUTING, CLASSIFICATION AND INFORMATION VIEWING WITHIN SOFTWARE APPLICATIONS IN BOTH HOSTED AND ON-PREMISE COMPUTER INFRASTRUCTURES , IN CLASS 42 (U.S. CLS. 100 AND 101).

FIRST USE 2-1-2007; IN COMMERCE 2-1-2007.

THE MARK CONSISTS OF STANDARD CHARACTERS WITHOUT CLAIM TO ANY PARTICULAR FONT, STYLE, SIZE, OR COLOR.

SER. NO. 77-252,777, FILED 8-10-2007.

ROBERT LAVACHE, EXAMINING ATTORNEY

**Int. Cl.: 43**

**Prior U.S. Cls.: 100 and 101**

**United States Patent and Trademark Office**

**Reg. No. 3,452,590**

**Registered June 24, 2008**

**SERVICE MARK  
PRINCIPAL REGISTER**

**PEARL PALMS CONCERT THEATER**

FIESTA PALMS, LLC (NEVADA LTD LIAB CO)  
4321 WEST FLAMINGO ROAD  
LAS VEGAS, NV 89103

OWNER OF U.S. REG. NOS. 2,773,483, 2,773,484,  
AND 2,819,261.

FOR: ARENA SERVICES, NAMELY, PROVIDING  
FACILITIES FOR SPORTS, CONCERTS, CONVEN-  
TIONS AND EXHIBITIONS, IN CLASS 43 (U.S. CLS.  
100 AND 101).

NO CLAIM IS MADE TO THE EXCLUSIVE  
RIGHT TO USE "CONCERT THEATER", APART  
FROM THE MARK AS SHOWN.

FIRST USE 3-17-2007; IN COMMERCE 3-17-2007.

SER. NO. 77-252,914, FILED 8-10-2007.

THE MARK CONSISTS OF STANDARD CHAR-  
ACTERS WITHOUT CLAIM TO ANY PARTICULAR  
FONT, STYLE, SIZE, OR COLOR.

YAT SYE, LEE, EXAMINING ATTORNEY

**Int. Cl.: 30**

**Prior U.S. Cl.: 46**

**United States Patent and Trademark Office**

**Reg. No. 3,452,591**

**Registered June 24, 2008**

**TRADEMARK  
PRINCIPAL REGISTER**

**PUTNEY PASTA**

THE NATURAL PASTA COMPANY, LLC (DELA-  
WARE LTD LIAB CO)  
28 VERNON STREET, SUITE 434  
BRATTLEBORO, VT 05301

OWNER OF U.S. REG. NO. 2,106,179.

FOR: PASTA, SAUCES, AND FROZEN, PRE-  
PARED, AND PACKAGED ENTREES CONSISTING  
PRIMARILY OF PASTA, IN CLASS 30 (U.S. CL. 46).

NO CLAIM IS MADE TO THE EXCLUSIVE  
RIGHT TO USE "PASTA", APART FROM THE  
MARK AS SHOWN.

FIRST USE 1-3-1984; IN COMMERCE 1-3-1984.

SER. NO. 77-253,733, FILED 8-13-2007.

THE MARK CONSISTS OF STANDARD CHAR-  
ACTERS WITHOUT CLAIM TO ANY PARTICULAR  
FONT, STYLE, SIZE, OR COLOR.

SEAN CROWLEY, EXAMINING ATTORNEY

**Int. Cl.: 40**

**Prior U.S. Cls.: 100, 103 and 106**

**United States Patent and Trademark Office**

**Reg. No. 3,452,592**

**Registered June 24, 2008**

**SERVICE MARK  
PRINCIPAL REGISTER**

# Presto Photo

PRESTO PHOTO, INC. (ILLINOIS CORPORATION)  
3759 PARADOR DRIVE  
NAPERVILLE, IL 60564

FOR: CREATION OF CUSTOM PORTRAITS AND PAINTINGS BASED ON PHOTOGRAPHS, SNAPSHOTS OR IMAGES PROVIDED BY THE CUSTOMER; DIGITAL IMAGE CORRECTION SERVICES OF VIDEOS; ELECTRONIC IMAGING, SCANNING, DIGITIZING, ALTERATION AND/OR RETOUCHING OF PHOTOGRAPHS; PHOTOGRAPHIC COMPUTER IMAGING; FRAMING OF WORKS OF ART; DIGITAL RESTORATION AND/OR ENHANCEMENT OF PHOTOGRAPHS; DIGITAL RESTORATION OF PHOTOGRAPHS; PHOTOGRAPHIC

RESTORATION, IN CLASS 40 (U.S. CLS. 100, 103 AND 106).

FIRST USE 9-20-2005; IN COMMERCE 9-20-2005.

THE MARK CONSISTS OF STANDARD CHARACTERS WITHOUT CLAIM TO ANY PARTICULAR FONT, STYLE, SIZE, OR COLOR.

NO CLAIM IS MADE TO THE EXCLUSIVE RIGHT TO USE "PHOTO" , APART FROM THE MARK AS SHOWN.

SER. NO. 77-253,831, FILED 8-13-2007.

KELLEY WELLS, EXAMINING ATTORNEY

**Int. Cl.: 3**

**Prior U.S. Cls.: 1, 4, 6, 50, 51 and 52**

**United States Patent and Trademark Office**

**Reg. No. 3,452,593**

**Registered June 24, 2008**

**TRADEMARK  
PRINCIPAL REGISTER**

**Y.E.S. YOUR ESSENTIAL SCENT**

EASTWOOD, LINDA (UNITED STATES INDIVIDUAL)  
11 COSTA DEL SOL  
MONARCH BEACH, CA 92629

FOR: NON-MEDICATED TOILETRIES; OILS FOR TOILETRY PURPOSES; BODY SPRAY USED AS A PERSONAL DEODORANT AND AS FRAGRANCE; FRAGRANCES FOR PERSONAL USE; EAU DE PERFUME; LIQUID PERFUMES; PERFUME; PERFUME OILS; PERFUME OILS FOR THE MANUFACTURE OF COSMETIC PREPARATIONS; COSMETIC CREAMS FOR SKIN CARE; COSMETIC OILS; COSMETIC PREPARATIONS FOR BODY CARE; COSMETIC PREPARATIONS FOR SKIN RENEWAL; COSMETIC PRODUCTS IN THE FORM OF AEROSOLS FOR SKIN CARE; COSMETIC SOAPS; COSMETIC OILS FOR THE EPIDERMIS; FACE CREAMS FOR COSMETIC USE; FOAMS CONTAINING COSMETICS AND SUNSCREENS; NUTRITIONAL OILS FOR COSMETIC PURPOSES;

COSMETIC SUN-PROTECTING PREPARATIONS; SKIN AND BODY TOPICAL LOTIONS, CREAMS AND OILS FOR COSMETIC USE; SKIN TONERS; TOPICAL SKIN SPRAYS FOR COSMETIC PURPOSES, IN CLASS 3 (U.S. CLS. 1, 4, 6, 50, 51 AND 52).

FIRST USE 8-9-2007; IN COMMERCE 8-9-2007.

THE MARK CONSISTS OF STANDARD CHARACTERS WITHOUT CLAIM TO ANY PARTICULAR FONT, STYLE, SIZE, OR COLOR.

NO CLAIM IS MADE TO THE EXCLUSIVE RIGHT TO USE "ESSENTIAL SCENT", APART FROM THE MARK AS SHOWN.

SER. NO. 77-254,333, FILED 8-14-2007.

CHRISTINA SOBRAL, EXAMINING ATTORNEY

**Int. Cl.: 43**

**Prior U.S. Cls.: 100 and 101**

**United States Patent and Trademark Office**

**Reg. No. 3,452,594**

**Registered June 24, 2008**

**SERVICE MARK  
PRINCIPAL REGISTER**

**NEWPRODUCTWORKS**

THE ARBOR STRATEGY GROUP, INC. (MICHIGAN CORPORATION)  
680 STATE CIRCLE  
ANN ARBOR, MI 48108

FOR: PROVIDING FACILITIES FOR EXHIBITIONS OF PRODUCT SAMPLES INCLUDING NEW PRODUCTS AND ONCE-NEW PRODUCTS THAT HAVE ALREADY BEEN INTRODUCED INTO THE MARKETPLACE, IN CLASS 43 (U.S. CLS. 100 AND 101).

FIRST USE 4-20-2001; IN COMMERCE 4-20-2001.

THE MARK CONSISTS OF STANDARD CHARACTERS WITHOUT CLAIM TO ANY PARTICULAR FONT, STYLE, SIZE, OR COLOR.

SER. NO. 77-254,790, FILED 8-14-2007.

SUSAN RICHARDS, EXAMINING ATTORNEY

**Int. Cl.: 35**

**Prior U.S. Cls.: 100, 101 and 102**

**United States Patent and Trademark Office**

**Reg. No. 3,452,595**

**Registered June 24, 2008**

**SERVICE MARK  
PRINCIPAL REGISTER**



CELGENE CORPORATION (DELAWARE CORPORATION)

86 MORRIS AVENUE  
SUMMIT, NJ 07901

FOR: ADMINISTRATION OF PATIENT REIMBURSEMENT PROGRAMS; ADMINISTERING PHARMACY REIMBURSEMENT PROGRAMS AND SERVICES, IN CLASS 35 (U.S. CLS. 100, 101 AND 102).

FIRST USE 10-30-2006; IN COMMERCE 10-30-2006.

OWNER OF U.S. REG. NOS. 3,226,059, 3,252,782, AND 3,273,986.

NO CLAIM IS MADE TO THE EXCLUSIVE RIGHT TO USE "PATIENT SUPPORT COORDINATOR", APART FROM THE MARK AS SHOWN.

THE COLOR(S) LIGHT BLUE AND DARK BLUE IS/ARE CLAIMED AS A FEATURE OF THE MARK.

THE MARK CONSISTS OF "PSC" IN LIGHT BLUE WITH A CURVED LINE IN LIGHT AND DARK BLUE AND "PATIENT SUPPORT COORDINATOR" IN LIGHT BLUE.

SER. NO. 77-254,811, FILED 8-14-2007.

KATHRYN COWARD, EXAMINING ATTORNEY



**Int. Cl.: 11**

**Prior U.S. Cls.: 13, 21, 23, 31 and 34**

**Reg. No. 3,452,596**

**United States Patent and Trademark Office**

**Registered June 24, 2008**

**TRADEMARK  
PRINCIPAL REGISTER**



LACY, JARVIS M (UNITED STATES INDIVIDUAL)  
2707 SCARBOROUGH DRIVE  
GRAND PRAIRIE, TX 75052

FOR: WATER FILTERS, IN CLASS 11 (U.S. CLS. 13, 21, 23, 31 AND 34).

FIRST USE 8-14-2007; IN COMMERCE 8-14-2007.

OWNER OF U.S. REG. NO. 3,299,919.

THE COLOR(S) ROYAL BLUE, RED, BLACK, WHITE, AND GRAYS IS/ARE CLAIMED AS A FEATURE OF THE MARK.

THE MARK CONSISTS OF THE COLOR ROYAL BLUE THAT APPEARS IN THE WORDING "VSHOWER", THE WORDING "USA" CONSISTS OF THE COLORS RED, WHITE AND BLUE, THE WORDING "THE VITAMIN SHOWER" CONSISTS OF THE COLOR BLACK, THE SOAP BUBBLES AND THEIR SHADOWS CONSIST OF VARIOUS SHADES OF GRAY WITH HIGHLIGHTS CONSISTING OF WHITE, GRAY, AND BLACK, WHITE APPEARS AS A RECTANGULAR OR CIRCULAR BACKGROUND OF THE MARK.

SER. NO. 77-254,987, FILED 8-14-2007.

SEAN CROWLEY, EXAMINING ATTORNEY

**Int. Cls.: 9 and 41**

**Prior U.S. Cls.: 21, 23, 26, 36, 38, 100, 101 and 107**

**United States Patent and Trademark Office**

**Reg. No. 3,452,597**

**Registered June 24, 2008**

**TRADEMARK  
SERVICE MARK  
PRINCIPAL REGISTER**

# Comanchero

MARGOLIS, SAMUEL, D. (UNITED STATES INDIVIDUAL)  
94 BOSTON AVE #1  
MEDFORD, MA 02155

FOR: COMPACT DISCS (CDS) FEATURING MUSICAL AND VOCAL PERFORMANCES; DOWNLOADABLE RING TONES, GRAPHICS AND MUSIC VIA A GLOBAL COMPUTER NETWORK AND WIRELESS DEVICES, IN CLASS 9 (U.S. CLS. 21, 23, 26, 36 AND 38).

FIRST USE 8-7-2007; IN COMMERCE 8-7-2007.

FOR: ENTERTAINMENT, NAMELY, LIVE PERFORMANCES BY A MUSICAL BAND; ENTERTAINMENT SERVICES, NAMELY, PROVIDING A WEB SITE FEATURING MUSICAL PERFORMANCES,

MUSICAL VIDEOS, RELATED FILM CLIPS, PHOTOGRAPHS, AND OTHER MULTIMEDIA MATERIALS; ENTERTAINMENT, NAMELY, LIVE MUSIC CONCERTS; MUSIC PRODUCTION SERVICES; MUSIC PUBLISHING SERVICES, IN CLASS 41 (U.S. CLS. 100, 101 AND 107).

FIRST USE 8-1-2007; IN COMMERCE 8-4-2007.

THE MARK CONSISTS OF STANDARD CHARACTERS WITHOUT CLAIM TO ANY PARTICULAR FONT, STYLE, SIZE, OR COLOR.

SER. NO. 77-255,402, FILED 8-14-2007.

JENNY PARK, EXAMINING ATTORNEY

**Int. Cl.: 37**

**Prior U.S. Cls.: 100, 103 and 106**

**United States Patent and Trademark Office**

**Reg. No. 3,452,598**

**Registered June 24, 2008**

**SERVICE MARK  
PRINCIPAL REGISTER**

**BERGELECTRIC**

BERGELECTRIC CORP. (CALIFORNIA CORPORATION)  
5650 WEST CENTINELA  
LOS ANGELES, CA 90045

FOR: BUILDING CONSTRUCTION, INSPECTION AND ELECTRICAL CONTRACTOR SERVICES; PROVIDING SERVICES IN THE NATURE OF REPAIR AND INSTALLATION OF ELECTRICAL, FIRE ALARMS, SMOKE CONTROL, INTRUSION DEVICES, THEFT PREVENTION DEVICES, SECURITY SYSTEMS, ACCESS CONTROL SYSTEMS, PUBLIC ADDRESS SYSTEMS, AND NURSE CALL SYSTEMS; INSTALLATION OF INTER-BUILDING BACKBONE SYSTEMS, INTRA-BUILDING BACKBONE SYSTEMS, HORIZONTAL CABLING INFRASTRUCTURE STATION CABLING, WIRELESS DISTRIBUTION SYSTEMS, TELECOMMUNICATION ROOMS, EQUIPMENT ROOMS, ENTRANCE FACILITIES,

TELECOMMUNICATIONS GROUND AND BONDING SYSTEMS; PROVIDING ON-SITE RESIDENTIAL, COMMERCIAL AND INDUSTRIAL ELECTRICAL AND TELECOMMUNICATIONS REPAIR AND INSTALLATION SERVICES, IN CLASS 37 (U.S. CLS. 100, 103 AND 106).

FIRST USE 1-9-1967; IN COMMERCE 1-9-1967.

THE MARK CONSISTS OF STANDARD CHARACTERS WITHOUT CLAIM TO ANY PARTICULAR FONT, STYLE, SIZE, OR COLOR.

SEC. 2(F).

SER. NO. 77-256,112, FILED 8-15-2007.

ZACHARY BELLO, EXAMINING ATTORNEY

**Int. Cl.: 16**

**Prior U.S. Cls.: 2, 5, 22, 23, 29, 37, 38 and 50**

**Reg. No. 3,452,599**

**United States Patent and Trademark Office**

**Registered June 24, 2008**

**TRADEMARK  
PRINCIPAL REGISTER**

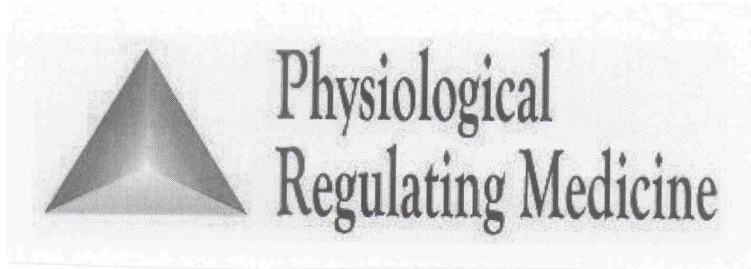

GUNA INC. (NEW MEXICO CORPORATION)  
SKYVIEW CENTER 150  
1520 TRAMWAY BLVD. NE  
ALBUQUERQUE, NM 87112

FOR: PUBLICATIONS, NAMELY, BROCHURES,  
BOOKLETS, AND TEACHING MATERIALS IN THE  
FIELD OF MEDICINE, IN CLASS 16 (U.S. CLS. 2, 5,  
22, 23, 29, 37, 38 AND 50).

FIRST USE 3-15-2006; IN COMMERCE 3-15-2006.

NO CLAIM IS MADE TO THE EXCLUSIVE  
RIGHT TO USE "PHYSIOLOGICAL REGULATING  
MEDICINE", APART FROM THE MARK AS  
SHOWN.

THE MARK CONSISTS OF THE WORDING  
"PHYSIOLOGICAL REGULATING MEDICINE"  
AND A PYRAMID DESIGN.

SER. NO. 77-256,199, FILED 8-15-2007.

ANDREA BUTLER, EXAMINING ATTORNEY

**Int. Cl.: 28**

**Prior U.S. Cls.: 22, 23, 38 and 50**

**United States Patent and Trademark Office**

**Reg. No. 3,452,600**

**Registered June 24, 2008**

**TRADEMARK  
PRINCIPAL REGISTER**

# Beersbee

PISIO, BRENNON T. (CANADA INDIVIDUAL)  
367 KENDERDINE ROAD  
SASKATOON, CANADA S7N3S5

THE MARK CONSISTS OF STANDARD CHARACTERS WITHOUT CLAIM TO ANY PARTICULAR FONT, STYLE, SIZE, OR COLOR.

FOR: EQUIPMENT SOLD AS A UNIT FOR PLAYING DRINKING GAMES, IN CLASS 28 (U.S. CLS. 22, 23, 38 AND 50).

SER. NO. 77-256,503, FILED 8-16-2007.

FIRST USE 1-1-2004; IN COMMERCE 8-14-2007.

TAMARA FRAZIER, EXAMINING ATTORNEY

**Int. Cl.: 37**

**Prior U.S. Cls.: 100, 103 and 106**

**United States Patent and Trademark Office**

**Reg. No. 3,452,601**

**Registered June 24, 2008**

**SERVICE MARK  
PRINCIPAL REGISTER**

# IN-CAPSULE

RED LEAF RESOURCES, INC. (DELAWARE CORPORATION)  
990 E. SOUTH UNION AVENUE, #31  
MIDVALE, UT 84047

FOR: MINING EXTRACTION SERVICES FOR THE RECOVERY OF OIL AND RELATED PRODUCTS FROM HYDROCARBON DEPOSITS, NAMELY, OIL SHALE, TAR SANDS, COAL, AND PEAT; LAND RECLAMATION, IN CLASS 37 (U.S. CLS. 100, 103 AND 106).

FIRST USE 12-20-2006; IN COMMERCE 12-20-2006.

THE MARK CONSISTS OF STANDARD CHARACTERS WITHOUT CLAIM TO ANY PARTICULAR FONT, STYLE, SIZE, OR COLOR.

SER. NO. 77-257,431, FILED 8-16-2007.

ZACHARY BELLO, EXAMINING ATTORNEY

**Int. Cl.: 9**

**Prior U.S. Cls.: 21, 23, 26, 36 and 38**

**United States Patent and Trademark Office**

**Reg. No. 3,452,602**

**Registered June 24, 2008**

**TRADEMARK  
PRINCIPAL REGISTER**



OUTLANDISH ENTERTAINMENT, LLC (FLORIDA LTD LIAB CO)  
3457 ROCK CLIFF PLACE  
LONGWOOD, FL 32779

FOR: DOWNLOADABLE MP3 FILES, MP3 RECORDINGS, ONLINE DISCUSSION BOARDS, WEBCASTS AND PODCASTS FEATURING MUSIC, AUDIO BOOKS AND NEWS BROADCASTS; DOWNLOADABLE MUSICAL SOUND RECORDINGS; DOWNLOADABLE RING TONES, GRAPHICS AND MUSIC VIA A GLOBAL COMPUTER NETWORK AND WIRELESS DEVICES; DOWNLOADABLE VIDEO RECORDINGS FEATURING MUSIC; DOWNLOADABLE MUSIC RINGTONES VIA THE INTERNET AND WIRELESS DEVICES; MUSICAL SOUND RECORDINGS; MUSICAL VIDEO RECORDINGS, IN CLASS 9 (U.S. CLS. 21, 23, 26, 36 AND 38).

FIRST USE 9-1-2005; IN COMMERCE 5-1-2006.

THE COLOR(S) RED, ORANGE, YELLOW, GREY, WHITE AND BLACK IS/ARE CLAIMED AS A FEATURE OF THE MARK.

THE MARK CONSISTS OF A CIRCLE EMBLAZED WITH ORANGE, RED & YELLOW INTERIOR, WITH A SMALLER CIRCLE ENCASED WITH ORANGE & RED AT THE TOP AND YELLOW & GRAY/BLACK AT THE BOTTOM; THE INTERIOR CONTAINS SOME RED & ORANGE & YELLOW WITH SOME BLACK/GRAY, AND AN UPPER CASE "E" COLORED IN BLACK. THE SPACE BETWEEN THE SMALLER CIRCLE AND THE OUTER CIRCLE CONSISTS OF YELLOW AT THE BOTTOM AND OFF-WHITE/WHITE TOWARDS THE TOP.

SER. NO. 77-257,606, FILED 8-16-2007.

DOMINIC J. FERRAIUOLO, EXAMINING ATTORNEY

**Int. Cl.: 25**

**Prior U.S. Cls.: 22 and 39**

**United States Patent and Trademark Office**

**Reg. No. 3,452,603**

**Registered June 24, 2008**

**TRADEMARK  
PRINCIPAL REGISTER**

# Precious Moments

PRECIOUS MOMENTS, INC. (ILLINOIS CORPORATION)  
SUITE 250  
2850 W. GOLF ROAD  
ROLLING MEADOWS, IL 60008

FOR: ANKLE SOCKS; APRONS; BABY BIBS NOT OF PAPER; BABY TOPS; BATH SLIPPERS; BATHING SUITS; BATHROBES; BEACH COVERUPS; BLOUSES; BOOTIES; CAMISOLES; CAPRI PANTS; CARDIGANS; CAPS; CHILDREN'S AND INFANTS' CLOTH BIBS; CLOTH DIAPERS; CREEPERS; DRESSES; EAR MUFFS; FLEECE PULLOVERS; FOOTWEAR, INCLUDING FLIP FLOPS; GAUCHOS; HALTER TOPS; HEADBANDS; INFANT AND TODDLER ONE PIECE CLOTHING; KNIT SHIRTS; JACKETS; LONG SLEEVED SHIRTS; MITTENS; NIGHTGOWNS; NIGHT SHIRTS; PAJAMAS; PANTIES; SKIRTS; SKORTS; SLEEPWEAR; SNEAKERS;

SNOW SUITS; SOCKS; SWEAT PANTS; SWEAT SHIRTS; TANK TOPS; TENNIS SHOES; T-SHIRTS; UNDER GARMENTS; VEILS; WEDDING DRESSES, WEDDING GOWNS AND WINTER BOOTS , IN CLASS 25 (U.S. CLS. 22 AND 39).

FIRST USE 5-1-1996; IN COMMERCE 5-1-1996.

THE MARK CONSISTS OF STANDARD CHARACTERS WITHOUT CLAIM TO ANY PARTICULAR FONT, STYLE, SIZE, OR COLOR.

OWNER OF U.S. REG. NOS. 2,159,356, 3,192,587 AND OTHERS.

SER. NO. 77-257,734, FILED 8-17-2007.

MARILYN IZZI, EXAMINING ATTORNEY



**Int. Cl.: 35**

**Prior U.S. Cls.: 100, 101 and 102**

**United States Patent and Trademark Office**

**Reg. No. 3,452,604**

**Registered June 24, 2008**

**SERVICE MARK  
PRINCIPAL REGISTER**

# PARTS GALORE

PARTS GALORE L.L.C. (MICHIGAN LTD LIAB  
CO)  
3400 EAST LAFAYETTE  
DETROIT, MI 48207

FOR: RETAIL OUTLETS FEATURING USED  
AUTOMOBILE AND TRUCK PARTS AND ACCES-  
SORIES, IN CLASS 35 (U.S. CLS. 100, 101 AND 102).

FIRST USE 6-30-2005; IN COMMERCE 6-30-2005.

THE MARK CONSISTS OF STANDARD CHAR-  
ACTERS WITHOUT CLAIM TO ANY PARTICULAR  
FONT, STYLE, SIZE, OR COLOR.

NO CLAIM IS MADE TO THE EXCLUSIVE  
RIGHT TO USE "PARTS", APART FROM THE  
MARK AS SHOWN.

SER. NO. 77-257,958, FILED 8-17-2007.

PAUL E. FAHRENKOPF, EXAMINING ATTORNEY

**Int. Cl.: 36**

**Prior U.S. Cls.: 100, 101 and 102**

**United States Patent and Trademark Office**

**Reg. No. 3,452,605**

**Registered June 24, 2008**

**SERVICE MARK  
PRINCIPAL REGISTER**

**Sleepless in San Diego**

SAN DIEGO RESCUE MISSION, INC. (CALIFORNIA CORPORATION)  
120 ELM STREET  
SAN DIEGO, CA 92101

FOR: CHARITABLE FUND RAISING FOR THE CONTINUUM OF CARE FOR THE HOMELESS, IN CLASS 36 (U.S. CLS. 100, 101 AND 102).

FIRST USE 5-19-2006; IN COMMERCE 5-19-2006.

THE MARK CONSISTS OF STANDARD CHARACTERS WITHOUT CLAIM TO ANY PARTICULAR FONT, STYLE, SIZE, OR COLOR.

NO CLAIM IS MADE TO THE EXCLUSIVE RIGHT TO USE "SAN DIEGO", APART FROM THE MARK AS SHOWN.

SER. NO. 77-258,377, FILED 8-17-2007.

ELLEN PERKINS, EXAMINING ATTORNEY

**Int. Cls.: 3 and 44**

**Prior U.S. Cls.: 1, 4, 6, 50, 51, 52, 100 and 101**

**United States Patent and Trademark Office**

**Reg. No. 3,452,606**

**Registered June 24, 2008**

**TRADEMARK  
SERVICE MARK  
PRINCIPAL REGISTER**

**FACES FIFTH AVENUE**

ELAHI, EBRAHIM (UNITED STATES INDIVIDUAL)  
1034 FIFTH AVENUE  
NEW YORK, NY 10028

FOR: COSMETICS; MAKE-UP KITS COMPRISED OF POST OPERATIVE COSMETICS, IN CLASS 3 (U.S. CLS. 1, 4, 6, 50, 51 AND 52).

FIRST USE 6-1-2005; IN COMMERCE 6-1-2005.

FOR: OPHTHALMOLOGY SERVICES; COSMETIC AND PLASTIC SURGERY, IN CLASS 44 (U.S. CLS. 100 AND 101).

FIRST USE 6-1-2005; IN COMMERCE 6-1-2005.

THE MARK CONSISTS OF STANDARD CHARACTERS WITHOUT CLAIM TO ANY PARTICULAR FONT, STYLE, SIZE, OR COLOR.

NO CLAIM IS MADE TO THE EXCLUSIVE RIGHT TO USE "FIFTH AVENUE", APART FROM THE MARK AS SHOWN.

SER. NO. 77-258,770, FILED 8-18-2007.

DEIRDRE ROBERTSON, EXAMINING ATTORNEY

**Int. Cl.: 41**

**Prior U.S. Cls.: 100, 101 and 107**

**United States Patent and Trademark Office**

**Reg. No. 3,452,607**

**Registered June 24, 2008**

**SERVICE MARK  
PRINCIPAL REGISTER**

**THE GREEN KIDS SHOW!**

GARZA, RAYNALDO GARZA (UNITED STATES INDIVIDUAL)  
14 MONARCH BAY PLAZA, SUITE 475  
MONARCH BEACH, CA 92629

FOR: ENTERTAINMENT SERVICES, NAMELY, LIVE THEATER STAGE PERFORMANCES AND EVENTS, NAMELY, A LIVE PERFORMANCE BY A MUSICAL BAND, MAGICIANS, COMICS AND DANCERS; ENTERTAINMENT IN THE NATURE OF AN ONGOING TELEVISION PROGRAM IN THE FIELD OF CHILDREN'S ENTERTAINMENT; ENTERTAINMENT SERVICES, IN THE NATURE OF AN ONGOING TELEVISION VARIETY PROGRAM; ANIMATION PRODUCTION SERVICES, PROVIDING INFORMATION IN THE FIELD OF ENTERTAINMENT, NAMELY, ANIMATION RENDERED BY MEANS OF A GLOBAL COMPUTER NETWORK; SPECIAL EFFECTS ANIMATION SERVICES FOR FILM AND VIDEO; EDUCATIONAL SERVICES, NAMELY, PROVIDING INCENTIVES TO INDIVIDUALS AND ORGANIZATIONS TO DEMONSTRATE EXCELLENCE IN MEDIA THROUGH THE ISSUANCE OF AWARDS; ENTERTAINMENT IN THE NATURE OF ON-GOING VARIETY TELEVISION PROGRAMS FEATURING VISUAL AND AUDIO PERFORMANCES IN THE FIELD OF DOCUMENTARIES, NEWS SHOWS, COOKING SHOWS, COMEDY, LIVE AND PRE-RECORDED MUSICALS AND MUSIC CONCERTS; SCHEDULING OF ONGOING EDUCATIONAL AND VARIETY PROGRAMMING BROADCAST OVER TELEVISION, SATELLITE, AUDIO, AND VIDEO MEDIA; ENTERTAINMENT SERVICES, NAMELY, THEATER PRODUCTIONS; DINNER THEATERS; PRODUCTION OF TELEVISION SHOWS; ENTERTAINMENT IN THE NATURE OF THEATER PRODUCTIONS, NAMELY, STAGE PLAYS; FAN CLUBS; ENTERTAINMENT SERVICES, NAMELY, PROVIDING A WEB SITE FEATURING MUSICAL PERFORMANCES, MUSICAL VIDEOS, RELATED FILM CLIPS, PHOTOGRAPHS, AND OTHER MULTIMEDIA MA-

TERIALS; ENTERTAINMENT SERVICES, NAMELY, LIVE, TELEVISED AND MOVIE APPEARANCES BY A PROFESSIONAL ENTERTAINER; MOTION PICTURE FILM PRODUCTION; MOTION PICTURE THEATERS; MOVIE STUDIOS; MOVIE THEATERS; MUSIC PRODUCTION SERVICES; MUSIC PUBLISHING SERVICES; PRODUCTION AND DISTRIBUTION OF MOTION PICTURES; PRODUCTION OF CABLE TELEVISION PROGRAMS; PRODUCTION OF CLOSED CAPTION TELEVISION PROGRAMS; PRODUCTION OF RADIO AND TELEVISION PROGRAMS; PRODUCTION OF VIDEO DISCS FOR OTHERS; PRODUCTION OF VIDEO CASSETTES; SCHEDULING SERVICES, NAMELY, PROGRAMMING EDUCATIONAL AND ENTERTAINMENT PROGRAMS ON A GLOBAL COMPUTER NETWORK; RADIO ENTERTAINMENT PRODUCTION AND SERVICES, NAMELY, PRODUCTION OF RADIO PROGRAMS FEATURING PERFORMANCES BY A RADIO PERSONALITY, MOTIVATIONAL SPEAKER, OR CELEBRITY GUEST; RECORD MASTER PRODUCTION; RECORD PRODUCTION; RECORDING STUDIOS; PROVIDING THEME PARK SERVICES; SCRIPT WRITING SERVICES; SONG WRITING SERVICES; SOUND RECORDING STUDIOS; TELEVISION PRODUCTION; TELEVISION PROGRAM SYNDICATION; THEATRICAL AND MUSICAL FLOOR SHOWS PROVIDED AT DISCOTEQUES AND NIGHTCLUBS; CINEMA STUDIOS; CINEMA THEATERS; DISTRIBUTION OF TELEVISION PROGRAMMING TO TELEVISION NETWORKS AND CABLE TELEVISION SYSTEMS. AWARDS PROGRAMS FOR MAJOR CORPORATIONS AND INDIVIDUALS WHO HAVE MADE SIGNIFICANT CHARITABLE CONTRIBUTIONS; CONDUCTING WORKSHOPS AND SEMINARS IN TELEVISION, RADIO, AND FILM PRODUCTION; ENTERTAINMENT SERVICES IN THE NATURE OF LIVE PERFORMANCES BY A MUSICAL BAND AND PRE-RECORDED PERFORMANCES BY A MUSICAL

BAND FOR MUSICAL CONCERT STAGE EVENTS,  
IN CLASS 41 (U.S. CLS. 100, 101 AND 107).

FIRST USE 4-27-2002; IN COMMERCE 6-20-2007.

THE MARK CONSISTS OF STANDARD CHAR-  
ACTERS WITHOUT CLAIM TO ANY PARTICULAR  
FONT, STYLE, SIZE, OR COLOR.

NO CLAIM IS MADE TO THE EXCLUSIVE  
RIGHT TO USE "KIDS SHOW", APART FROM  
THE MARK AS SHOWN.

SER. NO. 77-258,820, FILED 8-19-2007.

DAVID MURRAY, EXAMINING ATTORNEY

**Int. Cl.: 9**

**Prior U.S. Cls.: 21, 23, 26, 36 and 38**

**Reg. No. 3,452,608**

**United States Patent and Trademark Office**

**Registered June 24, 2008**

---

**TRADEMARK  
PRINCIPAL REGISTER**

**PRO SERIES EQUIPMENT**

BROWN, WILLIAM R. (UNITED STATES INDIVIDUAL)  
1552 WILLIAMSBURG COURT  
FRANKLIN, IN 46131

FOR: TIRE BALANCING MACHINES FOR LAND VEHICLES, IN CLASS 9 (U.S. CLS. 21, 23, 26, 36 AND 38).

FIRST USE 4-0-2006; IN COMMERCE 4-0-2006.

THE MARK CONSISTS OF STANDARD CHARACTERS WITHOUT CLAIM TO ANY PARTICULAR FONT, STYLE, SIZE, OR COLOR.

NO CLAIM IS MADE TO THE EXCLUSIVE RIGHT TO USE "PRO" AND "EQUIPMENT", APART FROM THE MARK AS SHOWN.

SER. NO. 77-258,849, FILED 8-19-2007.

MARGERY A. TIERNEY, EXAMINING ATTORNEY

**Int. Cl.: 40**

**Prior U.S. Cls.: 100, 103 and 106**

**United States Patent and Trademark Office**

**Reg. No. 3,452,609**

**Registered June 24, 2008**

**SERVICE MARK  
PRINCIPAL REGISTER**



STUDIO GRAF, LLC (ILLINOIS LTD LIAB CO)  
2310 COURTLAND COURT  
AURORA, IL 60502

FOR: CUSTOM FABRICATION OF DOLLS, PIL-  
LOWS, T-SHIRTS, AND STATIONARY FEATURING  
CHILDREN'S ARTWORK, IN CLASS 40 (U.S. CLS.  
100, 103 AND 106).

FIRST USE 3-9-2007; IN COMMERCE 4-21-2007.

THE COLOR(S) GREEN, BROWN AND BLACK IS/  
ARE CLAIMED AS A FEATURE OF THE MARK.

THE COLOR GREEN APPEARS IN THE WORDS  
"ART" AND "BELIEVE," IN THE DEPICTION OF A  
HUMAN STICK FIGURE, AND IN THE OUTLINE  
OF THE RECTANGLE. THE COLOR BROWN AP-  
PEARS IN THE DEPICTION OF A HUMAN STICK  
FIGURE. THE COLOR BLACK APPEARS IN THE  
NUMBER "2".

SER. NO. 77-259,093, FILED 8-20-2007.

EVELYN BRADLEY, EXAMINING ATTORNEY

**Int. Cl.: 35**

**Prior U.S. Cls.: 100, 101 and 102**

**United States Patent and Trademark Office**

**Reg. No. 3,452,610**

**Registered June 24, 2008**

**SERVICE MARK  
PRINCIPAL REGISTER**



LORTZ DIRECT MARKETING INCORPORATED  
(NEBRASKA CORPORATION)  
13936 GOLD CIRCLE  
OMAHA, NE 681442359

THE COLOR(S) BLACK AND BLUE IS/ARE  
CLAIMED AS A FEATURE OF THE MARK.

FOR: GENERAL BUSINESS NETWORKING RE-  
FERRAL SERVICES, NAMELY, PROMOTING THE  
GOODS AND SERVICES OF OTHERS BY PASSING  
BUSINESS LEADS AND REFERRALS AMONG  
GROUP MEMBERS , IN CLASS 35 (U.S. CLS. 100,  
101 AND 102).

THE MARK CONSISTS OF A BLUE BOOMER-  
ANG SHAPE FOLLOWED BY THE BLACK LET-  
TERS "LDMI", WITH THE WORDS "THE DIRECT  
MARKETING SPECIALISTS" APPEARING IN BLUE  
BELOW.

FIRST USE 10-31-1982; IN COMMERCE 10-31-1982.

SER. NO. 77-259,096, FILED 8-20-2007.

NO CLAIM IS MADE TO THE EXCLUSIVE  
RIGHT TO USE "THE DIRECT MARKETING SPE-  
CIALISTS", APART FROM THE MARK AS SHOWN.

KELLY MCCOY, EXAMINING ATTORNEY



**Int. Cl.: 35**

**Prior U.S. Cls.: 100, 101 and 102**

**United States Patent and Trademark Office**

**Reg. No. 3,452,611**

**Registered June 24, 2008**

**SERVICE MARK  
PRINCIPAL REGISTER**

**LDMI**

LORTZ DIRECT MARKETING INCORPORATED  
(NEBRASKA CORPORATION)  
13936 GOLD CIRCLE  
OMAHA, NE 681442359

FIRST USE 10-31-1982; IN COMMERCE 10-31-1982.

FOR: GENERAL BUSINESS NETWORKING RE-  
FERRAL SERVICES, NAMELY, PROMOTING THE  
GOODS AND SERVICES OF OTHERS BY PASSING  
BUSINESS LEADS AND REFERRALS AMONG  
GROUP MEMBERS , IN CLASS 35 (U.S. CLS. 100,  
101 AND 102).

THE MARK CONSISTS OF STANDARD CHAR-  
ACTERS WITHOUT CLAIM TO ANY PARTICULAR  
FONT, STYLE, SIZE, OR COLOR.

SER. NO. 77-259,143, FILED 8-20-2007.

KELLY MCCOY, EXAMINING ATTORNEY

**Int. Cl.: 35**

**Prior U.S. Cls.: 100, 101 and 102**

**United States Patent and Trademark Office**

**Reg. No. 3,452,612**

**Registered June 24, 2008**

**SERVICE MARK  
PRINCIPAL REGISTER**

**LDMI The Direct Marketing  
Specialists**

LORTZ DIRECT MARKETING INCORPORATED  
(NEBRASKA CORPORATION)  
13936 GOLD CIRCLE  
OMAHA, NE 681442359

FOR: GENERAL BUSINESS NETWORKING RE-  
FERRAL SERVICES, NAMELY, PROMOTING THE  
GOODS AND SERVICES OF OTHERS BY PASSING  
BUSINESS LEADS AND REFERRALS AMONG  
GROUP MEMBERS , IN CLASS 35 (U.S. CLS. 100,  
101 AND 102).

FIRST USE 10-31-1982; IN COMMERCE 10-31-1982.

THE MARK CONSISTS OF STANDARD CHAR-  
ACTERS WITHOUT CLAIM TO ANY PARTICULAR  
FONT, STYLE, SIZE, OR COLOR.

NO CLAIM IS MADE TO THE EXCLUSIVE  
RIGHT TO USE "THE DIRECT MARKETING SPE-  
CIALISTS", APART FROM THE MARK AS SHOWN.

SER. NO. 77-259,158, FILED 8-20-2007.

KELLY MCCOY, EXAMINING ATTORNEY

**Int. Cl.: 9**

**Prior U.S. Cls.: 21, 23, 26, 36 and 38**

**Reg. No. 3,452,613**

**United States Patent and Trademark Office**

**Registered June 24, 2008**

**TRADEMARK  
PRINCIPAL REGISTER**

**UNIQCYLE**

UNIQCYLE SOUNDS, LLC (COLORADO LTD  
LIAB CO)  
1927 MAHOGANY WAY  
WINDSOR, CO 80550

FIRST USE 9-19-2006; IN COMMERCE 9-19-2006.

FOR: AUDIO EQUIPMENT FOR MOTORCYCLES, NAMELY, STEREOS, MP3 PLAYERS, SATELITE RADIOS, SPEAKERS, AMPLIFIERS, EQUALIZERS, CROSSOVERS AND SPEAKER HOUSINGS; COMMUNICATION DEVICES FOR MOTORCYCLES, NAMELY, HELMET COMMUNICATION INTERCOM SYSTEMS, IN CLASS 9 (U.S. CLS. 21, 23, 26, 36 AND 38).

THE MARK CONSISTS OF STANDARD CHARACTERS WITHOUT CLAIM TO ANY PARTICULAR FONT, STYLE, SIZE, OR COLOR.

SER. NO. 77-259,601, FILED 8-20-2007.

JANET LEE, EXAMINING ATTORNEY

**Int. Cls.: 29 and 32**

**Prior U.S. Cls.: 45, 46 and 48**

**United States Patent and Trademark Office**

**Reg. No. 3,452,614**

**Registered June 24, 2008**

**TRADEMARK  
PRINCIPAL REGISTER**

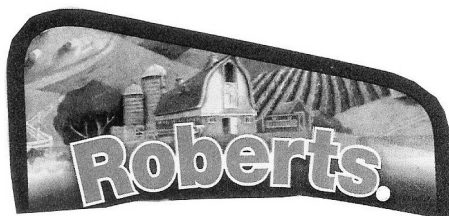

ROBERTS DAIRY COMPANY (NEBRASKA CORPORATION)  
2901 CUMING STREET  
OMAHA, NE 681312108

FOR: VITAMIN D WHITE MILK; 2% WHITE MILK; 1% WHITE MILK; SKIM MILK; 1% LOW FAT MILK; 2% REDUCED FAT MILK; 2% CHOCOLATE MILK; 1% CHOCOLATE MILK; ½ % CHOCOLATE MILK; CHOCOLATE SKIM MILK; BUTTERMILK; HALF AND HALF; WHIP CREAM; TABLE CREAM; HALF AND HALF CREAMERS; NON-DAIRY CREAMERS; OLD STYLE WHIP CREAM; BUTTER; OLEO MARGARINE; EGG NOG; SOUR CREAM; LOW FAT SOUR CREAM; DIPS; LOW FAT DIPS; 4% COTTAGE CHEESE; LOW FAT COTTAGE CHEESE; REGULAR YOGURT; LOW FAT YOGURT; RICOTTA CHEESE, IN CLASS 29 (U.S. CL. 46).

FIRST USE 6-1-2006; IN COMMERCE 6-1-2006.

FOR: ORANGE JUICE; FRUIT DRINKS; LEMONADE; APPLE JUICE; GRAPE JUICE; MANGO PUNCH; ORANGE FLAVORED BEVERAGES; FRUIT PUNCH, IN CLASS 32 (U.S. CLS. 45, 46 AND 48).

FIRST USE 6-1-2006; IN COMMERCE 6-1-2006.

OWNER OF U.S. REG. NOS. 2,077,905 AND 2,908,976.

THE MARK CONSISTS OF THE WORDING "ROBERTS" APPEARING UNDER A DESIGN OF A FARMHOUSE, BARN, SILOS, AND FIELDS.

SER. NO. 77-259,662, FILED 8-20-2007.

CORY BOONE, EXAMINING ATTORNEY

**Int. Cl.: 25**

**Prior U.S. Cls.: 22 and 39**

**United States Patent and Trademark Office**

**Reg. No. 3,452,615**

**Registered June 24, 2008**

**TRADEMARK  
PRINCIPAL REGISTER**



MOSCHELLA, JOHN C. (UNITED STATES INDIVIDUAL)  
41 KNOLL ROAD  
PLYMOUTH, MA 02360

FOR: CAPS; COATS; DRESS SHIRTS; GOLF SHIRTS; HEADGEAR, NAMELY, HATS AND CAPS; JERSEYS; KNIT SHIRTS; LONG-SLEEVED SHIRTS; NIGHT SHIRTS; OPEN-NECKED SHIRTS; POLO SHIRTS; SHIRTS; SHORT-SLEEVED OR LONG-SLEEVED T-SHIRTS; SHORT-SLEEVED SHIRTS; SPORT SHIRTS; T-SHIRTS; TEE SHIRTS; WIND

COATS; WIND SHIRTS, IN CLASS 25 (U.S. CLS. 22 AND 39).

FIRST USE 6-29-2007; IN COMMERCE 6-29-2007.

THE MARK CONSISTS OF A GRAPHIC IMAGE OF THE HEAD AND NECK OF A DOG.

SER. NO. 77-260,092, FILED 8-20-2007.

AMOS T. MATTHEWS, JR., EXAMINING ATTORNEY

**Int. Cl.: 9**

**Prior U.S. Cls.: 21, 23, 26, 36 and 38**

**Reg. No. 3,452,616**

**United States Patent and Trademark Office**

**Registered June 24, 2008**

---

**TRADEMARK  
PRINCIPAL REGISTER**

**CHANNEL GATE**

SIEMENS ENERGY & AUTOMATION, INC. (DE-  
LAWARE CORPORATION)  
3333 OLD MILTON PARKWAY  
ALPHARETTA, GA 30005

THE MARK CONSISTS OF STANDARD CHAR-  
ACTERS WITHOUT CLAIM TO ANY PARTICULAR  
FONT, STYLE, SIZE, OR COLOR.

FOR: AUTOMATED MAIL PROCESSING SYS-  
TEM COMPONENTS, NAMELY, MAIL SORTING  
DIVERTERS, IN CLASS 9 (U.S. CLS. 21, 23, 26, 36 AND  
38).

SER. NO. 77-260,186, FILED 8-21-2007.

FIRST USE 6-7-2007; IN COMMERCE 6-7-2007.

FLORENTINA BLANDU, EXAMINING ATTORNEY

**Int. Cl.: 9**

**Prior U.S. Cls.: 21, 23, 26, 36 and 38**

**Reg. No. 3,452,617**

**United States Patent and Trademark Office**

**Registered June 24, 2008**

**TRADEMARK  
PRINCIPAL REGISTER**

**HIPER STACKER**

SIEMENS ENERGY & AUTOMATION, INC. (DE-  
LAWARE CORPORATION)  
3333 OLD MILTON PARKWAY  
ALPHARETTA, GA 30005

FOR: AUTOMATED MAIL PROCESSING SYS-  
TEM COMPONENTS, NAMELY, MAIL SORTING  
STACKERS, IN CLASS 9 (U.S. CLS. 21, 23, 26, 36 AND  
38).

FIRST USE 6-7-2007; IN COMMERCE 6-7-2007.

THE MARK CONSISTS OF STANDARD CHAR-  
ACTERS WITHOUT CLAIM TO ANY PARTICULAR  
FONT, STYLE, SIZE, OR COLOR.

NO CLAIM IS MADE TO THE EXCLUSIVE  
RIGHT TO USE "STACKER", APART FROM THE  
MARK AS SHOWN.

SER. NO. 77-260,195, FILED 8-21-2007.

FLORENTINA BLANDU, EXAMINING ATTORNEY

**Int. Cl.: 35**

**Prior U.S. Cls.: 100, 101 and 102**

**United States Patent and Trademark Office**

**Reg. No. 3,452,618**

**Registered June 24, 2008**

**SERVICE MARK  
PRINCIPAL REGISTER**

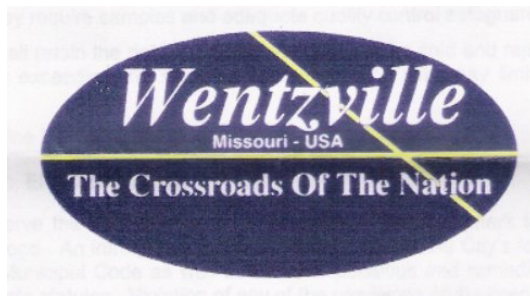

CITY OF WENTZVILLE (MISSOURI CORPORATION)  
310 WEST PEARCE BOULEVARD  
WENTZVILLE, MO 63385

FOR: BUSINESS ADMINISTRATION AND MANAGEMENT OF CITY SERVICES, IN CLASS 35 (U.S. CLS. 100, 101 AND 102).

FIRST USE 1-5-1997; IN COMMERCE 1-5-1997.

NO CLAIM IS MADE TO THE EXCLUSIVE RIGHT TO USE WENTZVILLE MISSOURI-USA, APART FROM THE MARK AS SHOWN.

THE COLOR(S) BLUE, WHITE AND YELLOW IS/ARE CLAIMED AS A FEATURE OF THE MARK.

THE COLOR BLUE APPEARS IN THE OVAL BACKGROUND, THE COLOR WHITE APPEARS IN THE WORDING "WENTZVILLE MISSOURI-USA THE CROSSROADS OF THE NATION" AND THE COLOR YELLOW APPEARS IN THE INTERSECTING HIGHWAYS.

SER. NO. 77-261,100, FILED 8-21-2007.

MICHELE SWAIN, EXAMINING ATTORNEY



**Int. Cls.: 35 and 44**

**Prior U.S. Cls.: 100, 101 and 102**

**United States Patent and Trademark Office**

**Reg. No. 3,452,619**

**Registered June 24, 2008**

**SERVICE MARK  
PRINCIPAL REGISTER**

**PATIENTS. OUR GREATEST  
CONCERN PHYSICIANS. OUR  
GREATEST ASSET**

SOUND INPATIENT PHYSICIANS, INC. (DELA-  
WARE CORPORATION)  
1709 DOCK STREET  
TACOMA, WA 98402

FOR: MEDICAL PRACTICE MANAGEMENT  
AND ADMINISTRATION, NAMELY, BUSINESS  
ADMINISTRATION AND MANAGEMENT FOR  
MEDICAL PRACTICES, IN CLASS 35 (U.S. CLS. 100,  
101 AND 102).

FIRST USE 2-0-2005; IN COMMERCE 2-0-2005.

FOR: MEDICAL SERVICES, IN CLASS 44 (U.S.  
CLS. 100 AND 101).

FIRST USE 2-0-2005; IN COMMERCE 2-0-2005.

THE MARK CONSISTS OF STANDARD CHAR-  
ACTERS WITHOUT CLAIM TO ANY PARTICULAR  
FONT, STYLE, SIZE, OR COLOR.

SER. NO. 77-261,502, FILED 8-22-2007.

KRISTIN DAHLING, EXAMINING ATTORNEY

**Int. Cl.: 9**

**Prior U.S. Cls.: 21, 23, 26, 36 and 38**

**Reg. No. 3,452,620**

**United States Patent and Trademark Office**

**Registered June 24, 2008**

**TRADEMARK  
PRINCIPAL REGISTER**

# THREATFIRE

PC TOOLS TECHNOLOGY PTY LIMITED (AUSTRALIA CORPORATION)  
LEVEL 6  
620 BOURKE STREET  
MELBOURNE, VICTORIA, AUSTRALIA 3000

FOR: ANTI-VIRUS SOFTWARE THAT IS DOWNLOADABLE AND RECORDED ON COMPUTER MEDIA; ANTI-SPYWARE SOFTWARE THAT IS DOWNLOADABLE AND RECORDED ON COMPUTER MEDIA; ANTI-MALWARE SOFTWARE THAT IS DOWNLOADABLE AND RECORDED ON COMPUTER MEDIA; ANTI-SPAM SOFTWARE THAT IS DOWNLOADABLE AND RECORDED ON COMPUTER MEDIA; COMPUTER SOFTWARE FOR ENSURING INTERNET SECURITY THAT IS DOWNLOADABLE AND RECORDED ON COMPUTER MEDIA; ANTI-PHISHING SOFTWARE THAT IS DOWNLOADABLE AND RECORDED ON COM-

PUTER MEDIA; AND USER MANUALS SUPPLIED WITH ALL OF THE FOREGOING, IN CLASS 9 (U.S. CLS. 21, 23, 26, 36 AND 38).

FIRST USE 6-18-2007; IN COMMERCE 8-17-2007.

THE MARK CONSISTS OF STANDARD CHARACTERS WITHOUT CLAIM TO ANY PARTICULAR FONT, STYLE, SIZE, OR COLOR.

PRIORITY CLAIMED UNDER SEC. 44(D) ON AUSTRALIA APPLICATION NO. 1182284, FILED 6-18-2007, REG. NO. 1182284, DATED 6-18-2007, EXPIRES 6-18-2017.

SER. NO. 77-261,892, FILED 8-22-2007.

TINA KUAN, EXAMINING ATTORNEY

**Int. Cl.: 44**

**Prior U.S. Cls.: 100 and 101**

**United States Patent and Trademark Office**

**Reg. No. 3,452,621**

**Registered June 24, 2008**

**SERVICE MARK  
PRINCIPAL REGISTER**

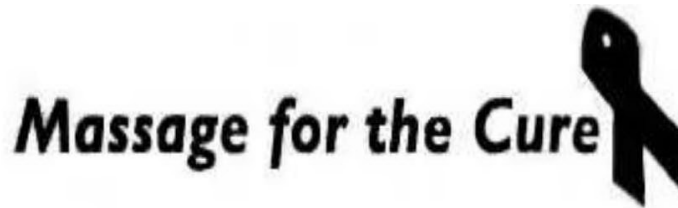

MASSAGE ENVY LIMITED, LLC (ARIZONA LTD  
LIAB CO)  
SUITE 200  
14350 NORTH 87TH STREET  
SCOTTSDALE, AZ 85260

FOR: THERAPEUTIC MESSAGES FOR THE BEN-  
EFIT OF NON-PROFIT CHARITABLE ENTITIES, IN  
CLASS 44 (U.S. CLS. 100 AND 101).

FIRST USE 6-18-2007; IN COMMERCE 6-18-2007.

NO CLAIM IS MADE TO THE EXCLUSIVE  
RIGHT TO USE "MASSAGE", APART FROM THE  
MARK AS SHOWN.

THE MARK CONSISTS OF A RIBBON AND THE  
WORDS "MASSAGE FOR THE CURE".

SER. NO. 77-262,061, FILED 8-22-2007.

CHRISTINA SOBRAL, EXAMINING ATTORNEY

**Int. Cls.: 35, 38 and 44**

**Prior U.S. Cls.: 100, 101, 102 and 104**

**United States Patent and Trademark Office**

**Reg. No. 3,452,622**

**Registered June 24, 2008**

**SERVICE MARK  
PRINCIPAL REGISTER**

**DENTISTRY.COM**

FUTURE DONTICS, INC. (CALIFORNIA CORPORATION)  
6060 CENTER DRIVE, 7TH FLOOR  
LOS ANGELES, CA 90045

FOR: PROVIDING ONLINE REFERRAL SERVICES FOR MEDICAL AND DENTAL PROFESSIONALS, PROVIDING ONLINE MARKETING FOR MEDICAL AND DENTAL PROFESSIONALS, IN CLASS 35 (U.S. CLS. 100, 101 AND 102).

FIRST USE 6-28-1995; IN COMMERCE 6-28-1995.

FOR: ELECTRONIC MAIL SERVICES; DELIVERY OF MESSAGES BY ELECTRONIC TRANSMISSION; AND PROVIDING ON-LINE CHAT ROOMS AND ELECTRONIC BULLETIN BOARDS FOR THE TRANSMISSION OF MESSAGES AMONG COMPUTER USERS CONCERNING HEALTH, NUTRITION, ORAL HYGIENE AND DENTISTRY, IN CLASS 38 (U.S. CLS. 100, 101 AND 104).

FIRST USE 6-28-1995; IN COMMERCE 6-28-1995.

FOR: PROVIDING EDUCATIONAL INFORMATION REGARDING HEALTH, NUTRITION, ORAL HYGIENE, AND DENTISTRY VIA THE INTERNET, IN CLASS 44 (U.S. CLS. 100 AND 101).

FIRST USE 6-28-1995; IN COMMERCE 6-28-1995.

THE MARK CONSISTS OF STANDARD CHARACTERS WITHOUT CLAIM TO ANY PARTICULAR FONT, STYLE, SIZE, OR COLOR.

SEC. 2(F).

SER. NO. 77-262,167, FILED 8-22-2007.

AISHA CLARKE, EXAMINING ATTORNEY

**Int. Cls.: 35, 38 and 44**

**Prior U.S. Cls.: 100, 101, 102 and 104**

**United States Patent and Trademark Office**

**Reg. No. 3,452,623**

**Registered June 24, 2008**

**SERVICE MARK  
PRINCIPAL REGISTER**



FUTURE DONTICS, INC. (CALIFORNIA CORPORATION)  
6060 CENTER DRIVE, 7TH FLOOR  
LOS ANGELES, CA 90045

FOR: PROVIDING ONLINE REFERRAL SERVICES FOR MEDICAL AND DENTAL PROFESSIONALS, PROVIDING ONLINE MARKETING FOR MEDICAL AND DENTAL PROFESSIONALS, IN CLASS 35 (U.S. CLS. 100, 101 AND 102).

FIRST USE 6-28-1995; IN COMMERCE 6-28-1995.

FOR: ELECTRONIC MAIL SERVICES; DELIVERY OF MESSAGES BY ELECTRONIC TRANSMISSION; AND PROVIDING ON-LINE CHAT ROOMS AND ELECTRONIC BULLETIN BOARDS FOR THE TRANSMISSION OF MESSAGES AMONG COMPUTER USERS CONCERNING HEALTH, NUTRITION, ORAL HYGIENE AND DENTISTRY, IN CLASS 38 (U.S. CLS. 100, 101 AND 104).

FIRST USE 6-28-1995; IN COMMERCE 6-28-1995.

FOR: PROVIDING EDUCATIONAL INFORMATION REGARDING HEALTH, NUTRITION, ORAL HYGIENE, AND DENTISTRY VIA THE INTERNET, IN CLASS 44 (U.S. CLS. 100 AND 101).

FIRST USE 6-28-1995; IN COMMERCE 6-28-1995.

THE COLOR(S) BLUE IS/ARE CLAIMED AS A FEATURE OF THE MARK.

THE MARK CONSISTS OF THE CHARACTERS DENTISTRY.COM BELOW A FOUR POINT STAR ALL IN BLUE.

SEC. 2(F).

SER. NO. 77-262,175, FILED 8-22-2007.

AISHA CLARKE, EXAMINING ATTORNEY

**Int. Cl.: 21**

**Prior U.S. Cls.: 2, 13, 23, 29, 30, 33, 40 and 50**

**Reg. No. 3,452,624**

**United States Patent and Trademark Office**

**Registered June 24, 2008**

---

**TRADEMARK  
PRINCIPAL REGISTER**

**SURE-LOCK**

HOME PRODUCTS INTERNATIONAL-NORTH  
AMERICA, INC. (DELAWARE CORPORATION)  
4501 WEST 47TH STREET  
CHICAGO, IL 60632

FOR: PLASTIC AND PLASTIC-COATED ACCESSORIES FOR THE HOME AND BATHROOM, NAMELY, TOILET TISSUE HOLDERS, IN CLASS 21 (U.S. CLS. 2, 13, 23, 29, 30, 33, 40 AND 50).

FIRST USE 7-15-1980; IN COMMERCE 7-15-1980.

THE MARK CONSISTS OF STANDARD CHARACTERS WITHOUT CLAIM TO ANY PARTICULAR FONT, STYLE, SIZE, OR COLOR.

SER. NO. 77-262,395, FILED 8-23-2007.

JOHN HWANG, EXAMINING ATTORNEY

**Int. Cl.: 5**

**Prior U.S. Cls.: 6, 18, 44, 46, 51 and 52**

**Reg. No. 3,452,625**

**United States Patent and Trademark Office**

**Registered June 24, 2008**

---

**TRADEMARK  
PRINCIPAL REGISTER**

# AmeriDip

HUFF BLANE (COLORADO CORPORATION)  
604 8TH ST. S.E. #F  
LOVELAND, CO 80537

THE MARK CONSISTS OF STANDARD CHAR-  
ACTERS WITHOUT CLAIM TO ANY PARTICULAR  
FONT, STYLE, SIZE, OR COLOR.

FOR: DRUG TESTING KITS COMPRISED OF  
MEDICAL DIAGNOSTIC REAGENTS AND ASSAYS  
FOR TESTING BODY FLUIDS, IN CLASS 5 (U.S.  
CLS. 6, 18, 44, 46, 51 AND 52).

SER. NO. 77-262,420, FILED 8-23-2007.

FIRST USE 8-23-2007; IN COMMERCE 8-23-2007.

JOHN E. MICHOS, EXAMINING ATTORNEY

**Int. Cl.: 25**

**Prior U.S. Cls.: 22 and 39**

**United States Patent and Trademark Office**

**Reg. No. 3,452,626**

**Registered June 24, 2008**

**TRADEMARK  
PRINCIPAL REGISTER**



S. W. ADAMS, INC. (GEORGIA CORPORATION)  
907 PATRIOTS POINT  
MCCORMICK, SC 29835

FOR: FOOTWEAR; HEADWEAR; SHIRTS, IN  
CLASS 25 (U.S. CLS. 22 AND 39).

FIRST USE 6-1-2007; IN COMMERCE 7-20-2007.

THE MARK CONSISTS OF A RACING DONKEY  
WITH A SADDLE CARRYING GOLF CLUBS AND A  
FLAG STICK WITH THE STYLIZED WORDS "RA-  
CING DONKEY" BELOW.

SER. NO. 77-262,583, FILED 8-23-2007.

DAVID TOOLEY, EXAMINING ATTORNEY



**Int. Cl.: 43**

**Prior U.S. Cls.: 100 and 101**

**United States Patent and Trademark Office**

**Reg. No. 3,452,627**

**Registered June 24, 2008**

**SERVICE MARK  
PRINCIPAL REGISTER**

**FLORIDA AS IT WAS MEANT TO  
BE . . .**

THE GASPARILLA INN & CLUB (DELAWARE  
CORPORATION)  
500 PALM AVENUE  
BOCA GRANDE, FL 33921

FOR: HOTEL, BAR AND RESTAURANT SERVI-  
CES; RESORT HOTEL WITH GOLF COURSE; SPA  
SERVICES, NAMELY, PROVIDING TEMPORARY  
ACCOMMODATIONS AND MEALS TO CLIENTS  
OF A HEALTH OR BEAUTY SPA , IN CLASS 43 (U.S.  
CLS. 100 AND 101).

FIRST USE 11-1-2006; IN COMMERCE 11-1-2006.

THE MARK CONSISTS OF STANDARD CHAR-  
ACTERS WITHOUT CLAIM TO ANY PARTICULAR  
FONT, STYLE, SIZE, OR COLOR.

SER. NO. 77-263,065, FILED 8-23-2007.

BARNEY CHARLON, EXAMINING ATTORNEY

**Int. Cl.: 41**

**Prior U.S. Cls.: 100, 101 and 107**

**United States Patent and Trademark Office**

**Reg. No. 3,452,628**

**Registered June 24, 2008**

**SERVICE MARK  
PRINCIPAL REGISTER**

**DOMINIO**

RUIZ, ISIDRO (UNITED STATES INDIVIDUAL)  
P.O. BOX 1502  
FABENS, TX 79838

FOR: ENTERTAINMENT IN THE NATURE OF  
LIVE MUSICAL BAND PERFORMANCES, NAME-  
LY, MUSICAL BAND, ROCK GROUP, IN CLASS 41  
(U.S. CLS. 100, 101 AND 107).

FIRST USE 4-28-2007; IN COMMERCE 5-15-2007.

THE MARK CONSISTS OF STANDARD CHAR-  
ACTERS WITHOUT CLAIM TO ANY PARTICULAR  
FONT, STYLE, SIZE, OR COLOR.

THE ENGLISH TRANSLATION OF THE WORD  
"DOMINIO" IN THE MARK IS "DOMAIN".

SER. NO. 77-263,307, FILED 8-24-2007.

MICHELLE DUBOIS, EXAMINING ATTORNEY

**Int. Cl.: 8**

**Prior U.S. Cls.: 23, 28 and 44**

**Reg. No. 3,452,629**

**United States Patent and Trademark Office**

**Registered June 24, 2008**

---

**TRADEMARK  
PRINCIPAL REGISTER**

**ICECUT**

USINES MÉTALLURGIQUES DE VALLORBE  
S.A. (SWITZERLAND CORPORATION)  
RUE DU MOUTIER 49  
1337 VALLORBE, SWITZERLAND

FOR: HAND-OPERATED SHARPENING TOOLS  
AND INSTRUMENTS FOR PARTS OF MACHINES,  
FOR TOOLS, HAND TOOLS, ICE SKATES, SKIS,  
SNOWBOARDS AND FOR SCISSORS , IN CLASS 8  
(U.S. CLS. 23, 28 AND 44).

THE MARK CONSISTS OF STANDARD CHAR-  
ACTERS WITHOUT CLAIM TO ANY PARTICULAR  
FONT, STYLE, SIZE, OR COLOR.

OWNER OF SWITZERLAND REG. NO. 483949,  
DATED 4-20-2001, EXPIRES 4-20-2011.

SER. NO. 77-263,761, FILED 8-24-2007.

AMY HELLA, EXAMINING ATTORNEY

**Int. Cl.: 9**

**Prior U.S. Cls.: 21, 23, 26, 36 and 38**

**Reg. No. 3,452,630**

**United States Patent and Trademark Office**

**Registered June 24, 2008**

---

**TRADEMARK  
PRINCIPAL REGISTER**

**WALLACE & TIERNAN**

SIEMENS WATER TECHNOLOGIES CORP.  
(MASSACHUSETTS CORPORATION)  
181 THORN HILL ROAD  
WARRENDALE, PA 15086

FOR: PRESSURE INDICATORS, CALIBRATORS,  
MONITORS, AND GAUGES; FLOWMETERS;  
FLUID FLOW CONTROLLERS; ELECTRONIC  
AND ELECTRICAL CONTROLLERS FOR CON-  
TROLLING WATER PURIFICATION EQUIPMENT;  
RESIDUAL CHEMICAL ANALYZERS; WEIGHING  
EQUIPMENT, NAMELY, SCALES; CHLORINE GAS  
DETECTORS; RESIDUAL CHLORINE TESTERS  
AND MONITORS, IN CLASS 9 (U.S. CLS. 21, 23, 26,  
36 AND 38).

FIRST USE 5-31-1989; IN COMMERCE 5-31-1989.

THE MARK CONSISTS OF STANDARD CHAR-  
ACTERS WITHOUT CLAIM TO ANY PARTICULAR  
FONT, STYLE, SIZE, OR COLOR.

OWNER OF U.S. REG. NO. 929,981.

SER. NO. 77-263,985, FILED 8-24-2007.

MIDGE BUTLER, EXAMINING ATTORNEY

**Int. Cl.: 9**

**Prior U.S. Cls.: 21, 23, 26, 36 and 38**

**Reg. No. 3,452,631**

**United States Patent and Trademark Office**

**Registered June 24, 2008**

**TRADEMARK  
PRINCIPAL REGISTER**



LIBRARYINSIGHT, INC. (MASSACHUSETTS CORPORATION)  
266 NASHUA ROAD  
GROTON, MA 01450

FOR: COMPUTER SOFTWARE PLATFORMS FOR ONLINE LIBRARY SERVICES, NAMELY, CALENDARS, READING PROGRAMS, MUSEUM PASS CIRCULATION, IN CLASS 9 (U.S. CLS. 21, 23, 26, 36 AND 38).

FIRST USE 4-14-2003; IN COMMERCE 4-14-2003.

THE COLOR(S) BLUE, AND YELLOW IS/ARE CLAIMED AS A FEATURE OF THE MARK.

THE MARK CONSISTS OF A BLUE CARTOUCHE SHAPE, WITH THE BLUE COLOR GOING FROM LIGHT BLUE AT THE TOP, TO DARK BLUE AT THE BOTTOM. INSIDE THE CARTOUCHE, THE TEXT "LIBRARYINSIGHT" APPEARS IN BLUE ON A YELLOW BACKGROUND. THE YELLOW BACKGROUND IS A GRADIENT GOING FROM LIGHT YELLOW AT THE TOP TO DARKER YELLOW AT THE BOTTOM.

SER. NO. 77-264,300, FILED 8-25-2007.

KYLE PEETE, EXAMINING ATTORNEY

**Int. Cls.: 35, 39, 41 and 42**

**Prior U.S. Cls.: 100, 101, 102, 105 and 107**

**United States Patent and Trademark Office**

**Reg. No. 3,452,632**

**Registered June 24, 2008**

**SERVICE MARK  
PRINCIPAL REGISTER**

**GREENER AMERICAN**

GREENER AMERICAN, L.L.C. (ALABAMA LTD  
LIAB CO)  
1709 TREE CROSSINGS PARKWAY  
BIRMINGHAM, AL 35244

FOR: PROVIDING A WEBSITE FEATURING INFORMATION FOR ECOLOGICALLY CONCERNED AND ENVIRONMENTALLY CONSCIOUS INDIVIDUALS AND COMPANIES, NAMELY, PROVIDING CONSUMER PRODUCT INFORMATION ABOUT PRODUCTS FOR THE HOMES AND VEHICLES, IN CLASS 35 (U.S. CLS. 100, 101 AND 102).

FIRST USE 7-10-2007; IN COMMERCE 7-10-2007.

FOR: PROVIDING A WEBSITE FEATURING INFORMATION FOR ECOLOGICALLY CONCERNED AND ENVIRONMENTALLY CONSCIOUS INDIVIDUALS AND COMPANIES, NAMELY, A WEBSITE FEATURING TRAVEL INFORMATION, IN CLASS 39 (U.S. CLS. 100 AND 105).

FIRST USE 7-10-2007; IN COMMERCE 7-10-2007.

FOR: PROVIDING A WEBSITE FEATURING INFORMATION FOR ECOLOGICALLY CONCERNED AND ENVIRONMENTALLY CONSCIOUS INDIVIDUALS AND COMPANIES, NAMELY, A WEBSITE PROVIDING NEWS IN THE NATURE OF CURRENT EVENT REPORTING RELATED TO THE ENVIRONMENT, IN CLASS 41 (U.S. CLS. 100, 101 AND 107).

FIRST USE 7-10-2007; IN COMMERCE 7-10-2007.

FOR: PROVIDING A WEBSITE FEATURING INFORMATION FOR ECOLOGICALLY CONCERNED AND ENVIRONMENTALLY CONSCIOUS INDIVIDUALS AND COMPANIES, NAMELY, PROVIDING A WEBSITE THAT GIVES COMPUTER USERS THE ABILITY TO UPLOAD, EXCHANGE AND SHARE PHOTOS, VIDEOS AND VIDEO LOGS, IN CLASS 42 (U.S. CLS. 100 AND 101).

FIRST USE 7-10-2007; IN COMMERCE 7-10-2007.

THE MARK CONSISTS OF STANDARD CHARACTERS WITHOUT CLAIM TO ANY PARTICULAR FONT, STYLE, SIZE, OR COLOR.

SER. NO. 77-264,509, FILED 8-26-2007.

BRENDAN MCCAULEY, EXAMINING ATTORNEY

**Int. Cl.: 29**

**Prior U.S. Cl.: 46**

**United States Patent and Trademark Office**

**Reg. No. 3,452,633**

**Registered June 24, 2008**

**TRADEMARK  
PRINCIPAL REGISTER**



PANAPACIFIC DISTRIBUTORS CORPORATION  
(CALIFORNIA CORPORATION)  
3353 UNIOIN PACIFIC AVE.  
LOS ANGELES, CA 90023

FOR: BOUILLON; REFRIED BEANS; FRUIT PRESERVES; FROZEN FRUITS; FROZEN VEGETABLES; SOUPS; VEGETABLE-BASED SNACK FOODS; OIL, NAMELY, OILS FOR FOOD; CHEESE; CREAM; MILK, IN CLASS 29 (U.S. CL. 46).

FIRST USE 5-11-2007; IN COMMERCE 6-11-2007.

OWNER OF U.S. REG. NO. 3,213,452.

THE COLOR(S) YELLOW, RED, WHITE, BLUE, GREEN, AND BLACK IS/ARE CLAIMED AS A FEATURE OF THE MARK.

THE MARK CONSISTS OF AN IMAGE OF A DECORATIVE CIRCULAR FRAME IN THE COLORS RED, YELLOW, BLUE, AND GREEN WITH AN IMAGE OF A BLUE MOUNTAIN AND A WHITE AND BLUE SEA SHORE, AND THE WORDING CHAPIN IN FRONT OF THE FRAME IN THE COLORS YELLOW, WHITE, AND RED AND A PARROT IN THE COLORS GREEN, YELLOW, RED, AND BLUE, OUTLINED IN THE COLOR BLACK AND WITH BLACK AND WHITE EYES, SITTING ON THE LETTER P.

THE FOREIGN WORDING IN THE MARK TRANSLATES INTO ENGLISH AS THE PEOPLE OF GUATEMALA.

SER. NO. 77-264,528, FILED 8-26-2007.

MARK PILARO, EXAMINING ATTORNEY

**Int. Cl.: 42**

**Prior U.S. Cls.: 100 and 101**

**United States Patent and Trademark Office**

**Reg. No. 3,452,634**

**Registered June 24, 2008**

**SERVICE MARK  
PRINCIPAL REGISTER**



PUBCREATOR, LLC (KENTUCKY LTD LIAB CO)  
2405 HEALY LANE  
LEXINGTON, KY 40509

FOR: PROVIDING TEMPORARY USE OF NON-DOWNLOADABLE, INTERNET-BASED SOFTWARE FOR PUBLISHING, IN CLASS 42 (U.S. CLS. 100 AND 101).

FIRST USE 12-17-2007; IN COMMERCE 12-17-2007.

THE MARK CONSISTS OF THE WORDS "PUB-CREATOR" APPEARING BENEATH AND ATOP A STYLIZED PAGE WITH AN ARCH ACROSS THE TOP OF THE WORDS.

SER. NO. 77-265,689, FILED 8-28-2007.

MARILYN IZZI, EXAMINING ATTORNEY



**Int. Cl.: 35**

**Prior U.S. Cls.: 100, 101 and 102**

**United States Patent and Trademark Office**

**Reg. No. 3,452,635**

**Registered June 24, 2008**

**SERVICE MARK  
PRINCIPAL REGISTER**



TREK BICYCLE CORPORATION (WISCONSIN  
CORPORATION)  
801 WEST MADISON ST  
WATERLOO, WI 53594

FOR: RETAIL BICYCLE STORE, IN CLASS 35  
(U.S. CLS. 100, 101 AND 102).

FIRST USE 8-1-2007; IN COMMERCE 8-1-2007.

SER. NO. 77-265,777, FILED S.R. 8-28-2007 AM. P.R.  
2-11-2008.

SHAUNIA CARLYLE, EXAMINING ATTORNEY

**Int. Cls.: 36, 39 and 42**

**Prior U.S. Cls.: 100, 101, 102 and 105**

**United States Patent and Trademark Office**

**Reg. No. 3,452,636**

**Registered June 24, 2008**

**SERVICE MARK  
PRINCIPAL REGISTER**

**DE LAGE LANDEN FINANCIAL  
SERVICES**

DE LAGE LANDEN ROYALTIES & TRADE-  
MARK LLC (DELAWARE LTD LIAB CO)  
SUITE 1300  
1105 NORTH MARKET STREET  
WILMINGTON, DE 19899

FOR: FINANCING SERVICES AND LEASE-FI-  
NANCING SERVICES IN CONNECTION WITH  
EQUIPMENT, MACHINERY, VEHICLES, COMPU-  
TERS AND REAL AND PERSONAL PROPERTY;  
LEASING OF OFFICE SPACE, APARTMENTS,  
REAL ESTATE AND REAL PROPERTY, IN CLASS  
36 (U.S. CLS. 100, 101 AND 102).

FIRST USE 4-1-1999; IN COMMERCE 7-1-1999.

FOR: LEASING OF AUTOMOBILES, TRUCKS  
AND VEHICLES, IN CLASS 39 (U.S. CLS. 100 AND  
105).

FIRST USE 4-1-1999; IN COMMERCE 7-1-1999.

FOR: LEASING OF COMPUTERS AND COMPU-  
TER FACILITIES, IN CLASS 42 (U.S. CLS. 100 AND  
101).

FIRST USE 4-1-1999; IN COMMERCE 7-1-1999.

THE MARK CONSISTS OF STANDARD CHAR-  
ACTERS WITHOUT CLAIM TO ANY PARTICULAR  
FONT, STYLE, SIZE, OR COLOR.

OWNER OF U.S. REG. NO. 2,483,994.

NO CLAIM IS MADE TO THE EXCLUSIVE  
RIGHT TO USE "FINANCIAL SERVICES", APART  
FROM THE MARK AS SHOWN.

SEC. 2(F).

SER. NO. 77-265,854, FILED 8-28-2007.

INGA ERVIN, EXAMINING ATTORNEY

**Int. Cl.: 35**

**Prior U.S. Cls.: 100, 101 and 102**

**United States Patent and Trademark Office**

**Reg. No. 3,452,637**

**Registered June 24, 2008**

**SERVICE MARK  
PRINCIPAL REGISTER**

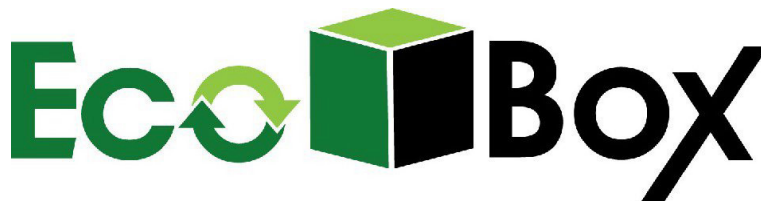

ECO BOX FRANCHISE CORPORATION (TEXAS CORPORATION)  
2215 RUTLAND DRIVE  
AUSTIN, TX 78758

FOR: FRANCHISE SERVICES, NAMELY, OFFERING TECHNICAL AND BUSINESS MANAGEMENT ASSISTANCE IN THE ESTABLISHMENT AND OPERATION OF RETAIL STORES PROVIDING SHIPPING, PACKAGING AND RELATED SUPPLIES AND SERVICES; INFORMATION MANAGEMENT SERVICES, NAMELY, SHIPMENT PROCESSING, PREPARING SHIPPING DOCUMENTS AND INVOICES, TRACKING DOCUMENTS, PACKAGES AND FREIGHT OVER COMPUTER NETWORKS; RETAIL STORE SERVICES FEATURING A WIDE VARIETY OF PACKAGING SUPPLIES, IN CLASS 35 (U.S. CLS. 100, 101 AND 102).

FIRST USE 8-23-2007; IN COMMERCE 8-24-2007.

OWNER OF U.S. REG. NO. 2,725,582.

NO CLAIM IS MADE TO THE EXCLUSIVE RIGHT TO USE "BOX", APART FROM THE MARK AS SHOWN.

THE COLOR(S) GREEN, LIGHT GREEN AND BLACK IS/ARE CLAIMED AS A FEATURE OF THE MARK.

THE COLORS GREEN, LIGHT GREEN AND BLACK ARE CLAIMED AS A FEATURE OF THE MARK. THE "E" AND "C" IN ECO ARE GREEN AND LIGHT GREEN WITH THE DARKER SHADE APPEARING ON THE LOWER HALF OF THE LETTER "O". THE SIDES OF THE DRAWING OF THE BOX ARE GREEN, LIGHT GREEN AND BLACK. THE WORD BOX IS ENTIRELY BLACK IN COLOR.

SER. NO. 77-265,998, FILED 8-28-2007.

HOWARD SMIGA, EXAMINING ATTORNEY

**Int. Cl.: 25**

**Prior U.S. Cls.: 22 and 39**

**United States Patent and Trademark Office**

**Reg. No. 3,452,638**

**Registered June 24, 2008**

**TRADEMARK  
PRINCIPAL REGISTER**

**STAN HERMAN**

STAN HERMAN STUDIO, INC. (NEW YORK CORPORATION)  
80 W. 40TH STREET  
NEW YORK, NY 10018

FOR: READY-TO-WEAR SPORTSWEAR, NAME-  
LY, SWEATERS, PONCHOS, TUNICS, GLOVES,  
SCARVES, HATS AND WRAPS; LOUNGEWEAR,  
NAMELY, ROBES, LOUNGERS IN THE NATURE  
OF ROBES AND SETS CONSISTING OF COMFOR-  
TABLE PANTS AND SHIRTS FOR WEARING AT  
HOME, SLEEPWEAR, PAJAMAS, CAFTANS; CA-  
REER APPAREL FOR MEN AND WOMEN, NAME-  
LY, JACKETS, SUITS, BLAZERS, COATS, PARKAS,  
BOMBER JACKETS, RAINWEAR, PANTS, SLACKS,  
SKIRTS, DRESSES, COVERALLS, VESTS, APRONS,  
SHIRTS, BLOUSES, SCARVES, TIES, HATS, CAPS,  
SHORTS, POLOS, T-SHIRTS, IN CLASS 25 (U.S. CLS.  
22 AND 39).

FIRST USE 0-0-1960; IN COMMERCE 0-0-1960.

THE MARK CONSISTS OF STANDARD CHAR-  
ACTERS WITHOUT CLAIM TO ANY PARTICULAR  
FONT, STYLE, SIZE, OR COLOR.

OWNER OF U.S. REG. NO. 1,071,405.

THE NAME "STAN HERMAN" IDENTIFIES A  
LIVING INDIVIDUAL WHOSE CONSENT IS OF  
RECORD.

SER. NO. 77-266,019, FILED 8-28-2007.

AISHA SALEM, EXAMINING ATTORNEY

**Int. Cl.: 45**

**Prior U.S. Cls.: 100 and 101**

**United States Patent and Trademark Office**

**Reg. No. 3,452,639**

**Registered June 24, 2008**

**SERVICE MARK  
PRINCIPAL REGISTER**

# Bridge Beyond

CORTLANDT ADVISORY (NEW YORK LTD  
LIAB CO)  
80 JOHN STREET, SUITE 8F  
NEW YORK, NY 10038

FOR: PROVIDING SERVICES TO PEOPLE DEALING WITH ISSUES RELATED TO DEATH, DYING AND GRIEF, NAMELY, PROVIDING INFORMATION REGARDING GRIEF COUNSELING, LEGAL SERVICES, SPECIFICALLY FOR WILLS AND ESTATES, AND FOR FUNERAL ARRANGEMENT SERVICES, IN CLASS 45 (U.S. CLS. 100 AND 101).

FIRST USE 4-25-2007; IN COMMERCE 4-25-2007.

THE MARK CONSISTS OF STANDARD CHARACTERS WITHOUT CLAIM TO ANY PARTICULAR FONT, STYLE, SIZE, OR COLOR.

SER. NO. 77-266,063, FILED 8-28-2007.

LINDA E. BLOHM, EXAMINING ATTORNEY

Int. Cl.: 34

Prior U.S. Cls.: 2, 8, 9 and 17

United States Patent and Trademark Office

Reg. No. 3,452,640

Registered June 24, 2008

TRADEMARK  
PRINCIPAL REGISTER



HOLT'S COMPANY (DELAWARE CORPORATION)  
12270 TOWNSEND ROAD  
PHILADELPHIA, PA 19154

FOR: CIGARS, CIGAR CASES AND CIGAR BOXES, IN CLASS 34 (U.S. CLS. 2, 8, 9 AND 17).

FIRST USE 8-14-2007; IN COMMERCE 8-14-2007.

OWNER OF U.S. REG. NO. 2,062,586.

NO CLAIM IS MADE TO THE EXCLUSIVE RIGHT TO USE "HANDMADE" AND "IMPORTED", APART FROM THE MARK AS SHOWN.

THE COLOR(S) RED, BROWN, WHITE, BLACK, BLUE, YELLOW, GREEN, GOLD, PINK, ORANGE, PEACH AND GRAY IS/ARE CLAIMED AS A FEATURE OF THE MARK.

THE MARK CONSISTS OF A PARROT IN THE COLORS RED, BROWN, GREEN, WHITE, BLACK, BLUE AND YELLOW WITH OUTSTRETCHED WINGS OVER THE SCENE OF A BAY WITH A PEACH SKY, BLUE WATER, GREEN AND BROWN PALM TREES AND SHIPS, AND GREEN MOUN-

TAINS. THE SCENE IS ENCIRCLED WITH A WREATH MADE OF GOLD COINS, BLUE AND WHITE CLOUDS, PINK, RED AND ORANGE FLOWERS WITH GREEN LEAVES, A WHITE BANNER WITH THE WORDS "HANDMADE" AND "IMPORTED" IN BLACK LETTERING, AND A BLUE CREST WITH THREE GOLD CASTLE TOWERS AND A GOLD KEY, A RED CREST WITH A GOLD SPADE SYMBOL, A RED AND WHITE CHECKERED CREST WITH TWO RED LION HEADS IN THE WHITE SQUARES AND TWO GOLD CASTLE TOWERS IN THE RED SQUARES, A BLUE CREST WITH A SINGLE GOLD CASTLE TOWER, A GOLD CREST WITH A RED LION, AND A GOLD CREST WITH A BLUE FLOWER. DIRECTLY ABOVE THE PARROT ARE GRAY LINES THAT RADIATE UPWARDS, AND THE WORDS "SAN CRISTOBAL" IN BROWN AND RED LETTERING, WITH GOLD OUTLINES. THE ENTIRE DESIGN IS SUPERIMPOSED OVER A YELLOW AND BROWN BACKGROUND WITH FAINT MAP LINES IN GRAY.

SER. NO. 77-266,098, FILED 8-28-2007.

SUSAN LESLIE DUBOIS, EXAMINING ATTORNEY

Int. Cl.: 34

Prior U.S. Cls.: 2, 8, 9 and 17

United States Patent and Trademark Office

Reg. No. 3,452,641

Registered June 24, 2008

TRADEMARK  
PRINCIPAL REGISTER



HOLT'S COMPANY (DELAWARE CORPORATION)  
12270 TOWNSEND ROAD  
PHILADELPHIA, PA 19154

FOR: CIGARS, CIGAR CASES AND CIGAR BOXES, IN CLASS 34 (U.S. CLS. 2, 8, 9 AND 17).

FIRST USE 8-14-2007; IN COMMERCE 8-14-2007.

OWNER OF U.S. REG. NO. 2,062,586.

NO CLAIM IS MADE TO THE EXCLUSIVE RIGHT TO USE "HANDMADE" AND "IMPORTED", APART FROM THE MARK AS SHOWN.

THE COLOR(S) RED, BROWN, BLACK, BLUE, YELLOW, GREEN, GOLD, PEACH, AND GRAY IS/ARE CLAIMED AS A FEATURE OF THE MARK.

THE MARK CONSISTS OF A PARROT IN THE COLORS RED, BROWN, GREEN, WHITE, BLACK,

BLUE AND YELLOW WITH OUTSTRETCHED WINGS OVER GOLD COINS, A PEACH BANNER WITH THE WORDS HANDMADE AND IMPORTED IN BLACK LETTERING, AND A BLUE CREST WITH THREE GOLD CASTLE TOWERS AND A GOLD KEY, AND A RED AND WHITE CHECKERED CREST WITH TWO RED LION HEADS IN THE WHITE SQUARES AND TWO GOLD CASTLE TOWERS IN THE RED SQUARES. DIRECTLY ABOVE THE PARROT ARE GRAY LINES THAT RADIATE UPWARDS, AND THE WORDS SAN CRISTOBAL IN BROWN AND RED LETTERING, WITH GOLD OUTLINES. THE ENTIRE DESIGN IS SUPERIMPOSED OVER A YELLOW AND BROWN MAP WITH INDISTINCT LETTERING AND CURLING EDGES ON A BLACK BACKGROUND AND A SCALLOPED GOLD BORDER.

SER. NO. 77-266,147, FILED 8-28-2007.

SUSAN LESLIE DUBOIS, EXAMINING ATTORNEY

**Int. Cl.: 45**

**Prior U.S. Cls.: 100 and 101**

**United States Patent and Trademark Office**

**Reg. No. 3,452,642**

**Registered June 24, 2008**

**SERVICE MARK  
PRINCIPAL REGISTER**



BEVERLY HILLS REGULATORY CONSULTANTS GROUP, INC. (CALIFORNIA CORPORATION)

415 NORTH CAMDEN DRIVE, SUITE 121  
BEVERLY HILLS, CA 90210

FOR: REGULATORY COMPLIANCE CONSULTING AND REVIEWING STANDARDS AND PRACTICES TO ASSURE COMPLIANCE WITH FINANCIAL LAWS AND REGULATIONS FOR FINANCIAL SERVICES FIRMS AND THEIR REPRESENTATIVES, IN CLASS 45 (U.S. CLS. 100 AND 101).

FIRST USE 1-0-2004; IN COMMERCE 1-30-2006.

OWNER OF U.S. REG. NO. 3,173,170.

NO CLAIM IS MADE TO THE EXCLUSIVE RIGHT TO USE "BEVERLY HILLS REGULATORY

CONSULTANTS GROUP INC.", APART FROM THE MARK AS SHOWN.

THE COLOR(S) BLUE AND YELLOW IS/ARE CLAIMED AS A FEATURE OF THE MARK.

THE MARK CONSISTS OF THE LETTERS "BHRCG"; THE LETTERS "B"."R"."C"."G" IN BLUE AND THE LETTER "H" IN YELLOW. TO THE RIGHT ARE THE TERMS "BEVERLY HILLS REGULATORY CONSULTANTS GROUP INC." IN YELLOW, WITHIN A BLUE RECTANGLE. THE WORDING "WWW.BHRCG.COM" APPEARS BELOW IN BLUE.

SER. NO. 77-266,499, FILED 8-28-2007.

EMILY CARLSEN, EXAMINING ATTORNEY



Int. Cl.: 36

Prior U.S. Cls.: 100, 101 and 102

United States Patent and Trademark Office

Reg. No. 3,452,643

Registered June 24, 2008

SERVICE MARK  
PRINCIPAL REGISTER

The logo features the word "Fans" in a highly stylized, cursive script. The letters are interconnected, with a large, sweeping flourish for the 'F' and 'a'. The 'n's are also connected and have a decorative, rounded top. The overall appearance is elegant and handwritten.

FRIENDS, ALUMNI, NEIGHBORS AND SUPPORTERS  
*of St. Joseph Medical Center*

ST. JOSEPH MEDICAL CENTER, INC. (MARY-  
LAND CORPORATION)  
7601 OSLER DRIVE  
TOWSON, MD 21204

THE MARK CONSISTS OF A STYLIZED DEPI-  
TION OF THE WORDS FANS FRIENDS, ALUMNI,  
NEIGHBORS AND SUPPORTERS OF ST. JOSEPH  
MEDICAL CENTER.

FOR: CHARITABLE FUND RAISING, IN CLASS  
36 (U.S. CLS. 100, 101 AND 102).

SER. NO. 77-266,547, FILED 8-28-2007.

FIRST USE 11-0-2006; IN COMMERCE 11-0-2006.

KEVIN CORWIN, EXAMINING ATTORNEY

**Int. Cl.: 9**

**Prior U.S. Cls.: 21, 23, 26, 36 and 38**

**Reg. No. 3,452,644**

**United States Patent and Trademark Office**

**Registered June 24, 2008**

---

**TRADEMARK  
PRINCIPAL REGISTER**

**CERTISOFT CM**

RYAN SOFTWARE, INC. (TEXAS CORPORATION)  
13155 NOEL ROAD  
DALLAS, TX 75240

THE MARK CONSISTS OF STANDARD CHARACTERS WITHOUT CLAIM TO ANY PARTICULAR FONT, STYLE, SIZE, OR COLOR.

FOR: COMPUTER SOFTWARE FOR MANAGEMENT OF TAX DOCUMENTS, IN CLASS 9 (U.S. CLS. 21, 23, 26, 36 AND 38).

SER. NO. 77-267,185, FILED 8-29-2007.

FIRST USE 6-26-2006; IN COMMERCE 6-26-2006.

JAY FLOWERS, EXAMINING ATTORNEY

Prior U.S. Cl.: 200

United States Patent and Trademark Office

Reg. No. 3,452,645

Registered June 24, 2008

**COLLECTIVE MEMBERSHIP  
PRINCIPAL REGISTER**



SISTERS OF MERCY OF THE AMERICAS, INC.  
(MARYLAND NON-PROFIT CORPORATION)  
8380 COLESVILLE ROAD  
SILVER SPRING, MD 20910

THE MARK CONSISTS OF CROSS DESIGN IM-  
AGE WITH MULTIPLE IMAGES AND SHADOWS  
OF A CROSS EMBEDDED WITHIN ANOTHER.

FOR: TO INDICATE MEMBERSHIP IN AN OR-  
GANIZATION FORMED FOR RELIGIOUS, CHARI-  
TABLE, AND EDUCATIONAL PURPOSES, IN  
CLASS 200 (U.S. CL. 200).

SER. NO. 77-267,686, FILED 8-29-2007.

FIRST USE 0-0-1975; IN COMMERCE 0-0-1975.

ELLEN BURNS, EXAMINING ATTORNEY

**Int. Cl.: 5**

**Prior U.S. Cls.: 6, 18, 44, 46, 51 and 52**

**Reg. No. 3,452,646**

**United States Patent and Trademark Office**

**Registered June 24, 2008**

**TRADEMARK  
PRINCIPAL REGISTER**

**TASKI**

JOHNSON DIVERSEY, INC. (DELAWARE CORPORATION)  
MS 509  
8310 16TH STREET  
STURTEVANT, WI 531770902

FOR: SANITIZING AND DISINFECTANT PREPARATIONS FOR USE ON HARD SURFACES; AIR FRESHENERS AND ROOM DEODORANTS; ALL OF THE FOREGOING FOR COMMERCIAL, INDUSTRIAL AND INSTITUTIONAL USE, IN CLASS 5 (U.S. CLS. 6, 18, 44, 46, 51 AND 52).

FIRST USE 12-31-2000; IN COMMERCE 12-31-2000.

THE MARK CONSISTS OF STANDARD CHARACTERS WITHOUT CLAIM TO ANY PARTICULAR FONT, STYLE, SIZE, OR COLOR.

OWNER OF U.S. REG. NOS. 1,491,824 AND 2,446,797.

SER. NO. 77-267,922, FILED 8-30-2007.

PAUL CROWLEY, EXAMINING ATTORNEY

**Int. Cl.: 39**

**Prior U.S. Cls.: 100 and 105**

**United States Patent and Trademark Office**

**Reg. No. 3,452,647**

**Registered June 24, 2008**

**SERVICE MARK  
PRINCIPAL REGISTER**

**FISHERMAN III**

MCGRUFF, ROSALEA (UNITED STATES INDIVIDUAL)  
1030 8TH STREET  
IMPERIAL BEACH, CA 91932

THE MARK CONSISTS OF STANDARD CHARACTERS WITHOUT CLAIM TO ANY PARTICULAR FONT, STYLE, SIZE, OR COLOR.

FOR: BOAT CHARTERING, IN CLASS 39 (U.S. CLS. 100 AND 105).

SER. NO. 77-267,977, FILED 8-30-2007.

FIRST USE 1-1-1985; IN COMMERCE 1-1-1985.

ATTIYA MALIK, EXAMINING ATTORNEY

**Int. Cl.: 25**

**Prior U.S. Cls.: 22 and 39**

**United States Patent and Trademark Office**

**Reg. No. 3,452,648**

**Registered June 24, 2008**

**TRADEMARK  
PRINCIPAL REGISTER**

**SURVIVAL OUTFITTERS**

MCINTOSH & SEYMOUR, INC. (OREGON CORPORATION)  
3233 SW PALATINE STREET  
PORTLAND, OR 97219

FOR: CLOTHING, NAMELY, JACKETS, SWEATERS, VESTS, SWEATSHIRTS, SWEATPANTS, SHORTS, PANTS, SHIRTS AND T-SHIRTS, IN CLASS 25 (U.S. CLS. 22 AND 39).

FIRST USE 0-0-1999; IN COMMERCE 0-0-1999.

THE MARK CONSISTS OF STANDARD CHARACTERS WITHOUT CLAIM TO ANY PARTICULAR FONT, STYLE, SIZE, OR COLOR.

NO CLAIM IS MADE TO THE EXCLUSIVE RIGHT TO USE "OUTFITTERS", APART FROM THE MARK AS SHOWN.

SER. NO. 77-268,189, FILED 8-30-2007.

TINA L. SNAPP, EXAMINING ATTORNEY

**Int. Cl.: 9**

**Prior U.S. Cls.: 21, 23, 26, 36 and 38**

**Reg. No. 3,452,649**

**United States Patent and Trademark Office**

**Registered June 24, 2008**

---

**TRADEMARK  
PRINCIPAL REGISTER**

**MASAR**

MASAR TECHNOLOGIES, INC. (DELAWARE CORPORATION)  
1688 LOST MOON COURT  
TUCSON, AZ 857377069

FIRST USE 4-19-1997; IN COMMERCE 12-15-1997.

FOR: COMPUTER SOFTWARE FOR REAL-TIME MONITORING, OPTIMIZATION, EVALUATION, TROUBLE-SHOOTING AND EARLY DETECTION AND ALARM NOTIFICATION OF MEMBRANE FOULING AND SCALING AT WATER DESALINATION PLANTS UTILIZING REVERSE OSMOSIS, NANOFILTRATION, ULTRAFILTRATION AND MICROFILTRATION TECHNOLOGIES AND PROCESSES, IN CLASS 9 (U.S. CLS. 21, 23, 26, 36 AND 38).

THE MARK CONSISTS OF STANDARD CHARACTERS WITHOUT CLAIM TO ANY PARTICULAR FONT, STYLE, SIZE, OR COLOR.

SEC. 2(F).

SER. NO. 77-268,268, FILED 8-30-2007.

ELIZABETH KAJUBI, EXAMINING ATTORNEY

Int. Cl.: 38

Prior U.S. Cls.: 100, 101 and 104

United States Patent and Trademark Office

Reg. No. 3,452,650

Registered June 24, 2008

**SERVICE MARK  
PRINCIPAL REGISTER**



**PJ Scout**

NATIONJOB INC. (IOWA CORPORATION)  
SUITES H & J  
601 SW 9TH STREET  
DES MOINES, IA 503094528

FOR: PROVIDING E-MAIL NOTIFICATION ALERTS CONCERNING JOB OPENINGS THAT MATCH PRE-SELECTED CRITERIA SUPPLIED BY SUBSCRIBERS SUCH AS DESIRED GEOGRAPHIC LOCATION, DESIRED TYPE OF JOB OR INDUSTRY, AND DESIRED COMPENSATION RANGE, IN CLASS 38 (U.S. CLS. 100, 101 AND 104).

FIRST USE 7-27-2007; IN COMMERCE 7-27-2007.

THE NAME(S), PORTRAIT(S), AND/OR SIGNATURE(S) SHOWN IN THE MARK DOES NOT IDENTIFY A PARTICULAR LIVING INDIVIDUAL.

THE MARK CONSISTS OF A FRONTAL HEAD-AND-SHOULDERS DRAWING OF A CAUCASIAN MAN WITH A BROAD MOUSTACHE, WEARING A COWBOY HAT, A SHIRT AND A BANDANNA.

SER. NO. 77-269,086, FILED 8-31-2007.

BARBARA GAYNOR, EXAMINING ATTORNEY



**Int. Cl.: 35**

**Prior U.S. Cls.: 100, 101 and 102**

**United States Patent and Trademark Office**

**Reg. No. 3,452,651**

**Registered June 24, 2008**

**SERVICE MARK  
PRINCIPAL REGISTER**

# Norada Real Estate

REIF1, INC. (CALIFORNIA CORPORATION)  
30251 GOLDEN LANTERN, SUITE E261  
LAGUNA NIGUEL, CA 92677 AND  
SANTARELLI, MARCO G. (CANADA INDIVIDUAL)  
30251 GOLDEN LANTERN, SUITE E261  
LAGUNA NIGUEL, CA 92677

FOR: REAL ESTATE MARKETING SERVICES,  
NAMELY, ON-LINE SERVICES FEATURING  
TOURS OF RESIDENTIAL AND COMMERCIAL  
REAL ESTATE, IN CLASS 35 (U.S. CLS. 100, 101  
AND 102).

FIRST USE 1-1-2004; IN COMMERCE 1-1-2004.

THE MARK CONSISTS OF STANDARD CHAR-  
ACTERS WITHOUT CLAIM TO ANY PARTICULAR  
FONT, STYLE, SIZE, OR COLOR.

NO CLAIM IS MADE TO THE EXCLUSIVE  
RIGHT TO USE "REAL ESTATE", APART FROM  
THE MARK AS SHOWN.

SER. NO. 77-270,029, FILED 8-31-2007.

GEORGIA CARTY, EXAMINING ATTORNEY

**Int. Cl.: 16**

**Prior U.S. Cls.: 2, 5, 22, 23, 29, 37, 38 and 50**

**Reg. No. 3,452,652**

**United States Patent and Trademark Office**

**Registered June 24, 2008**

**TRADEMARK  
PRINCIPAL REGISTER**

**EZ Fold**

THEA, ANDI (UNITED STATES INDIVIDUAL)  
PO BOX 2163  
SO. HACKENSACK, NJ 07606

THE MARK CONSISTS OF STANDARD CHARACTERS WITHOUT CLAIM TO ANY PARTICULAR FONT, STYLE, SIZE, OR COLOR.

FOR: EDUCATIONAL ACTIVITY PRODUCTS TO READ AND COLOR, NAMELY, PAPER PLACE MATS, PAPER TABLE MATS, AND CHILDREN'S LEARNING AND ACTIVITY BOOKS, FLASH CARDS AND MAGNETIC BOARDS , IN CLASS 16 (U.S. CLS. 2, 5, 22, 23, 29, 37, 38 AND 50).

NO CLAIM IS MADE TO THE EXCLUSIVE RIGHT TO USE "FOLD", APART FROM THE MARK AS SHOWN.

SER. NO. 77-270,232, FILED 9-2-2007.

FIRST USE 12-31-2004; IN COMMERCE 12-31-2004.

KELLY BOULTON, EXAMINING ATTORNEY

**Int. Cl.: 42**

**Prior U.S. Cls.: 100 and 101**

**United States Patent and Trademark Office**

**Reg. No. 3,452,653**

**Registered June 24, 2008**

**SERVICE MARK  
PRINCIPAL REGISTER**

# Total Customer Personalization

VORTEX TECHNOLOGY SERVICES LTD (NEW  
ZEALAND LIMITED COMPANY)  
3 ROLAND LANE  
CHRISTCHURCH, NEW ZEALAND

FOR: COMPUTER SERVICES IN THE NATURE  
OF CUSTOMIZED WEB PAGES FEATURING USER-  
DEFINED INFORMATION, PERSONAL PROFILES  
AND INFORMATION, IN CLASS 42 (U.S. CLS. 100  
AND 101).

FIRST USE 8-29-2007; IN COMMERCE 8-29-2007.

THE MARK CONSISTS OF STANDARD CHAR-  
ACTERS WITHOUT CLAIM TO ANY PARTICULAR  
FONT, STYLE, SIZE, OR COLOR.

NO CLAIM IS MADE TO THE EXCLUSIVE  
RIGHT TO USE "CUSTOMER PERSONALIZA-  
TION", APART FROM THE MARK AS SHOWN.

SER. NO. 77-270,474, FILED 9-3-2007.

KELLY BOULTON, EXAMINING ATTORNEY

Int. Cl.: 25

Prior U.S. Cls.: 22 and 39

United States Patent and Trademark Office

Reg. No. 3,452,654

Registered June 24, 2008

TRADEMARK  
PRINCIPAL REGISTER



HOLT'S COMPANY (DELAWARE CORPORATION)

12270 TOWNSEND ROAD

PHILADELPHIA, PA 19154

FOR: T-SHIRTS, IN CLASS 25 (U.S. CLS. 22 AND 39).

FIRST USE 8-15-2007; IN COMMERCE 8-15-2007.

NO CLAIM IS MADE TO THE EXCLUSIVE RIGHT TO USE "HANDMADE", APART FROM THE MARK AS SHOWN.

THE MARK CONSISTS OF A DESIGN OF A PARROT WITH COINS, A BANNER, SHIELDS AND THE OUTLINE OF A SUN.

SER. NO. 77-270,637, FILED 9-4-2007.

SUSAN LESLIE DUBOIS, EXAMINING ATTORNEY

**Int. Cl.: 25**

**Prior U.S. Cls.: 22 and 39**

**United States Patent and Trademark Office**

**Reg. No. 3,452,655**

**Registered June 24, 2008**

**TRADEMARK  
PRINCIPAL REGISTER**

**SAN CRISTOBAL**

HOLT'S COMPANY (DELAWARE CORPORATION)  
12270 TOWNSEND ROAD  
PHILADELPHIA, PA 19154

FOR: T-SHIRTS, IN CLASS 25 (U.S. CLS. 22 AND 39).

FIRST USE 8-15-2007; IN COMMERCE 8-15-2007.

OWNER OF U.S. REG. NO. 2,062,586.

THE MARK CONSISTS OF THE WORDS "SAN CRISTOBAL" IN A STYLIZED FORMAT.

THE FOREIGN WORDING IN THE MARK TRANSLATES INTO ENGLISH AS SAINT CHRISTOPHER.

SER. NO. 77-270,645, FILED 9-4-2007.

SUSAN LESLIE DUBOIS, EXAMINING ATTORNEY

**Int. Cl.: 21**

**Prior U.S. Cls.: 2, 13, 23, 29, 30, 33, 40 and 50**

**United States Patent and Trademark Office**

**Reg. No. 3,452,656**

**Registered June 24, 2008**

**TRADEMARK  
PRINCIPAL REGISTER**

**KITTY2GO!**

CORTEZ, ANGELINA MARIA (UNITED STATES  
INDIVIDUAL)  
LEGAL DEPARTMENT  
P.O BOX 370307  
DECATUR, GA 30037

THE MARK CONSISTS OF STANDARD CHAR-  
ACTERS WITHOUT CLAIM TO ANY PARTICULAR  
FONT, STYLE, SIZE, OR COLOR.

FOR: CAT LITTER BOXES, IN CLASS 21 (U.S. CLS.  
2, 13, 23, 29, 30, 33, 40 AND 50).

SER. NO. 77-271,063, FILED 9-4-2007.

FIRST USE 5-16-2003; IN COMMERCE 5-3-2005.

CHRISTINE COOPER, EXAMINING ATTORNEY

**Int. Cl.: 37**

**Prior U.S. Cls.: 100, 103 and 106**

**United States Patent and Trademark Office**

**Reg. No. 3,452,657**

**Registered June 24, 2008**

**SERVICE MARK  
PRINCIPAL REGISTER**

**CONCENTRIC SECURITY, LLC**

CONCENTRIC SECURITY, LLC (DELAWARE  
LTD LIAB CO)  
7566 MAIN STREET  
SYKESVILLE, MD 21784

FOR: CONSTRUCTION SERVICES, NAMELY,  
CONSTRUCTION OF PERIMETER SECURITY BAR-  
RIERS, ENTRY CONTROL FACILITIES, ACCESS  
CONTROL POINTS AND SECURED ENVIRON-  
MENTS FOR OTHERS; CONSTRUCTION MAN-  
AGEMENT AND INSTALLATION OF FENCING,  
GUARD BOOTHS, PERIMETER ACCESS BARRI-  
ERS, VEHICLE BARRIERS, ARCHITECTURAL  
CONCRETE BARRIERS, BLAST CURTAINS AND  
WINDOW BARRIERS IN THE FIELDS OF HOME-  
LAND SECURITY, PERIMETER SECURITY AND

BLAST MITIGATION, IN CLASS 37 (U.S. CLS. 100,  
103 AND 106).

FIRST USE 0-0-2004; IN COMMERCE 0-0-2004.

THE MARK CONSISTS OF STANDARD CHAR-  
ACTERS WITHOUT CLAIM TO ANY PARTICULAR  
FONT, STYLE, SIZE, OR COLOR.

NO CLAIM IS MADE TO THE EXCLUSIVE  
RIGHT TO USE "SECURITY, LLC", APART FROM  
THE MARK AS SHOWN.

SER. NO. 77-271,646, FILED 9-5-2007.

MICHELE SWAIN, EXAMINING ATTORNEY

**Int. Cl.: 28**

**Prior U.S. Cls.: 22, 23, 38 and 50**

**United States Patent and Trademark Office**

**Reg. No. 3,452,658**

**Registered June 24, 2008**

**TRADEMARK  
PRINCIPAL REGISTER**

**1-2-3D**

K1C2, LLC (CALIFORNIA LTD LIAB CO)  
#106  
2220 EASTMAN AVENUE  
VENTURA, CA 93003

THE MARK CONSISTS OF STANDARD CHAR-  
ACTERS WITHOUT CLAIM TO ANY PARTICULAR  
FONT, STYLE, SIZE, OR COLOR.

FOR: HOBBY CRAFT SETS FOR PAPER CRAFT-  
ING, IN CLASS 28 (U.S. CLS. 22, 23, 38 AND 50).

SER. NO. 77-271,805, FILED 9-5-2007.

FIRST USE 12-1-2006; IN COMMERCE 3-1-2007.

RICHARD WHITE, EXAMINING ATTORNEY



**Int. Cl.: 44**

**Prior U.S. Cls.: 100 and 101**

**United States Patent and Trademark Office**

**Reg. No. 3,452,659**

**Registered June 24, 2008**

**SERVICE MARK  
PRINCIPAL REGISTER**

**Balance Solutions** 

---

BALANCE SOLUTIONS PHYSICAL THERAPY,  
INC. (OHIO CORPORATION)  
SUITE 150  
14100 CEDAR ROAD  
UNIVERSITY HEIGHTS, OH 44121

FIRST USE 12-31-2003; IN COMMERCE 12-31-2003.

NO CLAIM IS MADE TO THE EXCLUSIVE  
RIGHT TO USE "BALANCE", APART FROM THE  
MARK AS SHOWN.

THE MARK CONSISTS OF A CARICATURE OF A  
MAN STANDING ON A BALANCE BOARD.

SER. NO. 77-271,884, FILED 9-5-2007.

FOR: HEALTH CARE SERVICES, NAMELY, PHY-  
SICAL THERAPY SERVICES AND CONSULTING  
SERVICES IN THE FIELD OF PHYSICAL REHABI-  
LITATION; PROVISION OF HEALTHCARE, TREAT-  
MENT, AND PROCEDURE INFORMATION IN THE  
FIELD OF BALANCE RESTORATION TO THE  
GENERAL PUBLIC, PATIENTS, HEALTH CARE  
PROVIDERS, PHYSICIANS, AND PHYSICAL  
THERAPISTS, IN CLASS 44 (U.S. CLS. 100 AND 101).

TINA L. SNAPP, EXAMINING ATTORNEY

**Int. Cl.: 28**

**Prior U.S. Cls.: 22, 23, 38 and 50**

**United States Patent and Trademark Office**

**Reg. No. 3,452,660**

**Registered June 24, 2008**

**TRADEMARK  
PRINCIPAL REGISTER**

**MEGA STUNT PACK**

MATTEL, INC. (DELAWARE CORPORATION)  
M1-1518  
333 CONTINENTAL BLVD.  
EL SEGUNDO, CA 90245

FOR: TOYS, GAMES AND PLAYTHINGS, NAME-  
LY, TOY VEHICLE TRACK SETS, TOY VEHICLE  
PLAYSETS, AND ACCESSORIES FOR ALL OF THE  
FOREGOING, IN CLASS 28 (U.S. CLS. 22, 23, 38 AND  
50).

FIRST USE 1-3-2008; IN COMMERCE 1-3-2008.

THE MARK CONSISTS OF STANDARD CHAR-  
ACTERS WITHOUT CLAIM TO ANY PARTICULAR  
FONT, STYLE, SIZE, OR COLOR.

OWNER OF U.S. REG. NO. 3,176,435.

NO CLAIM IS MADE TO THE EXCLUSIVE  
RIGHT TO USE "PACK", APART FROM THE MARK  
AS SHOWN.

SER. NO. 77-272,352, FILED 9-5-2007.

GINA HAYES, EXAMINING ATTORNEY

**Int. Cl.: 2**

**Prior U.S. Cls.: 6, 11 and 16**

**United States Patent and Trademark Office**

**Reg. No. 3,452,661**

**Registered June 24, 2008**

**TRADEMARK  
PRINCIPAL REGISTER**



WD-40 MANUFACTURING COMPANY (CALIFORNIA CORPORATION)  
1061 CUDAHY PLACE  
SAN DIEGO, CA 92110

FOR: CHEMICAL PRODUCT IN THE NATURE OF A PROTECTIVE COATING FOR LIQUID RUST PREVENTION AND CORROSION CONTROL, IN CLASS 2 (U.S. CLS. 6, 11 AND 16).

FIRST USE 7-0-1963; IN COMMERCE 7-0-1963.

OWNER OF U.S. REG. NOS. 670,503, 1,026,002 AND OTHERS.

THE COLOR(S) YELLOW AND BLUE IS/ARE CLAIMED AS A FEATURE OF THE MARK.

THE MARK CONSISTS OF THE TERM "WD-40" IN THE COLOR BLUE SUPERIMPOSED ON A YELLOW SHIELD WRAPPED AROUND THE TOP THIRD OF A CYLINDRICAL CAN, WITH THE BACKGROUND OF THE CAN COLORED BLUE. THE DOTTED OUTLINE OF THE CYLINDRICAL CAN AND CAP IS INTENDED TO SHOW THE POSITION OF THE MARK AND IS NOT PART OF THE MARK.

SER. NO. 77-272,436, FILED 9-5-2007.

MARIAM MAHMOUDI, EXAMINING ATTORNEY

**Int. Cl.: 44**

**Prior U.S. Cls.: 100 and 101**

**United States Patent and Trademark Office**

**Reg. No. 3,452,662**

**Registered June 24, 2008**

**SERVICE MARK  
PRINCIPAL REGISTER**

**Austin Podiatry**

AUSTIN PODIATRY, PA (TEXAS CORPORATION)

#2-102

4100 DUVAL RD.

AUSTIN, TX 78759

NO CLAIM IS MADE TO THE EXCLUSIVE RIGHT TO USE "PODIATRY", APART FROM THE MARK AS SHOWN.

FOR: PODIATRY MEDICAL SERVICES, IN CLASS 44 (U.S. CLS. 100 AND 101).

SEC. 2(F).

FIRST USE 9-12-1997; IN COMMERCE 9-12-1997.

SER. NO. 77-272,521, FILED 9-5-2007.

THE MARK CONSISTS OF STANDARD CHARACTERS WITHOUT CLAIM TO ANY PARTICULAR FONT, STYLE, SIZE, OR COLOR.

SOPHIA S. KIM, EXAMINING ATTORNEY

**Int. Cl.: 3**

**Prior U.S. Cls.: 1, 4, 6, 50, 51 and 52**

**Reg. No. 3,452,663**

**United States Patent and Trademark Office**

**Registered June 24, 2008**

**TRADEMARK  
PRINCIPAL REGISTER**

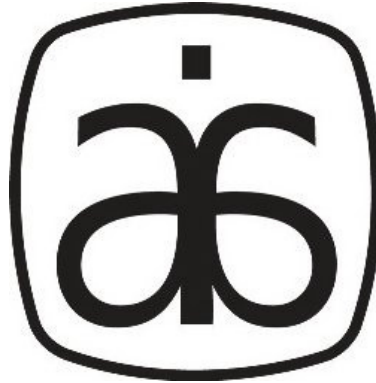

ARBONNE INTERNATIONAL, LLC (DELAWARE  
LTD LIAB CO)  
9400 JERONIMO ROAD  
IRVINE, CA 92618

FOR: COSMETICS, CONCEALERS, FOUNDATIONS,  
FACE COLOR, FACE POWDERS, EYE MAKEUP,  
EYE MAKEUP REMOVERS, BLUSHES,  
LIPSTICKS, LIP GLOSS, NON-MEDICATED LIP  
CARE PREPARATIONS, LASH TREATMENTS, MAKEUP  
PRIMERS, MAKEUP SAMPLES, COLOR

COMPACTS, COSMETIC COLOR PALETTES, IN  
CLASS 3 (U.S. CLS. 1, 4, 6, 50, 51 AND 52).

FIRST USE 5-1-2002; IN COMMERCE 5-1-2002.

THE MARK CONSISTS OF A DESIGN OF A  
BUTTERFLY.

SER. NO. 77-272,595, FILED 9-5-2007.

KIMBERLY FRYE, EXAMINING ATTORNEY

**Int. Cl.: 41**

**Prior U.S. Cls.: 100, 101 and 107**

**United States Patent and Trademark Office**

**Reg. No. 3,452,664**

**Registered June 24, 2008**

**SERVICE MARK  
PRINCIPAL REGISTER**

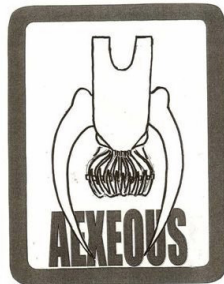

JOE G SILVA (UNITED STATES INDIVIDUAL)  
22 LIBERTY LANE  
NORT SCITUATE, RI 02857

OWNER OF U.S. REG. NO. 3,204,487.

FOR: ENTERTAINMENT SERVICES, NAMELY,  
LIVE PERFORMANCES BY AN ELECTRONICALLY  
OPERATED ROBOT, IN CLASS 41 (U.S. CLS. 100, 101  
AND 107).

THE MARK CONSISTS OF THE ROBOTIC CREA-  
TURE IMAGE THE WORD "AEXEOUS" BENEATH  
IT AND A BORDER AROUND THE ENTIRE THING.

SER. NO. 77-272,599, FILED 9-5-2007.

FIRST USE 3-17-2006; IN COMMERCE 8-11-2007.

KIMBERLY FRYE, EXAMINING ATTORNEY

**Int. Cl.: 25**

**Prior U.S. Cls.: 22 and 39**

**United States Patent and Trademark Office**

**Reg. No. 3,452,665**

**Registered June 24, 2008**

**TRADEMARK  
PRINCIPAL REGISTER**

**STRICTLY ORGANIC**

XCESSORY INTERNATIONAL LTD (NEW JERSEY LTD LIAB CO)  
390 FIFTH AVE SUITE 901  
NEW YORK, NY 10018

FOR: WOMEN'S, MEN'S AND CHILDREN'S CLOTHING, NAMELY, PANTS, SWEATERS, SHIRTS, JACKETS, SKIRTS, CARDIGANS, AND BLOUSES, ALL MADE PRIMARILY OF ORGANIC MATERIALS AND IN SUBSTANTIAL PART FROM ORGANIC MATERIALS, IN CLASS 25 (U.S. CLS. 22 AND 39).

FIRST USE 4-9-2007; IN COMMERCE 4-9-2007.

THE MARK CONSISTS OF STANDARD CHARACTERS WITHOUT CLAIM TO ANY PARTICULAR FONT, STYLE, SIZE, OR COLOR.

NO CLAIM IS MADE TO THE EXCLUSIVE RIGHT TO USE "ORGANIC", APART FROM THE MARK AS SHOWN.

SER. NO. 77-272,629, FILED 9-6-2007.

CAROLYN CATALDO, EXAMINING ATTORNEY

**Int. Cl.: 16**

**Prior U.S. Cls.: 2, 5, 22, 23, 29, 37, 38 and 50**

**Reg. No. 3,452,666**

**United States Patent and Trademark Office**

**Registered June 24, 2008**

---

**TRADEMARK  
PRINCIPAL REGISTER**

**S.M.A.R.T. GOALS**

THE MEYER RESOURCE GROUP, INC. (TEXAS  
CORPORATION)  
4565 LAKE SHORE DRIVE  
WACO, TX 76710

FOR: BOOKS, BOOKLETS, MANUALS AND  
PRINTED INSTRUCTIONAL MATERIALS RELAT-  
ING TO PERSONAL AND PROFESSIONAL DEVEL-  
OPMENT, SELF MOTIVATION AND  
IMPROVEMENT, GOAL SETTING, LEADERSHIP  
AND MANAGEMENT, IN CLASS 16 (U.S. CLS. 2, 5,  
22, 23, 29, 37, 38 AND 50).

FIRST USE 0-0-1965; IN COMMERCE 0-0-1965.

THE MARK CONSISTS OF STANDARD CHAR-  
ACTERS WITHOUT CLAIM TO ANY PARTICULAR  
FONT, STYLE, SIZE, OR COLOR.

NO CLAIM IS MADE TO THE EXCLUSIVE  
RIGHT TO USE GOALS, APART FROM THE MARK  
AS SHOWN.

SER. NO. 77-273,042, FILED 9-6-2007.

REBECCA SMITH, EXAMINING ATTORNEY



**Int. Cl.: 3**

**Prior U.S. Cls.: 1, 4, 6, 50, 51 and 52**

**United States Patent and Trademark Office**

**Reg. No. 3,452,667**

**Registered June 24, 2008**

**TRADEMARK  
PRINCIPAL REGISTER**

**ZIA SKIN BASICS**

ZIA COSMETICS, INC. (CALIFORNIA CORPORATION)  
3515 EASTHAM DRIVE  
CULVER CITY, CA 90232

FOR: COSMETICS, SKIN CARE PRODUCTS AND FACIAL CARE PRODUCTS, NAMELY, SKIN MOISTURIZING, SOFTENING, CONDITIONING, SMOOTHING, CONTOURING, AND FIRMSING LOTIONS, CREAMS AND GELS; CREAMS TO SMOOTH WRINKLES AND DIMINISH THE APPEARANCE OF WRINKLES; SKIN TONERS, SKIN CLEANSERS; EYE CREAMS AND GELS; SKIN EXFOLIANTS; SUN BLOCK AND SUNSCREEN PREPARATIONS, IN CLASS 3 (U.S. CLS. 1, 4, 6, 50, 51 AND 52).

FIRST USE 0-0-1995; IN COMMERCE 0-0-1995.

THE MARK CONSISTS OF STANDARD CHARACTERS WITHOUT CLAIM TO ANY PARTICULAR FONT, STYLE, SIZE, OR COLOR.

OWNER OF U.S. REG. NO. 2,422,418.

NO CLAIM IS MADE TO THE EXCLUSIVE RIGHT TO USE "SKIN", APART FROM THE MARK AS SHOWN.

SER. NO. 77-273,051, FILED 9-6-2007.

MATTHEW PAPPAS, EXAMINING ATTORNEY

**Int. Cl.: 35**

**Prior U.S. Cls.: 100, 101 and 102**

**United States Patent and Trademark Office**

**Reg. No. 3,452,668**

**Registered June 24, 2008**

**SERVICE MARK  
PRINCIPAL REGISTER**

**AMERICAN ASSOCIATION FOR  
PEDIATRIC OPHTHALMOLOGY  
AND STRABISMUS**

THE AMERICAN ASSOCIATION FOR PEDIA-  
TRIC OPHTHALMOLOGY AND STRABISMUS  
(D.C. NON-PROFIT CORPORATION)

655 BEACH STREET

SAN FRANCISCO, CA 941091342

FOR: ASSOCIATION SERVICES, NAMELY, PRO-  
MOTING THE INTERESTS OF PEDIATRIC OPH-  
THALMOLOGISTS , IN CLASS 35 (U.S. CLS. 100, 101  
AND 102).

FIRST USE 5-24-1974; IN COMMERCE 5-24-1974.

THE MARK CONSISTS OF STANDARD CHAR-  
ACTERS WITHOUT CLAIM TO ANY PARTICULAR  
FONT, STYLE, SIZE, OR COLOR.

NO CLAIM IS MADE TO THE EXCLUSIVE  
RIGHT TO USE "ASSOCIATION", APART FROM  
THE MARK AS SHOWN.

SEC. 2(F).

SER. NO. 77-273,127, FILED 9-6-2007.

JOHN WILKE, EXAMINING ATTORNEY

**Int. Cl.: 41**

**Prior U.S. Cls.: 100, 101 and 107**

**United States Patent and Trademark Office**

**Reg. No. 3,452,669**

**Registered June 24, 2008**

**SERVICE MARK  
PRINCIPAL REGISTER**

**AMERICAN ASSOCIATION FOR  
PEDIATRIC OPHTHALMOLOGY  
AND STRABISMUS**

THE AMERICAN ASSOCIATION FOR PEDIA-  
TRIC OPHTHALMOLOGY AND STRABISMUS  
(D.C. NON-PROFIT CORPORATION)  
655 BEACH STREET  
SAN FRANCISCO, CA 941091342

FOR: EDUCATIONAL AND TRAINING SERVI-  
CES, NAMELY, DEVELOPING AND PROVIDING  
CLASSES, SEMINARS, WORKSHOPS, MEETINGS  
AND TRAINING PROGRAMS IN THE FIELD OF  
PEDIATRIC OPHTHALMOLOGY; ONLINE PUBLI-  
CATIONS IN THE FIELDS OF EYE CARE, STRA-  
BISMUS, AND PEDIATRIC OPHTHALMOLOGY, IN  
CLASS 41 (U.S. CLS. 100, 101 AND 107).

FIRST USE 5-24-1974; IN COMMERCE 5-24-1974.

THE MARK CONSISTS OF STANDARD CHAR-  
ACTERS WITHOUT CLAIM TO ANY PARTICULAR  
FONT, STYLE, SIZE, OR COLOR.

NO CLAIM IS MADE TO THE EXCLUSIVE  
RIGHT TO USE "ASSOCIATION", APART FROM  
THE MARK AS SHOWN.

SEC. 2(F).

SER. NO. 77-273,148, FILED 9-6-2007.

JOHN WILKE, EXAMINING ATTORNEY

**Int. Cl.: 44**

**Prior U.S. Cls.: 100 and 101**

**United States Patent and Trademark Office**

**Reg. No. 3,452,670**

**Registered June 24, 2008**

**SERVICE MARK  
PRINCIPAL REGISTER**

**AMERICAN ASSOCIATION FOR  
PEDIATRIC OPHTHALMOLOGY  
AND STRABISMUS**

THE AMERICAN ASSOCIATION FOR PEDIA-  
TRIC OPHTHALMOLOGY AND STRABISMUS  
(D.C. NON-PROFIT CORPORATION)

655 BEACH STREET

SAN FRANCISCO, CA 941091342

FOR: PROVIDING INFORMATION IN THE  
FIELDS OF EYE CARE, STRABISMUS, AND PEDIA-  
TRIC OPHTHALMOLOGY , IN CLASS 44 (U.S. CLS.  
100 AND 101).

FIRST USE 5-24-1974; IN COMMERCE 5-24-1974.

THE MARK CONSISTS OF STANDARD CHAR-  
ACTERS WITHOUT CLAIM TO ANY PARTICULAR  
FONT, STYLE, SIZE, OR COLOR.

NO CLAIM IS MADE TO THE EXCLUSIVE  
RIGHT TO USE "ASSOCIATION", APART FROM  
THE MARK AS SHOWN.

SEC. 2(F).

SER. NO. 77-273,176, FILED 9-6-2007.

JOHN WILKE, EXAMINING ATTORNEY

**Int. Cl.: 37**

**Prior U.S. Cls.: 100, 103 and 106**

**United States Patent and Trademark Office**

**Reg. No. 3,452,671**

**Registered June 24, 2008**

**SERVICE MARK  
PRINCIPAL REGISTER**

**PROS INSTALL YOU ENJOY**

THE VALSPAR CORPORATION (DELAWARE  
CORPORATION)  
1101 SOUTH THIRD STREET  
MINNEAPOLIS, MN 55415

FOR: INSTALLATION AND REPAIR OF GAR-  
AGE FLOOR COATINGS, IN CLASS 37 (U.S. CLS.  
100, 103 AND 106).

FIRST USE 4-0-2007; IN COMMERCE 4-0-2007.

THE MARK CONSISTS OF STANDARD CHAR-  
ACTERS WITHOUT CLAIM TO ANY PARTICULAR  
FONT, STYLE, SIZE, OR COLOR.

NO CLAIM IS MADE TO THE EXCLUSIVE  
RIGHT TO USE "PROS INSTALL", APART FROM  
THE MARK AS SHOWN.

SER. NO. 77-273,222, FILED 9-6-2007.

KRISTIN DAHLING, EXAMINING ATTORNEY

**Int. Cl.: 20**

**Prior U.S. Cls.: 2, 13, 22, 25, 32 and 50**

**Reg. No. 3,452,672**

**United States Patent and Trademark Office**

**Registered June 24, 2008**

---

**TRADEMARK  
PRINCIPAL REGISTER**

**P.A.D. OUTDOOR**

BONERZ, ELI A. (UNITED STATES INDIVIDUAL)  
2238 SILVER LAKE BLVD.  
LOS ANGELES, CA 90039

FOR: FURNITURE; LAWN FURNITURE; TABLES; SOFAS; CHAIRS, IN CLASS 20 (U.S. CLS. 2, 13, 22, 25, 32 AND 50).

FIRST USE 7-31-2007; IN COMMERCE 7-31-2007.

THE MARK CONSISTS OF STANDARD CHARACTERS WITHOUT CLAIM TO ANY PARTICULAR FONT, STYLE, SIZE, OR COLOR.

NO CLAIM IS MADE TO THE EXCLUSIVE RIGHT TO USE "OUTDOOR", APART FROM THE MARK AS SHOWN.

SER. NO. 77-273,899, FILED 9-7-2007.

INGRID C. EULIN, EXAMINING ATTORNEY

**Int. Cl.: 10**

**Prior U.S. Cls.: 26, 39 and 44**

**United States Patent and Trademark Office**

**Reg. No. 3,452,673**

**Registered June 24, 2008**

**TRADEMARK  
PRINCIPAL REGISTER**

**RS-LFS**

INTERNATIONAL REHABILITATIVE SCIENCES,  
INC. (WASHINGTON CORPORATION), DBA  
RS MEDICAL  
14401 SE FIRST STREET  
VANCOUVER, WA 98684

FOR: ORTHOSES FOR POST-OPERATIVE LOW  
BACK SUPPORT AND THE RELIEF OF CHRONIC  
BACK PAIN, NAMELY, LOW BACK BRACES TO  
SUPPORT AND STABILIZE THE LUMBAR SA-  
CRAL REGION OF THE SPINE FOLLOWING LUM-  
BAR SPINAL SURGERY AND TO REDUCE LOAD

ON INTERVERTEBRAL DISCS IN NON-SURGICAL  
PATIENTS, IN CLASS 10 (U.S. CLS. 26, 39 AND 44).

FIRST USE 9-6-2007; IN COMMERCE 9-6-2007.

THE MARK CONSISTS OF STANDARD CHAR-  
ACTERS WITHOUT CLAIM TO ANY PARTICULAR  
FONT, STYLE, SIZE, OR COLOR.

SER. NO. 77-273,977, FILED 9-7-2007.

BENJAMIN ALLEN, EXAMINING ATTORNEY

**Int. Cl.: 10**

**Prior U.S. Cls.: 26, 39 and 44**

**Reg. No. 3,452,674**

**United States Patent and Trademark Office**

**Registered June 24, 2008**

---

**TRADEMARK  
PRINCIPAL REGISTER**

**RS-LSO**

INTERNATIONAL REHABILITATIVE SCIENCES,  
INC. (WASHINGTON CORPORATION), DBA  
RS MEDICAL  
14401 SE FIRST STREET  
VANCOUVER, WA 98684

FIRST USE 2-28-2006; IN COMMERCE 2-28-2006.

THE MARK CONSISTS OF STANDARD CHAR-  
ACTERS WITHOUT CLAIM TO ANY PARTICULAR  
FONT, STYLE, SIZE, OR COLOR.

FOR: ORTHOSES FOR THE RELIEF OF LOW  
BACK PAIN, NAMELY, LOW-BACK BRACES TO  
SUPPORT AND STABILIZE THE LUMBAR SACRAL  
REGION OF THE SPINE AND REDUCE LOAD ON  
INTERVERTEBRAL DISCS IN NON-SURGICAL PA-  
TIENTS, IN CLASS 10 (U.S. CLS. 26, 39 AND 44).

SER. NO. 77-273,983, FILED 9-7-2007.

BENJAMIN ALLEN, EXAMINING ATTORNEY



**Int. Cl.: 35**

**Prior U.S. Cls.: 100, 101 and 102**

**United States Patent and Trademark Office**

**Reg. No. 3,452,675**

**Registered June 24, 2008**

**SERVICE MARK  
PRINCIPAL REGISTER**

**REAL SIMPLE REWARDS**

TIME INC. (DELAWARE CORPORATION)  
1271 AVENUE OF THE AMERICAS  
NEW YORK, NY 10020

FOR: ADVERTISING, INCLUDING PROMOTION  
RELATING TO THE SALE OF ARTICLES AND  
SERVICES FOR THIRD PARTIES BY THE TRANS-  
MISSION OF ADVERTISING MATERIAL AND THE  
DISSEMINATION OF ADVERTISING MESSAGES  
ON COMPUTER NETWORKS, IN CLASS 35 (U.S.  
CLS. 100, 101 AND 102).

FIRST USE 2-29-2004; IN COMMERCE 2-29-2004.

THE MARK CONSISTS OF STANDARD CHAR-  
ACTERS WITHOUT CLAIM TO ANY PARTICULAR  
FONT, STYLE, SIZE, OR COLOR.

OWNER OF U.S. REG. NOS. 2,470,211, 3,098,845  
AND OTHERS.

SER. NO. 77-274,458, FILED 9-7-2007.

KRISTINA MORRIS, EXAMINING ATTORNEY

**Int. Cl.: 12**

**Prior U.S. Cls.: 19, 21, 23, 31, 35 and 44**

**Reg. No. 3,452,676**

**United States Patent and Trademark Office**

**Registered June 24, 2008**

---

**TRADEMARK  
PRINCIPAL REGISTER**

**Centurion**

FINELINE INDUSTRIES, INC. (CALIFORNIA  
CORPORATION)  
455 GROGAN AVENUE  
MERCED, CA 95340

THE MARK CONSISTS OF STANDARD CHAR-  
ACTERS WITHOUT CLAIM TO ANY PARTICULAR  
FONT, STYLE, SIZE, OR COLOR.

FOR: WATERSPORTS MOTORBOATS SHORTER  
THAN 30 FEET IN LENGTH, IN CLASS 12 (U.S. CLS.  
19, 21, 23, 31, 35 AND 44).

SER. NO. 77-274,648, FILED 9-7-2007.

FIRST USE 9-16-1979; IN COMMERCE 9-16-1979.

SUNG IN, EXAMINING ATTORNEY

**Int. Cl.: 44**

**Prior U.S. Cls.: 100 and 101**

**United States Patent and Trademark Office**

**Reg. No. 3,452,677**

**Registered June 24, 2008**

**SERVICE MARK  
PRINCIPAL REGISTER**

**Acupuncture Happy Hour**

CANYON, COLLEEN H (UNITED STATES INDIVIDUAL)

394 MOUNTAIN ROAD

UNION CITY, NJ 07087

FOR: ACUPUNCTURE SERVICES, IN CLASS 44  
(U.S. CLS. 100 AND 101).

FIRST USE 5-20-2004; IN COMMERCE 5-20-2004.

THE MARK CONSISTS OF STANDARD CHARACTERS WITHOUT CLAIM TO ANY PARTICULAR FONT, STYLE, SIZE, OR COLOR.

NO CLAIM IS MADE TO THE EXCLUSIVE RIGHT TO USE "ACUPUNCTURE", APART FROM THE MARK AS SHOWN.

SER. NO. 77-274,897, FILED 9-8-2007.

ROBERT LAVACHE, EXAMINING ATTORNEY

**Int. Cl.: 16**

**Prior U.S. Cls.: 2, 5, 22, 23, 29, 37, 38 and 50**

**United States Patent and Trademark Office**

**Reg. No. 3,452,678**

**Registered June 24, 2008**

**TRADEMARK  
PRINCIPAL REGISTER**

**KNOXVILLE VOICE**

BAKER, DOUGLAS D (UNITED STATES INDIVIDUAL)  
1147 TREYMOUR WAY  
KNOXVILLE, TN 37922

FOR: NEWSPAPERS, IN CLASS 16 (U.S. CLS. 2, 5, 22, 23, 29, 37, 38 AND 50).

FIRST USE 4-20-2006; IN COMMERCE 4-20-2006.

THE MARK CONSISTS OF STANDARD CHARACTERS WITHOUT CLAIM TO ANY PARTICULAR FONT, STYLE, SIZE, OR COLOR.

OWNER OF U.S. REG. NO. 3,299,862.

NO CLAIM IS MADE TO THE EXCLUSIVE RIGHT TO USE "KNOXVILLE", APART FROM THE MARK AS SHOWN.

SER. NO. 77-274,920, FILED 9-8-2007.

JAMES LOVELACE, EXAMINING ATTORNEY

**Int. Cl.: 9**

**Prior U.S. Cls.: 21, 23, 26, 36 and 38**

**Reg. No. 3,452,679**

**United States Patent and Trademark Office**

**Registered June 24, 2008**

**TRADEMARK  
PRINCIPAL REGISTER**

# NetOmnia

CENTINA SYSTEMS INC. (DELAWARE CORPORATION)  
SUITE 222  
1750 N COLLINS BLVD  
RICHARDSON, TX 75080

FOR: COMPUTER PROGRAMS AND SOFTWARE FOR THE ANALYSIS AND MODELING OF DATA COMMUNICATION AND VOICE COMMUNICATION NETWORKS; COMPUTER PROGRAMS AND SOFTWARE FOR THE COLLECTION, CONSOLIDATION, STORAGE AND ANALYSIS OF FAULT STATUS FROM NETWORK DEVICES, COMPUTER OPERATING SYSTEMS, AND SOFTWARE APPLICATIONS; COMPUTER PROGRAMS AND SOFTWARE FOR THE RETRIEVAL AND

PRESENTATION OF STORED NETWORK INFORMATION BY A GRAPHICAL, COMMAND LINE, AND MACHINE-TO-MACHINE INTERFACE, IN CLASS 9 (U.S. CLS. 21, 23, 26, 36 AND 38).

FIRST USE 10-1-2006; IN COMMERCE 4-1-2007.

THE MARK CONSISTS OF STANDARD CHARACTERS WITHOUT CLAIM TO ANY PARTICULAR FONT, STYLE, SIZE, OR COLOR.

SER. NO. 77-275,052, FILED 9-9-2007.

G. MAYERSCHOFF, EXAMINING ATTORNEY

**Int. Cl.: 9**

**Prior U.S. Cls.: 21, 23, 26, 36 and 38**

**United States Patent and Trademark Office**

**Reg. No. 3,452,680**

**Registered June 24, 2008**

**TRADEMARK  
PRINCIPAL REGISTER**



CENTINA SYSTEMS INC. (DELAWARE CORPORATION)  
SUITE 222  
1750 N COLLINS BLVD  
RICHARDSON, TX 75080

FOR: COMPUTER PROGRAMS AND SOFTWARE FOR THE ANALYSIS AND MODELING OF DATA COMMUNICATION AND VOICE COMMUNICATION NETWORKS; COMPUTER PROGRAMS AND SOFTWARE FOR THE COLLECTION, CONSOLIDATION, STORAGE AND ANALYSIS OF FAULT STATUS FROM NETWORK DEVICES, COMPUTER OPERATING SYSTEMS, AND SOFTWARE APPLICATIONS; COMPUTER PROGRAMS AND SOFTWARE FOR THE RETRIEVAL AND PRESENTATION OF STORED NETWORK INFORMATION BY A GRAPHICAL, COMMAND LINE, AND MACHINE-TO-MACHINE INTERFACE, IN CLASS 9 (U.S. CLS. 21, 23, 26, 36 AND 38).

FIRST USE 10-1-2006; IN COMMERCE 4-1-2007.

NO CLAIM IS MADE TO THE EXCLUSIVE RIGHT TO USE "NET", APART FROM THE MARK AS SHOWN.

THE MARK CONSISTS OF THE WORD "NETOMNIA" WITH THE FIRST THREE LETTERS, LOWER-CASE "NET" INSIDE RECTANGLES, AND THE LETTERS "OMNIA" CAPITALIZED, AND WITHIN THE LETTER "O" A REPRESENTATION OF A GLOBE WITH LATITUDE AND LONGITUDE MARKINGS.

THE ENGLISH TRANSLATION OF THE WORD "OMNIA" IN THE MARK IS EVERYTHING OR ALL THINGS FROM LATIN.

SER. NO. 77-275,079, FILED 9-9-2007.

G. MAYERSCHOFF, EXAMINING ATTORNEY

**Int. Cl.: 44**

**Prior U.S. Cls.: 100 and 101**

**United States Patent and Trademark Office**

**Reg. No. 3,452,681**

**Registered June 24, 2008**

**SERVICE MARK  
PRINCIPAL REGISTER**

**WASHBURN CENTER FOR  
CHILDREN**

WASHBURN CENTER FOR CHILDREN (MINNESOTA NON-PROFIT CORPORATION)  
2430 NUICOLLET AVENUE SOUTH  
MINNEAPOLIS, MN 55404

FOR: PSYCHOLOGICAL COUNSELING SERVICES TO CHILDREN WITH SOCIAL, EMOTIONAL AND BEHAVIORAL PROBLEMS, IN CLASS 44 (U.S. CLS. 100 AND 101).

FIRST USE 7-31-2007; IN COMMERCE 7-31-2007.

THE MARK CONSISTS OF STANDARD CHARACTERS WITHOUT CLAIM TO ANY PARTICULAR FONT, STYLE, SIZE, OR COLOR.

NO CLAIM IS MADE TO THE EXCLUSIVE RIGHT TO USE "CENTER FOR CHILDREN", APART FROM THE MARK AS SHOWN.

SER. NO. 77-275,268, FILED 9-10-2007.

DAVID MURRAY, EXAMINING ATTORNEY

**Int. Cls.: 35 and 44**

**Prior U.S. Cls.: 100, 101 and 102**

**United States Patent and Trademark Office**

**Reg. No. 3,452,682**

**Registered June 24, 2008**

**SERVICE MARK  
PRINCIPAL REGISTER**

**ANESTHESIAZONE**

AMN HEALTHCARE, INC. (NEVADA CORPORATION)  
12400 HIGH BLUFF DRIVE  
SAN DIEGO, CA 92130

FOR: PROVIDING A WEBSITE FEATURING CAREER INFORMATION FOR USE BY THE HEALTHCARE INDUSTRY AND HEALTHCARE PROFESSIONALS, IN CLASS 35 (U.S. CLS. 100, 101 AND 102).

FIRST USE 9-6-2007; IN COMMERCE 9-6-2007.

FOR: PROVIDING A WEBSITE FEATURING MEDICAL INFORMATION RELATING TO ANES-

THESIA AND RELATED SUBJECTS FOR USE BY THE HEALTHCARE INDUSTRY AND HEALTHCARE PROFESSIONALS, IN CLASS 44 (U.S. CLS. 100 AND 101).

FIRST USE 9-6-2007; IN COMMERCE 9-6-2007.

THE MARK CONSISTS OF STANDARD CHARACTERS WITHOUT CLAIM TO ANY PARTICULAR FONT, STYLE, SIZE, OR COLOR.

SER. NO. 77-275,735, FILED 9-10-2007.

CURTIS FRENCH, EXAMINING ATTORNEY



**Int. Cl.: 41**

**Prior U.S. Cls.: 100, 101 and 107**

**United States Patent and Trademark Office**

**Reg. No. 3,452,683**

**Registered June 24, 2008**

**SERVICE MARK  
PRINCIPAL REGISTER**



CM IT SOLUTIONS, INC. (TEXAS CORPORATION)  
1701 DIRECTORS BLVD., SUITE 300  
AUSTIN, TX 78701

FOR: COMPUTER EDUCATION TRAINING AND  
COMPUTER EDUCATION TRAINING CONSULTING  
SERVICES, IN CLASS 41 (U.S. CLS. 100, 101 AND  
107).

FIRST USE 8-8-2007; IN COMMERCE 8-8-2007.

OWNER OF U.S. REG. NOS. 2,986,348, 3,032,888,  
AND 3,132,824.

NO CLAIM IS MADE TO THE EXCLUSIVE  
RIGHT TO USE "SOLUTIONS", APART FROM  
THE MARK AS SHOWN.

THE MARK CONSISTS OF THE LETTERS "CMIT"  
AND THE WORD "SOLUTIONS" WITH THE  
WORDS "YOUR TECHNOLOGY TEAM" BELOW  
"SOLUTIONS". A CURVED LINE CONSISTING OF  
CIRCLES RUNS BETWEEN "CMIT" AND "SOLU-  
TIONS".

SER. NO. 77-275,910, FILED 9-10-2007.

CHARLES L. JENKINS, EXAMINING ATTORNEY

**Int. Cls.: 35 and 39**

**Prior U.S. Cls.: 100, 101, 102 and 105**

**United States Patent and Trademark Office**

**Reg. No. 3,452,684**

**Registered June 24, 2008**

**SERVICE MARK  
PRINCIPAL REGISTER**

**RevenueDirect**

DOTSTER, INC. (DELAWARE CORPORATION)  
SUITE 300  
8100 NE PARKWAY DRIVE  
VANCOUVER, WA 98682

FOR: DOMAIN MONETIZATION SERVICES FOR  
OTHERS, IN CLASS 35 (U.S. CLS. 100, 101 AND 102).

FIRST USE 1-28-2005; IN COMMERCE 11-1-2005.

FOR: PARKING DOMAIN NAMES FOR OTHERS,  
NAMELY, PROVIDING COMPUTER SERVERS FOR  
FACILITATION OF THE STORAGE OF DOMAIN

NAME ADDRESSES, IN CLASS 39 (U.S. CLS. 100  
AND 105).

FIRST USE 1-28-2005; IN COMMERCE 11-1-2005.

THE MARK CONSISTS OF STANDARD CHAR-  
ACTERS WITHOUT CLAIM TO ANY PARTICULAR  
FONT, STYLE, SIZE, OR COLOR.

SER. NO. 77-276,469, FILED 9-11-2007.

JILL PRATER, EXAMINING ATTORNEY

**Int. Cl.: 5**

**Prior U.S. Cls.: 6, 18, 44, 46, 51 and 52**

**Reg. No. 3,452,685**

**United States Patent and Trademark Office**

**Registered June 24, 2008**

---

**TRADEMARK  
PRINCIPAL REGISTER**

**Nutra/MD**

BLUE WATER NUTRITIONALS LTD (TEXAS  
LIMITED PARTNERSHIP)  
4724 SWEETWATER BOULEVARD, SUITE 102  
SUGAR LAND, TX 77479

THE MARK CONSISTS OF STANDARD CHAR-  
ACTERS WITHOUT CLAIM TO ANY PARTICULAR  
FONT, STYLE, SIZE, OR COLOR.

FOR: DIETARY AND NUTRITIONAL SUPPLE-  
MENTS; VITAMIN AND MINERAL SUPPLEMENTS,  
IN CLASS 5 (U.S. CLS. 6, 18, 44, 46, 51 AND 52).

SER. NO. 77-276,659, FILED 9-11-2007.

FIRST USE 5-1-2005; IN COMMERCE 7-25-2005.

REBECCA POVARCHUK, EXAMINING ATTOR-  
NEY

**Int. Cl.: 35**

**Prior U.S. Cls.: 100, 101 and 102**

**United States Patent and Trademark Office**

**Reg. No. 3,452,686**

**Registered June 24, 2008**

**SERVICE MARK  
PRINCIPAL REGISTER**



STONE FENCE HOLDINGS, INC. (KANSAS CORPORATION)  
7501 NW TIFFANY SPRINGS PKWY, STE. 200  
KANSAS CITY, MO 64153

FOR: BUSINESS PROCESS OUTSOURCING SERVICES IN THE FIELD OF MANAGING BAD CHECK COLLECTION AND RECOVERY, IN CLASS 35 (U.S. CLS. 100, 101 AND 102).

FIRST USE 3-23-2007; IN COMMERCE 6-11-2007.

NO CLAIM IS MADE TO THE EXCLUSIVE RIGHT TO USE "CHECK", APART FROM THE MARK AS SHOWN.

SER. NO. 77-276,869, FILED 9-11-2007.

PRISCILLA MILTON, EXAMINING ATTORNEY

**Int. Cl.: 5**

**Prior U.S. Cls.: 6, 18, 44, 46, 51 and 52**

**Reg. No. 3,452,687**

**United States Patent and Trademark Office**

**Registered June 24, 2008**

---

**TRADEMARK  
PRINCIPAL REGISTER**

**ODOR SACKER**

HARP DESIGNER PRODUCTS, INC. (NEW  
YORK CORPORATION)  
70 DALE STREET  
W. BABYLON, NY 11704

FOR: ODOR ELIMINATOR FOR USE IN SPORTS  
EQUIPMENT AND BAGS, LOCKER ROOMS,  
HEALTH CLUBS, GYMNASIUMS, AND FOR GEN-  
ERAL INDUSTRIAL, COMMERCIAL AND RESI-  
DENTIAL USE, IN CLASS 5 (U.S. CLS. 6, 18, 44, 46, 51  
AND 52).

FIRST USE 9-0-2007; IN COMMERCE 9-0-2007.

THE MARK CONSISTS OF STANDARD CHAR-  
ACTERS WITHOUT CLAIM TO ANY PARTICULAR  
FONT, STYLE, SIZE, OR COLOR.

NO CLAIM IS MADE TO THE EXCLUSIVE  
RIGHT TO USE "ODOR", APART FROM THE  
MARK AS SHOWN.

SER. NO. 77-276,937, FILED 9-11-2007.

SHAILA SETTLES, EXAMINING ATTORNEY

**Int. Cl.: 9**

**Prior U.S. Cls.: 21, 23, 26, 36 and 38**

**United States Patent and Trademark Office**

**Reg. No. 3,452,688**

**Registered June 24, 2008**

**TRADEMARK  
PRINCIPAL REGISTER**

**yapta** 

YAPTA, INC. (WASHINGTON CORPORATION)  
315 1ST AVE. S., SUITE #400  
SEATTLE, WA 98104

FOR: DOWNLOADABLE SOFTWARE WHICH  
ALLOWS FOR THE TAGGING AND TRACKING  
OF FLIGHT ITINERARIES AND ONLINE TRAVEL  
AGENTS TO MONITOR FLIGHT, RENTAL CAR,  
CRUISE AND HOTEL PRICES AND ALERT USERS  
TO PRICE CHANGES; DOWNLOADABLE SOFT-  
WARE WHICH PROVIDES ALERTS TO USERS  
REGARDING CHANGES IN FLIGHT, RENTAL  
CAR, CRUISE AND HOTEL PRICES TO FACILI-  
TATE OBTAINMENT OF TRAVEL VOUCHERS

AND/OR CASH REFUNDS; DOWNLOADABLE  
COMPUTER SOFTWARE WHICH ALLOWS USERS  
TO MONITOR TAGGED AND PURCHASED  
FLIGHTS, RENTAL CARS, CRUISES AND HOTELS,  
IN CLASS 9 (U.S. CLS. 21, 23, 26, 36 AND 38).

FIRST USE 1-0-2007; IN COMMERCE 1-0-2007.

THE MARK CONSISTS OF THE WORD "YAPTA"  
AND A DESIGN ELEMENT.

SER. NO. 77-277,002, FILED 9-11-2007.

ELIZABETH HUGHITT, EXAMINING ATTORNEY

**Int. Cl.: 16**

**Prior U.S. Cls.: 2, 5, 22, 23, 29, 37, 38 and 50**

**Reg. No. 3,452,689**

**United States Patent and Trademark Office**

**Registered June 24, 2008**

**TRADEMARK  
PRINCIPAL REGISTER**



CHEKEL, MARTIN (UNITED STATES INDIVIDUAL)  
1738 TRADEWINDS LANE  
NEWPORT BEACH, CA 92660

FIRST USE 1-2-1981; IN COMMERCE 6-1-1984.

SER. NO. 77-277,080, FILED 9-11-2007.

FOR: EDUCATIONAL BOOKS IN THE FIELD OF TEACHING ENGLISH, IN CLASS 16 (U.S. CLS. 2, 5, 22, 23, 29, 37, 38 AND 50).

JENNIFER VASQUEZ, EXAMINING ATTORNEY

**Int. Cl.: 9**

**Prior U.S. Cls.: 21, 23, 26, 36 and 38**

**Reg. No. 3,452,690**

**United States Patent and Trademark Office**

**Registered June 24, 2008**

---

**TRADEMARK  
PRINCIPAL REGISTER**

**UEILogger**

UNITED ELECTRONIC INDUSTRIES, INC.  
(MASSACHUSETTS CORPORATION)  
ATTN: LEGAL DEPT  
27 RENMAR AVENUE  
WALPOLE, MA 02081

FIRST USE 12-4-2006; IN COMMERCE 12-4-2006.

THE MARK CONSISTS OF STANDARD CHARACTERS WITHOUT CLAIM TO ANY PARTICULAR FONT, STYLE, SIZE, OR COLOR.

FOR: DATA LOGGER/RECORDER USED FOR ELECTRONIC STORAGE OF ACQUIRED ANALOG AND DIGITAL SIGNALS, IN CLASS 9 (U.S. CLS. 21, 23, 26, 36 AND 38).

SER. NO. 77-277,252, FILED 9-12-2007.

ANGELA M. MICHELI, EXAMINING ATTORNEY



**Int. Cl.: 17**

**Prior U.S. Cls.: 1, 5, 12, 13, 35 and 50**

**United States Patent and Trademark Office**

**Reg. No. 3,452,691**

**Registered June 24, 2008**

**TRADEMARK  
PRINCIPAL REGISTER**

**WHISPER QUIET SHELL PIPE**

PROSET SYSTEMS, INC. (GEORGIA CORPORATION)

1355 CAPITAL CIRCLE

LAWRENCEVILLE, GA 300435866

FOR: SOUNDPROOFING BARRIER FOR PIPES,  
IN CLASS 17 (U.S. CLS. 1, 5, 12, 13, 35 AND 50).

FIRST USE 12-4-2007; IN COMMERCE 12-4-2007.

THE MARK CONSISTS OF STANDARD CHARACTERS WITHOUT CLAIM TO ANY PARTICULAR FONT, STYLE, SIZE, OR COLOR.

NO CLAIM IS MADE TO THE EXCLUSIVE RIGHT TO USE PIPE, APART FROM THE MARK AS SHOWN.

SER. NO. 77-277,352, FILED 9-12-2007.

HOWARD SMIGA, EXAMINING ATTORNEY

Int. Cl.: 43

Prior U.S. Cls.: 100 and 101

United States Patent and Trademark Office

Reg. No. 3,452,692

Registered June 24, 2008

SERVICE MARK  
PRINCIPAL REGISTER



EAST COAST PIZZA, INC. (FLORIDA CORPORATION)

10711 CHESHAM HILL CT.

RIVERVIEW, FL 33579

FOR: RESTAURANT SERVICES FEATURING CALZONES, STROMBOLIS, HEROS, APPETIZERS, PASTA, ENTREES, SALADS, AND DESSERTS, IN CLASS 43 (U.S. CLS. 100 AND 101).

FIRST USE 5-0-2005; IN COMMERCE 7-14-2005.

NO CLAIM IS MADE TO THE EXCLUSIVE RIGHT TO USE "EAST COAST PIZZA", APART FROM THE MARK AS SHOWN.

THE MARK CONSISTS OF A LOGO THAT REPRESENTS THE ITALIAN FLAG, WITH A CHEF HAT AND MUSTACHE, AND THE STYLIZED TEXT "EAST COAST PIZZA".

SER. NO. 77-277,387, FILED 9-12-2007.

MICHAEL WEBSTER, EXAMINING ATTORNEY

**Int. Cl.: 17**

**Prior U.S. Cls.: 1, 5, 12, 13, 35 and 50**

**Reg. No. 3,452,693**

**United States Patent and Trademark Office**

**Registered June 24, 2008**

**TRADEMARK  
PRINCIPAL REGISTER**

**ULTRAPERF TECHNOLOGIES,  
INC.**

ULTRAPERF TECHNOLOGIES, INC. (CANADA  
CORPORATION)  
745 GRAND BERNIER SUITE # 7  
ST-JEAN-SUR-RICHELIEU, CANADA J3B8H7

FOR: PLASTIC IN THE FORM OF BARS, BLOCKS,  
PELLETS, RODS, SHEETS AND TUBES FOR USE IN  
MANUFACTURING, IN CLASS 17 (U.S. CLS. 1, 5, 12,  
13, 35 AND 50).

FIRST USE 9-10-2003; IN COMMERCE 9-10-2003.

THE MARK CONSISTS OF STANDARD CHAR-  
ACTERS WITHOUT CLAIM TO ANY PARTICULAR  
FONT, STYLE, SIZE, OR COLOR.

NO CLAIM IS MADE TO THE EXCLUSIVE  
RIGHT TO USE "TECHNOLOGIES, INC.", APART  
FROM THE MARK AS SHOWN.

SER. NO. 77-277,470, FILED 9-12-2007.

BRIAN NEVILLE, EXAMINING ATTORNEY

**Int. Cls.: 1 and 4**

**Prior U.S. Cls.: 1, 5, 6, 10, 15, 26 and 46**

**Reg. No. 3,452,694**

**United States Patent and Trademark Office**

**Registered June 24, 2008**

**TRADEMARK  
PRINCIPAL REGISTER**

**PUMP DEFENDER**

APACHE HOSE & BELTING COMPANY, INC.  
(IOWA CORPORATION)  
4805 BOWLING STREET SW  
CEDAR RAPIDS, IA 52404

FOR: ANTI-FREEZE FOR USE IN PRESSURE  
WASHERS WHILE NOT IN USE, IN CLASS 1 (U.S.  
CLS. 1, 5, 6, 10, 26 AND 46).

FIRST USE 8-0-2007; IN COMMERCE 8-0-2007.

FOR: ALL PURPOSE LUBRICATING LIQUID,  
LUBRICATING GREASES AND LUBRICATING  
OILS FOR USE IN PRESSURE WASHERS WHILE  
NOT IN USE, IN CLASS 4 (U.S. CLS. 1, 6 AND 15).

FIRST USE 8-0-2007; IN COMMERCE 8-0-2007.

THE MARK CONSISTS OF STANDARD CHAR-  
ACTERS WITHOUT CLAIM TO ANY PARTICULAR  
FONT, STYLE, SIZE, OR COLOR.

NO CLAIM IS MADE TO THE EXCLUSIVE  
RIGHT TO USE "PUMP", APART FROM THE MARK  
AS SHOWN.

SER. NO. 77-278,025, FILED 9-12-2007.

ELLEN PERKINS, EXAMINING ATTORNEY

**Int. Cl.: 36**

**Prior U.S. Cls.: 100, 101 and 102**

**United States Patent and Trademark Office**

**Reg. No. 3,452,695**

**Registered June 24, 2008**

**SERVICE MARK  
PRINCIPAL REGISTER**



WHITESIDE ENERGY LP (TEXAS LIMITED  
PARTNERSHIP)  
SUITE 1950  
5051 WESTHEIMER  
HOUSTON, TX 77056

VICES IN THE ENERGY SECTOR, IN CLASS 36 (U.S.  
CLS. 100, 101 AND 102).

FIRST USE 6-20-2007; IN COMMERCE 6-20-2007.

SER. NO. 77-278,757, FILED 9-13-2007.

FOR: FINANCIAL SERVICES, NAMELY, HEDGE  
FUND INVESTMENT AND MANAGEMENT SER-

MARIA-VICTORIA SUAREZ, EXAMINING ATTOR-  
NEY

Int. Cl.: 25

Prior U.S. Cls.: 22 and 39

United States Patent and Trademark Office

Reg. No. 3,452,696

Registered June 24, 2008

TRADEMARK  
PRINCIPAL REGISTER



AFFLICTION, LLC (CALIFORNIA LTD LIAB CO)  
2701 SIGNAL PARKWAY  
SIGNAL HILL, CA 90755

FOR: BELTS; BELTS MADE OF LEATHER; CAPS;  
CAPS WITH VISORS; DENIMS; BOOTS; LONG-  
SLEEVED SHIRTS; OPEN-NECKED SHIRTS; POLO  
SHIRTS; SHIRTS; SHORT-SLEEVED OR LONG-  
SLEEVED T-SHIRTS; SHORT-SLEEVED SHIRTS; T-  
SHIRTS; JACKETS; SWEAT SHIRTS; TANK TOPS,  
IN CLASS 25 (U.S. CLS. 22 AND 39).

FIRST USE 6-15-2005; IN COMMERCE 6-15-2005.

THE MARK CONSISTS OF A CROSS WITH TWO  
SKULLS ON IT AND WINGS BEHIND THE CROSS.  
THE BLACK BACKGROUND IS SIMPLY BACK-  
GROUND AND IS NOT PART OF THE MARK.

SER. NO. 77-278,769, FILED 9-13-2007.

KATHLEEN M. VANSTON, EXAMINING ATTOR-  
NEY

**Int. Cl.: 44**

**Prior U.S. Cls.: 100 and 101**

**United States Patent and Trademark Office**

**Reg. No. 3,452,697**

**Registered June 24, 2008**

**SERVICE MARK  
PRINCIPAL REGISTER**

**LANDMARKS FOR LIVING**

GREYSTONE COMMUNITIES, INC. (TEXAS  
CORPORATION)  
SUITE 2100  
222 WEST LAS COLINAS BOULEVARD  
IRVING, TX 75039

FOR: MENTAL HEALTH AND COGNITIVE SERVICES, NAMELY, PROVIDING INDIVIDUALIZED MANAGED HEALTH CARE FOR MEMORY LOSS THROUGH USE OF CHOICES, CONSISTENT SCHEDULES, AND SURROUNDINGS FAMILIAR TO THOSE RECEIVING THE SERVICES, IN CLASS 44 (U.S. CLS. 100 AND 101).

FIRST USE 12-19-2007; IN COMMERCE 12-19-2007.

THE MARK CONSISTS OF STANDARD CHARACTERS WITHOUT CLAIM TO ANY PARTICULAR FONT, STYLE, SIZE, OR COLOR.

SER. NO. 77-278,927, FILED 9-13-2007.

FRANK LATTUCA, EXAMINING ATTORNEY

**Int. Cl.: 43**

**Prior U.S. Cls.: 100 and 101**

**United States Patent and Trademark Office**

**Reg. No. 3,452,698**

**Registered June 24, 2008**

**SERVICE MARK  
PRINCIPAL REGISTER**

**1 HOT CINCO**

TJF USA, LLC (FLORIDA LTD LIAB CO)  
SUITE 202  
1051 WINDERLEY PLACE  
MAITLAND, FL 32751

FOR: RESTAURANT AND BAR SERVICES; RESTAURANT SERVICES; RESTAURANTS; TAKE-OUT RESTAURANT SERVICES, IN CLASS 43 (U.S. CLS. 100 AND 101).

FIRST USE 4-15-2007; IN COMMERCE 4-15-2007.

THE MARK CONSISTS OF STANDARD CHARACTERS WITHOUT CLAIM TO ANY PARTICULAR FONT, STYLE, SIZE, OR COLOR.

THE FOREIGN WORDING IN THE MARK TRANSLATES INTO ENGLISH AS FIVE.

SER. NO. 77-279,061, FILED 9-13-2007.

JASON TURNER, EXAMINING ATTORNEY



**Int. Cls.: 41 and 45**

**Prior U.S. Cls.: 100, 101 and 107**

**United States Patent and Trademark Office**

**Reg. No. 3,452,699**

**Registered June 24, 2008**

**SERVICE MARK  
PRINCIPAL REGISTER**



CBMC INTERNATIONAL (FLORIDA CORPORATION)  
1065 NORTH 115, SUITE 210  
OMAHA, NE 68154

FOR: PUBLICATION OF TEXTS, BOOKS, MAGAZINES AND OTHER PRINTED MATTER, IN CLASS 41 (U.S. CLS. 100, 101 AND 107).

FIRST USE 10-1-2005; IN COMMERCE 10-1-2005.

FOR: RELIGIOUS AND SPIRITUAL SERVICES, NAMELY, PROVIDING GATHERINGS AND RETREATS TO DEVELOP AND ENHANCE THE SPIRITUAL LIVES OF INDIVIDUALS, IN CLASS 45 (U.S. CLS. 100 AND 101).

FIRST USE 9-15-2006; IN COMMERCE 9-15-2006.

NO CLAIM IS MADE TO THE EXCLUSIVE RIGHT TO USE CHRISTIAN BUSINESS WOMEN'S

FELLOWSHIP, APART FROM THE MARK AS SHOWN.

THE COLOR(S) PURPLE AND PEACH IS/ARE CLAIMED AS A FEATURE OF THE MARK.

THE MARK CONSISTS OF A PURPLE @ SYMBOL WITH A PEACH HEART IN THE MIDDLE IS FOLLOWED BY THE PURPLE LETTERS CBWF. BELOW ARE THE WORDS CHRISTIAN BUSINESS WOMEN'S FELLOWSHIP IN PURPLE. A SMALL HORIZONTAL PURPLE LINE SEPARATES THE TOP PORTION FROM THE NAME BELOW..

SER. NO. 77-279,092, FILED 9-13-2007.

RICHARD A. STRASER, EXAMINING ATTORNEY

**Int. Cl.: 29**

**Prior U.S. Cl.: 46**

**United States Patent and Trademark Office**

**Reg. No. 3,452,700**

**Registered June 24, 2008**

**TRADEMARK  
PRINCIPAL REGISTER**

**A WRECK**

POTBELLY SANDWICH WORKS LLC (ILLINOIS  
LTD LIAB CO)  
23RD FLOOR  
222 MERCHANDISE MART PLAZA  
CHICAGO, IL 60654

FOR: VEGETABLE SALADS; SALADS NOT IN-  
CLUDING MACARONI, RICE, AND PASTA SALAD,  
IN CLASS 29 (U.S. CL. 46).

FIRST USE 9-0-2005; IN COMMERCE 9-0-2005.

THE MARK CONSISTS OF STANDARD CHAR-  
ACTERS WITHOUT CLAIM TO ANY PARTICULAR  
FONT, STYLE, SIZE, OR COLOR.

OWNER OF U.S. REG. NO. 2,304,375.

SER. NO. 77-279,106, FILED 9-13-2007.

LANA PHAM, EXAMINING ATTORNEY

**Int. Cl.: 18**

**Prior U.S. Cls.: 1, 2, 3, 22 and 41**

**United States Patent and Trademark Office**

**Reg. No. 3,452,701**

**Registered June 24, 2008**

**TRADEMARK  
PRINCIPAL REGISTER**

**belle**

INVENTISTA, INC. (COLORADO CORPORATION)  
97 BENTHAVEN PLACE  
BOULDER, CO 80305

THE MARK CONSISTS OF STANDARD CHARACTERS WITHOUT CLAIM TO ANY PARTICULAR FONT, STYLE, SIZE, OR COLOR.

FOR: BABY AND INFANT CARRIERS WORN ON THE BODY, IN CLASS 18 (U.S. CLS. 1, 2, 3, 22 AND 41).

SER. NO. 77-279,374, FILED 9-14-2007.

FIRST USE 8-12-2006; IN COMMERCE 9-23-2006.

DAVID I, EXAMINING ATTORNEY

**Int. Cl.: 7**

**Prior U.S. Cls.: 13, 19, 21, 23, 31, 34 and 35**

**Reg. No. 3,452,702**

**United States Patent and Trademark Office**

**Registered June 24, 2008**

---

**TRADEMARK  
PRINCIPAL REGISTER**

**ROBOMASK**

BUTTERWORTH INDUSTRIES, INC. (INDIANA CORPORATION)  
5050 EAST SIDE PARKWAY  
GAS CITY, IN 46933

FIRST USE 12-8-2006; IN COMMERCE 12-8-2006.

FOR: PROTECTIVE COVERINGS FOR INDUSTRIAL ROBOTS AND INDUSTRIAL AUTOMATION EQUIPMENT USED IN A MANUFACTURING PRODUCTION LINE, NAMELY, COVERINGS MADE WITH ENGINEERED POLYMER PROTECTIVE FILM, IN CLASS 7 (U.S. CLS. 13, 19, 21, 23, 31, 34 AND 35).

THE MARK CONSISTS OF STANDARD CHARACTERS WITHOUT CLAIM TO ANY PARTICULAR FONT, STYLE, SIZE, OR COLOR.

SER. NO. 77-279,392, FILED 9-14-2007.

ANGELA GAW, EXAMINING ATTORNEY

Int. Cl.: 41

Prior U.S. Cls.: 100, 101 and 107

United States Patent and Trademark Office

Reg. No. 3,452,703

Registered June 24, 2008

**SERVICE MARK  
PRINCIPAL REGISTER**



HANCOX, JUDITH A. (UNITED STATES INDIVIDUAL)  
1913 SW BRADFORD PLACE  
PALM CITY, FL 34990

FOR: EDUCATION SERVICES, NAMELY, PROVIDING LIVE AND ON-LINE CLASSES, SEMINARS, WORKSHOPS IN THE FIELD OF PSYCHOTHERAPY AND MENTAL HEALTH, IN CLASS 41 (U.S. CLS. 100, 101 AND 107).

FIRST USE 12-20-2007; IN COMMERCE 12-20-2007.

NO CLAIM IS MADE TO THE EXCLUSIVE RIGHT TO USE "THERAPY", APART FROM THE MARK AS SHOWN.

THE COLOR(S) WHITE, YELLOW, PINK, TURQUOISE AND GREY IS/ARE CLAIMED AS A FEATURE OF THE MARK.

THE COLOR(S) WHITE APPEARS IN THE OUTERMOST CIRCLE, THE COLOR YELLOW APPEARS IN THE DESIGN OF THE STARS, THE CENTER OF THE LOTUS BLOSSOM, AND IN THE WORDING SHIOME THERAPY, THE COLORS PINK AND WHITE APPEAR IN THE LOTUS BLOSSOM, THE COLOR GREY APPEARS IN THE DESIGN OF THE DOLPHINS, AND THE COLOR TURQUOISE APPEARS IN THE DESIGN OF THE WATER AND THE SPLASHES.

THE FOREIGN WORDING IN THE MARK TRANSLATES INTO ENGLISH AS RIP CURRENT.

SEC. 2(F).

SER. NO. 77-279,521, FILED 9-14-2007.

SUSAN RICHARDS, EXAMINING ATTORNEY

**Int. Cl.: 41**

**Prior U.S. Cls.: 100, 101 and 107**

**United States Patent and Trademark Office**

**Reg. No. 3,452,704**

**Registered June 24, 2008**

**SERVICE MARK  
PRINCIPAL REGISTER**

**SUNRISE HERALD**

BLETHEN MAINE NEWSPAPERS, INC. (WASHINGTON CORPORATION)  
390 CONGRESS STREET  
PORTLAND, ME 04101

FOR: PROVIDING ON-LINE PUBLICATIONS IN THE NATURE OF NEWSPAPERS FEATURING CURRENT EVENTS ABOUT MAINE, NEW ENGLAND AND THE WORLD, IN CLASS 41 (U.S. CLS. 100, 101 AND 107).

FIRST USE 9-4-2007; IN COMMERCE 9-4-2007.

THE MARK CONSISTS OF STANDARD CHARACTERS WITHOUT CLAIM TO ANY PARTICULAR FONT, STYLE, SIZE, OR COLOR.

SER. NO. 77-279,691, FILED 9-14-2007.

MICHAEL LEWIS, EXAMINING ATTORNEY

**Int. Cls.: 25 and 41**

**Prior U.S. Cls.: 22, 39, 100, 101 and 107**

**Reg. No. 3,452,705**

**United States Patent and Trademark Office**

**Registered June 24, 2008**

**TRADEMARK  
SERVICE MARK  
PRINCIPAL REGISTER**

**LACUNA COIL**

LACUNA COIL S.R.L. (ITALY LTD LIAB CO)  
PIAZZA CONCILIAZIONE, 5  
20123 MILAN, ITALY

FOR: CLOTHING, NAMELY, SHIRTS, SWEAT-SHIRTS, GLOVES, FOOTWEAR AND HEADGEAR, NAMELY, HATS AND CAPS, IN CLASS 25 (U.S. CLS. 22 AND 39).

FIRST USE 4-30-2006; IN COMMERCE 4-30-2006.

FOR: ENTERTAINMENT SERVICES IN THE NATURE OF LIVE PERFORMANCES BY A MUSICAL GROUP, IN CLASS 41 (U.S. CLS. 100, 101 AND 107).

FIRST USE 12-31-2001; IN COMMERCE 12-31-2001.

THE MARK CONSISTS OF STANDARD CHARACTERS WITHOUT CLAIM TO ANY PARTICULAR FONT, STYLE, SIZE, OR COLOR.

PRIORITY CLAIMED UNDER SEC. 44(D) ON ITALY APPLICATION NO. MI2007C00272, FILED 3-14-2007.

SER. NO. 77-280,000, FILED 9-14-2007.

PAUL CROWLEY, EXAMINING ATTORNEY

**Int. Cls.: 9 and 42**

**Prior U.S. Cls.: 21, 23, 26, 36, 38, 100 and 101**

**Reg. No. 3,452,706**

**United States Patent and Trademark Office**

**Registered June 24, 2008**

**TRADEMARK  
SERVICE MARK  
PRINCIPAL REGISTER**

**WSI**

WSI CORPORATION (MASSACHUSETTS CORPORATION)  
400 MINUTEMAN DRIVE  
ANDOVER, MA 01810

FOR: WEATHER INFORMATION SOFTWARE FOR THE PROCESSING AND DISPLAY OF WEATHER DATA AND FORECASTS FOR AVIATION AND OTHER APPLICATIONS , IN CLASS 9 (U.S. CLS. 21, 23, 26, 36 AND 38).

FIRST USE 11-1-1991; IN COMMERCE 11-1-1991.

FOR: PROVIDING WEATHER INFORMATION, IN CLASS 42 (U.S. CLS. 100 AND 101).

FIRST USE 3-1-1979; IN COMMERCE 3-1-1979.

THE MARK CONSISTS OF STANDARD CHARACTERS WITHOUT CLAIM TO ANY PARTICULAR FONT, STYLE, SIZE, OR COLOR.

OWNER OF U.S. REG. NOS. 1,441,513 AND 2,867,796.

SER. NO. 77-280,288, FILED 9-14-2007.

ANDREA BUTLER, EXAMINING ATTORNEY



**Int. Cl.: 16**

**Prior U.S. Cls.: 2, 5, 22, 23, 29, 37, 38 and 50**

**United States Patent and Trademark Office**

**Reg. No. 3,452,707**

**Registered June 24, 2008**

**TRADEMARK  
PRINCIPAL REGISTER**

**944 FASHION ENTERTAINMENT  
LIFESTYLE**

944 MEDIA, LLC (ARIZONA LTD LIAB CO)  
4253 N SCOTTSDALE ROAD SUITE 200  
SCOTTSDALE, AZ 85251

OWNER OF U.S. REG. NO. 3,273,648.

FOR: MAGAZINES FEATURING ACTIVITIES,  
NIGHT LIFE, CLOTHING AND FEATURES SPECI-  
FIC TO GEOGRAPHIC LOCALES, IN CLASS 16 (U.S.  
CLS. 2, 5, 22, 23, 29, 37, 38 AND 50).

NO CLAIM IS MADE TO THE EXCLUSIVE  
RIGHT TO USE FASHION, ENTERTAINMENT,  
AND LIFESTYLE, APART FROM THE MARK AS  
SHOWN.

FIRST USE 2-1-2002; IN COMMERCE 2-1-2002.

SER. NO. 77-280,362, FILED 9-14-2007.

THE MARK CONSISTS OF STANDARD CHAR-  
ACTERS WITHOUT CLAIM TO ANY PARTICULAR  
FONT, STYLE, SIZE, OR COLOR.

ELI HELLMAN, EXAMINING ATTORNEY

**Int. Cls.: 40, 41 and 42**

**Prior U.S. Cls.: 100, 101, 103, 106 and 107**

**United States Patent and Trademark Office**

**Reg. No. 3,452,708**

**Registered June 24, 2008**

**SERVICE MARK  
PRINCIPAL REGISTER**



MUNRO & ASSOCIATES (MICHIGAN CORPORATION)  
1749 NORTHWOOD DRIVE  
TROY, MI 48084

FOR: CONSULTING SERVICES PERTAINING TO ASSEMBLY FOR MANUFACTURING TECHNIQUES, IN CLASS 40 (U.S. CLS. 100, 103 AND 106).

FIRST USE 6-1-1989; IN COMMERCE 6-1-1989.

FOR: EDUCATIONAL SERVICES; NAMELY, CONDUCTING SEMINARS AND COURSES IN THE FIELD OF MANUFACTURING TECHNIQUES, IN CLASS 41 (U.S. CLS. 100, 101 AND 107).

FIRST USE 6-1-1989; IN COMMERCE 6-1-1989.

FOR: CONSULTING SERVICES PERTAINING TO DESIGN FOR MANUFACTURING TECHNIQUES, IN CLASS 42 (U.S. CLS. 100 AND 101).

FIRST USE 6-1-1989; IN COMMERCE 6-1-1989.

OWNER OF U.S. REG. NO. 2,639,348.

NO CLAIM IS MADE TO THE EXCLUSIVE RIGHT TO USE "VALUE PROFIT QUALITY", APART FROM THE MARK AS SHOWN.

THE MARK CONSISTS OF A TRIANGLE HAVING THE WORDS "VALUE", "PROFIT" AND "QUALITY" ALONG EACH SIDE THEREOF AND A HAVING THE LETTERS "D", "F" AND "M" DISPOSED WITHIN THE TRIANGLE.

SER. NO. 77-280,446, FILED 9-15-2007.

ESTHER A. BORSUK, EXAMINING ATTORNEY

**Int. Cl.: 18**

**Prior U.S. Cls.: 1, 2, 3, 22 and 41**

**United States Patent and Trademark Office**

**Reg. No. 3,452,709**

**Registered June 24, 2008**

**TRADEMARK  
PRINCIPAL REGISTER**



INVENTISTA, INC. (COLORADO CORPORATION)  
97 BENTHAVEN PLACE  
BOULDER, CO 80305

FOR: BABY AND INFANT CARRIERS WORN ON  
THE BODY, IN CLASS 18 (U.S. CLS. 1, 2, 3, 22 AND  
41).

FIRST USE 8-12-2006; IN COMMERCE 9-23-2006.

THE MARK CONSISTS OF PINWHEEL.

SER. NO. 77-280,465, FILED 9-15-2007.

DAVID I, EXAMINING ATTORNEY

**Int. Cl.: 11**

**Prior U.S. Cls.: 13, 21, 23, 31 and 34**

**United States Patent and Trademark Office**

**Reg. No. 3,452,710**

**Registered June 24, 2008**

**TRADEMARK  
PRINCIPAL REGISTER**



**Trail Designs**

TRAIL DESIGNS, LLC (CALIFORNIA LTD LIAB  
CO)  
7497 YOSEMITE PARK WAY  
YOSEMITE NATIONAL PARK, CA 95389

FOR: BACKPACKING ALCOHOL-FUELED  
STOVES AND ACCESSORIES THEREFOR, NAME-  
LY, WINDSCREENS AND PRIMER PANS SOLD AS  
COMPONENT PARTS OF STOVES , IN CLASS 11  
(U.S. CLS. 13, 21, 23, 31 AND 34).

FIRST USE 6-1-2006; IN COMMERCE 6-1-2006.

NO CLAIM IS MADE TO THE EXCLUSIVE  
RIGHT TO USE "DESIGNS", APART FROM THE  
MARK AS SHOWN.

THE MARK CONSISTS OF RECLINING "T" WITH  
A "D" ON ITS SIDE FORMING THE SHAPE OF A  
SUN SETTING BEHIND A MOUNTAIN.

SER. NO. 77-280,487, FILED 9-15-2007.

SIMON TENG, EXAMINING ATTORNEY

Int. Cl.: 16

Prior U.S. Cls.: 2, 5, 22, 23, 29, 37, 38 and 50

Reg. No. 3,452,711

United States Patent and Trademark Office

Registered June 24, 2008

TRADEMARK  
PRINCIPAL REGISTER

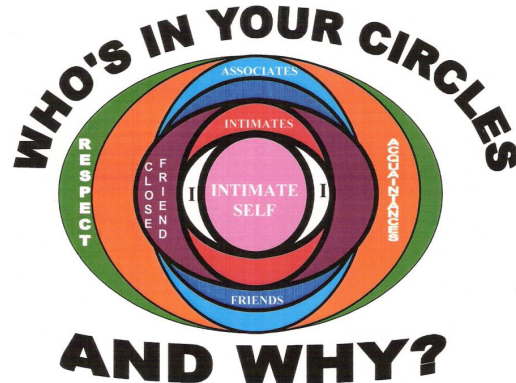

ALBERTY, JOHN CALVIN (UNITED STATES INDIVIDUAL), DBA WHO'S IN YOUR CIRCLES  
3714 WOODLAKE ROAD  
HEPHZIBAH, GA 30815

FOR: EDUCATIONAL PUBLICATIONS, NAME-  
LY, EDUCATIONAL LEARNING CARDS, FLASH  
CARDS, ACTIVITY CARDS, WORKBOOKS, TEXT-  
BOOKS, ACTIVITY BOOKS, STORY BOOKS, PUZ-  
ZLE BOOKS, PUZZLES, TEACHER GUIDES,  
MANUALS, POSTERS, EDUCATIONAL CARD  
GAMES AND EDUCATIONAL BOOKLETS IN THE  
FIELD OF COMMUNICATION, PSYCHOLOGY,  
SELF-HELP, EMPOWERMENT, IN CLASS 16 (U.S.  
CLS. 2, 5, 22, 23, 29, 37, 38 AND 50).

FIRST USE 9-1-2007; IN COMMERCE 9-3-2007.

THE COLOR(S) BLACK, GREEN, ORANGE,  
BLUE, ROYAL BLUE, PURPLE, RED, WHITE, PINK  
IS/ARE CLAIMED AS A FEATURE OF THE MARK.

THE MARK CONSISTS OF EIGHT CONCENTRIC  
CIRCLES AND OVALS, EACH CIRCLE OR OVAL  
GETS SMALLER AND ITS SURROUNDING BLACK  
LINES GET THICKER AS YOU GO FROM THE  
OUTER TO THE INNER MOST CIRCLES. THE  
OUTER MOST OVAL IS GREEN AND HAS THE

WORD "RESPECT" IN WHITE ON THE LEFT SIDE  
OF THE OVAL. THE NEXT OVAL IS ORANGE AND  
HAS THE WORD "ACQUAINTANCES" IN WHITE  
ON THE RIGHT SIDE OF THE CIRCLE. THE THIRD  
CIRCLE IS PURPLE AND THE WORDS "CLOSE  
FRIEND" APPEAR SIDE BY SIDE ON THE LEFT  
SIDE OF THE OVAL. THE NEXT OVAL APPEARS IN  
ROYAL BLUE AND HAS THE WORD "ASSOCI-  
ATES" ON THE TOP PORTION OF THE OVAL. THE  
NEXT OVAL APPEARS IN THE COLOR BLUE AND  
HAS WORD "FRIENDS" IN WHITE ON THE BOT-  
TOM PORTION OF THE OVAL. THE NEXT OVAL  
APPEARS IN RED AND HAS THE WORD "INTI-  
MATES" IN WHITE ON THE TOP PORTION OF THE  
OVAL. THE SECOND TO LAST OVAL IS IN WHITE  
AND HAS TWO "I" IN BLACK ON EITHER SIDE OF  
THE OVAL. THE INNERMOST CIRCLE IS IN PINK  
AND HAS THE WORDS "INTIMATE SELF" IN  
WHITE IN THE CENTER OF THE CIRCLE. SUR-  
ROUNDING THE CONCENTRIC CIRCLES AND  
OVALS IS THE WORDING "WHO'S IN YOUR  
CIRCLES" IN BLACK ON THE TOP OF THE CON-  
CENTRIC CIRCLES AND OVALS AND THE WORD-  
ING "AND WHY?" IN BLACK BELOW THE  
CONCENTRIC CIRCLES AND OVALS.

SER. NO. 77-280,556, FILED 9-16-2007.

DAVID I, EXAMINING ATTORNEY

**Int. Cl.: 25**

**Prior U.S. Cls.: 22 and 39**

**United States Patent and Trademark Office**

**Reg. No. 3,452,712**

**Registered June 24, 2008**

**TRADEMARK  
PRINCIPAL REGISTER**



DANA, ELIZABETH (UNITED STATES INDIVIDUAL)  
30072 OLIVE GROVE STREET  
LAKE ELSINORE, CA 92530

TOPS, TANK TOPS, HALTER TOPS, SKIRTS, DRESSES, HATS, CAPS, VISORS, BEANIES, SCARVES, BANDANNAS, BELTS, IN CLASS 25 (U.S. CLS. 22 AND 39).

FOR: CLOTHING FOR MEN, WOMEN AND CHILDREN, NAMELY, T-SHIRTS, SHORT SLEEVE SHIRTS, LONG SLEEVE SHIRTS, DRESS SHIRTS, POLO SHIRTS, SWEATERS, SWEATSHIRTS, HOODED PULLOVERS, SWEATPANTS, PANTS, SHORTS, BOXER SHORTS, BOARD SHORTS, RESORTWEAR, NAMELY, SWIM TRUNKS, SWIMSUITS, SWIMWEAR, AND BEACHWEAR, UNDERWEAR, ACTIVEWEAR, NAMELY, JOGGING SUITS, JACKETS, BLAZERS, BLOUSES, CROP

FIRST USE 6-16-2006; IN COMMERCE 6-16-2006.

THE MARK CONSISTS OF A STAR AND TWO CURVED CONICAL LINES.

SER. NO. 77-280,796, FILED 9-17-2007.

LANA PHAM, EXAMINING ATTORNEY

**Int. Cl.: 35**

**Prior U.S. Cls.: 100, 101 and 102**

**United States Patent and Trademark Office**

**Reg. No. 3,452,713**

**Registered June 24, 2008**

**SERVICE MARK  
PRINCIPAL REGISTER**

**CHARACTER COIN**

WATERSTONE PRIVATE WEALTH MANAGE-  
MENT (OKLAHOMA S CORPORATION)  
SUITE 106  
9500 NORTH 129TH EAST AVENUE  
OWASSO, OK 74055

FOR: PUBLIC ADVOCACY TO PROMOTE  
AWARENESS OF THE IMPORTANCE OF COURTE-  
SY AND INTEGRITY IN CONDUCT, IN CLASS 35  
(U.S. CLS. 100, 101 AND 102).

FIRST USE 9-7-2007; IN COMMERCE 9-7-2007.

THE MARK CONSISTS OF STANDARD CHAR-  
ACTERS WITHOUT CLAIM TO ANY PARTICULAR  
FONT, STYLE, SIZE, OR COLOR.

NO CLAIM IS MADE TO THE EXCLUSIVE  
RIGHT TO USE "COIN", APART FROM THE MARK  
AS SHOWN.

SER. NO. 77-281,050, FILED 9-17-2007.

H. M. FISHER, EXAMINING ATTORNEY

**Int. Cl.: 41**

**Prior U.S. Cls.: 100, 101 and 107**

**United States Patent and Trademark Office**

**Reg. No. 3,452,714**

**Registered June 24, 2008**

**SERVICE MARK  
PRINCIPAL REGISTER**

**YOBIVERSE**

INNOVATOR USA, INCORPORATED (MICHIGAN CORPORATION)  
6759 MINNOW POND DRIVE  
WEST BLOOMFIELD, MI 48322

FOR: ENTERTAINMENT SERVICES, NAMELY, CONDUCTING A REALITY-BASED COMPETITION INVOLVING VIDEO SUBMISSIONS VIA A WEBSITE AND A REALITY-BASED TELEVISION PROGRAM COMPETITION OVER A WIDE AREA NETWORK, IN CLASS 41 (U.S. CLS. 100, 101 AND 107).

FIRST USE 12-2-2007; IN COMMERCE 12-2-2007.

THE MARK CONSISTS OF STANDARD CHARACTERS WITHOUT CLAIM TO ANY PARTICULAR FONT, STYLE, SIZE, OR COLOR.

SER. NO. 77-281,083, FILED 9-17-2007.

NAKIA HENRY, EXAMINING ATTORNEY



**Int. Cl.: 3**

**Prior U.S. Cls.: 1, 4, 6, 50, 51 and 52**

**United States Patent and Trademark Office**

**Reg. No. 3,452,715**

**Registered June 24, 2008**

**TRADEMARK  
PRINCIPAL REGISTER**

**SCENTS UNLIMITED**

SCENTS UNLIMITED, LLC (SOUTH CAROLINA  
LTD LIAB CO)  
UNIT F  
2229 HIGHWAY 17  
LITTLE RIVER, SC 29566

FOR: PERFUMES AND NON-MEDICATED TOI-  
LETRIES, IN CLASS 3 (U.S. CLS. 1, 4, 6, 50, 51 AND  
52).

FIRST USE 4-30-2006; IN COMMERCE 4-30-2006.

THE MARK CONSISTS OF STANDARD CHAR-  
ACTERS WITHOUT CLAIM TO ANY PARTICULAR  
FONT, STYLE, SIZE, OR COLOR.

NO CLAIM IS MADE TO THE EXCLUSIVE  
RIGHT TO USE "SCENTS", APART FROM THE  
MARK AS SHOWN.

SER. NO. 77-281,795, FILED 9-18-2007.

WENDY GOODMAN, EXAMINING ATTORNEY

**Int. Cl.: 35**

**Prior U.S. Cls.: 100, 101 and 102**

**United States Patent and Trademark Office**

**Reg. No. 3,452,716**

**Registered June 24, 2008**

**SERVICE MARK  
PRINCIPAL REGISTER**



CITY OF SALEM, OREGON (OREGON MUNICIPAL CORPORATION)  
ROOM 205  
555 LIBERTY STREET SE  
SALEM, OR 973013513

FOR: ADVERTISING SERVICES, NAMELY, PROMOTING THE COMMERCIAL AIRLINE SERVICES OF OTHERS AND PROMOTING THE INTEREST OF COMMERCIAL AIRLINES BY ENCOURAGING THE USE OF COMMERCIAL FLIGHTS, IN CLASS 35 (U.S. CLS. 100, 101 AND 102).

FIRST USE 5-10-2007; IN COMMERCE 5-10-2007.

NO CLAIM IS MADE TO THE EXCLUSIVE RIGHT TO USE "FLY SALEM", APART FROM THE MARK AS SHOWN.

THE COLOR(S) BLACK, WHITE, GREEN, ORANGE, DARK BLUE, SKY BLUE, AND TEAL BLUE IS/ARE CLAIMED AS A FEATURE OF THE MARK.

THE MARK CONSISTS OF THREE AIRPLANE TAIL WINGS WITH A SWOOPING EXHAUST STREAM ON A RECTANGULAR SKY AND THE WORDING "FLY SALEM" BELOW THE RECTANGULAR SKY, ALL IN A RECTANGULAR BACKGROUND. THE COLOR BLACK APPEARS IN THE WORDING "FLY SALEM". FROM LEFT TO RIGHT, THE COLOR GREEN APPEARS IN THE FIRST TAIL WING, THE COLOR ORANGE APPEARS IN THE SECOND TAIL WING AND THE COLOR DARK BLUE APPEARS IN THE THIRD TAIL WING. THE COLORS TEAL GREEN AND WHITE APPEAR IN THE SWOOPING EXHAUST STEAM FADING FROM LEFT TO RIGHT. THE COLOR LIGHT SKY BLUE APPEARS IN THE RECTANGULAR SKY ENCOMPASSING THE TAIL WINGS AND EXHAUST STREAM. THE COLOR WHITE APPEARS IN THE OUTLINE OF EACH TAIL WING AND THE RECTANGULAR BACKGROUND OF THE MARK.

SER. NO. 77-282,203, FILED 9-18-2007.

TINA BROWN, EXAMINING ATTORNEY

Int. Cl.: 35

Prior U.S. Cls.: 100, 101 and 102

United States Patent and Trademark Office

Reg. No. 3,452,717

Registered June 24, 2008

**SERVICE MARK  
PRINCIPAL REGISTER**



JOHNSON, KATERINA (UNITED STATES INDIVIDUAL)  
71 GLENGARY DRIVE  
ROSSVILLE, GA 30741

FOR: RETAIL STORE FEATURING SPELL BOUND, WITCH OWNED, WITCH MADE, AND WITCH BLESSED CANDLES, JEWELRY, POTIONS, INCENSE, AROMATHERAPY OILS, CRYSTALS, BOOKS, AND DECORATIVE ITEMS , IN CLASS 35 (U.S. CLS. 100, 101 AND 102).

FIRST USE 2-14-1989; IN COMMERCE 10-29-2005.

THE COLOR(S) AQUA BLUE, BLACK, PINK, PURPLE IS/ARE CLAIMED AS A FEATURE OF THE MARK.

THE MARK CONSISTS OF ALL BLACK BACKGROUND, COMPANY NAME IS PURPLE LETTERING HIGHLIGHTED IN AQUA BLUE, WITH AQUA BLUE STARS, MY IMAGE WITH BLACK HAIR IS IN THE MIDDLE OF THE MARK AND IS TINTED IN AQUA BLUE WITH PINK AND PURPLE TREES SURROUNDING ME.

SER. NO. 77-282,231, FILED 9-18-2007.

CAROL SPILS, EXAMINING ATTORNEY

**Int. Cl.: 9**

**Prior U.S. Cls.: 21, 23, 26, 36 and 38**

**Reg. No. 3,452,718**

**United States Patent and Trademark Office**

**Registered June 24, 2008**

---

**TRADEMARK  
PRINCIPAL REGISTER**

**FFlex eSuite**

FLETCHER-FLORA HEALTH CARE SYSTEMS  
INC. (GEORGIA CORPORATION)  
1580 ORANGETHORPE WAY  
ANAHEIM, CA 92801

FOR: COMPUTER SOFTWARE THAT MANAGES  
PATIENT LABORATORY DATA FOR USE IN THE  
CLINICAL LABORATORY, IN CLASS 9 (U.S. CLS. 21,  
23, 26, 36 AND 38).

FIRST USE 2-1-2007; IN COMMERCE 2-1-2007.

THE MARK CONSISTS OF STANDARD CHAR-  
ACTERS WITHOUT CLAIM TO ANY PARTICULAR  
FONT, STYLE, SIZE, OR COLOR.

NO CLAIM IS MADE TO THE EXCLUSIVE  
RIGHT TO USE "ESUITE", APART FROM THE  
MARK AS SHOWN.

SER. NO. 77-282,242, FILED 9-18-2007.

JIM RINGLE, EXAMINING ATTORNEY

**Int. Cl.: 7**

**Prior U.S. Cls.: 13, 19, 21, 23, 31, 34 and 35**

**Reg. No. 3,452,719**

**United States Patent and Trademark Office**

**Registered June 24, 2008**

**TRADEMARK  
PRINCIPAL REGISTER**

**FLAME-THROWER**

PERTRONIX INC. (CALIFORNIA CORPORATION)  
440 E. ARROW HIGHWAY  
SAN DIMAS, CA 91773

FOR: AUTOMOTIVE ENGINE PARTS, NAMELY,  
SPARK PLUG WIRES; DISTRIBUTORS FOR VEHICLES  
AND PARTS THEREOF, IN CLASS 7 (U.S. CLS.  
13, 19, 21, 23, 31, 34 AND 35).

FIRST USE 6-30-1998; IN COMMERCE 6-30-1998.

THE MARK CONSISTS OF STANDARD CHARACTERS  
WITHOUT CLAIM TO ANY PARTICULAR FONT,  
STYLE, SIZE, OR COLOR.

OWNER OF U.S. REG. NO. 2,107,938.

SER. NO. 77-282,323, FILED 9-18-2007.

GEORGE LORENZO, EXAMINING ATTORNEY

**Int. Cl.: 9**

**Prior U.S. Cls.: 21, 23, 26, 36 and 38**

**Reg. No. 3,452,720**

**United States Patent and Trademark Office**

**Registered June 24, 2008**

---

**TRADEMARK  
PRINCIPAL REGISTER**

**DigiBahn**

TURN-LUCKILY INTERNATIONAL, INC (CALI-  
FORNIA CORPORATION), DBA TOTAL  
TECHNOLOGIES, LTD.  
9 STUDEBAKER ROAD  
IRVINE, CA 92618

THE MARK CONSISTS OF STANDARD CHAR-  
ACTERS WITHOUT CLAIM TO ANY PARTICULAR  
FONT, STYLE, SIZE, OR COLOR.

FOR: ELECTRONIC COMPONENTS, NAMELY,  
CONNECTORS, CABLES AND ADAPTERS, IN  
CLASS 9 (U.S. CLS. 21, 23, 26, 36 AND 38).

SER. NO. 77-282,733, FILED 9-18-2007.

FIRST USE 9-1-2007; IN COMMERCE 9-1-2007.

JAMES A. RAUEN, EXAMINING ATTORNEY

Int. Cl.: 41

Prior U.S. Cls.: 100, 101 and 107

United States Patent and Trademark Office

Reg. No. 3,452,721

Registered June 24, 2008

**SERVICE MARK  
PRINCIPAL REGISTER**



HAMILTON, MICHAEL (UNITED STATES INDIVIDUAL)  
227 DENTON PLACE  
ROOSEVELT, NY 11575

FOR: ENTERTAINMENT SERVICES, NAMELY, PROVIDING A WEBSITE FEATURING ADULT-THEMED PHOTOGRAPHS AND VIDEOS, IN CLASS 41 (U.S. CLS. 100, 101 AND 107).

FIRST USE 3-1-1999; IN COMMERCE 12-23-2006.

NO CLAIM IS MADE TO THE EXCLUSIVE RIGHT TO USE "DOMINICAN", APART FROM THE MARK AS SHOWN.

THE COLOR(S) RED, WHITE, BLUE AND GRAY IS/ARE CLAIMED AS A FEATURE OF THE MARK.

THE MARK CONSISTS OF A REPRESENTATION OF A WOMAN WITH THE UPPER LEFT SIDE AND LOWER RIGHT SIDE IN RED, THE UPPER RIGHT SIDE AND LOWER LEFT SIDE IN BLUE AND A WHITE CROSS IN THE MIDDLE; THE WORDING "DOMINICAN" IS IN RED, THE WORD "HIPZ" IS IN WHITE WITH A GRAY OUTLINE AND SHADING; A PARTIAL REFLECTION APPEARS BELOW THE DESIGN IN SLIGHTLY DULLED COLORS AS PREVIOUSLY INDICATED.

SER. NO. 77-282,866, FILED 9-18-2007.

SUE LAWRENCE, EXAMINING ATTORNEY

**Int. Cl.: 42**

**Prior U.S. Cls.: 100 and 101**

**United States Patent and Trademark Office**

**Reg. No. 3,452,722**

**Registered June 24, 2008**

**SERVICE MARK  
PRINCIPAL REGISTER**

**VortexDNA**

VORTEX TECHNOLOGY SERVICES LTD (NEW  
ZEALAND LIMITED COMPANY)  
3 ROLAND LANE  
CHRISTCHURCH, NEW ZEALAND

FOR: APPLICATION SERVICE PROVIDER (ASP)  
FEATURING SOFTWARE FOR USE IN EVALUAT-  
ING, ASSESSING AND PROFILING CUSTOMER  
RELATIONS WITH ORGANIZATIONS AND THE  
CONTEXTUAL WORLD TO ENHANCE THE QUAL-  
ITY OF THOSE RELATIONSHIPS, IN CLASS 42 (U.S.  
CLS. 100 AND 101).

FIRST USE 10-1-2006; IN COMMERCE 10-1-2006.

THE MARK CONSISTS OF STANDARD CHAR-  
ACTERS WITHOUT CLAIM TO ANY PARTICULAR  
FONT, STYLE, SIZE, OR COLOR.

SER. NO. 77-282,912, FILED 9-18-2007.

KELLY BOULTON, EXAMINING ATTORNEY



**Int. Cls.: 35, 37 and 42**

**Prior U.S. Cls.: 100, 101, 102, 103 and 106**

**United States Patent and Trademark Office**

**Reg. No. 3,452,723**

**Registered June 24, 2008**

**SERVICE MARK  
PRINCIPAL REGISTER**

# FORD & EARL

FORD & EARL ASSOCIATES, INC. (MICHIGAN CORPORATION)  
350 WEST BIG BEAVER ROAD  
TROY, MI 48084

FOR: ADVERTISING AND MARKETING SERVICES, NAMELY, PROVIDING STRATEGIC PROGRAMS AND PLANNING FOR PRODUCT, BRAND, MARK, AND IDENTITY RECOGNITION THROUGH AUDIO/VISUAL MEDIA PRODUCTION AND COMMUNICATION, IN CLASS 35 (U.S. CLS. 100, 101 AND 102).

FIRST USE 9-1-1983; IN COMMERCE 9-1-1983.

FOR: BUILDING CONSTRUCTION AND REPAIR; RESIDENTIAL, COMMERCIAL AND INDUSTRIAL BUILDING CONSTRUCTION; BUILDING CONSTRUCTION SITE ANALYSIS AND INSPECTION, IN CLASS 37 (U.S. CLS. 100, 103 AND 106).

FIRST USE 9-1-1983; IN COMMERCE 9-1-1983.

FOR: ARCHITECTURAL ENGINEERING AND DESIGN; INDUSTRIAL ENGINEERING AND DESIGN; GRAPHIC DESIGN AND PRESENTATION; INTERIOR DESIGN AND PLANNING; INSPECTION AND ANALYSIS OF PRE-EXISTING STRUCTURES FOR BUILDING CONSTRUCTION AND RENOVATION, IN CLASS 42 (U.S. CLS. 100 AND 101).

FIRST USE 9-1-1983; IN COMMERCE 9-1-1983.

THE MARK CONSISTS OF STANDARD CHARACTERS WITHOUT CLAIM TO ANY PARTICULAR FONT, STYLE, SIZE, OR COLOR.

SER. NO. 77-283,004, FILED 9-19-2007.

PAM WILLIS, EXAMINING ATTORNEY

**Int. Cl.: 35**

**Prior U.S. Cls.: 100, 101 and 102**

**United States Patent and Trademark Office**

**Reg. No. 3,452,724**

**Registered June 24, 2008**

**SERVICE MARK  
PRINCIPAL REGISTER**

**NOBC**

NATIONAL ORGANIZATION OF BAR COUNSEL  
(D.C. NON-PROFIT ORGANIZATION)  
C/O THE CENTER FOR ASSOCIATION RESOURCES  
1901 NORTH ROSELLE ROAD  
SCHAUMBURG, IL 60195

FOR: LEGAL ASSOCIATION SERVICES, NAME-  
LY, PROMOTING THE INTERESTS OF LAWYERS  
WHO REVIEW, UPDATE, ADMINISTER, AND EN-  
FORCE THE ETHICS RULES THAT REGULATE  
THE PROFESSIONAL CONDUCT OF LAWYERS;  
AND LEGAL ASSOCIATION SERVICES, NAMELY,  
PROMOTING PUBLIC AWARENESS OF THE NEED  
TO REVIEW, UPDATE, ADMINISTER, AND EN-

FORCE THE ETHICS RULES THAT REGULATE  
THE PROFESSIONAL CONDUCT OF LAWYERS, IN  
CLASS 35 (U.S. CLS. 100, 101 AND 102).

FIRST USE 3-11-1977; IN COMMERCE 8-0-1977.

THE MARK CONSISTS OF STANDARD CHAR-  
ACTERS WITHOUT CLAIM TO ANY PARTICULAR  
FONT, STYLE, SIZE, OR COLOR.

SER. NO. 77-283,065, FILED 9-19-2007.

KATHERINE CHANG, EXAMINING ATTORNEY

**Int. Cls.: 9 and 35**

**Prior U.S. Cls.: 21, 23, 26, 36, 38, 100, 101 and 102**

**Reg. No. 3,452,725**

**United States Patent and Trademark Office**

**Registered June 24, 2008**

**TRADEMARK  
SERVICE MARK  
PRINCIPAL REGISTER**



HR SERVICES, INC. (OHIO CORPORATION)  
216 NORTH ELIZABETH STREET, PO BOX 1155  
LIMA, OH 458021155

FOR: COMPUTER SOFTWARE FOR SOURCING AND TRACKING JOB APPLICANTS, AUTOMATING THE HIRING OF JOB APPLICANTS AND FOR ANALYZING AND PROCESSING DOCUMENTS IN THE FIELD OF HUMAN RESOURCES MANAGEMENT, IN CLASS 9 (U.S. CLS. 21, 23, 26, 36 AND 38).

FIRST USE 6-20-2007; IN COMMERCE 6-20-2007.

FOR: PERSONNEL SERVICES, NAMELY, PROVIDING SERVICES TO EMPLOYERS TO SOURCE AND TRACK JOB APPLICANTS, AUTOMATE THE

HIRING PROCESS AND ANALYZE AND PROCESS DOCUMENTS IN THE FIELD OF HUMAN RESOURCES, ALL DELIVERED VIA THE INTERNET, IN CLASS 35 (U.S. CLS. 100, 101 AND 102).

FIRST USE 6-20-2007; IN COMMERCE 6-20-2007.

OWNER OF U.S. REG. NO. 2,617,396.

THE MARK CONSISTS OF THE WORDS "MYSTAFFINGPRO" WITH THE "Y" REPRESENTED BY A THREE-POINT STAR WITH A CIRCLE ON TOP.

SER. NO. 77-283,121, FILED 9-19-2007.

ROBERT C. CLARK JR., EXAMINING ATTORNEY

Int. Cl.: 36

Prior U.S. Cls.: 100, 101 and 102

United States Patent and Trademark Office

Reg. No. 3,452,726

Registered June 24, 2008

SERVICE MARK  
PRINCIPAL REGISTER



THE MARK WINE GROUP LLC (CALIFORNIA  
LTD LIAB CO), DBA MONDOVINO  
60 LAURELWOOD DRIVE  
NOVATO, CA 94949

FOR: BROKERAGE IN THE FIELD OF WINE, IN  
CLASS 36 (U.S. CLS. 100, 101 AND 102).

FIRST USE 6-11-2007; IN COMMERCE 6-11-2007.

THE COLOR(S) GREEN AND RED IS/ARE  
CLAIMED AS A FEATURE OF THE MARK.

THE MARK CONSISTS OF THE NAME MONDO-  
VINO, COLOR OF THE FIRST PART OF THE NAME

I.E., "MONDO" IN GREEN AND THE SECOND  
HALF OF THE NAME I.E., "VINO" IN RED, FOL-  
LOWED BY A LARGE STYLIZED CAPITAL LET-  
TER "M" IN THE GREEN, LETTER "M" IS ABOVE  
AND TO THE RIGHT SIDE OF THE WORDING  
"MONDOVINO".

"THE FOREIGN WORDING IN THE MARK  
TRANSLATES INTO ENGLISH AS WORLD WINE."

SER. NO. 77-283,289, FILED 9-19-2007.

ANNE FARRELL, EXAMINING ATTORNEY

**Int. Cl.: 13**

**Prior U.S. Cls.: 2 and 9**

**United States Patent and Trademark Office**

**Reg. No. 3,452,727**

**Registered June 24, 2008**

**TRADEMARK  
PRINCIPAL REGISTER**

**FUSION**

FEDERAL CARTRIDGE COMPANY (MINNESOTA CORPORATION)  
900 EHLEN DRIVE  
ANOKA, MN 55303

FOR: AMMUNITION; AMMUNITION COMPONENTS; MUZZLE LOADING PRIMERS BEING AMMUNITION COMPONENTS; MUZZLE LOADING SABOTS AND MUZZLE LOADING BULLETS, IN CLASS 13 (U.S. CLS. 2 AND 9).

FIRST USE 9-30-2004; IN COMMERCE 2-9-2005.

THE MARK CONSISTS OF STANDARD CHARACTERS WITHOUT CLAIM TO ANY PARTICULAR FONT, STYLE, SIZE, OR COLOR.

OWNER OF U.S. REG. NOS. 3,113,819 AND 3,146,532.

SER. NO. 77-283,855, FILED 9-19-2007.

RUDY R. SINGLETON, EXAMINING ATTORNEY

**Int. Cls.: 35 and 36**

**Prior U.S. Cls.: 100, 101 and 102**

**United States Patent and Trademark Office**

**Reg. No. 3,452,728**

**Registered June 24, 2008**

**SERVICE MARK  
PRINCIPAL REGISTER**

**TAKE THIS JOB AND LOVE IT**

LANDRUM HUMAN RESOURCE COMPANIES,  
INC. (FLORIDA CORPORATION)  
6723 PLANTATION ROAD  
PENSACOLA, FL 32504

FOR: HUMAN RESOURCE SERVICES, NAMELY,  
PROVIDING EMPLOYMENT RECORDS MANAGE-  
MENT FOR BUSINESSES, IN CLASS 35 (U.S. CLS.  
100, 101 AND 102).

FIRST USE 11-30-2006; IN COMMERCE 11-30-2006.

FOR: HUMAN RESOURCE SERVICES, NAMELY,  
ADMINISTRATION OF EMPLOYEE BENEFIT  
PLANS CONCERNING INSURANCE AND FI-  
NANCE, PROCESSING UNEMPLOYMENT INSUR-

ANCE CLAIMS, UNDERWRITING AND  
ADMINISTERING WORKERS' COMPENSATION  
INSURANCE, IN CLASS 36 (U.S. CLS. 100, 101 AND  
102).

FIRST USE 11-30-2006; IN COMMERCE 11-30-2006.

THE MARK CONSISTS OF STANDARD CHAR-  
ACTERS WITHOUT CLAIM TO ANY PARTICULAR  
FONT, STYLE, SIZE, OR COLOR.

SER. NO. 77-284,665, FILED 9-20-2007.

MAUREEN DALL, EXAMINING ATTORNEY

**Int. Cl.: 16**

**Prior U.S. Cls.: 2, 5, 22, 23, 29, 37, 38 and 50**

**United States Patent and Trademark Office**

**Reg. No. 3,452,729**

**Registered June 24, 2008**

**TRADEMARK  
PRINCIPAL REGISTER**

**PIRANHA CLUB**

HEARST HOLDINGS, INC. (DELAWARE CORPORATION)  
959 EIGHTH AVENUE  
NEW YORK, NY 10019

FOR: CARTOON PRINTS; CARTOON STRIPS, IN CLASS 16 (U.S. CLS. 2, 5, 22, 23, 29, 37, 38 AND 50).

FIRST USE 9-30-1998; IN COMMERCE 9-30-1998.

THE MARK CONSISTS OF STANDARD CHARACTERS WITHOUT CLAIM TO ANY PARTICULAR FONT, STYLE, SIZE, OR COLOR.

SER. NO. 77-284,745, FILED 9-20-2007.

ALEXANDER L. POWERS, EXAMINING ATTORNEY

**Int. Cls.: 36 and 37**

**Prior U.S. Cls.: 100, 101, 102, 103 and 106**

**United States Patent and Trademark Office**

**Reg. No. 3,452,730**

**Registered June 24, 2008**

**SERVICE MARK  
PRINCIPAL REGISTER**

**AMERICA'S CAPITAL PARTNERS**

AMERICA'S CAPITAL PARTNERS, LLC (FLOR-  
IDA LTD LIAB CO)  
SUITE 900  
444 BRICKELL AVENUE  
MIAMI, FL 33131

FOR: REAL ESTATE SERVICES, NAMELY, REAL  
ESTATE BROKERAGE, MANAGEMENT AND  
LEASING SERVICES, IN CLASS 36 (U.S. CLS. 100,  
101 AND 102).

FIRST USE 6-0-1998; IN COMMERCE 6-0-1998.

FOR: REAL ESTATE DEVELOPMENT SERVICES,  
IN CLASS 37 (U.S. CLS. 100, 103 AND 106).

FIRST USE 6-0-1998; IN COMMERCE 6-0-1998.

THE MARK CONSISTS OF STANDARD CHAR-  
ACTERS WITHOUT CLAIM TO ANY PARTICULAR  
FONT, STYLE, SIZE, OR COLOR.

OWNER OF U.S. REG. NO. 2,505,635.

SEC. 2(F).

SER. NO. 77-284,780, FILED 9-20-2007.

NELSON SNYDER, EXAMINING ATTORNEY



**Int. Cl.: 35**

**Prior U.S. Cls.: 100, 101 and 102**

**United States Patent and Trademark Office**

**Reg. No. 3,452,731**

**Registered June 24, 2008**

**SERVICE MARK  
PRINCIPAL REGISTER**



enchanting **GROUP**

EMDECE GROUP S.A. (ARGENTINA CORPORATION)  
FLORIDA 935  
BUENOS AIRES, ARGENTINA C1005AAS

FOR: ADMINISTRATIVE HOTEL MANAGEMENT; BUSINESS MANAGEMENT OF HOTELS FOR OTHERS; HOTEL MANAGEMENT FOR OTHERS; MANAGEMENT OF HOTEL INCENTIVE PROGRAMS OF OTHERS; MANAGING AND OPERATING RESORT HOTELS AND BUSINESS CONFERENCE CENTERS OF OTHERS; PROVID-

ING HOTEL RATE COMPARISON INFORMATION, IN CLASS 35 (U.S. CLS. 100, 101 AND 102).

FIRST USE 3-1-2007; IN COMMERCE 3-1-2007.

NO CLAIM IS MADE TO THE EXCLUSIVE RIGHT TO USE "GROUP", APART FROM THE MARK AS SHOWN.

SER. NO. 77-284,854, FILED 9-20-2007.

DEIRDRE ROBERTSON, EXAMINING ATTORNEY

**Int. Cl.: 34**

**Prior U.S. Cls.: 2, 8, 9 and 17**

**United States Patent and Trademark Office**

**Reg. No. 3,452,732**

**Registered June 24, 2008**

**TRADEMARK  
PRINCIPAL REGISTER**

**Sublimes**

SUPERIOR CIGARS USA INC. (FLORIDA CORPORATION)  
5970 SW 18TH STREET, #302  
BOCA RATON, FL 33433

FOR: CIGARS; CIGAR CUTTERS; HUMIDORS,  
IN CLASS 34 (U.S. CLS. 2, 8, 9 AND 17).

FIRST USE 2-26-2004; IN COMMERCE 2-26-2004.

NO CLAIM IS MADE TO THE EXCLUSIVE  
RIGHT TO USE SUBLIMES, APART FROM THE  
MARK AS SHOWN.

THE MARK CONSISTS OF THE WORD "SUBLIMES" IN STYLIZED LETTERS.

SER. NO. 77-284,938, FILED 9-20-2007.

CHERYL CLAYTON, EXAMINING ATTORNEY

**Int. Cl.: 35**

**Prior U.S. Cls.: 100, 101 and 102**

**United States Patent and Trademark Office**

**Reg. No. 3,452,733**

**Registered June 24, 2008**

**SERVICE MARK  
PRINCIPAL REGISTER**

**TRUDYS BRIDES**

TRUDY'S, INC. (CALIFORNIA CORPORATION)  
1875 S. BASCOM AVENUE  
CAMPBELL, CA 95008

FOR: RETAIL STORE SERVICES FEATURING  
CLOTHING, JEWELRY AND ACCESSORIES FOR  
WEDDINGS AND SPECIAL OCCASIONS, IN CLASS  
35 (U.S. CLS. 100, 101 AND 102).

FIRST USE 6-1-1975; IN COMMERCE 6-1-1975.

THE MARK CONSISTS OF STANDARD CHAR-  
ACTERS WITHOUT CLAIM TO ANY PARTICULAR  
FONT, STYLE, SIZE, OR COLOR.

NO CLAIM IS MADE TO THE EXCLUSIVE  
RIGHT TO USE "BRIDES", APART FROM THE  
MARK AS SHOWN.

SER. NO. 77-285,104, FILED 9-20-2007.

RUDY R. SINGLETON, EXAMINING ATTORNEY

**Int. Cl.: 41**

**Prior U.S. Cls.: 100, 101 and 107**

**United States Patent and Trademark Office**

**Reg. No. 3,452,734**

**Registered June 24, 2008**

**SERVICE MARK  
PRINCIPAL REGISTER**

**GOD-O-METER**

BELIEFNET, INC. (DELAWARE CORPORATION)  
115 EAST 23RD STREET  
NEW YORK, NY 10010

FOR: ENTERTAINMENT SERVICES, NAMELY,  
PROVIDING A WEB SITE FEATURING ONLINE  
MAGAZINE ARTICLES AND AN INTERACTIVE  
METER FOR USE IN ANALYZING THE USE OF  
RELIGION AND SPIRITUALITY BY PRESIDENTIAL  
CANDIDATES, IN CLASS 41 (U.S. CLS. 100,  
101 AND 107).

FIRST USE 6-12-1999; IN COMMERCE 6-12-1999.

THE MARK CONSISTS OF STANDARD CHAR-  
ACTERS WITHOUT CLAIM TO ANY PARTICULAR  
FONT, STYLE, SIZE, OR COLOR.

SER. NO. 77-285,475, FILED 9-21-2007.

HOWARD SMIGA, EXAMINING ATTORNEY

**Int. Cl.: 22**

**Prior U.S. Cls.: 1, 2, 7, 19, 22, 42 and 50**

**Reg. No. 3,452,735**

**United States Patent and Trademark Office**

**Registered June 24, 2008**

**TRADEMARK  
PRINCIPAL REGISTER**

**TOPPLE STOPPER**

UPTOWN TOTS, LLC (CALIFORNIA LTD LIAB  
CO)  
1216 KORNBLUM AVE.  
TORRANCE, CA 90503

FOR: POLYESTER GROSGRAIN TETHERING  
CORD THAT CONNECTS ONE END TO A HIGH  
CHAIR OR STROLLER, AND THE OTHER END TO  
CHILDREN'S TOYS OR CUPS/BOTTLES, PREVENT-  
ING THEM FROM FALLING ON THE FLOOR, IN  
CLASS 22 (U.S. CLS. 1, 2, 7, 19, 22, 42 AND 50).

FIRST USE 7-14-2007; IN COMMERCE 10-8-2007.

THE MARK CONSISTS OF STANDARD CHAR-  
ACTERS WITHOUT CLAIM TO ANY PARTICULAR  
FONT, STYLE, SIZE, OR COLOR.

SER. NO. 77-285,565, FILED 9-21-2007.

STEVEN R. FINE, EXAMINING ATTORNEY

**Int. Cls.: 25 and 41**

**Prior U.S. Cls.: 22, 39, 100, 101 and 107**

**United States Patent and Trademark Office**

**Reg. No. 3,452,736**

**Registered June 24, 2008**

**TRADEMARK  
SERVICE MARK  
PRINCIPAL REGISTER**



CATZ LLC (DELAWARE LIMITED LIABILITY COMPANY)  
114 FIRST AVENUE  
NEEDHAM, MA 02494

FOR: CLOTHING, NAMELY, HATS, T-SHIRTS, SWEATSHIRT, SHIRTS, PANTS AND JACKETS, IN CLASS 25 (U.S. CLS. 22 AND 39).

FIRST USE 8-1-1999; IN COMMERCE 8-1-1999.

FOR: PERSONAL FITNESS TRAINING, ATHLETE CONDITIONING PROGRAMS, GROUP EXERCISE CLASSES, SPORTS PERFORMANCES CAMPS AND POST REHABILITATION; ARRANGING AND CONDUCTING CLASSES, SEMINARS AND WORKSHOPS IN THE FIELDS OF PHYSICAL FITNESS, ATHLETIC CONDITIONING, EXERCISE, SPORTS PERFORMANCE, PHYSICAL REHABILITATION, INJURY PREVENTION, SPORTS TRAINING, HEALTH AND NUTRITION; PROVIDING EDUCATIONAL INFORMATION IN THE FIELDS OF PHYSICAL FITNESS, ATHLETIC CONDITIONING, EXERCISE, SPORTS PERFORMANCE, PHYSICAL SPORTS REHABILITATION, AND SPORTS INJURY PREVENTION; PROVIDING NEWS AND INFORMATION IN THE FIELD OF SPORTS; ON-

LINE JOURNALS, NAMELY, BLOGS FEATURING PHYSICAL FITNESS, ATHLETIC CONDITIONING, EXERCISE, SPORTS PERFORMANCE, PHYSICAL REHABILITATION, INJURY PREVENTION, SPORTS TRAINING, HEALTH AND NUTRITION; AND PROVIDING ON-LINE PUBLICATIONS IN THE NATURE OF NEWSLETTERS IN THE FIELDS OF PHYSICAL FITNESS, ATHLETIC CONDITIONING, EXERCISE, SPORTS PERFORMANCE, PHYSICAL REHABILITATION, INJURY PREVENTION, SPORTS TRAINING, HEALTH AND NUTRITION, IN CLASS 41 (U.S. CLS. 100, 101 AND 107).

FIRST USE 8-1-1999; IN COMMERCE 8-1-1999.

OWNER OF U.S. REG. NO. 2,494,064.

THE MARK CONSISTS OF THE STYLIZED WORD "CATZ" WHERE A STYLIZED DEPICTION OF A CAT'S HEAD IS INCORPORATED IN THE LETTER "C".

SER. NO. 77-285,610, FILED 9-21-2007.

INGRID C. EULIN, EXAMINING ATTORNEY

**Int. Cl.: 37**

**Prior U.S. Cls.: 100, 103 and 106**

**United States Patent and Trademark Office**

**Reg. No. 3,452,737**

**Registered June 24, 2008**

**SERVICE MARK  
PRINCIPAL REGISTER**



ARPA SUPPORT SERVICES, INC. (FLORIDA CORPORATION)  
12800 NW 38TH AVE  
OPA LOCKA, FL 33054

FOR: HVAC CONTRACTOR SERVICES; MAINTENANCE AND/OR REPAIR OF COMMERCIAL EQUIPMENT, NAMELY, HEATING, VENTILATION, AIR CONDITIONING AND REFRIGERATION EQUIPMENT, IN CLASS 37 (U.S. CLS. 100, 103 AND 106).

FIRST USE 1-1-2004; IN COMMERCE 1-1-2004.

NO CLAIM IS MADE TO THE EXCLUSIVE RIGHT TO USE "SUPPORT SERVICES, INC.", APART FROM THE MARK AS SHOWN.

SER. NO. 77-286,171, FILED 9-21-2007.

PAUL MORENO, EXAMINING ATTORNEY

Int. Cl.: 35

Prior U.S. Cls.: 100, 101 and 102

United States Patent and Trademark Office

Reg. No. 3,452,738

Registered June 24, 2008

**SERVICE MARK  
PRINCIPAL REGISTER**



NEW WORLD CONNECTIONS, INC. (ILLINOIS CORPORATION)  
956 S. BARTLETT RD.  
BARTLETT, IL 601036552

FOR: BUSINESS CONSULTING IN THE FIELD OF PROFESSIONAL DEVELOPMENT; BUSINESS MANAGEMENT CONSULTING, IN CLASS 35 (U.S. CLS. 100, 101 AND 102).

FIRST USE 5-15-2002; IN COMMERCE 5-15-2002.

NO CLAIM IS MADE TO THE EXCLUSIVE RIGHT TO USE "INC.", APART FROM THE MARK AS SHOWN.

THE MARK CONSISTS OF A DRAGON OVER THE WORDS "NWC NEW WORLD CONNECTIONS, INC." IN STYLIZED TEXT.

SER. NO. 77-286,228, FILED 9-21-2007.

KATHY DE JONGE, EXAMINING ATTORNEY



**Int. Cl.: 41**

**Prior U.S. Cls.: 100, 101 and 107**

**United States Patent and Trademark Office**

**Reg. No. 3,452,739**

**Registered June 24, 2008**

**SERVICE MARK  
PRINCIPAL REGISTER**



AARON SCHOOL (NEW YORK LTD LIAB CO)  
309 EAST 45TH STREET  
NEW YORK, NY 10017

FOR: EDUCATION SERVICES, NAMELY, PROVIDING CLASSES IN THE FIELD OF CHILD DEVELOPMENT, IN CLASS 41 (U.S. CLS. 100, 101 AND 107).

FIRST USE 7-1-2003; IN COMMERCE 7-1-2003.

NO CLAIM IS MADE TO THE EXCLUSIVE RIGHT TO USE "SCHOOL" & "FOUNDED 2002", APART FROM THE MARK AS SHOWN.

THE MARK CONSISTS OF A TREE NEXT TO THE WORD "AARON". UNDER THIS, THERE IS A LINE; UNDER THE LINE READS "FOUNDED 2002" UNDER THE TREE, AND "SCHOOL" UNDER "AARON".

SER. NO. 77-286,307, FILED 9-21-2007.

PAM WILLIS, EXAMINING ATTORNEY

**Int. Cl.: 44**

**Prior U.S. Cls.: 100 and 101**

**United States Patent and Trademark Office**

**Reg. No. 3,452,740**

**Registered June 24, 2008**

**SERVICE MARK  
PRINCIPAL REGISTER**

**Wellife, LLC**

WELLIFE, LLC (PENNSYLVANIA LTD LIAB CO)  
1512 ASHLAND STREET  
1602 BROAD STREET  
GREENSBURG, PA 15601

FOR: MEDICAL COUNSELING; PROVIDING  
WELLNESS SERVICES, NAMELY, PERSONAL AS-  
SESSMENTS, PERSONALIZED ROUTINES, MAIN-  
TENANCE SCHEDULES, AND COUNSELING , IN  
CLASS 44 (U.S. CLS. 100 AND 101).

FIRST USE 3-0-2003; IN COMMERCE 3-0-2003.

THE MARK CONSISTS OF STANDARD CHAR-  
ACTERS WITHOUT CLAIM TO ANY PARTICULAR  
FONT, STYLE, SIZE, OR COLOR.

NO CLAIM IS MADE TO THE EXCLUSIVE  
RIGHT TO USE "LLC", APART FROM THE MARK  
AS SHOWN.

SER. NO. 77-286,574, FILED 9-23-2007.

ANNE E. GUSTASON, EXAMINING ATTORNEY

**Int. Cl.: 9**

**Prior U.S. Cls.: 21, 23, 26, 36 and 38**

**United States Patent and Trademark Office**

**Reg. No. 3,452,741**

**Registered June 24, 2008**

**TRADEMARK  
PRINCIPAL REGISTER**



MENG, CHUIYUAN (CHINA INDIVIDUAL)  
SCHOOL OF MUSIC, ROOM 352  
535 W MICHIGAN ST  
INDIANAPOLIS, IN 46202

FOR: COMPUTER HARDWARE AND COMPUTER SOFTWARE PROGRAMS FOR THE INTEGRATION OF TEXT, AUDIO, GRAPHICS, STILL IMAGES AND MOVING PICTURES INTO AN INTERACTIVE DELIVERY FOR MULTIMEDIA APPLICATIONS; COMPUTER SOFTWARE FOR ORGANIZING AND VIEWING DIGITAL IMAGES AND PHOTOGRAPHS; COMPUTER SOFTWARE FOR THE COLLECTION, EDITING, ORGANIZING, MODIFYING, BOOK MARKING, TRANSMISSION, STORAGE AND SHARING OF DATA AND INFORMATION; COMPUTER SOFTWARE FOR USE IN CUSTOMER RELATIONSHIP MANAGEMENT (CRM); DOWNLOADABLE COMPUTER SOFTWARE FOR COLLECTING, ORGANIZING, STORAGE AND SHARING OF DATA AND INFORMATION, IN CLASS 9 (U.S. CLS. 21, 23, 26, 36 AND 38).

FIRST USE 5-15-2007; IN COMMERCE 5-30-2007.

THE COLOR(S) ORANGE, LIGHT ORANGE, DARK ORANGE, GREY, LIGHT GREY, DARK GREY AND WHITE IS/ARE CLAIMED AS A FEATURE OF THE MARK.

THE MARK CONSISTS OF THE TERM "PAGICO" AS WELL AS TWO CONNECTED NOTEPADS WITH THE DESIGN OF COMMUNICATION WAVES BETWEEN THEM. THE DESIGN OF THE CLOCK FACE AND THE SILHOUETTE OF THE PERSON ON THE RIGHT NOTEPAD ARE BOTH GRAY IN COLOR. THE BORDERS AROUND THE NOTEPADS ARE DARK ORANGE, THE CURVED BANDS AND THE HORIZONTAL BAR IN THE TOP LEFT CORNER OF THE LEFT NOTEPAD ARE A MEDIUM SHADE OF ORANGE, AND THE PAGES OF THE NOTEPADS AND THE THIN HORIZONTAL LINES ON THE PADS ARE A LIGHTER SHADE OF ORANGE. THE SHADING OR HIGHLIGHTING SHOWN ON THE LEFT SIDES OF THE NOTEPADS AND AROUND THE INTERSECTING BORDERS OF THE PADS IS WHITE IN COLOR. THE LETTER "I" IN THE WORD "PAGICO" IS ORANGE, AND THE REMAINING LETTERS ARE GRAY, WITH A DARKER SHADE OF GRAY IN THE TOP PORTIONS OF THE LETTERS AND A LIGHTER SHADE IN THE BOTTOM PORTIONS OF THE LETTERS.

SER. NO. 77-286,664, FILED 9-23-2007.

ELIZABETH HUGHITT, EXAMINING ATTORNEY

Int. Cl.: 27

Prior U.S. Cls.: 19, 20, 37, 42 and 50

Reg. No. 3,452,742

United States Patent and Trademark Office

Registered June 24, 2008

TRADEMARK  
PRINCIPAL REGISTER



MABOLO NICHE CORPORATION SDN BHD  
(MALAYSIA LTD LIAB CO)  
P.O. BOX 546  
KUCHING, MALAYSIA 93710

FOR: ECO-FRIENDLY, RESILIENT AND DUR-  
ABLE HARD SURFACE WALL COVERING, IN  
CLASS 27 (U.S. CLS. 19, 20, 37, 42 AND 50).

FIRST USE 7-25-2000; IN COMMERCE 6-6-2006.

NO CLAIM IS MADE TO THE EXCLUSIVE  
RIGHT TO USE "JAPANESE WALL", APART FROM  
THE MARK AS SHOWN.

THE COLOR(S) BARLEY YELLOWISH GREEN IS/  
ARE CLAIMED AS A FEATURE OF THE MARK.

THE MARK CONSISTS OF THE LETTER "J" IS A  
STYLIZED CHARACTER WHICH REPRESENTS  
THE STALK OF WHEAT OR FERN, METAPHORI-  
CALLY MEANS ORGANIC AND NATURAL. THE  
COLOR BARLEY YELLOWISH GREEN APPEARS  
IN ALL OF THE WORDING OF THE MARK AND IN  
THE DESIGN OF THE FERN.

SER. NO. 77-286,685, FILED 9-24-2007.

CAROLYN CATALDO, EXAMINING ATTORNEY

Int. Cl.: 25

Prior U.S. Cls.: 22 and 39

United States Patent and Trademark Office

Reg. No. 3,452,743

Registered June 24, 2008

TRADEMARK  
PRINCIPAL REGISTER



GUNDERMANN, DANIELLE (UNITED STATES  
INDIVIDUAL)  
1415 VALLEJO DRIVE  
CORONA, CA 92882

FOR: HATS; SWEAT PANTS; SWEAT SHIRTS; T-  
SHIRTS; TANK TOPS; UNDERWEAR, IN CLASS 25  
(U.S. CLS. 22 AND 39).

FIRST USE 7-19-2007; IN COMMERCE 8-24-2007.

NO CLAIM IS MADE TO THE EXCLUSIVE  
RIGHT TO USE "TEES", APART FROM THE MARK  
AS SHOWN.

THE MARK CONSISTS OF A GRAPHIC OF A  
DIAMOND TO THE LEFT OF THE WORDS "KRYSTAL  
ME TEEZ". BELOW THE GRAPHIC AND  
WORDING IS A HORIZONTAL LINE AND THE  
PHRASE, "BE FABULOUS!".

SER. NO. 77-286,835, FILED 9-24-2007.

ALYSSA PALADINO, EXAMINING ATTORNEY

**Int. Cl.: 41**

**Prior U.S. Cls.: 100, 101 and 107**

**United States Patent and Trademark Office**

**Reg. No. 3,452,744**

**Registered June 24, 2008**

**SERVICE MARK  
PRINCIPAL REGISTER**

**TOOLMONGER**

POSTLAB MEDIA, LLC (TEXAS LTD LIAB CO)  
279 W. MAIN STREET, SUITE 138-109  
FRISCO, TX 75034

FOR: ENTERTAINMENT SERVICES IN THE  
NATURE OF ONLINE JOURNALS, NAMELY,  
BLOGS IN THE FIELD OF TOOLS AND ITEMS  
USED IN HOME IMPROVEMENT, IN CLASS 41 (U.S.  
CLS. 100, 101 AND 107).

FIRST USE 4-11-2006; IN COMMERCE 4-11-2006.

THE MARK CONSISTS OF STANDARD CHAR-  
ACTERS WITHOUT CLAIM TO ANY PARTICULAR  
FONT, STYLE, SIZE, OR COLOR.

SER. NO. 77-287,288, FILED 9-24-2007.

AHSEN KHAN, EXAMINING ATTORNEY

**Int. Cl.: 41**

**Prior U.S. Cls.: 100, 101 and 107**

**United States Patent and Trademark Office**

**Reg. No. 3,452,745**

**Registered June 24, 2008**

**SERVICE MARK  
PRINCIPAL REGISTER**

**toolm<sup>nut</sup>onger**

POSTLAB MEDIA, LLC (TEXAS LTD LIAB CO)  
279 W. MAIN STREET, SUITE 138-109  
FRISCO, TX 75034

FOR: ENTERTAINMENT SERVICES IN THE NATURE OF ONLINE JOURNALS, NAMELY, BLOGS IN THE FIELD OF TOOLS AND ITEMS USED IN HOME IMPROVEMENT, IN CLASS 41 (U.S. CLS. 100, 101 AND 107).

FIRST USE 4-11-2006; IN COMMERCE 4-11-2006.

THE COLOR(S) BLACK, RED AND GREY IS/ARE CLAIMED AS A FEATURE OF THE MARK.

THE COLOR BLACK APPEARS IN THE WORDING "TOOL" AND IN THE DESIGN OF THE HEXAGONAL NUT. THE COLOR GREY ALSO APPEARS IN THE DESIGN OF THE HEXAGONAL NUT. THE COLOR RED APPEARS IN THE WORDING "MONGER". THE MARK APPEARS OVER A TRANSPARENT BACKGROUND.

SER. NO. 77-287,389, FILED 9-24-2007.

AHSEN KHAN, EXAMINING ATTORNEY

**Int. Cl.: 41**

**Prior U.S. Cls.: 100, 101 and 107**

**United States Patent and Trademark Office**

**Reg. No. 3,452,746**

**Registered June 24, 2008**

**SERVICE MARK  
PRINCIPAL REGISTER**



BALANCE INTEGRATION CORPORATION  
(NEW YORK CORPORATION)  
212 W. 22ND STREET 2B  
NEW YORK, NY 10011

FOR: EDUCATION SERVICES, NAMELY, PROVIDING GROUP CLASSES AND INDIVIDUAL INSTRUCTION IN THE FIELDS OF STRESS MANAGEMENT, YOGA, AND ACHIEVING PROFESSIONAL AND PERSONAL GOALS, IN CLASS 41 (U.S. CLS. 100, 101 AND 107).

FIRST USE 9-6-2002; IN COMMERCE 9-6-2002.

NO CLAIM IS MADE TO THE EXCLUSIVE RIGHT TO USE "BALANCE", APART FROM THE MARK AS SHOWN.

THE MARK CONSISTS OF THE WORD "BALANCE" WITH FOUR IRREGULAR OVALS OVER IT.

SER. NO. 77-287,456, FILED 9-24-2007.

EUGENIA MARTIN, EXAMINING ATTORNEY



**Int. Cl.: 31**

**Prior U.S. Cls.: 1 and 46**

**United States Patent and Trademark Office**

**Reg. No. 3,452,747**

**Registered June 24, 2008**

**TRADEMARK  
PRINCIPAL REGISTER**

**Needlepoint Ornamental  
Peanut**

GARDEN'S EDGE GROWER'S, INC. (FLORIDA  
CORPORATION)  
POB 8459  
JACKSONVILLE, FL 32239

FOR: ORNAMENTAL PLANTS OF THE PEANUT  
FAMILY WITH A LONG SLENDER LEAF GROWN  
IN CONTAINERS AND ROLLS, IN CLASS 31 (U.S.  
CLS. 1 AND 46).

FIRST USE 8-8-2003; IN COMMERCE 8-8-2003.

THE MARK CONSISTS OF STANDARD CHAR-  
ACTERS WITHOUT CLAIM TO ANY PARTICULAR  
FONT, STYLE, SIZE, OR COLOR.

NO CLAIM IS MADE TO THE EXCLUSIVE  
RIGHT TO USE "ORNAMENTAL PEANUT", APART  
FROM THE MARK AS SHOWN.

SER. NO. 77-287,488, FILED 9-24-2007.

MICHAEL ENGEL, EXAMINING ATTORNEY

**Int. Cls.: 39 and 43**

**Prior U.S. Cls.: 100, 101 and 105**

**United States Patent and Trademark Office**

**Reg. No. 3,452,748**

**Registered June 24, 2008**

**SERVICE MARK  
PRINCIPAL REGISTER**

# EXECUTOURS

EXECUTOURS, INC. (CALIFORNIA CORPORATION)  
SUITE 460  
1901 AVENUE OF THE STARS  
LOS ANGELES, CA 90067

FOR: PROVISION OF TRAVEL AGENCY SERVICES TO INDIVIDUAL TRAVELERS AND GROUP TRAVELERS, NAMELY, ARRANGING AIR, SEA, AND LAND EXCURSIONS, RESERVATION AND BOOKING SEATS FOR TRAVEL, ORGANIZATION OF TRAVEL, ORGANIZATION OF EXCURSIONS, SIGHTSEEING TOURS, HOLIDAYS, TOURS AND TRAVEL; TRAVEL, EXCURSION AND CRUISE ARRANGEMENT, IN CLASS 39 (U.S. CLS. 100 AND 105).

FIRST USE 1-1-1977; IN COMMERCE 1-1-1977.

FOR: TRAVEL AGENCY SERVICES, NAMELY, MAKING RESERVATIONS AND BOOKING FOR TEMPORARY LODGING, RESTAURANTS, AND MEALS, IN CLASS 43 (U.S. CLS. 100 AND 101).

FIRST USE 1-1-1977; IN COMMERCE 1-1-1977.

THE MARK CONSISTS OF STANDARD CHARACTERS WITHOUT CLAIM TO ANY PARTICULAR FONT, STYLE, SIZE, OR COLOR.

SER. NO. 77-287,523, FILED 9-24-2007.

ROBIN CHOSID, EXAMINING ATTORNEY

**Int. Cl.: 45**

**Prior U.S. Cls.: 100 and 101**

**United States Patent and Trademark Office**

**Reg. No. 3,452,749**

**Registered June 24, 2008**

**SERVICE MARK  
PRINCIPAL REGISTER**

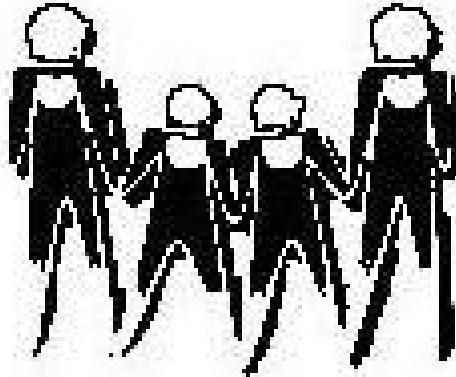

WALDEN FAMILY SERVICES (CALIFORNIA  
CORPORATION)  
#215  
3517 CAMINO DEL RIO SOUTH  
SAN DIEGO, CA 92108

THE MARK CONSISTS OF FOUR PEOPLE, 2  
ADULTS, 2 KIDS HOLDING HANDS WITH  
HEARTS IN THEIR CHESTS.

FOR: FOSTER CARE, IN CLASS 45 (U.S. CLS. 100  
AND 101).

SER. NO. 77-287,530, FILED 9-24-2007.

FIRST USE 9-1-2000; IN COMMERCE 9-1-2000.

KATINA MISTER, EXAMINING ATTORNEY

**Int. Cl.: 7**

**Prior U.S. Cls.: 13, 19, 21, 23, 31, 34 and 35**

**Reg. No. 3,452,750**

**United States Patent and Trademark Office**

**Registered June 24, 2008**

**TRADEMARK  
PRINCIPAL REGISTER**



FLOW INTERNATIONAL CORPORATION (WASHINGTON CORPORATION)  
23500 64TH AVENUE SOUTH  
KENT, WA 98032

PUMPS; INDUSTRIAL ROBOTS FOR USE IN MANUFACTURING AND INDUSTRIAL APPLICATIONS, IN CLASS 7 (U.S. CLS. 13, 19, 21, 23, 31, 34 AND 35).

FOR: WATERJET AND ABRASIVE-JET CUTTING, CLEANING AND MATERIAL FORMING MACHINES; ULTRAHIGH-PRESSURE FLUID PUMPS; STRUCTURAL AND REPLACEMENT PARTS FOR WATERJET AND ABRASIVE-JET CUTTING, CLEANING AND MATERIAL FORMING MACHINES AND ULTRAHIGH-PRESSURE FLUID

FIRST USE 8-22-2007; IN COMMERCE 8-22-2007.

SER. NO. 77-287,544, FILED 9-24-2007.

ROBIN CHOSID, EXAMINING ATTORNEY

**Int. Cl.: 9**

**Prior U.S. Cls.: 21, 23, 26, 36 and 38**

**Reg. No. 3,452,751**

**United States Patent and Trademark Office**

**Registered June 24, 2008**

**TRADEMARK  
PRINCIPAL REGISTER**



FLOW INTERNATIONAL CORPORATION (WA-  
SHINGTON CORPORATION)  
23500 64TH AVENUE SOUTH  
KENT, WA 98032

TOOL CONTROL; COMPUTER PROGRAMS FOR  
CAD/CAM APPLICATIONS, IN CLASS 9 (U.S. CLS.  
21, 23, 26, 36 AND 38).

FOR: COMPUTER SOFTWARE, NAMELY, COM-  
PUTER PROGRAMS FOR CONTROLLING ULTRA-  
HIGH-PRESSURE FLUID SYSTEMS FOR USE IN  
INDUSTRIAL CLEANING, CUTTING, MATERIAL  
FORMING AND SURFACE PREPARATION; COM-  
PUTER PROGRAMS FOR CAM AND MACHINE

FIRST USE 8-22-2007; IN COMMERCE 8-22-2007.

SER. NO. 77-287,550, FILED 9-24-2007.

ROBIN CHOSID, EXAMINING ATTORNEY

Int. Cl.: 45

Prior U.S. Cls.: 100 and 101

United States Patent and Trademark Office

Reg. No. 3,452,752

Registered June 24, 2008

**SERVICE MARK  
PRINCIPAL REGISTER**



IMIN LAW GROUP, LLC (ILLINOIS LTD LIAB  
CO)  
SUITE 512  
4801 W. PETERSON AVE.  
CHICAGO, IL 60646

FOR: LEGAL SERVICES, SPECIALIZING IN IM-  
MIGRATION LAW, IN CLASS 45 (U.S. CLS. 100 AND  
101).

FIRST USE 5-25-2007; IN COMMERCE 6-4-2007.

NO CLAIM IS MADE TO THE EXCLUSIVE  
RIGHT TO USE "IMIN LAW GROUP, LLC", APART  
FROM THE MARK AS SHOWN.

THE COLOR(S) GRAY AND DARK MAGENTA  
IS/ARE CLAIMED AS A FEATURE OF THE MARK.

THE MARK CONSISTS OF LETTERS "IMIN"  
VERTICALLY ALIGNED TO FORM HUMAN FIG-  
URES HOLDING HANDS. THE FIRST FIGURE IS A  
SOLID FIGURE WITH THE BODY AND HEAD  
FILLED IN WITH THE DARK MAGENTA COLOR  
AND THE LEGS AND ARMS FILLED IN WITH THE  
GRAY COLOR. THE SECOND FIGURE IS IDENTI-  
CAL TO THE FIRST FIGURE BUT NOT SOLID AND  
ONLY OUTLINED WITH THE SAME COLORS. THE  
WORDS "IMIN LAW" ARE IN DARK MAGENTA  
AND "GROUP, LLC" ARE IN GRAY.

THE FOREIGN WORDING IN THE MARK  
TRANSLATES INTO ENGLISH AS IMMIGRATION.

SER. NO. 77-287,569, FILED 9-24-2007.

DAVID TAYLOR, EXAMINING ATTORNEY

**Int. Cl.: 44**

**Prior U.S. Cls.: 100 and 101**

**United States Patent and Trademark Office**

**Reg. No. 3,452,753**

**Registered June 24, 2008**

**SERVICE MARK  
PRINCIPAL REGISTER**



GOWAN COMPANY, L.L.C. (ARIZONA LTD  
LIAB CO)  
370 S. MAIN STREET  
YUMA, AZ 85364

FOR: ADVISORY SERVICES, NAMELY, ADVIS-  
ING USERS OF THE BENEFITS OF ROTATING  
AGRICULTURAL HERBICIDES, IN CLASS 44 (U.S.  
CLS. 100 AND 101).

FIRST USE 9-10-2007; IN COMMERCE 9-10-2007.

OWNER OF U.S. REG. NOS. 1,923,249 AND  
2,812,460.

THE MARK CONSISTS OF THE WORD "RO-  
TATE" ON THE TOP OF A CIRCLE WITH BANDS  
TO EITHER SIDE, AND THE WORDS "WITH  
GROUP 8 FAR-GO FROM GOWAN" BELOW. IN-  
SIDE THE CIRCLE IS A TIRE WITH THE NUMERAL  
8 AT THE CENTER.

SER. NO. 77-288,133, FILED 9-25-2007.

FRANK LATTUCA, EXAMINING ATTORNEY

**Int. Cl.: 6**

**Prior U.S. Cls.: 2, 12, 13, 14, 23, 25 and 50**

**Reg. No. 3,452,754**

**United States Patent and Trademark Office**

**Registered June 24, 2008**

**TRADEMARK  
PRINCIPAL REGISTER**

**GUTTER GOALIE**

ALSCO METALS CORPORATION (NORTH CAROLINA CORPORATION)  
3101 POPLARWOOD COURT, SUITE 200  
RALEIGH, NC 27604

FOR: GUTTER PROTECTION DEVICES, NAME-  
LY, METAL COVERS FOR ATTACHMENT TO  
GUTTERS FOR KEEPING LEAVES AND DEBRIS  
OUT OF GUTTERS, IN CLASS 6 (U.S. CLS. 2, 12, 13,  
14, 23, 25 AND 50).

FIRST USE 8-15-2007; IN COMMERCE 8-15-2007.

THE MARK CONSISTS OF STANDARD CHAR-  
ACTERS WITHOUT CLAIM TO ANY PARTICULAR  
FONT, STYLE, SIZE, OR COLOR.

NO CLAIM IS MADE TO THE EXCLUSIVE  
RIGHT TO USE "GUTTER", APART FROM THE  
MARK AS SHOWN.

SER. NO. 77-288,203, FILED 9-25-2007.

WANDA KAY PRICE, EXAMINING ATTORNEY



**Int. Cl.: 19**

**Prior U.S. Cls.: 1, 12, 33 and 50**

**United States Patent and Trademark Office**

**Reg. No. 3,452,755**

**Registered June 24, 2008**

**TRADEMARK  
PRINCIPAL REGISTER**

**REDMAN HOMES**

REDMAN HOMES, INC. (DELAWARE CORPORATION)  
2550 WALNUT HILLS  
DALLAS, TX 75226

FOR: MANUFACTURED HOUSING, NAMELY, MOBILE HOMES; MODULAR HOMES AND MODULAR STRUCTURES, NAMELY, RESIDENTIAL AND COMMERCIAL BUILDINGS, IN CLASS 19 (U.S. CLS. 1, 12, 33 AND 50).

FIRST USE 6-0-1937; IN COMMERCE 6-0-1937.

THE MARK CONSISTS OF STANDARD CHARACTERS WITHOUT CLAIM TO ANY PARTICULAR FONT, STYLE, SIZE, OR COLOR.

OWNER OF U.S. REG. NO. 1,273,869.

NO CLAIM IS MADE TO THE EXCLUSIVE RIGHT TO USE "HOMES", APART FROM THE MARK AS SHOWN.

SER. NO. 77-288,364, FILED 9-25-2007.

SHAUNIA CARLYLE, EXAMINING ATTORNEY

**Int. Cl.: 43**

**Prior U.S. Cls.: 100 and 101**

**United States Patent and Trademark Office**

**Reg. No. 3,452,756**

**Registered June 24, 2008**

**SERVICE MARK  
PRINCIPAL REGISTER**

**THE 5°8 CLUB**

FOOD SERVICES, INC. (MINNESOTA CORPORATION)  
CABRIOLE CENTER  
9531 WEST 78TH STREET  
EDEN PRAIRIE, MN 55344

FOR: RESTAURANT SERVICES, IN CLASS 43  
(U.S. CLS. 100 AND 101).

FIRST USE 0-0-1928; IN COMMERCE 0-0-1928.

NO CLAIM IS MADE TO THE EXCLUSIVE RIGHT TO USE "CLUB", APART FROM THE MARK AS SHOWN.

THE MARK CONSISTS OF THE WORDS "THE 5 8 CLUB" WITH A DOT BETWEEN THE "5" AND THE "8".

SER. NO. 77-288,388, FILED 9-25-2007.

BARBARA RUTLAND, EXAMINING ATTORNEY

**Int. Cl.: 36**

**Prior U.S. Cls.: 100, 101 and 102**

**United States Patent and Trademark Office**

**Reg. No. 3,452,757**

**Registered June 24, 2008**

**SERVICE MARK  
PRINCIPAL REGISTER**

**ESOPConnection**

TRANSITION FINANCE STRATEGIES, LLC  
(VIRGINIA LIMITED LIABILITY COMPANY)  
154 HANSEN RD.  
CHARLOTTESVILLE, VA 22911

THE MARK CONSISTS OF STANDARD CHAR-  
ACTERS WITHOUT CLAIM TO ANY PARTICULAR  
FONT, STYLE, SIZE, OR COLOR.

FOR: FINANCIAL ADMINISTRATION OF RE-  
TIREMENT PLANS, IN CLASS 36 (U.S. CLS. 100, 101  
AND 102).

SER. NO. 77-288,896, FILED 9-25-2007.

FIRST USE 1-0-2002; IN COMMERCE 1-0-2002.

HEATHER SAPP, EXAMINING ATTORNEY

**Int. Cl.: 35**

**Prior U.S. Cls.: 100, 101 and 102**

**United States Patent and Trademark Office**

**Reg. No. 3,452,758**

**Registered June 24, 2008**

**SERVICE MARK  
PRINCIPAL REGISTER**



TEXAS CENTER FOR GRANTS DEVELOPMENT

HARRIS COUNTY DEPARTMENT OF EDUCATION (TEXAS EDUCATIONAL INSTITUTION)  
6300 IRVINGTON BLVD.  
HOUSTON, TX 770225618

FOR: WRITING OF GRANT PROPOSALS FOR NON-PROFIT ORGANIZATIONS, EDUCATIONAL INSTITUTIONS AND OTHER COMMUNITY ORGANIZATIONS, IN CLASS 35 (U.S. CLS. 100, 101 AND 102).

FIRST USE 8-22-2007; IN COMMERCE 8-22-2007.

NO CLAIM IS MADE TO THE EXCLUSIVE RIGHT TO USE "TEXAS CENTER FOR GRANTS DEVELOPMENT" AND THE REPRESENTATION OF THE OUTLINE OF THE STATE OF TEXAS, APART FROM THE MARK AS SHOWN.

THE MARK CONSISTS OF A STYLIZED BOX OF FOUR BLOCKS WITH "T", "C", "G", "D" IN EACH RESPECTIVE BLOCK.

SER. NO. 77-289,162, FILED 9-26-2007.

INGA ERVIN, EXAMINING ATTORNEY

**Int. Cl.: 36**

**Prior U.S. Cls.: 100, 101 and 102**

**United States Patent and Trademark Office**

**Reg. No. 3,452,759**

**Registered June 24, 2008**

**SERVICE MARK  
PRINCIPAL REGISTER**

**ECO2Pass**

ECO2PASS, INCORPORATED (MINNESOTA CORPORATION)  
1747 TAMBERWOOD TRAIL  
WOODBURY, MN 55125

FOR: ENVIRONMENTAL BROKERAGE SERVICES IN THE FIELD OF ENVIRONMENTAL AND POLLUTION CREDITS, NAMELY, ARRANGING EXCHANGES OF CARBON OFFSET CREDITS FOR OTHER ASSETS TO FUND CLEAN ENERGY PROJECTS, IN CLASS 36 (U.S. CLS. 100, 101 AND 102).

FIRST USE 8-21-2007; IN COMMERCE 9-13-2007.

THE MARK CONSISTS OF STANDARD CHARACTERS WITHOUT CLAIM TO ANY PARTICULAR FONT, STYLE, SIZE, OR COLOR.

SER. NO. 77-289,164, FILED 9-26-2007.

TINA L. SNAPP, EXAMINING ATTORNEY

**Int. Cl.: 35**

**Prior U.S. Cls.: 100, 101 and 102**

**United States Patent and Trademark Office**

**Reg. No. 3,452,760**

**Registered June 24, 2008**

**SERVICE MARK  
PRINCIPAL REGISTER**

**COX CROSS MEDIA**

COX HOLDINGS, INC. (DELAWARE CORPORATION)  
6205 PEACHTREE DUNWOODY ROAD  
ATLANTA, GA 30328

FOR: ADVERTISING SERVICES, NAMELY, PROMOTING THE GOODS, SERVICES, BRAND IDENTITY AND COMMERCIAL INFORMATION OF THIRD PARTIES THROUGH PRINT, AUDIO, VIDEO, DIGITAL AND ON-LINE MEDIUM, INCLUDING VIA THE INTERNET AND MOBILE DEVICES, IN CLASS 35 (U.S. CLS. 100, 101 AND 102).

FIRST USE 9-19-2007; IN COMMERCE 9-19-2007.

THE MARK CONSISTS OF STANDARD CHARACTERS WITHOUT CLAIM TO ANY PARTICULAR FONT, STYLE, SIZE, OR COLOR.

NO CLAIM IS MADE TO THE EXCLUSIVE RIGHT TO USE "CROSS MEDIA", APART FROM THE MARK AS SHOWN.

SER. NO. 77-289,342, FILED 9-26-2007.

RENEE MCCRAY, EXAMINING ATTORNEY

**Int. Cls.: 16 and 36**

**Prior U.S. Cls.: 2, 5, 22, 23, 29, 37, 38, 50, 100, 101 and 102**

**Reg. No. 3,452,761**

**United States Patent and Trademark Office**

**Registered June 24, 2008**

**TRADEMARK  
SERVICE MARK  
PRINCIPAL REGISTER**

**AN INDEPENDENT REVIEW OF  
CORPORATE BOND COVENANTS  
FOR THE SOPHISTICATED  
INVESTOR**

COVENANT REVIEW, LLC (NEW YORK LTD  
LIAB CO)  
6TH FLOOR  
708 THIRD AVENUE  
NEW YORK, NY 10017

FOR: PRINTED PUBLICATIONS, NAMELY, RE-  
PORTS AND NEWSLETTERS PROVIDING WRIT-  
TEN COMMENTARY ON BONDS, LOANS, AND  
OTHER DOCUMENTS USED IN CONNECTION  
WITH FINANCING ACTIVITIES, IN CLASS 16 (U.S.  
CLS. 2, 5, 22, 23, 29, 37, 38 AND 50).

FIRST USE 7-1-2007; IN COMMERCE 7-1-2007.

FOR: PROVIDING FINANCIAL INFORMATION  
TO INVESTORS IN THE FORM OF REVIEWS AND  
RESEARCH REPORTS, IN CLASS 36 (U.S. CLS. 100,  
101 AND 102).

FIRST USE 7-1-2007; IN COMMERCE 7-1-2007.

THE MARK CONSISTS OF STANDARD CHAR-  
ACTERS WITHOUT CLAIM TO ANY PARTICULAR  
FONT, STYLE, SIZE, OR COLOR.

SER. NO. 77-289,830, FILED 9-26-2007.

KIMBERLY FRYE, EXAMINING ATTORNEY

Int. Cl.: 36

Prior U.S. Cls.: 100, 101 and 102

United States Patent and Trademark Office

Reg. No. 3,452,762

Registered June 24, 2008

**SERVICE MARK  
PRINCIPAL REGISTER**



HUNTSVILLE HOSPITAL FOUNDATION (ALABAMA NON-PROFIT ORGANIZATION)  
101 SILVEY ROAD  
HUNTSVILLE, AL 35801

FOR: CHARITABLE MEMORIAL FUND RAISING SERVICES; ACCEPTING AND ADMINISTERING MONETARY CONTRIBUTIONS; CHARITABLE FUND RAISING SERVICES BY MEANS OF COMPETITIVE ATHLETIC EVENTS, SOCIAL EVENTS AND ENTERTAINMENT EVENTS, IN CLASS 36 (U.S. CLS. 100, 101 AND 102).

FIRST USE 11-30-2005; IN COMMERCE 11-30-2005.

NO CLAIM IS MADE TO THE EXCLUSIVE RIGHT TO USE "NEONATAL MEMORIAL FUND", APART FROM THE MARK AS SHOWN.

THE NAME "MELISSA GEORGE" DOES NOT IDENTIFY A LIVING INDIVIDUAL.

THE MARK CONSISTS OF A HALO ATOP OF PAIR OF WINGS ATOP THE WORDS "MELISSA GEORGE", ATOP THE WORDS "NEONATAL MEMORIAL FUND".

SER. NO. 77-290,064, FILED 9-27-2007.

ADA HAN, EXAMINING ATTORNEY



**Int. Cls.: 9, 12 and 28**

**Prior U.S. Cls.: 19, 21, 22, 23, 26, 31, 35, 36, 38, 44 and 50**

**Reg. No. 3,452,763**

**United States Patent and Trademark Office**

**Registered June 24, 2008**

---

**TRADEMARK  
PRINCIPAL REGISTER**

**RoboteX**

ROBOTEX INC (DELAWARE CORPORATION)  
2101 CANADA BLVD  
GLENDALE, CA 91208

FOR: REMOTE CONTROL TOYS, NAMELY,  
WEAPONIZED SMALL GROUND VEHICLES, IN  
CLASS 28 (U.S. CLS. 22, 23, 38 AND 50).

FOR: ROBOTS FOR PERSONAL OR HOBBY USE,  
IN CLASS 9 (U.S. CLS. 21, 23, 26, 36 AND 38).

FIRST USE 7-1-2005; IN COMMERCE 9-1-2006.

FIRST USE 7-1-2005; IN COMMERCE 9-1-2006.

THE MARK CONSISTS OF STANDARD CHAR-  
ACTERS WITHOUT CLAIM TO ANY PARTICULAR  
FONT, STYLE, SIZE, OR COLOR.

FOR: REMOTELY CONTROLLED LAND VEHI-  
CLE, IN CLASS 12 (U.S. CLS. 19, 21, 23, 31, 35 AND 44).

SER. NO. 77-290,212, FILED 9-27-2007.

FIRST USE 7-1-2005; IN COMMERCE 9-1-2006.

SANJEEV VOHRA, EXAMINING ATTORNEY

**Int. Cl.: 6**

**Prior U.S. Cls.: 2, 12, 13, 14, 23, 25 and 50**

**Reg. No. 3,452,764**

**United States Patent and Trademark Office**

**Registered June 24, 2008**

**TRADEMARK  
PRINCIPAL REGISTER**

**DOGAL**

SSAB TUNNPLAT AB (SWEDEN LTD LIAB CO)  
781 84  
BORLANGE, SWEDEN

THE MARK CONSISTS OF STANDARD CHARACTERS WITHOUT CLAIM TO ANY PARTICULAR FONT, STYLE, SIZE, OR COLOR.

FOR: STEEL IN THE FORM OF SHEETS, PLATES, FOILS AND COILS; ALLOY COATED STEEL IN THE FORM OF SHEETS, PLATES, FOILS AND COILS; METAL COATED STEEL IN THE FORM OF SHEETS, PLATES, FOILS AND COILS , IN CLASS 6 (U.S. CLS. 2, 12, 13, 14, 23, 25 AND 50).

THE MARK IS A COINED TERM AND HAS NO MEANING.

SER. NO. 77-290,273, FILED 9-27-2007.

FIRST USE 4-1-2004; IN COMMERCE 4-1-2004.

REBECCA SMITH, EXAMINING ATTORNEY

**Int. Cl.: 41**

**Prior U.S. Cls.: 100, 101 and 107**

**United States Patent and Trademark Office**

**Reg. No. 3,452,765**

**Registered June 24, 2008**

**SERVICE MARK  
PRINCIPAL REGISTER**

**SWITCHED-ON ONLINE**

ALPHA OMEGA PUBLICATIONS, INC. (ARIZONA CORPORATION)  
300 N. MCKEMY AVENUE  
CHANDLER, AZ 85226

FOR: EDUCATION SERVICES, NAMELY, PROVIDING LIVE AND ON-LINE COURSES OF INSTRUCTION AT THE ELEMENTARY, SECONDARY AND POST-SECONDARY LEVELS IN THE FIELD OF HISTORY, LANGUAGE ARTS, SCIENCE, MATH, BIBLE AND ELECTIVE COURSES, NAMELY, AMERICAN AND BRITISH LITERATURE, CONSUMER MATH, COLLEGE PLANNING, HEALTH, HOME ECONOMICS, SPANISH LANGUAGE, FRENCH LANGUAGE, CONSTITUTIONAL STUDIES AND STATE HISTORY, IN CLASS 41 (U.S. CLS. 100, 101 AND 107).

FIRST USE 5-1-2007; IN COMMERCE 7-14-2007.

THE MARK CONSISTS OF STANDARD CHARACTERS WITHOUT CLAIM TO ANY PARTICULAR FONT, STYLE, SIZE, OR COLOR.

OWNER OF U.S. REG. NOS. 2,287,005, 3,276,712 AND OTHERS.

NO CLAIM IS MADE TO THE EXCLUSIVE RIGHT TO USE "ONLINE", APART FROM THE MARK AS SHOWN.

SER. NO. 77-290,458, FILED 9-27-2007.

DAWN HAN, EXAMINING ATTORNEY

**Int. Cl.: 14**

**Prior U.S. Cls.: 2, 27, 28 and 50**

**United States Patent and Trademark Office**

**Reg. No. 3,452,766**

**Registered June 24, 2008**

**TRADEMARK  
PRINCIPAL REGISTER**

# Lucid Studios

HAW-WEN CHAI (NEW YORK SOLE PROPRIETORSHIP), DBA CHAI DESIGN

17 CEDARWOOD DRIVE

QUEENSBURY, NY 12804

FOR: JEWELRY, IN CLASS 14 (U.S. CLS. 2, 27, 28 AND 50).

FIRST USE 5-24-2006; IN COMMERCE 1-19-2007.

THE MARK CONSISTS OF STANDARD CHARACTERS WITHOUT CLAIM TO ANY PARTICULAR FONT, STYLE, SIZE, OR COLOR.

NO CLAIM IS MADE TO THE EXCLUSIVE RIGHT TO USE "STUDIOS", APART FROM THE MARK AS SHOWN.

SER. NO. 77-290,555, FILED 9-27-2007.

JASON TURNER, EXAMINING ATTORNEY

**Int. Cl.: 35**

**Prior U.S. Cls.: 100, 101 and 102**

**United States Patent and Trademark Office**

**Reg. No. 3,452,767**

**Registered June 24, 2008**

**SERVICE MARK  
PRINCIPAL REGISTER**

**CMTS**

COUNTRY MOTORS TRAILER SALES, INC. (ILLINOIS CORPORATION)  
RURAL ROUTE 2  
EDINBURG, IL 62531

THE MARK CONSISTS OF STANDARD CHARACTERS WITHOUT CLAIM TO ANY PARTICULAR FONT, STYLE, SIZE, OR COLOR.

FOR: DEALERSHIPS IN THE FIELD OF MOTORCOACHES, TRAILERS AND AUTOMOBILES, IN CLASS 35 (U.S. CLS. 100, 101 AND 102).

SER. NO. 77-290,684, FILED 9-27-2007.

FIRST USE 11-10-1992; IN COMMERCE 11-10-1992.

ALICE SUE CARRUTHERS, EXAMINING ATTORNEY

**Int. Cl.: 39**

**Prior U.S. Cls.: 100 and 105**

**United States Patent and Trademark Office**

**Reg. No. 3,452,768**

**Registered June 24, 2008**

**SERVICE MARK  
PRINCIPAL REGISTER**

**XPRESS SUITE**

BETAZONE, INC. (TENNESSEE CORPORATION)  
SUITE 290  
750 OLD HICKORY BLVD.  
BRENTWOOD, TN 37027

FOR: ELECTRONIC STORAGE AND RETRIEVAL  
OF DATA AND MESSAGES OVER A GLOBAL  
COMPUTER INFORMATION NETWORK FOR USE  
IN THE TRANSPORTATION FIELD, IN CLASS 39  
(U.S. CLS. 100 AND 105).

FIRST USE 2-0-1999; IN COMMERCE 2-0-1999.

THE MARK CONSISTS OF STANDARD CHAR-  
ACTERS WITHOUT CLAIM TO ANY PARTICULAR  
FONT, STYLE, SIZE, OR COLOR.

OWNER OF U.S. REG. NO. 2,495,149.

SEC. 2(F).

SER. NO. 77-290,840, FILED 9-27-2007.

ANDREA K. NADELMAN, EXAMINING ATTOR-  
NEY

**Int. Cl.: 41**

**Prior U.S. Cls.: 100, 101 and 107**

**United States Patent and Trademark Office**

**Reg. No. 3,452,769**

**Registered June 24, 2008**

**SERVICE MARK  
PRINCIPAL REGISTER**

**JR PHENOM CAMP**

PHENOM BASKETBALL, INC. (CALIFORNIA  
CORPORATION)  
26563 RHONE COURT  
MORENO VALLEY, CA 92555

FOR: BASKETBALL CAMPS; SPORT CAMPS;  
AMATEUR YOUTH SPORTS SERVICES, NAMELY,  
ORGANIZING, PROVIDING AND MANAGING  
YOUTH SPORTS ACTIVITIES, IN CLASS 41 (U.S.  
CLS. 100, 101 AND 107).

FIRST USE 8-5-2004; IN COMMERCE 8-5-2004.

THE MARK CONSISTS OF STANDARD CHAR-  
ACTERS WITHOUT CLAIM TO ANY PARTICULAR  
FONT, STYLE, SIZE, OR COLOR.

NO CLAIM IS MADE TO THE EXCLUSIVE  
RIGHT TO USE "CAMP", APART FROM THE  
MARK AS SHOWN.

SER. NO. 77-290,991, FILED 9-27-2007.

MICHAEL KEATING, EXAMINING ATTORNEY

Int. Cl.: 27

Prior U.S. Cls.: 19, 20, 37, 42 and 50

United States Patent and Trademark Office

Reg. No. 3,452,770

Registered June 24, 2008

TRADEMARK  
PRINCIPAL REGISTER



MABOLO NICHE CORPORATION SDN BHD  
(MALAYSIA LTD LIAB CO)  
P.O. BOX 546  
KUCHING, MALAYSIA 93710

FOR: ECO-FRIENDLY, RESILIENT AND DUR-  
ABLE HARD SURFACE WALL COVERING, IN  
CLASS 27 (U.S. CLS. 19, 20, 37, 42 AND 50).

FIRST USE 11-11-2006; IN COMMERCE 11-21-2006.

NO CLAIM IS MADE TO THE EXCLUSIVE  
RIGHT TO USE "WALL", APART FROM THE  
MARK AS SHOWN.

THE STIPPLING IS A FEATURE OF THE MARK  
AND DOES NOT INDICATE COLOR.

THE COLOR(S) BARLEY YELLOWISH GREEN IS/  
ARE CLAIMED AS A FEATURE OF THE MARK.

THE MARK CONSISTS OF A STYLIZED CHI-  
NESE CALLIGRAPHY WHICH TRANSLITERATE  
TO "ZEN KABE", MEANING "ZEN WALL" JAPA-  
NESE CHARACTERS ON THE SIDES OF THE  
CALLIGRAPHY IMAGE WHICH TRANSLITERATE  
TO "ZEN KABE", AND TRANSLATE TO "ZEN  
WALL".

THE FOREIGN WORDING IN THE MARK  
TRANSLATES INTO ENGLISH AS "ZEN WALL".

THE NON-LATIN CHARACTER(S) IN THE  
MARK TRANSLITERATE INTO "ZEN KABE",  
AND THIS MEANS "ZEN WALL" IN ENGLISH.

SER. NO. 77-291,036, FILED 9-27-2007.

CAROLYN CATALDO, EXAMINING ATTORNEY



**Int. Cl.: 36**

**Prior U.S. Cls.: 100, 101 and 102**

**United States Patent and Trademark Office**

**Reg. No. 3,452,771**

**Registered June 24, 2008**

**SERVICE MARK  
PRINCIPAL REGISTER**

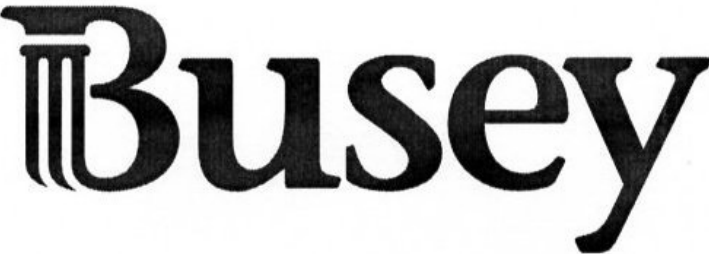
The logo for Busey features a stylized letter 'B' on the left, composed of three vertical bars of varying heights. To the right of the 'B' is the word 'Busey' in a bold, serif font.

FIRST BUSEY CORPORATION (NEVADA CORPORATION)  
201 W MAIN ST.  
URBANA, IL 61801

FOR: BANKING, IN CLASS 36 (U.S. CLS. 100, 101 AND 102).

FIRST USE 10-9-2007; IN COMMERCE 10-9-2007.

OWNER OF U.S. REG. NO. 3,153,643.

THE MARK CONSISTS OF THE WORD "BUSEY" WITH A COLUMN IN THE LETTER "B".

SER. NO. 77-291,316, FILED 9-28-2007.

JASON LOTT, EXAMINING ATTORNEY

**Int. Cl.: 19**

**Prior U.S. Cls.: 1, 12, 33 and 50**

**United States Patent and Trademark Office**

**Reg. No. 3,452,772**

**Registered June 24, 2008**

**TRADEMARK  
PRINCIPAL REGISTER**



GUARDIAN INDUSTRIES CORP. (DELAWARE CORPORATION)  
2300 HARMON  
AUBURN HILLS, MI 48326

OWNER OF U.S. REG. NO. 2,648,700.

FOR: UNFRAMED GLASS WINDOWS FOR USE IN BUILDINGS, NAMELY, INSULATING GLASS UNITS FOR MOUNTING INTO WINDOW FRAMES, IN CLASS 19 (U.S. CLS. 1, 12, 33 AND 50).

THE MARK CONSISTS OF THE A STYLIZED LETTER "G" WITH A HORSEMAN DESIGN IN THE CENTER.

SER. NO. 77-291,511, FILED 9-28-2007.

FIRST USE 0-0-1980; IN COMMERCE 0-0-1980.

JUSTINE D. PARKER, EXAMINING ATTORNEY

**Int. Cl.: 9**

**Prior U.S. Cls.: 21, 23, 26, 36 and 38**

**Reg. No. 3,452,773**

**United States Patent and Trademark Office**

**Registered June 24, 2008**

**TRADEMARK  
PRINCIPAL REGISTER**

**VIRTUA**

CODONICS, INC. (OHIO CORPORATION)  
17991 ENGLEWOOD DRIVE  
MIDDLEBURG HTS., OH 44130

FIRST USE 5-0-2006; IN COMMERCE 5-0-2006.

FOR: PORTABLE DIGITAL MEDIA DISC PUBLISHER, NAMELY, COMPUTER HARDWARE AND SOFTWARE FOR RECORDING AND PUBLISHING IMAGES, DOCUMENTS AND FILES ONTO PORTABLE DIGITAL MEDIA; ON-DEMAND MEDICAL DISC PUBLISHING BY MEANS OF COMPUTER PERIPHERALS IN THE FORM OF WORKSTATIONS, IN CLASS 9 (U.S. CLS. 21, 23, 26, 36 AND 38).

THE MARK CONSISTS OF STANDARD CHARACTERS WITHOUT CLAIM TO ANY PARTICULAR FONT, STYLE, SIZE, OR COLOR.

SER. NO. 77-291,529, FILED 9-28-2007.

RICHARD A. STRASER, EXAMINING ATTORNEY

**Int. Cl.: 19**

**Prior U.S. Cls.: 1, 12, 33 and 50**

**United States Patent and Trademark Office**

**Reg. No. 3,452,774**

**Registered June 24, 2008**

**TRADEMARK  
PRINCIPAL REGISTER**

**GUARDIAN**

GUARDIAN INDUSTRIES CORP. (DELAWARE  
CORPORATION)  
2300 HARMON  
AUBURN HILLS, MI 48326

FOR: UNFRAMED GLASS WINDOWS FOR USE  
IN BUILDINGS, NAMELY, INSULATING GLASS  
UNITS FOR MOUNTING INTO WINDOW FRAMES,  
IN CLASS 19 (U.S. CLS. 1, 12, 33 AND 50).

FIRST USE 0-0-1980; IN COMMERCE 0-0-1980.

THE MARK CONSISTS OF STANDARD CHAR-  
ACTERS WITHOUT CLAIM TO ANY PARTICULAR  
FONT, STYLE, SIZE, OR COLOR.

OWNER OF U.S. REG. NOS. 2,807,781 AND  
2,839,435.

SER. NO. 77-291,532, FILED 9-28-2007.

JUSTINE D. PARKER, EXAMINING ATTORNEY

**Int. Cl.: 42**

**Prior U.S. Cls.: 100 and 101**

**United States Patent and Trademark Office**

**Reg. No. 3,452,775**

**Registered June 24, 2008**

**SERVICE MARK  
PRINCIPAL REGISTER**



THE HLA GROUP, LANDSCAPE ARCHITECTS &  
PLANNERS, INC. (CALIFORNIA CORPORATION)

1050 20TH STREET, SUITE 200  
SACRAMENTO, CA 95814

FOR: LAND USE PLANNING SERVICES; LAND-  
SCAPE ARCHITECTURAL DESIGN; CIVIL ENGI-  
NEERING; URBAN PLANNING; CONSULTING IN  
THE FIELDS OF ENGINEERING AND ARCHITEC-  
TURE; ALL OF WHICH IS NOT RELATED TO NOR

IN THE FIELD OF HIGH LEVEL ARCHITECTURE,  
IN CLASS 42 (U.S. CLS. 100 AND 101).

FIRST USE 8-0-2000; IN COMMERCE 10-0-2000.

THE MARK CONSISTS OF THE LETTERS HLA.

SER. NO. 77-291,573, FILED 9-28-2007.

ANDREA K. NADELMAN, EXAMINING ATTOR-  
NEY

**Int. Cl.: 12**

**Prior U.S. Cls.: 19, 21, 23, 31, 35 and 44**

**Reg. No. 3,452,776**

**United States Patent and Trademark Office**

**Registered June 24, 2008**

**TRADEMARK  
PRINCIPAL REGISTER**

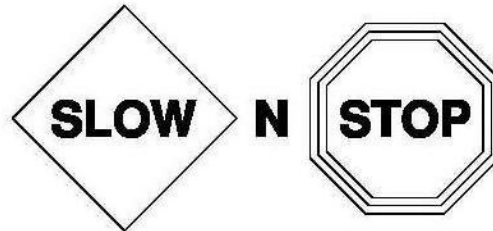

J. ALEXANDER EASLEY, JR. (UNITED STATES  
INDIVIDUAL)  
P.O BOX 1213  
KOKOMO, IN 46903

THE MARK CONSISTS OF THE WORD SLOW  
WITHIN A ROTATED SQUARE AND THE WORD  
STOP WITHIN AN OCTOGON SEPARATED BY THE  
LETTER N.

FOR: WHEELCHAIRS WITH BRAKES; BRAKING  
SYSTEM FOR WHEELCHAIRS, IN CLASS 12 (U.S.  
CLS. 19, 21, 23, 31, 35 AND 44).

SER. NO. 77-291,612, FILED 9-28-2007.

FIRST USE 10-3-2007; IN COMMERCE 10-3-2007.

SUSAN LESLIE DUBOIS, EXAMINING ATTORNEY

**Int. Cl.: 42**

**Prior U.S. Cls.: 100 and 101**

**United States Patent and Trademark Office**

**Reg. No. 3,452,777**

**Registered June 24, 2008**

**SERVICE MARK  
PRINCIPAL REGISTER**

**THE HLA GROUP**

THE HLA GROUP, LANDSCAPE ARCHITECTS &  
PLANNERS, INC. (CALIFORNIA CORPORATION)  
1050 20TH STREET, SUITE 200  
SACRAMENTO, CA 95814

FOR: CIVIL ENGINEERING; LAND USE PLAN-  
NING SERVICES; LANDSCAPE ARCHITECTURAL  
DESIGN; URBAN PLANNING; CONSULTING IN  
THE FIELDS OF ENGINEERING AND ARCHITEC-  
TURE; ALL OF WHICH IS NOT RELATED TO NOR  
IN THE FIELD OF HIGH LEVEL ARCHITECTURE,  
IN CLASS 42 (U.S. CLS. 100 AND 101).

FIRST USE 12-0-1990; IN COMMERCE 10-0-2000.

THE MARK CONSISTS OF STANDARD CHAR-  
ACTERS WITHOUT CLAIM TO ANY PARTICULAR  
FONT, STYLE, SIZE, OR COLOR.

NO CLAIM IS MADE TO THE EXCLUSIVE  
RIGHT TO USE "GROUP", APART FROM THE  
MARK AS SHOWN.

SER. NO. 77-291,635, FILED 9-28-2007.

ANDREA K. NADELMAN, EXAMINING ATTOR-  
NEY

**Int. Cl.: 35**

**Prior U.S. Cls.: 100, 101 and 102**

**United States Patent and Trademark Office**

**Reg. No. 3,452,778**

**Registered June 24, 2008**

**SERVICE MARK  
PRINCIPAL REGISTER**

**VISIT DULUTH**

DULUTH PUBLICITY BUREAU, INC. (MINNESOTA NON-PROFIT CORPORATION)  
SUITE 100  
21 WEST SUPERIOR STREET  
DULUTH, MN 55802

FOR: PROVIDING VISITOR AND CONVENTION INFORMATION SERVICES, NAMELY, PROVIDING INFORMATION TO PROMOTE TOURISM AND BUSINESS CONVENTIONS IN THE DULUTH AREA, IN CLASS 35 (U.S. CLS. 100, 101 AND 102).

FIRST USE 1-1-1995; IN COMMERCE 1-1-1995.

THE MARK CONSISTS OF STANDARD CHARACTERS WITHOUT CLAIM TO ANY PARTICULAR FONT, STYLE, SIZE, OR COLOR.

NO CLAIM IS MADE TO THE EXCLUSIVE RIGHT TO USE "DULUTH", APART FROM THE MARK AS SHOWN.

SER. NO. 77-291,779, FILED 9-28-2007.

REBECCA EISINGER, EXAMINING ATTORNEY



**Int. Cl.: 35**

**Prior U.S. Cls.: 100, 101 and 102**

**United States Patent and Trademark Office**

**Reg. No. 3,452,779**

**Registered June 24, 2008**

**SERVICE MARK  
PRINCIPAL REGISTER**



DULUTH PUBLICITY BUREAU, INC. (MINNE-  
SOTA NON-PROFIT CORPORATION)  
SUITE 100  
21 WEST SUPERIOR STREET  
DULUTH, MN 55802

FIRST USE 1-1-2005; IN COMMERCE 1-1-2005.

THE MARK CONSISTS OF A BRIDGE WITH A  
WAVE OF WATER UNDERNEATH.

FOR: PROVIDING VISITOR AND CONVENTION  
INFORMATION SERVICES, NAMELY, PROVIDING  
INFORMATION TO PROMOTE TOURISM AND  
BUSINESS CONVENTIONS IN THE DULUTH  
AREA, IN CLASS 35 (U.S. CLS. 100, 101 AND 102).

SER. NO. 77-291,804, FILED 9-28-2007.

REBECCA EISINGER, EXAMINING ATTORNEY

**Int. Cl.: 9**

**Prior U.S. Cls.: 21, 23, 26, 36 and 38**

**Reg. No. 3,452,780**

**United States Patent and Trademark Office**

**Registered June 24, 2008**

**TRADEMARK  
PRINCIPAL REGISTER**

# Lambda Predict

RELIASOFT CORPORATION (ARIZONA CORPORATION)  
1450 S EASTSIDE LOOP  
TUSCON, AZ 85710

FOR: COMPUTER SOFTWARE FOR STANDARDS BASED RELIABILITY PREDICTION ANALYSIS, NAMELY, FOR USE IN PERFORMING RELIABILITY ANALYSIS WHEN ACTUAL PRODUCT RELIABILITY DATA IS NOT AVAILABLE WITH THE USE OF INDUSTRY-WIDE ACCEPTED RELIABILITY PREDICTION STANDARDS, CONSISTING OF, BUT NOT LIMITED TO MIL-217, BELLCORE, NSWC, RDF2000, CHINA 299B, FIDES AND OTHER STANDARDS, IN CLASS 9 (U.S. CLS. 21, 23, 26, 36 AND 38).

FIRST USE 1-0-2003; IN COMMERCE 11-0-2004.

THE MARK CONSISTS OF STANDARD CHARACTERS WITHOUT CLAIM TO ANY PARTICULAR FONT, STYLE, SIZE, OR COLOR.

NO CLAIM IS MADE TO THE EXCLUSIVE RIGHT TO USE "PREDICT", APART FROM THE MARK AS SHOWN.

SER. NO. 77-291,865, FILED 9-28-2007.

SALLY SHIH, EXAMINING ATTORNEY

**Int. Cl.: 35**

**Prior U.S. Cls.: 100, 101 and 102**

**United States Patent and Trademark Office**

**Reg. No. 3,452,781**

**Registered June 24, 2008**

**SERVICE MARK  
PRINCIPAL REGISTER**



E.C. PROFESSIONAL VIDEO (NEW YORK CORPORATION)  
253 WEST 51ST STREET  
NEW YORK, NY 10019

FOR: RETAIL STORE SERVICES, MAIL ORDER SERVICES, AND ONLINE RETAIL STORE SERVICES OFFERED THROUGH A GLOBAL COMPUTER NETWORK, ALL OF WHICH FEATURE THE FOLLOWING GOODS: AUDIO, VIDEO, AND ELECTRONIC EQUIPMENT, COMPUTER HARDWARE, COMPUTER SOFTWARE, CAMERAS, CAMCORDERS, COMPACT DISCS, VIDEO TAPES, DIGITAL VIDEO DISCS, DIGITAL CAMERAS, VIDEO CAMERAS, TELEVISION CAMERAS, CAMERA SYSTEMS COMPRISED OF CAMERA SUPPORT DEVICES IN THE NATURE OF TRIPODS, HEADS AND MOUNTS, LENSES, MAGAZINES, BATTERIES, LENS CONTROLS, FILTERS, AND VIDEO ASSISTS, VIDEO SYSTEMS COMPRISED OF STUDIO MONITORS, VIDEOTAPE RECORDERS, DOWN CONVERTERS, FORMAT CONVERTERS, ROUTERS, CAMERA CONTROL UNITS, ON-BOARD MONITORS, WAVEFORM MONITORS, ENGINEERING RACKS, PEDESTAL MOUNTS AND INTERFACES, LENS CONTROL DEVICES, POWER SUPPLIES, TIMECODE GENERATORS, SYNC GENERATORS, AND BATTERIES, REMOTE CAMERA SYSTEMS COMPRISED OF CAMERA CRANES,

CRANE TRACKS, REMOTE CONTROLLED MOUNTS, REMOTE FOLLOW FOCUS DEVICES, VIDEO CAMERAS AND MONITORS, CAMERA POSITIONING DEVICES, AND CAMERA OPERATING CONTROLS, CAMERA ACCESSORIES USED ON CAMERAS IN THE NATURE OF MATTE BOXES, FOLLOW FOCUS DEVICES, BRACKETS, LENS SUPPORTS, LENS CONTROLS, SPEED CONTROLS, REMOTE CONTROL DEVICES, CABLES, BARNEYS, HEATERS, WEATHER PROTECTORS, RINGS, SHADES, SPEAKERS AND SPRAY DEFLECTORS, CUSTOM AUDIO, VIDEO, AND ELECTRONIC EQUIPMENT AND CAMERA LENSES, IN CLASS 35 (U.S. CLS. 100, 101 AND 102).

FIRST USE 7-10-2004; IN COMMERCE 7-10-2004.

THE COLOR(S) LIGHT BLUE IS/ARE CLAIMED AS A FEATURE OF THE MARK.

THE MARK CONSISTS OF A LIGHT BLUE LOWER CASE "E" WITH A LIGHT BLUE DIAGONAL SLASH THROUGH IT.

SER. NO. 77-292,010, FILED 9-28-2007.

APRIL ROACH, EXAMINING ATTORNEY

**Int. Cl.: 7**

**Prior U.S. Cls.: 13, 19, 21, 23, 31, 34 and 35**

**Reg. No. 3,452,782**

**United States Patent and Trademark Office**

**Registered June 24, 2008**

---

**TRADEMARK  
PRINCIPAL REGISTER**

**IceMan Ultra**

WINDCHASER PRODUCTS, INC (CALIFORNIA  
CORPORATION)  
4130 DEL REY AVENUE  
MARINA DEL REY, CA 90292

THE MARK CONSISTS OF STANDARD CHAR-  
ACTERS WITHOUT CLAIM TO ANY PARTICULAR  
FONT, STYLE, SIZE, OR COLOR.

FOR: PORTABLE ICE MAKER, IN CLASS 7 (U.S.  
CLS. 13, 19, 21, 23, 31, 34 AND 35).

SER. NO. 77-292,126, FILED 9-28-2007.

FIRST USE 1-7-2001; IN COMMERCE 1-7-2001.

SHARON MEIER, EXAMINING ATTORNEY

Int. Cl.: 3

Prior U.S. Cls.: 1, 4, 6, 50, 51 and 52

United States Patent and Trademark Office

Reg. No. 3,452,783

Registered June 24, 2008

TRADEMARK  
PRINCIPAL REGISTER

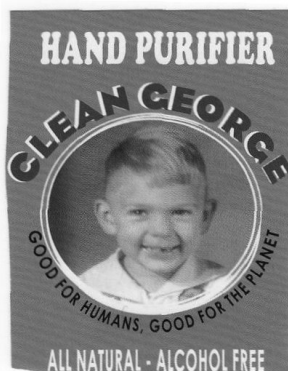

MILLER, TRACY (UNITED STATES INDIVIDUAL)

127 S. DETROIT ST.

LOS ANGELES, CA 90036

FOR: BATH SOAPS; ANTIBACTERIAL SOAP; COSMETIC CREAMS FOR SKIN CARE; SKIN TONERS; HAIR CREAMS; HAIR GEL; COSMETICS; LIP BALM; ADHESIVES FOR FALSE EYELASHES, HAIR AND NAILS; AFTER SUN CREAMS; AFTER-SHAVE BALMS; AFTER-SHAVE CREAMS; AFTER-SHAVE EMULSIONS; AFTER-SUN LOTIONS; AFTER-SUN GELS; AFTER-SUN MILKS; AFTER-SUN OILS; AGE RETARDANT GEL; AGE RETARDANT LOTION; AGE SPOT REDUCING CREAMS; ALL PURPOSE CLEANING PREPARATIONS; ALL-PURPOSE CLEANERS; ALMOND SOAPS; ALOE VERA GEL FOR COSMETIC PURPOSES; ANTIBACTERIAL SKIN SOAPS; ANTI-AGING CREAM; ANTI-STATIC DRYER SHEETS; ANTI-WRINKLE CREAMS; AROMATHERAPY CREAMS; AROMATHERAPY LOTIONS; AROMATHERAPY OILS; AROMATHERAPY PILLOWS COMPRISING POTPOURRI IN FABRIC CONTAINERS; AROMATHERAPY PILLOWS THAT MAY BE USED TO FRESHEN CLOTHING OR LAY OVER THE EYES; ASTRINGENTS FOR COSMETIC PURPOSES; AUTOMATIC DISHWASHING DETERGENTS; BABY HAIR CONDITIONER; BABY LOTION; BABY OILS; BABY SHAMPOO; BABY WIPES; BAR SOAP; BATH OILS; BATH OILS FOR COSMETIC PURPOSES; BATH SALTS; BATH SOAPS IN LIQUID, SOLID OR GEL FORM; BEAUTY LOTIONS; BEAUTY SERUMS; BLUSH; BODY LOTION; BODY EMULSIONS; BODY SCRUB; BODY SPRAY USED AS A PERSONAL DEODORANT AND AS FRAGRANCE; BODY

SPRAYS, NAMELY, WATER IN ATOMIZED CONTAINERS USED TO PRODUCE A COOLING EFFECT; BREATH FRESHENER; BREATH FRESHENING CONFECTIONARY, NAMELY, DISSOLVABLE BREATH STRIPS, BREATH MINTS, CANDY AND GUM; BUBBLE BATH; COSMETIC PREPARATIONS FOR BODY CARE; COSMETIC SOAPS; CREAM SOAPS; DEODORANT FOR PERSONAL USE; DEODORANTS FOR BODY CARE; DISHWASHER DETERGENTS; DISINFECTANT SOAPS; DISPOSABLE WIPES IMPREGNATED WITH CHEMICALS OR COMPOUNDS FOR PERSONAL HYGIENE; DISPOSABLE WIPES IMPREGNATED WITH CHEMICALS OR COMPOUNDS FOR HOUSEHOLD USE; ESSENTIAL OILS AS PERFUME FOR LAUNDRY PURPOSES; ESSENTIAL OILS; ESSENTIAL OILS FOR HOUSEHOLD USE; ESSENTIAL OILS FOR PERSONAL USE; ESSENTIAL OILS FOR USE IN THE MANUFACTURE OF SCENTED PRODUCTS; EYE CREAM; EYE GELS; FACE AND BODY LOTIONS; FACE CREAMS; FACIAL CLEANSERS; FACIAL LOTION; FACIAL WASHES; FACIAL SCRUBS; GERMICIDAL DETERGENTS; HAIR SHAMPOO; HAIR RINSES; HAIR SPRAY; HAND CLEANERS; HAND CLEANING PREPARATIONS; HAND CREAM; HAND LOTIONS; HAND SOAPS; HOUSEHOLD CLEANING PREPARATIONS; IMPREGNATED CLEANING CLOTHS; LAUNDRY SOAP; LAVENDER OIL; LIQUID BATH SOAPS; MOISTURIZING CREAMS; MOUTHWASHES; NATURAL ESSENTIAL OILS; NON-MEDICATED ACNE TREATMENT PREPARATIONS; NON-MEDICATED DIAPER RASH OINTMENTS AND LOTIONS; NON-MEDICATED SKIN CARE PREPARATIONS; NON-MEDICATED SKIN CREAMS; NON-MEDICATED SKIN CARE PREPARATIONS,

NAMELY, CREAMS, LOTIONS, GELS, TONERS, CLEANERS AND PEELS; NON-MEDICATED STIMULATING LOTIONS FOR THE SKIN; NON-MEDICATED SUN CARE PREPARATIONS; NON-MEDICATED TOILETRIES; NUTRITIONAL OILS FOR COSMETIC PURPOSES; PEPPERMINT OIL; PERSONAL DEODORANTS; PET SHAMPOO; PRE-MOISTENED COSMETIC TOWELETTES; PRE-MOISTENED COSMETIC WIPES; PRE-MOISTENED TOWELETTES IMPREGNATED WITH DISHWASHING DETERGENT; ROOM FRAGRANCES; SCENTED ROOM SPRAYS; SHAMPOOS; SHAMPOOS FOR BABIES; SHAMPOO-CONDITIONERS; SKIN AND BODY TOPICAL LOTIONS, CREAMS AND OILS FOR COSMETIC USE; SKIN CARE PREPARATION, NAMELY, BODY POLISH; SKIN CLARIFIERS; SKIN CLEANSERS; SKIN CLEANSING CREAM; SKIN CLEANSING LOTION; SKIN CONDITIONERS; SKIN CREAM; SKIN CREAMS; SKIN EMOLLIENTS; SKIN LOTION; SKIN MOISTURIZER; SKIN SOAP; SOAPS FOR BODY CARE; SOAPS FOR HOUSEHOLD USE; SOAPS FOR PERSONAL USE; SOAPS FOR TOILET PURPOSES; SUN BLOCK; SUN BLOCK PREPARATIONS; SUN CARE LOTIONS; SUN CREAMS; SUN SCREEN; SUN SCREEN PREPARATIONS; SUNSCREEN CREAM; SUN-BLOCK LOTIONS; TISSUES IMPREGNATED WITH

COSMETIC LOTIONS; TOOTH CLEANING PREPARATIONS; TOOTH GEL; TOOTH PASTE; TOOTH POLISH; TOOTH POWDER; TOOTHPASTE; TOPICAL SKIN SPRAYS FOR COSMETIC PURPOSES; WASHING-UP LIQUIDS; WATERLESS SOAP; HAND CLEANING PREPARATIONS, NAMELY, HAND PURIFIER, IN CLASS 3 (U.S. CLS. 1, 4, 6, 50, 51 AND 52).

FIRST USE 8-0-2006; IN COMMERCE 8-0-2006.

NO CLAIM IS MADE TO THE EXCLUSIVE RIGHT TO USE "CLEAN," "ALL NATURAL - ALCOHOL FREE," AND "HAND PURIFIER", APART FROM THE MARK AS SHOWN.

THE STIPPLING IS FOR SHADING PURPOSES ONLY.

THE NAME "CLEAN GEORGE" DOES NOT IDENTIFY A LIVING INDIVIDUAL. THE LIKENESS (OR "PORTRAIT") IN THE MARK DOES NOT IDENTIFY A LIVING INDIVIDUAL.

SER. NO. 77-292,153, FILED 9-28-2007.

MICHAEL GAAFAR, EXAMINING ATTORNEY

**Int. Cl.: 35**

**Prior U.S. Cls.: 100, 101 and 102**

**United States Patent and Trademark Office**

**Reg. No. 3,452,784**

**Registered June 24, 2008**

**SERVICE MARK  
PRINCIPAL REGISTER**



MULTICHOICE GROUP, INC. (GEORGIA CORPORATION)  
SUITE 300  
3855 HOLCOMB BRIDGE RD.  
NORCROSS, GA 30092

FOR: ADVERTISING, MARKETING AND PROMOTION SERVICES, IN CLASS 35 (U.S. CLS. 100, 101 AND 102).

FIRST USE 11-12-2006; IN COMMERCE 12-6-2006.

NO CLAIM IS MADE TO THE EXCLUSIVE RIGHT TO USE "MULTI-CHOICE MARKETING", APART FROM THE MARK AS SHOWN.

THE COLOR(S) GREY, RED, BLACK, WHITE IS/ ARE CLAIMED AS A FEATURE OF THE MARK.

THE MARK CONSISTS OF A CIRCLE THAT CONTAINS THE TWO LETTERS "MM" AND HAS A BLACK AND GREY TOP, RED BOTTOM, AND WHITE MIDDLE. TO THE RIGHT SIDE OF THE CIRCLE ARE TWO WORDS, "MULTICHOICE" AND "MARKETING." THE WORD "MULTICHOICE" APPEARS IN RED WITH A WHITE OUTLINE, AND THE WORD "MARKETING" APPEARS IN BLACK.

SER. NO. 77-292,188, FILED 9-28-2007.

EMILY CARLSEN, EXAMINING ATTORNEY

**Int. Cl.: 9**

**Prior U.S. Cls.: 21, 23, 26, 36 and 38**

**United States Patent and Trademark Office**

**Reg. No. 3,452,785**

**Registered June 24, 2008**

**TRADEMARK  
PRINCIPAL REGISTER**

TRUE  SUBSTANCE

TRUE SUBSTANCE INC. (OHIO CORPORATION), DBA VINTAGE  
920 BERKELEY RD.  
COLUMBUS, OH 43206

FOR: DOWNLOADABLE MP3 FILES, MP3 RECORDINGS, ONLINE DISCUSSION BOARDS, WEBCASTS AND PODCASTS FEATURING MUSIC, AUDIO BOOKS AND NEWS BROADCASTS; DOWNLOADABLE MUSICAL SOUND RECORDINGS; MUSICAL SOUND RECORDINGS; MUSICAL VIDEO RECORDINGS; COMPACT DISCS FEATURING MUSIC AND MUSIC VIDEOS; VIDEO DISCS FEATURING

TURING MUSIC VIDEOS, DOCUMENTARIES, IN CLASS 9 (U.S. CLS. 21, 23, 26, 36 AND 38).

FIRST USE 1-1-2000; IN COMMERCE 1-1-2000.

THE MARK CONSISTS OF THE WORDING "TRUE SUBSTANCE" WITH A SCRIBBLE MARK BETWEEN THE TWO WORDS.

SER. NO. 77-292,364, FILED 9-30-2007.

MARILYN IZZI, EXAMINING ATTORNEY



**Int. Cl.: 41**

**Prior U.S. Cls.: 100, 101 and 107**

**United States Patent and Trademark Office**

**Reg. No. 3,452,786**

**Registered June 24, 2008**

**SERVICE MARK  
PRINCIPAL REGISTER**

**COLLEGEWEEKLIVE**

PLATFORMQ, LLC (DELAWARE LTD LIAB CO)  
100 CRESCENT ROAD  
NEEDHAM, MA 02494

THE MARK CONSISTS OF STANDARD CHAR-  
ACTERS WITHOUT CLAIM TO ANY PARTICULAR  
FONT, STYLE, SIZE, OR COLOR.

FOR: ON-LINE COLLEGE FAIR SERVICES, IN  
CLASS 41 (U.S. CLS. 100, 101 AND 107).

SER. NO. 77-292,693, FILED 10-1-2007.

FIRST USE 11-13-2007; IN COMMERCE 11-13-2007.

AMY GEARIN, EXAMINING ATTORNEY

**Int. Cl.: 36**

**Prior U.S. Cls.: 100, 101 and 102**

**United States Patent and Trademark Office**

**Reg. No. 3,452,787**

**Registered June 24, 2008**

**SERVICE MARK  
PRINCIPAL REGISTER**

**Blue Ocean Commercial  
Funding**

BLUE OCEAN COMMERCIAL FUNDING, LLC  
(ILLINOIS LTD LIAB CO)

#204

101 BURR RIDGE PKWY  
BURR RIDGE, IL 60527

FOR: MORTGAGE BROKERAGE; MORTGAGE  
LENDING, IN CLASS 36 (U.S. CLS. 100, 101 AND 102).

FIRST USE 4-1-2007; IN COMMERCE 4-1-2007.

THE MARK CONSISTS OF STANDARD CHAR-  
ACTERS WITHOUT CLAIM TO ANY PARTICULAR  
FONT, STYLE, SIZE, OR COLOR.

NO CLAIM IS MADE TO THE EXCLUSIVE  
RIGHT TO USE "COMMERCIAL FUNDING",  
APART FROM THE MARK AS SHOWN.

SER. NO. 77-292,892, FILED 10-1-2007.

KIMBERLY PERRY, EXAMINING ATTORNEY

**Int. Cl.: 36**

**Prior U.S. Cls.: 100, 101 and 102**

**United States Patent and Trademark Office**

**Reg. No. 3,452,788**

**Registered June 24, 2008**

**SERVICE MARK  
PRINCIPAL REGISTER**



BLUE OCEAN COMMERCIAL FUNDING, LLC  
(ILLINOIS LTD LIAB CO)  
#204  
101 BURR RIDGE PKWY  
BURR RIDGE, IL 60527

FOR: MORTGAGE BROKERAGE; MORTGAGE  
LENDING, IN CLASS 36 (U.S. CLS. 100, 101 AND 102).

FIRST USE 4-1-2007; IN COMMERCE 4-1-2007.

NO CLAIM IS MADE TO THE EXCLUSIVE  
RIGHT TO USE "COMMERCIAL FUNDING",  
APART FROM THE MARK AS SHOWN.

THE COLOR(S) RED, ORANGE, BLUE, AND  
BLACK IS/ARE CLAIMED AS A FEATURE OF  
THE MARK.

THE MARK CONSISTS OF AN ORANGE AND  
RED SUN OVER BLUE WATER. THE WORDS  
"BLUE OCEAN COMMERCIAL FUNDING" IN  
THE COLOR BLACK ARE UNDER THE WATER.

SER. NO. 77-292,901, FILED 10-1-2007.

KIMBERLY PERRY, EXAMINING ATTORNEY

**Int. Cl.: 9**

**Prior U.S. Cls.: 21, 23, 26, 36 and 38**

**Reg. No. 3,452,789**

**United States Patent and Trademark Office**

**Registered June 24, 2008**

**TRADEMARK  
PRINCIPAL REGISTER**

**EBN**

EBN TECHNOLOGY CORPORATION (TAIWAN CORPORATION)  
10F., NO. 90, SEC. 1  
SINTAI 5TH ROAD  
SIJHIH CITY TAIPEI CTY, TAIWAN 221

FOR: CASH REGISTERS; ELECTRONIC CASH REGISTERS; LIQUID CRYSTAL DISPLAYS; TOUCH PANELS; COMPUTER KEYBOARDS; ELECTRONIC CARD READERS; FLASH CARD READERS; CHIP CARD READERS; COMPUTER TERMINALS, NAMELY, MULTIMEDIA SELF-SERVICE KIOSKS; PERSONAL COMPUTERS; HAND HELD LASER BARCODE SCANNERS; BARCODE SCANNERS; COMPUTER PRINTERS FOR RECEIPT PRINTING;

COMPUTER PRINTERS; PORTABLE POINT-OF-SALE TERMINALS, IN CLASS 9 (U.S. CLS. 21, 23, 26, 36 AND 38).

FIRST USE 1-5-2007; IN COMMERCE 3-5-2007.

THE MARK CONSISTS OF STANDARD CHARACTERS WITHOUT CLAIM TO ANY PARTICULAR FONT, STYLE, SIZE, OR COLOR.

SER. NO. 77-292,961, FILED 10-1-2007.

KRISTIN DAHLING, EXAMINING ATTORNEY

**Int. Cl.: 9**

**Prior U.S. Cls.: 21, 23, 26, 36 and 38**

**Reg. No. 3,452,790**

**United States Patent and Trademark Office**

**Registered June 24, 2008**

**TRADEMARK  
PRINCIPAL REGISTER**



RELIASOFT CORPORATION (ARIZONA CORPORATION)  
1450 S EASTSIDE LOOP  
TUCSON, AZ 85710

FOR: COMPUTER SOFTWARE FOR STANDARDS BASED RELIABILITY PREDICTION ANALYSIS, NAMELY, FOR USE IN PERFORMING RELIABILITY ANALYSIS WHEN ACTUAL PRODUCT RELIABILITY DATA IS NOT AVAILABLE WITH THE USE OF INDUSTRY-WIDE ACCEPTED RELIABILITY PREDICTION STANDARDS, CONSISTING OF, BUT NOT LIMITED TO MIL-217, BELLCORE, NSWC, RDF2000, CHINA 299B, FIDES AND OTHER STANDARDS, IN CLASS 9 (U.S. CLS. 21, 23, 26, 36 AND 38).

FIRST USE 1-0-2003; IN COMMERCE 11-0-2004.

NO CLAIM IS MADE TO THE EXCLUSIVE RIGHT TO USE "PREDICT", APART FROM THE MARK AS SHOWN.

THE MARK CONSISTS OF THE GREEK LETTER "LAMBDA" FOLLOWED BY THE WORD "PREDICT".

THE NON-LATIN CHARACTER(S) IN THE MARK TRANSLITERATE INTO "LAMBDA", AND THIS MEANS "LAMBDA" IN ENGLISH.

SER. NO. 77-293,084, FILED 10-1-2007.

SALLY SHIH, EXAMINING ATTORNEY

Int. Cl.: 36

Prior U.S. Cls.: 100, 101 and 102

United States Patent and Trademark Office

Reg. No. 3,452,791

Registered June 24, 2008

SERVICE MARK  
PRINCIPAL REGISTER



KENTUCKY HIGHER EDUCATION STUDENT  
LOAN CORPORATION (KENTUCKY MUNI-  
CIPAL CORPORATION), DBA THE STUDENT  
LOAN PEOPLE  
LEGAL SERVICES DIVISION  
10180 LINN STATION ROAD, SUITE C 200  
LOUISVILLE, KY 40223

FOR: PROVIDING STUDENT LOAN INFORMA-  
TION; STUDENT LOAN SERVICES , IN CLASS 36  
(U.S. CLS. 100, 101 AND 102).

FIRST USE 2-1-2003; IN COMMERCE 2-1-2003.

NO CLAIM IS MADE TO THE EXCLUSIVE  
RIGHT TO USE "STUDENT LOAN", APART FROM  
THE MARK AS SHOWN.

THE COLOR(S) DARK GREEN, DARK BLUE  
AND MEDIUM BLUE IS/ARE CLAIMED AS A  
FEATURE OF THE MARK.

THE MARK CONSISTS OF HEAD, LEFT ARM  
POINTING DOWN AND RIGHT ARM POINTING  
UP ALL IN NAVY BLUE; A DARK GREEN MOR-  
TAR BOARD APPEARS TILTED ABOVE THE  
RIGHT ARM; THE WORDS "THE STUDENT" AP-  
PEAR IN DARK BLUE DIRECTLY BENEATH THE  
FIGURE AND THE WORDS "LOAN PEOPLE" AP-  
PEAR IN DARK BLUE TEXT BENEATH THE PRE-  
VIOUS WORDS; THE WORDS ARE BORDERED ON  
THE TOP AND BOTTOM BY A THICK DARK  
GREEN LINE; THE WORDS "YOU CAN GO TO  
COLLEGE. WE'LL GET YOU THERE FOR LESS."  
APPEAR IN MEDIUM BLUE BENEATH THE BOT-  
TOM DARK GREEN LINE.

SER. NO. 77-293,470, FILED 10-2-2007.

DAVID YONTEF, EXAMINING ATTORNEY

Int. Cl.: 37

Prior U.S. Cls.: 100, 103 and 106

United States Patent and Trademark Office

Reg. No. 3,452,792

Registered June 24, 2008

SERVICE MARK  
PRINCIPAL REGISTER



KAY, CHRISTOPHER T. (UNITED STATES IN-  
DIVIDUAL)  
71 BROOKLINE STREET  
WATERTOWN, MA 02472

FOR: BUSINESS SERVICES, NAMELY, CLEAN-  
ING HOUSEHOLD AND COMMERCIAL APPLIAN-  
CES AND EQUIPMENT, IN CLASS 37 (U.S. CLS. 100,  
103 AND 106).

FIRST USE 4-2-2007; IN COMMERCE 4-2-2007.

THE MARK CONSISTS OF A STYLIZED LETTER  
"L" IN THE SHAPE OF A GRILLING SPATULA AND  
A STYLIZED LETTER "L" IN THE SHAPE OF A  
GRILLING FORK ON TOP OF A PROPANE GRIL-  
LING FLAME.

SER. NO. 77-293,486, FILED 10-2-2007.

VIVIAN MICZNIK FIRST, EXAMINING ATTOR-  
NEY

Int. Cl.: 9

Prior U.S. Cls.: 21, 23, 26, 36 and 38

Reg. No. 3,452,793

United States Patent and Trademark Office

Registered June 24, 2008

TRADEMARK  
PRINCIPAL REGISTER

Comprehensive

VCOM INTERNATIONAL MULTIMEDIA CORPORATION (NEW JERSEY CORPORATION)  
55 RUTA COURT  
SOUTH HACKENSACK, NJ 07606

FOR: AUDIO AND VIDEO AND COMPUTER COMPONENT PARTS AND ACCESSORIES, NAME-  
LY, ADAPTERS, AUDIO, VIDEO AND COMPUTER  
CABLE CONNECTERS, ELECTRIC CABLES, CABLE  
STRIPPERS, JUNCTION BOXES, CABLE TESTERS,  
CABLE TIES, ELECTRICAL MOULDING DUCT,  
CABLE ORGANIZERS, HOOK-UP WIRE, CABLE  
MARKERS; VIDEO INTERCONNECTING BOXES;  
DISTRIBUTION AMPLIFIERS; VIDEO AND BULK  
CABLE, WALLPLATES FOR ELECTRICAL

SWITCHES AND OUTLETS, SWITCHERS, CABLE  
EXTENDERS, SIGNAL PROCESSORS, PROJECTION  
SCREENS, DIGITAL VIDEO RECORDERS, CD AND  
DVD DUPLICATORS, MICROPHONES, VIDEO  
PROJECTORS, AUDIO SPEAKERS, COMPUTER  
MONITORS, IN CLASS 9 (U.S. CLS. 21, 23, 26, 36  
AND 38).

FIRST USE 10-30-1976; IN COMMERCE 10-30-1976.

SER. NO. 77-293,568, FILED 10-2-2007.

NAAKWAMA ANKRAH, EXAMINING ATTORNEY



Int. Cl.: 45

Prior U.S. Cls.: 100 and 101

United States Patent and Trademark Office

Reg. No. 3,452,794

Registered June 24, 2008

SERVICE MARK  
PRINCIPAL REGISTER



RELIANT FRANCHISING, INC. (NORTH CAROLINA CORPORATION), DBA RELIANT HOME CARE  
SUITE A  
445 DOLLEY MADISON RD.  
GREENSBORO, NC 27410

FOR: PROVIDING NON-MEDICAL PERSONAL ASSISTANT SERVICES FOR OTHERS IN THE NATURE OF PLANNING, ORGANIZING, COORDINATING, ARRANGING AND ASSISTING INDIVIDUALS TO PERFORM DAILY TASKS, IN CLASS 45 (U.S. CLS. 100 AND 101).

FIRST USE 9-20-2007; IN COMMERCE 9-20-2007.

NO CLAIM IS MADE TO THE EXCLUSIVE RIGHT TO USE "HOME CARE", APART FROM THE MARK AS SHOWN.

THE COLOR(S) BLUE AND GREEN IS/ARE CLAIMED AS A FEATURE OF THE MARK.

THE MARK CONSISTS OF A GREEN SQUARE ON THE LEFT SIDE OF THE MARK WITH THE LETTERS "RHC" IN BLUE WRITTEN DIAGONALLY FROM TOP TO BOTTOM INSIDE THE SQUARE AND AN IMAGE OF A ROOF TOP IN BLUE ABOVE THE LETTER "H," AND THE IMAGE OF A HAND IN BLUE BELOW THE LETTER "H." A BLUE SWOOSH SURROUNDS THE RIGHT SIDE OF THE SQUARE. THE WORD "RELIANT" IS WRITTEN TO THE RIGHT OF THE GREEN SQUARE IN CAPITAL LETTERS IN BLUE. THE WORDS "HOME CARE" APPEAR IN GREEN, ALL CAPITALIZED IN SMALLER TEXT BELOW THE WORD "RELIANT."

SER. NO. 77-293,573, FILED 10-2-2007.

YAT SYE, LEE, EXAMINING ATTORNEY

**Int. Cl.: 41**

**Prior U.S. Cls.: 100, 101 and 107**

**United States Patent and Trademark Office**

**Reg. No. 3,452,795**

**Registered June 24, 2008**

**SERVICE MARK  
PRINCIPAL REGISTER**

**State of Grace Yoga and  
Wellness Center**

ANGER, NANCY (UNITED STATES INDIVIDUAL)  
27 SOUTHWICK RD.  
SUTTON, MA 01590

FOR: EDUCATIONAL SERVICES, NAMELY, PROVIDING CLASSES AND WORKSHOPS IN THE FIELDS OF YOGA, HEALTH AND NUTRITION, BEAUTY, WEIGHT MANAGEMENT, DANCE, FITNESS AND PERSONAL IMPROVEMENT, IN CLASS 41 (U.S. CLS. 100, 101 AND 107).

FIRST USE 1-5-2008; IN COMMERCE 1-5-2008.

THE MARK CONSISTS OF STANDARD CHARACTERS WITHOUT CLAIM TO ANY PARTICULAR FONT, STYLE, SIZE, OR COLOR.

NO CLAIM IS MADE TO THE EXCLUSIVE RIGHT TO USE "YOGA AND WELLNESS CENTER", APART FROM THE MARK AS SHOWN.

SER. NO. 77-293,816, FILED 10-2-2007.

FRED CARL, EXAMINING ATTORNEY

Int. Cl.: 14

Prior U.S. Cls.: 2, 27, 28 and 50

United States Patent and Trademark Office

Reg. No. 3,452,796

Registered June 24, 2008

TRADEMARK  
PRINCIPAL REGISTER



JEWELS BY PARK LANE, INC. (ILLINOIS CORPORATION)  
100 EAST COMMERCE DRIVE  
SCHAUMBURG, IL 60173

FOR: JEWELRY, IN CLASS 14 (U.S. CLS. 2, 27, 28 AND 50).

FIRST USE 9-30-1992; IN COMMERCE 9-30-1992.

OWNER OF U.S. REG. NOS. 1,841,784, 1,946,925 AND OTHERS.

NO CLAIM IS MADE TO THE EXCLUSIVE RIGHT TO USE "JEWELS", "SINCE 1955" AND THE DEPICTION OF A GEMSTONE, APART FROM THE MARK AS SHOWN.

SER. NO. 77-294,046, FILED 10-2-2007.

HENRY S. ZAK, EXAMINING ATTORNEY

Prior U.S. Cl.: B

United States Patent and Trademark Office

Reg. No. 3,452,797

Registered June 24, 2008

CERTIFICATION MARK  
PRINCIPAL REGISTER



NATIONAL ASSOCIATION OF SOCIAL WORKERS (DELAWARE CORPORATION)

SUITE 700

750 FIRST STREET, NE

WASHINGTON, DC 20002

FOR: EDUCATIONAL SERVICES, NAMELY, CONTINUING EDUCATION FOR SOCIAL WORKERS IN THE FORM OF SEMINARS, WORKSHOPS, EDUCATIONAL PROGRAMS AND CONFERENCES ON SOCIAL SCIENCE, HEALTH, PSYCHOLOGY, ECONOMIC AND PRACTICE MANAGEMENT ISSUES, IN CLASS B (U.S. CL. B).

FIRST USE 6-0-2000; IN COMMERCE 6-0-2000.

OWNER OF U.S. REG. NO. 2,010,247.

NO CLAIM IS MADE TO THE EXCLUSIVE RIGHT TO USE "APPROVAL PROGRAM" OR "CE", APART FROM THE MARK AS SHOWN.

THE MARK CONSISTS OF CONCENTRIC CIRCLES RESEMBLING AN OFFICIAL SEAL AND CIRCLE WITH FOUR GEOMETRIC LINES RESEMBLING FINGERS.

THE CERTIFICATION MARK, AS USED BY AUTHORIZED PERSONS, CERTIFIES THAT THE CONTINUING EDUCATION PROGRAMMING PROVIDED IN CONNECTION WITH THE MARK MEETS THE STANDARDS AND REQUIREMENTS ESTABLISHED BY THE NATIONAL ASSOCIATION OF SOCIAL WORKERS.

SER. NO. 77-294,257, FILED 10-2-2007.

HENRY S. ZAK, EXAMINING ATTORNEY

**Int. Cl.: 36**

**Prior U.S. Cls.: 100, 101 and 102**

**United States Patent and Trademark Office**

**Reg. No. 3,452,798**

**Registered June 24, 2008**

**SERVICE MARK  
PRINCIPAL REGISTER**

**It's Our Time to Change  
the World**

SUSTAINABLE WORLD CAPITAL, LLC (GEOR-  
GIA LTD LIAB CO)  
388 PINE FOREST RD  
ATLANTA, GA 30342

THE MARK CONSISTS OF STANDARD CHAR-  
ACTERS WITHOUT CLAIM TO ANY PARTICULAR  
FONT, STYLE, SIZE, OR COLOR.

FOR: CAPITAL INVESTMENT CONSULTATION;  
INVESTMENT BANKING SERVICES, IN CLASS 36  
(U.S. CLS. 100, 101 AND 102).

SER. NO. 77-294,310, FILED 10-2-2007.

FIRST USE 6-30-2007; IN COMMERCE 6-30-2007.

LINDA MICKLEBURGH, EXAMINING ATTORNEY

**Int. Cl.: 9**

**Prior U.S. Cls.: 21, 23, 26, 36 and 38**

**Reg. No. 3,452,799**

**United States Patent and Trademark Office**

**Registered June 24, 2008**

**TRADEMARK  
PRINCIPAL REGISTER**

# ForeverScapes

MASSICOTTE, ROBERT A. (UNITED STATES  
INDIVIDUAL)  
15 MONROE STREET  
NASHUA, NH 03060

FOR: COMPUTER HARDWARE AND COMPUTER SOFTWARE PROGRAMS FOR THE INTEGRATION OF TEXT, AUDIO, GRAPHICS, STILL IMAGES AND MOVING PICTURES INTO AN INTERACTIVE DELIVERY FOR MULTIMEDIA APPLICATIONS; COMPUTER PROGRAMS FOR EDITING IMAGES, SOUND AND VIDEO; COMPUTER SOFTWARE FOR ORGANIZING AND VIEWING DIGITAL IMAGES AND PHOTOGRAPHS; COMPUTER SOFTWARE FOR USE IN RELATION TO DIGITAL ANIMATION AND SPECIAL EFFECTS OF IMAGES; COMPUTER SOFTWARE FOR USE IN THE ENCRYPTION AND DECRYPTION OF DIGITAL FILES, INCLUDING AUDIO, VIDEO, TEXT, BINARY, STILL IMAGES, GRAPHICS AND MULTIMEDIA FILES; COMPUTER SOFTWARE FOR USE

IN THE SAFEGUARDING OF DIGITAL FILES, INCLUDING AUDIO, VIDEO, TEXT, BINARY, STILL IMAGES, GRAPHICS AND MULTIMEDIA FILES; COMPUTER SOFTWARE TO ENHANCE THE AUDIO-VISUAL CAPABILITIES OF MULTIMEDIA APPLICATIONS, NAMELY, FOR THE INTEGRATION OF TEXT, AUDIO, GRAPHICS, STILL IMAGES AND MOVING PICTURES; SOFTWARE FOR PROCESSING IMAGES, GRAPHICS AND TEXT, IN CLASS 9 (U.S. CLS. 21, 23, 26, 36 AND 38).

FIRST USE 2-1-2007; IN COMMERCE 7-1-2007.

THE MARK CONSISTS OF STANDARD CHARACTERS WITHOUT CLAIM TO ANY PARTICULAR FONT, STYLE, SIZE, OR COLOR.

SER. NO. 77-294,469, FILED 10-2-2007.

JENNIFER HETU, EXAMINING ATTORNEY

**Int. Cl.: 33**

**Prior U.S. Cls.: 47 and 49**

**United States Patent and Trademark Office**

**Reg. No. 3,452,800**

**Registered June 24, 2008**

**TRADEMARK  
PRINCIPAL REGISTER**

**DANCING WATER**

ROSS TROWSDALE (NEW ZEALAND INDIVIDUAL)  
46 ROSSMORE TCE  
CHRISTCHURCH, NEW ZEALAND 8022 AND  
CLARE BISSO (NEW ZEALAND INDIVIDUAL)  
46 ROSSMORE TCE  
CHRISTCHURCH, NEW ZEALAND 8022 AND  
LINDSAY LLOYD (NEW ZEALAND INDIVIDUAL)  
46 ROSSMORE TCE  
CHRISTCHURCH, NEW ZEALAND 8022

THE MARK CONSISTS OF STANDARD CHARACTERS WITHOUT CLAIM TO ANY PARTICULAR FONT, STYLE, SIZE, OR COLOR.

OWNER OF NEW ZEALAND REG. NO. 750894,  
DATED 7-7-2006, EXPIRES 7-7-2016.

SER. NO. 77-294,600, FILED 10-2-2007.

FOR: WINES, IN CLASS 33 (U.S. CLS. 47 AND 49).

MARY MUNSON, EXAMINING ATTORNEY

**Int. Cl.: 28**

**Prior U.S. Cls.: 22, 23, 38 and 50**

**United States Patent and Trademark Office**

**Reg. No. 3,452,801**

**Registered June 24, 2008**

**TRADEMARK  
PRINCIPAL REGISTER**

**KE4**

GOLF GALAXY GOLFWORKS, INC. (OHIO CORPORATION)  
4820 JACKSONTOWN ROAD, P.O. BOX 3008  
NEWARK, OH 43058

THE MARK CONSISTS OF STANDARD CHARACTERS WITHOUT CLAIM TO ANY PARTICULAR FONT, STYLE, SIZE, OR COLOR.

FOR: GOLF CLUBS, HEAD COVERS FOR GOLF CLUBS, GOLF CLUB SHAFTS, IN CLASS 28 (U.S. CLS. 22, 23, 38 AND 50).

SER. NO. 77-294,691, FILED 10-3-2007.

FIRST USE 1-1-2006; IN COMMERCE 1-1-2006.

EVELYN BRADLEY, EXAMINING ATTORNEY



**Int. Cl.: 41**

**Prior U.S. Cls.: 100, 101 and 107**

**United States Patent and Trademark Office**

**Reg. No. 3,452,802**

**Registered June 24, 2008**

**SERVICE MARK  
PRINCIPAL REGISTER**

**TRIVERA TECHNOLOGIES**

TRIVERA TECHNOLOGIES, LLC (NEW JERSEY  
LTD LIAB CO)  
617 STOKES ROAD, SUITE 4 #326  
MEDFORD, NJ 08055

FOR: EDUCATIONAL SERVICES, NAMELY,  
CONDUCTING CLASSES IN THE FIELD OF TECH-  
NOLOGY AND THE DISTRIBUTION OF COURSE  
MATERIAL IN CONNECTION THEREWITH , IN  
CLASS 41 (U.S. CLS. 100, 101 AND 107).

FIRST USE 12-0-2001; IN COMMERCE 12-0-2001.

THE MARK CONSISTS OF STANDARD CHAR-  
ACTERS WITHOUT CLAIM TO ANY PARTICULAR  
FONT, STYLE, SIZE, OR COLOR.

NO CLAIM IS MADE TO THE EXCLUSIVE  
RIGHT TO USE "TECHNOLOGIES", APART FROM  
THE MARK AS SHOWN.

SER. NO. 77-294,788, FILED 10-3-2007.

INGA ERVIN, EXAMINING ATTORNEY

**Int. Cl.: 9**

**Prior U.S. Cls.: 21, 23, 26, 36 and 38**

**Reg. No. 3,452,803**

**United States Patent and Trademark Office**

**Registered June 24, 2008**

**TRADEMARK  
PRINCIPAL REGISTER**



P.C. SCALE, INC. (PENNSYLVANIA CORPORATION)  
211 EAST LOCUST STREET  
OXFORD, PA 19363

FOR: COMPUTER SOFTWARE; NAMELY, SOFTWARE FOR WEIGHING AND MEASURING DEVICES, TOGETHER WITH INSTRUCTIONAL MANUALS ASSOCIATED THEREWITH, SOLD AS A UNIT; COMPUTER SOFTWARE; NAMELY, SOFTWARE FOR ROUTE MANAGEMENT, TOGETHER WITH INSTRUCTIONAL MANUALS ASSOCIATED THEREWITH, SOLD AS A UNIT, IN CLASS 9 (U.S. CLS. 21, 23, 26, 36 AND 38).

FIRST USE 4-30-2007; IN COMMERCE 4-30-2007.

OWNER OF U.S. REG. NO. 2,336,891.

NO CLAIM IS MADE TO THE EXCLUSIVE RIGHT TO USE "PC", APART FROM THE MARK AS SHOWN.

THE COLOR(S) BLUE AND WHITE IS/ARE CLAIMED AS A FEATURE OF THE MARK.

THE MARK CONSISTS IN PART OF A STYLIZED HIGHWAY DESIGN. THE WORDING AND DESIGN ELEMENTS ARE ALL IN BLUE EXCEPT FOR THE OVERALL BACKGROUND, INNER EDGE OF THE RECTANGLE, AND ROADS THAT ARE WHITE.

SEC. 2(F) AS TO "PC SCALE".

SER. NO. 77-294,887, FILED 10-3-2007.

PAUL F. GAST, EXAMINING ATTORNEY

**Int. Cl.: 42**

**Prior U.S. Cls.: 100 and 101**

**United States Patent and Trademark Office**

**Reg. No. 3,452,804**

**Registered June 24, 2008**

**SERVICE MARK  
PRINCIPAL REGISTER**

# Non-Profit Soapbox

PICNET, INC. (CALIFORNIA CORPORATION)  
1341 G ST, NW, SUITE 1100  
WASHINGTON, DC 20005

FOR: COMPUTER SERVICES, NAMELY, CREATING AND MAINTAINING WEB SITES FOR OTHERS; COMPUTER SERVICES, NAMELY, HOSTING AND MAINTAINING AN ONLINE WEBSITE FOR OTHERS TO PROMOTE, ADVOCATE FOR, OR SUPPORT A CAUSE OR CHARITY; COMPUTER SERVICES, NAMELY, MANAGING WEB SITES FOR OTHERS; CREATING OR MAINTAINING WEB SITES FOR OTHERS; CREATION AND MAINTENANCE OF WEB SITES FOR OTHERS; CREATION AND PROVISION OF WEB PAGES TO AND FOR THIRD PARTIES; DESIGN AND MAINTENANCE OF COMPUTER SITES FOR THIRD PARTIES; DESIGN OF HOME PAGES, COMPUTER SOFTWARE AND WEB SITES; DESIGN OF HOMEPAGES AND WEB-SITES; DESIGN OF HOMEPAGES AND WEBSITES; DESIGN, CREATION, HOSTING AND MAINTENANCE OF INTERNET SITES FOR THIRD PARTIES; DESIGN, CREATION, HOSTING, MAINTENANCE OF WEBSITES FOR OTHERS; DISPLAY-

ING THE WEB SITES AND IMAGES OF OTHERS ON A COMPUTER SERVER; ELABORATION AND MAINTENANCE OF WEB SITES FOR THIRD PARTIES; PROVIDING A WEBSITE THAT GIVES COMPUTER USERS THE ABILITY TO UPLOAD, EXCHANGE AND SHARE PHOTOS, VIDEOS AND VIDEO LOGS; WEB SITE HOSTING SERVICES; WEBSITE DEVELOPMENT FOR OTHERS, IN CLASS 42 (U.S. CLS. 100 AND 101).

FIRST USE 1-1-2004; IN COMMERCE 1-1-2004.

THE MARK CONSISTS OF STANDARD CHARACTERS WITHOUT CLAIM TO ANY PARTICULAR FONT, STYLE, SIZE, OR COLOR.

NO CLAIM IS MADE TO THE EXCLUSIVE RIGHT TO USE "NON-PROFIT", APART FROM THE MARK AS SHOWN.

SER. NO. 77-294,895, FILED 10-3-2007.

JOHN GARTNER, EXAMINING ATTORNEY

**Int. Cl.: 35**

**Prior U.S. Cls.: 100, 101 and 102**

**United States Patent and Trademark Office**

**Reg. No. 3,452,805**

**Registered June 24, 2008**

**SERVICE MARK  
PRINCIPAL REGISTER**

NATURAL BEAUTY AT ITS BEST

STONE MART CORP. (CALIFORNIA CORPORATION)  
13425 SHERMAN WAY  
NORTH HOLLYWOOD, CA 91605

FOR: WHOLESALE DISTRIBUTORSHIPS FEATURING NATURAL STONE PRODUCTS, NAMELY, MARBLE, GRANITE, LIMESTONE, QUARTZ, TRAVERTINE, SLATE, JURASSIC FOSSIL STONE, AMETHYST, LAPIS LAZULI, MOTHER OF PEARL, WILD AGATE AND TIGER'S EYE; RETAIL STORE SERVICES FEATURING NATURAL STONE PRODUCTS, NAMELY, MARBLE, GRANITE, LIMESTONE, QUARTZ, TRAVERTINE, SLATE, JURASSIC FOSSIL STONE, AMETHYST, LAPIS LAZULI, MOTHER OF PEARL, WILD AGATE AND

TIGER'S EYE, IN CLASS 35 (U.S. CLS. 100, 101 AND 102).

FIRST USE 9-0-2006; IN COMMERCE 9-0-2006.

THE MARK CONSISTS OF STANDARD CHARACTERS WITHOUT CLAIM TO ANY PARTICULAR FONT, STYLE, SIZE, OR COLOR.

NO CLAIM IS MADE TO THE EXCLUSIVE RIGHT TO USE "NATURAL", APART FROM THE MARK AS SHOWN.

SER. NO. 77-295,045, FILED 10-3-2007.

DAWN HAN, EXAMINING ATTORNEY

**Int. Cl.: 41**

**Prior U.S. Cls.: 100, 101 and 107**

**United States Patent and Trademark Office**

**Reg. No. 3,452,806**

**Registered June 24, 2008**

**SERVICE MARK  
PRINCIPAL REGISTER**



BOSTON GLOBAL COMMUNICATIONS AND  
PERFORMANCE, INC. (MASSACHUSETTS  
CORPORATION)  
181 MARKET STREET  
LOWELL, MA 01852

FOR: EDUCATION SERVICES, NAMELY, PRO-  
VIDING TRAINING IN THE FIELD OF BUSINESS  
COMMUNICATIONS, IN CLASS 41 (U.S. CLS. 100,  
101 AND 107).

FIRST USE 6-1-2007; IN COMMERCE 6-1-2007.

NO CLAIM IS MADE TO THE EXCLUSIVE  
RIGHT TO USE "BOSTON GLOBAL COMMUNICA-  
TIONS & PERFORMANCE, INC.", APART FROM  
THE MARK AS SHOWN.

THE COLOR(S) BLACK, GRAY, PURPLE IS/ARE  
CLAIMED AS A FEATURE OF THE MARK.

THE COLOR BLACK APPEARS IN THE WORD-  
ING "BOSTON GLOBAL", THE COLOR PURPLE  
APPEARS IN THE WORDING, "COMMUNICA-  
TIONS & PERFORMANCE INC." AND IN THE  
DESIGN OF THE TWO SMALL SAILS, AND THE  
COLOR GRAY APPEARS IN THE LARGE GRAY  
SAIL.

SER. NO. 77-295,673, FILED 10-3-2007.

LANA PHAM, EXAMINING ATTORNEY

**Int. Cl.: 25**

**Prior U.S. Cls.: 22 and 39**

**United States Patent and Trademark Office**

**Reg. No. 3,452,807**

**Registered June 24, 2008**

**TRADEMARK  
PRINCIPAL REGISTER**



STEWART, MATTHEW W (UNITED STATES IN-  
DIVIDUAL)  
7524 E. COSTILLA BLVD.  
CENTENNIAL, CO 80112

FOR: SHORT-SLEEVED OR LONG-SLEEVED T-  
SHIRTS; T-SHIRTS; HATS; JERSEYS; PANTS; POLO  
SHIRTS; SWEAT SHIRTS; HEADGEAR, NAMELY,  
HATS, CAPS; SOCKS; SHORTS; FOOTWEAR; JACK-  
ETS; SKIRTS; DRESSES; TANK TOPS; TOPS, IN  
CLASS 25 (U.S. CLS. 22 AND 39).

FIRST USE 0-0-2001; IN COMMERCE 0-0-2007.

THE MARK CONSISTS OF THE LETTERS "V L E  
E" AND "T". THE TWO E'S ARE LOWER CASE,  
FACING EACH OTHER, AND OVERLAPPING  
EACH OTHER.

SER. NO. 77-295,729, FILED 10-4-2007.

MORGAN WYNNE, EXAMINING ATTORNEY

**Int. Cl.: 16**

**Prior U.S. Cls.: 2, 5, 22, 23, 29, 37, 38 and 50**

**Reg. No. 3,452,808**

**United States Patent and Trademark Office**

**Registered June 24, 2008**

---

**TRADEMARK  
PRINCIPAL REGISTER**

**INVISION**

ACCO BRANDS CORPORATION (DELAWARE  
CORPORATION)  
300 TOWER PARKWAY  
LINCOLNSHIRE, IL 60069

FOR: STAPLERS, IN CLASS 16 (U.S. CLS. 2, 5, 22,  
23, 29, 37, 38 AND 50).

FIRST USE 5-27-2004; IN COMMERCE 9-30-2004.

THE MARK CONSISTS OF STANDARD CHAR-  
ACTERS WITHOUT CLAIM TO ANY PARTICULAR  
FONT, STYLE, SIZE, OR COLOR.

OWNER OF U.S. REG. NO. 3,166,063.

SER. NO. 77-295,809, FILED 10-4-2007.

ELLEN PERKINS, EXAMINING ATTORNEY

**Int. Cl.: 16**

**Prior U.S. Cls.: 2, 5, 22, 23, 29, 37, 38 and 50**

**Reg. No. 3,452,809**

**United States Patent and Trademark Office**

**Registered June 24, 2008**

---

**TRADEMARK  
PRINCIPAL REGISTER**

**READY GRIP**

ACCO BRANDS CORPORATION (DELAWARE  
CORPORATION)  
300 TOWER PARKWAY  
LINCOLNSHIRE, IL 60069

FOR: STAPLERS, IN CLASS 16 (U.S. CLS. 2, 5, 22,  
23, 29, 37, 38 AND 50).

FIRST USE 3-31-2004; IN COMMERCE 3-31-2004.

THE MARK CONSISTS OF STANDARD CHAR-  
ACTERS WITHOUT CLAIM TO ANY PARTICULAR  
FONT, STYLE, SIZE, OR COLOR.

OWNER OF U.S. REG. NO. 3,149,626.

SER. NO. 77-295,818, FILED 10-4-2007.

ELLEN PERKINS, EXAMINING ATTORNEY



**Int. Cl.: 25**

**Prior U.S. Cls.: 22 and 39**

**United States Patent and Trademark Office**

**Reg. No. 3,452,810**

**Registered June 24, 2008**

**TRADEMARK  
PRINCIPAL REGISTER**

**KAL RIEMAN**

RIEMAN, CALLY (UNITED STATES INDIVIDUAL)  
116 2ND PLACE  
BROOKLYN, NY 11231

FOR: BLAZERS; PANTS; SKIRTS; SHIRTS; COATS; TEE SHIRTS; SWEATERS; DRESSES; TANK TOPS; KNIT SHIRTS, IN CLASS 25 (U.S. CLS. 22 AND 39).

FIRST USE 9-1-2007; IN COMMERCE 10-1-2007.

THE MARK CONSISTS OF STANDARD CHARACTERS WITHOUT CLAIM TO ANY PARTICULAR FONT, STYLE, SIZE, OR COLOR.

THE NAME "KAL RIEMAN" IDENTIFIES A LIVING INDIVIDUAL WHOSE CONSENT IS OF RECORD.

SER. NO. 77-295,822, FILED 10-4-2007.

NAAKWAMA ANKRAH, EXAMINING ATTORNEY

**Int. Cl.: 41**

**Prior U.S. Cls.: 100, 101 and 107**

**United States Patent and Trademark Office**

**Reg. No. 3,452,811**

**Registered June 24, 2008**

**SERVICE MARK  
PRINCIPAL REGISTER**

# Banana Lady

BANANA PRODUCTIONS, LLC (WISCONSIN  
LTD LIAB CO)  
404 WHISPERING PINES WAY  
MADISON, WI 53713

FOR: EDUCATIONAL AND ENTERTAINMENT  
SERVICES, NAMELY, PROVIDING LIVE PERFOR-  
MANCES BY A PROFESSIONAL ENTERTAINER IN  
THE FIELD OF HEALTH AND WELLNESS, IN  
CLASS 41 (U.S. CLS. 100, 101 AND 107).

FIRST USE 1-1-1987; IN COMMERCE 1-1-1987.

THE MARK CONSISTS OF STANDARD CHAR-  
ACTERS WITHOUT CLAIM TO ANY PARTICULAR  
FONT, STYLE, SIZE, OR COLOR.

SEC. 2(F).

SER. NO. 77-295,898, FILED 10-4-2007.

APRIL ROACH, EXAMINING ATTORNEY

**Int. Cl.: 35**

**Prior U.S. Cls.: 100, 101 and 102**

**United States Patent and Trademark Office**

**Reg. No. 3,452,812**

**Registered June 24, 2008**

**SERVICE MARK  
PRINCIPAL REGISTER**



TRUE WORLD FOODS NEW YORK, LLC (DE-  
LAWARE LTD LIAB CO), DBA NEW YORK  
FISH HOUSE, INC  
32-34 PAPETTI PLAZA  
ELIZABETH, NJ 07206

FOR: RETAIL STORES FEATURING SEAFOOD  
AND FISH PRODUCTS; WHOLESALE STORES FEATURING  
SEAFOOD AND FISH PRODUCTS; DIS-  
TRIBUTORSHIPS IN THE FIELD OF SEAFOOD  
AND FISH PRODUCTS, IN CLASS 35 (U.S. CLS.  
100, 101 AND 102).

FIRST USE 5-1-1985; IN COMMERCE 5-1-1985.

NO CLAIM IS MADE TO THE EXCLUSIVE  
RIGHT TO USE "FISH HOUSE", APART FROM  
THE MARK AS SHOWN.

SEC. 2(F).

SER. NO. 77-295,954, FILED 10-4-2007.

MATTHEW PAPPAS, EXAMINING ATTORNEY

**Int. Cls.: 20 and 21**

**Prior U.S. Cls.: 2, 13, 22, 23, 25, 29, 30, 32, 33, 40 and 50**

**Reg. No. 3,452,813**

**United States Patent and Trademark Office**

**Registered June 24, 2008**

**TRADEMARK  
PRINCIPAL REGISTER**



TAYLOR-MARTIN GROUP, LLC (MISSOURI LTD LIAB CO), DBA UNLEASHED LIFE, LLC  
214 W. PHELPS, SUITE 205  
SPRINGFIELD, MO 65806

FIRST USE 9-17-2007; IN COMMERCE 10-1-2007.

FOR: BEDS FOR HOUSEHOLD PETS, IN CLASS 20 (U.S. CLS. 2, 13, 22, 25, 32 AND 50).

THE MARK CONSISTS OF "UNLEASHED LIFE". THE ICON WITHIN THE MARK IS A STYLIZED "U".

FIRST USE 9-17-2007; IN COMMERCE 10-1-2007.

SER. NO. 77-296,074, FILED 10-4-2007.

FOR: PET FEEDING DISHES; PET FOOD CANNISTER SETS, IN CLASS 21 (U.S. CLS. 2, 13, 23, 29, 30, 33, 40 AND 50).

SANJEEV VOHRA, EXAMINING ATTORNEY

**Int. Cl.: 36**

**Prior U.S. Cls.: 100, 101 and 102**

**United States Patent and Trademark Office**

**Reg. No. 3,452,814**

**Registered June 24, 2008**

**SERVICE MARK  
PRINCIPAL REGISTER**

The word "claimetrics" is rendered in a stylized, outlined font. The letters are interconnected and have a consistent thickness, giving it a modern, geometric appearance. The 'c' and 'l' are particularly prominent, with the 'l' having a small circle above it. The 'm' and 'e' are also stylized, with the 'e' having a small circle above it. The 't' and 'r' are simple, clean shapes. The 'i' and 's' are also stylized, with the 'i' having a small circle above it. The overall effect is a clean, modern, and professional look.

HALLMARK NATIONAL, LLC (NEVADA LTD  
LIAB CO)  
8516 NW EXPRESSWAY  
OKLAHOMA CITY, OK 73162

NO CLAIM IS MADE TO THE EXCLUSIVE  
RIGHT TO USE "CLAIM METRICS", APART FROM  
THE MARK AS SHOWN.

FOR: PROCESSING AND ADMINISTRATION OF  
INSURANCE CLAIMS AND PAYMENT DATA, IN  
CLASS 36 (U.S. CLS. 100, 101 AND 102).

SER. NO. 77-296,087, FILED 10-4-2007.

FIRST USE 5-8-2007; IN COMMERCE 5-8-2007.

DANIEL CAPSHAW, EXAMINING ATTORNEY

**Int. Cl.: 36**

**Prior U.S. Cls.: 100, 101 and 102**

**United States Patent and Trademark Office**

**Reg. No. 3,452,815**

**Registered June 24, 2008**

**SERVICE MARK  
PRINCIPAL REGISTER**

**CapitalSouth**  
BANK

CAPITALSOUTH BANCORP (DELAWARE CORPORATION)  
SUITE 200  
2340 WOODCREST PLACE  
BIRMINGHAM, AL 35209

FOR: BANKING SERVICES AND RELATED FINANCIAL SERVICES NAMELY, CONSUMER FINANCING, CONSUMER LENDING, COMMERCIAL LENDING, EQUIPMENT FINANCING, MORTGAGE LENDING, MORTGAGE BANKING; INSURANCE BROKERAGE SERVICES; INVESTMENT BROKERAGE, INVESTMENT CONSULTATION, INVESTMENT MANAGEMENT, INVESTMENT ADVICE, IN CLASS 36 (U.S. CLS. 100, 101 AND 102).

FIRST USE 10-18-2007; IN COMMERCE 10-18-2007.

OWNER OF U.S. REG. NOS. 3,150,975 AND 3,176,592.

NO CLAIM IS MADE TO THE EXCLUSIVE RIGHT TO USE "BANK", APART FROM THE MARK AS SHOWN.

THE MARK CONSISTS OF THE WORD CAPITALSOUTH HAVING A STAR SHAPE AS THE DOT FOR THE I IN CAPITAL, ALL ABOVE A LINE SEPARATING IT FROM THE WORD BANK, WHICH IS LOCATED BELOW THE LINE AND TO THE LEFT SIDE.

SER. NO. 77-296,179, FILED 10-4-2007.

FRANK LATTUCA, EXAMINING ATTORNEY

**Int. Cl.: 36**

**Prior U.S. Cls.: 100, 101 and 102**

**United States Patent and Trademark Office**

**Reg. No. 3,452,816**

**Registered June 24, 2008**

**SERVICE MARK  
PRINCIPAL REGISTER**

**CAPITALSOUTH BANCO HISPANO**

CAPITALSOUTH BANCORP (DELAWARE CORPORATION)  
SUITE 200  
2340 WOODCREST PLACE  
BIRMINGHAM, AL 35209

FOR: BANKING SERVICES AND RELATED FINANCIAL SERVICES NAMELY, CONSUMER FINANCING, CONSUMER LENDING, COMMERCIAL LENDING, EQUIPMENT FINANCING, MORTGAGE LENDING, MORTGAGE BANKING; INSURANCE BROKERAGE SERVICES; INVESTMENT BROKERAGE, INVESTMENT CONSULTATION, INVESTMENT MANAGEMENT, INVESTMENT ADVICE, IN CLASS 36 (U.S. CLS. 100, 101 AND 102).

FIRST USE 9-30-2005; IN COMMERCE 9-30-2005.

THE MARK CONSISTS OF STANDARD CHARACTERS WITHOUT CLAIM TO ANY PARTICULAR FONT, STYLE, SIZE, OR COLOR.

OWNER OF U.S. REG. NOS. 3,150,975 AND 3,176,592.

NO CLAIM IS MADE TO THE EXCLUSIVE RIGHT TO USE BANCO HISPANO, APART FROM THE MARK AS SHOWN.

THE FOREIGN WORDING IN THE MARK TRANSLATES INTO ENGLISH AS HISPANIC BANK FROM THE SPANISH WORDING BANCO HISPANO.

SER. NO. 77-296,186, FILED 10-4-2007.

FRANK LATTUCA, EXAMINING ATTORNEY

**Int. Cl.: 41**

**Prior U.S. Cls.: 100, 101 and 107**

**United States Patent and Trademark Office**

**Reg. No. 3,452,817**

**Registered June 24, 2008**

**SERVICE MARK  
PRINCIPAL REGISTER**



**CORPORATE  
GURU**

BALANCE INTEGRATION CORPORATION  
(NEW YORK CORPORATION)  
212 W. 22ND STREET 2B  
NEW YORK, NY 10011

FOR: EDUCATION SERVICES, NAMELY, PROVIDING INDIVIDUAL TUTORIALS AND GROUP INSTRUCTION IN THE FIELDS OF ACHIEVING WORK/LIFE BALANCE, IMPROVING PRODUCTIVITY, AND STRESS MANAGEMENT, IN CLASS 41 (U.S. CLS. 100, 101 AND 107).

FIRST USE 3-31-2003; IN COMMERCE 3-31-2003.

NO CLAIM IS MADE TO THE EXCLUSIVE RIGHT TO USE "CORPORATE", APART FROM THE MARK AS SHOWN.

THE MARK CONSISTS OF A SILHOUETTE OF A BRIEFCASE WITH A CIRCLE CONTAINING FOUR IRREGULAR OVALS CENTERED WITHIN IT, ALL ABOVE THE WORDS "CORPORATE GURU".

SER. NO. 77-296,232, FILED 10-4-2007.

EUGENIA MARTIN, EXAMINING ATTORNEY



**Int. Cl.: 5**

**Prior U.S. Cls.: 6, 18, 44, 46, 51 and 52**

**Reg. No. 3,452,818**

**United States Patent and Trademark Office**

**Registered June 24, 2008**

---

**TRADEMARK  
PRINCIPAL REGISTER**

**O-O HERBICIDE**

REGAL CHEMICAL COMPANY (GEORGIA CORPORATION)  
P.O. BOX 900  
ALPHARETTA, GA 30239

FOR: HERBICIDES FOR AGRICULTURAL, COMMERCIAL AND DOMESTIC USE, IN CLASS 5 (U.S. CLS. 6, 18, 44, 46, 51 AND 52).

FIRST USE 12-31-1995; IN COMMERCE 12-31-1995.

THE MARK CONSISTS OF STANDARD CHARACTERS WITHOUT CLAIM TO ANY PARTICULAR FONT, STYLE, SIZE, OR COLOR.

NO CLAIM IS MADE TO THE EXCLUSIVE RIGHT TO USE "HERBICIDE", APART FROM THE MARK AS SHOWN.

SER. NO. 77-296,297, FILED 10-4-2007.

KATINA MISTER, EXAMINING ATTORNEY

**Int. Cl.: 35**

**Prior U.S. Cls.: 100, 101 and 102**

**United States Patent and Trademark Office**

**Reg. No. 3,452,819**

**Registered June 24, 2008**

**SERVICE MARK  
PRINCIPAL REGISTER**

**SELECT A CANDIDATE**

MINNESOTA PUBLIC RADIO (MINNESOTA  
NON-PROFIT CORPORATION)  
480 CEDAR STREET  
ST. PAUL, MN 55101

FOR: A POLITICAL OPINION SURVEY CON-  
DUCTED OVER THE INTERNET, AND ONLINE  
INFORMATION SERVICES IN THE FIELD OF  
POLITICAL ISSUES, IN CLASS 35 (U.S. CLS. 100,  
101 AND 102).

FIRST USE 8-8-2000; IN COMMERCE 8-8-2000.

THE MARK CONSISTS OF STANDARD CHAR-  
ACTERS WITHOUT CLAIM TO ANY PARTICULAR  
FONT, STYLE, SIZE, OR COLOR.

SEC. 2(F).

SER. NO. 77-296,325, FILED 10-4-2007.

KATHLEEN LORENZO, EXAMINING ATTORNEY

Int. Cls.: 9, 21 and 24

Prior U.S. Cls.: 2, 13, 21, 23, 26, 29, 30, 33, 36, 38, 40,  
42 and 50

Reg. No. 3,452,820

United States Patent and Trademark Office

Registered June 24, 2008

TRADEMARK  
PRINCIPAL REGISTER



TIGER ACCESSORY GROUP, L.L.C. (ILLINOIS LTD LIAB CO), DBA CLEAN-RITE PRODUCTS, L.L.C., AN ILLINOIS LIMITED LIABILITY COMPANY

625 BARCLAY BOULEVARD  
LINCOLNSHIRE, IL 60069

FOR: FIRE HOSE NOZZLES, IN CLASS 9 (U.S. CLS. 21, 23, 26, 36 AND 38).

FIRST USE 6-1-2006; IN COMMERCE 6-1-2006.

FOR: CLEANING CLOTHS, POLISHING PADS FOR USE ON THE EXTERIOR OF VEHICLES, POLISHING CLOTHS, VEHICLE WASHING MITTS, BUCKETS, WASH BRUSHES FOR WASHING VEHICLES AND COMBINED VEHICLE WASHING AND SCRUBBING MITTS, HOSE NOZZLES, IN CLASS 21 (U.S. CLS. 2, 13, 23, 29, 30, 33, 40 AND 50).

FIRST USE 6-1-2006; IN COMMERCE 6-1-2006.

FOR: CLEANING CLOTHS IN THE NATURE OF TOWELS AND TERRY TOWELS, IN CLASS 24 (U.S. CLS. 42 AND 50).

FIRST USE 6-1-2006; IN COMMERCE 6-1-2006.

NO CLAIM IS MADE TO THE EXCLUSIVE RIGHT TO USE "BRAND", APART FROM THE MARK AS SHOWN.

"THE COLOR(S) GOLD, NAVY BLUE, LIGHT BLUE, BLACK, YELLOW, WHITE AND ORANGE IS/ARE CLAIMED AS A FEATURE OF THE MARK."

THE MARK CONSISTS OF THE LITERAL ELEMENTS MARINE GOLD BRAND AND ASSOCIATED DESIGN. THE WORDS MARINE GOLD APPEAR IN GOLD ABOVE A LIGHT BLUE DIVIDING LINE WITH A WHITE CENTER PORTION. BELOW THE LINE, THE WORD BRAND IS LOCATED ABOVE A LOWER PART OF AN ANCHOR, AND BOTH COMPONENTS APPEAR IN GOLD. ABOVE THE WORDS MARINE GOLD ARE A STYLIZED SAILBOAT WITH A BLACK HULL AND WHITE, YELLOW, GOLD AND ORANGE SAILS ALL OUTLINED IN WHITE AND WHITE WAVES. THE ABOVE ELEMENTS ARE PLACED UPON A LIGHT BLUE LINED GRID FORMING A GLOBE, WHICH IS SET UPON A NAVY BLUE BACKGROUND.

SER. NO. 77-296,561, FILED 10-4-2007.

JUDITH HELFMAN, EXAMINING ATTORNEY

Int. Cl.: 20

Prior U.S. Cls.: 2, 13, 22, 25, 32 and 50

United States Patent and Trademark Office

Reg. No. 3,452,821

Registered June 24, 2008

TRADEMARK  
PRINCIPAL REGISTER

The logo for "SpaCushion" is written in a cursive, handwritten-style font. The word "Spa" is in a smaller, more compact script, while "Cushion" is larger and more flowing. A decorative flourish or underline is present beneath the "Cushion" part of the word.

GALLAHER, KAMI (UNITED STATES INDIVIDUAL)  
616 OCEAN AVE.  
SEA BRIGHT, NJ 07760

FOR: A FULL-LENGTH, CHAISE LOUNGE TYPE CUSHION TO LAY ON THAT HAS A PILLOW THAT MAY BE FLIPPED OVER FOR USE WHEN ONE LIES ON THEIR BACK, THAT HAS OPENINGS FOR THE KNEES AND A VENTILATION OPENING AT THE TOP FOR ONE'S FACE, ALL FOR USE IN MAINTAINING PROPER BODY ALIGNMENT WHEN LYING DOWN AND PRIMARILY FOR USE WHEN LYING OUTDOORS AND DURING MASSAGES, BUT NOT FOR USE IN THE BATH NOR FOR MEDICAL PURPOSES, IN CLASS 20 (U.S. CLS. 2, 13, 22, 25, 32 AND 50).

FIRST USE 5-25-2007; IN COMMERCE 5-25-2007.

NO CLAIM IS MADE TO THE EXCLUSIVE RIGHT TO USE "SPA CUSHION", APART FROM THE MARK AS SHOWN.

THE MARK CONSISTS OF THE STYLIZED WORDS "SPACUSHION" WITH A FANCIFUL CHAISE LOUNGE CUSHION UNDERNEATH.

SER. NO. 77-296,564, FILED 10-4-2007.

G. MAYERSCHOFF, EXAMINING ATTORNEY

Int. Cl.: 45

Prior U.S. Cls.: 100 and 101

United States Patent and Trademark Office

Reg. No. 3,452,822

Registered June 24, 2008

SERVICE MARK  
PRINCIPAL REGISTER



ROBINSON & MCELWEE PLLC (WEST VIRGINIA PROFESSIONAL LIMITED LIABILITY COMPANY)  
FIFTH THIRD CENTER, SUITE 400  
700 VIRGINIA STREET, EAST  
CHARLESTON, WV 25301

FOR: LEGAL SERVICES, IN CLASS 45 (U.S. CLS. 100 AND 101).

FIRST USE 1-0-2006; IN COMMERCE 1-0-2006.

NO CLAIM IS MADE TO THE EXCLUSIVE RIGHT TO USE "PLLC", APART FROM THE MARK AS SHOWN.

THE MARK CONSISTS OF A DESIGN AT THE TOP FEATURING THE LOWERCASE LETTER "R" SUPERIMPOSED OVER THE LOWERCASE LETTER "M", WITH THE NAME "ROBINSON & MCELWEE" IN THE MIDDLE AND "PLLC" IN WHITE LETTERS WITHIN A BLACK RECTANGLE AT THE BOTTOM

SER. NO. 77-296,838, FILED 10-5-2007.

GEOFFREY FOSDICK, EXAMINING ATTORNEY

**Int. Cl.: 41**

**Prior U.S. Cls.: 100, 101 and 107**

**United States Patent and Trademark Office**

**Reg. No. 3,452,823**

**Registered June 24, 2008**

**SERVICE MARK  
PRINCIPAL REGISTER**

**SAND SOCCER JAM**

CREATIVE ON DEMAND, INC. (FLORIDA CORPORATION)  
SUITE 1104  
2 ALHAMBRA PLAZA  
CORAL GABLES, FL 33134

FOR: ENTERTAINMENT SERVICES, NAMELY, CONDUCTING SAND SOCCER GAMES, PARTIES, CELEBRITY EXHIBITIONS AND LIVE MUSIC PERFORMANCES, IN CLASS 41 (U.S. CLS. 100, 101 AND 107).

FIRST USE 10-5-2007; IN COMMERCE 10-5-2007.

THE MARK CONSISTS OF STANDARD CHARACTERS WITHOUT CLAIM TO ANY PARTICULAR FONT, STYLE, SIZE, OR COLOR.

NO CLAIM IS MADE TO THE EXCLUSIVE RIGHT TO USE "SAND SOCCER", APART FROM THE MARK AS SHOWN.

SER. NO. 77-297,115, FILED 10-5-2007.

FRANK LATTUCA, EXAMINING ATTORNEY

**Int. Cl.: 42**

**Prior U.S. Cls.: 100 and 101**

**United States Patent and Trademark Office**

**Reg. No. 3,452,824**

**Registered June 24, 2008**

**SERVICE MARK  
PRINCIPAL REGISTER**



TRIOSOFT (ILLINOIS LTD LIAB CO)  
13210 WILLIAMS CIR  
GENOA, IL 60135

FOR: DEVELOPMENT OF COMPUTER SOFTWARE FOR USE IN THE DEBT, SKIP TRACING, AND EMPLOYEE PAYROLL AND TIME TRACKING INDUSTRIES, IN CLASS 42 (U.S. CLS. 100 AND 101).

FIRST USE 4-1-2006; IN COMMERCE 4-15-2006.

NO CLAIM IS MADE TO THE EXCLUSIVE RIGHT TO USE "LLC", APART FROM THE MARK AS SHOWN.

THE MARK CONSISTS OF THE WORDS "TRIOSOFT, LLC" IN STYLIZED TEXT. TO THE LEFT THERE ARE THREE CIRCLES IN THE FORM OF A TRIANGLE.

SER. NO. 77-297,143, FILED 10-5-2007.

AMY GEARIN, EXAMINING ATTORNEY

**Int. Cl.: 21**

**Prior U.S. Cls.: 2, 13, 23, 29, 30, 33, 40 and 50**

**Reg. No. 3,452,825**

**United States Patent and Trademark Office**

**Registered June 24, 2008**

**TRADEMARK  
PRINCIPAL REGISTER**



PLACONTROL, INC. (CALIFORNIA CORPORATION)  
SUITE 210  
12760 HIGH BLUFF DRIVE  
SAN DIEGO, CA 92130

THE MARK CONSISTS OF A STYLIZED ILLUSTRATION OF A BEE AND THE WORD "TWEENERS". COLOR IS NOT CLAIMED AS A FEATURE OF THE MARK.

FOR: ORAL CARE DEVICES, NAMELY, INTERDENTAL BRUSHES, IN CLASS 21 (U.S. CLS. 2, 13, 23, 29, 30, 33, 40 AND 50).

SER. NO. 77-297,422, FILED 10-5-2007.

FIRST USE 8-30-2007; IN COMMERCE 8-30-2007.

TARAH HARDY, EXAMINING ATTORNEY



**Int. Cl.: 9**

**Prior U.S. Cls.: 21, 23, 26, 36 and 38**

**Reg. No. 3,452,826**

**United States Patent and Trademark Office**

**Registered June 24, 2008**

---

**TRADEMARK  
PRINCIPAL REGISTER**

**LANGE**

JOHNSON DIVERSEY, INC. (DELAWARE CORPORATION)  
MS 509  
8310 16TH STREET  
STURTEVANT, WI 531770902

FOR: CALIPER FOR MEASURING THE THICKNESS OF HUMAN SKIN FOLDS, IN CLASS 9 (U.S. CLS. 21, 23, 26, 36 AND 38).

FIRST USE 12-31-1961; IN COMMERCE 12-31-1961.

THE MARK CONSISTS OF STANDARD CHARACTERS WITHOUT CLAIM TO ANY PARTICULAR FONT, STYLE, SIZE, OR COLOR.

SEC. 2(F).

SER. NO. 77-297,473, FILED 10-5-2007.

PAUL CROWLEY, EXAMINING ATTORNEY

**Int. Cl.: 35**

**Prior U.S. Cls.: 100, 101 and 102**

**United States Patent and Trademark Office**

**Reg. No. 3,452,827**

**Registered June 24, 2008**

**SERVICE MARK  
PRINCIPAL REGISTER**



CAMPUS VENTURE NETWORK, INC. (DELA-  
WARE CORPORATION)  
108 TURQUOISE CREEK DRIVE  
CARY, NC 27513

FOR: ONLINE BUSINESS NETWORKING SERVI-  
CES; BUSINESS NETWORKING; PROVIDING A  
FORUM FOR BUSINESS NETWORKING TO FA-  
CILITATE STUDENT ENTREPRENEURS TO COM-  
MUNICATE WITH POTENTIAL INVESTORS,  
ADVISERS AND SERVICE PROVIDERS; PROVID-  
ING ONLINE BUSINESS NETWORKING BETWEEN

STUDENT ENTREPRENEURS, IN CLASS 35 (U.S.  
CLS. 100, 101 AND 102).

FIRST USE 6-15-2007; IN COMMERCE 6-15-2007.

THE MARK CONSISTS OF THE LETTERS "S"  
AND "B" INTERTWINED WITH A GRADUATION  
HAT AND TASSEL ON TOP OF THE LETTER "S".

SER. NO. 77-297,524, FILED 10-5-2007.

MICHELE SWAIN, EXAMINING ATTORNEY

**Int. Cl.: 16**

**Prior U.S. Cls.: 2, 5, 22, 23, 29, 37, 38 and 50**

**Reg. No. 3,452,828**

**United States Patent and Trademark Office**

**Registered June 24, 2008**

---

**TRADEMARK  
PRINCIPAL REGISTER**

fomato

EMMIE S. HSU (UNITED STATES INDIVIDUAL),  
DBA FOMATO  
17719 LILIANA COURT  
ROWLAND HEIGHTS, CA 91748

FOR: GREETING CARDS, IN CLASS 16 (U.S. CLS.  
2, 5, 22, 23, 29, 37, 38 AND 50).

FIRST USE 9-21-2004; IN COMMERCE 9-21-2004.

THE MARK CONSISTS OF STANDARD CHAR-  
ACTERS WITHOUT CLAIM TO ANY PARTICULAR  
FONT, STYLE, SIZE, OR COLOR.

THE WORDING "FOMATO" HAS NO MEANING  
OTHER THAN TRADEMARK SIGNIFICANCE

SER. NO. 77-297,598, FILED 10-5-2007.

DAYNA BROWNE, EXAMINING ATTORNEY

Int. Cl.: 35

Prior U.S. Cls.: 100, 101 and 102

United States Patent and Trademark Office

Reg. No. 3,452,829

Registered June 24, 2008

**SERVICE MARK  
PRINCIPAL REGISTER**



KEARNEY, NICHOLAS (UNITED STATES INDIVIDUAL)  
8 CONSTITUTION ST.  
BRISTOL, RI 02809

FOR: RETAIL STORES FEATURING CLOTHING, HOME FURNISHINGS AND HOME FURNISHING ACCESSORIES, IN CLASS 35 (U.S. CLS. 100, 101 AND 102).

FIRST USE 6-1-2006; IN COMMERCE 6-1-2006.

OWNER OF U.S. REG. NO. 3,327,920.

THE COLOR(S) NAVY BLUE, LIME GREEN AND MINT GREEN IS/ARE CLAIMED AS A FEATURE OF THE MARK.

THE MARK CONSISTS OF A NAVY BLUE FISH POSITIONED WITHIN A CIRCULAR BACKGROUND THE TOP PORTION OF WHICH IS MINT GREEN AND THE BOTTOM PORTION OF WHICH IS LIME GREEN. THE WORDING "STRIPER MOON" IS POSITIONED BENEATH THE FISH LOGO, THE WORD "STRIPER" IS NAVY BLUE AND THE WORD "MOON" IS MINT GREEN.

SER. NO. 77-297,678, FILED 10-5-2007.

RONALD MCMORROW, EXAMINING ATTORNEY

**Int. Cl.: 41**

**Prior U.S. Cls.: 100, 101 and 107**

**United States Patent and Trademark Office**

**Reg. No. 3,452,830**

**Registered June 24, 2008**

**SERVICE MARK  
PRINCIPAL REGISTER**

**THE PIT**

HACKLEMAN, JOHN, H. (UNITED STATES IN-  
DIVIDUAL)  
1064 EAST GRAND AVE.  
ARROYO GRANDE, CA 93420

FOR: MARTIAL ARTS INSTRUCTION; OPERAT-  
ING OF MARTIAL ARTS SCHOOLS; ORGANIZING  
EXHIBITIONS FOR MARTIAL ARTS; ENTERTAIN-  
MENT SERVICES, NAMELY, PERSONAL APPEAR-  
ANCES BY MARTIAL ARTS ATHLETES;  
DEVELOPMENT OF MARTIAL ARTS FIGHTING  
AND TRAINING PROGRAMS, IN CLASS 41 (U.S.  
CLS. 100, 101 AND 107).

FIRST USE 0-0-1985; IN COMMERCE 0-0-1986.

THE MARK CONSISTS OF STANDARD CHAR-  
ACTERS WITHOUT CLAIM TO ANY PARTICULAR  
FONT, STYLE, SIZE, OR COLOR.

SER. NO. 77-297,817, FILED 10-5-2007.

FLORENTINA BLANDU, EXAMINING ATTORNEY

**Int. Cls.: 16, 35 and 41**

**Prior U.S. Cls.: 2, 5, 22, 23, 29, 37, 38, 50, 100, 101, 102  
and 107**

**Reg. No. 3,452,831**

**United States Patent and Trademark Office**

**Registered June 24, 2008**

**TRADEMARK  
SERVICE MARK  
PRINCIPAL REGISTER**



MUNCE, DON (UNITED STATES INDIVIDUAL)  
3651 N.E. RALPH POWELL ROAD  
LEE'S SUMMIT, MO 64064

FOR: PRINTED CARDS FEATURING INFORMATION ON POST-SECONDARY EDUCATIONAL OPPORTUNITIES, PROSPECTIVE EMPLOYERS AND YOUTH SERVICE PROVIDERS; PRINTED SURVEY QUESTIONNAIRES, IN CLASS 16 (U.S. CLS. 2, 5, 22, 23, 29, 37, 38 AND 50).

FIRST USE 5-0-2007; IN COMMERCE 5-0-2007.

FOR: ADMINISTERING SURVEYS TO AND COLLECTING INFORMATION FROM SECONDARY SCHOOL STUDENTS, AND PROVIDING INFORMATION TO POST-SECONDARY INSTITUTIONS, RECRUITERS AND YOUTH SERVICE PROVIDERS BASED ON DATA COLLECTED FROM STUDENTS; PROVIDING INFORMATION TO STUDENTS ABOUT POST-SECONDARY EDUCATIONAL INSTITUTIONS, EMPLOYERS AND YOUTH SERVICE OPPORTUNITIES BASED ON DATA COLLECTED FROM STUDENTS FOR THE PURPOSE OF ASSISTING STUDENTS IN ASSESSING EMPLOYMENT, YOUTH SERVICE AND POST-SECONDARY EDUCATIONAL OPPORTUNITIES; DIRECT MAIL ADVERTISING TO PROSPECTIVE POST-SECONDARY SCHOOL STUDENTS REGARDING EDUCATIONAL, EMPLOYMENT AND YOUTH SERVICE OPPORTUNITIES, IN CLASS 35 (U.S. CLS. 100, 101 AND 102).

FIRST USE 8-0-2005; IN COMMERCE 8-0-2005.

FOR: EDUCATIONAL INFORMATION SERVICES, NAMELY, PROVIDING INFORMATION AND REMINDERS TO PROSPECTIVE COLLEGE AND UNIVERSITY STUDENTS REGARDING ENROLLMENT AND PROVIDING INFORMATION REQUESTS FROM PROSPECTIVE STUDENT ADMISSIONS OFFICES VIA THE INTERNET; PROVIDING NEWSLETTERS IN THE FIELD OF EDUCATIONAL OPPORTUNITIES, EMPLOYMENTS OPPORTUNITIES AND YOUTH SERVICE OPPORTUNITIES VIA THE INTERNET, IN CLASS 41 (U.S. CLS. 100, 101 AND 107).

FIRST USE 5-0-2007; IN COMMERCE 5-0-2007.

OWNER OF U.S. REG. NOS. 1,700,753, 2,871,487, AND 3,207,669.

NO CLAIM IS MADE TO THE EXCLUSIVE RIGHT TO USE "COLLEGE OPTIONS", APART FROM THE MARK AS SHOWN.

THE MARK CONSISTS OF THE WORDS "MY COLLEGE OPTIONS" WITH FIVE CIRCLES.

SER. NO. 77-297,856, FILED 10-5-2007.

DORITT L. CARROLL, EXAMINING ATTORNEY

**Int. Cl.: 35**

**Prior U.S. Cls.: 100, 101 and 102**

**United States Patent and Trademark Office**

**Reg. No. 3,452,832**

**Registered June 24, 2008**

**SERVICE MARK  
PRINCIPAL REGISTER**

**Sidebar Legal Recruiting**

SIDEBAR LEGAL RECRUITING, INC. (CALI-  
FORNIA CORPORATION)  
SUITE C  
645 E. MAGNOLIA BLVD  
BURBANK, CA 91501

FOR: EMPLOYMENT SERVICES, NAMELY, EM-  
PLOYMENT RECRUITING CONSULTATION, IN  
CLASS 35 (U.S. CLS. 100, 101 AND 102).

FIRST USE 5-1-2006; IN COMMERCE 5-1-2006.

THE MARK CONSISTS OF STANDARD CHAR-  
ACTERS WITHOUT CLAIM TO ANY PARTICULAR  
FONT, STYLE, SIZE, OR COLOR.

NO CLAIM IS MADE TO THE EXCLUSIVE  
RIGHT TO USE "LEGAL RECRUITING", APART  
FROM THE MARK AS SHOWN.

SER. NO. 77-297,951, FILED 10-6-2007.

SETH A. RAPPAPORT, EXAMINING ATTORNEY

**Int. Cl.: 32**

**Prior U.S. Cls.: 45, 46 and 48**

**United States Patent and Trademark Office**

**Reg. No. 3,452,833**

**Registered June 24, 2008**

**TRADEMARK  
PRINCIPAL REGISTER**

**SNOW**

CHINA RESOURCE SNOW BREWERY (LIAO  
NING) COMPANY LIMITED (CHINA COR-  
PORATION)  
NO. 42 JIANSHE DONG ROAD, TIEXI DISTRICT  
SHENYANG, CHINA

FOR: BEER; BLACK BEER, IN CLASS 32 (U.S. CLS.  
45, 46 AND 48).

OWNER OF CHINA REG. NO. 1316805, DATED 9-  
21-1999, EXPIRES 9-21-2009.

OWNER OF U.S. REG. NOS. 2,794,806 AND  
2,794,807.

THE MARK CONSISTS OF AN ENGLISH WORD  
"SNOW".

SER. NO. 77-298,370, FILED 10-8-2007.

MARK PILARO, EXAMINING ATTORNEY



**Int. Cls.: 35 and 45**

**Prior U.S. Cls.: 100, 101 and 102**

**United States Patent and Trademark Office**

**Reg. No. 3,452,834**

**Registered June 24, 2008**

**SERVICE MARK  
PRINCIPAL REGISTER**

**30 WEST AVIATION**

30 WEST AVIATION, LLC (GEORGIA LTD LIAB  
CO)  
2343 LITTLEBROOKE LANE  
ATLANTA, GA 30338

FOR: BUSINESS CONSULTING SERVICES,  
NAMELY, AUDITING IN THE FIELD OF AVIA-  
TION OPERATION, IN CLASS 35 (U.S. CLS. 100, 101  
AND 102).

FIRST USE 5-13-2002; IN COMMERCE 5-13-2002.

FOR: CONSULTING SERVICES, NAMELY, RE-  
VIEWING STANDARDS AND PRACTICES TO AS-  
SURE COMPLIANCE WITH AVIATION INDUSTRY  
STANDARDS AND LAWS, IN CLASS 45 (U.S. CLS.  
100 AND 101).

FIRST USE 5-13-2002; IN COMMERCE 5-13-2002.

THE MARK CONSISTS OF STANDARD CHAR-  
ACTERS WITHOUT CLAIM TO ANY PARTICULAR  
FONT, STYLE, SIZE, OR COLOR.

NO CLAIM IS MADE TO THE EXCLUSIVE  
RIGHT TO USE "AVIATION", APART FROM THE  
MARK AS SHOWN.

SER. NO. 77-298,542, FILED 10-8-2007.

BERYL GARDNER, EXAMINING ATTORNEY

**Int. Cl.: 35**

**Prior U.S. Cls.: 100, 101 and 102**

**United States Patent and Trademark Office**

**Reg. No. 3,452,835**

**Registered June 24, 2008**

**SERVICE MARK  
PRINCIPAL REGISTER**

**SUNSTONE MEDIA**

NIEDERHAUSERN, NATHAN F. (UNITED STATES INDIVIDUAL)  
10416 184TH AVE NE  
REDMOND, WA 98052

FOR: CREATIVE MARKETING DESIGN SERVICES; PRODUCING PROMOTIONAL VIDEOTAPES, VIDEO DISCS, AND AUDIO VISUAL RECORDINGS; ADVERTISING AND PUBLICITY SERVICES, NAMELY, PROMOTING THE GOODS, SERVICES, BRAND IDENTITY AND COMMERCIAL INFORMATION AND NEWS OF THIRD PARTIES THROUGH PRINT, AUDIO, VIDEO, DIGITAL AND ON-LINE MEDIUM, IN CLASS 35 (U.S. CLS. 100, 101 AND 102).

FIRST USE 0-0-2005; IN COMMERCE 10-7-2007.

THE MARK CONSISTS OF STANDARD CHARACTERS WITHOUT CLAIM TO ANY PARTICULAR FONT, STYLE, SIZE, OR COLOR.

NO CLAIM IS MADE TO THE EXCLUSIVE RIGHT TO USE "MEDIA", APART FROM THE MARK AS SHOWN.

SER. NO. 77-298,673, FILED 10-8-2007.

JANICE KIM, EXAMINING ATTORNEY

**Int. Cl.: 33**

**Prior U.S. Cls.: 47 and 49**

**United States Patent and Trademark Office**

**Reg. No. 3,452,836**

**Registered June 24, 2008**

**TRADEMARK  
PRINCIPAL REGISTER**

HORSE HEAVEN ROUND-UP RED

BENTON-FRANKLIN FAIR ASSOCIATION (WA-  
SHINGTON NON-PROFIT CORPORATION)  
1500 SOUTH OAK  
KENNEWICK, WA 99337

NO CLAIM IS MADE TO THE EXCLUSIVE  
RIGHT TO USE "RED", APART FROM THE MARK  
AS SHOWN.

FOR: WINES, IN CLASS 33 (U.S. CLS. 47 AND 49).

FIRST USE 8-8-2007; IN COMMERCE 8-8-2007.

SER. NO. 77-298,767, FILED 10-8-2007.

THE MARK CONSISTS OF STANDARD CHAR-  
ACTERS WITHOUT CLAIM TO ANY PARTICULAR  
FONT, STYLE, SIZE, OR COLOR.

RENEE MCCRAY, EXAMINING ATTORNEY

**Int. Cl.: 41**

**Prior U.S. Cls.: 100, 101 and 107**

**United States Patent and Trademark Office**

**Reg. No. 3,452,837**

**Registered June 24, 2008**

**SERVICE MARK  
PRINCIPAL REGISTER**

# Solution Team

NICHOLAS CARLISLE (UNITED KINGDOM INDIVIDUAL), DBA NO BULLY  
3389 22ND STREET  
SAN FRANCISCO, CA 94110

FOR: EDUCATIONAL AND TRAINING SERVICES, NAMELY, PROVIDING COURSES OF INSTRUCTIONS, TRAINING AND CERTIFICATION FOR SCHOOL ADMINISTRATORS, TEACHERS, SCHOOL PSYCHOLOGISTS AND COUNSELORS AT THE PRIMARY, SECONDARY AND COLLEGE LEVELS IN HOW TO RESOLVE THE HARASSMENT OR BULLYING OF A STUDENT THROUGH ENGAGING A TEAM OF STUDENTS TO ADDRESS THE

PROBLEM AND DISTRIBUTING TRAINING MATERIALS IN CONNECTION THEREWITH, IN CLASS 41 (U.S. CLS. 100, 101 AND 107).

FIRST USE 8-20-2007; IN COMMERCE 8-20-2007.

THE MARK CONSISTS OF STANDARD CHARACTERS WITHOUT CLAIM TO ANY PARTICULAR FONT, STYLE, SIZE, OR COLOR.

SER. NO. 77-298,796, FILED 10-8-2007.

SUSAN LESLIE DUBOIS, EXAMINING ATTORNEY

**Int. Cl.: 42**

**Prior U.S. Cls.: 100 and 101**

**United States Patent and Trademark Office**

**Reg. No. 3,452,838**

**Registered June 24, 2008**

**SERVICE MARK  
PRINCIPAL REGISTER**

**'H' SCAN**

IESCO, INC. (CALIFORNIA CORPORATION)  
3445 KASHIWA STREET  
TORRANCE, CA 90505

FOR: INSPECTION OF FURNACE TUBES, IN  
CLASS 42 (U.S. CLS. 100 AND 101).

FIRST USE 11-0-1993; IN COMMERCE 11-0-1993.

THE MARK CONSISTS OF STANDARD CHAR-  
ACTERS WITHOUT CLAIM TO ANY PARTICULAR  
FONT, STYLE, SIZE, OR COLOR.

NO CLAIM IS MADE TO THE EXCLUSIVE  
RIGHT TO USE "SCAN", APART FROM THE MARK  
AS SHOWN.

THE LETTER "H" AND THE PHRASE "H SCAN"  
DOES NOT HAVE ANY SIGNIFICANCE IN APPLI-  
CANT'S TRADE OR INDUSTRY OR AS APPLIED  
TO INSPECTION OF FURNACE TUBES.

SER. NO. 77-298,906, FILED 10-8-2007.

DAVID YONTEF, EXAMINING ATTORNEY

**Int. Cl.: 41**

**Prior U.S. Cls.: 100, 101 and 107**

**United States Patent and Trademark Office**

**Reg. No. 3,452,839**

**Registered June 24, 2008**

**SERVICE MARK  
PRINCIPAL REGISTER**



NEWSWEEK, INC. (NEW YORK CORPORATION)  
251 WEST 57TH STREET  
NEW YORK, NY 100191894

FOR: PROVIDING AN ONLINE WEBSITE FEATURING INFORMATION FEATURING CURRENT EVENTS REPORTING, EDUCATIONAL INFORMATION, COLLEGE EDUCATIONAL INFORMATION, SPORTS INFORMATION, ENTERTAINMENT INFORMATION AND INFORMATION IN THE FIELD OF ARTS AND LEISURE; PROVIDING NEWSLETTERS IN THE FIELDS OF CURRENT EVENTS, POLITICS, POLICY, EDUCATION, COLLEGE-LIFE, HEALTH, RELATIONSHIPS, PERSONAL FINAN-

CES, TECHNOLOGY, SPORTS, ENTERTAINMENT, ARTS, LEISURE AND TRAVEL VIA EMAIL, IN CLASS 41 (U.S. CLS. 100, 101 AND 107).

FIRST USE 9-24-2007; IN COMMERCE 9-24-2007.

THE MARK CONSISTS OF THE WORD "NEWS-FREAK" STYLIZED WITH A SHADED RECTANGLE BEHIND THE WORD "NEWS."

SER. NO. 77-299,168, FILED 10-9-2007.

KATHERINE M. DUBRAY, EXAMINING ATTORNEY

**Int. Cl.: 35**

**Prior U.S. Cls.: 100, 101 and 102**

**United States Patent and Trademark Office**

**Reg. No. 3,452,840**

**Registered June 24, 2008**

**SERVICE MARK  
PRINCIPAL REGISTER**

**FORD ARTISTS**

FORD MODELS, INC. (DELAWARE CORPORATION)  
111 FIFTH AVENUE  
NEW YORK, NY 10003

FOR: REPRESENTATION AND MANAGEMENT OF MAKEUP ARTISTS, HAIRSTYLISTS, MANICURISTS, FASHION STYLISTS, WARDROBE STYLISTS, SET DESIGNERS, SET STYLISTS, PROP STYLISTS, AND PHOTOGRAPHERS , IN CLASS 35 (U.S. CLS. 100, 101 AND 102).

FIRST USE 11-1-2005; IN COMMERCE 11-1-2005.

THE MARK CONSISTS OF STANDARD CHARACTERS WITHOUT CLAIM TO ANY PARTICULAR FONT, STYLE, SIZE, OR COLOR.

OWNER OF U.S. REG. NO. 1,296,761.

NO CLAIM IS MADE TO THE EXCLUSIVE RIGHT TO USE "ARTISTS", APART FROM THE MARK AS SHOWN.

SER. NO. 77-299,217, FILED 10-9-2007.

KIMBERLY FRYE, EXAMINING ATTORNEY

**Int. Cl.: 17**

**Prior U.S. Cls.: 1, 5, 12, 13, 35 and 50**

**United States Patent and Trademark Office**

**Reg. No. 3,452,841**

**Registered June 24, 2008**

**TRADEMARK  
PRINCIPAL REGISTER**

**GAIAPRENE**

WINBOSS INDUSTRIAL CO., LTD (TAIWAN LTD  
LIAB CO)  
NO. 1, LANE 201 JEN HUA RD.  
TA LI CITY, TAIWAN

FOR: FOAMED PLASTICS AND FOAMED RUB-  
BERS IN THE FORM OF SHEETS, PLATES,  
BLOCKS, RODS, TUBES, PIPES, SEMI-FINISHED  
PRE-SHAPED FORMS, ALL FOR USE IN FURTHER  
MANUFACTURE OF FINISHED GOODS, IN CLASS  
17 (U.S. CLS. 1, 5, 12, 13, 35 AND 50).

FIRST USE 10-4-2007; IN COMMERCE 10-4-2007.

THE MARK CONSISTS OF STANDARD CHAR-  
ACTERS WITHOUT CLAIM TO ANY PARTICULAR  
FONT, STYLE, SIZE, OR COLOR.

OWNER OF U.S. REG. NO. 3,196,704.

SER. NO. 77-299,236, FILED 10-9-2007.

KATHERINE M. DUBRAY, EXAMINING ATTOR-  
NEY



**Int. Cl.: 12**

**Prior U.S. Cls.: 19, 21, 23, 31, 35 and 44**

**Reg. No. 3,452,842**

**United States Patent and Trademark Office**

**Registered June 24, 2008**

---

**TRADEMARK  
PRINCIPAL REGISTER**

**MAINETIRE**

GPX INTERNATIONAL TIRE CORPORATION  
(MASSACHUSETTS CORPORATION)  
730 EASTERN AVENUE  
MALDEN, MA 02148

THE MARK CONSISTS OF STANDARD CHAR-  
ACTERS WITHOUT CLAIM TO ANY PARTICULAR  
FONT, STYLE, SIZE, OR COLOR.

FOR: TIRES, OFF-THE-ROAD TIRES, RUBBER  
PRESS ON SOLID TIRES, PNEUMATIC SHAPED  
SOLID TIRES, IN CLASS 12 (U.S. CLS. 19, 21, 23, 31, 35  
AND 44).

SEC. 2(F).

SER. NO. 77-299,297, FILED 10-9-2007.

FIRST USE 12-31-1990; IN COMMERCE 12-31-1990.

MICHELE SWAIN, EXAMINING ATTORNEY

**Int. Cl.: 35**

**Prior U.S. Cls.: 100, 101 and 102**

**United States Patent and Trademark Office**

**Reg. No. 3,452,843**

**Registered June 24, 2008**

**SERVICE MARK  
PRINCIPAL REGISTER**

**PRIDESTAFF FINANCIAL**

PRIDESTAFF, INC. (CALIFORNIA CORPORATION)  
SUITE 101  
7535 N. PALM AVENUE  
FRESNO, CA 93711

FOR: EMPLOYMENT AGENCY SERVICES; PERSONNEL RELOCATION SERVICES; PERSONNEL PLACEMENT AND RECRUITMENT SERVICES; TEMPORARY PERSONNEL PLACEMENT AND RECRUITMENT SERVICES; CONTRACT STAFFING SERVICES; PERSONNEL MANAGEMENT CONSULTING SERVICES; AND PERSONNEL OUTPLACEMENT SERVICES, IN CLASS 35 (U.S. CLS. 100, 101 AND 102).

FIRST USE 10-3-2007; IN COMMERCE 10-3-2007.

THE MARK CONSISTS OF STANDARD CHARACTERS WITHOUT CLAIM TO ANY PARTICULAR FONT, STYLE, SIZE, OR COLOR.

OWNER OF U.S. REG. NO. 2,116,589.

NO CLAIM IS MADE TO THE EXCLUSIVE RIGHT TO USE "FINANCIAL", APART FROM THE MARK AS SHOWN.

SER. NO. 77-299,309, FILED 10-9-2007.

CAROLYN CATALDO, EXAMINING ATTORNEY

**Int. Cl.: 35**

**Prior U.S. Cls.: 100, 101 and 102**

**United States Patent and Trademark Office**

**Reg. No. 3,452,844**

**Registered June 24, 2008**

**SERVICE MARK  
PRINCIPAL REGISTER**

**READER SERVICE IN A  
NANOSECOND**

JLM UNLIMITED, INC. (ILLINOIS CORPORATION)  
1028 WEST DEVON AVENUE  
ELK GROVE VILLAGE, IL 60007

FOR: PROMOTING THE GOODS AND SERVICES OF OTHERS BY PROVIDING HYPERTEXT LINKS TO THE WEB SITES OF OTHERS FOR MAGAZINE SUBSCRIBERS AND READERS, IN CLASS 35 (U.S. CLS. 100, 101 AND 102).

FIRST USE 11-13-2007; IN COMMERCE 11-13-2007.

THE MARK CONSISTS OF STANDARD CHARACTERS WITHOUT CLAIM TO ANY PARTICULAR FONT, STYLE, SIZE, OR COLOR.

NO CLAIM IS MADE TO THE EXCLUSIVE RIGHT TO USE "READER SERVICE", APART FROM THE MARK AS SHOWN.

SER. NO. 77-299,406, FILED 10-9-2007.

JANICE KIM, EXAMINING ATTORNEY

**Int. Cl.: 29**

**Prior U.S. Cl.: 46**

**United States Patent and Trademark Office**

**Reg. No. 3,452,845**

**Registered June 24, 2008**

**TRADEMARK  
PRINCIPAL REGISTER**



FOODCOMM INTERNATIONAL (CALIFORNIA  
CORPORATION)  
4260 EL CAMINO REAL  
PALO ALTO, CA 94306

FIRST USE 5-10-2007; IN COMMERCE 5-10-2007.

SER. NO. 77-299,889, FILED 10-9-2007.

FOR: BEEF, IN CLASS 29 (U.S. CL. 46).

APRIL ROACH, EXAMINING ATTORNEY

**Int. Cl.: 35**

**Prior U.S. Cls.: 100, 101 and 102**

**United States Patent and Trademark Office**

**Reg. No. 3,452,846**

**Registered June 24, 2008**

**SERVICE MARK  
PRINCIPAL REGISTER**

**RPS Return Product  
Solutions**

CYBORNETIC SYSTEMS, INC. (PENNSYLVANIA  
CORPORATION)  
SUITE 2  
100 CORPORATE DRIVE  
MONTGOMERYVILLE, PA 18936

FOR: BUSINESS MANAGEMENT SERVICES,  
NAMELY, MANAGING LOGISTICS, REVERSE LO-  
GISTICS, SUPPLY CHAIN SERVICES, SUPPLY  
CHAIN VISIBILITY AND SYNCHRONIZATION,  
SUPPLY AND DEMAND FORECASTING AND PRO-  
DUCT DISTRIBUTION PROCESSES FOR OTHERS,  
IN CLASS 35 (U.S. CLS. 100, 101 AND 102).

FIRST USE 10-1-2007; IN COMMERCE 10-1-2007.

THE MARK CONSISTS OF STANDARD CHAR-  
ACTERS WITHOUT CLAIM TO ANY PARTICULAR  
FONT, STYLE, SIZE, OR COLOR.

NO CLAIM IS MADE TO THE EXCLUSIVE  
RIGHT TO USE "RETURN PRODUCT SOLUTIONS",  
APART FROM THE MARK AS SHOWN.

SER. NO. 77-299,897, FILED 10-9-2007.

REBECCA POVARCHUK, EXAMINING ATTOR-  
NEY

**Int. Cl.: 14**

**Prior U.S. Cls.: 2, 27, 28 and 50**

**United States Patent and Trademark Office**

**Reg. No. 3,452,847**

**Registered June 24, 2008**

**TRADEMARK  
PRINCIPAL REGISTER**

**FLEUR D' ORLEANS**

FENNER, JANN E. (UNITED STATES INDIVIDUAL)  
3701 MAGAZINE ST.  
NEW ORLEANS, LA 70115

NO CLAIM IS MADE TO THE EXCLUSIVE RIGHT TO USE "D' ORLEANS", APART FROM THE MARK AS SHOWN.

FOR: JEWELRY, IN CLASS 14 (U.S. CLS. 2, 27, 28 AND 50).

THE ENGLISH TRANSLATION OF "FLEUR D' ORLEANS" IS FLOWER OF ORLEANS.

FIRST USE 8-1-2004; IN COMMERCE 8-1-2004.

SER. NO. 77-299,972, FILED 10-9-2007.

THE MARK CONSISTS OF STANDARD CHARACTERS WITHOUT CLAIM TO ANY PARTICULAR FONT, STYLE, SIZE, OR COLOR.

CARYN GLASSER, EXAMINING ATTORNEY

**Int. Cls.: 35 and 45**

**Prior U.S. Cls.: 100, 101 and 102**

**United States Patent and Trademark Office**

**Reg. No. 3,452,848**

**Registered June 24, 2008**

**SERVICE MARK  
PRINCIPAL REGISTER**

**EFINDOUTTHETRUTH.COM The  
Background Check Superstore**

EFINDOUTTHETRUTH.COM, INC. (FLORIDA  
CORPORATION)

# 107

2637 E. ATLANTIC BLVD.  
POMPANO BEACH, FL 33062

FOR: ONLINE RETAIL STORE SERVICES FEATURING SURVEILLANCE EQUIPMENT, DIVERSION SAFES AND PERSONAL SECURITY PRODUCTS, IN CLASS 35 (U.S. CLS. 100, 101 AND 102).

FIRST USE 1-1-2002; IN COMMERCE 1-11-2002.

FOR: PERSONAL BACKGROUND INVESTIGATIONS; PRE-EMPLOYMENT BACKGROUND SCREENING, IN CLASS 45 (U.S. CLS. 100 AND 101).

FIRST USE 1-1-2002; IN COMMERCE 1-11-2002.

THE MARK CONSISTS OF STANDARD CHARACTERS WITHOUT CLAIM TO ANY PARTICULAR FONT, STYLE, SIZE, OR COLOR.

NO CLAIM IS MADE TO THE EXCLUSIVE RIGHT TO USE "BACKGROUND CHECK SUPERSTORE", APART FROM THE MARK AS SHOWN.

SER. NO. 77-300,044, FILED 10-9-2007.

REBECCA POVARCHUK, EXAMINING ATTORNEY

**Int. Cl.: 44**

**Prior U.S. Cls.: 100 and 101**

**United States Patent and Trademark Office**

**Reg. No. 3,452,849**

**Registered June 24, 2008**

**SERVICE MARK  
PRINCIPAL REGISTER**

**Harps and Hugs for Children**

HEALTHCARE HARPS INSTITUTE LLC (CALI-  
FORNIA LTD LIAB CO)  
8977 FOOTHILL BLVD #C  
RANCHO CUCAMONGA, CA 91730

FOR: PROVIDING MUSIC THERAPY, NAMELY,  
PROVIDING LIVE THERAPEUTIC HARP MUSIC  
TO EASE THE ANXIETY AND PAIN OF ILLNESS,  
IN CLASS 44 (U.S. CLS. 100 AND 101).

FIRST USE 6-5-2002; IN COMMERCE 7-8-2007.

THE MARK CONSISTS OF STANDARD CHAR-  
ACTERS WITHOUT CLAIM TO ANY PARTICULAR  
FONT, STYLE, SIZE, OR COLOR.

NO CLAIM IS MADE TO THE EXCLUSIVE  
RIGHT TO USE "FOR CHILDREN", APART FROM  
THE MARK AS SHOWN.

SER. NO. 77-300,068, FILED 10-9-2007.

LINDA M. KING, EXAMINING ATTORNEY



Int. Cl.: 41

Prior U.S. Cls.: 100, 101 and 107

United States Patent and Trademark Office

Reg. No. 3,452,850

Registered June 24, 2008

SERVICE MARK  
PRINCIPAL REGISTER



LEROY'S HORSE AND SPORTS PLACE (NEVADA CORPORATION)  
675 GRIER DRIVE  
LAS VEGAS, NV 89119

FOR: BETTING SERVICES, IN CLASS 41 (U.S. CLS. 100, 101 AND 107).

FIRST USE 7-0-2005; IN COMMERCE 7-0-2005.

OWNER OF U.S. REG. NOS. 2,143,897 AND 2,148,537.

NO CLAIM IS MADE TO THE EXCLUSIVE RIGHT TO USE "SPORTS CLUB", APART FROM THE MARK AS SHOWN.

THE MARK CONSISTS OF THE WORDS "LEROY'S SPORTS CLUB" WITH HORIZONTAL LINES TRAILING THE WORD "LEROY'S" SUGGESTING MOVEMENT.

SER. NO. 77-300,091, FILED 10-9-2007.

MARLENE BELL, EXAMINING ATTORNEY

**Int. Cl.: 42**

**Prior U.S. Cls.: 100 and 101**

**United States Patent and Trademark Office**

**Reg. No. 3,452,851**

**Registered June 24, 2008**

**SERVICE MARK  
PRINCIPAL REGISTER**



EDUCATIONAL BENCHMARKING, INC. (MISSOURI CORPORATION)  
1630 WEST ELFINDALE  
SPRINGFIELD, MO 65807

FOR: PROVIDING ON-LINE NON-DOWNLOADABLE SOFTWARE FOR COMPARISON ASSESSMENT AND ANALYSIS TO SUPPORT QUALITY IMPROVEMENT EFFORTS TO EDUCATIONAL INSTITUTIONS, IN CLASS 42 (U.S. CLS. 100 AND 101).

FIRST USE 10-0-2000; IN COMMERCE 10-0-2000.

NO CLAIM IS MADE TO THE EXCLUSIVE RIGHT TO USE "EDUCATIONAL" AND "BENCH-

MARKING", APART FROM THE MARK AS SHOWN.

THE MARK CONSISTS OF THE LETTERS "EBI", WITH A GLOBE IN BETWEEN THE "E" AND THE "B", THE WORD "EDUCATIONAL" ABOVE THE LETTERS "EBI" AND THE WORD "BENCHMARKING" BELOW THE LETTERS "EBI".

SER. NO. 77-300,188, FILED 10-10-2007.

NELSON SNYDER, EXAMINING ATTORNEY

**Int. Cl.: 42**

**Prior U.S. Cls.: 100 and 101**

**United States Patent and Trademark Office**

**Reg. No. 3,452,852**

**Registered June 24, 2008**

**SERVICE MARK  
PRINCIPAL REGISTER**



EDUCATIONAL BENCHMARKING, INC. (MISSOURI CORPORATION)  
1630 WEST ELFINDALE  
SPRINGFIELD, MO 65807

FOR: PROVIDING ON-LINE NON-DOWNLOADABLE SOFTWARE FOR COMPARISON ASSESSMENT AND ANALYSIS TO SUPPORT QUALITY IMPROVEMENT EFFORTS TO EDUCATIONAL INSTITUTIONS, IN CLASS 42 (U.S. CLS. 100 AND 101).

FIRST USE 12-0-2004; IN COMMERCE 12-0-2004.

NO CLAIM IS MADE TO THE EXCLUSIVE RIGHT TO USE "WEB-ENABLED SURVEY SYSTEM", APART FROM THE MARK AS SHOWN.

THE MARK CONSISTS OF A CIRCLE WITH A "W" IN THE MIDDLE AND THE WORDS "WESS WEB-ENABLED SURVEY SYSTEM".

SER. NO. 77-300,198, FILED 10-10-2007.

NELSON SNYDER, EXAMINING ATTORNEY

**Int. Cl.: 43**

**Prior U.S. Cls.: 100 and 101**

**United States Patent and Trademark Office**

**Reg. No. 3,452,853**

**Registered June 24, 2008**

**SERVICE MARK  
PRINCIPAL REGISTER**

**LUPA OSTERIA ROMANA**

RED CLAM LLC (NEW YORK LTD LIAB CO)  
170 THOMPSON STREET  
NEW YORK, NY 10012

FOR: RESTAURANT AND BAR SERVICES, IN  
CLASS 43 (U.S. CLS. 100 AND 101).

FIRST USE 10-1-1999; IN COMMERCE 10-1-1999.

THE MARK CONSISTS OF STANDARD CHAR-  
ACTERS WITHOUT CLAIM TO ANY PARTICULAR  
FONT, STYLE, SIZE, OR COLOR.

NO CLAIM IS MADE TO THE EXCLUSIVE  
RIGHT TO USE "OSTERIA", APART FROM THE  
MARK AS SHOWN.

THE FOREIGN WORDING IN THE MARK  
TRANSLATES INTO ENGLISH AS WOLF ROMAN  
TAPROOM.

SER. NO. 77-300,340, FILED 10-10-2007.

SALLY SHIH, EXAMINING ATTORNEY

**Int. Cl.: 3**

**Prior U.S. Cls.: 1, 4, 6, 50, 51 and 52**

**Reg. No. 3,452,854**

**United States Patent and Trademark Office**

**Registered June 24, 2008**

---

**TRADEMARK  
PRINCIPAL REGISTER**

**Youthfulness Forever**

SCHULTE, MICHELINE (WASHINGTON LTD  
LIAB CO), DBA MICHELLE COSMETICS LLC  
3925 225TH CT NE  
REDMOND, AZ 98053

THE MARK CONSISTS OF STANDARD CHAR-  
ACTERS WITHOUT CLAIM TO ANY PARTICULAR  
FONT, STYLE, SIZE, OR COLOR.

FOR: COSMETICS, FACE CREAMS, EYE SERUM,  
FACE LOTIONS, BODY LOTIONS, FACE CLEA-  
NERS, IN CLASS 3 (U.S. CLS. 1, 4, 6, 50, 51 AND 52).

SER. NO. 77-300,354, FILED 10-10-2007.

FIRST USE 12-7-2005; IN COMMERCE 4-10-2006.

CAROLINE WOOD, EXAMINING ATTORNEY

**Int. Cl.: 41**

**Prior U.S. Cls.: 100, 101 and 107**

**United States Patent and Trademark Office**

**Reg. No. 3,452,855**

**Registered June 24, 2008**

**SERVICE MARK  
PRINCIPAL REGISTER**

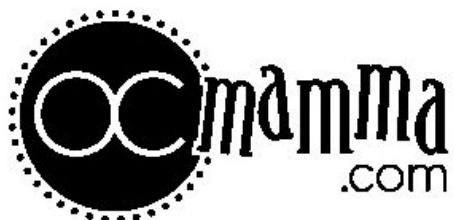

OCMAMMA.COM, INC. (CALIFORNIA CORPORATION)

16 MARISOL

NEWPORT COAST, CA 92657

FOR: ON-LINE JOURNALS, NAMELY, BLOGS FEATURING INFORMATION ON PRODUCTS, COMPANIES AND SERVICES FOR MOTHERS IN ORANGE COUNTY, CALIFORNIA, IN CLASS 41 (U.S. CLS. 100, 101 AND 107).

FIRST USE 4-1-2007; IN COMMERCE 4-1-2007.

NO CLAIM IS MADE TO THE EXCLUSIVE RIGHT TO USE "OC MAMMA .COM", APART FROM THE MARK AS SHOWN.

THE MARK CONSISTS OF THE LETTERS "OC" IN A CIRCLE WITH SMALL DOTS SURROUNDING IT AND THE LETTERS "MAMMA" NEXT TO IT. THE LETTERS ".COM" ARE BELOW THE LETTERS/WORD "MAMMA".

SER. NO. 77-300,393, FILED 10-10-2007.

KAREN SEVERSON, EXAMINING ATTORNEY

**Int. Cl.: 38**

**Prior U.S. Cls.: 100, 101 and 104**

**United States Patent and Trademark Office**

**Reg. No. 3,452,856**

**Registered June 24, 2008**

**SERVICE MARK  
PRINCIPAL REGISTER**

**DEVIANTWATCH**

DEVIANTART, INC. (DELAWARE CORPORATION)  
7095 HOLLYWOOD BOULEVARD, SUITE 788  
HOLLYWOOD, CA 90028

FOR: ELECTRONIC NOTIFICATION SERVICES, NAMELY, PROVIDING NOTIFICATIONS WHEN USERS HAVE POSTED NEW CONTENT, MESSAGES OR OTHER CONTENT ON A WEBSITE; TELECOMMUNICATIONS SERVICES, NAMELY, PROVIDING NOTIFICATIONS WHEN USERS HAVE POSTED NEW CONTENT, MESSAGES OR OTHER CONTENT ON A WEBSITE; PROVIDING TRANSMISSION OF MESSAGES AND DATA VIA

ELECTRONIC MEANS, IN CLASS 38 (U.S. CLS. 100, 101 AND 104).

FIRST USE 8-7-2000; IN COMMERCE 8-7-2000.

THE MARK CONSISTS OF STANDARD CHARACTERS WITHOUT CLAIM TO ANY PARTICULAR FONT, STYLE, SIZE, OR COLOR.

OWNER OF U.S. REG. NO. 3,072,464.

SER. NO. 77-300,427, FILED 10-10-2007.

JEFF DEFORD, EXAMINING ATTORNEY

**Int. Cl.: 9**

**Prior U.S. Cls.: 21, 23, 26, 36 and 38**

**Reg. No. 3,452,857**

**United States Patent and Trademark Office**

**Registered June 24, 2008**

**TRADEMARK  
PRINCIPAL REGISTER**



SKYECANDY PTY LTD (AUSTRALIA CORPORATION)  
PO BOX 1238  
C/O R UNDERHILL  
JULIAN, CA 92036

FOR: COMPUTER SOFTWARE PLUG-IN WHICH PROVIDES A CONTROLLED LIVE VIDEO SPEED DATING ENVIRONMENT, PROVIDING SOCIAL INTRODUCTION AND DATING RELATING COMMUNICATIONS USING A COMMUNICATIONS NETWORK AND RELATED SOFTWARE AND SERVICES AS THE COMMUNICATION PLATFORM, IN CLASS 9 (U.S. CLS. 21, 23, 26, 36 AND 38).

FIRST USE 8-19-2007; IN COMMERCE 8-19-2007.

THE COLOR(S) WHITE, POWDER BLUE, BLUE, BLACK, GRAY AND PINK IS/ARE CLAIMED AS A FEATURE OF THE MARK.

THE MARK CONSISTS OF STYLIZED EYEBALL CONSISTING OF WHITE AND GRADUATED GRAY, WITH A BLUE IRIS IN THE SHAPE OF A STYLIZED HEART, A BLACK PUPIL AND A WHITE REFLECTION HIGHLIGHT POSITIONED SO THAT THE REFLECTION PARTIALLY COVERS THE PUPIL ON THE TOP RIGHT QUADRANT OF THE PUPIL, WITH THE EYEBALL POSITIONED TO THE LEFT OF THE PHRASE "SKYECANDY," WITH THE PHRASE "SKYE CANDY" COLORED IN BLUE AND PINK, WITH THE BLUE GRADUATING TO PINK FROM LEFT TO RIGHT AND THE LETTERS BEING FORMED FROM A UNIQUE FONT.

SER. NO. 77-300,440, FILED 10-10-2007.

HEATHER BIDDULPH, EXAMINING ATTORNEY



**Int. Cl.: 42**

**Prior U.S. Cls.: 100 and 101**

**United States Patent and Trademark Office**

**Reg. No. 3,452,858**

**Registered June 24, 2008**

**SERVICE MARK  
PRINCIPAL REGISTER**

**39 degrees north**

39 DEGREES NORTH, LLC (INDIANA LTD LIAB  
CO)  
SUITE 106R  
501 N. MORTON STREET  
BLOOMINGTON, IN 47404

FOR: CONSULTING SERVICES IN THE FIELD  
OF DESIGN, SELECTION, IMPLEMENTATION  
AND USE OF COMPUTER HARDWARE AND  
SOFTWARE SYSTEMS FOR OTHERS SPECIALIZ-  
ING IN THE DESIGN AND IMPLEMENTATION OF  
GEOGRAPHIC INFORMATION SYSTEMS, DATA-  
BASES FEATURING GEOGRAPHIC INFORMA-  
TION, INTERNET MAPPING SOFTWARE  
APPLICATIONS, AND DATABASE MANAGEMENT

SOFTWARE FEATURING THE CREATION AND  
TRANSFER OF DATA, IN CLASS 42 (U.S. CLS. 100  
AND 101).

FIRST USE 12-15-2004; IN COMMERCE 12-15-2004.

THE MARK CONSISTS OF STANDARD CHAR-  
ACTERS WITHOUT CLAIM TO ANY PARTICULAR  
FONT, STYLE, SIZE, OR COLOR.

SER. NO. 77-300,613, FILED 10-10-2007.

SIMON TENG, EXAMINING ATTORNEY

Int. Cl.: 32

Prior U.S. Cls.: 45, 46 and 48

United States Patent and Trademark Office

Reg. No. 3,452,859

Registered June 24, 2008

TRADEMARK  
PRINCIPAL REGISTER

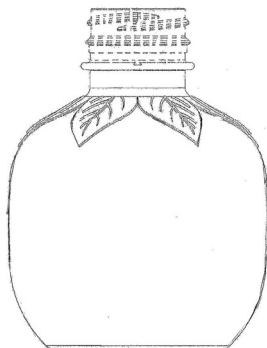

S. MARTINELLI & CO. (CALIFORNIA CORPORATION)  
P.O. BOX 1868  
WATSONVILLE, CA 95077

FOR: FRUIT JUICES, AERATED FRUIT JUICES AND SWEET CIDER, IN CLASS 32 (U.S. CLS. 45, 46 AND 48).

FIRST USE 12-21-2005; IN COMMERCE 12-21-2005.

OWNER OF U.S. REG. NOS. 2,294,894 AND 2,627,302.

THE STIPPLING IS A FEATURE OF THE MARK AND DOES NOT INDICATE COLOR.

THE MARK CONSISTS OF A CLEAR TEN OUNCE SPHEROID BOTTLE IN AN APPLE-LIKE SHAPE

WITH AN EMBOSSED ORNAMENTAL LEAF DESIGN AROUND THE CIRCUMFERENCE OF THE NECK AND A QUARTER INCH VERTICAL RISER FROM THE SHOULDER OF THE SPHERE TO THE BASE OF THE SCREW TOP THREADS. APPLICANT DOES NOT CLAIM THE THREADED NECK OF THE BOTTLE AS PART OF THE MARK TO BE PROTECTED (DEPICTED IN DOTTED LINES). LINES AND STIPPLING DEPICT FEATURES OF THE MARK AND DO NOT INDICATE COLOR.

SEC. 2(F) AS TO THE CLEAR APPLE-SHAPED BOTTLE WITH EMBOSSED LEAVES AROUND THE CIRCUMFERENCE OF THE NECK.

SER. NO. 77-300,693, FILED 10-10-2007.

RICHARD A. STRASER, EXAMINING ATTORNEY

**Int. Cl.: 42**

**Prior U.S. Cls.: 100 and 101**

**United States Patent and Trademark Office**

**Reg. No. 3,452,860**

**Registered June 24, 2008**

**SERVICE MARK  
PRINCIPAL REGISTER**



CARECENTRIC NATIONAL, LLC (GEORGIA  
LTD LIAB CO)  
SUITE 900, OVERLOOK II  
2839 PACES FERRY ROAD  
ATLANTA, GA 30339

FOR: COMPUTER SOFTWARE DEVELOPMENT,  
COMPUTER PROJECT MANAGEMENT SERVICES,  
AND DATA CONVERSION OF COMPUTER PRO-  
GRAM DATA OR INFORMATION, ALL IN THE  
FIELDS OF HOME HEALTH CARE, HOSPICE,  
HOME MEDICAL EQUIPMENT AND HOME CARE  
PHARMACY, IN CLASS 42 (U.S. CLS. 100 AND 101).

FIRST USE 4-1-2005; IN COMMERCE 4-1-2005.

OWNER OF U.S. REG. NOS. 2,170,988, 3,061,520  
AND OTHERS.

THE COLOR(S) RED, WHITE AND BLACK IS/  
ARE CLAIMED AS A FEATURE OF THE MARK.

THE MARK CONSISTS OF THE WORD "MY" IN  
WHITE, ENCLOSED IN A RED CIRCLE, WITH THE  
WORD "CARECENTRIC" NEXT TO IT IN BLACK.  
THE WORDS "ENABLING SUCCESS" ARE IN RED  
UNDERNEATH THE WORD "CARECENTRIC".

SER. NO. 77-300,841, FILED 10-10-2007.

RICHARD A. STRASER, EXAMINING ATTORNEY

**Int. Cl.: 44**

**Prior U.S. Cls.: 100 and 101**

**United States Patent and Trademark Office**

**Reg. No. 3,452,861**

**Registered June 24, 2008**

**SERVICE MARK  
PRINCIPAL REGISTER**

**PRECISION**

CHANEL, INC. (NEW YORK CORPORATION)  
LEGAL DEPARTMENT  
9 WEST 57TH STREET  
NEW YORK, NY 10019

FOR: CONSULTATION IN THE SELECTION AND  
USE OF SKIN CARE PRODUCTS, IN CLASS 44 (U.S.  
CLS. 100 AND 101).

FIRST USE 5-31-1997; IN COMMERCE 5-31-1997.

THE MARK CONSISTS OF STANDARD CHAR-  
ACTERS WITHOUT CLAIM TO ANY PARTICULAR  
FONT, STYLE, SIZE, OR COLOR.

OWNER OF U.S. REG. NOS. 2,091,534 AND  
2,582,486.

SER. NO. 77-300,959, FILED 10-10-2007.

PRISCILLA MILTON, EXAMINING ATTORNEY

**Int. Cl.: 35**

**Prior U.S. Cls.: 100, 101 and 102**

**United States Patent and Trademark Office**

**Reg. No. 3,452,862**

**Registered June 24, 2008**

**SERVICE MARK  
PRINCIPAL REGISTER**



ELITE HOME MANAGEMENT (NORTH CAROLINA LTD LIAB CO)  
P.O. BOX 20564  
WINSTON-SALEM, NC 27120

FOR: BUSINESS MANAGEMENT SERVICES FOR HOMEOWNERS, NAMELY, ARRANGING FOR HOME MAINTENANCE AND REPAIR SERVICES TO BE PERFORMED FOR HOMEOWNERS; AND WEB-BASED ADVERTISING AND MARKETING SERVICES, IN CLASS 35 (U.S. CLS. 100, 101 AND 102).

FIRST USE 9-1-2007; IN COMMERCE 9-1-2007.

NO CLAIM IS MADE TO THE EXCLUSIVE RIGHT TO USE "HOME MANAGEMENT", APART FROM THE MARK AS SHOWN.

THE MARK CONSISTS OF A HOUSE WITH THE STYLIZED TEXT "EHM ELITE HOME MANAGEMENT". ALSO HAS A SWOOSH AROUND IT.

SER. NO. 77-301,149, FILED 10-10-2007.

NAAKWAMA ANKRAH, EXAMINING ATTORNEY

**Int. Cl.: 42**

**Prior U.S. Cls.: 100 and 101**

**United States Patent and Trademark Office**

**Reg. No. 3,452,863**

**Registered June 24, 2008**

**SERVICE MARK  
PRINCIPAL REGISTER**

# LOCAL FORK

LOCAL FORK, INC. (DELAWARE CORPORATION)  
SUITE 9J  
435 EAST 79 STREET  
NEW YORK, NY 10075

FOR: HOSTING OF DIGITAL CONTENT ON THE INTERNET; COMPUTER SERVICES, NAMELY, ACTING AS AN APPLICATION SERVICE PROVIDER IN THE FIELD OF KNOWLEDGE MANAGEMENT TO HOST COMPUTER APPLICATION SOFTWARE FOR THE COLLECTION, EDITING, ORGANIZING, MODIFYING, BOOK MARKING, TRANSMISSION, STORAGE AND SHARING OF DATA AND INFORMATION; COMPUTER SERVICES, NAMELY, HOSTING ON-LINE WEB FACILITIES FOR ORGANIZING AND CONDUCTING ONLINE INTERACTIVE DISCUSSIONS AND FA-

CILITATING COMMERCE, IN CLASS 42 (U.S. CLS. 100 AND 101).

FIRST USE 9-14-2007; IN COMMERCE 9-14-2007.

THE MARK CONSISTS OF STANDARD CHARACTERS WITHOUT CLAIM TO ANY PARTICULAR FONT, STYLE, SIZE, OR COLOR.

NO CLAIM IS MADE TO THE EXCLUSIVE RIGHT TO USE "LOCAL", APART FROM THE MARK AS SHOWN.

SER. NO. 77-301,462, FILED 10-11-2007.

JIM RINGLE, EXAMINING ATTORNEY

**Int. Cl.: 35**

**Prior U.S. Cls.: 100, 101 and 102**

**United States Patent and Trademark Office**

**Reg. No. 3,452,864**

**Registered June 24, 2008**

**SERVICE MARK  
PRINCIPAL REGISTER**

**NATURAL RETAIL GROUP**

UNITED NATURAL FOODS, INC. (DELAWARE CORPORATION)

260 LAKE ROAD

DAYVILLE, CT 06241

FOR: RETAIL AND WHOLESALE HEALTH FOOD STORE SERVICES, MAIL ORDER SERVICES AND ONLINE RETAIL STORE SERVICES FEATURING NATURAL AND ORGANIC FOODS, VITAMINS AND DIETARY SUPPLEMENTS, AND HEALTH AND BEAUTY AIDS, IN CLASS 35 (U.S. CLS. 100, 101 AND 102).

FIRST USE 1-25-1999; IN COMMERCE 1-25-1999.

THE MARK CONSISTS OF STANDARD CHARACTERS WITHOUT CLAIM TO ANY PARTICULAR FONT, STYLE, SIZE, OR COLOR.

OWNER OF U.S. REG. NO. 2,584,043.

NO CLAIM IS MADE TO THE EXCLUSIVE RIGHT TO USE "RETAIL GROUP", APART FROM THE MARK AS SHOWN.

SEC. 2(F).

SER. NO. 77-301,706, FILED 10-11-2007.

WILLIAM P. SHANAHAN, EXAMINING ATTORNEY

**Int. Cl.: 35**

**Prior U.S. Cls.: 100, 101 and 102**

**United States Patent and Trademark Office**

**Reg. No. 3,452,865**

**Registered June 24, 2008**

**SERVICE MARK  
PRINCIPAL REGISTER**

# Iriepics

GREGORY, MICHAEL (UNITED STATES INDIVIDUAL)  
APT 408  
1550 WILDER AVENUE  
HONOLULU, HI 96822

FOR: PROVIDING ADVERTISING, MARKETING AND PROMOTIONAL SERVICES, NAMELY, DEVELOPMENT OF ADVERTISING CAMPAIGNS FOR PHOTOGRAPHY, CD-ROM, DVD, WEB DESIGN, FILM, RADIO, TELEVISION, PRINT, AND PDA, IN CLASS 35 (U.S. CLS. 100, 101 AND 102).

FIRST USE 3-1-2004; IN COMMERCE 3-1-2004.

THE MARK CONSISTS OF STANDARD CHARACTERS WITHOUT CLAIM TO ANY PARTICULAR FONT, STYLE, SIZE, OR COLOR.

SER. NO. 77-301,707, FILED 10-11-2007.

SALLY SHIH, EXAMINING ATTORNEY



**Int. Cl.: 41**

**Prior U.S. Cls.: 100, 101 and 107**

**United States Patent and Trademark Office**

**Reg. No. 3,452,866**

**Registered June 24, 2008**

**SERVICE MARK  
PRINCIPAL REGISTER**

**Phone OM**

BALANCE INTEGRATION CORPORATION  
(NEW YORK CORPORATION)  
212 W. 22ND STREET 2B  
NEW YORK, NY 10011

FOR: EDUCATION SERVICES, NAMELY, PROVIDING LESSONS IN THE FORM OF CUSTOMIZED RECORDED MESSAGES IN THE FIELDS OF STRESS REDUCTION, RELAXATION AND MEDITATION, IN CLASS 41 (U.S. CLS. 100, 101 AND 107).

FIRST USE 9-6-2002; IN COMMERCE 9-6-2002.

THE MARK CONSISTS OF STANDARD CHARACTERS WITHOUT CLAIM TO ANY PARTICULAR FONT, STYLE, SIZE, OR COLOR.

SER. NO. 77-301,873, FILED 10-11-2007.

EUGENIA MARTIN, EXAMINING ATTORNEY

**Int. Cl.: 35**

**Prior U.S. Cls.: 100, 101 and 102**

**United States Patent and Trademark Office**

**Reg. No. 3,452,867**

**Registered June 24, 2008**

**SERVICE MARK  
PRINCIPAL REGISTER**

**BREW MEDIA RELATIONS**

BREW PR LLC (NEW YORK LTD LIAB CO)  
NO. 2D  
45 WEST 10TH STREET  
NEW YORK, NY 10011

FOR: PUBLIC RELATIONS, IN CLASS 35 (U.S.  
CLS. 100, 101 AND 102).

FIRST USE 10-17-2005; IN COMMERCE 10-17-2005.

THE MARK CONSISTS OF STANDARD CHAR-  
ACTERS WITHOUT CLAIM TO ANY PARTICULAR  
FONT, STYLE, SIZE, OR COLOR.

NO CLAIM IS MADE TO THE EXCLUSIVE  
RIGHT TO USE "MEDIA RELATIONS", APART  
FROM THE MARK AS SHOWN.

SER. NO. 77-302,038, FILED 10-11-2007.

MARK PILARO, EXAMINING ATTORNEY

**Int. Cls.: 35 and 41**

**Prior U.S. Cls.: 100, 101, 102 and 107**

**United States Patent and Trademark Office**

**Reg. No. 3,452,868**

**Registered June 24, 2008**

**SERVICE MARK  
PRINCIPAL REGISTER**



DIVERSIFIED BUSINESS COMMUNICATIONS  
(MAINE CORPORATION)  
P.O. BOX 7437  
121 FREE STREET  
PORTLAND, ME 041127437

FOR: CONDUCTING TRADE SHOWS TO PROMOTE TECHNOLOGY, EQUIPMENT AND IDEAS FOR FISHING AND WORK BOAT PROFESSIONALS AND RELATED INDUSTRIES, IN CLASS 35 (U.S. CLS. 100, 101 AND 102).

FIRST USE 11-20-2003; IN COMMERCE 11-20-2003.

FOR: EDUCATIONAL SERVICES, NAMELY, CONDUCTING SEMINARS AND WORKSHOPS IN

TECHNOLOGY, EQUIPMENT AND IDEAS FOR FISHING AND WORK BOAT PROFESSIONALS, IN CLASS 41 (U.S. CLS. 100, 101 AND 107).

FIRST USE 11-20-2003; IN COMMERCE 11-20-2003.

OWNER OF U.S. REG. NO. 1,451,228.

NO CLAIM IS MADE TO THE EXCLUSIVE RIGHT TO USE "MARINE EXPO", APART FROM THE MARK AS SHOWN.

SER. NO. 77-302,058, FILED 10-11-2007.

TINA BROWN, EXAMINING ATTORNEY

**Int. Cls.: 1, 7 and 16**

**Prior U.S. Cls.: 1, 2, 5, 6, 10, 13, 19, 21, 22, 23, 26, 29, 31, 34, 35, 37, 38, 46 and 50**

**Reg. No. 3,452,869**

**United States Patent and Trademark Office**

**Registered June 24, 2008**

**TRADEMARK  
PRINCIPAL REGISTER**

# SILENCER

KC SPECIALTY PRODUCTS, INC. (TEXAS CORPORATION)  
SUITE 200  
1825 SUMMIT AVENUE  
PLANO, TX 75074

FOR: ADHESIVE CARTRIDGES FOR COMMERCIAL OR INDUSTRIAL USE, IN CLASS 1 (U.S. CLS. 1, 5, 6, 10, 26 AND 46).

FIRST USE 10-0-2007; IN COMMERCE 10-0-2007.

FOR: HOT MELT GLUE GUNS; HOT MELT GLUE GUNS AND HOT MELT GLUE GUN ADHESIVE CARTRIDGES SOLD AS A UNIT, IN CLASS 7 (U.S. CLS. 13, 19, 21, 23, 31, 34 AND 35).

FIRST USE 10-0-2007; IN COMMERCE 10-0-2007.

FOR: ADHESIVE CARTRIDGES FOR HOUSEHOLD OR OFFICE USE, IN CLASS 16 (U.S. CLS. 2, 5, 22, 23, 29, 37, 38 AND 50).

FIRST USE 10-0-2007; IN COMMERCE 10-0-2007.

THE MARK CONSISTS OF STANDARD CHARACTERS WITHOUT CLAIM TO ANY PARTICULAR FONT, STYLE, SIZE, OR COLOR.

SER. NO. 77-302,100, FILED 10-11-2007.

JENNIFER HETU, EXAMINING ATTORNEY

**Int. Cl.: 11**

**Prior U.S. Cls.: 13, 21, 23, 31 and 34**

**Reg. No. 3,452,870**

**United States Patent and Trademark Office**

**Registered June 24, 2008**

---

**TRADEMARK  
PRINCIPAL REGISTER**

**IceMan**

WINDCHASER PRODUCTS, INC (CALIFORNIA  
CORPORATION)  
4130 DEL REY AVENUE  
MARINA DEL REY, CA 90292

THE MARK CONSISTS OF STANDARD CHAR-  
ACTERS WITHOUT CLAIM TO ANY PARTICULAR  
FONT, STYLE, SIZE, OR COLOR.

FOR: ICE MAKER, IN CLASS 11 (U.S. CLS. 13, 21,  
23, 31 AND 34).

SER. NO. 77-302,101, FILED 10-11-2007.

FIRST USE 1-7-1995; IN COMMERCE 1-7-1995.

SHARON MEIER, EXAMINING ATTORNEY

**Int. Cls.: 18, 25 and 28**

**Prior U.S. Cls.: 1, 2, 3, 22, 23, 38, 39, 41 and 50**

**Reg. No. 3,452,871**

**United States Patent and Trademark Office**

**Registered June 24, 2008**

**TRADEMARK  
PRINCIPAL REGISTER**

# Go Man

MARTIN MALEK (UNITED STATES INDIVIDUAL)  
871 EAST 12TH ST.  
BROOKLYN, NY 11230

FOR: HANDBAGS, ALL-PURPOSE SPORTS BAGS, BRIEFCASES, SUITCASES, KNAPSACKS, WAIST PACKS, BACKPACKS, POCKET BOOKS, PURSES, ATTACHE CASES, WALLETS, SHOE BAGS FOR TRAVEL, IN CLASS 18 (U.S. CLS. 1, 2, 3, 22 AND 41).

FIRST USE 3-6-2007; IN COMMERCE 3-6-2007.

FOR: CLOTHING, NAMELY, SHIRTS, PANTS, SHORTS, JACKETS, WARM-UP SUITS, JOGGING SUITS, SOCKS, SWIM WEAR, SKIRTS, SWEATERS, UNDERWEAR, HEAD WEAR, CAPS, VISORS, HATS, HEADBANDS, SWEATBANDS, SLEEP WEAR, SCARVES, TIES, GLOVES AND WRISTBANDS; FOOTWEAR, SHOES AND SNEAKERS, IN CLASS 25 (U.S. CLS. 22 AND 39).

FIRST USE 3-6-2007; IN COMMERCE 3-6-2007.

FOR: EXERCISING MACHINES, NAMELY, WEIGHT LIFTING MACHINES, STATIONARY EXERCISE BICYCLES, ELLIPTICAL MACHINES,

STAIR-STEPPING MACHINES AND TREADMILLS; TOYS AND PLAYTHINGS, NAMELY, ACTION FIGURES, PLUSH TOYS, AND TOY VEHICLES; GAMES, NAMELY, BOARD GAMES; DOLLS; SKATEBOARDS; ICE SKATES; ROLLER SKATES; INLINE SKATES; PLAYGROUND BALLS; SOCCER EQUIPMENT, NAMELY, SOCCER BALLS; BASEBALL EQUIPMENT, NAMELY, BASEBALL BATS, BASEBALLS, BASEBALL MITTS AND BASEBALL GLOVES; BASKETBALL EQUIPMENT, NAMELY, BASKETBALLS AND BACKBOARD FOR BASKETBALL; HOCKEY EQUIPMENT, NAMELY, FIELD HOCKEY BALLS, HOCKEY STICKS, HOCKEY GLOVES AND HOCKEY PUCKS; AND FOOTBALL EQUIPMENT, NAMELY, FOOTBALLS, IN CLASS 28 (U.S. CLS. 22, 23, 38 AND 50).

FIRST USE 3-6-2007; IN COMMERCE 3-6-2007.

THE MARK CONSISTS OF STANDARD CHARACTERS WITHOUT CLAIM TO ANY PARTICULAR FONT, STYLE, SIZE, OR COLOR.

SER. NO. 77-302,166, FILED 10-11-2007.

YAT SYE, LEE, EXAMINING ATTORNEY

**Int. Cl.: 41**

**Prior U.S. Cls.: 100, 101 and 107**

**United States Patent and Trademark Office**

**Reg. No. 3,452,872**

**Registered June 24, 2008**

**SERVICE MARK  
PRINCIPAL REGISTER**



ZUMBA FITNESS, LLC (FLORIDA LTD LIAB CO)  
3801 NORTH 29TH AVENUE  
HOLLYWOOD, FL 33020

FOR: EDUCATION SERVICES, NAMELY, PROVIDING CLASSES IN THE FIELD OF DANCE AND EXERCISE, IN CLASS 41 (U.S. CLS. 100, 101 AND 107).

FIRST USE 6-30-2002; IN COMMERCE 6-30-2002.

OWNER OF U.S. REG. NOS. 3,046,534, 3,296,721 AND OTHERS.

NO CLAIM IS MADE TO THE EXCLUSIVE RIGHT TO USE "FITNESS", APART FROM THE MARK AS SHOWN.

THE COLOR(S) GREEN AND BLACK IS/ARE CLAIMED AS A FEATURE OF THE MARK.

THE COLOR BLACK APPEARS IN THE WORDING "ZUMBA FITNESS" AND IN THE STICK FIGURE DESIGN, AND THE COLOR GREEN APPEARS IN THE CIRCULAR BACKGROUND BEHIND THE STICK FIGURE.

THE FOREIGN WORDING IN THE MARK TRANSLATES INTO ENGLISH AS FAST.

SER. NO. 77-302,232, FILED 10-11-2007.

JOHN GARTNER, EXAMINING ATTORNEY

**Int. Cl.: 5**

**Prior U.S. Cls.: 6, 18, 44, 46, 51 and 52**

**United States Patent and Trademark Office**

**Reg. No. 3,452,873**

**Registered June 24, 2008**

**TRADEMARK  
PRINCIPAL REGISTER**



NEXT LEVEL NUTRITION (CALIFORNIA CORPORATION)

#297

2034 E. LINCOLN AVE.,  
ANAHEIM, CA 92806

FOR: DIETARY SUPPLEMENTS, IN CLASS 5 (U.S. CLS. 6, 18, 44, 46, 51 AND 52).

FIRST USE 6-1-2007; IN COMMERCE 6-1-2007.

NO CLAIM IS MADE TO THE EXCLUSIVE RIGHT TO USE "ELEVATE TESTOSTERONE AND BLOCK ESTROGEN", APART FROM THE MARK AS SHOWN.

THE COLOR(S) BLUE, BLACK, WHITE AND GRAY IS/ARE CLAIMED AS A FEATURE OF THE MARK.

THE MARK CONSISTS OF THE WORD(S) "SHOW DOWN" IN STYLIZED FORM, THE LETTER "W" IN THE WORD "SHOW" AND THE LETTER "D" IN THE WORD "DOWN" EXTENDS A LINE. BESIDES THE WORD "SHOW" THE SLOGAN "ELEVATE TESTOSTERONE" AND ON THE LEFT SIDE OF THE WORD "DOWN" THE SLOGAN "BLOCK ESTROGEN".

SER. NO. 77-302,330, FILED 10-11-2007.

GINA HAYES, EXAMINING ATTORNEY



**Int. Cl.: 35**

**Prior U.S. Cls.: 100, 101 and 102**

**United States Patent and Trademark Office**

**Reg. No. 3,452,874**

**Registered June 24, 2008**

**SERVICE MARK  
PRINCIPAL REGISTER**

**BETTENCOURT GREEN BUILDING  
SUPPLIES**

BETTENCOURT GREEN BUILDING SUPPLIES  
LLC (NEW YORK LTD LIAB CO)  
70 NORTH SIXTH STREET  
BROOKLYN, NY 11211

THE MARK CONSISTS OF STANDARD CHAR-  
ACTERS WITHOUT CLAIM TO ANY PARTICULAR  
FONT, STYLE, SIZE, OR COLOR.

FOR: DISTRIBUTORSHIPS IN THE FIELD OF  
ARCHITECTURAL MATERIALS AND SUPPLIES;  
ON-LINE RETAIL STORE SERVICES FEATURING  
ARCHITECTURAL MATERIALS AND SUPPLIES;  
RETAIL SHOPS FEATURING ARCHITECTURAL  
MATERIALS AND SUPPLIES, IN CLASS 35 (U.S.  
CLS. 100, 101 AND 102).

NO CLAIM IS MADE TO THE EXCLUSIVE  
RIGHT TO USE "GREEN BUILDING SUPPLIES",  
APART FROM THE MARK AS SHOWN.

SER. NO. 77-302,375, FILED 10-11-2007.

FIRST USE 4-15-2004; IN COMMERCE 9-9-2004.

B. PARADEWELAI, EXAMINING ATTORNEY

**Int. Cl.: 41**

**Prior U.S. Cls.: 100, 101 and 107**

**United States Patent and Trademark Office**

**Reg. No. 3,452,875**

**Registered June 24, 2008**

**SERVICE MARK  
PRINCIPAL REGISTER**

**VOS IZ NEIAS**

B2B HOLDINGS, LLC (NEW YORK LTD LIAB  
CO)  
2 LAKE STREET  
MONROE, NY 10950

FOR: PROVIDING A NEWSLETTER FEATURING  
NEWS AND FEATURES OF INTEREST TO THE  
JEWISH COMMUNITY; PROVIDING A WEBSITE  
FEATURING CURRENT EVENTS EVENT NEWS  
AND FEATURES OF INTEREST TO THE JEWISH  
COMMUNITY ALL RELATING TO EDUCATION-  
AL, CULTURAL, RELIGIOUS, SOCIAL EVENTS  
AND ENTERTAINMENT INFORMATION, IN  
CLASS 41 (U.S. CLS. 100, 101 AND 107).

FIRST USE 4-7-2004; IN COMMERCE 4-7-2004.

THE MARK CONSISTS OF STANDARD CHAR-  
ACTERS WITHOUT CLAIM TO ANY PARTICULAR  
FONT, STYLE, SIZE, OR COLOR.

THE FOREIGN WORDING IN THE MARK  
TRANSLATES INTO ENGLISH AS "WHAT'S THE  
NEWS".

SER. NO. 77-302,458, FILED 10-12-2007.

WILLIAM VERHOSEK, EXAMINING ATTORNEY

**Int. Cl.: 36**

**Prior U.S. Cls.: 100, 101 and 102**

**United States Patent and Trademark Office**

**Reg. No. 3,452,876**

**Registered June 24, 2008**

**SERVICE MARK  
PRINCIPAL REGISTER**



WEST VIRGINIA MUTUAL INSURANCE COM-  
PANY (WEST VIRGINIA CORPORATION)  
SUITE 1200  
500 VIRIGNIA STREET, EAST  
CHARLESTON, WV 25301

FOR: RISK MANAGEMENT IN THE FIELD OF  
MEDICAL PROFESSIONAL LIABILITY INSUR-  
ANCE, IN CLASS 36 (U.S. CLS. 100, 101 AND 102).

FIRST USE 6-0-2006; IN COMMERCE 6-0-2006.

NO CLAIM IS MADE TO THE EXCLUSIVE  
RIGHT TO USE THE IMAGE OF THE CADUCEUS,  
APART FROM THE MARK AS SHOWN.

THE COLOR(S) DARK BLUE, LIGHT BLUE AND  
GREEN IS/ARE CLAIMED AS A FEATURE OF THE  
MARK.

THE MARK CONSISTS OF THE LITERAL ELE-  
MENT "C.A.R.E." IN DARK BLUE SUPERIMPOSED  
ON A LIGHT BLUE AND GREEN CADUCEUS.

SER. NO. 77-302,492, FILED 10-12-2007.

CAROLYN CATALDO, EXAMINING ATTORNEY

Int. Cl.: 33

Prior U.S. Cls.: 47 and 49

United States Patent and Trademark Office

Reg. No. 3,452,877

Registered June 24, 2008

TRADEMARK  
PRINCIPAL REGISTER

MASSERIE PISARI

EMO CAPODILISTA,GIORDANO (ITALY INDIVIDUAL)  
SELVAZZANO DENTRO  
VIA MONTECCHIA, 18  
PADOVA, ITALY AND  
MARRA, FRANCESCO (ITALY INDIVIDUAL)  
UGENTO  
STRADA PROVINCIALE UGENTO-CASARANO  
LECCE, ITALY

FOR: APERITIF WINES; COOKING WINES;  
WINES IN GENERAL; PREPARED WINE COCKTAILS;  
DRINKS, NAMELY, WINE COOLERS; WINE PUNCHES,  
IN CLASS 33 (U.S. CLS. 47 AND 49).

FIRST USE 4-30-2007; IN COMMERCE 4-30-2007.

THE MARK CONSISTS OF STANDARD CHARACTERS WITHOUT CLAIM TO ANY PARTICULAR FONT, STYLE, SIZE, OR COLOR.

THE WORD "MASSERIE" TRANSLATES INTO ENGLISH AS "FARMS". THE TERM "PISARI" HAS NO KNOWN TRANSLATION FROM ANY FOREIGN LANGUAGE.

SER. NO. 77-302,538, FILED 10-12-2007.

LAURA KOVALSKY, EXAMINING ATTORNEY

Int. Cl.: 41

Prior U.S. Cls.: 100, 101 and 107

United States Patent and Trademark Office

Reg. No. 3,452,878

Registered June 24, 2008

SERVICE MARK  
PRINCIPAL REGISTER



BENLOSS, ANGELA (UNITED STATES INDIVIDUAL)  
5345 LA MIRADA AVENUE  
LOS ANGELES, CA 90029

FOR: PRODUCTION AND DISTRIBUTION OF INDEPENDENT MOTION PICTURES, IN CLASS 41 (U.S. CLS. 100, 101 AND 107).

FIRST USE 9-4-2007; IN COMMERCE 9-4-2007.

NO CLAIM IS MADE TO THE EXCLUSIVE RIGHT TO USE "PICTURES", APART FROM THE MARK AS SHOWN.

THE COLOR(S) BLUE, GRAY, AND WHITE IS/ARE CLAIMED AS A FEATURE OF THE MARK.

THE MARK CONSISTS OF A BLUE MOVIE CLAPPER WITH THE LETTER "Y" IN WHITE ON THE LOWER RIGHT HAND CORNER WITH A GRAY SHADOW BENEATH AND THE WORDS "YEMALLA PICTURES" IN BLUE ITALIC LETTERS ON THE RIGHT HAND SIDE OF THE CLAPPER.

SER. NO. 77-302,559, FILED 10-12-2007.

STEVEN JACKSON, EXAMINING ATTORNEY

**Int. Cl.: 11**

**Prior U.S. Cls.: 13, 21, 23, 31 and 34**

**Reg. No. 3,452,879**

**United States Patent and Trademark Office**

**Registered June 24, 2008**

**TRADEMARK  
PRINCIPAL REGISTER**

**Clean Water Revival, Inc.**

CLEAN WATER REVIVAL, INC. (FLORIDA CORPORATION), DBA CWR, ENVIRONMENTAL PRODUCTS  
SUITE G  
5155 CORPORATE WAY  
JUPITER, FL 33458

FOR: AIR FILTERS FOR DOMESTIC USE; WATER PURIFICATION UNITS, IN CLASS 11 (U.S. CLS. 13, 21, 23, 31 AND 34).

FIRST USE 2-1-1990; IN COMMERCE 2-1-1990.

THE MARK CONSISTS OF STANDARD CHARACTERS WITHOUT CLAIM TO ANY PARTICULAR FONT, STYLE, SIZE, OR COLOR.

NO CLAIM IS MADE TO THE EXCLUSIVE RIGHT TO USE "CLEAN WATER" AND "INC.", APART FROM THE MARK AS SHOWN.

SER. NO. 77-302,572, FILED 10-12-2007.

SARA THOMAS, EXAMINING ATTORNEY

**Int. Cl.: 41**

**Prior U.S. Cls.: 100, 101 and 107**

**United States Patent and Trademark Office**

**Reg. No. 3,452,880**

**Registered June 24, 2008**

**SERVICE MARK  
PRINCIPAL REGISTER**

**YEMALLA PICTURES**

BENLOSS, ANGELA (UNITED STATES INDIVIDUAL)  
5345 LA MIRADA AVENUE  
LOS ANGELES, CA 90029

FOR: PRODUCTION AND DISTRIBUTION OF INDEPENDENT MOTION PICTURES; PRODUCTION AND DISTRIBUTION OF TELEVISION SHOWS AND MOVIES; MULTIMEDIA ENTERTAINMENT SERVICES IN THE NATURE OF RECORDING, PRODUCTION AND POST-PRODUCTION SERVICES IN THE FIELDS OF MUSIC, VIDEO, AND FILMS, IN CLASS 41 (U.S. CLS. 100, 101 AND 107).

FIRST USE 9-4-2007; IN COMMERCE 9-4-2007.

THE MARK CONSISTS OF STANDARD CHARACTERS WITHOUT CLAIM TO ANY PARTICULAR FONT, STYLE, SIZE, OR COLOR.

NO CLAIM IS MADE TO THE EXCLUSIVE RIGHT TO USE "PICTURES", APART FROM THE MARK AS SHOWN.

SER. NO. 77-302,574, FILED 10-12-2007.

STEVEN JACKSON, EXAMINING ATTORNEY

**Int. Cl.: 41**

**Prior U.S. Cls.: 100, 101 and 107**

**United States Patent and Trademark Office**

**Reg. No. 3,452,881**

**Registered June 24, 2008**

**SERVICE MARK  
PRINCIPAL REGISTER**

**LEADERSHIP ORLANDO**

GREATER ORLANDO CHAMBER OF COM-  
MERCE, INC. (FLORIDA NON-PROFIT COR-  
PORATION)  
75 SOUTH IVANHOE BLVD.  
ORLANDO, FL 32804

FOR: EDUCATIONAL SERVICES, NAMELY,  
CONDUCTING MEETINGS, CONFERENCES AND  
FIELD TRIPS RELATED TO EXPANSION OF PER-  
SONAL AND BUSINESS CONTACTS NETWORKS,  
REVIEW OF VITAL COMMUNITY ISSUES AND  
EXPANSION OF OPPORTUNITIES FOR ASSUMING  
POSITIONS OF CIVIC RESPONSIBILITY, IN CLASS  
41 (U.S. CLS. 100, 101 AND 107).

FIRST USE 1-21-1975; IN COMMERCE 12-22-1996.

THE MARK CONSISTS OF STANDARD CHAR-  
ACTERS WITHOUT CLAIM TO ANY PARTICULAR  
FONT, STYLE, SIZE, OR COLOR.

SEC. 2(F).

SER. NO. 77-302,760, FILED 10-12-2007.

BONNIE LUKEN, EXAMINING ATTORNEY



**Int. Cl.: 31**

**Prior U.S. Cls.: 1 and 46**

**United States Patent and Trademark Office**

**Reg. No. 3,452,882**

**Registered June 24, 2008**

**TRADEMARK  
PRINCIPAL REGISTER**

**DAVE'S NATURALLY HEALTHY  
FOOD**

DAVE'S SODA & PET CITY (MASSACHUSETTS  
CORPORATION)

11 RAMAH CIRCLE NORTH

AGAWAM, MA 01001

FOR: ANIMAL FOODSTUFFS, IN CLASS 31 (U.S.  
CLS. 1 AND 46).

FIRST USE 10-8-2007; IN COMMERCE 10-8-2007.

THE MARK CONSISTS OF STANDARD CHAR-  
ACTERS WITHOUT CLAIM TO ANY PARTICULAR  
FONT, STYLE, SIZE, OR COLOR.

NO CLAIM IS MADE TO THE EXCLUSIVE  
RIGHT TO USE "NATURALLY HEALTHY FOOD",  
APART FROM THE MARK AS SHOWN.

SER. NO. 77-302,771, FILED 10-12-2007.

ALICE BENMAMAN, EXAMINING ATTORNEY

**Int. Cl.: 36**

**Prior U.S. Cls.: 100, 101 and 102**

**United States Patent and Trademark Office**

**Reg. No. 3,452,883**

**Registered June 24, 2008**

**SERVICE MARK  
PRINCIPAL REGISTER**



BUILDERS HOME REALTY, INC. (TEXAS CORPORATION)  
505 N. AVE C  
HUMBLE, TX 77338

FOR: REAL ESTATE BROKERAGE; REAL ESTATE AGENCY; NEW HOME BROKERAGE SERVICES; REAL ESTATE AGENCY AND BROKERAGE SERVICES FOR BUYERS, IN CLASS 36 (U.S. CLS. 100, 101 AND 102).

FIRST USE 4-0-2005; IN COMMERCE 4-0-2005.

THE MARK CONSISTS OF A FANCIFUL KEY DESIGN.

SER. NO. 77-302,782, FILED 10-12-2007.

EMILY CHUO, EXAMINING ATTORNEY

**Int. Cl.: 43**

**Prior U.S. Cls.: 100 and 101**

**United States Patent and Trademark Office**

**Reg. No. 3,452,884**

**Registered June 24, 2008**

**SERVICE MARK  
PRINCIPAL REGISTER**

**LUCKIE**

LUCKIE FOOD LOUNGE LLC (GEORGIA LTD  
LIAB CO)  
375 LUCKIE STREET NW  
ATLANTA, GA 30312

THE MARK CONSISTS OF STANDARD CHAR-  
ACTERS WITHOUT CLAIM TO ANY PARTICULAR  
FONT, STYLE, SIZE, OR COLOR.

FOR: RESTAURANT SERVICES, IN CLASS 43  
(U.S. CLS. 100 AND 101).

SER. NO. 77-302,943, FILED 10-12-2007.

FIRST USE 6-22-2007; IN COMMERCE 6-22-2007.

ELI HELLMAN, EXAMINING ATTORNEY

**Int. Cl.: 25**

**Prior U.S. Cls.: 22 and 39**

**United States Patent and Trademark Office**

**Reg. No. 3,452,885**

**Registered June 24, 2008**

**TRADEMARK  
PRINCIPAL REGISTER**

**Me(ël)**

PURE & SIMPLE CONCEPTS INC. (CANADA CORPORATION)  
6150 TRANSCANADA HIGHWAY  
MONTREAL (ST-LAURENT), CANADA H4T1X5

FOR: MEN'S, WOMEN'S, BOYS' AND GIRLS' CLOTHING, NAMELY, SHIRTS, PANTS, BLAZERS, JACKETS, VESTS, SKIRTS, SHORTS, JEANS, SWEATERS, T-SHIRTS, UNDERCLOTHING, UNDERGARMENTS, UNDERWEAR, LINGERIE, PANTIES, HOSIERY, CAMISOLES, SLEEPWEAR, AND FOOTWEAR, TOGETHER WITH ALL ACCESSORIES, NAMELY, BELTS, SOCKS, TIES, CAPS AND HATS, IN CLASS 25 (U.S. CLS. 22 AND 39).

FIRST USE 11-1-2005; IN COMMERCE 11-1-2005.

THE MARK CONSISTS OF STANDARD CHARACTERS WITHOUT CLAIM TO ANY PARTICULAR FONT, STYLE, SIZE, OR COLOR.

OWNER OF U.S. REG. NO. 3,153,829.

SER. NO. 77-303,111, FILED 10-12-2007.

SUE LAWRENCE, EXAMINING ATTORNEY

**Int. Cl.: 17**

**Prior U.S. Cls.: 1, 5, 12, 13, 35 and 50**

**United States Patent and Trademark Office**

**Reg. No. 3,452,886**

**Registered June 24, 2008**

**TRADEMARK  
PRINCIPAL REGISTER**

**GOSSEN**

GOSSEN CORPORATION (WISCONSIN CORPORATION)  
2030 WEST BENDER ROAD  
MILWAUKEE, WI 53209

FOR: EXTRUDED PLASTIC MATERIALS FOR USE IN WINDOW CASINGS, DOOR CASINGS, OUTSIDE INSULATION AND OTHER CONSTRUCTION APPLICATIONS, IN CLASS 17 (U.S. CLS. 1, 5, 12, 13, 35 AND 50).

FIRST USE 0-0-2000; IN COMMERCE 0-0-2000.

THE MARK CONSISTS OF STANDARD CHARACTERS WITHOUT CLAIM TO ANY PARTICULAR FONT, STYLE, SIZE, OR COLOR.

SEC. 2(F).

SER. NO. 77-303,220, FILED 10-12-2007.

CHARLES L. JENKINS, EXAMINING ATTORNEY

**Int. Cl.: 9**

**Prior U.S. Cls.: 21, 23, 26, 36 and 38**

**Reg. No. 3,452,887**

**United States Patent and Trademark Office**

**Registered June 24, 2008**

**TRADEMARK  
PRINCIPAL REGISTER**

**CABLE FOR LIFE**

MONSTER CABLE PRODUCTS, INC. (CALIFORNIA CORPORATION)  
455 VALLEY DRIVE  
BRISBANE, CA 940051209

FOR: ELECTRICAL AND ELECTROMAGNETIC SIGNAL TRANSMITTING, AMPLIFYING, RECEIVING, AND CONVERTING DEVICES, NAMELY, CABLES, WIRES, CONNECTORS, AND CONTROL DEVICES FOR USE WITH ELECTRICAL, ELECTRONIC, AND COMPUTER DEVICES, IN CLASS 9 (U.S. CLS. 21, 23, 26, 36 AND 38).

FIRST USE 8-6-2007; IN COMMERCE 8-6-2007.

THE MARK CONSISTS OF STANDARD CHARACTERS WITHOUT CLAIM TO ANY PARTICULAR FONT, STYLE, SIZE, OR COLOR.

OWNER OF U.S. REG. NOS. 2,220,851, 2,728,729 AND OTHERS.

NO CLAIM IS MADE TO THE EXCLUSIVE RIGHT TO USE "CABLE", APART FROM THE MARK AS SHOWN.

SER. NO. 77-303,242, FILED 10-12-2007.

JOHN WILKE, EXAMINING ATTORNEY

**Int. Cl.: 10**

**Prior U.S. Cls.: 26, 39 and 44**

**United States Patent and Trademark Office**

**Reg. No. 3,452,888**

**Registered June 24, 2008**

**TRADEMARK  
PRINCIPAL REGISTER**

**C H O L E S T R A K**

ACCUTECH, LLC (CALIFORNIA LTD LIAB CO)  
2641 LA MIRADA DRIVE  
VISTA, CA 92081

DETECTION OF HEART RELATED DISEASES, IN  
CLASS 10 (U.S. CLS. 26, 39 AND 44).

FIRST USE 10-18-1993; IN COMMERCE 10-18-1993.

FOR: MEDICAL DEVICES, NAMELY, SINGLE-  
USE NON-INSTRUMENTED, QUANTITATIVE  
HOME TEST DEVICE KIT COMPRISED OF BLOOD  
DRAWING APPARATUS, APPARATUS FOR  
BLOOD ANALYSIS AND FOR BLOOD MONITOR-  
ING, SOLD AS A UNIT FOR MEASURING TOTAL  
CHOLESTEROL IN WHOLE BLOOD, USED BY  
PHYSICIAN OR AT HOME FOR THE EARLY

THE MARK CONSISTS OF THE WORD "CHO-  
LESTRAK" IN GOUDYCATSCTREG FONT STYLE  
WITH A CHARACTER SPACE BETWEEN EACH  
LETTER.

SER. NO. 77-303,338, FILED 10-12-2007.

ELISSA GARBER KON, EXAMINING ATTORNEY

**Int. Cls.: 36 and 38**

**Prior U.S. Cls.: 100, 101, 102 and 104**

**United States Patent and Trademark Office**

**Reg. No. 3,452,889**

**Registered June 24, 2008**

**SERVICE MARK  
PRINCIPAL REGISTER**

# RGE MONITOR

ROUBINI GLOBAL ECONOMICS, LLC (DELA-  
WARE LTD LIAB CO)  
SUITE 1005  
131 VARICK STREET  
NEW YORK, NY 10013

FOR: NEWS REPORTING SERVICES IN THE  
FIELD OF FINANCIAL NEWS; FINANCIAL INFOR-  
MATION PROVIDED BY ELECTRONIC MEANS;  
FINANCIAL RESEARCH; FINANCIAL SERVICES,  
NAMELY, PROVIDING INFORMATION IN THE  
FIELDS OF FOREIGN CURRENCY, COMMOD-  
ITIES, FINANCIAL DERIVATIVES, INTEREST  
RATE PRODUCTS, AND EQUITIES VIA THE IN-  
TERNET AND INTRANET SYSTEMS, IN CLASS 36  
(U.S. CLS. 100, 101 AND 102).

FIRST USE 9-30-2005; IN COMMERCE 9-30-2005.

FOR: PROVIDING E-MAIL NOTIFICATION  
ALERTS OF RATING CHANGES THAT AFFECT  
FINANCIAL PORTFOLIOS, IN CLASS 38 (U.S. CLS.  
100, 101 AND 104).

FIRST USE 9-30-2005; IN COMMERCE 9-30-2005.

THE MARK CONSISTS OF STANDARD CHAR-  
ACTERS WITHOUT CLAIM TO ANY PARTICULAR  
FONT, STYLE, SIZE, OR COLOR.

NO CLAIM IS MADE TO THE EXCLUSIVE  
RIGHT TO USE "MONITOR", APART FROM THE  
MARK AS SHOWN.

SER. NO. 77-303,348, FILED 10-12-2007.

TARAH HARDY, EXAMINING ATTORNEY



**Int. Cl.: 41**

**Prior U.S. Cls.: 100, 101 and 107**

**United States Patent and Trademark Office**

**Reg. No. 3,452,890**

**Registered June 24, 2008**

**SERVICE MARK  
PRINCIPAL REGISTER**

**LEROY'S LINE**

LEROY'S HORSE AND SPORTS PLACE (NEVADA CORPORATION)  
675 GRIER DRIVE  
LAS VEGAS, NV 89119

FOR: ENTERTAINMENT SERVICES, NAMELY, AN ON-GOING SERIES FEATURING SPORTS AND BETTING INFORMATION PROVIDED THROUGH WEBCASTS, RADIO BROADCASTS AND PODCASTS, IN CLASS 41 (U.S. CLS. 100, 101 AND 107).

FIRST USE 7-0-2006; IN COMMERCE 7-0-2006.

THE MARK CONSISTS OF STANDARD CHARACTERS WITHOUT CLAIM TO ANY PARTICULAR FONT, STYLE, SIZE, OR COLOR.

OWNER OF U.S. REG. NOS. 2,143,897 AND 2,148,537.

SER. NO. 77-303,367, FILED 10-12-2007.

MARLENE BELL, EXAMINING ATTORNEY

**Int. Cl.: 41**

**Prior U.S. Cls.: 100, 101 and 107**

**United States Patent and Trademark Office**

**Reg. No. 3,452,891**

**Registered June 24, 2008**

**SERVICE MARK  
PRINCIPAL REGISTER**



SANFORD HEALTH (SOUTH DAKOTA NON-PROFIT CORPORATION)  
1305 W. 18TH STREET  
SIOUX FALLS, SD 571175039

FOR: MEDICAL EDUCATIONAL SERVICES, NAMELY, PROVIDING CLASSES, SEMINARS AND WORKSHOPS FOR THE GENERAL PUBLIC IN THE FIELD OF HEALTH AND DISSEMINATION OF RELATED EDUCATIONAL MATERIALS; PROVIDING CLASSES, SEMINARS AND TRAINING FOR MEDICAL STUDENTS, RESIDENTS AND OTHER HEALTH CARE PROFESSIONALS, AND PROVIDING CONTINUING MEDICAL EDUCATION FOR HEALTH CARE PROFESSIONALS;

WELLNESS AND FITNESS CENTER SERVICES, IN CLASS 41 (U.S. CLS. 100, 101 AND 107).

FIRST USE 0-0-1973; IN COMMERCE 0-0-1973.

OWNER OF U.S. REG. NO. 2,627,383.

THE MARK CONSISTS OF THE DESIGN OF A HEART WITH AN EMBEDDED LORRAINE CROSS AND A CHEVRON BENEATH IT.

SER. NO. 77-303,469, FILED 10-13-2007.

MICHAEL WIENER, EXAMINING ATTORNEY

**Int. Cl.: 42**

**Prior U.S. Cls.: 100 and 101**

**United States Patent and Trademark Office**

**Reg. No. 3,452,892**

**Registered June 24, 2008**

**SERVICE MARK  
PRINCIPAL REGISTER**



SANFORD HEALTH (SOUTH DAKOTA NON-  
PROFIT CORPORATION)  
1305 W. 18TH STREET  
SIOUX FALLS, SD 571175039

FOR: MEDICAL, BIOMEDICAL AND HEALTH  
CARE RELATED RESEARCH; MEDICAL LABORA-  
TORY SERVICES, IN CLASS 42 (U.S. CLS. 100 AND  
101).

FIRST USE 0-0-1997; IN COMMERCE 0-0-1997.

OWNER OF U.S. REG. NO. 2,627,383.

THE MARK CONSISTS OF THE DESIGN OF A  
HEART WITH AN EMBEDDED LORRAINE CROSS  
AND A CHEVRON BENEATH IT.

SER. NO. 77-303,471, FILED 10-13-2007.

MICHAEL WIENER, EXAMINING ATTORNEY

**Int. Cl.: 41**

**Prior U.S. Cls.: 100, 101 and 107**

**United States Patent and Trademark Office**

**Reg. No. 3,452,893**

**Registered June 24, 2008**

**SERVICE MARK  
PRINCIPAL REGISTER**

**Enlightened Entertainment**

COTTERILL, MALI A (UNITED STATES INDIVIDUAL)  
10856 CAMINITO ARCADA  
SAN DIEGO, CA 92131

FOR: CONDUCTING ENTERTAINMENT EXHIBITIONS IN THE NATURE OF POSITIVE MUSIC; EDUCATIONAL AND ENTERTAINMENT SERVICES, NAMELY, A CONTINUING PROGRAM ABOUT HEALTHY LIFESTYLE ACCESSIBLE BY RADIO, TELEVISION, SATELLITE, AUDIO, VIDEO AND COMPUTER NETWORKS; EDUCATIONAL AND ENTERTAINMENT SERVICES, NAMELY, PROVIDING MOTIVATIONAL AND EDUCATIONAL SPEAKERS; ENTERTAINMENT SERVICES NAMELY, PROVIDING A WEBSITE FEATURING PHOTOGRAPHIC, AUDIO, VIDEO AND PROSE PRESENTATIONS FEATURING POSITIVE MUSIC

AND HEALTHY LIFESTYLE, IN CLASS 41 (U.S. CLS. 100, 101 AND 107).

FIRST USE 7-8-2006; IN COMMERCE 7-8-2006.

THE MARK CONSISTS OF STANDARD CHARACTERS WITHOUT CLAIM TO ANY PARTICULAR FONT, STYLE, SIZE, OR COLOR.

NO CLAIM IS MADE TO THE EXCLUSIVE RIGHT TO USE "ENTERTAINMENT", APART FROM THE MARK AS SHOWN.

SER. NO. 77-303,550, FILED 10-13-2007.

MICHAEL WIENER, EXAMINING ATTORNEY

**Int. Cl.: 42**

**Prior U.S. Cls.: 100 and 101**

**United States Patent and Trademark Office**

**Reg. No. 3,452,894**

**Registered June 24, 2008**

**SERVICE MARK  
PRINCIPAL REGISTER**



WEBMISTRESS.COM, INC. (CALIFORNIA CORPORATION)

4660 LA JOLLA VILLAGE DRIVE, SUITE 500

SAN DIEGO, CA 92122

FOR: DESIGN OF HOMEPAGES AND WEBSITES; DESIGN, CREATION, HOSTING, MAINTENANCE OF WEBSITES FOR OTHERS; DESIGNING WEBSITES FOR ADVERTISING PURPOSES; WEBSITE DEVELOPMENT FOR OTHERS, IN CLASS 42 (U.S. CLS. 100 AND 101).

FIRST USE 6-15-2000; IN COMMERCE 6-15-2000.

NO CLAIM IS MADE TO THE EXCLUSIVE RIGHT TO USE "WEB AGENCY", APART FROM THE MARK AS SHOWN.

THE MARK CONSISTS OF THE WORD "WEBMISTRESS" WITH THE WORD "COM" VERTICALLY INCLINED ABOVE THE DOT IN THE "I" OF "WEBMISTRESS", WITH THE WORDS "WEB AGENCY" BELOW THE "RESS" OF "WEBMISTRESS", CONNECTED TO THE WORD "WEBMISTRESS" BY A LINE WITH A 90 DEGREE ANGLE IN IT.

SER. NO. 77-303,611, FILED 10-14-2007.

HANNO RITTNER, EXAMINING ATTORNEY

**Int. Cl.: 25**

**Prior U.S. Cls.: 22 and 39**

**United States Patent and Trademark Office**

**Reg. No. 3,452,895**

**Registered June 24, 2008**

**TRADEMARK  
PRINCIPAL REGISTER**

**TOKU**

B.B.K. LEATHER, INC. (CALIFORNIA CORPORATION)  
700 SOUTH SANTA FE AVENUE  
LOS ANGELES, CA 90021

THE MARK CONSISTS OF STANDARD CHARACTERS WITHOUT CLAIM TO ANY PARTICULAR FONT, STYLE, SIZE, OR COLOR.

FOR: SHIRTS; SWEAT SHIRTS; TEE SHIRTS; BLAZERS; DENIMS; PANTS, IN CLASS 25 (U.S. CLS. 22 AND 39).

SER. NO. 77-303,669, FILED 10-14-2007.

FIRST USE 7-14-2002; IN COMMERCE 7-14-2002.

JENNIFER HETU, EXAMINING ATTORNEY

**Int. Cl.: 43**

**Prior U.S. Cls.: 100 and 101**

**United States Patent and Trademark Office**

**Reg. No. 3,452,896**

**Registered June 24, 2008**

**SERVICE MARK  
PRINCIPAL REGISTER**

**BEIGNET STATION**

MAY-BIAS, LLC (LOUISIANA LTD LIAB CO)  
6655 ELYSIAN FIELD AVENUE  
NEW ORLEANS, LA 70112

FOR: CAFE RESTAURANT; CARRY-OUT RESTAURANT; RESTAURANT SERVICES, IN CLASS 43 (U.S. CLS. 100 AND 101).

FIRST USE 12-31-2006; IN COMMERCE 12-31-2006.

THE MARK CONSISTS OF STANDARD CHARACTERS WITHOUT CLAIM TO ANY PARTICULAR FONT, STYLE, SIZE, OR COLOR.

NO CLAIM IS MADE TO THE EXCLUSIVE RIGHT TO USE "BEIGNET", APART FROM THE MARK AS SHOWN.

SER. NO. 77-303,817, FILED 10-15-2007.

BENJAMIN ALLEN, EXAMINING ATTORNEY

**Int. Cl.: 36**

**Prior U.S. Cls.: 100, 101 and 102**

**United States Patent and Trademark Office**

**Reg. No. 3,452,897**

**Registered June 24, 2008**

**SERVICE MARK  
PRINCIPAL REGISTER**

# Texas First Bank

TEXAS INDEPENDENT BANCSHARES, INC.  
(TEXAS CORPORATION)  
3232 PALMER HIGHWAY  
TEXAS CITY, TX 77590

NO CLAIM IS MADE TO THE EXCLUSIVE  
RIGHT TO USE "FIRST BANK", APART FROM  
THE MARK AS SHOWN.

FOR: BANKING SERVICES, IN CLASS 36 (U.S.  
CLS. 100, 101 AND 102).

SEC. 2(F).

FIRST USE 7-7-1995; IN COMMERCE 7-7-1995.

SER. NO. 77-303,826, FILED 10-15-2007.

THE MARK CONSISTS OF STANDARD CHAR-  
ACTERS WITHOUT CLAIM TO ANY PARTICULAR  
FONT, STYLE, SIZE, OR COLOR.

WILLIAM VERHOSEK, EXAMINING ATTORNEY



**Int. Cl.: 43**

**Prior U.S. Cls.: 100 and 101**

**United States Patent and Trademark Office**

**Reg. No. 3,452,898**

**Registered June 24, 2008**

**SERVICE MARK  
PRINCIPAL REGISTER**

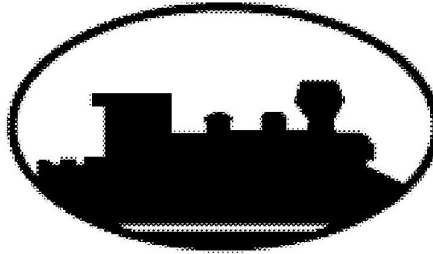

MAY-BIAS, LLC (LOUISIANA LTD LIAB CO)  
6655 ELYSIAN FIELD AVENUE  
NEW ORLEANS, LA 70112

FIRST USE 12-31-2006; IN COMMERCE 12-31-2006.

FOR: CAFE RESTAURANT; CARRY-OUT RESTAURANT; RESTAURANT SERVICES, IN CLASS 43 (U.S. CLS. 100 AND 101).

SER. NO. 77-303,837, FILED 10-15-2007.

BENJAMIN ALLEN, EXAMINING ATTORNEY

**Int. Cl.: 33**

**Prior U.S. Cls.: 47 and 49**

**United States Patent and Trademark Office**

**Reg. No. 3,452,899**

**Registered June 24, 2008**

**TRADEMARK  
PRINCIPAL REGISTER**

**SINGING WATER VINEYARDS**

SINGING WATER, INC. (TEXAS CORPORATION)  
316 MILL DAM ROAD  
COMFORT, TX 780132810

NO CLAIM IS MADE TO THE EXCLUSIVE  
RIGHT TO USE "VINEYARDS", APART FROM  
THE MARK AS SHOWN.

FOR: WINE, IN CLASS 33 (U.S. CLS. 47 AND 49).

FIRST USE 4-1-1998; IN COMMERCE 4-1-1998.

SER. NO. 77-303,841, FILED 10-15-2007.

THE MARK CONSISTS OF STANDARD CHARACTERS WITHOUT CLAIM TO ANY PARTICULAR FONT, STYLE, SIZE, OR COLOR.

BENJAMIN ALLEN, EXAMINING ATTORNEY

**Int. Cl.: 36**

**Prior U.S. Cls.: 100, 101 and 102**

**United States Patent and Trademark Office**

**Reg. No. 3,452,900**

**Registered June 24, 2008**

**SERVICE MARK  
PRINCIPAL REGISTER**

# Texas First

TEXAS INDEPENDENT BANCSHARES, INC.  
(TEXAS CORPORATION)  
3232 PALMER HIGHWAY  
TEXAS CITY, TX 77590

NO CLAIM IS MADE TO THE EXCLUSIVE  
RIGHT TO USE "FIRST", APART FROM THE  
MARK AS SHOWN.

FOR: BANKING SERVICES, IN CLASS 36 (U.S.  
CLS. 100, 101 AND 102).

SEC. 2(F).

FIRST USE 1-31-2002; IN COMMERCE 1-31-2002.

SER. NO. 77-303,885, FILED 10-15-2007.

THE MARK CONSISTS OF STANDARD CHAR-  
ACTERS WITHOUT CLAIM TO ANY PARTICULAR  
FONT, STYLE, SIZE, OR COLOR.

WILLIAM VERHOSEK, EXAMINING ATTORNEY

**Int. Cls.: 35 and 43**

**Prior U.S. Cls.: 100, 101 and 102**

**United States Patent and Trademark Office**

**Reg. No. 3,452,901**

**Registered June 24, 2008**

**SERVICE MARK  
PRINCIPAL REGISTER**



TK MANAGEMENT, LLC (CALIFORNIA LTD  
LIAB CO)  
6540 WASHINGTON STREET  
YOUNTVILLE, CA 94599

FOR: RETAIL BAKERY SHOPS, IN CLASS 35 (U.S.  
CLS. 100, 101 AND 102).

FIRST USE 7-31-2003; IN COMMERCE 7-31-2003.

FOR: RESTAURANT, BAR, AND CATERING  
SERVICES AND PROVIDING BANQUET AND SO-  
CIAL FUNCTION FACILITIES FOR SPECIAL OC-  
CASIONS, IN CLASS 43 (U.S. CLS. 100 AND 101).

FIRST USE 10-31-1998; IN COMMERCE 10-31-1998.

SER. NO. 77-303,915, FILED 10-15-2007.

WILLIAM VERHOSEK, EXAMINING ATTORNEY

**Int. Cl.: 41**

**Prior U.S. Cls.: 100, 101 and 107**

**United States Patent and Trademark Office**

**Reg. No. 3,452,902**

**Registered June 24, 2008**

**SERVICE MARK  
PRINCIPAL REGISTER**

**EXPLO**

EXPLORATION SCHOOL, INC. (MASSACHU-  
SETTS CORPORATION)  
P.O. BOX 368, 470 WASHINGTON STREET  
NORWOOD, MA 02062

FOR: EDUCATIONAL SERVICES, NAMELY,  
PROVIDING SUMMER PROGRAMS FOR ELEMEN-  
TARY, MIDDLE SCHOOL AND HIGH SCHOOL  
STUDENTS, FEATURING HANDS-ON CREATIVE  
ACADEMIC CLASSES OF INSTRUCTION, IN CLASS  
41 (U.S. CLS. 100, 101 AND 107).

FIRST USE 6-30-1982; IN COMMERCE 6-30-1982.

THE MARK CONSISTS OF STANDARD CHAR-  
ACTERS WITHOUT CLAIM TO ANY PARTICULAR  
FONT, STYLE, SIZE, OR COLOR.

OWNER OF U.S. REG. NO. 2,151,696.

SER. NO. 77-303,921, FILED 10-15-2007.

ODESSA BIBBINS, EXAMINING ATTORNEY

**Int. Cl.: 41**

**Prior U.S. Cls.: 100, 101 and 107**

**United States Patent and Trademark Office**

**Reg. No. 3,452,903**

**Registered June 24, 2008**

**SERVICE MARK  
PRINCIPAL REGISTER**

# 6.5 Fresh Steps

BROWN, MICHAEL D. (UNITED STATES INDIVIDUAL)  
7674 CONTINENTAL PLACE  
RANCHO CUCAMONGA, CA 91730

FOR: EDUCATIONAL SERVICES, NAMELY, CONDUCTING LECTURES, SEMINARS, AND TRAINING IN THE FIELD OF CUSTOMER SERVICE AND PERSONAL DEVELOPMENT AND DISTRIBUTION OF COURSE MATERIAL IN CONNECTION THEREWITH, IN CLASS 41 (U.S. CLS. 100, 101 AND 107).

FIRST USE 4-1-2000; IN COMMERCE 7-5-2005.

THE MARK CONSISTS OF STANDARD CHARACTERS WITHOUT CLAIM TO ANY PARTICULAR FONT, STYLE, SIZE, OR COLOR.

SER. NO. 77-303,925, FILED 10-15-2007.

JENNIFER MARTIN, EXAMINING ATTORNEY

Int. Cl.: 43

Prior U.S. Cls.: 100 and 101

United States Patent and Trademark Office

Reg. No. 3,452,904

Registered June 24, 2008

SERVICE MARK  
PRINCIPAL REGISTER



ISAC EFRAIM (UNITED STATES INDIVIDUAL)  
21382 MARINA COVE CIRCLE UNIT 17-D  
AVENTURA, FL 33180

FOR: RESTAURANT SERVICES, IN CLASS 43  
(U.S. CLS. 100 AND 101).

FIRST USE 2-1-2005; IN COMMERCE 10-1-2007.

OWNER OF U.S. REG. NOS. 3,063,105, 3,198,594,  
AND 3,202,191.

NO CLAIM IS MADE TO THE EXCLUSIVE  
RIGHT TO USE "KOSHER", APART FROM THE  
MARK AS SHOWN.

THE COLOR(S) BLACK, WHITE, BLUE AND RED  
IS/ARE CLAIMED AS A FEATURE OF THE MARK.

THE MARK CONSISTS OF A CIRCLE WITH A  
STAR INSIDE AND A BORDER, A MAN WITH A  
HAT, A BANDANA, AN EYE PATCH, AND A KNIFE  
IN BETWEEN HIS TEETH POSITIONED INSIDE  
THE STAR AND THE WORDS "KOSHER CAPT.  
SHRIMP" AT THE BOTTOM OF THE CIRCLE. THE  
COLOR BLACK APPEARS IN THE HAT, THE EYE  
PATCH, THE FACIAL FEATURES, THE EXTERIOR  
BORDER OF THE STAR, THE EXTERIOR BORDER  
OF THE CIRCLE AND AS THE COLOR OF THE  
WORDING "KOSHER CAPT. SHRIMP"; THE COL-  
OR WHITE APPEARS IN THE FACE, THE EARR-  
ING, AND THE SWORD; THE COLOR BLUE  
APPEARS IN THE INSIDE OF THE BACKGROUND  
CIRCLE AND THE INSIDE OF THE STAR; AND  
THE COLOR RED APPEARS IN THE BANDANA.

SER. NO. 77-303,945, FILED 10-15-2007.

KATINA MISTER, EXAMINING ATTORNEY

**Int. Cl.: 14**

**Prior U.S. Cls.: 2, 27, 28 and 50**

**United States Patent and Trademark Office**

**Reg. No. 3,452,905**

**Registered June 24, 2008**

**TRADEMARK  
PRINCIPAL REGISTER**

**KATE ASHBURY**

KATE JOINER (UNITED STATES INDIVIDUAL)  
522 WIND SOCK  
CARLSBAD, CA 92011

FOR: JEWELRY, IN CLASS 14 (U.S. CLS. 2, 27, 28  
AND 50).

FIRST USE 6-1-2005; IN COMMERCE 6-1-2005.

THE MARK CONSISTS OF STANDARD CHAR-  
ACTERS WITHOUT CLAIM TO ANY PARTICULAR  
FONT, STYLE, SIZE, OR COLOR.

NO CLAIM IS MADE TO THE EXCLUSIVE  
RIGHT TO USE "JEWELRY", APART FROM THE  
MARK AS SHOWN.

"THE NAME(S), PORTRAIT(S), AND/OR SIGNA-  
TURE(S) SHOWN IN THE MARK DOES NOT IDENTIFY  
A PARTICULAR LIVING INDIVIDUAL."

SER. NO. 77-303,971, FILED 10-15-2007.

ANDREA K. NADELMAN, EXAMINING ATTOR-  
NEY



**Int. Cl.: 41**

**Prior U.S. Cls.: 100, 101 and 107**

**United States Patent and Trademark Office**

**Reg. No. 3,452,906**

**Registered June 24, 2008**

**SERVICE MARK  
PRINCIPAL REGISTER**

# LA Promote

JPX MEDIA (ARIZONA SOLE PROPRIETOR-  
SHIP)  
9663 SANTA MONICA BLVD. # 187  
BEVERLY HILLS, CA 90210

FOR: PROVIDING INFORMATION, NEWS AND COMMENTARY IN THE FIELD OF ENTERTAINMENT; ENTERTAINMENT SERVICES, NAMELY, PROVIDING ON-LINE REVIEWS OF THE ENTERTAINMENT INDUSTRY, INCLUDING COMMENTARY AND ARTICLES ABOUT THE ENTERTAINMENT INDUSTRY; ENTERTAINMENT SERVICES, NAMELY, PROVIDING A WEBSITE FEATURING PHOTOGRAPHIC, AUDIO, VIDEO AND PROSE PRESENTATIONS FEATURING ACTORS, NEWS AND INFORMATION ABOUT THE ENTERTAINMENT INDUSTRY INCLUDING NEWSLETTERS, COMMENTARY AND ACTING

INFORMATION, IN CLASS 41 (U.S. CLS. 100, 101 AND 107).

FIRST USE 8-1-2007; IN COMMERCE 8-1-2007.

THE MARK CONSISTS OF STANDARD CHARACTERS WITHOUT CLAIM TO ANY PARTICULAR FONT, STYLE, SIZE, OR COLOR.

NO CLAIM IS MADE TO THE EXCLUSIVE RIGHT TO USE "LA", APART FROM THE MARK AS SHOWN.

SER. NO. 77-303,983, FILED 10-15-2007.

JACQUELINE A. LAVINE, EXAMINING ATTORNEY

**Int. Cl.: 9**

**Prior U.S. Cls.: 21, 23, 26, 36 and 38**

**Reg. No. 3,452,907**

**United States Patent and Trademark Office**

**Registered June 24, 2008**

**TRADEMARK  
PRINCIPAL REGISTER**

**MONSTERS LIVE FOREVER**

MONSTER CABLE PRODUCTS, INC. (CALIFORNIA CORPORATION)  
455 VALLEY DRIVE  
BRISBANE, CA 940051209

FOR: ELECTRICAL AND ELECTROMAGNETIC SIGNAL TRANSMITTING, AMPLIFYING, RECEIVING, AND CONVERTING DEVICES, NAMELY, CABLES, WIRES, CONNECTORS, AND CONTROL DEVICES FOR USE WITH ELECTRICAL, ELECTRONIC, AND COMPUTER DEVICES; COMPUTER COMPONENTS AND ACCESSORIES; SPEAKER MOUNTS; ELECTRONIC GAME EQUIPMENT AND ACCESSORIES; ELECTRICAL POWER CONTROL COMPONENTS AND ACCESSORIES, IN CLASS 9 (U.S. CLS. 21, 23, 26, 36 AND 38).

FIRST USE 4-30-1998; IN COMMERCE 4-30-1998.

THE MARK CONSISTS OF STANDARD CHARACTERS WITHOUT CLAIM TO ANY PARTICULAR FONT, STYLE, SIZE, OR COLOR.

OWNER OF U.S. REG. NOS. 2,220,851, 2,728,729 AND OTHERS.

SER. NO. 77-303,994, FILED 10-15-2007.

JOHN WILKE, EXAMINING ATTORNEY

**Int. Cl.: 35**

**Prior U.S. Cls.: 100, 101 and 102**

**United States Patent and Trademark Office**

**Reg. No. 3,452,908**

**Registered June 24, 2008**

**SERVICE MARK  
PRINCIPAL REGISTER**



BIO/START (OHIO CORPORATION)  
THIRD FLOOR  
3130 HIGHLAND AVENUE  
CINCINNATI, OH 452192374

FOR: NON-PROFIT BUSINESS MANAGEMENT  
SERVICES AND BUSINESS CONSULTING SERVI-  
CES TO FIRMS IN THE FIELDS OF BIOLOGICAL  
AND MEDICAL TECHNOLOGY, IN CLASS 35 (U.S.  
CLS. 100, 101 AND 102).

FIRST USE 8-31-2007; IN COMMERCE 8-31-2007.

OWNER OF U.S. REG. NO. 2,090,603.

THE MARK CONSISTS OF THREE CIRCLES OF  
ASCENDING DIAMETER CONNECTED BY A LINE  
APPEARING BEFORE AND ABOVE THE LETTER  
"B" IN THE WORD "BIOSTART".

SER. NO. 77-304,161, FILED 10-15-2007.

EMILY CARLSEN, EXAMINING ATTORNEY

**Int. Cl.: 28**

**Prior U.S. Cls.: 22, 23, 38 and 50**

**Reg. No. 3,452,909**

**United States Patent and Trademark Office**

**Registered June 24, 2008**

---

**TRADEMARK  
PRINCIPAL REGISTER**

**SKETCHY**

FUNDEX GAMES, LTD. (NEVADA CORPORATION)  
2920 FORTUNE CIRCLE WEST  
INDIANAPOLIS, IN 46241

THE MARK CONSISTS OF STANDARD CHARACTERS WITHOUT CLAIM TO ANY PARTICULAR FONT, STYLE, SIZE, OR COLOR.

FOR: GAMES AND TOYS, NAMELY, EQUIPMENT SOLD AS A UNIT FOR PLAYING A PALOR GAME, IN CLASS 28 (U.S. CLS. 22, 23, 38 AND 50).

SER. NO. 77-304,198, FILED 10-15-2007.

FIRST USE 10-10-2007; IN COMMERCE 10-10-2007.

LYDIA BELZER, EXAMINING ATTORNEY

**Int. Cl.: 35**

**Prior U.S. Cls.: 100, 101 and 102**

**United States Patent and Trademark Office**

**Reg. No. 3,452,910**

**Registered June 24, 2008**

**SERVICE MARK  
PRINCIPAL REGISTER**

**BETTER HEARING INSTITUTE**

BETTER HEARING INSTITUTE (VIRGINIA  
NON-PROFIT ASSOCIATION)

515 KING STREET, SUITE 420

ALEXANDRIA, VA 22314

FOR: PROMOTING PUBLIC AWARENESS OF  
THE PROBLEM OF HEARING LOSS AND RESOUR-  
CES AND SOLUTIONS FOR THE HEARING IM-  
PAIRED, IN CLASS 35 (U.S. CLS. 100, 101 AND 102).

FIRST USE 11-0-1973; IN COMMERCE 11-0-1973.

THE MARK CONSISTS OF STANDARD CHAR-  
ACTERS WITHOUT CLAIM TO ANY PARTICULAR  
FONT, STYLE, SIZE, OR COLOR.

NO CLAIM IS MADE TO THE EXCLUSIVE  
RIGHT TO USE "INSTITUTE", APART FROM THE  
MARK AS SHOWN.

SEC. 2(F).

SER. NO. 77-304,228, FILED 10-15-2007.

BRIAN CALLAGHAN, EXAMINING ATTORNEY

**Int. Cl.: 18**

**Prior U.S. Cls.: 1, 2, 3, 22 and 41**

**United States Patent and Trademark Office**

**Reg. No. 3,452,911**

**Registered June 24, 2008**

**TRADEMARK  
PRINCIPAL REGISTER**



ABUNDANT HEALTH, LLC (UTAH LTD LIAB  
CO)  
UNIT #9  
1460 N. MAIN ST.  
SPANISH FORK, UT 84660

THE MARK CONSISTS OF STYLIZED LETTERS  
SPELLING THE WORD "AROMA" ABOVE STY-  
LIZED LETTERS SPELLING THE WORD "READY".

FOR: CARRYING CASES, IN CLASS 18 (U.S. CLS.  
1, 2, 3, 22 AND 41).

SER. NO. 77-304,252, FILED 10-15-2007.

FIRST USE 9-28-2007; IN COMMERCE 9-28-2007.

MARK SPARACINO, EXAMINING ATTORNEY

**Int. Cl.: 42**

**Prior U.S. Cls.: 100 and 101**

**United States Patent and Trademark Office**

**Reg. No. 3,452,912**

**Registered June 24, 2008**

**SERVICE MARK  
PRINCIPAL REGISTER**

**Empower your ministry**

WORD ENTERPRISES, LTD. (PENNSYLVANIA  
CORPORATION), DBA ELEXIO  
29 S. MARKET STREET  
ELIZABETHTOWN, PA 17022

FOR: COMPUTER SERVICES FOR FAITH-  
BASED, EDUCATION AND BUSINESS ORGANIZA-  
TIONS, NAMELY, DESIGNING WEBSITE CON-  
TENT MANAGEMENT SOFTWARE FOR OTHERS  
, IN CLASS 42 (U.S. CLS. 100 AND 101).

FIRST USE 8-31-2007; IN COMMERCE 8-31-2007.

THE MARK CONSISTS OF STANDARD CHAR-  
ACTERS WITHOUT CLAIM TO ANY PARTICULAR  
FONT, STYLE, SIZE, OR COLOR.

SER. NO. 77-304,320, FILED 10-15-2007.

KATHERINE CHANG, EXAMINING ATTORNEY

**Int. Cl.: 42**

**Prior U.S. Cls.: 100 and 101**

**United States Patent and Trademark Office**

**Reg. No. 3,452,913**

**Registered June 24, 2008**

**SERVICE MARK  
PRINCIPAL REGISTER**

**Amplify your message**

WORD ENTERPRISES, LTD. (PENNSYLVANIA  
CORPORATION), DBA ELEXIO  
29 S. MARKET STREET  
ELIZABETHTOWN, PA 17022

FOR: COMPUTER SERVICES FOR FAITH-  
BASED, EDUCATION AND BUSINESS ORGANIZA-  
TIONS, NAMELY, DESIGNING WEBSITE CON-  
TENT MANAGEMENT SOFTWARE FOR OTHERS  
, IN CLASS 42 (U.S. CLS. 100 AND 101).

FIRST USE 8-31-2007; IN COMMERCE 8-31-2007.

THE MARK CONSISTS OF STANDARD CHAR-  
ACTERS WITHOUT CLAIM TO ANY PARTICULAR  
FONT, STYLE, SIZE, OR COLOR.

SER. NO. 77-304,328, FILED 10-15-2007.

KATHERINE CHANG, EXAMINING ATTORNEY



Int. Cl.: 40

Prior U.S. Cls.: 100, 103 and 106

United States Patent and Trademark Office

Reg. No. 3,452,914

Registered June 24, 2008

SERVICE MARK  
PRINCIPAL REGISTER



EXPRESS WELDING, INC. (MICHIGAN CORPORATION)  
2525 14TH AVENUE NORTH  
ESCANABA, MI 49829

FOR: CUSTOM MANUFACTURE OF TRAILERS  
AND TRAILER ACCESSORIES, IN CLASS 40 (U.S.  
CLS. 100, 103 AND 106).

FIRST USE 0-0-1988; IN COMMERCE 0-0-1988.

THE MARK CONSISTS OF THE WORD "EXPRESS" IN STYLIZED SCRIPT FONT WITH THE LOWER BAR OF THE FIRST LETTER "E" UNDERLINING THE REST OF THE WORD.

SER. NO. 77-304,341, FILED 10-15-2007.

SHANNON TWOHIG, EXAMINING ATTORNEY

**Int. Cl.: 41**

**Prior U.S. Cls.: 100, 101 and 107**

**United States Patent and Trademark Office**

**Reg. No. 3,452,915**

**Registered June 24, 2008**

**SERVICE MARK  
PRINCIPAL REGISTER**

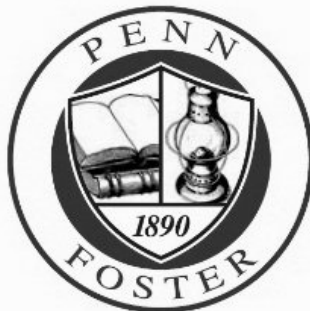

PENN FOSTER, INC. (PENNSYLVANIA CORPORATION)  
925 OAK STREET  
SCRANTON, PA 18615

FOR: PROVIDING PROGRAMS AND COURSES OF INSTRUCTION ON A VARIETY OF SUBJECTS AT THE HIGH SCHOOL, VOCATIONAL, AND COLLEGE LEVELS VIA DISTANCE LEARNING, IN CLASS 41 (U.S. CLS. 100, 101 AND 107).

FIRST USE 12-19-2005; IN COMMERCE 12-19-2005.

NO CLAIM IS MADE TO THE EXCLUSIVE RIGHT TO USE "PENN" OR "1890", APART FROM THE MARK AS SHOWN.

THE MARK CONSISTS OF A CIRCULAR SEAL DESIGN WITH A SOLID OUTER RING, WITH THE STYLIZED TEXT "PENN" INSIDE THE TOP HALF OF THE CIRCLE ON A WHITE BACKGROUND, AND THE STYLIZED TEXT "FOSTER" INSIDE THE BOTTOM HALF OF THE CIRCLE ON A WHITE BACKGROUND. THE CENTER OF THE MARK CONTAINS THE STYLIZED TEXT "1890" UNDERNEATH AN OPEN BOOK AND LANTERN, WITHIN THE OUTLINE OF A SHIELD.

SER. NO. 77-304,532, FILED 10-15-2007.

BENJAMIN OKEKE, EXAMINING ATTORNEY

**Int. Cl.: 41**

**Prior U.S. Cls.: 100, 101 and 107**

**United States Patent and Trademark Office**

**Reg. No. 3,452,916**

**Registered June 24, 2008**

**SERVICE MARK  
PRINCIPAL REGISTER**

**YOGASENSE**

BARENHOLTZ, THEODORA (UNITED STATES  
INDIVIDUAL)  
67 WATERVILLE ROAD  
SOUTHPORT, CT 06890

THE MARK CONSISTS OF STANDARD CHAR-  
ACTERS WITHOUT CLAIM TO ANY PARTICULAR  
FONT, STYLE, SIZE, OR COLOR.

FOR: EDUCATION SERVICES, NAMELY, PRO-  
VIDING CLASSES AND WORKSHOPS IN THE  
FIELD OF YOGA, IN CLASS 41 (U.S. CLS. 100, 101  
AND 107).

SER. NO. 77-304,558, FILED 10-15-2007.

FIRST USE 5-0-2006; IN COMMERCE 10-5-2006.

MICHAEL WIENER, EXAMINING ATTORNEY

**Int. Cl.: 41**

**Prior U.S. Cls.: 100, 101 and 107**

**United States Patent and Trademark Office**

**Reg. No. 3,452,917**

**Registered June 24, 2008**

**SERVICE MARK  
PRINCIPAL REGISTER**

**PENN FOSTER**

PENN FOSTER, INC. (PENNSYLVANIA CORPORATION)  
925 OAK STREET  
SCRANTON, PA 18615

FOR: PROVIDING PROGRAMS AND COURSES OF INSTRUCTION ON A VARIETY OF SUBJECTS AT THE HIGH SCHOOL, VOCATIONAL, AND COLLEGE LEVELS VIA DISTANCE LEARNING, IN CLASS 41 (U.S. CLS. 100, 101 AND 107).

FIRST USE 12-19-2005; IN COMMERCE 12-19-2005.

THE MARK CONSISTS OF STANDARD CHARACTERS WITHOUT CLAIM TO ANY PARTICULAR FONT, STYLE, SIZE, OR COLOR.

NO CLAIM IS MADE TO THE EXCLUSIVE RIGHT TO USE "PENN", APART FROM THE MARK AS SHOWN.

SER. NO. 77-304,594, FILED 10-15-2007.

BENJAMIN OKEKE, EXAMINING ATTORNEY

**Int. Cl.: 42**

**Prior U.S. Cls.: 100 and 101**

**United States Patent and Trademark Office**

**Reg. No. 3,452,918**

**Registered June 24, 2008**

**SERVICE MARK  
PRINCIPAL REGISTER**

**MYSMARTPLANS**

US REPROGRAPHICS NETWORK, LLC (MISSOURI LTD LIAB CO)  
17415 RIVERBEND ROAD  
KEARNEY, MO 64060

FOR: DEVELOPMENT AND CREATION OF CUSTOM SOFTWARE THAT RESIDES ON THE END-USER'S DESKTOP FOR USE IN CREATING, MANAGING, COLLABORATING AND EXCHANGING PROJECT-RELATED DOCUMENTS IN THE BUILDING AND CONSTRUCTION INDUSTRY; COMPUTER SERVICES, NAMELY, HOSTING AND MAINTAINING AN ONLINE WEB SITE FOR OTHERS IN THE BUILDING AND CONSTRUCTION INDUSTRY TO CREATE, MANAGE, COLLABORATE AND EXCHANGE PROJECT-RELATED DOCUMENTS SUCH AS PLANS, SPECS, ADDEN-

DA, PROJECT VIDEOS, SAFETY TRAINING, RFIS (REQUESTS FOR INFORMATION), ASIS (ARCHITECTURAL SUPPLEMENTAL INSTRUCTIONS) AND SUBMITTALS, IN CLASS 42 (U.S. CLS. 100 AND 101).

FIRST USE 2-10-2007; IN COMMERCE 2-10-2007.

THE MARK CONSISTS OF STANDARD CHARACTERS WITHOUT CLAIM TO ANY PARTICULAR FONT, STYLE, SIZE, OR COLOR.

SER. NO. 77-304,616, FILED 10-15-2007.

CHRISTINE COOPER, EXAMINING ATTORNEY

**Int. Cls.: 9 and 42**

**Prior U.S. Cls.: 21, 23, 26, 36, 38, 100 and 101**

**United States Patent and Trademark Office**

**Reg. No. 3,452,919**

**Registered June 24, 2008**

**TRADEMARK  
SERVICE MARK  
PRINCIPAL REGISTER**

**PHARMACY ONESOURCE**

PHARMACY ONESOURCE, INC. (DELAWARE CORPORATION)  
3535 FACTORIA BLVD. SE, STE. 440  
BELLEVUE, WA 98006

FOR: COMPUTER SOFTWARE FOR DATABASE MANAGEMENT, DOCUMENTATION, CALCULATION, SCHEDULING, COMMUNICATION AND REPORTING TO ASSIST HEALTHCARE PROVIDERS WITH PHARMACEUTICAL, CLINICAL AND MANAGEMENT DECISION MAKING AND REGULATORY COMPLIANCE, IN CLASS 9 (U.S. CLS. 21, 23, 26, 36 AND 38).

FIRST USE 6-0-2003; IN COMMERCE 6-0-2003.

FOR: PROVIDING ON-LINE NON-DOWNLOADABLE SOFTWARE FOR DATABASE MANAGEMENT, DOCUMENTATION, CALCULATION, SCHEDULING, AND COMMUNICATION AND REPORTING TO ASSIST HEALTHCARE PROVIDERS WITH PHARMACEUTICAL, CLINICAL AND MAN-

AGEMENT DECISION MAKING AND REGULATORY COMPLIANCE, IN CLASS 42 (U.S. CLS. 100 AND 101).

FIRST USE 6-0-2003; IN COMMERCE 6-0-2003.

THE MARK CONSISTS OF STANDARD CHARACTERS WITHOUT CLAIM TO ANY PARTICULAR FONT, STYLE, SIZE, OR COLOR.

OWNER OF U.S. REG. NOS. 2,530,411 AND 2,597,030.

NO CLAIM IS MADE TO THE EXCLUSIVE RIGHT TO USE "PHARMACY", APART FROM THE MARK AS SHOWN.

SER. NO. 77-304,662, FILED 10-15-2007.

LOURDES AYALA, EXAMINING ATTORNEY

**Int. Cl.: 37**

**Prior U.S. Cls.: 100, 103 and 106**

**Reg. No. 3,452,920**

**United States Patent and Trademark Office**

**Registered June 24, 2008**

---

**SERVICE MARK  
PRINCIPAL REGISTER**

**PETERWATERHEATER**

PETER WATER HEATER HOLDINGS, LLC (COL-  
ORADO LTD LIAB CO)  
15636 E. BATAVIA DRIVE  
AURORA, CO 80011

THE MARK CONSISTS OF STANDARD CHAR-  
ACTERS WITHOUT CLAIM TO ANY PARTICULAR  
FONT, STYLE, SIZE, OR COLOR.

FOR: INSTALLATION, SERVICING, REPAIRING,  
AND REPLACEMENT OF WATER HEATERS AND  
PLUMBING RELATING THERETO; PLUMBING  
SERVICES, IN CLASS 37 (U.S. CLS. 100, 103 AND 106).

SER. NO. 77-304,696, FILED 10-15-2007.

FIRST USE 10-1-2007; IN COMMERCE 10-1-2007.

SHAILA SETTLES, EXAMINING ATTORNEY

**Int. Cl.: 42**

**Prior U.S. Cls.: 100 and 101**

**Reg. No. 3,452,921**

**United States Patent and Trademark Office**

**Registered June 24, 2008**

**SERVICE MARK  
PRINCIPAL REGISTER**

# NETSUITE

NETSUITE, INC. (CALIFORNIA CORPORATION), DBA NETLEDGER, INC.  
SUITE 175  
2955 CAMPUS DRIVE  
SAN MATEO, CA 94403

FOR: BUSINESS APPLICATIONS SERVICE PROVIDER FOR GLOBAL, MULTI-ENTITY COMPANIES FEATURING ONLINE BUSINESS PROCESS AUTOMATION SOFTWARE APPLICATIONS THAT ENABLE CROSS-COUNTRY MANAGEMENT AND THE CONSOLIDATION OF BUSINESS AND FINANCIAL DATA, REGARDLESS OF LOCATION, CURRENCY AND LANGUAGE, FOR USE IN THE FIELDS OF: (I) ENTERPRISE RESOURCE PLANNING (ERP), IN THE NATURE OF ACCOUNTING, PAYROLL, ON-LINE BILL PAYING, E-PROCUREMENT, EMPLOYEE TIME AND BILLING AND EXPENSE REPORTING, FINANCIAL MANAGEMENT, BUSINESS MANAGEMENT, CUSTOMER SUPPORT, AND OFFICE AND BUSINESS PRODUCTIVITY, BUSINESS, FINANCE, PURCHASING, SALES, HUMAN RESOURCES, MANUFACTURING, SOURCING, AND INFORMATION TECHNOLOGY INFRASTRUCTURE, SUPPLY CHAIN MANAGEMENT, AND LOGISTICS; (II) CUSTOMER RELATIONSHIP MANAGEMENT (CRM), IN THE NATURE OF CONTACT MANAGEMENT, SALES FORCE AUTOMATION, COMMISSION AND QUOTA MANAGEMENT, MARKETING, PARTNER RELATIONSHIP MANAGEMENT, CUSTOMER SERVICE AND SUPPORT, CUSTOMER ISSUE AND ENHANCEMENT REQUEST MANAGEMENT; (III)

PROFESSIONAL SERVICES AUTOMATION (PSA), IN THE NATURE OF SALES, PLANNING, EXECUTION SUCH THAT PROJECT-BASED COMPANIES OR DIVISIONS OF COMPANIES CAN APPLY RESOURCES, TRACK, DELIVER AND BILL FOR SERVICES RENDERED WORLDWIDE; AND (IV) ELECTRONIC COMMERCE, IN THE NATURE OF PROVIDING A PLATFORM FOR OTHERS THAT ENABLE THE IMPLEMENTING, OPERATING, HOSTING AND MAINTAINING OF ELECTRONIC COMMERCE WEB SITES, THE CONDUCT OF BUSINESS GLOBALLY ACROSS THOSE ELECTRONIC COMMERCE WEB SITES, INCLUDING SOURCING, PROCUREMENT AND FULFILLMENT, AND THE CONDUCT OF BUSINESS INTELLIGENCE, INCLUDING REPORTING, CROSS-ENTITY BUSINESS ANALYTICS, AND DECISION SUPPORT, IN CLASS 42 (U.S. CLS. 100 AND 101).

FIRST USE 10-14-2002; IN COMMERCE 10-14-2002.

THE MARK CONSISTS OF STANDARD CHARACTERS WITHOUT CLAIM TO ANY PARTICULAR FONT, STYLE, SIZE, OR COLOR.

OWNER OF U.S. REG. NO. 2,913,982.

SEC. 2(F).

SER. NO. 77-304,714, FILED 10-15-2007.

TOBY BULLOFF, EXAMINING ATTORNEY



**Int. Cl.: 25**

**Prior U.S. Cls.: 22 and 39**

**United States Patent and Trademark Office**

**Reg. No. 3,452,922**

**Registered June 24, 2008**

**TRADEMARK  
PRINCIPAL REGISTER**

# Rachel Pally

BECKER, RACHEL (UNITED STATES INDIVIDUAL)  
4019 CLAYTON AVENUE  
LOS ANGELES, CA 90027

FOR: VESTS, JACKETS, DRESSES, PANTS, SHORTS, SKIRTS, BLOUSES, HEAD BANDS, TIGHTS, SWEATERS, SCARVES, BELTS, SHAWLS, IN CLASS 25 (U.S. CLS. 22 AND 39).

FIRST USE 10-31-2002; IN COMMERCE 12-31-2002.

THE MARK CONSISTS OF STANDARD CHARACTERS WITHOUT CLAIM TO ANY PARTICULAR FONT, STYLE, SIZE, OR COLOR.

THE NAME RACHEL BECKER (AKA RACHEL PALLY) IDENTIFIES A LIVING INDIVIDUAL WHOSE CONSENT IS OF RECORD.

SER. NO. 77-304,722, FILED 10-15-2007.

ZHALEH DELANEY, EXAMINING ATTORNEY

**Int. Cl.: 35**

**Prior U.S. Cls.: 100, 101 and 102**

**United States Patent and Trademark Office**

**Reg. No. 3,452,923**

**Registered June 24, 2008**

**SERVICE MARK  
PRINCIPAL REGISTER**

**eRoots**

ALL POINTS COMMUNICATIONS, LLC (NEW  
HAMPSHIRE LTD LIAB CO)  
487 HANOVER CENTER RD.  
ETNA, NH 03750

FOR: PROVIDING AN ON-LINE SEARCHABLE  
DATABASE FOR POLITICAL CAMPAIGNS WHICH  
ALLOW USERS TO COLLECT, ANALYZE AND  
DISSEMINATE INFORMATION ELECTRONICAL-  
LY , IN CLASS 35 (U.S. CLS. 100, 101 AND 102).

FIRST USE 7-11-2007; IN COMMERCE 8-23-2007.

THE MARK CONSISTS OF STANDARD CHAR-  
ACTERS WITHOUT CLAIM TO ANY PARTICULAR  
FONT, STYLE, SIZE, OR COLOR.

SER. NO. 77-304,911, FILED 10-16-2007.

LAURIE KAUFMAN, EXAMINING ATTORNEY

**Int. Cl.: 39**

**Prior U.S. Cls.: 100 and 105**

**United States Patent and Trademark Office**

**Reg. No. 3,452,924**

**Registered June 24, 2008**

**SERVICE MARK  
PRINCIPAL REGISTER**

YOUR THIRST'S FIRST CHOICE!

SPRING HILL FARM DAIRY, INC. (MASSACHU-  
SETTS CORPORATION)  
136 NECK ROAD  
WARD HILL, MA 01835

THE MARK CONSISTS OF STANDARD CHAR-  
ACTERS WITHOUT CLAIM TO ANY PARTICULAR  
FONT, STYLE, SIZE, OR COLOR.

FOR: DELIVERY OF BOTTLED SPRING WATER,  
IN CLASS 39 (U.S. CLS. 100 AND 105).

SER. NO. 77-304,954, FILED 10-16-2007.

FIRST USE 1-0-2002; IN COMMERCE 1-0-2002.

MARILYN IZZI, EXAMINING ATTORNEY

**Int. Cl.: 29**

**Prior U.S. Cl.: 46**

**United States Patent and Trademark Office**

**Reg. No. 3,452,925**

**Registered June 24, 2008**

**TRADEMARK  
PRINCIPAL REGISTER**

**NEW YORK'S BUTCHER TO  
GENERATIONS OF LEGENDARY  
CHEFS**

DEBRAGGA MAIL ORDER, LLC (NEW YORK  
LTD LIAB CO)  
826-D WASHINGTON STREET  
NEW YORK, NY 10014

FOR: MEAT, POULTRY, SAUSAGES, SALAMI,  
FRANKFURTERS FOR RESTAURANTS, CHEFS,  
HOTELS, CLUBS AND FOOD SERVICE ESTABLISH-  
MENTS, IN CLASS 29 (U.S. CL. 46).

FIRST USE 6-30-2007; IN COMMERCE 6-30-2007.

THE MARK CONSISTS OF STANDARD CHAR-  
ACTERS WITHOUT CLAIM TO ANY PARTICULAR  
FONT, STYLE, SIZE, OR COLOR.

SER. NO. 77-304,963, FILED 10-16-2007.

WILLIAM ROSSMAN, EXAMINING ATTORNEY

**Int. Cl.: 9**

**Prior U.S. Cls.: 21, 23, 26, 36 and 38**

**United States Patent and Trademark Office**

**Reg. No. 3,452,926**

**Registered June 24, 2008**

**TRADEMARK  
PRINCIPAL REGISTER**



ZUMBA FITNESS LLC (FLORIDA LTD LIAB CO)  
3801 NORTH 29TH AVENUE  
HOLLYWOOD, FL 33020

FOR: PRE-RECORDED CDS, VIDEO TAPES, LASER DISKS AND DVDS FEATURING PHYSICAL FITNESS AND EXERCISE INSTRUCTION; VIDEO RECORDINGS FEATURING PHYSICAL FITNESS AND EXERCISE INSTRUCTION, IN CLASS 9 (U.S. CLS. 21, 23, 26, 36 AND 38).

FIRST USE 10-31-2001; IN COMMERCE 10-31-2001.

OWNER OF U.S. REG. NOS. 3,046,534, 3,296,721 AND OTHERS.

NO CLAIM IS MADE TO THE EXCLUSIVE RIGHT TO USE "FITNESS", APART FROM THE MARK AS SHOWN.

THE COLOR(S) GREEN AND BLACK IS/ARE CLAIMED AS A FEATURE OF THE MARK.

THE COLOR BLACK APPEARS IN THE WORDING "ZUMBA FITNESS" AND IN THE STICK FIGURE DESIGN, AND THE COLOR GREEN APPEARS IN THE CIRCULAR BACKGROUND BEHIND THE STICK FIGURE.

THE FOREIGN WORDING IN THE MARK TRANSLATES INTO ENGLISH AS FAST.

SER. NO. 77-304,995, FILED 10-16-2007.

JOHN GARTNER, EXAMINING ATTORNEY

**Int. Cl.: 41**

**Prior U.S. Cls.: 100, 101 and 107**

**United States Patent and Trademark Office**

**Reg. No. 3,452,927**

**Registered June 24, 2008**

**SERVICE MARK  
PRINCIPAL REGISTER**

**EL TIEMPO**

OCHOA, DANIEL (MEXICO INDIVIDUAL)  
13422 LAMPSON AVE  
GARDEN GROVE, CA 92840

OWNER OF U.S. REG. NO. 2,459,315.

FOR: ENTERTAINMENT IN THE NATURE OF  
LIVE PERFORMANCES BY A MUSICAL GROUP, IN  
CLASS 41 (U.S. CLS. 100, 101 AND 107).

THE FOREIGN WORDING IN THE MARK  
TRANSLATES INTO ENGLISH AS "THE TIME" OR  
"THE WEATHER".

FIRST USE 1-1-1984; IN COMMERCE 1-1-1984.

SER. NO. 77-305,101, FILED 10-16-2007.

THE MARK CONSISTS OF STANDARD CHAR-  
ACTERS WITHOUT CLAIM TO ANY PARTICULAR  
FONT, STYLE, SIZE, OR COLOR.

CHRISIE B. KING, EXAMINING ATTORNEY

**Int. Cls.: 35, 36 and 38**

**Prior U.S. Cls.: 100, 101, 102 and 104**

**United States Patent and Trademark Office**

**Reg. No. 3,452,928**

**Registered June 24, 2008**

**SERVICE MARK  
PRINCIPAL REGISTER**

**National Stock Exchange**

NATIONAL STOCK EXCHANGE, INC. (OHIO CORPORATION)  
SUITE 2600  
ONE FINANCIAL PLAZA, 440 S. LASALLE ST.  
CHICAGO, IL 60605

FOR: PROVIDING FULLY AUTOMATED, ELECTRONIC EXECUTION AND CONFIRMATION OF SECURITIES TRANSACTIONS; PROVIDING A FINANCIAL MARKET FOR THE AUCTIONING OF SECURITIES, IN CLASS 35 (U.S. CLS. 100, 101 AND 102).

FIRST USE 11-7-2003; IN COMMERCE 11-7-2003.

FOR: OPERATING A STOCK EXCHANGE, NAMELY, PROVIDING A FINANCIAL MARKET FOR THE TRADING OF SECURITIES; COMPILING AND DISSEMINATING STOCK EXCHANGE PRICE QUOTATIONS AND RELATED INFORMATION, IN CLASS 36 (U.S. CLS. 100, 101 AND 102).

FIRST USE 11-7-2003; IN COMMERCE 11-7-2003.

FOR: ELECTRONIC TRANSMISSION OF DATA, MESSAGES AND DOCUMENTS TO BUYERS, SELL-

ERS AND BROKERS OF SECURITIES, ALL OF THE FOREGOING NOT IN THE FIELD OF SPORTS INFORMATION SERVICES, IN CLASS 38 (U.S. CLS. 100, 101 AND 104).

FIRST USE 11-7-2003; IN COMMERCE 11-7-2003.

THE MARK CONSISTS OF STANDARD CHARACTERS WITHOUT CLAIM TO ANY PARTICULAR FONT, STYLE, SIZE, OR COLOR.

OWNER OF U.S. REG. NOS. 3,025,264, 3,056,835, AND 3,246,912.

NO CLAIM IS MADE TO THE EXCLUSIVE RIGHT TO USE "STOCK EXCHANGE", APART FROM THE MARK AS SHOWN.

SEC. 2(F) "NATIONAL" .

SER. NO. 77-305,112, FILED 10-16-2007.

ZHALEH DELANEY, EXAMINING ATTORNEY

**Int. Cl.: 37**

**Prior U.S. Cls.: 100, 103 and 106**

**Reg. No. 3,452,929**

**United States Patent and Trademark Office**

**Registered June 24, 2008**

---

**SERVICE MARK  
PRINCIPAL REGISTER**

# PREProgram

JWC CONSTRUCTION, INC. (CALIFORNIA CORPORATION), DBA JON WAYNE CONSTRUCTION AND CONSULTING  
2580 FORTUNE WAY  
VISTA, CA 92081

AND BUILDING CONSTRUCTION SERVICES, IN CLASS 37 (U.S. CLS. 100, 103 AND 106).

FIRST USE 5-8-2003; IN COMMERCE 11-17-2003.

SER. NO. 77-305,133, FILED 10-16-2007.

FOR: CONSTRUCTION MANAGEMENT SERVICES, CONSTRUCTION CONSULTING SERVICES

THEODORE MCBRIDE, EXAMINING ATTORNEY



**Int. Cl.: 43**

**Prior U.S. Cls.: 100 and 101**

**United States Patent and Trademark Office**

**Reg. No. 3,452,930**

**Registered June 24, 2008**

**SERVICE MARK  
PRINCIPAL REGISTER**

**PLATINUM VILLAS**

AMERICAN EXPRESS MARKETING & DEVELOPMENT CORP (DELAWARE CORPORATION)

ATTN: DIANNE K CAHILL (01-49-12)

200 VESEY STREET  
NEW YORK, NY 10285

FOR: TRAVEL AGENCY SERVICES, NAMELY, MAKING RESERVATIONS AND BOOKING FOR TEMPORARY LODGING, IN CLASS 43 (U.S. CLS. 100 AND 101).

FIRST USE 6-0-2004; IN COMMERCE 6-0-2004.

THE MARK CONSISTS OF STANDARD CHARACTERS WITHOUT CLAIM TO ANY PARTICULAR FONT, STYLE, SIZE, OR COLOR.

NO CLAIM IS MADE TO THE EXCLUSIVE RIGHT TO USE "VILLAS", APART FROM THE MARK AS SHOWN.

SER. NO. 77-305,152, FILED 10-16-2007.

ZHALEH DELANEY, EXAMINING ATTORNEY

**Int. Cl.: 37**

**Prior U.S. Cls.: 100, 103 and 106**

**Reg. No. 3,452,931**

**United States Patent and Trademark Office**

**Registered June 24, 2008**

---

**SERVICE MARK  
PRINCIPAL REGISTER**

# **R.E.A.P. The Benefits**

JWC CONSTRUCTION, INC. (CALIFORNIA CORPORATION), DBA JON WAYNE CONSTRUCTION AND CONSULTING  
2580 FORTUNE WAY  
VISTA, CA 92081

AND BUILDING CONSTRUCTION SERVICES, IN CLASS 37 (U.S. CLS. 100, 103 AND 106).

FIRST USE 8-29-2006; IN COMMERCE 8-29-2007.

SER. NO. 77-305,155, FILED 10-16-2007.

FOR: CONSTRUCTION MANAGEMENT SERVICES, CONSTRUCTION CONSULTING SERVICES

THEODORE MCBRIDE, EXAMINING ATTORNEY

**Int. Cls.: 35 and 42**

**Prior U.S. Cls.: 100, 101 and 102**

**United States Patent and Trademark Office**

**Reg. No. 3,452,932**

**Registered June 24, 2008**

**SERVICE MARK  
PRINCIPAL REGISTER**

**COMBINING TALENT WITH  
TECHNOLOGY**

THE CONSORTIUM, INC. (VIRGINIA CORPORATION)  
SUITE 230  
4922 FAIRMONT AVENUE  
BETHESDA, MD 20814

FOR: EMPLOYMENT AGENCY SERVICES, IN CLASS 35 (U.S. CLS. 100, 101 AND 102).

FIRST USE 7-24-2007; IN COMMERCE 7-24-2007.

FOR: TECHNOLOGY CONSULTATION RELATED TO ADVANCED TECHNOLOGY DEVELOPMENT, QUALITY ASSURANCE/TEST ENGINEERING, ENGINEERING PROCESS IMPROVEMENT, SECTION 508 AUDITS, PRODUCT

ANALYSIS, AND HELP DESK AND NETWORK MANAGEMENT IN THE FIELD OF INFORMATION TECHNOLOGY, IN CLASS 42 (U.S. CLS. 100 AND 101).

FIRST USE 7-24-2007; IN COMMERCE 7-24-2007.

THE MARK CONSISTS OF STANDARD CHARACTERS WITHOUT CLAIM TO ANY PARTICULAR FONT, STYLE, SIZE, OR COLOR.

SER. NO. 77-305,187, FILED 10-16-2007.

RENEE MCCRAY, EXAMINING ATTORNEY

**Int. Cl.: 45**

**Prior U.S. Cls.: 100 and 101**

**United States Patent and Trademark Office**

**Reg. No. 3,452,933**

**Registered June 24, 2008**

**SERVICE MARK  
PRINCIPAL REGISTER**

The logo for SAFERXSCRIPT features the word "SAFER" in a bold, black, sans-serif font. The letter "R" is stylized, with its vertical stem extending downwards and curving to the right to form the letter "X". To the right of this "X" is the word "SCRIPT" in a white, outlined, sans-serif font.

THE RELIZON COMPANY (DELAWARE CORPORATION)  
220 EAST MONUMENT AVENUE  
DAYTON, OH 45402

THE MARK CONSISTS OF THE WORD "SAFER" SHADED IN BLACK AND THE LETTER "R" FORMING AN "X" FOLLOWED BY "SCRIPT" OUTLINED IN BLACK.

FOR: SECURITY PRINTING, NAMELY, ENCODING INFORMATION ON PRESCRIPTION PADS, IN CLASS 45 (U.S. CLS. 100 AND 101).

SER. NO. 77-305,237, FILED 10-16-2007.

FIRST USE 3-5-2007; IN COMMERCE 3-5-2007.

JENNY PARK, EXAMINING ATTORNEY

**Int. Cl.: 41**

**Prior U.S. Cls.: 100, 101 and 107**

**United States Patent and Trademark Office**

**Reg. No. 3,452,934**

**Registered June 24, 2008**

**SERVICE MARK  
PRINCIPAL REGISTER**

**HOUSE HUNTERS**

SCRIPPS NETWORKS, LLC (DELAWARE LTD  
LIAB CO)  
9721 SHERRILL BOULEVARD  
KNOXVILLE, TN 37932

FOR: ENTERTAINMENT SERVICES, NAMELY,  
AN ON-GOING AUDIO AND VISUAL PROGRAM  
DISTRIBUTED OVER AUDIO AND VIDEO MEDIA,  
NAMELY, TELEVISION, SATELLITE, WIRELESS,  
FIBER OPTICS, CABLE, AND GLOBAL COMPUTER  
NETWORK IN THE FIELDS OF REAL ESTATE,  
INTERIOR DESIGN AND DECORATING, IN CLASS  
41 (U.S. CLS. 100, 101 AND 107).

FIRST USE 9-30-1999; IN COMMERCE 9-30-1999.

THE MARK CONSISTS OF STANDARD CHAR-  
ACTERS WITHOUT CLAIM TO ANY PARTICULAR  
FONT, STYLE, SIZE, OR COLOR.

SER. NO. 77-305,300, FILED 10-16-2007.

DANNEAN HETZEL, EXAMINING ATTORNEY

**Int. Cl.: 41**

**Prior U.S. Cls.: 100, 101 and 107**

**United States Patent and Trademark Office**

**Reg. No. 3,452,935**

**Registered June 24, 2008**

**SERVICE MARK  
PRINCIPAL REGISTER**

HOUSE HUNTERS INTERNATIONAL

SCRIPPS NETWORKS, LLC (DELAWARE LTD  
LIAB CO)  
9721 SHERRILL BOULEVARD  
KNOXVILLE, TN 37932

FOR: ENTERTAINMENT SERVICES, NAMELY,  
AN ON-GOING AUDIO AND VISUAL PROGRAM  
DISTRIBUTED OVER AUDIO AND VIDEO MEDIA,  
NAMELY, TELEVISION, SATELLITE, WIRELESS,  
FIBER OPTICS, CABLE, AND GLOBAL COMPUTER  
NETWORK IN THE FIELDS OF REAL ESTATE,  
INTERIOR DESIGN AND DECORATING, IN CLASS  
41 (U.S. CLS. 100, 101 AND 107).

FIRST USE 2-20-2006; IN COMMERCE 2-20-2006.

THE MARK CONSISTS OF STANDARD CHAR-  
ACTERS WITHOUT CLAIM TO ANY PARTICULAR  
FONT, STYLE, SIZE, OR COLOR.

NO CLAIM IS MADE TO THE EXCLUSIVE  
RIGHT TO USE "INTERNATIONAL", APART  
FROM THE MARK AS SHOWN.

SER. NO. 77-305,304, FILED 10-16-2007.

DANNEAN HETZEL, EXAMINING ATTORNEY

**Int. Cl.: 16**

**Prior U.S. Cls.: 2, 5, 22, 23, 29, 37, 38 and 50**

**United States Patent and Trademark Office**

**Reg. No. 3,452,936**

**Registered June 24, 2008**

**TRADEMARK  
PRINCIPAL REGISTER**

**CRAFT-LITE CUTTER**

MERCHANT MEDIA, LLC (MASSACHUSETTS  
LTD LIAB CO)

10 CALIFORNIA AVENUE

FRAMINGHAM, MA 01701

FOR: PAPER CUTTERS, IN CLASS 16 (U.S. CLS. 2,  
5, 22, 23, 29, 37, 38 AND 50).

FIRST USE 9-20-2007; IN COMMERCE 9-20-2007.

THE MARK CONSISTS OF STANDARD CHAR-  
ACTERS WITHOUT CLAIM TO ANY PARTICULAR  
FONT, STYLE, SIZE, OR COLOR.

NO CLAIM IS MADE TO THE EXCLUSIVE  
RIGHT TO USE "CUTTER", APART FROM THE  
MARK AS SHOWN.

SER. NO. 77-305,347, FILED 10-16-2007.

ELLEN B. AWRICH, EXAMINING ATTORNEY

**Int. Cls.: 35 and 41**

**Prior U.S. Cls.: 100, 101, 102 and 107**

**United States Patent and Trademark Office**

**Reg. No. 3,452,937**

**Registered June 24, 2008**

**SERVICE MARK  
PRINCIPAL REGISTER**



THE WILDLIFE EXPERIENCE, INC. (COLORADO CORPORATION)  
10035 SOUTH PEORIA  
PARKER, CO 80134

OWNER OF U.S. REG. NOS. 2,622,047, 2,622,048  
AND OTHERS.

FOR: PROMOTING PUBLIC AWARENESS OF AND APPRECIATION FOR ENVIRONMENTAL AND ECOSYSTEM CONSERVATION AND WILDLIFE AND ITS HABITAT AND THE NEED FOR WILDLIFE CONSERVATION; RETAIL STORE SERVICES FEATURING A WIDE VARIETY OF MUSEUM GIFT SHOP ITEMS, IN CLASS 35 (U.S. CLS. 100, 101 AND 102).

NO CLAIM IS MADE TO THE EXCLUSIVE RIGHT TO USE "WILDLIFE" AND "MUSEUM", APART FROM THE MARK AS SHOWN.

FIRST USE 5-16-2007; IN COMMERCE 5-16-2007.

FOR: MUSEUMS; EDUCATIONAL SERVICES, NAMELY, PROVIDING EXHIBITS, MULTIMEDIA PRESENTATIONS AND SEMINARS IN THE FIELDS OF WILDLIFE AND ITS HABITAT AND THE NEED FOR WILDLIFE CONSERVATION AND ENVIRONMENTAL AND ECOSYSTEM CONSERVATION, IN CLASS 41 (U.S. CLS. 100, 101 AND 107).

THE MARK CONSISTS OF A BANDED CIRCLE WITHIN WHICH ARE THE WORDS "THE WILDLIFE EXPERIENCE" ROUNDED ABOVE A GRAPHIC DEPICTING SIX ANIMALS (A POLAR BEAR, GIRAFFE, BIGHORN SHEEP, TOUCAN, RHINOCEROS, AND LION) WHICH ARE AGAINST A BACKGROUND OF FOLIAGE. THE WORDS "MORE THAN A MUSEUM" ARE FEATURED BELOW THE GRAPHIC, ALSO WITHIN THE CIRCLE.

SER. NO. 77-305,363, FILED 10-16-2007.

FIRST USE 5-16-2007; IN COMMERCE 5-16-2007.

BRIAN CALLAGHAN, EXAMINING ATTORNEY



**Int. Cls.: 18 and 25**

**Prior U.S. Cls.: 1, 2, 3, 22, 39 and 41**

**United States Patent and Trademark Office**

**Reg. No. 3,452,938**

**Registered June 24, 2008**

**TRADEMARK  
PRINCIPAL REGISTER**



B-WAP, LLC (OKLAHOMA LTD LIAB CO)  
17913 PAWTUCKET LANE  
EDMOND, OK 73003

FOR: BACKPACKS, IN CLASS 18 (U.S. CLS. 1, 2, 3,  
22 AND 41).

FIRST USE 10-8-2007; IN COMMERCE 10-8-2007.

FOR: SHIRTS, IN CLASS 25 (U.S. CLS. 22 AND 39).

FIRST USE 10-8-2007; IN COMMERCE 10-8-2007.

THE MARK CONSISTS OF THE LOWER-CASE  
STYLIZED LETTER "B", FOLLOWED BY A DASH,  
FOLLOWED BY THE LOWER-CASE, STYLIZED  
LETTERS "W", "A" AND "P", WITH A RAISED  
OVAL-TYPE FIGURE BETWEEN THE "A" AND "P".

SER. NO. 77-305,447, FILED 10-16-2007.

BENJAMIN OKEKE, EXAMINING ATTORNEY

**Int. Cls.: 35 and 36**

**Prior U.S. Cls.: 100, 101 and 102**

**United States Patent and Trademark Office**

**Reg. No. 3,452,939**

**Registered June 24, 2008**

**SERVICE MARK  
PRINCIPAL REGISTER**

Support Collectors "making  
a difference... one family at  
a time."

SUPPORT COLLECTORS, INC. (MINNESOTA  
CORPORATION)  
12201 CHAMPLIN DR.  
MINNEAPOLIS, MN 55316

FOR: GENERAL INFORMATION CLEARING  
HOUSE; INFOMEDIARY SERVICES, NAMELY, FA-  
CILITATING TRANSACTIONS BETWEEN BUYERS  
AND SELLERS THROUGH PROVIDING BUYERS  
WITH INFORMATION ABOUT SELLERS, GOODS,  
AND/OR SERVICES; MARKETING SERVICES,  
NAMELY, PROVIDING INFORMATIONAL WEB  
PAGES DESIGNED TO GENERATE SALES TRAF-  
FIC VIA HYPERLINKS TO OTHER WEB SITES;  
PROVIDING AN ONLINE DIRECTORY INFORMA-  
TION SERVICE FEATURING INFORMATION RE-  
GARDING CHILD SUPPORT; PROVIDING  
CONSUMER INFORMATION AND RELATED  
NEWS IN THE FIELD OF CHILD SUPPORT; PRO-  
VIDING ON-LINE DIRECTORY INFORMATION  
SERVICES ALSO FEATURING HYPERLINKS TO  
OTHER WEB SITES, IN CLASS 35 (U.S. CLS. 100, 101  
AND 102).

FIRST USE 9-17-2007; IN COMMERCE 9-17-2007.

FOR: DEBT RECOVERY AND COLLECTION  
AGENCIES, IN CLASS 36 (U.S. CLS. 100, 101 AND  
102).

FIRST USE 9-17-2007; IN COMMERCE 9-17-2007.

THE MARK CONSISTS OF STANDARD CHAR-  
ACTERS WITHOUT CLAIM TO ANY PARTICULAR  
FONT, STYLE, SIZE, OR COLOR.

NO CLAIM IS MADE TO THE EXCLUSIVE  
RIGHT TO USE "SUPPORT COLLECTORS", APART  
FROM THE MARK AS SHOWN.

SER. NO. 77-305,485, FILED 10-16-2007.

JIM RINGLE, EXAMINING ATTORNEY

**Int. Cls.: 18 and 25**

**Prior U.S. Cls.: 1, 2, 3, 22, 39 and 41**

**United States Patent and Trademark Office**

**Reg. No. 3,452,940**

**Registered June 24, 2008**

**TRADEMARK  
PRINCIPAL REGISTER**

**backpacks with a purpose**

B-WAP, LLC (OKLAHOMA LTD LIAB CO)  
17913 PAWTUCKET  
EDMOND, OK 73003

FOR: BACKPACKS, IN CLASS 18 (U.S. CLS. 1, 2, 3,  
22 AND 41).

FIRST USE 10-8-2007; IN COMMERCE 10-8-2007.

FOR: (BASED ON USE IN COMMERCE) SHIRTS,  
IN CLASS 25 (U.S. CLS. 22 AND 39).

FIRST USE 10-8-2007; IN COMMERCE 10-8-2007.

THE MARK CONSISTS OF STANDARD CHAR-  
ACTERS WITHOUT CLAIM TO ANY PARTICULAR  
FONT, STYLE, SIZE, OR COLOR.

NO CLAIM IS MADE TO THE EXCLUSIVE  
RIGHT TO USE "BACKPACKS" AS TO THE CLASS  
018 GOODS, APART FROM THE MARK AS SHOWN.

SER. NO. 77-305,489, FILED 10-16-2007.

BENJAMIN OKEKE, EXAMINING ATTORNEY

**Int. Cl.: 16**

**Prior U.S. Cls.: 2, 5, 22, 23, 29, 37, 38 and 50**

**Reg. No. 3,452,941**

**United States Patent and Trademark Office**

**Registered June 24, 2008**

**TRADEMARK  
PRINCIPAL REGISTER**

**DR. SHANE'S**

SHANE, RICHARD (UNITED STATES INDIVIDUAL)  
SUITE 812  
1919 14TH STREET  
BOULDER, CO 80302

FOR: BOOKLETS IN THE FIELD OF LEARNING HOW TO SLEEP WELL WITHOUT MEDICATION; BOOKLETS REGARDING INSOMNIA TREATMENTS, IN CLASS 16 (U.S. CLS. 2, 5, 22, 23, 29, 37, 38 AND 50).

FIRST USE 8-8-2005; IN COMMERCE 9-17-2007.

THE MARK CONSISTS OF STANDARD CHARACTERS WITHOUT CLAIM TO ANY PARTICULAR FONT, STYLE, SIZE, OR COLOR.

OWNER OF U.S. REG. NO. 3,172,544.

THE NAME "DR. SHANE" IDENTIFIES A LIVING INDIVIDUAL WHOSE CONSENT IS OF RECORD.

SER. NO. 77-305,520, FILED 10-16-2007.

BILL DAWE, EXAMINING ATTORNEY

**Int. Cl.: 41**

**Prior U.S. Cls.: 100, 101 and 107**

**United States Patent and Trademark Office**

**Reg. No. 3,452,942**

**Registered June 24, 2008**

**SERVICE MARK  
PRINCIPAL REGISTER**

THE REAL ESTATE INVESTMENT  
QUEEN

IRVIN, VICKI (UNITED STATES INDIVIDUAL)  
2111 MEDINAH RIDGE RD.  
ACCOKEEK, MD 20607

FOR: PROFESSIONAL COACHING SERVICES IN  
THE FIELD OF REAL ESTATE INVESTING;  
TEACHING IN THE FIELD OF REAL ESTATE  
INVESTING, IN CLASS 41 (U.S. CLS. 100, 101 AND  
107).

FIRST USE 5-1-2006; IN COMMERCE 5-1-2006.

THE MARK CONSISTS OF STANDARD CHAR-  
ACTERS WITHOUT CLAIM TO ANY PARTICULAR  
FONT, STYLE, SIZE, OR COLOR.

NO CLAIM IS MADE TO THE EXCLUSIVE  
RIGHT TO USE "REAL ESTATE INVESTMENT",  
APART FROM THE MARK AS SHOWN.

SER. NO. 77-305,532, FILED 10-16-2007.

SUNG IN, EXAMINING ATTORNEY

**Int. Cl.: 35**

**Prior U.S. Cls.: 100, 101 and 102**

**United States Patent and Trademark Office**

**Reg. No. 3,452,943**

**Registered June 24, 2008**

**SERVICE MARK  
PRINCIPAL REGISTER**

**FAR MORE. CLOSE TO HOME.**

PAMIDA STORES OPERATING CO., LLC (DELA-  
WARE LTD LIAB CO)  
8800 F STREET  
OMAHA, NE 68127

THE MARK CONSISTS OF STANDARD CHAR-  
ACTERS WITHOUT CLAIM TO ANY PARTICULAR  
FONT, STYLE, SIZE, OR COLOR.

FOR: RETAIL DISCOUNT STORE SERVICES IN  
THE FIELD OF GENERAL MERCHANDISE, IN  
CLASS 35 (U.S. CLS. 100, 101 AND 102).

SER. NO. 77-305,539, FILED 10-16-2007.

FIRST USE 4-24-2006; IN COMMERCE 4-24-2006.

MICHAEL LITZAU, EXAMINING ATTORNEY

**Int. Cl.: 36**

**Prior U.S. Cls.: 100, 101 and 102**

**United States Patent and Trademark Office**

**Reg. No. 3,452,944**

**Registered June 24, 2008**

**SERVICE MARK  
PRINCIPAL REGISTER**

**KITE CAPITAL**

KITE CAPITAL GMBH (FED REP GERMANY  
CORPORATION)  
AINMILLERSTRASSE 37  
MUENCHEN, FED REP GERMANY 80801

FOR: PRIVATE EQUITY INVESTMENT CON-  
SULTING SERVICES, NAMELY, CONSULTING  
SERVICES TO INDIVIDUAL AND INSTITUTIONAL  
INVESTORS FOR EQUITY INVESTMENTS IN PRI-  
VATE GROWTH COMPANIES, IN CLASS 36 (U.S.  
CLS. 100, 101 AND 102).

FIRST USE 4-4-2006; IN COMMERCE 6-0-2006.

THE MARK CONSISTS OF STANDARD CHAR-  
ACTERS WITHOUT CLAIM TO ANY PARTICULAR  
FONT, STYLE, SIZE, OR COLOR.

NO CLAIM IS MADE TO THE EXCLUSIVE  
RIGHT TO USE "CAPITAL", APART FROM THE  
MARK AS SHOWN.

SER. NO. 77-305,609, FILED 10-16-2007.

JEFF DEFORD, EXAMINING ATTORNEY

**Int. Cl.: 25**

**Prior U.S. Cls.: 22 and 39**

**United States Patent and Trademark Office**

**Reg. No. 3,452,945**

**Registered June 24, 2008**

**TRADEMARK  
PRINCIPAL REGISTER**

**ISBA**

AURELIE GETAS (UNITED STATES INDIVIDUAL)  
10 LIBERTY SHIP WAY 4102  
SAUSALITO, CA 94965

THE MARK CONSISTS OF STANDARD CHARACTERS WITHOUT CLAIM TO ANY PARTICULAR FONT, STYLE, SIZE, OR COLOR.

FOR: ATHLETIC FOOTWEAR; FOOTWEAR, IN CLASS 25 (U.S. CLS. 22 AND 39).

SER. NO. 77-305,610, FILED 10-16-2007.

FIRST USE 11-17-2004; IN COMMERCE 11-17-2004.

JEFF DEFORD, EXAMINING ATTORNEY



**Int. Cl.: 42**

**Prior U.S. Cls.: 100 and 101**

**United States Patent and Trademark Office**

**Reg. No. 3,452,946**

**Registered June 24, 2008**

**SERVICE MARK  
PRINCIPAL REGISTER**

**Proficient Well Logging**

PROFICIENT WELL LOGGING LLC (WEST VIR-  
GINIA LTD LIAB CO)

2704 10TH AVE

VIENNA, WV 26105

FOR: WELL LOGGING, IN CLASS 42 (U.S. CLS.  
100 AND 101).

FIRST USE 6-14-2005; IN COMMERCE 6-14-2005.

THE MARK CONSISTS OF STANDARD CHAR-  
ACTERS WITHOUT CLAIM TO ANY PARTICULAR  
FONT, STYLE, SIZE, OR COLOR.

NO CLAIM IS MADE TO THE EXCLUSIVE  
RIGHT TO USE "WELL LOGGING", APART FROM  
THE MARK AS SHOWN.

SER. NO. 77-305,675, FILED 10-17-2007.

JAY FLOWERS, EXAMINING ATTORNEY

**Int. Cl.: 16**

**Prior U.S. Cls.: 2, 5, 22, 23, 29, 37, 38 and 50**

**United States Patent and Trademark Office**

**Reg. No. 3,452,947**

**Registered June 24, 2008**

**TRADEMARK  
PRINCIPAL REGISTER**



ENVIRONMENTAL EDUCATION FUND  
(NORTH CAROLINA CHARITABLE, NON-  
PROFIT CORPORATION)

PO BOX 25825  
RALEIGH, NC 27611

FOR: EDUCATIONAL PUBLICATIONS, NAME-  
LY, EDUCATIONAL LEARNING CARDS, FLASH  
CARDS, ACTIVITY CARDS, WORKBOOKS, TEXT-  
BOOKS, ACTIVITY BOOKS, STORY BOOKS, PUZ-  
ZLE BOOKS, PUZZLES, TEACHER GUIDES,  
MANUALS, POSTERS, EDUCATIONAL CARD  
GAMES AND EDUCATIONAL BOOKLETS IN THE  
FIELD OF ENVIRONMENTAL SCIENCE AND EDU-  
CATION, IN CLASS 16 (U.S. CLS. 2, 5, 22, 23, 29, 37, 38  
AND 50).

FIRST USE 7-1-2003; IN COMMERCE 7-1-2005.

THE COLOR(S) BLACK, WHITE, AND BLUE IS/  
ARE CLAIMED AS A FEATURE OF THE MARK.

THE MARK CONSISTS OF A WHITE CLOUD  
WITH A BLACK AND BLUE OUTLINE ENCIRCLED  
IN A BLUE ORB WITH BLUE RAIN FALLING  
FROM THE CLOUD. THE RAIN IS FALLING INTO  
STYLISTIC BLUE WAVES WITHIN WHICH "IT'S  
OUR WATER!" IS SPELLED OUT IN BLACK LET-  
TERS.

SER. NO. 77-305,710, FILED 10-17-2007.

JANICE KIM, EXAMINING ATTORNEY

**Int. Cl.: 30**

**Prior U.S. Cl.: 46**

**United States Patent and Trademark Office**

**Reg. No. 3,452,948**

**Registered June 24, 2008**

**TRADEMARK  
PRINCIPAL REGISTER**

**FIBER KRUNCH**

CARGILL, INCORPORATED (DELAWARE CORPORATION)  
15407 MCGINTY ROAD WEST  
WAYZATA, MN 55391

FOR: NUTRITIONAL INGREDIENTS, NAMELY, MODIFIED STARCH CONTAINING FIBER FOR USE IN FOODS FOR HUMAN CONSUMPTION, IN CLASS 30 (U.S. CL. 46).

FIRST USE 5-17-2007; IN COMMERCE 5-17-2007.

THE MARK CONSISTS OF STANDARD CHARACTERS WITHOUT CLAIM TO ANY PARTICULAR FONT, STYLE, SIZE, OR COLOR.

NO CLAIM IS MADE TO THE EXCLUSIVE RIGHT TO USE "FIBER", APART FROM THE MARK AS SHOWN.

SER. NO. 77-305,737, FILED 10-17-2007.

BRENDAN REGAN, EXAMINING ATTORNEY

**Int. Cl.: 5**

**Prior U.S. Cls.: 6, 18, 44, 46, 51 and 52**

**United States Patent and Trademark Office**

**Reg. No. 3,452,949**

**Registered June 24, 2008**

**TRADEMARK  
PRINCIPAL REGISTER**

**GREEN TEA EXTREME**

TSN LABS, INC. (UTAH CORPORATION)  
330 WEST 6100 SOUTH  
MURRAY, UT 84107

OWNER OF U.S. REG. NOS. 2,336,720, 3,176,796  
AND OTHERS.

FOR: DIETARY SUPPLEMENTS CONTAINING  
GREEN TEA, IN CLASS 5 (U.S. CLS. 6, 18, 44, 46, 51  
AND 52).

NO CLAIM IS MADE TO THE EXCLUSIVE  
RIGHT TO USE "GREEN TEA", APART FROM  
THE MARK AS SHOWN.

FIRST USE 7-16-2007; IN COMMERCE 7-16-2007.

SER. NO. 77-305,759, FILED 10-17-2007.

THE MARK CONSISTS OF STANDARD CHAR-  
ACTERS WITHOUT CLAIM TO ANY PARTICULAR  
FONT, STYLE, SIZE, OR COLOR.

BRIAN PINO, EXAMINING ATTORNEY

Int. Cl.: 32

Prior U.S. Cls.: 45, 46 and 48

United States Patent and Trademark Office

Reg. No. 3,452,950

Registered June 24, 2008

TRADEMARK  
PRINCIPAL REGISTER



LAUQUEN

R E S E R V E

NEW PATAGONIA S.A. (ARGENTINA CORPORATION)  
MONROE 3226  
BUENOS AIRES, ARGENTINA 1428

FOR: MINERAL WATER; DRINKING WATER, IN CLASS 32 (U.S. CLS. 45, 46 AND 48).

FIRST USE 11-30-2005; IN COMMERCE 10-31-2006.

NO CLAIM IS MADE TO THE EXCLUSIVE RIGHT TO USE "RESERVE", APART FROM THE MARK AS SHOWN.

THE MARK CONSISTS OF AN ABSTRACT DESIGN CONSISTING OF THREE SQUARE FRAMES, AN OUTER ONE, A MIDDLE ONE AND AN INNER

ONE FORMING A SQUARE FIGURE WITH THREE FRAMES CROSSED OVER ITS CENTRAL PORTION FROM TOP TO BOTTOM BY THREE CURVED LINES. BELOW THIS DESIGN APPEARS THE WORD "LAQUEN" IN STYLIZED CAPITAL LETTERS, BENEATH OF WHICH APPEARS A HORIZONTAL LINE AND BELOW IT THE WORD "RESERVE" IN STYLIZED CAPITAL LETTERS.

THE FOREIGN WORDING IN THE MARK TRANSLATES INTO ENGLISH AS "LAGOON".

SER. NO. 77-305,796, FILED 10-17-2007.

BILL DAWE, EXAMINING ATTORNEY

**Int. Cl.: 37**

**Prior U.S. Cls.: 100, 103 and 106**

**Reg. No. 3,452,951**

**United States Patent and Trademark Office**

**Registered June 24, 2008**

---

**SERVICE MARK  
PRINCIPAL REGISTER**

**COMMERCIALLED**

ALLIED STEEL BUILDINGS INC. (FLORIDA  
CORPORATION)  
SUITE 230  
6400 NORTH ANDREWS AVENUE  
FT. LAUDERDALE, FL 33309

THE MARK CONSISTS OF STANDARD CHAR-  
ACTERS WITHOUT CLAIM TO ANY PARTICULAR  
FONT, STYLE, SIZE, OR COLOR.

FOR: CONSTRUCTION OF PRE-ENGINEERED  
METAL BUILDINGS; CONSTRUCTION CONSUL-  
TATION, IN CLASS 37 (U.S. CLS. 100, 103 AND 106).

SER. NO. 77-305,809, FILED 10-17-2007.

FIRST USE 10-15-2007; IN COMMERCE 10-15-2007.

ROBERT C. CLARK JR., EXAMINING ATTORNEY

**Int. Cl.: 19**

**Prior U.S. Cls.: 1, 12, 33 and 50**

**Reg. No. 3,452,952**

**United States Patent and Trademark Office**

**Registered June 24, 2008**

**TRADEMARK  
PRINCIPAL REGISTER**



WEATHER SHIELD MFG., INC. (WISCONSIN CORPORATION)  
ONE WEATHER SHIELD PLAZA, P.O. BOX 309  
MEDFORD, WI 54451

FOR: WINDOWS AND DOORS PRIMARILY NOT OF METAL, IN CLASS 19 (U.S. CLS. 1, 12, 33 AND 50).

FIRST USE 3-1-2007; IN COMMERCE 3-1-2007.

OWNER OF U.S. REG. NO. 2,283,598.

NO CLAIM IS MADE TO THE EXCLUSIVE RIGHT TO USE "WINDOWS & DOORS", APART FROM THE MARK AS SHOWN.

THE MARK CONSISTS OF THE PHRASE "VISIONS WINDOWS & DOORS" AND DESIGN.

SER. NO. 77-305,821, FILED 10-17-2007.

ROBERT C. CLARK JR., EXAMINING ATTORNEY

**Int. Cl.: 45**

**Prior U.S. Cls.: 100 and 101**

**United States Patent and Trademark Office**

**Reg. No. 3,452,953**

**Registered June 24, 2008**

**SERVICE MARK  
PRINCIPAL REGISTER**

**Your Lawyer Should Be  
Tough.**

RUMBERGER, KIRK & CALDWELL, P.A. (FLOR-  
IDA CORPORATION)

300 S. ORANGE AVE., SUITE 1400

ORLANDO, FL 32801

FOR: LEGAL SERVICES, IN CLASS 45 (U.S. CLS.  
100 AND 101).

FIRST USE 6-4-2007; IN COMMERCE 6-4-2007.

THE MARK CONSISTS OF STANDARD CHAR-  
ACTERS WITHOUT CLAIM TO ANY PARTICULAR  
FONT, STYLE, SIZE, OR COLOR.

NO CLAIM IS MADE TO THE EXCLUSIVE  
RIGHT TO USE "YOUR LAWYER", APART FROM  
THE MARK AS SHOWN.

SER. NO. 77-305,833, FILED 10-17-2007.

SUSAN STIGLITZ, EXAMINING ATTORNEY



Int. Cl.: 30

Prior U.S. Cl.: 46

**United States Patent and Trademark Office**

**Reg. No. 3,452,954**

Registered June 24, 2008

**TRADEMARK  
PRINCIPAL REGISTER**



susan sez  
"say it with cake"

SAY IT WITH CAKE, LTD. (NEW YORK CORPORATION)  
155 WEST 68TH STREET  
NEW YORK, NY 10023

FOR: BAKERY DESSERTS AND BAKERY PRODUCTS, IN CLASS 30 (U.S. CL. 46).

FIRST USE 7-15-2007; IN COMMERCE 7-15-2007.

THE DESIGN CONSISTS OF A SQUARE CHEF'S HAT WITH EYES.

SER. NO. 77-305,863, FILED 10-17-2007.

PATRICIA EVANKO, EXAMINING ATTORNEY

**Int. Cl.: 38**

**Prior U.S. Cls.: 100, 101 and 104**

**United States Patent and Trademark Office**

**Reg. No. 3,452,955**

**Registered June 24, 2008**

**SERVICE MARK  
PRINCIPAL REGISTER**

**TELECOMTACTICS FOR CPE AND  
CONVERGENCE**

ACCESS INTELLIGENCE LLC (DELAWARE LTD  
LIAB CO)  
4 CHOKE CHERRY ROAD  
ROCKVILLE, MD 20850

OWNER OF U.S. REG. NOS. 2,501,531 AND  
3,058,971.

FOR: PROVIDING ON-LINE INFORMATION IN  
THE FIELD OF TELECOMMUNICATIONS, IN  
CLASS 38 (U.S. CLS. 100, 101 AND 104).

NO CLAIM IS MADE TO THE EXCLUSIVE  
RIGHT TO USE "CPE AND CONVERGENCE",  
APART FROM THE MARK AS SHOWN.

FIRST USE 1-1-2005; IN COMMERCE 1-1-2005.

SER. NO. 77-305,921, FILED 10-17-2007.

THE MARK CONSISTS OF STANDARD CHAR-  
ACTERS WITHOUT CLAIM TO ANY PARTICULAR  
FONT, STYLE, SIZE, OR COLOR.

NATALIE POLZER, EXAMINING ATTORNEY

**Int. Cl.: 35**

**Prior U.S. Cls.: 100, 101 and 102**

**United States Patent and Trademark Office**

**Reg. No. 3,452,956**

**Registered June 24, 2008**

**SERVICE MARK  
PRINCIPAL REGISTER**



COX HOLDINGS, INC. (DELAWARE CORPORATION)

6205 PEACHTREE DUNWOODY ROAD

ATLANTA, GA 30328

FOR: ADVERTISING SERVICES, NAMELY, PROMOTING THE GOODS, SERVICES, BRAND IDENTITY AND COMMERCIAL INFORMATION OF THIRD PARTIES THROUGH PRINT, AUDIO, VIDEO, DIGITAL AND ON-LINE MEDIUM, INCLUDING VIA THE INTERNET AND MOBILE DEVICES, IN CLASS 35 (U.S. CLS. 100, 101 AND 102).

FIRST USE 9-19-2007; IN COMMERCE 9-19-2007.

NO CLAIM IS MADE TO THE EXCLUSIVE RIGHT TO USE "CROSS MEDIA", APART FROM THE MARK AS SHOWN.

THE MARK CONSISTS OF THE WORDS "COX CROSS MEDIA" WITH THE "O" OF THE WORD "CROSS" DEPICTED AS A DESIGN OF A BULLSEYE AS WELL AS THE CENTER OF A LARGE LETTER "X" WITH THE WORDS "COXCROSSMEDIA.COM" UNDERNEATH THE LETTERS "SS MEDIA" AND SUPERIMPOSED OVER THE BOTTOM RIGHT LINE OF THE "X".

SER. NO. 77-306,018, FILED 10-17-2007.

RENEE MCCRAY, EXAMINING ATTORNEY

Int. Cl.: 35

Prior U.S. Cls.: 100, 101 and 102

United States Patent and Trademark Office

Reg. No. 3,452,957

Registered June 24, 2008

SERVICE MARK  
PRINCIPAL REGISTER



MUD HOLE CUSTOM TACKLE, INC. (FLORIDA CORPORATION)

400 KANE COURT

OVIEDO, FL 32765

FOR: RETAIL STORE SERVICES IN THE FIELD OF FISHING TACKLE, FISHING GEAR AND FISHING EQUIPMENT; RETAIL STORE SERVICES IN THE FIELD OF FISHING TACKLE, FISHING GEAR AND FISHING EQUIPMENT PROVIDED OVER THE GLOBAL COMPUTER NETWORK; AND MAIL ORDER CATALOG SERVICES FEATURING FISHING TACKLE, FISHING GEAR AND FISHING EQUIPMENT, IN CLASS 35 (U.S. CLS. 100, 101 AND 102).

FIRST USE 0-0-1976; IN COMMERCE 0-0-1999.

THE COLOR(S) RED, BLUE, YELLOW, BROWN AND BLACK IS/ARE CLAIMED AS A FEATURE OF THE MARK.

THE COLOR BLUE APPEARS IN THE WORDS "MUD HOLE", THE STYLIZED FISH, POND, BUBBLES AND ONE OF THE STAR DESIGN ELEMENTS. THE COLOR RED APPEARS IN THE MOUTH OF THE FISH DESIGN. THE WORDS "MUD HOLE" ARE OUTLINED IN YELLOW. A STAR DESIGN ABOVE THE POND IS YELLOW AND THE DESIGN OF A WORM IS BROWN. THE OUTLINE OF THE POND, BUBBLES, CIRCULAR DESIGN ELEMENTS WITHIN THE POND AND THE FISHING LINE ARE BLACK.

SER. NO. 77-306,098, FILED 10-17-2007.

BARBARA RUTLAND, EXAMINING ATTORNEY

**Int. Cl.: 35**

**Prior U.S. Cls.: 100, 101 and 102**

**United States Patent and Trademark Office**

**Reg. No. 3,452,958**

**Registered June 24, 2008**

**SERVICE MARK  
PRINCIPAL REGISTER**

# MUD HOLE

MUD HOLE CUSTOM TACKLE, INC. (FLORIDA CORPORATION)  
400 KANE COURT  
OVIEDO, FL 32765

FOR: RETAIL STORE SERVICES IN THE FIELD OF FISHING TACKLE, FISHING GEAR AND FISHING EQUIPMENT; RETAIL STORE SERVICES IN THE FIELD OF FISHING TACKLE, FISHING GEAR AND FISHING EQUIPMENT PROVIDED OVER THE GLOBAL COMPUTER NETWORK; AND MAIL ORDER CATALOG SERVICES FEATURING FISHING TACKLE, FISHING GEAR AND FISHING

EQUIPMENT, IN CLASS 35 (U.S. CLS. 100, 101 AND 102).

FIRST USE 0-0-1976; IN COMMERCE 0-0-1999.

THE MARK CONSISTS OF STANDARD CHARACTERS WITHOUT CLAIM TO ANY PARTICULAR FONT, STYLE, SIZE, OR COLOR.

SER. NO. 77-306,135, FILED 10-17-2007.

BARBARA RUTLAND, EXAMINING ATTORNEY

**Int. Cl.: 35**

**Prior U.S. Cls.: 100, 101 and 102**

**United States Patent and Trademark Office**

**Reg. No. 3,452,959**

**Registered June 24, 2008**

**SERVICE MARK  
PRINCIPAL REGISTER**

**QUICKFILE USA**

CREDIT UNION TAX SERVICES, LLC (TEXAS  
LTD LIAB CO)  
SUITE 800  
2425 WEST LOOP SOUTH  
HOUSTON, TX 77027

FOR: TAX PREPARATION SERVICES VIA ELEC-  
TRONIC MEANS, IN CLASS 35 (U.S. CLS. 100, 101  
AND 102).

FIRST USE 7-30-1994; IN COMMERCE 7-30-1994.

THE MARK CONSISTS OF STANDARD CHAR-  
ACTERS WITHOUT CLAIM TO ANY PARTICULAR  
FONT, STYLE, SIZE, OR COLOR.

NO CLAIM IS MADE TO THE EXCLUSIVE  
RIGHT TO USE "USA", APART FROM THE MARK  
AS SHOWN.

SER. NO. 77-306,167, FILED 10-17-2007.

SHANNON TWOHIG, EXAMINING ATTORNEY

**Int. Cl.: 1**

**Prior U.S. Cls.: 1, 5, 6, 10, 26 and 46**

**Reg. No. 3,452,960**

**United States Patent and Trademark Office**

**Registered June 24, 2008**

---

**TRADEMARK  
PRINCIPAL REGISTER**

**DURULENE**

VIBRATION MOUNTINGS & CONTROLS, INC.  
(NEW JERSEY CORPORATION)  
113 MAIN STREET  
BLOOMINGDALE, NJ 07403

FOR: A CROSS-LINKED POLYMER FOR USE AS  
AN ELASTOMER IN FURTHER MANUFACTUR-  
ING, IN CLASS 1 (U.S. CLS. 1, 5, 6, 10, 26 AND 46).

FIRST USE 10-31-2006; IN COMMERCE 10-31-2006.

THE MARK CONSISTS OF STANDARD CHAR-  
ACTERS WITHOUT CLAIM TO ANY PARTICULAR  
FONT, STYLE, SIZE, OR COLOR.

OWNER OF U.S. REG. NO. 3,357,310.

SER. NO. 77-306,498, FILED 10-17-2007.

JANICE L. MCMORROW, EXAMINING ATTOR-  
NEY

Int. Cl.: 16

Prior U.S. Cls.: 2, 5, 22, 23, 29, 37, 38 and 50

United States Patent and Trademark Office

Reg. No. 3,452,961

Registered June 24, 2008

TRADEMARK  
PRINCIPAL REGISTER

ULTRA GREEN

GPA ACQUISITION COMPANY, INC. (DELA-  
WARE CORPORATION)  
1151 WEST 40TH STREET  
CHICAGO, IL 60609

FOR: PAPER, IN CLASS 16 (U.S. CLS. 2, 5, 22, 23, 29,  
37, 38 AND 50).

FIRST USE 6-10-2007; IN COMMERCE 6-10-2007.

THE MARK CONSISTS OF STANDARD CHAR-  
ACTERS WITHOUT CLAIM TO ANY PARTICULAR  
FONT, STYLE, SIZE, OR COLOR.

OWNER OF U.S. REG. NOS. 2,198,201, 3,177,379  
AND OTHERS.

NO CLAIM IS MADE TO THE EXCLUSIVE  
RIGHT TO USE "GREEN", APART FROM THE  
MARK AS SHOWN.

SEC. 2(F) AS TO "ULTRA".

SER. NO. 77-306,727, FILED 10-17-2007.

JASON BLAIR, EXAMINING ATTORNEY



**Int. Cls.: 35, 36 and 37**

**Prior U.S. Cls.: 100, 101, 102, 103 and 106**

**United States Patent and Trademark Office**

**Reg. No. 3,452,962**

**Registered June 24, 2008**

**SERVICE MARK  
PRINCIPAL REGISTER**

MILLER BROTHERS INVESTMENT, LLC (CALIFORNIA LTD LIAB CO)  
SUITE 101  
4232-8 LAS VIRGENES ROAD  
CALABASAS, CA 91302

FOR: MANAGEMENT AND OPERATION ASSISTANCE TO COMMERCIAL BUSINESSES, NAMELY, COMMERCIAL TOWN CENTER, IN CLASS 35 (U.S. CLS. 100, 101 AND 102).

FIRST USE 4-15-1995; IN COMMERCE 4-15-1995.

FOR: LEASING OR RENTING OF BUILDINGS, IN CLASS 36 (U.S. CLS. 100, 101 AND 102).

FIRST USE 4-15-1995; IN COMMERCE 4-15-1995.

FOR: HOUSING PLANNING SERVICES, NAMELY, PLANNING AND LAYING OUT OF RESIDENTIAL COMMUNITIES, IN CLASS 37 (U.S. CLS. 100, 103 AND 106).

FIRST USE 4-15-1995; IN COMMERCE 4-15-1995.

OWNER OF U.S. REG. NO. 2,892,509.

NO CLAIM IS MADE TO THE EXCLUSIVE RIGHT TO USE "RANCH", APART FROM THE MARK AS SHOWN.

THE COLOR(S) BLUE AND GREEN IS/ARE CLAIMED AS A FEATURE OF THE MARK.

THE MARK CONSISTS OF STYLIZED WORDS "DOS VIENTOS RANCH" WITH TOP HALF OF LETTERING IN BLUE COLOR TRANSITIONING TO GREEN COLOR ON BOTTOM HALF OF LETTERING.

THE FOREIGN WORDING IN THE MARK TRANSLATES INTO ENGLISH AS "TWO WINDS RANCH".

SER. NO. 77-306,744, FILED 10-17-2007.

DORITT L. CARROLL, EXAMINING ATTORNEY

**Int. Cl.: 42**

**Prior U.S. Cls.: 100 and 101**

**United States Patent and Trademark Office**

**Reg. No. 3,452,963**

**Registered June 24, 2008**

**SERVICE MARK  
PRINCIPAL REGISTER**

**WORLD WIDE OPEN**

WORLD WIDE OPEN (CALIFORNIA CORPORATION)

# 325

455 CAPITOL MALL  
SACRAMENTO, CA 95814

FOR: HOSTING AN ONLINE COMMUNITY WEBSITE FEATURING TOOLS FOR PEOPLE, CHURCHES AND ORGANIZATIONS TO BE ABLE TO CONNECT AND FIND/SHARE RESOURCES AND KNOWLEDGE AND FIND/POST VOLUNTEER OPPORTUNITIES, IN CLASS 42 (U.S. CLS. 100 AND 101).

FIRST USE 2-0-2003; IN COMMERCE 2-0-2005.

THE MARK CONSISTS OF STANDARD CHARACTERS WITHOUT CLAIM TO ANY PARTICULAR FONT, STYLE, SIZE, OR COLOR.

SER. NO. 77-306,830, FILED 10-17-2007.

STEVEN R. FINE, EXAMINING ATTORNEY

**Int. Cl.: 42**

**Prior U.S. Cls.: 100 and 101**

**United States Patent and Trademark Office**

**Reg. No. 3,452,964**

**Registered June 24, 2008**

**SERVICE MARK  
PRINCIPAL REGISTER**



**WORLD WIDE OPEN (CALIFORNIA CORPORATION)**

**# 325**

**455 CAPITOL MALL  
SACRAMENTO, CA 95814**

**FOR: HOSTING AN ONLINE COMMUNITY WEBSITE FEATURING TOOLS FOR PEOPLE, CHURCHES AND ORGANIZATIONS TO BE ABLE TO CONNECT AND SHARE RESOURCES AND KNOWLEDGE AND FIND VOLUNTEER OPPORTUNITIES, IN CLASS 42 (U.S. CLS. 100 AND 101).**

**FIRST USE 4-0-2007; IN COMMERCE 4-0-2007.**

**THE MARK CONSISTS OF A SILHOUETTE OF A HUMAN AGAINST THE BACKGROUND OF THE WORLD (REPRESENTED AS A CIRCLE).**

**SER. NO. 77-306,832, FILED 10-17-2007.**

**STEVEN R. FINE, EXAMINING ATTORNEY**

**Int. Cl.: 28**

**Prior U.S. Cls.: 22, 23, 38 and 50**

**United States Patent and Trademark Office**

**Reg. No. 3,452,965**

**Registered June 24, 2008**

**TRADEMARK  
PRINCIPAL REGISTER**

**Lovisquare**

ABRUQUAH, KOBINA (UNITED STATES INDIVIDUAL)

# 516

620 SHERIDAN STREET  
HYATTSVILLE, MD 20783

THE MARK CONSISTS OF STANDARD CHARACTERS WITHOUT CLAIM TO ANY PARTICULAR FONT, STYLE, SIZE, OR COLOR.

FOR: NUMBERS PUZZLE MADE UP OF A GRID,  
IN CLASS 28 (U.S. CLS. 22, 23, 38 AND 50).

SER. NO. 77-306,833, FILED 10-17-2007.

FIRST USE 9-14-2004; IN COMMERCE 1-1-2007.

STEVEN R. FINE, EXAMINING ATTORNEY

**Int. Cl.: 36**

**Prior U.S. Cls.: 100, 101 and 102**

**United States Patent and Trademark Office**

**Reg. No. 3,452,966**

**Registered June 24, 2008**

**SERVICE MARK  
PRINCIPAL REGISTER**

**It's not just a plane.  
It's a passion.**

SWENSEN, KARA (UNITED STATES INDIVIDUAL)  
#1630-478  
21001 N TATUM BLVD.  
PHOENIX, AZ 85050

THE MARK CONSISTS OF STANDARD CHARACTERS WITHOUT CLAIM TO ANY PARTICULAR FONT, STYLE, SIZE, OR COLOR.

FOR: AIRCRAFT BROKERAGE, IN CLASS 36 (U.S. CLS. 100, 101 AND 102).

SER. NO. 77-306,840, FILED 10-17-2007.

FIRST USE 4-23-2007; IN COMMERCE 4-23-2007.

STEVEN R. FINE, EXAMINING ATTORNEY

**Int. Cl.: 35**

**Prior U.S. Cls.: 100, 101 and 102**

**United States Patent and Trademark Office**

**Reg. No. 3,452,967**

**Registered June 24, 2008**

**SERVICE MARK  
PRINCIPAL REGISTER**

**BEHMENTERPRISES**

BEHM, MATTHEW M. (UNITED STATES INDIVIDUAL)

7112 SEMINOLE RD NE  
ALBUQUERQUE, NM 87110

FOR: WORK ANALYSIS TO DETERMINE WORKER SKILL SETS AND OTHER WORKER REQUIREMENTS; TEMPORARY EMPLOYMENT AGENCIES; PROVIDING ORGANIZATIONAL DEVELOPMENT CONSULTING SERVICES; PROVIDING INFORMATION IN THE FIELD OF MARKETING AND ON-LINE MARKETING MEDIA VIA THE INTERNET; PROVIDING BUSINESS INFORMATION, ALSO VIA INTERNET, THE CABLE NETWORK OR OTHER FORMS OF DATA TRANSFER; PROVIDING BUSINESS MANAGEMENT INFORMATION IN CONNECTION WITH CONSULTING AND ADVISORY SERVICES IN THE FIELD OF STRATEGIC PLANNING; PROVIDING BUSINESS MARKETING INFORMATION; PROMOTION AND MARKETING SERVICES AND RELATED CONSULTING; PROMOTION OF BUSINESS OPPORTUNITIES; PROFESSIONAL BUSINESS CONSULTATION; PERSONNEL MANAGEMENT; PERSONNEL MANAGEMENT CONSULTATION; PERSONNEL PLACEMENT AND RECRUITMENT; ONLINE BUSINESS NETWORKING SERVICES; NEGOTIATION AND SETTLEMENT OF COMMERCIAL TRANSACTIONS FOR THIRD PARTIES; NEW BUSINESS VENTURE DEVELOPMENT AND FORMATION CONSULTING SERVICES; MARKET RESEARCH; MARKET RESEARCH CONSULTATION; MARKET RESEARCH SERVICES; MARKETING PLAN DEVELOPMENT; MANAGEMENT AND OPERATION ASSISTANCE TO COMMERCIAL BUSINESSES; MANAGEMENT ASSISTANCE; INFORMATION IN BUSINESS MATTERS; HUMAN RESOURCES CONSULTATION; HUMAN RESOURCES MANAGEMENT; HUMAN RESOURCES SERVICES, NAMELY, PERSONNEL SELECTION FOR OTHERS; EMPLOYMENT HIRING, RECRUITING, PLACEMENT, STAFFING AND CAREER NETWORKING SERVICES; EMPLOYMENT RECRUITING CONSULTATION; EXECUTIVE SEARCH AND PLACEMENT SERVICES; EMPLOYEE LEASING; EMPLOYMENT AGENCIES; DEVELOPMENT OF MARKETING STRATEGIES AND CONCEPTS; CONSULTING SERVICES IN THE FIELD OF HUMAN RESOURCES DEVELOPMENT,

NAMELY, FOR THE PROMOTION OF EMPLOYEE RETENTION, CAREER GROWTH, AND INCREASED PRODUCTIVITY FOR EMPLOYEES AND EMPLOYERS; COPYING OF DOCUMENTS; CORPORATE MANAGEMENT ASSISTANCE; CONDUCTING BUSINESS RESEARCH AND SURVEYS; CONDUCTING ON-LINE BUSINESS MANAGEMENT RESEARCH SURVEYS; CONSULTANCY OF PERSONNEL RECRUITMENT; CONSULTING SERVICES IN BUSINESS ORGANIZATION AND MANAGEMENT; COMMERCIAL AND INDUSTRIAL MANAGEMENT ASSISTANCE; COMMERCIAL ASSISTANCE IN BUSINESS MANAGEMENT; COMMERCIAL BUSINESS MANAGEMENT; COMMERCIAL MANAGEMENT; COMMERCIAL REGISTERED AGENT SERVICES; BUSINESS SERVICES, NAMELY, MATCHING POTENTIAL PRIVATE INVESTORS WITH ENTREPRENEURS NEEDING FUNDING; BUSINESS SUPERVISION; BUSINESS ORGANIZATION AND MANAGEMENT CONSULTING; BUSINESS ORGANIZATION AND OPERATION CONSULTANCY; BUSINESS ORGANIZATION CONSULTING; BUSINESS ORGANIZATIONAL CONSULTATION; BUSINESS PLANNING; BUSINESS RESEARCH; BUSINESS RESEARCH AND SURVEYS; BUSINESS RESEARCH CONSULTATION; BUSINESS MANAGEMENT PLANNING; BUSINESS MANAGEMENT SERVICES, NAMELY, PURCHASING OF AND SELLING OF COMPANIES FOR OTHERS; BUSINESS MANAGEMENT SUPERVISION; BUSINESS NETWORKING; BUSINESS NETWORKING OF PEER TO PEER LEARNING GROUPS OF HIGH NET WORTH INDIVIDUALS; BUSINESS OPERATION, BUSINESS ADMINISTRATION AND OFFICE FUNCTIONS; BUSINESS ORGANISATION AND MANAGEMENT CONSULTING SERVICES; BUSINESS ORGANISATION CONSULTING; BUSINESS ORGANIZATION ADVICE; BUSINESS MANAGEMENT AND ADVICE; BUSINESS MANAGEMENT AND CONSULTATION; BUSINESS MANAGEMENT ASSISTANCE TO INDUSTRIAL OR COMMERCIAL COMPANIES; BUSINESS MANAGEMENT CONSULTANCY AND ADVISORY SERVICES; BUSINESS MANAGEMENT CONSULTANCY SERVICES; BUSINESS MANAGEMENT CONSULTATION; BUSINESS MANAGEMENT CONSULTATION IN THE FIELD OF EXECUTIVE AND LEADERSHIP DEVELOPMENT;

BUSINESS MANAGEMENT CONSULTING; BUSINESS MANAGEMENT CONSULTING AND ADVISORY SERVICES; BUSINESS CONSULTING AND BUSINESS INFORMATION FOR ENTERPRISES; BUSINESS CONSULTING AND INFORMATION SERVICES; BUSINESS CONSULTING, MANAGEMENT, PLANNING AND SUPERVISION; BUSINESS DEVELOPMENT SERVICES, NAMELY, PROVIDING START-UP SUPPORT FOR BUSINESSES OF OTHERS; BUSINESS ADMINISTRATION CONSULTANCY; BUSINESS ADVICE AND COMMERCIAL INFORMATION; BUSINESS ADVICE AND INFORMATION; BUSINESS ADVICE, INQUIRIES OR INFORMATION; BUSINESS CONSULTATION; BUSINESS CONSULTATION SERVICES; BUSINESS ADMINISTRATION AND MANAGEMENT; ASSISTANCE IN MANAGEMENT OF BUSINESS ACTIVITIES; ASSISTANCE TO INDUSTRIAL OR COMMERCIAL ENTERPRISES IN THE RUNNING OF THEIR BUSINESS; ASSISTANCE WITH BUSINESS MANAGEMENT AND PLANNING; ASSISTANCE, ADVISORY SERVICES AND CONSULTANCY WITH REGARD TO BUSINESS PLANNING, BUSINESS ANALYSIS, BUSINESS MANAGEMENT, AND BUSINESS ORGANIZATION; ADVICE RELATING TO THE ORGANISATION AND MANAGEMENT OF BUSINESS; ADVISORY SERVICE FOR ORGANIZATIONAL ISSUES AND BUSINESS ADMINISTRATION, WITH AND WITHOUT THE HELP OF ELECTRONIC

DATA BASES; ADVISORY SERVICES RELATING TO BUSINESS MANAGEMENT AND BUSINESS OPERATIONS, IN CLASS 35 (U.S. CLS. 100, 101 AND 102).

FIRST USE 6-30-2006; IN COMMERCE 8-1-2006.

OWNER OF U.S. REG. NO. 3,278,111.

THE MARK CONSISTS OF THE WORDS "BEHM ENTERPRISES" WITH "BEHM" BEING IN THE COLOR GREY AND "ENTERPRISES" BEING IN THE COLOR WHITE AND WITHOUT A SPACE BETWEEN THE WORDS "BEHM" AND "ENTERPRISES" SUCH THAT IT READS "BEHMENTERPRISES" RATHER THAN "BEHM ENTERPRISES". THERE ARE TWO WHITE LINES THAT STRETCH ACROSS FROM THE FIRST LETTER "B" IN "BEHM" TO THE LAST LETTER "S" IN "ENTERPRISES" WITH ONE OF THOSE WHITE LINES HOVERING ABOVE AND ONE OF THOSE WHITE LINES HOVERING BELOW ALL OF THESE LETTERS CONTAINED WITHIN "BEHMENTERPRISES". ALL THE ABOVE OF WHICH IS PRESENTED WITH A BLACK BACKGROUND.

SER. NO. 77-306,926, FILED 10-18-2007.

ROBIN MITTLER, EXAMINING ATTORNEY

**Int. Cl.: 35**

**Prior U.S. Cls.: 100, 101 and 102**

**United States Patent and Trademark Office**

**Reg. No. 3,452,968**

**Registered June 24, 2008**

**SERVICE MARK  
PRINCIPAL REGISTER**

**MOMSPACE**

REISEN PRODUCTIONS, INC. (PENNSYLVANIA  
CORPORATION)  
3 CARRIAGE PATH  
CHADDS FORD, PA 19317

FOR: PROMOTING THE GOODS AND SERVICES  
OF OTHERS BY ARRANGING FOR SPONSORS TO  
AFFILIATE THEIR GOODS OR SERVICES WITH A  
WEBSITE FEATURING PRODUCT REVIEWS,  
LINKS TO RETAIL WEB SITES OF OTHERS, AND  
INFORMATION TO WOMEN AND MOTHERS ON  
VARIOUS GOODS AND SERVICES PROVIDERS  
AVAILABLE IN MULTIPLE CATEGORIES AND  
GEOGRAPHIES; ADVERTISING, INCLUDING  
PROMOTION OF PRODUCTS AND SERVICES OF  
THIRD PARTIES THROUGH SPONSORING AR-

RANGEMENTS, IN CLASS 35 (U.S. CLS. 100, 101  
AND 102).

FIRST USE 3-17-2006; IN COMMERCE 3-17-2006.

THE MARK CONSISTS OF STANDARD CHAR-  
ACTERS WITHOUT CLAIM TO ANY PARTICULAR  
FONT, STYLE, SIZE, OR COLOR.

OWNER OF U.S. REG. NO. 3,357,910.

SER. NO. 77-307,070, FILED 10-18-2007.

MARK PILARO, EXAMINING ATTORNEY



**Int. Cl.: 35**

**Prior U.S. Cls.: 100, 101 and 102**

**United States Patent and Trademark Office**

**Reg. No. 3,452,969**

**Registered June 24, 2008**

**SERVICE MARK  
PRINCIPAL REGISTER**



REISEN PRODUCTIONS, INC. (PENNSYLVANIA CORPORATION)  
3 CARRIAGE PATH  
CHADDS FORD, PA 19317

FOR: PROMOTING THE GOODS AND SERVICES OF OTHERS BY ARRANGING FOR SPONSORS TO AFFILIATE THEIR GOODS OR SERVICES WITH A WEBSITE FEATURING PRODUCT REVIEWS, LINKS TO RETAIL WEB SITES OF OTHERS, AND INFORMATION TO WOMEN AND MOTHERS ON VARIOUS GOODS AND SERVICES PROVIDERS AVAILABLE IN MULTIPLE CATEGORIES AND GEOGRAPHIES; ADVERTISING, INCLUDING PROMOTION OF PRODUCTS AND SERVICES OF THIRD PARTIES THROUGH SPONSORING AR-

RANGEMENTS, IN CLASS 35 (U.S. CLS. 100, 101 AND 102).

FIRST USE 3-17-2006; IN COMMERCE 3-17-2006.

OWNER OF U.S. REG. NO. 3,357,910.

THE MARK CONSISTS OF THE WORD "MOM-SPACE" WITH A FLOWER REPLACING THE LETTER "O".

SER. NO. 77-307,075, FILED 10-18-2007.

MARK PILARO, EXAMINING ATTORNEY

**Int. Cl.: 35**

**Prior U.S. Cls.: 100, 101 and 102**

**United States Patent and Trademark Office**

**Reg. No. 3,452,970**

**Registered June 24, 2008**

**SERVICE MARK  
PRINCIPAL REGISTER**



LOGO DESIGN GURU (DELAWARE CORPORATION)  
SUITE A-3  
19 SOUTH MAIN STREET  
YARDLEY, PA 19067

FOR: BUSINESS MANAGEMENT AND CONSULTATION IN THE FIELD OF OBTAINING AND IMPLEMENTING OUTSOURCING SERVICES AND OFFSHORE SERVICES; ADVERTISING SERVICES, NAMELY, CREATING CORPORATE LOGOS FOR OTHERS; DESIGN OF ADVERTISING MATERIALS FOR OTHERS, IN CLASS 35 (U.S. CLS. 100, 101 AND 102).

FIRST USE 11-15-2005; IN COMMERCE 11-15-2005.

NO CLAIM IS MADE TO THE EXCLUSIVE RIGHT TO USE ".COM", APART FROM THE MARK AS SHOWN.

THE COLOR(S) ORANGE AND BLUE IS/ARE CLAIMED AS A FEATURE OF THE MARK.

THE MARK CONSISTS OF THE LETTER "C" IN ORANGE WITH AN ORANGE DOT IN THE CENTER, THE LETTER "S" IS CREATED BY A BLUE OUTLINE; THE COLOR BLUE APPEARS IN THE TEXT "CENTRICSOURCE.COM." THE COLOR WHITE IS NOT A FEATURE OF THE MARK. THE PORTIONS OF THE MARK THAT APPEAR WHITE ARE TRANSPARENT AND WILL SHOW WHATEVER BACKGROUND COLOR IS USED BEHIND THE MARK.

SER. NO. 77-307,091, FILED 10-18-2007.

PAUL E. FAHRENKOPF, EXAMINING ATTORNEY

**Int. Cl.: 41**

**Prior U.S. Cls.: 100, 101 and 107**

**United States Patent and Trademark Office**

**Reg. No. 3,452,971**

**Registered June 24, 2008**

---

**SERVICE MARK  
PRINCIPAL REGISTER**

**GRAMPLAND**

ROBBIE BOYETTE (UNITED STATES INDIVIDUAL)  
212 MARROW STREET  
GREER, SC 29650

FOR: ENTERTAINMENT SERVICES, NAMELY, PROVIDING A WEBSITE FEATURING PHOTOGRAPHS AND VIDEOS IN THE FIELD OF ADULT ENTERTAINMENT, IN CLASS 41 (U.S. CLS. 100, 101 AND 107).

FIRST USE 12-2-2002; IN COMMERCE 12-2-2002.

THE MARK CONSISTS OF STANDARD CHARACTERS WITHOUT CLAIM TO ANY PARTICULAR FONT, STYLE, SIZE, OR COLOR.

SER. NO. 77-307,227, FILED 10-18-2007.

GINA FINK, EXAMINING ATTORNEY

**Int. Cl.: 36**

**Prior U.S. Cls.: 100, 101 and 102**

**United States Patent and Trademark Office**

**Reg. No. 3,452,972**

**Registered June 24, 2008**

---

**SERVICE MARK  
PRINCIPAL REGISTER**

**Bringing an Institutional  
Approach to Personal  
Investing**

YOUNG, TROY A. (UNITED STATES INDIVIDUAL)  
SUITE 128  
5825 GLENRIDGE DRIVE BUILDING 1  
ATLANTA, GA 30328

FOR: FINANCIAL SERVICES, NAMELY, ADVICE RELATING TO INVESTMENTS, ALTERNATIVE INVESTMENTS, AND HEDGING STRATEGIES FOR HIGH NET WORTH INVESTORS; INVESTMENT SERVICES, NAMELY, ASSET ACQUISITION, CONSULTATION, DEVELOPMENT AND MANAGEMENT SERVICES; CASH MANAGEMENT; FINANCIAL ANALYSIS AND CONSULTATION;

FINANCIAL PLANNING CONSULTATION, IN CLASS 36 (U.S. CLS. 100, 101 AND 102).

FIRST USE 9-7-2007; IN COMMERCE 9-7-2007.

THE MARK CONSISTS OF STANDARD CHARACTERS WITHOUT CLAIM TO ANY PARTICULAR FONT, STYLE, SIZE, OR COLOR.

SER. NO. 77-307,229, FILED 10-18-2007.

GINA FINK, EXAMINING ATTORNEY

**Int. Cl.: 20**

**Prior U.S. Cls.: 2, 13, 22, 25, 32 and 50**

**United States Patent and Trademark Office**

**Reg. No. 3,452,973**

**Registered June 24, 2008**

**TRADEMARK  
PRINCIPAL REGISTER**

# The Right Position

THE RIGHT POSITION, INC. (MASSACHUSETTS  
CORPORATION)  
25 BALTIMORE STREET  
MILLIS, MA 02054

THE MARK CONSISTS OF STANDARD CHAR-  
ACTERS WITHOUT CLAIM TO ANY PARTICULAR  
FONT, STYLE, SIZE, OR COLOR.

FOR: ANGLED FOAM CUSHION DESIGNED TO  
PROVIDE COMFORT AND SUPPORT FOR THE  
BODY OR HEAD, IN CLASS 20 (U.S. CLS. 2, 13, 22, 25,  
32 AND 50).

SER. NO. 77-307,243, FILED 10-18-2007.

FIRST USE 10-16-2007; IN COMMERCE 10-16-2007.

JACLYN KIDWELL, EXAMINING ATTORNEY

Int. Cl.: 9

Prior U.S. Cls.: 21, 23, 26, 36 and 38

Reg. No. 3,452,974

United States Patent and Trademark Office

Registered June 24, 2008

TRADEMARK  
PRINCIPAL REGISTER



DEUTSCHE TELEKOM AG (FED REP GERMAN-  
NY CORPORATION)  
FRIEDRICH-EBERT-ALLEE 140  
BONN 53113, FED REP GERMANY

FOR: ELECTRIC, ELECTRONIC, OPTICAL, MEASURING, SIGNALING, CONTROLLING AND TEACHING APPARATUS AND INSTRUMENTS, ALL FOR USE WITH TELECOMMUNICATIONS, NAMELY, APPARATUS FOR PRODUCING SOUND, IMAGES OR DATA; BLANK MAGNETIC AND OPTICAL DATA CARRIERS; DATA PROCESSORS; COMPUTERS, NAMELY, MICROCOMPUTERS, MINICOMPUTERS, COMPUTER CENTRAL PROCESSORS, COMPUTER MONITORS, COMPUTER KEYBOARDS, COMPUTER TERMINALS, COMPUTER MEMORIES, COMPUTER LASER PRINTERS, COMPUTER IMPACT PRINTERS, COMPUTER DOT MATRIX PRINTERS, COMPUTERS AND INSTRUCTIONAL MANUALS SOLD AS A UNIT; COMPUTER MEMORY HARDWARE; COMPUTER INTERFACE APPARATUS, NAMELY, COMPUTER INTERFACE BOARDS, COMPUTER MOUSE AND MOUSE PAD, COMPUTER PERIPHERALS AND PARTS THEREOF; COMPUTER SOFTWARE PROGRAMS FOR USE IN OPERATING TELECOMMUNICATIONS AND BUSINESS MANAGEMENT SYSTEMS AND RELATED INSTRUCTION MANUALS SOLD AS A UNIT; COMPUTER SOFTWARE FOR FINANCIAL ACCOUNTING, FOR THE PROVISION OF ONLINE INFORMATION SERVICES IN THE FIELD OF NEWS, SPORTS, ENTERTAINMENT, CULTURE, BUSINESS AND FINANCE, WEATHER AND TRAVEL, NETWORK MANAGEMENT, COMPUTER PROXY, FOR CONTROLLING ACCESS AND ALARM MONITORING OF HOMES, APARTMENTS, BUILDINGS AND OTHER PROPERTIES, BILLING ANALYSIS, NETWORK ACCESS CONTROL AND FOR CREATING AND MAINTAINING FIREWALLS; COMPUTER SOFTWARE PROGRAMS FOR ACCESSING A GLOBAL COMPUTER NETWORK AND INTERACTIVE COMPUTER COMMUNICATIONS NETWORKS; OPTICAL FIBERS SOLD AS A COMPONENT OF FIBER OPTICAL CABLES; FIBER OPTIC CABLES; OPTICAL SCAN-

TERS; OPTICAL CHARACTER READERS; OPTICAL BLANK DISCS; OPTICAL GLASS FOR SIGNAL TRANSMISSION; OPTIC TRANSMITTERS FOR RADIO, TELEPHONE; OPTIC RECEIVERS FOR TELEPHONE, AUDIO, VIDEO; OPTICAL SIGNAL PROCESSORS; OPTIC TELECOMMUNICATIONS SWITCHES; OPTICAL ATTENUATORS; OPTICAL AMPLIFIERS; OPTICAL CHARACTER RECOGNITION APPARATUS, FOR USE IN THE TELECOMMUNICATIONS FIELD, AND PARTS THEREOF; TELEPHONE LOCAL AREA NETWORKS; TELECOMMUNICATION AUDIO, VIDEO AND DATA COMMUNICATIONS SYSTEMS, NAMELY, DIGITAL AND ANALOGUE SIGNAL TRANSMITTERS; RECEIVERS AND CONVERTERS FOR USE WITH TELEPHONE, AUDIO, VIDEO; RADIO AND TELEPHONE TRANSMITTERS; COMMUNICATION RECEIVERS AND SERVERS FOR TELEPHONE, AUDIO, VIDEO; TELEPHONE ANSWERING MACHINES; TELEPROMPTERS; TELETYPEWRITERS AND PARTS THEREOF, NAMELY, CALLER IDENTIFICATION BOXES, DIALING ASSEMBLIES, TELEPHONE UNITS, AUDIO OPERATED RELAYS, AUDIO/VIDEO SIGNAL AND OPTICAL FILTERS, PROTECTORS AND AUTOMATIC SIGNALING AND CONTROL EQUIPMENT, TELEMETERS, WIRELESS AND CELLULAR TELEPHONES, AND RADIO PAGERS; INTERCOMS; FACSIMILE MACHINE; ELECTRONIC MAIL APPARATUS FOR ELECTRONIC EXCHANGE OF DATA IMAGES AND MESSAGES; ELECTRICAL WIRE; ELECTRICAL WIRE CONNECTORS; INTEGRATED CIRCUITS; PRINTED CIRCUITS; ELECTRIC CIRCUITS; CIRCUIT BREAKERS; PRINTED CIRCUIT BOARDS; CIRCUIT CONNECTORS; ELECTRICAL CONTROLLERS; ELECTRICAL CONVERTERS; ELECTRICAL CONDUCTORS; ELECTRICAL FUSES; ELECTRIC LUMINESCENT DISPLAY PANELS; ELECTRICAL SWITCH PLATES; ELECTRIC PLUGS; ELECTRIC COILS; ANTENNAS; ELECTRICAL CABLES; COMPUTER CABLES; COMPUTER CHIPS; SILICON CHIPS; CHRONOGRAPHS FOR USE AS SPECIALIZED TIME RECORDING APPARATUS; COMPUTER BUFFERS; BLANK COMPUTER DISCS; BLANK COMPUTER

FLOPPY DISKS; COMPUTER HARD DISCS; ACOUSTIC CONDUITS; ELECTRICAL CONDUITS; FIBER OPTIC CONDUITS AND PARTS THEREOF; COMPACT DISC PLAYERS; AUDIO AND VIDEO TAPE RECORDERS; AUDIO AND VIDEOTAPE PLAYERS; AUDIO AND VIDEOCASSETTE RECORDERS; AUDIO AND VIDEOCASSETTE PLAYERS; BLANK AUDIO AND VIDEOTAPES, CASSETTES, DISCS AND MICROFICHE; AUDIO AND VIDEO TAPES, CASSETTES, DISCS AND MICROFICHE FEATURING INFORMATION CONCERNING TELECOMMUNICATIONS, AND CONCERNING PERSONAL AND BUSINESS MANAGEMENT SYSTEMS; AUDIO AND VIDEO RECORDINGS IN THE FIELD OF TELECOMMUNICATIONS, INFORMATION TECHNOLOGY AND SAFETY; TELEVISION AND TELEVISION PERIPHERAL EQUIPMENT, NAMELY, CAMERAS, SET TOP BOXES, REMOTE CONTROL UNITS FOR INTERACTIVE AND NON-INTERACTIVE USE; VIDEO MONITORS; AUTOMATIC VENDING MACHINES AND TIMING MECHANISMS THEREFOR AND PARTS THEREOF; MACHINE READABLE, MAGNETICALLY ENCODED CARDS, NAMELY, PREPAID TELEPHONE CALLING CARDS AND CREDIT CARDS; BLANK SMART CARDS; MAGNETIC CODED CARD READERS; DATA PROCESSORS AND READERS; WORD PROCESSORS; MICROPROCESSORS; ELECTRONIC ENCRYPTION UNITS; DEMAGNETIZERS FOR MAGNETIC TAPES AND PARTS THEREOF; LASERS NOT FOR MEDICAL USE; LIGHT EMITTING DIODES; LIGHT EMITTING DIODE DISPLAYS; COMPUTER, DATA AND VIDEO NETWORKING AND CONFERENCING EQUIPMENT, NAMELY, TELECONFERENCING EQUIPMENT AND AUDIO-VISUAL TEACHING EQUIPMENT IN THE NATURE OF OVERHEAD FILM, PHOTOGRAPHIC AND SLIDE PROJECTORS; PROJECTION SCREENS; COMPUTER BASED INFORMATION DISPLAY EQUIPMENT, NAMELY, COMPUTERS WHICH DISPLAY INFORMATION ON AN OVERHEAD SCREEN; PORTABLE DEVICES, NAMELY, LAPTOPS, HANDHELD AND POCKET COMPUTERS, WIRELESS FAX MACHINES; PERSONAL COMMUNICATIONS EQUIPMENT, NAMELY, PERSONAL

DIGITAL ASSISTANTS; CALCULATORS AND RELATED PERIPHERALS; SATELLITE PROCESSORS, SATELLITE AND SATELLITE COMMUNICATION EARTH STATIONS BOTH STATIONARY AND MOVEABLE; COMPUTER GAME PROGRAMS FOR CHILDREN AND ADULTS; VIDEO AND COMPUTER GAME CARTRIDGES; AUDIO AND VIDEO RECORDINGS IN THE FIELD OF NEWS, SPORTS, ENTERTAINMENT, CULTURE, BUSINESS AND FINANCE, WEATHER AND TRAVEL; PRE-RECORDED COMPACT DISCS, AUDIOCASSETTE TAPES, VIDEOCASSETTE TAPES, DIGITAL AUDIO-TAPES AND DIGITAL VIDEO DISCS FEATURING MUSICAL, VARIETY, NEWS AND COMEDY SHOWS; CARRYING CASES FOR POCKET CALCULATORS AND CELLPHONES; TELECOMMUNICATIONS SOFTWARE, NAMELY, SOFTWARE FOR WIRELESS CONTENT DELIVERY, SOFTWARE TO ENABLE THE TRANSMISSION OF PHOTOGRAPHS TO MOBILE TELEPHONES, SOFTWARE FOR ACCESSING INFORMATION DIRECTORIES THAT MAY BE DOWNLOADED FROM THE INTERNET, AND COMPUTER APPLICATION SOFTWARE FOR MOBILE PHONES, IN CLASS 9 (U.S. CLS. 21, 23, 26, 36 AND 38).

PRIORITY CLAIMED UNDER SEC. 44(D) ON FED REP GERMANY APPLICATION NO. 30726361438, FILED 4-20-2007, REG. NO. 30726361, DATED 7-26-2007, EXPIRES 4-30-2017.

OWNER OF U.S. REG. NOS. 2,508,277, 3,148,182 AND OTHERS.

THE COLOR(S) MAGENTA IS/ARE CLAIMED AS A FEATURE OF THE MARK.

THE COLOR MAGENTA APPEARS IN THE LETTER "T" AND IN THE SQUARE DESIGNS

SER. NO. 77-307,271, FILED 10-18-2007.

CAROLINE WOOD, EXAMINING ATTORNEY

Int. Cl.: 36

Prior U.S. Cls.: 100, 101 and 102

United States Patent and Trademark Office

Reg. No. 3,452,975

Registered June 24, 2008

SERVICE MARK  
PRINCIPAL REGISTER



DEUTSCHE TELEKOM AG (FED REP GERMA-  
NY CORPORATION)  
FRIEDRICH-EBERT-ALLEE 140  
BONN 53113, FED REP GERMANY

FOR: INSURANCE SERVICES, NAMELY, INSURANCE BROKERAGE, INSURANCE CLAIMS PROCESSING; FINANCIAL SERVICES, NAMELY, CLEARING OF SECURE FINANCIAL TRANSACTIONS THROUGH ONLINE SERVICES; FINANCIAL ANALYSIS AND CONSULTATION; FINANCIAL INFORMATION PROVIDED BY ELECTRONIC MEANS; FINANCIAL INFORMATION PROCESSING; FINANCIAL PORTFOLIO MANAGEMENT; FINANCIAL SERVICES, NAMELY, FINANCIAL CONSULTATION IN THE FIELD OF FINANCIAL SECURITIES; SAFE DEPOSIT BOX SERVICES FOR THE SAFEKEEPING OF SECURITIES; FINANCIAL SPONSORSHIP OF SPORTS, EDUCATIONAL AND ENTERTAINMENT PROGRAMS AND EVENTS; COMMERCIAL LENDING SERVICES; MONETARY EXCHANGE; CREDIT CARD SERVICES; TELEPHONE CALLING CARD SERVICES; ELECTRONIC COMMERCE SERVICES, NAMELY, ELECTRONIC DEBIT AND CREDIT CARD TRANSACTION PROCESSING SERVICES, FUNDS TRANSFER AND BILL PAYMENT-PROCESSING SERVICES; DISCOUNT BROKERAGE SERVICES; SECURITY BROKERAGE; BROKERAGE IN THE FIELD OF INSURANCE, STOCKS, COMMODITIES; CUSTOM BROKERAGE FOR THIRD PARTIES IN THE FIELD OF INSURANCE, STOCKS, COMMODITIES; BROKERAGE OF SHARES AND VENTURE CAPITAL FUNDING SERVICES TO START-UP COMPANIES; BROKER-

AGE OF FUND SHARES; BROKERAGE OF PRODUCTIVE INVESTMENT OF FUNDS; REAL ESTATE SERVICES, NAMELY, BROKERAGE, MANAGEMENT, LEASING, AND APPRAISAL OF REAL PROPERTY; CONSULTING SERVICES RELATING TO INSURANCE SERVICES, NAMELY, PROVIDING INFORMATION AND BROKERAGE OF INSURANCES IN THE FIELD OF HOME INSURANCE, ACCIDENT INSURANCE AND HEALTH INSURANCE; CONSULTING SERVICES RELATING TO BANK SERVICES; PROVIDING INFORMATION VIA THE TELEPHONE AND THE GLOBAL COMMUNICATION NETWORKS IN THE FIELD OF FINANCE, IN CLASS 36 (U.S. CLS. 100, 101 AND 102).

PRIORITY CLAIMED UNDER SEC. 44(D) ON FED REP GERMANY APPLICATION NO. 30726361438, FILED 4-20-2007, REG. NO. 30726361, DATED 7-26-2007, EXPIRES 4-30-2017.

OWNER OF U.S. REG. NOS. 2,508,277, 3,148,182 AND OTHERS.

THE COLOR(S) MAGENTA IS/ARE CLAIMED AS A FEATURE OF THE MARK.

THE COLOR MAGENTA APPEARS IN THE LETTER "T" AND IN THE SQUARE DESIGNS

SER. NO. 77-307,272, FILED 10-18-2007.

CAROLINE WOOD, EXAMINING ATTORNEY



Int. Cl.: 16

Prior U.S. Cls.: 2, 5, 22, 23, 29, 37, 38 and 50

United States Patent and Trademark Office

Reg. No. 3,452,976

Registered June 24, 2008

TRADEMARK  
PRINCIPAL REGISTER



DEUTSCHE TELEKOM AG (FED REP GERMA-  
NY CORPORATION)  
FRIEDRICH-EBERT-ALLEE 140  
BONN 53113, FED REP GERMANY

FOR: PRINTED MATTER, NAMELY, TELEPHONE DIRECTORIES, SERIES OF BOOKS, NEWSLETTERS, PAMPHLETS, BROCHURES, MAGAZINES AND PAPERBACKS, ALL IN THE FIELD OF TELECOMMUNICATIONS; PRINTED AND STAMPED PLASTIC AND CARDBOARD GREETING, BLANK, NOTE, AND INDEX CARDS; NOTE PAPER AND ENVELOPES; NAMETAGS AND LABELS MADE FROM PAPER OR CARDBOARD; NOTEBOOKS; NOTE PADS; STATIONERY; PAPER, NAMELY, BOND PAPER AND ART PAPER; GIFT-WRAP PAPER; DIARIES; ADDRESS BOOKS; STUDENT CALENDARS; STAMP ALBUMS AND PHOTO-ALBUMS; FOLDERS FOR LETTERS AND LOOSE PAPERS; STATIONERY CLEAR HOLE TAB REINFORCEMENTS; RUBBER STAMPS AND IMPRESSION STAMPS; PAPER WEIGHTS; LETTER OPENERS; DRAWING AND UNGRADUATED RULERS; ERASERS; STAPLERS; PAPER CLIPS; BLOT-  
TING PADS; DESK FILE TRAYS; DESK STANDS AND HOLDERS FOR HOLDING STATIONERY AND OFFICE IMPLEMENTS; PRINTED INSTRUCTIONAL AND TEACHING MATERIALS, ALL IN THE FIELDS OF TELECOMMUNICATIONS, INFORMATION TECHNOLOGY, SAFETY, NEWS, SPORTS, ENTERTAINMENT, CULTURE, BUSINESS AND FINANCE, WEATHER AND TRAVEL; BOOK-

MARKERS; STENCILS; SCRATCH PICTURES; PVC STICKERS; BLACKBOARDS; CHALK STICKS; ADHESIVES FOR STATIONERY OR HOUSEHOLD PURPOSES; DRAWING AND PAINTING MATERIALS, NAMELY, PENCILS, DRAWING PENCILS, PENS, DRAWING PENS, PAINT TRAYS, PAINTING SETS FOR CHILDREN, ARTS AND CRAFT PAINT KITS, AND PENCIL CASES; NON-MAGNETICALLY ENCODED PREPAID TELEPHONE CALLING CARDS, IN CLASS 16 (U.S. CLS. 2, 5, 22, 23, 29, 37, 38 AND 50).

PRIORITY CLAIMED UNDER SEC. 44(D) ON FED REP GERMANY APPLICATION NO. 30726361438, FILED 4-20-2007, REG. NO. 30726361, DATED 7-26-2007, EXPIRES 4-30-2017.

OWNER OF U.S. REG. NOS. 2,508,277, 3,148,182 AND OTHERS.

THE COLOR(S) MAGENTA IS/ARE CLAIMED AS A FEATURE OF THE MARK.

THE COLOR MAGENTA APPEARS IN THE "T" AND IN THE SQUARE DESIGNS

SER. NO. 77-307,273, FILED 10-18-2007.

CAROLINE WOOD, EXAMINING ATTORNEY

**Int. Cl.: 35**

**Prior U.S. Cls.: 100, 101 and 102**

**United States Patent and Trademark Office**

**Reg. No. 3,452,977**

**Registered June 24, 2008**

**SERVICE MARK  
PRINCIPAL REGISTER**



DEUTSCHE TELEKOM AG (FED REP GERMA-  
NY CORPORATION)  
FRIEDRICH-EBERT-ALLEE 140  
BONN 53113, FED REP GERMANY

FOR: TELEPHONE DIRECTORY ASSISTANCE SERVICES; ADVERTISING SERVICES, NAMELY, PREPARING AND PLACING ADVERTISEMENTS FOR OTHERS PROMOTING THE GOODS AND SERVICES OF OTHERS THROUGH PRINTED ADVERTISING, PRINTED DIRECTORIES, THROUGH ENCODED MEDIA, THROUGH THE DISSEMINATION OF PROMOTIONAL MATERIALS, THROUGH DIRECT MAIL ADVERTISING, THROUGH ELECTRONIC BILLBOARD ADVERTISING, PREPARING AUDIO-VISUAL PRESENTATIONS FOR USE IN ADVERTISING; BUSINESS MANAGEMENT SERVICES, NAMELY, BUSINESS APPRAISALS, BUSINESS AUDITING, PROVIDING BUSINESS INFORMATION, NAMELY, PREPARING BUSINESS REPORTS AND CONDUCTING BUSINESS RESEARCH, ANALYSIS AND SURVEYS, BUSINESS MANAGEMENT PLANNING, BUSINESS MANAGEMENT CONSULTATION, BUSINESS MANAGEMENT SUPERVISION, CONDUCTING BUSINESS NETWORKING FOR OTHERS; BUSINESS MANAGEMENT AND CONSULTING SERVICES, EXCLUDING AGRICULTURAL BUSINESS MANAGEMENT AND CONSULTING SERVICES;

PROVIDING INFORMATION VIA THE TELEPHONE AND THE GLOBAL COMMUNICATION NETWORKS IN THE FIELD OF ADVERTISING AND BUSINESS MARKETING; PROFESSIONAL CONSULTANCY IN THE FIELD OF DATA PROCESSING; RENTAL OF AUTOMATIC VENDING MACHINES; RENTAL OF DATA PROCESSING EQUIPMENT; ORGANIZING JOB FAIRS, IN CLASS 35 (U.S. CLS. 100, 101 AND 102).

PRIORITY CLAIMED UNDER SEC. 44(D) ON FED REP GERMANY APPLICATION NO. 30726361438, FILED 4-20-2007, REG. NO. 30726361, DATED 7-26-2007, EXPIRES 4-30-2017.

OWNER OF U.S. REG. NOS. 2,508,277, 3,148,182 AND OTHERS.

THE COLOR(S) MAGENTA IS/ARE CLAIMED AS A FEATURE OF THE MARK.

THE COLOR MAGENTA APPEARS IN THE LETTER "T" AND IN THE SQUARE DESIGNS.

SER. NO. 77-307,274, FILED 10-18-2007.

CAROLINE WOOD, EXAMINING ATTORNEY

**Int. Cl.: 37**

**Prior U.S. Cls.: 100, 103 and 106**

**United States Patent and Trademark Office**

**Reg. No. 3,452,978**

**Registered June 24, 2008**

**SERVICE MARK  
PRINCIPAL REGISTER**

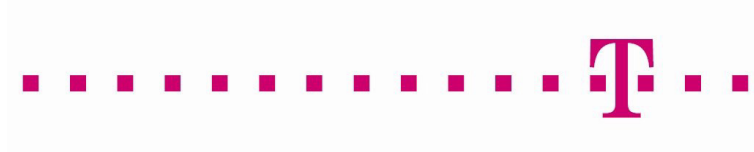

DEUTSCHE TELEKOM AG (FED REP GERMA-  
NY CORPORATION)  
FRIEDRICH-EBERT-ALLEE 140  
BONN 53113, FED REP GERMANY

FOR: CUSTOM CONSTRUCTION AND BUILD-  
ING RENOVATION; CONSTRUCTION PLANNING,  
CONSTRUCTION SUPERVISION; MAINTENANCE  
AND REPAIR OF TELECOMMUNICATIONS NET-  
WORKS APPARATUS AND INSTRUMENTS; IN-  
STALLATION OF TELECOMMUNICATIONS  
NETWORK, APPARATUS AND INSTRUMENTS;  
INSTALLATION, MAINTENANCE AND REPAIR  
OF COMPUTER NETWORKS AND COMPUTER  
HARDWARE FOR TELECOMMUNICATION PUR-  
POSES, IN CLASS 37 (U.S. CLS. 100, 103 AND 106).

PRIORITY CLAIMED UNDER SEC. 44(D) ON FED  
REP GERMANY APPLICATION NO. 30726361438,

FILED 4-20-2007, REG. NO. 30726361, DATED 7-26-  
2007, EXPIRES 4-30-2017.

OWNER OF U.S. REG. NOS. 2,508,277, 3,148,182  
AND OTHERS.

THE COLOR(S) MAGENTA IS/ARE CLAIMED AS  
A FEATURE OF THE MARK.

THE COLOR MAGENTA APPEARS IN THE LET-  
TER "T" AND IN THE SQUARE DESIGNS.

SER. NO. 77-307,275, FILED 10-18-2007.

CAROLINE WOOD, EXAMINING ATTORNEY

**Int. Cl.: 38**

**Prior U.S. Cls.: 100, 101 and 104**

**United States Patent and Trademark Office**

**Reg. No. 3,452,979**

**Registered June 24, 2008**

**SERVICE MARK  
PRINCIPAL REGISTER**



DEUTSCHE TELEKOM AG (FED REP GERMA-  
NY CORPORATION)  
FRIEDRICH-EBERT-ALLEE 140  
BONN 53113, FED REP GERMANY

FOR: TELECOMMUNICATION AND INFORMATION TECHNOLOGY SERVICES, NAMELY, ELECTRIC, DIGITAL, CELLULAR AND WIRELESS TRANSMISSION OF VOICE, DATA, INFORMATION IMAGES, SIGNALS AND MESSAGES AND TRANSMISSION OF VOICE, DATA, IMAGES, AUDIO, VIDEO AND INFORMATION VIA TELEPHONE, TELEVISION AND GLOBAL COMMUNICATION NETWORKS; PROVIDING TELECOMMUNICATIONS CONNECTIONS OVER A GLOBAL COMMUNICATIONS NETWORK, ELECTRONIC STORE-AND-FORWARD MESSAGING; RENTAL OF TELECOMMUNICATIONS EQUIPMENT, NAMELY, EQUIPMENT FOR ELECTRONIC ACCESS TO GLOBAL TELECOMMUNICATIONS NETWORK, EQUIPMENT FOR TRANSMITTING, RECEIVING, RECORDING AND MONITORING VOICE, DATA, INFORMATION IMAGES, SIGNALS, MESSAGES COMPRISED OF DATA AND WORD PROCESSORS, AND TELECOMMUNICATIONS HARDWARE COMPONENTS AND PERIPHERALS THEREOF FOR USE IN THE TELECOMMUNICATIONS INDUSTRY, AND RENTAL OF EQUIPMENT FOR TRANSMITTING, RECEIVING, RECORDING AND MONITORING COMPUTER PROGRAMS FOR USE IN OPERATING AND ACCESSING TELECOMMUNICATIONS SYSTEMS; AUDIO AND VIDEO BROADCASTING; PROVID-

ING MULTIPLE-USER DIAL-UP AND DEDICATED ACCESS TO THE INTERNET; PERSONAL COMMUNICATIONS SERVICES; PAGER SERVICES; TRANSMISSION AND BROADCAST OF AUDIO AND VIDEO PROGRAMMING; LEASING OF TELECOMMUNICATIONS EQUIPMENT, COMPONENTS AND SYSTEMS; PROVIDING INFORMATION VIA THE TELEPHONE AND THE GLOBAL COMMUNICATION NETWORKS IN THE FIELD OF TELECOMMUNICATIONS; CONSULTING IN THE FIELD OF TELECOMMUNICATIONS, IN CLASS 38 (U.S. CLS. 100, 101 AND 104).

PRIORITY CLAIMED UNDER SEC. 44(D) ON FED REP GERMANY APPLICATION NO. 30726361438, FILED 4-20-2007, REG. NO. 30726361, DATED 7-26-2007, EXPIRES 4-30-2017.

OWNER OF U.S. REG. NOS. 2,508,277, 3,148,182 AND OTHERS.

THE COLOR(S) MAGENTA IS/ARE CLAIMED AS A FEATURE OF THE MARK.

THE COLOR MAGENTA APPEARS IN THE LETTER "T" AND IN THE SQUARE DESIGNS.

SER. NO. 77-307,277, FILED 10-18-2007.

CAROLINE WOOD, EXAMINING ATTORNEY

**Int. Cl.: 41**

**Prior U.S. Cls.: 100, 101 and 107**

**United States Patent and Trademark Office**

**Reg. No. 3,452,980**

**Registered June 24, 2008**

**SERVICE MARK  
PRINCIPAL REGISTER**



DEUTSCHE TELEKOM AG (FED REP GERMA-  
NY CORPORATION)  
FRIEDRICH-EBERT-ALLEE 140  
BONN, FED REP GERMANY 53113

FOR: EDUCATION AND INSTRUCTION, NAME-  
LY, EDUCATIONAL SERVICES IN THE NATURE  
OF CLASSES AND SEMINARS IN THE FIELDS OF  
BUSINESS, TELECOMMUNICATIONS AND COM-  
PUTERS, AND THE DISTRIBUTION OF COURSE  
MATERIALS THEREWITH; ENTERTAINMENT IN  
THE NATURE OF VISUAL AND AUDIO PERFOR-  
MANCES, NAMELY, MUSICAL BANDS, GYMNAS-  
TIC, DANCE, AND BALLET PERFORMANCES;  
ENTERTAINMENT SERVICES, NAMELY, PROVID-  
ING MUSICAL, VARIETY, NEWS AND COMEDY  
SHOWS VIA A GLOBAL COMPUTER INFORMA-  
TION NETWORK; PROVIDING ENTERTAINMENT  
INFORMATION AT THE SPECIFIC REQUEST OF  
END-USERS BY MEANS OF TELEPHONE OR GLO-  
BAL COMMUNICATIONS NETWORKS; ENTER-  
TAINMENT SERVICES, NAMELY, PROVIDING  
ON-LINE COMPUTER GAMES FOR CHILDREN  
AND ADULTS; ORGANIZING COMMUNITY  
SPORTING AND CULTURAL EVENTS; PUBLICA-  
TION OF BOOKS, MAGAZINES, JOURNALS, MAN-  
UALS, BROCHURES AND LEAFLETS ON THE  
SUBJECT OF TELECOMMUNICATIONS; ELEC-  
TRONIC PUBLISHING SERVICES, NAMELY, PUB-

LICATION OF TEXT AND GRAPHIC WORKS OF  
OTHERS ON TELECOMMUNICATIONS RECOR-  
DED ON ELECTRONIC MEDIA, NAMELY, CD,  
DVD AND ONLINE; ORGANIZING FAIRS AND  
EXHIBITIONS IN THE FIELD OF VISUAL AND  
AUDIO PERFORMANCES, NAMELY, ROCK  
GROUP, GYMNAS-TIC, DANCE, AND BALLET PER-  
FORMANCES, IN CLASS 41 (U.S. CLS. 100, 101 AND  
107).

PRIORITY CLAIMED UNDER SEC. 44(D) ON FED  
REP GERMANY APPLICATION NO. 30726361438,  
FILED 4-20-2007, REG. NO. 30726361, DATED 7-26-  
2007, EXPIRES 4-30-2017.

OWNER OF U.S. REG. NOS. 2,508,277, 3,148,182  
AND OTHERS.

THE COLOR(S) MAGENTA IS/ARE CLAIMED AS  
A FEATURE OF THE MARK.

THE COLOR MAGENTA APPEARS IN THE LET-  
TER "T" AND IN THE SQUARE DESIGNS.

SER. NO. 77-307,279, FILED 10-18-2007.

CAROLINE WOOD, EXAMINING ATTORNEY

Int. Cl.: 42

Prior U.S. Cls.: 100 and 101

United States Patent and Trademark Office

Reg. No. 3,452,981

Registered June 24, 2008

SERVICE MARK  
PRINCIPAL REGISTER



DEUTSCHE TELEKOM AG (FED REP GERMA-  
NY CORPORATION)  
FRIEDRICH-EBERT-ALLEE 140  
BONN 53113, FED REP GERMANY

FOR: COMPUTER PROGRAMMING SERVICES FOR OTHERS; RENTAL OF COMPUTER SOFTWARE AND HARDWARE FOR ONLINE ACCESS; DATA ENCRYPTION SERVICES; APPLICATION SERVICE PROVIDER, NAMELY, HOSTING COMPUTER SOFTWARE APPLICATIONS FOR OTHERS, HOSTING OF DIGITAL CONTENT ON THE INTERNET; HOSTING THE WEBSITES OF OTHERS ON A COMPUTER SERVER FOR A GLOBAL COMPUTER NETWORK; COMPUTER SERVICES, NAMELY, CREATING INDEXES OF INFORMATION AVAILABLE ON COMPUTER NETWORKS; PROVIDING INFORMATION VIA THE TELEPHONE AND THE GLOBAL COMMUNICATION NETWORKS IN THE FIELD OF INFORMATION TECHNOLOGY; CONSULTING SERVICES IN THE FIELD OF DESIGN, SELECTION, IMPLEMENTATION AND USE OF COMPUTER HARDWARE AND SOFTWARE SYSTEMS FOR OTHERS; INSTALLATION, MAINTENANCE AND REPAIR OF COMPUTER SOFTWARE; TECHNICAL PROJECT PLANNING SERVICES RELATED TO TELECOMMUNICATIONS EQUIPMENT; PROVIDING INFORMATION AT THE

SPECIFIC REQUEST OF END-USERS BY MEANS OF TELEPHONE OR GLOBAL COMMUNICATIONS NETWORKS; PROVIDING TEMPORARY USE OF ONLINE NON-DOWNLOADABLE TELECOMMUNICATIONS SOFTWARE FOR PROVIDING MULTIPLE USER ACCESS TO THE GLOBAL COMPUTER NETWORK, IN CLASS 42 (U.S. CLS. 100 AND 101).

PRIORITY CLAIMED UNDER SEC. 44(D) ON FED REP GERMANY APPLICATION NO. 30726361438, FILED 4-20-2007, REG. NO. 30726361, DATED 7-26-2007, EXPIRES 4-30-2017.

OWNER OF U.S. REG. NOS. 2,508,277, 3,148,182 AND OTHERS.

THE COLOR(S) MAGENTA IS/ARE CLAIMED AS A FEATURE OF THE MARK.

THE COLOR MAGENTA APPEARS IN THE LETTER "T" AND IN THE SQUARE DESIGNS.

SER. NO. 77-307,280, FILED 10-18-2007.

CAROLINE WOOD, EXAMINING ATTORNEY

**Int. Cl.: 45**

**Prior U.S. Cls.: 100 and 101**

**United States Patent and Trademark Office**

**Reg. No. 3,452,982**

**Registered June 24, 2008**

**SERVICE MARK  
PRINCIPAL REGISTER**



DEUTSCHE TELEKOM AG (FED REP GERMA-  
NY CORPORATION)  
FRIEDRICH-EBERT-ALLEE 140  
BONN, FED REP GERMANY 53113

FOR: LICENSING OF INDUSTRIAL PROPERTY  
RIGHTS, IN CLASS 45 (U.S. CLS. 100 AND 101).

PRIORITY CLAIMED UNDER SEC. 44(D) ON FED  
REP GERMANY APPLICATION NO. 30726361438,  
FILED 4-20-2007, REG. NO. 30726361, DATED 7-26-  
2007, EXPIRES 4-30-2017.

OWNER OF U.S. REG. NOS. 2,508,277, 3,148,182  
AND OTHERS.

THE COLOR(S) MAGENTA IS/ARE CLAIMED AS  
A FEATURE OF THE MARK.

THE COLOR MAGENTA APPEARS IN THE LET-  
TER "T" AND IN THE SQUARE DESIGNS.

SER. NO. 77-307,281, FILED 10-18-2007.

CAROLINE WOOD, EXAMINING ATTORNEY

**Int. Cl.: 36**

**Prior U.S. Cls.: 100, 101 and 102**

**United States Patent and Trademark Office**

**Reg. No. 3,452,983**

**Registered June 24, 2008**

**SERVICE MARK  
PRINCIPAL REGISTER**

**Retirement Solutions for a  
Life Time Partnering with  
you and those you care  
about**

EMON, BERGER, SUYAMA AND ASSOCIATES  
(VIRGINIA PARTNERSHIP)  
3959 PENDER DRIVE SUITE 108  
FAIRFAX, VA 220306041

FOR: PROVIDING FINANCIAL PRE AND POST  
RETIREMENT CONSULTING FOR INDIVIDUALS,  
COUPLES AND COMPANIES THAT SPONSOR EM-  
PLOYEE RETIREMENT PLANS , IN CLASS 36 (U.S.  
CLS. 100, 101 AND 102).

FIRST USE 10-1-2006; IN COMMERCE 10-1-2006.

THE MARK CONSISTS OF STANDARD CHAR-  
ACTERS WITHOUT CLAIM TO ANY PARTICULAR  
FONT, STYLE, SIZE, OR COLOR.

SER. NO. 77-307,285, FILED 10-18-2007.

BARBARA BROWN, EXAMINING ATTORNEY



**Int. Cl.: 45**

**Prior U.S. Cls.: 100 and 101**

**United States Patent and Trademark Office**

**Reg. No. 3,452,984**

**Registered June 24, 2008**

**SERVICE MARK  
PRINCIPAL REGISTER**



DOTHAN SECURITY INC. (ALABAMA CORPORATION), DBA DSI SECURITY SERVICES  
600 WEST ADAMS STREET  
DOTHAN, AL 36303

FOR: SECURITY GUARD SERVICES, SECURITY GUARDING FOR FACILITIES, SECURITY SERVICES, NAMELY, PROVIDING SECURITY ASSESSMENTS OF PHYSICAL LOCATIONS, INFORMATION SYSTEMS, AND WORKING ENVIRONMENTS, HOME SECURITY MONITORING USING WIRELESS AND WIRED SENSORS FOR GLASS BREAKAGE, MOTION DETECTORS, CAMERAS, POOL ALARMS, WATER ALARMS AND SHUTOFF VALVES, GATE, DOOR AND WINDOW CONTACT SENSORS, SEVERE WEATHER ALARMS, MONITORING BURGLAR AND SECURITY ALARMS, IN CLASS 45 (U.S. CLS. 100 AND 101).

FIRST USE 1-1-2005; IN COMMERCE 1-1-2005.

NO CLAIM IS MADE TO THE EXCLUSIVE RIGHT TO USE "SECURITY SERVICES", APART FROM THE MARK AS SHOWN.

THE MARK CONSISTS OF THE STYLIZED WORDS "DSI DWYSYWD SECURITY SERVICES". "DSI" IS INSIDE OF A PENTAGON THAT IS LOCATED ON THE LEFT. "DWYSYWD" IS LOCATED IN A BANNER TO THE RIGHT OF THE PENTAGON. "SECURITY SERVICES" IS LOCATED UNDER THE BANNER WITH THE TEXT "DWYSYWD".

SER. NO. 77-307,390, FILED 10-18-2007.

PATRICIA EVANKO, EXAMINING ATTORNEY

**Int. Cl.: 30**

**Prior U.S. Cl.: 46**

**United States Patent and Trademark Office**

**Reg. No. 3,452,985**

**Registered June 24, 2008**

**TRADEMARK  
PRINCIPAL REGISTER**

**SchoolHouse Kitchen**

SCHOOLHOUSE KITCHEN, LLC (NEW YORK  
LTD LIAB CO)

232 THIRD STREET #C2A

BROOKLYN, NY 11215

FOR: MUSTARD; CHUTNEY; SALAD DRES-  
SINGS, IN CLASS 30 (U.S. CL. 46).

FIRST USE 10-1-2004; IN COMMERCE 1-1-2005.

THE MARK CONSISTS OF STANDARD CHAR-  
ACTERS WITHOUT CLAIM TO ANY PARTICULAR  
FONT, STYLE, SIZE, OR COLOR.

NO CLAIM IS MADE TO THE EXCLUSIVE  
RIGHT TO USE "KITCHEN", APART FROM THE  
MARK AS SHOWN.

SER. NO. 77-307,406, FILED 10-18-2007.

KATHLEEN LORENZO, EXAMINING ATTORNEY

**Int. Cl.: 35**

**Prior U.S. Cls.: 100, 101 and 102**

**United States Patent and Trademark Office**

**Reg. No. 3,452,986**

**Registered June 24, 2008**

**SERVICE MARK  
PRINCIPAL REGISTER**

**DFW Franchise Expo**

AB FRANCHISE MANAGEMENT GROUP, INC.  
(TEXAS CORPORATION)  
13140 COIT RD., STE. 211  
DALLAS, TX 75240

FOR: ARRANGING AND CONDUCTING TRADE SHOWS IN THE FIELD OF FRANCHISES AND BUSINESS OPPORTUNITIES; PROMOTING AND CONDUCTING TRADE SHOWS IN THE FIELD OF FRANCHISES AND BUSINESS OPPORTUNITIES, IN CLASS 35 (U.S. CLS. 100, 101 AND 102).

FIRST USE 4-1-2006; IN COMMERCE 4-1-2006.

THE MARK CONSISTS OF STANDARD CHARACTERS WITHOUT CLAIM TO ANY PARTICULAR FONT, STYLE, SIZE, OR COLOR.

NO CLAIM IS MADE TO THE EXCLUSIVE RIGHT TO USE "FRANCHISE EXPO", APART FROM THE MARK AS SHOWN.

SER. NO. 77-307,449, FILED 10-18-2007.

FLORENTINA BLANDU, EXAMINING ATTORNEY

**Int. Cl.: 35**

**Prior U.S. Cls.: 100, 101 and 102**

**United States Patent and Trademark Office**

**Reg. No. 3,452,987**

**Registered June 24, 2008**

**SERVICE MARK  
PRINCIPAL REGISTER**

**ADROVER**

ADSCOPE MEDIA, LLC (MICHIGAN LTD LIAB  
CO)  
SUITE F  
1407 ALLEN DRIVE  
TROY, MI 48083

FOR: ADVERTISING SERVICES, IN CLASS 35  
(U.S. CLS. 100, 101 AND 102).

FIRST USE 0-0-2005; IN COMMERCE 0-0-2005.

THE MARK CONSISTS OF STANDARD CHAR-  
ACTERS WITHOUT CLAIM TO ANY PARTICULAR  
FONT, STYLE, SIZE, OR COLOR.

SER. NO. 77-307,543, FILED 10-18-2007.

AMOS T. MATTHEWS, JR., EXAMINING ATTOR-  
NEY

**Int. Cl.: 36**

**Prior U.S. Cls.: 100, 101 and 102**

**United States Patent and Trademark Office**

**Reg. No. 3,452,988**

**Registered June 24, 2008**

**SERVICE MARK  
PRINCIPAL REGISTER**

**WEST COAST BANCORP**

WEST COAST BANCORP (OREGON CORPORATION)  
SUITE 201  
5335 MEADOWS ROAD  
LAKE OSWEGO, OR 97035

FOR: BANKING SERVICES, NAMELY, CHECKING ACCOUNT SERVICES, SAVINGS ACCOUNT SERVICES, ON-LINE BANKING SERVICES, PERSONAL LOAN SERVICES, MORTGAGE LOAN SERVICES, AND HOME EQUITY LOAN SERVICES; FINANCIAL SERVICES, NAMELY, STOCK BROKERAGE AND INSURANCE BROKERAGE; DEBIT AND CREDIT CARD SERVICES, IN CLASS 36 (U.S. CLS. 100, 101 AND 102).

FIRST USE 0-0-1981; IN COMMERCE 0-0-1996.

THE MARK CONSISTS OF STANDARD CHARACTERS WITHOUT CLAIM TO ANY PARTICULAR FONT, STYLE, SIZE, OR COLOR.

NO CLAIM IS MADE TO THE EXCLUSIVE RIGHT TO USE "BANCORP", APART FROM THE MARK AS SHOWN.

SEC. 2(F).

SER. NO. 77-307,545, FILED 10-18-2007.

MARIA-VICTORIA SUAREZ, EXAMINING ATTORNEY

**Int. Cl.: 29**

**Prior U.S. Cl.: 46**

**United States Patent and Trademark Office**

**Reg. No. 3,452,989**

**Registered June 24, 2008**

**TRADEMARK  
PRINCIPAL REGISTER**

**GOOSE'S**

GOOSE'S BBQ PRODUCTS, LLC (NEW JERSEY  
LTD LIAB CO)  
9 BUSINESS PARK, UNIT 2-3  
BRANFORD, CT 06405

FOR: SEASONED, PREPACKAGED MEATS, RAW  
OR PRECOOKED, NAMELY, PULLED PORK AND  
BEEF, SHREDDED CHICKEN, MEATBALLS, SAU-  
SAGES AND PORK RIBS, IN CLASS 29 (U.S. CL. 46).

FIRST USE 5-18-2004; IN COMMERCE 7-16-2004.

THE MARK CONSISTS OF STANDARD CHAR-  
ACTERS WITHOUT CLAIM TO ANY PARTICULAR  
FONT, STYLE, SIZE, OR COLOR.

OWNER OF U.S. REG. NOS. 3,244,720 AND  
3,275,064.

SER. NO. 77-307,556, FILED 10-18-2007.

KATHRYN COWARD, EXAMINING ATTORNEY

**Int. Cl.: 23**

**Prior U.S. Cl.: 43**

**United States Patent and Trademark Office**

**Reg. No. 3,452,990**

**Registered June 24, 2008**

**TRADEMARK  
PRINCIPAL REGISTER**

**ILLUMINATIONS**

DEBBIE MUMM, INC. (WASHINGTON COR-  
PORATION)  
1116 E. WESTVIEW COURT  
SPOKANE, WA 99218

THE MARK CONSISTS OF STANDARD CHAR-  
ACTERS WITHOUT CLAIM TO ANY PARTICULAR  
FONT, STYLE, SIZE, OR COLOR.

FOR: YARN, IN CLASS 23 (U.S. CL. 43).

SER. NO. 77-307,577, FILED 10-18-2007.

FIRST USE 10-15-2007; IN COMMERCE 10-15-2007.

B. PARADEWELAI, EXAMINING ATTORNEY

**Int. Cl.: 38**

**Prior U.S. Cls.: 100, 101 and 104**

**United States Patent and Trademark Office**

**Reg. No. 3,452,991**

**Registered June 24, 2008**

**SERVICE MARK  
PRINCIPAL REGISTER**

**FINAIM**

AOL LLC (DELAWARE LTD LIAB CO)  
22000 AOL WAY  
DULLES, VA 20166

FOR: TELECOMMUNICATIONS SERVICES, NAMELY, PROVIDING MULTIPLE USE ACCESS TO COMPUTER NETWORKS; ELECTRONIC TRANSMISSION OF DATA, TEXT, IMAGES, DOCUMENTS, AND SOUND VIA COMPUTER NETWORKS; PROVIDING ONLINE ELECTRONIC BULLETIN BOARDS AND CHAT ROOMS FOR TRANSMISSION OF MESSAGES, PHOTOS, AND NOTES AMONG A GROUP OF COMPUTER USERS CONCERNING BUSINESS, FINANCE, INVESTMENT, TRADE, COMMERCE, AND USER-DEFINED TOPICS; PROVIDING ONLINE COMPUTER NETWORK FACILITIES FOR REAL-TIME INTER-

ACTION AND COMMUNICATION WITH OTHER COMPUTER USERS CONCERNING TOPICS OF GENERAL INTEREST; ELECTRONIC MAIL SERVICES, IN CLASS 38 (U.S. CLS. 100, 101 AND 104).

FIRST USE 5-10-2007; IN COMMERCE 5-10-2007.

THE MARK CONSISTS OF STANDARD CHARACTERS WITHOUT CLAIM TO ANY PARTICULAR FONT, STYLE, SIZE, OR COLOR.

OWNER OF U.S. REG. NOS. 2,423,367, 2,665,694, AND 3,295,093.

SER. NO. 77-307,600, FILED 10-18-2007.

MICHELLE DUBOIS, EXAMINING ATTORNEY



**Int. Cl.: 23**

**Prior U.S. Cl.: 43**

**United States Patent and Trademark Office**

**Reg. No. 3,452,992**

**Registered June 24, 2008**

**TRADEMARK  
PRINCIPAL REGISTER**

**REMINISCENCE**

DEBBIE MUMM, INC. (WASHINGTON COR-  
PORATION)  
1116 E. WESTVIEW COURT  
SPOKANE, WA 99218

THE MARK CONSISTS OF STANDARD CHAR-  
ACTERS WITHOUT CLAIM TO ANY PARTICULAR  
FONT, STYLE, SIZE, OR COLOR.

FOR: YARN, IN CLASS 23 (U.S. CL. 43).

SER. NO. 77-307,605, FILED 10-18-2007.

FIRST USE 10-15-2007; IN COMMERCE 10-15-2007.

B. PARADEWELAI, EXAMINING ATTORNEY

**Int. Cl.: 23**

**Prior U.S. Cl.: 43**

**United States Patent and Trademark Office**

**Reg. No. 3,452,993**

**Registered June 24, 2008**

**TRADEMARK  
PRINCIPAL REGISTER**

**SOUVENIRS**

DEBBIE MUMM, INC. (WASHINGTON COR-  
PORATION)  
1116 E. WESTVIEW COURT  
SPOKANE, WA 99218

THE MARK CONSISTS OF STANDARD CHAR-  
ACTERS WITHOUT CLAIM TO ANY PARTICULAR  
FONT, STYLE, SIZE, OR COLOR.

FOR: YARN, IN CLASS 23 (U.S. CL. 43).

SER. NO. 77-307,624, FILED 10-18-2007.

FIRST USE 10-15-2007; IN COMMERCE 10-15-2007.

B. PARADEWELAI, EXAMINING ATTORNEY

**Int. Cl.: 11**

**Prior U.S. Cls.: 13, 21, 23, 31 and 34**

**Reg. No. 3,452,994**

**United States Patent and Trademark Office**

**Registered June 24, 2008**

**TRADEMARK  
PRINCIPAL REGISTER**

**SCORPIONHUNTER**

WALTERSCHEID, KELLY (UNITED STATES IN-  
DIVIDUAL), DBA NEUTEK  
P.O. BOX 1061  
MESA, AZ 85211

THE MARK CONSISTS OF STANDARD CHAR-  
ACTERS WITHOUT CLAIM TO ANY PARTICULAR  
FONT, STYLE, SIZE, OR COLOR.

FOR: FLASHLIGHTS, IN CLASS 11 (U.S. CLS. 13,  
21, 23, 31 AND 34).

SER. NO. 77-307,630, FILED 10-18-2007.

FIRST USE 7-1-2003; IN COMMERCE 10-19-2003.

DAVID ELTON, EXAMINING ATTORNEY

**Int. Cls.: 35 and 42**

**Prior U.S. Cls.: 100, 101 and 102**

**United States Patent and Trademark Office**

**Reg. No. 3,452,995**

**Registered June 24, 2008**

**SERVICE MARK  
PRINCIPAL REGISTER**

FOCUS TECHNOLOGY CONSULTING

FOCUS TECHNOLOGY CONSULTING LLC (DE-  
LAWARE LTD LIAB CO)  
SUITE 460  
1355 PICCARD DRIVE  
ROCKVILLE, MD 20850

FOR: EMPLOYMENT RECRUITING CONSULTA-  
TION; EMPLOYMENT AGENCIES, NAMELY, PLA-  
CING TECHNICAL PERSONNEL WITH  
INFORMATION TECHNOLOGY COMPANIES , IN  
CLASS 35 (U.S. CLS. 100, 101 AND 102).

FIRST USE 11-1-2000; IN COMMERCE 12-1-2000.

FOR: INFORMATION TECHNOLOGY CON-  
SULTING SERVICES, IN CLASS 42 (U.S. CLS. 100  
AND 101).

FIRST USE 11-1-2000; IN COMMERCE 12-1-2000.

THE MARK CONSISTS OF STANDARD CHAR-  
ACTERS WITHOUT CLAIM TO ANY PARTICULAR  
FONT, STYLE, SIZE, OR COLOR.

NO CLAIM IS MADE TO THE EXCLUSIVE  
RIGHT TO USE "TECHNOLOGY CONSULTING",  
APART FROM THE MARK AS SHOWN.

SER. NO. 77-307,712, FILED 10-18-2007.

AHSEN KHAN, EXAMINING ATTORNEY

**Int. Cl.: 42**

**Prior U.S. Cls.: 100 and 101**

**United States Patent and Trademark Office**

**Reg. No. 3,452,996**

**Registered June 24, 2008**

**SERVICE MARK  
PRINCIPAL REGISTER**

**GRANITE CONNECTION**

GRANITE CONNECTION LLC (VIRGINIA LTD  
LIAB CO)  
47408 RIVER CREST STREET  
POTOMAC FALLS, VA 20165

FOR: CONSULTATION IN THE FIELD OF IN-  
TERIOR DESIGN, IN CLASS 42 (U.S. CLS. 100 AND  
101).

FIRST USE 10-9-2004; IN COMMERCE 12-22-2004.

THE MARK CONSISTS OF STANDARD CHAR-  
ACTERS WITHOUT CLAIM TO ANY PARTICULAR  
FONT, STYLE, SIZE, OR COLOR.

NO CLAIM IS MADE TO THE EXCLUSIVE  
RIGHT TO USE "GRANITE", APART FROM THE  
MARK AS SHOWN.

SER. NO. 77-307,742, FILED 10-18-2007.

JAY BESCH, EXAMINING ATTORNEY

**Int. Cls.: 35 and 40**

**Prior U.S. Cls.: 100, 101, 102, 103 and 106**

**United States Patent and Trademark Office**

**Reg. No. 3,452,997**

**Registered June 24, 2008**

**SERVICE MARK  
PRINCIPAL REGISTER**

**SWIFT FLAG REPAIR SERVICE**

SWIFT FLAG COMPANY/ SWIFT FLAG REPAIR  
SERVICE, LLC (ARIZONA LTD LIAB CO)  
P.O. BOX 125  
PEORIA, AZ 85380

THE MARK CONSISTS OF STANDARD CHAR-  
ACTERS WITHOUT CLAIM TO ANY PARTICULAR  
FONT, STYLE, SIZE, OR COLOR.

FOR: RETAIL STORE SERVICES FEATURING  
FLAGS, IN CLASS 35 (U.S. CLS. 100, 101 AND 102).

NO CLAIM IS MADE TO THE EXCLUSIVE  
RIGHT TO USE "FLAG REPAIR SERVICE", APART  
FROM THE MARK AS SHOWN.

FIRST USE 11-0-1972; IN COMMERCE 11-0-1972.

FOR: SEWING SERVICES, IN CLASS 40 (U.S. CLS.  
100, 103 AND 106).

SER. NO. 77-307,883, FILED 10-18-2007.

FIRST USE 11-0-1972; IN COMMERCE 11-0-1972.

JOHN GARTNER, EXAMINING ATTORNEY

**Int. Cls.: 3 and 21**

**Prior U.S. Cls.: 1, 2, 4, 6, 13, 23, 29, 30, 33, 40, 50, 51  
and 52**

**Reg. No. 3,452,998**

**United States Patent and Trademark Office**

**Registered June 24, 2008**

**TRADEMARK  
PRINCIPAL REGISTER**

**P R Í M A**

MARTINEZ, HEATHER NYDAM (UNITED STATES INDIVIDUAL)  
1745 SOUTH BROADWAY  
DENVER, CO 80210

FOR: AUTOMOBILE POLISHES, IN CLASS 3 (U.S. CLS. 1, 4, 6, 50, 51 AND 52).

FIRST USE 9-12-2005; IN COMMERCE 11-8-2005.

FOR: CLEANING CLOTHS FOR AUTOMOBILE DETAILING, IN CLASS 21 (U.S. CLS. 2, 13, 23, 29, 30, 33, 40 AND 50).

FIRST USE 8-31-2007; IN COMMERCE 8-31-2007.

THE MARK CONSISTS OF THE WORD "PRIMA", IN A SPECIALIZED FONT, INCLUDING AN ACCENT MARK FOR THE DOT OVER THE "I".

THE FOREIGN WORDING IN THE MARK TRANSLATES INTO ENGLISH AS "FIRST".

SER. NO. 77-307,889, FILED 10-18-2007.

JOHN GARTNER, EXAMINING ATTORNEY

**Int. Cl.: 41**

**Prior U.S. Cls.: 100, 101 and 107**

**United States Patent and Trademark Office**

**Reg. No. 3,452,999**

**Registered June 24, 2008**

**SERVICE MARK  
PRINCIPAL REGISTER**

**SIMPLY SOCIAL**

LAURA J. TAPPER (UNITED STATES INDIVIDUAL)  
3305 TOWNSEND DRIVE  
DALLAS, TX 75229

THE MARK CONSISTS OF STANDARD CHARACTERS WITHOUT CLAIM TO ANY PARTICULAR FONT, STYLE, SIZE, OR COLOR.

FOR: SPECIAL EVENT PLANNING, IN CLASS 41 (U.S. CLS. 100, 101 AND 107).

SER. NO. 77-307,909, FILED 10-18-2007.

FIRST USE 6-0-2001; IN COMMERCE 10-0-2003.

BRENDAN REGAN, EXAMINING ATTORNEY



**Int. Cl.: 30**

**Prior U.S. Cl.: 46**

**United States Patent and Trademark Office**

**Reg. No. 3,453,000**

**Registered June 24, 2008**

**TRADEMARK  
PRINCIPAL REGISTER**

**SLEEP IS OVERRATED**

SHOCK COFFEE LLC (NEW YORK LTD LIAB  
CO)  
5707 31ST AVENUE  
WOODSIDE, NY 11377

FOR: COFFEE, COFFEE BEANS, COFFEE BASED  
BEVERAGES, COFFEE FLAVORED SYRUP FOR  
COFFEE DRINKS, CONFECTIONARY, NAMELY,  
CANDY, CHOCOLATE AND GUM, IN CLASS 30  
(U.S. CL. 46).

FIRST USE 11-21-1996; IN COMMERCE 11-21-1996.

THE MARK CONSISTS OF STANDARD CHAR-  
ACTERS WITHOUT CLAIM TO ANY PARTICULAR  
FONT, STYLE, SIZE, OR COLOR.

OWNER OF U.S. REG. NO. 3,035,488.

SER. NO. 77-307,926, FILED 10-18-2007.

REGINA DRUMMOND, EXAMINING ATTORNEY

**Int. Cl.: 44**

**Prior U.S. Cls.: 100 and 101**

**United States Patent and Trademark Office**

**Reg. No. 3,453,001**

**Registered June 24, 2008**

**SERVICE MARK  
PRINCIPAL REGISTER**

WELLNESS RESOURCE CENTER

CRC HEALTH CORPORATION (DELAWARE CORPORATION)  
20400 STEVENS CREEK ROAD, SUITE 600  
CUPERTINO, CA 95014

FOR: ADDICTION AND ADDICTIVE DISORDER COUNSELING AND TREATMENT SERVICES; PSYCHIATRIC AND PSYCHOLOGICAL TREATMENT SERVICES; PSYCHIATRIC, PSYCHOLOGICAL, AND MENTAL HEALTH COUNSELING AND TREATMENT SERVICES FOR EMOTIONAL, PSYCHOLOGICAL OR PSYCHIATRIC CONDITIONS, IN CLASS 44 (U.S. CLS. 100 AND 101).

FIRST USE 0-0-1996; IN COMMERCE 0-0-1996.

THE MARK CONSISTS OF STANDARD CHARACTERS WITHOUT CLAIM TO ANY PARTICULAR FONT, STYLE, SIZE, OR COLOR.

NO CLAIM IS MADE TO THE EXCLUSIVE RIGHT TO USE "CENTER", APART FROM THE MARK AS SHOWN.

SEC. 2(F).

SER. NO. 77-307,951, FILED 10-18-2007.

MICHAEL TANNER, EXAMINING ATTORNEY

**Int. Cl.: 35**

**Prior U.S. Cls.: 100, 101 and 102**

**United States Patent and Trademark Office**

**Reg. No. 3,453,002**

**Registered June 24, 2008**

**SERVICE MARK  
PRINCIPAL REGISTER**

**LineLeap**  
Food thru TXT

MCCLAY, BRET J. (UNITED STATES INDIVIDUAL)  
2967 MICHELSON DRIVE, SUITE G  
#203  
IRVINE, CA 92612

FOR: COMPUTERIZED ON-LINE ORDERING SERVICES IN THE FIELD OF RESTAURANT FOOD; ON-LINE ORDERING SERVICES FEATURING TEXT MESSAGE BASED FOOD ORDERING; ON-LINE ORDERING SERVICES IN THE FIELD OF RESTAURANT TAKE-OUT AND DELIVERY; PROMOTING THE GOODS AND SERVICES OF OTHERS THROUGH ON-LINE ORDERING AND CATALOGING OF THOSE GOODS AND SERVICES, IN CLASS 35 (U.S. CLS. 100, 101 AND 102).

FIRST USE 9-22-2007; IN COMMERCE 10-16-2007.

NO CLAIM IS MADE TO THE EXCLUSIVE RIGHT TO USE "FOOD", APART FROM THE MARK AS SHOWN.

THE COLOR(S) ORANGE AND LIGHT GREEN IS/ ARE CLAIMED AS A FEATURE OF THE MARK.

THE MARK CONSISTS OF THE FONT OF ALL LETTERS IS CENTURY GOTHIC. CAPITAL LETTER "L" FOLLOWED BY LOWER CASE LETTERS "I," "N," AND "E". FOLLOWED BY CAPITAL LETTER "L" FOLLOWED BY LOWER CASE LETTERS "E", "A", AND "P". THERE IS NO SPACE BETWEEN THE WORDS "LINE" AND "LEAP," READING: "LINELEAP". BELOW THE "LEAP" PORTION ARE THE WORDS "FOOD THRU TXT" IN SMALLER LETTERS. THE LETTER "F" IN FOOD IS CAPITALIZED, AS IS THE TERM "TXT". ALL THE LETTERS HAVE AN ORANGE BODY, WITH A LIGHT GREEN SHADOWING BACKGROUND TO THE LOWER RIGHT OF EACH LETTER.

SER. NO. 77-308,048, FILED 10-18-2007.

KATHERINE STOIDES, EXAMINING ATTORNEY

**Int. Cl.: 42**

**Prior U.S. Cls.: 100 and 101**

**United States Patent and Trademark Office**

**Reg. No. 3,453,003**

**Registered June 24, 2008**

**SERVICE MARK  
PRINCIPAL REGISTER**

**Local Solutions for a  
Global Problem**

STEVEN S. MATT (UNITED STATES INDIVIDUAL)  
APT 1  
200 WASHINGTON PARK #1  
BOOKLYN, NY 11205

FOR: PROVIDING A WEB SITE FEATURING INFORMATION ABOUT GLOBAL WARMING AND ITS EFFECT ON NATURE AND THE ENVIRONMENT; PROVIDING CUSTOMIZED ON-LINE WEB PAGES FEATURING USER-DEFINED INFORMATION, WHICH INCLUDES SEARCH ENGINES

AND ON-LINE WEB LINKS TO OTHER WEB SITES, IN CLASS 42 (U.S. CLS. 100 AND 101).

FIRST USE 4-1-2006; IN COMMERCE 4-1-2007.

THE MARK CONSISTS OF STANDARD CHARACTERS WITHOUT CLAIM TO ANY PARTICULAR FONT, STYLE, SIZE, OR COLOR.

SER. NO. 77-308,063, FILED 10-19-2007.

RAUL CORDOVA, EXAMINING ATTORNEY

Int. Cl.: 35

Prior U.S. Cls.: 100, 101 and 102

United States Patent and Trademark Office

Reg. No. 3,453,004

Registered June 24, 2008

SERVICE MARK  
PRINCIPAL REGISTER



ARGUELLES, JORGE (MEXICO INDIVIDUAL)  
COL. LOMAS DEL VALLE  
PROLONGACIÓN MORALILLO #125  
SAN PEDRO GARZA GARCÍA, MEXICO 66256

FOR: PROVIDING ON-LINE DIRECTORY INFORMATION SERVICES ALSO FEATURING HYPERLINKS TO OTHER WEB SITES, IN CLASS 35 (U.S. CLS. 100, 101 AND 102).

FIRST USE 8-1-2007; IN COMMERCE 8-1-2007.

NO CLAIM IS MADE TO THE EXCLUSIVE RIGHT TO USE "PRODUCTS AND SUPPLIERS", APART FROM THE MARK AS SHOWN.

THE COLOR(S) RED AND GREY IS/ARE CLAIMED AS A FEATURE OF THE MARK.

THE MARK CONSISTS OF A DESIGN CONSISTING OF TWO GREY ARROWS POSITIONED HORIZONTALLY FACING EACH OTHER AND TWO RED ARROWS POSITIONED VERTICALLY FACING EACH OTHER FOLLOWED BY THE WORDS PROPLIERS PRODUCTS AND SUPPLIERS. THE COLOR RED ALSO APPEARS IN THE LETTERS PRO OF THE THE WORD PROPLIERS AND IN THE WORD PRODUCTS AND THE COLOR GREY APPEARS IN THE LETTERS PLIERS OF THE WORD PROPLIERS AND IN THE WORD SUPPLIERS.

SER. NO. 77-308,075, FILED 10-19-2007.

GIANCARLO CASTRO, EXAMINING ATTORNEY

**Int. Cl.: 39**

**Prior U.S. Cls.: 100 and 105**

**United States Patent and Trademark Office**

**Reg. No. 3,453,005**

**Registered June 24, 2008**

**SERVICE MARK  
PRINCIPAL REGISTER**

**AAPARKING**

BENNETT, ROBERT T. (UNITED STATES INDIVIDUAL)  
241 NORTH COURTLAND, SUITE 259  
ARROYO GRANDE, CA 93420

FOR: PARKING SPACE RESERVATION SERVICE; PROVIDING A WEBSITE AND WEBSITE LINKS TO GEOGRAPHIC INFORMATION, MAP IMAGES, AND TRIP ROUTING; TRAVEL INFORMATION SERVICES; TRANSPORTATION RESERVATION SERVICES, IN CLASS 39 (U.S. CLS. 100 AND 105).

FIRST USE 9-23-2004; IN COMMERCE 9-23-2004.

THE MARK CONSISTS OF STANDARD CHARACTERS WITHOUT CLAIM TO ANY PARTICULAR FONT, STYLE, SIZE, OR COLOR.

SER. NO. 77-308,092, FILED 10-19-2007.

WON TEAK OH, EXAMINING ATTORNEY

**Int. Cl.: 20**

**Prior U.S. Cls.: 2, 13, 22, 25, 32 and 50**

**United States Patent and Trademark Office**

**Reg. No. 3,453,006**

**Registered June 24, 2008**

**TRADEMARK  
PRINCIPAL REGISTER**

# Penalizer

GOLDBECK, TODD G (UNITED STATES INDIVIDUAL)  
8261 STARR GRASS DRIVE  
MADISON, WI 53719

THE MARK CONSISTS OF STANDARD CHARACTERS WITHOUT CLAIM TO ANY PARTICULAR FONT, STYLE, SIZE, OR COLOR.

FOR: NON-ELECTRIC, PLASTIC SCOREBOARDS FOR SPORTS, IN CLASS 20 (U.S. CLS. 2, 13, 22, 25, 32 AND 50).

SER. NO. 77-308,099, FILED 10-19-2007.

FIRST USE 9-26-2007; IN COMMERCE 9-26-2007.

ROBIN MITTLER, EXAMINING ATTORNEY

**Int. Cl.: 13**

**Prior U.S. Cls.: 2 and 9**

**United States Patent and Trademark Office**

**Reg. No. 3,453,007**

**Registered June 24, 2008**

**TRADEMARK  
PRINCIPAL REGISTER**

**SKIN-PACK**

SHOCK TUBE SYSTEMS, INC. (CONNECTICUT  
CORPORATION)  
P.O. BOX 176  
110 INDUSTRIAL PARK ROAD, UNIT 1  
STERLING, CT 06377

FOR: SHOCK TUBE ASSEMBLY CONSISTING  
PRIMARILY OF A COILED SHOCK TUBE PACK-  
AGED TOGETHER WITH A SHOCK TUBE DETO-  
NATOR, IN CLASS 13 (U.S. CLS. 2 AND 9).

FIRST USE 1-27-2005; IN COMMERCE 1-27-2005.

THE MARK CONSISTS OF STANDARD CHAR-  
ACTERS WITHOUT CLAIM TO ANY PARTICULAR  
FONT, STYLE, SIZE, OR COLOR.

SER. NO. 77-308,149, FILED 10-19-2007.

BARBARA GAYNOR, EXAMINING ATTORNEY



**Int. Cl.: 28**

**Prior U.S. Cls.: 22, 23, 38 and 50**

**Reg. No. 3,453,008**

**United States Patent and Trademark Office**

**Registered June 24, 2008**

---

**TRADEMARK  
PRINCIPAL REGISTER**

**MUMBO JUMBO**

FUNDEX GAMES, LTD. (NEVADA CORPORATION)  
2920 FORTUNE CIRCLE WEST  
INDIANAPOLIS, IN 46241

THE MARK CONSISTS OF STANDARD CHARACTERS WITHOUT CLAIM TO ANY PARTICULAR FONT, STYLE, SIZE, OR COLOR.

FOR: GAMES AND TOYS, NAMELY, EQUIPMENT SOLD AS A UNIT FOR PLAYING A PARLOR GAME, IN CLASS 28 (U.S. CLS. 22, 23, 38 AND 50).

SER. NO. 77-308,173, FILED 10-19-2007.

FIRST USE 10-10-2007; IN COMMERCE 10-10-2007.

LYDIA BELZER, EXAMINING ATTORNEY

**Int. Cl.: 35**

**Prior U.S. Cls.: 100, 101 and 102**

**United States Patent and Trademark Office**

**Reg. No. 3,453,009**

**Registered June 24, 2008**

**SERVICE MARK  
PRINCIPAL REGISTER**



TOY SHIPPERS ASSOCIATION, INC. (DELA-  
WARE CORPORATION)  
SUITE 706  
11260 CORNELL PARK DRIVE  
CINCINNATI, OH 45242

FOR: TRANSPORTATION LOGISTICS MANAGE-  
MENT SERVICES, NAMELY, PLANNING AND  
SCHEDULING THE COMBINING OF SHIPMENTS  
AND NEGOTIATING FREIGHT CONTRACTS AND  
LOWER SUPPLY CHAIN COSTS FOR THE USERS  
OF TRANSPORTATION SERVICES, NAMELY,  
MANUFACTURERS AND DISTRIBUTORS OF  
TOYS, JUVENILE PRODUCTS, HOME GOODS,

PROMOTIONAL PRODUCTS AND RELATED COM-  
MODITIES, IN CLASS 35 (U.S. CLS. 100, 101 AND  
102).

FIRST USE 8-23-2007; IN COMMERCE 8-23-2007.

THE MARK CONSISTS OF THE WORD "TOYSA"  
WITH A PICTURE OF A GLOBE FOR THE LETTER  
"O".

SER. NO. 77-308,182, FILED 10-19-2007.

DAVID ELTON, EXAMINING ATTORNEY

**Int. Cl.: 35**

**Prior U.S. Cls.: 100, 101 and 102**

**United States Patent and Trademark Office**

**Reg. No. 3,453,010**

**Registered June 24, 2008**

**SERVICE MARK  
PRINCIPAL REGISTER**

**EPNDesk**

CORPORATE EXECUTIVE BOARD COMPANY  
(DELAWARE CORPORATION)  
2000 PENNSYLVANIA AVE., NW, SUITE 6000  
WASHINGTON DC, DC 20006

THE MARK CONSISTS OF STANDARD CHAR-  
ACTERS WITHOUT CLAIM TO ANY PARTICULAR  
FONT, STYLE, SIZE, OR COLOR.

FOR: PROVIDING MEMBERSHIP-BASED BUSI-  
NESS ADVICE AND BUSINESS INFORMATION  
OVER TELEPHONE OR INTERNET, IN CLASS 35  
(U.S. CLS. 100, 101 AND 102).

SER. NO. 77-308,185, FILED 10-19-2007.

FIRST USE 8-31-2007; IN COMMERCE 8-31-2007.

TOBY BULLOFF, EXAMINING ATTORNEY

**Int. Cl.: 41**

**Prior U.S. Cls.: 100, 101 and 107**

**United States Patent and Trademark Office**

**Reg. No. 3,453,011**

**Registered June 24, 2008**

**SERVICE MARK  
PRINCIPAL REGISTER**

# AUTHOR QUEST

AUDIOCRAFT PUBLISHING, INC. (MICHIGAN CORPORATION)  
P.O. BOX 281  
TOPINABEE ISLAND, MI 49791

FOR: RECREATIONAL CAMP SERVICES, NAME-  
LY, WRITING CAMPS, IN CLASS 41 (U.S. CLS. 100,  
101 AND 107).

FIRST USE 8-8-2007; IN COMMERCE 8-8-2007.

THE MARK CONSISTS OF STANDARD CHAR-  
ACTERS WITHOUT CLAIM TO ANY PARTICULAR  
FONT, STYLE, SIZE, OR COLOR.

NO CLAIM IS MADE TO THE EXCLUSIVE  
RIGHT TO USE "AUTHOR", APART FROM THE  
MARK AS SHOWN.

SER. NO. 77-308,191, FILED 10-19-2007.

JUSTINE D. PARKER, EXAMINING ATTORNEY

**Int. Cl.: 35**

**Prior U.S. Cls.: 100, 101 and 102**

**United States Patent and Trademark Office**

**Reg. No. 3,453,012**

**Registered June 24, 2008**

**SERVICE MARK  
PRINCIPAL REGISTER**

**EPNConnect**

CORPORATE EXECUTIVE BOARD COMPANY  
(DELAWARE CORPORATION)  
2000 PENNSYLVANIA AVE., NW, SUITE 6000  
WASHINGTON DC, DC 20006

THE MARK CONSISTS OF STANDARD CHAR-  
ACTERS WITHOUT CLAIM TO ANY PARTICULAR  
FONT, STYLE, SIZE, OR COLOR.

FOR: PROVIDING MEMBERSHIP-BASED BUSI-  
NESS ADVICE AND BUSINESS INFORMATION  
OVER TELEPHONE OR INTERNET, IN CLASS 35  
(U.S. CLS. 100, 101 AND 102).

SER. NO. 77-308,202, FILED 10-19-2007.

FIRST USE 8-31-2007; IN COMMERCE 8-31-2007.

TOBY BULLOFF, EXAMINING ATTORNEY

**Int. Cls.: 36, 37, 41 and 43**

**Prior U.S. Cls.: 100, 101, 102, 103, 106 and 107**

**United States Patent and Trademark Office**

**Reg. No. 3,453,013**

**Registered June 24, 2008**

**SERVICE MARK  
PRINCIPAL REGISTER**

**CASUAL ELEGANCE TEXAS  
STYLE**

BOOT RANCH REAL ESTATE, LLC (DELAWARE  
LTD LIAB CO)  
77 BOOT RANCH CIRCLE  
FREDERICKSBURG, TX 78624

FOR: REAL ESTATE SERVICES, NAMELY,  
BROKERAGE, LISTING AND MANAGEMENT SER-  
VICES, IN CLASS 36 (U.S. CLS. 100, 101 AND 102).

FIRST USE 12-31-2004; IN COMMERCE 12-31-2004.

FOR: REAL ESTATE DEVELOPMENT SERVICES,  
NAMELY, PLANNING, LAYING OUT AND DEVEL-  
OPING RESORT RESIDENTIAL COMMUNITY OF  
HOMES AND SUNDAY HOUSES, IN CLASS 37 (U.S.  
CLS. 100, 103 AND 106).

FIRST USE 12-31-2004; IN COMMERCE 12-31-2004.

FOR: PROVIDING RECREATIONAL FACILITIES  
FOR OTHERS AND PROVIDING ENTERTAIN-  
MENT SERVICES FOR RESORT GUESTS AND  
RESIDENTS, NAMELY, GOLF CLUB AND COUN-  
TRY CLUB SERVICES, AND GOLF COURSES;  
EDUCATIONAL SERVICES FOR RESORT GUESTS  
AND RESIDENTS, NAMELY, GOLF INSTRU-  
CTION; ORGANIZING AND ARRANGING GOLF

TOURNAMENTS, GOLF SCHOOLS, AND GOLF  
CLINICS, IN CLASS 41 (U.S. CLS. 100, 101 AND 107).

FIRST USE 12-31-2004; IN COMMERCE 12-31-2004.

FOR: HOTEL AND RESORT SERVICES, NAME-  
LY, PROVIDING RESORT LODGING, AND PRO-  
VIDING BANQUET, SOCIAL FUNCTION,  
CONVENTION AND EXHIBITION FACILITIES  
FOR SPECIAL OCCASIONS AND GENERAL USE;  
HOTEL AND RESTAURANT SERVICES, IN CLASS  
43 (U.S. CLS. 100 AND 101).

FIRST USE 12-31-2004; IN COMMERCE 12-31-2004.

THE MARK CONSISTS OF STANDARD CHAR-  
ACTERS WITHOUT CLAIM TO ANY PARTICULAR  
FONT, STYLE, SIZE, OR COLOR.

NO CLAIM IS MADE TO THE EXCLUSIVE  
RIGHT TO USE "TEXAS", APART FROM THE  
MARK AS SHOWN.

SER. NO. 77-308,228, FILED 10-19-2007.

DANNEAN HETZEL, EXAMINING ATTORNEY

Int. Cl.: 30

Prior U.S. Cl.: 46

United States Patent and Trademark Office

Reg. No. 3,453,014

Registered June 24, 2008

TRADEMARK  
PRINCIPAL REGISTER



CARMACK, JUANITA S. (UNITED STATES INDIVIDUAL)  
P.O. BOX 1370  
RATHDRUM, ID 83858 AND  
CARMACK, JOHN W. (UNITED STATES INDIVIDUAL)  
PO BOX 1370  
RATHDRUM, ID 83858

FOR: MEXICAN FOOD PRODUCTS, NAMELY, SALSAS, HOT SAUCES, DIPPING SAUCES, TORTILLAS, SPICES, TAMALES, ENCHILADAS, AND BURRITOS, IN CLASS 30 (U.S. CL. 46).

FIRST USE 1-3-2004; IN COMMERCE 3-1-2004.

NO CLAIM IS MADE TO THE EXCLUSIVE RIGHT TO USE "TACO" AND "SALSA", APART FROM THE MARK AS SHOWN.

SER. NO. 77-308,245, FILED 10-19-2007.

ALEXANDER L. POWERS, EXAMINING ATTORNEY

**Int. Cl.: 16**

**Prior U.S. Cls.: 2, 5, 22, 23, 29, 37, 38 and 50**

**Reg. No. 3,453,015**

**United States Patent and Trademark Office**

**Registered June 24, 2008**

**TRADEMARK  
PRINCIPAL REGISTER**

**BUCKHEAD HOME & LIFE**

SIMON PUBLISHING, LLC (GEORGIA LTD LIAB  
CO)  
P.O. BOX 550307  
ATLANTA, GA 30355

FOR: MAGAZINES IN THE FIELD OF HOMES  
AND LIFESTYLES, IN CLASS 16 (U.S. CLS. 2, 5, 22, 23,  
29, 37, 38 AND 50).

FIRST USE 9-1-2007; IN COMMERCE 9-1-2007.

THE MARK CONSISTS OF STANDARD CHAR-  
ACTERS WITHOUT CLAIM TO ANY PARTICULAR  
FONT, STYLE, SIZE, OR COLOR.

NO CLAIM IS MADE TO THE EXCLUSIVE  
RIGHT TO USE "BUCKHEAD HOME", APART  
FROM THE MARK AS SHOWN.

SER. NO. 77-308,249, FILED 10-19-2007.

DAVID COLLIER, EXAMINING ATTORNEY



**Int. Cl.: 42**

**Prior U.S. Cls.: 100 and 101**

**United States Patent and Trademark Office**

**Reg. No. 3,453,016**

**Registered June 24, 2008**

**SERVICE MARK  
PRINCIPAL REGISTER**

**GOLDEN PACIFIC**

GOLDEN PACIFIC LABORATORIES, LLC (CALIFORNIA LTD LIAB CO)  
SUITE 105  
4720 WEST JENNIFER AVE  
FRESNO, CA 93722

FOR: LABORATORY SERVICES, NAMELY, LABORATORY RESEARCH AND ANALYSIS IN THE FIELD OF RESIDUE ANALYSIS AND ANALYTICAL CHEMISTRY; SCIENTIFIC AND TECHNOLOGICAL SERVICES, NAMELY, SCIENTIFIC INVESTIGATIONS AND RESEARCH AND DEVELOPMENT OF PHARMACEUTICALS, PESTICIDES, HOUSEHOLD PRODUCTS, ENVIRONMENTAL

POLLUTANTS, AND FRAGRANCES, IN CLASS 42 (U.S. CLS. 100 AND 101).

FIRST USE 4-5-2004; IN COMMERCE 4-5-2004.

THE MARK CONSISTS OF STANDARD CHARACTERS WITHOUT CLAIM TO ANY PARTICULAR FONT, STYLE, SIZE, OR COLOR.

SER. NO. 77-308,317, FILED 10-19-2007.

JAMES MACFARLANE, EXAMINING ATTORNEY

**Int. Cl.: 41**

**Prior U.S. Cls.: 100, 101 and 107**

**United States Patent and Trademark Office**

**Reg. No. 3,453,017**

**Registered June 24, 2008**

**SERVICE MARK  
PRINCIPAL REGISTER**

# Vibrant Cuisine

JEEP, ROBIN (UNITED STATES INDIVIDUAL)  
3233 BRANNON  
WACO, TX 76710

FOR: EDUCATION SERVICES, NAMELY, PROVIDING LECTURES, WORKSHOPS, AND PERSONAL COACHING IN THE FIELD OF HOLISM, NUTRITION, ANTIOXIDANT CULINARY INSTRUCTION AND PHYSICAL FITNESS , IN CLASS 41 (U.S. CLS. 100, 101 AND 107).

FIRST USE 9-10-2007; IN COMMERCE 9-10-2007.

THE MARK CONSISTS OF STANDARD CHARACTERS WITHOUT CLAIM TO ANY PARTICULAR FONT, STYLE, SIZE, OR COLOR.

NO CLAIM IS MADE TO THE EXCLUSIVE RIGHT TO USE "CUISINE", APART FROM THE MARK AS SHOWN.

SER. NO. 77-308,335, FILED 10-19-2007.

ELLEN PERKINS, EXAMINING ATTORNEY

**Int. Cls.: 16, 35 and 41**

**Prior U.S. Cls.: 2, 5, 22, 23, 29, 37, 38, 50, 100, 101, 102  
and 107**

**Reg. No. 3,453,018**

**United States Patent and Trademark Office**

**Registered June 24, 2008**

**TRADEMARK  
SERVICE MARK  
PRINCIPAL REGISTER**

**CMAA**

CONSTRUCTION MANAGEMENT ASSOCIATION OF AMERICA, INC. (VIRGINIA CORPORATION)  
SUITE 800  
7926 JONES BRANCH DRIVE  
MCLEAN, VA 22102

FOR: PRINTED PUBLICATIONS, NAMELY, BOOKS, MANUALS, GUIDES, NEWSLETTERS, MAGAZINES, WHITE PAPERS AND JOURNALS IN THE FIELD OF CONSTRUCTION MANAGEMENT, IN CLASS 16 (U.S. CLS. 2, 5, 22, 23, 29, 37, 38 AND 50).

FIRST USE 0-0-1982; IN COMMERCE 0-0-1982.

FOR: ASSOCIATION SERVICES, NAMELY, PROMOTING THE INTERESTS OF CONSTRUCTION MANAGEMENT PROFESSIONALS AND THE FIELD OF CONSTRUCTION MANAGEMENT IN AN EFFORT TO PROMOTE AND ENHANCE LEADERSHIP, PROFESSIONALISM, AND EXCELLENCE IN THE MANAGEMENT OF THE CONSTRUCTION PROCESS; LOBBYING SERVICES, NAMELY, PROMOTING THE INTERESTS OF CONSTRUCTION MANAGEMENT PROFESSIONALS AND THE CONSTRUCTION MANAGEMENT INDUSTRY IN THE FIELDS OF LEGISLATION AND REGULATION; PROVIDING AN ON-LINE

SEARCHABLE DATABASE FEATURING CLASSIFIED AD LISTINGS AND EMPLOYMENT OPPORTUNITIES; ARRANGING AND CONDUCTING TRADE SHOWS IN THE FIELD OF CONSTRUCTION MANAGEMENT, IN CLASS 35 (U.S. CLS. 100, 101 AND 102).

FIRST USE 0-0-1982; IN COMMERCE 0-0-1982.

FOR: EDUCATIONAL SERVICES, NAMELY, DEVELOPING, ARRANGING AND CONDUCTING COURSES OF INSTRUCTION, SEMINARS, WORKSHOPS, SYMPOSIA AND EDUCATIONAL CONFERENCES IN THE FIELD OF CONSTRUCTION MANAGEMENT, IN CLASS 41 (U.S. CLS. 100, 101 AND 107).

FIRST USE 0-0-1982; IN COMMERCE 0-0-1982.

THE MARK CONSISTS OF STANDARD CHARACTERS WITHOUT CLAIM TO ANY PARTICULAR FONT, STYLE, SIZE, OR COLOR.

SER. NO. 77-308,401, FILED 10-19-2007.

BRIAN NEVILLE, EXAMINING ATTORNEY

**Int. Cl.: 9**

**Prior U.S. Cls.: 21, 23, 26, 36 and 38**

**Reg. No. 3,453,019**

**United States Patent and Trademark Office**

**Registered June 24, 2008**

**TRADEMARK  
PRINCIPAL REGISTER**

**GLESS STREET RECORDS**

VICTORY OUTREACH INTERNATIONAL (CALIFORNIA CORPORATION)

250 W ARROW HWY

SAN DIMAS, CA 91773

FOR: PRE-RECORDED CDS FEATURING MUSIC, IN CLASS 9 (U.S. CLS. 21, 23, 26, 36 AND 38).

FIRST USE 7-1-2007; IN COMMERCE 7-1-2007.

THE MARK CONSISTS OF STANDARD CHARACTERS WITHOUT CLAIM TO ANY PARTICULAR FONT, STYLE, SIZE, OR COLOR.

NO CLAIM IS MADE TO THE EXCLUSIVE RIGHT TO USE "RECORDS", APART FROM THE MARK AS SHOWN.

SER. NO. 77-308,453, FILED 10-19-2007.

ERIN FALK, EXAMINING ATTORNEY

**Int. Cl.: 8**

**Prior U.S. Cls.: 23, 28 and 44**

**Reg. No. 3,453,020**

**United States Patent and Trademark Office**

**Registered June 24, 2008**

---

**TRADEMARK  
PRINCIPAL REGISTER**

**POCKET PAL**

SMITH ABRASIVES, INC. (DELAWARE CORPORATION)  
1700 SLEEPY VALLEY ROAD  
HOT SPRINGS, AR 71901

FOR: HAND-OPERATED SHARPENING TOOLS AND INSTRUMENTS; HAND TOOLS, NAMELY, KNIFE SHARPENERS; KNIFE SHARPENERS; MANUALLY OPERATED SHARPENERS, IN CLASS 8 (U.S. CLS. 23, 28 AND 44).

FIRST USE 10-31-2006; IN COMMERCE 10-31-2006.

THE MARK CONSISTS OF STANDARD CHARACTERS WITHOUT CLAIM TO ANY PARTICULAR FONT, STYLE, SIZE, OR COLOR.

SER. NO. 77-308,460, FILED 10-19-2007.

MICHAEL WIENER, EXAMINING ATTORNEY

**Int. Cl.: 36**

**Prior U.S. Cls.: 100, 101 and 102**

**United States Patent and Trademark Office**

**Reg. No. 3,453,021**

**Registered June 24, 2008**

**SERVICE MARK  
PRINCIPAL REGISTER**

**MOMENTUM MATRIX**

CHANGE POINT ANALYTICS LTD (IRELAND  
CORPORATION)  
2330 LAS FLORES CANYON ROAD  
MALIBU, CA 90265

FOR: PROVIDING STOCK/SECURITIES MAR-  
KET INFORMATION, IN CLASS 36 (U.S. CLS. 100,  
101 AND 102).

FIRST USE 11-1-2006; IN COMMERCE 11-1-2006.

THE MARK CONSISTS OF STANDARD CHAR-  
ACTERS WITHOUT CLAIM TO ANY PARTICULAR  
FONT, STYLE, SIZE, OR COLOR.

SER. NO. 77-308,487, FILED 10-19-2007.

MARK T. MULLEN, EXAMINING ATTORNEY

**Int. Cl.: 9**

**Prior U.S. Cls.: 21, 23, 26, 36 and 38**

**Reg. No. 3,453,022**

**United States Patent and Trademark Office**

**Registered June 24, 2008**

**TRADEMARK  
PRINCIPAL REGISTER**



RF CODE, INC. (DELAWARE CORPORATION)  
9229 WATERFORD CENTER BLVD., SUITE 500  
AUSTIN, TX 78758

FOR: COMPUTER HARDWARE, CIRCUIT ASSEMBLIES, INTEGRATED CIRCUITS, ASSOCIATED WITH RECEIVERS, TRANSMITTERS, INTERROGATORS, READERS, TRANSPONDERS, AND TAGS ALL IN THE FIELD OF ITEM TRACKING, ITEM IDENTIFICATION, DOCUMENT TRACKING, DOCUMENT IDENTIFICATION, INVENTORY MANAGEMENT, THE EXCHANGE OF INFORMATION TO AND FROM A CUSTOMER DATABASE, AND THE EXCHANGE OF INFORMATION TO AND FROM A GENERAL DATABASE; COMPUTER SOFTWARE FOR ITEM TRACKING, ITEM IDENTIFICATION, DOCUMENT TRACKING, DOCUMENT IDENTIFICATION, INVENTORY MANAGEMENT, THE EXCHANGE OF INFORMATION TO AND FROM A CUSTOMER DATABASE,

AND THE EXCHANGE OF INFORMATION TO AND FROM A GENERAL DATABASE; COMPUTER SOFTWARE FOR USE IN THE FIELD OF WIRELESS DATA COMMUNICATION; COMPUTER SOFTWARE FOR CONTROLLING RECEIVERS, TRANSMITTERS, INTERROGATORS, READERS, TRANSPONDERS, AND TAGS, IN CLASS 9 (U.S. CLS. 21, 23, 26, 36 AND 38).

FIRST USE 5-15-2007; IN COMMERCE 5-15-2007.

THE MARK CONSISTS OF AN ARC WITH AN OVAL LOCATED ADJACENT THE CONCAVE SURFACE OF THE ARC.

SER. NO. 77-308,751, FILED 10-19-2007.

JANICE L. MCMORROW, EXAMINING ATTORNEY

**Int. Cl.: 42**

**Prior U.S. Cls.: 100 and 101**

**United States Patent and Trademark Office**

**Reg. No. 3,453,023**

**Registered June 24, 2008**

**SERVICE MARK  
PRINCIPAL REGISTER**



OUTCOMES, INC. (ALABAMA CORPORATION)  
300 RIVERCHASE PARKWAY EAST  
BIRMINGHAM, AL 35244

FOR: MEASUREMENT EVALUATIONS IN THE  
CONTINUING EDUCATION FIELD, IN CLASS 42  
(U.S. CLS. 100 AND 101).

FIRST USE 5-1-2005; IN COMMERCE 7-1-2007.

NO CLAIM IS MADE TO THE EXCLUSIVE  
RIGHT TO USE "QUALITY OF EDUCATION IN-  
DEX", APART FROM THE MARK AS SHOWN.

THE COLOR(S) NAVY BLUE, RED, GREEN,  
LAVENDER AND LIGHT BLUE IS/ARE CLAIMED  
AS A FEATURE OF THE MARK.

THE COLOR NAVY BLUE APPEARS IN THE  
LETTERS "Q" AND "E," THE WORDING "QUALITY  
OF EDUCATION INDEX," AND THE DESIGN OF  
THE BRACKETS AND THE BACKGROUND OF  
THE CIRCULAR DESIGN. THE CURVED LINE  
DESIGN EXTENDING FROM THE LETTER "Q"  
TO THE LETTER "E" IS SHOWN IN RED, NAVY  
BLUE AND GREEN. THE COLORS LAVENDER  
AND LIGHT BLUE ARE SHOWN AS CROSSED  
LINES IN THE NAVY BLUE CIRCLE.

SER. NO. 77-308,771, FILED S.R. 10-19-2007 AM.  
P.R. 2-5-2008.

SHANNON TWOHIG, EXAMINING ATTORNEY



**Int. Cl.: 35**

**Prior U.S. Cls.: 100, 101 and 102**

**United States Patent and Trademark Office**

**Reg. No. 3,453,024**

**Registered June 24, 2008**

**SERVICE MARK  
PRINCIPAL REGISTER**

**Global**



**Condo Center**

GLOBAL CONDOCENTER CORP. (CANADA CORPORATION)  
851 HOMER STREET  
VANCOUVER, CANADA V6B2W2

FOR: REAL ESTATE MARKETING SERVICES, NAMELY, PROVIDING ON-LINE AND STORE-FRONT SERVICES THAT FEATURE LISTINGS, RESOURCES AND INFORMATION FROM OWNERS, MANAGEMENT COMPANIES AND DEVELOPERS TO CONSUMERS SEEKING RECREATIONAL AND RESIDENTIAL PROPERTIES, IN CLASS 35 (U.S. CLS. 100, 101 AND 102).

FIRST USE 6-1-2006; IN COMMERCE 6-1-2006.

NO CLAIM IS MADE TO THE EXCLUSIVE RIGHT TO USE "CONDO CENTER", APART FROM THE MARK AS SHOWN.

THE COLOR(S) RED, BLUE, YELLOW, WHITE AND GREY IS/ARE CLAIMED AS A FEATURE OF THE MARK.

THE MARK CONSISTS OF THE WORDS "GLOBAL CONDO CENTER" IN BLACK, TOGETHER WITH A DESIGN OF A SHOPPING BAG IN THE COLORS BLUE AND BLACK ON THE BAG INTERIOR AND ONE HANDLE, THE COLOR YELLOW FOR A BAG FACE, THE COLOR RED FOR A HANDLE AND A BAG FACE WITH A WHITE LINE DESIGN OF A GLOBE, AND THE COLOR GREY FOR A BAG SHADOW.

SER. NO. 77-308,887, FILED 10-19-2007.

JOHN WILKE, EXAMINING ATTORNEY

**Int. Cls.: 35 and 41**

**Prior U.S. Cls.: 100, 101, 102 and 107**

**United States Patent and Trademark Office**

**Reg. No. 3,453,025**

**Registered June 24, 2008**

**SERVICE MARK  
PRINCIPAL REGISTER**

# A Hire Connection

A HIRE CONNECTION, INC. (CALIFORNIA CORPORATION)  
516 WALKER ROAD  
SAN DIMAS, CA 91773

FOR: EMPLOYEE SEARCH AND PLACEMENT SERVICES, EMPLOYMENT RECRUITING CONSULTATION, IN CLASS 35 (U.S. CLS. 100, 101 AND 102).

FIRST USE 10-15-2006; IN COMMERCE 1-15-2007.

FOR: PROFESSIONAL COACHING SERVICES IN THE FIELD OF EMPLOYEE PERFORMANCE AND LEADERSHIP DEVELOPMENT, EDUCATIONAL

SERVICES, NAMELY, CONDUCTING WORKSHOPS AND SEMINARS IN THE FIELD OF EMPLOYEE RECRUITMENT AND RETENTION, IN CLASS 41 (U.S. CLS. 100, 101 AND 107).

FIRST USE 10-15-2006; IN COMMERCE 1-15-2007.

THE MARK CONSISTS OF STANDARD CHARACTERS WITHOUT CLAIM TO ANY PARTICULAR FONT, STYLE, SIZE, OR COLOR.

SER. NO. 77-308,997, FILED 10-19-2007.

AHSEN KHAN, EXAMINING ATTORNEY

**Int. Cl.: 37**

**Prior U.S. Cls.: 100, 103 and 106**

**United States Patent and Trademark Office**

**Reg. No. 3,453,026**

**Registered June 24, 2008**

**SERVICE MARK  
PRINCIPAL REGISTER**



BRITMAN CONSTRUCTION INC (COLORADO  
CORPORATION)  
P.O. BOX 100668  
DENVER, CO 802500668

FOR: CONSTRUCTION SERVICES, NAMELY,  
CUSTOM CONSTRUCTION AND REPAIR OF  
BUILDINGS, CUSTOM FRAMING CONTRACTOR

SERVICES AND REMODELING OF BUILDINGS, IN  
CLASS 37 (U.S. CLS. 100, 103 AND 106).

FIRST USE 5-19-2005; IN COMMERCE 5-19-2005.

SER. NO. 77-309,011, FILED 10-19-2007.

JESSICA A. POWERS, EXAMINING ATTORNEY

**Int. Cl.: 36**

**Prior U.S. Cls.: 100, 101 and 102**

**United States Patent and Trademark Office**

**Reg. No. 3,453,027**

**Registered June 24, 2008**

**SERVICE MARK  
PRINCIPAL REGISTER**

**Foothills Insider**

BELAKOVSKAIA, ANJELINA (UNITED STATES  
INDIVIDUAL)  
6061 NORTH PASEO ZALDIVAR  
TUCSON, AZ 85750

THE MARK CONSISTS OF STANDARD CHAR-  
ACTERS WITHOUT CLAIM TO ANY PARTICULAR  
FONT, STYLE, SIZE, OR COLOR.

FOR: REAL ESTATE AGENCIES, IN CLASS 36  
(U.S. CLS. 100, 101 AND 102).

SER. NO. 77-309,049, FILED 10-19-2007.

FIRST USE 10-7-2007; IN COMMERCE 10-7-2007.

JAMES LOVELACE, EXAMINING ATTORNEY

**Int. Cl.: 42**

**Prior U.S. Cls.: 100 and 101**

**United States Patent and Trademark Office**

**Reg. No. 3,453,028**

**Registered June 24, 2008**

**SERVICE MARK  
PRINCIPAL REGISTER**



PROFILE TECHNOLOGIES, INC. (DELAWARE CORPORATION)

2 PARK AVE

MANHASSET, NY 11030

FOR: PIPELINE INSPECTION SERVICES, IN CLASS 42 (U.S. CLS. 100 AND 101).

FIRST USE 9-30-2007; IN COMMERCE 10-1-2007.

NO CLAIM IS MADE TO THE EXCLUSIVE RIGHT TO USE "TECHNOLOGIES, INC.", APART FROM THE MARK AS SHOWN.

THE MARK CONSISTS IN PART, OF TWO CONCENTRIC CIRCLES WITH A WAVE PASSING THROUGH THE CIRCLES.

SER. NO. 77-309,104, FILED 10-19-2007.

EDWARD NELSON, EXAMINING ATTORNEY

Int. Cl.: 41

Prior U.S. Cls.: 100, 101 and 107

United States Patent and Trademark Office

Reg. No. 3,453,029

Registered June 24, 2008

SERVICE MARK  
PRINCIPAL REGISTER



THE P SPOT (DELAWARE LTD LIAB CO)  
210 RHODE ISLAND AVE  
WASHINGTON, DC 20001

FOR: PHYSICAL FITNESS INSTRUCTION; PHYSICAL FITNESS CONSULTATION; EDUCATION SERVICES, NAMELY, PROVIDING CLASSES AND INSTRUCTION IN THE FIELDS OF PHYSICAL FITNESS, STRENGTH, CONDITIONING, AND EXERCISE IMPROVEMENT IN THEIR DAILY LIVING, IN CLASS 41 (U.S. CLS. 100, 101 AND 107).

FIRST USE 12-17-2005; IN COMMERCE 3-7-2006.

NO CLAIM IS MADE TO THE EXCLUSIVE RIGHT TO USE "FITNESS STUDIO", APART FROM THE MARK AS SHOWN.

THE MARK CONSISTS OF THE WORDS "THE P SPOT FITNESS STUDIO" IN STYLIZED TEXT. THE LOGO IS A CIRCLE WITH THE LETTER "P". THERE IS A WOMAN SITTING WITHIN THE LETTER.

SER. NO. 77-309,121, FILED 10-19-2007.

JOHN WILKE, EXAMINING ATTORNEY

**Int. Cl.: 37**

**Prior U.S. Cls.: 100, 103 and 106**

**United States Patent and Trademark Office**

**Reg. No. 3,453,030**

**Registered June 24, 2008**

**SERVICE MARK  
PRINCIPAL REGISTER**



MANAGED MOBILE, INC. (CALIFORNIA CORPORATION)  
UNIT B  
1030 NORTH BATAVIA STREET  
ORANGE, CA 92867

THE MARK CONSISTS OF THE MANAGED MOBILE OIL DROP LOGO WITH A BLACK AND YELLOW SWIRL OF COLORS IN THE SHAPE OF AN OIL DROP.

FOR: VEHICLE REPAIR AND MAINTENANCE,  
IN CLASS 37 (U.S. CLS. 100, 103 AND 106).

SER. NO. 77-309,256, FILED 10-20-2007.

FIRST USE 7-18-2001; IN COMMERCE 7-18-2001.

THE COLOR(S) BLACK AND YELLOW IS/ARE CLAIMED AS A FEATURE OF THE MARK.

JULIE WATSON, EXAMINING ATTORNEY

**Int. Cl.: 28**

**Prior U.S. Cls.: 22, 23, 38 and 50**

**United States Patent and Trademark Office**

**Reg. No. 3,453,031**

**Registered June 24, 2008**

**TRADEMARK  
PRINCIPAL REGISTER**

**spark a conversation**

CLEARY, EAVAN M. (UNITED STATES INDIVIDUAL)  
338A LAFAYETTE AVENUE, #2  
BROOKLYN, NY 11238

THE MARK CONSISTS OF STANDARD CHARACTERS WITHOUT CLAIM TO ANY PARTICULAR FONT, STYLE, SIZE, OR COLOR.

FOR: BOARD GAMES; CARD GAMES, IN CLASS 28 (U.S. CLS. 22, 23, 38 AND 50).

SER. NO. 77-309,269, FILED 10-20-2007.

FIRST USE 10-1-2007; IN COMMERCE 10-1-2007.

PAUL E. FAHRENKOPF, EXAMINING ATTORNEY



**Int. Cls.: 18 and 25**

**Prior U.S. Cls.: 1, 2, 3, 22, 39 and 41**

**United States Patent and Trademark Office**

**Reg. No. 3,453,032**

**Registered June 24, 2008**

**TRADEMARK  
PRINCIPAL REGISTER**

**WHEN YOU NEED TO BE SEEN**

JAC AND COOPER, LLC (DELAWARE LTD LIAB CO), DBA JAC AND COOPER  
62 LAKESHORE DRIVE  
HOPKINTON, MA 01748

FOR: DOG CLOTHING; DOG COLLARS; DOG LEASHES; HORSE BLANKETS; SADDLE BLANKETS, IN CLASS 18 (U.S. CLS. 1, 2, 3, 22 AND 41).

FIRST USE 4-5-2007; IN COMMERCE 4-5-2007.

FOR: FLEECE PULLOVERS; PULLOVERS; CREWNECK SWEATERS; MOCK TURTLE-NECK SWEATERS; SWEATERS; TURTLENECK SWEATERS; V-NECK SWEATERS; JOGGING PANTS; LOUNGE PANTS; PANTS; STRETCH PANTS; SWEAT PANTS; TOBOGGAN HATS, PANTS AND CAPS; MEN AND WOMEN JACKETS, COATS, TROUSERS, VESTS; TROUSERS; TROUSERS FOR SWEATING; INFANTS' TROUSERS; JACKETS; LIGHT-REFLECTING JACKETS; SHELL JACKETS; SLEEVED OR SLEEVELESS JACKETS; SPORTS JACKETS; WATERPROOF JACKETS AND PANTS; WIND RESISTANT JACKETS; WIND-JACKETS;

COATS; COATS FOR MEN AND WOMEN; LIGHT-REFLECTING COATS; FLEECE VESTS; HUNTING VESTS; VESTS; WIND VESTS; HATS; WOOLLY HATS; HEADBANDS; SCARVES; GLOVES; OUTDOOR GLOVES; CROSS-COUNTRY MITTENS; MITTENS; OUTDOOR MITTENS; SNOWBOARD MITTENS; DRESSES; SKIRTS AND DRESSES; MEN'S SOCKS; SOCKS; THERMAL SOCKS; WOOLLEN SOCKS; BABY BIBS NOT OF PAPER; CHILDREN'S AND INFANTS' CLOTH BIBS; CHILDREN'S CLOTH EATING BIBS; CLOTH BIBS; BABY BUNTING, IN CLASS 25 (U.S. CLS. 22 AND 39).

FIRST USE 4-5-2007; IN COMMERCE 4-5-2007.

THE MARK CONSISTS OF STANDARD CHARACTERS WITHOUT CLAIM TO ANY PARTICULAR FONT, STYLE, SIZE, OR COLOR.

SER. NO. 77-309,279, FILED 10-20-2007.

CAROLYN GRAY, EXAMINING ATTORNEY

Int. Cl.: 35

Prior U.S. Cls.: 100, 101 and 102

United States Patent and Trademark Office

Reg. No. 3,453,033

Registered June 24, 2008

SERVICE MARK  
PRINCIPAL REGISTER



SINDONI, RONALD BRUCE (UNITED STATES  
INDIVIDUAL)  
PO BOX 12856  
MARINA DEL REY, CA 90295

FOR: ADVERTISING AND ADVERTISEMENT SERVICES; ADVERTISING AND COMMERCIAL INFORMATION SERVICES, VIA THE INTERNET; ADVERTISING AND MARKETING; ADVERTISING AND PROMOTIONAL SERVICES; ADVERTISING AND PUBLICITY SERVICES; ADVERTISING AND PUBLICITY SERVICES, NAMELY, PROMOTING THE GOODS, SERVICES, BRAND IDENTITY AND COMMERCIAL INFORMATION AND NEWS OF THIRD PARTIES THROUGH PRINT, AUDIO, VIDEO, DIGITAL AND ON-LINE MEDIUM; ADVERTISING BUSINESS ESPECIALLY IN THE FIELD OF TELEMATIC AND TELEPHONE NETWORKS; ADVERTISING BY TRANSMISSION OF ON-LINE PUBLICITY FOR THIRD PARTIES THROUGH ELECTRONIC COMMUNICATIONS NETWORKS; ADVERTISING CONSULTATION; ADVERTISING PARTICULARLY SERVICES FOR THE PROMOTION OF GOODS; ADVERTISING SERVICES; ADVERTISING SERVICES FOR PROMOTING THE BROKERAGE OF STOCKS AND OTHER SECURITIES; ADVERTISING SERVICES, FOR THIRD PARTIES, IN CONNECTION WITH THE COMMERCIALIZATION AND SALE OF PERFUMERY AND COSMETIC ARTICLES, PRODUCTS FOR HOUSEHOLD PURPOSES, OPTICAL PRODUCTS, CLOCKS AND TIMEPIECES, JEWELLERY, FURNISHING ARTICLES; ADVERTISING SERVICES, NAMELY PROMOTING PROPERTIES FOR SALE BY OWNER VIA THE INTERNET; ADVERTISING SERVICES, NAMELY, PROMOTING AND MARKETING THE GOODS AND SERVICES OF OTHERS THROUGH ALL PUBLIC COMMUNICATION MEANS; ADVERTISING SERVICES, NAMELY, PROMOTING THE FOOD AND WINE OF OTHERS; ADVERTISING SERVICES, NAMELY, PROMOTING THE GIFT CARDS OF OTHERS; ADVERTISING

SERVICES, PUBLIC RELATIONS AND MARKETING SERVICES, NAMELY, PROMOTING AND MARKETING THE GOODS AND SERVICES OF OTHERS THROUGH ALL PUBLIC COMMUNICATION MEANS; ADVERTISING THROUGH ALL PUBLIC COMMUNICATION MEANS; ADVERTISING VIA ELECTRONIC MEDIA AND SPECIFICALLY THE INTERNET; ADVERTISING, INCLUDING PROMOTION RELATING TO THE SALE OF ARTICLES AND SERVICES FOR THIRD PARTIES BY THE TRANSMISSION OF ADVERTISING MATERIAL AND THE DISSEMINATION OF ADVERTISING MESSAGES ON COMPUTER NETWORKS; ADVERTISING, MARKETING AND PROMOTION SERVICES; ADVERTISING, MARKETING AND PROMOTIONAL SERVICES FOR AUTOMOTIVE DEALERSHIPS; CINEMA ADVERTISING; COOPERATIVE ADVERTISING AND MARKETING; COOPERATIVE ADVERTISING AND MARKETING SERVICES BY WAY OF SOLICITATION, CUSTOMER SERVICE AND PROVIDING MARKETING INFORMATION VIA WEBSITES ON A GLOBAL COMPUTER NETWORK; CREATING AND UPDATING ADVERTISING MATERIAL; DESIGN OF ADVERTISING FLYERS FOR OTHERS; DESIGN OF ADVERTISING MATERIALS FOR OTHERS; DESIGN OF INTERNET ADVERTISING; DISPLAYING ADVERTISEMENTS FOR OTHERS; DISSEMINATION OF ADVERTISEMENTS; DISSEMINATION OF ADVERTISING FOR OTHERS VIA AN ON-LINE COMMUNICATIONS NETWORK ON THE INTERNET; DISSEMINATION OF ADVERTISING FOR OTHERS VIA THE INTERNET; DISSEMINATION OF ADVERTISING MATTER; DISTRIBUTION OF ADVERTISEMENTS AND COMMERCIAL ANNOUNCEMENTS; DISTRIBUTION OF PRODUCTS FOR ADVERTISING PURPOSES; ELECTRONIC BILLBOARD ADVERTISING; ELECTRONIC COMMERCE SERVICES, NAMELY, PROVIDING INFORMATION ABOUT PRODUCTS VIA TELECOMMUNICATION NETWORKS FOR ADVERTISING AND SALES PURPOSES; INSURANCE

LEAD COLLECTION AND MATCHING SERVICES, NAMELY, MATCHING CONSUMER REQUESTS FOR INSURANCE POLICY QUOTES COLLECTED OVER THE INTERNET TO PRE-QUALIFIED INSURANCE BROKERS, AGENTS AND AGENCIES INTERESTED IN THOSE REQUESTS; INTERNET ADVERTISING SERVICES; LAYOUT SERVICES FOR ADVERTISING PURPOSES; MARKETING AND ADVERTISING SERVICES FOR AUTOMOBILE DEALERSHIPS; MARKETING, PROMOTIONAL AND ADVERTISING SERVICES PROVIDED BY MOBILE TELEPHONE CONNECTIONS; MODELING SERVICES FOR ADVERTISING OR SALES PROMOTION; ON-LINE ADVERTISING AND MARKETING SERVICES; ON-LINE ADVERTISING ON COMPUTER COMMUNICATION NETWORKS; ON-LINE TRADING SERVICES IN WHICH SELLER POSTS PRODUCTS TO BE AUCTIONED AND BIDDING IS DONE VIA THE INTERNET; PLACING ADVERTISEMENTS FOR OTHERS; PREPARATION AND REALIZATION OF MEDIA AND ADVERTISING PLANS AND CONCEPTS; PREPARATION OF CUSTOM ADVERTISEMENTS FOR OTHERS; PREPARATION OF CUSTOM OR NON-CUSTOM ADVERTISING FOR BUSINESSES FOR DISSEMINATION VIA THE WEB, CD OR DVD FOR OPTIONAL UPLOAD OR DOWNLOAD TO A COMPUTER; PREPARING ADVERTISEMENTS FOR OTHERS; PREPARING AND PLACING ADVERTISEMENTS FOR OTHERS; PREPARING AND PLACING OF ADVERTISEMENTS; PROMOTING THE GOODS AND SERVICES OF OTHERS BY DISTRIBUTING ADVERTISING MATERIALS THROUGH A VARIETY OF METHODS; PROMOTING THE GOODS AND SERVICES OF OTHERS BY PREPARING AND PLACING ADVERTISEMENTS IN AN ELECTRONIC MAGAZINE ACCESSED THROUGH A GLOBAL COMPUTER NETWORK; PROMOTING, ADVERTISING AND MARKETING OF THE ON-LINE WEBSITES OF OTHERS; PROMOTION, ADVERTISING AND MARKETING OF ON-LINE WEBSITES; PROVIDING A SEARCHABLE ONLINE ADVERTISING GUIDE FEATURING THE GOODS AND SERVICES OF OTHER ON-LINE VENDORS ON THE INTERNET; PROVIDING A WEB SITE THAT ENABLES USERS TO POST ITEMS FOR SALE THROUGH ON-LINE CLASSIFIED ADVERTISEMENTS; PROVIDING A WEB SITE WHICH FEATURES ADVERTISEMENTS FOR THE GOODS AND SERVICES OF OTHERS ON A GLOBAL COMPUTER NETWORK; PROVIDING ADVERTISING, MARKETING AND PROMOTIONAL SERVICES FOR THE PHARMACEUTICAL AND MEDICAL INDUSTRY; PROVIDING ADVERTISING, MARKETING AND PROMOTIONAL SERVICES FOR THE PHARMACEUTICAL AND MEDICAL PRODUCTS OF OTHERS; PROVIDING AN ON-LINE COMMERCIAL INFORMATION DIRECTORY ON THE INTERNET; PROVIDING AND RENTAL OF ADVERTISING SPACE ON THE INTERNET; PROVIDING BUSINESS INFORMATION, ALSO VIA INTERNET, THE CABLE NETWORK OR OTHER

FORMS OF DATA TRANSFER; PROVIDING CONSUMER PRODUCT INFORMATION VIA THE INTERNET; PROVIDING INFORMATION ABOUT AUTOMOBILES FOR SALE BY MEANS OF THE INTERNET; PROVIDING SPACE AT A WEB SITE FOR THE ADVERTISEMENT OF THE GOODS AND SERVICES OF OTHERS; PROVISION OF ADVERTISING SPACE BY ELECTRONIC MEANS AND GLOBAL INFORMATION NETWORKS; PUBLISHING OF ADVERTISING TEXTS; REAL ESTATE ADVERTISING SERVICES; RENTAL OF ADVERTISING SPACE; RENTAL OF ADVERTISING SPACE ON WEB SITES; RENTAL OF SIGNS FOR ADVERTISING PURPOSES; TELEVISION ADVERTISING AGENCIES; INFORMATION IN BUSINESS MATTERS; INFORMATION IN THE FIELD OF ENERGY EFFICIENCY; INFORMATION IN THE FIELD OF GOVERNMENT AFFAIRS; MANAGED CARE SERVICES, NAMELY, ELECTRONIC PROCESSING OF HEALTH CARE INFORMATION; ON-LINE POSTING OF REWARDS FOR INFORMATION; PROVIDING INFORMATION REGARDING POLITICAL ISSUES, KNOWING HOW TO VOTE AND KNOWING HOW TO REGISTER TO VOTE; PROVIDING ON-LINE DIRECTORY INFORMATION SERVICES ALSO FEATURING HYPERLINKS TO OTHER WEB SITES; PROVIDING TRADE INFORMATION, IN CLASS 35 (U.S. CLS. 100, 101 AND 102).

FIRST USE 10-14-2007; IN COMMERCE 10-14-2007.

THE COLOR(S) RAINBOW COLORS, RED, ORANGE, YELLOW, GREEN, BLUE, PURPLE, WHITE, BLACK, REDDISH PINK, AND REDDISH PINK SKIN COLOR IS/ARE CLAIMED AS A FEATURE OF THE MARK.

THE MARK CONSISTS OF THE LETTERS OF THE NAME DWEBEE ARE FILLED WITH HORIZONTAL RAINBOW COLORS, WITH RED ON THE TOP, ORANGE UNDER RED, YELLOW UNDER ORANGE, GREEN UNDER YELLOW, BLUE UNDER GREEN, AND PURPLE UNDER BLUE. ALL LETTERS HAVE A BLACK BORDER. ON THE RIGHT SIDE OF THE LETTERS THERE IS ONE SMILING RED TOMATO MAN WITH GREEN VINE LIKE HAIR. HE IS WEARING WHITE SHOES WITH LIGHT BLUE SOLES AND LIGHT BLUE SHOE LACES. HE HAS TWO WHITE GLOVES ON HIS TWO HANDS. HIS HANDS ARE CONNECTED TO TWO SMALL REDDISH PINK SKIN COLORED ARMS THAT CONNECT TO HIS RED TOMATO BODY. HE HAS A REDDISH PINK TONGUE, WHITE TEETH AND TWO WHITE EYES WITH SMALL BLACK PUPILS IN THE CENTER OF HIS EYES. HE HAS A REDDISH PINK SKIN COLORED NOSE.

SER. NO. 77-309,290, FILED 10-20-2007.

STEVEN JACKSON, EXAMINING ATTORNEY

**Int. Cl.: 36**

**Prior U.S. Cls.: 100, 101 and 102**

**United States Patent and Trademark Office**

**Reg. No. 3,453,034**

**Registered June 24, 2008**

**SERVICE MARK  
PRINCIPAL REGISTER**

OPENING FINE HOMES TO THE  
WORLD

LILA DELMAN REAL ESTATE LTD (RHODE  
ISLAND CORPORATION)  
41 OCEAN RD  
NARRAGANSETT, RI 02882

THE MARK CONSISTS OF STANDARD CHAR-  
ACTERS WITHOUT CLAIM TO ANY PARTICULAR  
FONT, STYLE, SIZE, OR COLOR.

FOR: REAL ESTATE AGENCIES, IN CLASS 36  
(U.S. CLS. 100, 101 AND 102).

SER. NO. 77-309,295, FILED 10-20-2007.

FIRST USE 6-30-2006; IN COMMERCE 6-30-2006.

MICHAEL LITZAU, EXAMINING ATTORNEY

Int. Cl.: 30

Prior U.S. Cl.: 46

Reg. No. 3,453,035

United States Patent and Trademark Office

Registered June 24, 2008

TRADEMARK  
PRINCIPAL REGISTER



WAHL, MICHELLE C (UNITED STATES INDIVIDUAL), DBA BIG ASS GRILL  
2050 W WHISPERING WIND DR #152  
PHOENIX, AZ 85085

NO CLAIM IS MADE TO THE EXCLUSIVE RIGHT TO USE "GRILL" , APART FROM THE MARK AS SHOWN.

FOR: MARINADES, IN CLASS 30 (U.S. CL. 46).

SER. NO. 77-309,365, FILED 10-21-2007.

FIRST USE 10-20-2007; IN COMMERCE 10-20-2007.

DEBRA LEE, EXAMINING ATTORNEY

**Int. Cl.: 14**

**Prior U.S. Cls.: 2, 27, 28 and 50**

**United States Patent and Trademark Office**

**Reg. No. 3,453,036**

**Registered June 24, 2008**

**TRADEMARK  
PRINCIPAL REGISTER**

**Healed by God**

STICKY JEWELRY, INC. (FLORIDA CORPORATION)  
2082 KANSAS AV. NE  
SAINT PETERSBURG, FL 33703

THE MARK CONSISTS OF STANDARD CHARACTERS WITHOUT CLAIM TO ANY PARTICULAR FONT, STYLE, SIZE, OR COLOR.

FOR: BRACELETS; PENDANTS; NECKLACES; JEWELRY, IN CLASS 14 (U.S. CLS. 2, 27, 28 AND 50).

SER. NO. 77-309,388, FILED 10-21-2007.

FIRST USE 10-15-2007; IN COMMERCE 10-15-2007.

EMILY CHUO, EXAMINING ATTORNEY

**Int. Cl.: 35**

**Prior U.S. Cls.: 100, 101 and 102**

**United States Patent and Trademark Office**

**Reg. No. 3,453,037**

**Registered June 24, 2008**

**SERVICE MARK  
PRINCIPAL REGISTER**

# Royalty Agency

ROYALTY AGENCY INC. (MICHIGAN CORPORATION)

1305 S. CEDAR STREET, SUITE 203

LANSING, MI 48910

FOR: MODELING AGENCIES, IN CLASS 35 (U.S. CLS. 100, 101 AND 102).

FIRST USE 6-1-2006; IN COMMERCE 6-1-2006.

THE MARK CONSISTS OF STANDARD CHARACTERS WITHOUT CLAIM TO ANY PARTICULAR FONT, STYLE, SIZE, OR COLOR.

NO CLAIM IS MADE TO THE EXCLUSIVE RIGHT TO USE "AGENCY", APART FROM THE MARK AS SHOWN.

SER. NO. 77-309,400, FILED 10-21-2007.

EMILY CHUO, EXAMINING ATTORNEY

**Int. Cl.: 36**

**Prior U.S. Cls.: 100, 101 and 102**

**United States Patent and Trademark Office**

**Reg. No. 3,453,038**

**Registered June 24, 2008**

**SERVICE MARK  
PRINCIPAL REGISTER**

**Girlfriends Movin' Up**

KELSO, BRENDA A (UNITED STATES INDIVIDUAL)  
4950 NIGHTSHADE CIRCLE  
COLORADO SPRINGS, CO 80919

THE MARK CONSISTS OF STANDARD CHARACTERS WITHOUT CLAIM TO ANY PARTICULAR FONT, STYLE, SIZE, OR COLOR.

FOR: REAL ESTATE AGENCIES, IN CLASS 36 (U.S. CLS. 100, 101 AND 102).

SER. NO. 77-309,421, FILED 10-21-2007.

FIRST USE 4-1-2007; IN COMMERCE 9-1-2007.

SHAILA SETTLES, EXAMINING ATTORNEY



**Int. Cl.: 28**

**Prior U.S. Cls.: 22, 23, 38 and 50**

**Reg. No. 3,453,039**

**United States Patent and Trademark Office**

**Registered June 24, 2008**

**TRADEMARK  
PRINCIPAL REGISTER**

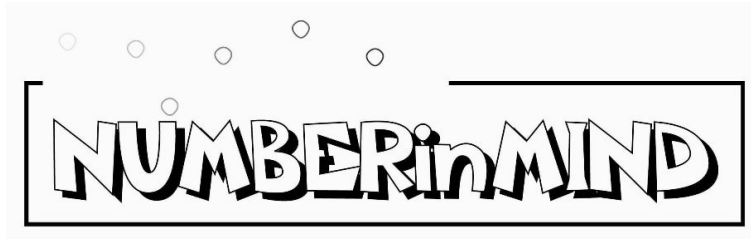

ICG ENTERPRISES, LLC (VIRGINIA LTD LIAB  
CO)  
P.O. BOX 216  
ASHBURN, VA 20146

FOR: CARD GAMES, IN CLASS 28 (U.S. CLS. 22,  
23, 38 AND 50).

FIRST USE 10-21-2007; IN COMMERCE 10-21-2007.

THE MARK CONSISTS OF A PARTIALLY OPEN  
RECTANGLE WITH A BOUNCING DOT LANDING  
ON THE "I" IN THE MIDDLE OF THE LOGO  
CONSISTING OF THE LETTERS "NUMBERIN-  
MIND".

SER. NO. 77-309,447, FILED 10-21-2007.

CAROLYN CATALDO, EXAMINING ATTORNEY

**Int. Cls.: 1, 7, 9 and 12**

**Prior U.S. Cls.: 1, 5, 6, 10, 13, 19, 21, 23, 26, 31, 34, 35,  
36, 38, 44 and 46**

**Reg. No. 3,453,040**

**United States Patent and Trademark Office**

**Registered June 24, 2008**

**TRADEMARK  
PRINCIPAL REGISTER**

# ASK US HOW

LORD CORPORATION (PENNSYLVANIA CORPORATION)  
111 LORD DRIVE  
CARY, NC 27511

FOR: FLUIDS CONTAINING MAGNETICALLY ACTIVE MATERIALS, MAGNETO-RHEOLOGICAL FLUIDS, FOR USE IN DEVICES CONSISTING OF SHOCK ABSORBERS, DAMPERS, CLUTCHES, BRAKES, AND HYDRAULIC VALVES FOR CONTROLLED ENERGY DISSIPATION, IN CLASS 1 (U.S. CLS. 1, 5, 6, 10, 26 AND 46).

FIRST USE 1-18-2005; IN COMMERCE 10-17-2007.

FOR: MACHINE PARTS CONTAINING FIELD RESPONSIVE MATERIALS, NAMELY, SHOCK ABSORBERS, DAMPERS, CLUTCHES, BRAKES, MOUNTS, SUSPENSION SYSTEMS, LOCKS AND POSITIONERS, IN CLASS 7 (U.S. CLS. 13, 19, 21, 23, 31, 34 AND 35).

FIRST USE 1-18-2005; IN COMMERCE 10-17-2007.

FOR: ELECTRICAL DEVICES AND SYSTEMS, NAMELY, SUSPENSION AND HAPTIC CONTROL SYSTEMS CONSISTING OF COMPUTERS, COMPU-

TER SOFTWARE, TRANSMITTERS, RECEIVERS, SHOCK ABSORBERS, DAMPERS, CLUTCHES, BRAKES, MOUNTS, SUSPENSION SYSTEMS, LOCKS, POSITIONERS, NETWORK INTERFACE DEVICES AND ELECTRONIC CONTROLS, IN CLASS 9 (U.S. CLS. 21, 23, 26, 36 AND 38).

FIRST USE 1-18-2005; IN COMMERCE 10-17-2007.

FOR: VEHICLE PARTS CONTAINING FIELD RESPONSIVE MATERIALS, NAMELY, SHOCK ABSORBERS, DAMPERS, CLUTCHES, BRAKES, MOUNTS, SUSPENSION SYSTEMS, LOCKS AND POSITIONERS, IN CLASS 12 (U.S. CLS. 19, 21, 23, 31, 35 AND 44).

FIRST USE 1-18-2005; IN COMMERCE 10-17-2007.

THE MARK CONSISTS OF STANDARD CHARACTERS WITHOUT CLAIM TO ANY PARTICULAR FONT, STYLE, SIZE, OR COLOR.

SER. NO. 77-309,504, FILED 10-22-2007.

KATHRYN COWARD, EXAMINING ATTORNEY

**Int. Cl.: 42**

**Prior U.S. Cls.: 100 and 101**

**United States Patent and Trademark Office**

**Reg. No. 3,453,041**

**Registered June 24, 2008**

**SERVICE MARK  
PRINCIPAL REGISTER**

DESIGNED WITH YOU IN MIND

CLOSEREDGE, LLC (FLORIDA LTD LIAB CO)  
SUITE 8  
8280 PRINCETON SQUARE BLVD. WEST  
JACKSONVILLE, FL 32256

FOR: APPLICATION SERVICE PROVIDER (ASP)  
FEATURING ONLINE, NON-DOWNLOADABLE  
SOFTWARE IN THE FIELD OF REAL ESTATE  
SETTLEMENT SERVICES THAT OFFERS PARTIES  
A FRAMEWORK WITHIN WHICH TO COMMUNI-  
CATE REAL-TIME STATUS OF DIFFERENT ELE-

MENTS OF THE REAL ESTATE TRANSACTION, IN  
CLASS 42 (U.S. CLS. 100 AND 101).

FIRST USE 10-4-2007; IN COMMERCE 10-4-2007.

THE MARK CONSISTS OF STANDARD CHAR-  
ACTERS WITHOUT CLAIM TO ANY PARTICULAR  
FONT, STYLE, SIZE, OR COLOR.

SER. NO. 77-309,523, FILED 10-22-2007.

JAY FLOWERS, EXAMINING ATTORNEY

**Int. Cl.: 14**

**Prior U.S. Cls.: 2, 27, 28 and 50**

**United States Patent and Trademark Office**

**Reg. No. 3,453,042**

**Registered June 24, 2008**

---

**TRADEMARK  
PRINCIPAL REGISTER**

**ZINGOZ**

GANZ (CANADA PARTNERSHIP)  
1 PEARCE ROAD  
WOODBIDGE, CANADA L4L3T2

THE MARK CONSISTS OF STANDARD CHAR-  
ACTERS WITHOUT CLAIM TO ANY PARTICULAR  
FONT, STYLE, SIZE, OR COLOR.

FOR: JEWELRY, IN CLASS 14 (U.S. CLS. 2, 27, 28  
AND 50).

SER. NO. 77-309,530, FILED 10-22-2007.

FIRST USE 8-3-2007; IN COMMERCE 8-3-2007.

ANNE E. GUSTASON, EXAMINING ATTORNEY

**Int. Cl.: 33**

**Prior U.S. Cls.: 47 and 49**

**United States Patent and Trademark Office**

**Reg. No. 3,453,043**

**Registered June 24, 2008**

**TRADEMARK  
PRINCIPAL REGISTER**

**TORREY RIDGE WINERY**

JOHN B. EARLE AND ESTHER L. EARLE (NEW  
YORK PARTNERSHIP)  
2770 RTE 14  
PENN YAN, NY 14527

NO CLAIM IS MADE TO THE EXCLUSIVE  
RIGHT TO USE "WINERY", APART FROM THE  
MARK AS SHOWN.

FOR: WINES, IN CLASS 33 (U.S. CLS. 47 AND 49).

FIRST USE 9-18-1999; IN COMMERCE 9-18-1999.

SER. NO. 77-309,635, FILED 10-22-2007.

THE MARK CONSISTS OF STANDARD CHAR-  
ACTERS WITHOUT CLAIM TO ANY PARTICULAR  
FONT, STYLE, SIZE, OR COLOR.

DAVID COLLIER, EXAMINING ATTORNEY

**Int. Cl.: 35**

**Prior U.S. Cls.: 100, 101 and 102**

**United States Patent and Trademark Office**

**Reg. No. 3,453,044**

**Registered June 24, 2008**

**SERVICE MARK  
PRINCIPAL REGISTER**



UNICEP PACKAGING, INC. (IDAHO CORPORATION)  
1702 INDUSTRIAL DRIVE  
SANDPOINT, ID 83864

FOR: PACKAGING ARTICLES TO THE ORDER  
AND SPECIFICATION OF OTHERS, IN CLASS 35  
(U.S. CLS. 100, 101 AND 102).

FIRST USE 2-6-1992; IN COMMERCE 2-6-1992.

OWNER OF U.S. REG. NOS. 1,852,319 AND  
2,520,027.

THE MARK CONSISTS OF "UNICEP" AND DESIGN.

SER. NO. 77-309,659, FILED 10-22-2007.

MICHAEL LITZAU, EXAMINING ATTORNEY

**Int. Cls.: 36 and 42**

**Prior U.S. Cls.: 100, 101 and 102**

**United States Patent and Trademark Office**

**Reg. No. 3,453,045**

**Registered June 24, 2008**

**SERVICE MARK  
PRINCIPAL REGISTER**

**WORKING TOGETHER FOR A  
BETTER TOMORROW**

CMX INC. (NEW JERSEY CORPORATION)  
200 STATE HIGHWAY 9  
P.O. BOX 900 JUSTIN CORPORATE CENTER  
MANALAPAN, NJ 077260900

FOR: REAL ESTATE CONSULTING, IN CLASS 36  
(U.S. CLS. 100, 101 AND 102).

FIRST USE 9-14-2007; IN COMMERCE 9-14-2007.

FOR: CIVIL ENGINEERING, ENVIRONMENTAL  
ENGINEERING, MUNICIPAL ENGINEERING,  
LAND SURVEYING, LANDSCAPE ARCHITECT-

TURE ENGINEERING, DESIGN AND CONSULT-  
ING SERVICES, IN CLASS 42 (U.S. CLS. 100 AND  
101).

FIRST USE 9-14-2007; IN COMMERCE 9-14-2007.

THE MARK CONSISTS OF STANDARD CHAR-  
ACTERS WITHOUT CLAIM TO ANY PARTICULAR  
FONT, STYLE, SIZE, OR COLOR.

SER. NO. 77-309,664, FILED 10-22-2007.

GENE MACIOL, EXAMINING ATTORNEY

**Int. Cl.: 41**

**Prior U.S. Cls.: 100, 101 and 107**

**United States Patent and Trademark Office**

**Reg. No. 3,453,046**

**Registered June 24, 2008**

**SERVICE MARK  
PRINCIPAL REGISTER**

# Actors Connection

NY ACTORS CONNECTION INC. (NEW YORK  
CORPORATION)  
SUITE 1410  
630 NINTH AVENUE  
NEW YORK, NY 10036

FOR: EDUCATIONAL SERVICES IN THE NAT-  
URE OF ACTING SCHOOLS, IN CLASS 41 (U.S. CLS.  
100, 101 AND 107).

FIRST USE 3-1-2001; IN COMMERCE 3-1-2001.

THE MARK CONSISTS OF STANDARD CHAR-  
ACTERS WITHOUT CLAIM TO ANY PARTICULAR  
FONT, STYLE, SIZE, OR COLOR.

NO CLAIM IS MADE TO THE EXCLUSIVE  
RIGHT TO USE "ACTORS", APART FROM THE  
MARK AS SHOWN.

SER. NO. 77-309,699, FILED 10-22-2007.

PAUL F. GAST, EXAMINING ATTORNEY



**Int. Cl.: 29**

**Prior U.S. Cl.: 46**

**United States Patent and Trademark Office**

**Reg. No. 3,453,047**

**Registered June 24, 2008**

**TRADEMARK  
PRINCIPAL REGISTER**

**NEXCEL**

SPECTRUM FOODS, INC. (DELAWARE CORPORATION)  
2520 S. GRAND AVENUE EAST, P.O. BOX 3483  
SPRINGFIELD, IL 62708

FOR: OIL, NAMELY, VEGETABLE OIL, SOY-BEAN OIL, CANOLA OIL, SUNFLOWER OIL, SAFFLOWER OIL, AND FLAX OIL, IN CLASS 29 (U.S. CL. 46).

FIRST USE 4-30-2006; IN COMMERCE 4-30-2006.

THE MARK CONSISTS OF STANDARD CHARACTERS WITHOUT CLAIM TO ANY PARTICULAR FONT, STYLE, SIZE, OR COLOR.

SER. NO. 77-309,716, FILED 10-22-2007.

DEIRDRE ROBERTSON, EXAMINING ATTORNEY

**Int. Cl.: 36**

**Prior U.S. Cls.: 100, 101 and 102**

**United States Patent and Trademark Office**

**Reg. No. 3,453,048**

**Registered June 24, 2008**

**SERVICE MARK  
PRINCIPAL REGISTER**

**VERAX**

VERAX CAPITAL PARTNERS, LP (DELAWARE  
LIMITED PARTNERSHIP)  
SUITE 111  
90 EAST HALSEY ROAD  
PARSIPPANY, NJ 07054

FOR: PRIVATE EQUITY FUND INVESTMENT  
SERVICES, PRIVATE EQUITY FUNDS, HEDGE  
FUNDS AND HEDGE FUND INVESTMENT SERVI-  
CES, IN CLASS 36 (U.S. CLS. 100, 101 AND 102).

FIRST USE 8-1-2006; IN COMMERCE 8-1-2006.

THE MARK CONSISTS OF STANDARD CHAR-  
ACTERS WITHOUT CLAIM TO ANY PARTICULAR  
FONT, STYLE, SIZE, OR COLOR.

SER. NO. 77-309,727, FILED 10-22-2007.

ESTHER A. BORSUK, EXAMINING ATTORNEY

**Int. Cl.: 41**

**Prior U.S. Cls.: 100, 101 and 107**

**United States Patent and Trademark Office**

**Reg. No. 3,453,049**

**Registered June 24, 2008**

---

**SERVICE MARK  
PRINCIPAL REGISTER**

**CURVES**

CURVES INTERNATIONAL, INC. (TEXAS CORPORATION)  
100 RITCHIE ROAD  
WACO, TX 76712

FOR: PROVIDING FITNESS AND EXERCISE FACILITIES, IN CLASS 41 (U.S. CLS. 100, 101 AND 107).

FIRST USE 1-1-1993; IN COMMERCE 1-1-1993.

THE MARK CONSISTS OF STANDARD CHARACTERS WITHOUT CLAIM TO ANY PARTICULAR FONT, STYLE, SIZE, OR COLOR.

OWNER OF U.S. REG. NOS. 2,923,501, 2,947,574, AND 3,164,796.

SER. NO. 77-309,740, FILED 10-22-2007.

NORA BUCHANAN WILL, EXAMINING ATTORNEY

**Int. Cl.: 35**

**Prior U.S. Cls.: 100, 101 and 102**

**United States Patent and Trademark Office**

**Reg. No. 3,453,050**

**Registered June 24, 2008**

**SERVICE MARK  
PRINCIPAL REGISTER**

**TALENT & OPPORTUNITY  
INTERSECTION**

THE MARATHON CLUB FOR ENTREPRENEUR-  
SHIP (D.C. CORPORATION)  
SUITE 700  
1300 PENNSYLVANIA AVE., N.W.  
WASHINGTON, DC 20004

THE MARK CONSISTS OF STANDARD CHAR-  
ACTERS WITHOUT CLAIM TO ANY PARTICULAR  
FONT, STYLE, SIZE, OR COLOR.

FOR: EXECUTIVE AND BOARD OF DIRECTOR  
SEARCH AND RECRUITMENT SERVICES, IN  
CLASS 35 (U.S. CLS. 100, 101 AND 102).

SER. NO. 77-309,751, FILED 10-22-2007.

FIRST USE 7-16-2007; IN COMMERCE 7-16-2007.

GIANCARLO CASTRO, EXAMINING ATTORNEY

**Int. Cl.: 35**

**Prior U.S. Cls.: 100, 101 and 102**

**United States Patent and Trademark Office**

**Reg. No. 3,453,051**

**Registered June 24, 2008**

**SERVICE MARK  
PRINCIPAL REGISTER**

**DEMDACO**

DD TRADERS, INC. (DELAWARE CORPORATION), DBA DEMDACO  
7500 WEST 160TH STREET  
STILLWELL, KS 66085

FOR: WHOLESALE ORDERING SERVICES IN THE FIELD OF DECORATIVE HOUSEWARES AND GIFTWARE PRODUCTS, IN CLASS 35 (U.S. CLS. 100, 101 AND 102).

FIRST USE 6-1-1997; IN COMMERCE 6-1-1997.

THE MARK CONSISTS OF STANDARD CHARACTERS WITHOUT CLAIM TO ANY PARTICULAR FONT, STYLE, SIZE, OR COLOR.

OWNER OF U.S. REG. NOS. 2,267,600 AND 2,278,330.

SER. NO. 77-309,756, FILED 10-22-2007.

GIANCARLO CASTRO, EXAMINING ATTORNEY

Int. Cl.: 44

Prior U.S. Cls.: 100 and 101

United States Patent and Trademark Office

Reg. No. 3,453,052

Registered June 24, 2008

SERVICE MARK  
PRINCIPAL REGISTER



SOLAGE HOTELS AND RESORTS LLC (CALIFORNIA LTD LIAB CO)  
591 REDWOOD HIGHWAY, SUITE 3150  
MILL VALLEY, CA 94941

FOR: HEALTH SPA SERVICES, NAMELY, COSMETIC BODY CARE SERVICES; SALON SERVICES, NAMELY, HAIRDRESSING, FACIALS, MASSAGES, MANICURES AND PEDICURES; PROVIDING STEAM, WHIRLPOOL, BATH AND MUD BATH FACILITIES; AROMATHERAPY SERVICES; CONSULTING SERVICES IN THE FIELD OF HEALTH AND NUTRITION, IN CLASS 44 (U.S. CLS. 100 AND 101).

FIRST USE 9-21-2007; IN COMMERCE 9-21-2007.

OWNER OF U.S. REG. NOS. 3,350,030 AND 3,360,733.

NO CLAIM IS MADE TO THE EXCLUSIVE RIGHT TO USE "SPA", APART FROM THE MARK AS SHOWN.

THE MARK CONSISTS OF VARIOUS-SIZED CIRCLES LOCATED ABOVE THE WORDS "SPA SOLAGE".

SER. NO. 77-309,765, FILED 10-22-2007.

RON FAIRBANKS, EXAMINING ATTORNEY

**Int. Cl.: 41**

**Prior U.S. Cls.: 100, 101 and 107**

**United States Patent and Trademark Office**

**Reg. No. 3,453,053**

**Registered June 24, 2008**

**SERVICE MARK  
PRINCIPAL REGISTER**

**URBANPROMISE**

URBAN PROMISE MINISTRIES, INC. (NEW JERSEY NON-PROFIT CORPORATION)  
P.O. BOX 1479  
CAMDEN, NJ 08105

FOR: SUMMER CAMPS, EDUCATIONAL SERVICES AND AFTER SCHOOL PROGRAMS, NAMELY, PROVIDING CLASSES, SEMINARS, WORKSHOPS AND MENTORING IN THE FIELDS OF JOB TRAINING AND COLLEGE PREPARATION, IN CLASS 41 (U.S. CLS. 100, 101 AND 107).

FIRST USE 7-27-1994; IN COMMERCE 7-27-1994.

THE MARK CONSISTS OF STANDARD CHARACTERS WITHOUT CLAIM TO ANY PARTICULAR FONT, STYLE, SIZE, OR COLOR.

SER. NO. 77-309,824, FILED 10-22-2007.

FRANK LATTUCA, EXAMINING ATTORNEY

**Int. Cl.: 41**

**Prior U.S. Cls.: 100, 101 and 107**

**United States Patent and Trademark Office**

**Reg. No. 3,453,054**

**Registered June 24, 2008**

**SERVICE MARK  
PRINCIPAL REGISTER**

**Take Your Higher Self to  
Work**

MOLLOY COMMUNICATIONS, INC. (GEORGIA  
CORPORATION)  
1519 OAKMOOR PLACE  
MARIETTA, GA 30062

FOR: EDUCATIONAL SERVICES, NAMELY,  
CONDUCTING WORKSHOPS, SEMINARS AND  
CLASSES IN THE FIELD OF BUSINESS AND PER-  
SONAL DEVELOPMENT, AND DISTRIBUTION OF  
COURSE MATERIAL IN CONNECTION THERE-  
WITH, IN CLASS 41 (U.S. CLS. 100, 101 AND 107).

FIRST USE 10-22-2007; IN COMMERCE 10-22-2007.

THE MARK CONSISTS OF STANDARD CHAR-  
ACTERS WITHOUT CLAIM TO ANY PARTICULAR  
FONT, STYLE, SIZE, OR COLOR.

SER. NO. 77-309,842, FILED S.R. 10-22-2007 AM.  
P.R. 2-1-2008.

MICHAEL WIENER, EXAMINING ATTORNEY



**Int. Cl.: 41**

**Prior U.S. Cls.: 100, 101 and 107**

**United States Patent and Trademark Office**

**Reg. No. 3,453,055**

**Registered June 24, 2008**

**SERVICE MARK  
PRINCIPAL REGISTER**

**WNBA ALL-STAR**

WNBA ENTERPRISES, LLC (DELAWARE LTD  
LIAB CO)  
450 HARMON MEADOW BOULEVARD  
SECAUCUS, NJ 07094

FOR: ENTERTAINMENT AND EDUCATIONAL SERVICES IN THE NATURE OF ONGOING TELEVISION PROGRAMS IN THE FIELD OF BASKETBALL, AND RENDERING LIVE BASKETBALL GAMES AND BASKETBALL EXHIBITIONS; THE PRODUCTION AND DISTRIBUTION OF RADIO AND TELEVISION BROADCASTS OF BASKETBALL GAMES AND BASKETBALL EXHIBITIONS, BASKETBALL EVENTS AND PROGRAMS IN THE FIELD OF BASKETBALL; CONDUCTING AND ARRANGING BASKETBALL CLINICS AND COACHES CLINICS AND BASKETBALL EVENTS, IN CLASS 41 (U.S. CLS. 100, 101 AND 107).

FIRST USE 7-14-1999; IN COMMERCE 7-14-1999.

THE MARK CONSISTS OF STANDARD CHARACTERS WITHOUT CLAIM TO ANY PARTICULAR FONT, STYLE, SIZE, OR COLOR.

OWNER OF U.S. REG. NOS. 2,458,072, 2,698,058 AND OTHERS.

NO CLAIM IS MADE TO THE EXCLUSIVE RIGHT TO USE "ALL-STAR", APART FROM THE MARK AS SHOWN.

SER. NO. 77-309,855, FILED 10-22-2007.

KELLEY WELLS, EXAMINING ATTORNEY

**Int. Cl.: 41**

**Prior U.S. Cls.: 100, 101 and 107**

**United States Patent and Trademark Office**

**Reg. No. 3,453,056**

**Registered June 24, 2008**

**SERVICE MARK  
PRINCIPAL REGISTER**



URBAN PROMISE MINISTRIES, INC. (NEW JERSEY NON-PROFIT CORPORATION)  
P.O. BOX 1479  
CAMDEN, NJ 08105

FOR: SUMMER CAMPS, EDUCATIONAL SERVICES AND AFTER SCHOOL PROGRAMS, NAMELY, PROVIDING CLASSES, SEMINARS, WORKSHOPS AND MENTORING IN THE FIELDS OF JOB TRAINING AND COLLEGE PREPARATION, IN CLASS 41 (U.S. CLS. 100, 101 AND 107).

FIRST USE 7-27-1994; IN COMMERCE 7-27-1994.

THE MARK CONSISTS OF THE STYLIZED REPRESENTATION OF A SCHOOL HOUSE.

SER. NO. 77-309,856, FILED 10-22-2007.

FRANK LATTUCA, EXAMINING ATTORNEY

**Int. Cl.: 41**

**Prior U.S. Cls.: 100, 101 and 107**

**United States Patent and Trademark Office**

**Reg. No. 3,453,057**

**Registered June 24, 2008**

**SERVICE MARK  
PRINCIPAL REGISTER**

**The Boomerang Effect**

SANDY DUMONT (VIRGINIA SOLE PROPRIETORSHIP)  
921 BOTETOURT GARDENS  
NORFOLK, VA 23507

FOR: EDUCATIONAL SERVICES, NAMELY, CONDUCTING CLASSES, WORKSHOPS, AND SEMINARS IN THE FIELD OF BEAUTY AND IMAGE CONSULTING AND DISTRIBUTION OF COURSE MATERIAL IN CONNECTION THEREWITH, IN CLASS 41 (U.S. CLS. 100, 101 AND 107).

FIRST USE 9-22-2007; IN COMMERCE 9-22-2007.

THE MARK CONSISTS OF STANDARD CHARACTERS WITHOUT CLAIM TO ANY PARTICULAR FONT, STYLE, SIZE, OR COLOR.

SER. NO. 77-309,878, FILED 10-22-2007.

RICHARD WHITE, EXAMINING ATTORNEY

**Int. Cl.: 42**

**Prior U.S. Cls.: 100 and 101**

**United States Patent and Trademark Office**

**Reg. No. 3,453,058**

**Registered June 24, 2008**

**SERVICE MARK  
PRINCIPAL REGISTER**

**OPTIMUM QUALITY CHECK**

CSC HOLDINGS, INC. (DELAWARE CORPORATION)

1111 STEWART AVENUE

BETHPAGE, NY 11714

FOR: TESTING, EVALUATION AND INSPECTION OF HOME CABLE WIRING TO ASSURE ITS TECHNICAL QUALITY FOR CABLE TELEVISION, INTERNET, AND PHONE SERVICES, IN CLASS 42 (U.S. CLS. 100 AND 101).

FIRST USE 9-24-2007; IN COMMERCE 9-24-2007.

THE MARK CONSISTS OF STANDARD CHARACTERS WITHOUT CLAIM TO ANY PARTICULAR FONT, STYLE, SIZE, OR COLOR.

OWNER OF U.S. REG. NOS. 2,609,003, 3,021,926 AND OTHERS.

NO CLAIM IS MADE TO THE EXCLUSIVE RIGHT TO USE "QUALITY CHECK", APART FROM THE MARK AS SHOWN.

SER. NO. 77-309,887, FILED 10-22-2007.

JAMES MACFARLANE, EXAMINING ATTORNEY

**Int. Cl.: 6**

**Prior U.S. Cls.: 2, 12, 13, 14, 23, 25 and 50**

**Reg. No. 3,453,059**

**United States Patent and Trademark Office**

**Registered June 24, 2008**

---

**TRADEMARK  
PRINCIPAL REGISTER**

**STAND GUARDIAN**

JEFF MURRAY OUTDOORS, INC. (MINNESOTA  
CORPORATION)  
5702 FISH LAKE DAM  
DULUTH, MN 55803

FOR: METAL CABLE LOCKS FOR USE IN THE  
HUNTING INDUSTRY, IN CLASS 6 (U.S. CLS. 2, 12,  
13, 14, 23, 25 AND 50).

FIRST USE 10-11-2007; IN COMMERCE 10-11-2007.

THE MARK CONSISTS OF STANDARD CHAR-  
ACTERS WITHOUT CLAIM TO ANY PARTICULAR  
FONT, STYLE, SIZE, OR COLOR.

NO CLAIM IS MADE TO THE EXCLUSIVE  
RIGHT TO USE "STAND", APART FROM THE  
MARK AS SHOWN.

SER. NO. 77-309,895, FILED 10-22-2007.

SHAILA SETTLES, EXAMINING ATTORNEY

**Int. Cl.: 16**

**Prior U.S. Cls.: 2, 5, 22, 23, 29, 37, 38 and 50**

**Reg. No. 3,453,060**

**United States Patent and Trademark Office**

**Registered June 24, 2008**

---

**TRADEMARK  
PRINCIPAL REGISTER**

**SPS**

MBM CORPORATION (SOUTH CAROLINA CORPORATION)  
3134 INDUSTRY DRIVE  
CHARLESTON, SC 29418

THE MARK CONSISTS OF STANDARD CHARACTERS WITHOUT CLAIM TO ANY PARTICULAR FONT, STYLE, SIZE, OR COLOR.

FOR: PAPER SHREDDERS, IN CLASS 16 (U.S. CLS. 2, 5, 22, 23, 29, 37, 38 AND 50).

SER. NO. 77-309,909, FILED 10-22-2007.

FIRST USE 1-15-2007; IN COMMERCE 1-15-2007.

AHSEN KHAN, EXAMINING ATTORNEY

**Int. Cl.: 41**

**Prior U.S. Cls.: 100, 101 and 107**

**United States Patent and Trademark Office**

**Reg. No. 3,453,061**

**Registered June 24, 2008**

---

**SERVICE MARK  
PRINCIPAL REGISTER**

**SKETCHBOOK**

COLLABORATION THEATRE COMPANY (IL-  
LINOIS CORPORATION)  
437 N. WOLCOTT, #102  
CHICAGO, IL 60622

THE MARK CONSISTS OF STANDARD CHAR-  
ACTERS WITHOUT CLAIM TO ANY PARTICULAR  
FONT, STYLE, SIZE, OR COLOR.

FOR: ENTERTAINMENT IN THE NATURE OF  
THEATER PRODUCTIONS, IN CLASS 41 (U.S. CLS.  
100, 101 AND 107).

SER. NO. 77-309,921, FILED 10-22-2007.

FIRST USE 1-1-2000; IN COMMERCE 1-1-2000.

SETH A. RAPPAPORT, EXAMINING ATTORNEY

**Int. Cl.: 41**

**Prior U.S. Cls.: 100, 101 and 107**

**United States Patent and Trademark Office**

**Reg. No. 3,453,062**

**Registered June 24, 2008**

**SERVICE MARK  
PRINCIPAL REGISTER**

**I WANT THAT! BATHS**

SCRIPPS NETWORKS, LLC (DELAWARE LTD  
LIAB CO)  
9721 SHERRILL BOULEVARD  
KNOXVILLE, TN 37932

FOR: ENTERTAINMENT SERVICES, NAMELY,  
AN ONGOING AUDIO AND VISUAL PROGRAM  
DISTRIBUTED OVER TELEVISION, SATELLITE,  
WIRELESS, AUDIO AND VIDEO MEDIA, FIBER  
OPTICS, CABLE AND A GLOBAL COMPUTER  
NETWORK IN THE FIELDS OF PRODUCTS AND  
INNOVATION, IN CLASS 41 (U.S. CLS. 100, 101 AND  
107).

FIRST USE 3-8-2006; IN COMMERCE 3-8-2006.

THE MARK CONSISTS OF STANDARD CHAR-  
ACTERS WITHOUT CLAIM TO ANY PARTICULAR  
FONT, STYLE, SIZE, OR COLOR.

NO CLAIM IS MADE TO THE EXCLUSIVE  
RIGHT TO USE "BATHS", APART FROM THE  
MARK AS SHOWN.

SER. NO. 77-309,940, FILED 10-22-2007.

DANNEAN HETZEL, EXAMINING ATTORNEY



**Int. Cl.: 41**

**Prior U.S. Cls.: 100, 101 and 107**

**United States Patent and Trademark Office**

**Reg. No. 3,453,063**

**Registered June 24, 2008**

**SERVICE MARK  
PRINCIPAL REGISTER**

**I WANT THAT! KITCHENS**

SCRIPPS NETWORKS, LLC (DELAWARE LTD  
LIAB CO)  
9721 SHERRILL BOULEVARD  
KNOXVILLE, TN 37932

FOR: ENTERTAINMENT SERVICES, NAMELY,  
AN ONGOING AUDIO AND VISUAL PROGRAM  
DISTRIBUTED OVER TELEVISION, SATELLITE,  
WIRELESS, AUDIO AND VIDEO MEDIA, FIBER  
OPTICS, CABLE AND A GLOBAL COMPUTER  
NETWORK IN THE FIELDS OF PRODUCTS AND  
INNOVATION, IN CLASS 41 (U.S. CLS. 100, 101 AND  
107).

FIRST USE 3-8-2006; IN COMMERCE 3-8-2006.

THE MARK CONSISTS OF STANDARD CHAR-  
ACTERS WITHOUT CLAIM TO ANY PARTICULAR  
FONT, STYLE, SIZE, OR COLOR.

NO CLAIM IS MADE TO THE EXCLUSIVE  
RIGHT TO USE "KITCHENS", APART FROM THE  
MARK AS SHOWN.

SER. NO. 77-309,944, FILED 10-22-2007.

DANNEAN HETZEL, EXAMINING ATTORNEY

**Int. Cl.: 41**

**Prior U.S. Cls.: 100, 101 and 107**

**United States Patent and Trademark Office**

**Reg. No. 3,453,064**

**Registered June 24, 2008**

**SERVICE MARK  
PRINCIPAL REGISTER**

# LeadersCore

CPD, INC. (KANSAS CORPORATION)  
PO BOX 860525  
SHAWNEE MISSION, KS 66286

FIRST USE 10-1-1995; IN COMMERCE 1-1-1996.

FOR: EDUCATIONAL SERVICES, NAMELY,  
CONDUCTING SEMINARS, LECTURES, CONFER-  
ENCES AND WORKSHOPS IN THE FIELD OF  
MOTIVATIONAL DEVELOPMENT AND DISTRIBU-  
TION OF COURSE MATERIAL IN CONNECTION  
THEREWITH, IN CLASS 41 (U.S. CLS. 100, 101 AND  
107).

THE MARK CONSISTS OF STANDARD CHAR-  
ACTERS WITHOUT CLAIM TO ANY PARTICULAR  
FONT, STYLE, SIZE, OR COLOR.

SER. NO. 77-309,955, FILED 10-22-2007.

ASMAT KHAN, EXAMINING ATTORNEY

**Int. Cl.: 16**

**Prior U.S. Cls.: 2, 5, 22, 23, 29, 37, 38 and 50**

**Reg. No. 3,453,065**

**United States Patent and Trademark Office**

**Registered June 24, 2008**

---

**TRADEMARK  
PRINCIPAL REGISTER**

**SCS**

MBM CORPORATION (SOUTH CAROLINA CORPORATION)  
3134 INDUSTRY DRIVE  
CHARLESTON, SC 29418

THE MARK CONSISTS OF STANDARD CHARACTERS WITHOUT CLAIM TO ANY PARTICULAR FONT, STYLE, SIZE, OR COLOR.

FOR: PAPER CUTTERS, IN CLASS 16 (U.S. CLS. 2, 5, 22, 23, 29, 37, 38 AND 50).

SER. NO. 77-309,973, FILED 10-22-2007.

FIRST USE 9-1-2007; IN COMMERCE 9-1-2007.

AHSEN KHAN, EXAMINING ATTORNEY

Int. Cl.: 16

Prior U.S. Cls.: 2, 5, 22, 23, 29, 37, 38 and 50

United States Patent and Trademark Office

Reg. No. 3,453,066

Registered June 24, 2008

TRADEMARK  
PRINCIPAL REGISTER



TAURISANO, FRANCESCA (ITALY INDIVIDUAL)  
IL CARTIGLIO, VIA BOLOGNESE 46  
FIRENZE 50139, ITALY

FOR: BLANK JOURNAL BOOKS; PHOTOGRAPH ALBUMS; DIARIES; PEN OR PENCIL HOLDERS; NOTE PAD HOLDERS; NOTE PADS; PAPER EXPANDING FILES; DESK SETS, IN CLASS 16 (U.S. CLS. 2, 5, 22, 23, 29, 37, 38 AND 50).

FIRST USE 12-31-1980; IN COMMERCE 1-1-2005.

THE MARK CONSISTS OF AN OPEN SCROLL IN A RECTANGULAR SHAPE SHOWING THE WORD

"CARTIGLIO", PRECEDED BY THE WORD "IL". THE SERIF LETTERS IN "CARTIGLIO" ARE WHITE, OUTLINED IN BLACK, ON THE BOTTOM, AND SOLID BLACK ON TOP.

THE FOREIGN WORDING IN THE MARK TRANSLATES INTO ENGLISH AS THE CARTOUCHE.

SER. NO. 77-310,030, FILED 10-22-2007.

KYLE PEETE, EXAMINING ATTORNEY

**Int. Cl.: 37**

**Prior U.S. Cls.: 100, 103 and 106**

**United States Patent and Trademark Office**

**Reg. No. 3,453,067**

**Registered June 24, 2008**

**SERVICE MARK  
PRINCIPAL REGISTER**

**GOOD PEOPLE HELPING GOOD  
PEOPLE**

DENNY HECKER'S AUTOMOTIVE GROUP, INC.  
(MINNESOTA CORPORATION)  
500 FORD ROAD  
MINNEAPOLIS, MN 55402

THE MARK CONSISTS OF STANDARD CHAR-  
ACTERS WITHOUT CLAIM TO ANY PARTICULAR  
FONT, STYLE, SIZE, OR COLOR.

FOR: AUTOMOBILE REPAIR AND MAINTENANCE;  
VEHICLE REPAIR AND MAINTENANCE,  
IN CLASS 37 (U.S. CLS. 100, 103 AND 106).

SER. NO. 77-310,078, FILED 10-22-2007.

FIRST USE 7-0-1999; IN COMMERCE 7-0-1999.

LAURA HAMMEL, EXAMINING ATTORNEY

**Int. Cl.: 35**

**Prior U.S. Cls.: 100, 101 and 102**

**United States Patent and Trademark Office**

**Reg. No. 3,453,068**

**Registered June 24, 2008**

**SERVICE MARK  
PRINCIPAL REGISTER**

**GOOD PEOPLE HELPING GOOD  
PEOPLE**

DENNY HECKER'S AUTOMOTIVE GROUP, INC.  
(MINNESOTA CORPORATION)  
500 FORD ROAD  
MINNEAPOLIS, MN 55402

THE MARK CONSISTS OF STANDARD CHAR-  
ACTERS WITHOUT CLAIM TO ANY PARTICULAR  
FONT, STYLE, SIZE, OR COLOR.

FOR: AUTOMOBILE DEALERSHIPS; ON-LINE  
RETAIL STORE SERVICES FEATURING NEW  
AND USED MOTOR VEHICLES, IN CLASS 35 (U.S.  
CLS. 100, 101 AND 102).

SER. NO. 77-310,083, FILED 10-22-2007.

FIRST USE 7-0-1999; IN COMMERCE 7-0-1999.

LAURA HAMMEL, EXAMINING ATTORNEY

**Int. Cl.: 30**

**Prior U.S. Cl.: 46**

**United States Patent and Trademark Office**

**Reg. No. 3,453,069**

**Registered June 24, 2008**

**TRADEMARK  
PRINCIPAL REGISTER**



HOUSTON COFFEE EXCHANGE, L.L.C. (TEXAS  
LTD LIAB CO)  
11800 BIG JOHN STREET  
HOUSTON, TX 770383329

FOR: TEA, IN CLASS 30 (U.S. CL. 46).

FIRST USE 12-1-2006; IN COMMERCE 12-1-2006.

NO CLAIM IS MADE TO THE EXCLUSIVE  
RIGHT TO USE "TEA", APART FROM THE MARK  
AS SHOWN.

THE MARK CONSISTS OF CONCENTRIC OVALS  
WITH THE INTERIOR OVAL SHADED AND CON-  
TAINING A TEA CUP WITH TEA LEAVES ON IT.  
THE OVAL ALSO CONTAINS THE WORDS "HIGH  
ISLAND TEA" ABOVE THE TEA CUP.

SER. NO. 77-310,111, FILED 10-22-2007.

MATTHEW MCDOWELL, EXAMINING ATTOR-  
NEY

**Int. Cl.: 38**

**Prior U.S. Cls.: 100, 101 and 104**

**United States Patent and Trademark Office**

**Reg. No. 3,453,070**

**Registered June 24, 2008**

---

**SERVICE MARK  
PRINCIPAL REGISTER**

**jetbroadband**

JETBROADBAND MANAGEMENT HOLDINGS,  
LLC (DELAWARE LTD LIAB CO)  
5 INTERNATIONAL DRIVE  
RYE BROOK, NY 10573

THE MARK CONSISTS OF STANDARD CHAR-  
ACTERS WITHOUT CLAIM TO ANY PARTICULAR  
FONT, STYLE, SIZE, OR COLOR.

FOR: CABLE TELEVISION BROADCASTING;  
CABLE TELEVISION TRANSMISSION; INTERNET  
SERVICE PROVIDER (ISP), IN CLASS 38 (U.S. CLS.  
100, 101 AND 104).

SER. NO. 77-310,113, FILED 10-22-2007.

FIRST USE 10-1-2005; IN COMMERCE 10-1-2005.

JANICE KIM, EXAMINING ATTORNEY



**Int. Cls.: 3 and 5**

**Prior U.S. Cls.: 1, 4, 6, 18, 44, 46, 50, 51 and 52**

**United States Patent and Trademark Office**

**Reg. No. 3,453,071**

**Registered June 24, 2008**

**TRADEMARK  
PRINCIPAL REGISTER**



ROSEBUD PERFUME COMPANY, INC. (MARY-  
LAND CORPORATION)  
6 NORTH MAIN STREET  
WOODSBORO, MD 21798

FOR: PERSONAL CARE PRODUCTS, NAMELY,  
NON-MEDICATED BODY SALVES AND NON-  
MEDICATED LIP BALMS, IN CLASS 3 (U.S. CLS. 1,  
4, 6, 50, 51 AND 52).

FIRST USE 12-31-1962; IN COMMERCE 12-31-1962.

FOR: PERSONAL CARE PRODUCTS, NAMELY,  
MEDICATED BODY SALVES AND MEDICATED  
LIP BALMS, IN CLASS 5 (U.S. CLS. 6, 18, 44, 46, 51  
AND 52).

FIRST USE 12-31-1962; IN COMMERCE 12-31-1962.

THE MARK CONSISTS OF A CAPITAL "R" WITH  
TWO LOWER CASE "S" LETTERS WITHIN THE "R"  
MARK; ONE "S" IS LOCATED WITHIN THE TOP,  
OVAL, CLOSED PORTION OF THE "R", THE  
OTHER "S", IS LOCATED DIRECTLY UNDER-  
NEATH THE TOP "S" IN THE CENTER OF THE  
BOTTOM, OPEN PORTION OF THE "R". THE  
CAPITAL "R", WHICH ENCAPSULATES BOTH "S"  
LETTERS, IS, ITSELF, ENCIRCLED BY A RING OF  
STEMMED ROSES.

SER. NO. 77-310,124, FILED 10-22-2007.

ADA HAN, EXAMINING ATTORNEY

**Int. Cl.: 21**

**Prior U.S. Cls.: 2, 13, 23, 29, 30, 33, 40 and 50**

**Reg. No. 3,453,072**

**United States Patent and Trademark Office**

**Registered June 24, 2008**

**TRADEMARK  
PRINCIPAL REGISTER**

**CARING HANDS**

BIG TIME HOLDINGS, INC. (GEORGIA CORPORATION)  
2 WILBANKS ROAD  
ROME, GA 30161

FOR: VINYL AND NON-VINYL HOUSEHOLD GLOVES, LATEX AND NON-LATEX HOUSEHOLD GLOVES, WORK GLOVES, AND NEOPRENE HOUSEHOLD AND WORK GLOVES, IN CLASS 21 (U.S. CLS. 2, 13, 23, 29, 30, 33, 40 AND 50).

FIRST USE 5-15-2007; IN COMMERCE 5-15-2007.

THE MARK CONSISTS OF STANDARD CHARACTERS WITHOUT CLAIM TO ANY PARTICULAR FONT, STYLE, SIZE, OR COLOR.

NO CLAIM IS MADE TO THE EXCLUSIVE RIGHT TO USE "HANDS", APART FROM THE MARK AS SHOWN.

SER. NO. 77-310,133, FILED 10-22-2007.

LINDSEY RUBIN, EXAMINING ATTORNEY

Int. Cl.: 35

Prior U.S. Cls.: 100, 101 and 102

United States Patent and Trademark Office

Reg. No. 3,453,073

Registered June 24, 2008

SERVICE MARK  
PRINCIPAL REGISTER

# Social Good

## Marketing + Design, Inc.

SOCIAL GOOD MARKETING & DESIGN INC.  
(CALIFORNIA CORPORATION)  
374 POLI STREET, SUITE 207  
VENTURA, CA 93001

FOR: ADVERTISING AND MARKETING; ADVERTISING SERVICES, NAMELY, PROMOTING AND MARKETING THE GOODS AND SERVICES OF OTHERS THROUGH ALL PUBLIC COMMUNICATION MEANS; ADVERTISING SERVICES, PUBLIC RELATIONS AND MARKETING SERVICES, NAMELY, PROMOTING AND MARKETING THE GOODS AND SERVICES OF OTHERS THROUGH ALL PUBLIC COMMUNICATION MEANS; ADVERTISING, MARKETING AND PROMOTION SERVICES; ADVERTISING, PROMOTION AND MARKETING SERVICES IN THE NATURE OF E-MAIL BLAST CAMPAIGNS FOR OTHERS; ADVICE IN THE FIELD OF BUSINESS MANAGEMENT AND MARKETING; ARRANGING AND CONDUCTING MARKETING PROMOTIONAL EVENTS FOR OTHERS; BUSINESS ADVICE AND ANALYSIS OF MARKETS; BUSINESS CONSULTATION AND MANAGEMENT REGARDING MARKETING ACTIVITIES AND LAUNCHING OF NEW PRODUCTS; BUSINESS MARKETING AND DIRECT MAIL CONSULTING SERVICES; BUSINESS MARKETING CONSULTING SERVICES; BUSINESS MARKETING SERVICES; CREATIVE MARKETING DESIGN SER-

VICES; CUSTOM WRITING SERVICES COMPRISING PUBLIC RELATIONS AND MARKETING MATERIALS FOR THE AUDIO, VIDEO AND TECHNOLOGY INDUSTRIES; DEVELOPMENT OF MARKETING STRATEGIES AND CONCEPTS; IMPLEMENTATION AND FOLLOW-UP OF ADVICE IN THE FIELDS OF MARKETING; INFORMATION OR ENQUIRIES ON BUSINESS AND MARKETING; MARKET RESEARCH; MARKETING CONSULTING; MARKETING PLAN DEVELOPMENT; MARKETING SERVICES IN THE FIELD OF PLANNED-GIVING FOR NON-PROFIT AND CHARITABLE ORGANIZATIONS, IN CLASS 35 (U.S. CLS. 100, 101 AND 102).

FIRST USE 10-1-2006; IN COMMERCE 3-2-2007.

NO CLAIM IS MADE TO THE EXCLUSIVE RIGHT TO USE "MARKETING AND DESIGN, INC.", APART FROM THE MARK AS SHOWN.

THE MARK CONSISTS OF LOGO FOR "SOCIAL GOOD MARKETING & DESIGN, INC."

SER. NO. 77-310,149, FILED 10-22-2007.

EDWARD FENNESSY, EXAMINING ATTORNEY

**Int. Cl.: 42**

**Prior U.S. Cls.: 100 and 101**

**United States Patent and Trademark Office**

**Reg. No. 3,453,074**

**Registered June 24, 2008**

**SERVICE MARK  
PRINCIPAL REGISTER**

**CONNX**

CONNX SOLUTIONS, INC. (WASHINGTON CORPORATION)  
2039 152ND AVENUE NE  
REDMOND, WA 98052

FOR: COMPUTER SOFTWARE CONSULTANCY; COMPUTER SOFTWARE DEVELOPMENT; COMPUTER PROGRAMMING SERVICES; DATABASE DEVELOPMENT SERVICES; TECHNICAL SUPPORT SERVICES, NAMELY, TROUBLESHOOTING OF COMPUTER SOFTWARE PROBLEMS, IN CLASS 42 (U.S. CLS. 100 AND 101).

FIRST USE 6-0-1998; IN COMMERCE 6-0-1998.

THE MARK CONSISTS OF STANDARD CHARACTERS WITHOUT CLAIM TO ANY PARTICULAR FONT, STYLE, SIZE, OR COLOR.

OWNER OF U.S. REG. NOS. 1,990,616 AND 2,613,280.

SER. NO. 77-310,164, FILED 10-22-2007.

VIVIAN MICZNIK FIRST, EXAMINING ATTORNEY

**Int. Cl.: 42**

**Prior U.S. Cls.: 100 and 101**

**United States Patent and Trademark Office**

**Reg. No. 3,453,075**

**Registered June 24, 2008**

**SERVICE MARK  
PRINCIPAL REGISTER**

**Pinnacle Mapping  
Technologies, Inc.**

PINNACLE MAPPING TECHNOLOGIES, INC.  
(ARIZONA CORPORATION), DBA PINNACLE  
MAPPING TECHNOLOGIES

601 N. HUMPHREYS ST.  
FLAGSTAFF, AZ 860013023

FOR: CARTOGRAPHY AND MAPPING, IN  
CLASS 42 (U.S. CLS. 100 AND 101).

FIRST USE 6-29-2000; IN COMMERCE 6-29-2000.

THE MARK CONSISTS OF STANDARD CHAR-  
ACTERS WITHOUT CLAIM TO ANY PARTICULAR  
FONT, STYLE, SIZE, OR COLOR.

NO CLAIM IS MADE TO THE EXCLUSIVE  
RIGHT TO USE "MAPPING TECHNOLOGIES,  
INC.", APART FROM THE MARK AS SHOWN.

SER. NO. 77-310,193, FILED 10-22-2007.

TARAH HARDY, EXAMINING ATTORNEY

Int. Cl.: 9

Prior U.S. Cls.: 21, 23, 26, 36 and 38

Reg. No. 3,453,076

United States Patent and Trademark Office

Registered June 24, 2008

TRADEMARK  
PRINCIPAL REGISTER



DUNLEAVY, KEVIN (UNITED STATES INDIVIDUAL)  
1030 TERRACE BLVD  
ORLANDO, FL 32803

NO CLAIM IS MADE TO THE EXCLUSIVE RIGHT TO USE "VIRTUAL WINE SELECTOR", APART FROM THE MARK AS SHOWN.

FOR: INTERACTIVE COMPUTER KIOSKS COMPRISING COMPUTERS, COMPUTER HARDWARE, COMPUTER PERIPHERALS, COMPUTER OPERATING SOFTWARE FOR USE IN PROVIDING INFORMATION IN THE FIELD OF FOOD AND BEVERAGE EDUCATION AND INFORMATION FOR CONSUMERS, IN CLASS 9 (U.S. CLS. 21, 23, 26, 36 AND 38).

THE MARK CONSISTS OF THREE WINE BOTTLES WITH THE WORDS "VIRTUAL WINE SELECTOR" UNDERNEATH.

SER. NO. 77-310,205, FILED 10-22-2007.

FIRST USE 2-16-2005; IN COMMERCE 2-16-2005.

DAWN FELDMAN, EXAMINING ATTORNEY

**Int. Cl.: 33**

**Prior U.S. Cls.: 47 and 49**

**United States Patent and Trademark Office**

**Reg. No. 3,453,077**

**Registered June 24, 2008**

**TRADEMARK  
PRINCIPAL REGISTER**



DIAGEO NORTH AMERICA, INC. (CONNECTI-  
CUT CORPORATION)  
801 MAIN AVENUE  
NORWALK, CT 06851

THE MARK CONSISTS OF A SILHOUETTE OF  
TWO PERSONS ROWING IN A CANOE WITH THE  
REFLECTIONS ON THE WATER.

FOR: WINES, IN CLASS 33 (U.S. CLS. 47 AND 49).

SER. NO. 77-310,250, FILED 10-22-2007.

FIRST USE 3-0-2000; IN COMMERCE 3-0-2000.

OWNER OF U.S. REG. NOS. 2,895,439 AND  
3,246,004.

BERYL GARDNER, EXAMINING ATTORNEY

Int. Cl.: 33

Prior U.S. Cls.: 47 and 49

**United States Patent and Trademark Office**

**Reg. No. 3,453,078**

Registered June 24, 2008

**TRADEMARK  
PRINCIPAL REGISTER**



VICENTE GANDÍA PLA, S.A. (SPAIN SOCIEDAD ANONIMA)

CHIVA

CTRA. CHESTE A GODELLETA, S/N  
VALENCIA, SPAIN 46370

OWNER OF U.S. REG. NO. 3,318,560.

THE NAME "VICENTE GANDIA" DOES NOT IDENTIFY A LIVING INDIVIDUAL.

FOR: ALCOHOLIC BEVERAGES, NAMELY, WINE, IN CLASS 33 (U.S. CLS. 47 AND 49).

SER. NO. 77-310,266, FILED 10-22-2007.

FIRST USE 1-1-2006; IN COMMERCE 1-1-2006.

KATHERINE CHANG, EXAMINING ATTORNEY



**Int. Cl.: 19**

**Prior U.S. Cls.: 1, 12, 33 and 50**

**United States Patent and Trademark Office**

**Reg. No. 3,453,079**

**Registered June 24, 2008**

**TRADEMARK  
PRINCIPAL REGISTER**

**332BEAD**

TEXTURED FOREST PRODUCTS, INC. (ORE-  
GON CORPORATION)  
P.O. BOX 125  
WASHOUGAL, WA 98671

THE MARK CONSISTS OF STANDARD CHAR-  
ACTERS WITHOUT CLAIM TO ANY PARTICULAR  
FONT, STYLE, SIZE, OR COLOR.

FOR: NONMETAL BUILDING MATERIALS,  
NAMELY, PROFILED PLYWOOD PANELING, IN  
CLASS 19 (U.S. CLS. 1, 12, 33 AND 50).

SER. NO. 77-310,267, FILED 10-22-2007.

FIRST USE 10-15-2007; IN COMMERCE 10-15-2007.

KATHERINE CHANG, EXAMINING ATTORNEY

**Int. Cl.: 33**

**Prior U.S. Cls.: 47 and 49**

**United States Patent and Trademark Office**

**Reg. No. 3,453,080**

**Registered June 24, 2008**

**TRADEMARK  
PRINCIPAL REGISTER**

**S O L A R I S**

DIAGEO NORTH AMERICA, INC. (CONNECTI-  
CUT CORPORATION)

801 MAIN AVENUE  
NORWALK, CT 06851

FOR: WINES, IN CLASS 33 (U.S. CLS. 47 AND 49).

FIRST USE 8-0-2003; IN COMMERCE 8-0-2003.

OWNER OF U.S. REG. NOS. 2,160,811 AND  
3,194,170.

THE MARK CONSISTS OF A STYLIZED FORM  
OF THE WORD "SOLARIS".

SER. NO. 77-310,289, FILED 10-22-2007.

BERYL GARDNER, EXAMINING ATTORNEY

**Int. Cl.: 35**

**Prior U.S. Cls.: 100, 101 and 102**

**United States Patent and Trademark Office**

**Reg. No. 3,453,081**

**Registered June 24, 2008**

**SERVICE MARK  
PRINCIPAL REGISTER**

**The Business Whisperer**

MCLAUGHLIN, J P (UNITED STATES INDIVIDUAL)  
2335 NW RALEIGH ST #129  
PORTLAND, OR 97210

FOR: BUSINESS CONSULTATION SERVICES; BUSINESS CONSULTING AND BUSINESS INFORMATION FOR ENTERPRISES; BUSINESS CONSULTING AND INFORMATION SERVICES; BUSINESS CONSULTING, MANAGEMENT, PLANNING AND SUPERVISION; BUSINESS LEADERSHIP DEVELOPMENT; BUSINESS MANAGEMENT ASSISTANCE TO INDUSTRIAL OR COMMERCIAL COMPANIES; BUSINESS MANAGEMENT CONSULTANCY AND ADVISORY SERVICES; BUSINESS MANAGEMENT; BUSINESS MANAGEMENT AND ADVICE; BUSINESS MANAGEMENT AND CONSULTATION; BUSINESS MANAGEMENT CONSULTANCY SERVICES; BUSINESS MANAGEMENT CONSULTATION; BUSINESS MANAGEMENT CONSULTATION IN THE FIELD OF EXECUTIVE AND LEADERSHIP DEVELOPMENT; BUSINESS MANAGEMENT CONSULTING; BUSINESS MANAGEMENT CONSULTING AND ADVISORY SERVICES; BUSINESS MANAGEMENT INFORMATION ON A WIDE VARIETY OF TOPICS TO SERVICE PROVIDING PROFESSIONALS; BUSINESS MANAGEMENT OF THE NONPROFIT CORPORATIONS AND TRADE ASSOCIATIONS OF OTHERS; BUSINESS MANAGEMENT PLANNING; BUSINESS MARKETING CONSULTING SERVICES; BUSINESS

MARKETING SERVICES; BUSINESS MEETING PLANNING; BUSINESS ORGANISATION CONSULTING; BUSINESS ORGANIZATION ADVICE; BUSINESS ORGANIZATION AND MANAGEMENT CONSULTING; BUSINESS ORGANIZATION AND OPERATION CONSULTANCY; BUSINESS ORGANIZATION CONSULTING; BUSINESS ORGANIZATIONAL CONSULTATION; BUSINESS PLANNING; BUSINESS PROCESS RE-ENGINEERING SERVICES; BUSINESS RESEARCH; BUSINESS RESEARCH AND SURVEYS; BUSINESS RESEARCH CONSULTATION; BUSINESS RISK MANAGEMENT; BUSINESS RISK MANAGEMENT CONSULTATION, IN CLASS 35 (U.S. CLS. 100, 101 AND 102).

FIRST USE 10-1-2007; IN COMMERCE 10-1-2007.

THE MARK CONSISTS OF STANDARD CHARACTERS WITHOUT CLAIM TO ANY PARTICULAR FONT, STYLE, SIZE, OR COLOR.

NO CLAIM IS MADE TO THE EXCLUSIVE RIGHT TO USE "BUSINESS", APART FROM THE MARK AS SHOWN.

SER. NO. 77-310,306, FILED 10-22-2007.

KATHERINE CONNOLLY, EXAMINING ATTORNEY

**Int. Cl.: 19**

**Prior U.S. Cls.: 1, 12, 33 and 50**

**United States Patent and Trademark Office**

**Reg. No. 3,453,082**

**Registered June 24, 2008**

**TRADEMARK  
PRINCIPAL REGISTER**

**VARIAVENT**

DIVERSI-PLAST PRODUCTS, INC. (MINNESOTA CORPORATION)  
5600 NORTH HIGHWAY 169  
MINNEAPOLIS, MN 55428

FOR: NON-METAL ROOF RIDGE VENTILATION SYSTEM COMPRISED OF ROOF RIDGE VENTS AND FOAM ENDCAPS, SOLD AS A UNIT; AIR PERMEABLE AND PRECIPITATION-RESISTANT ROOFING MEMBRANE; ROOF RIDGE VENTILATORS, NAMELY, CORRUGATED PLASTIC SHINGLE-OVER RIDGE VENTS AND STRUCTURAL

PARTS THEREFOR, IN CLASS 19 (U.S. CLS. 1, 12, 33 AND 50).

FIRST USE 7-31-2007; IN COMMERCE 7-31-2007.

THE MARK CONSISTS OF STANDARD CHARACTERS WITHOUT CLAIM TO ANY PARTICULAR FONT, STYLE, SIZE, OR COLOR.

SER. NO. 77-310,321, FILED 10-22-2007.

TINA KUAN, EXAMINING ATTORNEY

**Int. Cl.: 35**

**Prior U.S. Cls.: 100, 101 and 102**

**United States Patent and Trademark Office**

**Reg. No. 3,453,083**

**Registered June 24, 2008**

**SERVICE MARK  
PRINCIPAL REGISTER**



SKYHAWKS SPORTS ACADEMY, INC. (WA-  
SHINGTON CORPORATION)  
6311 E. MT. SPOKANE PARK DR., SUITE B  
MEAD, WA 99021

FOR: FRANCHISE SERVICES, NAMELY, OFFER-  
ING TECHNICAL AND BUSINESS MANAGEMENT  
ASSISTANCE IN THE ESTABLISHMENT AND OP-  
ERATION OF BUSINESSES WHICH PROVIDE  
SPORTS AND RECREATIONAL CAMPS, SPORTS  
PROGRAMS AND CLINICS, IN CLASS 35 (U.S. CLS.  
100, 101 AND 102).

FIRST USE 7-30-2007; IN COMMERCE 7-30-2007.

OWNER OF U.S. REG. NO. 2,341,270.

THE MARK CONSISTS OF A DESIGN OF A  
HAWK'S HEAD.

SER. NO. 77-310,335, FILED 10-22-2007.

LANA PHAM, EXAMINING ATTORNEY

**Int. Cl.: 3**

**Prior U.S. Cls.: 1, 4, 6, 50, 51 and 52**

**Reg. No. 3,453,084**

**United States Patent and Trademark Office**

**Registered June 24, 2008**

**TRADEMARK  
PRINCIPAL REGISTER**

**Chaz**

C.L.S. GENERAL MERCHANSISE, INC. (CALI-  
FORNIA CORPORATION)  
1020 WILDE STREET  
LOS ANGELES, CA 90021

FOR: BODY SPRAY USED AS A PERSONAL  
DEODORANT AND AS FRAGRANCE; BODY  
SPRAYS; FEMININE DEODORANT SPRAYS; SCEN-  
TED BODY SPRAY; EAU DE TOILETTE; EAU-DE-  
TOILETTE; EAUX DE TOILETTE; TOILET WATER;  
PERFUME; PERFUMED POWDER; PERFUMED  
POWDERS; PERFUMED SOAP; PERFUMED SOAPS;  
PERFUMES; EAU DE PERFUME; COLOGNE; CO-  
LOGNE WATER; EAU DE COLOGNE; AFTER-  
SHAVE LOTIONS; BATH LOTION; BATHING LO-  
TIONS; BEAUTY LOTIONS; BODY LOTION; BODY

LOTIONS; FACE AND BODY LOTIONS; HAND  
LOTIONS; TOILET SOAP; TOILET SOAPS; BODY  
POWDER; TALCUM POWDER; TALCUM POW-  
DERS; FRAGRANCES FOR PERSONAL USE, IN  
CLASS 3 (U.S. CLS. 1, 4, 6, 50, 51 AND 52).

FIRST USE 3-19-1999; IN COMMERCE 3-19-1999.

THE MARK CONSISTS OF STANDARD CHAR-  
ACTERS WITHOUT CLAIM TO ANY PARTICULAR  
FONT, STYLE, SIZE, OR COLOR.

SER. NO. 77-310,343, FILED 10-22-2007.

MARGERY A. TIERNEY, EXAMINING ATTORNEY

**Int. Cl.: 44**

**Prior U.S. Cls.: 100 and 101**

**United States Patent and Trademark Office**

**Reg. No. 3,453,085**

**Registered June 24, 2008**

**SERVICE MARK  
PRINCIPAL REGISTER**

**PASSPORT BATCHSOURCE**

PASSPORT HEALTH COMMUNICATIONS, INC.  
(TENNESSEE CORPORATION)  
SUITE 450  
720 COOL SPRINGS BOULEVARD  
FRANKLIN, TN 37067

FOR: PROVISION OF HEALTHCARE INFORMATION BY ELECTRONIC MEANS, IN CLASS 44 (U.S. CLS. 100 AND 101).

FIRST USE 5-31-2006; IN COMMERCE 5-31-2006.

THE MARK CONSISTS OF STANDARD CHARACTERS WITHOUT CLAIM TO ANY PARTICULAR FONT, STYLE, SIZE, OR COLOR.

SER. NO. 77-310,360, FILED 10-22-2007.

KATHERINE CONNOLLY, EXAMINING ATTORNEY

**Int. Cl.: 44**

**Prior U.S. Cls.: 100 and 101**

**United States Patent and Trademark Office**

**Reg. No. 3,453,086**

**Registered June 24, 2008**

**SERVICE MARK  
PRINCIPAL REGISTER**

**PASSPORT INTELLISOURCE**

PASSPORT HEALTH COMMUNICATIONS, INC.  
(TENNESSEE CORPORATION)  
SUITE 450  
720 COOL SPRINGS BOULEVARD  
FRANKLIN, TN 37067

FOR: PROVISION OF HEALTHCARE INFORMATION BY ELECTRONIC MEANS, IN CLASS 44 (U.S. CLS. 100 AND 101).

FIRST USE 3-24-2006; IN COMMERCE 3-24-2006.

THE MARK CONSISTS OF STANDARD CHARACTERS WITHOUT CLAIM TO ANY PARTICULAR FONT, STYLE, SIZE, OR COLOR.

SER. NO. 77-310,367, FILED 10-22-2007.

KATHERINE CONNOLLY, EXAMINING ATTORNEY



**Int. Cl.: 9**

**Prior U.S. Cls.: 21, 23, 26, 36 and 38**

**Reg. No. 3,453,087**

**United States Patent and Trademark Office**

**Registered June 24, 2008**

**TRADEMARK  
PRINCIPAL REGISTER**

**TEN STAR**  
  
**RECORDS**

TEN STAR ENTERTAINMENT, INC. (GEORGIA CORPORATION)  
1888 EMERY STREET, SUITE 111  
ATLANTA, GA 30318

FOR: SOUND RECORDINGS FEATURING MUSIC; DOWNLOADABLE MP3 FILES FEATURING MUSIC; MP3 RECORDINGS FEATURING MUSIC, IN CLASS 9 (U.S. CLS. 21, 23, 26, 36 AND 38).

FIRST USE 9-30-2007; IN COMMERCE 9-30-2007.

NO CLAIM IS MADE TO THE EXCLUSIVE RIGHT TO USE "RECORDS", APART FROM THE MARK AS SHOWN.

THE MARK CONSISTS OF THE WORDING "TEN STAR" ABOVE A ROW OF TEN STARS HOUSED IN A RECTANGLE, WITH THE WORD "RECORDS" ABOVE.

SER. NO. 77-310,397, FILED 10-22-2007.

ADA HAN, EXAMINING ATTORNEY

**Int. Cl.: 30**

**Prior U.S. Cl.: 46**

**United States Patent and Trademark Office**

**Reg. No. 3,453,088**

**Registered June 24, 2008**

**TRADEMARK  
PRINCIPAL REGISTER**

**Tomato Picker-Upper Sauce**

MAUDADAUTA, LLC (NEW JERSEY LTD LIAB  
CO)  
4122 BEL VISTA COURT  
LODI, NJ 07644

NO CLAIM IS MADE TO THE EXCLUSIVE  
RIGHT TO USE "TOMATO" AND "SAUCE", APART  
FROM THE MARK AS SHOWN.

FOR: TOMATO SAUCE, IN CLASS 30 (U.S. CL. 46).

FIRST USE 7-17-2007; IN COMMERCE 7-17-2007.

SER. NO. 77-310,431, FILED S.R. 10-22-2007 AM.  
P.R. 2-2-2008.

THE MARK CONSISTS OF STANDARD CHAR-  
ACTERS WITHOUT CLAIM TO ANY PARTICULAR  
FONT, STYLE, SIZE, OR COLOR.

BARBARA RUTLAND, EXAMINING ATTORNEY

**Int. Cl.: 3**

**Prior U.S. Cls.: 1, 4, 6, 50, 51 and 52**

**United States Patent and Trademark Office**

**Reg. No. 3,453,089**

**Registered June 24, 2008**

**TRADEMARK  
PRINCIPAL REGISTER**



MEGA PACIFIC TECHNOLOGY INC. (CALIFORNIA CORPORATION)  
2005 VISTA AVE.  
SIERRA MADRE, CA 91024

FOR: ALL PURPOSE CLEANING PREPARATIONS; ALL-PURPOSE CLEANERS; AUTOMOTIVE CLEANING PREPARATIONS; CLEANING PREPARATIONS FOR HOUSEHOLD PURPOSES; DEGREASING PREPARATIONS FOR HOUSEHOLD PURPOSES; DEGREASING PREPARATIONS FOR AUTOMOBILES, KITCHENS, SPORTING GOODS, MACHINERY, BARBEQUES, IN CLASS 3 (U.S. CLS. 1, 4, 6, 50, 51 AND 52).

FIRST USE 10-17-2007; IN COMMERCE 10-17-2007.

NO CLAIM IS MADE TO THE EXCLUSIVE RIGHT TO USE "NATURAL CITRUS MULTI-PURPOSE DEGREASER", APART FROM THE MARK AS SHOWN.

THE COLOR(S) ORANGE, YELLOW, GREEN AND WHITE IS/ARE CLAIMED AS A FEATURE OF THE MARK.

THE MARK CONSISTS OF THREE SHOOTING STARS WITH THREE TRAILING TAILS ON TOP AND BOTTOM OF MARK WITH LITERAL ELEMENTS IN THE MIDDLE. THE TAILS OF THE STARS FADE FROM YELLOW TO ORANGE LEADING TO THREE STARS EACH ON TOP AND BOTTOM WITH ORANGE OUTLINE AND YELLOW CENTER. LITERAL ELEMENTS IN THE CENTER OF MARK ARE "DECLEAN" WITH WHITE TYPE OUTLINED IN GREEN WITH A YELLOW BORDER ON TOP OF "NATURAL CITRUS MULTI-PURPOSE DEGREASER" IN YELLOW TYPE WITH GREEN BORDER.

SER. NO. 77-310,467, FILED 10-22-2007.

MARK T. MULLEN, EXAMINING ATTORNEY

**Int. Cl.: 33**

**Prior U.S. Cls.: 47 and 49**

**United States Patent and Trademark Office**

**Reg. No. 3,453,090**

**Registered June 24, 2008**

**TRADEMARK  
PRINCIPAL REGISTER**

# Tombstone Red

DOMAINES ELLAM, INC. (ARIZONA CORPORATION)

HC1 BOX 46

ELGIN, AZ 85611

FOR: GRAPE WINE; RED WINE; TABLE WINES; WINE; WINES, IN CLASS 33 (U.S. CLS. 47 AND 49).

FIRST USE 1-1-1982; IN COMMERCE 1-1-1982.

THE MARK CONSISTS OF STANDARD CHARACTERS WITHOUT CLAIM TO ANY PARTICULAR FONT, STYLE, SIZE, OR COLOR.

NO CLAIM IS MADE TO THE EXCLUSIVE RIGHT TO USE "RED", APART FROM THE MARK AS SHOWN.

SER. NO. 77-310,473, FILED 10-22-2007.

ALYSSA PALADINO, EXAMINING ATTORNEY

**Int. Cl.: 36**

**Prior U.S. Cls.: 100, 101 and 102**

**United States Patent and Trademark Office**

**Reg. No. 3,453,091**

**Registered June 24, 2008**

**SERVICE MARK  
PRINCIPAL REGISTER**

**OPTIONWINDOW**

OPTIQUOTES (CALIFORNIA PARTNERSHIP)  
2775 MESA VERDE DRIVE EAST  
#210  
COSTA MESA, CA 92626

FIRST USE 10-22-2007; IN COMMERCE 10-22-2007.

FOR: FINANCIAL SERVICES, NAMELY PROVIDING INFORMATION IN THE FIELDS OF FOREIGN CURRENCY, COMMODITIES, FINANCIAL DERIVATIVES, INTEREST RATE PRODUCTS, AND EQUITIES VIA THE INTERNET AND INTRANET SYSTEMS, IN CLASS 36 (U.S. CLS. 100, 101 AND 102).

THE MARK CONSISTS OF STANDARD CHARACTERS WITHOUT CLAIM TO ANY PARTICULAR FONT, STYLE, SIZE, OR COLOR.

SER. NO. 77-310,481, FILED 10-22-2007.

KAREN K. BUSH, EXAMINING ATTORNEY

**Int. Cl.: 36**

**Prior U.S. Cls.: 100, 101 and 102**

**United States Patent and Trademark Office**

**Reg. No. 3,453,092**

**Registered June 24, 2008**

**SERVICE MARK  
PRINCIPAL REGISTER**

**SPREADWINDOW**

OPTIQUOTES (CALIFORNIA PARTNERSHIP)  
2775 MESA VERDE DRIVE EAST  
#210  
COSTA MESA, CA 92626

FIRST USE 10-22-2007; IN COMMERCE 10-22-2007.

FOR: FINANCIAL SERVICES, NAMELY, PROVIDING INFORMATION IN THE FIELDS OF FOREIGN CURRENCY, COMMODITIES, FINANCIAL DERIVATIVES, INTEREST RATE PRODUCTS, AND EQUITIES VIA THE INTERNET AND INTRANET SYSTEMS, IN CLASS 36 (U.S. CLS. 100, 101 AND 102).

THE MARK CONSISTS OF STANDARD CHARACTERS WITHOUT CLAIM TO ANY PARTICULAR FONT, STYLE, SIZE, OR COLOR.

SER. NO. 77-310,492, FILED 10-22-2007.

KAREN K. BUSH, EXAMINING ATTORNEY

**Int. Cl.: 36**

**Prior U.S. Cls.: 100, 101 and 102**

**United States Patent and Trademark Office**

**Reg. No. 3,453,093**

**Registered June 24, 2008**

**SERVICE MARK  
PRINCIPAL REGISTER**

**FUTURESWINDOW**

OPTIQUOTES (CALIFORNIA PARTNERSHIP)  
2775 MESA VERDE DRIVE EAST  
#210  
COSTA MESA, CA 92626

FIRST USE 10-22-2007; IN COMMERCE 10-22-2007.

FOR: FINANCIAL SERVICES, NAMELY, PROVIDING INFORMATION IN THE FIELDS OF FOREIGN CURRENCY, COMMODITIES, FINANCIAL DERIVATIVES, INTEREST RATE PRODUCTS, AND EQUITIES VIA THE INTERNET AND INTRANET SYSTEMS, IN CLASS 36 (U.S. CLS. 100, 101 AND 102).

THE MARK CONSISTS OF STANDARD CHARACTERS WITHOUT CLAIM TO ANY PARTICULAR FONT, STYLE, SIZE, OR COLOR.

SER. NO. 77-310,499, FILED 10-22-2007.

KAREN K. BUSH, EXAMINING ATTORNEY

**Int. Cl.: 33**

**Prior U.S. Cls.: 47 and 49**

**United States Patent and Trademark Office**

**Reg. No. 3,453,094**

**Registered June 24, 2008**

**TRADEMARK  
PRINCIPAL REGISTER**

# Four Monkey Wines

DOMAINES ELLAM, INC. (ARIZONA CORPORATION)  
HC1 BOX 46  
ELGIN, AZ 85611

FOR: APERITIF WINES; GRAPE WINE; NATURAL SPARKLING WINES; PORT WINES; RED WINE; SPARKLING GRAPE WINE; SPARKLING WINES; SWEET WINES; TABLE WINES; WHITE WINE; WINE; WINES , IN CLASS 33 (U.S. CLS. 47 AND 49).

FIRST USE 1-1-2005; IN COMMERCE 1-1-2005.

THE MARK CONSISTS OF STANDARD CHARACTERS WITHOUT CLAIM TO ANY PARTICULAR FONT, STYLE, SIZE, OR COLOR.

NO CLAIM IS MADE TO THE EXCLUSIVE RIGHT TO USE "WINES", APART FROM THE MARK AS SHOWN.

SER. NO. 77-310,519, FILED 10-22-2007.

ALYSSA PALADINO, EXAMINING ATTORNEY



**Int. Cl.: 28**

**Prior U.S. Cls.: 22, 23, 38 and 50**

**United States Patent and Trademark Office**

**Reg. No. 3,453,095**

**Registered June 24, 2008**

**TRADEMARK  
PRINCIPAL REGISTER**

# Playing Gods

RADFORD, BENJAMIN T (UNITED STATES IN-  
DIVIDUAL)  
732 BALTIC AVE. SE  
RIO RANCHO, NM 87124

THE MARK CONSISTS OF STANDARD CHAR-  
ACTERS WITHOUT CLAIM TO ANY PARTICULAR  
FONT, STYLE, SIZE, OR COLOR.

FOR: BOARD GAMES, IN CLASS 28 (U.S. CLS. 22,  
23, 38 AND 50).

SER. NO. 77-310,521, FILED 10-22-2007.

FIRST USE 9-2-2007; IN COMMERCE 9-2-2007.

KAPIL BHANOT, EXAMINING ATTORNEY

**Int. Cl.: 42**

**Prior U.S. Cls.: 100 and 101**

**United States Patent and Trademark Office**

**Reg. No. 3,453,096**

**Registered June 24, 2008**

**SERVICE MARK  
PRINCIPAL REGISTER**

**Bayview Research Group**

BAYVIEW RESEARCH GROUP LLC (CALIFORNIA LTD LIAB CO)  
9903 SANTA MONICA BOULEVARD  
SUITE 313  
BEVERLY HILLS, CA 90212

FOR: PHARMACEUTICAL RESEARCH SERVICES, IN CLASS 42 (U.S. CLS. 100 AND 101).

FIRST USE 11-17-2004; IN COMMERCE 11-17-2004.

THE MARK CONSISTS OF STANDARD CHARACTERS WITHOUT CLAIM TO ANY PARTICULAR FONT, STYLE, SIZE, OR COLOR.

NO CLAIM IS MADE TO THE EXCLUSIVE RIGHT TO USE "RESEARCH GROUP", APART FROM THE MARK AS SHOWN.

SER. NO. 77-310,524, FILED 10-22-2007.

LAURA HAMMEL, EXAMINING ATTORNEY

**Int. Cl.: 3**

**Prior U.S. Cls.: 1, 4, 6, 50, 51 and 52**

**United States Patent and Trademark Office**

**Reg. No. 3,453,097**

**Registered June 24, 2008**

**TRADEMARK  
PRINCIPAL REGISTER**

**ENORMOUS LASH**

INTUIT BEAUTY, INC. (NEVADA CORPORATION)

1802 N. CARSON ST. STE 212

CARSON CITY, NV 89701

FOR: COSMETIC PREPARATIONS FOR EYE LASHES, IN CLASS 3 (U.S. CLS. 1, 4, 6, 50, 51 AND 52).

FIRST USE 8-23-2007; IN COMMERCE 8-23-2007.

THE MARK CONSISTS OF STANDARD CHARACTERS WITHOUT CLAIM TO ANY PARTICULAR FONT, STYLE, SIZE, OR COLOR.

NO CLAIM IS MADE TO THE EXCLUSIVE RIGHT TO USE "LASH", APART FROM THE MARK AS SHOWN.

SER. NO. 77-310,533, FILED 10-23-2007.

LYDIA BELZER, EXAMINING ATTORNEY

**Int. Cl.: 38**

**Prior U.S. Cls.: 100, 101 and 104**

**United States Patent and Trademark Office**

**Reg. No. 3,453,098**

**Registered June 24, 2008**

**SERVICE MARK  
PRINCIPAL REGISTER**

BRINGING VALUE BACK TO THE  
HOME PHONE

TOLY DIGITAL NETWORKS, INC. (FLORIDA  
CORPORATION)  
4425 MILITARY TRAIL SUITE 209  
JUPITER, FL 33458

FOR: TELECOMMUNICATION SERVICES,  
NAMELY, LOCAL AND LONG DISTANCE TRANS-  
MISSION OF VOICE, DATA, GRAPHICS AND VI-  
DEO BY MEANS OF BROADBAND, COPPER AND  
OPTICAL OR WIRELESS NETWORKS, IN CLASS 38  
(U.S. CLS. 100, 101 AND 104).

FIRST USE 3-31-2007; IN COMMERCE 3-31-2007.

THE MARK CONSISTS OF STANDARD CHAR-  
ACTERS WITHOUT CLAIM TO ANY PARTICULAR  
FONT, STYLE, SIZE, OR COLOR.

SER. NO. 77-310,574, FILED 10-23-2007.

SUSAN LESLIE DUBOIS, EXAMINING ATTORNEY

**Int. Cl.: 36**

**Prior U.S. Cls.: 100, 101 and 102**

**United States Patent and Trademark Office**

**Reg. No. 3,453,099**

**Registered June 24, 2008**

**SERVICE MARK  
PRINCIPAL REGISTER**

**DETAILS MATTER.**

RESOURCE COMMERCIAL REAL ESTATE, LLC  
(INDIANA LTD LIAB CO)  
280 E. 96TH STREET, SUITE 350  
INDIANAPOLIS, IN 46240

FOR: LEASING OF REAL ESTATE; REAL ES-  
TATE ACQUISITION SERVICES; REAL ESTATE  
BROKERAGE; REAL ESTATE CONSULTANCY;  
REAL ESTATE LISTING , IN CLASS 36 (U.S. CLS.  
100, 101 AND 102).

FIRST USE 9-10-2007; IN COMMERCE 9-10-2007.

THE MARK CONSISTS OF STANDARD CHAR-  
ACTERS WITHOUT CLAIM TO ANY PARTICULAR  
FONT, STYLE, SIZE, OR COLOR.

SER. NO. 77-310,606, FILED 10-23-2007.

KATHERINE CHANG, EXAMINING ATTORNEY

**Int. Cl.: 42**

**Prior U.S. Cls.: 100 and 101**

**United States Patent and Trademark Office**

**Reg. No. 3,453,100**

**Registered June 24, 2008**

**SERVICE MARK  
PRINCIPAL REGISTER**

# BenefitTube

HEALTHX, INC. (INDIANA CORPORATION)  
STE 150  
9339 PRIORITY WAY WEST DRIVE  
INDIANAPOLIS, IN 46240

FOR: PROVIDING ON-LINE NON-DOWNLOAD-  
ABLE SOFTWARE TO ENABLE USERS TO POST,  
SHARE AND ACCESS VIDEO FILES, AUDIO FILES  
AND OTHER MULTIMEDIA CONTENT THROUGH  
A MANAGED NETWORK, IN CLASS 42 (U.S. CLS.  
100 AND 101).

FIRST USE 8-28-2007; IN COMMERCE 8-28-2007.

THE MARK CONSISTS OF STANDARD CHAR-  
ACTERS WITHOUT CLAIM TO ANY PARTICULAR  
FONT, STYLE, SIZE, OR COLOR.

SER. NO. 77-310,609, FILED 10-23-2007.

STEVEN JACKSON, EXAMINING ATTORNEY

**Int. Cl.: 9**

**Prior U.S. Cls.: 21, 23, 26, 36 and 38**

**Reg. No. 3,453,101**

**United States Patent and Trademark Office**

**Registered June 24, 2008**

---

**TRADEMARK  
PRINCIPAL REGISTER**

**FLYCAMONE**

BRINKMEYER, JORG (FED REP GERMANY  
INDIVIDUAL), DBA ACME THE GAME COM-  
PANY  
AGATHASTRASSE 20, 33397  
RIETBERG, FED REP GERMANY

THE MARK CONSISTS OF STANDARD CHAR-  
ACTERS WITHOUT CLAIM TO ANY PARTICULAR  
FONT, STYLE, SIZE, OR COLOR.

FOR: VIDEO CAMERAS, IN CLASS 9 (U.S. CLS. 21,  
23, 26, 36 AND 38).

SER. NO. 77-310,641, FILED 10-23-2007.

FIRST USE 7-1-2007; IN COMMERCE 7-1-2007.

NATALIE POLZER, EXAMINING ATTORNEY

**Int. Cl.: 3**

**Prior U.S. Cls.: 1, 4, 6, 50, 51 and 52**

**United States Patent and Trademark Office**

**Reg. No. 3,453,102**

**Registered June 24, 2008**

**TRADEMARK  
PRINCIPAL REGISTER**

**ZEASORB**

STIEFEL LABORATORIES, INC. (DELAWARE  
CORPORATION)  
255 ALHAMBRA CIRCLE, STE. 1000  
CORAL GABLES, FL 33134

FOR: NON-MEDICATED SKIN CARE PREPARA-  
TIONS FOR THE TREATMENT OF CONDITIONS  
OF THE SKIN AND FOOT, NAMELY, ATHLETE'S  
FOOT, CHAFING, HEAT RASH, AND DIAPER  
RASH, IN CLASS 3 (U.S. CLS. 1, 4, 6, 50, 51 AND 52).

FIRST USE 9-4-1959; IN COMMERCE 9-4-1959.

THE MARK CONSISTS OF STANDARD CHAR-  
ACTERS WITHOUT CLAIM TO ANY PARTICULAR  
FONT, STYLE, SIZE, OR COLOR.

SER. NO. 77-310,643, FILED 10-23-2007.

JOHN DALIER, EXAMINING ATTORNEY



**Int. Cl.: 41**

**Prior U.S. Cls.: 100, 101 and 107**

**United States Patent and Trademark Office**

**Reg. No. 3,453,103**

**Registered June 24, 2008**

**SERVICE MARK  
PRINCIPAL REGISTER**

# Liquid Moon

MANN, SEAN (UNITED STATES INDIVIDUAL)  
101 MILL STREET  
PETERSTOWN, WV 24963 AND  
BALLARD, JOHN (UNITED STATES INDIVIDUAL)  
303 MARKET STREET  
PETERSTOWN, WV 24963 AND  
DUNN, BRANDON (UNITED STATES INDIVIDUAL)  
19 OAK HOLLOW LANE  
PETERSTOWN, WV 24963 AND  
CARDEN, JONAH (UNITED STATES INDIVIDUAL)  
BOX 33-B  
HC 77  
PETERSTOWN, WV 24963

FOR: ENTERTAINMENT, NAMELY, LIVE PERFORMANCES BY A MUSICAL BAND, IN CLASS 41 (U.S. CLS. 100, 101 AND 107).

FIRST USE 7-12-2007; IN COMMERCE 7-12-2007.

THE MARK CONSISTS OF STANDARD CHARACTERS WITHOUT CLAIM TO ANY PARTICULAR FONT, STYLE, SIZE, OR COLOR.

SER. NO. 77-310,669, FILED 10-23-2007.

SHANNON TWOHIG, EXAMINING ATTORNEY

**Int. Cl.: 35**

**Prior U.S. Cls.: 100, 101 and 102**

**United States Patent and Trademark Office**

**Reg. No. 3,453,104**

**Registered June 24, 2008**

**SERVICE MARK  
PRINCIPAL REGISTER**



INCOMM INTERNATIONAL, INC. (FLORIDA CORPORATION), DBA BROOKSLACAYO, ADVERTISING, BRANDING, PR  
4736 BLANDING BLVD.  
JACKSONVILLE, FL 32210

FOR: ADVERTISING AND BUSINESS SERVICES, NAMELY, SECURING AIRTIME ON ALL FORMS OF MEDIA COMMUNICATIONS STATIONS, SYSTEMS, NETWORKS, AND SERVICES FOR THE PURPOSE OF PROMOTING THE GOODS AND SERVICES OF OTHERS; ADVERTISING AND PUBLICITY SERVICES, NAMELY, PROMOTING THE GOODS, SERVICES, BRAND IDENTITY AND COMMERCIAL INFORMATION AND NEWS OF THIRD PARTIES THROUGH PRINT, AUDIO, VIDEO, DIGITAL AND ON-LINE MEDIUM; ADVERTISING SERVICES, NAMELY, CREATING CORPORATE AND BRAND IDENTITY FOR OTHERS; ADVERTISING THROUGH ALL PUBLIC COMMUNICATION MEANS; ADVERTISING, MARKETING AND PROMOTION SERVICES; BUSINESS CONSULTATION AND MANAGEMENT REGARDING MARKETING ACTIVITIES AND LAUNCHING OF NEW PRODUCTS; BUSINESS MARKETING CONSULTING SERVICES; BUSINESS MARKETING SERVICES; CONSULTING SERVICES RELATING TO PUBLICITY; DEVELOPMENT OF MARKETING STRATEGIES AND CONCEPTS; GENERAL BUSINESS

MERCHANDISING SERVICES, NAMELY, MARKETING; PREPARATION OF CUSTOM OR NON-CUSTOM ADVERTISING FOR BUSINESSES FOR DISSEMINATION VIA THE WEB, CD OR DVD FOR OPTIONAL UPLOAD OR DOWNLOAD TO A COMPUTER; PREPARING BUSINESS REPORTS; PREPARING COMPUTER SLIDE TRANSPARENCIES FOR USE BY BUSINESS; PUBLIC RELATIONS; PUBLICITY AND SALES PROMOTION SERVICES, IN CLASS 35 (U.S. CLS. 100, 101 AND 102).

FIRST USE 9-4-2007; IN COMMERCE 9-4-2007.

THE COLOR(S) ORANGE AND BLACK IS/ARE CLAIMED AS A FEATURE OF THE MARK.

THE MARK CONSISTS OF AN ORANGE UPPER-CASE STYLIZED "B" WITH THE VERTICAL LINE FORMING THE LEFT SIDE OF THE "B" CLOSING ONLY THE BOTTOM LOOP, LEAVING THE UPPER HALF OF THE "B" APPEARING AS HALF OF A CIRCLE. THE WORD "BROOKSLACAYO" APPEARS IN BLACK BENEATH THE "B."

SER. NO. 77-310,674, FILED 10-23-2007.

CHRISTINA SOBRAL, EXAMINING ATTORNEY

**Int. Cl.: 36**

**Prior U.S. Cls.: 100, 101 and 102**

**United States Patent and Trademark Office**

**Reg. No. 3,453,105**

**Registered June 24, 2008**

**SERVICE MARK  
PRINCIPAL REGISTER**

**MaxOver**

DELTA DENTAL OF VIRGINIA (VIRGINIA  
NON-PROFIT CORPORATION)  
4818 STARKEY ROAD  
ROANOKE, VA 240188542

FOR: DENTAL HEALTH INSURANCE UNDER-  
WRITING AND ADMINISTRATION; DENTAL  
HEALTH INSURANCE ADMINISTRATION; PRO-  
VIDING INFORMATION IN INSURANCE MAT-  
TERS , IN CLASS 36 (U.S. CLS. 100, 101 AND 102).

FIRST USE 9-0-2007; IN COMMERCE 9-0-2007.

THE MARK CONSISTS OF STANDARD CHAR-  
ACTERS WITHOUT CLAIM TO ANY PARTICULAR  
FONT, STYLE, SIZE, OR COLOR.

SER. NO. 77-310,681, FILED 10-23-2007.

JORDAN BAKER, EXAMINING ATTORNEY

**Int. Cl.: 28**

**Prior U.S. Cls.: 22, 23, 38 and 50**

**Reg. No. 3,453,106**

**United States Patent and Trademark Office**

**Registered June 24, 2008**

---

**TRADEMARK  
PRINCIPAL REGISTER**

**MR. BILLIARDS**

LONG'S AMUSEMENT COMPANY, INC. (VIRGINIA CORPORATION)  
9908 WARWICK BOULEVARD  
NEWPORT NEWS, VA 23601

FOR: BILLIARD CUE STICKS, BILLIARD CUE RACKS, BILLIARD BRIDGES, BILLIARD GAME PLAYING EQUIPMENT, BILLIARD TABLES, BILLIARD TIPS, BILLIARD TRIANGLES, BILLIARD NETS, BILLIARD BALLS, BILLIARD BUMPERS, BILLIARD CHALK, BILLIARD TALLY BALLS, IN CLASS 28 (U.S. CLS. 22, 23, 38 AND 50).

FIRST USE 8-0-1998; IN COMMERCE 8-0-1998.

THE MARK CONSISTS OF STANDARD CHARACTERS WITHOUT CLAIM TO ANY PARTICULAR FONT, STYLE, SIZE, OR COLOR.

OWNER OF U.S. REG. NO. 2,450,679.

SER. NO. 77-310,683, FILED 10-23-2007.

MICHELE SWAIN, EXAMINING ATTORNEY

**Int. Cl.: 21**

**Prior U.S. Cls.: 2, 13, 23, 29, 30, 33, 40 and 50**

**Reg. No. 3,453,107**

**United States Patent and Trademark Office**

**Registered June 24, 2008**

**TRADEMARK  
PRINCIPAL REGISTER**

# MONTAGE

MONTAGE HOTELS AND RESORTS, LLC (NEVADA LTD LIAB CO)  
31106 SOUTH COAST HIGHWAY  
LAGUNA BEACH, CA 92651

FOR: COOKWARE, NAMELY, POTS AND PANS; COOKING AND HOUSEHOLD UTENSILS, NAMELY, SOUFFLÉ DISHES, CUTTING BOARDS, SERVING LADLES, LADLES FOR KITCHEN USE, SPATULAS, BASTING BRUSHES, SALAD SPINNERS, HOUSEHOLD UTENSILS, NAMELY, GRATERS, BOTTLE OPENERS, WINE BOTTLE OPENERS, ROLLING PINS, COOKIE CUTTERS, PASTRY CUTTERS, WHISKS, PASTRY MOLDS, CAKE MOLDS, CHOCOLATE MOLDS, RING PASTRY CUTTERS, RING MOLDS, PUFF PASTRY CUTTERS, BREAD CUTTERS, GELATIN CUTTERS, CAKE PANS, TART MOLDS, COOKING PANS, COOKIE SHEET PANS, FLEXIBLE PANS, CAST IRON PANS, NON-STICK PANS, STAINLESS STEEL STORAGE PANS, COPPER PANS, FRY PANS, BAKING PANS FOR USE WITH INDUCTION OVENS, CAKE RINGS, SQUEEZE BOTTLES SOLD EMPTY, PAN USED TO MAKE PANCAKES AND BLINIS, PASTRY BAGS FOR CAKE AND PASTRY DECORATIONS, SERVING PLATTERS, SERVING TONGS, SIEVES, COOKING SKEWERS, NON-ELECTRIC JUICERS, SCOOPS, COPPER PANS, FUNNELS, MIXING BOWLS, BUTCHER BLOCKS IN THE NATURE OF WOODEN CUTTING BOARDS, COLANDERS, TEA CADDIES, SPICE CADDIES, COFFEE CADDIES, SUGAR CADDIES, CREAM CADDIES,

CHEESE CADDIES, SHELL FISH CADDIES, PLATES, BOWLS, CUPS, SAUCERS, COFFEE CUPS, ESPRESSO CUPS, PORCELAIN SERVING PLATTERS, TERRINES, GLASS VOTIVES, CANDLE VOTIVES, VASES, COFFEE PITCHERS, PEPPER MILLS, CAVIAR COOLERS, DECANTERS, CREAMER PITCHERS, NON-METAL BREAD BASKETS, CAKE PLATES, NON-ELECTRIC COFFEE PRESSES, CRYSTAL BEVERAGE GLASSWARE, BEVERAGE GLASSWARE, WINE BUCKETS, RELISH SERVING TRAYS NOT OF PRECIOUS METAL, PLASTIC COASTERS, RAMEKINS, SUGAR SERVING TONGS, MEAL TRAYS, SERVING TRAYS NOT OF PRECIOUS METAL, EGG POACHERS, ICE BUCKETS, SALT GRINDERS, PEPPER GRINDERS, SPICE GRINDERS AND NON-ELECTRIC COFFEE GRINDERS, IN CLASS 21 (U.S. CLS. 2, 13, 23, 29, 30, 33, 40 AND 50).

FIRST USE 3-1-2003; IN COMMERCE 3-1-2003.

THE MARK CONSISTS OF STANDARD CHARACTERS WITHOUT CLAIM TO ANY PARTICULAR FONT, STYLE, SIZE, OR COLOR.

OWNER OF U.S. REG. NOS. 2,801,152 AND 3,038,275.

SER. NO. 77-310,727, FILED 10-23-2007.

ELLEN B. AWRICH, EXAMINING ATTORNEY

**Int. Cl.: 36**

**Prior U.S. Cls.: 100, 101 and 102**

**United States Patent and Trademark Office**

**Reg. No. 3,453,108**

**Registered June 24, 2008**

---

**SERVICE MARK  
PRINCIPAL REGISTER**

**BETTER PARTNERSHIPS,  
BETTER BRANDS**

CIRCLE PEAK CAPITAL LLC (NEW YORK LTD  
LIAB CO)  
25TH FLOOR  
1325 AVENUE OF THE AMERICAS  
NEW YORK, NY 10019

FOR: PRIVATE EQUITY INVESTMENTS, IN  
CLASS 36 (U.S. CLS. 100, 101 AND 102).

FIRST USE 10-18-2007; IN COMMERCE 10-18-2007.

THE MARK CONSISTS OF STANDARD CHAR-  
ACTERS WITHOUT CLAIM TO ANY PARTICULAR  
FONT, STYLE, SIZE, OR COLOR.

OWNER OF U.S. REG. NO. 3,343,356.

SER. NO. 77-310,789, FILED 10-23-2007.

LAURA KOVALSKY, EXAMINING ATTORNEY

**Int. Cl.: 41**

**Prior U.S. Cls.: 100, 101 and 107**

**United States Patent and Trademark Office**

**Reg. No. 3,453,109**

**Registered June 24, 2008**

**SERVICE MARK  
PRINCIPAL REGISTER**

**MY LIFE MY TIME**

LIFETIME ENTERTAINMENT SERVICES (NEW YORK JOINT VENTURE)  
309 WEST 49TH STREET, 16TH FLOOR  
NEW YORK, NY 10019

FOR: ONLINE SERVICES, NAMELY, PROVIDING A WEBSITE FEATURING INFORMATION REGARDING TELEVISION AND THE DISTRIBUTION THEREOF AND ISSUES OF INTEREST AND CONCERN TO WOMEN, NAMELY, SPORTS, MUSIC, MOVIES, BOOKS, CELEBRITIES, FASHION, ADVOCACY INITIATIVES TOWARDS ENDING VIOLENCE AGAINST WOMEN, BIOGRAPHIES OF EVERYDAY WOMEN, SHOPPING, COOKING, WEDDINGS, ASTROLOGY, INTERIOR DESIGN AND DECORATING, BEAUTY, RELATIONSHIPS,

GARDENING, GAMES, SELF-IMPROVEMENT AND ADVOCACY FOR BREAST CANCER AWARENESS AND SUPPORT, IN CLASS 41 (U.S. CLS. 100, 101 AND 107).

FIRST USE 8-2-2007; IN COMMERCE 8-2-2007.

THE MARK CONSISTS OF STANDARD CHARACTERS WITHOUT CLAIM TO ANY PARTICULAR FONT, STYLE, SIZE, OR COLOR.

SER. NO. 77-310,791, FILED 10-23-2007.

JILL C. ALT, EXAMINING ATTORNEY

**Int. Cl.: 36**

**Prior U.S. Cls.: 100, 101 and 102**

**United States Patent and Trademark Office**

**Reg. No. 3,453,110**

**Registered June 24, 2008**

**SERVICE MARK  
PRINCIPAL REGISTER**

**SPREAD THE WORD**

UNIVERSITY OF WISCONSIN CREDIT UNION  
(WISCONSIN CREDIT UNION)  
3500 UNIVERSITY AVE  
MADISON, WI 53705

FOR: FINANCIAL SERVICES, NAMELY, CREDIT UNION SERVICES, CONSUMER LOANS, MORTGAGE LOANS, INSTALLMENT LOANS, SAVINGS ACCOUNT SERVICES, CHECKING ACCOUNT SERVICES, MONEY MARKET DEPOSIT ACCOUNT SERVICES, CERTIFICATE OF DEPOSIT SERVICES, INDIVIDUAL RETIREMENT ACCOUNT SERVICES, CREDIT CARD SERVICES, CHECK CARD SERVICES, AUTO FINANCING, PROVIDING PERSONAL LINES OF CREDIT, AUTOMATED TELLER MA-

CHINE SERVICES, TELEPHONE BANKING, INTERNET BANKING, STOCK AND BOND BROKERAGE SERVICES AND MUTUAL FUND BROKERAGE SERVICES, IN CLASS 36 (U.S. CLS. 100, 101 AND 102).

FIRST USE 8-21-2007; IN COMMERCE 8-23-2007.

THE MARK CONSISTS OF STANDARD CHARACTERS WITHOUT CLAIM TO ANY PARTICULAR FONT, STYLE, SIZE, OR COLOR.

SER. NO. 77-310,801, FILED 10-23-2007.

GINA HAYES, EXAMINING ATTORNEY



Int. Cl.: 33

Prior U.S. Cls.: 47 and 49

**United States Patent and Trademark Office**

**Reg. No. 3,453,111**

Registered June 24, 2008

**TRADEMARK  
PRINCIPAL REGISTER**



THE OLD BUSHMILLS DISTILLERY COMPANY  
LIMITED (NORTHERN IRELAND LIMITED  
COMPANY (LTD.))  
BUSHMILLS  
CO. ANTRIM, NORTHERN IRELAND BT578XH

OWNER OF U.S. REG. NO. 3,206,237.

THE MARK CONSISTS OF A BRICK HOUSE  
WITH A POT STILL ON TOP.

FOR: DISTILLED SPIRITS, IN CLASS 33 (U.S. CLS.  
47 AND 49).

SER. NO. 77-310,821, FILED 10-23-2007.

FIRST USE 0-0-1933; IN COMMERCE 0-0-1933.

RENEE MCCRAY, EXAMINING ATTORNEY

Int. Cl.: 25

Prior U.S. Cls.: 22 and 39

United States Patent and Trademark Office

Reg. No. 3,453,112

Registered June 24, 2008

TRADEMARK  
PRINCIPAL REGISTER



DAP-RUGGET

CEDRIC S. KING (UNITED STATES INDIVIDUAL)  
2375 WESLEY CHAPEL RD. SUITE 3-1283  
DECATUR, GA 30035

FOR: ANGLERS' SHOES; APRES-SKI SHOES; ATHLETIC SHOES; BALLET SHOES; BALLOON PANTS; BASEBALL SHOES; BEACH SHOES; BOWLING SHOES; BOXING SHOES; CANVAS SHOES; CAPRI PANTS; CARGO PANTS; CLEATS FOR ATTACHMENT TO SPORTS SHOES; CYCLING SHOES; DECK-SHOES; DENIMS; DRIVERS; FOOTBALL SHOES; GOLF SHOES; GYMNASIIC SHOES; HANDBALL SHOES; HEEL PIECES FOR SHOES; HOCKEY SHOES; INFANTS' SHOES AND BOOTS; INSOLES; JOGGING PANTS; LEATHER PANTS; LEATHER SHOES; LOUNGE PANTS; NON-DISPOSABLE CLOTH TRAINING PANTS; NURSE PANTS; PANTS; PAPER SHOES USED WHEN GOING THROUGH METAL DETECTORS TO KEEP FEET AND SOCKS CLEAN; PETTI-PANTS; PROTECTIVE METAL MEMBERS FOR SHOES AND BOOTS; RUBBER SHOES; RUGBY SHOES; RUNNING SHOES; SHOE DOWELS; SHOE INSERTS FOR PRIMARILY NON-ORTHOPEDIC PURPOSES; SHOE PEGS; SHOE SOLES; SHOES; SHOES SOLES FOR REPAIR; SKI AND SNOWBOARD SHOES AND PARTS THEREOF; SKI PANTS; SKIING SHOES; SNOW PANTS; SNOWBOARD PANTS; SOCCER SHOES; STRETCH PANTS; SWEAT PANTS; TAP PANTS; TAP SHOES; TENNIS SHOES; TOBOGGAN HATS, PANTS AND CAPS; TONGUE OR PULLSTRAP FOR SHOES AND BOOTS; TRACK AND FIELD SHOES; TRACK

PANTS; TRAINING SHOES; VOLLEYBALL SHOES; WATERPROOF JACKETS AND PANTS; WIND PANTS; WOMEN'S SHOES; WORK SHOES AND BOOTS; YOGA PANTS; BLAZERS; BUTTON-FRONT ALOHA SHIRTS; CAMP SHIRTS; CHEF'S HATS; DRESS SHIRTS; FUR HATS; GOLF SHIRTS; HAT BANDS; HATS; KNIT SHIRTS; LONG-SLEEVED SHIRTS; NIGHT SHIRTS; OPEN-NECKED SHIRTS; PAPER HATS FOR USE AS CLOTHING ITEMS; PIQUE SHIRTS; POLO SHIRTS; RUGBY SHIRTS; SEDGE HATS (SUGE-GASA); SHIRT FRONTS; SHIRT YOKES; SHIRTS; SHIRTS FOR SUITS; SHORT-SLEEVED OR LONG-SLEEVED T-SHIRTS; SHORT-SLEEVED SHIRTS; SLEEP SHIRTS; SMALL HATS; SPORT SHIRTS; SPORTS SHIRTS; SPORTS SHIRTS WITH SHORT SLEEVES; SWEAT SHIRTS; T-SHIRTS; TEE SHIRTS; TRIATHLON CLOTHING, NAMELY, TRIATHLON TIGHTS, TRIATHLON SHORTS, TRIATHLON SINGLETs, TRIATHLON SHIRTS, TRIATHLON SUITS; WIND SHIRTS; WOOLLY HATS; YOGA SHIRTS, IN CLASS 25 (U.S. CLS. 22 AND 39).

FIRST USE 6-24-1996; IN COMMERCE 7-29-1997.

THE MARK CONSISTS OF VECTOR ART ROOSTER AND THE WORD "DAP-RUGGET".

SER. NO. 77-310,823, FILED 10-23-2007.

RENEE MCCRAY, EXAMINING ATTORNEY

**Int. Cl.: 25**

**Prior U.S. Cls.: 22 and 39**

**United States Patent and Trademark Office**

**Reg. No. 3,453,113**

**Registered June 24, 2008**

**TRADEMARK  
PRINCIPAL REGISTER**

**SAVA**

SAN MAR CORPORATION (WASHINGTON  
CORPORATION)  
P.O. BOX 529  
PRESTON, WA 98050

THE MARK CONSISTS OF STANDARD CHAR-  
ACTERS WITHOUT CLAIM TO ANY PARTICULAR  
FONT, STYLE, SIZE, OR COLOR.

FOR: CLOTHING, NAMELY, SHIRTS, POLO  
SHIRTS, SPORT SHIRTS, IN CLASS 25 (U.S. CLS. 22  
AND 39).

SER. NO. 77-310,827, FILED 10-23-2007.

FIRST USE 8-29-2006; IN COMMERCE 8-29-2006.

ESTHER BELENKER, EXAMINING ATTORNEY

**Int. Cl.: 25**

**Prior U.S. Cls.: 22 and 39**

**United States Patent and Trademark Office**

**Reg. No. 3,453,114**

**Registered June 24, 2008**

**TRADEMARK  
PRINCIPAL REGISTER**

**TALISKER**

DIAGEO SCOTLAND LIMITED (UNITED KING-  
DOM CORPORATION)  
5 LOCHSIDE WAY  
EDINBURGH PARK  
EDINBURGH, UNITED KINGDOM EH129DT

FOR: SHIRTS; JACKETS; HATS, IN CLASS 25 (U.S.  
CLS. 22 AND 39).

FIRST USE 9-30-2003; IN COMMERCE 9-30-2003.

THE MARK CONSISTS OF STANDARD CHAR-  
ACTERS WITHOUT CLAIM TO ANY PARTICULAR  
FONT, STYLE, SIZE, OR COLOR.

OWNER OF U.S. REG. NO. 739,139.

SER. NO. 77-310,830, FILED 10-23-2007.

ESTHER BELENKER, EXAMINING ATTORNEY

Int. Cl.: 33

Prior U.S. Cls.: 47 and 49

United States Patent and Trademark Office

Reg. No. 3,453,115

Registered June 24, 2008

TRADEMARK  
PRINCIPAL REGISTER

EMMETS

R & A BAILEY & CO (IRELAND COMPANY)  
WESTERN ESTATE  
NANGOR HOUSE  
DUBLIN 12, IRELAND

FOR: LIQUEURS, IN CLASS 33 (U.S. CLS. 47 AND  
49).

FIRST USE 10-1-1987; IN COMMERCE 10-1-1987.

THE MARK CONSISTS OF STANDARD CHAR-  
ACTERS WITHOUT CLAIM TO ANY PARTICULAR  
FONT, STYLE, SIZE, OR COLOR.

OWNER OF U.S. REG. NOS. 1,288,093 AND  
1,656,411.

SER. NO. 77-310,833, FILED 10-23-2007.

ESTHER BELENKER, EXAMINING ATTORNEY

**Int. Cl.: 36**

**Prior U.S. Cls.: 100, 101 and 102**

**United States Patent and Trademark Office**

**Reg. No. 3,453,116**

**Registered June 24, 2008**

---

**SERVICE MARK  
PRINCIPAL REGISTER**

**FIRSTECH**

FIRSTECH, INC. (ILLINOIS CORPORATION)  
130 NORTH WATER STREET  
DECATUR, IL 62523

FOR: BILL PAYMENT SERVICES, IN CLASS 36  
(U.S. CLS. 100, 101 AND 102).

FIRST USE 8-17-1988; IN COMMERCE 2-14-1989.

THE MARK CONSISTS OF STANDARD CHAR-  
ACTERS WITHOUT CLAIM TO ANY PARTICULAR  
FONT, STYLE, SIZE, OR COLOR.

OWNER OF U.S. REG. NO. 1,617,013.

SER. NO. 77-310,834, FILED 10-23-2007.

RENEE MCCRAY, EXAMINING ATTORNEY

**Int. Cls.: 9 and 41**

**Prior U.S. Cls.: 21, 23, 26, 36, 38, 100, 101 and 107**

**United States Patent and Trademark Office**

**Reg. No. 3,453,117**

**Registered June 24, 2008**

**TRADEMARK  
SERVICE MARK  
PRINCIPAL REGISTER**

**BRANDWORTH**

THE TRACEY EDWARDS COMPANY, INC.  
(NEW HAMPSHIRE CORPORATION)  
25 CONSTITUTION DRIVE  
BEDFORD, NH 03110

FOR: PROVIDING DOWNLOADABLE ELECTRO-  
NIC NEWSLETTERS IN FIELD OF ADVERTISING,  
MARKETING, AND BUSINESS CONSULTING , IN  
CLASS 9 (U.S. CLS. 21, 23, 26, 36 AND 38).

FIRST USE 12-5-2006; IN COMMERCE 12-5-2006.

FOR: PROVIDING NEWSLETTERS IN FIELD OF  
ADVERTISING, MARKETING AND BUSINESS

CONSULTING VIA E-MAIL, IN CLASS 41 (U.S.  
CLS. 100, 101 AND 107).

FIRST USE 12-5-2006; IN COMMERCE 12-5-2006.

THE MARK CONSISTS OF STANDARD CHAR-  
ACTERS WITHOUT CLAIM TO ANY PARTICULAR  
FONT, STYLE, SIZE, OR COLOR.

SER. NO. 77-310,919, FILED 10-23-2007.

NORA BUCHANAN WILL, EXAMINING ATTOR-  
NEY

**Int. Cl.: 33**

**Prior U.S. Cls.: 47 and 49**

**United States Patent and Trademark Office**

**Reg. No. 3,453,118**

**Registered June 24, 2008**

**TRADEMARK  
PRINCIPAL REGISTER**

**LE VOL DES ANGES**

BONNY DOON WINERY, INC. (CALIFORNIA  
CORPORATION)  
P. O. BOX 8376  
SANTA CRUZ, CA 95061

THE FOREIGN WORDING IN THE MARK  
TRANSLATES INTO ENGLISH AS "FLIGHT OF  
ANGELS".

FOR: WINE, IN CLASS 33 (U.S. CLS. 47 AND 49).

FIRST USE 8-0-2007; IN COMMERCE 8-0-2007.

SER. NO. 77-310,921, FILED 10-23-2007.

THE MARK CONSISTS OF STANDARD CHAR-  
ACTERS WITHOUT CLAIM TO ANY PARTICULAR  
FONT, STYLE, SIZE, OR COLOR.

ODESSA BIBBINS, EXAMINING ATTORNEY



**Int. Cl.: 5**

**Prior U.S. Cls.: 6, 18, 44, 46, 51 and 52**

**United States Patent and Trademark Office**

**Reg. No. 3,453,119**

**Registered June 24, 2008**

**TRADEMARK  
PRINCIPAL REGISTER**

**CHELATORPRO**

ADVANCED LIFE RESEARCH, INC. (NEVADA  
CORPORATION)  
PO BOX 27740  
LAS VEGAS, NV 89126

THE MARK CONSISTS OF STANDARD CHAR-  
ACTERS WITHOUT CLAIM TO ANY PARTICULAR  
FONT, STYLE, SIZE, OR COLOR.

FOR: DIETARY SUPPLEMENT, IN CLASS 5 (U.S.  
CLS. 6, 18, 44, 46, 51 AND 52).

SER. NO. 77-310,929, FILED 10-23-2007.

FIRST USE 6-21-2006; IN COMMERCE 6-21-2006.

KEVIN DINALLO, EXAMINING ATTORNEY

**Int. Cl.: 32**

**Prior U.S. Cls.: 45, 46 and 48**

**United States Patent and Trademark Office**

**Reg. No. 3,453,120**

**Registered June 24, 2008**

**TRADEMARK  
PRINCIPAL REGISTER**

**RAISE WHAT'S RAISED IN  
IRELAND, RESPONSIBLY**

DIAGEO IRELAND (IRELAND CORPORATION)  
ST. JAMES'S GATE  
DUBLIN 8, IRELAND

FOR: BEER, IN CLASS 32 (U.S. CLS. 45, 46 AND 48).

FIRST USE 7-30-2006; IN COMMERCE 7-30-2006.

THE MARK CONSISTS OF STANDARD CHAR-  
ACTERS WITHOUT CLAIM TO ANY PARTICULAR  
FONT, STYLE, SIZE, OR COLOR.

SER. NO. 77-310,949, FILED 10-23-2007.

MATTHEW MCDOWELL, EXAMINING ATTOR-  
NEY

**Int. Cl.: 5**

**Prior U.S. Cls.: 6, 18, 44, 46, 51 and 52**

**United States Patent and Trademark Office**

**Reg. No. 3,453,121**

**Registered June 24, 2008**

**TRADEMARK  
PRINCIPAL REGISTER**

**COLONBIOTIC**

ADVANCED LIFE RESEARCH, INC. (NEVADA  
CORPORATION)  
PO BOX 27740  
LAS VEGAS, NV 89126

THE MARK CONSISTS OF STANDARD CHAR-  
ACTERS WITHOUT CLAIM TO ANY PARTICULAR  
FONT, STYLE, SIZE, OR COLOR.

FOR: DIETARY SUPPLEMENT, IN CLASS 5 (U.S.  
CLS. 6, 18, 44, 46, 51 AND 52).

SER. NO. 77-310,962, FILED 10-23-2007.

FIRST USE 3-14-2006; IN COMMERCE 3-14-2006.

KEVIN DINALLO, EXAMINING ATTORNEY

**Int. Cls.: 36 and 45**

**Prior U.S. Cls.: 100, 101 and 102**

**United States Patent and Trademark Office**

**Reg. No. 3,453,122**

**Registered June 24, 2008**

**SERVICE MARK  
PRINCIPAL REGISTER**

**IDV**

CYBER NEW WORLD BUSINESS, INC. (CALIFORNIA CORPORATION)  
SUITE 600  
425 EAST COLORADO BOULEVARD  
GLENDALE, CA 91205

FOR: FINANCIAL RISK MANAGEMENT; FINANCIAL SERVICES IN THE FIELD OF MONEY LENDING; AND FINANCIAL SERVICES, NAMELY, PROVIDING A VIRTUAL CURRENCY FOR USE BY MEMBERS OF AN ONLINE COMMUNITY VIA A GLOBAL COMPUTER NETWORK, IN CLASS 36 (U.S. CLS. 100, 101 AND 102).

FIRST USE 2-25-2003; IN COMMERCE 2-25-2003.

FOR: IDENTIFICATION VERIFICATION SERVICES, NAMELY, PROVIDING IDENTITY VERIFICATION AND AUTHENTICATION OF PERSONAL IDENTIFICATION INFORMATION, IN CLASS 45 (U.S. CLS. 100 AND 101).

FIRST USE 2-25-2003; IN COMMERCE 2-25-2003.

THE MARK CONSISTS OF STANDARD CHARACTERS WITHOUT CLAIM TO ANY PARTICULAR FONT, STYLE, SIZE, OR COLOR.

SER. NO. 77-311,011, FILED 10-23-2007.

WARREN L. OLANDRIA, EXAMINING ATTORNEY

**Int. Cls.: 36 and 45**

**Prior U.S. Cls.: 100, 101 and 102**

**United States Patent and Trademark Office**

**Reg. No. 3,453,123**

**Registered June 24, 2008**

**SERVICE MARK  
PRINCIPAL REGISTER**

**IDVSYSTEM**

CYBER NEW WORLD BUSINESS, INC. (CALIFORNIA CORPORATION)  
SUITE 600  
425 EAST COLORADO BOULEVARD  
GLENDALE, CA 91205

FOR: FINANCIAL RISK MANAGEMENT; FINANCIAL SERVICES IN THE FIELD OF MONEY LENDING; AND FINANCIAL SERVICES, NAMELY, PROVIDING A VIRTUAL CURRENCY FOR USE BY MEMBERS OF AN ONLINE COMMUNITY VIA A GLOBAL COMPUTER NETWORK, IN CLASS 36 (U.S. CLS. 100, 101 AND 102).

FIRST USE 2-25-2003; IN COMMERCE 2-25-2003.

FOR: IDENTIFICATION VERIFICATION SERVICES, NAMELY, PROVIDING IDENTITY VERIFICATION AND AUTHENTICATION OF PERSONAL IDENTIFICATION INFORMATION, IN CLASS 45 (U.S. CLS. 100 AND 101).

FIRST USE 2-25-2003; IN COMMERCE 2-25-2003.

THE MARK CONSISTS OF STANDARD CHARACTERS WITHOUT CLAIM TO ANY PARTICULAR FONT, STYLE, SIZE, OR COLOR.

SER. NO. 77-311,034, FILED 10-23-2007.

WARREN L. OLANDRIA, EXAMINING ATTORNEY

**Int. Cl.: 42**

**Prior U.S. Cls.: 100 and 101**

**United States Patent and Trademark Office**

**Reg. No. 3,453,124**

**Registered June 24, 2008**

**SERVICE MARK  
PRINCIPAL REGISTER**

**INFOLUX**

INFOLUX, INC. (GEORGIA CORPORATION)  
12460 CRABAPPLE ROAD, SUITE 202, #410  
ALPHARETTA, GA 30004

THE MARK CONSISTS OF STANDARD CHAR-  
ACTERS WITHOUT CLAIM TO ANY PARTICULAR  
FONT, STYLE, SIZE, OR COLOR.

FOR: PROVIDING ONLINE NON-DOWNLOAD-  
ABLE COMPUTER SOFTWARE FOR APPLICATION  
AND DATABASE INTEGRATION, IN CLASS 42 (U.S.  
CLS. 100 AND 101).

SER. NO. 77-311,036, FILED 10-23-2007.

FIRST USE 11-18-2004; IN COMMERCE 11-18-2004.

DEIRDRE ROBERTSON, EXAMINING ATTORNEY

**Int. Cl.: 14**

**Prior U.S. Cls.: 2, 27, 28 and 50**

**United States Patent and Trademark Office**

**Reg. No. 3,453,125**

**Registered June 24, 2008**

**TRADEMARK  
PRINCIPAL REGISTER**

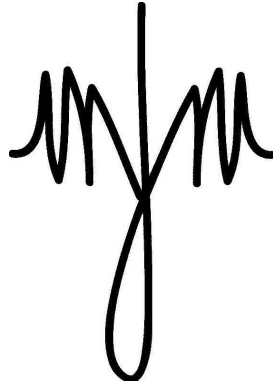

MELISSA JOY MANNING, INC. (CALIFORNIA CORPORATION)  
2500 MARKET ST., UNIT A  
OAKLAND, CA 94607

FOR: JEWELRY, IN CLASS 14 (U.S. CLS. 2, 27, 28 AND 50).

FIRST USE 8-10-2007; IN COMMERCE 8-10-2007.

OWNER OF U.S. REG. NO. 3,311,470.

THE MARK CONSISTS OF THE LETTERS "M", "J", AND "M" IN A STYLIZED SCRIPT.

SER. NO. 77-311,057, FILED 10-23-2007.

SARA THOMAS, EXAMINING ATTORNEY

**Int. Cl.: 44**

**Prior U.S. Cls.: 100 and 101**

**United States Patent and Trademark Office**

**Reg. No. 3,453,126**

**Registered June 24, 2008**

**SERVICE MARK  
PRINCIPAL REGISTER**



ORTHOPEDIC INSTITUTE, P.C. (SOUTH DAKOTA CORPORATION)  
810 E 23RD ST  
SIOUX FALLS, SD 571175116

FIRST USE 0-0-2000; IN COMMERCE 0-0-2000.

SER. NO. 77-311,058, FILED 10-23-2007.

FOR: MEDICAL AND HEALTH CARE SERVICES,  
IN CLASS 44 (U.S. CLS. 100 AND 101).

KELLY MCCOY, EXAMINING ATTORNEY



**Int. Cl.: 35**

**Prior U.S. Cls.: 100, 101 and 102**

**United States Patent and Trademark Office**

**Reg. No. 3,453,127**

**Registered June 24, 2008**

---

**SERVICE MARK  
PRINCIPAL REGISTER**

**YOU'RE BUSTED BUDDY**

ADAMS, SCOTT (UNITED STATES INDIVIDUAL)  
204 N. ROBINSON AVE., 25TH FLOOR  
OKLAHOMA CITY, OK 73102

FOR: PROMOTING THE PUBLIC AWARENESS OF THE NEED FOR CRIME PREVENTION BY CONDUCTING NATIONWIDE ADVERTISING CAMPAIGNS WHICH PROMOTE VOLUNTARY CITIZEN ACTIONS PERTAINING TO AND PUBLIC UNDERSTANDING OF CRIME PREVENTION, IN CLASS 35 (U.S. CLS. 100, 101 AND 102).

FIRST USE 8-1-1996; IN COMMERCE 8-1-1996.

THE MARK CONSISTS OF STANDARD CHARACTERS WITHOUT CLAIM TO ANY PARTICULAR FONT, STYLE, SIZE, OR COLOR.

SER. NO. 77-311,104, FILED 10-23-2007.

LINDA ESTRADA, EXAMINING ATTORNEY

**Int. Cl.: 37**

**Prior U.S. Cls.: 100, 103 and 106**

**United States Patent and Trademark Office**

**Reg. No. 3,453,128**

**Registered June 24, 2008**

**SERVICE MARK  
PRINCIPAL REGISTER**

**YOU KNOW YOU WANT IT**

HUSBAND FOR A DAY, INC. (MICHIGAN CORPORATION)  
809 WORCHESTER DRIVE  
FENTON, MI 48430

FOR: GENERAL HANDYMAN SERVICES, NAMELY, CABINET REFACING, CABINET REPAIR, REPAIR AND MAINTENANCE OF ELECTRIC LIGHTING APPARATUS, PLUMBING, CARPENTRY, PAINTING, PLASTERING, CONSTRUCTING PORCHES, CONSTRUCTING DECKS, INSTALLATION OF CABINETS, ELECTRICAL SYSTEMS, KITCHEN APPLIANCES, KITCHEN CABINETS, CARPET, DRYWALL PANELS, FLOOR TILE, AND WOOD FLOORING, REMODELING OF KITCHENS, BATHROOMS, BEDROOMS, LIVING ROOMS, DINING ROOMS, AND LIVING SPACES; REPAIR, IMPROVEMENT, AND CONSTRUCTION OF RESIDENTIAL REAL PROPERTY; PROVIDING MAINTENANCE AND REPAIRS ON THE HOMES

OF THOSE IN NEED; GENERAL CONTRACTOR SERVICES, NAMELY, CARPENTRY, ELECTRICAL CONTRACTOR SERVICES, GENERAL CONSTRUCTION CONTRACTING, PLUMBING CONTRACTOR SERVICES, DRYWALL CONTRACTOR SERVICES, PAINTING, PLASTERING, INSTALLING FLOOR TILE, AND TILE LAYING, IN CLASS 37 (U.S. CLS. 100, 103 AND 106).

FIRST USE 7-15-2007; IN COMMERCE 7-15-2007.

THE MARK CONSISTS OF STANDARD CHARACTERS WITHOUT CLAIM TO ANY PARTICULAR FONT, STYLE, SIZE, OR COLOR.

SER. NO. 77-311,117, FILED 10-23-2007.

JULIE WATSON, EXAMINING ATTORNEY

**Int. Cl.: 39**

**Prior U.S. Cls.: 100 and 105**

**United States Patent and Trademark Office**

**Reg. No. 3,453,129**

**Registered June 24, 2008**

**SERVICE MARK  
PRINCIPAL REGISTER**

# Integration

MOBILITY SUPPORT SYSTEMS, LLC (NEVADA  
LTD LIAB CO)  
200 E. FIRST ST.  
TEA, SD 57064

FOR: VEHICLE RENTAL AND LEASING SERVICES UNIQUE TO A PARTICULAR VEHICLE STYLE, WITH A VEHICLE MAINTENANCE AND REPAIR PROGRAM, AND A ROADSIDE ASSISTANCE SERVICE PROGRAM, ASSOCIATED THEREWITH, IN CLASS 39 (U.S. CLS. 100 AND 105).

FIRST USE 10-22-2007; IN COMMERCE 10-22-2007.

THE MARK CONSISTS OF STANDARD CHARACTERS WITHOUT CLAIM TO ANY PARTICULAR FONT, STYLE, SIZE, OR COLOR.

SER. NO. 77-311,171, FILED 10-23-2007.

SUNG IN, EXAMINING ATTORNEY

**Int. Cl.: 8**

**Prior U.S. Cls.: 23, 28 and 44**

**United States Patent and Trademark Office**

**Reg. No. 3,453,130**

**Registered June 24, 2008**

**TRADEMARK  
PRINCIPAL REGISTER**

**SNOW WOLF**

SNOW SOLUTIONS LLC (DELAWARE LTD LIAB  
CO)

55 SAINT JOHN PLACE, SUITE 201

NEW CANAAN, CT 06840

FOR: SHOVELS, IN CLASS 8 (U.S. CLS. 23, 28 AND  
44).

FIRST USE 9-30-2007; IN COMMERCE 9-30-2007.

THE MARK CONSISTS OF STANDARD CHAR-  
ACTERS WITHOUT CLAIM TO ANY PARTICULAR  
FONT, STYLE, SIZE, OR COLOR.

NO CLAIM IS MADE TO THE EXCLUSIVE  
RIGHT TO USE "SNOW", APART FROM THE  
MARK AS SHOWN.

SER. NO. 77-311,177, FILED 10-23-2007.

ATTIYA MALIK, EXAMINING ATTORNEY

**Int. Cl.: 9**

**Prior U.S. Cls.: 21, 23, 26, 36 and 38**

**United States Patent and Trademark Office**

**Reg. No. 3,453,131**

**Registered June 24, 2008**

**TRADEMARK  
PRINCIPAL REGISTER**

**noizie**

MUELLER, BRIGITTE (SWITZERLAND INDIVIDUAL)  
361 1/2 N. ORANGE GROVE AVE.  
LOS ANGELES, CA 90036

FOR: PROVIDING ON-LINE, NON-DOWNLOADABLE SOFTWARE FOR USE IN ONLINE PHOTO, VIDEO AND MUSIC FILE SHARING, CREATING, SENDING AND TRACKING CUSTOMIZED ON-LINE INVITATIONS AND ECARDS, CREATING AND HOSTING WEB PAGES, MANAGING AND SHARING ONLINE CONTACT LISTS, POSTING INTERACTIVE ONLINE DISCUSSIONS, AND ON-

LINE SOCIAL NETWORKING, IN CLASS 9 (U.S. CLS. 21, 23, 26, 36 AND 38).

FIRST USE 1-12-2006; IN COMMERCE 1-12-2006.

THE MARK CONSISTS OF STANDARD CHARACTERS WITHOUT CLAIM TO ANY PARTICULAR FONT, STYLE, SIZE, OR COLOR.

SER. NO. 77-311,193, FILED 10-23-2007.

JOHN DALIER, EXAMINING ATTORNEY

Int. Cl.: 39

Prior U.S. Cls.: 100 and 105

United States Patent and Trademark Office

Reg. No. 3,453,132

Registered June 24, 2008

**SERVICE MARK  
PRINCIPAL REGISTER**

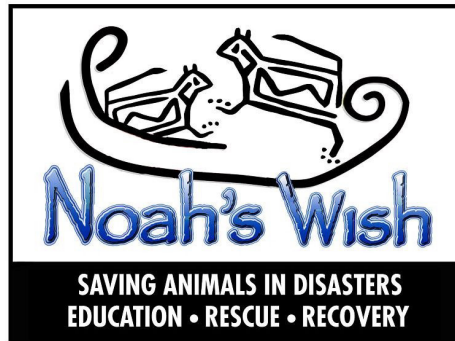

NOAH'S WISH, INC. (CALIFORNIA CORPORATION)  
SUITE 100  
5047 ROBERT MATTHEWS PARKWAY  
EL DORADO, CA 95762

FOR: ANIMAL RESCUE SERVICES, IN CLASS 39  
(U.S. CLS. 100 AND 105).

FIRST USE 6-1-2002; IN COMMERCE 6-1-2002.

NO CLAIM IS MADE TO THE EXCLUSIVE  
RIGHT TO USE "SAVING ANIMALS IN DISASTERS,  
EDUCATION, RESCUE, RECOVERY", APART  
FROM THE MARK AS SHOWN.

THE COLOR(S) BLUE, WHITE AND BLACK IS/  
ARE CLAIMED AS A FEATURE OF THE MARK.

THE MARK CONSISTS OF THE WORDS "NOAH'S  
WISH" IS BLUE; ALL OTHER WORDS ARE WHITE  
WITH A BLACK BACKGROUND.

SER. NO. 77-311,239, FILED 10-23-2007.

RON FAIRBANKS, EXAMINING ATTORNEY

**Int. Cl.: 29**

**Prior U.S. Cl.: 46**

**United States Patent and Trademark Office**

**Reg. No. 3,453,133**

**Registered June 24, 2008**

**TRADEMARK  
PRINCIPAL REGISTER**

**GOLDEN TIN**

GOLDEN INTERNATIONAL IMPORT AND EXPORT CORPORATION (WASHINGTON CORPORATION)

18915 84TH AVE S  
KENT, WA 98032

FOR: CANNED FRUITS; CANNED OR BOTTLED VEGETABLES; DRIED FRUITS; DRIED VEGETABLES, IN CLASS 29 (U.S. CL. 46).

FIRST USE 5-15-1989; IN COMMERCE 5-15-1989.

THE MARK CONSISTS OF STANDARD CHARACTERS WITHOUT CLAIM TO ANY PARTICULAR FONT, STYLE, SIZE, OR COLOR.

NO CLAIM IS MADE TO THE EXCLUSIVE RIGHT TO USE "TIN", APART FROM THE MARK AS SHOWN.

SER. NO. 77-311,263, FILED 10-23-2007.

RON FAIRBANKS, EXAMINING ATTORNEY

**Int. Cl.: 33**

**Prior U.S. Cls.: 47 and 49**

**United States Patent and Trademark Office**

**Reg. No. 3,453,134**

**Registered June 24, 2008**

**TRADEMARK  
PRINCIPAL REGISTER**

**TATTOO YOUR NIGHT**

DIAGEO NORTH AMERICA, INC. (CONNECTI-  
CUT CORPORATION)  
801 MAIN AVENUE  
NORWALK, CT 06851

FOR: DISTILLED SPIRITS, IN CLASS 33 (U.S. CLS.  
47 AND 49).

FIRST USE 4-30-2005; IN COMMERCE 4-30-2005.

THE MARK CONSISTS OF STANDARD CHAR-  
ACTERS WITHOUT CLAIM TO ANY PARTICULAR  
FONT, STYLE, SIZE, OR COLOR.

OWNER OF U.S. REG. NOS. 2,975,653, 3,032,300,  
AND 3,177,813.

SER. NO. 77-311,272, FILED 10-23-2007.

KATHERINE STOIDES, EXAMINING ATTORNEY



**Int. Cls.: 41 and 43**

**Prior U.S. Cls.: 100, 101 and 107**

**United States Patent and Trademark Office**

**Reg. No. 3,453,135**

**Registered June 24, 2008**

**SERVICE MARK  
PRINCIPAL REGISTER**

# REFINERY

ERWIN'S GYM BALLROOM AND BANQUET  
CENTER INC. (ILLINOIS CORPORATION)  
2302 WEST JOHN STREET  
CHAMPAIGN, IL 61821

FOR: HEALTH CLUB SERVICES, NAMELY, PROVIDING INSTRUCTION AND EQUIPMENT IN THE FIELD OF PHYSICAL EXERCISE; PERSONAL TRAINING SERVICES, NAMELY, STRENGTH AND CONDITIONING TRAINING; GYMNASIUMS; PROVIDING ASSISTANCE, PERSONAL TRAINING AND PHYSICAL FITNESS CONSULTATION TO INDIVIDUALS TO HELP THEM MAKE PHYSICAL FITNESS, STRENGTH, CONDITIONING, AND EXERCISE IMPROVEMENT IN THEIR DAILY LIVING, IN CLASS 41 (U.S. CLS. 100, 101 AND 107).

FIRST USE 12-31-2004; IN COMMERCE 12-31-2004.

FOR: PROVIDING BANQUET AND SOCIAL FUNCTION FACILITIES FOR SPECIAL OCCASIONS, IN CLASS 43 (U.S. CLS. 100 AND 101).

FIRST USE 12-31-2004; IN COMMERCE 12-31-2004.

THE MARK CONSISTS OF STANDARD CHARACTERS WITHOUT CLAIM TO ANY PARTICULAR FONT, STYLE, SIZE, OR COLOR.

SER. NO. 77-311,288, FILED 10-23-2007.

JUDITH HELFMAN, EXAMINING ATTORNEY

**Int. Cls.: 41 and 43**

**Prior U.S. Cls.: 100, 101 and 107**

**United States Patent and Trademark Office**

**Reg. No. 3,453,136**

**Registered June 24, 2008**

**SERVICE MARK  
PRINCIPAL REGISTER**

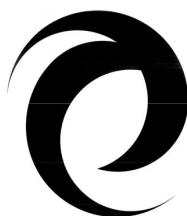

r e f i n e r y

ERWIN'S GYM BALLROOM AND BANQUET  
CENTER INC. (ILLINOIS CORPORATION)  
2302 WEST JOHN STREET  
CHAMPAIGN, IL 61821

FOR: HEALTH CLUB SERVICES, NAMELY, PROVIDING INSTRUCTION AND EQUIPMENT IN THE FIELD OF PHYSICAL EXERCISE; PERSONAL TRAINING SERVICES, NAMELY, STRENGTH AND CONDITIONING TRAINING; GYMNASIUMS; PROVIDING ASSISTANCE, PERSONAL TRAINING AND PHYSICAL FITNESS CONSULTATION TO INDIVIDUALS TO HELP THEM MAKE PHYSICAL FITNESS, STRENGTH, CONDITIONING, AND EXERCISE IMPROVEMENT IN THEIR DAILY LIVING, IN CLASS 41 (U.S. CLS. 100, 101 AND 107).

FIRST USE 12-31-2004; IN COMMERCE 12-31-2004.

FOR: PROVIDING BANQUET AND SOCIAL FUNCTION FACILITIES FOR SPECIAL OCCASIONS, IN CLASS 43 (U.S. CLS. 100 AND 101).

FIRST USE 3-31-2005; IN COMMERCE 3-31-2005.

THE MARK CONSISTS OF THE WORD REFINERY UNDER TWO INTERLOCKING CRESCENT SHAPES.

SER. NO. 77-311,297, FILED 10-23-2007.

JUDITH HELFMAN, EXAMINING ATTORNEY

**Int. Cl.: 42**

**Prior U.S. Cls.: 100 and 101**

**United States Patent and Trademark Office**

**Reg. No. 3,453,137**

**Registered June 24, 2008**

**SERVICE MARK  
PRINCIPAL REGISTER**

**PingIdentity**

PING IDENTITY CORPORATION (DELAWARE CORPORATION)  
SUITE 2950  
1099 18TH STREET  
DENVER, CO 80202

FOR: CONSULTING SERVICES RELATED TO STANDARDS, PROCESSES AND METHODS IN THE FIELD OF DIGITAL SECURITY AND IDENTITY VERIFICATION, IN CLASS 42 (U.S. CLS. 100 AND 101).

FIRST USE 6-1-2006; IN COMMERCE 6-1-2006.

OWNER OF U.S. REG. NO. 3,127,602.

THE COLOR(S) BLACK AND RED IS/ARE CLAIMED AS A FEATURE OF THE MARK.

THE MARK CONSISTS OF THE WORD "PING" IN BLACK STYLIZED LETTERS AND THE WORD "IDENTITY" IN RED STYLIZED LETTERS FOLLOWING "PING".

SER. NO. 77-311,321, FILED 10-23-2007.

ELI HELLMAN, EXAMINING ATTORNEY

Int. Cl.: 41

Prior U.S. Cls.: 100, 101 and 107

United States Patent and Trademark Office

Reg. No. 3,453,138

Registered June 24, 2008

**SERVICE MARK  
PRINCIPAL REGISTER**



IANNUCCI, EDWARD (UNITED STATES INDIVIDUAL)  
63 W.CHELTENHAM AVE.  
CHELTENHAM, PA 19012

FOR: TRAINING SERVICES IN THE FIELD OF SECURITY FOR OFFICERS EMPLOYED OR VOLUNTEERING IN CHURCHES, IN CLASS 41 (U.S. CLS. 100, 101 AND 107).

FIRST USE 9-25-2007; IN COMMERCE 9-25-2007.

THE MARK CONSISTS OF A HELMET AND SHEILD. THE SHEILD IS IN HALF WITH A HALF OF A CROSS ON THE SHEILD.

SER. NO. 77-311,357, FILED 10-23-2007.

KATHERINE STOIDES, EXAMINING ATTORNEY

**Int. Cl.: 16**

**Prior U.S. Cls.: 2, 5, 22, 23, 29, 37, 38 and 50**

**Reg. No. 3,453,139**

**United States Patent and Trademark Office**

**Registered June 24, 2008**

**TRADEMARK  
PRINCIPAL REGISTER**

**GERFFERT**

GERFFERT COMPANY INC. (NEW YORK CORPORATION)  
47-55 37TH STREET  
LONG ISLAND CITY, NY 11101

FIRST USE 12-31-1955; IN COMMERCE 12-31-1955.

FOR: HOLY CARDS; HOLY PICTURES; PRAYER CARDS; MASS CARDS; FRAMED PRINTS; PRINTED CONFIRMATION CERTIFICATES; PRINTED COMMUNION CERTIFICATES; PRINTED MARRIAGE CERTIFICATES; AND PRINTED BAPTISMAL CERTIFICATES, IN CLASS 16 (U.S. CLS. 2, 5, 22, 23, 29, 37, 38 AND 50).

THE MARK CONSISTS OF STANDARD CHARACTERS WITHOUT CLAIM TO ANY PARTICULAR FONT, STYLE, SIZE, OR COLOR.

SER. NO. 77-311,358, FILED 10-23-2007.

COLLEEN DOMBROW, EXAMINING ATTORNEY

**Int. Cl.: 12**

**Prior U.S. Cls.: 19, 21, 23, 31, 35 and 44**

**Reg. No. 3,453,140**

**United States Patent and Trademark Office**

**Registered June 24, 2008**

---

**TRADEMARK  
PRINCIPAL REGISTER**

**SEAT ANGEL**

RAEI CORPORATION (NEVADA CORPORATION)  
10776 TETON VILLAGE COURT  
HENDERSON, NV 890528645

FOR: PROTECTIVE COVER FOR CHILDREN'S SAFETY VEHICLE SEATS, IN CLASS 12 (U.S. CLS. 19, 21, 23, 31, 35 AND 44).

FIRST USE 7-13-2007; IN COMMERCE 7-13-2007.

THE MARK CONSISTS OF STANDARD CHARACTERS WITHOUT CLAIM TO ANY PARTICULAR FONT, STYLE, SIZE, OR COLOR.

NO CLAIM IS MADE TO THE EXCLUSIVE RIGHT TO USE "SEAT", APART FROM THE MARK AS SHOWN.

SER. NO. 77-311,370, FILED 10-23-2007.

CYNTHIA SLOAN, EXAMINING ATTORNEY

**Int. Cl.: 6**

**Prior U.S. Cls.: 2, 12, 13, 14, 23, 25 and 50**

**Reg. No. 3,453,141**

**United States Patent and Trademark Office**

**Registered June 24, 2008**

**TRADEMARK  
PRINCIPAL REGISTER**



INDUSTRIA DE MAQUINAS MIRUNA LTDA.  
(BRAZIL LIMITED CORPORATION)  
NO. 295  
RUA HOWARD A. ACHESON JUNIOR  
GALPAO A, COTIA SP, BRAZIL CEP06711-

FOR: WIRE, IN CLASS 6 (U.S. CLS. 2, 12, 13, 14, 23,  
25 AND 50).

FIRST USE 9-18-1987; IN COMMERCE 10-1-1996.

THE MARK CONSISTS OF THE STYLIZED  
WORD "MIRUNA" TO THE RIGHT OF A TRIAN-  
GULAR LIKE SHAPED DESIGN.

THE WORDING "MIRUNA" HAS NO MEANING  
IN ENGLISH.

SER. NO. 77-311,406, FILED 10-23-2007.

MARK PILARO, EXAMINING ATTORNEY

**Int. Cl.: 32**

**Prior U.S. Cls.: 45, 46 and 48**

**Reg. No. 3,453,142**

**United States Patent and Trademark Office**

**Registered June 24, 2008**

---

**TRADEMARK  
PRINCIPAL REGISTER**

**ASTRIX**

BIG ONE ENERGY, INC. (CALIFORNIA CORPORATION)  
12426 BURBANK BLVD.  
NORTH HOLLYWOOD, CA 91607

THE MARK CONSISTS OF STANDARD CHARACTERS WITHOUT CLAIM TO ANY PARTICULAR FONT, STYLE, SIZE, OR COLOR.

FOR: ENERGY DRINKS; SPORTS DRINKS, IN CLASS 32 (U.S. CLS. 45, 46 AND 48).

SER. NO. 77-311,410, FILED 10-23-2007.

FIRST USE 10-10-2007; IN COMMERCE 10-16-2007.

MARK PILARO, EXAMINING ATTORNEY



**Int. Cl.: 9**

**Prior U.S. Cls.: 21, 23, 26, 36 and 38**

**Reg. No. 3,453,143**

**United States Patent and Trademark Office**

**Registered June 24, 2008**

**TRADEMARK  
PRINCIPAL REGISTER**

**TRUCKER'S EYE**

ZELLER, LEWIS N. (UNITED STATES INDIVIDUAL), DBA TRUCKER'S EYE  
3306 PORTSIDE DRIVE  
VERMILION, OH 44089

FOR: VEHICLE SAFETY EQUIPMENT, NAMELY, SIDE MIRROR-MOUNTED VIDEO CAMERAS AND DASHBOARD MONITORS, IN CLASS 9 (U.S. CLS. 21, 23, 26, 36 AND 38).

FIRST USE 4-3-2005; IN COMMERCE 4-3-2005.

THE MARK CONSISTS OF STANDARD CHARACTERS WITHOUT CLAIM TO ANY PARTICULAR FONT, STYLE, SIZE, OR COLOR.

NO CLAIM IS MADE TO THE EXCLUSIVE RIGHT TO USE "TRUCKER'S", APART FROM THE MARK AS SHOWN.

SER. NO. 77-311,412, FILED 10-23-2007.

MARK PILARO, EXAMINING ATTORNEY

**Int. Cl.: 25**

**Prior U.S. Cls.: 22 and 39**

**United States Patent and Trademark Office**

**Reg. No. 3,453,144**

**Registered June 24, 2008**

**TRADEMARK  
PRINCIPAL REGISTER**

**EQC**

PUYALLUP TRIBE OF INDIANS (UNITED STATES FEDERALLY-RECOGNIZED INDIAN TRIBE)  
3009 EAST PORTLAND AVENUE  
TACOMA, WA 98404

FOR: CLOTHING, NAMELY, HATS, SHIRTS, JACKETS, PANTS, TANK TOPS, SWEATSHIRTS, AND SWEATPANTS, IN CLASS 25 (U.S. CLS. 22 AND 39).

FIRST USE 4-19-1997; IN COMMERCE 4-19-1997.

THE MARK CONSISTS OF STANDARD CHARACTERS WITHOUT CLAIM TO ANY PARTICULAR FONT, STYLE, SIZE, OR COLOR.

SER. NO. 77-311,522, FILED 10-23-2007.

ANDREA HACK, EXAMINING ATTORNEY

**Int. Cl.: 25**

**Prior U.S. Cls.: 22 and 39**

**United States Patent and Trademark Office**

**Reg. No. 3,453,145**

**Registered June 24, 2008**

**TRADEMARK  
PRINCIPAL REGISTER**

**VULGAR**

SMITH, BARBARA (UNITED STATES INDIVIDUAL)  
11917 MOORISH ROAD  
BIRCH RUN, MI 48415

FOR: HATS; JEANS; TOPS; SWIMWEAR; SHOES;  
SWEAT SHIRTS; PANTS; SHORTS; SHIRTS; SHORT-SLEEVED OR LONG-SLEEVED T-SHIRTS; COATS;  
JACKETS, IN CLASS 25 (U.S. CLS. 22 AND 39).

FIRST USE 8-1-2004; IN COMMERCE 8-1-2004.

THE MARK CONSISTS OF STANDARD CHARACTERS WITHOUT CLAIM TO ANY PARTICULAR FONT, STYLE, SIZE, OR COLOR.

SER. NO. 77-311,542, FILED 10-23-2007.

MARTHA FROMM, EXAMINING ATTORNEY

**Int. Cl.: 41**

**Prior U.S. Cls.: 100, 101 and 107**

**United States Patent and Trademark Office**

**Reg. No. 3,453,146**

**Registered June 24, 2008**

**SERVICE MARK  
PRINCIPAL REGISTER**

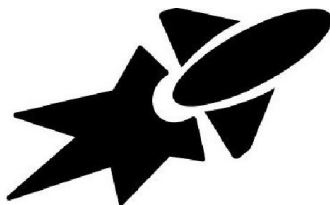

**LaunchPad**

YOUTHFRIENDS (MISSOURI NON-PROFIT CORPORATION)  
SUITE 400  
1800 BALTIMORE  
KANSAS CITY, MO 64108

FOR: EDUCATIONAL SERVICES, NAMELY, PROVIDING EXTERNSHIPS IN SCIENCE, TECHNOLOGY, ENGINEERING, AND MATHEMATICS FOR MIDDLE SCHOOL AND HIGH SCHOOL STUDENTS AND PROVIDING JOB SHADOWING FOR MIDDLE SCHOOL AND HIGH SCHOOL STUDENTS, IN CLASS 41 (U.S. CLS. 100, 101 AND 107).

FIRST USE 2-1-2007; IN COMMERCE 2-1-2007.

OWNER OF U.S. REG. NO. 3,349,121.

THE MARK CONSISTS OF A ROCKET SHIP TAKING OFF ABOVE THE WORD "LAUNCHPAD".

SER. NO. 77-311,547, FILED 10-23-2007.

JOHN SCHUYLER YARD, EXAMINING ATTORNEY

**Int. Cl.: 41**

**Prior U.S. Cls.: 100, 101 and 107**

**United States Patent and Trademark Office**

**Reg. No. 3,453,147**

**Registered June 24, 2008**

**SERVICE MARK  
PRINCIPAL REGISTER**

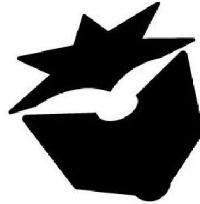

**TeacherTech**

YOUTHFRIENDS (MISSOURI NON-PROFIT CORPORATION)  
SUITE 400  
1800 BALTIMORE  
KANSAS CITY, MO 64108

FOR: EDUCATIONAL SERVICES, NAMELY, PROVIDING EXTERNSHIPS IN SCIENCE, TECHNOLOGY, ENGINEERING, AND MATHEMATICS FOR KINDERGARTEN THROUGH TWELFTH GRADE TEACHERS TO PROMOTE EXCELLENCE IN TEACHING AND RETENTION OF TEACHERS, IN CLASS 41 (U.S. CLS. 100, 101 AND 107).

FIRST USE 2-1-2007; IN COMMERCE 2-1-2007.

OWNER OF U.S. REG. NO. 3,350,429.

THE MARK CONSISTS OF A STAR AND AN OPENED BOOK ABOVE THE WORD "TEACHER-TECH".

SER. NO. 77-311,583, FILED 10-23-2007.

JOHN SCHUYLER YARD, EXAMINING ATTORNEY

**Int. Cl.: 41**

**Prior U.S. Cls.: 100, 101 and 107**

**United States Patent and Trademark Office**

**Reg. No. 3,453,148**

**Registered June 24, 2008**

**SERVICE MARK  
PRINCIPAL REGISTER**

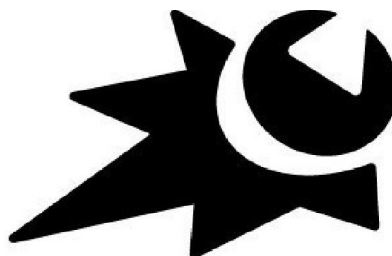

**UpLink**

YOUTHFRIENDS (MISSOURI NON-PROFIT CORPORATION)  
SUITE 400  
1800 BALTIMORE  
KANSAS CITY, MO 64108

FOR: EDUCATIONAL SERVICES, NAMELY, ASSISTING SCHOOL DISTRICTS TO PROVIDE ONE-TO-ONE MENTORING OF STUDENTS IN THE FIELDS OF SCIENCE, TECHNOLOGY, ENGINEERING, AND MATHEMATICS; PROVIDING EXTERNSHIPS IN SCIENCE, TECHNOLOGY, ENGINEERING, AND MATHEMATICS FOR KINDERGARTEN THROUGH TWELFTH GRADE TEACHERS AND HIGH SCHOOL STUDENTS; PROVIDING JOB SHADOWING FOR MIDDLE

SCHOOL STUDENTS, IN CLASS 41 (U.S. CLS. 100, 101 AND 107).

FIRST USE 2-1-2007; IN COMMERCE 2-1-2007.

OWNER OF U.S. REG. NO. 3,356,887.

THE MARK CONSISTS OF A PARTIAL SUNBURST ABOVE THE WORD "UPLINK".

SER. NO. 77-311,593, FILED 10-23-2007.

JOHN SCHUYLER YARD, EXAMINING ATTORNEY

**Int. Cl.: 38**

**Prior U.S. Cls.: 100, 101 and 104**

**United States Patent and Trademark Office**

**Reg. No. 3,453,149**

**Registered June 24, 2008**

**SERVICE MARK  
PRINCIPAL REGISTER**

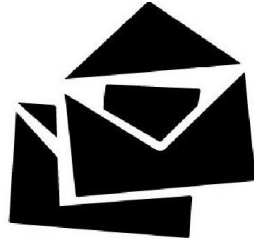

**MentorMail**

YOUTHFRIENDS (MISSOURI NON-PROFIT CORPORATION)  
SUITE 400  
1800 BALTIMORE  
KANSAS CITY, MO 64108

FOR: ELECTRONIC MAIL SERVICES, NAMELY, FACILITATING AND MONITORING ELECTRONIC COMMUNICATION BY MEANS OF THE INTERNET BETWEEN MENTORS AND THEIR MENTEES, IN CLASS 38 (U.S. CLS. 100, 101 AND 104).

FIRST USE 9-1-2007; IN COMMERCE 9-1-2007.

OWNER OF U.S. REG. NO. 3,349,146.

THE MARK CONSISTS OF TWO ENVELOPES, ONE ON TOP OF THE OTHER, WITH THE TOP ENVELOPE OPENED ABOVE THE WORD "MENTORMAIL".

SER. NO. 77-311,602, FILED 10-23-2007.

JOHN SCHUYLER YARD, EXAMINING ATTORNEY

**Int. Cl.: 33**

**Prior U.S. Cls.: 47 and 49**

**United States Patent and Trademark Office**

**Reg. No. 3,453,150**

**Registered June 24, 2008**

**TRADEMARK  
PRINCIPAL REGISTER**

**PATZ & HALL**

HALL, JAMES (UNITED STATES INDIVIDUAL)  
851 NAPA VALLEY CORPORATE WAY, SUITE A  
NAPA, CA 94558 AND

MOSES, ANNE T. (UNITED STATES INDIVIDUAL)  
851 NAPA VALLEY CORPORATE WAY, SUITE A  
NAPA, CA 94558 AND

PATZ, HEATHER B. (UNITED STATES INDIVIDUAL)

851 NAPA VALLEY CORPORATE WAY, SUITE A  
NAPA, CA 94558 AND

PATZ JR., DONALD R. (UNITED STATES INDIVIDUAL)

851 NAPA VALLEY CORPORATE WAY, SUITE A  
NAPA, CA 94558

FOR: WINES, IN CLASS 33 (U.S. CLS. 47 AND 49).

FIRST USE 9-1-1989; IN COMMERCE 9-1-1989.

THE MARK CONSISTS OF STANDARD CHARACTERS WITHOUT CLAIM TO ANY PARTICULAR FONT, STYLE, SIZE, OR COLOR.

OWNER OF U.S. REG. NO. 3,119,833.

SER. NO. 77-311,641, FILED 10-23-2007.

AMY MCMENAMIN, EXAMINING ATTORNEY



Int. Cl.: 31

Prior U.S. Cls.: 1 and 46

United States Patent and Trademark Office

Reg. No. 3,453,151

Registered June 24, 2008

TRADEMARK  
PRINCIPAL REGISTER



UNITED FRESH SALES, LLC (NEW JERSEY LTD  
LIAB CO)  
343 INDIAN MILLS ROAD  
SHAMONG, NJ 08088

THE MARK CONSISTS OF A GREEN LEAF OUT-  
LINED IN BLACK, GREEN LETTERING OUT-  
LINED IN BLACK.

FOR: FRESH FRUITS; FRESH VEGETABLES, IN  
CLASS 31 (U.S. CLS. 1 AND 46).

SER. NO. 77-311,648, FILED 10-23-2007.

FIRST USE 9-1-2007; IN COMMERCE 10-22-2007.

THE COLOR(S) GREEN AND BLACK IS/ARE  
CLAIMED AS A FEATURE OF THE MARK.

BRIAN NEVILLE, EXAMINING ATTORNEY

**Int. Cls.: 35, 41 and 42**

**Prior U.S. Cls.: 100, 101, 102 and 107**

**United States Patent and Trademark Office**

**Reg. No. 3,453,152**

**Registered June 24, 2008**

**SERVICE MARK  
PRINCIPAL REGISTER**

The logo for Belief Design features the word "belief" in a lowercase, bold, sans-serif font. Above the letter "i" is a stylized geometric icon consisting of three overlapping shapes: a triangle pointing up and to the right, a square, and a triangle pointing down and to the right. To the right of "belief" is the word "DESIGN" in a smaller, uppercase, sans-serif font.

BELIEF, LLC (CALIFORNIA LTD LIAB CO)  
1832 FRANKLIN STREET  
SANTA MONICA, CA 90404

FOR: POST-PRODUCTION EDITING SERVICES FOR VIDEO AND AUDIO COMMERCIALS; PRODUCTION AND DISTRIBUTION OF RADIO AND TELEVISION COMMERCIALS; PRODUCTION OF TELEVISION COMMERCIALS AND PUBLIC SERVICE ANNOUNCEMENTS; PRODUCTION OF VIDEO AND CREATION OF VISUAL EFFECTS FOR OTHERS FOR USE IN TELEVISION COMMERCIALS AND ON WEBSITE ADVERTISEMENTS; DISTRIBUTORSHIPS IN THE FIELD OF VIDEOS AND DVDS, IN CLASS 35 (U.S. CLS. 100, 101 AND 102).

FIRST USE 9-1-2007; IN COMMERCE 9-1-2007.

FOR: AUDIO RECORDING AND PRODUCTION; EDITING AND RECORDING OF SOUNDS AND IMAGES; MOTION PICTURE FILM AND VIDEO PRODUCTION; PHOTO EDITING; PRODUCTION AND DISTRIBUTION OF MOTION PICTURES; VIDEO EDITING; PRODUCTION OF VISUAL EFFECTS FOR VIDEOS, TELEVISION AND FOR INTERNET WEBSITES; PRODUCTION OF VIDEO AND CREATION OF VISUAL EFFECTS FOR OTH-

ERS FOR USE IN DVDS; PRODUCTION OF VISUAL EFFECTS FOR DVDS, IN CLASS 41 (U.S. CLS. 100, 101 AND 107).

FIRST USE 9-1-2007; IN COMMERCE 9-1-2007.

FOR: INTERNET WEBSITE DESIGN FOR OTHERS; DVD AUTHORIZING SERVICES; GRAPHIC DESIGN SERVICES, IN CLASS 42 (U.S. CLS. 100 AND 101).

FIRST USE 9-1-2007; IN COMMERCE 9-1-2007.

OWNER OF U.S. REG. NOS. 2,418,936 AND 3,367,937.

NO CLAIM IS MADE TO THE EXCLUSIVE RIGHT TO USE "DESIGN", APART FROM THE MARK AS SHOWN.

THE MARK CONSISTS OF THE WORDS "BELIEF DESIGN" WITH A GEOMETRIC DESIGN ABOVE THE "IE" OF "BELIEF".

SER. NO. 77-311,660, FILED 10-23-2007.

LEIGH CAROLINE CASE, EXAMINING ATTORNEY

**Int. Cl.: 41**

**Prior U.S. Cls.: 100, 101 and 107**

**United States Patent and Trademark Office**

**Reg. No. 3,453,153**

**Registered June 24, 2008**

**SERVICE MARK  
PRINCIPAL REGISTER**

**Prelexia**

WOLF, STEPHEN A (UNITED STATES INDIVIDUAL)  
13008 WELLS FARGO TRAIL  
AUSTIN, TX 78737

THE MARK CONSISTS OF STANDARD CHARACTERS WITHOUT CLAIM TO ANY PARTICULAR FONT, STYLE, SIZE, OR COLOR.

FOR: EDUCATIONAL PROGRAMS, NAMELY, PRE-SCHOOLS, IN CLASS 41 (U.S. CLS. 100, 101 AND 107).

SER. NO. 77-311,693, FILED 10-23-2007.

FIRST USE 12-24-2006; IN COMMERCE 12-24-2006.

APRIL ROACH, EXAMINING ATTORNEY

**Int. Cl.: 9**

**Prior U.S. Cls.: 21, 23, 26, 36 and 38**

**Reg. No. 3,453,154**

**United States Patent and Trademark Office**

**Registered June 24, 2008**

**TRADEMARK  
PRINCIPAL REGISTER**



EDUCATIONAL MANAGEMENT SYSTEMS, LLC  
(IDAHO LTD LIAB CO)  
47 PROFESSIONAL PLAZA  
REXBURG, ID 83440

FOR: CHILDREN'S EDUCATIONAL SOFTWARE;  
EDUCATIONAL SOFTWARE FEATURING IN-  
STRUCTION IN SPELLING; COMPUTER SOFT-  
WARE FOR THE MANAGEMENT, TEACHING,  
AND LEARNING OF SPELLING THAT MAY BE  
DOWNLOADED FROM A GLOBAL COMPUTER  
NETWORK; COMPUTER SOFTWARE FOR THE  
MANAGEMENT, TEACHING, AND LEARNING

OF SPELLING, IN CLASS 9 (U.S. CLS. 21, 23, 26, 36  
AND 38).

FIRST USE 9-30-2006; IN COMMERCE 9-30-2006.

THE MARK CONSISTS OF A PARTIAL CIRCLE  
ON A SEMICIRCLE BACKGROUND WITH TWO  
UPWARDLY ARCHES, INVOKING A SUNRISE OR  
A CHILD WITH UPRAISED ARMS.

SER. NO. 77-311,701, FILED 10-24-2007.

ANDREA SAUNDERS, EXAMINING ATTORNEY

Int. Cl.: 16

Prior U.S. Cls.: 2, 5, 22, 23, 29, 37, 38 and 50

United States Patent and Trademark Office

Reg. No. 3,453,155

Registered June 24, 2008

TRADEMARK  
PRINCIPAL REGISTER

Pájaro Loco

ABREU, JOSE (UNITED STATES INDIVIDUAL)  
159 GOODRICH ST.  
HAYWARD, CA 94545

FOR: PRE-PAID TELEPHONE CALLING CARDS,  
NOT MAGNETICALLY ENCODED, IN CLASS 16  
(U.S. CLS. 2, 5, 22, 23, 29, 37, 38 AND 50).

FIRST USE 10-1-2007; IN COMMERCE 10-1-2007.

THE MARK CONSISTS OF STANDARD CHAR-  
ACTERS WITHOUT CLAIM TO ANY PARTICULAR  
FONT, STYLE, SIZE, OR COLOR.

THE FOREIGN WORDING IN THE MARK  
TRANSLATES INTO ENGLISH AS "CRAZY BIRD".

SER. NO. 77-311,704, FILED 10-24-2007.

KATINA MISTER, EXAMINING ATTORNEY

**Int. Cl.: 28**

**Prior U.S. Cls.: 22, 23, 38 and 50**

**United States Patent and Trademark Office**

**Reg. No. 3,453,156**

**Registered June 24, 2008**

**TRADEMARK  
PRINCIPAL REGISTER**

**As Real As It Gets**

KT TRAN (CALIFORNIA CORPORATION)  
2215 RINGWOOD AVE  
SAN JOSE, CA 95131

THE MARK CONSISTS OF STANDARD CHAR-  
ACTERS WITHOUT CLAIM TO ANY PARTICULAR  
FONT, STYLE, SIZE, OR COLOR.

FOR: PAINTBALL GUNS; PAINTBALLS, IN  
CLASS 28 (U.S. CLS. 22, 23, 38 AND 50).

SER. NO. 77-311,713, FILED 10-24-2007.

FIRST USE 10-1-2002; IN COMMERCE 10-1-2002.

CHRISIE B. KING, EXAMINING ATTORNEY

**Int. Cl.: 41**

**Prior U.S. Cls.: 100, 101 and 107**

**United States Patent and Trademark Office**

**Reg. No. 3,453,157**

**Registered June 24, 2008**

**SERVICE MARK  
PRINCIPAL REGISTER**

**DANDEMONKEY**

NG YAN KIN LOUIS (HONG KONG INDIVIDUAL)  
FLAT 4C, LIBERTY MANSION, 72 WATERLOO RD  
HO MAN TIN, KOWLOON, HONG KONG N/A

FOR: ON-LINE JOURNALS, NAMELY, BLOGS  
FEATURING TRAVEL EXPERIENCES, IN CLASS 41  
(U.S. CLS. 100, 101 AND 107).

THE MARK CONSISTS OF STANDARD CHARACTERS WITHOUT CLAIM TO ANY PARTICULAR FONT, STYLE, SIZE, OR COLOR.

SER. NO. 77-311,724, FILED 10-24-2007.

FIRST USE 10-13-2007; IN COMMERCE 10-13-2007.

ELISSA GARBER KON, EXAMINING ATTORNEY

**Int. Cl.: 44**

**Prior U.S. Cls.: 100 and 101**

**United States Patent and Trademark Office**

**Reg. No. 3,453,158**

**Registered June 24, 2008**

**SERVICE MARK  
PRINCIPAL REGISTER**

**BONE DIVA**

ROCHE THERAPEUTICS INC. (DELAWARE  
CORPORATION)  
340 KINGSLAND ST.  
NUTLEY, NJ 07110

FOR: PROVIDING INFORMATION VIA AN IN-  
TERNET WEBSITE TO WOMEN REGARDING  
BONE HEALTH TO ENCOURAGE LIVING A HEAL-  
THY ACTIVE LIFESTYLE, IN CLASS 44 (U.S. CLS.  
100 AND 101).

FIRST USE 10-31-2006; IN COMMERCE 10-31-2006.

THE MARK CONSISTS OF STANDARD CHAR-  
ACTERS WITHOUT CLAIM TO ANY PARTICULAR  
FONT, STYLE, SIZE, OR COLOR.

OWNER OF U.S. REG. NO. 3,162,470.

NO CLAIM IS MADE TO THE EXCLUSIVE  
RIGHT TO USE "BONE", APART FROM THE MARK  
AS SHOWN.

SER. NO. 77-311,731, FILED 10-24-2007.

PAUL CROWLEY, EXAMINING ATTORNEY



**Int. Cls.: 9 and 42**

**Prior U.S. Cls.: 21, 23, 26, 36, 38, 100 and 101**

**United States Patent and Trademark Office**

**Reg. No. 3,453,159**

**Registered June 24, 2008**

**TRADEMARK  
SERVICE MARK  
PRINCIPAL REGISTER**

**BOOMI**

BOOMI INC. (PENNSYLVANIA CORPORATION)  
SUITE 120  
801 CASSATT ROAD  
BERWYN, PA 19312

FOR: COMPUTER SOFTWARE, NAMELY, COMPUTER SOFTWARE FOR USE IN DATA AND APPLICATION INTEGRATION WITHIN AND/OR AMONG ENTERPRISES, IN CLASS 9 (U.S. CLS. 21, 23, 26, 36 AND 38).

FIRST USE 0-0-2000; IN COMMERCE 0-0-2000.

FOR: ONLINE SOFTWARE SERVICES, NAMELY, PROVIDING TEMPORARY USE VIA GLOBAL AND/OR LOCAL COMMUNICATIONS NETWORKS OF NON-DOWNLOADABLE COMPUTER SOFTWARE FOR USE IN DATA AND APPLICATION INTEGRATION WITHIN AND/OR AMONG ENTER-

PRISES; COMPUTER PROGRAMMING SERVICES, NAMELY, DEVELOPMENT OF COMPUTER SOFTWARE FOR USE IN DATA AND APPLICATION INTEGRATION WITHIN AND/OR AMONG ENTERPRISES; CONSULTING IN THE FIELD OF DATA AND APPLICATION INTEGRATION WITHIN AND/OR AMONG ENTERPRISES, IN CLASS 42 (U.S. CLS. 100 AND 101).

FIRST USE 0-0-2000; IN COMMERCE 0-0-2000.

THE MARK CONSISTS OF STANDARD CHARACTERS WITHOUT CLAIM TO ANY PARTICULAR FONT, STYLE, SIZE, OR COLOR.

SER. NO. 77-311,748, FILED 10-24-2007.

KATHERINE CONNOLLY, EXAMINING ATTORNEY

**Int. Cl.: 42**

**Prior U.S. Cls.: 100 and 101**

**United States Patent and Trademark Office**

**Reg. No. 3,453,160**

**Registered June 24, 2008**

**SERVICE MARK  
PRINCIPAL REGISTER**

**BOOMI ON DEMAND**

BOOMI INC. (PENNSYLVANIA CORPORATION)  
SUITE 120  
801 CASSATT ROAD  
BERWYN, PA 19312

FOR: ONLINE SOFTWARE SERVICES, NAMELY,  
PROVIDING TEMPORARY USE VIA GLOBAL  
AND/OR LOCAL COMMUNICATIONS NETWORKS  
OF NON-DOWNLOADABLE COMPUTER SOFT-  
WARE FOR USE IN DATA AND APPLICATION  
INTEGRATION WITHIN AND/OR AMONG ENTER-  
PRISES, IN CLASS 42 (U.S. CLS. 100 AND 101).

FIRST USE 6-0-2007; IN COMMERCE 6-0-2007.

THE MARK CONSISTS OF STANDARD CHAR-  
ACTERS WITHOUT CLAIM TO ANY PARTICULAR  
FONT, STYLE, SIZE, OR COLOR.

NO CLAIM IS MADE TO THE EXCLUSIVE  
RIGHT TO USE "ON DEMAND", APART FROM  
THE MARK AS SHOWN.

SER. NO. 77-311,751, FILED 10-24-2007.

KATHERINE CONNOLLY, EXAMINING ATTOR-  
NEY

**Int. Cl.: 1**

**Prior U.S. Cls.: 1, 5, 6, 10, 26 and 46**

**Reg. No. 3,453,161**

**United States Patent and Trademark Office**

**Registered June 24, 2008**

---

**TRADEMARK  
PRINCIPAL REGISTER**

**Tru-Stik**

OMEGA NATIONAL PRODUCTS (KENTUCKY  
CORPORATION)  
900 BAXTER AVENUE, P.O. BOX 4368  
LOUISVILLE, KY 40204

THE MARK CONSISTS OF STANDARD CHAR-  
ACTERS WITHOUT CLAIM TO ANY PARTICULAR  
FONT, STYLE, SIZE, OR COLOR.

FOR: ADHESIVES FOR APPLYING FLOOR  
TILES, IN CLASS 1 (U.S. CLS. 1, 5, 6, 10, 26 AND 46).

SER. NO. 77-311,755, FILED 10-24-2007.

FIRST USE 10-24-2007; IN COMMERCE 10-24-2007.

PAUL CROWLEY, EXAMINING ATTORNEY

**Int. Cl.: 20**

**Prior U.S. Cls.: 2, 13, 22, 25, 32 and 50**

**Reg. No. 3,453,162**

**United States Patent and Trademark Office**

**Registered June 24, 2008**

**TRADEMARK  
PRINCIPAL REGISTER**



J. TERENCE THOMPSON, INC. (MARYLAND CORPORATION)  
1916 APPLEWOOD CIRCLE  
HAGERSTOWN, MD 21740

THE MARK CONSISTS OF THE WORD THE ON TOP OF THE WORD PACKER ON TOP OF THE WORD STACKER.

FOR: PLASTIC STORAGE CONTAINERS FOR COMMERCIAL AND INDUSTRIAL USE, IN CLASS 20 (U.S. CLS. 2, 13, 22, 25, 32 AND 50).

SER. NO. 77-311,756, FILED 10-24-2007.

FIRST USE 9-1-2007; IN COMMERCE 9-1-2007.

STEVEN JACKSON, EXAMINING ATTORNEY

**Int. Cl.: 1**

**Prior U.S. Cls.: 1, 5, 6, 10, 26 and 46**

**Reg. No. 3,453,163**

**United States Patent and Trademark Office**

**Registered June 24, 2008**

---

**TRADEMARK  
PRINCIPAL REGISTER**

**DERMA-TAK**

INDOPCO, INC. (DELAWARE CORPORATION),  
DBA NATIONAL STARCH AND CHEMICAL  
COMPANY  
10 FINDERNE AVENUE  
BRIDGEWATER, NJ 08807

FOR: ADHESIVES FOR USE IN THE MANUFACTURE OF SKIN CONTACT PRODUCTS, IN CLASS 1 (U.S. CLS. 1, 5, 6, 10, 26 AND 46).

FIRST USE 10-3-2001; IN COMMERCE 10-3-2001.

THE MARK CONSISTS OF STANDARD CHARACTERS WITHOUT CLAIM TO ANY PARTICULAR FONT, STYLE, SIZE, OR COLOR.

OWNER OF U.S. REG. NO. 2,579,377.

SER. NO. 77-311,760, FILED 10-24-2007.

KAREN K. BUSH, EXAMINING ATTORNEY

**Int. Cl.: 41**

**Prior U.S. Cls.: 100, 101 and 107**

**United States Patent and Trademark Office**

**Reg. No. 3,453,164**

**Registered June 24, 2008**

**SERVICE MARK  
PRINCIPAL REGISTER**

**HIS HARVEST IS READY**

THREE ANGELS BROADCASTING NETWORK,  
INC. (ILLINOIS CORPORATION)  
PO BOX 220  
3391 CHARLEY GOOD RD.  
WEST FRANKFORT, IL 62896

FOR: ENTERTAINMENT, NAMELY A CONTINUING RELIGIOUS SHOW BROADCAST OVER TELEVISION, SATELLITE, AUDIO, AND VIDEO MEDIA; PRODUCTION OF RADIO AND TELEVISION PROGRAMS; TELEVISION SHOW PRODUCTION, IN CLASS 41 (U.S. CLS. 100, 101 AND 107).

FIRST USE 9-1-2007; IN COMMERCE 10-5-2007.

THE MARK CONSISTS OF STANDARD CHARACTERS WITHOUT CLAIM TO ANY PARTICULAR FONT, STYLE, SIZE, OR COLOR.

SER. NO. 77-311,765, FILED 10-24-2007.

KAREN K. BUSH, EXAMINING ATTORNEY

**Int. Cl.: 41**

**Prior U.S. Cls.: 100, 101 and 107**

**United States Patent and Trademark Office**

**Reg. No. 3,453,165**

**Registered June 24, 2008**

**SERVICE MARK  
PRINCIPAL REGISTER**

**S&B MIX**

STEVE & BARRY'S LLC (DELAWARE LTD LIAB  
CO)  
12 HARBOR PARK DRIVE  
PORT WASHINGTON, NY 11050

FOR: ENTERTAINMENT SERVICES, NAMELY,  
PROVIDING INTERACTIVE COMPUTERIZED  
KIOSKS THAT ALLOW USERS TO DOWNLOAD,  
MANIPULATE AND PRINT DIGITAL PHOTO-  
GRAPHS, LISTEN TO PRERECORDED MUSIC,  
AND RECORD PRERECORDED MUSIC TO DIGI-  
TAL MEDIA, IN CLASS 41 (U.S. CLS. 100, 101 AND  
107).

FIRST USE 10-22-2007; IN COMMERCE 10-22-2007.

THE MARK CONSISTS OF STANDARD CHAR-  
ACTERS WITHOUT CLAIM TO ANY PARTICULAR  
FONT, STYLE, SIZE, OR COLOR.

NO CLAIM IS MADE TO THE EXCLUSIVE  
RIGHT TO USE "MIX", APART FROM THE MARK  
AS SHOWN.

SER. NO. 77-311,774, FILED 10-24-2007.

PAUL CROWLEY, EXAMINING ATTORNEY

**Int. Cl.: 7**

**Prior U.S. Cls.: 13, 19, 21, 23, 31, 34 and 35**

**United States Patent and Trademark Office**

**Reg. No. 3,453,166**

**Registered June 24, 2008**

**TRADEMARK  
PRINCIPAL REGISTER**

**DRI-PLANE**

BUNTING BEARINGS CORP. (OHIO CORPORATION)  
1001 HOLLAND PARK BLVD.  
HOLLAND, OH 43528

FOR: MACHINE PARTS, NAMELY, SINTERED BEARINGS FOR DRY LUBRICATION AND/OR HIGH TEMPERATURE APPLICATIONS IN FOOD PROCESSING, ELECTRICAL EQUIPMENT, PHARMACEUTICALS, FURNACES, OVENS, AEROSPACE, VACUUM PROCESSES, AND GLASS MANUFACTURING, IN CLASS 7 (U.S. CLS. 13, 19, 21, 23, 31, 34 AND 35).

FIRST USE 1-1-1997; IN COMMERCE 1-1-1998.

THE MARK CONSISTS OF STANDARD CHARACTERS WITHOUT CLAIM TO ANY PARTICULAR FONT, STYLE, SIZE, OR COLOR.

SER. NO. 77-311,786, FILED 10-24-2007.

RAUL CORDOVA, EXAMINING ATTORNEY



**Int. Cl.: 11**

**Prior U.S. Cls.: 13, 21, 23, 31 and 34**

**United States Patent and Trademark Office**

**Reg. No. 3,453,167**

**Registered June 24, 2008**

**TRADEMARK  
PRINCIPAL REGISTER**

**REAL FLAME**

JENSEN METAL PRODUCTS (WISCONSIN CORPORATION)  
7800 NORTHWESTERN AVENUE  
RACINE, WI 53406

FOR: FIREPLACES FOR OUTDOOR USE, ADAPTED FOR USE WITH GEL FUEL, AND ACCESSORIES THEREFOR, NAMELY, LOG SETS AND BURNERS, IN CLASS 11 (U.S. CLS. 13, 21, 23, 31 AND 34).

FIRST USE 4-30-2004; IN COMMERCE 4-30-2004.

THE MARK CONSISTS OF STANDARD CHARACTERS WITHOUT CLAIM TO ANY PARTICULAR FONT, STYLE, SIZE, OR COLOR.

OWNER OF U.S. REG. NO. 2,573,461.

SEC. 2(F).

SER. NO. 77-311,801, FILED 10-24-2007.

CAROLYN CATALDO, EXAMINING ATTORNEY

**Int. Cl.: 35**

**Prior U.S. Cls.: 100, 101 and 102**

**United States Patent and Trademark Office**

**Reg. No. 3,453,168**

**Registered June 24, 2008**

**SERVICE MARK  
PRINCIPAL REGISTER**

**THE NEW APPALACHIA**

SOUTHERN & EASTERN KENTUCKY TOURISM  
DEVELOPMENT ASSOCIATION, INC. (KEN-  
TUCKY CORPORATION), DBA TOUR SOUTH-  
ERN & EASTERN KENTUCKY  
SUITE 230  
2292 SOUTH HWY 27  
SOMERSET, KY 42501

FOR: CHAMBER OF COMMERCE SERVICES,  
NAMELY, PROMOTING BUSINESS AND TOURISM  
IN THE SOUTHERN AND EASTERN KENTUCKY  
AREA, IN CLASS 35 (U.S. CLS. 100, 101 AND 102).

FIRST USE 8-1-2007; IN COMMERCE 9-12-2007.

THE MARK CONSISTS OF STANDARD CHAR-  
ACTERS WITHOUT CLAIM TO ANY PARTICULAR  
FONT, STYLE, SIZE, OR COLOR.

NO CLAIM IS MADE TO THE EXCLUSIVE  
RIGHT TO USE "APPALACHIA", APART FROM  
THE MARK AS SHOWN.

SER. NO. 77-311,848, FILED 10-24-2007.

ADA HAN, EXAMINING ATTORNEY

**Int. Cl.: 41**

**Prior U.S. Cls.: 100, 101 and 107**

**United States Patent and Trademark Office**

**Reg. No. 3,453,169**

**Registered June 24, 2008**

**SERVICE MARK  
PRINCIPAL REGISTER**



COACHMEFIT, LLC (MICHIGAN LTD LIAB CO)  
2300 EAST STADIUM  
ANN ARBOR, MI 48104

FOR: HEALTH CLUB SERVICES PROVIDING  
ON-SITE PHYSICAL FITNESS CONSULTING, IN  
CLASS 41 (U.S. CLS. 100, 101 AND 107).

FIRST USE 3-28-2005; IN COMMERCE 3-28-2005.

OWNER OF U.S. REG. NO. 3,307,754.

THE COLOR(S) GREEN AND BLUE IS/ARE  
CLAIMED AS A FEATURE OF THE MARK.

THE MARK CONSISTS OF BLUE OUTLINE OF A  
PERSON STRETCHING WITH ONE ARM UP IN  
THE AIR AND THE OTHER ON THE GROUND  
WITH THE UPPERCASE WORD "COACHMEFIT"  
IN GREEN AND BLUE LETTERS RUNNING  
THROUGH THE TORSO.

SER. NO. 77-311,855, FILED 10-24-2007.

ALICIA COLLINS, EXAMINING ATTORNEY

**Int. Cl.: 9**

**Prior U.S. Cls.: 21, 23, 26, 36 and 38**

**Reg. No. 3,453,170**

**United States Patent and Trademark Office**

**Registered June 24, 2008**

---

**TRADEMARK  
PRINCIPAL REGISTER**

**ProBalance**

PROPLANNER, INC (IOWA CORPORATION)  
2500 NORTH LOOP DRIVE  
AMES, IA 50010

THE MARK CONSISTS OF STANDARD CHARACTERS WITHOUT CLAIM TO ANY PARTICULAR FONT, STYLE, SIZE, OR COLOR.

FOR: COMPUTER SOFTWARE FOR COMPUTER SYSTEM AND APPLICATION DEVELOPMENT, DEPLOYMENT AND MANAGEMENT, IN CLASS 9 (U.S. CLS. 21, 23, 26, 36 AND 38).

SER. NO. 77-311,882, FILED 10-24-2007.

FIRST USE 1-1-2006; IN COMMERCE 7-1-2006.

MATTHEW MCDOWELL, EXAMINING ATTORNEY

**Int. Cl.: 1**

**Prior U.S. Cls.: 1, 5, 6, 10, 26 and 46**

**United States Patent and Trademark Office**

**Reg. No. 3,453,171**

**Registered June 24, 2008**

**TRADEMARK  
PRINCIPAL REGISTER**



SIGMA ORGANICS INC. (TENNESSEE CORPORATION)  
2475 BRANSFORD AVE.  
NASHVILLE, TN 37204

FOR: ADJUVANTS FOR USE IN THE MANUFACTURE OF SPONGEFIED PLANT LEAF ADJUVANT TREATMENT, IN CLASS 1 (U.S. CLS. 1, 5, 6, 10, 26 AND 46).

FIRST USE 1-3-2006; IN COMMERCE 1-3-2006.

THE COLOR(S) GREEN AND BLACK IS/ARE CLAIMED AS A FEATURE OF THE MARK.

THE MARK CONSISTS OF GREEN BACKGROUND WITH BLACK LETTERS STATING "SPLAT" .

SER. NO. 77-311,894, FILED 10-24-2007.

C. DIONNE CLYBURN, EXAMINING ATTORNEY

**Int. Cl.: 42**

**Prior U.S. Cls.: 100 and 101**

**United States Patent and Trademark Office**

**Reg. No. 3,453,172**

**Registered June 24, 2008**

**SERVICE MARK  
PRINCIPAL REGISTER**

# Ruby Lane

RUBY LANE, INC. (CALIFORNIA CORPORATION)  
381 BUSH ST. #400  
SAN FRANCISCO, CA 94104

FOR: COMPUTER SERVICES, NAMELY, PROVIDING SEARCH ENGINES FOR OBTAINING DATA ON A GLOBAL COMPUTER NETWORK; HOSTING THE WEB SITES OF OTHERS ON A COMPUTER SERVER FOR A GLOBAL COMPUTER NETWORK, IN CLASS 42 (U.S. CLS. 100 AND 101).

FIRST USE 8-1-1998; IN COMMERCE 8-1-1998.

THE MARK CONSISTS OF STANDARD CHARACTERS WITHOUT CLAIM TO ANY PARTICULAR FONT, STYLE, SIZE, OR COLOR.

SER. NO. 77-311,906, FILED 10-24-2007.

ALYSSA PALADINO, EXAMINING ATTORNEY

**Int. Cl.: 35**

**Prior U.S. Cls.: 100, 101 and 102**

**United States Patent and Trademark Office**

**Reg. No. 3,453,173**

**Registered June 24, 2008**

**SERVICE MARK  
PRINCIPAL REGISTER**

FAITH HOPE AND... CHOCOLATE

FAITH, HOPE AND...CHOCOLATE! INC. (FLOR-  
IDA CORPORATION)

# 13

2044 14TH AVE.

VERO BEACH, FL 32960

FOR: RETAIL CHOCOLATE BOUTIQUE, FEATURING NATURAL CHOCOLATES AND CHOCOLATE PRODUCTS, IN CLASS 35 (U.S. CLS. 100, 101 AND 102).

FIRST USE 8-1-2006; IN COMMERCE 11-1-2006.

THE MARK CONSISTS OF STANDARD CHARACTERS WITHOUT CLAIM TO ANY PARTICULAR FONT, STYLE, SIZE, OR COLOR.

NO CLAIM IS MADE TO THE EXCLUSIVE RIGHT TO USE "CHOCOLATE", APART FROM THE MARK AS SHOWN.

SER. NO. 77-311,949, FILED 10-24-2007.

NATALIE POLZER, EXAMINING ATTORNEY

**Int. Cl.: 36**

**Prior U.S. Cls.: 100, 101 and 102**

**United States Patent and Trademark Office**

**Reg. No. 3,453,174**

**Registered June 24, 2008**

**SERVICE MARK  
PRINCIPAL REGISTER**

**UP2DATE**

WILLIS, DOUG (UNITED STATES INDIVIDUAL)  
2251 E VILLA ST  
PASADENA, CA 91107

THE MARK CONSISTS OF STANDARD CHAR-  
ACTERS WITHOUT CLAIM TO ANY PARTICULAR  
FONT, STYLE, SIZE, OR COLOR.

FOR: REAL ESTATE BROKERAGE, IN CLASS 36  
(U.S. CLS. 100, 101 AND 102).

SER. NO. 77-311,979, FILED 10-24-2007.

FIRST USE 9-25-2005; IN COMMERCE 9-25-2005.

DAVID MILLER, EXAMINING ATTORNEY



**Int. Cl.: 35**

**Prior U.S. Cls.: 100, 101 and 102**

**United States Patent and Trademark Office**

**Reg. No. 3,453,175**

**Registered June 24, 2008**

**SERVICE MARK  
PRINCIPAL REGISTER**

# CATCH BUSINESS

ZAKHOZHAI, IRINA (UKRAINE INDIVIDUAL)  
# A-212  
940 IRVINE AVE.  
NEWPORT BEACH, CA 92663

FOR: ADVERTISING AND COMMERCIAL INFORMATION SERVICES, VIA THE INTERNET; ADVERTISING SERVICES, NAMELY, PROMOTING PROPERTIES FOR SALE BY OWNER VIA THE INTERNET; ADVERTISING VIA ELECTRONIC MEDIA AND SPECIFICALLY THE INTERNET; ADVERTISING BUSINESS; ADVICE AND INFORMATION ABOUT CUSTOMER SERVICES AND PRODUCT MANAGEMENT AND PRICES ON INTERNET SITES IN CONNECTION WITH PURCHASES MADE OVER THE INTERNET; COMPUTER SERVICES, NAMELY, ADDRESS CHANGE NOTIFICATION SERVICES IN THE NATURE OF POSTING NOTIFICATIONS OF CHANGES OF ADDRESSES FOR BUSINESSES VIA THE INTERNET; DESIGN OF INTERNET ADVERTISING; DISSEMINATION OF ADVERTISING FOR OTHERS VIA THE INTERNET; DISSEMINATION OF ADVERTISING FOR OTHERS VIA AN ON-LINE COMMUNICATIONS NETWORK ON THE INTERNET; FACILITATING THE EXCHANGE OF NEEDED INFORMATION FOR FINANCIAL COMPENSATION VIA THE INTERNET; INFORMATION MANAGEMENT SERVICES, NAMELY, SHIPMENT PROCESSING, PREPARING SHIPPING DOCUMENTS AND INVOICES, TRACKING DOCUMENTS, PACKAGES AND FREIGHT OVER COMPUTER NETWORKS, INTRANETS AND INTERNETS; INFORMATION, ADVISORY AND CONSULTANCY SERVICES RELATING TO BUSINESS AND MANAGEMENT OR BUSINESS ADMINISTRATION, INCLUDING SUCH SERVICES PROVIDED ON LINE OR VIA THE INTERNET; INSURANCE LEAD COLLECTION AND MATCHING SERVICES, NAMELY, MATCHING CONSUMER REQUESTS FOR INSURANCE POLICY QUOTES COLLECTED OVER THE INTERNET TO PRE-QUALIFIED INSURANCE BROKERS, AGENTS

AND AGENCIES INTERESTED IN THOSE REQUESTS; INTERNET ADVERTISING SERVICES; MARKET MANIPULATION, RESEARCH AND ANALYSIS, WHETHER OR NOT VIA THE INTERNET; ON-LINE TRADING SERVICES IN WHICH SELLER POSTS PRODUCTS TO BE AUCTIONED AND BIDDING IS DONE VIA THE INTERNET; ORGANISATION OF INTERNET AUCTIONS; PROVIDING A SEARCHABLE ONLINE ADVERTISING GUIDE FEATURING THE GOODS AND SERVICES OF OTHER ON-LINE VENDORS ON THE INTERNET; PROVIDING A SECURED ACCESS DATABASE VIA THE INTERNET THROUGH WHICH DOCUMENTS AND IMAGES CAN BE VIEWED, COPIED, AND PRINTED FOR PURPOSES OF CONDUCTING CORPORATE TRANSACTIONS; PROVIDING AN ON-LINE COMMERCIAL INFORMATION DIRECTORY ON THE INTERNET; PROVIDING AND RENTAL OF ADVERTISING SPACE ON THE INTERNET; PROVIDING BUSINESS INFORMATION, ALSO VIA INTERNET, THE CABLE NETWORK OR OTHER FORMS OF DATA TRANSFER; PROVIDING BUSINESS INFORMATION, ALSO VIA INTERNET, THE CABLE NETWORK OR OTHER FORMS OF DATA TRANSFER; PROVIDING CONSUMER PRODUCT INFORMATION VIA THE INTERNET; PROVIDING INFORMATION ABOUT AUTOMOBILES FOR SALE BY MEANS OF THE INTERNET; PROVIDING INFORMATION IN THE FIELD OF MARKETING AND ON-LINE MARKETING MEDIA VIA THE INTERNET; PROVIDING INFORMATION IN THE FIELD OF AVIATION FUEL MANAGEMENT VIA THE INTERNET, NAMELY, THE AMOUNT OF FUEL LOADED ONTO AIRCRAFT AND MAINTAINING OPERATIONAL CONTROL OF FUEL AVAILABLE AND DELIVERED TO AIRCRAFT; SUBSCRIPTION TO A TELEMATICS, TELEPHONE OR COMPUTER SERVICE, IN CLASS 35 (U.S. CLS. 100, 101 AND 102).

FIRST USE 7-0-2007; IN COMMERCE 8-11-2007.

THE MARK CONSISTS OF STANDARD CHARACTERS WITHOUT CLAIM TO ANY PARTICULAR FONT, STYLE, SIZE, OR COLOR.

SER. NO. 77-311,984, FILED 10-24-2007.

NO CLAIM IS MADE TO THE EXCLUSIVE RIGHT TO USE "BUSINESS", APART FROM THE MARK AS SHOWN.

ANTHONY RINKER, EXAMINING ATTORNEY

**Int. Cl.: 18**

**Prior U.S. Cls.: 1, 2, 3, 22 and 41**

**Reg. No. 3,453,176**

**United States Patent and Trademark Office**

**Registered June 24, 2008**

---

**TRADEMARK  
PRINCIPAL REGISTER**

**ACTIVSPORT**

VPI CORP. (DELAWARE CORPORATION)  
103 FOULK ROAD - SUITE 200  
WILMINGTON, DE 19803

FOR: LUGGAGE, GYM BAGS, OVERNIGHT  
BAGS AND CARRYALL BAGS, IN CLASS 18 (U.S.  
CLS. 1, 2, 3, 22 AND 41).

FIRST USE 7-31-2004; IN COMMERCE 7-31-2004.

THE MARK CONSISTS OF STANDARD CHAR-  
ACTERS WITHOUT CLAIM TO ANY PARTICULAR  
FONT, STYLE, SIZE, OR COLOR.

OWNER OF U.S. REG. NO. 2,887,133.

SER. NO. 77-312,000, FILED 10-24-2007.

TARAH HARDY, EXAMINING ATTORNEY

**Int. Cl.: 35**

**Prior U.S. Cls.: 100, 101 and 102**

**United States Patent and Trademark Office**

**Reg. No. 3,453,177**

**Registered June 24, 2008**

**SERVICE MARK  
PRINCIPAL REGISTER**

**BECAUSE WE'RE STRONGER  
TOGETHER**

GENERATIONS UNITED (D.C. NON-PROFIT CORPORATION)  
SUITE 900  
1331 H STREET, NW  
WASHINGTON, DC 20005

FOR: PUBLIC POLICY RESEARCH SERVICES, NAMELY, IDENTIFYING AND ANALYZING EXISTING AND PROPOSED PUBLIC POLICIES WITH INTERGENERATIONAL IMPLICATIONS, PLANNING AND INITIATING RESEARCH ACTIVITIES AROUND INTERGENERATIONAL PUBLIC POLICIES AND PROGRAMS; CHARITABLE ASSOCIATION SERVICES, NAMELY COLLECTING AND DISSEMINATING TO THE PUBLIC INFORMATION ADVANCING INTERGENERATIONAL POLICIES

AND PROGRAMS, INCLUDING THOSE AFFECTING GRANDPARENTS AND OTHER RELATIVES RAISING CHILDREN, IN CLASS 35 (U.S. CLS. 100, 101 AND 102).

FIRST USE 7-26-2007; IN COMMERCE 7-26-2007.

THE MARK CONSISTS OF STANDARD CHARACTERS WITHOUT CLAIM TO ANY PARTICULAR FONT, STYLE, SIZE, OR COLOR.

SER. NO. 77-312,021, FILED 10-24-2007.

KIMBERLY FRYE, EXAMINING ATTORNEY

**Int. Cl.: 35**

**Prior U.S. Cls.: 100, 101 and 102**

**United States Patent and Trademark Office**

**Reg. No. 3,453,178**

**Registered June 24, 2008**

**SERVICE MARK  
PRINCIPAL REGISTER**

**The Raw Connection**

THE RAW CONNECTION, INC. (CALIFORNIA CORPORATION)  
26549 CARMEL RANCHO BLVD.  
CARMEL, CA 93923

THE MARK CONSISTS OF STANDARD CHARACTERS WITHOUT CLAIM TO ANY PARTICULAR FONT, STYLE, SIZE, OR COLOR.

FOR: RETAIL STORE SERVICES AND ONLINE RETAIL STORE SERVICES FEATURING PET FOOD, IN CLASS 35 (U.S. CLS. 100, 101 AND 102).

SER. NO. 77-312,022, FILED 10-24-2007.

FIRST USE 6-1-2002; IN COMMERCE 6-1-2002.

KATHLEEN LORENZO, EXAMINING ATTORNEY

**Int. Cl.: 14**

**Prior U.S. Cls.: 2, 27, 28 and 50**

**United States Patent and Trademark Office**

**Reg. No. 3,453,179**

**Registered June 24, 2008**

**TRADEMARK  
PRINCIPAL REGISTER**

**OVED**

OVED DIAMOND COMPANY LTD. (NEW YORK  
CORPORATION)  
8TH FLOOR  
1156 AVENUE OF THE AMERICAS  
NEW YORK, NY 10036

THE MARK CONSISTS OF STANDARD CHAR-  
ACTERS WITHOUT CLAIM TO ANY PARTICULAR  
FONT, STYLE, SIZE, OR COLOR.

FOR: JEWELRY; DIAMONDS, IN CLASS 14 (U.S.  
CLS. 2, 27, 28 AND 50).

SER. NO. 77-312,082, FILED 10-24-2007.

FIRST USE 1-0-1999; IN COMMERCE 1-0-1999.

ALICE BENMAMAN, EXAMINING ATTORNEY

**Int. Cl.: 41**

**Prior U.S. Cls.: 100, 101 and 107**

**United States Patent and Trademark Office**

**Reg. No. 3,453,180**

**Registered June 24, 2008**

**SERVICE MARK  
PRINCIPAL REGISTER**

**SHARED VENTURES**

SHARED VENTURES (VERMONT LTD LIAB CO)  
29 KINGS ROW  
P.O. BOX 716  
EAST MIDDLEBURY, VT 05740

FOR: EDUCATIONAL SERVICES, NAMELY,  
PROVIDING CLASSES, LECTURES, COACHING  
AND HOME STUDY PROGRAMS IN THE FIELD  
OF PARENTING, IN CLASS 41 (U.S. CLS. 100, 101  
AND 107).

FIRST USE 1-1-2001; IN COMMERCE 1-1-2001.

THE MARK CONSISTS OF STANDARD CHAR-  
ACTERS WITHOUT CLAIM TO ANY PARTICULAR  
FONT, STYLE, SIZE, OR COLOR.

SER. NO. 77-312,113, FILED 10-24-2007.

CAROLINE WOOD, EXAMINING ATTORNEY

Int. Cl.: 14

Prior U.S. Cls.: 2, 27, 28 and 50

United States Patent and Trademark Office

Reg. No. 3,453,181

Registered June 24, 2008

TRADEMARK  
PRINCIPAL REGISTER



MONIQUE R. ZHANG (UNITED STATES INDIVIDUAL), DBA 1611 EZRA  
13240 1/2 RAMONA BLVD  
BALDWIN PARK, CA 91706

FOR: JEWELRY, IN CLASS 14 (U.S. CLS. 2, 27, 28 AND 50).

FIRST USE 6-6-2007; IN COMMERCE 6-6-2007.

NO CLAIM IS MADE TO THE EXCLUSIVE RIGHT TO USE "DESIGNS", APART FROM THE MARK AS SHOWN.

THE NAME "ZHANG RAY" DOES NOT IDENTIFY A LIVING INDIVIDUAL.

THE COLOR(S) BLACK, GOLD, BRONZE IS/ARE CLAIMED AS A FEATURE OF THE MARK.

ALL THE WORDING, NUMBERS AND PLAQUE DESIGN ARE TWO-TONE GOLD AND BRONZE. THE UPPER PART OF EACH LETTER, NUMBER AND DESIGN ELEMENT IS LIGHTER GOLD COLOR, AND THE LOWER PART OF EACH LETTER, NUMBER AND DESIGN ELEMENT IS DARKER BRONZE COLOR. THE BACKGROUND IS BLACK.

SER. NO. 77-312,134, FILED 10-24-2007.

IRA J. GOODSaid, EXAMINING ATTORNEY



**Int. Cl.: 5**

**Prior U.S. Cls.: 6, 18, 44, 46, 51 and 52**

**Reg. No. 3,453,182**

**United States Patent and Trademark Office**

**Registered June 24, 2008**

---

**TRADEMARK  
PRINCIPAL REGISTER**

# Hand Sanity

COATS RETAIL GROUP, LLC (TEXAS LTD LIAB  
CO)

905 SE 21ST STREET

BENTONVILLE, AR 72712

FOR: HAND-SANITIZING PREPARATIONS, IN  
CLASS 5 (U.S. CLS. 6, 18, 44, 46, 51 AND 52).

FIRST USE 10-0-2007; IN COMMERCE 10-0-2007.

THE MARK CONSISTS OF STANDARD CHAR-  
ACTERS WITHOUT CLAIM TO ANY PARTICULAR  
FONT, STYLE, SIZE, OR COLOR.

NO CLAIM IS MADE TO THE EXCLUSIVE  
RIGHT TO USE "HAND", APART FROM THE  
MARK AS SHOWN.

SER. NO. 77-312,149, FILED 10-24-2007.

CHRIS WELLS, EXAMINING ATTORNEY

**Int. Cl.: 9**

**Prior U.S. Cls.: 21, 23, 26, 36 and 38**

**Reg. No. 3,453,183**

**United States Patent and Trademark Office**

**Registered June 24, 2008**

**TRADEMARK  
PRINCIPAL REGISTER**



WIRELESS TECHNOLOGY, INC. (NEVADA CORPORATION)  
2064 EASTMAN AVE., STE 113  
VENTURA, CA 930037787

FIRST USE 10-31-2005; IN COMMERCE 7-31-2007.

SER. NO. 77-312,203, FILED 10-24-2007.

FOR: DIGITAL CAMERAS; VIDEO CAMERAS;  
DEVICES FOR WIRELESS RADIO TRANSMISSION,  
IN CLASS 9 (U.S. CLS. 21, 23, 26, 36 AND 38).

DAYNA BROWNE, EXAMINING ATTORNEY

**Int. Cl.: 43**

**Prior U.S. Cls.: 100 and 101**

**United States Patent and Trademark Office**

**Reg. No. 3,453,184**

**Registered June 24, 2008**

**SERVICE MARK  
PRINCIPAL REGISTER**

**TONY SINCLAIR**

DIAGEO BRANDS B.V. (NETHERLANDS PRIVATE LIMITED COMPANY)  
MOLENWERF 10-12  
AMSTERDAM 1014 BG, NETHERLANDS

FOR: PROVIDING AN INTERACTIVE WEBSITE IN THE FIELD OF ALCOHOLIC BEVERAGES AND COCKTAIL RECIPES, IN CLASS 43 (U.S. CLS. 100 AND 101).

FIRST USE 4-11-2005; IN COMMERCE 4-11-2005.

THE MARK CONSISTS OF STANDARD CHARACTERS WITHOUT CLAIM TO ANY PARTICULAR FONT, STYLE, SIZE, OR COLOR.

THE NAME(S), PORTRAIT(S), AND/OR SIGNATURE(S) SHOWN IN THE MARK DOES NOT IDENTIFY A PARTICULAR LIVING INDIVIDUAL.

SER. NO. 77-312,206, FILED 10-24-2007.

ANN E. SAPPENFIELD, EXAMINING ATTORNEY

**Int. Cl.: 43**

**Prior U.S. Cls.: 100 and 101**

**United States Patent and Trademark Office**

**Reg. No. 3,453,185**

**Registered June 24, 2008**

---

**SERVICE MARK  
PRINCIPAL REGISTER**

**EQC**

PUYALLUP TRIBE OF INDIANS (UNITED STATES FEDERALLY-RECOGNIZED INDIAN TRIBE)  
3009 EAST PORTLAND AVENUE  
TACOMA, WA 98404

THE MARK CONSISTS OF STANDARD CHARACTERS WITHOUT CLAIM TO ANY PARTICULAR FONT, STYLE, SIZE, OR COLOR.

FOR: HOTEL, BAR AND RESTAURANT SERVICES, IN CLASS 43 (U.S. CLS. 100 AND 101).

SER. NO. 77-312,226, FILED 10-24-2007.

FIRST USE 4-19-1997; IN COMMERCE 4-19-1997.

ANDREA HACK, EXAMINING ATTORNEY

**Int. Cl.: 9**

**Prior U.S. Cls.: 21, 23, 26, 36 and 38**

**Reg. No. 3,453,186**

**United States Patent and Trademark Office**

**Registered June 24, 2008**

---

**TRADEMARK  
PRINCIPAL REGISTER**

**WTI**

WIRELESS TECHNOLOGY, INC. (NEVADA CORPORATION)  
2064 EASTMAN AVE., STE. 113  
VENTURA, CA 930037787

THE MARK CONSISTS OF STANDARD CHARACTERS WITHOUT CLAIM TO ANY PARTICULAR FONT, STYLE, SIZE, OR COLOR.

FOR: DIGITAL CAMERAS; VIDEO CAMERAS; DEVICES FOR WIRELESS RADIO TRANSMISSION, IN CLASS 9 (U.S. CLS. 21, 23, 26, 36 AND 38).

SER. NO. 77-312,236, FILED 10-24-2007.

FIRST USE 8-31-2003; IN COMMERCE 11-30-2003.

DAYNA BROWNE, EXAMINING ATTORNEY

**Int. Cl.: 3**

**Prior U.S. Cls.: 1, 4, 6, 50, 51 and 52**

**Reg. No. 3,453,187**

**United States Patent and Trademark Office**

**Registered June 24, 2008**

---

**TRADEMARK  
PRINCIPAL REGISTER**

**EYE SILK**

REVANCE THERAPEUTICS, INC. (DELAWARE  
CORPORATION)  
2400 BAYSHORE PARKWAY, SUITE 100  
MOUNTAIN VIEW, CA 94043

FOR: EYE CREAMS USED AS COSMETIC PRE-  
PARATIONS FOR SKIN RENEWAL, SKIN FIRM-  
ING AND SKIN WRINKLE REMOVING, IN CLASS 3  
(U.S. CLS. 1, 4, 6, 50, 51 AND 52).

FIRST USE 7-6-2006; IN COMMERCE 7-6-2006.

THE MARK CONSISTS OF STANDARD CHAR-  
ACTERS WITHOUT CLAIM TO ANY PARTICULAR  
FONT, STYLE, SIZE, OR COLOR.

NO CLAIM IS MADE TO THE EXCLUSIVE  
RIGHT TO USE "EYE", APART FROM THE MARK  
AS SHOWN.

SER. NO. 77-312,244, FILED 10-24-2007.

EDWARD FENNESSY, EXAMINING ATTORNEY

**Int. Cl.: 41**

**Prior U.S. Cls.: 100, 101 and 107**

**United States Patent and Trademark Office**

**Reg. No. 3,453,188**

**Registered June 24, 2008**

**SERVICE MARK  
PRINCIPAL REGISTER**

**JDP JUNIOR DEVELOPMENT  
PATHWAY**

TENNIS CORPORATION OF AMERICA (DELA-  
WARE CORPORATION)  
3611 N. KEDZIE AVE.  
CHICAGO, IL 60618

FOR: PROVIDING INSTRUCTIONS AND TRAIN-  
ING PROGRAMS FOR THE DEVELOPMENT OF  
RACQUET SPORT SKILLS, IN CLASS 41 (U.S. CLS.  
100, 101 AND 107).

FIRST USE 9-0-2006; IN COMMERCE 9-0-2006.

THE MARK CONSISTS OF STANDARD CHAR-  
ACTERS WITHOUT CLAIM TO ANY PARTICULAR  
FONT, STYLE, SIZE, OR COLOR.

NO CLAIM IS MADE TO THE EXCLUSIVE  
RIGHT TO USE "JUNIOR DEVELOPMENT", APART  
FROM THE MARK AS SHOWN.

SER. NO. 77-312,291, FILED 10-24-2007.

JUDITH HELFMAN, EXAMINING ATTORNEY

**Int. Cl.: 9**

**Prior U.S. Cls.: 21, 23, 26, 36 and 38**

**Reg. No. 3,453,189**

**United States Patent and Trademark Office**

**Registered June 24, 2008**

**TRADEMARK  
PRINCIPAL REGISTER**

**AGRO**

AGUILAR AMPLIFICATION, LLC (NEW YORK  
LTD LIAB CO)  
7TH FLOOR  
599 BROADWAY  
NEW YORK, NY 10994

THE MARK CONSISTS OF STANDARD CHAR-  
ACTERS WITHOUT CLAIM TO ANY PARTICULAR  
FONT, STYLE, SIZE, OR COLOR.

FOR: AMPLIFIERS; AUDIO AMPLIFIERS; MUSI-  
CAL INSTRUMENT AMPLIFIERS; POWER AMPLI-  
FIERS; PRE-AMPLIFIERS; SOUND AMPLIFIERS, IN  
CLASS 9 (U.S. CLS. 21, 23, 26, 36 AND 38).

SER. NO. 77-312,299, FILED 10-24-2007.

FIRST USE 11-15-2006; IN COMMERCE 11-15-2006.

ALICE SUE CARRUTHERS, EXAMINING ATTOR-  
NEY



**Int. Cl.: 25**

**Prior U.S. Cls.: 22 and 39**

**United States Patent and Trademark Office**

**Reg. No. 3,453,190**

**Registered June 24, 2008**

**TRADEMARK  
PRINCIPAL REGISTER**

**ECN**

LINDSEY J. POLLARD (UNITED STATES INDIVIDUAL)  
28 CARRIAGE LANE  
NEWARK, DE 19711

THE MARK CONSISTS OF STANDARD CHARACTERS WITHOUT CLAIM TO ANY PARTICULAR FONT, STYLE, SIZE, OR COLOR.

FOR: SWEAT PANTS; SWEAT SHIRTS; T-SHIRTS; HEADGEAR, NAMELY, HATS AND CAPS, IN CLASS 25 (U.S. CLS. 22 AND 39).

SER. NO. 77-312,307, FILED 10-25-2007.

FIRST USE 6-30-2006; IN COMMERCE 6-30-2006.

CAROLINE WOOD, EXAMINING ATTORNEY

**Int. Cl.: 28**

**Prior U.S. Cls.: 22, 23, 38 and 50**

**Reg. No. 3,453,191**

**United States Patent and Trademark Office**

**Registered June 24, 2008**

**TRADEMARK  
PRINCIPAL REGISTER**

**EVF**

WET GLASS, INC. (CALIFORNIA CORPORATION)  
8575 MIRAMAR PLACE  
SAN DIEGO, CA 92121

FIRST USE 10-1-2007; IN COMMERCE 10-1-2007.

FOR: SURFBOARDS, BODYBOARDS, KNEEBOARDS, WAKEBOARDS, SAILBOARDS, SURF SKIS, SNOWBOARDS, SNOW SKIS, WATER-SKIS, SKATEBOARDS AND KITE BOARDS; WAX FOR SURFBOARDS; PADDLES FOR USE WITH SURFBOARDS; BAGS ESPECIALLY DESIGNED FOR SURFBOARDS, IN CLASS 28 (U.S. CLS. 22, 23, 38 AND 50).

THE MARK CONSISTS OF STANDARD CHARACTERS WITHOUT CLAIM TO ANY PARTICULAR FONT, STYLE, SIZE, OR COLOR.

SER. NO. 77-312,328, FILED 10-24-2007.

MICHAEL SOUDERS, EXAMINING ATTORNEY

**Int. Cl.: 38**

**Prior U.S. Cls.: 100, 101 and 104**

**United States Patent and Trademark Office**

**Reg. No. 3,453,192**

**Registered June 24, 2008**

**SERVICE MARK  
PRINCIPAL REGISTER**

**IO TV**

CSC HOLDINGS, INC. (DELAWARE CORPORATION)  
1111 STEWART AVENUE  
BETHPAGE, NY 11714

FOR: CABLE TELEVISION BROADCASTING SERVICES; RECEIPT, TRANSMISSION AND BROADCASTING OF TELEVISION PROGRAMMING, DATA, SOUND, TEXT, IMAGES, VIDEO, AND VIDEO-ON-DEMAND BY MEANS OF BROADBAND CABLE NETWORK; CABLE TELEVISION TRANSMISSION AND INTERACTIVE COMMUNICATION SERVICES, NAMELY, RECEIPT, TRANSMISSION AND BROADCASTING OF DATA, SOUND, TEXT, IMAGES, VIDEO, VIDEO-ON-DEMAND, AND AUDIO AND VIDEO-ON-DEMAND, BY MEANS OF CABLE NETWORKS AND SATELLITE, IN CLASS 38 (U.S. CLS. 100, 101 AND 104).

FIRST USE 9-11-2007; IN COMMERCE 9-11-2007.

THE MARK CONSISTS OF STANDARD CHARACTERS WITHOUT CLAIM TO ANY PARTICULAR FONT, STYLE, SIZE, OR COLOR.

OWNER OF U.S. REG. NOS. 2,784,728, 3,036,132 AND OTHERS.

NO CLAIM IS MADE TO THE EXCLUSIVE RIGHT TO USE "TV", APART FROM THE MARK AS SHOWN.

SER. NO. 77-312,373, FILED 10-24-2007.

JAMES MACFARLANE, EXAMINING ATTORNEY

**Int. Cl.: 35**

**Prior U.S. Cls.: 100, 101 and 102**

**United States Patent and Trademark Office**

**Reg. No. 3,453,193**

**Registered June 24, 2008**

**SERVICE MARK  
PRINCIPAL REGISTER**

**The Future of  
Manufacturing is Innovation**

CONNECTICUT CENTER FOR ADVANCED  
TECHNOLOGY, INC. (CONNECTICUT COR-  
PORATION)

SUITE 101  
222 PIKTIN STREET  
EAST HARTFORD, CT 06108

FOR: ARRANGING AND CONDUCTING BUSI-  
NESS CONFERENCES; BUSINESS DEVELOPMENT  
SERVICES, NAMELY, PROVIDING START-UP SUP-  
PORT FOR BUSINESSES OF OTHERS; BUSINESS  
INFORMATION IN THE FIELD OF DEVELOPING  
SMALL TECHNOLOGY COMPANIES; PROMOT-  
ING THE ECONOMIC DEVELOPMENT IN THE

STATE OF CONNECTICUT, IN CLASS 35 (U.S. CLS.  
100, 101 AND 102).

FIRST USE 9-1-2005; IN COMMERCE 9-1-2005.

THE MARK CONSISTS OF STANDARD CHAR-  
ACTERS WITHOUT CLAIM TO ANY PARTICULAR  
FONT, STYLE, SIZE, OR COLOR.

SER. NO. 77-312,374, FILED 10-24-2007.

DAYNA BROWNE, EXAMINING ATTORNEY

**Int. Cl.: 3**

**Prior U.S. Cls.: 1, 4, 6, 50, 51 and 52**

**United States Patent and Trademark Office**

**Reg. No. 3,453,194**

**Registered June 24, 2008**

**TRADEMARK  
PRINCIPAL REGISTER**

**BABY SPRITZ**

BABY SPRITZ, INC. (NEW YORK CORPORATION)

3 HARRIET LANE

WESLEY HILLS, NY 10977

FOR: LIQUID SKIN CLEANSERS AND NON-MEDICATED DIAPER RASH SPRAY, IN CLASS 3 (U.S. CLS. 1, 4, 6, 50, 51 AND 52).

FIRST USE 3-29-2001; IN COMMERCE 3-29-2001.

THE MARK CONSISTS OF STANDARD CHARACTERS WITHOUT CLAIM TO ANY PARTICULAR FONT, STYLE, SIZE, OR COLOR.

OWNER OF U.S. REG. NO. 2,586,918.

SEC. 2(F).

SER. NO. 77-312,375, FILED 10-24-2007.

TRACY WHITTAKER-BROWN, EXAMINING ATTORNEY

**Int. Cl.: 2**

**Prior U.S. Cls.: 6, 11 and 16**

**United States Patent and Trademark Office**

**Reg. No. 3,453,195**

**Registered June 24, 2008**

**TRADEMARK  
PRINCIPAL REGISTER**

**VANTAGE PLUS**

VOGEL PAINT & WAX COMPANY, INCORPORATED (IOWA CORPORATION)  
1020 ALBANY PLACE SOUTH  
ORANGE CITY, IA 51041

FOR: COATINGS, FOR INTERIOR USE, IN THE CHARACTER OF PAINT, IN CLASS 2 (U.S. CLS. 6, 11 AND 16).

FIRST USE 6-21-2007; IN COMMERCE 6-21-2007.

THE MARK CONSISTS OF STANDARD CHARACTERS WITHOUT CLAIM TO ANY PARTICULAR FONT, STYLE, SIZE, OR COLOR.

SER. NO. 77-312,382, FILED 10-24-2007.

LEIGH CAROLINE CASE, EXAMINING ATTORNEY

**Int. Cl.: 28**

**Prior U.S. Cls.: 22, 23, 38 and 50**

**United States Patent and Trademark Office**

**Reg. No. 3,453,196**

**Registered June 24, 2008**

**TRADEMARK  
PRINCIPAL REGISTER**

**COPY CATS**

TREND ENTERPRISES, INC. (MINNESOTA CORPORATION)  
300 NINTH AVENUE S.W.  
ST. PAUL, MN 55164

THE MARK CONSISTS OF STANDARD CHARACTERS WITHOUT CLAIM TO ANY PARTICULAR FONT, STYLE, SIZE, OR COLOR.

FOR: EDUCATIONAL PUBLICATIONS, NAME-  
LY, EDUCATIONAL CARD GAMES IN THE FIELD  
OF MATH, IN CLASS 28 (U.S. CLS. 22, 23, 38 AND 50).

SER. NO. 77-312,403, FILED 10-24-2007.

FIRST USE 9-17-2007; IN COMMERCE 9-17-2007.

CHRIS WELLS, EXAMINING ATTORNEY

**Int. Cl.: 28**

**Prior U.S. Cls.: 22, 23, 38 and 50**

**United States Patent and Trademark Office**

**Reg. No. 3,453,197**

**Registered June 24, 2008**

**TRADEMARK  
PRINCIPAL REGISTER**

**1-2-3 FARMYARD!**

TREND ENTERPRISES, INC. (MINNESOTA CORPORATION)  
300 NINTH AVENUE S.W.  
ST. PAUL, MN 55164

THE MARK CONSISTS OF STANDARD CHARACTERS WITHOUT CLAIM TO ANY PARTICULAR FONT, STYLE, SIZE, OR COLOR.

FOR: EDUCATIONAL PUBLICATIONS, NAME-  
LY, EDUCATIONAL CARD GAMES IN THE FIELD  
OF MATH, IN CLASS 28 (U.S. CLS. 22, 23, 38 AND 50).

SER. NO. 77-312,406, FILED 10-24-2007.

FIRST USE 9-17-2007; IN COMMERCE 9-17-2007.

CHRIS WELLS, EXAMINING ATTORNEY



**Int. Cl.: 28**

**Prior U.S. Cls.: 22, 23, 38 and 50**

**United States Patent and Trademark Office**

**Reg. No. 3,453,198**

**Registered June 24, 2008**

**TRADEMARK  
PRINCIPAL REGISTER**

**3CORNER**

TREND ENTERPRISES, INC. (MINNESOTA CORPORATION)  
300 NINTH AVENUE S.W.  
ST. PAUL, MN 55164

THE MARK CONSISTS OF STANDARD CHARACTERS WITHOUT CLAIM TO ANY PARTICULAR FONT, STYLE, SIZE, OR COLOR.

FOR: EDUCATIONAL CARD GAMES IN THE FIELD OF DESIGN, SHAPE AND COLOR RECOGNITION, IN CLASS 28 (U.S. CLS. 22, 23, 38 AND 50).

SER. NO. 77-312,415, FILED 10-24-2007.

FIRST USE 9-17-2007; IN COMMERCE 9-17-2007.

CHRIS WELLS, EXAMINING ATTORNEY

**Int. Cl.: 16**

**Prior U.S. Cls.: 2, 5, 22, 23, 29, 37, 38 and 50**

**Reg. No. 3,453,199**

**United States Patent and Trademark Office**

**Registered June 24, 2008**

**TRADEMARK  
PRINCIPAL REGISTER**



MEADWESTVACO CORPORATION (DELAWARE CORPORATION)  
ATTN: EDITH FORBES  
11013 WEST BROAD STREET  
GLEN ALLEN, VA 230605937

FOR: PRINTED MATERIALS, NAMELY, ADVERTISING PAMPHLETS AND BROCHURES, AND SIGNS MADE OF PAPER, USED TO PROMOTE THE SALE OF DISPENSING SYSTEMS AND TRIG-

GER SPRAYS, IN CLASS 16 (U.S. CLS. 2, 5, 22, 23, 29, 37, 38 AND 50).

FIRST USE 11-1-2004; IN COMMERCE 11-1-2004.

OWNER OF U.S. REG. NO. 1,642,097.

SER. NO. 77-312,423, FILED 10-24-2007.

MONIQUE MILLER, EXAMINING ATTORNEY

**Int. Cl.: 3**

**Prior U.S. Cls.: 1, 4, 6, 50, 51 and 52**

**United States Patent and Trademark Office**

**Reg. No. 3,453,200**

**Registered June 24, 2008**

**TRADEMARK  
PRINCIPAL REGISTER**

# Pediology

COATS RETAIL GROUP, LLC (TEXAS LTD LIAB  
CO)  
905 SE 21ST STREET  
BENTONVILLE, AR 72712

THE MARK CONSISTS OF STANDARD CHAR-  
ACTERS WITHOUT CLAIM TO ANY PARTICULAR  
FONT, STYLE, SIZE, OR COLOR.

FOR: NON-MEDICATED FOOT CREAM, IN  
CLASS 3 (U.S. CLS. 1, 4, 6, 50, 51 AND 52).

SER. NO. 77-312,425, FILED 10-24-2007.

FIRST USE 10-0-2007; IN COMMERCE 10-0-2007.

CHRIS WELLS, EXAMINING ATTORNEY

**Int. Cls.: 41 and 44**

**Prior U.S. Cls.: 100, 101 and 107**

**United States Patent and Trademark Office**

**Reg. No. 3,453,201**

**Registered June 24, 2008**

**SERVICE MARK  
PRINCIPAL REGISTER**



ENERGY OASIS, INC. (GEORGIA CORPORATION)

111 MARKET STREET  
RICHMOND HILL, GA 31324

FOR: EXERCISE FACILITIES, IN CLASS 41 (U.S. CLS. 100, 101 AND 107).

FIRST USE 11-30-2005; IN COMMERCE 11-30-2005.

FOR: MASSAGE SERVICES, HEALTH SPA SERVICES FOR WELLNESS OF THE BODY AND SPIRIT OFFERED AT AN EXERCISE FACILITY, IN CLASS 44 (U.S. CLS. 100 AND 101).

FIRST USE 11-30-2005; IN COMMERCE 11-30-2005.

SER. NO. 77-312,429, FILED 10-24-2007.

DANIEL CAPSHAW, EXAMINING ATTORNEY

**Int. Cl.: 36**

**Prior U.S. Cls.: 100, 101 and 102**

**United States Patent and Trademark Office**

**Reg. No. 3,453,202**

**Registered June 24, 2008**

**SERVICE MARK  
PRINCIPAL REGISTER**

AMERICA'S AFFORDABLE WAY  
TO MOVE

REAL ESTATE AMERICA CORPORATION  
(MARYLAND CORPORATION)  
SUITE 820  
19644 CLUB HOUSE ROAD  
MONTGOMERY VILLAGE, MD 20886

THE MARK CONSISTS OF STANDARD CHAR-  
ACTERS WITHOUT CLAIM TO ANY PARTICULAR  
FONT, STYLE, SIZE, OR COLOR.

FOR: REAL ESTATE BROKERAGE, IN CLASS 36  
(U.S. CLS. 100, 101 AND 102).

SER. NO. 77-312,431, FILED 10-24-2007.

FIRST USE 1-0-2001; IN COMMERCE 1-0-2001.

SALLY SHIH, EXAMINING ATTORNEY

**Int. Cls.: 37 and 42**

**Prior U.S. Cls.: 100, 101, 103 and 106**

**United States Patent and Trademark Office**

**Reg. No. 3,453,203**

**Registered June 24, 2008**

**SERVICE MARK  
PRINCIPAL REGISTER**

**IICc**

INTERNATIONAL INSPECTION CONTROL CO.,  
LTD. (TAIWAN CORPORATION)  
4F, NO.6, LANE 195, SEC.4, HSING LUNG RD  
TAIPEI, TAIWAN

FOR: MAINTENANCE AND REPAIR FOR OTHERS OF POWER SUPPLIES, MOTHERBOARDS, KEYBOARDS OF COMPUTERS, COMPUTER DISKS AND CARTRIDGES, COLOR MONITORS, BLACK-AND-WHITE MONITORS, THIN FILM TRANSISTOR LIQUID CRYSTAL DISPLAYS, CELL PHONES, TELEVISIONS, PLASMA DISPLAY PANEL, COAXIAL CABLES, NOTEBOOK COMPUTERS, DESKTOP COMPUTERS, CD PLAYERS AND DVD PLAYERS, IN CLASS 37 (U.S. CLS. 100, 103 AND 106).

FIRST USE 11-28-2000; IN COMMERCE 1-1-2003.

FOR: QUALITY CONTROL AND MATERIAL TESTING FOR OTHERS OF POWER SUPPLIES;

MOTHERBOARDS; KEYBOARDS OF COMPUTERS; COMPUTER DISKS AND CARTRIDGES; COLOR MONITORS; BLACK-AND-WHITE MONITORS; THIN FILM TRANSISTOR LIQUID CRYSTAL DISPLAYS; CELL PHONES; TELEVISIONS; PLASMA DISPLAY PANEL; COAXIAL CABLES; NOTEBOOK COMPUTERS AND DESKTOP COMPUTERS, IN CLASS 42 (U.S. CLS. 100 AND 101).

FIRST USE 11-28-2000; IN COMMERCE 1-1-2003.

THE MARK CONSISTS OF STANDARD CHARACTERS WITHOUT CLAIM TO ANY PARTICULAR FONT, STYLE, SIZE, OR COLOR.

SER. NO. 77-312,490, FILED 10-24-2007.

MELVIN AXILBUND, EXAMINING ATTORNEY

**Int. Cl.: 35**

**Prior U.S. Cls.: 100, 101 and 102**

**United States Patent and Trademark Office**

**Reg. No. 3,453,204**

**Registered June 24, 2008**

**SERVICE MARK  
PRINCIPAL REGISTER**



NOKOTA HORSE CONSERVANCY, INC.  
(NORTH DAKOTA CORPORATION)  
420 S. BROADWAY  
LINTON, ND 58552

FOR: ASSOCIATION SERVICES FOR THE PROMOTION OF THE INTERESTS OF A CERTAIN UNIQUE BREED OF HORSES, IN CLASS 35 (U.S. CLS. 100, 101 AND 102).

FIRST USE 6-0-2005; IN COMMERCE 6-0-2005.

THE MARK CONSISTS OF A SET OF THREE CONCENTRIC CIRCLES. THE OUTERMOST CIRCLE CONTAINS FOUR STYLIZED HORSES, EQUALLY SPACED AND SLIGHTLY OVERLAPPING. THE INNERMOST CIRCLE IS DIVIDED TWICE DIAGONALLY INTO FOUR EQUAL PIE SHAPES.

SER. NO. 77-312,504, FILED 10-24-2007.

JERI J. FICKES, EXAMINING ATTORNEY

**Int. Cl.: 25**

**Prior U.S. Cls.: 22 and 39**

**United States Patent and Trademark Office**

**Reg. No. 3,453,205**

**Registered June 24, 2008**

**TRADEMARK  
PRINCIPAL REGISTER**

**ANTI INDIGO**

PACIFIC LA & D, INC. (CALIFORNIA CORPORATION)  
6108 CAMEILLA AVE  
TEMPLE CITY, CA 91780

FOR: JEANS; DENIMS; BALLOON PANTS; CAPRI PANTS; CARGO PANTS; JOGGING PANTS; LEATHER PANTS; LOUNGE PANTS; PANTS; MEN AND WOMEN JACKETS, COATS, TROUSERS, VESTS; OVER-TROUSERS; SHORT TROUSERS; TROUSERS; CAPRIS, IN CLASS 25 (U.S. CLS. 22 AND 39).

FIRST USE 10-24-2007; IN COMMERCE 10-24-2007.

THE MARK CONSISTS OF STANDARD CHARACTERS WITHOUT CLAIM TO ANY PARTICULAR FONT, STYLE, SIZE, OR COLOR.

NO CLAIM IS MADE TO THE EXCLUSIVE RIGHT TO USE "INDIGO", APART FROM THE MARK AS SHOWN.

SER. NO. 77-312,523, FILED 10-24-2007.

SUSAN STIGLITZ, EXAMINING ATTORNEY



**Int. Cl.: 25**

**Prior U.S. Cls.: 22 and 39**

**United States Patent and Trademark Office**

**Reg. No. 3,453,206**

**Registered June 24, 2008**

**TRADEMARK  
PRINCIPAL REGISTER**

**UKA**

PACIFIC LA & D INC (CALIFORNIA CORPORATION)  
6108 CAMEILLA AVE  
TEMPLE CITY, CA 91780

FOR: JEANS; DENIMS; BALLOON PANTS; CAPRI PANTS; CARGO PANTS; LOUNGE PANTS; CAPRIS; INFANTS' TROUSERS; MEN AND WOMEN JACKETS, COATS, TROUSERS, VESTS; OVER-TROUSERS; SHORT TROUSERS; TROUSERS, IN CLASS 25 (U.S. CLS. 22 AND 39).

FIRST USE 10-24-2007; IN COMMERCE 10-24-2007.

THE MARK CONSISTS OF STANDARD CHARACTERS WITHOUT CLAIM TO ANY PARTICULAR FONT, STYLE, SIZE, OR COLOR.

SER. NO. 77-312,536, FILED 10-24-2007.

DAVID I, EXAMINING ATTORNEY

**Int. Cl.: 11**

**Prior U.S. Cls.: 13, 21, 23, 31 and 34**

**United States Patent and Trademark Office**

**Reg. No. 3,453,207**

**Registered June 24, 2008**

**TRADEMARK  
PRINCIPAL REGISTER**

**DRYER MATE**

BUILDER'S BEST, INC. (MICHIGAN CORPORATION), DBA NEMCO, INC.  
201 BROILES DRIVE  
JACKSONVILLE, TX 75766

OWNER OF U.S. REG. NOS. 1,462,672 AND 1,462,673.

FOR: VENTS FOR CLOTHES DRYERS, IN CLASS 11 (U.S. CLS. 13, 21, 23, 31 AND 34).

NO CLAIM IS MADE TO THE EXCLUSIVE RIGHT TO USE "DRYER", APART FROM THE MARK AS SHOWN.

FIRST USE 8-1-1985; IN COMMERCE 9-16-1985.

SER. NO. 77-312,564, FILED 10-24-2007.

THE MARK CONSISTS OF STANDARD CHARACTERS WITHOUT CLAIM TO ANY PARTICULAR FONT, STYLE, SIZE, OR COLOR.

GENE MACIOL, EXAMINING ATTORNEY

**Int. Cl.: 9**

**Prior U.S. Cls.: 21, 23, 26, 36 and 38**

**Reg. No. 3,453,208**

**United States Patent and Trademark Office**

**Registered June 24, 2008**

---

**TRADEMARK  
PRINCIPAL REGISTER**

**KEYAUTHORITY**

NCIPHER CORPORATION LTD. (UNITED KING-  
DOM CORPORATION)  
JUPITER HOUSE, STATION ROAD  
CAMBRIDGE, UNITED KINGDOM

FOR: COMPUTER HARDWARE AND SOFT-  
WARE USED IN THE GENERATION, ARCHIVING,  
MANAGEMENT, AUTHENTICATION, AND DIS-  
TRIBUTION OF CRYPTOGRAPHIC KEYS , IN  
CLASS 9 (U.S. CLS. 21, 23, 26, 36 AND 38).

FIRST USE 3-1-2005; IN COMMERCE 12-8-2005.

THE MARK CONSISTS OF STANDARD CHAR-  
ACTERS WITHOUT CLAIM TO ANY PARTICULAR  
FONT, STYLE, SIZE, OR COLOR.

SER. NO. 77-312,573, FILED 10-24-2007.

AMY GEARIN, EXAMINING ATTORNEY

**Int. Cl.: 36**

**Prior U.S. Cls.: 100, 101 and 102**

**United States Patent and Trademark Office**

**Reg. No. 3,453,209**

**Registered June 24, 2008**

**SERVICE MARK  
PRINCIPAL REGISTER**



FIRSTECH, INC. (ILLINOIS CORPORATION)  
130 NORTH WATER STREET  
DECATUR, IL 62523

FOR: BILL PAYMENT SERVICES, IN CLASS 36  
(U.S. CLS. 100, 101 AND 102).

FIRST USE 4-0-1998; IN COMMERCE 4-0-1998.

THE COLOR(S) BLUE, GRAY AND BLACK IS/  
ARE CLAIMED AS A FEATURE OF THE MARK.

THE MARK CONSISTS OF A STYLIZED CHAIN,  
WHERE BLUE AND GRAY APPEAR ON LEFT AND  
RIGHT LINKS OF THE CHAIN RESPECTIVELY,  
OVER A BLACK SQUARE BACKGROUND.

SER. NO. 77-312,582, FILED 10-24-2007.

RENEE MCCRAY, EXAMINING ATTORNEY

Int. Cl.: 35

Prior U.S. Cls.: 100, 101 and 102

United States Patent and Trademark Office

Reg. No. 3,453,210

Registered June 24, 2008

SERVICE MARK  
PRINCIPAL REGISTER



WESTHUIS, SUSAN (UNITED STATES INDIVIDUAL)

720 W. 10TH AVE.  
OSHKOSH, WI 54902

FOR: ON-LINE RETAIL STORE SERVICES FEATURING CHILDREN'S CLOTHING AND ACCESSORIES; ONLINE AUCTION SERVICES, IN CLASS 35 (U.S. CLS. 100, 101 AND 102).

FIRST USE 10-5-2007; IN COMMERCE 10-5-2007.

THE STIPLING IS FOR SHADING PURPOSES ONLY.

THE MARK CONSISTS OF THE STYLIZED WORDS "LITTLE SID BEAN". NEXT TO THE WORD "BEAN" IS AN IMAGE OF A GREEN BEAN WITH A SMILING, HAPPY LITTLE GIRL POPPING HER HEAD AND HANDS OUT.

SER. NO. 77-312,595, FILED 10-24-2007.

CAROLINE WOOD, EXAMINING ATTORNEY

**Int. Cl.: 39**

**Prior U.S. Cls.: 100 and 105**

**United States Patent and Trademark Office**

**Reg. No. 3,453,211**

**Registered June 24, 2008**

**SERVICE MARK  
PRINCIPAL REGISTER**



TAMPA BAY DREAM CARS, LLC (FLORIDA  
LTD LIAB CO)  
3105 W. KNIGHTS AVE.  
TAMPA, FL 33611

FOR: RENTAL OF CARS, IN CLASS 39 (U.S. CLS.  
100 AND 105).

FIRST USE 6-1-2006; IN COMMERCE 6-1-2006.

NO CLAIM IS MADE TO THE EXCLUSIVE  
RIGHT TO USE "TAMPA BAY EXTREME CARS" ,  
APART FROM THE MARK AS SHOWN.

THE MARK CONSISTS OF A CURVED BAY-  
SHORE ROAD WITH THE STYLIZED WORDS  
"TAMPA BAY EXTREME CARS" NEXT TO IT.

SER. NO. 77-312,603, FILED 10-24-2007.

CAROLINE WOOD, EXAMINING ATTORNEY

**Int. Cls.: 35 and 42**

**Prior U.S. Cls.: 100, 101 and 102**

**United States Patent and Trademark Office**

**Reg. No. 3,453,212**

**Registered June 24, 2008**

**SERVICE MARK  
PRINCIPAL REGISTER**

# Flipsidedesign

FLIPSIDE DESIGN (CALIFORNIA SOLE PROPRIETORSHIP)  
PO BOX 3303  
CARMEL, CA 93921

FOR: CONCEPT AND BRAND DEVELOPMENT IN THE FOOD AND BEVERAGE INDUSTRY; ADVERTISING SERVICES, NAMELY, CREATING CORPORATE AND BRAND IDENTITY FOR OTHERS, IN CLASS 35 (U.S. CLS. 100, 101 AND 102).

FIRST USE 10-31-1984; IN COMMERCE 3-31-1987.

FOR: PRODUCT DEVELOPMENT FOR OTHERS; PACKAGING DESIGN FOR OTHERS; GRAPHIC

DESIGN SERVICES, IN CLASS 42 (U.S. CLS. 100 AND 101).

FIRST USE 10-31-1984; IN COMMERCE 3-31-1987.

THE MARK CONSISTS OF STANDARD CHARACTERS WITHOUT CLAIM TO ANY PARTICULAR FONT, STYLE, SIZE, OR COLOR.

SER. NO. 77-312,634, FILED 10-24-2007.

KATINA MISTER, EXAMINING ATTORNEY

Int. Cl.: 41

Prior U.S. Cls.: 100, 101 and 107

United States Patent and Trademark Office

Reg. No. 3,453,213

Registered June 24, 2008

SERVICE MARK  
PRINCIPAL REGISTER



THE WESTERN STOCK SHOW ASSOCIATION  
(COLORADO NON-PROFIT CORPORATION)  
4655 HUMBOLDT STREET  
DENVER, CO 80216

FOR: ORGANIZING AND CONDUCTING RO-  
DEO, LIVESTOCK AND HORSE SHOWS, IN CLASS  
41 (U.S. CLS. 100, 101 AND 107).

FIRST USE 2-28-2006; IN COMMERCE 7-31-2006.

OWNER OF U.S. REG. NOS. 2,406,305 AND  
2,414,031.

NO CLAIM IS MADE TO THE EXCLUSIVE  
RIGHT TO USE "STOCK SHOW", APART FROM  
THE MARK AS SHOWN.

THE MARK CONSISTS OF THE WORDS "NA-  
TIONAL WESTERN STOCK SHOW" AND THE  
LETTERS "N" AND "W" WITHIN A CIRCLE.

SEC. 2(F) AS TO "NATIONAL WESTERN".

SER. NO. 77-312,650, FILED 10-24-2007.

LINDA M. KING, EXAMINING ATTORNEY



Int. Cl.: 28

Prior U.S. Cls.: 22, 23, 38 and 50

United States Patent and Trademark Office

Reg. No. 3,453,214

Registered June 24, 2008

TRADEMARK  
PRINCIPAL REGISTER



COSTCO WHOLESALE CORPORATION (WASHINGTON CORPORATION)  
999 LAKE DRIVE  
ISSAQUAH, WA 98027

FOR: SNOW GLOBES; WATER GLOBES; ARTIFICIAL CHRISTMAS GARLANDS; ARTIFICIAL CHRISTMAS TREES, IN CLASS 28 (U.S. CLS. 22, 23, 38 AND 50).

FIRST USE 9-30-1995; IN COMMERCE 9-30-1995.

OWNER OF U.S. REG. NO. 2,341,588.

THE COLOR(S) RED, WHITE, BLACK IS/ARE CLAIMED AS A FEATURE OF THE MARK.

THE MARK CONSISTS OF THE WORDS "KIRKLAND SIGNATURE" IN STYLIZED LETTERING WITH "KIRKLAND" IN WHITE (EXCEPT FOR THE CROSS-HATCH OF THE "A" IN "KIRKLAND", WHICH IS IN RED) OVER "SIGNATURE" IN RED, ALL IN A BLACK RECTANGULAR BOX.

SER. NO. 77-312,661, FILED 10-24-2007.

MARK PILARO, EXAMINING ATTORNEY

Int. Cl.: 32

Prior U.S. Cls.: 45, 46 and 48

United States Patent and Trademark Office

Reg. No. 3,453,215

Registered June 24, 2008

TRADEMARK  
PRINCIPAL REGISTER



COSTCO WHOLESALE CORPORATION (WASHINGTON CORPORATION)  
999 LAKE DRIVE  
ISSAQUAH, WA 98027

FOR: BOTTLED WATER; SOFT DRINKS, IN CLASS 32 (U.S. CLS. 45, 46 AND 48).

FIRST USE 7-31-2001; IN COMMERCE 7-31-2001.

OWNER OF U.S. REG. NOS. 2,127,876, 2,866,982 AND OTHERS.

THE COLOR(S) RED, WHITE, BLACK IS/ARE CLAIMED AS A FEATURE OF THE MARK.

THE MARK CONSISTS OF THE WORDS "KIRKLAND SIGNATURE" IN STYLIZED LETTERING WITH "KIRKLAND" IN WHITE (EXCEPT FOR THE CROSS-HATCH OF THE "A" IN "KIRKLAND", WHICH IS IN RED) OVER "SIGNATURE" IN RED, ALL IN A BLACK RECTANGULAR BOX.

SER. NO. 77-312,674, FILED 10-24-2007.

MARK PILARO, EXAMINING ATTORNEY

Int. Cl.: 33

Prior U.S. Cls.: 47 and 49

United States Patent and Trademark Office

Reg. No. 3,453,216

Registered June 24, 2008

TRADEMARK  
PRINCIPAL REGISTER



COSTCO WHOLESALE CORPORATION (WA-  
SHINGTON CORPORATION)  
999 LAKE DRIVE  
ISSAQUAH, WA 98027

FOR: WINES, IN CLASS 33 (U.S. CLS. 47 AND 49).

FIRST USE 7-25-2004; IN COMMERCE 7-25-2004.

OWNER OF U.S. REG. NO. 2,925,867.

THE COLOR(S) RED, WHITE, BLACK IS/ARE  
CLAIMED AS A FEATURE OF THE MARK.

THE MARK CONSISTS OF THE WORDS "KIRK-  
LAND SIGNATURE" IN STYLIZED LETTERING  
WITH "KIRKLAND" IN WHITE (EXCEPT FOR THE  
CROSS-HATCH OF THE "A" IN "KIRKLAND",  
WHICH IS IN RED) OVER "SIGNATURE" IN RED,  
ALL IN A BLACK RECTANGULAR BOX.

SER. NO. 77-312,682, FILED 10-24-2007.

MARK PILARO, EXAMINING ATTORNEY

**Int. Cl.: 20**

**Prior U.S. Cls.: 2, 13, 22, 25, 32 and 50**

**United States Patent and Trademark Office**

**Reg. No. 3,453,217**

**Registered June 24, 2008**

**TRADEMARK  
PRINCIPAL REGISTER**

**SkinnyPac**

EAZYPOWER CORP. (ILLINOIS CORPORATION)  
4006 WEST BELDEN AVENUE  
CHICAGO, IL 60639

THE MARK CONSISTS OF STANDARD CHAR-  
ACTERS WITHOUT CLAIM TO ANY PARTICULAR  
FONT, STYLE, SIZE, OR COLOR.

FOR: DISPLAY CASES FOR MERCHANDISE;  
DISPLAY RACKS; METAL DISPLAY STANDS; DIS-  
PLAY BOARDS, IN CLASS 20 (U.S. CLS. 2, 13, 22, 25,  
32 AND 50).

SER. NO. 77-312,685, FILED 10-24-2007.

FIRST USE 12-15-1995; IN COMMERCE 12-15-1995.

LINDA M. KING, EXAMINING ATTORNEY

**Int. Cl.: 41**

**Prior U.S. Cls.: 100, 101 and 107**

**United States Patent and Trademark Office**

**Reg. No. 3,453,218**

**Registered June 24, 2008**

---

**SERVICE MARK  
PRINCIPAL REGISTER**

**DEVIOUSNESS**

DEVIANTART, INC. (DELAWARE CORPORATION)  
7095 HOLLYWOOD BOULEVARD, SUITE 788  
HOLLYWOOD, CA 90028

FOR: CONTESTS AND AWARDS IN THE FIELD OF ART AND ARTWORK; CONDUCTING CONTESTS AMONG ARTISTS; PROVIDING RECOGNITION AND INCENTIVES BY THE WAY OF AWARDS AND CONTESTS TO DEMONSTRATE EXCELLENCE IN THE FIELD OF ART, IN CLASS 41 (U.S. CLS. 100, 101 AND 107).

FIRST USE 8-7-2000; IN COMMERCE 8-7-2000.

THE MARK CONSISTS OF STANDARD CHARACTERS WITHOUT CLAIM TO ANY PARTICULAR FONT, STYLE, SIZE, OR COLOR.

SER. NO. 77-312,712, FILED 10-24-2007.

JEFF DEFORD, EXAMINING ATTORNEY

**Int. Cl.: 45**

**Prior U.S. Cls.: 100 and 101**

**United States Patent and Trademark Office**

**Reg. No. 3,453,219**

**Registered June 24, 2008**

**SERVICE MARK  
PRINCIPAL REGISTER**

Waiting Room

WAITING ROOM MINISTRY, INC. (ARIZONA CORPORATION)  
1790 HEAVENLY COURT  
PRESCOTT, AZ 86305

FOR: MINISTERIAL SERVICES, IN CLASS 45 (U.S. CLS. 100 AND 101).

FIRST USE 9-23-2006; IN COMMERCE 9-23-2006.

THE MARK CONSISTS OF THE STYLIZED WORDS "WAITING ROOM". THE LETTER "T" IN THE WORD "WAITING" IS A LARGER POINT SIZE WITH A HALF CIRCLE OVER THE HORIZONTAL PORTION THAT RESEMBLES A HALF SUN WITH 4 EXTENDING RAY POINTS.

SER. NO. 77-312,748, FILED 10-24-2007.

TOBY BULLOFF, EXAMINING ATTORNEY

**Int. Cl.: 14**

**Prior U.S. Cls.: 2, 27, 28 and 50**

**United States Patent and Trademark Office**

**Reg. No. 3,453,220**

**Registered June 24, 2008**

**TRADEMARK  
PRINCIPAL REGISTER**

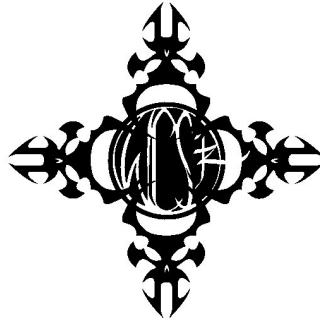

WILL'S MAYHEM INC. (NEW YORK CORPORATION)  
APT. 6B  
141-50 85 ROAD  
BRIARWOOD, NY 11435

FOR: JEWELRY, IN CLASS 14 (U.S. CLS. 2, 27, 28 AND 50).

FIRST USE 1-0-1994; IN COMMERCE 1-0-1994.

THE MARK CONSISTS OF A SERIES OF 4 STYLIZED GRAPHIC SKULLS WITH THE INITIALS "W C S JR" EMBEDDED IN THEM.

SER. NO. 77-312,754, FILED 10-24-2007.

KATHERINE M. DUBRAY, EXAMINING ATTORNEY

**Int. Cls.: 35 and 41**

**Prior U.S. Cls.: 100, 101, 102 and 107**

**United States Patent and Trademark Office**

**Reg. No. 3,453,221**

**Registered June 24, 2008**

**SERVICE MARK  
PRINCIPAL REGISTER**

**FRESH CULTURE**

FRESH CULTURE, LLC (CALIFORNIA LTD  
LIAB CO)  
P.O. BOX 82  
MANHATTAN BEACH, CA 90267

FOR: ADVERTISING, MARKETING AND PRO-  
MOTION SERVICES; PROVIDING MARKETING  
AND PROMOTION OF SPECIAL EVENTS, IN CLASS  
35 (U.S. CLS. 100, 101 AND 102).

FIRST USE 0-0-1999; IN COMMERCE 0-0-1999.

FOR: ENTERTAINMENT IN THE NATURE OF  
LIVE PERFORMANCES BY MUSICAL GROUPS;  
CONDUCTING ENTERTAINMENT EXHIBITIONS  
IN THE NATURE OF MUSIC FESTIVALS; ARRAN-  
GING OF EXHIBITIONS, SEMINARS AND CON-  
FERENCES; EDUCATIONAL SERVICES, NAMELY,

CONDUCTING CLASSES, SEMINARS, CONFEREN-  
CES, AND WORKSHOPS IN THE FIELD OF EN-  
TERTAINMENT, MUSIC, BUSINESS, HEALTH,  
SELF-HELP, PERSONAL EMPOWERMENT, AND  
SPIRITUALITY AND DISTRIBUTION OF COURSE  
MATERIAL IN CONNECTION THEREWITH , IN  
CLASS 41 (U.S. CLS. 100, 101 AND 107).

FIRST USE 0-0-1999; IN COMMERCE 0-0-1999.

THE MARK CONSISTS OF STANDARD CHAR-  
ACTERS WITHOUT CLAIM TO ANY PARTICULAR  
FONT, STYLE, SIZE, OR COLOR.

SER. NO. 77-312,792, FILED 10-24-2007.

MELISSA VALLILLO, EXAMINING ATTORNEY



**Int. Cl.: 35**

**Prior U.S. Cls.: 100, 101 and 102**

**United States Patent and Trademark Office**

**Reg. No. 3,453,222**

**Registered June 24, 2008**

**SERVICE MARK  
PRINCIPAL REGISTER**

**Bringing the Power of  
Tomorrow to Business Today**

OSAM DOCUMENT SOLUTIONS INC. (ARIZONA CORPORATION)  
3520 NORTH 16TH STREET  
PHOENIX, AZ 85016

FOR: BUSINESS CONSULTING IN THE FIELD OF MARKETING OF HARDWARE, NAMELY, DIGITAL SCANNERS, MICROFILM AND MICROFICHE READERS AND PRINTERS, AND MULTI-FUNCTION NETWORK PRINTERS, SCANNERS AND COPIERS; BUSINESS CONSULTING IN THE FIELD OF MARKETING OF SOFTWARE, NAMELY, ELECTRONIC DATA AND DOCUMENT MAN-

AGEMENT SOFTWARE, IN CLASS 35 (U.S. CLS. 100, 101 AND 102).

FIRST USE 4-13-2005; IN COMMERCE 4-13-2005.

THE MARK CONSISTS OF STANDARD CHARACTERS WITHOUT CLAIM TO ANY PARTICULAR FONT, STYLE, SIZE, OR COLOR.

SER. NO. 77-312,793, FILED 10-24-2007.

CHRISTOPHER BUONGIORNO, EXAMINING ATTORNEY

**Int. Cl.: 45**

**Prior U.S. Cls.: 100 and 101**

**United States Patent and Trademark Office**

**Reg. No. 3,453,223**

**Registered June 24, 2008**

**SERVICE MARK  
PRINCIPAL REGISTER**

**SandBoxLife**

SANDBOXLIFE, INC. (NEVADA CORPORATION)  
6370 WEST FLAMINGO ROAD  
SUITE 1  
LAS VEGAS, NV 89103

FIRST USE 7-7-2007; IN COMMERCE 7-7-2007.

FOR: PERSONALITY AND BEHAVIORAL ANALYSIS AND ASSESSMENT SERVICES FOR USE IN THE BUSINESS ENVIRONMENT, EDUCATIONAL, PERSONAL DEVELOPMENT, AND PERSONAL RELATIONSHIP FIELDS , IN CLASS 45 (U.S. CLS. 100 AND 101).

THE MARK CONSISTS OF STANDARD CHARACTERS WITHOUT CLAIM TO ANY PARTICULAR FONT, STYLE, SIZE, OR COLOR.

SER. NO. 77-312,800, FILED 10-24-2007.

TARAH HARDY, EXAMINING ATTORNEY

Int. Cl.: 44

Prior U.S. Cls.: 100 and 101

United States Patent and Trademark Office

Reg. No. 3,453,224

Registered June 24, 2008

SERVICE MARK  
PRINCIPAL REGISTER



THE STERN CARDIOVASCULAR CENTER, P.A.  
(TENNESSEE CORPORATION)  
8060 WOLF RIVER RD  
GERMANTOWN, TN 38138

FOR: MEDICAL SERVICES, IN CLASS 44 (U.S.  
CLS. 100 AND 101).

FIRST USE 8-1-1997; IN COMMERCE 8-1-1997.

NO CLAIM IS MADE TO THE EXCLUSIVE  
RIGHT TO USE "CARDIOVASCULAR CENTER  
1920", APART FROM THE MARK AS SHOWN.

THE COLOR(S) GOLD, WHITE, GREEN, AND  
ROYAL BLUE IS/ARE CLAIMED AS A FEATURE  
OF THE MARK.

THE MARK CONSISTS OF GOLD ROPE SUR-  
ROUNDING AN OUTER GREEN CIRCLE WITH  
WHITE LETTERING SEPARATED BY GOLD,  
WHITE AND GOLD CIRCULAR LINES WITH A  
ROYAL BLUE INNER CIRCLE WITH A GOLD  
HUMAN HEART IN THE CENTER AND A GREEN  
SNAKE WRAP AROUND A GREEN POLE IN THE  
MIDDLE.

SER. NO. 77-312,812, FILED 10-24-2007.

MARY MUNSON, EXAMINING ATTORNEY

**Int. Cl.: 9**

**Prior U.S. Cls.: 21, 23, 26, 36 and 38**

**Reg. No. 3,453,225**

**United States Patent and Trademark Office**

**Registered June 24, 2008**

---

**TRADEMARK  
PRINCIPAL REGISTER**

**PayNow**

PAYSETT CORPORATION (DELAWARE CORPORATION)  
SUITE 1800  
3340 PEACHTREE RD. NE  
ATLANTA, GA 30326

FOR: COMPUTER PROGRAMS FOR THE PROCESSING OF ELECTRONIC PAYMENTS IN A HIGH PRIORITY MANNER, IN CLASS 9 (U.S. CLS. 21, 23, 26, 36 AND 38).

FIRST USE 10-2-2006; IN COMMERCE 10-2-2006.

THE MARK CONSISTS OF STANDARD CHARACTERS WITHOUT CLAIM TO ANY PARTICULAR FONT, STYLE, SIZE, OR COLOR.

SER. NO. 77-312,850, FILED 10-25-2007.

ANDREA BUTLER, EXAMINING ATTORNEY

**Int. Cl.: 25**

**Prior U.S. Cls.: 22 and 39**

**United States Patent and Trademark Office**

**Reg. No. 3,453,226**

**Registered June 24, 2008**

**TRADEMARK  
PRINCIPAL REGISTER**

**EAST COAST NORMAL**

LINDSEY J. POLLARD (UNITED STATES INDIVIDUAL)  
28 CARRIAGE LANE  
NEWARK, DE 19711

THE MARK CONSISTS OF STANDARD CHARACTERS WITHOUT CLAIM TO ANY PARTICULAR FONT, STYLE, SIZE, OR COLOR.

FOR: SWEAT PANTS; SWEAT SHIRTS; T-SHIRTS; HEADGEAR, NAMELY, HATS AND CAPS, IN CLASS 25 (U.S. CLS. 22 AND 39).

SER. NO. 77-312,922, FILED 10-25-2007.

FIRST USE 6-30-2007; IN COMMERCE 6-30-2007.

CAROLINE WOOD, EXAMINING ATTORNEY

**Int. Cl.: 25**

**Prior U.S. Cls.: 22 and 39**

**United States Patent and Trademark Office**

**Reg. No. 3,453,227**

**Registered June 24, 2008**

**TRADEMARK  
PRINCIPAL REGISTER**

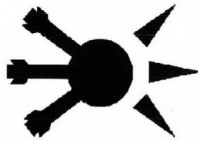

LINDSEY J. POLLARD (UNITED STATES IN-  
DIVIDUAL)  
28 CARRIAGE LANE  
NEWARK, DE 19711

THE MARK CONSISTS OF HALF SNOW FLAKE  
HALF SUN RAYS.

FOR: SWEAT PANTS; SWEAT SHIRTS; T-SHIRTS;  
HEADGEAR, NAMELY, HATS AND CAPS, IN  
CLASS 25 (U.S. CLS. 22 AND 39).

SER. NO. 77-312,924, FILED 10-25-2007.

FIRST USE 6-30-2006; IN COMMERCE 6-30-2006.

CAROLINE WOOD, EXAMINING ATTORNEY

**Int. Cl.: 9**

**Prior U.S. Cls.: 21, 23, 26, 36 and 38**

**Reg. No. 3,453,228**

**United States Patent and Trademark Office**

**Registered June 24, 2008**

---

**TRADEMARK  
PRINCIPAL REGISTER**

**CYNERGY ERGONOMICS**

CYNERGY ERGONOMICS, INC. (MISSOURI CORPORATION)  
13144 BARRETT MEADOWS DRIVE  
BALLWIN, MO 63021

THE MARK CONSISTS OF STANDARD CHARACTERS WITHOUT CLAIM TO ANY PARTICULAR FONT, STYLE, SIZE, OR COLOR.

FOR: ELECTRICAL CONTROLS AND SOFTWARE FOR AUTOMATED AND ROBOTIC ERGONOMIC MATERIAL HANDLING MACHINES AND EQUIPMENT FOR LIFTING, HOLDING, CONVEYING AND POSITIONING ARTICLES FOR FABRICATION, ASSEMBLY AND TRANSPORT, IN CLASS 9 (U.S. CLS. 21, 23, 26, 36 AND 38).

NO CLAIM IS MADE TO THE EXCLUSIVE RIGHT TO USE "ERGONOMICS", APART FROM THE MARK AS SHOWN.

SER. NO. 77-312,925, FILED 10-25-2007.

FIRST USE 10-6-2004; IN COMMERCE 11-16-2004.

JOHN E. MICHOS, EXAMINING ATTORNEY

Int. Cl.: 37

Prior U.S. Cls.: 100, 103 and 106

United States Patent and Trademark Office

Reg. No. 3,453,229

Registered June 24, 2008

**SERVICE MARK  
PRINCIPAL REGISTER**



**COX-SCHEPP** | **U**  
**CONSTRUCTION** | **N**

COX & SCHEPP CONSTRUCTION, INC. (NORTH CAROLINA CORPORATION)  
2410 DUNAVANT STREET  
CHARLOTTE, NC 28203

FOR: BUILDING CONSTRUCTION AND REPAIR; BUILDING CONSTRUCTION SERVICES; BUILDING DEMOLITION; BUILDING MAINTENANCE AND REPAIR; BUILDING RESTORATION; CONSTRUCTION AND RENOVATION OF BUILDINGS; CONSTRUCTION AND REPAIR OF BUILDINGS; CONSULTATION IN BUILDING CONSTRUCTION SUPERVISION; CONSULTING IN THE FIELD OF BUILDING CONSTRUCTION; CUSTOM CONSTRUCTION AND BUILDING RENOVATION; INSTALLATION OF BUILDING INSULATION; INSTALLATION SERVICES OF BUILDING SCAFFOLDS, WORKING AND BUILDING PLATFORMS; MAINTENANCE AND REPAIR OF BUILDINGS; REPAIR OF BUILDINGS; REPAIR WORK ON BUILDINGS; RESIDENTIAL AND COMMERCIAL BUILDING CONSTRUCTION; CONSTRUCTION MANAGEMENT; CONSTRUCTION OF MEDICAL ESTABLISHMENTS; CONSTRUCTION PLANNING; CONSTRUCTION SUPERVISION; CONSTRUCTION, MAINTENANCE AND RENOVATION OF PROPERTY; GENERAL CON-

STRUCTION CONTRACTING; WAREHOUSE CONSTRUCTION AND REPAIR, IN CLASS 37 (U.S. CLS. 100, 103 AND 106).

FIRST USE 2-12-2002; IN COMMERCE 2-12-2002.

NO CLAIM IS MADE TO THE EXCLUSIVE RIGHT TO USE "CONSTRUCTION INC.", APART FROM THE MARK AS SHOWN.

THE COLOR(S) BLACK AND GOLD IS/ARE CLAIMED AS A FEATURE OF THE MARK.

THE MARK CONSISTS OF THE WORDING "COX SCHEPP CONSTRUCTION INC.", ALL APPEARING IN BLACK. THE WORDS "COX" AND "SCHEPP" ARE SEPARATED BY A SMALL GOLD SQUARE. ABOVE THE WORDING, THERE IS A DESIGN OF TWO BROKEN SQUARES AND A SMALLER SQUARE IN THE CENTER, ALL APPEARING IN GOLD.

SER. NO. 77-312,934, FILED 10-25-2007.

GISELLE AGOSTO, EXAMINING ATTORNEY



**Int. Cl.: 42**

**Prior U.S. Cls.: 100 and 101**

**United States Patent and Trademark Office**

**Reg. No. 3,453,230**

**Registered June 24, 2008**

**SERVICE MARK  
PRINCIPAL REGISTER**

**CYNERGY ERGONOMICS**

CYNERGY ERGONOMICS, INC. (MISSOURI CORPORATION)  
13144 BARRETT MEADOWS DRIVE  
BALLWIN, MO 63021

FOR: CONSULTING SERVICES IN THE FIELD OF INDUSTRIAL ERGONOMICS INVOLVING THE ANALYSIS AND DESIGN OF MANUAL, AUTOMATED AND ROBOTIC MATERIAL HANDLING MACHINERY AND EQUIPMENT, ERGONOMIC PRODUCTS AND ERGONOMIC WORK STATIONS, IN CLASS 42 (U.S. CLS. 100 AND 101).

FIRST USE 10-6-2004; IN COMMERCE 11-16-2004.

THE MARK CONSISTS OF STANDARD CHARACTERS WITHOUT CLAIM TO ANY PARTICULAR FONT, STYLE, SIZE, OR COLOR.

NO CLAIM IS MADE TO THE EXCLUSIVE RIGHT TO USE "ERGONOMICS", APART FROM THE MARK AS SHOWN.

SER. NO. 77-312,949, FILED 10-25-2007.

JOHN E. MICHOS, EXAMINING ATTORNEY

**Int. Cl.: 5**

**Prior U.S. Cls.: 6, 18, 44, 46, 51 and 52**

**Reg. No. 3,453,231**

**United States Patent and Trademark Office**

**Registered June 24, 2008**

**TRADEMARK  
PRINCIPAL REGISTER**

**NUTRIVIDA**

FRANK HUERTA (UNITED STATES INDIVIDUAL)  
5307 BERGENLINE AVE.  
WEST NEW YORK, NJ 07093

THE MARK CONSISTS OF STANDARD CHARACTERS WITHOUT CLAIM TO ANY PARTICULAR FONT, STYLE, SIZE, OR COLOR.

FOR: DIETARY SUPPLEMENTS; DIETARY SUPPLEMENTS FOR HUMAN CONSUMPTION, IN CLASS 5 (U.S. CLS. 6, 18, 44, 46, 51 AND 52).

SER. NO. 77-312,964, FILED 10-25-2007.

FIRST USE 10-1-2003; IN COMMERCE 10-1-2003.

LINDA ORNDORFF, EXAMINING ATTORNEY

**Int. Cl.: 9**

**Prior U.S. Cls.: 21, 23, 26, 36 and 38**

**Reg. No. 3,453,232**

**United States Patent and Trademark Office**

**Registered June 24, 2008**

---

**TRADEMARK  
PRINCIPAL REGISTER**

LEVERAGING THE POWER OF MAN

CYNERGY ERGONOMICS, INC. (MISSOURI CORPORATION)  
13144 BARRETT MEADOWS DRIVE  
BALLWIN, MO 63021

FOR: ELECTRICAL CONTROLS AND SOFTWARE FOR AUTOMATED AND ROBOTIC ERGONOMIC MATERIAL HANDLING MACHINES AND EQUIPMENT FOR LIFTING, HOLDING, CONVEYING AND POSITIONING ARTICLES FOR FABRICATION, ASSEMBLY AND TRANSPORT, IN CLASS 9 (U.S. CLS. 21, 23, 26, 36 AND 38).

FIRST USE 10-6-2004; IN COMMERCE 11-16-2004.

THE MARK CONSISTS OF STANDARD CHARACTERS WITHOUT CLAIM TO ANY PARTICULAR FONT, STYLE, SIZE, OR COLOR.

SER. NO. 77-312,966, FILED 10-25-2007.

JOHN E. MICHOS, EXAMINING ATTORNEY

**Int. Cl.: 28**

**Prior U.S. Cls.: 22, 23, 38 and 50**

**United States Patent and Trademark Office**

**Reg. No. 3,453,233**

**Registered June 24, 2008**

**TRADEMARK  
PRINCIPAL REGISTER**

**MICRO SKYRAY**

CHENG, RANDY (UNITED STATES INDIVIDUAL)  
P. O. BOX 2170  
TEMPLE CITY, CA 91780

FOR: REMOTE CONTROL TOYS, NAMELY, AIRPLANES AND HELICOPTERS, IN CLASS 28 (U.S. CLS. 22, 23, 38 AND 50).

FIRST USE 7-12-2007; IN COMMERCE 7-12-2007.

THE MARK CONSISTS OF STANDARD CHARACTERS WITHOUT CLAIM TO ANY PARTICULAR FONT, STYLE, SIZE, OR COLOR.

NO CLAIM IS MADE TO THE EXCLUSIVE RIGHT TO USE "MICRO", APART FROM THE MARK AS SHOWN.

SER. NO. 77-312,967, FILED 10-25-2007.

JAY FLOWERS, EXAMINING ATTORNEY

**Int. Cl.: 36**

**Prior U.S. Cls.: 100, 101 and 102**

**United States Patent and Trademark Office**

**Reg. No. 3,453,234**

**Registered June 24, 2008**

**SERVICE MARK  
PRINCIPAL REGISTER**

# Night of Wonder

THE PROGERIA RESEARCH FOUNDATION,  
INC. (MASSACHUSETTS CORPORATION)  
PO BOX 3453  
532 LOWELL STREET  
PEABODY, MA 01960

FOR: CHARITABLE FUND RAISING SERVICES  
BY MEANS OF AN ENTERTAINMENT EVENT, IN  
CLASS 36 (U.S. CLS. 100, 101 AND 102).

FIRST USE 0-0-2001; IN COMMERCE 0-0-2001.

THE MARK CONSISTS OF STANDARD CHAR-  
ACTERS WITHOUT CLAIM TO ANY PARTICULAR  
FONT, STYLE, SIZE, OR COLOR.

NO CLAIM IS MADE TO THE EXCLUSIVE  
RIGHT TO USE "NIGHT", APART FROM THE  
MARK AS SHOWN.

SER. NO. 77-312,976, FILED 10-25-2007.

HANNO RITTNER, EXAMINING ATTORNEY

**Int. Cl.: 35**

**Prior U.S. Cls.: 100, 101 and 102**

**United States Patent and Trademark Office**

**Reg. No. 3,453,235**

**Registered June 24, 2008**

---

**SERVICE MARK  
PRINCIPAL REGISTER**

**Confero**

CONFERO, INC. (NORTH CAROLINA COR-  
PORATION)  
SUITE 100  
1152 EXECUTIVE CIRCLE  
CARY, NC 27511

THE MARK CONSISTS OF STANDARD CHAR-  
ACTERS WITHOUT CLAIM TO ANY PARTICULAR  
FONT, STYLE, SIZE, OR COLOR.

FOR: MARKET RESEARCH SERVICES, IN CLASS  
35 (U.S. CLS. 100, 101 AND 102).

SER. NO. 77-312,986, FILED 10-25-2007.

FIRST USE 9-10-1986; IN COMMERCE 9-10-1986.

JANICE KIM, EXAMINING ATTORNEY

**Int. Cl.: 37**

**Prior U.S. Cls.: 100, 103 and 106**

**United States Patent and Trademark Office**

**Reg. No. 3,453,236**

**Registered June 24, 2008**

**SERVICE MARK  
PRINCIPAL REGISTER**



COLLINS ELECTRICAL SYSTEMS, INC. (MINNESOTA CORPORATION)  
4990 NORTH HIGHWAY 169  
NEW HOPE, MN 55428

FOR: ELECTRICAL SYSTEM INSTALLATION, CONSTRUCTION, MAINTENANCE AND TECHNICAL SUPPORT SERVICES IN THE NATURE OF PROVIDING TECHNICAL ADVICE IN THE FIELD OF INSTALLATION, CONSTRUCTION, MAINTENANCE, OVERHAUL AND REPAIR OF LOW VOLTAGE COMMUNICATIONS SYSTEMS AND HIGH VOLTAGE POWER LINES FOR CITIES, MUNICIPALITIES, GOVERNMENTAL APPLICATIONS, SPORTS FACILITIES, COMMERCIAL BUSINESS, PARKING AREAS, HIGH RISE HOUSING, INDUSTRIAL PLANTS, MEDICAL FACILITIES, OFFICES AND RETAIL FACILITIES; INSTALLATION AND MAINTENANCE OF HIGHWAY LIGHTING, TRAFFIC SIGNALS, TUNNEL LIGHTING, CLOSED-CIR-

CUIT TELEVISION AND SOPHISTICATED FIBER INTEGRATED TRAFFIC MANAGEMENT AND EMERGENCY VEHICLE PREEMPTION SYSTEMS, IN CLASS 37 (U.S. CLS. 100, 103 AND 106).

FIRST USE 10-4-1991; IN COMMERCE 10-4-1991.

THE COLOR(S) GREEN AND BLACK IS/ARE CLAIMED AS A FEATURE OF THE MARK.

THE MARK CONSISTS OF THE STYLIZED WORD "COLLISYS" IN BLACK WITH THREE GREEN LINES ON EACH SIDE AND TWO GREEN LINES ON THE BOTTOM.

SER. NO. 77-312,993, FILED 10-25-2007.

TOBY BULLOFF, EXAMINING ATTORNEY

**Int. Cl.: 36**

**Prior U.S. Cls.: 100, 101 and 102**

**United States Patent and Trademark Office**

**Reg. No. 3,453,237**

**Registered June 24, 2008**

**SERVICE MARK  
PRINCIPAL REGISTER**

**CHAFFIN LIGHT**

CHAFFIN LIGHT REAL ESTATE, LLC (COLOR-  
ADO LTD LIAB CO)  
24398 HIGHWAY 82  
BASALT, CO 81621

FOR: REAL ESTATE SERVICES, NAMELY,  
BROKERAGE SERVICES AND RENTAL OF COM-  
MERCIAL AND RESIDENTIAL PROPERTIES, IN  
CLASS 36 (U.S. CLS. 100, 101 AND 102).

FIRST USE 6-1-2007; IN COMMERCE 6-1-2007.

THE MARK CONSISTS OF STANDARD CHAR-  
ACTERS WITHOUT CLAIM TO ANY PARTICULAR  
FONT, STYLE, SIZE, OR COLOR.

SER. NO. 77-313,018, FILED 10-25-2007.

DAVID H. STINE, EXAMINING ATTORNEY



**Int. Cl.: 36**

**Prior U.S. Cls.: 100, 101 and 102**

**United States Patent and Trademark Office**

**Reg. No. 3,453,238**

**Registered June 24, 2008**

---

**SERVICE MARK  
PRINCIPAL REGISTER**

**OPEN A NEW DOOR**

CHAFFIN LIGHT REAL ESTATE, LLC (COLOR-  
ADO LTD LIAB CO)  
24398 HIGHWAY 82  
BASALT, CO 81621

FOR: REAL ESTATE SERVICES, NAMELY,  
BROKERAGE SERVICES AND RENTAL OF COM-  
MERCIAL AND RESIDENTIAL PROPERTIES, IN  
CLASS 36 (U.S. CLS. 100, 101 AND 102).

FIRST USE 6-1-2007; IN COMMERCE 6-1-2007.

THE MARK CONSISTS OF STANDARD CHAR-  
ACTERS WITHOUT CLAIM TO ANY PARTICULAR  
FONT, STYLE, SIZE, OR COLOR.

SER. NO. 77-313,023, FILED 10-25-2007.

DAVID H. STINE, EXAMINING ATTORNEY

**Int. Cl.: 35**

**Prior U.S. Cls.: 100, 101 and 102**

**United States Patent and Trademark Office**

**Reg. No. 3,453,239**

**Registered June 24, 2008**

**SERVICE MARK  
PRINCIPAL REGISTER**

**CNIC**

ACS MARKETING, L.P. (DELAWARE LIMITED  
PARTNERSHIP)  
2828 N. HASKELL  
DALLAS, TX 75204

FOR: TAX COMPLIANCE SERVICES, NAMELY,  
ANALYZING TAX PAYER FILINGS, IDENTIFYING  
NON-COMPLIANT METHODS AND CALCULA-  
TIONS, AND PROVIDING REPORTS CONTAINING  
COMPLIANT CALCULATIONS AND ADJUST-  
MENTS, IN CLASS 35 (U.S. CLS. 100, 101 AND 102).

FIRST USE 10-31-2005; IN COMMERCE 10-31-2005.

THE MARK CONSISTS OF STANDARD CHAR-  
ACTERS WITHOUT CLAIM TO ANY PARTICULAR  
FONT, STYLE, SIZE, OR COLOR.

SER. NO. 77-313,026, FILED 10-25-2007.

COLLEEN DOMBROW, EXAMINING ATTORNEY

**Int. Cl.: 36**

**Prior U.S. Cls.: 100, 101 and 102**

**United States Patent and Trademark Office**

**Reg. No. 3,453,240**

**Registered June 24, 2008**

**SERVICE MARK  
PRINCIPAL REGISTER**

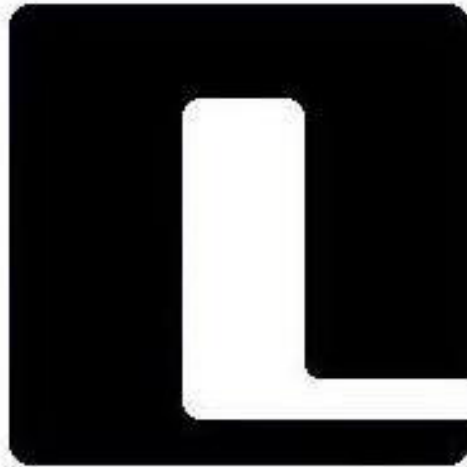

CHAFFIN LIGHT REAL ESTATE, LLC (COLOR-  
ADO LTD LIAB CO)  
24398 HIGHWAY 82  
BASALT, CO 81621

FOR: REAL ESTATE SERVICES, NAMELY,  
BROKERAGE SERVICES AND RENTAL OF COM-  
MERCIAL AND RESIDENTIAL PROPERTIES, IN  
CLASS 36 (U.S. CLS. 100, 101 AND 102).

FIRST USE 6-1-2007; IN COMMERCE 6-1-2007.

THE MARK CONSISTS OF STYLIZED LETTERS  
"C" AND "L."

SER. NO. 77-313,027, FILED 10-25-2007.

DAVID H. STINE, EXAMINING ATTORNEY

**Int. Cl.: 16**

**Prior U.S. Cls.: 2, 5, 22, 23, 29, 37, 38 and 50**

**Reg. No. 3,453,241**

**United States Patent and Trademark Office**

**Registered June 24, 2008**

**TRADEMARK  
PRINCIPAL REGISTER**

**FLIP4SCIENCE**

LEARNING RESOURCES, INC. (ILLINOIS CORPORATION)  
380 N. FAIRWAY DRIVE  
VERNON HILLS, IL 60061

FOR: EDUCATIONAL PUBLICATIONS, NAME-  
LY, TEACHER'S GUIDE, ACTIVITY BOOK, BLANK  
JOURNALS CONTAINING LINED PAPER AND  
GRAPH PAPER, AND MANIPULATIVE TOYS, ALL  
SOLD AS A UNIT, FOR TEACHING ABOUT SCI-  
ENCE, IN CLASS 16 (U.S. CLS. 2, 5, 22, 23, 29, 37, 38  
AND 50).

FIRST USE 1-0-2007; IN COMMERCE 1-0-2007.

THE MARK CONSISTS OF STANDARD CHAR-  
ACTERS WITHOUT CLAIM TO ANY PARTICULAR  
FONT, STYLE, SIZE, OR COLOR.

SER. NO. 77-313,033, FILED 10-25-2007.

CHRISTINE COOPER, EXAMINING ATTORNEY

**Int. Cl.: 37**

**Prior U.S. Cls.: 100, 103 and 106**

**United States Patent and Trademark Office**

**Reg. No. 3,453,242**

**Registered June 24, 2008**

**SERVICE MARK  
PRINCIPAL REGISTER**

LEVERAGING THE POWER OF MAN

CYNERGY ERGONOMICS, INC. (MISSOURI CORPORATION)  
13144 BARRETT MEADOWS DRIVE  
BALLWIN, MO 63021

FOR: INSTALLATION, MAINTENANCE AND REPAIR OF MANUAL, AUTOMATED AND ROBOTIC ERGONOMIC MATERIAL HANDLING MACHINES AND EQUIPMENT FOR LIFTING, HOLDING, CONVEYING AND POSITIONING ARTICLES FOR FABRICATION, ASSEMBLY AND TRANSPORT AND CONSULTATION RELATING TO THE INSTALLATION, MAINTENANCE AND

REPAIR OF THE FOREGOING, IN CLASS 37 (U.S. CLS. 100, 103 AND 106).

FIRST USE 10-6-2004; IN COMMERCE 11-16-2004.

THE MARK CONSISTS OF STANDARD CHARACTERS WITHOUT CLAIM TO ANY PARTICULAR FONT, STYLE, SIZE, OR COLOR.

SER. NO. 77-313,037, FILED 10-25-2007.

JOHN E. MICHOS, EXAMINING ATTORNEY

**Int. Cl.: 36**

**Prior U.S. Cls.: 100, 101 and 102**

**United States Patent and Trademark Office**

**Reg. No. 3,453,243**

**Registered June 24, 2008**

---

**SERVICE MARK  
PRINCIPAL REGISTER**

**HALCYON**

HALCYON UNDERWRITERS, INC. (FLORIDA  
CORPORATION)  
SUITE 304  
2600 LAKE LUCIEN DRIVE  
MAITLAND, FL 327517234

THE MARK CONSISTS OF STANDARD CHAR-  
ACTERS WITHOUT CLAIM TO ANY PARTICULAR  
FONT, STYLE, SIZE, OR COLOR.

FOR: INSURANCE ADMINISTRATION; INSUR-  
ANCE BROKERAGE, IN CLASS 36 (U.S. CLS. 100, 101  
AND 102).

SER. NO. 77-313,039, FILED 10-25-2007.

FIRST USE 0-0-1986; IN COMMERCE 0-0-1986.

TARAH HARDY, EXAMINING ATTORNEY

**Int. Cl.: 36**

**Prior U.S. Cls.: 100, 101 and 102**

**United States Patent and Trademark Office**

**Reg. No. 3,453,244**

**Registered June 24, 2008**

**SERVICE MARK  
PRINCIPAL REGISTER**

**YOUR PARTNER IN  
PRODUCTION, MAKING THE  
DIFFERENCE**

HALCYON UNDERWRITERS, INC. (FLORIDA  
CORPORATION)  
SUITE 304  
2600 LAKE LUCIEN DRIVE  
MAITLAND, FL 327517234

THE MARK CONSISTS OF STANDARD CHAR-  
ACTERS WITHOUT CLAIM TO ANY PARTICULAR  
FONT, STYLE, SIZE, OR COLOR.

FOR: INSURANCE ADMINISTRATION; INSUR-  
ANCE BROKERAGE, IN CLASS 36 (U.S. CLS. 100, 101  
AND 102).

SER. NO. 77-313,040, FILED 10-25-2007.

FIRST USE 6-0-2007; IN COMMERCE 6-0-2007.

TARAH HARDY, EXAMINING ATTORNEY

**Int. Cl.: 41**

**Prior U.S. Cls.: 100, 101 and 107**

**United States Patent and Trademark Office**

**Reg. No. 3,453,245**

**Registered June 24, 2008**

**SERVICE MARK  
PRINCIPAL REGISTER**



BABY IMAGING, LLC (MARYLAND LTD LIAB CO), DBA D/B/A PRECIOUS PREVIEWS ULTRASOUND

30 E. PENNSYLVANIA AVENUE, SUITE 500  
BEL AIR, MD 21014

FOR: PHOTOGRAPHIC AND VIDEO SERVICES, NAMELY, PHOTOGRAPHIC AND VIDEO CAPTURE, IN CLASS 41 (U.S. CLS. 100, 101 AND 107).

FIRST USE 7-0-2005; IN COMMERCE 8-5-2005.

NO CLAIM IS MADE TO THE EXCLUSIVE RIGHT TO USE "ULTRASOUND", APART FROM THE MARK AS SHOWN.

THE COLOR(S) NAVY BLUE, LIGHT GREEN IS/ ARE CLAIMED AS A FEATURE OF THE MARK.

THE MARK CONSISTS OF A LIGHT GREEN OUTLINE PROFILE/SILLOUETTE OF A BABY'S FACE ABOVE THE THE WORDS "PRECIOUS PREVIEWS" WHICH ARE NAVY BLUE; THE WORD "ULTRASOUND" IS LIGHT GREEN, AND IS UNDER THE WORDS PRECIOUS PREVIEWS.

SER. NO. 77-313,048, FILED 10-25-2007.

CHRISTINA SOBRAL, EXAMINING ATTORNEY



**Int. Cl.: 42**

**Prior U.S. Cls.: 100 and 101**

**United States Patent and Trademark Office**

**Reg. No. 3,453,246**

**Registered June 24, 2008**

**SERVICE MARK  
PRINCIPAL REGISTER**

**DOWNELINK**

DL DEVELOPMENT LLC (DELAWARE LTD  
LIAB CO)  
1515 BROADWAY  
NEW YORK, NY 10036

THE MARK CONSISTS OF STANDARD CHAR-  
ACTERS WITHOUT CLAIM TO ANY PARTICULAR  
FONT, STYLE, SIZE, OR COLOR.

FOR: COMPUTER SERVICES, NAMELY, CREAT-  
ING AN ONLINE COMMUNITY FOR USERS TO  
ENGAGE IN SOCIAL NETWORKING, IN CLASS 42  
(U.S. CLS. 100 AND 101).

SER. NO. 77-313,057, FILED 10-25-2007.

FIRST USE 2-9-2004; IN COMMERCE 2-9-2004.

TAMARA FRAZIER, EXAMINING ATTORNEY

**Int. Cl.: 42**

**Prior U.S. Cls.: 100 and 101**

**United States Patent and Trademark Office**

**Reg. No. 3,453,247**

**Registered June 24, 2008**

**SERVICE MARK  
PRINCIPAL REGISTER**

LEVERAGING THE POWER OF MAN

CYNERGY ERGONOMICS, INC. (MISSOURI CORPORATION)  
13144 BARRETT MEADOWS DRIVE  
BALLWIN, MO 63021

FOR: CONSULTING SERVICES IN THE FIELD OF INDUSTRIAL ERGONOMICS INVOLVING THE ANALYSIS AND DESIGN OF MANUAL, AUTOMATED AND ROBOTIC MATERIAL HANDLING MACHINERY AND EQUIPMENT, ERGONOMIC PRODUCTS AND ERGONOMIC WORK STATIONS, IN CLASS 42 (U.S. CLS. 100 AND 101).

FIRST USE 10-6-2004; IN COMMERCE 11-16-2004.

THE MARK CONSISTS OF STANDARD CHARACTERS WITHOUT CLAIM TO ANY PARTICULAR FONT, STYLE, SIZE, OR COLOR.

SER. NO. 77-313,060, FILED 10-25-2007.

JOHN E. MICHOS, EXAMINING ATTORNEY

**Int. Cl.: 9**

**Prior U.S. Cls.: 21, 23, 26, 36 and 38**

**Reg. No. 3,453,248**

**United States Patent and Trademark Office**

**Registered June 24, 2008**

**TRADEMARK  
PRINCIPAL REGISTER**

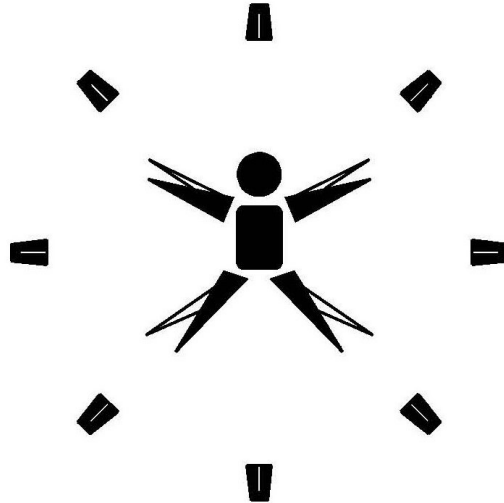

**CYNERGY ERGONOMICS, INC. (MISSOURI CORPORATION)  
13144 BARRETT MEADOWS DRIVE  
BALLWIN, MO 63021**

**FIRST USE 10-11-2005; IN COMMERCE 10-11-2005.**

**FOR: ELECTRICAL CONTROLS AND SOFTWARE FOR AUTOMATED AND ROBOTIC ERGONOMIC MATERIAL HANDLING MACHINES AND EQUIPMENT FOR LIFTING, HOLDING, CONVEYING AND POSITIONING ARTICLES FOR FABRICATION, ASSEMBLY AND TRANSPORT, IN CLASS 9 (U.S. CLS. 21, 23, 26, 36 AND 38).**

**THE MARK CONSISTS OF A HUMAN FIGURE WITH SECTIONAL OUTSPREAD ARMS AND LEGS WITHIN A CIRCULAR FORMATION OF EIGHT QUADRILATERAL MARKERS.**

**SER. NO. 77-313,073, FILED 10-25-2007.**

**JOHN E. MICHOS, EXAMINING ATTORNEY**

**Int. Cl.: 37**

**Prior U.S. Cls.: 100, 103 and 106**

**United States Patent and Trademark Office**

**Reg. No. 3,453,249**

**Registered June 24, 2008**

**SERVICE MARK  
PRINCIPAL REGISTER**

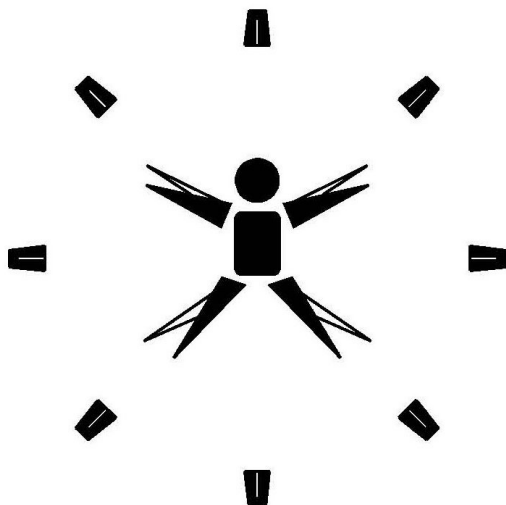

CYNERGY ERGONOMICS, INC. (MISSOURI CORPORATION)  
13144 BARRETT MEADOWS DRIVE  
BALLWIN, MO 63021

FOR: INSTALLATION, MAINTENANCE AND REPAIR OF MANUAL, AUTOMATED AND ROBOTIC ERGONOMIC MATERIAL HANDLING MACHINES AND EQUIPMENT FOR LIFTING, HOLDING, CONVEYING AND POSITIONING ARTICLES FOR FABRICATION, ASSEMBLY AND TRANSPORT AND CONSULTATION RELATING TO THE INSTALLATION, MAINTENANCE AND

REPAIR OF THE FOREGOING, IN CLASS 37 (U.S. CLS. 100, 103 AND 106).

FIRST USE 10-11-2005; IN COMMERCE 10-11-2005.

THE MARK CONSISTS OF A HUMAN FIGURE WITH SECTIONAL OUTSPREAD ARMS AND LEGS WITHIN A CIRCULAR FORMATION OF EIGHT QUADRILATERAL MARKERS.

SER. NO. 77-313,104, FILED 10-25-2007.

JOHN E. MICHOS, EXAMINING ATTORNEY

**Int. Cl.: 42**

**Prior U.S. Cls.: 100 and 101**

**United States Patent and Trademark Office**

**Reg. No. 3,453,250**

**Registered June 24, 2008**

**SERVICE MARK  
PRINCIPAL REGISTER**

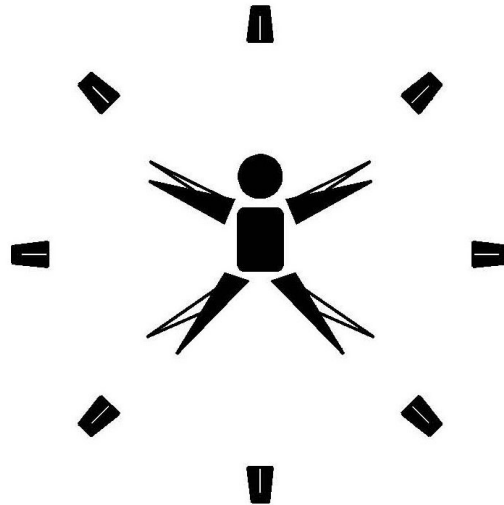

**CYNERGY ERGONOMICS, INC. (MISSOURI CORPORATION)  
13144 BARRETT MEADOWS DRIVE  
BALLWIN, MO 63021**

**FIRST USE 10-11-2005; IN COMMERCE 10-11-2005.**

**FOR: CONSULTING SERVICES IN THE FIELD OF INDUSTRIAL ERGONOMICS INVOLVING THE ANALYSIS AND DESIGN OF MANUAL, AUTOMATED AND ROBOTIC MATERIAL HANDLING MACHINERY AND EQUIPMENT, ERGONOMIC PRODUCTS AND ERGONOMIC WORK STATIONS, IN CLASS 42 (U.S. CLS. 100 AND 101).**

**THE MARK CONSISTS OF A HUMAN FIGURE WITH SECTIONAL OUTSPREAD ARMS AND LEGS WITHIN A CIRCULAR FORMATION OF EIGHT QUADRILATERAL MARKERS.**

**SER. NO. 77-313,115, FILED 10-25-2007.**

**JOHN E. MICHOS, EXAMINING ATTORNEY**

**Int. Cl.: 35**

**Prior U.S. Cls.: 100, 101 and 102**

**United States Patent and Trademark Office**

**Reg. No. 3,453,251**

**Registered June 24, 2008**

**SERVICE MARK  
PRINCIPAL REGISTER**

# SILVER DOOR

THORNTON, RANDI (UNITED STATES INDIVIDUAL)  
192 2ND STREET  
EXCELSIOR, MN 55331

FOR: MATCHING CONSUMERS WITH REAL ESTATE PROFESSIONALS IN THE FIELD OF REAL ESTATE SERVICES VIA COMPUTER NETWORK; MATCHING POTENTIAL BUYERS TO FACILITATE CO-OWNERSHIP OF RESIDENTIAL REAL PROPERTY; PROMOTING THE GOODS OF OTHERS BY MEANS OF ON-LINE REAL TIME PRESENTATION FOR INSPECTION, VIEWING OR SHOWING OF REAL ESTATE; PROVIDING A DATABASE FEATURING REAL PROPERTY TAX INFORMATION; PROVIDING INTERACTIVE SALES ASSESSMENT SERVICES VIA THE TELEPHONE FOR MEASURING THE SKILLS AND KNOWLEDGE OF FIELD SALES FORCES IN REAL WORLD SELLING SITUA-

TIONS; PROVIDING REAL ESTATE LEADS FOR PROSPECTIVE PURCHASERS; REAL ESTATE ADVERTISING SERVICES; REAL ESTATE MARKETING SERVICES IN THE FIELD OF HOMES; REAL ESTATE MARKETING SERVICES, NAMELY, ON-LINE SERVICES FEATURING TOURS OF RESIDENTIAL AND COMMERCIAL REAL ESTATE, IN CLASS 35 (U.S. CLS. 100, 101 AND 102).

FIRST USE 8-27-2007; IN COMMERCE 8-27-2007.

THE MARK CONSISTS OF STANDARD CHARACTERS WITHOUT CLAIM TO ANY PARTICULAR FONT, STYLE, SIZE, OR COLOR.

SER. NO. 77-313,163, FILED 10-25-2007.

JESSICA A. POWERS, EXAMINING ATTORNEY

**Int. Cl.: 35**

**Prior U.S. Cls.: 100, 101 and 102**

**United States Patent and Trademark Office**

**Reg. No. 3,453,252**

**Registered June 24, 2008**

---

**SERVICE MARK  
PRINCIPAL REGISTER**

**LAX ZONE**

LACROSSEWEAR, INC. (NEW JERSEY CORPORATION)  
4801 JOHNSON RD., SUITE 5  
COCONUT CREEK, FL 33073

FOR: ON-LINE RETAIL STORE SERVICES FEATURING SPORTING GOODS AND SPORTING GOODS ACCESSORIES; RETAIL STORE SERVICES FEATURING SPORTING GOODS AND SPORTING GOODS ACCESSORIES, IN CLASS 35 (U.S. CLS. 100, 101 AND 102).

FIRST USE 1-0-2002; IN COMMERCE 6-0-2003.

THE MARK CONSISTS OF STANDARD CHARACTERS WITHOUT CLAIM TO ANY PARTICULAR FONT, STYLE, SIZE, OR COLOR.

SER. NO. 77-313,168, FILED 10-25-2007.

BILL DAWE, EXAMINING ATTORNEY

**Int. Cl.: 36**

**Prior U.S. Cls.: 100, 101 and 102**

**United States Patent and Trademark Office**

**Reg. No. 3,453,253**

**Registered June 24, 2008**

**SERVICE MARK  
PRINCIPAL REGISTER**



HALCYON UNDERWRITERS, INC. (FLORIDA  
CORPORATION)  
2600 LAKE LUCIEN DRIVE, SUITE 304  
MAITLAND, FL 327517234

FOR: INSURANCE ADMINISTRATION; INSUR-  
ANCE BROKERAGE, IN CLASS 36 (U.S. CLS. 100, 101  
AND 102).

FIRST USE 6-0-2007; IN COMMERCE 6-0-2007.

THE MARK CONSISTS OF A BIRD DESIGN.

SER. NO. 77-313,172, FILED 10-25-2007.

TARAH HARDY, EXAMINING ATTORNEY



**Int. Cl.: 43**

**Prior U.S. Cls.: 100 and 101**

**United States Patent and Trademark Office**

**Reg. No. 3,453,254**

**Registered June 24, 2008**

**SERVICE MARK  
PRINCIPAL REGISTER**

**Q CUMBER'S**

LIGHT FOOD, INC. (NEW YORK CORPORATION), DBA Q CUMBER'S  
1059 BROADWAY  
WOODMERE, NY 11598

THE MARK CONSISTS OF STANDARD CHARACTERS WITHOUT CLAIM TO ANY PARTICULAR FONT, STYLE, SIZE, OR COLOR.

FOR: RESTAURANT SERVICES, IN CLASS 43 (U.S. CLS. 100 AND 101).

SER. NO. 77-313,181, FILED 10-25-2007.

FIRST USE 1-31-2006; IN COMMERCE 1-31-2006.

HANNO RITTNER, EXAMINING ATTORNEY

**Int. Cl.: 16**

**Prior U.S. Cls.: 2, 5, 22, 23, 29, 37, 38 and 50**

**Reg. No. 3,453,255**

**United States Patent and Trademark Office**

**Registered June 24, 2008**

**TRADEMARK  
PRINCIPAL REGISTER**



SKM INDUSTRIES, INC. (PENNSYLVANIA CORPORATION)  
PO BOX 278  
1012 UNDERWOOD RD.  
OLYPHANT, PA 18447

FOR: FIBER-TIP MARKERS, IN CLASS 16 (U.S. CLS. 2, 5, 22, 23, 29, 37, 38 AND 50).

FIRST USE 4-7-2007; IN COMMERCE 8-21-2007.

NO CLAIM IS MADE TO THE EXCLUSIVE RIGHT TO USE "GALVANIZED STEEL MARKER", APART FROM THE MARK AS SHOWN.

THE COLOR(S) WHITE, BLACK, BROWN, AND GOLD IS/ARE CLAIMED AS A FEATURE OF THE MARK.

THE MARKS CONSISTS OF THE WORDING METAL-PRO IN WHITE ABOVE A GOLD METALLIC BAR WITH THE WORDING GALVANIZED STEEL MARKER IN BLACK. THE ENTIRE MARK HAS A BROWN RECTANGULAR BACKGROUND.

SER. NO. 77-313,207, FILED 10-25-2007.

TARAH HARDY, EXAMINING ATTORNEY

**Int. Cl.: 30**

**Prior U.S. Cl.: 46**

**United States Patent and Trademark Office**

**Reg. No. 3,453,256**

**Registered June 24, 2008**

**TRADEMARK  
PRINCIPAL REGISTER**



HI-HO TRADING LLC (INDIANA LTD LIAB CO)  
636 FREEMAN RIDGE ROAD  
NASHVILLE, IN 47448

THE MARK CONSISTS OF THE WORDS "HI HO  
TRADING" IN STYLIZED TEXT.

FOR: SALAD DRESSINGS; MARINADES, IN  
CLASS 30 (U.S. CL. 46).

SER. NO. 77-313,223, FILED 10-25-2007.

FIRST USE 1-23-2002; IN COMMERCE 1-23-2002.

ADA HAN, EXAMINING ATTORNEY

**Int. Cl.: 33**

**Prior U.S. Cls.: 47 and 49**

**United States Patent and Trademark Office**

**Reg. No. 3,453,257**

**Registered June 24, 2008**

**TRADEMARK  
PRINCIPAL REGISTER**

**TOUTES DIRECTIONS**

BARTON & GUESTIER S.A.S, (FRANCE SOCIÉTÉ  
PAR ACTIONS SIMPLIFIÉE (SAS))  
CHATEAU MAGNOL  
87 RUE DU DEHEZ  
BLANQUEFORT, FRANCE

FOR: ALCOHOLIC BEVERAGES, NAMELY,  
WINES, IN CLASS 33 (U.S. CLS. 47 AND 49).

THE MARK CONSISTS OF STANDARD CHAR-  
ACTERS WITHOUT CLAIM TO ANY PARTICULAR  
FONT, STYLE, SIZE, OR COLOR.

OWNER OF ERPN CMNTY TM OFC REG. NO.  
004462842, DATED 5-26-2006, EXPIRES 5-25-2015.

THE FOREIGN WORDING IN THE MARK  
TRANSLATES INTO ENGLISH AS ALL.

SER. NO. 77-313,235, FILED 10-25-2007.

JESSICA A. POWERS, EXAMINING ATTORNEY

**Int. Cl.: 35**

**Prior U.S. Cls.: 100, 101 and 102**

**United States Patent and Trademark Office**

**Reg. No. 3,453,258**

**Registered June 24, 2008**

**SERVICE MARK  
PRINCIPAL REGISTER**



B & D DIG IN LLC (NEW YORK LTD LIAB CO)  
153 EAST 57TH STREET  
NEW YORK, NY 10022

FOR: CATALOG ORDERING SERVICE FEATURING WINES AND SPIRITS; MAIL ORDER SERVICES FEATURING WINES AND SPIRITS; ON-LINE RETAIL STORE SERVICES FEATURING WINES AND SPIRITS; RETAIL STORE SERVICES FEATURING WINES AND SPIRITS, IN CLASS 35 (U.S. CLS. 100, 101 AND 102).

FIRST USE 2-26-2005; IN COMMERCE 2-26-2005.

OWNER OF U.S. REG. NO. 3,076,451.

NO CLAIM IS MADE TO THE EXCLUSIVE RIGHT TO USE "WINE & SPIRITS", APART FROM THE MARK AS SHOWN.

THE MARK CONSISTS OF THE WORD CRUSH WITH THE "H" AS AN UPSIDE DOWN WINE GLASS AND THE WORDS WINE & SPIRITS BELOW.

SER. NO. 77-313,254, FILED 10-25-2007.

THEODORE MCBRIDE, EXAMINING ATTORNEY

**Int. Cl.: 42**

**Prior U.S. Cls.: 100 and 101**

**United States Patent and Trademark Office**

**Reg. No. 3,453,259**

**Registered June 24, 2008**

**SERVICE MARK  
PRINCIPAL REGISTER**

**ELearn@Work**

JWAY GROUP, INC. (CALIFORNIA CORPORATION)  
4125 BLACKFORD AVENUE, SUITE 128  
SAN JOSE, CA 95117

FOR: COMPUTER SERVICES, NAMELY, DESIGNING AND IMPLEMENTING WEB SITES FOR OTHERS; RESEARCH AND DEVELOPMENT OF ADVANCED LEARNING TECHNOLOGIES AND TEACHING METHODS, IN CLASS 42 (U.S. CLS. 100 AND 101).

FIRST USE 2-0-2007; IN COMMERCE 2-0-2007.

THE MARK CONSISTS OF STANDARD CHARACTERS WITHOUT CLAIM TO ANY PARTICULAR FONT, STYLE, SIZE, OR COLOR.

SER. NO. 77-313,272, FILED 10-25-2007.

FRED CARL, EXAMINING ATTORNEY

**Int. Cl.: 12**

**Prior U.S. Cls.: 19, 21, 23, 31, 35 and 44**

**United States Patent and Trademark Office**

**Reg. No. 3,453,260**

**Registered June 24, 2008**

**TRADEMARK  
PRINCIPAL REGISTER**

GO ANYWHERE DO ANYTHING

CHRYSLER LLC (DELAWARE LTD LIAB CO)  
CIMS 483-02-19  
1000 CHRYSLER DR.  
AUBURN HILLS, MI 48326

THE MARK CONSISTS OF STANDARD CHAR-  
ACTERS WITHOUT CLAIM TO ANY PARTICULAR  
FONT, STYLE, SIZE, OR COLOR.

FOR: MOTOR VEHICLES AND STRUCTURAL  
PARTS THEREFOR, IN CLASS 12 (U.S. CLS. 19, 21, 23,  
31, 35 AND 44).

SER. NO. 77-313,295, FILED 10-25-2007.

FIRST USE 5-30-2007; IN COMMERCE 5-30-2007.

JENNIFER DIXON, EXAMINING ATTORNEY

**Int. Cl.: 9**

**Prior U.S. Cls.: 21, 23, 26, 36 and 38**

**Reg. No. 3,453,261**

**United States Patent and Trademark Office**

**Registered June 24, 2008**

**TRADEMARK  
PRINCIPAL REGISTER**

**Cyberview Technology**

CYBERVIEW TECHNOLOGY (DELAWARE CORPORATION)  
BUILDING 2, SUITE 500  
3000 EL CAMINO REAL  
PALO ALTO, CA 94306

FOR: GAMING EQUIPMENT, NAMELY, SLOT MACHINES WITH OR WITHOUT VIDEO OUTPUT; SLOT MACHINES; GAMING MACHINES; GAMING MACHINES THAT GENERATE OR DISPLAY WAGER OUTCOMES; GAMING SOFTWARE THAT GENERATES OR DISPLAYS WAGER OUTCOMES OF GAMING MACHINES; MACHINES FOR PLAYING GAMES OF CHANCE, IN CLASS 9 (U.S. CLS. 21, 23, 26, 36 AND 38).

FIRST USE 1-10-1996; IN COMMERCE 8-24-2004.

THE MARK CONSISTS OF STANDARD CHARACTERS WITHOUT CLAIM TO ANY PARTICULAR FONT, STYLE, SIZE, OR COLOR.

NO CLAIM IS MADE TO THE EXCLUSIVE RIGHT TO USE "TECHNOLOGY", APART FROM THE MARK AS SHOWN.

SER. NO. 77-313,316, FILED 10-25-2007.

DAVID YONTEF, EXAMINING ATTORNEY



**Int. Cl.: 42**

**Prior U.S. Cls.: 100 and 101**

**United States Patent and Trademark Office**

**Reg. No. 3,453,262**

**Registered June 24, 2008**

**SERVICE MARK  
PRINCIPAL REGISTER**

**Together, we WILL find the  
cure!**

THE PROGERIA RESEARCH FOUNDATION.  
INC. (MASSACHUSETTS CORPORATION)  
532 LOWELL STREET  
PO BOX 3453  
PEABODY, MA 01960

THE MARK CONSISTS OF STANDARD CHAR-  
ACTERS WITHOUT CLAIM TO ANY PARTICULAR  
FONT, STYLE, SIZE, OR COLOR.

FOR: MEDICAL RESEARCH, IN CLASS 42 (U.S.  
CLS. 100 AND 101).

SER. NO. 77-313,347, FILED 10-25-2007.

FIRST USE 0-0-2000; IN COMMERCE 0-0-2000.

H. M. FISHER, EXAMINING ATTORNEY

**Int. Cl.: 9**

**Prior U.S. Cls.: 21, 23, 26, 36 and 38**

**Reg. No. 3,453,263**

**United States Patent and Trademark Office**

**Registered June 24, 2008**

**TRADEMARK  
PRINCIPAL REGISTER**

**Zena**

CYBERVIEW TECHNOLOGY (DELAWARE CORPORATION)  
BUILDING 2, SUITE 500  
3000 EL CAMINO REAL  
PALO ALTO, CA 94306

FOR: GAMING EQUIPMENT, NAMELY, SLOT MACHINES WITH OR WITHOUT VIDEO OUTPUT; SLOT MACHINES; GAMING MACHINES; GAMING MACHINES THAT GENERATE OR DISPLAY WAGER OUTCOMES; MACHINES FOR PLAYING GAMES OF CHANCE, IN CLASS 9 (U.S. CLS. 21, 23, 26, 36 AND 38).

FIRST USE 4-5-2005; IN COMMERCE 4-26-2007.

THE MARK CONSISTS OF STANDARD CHARACTERS WITHOUT CLAIM TO ANY PARTICULAR FONT, STYLE, SIZE, OR COLOR.

SER. NO. 77-313,366, FILED 10-25-2007.

DAVID YONTEF, EXAMINING ATTORNEY

**Int. Cl.: 3**

**Prior U.S. Cls.: 1, 4, 6, 50, 51 and 52**

**United States Patent and Trademark Office**

**Reg. No. 3,453,264**

**Registered June 24, 2008**

**TRADEMARK  
PRINCIPAL REGISTER**

**CLAYTON SHAGAL**

RENAUD, DANIEL (CANADA INDIVIDUAL)  
14056 CURE-LABELLE BLVD, SUITE 105  
MIRABEL (QUEBEC), CANADA J7J1L6

FOR: BODY CREAMS; FACE CREAMS; HAND  
CREAMS; MASSAGE CREAMS; MOISTURIZING  
CREAMS, IN CLASS 3 (U.S. CLS. 1, 4, 6, 50, 51 AND  
52).

FIRST USE 9-30-1997, THE MARK WAS FIRST  
USED ANYWHERE IN A DIFFERENT FORM  
OTHER THAN THAT SOUGHT TO BE  
REGISTERED ON 05/02/1985.; IN COMMERCE  
9-30-1997, THE MARK WAS FIRST USED IN  
COMMERCE IN A DIFFERENT FORM OTHER

THAN THAT SOUGHT TO BE REGISTERED ON  
05/02/1985..

THE MARK CONSISTS OF STANDARD CHAR-  
ACTERS WITHOUT CLAIM TO ANY PARTICULAR  
FONT, STYLE, SIZE, OR COLOR.

OWNER OF U.S. REG. NO. 1,475,576.

THE NAME(S), PORTRAIT(S), AND/OR SIGNA-  
TURE(S) SHOWN IN THE MARK DOES NOT IDENT-  
IFY A PARTICULAR LIVING INDIVIDUAL.

SER. NO. 77-313,390, FILED 10-25-2007.

ADA HAN, EXAMINING ATTORNEY

**Int. Cl.: 27**

**Prior U.S. Cls.: 19, 20, 37, 42 and 50**

**United States Patent and Trademark Office**

**Reg. No. 3,453,265**

**Registered June 24, 2008**

**TRADEMARK  
PRINCIPAL REGISTER**

**SOFT CLASSICS**

BEAULIEU GROUP, LLC (GEORGIA LTD LIAB  
CO)

1502 CORONET DRIVE

DALTON, GA 30720

FOR: CARPETS, IN CLASS 27 (U.S. CLS. 19, 20, 37,  
42 AND 50).

FIRST USE 10-28-2006; IN COMMERCE 10-28-2006.

THE MARK CONSISTS OF STANDARD CHAR-  
ACTERS WITHOUT CLAIM TO ANY PARTICULAR  
FONT, STYLE, SIZE, OR COLOR.

NO CLAIM IS MADE TO THE EXCLUSIVE  
RIGHT TO USE "SOFT", APART FROM THE MARK  
AS SHOWN.

SER. NO. 77-313,422, FILED 10-25-2007.

KATINA MISTER, EXAMINING ATTORNEY

**Int. Cl.: 42**

**Prior U.S. Cls.: 100 and 101**

**United States Patent and Trademark Office**

**Reg. No. 3,453,266**

**Registered June 24, 2008**

**SERVICE MARK  
PRINCIPAL REGISTER**

**COTSWORKS**

CHAMPION OPTICAL TECHNOLOGY SERVICES  
(OHIO LTD LIAB CO)  
749 MINER ROAD  
HIGHLAND HEIGHTS, OH 44143

FOR: ENGINEERING DESIGN AND TESTING SERVICES, NAMELY, ENGINEERING AND DESIGN OF OPTICAL COMPONENTS, OPTICAL NETWORKS, OPTICAL NETWORKING EQUIPMENT, AND TEST EQUIPMENT FOR USE IN MILITARY, AEROSPACE, INDUSTRIAL OR GENERAL HARSH ENVIRONMENTS, IN CLASS 42 (U.S. CLS. 100 AND 101).

FIRST USE 1-0-2006; IN COMMERCE 1-0-2006.

THE MARK CONSISTS OF STANDARD CHARACTERS WITHOUT CLAIM TO ANY PARTICULAR FONT, STYLE, SIZE, OR COLOR.

SER. NO. 77-313,452, FILED 10-25-2007.

JILL C. ALT, EXAMINING ATTORNEY

**Int. Cl.: 12**

**Prior U.S. Cls.: 19, 21, 23, 31, 35 and 44**

**United States Patent and Trademark Office**

**Reg. No. 3,453,267**

**Registered June 24, 2008**

**TRADEMARK  
PRINCIPAL REGISTER**

The logo consists of the word 'twenty' in a lowercase, sans-serif font, followed by a large, stylized number '6'. The '6' is formed by a thick, curved line that starts from the bottom left, loops around the right side, and ends at the top right, creating a shape that resembles a '6' but with a more fluid, calligraphic feel.

TWENTY 6 PRODUCTS, LLC (MONTANA LTD  
LIAB CO)  
805 MANTLE DRIVE, APARTMENT B  
BELGRADE, MT 59714

FOR: BICYCLE PARTS, NAMELY, BRAKE LE-  
VERS, PEDALS, HANDLE BAR STEMS, HANDLE  
BAR ENDS, IN CLASS 12 (U.S. CLS. 19, 21, 23, 31, 35  
AND 44).

FIRST USE 4-1-2006; IN COMMERCE 4-1-2006.

THE MARK CONSISTS OF THE NUMBER TWEN-  
TY 6.

SER. NO. 77-313,458, FILED 10-25-2007.

VIVIAN MICZNIK FIRST, EXAMINING ATTOR-  
NEY

**Int. Cl.: 16**

**Prior U.S. Cls.: 2, 5, 22, 23, 29, 37, 38 and 50**

**Reg. No. 3,453,268**

**United States Patent and Trademark Office**

**Registered June 24, 2008**

---

**TRADEMARK  
PRINCIPAL REGISTER**

**REJUVENATE**

MCCLATCHY MANAGEMENT SERVICES, INC.  
(DELAWARE CORPORATION)  
LEGAL DEPARTMENT  
2100 Q STREET  
SACRAMENTO, CA 95816

THE MARK CONSISTS OF STANDARD CHAR-  
ACTERS WITHOUT CLAIM TO ANY PARTICULAR  
FONT, STYLE, SIZE, OR COLOR.

FOR: GENERAL FEATURE MAGAZINES FOR  
WOMEN, IN CLASS 16 (U.S. CLS. 2, 5, 22, 23, 29, 37, 38  
AND 50).

SER. NO. 77-313,465, FILED 10-25-2007.

FIRST USE 2-7-2007; IN COMMERCE 2-7-2007.

LINDA POWELL, EXAMINING ATTORNEY

**Int. Cl.: 31**

**Prior U.S. Cls.: 1 and 46**

**United States Patent and Trademark Office**

**Reg. No. 3,453,269**

**Registered June 24, 2008**

**TRADEMARK  
PRINCIPAL REGISTER**

**COUNTRY PRIDE**

SMG BRANDS, INC. (DELAWARE CORPORATION)  
1105 N MARKET STREET, SUITE 1300  
WILMINGTON, DE 19801

THE MARK CONSISTS OF STANDARD CHARACTERS WITHOUT CLAIM TO ANY PARTICULAR FONT, STYLE, SIZE, OR COLOR.

FOR: WILD BIRD FOOD, IN CLASS 31 (U.S. CLS. 1 AND 46).

SER. NO. 77-313,472, FILED 10-25-2007.

FIRST USE 1-1-1994; IN COMMERCE 1-1-1994.

MICHAEL SOUDERS, EXAMINING ATTORNEY



**Int. Cl.: 9**

**Prior U.S. Cls.: 21, 23, 26, 36 and 38**

**Reg. No. 3,453,270**

**United States Patent and Trademark Office**

**Registered June 24, 2008**

---

**TRADEMARK  
PRINCIPAL REGISTER**

**MALPA**

MOSCOT MANAGEMENT CORP. (NEW YORK CORPORATION)  
118 ORCHARD STREET  
NEW YORK, NY 10002

FOR: EYEGLOSS FRAMES, IN CLASS 9 (U.S. CLS. 21, 23, 26, 36 AND 38).

FIRST USE 3-1-2003; IN COMMERCE 3-1-2003.

THE MARK CONSISTS OF STANDARD CHARACTERS WITHOUT CLAIM TO ANY PARTICULAR FONT, STYLE, SIZE, OR COLOR.

THE WORDING "MALPA" HAS NO MEANING IN A FOREIGN LANGUAGE.

SER. NO. 77-313,483, FILED 10-25-2007.

HEATHER THOMPSON, EXAMINING ATTORNEY

**Int. Cl.: 43**

**Prior U.S. Cls.: 100 and 101**

**United States Patent and Trademark Office**

**Reg. No. 3,453,271**

**Registered June 24, 2008**

**SERVICE MARK  
PRINCIPAL REGISTER**

**ZENBU**

MATTHEW AND JACQUELINE RIMEL (UNITED STATES INDIVIDUAL)  
6823 DRAPER AVE  
LA JOLLA, CA 92037

THE MARK CONSISTS OF STANDARD CHARACTERS WITHOUT CLAIM TO ANY PARTICULAR FONT, STYLE, SIZE, OR COLOR.

FOR: RESTAURANT, CATERING AND TAKE-OUT SERVICES, IN CLASS 43 (U.S. CLS. 100 AND 101).

SER. NO. 77-313,508, FILED 10-25-2007.

FIRST USE 10-4-2000; IN COMMERCE 10-4-2000.

AISHA CLARKE, EXAMINING ATTORNEY

Int. Cl.: 37

Prior U.S. Cls.: 100, 103 and 106

United States Patent and Trademark Office

Reg. No. 3,453,272

Registered June 24, 2008

SERVICE MARK  
PRINCIPAL REGISTER

The logo for 'Wash n' Run' is written in a cursive, script font. The letters are bold and have a slight shadow effect. Below the text is a thick, black, wavy underline that follows the contour of the words.

EXXONMOBIL OIL CORPORATION (NEW  
YORK CORPORATION)  
5959 LAS COLINAS BOULEVARD  
IRVING, TX 75039

THE MARK CONSISTS OF THE WORDS "WASH  
N' RUN" IN STYLIZED FORM WITH A WAVY  
UNDERLINE.

FOR: AUTOMOBILE CLEANING AND CAR  
WASHING, IN CLASS 37 (U.S. CLS. 100, 103 AND 106).

SER. NO. 77-313,540, FILED 10-25-2007.

FIRST USE 9-4-2002; IN COMMERCE 9-4-2002.

OWNER OF U.S. REG. NO. 2,792,917.

MICHAEL SOUDERS, EXAMINING ATTORNEY

**Int. Cl.: 41**

**Prior U.S. Cls.: 100, 101 and 107**

**United States Patent and Trademark Office**

**Reg. No. 3,453,273**

**Registered June 24, 2008**

**SERVICE MARK  
PRINCIPAL REGISTER**

**FOR PEOPLE WITH A PASSION  
FOR HORSES**

**PHELPS/HATHAWAY ENTERPRISES INCORPORATED (FLORIDA CORPORATION)  
P.O. BOX 868  
DELEON SPRINGS, FL 32130**

**FOR: PROVIDING ON-LINE NEWSLETTER AND MAGAZINE REGARDING EQUESTRIAN NEWS THROUGH TEXTUAL MATERIAL, PHOTOGRAPHS, GRAPHIC DEVICES AND VIDEOS , IN CLASS 41 (U.S. CLS. 100, 101 AND 107).**

**FIRST USE 1-15-2000; IN COMMERCE 1-15-2000.**

**THE MARK CONSISTS OF STANDARD CHARACTERS WITHOUT CLAIM TO ANY PARTICULAR FONT, STYLE, SIZE, OR COLOR.**

**SER. NO. 77-313,547, FILED 10-25-2007.**

**PAUL F. GAST, EXAMINING ATTORNEY**

**Int. Cl.: 5**

**Prior U.S. Cls.: 6, 18, 44, 46, 51 and 52**

**Reg. No. 3,453,274**

**United States Patent and Trademark Office**

**Registered June 24, 2008**

---

**TRADEMARK  
PRINCIPAL REGISTER**

**NATURAL FREAK**

ALL AMERICAN PHARMACEUTICAL & NATURAL FOODS CORPORATION (MONTANA CORPORATION)  
1831 MAIN STREET  
BILLINGS, MT 59015

THE MARK CONSISTS OF STANDARD CHARACTERS WITHOUT CLAIM TO ANY PARTICULAR FONT, STYLE, SIZE, OR COLOR.

FOR: NUTRITIONAL SUPPLEMENTS, IN CLASS 5 (U.S. CLS. 6, 18, 44, 46, 51 AND 52).

SER. NO. 77-313,561, FILED 10-25-2007.

FIRST USE 6-1-2007; IN COMMERCE 6-1-2007.

ANN E. SAPPENFIELD, EXAMINING ATTORNEY

**Int. Cl.: 41**

**Prior U.S. Cls.: 100, 101 and 107**

**United States Patent and Trademark Office**

**Reg. No. 3,453,275**

**Registered June 24, 2008**

**SERVICE MARK  
PRINCIPAL REGISTER**

**GMTI**

THE INSPIRATIONAL NETWORK, INC. (NORTH  
CAROLINA NON-PROFIT CORPORATION)  
SUITE 500  
7910 CRESCENT EXECUTIVE CENTER DRIVE  
CHARLOTTE, NC 28217

FOR: EDUCATIONAL SERVICES, NAMELY,  
CONDUCTING PROGRAMS IN THE USE OF ELEC-  
TRONIC AND BROADCAST MEDIA FOR CHRIS-  
TIAN MINISTRY, IN CLASS 41 (U.S. CLS. 100, 101  
AND 107).

FIRST USE 3-0-2007; IN COMMERCE 3-0-2007.

THE MARK CONSISTS OF STANDARD CHAR-  
ACTERS WITHOUT CLAIM TO ANY PARTICULAR  
FONT, STYLE, SIZE, OR COLOR.

SER. NO. 77-313,570, FILED 10-25-2007.

KEVIN DINALLO, EXAMINING ATTORNEY

**Int. Cl.: 9**

**Prior U.S. Cls.: 21, 23, 26, 36 and 38**

**Reg. No. 3,453,276**

**United States Patent and Trademark Office**

**Registered June 24, 2008**

---

**TRADEMARK  
PRINCIPAL REGISTER**

**LEMTOSH**

MOSCOT MANAGEMENT CORP. (NEW YORK CORPORATION)  
118 ORCHARD STREET  
NEW YORK, NY 10002

FOR: EYEGLOSS FRAMES, IN CLASS 9 (U.S. CLS. 21, 23, 26, 36 AND 38).

FIRST USE 3-1-2003; IN COMMERCE 3-1-2003.

THE MARK CONSISTS OF STANDARD CHARACTERS WITHOUT CLAIM TO ANY PARTICULAR FONT, STYLE, SIZE, OR COLOR.

THE WORDING "LEMTOSH" HAS NO MEANING IN A FOREIGN LANGUAGE.

SER. NO. 77-313,573, FILED 10-25-2007.

HEATHER THOMPSON, EXAMINING ATTORNEY

**Int. Cl.: 41**

**Prior U.S. Cls.: 100, 101 and 107**

**United States Patent and Trademark Office**

**Reg. No. 3,453,277**

**Registered June 24, 2008**

**SERVICE MARK  
PRINCIPAL REGISTER**

**SILENT MIND**

BRIGHT, JAMIE (UNITED STATES INDIVIDUAL)  
294 BISCAYNE HTS.  
COLCHESTER, VT 05446

THE MARK CONSISTS OF STANDARD CHARACTERS WITHOUT CLAIM TO ANY PARTICULAR FONT, STYLE, SIZE, OR COLOR.

FOR: ENTERTAINMENT, NAMELY, LIVE PERFORMANCES BY A MUSICAL BAND, IN CLASS 41 (U.S. CLS. 100, 101 AND 107).

SER. NO. 77-313,660, FILED 10-25-2007.

FIRST USE 10-5-2004; IN COMMERCE 10-5-2004.

MORGAN WYNNE, EXAMINING ATTORNEY



**Int. Cl.: 9**

**Prior U.S. Cls.: 21, 23, 26, 36 and 38**

**Reg. No. 3,453,278**

**United States Patent and Trademark Office**

**Registered June 24, 2008**

---

**TRADEMARK  
PRINCIPAL REGISTER**

**NEBB**

MOSCOT MANAGEMENT CORP. (NEW YORK  
CORPORATION)  
118 ORCHARD STREET  
NEW YORK, NY 10002

THE MARK CONSISTS OF STANDARD CHAR-  
ACTERS WITHOUT CLAIM TO ANY PARTICULAR  
FONT, STYLE, SIZE, OR COLOR.

FOR: EYEGLASS FRAMES, IN CLASS 9 (U.S. CLS.  
21, 23, 26, 36 AND 38).

SER. NO. 77-313,665, FILED 10-25-2007.

FIRST USE 3-1-2003; IN COMMERCE 3-1-2003.

HEATHER THOMPSON, EXAMINING ATTORNEY

**Int. Cl.: 9**

**Prior U.S. Cls.: 21, 23, 26, 36 and 38**

**Reg. No. 3,453,279**

**United States Patent and Trademark Office**

**Registered June 24, 2008**

---

**TRADEMARK  
PRINCIPAL REGISTER**

**SuperMAG**

GALVOTEC ALLOYS, INC. (TEXAS CORPORATION)  
6712 S. 36TH STREET  
MCALLEN, TX 78503

THE MARK CONSISTS OF STANDARD CHARACTERS WITHOUT CLAIM TO ANY PARTICULAR FONT, STYLE, SIZE, OR COLOR.

FOR: MAGNESIUM ANODES USED FOR CATHODIC PROTECTION, IN CLASS 9 (U.S. CLS. 21, 23, 26, 36 AND 38).

SER. NO. 77-313,674, FILED 10-25-2007.

FIRST USE 8-31-2002; IN COMMERCE 8-31-2002.

ANDREA K. NADELMAN, EXAMINING ATTORNEY

**Int. Cl.: 35**

**Prior U.S. Cls.: 100, 101 and 102**

**United States Patent and Trademark Office**

**Reg. No. 3,453,280**

**Registered June 24, 2008**

---

**SERVICE MARK  
PRINCIPAL REGISTER**

**TASTE BUDDS**

TASTEVINE, INC. (GEORGIA CORPORATION)  
4651 ROSWELL RD.  
ATLANTA, GA 30342

FIRST USE 6-2-2007; IN COMMERCE 6-2-2007.

FOR: ADVERTISING AND INFORMATION DISTRIBUTION SERVICES, NAMELY, PROVIDING ADVERTISING SPACE VIA THE INTERNET; PROMOTING THE GOODS AND SERVICES OF OTHERS OVER THE INTERNET; PROVIDING ON-LINE COMPUTER DATABASES AND ON-LINE SEARCHABLE DATABASES FEATURING GOODS AND SERVICES, IN CLASS 35 (U.S. CLS. 100, 101 AND 102).

THE MARK CONSISTS OF STANDARD CHARACTERS WITHOUT CLAIM TO ANY PARTICULAR FONT, STYLE, SIZE, OR COLOR.

SER. NO. 77-313,683, FILED 10-25-2007.

RAUL CORDOVA, EXAMINING ATTORNEY

**Int. Cl.: 18**

**Prior U.S. Cls.: 1, 2, 3, 22 and 41**

**United States Patent and Trademark Office**

**Reg. No. 3,453,281**

**Registered June 24, 2008**

**TRADEMARK  
PRINCIPAL REGISTER**

**COMELY**

FASHION INNOVATION INC. (CALIFORNIA  
CORPORATION), DBA COMELY  
4621 S. ALAMEDA STREET  
LOS ANGELES, CA 90058

THE MARK CONSISTS OF STANDARD CHAR-  
ACTERS WITHOUT CLAIM TO ANY PARTICULAR  
FONT, STYLE, SIZE, OR COLOR.

FOR: HANDBAGS; TOTE BAGS; BACKPACKS, IN  
CLASS 18 (U.S. CLS. 1, 2, 3, 22 AND 41).

SER. NO. 77-313,702, FILED 10-25-2007.

FIRST USE 7-1-2005; IN COMMERCE 7-1-2005.

MARY CRAWFORD, EXAMINING ATTORNEY

**Int. Cl.: 19**

**Prior U.S. Cls.: 1, 12, 33 and 50**

**United States Patent and Trademark Office**

**Reg. No. 3,453,282**

**Registered June 24, 2008**

**TRADEMARK  
PRINCIPAL REGISTER**

**BIG RED**

STORMWATER PRODUCTS, LLC (MISSOURI  
LTD LIAB CO)  
158 SKYVIEW LANE  
LABADIE, MO 63055

FOR: NON-METAL STORM WATER CURB IN-  
LET PROTECTION FILTERS, NAMELY, NON-ME-  
TAL FILTERS FOR CURB INLETS, IN CLASS 19  
(U.S. CLS. 1, 12, 33 AND 50).

FIRST USE 8-1-2007; IN COMMERCE 8-1-2007.

THE MARK CONSISTS OF STANDARD CHAR-  
ACTERS WITHOUT CLAIM TO ANY PARTICULAR  
FONT, STYLE, SIZE, OR COLOR.

NO CLAIM IS MADE TO THE EXCLUSIVE  
RIGHT TO USE "RED", APART FROM THE MARK  
AS SHOWN.

SER. NO. 77-313,705, FILED 10-25-2007.

SIMON TENG, EXAMINING ATTORNEY

**Int. Cl.: 9**

**Prior U.S. Cls.: 21, 23, 26, 36 and 38**

**Reg. No. 3,453,283**

**United States Patent and Trademark Office**

**Registered June 24, 2008**

---

**TRADEMARK  
PRINCIPAL REGISTER**

**VILDA**

MOSCOT MANAGEMENT CORP. (NEW YORK  
CORPORATION)  
118 ORCHARD STREET  
NEW YORK, NY 10002

THE MARK CONSISTS OF STANDARD CHAR-  
ACTERS WITHOUT CLAIM TO ANY PARTICULAR  
FONT, STYLE, SIZE, OR COLOR.

FOR: EYEGLASS FRAMES, IN CLASS 9 (U.S. CLS.  
21, 23, 26, 36 AND 38).

SER. NO. 77-313,726, FILED 10-25-2007.

FIRST USE 3-1-2003; IN COMMERCE 3-1-2003.

HEATHER THOMPSON, EXAMINING ATTORNEY

**Int. Cl.: 41**

**Prior U.S. Cls.: 100, 101 and 107**

**United States Patent and Trademark Office**

**Reg. No. 3,453,284**

**Registered June 24, 2008**

**SERVICE MARK  
PRINCIPAL REGISTER**

**THE FAST TRACK TO INDY**

BRICKYARD TRADEMARKS, INC. (NEVADA  
CORPORATION)  
2215 B RENAISSANCE DRIVE  
LAS VEGAS, NV 89119

FOR: ENTERTAINMENT IN THE NATURE OF  
AUTOMOBILE RACES, IN CLASS 41 (U.S. CLS. 100,  
101 AND 107).

FIRST USE 1-0-2005; IN COMMERCE 1-0-2005.

THE MARK CONSISTS OF STANDARD CHAR-  
ACTERS WITHOUT CLAIM TO ANY PARTICULAR  
FONT, STYLE, SIZE, OR COLOR.

OWNER OF U.S. REG. NOS. 1,836,834, 2,542,044  
AND OTHERS.

SER. NO. 77-313,732, FILED 10-25-2007.

DAVID H. STINE, EXAMINING ATTORNEY

**Int. Cl.: 25**

**Prior U.S. Cls.: 22 and 39**

**United States Patent and Trademark Office**

**Reg. No. 3,453,285**

**Registered June 24, 2008**

**TRADEMARK  
PRINCIPAL REGISTER**

**SWEETFACE**

SWEETFACE FASHION, LLC (NEW YORK LTD  
LIAB CO)  
1071 AVENUE OF THE AMERICAS, SUITE 502  
NEW YORK, NY 10018

FOR: COATS; DRESSES; JACKETS; PANTS;  
SHIRTS; SHORTS; SKIRTS; SWEATERS; TANK-  
TOPS; TOPS, IN CLASS 25 (U.S. CLS. 22 AND 39).

FIRST USE 12-1-2003; IN COMMERCE 12-1-2003.

THE MARK CONSISTS OF STANDARD CHAR-  
ACTERS WITHOUT CLAIM TO ANY PARTICULAR  
FONT, STYLE, SIZE, OR COLOR.

OWNER OF U.S. REG. NO. 3,119,542.

SER. NO. 77-313,747, FILED 10-25-2007.

EDWARD NELSON, EXAMINING ATTORNEY



**Int. Cl.: 9**

**Prior U.S. Cls.: 21, 23, 26, 36 and 38**

**Reg. No. 3,453,286**

**United States Patent and Trademark Office**

**Registered June 24, 2008**

---

**TRADEMARK  
PRINCIPAL REGISTER**

**ZELIG**

MOSCOT MANAGEMENT CORP. (NEW YORK  
CORPORATION)  
118 ORCHARD STREET  
NEW YORK, NY 10002

THE MARK CONSISTS OF STANDARD CHAR-  
ACTERS WITHOUT CLAIM TO ANY PARTICULAR  
FONT, STYLE, SIZE, OR COLOR.

FOR: EYEGLASS FRAMES, IN CLASS 9 (U.S. CLS.  
21, 23, 26, 36 AND 38).

SER. NO. 77-313,751, FILED 10-25-2007.

FIRST USE 3-1-2003; IN COMMERCE 3-1-2003.

HEATHER THOMPSON, EXAMINING ATTORNEY

**Int. Cl.: 41**

**Prior U.S. Cls.: 100, 101 and 107**

**United States Patent and Trademark Office**

**Reg. No. 3,453,287**

**Registered June 24, 2008**

**SERVICE MARK  
PRINCIPAL REGISTER**

**VENOMGIRLS.COM**

VENOM ENTERPRISES, LLC (NEVADA LTD  
LIAB CO)  
3415 RAWHIDE STREET  
LAS VEGAS, NV 89120

FOR: ENTERTAINMENT SERVICES, NAMELY,  
PROVIDING A WEBSITE FEATURING PHOTO-  
GRAPHIC, AUDIO, VIDEO AND PROSE PRESEN-  
TATIONS FEATURING AN ON-LINE MAGAZINE  
IN THE FIELD OF ADULT ENTERTAINMENT, IN  
CLASS 41 (U.S. CLS. 100, 101 AND 107).

FIRST USE 6-4-2006; IN COMMERCE 6-4-2006.

THE MARK CONSISTS OF STANDARD CHAR-  
ACTERS WITHOUT CLAIM TO ANY PARTICULAR  
FONT, STYLE, SIZE, OR COLOR.

SER. NO. 77-313,774, FILED 10-25-2007.

HEATHER THOMPSON, EXAMINING ATTORNEY

**Int. Cl.: 35**

**Prior U.S. Cls.: 100, 101 and 102**

**United States Patent and Trademark Office**

**Reg. No. 3,453,288**

**Registered June 24, 2008**

**SERVICE MARK  
PRINCIPAL REGISTER**

# Cascade Florists

CHISHOLM, ROSE (UNITED STATES INDIVIDUAL)  
PO BOX 1120  
FALL CITY, WA 98024

FOR: ON-LINE RETAIL STORE SERVICES FEATURING FLOWERS AND FLOWER ARRANGEMENTS; RETAIL FLORIST SHOPS, IN CLASS 35 (U.S. CLS. 100, 101 AND 102).

FIRST USE 8-1-1985; IN COMMERCE 8-1-1998.

THE MARK CONSISTS OF STANDARD CHARACTERS WITHOUT CLAIM TO ANY PARTICULAR FONT, STYLE, SIZE, OR COLOR.

NO CLAIM IS MADE TO THE EXCLUSIVE RIGHT TO USE "FLORISTS", APART FROM THE MARK AS SHOWN.

SER. NO. 77-313,775, FILED 10-25-2007.

HEATHER THOMPSON, EXAMINING ATTORNEY

**Int. Cl.: 9**

**Prior U.S. Cls.: 21, 23, 26, 36 and 38**

**Reg. No. 3,453,289**

**United States Patent and Trademark Office**

**Registered June 24, 2008**

**TRADEMARK  
PRINCIPAL REGISTER**

**MILTZEN**

MOSCOT MANAGEMENT CORP. (NEW YORK  
CORPORATION)  
118 ORCHARD STREET  
NEW YORK, NY 10002

THE MARK CONSISTS OF STANDARD CHAR-  
ACTERS WITHOUT CLAIM TO ANY PARTICULAR  
FONT, STYLE, SIZE, OR COLOR.

FOR: EYEGLASS FRAMES, IN CLASS 9 (U.S. CLS.  
21, 23, 26, 36 AND 38).

SER. NO. 77-313,777, FILED 10-25-2007.

FIRST USE 3-1-2003; IN COMMERCE 3-1-2003.

HEATHER THOMPSON, EXAMINING ATTORNEY

**Int. Cl.: 3**

**Prior U.S. Cls.: 1, 4, 6, 50, 51 and 52**

**United States Patent and Trademark Office**

**Reg. No. 3,453,290**

**Registered June 24, 2008**

**TRADEMARK  
PRINCIPAL REGISTER**

**ECO-1**

WYMAN, STEPHEN B. (UNITED STATES INDIVIDUAL)  
114 ARBOR COURT  
CLINTON, MS 39056

THE MARK CONSISTS OF STANDARD CHARACTERS WITHOUT CLAIM TO ANY PARTICULAR FONT, STYLE, SIZE, OR COLOR.

FOR: ALL PURPOSE CLEANING PREPARATIONS, IN CLASS 3 (U.S. CLS. 1, 4, 6, 50, 51 AND 52).

SER. NO. 77-313,780, FILED 10-25-2007.

FIRST USE 8-1-2007; IN COMMERCE 8-1-2007.

LOURDES AYALA, EXAMINING ATTORNEY

**Int. Cl.: 16**

**Prior U.S. Cls.: 2, 5, 22, 23, 29, 37, 38 and 50**

**Reg. No. 3,453,291**

**United States Patent and Trademark Office**

**Registered June 24, 2008**

---

**TRADEMARK  
PRINCIPAL REGISTER**

**GoNotes**

AXEL, RAY (UNITED STATES INDIVIDUAL)  
1851 E. 1ST STREET SUITE 1220  
SANTA ANA, CA 92705 AND  
FUENTES, VICTOR MANUEL (UNITED STATES  
INDIVIDUAL)  
1851 E. 1ST STREET SUITE 1220  
SANTA ANA, CA 92705

FIRST USE 9-20-2007; IN COMMERCE 10-16-2007.

THE MARK CONSISTS OF STANDARD CHAR-  
ACTERS WITHOUT CLAIM TO ANY PARTICULAR  
FONT, STYLE, SIZE, OR COLOR.

FOR: ADHESIVE NOTE PADS; NOTE PAD HOLD-  
ERS, IN CLASS 16 (U.S. CLS. 2, 5, 22, 23, 29, 37, 38 AND  
50).

SER. NO. 77-313,794, FILED 10-25-2007.

EDWARD NELSON, EXAMINING ATTORNEY

**Int. Cl.: 9**

**Prior U.S. Cls.: 21, 23, 26, 36 and 38**

**United States Patent and Trademark Office**

**Reg. No. 3,453,292**

**Registered June 24, 2008**

**TRADEMARK  
PRINCIPAL REGISTER**

**iPrecision Timing Solutions**

SPECTRATIME, INC. (SWITZERLAND CORPORATION)  
VOUSEYON 29  
2000 NEUCHATEL, SWITZERLAND

FOR: ELECTRONIC SCIENTIFIC INSTRUMENTS, NAMELY, PORTABLE RUBIDIUM ATOMIC CLOCKS FOR USE IN TESTING PRECISE MEASUREMENTS OF TIME AND FREQUENCY SIGNALS IN CALIBRATION, OSCILLATOR/CLOCK CHARACTERIZATION, TIME INTERVAL ERROR MEASUREMENTS AND LAB INSTRUMENT APPLICATION IN THE TELECOMMUNICATIONS, DEFENSE, NAVIGATION, BROADCASTING AND SPACE INDUSTRIES, IN CLASS 9 (U.S. CLS. 21, 23, 26, 36 AND 38).

FIRST USE 12-0-2003; IN COMMERCE 12-0-2003.

THE MARK CONSISTS OF STANDARD CHARACTERS WITHOUT CLAIM TO ANY PARTICULAR FONT, STYLE, SIZE, OR COLOR.

NO CLAIM IS MADE TO THE EXCLUSIVE RIGHT TO USE "TIMING SOLUTIONS", APART FROM THE MARK AS SHOWN.

SER. NO. 77-313,842, FILED 10-25-2007.

ALYSSA PALADINO, EXAMINING ATTORNEY

**Int. Cl.: 5**

**Prior U.S. Cls.: 6, 18, 44, 46, 51 and 52**

**Reg. No. 3,453,293**

**United States Patent and Trademark Office**

**Registered June 24, 2008**

**TRADEMARK  
PRINCIPAL REGISTER**

**PFB VANISH**

PFB VANISH, INC. (CALIFORNIA CORPORATION)  
20 GALWAY LANE  
SAN RAFAEL, CA 94903

FOR: TOPICAL GEL FOR THE RELIEF OF IRRITATION ASSOCIATED WITH SHAVING, WAXING, ELECTROLYSIS AND LASER HAIR REMOVAL, IN CLASS 5 (U.S. CLS. 6, 18, 44, 46, 51 AND 52).

FIRST USE 2-1-2002; IN COMMERCE 2-1-2002.

THE MARK CONSISTS OF STANDARD CHARACTERS WITHOUT CLAIM TO ANY PARTICULAR FONT, STYLE, SIZE, OR COLOR.

NO CLAIM IS MADE TO THE EXCLUSIVE RIGHT TO USE "PFB", APART FROM THE MARK AS SHOWN.

SER. NO. 77-313,906, FILED 10-25-2007.

DARRYL SPRUILL, EXAMINING ATTORNEY



**Int. Cl.: 41**

**Prior U.S. Cls.: 100, 101 and 107**

**United States Patent and Trademark Office**

**Reg. No. 3,453,294**

**Registered June 24, 2008**

**SERVICE MARK  
PRINCIPAL REGISTER**

**LINDENWOOD**

LINDENWOOD FEMALE COLLEGE (MISSOURI  
CORPORATION)  
209 S. KINGSHIGHWAY  
ST. CHARLES, MO 633011695

FOR: EDUCATIONAL SERVICES, NAMELY,  
PROVIDING COURSES OF INSTRUCTION AT  
THE COLLEGE, GRADUATE, AND POST-GRADU-  
ATE LEVELS; ENTERTAINMENT SERVICES,  
NAMELY, ARRANGING AND CONDUCTING  
ATHLETIC EVENTS AND COMPETITIONS AT  
THE COLLEGE LEVEL, IN CLASS 41 (U.S. CLS. 100,  
101 AND 107).

FIRST USE 0-0-1853; IN COMMERCE 0-0-1853.

THE MARK CONSISTS OF STANDARD CHAR-  
ACTERS WITHOUT CLAIM TO ANY PARTICULAR  
FONT, STYLE, SIZE, OR COLOR.

SER. NO. 77-313,908, FILED 10-25-2007.

ELLEN PERKINS, EXAMINING ATTORNEY

**Int. Cl.: 41**

**Prior U.S. Cls.: 100, 101 and 107**

**United States Patent and Trademark Office**

**Reg. No. 3,453,295**

**Registered June 24, 2008**

**SERVICE MARK  
PRINCIPAL REGISTER**

**LINDENWOOD UNIVERSITY**

LINDENWOOD FEMALE COLLEGE (MISSOURI CORPORATION)  
209 S. KINGSHIGHWAY  
ST. CHARLES, MO 633011695

FOR: EDUCATIONAL SERVICES, NAMELY, PROVIDING COURSES OF INSTRUCTION AT THE COLLEGE, GRADUATE, AND POST-GRADUATE LEVELS; ENTERTAINMENT SERVICES, NAMELY, ARRANGING AND CONDUCTING ATHLETIC EVENTS AND COMPETITIONS AT THE COLLEGE LEVEL, IN CLASS 41 (U.S. CLS. 100, 101 AND 107).

FIRST USE 0-0-1997; IN COMMERCE 0-0-1997.

THE MARK CONSISTS OF STANDARD CHARACTERS WITHOUT CLAIM TO ANY PARTICULAR FONT, STYLE, SIZE, OR COLOR.

NO CLAIM IS MADE TO THE EXCLUSIVE RIGHT TO USE "UNIVERSITY", APART FROM THE MARK AS SHOWN.

SER. NO. 77-313,912, FILED 10-25-2007.

SARA THOMAS, EXAMINING ATTORNEY

**Int. Cl.: 30**

**Prior U.S. Cl.: 46**

**United States Patent and Trademark Office**

**Reg. No. 3,453,296**

**Registered June 24, 2008**

**TRADEMARK  
PRINCIPAL REGISTER**

**ROCKY MOUNTAIN PEAK**

ROCKY MOUNTAIN CHOCOLATE FACTORY,  
INC. (COLORADO CORPORATION)  
265 TURNER DRIVE  
DURANGO, CO 81303

FOR: CHOCOLATE CANDY FOR CONSUMPTION ON OR OFF THE PREMISES, IN CLASS 30 (U.S. CL. 46).

FIRST USE 10-18-2007; IN COMMERCE 10-24-2007.

THE MARK CONSISTS OF STANDARD CHARACTERS WITHOUT CLAIM TO ANY PARTICULAR FONT, STYLE, SIZE, OR COLOR.

OWNER OF U.S. REG. NOS. 1,552,146, 2,015,284 AND OTHERS.

SER. NO. 77-313,920, FILED 10-25-2007.

ELLEN PERKINS, EXAMINING ATTORNEY

Int. Cl.: 10

Prior U.S. Cls.: 26, 39 and 44

United States Patent and Trademark Office

Reg. No. 3,453,297

Registered June 24, 2008

TRADEMARK  
PRINCIPAL REGISTER



ATP MANUFACTURING, LLC (RHODE ISLAND  
LTD LIAB CO)  
761 GREAT ROAD  
NORTH SMITHFIELD, RI 02896

FOR: BIOMECHANICALLY DESIGNED FOOT  
ORTHOSES FOR USE IN TREATMENT OF MANY  
CLINICAL PATHOLOGIES DIAGNOSED BY FOOT-  
CARE PROFESSIONALS, IN CLASS 10 (U.S. CLS. 26,  
39 AND 44).

FIRST USE 11-1-1997; IN COMMERCE 3-1-1998.

THE MARK CONSISTS OF THE WORD PROTHO-  
TICS IN WHICH THE WORD IS UNDERLINED; A  
VERTICAL LINE IS PLACED TO THE LEFT OF THE  
LETTER "P" OF THE WORD PROTHOTICS, THIS  
VERTICAL LINE HAS A LENGTH FROM ABOVE

THE LETTER "P" TO BELOW THE LETTER "P"; THE  
VERTICAL LINE HAS A PERPENDICUALR INTER-  
SECTION WITH THE UNDERLINE; THIS INTER-  
SECTION IS TO THE LEFT OF THE LETTER "P"  
AND BELOW THE LETTER "P" OF THE WORD  
PROTHOTICS' A CIRCLE IS PLACED AROUND  
THE INTERSECTION; A CURVED LINE TRAVELS  
UP FROM THE EDGE OF THE CIRCLE; THE  
LETTERS "PRO" OF THE WORD PROTHOTICS  
HAVE MULTIPLE WHITE PARALLEL LINES RUN-  
NING THROUGH THE LETTERING; THE LETTERS  
"THOTICS" ARE IN BOLD.

SER. NO. 77-313,921, FILED 10-25-2007.

BRIAN CALLAGHAN, EXAMINING ATTORNEY

**Int. Cl.: 25**

**Prior U.S. Cls.: 22 and 39**

**United States Patent and Trademark Office**

**Reg. No. 3,453,298**

**Registered June 24, 2008**

**TRADEMARK  
PRINCIPAL REGISTER**

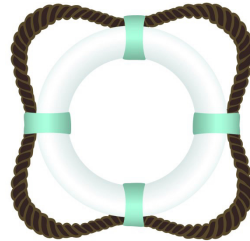

**float**

FLOAT LLC (VERMONT LTD LIAB CO)  
283 SOUTH UNION STREET SUITE #6  
BURLINGTON, VT 05401

FOR: BEACHWEAR; SWIM WEAR; BEACH COVER-UPS; TUNICS; CAPRI PANTS; LOUNGE PANTS, IN CLASS 25 (U.S. CLS. 22 AND 39).

FIRST USE 1-1-2007; IN COMMERCE 4-1-2007.

THE COLOR(S) WHITE, LIGHT BROWN, DARK BROWN, AND LIGHT BLUE IS/ARE CLAIMED AS A FEATURE OF THE MARK.

THE ROPE DESIGN IS IN LIGHT AND DARK BROWN. THE BUOY DESIGN IS IN WHITE WITH FOUR LIGHT BLUE AREAS WHERE THE BUOY IS ATTACHED TO THE ROPE DESIGN. THE LETTERS F,L,A, AND T IN FLOAT ARE IN DARK BROWN WHILE THE LETTER O IS IN LIGHT BLUE. THE BACKGROUND OF THE MARK IS IN WHITE.

SER. NO. 77-313,926, FILED 10-25-2007.

ERNEST SHOSHO, EXAMINING ATTORNEY

**Int. Cl.: 25**

**Prior U.S. Cls.: 22 and 39**

**United States Patent and Trademark Office**

**Reg. No. 3,453,299**

**Registered June 24, 2008**

**TRADEMARK  
PRINCIPAL REGISTER**

**ALCOHOLOFAME**

MONTAG, JASON D (UNITED STATES INDIVIDUAL)  
238 SE 2ND AVENUE  
BOYNTON BEACH, FL 33435

THE MARK CONSISTS OF STANDARD CHARACTERS WITHOUT CLAIM TO ANY PARTICULAR FONT, STYLE, SIZE, OR COLOR.

FOR: KNIT SHIRTS; SHORT-SLEEVED SHIRTS; T-SHIRTS; TEE SHIRTS, IN CLASS 25 (U.S. CLS. 22 AND 39).

SER. NO. 77-313,931, FILED 10-25-2007.

FIRST USE 6-15-2007; IN COMMERCE 7-1-2007.

ERNEST SHOSHO, EXAMINING ATTORNEY

**Int. Cl.: 16**

**Prior U.S. Cls.: 2, 5, 22, 23, 29, 37, 38 and 50**

**Reg. No. 3,453,300**

**United States Patent and Trademark Office**

**Registered June 24, 2008**

**TRADEMARK  
PRINCIPAL REGISTER**

**Caracol Tarjeta Telefonica**

KDI DISTRIBUTION INC (CALIFORNIA CORPORATION), DBA KROSSLAND COMMUNICATIONS INC  
7771 STANTON AVE.  
BUENA PARK, CA 90620

FOR: TELEPHONE CALLING CARDS, NOT MAGNETICALLY ENCODED, IN CLASS 16 (U.S. CLS. 2, 5, 22, 23, 29, 37, 38 AND 50).

FIRST USE 10-25-2007; IN COMMERCE 10-25-2007.

THE MARK CONSISTS OF STANDARD CHARACTERS WITHOUT CLAIM TO ANY PARTICULAR FONT, STYLE, SIZE, OR COLOR.

NO CLAIM IS MADE TO THE EXCLUSIVE RIGHT TO USE "TARJETA TELEFONICA", APART FROM THE MARK AS SHOWN.

THE FOREIGN WORDING IN THE MARK TRANSLATES INTO ENGLISH AS SNAIL PHONE CARD.

SER. NO. 77-313,939, FILED 10-25-2007.

LEIGH CAROLINE CASE, EXAMINING ATTORNEY

**Int. Cl.: 25**

**Prior U.S. Cls.: 22 and 39**

**United States Patent and Trademark Office**

**Reg. No. 3,453,301**

**Registered June 24, 2008**

**TRADEMARK  
PRINCIPAL REGISTER**



BRIAN PETRECCIA (UNITED STATES INDIVIDUAL), DBA BACKWORDZ CLOTHING  
5640 SMOKEY MOUNTAIN WAY  
YORBA LINDA, CA 92887

FOR: SHORT-SLEEVED OR LONG-SLEEVED T-SHIRTS; T-SHIRTS; DRESS SHIRTS; GOLF SHIRTS; HEADBANDS AGAINST SWEATING; LONG-SLEEVED SHIRTS; POLO SHIRTS; SHIRTS; SHORT-SLEEVED SHIRTS; SLEEP SHIRTS; SWEAT BANDS; SWEAT PANTS; SWEAT SHIRTS; SWEAT SHORTS; SWEAT SUITS; DENIM JACKETS; DOWN JACKETS; HEAVY JACKETS; JACKETS; SLEEVED OR SLEEVELESS JACKETS; WIND RESISTANT JACKETS; WIND-JACKETS; HEADGEAR, NAME-

LY, HATS, BEANIES, AND BANDANAS; HATS; BEANIES; BANDANAS, IN CLASS 25 (U.S. CLS. 22 AND 39).

FIRST USE 10-1-2007; IN COMMERCE 10-10-2007.

THE MARK CONSISTS OF THE LETTER "B" FLIPPED BACKWARDS WRITTEN IN A STYLIZED GOTHIC FONT.

SER. NO. 77-313,956, FILED 10-25-2007.

JAY FLOWERS, EXAMINING ATTORNEY



**Int. Cl.: 9**

**Prior U.S. Cls.: 21, 23, 26, 36 and 38**

**Reg. No. 3,453,302**

**United States Patent and Trademark Office**

**Registered June 24, 2008**

**TRADEMARK  
PRINCIPAL REGISTER**

**EVOLVER**

COLE INDUSTRIES, INC. (NEVADA CORPORATION)  
4170-103 DISTRIBUTION CIRCLE  
NORTH LAS VEGAS, NV 89030

FOR: GAMING EQUIPMENT, NAMELY, CABINETS AND HOUSINGS FOR ELECTRONICALLY AND ELECTRO-MECHANICALLY OPERATED GAMING MACHINES, IN CLASS 9 (U.S. CLS. 21, 23, 26, 36 AND 38).

FIRST USE 11-13-2007; IN COMMERCE 11-13-2007.

THE MARK CONSISTS OF STANDARD CHARACTERS WITHOUT CLAIM TO ANY PARTICULAR FONT, STYLE, SIZE, OR COLOR.

SER. NO. 77-313,969, FILED 10-25-2007.

MICHELLE DUBOIS, EXAMINING ATTORNEY

**Int. Cl.: 35**

**Prior U.S. Cls.: 100, 101 and 102**

**United States Patent and Trademark Office**

**Reg. No. 3,453,303**

**Registered June 24, 2008**

---

**SERVICE MARK  
PRINCIPAL REGISTER**

**AdSpeed**

SON & EILEEN CORPORATION (CALIFORNIA CORPORATION), DBA ADSPEED.COM  
1154 SPIRO DRIVE  
SAN JOSE, CA 95116

FOR: DISSEMINATION OF ADVERTISING FOR OTHERS VIA THE INTERNET; PROMOTING, ADVERTISING AND MARKETING OF THE ON-LINE WEBSITES OF OTHERS, IN CLASS 35 (U.S. CLS. 100, 101 AND 102).

FIRST USE 6-17-2005; IN COMMERCE 6-17-2005.

THE MARK CONSISTS OF STANDARD CHARACTERS WITHOUT CLAIM TO ANY PARTICULAR FONT, STYLE, SIZE, OR COLOR.

SER. NO. 77-313,984, FILED 10-25-2007.

MICHELLE DUBOIS, EXAMINING ATTORNEY

**Int. Cl.: 36**

**Prior U.S. Cls.: 100, 101 and 102**

**United States Patent and Trademark Office**

**Reg. No. 3,453,304**

**Registered June 24, 2008**

**SERVICE MARK  
PRINCIPAL REGISTER**

**DRIBBLE FOR CANCER**

ADELIN, BUDARARA (BURUNDI INDIVIDUAL), DBA DRIBBLEFORCANCER.COM / STARLABS STUDIOS GLOBAL MEDIA  
APT# 102  
1715 MCALLISTER STREET  
SAN FRANCISCO, CA 94115

FOR: CHARITABLE FUND RAISING SERVICES BY MEANS OF AN ENTERTAINMENT EVENT, IN CLASS 36 (U.S. CLS. 100, 101 AND 102).

FIRST USE 5-6-2006; IN COMMERCE 5-6-2006.

THE MARK CONSISTS OF STANDARD CHARACTERS WITHOUT CLAIM TO ANY PARTICULAR FONT, STYLE, SIZE, OR COLOR.

SER. NO. 77-314,046, FILED 10-26-2007.

SUE LAWRENCE, EXAMINING ATTORNEY

**Int. Cl.: 41**

**Prior U.S. Cls.: 100, 101 and 107**

**United States Patent and Trademark Office**

**Reg. No. 3,453,305**

**Registered June 24, 2008**

**SERVICE MARK  
PRINCIPAL REGISTER**

**HOTSWEEPS**

SWEEPSNATION LLC (DELAWARE LTD LIAB  
CO)  
30 CANNONADE DR.  
MARLBORO, NJ 07746

FOR: SWEEPSTAKE SERVICES PROVIDED  
OVER A GLOBAL COMPUTER NETWORK, IN  
CLASS 41 (U.S. CLS. 100, 101 AND 107).

FIRST USE 10-1-2007; IN COMMERCE 10-1-2007.

THE MARK CONSISTS OF STANDARD CHAR-  
ACTERS WITHOUT CLAIM TO ANY PARTICULAR  
FONT, STYLE, SIZE, OR COLOR.

SER. NO. 77-314,060, FILED 10-26-2007.

CHRISTOPHER BUONGIORNO, EXAMINING AT-  
TORNEY

**Int. Cl.: 41**

**Prior U.S. Cls.: 100, 101 and 107**

**United States Patent and Trademark Office**

**Reg. No. 3,453,306**

**Registered June 24, 2008**

**SERVICE MARK  
PRINCIPAL REGISTER**

**PROGRESSIVE SWEEPS**

SWEEPSNATION LLC (DELAWARE LTD LIAB  
CO)  
30 CANNONADE DR.  
MARLBORO, NJ 07746

FOR: SWEEPSTAKE SERVICES PROVIDED  
OVER A GLOBAL COMPUTER NETWORK, IN  
CLASS 41 (U.S. CLS. 100, 101 AND 107).

FIRST USE 10-1-2007; IN COMMERCE 10-1-2007.

THE MARK CONSISTS OF STANDARD CHAR-  
ACTERS WITHOUT CLAIM TO ANY PARTICULAR  
FONT, STYLE, SIZE, OR COLOR.

SER. NO. 77-314,062, FILED 10-26-2007.

CHRISTOPHER BUONGIORNO, EXAMINING AT-  
TORNEY

**Int. Cl.: 41**

**Prior U.S. Cls.: 100, 101 and 107**

**United States Patent and Trademark Office**

**Reg. No. 3,453,307**

**Registered June 24, 2008**

**SERVICE MARK  
PRINCIPAL REGISTER**



SWEEPSNATION LLC (DELAWARE CORPORATION)  
30 CANNONADE DR.  
MARLBORO, NJ 07746

FOR: SWEEPSTAKE SERVICES PROVIDED  
OVER A GLOBAL COMPUTER NETWORK, IN  
CLASS 41 (U.S. CLS. 100, 101 AND 107).

FIRST USE 10-1-2007; IN COMMERCE 10-1-2007.

THE COLOR(S) RED, BLUE, WHITE AND LIGHT  
BLUE IS/ARE CLAIMED AS A FEATURE OF THE  
MARK.

THE MARK CONSISTS OF THE STYLIZED TERM  
"SWEEPS" IN THE COLOR RED COMBINED WITH  
THE STYLIZED TERM "NATION" THAT IS IN THE  
COLOR BLUE; A BLUE WAVE DESIGN APPEARS  
BEHIND THE TERM "SWEEPS" AND ABOVE IT;  
THE LETTERING OF THE TERMS HAVE A WHITE  
SHADOW ON THE EDGE; ALL OF THE ELEMENTS  
IN THE MARK APPEAR AGAINST A LIGHT BLUE  
RECTANGLE BACKGROUND.

SER. NO. 77-314,068, FILED 10-26-2007.

CHRISTOPHER BUONGIORNO, EXAMINING AT-  
TORNEY

**Int. Cl.: 35**

**Prior U.S. Cls.: 100, 101 and 102**

**United States Patent and Trademark Office**

**Reg. No. 3,453,308**

**Registered June 24, 2008**

---

**SERVICE MARK  
PRINCIPAL REGISTER**

**Fittron**

FITTRON (NEW JERSEY LTD LIAB CO)  
200 LINCOLN ST.  
ENGLEWOOD, NJ 07631

FIRST USE 7-10-2007; IN COMMERCE 8-7-2007.

FOR: PROVIDING A WEBSITE AT WHICH FITNESS PROFESSIONALS AND FACILITIES CAN POST PROMOTIONAL PROFILES AND RESPOND TO ADVERTISEMENTS FOR THEIR SERVICES, IN CLASS 35 (U.S. CLS. 100, 101 AND 102).

THE MARK CONSISTS OF STANDARD CHARACTERS WITHOUT CLAIM TO ANY PARTICULAR FONT, STYLE, SIZE, OR COLOR.

SER. NO. 77-314,086, FILED 10-26-2007.

ZACHARY BELLO, EXAMINING ATTORNEY

**Int. Cl.: 33**

**Prior U.S. Cls.: 47 and 49**

**United States Patent and Trademark Office**

**Reg. No. 3,453,309**

**Registered June 24, 2008**

**TRADEMARK  
PRINCIPAL REGISTER**

**LISTEL**

DOMAINES LISTEL (FRANCE SOCIÉTÉ ANON-  
YME PAR ACTIONS SIMPLIFIÉE)  
RN 112  
CHÂTEAU DE VILLEROY  
SÈTE, FRANCE 34200

THE MARK CONSISTS OF STANDARD CHAR-  
ACTERS WITHOUT CLAIM TO ANY PARTICULAR  
FONT, STYLE, SIZE, OR COLOR.

FOR: WINES, IN CLASS 33 (U.S. CLS. 47 AND 49).

SER. NO. 77-314,117, FILED 10-26-2007.

FIRST USE 10-0-2005; IN COMMERCE 10-0-2005.

HOWARD SMIGA, EXAMINING ATTORNEY



**Int. Cl.: 42**

**Prior U.S. Cls.: 100 and 101**

**United States Patent and Trademark Office**

**Reg. No. 3,453,310**

**Registered June 24, 2008**

**SERVICE MARK  
PRINCIPAL REGISTER**



DIGITAL ANGEL CORPORATION (DELAWARE CORPORATION)  
490 VILLAUME AVE  
SOUTH ST. PAUL, MN 55075

FOR: DESIGN OF RADIO FREQUENCY IDENTIFICATION PRODUCTS FOR OTHERS, IN CLASS 42 (U.S. CLS. 100 AND 101).

FIRST USE 10-1-2007; IN COMMERCE 10-1-2007.

THE COLOR(S) BLACK AND ORANGE IS/ARE CLAIMED AS A FEATURE OF THE MARK.

THE COLOR BLACK APPEARS IN THE STYLIZED "D" AND IN THE LOWER PORTION OF THE STYLIZED "F", THE COLOR ORANGE APPEARS IN THE UPPER PORTION OF THE STYLIZED "F".

SER. NO. 77-314,151, FILED 10-26-2007.

KAREN K. BUSH, EXAMINING ATTORNEY

**Int. Cl.: 9**

**Prior U.S. Cls.: 21, 23, 26, 36 and 38**

**United States Patent and Trademark Office**

**Reg. No. 3,453,311**

**Registered June 24, 2008**

**TRADEMARK  
PRINCIPAL REGISTER**

**DESTRON FEARING**

DIGITAL ANGEL CORPORATION (DELAWARE  
CORPORATION)  
490 VILLAUME AVE  
SOUTH ST. PAUL, MN 55075

FOR: RADIO FREQUENCY IDENTIFICATION  
AND BIOMETRIC SENSING PRODUCTS, NAMELY,  
MICROCHIPS AND READERS FOR ASSET, PER-  
SONNEL, AND ANIMAL IDENTIFICATION AND  
TRACKING, IN CLASS 9 (U.S. CLS. 21, 23, 26, 36 AND  
38).

FIRST USE 0-0-1994; IN COMMERCE 0-0-1994.

THE MARK CONSISTS OF STANDARD CHAR-  
ACTERS WITHOUT CLAIM TO ANY PARTICULAR  
FONT, STYLE, SIZE, OR COLOR.

OWNER OF U.S. REG. NOS. 1,476,570 AND  
2,312,960.

SER. NO. 77-314,156, FILED 10-26-2007.

KAREN K. BUSH, EXAMINING ATTORNEY

**Int. Cl.: 42**

**Prior U.S. Cls.: 100 and 101**

**United States Patent and Trademark Office**

**Reg. No. 3,453,312**

**Registered June 24, 2008**

**SERVICE MARK  
PRINCIPAL REGISTER**

**DESTRON FEARING**

DIGITAL ANGEL CORPROATION (DELAWARE  
CORPORATION)  
490 VILLAUME AVE  
SOUTH ST. PAUL, MN 55075

FOR: DESIGN OF RADIO FREQUENCY IDENTI-  
FICATION PRODUCTS FOR OTHERS, IN CLASS 42  
(U.S. CLS. 100 AND 101).

FIRST USE 0-0-1994; IN COMMERCE 0-0-1994.

THE MARK CONSISTS OF STANDARD CHAR-  
ACTERS WITHOUT CLAIM TO ANY PARTICULAR  
FONT, STYLE, SIZE, OR COLOR.

OWNER OF U.S. REG. NOS. 1,476,570 AND  
2,312,960.

SER. NO. 77-314,159, FILED 10-26-2007.

KAREN K. BUSH, EXAMINING ATTORNEY

**Int. Cl.: 5**

**Prior U.S. Cls.: 6, 18, 44, 46, 51 and 52**

**Reg. No. 3,453,313**

**United States Patent and Trademark Office**

**Registered June 24, 2008**

---

**TRADEMARK  
PRINCIPAL REGISTER**

**ADAPTIVE ADVANTAGES**

VITA-ROYAL PRODUCTS, INC. (SOUTH DAKOTA CORPORATION)  
840 HUSKER PLACE  
RAPID CITY, SD 57701

THE MARK CONSISTS OF STANDARD CHARACTERS WITHOUT CLAIM TO ANY PARTICULAR FONT, STYLE, SIZE, OR COLOR.

FOR: DIETARY SUPPLEMENTS, IN CLASS 5 (U.S. CLS. 6, 18, 44, 46, 51 AND 52).

SER. NO. 77-314,167, FILED 10-26-2007.

FIRST USE 1-24-1995; IN COMMERCE 1-24-1995.

MARK RADEMACHER, EXAMINING ATTORNEY

**Int. Cl.: 12**

**Prior U.S. Cls.: 19, 21, 23, 31, 35 and 44**

**Reg. No. 3,453,314**

**United States Patent and Trademark Office**

**Registered June 24, 2008**

---

**TRADEMARK  
PRINCIPAL REGISTER**

***Racing Hart***

TAKECHI PROJECT CO., LTD. (JAPAN CORPORATION)  
1436-1, HIRAI, MATSUYAMA  
EHIME-KEN, JAPAN

FIRST USE 1-0-1997; IN COMMERCE 1-0-1997.

SER. NO. 77-314,170, FILED 10-26-2007.

FOR: AUTOMOBILE PARTS, NAMELY, AUTOMOBILE WHEELS, IN CLASS 12 (U.S. CLS. 19, 21, 23, 31, 35 AND 44).

MARK RADEMACHER, EXAMINING ATTORNEY

**Int. Cl.: 14**

**Prior U.S. Cls.: 2, 27, 28 and 50**

**United States Patent and Trademark Office**

**Reg. No. 3,453,315**

**Registered June 24, 2008**

**TRADEMARK  
PRINCIPAL REGISTER**

**COVENANT HEARTS**

COVENANT HEARTS MINISTRIES, INC. (KENTUCKY CORPORATION)

3129 CHATHAM DRIVE

LEXINGTON, KY 40503

FOR: JEWELRY, NAMELY, RINGS AND PENDANTS, IN CLASS 14 (U.S. CLS. 2, 27, 28 AND 50).

FIRST USE 12-11-2006; IN COMMERCE 12-11-2006.

THE MARK CONSISTS OF STANDARD CHARACTERS WITHOUT CLAIM TO ANY PARTICULAR FONT, STYLE, SIZE, OR COLOR.

NO CLAIM IS MADE TO THE EXCLUSIVE RIGHT TO USE 'HEARTS', APART FROM THE MARK AS SHOWN.

SER. NO. 77-314,172, FILED 10-26-2007.

DAWN FELDMAN, EXAMINING ATTORNEY

**Int. Cls.: 37 and 44**

**Prior U.S. Cls.: 100, 101, 103 and 106**

**United States Patent and Trademark Office**

**Reg. No. 3,453,316**

**Registered June 24, 2008**

**SERVICE MARK  
PRINCIPAL REGISTER**

**ENHANCESCAPE**

ENHANCESCAPE CORPORATION (DELAWARE CORPORATION)

SUITE 2A

706 GIDDINGS AVENUE

ANNAPOLIS, MD 21401

FOR: ASPHALT REPAIR AND SEAL COATING SERVICES; PRESSURE WASHING SERVICES, IN CLASS 37 (U.S. CLS. 100, 103 AND 106).

FIRST USE 2-28-2006; IN COMMERCE 2-28-2006.

FOR: LANDSCAPING SERVICES, IN CLASS 44 (U.S. CLS. 100 AND 101).

FIRST USE 2-28-2006; IN COMMERCE 2-28-2006.

THE MARK CONSISTS OF STANDARD CHARACTERS WITHOUT CLAIM TO ANY PARTICULAR FONT, STYLE, SIZE, OR COLOR.

SER. NO. 77-314,181, FILED 10-26-2007.

MATTHEW PAPPAS, EXAMINING ATTORNEY

**Int. Cl.: 1**

**Prior U.S. Cls.: 1, 5, 6, 10, 26 and 46**

**Reg. No. 3,453,317**

**United States Patent and Trademark Office**

**Registered June 24, 2008**

---

**TRADEMARK  
PRINCIPAL REGISTER**

# Enviropol

LENDELL MANUFACTURING, INC. (MICHIGAN CORPORATION)  
5301 S. GRAHAM ROAD  
SAINT CHARLES, MI 48655

THE MARK CONSISTS OF STANDARD CHARACTERS WITHOUT CLAIM TO ANY PARTICULAR FONT, STYLE, SIZE, OR COLOR.

FOR: POLYMER BASE COMPOSITIONS USED IN THE MANUFACTURE OF COMMERCIAL, INDUSTRIAL AND DOMESTIC GOODS, IN CLASS 1 (U.S. CLS. 1, 5, 6, 10, 26 AND 46).

SER. NO. 77-314,207, FILED 10-26-2007.

FIRST USE 3-25-2007; IN COMMERCE 6-4-2007.

DAVID COLLIER, EXAMINING ATTORNEY



**Int. Cl.: 44**

**Prior U.S. Cls.: 100 and 101**

**United States Patent and Trademark Office**

**Reg. No. 3,453,318**

**Registered June 24, 2008**

**SERVICE MARK  
PRINCIPAL REGISTER**

**IN A WRECK YOU NEED TO GET  
CHECKED**

PICCIRILLO, DANA (UNITED STATES INDIVIDUAL)  
BUILDING 3, SUTIE 114  
2171 NORTH LAKE PARKWAY  
TUCKER, GA 30084

THE MARK CONSISTS OF STANDARD CHARACTERS WITHOUT CLAIM TO ANY PARTICULAR FONT, STYLE, SIZE, OR COLOR.

FOR: MEDICAL SERVICES; CHIROPRACTIC SERVICES; PHYSICAL THERAPY, IN CLASS 44 (U.S. CLS. 100 AND 101).

SER. NO. 77-314,219, FILED 10-26-2007.

FIRST USE 1-15-2007; IN COMMERCE 1-15-2007.

ROSELLE HERRERA, EXAMINING ATTORNEY

**Int. Cl.: 17**

**Prior U.S. Cls.: 1, 5, 12, 13, 35 and 50**

**United States Patent and Trademark Office**

**Reg. No. 3,453,319**

**Registered June 24, 2008**

**TRADEMARK  
PRINCIPAL REGISTER**

# Nolasponge

LENDELL MANUFACTURING, INC. (MICHIGAN CORPORATION)  
5301 S. GRAHAM ROAD  
SAINT CHARLES, MI 48655

THE MARK CONSISTS OF STANDARD CHARACTERS WITHOUT CLAIM TO ANY PARTICULAR FONT, STYLE, SIZE, OR COLOR.

FOR: OPEN CELL FOAM IN ROLL FORM, IN CLASS 17 (U.S. CLS. 1, 5, 12, 13, 35 AND 50).

SER. NO. 77-314,221, FILED 10-26-2007.

FIRST USE 10-28-1998; IN COMMERCE 10-28-1998.

DAVID COLLIER, EXAMINING ATTORNEY

**Int. Cls.: 9, 16 and 41**

**Prior U.S. Cls.: 2, 5, 21, 22, 23, 26, 29, 36, 37, 38, 50,  
100, 101 and 107**

**Reg. No. 3,453,320**

**United States Patent and Trademark Office**

**Registered June 24, 2008**

**TRADEMARK  
SERVICE MARK  
PRINCIPAL REGISTER**

**THE CHICAGO MANUAL OF STYLE**

THE UNIVERSITY OF CHICAGO (ILLINOIS  
NON-PROFIT CORPORATION)  
5801 ELLIS AVENUE  
CHICAGO, IL 60637

FOR: ELECTRONIC PUBLICATIONS, NAMELY,  
MANUAL FEATURING A STYLE GUIDE FOR  
WRITERS AND EDITORS RECORDED ON COM-  
PUTER MEDIA; MULTIMEDIA SOFTWARE RE-  
CORDED ON CD-ROM FEATURING A STYLE  
GUIDE FOR WRITERS AND EDITORS, IN CLASS  
9 (U.S. CLS. 21, 23, 26, 36 AND 38).

FIRST USE 0-0-2006; IN COMMERCE 0-0-2006.

FOR: MANUALS IN THE FIELD OF EDITING  
AND WRITING; BOOKS IN THE FIELD OF EDIT-  
ING AND WRITING, IN CLASS 16 (U.S. CLS. 2, 5, 22,  
23, 29, 37, 38 AND 50).

FIRST USE 0-0-1982; IN COMMERCE 0-0-1982.

FOR: ON-LINE PUBLICATION OF A STYLE  
GUIDE FOR WRITERS AND EDITORS, IN CLASS  
41 (U.S. CLS. 100, 101 AND 107).

FIRST USE 9-0-2006; IN COMMERCE 9-0-2006.

THE MARK CONSISTS OF STANDARD CHAR-  
ACTERS WITHOUT CLAIM TO ANY PARTICULAR  
FONT, STYLE, SIZE, OR COLOR.

NO CLAIM IS MADE TO THE EXCLUSIVE  
RIGHT TO USE "MANUAL OF STYLE", APART  
FROM THE MARK AS SHOWN.

SEC. 2(F).

SER. NO. 77-314,245, FILED 10-26-2007.

JULIE WATSON, EXAMINING ATTORNEY

**Int. Cl.: 36**

**Prior U.S. Cls.: 100, 101 and 102**

**United States Patent and Trademark Office**

**Reg. No. 3,453,321**

**Registered June 24, 2008**

**SERVICE MARK  
PRINCIPAL REGISTER**

**GREAT THINGS HAPPEN**

HEARTLAND FINANCIAL USA, INC. (DELA-  
WARE CORPORATION)  
1398 CENTRAL AVENUE  
DUBUQUE, IA 52001

THE MARK CONSISTS OF STANDARD CHAR-  
ACTERS WITHOUT CLAIM TO ANY PARTICULAR  
FONT, STYLE, SIZE, OR COLOR.

FOR: BANKING SERVICES, IN CLASS 36 (U.S.  
CLS. 100, 101 AND 102).

SER. NO. 77-314,246, FILED 10-26-2007.

FIRST USE 1-15-2007; IN COMMERCE 1-15-2007.

SARA THOMAS, EXAMINING ATTORNEY

**Int. Cl.: 35**

**Prior U.S. Cls.: 100, 101 and 102**

**United States Patent and Trademark Office**

**Reg. No. 3,453,322**

**Registered June 24, 2008**

**SERVICE MARK  
PRINCIPAL REGISTER**

**Guard Dog Brand Development**

CASINI, MARIA (UNITED STATES INDIVIDUAL)  
16 KEVIN CT.  
MALVERNE, NY 11565 AND  
DESANTIS, CAMILLE (UNITED STATES INDIVIDUAL)  
16 KEVIN CT.  
MALVERNE, NY 11565

FOR: ADVERTISING, MARKETING, BRANDING, NAMELY, CREATING BRAND STRATEGIES AND BRAND IDENTITIES FOR COMPANIES AND PRODUCTS, AND PROMOTION SERVICES, IN CLASS 35 (U.S. CLS. 100, 101 AND 102).

FIRST USE 9-1-2007; IN COMMERCE 9-1-2007.

THE MARK CONSISTS OF STANDARD CHARACTERS WITHOUT CLAIM TO ANY PARTICULAR FONT, STYLE, SIZE, OR COLOR.

NO CLAIM IS MADE TO THE EXCLUSIVE RIGHT TO USE "BRAND DEVELOPMENT", APART FROM THE MARK AS SHOWN.

SER. NO. 77-314,249, FILED 10-26-2007.

JANICE KIM, EXAMINING ATTORNEY

**Int. Cl.: 33**

**Prior U.S. Cls.: 47 and 49**

**United States Patent and Trademark Office**

**Reg. No. 3,453,323**

**Registered June 24, 2008**

**TRADEMARK  
PRINCIPAL REGISTER**

**CEVICHE**

ZWINECO LLC (CALIFORNIA LTD LIAB CO)  
P.O. BOX 6979  
NAPA, CA 94581

THE MARK CONSISTS OF STANDARD CHAR-  
ACTERS WITHOUT CLAIM TO ANY PARTICULAR  
FONT, STYLE, SIZE, OR COLOR.

FOR: WINE, IN CLASS 33 (U.S. CLS. 47 AND 49).

SER. NO. 77-314,261, FILED 10-26-2007.

FIRST USE 12-11-2003; IN COMMERCE 12-11-2003.

MATTHEW PAPPAS, EXAMINING ATTORNEY

**Int. Cl.: 41**

**Prior U.S. Cls.: 100, 101 and 107**

**United States Patent and Trademark Office**

**Reg. No. 3,453,324**

**Registered June 24, 2008**

**SERVICE MARK  
PRINCIPAL REGISTER**

**SUCCESS LITERACY**

FOSTER, MARTIN (UNITED STATES INDIVIDUAL)  
P.O. BOX 248  
ROSELLE, NJ 07203

FOR: INSTRUCTION IN THE FIELD OF ALTRUISM, INSPIRATION, MOTIVATION, HEALTH AND FITNESS, POSITIVE THINKING, POSITIVE LIVING, RELATIONSHIPS, WEALTH, FINANCIAL MANAGEMENT, SELF-DEVELOPMENT, SELF-IMPROVEMENT, PEACE, HARMONY, SOCIAL CONSCIOUSNESS, SPIRITUALITY, SELF-HELP AND PERSONAL EMPOWERMENT, THROUGH ELECTRONIC DATABASES, ONLINE NEWS ARTICLES, WEB-LOGS, BOOKS, MAGAZINES, NEWS-

LETTERS, MEMBERSHIPS, POLLS, INTERNET AND TELEVISION-QUALITY VIDEOS, COMMENTARY AND INTERVIEWS, IN CLASS 41 (U.S. CLS. 100, 101 AND 107).

FIRST USE 10-20-2007; IN COMMERCE 10-20-2007.

THE MARK CONSISTS OF STANDARD CHARACTERS WITHOUT CLAIM TO ANY PARTICULAR FONT, STYLE, SIZE, OR COLOR.

SER. NO. 77-314,270, FILED 10-26-2007.

FRED MANDIR, EXAMINING ATTORNEY

**Int. Cl.: 45**

**Prior U.S. Cls.: 100 and 101**

**United States Patent and Trademark Office**

**Reg. No. 3,453,325**

**Registered June 24, 2008**

**SERVICE MARK  
PRINCIPAL REGISTER**

**SUCCESS LITERACY**

FOSTER, MARTIN (UNITED STATES INDIVIDUAL)  
P.O. BOX 248  
ROSELLE, NJ 07203

FOR: PROVIDING ON-LINE INFORMATION IN THE FIELD OF SPIRITUALITY, SELF-HELP, AND PERSONAL EMPOWERMENT SUBJECT MATTERS; PROVIDING INFORMATION IN THE FIELD OF SELF-IMPROVEMENT , IN CLASS 45 (U.S. CLS. 100 AND 101).

FIRST USE 10-20-2007; IN COMMERCE 10-20-2007.

THE MARK CONSISTS OF STANDARD CHARACTERS WITHOUT CLAIM TO ANY PARTICULAR FONT, STYLE, SIZE, OR COLOR.

SER. NO. 77-314,274, FILED 10-26-2007.

FRED MANDIR, EXAMINING ATTORNEY



**Int. Cl.: 5**

**Prior U.S. Cls.: 6, 18, 44, 46, 51 and 52**

**Reg. No. 3,453,326**

**United States Patent and Trademark Office**

**Registered June 24, 2008**

**TRADEMARK  
PRINCIPAL REGISTER**

**LIFECAPS**

LIFE CAPS LLC (UTAH LTD LIAB CO)  
1401 LOMBARDY PLACE  
SALT LAKE CITY, UT 84121

THE MARK CONSISTS OF STANDARD CHAR-  
ACTERS WITHOUT CLAIM TO ANY PARTICULAR  
FONT, STYLE, SIZE, OR COLOR.

FOR: DIETARY SUPPLEMENTS; NUTRITIONAL  
SUPPLEMENTS, IN CLASS 5 (U.S. CLS. 6, 18, 44, 46, 51  
AND 52).

SER. NO. 77-314,290, FILED 10-26-2007.

FIRST USE 9-1-2007; IN COMMERCE 9-1-2007.

LINDA MICKLEBURGH, EXAMINING ATTORNEY

**Int. Cl.: 5**

**Prior U.S. Cls.: 6, 18, 44, 46, 51 and 52**

**Reg. No. 3,453,327**

**United States Patent and Trademark Office**

**Registered June 24, 2008**

**TRADEMARK  
PRINCIPAL REGISTER**

**FOODFORM MANNA**

INTRACELL NUTRITION INC. (HAWAII COR-  
PORATION)  
SIXTH FLOOR  
433 HACKENSACK AVENUE  
HACKENSACK, NJ 07601

FOR: DIETARY FOOD SUPPLEMENTS FOR HU-  
MAN CONSUMPTION, IN CLASS 5 (U.S. CLS. 6, 18,  
44, 46, 51 AND 52).

FIRST USE 6-0-1984; IN COMMERCE 6-0-1984.

THE MARK CONSISTS OF STANDARD CHAR-  
ACTERS WITHOUT CLAIM TO ANY PARTICULAR  
FONT, STYLE, SIZE, OR COLOR.

OWNER OF U.S. REG. NOS. 1,340,011, 2,422,411,  
AND 3,116,928.

SER. NO. 77-314,308, FILED 10-26-2007.

SOPHIA S. KIM, EXAMINING ATTORNEY

**Int. Cls.: 35 and 41**

**Prior U.S. Cls.: 100, 101, 102 and 107**

**United States Patent and Trademark Office**

**Reg. No. 3,453,328**

**Registered June 24, 2008**

**SERVICE MARK  
PRINCIPAL REGISTER**

**CHIRA DHARMA**

WALLS, SUSANA D. (UNITED STATES INDIVIDUAL), DBA CHIRA DHARMA PUBLISHING  
10 WHITEHEAD CIRCLE  
WESTON, FL 33326

FOR: ON-LINE RETAIL STORE SERVICES FEATURING PRINTED PUBLICATIONS, IN CLASS 35 (U.S. CLS. 100, 101 AND 102).

FIRST USE 9-26-2007; IN COMMERCE 9-26-2007.

FOR: PUBLISHING OF BOOKS, IN CLASS 41 (U.S. CLS. 100, 101 AND 107).

FIRST USE 9-26-2007; IN COMMERCE 10-8-2007.

THE MARK CONSISTS OF STANDARD CHARACTERS WITHOUT CLAIM TO ANY PARTICULAR FONT, STYLE, SIZE, OR COLOR.

THE FOREIGN WORDING IN THE MARK "DHARMA" TRANSLATES INTO ENGLISH AS THAT WHICH UPHOLDS AND SUPPORTS.

SER. NO. 77-314,313, FILED 10-26-2007.

SOPHIA S. KIM, EXAMINING ATTORNEY

**Int. Cl.: 29**

**Prior U.S. Cl.: 46**

**United States Patent and Trademark Office**

**Reg. No. 3,453,329**

**Registered June 24, 2008**

**TRADEMARK  
PRINCIPAL REGISTER**

**49TH STAR**

NORTH PACIFIC SEAFOODS, INC. (WASHINGTON CORPORATION)  
4 NICKERSON STREET, SUITE 400  
SEATTLE, WA 98103

FOR: FRESH, FROZEN, AND PROCESSED SEAFOOD, IN CLASS 29 (U.S. CL. 46).

FIRST USE 5-9-1973; IN COMMERCE 5-9-1973.

THE MARK CONSISTS OF STANDARD CHARACTERS WITHOUT CLAIM TO ANY PARTICULAR FONT, STYLE, SIZE, OR COLOR.

OWNER OF U.S. REG. NOS. 1,504,152 AND 2,230,756.

SER. NO. 77-314,317, FILED 10-26-2007.

LINDA ORNDORFF, EXAMINING ATTORNEY

**Int. Cl.: 11**

**Prior U.S. Cls.: 13, 21, 23, 31 and 34**

**United States Patent and Trademark Office**

**Reg. No. 3,453,330**

**Registered June 24, 2008**

**TRADEMARK  
PRINCIPAL REGISTER**

**TRANS GLOBE**

BEL AIR LIGHTING, INC. (CALIFORNIA CORPORATION)  
28104 WITHERSPOON PARKWAY  
VALENCIA, CA 91355

FOR: LAMP SHADES; LAMPS; LAMP BASES; LIGHTING FIXTURES; WALL LIGHTS; SCONCE LIGHTING FIXTURES; LED (LIGHT EMITTING DIODES) LIGHTING FIXTURES FOR USE IN DISPLAY, COMMERCIAL, INDUSTRIAL, RESIDENTIAL, AND ARCHITECTURAL ACCENT LIGHTING APPLICATIONS, IN CLASS 11 (U.S. CLS. 13, 21, 23, 31 AND 34).

FIRST USE 1-0-1986; IN COMMERCE 1-0-1986.

THE MARK CONSISTS OF STANDARD CHARACTERS WITHOUT CLAIM TO ANY PARTICULAR FONT, STYLE, SIZE, OR COLOR.

SER. NO. 77-314,319, FILED 10-26-2007.

KHANH LE, EXAMINING ATTORNEY

**Int. Cl.: 3**

**Prior U.S. Cls.: 1, 4, 6, 50, 51 and 52**

**United States Patent and Trademark Office**

**Reg. No. 3,453,331**

**Registered June 24, 2008**

**TRADEMARK  
PRINCIPAL REGISTER**

# ProFollica

LEADING EDGE MARKETING, INC. (BAHAMAS  
CORPORATION)  
SUITE 1210 P.O. BOX CR 56766  
#33 HARBOUR BAY PLAZA  
NASSAU, NEW PROVIDENCE, BAHAMAS

FOR: SHAMPOOS; HAIR CARE KITS COMPRIS-  
ING NON-MEDICATED HAIR CARE PREPARA-  
TIONS, NAMELY, A SHAMPOO AND ACTIVATOR  
GEL.; HAIR GEL, IN CLASS 3 (U.S. CLS. 1, 4, 6, 50, 51  
AND 52).

FIRST USE 1-1-2006; IN COMMERCE 1-1-2006.

THE MARK CONSISTS OF STANDARD CHAR-  
ACTERS WITHOUT CLAIM TO ANY PARTICULAR  
FONT, STYLE, SIZE, OR COLOR.

SER. NO. 77-314,346, FILED 10-26-2007.

MARIA-VICTORIA SUAREZ, EXAMINING ATTOR-  
NEY

**Int. Cls.: 37 and 42**

**Prior U.S. Cls.: 100, 101, 103 and 106**

**United States Patent and Trademark Office**

**Reg. No. 3,453,332**

**Registered June 24, 2008**

**SERVICE MARK  
PRINCIPAL REGISTER**



TRI-STATE UTILITIES CO. (VIRGINIA CORPORATION)  
2111 SMITH AVENUE  
CHESAPEAKE, VA 23320

FOR: PIPELINE INSTALLATION AND REPAIR,  
IN CLASS 37 (U.S. CLS. 100, 103 AND 106).

FIRST USE 9-26-1990; IN COMMERCE 9-26-1990.

FOR: PIPELINE INSPECTION SERVICES, IN  
CLASS 42 (U.S. CLS. 100 AND 101).

FIRST USE 9-26-1990; IN COMMERCE 9-26-1990.

NO CLAIM IS MADE TO THE EXCLUSIVE  
RIGHT TO USE "UTILITIES" AND THE REPRESENTATION

OF THE CONTIGUOUS STATES OF VIRGINIA, NORTH CAROLINA, AND SOUTH CAROLINA, APART FROM THE MARK AS SHOWN.

THE MARK CONSISTS OF THE STYLIZED WORDS "TRI STATE UTILITIES" LOCATED WITHIN AN OVAL BORDER. LOCATED WITHIN THE BOTTOM LOOP OF THE "S" IN "STATE" IS A GRAPHIC REPRESENTATION OF THE CONTIGUOUS STATES OF VIRGINIA, NORTH CAROLINA, AND SOUTH CAROLINA.

SER. NO. 77-314,355, FILED 10-26-2007.

HANNO RITTNER, EXAMINING ATTORNEY

**Int. Cl.: 1**

**Prior U.S. Cls.: 1, 5, 6, 10, 26 and 46**

**Reg. No. 3,453,333**

**United States Patent and Trademark Office**

**Registered June 24, 2008**

---

**TRADEMARK  
PRINCIPAL REGISTER**

**Optipol**

LENDELL MANUFACTURING, INC. (MICHIGAN CORPORATION)  
5301 S. GRAHAM ROAD  
SAINT CHARLES, MI 48655

THE MARK CONSISTS OF STANDARD CHARACTERS WITHOUT CLAIM TO ANY PARTICULAR FONT, STYLE, SIZE, OR COLOR.

FOR: POLYMER BASE COMPOSITIONS USED IN THE MANUFACTURE OF COMMERCIAL, INDUSTRIAL AND DOMESTIC GOODS, IN CLASS 1 (U.S. CLS. 1, 5, 6, 10, 26 AND 46).

SER. NO. 77-314,378, FILED 10-26-2007.

FIRST USE 9-14-2001; IN COMMERCE 9-14-2001.

DAVID COLLIER, EXAMINING ATTORNEY



**Int. Cl.: 38**

**Prior U.S. Cls.: 100, 101 and 104**

**United States Patent and Trademark Office**

**Reg. No. 3,453,334**

**Registered June 24, 2008**

**SERVICE MARK  
PRINCIPAL REGISTER**

**COMP-U-CALL plus**

BLUERATE TELECOM USA, INC. (FLORIDA  
CORPORATION)  
2675 HORSESHOE DRIVE SOUTH # 401  
NAPLES, FL 34104

THE MARK CONSISTS OF STANDARD CHAR-  
ACTERS WITHOUT CLAIM TO ANY PARTICULAR  
FONT, STYLE, SIZE, OR COLOR.

FOR: VOICE OVER INTERNET PROTOCOL  
(VOIP) SERVICES, IN CLASS 38 (U.S. CLS. 100, 101  
AND 104).

SER. NO. 77-314,403, FILED 10-26-2007.

FIRST USE 5-31-2007; IN COMMERCE 9-10-2007.

RAUL CORDOVA, EXAMINING ATTORNEY

**Int. Cl.: 45**

**Prior U.S. Cls.: 100 and 101**

**United States Patent and Trademark Office**

**Reg. No. 3,453,335**

**Registered June 24, 2008**

**SERVICE MARK  
PRINCIPAL REGISTER**

**PROTECTING THE RIGHTS OF  
CREATIVE MINDS**

BUCKNER, KRISTOPHER (UNITED STATES IN-  
DIVIDUAL)  
14979 PRAIRIE AVENUE  
LAWNDALE, CA 90260

FOR: BACKGROUND INVESTIGATION AND  
RESEARCH SERVICES; DETECTIVE INVESTIGA-  
TIONS; INVESTIGATION OR SURVEILLANCE ON  
BACKGROUND PROFILES; PERSONAL BACK-  
GROUND INVESTIGATIONS; PRIVATE INVESTI-  
GATION, IN CLASS 45 (U.S. CLS. 100 AND 101).

FIRST USE 10-15-2007; IN COMMERCE 10-15-2007.

THE MARK CONSISTS OF STANDARD CHAR-  
ACTERS WITHOUT CLAIM TO ANY PARTICULAR  
FONT, STYLE, SIZE, OR COLOR.

SER. NO. 77-314,428, FILED 10-26-2007.

MATTHEW PAPPAS, EXAMINING ATTORNEY

**Int. Cl.: 28**

**Prior U.S. Cls.: 22, 23, 38 and 50**

**Reg. No. 3,453,336**

**United States Patent and Trademark Office**

**Registered June 24, 2008**

---

**TRADEMARK  
PRINCIPAL REGISTER**

**BRADBOW**

BRADBOW, INC. (GEORGIA CORPORATION)  
26 PUTTER'S PLACE  
SAVANNAH, GA 31419

THE MARK CONSISTS OF STANDARD CHAR-  
ACTERS WITHOUT CLAIM TO ANY PARTICULAR  
FONT, STYLE, SIZE, OR COLOR.

FOR: ARCHERY EQUIPMENT, NAMELY, NON-  
TELESCOPIC BOW SIGHTS, IN CLASS 28 (U.S. CLS.  
22, 23, 38 AND 50).

SER. NO. 77-314,463, FILED 10-26-2007.

FIRST USE 8-1-2007; IN COMMERCE 9-30-2007.

GEORGE LORENZO, EXAMINING ATTORNEY

**Int. Cl.: 35**

**Prior U.S. Cls.: 100, 101 and 102**

**United States Patent and Trademark Office**

**Reg. No. 3,453,337**

**Registered June 24, 2008**

**SERVICE MARK  
PRINCIPAL REGISTER**



PLANITOPEN, LLC (VIRGINIA LTD LIAB CO)  
40644 STONEBURNER MILL LANE  
LOVETTSVILLE, VA 201802241

FOR: NATIONAL ON-LINE OPEN HOUSE LISTING SERVICE PROVIDING ADVERTISING OF CURRENT REAL ESTATE OPEN HOUSES VIA THE INTERNET, IN CLASS 35 (U.S. CLS. 100, 101 AND 102).

FIRST USE 4-19-2007; IN COMMERCE 4-19-2007.

THE COLOR(S) BLUE, GREEN, RED, ORANGE, YELLOW AND BLACK IS/ARE CLAIMED AS A FEATURE OF THE MARK.

THE MARK CONSISTS OF THE COLOR GREEN APPEARS IN HOUSE ROOF; THE COLOR BLUE APPEARS IN THE WINDOWS; THE COLOR RED APPEARS IN THE TERM "PLANITOPEN" AND "COM"; THE COLOR ORANGE APPEARS IN THE DOT BEFORE THE TERM "COM" AND IN THE HOUSE AND IN THE CENTER OF THE WHEELS; THE COLOR YELLOW APPEARS IN THE HOUSE; THE COLOR BLACK APPEARS IN THE WHEELS AND IN THE PHRASE "YOUR OPEN HOUSE EVOLVED".

SER. NO. 77-314,517, FILED 10-26-2007.

CHRISTOPHER BUONGIORNO, EXAMINING ATTORNEY

**Int. Cl.: 10**

**Prior U.S. Cls.: 26, 39 and 44**

**Reg. No. 3,453,338**

**United States Patent and Trademark Office**

**Registered June 24, 2008**

---

**TRADEMARK  
PRINCIPAL REGISTER**

**Medis**

TIANJIN MEDIS MEDICAL DEVICE CO., LTD.  
(CHINA CORPORATION)  
NO.12 HONG YUANG RD, XIQING ECO.DEV.ZONE  
10-A TIANJIN INDUSTRIAL CENTER  
TIANJIN, CHINA

THE MARK CONSISTS OF STANDARD CHAR-  
ACTERS WITHOUT CLAIM TO ANY PARTICULAR  
FONT, STYLE, SIZE, OR COLOR.

FOR: MEDICAL DEVICES, NAMELY, LARYN-  
GEAL MASKS, IN CLASS 10 (U.S. CLS. 26, 39 AND  
44).

SER. NO. 77-314,518, FILED 10-26-2007.

FIRST USE 0-0-2001; IN COMMERCE 0-0-2006.

MARY CRAWFORD, EXAMINING ATTORNEY

**Int. Cl.: 17**

**Prior U.S. Cls.: 1, 5, 12, 13, 35 and 50**

**United States Patent and Trademark Office**

**Reg. No. 3,453,339**

**Registered June 24, 2008**

**TRADEMARK  
PRINCIPAL REGISTER**

# Nolaphil

LENDELL MANUFACTURING, INC. (MICHIGAN CORPORATION)  
5301 S. GRAHAM ROAD  
SAINT CHARLES, MI 48655

THE MARK CONSISTS OF STANDARD CHARACTERS WITHOUT CLAIM TO ANY PARTICULAR FONT, STYLE, SIZE, OR COLOR.

FOR: OPEN CELL FOAM IN ROLL FORM, IN CLASS 17 (U.S. CLS. 1, 5, 12, 13, 35 AND 50).

SER. NO. 77-314,550, FILED 10-26-2007.

FIRST USE 8-16-1999; IN COMMERCE 8-16-1999.

DAVID COLLIER, EXAMINING ATTORNEY

**Int. Cl.: 42**

**Prior U.S. Cls.: 100 and 101**

**United States Patent and Trademark Office**

**Reg. No. 3,453,340**

**Registered June 24, 2008**

**SERVICE MARK  
PRINCIPAL REGISTER**

# Customer Dynamics

REDWARE, INC. (UTAH CORPORATION)  
SUITE 200  
254 SOUTH 600 EAST  
SALT LAKE CITY, UT 84102

FOR: COMPUTER SOFTWARE CONSULTATION  
SERVICES FOR CUSTOMER RELATIONSHIP SOFTWARE  
APPLICATIONS, IN CLASS 42 (U.S. CLS. 100  
AND 101).

FIRST USE 4-15-2007; IN COMMERCE 4-15-2007.

THE MARK CONSISTS OF STANDARD CHAR-  
ACTERS WITHOUT CLAIM TO ANY PARTICULAR  
FONT, STYLE, SIZE, OR COLOR.

NO CLAIM IS MADE TO THE EXCLUSIVE  
RIGHT TO USE "CUSTOMER", APART FROM  
THE MARK AS SHOWN.

SER. NO. 77-314,556, FILED 10-26-2007.

KIMBERLY FRYE, EXAMINING ATTORNEY

**Int. Cl.: 28**

**Prior U.S. Cls.: 22, 23, 38 and 50**

**United States Patent and Trademark Office**

**Reg. No. 3,453,341**

**Registered June 24, 2008**

**TRADEMARK  
PRINCIPAL REGISTER**

**NOWSTALGIC TOYS**

NOWSTALGIC TOYS, INC. (OHIO CORPORATION)  
7285 ZAPATA PLACE NW  
PICKERINGTON, OH 43147

FOR: PLUSH TOYS; HAND PUPPETS; STUFFED PUPPETS; MAGIC TRICKS, IN CLASS 28 (U.S. CLS. 22, 23, 38 AND 50).

FIRST USE 8-10-2007; IN COMMERCE 8-10-2007.

THE MARK CONSISTS OF STANDARD CHARACTERS WITHOUT CLAIM TO ANY PARTICULAR FONT, STYLE, SIZE, OR COLOR.

NO CLAIM IS MADE TO THE EXCLUSIVE RIGHT TO USE "TOYS", APART FROM THE MARK AS SHOWN.

SER. NO. 77-314,558, FILED 10-26-2007.

KIMBERLY FRYE, EXAMINING ATTORNEY



**Int. Cl.: 5**

**Prior U.S. Cls.: 6, 18, 44, 46, 51 and 52**

**Reg. No. 3,453,342**

**United States Patent and Trademark Office**

**Registered June 24, 2008**

---

**TRADEMARK  
PRINCIPAL REGISTER**

# Flock Buster

SKEET-R-GONE, INC. (NORTH DAKOTA CORPORATION)

159 - 8TH AVENUE NW

WAHPETON, ND 58078

FOR: BIRD REPELLENTS, IN CLASS 5 (U.S. CLS. 6, 18, 44, 46, 51 AND 52).

FIRST USE 9-1-2007; IN COMMERCE 9-14-2007.

THE MARK CONSISTS OF STANDARD CHARACTERS WITHOUT CLAIM TO ANY PARTICULAR FONT, STYLE, SIZE, OR COLOR.

NO CLAIM IS MADE TO THE EXCLUSIVE RIGHT TO USE "FLOCK", APART FROM THE MARK AS SHOWN.

SER. NO. 77-314,582, FILED 10-26-2007.

ALICE BENMAMAN, EXAMINING ATTORNEY

**Int. Cl.: 28**

**Prior U.S. Cls.: 22, 23, 38 and 50**

**United States Patent and Trademark Office**

**Reg. No. 3,453,343**

**Registered June 24, 2008**

**TRADEMARK  
PRINCIPAL REGISTER**

**THE MAGICAL PET**

ZEALER, CARL (UNITED STATES INDIVIDUAL)  
7285 ZAPATA PLACE NW  
PICKERINGTON, OH 43147

FOR: STUFFED PUPPETS; HAND PUPPETS;  
PLUSH TOYS, IN CLASS 28 (U.S. CLS. 22, 23, 38  
AND 50).

FIRST USE 12-13-2006; IN COMMERCE 12-13-2006.

THE MARK CONSISTS OF STANDARD CHAR-  
ACTERS WITHOUT CLAIM TO ANY PARTICULAR  
FONT, STYLE, SIZE, OR COLOR.

NO CLAIM IS MADE TO THE EXCLUSIVE  
RIGHT TO USE "PET", APART FROM THE MARK  
AS SHOWN.

SER. NO. 77-314,587, FILED 10-26-2007.

ALICE BENMAMAN, EXAMINING ATTORNEY

**Int. Cl.: 27**

**Prior U.S. Cls.: 19, 20, 37, 42 and 50**

**United States Patent and Trademark Office**

**Reg. No. 3,453,344**

**Registered June 24, 2008**

**TRADEMARK  
PRINCIPAL REGISTER**

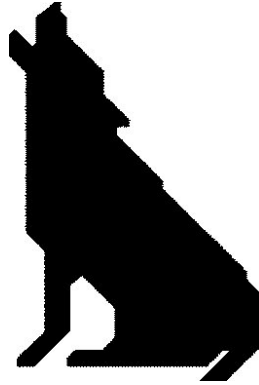

WOLF-GORDON, INC. (NEW YORK CORPORATION)  
33-00 47TH AVENUE  
LONG ISLAND CITY, NY 11101

FOR: WALLCOVERINGS, IN CLASS 27 (U.S. CLS. 19, 20, 37, 42 AND 50).

FIRST USE 5-0-2007; IN COMMERCE 5-0-2007.

OWNER OF U.S. REG. NO. 3,035,029.

THE MARK CONSISTS OF A SITTING WOLF.

SER. NO. 77-314,635, FILED 10-26-2007.

LEIGH CAROLINE CASE, EXAMINING ATTORNEY

**Int. Cl.: 3**

**Prior U.S. Cls.: 1, 4, 6, 50, 51 and 52**

**United States Patent and Trademark Office**

**Reg. No. 3,453,345**

**Registered June 24, 2008**

**TRADEMARK  
PRINCIPAL REGISTER**



THE PROCTER & GAMBLE COMPANY (OHIO CORPORATION)  
ONE PROCTER & GAMBLE PLAZA  
CINCINNATI, OH 45202

FOR: SKIN PREPARATION, NAMELY, NON-MEDICATED OINTMENT TO HELP SOOTHE AND COMFORT, IN CLASS 3 (U.S. CLS. 1, 4, 6, 50, 51 AND 52).

FIRST USE 6-30-2007; IN COMMERCE 6-30-2007.

THE MARK CONSISTS OF THE WORD BABYRUB WITH THREE LINES OF "STEAM" COMING UP FROM THE LETTERS "A" AND "B" IN BABY.

SER. NO. 77-314,637, FILED 10-26-2007.

CHRISTOPHER BUONGIORNO, EXAMINING ATTORNEY

**Int. Cl.: 16**

**Prior U.S. Cls.: 2, 5, 22, 23, 29, 37, 38 and 50**

**United States Patent and Trademark Office**

**Reg. No. 3,453,346**

**Registered June 24, 2008**

**TRADEMARK  
PRINCIPAL REGISTER**

**SPEEDI-SEAL**

CURTIS 1000, INC. (GEORGIA CORPORATION)  
1725 BRECKINRIDGE PARKWAY  
DULUTH, GA 30096

FOR: ENVELOPES, IN CLASS 16 (U.S. CLS. 2, 5, 22,  
23, 29, 37, 38 AND 50).

FIRST USE 1-11-1949; IN COMMERCE 1-11-1949.

THE MARK CONSISTS OF STANDARD CHAR-  
ACTERS WITHOUT CLAIM TO ANY PARTICULAR  
FONT, STYLE, SIZE, OR COLOR.

OWNER OF U.S. REG. NO. 651,759.

SER. NO. 77-314,644, FILED 10-26-2007.

REBECCA SMITH, EXAMINING ATTORNEY

**Int. Cl.: 41**

**Prior U.S. Cls.: 100, 101 and 107**

**United States Patent and Trademark Office**

**Reg. No. 3,453,347**

**Registered June 24, 2008**

**SERVICE MARK  
PRINCIPAL REGISTER**

**TRAPEZE**

MOSTOW, ALAN (UNITED STATES INDIVIDUAL)  
3555 NW 10TH AVENUE  
OAKLAND PARK, FL 33309 AND  
FREELAND, DENNIS (UNITED STATES INDIVIDUAL)  
3555 NW 10TH AVENUE  
OAKLAND PARK, FL 33309

FOR: NIGHT CLUBS; ENTERTAINMENT SERVICES, NAMELY, CONDUCTING PARTIES; ENTERTAINMENT SERVICES, NAMELY, CONDUCTING PARTIES FOR THE PURPOSE OF DATING AND

SOCIAL INTRODUCTION FOR ADULTS, IN CLASS 41 (U.S. CLS. 100, 101 AND 107).

FIRST USE 3-29-2004; IN COMMERCE 3-29-2004.

THE MARK CONSISTS OF STANDARD CHARACTERS WITHOUT CLAIM TO ANY PARTICULAR FONT, STYLE, SIZE, OR COLOR.

SER. NO. 77-314,646, FILED 10-26-2007.

SHANNON TWOHIG, EXAMINING ATTORNEY

**Int. Cl.: 30**

**Prior U.S. Cl.: 46**

**United States Patent and Trademark Office**

**Reg. No. 3,453,348**

**Registered June 24, 2008**

**TRADEMARK  
PRINCIPAL REGISTER**

**SACRED CACAO**

KAPLAN, DAVID (UNITED STATES INDIVIDUAL)  
5 QUAIL WAY  
SAN ANSELMO, CA 94960

FOR: COCOA EXTRACTS FOR HUMAN CONSUMPTION; COCOA; COCOA MIXES; CHOCOLATE PASTES; COCOA PODS; COCOA BEANS; COCOA BEAN PIECES, NAMELY, NIBS AND COCOA POWDER, IN CLASS 30 (U.S. CL. 46).

FIRST USE 10-6-2007; IN COMMERCE 10-6-2007.

THE MARK CONSISTS OF STANDARD CHARACTERS WITHOUT CLAIM TO ANY PARTICULAR FONT, STYLE, SIZE, OR COLOR.

NO CLAIM IS MADE TO THE EXCLUSIVE RIGHT TO USE "CACAO", APART FROM THE MARK AS SHOWN.

SER. NO. 77-314,688, FILED 10-26-2007.

MARK T. MULLEN, EXAMINING ATTORNEY

Int. Cl.: 35

Prior U.S. Cls.: 100, 101 and 102

United States Patent and Trademark Office

Reg. No. 3,453,349

Registered June 24, 2008

SERVICE MARK  
PRINCIPAL REGISTER



THE TRUSTEES OF THE DONNA M. DIFELICE  
TRUST (VIRGINIA TRUST)  
1633 12TH STREET SOUTH  
ARLINGTON, VA 222044708

FIRST USE 10-26-2007; IN COMMERCE 10-26-2007.

FOR: PROMOTING THE GOODS, SERVICES, INFORMATION AND RESOURCES OF OTHERS BY MEANS OF OPERATING AN ONLINE WEBSITE PORTAL WITH LINKS TO THE WEB SITES OF OTHERS; PROVIDING ONLINE DIRECTORY INFORMATION REGARDING SELECTED VENUES FOCUSED ON LOCATING PRODUCTS AND SERVICES, DESCRIBING PRODUCTS AND SERVICES, PRICING PRODUCTS AND SERVICES, COMPARING PRICES OF PRODUCTS AND SERVICES, PRODUCT AND SERVICE REVIEWS AND RATINGS, RETAILING GENERAL MERCHANDISE AND GENERAL CONSUMER GOODS, RETAILING CONSUMER SERVICES, PROVIDING CONSUMER INFORMATION, PROVIDING CONSUMER EDUCATION AND ADVICE, PROVIDING RESEARCH AND REFERENCE SERVICES, PROVIDING CHARITABLE SERVICES, AND ENCOURAGING FINANCIAL LITERACY, IN CLASS 35 (U.S. CLS. 100, 101 AND 102).

NO CLAIM IS MADE TO THE EXCLUSIVE RIGHT TO USE "PORTAL", APART FROM THE MARK AS SHOWN.

THE MARK CONSISTS OF LOWERCASE LETTER "B" DEPICTED GRAPHICALLY AS A SHOPPING CART FOLLOWED BY LOWER CASE LETTERS "UYVENUE" AT SIMILAR LEVEL FOLLOWED BY A PERIOD FOLLOWED BY LOWER CASE LETTERS COM IN REDUCED POINT SIZE ALL ON LINE ONE FOLLOWED BY LINE TWO LETTERING UPPER CASE "P" LOWER CASE LETTERS "ORTAL" SPACE LOWER CASE LETTERS TO SPACE UPPER CASE "S" LOWER CASE LETTERS "MART" SPACE UPPER CASE "S" LOWER CASE LETTERS "AVINGS".

SER. NO. 77-314,729, FILED 10-26-2007.

TRACY CROSS, EXAMINING ATTORNEY



**Int. Cls.: 3 and 7**

**Prior U.S. Cls.: 1, 4, 6, 13, 19, 21, 23, 31, 34, 35, 50, 51  
and 52**

**Reg. No. 3,453,350**

**United States Patent and Trademark Office**

**Registered June 24, 2008**

---

**TRADEMARK  
PRINCIPAL REGISTER**

**HEALTHY CARPETS, HEALTHY  
BUILDINGS**

R.E. WHITTAKER COMPANY (PENNSYLVANIA  
CORPORATION)  
302 SOUTH CROTON AVENUE  
NEW CASTLE, PA 16101

FIRST USE 10-8-2007; IN COMMERCE 10-8-2007.

FOR: CARPET CLEANING PREPARATIONS, IN  
CLASS 3 (U.S. CLS. 1, 4, 6, 50, 51 AND 52).

THE MARK CONSISTS OF STANDARD CHAR-  
ACTERS WITHOUT CLAIM TO ANY PARTICULAR  
FONT, STYLE, SIZE, OR COLOR.

FIRST USE 10-8-2007; IN COMMERCE 10-8-2007.

SER. NO. 77-314,731, FILED 10-26-2007.

FOR: CARPET CLEANING MACHINES, IN  
CLASS 7 (U.S. CLS. 13, 19, 21, 23, 31, 34 AND 35).

ANGELA M. MICHELI, EXAMINING ATTORNEY

**Int. Cl.: 20**

**Prior U.S. Cls.: 2, 13, 22, 25, 32 and 50**

**United States Patent and Trademark Office**

**Reg. No. 3,453,351**

**Registered June 24, 2008**

**TRADEMARK  
PRINCIPAL REGISTER**

**QAMPLES**

QUAN DO (CALIFORNIA CORPORATION)  
14862 MORAN STREET  
FOUNTAIN VALLEY, CA 92708

THE MARK CONSISTS OF STANDARD CHAR-  
ACTERS WITHOUT CLAIM TO ANY PARTICULAR  
FONT, STYLE, SIZE, OR COLOR.

FOR: KITCHEN CABINETS, IN CLASS 20 (U.S.  
CLS. 2, 13, 22, 25, 32 AND 50).

SER. NO. 77-314,733, FILED 10-26-2007.

FIRST USE 9-1-2007; IN COMMERCE 9-1-2007.

ANGELA M. MICHELI, EXAMINING ATTORNEY

**Int. Cl.: 25**

**Prior U.S. Cls.: 22 and 39**

**United States Patent and Trademark Office**

**Reg. No. 3,453,352**

**Registered June 24, 2008**

**TRADEMARK  
PRINCIPAL REGISTER**

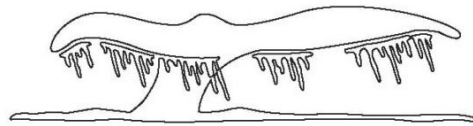

FARLEY, WILLIAM J. (UNITED STATES INDIVIDUAL)  
P.O. BOX 687  
NANTUCKET, MA 02554

THE MARK CONSISTS OF A WHALE TAIL, WITH WATER DRIPPING OFF, SUBMERGING BENEATH A WATERLINE.

FOR: SHIRTS; HATS; JACKETS; SWEAT SHIRTS, IN CLASS 25 (U.S. CLS. 22 AND 39).

SER. NO. 77-314,744, FILED 10-26-2007.

FIRST USE 10-0-2004; IN COMMERCE 5-26-2005.

ODESSA BIBBINS, EXAMINING ATTORNEY

**Int. Cl.: 41**

**Prior U.S. Cls.: 100, 101 and 107**

**United States Patent and Trademark Office**

**Reg. No. 3,453,353**

**Registered June 24, 2008**

**SERVICE MARK  
PRINCIPAL REGISTER**

# OnePaper

ONEPAPER, INC. (FLORIDA CORPORATION)  
SUITE 106-185  
1113 MURFREESBORO ROAD  
FRANKLIN, TN 37064

THE MARK CONSISTS OF STANDARD CHAR-  
ACTERS WITHOUT CLAIM TO ANY PARTICULAR  
FONT, STYLE, SIZE, OR COLOR.

FOR: NEWS AGENCIES, NAMELY, GATHERING  
AND DISSEMINATION OF NEWS, IN CLASS 41 (U.S.  
CLS. 100, 101 AND 107).

SER. NO. 77-314,760, FILED 10-26-2007.

FIRST USE 12-14-1999; IN COMMERCE 12-14-1999.

KEVIN DINALLO, EXAMINING ATTORNEY

Int. Cl.: 30

Prior U.S. Cl.: 46

Reg. No. 3,453,354

United States Patent and Trademark Office

Registered June 24, 2008

TRADEMARK  
PRINCIPAL REGISTER



PORTSMOUTH TEA COMPANY LLC (NEW  
HAMPSHIRE LTD LIAB CO)  
121 MAPLE STREET EXTENSION  
SOMERSWORTH, NH 03878

THE MARK CONSISTS OF STYLIZED VERSION  
OF THE WORD "PORTSMOUTH" WITH A LEAF  
DESIGN AS PART OF THE "P" ABOVE THE WORDS  
"TEA COMPANY" IN BLOCK LETTERS.

FOR: TEA, IN CLASS 30 (U.S. CL. 46).

FIRST USE 4-1-2005; IN COMMERCE 4-1-2005.

SER. NO. 77-314,780, FILED 10-26-2007.

NO CLAIM IS MADE TO THE EXCLUSIVE  
RIGHT TO USE "TEA COMPANY", APART FROM  
THE MARK AS SHOWN.

EDWARD FENNESSY, EXAMINING ATTORNEY

**Int. Cl.: 38**

**Prior U.S. Cls.: 100, 101 and 104**

**United States Patent and Trademark Office**

**Reg. No. 3,453,355**

**Registered June 24, 2008**

**SERVICE MARK  
PRINCIPAL REGISTER**

# Boasts & Toasts

THE TRUSTEES OF THE DONNA M. DIFELICE  
(VIRGINIA TRUST)  
1633 12TH STREET SOUTH  
ARLINGTON, VA 222044708

FOR: PROVIDING ON-LINE FORUMS FOR TRANSMISSION OF MESSAGES AMONG COMPUTER USERS CONCERNING GENERAL MERCHANDISE AND CONSUMER GOODS AND SERVICES, PRODUCT AND SERVICE PRICING INFORMATION, PRODUCT AND SERVICE PURCHASING INFORMATION, PRODUCT AND SERVICE REVIEWS AND RATINGS, MERCHANTS, PURCHASES, BEST BUYS, FAVORITE FINDS, MONEY-SAVING IDEAS, CONSUMER INFORMATION, CONSUMER EDUCATION AND ADVICE, RE-

SEARCH AND REFERENCE SERVICES, CHARITABLE SERVICES, PERSONAL FINANCIAL PLANNING AND FINANCIAL LITERACY, IN CLASS 38 (U.S. CLS. 100, 101 AND 104).

FIRST USE 10-26-2007; IN COMMERCE 10-26-2007.

THE MARK CONSISTS OF STANDARD CHARACTERS WITHOUT CLAIM TO ANY PARTICULAR FONT, STYLE, SIZE, OR COLOR.

SER. NO. 77-314,784, FILED 10-26-2007.

TRACY CROSS, EXAMINING ATTORNEY

Int. Cl.: 43

Prior U.S. Cls.: 100 and 101

United States Patent and Trademark Office

Reg. No. 3,453,356

Registered June 24, 2008

SERVICE MARK  
PRINCIPAL REGISTER



PORTSMOUTH TEA COMPANY LLC (NEW  
HAMPSHIRE LTD LIAB CO)  
121 MAPLE STREET EXTENSION  
SOMERSWORTH, NH 03878

THE MARK CONSISTS OF STYLIZED VERSION  
OF THE WORD "PORTSMOUTH" WITH A LEAF  
DESIGN AS PART OF THE "P" ABOVE THE WORDS  
"TEA COMPANY" IN BLOCK LETTERS.

FOR: TEA ROOMS, IN CLASS 43 (U.S. CLS. 100  
AND 101).

FIRST USE 4-1-2005; IN COMMERCE 4-1-2005.

SER. NO. 77-314,789, FILED 10-26-2007.

NO CLAIM IS MADE TO THE EXCLUSIVE  
RIGHT TO USE "TEA COMPANY", APART FROM  
THE MARK AS SHOWN.

EDWARD FENNESSY, EXAMINING ATTORNEY

**Int. Cl.: 43**

**Prior U.S. Cls.: 100 and 101**

**United States Patent and Trademark Office**

**Reg. No. 3,453,357**

**Registered June 24, 2008**

**SERVICE MARK  
PRINCIPAL REGISTER**



PORTSMOUTH TEA COMPANY LLC (NEW  
HAMPSHIRE LTD LIAB CO)  
121 MAPLE STREET EXTENSION  
SOMERSWORTH, NH 03878

THE MARK CONSISTS OF STYLIZED VERSION  
OF THE LETTER "P".

FOR: TEA ROOMS, IN CLASS 43 (U.S. CLS. 100  
AND 101).

SER. NO. 77-314,795, FILED 10-26-2007.

FIRST USE 4-1-2005; IN COMMERCE 4-1-2005.

EDWARD FENNESSY, EXAMINING ATTORNEY



**Int. Cl.: 30**

**Prior U.S. Cl.: 46**

**United States Patent and Trademark Office**

**Reg. No. 3,453,358**

**Registered June 24, 2008**

**TRADEMARK  
PRINCIPAL REGISTER**



PORTSMOUTH TEA COMPANY LLC (NEW  
HAMPSHIRE LTD LIAB CO)  
121 MAPLE STREET EXTENSION  
SOMERSWORTH, NH 03878

THE MARK CONSISTS OF STYLIZED VERSION  
OF THE LETTER "P".

FOR: TEA, IN CLASS 30 (U.S. CL. 46).

SER. NO. 77-314,799, FILED 10-26-2007.

FIRST USE 4-1-2005; IN COMMERCE 4-1-2005.

EDWARD FENNESSY, EXAMINING ATTORNEY

**Int. Cl.: 25**

**Prior U.S. Cls.: 22 and 39**

**United States Patent and Trademark Office**

**Reg. No. 3,453,359**

**Registered June 24, 2008**

**TRADEMARK  
PRINCIPAL REGISTER**



LASHER, MATTHEW P. (UNITED STATES INDIVIDUAL)  
10189 HOLBURN DRIVE  
HUNTINGTON BEACH, CA 92646

FOR: MEN, WOMEN AND CHILDREN'S CLOTHING, NAMELY, T-SHIRTS, SWEATSHIRTS, JACKETS AND HATS, IN CLASS 25 (U.S. CLS. 22 AND 39).

FIRST USE 6-1-2007; IN COMMERCE 6-1-2007.

THE MARK CONSISTS OF THE WORD "PROP" WITH THE DESIGN OF ONE CIRCLE FOLLOWED BY AN IRREGULAR RECTANGLE FOLLOWED BY TWO CIRCLES ATOP OF EACH LETTER IN THE WORD "PROP".

SER. NO. 77-314,801, FILED 10-26-2007.

ADA HAN, EXAMINING ATTORNEY

**Int. Cl.: 21**

**Prior U.S. Cls.: 2, 13, 23, 29, 30, 33, 40 and 50**

**Reg. No. 3,453,360**

**United States Patent and Trademark Office**

**Registered June 24, 2008**

---

**TRADEMARK  
PRINCIPAL REGISTER**

**CRANKANDSTEIN**

OBENAUER, DONALD (UNITED STATES INDIVIDUAL)  
2162 BROOKVIEW DRIVE, NW  
ATLANTA, GA 30318

THE MARK CONSISTS OF STANDARD CHARACTERS WITHOUT CLAIM TO ANY PARTICULAR FONT, STYLE, SIZE, OR COLOR.

FOR: MANUALLY OPERATED GRAIN MILLS FOR HOUSEHOLD PURPOSES, IN CLASS 21 (U.S. CLS. 2, 13, 23, 29, 30, 33, 40 AND 50).

SER. NO. 77-314,848, FILED 10-26-2007.

FIRST USE 0-0-1998; IN COMMERCE 0-0-1998.

JAMES MACFARLANE, EXAMINING ATTORNEY

**Int. Cl.: 44**

**Prior U.S. Cls.: 100 and 101**

**United States Patent and Trademark Office**

**Reg. No. 3,453,361**

**Registered June 24, 2008**

**SERVICE MARK  
PRINCIPAL REGISTER**

# Equimed

EQUIMED, LLC (CALIFORNIA LTD LIAB CO)  
395 SAN BRUNO AVE.  
MORGAN HILL, CA 95037

FOR: PROVIDING INFORMATION AND AN ON-LINE COMPUTER DATABASE IN THE FIELD OF EQUINE HEALTHCARE, NAMELY, HEALTH AND MEDICINE, EQUINE FITNESS, NUTRITION, BREEDING, HOOF AND FOOT CARE, BARN SAFETY, BEHAVIOR, DENTAL CARE AND FIRST AID TO CONSUMERS, PROVIDERS, AND ADMINIS-

TRATORS IN THE EQUINE HEALTHCARE INDUSTRY, IN CLASS 44 (U.S. CLS. 100 AND 101).

FIRST USE 6-15-2007; IN COMMERCE 9-15-2007.

THE MARK CONSISTS OF STANDARD CHARACTERS WITHOUT CLAIM TO ANY PARTICULAR FONT, STYLE, SIZE, OR COLOR.

SER. NO. 77-314,862, FILED 10-26-2007.

JANET LEE, EXAMINING ATTORNEY

**Int. Cl.: 41**

**Prior U.S. Cls.: 100, 101 and 107**

**United States Patent and Trademark Office**

**Reg. No. 3,453,362**

**Registered June 24, 2008**

**SERVICE MARK  
PRINCIPAL REGISTER**

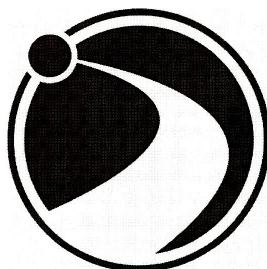

AMERICAN PHARMACISTS ASSOCIATION  
FOUNDATION (D.C. CORPORATION)  
SUITE 400  
1100 15TH STREET, NW  
WASHINGTON, DC 20005

FOR: EDUCATIONAL PROGRAMS, NAMELY,  
DEVELOPING EDUCATIONAL PROGRAMS FOR  
OTHERS FOR IMPLEMENTATION BY HEALTH-  
CARE PROVIDERS AND EMPLOYERS FOR THE  
PURPOSE OF EDUCATING PATIENTS ON HOW TO  
SELF-MANAGE THEIR MEDICAL CONDITION(S);  
AND PROVIDING EDUCATIONAL CONSULTA-  
TION FOR HEALTHCARE PROVIDERS AND EM-  
PLOYERS REGARDING THE IMPLEMENTATION  
OF THE PATIENT SELF MANAGEMENT PRO-  
GRAMS, IN CLASS 41 (U.S. CLS. 100, 101 AND 107).

FIRST USE 2-15-2007; IN COMMERCE 2-15-2007.

THE MARK CONSISTS OF ONE CLEAR CIRCLE  
ENCOMPASSING SURROUNDING AN OPAQUE  
CIRCLE; A PATH WHICH BENDS FROM THE  
LOWER LEFT CORNER TOWARD THE CENTER  
RIGHT AND UP TO THE UPPER LEFT CORNER  
WHICH ENDS AT A MUCH SMALLER OPAQUE  
CIRCLE.

SER. NO. 77-314,883, FILED 10-26-2007.

ANDREA SAUNDERS, EXAMINING ATTORNEY

**Int. Cls.: 38, 41 and 42**

**Prior U.S. Cls.: 100, 101, 104 and 107**

**United States Patent and Trademark Office**

**Reg. No. 3,453,363**

**Registered June 24, 2008**

**SERVICE MARK  
PRINCIPAL REGISTER**

**YOUR LIFE IN REAL TIME**

ZANNEL, INC. (DELAWARE CORPORATION)  
113 STILLMAN STREET  
SAN FRANCISCO, CA 94107

FOR: COMMUNICATIONS BY MEANS OF MOBILE PHONES; ELECTRONIC MESSAGE TRANSMISSION; ELECTRONIC TRANSMISSION OF MESSAGES AND DATA; INSTANT MESSAGING SERVICES; MOBILE MEDIA SERVICES IN THE NATURE OF ELECTRONIC TRANSMISSION OF ENTERTAINMENT MEDIA CONTENT; PROVIDING ON-LINE CHAT ROOMS AND ELECTRONIC BULLETIN BOARDS FOR TRANSMISSION OF MESSAGES AMONG USERS IN THE FIELD OF GENERAL INTEREST; TRANSMISSION OF SHORT MESSAGES; VIRTUAL CHATROOMS ESTABLISHED VIA TEXT MESSAGING; WEB MESSAGING; WIRELESS COMMUNICATIONS SERVICES, NAMELY, TRANSMISSION OF GRAPHICS TO MOBILE TELEPHONES, IN CLASS 38 (U.S. CLS. 100, 101 AND 104).

FIRST USE 8-27-2007; IN COMMERCE 8-27-2007.

FOR: ENTERTAINMENT SERVICES, NAMELY, NON-DOWNLOADABLE RINGTONES, PRE-RECORDED MUSIC, VIDEO AND GRAPHICS PRESENTED TO MOBILE COMMUNICATIONS DEVICES VIA A GLOBAL COMPUTER NETWORK AND WIRELESS NETWORKS, IN CLASS 41 (U.S. CLS. 100, 101 AND 107).

FIRST USE 8-27-2007; IN COMMERCE 8-27-2007.

FOR: APPLICATION SERVICE PROVIDER, NAMELY, PROVIDING, HOSTING, MANAGING, DEVELOPING, AND MAINTAINING APPLICATIONS, SOFTWARE, WEBSITES, AND DATABASES IN THE FIELDS OF PERSONAL PRODUCTIVITY, WIRELESS COMMUNICATION, MOBILE INFORMATION ACCESS, AND REMOTE DATA MANAGEMENT FOR WIRELESS DELIVERY OF CONTENT TO HANDHELD COMPUTERS, LAPTOPS AND MOBILE ELECTRONIC DEVICES; COMPUTER SERVICES, NAMELY, PROVIDING SEARCH PLATFORMS TO ALLOW USERS TO REQUEST CONTENT FROM AND RECEIVE CONTENT TO A MOBILE DEVICE; PROVIDING CUSTOMER-DEFINED GENERATED CONTENT AND CONTENT OF OTHERS AUTOMATICALLY SELECTED AND CUSTOMIZED BASED ON THE KNOWN OR ESTIMATED GEOGRAPHICAL LOCATION OF AN INTERNET, MOBILE TELEPHONE OR OTHER WIRED OR WIRELESS DIGITAL NETWORK BASED CUSTOMER, IN CLASS 42 (U.S. CLS. 100 AND 101).

FIRST USE 8-27-2007; IN COMMERCE 8-27-2007.

THE MARK CONSISTS OF STANDARD CHARACTERS WITHOUT CLAIM TO ANY PARTICULAR FONT, STYLE, SIZE, OR COLOR.

SER. NO. 77-314,902, FILED 10-26-2007.

JAMES MACFARLANE, EXAMINING ATTORNEY

**Int. Cl.: 37**

**Prior U.S. Cls.: 100, 103 and 106**

**United States Patent and Trademark Office**

**Reg. No. 3,453,364**

**Registered June 24, 2008**

**SERVICE MARK  
PRINCIPAL REGISTER**

**FSG**

FACILITY SOLUTIONS GROUP (TEXAS CORPORATION)

#310

4401 WEST GATE  
AUSTIN, TX 78745

FOR: ELECTRICAL CONTRACTING; ELECTRICAL CONTRACTOR SERVICES; ELECTRICAL REPAIRS AND INSTALLATION OF ELECTRICAL WIRING, IN CLASS 37 (U.S. CLS. 100, 103 AND 106).

FIRST USE 12-31-1999; IN COMMERCE 12-31-1999.

THE MARK CONSISTS OF STANDARD CHARACTERS WITHOUT CLAIM TO ANY PARTICULAR FONT, STYLE, SIZE, OR COLOR.

SER. NO. 77-314,905, FILED 10-26-2007.

EDWARD FENNESSY, EXAMINING ATTORNEY

**Int. Cl.: 41**

**Prior U.S. Cls.: 100, 101 and 107**

**United States Patent and Trademark Office**

**Reg. No. 3,453,365**

**Registered June 24, 2008**

**SERVICE MARK  
PRINCIPAL REGISTER**

# Osteotherapeutics

GUILLAUME CAUNEGRE (FRANCE INDIVIDUAL)  
3407 WOOLSEY DRIVE  
CHEVY CHASE, MD 20815

FOR: ARRANGING AND CONDUCTING EDUCATIONAL CONFERENCES; DEVELOPING EDUCATIONAL MANUALS FOR OTHERS IN THE FIELD OF BODYWORK; DEVELOPMENT AND DISSEMINATION OF EDUCATIONAL MATERIALS OF OTHERS IN THE FIELD OF BODYWORK; EDUCATION SERVICES, NAMELY, MENTORING IN THE FIELD OF MASSAGE; EDUCATION SERVICES, NAMELY, PROVIDING TRAINING AND

INSTRUCTION IN THE FIELD OF MASSAGE, IN CLASS 41 (U.S. CLS. 100, 101 AND 107).

FIRST USE 5-10-2007; IN COMMERCE 5-10-2007.

THE MARK CONSISTS OF STANDARD CHARACTERS WITHOUT CLAIM TO ANY PARTICULAR FONT, STYLE, SIZE, OR COLOR.

SER. NO. 77-314,909, FILED 10-26-2007.

ERNEST SHOSHO, EXAMINING ATTORNEY



**Int. Cl.: 22**

**Prior U.S. Cls.: 1, 2, 7, 19, 22, 42 and 50**

**Reg. No. 3,453,366**

**United States Patent and Trademark Office**

**Registered June 24, 2008**

**TRADEMARK  
PRINCIPAL REGISTER**

**TOMMY STRAP**

TOMMY STRAP, LLC (WISCONSIN LTD LIAB  
CO)

4855 HWY K WEST

CONOVER, WI 54519

FOR: BUNGIE CORDS, IN CLASS 22 (U.S. CLS. 1,  
2, 7, 19, 22, 42 AND 50).

FIRST USE 10-3-2007; IN COMMERCE 10-9-2007.

THE MARK CONSISTS OF STANDARD CHAR-  
ACTERS WITHOUT CLAIM TO ANY PARTICULAR  
FONT, STYLE, SIZE, OR COLOR.

NO CLAIM IS MADE TO THE EXCLUSIVE  
RIGHT TO USE "STRAP", APART FROM THE  
MARK AS SHOWN.

SER. NO. 77-314,915, FILED 10-26-2007.

MICHAEL GAAFAR, EXAMINING ATTORNEY

**Int. Cl.: 41**

**Prior U.S. Cls.: 100, 101 and 107**

**United States Patent and Trademark Office**

**Reg. No. 3,453,367**

**Registered June 24, 2008**

**SERVICE MARK  
PRINCIPAL REGISTER**



MOSTOW, ALAN (UNITED STATES INDIVIDUAL)

3555 NW 10TH AVENUE  
OAKLAND PARK, FL 33309 AND

FREELAND, DENNIS (UNITED STATES INDIVIDUAL)

3555 NW 10TH AVENUE  
OAKLAND PARK, FL 33309

FOR: NIGHT CLUBS; ENTERTAINMENT SERVICES, NAMELY, CONDUCTING PARTIES; ENTERTAINMENT SERVICES, NAMELY, CONDUCTING PARTIES FOR THE PURPOSE OF DATING AND SOCIAL INTRODUCTION FOR ADULTS, IN CLASS 41 (U.S. CLS. 100, 101 AND 107).

FIRST USE 3-29-2004; IN COMMERCE 3-29-2004.

THE COLOR(S) RED AND DIFFERENT SHADES OF GRAY IS/ARE CLAIMED AS A FEATURE OF THE MARK.

THE MARK CONSISTS OF A LETTER "T" THAT IS RED WITH A GRAY BORDER. THE MARK ALSO CONSISTS OF FOUR CURVED BANDS ADJACENT TO THE SIDES OF THE LETTER "T". EACH BAND CONSISTS OF VARIOUS SHADES OF GRAY FADING FROM DARK GRAY TO LIGHT GRAY AND VICE VERSA.

SER. NO. 77-314,921, FILED 10-26-2007.

SHANNON TWOHIG, EXAMINING ATTORNEY

**Int. Cl.: 16**

**Prior U.S. Cls.: 2, 5, 22, 23, 29, 37, 38 and 50**

**Reg. No. 3,453,368**

**United States Patent and Trademark Office**

**Registered June 24, 2008**

**TRADEMARK  
PRINCIPAL REGISTER**

**REWIRED**

PRISON FELLOWSHIP MINISTRIES (D.C. NON-PROFIT CORPORATION)  
44180 RIVERSIDE PARKWAY  
LANSLOWNE, VA 20176

FOR: STUDY GUIDES, INSTRUCTIONAL AND TEACHING MANUALS, EDUCATIONAL CURRICULA, BOOKS, BOOKLETS, PAMPHLETS, BROCHURES, MAGAZINES, NEWSLETTERS, NEWSPAPERS, WORKBOOKS, REPORTS, JOURNALS, ALL IN THE FIELDS OF CHRISTIANITY, RELIGION, THEOLOGY, SPIRITUALITY, THE ARTS, COMMUNICATIONS, JOURNALISM, EDUCATION, HISTORY, POLITICAL SCIENCE, LAW, LITERATURE, PHILOSOPHY, SCIENCE, MATHEMATICS, SOCIAL SCIENCES, PSYCHOLOGY, SOCIAL AND ETHICAL ISSUES, JUSTICE, HUMAN RIGHTS, BIOETHICS, ETHICS AND VALUES, MORALITY, SEXUALITY, FAMILY, RELATIONSHIPS,

CAREERS, DRUGS AND ALCOHOL, CRIME, HEALTH, POLITICS, LEADERSHIP, GOVERNMENT, ECONOMICS, CURRENT EVENTS, BUSINESS, SOCIOLOGY, CULTURE, RACE AND ETHNICITY, EDUCATION, MEDIA AND COMMUNICATIONS, AND DEVELOPMENT OF A CHRISTIAN WORLDVIEW, IN CLASS 16 (U.S. CLS. 2, 5, 22, 23, 29, 37, 38 AND 50).

FIRST USE 8-29-2006; IN COMMERCE 10-5-2006.

THE MARK CONSISTS OF STANDARD CHARACTERS WITHOUT CLAIM TO ANY PARTICULAR FONT, STYLE, SIZE, OR COLOR.

SER. NO. 77-314,928, FILED 10-26-2007.

MICHAEL KEATING, EXAMINING ATTORNEY

**Int. Cl.: 41**

**Prior U.S. Cls.: 100, 101 and 107**

**United States Patent and Trademark Office**

**Reg. No. 3,453,369**

**Registered June 24, 2008**

**SERVICE MARK  
PRINCIPAL REGISTER**

**THE EXPIRED REAL ESTATE  
GAME**

THE REAL ESTATE GAMES, LLC (NEVADA LTD  
LIAB CO)  
112 NORTH CURRY STREET  
CARSON CITY, NV 89703

FOR: EDUCATIONAL SERVICES, NAMELY, INDIVIDUAL SESSIONS, GROUP SESSIONS, CLASSES, SEMINARS, WORKSHOPS, SPEECHES AND EDUCATIONAL CONFERENCES DELIVERED IN-PERSON, BY COMPUTER, TELEPHONE OR OTHER MEANS IN THE FIELD OF INSTRUCTION AND SUPPORT IN THE AREAS OF REAL ESTATE SALES TRAINING FOR PEAK PERFORMANCE AND DISTRIBUTING COURSE MATERIALS IN CONNECTION THEREWITH, IN CLASS 41 (U.S. CLS. 100, 101 AND 107).

FIRST USE 2-1-2007; IN COMMERCE 2-1-2007.

THE MARK CONSISTS OF STANDARD CHARACTERS WITHOUT CLAIM TO ANY PARTICULAR FONT, STYLE, SIZE, OR COLOR.

OWNER OF U.S. REG. NOS. 3,229,483 AND 3,374,215.

NO CLAIM IS MADE TO THE EXCLUSIVE RIGHT TO USE "EXPIRED REAL ESTATE", APART FROM THE MARK AS SHOWN.

SER. NO. 77-314,936, FILED 10-26-2007.

ELI HELLMAN, EXAMINING ATTORNEY

**Int. Cl.: 9**

**Prior U.S. Cls.: 21, 23, 26, 36 and 38**

**Reg. No. 3,453,370**

**United States Patent and Trademark Office**

**Registered June 24, 2008**

**TRADEMARK  
PRINCIPAL REGISTER**

**REWIRED**

PRISON FELLOWSHIP MINISTRIES (D.C. NON-PROFIT CORPORATION)  
44180 RIVERSIDE PARKWAY  
LANSLOWNE, VA 20176

FOR: PRERECORDED AUDIO AND VIDEO CASSETTES, CDS, CD-ROMS, AND DVDS IN THE FIELDS OF CHRISTIANITY, RELIGION, THEOLOGY, SPIRITUALITY, THE ARTS, COMMUNICATIONS, JOURNALISM, EDUCATION, HISTORY, POLITICAL SCIENCE, LAW, LITERATURE, PHILOSOPHY, SCIENCE, MATHEMATICS, SOCIAL SCIENCES, PSYCHOLOGY, SOCIAL AND ETHICAL ISSUES, JUSTICE, HUMAN RIGHTS, BIOETHICS, ETHICS AND VALUES, MORALITY, SEXUALITY, FAMILY, RELATIONSHIPS, CAREERS, DRUGS AND ALCOHOL, CRIME, HEALTH, POLITICS, LEA-

DERSHIP, GOVERNMENT, ECONOMICS, CURRENT EVENTS, BUSINESS, SOCIOLOGY, CULTURE, RACE AND ETHNICITY, EDUCATION, MEDIA AND COMMUNICATIONS, AND DEVELOPMENT OF A CHRISTIAN WORLDVIEW, IN CLASS 9 (U.S. CLS. 21, 23, 26, 36 AND 38).

FIRST USE 8-29-2006; IN COMMERCE 10-5-2006.

THE MARK CONSISTS OF STANDARD CHARACTERS WITHOUT CLAIM TO ANY PARTICULAR FONT, STYLE, SIZE, OR COLOR.

SER. NO. 77-314,961, FILED 10-26-2007.

MICHAEL KEATING, EXAMINING ATTORNEY

**Int. Cl.: 5**

**Prior U.S. Cls.: 6, 18, 44, 46, 51 and 52**

**United States Patent and Trademark Office**

**Reg. No. 3,453,371**

**Registered June 24, 2008**

**TRADEMARK  
PRINCIPAL REGISTER**



LEADING EDGE MARKETING, INC. (BAHAMAS CORPORATION)  
SUITE 1210, P.O. BOX CR 56766  
#33 HARBOUR BAY PLAZA  
NASSAU, NEW PROVIDENCE, BAHAMAS

FOR: DIETARY SUPPLEMENTS, IN CLASS 5 (U.S. CLS. 6, 18, 44, 46, 51 AND 52).

FIRST USE 1-1-2006; IN COMMERCE 1-1-2006.

THE COLOR(S) BLACK, RED, AND WHITE IS/ARE CLAIMED AS A FEATURE OF THE MARK.

THE MARK CONSISTS OF THE LETTERS "CIG" IN BLACK ITALICS FOLLOWED BY THE LETTERS "ARETTE" IN WHITE ALL-CAPS; "ARETTE" IS TRAVERSED DIAGONALLY NORTHWEST TO SOUTHEAST BY AN IMAGE OF A WHITE CIGARETTE; THERE IS AN IMAGE OF A RED STOP SIGN IN THE BACKGROUND BEHIND BOTH THE LETTERS "ARETTE" AND THE CIGARETTE IMAGE.

SER. NO. 77-314,970, FILED 10-26-2007.

MARIA-VICTORIA SUAREZ, EXAMINING ATTORNEY

**Int. Cl.: 35**

**Prior U.S. Cls.: 100, 101 and 102**

**United States Patent and Trademark Office**

**Reg. No. 3,453,372**

**Registered June 24, 2008**

**SERVICE MARK  
PRINCIPAL REGISTER**

**Global Marathon For, By  
and About Women in  
Engineering**

NATIONAL SOCIETY OF PROFESSIONAL ENGINEERS (SOUTH CAROLINA CORPORATION), DBA NATIONAL ENGINEERS WEEK FOUNDATION  
1420 KING STREET  
ALEXANDRIA, VA 22314

FOR: PUBLIC ADVOCACY TO PROMOTE AWARENESS OF CAREERS FOR WOMEN IN ENGINEERING VIA WEBCAST, INTERNET AND TELECONFERENCE, IN CLASS 35 (U.S. CLS. 100, 101 AND 102).

FIRST USE 12-1-2004; IN COMMERCE 12-1-2004.

THE MARK CONSISTS OF STANDARD CHARACTERS WITHOUT CLAIM TO ANY PARTICULAR FONT, STYLE, SIZE, OR COLOR.

SER. NO. 77-314,973, FILED 10-26-2007.

CHRISTOPHER BUONGIORNO, EXAMINING ATTORNEY

Int. Cl.: 45

Prior U.S. Cls.: 100 and 101

United States Patent and Trademark Office

Reg. No. 3,453,373

Registered June 24, 2008

SERVICE MARK  
PRINCIPAL REGISTER



FIT TRAINING LLC (CONNECTICUT LTD LIAB  
CO)  
47 HOUSATONIC DRIVE  
MILFORD, CT 06460

FOR: ORGANIZING AND CONDUCTING SUP-  
PORT GROUPS IN THE FIELD OF WOMEN'S  
HEALTH AND FITNESS, IN CLASS 45 (U.S. CLS.  
100 AND 101).

FIRST USE 10-1-2007; IN COMMERCE 10-1-2007.

THE MARK CONSISTS OF THE WORDS "FITCH-  
ICKS" IN STYLIZED TEXT. THERE IS AN ILLUS-  
TRATION OF A WOMAN WORKING-OUT TO THE  
LEFT.

SER. NO. 77-314,997, FILED 10-26-2007.

GINA FINK, EXAMINING ATTORNEY



**Int. Cl.: 29**

**Prior U.S. Cl.: 46**

**United States Patent and Trademark Office**

**Reg. No. 3,453,374**

**Registered June 24, 2008**

**TRADEMARK  
PRINCIPAL REGISTER**

**A TASTE OF PARADISE!**

KAPLAN, DAVID (UNITED STATES INDIVIDUAL)  
5 QUAIL WAY  
SAN ANSELMO, CA 94960

THE MARK CONSISTS OF STANDARD CHARACTERS WITHOUT CLAIM TO ANY PARTICULAR FONT, STYLE, SIZE, OR COLOR.

FOR: COCONUT OIL; OLIVE OIL; PALM OIL, IN CLASS 29 (U.S. CL. 46).

SER. NO. 77-315,005, FILED 10-26-2007.

FIRST USE 12-5-2006; IN COMMERCE 12-5-2006.

MARK T. MULLEN, EXAMINING ATTORNEY

**Int. Cl.: 29**

**Prior U.S. Cl.: 46**

**Reg. No. 3,453,375**

**United States Patent and Trademark Office**

**Registered June 24, 2008**

---

**TRADEMARK  
PRINCIPAL REGISTER**

**COBBO**

MCCARNEY, KEVIN T. (UNITED STATES INDIVIDUAL), DBA POQUITO MAS  
P.O. BOX 2309  
NORTH HOLLYWOOD, CA 91610

FIRST USE 2-28-2004; IN COMMERCE 2-28-2004.

FOR: FOOD PRODUCTS, NAMELY, SALADS, NAMELY, VEGETABLE AND GARDEN SALADS, NOT INCLUDING MACARONI, RICE AND PASTA SALAD, PREPARED BY A RESTAURANT FOR CONSUMPTION ON AND OFF PREMISES, IN CLASS 29 (U.S. CL. 46).

THE MARK CONSISTS OF STANDARD CHARACTERS WITHOUT CLAIM TO ANY PARTICULAR FONT, STYLE, SIZE, OR COLOR.

SER. NO. 77-315,070, FILED 10-26-2007.

CHRISTINA SOBRAL, EXAMINING ATTORNEY

**Int. Cl.: 22**

**Prior U.S. Cls.: 1, 2, 7, 19, 22, 42 and 50**

**Reg. No. 3,453,376**

**United States Patent and Trademark Office**

**Registered June 24, 2008**

---

**TRADEMARK  
PRINCIPAL REGISTER**

**SPINCERELY YOURS**

CHRISTENSEN, TAMARA (UNITED STATES IN-  
DIVIDUAL), DBA SPINCERELY YOURS  
56 LAUREL ROAD  
HARWINTON, CT 06791

FOR: SEMI-SYNTHETIC FIBERS; SILK FIBERS;  
TEXTILE FIBERS; YARN FIBERS; WOOL; ANIMAL  
HAIR; CHEMICAL FIBERS FOR TEXTILE USE;  
COTTON FIBERS; FLAX FIBER , IN CLASS 22 (U.S.  
CLS. 1, 2, 7, 19, 22, 42 AND 50).

FIRST USE 7-27-2006; IN COMMERCE 7-14-2007.

THE MARK CONSISTS OF STANDARD CHAR-  
ACTERS WITHOUT CLAIM TO ANY PARTICULAR  
FONT, STYLE, SIZE, OR COLOR.

SER. NO. 77-315,090, FILED 10-26-2007.

ERNEST SHOSHO, EXAMINING ATTORNEY

**Int. Cls.: 16 and 41**

**Prior U.S. Cls.: 2, 5, 22, 23, 29, 37, 38, 50, 100, 101 and 107**

**Reg. No. 3,453,377**

**United States Patent and Trademark Office**

**Registered June 24, 2008**

**TRADEMARK  
SERVICE MARK  
PRINCIPAL REGISTER**



DOWNING, NAOMI KINSMAN (UNITED STATES INDIVIDUAL), DBA NAOMI KINSMAN

2240 HOMESTEAD COURT #108  
LOS ALTOS, CA 94024

FOR: SCHOOL SUPPLY KITS CONTAINING VARIOUS COMBINATIONS OF SELECTED SCHOOL SUPPLIES, NAMELY, WRITING INSTRUMENTS, PENS, PENCILS, MECHANICAL PENCILS, ERASERS, MARKERS, CRAYONS, HIGHLIGHTERS, FOLDERS, NOTEBOOKS, PAPER, GRADUATED RULERS, PROTRACTORS, PAPER CLIPS, PENCIL SHARPENERS, WRITING GRIPS, GLUE AND BOOK MARKS; A SERIES OF BOOKS, WRITTEN ARTICLES, HANDOUTS AND WORKSHEETS

IN THE FIELD OF CREATIVE WRITING, IN CLASS 16 (U.S. CLS. 2, 5, 22, 23, 29, 37, 38 AND 50).

FIRST USE 1-1-2006; IN COMMERCE 2-15-2006.

FOR: EDUCATION SERVICES, NAMELY, PROVIDING LIVE AND ON-LINE WORKSHOPS IN THE FIELD OF CREATIVE WRITING, IN CLASS 41 (U.S. CLS. 100, 101 AND 107).

FIRST USE 1-1-2006; IN COMMERCE 5-1-2006.

SER. NO. 77-315,126, FILED 10-26-2007.

KATHERINE CONNOLLY, EXAMINING ATTORNEY

**Int. Cl.: 5**

**Prior U.S. Cls.: 6, 18, 44, 46, 51 and 52**

**Reg. No. 3,453,378**

**United States Patent and Trademark Office**

**Registered June 24, 2008**

---

**TRADEMARK  
PRINCIPAL REGISTER**

**JOINT PROTECT**

WELLMED, LLC (CALIFORNIA LTD LIAB CO)  
18730 OXNARD STREET, SUITE 203  
TARZANA, CA 91356

FOR: DIETARY SUPPLEMENTS, IN CLASS 5 (U.S.  
CLS. 6, 18, 44, 46, 51 AND 52).

FIRST USE 3-0-2003; IN COMMERCE 3-0-2003.

THE MARK CONSISTS OF STANDARD CHAR-  
ACTERS WITHOUT CLAIM TO ANY PARTICULAR  
FONT, STYLE, SIZE, OR COLOR.

NO CLAIM IS MADE TO THE EXCLUSIVE  
RIGHT TO USE "JOINT", APART FROM THE  
MARK AS SHOWN.

SER. NO. 77-315,130, FILED 10-26-2007.

REBECCA GILBERT, EXAMINING ATTORNEY

**Int. Cl.: 2**

**Prior U.S. Cls.: 6, 11 and 16**

**United States Patent and Trademark Office**

**Reg. No. 3,453,379**

**Registered June 24, 2008**

**TRADEMARK  
PRINCIPAL REGISTER**

**imagine**

CG DIRECT, INC (CALIFORNIA CORPORATION)  
6022 VARIEL AVENUE  
WOODLAND HILLS, CA 91367

FOR: PHOTOCOPIER TONER; PHOTOCOPIER TONER IN CARTRIDGES; TONER; TONER CARTRIDGES; TONER FOR COPIERS; INK CARTRIDGES FOR PRINTERS; INK JET CARTRIDGES; INK JET PRINTER INK , IN CLASS 2 (U.S. CLS. 6, 11 AND 16).

FIRST USE 10-22-2007; IN COMMERCE 10-22-2007.

THE MARK CONSISTS OF STANDARD CHARACTERS WITHOUT CLAIM TO ANY PARTICULAR FONT, STYLE, SIZE, OR COLOR.

SER. NO. 77-315,131, FILED 10-26-2007.

LINDA MICKLEBURGH, EXAMINING ATTORNEY

**Int. Cl.: 45**

**Prior U.S. Cls.: 100 and 101**

**United States Patent and Trademark Office**

**Reg. No. 3,453,380**

**Registered June 24, 2008**

**SERVICE MARK  
PRINCIPAL REGISTER**

## Reminders From God

RA INFORMATICS (NORTH CAROLINA SOLE  
PROPRIETORSHIP)  
10101 CREEDMOOR RD RALEIGH NC 27615  
RALEIGH, NC 27615

FOR: PROVIDING ON-LINE INFORMATION IN  
THE FIELD OF SPIRITUALITY, SELF-HELP, AND  
PERSONAL EMPOWERMENT SUBJECT MATTERS,  
IN CLASS 45 (U.S. CLS. 100 AND 101).

FIRST USE 9-25-2007; IN COMMERCE 9-25-2007.

THE MARK CONSISTS OF STANDARD CHAR-  
ACTERS WITHOUT CLAIM TO ANY PARTICULAR  
FONT, STYLE, SIZE, OR COLOR.

SER. NO. 77-315,143, FILED 10-26-2007.

TRACY WHITTAKER-BROWN, EXAMINING AT-  
TORNEY

**Int. Cl.: 45**

**Prior U.S. Cls.: 100 and 101**

**United States Patent and Trademark Office**

**Reg. No. 3,453,381**

**Registered June 24, 2008**

---

**SERVICE MARK  
PRINCIPAL REGISTER**

**FILL THE HOUSE**

SEATSUB, INC. (CALIFORNIA CORPORATION)  
42 GREENFIELD AVE., SUITE G  
SAN ANSELMO, CA 94960

THE MARK CONSISTS OF STANDARD CHAR-  
ACTERS WITHOUT CLAIM TO ANY PARTICULAR  
FONT, STYLE, SIZE, OR COLOR.

FOR: ONLINE SOCIAL NETWORKING SERVI-  
CES, IN CLASS 45 (U.S. CLS. 100 AND 101).

SER. NO. 77-315,151, FILED 10-26-2007.

FIRST USE 8-8-2007; IN COMMERCE 8-8-2007.

SUSAN STIGLITZ, EXAMINING ATTORNEY



**Int. Cl.: 45**

**Prior U.S. Cls.: 100 and 101**

**United States Patent and Trademark Office**

**Reg. No. 3,453,382**

**Registered June 24, 2008**

---

**SERVICE MARK  
PRINCIPAL REGISTER**

**SEATSUB**

SEATSUB, INC. (CALIFORNIA CORPORATION)  
42 GREENFIELD AVE., SUITE G  
SAN ANSELMO, CA 94960

THE MARK CONSISTS OF STANDARD CHAR-  
ACTERS WITHOUT CLAIM TO ANY PARTICULAR  
FONT, STYLE, SIZE, OR COLOR.

FOR: ONLINE SOCIAL NETWORKING SERVI-  
CES, IN CLASS 45 (U.S. CLS. 100 AND 101).

SER. NO. 77-315,152, FILED 10-26-2007.

FIRST USE 4-2-2007; IN COMMERCE 4-2-2007.

SUSAN STIGLITZ, EXAMINING ATTORNEY

**Int. Cl.: 18**

**Prior U.S. Cls.: 1, 2, 3, 22 and 41**

**Reg. No. 3,453,383**

**United States Patent and Trademark Office**

**Registered June 24, 2008**

**TRADEMARK  
PRINCIPAL REGISTER**

**PUPPY**

TIMES TRADING, INC. (NEW YORK CORPORATION)  
73-21 52ND ROAD  
MASPETH, NY 11378

FOR: BEACH UMBRELLAS; BEACH UMBRELLAS; GOLF UMBRELLAS; PARASOLS; PATIO UMBRELLAS; TABLE UMBRELLAS; TELESCOPIC UMBRELLAS; UMBRELLAS; UMBRELLAS AND THEIR PARTS, IN CLASS 18 (U.S. CLS. 1, 2, 3, 22 AND 41).

FIRST USE 11-0-2006; IN COMMERCE 11-0-2006.

THE MARK CONSISTS OF STANDARD CHARACTERS WITHOUT CLAIM TO ANY PARTICULAR FONT, STYLE, SIZE, OR COLOR.

SER. NO. 77-315,160, FILED 10-27-2007.

ZACHARY BELLO, EXAMINING ATTORNEY

**Int. Cl.: 16**

**Prior U.S. Cls.: 2, 5, 22, 23, 29, 37, 38 and 50**

**United States Patent and Trademark Office**

**Reg. No. 3,453,384**

**Registered June 24, 2008**

**TRADEMARK  
PRINCIPAL REGISTER**

**Boing!**

BOING! DESIGNS, LLC (OREGON LTD LIAB CO)  
25159 NE BUTTEVILLE RD  
AURORA, OR 97002

THE MARK CONSISTS OF STANDARD CHAR-  
ACTERS WITHOUT CLAIM TO ANY PARTICULAR  
FONT, STYLE, SIZE, OR COLOR.

FOR: PENS, IN CLASS 16 (U.S. CLS. 2, 5, 22, 23, 29,  
37, 38 AND 50).

SER. NO. 77-315,168, FILED 10-27-2007.

FIRST USE 6-1-2006; IN COMMERCE 6-1-2006.

HANNO RITTNER, EXAMINING ATTORNEY

**Int. Cl.: 16**

**Prior U.S. Cls.: 2, 5, 22, 23, 29, 37, 38 and 50**

**Reg. No. 3,453,385**

**United States Patent and Trademark Office**

**Registered June 24, 2008**

---

**TRADEMARK  
PRINCIPAL REGISTER**

**Helios**

BOING! DESIGNS, LLC (OREGON LTD LIAB CO)  
25159 NE BUTTEVILLE ROAD  
AURORA, OR 97002

THE MARK CONSISTS OF STANDARD CHAR-  
ACTERS WITHOUT CLAIM TO ANY PARTICULAR  
FONT, STYLE, SIZE, OR COLOR.

FOR: PENS, IN CLASS 16 (U.S. CLS. 2, 5, 22, 23, 29,  
37, 38 AND 50).

SER. NO. 77-315,169, FILED 10-27-2007.

FIRST USE 6-1-2006; IN COMMERCE 6-1-2006.

HANNO RITTNER, EXAMINING ATTORNEY

**Int. Cl.: 37**

**Prior U.S. Cls.: 100, 103 and 106**

**United States Patent and Trademark Office**

**Reg. No. 3,453,386**

**Registered June 24, 2008**

**SERVICE MARK  
PRINCIPAL REGISTER**

**AGRICULTURALLIED**

ALLIED STEEL BUILDINGS INC. (FLORIDA  
CORPORATION)  
SUITE 230  
6400 NORTH ANDREWS AVENUE  
FT. LAUDERDALE, FL 33309

FOR: CONSTRUCTION CONSULTATION; CON-  
STRUCTION OF PRE-ENGINEERED METAL  
BUILDINGS, IN CLASS 37 (U.S. CLS. 100, 103 AND  
106).

FIRST USE 10-25-2007; IN COMMERCE 10-25-2007.

THE MARK CONSISTS OF STANDARD CHAR-  
ACTERS WITHOUT CLAIM TO ANY PARTICULAR  
FONT, STYLE, SIZE, OR COLOR.

SER. NO. 77-315,175, FILED 10-27-2007.

ROBERT C. CLARK JR., EXAMINING ATTORNEY

**Int. Cl.: 37**

**Prior U.S. Cls.: 100, 103 and 106**

**United States Patent and Trademark Office**

**Reg. No. 3,453,387**

**Registered June 24, 2008**

**SERVICE MARK  
PRINCIPAL REGISTER**

**INDUSTRIALLIED**

ALLIED STEEL BUILDINGS INC. (FLORIDA  
CORPORATION)  
SUITE 230  
6400 NORTH ANDREWS AVENUE  
FT. LAUDERDALE, FL 33309

FOR: CONSTRUCTION CONSULTATION; CON-  
STRUCTION OF PRE-ENGINEERED METAL  
BUILDINGS, IN CLASS 37 (U.S. CLS. 100, 103 AND  
106).

FIRST USE 10-25-2007; IN COMMERCE 10-25-2007.

THE MARK CONSISTS OF STANDARD CHAR-  
ACTERS WITHOUT CLAIM TO ANY PARTICULAR  
FONT, STYLE, SIZE, OR COLOR.

SER. NO. 77-315,177, FILED 10-27-2007.

ROBERT C. CLARK JR., EXAMINING ATTORNEY

**Int. Cl.: 37**

**Prior U.S. Cls.: 100, 103 and 106**

**United States Patent and Trademark Office**

**Reg. No. 3,453,388**

**Registered June 24, 2008**

**SERVICE MARK  
PRINCIPAL REGISTER**

**INSTITUTIONALLIED**

ALLIED STEEL BUILDINGS INC. (FLORIDA  
CORPORATION)  
SUITE 230  
6400 NORTH ANDREWS AVENUE  
FT. LAUDERDALE, FL 33309

FOR: CONSTRUCTION CONSULTATION; CON-  
STRUCTION OF PRE-ENGINEERED METAL  
BUILDINGS, IN CLASS 37 (U.S. CLS. 100, 103 AND  
106).

FIRST USE 10-25-2007; IN COMMERCE 10-25-2007.

THE MARK CONSISTS OF STANDARD CHAR-  
ACTERS WITHOUT CLAIM TO ANY PARTICULAR  
FONT, STYLE, SIZE, OR COLOR.

SER. NO. 77-315,178, FILED 10-27-2007.

ROBERT C. CLARK JR., EXAMINING ATTORNEY

**Int. Cl.: 37**

**Prior U.S. Cls.: 100, 103 and 106**

**United States Patent and Trademark Office**

**Reg. No. 3,453,389**

**Registered June 24, 2008**

**SERVICE MARK  
PRINCIPAL REGISTER**

**RESIDENTIALLED**

ALLIED STEEL BUILDINGS INC. (FLORIDA  
CORPORATION)  
SUITE 230  
6400 NORTH ANDREWS AVENUE  
FT. LAUDERDALE, FL 33309

FOR: CONSTRUCTION CONSULTATION; CON-  
STRUCTION OF PRE-ENGINEERED METAL  
BUILDINGS, IN CLASS 37 (U.S. CLS. 100, 103 AND  
106).

FIRST USE 10-25-2007; IN COMMERCE 10-25-2007.

THE MARK CONSISTS OF STANDARD CHAR-  
ACTERS WITHOUT CLAIM TO ANY PARTICULAR  
FONT, STYLE, SIZE, OR COLOR.

SER. NO. 77-315,179, FILED 10-27-2007.

ROBERT C. CLARK JR., EXAMINING ATTORNEY



**Int. Cl.: 41**

**Prior U.S. Cls.: 100, 101 and 107**

**United States Patent and Trademark Office**

**Reg. No. 3,453,390**

**Registered June 24, 2008**

**SERVICE MARK  
PRINCIPAL REGISTER**

**NARROWAY**

NARROWAY PRODUCTIONS (SOUTH CAROLINA CORPORATION)  
3346 HIGHWAY 21  
FORT MILL, SC 29715

FOR: ENTERTAINMENT IN THE NATURE OF CHRISTIAN THEATER PRODUCTIONS, IN CLASS 41 (U.S. CLS. 100, 101 AND 107).

FIRST USE 6-0-1986; IN COMMERCE 9-0-1996.

THE MARK CONSISTS OF STANDARD CHARACTERS WITHOUT CLAIM TO ANY PARTICULAR FONT, STYLE, SIZE, OR COLOR.

OWNER OF U.S. REG. NO. 2,836,341.

SER. NO. 77-315,224, FILED 10-27-2007.

ELLEN PERKINS, EXAMINING ATTORNEY

Int. Cl.: 41

Prior U.S. Cls.: 100, 101 and 107

United States Patent and Trademark Office

Reg. No. 3,453,391

Registered June 24, 2008

SERVICE MARK  
PRINCIPAL REGISTER

The logo for NarrowWay Productions features the word "NarrowWay" in a stylized, cursive script font. A horizontal line is drawn beneath the word, and the word "PRODUCTIONS" is written in a clean, sans-serif, all-caps font directly below the line.

NARROWWAY PRODUCTIONS, INC. (SOUTH  
CAROLINA CORPORATION)  
3346 HIGHWAY 21  
FORT MILL, SC 29715

FOR: ENTERTAINMENT IN THE NATURE OF  
CHRISTIAN THEATER PRODUCTIONS, IN CLASS  
41 (U.S. CLS. 100, 101 AND 107).

FIRST USE 3-0-2006; IN COMMERCE 3-0-2006.

OWNER OF U.S. REG. NO. 2,836,341.

NO CLAIM IS MADE TO THE EXCLUSIVE  
RIGHT TO USE "PRODUCTIONS", APART FROM  
THE MARK AS SHOWN.

SER. NO. 77-315,228, FILED 10-27-2007.

ELLEN PERKINS, EXAMINING ATTORNEY

**Int. Cl.: 41**

**Prior U.S. Cls.: 100, 101 and 107**

**Reg. No. 3,453,392**

**United States Patent and Trademark Office**

**Registered June 24, 2008**

---

**SERVICE MARK  
PRINCIPAL REGISTER**

elite fitness  
endurance training

ELITE FITNESS ENDURANCE TRAINING (CALIFORNIA LTD LIAB CO)

1017 VALLEJO WAY

SACRAMENTO, CA 95818

FOR: PHYSICAL EDUCATION SERVICES, IN CLASS 41 (U.S. CLS. 100, 101 AND 107).

FIRST USE 1-1-2006; IN COMMERCE 1-1-2006.

THE MARK CONSISTS OF STANDARD CHARACTERS WITHOUT CLAIM TO ANY PARTICULAR FONT, STYLE, SIZE, OR COLOR.

NO CLAIM IS MADE TO THE EXCLUSIVE RIGHT TO USE "FITNESS ENDURANCE TRAINING", APART FROM THE MARK AS SHOWN.

SER. NO. 77-315,264, FILED 10-27-2007.

DAVID H. STINE, EXAMINING ATTORNEY

**Int. Cl.: 35**

**Prior U.S. Cls.: 100, 101 and 102**

**United States Patent and Trademark Office**

**Reg. No. 3,453,393**

**Registered June 24, 2008**

**SERVICE MARK  
PRINCIPAL REGISTER**

**doCoup**

MAHER, JONATHAN BANNON (UNITED STATES INDIVIDUAL)  
433 WEST 21ST STREET, 1E  
NEW YORK, NY 10011

THE MARK CONSISTS OF STANDARD CHARACTERS WITHOUT CLAIM TO ANY PARTICULAR FONT, STYLE, SIZE, OR COLOR.

FOR: PROVIDING AN ONLINE DIRECTORY INFORMATION SERVICE FEATURING INFORMATION REGARDING HEALTHCARE PROFESSIONALS, IN CLASS 35 (U.S. CLS. 100, 101 AND 102).

SER. NO. 77-315,300, FILED 10-27-2007.

FIRST USE 10-25-2007; IN COMMERCE 10-25-2007.

MELVIN AXILBUND, EXAMINING ATTORNEY

**Int. Cl.: 14**

**Prior U.S. Cls.: 2, 27, 28 and 50**

**Reg. No. 3,453,394**

**United States Patent and Trademark Office**

**Registered June 24, 2008**

---

**TRADEMARK  
PRINCIPAL REGISTER**

**JewelryWonder.com**

INNOVAZON CORPORATION (VIRGINIA CORPORATION), DBA JEWELRYWONDER.COM  
43790 ABBOTT PLACE  
ASHBURN, VA 20147

THE MARK CONSISTS OF STANDARD CHARACTERS WITHOUT CLAIM TO ANY PARTICULAR FONT, STYLE, SIZE, OR COLOR.

FOR: NECKLACES; PENDANTS; BRACELETS; EARRINGS; JEWELRY; COSTUME JEWELRY; GEMSTONE JEWELRY, IN CLASS 14 (U.S. CLS. 2, 27, 28 AND 50).

SER. NO. 77-315,448, FILED 10-28-2007.

FIRST USE 4-9-2007; IN COMMERCE 7-31-2007.

MARY CRAWFORD, EXAMINING ATTORNEY

**Int. Cl.: 45**

**Prior U.S. Cls.: 100 and 101**

**United States Patent and Trademark Office**

**Reg. No. 3,453,395**

**Registered June 24, 2008**

**SERVICE MARK  
PRINCIPAL REGISTER**

**AUNT MARY'S DOGHOUSE**

AUNT MARY'S DOGHOUSE, INC. (NEW JERSEY  
CORPORATION)  
P.O. BOX 271  
HOPE, NJ 07884

FOR: ANIMAL ADOPTION SERVICE, NAMELY,  
ARRANGING FOR DOGS AND CATS FROM SHEL-  
TERS TO BE PLACED IN HOMES; ADOPTION  
SERVICES FOR DOMESTIC ANIMALS, IN CLASS  
45 (U.S. CLS. 100 AND 101).

FIRST USE 11-30-2000; IN COMMERCE 11-30-2000.

THE MARK CONSISTS OF STANDARD CHAR-  
ACTERS WITHOUT CLAIM TO ANY PARTICULAR  
FONT, STYLE, SIZE, OR COLOR.

SER. NO. 77-315,449, FILED 10-28-2007.

MELVIN AXILBUND, EXAMINING ATTORNEY

Int. Cl.: 28

Prior U.S. Cls.: 22, 23, 38 and 50

United States Patent and Trademark Office

Reg. No. 3,453,396

Registered June 24, 2008

TRADEMARK  
PRINCIPAL REGISTER

H3

GENERAL MOTORS CORPORATION (DELA-  
WARE CORPORATION)  
300 RENAISSANCE CENTER, P.O. BOX 300  
DETROIT, MI 482653000

FOR: MINIATURE MODELS OF VEHICLES, TOY  
VEHICLES, HOBBY KITS FOR THE CONSTRU-  
TION OF TOY VEHICLES, COLLECTABLE TOY  
CARS, RADIO CONTROLLED TOY CARS, RIDE-  
ON TOYS IN THE NATURE OF PEDAL CARS,  
BOARD GAMES, BALLOONS, STAND ALONE VI-  
DEO GAME MACHINES, HAND HELD UNIT FOR  
PLAYING VIDEO GAMES, PINBALL MACHINES,  
CHRISTMAS TREE ORNAMENTS, GOLF BALL

MARKERS, GOLF BALLS, GOLF CLUBS, IN CLASS  
28 (U.S. CLS. 22, 23, 38 AND 50).

FIRST USE 7-5-2005; IN COMMERCE 7-5-2005.

THE MARK CONSISTS OF STANDARD CHAR-  
ACTERS WITHOUT CLAIM TO ANY PARTICULAR  
FONT, STYLE, SIZE, OR COLOR.

OWNER OF U.S. REG. NO. 3,058,165.

SER. NO. 77-315,490, FILED 10-29-2007.

STEVEN PEREZ, EXAMINING ATTORNEY

**Int. Cl.: 7**

**Prior U.S. Cls.: 13, 19, 21, 23, 31, 34 and 35**

**Reg. No. 3,453,397**

**United States Patent and Trademark Office**

**Registered June 24, 2008**

**TRADEMARK  
PRINCIPAL REGISTER**

**FARMATE**

TAIZHOU SUNNY AGRICULTURAL MACHIN-  
ERY CO., LTD. (CHINA CORPORATION)  
HENGJIEZHEN IND. ZONE, LUQIAO DISTRICT  
TAIZHOU  
ZHEJIANG, CHINA

FOR: AGRICULTURAL SEED PLANTING MA-  
CHINE; AGRICULTURAL MACHINERY, NAME-  
LY, COMBINES, HARVESTERS, THRESHERS AND  
CULTIPACKERS; ELECTRIC KNIVES; POWER-OP-  
ERATED SPRAYERS; AGRICULTURAL IMPLE-  
MENTS, NAMELY, SEED DRILLS; POWER-  
OPERATED SAWS; PACKAGING MACHINES; DY-  
NAMOS; ELECTRIC PUMPS; PUMP CONTROL

VALVES; SERVO-VALVES; VALVES FOR PUMPS,  
IN CLASS 7 (U.S. CLS. 13, 19, 21, 23, 31, 34 AND 35).

FIRST USE 5-0-2002; IN COMMERCE 5-0-2006.

THE MARK CONSISTS OF STANDARD CHAR-  
ACTERS WITHOUT CLAIM TO ANY PARTICULAR  
FONT, STYLE, SIZE, OR COLOR.

SER. NO. 77-315,492, FILED 10-29-2007.

AMY HELLA, EXAMINING ATTORNEY



**Int. Cl.: 35**

**Prior U.S. Cls.: 100, 101 and 102**

**United States Patent and Trademark Office**

**Reg. No. 3,453,398**

**Registered June 24, 2008**

**SERVICE MARK  
PRINCIPAL REGISTER**

***MRINetwork Way***

BROWNS CANYON CORPORATION (DELA-  
WARE CORPORATION)  
103 FOULK ROAD, SUITE 222  
WILMINGTON, DE 19803

FOR: EMPLOYMENT AGENCY SERVICES; EM-  
PLOYMENT OUTPLACEMENT SERVICES; PER-  
SONNEL MANAGEMENT CONSULTATION,  
NAMELY, PERSONNEL EVALUATION SERVICES  
AND REFERENCE CHECKING; BUSINESS MAN-  
AGEMENT AND CONSULTATION IN THE FIELD  
OF EMPLOYMENT COUNSELING, EXCLUDING  
THE FIELDS OF THE PHYSICAL, BIOLOGICAL,  
ENGINEERING AND ECONOMICS MANAGE-  
MENT SCIENCES; PERSONNEL RELOCATION

AND TRAVEL MANAGEMENT SERVICES, IN  
CLASS 35 (U.S. CLS. 100, 101 AND 102).

FIRST USE 9-0-2005; IN COMMERCE 9-0-2005.

OWNER OF U.S. REG. NOS. 1,313,807, 3,286,712  
AND OTHERS.

THE MARK CONSISTS OF ALL LETTERS ITALI-  
CIZED.

SER. NO. 77-315,499, FILED 10-29-2007.

RENEE MCCRAY, EXAMINING ATTORNEY

**Int. Cls.: 35 and 44**

**Prior U.S. Cls.: 100, 101 and 102**

**United States Patent and Trademark Office**

**Reg. No. 3,453,399**

**Registered June 24, 2008**

**SERVICE MARK  
PRINCIPAL REGISTER**

**AMPLIFY YOUR LIFE**

MAAS-KAUTZKY INC. (IOWA CORPORATION),  
DBA CLEAR CHOICE HEARING CENTER  
6993 NW TRAIL RIDGE DRIVE  
JOHNSTON, IA 501311324

FOR: RETAIL STORE SERVICES IN THE FIELD  
OF HEARING AIDS, IN CLASS 35 (U.S. CLS. 100, 101  
AND 102).

FIRST USE 12-1-2006; IN COMMERCE 12-1-2006.

FOR: HEARING AID SERVICES, IN CLASS 44  
(U.S. CLS. 100 AND 101).

FIRST USE 12-1-2006; IN COMMERCE 12-1-2006.

THE MARK CONSISTS OF STANDARD CHAR-  
ACTERS WITHOUT CLAIM TO ANY PARTICULAR  
FONT, STYLE, SIZE, OR COLOR.

SER. NO. 77-315,583, FILED 10-29-2007.

RENEE MCCRAY, EXAMINING ATTORNEY

**Int. Cl.: 36**

**Prior U.S. Cls.: 100, 101 and 102**

**United States Patent and Trademark Office**

**Reg. No. 3,453,400**

**Registered June 24, 2008**

**SERVICE MARK  
PRINCIPAL REGISTER**

**CAREERGUARD**

MARKEL CORPORATION (VIRGINIA CORPORATION)  
4521 HIGHWOODS PARKWAY  
GLEN ALLEN, VA 23060

THE MARK CONSISTS OF STANDARD CHARACTERS WITHOUT CLAIM TO ANY PARTICULAR FONT, STYLE, SIZE, OR COLOR.

FOR: INSURANCE UNDERWRITING IN THE FIELD OF PROFESSIONAL LIABILITY, IN CLASS 36 (U.S. CLS. 100, 101 AND 102).

SER. NO. 77-315,619, FILED 10-29-2007.

FIRST USE 11-20-2005; IN COMMERCE 11-20-2005.

ROBIN CHOSID, EXAMINING ATTORNEY

**Int. Cl.: 38**

**Prior U.S. Cls.: 100, 101 and 104**

**United States Patent and Trademark Office**

**Reg. No. 3,453,401**

**Registered June 24, 2008**

**SERVICE MARK  
PRINCIPAL REGISTER**

**WE PLAY IT ALL**

FOREVER OF PA, INC (GEORGIA CORPORATION)  
1 FOREVER DR  
HOLLIDAYSBURG, PA 16648

THE MARK CONSISTS OF STANDARD CHARACTERS WITHOUT CLAIM TO ANY PARTICULAR FONT, STYLE, SIZE, OR COLOR.

FOR: RADIO BROADCASTING, IN CLASS 38 (U.S. CLS. 100, 101 AND 104).

SER. NO. 77-315,681, FILED 10-29-2007.

FIRST USE 10-26-2007; IN COMMERCE 10-26-2007.

JAMES A. RAUEN, EXAMINING ATTORNEY

**Int. Cl.: 35**

**Prior U.S. Cls.: 100, 101 and 102**

**United States Patent and Trademark Office**

**Reg. No. 3,453,402**

**Registered June 24, 2008**

**SERVICE MARK  
PRINCIPAL REGISTER**

**Green Vanderbilt Company**

ROSEN, JEFFREY S. (UNITED STATES INDIVIDUAL)  
110 WALL STREET 11TH FLOOR  
NEW YORK, NY 10005

FOR: EXPORT AND IMPORT AGENCIES; GENERAL BUSINESS NETWORKING REFERRAL SERVICES, NAMELY, PROMOTING THE GOODS AND SERVICES OF OTHERS BY PASSING BUSINESS LEADS AND REFERRALS AMONG GROUP MEMBERS, IN CLASS 35 (U.S. CLS. 100, 101 AND 102).

FIRST USE 3-1-2006; IN COMMERCE 3-1-2006.

THE MARK CONSISTS OF STANDARD CHARACTERS WITHOUT CLAIM TO ANY PARTICULAR FONT, STYLE, SIZE, OR COLOR.

NO CLAIM IS MADE TO THE EXCLUSIVE RIGHT TO USE "COMPANY", APART FROM THE MARK AS SHOWN.

SER. NO. 77-315,727, FILED 10-29-2007.

KATHY DE JONGE, EXAMINING ATTORNEY

**Int. Cl.: 41**

**Prior U.S. Cls.: 100, 101 and 107**

**United States Patent and Trademark Office**

**Reg. No. 3,453,403**

**Registered June 24, 2008**

**SERVICE MARK  
PRINCIPAL REGISTER**

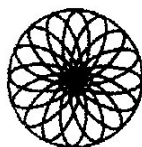

**Stress Release Technology**

CARRIGAN, FRANCES (UNITED STATES INDIVIDUAL)  
210 SUMMERSTON PLACE  
MAULDIN, SC 29662 AND  
OLKINETZKY, TOVA (UNITED STATES INDIVIDUAL)  
210 SUMMERSTON PLACE  
MAULDIN, SC 29662

FOR: EDUCATIONAL SERVICES, NAMELY, CONDUCTING SEMINARS AND WORKSHOPS IN THE FIELD OF THE INSTRUCTION AND TECHNIQUES OF RELEASING STRESS AND DISTRIBUTION OF COURSE MATERIAL IN CONNECTION THEREWITH, IN CLASS 41 (U.S. CLS. 100, 101 AND 107).

FIRST USE 12-31-1991; IN COMMERCE 12-31-1991.

NO CLAIM IS MADE TO THE EXCLUSIVE RIGHT TO USE "STRESS RELEASE TECHNOLOGY", APART FROM THE MARK AS SHOWN.

THE MARK CONSISTS OF SIXTEEN OVALS CONTAINED WITHIN A CIRCLE WITH THE STYLIZED WORDS "STRESS RELEASE TECHNOLOGY" NEXT TO IT.

SER. NO. 77-315,794, FILED 10-29-2007.

NICHOLAS ALTREE, EXAMINING ATTORNEY

**Int. Cl.: 28**

**Prior U.S. Cls.: 22, 23, 38 and 50**

**United States Patent and Trademark Office**

**Reg. No. 3,453,404**

**Registered June 24, 2008**

**TRADEMARK  
PRINCIPAL REGISTER**

**NIGHT YACKLE**

TTALF CORPORATION (NORTH CAROLINA  
CORPORATION)  
369 S. MAIN ST  
TROUTMAN, NC 28166

FOR: SPORT BALLS, IN CLASS 28 (U.S. CLS. 22, 23,  
38 AND 50).

FIRST USE 1-0-2007; IN COMMERCE 8-18-2007.

THE MARK CONSISTS OF STANDARD CHAR-  
ACTERS WITHOUT CLAIM TO ANY PARTICULAR  
FONT, STYLE, SIZE, OR COLOR.

OWNER OF U.S. REG. NO. 3,181,825.

SER. NO. 77-315,800, FILED 10-29-2007.

ROBIN CHOSID, EXAMINING ATTORNEY

**Int. Cl.: 30**

**Prior U.S. Cl.: 46**

**United States Patent and Trademark Office**

**Reg. No. 3,453,405**

**Registered June 24, 2008**

**TRADEMARK  
PRINCIPAL REGISTER**



TASTE ADVANTAGE, LLC (FLORIDA LTD LIAB  
CO)  
3135 DRANE FIELD ROAD, NO. 19-22  
LAKELAND, FL 33811

FOR: FLAVORING ADDITIVES FOR NON-NU-  
TRITIONAL PURPOSES, IN CLASS 30 (U.S. CL. 46).

FIRST USE 2-12-2007; IN COMMERCE 3-7-2007.

THE MARK CONSISTS OF THE LETTER "T"  
ADJACENT TO A STYLIZED LETTER "A" WITH  
AN APPLE CUTOUT.

SER. NO. 77-315,839, FILED 10-29-2007.

HENRY S. ZAK, EXAMINING ATTORNEY



**Int. Cl.: 5**

**Prior U.S. Cls.: 6, 18, 44, 46, 51 and 52**

**Reg. No. 3,453,406**

**United States Patent and Trademark Office**

**Registered June 24, 2008**

**TRADEMARK  
PRINCIPAL REGISTER**

**ALL AMERICAN**

ALL AMERICAN PHARMACEUTICAL & NAT-  
URAL FOODS CORPORATION (MONTANA  
CORPORATION)  
1831 MAIN STREET  
BILLINGS, MT 59105

FOR: NUTRITIONAL SUPPLEMENTS, IN CLASS  
5 (U.S. CLS. 6, 18, 44, 46, 51 AND 52).

FIRST USE 3-1-1985; IN COMMERCE 3-1-1985.

THE MARK CONSISTS OF STANDARD CHAR-  
ACTERS WITHOUT CLAIM TO ANY PARTICULAR  
FONT, STYLE, SIZE, OR COLOR.

OWNER OF U.S. REG. NO. 1,458,947.

SER. NO. 77-315,938, FILED 10-29-2007.

ANN E. SAPPENFIELD, EXAMINING ATTORNEY

**Int. Cl.: 25**

**Prior U.S. Cls.: 22 and 39**

**United States Patent and Trademark Office**

**Reg. No. 3,453,407**

**Registered June 24, 2008**

**TRADEMARK  
PRINCIPAL REGISTER**

**AHH, SAID THE FOOT**

KAYSER-ROTH CORPORATION (DELAWARE  
CORPORATION)  
102 CORPORATE CENTER BOULEVARD  
GREENSBORO, NC 27408

THE MARK CONSISTS OF STANDARD CHAR-  
ACTERS WITHOUT CLAIM TO ANY PARTICULAR  
FONT, STYLE, SIZE, OR COLOR.

FOR: SOCKS AND SOCK LINERS FOR FOOT-  
WEAR, IN CLASS 25 (U.S. CLS. 22 AND 39).

SER. NO. 77-315,944, FILED 10-29-2007.

FIRST USE 12-31-2004; IN COMMERCE 12-31-2004.

JEFF DEFORD, EXAMINING ATTORNEY

**Int. Cls.: 20 and 24**

**Prior U.S. Cls.: 2, 13, 22, 25, 32, 42 and 50**

**United States Patent and Trademark Office**

**Reg. No. 3,453,408**

**Registered June 24, 2008**

**TRADEMARK  
PRINCIPAL REGISTER**

**CLEANASSURE**

NVISION MARKETING LLC (NORTH CAROLINA LTD LIAB CO)  
11225 CREEK POINTE DR  
MATTHEWS, NC 28105

FOR: PILLOWS, IN CLASS 20 (U.S. CLS. 2, 13, 22, 25, 32 AND 50).

FIRST USE 9-12-2007; IN COMMERCE 10-21-2007.

FOR: MATTRESS PADS; COMFORTERS; BED SHEETS, IN CLASS 24 (U.S. CLS. 42 AND 50).

FIRST USE 9-12-2007; IN COMMERCE 10-21-2007.

THE MARK CONSISTS OF STANDARD CHARACTERS WITHOUT CLAIM TO ANY PARTICULAR FONT, STYLE, SIZE, OR COLOR.

SER. NO. 77-316,062, FILED 10-29-2007.

TARAH HARDY, EXAMINING ATTORNEY

Int. Cl.: 43

Prior U.S. Cls.: 100 and 101

United States Patent and Trademark Office

Reg. No. 3,453,409

Registered June 24, 2008

**SERVICE MARK  
PRINCIPAL REGISTER**

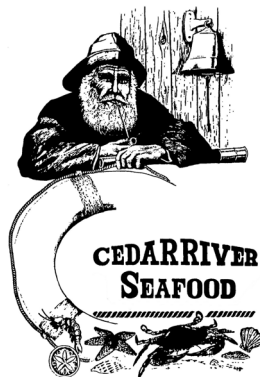

BELL, KATHY L. (UNITED STATES INDIVIDUAL)

6319 PINE AVENUE

GREEN COVE SPRINGS, FL 32043

FOR: CARRY-OUT RESTAURANTS, IN CLASS 43 (U.S. CLS. 100 AND 101).

FIRST USE 1-1-1982; IN COMMERCE 1-1-1982.

OWNER OF U.S. REG. NOS. 3,198,528 AND 3,198,617.

NO CLAIM IS MADE TO THE EXCLUSIVE RIGHT TO USE "SEAFOOD", APART FROM THE MARK AS SHOWN.

THE MARK CONSISTS OF BEARDED SEAMAN WITH PIPE IN MOUTH HOLDING LIFE PRESERVER WHICH ENCIRCLES THE WORDS "CEDAR RIVER SEAFOOD" AND VARIOUS OCEANIC CRUSTACEANS.

SER. NO. 77-316,072, FILED 10-29-2007.

VIVIAN MICZNIK FIRST, EXAMINING ATTORNEY

**Int. Cl.: 31**

**Prior U.S. Cls.: 1 and 46**

**United States Patent and Trademark Office**

**Reg. No. 3,453,410**

**Registered June 24, 2008**

**TRADEMARK  
PRINCIPAL REGISTER**

# PlastiLitter

DEE VETERINARY PRODUCTS, LLC (FLORIDA  
LTD LIAB CO)  
610 NORTH 32ND AVENUE  
HOLLYWOOD, FL 33021

THE MARK CONSISTS OF STANDARD CHAR-  
ACTERS WITHOUT CLAIM TO ANY PARTICULAR  
FONT, STYLE, SIZE, OR COLOR.

FOR: CAT LITTER, IN CLASS 31 (U.S. CLS. 1 AND  
46).

SER. NO. 77-316,087, FILED 10-29-2007.

FIRST USE 3-1-2007; IN COMMERCE 5-1-2007.

CAROL SPILS, EXAMINING ATTORNEY

**Int. Cl.: 43**

**Prior U.S. Cls.: 100 and 101**

**United States Patent and Trademark Office**

**Reg. No. 3,453,411**

**Registered June 24, 2008**

**SERVICE MARK  
PRINCIPAL REGISTER**



LWIN FAMILY CO. (NORTH CAROLINA CORPORATION), DBA HISSHO SUSHI  
11949 STEELE CREEK ROAD  
CHARLOTTE, NC 28273

FOR: RESTAURANT SERVICES, IN CLASS 43  
(U.S. CLS. 100 AND 101).

FIRST USE 1-25-2007; IN COMMERCE 1-25-2007.

OWNER OF U.S. REG. NO. 3,094,755.

NO CLAIM IS MADE TO THE EXCLUSIVE  
RIGHT TO USE "ASIAN TO GO", APART FROM  
THE MARK AS SHOWN.

THE COLOR(S) RED AND BLACK IS/ARE  
CLAIMED AS A FEATURE OF THE MARK.

THE MARK CONSISTS IN PART OF A STYLIZED  
LETTER "H" THE CURVED LINES FORMING THE  
SIDES OF THE LETTER "H" ARE BLACK. THE  
WORDING "ASIAN TO GO" AND ZIG-ZAG LINE  
FORMING THE HORIZONTAL PART OF THE  
LETTER "H" ARE RED.

SER. NO. 77-316,099, FILED 10-29-2007.

IRA J. GOODSID, EXAMINING ATTORNEY

Int. Cl.: 43

Prior U.S. Cls.: 100 and 101

United States Patent and Trademark Office

Reg. No. 3,453,412

Registered June 24, 2008

**SERVICE MARK  
PRINCIPAL REGISTER**

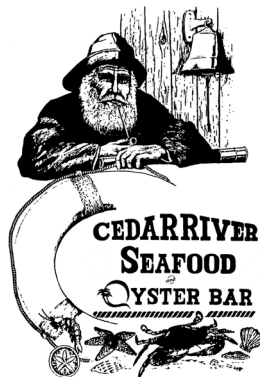

BELL, KATHY L. (UNITED STATES INDIVIDUAL)

6319 PINE AVENUE

GREEN COVE SPRINGS, FL 32043

FOR: CARRY-OUT RESTAURANTS, IN CLASS 43 (U.S. CLS. 100 AND 101).

FIRST USE 8-23-1977; IN COMMERCE 11-16-1982.

OWNER OF U.S. REG. NOS. 3,198,528 AND 3,198,617.

NO CLAIM IS MADE TO THE EXCLUSIVE RIGHT TO USE "SEAFOOD & OYSTER BAR", APART FROM THE MARK AS SHOWN.

THE MARK CONSISTS OF BEARDED SEAMAN WITH PIPE IN MOUTH HOLDING LIFE PRESERVER WHICH ENCIRCLES THE WORDS "CEDAR RIVER SEAFOOD AND OYSTER BAR" AND VARIOUS OCEANIC CRUSTACEANS.

SER. NO. 77-316,126, FILED 10-29-2007.

VIVIAN MICZNIK FIRST, EXAMINING ATTORNEY

**Int. Cl.: 42**

**Prior U.S. Cls.: 100 and 101**

**United States Patent and Trademark Office**

**Reg. No. 3,453,413**

**Registered June 24, 2008**

**SERVICE MARK  
PRINCIPAL REGISTER**

**NABITDATA**

TOLY DIGITAL NETWORKS, INC. (FLORIDA  
CORPORATION)  
4425 MILITARY TRAIL SUITE 209  
JUPITER, FL 33458

THE MARK CONSISTS OF STANDARD CHAR-  
ACTERS WITHOUT CLAIM TO ANY PARTICULAR  
FONT, STYLE, SIZE, OR COLOR.

FOR: DATA BACKUP AND RECOVERY SERVI-  
CES, IN CLASS 42 (U.S. CLS. 100 AND 101).

SER. NO. 77-316,151, FILED 10-29-2007.

FIRST USE 1-31-2007; IN COMMERCE 1-31-2007.

SUSAN LESLIE DUBOIS, EXAMINING ATTORNEY



**Int. Cl.: 41**

**Prior U.S. Cls.: 100, 101 and 107**

**United States Patent and Trademark Office**

**Reg. No. 3,453,414**

**Registered June 24, 2008**

**SERVICE MARK  
PRINCIPAL REGISTER**



ICD PUBLICATIONS, INC. (ILLINOIS CORPORATION)  
45 RESEARCH WAY, SUITE 106  
EAST SETAUKET, NY 11733

FOR: PROVIDING RECOGNITION BY THE WAY OF AWARDS TO DEMONSTRATE EXCELLENCE IN THE FIELDS OF PRODUCT DESIGN AND RETAIL MERCHANDISING , IN CLASS 41 (U.S. CLS. 100, 101 AND 107).

FIRST USE 9-1-2003; IN COMMERCE 9-1-2003.

OWNER OF U.S. REG. NO. 3,056,676.

NO CLAIM IS MADE TO THE EXCLUSIVE RIGHT TO USE "HOUSEWARES DESIGN AWARDS", APART FROM THE MARK AS SHOWN.

THE COLOR(S) BLUE, YELLOW, WHITE, PURPLE, GRAY, BLACK AND GREEN IS/ARE CLAIMED AS A FEATURE OF THE MARK.

THE COLORS BLUE, PURPLE AND WHITE APPEAR IN A HOUSE-LIKE DESIGN; THE COLOR GRAY APPEARS ON A GEAR-LIKE DESIGN BEHIND HOUSE; THE COLOR YELLOW APPEARS IN THE WORDING "HOUSEWARES DESIGN AWARDS"; AND THE COLOR BLACK IS THE BACKGROUND COLOR IN A CIRCULAR SHAPE WITH A GREEN GRID.

SER. NO. 77-316,175, FILED 10-29-2007.

JORDAN BAKER, EXAMINING ATTORNEY

Int. Cl.: 35

Prior U.S. Cls.: 100, 101 and 102

United States Patent and Trademark Office

Reg. No. 3,453,415

Registered June 24, 2008

**SERVICE MARK  
PRINCIPAL REGISTER**



THE RAW CONNECTION, INC. (CALIFORNIA CORPORATION)  
26549 CARMEL RANCHO BLVD.  
CARMEL, CA 93923

THE MARK CONSISTS OF A LARGE DOG WITH A SMALL DOG IN FRONT OF IT.

FOR: RETAIL STORE SERVICES AND ONLINE RETAIL STORE SERVICES FEATURING PET FOOD, IN CLASS 35 (U.S. CLS. 100, 101 AND 102).

SER. NO. 77-316,197, FILED 10-29-2007.

FIRST USE 6-1-2002; IN COMMERCE 6-1-2002.

KATHLEEN LORENZO, EXAMINING ATTORNEY

**Int. Cl.: 25**

**Prior U.S. Cls.: 22 and 39**

**United States Patent and Trademark Office**

**Reg. No. 3,453,416**

**Registered June 24, 2008**

**TRADEMARK  
PRINCIPAL REGISTER**

**THERE IS NO LIMIT.**

BOHANNON, KIMBERLY KENNEDY (UNITED STATES INDIVIDUAL)  
7006 SPRING VISTA COURT  
LOUISVILLE, KY 40229

FOR: BASEBALL CAPS; CAP VISORS; CAPS WITH VISORS; FLEECE SHORTS; GOLF CAPS; GYM SHORTS; HEADGEAR, NAMELY, HATS AND CAPS; HOODS; JERSEYS; KNITTED CAPS; SHORT-SLEEVED OR LONG-SLEEVED T-SHIRTS; SHORT-SLEEVED SHIRTS; SHORTS; SPORTS SHIRTS WITH SHORT SLEEVES; SWEAT SHORTS; T-SHIRTS; TO-

BOGGAN HATS, PANTS AND CAPS; TOPS, IN CLASS 25 (U.S. CLS. 22 AND 39).

FIRST USE 8-9-1994; IN COMMERCE 8-9-1994.

THE MARK CONSISTS OF STANDARD CHARACTERS WITHOUT CLAIM TO ANY PARTICULAR FONT, STYLE, SIZE, OR COLOR.

SER. NO. 77-316,230, FILED 10-29-2007.

CYNTHIA SLOAN, EXAMINING ATTORNEY

**Int. Cl.: 25**

**Prior U.S. Cls.: 22 and 39**

**United States Patent and Trademark Office**

**Reg. No. 3,453,417**

**Registered June 24, 2008**

**TRADEMARK  
PRINCIPAL REGISTER**

**GFYD**

BOHANNON, KIMBERLY KENNEDY (UNITED STATES INDIVIDUAL)  
7006 SPRING VISTA COURT  
LOUISVILLE, KY 40229

FOR: BASEBALL CAPS; CAP VISORS; CAPS; CAPS WITH VISORS; FLEECE SHORTS; GOLF CAPS; GYM SHORTS; HATS; HEADGEAR, NAMELY, HATS AND CAPS; HOODS; JERSEYS; KNITTED CAPS; SHORT-SLEEVED OR LONG-SLEEVED T-SHIRTS; SHORT-SLEEVED SHIRTS; SHORTS; SPORTS SHIRTS WITH SHORT SLEEVES; SWEAT SHORTS; T-SHIRTS; TOBOGGAN HATS, PANTS

AND CAPS; TOPS, IN CLASS 25 (U.S. CLS. 22 AND 39).

FIRST USE 8-9-1994; IN COMMERCE 8-9-1994.

THE MARK CONSISTS OF STANDARD CHARACTERS WITHOUT CLAIM TO ANY PARTICULAR FONT, STYLE, SIZE, OR COLOR.

SER. NO. 77-316,261, FILED 10-29-2007.

CYNTHIA SLOAN, EXAMINING ATTORNEY

**Int. Cls.: 29, 30 and 31**

**Prior U.S. Cls.: 1 and 46**

**United States Patent and Trademark Office**

**Reg. No. 3,453,418**

**Registered June 24, 2008**

**TRADEMARK  
PRINCIPAL REGISTER**

**DISCOVER A WHOLE NEW WORLD  
OF SNACKING**

ANN'S HOUSE OF NUTS, INC. (MARYLAND CORPORATION)  
8375 PATUXENT RANGE ROAD  
JESSUP, MD 20794

FOR: PROCESSED, EDIBLE SEAWEED; DRIED FRUITS; ORGANIC DRIED FRUITS; DRIED VEGETABLES; EDIBLE SHAVINGS OF DRIED KELP (TORORO-KOMBU); FRUIT CHIPS; PROCESSED FRUITS; PROCESSED VEGETABLES AND FRUITS; VEGETABLE CHIPS; IN-SHELL NUTS, IN CLASS 29 (U.S. CL. 46).

FIRST USE 6-11-2007; IN COMMERCE 6-11-2007.

FOR: CHOCOLATE COVERED NUTS; SNACK MIX CONSISTING PRIMARILY OF CRACKERS, PRETZELS, CANDIED NUTS AND/OR POPPED POPCORN; PRETZELS; CHOCOLATE COVERED PRETZELS; PITA CHIPS; BAGEL CHIPS; TORTILLA CHIPS; CHOCOLATE CANDIES; CHOCOLATE;

CANDY; CANDY BARS; COOKIES, IN CLASS 30 (U.S. CL. 46).

FIRST USE 6-11-2007; IN COMMERCE 6-11-2007.

FOR: RAW NUTS; UNPROCESSED NUTS; FRESH ORGANIC NUTS, IN CLASS 31 (U.S. CLS. 1 AND 46).

FIRST USE 6-11-2007; IN COMMERCE 6-11-2007.

THE MARK CONSISTS OF STANDARD CHARACTERS WITHOUT CLAIM TO ANY PARTICULAR FONT, STYLE, SIZE, OR COLOR.

OWNER OF U.S. REG. NO. 3,376,606.

SER. NO. 77-316,281, FILED 10-29-2007.

MARIA-VICTORIA SUAREZ, EXAMINING ATTORNEY

**Int. Cl.: 35**

**Prior U.S. Cls.: 100, 101 and 102**

**United States Patent and Trademark Office**

**Reg. No. 3,453,419**

**Registered June 24, 2008**

**SERVICE MARK  
PRINCIPAL REGISTER**

**BRAG ABOUT YOUR BAG**

COUNTY OF LOS ANGELES (CALIFORNIA POLITICAL SUBDIVISION OF THE STATE OF CALIFORNIA,)  
DEPT. OF PUBLIC WORKS/ENVIR. PROG. DIV.  
900 S. FREEMONT AVE.  
ALHAMBRA, CA 91803

FOR: PROMOTING PUBLIC AWARENESS OF THE NEED FOR USING REUSEABLE BAGS TO REDUCE LITTER WHILE ENCOURAGING RECYCLING EFFORTS THROUGH PUBLIC SERVICE MESSAGES AND ADVERTISEMENTS, IN CLASS 35 (U.S. CLS. 100, 101 AND 102).

FIRST USE 9-9-2007; IN COMMERCE 9-9-2007.

THE MARK CONSISTS OF STANDARD CHARACTERS WITHOUT CLAIM TO ANY PARTICULAR FONT, STYLE, SIZE, OR COLOR.

SER. NO. 77-316,289, FILED 10-29-2007.

HANNO RITTNER, EXAMINING ATTORNEY

**Int. Cls.: 37 and 41**

**Prior U.S. Cls.: 100, 101, 103, 106 and 107**

**United States Patent and Trademark Office**

**Reg. No. 3,453,420**

**Registered June 24, 2008**

**SERVICE MARK  
PRINCIPAL REGISTER**

# Exact-Built

MULTIVISTA, LLC (ARIZONA LTD LIAB CO)  
2211 EAST CAMELBACK ROAD, SUITE 202  
PHOENIX, AZ 85016

FOR: BUILDING CONSTRUCTION AND REPAIR; BUILDING CONSTRUCTION SERVICES; BUILDING INSPECTION; CONSTRUCTION AND RENOVATION OF BUILDINGS; CONSTRUCTION AND REPAIR OF BUILDINGS; CONSTRUCTION CONSULTANCY; CONSTRUCTION CONSULTATION; CONSTRUCTION MANAGEMENT; CONSTRUCTION PLANNING; CONSTRUCTION SERVICES, NAMELY, PLANNING, LAYING OUT AND CUSTOM CONSTRUCTION OF RESIDENTIAL AND COMMERCIAL COMMUNITIES; CONSTRUCTION SUPERVISION; CONSTRUCTION, MAINTENANCE AND RENOVATION OF PROPERTY; CONSULTATION IN BUILDING CONSTRUCTION SUPERVISION; CONSULTING IN THE FIELD OF BUILDING CONSTRUCTION; CONSULTING SERVICES FOR THE CONSTRUCTION OF WATER TREATMENT AND PURIFICATION PLANTS, SOLID WASTE TREATMENT PLANTS AND OTHER MUNICIPAL INFRASTRUCTURE FACILITIES; CUSTOM CONSTRUCTION AND BUILDING RENOVATION; CUSTOM CONSTRUCTION OF HOMES; GENERAL CONSTRUCTION CONTRACT-

ING; HOUSING SERVICES, NAMELY, DEVELOPMENT OF REAL PROPERTY, NAMELY, REPAIR, IMPROVEMENT, AND NEW CONSTRUCTION; HOUSING SERVICES, NAMELY, REPAIR, IMPROVEMENT, AND CONSTRUCTION OF RESIDENTIAL REAL PROPERTY; RESIDENTIAL AND BUILDING CONSTRUCTION CONSULTING; RESIDENTIAL AND COMMERCIAL BUILDING CONSTRUCTION, IN CLASS 37 (U.S. CLS. 100, 103 AND 106).

FIRST USE 10-23-2006; IN COMMERCE 10-23-2006.

FOR: AERIAL PHOTOGRAPHY; PHOTOGRAPHY SERVICES, IN CLASS 41 (U.S. CLS. 100, 101 AND 107).

FIRST USE 10-23-2006; IN COMMERCE 10-23-2006.

THE MARK CONSISTS OF STANDARD CHARACTERS WITHOUT CLAIM TO ANY PARTICULAR FONT, STYLE, SIZE, OR COLOR.

SER. NO. 77-316,307, FILED 10-29-2007.

ERIN FALK, EXAMINING ATTORNEY

**Int. Cl.: 3**

**Prior U.S. Cls.: 1, 4, 6, 50, 51 and 52**

**United States Patent and Trademark Office**

**Reg. No. 3,453,421**

**Registered June 24, 2008**

**TRADEMARK  
PRINCIPAL REGISTER**

**CHEMLIFT**

SWEANEY, MICHAEL (UNITED STATES INDIVIDUAL)  
8533 NE 135TH STREET  
KIRKLAND, WA 98034

THE MARK CONSISTS OF STANDARD CHARACTERS WITHOUT CLAIM TO ANY PARTICULAR FONT, STYLE, SIZE, OR COLOR.

FOR: SKIN TIGHTENING TOPICAL FACIAL COSMETIC DESIGNED TO REDUCE WRINKLES, IN CLASS 3 (U.S. CLS. 1, 4, 6, 50, 51 AND 52).

SER. NO. 77-316,360, FILED 10-29-2007.

FIRST USE 4-2-2007; IN COMMERCE 8-10-2007.

SANI KHOURI, EXAMINING ATTORNEY



**Int. Cl.: 9**

**Prior U.S. Cls.: 21, 23, 26, 36 and 38**

**Reg. No. 3,453,422**

**United States Patent and Trademark Office**

**Registered June 24, 2008**

---

**TRADEMARK  
PRINCIPAL REGISTER**

# Kornucopia

BODIE TECHNOLOGY, INC. (PENNSYLVANIA  
CORPORATION)  
103 MOUGINS CIRCLE  
KENNETT SQUARE, PA 19348

FOR: COMPUTER SOFTWARE FOR USE IN EN-  
GINEERING AND SCIENCE, NAMELY, FOR DIGI-  
TAL DATA MANIPULATION, ANALYSIS, AND  
CALCULATION, IN CLASS 9 (U.S. CLS. 21, 23, 26,  
36 AND 38).

FIRST USE 1-6-2007; IN COMMERCE 4-16-2007.

THE MARK CONSISTS OF STANDARD CHAR-  
ACTERS WITHOUT CLAIM TO ANY PARTICULAR  
FONT, STYLE, SIZE, OR COLOR.

SER. NO. 77-316,381, FILED 10-29-2007.

PAUL F. GAST, EXAMINING ATTORNEY

**Int. Cl.: 41**

**Prior U.S. Cls.: 100, 101 and 107**

**United States Patent and Trademark Office**

**Reg. No. 3,453,423**

**Registered June 24, 2008**

**SERVICE MARK  
PRINCIPAL REGISTER**

**The Daily Rock Rewind**

AIRWAVES ENTERTAINMENT, LLC (CALIFORNIA LTD LIAB CO)  
357 NORTH KINGS ROAD  
LOS ANGELES, CA 90048

FOR: PRODUCTION AND DISTRIBUTION OF RADIO PROGRAMS; PRODUCTION OF RADIO OR TELEVISION PROGRAMS; RADIO ENTERTAINMENT PRODUCTION; RADIO ENTERTAINMENT SERVICES, NAMELY, RADIO PROGRAMS FEATURING PERFORMANCES BY A RADIO PERSONALITY.; RADIO PROGRAM SYNDICATION; NEWS ANALYSIS AND FEATURES DISTRIBUTION; NEWS REPORTING SERVICES; PROVIDING INFORMATION, NEWS AND COMMENTARY IN THE FIELD OF ENTERTAINMENT; PROVIDING NEWS IN THE NATURE OF CURRENT EVENT REPORTING; ENTERTAINMENT IN THE NATURE OF PRERECORDED NEWS AND MUSICAL FEATURE MESSAGES BY TELEPHONE; ENTERTAINMENT IN THE NATURE OF VISUAL AND AUDIO PERFORMANCES, AND MUSICAL, VARIETY, NEWS AND COMEDY SHOWS; AUDIO RECORDING AND PRODUCTION; ENTERTAINMENT, NAMELY, A CONTINUING NEWS SHOW BROAD-

CAST OVER TELEVISION, SATELLITE, AUDIO, AND VIDEO MEDIA; ENTERTAINMENT SERVICES, NAMELY, AN ON-GOING SERIES FEATURING ENTERTAINMENT NEWS PROVIDED THROUGH RADIO BROADCASTS; ENTERTAINMENT SERVICES, NAMELY, PROVIDING A RADIO PROGRAM IN THE FIELD OF ENTERTAINMENT NEWS VIA A GLOBAL COMPUTER NETWORK, IN CLASS 41 (U.S. CLS. 100, 101 AND 107).

FIRST USE 7-1-2007; IN COMMERCE 7-1-2007.

THE MARK CONSISTS OF STANDARD CHARACTERS WITHOUT CLAIM TO ANY PARTICULAR FONT, STYLE, SIZE, OR COLOR.

NO CLAIM IS MADE TO THE EXCLUSIVE RIGHT TO USE "DAILY ROCK", APART FROM THE MARK AS SHOWN.

SER. NO. 77-316,405, FILED 10-29-2007.

DORITT L. CARROLL, EXAMINING ATTORNEY

**Int. Cl.: 11**

**Prior U.S. Cls.: 13, 21, 23, 31 and 34**

**Reg. No. 3,453,424**

**United States Patent and Trademark Office**

**Registered June 24, 2008**

---

**TRADEMARK  
PRINCIPAL REGISTER**

**SWEET WATER**

METHOD PRODUCTS, INC. (DELAWARE CORPORATION)  
SUITE 300  
637 COMMERCIAL STREET  
SAN FRANCISCO, CA 94111

FOR: DIFFUSERS FOR DISPENSING FRAGRANCES; DISPENSING UNITS FOR ROOM DEODORANTS; HOUSEHOLD AIR CLEANERS, IN CLASS 11 (U.S. CLS. 13, 21, 23, 31 AND 34).

FIRST USE 1-16-2006; IN COMMERCE 1-16-2006.

THE MARK CONSISTS OF STANDARD CHARACTERS WITHOUT CLAIM TO ANY PARTICULAR FONT, STYLE, SIZE, OR COLOR.

SER. NO. 77-316,422, FILED 10-29-2007.

GIANCARLO CASTRO, EXAMINING ATTORNEY

**Int. Cl.: 20**

**Prior U.S. Cls.: 2, 13, 22, 25, 32 and 50**

**Reg. No. 3,453,425**

**United States Patent and Trademark Office**

**Registered June 24, 2008**

---

**TRADEMARK  
PRINCIPAL REGISTER**

**ZIPMATE**

EATON CORPORATION (OHIO CORPORATION)  
1111 SUPERIOR AVENUE  
CLEVELAND, OH 44114

FIRST USE 10-1-1993; IN COMMERCE 10-1-1993.

FOR: PLASTIC CLOSURE FOR PLASTIC BAGS,  
PLASTIC CLOSURE IN THE NATURE OF A LOCK-  
ING STRIP FOR PLASTIC BAGS, PLASTIC CLO-  
SURES IN THE NATURE OF PLASTIC STRIPS FOR  
SEALING BAGS , IN CLASS 20 (U.S. CLS. 2, 13, 22, 25,  
32 AND 50).

THE MARK CONSISTS OF STANDARD CHAR-  
ACTERS WITHOUT CLAIM TO ANY PARTICULAR  
FONT, STYLE, SIZE, OR COLOR.

SER. NO. 77-316,701, FILED 10-30-2007.

SHARON MEIER, EXAMINING ATTORNEY

**Int. Cl.: 35**

**Prior U.S. Cls.: 100, 101 and 102**

**United States Patent and Trademark Office**

**Reg. No. 3,453,426**

**Registered June 24, 2008**

**SERVICE MARK  
PRINCIPAL REGISTER**

**THE CURE FOR THE COMMON  
DRUG STORE**

ELEPHANT PHARMACY, INC. (DELAWARE  
CORPORATION)  
1250 9TH STREET  
BERKELEY, CA 94710

FOR: RETAIL CONVENIENCE STORES; RETAIL  
DRUG STORE SERVICES; RETAIL FLORIST  
SHOPS; RETAIL PHARMACY SERVICES; FOOD  
KIOSK SERVICES, IN CLASS 35 (U.S. CLS. 100, 101  
AND 102).

FIRST USE 6-1-2007; IN COMMERCE 6-1-2007.

THE MARK CONSISTS OF STANDARD CHAR-  
ACTERS WITHOUT CLAIM TO ANY PARTICULAR  
FONT, STYLE, SIZE, OR COLOR.

SER. NO. 77-316,711, FILED 10-30-2007.

MARIAM MAHMOUDI, EXAMINING ATTORNEY

**Int. Cl.: 9**

**Prior U.S. Cls.: 21, 23, 26, 36 and 38**

**Reg. No. 3,453,427**

**United States Patent and Trademark Office**

**Registered June 24, 2008**

---

**TRADEMARK  
PRINCIPAL REGISTER**

**SmartREF**

APEX DATA SERVICES, INC (VIRGINIA CORPORATION)  
SUITE 200  
198 VAN BUREN STREET  
HERNDON, VA 20170

FOR: COMPUTER PROGRAM WHICH TRANSFORMS BIBLIOGRAPHIC CITATIONS FROM ELECTRONIC OR HARDCOPY INTO A LINKED, INDEXED AND CROSS-REFERENCED DATABASE , IN CLASS 9 (U.S. CLS. 21, 23, 26, 36 AND 38).

FIRST USE 7-1-2005; IN COMMERCE 7-25-2005.

THE MARK CONSISTS OF STANDARD CHARACTERS WITHOUT CLAIM TO ANY PARTICULAR FONT, STYLE, SIZE, OR COLOR.

OWNER OF U.S. REG. NO. 3,355,474.

SER. NO. 77-316,721, FILED 10-30-2007.

JUSTINE D. PARKER, EXAMINING ATTORNEY

**Int. Cl.: 35**

**Prior U.S. Cls.: 100, 101 and 102**

**United States Patent and Trademark Office**

**Reg. No. 3,453,428**

**Registered June 24, 2008**

**SERVICE MARK  
PRINCIPAL REGISTER**

**RATIONAL CHOICE MED/SURG**

PREMIER, INC. (DELAWARE CORPORATION)  
12225 EL CAMINO REAL  
SAN DIEGO, CA 92130

OWNER OF U.S. REG. NOS. 2,510,895 AND  
2,517,984.

FOR: PROCUREMENT, NAMELY, PURCHASING  
HOSPITAL AND HEALTH CARE PRODUCTS FOR  
OTHERS, IN CLASS 35 (U.S. CLS. 100, 101 AND 102).

NO CLAIM IS MADE TO THE EXCLUSIVE  
RIGHT TO USE "MED/SURG", APART FROM THE  
MARK AS SHOWN.

FIRST USE 10-0-2006; IN COMMERCE 10-0-2006.

SER. NO. 77-316,839, FILED 10-30-2007.

THE MARK CONSISTS OF STANDARD CHAR-  
ACTERS WITHOUT CLAIM TO ANY PARTICULAR  
FONT, STYLE, SIZE, OR COLOR.

EVELYN BRADLEY, EXAMINING ATTORNEY

**Int. Cl.: 9**

**Prior U.S. Cls.: 21, 23, 26, 36 and 38**

**Reg. No. 3,453,429**

**United States Patent and Trademark Office**

**Registered June 24, 2008**

**TRADEMARK  
PRINCIPAL REGISTER**

# EtherWAN

ETHERWAN SYSTEMS, INC. (CALIFORNIA CORPORATION)  
4570 E. EISENHOWER CIRCLE  
ANAHEIM, CA 92807

FIRST USE 2-1-1997; IN COMMERCE 2-1-1997.

FOR: ETHERNET SWITCHES; LAN (LOCAL AREA NETWORK) COMPUTER CARDS FOR CONNECTING PORTABLE COMPUTER DEVICES TO COMPUTER NETWORKS; NETWORK ACCESS SERVER HARDWARE; POWER SUPPLY CONNECTORS AND ADAPTORS FOR USE WITH PORTABLE ELECTRONIC DEVICES, IN CLASS 9 (U.S. CLS. 21, 23, 26, 36 AND 38).

THE MARK CONSISTS OF STANDARD CHARACTERS WITHOUT CLAIM TO ANY PARTICULAR FONT, STYLE, SIZE, OR COLOR.

SER. NO. 77-316,872, FILED 10-30-2007.

CYNTHIA SLOAN, EXAMINING ATTORNEY



**Int. Cl.: 41**

**Prior U.S. Cls.: 100, 101 and 107**

**United States Patent and Trademark Office**

**Reg. No. 3,453,430**

**Registered June 24, 2008**

**SERVICE MARK  
PRINCIPAL REGISTER**

# SwarmForce

SWARMSFORCE, INC. (DELAWARE CORPORATION)  
911 CANTERBURY  
CEDAR HILL, TX 75104

FOR: MULTIMEDIA PUBLISHING OF BOOKS,  
MAGAZINES, JOURNALS, SOFTWARE, GAMES,  
MUSIC, AND ELECTRONIC PUBLICATIONS, IN  
CLASS 41 (U.S. CLS. 100, 101 AND 107).

FIRST USE 10-5-2007; IN COMMERCE 10-5-2007.

THE MARK CONSISTS OF STANDARD CHARACTERS WITHOUT CLAIM TO ANY PARTICULAR FONT, STYLE, SIZE, OR COLOR.

SER. NO. 77-316,913, FILED 10-30-2007.

CHRISTOPHER BUONGIORNO, EXAMINING ATTORNEY

**Int. Cl.: 14**

**Prior U.S. Cls.: 2, 27, 28 and 50**

**United States Patent and Trademark Office**

**Reg. No. 3,453,431**

**Registered June 24, 2008**

**TRADEMARK  
PRINCIPAL REGISTER**

**FILTHY RICH**

FILTHY RICH, INC. (FLORIDA CORPORATION)  
922 LOTUS VISTA DRIVE, # 102  
ALTAMONTE SPRINGS, FL 32714

FOR: JEWELLRY - IMITATION, IN CLASS 14 (U.S.  
CLS. 2, 27, 28 AND 50).

FIRST USE 5-1-2003; IN COMMERCE 5-1-2003.

THE MARK CONSISTS OF TWO WORDS (FIL-  
THY, WITH A CAPITAL F, AND RICH, WITH A  
CAPITAL R) SHOWN IN SPACETOASTER FONT  
ONLY AND NO COLOR DOTS ON THE I'S; ALL  
BLACK LETTERS.

SER. NO. 77-317,094, FILED 10-30-2007.

ROBIN CHOSID, EXAMINING ATTORNEY

Int. Cl.: 32

Prior U.S. Cls.: 45, 46 and 48

Reg. No. 3,453,432

United States Patent and Trademark Office

Registered June 24, 2008

TRADEMARK  
PRINCIPAL REGISTER



SCHWAN'S IP, LLC (MINNESOTA LTD LIAB CO)  
115 W. COLLEGE DRIVE  
MARSHALL, MN 56258

FOR: JUICE BASE CONCENTRATES, IN CLASS 32  
(U.S. CLS. 45, 46 AND 48).

FIRST USE 1-1-2001; IN COMMERCE 1-1-2001.

OWNER OF U.S. REG. NOS. 2,832,738, 3,076,389  
AND OTHERS.

THE MARK CONSISTS OF A SWAN OVER THE  
WORD "SCHWAN'S" WITH THE BOTTOM OF THE  
SWAN CONNECTING INTO THE MAIN LINE OF  
THE "H".

SER. NO. 77-317,142, FILED 10-30-2007.

AMY GEARIN, EXAMINING ATTORNEY

**Int. Cl.: 35**

**Prior U.S. Cls.: 100, 101 and 102**

**United States Patent and Trademark Office**

**Reg. No. 3,453,433**

**Registered June 24, 2008**

**SERVICE MARK  
PRINCIPAL REGISTER**

**partstap.com**

SKP DISTRIBUTION, INC. (CALIFORNIA CORPORATION)  
14559 GILMORE STREET  
VAN NUYS, CA 91411

FOR: ON-LINE RETAIL STORE SERVICES FEATURING REPLACEMENT PARTS, ACCESSORIES AND SUPPLIES FOR APPLIANCES.; ON-LINE ORDERING SERVICES FEATURING REPLACEMENT PARTS, ACCESSORIES AND SUPPLIES FOR APPLIANCES, IN CLASS 35 (U.S. CLS. 100, 101 AND 102).

FIRST USE 5-5-2006; IN COMMERCE 2-4-2007.

THE MARK CONSISTS OF STANDARD CHARACTERS WITHOUT CLAIM TO ANY PARTICULAR FONT, STYLE, SIZE, OR COLOR.

SER. NO. 77-317,159, FILED 10-30-2007.

TEJBIR SINGH, EXAMINING ATTORNEY

**Int. Cl.: 25**

**Prior U.S. Cls.: 22 and 39**

**United States Patent and Trademark Office**

**Reg. No. 3,453,434**

**Registered June 24, 2008**

**TRADEMARK  
PRINCIPAL REGISTER**



METHOD PRODUCTS, INC. (DELAWARE CORPORATION)  
SUITE 300  
637 COMMERCIAL STREET  
SAN FRANCISCO, CA 94111

OWNER OF U.S. REG. NO. 2,733,195.

THE MARK CONSISTS OF A LOWER CASE "M" WITH A DOT AS PART OF THE LETTER, WITHIN A CIRCLE.

FOR: CAPS; HATS; T-SHIRTS, IN CLASS 25 (U.S. CLS. 22 AND 39).

SER. NO. 77-317,194, FILED 10-30-2007.

FIRST USE 12-2-2006; IN COMMERCE 12-2-2006.

GIANCARLO CASTRO, EXAMINING ATTORNEY

**Int. Cl.: 25**

**Prior U.S. Cls.: 22 and 39**

**United States Patent and Trademark Office**

**Reg. No. 3,453,435**

**Registered June 24, 2008**

**TRADEMARK  
PRINCIPAL REGISTER**

**PEOPLE AGAINST DIRTY**

METHOD PRODUCTS, INC. (DELAWARE CORPORATION)  
SUITE 300  
637 COMMERCIAL STREET  
SAN FRANCISCO, CA 94111

FOR: CAPS; HATS; T-SHIRTS, IN CLASS 25 (U.S. CLS. 22 AND 39).

FIRST USE 12-2-2006; IN COMMERCE 12-2-2006.

THE MARK CONSISTS OF STANDARD CHARACTERS WITHOUT CLAIM TO ANY PARTICULAR FONT, STYLE, SIZE, OR COLOR.

OWNER OF U.S. REG. NO. 3,242,818.

SER. NO. 77-317,214, FILED 10-30-2007.

GIANCARLO CASTRO, EXAMINING ATTORNEY

**Int. Cl.: 33**

**Prior U.S. Cls.: 47 and 49**

**United States Patent and Trademark Office**

**Reg. No. 3,453,436**

**Registered June 24, 2008**

**TRADEMARK  
PRINCIPAL REGISTER**

**Antelope Valley Winery**

ANTELOPE VALLEY WINERY (CALIFORNIA  
LTD LIAB CO)  
42041 20TH ST. W.  
LANCASTER, CA 93534

NO CLAIM IS MADE TO THE EXCLUSIVE  
RIGHT TO USE "WINERY", APART FROM THE  
MARK AS SHOWN.

FOR: WINE, IN CLASS 33 (U.S. CLS. 47 AND 49).

SEC. 2(F).

FIRST USE 5-2-1991; IN COMMERCE 5-2-1991.

SER. NO. 77-317,287, FILED 10-30-2007.

THE MARK CONSISTS OF STANDARD CHAR-  
ACTERS WITHOUT CLAIM TO ANY PARTICULAR  
FONT, STYLE, SIZE, OR COLOR.

MICHAEL KAZAZIAN, EXAMINING ATTORNEY

**Int. Cl.: 18**

**Prior U.S. Cls.: 1, 2, 3, 22 and 41**

**United States Patent and Trademark Office**

**Reg. No. 3,453,437**

**Registered June 24, 2008**

**TRADEMARK  
PRINCIPAL REGISTER**

**SLEEKY** 

HUNTER GROUP LTD. PART (THAILAND LIMITED PARTNERSHIP)  
537 SOI SOONVIJAI 4, RAMA 9 RD. BANGKAPI  
HUAYKWANG, BANGKOK, THAILAND

FOR: HARNESES, LEASHES, COLLARS AND LEADS FOR PETS; MUZZLES; RAW HIDE CHEWS FOR DOGS; PET CLOTHING, IN CLASS 18 (U.S. CLS. 1, 2, 3, 22 AND 41).

FIRST USE 8-30-2007; IN COMMERCE 8-30-2007.

SER. NO. 77-317,359, FILED 10-30-2007.

STEVEN PEREZ, EXAMINING ATTORNEY



**Int. Cl.: 17**

**Prior U.S. Cls.: 1, 5, 12, 13, 35 and 50**

**United States Patent and Trademark Office**

**Reg. No. 3,453,438**

**Registered June 24, 2008**

**TRADEMARK  
PRINCIPAL REGISTER**

# Novapreme

LENDELL MANUFACTURING, INC. (MICHIGAN CORPORATION)  
5301 S. GRAHAM ROAD  
SAINT CHARLES, MI 48655

THE MARK CONSISTS OF STANDARD CHARACTERS WITHOUT CLAIM TO ANY PARTICULAR FONT, STYLE, SIZE, OR COLOR.

FOR: OPEN CELL FOAM IN ROLL FORM, IN CLASS 17 (U.S. CLS. 1, 5, 12, 13, 35 AND 50).

SER. NO. 77-317,463, FILED 10-30-2007.

FIRST USE 12-6-2004; IN COMMERCE 12-6-2004.

DAVID COLLIER, EXAMINING ATTORNEY

**Int. Cl.: 17**

**Prior U.S. Cls.: 1, 5, 12, 13, 35 and 50**

**Reg. No. 3,453,439**

**United States Patent and Trademark Office**

**Registered June 24, 2008**

---

**TRADEMARK  
PRINCIPAL REGISTER**

**Novalite**

LENDELL MANUFACTURING, INC. (MICHIGAN CORPORATION)  
5301 S. GRAHAM ROAD  
SAINT CHARLES, MI 48655

THE MARK CONSISTS OF STANDARD CHARACTERS WITHOUT CLAIM TO ANY PARTICULAR FONT, STYLE, SIZE, OR COLOR.

FOR: OPEN CELL FOAM IN ROLL FORM, IN CLASS 17 (U.S. CLS. 1, 5, 12, 13, 35 AND 50).

SER. NO. 77-317,465, FILED 10-30-2007.

FIRST USE 9-11-2006; IN COMMERCE 9-11-2006.

DAVID COLLIER, EXAMINING ATTORNEY

**Int. Cl.: 33**

**Prior U.S. Cls.: 47 and 49**

**United States Patent and Trademark Office**

**Reg. No. 3,453,440**

**Registered June 24, 2008**

**TRADEMARK  
PRINCIPAL REGISTER**

**GROWN TO BE THE WORLD'S  
BEST RUM**

DIAGEO NORTH AMERICA, INC. (CONNECTI-  
CUT CORPORATION)  
801 MAIN AVENUE  
NORWALK, CT 06851

FOR: DISTILLED SPIRITS, IN CLASS 33 (U.S. CLS.  
47 AND 49).

FIRST USE 4-30-2006; IN COMMERCE 4-30-2006.

THE MARK CONSISTS OF STANDARD CHAR-  
ACTERS WITHOUT CLAIM TO ANY PARTICULAR  
FONT, STYLE, SIZE, OR COLOR.

OWNER OF U.S. REG. NO. 3,309,382.

SER. NO. 77-317,619, FILED 10-31-2007.

KATHERINE STOIDES, EXAMINING ATTORNEY

**Int. Cl.: 13**

**Prior U.S. Cls.: 2 and 9**

**United States Patent and Trademark Office**

**Reg. No. 3,453,441**

**Registered June 24, 2008**

**TRADEMARK  
PRINCIPAL REGISTER**

**FLEXFIRE**

SHOCK TUBE SYSTEMS, INC. (CONNECTICUT CORPORATION)  
P.O. BOX 176, 110 INDUSTRIAL PARK ROAD  
STERLING, CT 06377

FOR: REMOTELY OPERABLE FIRING DEVICE FOR A PERCUSSION SHOCK TUBE DETONATOR ASSEMBLY, NAMELY, AN ELECTRICALLY ACTIVATED INITIATOR HAVING A PERCUSSION FIRING PIN, IN CLASS 13 (U.S. CLS. 2 AND 9).

FIRST USE 11-18-2002; IN COMMERCE 11-18-2002.

THE MARK CONSISTS OF STANDARD CHARACTERS WITHOUT CLAIM TO ANY PARTICULAR FONT, STYLE, SIZE, OR COLOR.

SER. NO. 77-317,723, FILED 10-31-2007.

BARBARA GAYNOR, EXAMINING ATTORNEY

**Int. Cls.: 16, 35 and 41**

**Prior U.S. Cls.: 2, 5, 22, 23, 29, 37, 38, 50, 100, 101, 102  
and 107**

**Reg. No. 3,453,442**

**United States Patent and Trademark Office**

**Registered June 24, 2008**

**TRADEMARK  
SERVICE MARK  
PRINCIPAL REGISTER**

**THE MARATHON CLUB**

THE MARATHON CLUB FOR ENTREPRENEUR-  
SHIP (D.C. CORPORATION)  
1300 PENNSYLVANIA AVENUE, N.W., STE 700  
WASHINGTON, DC 20004

FOR: PRINTED PUBLICATIONS, NAMELY,  
LEAFLETS, BROCHURES, AND REPORTS IN THE  
FIELDS OF ENTREPRENEURSHIP AND PRIVATE  
EQUITY CAPITAL, IN CLASS 16 (U.S. CLS. 2, 5, 22, 23,  
29, 37, 38 AND 50).

FIRST USE 4-0-2004; IN COMMERCE 4-0-2004.

FOR: ASSOCIATION SERVICES, NAMELY, PRO-  
MOTING THE INTERESTS OF MINORITIES IN THE  
FIELDS OF ENTREPRENEURSHIP AND PRIVATE  
EQUITY CAPITAL; BUSINESS NETWORKING  
EVENTS AND ON-LINE BUSINESS NETWORKING  
SERVICES, IN CLASS 35 (U.S. CLS. 100, 101 AND 102).

FIRST USE 4-0-2004; IN COMMERCE 4-0-2004.

FOR: EDUCATIONAL SERVICES, NAMELY, AR-  
RANGING AND CONDUCTING CLASSES, WORK-  
SHOPS, SEMINARS AND CONFERENCES IN THE  
FIELDS OF ENTREPRENEURSHIP AND PRIVATE  
EQUITY CAPITAL, IN CLASS 41 (U.S. CLS. 100, 101  
AND 107).

FIRST USE 4-0-2004; IN COMMERCE 4-0-2004.

THE MARK CONSISTS OF STANDARD CHAR-  
ACTERS WITHOUT CLAIM TO ANY PARTICULAR  
FONT, STYLE, SIZE, OR COLOR.

SER. NO. 77-318,140, FILED 10-31-2007.

GIANCARLO CASTRO, EXAMINING ATTORNEY

**Int. Cl.: 44**

**Prior U.S. Cls.: 100 and 101**

**United States Patent and Trademark Office**

**Reg. No. 3,453,443**

**Registered June 24, 2008**

---

**SERVICE MARK  
PRINCIPAL REGISTER**

**L'Escape**

PHAM, JENNIFER Q. (UNITED STATES INDIVIDUAL)  
1217 BURLINGAME AVENUE  
BURLINGAME, CA 94010

FOR: FACIAL TREATMENT SERVICES, NAME-  
LY, COSMETIC PEELS; MASSAGE; BODY WAXING  
SERVICES, IN CLASS 44 (U.S. CLS. 100 AND 101).

FIRST USE 6-1-2003; IN COMMERCE 6-1-2003.

THE MARK CONSISTS OF STANDARD CHAR-  
ACTERS WITHOUT CLAIM TO ANY PARTICULAR  
FONT, STYLE, SIZE, OR COLOR.

THE ENGLISH TRANSLATION OF "L'ESCAPE"  
IN THE MARK IS "THE ESCAPE."

SER. NO. 77-318,311, FILED 10-31-2007.

TAMARA FRAZIER, EXAMINING ATTORNEY

**Int. Cl.: 35**

**Prior U.S. Cls.: 100, 101 and 102**

**United States Patent and Trademark Office**

**Reg. No. 3,453,444**

**Registered June 24, 2008**

**SERVICE MARK  
PRINCIPAL REGISTER**

**MY PROPERTY PORTFOLIO**

SANTA FE PROPERTIES, INC. (NEW MEXICO CORPORATION)  
1000 PASEO DE PERALTA  
SANTA FE, NM 87501

FOR: REAL ESTATE SERVICES PROVIDED OVER THE WORLD WIDE WEB AND/OR INTERNET, NAMELY, PROVIDING REAL ESTATE LISTINGS AND REAL ESTATE INFORMATION VIA THE INTERNET IN THE FORM OF A SECURE USER DATABASE FOR STORING INFORMATION RELATED TO ONE OR MORE REAL PROPERTY INTERESTS, MAP DATA, AND USER-SELECTED TRACKING PARAMETERS RELATED TO SUCH REAL PROPERTY INTERESTS, IN CLASS 35 (U.S. CLS. 100, 101 AND 102).

FIRST USE 11-5-2006; IN COMMERCE 11-5-2006.

THE MARK CONSISTS OF STANDARD CHARACTERS WITHOUT CLAIM TO ANY PARTICULAR FONT, STYLE, SIZE, OR COLOR.

NO CLAIM IS MADE TO THE EXCLUSIVE RIGHT TO USE "PROPERTY PORTFOLIO", APART FROM THE MARK AS SHOWN.

SER. NO. 77-318,373, FILED 10-31-2007.

SUNG IN, EXAMINING ATTORNEY

**Int. Cl.: 16**

**Prior U.S. Cls.: 2, 5, 22, 23, 29, 37, 38 and 50**

**United States Patent and Trademark Office**

**Reg. No. 3,453,445**

**Registered June 24, 2008**

**TRADEMARK  
PRINCIPAL REGISTER**

PARENTHESES HAVE A PLACE  
BUT NOT ON YOUR FACE

ALLERGAN, INC. (DELAWARE CORPORATION)  
2525 DUPONT DRIVE  
IRVINE, CA 92612

THE MARK CONSISTS OF STANDARD CHAR-  
ACTERS WITHOUT CLAIM TO ANY PARTICULAR  
FONT, STYLE, SIZE, OR COLOR.

FOR: INFORMATIONAL BROCHURES, FLIP-  
CHARTS AND FLYERS CONCERNING DERMAL  
FILLERS, IN CLASS 16 (U.S. CLS. 2, 5, 22, 23, 29, 37, 38  
AND 50).

SER. NO. 77-318,530, FILED 10-31-2007.

FIRST USE 8-15-2006; IN COMMERCE 1-2-2007.

REBECCA EISINGER, EXAMINING ATTORNEY



**Int. Cl.: 36**

**Prior U.S. Cls.: 100, 101 and 102**

**United States Patent and Trademark Office**

**Reg. No. 3,453,446**

**Registered June 24, 2008**

**SERVICE MARK  
PRINCIPAL REGISTER**

**MYPOWER**

BLUESTAR ENERGY SERVICES, INC. (ILLINOIS  
CORPORATION)  
SUITE 700  
363 W. ERIE  
CHICAGO, IL 60610

THE MARK CONSISTS OF STANDARD CHAR-  
ACTERS WITHOUT CLAIM TO ANY PARTICULAR  
FONT, STYLE, SIZE, OR COLOR.

FOR: BROKERAGE OF ENERGY, NAMELY, GAS  
AND ELECTRICITY, IN CLASS 36 (U.S. CLS. 100, 101  
AND 102).

SER. NO. 77-319,168, FILED 11-1-2007.

FIRST USE 10-1-2006; IN COMMERCE 10-1-2006.

CAROLYN CATALDO, EXAMINING ATTORNEY

**Int. Cl.: 36**

**Prior U.S. Cls.: 100, 101 and 102**

**United States Patent and Trademark Office**

**Reg. No. 3,453,447**

**Registered June 24, 2008**

**SERVICE MARK  
PRINCIPAL REGISTER**

**MYPRICE**

BLUESTAR ENERGY SERVICES, INC. (ILLINOIS  
CORPORATION)  
SUITE 700  
363 W. ERIE  
CHICAGO, IL 60610

THE MARK CONSISTS OF STANDARD CHAR-  
ACTERS WITHOUT CLAIM TO ANY PARTICULAR  
FONT, STYLE, SIZE, OR COLOR.

FOR: BROKERAGE OF ENERGY, NAMELY, GAS  
AND ELECTRICITY, IN CLASS 36 (U.S. CLS. 100, 101  
AND 102).

SER. NO. 77-319,181, FILED 11-1-2007.

FIRST USE 10-1-2006; IN COMMERCE 10-1-2006.

CAROLYN CATALDO, EXAMINING ATTORNEY

**Int. Cl.: 36**

**Prior U.S. Cls.: 100, 101 and 102**

**United States Patent and Trademark Office**

**Reg. No. 3,453,448**

**Registered June 24, 2008**

**SERVICE MARK  
PRINCIPAL REGISTER**

**MYINDEX**

BLUESTAR ENERGY SERVICES, INC. (ILLINOIS  
CORPORATION)  
SUITE 700  
363 W. ERIE  
CHICAGO, IL 60610

THE MARK CONSISTS OF STANDARD CHAR-  
ACTERS WITHOUT CLAIM TO ANY PARTICULAR  
FONT, STYLE, SIZE, OR COLOR.

FOR: BROKERAGE OF ENERGY, NAMELY, GAS  
AND ELECTRICITY, IN CLASS 36 (U.S. CLS. 100, 101  
AND 102).

SER. NO. 77-319,187, FILED 11-1-2007.

FIRST USE 10-1-2006; IN COMMERCE 10-1-2006.

CAROLYN CATALDO, EXAMINING ATTORNEY

**Int. Cl.: 36**

**Prior U.S. Cls.: 100, 101 and 102**

**United States Patent and Trademark Office**

**Reg. No. 3,453,449**

**Registered June 24, 2008**

**SERVICE MARK  
PRINCIPAL REGISTER**

**MYBLEND**

BLUESTAR ENERGY SERVICES, INC. (ILLINOIS  
CORPORATION)  
363 W. ERIE, SUITE 700  
CHICAGO, IL 60610

THE MARK CONSISTS OF STANDARD CHAR-  
ACTERS WITHOUT CLAIM TO ANY PARTICULAR  
FONT, STYLE, SIZE, OR COLOR.

FOR: BROKERAGE OF ENERGY, NAMELY, GAS  
AND ELECTRICITY, IN CLASS 36 (U.S. CLS. 100, 101  
AND 102).

SER. NO. 77-319,204, FILED 11-1-2007.

FIRST USE 10-1-2006; IN COMMERCE 10-1-2006.

CAROLYN CATALDO, EXAMINING ATTORNEY

**Int. Cl.: 5**

**Prior U.S. Cls.: 6, 18, 44, 46, 51 and 52**

**Reg. No. 3,453,450**

**United States Patent and Trademark Office**

**Registered June 24, 2008**

---

**TRADEMARK  
PRINCIPAL REGISTER**

**REUMAFIN**

LACURA, INC. (NEW YORK CORPORATION)  
107 OTIS STREET  
W. BABYLON, NY 11704

FIRST USE 9-28-2007; IN COMMERCE 9-28-2007.

FOR: TRANSDERMAL PATCHES FOR USE IN  
THE TREATMENT OF PAIN; MULTIPURPOSE  
MEDICATED ANTIBIOTIC CREAM, ANALGESIC  
BALM AND MENTHOLATED SALVE; TOPICAL  
ANALGESICS, IN CLASS 5 (U.S. CLS. 6, 18, 44, 46,  
51 AND 52).

THE MARK CONSISTS OF STANDARD CHAR-  
ACTERS WITHOUT CLAIM TO ANY PARTICULAR  
FONT, STYLE, SIZE, OR COLOR.

SER. NO. 77-319,220, FILED 11-1-2007.

MARIAM MAHMOUDI, EXAMINING ATTORNEY

**Int. Cl.: 42**

**Prior U.S. Cls.: 100 and 101**

**United States Patent and Trademark Office**

**Reg. No. 3,453,451**

**Registered June 24, 2008**

**SERVICE MARK  
PRINCIPAL REGISTER**

CONNECT. EMPOWER. IMPACT

WORLD WIDE OPEN (CALIFORNIA CORPORATION)

# 325

455 CAPITOL MALL  
SACRAMENTO, CA 95814

FOR: HOSTING AN ONLINE COMMUNITY WEBSITE FEATURING TOOLS FOR PEOPLE, CHURCHES AND ORGANIZATIONS TO BE ABLE TO CONNECT AND SHARE RESOURCES AND KNOWLEDGE AND FIND VOLUNTEER OPPORTUNITIES, IN CLASS 42 (U.S. CLS. 100 AND 101).

FIRST USE 7-0-2005; IN COMMERCE 11-0-2005.

THE MARK CONSISTS OF STANDARD CHARACTERS WITHOUT CLAIM TO ANY PARTICULAR FONT, STYLE, SIZE, OR COLOR.

SER. NO. 77-319,390, FILED 11-1-2007.

STEVEN R. FINE, EXAMINING ATTORNEY

**Int. Cl.: 36**

**Prior U.S. Cls.: 100, 101 and 102**

**United States Patent and Trademark Office**

**Reg. No. 3,453,452**

**Registered June 24, 2008**

**SERVICE MARK  
PRINCIPAL REGISTER**

**ECHECK SOLUTIONS**

WEST COAST BANCORP (OREGON CORPORATION)  
SUITE 201  
5335 MEADOWS ROAD  
LAKE OSWEGO, OR 97035

FOR: CHECK PROCESSING AND DEPOSIT SERVICES, NAMELY, CONVERSION OF PAPER CHECKS TO ACH FUND TRANSFERS, IN CLASS 36 (U.S. CLS. 100, 101 AND 102).

FIRST USE 8-0-2007; IN COMMERCE 8-0-2007.

THE MARK CONSISTS OF STANDARD CHARACTERS WITHOUT CLAIM TO ANY PARTICULAR FONT, STYLE, SIZE, OR COLOR.

NO CLAIM IS MADE TO THE EXCLUSIVE RIGHT TO USE "ECHECK", APART FROM THE MARK AS SHOWN.

SER. NO. 77-319,530, FILED 11-1-2007.

MARIA-VICTORIA SUAREZ, EXAMINING ATTORNEY

Int. Cl.: 30

Prior U.S. Cl.: 46

United States Patent and Trademark Office

Reg. No. 3,453,453

Registered June 24, 2008

TRADEMARK  
PRINCIPAL REGISTER



BRUZZESE, KATHY J. (UNITED STATES INDIVIDUAL)  
5233 CAMINO PLAYA MALAGA  
SAN DIEGO, CA 92124 AND  
DOMINGUES, ANTONIO F. (BRAZIL INDIVIDUAL)  
5233 CAMINO PLAYA MALAGA  
SAN DIEGO, CA 92124

FOR: CONFECTIONERY, NAMELY CANDY, CHOCOLATE, & CAKES, IN CLASS 30 (U.S. CL. 46).

FIRST USE 8-22-2001; IN COMMERCE 8-22-2001.

NO CLAIM IS MADE TO THE EXCLUSIVE RIGHT TO USE "FOODS", APART FROM THE MARK AS SHOWN.

THE MARK CONSISTS OF A SOLID OVAL WITH THE WORDS FORTTUNA FOODS LOCATED WITHIN.

THE MARK HAS NO SIGNIFICANCE IN THE RELEVANT TRADE OR INDUSTRY NOR ANY MEANING IN A FOREIGN LANGUAGE.

SER. NO. 77-319,881, FILED 11-2-2007.

MARLENE BELL, EXAMINING ATTORNEY



**Int. Cl.: 36**

**Prior U.S. Cls.: 100, 101 and 102**

**United States Patent and Trademark Office**

**Reg. No. 3,453,454**

**Registered June 24, 2008**

**SERVICE MARK  
PRINCIPAL REGISTER**



TAYLOR, BEAN & WHITAKER MORTGAGE  
CORP. (FLORIDA CORPORATION)  
315 NE 14TH STREET  
OCALA, FL 34470

FOR: MORTGAGE BANKING, MORTGAGE  
LENDING AND MORTGAGE SERVICING, IN  
CLASS 36 (U.S. CLS. 100, 101 AND 102).

FIRST USE 4-30-2006; IN COMMERCE 4-30-2006.

OWNER OF U.S. REG. NO. 2,777,621.

NO CLAIM IS MADE TO THE EXCLUSIVE  
RIGHT TO USE "MORTGAGE CORP", APART  
FROM THE MARK AS SHOWN.

SER. NO. 77-320,359, FILED 11-2-2007.

ELIZABETH KAJUBI, EXAMINING ATTORNEY

**Int. Cl.: 36**

**Prior U.S. Cls.: 100, 101 and 102**

**United States Patent and Trademark Office**

**Reg. No. 3,453,455**

**Registered June 24, 2008**

**SERVICE MARK  
PRINCIPAL REGISTER**

OPENING HOMES TO THE WORLD

LILA DELMAN REAL ESTATE, LTD. (RHODE  
ISLAND CORPORATION)  
41 OCEAN ROAD  
NARRAGANSETT, RI 02882

THE MARK CONSISTS OF STANDARD CHAR-  
ACTERS WITHOUT CLAIM TO ANY PARTICULAR  
FONT, STYLE, SIZE, OR COLOR.

FOR: REAL ESTATE AGENCIES, IN CLASS 36  
(U.S. CLS. 100, 101 AND 102).

SER. NO. 77-320,926, FILED 11-4-2007.

FIRST USE 4-30-2006; IN COMMERCE 4-30-2006.

MICHAEL LITZAU, EXAMINING ATTORNEY

**Int. Cl.: 9**

**Prior U.S. Cls.: 21, 23, 26, 36 and 38**

**Reg. No. 3,453,456**

**United States Patent and Trademark Office**

**Registered June 24, 2008**

---

**TRADEMARK  
PRINCIPAL REGISTER**

**SLIK STIK**

J & D BRUSH CO., INC. (NEW YORK CORPORATION)  
5 ADAMS AVENUE  
HAUPPAUGE, NY 11788

THE MARK CONSISTS OF STANDARD CHARACTERS WITHOUT CLAIM TO ANY PARTICULAR FONT, STYLE, SIZE, OR COLOR.

FOR: ELECTRIC FLAT IRON, IN CLASS 9 (U.S. CLS. 21, 23, 26, 36 AND 38).

SER. NO. 77-321,199, FILED 11-5-2007.

FIRST USE 4-0-2007; IN COMMERCE 4-0-2007.

TINA L. SNAPP, EXAMINING ATTORNEY

Int. Cls.: 35 and 36

Prior U.S. Cls.: 100, 101 and 102

United States Patent and Trademark Office

Reg. No. 3,453,457

Registered June 24, 2008

**SERVICE MARK  
PRINCIPAL REGISTER**



THREE RIVERS HOLDING, INC. (DELAWARE CORPORATION)  
1201 ORANGE STREET, SUITE 500  
C/O DELAWARE CORPORATE REGISTRY, INC.  
WILMINGTON, DE 19801

FOR: PROVIDING A RECOGNITION AND REWARDS PROGRAM TO RECOGNIZE THE EXCELLENCE OF PARTICIPATING PHYSICIANS WITH RESPECT TO THEIR COMMITMENT TO THE HEALTH PLAN, THEIR ACCESSIBILITY TO HEALTH PLAN MEMBERS, THEIR PROVISION OF EFFECTIVE AND ECONOMIC MEDICAL SERVICES, THEIR QUALITY OF CARE AND SERVICE, AND THEIR ADMINISTRATIVE EFFICIENCY, AND TO REWARD THEM WITH RECOGNITION, PUBLICITY, RELIEF FROM SPECIFIED HEALTH PLAN ADMINISTRATIVE REQUIREMENTS SUCH AS ASPECTS OF PRIOR AUTHORIZATION FOR DOCUMENTATION OF MEDICAL NECESSITY OF COVERED SERVICES, AND FINANCIAL BONUSES, FOR THE PURPOSE OF IMPROVING THE QUALITY OF HEALTH CARE SERVICES DELIVERED TO MEMBERS OF THE HEALTH PLANS AND TO REDUCE ADMINISTRATIVE BURDENS FOR THE

PROVIDERS AND THE HEALTH PLAN ADMINISTRATORS, IN CLASS 35 (U.S. CLS. 100, 101 AND 102).

FIRST USE 2-1-2007; IN COMMERCE 2-1-2007.

FOR: ADMINISTRATION OF HEALTH CARE BENEFIT PLANS FOR MEDICARE AND MEDICAID ELIGIBLE INDIVIDUALS, MANAGED CARE INSURANCE SERVICE (HMO), IN CLASS 36 (U.S. CLS. 100, 101 AND 102).

FIRST USE 2-1-2007; IN COMMERCE 2-1-2007.

OWNER OF U.S. REG. NOS. 3,089,857, 3,182,743, AND 3,202,785.

NO CLAIM IS MADE TO THE EXCLUSIVE RIGHT TO USE "PROVIDER", APART FROM THE MARK AS SHOWN.

SER. NO. 77-321,205, FILED 11-5-2007.

WILLIAM VERHOSEK, EXAMINING ATTORNEY

**Int. Cl.: 35**

**Prior U.S. Cls.: 100, 101 and 102**

**United States Patent and Trademark Office**

**Reg. No. 3,453,458**

**Registered June 24, 2008**

**SERVICE MARK  
PRINCIPAL REGISTER**



RYAN WINDOWS & SIDING, INC. (MINNESOTA CORPORATION)  
PO BOX 5937  
HIGHWAY 52 NORTH  
ROCHESTER, MN 55903

FOR: RETAIL STORE SERVICES FEATURING WINDOWS, SIDING, SUNROOMS, AWNINGS, DOORS AND SHUTTERS, IN CLASS 35 (U.S. CLS. 100, 101 AND 102).

FIRST USE 1-31-2005; IN COMMERCE 1-31-2005.

OWNER OF U.S. REG. NO. 2,440,840.

NO CLAIM IS MADE TO THE EXCLUSIVE RIGHT TO USE "WINDOWS & SIDING INC.", APART FROM THE MARK AS SHOWN.

THE COLOR(S) GREEN, BLACK, SILVER AND WHITE IS/ARE CLAIMED AS A FEATURE OF THE MARK.

THE MARK CONSISTS OF A GREEN CLOVER-LEAF INTERSECTED WITH WHITE LINES BEHIND THE WORD "RYAN" INSIDE OF A SILVER OVAL DESIGN; THE WORDS "RYAN WINDOWS & SIDING INC." ARE IN BLACK. THE WHITE BACKGROUND IS NOT PART OF THE MARK AS SHOWN.

SER. NO. 77-321,210, FILED 11-5-2007.

WILLIAM VERHOSEK, EXAMINING ATTORNEY

**Int. Cl.: 36**

**Prior U.S. Cls.: 100, 101 and 102**

**United States Patent and Trademark Office**

**Reg. No. 3,453,459**

**Registered June 24, 2008**

**SERVICE MARK  
PRINCIPAL REGISTER**

**SBI BAIL BONDS "ANYTIME,  
ANYWHERE...CALL US, WE'LL  
BE THERE!"**

ACCURATE BAIL BONDS, INC. (NEW JERSEY  
CORPORATION), DBA SBI BAIL BONDS  
SUITE #208  
37-39 BELVIDERE AVENUE  
WASHINGTON, NJ 07882

FOR: BAIL BONDING, IN CLASS 36 (U.S. CLS. 100,  
101 AND 102).

FIRST USE 3-29-1998; IN COMMERCE 3-29-1998.

THE MARK CONSISTS OF STANDARD CHAR-  
ACTERS WITHOUT CLAIM TO ANY PARTICULAR  
FONT, STYLE, SIZE, OR COLOR.

NO CLAIM IS MADE TO THE EXCLUSIVE  
RIGHT TO USE "BAIL BONDS", APART FROM  
THE MARK AS SHOWN.

SER. NO. 77-321,211, FILED 11-5-2007.

WILLIAM VERHOSEK, EXAMINING ATTORNEY

**Int. Cl.: 41**

**Prior U.S. Cls.: 100, 101 and 107**

**United States Patent and Trademark Office**

**Reg. No. 3,453,460**

**Registered June 24, 2008**

**SERVICE MARK  
PRINCIPAL REGISTER**



BURNING RIVER LACROSSE, LLC (OHIO LTD  
LIAB CO)  
SUITE 926  
2154 ARTHUR AVENUE  
LAKEWOOD, OH 44107

FOR: ENTERTAINMENT IN THE NATURE OF  
ORGANIZING AND CONDUCTING LACROSSE  
ALL STAR TRAVEL TEAMS, LEAGUES, TOURNA-  
MENTS, CAMPS, AND CLINICS , IN CLASS 41 (U.S.  
CLS. 100, 101 AND 107).

FIRST USE 2-1-2007; IN COMMERCE 2-1-2007.

NO CLAIM IS MADE TO THE EXCLUSIVE  
RIGHT TO USE "LACROSSE", APART FROM THE  
MARK AS SHOWN.

THE COLOR(S) MAROON IS/ARE CLAIMED AS  
A FEATURE OF THE MARK.

THE MARK CONSISTS OF THE MAROON CO-  
LORED STYLIZED LETTERING "BR" WITH THE  
MAROON COLORED WORDING "LACROSSE" UN-  
DERNEATH IT AND A MAROON COLORED RING  
ENCIRCLING ALL OF THE WORDING.

SER. NO. 77-321,214, FILED 11-5-2007.

BRIAN CALLAGHAN, EXAMINING ATTORNEY

**Int. Cl.: 43**

**Prior U.S. Cls.: 100 and 101**

**United States Patent and Trademark Office**

**Reg. No. 3,453,461**

**Registered June 24, 2008**

**SERVICE MARK  
PRINCIPAL REGISTER**

**GRAND LUX CAFE**

THE CHEESECAKE FACTORY ASSETS CO. LLC  
(NEVADA LTD LIAB CO)  
26901 MALIBU HILLS ROAD  
CALABASAS HILLS, CA 91301

OWNER OF U.S. REG. NOS. 2,383,025, 2,845,132  
AND OTHERS.

FOR: RESTAURANT SERVICES, IN CLASS 43  
(U.S. CLS. 100 AND 101).

NO CLAIM IS MADE TO THE EXCLUSIVE  
RIGHT TO USE "CAFE", APART FROM THE MARK  
AS SHOWN.

FIRST USE 5-13-1999; IN COMMERCE 5-13-1999.

SER. NO. 77-321,219, FILED 11-5-2007.

THE MARK CONSISTS OF STANDARD CHAR-  
ACTERS WITHOUT CLAIM TO ANY PARTICULAR  
FONT, STYLE, SIZE, OR COLOR.

WILLIAM VERHOSEK, EXAMINING ATTORNEY



**Int. Cls.: 25, 36 and 41**

**Prior U.S. Cls.: 22, 39, 100, 101, 102 and 107**

**Reg. No. 3,453,462**

**United States Patent and Trademark Office**

**Registered June 24, 2008**

**TRADEMARK  
SERVICE MARK  
PRINCIPAL REGISTER**

i[2]y

I'M TOO YOUNG FOR THIS! CANCER FOUNDATION, INC. (NEW YORK NON-PROFIT CORPORATION)  
34 - 71ST STREET  
BROOKLYN, NY 11209

FOR: SHORT-SLEEVED OR LONG-SLEEVED T-SHIRTS; TANK TOPS; CAPS; JERSEYS; BABY BODYSUITS; TRACK SUITS; APRONS; THONGS; SWEAT SHIRTS, IN CLASS 25 (U.S. CLS. 22 AND 39).

FIRST USE 11-1-2006; IN COMMERCE 11-1-2006.

FOR: CHARITABLE FUND RAISING, IN CLASS 36 (U.S. CLS. 100, 101 AND 102).

FIRST USE 11-1-2006; IN COMMERCE 11-1-2006.

FOR: EDUCATIONAL SERVICES, NAMELY, PROVIDING ORGANIZING AND CONDUCTING INFORMAL WORKSHOPS, CONFERENCES AND

SEMINARS IN THE FIELDS OF CANCER, CANCER RECOVERY AND SURVIVAL; ENTERTAINMENT SERVICES, NAMELY, PROVIDING A WEBSITE FEATURING PHOTOGRAPHIC, AUDIO, VIDEO AND PROSE PRESENTATIONS FEATURING PERSONAL NARRATIVE STORIES, ART AND MUSIC RELATING TO CANCER, CANCER RECOVERY AND SURVIVAL FOR INSTRUCTIONAL AND ENTERTAINMENT PURPOSES, IN CLASS 41 (U.S. CLS. 100, 101 AND 107).

FIRST USE 11-1-2006; IN COMMERCE 11-1-2006.

THE MARK CONSISTS OF STANDARD CHARACTERS WITHOUT CLAIM TO ANY PARTICULAR FONT, STYLE, SIZE, OR COLOR.

SER. NO. 77-321,221, FILED 11-5-2007.

ELLEN PERKINS, EXAMINING ATTORNEY

**Int. Cls.: 25, 36 and 41**

**Prior U.S. Cls.: 22, 39, 100, 101, 102 and 107**

**Reg. No. 3,453,463**

**United States Patent and Trademark Office**

**Registered June 24, 2008**

**TRADEMARK  
SERVICE MARK  
PRINCIPAL REGISTER**

**STUPID CANCER**

I'M TOO YOUNG FOR THIS! CANCER FOUNDATION, INC. (NEW YORK NON-PROFIT CORPORATION)  
34 - 71ST STREET  
BROOKLYN, NY 11209

FOR: SHORT-SLEEVED OR LONG-SLEEVED T-SHIRTS; TANK TOPS; CAPS; JERSEYS; BABY BODYSUITS; TRACK SUITS; APRONS; THONGS; SWEAT SHIRTS, IN CLASS 25 (U.S. CLS. 22 AND 39).

FIRST USE 11-1-2006; IN COMMERCE 11-1-2006.

FOR: CHARITABLE FUND RAISING, IN CLASS 36 (U.S. CLS. 100, 101 AND 102).

FIRST USE 11-1-2006; IN COMMERCE 11-1-2006.

FOR: EDUCATIONAL SERVICES, NAMELY, PROVIDING ORGANIZING AND CONDUCTING INFORMAL WORKSHOPS, CONFERENCES AND

SEMINARS IN THE FIELDS OF CANCER, CANCER RECOVERY AND SURVIVAL; ENTERTAINMENT SERVICES, NAMELY, PROVIDING A WEBSITE FEATURING PHOTOGRAPHIC, AUDIO, VIDEO AND PROSE PRESENTATIONS FEATURING PERSONAL NARRATIVE STORIES, ART AND MUSIC RELATING TO CANCER, CANCER RECOVERY AND SURVIVAL FOR INSTRUCTIONAL AND ENTERTAINMENT PURPOSES, IN CLASS 41 (U.S. CLS. 100, 101 AND 107).

FIRST USE 11-1-2006; IN COMMERCE 11-1-2006.

THE MARK CONSISTS OF STANDARD CHARACTERS WITHOUT CLAIM TO ANY PARTICULAR FONT, STYLE, SIZE, OR COLOR.

SER. NO. 77-321,235, FILED 11-5-2007.

SARA THOMAS, EXAMINING ATTORNEY

**Int. Cl.: 35**

**Prior U.S. Cls.: 100, 101 and 102**

**United States Patent and Trademark Office**

**Reg. No. 3,453,464**

**Registered June 24, 2008**

**SERVICE MARK  
PRINCIPAL REGISTER**

# Stylish Girlfriends

STYLISH ENTERPRISES LLC (CALIFORNIA LTD  
LIAB CO)  
23216 SORREL COURT  
VALENCIA, CA 91354

FOR: RETAIL SERVICES BY MEANS OF SHOP-  
AT-HOME PARTIES AND TEMPORARY RETAIL  
STORES SET UP AT VARIOUS BOUTIQUE LOCA-  
TIONS, ALL IN THE FIELD OF CLOTHING, IN  
CLASS 35 (U.S. CLS. 100, 101 AND 102).

FIRST USE 9-11-2007; IN COMMERCE 9-19-2007.

THE MARK CONSISTS OF STANDARD CHAR-  
ACTERS WITHOUT CLAIM TO ANY PARTICULAR  
FONT, STYLE, SIZE, OR COLOR.

SER. NO. 77-321,236, FILED 11-5-2007.

BENJAMIN ALLEN, EXAMINING ATTORNEY

**Int. Cl.: 18**

**Prior U.S. Cls.: 1, 2, 3, 22 and 41**

**United States Patent and Trademark Office**

**Reg. No. 3,453,465**

**Registered June 24, 2008**

**TRADEMARK  
PRINCIPAL REGISTER**

**STORMCHEETA**

M. J. AINGE & CO. LIMITED (UNITED KING-  
DOM CORPORATION)  
15 SOUTHERN AVENUE, LEOMINSTER  
HEREFORDSHIRE, UNITED KINGDOM HR60QF

FOR: ARTICLES OF CLOTHING FOR HORSES,  
NAMELY, HORSE RUGS AND BLANKETS, IN  
CLASS 18 (U.S. CLS. 1, 2, 3, 22 AND 41).

FIRST USE 7-0-1996; IN COMMERCE 7-0-1996.

THE MARK CONSISTS OF STANDARD CHAR-  
ACTERS WITHOUT CLAIM TO ANY PARTICULAR  
FONT, STYLE, SIZE, OR COLOR.

OWNER OF U.S. REG. NO. 3,251,374.

SER. NO. 77-321,244, FILED 11-5-2007.

DAVID TAYLOR, EXAMINING ATTORNEY

**Int. Cl.: 28**

**Prior U.S. Cls.: 22, 23, 38 and 50**

**United States Patent and Trademark Office**

**Reg. No. 3,453,466**

**Registered June 24, 2008**

**TRADEMARK  
PRINCIPAL REGISTER**

**Looney Laundry**

BLUEBONNET GAMES (TEXAS CORPORATION)  
2708 ASPEN DR.  
MCKINNEY, TX 75070

THE MARK CONSISTS OF STANDARD CHAR-  
ACTERS WITHOUT CLAIM TO ANY PARTICULAR  
FONT, STYLE, SIZE, OR COLOR.

FOR: BOARD GAMES, IN CLASS 28 (U.S. CLS. 22,  
23, 38 AND 50).

SER. NO. 77-321,248, FILED 11-5-2007.

FIRST USE 7-1-2005; IN COMMERCE 11-24-2005.

JASON TURNER, EXAMINING ATTORNEY

**Int. Cl.: 41**

**Prior U.S. Cls.: 100, 101 and 107**

**United States Patent and Trademark Office**

**Reg. No. 3,453,467**

**Registered June 24, 2008**

**SERVICE MARK  
PRINCIPAL REGISTER**

**CFPA**

THE CENTER FOR PROFESSIONAL ADVANCE-  
MENT, INC. (NEW JERSEY CORPORATION)  
25 KENNEDY BLVD, SUITE 400 PO BOX 7077  
EAST BRUNSWICK, NJ 08816

FOR: EDUCATIONAL SERVICES, NAMELY,  
PROVIDING TECHNICAL SEMINARS AND WORK-  
SHOPS FOR PROFESSIONAL, TECHNICAL AND  
MANAGERIAL EDUCATION IN THE FIELDS OF  
SCIENCE, PHARMACEUTICAL TECHNOLOGY  
AND MANUFACTURING, IN CLASS 41 (U.S. CLS.  
100, 101 AND 107).

FIRST USE 1-12-2004; IN COMMERCE 1-12-2004.

THE MARK CONSISTS OF A CAPITAL "C", A  
LOWER CASE "F", A CAPITAL "P" AND A CAPITAL  
"A".

SER. NO. 77-321,250, FILED 11-5-2007.

REBECCA SMITH, EXAMINING ATTORNEY

**Int. Cl.: 43**

**Prior U.S. Cls.: 100 and 101**

**United States Patent and Trademark Office**

**Reg. No. 3,453,468**

**Registered June 24, 2008**

**SERVICE MARK  
PRINCIPAL REGISTER**



FREEDOM HOSPITALITY LTD. (NEW YORK  
LTD LIAB CO)  
16TH FLOOR  
100 PARK AVE.  
NEW YORK, NY 10017

FOR: CONSULTING SERVICES IN THE FIELD  
OF HOSPITALITY; TRAVEL AGENCY SERVICES,  
NAMELY, MAKING RESERVATIONS AND BOOK-  
ING FOR TEMPORARY LODGING, IN CLASS 43  
(U.S. CLS. 100 AND 101).

FIRST USE 11-4-2004; IN COMMERCE 11-4-2004.

NO CLAIM IS MADE TO THE EXCLUSIVE  
RIGHT TO USE "HOSPITALITY", APART FROM  
THE MARK AS SHOWN.

THE MARK CONSISTS OF THE TEXT "FREE-  
DOM" IN LARGE PRINT OVER "HOSPITALITY" IN  
SMALLER PRINT WITH A WAVE EXTENDED  
THROUGH BOTH WORDS.

SER. NO. 77-321,262, FILED 11-5-2007.

MICHAEL KAZAZIAN, EXAMINING ATTORNEY

**Int. Cl.: 5**

**Prior U.S. Cls.: 6, 18, 44, 46, 51 and 52**

**Reg. No. 3,453,469**

**United States Patent and Trademark Office**

**Registered June 24, 2008**

**TRADEMARK  
PRINCIPAL REGISTER**

**REPRESSOR-E**

WALCO INTERNATIONAL, INC. (CALIFORNIA  
CORPORATION)  
7 VILLAGE CIRCLE, SUITE 200  
WESTLAKE, TX 76262

THE MARK CONSISTS OF STANDARD CHAR-  
ACTERS WITHOUT CLAIM TO ANY PARTICULAR  
FONT, STYLE, SIZE, OR COLOR.

FOR: VETERINARY PREPARATIONS FOR ANI-  
MAL HEALTHCARE, NAMELY, AN INJECTABLE  
EQUINE BUTORPHANOL TARTRATE, IN CLASS 5  
(U.S. CLS. 6, 18, 44, 46, 51 AND 52).

SER. NO. 77-321,263, FILED 11-5-2007.

FIRST USE 4-0-2003; IN COMMERCE 4-0-2003.

KIMBERLY PERRY, EXAMINING ATTORNEY



**Int. Cl.: 41**

**Prior U.S. Cls.: 100, 101 and 107**

**United States Patent and Trademark Office**

**Reg. No. 3,453,470**

**Registered June 24, 2008**

**SERVICE MARK  
PRINCIPAL REGISTER**

**Secrets of Successful High  
Earners**

BARBARA STANNY, INCORPORATED (WA-  
SHINGTON CORPORATION)  
221 MIDDLEPOINT RD.  
PORT TOWNSEND, WA 98368

FOR: EDUCATIONAL SERVICES, NAMELY,  
CONDUCTING SEMINARS, CONFERENCES,  
WORKSHOPS AND PROGRAMS IN THE FIELDS  
OF PERSONAL FINANCIAL DEVELOPMENT AND  
PROFESSIONAL FINANCIAL DEVELOPMENT  
AND DISTRIBUTING INSTRUCTIONAL AND  
WORKSHOP COURSE MATERIALS IN CONNEC-  
TION THEREWITH; EDUCATIONAL AND ENTER-  
TAINMENT SERVICES, NAMELY, PROVIDING  
MOTIVATIONAL AND EDUCATIONAL SPEAKERS  
IN THE FIELDS OF PERSONAL FINANCIAL DE-  
VELOPMENT AND PROFESSIONAL FINANCIAL

DEVELOPMENT, AND ENTERTAINMENT SERVI-  
CES, NAMELY, PERSONAL APPEARANCES BY  
MOTIVATIONAL SPEAKERS IN THE FIELDS OF  
FINANCE AND PERSONAL DEVELOPMENT, IN  
CLASS 41 (U.S. CLS. 100, 101 AND 107).

FIRST USE 9-8-2006; IN COMMERCE 9-8-2006.

THE MARK CONSISTS OF STANDARD CHAR-  
ACTERS WITHOUT CLAIM TO ANY PARTICULAR  
FONT, STYLE, SIZE, OR COLOR.

SER. NO. 77-321,266, FILED 11-5-2007.

ADA HAN, EXAMINING ATTORNEY

**Int. Cl.: 5**

**Prior U.S. Cls.: 6, 18, 44, 46, 51 and 52**

**Reg. No. 3,453,471**

**United States Patent and Trademark Office**

**Registered June 24, 2008**

**TRADEMARK  
PRINCIPAL REGISTER**

**LAXADE**

WALCO INTERNATIONAL, INC. (CALIFORNIA  
CORPORATION)  
7 VILLAGE CIRCLE, SUITE 200  
WESTLAKE, TX 76262

THE MARK CONSISTS OF STANDARD CHAR-  
ACTERS WITHOUT CLAIM TO ANY PARTICULAR  
FONT, STYLE, SIZE, OR COLOR.

FOR: VETERINARY PREPARATIONS FOR ANI-  
MAL HEALTHCARE, NAMELY, AN ORAL BOVINE  
MAGNESIUM OXIDE LAXATIVE IN BOLUS FORM,  
IN CLASS 5 (U.S. CLS. 6, 18, 44, 46, 51 AND 52).

SER. NO. 77-321,283, FILED 11-5-2007.

FIRST USE 0-0-1976; IN COMMERCE 0-0-1976.

KIMBERLY PERRY, EXAMINING ATTORNEY

**Int. Cl.: 9**

**Prior U.S. Cls.: 21, 23, 26, 36 and 38**

**United States Patent and Trademark Office**

**Reg. No. 3,453,472**

**Registered June 24, 2008**

**TRADEMARK  
PRINCIPAL REGISTER**

**Grill-Per'fect**

BURTON PLASTICS CORP (CALIFORNIA CORPORATION)  
8928 NATIONAL BLVD.  
LOS ANGELES, CA 90034

FOR: COLOR CHANGING THERMOMETER FOR BEEF, FISH OR POULTRY; INTERNAL TEMPERATURE MEASURING DEVICE NOT FOR MEDICAL USE, IN CLASS 9 (U.S. CLS. 21, 23, 26, 36 AND 38).

FIRST USE 2-6-2001; IN COMMERCE 2-6-2001.

THE MARK CONSISTS OF STANDARD CHARACTERS WITHOUT CLAIM TO ANY PARTICULAR FONT, STYLE, SIZE, OR COLOR.

SER. NO. 77-321,288, FILED S.R. 11-5-2007 AM. P.R. 2-20-2008.

JOHN WILKE, EXAMINING ATTORNEY

**Int. Cl.: 38**

**Prior U.S. Cls.: 100, 101 and 104**

**United States Patent and Trademark Office**

**Reg. No. 3,453,473**

**Registered June 24, 2008**

**SERVICE MARK  
PRINCIPAL REGISTER**

**OMNILERT**

OMNILERT, LLC (VIRGINIA LTD LIAB CO)  
#232  
525-K EAST MARKET STREET  
LEESBURG, VA 20176

FIRST USE 11-10-2005; IN COMMERCE 11-10-2005.

FOR: COMMUNICATION SERVICES, NAMELY,  
ELECTRONIC TRANSMISSION OF TIME SENSITIVE  
INFORMATION FROM A CLIENT-ACCESSIBLE,  
WEB-BASED INTERFACE TO  
COMMUNICATION DEVICES, IN CLASS 38 (U.S.  
CLS. 100, 101 AND 104).

THE MARK CONSISTS OF STANDARD CHARACTERS  
WITHOUT CLAIM TO ANY PARTICULAR  
FONT, STYLE, SIZE, OR COLOR.

SER. NO. 77-321,341, FILED 11-5-2007.

KIMBERLY PERRY, EXAMINING ATTORNEY

**Int. Cl.: 38**

**Prior U.S. Cls.: 100, 101 and 104**

**United States Patent and Trademark Office**

**Reg. No. 3,453,474**

**Registered June 24, 2008**

**SERVICE MARK  
PRINCIPAL REGISTER**

**AMERILERT**

OMNILERT, LLC (VIRGINIA LTD LIAB CO)  
#232  
525-K EAST MARKET STREET  
LEESBURG, VA 20176

FOR: COMMUNICATION SERVICES, NAMELY,  
ELECTRONIC TRANSMISSION OF TIME SENSITIVE  
INFORMATION FROM A CLIENT-ACCESSIBLE,  
WEB-BASED INTERFACE TO  
COMMUNICATION DEVICES, IN CLASS 38 (U.S.  
CLS. 100, 101 AND 104).

FIRST USE 3-21-2006; IN COMMERCE 3-21-2006.

THE MARK CONSISTS OF STANDARD CHARACTERS  
WITHOUT CLAIM TO ANY PARTICULAR  
FONT, STYLE, SIZE, OR COLOR.

SER. NO. 77-321,365, FILED 11-5-2007.

KIMBERLY PERRY, EXAMINING ATTORNEY

**Int. Cl.: 21**

**Prior U.S. Cls.: 2, 13, 23, 29, 30, 33, 40 and 50**

**United States Patent and Trademark Office**

**Reg. No. 3,453,475**

**Registered June 24, 2008**

**TRADEMARK  
PRINCIPAL REGISTER**

**ICEMULE**

COLLIE, JAMES E. (UNITED STATES INDIVIDUAL)  
1205 WYNDCROFTE PLACE  
CHARLOTTE, NC 28209

THE MARK CONSISTS OF STANDARD CHARACTERS WITHOUT CLAIM TO ANY PARTICULAR FONT, STYLE, SIZE, OR COLOR.

FOR: PORTABLE COOLERS FOR FOODS AND BEVERAGES, IN CLASS 21 (U.S. CLS. 2, 13, 23, 29, 30, 33, 40 AND 50).

SER. NO. 77-321,385, FILED 11-5-2007.

FIRST USE 6-12-1997; IN COMMERCE 6-12-1997.

KIMBERLY PERRY, EXAMINING ATTORNEY

**Int. Cl.: 5**

**Prior U.S. Cls.: 6, 18, 44, 46, 51 and 52**

**Reg. No. 3,453,476**

**United States Patent and Trademark Office**

**Registered June 24, 2008**

---

**TRADEMARK  
PRINCIPAL REGISTER**

**SURE-START**

WALCO INTERNATIONAL, INC. (CALIFORNIA  
CORPORATION)  
7 VILLAGE CIRCLE, SUITE 200  
WESTLAKE, TX 76262

FOR: VETERINARY PREPARATIONS FOR ANI-  
MAL HEALTHCARE, NAMELY, AN ORAL BOVINE  
PROBIOTIC AND DIETARY SUPPLEMENT WITH  
VITAMINS IN PASTE FORM , IN CLASS 5 (U.S. CLS.  
6, 18, 44, 46, 51 AND 52).

FIRST USE 0-0-1991; IN COMMERCE 0-0-1991.

THE MARK CONSISTS OF STANDARD CHAR-  
ACTERS WITHOUT CLAIM TO ANY PARTICULAR  
FONT, STYLE, SIZE, OR COLOR.

SER. NO. 77-321,388, FILED 11-5-2007.

KIMBERLY PERRY, EXAMINING ATTORNEY

**Int. Cl.: 38**

**Prior U.S. Cls.: 100, 101 and 104**

**United States Patent and Trademark Office**

**Reg. No. 3,453,477**

**Registered June 24, 2008**

**SERVICE MARK  
PRINCIPAL REGISTER**

**INFO ON THE GO**

OMNILERT, LLC (VIRGINIA LTD LIAB CO)  
#232  
525-K EAST MARKET STREET  
LEESBURG, VA 20176

FOR: COMMUNICATION SERVICES, NAMELY,  
ELECTRONIC TRANSMISSION OF TIME SENSITIVE  
INFORMATION FROM A CLIENT-ACCESSIBLE,  
WEB-BASED INTERFACE TO  
COMMUNICATION DEVICES, IN CLASS 38 (U.S.  
CLS. 100, 101 AND 104).

FIRST USE 5-24-2006; IN COMMERCE 6-18-2006.

THE MARK CONSISTS OF STANDARD CHARACTERS  
WITHOUT CLAIM TO ANY PARTICULAR  
FONT, STYLE, SIZE, OR COLOR.

NO CLAIM IS MADE TO THE EXCLUSIVE  
RIGHT TO USE "INFO", APART FROM THE MARK  
AS SHOWN.

SER. NO. 77-321,400, FILED 11-5-2007.

KIMBERLY PERRY, EXAMINING ATTORNEY



**Int. Cl.: 5**

**Prior U.S. Cls.: 6, 18, 44, 46, 51 and 52**

**Reg. No. 3,453,478**

**United States Patent and Trademark Office**

**Registered June 24, 2008**

---

**TRADEMARK  
PRINCIPAL REGISTER**

**BISMUSAL**

WALCO INTERNATIONAL, INC. (CALIFORNIA  
CORPORATION)  
7 VILLAGE CIRCLE, SUITE 200  
WESTLAKE, TX 76262

FOR: VETERINARY PREPARATIONS FOR ANI-  
MAL HEALTHCARE, NAMELY, AN ORAL BO-  
VINE, EQUINE, CANINE AND FELINE ANTI-  
DIARRHEAL IN LIQUID FORM , IN CLASS 5 (U.S.  
CLS. 6, 18, 44, 46, 51 AND 52).

FIRST USE 1-6-2000; IN COMMERCE 1-6-2000.

THE MARK CONSISTS OF STANDARD CHAR-  
ACTERS WITHOUT CLAIM TO ANY PARTICULAR  
FONT, STYLE, SIZE, OR COLOR.

SER. NO. 77-321,401, FILED 11-5-2007.

KIMBERLY PERRY, EXAMINING ATTORNEY

**Int. Cl.: 44**

**Prior U.S. Cls.: 100 and 101**

**United States Patent and Trademark Office**

**Reg. No. 3,453,479**

**Registered June 24, 2008**

**SERVICE MARK  
PRINCIPAL REGISTER**



THE ANDERSONS, INC. (OHIO CORPORATION)  
480 W. DUSSEL DRIVE  
MAUMEE, OH 43537

FOR: CONSULTING SERVICES IN THE FIELD  
OF LAWN CARE, LANDSCAPE GARDENING AND  
GOLF COURSE TURF CARE, IN CLASS 44 (U.S. CLS.  
100 AND 101).

FIRST USE 2-1-2007; IN COMMERCE 2-1-2007.

THE COLOR(S) RED AND BLACK IS/ARE  
CLAIMED AS A FEATURE OF THE MARK.

THE MARK CONSISTS OF A RED CIRCLE HAV-  
ING THE BLACK LETTERS "QST".

SER. NO. 77-321,405, FILED 11-5-2007.

KIMBERLY PERRY, EXAMINING ATTORNEY

**Int. Cl.: 10**

**Prior U.S. Cls.: 26, 39 and 44**

**Reg. No. 3,453,480**

**United States Patent and Trademark Office**

**Registered June 24, 2008**

**TRADEMARK  
PRINCIPAL REGISTER**

**IVS TUNNELLER**

COVIDIEN AG (SWITZERLAND AKTIENGE-  
SELLSCHAFT)  
CH 8212  
VICTOR VON BRUNS-STRASSE 19  
NEUHAUSEN AM RHEINFALL, SWITZERLAND  
CH8212

FOR: SURGICAL DEVICE, NAMELY, AN IN-  
STRUMENT FOR POSITIONING A POLYPROPY-  
LENE TAPE IN THE VAGINA FOR TREATMENT  
OF FEMALE URINARY INCONTINENCE , IN  
CLASS 10 (U.S. CLS. 26, 39 AND 44).

FIRST USE 9-25-2002; IN COMMERCE 9-25-2002.

THE MARK CONSISTS OF STANDARD CHAR-  
ACTERS WITHOUT CLAIM TO ANY PARTICULAR  
FONT, STYLE, SIZE, OR COLOR.

NO CLAIM IS MADE TO THE EXCLUSIVE  
RIGHT TO USE "IVS", APART FROM THE MARK  
AS SHOWN.

SEC. 2(F).

SER. NO. 77-321,440, FILED 11-5-2007.

FRED CARL, EXAMINING ATTORNEY

**Int. Cl.: 35**

**Prior U.S. Cls.: 100, 101 and 102**

**United States Patent and Trademark Office**

**Reg. No. 3,453,481**

**Registered June 24, 2008**

**SERVICE MARK  
PRINCIPAL REGISTER**

# Adscriber

TYBIT, INC. (NORTH CAROLINA CORPORATION)  
421 MAIDEN LANE  
FAYETTEVILLE, NC 28301

FOR: ADVERTISING, MARKETING AND PROMOTION SERVICES; PROVIDING ADVERTISING, MARKETING AND PROMOTIONAL SERVICES, NAMELY, DEVELOPMENT OF ADVERTISING CAMPAIGNS FOR ELECTRONIC COMMERCE; CUSTOMER RELATIONSHIP MANAGEMENT; COOPERATIVE ADVERTISING AND MARKETING SERVICES BY WAY OF SOLICITATION, CUSTOMER SERVICE AND PROVIDING MARKETING INFORMATION VIA WEBSITES ON A GLOBAL COMPUTER NETWORK; ADVERTISING AND COMMERCIAL INFORMATION SERVICES, VIA THE INTERNET; ADVERTISING VIA ELECTRONIC MEDIA AND SPECIFICALLY THE INTERNET; DESIGN OF INTERNET ADVERTISING; DISSEMINATION OF ADVERTISING FOR OTHERS VIA AN ON-LINE COMMUNICATIONS NETWORK ON THE INTERNET; DISSEMINATION OF ADVERTISING FOR OTHERS VIA THE INTERNET; PROVIDING A SEARCHABLE ONLINE ADVERTISING GUIDE FEATURING THE GOODS AND SERVICES OF OTHER ON-LINE VENDORS ON THE INTERNET; PROVIDING AND RENTAL OF ADVERTISING SPACE ON THE INTERNET; ELECTRONIC COM-

MERCE SERVICES, NAMELY, PROVIDING INFORMATION ABOUT PRODUCTS VIA TELECOMMUNICATION NETWORKS FOR ADVERTISING AND SALES PURPOSES; ADVERTISING AND MARKETING; COOPERATIVE ADVERTISING AND MARKETING; CREATION OF MARKETING TOOLS DESIGNED TO INCREASE A CLIENT COMPANY'S KNOWLEDGE OF CUSTOMER NEEDS, AND ITS COMPETITORS' PRODUCTS AND SERVICES, PRICING, ADVERTISING STRATEGY AND SALES STRATEGY; ON-LINE ADVERTISING AND MARKETING SERVICES; PROMOTING, ADVERTISING AND MARKETING OF THE ON-LINE WEBSITES OF OTHERS; PROMOTION, ADVERTISING AND MARKETING OF ON-LINE WEBSITES, IN CLASS 35 (U.S. CLS. 100, 101 AND 102).

FIRST USE 10-30-2007; IN COMMERCE 10-30-2007.

THE MARK CONSISTS OF STANDARD CHARACTERS WITHOUT CLAIM TO ANY PARTICULAR FONT, STYLE, SIZE, OR COLOR.

SER. NO. 77-321,466, FILED 11-5-2007.

GINA FINK, EXAMINING ATTORNEY

**Int. Cl.: 42**

**Prior U.S. Cls.: 100 and 101**

**United States Patent and Trademark Office**

**Reg. No. 3,453,482**

**Registered June 24, 2008**

**SERVICE MARK  
PRINCIPAL REGISTER**

**AUTOJINI**

OCTADYNE SYSTEMS LLC (IOWA LTD LIAB  
CO)  
SUITE 201  
310 MAIN STREET  
AMES, IA 50010

FOR: PROVIDING TEMPORARY USE OF ON-  
LINE NON-DOWNLOADABLE SOFTWARE FOR  
DEALERS IN THE AUTOMOBILE INDUSTRY TO  
MANAGE THEIR INVENTORY, MAINTAIN AND  
UPDATE THEIR WEB SITE, AND MARKET THEIR  
AUTOMOBILES; COMPUTER SERVICES, NAMELY,  
DESIGNING AND IMPLEMENTING WEB SITES  
FOR OTHERS; CREATING OR MAINTAINING  
WEB SITES FOR OTHERS; DESIGN OF HOME

PAGES, COMPUTER SOFTWARE AND WEB SITES;  
WEB SITE HOSTING SERVICES, IN CLASS 42 (U.S.  
CLS. 100 AND 101).

FIRST USE 6-0-2002; IN COMMERCE 6-0-2002.

THE MARK CONSISTS OF STANDARD CHAR-  
ACTERS WITHOUT CLAIM TO ANY PARTICULAR  
FONT, STYLE, SIZE, OR COLOR.

SER. NO. 77-321,472, FILED 11-5-2007.

MATTHEW MCDOWELL, EXAMINING ATTOR-  
NEY

**Int. Cl.: 41**

**Prior U.S. Cls.: 100, 101 and 107**

**United States Patent and Trademark Office**

**Reg. No. 3,453,483**

**Registered June 24, 2008**

**SERVICE MARK  
PRINCIPAL REGISTER**



ANAHEIM DUCKS HOCKEY CLUB, LLC (CALI-  
FORNIA LTD LIAB CO)  
2695 EAST KATELLA AVENUE  
ANAHEIM, CA 92806

FOR: ENTERTAINMENT SERVICES, NAMELY,  
PROVIDING ICE HOCKEY EXHIBITIONS, IN  
CLASS 41 (U.S. CLS. 100, 101 AND 107).

FIRST USE 6-0-2006; IN COMMERCE 9-0-2006.

THE MARK CONSISTS OF A WEBBED D.

SER. NO. 77-321,474, FILED 11-5-2007.

ERNEST SHOSHO, EXAMINING ATTORNEY

**Int. Cl.: 21**

**Prior U.S. Cls.: 2, 13, 23, 29, 30, 33, 40 and 50**

**United States Patent and Trademark Office**

**Reg. No. 3,453,484**

**Registered June 24, 2008**

**TRADEMARK  
PRINCIPAL REGISTER**

**COMBFORT**

TU NGUYEN TRAN (NEW JERSEY LTD LIAB  
CO)  
P.O BOX 135  
LEWISTON, NY 14092

THE MARK CONSISTS OF STANDARD CHAR-  
ACTERS WITHOUT CLAIM TO ANY PARTICULAR  
FONT, STYLE, SIZE, OR COLOR.

FOR: HAIR COMBS, IN CLASS 21 (U.S. CLS. 2, 13,  
23, 29, 30, 33, 40 AND 50).

SER. NO. 77-321,477, FILED 11-5-2007.

FIRST USE 7-1-2007; IN COMMERCE 7-1-2007.

DAVID MURRAY, EXAMINING ATTORNEY

**Int. Cl.: 41**

**Prior U.S. Cls.: 100, 101 and 107**

**United States Patent and Trademark Office**

**Reg. No. 3,453,485**

**Registered June 24, 2008**

**SERVICE MARK  
PRINCIPAL REGISTER**

**Life Happens - Capture It  
- Today, Tomorrow,  
Forever...**

LORA JANE ARD HORNAGE (MARYLAND  
SOLE PROPRIETORSHIP), DBA LORA J. PHOTOGRAPHY  
773 211TH STREET  
PASADENA, MD 21122

FOR: PHOTOGRAPHY SERVICES; PORTRAIT  
PHOTOGRAPHY, IN CLASS 41 (U.S. CLS. 100, 101  
AND 107).

FIRST USE 10-15-2006; IN COMMERCE 10-15-2006.

THE MARK CONSISTS OF STANDARD CHAR-  
ACTERS WITHOUT CLAIM TO ANY PARTICULAR  
FONT, STYLE, SIZE, OR COLOR.

SER. NO. 77-321,480, FILED 11-5-2007.

MATTHEW MCDOWELL, EXAMINING ATTOR-  
NEY



**Int. Cl.: 29**

**Prior U.S. Cl.: 46**

**United States Patent and Trademark Office**

**Reg. No. 3,453,486**

**Registered June 24, 2008**

**TRADEMARK  
PRINCIPAL REGISTER**

**BEAR & WOLF**

BEAR & WOLF LLC (WASHINGTON LTD LIAB  
CO)  
4209 21ST AVE W, SUITE 400  
SEATTLE, WA 98199

THE MARK CONSISTS OF STANDARD CHAR-  
ACTERS WITHOUT CLAIM TO ANY PARTICULAR  
FONT, STYLE, SIZE, OR COLOR.

FOR: CANNED, FRESH AND FROZEN SEA-  
FOOD, IN CLASS 29 (U.S. CL. 46).

SER. NO. 77-321,486, FILED 11-5-2007.

FIRST USE 4-0-2000; IN COMMERCE 4-0-2000.

ELLEN PERKINS, EXAMINING ATTORNEY

**Int. Cl.: 9**

**Prior U.S. Cls.: 21, 23, 26, 36 and 38**

**Reg. No. 3,453,487**

**United States Patent and Trademark Office**

**Registered June 24, 2008**

---

**TRADEMARK  
PRINCIPAL REGISTER**

**PARTNERLINK**

PKWARE, INC. (WISCONSIN CORPORATION)  
STE 220  
648 N PLANKINTON AVE  
MILWAUKEE, WI 53203

FIRST USE 2-13-2006; IN COMMERCE 2-13-2006.

FOR: SOFTWARE TO SECURE DATA EXCHANGE BETWEEN USERS ON THE SAME OR DIFFERENT OPERATING SYSTEMS; SOFTWARE FOR THE ENCRYPTION, DECRYPTION AND AUTHENTICATION OF DATA; AND USER MANUALS DISTRIBUTED THEREWITH, IN CLASS 9 (U.S. CLS. 21, 23, 26, 36 AND 38).

THE MARK CONSISTS OF STANDARD CHARACTERS WITHOUT CLAIM TO ANY PARTICULAR FONT, STYLE, SIZE, OR COLOR.

SER. NO. 77-321,499, FILED 11-5-2007.

DAVID MURRAY, EXAMINING ATTORNEY

**Int. Cl.: 35**

**Prior U.S. Cls.: 100, 101 and 102**

**United States Patent and Trademark Office**

**Reg. No. 3,453,488**

**Registered June 24, 2008**

**SERVICE MARK  
PRINCIPAL REGISTER**

**IQUOTESURFER**

COST CONTAINMENT GROUP, INC. (DELA-  
WARE CORPORATION)  
160 EILEEN WAY  
SYOSSET, NY 11791

THE MARK CONSISTS OF STANDARD CHAR-  
ACTERS WITHOUT CLAIM TO ANY PARTICULAR  
FONT, STYLE, SIZE, OR COLOR.

FOR: PROVIDING INSURANCE QUOTES FOR  
SPECIAL RISK INSURANCE COVERAGE VIA THE  
INTERNET, IN CLASS 35 (U.S. CLS. 100, 101 AND  
102).

SER. NO. 77-321,504, FILED 11-5-2007.

FIRST USE 6-1-2007; IN COMMERCE 6-1-2007.

ATTIYA MALIK, EXAMINING ATTORNEY

**Int. Cl.: 36**

**Prior U.S. Cls.: 100, 101 and 102**

**United States Patent and Trademark Office**

**Reg. No. 3,453,489**

**Registered June 24, 2008**

**SERVICE MARK  
PRINCIPAL REGISTER**

**OTTER TAIL CORPORATION**

OTTER TAIL CORPORATION (MINNESOTA CORPORATION)  
P.O. BOX 496  
215 SOUTH CASCADE STREET  
FERGUS FALLS, MN 565380496

FOR: HOLDING COMPANY SERVICES, NAME-  
LY, ACQUISITION, MANAGEMENT, AND TRANS-  
FER OF COMPANY STAKES AS WELL AS THE  
INTERMEDIATION OF EQUITY CAPITAL FINAN-  
CING OF COMPANIES, NAMELY, ASSET ACQUI-  
SITION, CONSULTATION, DEVELOPMENT AND  
MANAGEMENT SERVICES; FINANCIAL SERVI-  
CES, NAMELY FINANCIAL ANALYSIS AND CON-  
SULTATION; FINANCIAL PLANNING;  
FINANCIAL RISK MANAGEMENT, IN CLASS 36  
(U.S. CLS. 100, 101 AND 102).

FIRST USE 6-30-2001; IN COMMERCE 6-30-2001.

THE MARK CONSISTS OF STANDARD CHAR-  
ACTERS WITHOUT CLAIM TO ANY PARTICULAR  
FONT, STYLE, SIZE, OR COLOR.

OWNER OF U.S. REG. NOS. 2,624,849 AND  
2,624,866.

NO CLAIM IS MADE TO THE EXCLUSIVE  
RIGHT TO USE "CORPORATION", APART FROM  
THE MARK AS SHOWN.

SER. NO. 77-321,507, FILED 11-5-2007.

BRENDAN REGAN, EXAMINING ATTORNEY

**Int. Cls.: 41 and 42**

**Prior U.S. Cls.: 100, 101 and 107**

**United States Patent and Trademark Office**

**Reg. No. 3,453,490**

**Registered June 24, 2008**

**SERVICE MARK  
PRINCIPAL REGISTER**

**HARVARDSCIENCE**

PRESIDENT AND FELLOWS OF HARVARD  
COLLEGE (MASSACHUSETTS CORPORATION)  
124 MOUNT AUBURN STREET, SUITE 570-N  
CAMBRIDGE, MA 02138

FOR: ON-LINE PUBLICATION OF ARTICLES,  
PAPERS AND REPORTS, IN CLASS 41 (U.S. CLS.  
100, 101 AND 107).

FIRST USE 10-19-2007; IN COMMERCE 10-19-2007.

FOR: PROVIDING INFORMATION IN THE  
FIELD OF SCIENCE VIA THE INTERNET, IN CLASS  
42 (U.S. CLS. 100 AND 101).

FIRST USE 10-19-2007; IN COMMERCE 10-19-2007.

THE MARK CONSISTS OF STANDARD CHAR-  
ACTERS WITHOUT CLAIM TO ANY PARTICULAR  
FONT, STYLE, SIZE, OR COLOR.

OWNER OF U.S. REG. NOS. 1,608,533, 1,624,908  
AND OTHERS.

SER. NO. 77-321,516, FILED 11-5-2007.

BRENDAN REGAN, EXAMINING ATTORNEY

**Int. Cl.: 42**

**Prior U.S. Cls.: 100 and 101**

**United States Patent and Trademark Office**

**Reg. No. 3,453,491**

**Registered June 24, 2008**

**SERVICE MARK  
PRINCIPAL REGISTER**

**PI**

CAKE, LLC (CALIFORNIA LTD LIAB CO)  
1545 26TH STREET  
SANTA MONICA, CA 90404

FOR: VISUAL EFFECTS AND COMPUTER GRAPHIC DESIGN SERVICES FOR MOTION PICTURE, TELEVISION, CABLE, COMMERCIAL AND VIDEOS, NAMELY, DESIGN OF COMPUTER GENERATED SPECIAL EFFECTS FOR OTHERS; DESIGN OF ON-SCREEN BROADCAST GRAPHICS AND SPECIAL EFFECTS, IN CLASS 42 (U.S. CLS. 100 AND 101).

FIRST USE 10-1-2006; IN COMMERCE 10-1-2006.

THE MARK CONSISTS OF STANDARD CHARACTERS WITHOUT CLAIM TO ANY PARTICULAR FONT, STYLE, SIZE, OR COLOR.

OWNER OF U.S. REG. NO. 3,310,657.

SER. NO. 77-321,529, FILED 11-5-2007.

MICHAEL ENGEL, EXAMINING ATTORNEY

**Int. Cl.: 43**

**Prior U.S. Cls.: 100 and 101**

**United States Patent and Trademark Office**

**Reg. No. 3,453,492**

**Registered June 24, 2008**

**SERVICE MARK  
PRINCIPAL REGISTER**

**WESTCOTT LAKES**

PRAXEIS, LLC (MARYLAND LTD LIAB CO)  
4250 LAKESIDE DRIVE  
JACKSONVILLE, FL 32210

THE MARK CONSISTS OF STANDARD CHAR-  
ACTERS WITHOUT CLAIM TO ANY PARTICULAR  
FONT, STYLE, SIZE, OR COLOR.

FOR: RETIREMENT HOMES COMMUNITY PRO-  
VIDING CONTINUING CARE SERVICES IN THE  
NATURE OF ELDER CARE, IN CLASS 43 (U.S. CLS.  
100 AND 101).

SER. NO. 77-321,530, FILED 11-5-2007.

FIRST USE 5-0-2006; IN COMMERCE 5-0-2006.

DORITT L. CARROLL, EXAMINING ATTORNEY

**Int. Cl.: 21**

**Prior U.S. Cls.: 2, 13, 23, 29, 30, 33, 40 and 50**

**United States Patent and Trademark Office**

**Reg. No. 3,453,493**

**Registered June 24, 2008**

**TRADEMARK  
PRINCIPAL REGISTER**

**SIMPLY FINE LENOX**

LENOX, INCORPORATED (NEW JERSEY CORPORATION)  
LEGAL DEPARTMENT  
1414 RADCLIFFE STREET  
BRISTOL, PA 190075496

THE MARK CONSISTS OF STANDARD CHARACTERS WITHOUT CLAIM TO ANY PARTICULAR FONT, STYLE, SIZE, OR COLOR.

FOR: DINNERWARE, IN CLASS 21 (U.S. CLS. 2, 13, 23, 29, 30, 33, 40 AND 50).

SER. NO. 77-321,532, FILED 11-5-2007.

FIRST USE 10-27-2007; IN COMMERCE 10-27-2007.

MICHAEL ENGEL, EXAMINING ATTORNEY



**Int. Cl.: 9**

**Prior U.S. Cls.: 21, 23, 26, 36 and 38**

**United States Patent and Trademark Office**

**Reg. No. 3,453,494**

**Registered June 24, 2008**

**TRADEMARK  
PRINCIPAL REGISTER**

**STUDIOCODE**

SPORTSTEC PTY LIMITED (AUSTRALIA CORPORATION)  
UNIT 10, NO. 7 JUBILEE AVENUE  
WARRIWOOD, AUSTRALIA 2102

FOR: COMPUTER SOFTWARE FOR THE ANALYSIS AND VIDEO EDITING OF GAMES, SPORTS AND ATHLETIC ACTIVITIES, IN CLASS 9 (U.S. CLS. 21, 23, 26, 36 AND 38).

THE MARK CONSISTS OF STANDARD CHARACTERS WITHOUT CLAIM TO ANY PARTICULAR FONT, STYLE, SIZE, OR COLOR.

OWNER OF AUSTRALIA REG. NO. 923008, DATED 8-12-2002, EXPIRES 8-12-2012.

SER. NO. 77-321,598, FILED 11-5-2007.

TARAH HARDY, EXAMINING ATTORNEY

**Int. Cl.: 36**

**Prior U.S. Cls.: 100, 101 and 102**

**United States Patent and Trademark Office**

**Reg. No. 3,453,495**

**Registered June 24, 2008**

**SERVICE MARK  
PRINCIPAL REGISTER**

**GEMSTONE LIFE**

AMERICAN INTERNATIONAL GROUP, INC.  
(DELAWARE CORPORATION)  
70 PINE STREET  
NEW YORK, NY 10270

OWNER OF U.S. REG. NO. 2,518,717.

FOR: INSURANCE UNDERWRITING IN THE  
FIELD OF UNIVERSAL LIFE INSURANCE, IN  
CLASS 36 (U.S. CLS. 100, 101 AND 102).

NO CLAIM IS MADE TO THE EXCLUSIVE  
RIGHT TO USE "LIFE", APART FROM THE MARK  
AS SHOWN.

FIRST USE 1-1-2001; IN COMMERCE 1-1-2001.

SER. NO. 77-321,827, FILED 11-5-2007.

THE MARK CONSISTS OF STANDARD CHAR-  
ACTERS WITHOUT CLAIM TO ANY PARTICULAR  
FONT, STYLE, SIZE, OR COLOR.

KEVIN DINALLO, EXAMINING ATTORNEY

**Int. Cls.: 35, 39 and 41**

**Prior U.S. Cls.: 100, 101, 102, 105 and 107**

**United States Patent and Trademark Office**

**Reg. No. 3,453,496**

**Registered June 24, 2008**

**SERVICE MARK  
PRINCIPAL REGISTER**

**PREMIUM RESPONSE IMAGING**

STORETRIEVE, INC. (CALIFORNIA CORPORATION)  
1150 SOUTH TAYLOR AVENUE  
MONTEBELLO, CA 90640

FOR: RECORDS MANAGEMENT SERVICES, NAMELY, DOCUMENT INDEXING FOR OTHERS; MANAGEMENT OF COMPUTERIZED FILES; DOCUMENT REPRODUCTION, IN CLASS 35 (U.S. CLS. 100, 101 AND 102).

FIRST USE 2-1-2007; IN COMMERCE 2-1-2007.

FOR: PHYSICAL STORAGE OF ELECTRONICALLY-STORED DATA OR DOCUMENTS; ELECTRONIC STORAGE OF DOCUMENTS AND FILES, IN CLASS 39 (U.S. CLS. 100 AND 105).

FIRST USE 2-1-2007; IN COMMERCE 2-1-2007.

FOR: DIGITAL IMAGING SERVICES, IN CLASS 41 (U.S. CLS. 100, 101 AND 107).

FIRST USE 2-1-2007; IN COMMERCE 2-1-2007.

THE MARK CONSISTS OF STANDARD CHARACTERS WITHOUT CLAIM TO ANY PARTICULAR FONT, STYLE, SIZE, OR COLOR.

NO CLAIM IS MADE TO THE EXCLUSIVE RIGHT TO USE "PREMIUM" AND "IMAGING", APART FROM THE MARK AS SHOWN.

SER. NO. 77-321,933, FILED 11-5-2007.

JIM RINGLE, EXAMINING ATTORNEY

**Int. Cl.: 41**

**Prior U.S. Cls.: 100, 101 and 107**

**United States Patent and Trademark Office**

**Reg. No. 3,453,497**

**Registered June 24, 2008**

**SERVICE MARK  
PRINCIPAL REGISTER**

**JBC**

JBC GLOBAL DIVERSITY AND INCLUSION IN-  
STITUTE (NORTH CAROLINA NON-PROFIT  
CORPORATION)  
900 EAST WASHINGTON STREET  
GREENSBORO, NC 27401

THE MARK CONSISTS OF STANDARD CHAR-  
ACTERS WITHOUT CLAIM TO ANY PARTICULAR  
FONT, STYLE, SIZE, OR COLOR.

FOR: LEADERSHIP TRAINING SERVICES, IN  
CLASS 41 (U.S. CLS. 100, 101 AND 107).

SER. NO. 77-322,251, FILED 11-6-2007.

FIRST USE 0-0-2005; IN COMMERCE 0-0-2005.

DAVID MILLER, EXAMINING ATTORNEY

**Int. Cls.: 9 and 16**

**Prior U.S. Cls.: 2, 5, 21, 22, 23, 26, 29, 36, 37, 38 and 50**

**Reg. No. 3,453,498**

**United States Patent and Trademark Office**

**Registered June 24, 2008**

**TRADEMARK  
PRINCIPAL REGISTER**

**LUNAGIRL**

SUMMERTOWNSUN PUBLISHING (TENNESSEE  
LTD LIAB CO)  
411 CORBIN ST.  
SUMMERTOWN, TN 38483

FOR: PRERECORDED CDS FEATURING DIGI-  
TAL IMAGES IN THE NATURE OF PHOTOGRAPHS  
AND ART; DIGITAL MATERIALS, NAMELY,  
DOWNLOADABLE IMAGE FILES FEATURING  
PHOTOGRAPHS AND ART; MAGNETS; CARDS,  
NAMELY, MAGNETIC CARDS, CD TRADING  
CARDS, IN CLASS 9 (U.S. CLS. 21, 23, 26, 36 AND 38).

FIRST USE 4-18-2005; IN COMMERCE 4-18-2005.

FOR: ART PRINTS; CARDS, NAMELY, BLANK  
CARDS, GREETING CARDS, INDEX CARDS, INVI-  
TATION CARDS, NOTE CARDS, POST CARDS;

STICKERS; PAPER TRANSPARENCIES; PRINTED  
MATERIALS, NAMELY, SHEETS IN THE NATURE  
OF COLLAGES, IN CLASS 16 (U.S. CLS. 2, 5, 22, 23, 29,  
37, 38 AND 50).

FIRST USE 4-18-2005; IN COMMERCE 4-18-2005.

THE MARK CONSISTS OF STANDARD CHAR-  
ACTERS WITHOUT CLAIM TO ANY PARTICULAR  
FONT, STYLE, SIZE, OR COLOR.

THE NAME "LUNAGIRL" DOES NOT IDENTIFY  
A LIVING INDIVIDUAL.

SER. NO. 77-322,339, FILED 11-6-2007.

JAY BESCH, EXAMINING ATTORNEY

**Int. Cl.: 37**

**Prior U.S. Cls.: 100, 103 and 106**

**United States Patent and Trademark Office**

**Reg. No. 3,453,499**

**Registered June 24, 2008**

**SERVICE MARK  
PRINCIPAL REGISTER**

**BEST-TEMP MECHANICAL**

BEST-TEMP MECHANICAL CORP. (NEW YORK CORPORATION)  
1755 JULIA GOLDBACH AVE  
RONKONKOMA, NY 11779

FOR: HVAC/R CONTRACTOR SERVICES, NAME-  
LY, THE INSTALLATION, MAINTENANCE, AND  
REPAIR THEREOF, IN THE COMMERCIAL, IN-  
DUSTRIAL AND RESIDENTIAL SETTINGS, IN  
CLASS 37 (U.S. CLS. 100, 103 AND 106).

FIRST USE 9-0-1976; IN COMMERCE 9-0-1976.

THE MARK CONSISTS OF STANDARD CHAR-  
ACTERS WITHOUT CLAIM TO ANY PARTICULAR  
FONT, STYLE, SIZE, OR COLOR.

NO CLAIM IS MADE TO THE EXCLUSIVE  
RIGHT TO USE "MECHANICAL", APART FROM  
THE MARK AS SHOWN.

SER. NO. 77-322,699, FILED 11-6-2007.

MORGAN WYNNE, EXAMINING ATTORNEY

**Int. Cl.: 36**

**Prior U.S. Cls.: 100, 101 and 102**

**United States Patent and Trademark Office**

**Reg. No. 3,453,500**

**Registered June 24, 2008**

**SERVICE MARK  
PRINCIPAL REGISTER**

**BANRISUL**

BANCO DO ESTADO DO RIO GRANDE DO SUL,  
S.A. (BRAZIL SOCIEDAD ANONIMA (SA))  
500 FIFTH AVENUE, SUITE 2310  
NEW YORK, NY 10110

FOR: BANKING SERVICES, IN CLASS 36 (U.S.  
CLS. 100, 101 AND 102).

FIRST USE 10-0-1982; IN COMMERCE 10-0-1982.

THE MARK CONSISTS OF STANDARD CHAR-  
ACTERS WITHOUT CLAIM TO ANY PARTICULAR  
FONT, STYLE, SIZE, OR COLOR.

"BANRISUL" IN THE MARK HAS NO MEANING  
IN A FOREIGN LANGUAGE.

SER. NO. 77-322,703, FILED 11-6-2007.

REBECCA EISINGER, EXAMINING ATTORNEY

**Int. Cl.: 41**

**Prior U.S. Cls.: 100, 101 and 107**

**Reg. No. 3,453,501**

**United States Patent and Trademark Office**

**Registered June 24, 2008**

---

**SERVICE MARK  
PRINCIPAL REGISTER**

**Awareness Assessment Action**

TORIBIO, JULIO R (UNITED STATES INDIVIDUAL)  
636 LIGHTHOUSE AVENUE  
MONTEREY, CA 93940

THE MARK CONSISTS OF STANDARD CHARACTERS WITHOUT CLAIM TO ANY PARTICULAR FONT, STYLE, SIZE, OR COLOR.

FOR: MARTIAL ARTS INSTRUCTION, IN CLASS 41 (U.S. CLS. 100, 101 AND 107).

SER. NO. 77-322,708, FILED 11-6-2007.

FIRST USE 6-1-1993; IN COMMERCE 6-1-1993.

SUSAN LESLIE DUBOIS, EXAMINING ATTORNEY



**Int. Cl.: 36**

**Prior U.S. Cls.: 100, 101 and 102**

**United States Patent and Trademark Office**

**Reg. No. 3,453,502**

**Registered June 24, 2008**

**SERVICE MARK  
PRINCIPAL REGISTER**

**BUTTERFLIES FROM HEAVEN**

BUTTERFLIES FROM HEAVEN FOUNDATION  
INC. (FLORIDA CORPORATION)  
14611 KIRSTEN COURT  
DAVIE, FL 33325

THE MARK CONSISTS OF STANDARD CHAR-  
ACTERS WITHOUT CLAIM TO ANY PARTICULAR  
FONT, STYLE, SIZE, OR COLOR.

FOR: CHARITABLE FUND RAISING, IN CLASS  
36 (U.S. CLS. 100, 101 AND 102).

SER. NO. 77-322,715, FILED 11-6-2007.

FIRST USE 2-1-2007; IN COMMERCE 5-1-2007.

REBECCA EISINGER, EXAMINING ATTORNEY

**Int. Cl.: 28**

**Prior U.S. Cls.: 22, 23, 38 and 50**

**United States Patent and Trademark Office**

**Reg. No. 3,453,503**

**Registered June 24, 2008**

**TRADEMARK  
PRINCIPAL REGISTER**

**A-REST-A-PEST BUGGIES**

A REST A PEST, INC. (NEVADA CORPORATION)  
91 MISTY RAIN STREET  
HENDERSON, NV 89012

FOR: STUFFED TOYS, IN CLASS 28 (U.S. CLS. 22,  
23, 38 AND 50).

FIRST USE 3-27-2006; IN COMMERCE 3-27-2006.

THE MARK CONSISTS OF STANDARD CHAR-  
ACTERS WITHOUT CLAIM TO ANY PARTICULAR  
FONT, STYLE, SIZE, OR COLOR.

NO CLAIM IS MADE TO THE EXCLUSIVE  
RIGHT TO USE "BUGGIES", APART FROM THE  
MARK AS SHOWN.

SER. NO. 77-322,720, FILED 11-6-2007.

REBECCA EISINGER, EXAMINING ATTORNEY

**Int. Cl.: 5**

**Prior U.S. Cls.: 6, 18, 44, 46, 51 and 52**

**United States Patent and Trademark Office**

**Reg. No. 3,453,504**

**Registered June 24, 2008**

**TRADEMARK  
PRINCIPAL REGISTER**

**RAZOR BURN**

NUFARM AMERICAS, INC. (ILLINOIS COR-  
PORATION)  
SUITE 200  
150 HARVESTER DRIVE  
BURR RIDGE, IL 60527

THE MARK CONSISTS OF STANDARD CHAR-  
ACTERS WITHOUT CLAIM TO ANY PARTICULAR  
FONT, STYLE, SIZE, OR COLOR.

FOR: HERBICIDES; PESTICIDES; FUNGICIDES;  
INSECTICIDES, IN CLASS 5 (U.S. CLS. 6, 18, 44, 46, 51  
AND 52).

SER. NO. 77-322,725, FILED 11-6-2007.

FIRST USE 2-28-2006; IN COMMERCE 2-28-2006.

REBECCA EISINGER, EXAMINING ATTORNEY

**Int. Cl.: 9**

**Prior U.S. Cls.: 21, 23, 26, 36 and 38**

**United States Patent and Trademark Office**

**Reg. No. 3,453,505**

**Registered June 24, 2008**

**TRADEMARK  
PRINCIPAL REGISTER**

**THE MONKEES**

RHINO ENTERTAINMENT COMPANY (DELA-  
WARE CORPORATION)  
3400 WEST OLIVE AVENUE  
BURBANK, CA 91505

FOR: MUSICAL SOUND AND VIDEO RECORD-  
INGS; DOWNLOADABLE MUSICAL SOUND AND  
VIDEO RECORDINGS; DOWNLOADABLE RING  
TONES, RING BACK TONES AND GRAPHICS VIA  
A GLOBAL COMPUTER NETWORK AND WIRE-  
LESS DEVICES, IN CLASS 9 (U.S. CLS. 21, 23, 26, 36  
AND 38).

FIRST USE 10-0-1966; IN COMMERCE 10-0-1966.

THE MARK CONSISTS OF STANDARD CHAR-  
ACTERS WITHOUT CLAIM TO ANY PARTICULAR  
FONT, STYLE, SIZE, OR COLOR.

PRIORITY CLAIMED UNDER SEC. 44(D) ON  
ERPN CMNTY TM OFC APPLICATION NO.  
6037031, FILED 6-15-2007.

OWNER OF U.S. REG. NOS. 847,385 AND 848,385.

SER. NO. 77-322,730, FILED 11-6-2007.

PRISCILLA MILTON, EXAMINING ATTORNEY

**Int. Cl.: 38**

**Prior U.S. Cls.: 100, 101 and 104**

**United States Patent and Trademark Office**

**Reg. No. 3,453,506**

**Registered June 24, 2008**

---

**SERVICE MARK  
PRINCIPAL REGISTER**

**WRAZ-TV**

CAPITOL BROADCASTING COMPANY, INCORPORATED (NORTH CAROLINA CORPORATION)  
2619 WESTERN BOULEVARD  
RALEIGH, NC 27606

THE MARK CONSISTS OF STANDARD CHARACTERS WITHOUT CLAIM TO ANY PARTICULAR FONT, STYLE, SIZE, OR COLOR.

FOR: TELEVISION BROADCASTING SERVICES,  
IN CLASS 38 (U.S. CLS. 100, 101 AND 104).

SER. NO. 77-322,737, FILED 11-6-2007.

FIRST USE 12-0-1994; IN COMMERCE 12-0-1994.

JANICE KIM, EXAMINING ATTORNEY

**Int. Cl.: 36**

**Prior U.S. Cls.: 100, 101 and 102**

**United States Patent and Trademark Office**

**Reg. No. 3,453,507**

**Registered June 24, 2008**

**SERVICE MARK  
PRINCIPAL REGISTER**

**ADVANCING HEALTHCARE'S  
FINANCIAL INTELLIGENCE**

SEARCH AMERICA, INC. (MINNESOTA CORPORATION)  
7001 E. FISH LAKE ROAD  
MAPLE GROVE, MN 55311

FOR: COMPUTER SERVICES, NAMELY, PROVIDING INFORMATION TO HEALTHCARE ORGANIZATIONS REGARDING CUSTOMERS' LOCATIONS AND FINANCIAL CAPABILITIES INCLUDING CUSTOMERS' ABILITY TO PAY FOR SERVICES AND/OR QUALIFY FOR PARTIAL OR FULL PAYMENT OF MEDICAL EXPENSES BY GOVERNMENT PROGRAMS OR THIRD PARTIES BASED UPON A CREDIT SCREENING AND SCOR-

ING SERVICE VIA A GLOBAL COMPUTER NETWORK, IN CLASS 36 (U.S. CLS. 100, 101 AND 102).

FIRST USE 6-1-2005; IN COMMERCE 6-1-2005.

THE MARK CONSISTS OF STANDARD CHARACTERS WITHOUT CLAIM TO ANY PARTICULAR FONT, STYLE, SIZE, OR COLOR.

SER. NO. 77-322,750, FILED 11-6-2007.

AMY HELLA, EXAMINING ATTORNEY

Int. Cls.: 35, 37 and 42

Prior U.S. Cls.: 100, 101, 102, 103 and 106

United States Patent and Trademark Office

Reg. No. 3,453,508

Registered June 24, 2008

SERVICE MARK  
PRINCIPAL REGISTER

**TERPSYS**

TERRAPIN SYSTEMS LLC (DELAWARE LTD  
LIAB CO), DBA TERPSYS  
SUITE 300  
1201 SEVEN LOCKS ROAD  
ROCKVILLE, MD 208542966

FOR: MANAGEMENT OF TELEPHONE CALL  
CENTERS FOR OTHERS, IN CLASS 35 (U.S. CLS.  
100, 101 AND 102).

FIRST USE 8-1-2000; IN COMMERCE 8-1-2000.

FOR: INSTALLATION OF COMPUTER NET-  
WORKS; MAINTENANCE AND REPAIR OF COM-  
PUTER NETWORKS, IN CLASS 37 (U.S. CLS. 100, 103  
AND 106).

FIRST USE 8-1-2000; IN COMMERCE 8-1-2000.

FOR: COMPUTER NETWORK DESIGN FOR  
OTHERS; COMPUTER SERVICES, NAMELY, DE-  
SIGNING AND IMPLEMENTING NETWORK WEB  
PAGES FOR OTHERS; DESIGN AND DEVELOP-

MENT OF NETWORKS; PROVIDING CUSTO-  
MIZED ON-LINE WEB PAGES FEATURING USER-  
DEFINED INFORMATION, WHICH INCLUDES  
SEARCH ENGINES AND ON-LINE WEB LINKS TO  
OTHER WEB SITES; COMPUTER SERVICES IN THE  
NATURE OF CUSTOMIZED WEB PAGES FEATUR-  
ING USER-DEFINED INFORMATION, PERSONAL  
PROFILES AND INFORMATION, IN CLASS 42 (U.S.  
CLS. 100 AND 101).

FIRST USE 8-1-2000; IN COMMERCE 8-1-2000.

OWNER OF U.S. REG. NOS. 2,734,154 AND  
3,045,335.

THE MARK CONSISTS OF THE NAME "TERP-  
SYS" AS A LOGO IN A STYLIZED, DISTINCTIVE  
TYPEFACE.

SER. NO. 77-322,751, FILED 11-6-2007.

REBECCA SMITH, EXAMINING ATTORNEY

**Int. Cl.: 35**

**Prior U.S. Cls.: 100, 101 and 102**

**United States Patent and Trademark Office**

**Reg. No. 3,453,509**

**Registered June 24, 2008**

**SERVICE MARK  
PRINCIPAL REGISTER**



KEN SLAUF & ASSOCIATES, INC. (ILLINOIS CORPORATION)  
1 N MAIN ST.  
LOMBARD, IL 60148

FOR: ADVERTISING VIA ELECTRONIC MEDIA AND SPECIFICALLY THE INTERNET, IN CLASS 35 (U.S. CLS. 100, 101 AND 102).

FIRST USE 6-27-2007; IN COMMERCE 6-27-2007.

THE COLOR(S) GREY, RED AND BLACK IS/ARE CLAIMED AS A FEATURE OF THE MARK.

THE MARK CONSISTS OF THE GREY CHARACTERS "E" AND "VOLVE" IN LOWER-CASE LETTERS, WITH THE "E" HAVING BLACK SHADING AND BEING SEPARATED FROM THE REMAINING TEXT BY A RED HYPHEN.

SER. NO. 77-322,757, FILED 11-6-2007.

REBECCA EISINGER, EXAMINING ATTORNEY



**Int. Cls.: 38 and 41**

**Prior U.S. Cls.: 100, 101, 104 and 107**

**United States Patent and Trademark Office**

**Reg. No. 3,453,510**

**Registered June 24, 2008**

**SERVICE MARK  
PRINCIPAL REGISTER**

**WRAL**

CAPITOL BROADCASTING COMPANY, INCORPORATED (NORTH CAROLINA CORPORATION)  
2619 WESTERN BOULEVARD  
RALEIGH, NC 27606

FOR: TELEVISION BROADCASTING SERVICES, IN CLASS 38 (U.S. CLS. 100, 101 AND 104).

FIRST USE 12-15-1956; IN COMMERCE 12-15-1956.

FOR: TELEVISION PROGRAMMING, TELEVISION SCHEDULING AND TELEVISION PRODUCTION, IN CLASS 41 (U.S. CLS. 100, 101 AND 107).

FIRST USE 12-15-1956; IN COMMERCE 12-15-1956.

THE MARK CONSISTS OF STANDARD CHARACTERS WITHOUT CLAIM TO ANY PARTICULAR FONT, STYLE, SIZE, OR COLOR.

SER. NO. 77-322,771, FILED 11-6-2007.

JANICE KIM, EXAMINING ATTORNEY

**Int. Cl.: 41**

**Prior U.S. Cls.: 100, 101 and 107**

**United States Patent and Trademark Office**

**Reg. No. 3,453,511**

**Registered June 24, 2008**

**SERVICE MARK  
PRINCIPAL REGISTER**

# Are You Fascinated?

TUCKER, KEN (UNITED STATES INDIVIDUAL)  
2254 F HUNTERS WOODS PLAZA  
RESTON, VA 20191

FOR: EDUCATION SERVICES, NAMELY, PROVIDING CLASSES, SEMINARS, AND WORKSHOPS IN THE FIELD OF BUSINESS MANAGEMENT, LEADERSHIP DEVELOPMENT, MOTIVATING OTHERS, SELECTING EMPLOYEES AND EXECUTIVE COACHING, IN CLASS 41 (U.S. CLS. 100, 101 AND 107).

FIRST USE 10-1-2007; IN COMMERCE 10-1-2007.

THE MARK CONSISTS OF STANDARD CHARACTERS WITHOUT CLAIM TO ANY PARTICULAR FONT, STYLE, SIZE, OR COLOR.

SER. NO. 77-322,783, FILED 11-6-2007.

JAMES LOVELACE, EXAMINING ATTORNEY

**Int. Cl.: 40**

**Prior U.S. Cls.: 100, 103 and 106**

**United States Patent and Trademark Office**

**Reg. No. 3,453,512**

**Registered June 24, 2008**

**SERVICE MARK  
PRINCIPAL REGISTER**

**GERMANE RED**

GERMANE RED, LLC (NORTH CAROLINA LTD  
LIAB CO)  
706A PERFORMANCE ROAD  
MOORESVILLE, NC 28115

THE MARK CONSISTS OF STANDARD CHAR-  
ACTERS WITHOUT CLAIM TO ANY PARTICULAR  
FONT, STYLE, SIZE, OR COLOR.

FOR: MANUFACTURING SERVICES, NAMELY,  
CUSTOM AUTO PARTS FOR THE MOTORSPORTS  
INDUSTRY, IN CLASS 40 (U.S. CLS. 100, 103 AND  
106).

SER. NO. 77-323,824, FILED 11-7-2007.

FIRST USE 6-0-2007; IN COMMERCE 6-0-2007.

KAREN SEVERSON, EXAMINING ATTORNEY

**Int. Cls.: 40 and 42**

**Prior U.S. Cls.: 100, 101, 103 and 106**

**United States Patent and Trademark Office**

**Reg. No. 3,453,513**

**Registered June 24, 2008**

**SERVICE MARK  
PRINCIPAL REGISTER**

**SHERWOOD**

SHERWOOD RTM CORP. (OHIO CORPORATION)  
4043 BECK AVENUE, N. E.  
LOUISVILLE, OH 446419458

FOR: CUSTOM MANUFACTURE FOR OTHERS OF MOLDED COMPOSITE MATERIALS FOR USE IN THE AEROSPACE, AVIATION, COMMUNICATIONS, DEFENSE, AND MEDICAL EQUIPMENT INDUSTRIES; CUSTOM MANUFACTURE FOR OTHERS OF MOLDED COMPOSITE MATERIALS USED IN MASS TRANSIT VEHICLES, IN CLASS 40 (U.S. CLS. 100, 103 AND 106).

FIRST USE 3-3-1967; IN COMMERCE 3-3-1967.

FOR: CUSTOM DESIGN AND ENGINEERING OF MOLDED COMPOSITE MATERIALS AND PRODUCTS MADE FROM MOLDED COMPOSITE MATERIALS FOR OTHERS; PRODUCT

DEVELOPMENT AND ENGINEERING SERVICES FOR OTHERS OF MOLDED COMPOSITE MATERIALS AND PRODUCTS MADE FROM MOLDED COMPOSITE MATERIALS; RESEARCH AND DEVELOPMENT FOR NEW PRODUCTS FOR OTHERS OF MOLDED COMPOSITE MATERIALS AND PRODUCTS MADE FROM MOLDED COMPOSITE MATERIALS, IN CLASS 42 (U.S. CLS. 100 AND 101).

FIRST USE 3-3-1967; IN COMMERCE 3-3-1967.

THE MARK CONSISTS OF STANDARD CHARACTERS WITHOUT CLAIM TO ANY PARTICULAR FONT, STYLE, SIZE, OR COLOR.

SER. NO. 77-323,826, FILED 11-7-2007.

MICHAEL TANNER, EXAMINING ATTORNEY

**Int. Cl.: 41**

**Prior U.S. Cls.: 100, 101 and 107**

**United States Patent and Trademark Office**

**Reg. No. 3,453,514**

**Registered June 24, 2008**

**SERVICE MARK  
PRINCIPAL REGISTER**

**AMERICAN PROFILE**

NATIONAL CABLE SATELLITE CORPORATION  
(D.C. CORPORATION)  
SUITE 650  
400 NORTH CAPITOL STREET, NW  
WASHINGTON, DC 20001

FOR: TELEVISION ENTERTAINMENT SERVICES, NAMELY, AN ON-GOING TELEVISION PROGRAM IN THE NATURE OF INTERVIEWS WITH PROMINENT FIGURES IN PUBLIC LIFE, IN CLASS 41 (U.S. CLS. 100, 101 AND 107).

FIRST USE 11-27-1986; IN COMMERCE 11-27-1986.

THE MARK CONSISTS OF STANDARD CHARACTERS WITHOUT CLAIM TO ANY PARTICULAR FONT, STYLE, SIZE, OR COLOR.

SEC. 2(F).

SER. NO. 77-323,834, FILED 11-7-2007.

TIMOTHY FINNEGAN, EXAMINING ATTORNEY

**Int. Cl.: 35**

**Prior U.S. Cls.: 100, 101 and 102**

**United States Patent and Trademark Office**

**Reg. No. 3,453,515**

**Registered June 24, 2008**

**SERVICE MARK  
PRINCIPAL REGISTER**

**FUTUREMINDS TRANSFORMING  
AMERICAN SCHOOL SYSTEMS**

ASSOCIATION FOR EDUCATIONAL COMMUNI-  
CATIONS AND TECHNOLOGY (INDIANA  
CORPORATION)

1800 N. STONELAKE DIVE, STE. 2  
BLOOMINGTON, IN 47404

FOR: PROMOTING PUBLIC AWARENESS OF  
THE NEED FOR REFORM IN THE FIELD OF K-12  
EDUCATION, IN CLASS 35 (U.S. CLS. 100, 101 AND  
102).

FIRST USE 3-0-2007; IN COMMERCE 3-0-2007.

THE MARK CONSISTS OF STANDARD CHAR-  
ACTERS WITHOUT CLAIM TO ANY PARTICULAR  
FONT, STYLE, SIZE, OR COLOR.

NO CLAIM IS MADE TO THE EXCLUSIVE  
RIGHT TO USE "TRANSFORMING AMERICAN  
SCHOOL SYSTEMS", APART FROM THE MARK  
AS SHOWN.

SER. NO. 77-323,865, FILED 11-7-2007.

REBECCA GILBERT, EXAMINING ATTORNEY

**Int. Cl.: 3**

**Prior U.S. Cls.: 1, 4, 6, 50, 51 and 52**

**Reg. No. 3,453,516**

**United States Patent and Trademark Office**

**Registered June 24, 2008**

---

**TRADEMARK  
PRINCIPAL REGISTER**

**ALL THAT GLITTERS**

NATERRA INTERNATIONAL, INC. (TEXAS  
CORPORATION)  
3030 LBJ FREEWAY  
DALLAS, TX 75234

THE MARK CONSISTS OF STANDARD CHAR-  
ACTERS WITHOUT CLAIM TO ANY PARTICULAR  
FONT, STYLE, SIZE, OR COLOR.

FOR: COSMETICS; BODY POWDER; SCENTED  
BODY SPRAY; NON-MEDICATED SKIN CARE  
PREPARATIONS, IN CLASS 3 (U.S. CLS. 1, 4, 6, 50,  
51 AND 52).

SER. NO. 77-323,871, FILED 11-7-2007.

FIRST USE 11-1-2005; IN COMMERCE 11-1-2005.

NICHOLAS ALTREE, EXAMINING ATTORNEY

**Int. Cl.: 41**

**Prior U.S. Cls.: 100, 101 and 107**

**United States Patent and Trademark Office**

**Reg. No. 3,453,517**

**Registered June 24, 2008**

**SERVICE MARK  
PRINCIPAL REGISTER**

**JOE'S WILDSIDE ADVENTURES**

WILDSIDE ADVENTURES, LLC (PENNSYLVANIA LTD LIAB CO)  
100 DEMMEL DRIVE  
MCMURRAY, PA 15317

FOR: ENTERTAINMENT, NAMELY, A CONTINUING FISHING, HUNTING, AND COOKING SHOW BROADCAST OVER TELEVISION, SATELLITE, AUDIO, AND VIDEO MEDIA; ENTERTAINMENT SERVICES, NAMELY, PROVIDING A WEBSITE FEATURING PHOTOGRAPHIC, AUDIO, VIDEO AND PROSE PRESENTATIONS FEATURING FISHING, HUNTING AND COOKING, IN CLASS 41 (U.S. CLS. 100, 101 AND 107).

FIRST USE 3-7-2007; IN COMMERCE 3-7-2007.

THE MARK CONSISTS OF STANDARD CHARACTERS WITHOUT CLAIM TO ANY PARTICULAR FONT, STYLE, SIZE, OR COLOR.

NO CLAIM IS MADE TO THE EXCLUSIVE RIGHT TO USE "ADVENTURES", APART FROM THE MARK AS SHOWN.

SER. NO. 77-323,873, FILED 11-7-2007.

RONALD MCMORROW, EXAMINING ATTORNEY



**Int. Cl.: 41**

**Prior U.S. Cls.: 100, 101 and 107**

**United States Patent and Trademark Office**

**Reg. No. 3,453,518**

**Registered June 24, 2008**

**SERVICE MARK  
PRINCIPAL REGISTER**

**FISHER COLLEGE OF BUSINESS**

THE OHIO STATE UNIVERSITY (OHIO STATE  
UNIVERSITY)  
190 NORTH OVAL MALL  
COLUMBUS, OH 43210

FOR: EDUCATIONAL SERVICES, NAMELY,  
PROVIDING COURSES OF INSTRUCTION AT  
THE COLLEGE AND GRADUATE LEVELS AND  
DISTRIBUTING COURSE MATERIALS IN CON-  
NECTION THEREWITH; ARRANGING AND CON-  
DUCTING EDUCATIONAL CONFERENCES IN  
THE FIELD OF BUSINESS STUDIES, IN CLASS 41  
(U.S. CLS. 100, 101 AND 107).

FIRST USE 6-15-1994; IN COMMERCE 6-15-1994.

THE MARK CONSISTS OF STANDARD CHAR-  
ACTERS WITHOUT CLAIM TO ANY PARTICULAR  
FONT, STYLE, SIZE, OR COLOR.

NO CLAIM IS MADE TO THE EXCLUSIVE  
RIGHT TO USE "COLLEGE OF BUSINESS", APART  
FROM THE MARK AS SHOWN.

SEC. 2(F).

SER. NO. 77-323,888, FILED 11-7-2007.

KAREN SEVERSON, EXAMINING ATTORNEY

**Int. Cl.: 41**

**Prior U.S. Cls.: 100, 101 and 107**

**United States Patent and Trademark Office**

**Reg. No. 3,453,519**

**Registered June 24, 2008**

**SERVICE MARK  
PRINCIPAL REGISTER**

**COOKING ON THE WILDSIDE**

WILDSIDE ADVENTURES, LLC (PENNSYLVANIA LTD LIAB CO)  
100 DEMMEL DRIVE  
MCMURRAY, PA 15317

FOR: ENTERTAINMENT, NAMELY, A CONTINUING FISHING, HUNTING AND COOKING SHOW BROADCAST OVER TELEVISION, SATELLITE, AUDIO, AND VIDEO MEDIA; ENTERTAINMENT SERVICES, NAMELY, PROVIDING A WEBSITE FEATURING PHOTOGRAPHIC, AUDIO, VIDEO AND PROSE PRESENTATIONS FEATURING FISHING, HUNTING AND COOKING, IN CLASS 41 (U.S. CLS. 100, 101 AND 107).

FIRST USE 1-1-2006; IN COMMERCE 1-1-2006.

THE MARK CONSISTS OF STANDARD CHARACTERS WITHOUT CLAIM TO ANY PARTICULAR FONT, STYLE, SIZE, OR COLOR.

NO CLAIM IS MADE TO THE EXCLUSIVE RIGHT TO USE "COOKING", APART FROM THE MARK AS SHOWN.

SER. NO. 77-323,903, FILED 11-7-2007.

RONALD MCMORROW, EXAMINING ATTORNEY

**Int. Cl.: 36**

**Prior U.S. Cls.: 100, 101 and 102**

**United States Patent and Trademark Office**

**Reg. No. 3,453,520**

**Registered June 24, 2008**

**SERVICE MARK  
PRINCIPAL REGISTER**

**MAR VISTA**

MAR VISTA INVESTMENT PARTNERS, LLC  
(DELAWARE LTD LIAB CO)  
SUITE 1000  
100 WILSHIRE BLVD.  
SANTA MONICA, CA 90401

THE MARK CONSISTS OF STANDARD CHAR-  
ACTERS WITHOUT CLAIM TO ANY PARTICULAR  
FONT, STYLE, SIZE, OR COLOR.

FOR: INVESTMENT MANAGEMENT, IN CLASS  
36 (U.S. CLS. 100, 101 AND 102).

SER. NO. 77-323,922, FILED 11-7-2007.

FIRST USE 11-0-2007; IN COMMERCE 11-0-2007.

FRED CARL, EXAMINING ATTORNEY

**Int. Cl.: 44**

**Prior U.S. Cls.: 100 and 101**

**United States Patent and Trademark Office**

**Reg. No. 3,453,521**

**Registered June 24, 2008**

**SERVICE MARK  
PRINCIPAL REGISTER**

**SONATINA**

SANAM LLC (CALIFORNIA LTD LIAB CO)  
21 TAMAL VISTA BOULEVARD, SUITE 174  
CORTE MADERA, CA 94925

THE MARK CONSISTS OF STANDARD CHAR-  
ACTERS WITHOUT CLAIM TO ANY PARTICULAR  
FONT, STYLE, SIZE, OR COLOR.

FOR: VINEYARD AND WINERY SERVICES,  
NAMELY, THE CULTIVATION OF GRAPES FOR  
OTHERS, IN CLASS 44 (U.S. CLS. 100 AND 101).

SER. NO. 77-323,927, FILED 11-7-2007.

FIRST USE 9-0-1999; IN COMMERCE 9-0-1999.

FRED CARL, EXAMINING ATTORNEY

**Int. Cl.: 42**

**Prior U.S. Cls.: 100 and 101**

**United States Patent and Trademark Office**

**Reg. No. 3,453,522**

**Registered June 24, 2008**

**SERVICE MARK  
PRINCIPAL REGISTER**

**WESTRAX**

WESTAT, INC. (DELAWARE CORPORATION)  
1650 RESEARCH BOULEVARD  
ROCKVILLE, MD 208503129

THE MARK CONSISTS OF STANDARD CHAR-  
ACTERS WITHOUT CLAIM TO ANY PARTICULAR  
FONT, STYLE, SIZE, OR COLOR.

FOR: COLLECTION, MANAGEMENT, ANALYSIS  
AND REPORTING OF CLINICAL TRIALS DATA, IN  
CLASS 42 (U.S. CLS. 100 AND 101).

SER. NO. 77-323,934, FILED 11-7-2007.

FIRST USE 11-1-2003; IN COMMERCE 11-1-2003.

FRED CARL, EXAMINING ATTORNEY

**Int. Cl.: 17**

**Prior U.S. Cls.: 1, 5, 12, 13, 35 and 50**

**United States Patent and Trademark Office**

**Reg. No. 3,453,523**

**Registered June 24, 2008**

**TRADEMARK  
PRINCIPAL REGISTER**

# TerraFoam

LENDELL MANUFACTURING, INC. (MICHIGAN CORPORATION)  
5301 S. GRAHAM ROAD  
SAINT CHARLES, MI 48655

THE MARK CONSISTS OF STANDARD CHARACTERS WITHOUT CLAIM TO ANY PARTICULAR FONT, STYLE, SIZE, OR COLOR.

FOR: OPEN CELL FOAM IN ROLL FORM, IN CLASS 17 (U.S. CLS. 1, 5, 12, 13, 35 AND 50).

SER. NO. 77-324,431, FILED 11-8-2007.

FIRST USE 11-8-2007; IN COMMERCE 11-8-2007.

DAVID COLLIER, EXAMINING ATTORNEY

**Int. Cl.: 10**

**Prior U.S. Cls.: 26, 39 and 44**

**Reg. No. 3,453,524**

**United States Patent and Trademark Office**

**Registered June 24, 2008**

---

**TRADEMARK  
PRINCIPAL REGISTER**

**ULTRAWAND**

ST. JUDE MEDICAL, ATRIAL FIBRILLATION  
DIVISION, INC. (MINNESOTA CORPORATION)  
6500 WEDGWOOD ROAD  
MAPLE GROVE, MN 553113642

THE MARK CONSISTS OF STANDARD CHAR-  
ACTERS WITHOUT CLAIM TO ANY PARTICULAR  
FONT, STYLE, SIZE, OR COLOR.

FOR: MEDICAL DEVICES, NAMELY, TISSUE  
ABLATION DEVICES, IN CLASS 10 (U.S. CLS. 26, 39  
AND 44).

SER. NO. 77-324,941, FILED 11-8-2007.

FIRST USE 12-17-2004; IN COMMERCE 12-17-2004.

LAURA KOVALSKY, EXAMINING ATTORNEY

**Int. Cl.: 10**

**Prior U.S. Cls.: 26, 39 and 44**

**United States Patent and Trademark Office**

**Reg. No. 3,453,525**

**Registered June 24, 2008**

**TRADEMARK  
PRINCIPAL REGISTER**

**ULTRACINCH**

ST. JUDE MEDICAL, ATRIAL FIBRILLATION  
DIVISION, INC. (MINNESOTA CORPORATION)  
6500 WEDGWOOD ROAD  
MAPLE GROVE, MN 553113642

THE MARK CONSISTS OF STANDARD CHAR-  
ACTERS WITHOUT CLAIM TO ANY PARTICULAR  
FONT, STYLE, SIZE, OR COLOR.

FOR: MEDICAL DEVICES, NAMELY, TISSUE  
ABLATION DEVICES, IN CLASS 10 (U.S. CLS. 26, 39  
AND 44).

SER. NO. 77-324,951, FILED 11-8-2007.

FIRST USE 12-17-2004; IN COMMERCE 12-17-2004.

LAURA KOVALSKY, EXAMINING ATTORNEY



**Int. Cls.: 35 and 43**

**Prior U.S. Cls.: 100, 101 and 102**

**United States Patent and Trademark Office**

**Reg. No. 3,453,526**

**Registered June 24, 2008**

**SERVICE MARK  
PRINCIPAL REGISTER**

**IN**

INTELLIGENT NUTRIENTS, LLC (DELAWARE  
LTD LIAB CO)  
983 EAST HENNEPIN AVENUE  
MINNEAPOLIS, MN 55414

FOR: RETAIL STORE SERVICES FEATURING  
HEALTH, WELLNESS, HOME AND PERSONAL  
CARE PRODUCTS, NAMELY, DIETARY SUPPLE-  
MENTS, SNACK BARS, FOOD, BEVERAGES, JEW-  
ELRY, CANDY, OILS, PERFUMES, HAIR CARE,  
SKIN CARE, HOME CLEANING PRODUCTS, AIR  
FRESHENERS, ROOM DEODORIZERS, BOOKS,  
GIFTS AND NOVELTIES; AND PROVIDING FACIL-  
ITIES FOR BUSINESS MEETINGS, IN CLASS 35 (U.S.  
CLS. 100, 101 AND 102).

FIRST USE 12-1-2004; IN COMMERCE 12-1-2004.

FOR: RESTAURANT AND BAR SERVICES; AND  
PROVIDING BANQUET AND SOCIAL FUNCTION  
FACILITIES FOR SPECIAL OCCASIONS, IN CLASS  
43 (U.S. CLS. 100 AND 101).

FIRST USE 12-1-2004; IN COMMERCE 12-1-2004.

THE MARK CONSISTS OF STANDARD CHAR-  
ACTERS WITHOUT CLAIM TO ANY PARTICULAR  
FONT, STYLE, SIZE, OR COLOR.

SER. NO. 77-325,139, FILED 11-8-2007.

GRETТА YAO, EXAMINING ATTORNEY

**Int. Cl.: 37**

**Prior U.S. Cls.: 100, 103 and 106**

**United States Patent and Trademark Office**

**Reg. No. 3,453,527**

**Registered June 24, 2008**

**SERVICE MARK  
PRINCIPAL REGISTER**



WHELAN'S INTERNATIONAL CO., INC. (NEW  
YORK CORPORATION)  
731 UNION PARKWAY  
RONKONKOMA, NY 11779

FOR: INTERIOR AND EXTERIOR CLEANING  
AND MAINTENANCE SERVICES FOR COMMER-  
CIAL BUILDINGS; JANITORIAL SERVICES; IN-  
STALLATION AND REPAIR OF FLOORING AND  
FLOOR COVERINGS; INTERIOR AND EXTERIOR  
PAINTING, IN CLASS 37 (U.S. CLS. 100, 103 AND  
106).

FIRST USE 1-1-2001; IN COMMERCE 1-1-2001.

NO CLAIM IS MADE TO THE EXCLUSIVE  
RIGHT TO USE "INTERNATIONAL" AND "FACIL-  
ITIES MANAGEMENT COMPANY", APART FROM  
THE MARK AS SHOWN.

SER. NO. 77-325,519, FILED 11-9-2007.

MELISSA VALLILLO, EXAMINING ATTORNEY

**Int. Cl.: 41**

**Prior U.S. Cls.: 100, 101 and 107**

**United States Patent and Trademark Office**

**Reg. No. 3,453,528**

**Registered June 24, 2008**

**SERVICE MARK  
PRINCIPAL REGISTER**

**DESIGNED FOR REAL PEOPLE**

TRANSFORM FITNESS INC. (ILLINOIS COR-  
PORATION)  
118 BRIARWOOD DR.  
GILBERTS, IL 60136

THE MARK CONSISTS OF STANDARD CHAR-  
ACTERS WITHOUT CLAIM TO ANY PARTICULAR  
FONT, STYLE, SIZE, OR COLOR.

FOR: PHYSICAL FITNESS INSTRUCTION, IN  
CLASS 41 (U.S. CLS. 100, 101 AND 107).

SER. NO. 77-325,736, FILED 11-9-2007.

FIRST USE 8-1-2007; IN COMMERCE 9-12-2007.

CHARLES L. JENKINS, EXAMINING ATTORNEY

**Int. Cl.: 9**

**Prior U.S. Cls.: 21, 23, 26, 36 and 38**

**Reg. No. 3,453,529**

**United States Patent and Trademark Office**

**Registered June 24, 2008**

**TRADEMARK  
PRINCIPAL REGISTER**

**The Wood Whisperer**

SPAGNUOLO, MARC J (UNITED STATES INDIVIDUAL), DBA MARC'S WOOD CREATIONS LLC  
5311 N. 196TH AVE.  
LITCHFIELD PARK, AZ 85340

FOR: DOWNLOADABLE VIDEO RECORDINGS FEATURING WOODWORKING; DOWNLOADABLE MULTIMEDIA FILE CONTAINING ARTWORK, TEXT, AUDIO, VIDEO, GAMES, AND INTERNET WEB LINKS RELATING TO WOODWORKING, IN CLASS 9 (U.S. CLS. 21, 23, 26, 36 AND 38).

FIRST USE 10-10-2006; IN COMMERCE 10-10-2006.

THE MARK CONSISTS OF STANDARD CHARACTERS WITHOUT CLAIM TO ANY PARTICULAR FONT, STYLE, SIZE, OR COLOR.

NO CLAIM IS MADE TO THE EXCLUSIVE RIGHT TO USE "WOOD", APART FROM THE MARK AS SHOWN.

SER. NO. 77-326,000, FILED 11-9-2007.

KATHERINE M. DUBRAY, EXAMINING ATTORNEY

**Int. Cl.: 33**

**Prior U.S. Cls.: 47 and 49**

**United States Patent and Trademark Office**

**Reg. No. 3,453,530**

**Registered June 24, 2008**

**TRADEMARK  
PRINCIPAL REGISTER**

**SLINGER**

SPB LLC (WISCONSIN LTD LIAB CO)  
2617 WATER STREET  
STEVENS POINT, WI 54481

THE MARK CONSISTS OF STANDARD CHAR-  
ACTERS WITHOUT CLAIM TO ANY PARTICULAR  
FONT, STYLE, SIZE, OR COLOR.

FOR: FLAVORED BREWED MALT BEVERAGE,  
IN CLASS 33 (U.S. CLS. 47 AND 49).

SER. NO. 77-326,018, FILED 11-9-2007.

FIRST USE 10-1-2007; IN COMMERCE 10-1-2007.

KEVIN DINALLO, EXAMINING ATTORNEY

**Int. Cl.: 9**

**Prior U.S. Cls.: 21, 23, 26, 36 and 38**

**United States Patent and Trademark Office**

**Reg. No. 3,453,531**

**Registered June 24, 2008**

**TRADEMARK  
PRINCIPAL REGISTER**

**We Get Your Lady Up To  
Speed On Sports With No  
Sweat From You**

NADA—J PRODUCTIONS, LLC (NEW JERSEY  
LTD LIAB CO)  
PO BOX 284  
CARLSTADT, NJ 07072

FOR: DIGITAL MATERIALS, NAMELY, DVDS  
FEATURING SUBJECT MATTER RELATED TO  
SPORTS INSTRUCTION AND INTERPERSONAL  
RELATIONSHIPS; DIGITAL MEDIA, NAMELY,  
DVDS FEATURING SUBJECT MATTER RELATED  
TO SPORTS INSTRUCTION AND INTERPERSONAL  
RELATIONSHIPS; DVDS FEATURING SUB-  
JECT MATTER RELATED TO SPORTS  
INSTRUCTION AND INTERPERSONAL RELA-

TIONSHIPS, IN CLASS 9 (U.S. CLS. 21, 23, 26, 36  
AND 38).

FIRST USE 9-11-2007; IN COMMERCE 9-11-2007.

THE MARK CONSISTS OF STANDARD CHAR-  
ACTERS WITHOUT CLAIM TO ANY PARTICULAR  
FONT, STYLE, SIZE, OR COLOR.

SER. NO. 77-326,135, FILED 11-9-2007.

MARIA-VICTORIA SUAREZ, EXAMINING ATTOR-  
NEY

Int. Cl.: 25

Prior U.S. Cls.: 22 and 39

United States Patent and Trademark Office

Reg. No. 3,453,532

Registered June 24, 2008

TRADEMARK  
PRINCIPAL REGISTER



VERITY INTERNATIONAL LTD. (SAMOA CORPORATION)  
NIA MALL, SUITE 11, LEVEL 2  
SALEUFI, APIA, SAMOA

FOR: CAPS; JERSEYS; LEATHER BELTS; DRESS SHIRTS; GOLF SHIRTS; KNIT SHIRTS; LONG-SLEEVED SHIRTS; NIGHT SHIRTS; POLO SHIRTS; RUGBY SHIRTS; SHIRTS; SHIRTS FOR SUITS; SHORT-SLEEVED OR LONG-SLEEVED T-SHIRTS; SHORT-SLEEVED SHIRTS; SPORT SHIRTS; SPORTS SHIRTS; SPORTS SHIRTS WITH SHORT SLEEVES; SWEAT SHIRTS; T-SHIRTS; TEE SHIRTS; WIND SHIRTS; YOGA SHIRTS; DOWN JACKETS; FISHERMEN'S JACKETS; HEAVY JACKETS; JACKETS; LEATHER JACKETS; LONG JACKETS; MEN AND WOMEN JACKETS, COATS, TROUSERS, VESTS;

RAIN JACKETS; RAINPROOF JACKETS; REVERSIBLE JACKETS; SHELL JACKETS; SKI JACKETS; SLEEVED OR SLEEVELESS JACKETS; SPORTS JACKETS; STUFF JACKETS; SUEDE JACKETS; WATERPROOF JACKETS AND PANTS; WIND RESISTANT JACKETS; WIND-JACKETS, IN CLASS 25 (U.S. CLS. 22 AND 39).

FIRST USE 9-24-2007; IN COMMERCE 11-11-2007.

THE MARK CONSISTS OF A LABEL WITH THE STYLIZED TEXT "MARIA & ANNA".

SER. NO. 77-326,752, FILED 11-11-2007.

DAVID COLLIER, EXAMINING ATTORNEY

**Int. Cl.: 18**

**Prior U.S. Cls.: 1, 2, 3, 22 and 41**

**United States Patent and Trademark Office**

**Reg. No. 3,453,533**

**Registered June 24, 2008**

**TRADEMARK  
PRINCIPAL REGISTER**

WHERE STYLE IS EVERYTHING

JAFFERSAN, INC. (TEXAS CORPORATION)  
2319 CREEKSIDE CIRCLE NORTH  
IRVING, TX 75063

THE MARK CONSISTS OF STANDARD CHAR-  
ACTERS WITHOUT CLAIM TO ANY PARTICULAR  
FONT, STYLE, SIZE, OR COLOR.

FOR: HANDBAGS, IN CLASS 18 (U.S. CLS. 1, 2, 3,  
22 AND 41).

SER. NO. 77-326,758, FILED 11-11-2007.

FIRST USE 4-30-2006; IN COMMERCE 4-30-2006.

LAURIE KAUFMAN, EXAMINING ATTORNEY



**Int. Cl.: 5**

**Prior U.S. Cls.: 6, 18, 44, 46, 51 and 52**

**United States Patent and Trademark Office**

**Reg. No. 3,453,534**

**Registered June 24, 2008**

**TRADEMARK  
PRINCIPAL REGISTER**

**FOR THE MAN INSIDE YOU**

BIOFILM IP, LLC (NEVADA LTD LIAB CO)  
3225 EXECUTIVE RIDGE  
VISTA, CA 92081

THE MARK CONSISTS OF STANDARD CHAR-  
ACTERS WITHOUT CLAIM TO ANY PARTICULAR  
FONT, STYLE, SIZE, OR COLOR.

FOR: PERSONAL LUBRICANTS, NAMELY, SEX-  
UAL LUBRICATING PREPARATIONS, IN CLASS 5  
(U.S. CLS. 6, 18, 44, 46, 51 AND 52).

SER. NO. 77-326,770, FILED 11-12-2007.

FIRST USE 11-9-2007; IN COMMERCE 11-9-2007.

HANNO RITTNER, EXAMINING ATTORNEY

**Int. Cl.: 28**

**Prior U.S. Cls.: 22, 23, 38 and 50**

**United States Patent and Trademark Office**

**Reg. No. 3,453,535**

**Registered June 24, 2008**

---

**TRADEMARK  
PRINCIPAL REGISTER**

**ZITZ**

WALD, HARRY (UNITED STATES INDIVIDUAL)  
3156 HOWLAND ROAD  
ALMONT, MI 48003

THE MARK CONSISTS OF STANDARD CHAR-  
ACTERS WITHOUT CLAIM TO ANY PARTICULAR  
FONT, STYLE, SIZE, OR COLOR.

FOR: FISHING LURES, IN CLASS 28 (U.S. CLS. 22,  
23, 38 AND 50).

SER. NO. 77-326,786, FILED 11-12-2007.

FIRST USE 2-1-2007; IN COMMERCE 2-1-2007.

COLLEEN DOMBROW, EXAMINING ATTORNEY

**Int. Cl.: 35**

**Prior U.S. Cls.: 100, 101 and 102**

**United States Patent and Trademark Office**

**Reg. No. 3,453,536**

**Registered June 24, 2008**

**SERVICE MARK  
PRINCIPAL REGISTER**

**CommCare**

TANGOE, INC. (DELAWARE CORPORATION)  
35 EXECUTIVE BOULEVARD  
ORANGE, CT 06477

FIRST USE 9-11-2007; IN COMMERCE 9-11-2007.

FOR: BUSINESS MARKETING CONSULTING SERVICES, NAMELY, PROCUREMENT OF VOICE AND DATA SERVICES FOR OTHERS; AND INVOICE AND INVENTORY MANAGEMENT OF VOICE AND DATA SERVICES FOR OTHERS , IN CLASS 35 (U.S. CLS. 100, 101 AND 102).

THE MARK CONSISTS OF STANDARD CHARACTERS WITHOUT CLAIM TO ANY PARTICULAR FONT, STYLE, SIZE, OR COLOR.

SER. NO. 77-326,804, FILED 11-12-2007.

JEFF DEFORD, EXAMINING ATTORNEY

**Int. Cl.: 41**

**Prior U.S. Cls.: 100, 101 and 107**

**United States Patent and Trademark Office**

**Reg. No. 3,453,537**

**Registered June 24, 2008**

**SERVICE MARK  
PRINCIPAL REGISTER**

# THE CAGES

PATRICK SCULLY (UNITED STATES INDIVIDUAL)  
1444 STEELE ST.  
DENVER, CO 80206

THE MARK CONSISTS OF STANDARD CHARACTERS WITHOUT CLAIM TO ANY PARTICULAR FONT, STYLE, SIZE, OR COLOR.

FOR: ENTERTAINMENT, NAMELY, LIVE PERFORMANCES BY A MUSICAL BAND, IN CLASS 41 (U.S. CLS. 100, 101 AND 107).

SER. NO. 77-326,812, FILED 11-12-2007.

FIRST USE 6-1-2004; IN COMMERCE 6-1-2004.

JEFF DEFORD, EXAMINING ATTORNEY

**Int. Cl.: 16**

**Prior U.S. Cls.: 2, 5, 22, 23, 29, 37, 38 and 50**

**United States Patent and Trademark Office**

**Reg. No. 3,453,538**

**Registered June 24, 2008**

**TRADEMARK  
PRINCIPAL REGISTER**

**Heartlight Dog Productions**



AUSTIN, LYNDA (UNITED STATES INDIVIDUAL)  
40290 BARRINGTON  
PALM DESERT, CA 92211

FOR: CHILDREN'S BOOKS, IN CLASS 16 (U.S. CLS. 2, 5, 22, 23, 29, 37, 38 AND 50).

FIRST USE 7-1-2006; IN COMMERCE 7-1-2006.

NO CLAIM IS MADE TO THE EXCLUSIVE RIGHT TO USE "PRODUCTIONS", APART FROM THE MARK AS SHOWN.

THE MARK CONSISTS OF THE WORDS "HEARTLIGHT DOG PRODUCTIONS", ABOVE THE DESIGN OF A MINIATURE SCHNAUZER DOG ON THE LEFT WEARING A TUXEDO JACKET WITH VEST AND A BOW TIE, AND A MINIATURE SCHNAUZER DOG ON THE RIGHT WEARING A DRESS AND A BEADED NECKLACE.

SER. NO. 77-326,854, FILED 11-12-2007.

ELISSA GARBER KON, EXAMINING ATTORNEY

**Int. Cl.: 35**

**Prior U.S. Cls.: 100, 101 and 102**

**United States Patent and Trademark Office**

**Reg. No. 3,453,539**

**Registered June 24, 2008**

**SERVICE MARK  
PRINCIPAL REGISTER**



BUSINESS AUTOMATION SOLUTIONS, INC. (IL-  
LINOIS CORPORATION)  
3821 LIZETTE LANE  
GLENVIEW, IL 60026

FOR: ON-LINE COMPUTER DATABASE FEATURING INFORMATION IN THE AREAS OF SALES, MARKETING AND CUSTOMER SERVICE FOR THE BUSINESSES OF OTHERS, IN CLASS 35 (U.S. CLS. 100, 101 AND 102).

THE MARK CONSISTS OF A GLOBE VISUAL IS USED AS THE LETTER "O" IN THE WORD "PROACT". "PROACT CONTACT" USES A COMBINATION OF UPPER AND LOWERCASE LETTERS. THE WORDS HAVE TWO SWIRLS SURROUNDING THEM.

SER. NO. 77-326,856, FILED 11-12-2007.

FIRST USE 10-1-2007; IN COMMERCE 10-5-2007.

JAY FLOWERS, EXAMINING ATTORNEY

**Int. Cl.: 44**

**Prior U.S. Cls.: 100 and 101**

**United States Patent and Trademark Office**

**Reg. No. 3,453,540**

**Registered June 24, 2008**

**SERVICE MARK  
PRINCIPAL REGISTER**

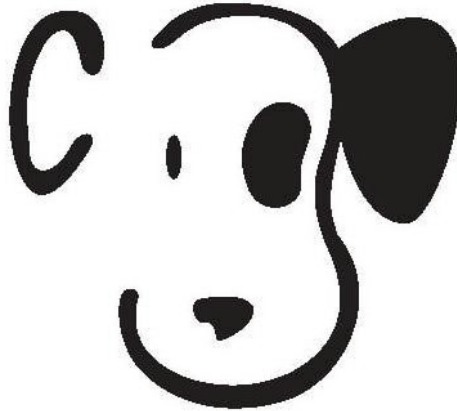

ZPUP INC. (RHODE ISLAND CORPORATION)  
600 GEORGE WASHINGTON HIGHWAY UNIT #1  
LINCOLN, RI 02865

THE MARK CONSISTS OF AN ILLUSTRATION  
OF THE FACE OF A PUPPY.

FOR: PET CARE SERVICES, NAMELY, NON-  
MEDICATED PET GROOMING AND BATHING,  
IN CLASS 44 (U.S. CLS. 100 AND 101).

SER. NO. 77-326,861, FILED 11-12-2007.

FIRST USE 11-10-2007; IN COMMERCE 11-10-2007.

GEORGE LORENZO, EXAMINING ATTORNEY

**Int. Cl.: 30**

**Prior U.S. Cl.: 46**

**United States Patent and Trademark Office**

**Reg. No. 3,453,541**

**Registered June 24, 2008**

**TRADEMARK  
PRINCIPAL REGISTER**

TRUST HEINZ TO MAKE  
ENTERTAINING DELIGHTFULLY  
EASY AND SPECIAL

PROMARK BRANDS INC. (IDAHO CORPORATION)

2541 NORTH STOKESBERRY PLACE, SUITE 100

MERIDIAN, ID 83646

FOR: SAUCES, IN CLASS 30 (U.S. CL. 46).

FIRST USE 12-15-2007; IN COMMERCE 12-15-2007.

THE MARK CONSISTS OF STANDARD CHARACTERS WITHOUT CLAIM TO ANY PARTICULAR FONT, STYLE, SIZE, OR COLOR.

OWNER OF U.S. REG. NOS. 62,182, 2,224,447 AND OTHERS.

SER. NO. 77-326,878, FILED 11-12-2007.

MARY MUNSON, EXAMINING ATTORNEY



**Int. Cl.: 43**

**Prior U.S. Cls.: 100 and 101**

**United States Patent and Trademark Office**

**Reg. No. 3,453,542**

**Registered June 24, 2008**

**SERVICE MARK  
PRINCIPAL REGISTER**

**HOT STOVE**

HOT STOVE, INC. (MASSACHUSETTS CORPORATION)  
551 ROUTE 28  
HARWICH PORT, MA 02646

FOR: RESTAURANT AND BAR SERVICES, IN CLASS 43 (U.S. CLS. 100 AND 101).

FIRST USE 5-3-2005; IN COMMERCE 5-3-2005.

THE MARK CONSISTS OF STANDARD CHARACTERS WITHOUT CLAIM TO ANY PARTICULAR FONT, STYLE, SIZE, OR COLOR.

SER. NO. 77-326,888, FILED 11-12-2007.

ALICE SUE CARRUTHERS, EXAMINING ATTORNEY

**Int. Cl.: 41**

**Prior U.S. Cls.: 100, 101 and 107**

**United States Patent and Trademark Office**

**Reg. No. 3,453,543**

**Registered June 24, 2008**

**SERVICE MARK  
PRINCIPAL REGISTER**

# DIPOMETRY

O'CONNELL, SUSAN (UNITED STATES INDIVIDUAL)  
4741 AQUEDUCT AVE.  
ENCINO, CA 91436

FOR: EDUCATIONAL SERVICES, NAMELY, CONDUCTING CLASSES IN THE FIELD OF SELF HELP AND HEALING AND DISTRIBUTION OF COURSE MATERIAL IN CONNECTION THEREWITH, IN CLASS 41 (U.S. CLS. 100, 101 AND 107).

FIRST USE 7-22-2007; IN COMMERCE 7-22-2007.

THE MARK CONSISTS OF STANDARD CHARACTERS WITHOUT CLAIM TO ANY PARTICULAR FONT, STYLE, SIZE, OR COLOR.

SER. NO. 77-327,105, FILED 11-12-2007.

DOMINICK J. SALEMI, EXAMINING ATTORNEY

**Int. Cl.: 42**

**Prior U.S. Cls.: 100 and 101**

**United States Patent and Trademark Office**

**Reg. No. 3,453,544**

**Registered June 24, 2008**

**SERVICE MARK  
PRINCIPAL REGISTER**

**PLANT**

SEED FIRST LLC (VIRGINIA LTD LIAB CO)  
6253 SIBEL PLACE  
ALEXANDRIA, VA 22310

THE MARK CONSISTS OF STANDARD CHAR-  
ACTERS WITHOUT CLAIM TO ANY PARTICULAR  
FONT, STYLE, SIZE, OR COLOR.

FOR: INFORMATION TECHNOLOGY CONSUL-  
TATION, IN CLASS 42 (U.S. CLS. 100 AND 101).

SER. NO. 77-327,107, FILED 11-12-2007.

FIRST USE 9-1-2006; IN COMMERCE 9-1-2006.

DOMINICK J. SALEMI, EXAMINING ATTORNEY

**Int. Cl.: 25**

**Prior U.S. Cls.: 22 and 39**

**United States Patent and Trademark Office**

**Reg. No. 3,453,545**

**Registered June 24, 2008**

**TRADEMARK  
PRINCIPAL REGISTER**

**SLAMPIGZ**

SLAMPIGZ LLC (CONNECTICUT LTD LIAB CO)  
19 CRESCENT PLACE  
MONROE, CT 06468

THE MARK CONSISTS OF STANDARD CHAR-  
ACTERS WITHOUT CLAIM TO ANY PARTICULAR  
FONT, STYLE, SIZE, OR COLOR.

FOR: CLOTHING, NAMELY, SHIRTS, TOPS, T-  
SHIRTS, SWEAT SHIRTS, HEADWEAR, AND FOOT-  
WEAR, IN CLASS 25 (U.S. CLS. 22 AND 39).

SER. NO. 77-327,121, FILED 11-12-2007.

FIRST USE 1-16-2008; IN COMMERCE 1-16-2008.

DOMINICK J. SALEMI, EXAMINING ATTORNEY

**Int. Cl.: 41**

**Prior U.S. Cls.: 100, 101 and 107**

**United States Patent and Trademark Office**

**Reg. No. 3,453,546**

**Registered June 24, 2008**

**SERVICE MARK  
PRINCIPAL REGISTER**

# Debt-Free Expo

JAMES GORDON (UNITED STATES INDIVIDUAL)  
4101 DUBLIN BLVD, STE F-231  
DUBLIN, CA 94568

FOR: ARRANGING AND CONDUCTING EDUCATIONAL CONFERENCES; ARRANGING OF SEMINARS AND CONFERENCES; EDUCATION IN THE FIELD OF FINANCE RENDERED THROUGH VIDEO CONFERENCE; EDUCATIONAL SERVICES, NAMELY, CONDUCTING CONFERENCES, SUMMITS AND EXPOS IN THE FIELD OF FINANCE AND DISTRIBUTION OF COURSE MATERIAL IN CONNECTION THEREWITH; EDUCATIONAL SERVICES, NAMELY, DEVELOPING, ARRANGING, AND CONDUCTING EDUCATIONAL CONFERENCES AND PROGRAMS AND PROVIDING COURSES OF INSTRUCTION IN THE FIELD OF FINANCE; EDUCATIONAL SERVICES, NAMELY, CONDUCTING CONFERENCES, SUM-

MITS AND EXPOS IN THE FIELD OF FINANCE; ORGANISATION OF CONFERENCES AND SYMPOSIA IN THE FIELD OF MEDICAL SCIENCE , IN CLASS 41 (U.S. CLS. 100, 101 AND 107).

FIRST USE 11-1-2007; IN COMMERCE 11-1-2007.

THE MARK CONSISTS OF STANDARD CHARACTERS WITHOUT CLAIM TO ANY PARTICULAR FONT, STYLE, SIZE, OR COLOR.

NO CLAIM IS MADE TO THE EXCLUSIVE RIGHT TO USE "EXPO", APART FROM THE MARK AS SHOWN.

SER. NO. 77-327,132, FILED 11-12-2007.

DOMINICK J. SALEMI, EXAMINING ATTORNEY

**Int. Cl.: 35**

**Prior U.S. Cls.: 100, 101 and 102**

**United States Patent and Trademark Office**

**Reg. No. 3,453,547**

**Registered June 24, 2008**

---

**SERVICE MARK  
PRINCIPAL REGISTER**

**MDOUTLOOK**

THE ARCAS GROUP, LLC (GEORGIA LTD LIAB  
CO)  
5200 DEERLAKE DRIVE  
ALPHARETTA, GA 300053601

THE MARK CONSISTS OF STANDARD CHAR-  
ACTERS WITHOUT CLAIM TO ANY PARTICULAR  
FONT, STYLE, SIZE, OR COLOR.

FOR: BUSINESS CONSULTING AND INFORMA-  
TION SERVICES; BUSINESS CONSULTING, INQUI-  
RIES OR INFORMATION, IN CLASS 35 (U.S. CLS.  
100, 101 AND 102).

SER. NO. 77-327,139, FILED 11-12-2007.

FIRST USE 10-30-2007; IN COMMERCE 11-1-2007.

DOMINICK J. SALEMI, EXAMINING ATTORNEY

**Int. Cl.: 35**

**Prior U.S. Cls.: 100, 101 and 102**

**United States Patent and Trademark Office**

**Reg. No. 3,453,548**

**Registered June 24, 2008**

**SERVICE MARK  
PRINCIPAL REGISTER**

**CINCO DE MANGO**

NATIONAL MANGO BOARD INC. (FLORIDA  
NON-PROFIT CORPORATION)  
1417 CARDINAL ROAD  
ORLANDO, FL 32803

FOR: ADVERTISING, MARKETING AND PRO-  
MOTION SERVICES, NAMELY, PROMOTING THE  
SALE AND CONSUMPTION BY OTHERS OF MAN-  
GOS, IN CLASS 35 (U.S. CLS. 100, 101 AND 102).

FIRST USE 4-0-2006; IN COMMERCE 4-0-2006.

THE MARK CONSISTS OF STANDARD CHAR-  
ACTERS WITHOUT CLAIM TO ANY PARTICULAR  
FONT, STYLE, SIZE, OR COLOR.

NO CLAIM IS MADE TO THE EXCLUSIVE  
RIGHT TO USE "MANGO", APART FROM THE  
MARK AS SHOWN.

THE FOREIGN WORDING IN THE MARK  
TRANSLATES INTO ENGLISH AS FIVE.

SER. NO. 77-327,141, FILED 11-12-2007.

BENJAMIN ALLEN, EXAMINING ATTORNEY

**Int. Cls.: 35, 36, 37, 39 and 40**

**Prior U.S. Cls.: 100, 101, 102, 103, 105 and 106**

**United States Patent and Trademark Office**

**Reg. No. 3,453,549**

**Registered June 24, 2008**

**SERVICE MARK  
PRINCIPAL REGISTER**

# Alternity Wind Power

CONTI, KURT G. (UNITED STATES INDIVIDUAL)

C/O CONTI ENTERPRISES, INC.  
ONE CRAGWOOD ROAD  
SOUTH PLAINFIELD, NJ 07080

FOR: ENERGY USAGE MANAGEMENT; INFORMATION IN THE FIELD OF ENERGY EFFICIENCY, IN CLASS 35 (U.S. CLS. 100, 101 AND 102).

FIRST USE 6-0-2007; IN COMMERCE 6-0-2007.

FOR: CONSULTANCY CONCERNING FINANCING OF ENERGY PROJECTS, IN CLASS 36 (U.S. CLS. 100, 101 AND 102).

FIRST USE 6-0-2007; IN COMMERCE 6-0-2007.

FOR: INSTALLATION OF RENEWABLE ENERGY SYSTEMS FOR WIND ENERGY COLLECTION AND DISPERSION, IN CLASS 37 (U.S. CLS. 100, 103 AND 106).

FIRST USE 3-0-2006; IN COMMERCE 3-0-2006.

FOR: DISTRIBUTION OF ENERGY, IN CLASS 39 (U.S. CLS. 100 AND 105).

FIRST USE 9-0-2007; IN COMMERCE 9-0-2007.

FOR: GENERATION OF ENERGY; PRODUCTION OF ENERGY, IN CLASS 40 (U.S. CLS. 100, 103 AND 106).

FIRST USE 9-0-2007; IN COMMERCE 9-0-2007.

THE MARK CONSISTS OF STANDARD CHARACTERS WITHOUT CLAIM TO ANY PARTICULAR FONT, STYLE, SIZE, OR COLOR.

OWNER OF U.S. REG. NOS. 3,135,284, 3,191,267 AND OTHERS.

NO CLAIM IS MADE TO THE EXCLUSIVE RIGHT TO USE "WIND POWER", APART FROM THE MARK AS SHOWN.

SER. NO. 77-327,474, FILED 11-12-2007.

CARRIE GENOVESE, EXAMINING ATTORNEY



**Int. Cl.: 9**

**Prior U.S. Cls.: 21, 23, 26, 36 and 38**

**Reg. No. 3,453,550**

**United States Patent and Trademark Office**

**Registered June 24, 2008**

---

**TRADEMARK  
PRINCIPAL REGISTER**

**Cooked-Per'fect**

BURTON PLASTICS CORP. (CALIFORNIA CORPORATION)  
8928 NATIONAL BLVD.  
LOS ANGELES, CA 90034

FOR: REUSABLE COLOR CHANGING THERMOMETER FOR BEEF, FISH, POULTRY IN THE NATURE OF AN INTERNAL TEMPERATURE MEASURING DEVICE NOT FOR MEDICAL USE, IN CLASS 9 (U.S. CLS. 21, 23, 26, 36 AND 38).

FIRST USE 2-6-2001; IN COMMERCE 2-6-2001.

THE MARK CONSISTS OF STANDARD CHARACTERS WITHOUT CLAIM TO ANY PARTICULAR FONT, STYLE, SIZE, OR COLOR.

SER. NO. 77-327,645, FILED 11-12-2007.

DAVID C. REIHNER, EXAMINING ATTORNEY

**Int. Cl.: 41**

**Prior U.S. Cls.: 100, 101 and 107**

**United States Patent and Trademark Office**

**Reg. No. 3,453,551**

**Registered June 24, 2008**

**SERVICE MARK  
PRINCIPAL REGISTER**

**PACKETWARS**

FITE, BRYAN (UNITED STATES INDIVIDUAL)  
P.O. BOX 751174  
DAYTON, OH 45475

FOR: ENTERTAINMENT SERVICES, NAMELY,  
ORGANIZING, CONDUCTING AND FACILITAT-  
ING COMPUTER GAMING EVENTS, NAMELY,  
COMPUTER SIMULATIONS INVOLVING CYBER-  
WAR AND SIMULATED NETWORK COMBAT,  
RENDERED LIVE OR ONLINE, IN CLASS 41 (U.S.  
CLS. 100, 101 AND 107).

FIRST USE 11-9-2004; IN COMMERCE 11-9-2004.

THE MARK CONSISTS OF STANDARD CHAR-  
ACTERS WITHOUT CLAIM TO ANY PARTICULAR  
FONT, STYLE, SIZE, OR COLOR.

THE WORDING "PACKETWARS" HAS NO  
MEANING OTHER THAN TRADEMARK SIGNIFI-  
CANCE.

SER. NO. 77-327,708, FILED 11-12-2007.

ESTHER BELENKER, EXAMINING ATTORNEY

**Int. Cls.: 1, 2, 16 and 17**

**Prior U.S. Cls.: 1, 2, 5, 6, 10, 11, 12, 13, 16, 22, 23, 26, 29, 35, 37, 38, 46 and 50**

**Reg. No. 3,453,552**

**United States Patent and Trademark Office**

**Registered June 24, 2008**

**TRADEMARK  
PRINCIPAL REGISTER**

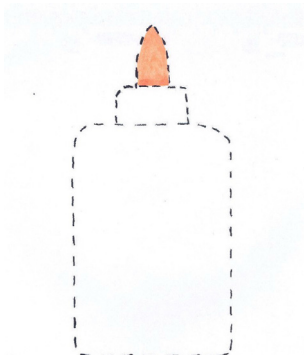

ELMER'S INVESTMENTS LLC (DELAWARE CORPORATION)  
ONE EASTON OVAL  
COLUMBUS, OH 43219

FOR: CONTACT CEMENT; CONSTRUCTION INDUSTRY ADHESIVES AND INDUSTRIAL ADHESIVES; WOOD GLUE FOR BONDING AND REPAIRING FOR USE IN CONSTRUCTION AND INDUSTRIAL APPLICATIONS; GENERAL PURPOSE PUTTY-LIKE EPOXY RESINS FOR FILLING, BONDING AND REBUILDING; POLYVINYL ACETATE RESINS FOR BONDING AND SEALING CONCRETE, IN CLASS 1 (U.S. CLS. 1, 5, 6, 10, 26 AND 46).

FIRST USE 7-1-1975; IN COMMERCE 7-1-1975.

FOR: PREPARATIONS FOR CONCEALING HOLES, IMPERFECTIONS AND BLEMISHES IN WOOD AND SIMILAR MATERIALS, NAMELY, WOOD PUTTY, IN CLASS 2 (U.S. CLS. 6, 11 AND 16).

FIRST USE 1-31-1980; IN COMMERCE 1-31-1980.

FOR: GLUE FOR HOUSEHOLD AND STATIONERY USE; GLUE STICKS FOR STATIONERY AND HOUSEHOLD USE; WOOD GLUE PENS FOR STATIONERY AND HOUSEHOLD USE, IN CLASS 16 (U.S. CLS. 2, 5, 22, 23, 29, 37, 38 AND 50).

FIRST USE 1-31-1963; IN COMMERCE 1-31-1963.

FOR: WHITE ACRYLIC LATEX TUB CAULKING; ACRYLIC LATEX CAULKING; GROUT SEALANT, IN CLASS 17 (U.S. CLS. 1, 5, 12, 13, 35 AND 50).

FIRST USE 8-31-1975; IN COMMERCE 8-31-1975.

OWNER OF U.S. REG. NO. 3,040,902.

THE COLOR(S) ORANGE IS/ARE CLAIMED AS A FEATURE OF THE MARK.

THE MARK CONSISTS OF THE COLOR ORANGE AS APPLIED TO CAPS IN VARIOUS SHAPES FOR VARIOUS PRODUCT CONTAINERS. THE DOTTED OUTLINE OF THE PACKAGING OF THE GOODS IS INTENDED TO SHOW THE POSITION OF THE MARK ON THE GOODS AND IS NOT PART OF THE MARK.

SEC. 2(F).

SER. NO. 77-327,872, FILED 11-13-2007.

MICHAEL TANNER, EXAMINING ATTORNEY

**Int. Cls.: 9 and 35**

**Prior U.S. Cls.: 21, 23, 26, 36, 38, 100, 101 and 102**

**United States Patent and Trademark Office**

**Reg. No. 3,453,553**

**Registered June 24, 2008**

**TRADEMARK  
SERVICE MARK  
PRINCIPAL REGISTER**

**PROVIDENT-INTEGRITY  
DISTRIBUTION**

PROVIDENT DISTRIBUTION LLC (DELAWARE  
LTD LIAB CO)  
741 COOL SPRINGS BLVD  
FRANKLIN, TN 37067 AND  
INTEGRITY MEDIA, INC. (ALABAMA CORPORA-  
TION)  
100 CODY ROAD  
MOBILE, AL 366953425

FOR: MUSICAL SOUND RECORDINGS AND  
AUDIO-VISUAL RECORDINGS FEATURING MU-  
SIC; DOWNLOADABLE MUSICAL SOUND RE-  
CORDINGS AND DOWNLOADABLE AUDIO-  
VIDEO RECORDINGS FEATURING MUSIC, IN  
CLASS 9 (U.S. CLS. 21, 23, 26, 36 AND 38).

FIRST USE 1-1-2005; IN COMMERCE 1-1-2005.

FOR: DISTRIBUTORSHIPS IN THE FIELD OF  
MUSICAL SOUND RECORDINGS AND AUDIO-  
VISUAL RECORDINGS FEATURING MUSIC, IN  
CLASS 35 (U.S. CLS. 100, 101 AND 102).

FIRST USE 1-1-2005; IN COMMERCE 1-1-2005.

THE MARK CONSISTS OF STANDARD CHAR-  
ACTERS WITHOUT CLAIM TO ANY PARTICULAR  
FONT, STYLE, SIZE, OR COLOR.

NO CLAIM IS MADE TO THE EXCLUSIVE  
RIGHT TO USE "DISTRIBUTION", APART FROM  
THE MARK AS SHOWN.

SER. NO. 77-327,914, FILED 11-13-2007.

MICHAEL ENGEL, EXAMINING ATTORNEY

**Int. Cl.: 35**

**Prior U.S. Cls.: 100, 101 and 102**

**United States Patent and Trademark Office**

**Reg. No. 3,453,554**

**Registered June 24, 2008**

**SERVICE MARK  
PRINCIPAL REGISTER**

**PADMA MEDIA**

PADMA MEDIA, INC. (MASSACHUSETTS CORPORATION)  
3RD FLOOR  
393 MASSACHUSETTS AVENUE  
ARLINGTON, MA 02474

FOR: PUBLIC RELATIONS AND MARKETING CONSULTING SERVICES, IN CLASS 35 (U.S. CLS. 100, 101 AND 102).

FIRST USE 5-8-2003; IN COMMERCE 5-8-2003.

THE MARK CONSISTS OF STANDARD CHARACTERS WITHOUT CLAIM TO ANY PARTICULAR FONT, STYLE, SIZE, OR COLOR.

NO CLAIM IS MADE TO THE EXCLUSIVE RIGHT TO USE "MEDIA", APART FROM THE MARK AS SHOWN.

THE ENGLISH TRANSLATION OF THE WORD "PADMA" IN THE MARK IS LOTUS.

SER. NO. 77-328,171, FILED 11-13-2007.

ALLISON HOLTZ, EXAMINING ATTORNEY

**Int. Cls.: 3 and 4**

**Prior U.S. Cls.: 1, 4, 6, 15, 50, 51 and 52**

**United States Patent and Trademark Office**

**Reg. No. 3,453,555**

**Registered June 24, 2008**

**TRADEMARK  
PRINCIPAL REGISTER**

**ARDENT**

ARDENT OUTDOORS INC. (MISSOURI CORPORATION)  
425 SOUTH WOODS MILL ROAD, SUITE 170  
ST. LOUIS, MO 63017

THE MARK CONSISTS OF STANDARD CHARACTERS WITHOUT CLAIM TO ANY PARTICULAR FONT, STYLE, SIZE, OR COLOR.

FOR: FISHING REEL CLEANERS, IN CLASS 3 (U.S. CLS. 1, 4, 6, 50, 51 AND 52).

OWNER OF U.S. REG. NOS. 2,626,051, 3,135,386, AND 3,242,142.

FIRST USE 6-1-2006; IN COMMERCE 6-1-2006.

FOR: FISHING REEL LUBRICANTS, IN CLASS 4 (U.S. CLS. 1, 6 AND 15).

SER. NO. 77-328,211, FILED 11-13-2007.

FIRST USE 6-1-2006; IN COMMERCE 6-1-2006.

PETER B. BROMAGHIM, EXAMINING ATTORNEY

**Int. Cl.: 35**

**Prior U.S. Cls.: 100, 101 and 102**

**United States Patent and Trademark Office**

**Reg. No. 3,453,556**

**Registered June 24, 2008**

**SERVICE MARK  
PRINCIPAL REGISTER**

# Field of Dreams

THE TRAVELERS INDEMNITY COMPANY  
(CONNECTICUT CORPORATION)  
ONE TOWER SQUARE  
HARTFORD, CT 06183

FOR: CONDUCTING AGENT INCENTIVE  
AWARD PROGRAMS TO PROMOTE PRODUCTIV-  
ITY IN THE FIELD OF PROPERTY CASUALTY  
INSURANCE, IN CLASS 35 (U.S. CLS. 100, 101 AND  
102).

FIRST USE 10-1-2007; IN COMMERCE 10-1-2007.

THE MARK CONSISTS OF STANDARD CHAR-  
ACTERS WITHOUT CLAIM TO ANY PARTICULAR  
FONT, STYLE, SIZE, OR COLOR.

SER. NO. 77-328,335, FILED 11-13-2007.

MICHAEL WEBSTER, EXAMINING ATTORNEY

**Int. Cl.: 35**

**Prior U.S. Cls.: 100, 101 and 102**

**United States Patent and Trademark Office**

**Reg. No. 3,453,557**

**Registered June 24, 2008**

**SERVICE MARK  
PRINCIPAL REGISTER**

FIND YOUR CALLING AND  
PEACE WILL BE WITH YOU;  
PURSUE YOUR CALLING AND  
HAPPINESS WILL FIND YOU;  
FULFILL YOUR CALLING AND  
SUCCESS WILL NOT MISS YOU.

FOSTER, MARTIN (UNITED STATES INDIVIDUAL)  
P.O. BOX 248  
ROSELLE, NJ 07203

FOR: ADVERTISING SERVICES, NAMELY PROMOTING PROPERTIES FOR SALE BY OWNER VIA THE INTERNET; ADVERTISING VIA ELECTRONIC MEDIA AND SPECIFICALLY THE INTERNET; DISSEMINATION OF ADVERTISING FOR OTHERS VIA THE INTERNET; ON-LINE ADVERTISING ON COMPUTER COMMUNICATION NETWORKS; PROMOTING, ADVERTISING AND MARKETING OF THE ON-LINE WEBSITES OF OTHERS; PROVIDING AND RENTAL OF ADVERTISING SPACE ON THE INTERNET; PROVISION OF ADVERTISING

SPACE BY ELECTRONIC MEANS AND GLOBAL INFORMATION NETWORKS; RENTAL OF ADVERTISING SPACE ON WEB SITES, IN CLASS 35 (U.S. CLS. 100, 101 AND 102).

FIRST USE 10-20-2007; IN COMMERCE 10-20-2007.

THE MARK CONSISTS OF STANDARD CHARACTERS WITHOUT CLAIM TO ANY PARTICULAR FONT, STYLE, SIZE, OR COLOR.

SER. NO. 77-328,700, FILED 11-13-2007.

FRED MANDIR, EXAMINING ATTORNEY



**Int. Cls.: 9 and 18**

**Prior U.S. Cls.: 1, 2, 3, 21, 22, 23, 26, 36, 38 and 41**

**United States Patent and Trademark Office**

**Reg. No. 3,453,558**

**Registered June 24, 2008**

**TRADEMARK  
PRINCIPAL REGISTER**

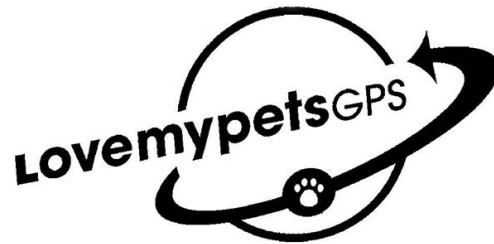

LOVEMYPETS, LLC (SOUTH CAROLINA LTD  
LIAB CO)  
2801 WADE HAMPTON BLVD., #101  
TAYLORS, SC 29687

FOR: ELECTRONIC TRANSMITTER AND RE-  
CEIVER USED TO LOCATE LOST PETS; ELECTRO-  
NIC ANIMAL TRACKING UNIT COMPRISING AN  
ELECTRONIC TRANSMITTER AND RECEIVER  
CARRIED BY COLLAR AND BY HARNESS USED  
TO LOCATE LOST PETS, IN CLASS 9 (U.S. CLS. 21,  
23, 26, 36 AND 38).

FIRST USE 9-18-2007; IN COMMERCE 9-18-2007.

FOR: COLLARS, HARNESES, LEASHES, AND  
LEADS FOR PETS, IN CLASS 18 (U.S. CLS. 1, 2, 3, 22  
AND 41).

FIRST USE 9-18-2007; IN COMMERCE 9-18-2007.

OWNER OF U.S. REG. NO. 3,376,516.

SER. NO. 77-328,878, FILED 11-14-2007.

STEPHEN AQUILA, EXAMINING ATTORNEY

**Int. Cl.: 36**

**Prior U.S. Cls.: 100, 101 and 102**

**United States Patent and Trademark Office**

**Reg. No. 3,453,559**

**Registered June 24, 2008**

**SERVICE MARK  
PRINCIPAL REGISTER**

**PALMETTO EXPRESS REMOTE  
DEPOSIT**

THE PALMETTO BANK (SOUTH CAROLINA  
CORPORATION)  
P.O. BOX 49  
LAURENS, SC 29360

OWNER OF U.S. REG. NOS. 1,799,642, 1,829,012  
AND OTHERS.

FOR: CHECKING ACCOUNT SERVICES; BANK-  
ING; ON-LINE BANKING SERVICES, IN CLASS 36  
(U.S. CLS. 100, 101 AND 102).

NO CLAIM IS MADE TO THE EXCLUSIVE  
RIGHT TO USE "EXPRESS REMOTE DEPOSIT",  
APART FROM THE MARK AS SHOWN.

FIRST USE 3-0-2007; IN COMMERCE 3-0-2007.

SER. NO. 77-328,938, FILED 11-14-2007.

THE MARK CONSISTS OF STANDARD CHAR-  
ACTERS WITHOUT CLAIM TO ANY PARTICULAR  
FONT, STYLE, SIZE, OR COLOR.

LAURA KOVALSKY, EXAMINING ATTORNEY

**Int. Cl.: 41**

**Prior U.S. Cls.: 100, 101 and 107**

**United States Patent and Trademark Office**

**Reg. No. 3,453,560**

**Registered June 24, 2008**

**SERVICE MARK  
PRINCIPAL REGISTER**



OMNIA EDUCATION INC (PENNSYLVANIA  
CORPORATION)  
SUITE 300  
500 OFFICE CENTER DR  
FORT WASHINGTON, PA 19034

FOR: PROVIDING CONTINUING MEDICAL  
EDUCATION COURSES, IN CLASS 41 (U.S. CLS.  
100, 101 AND 107).

FIRST USE 1-1-2000; IN COMMERCE 1-1-2000.

NO CLAIM IS MADE TO THE EXCLUSIVE  
RIGHT TO USE "EDUCATION", APART FROM  
THE MARK AS SHOWN.

THE COLOR(S) PURPLE AND WHITE IS/ARE  
CLAIMED AS A FEATURE OF THE MARK.

THE WORDING "OMNIA EDUCATION" AND  
THE DESIGN OF THE PLUS SIGN APPEAR IN  
PURPLE. THE MARK APPEARS ON A WHITE  
BACKGROUND.

SER. NO. 77-329,063, FILED 11-14-2007.

SAIMA MAKHDOOM, EXAMINING ATTORNEY

**Int. Cl.: 25**

**Prior U.S. Cls.: 22 and 39**

**United States Patent and Trademark Office**

**Reg. No. 3,453,561**

**Registered June 24, 2008**

**TRADEMARK  
PRINCIPAL REGISTER**



BELIEVER DESIGNS INTERNATIONAL INC.  
(NEW JERSEY CORPORATION)  
1ST FL  
57 HARTFORD ST.  
NEWARK, NJ 07103

FOR: CAMP SHIRTS; DRESS SHIRTS; GOLF SHIRTS; KNIT SHIRTS; LONG-SLEEVED SHIRTS; OPEN-NECKED SHIRTS; PIQUE SHIRTS; POLO SHIRTS; RUGBY SHIRTS; SHIRTS; SHIRTS FOR SUITS; SHORT-SLEEVED OR LONG-SLEEVED T-SHIRTS; SHORT-SLEEVED SHIRTS; SPORT SHIRTS; SPORTS SHIRTS; SPORTS SHIRTS WITH SHORT SLEEVES; SWEAT SHIRTS; T-SHIRTS; TEE SHIRTS; WIND SHIRTS; DENIM JACKETS; DOWN JACKETS; FISHERMEN'S JACKETS; HEAVY JACKETS; JACKETS; LEATHER JACKETS; LIGHT-REFLECTING JACKETS; MEN AND WOMEN JACKETS,

COATS, TROUSERS, VESTS; RAIN JACKETS; RAIN-PROOF JACKETS; REVERSIBLE JACKETS; SHELL JACKETS; SKI JACKETS; SLEEVED OR SLEEVELESS JACKETS; SPORTS JACKETS; SUEDE JACKETS; WATERPROOF JACKETS AND PANTS; WIND RESISTANT JACKETS; WIND-JACKETS, IN CLASS 25 (U.S. CLS. 22 AND 39).

FIRST USE 8-0-1994; IN COMMERCE 8-0-1994.

THE MARK CONSISTS OF A SILHOUETTE DEPICTING A MALE FIGURE IN A SITTING OR KNEELING POSITION OF PRAYER.

SER. NO. 77-329,235, FILED 11-14-2007.

CHRISTINE COOPER, EXAMINING ATTORNEY

**Int. Cl.: 45**

**Prior U.S. Cls.: 100 and 101**

**United States Patent and Trademark Office**

**Reg. No. 3,453,562**

**Registered June 24, 2008**

**SERVICE MARK  
PRINCIPAL REGISTER**

FIND YOUR CALLING AND  
PEACE WILL BE WITH YOU;  
PURSUE YOUR CALLING AND  
HAPPINESS WILL FIND YOU;  
FULFILL YOU CALLING AND  
SUCCESS WILL NOT MISS YOU

FOSTER, MARTIN (UNITED STATES INDIVI-  
DUAL)  
P.O. BOX 248  
ROSELLE, NJ 07203

FOR: PROVIDING ON-LINE INFORMATION IN  
THE FIELD OF SPIRITUALITY, SELF-HELP, AND  
PERSONAL EMPOWERMENT SUBJECT MATTERS;  
PROVIDING INFORMATION IN THE FIELD OF  
SELF-IMPROVEMENT , IN CLASS 45 (U.S. CLS. 100  
AND 101).

FIRST USE 10-20-2007; IN COMMERCE 10-20-2007.

THE MARK CONSISTS OF STANDARD CHAR-  
ACTERS WITHOUT CLAIM TO ANY PARTICULAR  
FONT, STYLE, SIZE, OR COLOR.

SER. NO. 77-329,537, FILED 11-14-2007.

FRED MANDIR, EXAMINING ATTORNEY

**Int. Cl.: 14**

**Prior U.S. Cls.: 2, 27, 28 and 50**

**Reg. No. 3,453,563**

**United States Patent and Trademark Office**

**Registered June 24, 2008**

---

**TRADEMARK  
PRINCIPAL REGISTER**

**KS Studio**

KENDRA SCOTT DESIGN, INC. (TEXAS CORPORATION)

3601 S. CONGRESS AVE., STE B201

AUSTIN, TX 78704

FOR: JEWELRY, IN CLASS 14 (U.S. CLS. 2, 27, 28 AND 50).

FIRST USE 7-6-2007; IN COMMERCE 7-6-2007.

THE MARK CONSISTS OF STANDARD CHARACTERS WITHOUT CLAIM TO ANY PARTICULAR FONT, STYLE, SIZE, OR COLOR.

NO CLAIM IS MADE TO THE EXCLUSIVE RIGHT TO USE "STUDIO", APART FROM THE MARK AS SHOWN.

SER. NO. 77-329,774, FILED 11-14-2007.

CORY BOONE, EXAMINING ATTORNEY

**Int. Cl.: 9**

**Prior U.S. Cls.: 21, 23, 26, 36 and 38**

**Reg. No. 3,453,564**

**United States Patent and Trademark Office**

**Registered June 24, 2008**

---

**TRADEMARK  
PRINCIPAL REGISTER**

**IPOD SHUFFLE**

APPLE INC. (CALIFORNIA CORPORATION)  
1 INFINITE LOOP  
CUPERTINO, CA 95014

FIRST USE 1-11-2005; IN COMMERCE 1-11-2005.

FOR: PORTABLE AND HANDHELD DIGITAL ELECTRONIC DEVICES FOR RECORDING, ORGANIZING, TRANSMITTING, MANIPULATING, AND REVIEWING TEXT, DATA, AND AUDIO FILES; COMPUTER SOFTWARE FOR USE IN ORGANIZING, TRANSMITTING, MANIPULATING, AND REVIEWING TEXT, DATA, AND AUDIO FILES ON PORTABLE AND HANDHELD DIGITAL ELECTRONIC DEVICES, IN CLASS 9 (U.S. CLS. 21, 23, 26, 36 AND 38).

THE MARK CONSISTS OF STANDARD CHARACTERS WITHOUT CLAIM TO ANY PARTICULAR FONT, STYLE, SIZE, OR COLOR.

OWNER OF U.S. REG. NOS. 2,835,698, 3,192,683 AND OTHERS.

SER. NO. 77-329,841, FILED 11-14-2007.

SKYE YOUNG, EXAMINING ATTORNEY

Int. Cl.: 8

Prior U.S. Cls.: 23, 28 and 44

United States Patent and Trademark Office

Reg. No. 3,453,565

Registered June 24, 2008

TRADEMARK  
PRINCIPAL REGISTER

劍  
の  
涙

ROBERT MARTIN (UNITED STATES INDIVIDUAL)  
2243 W. SADDLE LANE  
IDAHO FALLS, ID 83402

FOR: KNIVES , NAMELY, MILITARY, HUNTING, SIDEARM, JACK, POCKET, SPORT, THROWING, FISHING, BUTCHER, STEAK, AND FOLDING KNIVES, IN CLASS 8 (U.S. CLS. 23, 28 AND 44).

FIRST USE 6-30-2006; IN COMMERCE 6-30-2006.

THE MARK CONSISTS OF CHARACTERS OF JAPANESE KANJI; THE NON-LATIN CHARAC-

TERS IN THE MARK TRANSLITERATE TO "TSURUGI NO NAMIDA" WHICH MEANS IN JAPANESE "TEARS OF THE SWORD".

THE JAPANESE KANJI CHARACTERS IN THE MARK TRANSLITERATE TO "TSURUGI NO NAMIDA," AND THIS MEANS "TEARS OF THE SWORD" IN ENGLISH.

SER. NO. 77-329,964, FILED 11-14-2007.

MATTHEW EINSTEIN, EXAMINING ATTORNEY



**Int. Cl.: 41**

**Prior U.S. Cls.: 100, 101 and 107**

**United States Patent and Trademark Office**

**Reg. No. 3,453,566**

**Registered June 24, 2008**

**SERVICE MARK  
PRINCIPAL REGISTER**

# MasteryCast

MASTERY MAZE LLC (NEW YORK LTD LIAB  
CO)  
291 WELLINGWOOD DRIVE  
EAST AMHERST, NY 14051

FOR: EDUCATIONAL SERVICES, NAMELY,  
PROVIDING PODCASTS WHICH INCORPORATE  
EDUCATIONAL MATERIALS IN VARIOUS  
FIELDS, INCLUDING HISTORY, MATHEMATICS,  
SCIENCE, ENGLISH, LANGUAGES , IN CLASS 41  
(U.S. CLS. 100, 101 AND 107).

FIRST USE 10-31-2007; IN COMMERCE 10-31-2007.

THE MARK CONSISTS OF STANDARD CHAR-  
ACTERS WITHOUT CLAIM TO ANY PARTICULAR  
FONT, STYLE, SIZE, OR COLOR.

SER. NO. 77-330,078, FILED 11-15-2007.

MELVIN AXILBUND, EXAMINING ATTORNEY

**Int. Cl.: 21**

**Prior U.S. Cls.: 2, 13, 23, 29, 30, 33, 40 and 50**

**Reg. No. 3,453,567**

**United States Patent and Trademark Office**

**Registered June 24, 2008**

**TRADEMARK  
PRINCIPAL REGISTER**

**FILTRON PRO**

SAME DAY DISTRIBUTING, INC. (CALIFORNIA CORPORATION)

5692 BUCKINGHAM DRIVE

HUNTINGTON BEACH, CA 92649

FOR: NON-ELECTRIC COFFEE POTS, IN CLASS 21 (U.S. CLS. 2, 13, 23, 29, 30, 33, 40 AND 50).

FIRST USE 1-1-1999; IN COMMERCE 1-1-1999.

THE MARK CONSISTS OF STANDARD CHARACTERS WITHOUT CLAIM TO ANY PARTICULAR FONT, STYLE, SIZE, OR COLOR.

NO CLAIM IS MADE TO THE EXCLUSIVE RIGHT TO USE "PRO", APART FROM THE MARK AS SHOWN.

SER. NO. 77-330,283, FILED 11-15-2007.

BILL DAWE, EXAMINING ATTORNEY

Int. Cl.: 9

Prior U.S. Cls.: 21, 23, 26, 36 and 38

Reg. No. 3,453,568

United States Patent and Trademark Office

Registered June 24, 2008

TRADEMARK  
PRINCIPAL REGISTER



*ADORI*

BLU VISION GROUP INC. (NEW YORK CORPORATION)  
1201 BROADWAY, STE. 306  
NEW YORK, NY 10001

FOR: EYEWEAR, NAMELY, SUNGLASSES, OPTICAL FRAMES, OPTICAL LENSES, READING EYEGLASSES, EYEGLASSES, EYEGLASSES FRAMES, EYEGLASS LENSES, EYEGLASS CHAINS AND EYEGLASS CASES , IN CLASS 9 (U.S. CLS. 21, 23, 26, 36 AND 38).

FIRST USE 9-0-2007; IN COMMERCE 9-0-2007.

THE MARK CONSISTS OF AN ADORABLE BEAR TILTING ITS HEAD WHILE HOLDING A LARGE HEART TOWARDS ITS BODY.

SER. NO. 77-330,369, FILED 11-15-2007.

CHERYL CLAYTON, EXAMINING ATTORNEY

**Int. Cl.: 7**

**Prior U.S. Cls.: 13, 19, 21, 23, 31, 34 and 35**

**United States Patent and Trademark Office**

**Reg. No. 3,453,569**

**Registered June 24, 2008**

**TRADEMARK  
PRINCIPAL REGISTER**

**AccuFire**

HAYNES CORPORATION (FLORIDA CORPORATION)  
3581 MERCANTILE AVE.  
NAPLES, FL 34104

THE MARK CONSISTS OF STANDARD CHARACTERS WITHOUT CLAIM TO ANY PARTICULAR FONT, STYLE, SIZE, OR COLOR.

FOR: FUEL INJECTORS, IN CLASS 7 (U.S. CLS. 13, 19, 21, 23, 31, 34 AND 35).

SER. NO. 77-330,377, FILED 11-15-2007.

FIRST USE 2-0-2004; IN COMMERCE 7-0-2004.

CARRIE GENOVESE, EXAMINING ATTORNEY

Int. Cl.: 41

Prior U.S. Cls.: 100, 101 and 107

United States Patent and Trademark Office

Reg. No. 3,453,570

Registered June 24, 2008

SERVICE MARK  
PRINCIPAL REGISTER



LINK, SHARON (UNITED STATES INDIVIDUAL)  
312 S. TAMARACK DR.  
POST FALLS, ID 83854

FOR: EDUCATION SERVICES, NAMELY, PROVIDING WORKSHOPS AND SEMINARS IN THE FIELDS OF AUTISM SPECTRUM DISORDERS, IN CLASS 41 (U.S. CLS. 100, 101 AND 107).

FIRST USE 6-19-2007; IN COMMERCE 6-19-2007.

THE MARK CONSISTS OF A CIRCLE WITH THE STYLIZED WORDS "LEADING OTHERS TO UN-

DERSTANDING". IN THE CENTER IS A PUZZLE PIECE. THE PUZZLE PIECE INCLUDES TWO OUTLINES OF A BOY AND GIRL HOLDING HANDS. THE BOY IS MISSING A PUZZLE PIECE OUT OF THE MIDDLE. THE MISSING SMALLER PUZZLE PICE IS LAYING AT THE FEET OF THE LITTLE GIRL.

SER. NO. 77-330,406, FILED 11-15-2007.

WENDY JUN, EXAMINING ATTORNEY

**Int. Cl.: 9**

**Prior U.S. Cls.: 21, 23, 26, 36 and 38**

**Reg. No. 3,453,571**

**United States Patent and Trademark Office**

**Registered June 24, 2008**

---

**TRADEMARK  
PRINCIPAL REGISTER**

**VISIO**

TABATA CO., LTD. (JAPAN CORPORATION)  
SUMIDA-KU  
1-3-17 HIGASHIKOMAGATA  
TOKYO, JAPAN 130

FOR: SWIMMING GOGGLES, IN CLASS 9 (U.S.  
CLS. 21, 23, 26, 36 AND 38).

FIRST USE 0-0-1999; IN COMMERCE 0-0-2000.

THE MARK CONSISTS OF STANDARD CHAR-  
ACTERS WITHOUT CLAIM TO ANY PARTICULAR  
FONT, STYLE, SIZE, OR COLOR.

OWNER OF U.S. REG. NO. 2,492,846.

SER. NO. 77-330,414, FILED 11-15-2007.

GINA FINK, EXAMINING ATTORNEY

**Int. Cl.: 41**

**Prior U.S. Cls.: 100, 101 and 107**

**United States Patent and Trademark Office**

**Reg. No. 3,453,572**

**Registered June 24, 2008**

**SERVICE MARK  
PRINCIPAL REGISTER**

**FSAE**

SAE INTERNATIONAL (PENNSYLVANIA CORPORATION)  
400 COMMONWEALTH DRIVE  
WARRENDALE, PA 15096

FOR: EDUCATIONAL STUDENT DESIGN COMPETITION, IN CLASS 41 (U.S. CLS. 100, 101 AND 107).

FIRST USE 7-29-1993; IN COMMERCE 7-29-1993.

THE MARK CONSISTS OF STANDARD CHARACTERS WITHOUT CLAIM TO ANY PARTICULAR FONT, STYLE, SIZE, OR COLOR.

OWNER OF U.S. REG. NO. 1,431,541.

SER. NO. 77-330,424, FILED 11-15-2007.

GINA FINK, EXAMINING ATTORNEY

**Int. Cl.: 42**

**Prior U.S. Cls.: 100 and 101**

**United States Patent and Trademark Office**

**Reg. No. 3,453,573**

**Registered June 24, 2008**

**SERVICE MARK  
PRINCIPAL REGISTER**

# Cynios

CYNIOS TECHNOLOGIES LLC (ILLINOIS LTD  
LIAB CO)  
829 CLOVER RIDGE LANE  
ITASCA, IL 60143

FOR: CONSULTING SERVICES IN THE FIELD  
OF COMPUTER OPERATING SYSTEM DEPLOY-  
MENT AND MIGRATIONS, IN CLASS 42 (U.S. CLS.  
100 AND 101).

FIRST USE 7-12-2007; IN COMMERCE 10-29-2007.

THE MARK CONSISTS OF STANDARD CHAR-  
ACTERS WITHOUT CLAIM TO ANY PARTICULAR  
FONT, STYLE, SIZE, OR COLOR.

THE WORDING "CYNIOS" HAS NO MEANING  
IN A FOREIGN LANGUAGE.

SER. NO. 77-330,433, FILED 11-15-2007.

MARK PILARO, EXAMINING ATTORNEY



**Int. Cl.: 2**

**Prior U.S. Cls.: 6, 11 and 16**

**United States Patent and Trademark Office**

**Reg. No. 3,453,574**

**Registered June 24, 2008**

**TRADEMARK  
PRINCIPAL REGISTER**

**UNIVERSAL**

RUST-OLEUM BRANDS COMPANY (DELA-  
WARE CORPORATION)  
LEGAL DEPT.  
11 HAWTHORN PARKWAY  
VERNON HILLS, IL 60061

THE MARK CONSISTS OF STANDARD CHAR-  
ACTERS WITHOUT CLAIM TO ANY PARTICULAR  
FONT, STYLE, SIZE, OR COLOR.

FOR: PAINTS, IN CLASS 2 (U.S. CLS. 6, 11 AND 16).

SER. NO. 77-330,490, FILED 11-15-2007.

FIRST USE 1-19-2008; IN COMMERCE 1-19-2008.

HOWARD B. LEVINE, EXAMINING ATTORNEY

**Int. Cls.: 19 and 20**

**Prior U.S. Cls.: 1, 2, 12, 13, 22, 25, 32, 33 and 50**

**United States Patent and Trademark Office**

**Reg. No. 3,453,575**

**Registered June 24, 2008**

**TRADEMARK  
PRINCIPAL REGISTER**

**SUNCAST**

SUNCAST CORPORATION (ILLINOIS CORPORATION)  
700 N. KIRK ROAD  
BATAVIA, IL 60510

FOR: PET SHELTERS, NAMELY, PREFABRICATED DOG HOUSES, IN CLASS 19 (U.S. CLS. 1, 12, 33 AND 50).

FIRST USE 7-1-2007; IN COMMERCE 7-1-2007.

FOR: BEDS FOR PETS, IN CLASS 20 (U.S. CLS. 2, 13, 22, 25, 32 AND 50).

FIRST USE 7-1-2007; IN COMMERCE 7-1-2007.

THE MARK CONSISTS OF STANDARD CHARACTERS WITHOUT CLAIM TO ANY PARTICULAR FONT, STYLE, SIZE, OR COLOR.

SER. NO. 77-330,505, FILED 11-15-2007.

REBECCA EISINGER, EXAMINING ATTORNEY

**Int. Cl.: 36**

**Prior U.S. Cls.: 100, 101 and 102**

**United States Patent and Trademark Office**

**Reg. No. 3,453,576**

**Registered June 24, 2008**

**SERVICE MARK  
PRINCIPAL REGISTER**

SAVE YOUR TIME. SAVE YOUR  
MONEY.

CAR INSURANCE.COM, INC. (FLORIDA COR-  
PORATION)  
SUITE 1251  
745 ORIENTA AVENUE  
ALTAMONTE SPRINGS, FL 32701

FOR: INSURANCE BROKERAGE, INSURANCE  
AGENCY SERVICES IN THE FIELD OF AUTOMO-  
BILE INSURANCE, IN CLASS 36 (U.S. CLS. 100, 101  
AND 102).

FIRST USE 9-0-2003; IN COMMERCE 9-0-2003.

THE MARK CONSISTS OF STANDARD CHAR-  
ACTERS WITHOUT CLAIM TO ANY PARTICULAR  
FONT, STYLE, SIZE, OR COLOR.

SER. NO. 77-330,527, FILED 11-15-2007.

HEATHER BIDDULPH, EXAMINING ATTORNEY

**Int. Cl.: 9**

**Prior U.S. Cls.: 21, 23, 26, 36 and 38**

**Reg. No. 3,453,577**

**United States Patent and Trademark Office**

**Registered June 24, 2008**

---

**TRADEMARK  
PRINCIPAL REGISTER**

**EZ DAA**

INTEGRATION ASSOCIATES INC. (CALIFORNIA CORPORATION)  
110 PIONEER WAY  
MOUNTAIN VIEW, CA 94041

FOR: SEMICONDUCTOR DEVICES; SEMICONDUCTORS; INTEGRATED CIRCUITS, IN CLASS 9 (U.S. CLS. 21, 23, 26, 36 AND 38).

FIRST USE 8-1-2006; IN COMMERCE 8-1-2006.

THE MARK CONSISTS OF STANDARD CHARACTERS WITHOUT CLAIM TO ANY PARTICULAR FONT, STYLE, SIZE, OR COLOR.

NO CLAIM IS MADE TO THE EXCLUSIVE RIGHT TO USE "DAA", APART FROM THE MARK AS SHOWN.

SER. NO. 77-330,564, FILED 11-15-2007.

ALLISON SCHRODY, EXAMINING ATTORNEY

**Int. Cl.: 33**

**Prior U.S. Cls.: 47 and 49**

**United States Patent and Trademark Office**

**Reg. No. 3,453,578**

**Registered June 24, 2008**

**TRADEMARK  
PRINCIPAL REGISTER**



WINGARD, INC. (NEW YORK CORPORATION)  
1979 MARCUS AVENUE  
NEW HYDE PARK, NY 11042

THE MARK CONSISTS OF THE LETTER "V",  
NUMERAL "2" AND A DRAGON DESIGN.

FOR: DISTILLED SPIRIT SPECIALTIES, NAME-  
LY, VODKA CONTAINING TAURINE AND CAF-  
FEINE, IN CLASS 33 (U.S. CLS. 47 AND 49).

SER. NO. 77-330,706, FILED 11-15-2007.

FIRST USE 12-15-2006; IN COMMERCE 12-15-2006.

GIANCARLO CASTRO, EXAMINING ATTORNEY

Int. Cl.: 35

Prior U.S. Cls.: 100, 101 and 102

United States Patent and Trademark Office

Reg. No. 3,453,579

Registered June 24, 2008

**SERVICE MARK  
PRINCIPAL REGISTER**



**AMERICAN RESPIRATORY ALLIANCE**  
of WESTERN PENNSYLVANIA

AMERICAN RESPIRATORY ALLIANCE OF  
WESTERN PENNSYLVANIA (PENNSYLVANIA  
CORPORATION)  
AMERICAN RESPIRATORY ALLIANCE OF WESTERN  
201 SMITH DRIVE SUITE E  
CRANBERRY, PA 16066

FOR: PROMOTING THE INTERESTS OF THE  
PUBLIC IN THE PREVENTION AND CONTROL OF  
LUNG AND RESPIRATORY DISEASES, IN CLASS  
35 (U.S. CLS. 100, 101 AND 102).

FIRST USE 1-4-1999; IN COMMERCE 1-4-1999.

OWNER OF U.S. REG. NOS. 2,568,526 AND  
2,568,542.

THE MARK CONSISTS OF AN ILLUSTRATION  
OF A PAIR OF LUNGS WITH THE WORDS "AMERICAN  
RESPIRATORY ALLIANCE" AND "OF WESTERN  
PENNSYLVANIA" UNDERNEATH SAID  
ILLUSTRATION.

SEC. 2(F).

SER. NO. 77-330,714, FILED 11-15-2007.

MARY ROSSMAN, EXAMINING ATTORNEY

**Int. Cl.: 28**

**Prior U.S. Cls.: 22, 23, 38 and 50**

**Reg. No. 3,453,580**

**United States Patent and Trademark Office**

**Registered June 24, 2008**

---

**TRADEMARK  
PRINCIPAL REGISTER**

**MARK 1**

SPORT SUPPLY GROUP, INC. (DELAWARE  
CORPORATION)  
1901 DIPLOMAT DRIVE  
FARMERS BRANCH, TX 75234

FOR: BASEBALLS, SOFTBALLS, VOLLEYBALLS,  
AND BASEBALLS SOLD IN BULK CONTAINERS,  
IN CLASS 28 (U.S. CLS. 22, 23, 38 AND 50).

FIRST USE 1-25-2000; IN COMMERCE 1-25-2000.

THE MARK CONSISTS OF STANDARD CHAR-  
ACTERS WITHOUT CLAIM TO ANY PARTICULAR  
FONT, STYLE, SIZE, OR COLOR.

OWNER OF U.S. REG. NOS. 2,431,716 AND  
2,447,836.

SER. NO. 77-330,822, FILED 11-15-2007.

JOHN WILKE, EXAMINING ATTORNEY

**Int. Cl.: 21**

**Prior U.S. Cls.: 2, 13, 23, 29, 30, 33, 40 and 50**

**Reg. No. 3,453,581**

**United States Patent and Trademark Office**

**Registered June 24, 2008**

---

**TRADEMARK  
PRINCIPAL REGISTER**

**MICROSCRUB**

IMPACT PRODUCTS LLC (DELAWARE LTD  
LIAB CO)  
2840 CENTENNIAL ROAD  
TOLEDO, OH 43617

FOR: CLEANING PRODUCTS, NAMELY, POL-  
ISHING, CLEANING, AND DUSTING CLOTHS;  
DUST MOPS, WET MOPS, AND HANDLES AND  
FRAMES FOR MOPS; AND DUSTERS, BUCKETS,  
AND BUCKET AND MOP STORAGE CADDIES, IN  
CLASS 21 (U.S. CLS. 2, 13, 23, 29, 30, 33, 40 AND 50).

FIRST USE 9-1-1998; IN COMMERCE 9-1-1998.

THE MARK CONSISTS OF STANDARD CHAR-  
ACTERS WITHOUT CLAIM TO ANY PARTICULAR  
FONT, STYLE, SIZE, OR COLOR.

SER. NO. 77-330,842, FILED 11-15-2007.

TRACY CROSS, EXAMINING ATTORNEY



**Int. Cls.: 42 and 44**

**Prior U.S. Cls.: 100 and 101**

**United States Patent and Trademark Office**

**Reg. No. 3,453,582**

**Registered June 24, 2008**

**SERVICE MARK  
PRINCIPAL REGISTER**

**SCIENCE TRANSFORMING LIFE**

NATIONAL JEWISH MEDICAL AND RESEARCH  
CENTER (COLORADO NON-PROFIT COR-  
PORATION)  
1400 JACKSON STREET  
DENVER, CO 80206

FOR: MEDICAL RESEARCH, IN CLASS 42 (U.S.  
CLS. 100 AND 101).

FIRST USE 11-15-2007; IN COMMERCE 11-15-2007.

FOR: PATIENT CARE SERVICES, NAMELY,  
HEALTH CARE, IN CLASS 44 (U.S. CLS. 100 AND  
101).

FIRST USE 11-15-2007; IN COMMERCE 11-15-2007.

THE MARK CONSISTS OF STANDARD CHAR-  
ACTERS WITHOUT CLAIM TO ANY PARTICULAR  
FONT, STYLE, SIZE, OR COLOR.

SER. NO. 77-330,845, FILED 11-15-2007.

ANDREA HACK, EXAMINING ATTORNEY

**Int. Cl.: 44**

**Prior U.S. Cls.: 100 and 101**

**United States Patent and Trademark Office**

**Reg. No. 3,453,583**

**Registered June 24, 2008**

**SERVICE MARK  
PRINCIPAL REGISTER**

**HORSE HEALTH MATTERS**

EQUIMED, LLC (CALIFORNIA LTD LIAB CO)  
395 SAN BRUNO AVE.  
MORGAN HILL, CA 95037

FOR: PROVIDING INFORMATION AND AN ON-LINE COMPUTER DATABASE IN THE FIELD OF EQUINE HEALTHCARE, NAMELY, HEALTH AND MEDICINE, EQUINE FITNESS, NUTRITION, BREEDING, HOOF AND FOOT CARE, BARN SAFETY, BEHAVIOR, DENTAL CARE AND FIRST AID TO CONSUMERS, PROVIDERS, AND ADMINISTRATORS IN THE EQUINE HEALTHCARE INDUSTRY, IN CLASS 44 (U.S. CLS. 100 AND 101).

FIRST USE 6-15-2007; IN COMMERCE 9-15-2007.

THE MARK CONSISTS OF STANDARD CHARACTERS WITHOUT CLAIM TO ANY PARTICULAR FONT, STYLE, SIZE, OR COLOR.

NO CLAIM IS MADE TO THE EXCLUSIVE RIGHT TO USE "HORSE HEALTH", APART FROM THE MARK AS SHOWN.

SER. NO. 77-331,010, FILED 11-15-2007.

JANET LEE, EXAMINING ATTORNEY

**Int. Cl.: 31**

**Prior U.S. Cls.: 1 and 46**

**United States Patent and Trademark Office**

**Reg. No. 3,453,584**

**Registered June 24, 2008**

**TRADEMARK  
PRINCIPAL REGISTER**

**PURINA MILLS**

SOCIETE DES PRODUITS NESTLE S.A. (SWIT-  
ZERLAND SOCIÉTÉ ANONYME (SA))  
INTELLECTUAL PROPERTY DEPARTMENT  
CASE POSTALE 353  
VEVEY, SWITZERLAND 1800

FOR: ANIMAL FEED, IN CLASS 31 (U.S. CLS. 1  
AND 46).

FIRST USE 4-1-1986; IN COMMERCE 4-1-1986.

THE MARK CONSISTS OF STANDARD CHAR-  
ACTERS WITHOUT CLAIM TO ANY PARTICULAR  
FONT, STYLE, SIZE, OR COLOR.

OWNER OF U.S. REG. NOS. 61,064, 772,457 AND  
OTHERS.

SER. NO. 77-331,284, FILED 11-16-2007.

C. DIONNE CLYBURN, EXAMINING ATTORNEY

**Int. Cl.: 2**

**Prior U.S. Cls.: 6, 11 and 16**

**United States Patent and Trademark Office**

**Reg. No. 3,453,585**

**Registered June 24, 2008**

**TRADEMARK  
PRINCIPAL REGISTER**

**Imaging Technologies Direct**

CG DIRECT, INC. (CALIFORNIA CORPORATION)  
6022 VARIEL AVENUE  
WOODLAND HILLS, CA 91367

FOR: PHOTOCOPIER TONER; PHOTOCOPIER TONER IN CARTRIDGES; TONER; TONER CARTRIDGES; TONER FOR COPIERS; TONERS; INK CARTRIDGES FOR PRINTERS; INK JET CARTRIDGES; INK JET PRINTER INK , IN CLASS 2 (U.S. CLS. 6, 11 AND 16).

FIRST USE 11-1-2007; IN COMMERCE 11-1-2007.

THE MARK CONSISTS OF STANDARD CHARACTERS WITHOUT CLAIM TO ANY PARTICULAR FONT, STYLE, SIZE, OR COLOR.

NO CLAIM IS MADE TO THE EXCLUSIVE RIGHT TO USE "IMAGING" OR "TECHNOLOGIES", APART FROM THE MARK AS SHOWN.

SER. NO. 77-331,381, FILED 11-16-2007.

LINDA MICKLEBURGH, EXAMINING ATTORNEY

**Int. Cl.: 28**

**Prior U.S. Cls.: 22, 23, 38 and 50**

**United States Patent and Trademark Office**

**Reg. No. 3,453,586**

**Registered June 24, 2008**

**TRADEMARK  
PRINCIPAL REGISTER**

**ARDENT**

ARDENT OUTDOORS INC. (MISSOURI CORPORATION)  
425 SOUTH WOODS MILL ROAD, SUITE 170  
ST. LOUIS, MO 63017

FOR: FISHING REELS, IN CLASS 28 (U.S. CLS. 22, 23, 38 AND 50).

FIRST USE 7-1-2000; IN COMMERCE 7-1-2000.

THE MARK CONSISTS OF STANDARD CHARACTERS WITHOUT CLAIM TO ANY PARTICULAR FONT, STYLE, SIZE, OR COLOR.

OWNER OF U.S. REG. NOS. 2,626,051, 3,135,386, AND 3,242,142.

SER. NO. 77-331,467, FILED 11-16-2007.

PETER B. BROMAGHIM, EXAMINING ATTORNEY

**Int. Cls.: 3 and 4**

**Prior U.S. Cls.: 1, 4, 6, 15, 50, 51 and 52**

**United States Patent and Trademark Office**

**Reg. No. 3,453,587**

**Registered June 24, 2008**

**TRADEMARK  
PRINCIPAL REGISTER**



ARDENT OUTDOORS INC. (MISSOURI CORPORATION)  
425 SOUTH WOODS MILL ROAD, SUITE 170  
ST. LOUIS, MO 63017

FOR: FISHING REEL CLEANERS, IN CLASS 3  
(U.S. CLS. 1, 4, 6, 50, 51 AND 52).

FIRST USE 3-17-2006; IN COMMERCE 3-17-2006.

FOR: FISHING REEL LUBRICANTS, IN CLASS 4  
(U.S. CLS. 1, 6 AND 15).

FIRST USE 3-17-2006; IN COMMERCE 3-17-2006.

OWNER OF U.S. REG. NOS. 2,626,051, 3,135,386,  
AND 3,242,142.

THE MARK CONSISTS OF THE WORD "ARDENT"  
WITH A STAR TO THE RIGHT.

SER. NO. 77-331,477, FILED 11-16-2007.

PETER B. BROMAGHIM, EXAMINING ATTORNEY

**Int. Cl.: 28**

**Prior U.S. Cls.: 22, 23, 38 and 50**

**United States Patent and Trademark Office**

**Reg. No. 3,453,588**

**Registered June 24, 2008**

**TRADEMARK  
PRINCIPAL REGISTER**



ARDENT OUTDOORS INC. (MISSOURI CORPORATION)  
425 SOUTH WOODS MILL ROAD, SUITE 170  
ST. LOUIS, MO 63017

FOR: FISHING REELS, IN CLASS 28 (U.S. CLS. 22,  
23, 38 AND 50).

FIRST USE 3-17-2006; IN COMMERCE 3-17-2006.

OWNER OF U.S. REG. NOS. 2,626,051, 3,135,386,  
AND 3,242,142.

THE MARK CONSISTS OF THE WORD ARDENT  
WITH A STAR TO THE RIGHT.

SER. NO. 77-331,483, FILED 11-16-2007.

PETER B. BROMAGHIM, EXAMINING ATTORNEY

**Int. Cl.: 14**

**Prior U.S. Cls.: 2, 27, 28 and 50**

**United States Patent and Trademark Office**

**Reg. No. 3,453,589**

**Registered June 24, 2008**

**TRADEMARK  
PRINCIPAL REGISTER**

**THE ART OF TIME**

MOVADO LLC (DELAWARE LTD LIAB CO)  
SILVERSIDE CARR EXECUTIVE CENTER  
501 SILVERSIDE ROAD  
WILMINGTON, DE 19809

THE MARK CONSISTS OF STANDARD CHAR-  
ACTERS WITHOUT CLAIM TO ANY PARTICULAR  
FONT, STYLE, SIZE, OR COLOR.

FOR: HOROLOGICAL AND CHRONOMETIC IN-  
STRUMENTS, IN CLASS 14 (U.S. CLS. 2, 27, 28 AND  
50).

SER. NO. 77-331,664, FILED 11-16-2007.

FIRST USE 3-0-2001; IN COMMERCE 3-0-2001.

DAYNA BROWNE, EXAMINING ATTORNEY



**Int. Cl.: 25**

**Prior U.S. Cls.: 22 and 39**

**United States Patent and Trademark Office**

**Reg. No. 3,453,590**

**Registered June 24, 2008**

**TRADEMARK  
PRINCIPAL REGISTER**

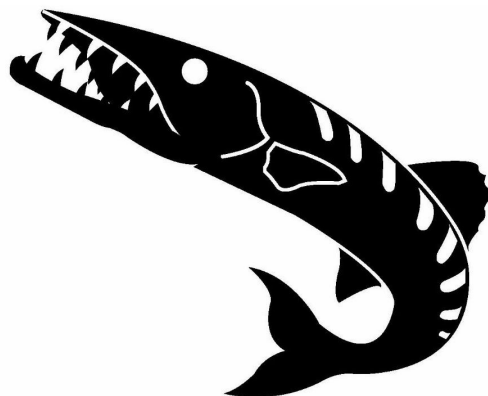

PERNIA, PATRICK P. (UNITED STATES INDIVIDUAL)  
4214 MACKIN WOODS LANE  
SAN JOSE, CA 95135

FOR: SWEATERS, BLAZERS, SHIRTS, POLO SHIRTS, DRESS SHIRTS, TURTLE NECK SHIRTS, TEE-SHIRTS, SWEATSHIRTS, KNIT SHIRTS, JACKETS, PARKAS, TROUSERS, SHORTS, BERMUDA SHORTS, TRACK SUIT TROUSERS, TRACK SUITS, SKIRTS, DRESSES, BEACHWEAR, SOCKS, WRIST BANDS, HEAD BANDS, SCARVES, HEADWEAR, NECKWEAR, GLOVES, UNDERWEAR, FOOTWEAR, IN CLASS 25 (U.S. CLS. 22 AND 39).

FIRST USE 12-4-2007; IN COMMERCE 12-4-2007.

THE MARK CONSISTS OF FISH FACING LEFT WITH MOUTH WIDE OPEN, TEETH SHOWN, AND WITH TAIL CURVING DOWNWARD FROM RIGHT TO LEFT.

SER. NO. 77-332,363, FILED 11-17-2007.

INGRID C. EULIN, EXAMINING ATTORNEY

**Int. Cl.: 1**

**Prior U.S. Cls.: 1, 5, 6, 10, 26 and 46**

**Reg. No. 3,453,591**

**United States Patent and Trademark Office**

**Registered June 24, 2008**

---

**TRADEMARK  
PRINCIPAL REGISTER**

**COSMOWET**

SURFATECH CORPORATION (GEORGIA CORPORATION)  
2170 LUKE EDWARD ROAD  
DACULA, GA 30019

FOR: CHEMICAL ADDITIVES FOR USE IN THE  
MANUFACTURE OF COSMETICS USED AS SUR-  
FACE ACTIVE AGENTS FOR WHOLESALE USE,  
NOT FOR SALE AT THE RETAIL LEVEL, IN CLASS  
1 (U.S. CLS. 1, 5, 6, 10, 26 AND 46).

FIRST USE 9-4-2006; IN COMMERCE 9-4-2006.

THE MARK CONSISTS OF STANDARD CHAR-  
ACTERS WITHOUT CLAIM TO ANY PARTICULAR  
FONT, STYLE, SIZE, OR COLOR.

SER. NO. 77-332,390, FILED 11-17-2007.

ANNE FARRELL, EXAMINING ATTORNEY

**Int. Cl.: 7**

**Prior U.S. Cls.: 13, 19, 21, 23, 31, 34 and 35**

**Reg. No. 3,453,592**

**United States Patent and Trademark Office**

**Registered June 24, 2008**

---

**TRADEMARK  
PRINCIPAL REGISTER**

**MAX-N-MUD**

WHITNEY INNOVATIONS, INC. (WASHINGTON  
CORPORATION)  
2581 COUNTY ROAD 306  
ELK CREEK, CA 95939

THE MARK CONSISTS OF STANDARD CHAR-  
ACTERS WITHOUT CLAIM TO ANY PARTICULAR  
FONT, STYLE, SIZE, OR COLOR.

FOR: POWER DRILL OPERATED MECHANICAL  
PAINT AND LIQUID MIXER, IN CLASS 7 (U.S. CLS.  
13, 19, 21, 23, 31, 34 AND 35).

SER. NO. 77-333,121, FILED 11-19-2007.

FIRST USE 8-2-2007; IN COMMERCE 8-2-2007.

KEVIN DINALLO, EXAMINING ATTORNEY

**Int. Cl.: 35**

**Prior U.S. Cls.: 100, 101 and 102**

**United States Patent and Trademark Office**

**Reg. No. 3,453,593**

**Registered June 24, 2008**

**SERVICE MARK  
PRINCIPAL REGISTER**

**WINE KING**

MNI MANAGEMENT, INC. (NEW JERSEY CORPORATION)  
406 JAY COURT  
FRANKLIN LAKES, NJ 07417

FOR: RETAIL STORE SERVICES FEATURING A WIDE VARIETY OF CONSUMER GOODS OF OTHERS; RETAIL STORE SERVICES IN THE FIELD OF ALCOHOLIC AND NON-ALCOHOLIC BEVERAGES, ICE, SMOKERS' ARTICLES, SNACK FOODS, BOOKS, CORK SCREWS, WINE TOTE BAGS, AND WINE ACCESSORIES, NAMELY, STEMWARE, WINE BOTTLE STOPPERS, DECANTERS AND FEATURING A BONUS INCENTIVE PROGRAM FOR CUSTOMERS, IN CLASS 35 (U.S. CLS. 100, 101 AND 102).

FIRST USE 0-0-2001; IN COMMERCE 0-0-2001.

THE MARK CONSISTS OF STANDARD CHARACTERS WITHOUT CLAIM TO ANY PARTICULAR FONT, STYLE, SIZE, OR COLOR.

NO CLAIM IS MADE TO THE EXCLUSIVE RIGHT TO USE "WINE", APART FROM THE MARK AS SHOWN.

THE FOREIGN WORDING IN THE MARK TRANSLATES INTO ENGLISH AS WANDERING OR ADVENTURES OR DANGEROUS AREAS.

SER. NO. 77-333,384, FILED 11-19-2007.

HENRY S. ZAK, EXAMINING ATTORNEY

**Int. Cl.: 7**

**Prior U.S. Cls.: 13, 19, 21, 23, 31, 34 and 35**

**Reg. No. 3,453,594**

**United States Patent and Trademark Office**

**Registered June 24, 2008**

**TRADEMARK  
PRINCIPAL REGISTER**



INA ACQUISITION CORP. (DELAWARE CORPORATION)  
NEMOURS BUILDING, SUITE 1410  
1007 ORANGE STREET  
WILMINGTON, DE 19801

FOR: PIPE AND CONDUIT REPAIR AND REHABILITATION MACHINES, NAMELY, INSERTION DEVICE FOR INSERTING FLEXIBLE LINERS INTO EXISTING PIPES AND CONDUITS FOR THE REPAIR AND REHABILITATION OF EXISTING PIPES

AND CONDUITS, IN CLASS 7 (U.S. CLS. 13, 19, 21, 23, 31, 34 AND 35).

FIRST USE 10-24-1995; IN COMMERCE 10-24-1995.

THE MARK CONSISTS OF A SERIES OF ARCULATE SHAPES INSIDE A CIRCLE.

SER. NO. 77-333,481, FILED 11-19-2007.

JANICE L. MCMORROW, EXAMINING ATTORNEY

**Int. Cls.: 29 and 30**

**Prior U.S. Cl.: 46**

**United States Patent and Trademark Office**

**Reg. No. 3,453,595**

**Registered June 24, 2008**

**TRADEMARK  
PRINCIPAL REGISTER**



SCHWAN'S IP, LLC (MINNESOTA LTD LIAB CO)  
115 W. COLLEGE DRIVE  
MARSHALL, MN 56258

OWNER OF U.S. REG. NOS. 2,114,646, 3,095,967  
AND OTHERS.

FOR: BACON; PEPPERONI; CHEESE, IN CLASS 29  
(U.S. CL. 46).

THE MARK CONSISTS OF PALM BRANCHES ON  
EITHER SIDE OF A BANNER THAT READS "FRE-  
SCHETTA" WITH RIBBONS DRAPING ABOVE AND  
BELOW THE BANNER.

FIRST USE 7-1-2006; IN COMMERCE 7-1-2006.

FOR: PIZZA; PIZZA CRUST; PIZZA SAUCE, IN  
CLASS 30 (U.S. CL. 46).

SER. NO. 77-334,011, FILED 11-20-2007.

FIRST USE 7-1-2006; IN COMMERCE 7-1-2006.

AMY GEARIN, EXAMINING ATTORNEY

**Int. Cl.: 35**

**Prior U.S. Cls.: 100, 101 and 102**

**United States Patent and Trademark Office**

**Reg. No. 3,453,596**

**Registered June 24, 2008**

**SERVICE MARK  
PRINCIPAL REGISTER**

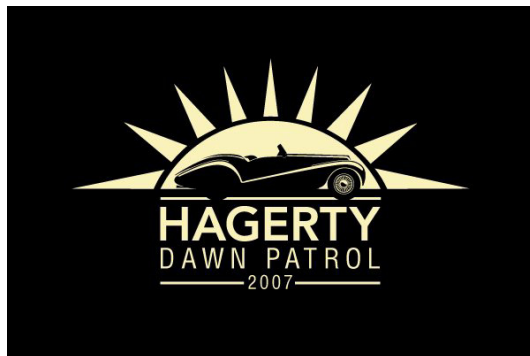

HAGERTY INSURANCE AGENCY, INC. (MICHIGAN CORPORATION)  
P.O. BOX 87  
141 RIVER'S EDGE DRIVE  
TRAVERSE CITY, MI 49684

FOR: ADVERTISING AND PROMOTIONAL SERVICES, IN CLASS 35 (U.S. CLS. 100, 101 AND 102).

FIRST USE 8-1-2002; IN COMMERCE 8-1-2002.

OWNER OF U.S. REG. NOS. 3,103,048, 3,240,367 AND OTHERS.

NO CLAIM IS MADE TO THE EXCLUSIVE RIGHT TO USE "2007", APART FROM THE MARK AS SHOWN.

THE COLOR(S) BLACK AND YELLOW IS/ARE CLAIMED AS A FEATURE OF THE MARK.

THE MARK CONSISTS OF HALF OF YELLOW SUN WITH AN ANTIQUE AUTOMOBILE IN FRONT OF IT IN BLACK AND THE WORDING "HAGERTY DAWN PATROL 2007" UNDERNEATH IN YELLOW ALL SET AGAINST A BLACK BACKGROUND.

SER. NO. 77-334,097, FILED 11-20-2007.

JOHN WILKE, EXAMINING ATTORNEY

**Int. Cl.: 7**

**Prior U.S. Cls.: 13, 19, 21, 23, 31, 34 and 35**

**United States Patent and Trademark Office**

**Reg. No. 3,453,597**

**Registered June 24, 2008**

**TRADEMARK  
PRINCIPAL REGISTER**

**QUIK STIK PLUS**

CONAIR CORPORATION (DELAWARE CORPORATION)  
ONE CUMMINGS POINT ROAD  
STAMFORD, CT 06902

FOR: ELECTRIC FOOD BLENDERS, IN CLASS 7  
(U.S. CLS. 13, 19, 21, 23, 31, 34 AND 35).

FIRST USE 4-18-2005; IN COMMERCE 4-18-2005.

THE MARK CONSISTS OF STANDARD CHARACTERS WITHOUT CLAIM TO ANY PARTICULAR FONT, STYLE, SIZE, OR COLOR.

OWNER OF U.S. REG. NO. 2,667,337.

SER. NO. 77-334,134, FILED 11-20-2007.

KIMBERLY FRYE, EXAMINING ATTORNEY



**Int. Cls.: 16 and 21**

**Prior U.S. Cls.: 2, 5, 13, 22, 23, 29, 30, 33, 37, 38, 40  
and 50**

**Reg. No. 3,453,598**

**United States Patent and Trademark Office**

**Registered June 24, 2008**

**TRADEMARK  
PRINCIPAL REGISTER**

**FIVESTARPET**

V.P. FOOTWEAR, INC. (CALIFORNIA COR-  
PORATION)  
10322 E. RUSH STREET  
S. EL MONTE, CA 91733

FOR: DISPOSABLE PLASTIC BAGS FOR PET  
WASTE AND DISPENSER SOLD TOGETHER AS A  
UNIT, IN CLASS 16 (U.S. CLS. 2, 5, 22, 23, 29, 37, 38  
AND 50).

FIRST USE 10-0-2005; IN COMMERCE 10-0-2005.

FOR: DISPENSER FOR PET WASTE BAGS WITH  
PET WASTE COLLECTION BAGS SOLD TOGE-

TER AS A UNIT, IN CLASS 21 (U.S. CLS. 2, 13, 23,  
29, 30, 33, 40 AND 50).

FIRST USE 10-0-2005; IN COMMERCE 10-0-2005.

THE MARK CONSISTS OF STANDARD CHAR-  
ACTERS WITHOUT CLAIM TO ANY PARTICULAR  
FONT, STYLE, SIZE, OR COLOR.

OWNER OF U.S. REG. NO. 3,313,121.

SER. NO. 77-334,320, FILED 11-20-2007.

ANDREW RHIM, EXAMINING ATTORNEY

**Int. Cl.: 3**

**Prior U.S. Cls.: 1, 4, 6, 50, 51 and 52**

**United States Patent and Trademark Office**

**Reg. No. 3,453,599**

**Registered June 24, 2008**

**TRADEMARK  
PRINCIPAL REGISTER**

**ComPolWax**

ALL STAR AUTO PRODUCTS LLC (NEW JERSEY LTD LIAB CO)  
92 RAILROAD AVE  
HASBROUCK, NJ 07604

THE MARK CONSISTS OF STANDARD CHARACTERS WITHOUT CLAIM TO ANY PARTICULAR FONT, STYLE, SIZE, OR COLOR.

FOR: AUTOMOBILE WAX; AUTOMOBILE POLISH; AUTOMOBILE CLEANERS, IN CLASS 3 (U.S. CLS. 1, 4, 6, 50, 51 AND 52).

SER. NO. 77-334,321, FILED 11-20-2007.

FIRST USE 7-1-2007; IN COMMERCE 9-11-2007.

ELISSA GARBER KON, EXAMINING ATTORNEY

**Int. Cl.: 31**

**Prior U.S. Cls.: 1 and 46**

**United States Patent and Trademark Office**

**Reg. No. 3,453,600**

**Registered June 24, 2008**

**TRADEMARK  
PRINCIPAL REGISTER**

**TRI STAR**

MOUNTAIN VIEW SEEDS, LTD. (OREGON CORPORATION)  
8955 SUNNYVIEW ROAD NE  
SALEM, OR 97305

THE MARK CONSISTS OF STANDARD CHARACTERS WITHOUT CLAIM TO ANY PARTICULAR FONT, STYLE, SIZE, OR COLOR.

FOR: GRASS SEED, IN CLASS 31 (U.S. CLS. 1 AND 46).

SER. NO. 77-334,340, FILED 11-20-2007.

FIRST USE 6-1-2007; IN COMMERCE 9-9-2007.

HOWARD B. LEVINE, EXAMINING ATTORNEY

**Int. Cl.: 36**

**Prior U.S. Cls.: 100, 101 and 102**

**United States Patent and Trademark Office**

**Reg. No. 3,453,601**

**Registered June 24, 2008**

**SERVICE MARK  
PRINCIPAL REGISTER**

# CentreInvest

CENTREINVEST, INC. (NEW YORK CORPORATION)  
140 BROADWAY  
NEW YORK, NY 10005

FOR: FINANCIAL INVESTMENT IN THE FIELD OF EMERGING MARKETS, FINANCIAL MANAGEMENT SERVICES, FINANCIAL PORTFOLIO MANAGEMENT SERVICES, AND FINANCIAL TRADING SERVICES, IN CLASS 36 (U.S. CLS. 100, 101 AND 102).

FIRST USE 7-7-1997; IN COMMERCE 7-7-1997.

THE MARK CONSISTS OF STANDARD CHARACTERS WITHOUT CLAIM TO ANY PARTICULAR FONT, STYLE, SIZE, OR COLOR.

SER. NO. 77-334,361, FILED 11-20-2007.

JOHN WILKE, EXAMINING ATTORNEY

**Int. Cl.: 5**

**Prior U.S. Cls.: 6, 18, 44, 46, 51 and 52**

**Reg. No. 3,453,602**

**United States Patent and Trademark Office**

**Registered June 24, 2008**

**TRADEMARK  
PRINCIPAL REGISTER**

# VAPONASE

BIOPHARM R&D CORPORATION LIMITED  
(GREAT BRITAIN CORPORATION), DBA BIO-  
PHARM  
57 KORNICHE EL NILE STREET, MAADI  
CAIRO, EGYPT 11431

FOR: PREPARATIONS FOR TREATING COLDS;  
COUGH TREATMENT PREPARATIONS; PHARMA-  
CEUTICAL AND NUTRACEUTICAL FORMULA-  
TIONS FOR THE TREATMENT OF COUGHS,  
COLDS, CONGESTION, AND BRONCHIAL IRRITA-  
TION; PHARMACEUTICAL AND NUTRACEUTI-  
CAL ANTITUSSIVE COLD PREPARATIONS;  
INHALED PHARMACEUTICAL AND NUTRACEU-  
TICAL PREPARATIONS FOR THE TREATMENT

OF RESPIRATORY DISEASES AND DISORDERS;  
VAPOR TABLETS OR GELCAPS FOR USE IN  
RELIEVING THROAT AND BRONCHIAL IRRITA-  
TION, IN CLASS 5 (U.S. CLS. 6, 18, 44, 46, 51 AND 52).

FIRST USE 9-15-2003; IN COMMERCE 9-15-2003.

THE MARK CONSISTS OF STANDARD CHAR-  
ACTERS WITHOUT CLAIM TO ANY PARTICULAR  
FONT, STYLE, SIZE, OR COLOR.

SER. NO. 77-334,378, FILED 11-20-2007.

CHRIS WELLS, EXAMINING ATTORNEY

**Int. Cl.: 33**

**Prior U.S. Cls.: 47 and 49**

**United States Patent and Trademark Office**

**Reg. No. 3,453,603**

**Registered June 24, 2008**

**TRADEMARK  
PRINCIPAL REGISTER**

**TIERS**

LION NATHAN WINE GROUP AUSTRALIA  
LIMITED (AUSTRALIA LIMITED COMPANY)  
LEVEL 30  
363 GEORGE STREET  
SYDNEY, AUSTRALIA NSW2000

THE MARK CONSISTS OF STANDARD CHAR-  
ACTERS WITHOUT CLAIM TO ANY PARTICULAR  
FONT, STYLE, SIZE, OR COLOR.

FOR: WINES, IN CLASS 33 (U.S. CLS. 47 AND 49).

SER. NO. 77-334,640, FILED 11-20-2007.

FIRST USE 0-0-1997; IN COMMERCE 6-0-1999.

DAVID MILLER, EXAMINING ATTORNEY

**Int. Cl.: 35**

**Prior U.S. Cls.: 100, 101 and 102**

**United States Patent and Trademark Office**

**Reg. No. 3,453,604**

**Registered June 24, 2008**

**SERVICE MARK  
PRINCIPAL REGISTER**

**BE MY SUPPORT. BE MY  
STRENGTH. BE MY BRA.**

LIFETIME ENTERTAINMENT SERVICES (NEW  
YORK JOINT VENTURE)  
309 WEST 49TH STREET, 16TH FLOOR  
NEW YORK, NY 10019

FOR: PROMOTING PUBLIC AWARENESS IN  
THE FIELD OF BREAST CANCER PREVENTION,  
DIAGNOSIS, TREATMENT, AND SUPPORT, IN  
CLASS 35 (U.S. CLS. 100, 101 AND 102).

FIRST USE 10-1-2007; IN COMMERCE 10-1-2007.

THE MARK CONSISTS OF STANDARD CHAR-  
ACTERS WITHOUT CLAIM TO ANY PARTICULAR  
FONT, STYLE, SIZE, OR COLOR.

SER. NO. 77-335,194, FILED 11-21-2007.

JILL C. ALT, EXAMINING ATTORNEY

**Int. Cl.: 9**

**Prior U.S. Cls.: 21, 23, 26, 36 and 38**

**Reg. No. 3,453,605**

**United States Patent and Trademark Office**

**Registered June 24, 2008**

**TRADEMARK  
PRINCIPAL REGISTER**

**MONSTER  
FLATSCREEN**

MONSTER CABLE PRODUCTS, INC. (CALIFORNIA CORPORATION)  
455 VALLEY DRIVE  
BRISBANE, CA 940051209

OWNER OF U.S. REG. NOS. 2,220,851, 2,728,729  
AND OTHERS.

FOR: ELECTRICAL AND ELECTROMAGNETIC SIGNAL TRANSMITTING, AMPLIFYING, RECEIVING, AND CONVERTING DEVICES, NAMELY, CABLES, WIRES, CONNECTORS, AND CONTROL DEVICES FOR USE WITH ELECTRICAL, ELECTRONIC, AND COMPUTER DEVICES; TV DISPLAYS AND MOUNTS; VIDEO EQUIPMENT AND ACCESSORIES; ELECTRICAL POWER CONTROL COMPONENTS AND ACCESSORIES; AND ENERGY CONDITIONING DEVICES, IN CLASS 9 (U.S. CLS. 21, 23, 26, 36 AND 38).

NO CLAIM IS MADE TO THE EXCLUSIVE RIGHT TO USE "FLATSCREEN", APART FROM THE MARK AS SHOWN.

THE MARK CONSISTS OF THE STYLIZED WORD "MONSTER" ABOVE THE STYLIZED WORD "FLATSCREEN".

SER. NO. 77-337,012, FILED 11-26-2007.

FIRST USE 11-3-2006; IN COMMERCE 11-3-2006.

JOHN WILKE, EXAMINING ATTORNEY



**Int. Cl.: 6**

**Prior U.S. Cls.: 2, 12, 13, 14, 23, 25 and 50**

**Reg. No. 3,453,606**

**United States Patent and Trademark Office**

**Registered June 24, 2008**

---

**TRADEMARK  
PRINCIPAL REGISTER**

**ARMORCAST**

ARMORCAST PRODUCTS CO. (CALIFORNIA  
CORPORATION)  
13230 SATICOY STREET  
NORTH HOLLYWOOD, CA 91605

THE MARK CONSISTS OF STANDARD CHAR-  
ACTERS WITHOUT CLAIM TO ANY PARTICULAR  
FONT, STYLE, SIZE, OR COLOR.

FOR: METAL GUARD BARRIERS FOR PARK-  
ING CONTROL; METAL MANHOLE COVERS, IN  
CLASS 6 (U.S. CLS. 2, 12, 13, 14, 23, 25 AND 50).

SER. NO. 77-338,447, FILED 11-28-2007.

FIRST USE 6-30-1980; IN COMMERCE 6-30-1980.

LINDA ORNDORFF, EXAMINING ATTORNEY

**Int. Cl.: 9**

**Prior U.S. Cls.: 21, 23, 26, 36 and 38**

**Reg. No. 3,453,607**

**United States Patent and Trademark Office**

**Registered June 24, 2008**

---

**TRADEMARK  
PRINCIPAL REGISTER**

**ARMORCAST**

ARMORCAST PRODUCTS CO. (CALIFORNIA  
CORPORATION)  
13230 SATICOY STREET  
NORTH HOLLYWOOD, CA 91605

THE MARK CONSISTS OF STANDARD CHAR-  
ACTERS WITHOUT CLAIM TO ANY PARTICULAR  
FONT, STYLE, SIZE, OR COLOR.

FOR: JUNCTION BOXES; SWITCH BOXES; ELEC-  
TRIC JUNCTION BOXES, IN CLASS 9 (U.S. CLS. 21,  
23, 26, 36 AND 38).

SER. NO. 77-338,453, FILED 11-28-2007.

FIRST USE 6-30-1980; IN COMMERCE 6-30-1980.

LINDA ORNDORFF, EXAMINING ATTORNEY

**Int. Cl.: 19**

**Prior U.S. Cls.: 1, 12, 33 and 50**

**United States Patent and Trademark Office**

**Reg. No. 3,453,608**

**Registered June 24, 2008**

**TRADEMARK  
PRINCIPAL REGISTER**

**ARMORCAST**

ARMORCAST PRODUCTS CO. (CALIFORNIA CORPORATION)  
13230 SATICOY STREET  
NORTH HOLLYWOOD, CA 91605

FOR: CRASH BARRIERS OF PLASTIC FOR ROADS; NON-METAL BARRIERS FOR PEDESTRIAN TRAFFIC CONTROL; PORTABLE NON-METAL FREE-STANDING BARRIERS; PORTABLE NON-METAL TRAFFIC BARRIERS; NON-METAL FLOOR TILES; PAVEMENT TILES; NON-METAL MANHOLE COVERS; CONCRETE VAULTS; CONCRETE DRAINAGE STRUCTURES, NAMELY,

STORM MANHOLES, IN CLASS 19 (U.S. CLS. 1, 12, 33 AND 50).

FIRST USE 6-30-1980; IN COMMERCE 6-30-1980.

THE MARK CONSISTS OF STANDARD CHARACTERS WITHOUT CLAIM TO ANY PARTICULAR FONT, STYLE, SIZE, OR COLOR.

SER. NO. 77-338,463, FILED 11-28-2007.

LINDA ORNDORFF, EXAMINING ATTORNEY

**Int. Cls.: 16 and 41**

**Prior U.S. Cls.: 2, 5, 22, 23, 29, 37, 38, 50, 100, 101 and 107**

**Reg. No. 3,453,609**

**United States Patent and Trademark Office**

**Registered June 24, 2008**

**TRADEMARK  
SERVICE MARK  
PRINCIPAL REGISTER**



THE INSTITUTE OF ELECTRICAL AND ELECTRONICS ENGINEERS, INC. (NEW YORK CORPORATION), DBA IEEE  
445 HOES LANE  
PISCATAWAY, NJ 088551331

FOR: PRINTED PUBLICATIONS IN THE NATURE OF DIGESTS, MAGAZINES, JOURNALS AND NEWSLETTERS IN THE FIELD OF MAGNETICS ENGINEERING, IN CLASS 16 (U.S. CLS. 2, 5, 22, 23, 29, 37, 38 AND 50).

FIRST USE 4-0-1963; IN COMMERCE 4-0-1963.

FOR: EDUCATIONAL SERVICES, NAMELY, CONDUCTING CONFERENCES IN THE FIELD OF

MAGNETICS ENGINEERING; DISTRIBUTING COURSE MATERIALS IN CONNECTION THEREWITH, IN CLASS 41 (U.S. CLS. 100, 101 AND 107).

FIRST USE 4-0-1964; IN COMMERCE 4-0-1964.

OWNER OF U.S. REG. NO. 840,506.

THE MARK CONSISTS OF A GLOBE OVER A MAGNETIC HYSTERESIS LOOP.

SER. NO. 77-339,705, FILED 11-29-2007.

JERI J. FICKES, EXAMINING ATTORNEY

**Int. Cl.: 9**

**Prior U.S. Cls.: 21, 23, 26, 36 and 38**

**United States Patent and Trademark Office**

**Reg. No. 3,453,610**

**Registered June 24, 2008**

**TRADEMARK  
PRINCIPAL REGISTER**

**IT'S ALL ABOUT YOU.**

UNITED STATES LUGGAGE COMPANY L.L.C.  
(NEW YORK LTD LIAB CO)  
400 WIRELESS BOULEVARD  
HAUPPAUGE, NY 11788

THE MARK CONSISTS OF STANDARD CHAR-  
ACTERS WITHOUT CLAIM TO ANY PARTICULAR  
FONT, STYLE, SIZE, OR COLOR.

FOR: BUSINESS CASES, NAMELY, CASES FOR  
COMPUTERS, LAPTOPS AND COMPUTER ACCES-  
SORIES, IN CLASS 9 (U.S. CLS. 21, 23, 26, 36 AND 38).

SER. NO. 77-340,218, FILED 11-29-2007.

FIRST USE 10-0-2006; IN COMMERCE 10-0-2006.

LINDA M. KING, EXAMINING ATTORNEY

**Int. Cl.: 25**

**Prior U.S. Cls.: 22 and 39**

**United States Patent and Trademark Office**

**Reg. No. 3,453,611**

**Registered June 24, 2008**

**TRADEMARK  
PRINCIPAL REGISTER**



KIDRO PRODUCTIONS, INC. (CALIFORNIA CORPORATION)  
SUITE 1710  
1500 BROADWAY  
NEW YORK, NY 10036

FIRST USE 7-31-2005; IN COMMERCE 7-31-2005.

THE MARK CONSISTS OF FOUR SMILING PEOPLE WITHOUT EYES, NOSES, EARS OR ARMS.

FOR: FLEECE PULLOVERS, JACKETS, SHORT-SLEEVED OR LONG-SLEEVED T-SHIRTS, SWEAT SHIRTS, AND HEAD WEAR, NAMELY, HATS, IN CLASS 25 (U.S. CLS. 22 AND 39).

SER. NO. 77-340,427, FILED 11-29-2007.

WON TEAK OH, EXAMINING ATTORNEY

**Int. Cl.: 39**

**Prior U.S. Cls.: 100 and 105**

**United States Patent and Trademark Office**

**Reg. No. 3,453,612**

**Registered June 24, 2008**

**SERVICE MARK  
PRINCIPAL REGISTER**

**"THE DRIVING FORCE IN  
TRANSPORTATION"**

EMT USA, LLC (MISSOURI LTD LIAB CO)  
6780 SOUTHWEST AVENUE  
ST. LOUIS, MO 63143

THE MARK CONSISTS OF STANDARD CHAR-  
ACTERS WITHOUT CLAIM TO ANY PARTICULAR  
FONT, STYLE, SIZE, OR COLOR.

FOR: TRANSPORTATION AND COURIER SER-  
VICES FOR PASSENGERS AND GOODS BY AUTO-  
MOBILES AND VANS, IN CLASS 39 (U.S. CLS. 100  
AND 105).

SER. NO. 77-340,474, FILED 11-29-2007.

FIRST USE 3-0-1996; IN COMMERCE 3-0-1996.

NAKIA HENRY, EXAMINING ATTORNEY

**Int. Cl.: 9**

**Prior U.S. Cls.: 21, 23, 26, 36 and 38**

**Reg. No. 3,453,613**

**United States Patent and Trademark Office**

**Registered June 24, 2008**

---

**TRADEMARK  
PRINCIPAL REGISTER**

**SMARTFEATURE**

QUALITY VISION INTERNATIONAL, INC. (NEW  
YORK CORPORATION)  
850 HUDSON AVE  
ROCHESTER, NY 14621

FOR: COMPUTER SOFTWARE FOR ALLOWING  
SUBSETS OF A LARGER COMPUTER SOFTWARE  
PROGRAM IN THE FIELD OF METROLOGY TO  
OPERATE WITHOUT ALTERING THE ORIGINAL  
COMPUTER SOFTWARE , IN CLASS 9 (U.S. CLS. 21,  
23, 26, 36 AND 38).

FIRST USE 4-3-2006; IN COMMERCE 4-3-2006.

THE MARK CONSISTS OF STANDARD CHAR-  
ACTERS WITHOUT CLAIM TO ANY PARTICULAR  
FONT, STYLE, SIZE, OR COLOR.

SER. NO. 77-340,639, FILED 11-29-2007.

GINA HAYES, EXAMINING ATTORNEY



**Int. Cl.: 9**

**Prior U.S. Cls.: 21, 23, 26, 36 and 38**

**Reg. No. 3,453,614**

**United States Patent and Trademark Office**

**Registered June 24, 2008**

---

**TRADEMARK  
PRINCIPAL REGISTER**

**SMARTSCRIPT**

QUALITY VISION INTERNATIONAL, INC. (NEW  
YORK CORPORATION)  
850 HUDSON AVE  
ROCHESTER, NY 14621

THE MARK CONSISTS OF STANDARD CHAR-  
ACTERS WITHOUT CLAIM TO ANY PARTICULAR  
FONT, STYLE, SIZE, OR COLOR.

FOR: COMPUTER SOFTWARE FOR DEVELOP-  
ING SOFTWARE IN THE FIELD OF METROLOGY  
USING SCRIPTING LANGUAGES, IN CLASS 9 (U.S.  
CLS. 21, 23, 26, 36 AND 38).

SER. NO. 77-340,647, FILED 11-29-2007.

FIRST USE 4-0-2007; IN COMMERCE 4-0-2007.

GINA HAYES, EXAMINING ATTORNEY

**Int. Cl.: 41**

**Prior U.S. Cls.: 100, 101 and 107**

**United States Patent and Trademark Office**

**Reg. No. 3,453,615**

**Registered June 24, 2008**

**SERVICE MARK  
PRINCIPAL REGISTER**

**IT'S POINTLESS TO PLAY  
ANYWHERE ELSE**

BOYD GAMING CORPORATION (NEVADA  
CORPORATION)  
ATTN: MR. LOU NUNZIATA  
6465 SOUTH RAINBOW BOULEVARD  
LAS VEGAS, NV 89118

FOR: CASINOS; CONDUCTING AND PROVID-  
ING FACILITIES FOR SPECIAL EVENTS FEATUR-  
ING CASINO AND GAMING CONTESTS AND  
TOURNAMENTS; PROVIDING CASINO FACIL-  
ITIES, IN CLASS 41 (U.S. CLS. 100, 101 AND 107).

FIRST USE 6-1-2004; IN COMMERCE 6-1-2004.

THE MARK CONSISTS OF STANDARD CHAR-  
ACTERS WITHOUT CLAIM TO ANY PARTICULAR  
FONT, STYLE, SIZE, OR COLOR.

SER. NO. 77-341,115, FILED 11-30-2007.

RON FAIRBANKS, EXAMINING ATTORNEY

**Int. Cl.: 41**

**Prior U.S. Cls.: 100, 101 and 107**

**United States Patent and Trademark Office**

**Reg. No. 3,453,616**

**Registered June 24, 2008**

**SERVICE MARK  
PRINCIPAL REGISTER**

STEVEN'S UNTITLED ROCK SHOW

FUSE NETWORKS LLC (NEW YORK LTD LIAB  
CO)  
1111 STEWART AVENUE  
BETHPAGE, NY 11714

FOR: ENTERTAINMENT SERVICES, NAMELY,  
AN ON-GOING CABLE TELEVISION PROGRAM IN  
THE FIELD OF MUSIC, IN CLASS 41 (U.S. CLS. 100,  
101 AND 107).

FIRST USE 12-20-2004; IN COMMERCE 12-20-2004.

THE MARK CONSISTS OF STANDARD CHAR-  
ACTERS WITHOUT CLAIM TO ANY PARTICULAR  
FONT, STYLE, SIZE, OR COLOR.

NO CLAIM IS MADE TO THE EXCLUSIVE  
RIGHT TO USE "ROCK SHOW", APART FROM  
THE MARK AS SHOWN.

SER. NO. 77-341,357, FILED 11-30-2007.

JOHN WILKE, EXAMINING ATTORNEY

**Int. Cl.: 41**

**Prior U.S. Cls.: 100, 101 and 107**

**United States Patent and Trademark Office**

**Reg. No. 3,453,617**

**Registered June 24, 2008**

---

**SERVICE MARK  
PRINCIPAL REGISTER**

**HITS**

ALCON, INC. (SWITZERLAND CORPORATION)  
BOSCH 69  
CH-6331, SWITZERLAND

THE MARK CONSISTS OF STANDARD CHAR-  
ACTERS WITHOUT CLAIM TO ANY PARTICULAR  
FONT, STYLE, SIZE, OR COLOR.

FOR: EDUCATIONAL SERVICES NAMELY,  
CONDUCTING CONFERENCES IN THE FIELD OF  
OPHTHALMOLOGY, IN CLASS 41 (U.S. CLS. 100, 101  
AND 107).

SER. NO. 77-342,209, FILED 12-3-2007.

FIRST USE 5-1-2006; IN COMMERCE 5-1-2006.

SALLY SHIH, EXAMINING ATTORNEY

**Int. Cl.: 41**

**Prior U.S. Cls.: 100, 101 and 107**

**United States Patent and Trademark Office**

**Reg. No. 3,453,618**

**Registered June 24, 2008**

**SERVICE MARK  
PRINCIPAL REGISTER**

**HELPING IMPROVE  
THERAPEUTIC SUCCESS**

ALCON, INC. (SWITZERLAND CORPORATION)  
BOSCH 69  
CH-6331 HUNENBERG, SWITZERLAND

THE MARK CONSISTS OF STANDARD CHAR-  
ACTERS WITHOUT CLAIM TO ANY PARTICULAR  
FONT, STYLE, SIZE, OR COLOR.

FOR: EDUCATIONAL SERVICES, NAMELY,  
CONDUCTING CONFERENCES IN THE FIELD OF  
OPHTHALMOLOGY, IN CLASS 41 (U.S. CLS. 100, 101  
AND 107).

SER. NO. 77-342,220, FILED 12-3-2007.

FIRST USE 5-1-2006; IN COMMERCE 5-1-2006.

SALLY SHIH, EXAMINING ATTORNEY

Int. Cl.: 28

Prior U.S. Cls.: 22, 23, 38 and 50

United States Patent and Trademark Office

Reg. No. 3,453,619

Registered June 24, 2008

TRADEMARK  
PRINCIPAL REGISTER



PARAMOUNT PICTURES CORPORATION (DE-  
LAWARE CORPORATION)  
5555 MELROSE AVENUE  
HOLLYWOOD, CA 90038

FOR: COLLECTIBLE TOY FIGURES; FANTASY  
CHARACTER TOYS; PLASTIC CHARACTER TOYS;  
TOY ACTION FIGURES AND ACCESSORIES  
THEREFOR, IN CLASS 28 (U.S. CLS. 22, 23, 38 AND  
50).

FIRST USE 11-15-2007; IN COMMERCE 11-15-2007.

THE COLOR(S) RED, GOLD AND BLACK IS/ARE  
CLAIMED AS A FEATURE OF THE MARK.

THE WORD "BEOWULF" IS IN GOLD AND  
BLACK, A DAGGER FORMS IN PART THE LETTER  
"B," THERE IS A RED ORB WITHIN THE LETTER  
"O" THAT CONSISTS IN PART OF A SMALL GOLD  
SERPENT ALL OF WHICH APPEAR UPON A  
BLACK RECTANGLE.

SER. NO. 77-342,895, FILED 12-3-2007.

EDWARD NELSON, EXAMINING ATTORNEY

**Int. Cl.: 10**

**Prior U.S. Cls.: 26, 39 and 44**

**United States Patent and Trademark Office**

**Reg. No. 3,453,620**

**Registered June 24, 2008**

**TRADEMARK  
PRINCIPAL REGISTER**

**VIBROLISSE**

L'OREAL (FRANCE SOCIÉTÉ ANONYME (SA))  
14 RUE ROYALE  
PARIS, FRANCE 75008

FOR: MASSAGE APPARATUS FOR THE FACE  
TO BE USED BY BEAUTICIANS IN HAIR SALONS,  
IN CLASS 10 (U.S. CLS. 26, 39 AND 44).

THE MARK CONSISTS OF STANDARD CHAR-  
ACTERS WITHOUT CLAIM TO ANY PARTICULAR  
FONT, STYLE, SIZE, OR COLOR.

PRIORITY CLAIMED UNDER SEC. 44(D) ON  
FRANCE APPLICATION NO. 073507199, FILED 6-  
15-2007, REG. NO. 073507199, DATED 6-15-2007, EX-  
PIRES 6-15-2017.

SER. NO. 77-343,463, FILED 12-4-2007.

SIMON TENG, EXAMINING ATTORNEY

**Int. Cl.: 6**

**Prior U.S. Cls.: 2, 12, 13, 14, 23, 25 and 50**

**Reg. No. 3,453,621**

**United States Patent and Trademark Office**

**Registered June 24, 2008**

---

**TRADEMARK  
PRINCIPAL REGISTER**



ARMORCAST PRODUCTS CO. (CALIFORNIA  
CORPORATION)  
13230 SATICOY STREET  
NORTH HOLLYWOOD, CA 91605

FIRST USE 6-30-1980; IN COMMERCE 6-30-1980.

SER. NO. 77-343,519, FILED 12-4-2007.

FOR: METAL GUARD BARRIERS FOR PARK-  
ING CONTROL; METAL MANHOLE COVERS, IN  
CLASS 6 (U.S. CLS. 2, 12, 13, 14, 23, 25 AND 50).

LINDA ORNDORFF, EXAMINING ATTORNEY



**Int. Cl.: 9**

**Prior U.S. Cls.: 21, 23, 26, 36 and 38**

**Reg. No. 3,453,622**

**United States Patent and Trademark Office**

**Registered June 24, 2008**

**TRADEMARK  
PRINCIPAL REGISTER**



AMORCAST PRODUCTS CO. (CALIFORNIA  
CORPORATION)  
13230 SATICOY STREET  
NORTH HOLLYWOOD, CA 91605

FIRST USE 6-30-1980; IN COMMERCE 6-30-1980.

SER. NO. 77-343,529, FILED 12-4-2007.

FOR: JUNCTION BOXES; SWITCH BOXES; ELEC-  
TRIC JUNCTION BOXES, IN CLASS 9 (U.S. CLS. 21,  
23, 26, 36 AND 38).

LINDA ORNDORFF, EXAMINING ATTORNEY

**Int. Cl.: 19**

**Prior U.S. Cls.: 1, 12, 33 and 50**

**Reg. No. 3,453,623**

**United States Patent and Trademark Office**

**Registered June 24, 2008**

**TRADEMARK  
PRINCIPAL REGISTER**



ARMORCAST PRODUCTS CO. (CALIFORNIA CORPORATION)  
13230 SATICOY STREET  
NORTH HOLLYWOOD, CA 91605

MANHOLE COVERS; CONCRETE VAULTS; CONCRETE DRAINAGE STRUCTURES, NAMELY, STORM MANHOLES, IN CLASS 19 (U.S. CLS. 1, 12, 33 AND 50).

FOR: CRASH BARRIERS OF PLASTIC FOR ROADS; NON-METAL BARRIERS FOR PEDESTRIAN TRAFFIC CONTROL; PORTABLE NON-METAL FREE-STANDING BARRIERS; PORTABLE NON-METAL TRAFFIC BARRIERS; NON-METAL FLOOR TILES; PAVEMENT TILES; NON-METAL

FIRST USE 6-30-1980; IN COMMERCE 6-30-1980.

SER. NO. 77-343,545, FILED 12-4-2007.

LINDA ORNDORFF, EXAMINING ATTORNEY

**Int. Cl.: 32**

**Prior U.S. Cls.: 45, 46 and 48**

**United States Patent and Trademark Office**

**Reg. No. 3,453,624**

**Registered June 24, 2008**

**TRADEMARK  
PRINCIPAL REGISTER**

**VERJUS DE CIGARE**

BONNY DOON WINERY, INC. (CALIFORNIA  
CORPORATION)  
P. O. BOX 8376  
SANTA CRUZ, CA 95061

OWNER OF U.S. REG. NO. 2,121,708.

FOR: FRUIT JUICES, NAMELY, GRAPE JUICE,  
IN CLASS 32 (U.S. CLS. 45, 46 AND 48).

THE FOREIGN WORDING IN THE MARK  
TRANSLATES INTO ENGLISH AS GREEN JUICE  
OF CIGAR.

FIRST USE 10-17-2007; IN COMMERCE 10-17-2007.

SER. NO. 77-344,146, FILED 12-4-2007.

THE MARK CONSISTS OF STANDARD CHAR-  
ACTERS WITHOUT CLAIM TO ANY PARTICULAR  
FONT, STYLE, SIZE, OR COLOR.

ODESSA BIBBINS, EXAMINING ATTORNEY

**Int. Cl.: 33**

**Prior U.S. Cls.: 47 and 49**

**United States Patent and Trademark Office**

**Reg. No. 3,453,625**

**Registered June 24, 2008**

**TRADEMARK  
PRINCIPAL REGISTER**

**LE CIGARE BLANC**

BONNY DOON WINERY, INC. (CALIFORNIA  
CORPORATION)  
P. O. BOX 8376  
SANTA CRUZ, CA 95061

FOR: WINES, IN CLASS 33 (U.S. CLS. 47 AND 49).

FIRST USE 7-29-2004; IN COMMERCE 7-29-2004.

THE MARK CONSISTS OF STANDARD CHAR-  
ACTERS WITHOUT CLAIM TO ANY PARTICULAR  
FONT, STYLE, SIZE, OR COLOR.

OWNER OF U.S. REG. NO. 2,121,708.

THE FOREIGN WORDING IN THE MARK  
TRANSLATES INTO ENGLISH AS THE WHITE  
CIGAR.

SER. NO. 77-344,150, FILED 12-4-2007.

ODESSA BIBBINS, EXAMINING ATTORNEY

**Int. Cl.: 35**

**Prior U.S. Cls.: 100, 101 and 102**

**United States Patent and Trademark Office**

**Reg. No. 3,453,626**

**Registered June 24, 2008**

**SERVICE MARK  
PRINCIPAL REGISTER**

**InvestClub USA**

INVEST CLUB USA, LLC (NEVADA LTD LIAB  
CO)

4581 42ND ST.

SAN DIEGO, CA 92116

FOR: ONLINE BUSINESS NETWORKING SERVI-  
CES, IN CLASS 35 (U.S. CLS. 100, 101 AND 102).

FIRST USE 10-19-2007; IN COMMERCE 10-19-2007.

THE MARK CONSISTS OF STANDARD CHAR-  
ACTERS WITHOUT CLAIM TO ANY PARTICULAR  
FONT, STYLE, SIZE, OR COLOR.

NO CLAIM IS MADE TO THE EXCLUSIVE  
RIGHT TO USE "USA", APART FROM THE MARK  
AS SHOWN.

SER. NO. 77-344,451, FILED 12-5-2007.

JAMES A. RAUEN, EXAMINING ATTORNEY

**Int. Cl.: 10**

**Prior U.S. Cls.: 26, 39 and 44**

**Reg. No. 3,453,627**

**United States Patent and Trademark Office**

**Registered June 24, 2008**

---

**TRADEMARK  
PRINCIPAL REGISTER**

**REFLEXION SPIRAL**

ST. JUDE MEDICAL, ATRIAL FIBRILLATION  
DIVISION, INC. (MINNESOTA CORPORATION)  
6500 WEDGWOOD ROAD  
MAPLE GROVE, MN 553113642

FOR: MEDICAL DEVICES, NAMELY, CATHETERS,  
ELECTRODE CATHETERS, AND MAPPING  
CATHETERS FOR THE INVESTIGATION, PREVENTION,  
DIAGNOSIS, OR TREATMENT OF MEDICAL  
CONDITIONS, IN CLASS 10 (U.S. CLS. 26, 39 AND  
44).

FIRST USE 1-31-2007; IN COMMERCE 1-31-2007.

THE MARK CONSISTS OF STANDARD CHARACTERS  
WITHOUT CLAIM TO ANY PARTICULAR  
FONT, STYLE, SIZE, OR COLOR.

NO CLAIM IS MADE TO THE EXCLUSIVE  
RIGHT TO USE "SPIRAL", APART FROM THE  
MARK AS SHOWN.

SER. NO. 77-345,187, FILED 12-5-2007.

LAURA KOVALSKY, EXAMINING ATTORNEY

**Int. Cl.: 28**

**Prior U.S. Cls.: 22, 23, 38 and 50**

**Reg. No. 3,453,628**

**United States Patent and Trademark Office**

**Registered June 24, 2008**

---

**TRADEMARK  
PRINCIPAL REGISTER**

**TTP**)system

ARDENT OUTDOORS INC. (MISSOURI CORPORATION)

425 SOUTH WOODS MILL ROAD, SUITE 170

ST. LOUIS, MO 63017

FOR: FISHING REELS, IN CLASS 28 (U.S. CLS. 22, 23, 38 AND 50).

FIRST USE 12-4-2007; IN COMMERCE 12-4-2007.

NO CLAIM IS MADE TO THE EXCLUSIVE RIGHT TO USE "SYSTEM", APART FROM THE MARK AS SHOWN.

THE MARK CONSISTS OF THE LETTERS TTP FOLLOWING BY A ROUNDED RIGHT HALF CIRCLE BEFORE THE WORD SYSTEM.

SER. NO. 77-346,895, FILED 12-7-2007.

PETER B. BROMAGHIM, EXAMINING ATTORNEY

**Int. Cl.: 35**

**Prior U.S. Cls.: 100, 101 and 102**

**United States Patent and Trademark Office**

**Reg. No. 3,453,629**

**Registered June 24, 2008**

**SERVICE MARK  
PRINCIPAL REGISTER**

**THOMPSON CIGAR TOUR**

THOMPSON & CO. OF TAMPA, INC. (FLORIDA CORPORATION)  
5401 HANGAR COURT  
TAMPA, FL 33634

FOR: PROVIDING A WEB SITE FEATURING ONLINE REGISTRATION SERVICES FOR CIGAR CLUB MEMBERSHIP, IN CLASS 35 (U.S. CLS. 100, 101 AND 102).

FIRST USE 11-19-2007; IN COMMERCE 11-19-2007.

THE MARK CONSISTS OF STANDARD CHARACTERS WITHOUT CLAIM TO ANY PARTICULAR FONT, STYLE, SIZE, OR COLOR.

OWNER OF U.S. REG. NO. 1,069,489.

NO CLAIM IS MADE TO THE EXCLUSIVE RIGHT TO USE "CIGAR TOUR", APART FROM THE MARK AS SHOWN.

SEC. 2(F) AS TO "THOMPSON".

SER. NO. 77-348,980, FILED 12-11-2007.

NAPOLEON SHARMA, EXAMINING ATTORNEY



**Int. Cl.: 3**

**Prior U.S. Cls.: 1, 4, 6, 50, 51 and 52**

**United States Patent and Trademark Office**

**Reg. No. 3,453,630**

**Registered June 24, 2008**

**TRADEMARK  
PRINCIPAL REGISTER**

**SOFTWARE**

CONAIR CORPORATION (DELAWARE CORPORATION)  
ONE CUMMINGS POINT ROAD  
STAMFORD, CT 06902

THE MARK CONSISTS OF STANDARD CHARACTERS WITHOUT CLAIM TO ANY PARTICULAR FONT, STYLE, SIZE, OR COLOR.

FOR: HAIR STYLING PREPARATIONS, IN CLASS 3 (U.S. CLS. 1, 4, 6, 50, 51 AND 52).

SER. NO. 77-349,077, FILED 12-11-2007.

FIRST USE 10-1-2007; IN COMMERCE 10-1-2007.

KIMBERLY FRYE, EXAMINING ATTORNEY

**Int. Cl.: 33**

**Prior U.S. Cls.: 47 and 49**

**United States Patent and Trademark Office**

**Reg. No. 3,453,631**

**Registered June 24, 2008**

**TRADEMARK  
PRINCIPAL REGISTER**

**SCORESBY**

DIAGEO NORTH AMERICA, INC. (CONNECTI-  
CUT CORPORATION)  
801 MAIN AVENUE  
NORWALK, CT 06851

FOR: DISTILLED SPIRITS, IN CLASS 33 (U.S. CLS.  
47 AND 49).

FIRST USE 10-0-1960; IN COMMERCE 7-0-1961.

THE MARK CONSISTS OF STANDARD CHAR-  
ACTERS WITHOUT CLAIM TO ANY PARTICULAR  
FONT, STYLE, SIZE, OR COLOR.

OWNER OF U.S. REG. NO. 872,715.

SER. NO. 77-349,805, FILED 12-12-2007.

KATHERINE STOIDES, EXAMINING ATTORNEY

**Int. Cl.: 5**

**Prior U.S. Cls.: 6, 18, 44, 46, 51 and 52**

**United States Patent and Trademark Office**

**Reg. No. 3,453,632**

**Registered June 24, 2008**

**TRADEMARK  
PRINCIPAL REGISTER**



BIOPHARMA SCIENTIFIC, INC. (NEVADA CORPORATION)  
9010 KENAMAR DRIVE, SUITE 101  
SAN DIEGO, CA 92121

FOR: HEALTH SUPPLEMENTS, NAMELY, DIETARY, NUTRITIONAL, HERBAL, VITAMIN, MINERAL, NUTRACEUTICAL DIETARY SUPPLEMENTS, AND FOOD SUPPLEMENTS, IN CLASS 5 (U.S. CLS. 6, 18, 44, 46, 51 AND 52).

FIRST USE 8-12-2005; IN COMMERCE 8-12-2005.

THE COLOR(S) ORANGE, WHITE AND BLUE IS/ARE CLAIMED AS A FEATURE OF THE MARK.

THE MARK CONSISTS OF A BLUE SQUARE WITH THE LETTER "N" APPEARING IN THE MIDDLE OF THE SQUARE IN WHITE, STYLIZED FONT. THE BLUE SQUARE IS SURROUNDED BY A WHITE BORDER. THE WHITE BORDER IS SURROUNDED BY AN ORANGE BORDER. THE BOTTOM OF THE ORANGE BORDER IS DIVIDED BY A WHITE STRIPE THAT CONNECTS THE WHITE BORDER WITH THE OUTER MARGIN OF THE ORANGE BORDER.

SER. NO. 77-350,020, FILED 12-12-2007.

BILL DAWE, EXAMINING ATTORNEY

**Int. Cl.: 33**

**Prior U.S. Cls.: 47 and 49**

**United States Patent and Trademark Office**

**Reg. No. 3,453,633**

**Registered June 24, 2008**

**TRADEMARK  
PRINCIPAL REGISTER**

**FIDEAUX**

DIAGEO NORTH AMERICA, INC. (CONNECTI-  
CUT CORPORATION)  
SIXTH FLOOR  
801 MAIN AVENUE  
NORWALK, CT 068511127

THE MARK CONSISTS OF STANDARD CHAR-  
ACTERS WITHOUT CLAIM TO ANY PARTICULAR  
FONT, STYLE, SIZE, OR COLOR.

FOR: WINES, IN CLASS 33 (U.S. CLS. 47 AND 49).

SER. NO. 77-350,847, FILED 12-13-2007.

FIRST USE 7-1-2007; IN COMMERCE 7-1-2007.

KATHERINE STOIDES, EXAMINING ATTORNEY

**Int. Cl.: 1**

**Prior U.S. Cls.: 1, 5, 6, 10, 26 and 46**

**Reg. No. 3,453,634**

**United States Patent and Trademark Office**

**Registered June 24, 2008**

---

**TRADEMARK  
PRINCIPAL REGISTER**

**ALCODRILL**

INDOPCO, INC. (DELAWARE CORPORATION),  
DBA NATIONAL STARCH AND CHEMICAL  
COMPANY  
10 FINDERNE AVENUE  
BRIDGEWATER, NJ 08807

THE MARK CONSISTS OF STANDARD CHAR-  
ACTERS WITHOUT CLAIM TO ANY PARTICULAR  
FONT, STYLE, SIZE, OR COLOR.

FOR: POLYMER DEFLOCCULANTS USED FOR  
DRILLING FLUID APPLICATIONS, IN CLASS 1  
(U.S. CLS. 1, 5, 6, 10, 26 AND 46).

SER. NO. 77-351,001, FILED 12-13-2007.

FIRST USE 12-31-1986; IN COMMERCE 12-31-1986.

KAREN K. BUSH, EXAMINING ATTORNEY

**Int. Cl.: 31**

**Prior U.S. Cls.: 1 and 46**

**United States Patent and Trademark Office**

**Reg. No. 3,453,635**

**Registered June 24, 2008**

**TRADEMARK  
PRINCIPAL REGISTER**

**SWEET STUFF**

CARGILL, INCORPORATED (DELAWARE CORPORATION)  
15407 MCGINTY ROAD WEST  
WAYZATA, MN 55391

THE MARK CONSISTS OF STANDARD CHARACTERS WITHOUT CLAIM TO ANY PARTICULAR FONT, STYLE, SIZE, OR COLOR.

FOR: ANIMAL FEED, IN CLASS 31 (U.S. CLS. 1 AND 46).

SER. NO. 77-351,016, FILED 12-13-2007.

FIRST USE 12-31-1998; IN COMMERCE 12-31-1998.

WILLIAM VERHOSEK, EXAMINING ATTORNEY

**Int. Cl.: 1**

**Prior U.S. Cls.: 1, 5, 6, 10, 26 and 46**

**Reg. No. 3,453,636**

**United States Patent and Trademark Office**

**Registered June 24, 2008**

---

**TRADEMARK  
PRINCIPAL REGISTER**

**ALCOCLEAR**

INDOPCO, INC. (DELAWARE CORPORATION),  
DBA NATIONAL STARCH AND CHEMICAL  
COMPANY  
10 FINDERNE AVENUE  
BRIDGEWATER, NJ 08807

FOR: WATER CLARIFICATION POLYMERS FOR  
USE IN THE PETROLEUM PRODUCTION INDUS-  
TRY AND PROCESS WATER APPLICATIONS, IN  
CLASS 1 (U.S. CLS. 1, 5, 6, 10, 26 AND 46).

FIRST USE 12-31-1993; IN COMMERCE 12-31-1993.

THE MARK CONSISTS OF STANDARD CHAR-  
ACTERS WITHOUT CLAIM TO ANY PARTICULAR  
FONT, STYLE, SIZE, OR COLOR.

SER. NO. 77-351,037, FILED 12-13-2007.

KAREN K. BUSH, EXAMINING ATTORNEY

**Int. Cl.: 1**

**Prior U.S. Cls.: 1, 5, 6, 10, 26 and 46**

**Reg. No. 3,453,637**

**United States Patent and Trademark Office**

**Registered June 24, 2008**

---

**TRADEMARK  
PRINCIPAL REGISTER**

**FLOC AID**

INDOPCO, INC. (DELAWARE CORPORATION),  
DBA NATIONAL STARCH AND CHEMICAL  
COMPANY

10 FINDERNE AVENUE  
BRIDGEWATER, NJ 08807

FOR: FLOCCULANTS FOR INDUSTRIAL USE, IN  
CLASS 1 (U.S. CLS. 1, 5, 6, 10, 26 AND 46).

FIRST USE 10-1-1957; IN COMMERCE 10-1-1957.

THE MARK CONSISTS OF STANDARD CHAR-  
ACTERS WITHOUT CLAIM TO ANY PARTICULAR  
FONT, STYLE, SIZE, OR COLOR.

NO CLAIM IS MADE TO THE EXCLUSIVE  
RIGHT TO USE "FLOC", APART FROM THE MARK  
AS SHOWN.

SER. NO. 77-351,067, FILED 12-13-2007.

KAREN K. BUSH, EXAMINING ATTORNEY



**Int. Cls.: 41 and 43**

**Prior U.S. Cls.: 100, 101 and 107**

**United States Patent and Trademark Office**

**Reg. No. 3,453,638**

**Registered June 24, 2008**

**SERVICE MARK  
PRINCIPAL REGISTER**

**SBE**

SBE ENTERTAINMENT GROUP, LLC (CALIFORNIA LTD LIAB CO), AKA SBE HOTEL GROUP, LLC IS A WHOLLY OWNED SUBSIDIARY OF SBE ENTERTAINMENT GROUP, LLC.

8000 BEVERLY BOULEVARD  
LOS ANGELES, CA 90048

FOR: NIGHT CLUBS, IN CLASS 41 (U.S. CLS. 100, 101 AND 107).

FIRST USE 7-1-2004; IN COMMERCE 7-1-2004.

FOR: HOTEL, BAR AND RESTAURANT SERVICES, IN CLASS 43 (U.S. CLS. 100 AND 101).

FIRST USE 7-1-2004; IN COMMERCE 7-1-2004.

THE MARK CONSISTS OF STANDARD CHARACTERS WITHOUT CLAIM TO ANY PARTICULAR FONT, STYLE, SIZE, OR COLOR.

OWNER OF U.S. REG. NOS. 3,244,476, 3,247,027, AND 3,367,844.

SER. NO. 77-351,243, FILED 12-13-2007.

DAVID YONTEF, EXAMINING ATTORNEY

**Int. Cl.: 35**

**Prior U.S. Cls.: 100, 101 and 102**

**United States Patent and Trademark Office**

**Reg. No. 3,453,639**

**Registered June 24, 2008**

**SERVICE MARK  
PRINCIPAL REGISTER**

**OPTIMUM STORE.COM**

CSC HOLDINGS, INC. (DELAWARE CORPORATION)  
1111 STEWART AVENUE  
BETHPAGE, NY 11714

FOR: ONLINE RETAIL STORE SERVICES IN THE FIELD OF EQUIPMENT AND SERVICES FOR INTERNET ACCESS, TELECOMMUNICATIONS, AND CABLE AND SATELLITE TELEVISION; DEMONSTRATION OF EQUIPMENT USED FOR INTERNET ACCESS, TELECOMMUNICATIONS, AND CABLE AND SATELLITE TELEVISION; CUSTOMER SERVICE IN THE FIELD OF BILL PAYMENT; CUSTOMER SERVICE IN THE FIELD OF SCHEDULING REPAIR, MAINTENANCE, AND INSTALLATION OF EQUIPMENT AND SERVICES FOR INTERNET ACCESS, TELECOMMUNICATIONS, AND CABLE AND SATELLITE TELEVISION, IN CLASS 35 (U.S. CLS. 100, 101 AND 102).

FIRST USE 1-0-2006; IN COMMERCE 1-0-2006.

THE MARK CONSISTS OF STANDARD CHARACTERS WITHOUT CLAIM TO ANY PARTICULAR FONT, STYLE, SIZE, OR COLOR.

OWNER OF U.S. REG. NO. 3,186,404.

NO CLAIM IS MADE TO THE EXCLUSIVE RIGHT TO USE "STORE.COM", APART FROM THE MARK AS SHOWN.

SER. NO. 77-351,484, FILED 12-13-2007.

JAMES MACFARLANE, EXAMINING ATTORNEY

**Int. Cl.: 35**

**Prior U.S. Cls.: 100, 101 and 102**

**United States Patent and Trademark Office**

**Reg. No. 3,453,640**

**Registered June 24, 2008**

**SERVICE MARK  
PRINCIPAL REGISTER**

**OPTIMUM STORE**

CSC HOLDINGS, INC. (DELAWARE CORPORATION)  
1111 STEWART AVENUE  
BETHPAGE, NY 11714

FOR: RETAIL STORE SERVICES IN THE FIELD OF EQUIPMENT AND SERVICES FOR INTERNET ACCESS, TELECOMMUNICATIONS, AND CABLE AND SATELLITE TELEVISION; DEMONSTRATION OF EQUIPMENT USED FOR INTERNET ACCESS, TELECOMMUNICATIONS, AND CABLE AND SATELLITE TELEVISION; CUSTOMER SERVICE IN THE FIELD OF BILL PAYMENT; CUSTOMER SERVICE IN THE FIELD OF SCHEDULING REPAIR, MAINTENANCE, AND INSTALLATION OF EQUIPMENT AND SERVICES FOR INTERNET ACCESS, TELECOMMUNICATIONS, AND CABLE AND SATELLITE TELEVISION, IN CLASS 35 (U.S. CLS. 100, 101 AND 102).

FIRST USE 1-0-2006; IN COMMERCE 1-0-2006.

THE MARK CONSISTS OF STANDARD CHARACTERS WITHOUT CLAIM TO ANY PARTICULAR FONT, STYLE, SIZE, OR COLOR.

OWNER OF U.S. REG. NO. 3,186,404.

NO CLAIM IS MADE TO THE EXCLUSIVE RIGHT TO USE "STORE", APART FROM THE MARK AS SHOWN.

SER. NO. 77-351,595, FILED 12-13-2007.

JAMES MACFARLANE, EXAMINING ATTORNEY

**Int. Cl.: 38**

**Prior U.S. Cls.: 100, 101 and 104**

**United States Patent and Trademark Office**

**Reg. No. 3,453,641**

**Registered June 24, 2008**

**SERVICE MARK  
PRINCIPAL REGISTER**

**OPTIMUM ONLINE EXPRESS  
LINK TECHNOLOGY**

CSC HOLDINGS, INC. (DELAWARE CORPORATION)  
1111 STEWART AVENUE  
BETHPAGE, NY 11714

FOR: PROVIDING HIGH SPEED INTERNET ACCESS, IN CLASS 38 (U.S. CLS. 100, 101 AND 104).

FIRST USE 11-30-2007; IN COMMERCE 11-30-2007.

THE MARK CONSISTS OF STANDARD CHARACTERS WITHOUT CLAIM TO ANY PARTICULAR FONT, STYLE, SIZE, OR COLOR.

OWNER OF U.S. REG. NOS. 2,693,273, 3,091,378 AND OTHERS.

NO CLAIM IS MADE TO THE EXCLUSIVE RIGHT TO USE "ONLINE EXPRESS LINK TECHNOLOGY", APART FROM THE MARK AS SHOWN.

SER. NO. 77-351,599, FILED 12-13-2007.

JAMES MACFARLANE, EXAMINING ATTORNEY

**Int. Cl.: 35**

**Prior U.S. Cls.: 100, 101 and 102**

**United States Patent and Trademark Office**

**Reg. No. 3,453,642**

**Registered June 24, 2008**

**SERVICE MARK  
PRINCIPAL REGISTER**

OFF YOUR SHELVES AND INTO  
THEIR HEARTS

DD TRADERS, INC. (DELAWARE CORPORATION), DBA DEMDACO  
7500 WEST 160TH STREET  
STILLWELL, KS 66085

THE MARK CONSISTS OF STANDARD CHARACTERS WITHOUT CLAIM TO ANY PARTICULAR FONT, STYLE, SIZE, OR COLOR.

FOR: WHOLESALE ORDERING SERVICES IN THE FIELD OF DECORATIVE HOUSEWARES AND GIFTWARE PRODUCTS, IN CLASS 35 (U.S. CLS. 100, 101 AND 102).

SER. NO. 77-351,668, FILED 12-13-2007.

FIRST USE 12-13-2007; IN COMMERCE 12-13-2007.

GIANCARLO CASTRO, EXAMINING ATTORNEY

**Int. Cl.: 14**

**Prior U.S. Cls.: 2, 27, 28 and 50**

**United States Patent and Trademark Office**

**Reg. No. 3,453,643**

**Registered June 24, 2008**

**TRADEMARK  
PRINCIPAL REGISTER**

**PACE DESIGNS**

RICHLINE GROUP, INC. (DELAWARE CORPORATION)  
516 FIFTH AVENUE  
NEW YORK, NY 10036

OWNER OF U.S. REG. NO. 2,443,725.

FOR: JEWELRY, IN CLASS 14 (U.S. CLS. 2, 27, 28 AND 50).

NO CLAIM IS MADE TO THE EXCLUSIVE RIGHT TO USE "DESIGNS", APART FROM THE MARK AS SHOWN.

FIRST USE 9-16-2002; IN COMMERCE 9-16-2002.

SER. NO. 77-352,234, FILED 12-14-2007.

THE MARK CONSISTS OF STANDARD CHARACTERS WITHOUT CLAIM TO ANY PARTICULAR FONT, STYLE, SIZE, OR COLOR.

TRACY CROSS, EXAMINING ATTORNEY

**Int. Cl.: 10**

**Prior U.S. Cls.: 26, 39 and 44**

**United States Patent and Trademark Office**

**Reg. No. 3,453,644**

**Registered June 24, 2008**

**TRADEMARK  
PRINCIPAL REGISTER**

**SWINGTOP**

SURGICAL INNOVATIONS LIMITED (UNITED  
KINGDOM LIMITED COMPANY (LTD.))  
CLAYTON PARK  
CLAYTON WOOD RISE  
LEEDS, UNITED KINGDOM LS166RF

FOR: SURGICAL APPARATUS AND INSTRUMENTS FOR USE IN GENERAL SURGERY AND LAPAROSCOPIC SURGERY; MEDICAL APPARATUS AND INSTRUMENTS, NAMELY, PORT ACCESS SYSTEMS COMPRISING CANNULAE, TROCARS, VALVES, SEALS, LUER CAPS AND FACIA ADAPTERS; PARTS AND FITTINGS FOR SURGICAL AND MEDICAL APPARATUS AND

INSTRUMENTS, NAMELY, CANNULAE, TROCARS, VALVES, SEALS, LUER CAPS AND FACIA ADAPTERS, IN CLASS 10 (U.S. CLS. 26, 39 AND 44).

FIRST USE 7-31-2007; IN COMMERCE 7-31-2007.

THE MARK CONSISTS OF STANDARD CHARACTERS WITHOUT CLAIM TO ANY PARTICULAR FONT, STYLE, SIZE, OR COLOR.

SER. NO. 77-354,393, FILED 12-18-2007.

MARGERY A. TIERNEY, EXAMINING ATTORNEY

**Int. Cl.: 5**

**Prior U.S. Cls.: 6, 18, 44, 46, 51 and 52**

**United States Patent and Trademark Office**

**Reg. No. 3,453,645**

**Registered June 24, 2008**

**TRADEMARK  
PRINCIPAL REGISTER**

**PLEXTAM**

NOVARTIS AG (SWITZERLAND CORPORATION)  
4002  
BASEL, SWITZERLAND

FOR: PHARMACEUTICAL PREPARATIONS FOR THE PREVENTION AND TREATMENT OF DISORDERS OF THE NERVOUS SYSTEM, THE IMMUNE SYSTEM, THE CARDIO-VASCULAR SYSTEM, THE METABOLIC SYSTEM, THE RESPIRATORY SYSTEM, THE MUSCULO-SKELETAL SYSTEM, THE GENITOURINARY SYSTEM; FOR THE TREATMENT OF INFLAMMATORY DISORDERS; FOR USE IN DERMATOLOGY, ONCOLOGY, HEMATOLOGY AND IN TISSUE AND ORGAN TRANSPLANTATION, IN OPHTHALMOLOGY AND FOR GASTROENTEROLOGICAL DISORDERS; PHARMACEUTICAL PREPARATIONS FOR THE PREVENTION AND TREATMENT OF OCULAR DISORDERS OR DISEASES; FOR THE TREAT-

MENT OF BACTERIA-BASED DISEASES; FOR THE TREATMENT OF DIABETES, ANTI-INFECTIVE PREPARATIONS, ANTIVIRAL PREPARATIONS, ANTIBIOTICS, ANTIFUNGAL PREPARATIONS AND VACCINES, IN CLASS 5 (U.S. CLS. 6, 18, 44, 46, 51 AND 52).

THE MARK CONSISTS OF STANDARD CHARACTERS WITHOUT CLAIM TO ANY PARTICULAR FONT, STYLE, SIZE, OR COLOR.

OWNER OF SWITZERLAND REG. NO. 526394, DATED 10-5-2004, EXPIRES 9-20-2014.

OWNER OF U.S. REG. NO. 3,036,038.

SER. NO. 77-354,579, FILED 12-18-2007.

DOMINIC FATHY, EXAMINING ATTORNEY



**Int. Cl.: 35**

**Prior U.S. Cls.: 100, 101 and 102**

**United States Patent and Trademark Office**

**Reg. No. 3,453,646**

**Registered June 24, 2008**

**SERVICE MARK  
PRINCIPAL REGISTER**

**LUXURYVINTAGE**

I-GLOBALMALL.COM, INC. (TEXAS CORPORATION)  
18570 PAINTBRUSH TRAIL  
SKY VALLEY, CA 92241

FOR: ON-LINE RETAIL STORE SERVICES FEATURING A VARIETY OF GOODS, NAMELY, HANDBAGS, JEWELRY, FASHION ACCESSORIES, CLOTHING AND APPAREL, IN CLASS 35 (U.S. CLS. 100, 101 AND 102).

FIRST USE 9-17-2002; IN COMMERCE 9-17-2002.

THE MARK CONSISTS OF STANDARD CHARACTERS WITHOUT CLAIM TO ANY PARTICULAR FONT, STYLE, SIZE, OR COLOR.

SER. NO. 77-355,874, FILED 12-19-2007.

TARAH HARDY, EXAMINING ATTORNEY

**Int. Cl.: 28**

**Prior U.S. Cls.: 22, 23, 38 and 50**

**United States Patent and Trademark Office**

**Reg. No. 3,453,647**

**Registered June 24, 2008**

**TRADEMARK  
PRINCIPAL REGISTER**

**YACKLE BALL**

TTALF CORPORATION (NORTH CAROLINA  
CORPORATION)  
369 S. MAIN ST.  
TROUTMAN, NC 28166

OWNER OF U.S. REG. NOS. 3,181,825 AND  
3,338,809.

FOR: SPORT BALLS, IN CLASS 28 (U.S. CLS. 22, 23,  
38 AND 50).

NO CLAIM IS MADE TO THE EXCLUSIVE  
RIGHT TO USE "BALL", APART FROM THE MARK  
AS SHOWN.

FIRST USE 5-20-1994; IN COMMERCE 5-20-1994.

SER. NO. 77-356,315, FILED 12-19-2007.

THE MARK CONSISTS OF STANDARD CHAR-  
ACTERS WITHOUT CLAIM TO ANY PARTICULAR  
FONT, STYLE, SIZE, OR COLOR.

ROBIN CHOSID, EXAMINING ATTORNEY

**Int. Cl.: 35**

**Prior U.S. Cls.: 100, 101 and 102**

**United States Patent and Trademark Office**

**Reg. No. 3,453,648**

**Registered June 24, 2008**

---

**SERVICE MARK  
PRINCIPAL REGISTER**

**VALUEBAGS**

I-GLOBMALL.COM, INC. (TEXAS CORPORATION)  
18570 PAINTBRUSH TRAIL  
SKY VALLEY, CA 92241

THE MARK CONSISTS OF STANDARD CHARACTERS WITHOUT CLAIM TO ANY PARTICULAR FONT, STYLE, SIZE, OR COLOR.

FOR: ON-LINE RETAIL STORE SERVICES FEATURING HANDBAGS, JEWELRY, FASHION ACCESSORIES, CLOTHING AND APPAREL, IN CLASS 35 (U.S. CLS. 100, 101 AND 102).

SER. NO. 77-356,788, FILED 12-20-2007.

FIRST USE 10-30-2001; IN COMMERCE 10-30-2001.

TARAH HARDY, EXAMINING ATTORNEY

**Int. Cl.: 41**

**Prior U.S. Cls.: 100, 101 and 107**

**United States Patent and Trademark Office**

**Reg. No. 3,453,649**

**Registered June 24, 2008**

**SERVICE MARK  
PRINCIPAL REGISTER**



MARTINDALE CONSULTANTS, INC. (OKLAHOMA CORPORATION)  
4242 NORTH MERIDIAN  
OKLAHOMA CITY, OK 73112

FOR: TRAINING SERVICES IN THE FIELD OF ACCOUNTING AS IT RELATES TO THE ENERGY INDUSTRY, IN CLASS 41 (U.S. CLS. 100, 101 AND 107).

FIRST USE 9-24-2007; IN COMMERCE 9-24-2007.

THE MARK CONSISTS OF LETTERING SUPERIMPOSED ON A WORLD GLOBE.

SER. NO. 77-357,187, FILED 12-20-2007.

JILL C. ALT, EXAMINING ATTORNEY

**Int. Cl.: 32**

**Prior U.S. Cls.: 45, 46 and 48**

**Reg. No. 3,453,650**

**United States Patent and Trademark Office**

**Registered June 24, 2008**

**TRADEMARK  
PRINCIPAL REGISTER**



CHOICE FIRST DISTRIBUTION, LLC (ARIZONA  
LTD LIAB CO)  
5225 N. CENTRAL AVE., SUITE 101  
PHOENIX, AZ 85012

THE MARK CONSISTS OF A BARBED WIRE  
KNOT WITH AN OUTER BORDER.

FOR: ENERGY DRINKS; SOFT DRINKS; SPORTS  
DRINKS, IN CLASS 32 (U.S. CLS. 45, 46 AND 48).

SER. NO. 77-358,004, FILED 12-21-2007.

FIRST USE 8-23-2007; IN COMMERCE 8-23-2007.

DAWN HAN, EXAMINING ATTORNEY

**Int. Cl.: 33**

**Prior U.S. Cls.: 47 and 49**

**United States Patent and Trademark Office**

**Reg. No. 3,453,651**

**Registered June 24, 2008**

**TRADEMARK  
PRINCIPAL REGISTER**

**BRIDGEWATER MILL**

LION NATHAN WINE GROUP AUSTRALIA  
LIMITED (AUSTRALIA LIMITED COMPANY  
(LTD.))  
LEVEL 30, 363 GEORGE STREET  
SYDNEY NSW 2000, AUSTRALIA

FOR: WINES, IN CLASS 33 (U.S. CLS. 47 AND 49).

THE MARK CONSISTS OF STANDARD CHAR-  
ACTERS WITHOUT CLAIM TO ANY PARTICULAR  
FONT, STYLE, SIZE, OR COLOR.

OWNER OF AUSTRALIA REG. NO. 584092, DA-  
TED 8-11-1992, EXPIRES 8-11-2009.

OWNER OF U.S. REG. NO. 2,396,014.

SER. NO. 77-358,197, FILED 12-21-2007.

DAVID MILLER, EXAMINING ATTORNEY

**Int. Cl.: 35**

**Prior U.S. Cls.: 100, 101 and 102**

**United States Patent and Trademark Office**

**Reg. No. 3,453,652**

**Registered June 24, 2008**

**SERVICE MARK  
PRINCIPAL REGISTER**

# Signature Growers

CARGILL, INCORPORATED (DELAWARE CORPORATION)  
15407 MCGINTY ROAD WEST  
WAYZATA, MN 55391

FOR: ADMINISTRATION OF A CUSTOMER RECOGNITION PROGRAM FOR GRAIN FARMERS AND SUPPLIERS THAT ENABLES THOSE WHO MEET CERTAIN CRITERIA TO RECEIVE MARKET COMMUNICATIONS AND PREFERRED ACCESS TO CONTRACTING OPPORTUNITIES, IN CLASS 35 (U.S. CLS. 100, 101 AND 102).

FIRST USE 3-31-2007; IN COMMERCE 3-31-2007.

THE MARK CONSISTS OF STANDARD CHARACTERS WITHOUT CLAIM TO ANY PARTICULAR FONT, STYLE, SIZE, OR COLOR.

NO CLAIM IS MADE TO THE EXCLUSIVE RIGHT TO USE "GROWERS", APART FROM THE MARK AS SHOWN.

SER. NO. 77-358,372, FILED 12-21-2007.

WILLIAM VERHOSEK, EXAMINING ATTORNEY

**Int. Cl.: 9**

**Prior U.S. Cls.: 21, 23, 26, 36 and 38**

**Reg. No. 3,453,653**

**United States Patent and Trademark Office**

**Registered June 24, 2008**

**TRADEMARK  
PRINCIPAL REGISTER**

**DRI BOX**

ARLINGTON INDUSTRIES, INC. (NEW YORK  
CORPORATION)  
9051 N.W. 97TH TERRACE  
MIAMI, FL 33178

OWNER OF U.S. REG. NO. 2,068,538.

FOR: ELECTRIC JUNCTION BOXES, IN CLASS 9  
(U.S. CLS. 21, 23, 26, 36 AND 38).

NO CLAIM IS MADE TO THE EXCLUSIVE  
RIGHT TO USE "BOX", APART FROM THE MARK  
AS SHOWN.

FIRST USE 3-1-1995; IN COMMERCE 3-1-1995.

SER. NO. 77-359,164, FILED 12-25-2007.

THE MARK CONSISTS OF STANDARD CHAR-  
ACTERS WITHOUT CLAIM TO ANY PARTICULAR  
FONT, STYLE, SIZE, OR COLOR.

CORY BOONE, EXAMINING ATTORNEY



**Int. Cl.: 36**

**Prior U.S. Cls.: 100, 101 and 102**

**United States Patent and Trademark Office**

**Reg. No. 3,453,654**

**Registered June 24, 2008**

**SERVICE MARK  
PRINCIPAL REGISTER**

# Unshakable

MARKEL CORPORATION (VIRGINIA CORPORATION), DBA MARKEL INSURANCE COMPANY  
MARKETING DEPARTMENT  
4600 COX ROAD  
GLEN ALLEN, VA 23060

FOR: INSURANCE UNDERWRITING SERVICES FOR ALL TYPES OF INSURANCE, IN CLASS 36 (U.S. CLS. 100, 101 AND 102).

FIRST USE 12-21-2007; IN COMMERCE 12-21-2007.

THE MARK CONSISTS OF STANDARD CHARACTERS WITHOUT CLAIM TO ANY PARTICULAR FONT, STYLE, SIZE, OR COLOR.

SER. NO. 77-360,257, FILED 12-27-2007.

ROBIN CHOSID, EXAMINING ATTORNEY

**Int. Cl.: 9**

**Prior U.S. Cls.: 21, 23, 26, 36 and 38**

**Reg. No. 3,453,655**

**United States Patent and Trademark Office**

**Registered June 24, 2008**

---

**TRADEMARK  
PRINCIPAL REGISTER**

**GREENTALKS**

BALL HORTICULTURAL COMPANY (ILLINOIS  
CORPORATION)  
622 TOWN ROAD  
WEST CHICAGO, IL 60185

FOR: DOWNLOADABLE ELECTRONIC NEWS-  
LETTER IN THE FIELDS OF AGRICULTURAL,  
HORTICULTURAL, GARDENING AND SUSTAIN-  
ABLE PRODUCTS AND MARKETING AND BUSI-  
NESS ISSUES RELATED THERETO , IN CLASS 9  
(U.S. CLS. 21, 23, 26, 36 AND 38).

FIRST USE 11-9-2007; IN COMMERCE 11-9-2007.

THE MARK CONSISTS OF STANDARD CHAR-  
ACTERS WITHOUT CLAIM TO ANY PARTICULAR  
FONT, STYLE, SIZE, OR COLOR.

SER. NO. 77-360,462, FILED 12-27-2007.

KEVIN DINALLO, EXAMINING ATTORNEY

**Int. Cl.: 41**

**Prior U.S. Cls.: 100, 101 and 107**

**United States Patent and Trademark Office**

**Reg. No. 3,453,656**

**Registered June 24, 2008**

**SERVICE MARK  
PRINCIPAL REGISTER**

**OMNIVORACIOUS**

AMAZON TECHNOLOGIES, INC. (NEVADA  
CORPORATION)  
ATTN: TRADEMARKS  
PO BOX 8102  
RENO, NV 89507

FOR: ONLINE JOURNALS, NAMELY, BLOGS  
FEATURING BOOKS AND AUTHORS, BOOK  
AWARDS, READING RECOMMENDATIONS, LIT-  
ERARY CRITICISM, HUMOR AND OTHER TOPICS  
OF GENERAL INTEREST TO AUTHORS, PUBLISH-  
ERS AND READERS, IN CLASS 41 (U.S. CLS. 100, 101  
AND 107).

FIRST USE 10-20-2007; IN COMMERCE 10-20-2007.

THE MARK CONSISTS OF STANDARD CHAR-  
ACTERS WITHOUT CLAIM TO ANY PARTICULAR  
FONT, STYLE, SIZE, OR COLOR.

SER. NO. 77-360,524, FILED 12-27-2007.

CHRIS WELLS, EXAMINING ATTORNEY

**Int. Cl.: 41**

**Prior U.S. Cls.: 100, 101 and 107**

**United States Patent and Trademark Office**

**Reg. No. 3,453,657**

**Registered June 24, 2008**

**SERVICE MARK  
PRINCIPAL REGISTER**

**AL DENTE**

AMAZON TECHNOLOGIES, INC. (NEVADA  
CORPORATION)  
ATTN: TRADEMARKS  
PO BOX 8102  
RENO, NV 89507

FOR: ONLINE JOURNALS, NAMELY, BLOGS  
FEATURING FOOD AND DRINKS, HEALTH AND  
NUTRITION, RESTAURANTS, CHEFS, RECIPES  
AND COOKBOOKS, HOUSEWARES, COOKING  
EQUIPMENT, KITCHEN APPLIANCES, CULINARY  
EDUCATION AND ENTERTAINMENT, IN CLASS  
41 (U.S. CLS. 100, 101 AND 107).

FIRST USE 10-27-2006; IN COMMERCE 10-27-2006.

THE MARK CONSISTS OF STANDARD CHAR-  
ACTERS WITHOUT CLAIM TO ANY PARTICULAR  
FONT, STYLE, SIZE, OR COLOR.

THE FOREIGN WORDING IN THE MARK  
TRANSLATES INTO ENGLISH AS TO THE TOOTH.

SER. NO. 77-360,527, FILED 12-27-2007.

CHRIS WELLS, EXAMINING ATTORNEY

**Int. Cl.: 39**

**Prior U.S. Cls.: 100 and 105**

**United States Patent and Trademark Office**

**Reg. No. 3,453,658**

**Registered June 24, 2008**

**SERVICE MARK  
PRINCIPAL REGISTER**

**REMOTELoad**

AMAZON TECHNOLOGIES, INC. (NEVADA  
CORPORATION)  
ATTN: TRADEMARKS  
PO BOX 8102  
RENO, NV 89705

FOR: DIGITAL MEDIA STORAGE, NAMELY,  
PHYSICAL STORAGE OF ELECTRONICALLY-  
STORED DATA OR DOCUMENTS; ELECTRONIC  
STORAGE OF DATA, IN CLASS 39 (U.S. CLS. 100  
AND 105).

FIRST USE 9-7-2006; IN COMMERCE 9-7-2006.

THE MARK CONSISTS OF STANDARD CHAR-  
ACTERS WITHOUT CLAIM TO ANY PARTICULAR  
FONT, STYLE, SIZE, OR COLOR.

SER. NO. 77-360,529, FILED 12-27-2007.

CHRIS WELLS, EXAMINING ATTORNEY

**Int. Cl.: 38**

**Prior U.S. Cls.: 100, 101 and 104**

**United States Patent and Trademark Office**

**Reg. No. 3,453,659**

**Registered June 24, 2008**

**SERVICE MARK  
PRINCIPAL REGISTER**

**REMOTELoad**

AMAZON TECHNOLOGIES, INC. (NEVADA  
CORPORATION)  
ATTN: TRADEMARKS  
PO BOX 8102  
RENO, NV 89507

FOR: TRANSMISSION OF ENTERTAINMENT  
AND EDUCATIONAL SOUND, VIDEO AND IN-  
FORMATION BY MEANS OF DIGITAL MEDIA  
TRANSMISSION OVER THE INTERNET, IN CLASS  
38 (U.S. CLS. 100, 101 AND 104).

FIRST USE 9-7-2006; IN COMMERCE 9-7-2006.

THE MARK CONSISTS OF STANDARD CHAR-  
ACTERS WITHOUT CLAIM TO ANY PARTICULAR  
FONT, STYLE, SIZE, OR COLOR.

SER. NO. 77-360,533, FILED 12-27-2007.

CHRIS WELLS, EXAMINING ATTORNEY

**Int. Cl.: 9**

**Prior U.S. Cls.: 21, 23, 26, 36 and 38**

**Reg. No. 3,453,660**

**United States Patent and Trademark Office**

**Registered June 24, 2008**

---

**TRADEMARK  
PRINCIPAL REGISTER**

**ANYBODY**

ARLINGTON INDUSTRIES, INC. (NEW YORK  
CORPORATION)  
9051 N.W. 97TH TERRACE  
MIAMI, FL 33178

THE MARK CONSISTS OF STANDARD CHAR-  
ACTERS WITHOUT CLAIM TO ANY PARTICULAR  
FONT, STYLE, SIZE, OR COLOR.

FOR: ELECTRIC JUNCTION BOXES, IN CLASS 9  
(U.S. CLS. 21, 23, 26, 36 AND 38).

SER. NO. 77-361,128, FILED 12-28-2007.

FIRST USE 11-1-2007; IN COMMERCE 11-1-2007.

CORY BOONE, EXAMINING ATTORNEY

**Int. Cl.: 33**

**Prior U.S. Cls.: 47 and 49**

**United States Patent and Trademark Office**

**Reg. No. 3,453,661**

**Registered June 24, 2008**

**TRADEMARK  
PRINCIPAL REGISTER**

**SVEDKA**

SPIRITS MARQUE ONE LLC (DELAWARE LTD  
LIAB CO)  
598 MADISON AVE., SUITE 4R  
NEW YORK, NY 10022

OWNER OF U.S. REG. NO. 2,126,196.

FOR: DISTILLED SPIRITS, FLAVORED VODKA,  
IN CLASS 33 (U.S. CLS. 47 AND 49).

SER. NO. 77-362,089, FILED 12-31-2007.

FIRST USE 12-9-1996; IN COMMERCE 12-9-1996.

SOPHIA S. KIM, EXAMINING ATTORNEY



**Int. Cl.: 39**

**Prior U.S. Cls.: 100 and 105**

**United States Patent and Trademark Office**

**Reg. No. 3,453,662**

**Registered June 24, 2008**

**SERVICE MARK  
PRINCIPAL REGISTER**

# City Lighting Van

EASTERN EFFECTS, INC. (DELAWARE CORPORATION)  
210 DOUGLASS STREET  
BROOKLYN, NY 11217

FOR: TRANSPORT BY SMALL TRUCKS OR VANS USED FOR THE FILM AND TELEVISION INDUSTRY, IN CLASS 39 (U.S. CLS. 100 AND 105).

FIRST USE 6-1-2006; IN COMMERCE 6-1-2006.

THE MARK CONSISTS OF STANDARD CHARACTERS WITHOUT CLAIM TO ANY PARTICULAR FONT, STYLE, SIZE, OR COLOR.

NO CLAIM IS MADE TO THE EXCLUSIVE RIGHT TO USE "LIGHTING VAN", APART FROM THE MARK AS SHOWN.

SER. NO. 77-362,383, FILED 1-2-2008.

BENJAMIN OKEKE, EXAMINING ATTORNEY

**Int. Cl.: 42**

**Prior U.S. Cls.: 100 and 101**

**United States Patent and Trademark Office**

**Reg. No. 3,453,663**

**Registered June 24, 2008**

**SERVICE MARK  
PRINCIPAL REGISTER**

# R-Attachments

RENAISSANCE SYSTEMS AND SERVICES, LLC  
(MICHIGAN LTD LIAB CO)  
4100 OKEMOS RD.  
OKEMOS, MI 48864

FOR: COMPUTER SERVICES, NAMELY, THE  
UPLOADING OF ELECTRONIC ATTACHMENTS  
FROM MEDICAL AND DENTAL OFFICES FOR  
SUBMITTING ELECTRONICALLY OR BY MAIL TO  
INSURANCE CARRIERS , IN CLASS 42 (U.S. CLS.  
100 AND 101).

FIRST USE 10-31-2006; IN COMMERCE 2-28-2007.

THE MARK CONSISTS OF STANDARD CHAR-  
ACTERS WITHOUT CLAIM TO ANY PARTICULAR  
FONT, STYLE, SIZE, OR COLOR.

SER. NO. 77-363,102, FILED 1-3-2008.

DEZMONA MIZELLE, EXAMINING ATTORNEY

**Int. Cl.: 18**

**Prior U.S. Cls.: 1, 2, 3, 22 and 41**

**Reg. No. 3,453,664**

**United States Patent and Trademark Office**

**Registered June 24, 2008**

**TRADEMARK  
PRINCIPAL REGISTER**

**CHARLOTTE**

GMA ACCESSORIES, INC. (NEW YORK CORPORATION)  
9TH FLOOR  
1 EAST 33RD STREET  
NEW YORK, NY 10016

FOR: LEATHER AND IMITATION LEATHER BAGS; ALL-PURPOSE CARRYING BAGS; CLUTCH BAGS; MESSENGER BAGS; FUR; SHOULDER BAGS; PET CLOTHING; PET COLLAR ACCESSORIES, NAMELY, BOWS AND CHARMS; BACKPACKS; BEACH BAGS, IN CLASS 18 (U.S. CLS. 1, 2, 3, 22 AND 41).

FIRST USE 11-1-1996; IN COMMERCE 11-1-1996.

THE MARK CONSISTS OF STANDARD CHARACTERS WITHOUT CLAIM TO ANY PARTICULAR FONT, STYLE, SIZE, OR COLOR.

OWNER OF U.S. REG. NOS. 2,216,405, 2,535,454 AND OTHERS.

SER. NO. 77-364,972, FILED 1-5-2008.

MICHAEL KAZAZIAN, EXAMINING ATTORNEY

**Int. Cl.: 41**

**Prior U.S. Cls.: 100, 101 and 107**

**United States Patent and Trademark Office**

**Reg. No. 3,453,665**

**Registered June 24, 2008**

**SERVICE MARK  
PRINCIPAL REGISTER**



MCCULLOUGH, PRESLEY L, (UNITED STATES INDIVIDUAL)  
63 W. HUDSON AVE. APT.B18  
ENGLEWOOD, NJ 07631

FOR: COUNSELING SERVICES IN THE FIELD PHYSICAL FITNESS; PHYSICAL FITNESS CONDITIONING CLASSES; PHYSICAL FITNESS CONSULTATION; PHYSICAL FITNESS INSTRUCTION; PROVIDING A WEBSITE FEATURING INFORMATION ON EXERCISE AND FITNESS; PROVIDING ASSISTANCE, PERSONAL TRAINING AND PHYSICAL FITNESS CONSULTATION TO CORPORATE CLIENTS TO HELP THEIR EMPLOYEES MAKE PHYSICAL FITNESS, STRENGTH, CONDITIONING, AND EXERCISE ALTERATIONS IN THEIR DAILY LIVING; PROVIDING ASSISTANCE, PERSONAL TRAINING AND PHYSICAL FITNESS CONSULTATION TO INDIVIDUALS TO HELP THEM MAKE PHYSICAL FITNESS, STRENGTH, CONDI-

TIONING, AND EXERCISE IMPROVEMENT IN THEIR DAILY LIVING; PROVIDING FITNESS AND EXERCISE FACILITIES, IN CLASS 41 (U.S. CLS. 100, 101 AND 107).

FIRST USE 10-11-2007; IN COMMERCE 10-16-2007.

NO CLAIM IS MADE TO THE EXCLUSIVE RIGHT TO USE "FITNESS BOXING CLUB", APART FROM THE MARK AS SHOWN.

THE MARK CONSISTS OF AN OVAL SHAPE - WITH THE WORDS: FITNESS BOXING CLUB INSIDE.

SER. NO. 77-367,117, FILED 1-9-2008.

TAMARA FRAZIER, EXAMINING ATTORNEY

**Int. Cl.: 41**

**Prior U.S. Cls.: 100, 101 and 107**

**United States Patent and Trademark Office**

**Reg. No. 3,453,666**

**Registered June 24, 2008**

**SERVICE MARK  
PRINCIPAL REGISTER**



LINDENWOOD FEMALE COLLEGE (MISSOURI  
CORPORATION CHARTERED BY THE MIS-  
SOURI GENERAL ASSEMBLY)  
209 S. KINGSHIGHWAY  
ST. CHARLES, MO 633011695

FOR: ENTERTAINMENT IN THE NATURE OF  
SPORTING EXHIBITIONS AND ATHLETIC COM-  
PETITIONS AT THE COLLEGE LEVEL, IN CLASS 41  
(U.S. CLS. 100, 101 AND 107).

FIRST USE 10-0-2004; IN COMMERCE 10-0-2004.

THE MARK CONSISTS OF A STYLIZED LION.

SER. NO. 77-373,513, FILED 1-16-2008.

SARA THOMAS, EXAMINING ATTORNEY

Int. Cl.: 41

Prior U.S. Cls.: 100, 101 and 107

United States Patent and Trademark Office

Reg. No. 3,453,667

Registered June 24, 2008

**SERVICE MARK  
PRINCIPAL REGISTER**



LINDENWOOD FEMALE COLLEGE (MISSOURI  
CORPORATION CHARTERED BY THE MIS-  
SOURI GENERAL ASSEMBLY)  
209 S. KINGSHIGHWAY  
ST. CHARLES, MO 633011695

FOR: ENTERTAINMENT IN THE NATURE OF  
SPORTING EXHIBITIONS AND ATHLETIC COM-  
PETITIONS AT THE COLLEGE LEVEL, IN CLASS 41  
(U.S. CLS. 100, 101 AND 107).

FIRST USE 9-0-2007; IN COMMERCE 9-0-2007.

THE STIPPLING IS FOR SHADING PURPOSES  
ONLY.

THE MARK CONSISTS OF A STYLIZED LION-  
ESS.

SER. NO. 77-373,521, FILED 1-16-2008.

ELLEN PERKINS, EXAMINING ATTORNEY

**Int. Cl.: 45**

**Prior U.S. Cls.: 100 and 101**

**United States Patent and Trademark Office**

**Reg. No. 3,453,668**

**Registered June 24, 2008**

**SERVICE MARK  
PRINCIPAL REGISTER**

**COSMOPOLITAN**

HEARST COMMUNICATIONS, INC. (DELA-  
WARE CORPORATION)  
959 EIGHTH AVENUE  
NEW YORK, NY 10019

FOR: PROVIDING A SELECTION OF ON-LINE  
ELECTRONIC GREETING CARDS, IN CLASS 45  
(U.S. CLS. 100 AND 101).

FIRST USE 5-24-2007; IN COMMERCE 5-24-2007.

THE MARK CONSISTS OF STANDARD CHAR-  
ACTERS WITHOUT CLAIM TO ANY PARTICULAR  
FONT, STYLE, SIZE, OR COLOR.

OWNER OF U.S. REG. NOS. 630,028, 1,911,389 AND  
OTHERS.

SER. NO. 77-378,270, FILED 1-23-2008.

JOHN E. MICHOS, EXAMINING ATTORNEY

**Int. Cl.: 25**

**Prior U.S. Cls.: 22 and 39**

**United States Patent and Trademark Office**

**Reg. No. 3,453,669**

**Registered June 24, 2008**

**TRADEMARK  
PRINCIPAL REGISTER**

**COSMOPOLITAN**

HEARST COMMUNICATIONS, INC. (DELA-  
WARE CORPORATION)

959 EIGHTH AVENUE

NEW YORK, NY 10019

FOR: SHIRTS, IN CLASS 25 (U.S. CLS. 22 AND 39).

FIRST USE 4-6-2007; IN COMMERCE 4-6-2007.

THE MARK CONSISTS OF STANDARD CHAR-  
ACTERS WITHOUT CLAIM TO ANY PARTICULAR  
FONT, STYLE, SIZE, OR COLOR.

OWNER OF U.S. REG. NOS. 630,028, 1,685,161 AND  
OTHERS.

SER. NO. 77-378,274, FILED 1-23-2008.

JOHN E. MICHOS, EXAMINING ATTORNEY



**Int. Cl.: 18**

**Prior U.S. Cls.: 1, 2, 3, 22 and 41**

**United States Patent and Trademark Office**

**Reg. No. 3,453,670**

**Registered June 24, 2008**

**TRADEMARK  
PRINCIPAL REGISTER**

**COSMOPOLITAN**

HEARST COMMUNICATIONS, INC. (DELA-  
WARE CORPORATION)  
959 EIGHTH AVENUE  
NEW YORK, NY 10019

FOR: COSMETIC BAGS SOLD EMPTY, IN CLASS  
18 (U.S. CLS. 1, 2, 3, 22 AND 41).

FIRST USE 4-6-2007; IN COMMERCE 4-6-2007.

THE MARK CONSISTS OF STANDARD CHAR-  
ACTERS WITHOUT CLAIM TO ANY PARTICULAR  
FONT, STYLE, SIZE, OR COLOR.

OWNER OF U.S. REG. NOS. 630,028, 3,276,308 AND  
OTHERS.

SER. NO. 77-378,278, FILED 1-23-2008.

JOHN E. MICHOS, EXAMINING ATTORNEY

**Int. Cl.: 45**

**Prior U.S. Cls.: 100 and 101**

**United States Patent and Trademark Office**

**Reg. No. 3,453,671**

**Registered June 24, 2008**

**SERVICE MARK  
PRINCIPAL REGISTER**

**COSMO GIRL!**

HEARST COMMUNICATIONS, INC. (DELA-  
WARE CORPORATION)  
959 EIGHTH AVENUE  
NEW YORK, NY 10019

FOR: PROVIDING A SELECTION OF ON-LINE  
ELECTRONIC GREETING CARDS, IN CLASS 45  
(U.S. CLS. 100 AND 101).

FIRST USE 2-23-2007; IN COMMERCE 2-23-2007.

THE MARK CONSISTS OF STANDARD CHAR-  
ACTERS WITHOUT CLAIM TO ANY PARTICULAR  
FONT, STYLE, SIZE, OR COLOR.

OWNER OF U.S. REG. NOS. 2,407,134, 2,976,367  
AND OTHERS.

SER. NO. 77-378,790, FILED 1-23-2008.

JOHN E. MICHOS, EXAMINING ATTORNEY

**Int. Cl.: 6**

**Prior U.S. Cls.: 2, 12, 13, 14, 23, 25 and 50**

**Reg. No. 3,453,672**

**United States Patent and Trademark Office**

**Registered June 24, 2008**

**TRADEMARK  
PRINCIPAL REGISTER**



AMERICAN INTERNATIONAL GROUP, INC.  
(DELAWARE CORPORATION)  
70 PINE STREET  
NEW YORK, NY 10270

OWNER OF U.S. REG. NOS. 1,151,229, 1,273,845  
AND OTHERS.

FOR: PIGGY BANKS MADE OF PRECIOUS METAL;  
BOTTLE CLOSURES OF METAL, IN CLASS 6  
(U.S. CLS. 2, 12, 13, 14, 23, 25 AND 50).

SER. NO. 77-380,911, FILED 1-25-2008.

FIRST USE 5-1-2006; IN COMMERCE 5-1-2006.

DANNEAN HETZEL, EXAMINING ATTORNEY

**Int. Cl.: 9**

**Prior U.S. Cls.: 21, 23, 26, 36 and 38**

**Reg. No. 3,453,673**

**United States Patent and Trademark Office**

**Registered June 24, 2008**

**TRADEMARK  
PRINCIPAL REGISTER**



AMERICAN INTERNATIONAL GROUP, INC.  
(DELAWARE CORPORATION)  
70 PINE STREET  
NEW YORK, NY 10270

OWNER OF U.S. REG. NOS. 1,151,229, 1,273,845  
AND OTHERS.

FOR: LASER POINTERS; MP3 PLAYERS, IN  
CLASS 9 (U.S. CLS. 21, 23, 26, 36 AND 38).

SER. NO. 77-380,928, FILED 1-25-2008.

FIRST USE 2-1-2007; IN COMMERCE 2-1-2007.

DANNEAN HETZEL, EXAMINING ATTORNEY

**Int. Cl.: 14**

**Prior U.S. Cls.: 2, 27, 28 and 50**

**United States Patent and Trademark Office**

**Reg. No. 3,453,674**

**Registered June 24, 2008**

**TRADEMARK  
PRINCIPAL REGISTER**



AMERICAN INTERNATIONAL GROUP, INC.  
(DELAWARE CORPORATION)  
70 PINE STREET  
NEW YORK, NY 10270

OWNER OF U.S. REG. NOS. 1,151,229, 1,273,845  
AND OTHERS.

FOR: CLOCKS AND WATCHES, IN CLASS 14 (U.S.  
CLS. 2, 27, 28 AND 50).

SER. NO. 77-380,951, FILED 1-25-2008.

FIRST USE 6-1-2005; IN COMMERCE 6-1-2005.

DANNEAN HETZEL, EXAMINING ATTORNEY

**Int. Cl.: 20**

**Prior U.S. Cls.: 2, 13, 22, 25, 32 and 50**

**United States Patent and Trademark Office**

**Reg. No. 3,453,675**

**Registered June 24, 2008**

**TRADEMARK  
PRINCIPAL REGISTER**



AMERICAN INTERNATIONAL GROUP, INC.  
(DELAWARE CORPORATION)  
70 PINE STREET  
NEW YORK, NY 10270

OWNER OF U.S. REG. NOS. 1,151,229, 1,273,845  
AND OTHERS.

FOR: PICTURE FRAMES; CHAIRS, IN CLASS 20  
(U.S. CLS. 2, 13, 22, 25, 32 AND 50).

SER. NO. 77-380,963, FILED 1-25-2008.

FIRST USE 3-1-2007; IN COMMERCE 3-1-2007.

DANNEAN HETZEL, EXAMINING ATTORNEY

**Int. Cl.: 24**

**Prior U.S. Cls.: 42 and 50**

**United States Patent and Trademark Office**

**Reg. No. 3,453,676**

**Registered June 24, 2008**

**TRADEMARK  
PRINCIPAL REGISTER**



AMERICAN INTERNATIONAL GROUP, INC.  
(DELAWARE CORPORATION)  
70 PINE STREET  
NEW YORK, NY 10270

OWNER OF U.S. REG. NOS. 1,151,229, 1,273,845  
AND OTHERS.

FOR: BLANKETS FOR OUTDOOR USE; BEACH  
TOWELS, IN CLASS 24 (U.S. CLS. 42 AND 50).

SER. NO. 77-380,969, FILED 1-25-2008.

FIRST USE 3-1-2007; IN COMMERCE 3-1-2007.

DANNEAN HETZEL, EXAMINING ATTORNEY

**Int. Cl.: 16**

**Prior U.S. Cls.: 2, 5, 22, 23, 29, 37, 38 and 50**

**Reg. No. 3,453,677**

**United States Patent and Trademark Office**

**Registered June 24, 2008**

**TRADEMARK  
PRINCIPAL REGISTER**

**COMMON SENSE ON A ROLL**

KIMBERLY-CLARK WORLDWIDE, INC. (DELA-  
WARE CORPORATION)  
401 NORTH LAKE STREET  
NEENAH, WI 54956

FOR: PAPER PRODUCTS, NAMELY, BATH TIS-  
SUE AND PAPER TOWELS, IN CLASS 16 (U.S. CLS.  
2, 5, 22, 23, 29, 37, 38 AND 50).

FIRST USE 7-8-2005; IN COMMERCE 7-8-2005.

THE MARK CONSISTS OF STANDARD CHAR-  
ACTERS WITHOUT CLAIM TO ANY PARTICULAR  
FONT, STYLE, SIZE, OR COLOR.

NO CLAIM IS MADE TO THE EXCLUSIVE  
RIGHT TO USE "ON A ROLL", APART FROM THE  
MARK AS SHOWN.

SER. NO. 77-381,059, FILED 1-25-2008.

PRISCILLA MILTON, EXAMINING ATTORNEY



**Int. Cl.: 3**

**Prior U.S. Cls.: 1, 4, 6, 50, 51 and 52**

**United States Patent and Trademark Office**

**Reg. No. 3,453,678**

**Registered June 24, 2008**

**TRADEMARK  
PRINCIPAL REGISTER**

SWINGIT, INC. (NEW YORK CORPORATION)  
1787 MADISON, AVE.  
NEW YORK, NY 10035

FOR: HAIR CONDITIONER; HAIR CREAMS;  
HAIR SHAMPOO; HAIR LOTION, IN CLASS 3 (U.S.  
CLS. 1, 4, 6, 50, 51 AND 52).

FIRST USE 12-1-2007; IN COMMERCE 12-1-2007.

NO CLAIM IS MADE TO THE EXCLUSIVE  
RIGHT TO USE "WEAVE", APART FROM THE  
MARK AS SHOWN.

THE COLOR(S) PURPLE IS/ARE CLAIMED AS A  
FEATURE OF THE MARK.

THE MARK CONSISTS OF THE WORD "WEAVE  
AID" IN PURPLE, CURSIVE SCRIPT.

SER. NO. 77-381,596, FILED 1-27-2008.

BARNEY CHARLON, EXAMINING ATTORNEY

**Int. Cls.: 9 and 39**

**Prior U.S. Cls.: 21, 23, 26, 36, 38, 100 and 105**

**United States Patent and Trademark Office**

**Reg. No. 3,453,679**

**Registered June 24, 2008**

**TRADEMARK  
SERVICE MARK  
PRINCIPAL REGISTER**



ESKER, S.A. (FRANCE SOCIÉTÉ ANONYME (SA))  
10, RUE DES EMERAUDES F-69006  
LYON, FRANCE

FOR: COMPUTER SOFTWARE FOR ACCESSING PERSONAL COMPUTER TO HOST CONNECTIVITY, WEB BROWSER TO HOST CONNECTIVITY, AND THIN-CLIENT TO HOST CONNECTIVITY AND INSTRUCTIONAL MANUALS SOLD AS A UNIT, COMPUTER SOFTWARE FOR FILE TRANSFERRING, FAX ROUTING, PROVIDING DATABASE ACCESS TO MESSAGING AND FAX APPLICATIONS, PRINTING, AND RENEWING LEGACY APPLICATIONS THROUGH WEB INTEGRATION AND INSTRUCTIONAL MANUALS SOLD AS A UNIT, COMPUTER SOFTWARE FOR CONNECTING VARIED USER POPULATIONS TO CRITICAL HOST, DATA, AND NETWORK RESOURCES AND INSTRUCTIONAL MANUALS SOLD AS A UNIT, COMPUTER SOFTWARE THAT INTEGRATES PERSONAL COMPUTERS INTO HETEROGENEOUS NETWORKS AND INSTRUCTIONAL MANUALS SOLD AS A UNIT, COMPUTER SOFTWARE THAT PROVIDES DATABASE ACCESS TO LOCAL AND GLOBAL COMPUTER INFORMATION NETWORKS AND INSTRUCTIONAL MANUALS SOLD AS A UNIT, IN CLASS 9 (U.S. CLS. 21, 23, 26, 36 AND 38).

FIRST USE 4-23-2006; IN COMMERCE 4-23-2006.

FOR: SHIPPING AND DELIVERY SERVICES, NAMELY, PICKUP, PACKAGING, STORAGE, TRANSPORT, RELAY AND DELIVERY OF PARCELS, MAIL, PACKAGES, WRITTEN ITEMS AND OTHER INFORMATION, IN PARTICULAR LETTERS, POSTCARDS, PRINTED MATTER, ADVERTISING MAILINGS, ADVERTISING MAILINGS WITH OR WITHOUT ADDRESS, CONSIGNMENTS OF BOOKS, UNADDRESSED MAILINGS, NEWSPAPERS, PERIODICALS, BY ALL MEANS OF TRANSPORT, NAMELY, TRANSPORTATION BY AIR, BOAT, RAIL, TRUCK, TRAIN; STORAGE OF DATA AND DOCUMENTS HELD IN ELECTRONIC FORM FOR THE PRODUCTION OF POSTAL ITEMS AND MAILINGS, NAMELY, CIRCULARS, FOR OTHERS; PROVIDING INFORMATION VIA THE INTERNET REGARDING THE TRANSPORT OF GOODS, IN PARTICULAR LETTERS, PARCELS, SMALL PARCELS, IN CLASS 39 (U.S. CLS. 100 AND 105).

FIRST USE 4-23-2006; IN COMMERCE 4-23-2006.

OWNER OF U.S. REG. NOS. 2,600,175 AND 2,609,660.

SER. NO. 77-381,898, FILED 1-28-2008.

MICHAEL TANNER, EXAMINING ATTORNEY

**Int. Cl.: 21**

**Prior U.S. Cls.: 2, 13, 23, 29, 30, 33, 40 and 50**

**Reg. No. 3,453,680**

**United States Patent and Trademark Office**

**Registered June 24, 2008**

**TRADEMARK  
PRINCIPAL REGISTER**



AMERICAN INTERNATIONAL GROUP, INC.  
(DELAWARE CORPORATION)  
70 PINE STREET  
NEW YORK, NY 10270

OWNER OF U.S. REG. NOS. 1,151,229, 1,273,845  
AND OTHERS.

FOR: BOTTLE OPENERS, IN CLASS 21 (U.S. CLS.  
2, 13, 23, 29, 30, 33, 40 AND 50).

SER. NO. 77-381,914, FILED 1-28-2008.

FIRST USE 8-1-2006; IN COMMERCE 8-1-2006.

DANNEAN HETZEL, EXAMINING ATTORNEY

**Int. Cl.: 29**

**Prior U.S. Cl.: 46**

**United States Patent and Trademark Office**

**Reg. No. 3,453,681**

**Registered June 24, 2008**

**TRADEMARK  
PRINCIPAL REGISTER**



AMERICAN INTERNATIONAL GROUP, INC.  
(DELAWARE CORPORATION)  
70 PINE STREET  
NEW YORK, NY 10270

OWNER OF U.S. REG. NOS. 1,151,229, 1,273,845  
AND OTHERS.

FOR: PROCESSED ALMONDS, IN CLASS 29 (U.S.  
CL. 46).

SER. NO. 77-381,937, FILED 1-28-2008.

FIRST USE 11-1-2007; IN COMMERCE 11-1-2007.

DANNEAN HETZEL, EXAMINING ATTORNEY

**Int. Cl.: 30**

**Prior U.S. Cl.: 46**

**United States Patent and Trademark Office**

**Reg. No. 3,453,682**

**Registered June 24, 2008**

**TRADEMARK  
PRINCIPAL REGISTER**



AMERICAN INTERNATIONAL GROUP, INC.  
(DELAWARE CORPORATION)  
70 PINE STREET  
NEW YORK, NY 10270

OWNER OF U.S. REG. NOS. 1,151,229, 1,273,845  
AND OTHERS.

FOR: CHEWING GUM, IN CLASS 30 (U.S. CL. 46).

SER. NO. 77-381,946, FILED 1-28-2008.

FIRST USE 2-1-2005; IN COMMERCE 2-1-2005.

DANNEAN HETZEL, EXAMINING ATTORNEY

**Int. Cl.: 5**

**Prior U.S. Cls.: 6, 18, 44, 46, 51 and 52**

**United States Patent and Trademark Office**

**Reg. No. 3,453,683**

**Registered June 24, 2008**

**TRADEMARK  
PRINCIPAL REGISTER**



AMERICAN INTERNATIONAL GROUP, INC.  
(DELAWARE CORPORATION)  
70 PINE STREET  
NEW YORK, NY 10270

OWNER OF U.S. REG. NOS. 1,151,229, 1,273,845  
AND OTHERS.

FOR: ANTIBACTERIAL ALCOHOL SKIN SANI-  
TIZER GEL, IN CLASS 5 (U.S. CLS. 6, 18, 44, 46, 51  
AND 52).

SER. NO. 77-381,956, FILED 1-28-2008.

FIRST USE 8-1-2005; IN COMMERCE 8-1-2005.

DANNEAN HETZEL, EXAMINING ATTORNEY

**Int. Cl.: 35**

**Prior U.S. Cls.: 100, 101 and 102**

**United States Patent and Trademark Office**

**Reg. No. 3,453,684**

**Registered June 24, 2008**

**SERVICE MARK  
PRINCIPAL REGISTER**

**Books.  Hand**

AMERICAN READING COMPANY (PENNSYLVANIA CORPORATION)  
201 S. GULPH ROAD  
KING OF PRUSSIA, PA 19406

FOR: ONLINE RETAIL BOOK STORE SERVICES; RETAIL BOOK STORE SERVICES; RETAIL BOOK STORE SERVICES IN THE FIELD OF A READING PROGRAM FOR PRE-KINDERGARTEN THROUGH SECONDARY SCHOOL STUDENTS FOR ASSESSING THE LEVEL OF DIFFICULTY OF BOOKS, IN CLASS 35 (U.S. CLS. 100, 101 AND 102).

FIRST USE 1-1-2008; IN COMMERCE 1-1-2008.

NO CLAIM IS MADE TO THE EXCLUSIVE RIGHT TO USE "BOOKS", APART FROM THE MARK AS SHOWN.

THE MARK CONSISTS OF BOOKS "IN HAND" WITH TWO HANDS IN THE "H".

SER. NO. 77-387,872, FILED 2-4-2008.

NAPOLEON SHARMA, EXAMINING ATTORNEY

**Int. Cls.: 35 and 39**

**Prior U.S. Cls.: 100, 101, 102 and 105**

**United States Patent and Trademark Office**

**Reg. No. 3,453,685**

**Registered June 24, 2008**

**SERVICE MARK  
PRINCIPAL REGISTER**



TRAVEL JOURNALISTS GUILD (DELAWARE CORPORATION)  
P.O. BOX 10643  
CHICAGO, IL 60610

FOR: ASSOCIATION SERVICES, NAMELY, PROMOTING THE INTEREST OF TRAVEL PROFESSIONALS, IN CLASS 35 (U.S. CLS. 100, 101 AND 102).

FIRST USE 9-26-2006; IN COMMERCE 9-26-2006.

FOR: TRAVEL INFORMATION SERVICES; PROVIDING ON-LINE COMPUTER DATABASE IN THE FIELD OF TRAVEL INFORMATION SERVICES; PROVIDING REVIEWS OF TRAVEL SERVICES PROVIDERS, TRAVEL DESTINATIONS, AND LO-

CAL ATTRACTIONS VIA A GLOBAL COMPUTER NETWORK, IN CLASS 39 (U.S. CLS. 100 AND 105).

FIRST USE 9-26-2006; IN COMMERCE 9-26-2006.

THE MARK CONSISTS OF THE WORDS "TRAVEL JOURNALISTS GUILD" AND A CURVED LINE TO THE LEFT OF THE WORDING.

SEC. 2(F) AS TO "TRAVEL JOURNALISTS GUILD".

SER. NO. 77-975,185, FILED 4-24-2007.

SALLY SHIH, EXAMINING ATTORNEY



**Int. Cl.: 25**

**Prior U.S. Cls.: 22 and 39**

**United States Patent and Trademark Office**

**Reg. No. 3,453,686**

**Registered June 24, 2008**

**TRADEMARK  
PRINCIPAL REGISTER**

**THE ABBEY FOOD & BAR**

ABBAY RESTAURANTS AND BARS USA, LLC  
(DELAWARE LTD LIAB CO)

8000 BEVERLY BOULEVARD

LOS ANGELES, CA 90048

FOR: T-SHIRTS, IN CLASS 25 (U.S. CLS. 22 AND  
39).

FIRST USE 0-0-1995; IN COMMERCE 0-0-1995.

THE MARK CONSISTS OF STANDARD CHAR-  
ACTERS WITHOUT CLAIM TO ANY PARTICULAR  
FONT, STYLE, SIZE, OR COLOR.

NO CLAIM IS MADE TO THE EXCLUSIVE  
RIGHT TO USE "FOOD & BAR", APART FROM  
THE MARK AS SHOWN.

SER. NO. 77-975,186, FILED 2-23-2007.

RUDY R. SINGLETON, EXAMINING ATTORNEY

**Int. Cl.: 5**

**Prior U.S. Cls.: 6, 18, 44, 46, 51 and 52**

**United States Patent and Trademark Office**

**Reg. No. 3,453,687**

**Registered June 24, 2008**

**TRADEMARK  
PRINCIPAL REGISTER**

**PERGOVERIS**

ARES TRADING S.A. (SWITZERLAND SOCIETE  
ANONYME)

ZONE INDUSTRIELLE DE L'OURIETTAZ

AUBONNE, SWITZERLAND CH-1170

FOR: PHARMACEUTICAL PREPARATIONS FOR  
HUMAN USE, NAMELY, PREPARATIONS FOR  
THE TREATMENT OF INFERTILITY DISEASES  
AND DISORDERS, IN CLASS 5 (U.S. CLS. 6, 18, 44,  
46, 51 AND 52).

THE MARK CONSISTS OF STANDARD CHAR-  
ACTERS WITHOUT CLAIM TO ANY PARTICULAR  
FONT, STYLE, SIZE, OR COLOR.

PRIORITY CLAIMED UNDER SEC. 44(D) ON  
SWITZERLAND APPLICATION NO. 60628/2006,  
FILED 11-23-2006, REG. NO. 552917, DATED 11-29-  
2006, EXPIRES 11-23-2016.

SER. NO. 77-975,217, FILED 5-16-2007.

KIMBERLY FRYE, EXAMINING ATTORNEY

**Int. Cl.: 9**

**Prior U.S. Cls.: 21, 23, 26, 36 and 38**

**Reg. No. 3,453,688**

**United States Patent and Trademark Office**

**Registered June 24, 2008**

**TRADEMARK  
PRINCIPAL REGISTER**



THE RAY CHARLES FOUNDATION (CALIFORNIA CORPORATION)  
2107 WEST WASHINGTON BOULEVARD  
SUITE 200  
LOS ANGELES, CA 90018

THE MARK CONSISTS OF A CARICATURE OF DECEASED SINGER RAY CHARLES FEATURING THE LAPELS OF A SUIT JACKET, THE BREAST OF A DRESS SHIRT, A BOW TIE, AND THE FACE OF RAY CHARLES WEARING SUNGLASSES.

FOR: PRERECORDED AUDIO TAPES, AUDIO CASSETTES, AUDIO DISCS, AUDIO SOUND RECORDINGS, AUDIO DIGITAL TAPES, CD'S, ALL FEATURING MUSIC AND SPEECH , IN CLASS 9 (U.S. CLS. 21, 23, 26, 36 AND 38).

SER. NO. 77-975,498, FILED 12-11-2006.

FIRST USE 0-0-2002; IN COMMERCE 0-0-2002.

SANJEEV VOHRA, EXAMINING ATTORNEY

**Int. Cls.: 42 and 45**

**Prior U.S. Cls.: 100 and 101**

**United States Patent and Trademark Office**

**Reg. No. 3,453,689**

**Registered June 24, 2008**

**SERVICE MARK  
PRINCIPAL REGISTER**

# LifeTraits

ZELENY GROUP LLC (COLORADO LTD LIAB  
CO)  
P.O. BOX 270704  
FORT COLLINS, CO 80527

FOR: (BASED ON USE) CONSULTATION IN THE FIELD OF INTERIOR DESIGN FEATURING PERSONALITY TYPING TO FIND THE BEST LIFESTYLE CHOICES FOR THE DESIGN OF ONES ENVIRONMENT; PROVIDING INFORMATION IN THE FIELD OF INTERIOR DESIGN FEATURING PERSONALITY TYPING TO FIND THE BEST LIFESTYLE CHOICES FOR THE DESIGN OF ONES ENVIRONMENT VIA THE INTERNET; INTERIOR DESIGN SERVICES, NAMELY TEST ADMINISTRATION AND EVALUATION FEATURING PERSONALITY TYPING TO FIND THE BEST LIFESTYLE CHOICES FOR THE DESIGN OF ONES ENVIRONMENT; PROVIDING TEMPORARY USE OF ON-LINE NON-DOWNLOADABLE SOFTWARE FOR TESTING AND SCORING OF TESTS OVER THE INTERNET IN THE FIELD OF INTERIOR DESIGN

FEATURING PERSONALITY TYPING TO FIND THE BEST LIFESTYLE CHOICES FOR THE DESIGN OF ONES ENVIRONMENT, IN CLASS 42 (U.S. CLS. 100 AND 101).

FIRST USE 12-31-2001; IN COMMERCE 5-26-2002.

FOR: (BASED ON USE) PERSONAL LIFESTYLE CONSULTING SERVICES, IN CLASS 45 (U.S. CLS. 100 AND 101).

FIRST USE 12-31-2001; IN COMMERCE 5-26-2002.

THE MARK CONSISTS OF STANDARD CHARACTERS WITHOUT CLAIM TO ANY PARTICULAR FONT, STYLE, SIZE, OR COLOR.

SER. NO. 77-975,603, FILED 10-10-2006.

SIMON TENG, EXAMINING ATTORNEY

**Int. Cl.: 18**

**Prior U.S. Cls.: 1, 2, 3, 22 and 41**

**Reg. No. 3,453,690**

**United States Patent and Trademark Office**

**Registered June 24, 2008**

**TRADEMARK  
PRINCIPAL REGISTER**

**NEWEST**

SHANGHAI OVERSEAS IMPORT & EXPORT CO.  
LTD. (CHINA CORPORATION)  
TANGCHEN CENTER NO. 158  
ZHANGYANG ROAD, PUDONG DISTRICT  
SHANGHAI, CHINA N/A

FOR: BACKPACKS, KNAPSACKS, RUCKSACKS,  
LUGGAGE, TRAVEL BAGS, BRIEFCASES, AT-  
TACHE' CASES, HANDBAGS, SHOULDER BAGS,  
VANITY CASES SOLD EMPTY, GARMENT BAGS  
FOR TRAVEL, STRAPS FOR HANDBAGS, STRAPS

FOR LUGGAGE, ALL THE FOREGOING GOODS  
NOT PRINCIPALLY OF LEATHER, IN CLASS 18  
(U.S. CLS. 1, 2, 3, 22 AND 41).

FIRST USE 11-22-1996; IN COMMERCE 10-17-1999.

SER. NO. 78-173,441, FILED 10-11-2002.

MARY CRAWFORD, EXAMINING ATTORNEY

**Int. Cl.: 16**

**Prior U.S. Cls.: 2, 5, 22, 23, 29, 37, 38 and 50**

**United States Patent and Trademark Office**

**Reg. No. 3,453,691**

**Registered June 24, 2008**

---

**TRADEMARK  
PRINCIPAL REGISTER**

**PUP FICTION**

HEFLICK, LAMONTE O. (UNITED STATES IN-  
DIVIDUAL)  
30862 JANET  
GRANGER, IN 46530

NO CLAIM IS MADE TO THE EXCLUSIVE  
RIGHT TO USE "FICTION", APART FROM THE  
MARK AS SHOWN.

FOR: BOOKS IN THE FIELD OF CHILDREN'S  
BOOKS, IN CLASS 16 (U.S. CLS. 2, 5, 22, 23, 29, 37, 38  
AND 50).

SER. NO. 78-221,471, FILED 3-4-2003.

FIRST USE 4-4-2001; IN COMMERCE 4-4-2001.

TARAH HARDY, EXAMINING ATTORNEY

**Int. Cl.: 3**

**Prior U.S. Cls.: 1, 4, 6, 50, 51 and 52**

**Reg. No. 3,453,692**

**United States Patent and Trademark Office**

**Registered June 24, 2008**

---

**TRADEMARK  
PRINCIPAL REGISTER**

**PLUSH PUPPY**

PLUSH PUPPY PTY LTD. (AUSTRALIA CORPORATION)  
24 RUTLAND ROAD  
BOX HILL, VICTORIA, AUSTRALIA 3128

FOR: DOG CARE PRODUCTS, NAMELY, NON-MEDICATED GROOMING PREPARATIONS FOR DOGS AND PUPPIES, NAMELY, SHAMPOOS AND HAIR CONDITIONERS FOR DOGS AND PUPPIES; NON-MEDICATED SKIN CARE AND HAIR CARE PREPARATIONS FOR DOGS AND PUPPIES; SOAPS FOR DOGS AND PUPPIES, ALL OF THE FOREGOING TARGETED AT OWNERS AND BREEDERS OF SHOW DOGS AND OTHER PROFESSIONALS IN

THE DOG SHOW BUSINESS SEEKING GROOMING PRODUCTS, IN CLASS 3 (U.S. CLS. 1, 4, 6, 50, 51 AND 52).

FIRST USE 3-31-2000; IN COMMERCE 3-31-2000.

NO CLAIM IS MADE TO THE EXCLUSIVE RIGHT TO USE "PUPPY", APART FROM THE MARK AS SHOWN.

SER. NO. 78-235,740, FILED 4-9-2003.

JAMES GRIFFIN, EXAMINING ATTORNEY

**Int. Cls.: 9, 16 and 35**

**Prior U.S. Cls.: 2, 5, 21, 22, 23, 26, 29, 36, 37, 38, 50,  
100, 101 and 102**

**Reg. No. 3,453,693**

**United States Patent and Trademark Office**

**Registered June 24, 2008**

**TRADEMARK  
SERVICE MARK  
PRINCIPAL REGISTER**

**DDD**

IMS SOFTWARE SERVICES, LTD. (DELAWARE CORPORATION)  
SUITE 402, PENNSYLVANIA BUILDING  
110 SOUTH FRENCH STREET  
WILMINGTON, DE 19801

FOR: DOWNLOADABLE REPORTS PROVIDING SALES INFORMATION RELATED TO THE PHARMACEUTICAL AND HEALTHCARE INDUSTRIES VIA THE INTERNET AND ON ELECTRONIC MEDIA, NAMELY, RECORDABLE MAGNETIC TAPES, CD-ROMS, FLOPPY DISKETTES, AND/OR IN ELECTRONIC FORMAT VIA FTP OR VPN; COMPUTER SOFTWARE AND INSTRUCTIONAL MANUALS THEREFORE IN THE PHARMACEUTICAL, MEDICAL AND HEALTH CARE INDUSTRIES FOR ACCESSING, ANALYZING AND DISPLAYING INFORMATION ON SALES AND DEMOGRAPHICS OF PHARMACEUTICALS; ELECTRONIC DATABASES RECORDED ON COMPUTER MEDIA IN THE PHARMACEUTICAL, MEDICAL AND HEALTH CARE INDUSTRIES; MICROFICHE CONTAINING INFORMATION RELATED TO SALES AND DEMOGRAPHIC INFORMATION IN THE PHARMACEUTICAL, MEDICAL AND HEALTHCARE

INDUSTRIES, IN CLASS 9 (U.S. CLS. 21, 23, 26, 36 AND 38).

FIRST USE 0-0-1972; IN COMMERCE 0-0-1972.

FOR: PRINTED REPORTS AND PRINT TAPES CONTAINING INFORMATION RELATED TO SALES AND DEMOGRAPHIC INFORMATION IN THE PHARMACEUTICAL, MEDICAL AND HEALTHCARE INDUSTRIES, IN CLASS 16 (U.S. CLS. 2, 5, 22, 23, 29, 37, 38 AND 50).

FIRST USE 0-0-1969; IN COMMERCE 0-0-1969.

FOR: BUSINESS MARKET CONSULTATION SERVICES RELATED TO THE PHARMACEUTICAL, MEDICAL, AND HEALTHCARE INDUSTRIES, IN CLASS 35 (U.S. CLS. 100, 101 AND 102).

FIRST USE 0-0-1969; IN COMMERCE 0-0-1969.

SER. NO. 78-242,667, FILED 4-28-2003.

INGRID C. EULIN, EXAMINING ATTORNEY



**Int. Cl.: 9**

**Prior U.S. Cls.: 21, 23, 26, 36 and 38**

**Reg. No. 3,453,694**

**United States Patent and Trademark Office**

**Registered June 24, 2008**

---

**TRADEMARK  
PRINCIPAL REGISTER**

**INNOVA**

INNOVA HOLDINGS, INC. (TEXAS CORPORATION)  
8383 N. SAM HOUSTON PKWY W.  
HOUSTON, TX 770643452

FOR: LOW VOLTAGE ELECTRONIC POWER SUPPLY UNITS SOLD FOR DOWNHOLE TOOLS USED IN MEASUREMENT-WHILE-DRILLING TOOLS; HIGH VOLTAGE ELECTRONIC SUPPLY UNITS SOLD FOR USE IN CONNECTION WITH NUCLEAR DETECTORS, RUGGEDIZED, HIGH TEMPERATURE ELECTRONIC DEVICES SOLD IN

THE PETROCHEMICAL, MILITARY, MEDICAL AND AEROSPACE INDUSTRIES, NAMELY-SUN-LIGHT VIEWABLE DISPLAY MONITORS AND RACK-AND-PANEL-MOUNT VIDEO MONITORS, IN CLASS 9 (U.S. CLS. 21, 23, 26, 36 AND 38).

FIRST USE 12-31-1989; IN COMMERCE 12-31-1989.

SER. NO. 78-306,952, FILED 9-29-2003.

MARK T. MULLEN, EXAMINING ATTORNEY

**Int. Cl.: 41**

**Prior U.S. Cls.: 100, 101 and 107**

**United States Patent and Trademark Office**

**Reg. No. 3,453,695**

**Registered June 24, 2008**

**SERVICE MARK  
PRINCIPAL REGISTER**

**SPARTY**

SPARTY, INC. (NEW YORK CORPORATION)  
SUITE #3N  
9 BARROW STREET  
NEW YORK, NY 10014

THE MARK CONSISTS OF STANDARD CHAR-  
ACTERS WITHOUT CLAIM TO ANY PARTICULAR  
FONT, STYLE, SIZE, OR COLOR.

FOR: PLANNING AND CONDUCTING PARTIES  
AND SPECIAL EVENTS FOR OTHERS, IN CLASS 41  
(U.S. CLS. 100, 101 AND 107).

SER. NO. 78-329,148, FILED 11-17-2003.

FIRST USE 10-0-2002; IN COMMERCE 10-0-2002.

ESTHER A. BORSUK, EXAMINING ATTORNEY

**Int. Cl.: 12**

**Prior U.S. Cls.: 19, 21, 23, 31, 35 and 44**

**United States Patent and Trademark Office**

**Reg. No. 3,453,696**

**Registered June 24, 2008**

**TRADEMARK  
PRINCIPAL REGISTER**

**BIGFOOT 4X4**

BIGFOOT 4X4, INC. (MISSOURI CORPORATION)  
6311 N. LINDBERGH BLVD.  
HAZELWOOD, MO 630422876

OWNER OF U.S. REG. NOS. 1,387,617, 1,973,606  
AND OTHERS.

FOR: MONSTER TRUCKS WITH TIRES EQUAL  
TO OR GREATER THAN 48 INCHES, IN CLASS 12  
(U.S. CLS. 19, 21, 23, 31, 35 AND 44).

NO CLAIM IS MADE TO THE EXCLUSIVE  
RIGHT TO USE "4X4", APART FROM THE MARK  
AS SHOWN.

FIRST USE 7-1-1976; IN COMMERCE 7-1-1976.

SER. NO. 78-344,220, FILED 12-22-2003.

THE MARK CONSISTS OF STANDARD CHAR-  
ACTERS WITHOUT CLAIM TO ANY PARTICULAR  
FONT, STYLE, SIZE, OR COLOR.

BARBARA GAYNOR, EXAMINING ATTORNEY

**Int. Cl.: 20**

**Prior U.S. Cls.: 2, 13, 22, 25, 32 and 50**

**United States Patent and Trademark Office**

**Reg. No. 3,453,697**

**Registered June 24, 2008**

**TRADEMARK  
PRINCIPAL REGISTER**

**Anywheres**

THREE BY THREE, INC. (WASHINGTON COR-  
PORATION)  
1518 NW 52ND STREET  
SEATTLE, WA 98107

THE MARK CONSISTS OF STANDARD CHAR-  
ACTERS WITHOUT CLAIM TO ANY PARTICULAR  
FONT, STYLE, SIZE, OR COLOR.

FOR: MAGNETIC BULLETIN BOARD, IN CLASS  
20 (U.S. CLS. 2, 13, 22, 25, 32 AND 50).

SER. NO. 78-350,786, FILED 1-12-2004.

FIRST USE 8-20-2003; IN COMMERCE 8-20-2003.

DAVID MURRAY, EXAMINING ATTORNEY

**Int. Cls.: 9, 40, 41 and 42**

**Prior U.S. Cls.: 21, 23, 26, 36, 38, 100, 101, 103, 106  
and 107**

**Reg. No. 3,453,698**

**United States Patent and Trademark Office**

**Registered June 24, 2008**

**TRADEMARK  
SERVICE MARK  
PRINCIPAL REGISTER**



TECHNOS CO., LTD. (JAPAN CORPORATION)  
32-1, NAGAOTANMACHI 1-CHOME  
HIRAKATA-SHI  
OSAKA, JAPAN

FOR: APPARATUS FOR INSPECTING SEMICONDUCTORS; APPARATUS FOR ANALYZING CHEMICAL COMPONENTS OF ORGANIC AND INORGANIC MATERIALS; APPARATUS FOR ANALYZING THE SUBSTANCE STRUCTURE OF ORGANIC AND INORGANIC MATERIALS; MEASURING AND ANALYZING APPARATUSES, NAMELY, X-RAY FLUORESCENCE SPECTROMETERS, X-RAY ABSORPTION FINE STRUCTURE ANALYZING APPARATUS, X-RAY DIFFRACTMETERS, MASS SPECTROMETERS, SPECTROPHOTOMETERS, MAGNETIC RESONANCE APPARATUS, CHROMATOGRAPH APPARATUS; ELECTRON MICROSCOPES; NON-MEDICAL INDUSTRIAL X-RAY MACHINES; NON-MEDICAL X-RAY APPARATUS FOR INDUSTRIAL USE; COMPUTER PROGRAMS FOR USE IN SEMICONDUCTOR INSPECTION, CHEMICAL ANALYSIS AND X-RAY INSPECTION OR ANALYSIS; ELECTRONIC PUBLICATIONS, NAMELY, ELECTRONIC BOOKS, ELECTRONIC MAGAZINES, AND ELECTRONIC NEWSPAPERS RECORDED IN COMPUTER RECORDING MEDIA RELATING TO SEMICONDUCTOR INSPECTION, CHEMICAL ANALYSIS AND X-RAY INSPECTION OR ANALYSIS; COMPUTERS, IN CLASS 9 (U.S. CLS. 21, 23, 26, 36 AND 38).

FOR: MANUFACTURING OF SEMICONDUCTORS TO ORDER AND/OR SPECIFICATION OF OTHERS; INFORMATION AND CONSULTANCY SERVICES IN THE FIELD OF MANUFACTURING SEMICONDUCTORS TO ORDER AND/OR SPECIFICATION OF OTHERS; TREATMENT OF METALS, RUBBER, PLASTIC AND CERAMIC MATERIALS; RENTAL OF CHEMICAL PROCESSING MACHINES AND APPARATUS, IN CLASS 40 (U.S. CLS. 100, 103 AND 106).

FOR: INSTRUCTIONAL AND EDUCATIONAL SERVICES, NAMELY, ARRANGING AND ORGANIZING CLASSES, SEMINARS, WORKING GROUPS, RESEARCH GROUPS, CONFERENCES AND CONVENTIONS IN THE FIELDS OF MANUFACTURING, INSPECTING, AND ANALYZING SEMICONDUCTORS, ANALYZING CHEMICAL COMPONENTS, STRUCTURALLY ANALYZING SUBSTANCES, AND INSPECTING AND ANALYZING MATERIALS EMPLOYING X-RAY TECHNOLOGY, AND THE DISTRIBUTION OF PRINTED AND ELECTRONIC COURSE MATERIALS IN CONNECTION THEREWITH; PUBLISHING OF ELECTRONIC PUBLICATIONS, IN CLASS 41 (U.S. CLS. 100, 101 AND 107).

FOR: INSPECTION AND ANALYSIS OF SEMICONDUCTORS; INFORMATION AND CONSULTANCY SERVICES IN THE FIELDS OF INSPECTION AND ANALYSIS OF SEMICONDUCTORS, ANALYSIS OF CHEMICAL COMPONENTS, AND STRUCTURAL ANALYSIS OF SUBSTANCES;

ANALYSIS OF CHEMICAL COMPONENTS FOR OTHERS; CHEMICAL ANALYSIS, NAMELY, STRUCTURAL ANALYSIS OF SUBSTANCES FOR OTHERS; TECHNICAL CONSULTING SERVICES RELATING TO THE PERFORMANCE AND OPERATION OF APPARATUSES; DESIGNING OF MACHINES, APPARATUSES, INSTRUMENTS, SYSTEMS AND PARTS THEREFORE OF MACHINES FOR USE IN THE FIELDS OF MANUFACTURING, INSPECTING, AND ANALYZING SEMICONDUCTORS, ANALYZING CHEMICAL COMPONENTS, STRUCTURALLY ANALYZING SUBSTANCES, AND INSPECTING AND ANALYZING MATERIALS EMPLOYING X-RAY TECHNOLOGY; COMPUTER SOFTWARE DESIGN, COMPUTER PROGRAMMING, AND MAINTENANCE OF COMPUTER SOFTWARE; TESTING, INSPECTION AND RESEARCH OF PHARMACEUTICALS, COSMETICS AND FOODSTUFFS; TESTING AND RESEARCH IN THE FIELDS OF ELECTRICITY, X-RAY TECHNOLOGY, MACHINES AND APPARATUSES; RENTAL OF MEASURING AND TESTING MACHINES AND INSTRUMENTS; RENTAL OF INDUSTRIAL X-RAY MACHINES

AND APPARATUSES; RENTAL OF COMPUTERS; RENTAL OF LABORATORY APPARATUSES AND INSTRUMENTS, IN CLASS 42 (U.S. CLS. 100 AND 101).

OWNER OF JAPAN REG. NO. 4868511, DATED 6-3-2005, EXPIRES 6-5-2015.

THE COLOR(S) RED, WHITE AND BLACK IS/ ARE CLAIMED AS A FEATURE OF THE MARK.

THE MARK CONSISTS OF A STYLIZED LETTER "T" CONSISTING OF A BLACK COLORED ARC WHICH NARROWS AS IT CURVES TO THE RIGHT, A WHITE CENTER ARC AND A RED, RIGHT TRIANGULAR FIGURE WITH A BOWED SIDE CORRESPONDING TO THE WHITE AND BLACK ARCS BENEATH IT.

SER. NO. 78-406,211, FILED 4-22-2004.

LOURDES AYALA, EXAMINING ATTORNEY

**Int. Cls.: 35 and 41**

**Prior U.S. Cls.: 100, 101, 102 and 107**

**United States Patent and Trademark Office**

**Reg. No. 3,453,699**

**Registered June 24, 2008**

**SERVICE MARK  
PRINCIPAL REGISTER**

**HUDSON**

HUDSON HIGHLAND GROUP, INC. (DELA-  
WARE CORPORATION)  
225 WEST WACKER DRIVE  
CHICAGO, IL 60606

FOR: EMPLOYMENT HIRING, RECRUITING,  
PLACEMENT, AND STAFFING SERVICES; HU-  
MAN RESOURCES CONSULTING; BUSINESS  
MANAGEMENT CONSULTING; BUSINESS NET-  
WORKING; EMPLOYMENT HIRING, RECRUIT-  
ING, PLACEMENT, AND STAFFING SERVICES;  
HUMAN RESOURCES CONSULTING; BUSINESS  
MANAGEMENT CONSULTING, IN CLASS 35 (U.S.  
CLS. 100, 101 AND 102).

FIRST USE 12-0-2003; IN COMMERCE 12-0-2003.

FOR: EDUCATIONAL SERVICES, NAMELY,  
CONDUCTING TRAINING PROGRAMS, SEMI-  
NARS, LECTURES, CONFERENCES, AND WORK-

SHOPS IN THE FIELD OF DIVERSITY AND  
DISTRIBUTING COURSE MATERIALS IN CON-  
NECTION THEREWITH, IN CLASS 41 (U.S. CLS.  
100, 101 AND 107).

FIRST USE 12-0-2003; IN COMMERCE 12-0-2003.

THE MARK CONSISTS OF STANDARD CHAR-  
ACTERS WITHOUT CLAIM TO ANY PARTICULAR  
FONT, STYLE, SIZE, OR COLOR.

PRIORITY CLAIMED UNDER SEC. 44(D) ON  
NEW ZEALAND APPLICATION NO. 705575, FILED  
12-8-2003.

SER. NO. 78-419,042, FILED 5-14-2004.

KATHERINE STOIDES, EXAMINING ATTORNEY

**Int. Cl.: 4**

**Prior U.S. Cls.: 1, 6 and 15**

**United States Patent and Trademark Office**

**Reg. No. 3,453,700**

**Registered June 24, 2008**

**TRADEMARK  
PRINCIPAL REGISTER**

**TRILOGY SPA**

SHAH, CHANDRA LEIHUANANI (UNITED STATES INDIVIDUAL)  
915 BOUNDARY PLACE  
MANHATTAN BEACH, CA 90266

FOR: CANDLES, NAMELY, UNSCENTED AND PERFUMED CANDLES, IN CLASS 4 (U.S. CLS. 1, 6 AND 15).

FIRST USE 8-1-2003; IN COMMERCE 8-1-2003.

THE MARK CONSISTS OF STANDARD CHARACTERS WITHOUT CLAIM TO ANY PARTICULAR FONT, STYLE, SIZE, OR COLOR.

NO CLAIM IS MADE TO THE EXCLUSIVE RIGHT TO USE "SPA", APART FROM THE MARK AS SHOWN.

SER. NO. 78-426,390, FILED 5-27-2004.

JOHN GARTNER, EXAMINING ATTORNEY



**Int. Cl.: 33**

**Prior U.S. Cls.: 47 and 49**

**United States Patent and Trademark Office**

**Reg. No. 3,453,701**

**Registered June 24, 2008**

**TRADEMARK  
PRINCIPAL REGISTER**

**KASPROWY**

NFK MILLESIMES (FRANCE LIMITED LIABILITY COMPANY)  
61 RUE DE PARIS  
GOUSSAINVILLE, FRANCE 28410

FOR: DISTILLED SPIRITS, NAMELY, VODKA AND READY-MIX COCKTAILS MADE WITH VODKA, IN CLASS 33 (U.S. CLS. 47 AND 49).

THE MARK CONSISTS OF STANDARD CHARACTERS WITHOUT CLAIM TO ANY PARTICULAR FONT, STYLE, SIZE, OR COLOR.

PRIORITY CLAIMED UNDER SEC. 44(D) ON POLAND APPLICATION NO. Z-273501, FILED 12-5-2003, REG. NO. 183620, DATED 10-6-2006, EXPIRES 12-5-2013.

SER. NO. 78-427,958, FILED 6-1-2004.

TIMOTHY FINNEGAN, EXAMINING ATTORNEY

**Int. Cl.: 30**

**Prior U.S. Cl.: 46**

**United States Patent and Trademark Office**

**Reg. No. 3,453,702**

**Registered June 24, 2008**

**TRADEMARK  
PRINCIPAL REGISTER**

**RED RIPPER**

AUSTRALIAN CHOCOLATE PTY LTD (AUSTRALIA CORPORATION)  
15/14 FRENCHS FORREST ROAD  
FRENCHS FORREST NSW, AUSTRALIA 2086

FOR: CHOCOLATE BAR, CANDY, ICES, IN CLASS 30 (U.S. CL. 46).

FIRST USE 3-18-2003; IN COMMERCE 5-15-2004.

THE MARK CONSISTS OF STANDARD CHARACTERS WITHOUT CLAIM TO ANY PARTICULAR FONT, STYLE, SIZE, OR COLOR.

OWNER OF AUSTRALIA REG. NO. 947526, DATED 3-18-2003, EXPIRES 3-18-2013.

SER. NO. 78-431,317, FILED 6-7-2004.

TERESA M. RUPP, EXAMINING ATTORNEY

**Int. Cl.: 25**

**Prior U.S. Cls.: 22 and 39**

**United States Patent and Trademark Office**

**Reg. No. 3,453,703**

**Registered June 24, 2008**

**TRADEMARK  
PRINCIPAL REGISTER**

**BEEHIVE**

AMERICAN SOCCER COMPANY (CALIFORNIA  
CORPORATION)  
726 EAST ANAHEIM STREET  
WILMINGTON, CA 90744

FOR: SOCCER UNIFORMS SOLD DIRECTLY TO  
SOCCER CLUBS, IN CLASS 25 (U.S. CLS. 22 AND 39).

FIRST USE 12-31-1998; IN COMMERCE 12-31-1998.

THE MARK CONSISTS OF STANDARD CHAR-  
ACTERS WITHOUT CLAIM TO ANY PARTICULAR  
FONT, STYLE, SIZE, OR COLOR.

SER. NO. 78-434,633, FILED 6-14-2004.

GENE MACIOL, EXAMINING ATTORNEY

**Int. Cl.: 10**

**Prior U.S. Cls.: 26, 39 and 44**

**United States Patent and Trademark Office**

**Reg. No. 3,453,704**

**Registered June 24, 2008**

**TRADEMARK  
PRINCIPAL REGISTER**

**PULSE CDC**

IS2 MEDICAL SYSTEMS INC. (CANADA CORPORATION)  
20 GURDWARA ROAD #3-10  
NEPEAN, CANADA K2E 8B3

FOR: NUCLEAR MEDICINE DIAGNOSTIC IMAGING APPARATUS IN THE NATURE OF A GAMMA CAMERA, IN CLASS 10 (U.S. CLS. 26, 39 AND 44).

FIRST USE 5-31-2004; IN COMMERCE 5-31-2004.

THE MARK CONSISTS OF STANDARD CHARACTERS WITHOUT CLAIM TO ANY PARTICULAR FONT, STYLE, SIZE, OR COLOR.

PRIORITY CLAIMED UNDER SEC. 44(D) ON CANADA APPLICATION NO. 1,199,691, FILED 12-16-2003.

OWNER OF CANADA REG. NO. TMA704020, DATED 1-8-2008, EXPIRES 1-8-2023.

NO CLAIM IS MADE TO THE EXCLUSIVE RIGHT TO USE "CDC", APART FROM THE MARK AS SHOWN.

SER. NO. 78-434,659, FILED 6-14-2004.

KIMBERLY FRYE, EXAMINING ATTORNEY

**Int. Cl.: 9**

**Prior U.S. Cls.: 21, 23, 26, 36 and 38**

**Reg. No. 3,453,705**

**United States Patent and Trademark Office**

**Registered June 24, 2008**

**TRADEMARK  
PRINCIPAL REGISTER**

**OMNIPLANAR**

METROLOGIC INSTRUMENTS, INC. (NEW JERSEY CORPORATION)  
90 COLES ROAD  
BLACKWOOD, NJ 08012

THE MARK CONSISTS OF STANDARD CHARACTERS WITHOUT CLAIM TO ANY PARTICULAR FONT, STYLE, SIZE, OR COLOR.

FOR: SOFTWARE FOR USE IN IMAGE CAPTURE AND DECODING BAR CODE SYMBOLS, IN CLASS 9 (U.S. CLS. 21, 23, 26, 36 AND 38).

SER. NO. 78-497,820, FILED 10-11-2004.

FIRST USE 3-1-1989; IN COMMERCE 3-1-1989.

BARBARA RUTLAND, EXAMINING ATTORNEY

**Int. Cl.: 9**

**Prior U.S. Cls.: 21, 23, 26, 36 and 38**

**Reg. No. 3,453,706**

**United States Patent and Trademark Office**

**Registered June 24, 2008**

---

**TRADEMARK  
PRINCIPAL REGISTER**

**STRATEGIC COMMAND**  
**2**

FURY SOFTWARE (CANADA SOLE PROPRIETORSHIP)  
321 VIA CARMINE AVE  
WOODBIDGE, ONTARIO, CANADA L4H 2R4

THE MARK CONSISTS OF STANDARD CHARACTERS WITHOUT CLAIM TO ANY PARTICULAR FONT, STYLE, SIZE, OR COLOR.

FOR: COMPUTER GAME SOFTWARE, IN CLASS 9 (U.S. CLS. 21, 23, 26, 36 AND 38).

SER. NO. 78-516,514, FILED 11-13-2004.

FIRST USE 11-13-2004; IN COMMERCE 4-28-2006.

BENJAMIN OKEKE, EXAMINING ATTORNEY

**Int. Cl.: 35**

**Prior U.S. Cls.: 100, 101 and 102**

**United States Patent and Trademark Office**

**Reg. No. 3,453,707**

**Registered June 24, 2008**

**SERVICE MARK  
PRINCIPAL REGISTER**

**SLUMBERLAND  
FURNITURE  
ADVANTAGE CARD**

SLUMBERLAND, INC. (MINNESOTA CORPORATION)  
3060 CENTERVILLE ROAD  
LITTLE CANADA, MN 55117

FOR: CUSTOMER LOYALTY INCENTIVE PROGRAM, IN CLASS 35 (U.S. CLS. 100, 101 AND 102).

FIRST USE 11-8-2004; IN COMMERCE 11-8-2004.

THE MARK CONSISTS OF STANDARD CHARACTERS WITHOUT CLAIM TO ANY PARTICULAR FONT, STYLE, SIZE, OR COLOR.

OWNER OF U.S. REG. NOS. 1,967,577 AND 2,247,003.

NO CLAIM IS MADE TO THE EXCLUSIVE RIGHT TO USE "FURNITURE" AND "CARD", APART FROM THE MARK AS SHOWN.

SER. NO. 78-525,454, FILED 12-1-2004.

KRISTINA MORRIS, EXAMINING ATTORNEY

**Int. Cls.: 38 and 41**

**Prior U.S. Cls.: 100, 101, 104 and 107**

**United States Patent and Trademark Office**

**Reg. No. 3,453,708**

**Registered June 24, 2008**

**SERVICE MARK  
PRINCIPAL REGISTER**



THE NOSTALGIA NETWORK, INC. (DELAWARE CORPORATION)  
1133 19TH ST., N.W.  
SUITE 800  
WASHINGTON, DC 20036

FOR: CABLE CASTING SERVICES, IN CLASS 38 (U.S. CLS. 100, 101 AND 104).

FIRST USE 4-1-2005; IN COMMERCE 4-1-2005.

FOR: TELEVISION PRODUCTION; ENTERTAINMENT IN THE NATURE OF ON-GOING TELEVISION PROGRAMS IN THE FIELD OF DRAMAS,

COMEDIES, VARIETY, AND VARIETY NEWS SHOWS, IN CLASS 41 (U.S. CLS. 100, 101 AND 107).

FIRST USE 4-1-2005; IN COMMERCE 4-1-2005.

NO CLAIM IS MADE TO THE EXCLUSIVE RIGHT TO USE "TV NETWORK", APART FROM THE MARK AS SHOWN.

SER. NO. 78-526,678, FILED 12-3-2004.

DAVID MILLER, EXAMINING ATTORNEY



Int. Cls.: 16 and 26

Prior U.S. Cls.: 2, 5, 22, 23, 29, 37, 38, 39, 40, 42 and 50

United States Patent and Trademark Office

Reg. No. 3,453,709

Registered June 24, 2008

TRADEMARK  
PRINCIPAL REGISTER



SCHMITTY SAYS LLC (NEW YORK LTD LIAB  
CO)  
27 WEST 67TH STREET, #5RE  
NEW YORK, NY 10023

FOR: GREETING CARDS, STATIONERY, IN  
CLASS 16 (U.S. CLS. 2, 5, 22, 23, 29, 37, 38 AND 50).

FIRST USE 4-0-2004; IN COMMERCE 4-0-2004.

FOR: CAMPAIGN BUTTONS AND ORNAMEN-  
TAL NOVELTY BUTTONS, IN CLASS 26 (U.S. CLS.  
37, 39, 40, 42 AND 50).

FIRST USE 4-0-2004; IN COMMERCE 4-0-2004.

NO CLAIM IS MADE TO THE EXCLUSIVE  
RIGHT TO USE GREETINGS IN CONNECTION  
WITH THE GOODS IN CLASS 016., APART FROM  
THE MARK AS SHOWN.

THE MARK CONSISTS OF AN IMAGE OF A  
FACE OF A DOG SURROUNDED BY CIRCULAR  
BAND CONTAINING THE WORDS NEW YORKIE  
GREETINGS; THE STIPPLING IN THE MARK IS  
FOR SHADING PURPOSES ONLY AND IS NOT  
MEANT TO INDICATE COLOR.

SER. NO. 78-532,088, FILED 12-14-2004.

JOSETTE BEVERLY, EXAMINING ATTORNEY

**Int. Cl.: 41**

**Prior U.S. Cls.: 100, 101 and 107**

**United States Patent and Trademark Office**

**Reg. No. 3,453,710**

**Registered June 24, 2008**

**SERVICE MARK  
PRINCIPAL REGISTER**

**MODESTO NUTS**

HWS BASEBALL IV, LLC (DELAWARE LTD  
LIAB CO)  
690 CANTON STREET  
SUITE 255  
WESTWOOD, MA 02090

FOR: ENTERTAINMENT SERVICES IN THE  
NATURE OF BASEBALL GAMES, EXHIBITIONS  
AND MASCOT APPEARANCES, IN CLASS 41 (U.S.  
CLS. 100, 101 AND 107).

FIRST USE 11-24-2004; IN COMMERCE 12-1-2004.

THE MARK CONSISTS OF STANDARD CHAR-  
ACTERS WITHOUT CLAIM TO ANY PARTICULAR  
FONT, STYLE, SIZE, OR COLOR.

NO CLAIM IS MADE TO THE EXCLUSIVE  
RIGHT TO USE "MODESTO", APART FROM THE  
MARK AS SHOWN.

SER. NO. 78-533,751, FILED 12-16-2004.

MARTHA FROMM, EXAMINING ATTORNEY

Int. Cl.: 25

Prior U.S. Cls.: 22 and 39

United States Patent and Trademark Office

Reg. No. 3,453,711

Registered June 24, 2008

TRADEMARK  
PRINCIPAL REGISTER



HWS BASEBALL IV, LLC (DELAWARE LTD  
LIAB CO)  
690 CANTON STREET  
SUITE 255  
WESTWOOD, MA 02090

FOR: CLOTHING, NAMELY, APRONS, ATHLET-  
IC UNIFORMS, BANDANAS, BOXER SHORTS,  
CAPS, CLOTH BABY BIBS, COATS, GOLF SHIRTS,  
GYM SHORTS, GYM SUITS, HATS, JACKETS, JER-  
SEYS, JOGGING SUITS, KNIT SHIRTS, PAJAMAS,  
POLO SHIRTS, PONCHOS, PULLOVERS, RAIN  
COATS, RAINWEAR, SWEATERS, SWEAT PANTS,  
SWEAT SHIRTS, SWEAT SUITS, SOCKS, SPORT

SHIRTS, T- SHIRTS, TANK TOPS, TIES, VISORS,  
WIND RESISTANT JACKETS AND WRISTBANDS,  
IN CLASS 25 (U.S. CLS. 22 AND 39).

FIRST USE 11-24-2004; IN COMMERCE 12-1-2004.

NO CLAIM IS MADE TO THE EXCLUSIVE  
RIGHT TO USE "MODESTO", APART FROM THE  
MARK AS SHOWN.

SER. NO. 78-533,889, FILED 12-16-2004.

MARTHA FROMM, EXAMINING ATTORNEY

Int. Cl.: 16

Prior U.S. Cls.: 2, 5, 22, 23, 29, 37, 38 and 50

Reg. No. 3,453,712

United States Patent and Trademark Office

Registered June 24, 2008

TRADEMARK  
PRINCIPAL REGISTER



HWS BASEBALL IV, LLC (DELAWARE LTD  
LIAB CO)  
690 CANTON STREET  
SUITE 255  
WESTWOOD, MA 02090

BASEBALL FANS, REFERENCE BOOKS OF INTER-  
EST TO BASEBALL FANS, SCORE BOOKS, SCORE  
CARDS, SCORE SHEETS, STICKERS, STICKER AL-  
BUMS AND TRADING CARDS, IN CLASS 16 (U.S.  
CLS. 2, 5, 22, 23, 29, 37, 38 AND 50).

FOR: PAPER GOODS AND PRINTED MATTER,  
NAMELY, AUTOGRAPH BOOKS, BINDERS, BOOK-  
MARKS, BUMPER STICKERS, CALENDARS, CAT-  
ALOGS OF INTEREST TO BASEBALL FANS,  
DECALS, MERCHANDISE BAGS, NEWSLETTERS  
OF INTEREST TO BASEBALL FANS, NOTE PADS,  
PAPER CONTAINERS, PAPER PENNANTS, PAPER  
SCHEDULES, PENS, PENCILS, POSTCARDS, POS-  
TERS, PRINTED AWARDS, PRINTED GAME TICK-  
ETS, PRINTED GUIDES OF INTEREST TO

FIRST USE 11-24-2004; IN COMMERCE 12-1-2004.

NO CLAIM IS MADE TO THE EXCLUSIVE  
RIGHT TO USE "MODESTO", APART FROM THE  
MARK AS SHOWN.

SER. NO. 78-533,941, FILED 12-16-2004.

MARTHA FROMM, EXAMINING ATTORNEY

**Int. Cl.: 42**

**Prior U.S. Cls.: 100 and 101**

**United States Patent and Trademark Office**

**Reg. No. 3,453,713**

**Registered June 24, 2008**

**SERVICE MARK  
PRINCIPAL REGISTER**



QUINN FABLE ADVERTISING, INC. (NEW  
YORK CORPORATION)  
115 EAST 55TH STREET  
NEW YORK, NY 10022

FOR: COMPUTER SOFTWARE DESIGN FOR  
OTHERS, NAMELY, CUSTOM DESIGN OF COM-  
PUTER PROGRAMS IN THE FIELD OF DIRECT  
RESPONSE ADVERTISING AND DIRECT MAR-  
KETING THAT ENABLE A WEB-BASED APPLICA-  
TION TO STORE, ARCHIVE, AND TRACK THE  
USAGE OF PHOTOGRAPHS AND OTHER GRA-  
PHIC ASSETS USED IN MARKETING CAMPAIGNS,  
IN CLASS 42 (U.S. CLS. 100 AND 101).

FIRST USE 2-25-2003; IN COMMERCE 2-25-2003.

NO CLAIM IS MADE TO THE EXCLUSIVE  
RIGHT TO USE "PIXSHARE", APART FROM THE  
MARK AS SHOWN.

THE COLOR(S) PURPLE AND GRAY ARE  
CLAIMED AS A FEATURE OF THE MARK.

THE COLOR PURPLE APPEARS IN THE TWO  
CIRCLES ENCAPSULATING THE GRAY LETTERS  
"Q" AND "F", AND THE COLOR PURPLE APPEARS  
IN THE WORD "PIXSHARE".

SER. NO. 78-541,625, FILED 1-4-2005.

SUNG IN, EXAMINING ATTORNEY

**Int. Cl.: 42**

**Prior U.S. Cls.: 100 and 101**

**United States Patent and Trademark Office**

**Reg. No. 3,453,714**

**Registered June 24, 2008**

**SERVICE MARK  
PRINCIPAL REGISTER**



QUINN FABLE ADVERTISING, INC. (NEW  
YORK CORPORATION)  
115 EAST 55TH STREET  
NEW YORK, NY 10022

FOR: COMPUTER SOFTWARE DESIGN FOR  
OTHERS, NAMELY, CUSTOM DESIGN OF COM-  
PUTER PROGRAMS IN THE FIELD OF DIRECT  
RESPONSE ADVERTISING AND DIRECT MAR-  
KETING THAT ENABLE CORPORATE DEVEL-  
OPED COMMUNICATIONS TO BE  
PERSONALIZED AND DISTRIBUTED AS ONE TO  
ONE E-MAIL MESSAGES, IN CLASS 42 (U.S. CLS. 100  
AND 101).

FIRST USE 6-22-2003; IN COMMERCE 6-22-2003.

NO CLAIM IS MADE TO THE EXCLUSIVE  
RIGHT TO USE "ESHARE", APART FROM THE  
MARK AS SHOWN.

THE COLOR(S) PURPLE AND GRAY ARE  
CLAIMED AS A FEATURE OF THE MARK.

THE COLOR PURPLE APPEARS IN THE TWO  
CIRCLES ENCAPSULATING THE GRAY LETTERS  
"Q" AND "F", AND THE COLOR PURPLE APPEARS  
IN THE WORD "ESHARE".

SER. NO. 78-541,911, FILED 1-4-2005.

SUNG IN, EXAMINING ATTORNEY

**Int. Cl.: 42**

**Prior U.S. Cls.: 100 and 101**

**United States Patent and Trademark Office**

**Reg. No. 3,453,715**

**Registered June 24, 2008**

**SERVICE MARK  
PRINCIPAL REGISTER**



QUINN FABLE ADVERTISING, INC. (NEW YORK CORPORATION)

115 EAST 55TH STREET

NEW YORK, NY 10022

FOR: COMPUTER SOFTWARE DESIGN FOR OTHERS, NAMELY, CUSTOM DESIGN OF COMPUTER PROGRAMS IN THE FIELD OF DIRECT RESPONSE ADVERTISING AND DIRECT MARKETING THAT PROVIDE A WEB-BASED TOOL FOR A CENTRALIZED END TO END SOLUTION FOR THE DEVELOPMENT, DISTRIBUTION AND TRACKING OF E-MAIL CAMPAIGNS, IN CLASS 42 (U.S. CLS. 100 AND 101).

FIRST USE 10-15-2003; IN COMMERCE 10-15-2003.

NO CLAIM IS MADE TO THE EXCLUSIVE RIGHT TO USE "E BROADCAST", APART FROM THE MARK AS SHOWN.

THE COLOR(S) PURPLE AND GRAY IS/ARE CLAIMED AS A FEATURE OF THE MARK.

THE COLOR PURPLE APPEARS IN THE TWO CIRCLES ENCAPSULATING THE GRAY LETTERS "Q" AND "F", AND THE COLOR PURPLE APPEARS IN THE WORD "E BROADCAST".

SER. NO. 78-542,368, FILED 1-5-2005.

SUNG IN, EXAMINING ATTORNEY

**Int. Cls.: 5 and 10**

**Prior U.S. Cls.: 6, 18, 26, 39, 44, 46, 51 and 52**

**United States Patent and Trademark Office**

**Reg. No. 3,453,716**

**Registered June 24, 2008**

**TRADEMARK  
PRINCIPAL REGISTER**



MALEKAN, BEN (CALIFORNIA CORPORATION)  
23114 PARK TERRA  
CALABASAS, CA 91302

NO CLAIM IS MADE TO THE EXCLUSIVE RIGHT TO USE "DENTAL SUPPLY", APART FROM THE MARK AS SHOWN.

FOR: DENTAL CEMENTS, ALLOYS, WAXES, SEALANTS, RESTORATIVE, ACRYLICS, TEMPORARY ACRYLICS, ALL FOR DENTAL USE, DENTAL ANESTHETICS, DENTAL BLEACHING GEL, DENTAL IMPRESSION MATERIAL, DENTAL BONDING AGENTS, VINYL POLYSILOXANE, GYPSUM; PREPARATIONS FOR ETCHING AND SEALERS IN THE NATURE OF DENTAL CEMENT, IN CLASS 5 (U.S. CLS. 6, 18, 44, 46, 51 AND 52).

THE COLOR(S) RED, WHITE, LIGHT BLUE, BRIGHT BLUE, AND BLACK IS/ARE CLAIMED AS A FEATURE OF THE MARK.

FIRST USE 10-1-2003; IN COMMERCE 10-8-2003.

FOR: DENTAL CHAIRS, DENTAL INSTRUMENTS, NAMELY, DENTAL ARTICULATORS, BITE TRAYS, BROACHES, BURS, CAPS, CROWNS, DAMS, DRILLS, IMPRESSION TRAYS, INLAYS, MIRRORS, ALUMINUM CAPS, MIRRORS, BUR BLOCKS, SALIVA EJECTORS, SUTURES, LINERS, PINS, SPONGES, POSTS, NEEDLES, MEDICAL LATEX GLOVES, GYPSUM, ARTICULATING PAPER, ARTICULATING FILMS, METAL FOIL, ARTICULATING PAPER FORCEPS, HANDPIECES, DRY HEAT STERILIZERS; AUTOCLAVES FOR MEDICAL/DENTAL USE; X-RAY FILM FOR DENTAL USE, IN CLASS 10 (U.S. CLS. 26, 39 AND 44).

THE MARK CONSISTS OF THE WORDING "UNITED" IS SHOWN IN WHITE ON A RED RECTANGULAR BACKGROUND ABOVE THE WORDING "DENTAL SUPPLY" THAT IS SHOWN IN RED ON A WHITE RECTANGULAR BACKGROUND THAT IS ALSO OUTLINED IN RED. THE LARGE CENTER STAR IS WHITE WITH A BLUE BORDER THAT IS LIGHT BLUE NEAREST TO THE WHITE CENTER STAR AND GROWS INCREASINGLY DARKER TO BRIGHT BLUE AT THE EDGE AND IS OUTLINED IN BLACK. THE CENTER WHITE AND BLUE BORDERED STAR IS FLANKED BY THREE RED HORIZONTAL LINES ON EITHER SIDE AND RESTS ON TOP OF THREE VERTICAL LIGHT BLUE LINES. THE THREE BRIGHT BLUE STARS ARE SHOWN ABOVE EACH PAIR OF HORIZONTAL RED LINES ON EITHER SIDE OF THE CENTER STAR AND THREE LIGHT BLUE STARS ARE SHOWN BELOW EACH PAIR OF HORIZONTAL RED LINES ON EITHER SIDE OF THE CENTER STAR.

FIRST USE 10-1-2003; IN COMMERCE 10-8-2003.



SER. NO. 78-559,228, FILED 2-2-2005.

JACQUELINE A. LAVINE, EXAMINING ATTOR-  
NEY

**Int. Cl.: 9**

**Prior U.S. Cls.: 21, 23, 26, 36 and 38**

**Reg. No. 3,453,717**

**United States Patent and Trademark Office**

**Registered June 24, 2008**

**TRADEMARK  
PRINCIPAL REGISTER**

**DM3**

INTEGRATED DATA CORPORATION (NEVADA CORPORATION)  
3555 HAYDEN AVENUE  
CULVER CITY, CA 90232

FOR: COMPUTER PROGRAM FOR DATA AND DOCUMENT MANAGEMENT, TRANSMISSION, REPLICATION AND DISTRIBUTION OVER NETWORKS OF ELECTRONIC CONTENT FOR INTEGRATED DOCUMENT MANAGEMENT, ROUTING, RETRIEVAL AND DATA ANALYSIS, IN CLASS 9 (U.S. CLS. 21, 23, 26, 36 AND 38).

FIRST USE 1-5-2004; IN COMMERCE 3-15-2004.

THE MARK CONSISTS OF STANDARD CHARACTERS WITHOUT CLAIM TO ANY PARTICULAR FONT, STYLE, SIZE, OR COLOR.

SER. NO. 78-569,700, FILED 2-17-2005.

LINDA MICKLEBURGH, EXAMINING ATTORNEY

**Int. Cls.: 35, 44 and 45**

**Prior U.S. Cls.: 100, 101 and 102**

**United States Patent and Trademark Office**

**Reg. No. 3,453,718**

**Registered June 24, 2008**

**SERVICE MARK  
PRINCIPAL REGISTER**

**INSPIRIS**

INSPIRIS, INC. (DELAWARE CORPORATION)  
SUITE 350  
TWO CREEKSIDE CROSSING 10 CADILLAC DRIVE  
BRENTWOOD, TN 37027

FOR: COMPREHENSIVE COST MANAGEMENT  
FOR THE HEALTH BENEFIT PLANS OF OTHERS,  
IN CLASS 35 (U.S. CLS. 100, 101 AND 102).

FIRST USE 9-9-2004; IN COMMERCE 9-9-2004.

FOR: HOSPICE SERVICES; HEALTHCARE SER-  
VICES; SKILLED NURSING HOMES AND HOSPI-  
TALS, IN CLASS 44 (U.S. CLS. 100 AND 101).

FIRST USE 9-9-2004; IN COMMERCE 9-9-2004.

FOR: CASE MANAGEMENT SERVICES, NAME-  
LY, COORDINATION OF LEGAL, SOCIAL AND  
PSYCHOLOGICAL SERVICES FOR FRAIL AND  
DISABLED MEDICARE BENEFICIARIES, IN CLASS  
45 (U.S. CLS. 100 AND 101).

FIRST USE 9-9-2004; IN COMMERCE 9-9-2004.

THE MARK CONSISTS OF STANDARD CHAR-  
ACTERS WITHOUT CLAIM TO ANY PARTICULAR  
FONT, STYLE, SIZE, OR COLOR.

SER. NO. 78-586,824, FILED 3-14-2005.

LINDA M. KING, EXAMINING ATTORNEY

**Int. Cl.: 3**

**Prior U.S. Cls.: 1, 4, 6, 50, 51 and 52**

**United States Patent and Trademark Office**

**Reg. No. 3,453,719**

**Registered June 24, 2008**

**TRADEMARK  
PRINCIPAL REGISTER**

**I t  
,  
S A**

AIR ENTERTAINMENT, INC (JAPAN KABUSH-  
IKI KAISHA), DBA G-COSMETIC CO, LTD.  
1-5-6 SHINBASHI  
MINATO-KU, JAPAN 105-0004

FOR: COSMETICS, SOAP, TOOTH PASTE, PER-  
FUME, IN CLASS 3 (U.S. CLS. 1, 4, 6, 50, 51 AND 52).

FIRST USE 4-20-2004; IN COMMERCE 4-20-2004.

OWNER OF JAPAN REG. NO. 4828477, DATED 12-  
24-2004, EXPIRES 12-24-2014.

SER. NO. 78-591,663, FILED 3-21-2005.

KARANENDRA S. CHHINA, EXAMINING ATTOR-  
NEY

**Int. Cl.: 33**

**Prior U.S. Cls.: 47 and 49**

**United States Patent and Trademark Office**

**Reg. No. 3,453,720**

**Registered June 24, 2008**

**TRADEMARK  
PRINCIPAL REGISTER**

**RED CORAL SKIN**

CAVES VIDIGAL, S.A. (PORTUGAL SOCIEDAD ANONIMA)

CORTES

QUINTA DA BATARRA, 230

LEIRIA, PORTUGAL 2410-847

FOR: WINES, IN CLASS 33 (U.S. CLS. 47 AND 49).

THE MARK CONSISTS OF STANDARD CHARACTERS WITHOUT CLAIM TO ANY PARTICULAR FONT, STYLE, SIZE, OR COLOR.

PRIORITY CLAIMED UNDER SEC. 44(D) ON PORTUGAL APPLICATION NO. 389.060, FILED 3-17-2005, REG. NO. 389060, DATED 3-3-2006, EXPIRES 3-3-2016.

NO CLAIM IS MADE TO THE EXCLUSIVE RIGHT TO USE "RED", APART FROM THE MARK AS SHOWN.

SER. NO. 78-596,993, FILED 3-29-2005.

DAVID YONTEF, EXAMINING ATTORNEY

**Int. Cls.: 16 and 41**

**Prior U.S. Cls.: 2, 5, 22, 23, 29, 37, 38, 50, 100, 101 and 107**

**Reg. No. 3,453,721**

**United States Patent and Trademark Office**

**Registered June 24, 2008**

**TRADEMARK  
SERVICE MARK  
PRINCIPAL REGISTER**

# NORDIC REACH

I. KIMBERLEY, CRISPENSEN & SONS, INC.  
(NEW JERSEY CORPORATION)  
354 NORTH AVENUE EAST  
CRANFORD, NJ 07016

FOR: PRINTED MATTER AND PUBLICATIONS, NAMELY, A MAGAZINE IN THE FIELD OF NORDIC AND NORDIC-RELATED CULTURE, ARCHITECTURE, HISTORY, TRAVEL, FASHION, DESIGN AND DECORATION, FOOD, ART, RECREATION, ENTERTAINMENT, BUSINESS, AND CURRENT EVENTS, IN CLASS 16 (U.S. CLS. 2, 5, 22, 23, 29, 37, 38 AND 50).

FIRST USE 5-0-2002; IN COMMERCE 6-0-2002.

FOR: COMPUTER SERVICES, NAMELY, PROVIDING AN ON-LINE MAGAZINE IN THE FIELD OF NORDIC AND NORDIC-RELATED CULTURE, ARCHITECTURE, HISTORY, TRAVEL, FASHION, DESIGN AND DECORATION, FOOD, ART, RECREATION, ENTERTAINMENT, BUSINESS, AND CURRENT EVENTS; PROVIDING AN ONLINE IN-

TERACTIVE MULTIMEDIA MAGAZINE IN THE FIELD OF NORDIC AND NORDIC-RELATED CULTURE, ARCHITECTURE, HISTORY, TRAVEL, FASHION, DESIGN AND DECORATION, FOOD, ART, RECREATION, ENTERTAINMENT, BUSINESS, AND CURRENT EVENTS RENDERED BY MEANS OF A GLOBAL COMPUTER NETWORK, IN CLASS 41 (U.S. CLS. 100, 101 AND 107).

FIRST USE 5-0-2002; IN COMMERCE 10-24-2002.

THE MARK CONSISTS OF STANDARD CHARACTERS WITHOUT CLAIM TO ANY PARTICULAR FONT, STYLE, SIZE, OR COLOR.

NO CLAIM IS MADE TO THE EXCLUSIVE RIGHT TO USE "NORDIC", APART FROM THE MARK AS SHOWN.

SER. NO. 78-609,989, FILED 4-15-2005.

DAVID MURRAY, EXAMINING ATTORNEY

**Int. Cl.: 16**

**Prior U.S. Cls.: 2, 5, 22, 23, 29, 37, 38 and 50**

**United States Patent and Trademark Office**

**Reg. No. 3,453,722**

**Registered June 24, 2008**

**TRADEMARK  
PRINCIPAL REGISTER**

**INVISIBLE WRITER**

IQ HONG KONG, LTD. (HONG KONG CORPORATION)

RM9, 21F MEGA TRADE CENTRE 1-6 MEI WAN STREET

TSUEN WAN, N.T., HONG KONG

FOR: PEN WITH ULTRAVIOLET INK AND AN ULTRAVIOLET LIGHT, IN CLASS 16 (U.S. CLS. 2, 5, 22, 23, 29, 37, 38 AND 50).

FIRST USE 5-31-2002; IN COMMERCE 5-31-2002.

THE MARK CONSISTS OF STANDARD CHARACTERS WITHOUT CLAIM TO ANY PARTICULAR FONT, STYLE, SIZE, OR COLOR.

NO CLAIM IS MADE TO THE EXCLUSIVE RIGHT TO USE "WRITER", APART FROM THE MARK AS SHOWN.

SEC. 2(F).

SER. NO. 78-611,648, FILED 4-19-2005.

IRA J. GOODSaid, EXAMINING ATTORNEY

**Int. Cls.: 9, 36 and 42**

**Prior U.S. Cls.: 21, 23, 26, 36, 38, 100, 101 and 102**

**Reg. No. 3,453,723**

**United States Patent and Trademark Office**

**Registered June 24, 2008**

**TRADEMARK  
SERVICE MARK  
PRINCIPAL REGISTER**

**ALPHAXPLORER**

THE BEAR STEARNS COMPANIES INC. (DELA-  
WARE CORPORATION)  
383 MADISON AVENUE  
NEW YORK, NY 10179

FOR: COMPUTER SOFTWARE FOR ANALYZ-  
ING PORTFOLIO RISK AND EXPOSURE, COM-  
PARING INVESTMENTS AND MANAGING  
FINANCIAL PORTFOLIOS , IN CLASS 9 (U.S. CLS.  
21, 23, 26, 36 AND 38).

FIRST USE 12-0-2006; IN COMMERCE 12-0-2006.

FOR: FINANCIAL ANALYSIS SERVICES PROVID-  
ED VIA THE INTERNET, NAMELY, ANALYSIS  
OF PORTFOLIO RISK AND EXPOSURE, ANALYSIS  
OF INVESTMENTS; FINANCIAL MANAGEMENT  
SERVICES PROVIDED VIA THE INTERNET,  
NAMELY, MANAGEMENT OF FINANCIAL PORT-  
FOLIOS, IN CLASS 36 (U.S. CLS. 100, 101 AND 102).

FIRST USE 12-0-2006; IN COMMERCE 12-0-2006.

FOR: PROVIDING ONLINE NON-DOWNLOAD-  
ABLE SOFTWARE FOR ANALYZING PORTFOLIO  
RISK AND EXPOSURE, COMPARING INVEST-  
MENTS AND MANAGING FINANCIAL PORTFO-  
LIOS, IN CLASS 42 (U.S. CLS. 100 AND 101).

FIRST USE 12-0-2006; IN COMMERCE 12-0-2006.

THE MARK CONSISTS OF STANDARD CHAR-  
ACTERS WITHOUT CLAIM TO ANY PARTICULAR  
FONT, STYLE, SIZE, OR COLOR.

SER. NO. 78-630,059, FILED 5-13-2005.

LAURA HAMMEL, EXAMINING ATTORNEY



**Int. Cl.: 36**

**Prior U.S. Cls.: 100, 101 and 102**

**United States Patent and Trademark Office**

**Reg. No. 3,453,724**

**Registered June 24, 2008**

**SERVICE MARK  
PRINCIPAL REGISTER**

**HEDGE CONNECTION**

VIONI, LISA (UNITED STATES INDIVIDUAL)  
603 LONGBOAT CLUB ROAD, #504N  
LONGBOAT KEY, FL 34288

THE MARK CONSISTS OF STANDARD CHARACTERS WITHOUT CLAIM TO ANY PARTICULAR FONT, STYLE, SIZE, OR COLOR.

FOR: FINANCIAL SERVICES FOR INVESTORS AND HEDGE FUNDS, NAMELY, PROVIDING INFORMATION REGARDING VARIOUS HEDGE FUNDS AND HEDGE FUND INVESTORS VIA A REMOTELY ACCESSIBLE ELECTRONIC PLATFORM THAT FACILITATES DIRECT COMMUNICATION BETWEEN INVESTORS AND FUNDS, IN CLASS 36 (U.S. CLS. 100, 101 AND 102).

NO CLAIM IS MADE TO THE EXCLUSIVE RIGHT TO USE "HEDGE", APART FROM THE MARK AS SHOWN.

SER. NO. 78-630,248, FILED 5-16-2005.

FIRST USE 5-1-2005; IN COMMERCE 5-1-2005.

ELI HELLMAN, EXAMINING ATTORNEY

**Int. Cl.: 3**

**Prior U.S. Cls.: 1, 4, 6, 50, 51 and 52**

**United States Patent and Trademark Office**

**Reg. No. 3,453,725**

**Registered June 24, 2008**

**TRADEMARK  
PRINCIPAL REGISTER**



**JUST WIPE**

JUST WIPE LTD. (ISRAEL CORPORATION)  
37 MICHAEL STREET  
BIALIK VILLAGE, ISRAEL 27905

FOR: POLISHING PREPARATIONS FOR AUTO-  
MOTIVE AND HOUSEHOLD PURPOSES, IN CLASS  
3 (U.S. CLS. 1, 4, 6, 50, 51 AND 52).

FIRST USE 4-1-2004; IN COMMERCE 8-1-2004.

PRIORITY CLAIMED UNDER SEC. 44(D) ON  
ISRAEL APPLICATION NO. 177659, FILED 1-12-  
2005, REG. NO. 177659, DATED 7-6-2006, EXPIRES 1-  
12-2015.

THE COLOR(S) BLACK, YELLOW AND WHITE  
IS/ARE CLAIMED AS A FEATURE OF THE MARK.

THE MARK CONSISTS OF THE COLOR WHITE  
APPEARING IN THE STAR, THE COLOR YELLOW  
APPEARING IN THE TAIL, AND COLOR BLACK  
APPEARING IN THE SQUARE BACKGROUND  
AND IN THE WORDS "JUST WIPE".

SER. NO. 78-630,822, FILED 5-16-2005.

DAYNA BROWNE, EXAMINING ATTORNEY

**Int. Cl.: 2**

**Prior U.S. Cls.: 6, 11 and 16**

**United States Patent and Trademark Office**

**Reg. No. 3,453,726**

**Registered June 24, 2008**

**TRADEMARK  
PRINCIPAL REGISTER**

**CLEARBRA**

CLEARBRA FRANCHISING, LLC (UTAH LTD  
LIAB CO)  
452 EAST 500 SOUTH  
SALT LAKE CITY, UT 84111

THE MARK CONSISTS OF STANDARD CHAR-  
ACTERS WITHOUT CLAIM TO ANY PARTICULAR  
FONT, STYLE, SIZE, OR COLOR.

FOR: CLEAR COATING PROTECTANT FOR USE  
ON AUTOMOBILES, BOATS, ALL TERRAIN VEHI-  
CLES, FLOORING SURFACES, WOOD SURFACES  
AND PAINTED SURFACES, IN CLASS 2 (U.S. CLS. 6,  
11 AND 16).

SER. NO. 78-635,176, FILED 5-23-2005.

FIRST USE 6-0-1994; IN COMMERCE 6-0-1994.

NORA BUCHANAN WILL, EXAMINING ATTOR-  
NEY

**Int. Cl.: 41**

**Prior U.S. Cls.: 100, 101 and 107**

**United States Patent and Trademark Office**

**Reg. No. 3,453,727**

**Registered June 24, 2008**

**SERVICE MARK  
PRINCIPAL REGISTER**

**CONTEMPORARY CHINESE PULSE  
DIAGNOSIS**

DRAGON RISES SEMINARS (FLORIDA SOLE  
PROPRIETORSHIP)  
901 NW 8TH AVENUE, SUITE B-5  
GAINESVILLE, FL 32601

FOR: EDUCATIONAL SERVICES, NAMELY,  
CONDUCTING CLASSES, SEMINARS, CONFEREN-  
CES, WORKSHOPS AND PERSONAL INSTRUCC-  
TION IN THE FIELD OF ORIENTAL MEDICINE ,  
IN CLASS 41 (U.S. CLS. 100, 101 AND 107).

FIRST USE 0-0-2001; IN COMMERCE 0-0-2001.

THE MARK CONSISTS OF STANDARD CHAR-  
ACTERS WITHOUT CLAIM TO ANY PARTICULAR  
FONT, STYLE, SIZE, OR COLOR.

SEC. 2(F).

SER. NO. 78-650,679, FILED 6-14-2005.

DAVID C. REIHNER, EXAMINING ATTORNEY

**Int. Cls.: 36 and 41**

**Prior U.S. Cls.: 100, 101, 102 and 107**

**Reg. No. 3,453,728**

**United States Patent and Trademark Office**

**Registered June 24, 2008**

**SERVICE MARK  
PRINCIPAL REGISTER**

# ED-DATA

KERN COUNTY SUPERINTENDENT OF  
SCHOOLS (CALIFORNIA POLITICAL SUBDI-  
VISION OF THE STATE OF CALIFORNIA)  
1300 17TH STREET CITY CENTRE  
BAKERSFIELD, CA 933014533

FOR: PROVIDING A WEB SITE FEATURING  
INFORMATION, DATA, AND STATISTICS ON  
THE FINANCIALS OF THE STATE, COUNTY, DIS-  
TRICT, SCHOOL AND OTHER LEVELS, ALL RE-  
LATING TO CALIFORNIA K-12 EDUCATION;  
PROVIDING CUSTOM DATA ANALYSIS, AND  
RESEARCH SUPPORT RELATED TO CALIFORNIA  
K-12 EDUCATION DATA, NAMELY, COMPILING,  
ANALYZING, AND REPORTING ON DATA AND  
STATISTICS ON THE FINANCIAL ASPECTS OF  
STATE, COUNTY, DISTRICT, SCHOOL AND  
OTHER LEVELS FOR OTHERS, IN CLASS 36 (U.S.  
CLS. 100, 101 AND 102).

FIRST USE 1-1-1996; IN COMMERCE 1-1-1996.

FOR: PROVIDING INFORMATION VIA A WEB  
SITE FEATURING DATA AND STATISTICS IN THE  
FIELD OF EDUCATIONAL TEST SCORES AS RE-  
LATING TO THE CALIFORNIA K-12 EDUCATION  
SYSTEM; PROVIDING INFORMATION VIA A WEB  
SITE FEATURING DATA AND STATISTICS ON

STUDENT TESTING PERFORMANCE WITHIN  
THE CALIFORNIA K-12 EDUCATION SYSTEM AT  
THE STATE, COUNTY, DISTRICT AND INDIVI-  
DUAL SCHOOL LEVELS; PROVIDING INFORMA-  
TION VIA A WEB SITE FEATURING DATA AND  
STATISTICS ON THE USE EDUCATIONAL TECH-  
NOLOGY WITHIN THE CALIFORNIA K-12 EDU-  
CATION SYSTEM AT THE STATE, COUNTY,  
DISTRICT AND INDIVIDUAL SCHOOL LEVELS;  
PROVIDING A WEB SITE FEATURING TECHNICAL  
DEFINITIONS, A GLOSSARY, QUESTION  
AND ANSWER FACT SHEETS, AND ARTICLES,  
ALL RELATING TO CALIFORNIA K-12 EDUCA-  
TION, IN CLASS 41 (U.S. CLS. 100, 101 AND 107).

FIRST USE 1-1-1996; IN COMMERCE 1-1-1996.

THE MARK CONSISTS OF STANDARD CHAR-  
ACTERS WITHOUT CLAIM TO ANY PARTICULAR  
FONT, STYLE, SIZE, OR COLOR.

SEC. 2(F).

SER. NO. 78-663,139, FILED 7-1-2005.

KYLE PEETE, EXAMINING ATTORNEY

**Int. Cls.: 35, 36, 41 and 45**

**Prior U.S. Cls.: 100, 101, 102 and 107**

**United States Patent and Trademark Office**

**Reg. No. 3,453,729**

**Registered June 24, 2008**

**SERVICE MARK  
PRINCIPAL REGISTER**

**SCOTLAND HOUSE**

THE AMERICAN-SCOTTISH FOUNDATION,  
INC. (NEW YORK CHARITABLE CORPORATION)  
SUITE 1006  
575 MADISON AVENUE  
NEW YORK, NY 10022

FOR: BUSINESS CONSULTATION AND CHAMBER OF COMMERCE SERVICES, NAMELY, PROMOTING BUSINESS, COMMERCIAL, INDUSTRIAL, FINANCIAL AND ECONOMIC RELATIONS AND COOPERATION; TRADE INFORMATION SERVICES, NAMELY, PROVIDING TRADE INFORMATION BETWEEN AND AMONG THE UNITED STATES, SCOTLAND AND THE AMERICAN-SCOTTISH COMMUNITY; BUSINESS SERVICES, NAMELY, PROVIDING CONSULTATION, ADVICE AND SUPPORT TO ESTABLISH JOINT VENTURES BETWEEN COMMUNITIES, BUSINESSES AND GOVERNMENTS OF THE UNITED STATES, SCOTLAND AND THE AMERICAN-SCOTTISH COMMUNITY, IN CLASS 35 (U.S. CLS. 100, 101 AND 102).

FIRST USE 10-24-1976; IN COMMERCE 10-24-1976.

FOR: CHARITABLE FUND RAISING SERVICES TO BENEFIT SCOTTISH CULTURE AND HERITAGE AND THE AMERICAN-SCOTTISH COMMUNITY, IN CLASS 36 (U.S. CLS. 100, 101 AND 102).

FIRST USE 10-24-1976; IN COMMERCE 10-24-1976.

FOR: ORGANIZING COMMUNITY FESTIVALS AND EVENTS FEATURING A VARIETY OF ACTIV-

ITIES IN THE NATURE OF PARADES, PAGEANTS, DANCES, GOLF TOURNAMENTS, DINNERS, AWARD CEREMONIES, DANCES, FAIRS AND THE LIKE; ENTERTAINMENT SERVICES, NAMELY, CONDUCTING PRIVATE PARTIES FOR SOCIAL INTRODUCTION, SOCIAL GATHERINGS AND MEETINGS; PROVIDING EDUCATIONAL AND PROFESSIONAL DEVELOPMENT SERVICES IN THE NATURE OF CLASSES, SEMINARS, WORKSHOPS, MEETING, CONFERENCES, EXHIBITIONS AND FAIRS TO PROMOTE SOCIAL INTERACTION, LEADERSHIP AND FOSTER DEVELOPMENT OF ENTREPRENEURSHIP AND BUSINESS AMONG THE UNITED STATES, SCOTTISH AND THE AMERICAN-SCOTTISH COMMUNITY; LIBRARY SERVICES, IN CLASS 41 (U.S. CLS. 100, 101 AND 107).

FIRST USE 10-24-1976; IN COMMERCE 10-24-1976.

FOR: SOCIAL INTRODUCTION SERVICES, IN CLASS 45 (U.S. CLS. 100 AND 101).

FIRST USE 10-24-1976; IN COMMERCE 10-24-1976.

THE MARK CONSISTS OF STANDARD CHARACTERS WITHOUT CLAIM TO ANY PARTICULAR FONT, STYLE, SIZE, OR COLOR.

SEC. 2(F) AS TO "SCOTLAND".

SER. NO. 78-668,890, FILED 7-12-2005.

DANNEAN HETZEL, EXAMINING ATTORNEY

**Int. Cls.: 5 and 29**

**Prior U.S. Cls.: 6, 18, 44, 46, 51 and 52**

**United States Patent and Trademark Office**

**Reg. No. 3,453,730**

**Registered June 24, 2008**

**TRADEMARK  
PRINCIPAL REGISTER**



ESPRIT BIO (FRANCE SOCIETE PAR ACTIONS  
SIMPLIFIEE)  
RUE CHRISTOPHE COLOMB, 8  
PARIS, FRANCE 75008

FOR: DIETETIC FOODS ADAPTED FOR MEDI-  
CAL USE; FOOD SUPPLEMENTS; NUTRITIONAL  
SUPPLEMENTS, IN CLASS 5 (U.S. CLS. 6, 18, 44, 46, 51  
AND 52).

FOR: SOY-BASED CULINARY PREPARATIONS,  
NAMELY, SOY BASED DIPS, IN CLASS 29 (U.S. CL.  
46).

PRIORITY CLAIMED UNDER SEC. 44(D) ON  
ERPNTY TM OFC APPLICATION NO.  
4316709, FILED 3-1-2005, REG. NO. 4316709, DATED  
2-7-2006, EXPIRES 2-7-2016.

NO CLAIM IS MADE TO THE EXCLUSIVE  
RIGHT TO USE "MISO CUBE", APART FROM THE  
MARK AS SHOWN.

THE COLOR(S) RED, BLACK, BROWN, ORANGE  
AND WHITE IS/ARE CLAIMED AS A FEATURE OF  
THE MARK.

THE MARK CONSISTS OF LARGE RED CIRCLE  
WITH THE WORDING "MISO CUBE" APPEARING  
ACROSS IT IN BLACK. TO THE LOWER LEFT OF  
THE CIRCLE IS A CUP OF SOUP. THE CUP IS RED  
AND WHITE. THE SOUP IS BROWN. AN ORANGE  
CUBE APPEARS ELEVATED ABOVE THE SOUP.

SER. NO. 78-675,573, FILED 7-21-2005.

WENDY GOODMAN, EXAMINING ATTORNEY

**Int. Cls.: 16 and 41**

**Prior U.S. Cls.: 2, 5, 22, 23, 29, 37, 38, 50, 100, 101 and 107**

**Reg. No. 3,453,731**

**United States Patent and Trademark Office**

**Registered June 24, 2008**

**TRADEMARK  
SERVICE MARK  
PRINCIPAL REGISTER**

**DEEPCASTER FORTRESS ASSETS**

DEEPCASTER LLC (NEVADA LTD LIAB CO)  
SUITE 1300  
5 THIRD STREET  
SAN FRANCISCO, CA 94103

FOR: NEWSLETTERS DISSEMINATED IN PAPER FORM CONTAINING ARTICLES AND INFORMATION ON THE TOPICS OF INVESTMENTS, FINANCIAL MANAGEMENT AND ASSET PROTECTION AND OTHER FINANCIAL-RELATED TOPICS, IN CLASS 16 (U.S. CLS. 2, 5, 22, 23, 29, 37, 38 AND 50).

FIRST USE 4-7-2006; IN COMMERCE 4-7-2006.

FOR: NEWSLETTERS DISSEMINATED IN ONLINE AND E-MAIL FORM CONTAINING ARTICLES AND INFORMATION ON THE TOPICS OF INVESTMENTS, FINANCIAL MANAGEMENT AND ASSET PROTECTION AND OTHER FINANCIAL-RELATED TOPICS; WEB-BASED NEWSLETTER

CONTAINING ARTICLES AND INFORMATION ON THE TOPICS OF INVESTMENTS, FINANCIAL MANAGEMENT AND ASSET PROTECTION AND OTHER FINANCIAL-RELATED TOPICS, IN CLASS 41 (U.S. CLS. 100, 101 AND 107).

FIRST USE 1-30-2006; IN COMMERCE 1-30-2006.

THE MARK CONSISTS OF STANDARD CHARACTERS WITHOUT CLAIM TO ANY PARTICULAR FONT, STYLE, SIZE, OR COLOR.

NO CLAIM IS MADE TO THE EXCLUSIVE RIGHT TO USE "ASSETS", APART FROM THE MARK AS SHOWN.

SER. NO. 78-680,702, FILED 7-28-2005.

H. M. FISHER, EXAMINING ATTORNEY



**Int. Cl.: 35**

**Prior U.S. Cls.: 100, 101 and 102**

**United States Patent and Trademark Office**

**Reg. No. 3,453,732**

**Registered June 24, 2008**

**SERVICE MARK  
PRINCIPAL REGISTER**

**UTAH SKI**

PHONE DIRECTORIES COMPANY, LP (DELA-  
WARE LIMITED PARTNERSHIP)  
135 SOUTH MOUNTAIN WAY DRIVE  
OREM, UT 84058

FOR: PROMOTING THE GOODS AND SERVICES  
OF OTHERS THROUGH THE DISTRIBUTION OF  
TELEPHONE DIRECTORIES; PROVIDING TELE-  
PHONE DIRECTORY INFORMATION REGARD-  
ING COMMUNITY, ENTERTAINMENT,  
EDUCATION AND GOVERNMENT AFFAIRS; DIS-  
SEMINATION OF ADVERTISING FOR OTHERS ,  
SOLELY THROUGH ONLINE TELEPHONE DIREC-  
TORIES, IN CLASS 35 (U.S. CLS. 100, 101 AND 102).

FIRST USE 9-0-1981; IN COMMERCE 9-0-1981.

THE MARK CONSISTS OF STANDARD CHAR-  
ACTERS WITHOUT CLAIM TO ANY PARTICULAR  
FONT, STYLE, SIZE, OR COLOR.

SEC. 2(F).

SER. NO. 78-682,963, FILED 8-1-2005.

SHARON MEIER, EXAMINING ATTORNEY

**Int. Cl.: 35**

**Prior U.S. Cls.: 100, 101 and 102**

**United States Patent and Trademark Office**

**Reg. No. 3,453,733**

**Registered June 24, 2008**

**SERVICE MARK  
PRINCIPAL REGISTER**

**KANSAS CURES**

KANSAS COALITION FOR LIFESAVING CURES  
INC. (KANSAS NON-PROFIT CORPORATION)  
STE. 500  
6201 COLLEGE BLVD.  
OVERLAND PARK, KS 66211

FOR: PROMOTING PUBLIC AWARENESS OF  
THE NEED FOR AND AVAILABILITY OF SCIENTIFIC  
RESEARCH, TREATMENT, AND EDUCATION  
IN THE FIELD OF STEM CELL RESEARCH  
AND PROVIDING INFORMATION IN CONNECTION  
THEREWITH; PUBLIC AWARENESS SERVICES,  
NAMELY, PROMOTING THE NEED FOR  
SCIENTIFIC RESEARCH, TREATMENT AND  
EDUCATION IN THE FIELD OF STEM CELLS,  
IN CLASS 35 (U.S. CLS. 100, 101 AND 102).

FIRST USE 7-0-2005; IN COMMERCE 7-0-2005.

THE MARK CONSISTS OF STANDARD CHARACTERS  
WITHOUT CLAIM TO ANY PARTICULAR  
FONT, STYLE, SIZE, OR COLOR.

NO CLAIM IS MADE TO THE EXCLUSIVE  
RIGHT TO USE "KANSAS", APART FROM THE  
MARK AS SHOWN.

SER. NO. 78-683,006, FILED 8-1-2005.

ELLEN PERKINS, EXAMINING ATTORNEY

**Int. Cl.: 32**

**Prior U.S. Cls.: 45, 46 and 48**

**Reg. No. 3,453,734**

**United States Patent and Trademark Office**

**Registered June 24, 2008**

**TRADEMARK  
PRINCIPAL REGISTER**

**KIJU**

NOTHING BUT NATURE INC. (CANADA CORPORATION)  
UNIT 11  
564 WEBER STREET NORTH  
WATERLOO, CANADA N2L 5C6

PRIORITY CLAIMED UNDER SEC. 44(D) ON CANADA APPLICATION NO. 1246861, FILED 2-11-2005, REG. NO. TMA707157, DATED 2-12-2008, EXPIRES 2-12-2023.

FOR: FRUIT JUICES, IN CLASS 32 (U.S. CLS. 45, 46 AND 48).

SER. NO. 78-684,444, FILED 8-3-2005.

THE MARK CONSISTS OF STANDARD CHARACTERS WITHOUT CLAIM TO ANY PARTICULAR FONT, STYLE, SIZE, OR COLOR.

HENRY S. ZAK, EXAMINING ATTORNEY

**Int. Cl.: 3**

**Prior U.S. Cls.: 1, 4, 6, 50, 51 and 52**

**United States Patent and Trademark Office**

**Reg. No. 3,453,735**

**Registered June 24, 2008**

**TRADEMARK  
PRINCIPAL REGISTER**

**L'OREAL INFINIUM**

L'OREAL (FRANCE SOCIETE ANONYME)  
14, RUE ROYALE  
PARIS, FRANCE 75008

OWNER OF FRANCE REG. NO. 97708935, DATED  
12-15-1997, EXPIRES 12-15-2008.

FOR: HAIR SPRAY, IN CLASS 3 (U.S. CLS. 1, 4, 6,  
50, 51 AND 52).

OWNER OF U.S. REG. NOS. 661,746 AND 1,426,174.

FIRST USE 10-1-2006; IN COMMERCE 10-1-2006.

SER. NO. 78-685,333, FILED 8-4-2005.

THE MARK CONSISTS OF STANDARD CHAR-  
ACTERS WITHOUT CLAIM TO ANY PARTICULAR  
FONT, STYLE, SIZE, OR COLOR.

ALLISON SCHRODY, EXAMINING ATTORNEY

**Int. Cl.: 41**

**Prior U.S. Cls.: 100, 101 and 107**

**United States Patent and Trademark Office**

**Reg. No. 3,453,736**

**Registered June 24, 2008**

**SERVICE MARK  
PRINCIPAL REGISTER**

# NHRA Nationals

NATIONAL HOT ROD ASSOCIATION (CALI-  
FORNIA CORPORATION)  
2035 FINANCIAL WAY  
GLEN DORA, CA 91741

OWNER OF U.S. REG. NOS. 1,293,428, 2,221,363  
AND OTHERS.

FOR: ENTERTAINMENT IN THE NATURE OF  
AUTOMOBILE RACES, IN CLASS 41 (U.S. CLS. 100,  
101 AND 107).

NO CLAIM IS MADE TO THE EXCLUSIVE  
RIGHT TO USE "NATIONALS", APART FROM  
THE MARK AS SHOWN.

FIRST USE 12-31-1999; IN COMMERCE 12-31-1999.

SER. NO. 78-687,591, FILED 8-8-2005.

THE MARK CONSISTS OF STANDARD CHAR-  
ACTERS WITHOUT CLAIM TO ANY PARTICULAR  
FONT, STYLE, SIZE, OR COLOR.

TRICIA SONNEBORN, EXAMINING ATTORNEY

**Int. Cl.: 25**

**Prior U.S. Cls.: 22 and 39**

**United States Patent and Trademark Office**

**Reg. No. 3,453,737**

**Registered June 24, 2008**

**TRADEMARK  
PRINCIPAL REGISTER**

# Magellan's

MAGELLAN'S INTERNATIONAL TRAVEL LLC  
(DELAWARE LTD LIAB CO)  
100 WEST SOLA STREET  
SANTA BARBARA, CA 93101

FOR: CLOTHING, NAMELY, MEN'S AND WOMEN'S JACKETS, SWEATERS, RAINCOATS, PONCHOS, VESTS, UNDERWEAR, PANTS, SHORTS, BATHROBES, SLEEPWEAR, AND SWIMWEAR; MEN'S SHIRTS AND TOPS; AND WOMEN'S BLOUSES AND TOPS, SKIRTS AND DRESSES, ALL SOLD THROUGH MAIL ORDER CATALOGS, RETAIL STORES AND WEBSITES SPECIALIZING IN TRAVEL-RELATED PRODUCTS, IN CLASS 25 (U.S. CLS. 22 AND 39).

FIRST USE 1-1-1998; IN COMMERCE 1-1-1998.

THE MARK CONSISTS OF STANDARD CHARACTERS WITHOUT CLAIM TO ANY PARTICULAR FONT, STYLE, SIZE, OR COLOR.

OWNER OF U.S. REG. NOS. 2,058,589, 2,147,070, AND 2,763,119.

SER. NO. 78-695,998, FILED 8-18-2005.

JANICE L. MCMORROW, EXAMINING ATTORNEY

**Int. Cl.: 25**

**Prior U.S. Cls.: 22 and 39**

**United States Patent and Trademark Office**

**Reg. No. 3,453,738**

**Registered June 24, 2008**

**TRADEMARK  
PRINCIPAL REGISTER**

# Magellan's

MAGELLAN'S INTERNATIONAL TRAVEL LLC  
(DELAWARE LTD LIAB CO)  
100 WEST SOLA STREET  
SANTA BARBARA, CA 93101

FOR: LUGGAGE, NAMELY, ROLLING LUGGAGE, NON-ROLLING LUGGAGE, ROLLING TOTE BAGS, AND NON-ROLLING TOTE BAGS, ALL SOLD THROUGH MAIL ORDER CATALOGS, RETAIL STORES AND WEBSITES SPECIALIZING IN TRAVEL-RELATED PRODUCTS, IN CLASS 25 (U.S. CLS. 22 AND 39).

FIRST USE 1-1-1999; IN COMMERCE 1-1-1999.

THE MARK CONSISTS OF STANDARD CHARACTERS WITHOUT CLAIM TO ANY PARTICULAR FONT, STYLE, SIZE, OR COLOR.

OWNER OF U.S. REG. NOS. 2,058,589, 2,147,070, AND 2,763,119.

SER. NO. 78-696,002, FILED 8-18-2005.

JANICE L. MCMORROW, EXAMINING ATTORNEY

**Int. Cl.: 38**

**Prior U.S. Cls.: 100, 101 and 104**

**United States Patent and Trademark Office**

**Reg. No. 3,453,739**

**Registered June 24, 2008**

**SERVICE MARK  
PRINCIPAL REGISTER**

**METROVIBE**

FIRST MEDIA GROUP INC. (CANADA CORPORATION)  
536 KIPLING AVENUE  
TORONTO, CANADA M8Z 5E3

FOR: OPERATION OF AN INTERACTIVE FORUM ACCESSIBLE BY TELEPHONE THAT ENABLES THE RECORDAL, STORAGE AND TRANSMISSION OF MESSAGES FOR DATING, FRIENDSHIP OR SOCIAL PURPOSES; TELEPHONE COMMUNICATION SERVICES, NAMELY, TELEPHONE CONNECTION AND INTERACTIVE VOICE RESPONSE SERVICES ENABLING PROMPTING, RECORDING, STORAGE AND TRANSMISSION OF VOICE MESSAGES BY TELEPHONE OR ELECTRONICALLY; ELECTRONIC VOICE MESSAGING SERVICES ENABLING CUSTOMERS TO RECORD, STORE AND TRANSMIT VOICE MESSAGES AND OPTIONALLY

ENGAGE IN LIVE TELEPHONE CONVERSATIONS WITH SELECTED OTHER CUSTOMERS, IN CLASS 38 (U.S. CLS. 100, 101 AND 104).

THE MARK CONSISTS OF STANDARD CHARACTERS WITHOUT CLAIM TO ANY PARTICULAR FONT, STYLE, SIZE, OR COLOR.

PRIORITY CLAIMED UNDER SEC. 44(D) ON CANADA APPLICATION NO. 1259337, FILED 5-30-2005, REG. NO. TMA703000, DATED 12-12-2007, EXPIRES 12-12-2022.

SER. NO. 78-699,289, FILED 8-24-2005.

KEVON CHISOLM, EXAMINING ATTORNEY



**Int. Cl.: 3**

**Prior U.S. Cls.: 1, 4, 6, 50, 51 and 52**

**United States Patent and Trademark Office**

**Reg. No. 3,453,740**

**Registered June 24, 2008**

**TRADEMARK  
PRINCIPAL REGISTER**

**PURELOGICOL**

PURELOGICOL INTERNATIONAL LIMITED  
(UNITED KINGDOM CORPORATION)  
2 REDWOOD AVENUE PEEL PARK  
EAST KILBRIDE, UNITED KINGDOM G74 5PE

FOR: SUNSCREEN PREPARATIONS; PERFUM-  
ERY; COSMETICS; HAIRCARE PREPARATIONS;  
ESSENTIAL OILS; FACE MASKS; HAIR LOTIONS;  
DENTIFRICES; SKIN CLEANSERS; COSMETIC  
KITS CONSISTING OF FACIAL MASKS AND  
MOISTURIZERS; LOTIONS FOR COSMETIC PUR-  
POSES; COSMETIC PREPARATIONS FOR SKIN

CARE; TISSUES IMPREGNATED WITH COSMETIC  
LOTIONS; COLLAGEN BASED COSMETICS; GELS  
FOR THE LIPS AND FOR THE SKIN, IN CLASS 3  
(U.S. CLS. 1, 4, 6, 50, 51 AND 52).

OWNER OF ERPN CMNTY TM OFC REG. NO.  
002941318, DATED 4-21-2005, EXPIRES 11-21-2012.

SER. NO. 78-712,641, FILED 9-14-2005.

LESLEY LAMOTHE, EXAMINING ATTORNEY

**Int. Cls.: 9, 16, 35, 36, 37, 39, 41 and 42**

**Prior U.S. Cls.: 2, 5, 21, 22, 23, 26, 29, 36, 37, 38, 50,  
100, 101, 102, 103, 105, 106 and 107**

**Reg. No. 3,453,741**

**United States Patent and Trademark Office**

**Registered June 24, 2008**

**TRADEMARK  
SERVICE MARK  
PRINCIPAL REGISTER**



PALM, INC. (DELAWARE CORPORATION)  
950 W. MAUDE AVENUE  
SUNNYVALE, CA 94085

FOR: SCIENTIFIC, PHOTOGRAPHIC, CINEMATOGRAPHIC, OPTICAL, ELECTRONIC AND TEACHING APPARATUS AND INSTRUMENTS, AS WELL AS APPARATUS FOR RECORDING, TRANSMISSION OF REPRODUCTION OF DATA, TEXT, GRAPHICS, SOUND OR IMAGES, NAMELY, COMPUTERS; COMPUTER HARDWARE; PERSONAL DIGITAL ASSISTANTS; MOBILE COMPUTERS; HANDHELD COMPUTERS; TABLET COMPUTERS; COMPUTER MEMORIES; COMPUTER STORAGE HARDWARE; CIRCUIT BOARDS; INTEGRATED CIRCUITS; SEMICONDUCTORS; COMPUTER KEYBOARDS; INPUT DEVICES, NAMELY, COMPUTER KEYPADS, MICE, TRACKBALLS AND JOYSTICKS AND MICROPHONES; STORAGE DEVICES, NAMELY, BLANK FLOPPY AND COMPACT DISCS; GLOBAL POSITIONING SYSTEM RECEIVERS; RADIOS; SCANNERS; PRINTERS; BATTERY CHARGERS; POWER CONVERTERS, NAMELY, VOLTAGE REGULATORS FOR ELECTRIC POWER; COMPUTER CABLES; APPARATUS AND INSTRUMENTS FOR INTERCONNECTING ELECTRICAL AND ELECTRONIC EQUIPMENT, NAMELY, ELECTRICAL CABLES, ELECTRICAL CONNECTORS, AND ELECTRICAL CONVERTER BOXES; COMPUTER STY-

LUSES; COMMUNICATIONS COMPUTER HARDWARE; COMPUTER PERIPHERALS; TELECOMMUNICATIONS COMPUTER HARDWARE; TELEPHONES; MOBILE TELEPHONES; PAGERS; DIGITAL AUDIO PLAYERS; DIGITAL VIDEO PLAYERS; DIGITAL MULTIMEDIA PLAYERS; TRANSCEIVERS; DIGITAL AUDIO AND VIDEO RECORDERS; DIGITAL CAMERAS; COMPUTER SOFTWARE, NAMELY, OPERATING SYSTEMS PROGRAMS, HANDWRITING RECOGNITION SOFTWARE, DATA SYNCHRONIZATION PROGRAMS, MOBILE COMMUNICATIONS SOFTWARE, APPLICATIONS AND APPLICATION DEVELOPMENT TOOLS PROGRAMS FOR PERSONAL AND HAND-HELD COMPUTERS; COMPUTER CARRYING CASES; DOWNLOADABLE ELECTRONIC OR DIGITAL PUBLICATIONS, NAMELY, BROCHURES, MANUALS, MAGAZINES AND NEWSLETTERS IN THE FIELDS OF COMPUTER HARDWARE AND COMPUTER SOFTWARE, IN CLASS 9 (U.S. CLS. 21, 23, 26, 36 AND 38).

FIRST USE 7-14-2005; IN COMMERCE 7-14-2005.

FOR: PRINTED MATTER, NAMELY, BOOKS, MAGAZINES, BROCHURES, NEWSLETTERS, INSTRUCTIONAL AND TEACHING MATERIAL ALL IN THE FIELD OF COMPUTERS, COMPUTER SOFTWARE, WIRELESS COMMUNICATIONS AND COMPUTING; STATIONERY, NOTE PADS,

PENS, PENCILS; AND DESK STANDS AND HOLDERS FOR PENS, PENCILS AND INK , IN CLASS 16 (U.S. CLS. 2, 5, 22, 23, 29, 37, 38 AND 50).

FIRST USE 7-14-2005; IN COMMERCE 7-14-2005.

FOR: ADVERTISING SERVICES, NAMELY, DISSEMINATING ADVERTISING FOR OTHERS IN THE FIELDS OF COMPUTERS, COMPUTING PRODUCTS, COMMUNICATIONS PRODUCTS, AND INFORMATIONAL MATERIALS AND ACCESSORIES ASSOCIATED THEREWITH VIA THE INTERNET AND DIRECT MAIL; RETAIL STORE SERVICES IN THE FIELDS OF COMPUTERS, COMPUTING PRODUCTS, COMMUNICATIONS PRODUCTS, AND INFORMATIONAL MATERIALS AND ACCESSORIES ASSOCIATED THEREWITH, AVAILABLE VIA TELEPHONE, MAIL, THE INTERNET AND IN PERSON; ARRANGING AND CONDUCTING LIVE OR ELECTRONIC TRADE SHOWS IN THE FIELDS OF COMPUTERS, COMPUTING PRODUCTS, COMMUNICATIONS PRODUCTS, AND INFORMATIONAL MATERIALS AND ACCESSORIES; BUSINESS REFERRAL SERVICES, NAMELY, ADVERTISING THE GOODS AND SERVICES OF OTHERS IN JOINT MARKETING AND PROMOTIONAL EFFORTS, IN CLASS 35 (U.S. CLS. 100, 101 AND 102).

FIRST USE 7-14-2005; IN COMMERCE 7-14-2005.

FOR: PROVIDING WEBSITES FEATURING INFORMATION AND LINKS TO OTHER WEBSITES IN THE FIELD OF FINANCE, INSURANCE AND INVESTING; FINANCIAL SERVICES, NAMELY, PROVIDING ONLINE BILL PAYMENT SERVICES; FINANCING SERVICES; VENTURE CAPITAL SERVICES, NAMELY, PROVIDING FINANCING TO EMERGING AND START-UP COMPANIES IN THE FIELD OF CONSUMER ELECTRONIC PRODUCTS, IN CLASS 36 (U.S. CLS. 100, 101 AND 102).

FIRST USE 7-14-2005; IN COMMERCE 7-14-2005.

FOR: INSTALLATION, MAINTENANCE AND REPAIR OF COMPUTERS, COMPUTER HARDWARE, COMMUNICATIONS HARDWARE AND COMPUTER PERIPHERALS, IN CLASS 37 (U.S. CLS. 100, 103 AND 106).

FIRST USE 7-14-2005; IN COMMERCE 7-14-2005.

FOR: ELECTRONIC STORAGE OF DATA, IMAGES, AUDIO OR GRAPHICS ON OPTICAL, DIGITAL OR MAGNETIC MEDIA, IN CLASS 39 (U.S. CLS. 100 AND 105).

FIRST USE 7-14-2005; IN COMMERCE 7-14-2005.

FOR: PUBLICATION OF BOOKS, INSTRUCTIONAL MANUALS, BROCHURES; ELECTRONIC PUBLISHING, NAMELY, PUBLICATION OF TEXT, AUDIO, VIDEO AND MULTIMEDIA CONTENT

FOR OTHERS IN THE FIELDS OF COMPUTERS, COMPUTING, COMMUNICATIONS PRODUCTS AND ENTERTAINMENT ON CDS, DVDS, THE INTERNET AND COMMUNICATIONS NETWORKS; PROVIDING WEBSITES FEATURING INFORMATION AND LINKS TO OTHER WEBSITES IN THE FIELDS OF ENTERTAINMENT AND EDUCATION; ENTERTAINMENT SERVICES, NAMELY, PROVIDING COMPUTER GAMES VIA THE INTERNET AND COMMUNICATIONS NETWORKS; TELEVISION AND RADIO PROGRAMMING, NOT INCLUDING PROGRAMMING WHERE THE PRIMARY CONTENT IS PRE-RECORDED MUSICAL PERFORMANCES OR MUSIC VIDEOS , IN CLASS 41 (U.S. CLS. 100, 101 AND 107).

FIRST USE 7-14-2005; IN COMMERCE 7-14-2005.

FOR: SCIENTIFIC RESEARCH AND DEVELOPMENT OF NEW TECHNOLOGY AND DESIGN THEREOF IN THE FIELDS OF COMPUTERS, COMPUTER HARDWARE, COMMUNICATIONS PRODUCTS AND COMPUTER SOFTWARE; COMPUTER SERVICES, NAMELY, COMPUTER PROGRAMMING, COMPUTER HARDWARE AND SOFTWARE CONSULTANCY, COMPUTER SYSTEM AND SOFTWARE DESIGN AND ANALYSIS, INSTALLATION, REPAIR AND MAINTENANCE OF COMPUTER SOFTWARE AND TELECOMMUNICATIONS SOFTWARE, CREATING AND MAINTAINING WEBSITES FOR OTHERS; PROVIDING SEARCH ENGINES FOR OBTAINING DATA ON A GLOBAL COMPUTER NETWORK; APPLICATION SERVICES PROVIDER SERVICES, NAMELY, HOSTING, OPERATING, RENTING, CREATING AND UPDATING COMPUTER SOFTWARE FOR OTHERS; CREATING AND MAINTAINING WEBSITES FEATURING LINKS TO WEBSITES OF OTHERS IN THE FIELDS OF COMPUTERS, COMPUTING, ADVERTISING, BUSINESS, COMMUNICATIONS, TELECOMMUNICATIONS, ENTERTAINMENT AND EDUCATION, IN CLASS 42 (U.S. CLS. 100 AND 101).

FIRST USE 7-14-2005; IN COMMERCE 7-14-2005.

OWNER OF U.S. REG. NOS. 2,653,036, 2,970,850 AND OTHERS.

THE COLOR(S) ORANGE, WHITE AND GREY IS/ ARE CLAIMED AS A FEATURE OF THE MARK.

THE COLOR ORANGE APPEARS IN THE BACKGROUND CIRCLE, WHITE APPEARS IN THE LETTERS AND OUTER CIRCLE, AND GREY APPEARS IN THE BORDER.

SEC. 2(F).

SER. NO. 78-717,319, FILED 9-21-2005.

ROBERT C. CLARK JR., EXAMINING ATTORNEY

**Int. Cl.: 38**

**Prior U.S. Cls.: 100, 101 and 104**

**United States Patent and Trademark Office**

**Reg. No. 3,453,742**

**Registered June 24, 2008**

**SERVICE MARK  
PRINCIPAL REGISTER**

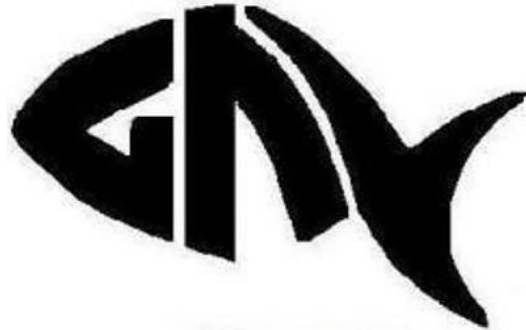

MISSOURI RIVER CHRISTIAN BROADCAST-  
ING, INC. (MISSOURI CORPORATION)  
PO BOX 187  
WASHINGTON, MO 63090

FOR: RADIO BROADCASTING, IN CLASS 38 (U.S.  
CLS. 100, 101 AND 104).

FIRST USE 9-10-2002; IN COMMERCE 9-10-2002.

THE MARK CONSISTS OF THE LETTERS GNV  
FORM THE SHAPE OF A FISH WITH THE LAST  
LETTER V IN ADDITION TO FORMING THE FISH  
ALSO BY ITSELF IS IN THE SHAPE OF A DOVE.

SER. NO. 78-722,658, FILED 9-28-2005.

RONALD AIKENS, EXAMINING ATTORNEY

**Int. Cls.: 9 and 41**

**Prior U.S. Cls.: 21, 23, 26, 36, 38, 100, 101 and 107**

**United States Patent and Trademark Office**

**Reg. No. 3,453,743**

**Registered June 24, 2008**

**TRADEMARK  
SERVICE MARK  
PRINCIPAL REGISTER**



**STUDIO B PRODUCTIONS**

STUDIO B PRODUCTIONS INC. (CANADA CORPORATION)  
SUITE 600  
190 ALEXANDER ST.  
VANCOUVER, CANADA V6A 1B5

FOR: ANIMATED FILMS, ANIMATED TELEVISION FILM RECORDINGS, AND COMPACT DISCS AND VIDEO DISCS FEATURING ANIMATION, IN CLASS 9 (U.S. CLS. 21, 23, 26, 36 AND 38).

FIRST USE 0-0-2003; IN COMMERCE 4-25-2005.

FOR: ENTERTAINMENT SERVICES, NAMELY, PRODUCTION OF ANIMATED FILMS, ANIMATED TELEVISION PROGRAMS, COMPACT DISC AND VIDEO DISC RECORDINGS FEATURING ANIMATION, AND ONGOING TELEVISION PROGRAMS

IN THE FIELD OF ANIMATION, IN CLASS 41 (U.S. CLS. 100, 101 AND 107).

FIRST USE 0-0-2003; IN COMMERCE 0-0-2003.

PRIORITY CLAIMED UNDER SEC. 44(D) ON CANADA APPLICATION NO. 1252809, FILED 4-4-2005, REG. NO. TMA662965, DATED 4-21-2006, EXPIRES 4-21-2021.

NO CLAIM IS MADE TO THE EXCLUSIVE RIGHT TO USE "STUDIO" AND "PRODUCTIONS", APART FROM THE MARK AS SHOWN.

SER. NO. 78-726,529, FILED 10-4-2005.

BONNIE LUKEN, EXAMINING ATTORNEY

**Int. Cls.: 9 and 16**

**Prior U.S. Cls.: 2, 5, 21, 22, 23, 26, 29, 36, 37, 38 and 50**

**United States Patent and Trademark Office**

**Reg. No. 3,453,744**

**Registered June 24, 2008**

**TRADEMARK  
PRINCIPAL REGISTER**

**HEALTHCARE EXECUTIVE**

AMERICAN COLLEGE OF HEALTHCARE EXECUTIVES (ILLINOIS NON-PROFIT CORPORATION)

SUITE 1700  
1 NORTH FRANKLIN  
CHICAGO, IL 606064425

FOR: ELECTRONIC PUBLICATIONS, NAMELY, MAGAZINES IN THE AREA OF HEALTHCARE MANAGEMENT, DOWNLOADABLE VIA A GLOBAL COMPUTER NETWORK, IN CLASS 9 (U.S. CLS. 21, 23, 26, 36 AND 38).

FIRST USE 1-1-2005; IN COMMERCE 1-1-2005.

FOR: PRINTED PUBLICATIONS, NAMELY, MAGAZINES IN THE AREA OF HEALTHCARE MANAGEMENT, IN CLASS 16 (U.S. CLS. 2, 5, 22, 23, 29, 37, 38 AND 50).

FIRST USE 1-1-1985; IN COMMERCE 1-1-1985.

THE MARK CONSISTS OF STANDARD CHARACTERS WITHOUT CLAIM TO ANY PARTICULAR FONT, STYLE, SIZE, OR COLOR.

NO CLAIM IS MADE TO THE EXCLUSIVE RIGHT TO USE "HEALTHCARE" , APART FROM THE MARK AS SHOWN.

SEC. 2(F).

SER. NO. 78-730,166, FILED 10-10-2005.

MYRIAH HABEEB, EXAMINING ATTORNEY

**Int. Cl.: 16**

**Prior U.S. Cls.: 2, 5, 22, 23, 29, 37, 38 and 50**

**United States Patent and Trademark Office**

**Reg. No. 3,453,745**

**Registered June 24, 2008**

**TRADEMARK  
PRINCIPAL REGISTER**

**TE SACAN DE APUROS!**

KRUGER PRODUCTS LIMITED (CANADA CORPORATION)  
1900 MINNESOTA COURT, SUITE 200  
MISSISSAUGA, ONTARIO L5N 5R5

FOR: PAPER TOWELS, IN CLASS 16 (U.S. CLS. 2, 5, 22, 23, 29, 37, 38 AND 50).

THE MARK CONSISTS OF STANDARD CHARACTERS WITHOUT CLAIM TO ANY PARTICULAR FONT, STYLE, SIZE, OR COLOR.

PRIORITY CLAIMED UNDER SEC. 44(D) ON CANADA APPLICATION NO. 1,275,708, FILED 10-14-2005, REG. NO. TMA684153, DATED 3-20-2007, EXPIRES 3-20-2022.

THE ENGLISH TRANSLATION OF THE WORDING IN THE MARK IS "GETTING YOU OUT OF TROUBLE."

SER. NO. 78-740,651, FILED 10-26-2005.

JULIE GUTTADAURO, EXAMINING ATTORNEY

**Int. Cl.: 35**

**Prior U.S. Cls.: 100, 101 and 102**

**United States Patent and Trademark Office**

**Reg. No. 3,453,746**

**Registered June 24, 2008**

**SERVICE MARK  
PRINCIPAL REGISTER**

**HOME REWARDS**

GMAC MORTGAGE LLC (DELAWARE LTD  
LIAB CO)  
2711 CENTERVILLE ROAD  
SUITE 400  
WILMINGTON, DE 19808

FOR: PROMOTING THE USE OF FRANCHISEES  
REAL ESTATE AGENT SERVICES THROUGH THE  
ADMINISTRATION OF AN INCENTIVE AWARD  
PROGRAM PROVIDING SERVICES TO CONSUMERS  
WHO HAVE BOUGHT OR SOLD HOMES  
THROUGH REAL ESTATE AGENT FRANCHISEES,  
IN CLASS 35 (U.S. CLS. 100, 101 AND 102).

FIRST USE 1-1-1998; IN COMMERCE 1-1-1998.

THE MARK CONSISTS OF STANDARD CHARACTERS  
WITHOUT CLAIM TO ANY PARTICULAR  
FONT, STYLE, SIZE, OR COLOR.

NO CLAIM IS MADE TO THE EXCLUSIVE  
RIGHT TO USE "REWARDS", APART FROM THE  
MARK AS SHOWN.

SEC. 2(F).

SER. NO. 78-742,599, FILED 10-28-2005.

JEFF DEFORD, EXAMINING ATTORNEY



**Int. Cl.: 44**

**Prior U.S. Cls.: 100 and 101**

**United States Patent and Trademark Office**

**Reg. No. 3,453,747**

**Registered June 24, 2008**

**SERVICE MARK  
PRINCIPAL REGISTER**

**Where dreams are conceived**

CENTER FOR REPRODUCTIVE MEDICINE  
(FLORIDA CORPORATION)  
3435 PINEHURST AVENUE  
ORLANDO, FL 32804

THE MARK CONSISTS OF STANDARD CHAR-  
ACTERS WITHOUT CLAIM TO ANY PARTICULAR  
FONT, STYLE, SIZE, OR COLOR.

FOR: MEDICAL SERVICES IN THE FIELD OF  
REPRODUCTIVE ENDOCRINOLOGY AND INFER-  
TILITY, IN CLASS 44 (U.S. CLS. 100 AND 101).

SER. NO. 78-746,952, FILED 11-4-2005.

FIRST USE 8-22-2005; IN COMMERCE 8-22-2005.

ANN E. SAPPENFIELD, EXAMINING ATTORNEY

Int. Cls.: 7, 12, 37 and 42

Prior U.S. Cls.: 13, 19, 21, 23, 31, 34, 35, 44, 100, 101,  
103 and 106

Reg. No. 3,453,748

United States Patent and Trademark Office

Registered June 24, 2008

TRADEMARK  
SERVICE MARK  
PRINCIPAL REGISTER

# TURBOMECA

TURBOMECA (FRANCE SOCIETE ANONYME)  
64511 BORDES  
CEDEX, FRANCE

FOR: (BASED ON 44(E)) ENGINES OTHER THAN FOR LAND VEHICLES, AND IN PARTICULAR, FOR JET ENGINES, TURBINES, TURBINE ENGINES, TURBOJETS, TURBO-PROPS IN THE NATURE OF GAS TURBINE ENGINES, TURBOCHARGERS FOR AIRCRAFT AND AIRCRAFT ENGINES, ENGINES FOR MISSILES, ENGINES FOR HELICOPTERS, ENGINES FOR AIRCRAFT; SOLAR-POWERED OR FUELS-POWERED ELECTRICITY GENERATORS; COMPRESSORS FOR ELECTRICITY GENERATORS, AUXILIARY POWER GROUPS FOR AIRCRAFT AND COGENERATION PLANTS, NAMELY, AUXILIARY POWER UNITS FOR SUPPLYING ELECTRICAL POWER TO HEAT AND POWER GENERATORS, IN CLASS 7 (U.S. CLS. 13, 19, 21, 23, 31, 34 AND 35).

FOR: (BASED ON USE IN COMMERCE) AND (BASED ON 44(E)) MACHINES FOR LOCOMOTION BY LAND, AIR OR WATER, NAMELY, HELICOPTERS, AIRCRAFT, LAND VEHICLES; ENGINES FOR LAND VEHICLES, ENGINES USED IN THE RAILROAD DOMAIN, NAMELY, ENGINES FOR LOCOMOTIVES AND TRAINS, IN CLASS 12 (U.S. CLS. 19, 21, 23, 31, 35 AND 44).

FIRST USE 5-13-1980; IN COMMERCE 5-13-1980.

FOR: (BASED ON USE IN COMMERCE) AND (BASED ON 44(E)) REPAIR AND MAINTENANCE OF VEHICLES AND ENGINES, NAMELY, AIRCRAFT, HELICOPTERS, TURBINE ENGINES, TURBOJETS, TURBOCHARGERS FOR AIRCRAFT AND AIRCRAFT ENGINES AND ENGINES USED IN THE

RAILROAD DOMAIN, NAMELY, ENGINES FOR LOCOMOTIVES AND TRAINS; TECHNICAL CONSULTATION IN CONNECTION WITH THE REPAIR AND MAINTENANCE OF VEHICLES AND ENGINES, NAMELY, AIRCRAFT, HELICOPTERS, TURBINE ENGINES, TURBOJETS, TURBOCHARGERS FOR AIRCRAFT AND AIRCRAFT ENGINES AND ENGINES USED IN THE RAILROAD DOMAIN, NAMELY, ENGINES FOR LOCOMOTIVES AND TRAINS, IN CLASS 37 (U.S. CLS. 100, 103 AND 106).

FIRST USE 5-13-1980; IN COMMERCE 5-13-1980.

FOR: (BASED ON USE IN COMMERCE) AND (BASED ON 44(E)) TECHNICAL SUPPORT SERVICES, NAMELY, INSPECTIONS AND TESTING OF AIRCRAFT, AIRPLANES, HELICOPTERS, MISSILES AND ENGINES TO ENSURE THAT THE GOODS ARE RELIABLE AND ARE OPERATING CORRECTLY; PRODUCT RESEARCH AND DEVELOPMENT IN THE FIELD OF AIRCRAFT AND HELICOPTER ENGINES; ENGINEERING SERVICES, IN CLASS 42 (U.S. CLS. 100 AND 101).

FIRST USE 5-13-1980; IN COMMERCE 5-13-1980.

THE MARK CONSISTS OF STANDARD CHARACTERS WITHOUT CLAIM TO ANY PARTICULAR FONT, STYLE, SIZE, OR COLOR.

OWNER OF FRANCE REG. NO. 013088111, DATED 3-12-2001, EXPIRES 3-12-2011.

OWNER OF U.S. REG. NO. 1,934,734.

SER. NO. 78-752,113, FILED 11-11-2005.

AMY ALFIERI, EXAMINING ATTORNEY

Int. Cl.: 43

Prior U.S. Cls.: 100 and 101

United States Patent and Trademark Office

Reg. No. 3,453,749

Registered June 24, 2008

SERVICE MARK  
PRINCIPAL REGISTER



WEE WATCH DAY CARE SYSTEMS INC. (CANADA CORPORATION)

105 MAIN STREET

UNIONVILLE, ONTARIO, CANADA L3R 2G1

FOR: PRIVATE HOME CHILD CARE SERVICES,  
IN CLASS 43 (U.S. CLS. 100 AND 101).

PRIORITY CLAIMED UNDER SEC. 44(D) ON  
CANADA APPLICATION NO. 1277099, FILED 10-26-  
2005, REG. NO. TMA684,400, DATED 3-22-2007, EX-  
PIRES 3-22-2022.

OWNER OF U.S. REG. NOS. 2,096,946 AND  
2,621,624.

NO CLAIM IS MADE TO THE EXCLUSIVE  
RIGHT TO USE "HOME CHILD CARE", APART  
FROM THE MARK AS SHOWN.

THE COLOR(S) GREEN AND BLUE IS/ARE  
CLAIMED AS A FEATURE OF THE MARK.

THE MARK CONSISTS OF THE WORD "WEE-  
WATCH" IN GREEN, THE WORDING "ENRICHED  
HOME CHILD CARE" IN BLUE AND A CURVED  
BAND TO THE LEFT OF ALL OF THE WORDING  
IN BLUE.

SER. NO. 78-754,135, FILED 11-15-2005.

JULIE GUTTADAURO, EXAMINING ATTORNEY

**Int. Cls.: 37 and 42**

**Prior U.S. Cls.: 100, 101, 103 and 106**

**United States Patent and Trademark Office**

**Reg. No. 3,453,750**

**Registered June 24, 2008**

**SERVICE MARK  
PRINCIPAL REGISTER**



MAINLINE INFORMATION SYSTEMS, INC.  
(FLORIDA CORPORATION)  
1700 SUMMIT LAKE DRIVE  
TALLAHASSEE, FL 32317

FOR: MAINTENANCE OF COMPUTER SYSTEMS, NETWORKS, AND INFRASTRUCTURE, IN CLASS 37 (U.S. CLS. 100, 103 AND 106).

FIRST USE 12-1-2001; IN COMMERCE 12-1-2001.

FOR: ENTERPRISE INFORMATION TECHNOLOGY AND INFRASTRUCTURE CONSULTATION; INTEGRATION AND IMPLEMENTATION OF

COMPUTER SYSTEMS, NETWORKS, AND INFRASTRUCTURE, IN CLASS 42 (U.S. CLS. 100 AND 101).

FIRST USE 12-1-2001; IN COMMERCE 12-1-2001.

NO CLAIM IS MADE TO THE EXCLUSIVE RIGHT TO USE "INFORMATION SYSTEMS", APART FROM THE MARK AS SHOWN.

SER. NO. 78-755,018, FILED 11-16-2005.

LAURIE KAUFMAN, EXAMINING ATTORNEY

**Int. Cls.: 16, 35 and 41**

**Prior U.S. Cls.: 2, 5, 22, 23, 29, 37, 38, 50, 100, 101, 102  
and 107**

**Reg. No. 3,453,751**

**United States Patent and Trademark Office**

**Registered June 24, 2008**

**TRADEMARK  
SERVICE MARK  
PRINCIPAL REGISTER**

**MOLEIRO**

MOLEIRO, MANUEL (SPAIN INDIVIDUAL)  
TRAVESERA DE GRACIA, 17, 6-2  
08021 BARCELONA, SPAIN

FOR: FICTION AND NON-FICTION BOOKS IN THE FIELD OF ART AND RELIGION; PRINTS, PRINTED CHARTS AND CALENDARS FEATURING ART; POSTCARDS, CARDBOARD; PORTRAITS; PARCHMENT PAPER; BOOK BINDINGS; PRINTED ART REPRODUCTIONS; PAPER, NAMELY, PRINTING PAPER; PAINTINGS AND THEIR REPRODUCTIONS; GENERAL FEATURE MAGAZINES; ENGRAVINGS AND THEIR REPRODUCTIONS; REPRODUCTION PAPER, IN CLASS 16 (U.S. CLS. 2, 5, 22, 23, 29, 37, 38 AND 50).

FIRST USE 12-31-1998; IN COMMERCE 4-3-1997.

FOR: ADVERTISING SERVICES; COMMERCIAL MANAGEMENT; PUBLICATION OF PUBLICITY TEXTS; PROMOTING THE GOODS AND SERVICES OF OTHERS BY MEANS OF OPERATING AN ON-LINE SHOPPING MALL WITH LINKS ON THE RETAIL WEB SITES OF OTHERS; BUSINESS ADVISORY SERVICES IN THE FIELD OF SELLING PRODUCTS AND RENDERING SERVICES; EXPORT AND IMPORT AGENCY SERVICES; ADMINISTRATION OF CULTURAL AND EDUCATIONAL EXCHANGE PROGRAMS; PRODUCT MERCHANDISING; ONLINE RETAIL STORE SERVICES FEATURING PRINTED PRODUCTS, BOOKS, CHARTS,

MAPS, PICTURES, AND OTHER RELATED PRODUCTS; DOCUMENT REPRODUCTION, IN CLASS 35 (U.S. CLS. 100, 101 AND 102).

FIRST USE 12-31-1998; IN COMMERCE 4-3-1997.

FOR: PUBLICATION OF BOOKS, MAGAZINES, ALMANACS, JOURNALS, NEWSPAPERS, PERIODICALS, CATALOGS, AND BROCHURES; ARRANGING EDUCATIONAL AND CULTURAL EXHIBITIONS; EDUCATIONAL AND ENTERTAINMENT SERVICES, NAMELY, PROVIDING MOTIVATIONAL AND EDUCATIONAL SPEAKERS; ARRANGING FOR TICKET RESERVATIONS FOR SHOWS AND OTHER ENTERTAINMENT EVENTS; EDUCATION SERVICES, NAMELY, MENTORING IN THE FIELD OF ART, HISTORY, AND BIBLIOPHILY, IN CLASS 41 (U.S. CLS. 100, 101 AND 107).

FIRST USE 12-31-1998; IN COMMERCE 4-3-1997.

THE MARK CONSISTS OF STANDARD CHARACTERS WITHOUT CLAIM TO ANY PARTICULAR FONT, STYLE, SIZE, OR COLOR.

SEC. 2(F).

SER. NO. 78-756,029, FILED 11-17-2005.

EVELYN BRADLEY, EXAMINING ATTORNEY

**Int. Cls.: 14 and 25**

**Prior U.S. Cls.: 2, 22, 27, 28, 39 and 50**

**United States Patent and Trademark Office**

**Reg. No. 3,453,752**

**Registered June 24, 2008**

**TRADEMARK  
PRINCIPAL REGISTER**



THE CHI PHI FRATERNITY, INC. (GEORGIA CORPORATION)  
850 INDIAN TRAIL ROAD, NW  
LILBURN, GA 30047

FOR: JEWELRY, IN CLASS 14 (U.S. CLS. 2, 27, 28 AND 50).

FIRST USE 0-0-1895; IN COMMERCE 0-0-1895.

FOR: HATS; PANTS; SHIRTS; SHORTS; SWEAT PANTS; SWEAT SHIRTS, IN CLASS 25 (U.S. CLS. 22 AND 39).

FIRST USE 0-0-1959; IN COMMERCE 0-0-1959.

OWNER OF U.S. REG. NO. 3,329,180.

THE MARK CONSISTS OF THE GREEK LETTER "CHI" SUPERIMPOSED OVER THE GREEK LETTER "PHI".

SER. NO. 78-758,019, FILED 11-21-2005.

SANI KHOURI, EXAMINING ATTORNEY

**Int. Cl.: 33**

**Prior U.S. Cls.: 47 and 49**

**United States Patent and Trademark Office**

**Reg. No. 3,453,753**

**Registered June 24, 2008**

**TRADEMARK  
PRINCIPAL REGISTER**

**STE. CHAPELLE**

CONSTELLATION WINES U.S., INC (NEW YORK CORPORATION)

235 NORTH BLOOMFIELD ROAD

CANANDAIGUA, NY 144241059

FOR: WINE, IN CLASS 33 (U.S. CLS. 47 AND 49).

FIRST USE 12-0-1976; IN COMMERCE 4-0-1978.

THE MARK CONSISTS OF STANDARD CHARACTERS WITHOUT CLAIM TO ANY PARTICULAR FONT, STYLE, SIZE, OR COLOR.

THE ENGLISH TRANSLATION OF THE WORD STE. CHAPELLE IN THE MARK IS SAINT CHAPEL.

SER. NO. 78-758,715, FILED 11-21-2005.

ESTHER A. BORSUK, EXAMINING ATTORNEY

**Int. Cl.: 12**

**Prior U.S. Cls.: 19, 21, 23, 31, 35 and 44**

**United States Patent and Trademark Office**

**Reg. No. 3,453,754**

**Registered June 24, 2008**

**TRADEMARK  
PRINCIPAL REGISTER**

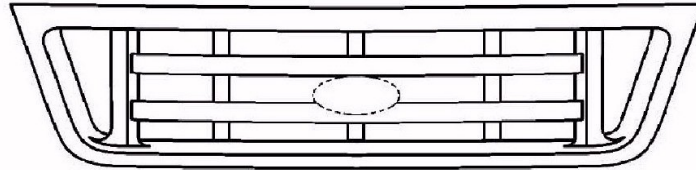

FORD MOTOR COMPANY (DELAWARE CORPORATION)  
ONE AMERICAN ROAD  
DEARBORN, MI 48126

FOR: AUTOMOBILE GRILLES, IN CLASS 12 (U.S. CLS. 19, 21, 23, 31, 35 AND 44).

FIRST USE 1-1-2003; IN COMMERCE 1-1-2003.

THE MARK CONSISTS OF A CONFIGURATION OF A VEHICLE GRILLE.

SEC. 2(F).

SER. NO. 78-759,403, FILED 11-22-2005.

DAWN FELDMAN, EXAMINING ATTORNEY



Int. Cls.: 6, 16, 17, 20 and 28

Prior U.S. Cls.: 1, 2, 5, 12, 13, 14, 22, 23, 25, 29, 32, 35,  
37, 38 and 50

Reg. No. 3,453,755

United States Patent and Trademark Office

Registered June 24, 2008

TRADEMARK  
PRINCIPAL REGISTER



KATY SUE DESIGNS LIMITED (UNITED KINGDOM LIMITED COMPANY)  
UNIT 308 TEDCO BUSINESS WORKS HENRY ROBS  
ON WAY SOUTH SHIELDS;  
TYNE & WEAR, UNITED KINGDOM NE33 1RF

FOR: ARTISTIC MATERIALS, NAMELY, FLORIST WIRE, IN CLASS 6 (U.S. CLS. 2, 12, 13, 14, 23, 25 AND 50).

FOR: STATIONERY; GREETINGS CARDS; CALENDARS; DIARIES; BOOKS, NAMELY, INSTRUCTIONAL BOOKS FEATURING INSTRUCTION IN GENERAL CRAFTS, MAKING SCRAPBOOKS, MAKING MEMORY BOOKS, CARD MAKING, DOLLS' HOUSES AND MINIATURES, HOBBIES, PAPER CRAFTS, CHILDREN'S CRAFT, MODEL MAKING; SCRAPBOOKS, PHOTOGRAPH ALBUMS, BOOKS IN THE FIELD OF HOBBIES AND CRAFTS, MEMORY BOOKS, BIRTHDAY BOOKS, NOTEBOOKS; POSTERS; PHOTOGRAPHS; ADDRESS BOOKS; PRINTS; GIFT WRAP MADE OF PAPER, METALLIC FOIL AND PLASTIC; GIFT BAGS MADE OF PAPER, CARD STOCK AND FABRIC; PAPER GIFT TAGS; STICKERS; PENCIL AND PEN CASES AND BOXES; ARTISTIC MATERIALS, NAMELY, ADHESIVES FOR STATIONERY OR HOUSEHOLD PURPOSES, MODELING MATERIALS AND COMPOUNDS FOR USE BY CHILDREN, STENCILS; ARTISTIC MATERIALS IN THE NATURE OF COLORING MATERIALS, NAMELY, CHALKS AND INK PADS; PAINTBRUSHES, COLORING PENS AND PENCILS, PAPER, CARD STOCK; ARTISTIC MATERIALS IN THE NATURE OF DECORATIVE MATERIALS, NAMELY, METALLIC PAPER PARTY DECORATIONS, PAPER PARTY DECORATIONS, DECORATIVE PAPER CENTERPIECES, AND TABLE DECORATIONS OF PAPER, NAMELY, PAPER PLACE SETTING CARDS, MENU CARDS, JAPANESE PAPER, PAPER RIBBONS; ARTISTIC MATERIALS IN THE NATURE OF ARTS

AND CRAFT CARD-MAKING KITS COMPRISED OF CARD PAPER, PAPER, STICKERS, PAPER DIE-CUT SHAPES, GLUE FOR STATIONERY OR HOUSEHOLD PURPOSES, PAPER RIBBON, RUBBER STAMPS, WIRE, INK PADS, CHALKS, PENS AND DECORATIVE FOAM PARTICLES; ARTISTIC MATERIALS, NAMELY, CARD PAPER, STICKERS, PAPER DIE-CUT SHAPES, GLUE FOR STATIONERY OR HOUSEHOLD USE, PAPER RIBBON, RUBBER STAMPS, INK PADS, CHALKS, PENS; ARTISTIC MATERIALS IN THE NATURE OF ARTS AND CRAFTS SCRAPBOOK KITS COMPRISED OF SCRAPBOOKS, STICKERS, PAPER DIE-CUT SHAPES, WIRES, GLUE FOR STATIONERY OR HOUSEHOLD USE, PAPER RIBBON, RUBBER STAMPS, INK PADS, CHALKS AND PENS AND DECORATIVE FOAM PARTICLES, IN CLASS 16 (U.S. CLS. 2, 5, 22, 23, 29, 37, 38 AND 50).

FOR: FOAM RUBBER, NAMELY, DECORATIVE FOAM PARTICLES DYED IN A VARIETY OF COLORS FOR USE AS DECORATIVE MATERIALS; PLASTIC FOAM USED FOR ARTS AND CRAFTS, NAMELY, DECORATIVE FOAM PARTICLES DYED IN A VARIETY OF COLORS FOR USE AS DECORATIVE MATERIALS, IN CLASS 17 (U.S. CLS. 1, 5, 12, 13, 35 AND 50).

FOR: ARTISTIC MATERIALS, NAMELY, DECORATIVE GLITTER AND DECORATIVE GLITTER MADE OF FOAM PARTICLES, IN CLASS 20 (U.S. CLS. 2, 13, 22, 25, 32 AND 50).

FOR: TOYS AND PLAYTHINGS, NAMELY, TOY MODEL HOBBYCRAFT KITS, NAMELY, MODEL-MAKING KITS; HOBBY CRAFT KITS COMPRISING GREETINGS CARDS, CALENDARS, AND PICTURE FRAMES; HOBBY CRAFT KITS COMPRISING MEMORY BOOKS AND DOLLS; DOLLS AND PARTS THEREFOR, NAMELY, REPLACEMENT BODY PARTS, WIGS, CLOTHING, ACCESSORIES

AND SHOES; CONFETTI, IN CLASS 28 (U.S. CLS. 22, 23, 38 AND 50).

PRIORITY CLAIMED UNDER SEC. 44(D) ON ERPN CMNTY TM OFC APPLICATION NO. 004606299, FILED 8-23-2005, REG. NO. 004606299, DATED 1-19-2007, EXPIRES 8-23-2015.

THE COLOR(S) BLUE, YELLOW, GREEN, PINK, RED, ORANGE, PURPLE AND WHITE IS/ARE CLAIMED AS A FEATURE OF THE MARK.

THE MARK IS COMPRISED OF THE WORDING, "FLOWER SOFT" IN STYLIZED LETTERS WITH DESIGN ELEMENTS COMPRISED OF CURVED LINES IN THE LETTERS "F" AND "S". THE WORDING AND CURVED LINES ARE COMPRISED OF SMALL FLECKS OF THE COLORS, BLUE, YELLOW, GREEN, PINK, RED, ORANGE, PURPLE AND WHITE.

SER. NO. 78-761,834, FILED 11-28-2005.

PAUL CROWLEY, EXAMINING ATTORNEY

**Int. Cls.: 35, 38 and 41**

**Prior U.S. Cls.: 100, 101, 102, 104 and 107**

**United States Patent and Trademark Office**

**Reg. No. 3,453,756**

**Registered June 24, 2008**

**SERVICE MARK  
PRINCIPAL REGISTER**

**CONVERGENCE PUBLISHING  
PROGRAM**

VILLAGEPROFILE.COM, INC. (ILLINOIS CORPORATION)  
33 NORTH GENEVA  
ELGIN, IL 60172

FOR: COLLECTION, ACQUISITION, PROCESSING, TRANSCRIPTION, COMPILATION, PREPARATION AND SYSTEMIZATION OF DATA AND STATISTICS RELATING TO BUSINESS, NAMELY, CORPORATIONS, CHAMBERS OF COMMERCE AND OTHER COMMUNITIES, AND PROVISION OF SAID INFORMATION IN AN ON-LINE BUSINESS DIRECTORY AND IN ELECTRONIC AND PRINT PUBLICATIONS, IN CLASS 35 (U.S. CLS. 100, 101 AND 102).

FIRST USE 8-30-2003; IN COMMERCE 8-30-2003.

FOR: TRANSMISSION OF ELECTRONIC DATA USING INTERNET SERVICES, WIRELESS SERVICES, AND WIRELESS APPLICATION PROTOCOL (WAP) SERVICES, IN CLASS 38 (U.S. CLS. 100, 101 AND 104).

FIRST USE 8-30-2003; IN COMMERCE 8-30-2003.

FOR: PUBLISHING OF MAGAZINES AND GUIDES FOR OTHERS CONTAINING INFORMATION REGARDING DATA AND STATISTICS RELATING TO BUSINESS, NAMELY, CORPORATIONS, CHAMBERS OF COMMERCE AND OTHER COMMUNITIES, IN CLASS 41 (U.S. CLS. 100, 101 AND 107).

FIRST USE 8-30-2003; IN COMMERCE 8-30-2003.

THE MARK CONSISTS OF STANDARD CHARACTERS WITHOUT CLAIM TO ANY PARTICULAR FONT, STYLE, SIZE, OR COLOR.

NO CLAIM IS MADE TO THE EXCLUSIVE RIGHT TO USE "PUBLISHING PROGRAM", APART FROM THE MARK AS SHOWN.

SER. NO. 78-764,336, FILED 12-1-2005.

KELLY BOULTON, EXAMINING ATTORNEY

**Int. Cl.: 44**

**Prior U.S. Cls.: 100 and 101**

**United States Patent and Trademark Office**

**Reg. No. 3,453,757**

**Registered June 24, 2008**

**SERVICE MARK  
PRINCIPAL REGISTER**

**Health@Work**

INLAND NORTHWEST HEALTH SERVICES  
(WASHINGTON CORPORATION)  
157 S. HOWARD SUITE 500  
SPOKANE, WA 99201

THE MARK CONSISTS OF STANDARD CHAR-  
ACTERS WITHOUT CLAIM TO ANY PARTICULAR  
FONT, STYLE, SIZE, OR COLOR.

FOR: PROVIDING HEALTH INFORMATION, IN  
CLASS 44 (U.S. CLS. 100 AND 101).

SER. NO. 78-765,509, FILED 12-2-2005.

FIRST USE 1-1-2005; IN COMMERCE 1-1-2005.

HEATHER THOMPSON, EXAMINING ATTORNEY

**Int. Cl.: 35**

**Prior U.S. Cls.: 100, 101 and 102**

**United States Patent and Trademark Office**

**Reg. No. 3,453,758**

**Registered June 24, 2008**

**SERVICE MARK  
PRINCIPAL REGISTER**

**SWIMOUTLET.com THE WEB'S  
MOST POPULAR SWIM SHOP**

CLUB SWIM, INC. (NEVADA CORPORATION)  
39630 EUREKA DRIVE  
NEWARK, CA 94560

FOR: ON-LINE RETAIL STORE SERVICES FEATURING SWIMWEAR, APPAREL, AQUATICS GEAR AND EQUIPMENT, BOOKS AND VIDEOS, AWARDS, SPORTS NUTRITIONAL PRODUCTS, AND PERSONAL CARE PRODUCTS FOR SWIMMERS , IN CLASS 35 (U.S. CLS. 100, 101 AND 102).

FIRST USE 12-31-2004; IN COMMERCE 12-31-2004.

THE MARK CONSISTS OF STANDARD CHARACTERS WITHOUT CLAIM TO ANY PARTICULAR FONT, STYLE, SIZE, OR COLOR.

NO CLAIM IS MADE TO THE EXCLUSIVE RIGHT TO USE "SWIM SHOP", APART FROM THE MARK AS SHOWN.

SEC. 2(F).

SER. NO. 78-770,682, FILED 12-9-2005.

MICHELE SWAIN, EXAMINING ATTORNEY

**Int. Cl.: 41**

**Prior U.S. Cls.: 100, 101 and 107**

**United States Patent and Trademark Office**

**Reg. No. 3,453,759**

**Registered June 24, 2008**

**SERVICE MARK  
PRINCIPAL REGISTER**



STERN, HOWARD (UNITED STATES INDIVIDUAL)  
C/O ONE TWELVE INC.  
600 MADISON AVENUE  
NEW YORK, NY 10022

FOR: ENTERTAINMENT SERVICES, NAMELY, LIVE PERFORMANCES BY AN INDIVIDUAL FEATURING OBSERVATIONS OF THE HUMAN CONDITION, IN CLASS 41 (U.S. CLS. 100, 101 AND 107).

FIRST USE 12-16-2005; IN COMMERCE 12-16-2005.

OWNER OF U.S. REG. NOS. 2,142,867 AND 2,142,868.

THE MARK CONSISTS OF A STYLIZED FIST, THE SECOND AND THIRD FINGERS FORMING THE LETTER H AND THE FIST CONTAINING THE NAME HOWARD..

SER. NO. 78-785,373, FILED 1-5-2006.

KATHERINE STOIDES, EXAMINING ATTORNEY

**Int. Cl.: 3**

**Prior U.S. Cls.: 1, 4, 6, 50, 51 and 52**

**Reg. No. 3,453,760**

**United States Patent and Trademark Office**

**Registered June 24, 2008**

---

**TRADEMARK  
PRINCIPAL REGISTER**

**PHATTENUP**

BRENDA CHRISTIAN COSMETICS, INC. (FLOR-  
IDA CORPORATION)  
1518 ROBERTS DRIVE  
JACKSONVILLE BEACH, FL 32250

FOR: NON-MEDICATED LIP CREAM DISTRIB-  
UTED FOR SALE IN BEAUTY SALONS, BEAUTY  
SUPPLY RETAILERS, ONLINE SHOPPING CHAN-  
NELS, SPAS, COSMETICS, AND PLASTIC SUR-  
GERY SPECIALISTS, IN CLASS 3 (U.S. CLS. 1, 4, 6,  
50, 51 AND 52).

FIRST USE 10-10-2005; IN COMMERCE 12-1-2005.

THE MARK CONSISTS OF STANDARD CHAR-  
ACTERS WITHOUT CLAIM TO ANY PARTICULAR  
FONT, STYLE, SIZE, OR COLOR.

SER. NO. 78-793,128, FILED 1-17-2006.

LINDA ORNDORFF, EXAMINING ATTORNEY

**Int. Cls.: 9, 35 and 36**

**Prior U.S. Cls.: 21, 23, 26, 36, 38, 100, 101 and 102**

**Reg. No. 3,453,761**

**United States Patent and Trademark Office**

**Registered June 24, 2008**

**TRADEMARK  
SERVICE MARK  
PRINCIPAL REGISTER**

**IPEEX**

IPEEX LIMITED (JERSEY CORPORATION)  
3 OLD STREET  
ST. HELIER, JERSEY

FOR: DOWNLOADABLE PUBLICATIONS IN ELECTRONIC FORM, NAMELY, NEWSLETTERS, INSTRUCTION MANUALS, AND MARKETING LEAFLETS, SUPPLIED ON-LINE FROM DATABASES OR FROM THE INTERNET IN THE FIELD OF COMMERCIAL, FINANCIAL, AND INVESTMENT DATA, IN CLASS 9 (U.S. CLS. 21, 23, 26, 36 AND 38).

FIRST USE 7-31-2001; IN COMMERCE 7-31-2001.

FOR: COMMERCIAL INFORMATION SERVICES PROVIDED VIA AN ONLINE COMPUTER DATABASE; COMPILATION OF INFORMATION INTO COMPUTER DATABASES; DATA-BASE MANAGEMENT; PROVISION OF COMMERCIAL BUSINESS INFORMATION BY MEANS OF A COMPUTER DATABASE, IN CLASS 35 (U.S. CLS. 100, 101 AND 102).

FIRST USE 7-31-2001; IN COMMERCE 7-31-2001.

FOR: FINANCIAL CONSULTATION SERVICES, NAMELY, FACILITATING INVESTMENT, LOAN, AND VENTURE CAPITAL OPPORTUNITIES; PROVIDING FINANCIAL INFORMATION VIA AN ONLINE COMPUTER DATABASE; INFORMATION AND DATA RELATING TO FINANCE AND INVESTMENT PROVIDED ON-LINE FROM A COMPUTER DATABASE OR THE INTERNET; FINANCIAL INFORMATION SERVICES PROVIDED VIA AN ONLINE COMPUTER DATABASE; PROVISION OF FINANCIAL INFORMATION BY MEANS OF A COMPUTER DATABASE; PROVISION OF FINANCIAL ANALYSIS SERVICES AND RESEARCH SERVICES, IN CLASS 36 (U.S. CLS. 100, 101 AND 102).

FIRST USE 7-31-2001; IN COMMERCE 7-31-2001.

THE MARK CONSISTS OF STANDARD CHARACTERS WITHOUT CLAIM TO ANY PARTICULAR FONT, STYLE, SIZE, OR COLOR.

SER. NO. 78-817,266, FILED 2-17-2006.

KEVIN DINALLO, EXAMINING ATTORNEY



**Int. Cl.: 45**

**Prior U.S. Cls.: 100 and 101**

**United States Patent and Trademark Office**

**Reg. No. 3,453,762**

**Registered June 24, 2008**

**SERVICE MARK  
PRINCIPAL REGISTER**

**OTHERS ONLINE**

OTHERS ONLINE, INC. (DELAWARE CORPORATION)  
7817 NE 124TH STREET  
KIRKLAND, WA 98034

FOR: ONLINE SOCIAL NETWORKING SERVICES, NAMELY, PROVIDING ONLINE APPLICATION THAT DISPLAYS RELEVANT ONLINE PROFILES OF INTERNET USERS AND THEIR INTERESTS, BEHAVIORS, INTERNET CONTENT AND INTERNET PRESENCE, IN CLASS 45 (U.S. CLS. 100 AND 101).

FIRST USE 7-13-2006; IN COMMERCE 7-13-2006.

THE MARK CONSISTS OF STANDARD CHARACTERS WITHOUT CLAIM TO ANY PARTICULAR FONT, STYLE, SIZE, OR COLOR.

NO CLAIM IS MADE TO THE EXCLUSIVE RIGHT TO USE "ONLINE", APART FROM THE MARK AS SHOWN.

SER. NO. 78-819,689, FILED 2-21-2006.

DORITT L. CARROLL, EXAMINING ATTORNEY

**Int. Cl.: 16**

**Prior U.S. Cls.: 2, 5, 22, 23, 29, 37, 38 and 50**

**United States Patent and Trademark Office**

**Reg. No. 3,453,763**

**Registered June 24, 2008**

**TRADEMARK  
PRINCIPAL REGISTER**

**INSIDE THE ROPES**

KEMPER SPORTS MANAGEMENT, INC. (ILLINOIS CORPORATION)  
500 SKOKIE BLVD., SUITE 444  
NORTHBROOK, IL 60062

THE MARK CONSISTS OF STANDARD CHARACTERS WITHOUT CLAIM TO ANY PARTICULAR FONT, STYLE, SIZE, OR COLOR.

FOR: NEWSLETTERS IN THE FIELD OF GOLF,  
IN CLASS 16 (U.S. CLS. 2, 5, 22, 23, 29, 37, 38 AND 50).

SER. NO. 78-820,506, FILED 2-22-2006.

FIRST USE 0-0-1998; IN COMMERCE 0-0-1998.

JOHN DWYER, EXAMINING ATTORNEY

**Int. Cl.: 25**

**Prior U.S. Cls.: 22 and 39**

**United States Patent and Trademark Office**

**Reg. No. 3,453,764**

**Registered June 24, 2008**

**TRADEMARK  
PRINCIPAL REGISTER**



MAES, PATRICK, JUDE (UNITED STATES INDIVIDUAL)  
316 NE 60TH AVE APT A1  
PORTLAND, OR 97213

FOR: SHORT-SLEEVED OR LONG-SLEEVED T-SHIRTS, IN CLASS 25 (U.S. CLS. 22 AND 39).

FIRST USE 2-2-1999; IN COMMERCE 2-2-1999.

THE COLOR(S) BLACK, RED AND WHITE IS/ARE CLAIMED AS A FEATURE OF THE MARK.

THE MARK CONSISTS OF THIS EXAMPLE IS WHITE FONT WITH A RED STROKE ON A BLACK BACKGROUND.

SER. NO. 78-825,923, FILED 2-28-2006.

THEODORE MCBRIDE, EXAMINING ATTORNEY

**Int. Cl.: 25**

**Prior U.S. Cls.: 22 and 39**

**United States Patent and Trademark Office**

**Reg. No. 3,453,765**

**Registered June 24, 2008**

**TRADEMARK  
PRINCIPAL REGISTER**

**STAY METAL**

MAES, PATRICK JUDE (UNITED STATES INDIVIDUAL)  
316 NE 60TH AVE APT A1  
PORTLAND, OR 97213

THE MARK CONSISTS OF STANDARD CHARACTERS WITHOUT CLAIM TO ANY PARTICULAR FONT, STYLE, SIZE, OR COLOR.

FOR: SHORT-SLEEVED OR LONG-SLEEVED T-SHIRTS, IN CLASS 25 (U.S. CLS. 22 AND 39).

SER. NO. 78-829,475, FILED 3-5-2006.

FIRST USE 2-2-1999; IN COMMERCE 2-2-1999.

THEODORE MCBRIDE, EXAMINING ATTORNEY

**Int. Cl.: 41**

**Prior U.S. Cls.: 100, 101 and 107**

**United States Patent and Trademark Office**

**Reg. No. 3,453,766**

**Registered June 24, 2008**

**SERVICE MARK  
PRINCIPAL REGISTER**

**UNTIL DAWN**

ERIC A. PROVENZANO (UNITED STATES INDIVIDUAL)  
2276 GLEN LAUREL RD  
CLAYTON, NC 27527

THE MARK CONSISTS OF STANDARD CHARACTERS WITHOUT CLAIM TO ANY PARTICULAR FONT, STYLE, SIZE, OR COLOR.

FOR: ENTERTAINMENT SERVICES, NAMELY, LIVE PERFORMANCES BY A HEAVY METAL ROCK MUSICAL BAND, IN CLASS 41 (U.S. CLS. 100, 101 AND 107).

SER. NO. 78-830,259, FILED 3-6-2006.

FIRST USE 3-11-1990; IN COMMERCE 1-1-1996.

AMY MCMENAMIN, EXAMINING ATTORNEY

**Int. Cl.: 9**

**Prior U.S. Cls.: 21, 23, 26, 36 and 38**

**Reg. No. 3,453,767**

**United States Patent and Trademark Office**

**Registered June 24, 2008**

**TRADEMARK  
PRINCIPAL REGISTER**

**KS**

KS AUDIO USA CORP. (FLORIDA CORPORATION)  
1062 CEPHAS DRIVE  
CLEARWATER, FL 33765

POWER AMPLIFIERS; SOUND AMPLIFIERS;  
SPEAKER ENCLOSURES, IN CLASS 9 (U.S. CLS.  
21, 23, 26, 36 AND 38).

FIRST USE 1-1-2005; IN COMMERCE 1-1-2005.

FOR: APPARATUS FOR RECORDING, TRANSMISSION OR REPRODUCTION OF SOUND AND IMAGES; APPARATUS FOR TRANSMITTING AND REPRODUCING SOUND OR IMAGES; AUDIO AMPLIFIERS; AUDIO SPEAKER ENCLOSURES; AUDIO SPEAKERS; CENTRAL PROCESSING UNITS FOR PROCESSING INFORMATION, DATA, SOUND OR IMAGES; LOUD SPEAKER SYSTEMS; LOUDSPEAKERS WITH BUILT IN AMPLIFIERS;

THE MARK CONSISTS OF STANDARD CHARACTERS WITHOUT CLAIM TO ANY PARTICULAR FONT, STYLE, SIZE, OR COLOR.

SER. NO. 78-830,928, FILED 3-7-2006.

RICHARD A. STRASER, EXAMINING ATTORNEY

**Int. Cl.: 35**

**Prior U.S. Cls.: 100, 101 and 102**

**United States Patent and Trademark Office**

**Reg. No. 3,453,768**

**Registered June 24, 2008**

**SERVICE MARK  
PRINCIPAL REGISTER**

# HomeGift Realty

HOMEGIFT REALTY, INC. (MASSACHUSETTS CORPORATION)  
18 NORTH MAIN STREET  
SHERBORN, MA 01770

OWNER OF U.S. REG. NO. 3,182,816.

FOR: REAL ESTATE SERVICES, NAMELY, REFERRALS IN THE FIELD OF REAL ESTATE, IN CLASS 35 (U.S. CLS. 100, 101 AND 102).

NO CLAIM IS MADE TO THE EXCLUSIVE RIGHT TO USE "REALTY", APART FROM THE MARK AS SHOWN.

FIRST USE 4-6-2005; IN COMMERCE 4-15-2005.

SER. NO. 78-835,321, FILED 3-13-2006.

THE MARK CONSISTS OF STANDARD CHARACTERS WITHOUT CLAIM TO ANY PARTICULAR FONT, STYLE, SIZE, OR COLOR.

EDWARD FENNESSY, EXAMINING ATTORNEY

**Int. Cls.: 9, 39 and 42**

**Prior U.S. Cls.: 21, 23, 26, 36, 38, 100, 101 and 105**

**Reg. No. 3,453,769**

**United States Patent and Trademark Office**

**Registered June 24, 2008**

**TRADEMARK  
SERVICE MARK  
PRINCIPAL REGISTER**

# CARTRAWLER

ETRAWLER LIMITED (IRELAND CORPORATION)  
28 HARCOURT STREET  
DUBLIN 2, IRELAND

FOR: COMPUTER SEARCH ENGINE SOFTWARE; COMPUTER SOFTWARE TO ENABLE SEARCHING OF DATA; COMPUTER SOFTWARE FOR THE COLLECTION, EDITING, ORGANIZING, MODIFYING, BOOK MARKING, TRANSMISSION, STORAGE AND SHARING OF DATA AND INFORMATION; COMPUTER PROGRAMS FOR AUTOMATICALLY SEARCHING THE CONTENTS OF COMPUTERS AND COMPUTER NETWORKS; COMPUTER E-COMMERCE SOFTWARE TO ALLOW USERS TO PERFORM ELECTRONIC BUSINESS TRANSACTIONS VIA A GLOBAL COMPUTER NETWORK; COMPUTER SOFTWARE FOR PROVIDING AN ONLINE DATABASE IN THE FIELD OF TRANSACTION PROCESSING TO UPLOAD TRANSACTIONAL DATA, PROVIDE STATISTICAL ANALYSIS, AND PRODUCE NOTIFICATIONS AND REPORTS; COMPUTER SOFTWARE FOR ACCESSING INFORMATION DIRECTORIES THAT MAY BE DOWNLOADED FROM THE GLOBAL COMPUTER NETWORK; COMPUTER SOFTWARE, NAMELY, SOFTWARE DEVELOPMENT TOOLS FOR THE CREATION OF CLIENT INTERFACES; GRAPHICAL USER INTERFACE SOFTWARE; DOWNLOADABLE PUBLICATIONS AND ELECTRONIC PUBLICATIONS RECORDED ON COMPUTER MEDIA RELATING TO LEASING, RENTAL AND RESERVATION OF VEHICLES, OR TO TRANSPORT, TRAVEL OR BOOKING AGENCY SERVICES, IN CLASS 9 (U.S. CLS. 21, 23, 26, 36 AND 38).

FOR: VEHICLE LEASING AND RENTAL/HIRE SERVICES AND RESERVATION SERVICES FOR THE RENTAL/HIRE AND LEASING OF VEHICLES; TRANSPORT BROKERAGE; TRAVEL ARRANGE-

MENT; BOOKING AGENCY SERVICES AND BOOKING SERVICES FOR TRAVEL AND VEHICLE RENTAL; CHARTERING OF CARS, TRUCKS, VANS, MOTORBIKES, BUSES, AIRPLANES OR BOATS FOR TRAVELING, PROVISION OF INFORMATION AND ADVICE ON PLANNING OF ROUTES FOR TRAVEL, TRAVEL GUIDE SERVICES, TOURIST AGENCY SERVICES; MAKING RESERVATIONS AND BOOKINGS FOR TRANSPORTATION; PROVISION OF INFORMATION AND ADVISORY SERVICES RELATING TO LEASING, RENTAL AND RESERVATION OF VEHICLES, OR TO TRANSPORT, TRAVEL OR BOOKING AGENCY SERVICES, INCLUDING PROVIDED BY MEANS OF AN ONLINE DATABASE OR THE INTERNET, IN CLASS 39 (U.S. CLS. 100 AND 105).

FOR: TECHNOLOGICAL RESEARCH AND DEVELOPMENT SERVICES IN THE FIELD OF LEASING, RENTAL AND RESERVATION OF VEHICLES, OR TRANSPORT, TRAVEL OR BOOKING AGENCY SERVICES; DESIGN AND DEVELOPMENT OF INFORMATION AND DATA BASES; DESIGN AND DEVELOPMENT OF COMPUTER HARDWARE FOR OTHERS; LICENSING OF INTELLECTUAL PROPERTY; COMPUTER PROGRAMMING FOR OTHERS; DESIGN, DEVELOPMENT, MAINTENANCE AND UPDATING OF COMPUTER SOFTWARE FOR OTHERS; INSTALLATION OF COMPUTER SOFTWARE; DESIGN OF COMPUTER SOFTWARE, WEBSITES AND NETWORKING SYSTEMS FOR USE IN THE SEARCHING AND RETRIEVAL OF INFORMATION VIA THE INTERNET AND ON-LINE DATABASES; CREATING AND MAINTAINING WEBSITES FOR OTHERS; DESIGN OF COMPUTER SOFTWARE, WEBSITES AND NETWORKING SYSTEMS FOR USE IN COMPUTERIZED ON-LINE SEARCHING, ORDERING, DELIVERY AND TRANSPORTATION OF CONSUMER GOODS; COMPUTER SOFTWARE CONSULTATION; TECHNICAL SUPPORT SERVICES,



NAMELY, TROUBLESHOOTING OF COMPUTER HARDWARE AND SOFTWARE PROBLEMS AND PROVIDING BACK-UP COMPUTER PROGRAMS AND FACILITIES; DIAGNOSIS OF FAULTS IN COMPUTER SOFTWARE; LEASING OF COMPUTER SOFTWARE RELATING TO PRICE QUOTES; PROVIDING TEMPORARY USE OF ONLINE, NON-DOWNLOADABLE COMPUTER SOFTWARE DEVELOPMENT TOOLS; HOSTING THE WEB SITES OF OTHERS ON A COMPUTER SERVER FOR A GLOBAL COMPUTER NETWORK; PROVIDING CUSTOMIZED ON-LINE WEB PAGES FEATURING USER-DEFINED INFORMATION, WHICH INCLUDES SEARCH ENGINES AND ON-LINE WEB LINKS TO OTHER WEB SITES; PROVIDING INFORMATION AT THE SPECIFIC REQUEST OF END-USERS BY MEANS OF TELEPHONE OR GLO-

BAL COMPUTER NETWORKS, IN CLASS 42 (U.S. CLS. 100 AND 101).

THE MARK CONSISTS OF STANDARD CHARACTERS WITHOUT CLAIM TO ANY PARTICULAR FONT, STYLE, SIZE, OR COLOR.

PRIORITY CLAIMED UNDER SEC. 44(D) ON ERPN CMNTY TM OFC APPLICATION NO. 4640471, FILED 9-19-2005, REG. NO. 4640471, DATED 12-10-2007, EXPIRES 9-19-2015.

"CARTRAWLER" HAS NO MEANING IN A FOREIGN LANGUAGE.

SER. NO. 78-838,917, FILED 3-16-2006.

DORITT L. CARROLL, EXAMINING ATTORNEY

**Int. Cls.: 35 and 36**

**Prior U.S. Cls.: 100, 101 and 102**

**United States Patent and Trademark Office**

**Reg. No. 3,453,770**

**Registered June 24, 2008**

**SERVICE MARK  
PRINCIPAL REGISTER**

**COPERNICAN CAPITAL CORP.**

AIC LIMITED (CANADA CORPORATION)  
1375 KERNS ROAD  
BURLINGTON, CANADA L7R 4X8

FOR: ADVERTISING AND PROMOTIONS SERVICES, NAMELY, PROMOTING INVESTMENT FUNDS, MUTUAL FUNDS AND SECURITIES-BASED INVESTMENT PRODUCTS TO OTHERS, NAMELY, BROKERS, DEALERS AND FINANCIAL ADVISORS, IN CLASS 35 (U.S. CLS. 100, 101 AND 102).

FOR: MUTUAL FUND AND INVESTMENT PORTFOLIO TRUSTEE SERVICES; ESTABLISHING, MANAGING, AND OFFERING INVESTMENT FUNDS, MUTUAL FUNDS, AND SECURITIES-BASED INVESTMENT PRODUCTS THROUGH BROKERS, DEALERS AND FINANCIAL ADVISORS; AND INVESTMENT COUNSELING, FINANCIAL PLANNING AND PORTFOLIO

MANAGEMENT SERVICES, IN CLASS 36 (U.S. CLS. 100, 101 AND 102).

THE MARK CONSISTS OF STANDARD CHARACTERS WITHOUT CLAIM TO ANY PARTICULAR FONT, STYLE, SIZE, OR COLOR.

PRIORITY CLAIMED UNDER SEC. 44(D) ON CANADA APPLICATION NO. 1284154, FILED 12-21-2005, REG. NO. TMA693,034, DATED 7-31-2007, EXPIRES 7-31-2022.

NO CLAIM IS MADE TO THE EXCLUSIVE RIGHT TO USE "CAPITAL CORP.", APART FROM THE MARK AS SHOWN.

SER. NO. 78-838,988, FILED 3-16-2006.

ASMAT KHAN, EXAMINING ATTORNEY

**Int. Cl.: 25**

**Prior U.S. Cls.: 22 and 39**

**United States Patent and Trademark Office**

**Reg. No. 3,453,771**

**Registered June 24, 2008**

**TRADEMARK  
PRINCIPAL REGISTER**



VILLASANTE, ALINA (UNITED STATES INDIVIDUAL)  
7841 NW 56 ST.  
MIAMI, FL 33166

FOR: OPEN-NECKED SHIRTS; SHORT-SLEEVED OR LONG-SLEEVED T-SHIRTS; SPORT SHIRTS; T-SHIRTS, IN CLASS 25 (U.S. CLS. 22 AND 39).

FIRST USE 2-25-2006; IN COMMERCE 2-25-2006.

THE MARK CONSISTS OF A HAND-DRAWN PEACE SYMBOL WHICH IS ADJACENT TO A HAND-DRAWN HEART SYMBOL WHICH IS FURTHER ADJACENT TO A HAND-DRAWN SMILING FACE.

SER. NO. 78-839,247, FILED 3-16-2006.

CORY BOONE, EXAMINING ATTORNEY

**Int. Cl.: 9**

**Prior U.S. Cls.: 21, 23, 26, 36 and 38**

**Reg. No. 3,453,772**

**United States Patent and Trademark Office**

**Registered June 24, 2008**

**TRADEMARK  
PRINCIPAL REGISTER**

**BMC**

KDF ELECTRONIC & VACUUM SERVICES, INC.  
(NEW YORK CORPORATION)  
10 VOLVO DRIVE  
ROCKLEIGH, NJ 07647

FOR: SYSTEMS AND PARTS THEREFORE USED  
IN THE PRODUCTION OF SEMICONDUCTORS,  
NAMELY, PHOTOMASKS; WIRELESS RADIO FRE-  
QUENCY GENERATORS; PRINTED CIRCUITS  
AND POWER SUPPLIES; SEMI-CONDUCTING  
AND SEMI-INSULATING AND POLYCRYSTAL-  
LINE GALLIUM ARSENIDE IN THE FORM OF  
WAFERS; HIGH DENSITY INTERCONNECTORS;  
ELECTRIC OR ELECTRONIC SENSORS FOR SEN-  
SING LIGHT; OPTO-ELECTRONICS, NAMELY, LA-  
SERS AND BLANK OPTICAL DISCS; FLAT

ELECTRIC LUMINESCENT DISPLAY PANELS;  
RADIO FREQUENCY POWER DEVICES, NAMELY,  
RADIO FREQUENCY GENERATORS AND POWER  
SUPPLIES; AND CATHODE RAY TUBES, IN CLASS  
9 (U.S. CLS. 21, 23, 26, 36 AND 38).

FIRST USE 1-1-2008; IN COMMERCE 1-1-2008.

THE MARK CONSISTS OF STANDARD CHAR-  
ACTERS WITHOUT CLAIM TO ANY PARTICULAR  
FONT, STYLE, SIZE, OR COLOR.

SER. NO. 78-839,815, FILED 3-17-2006.

INGRID C. EULIN, EXAMINING ATTORNEY

**Int. Cls.: 16 and 41**

**Prior U.S. Cls.: 2, 5, 22, 23, 29, 37, 38, 50, 100, 101 and 107**

**Reg. No. 3,453,773**

**United States Patent and Trademark Office**

**Registered June 24, 2008**

**TRADEMARK  
SERVICE MARK  
PRINCIPAL REGISTER**

**IT ALL FLOWS TO ME**

WATER REPLENISHMENT DISTRICT (CALIFORNIA BODY POLITIC AND CORPORATE)  
12621 EAST 166TH STREET  
CERRITOS, CA 90703

FOR: PRINTED EDUCATIONAL PUBLICATIONS, NAMELY, TRAINING MANUALS, TRAINING CURRICULA, BROCHURES, BOOKS AND OTHER PRINTED MATERIALS IN THE NATURE OF PAMPHLETS AND BOOKLETS IN THE FIELD OF WATERSHED EDUCATION AND WATER AWARENESS, IN CLASS 16 (U.S. CLS. 2, 5, 22, 23, 29, 37, 38 AND 50).

FIRST USE 8-26-2005; IN COMMERCE 10-15-2005.

FOR: EDUCATION SERVICES, NAMELY, PROVIDING CLASSES, SEMINARS, WORKSHOPS, AND DEMONSTRATIONS IN THE FIELD WATERSHED EDUCATION AND WATER AWARENESS, IN CLASS 41 (U.S. CLS. 100, 101 AND 107).

FIRST USE 8-26-2005; IN COMMERCE 10-15-2005.

THE MARK CONSISTS OF STANDARD CHARACTERS WITHOUT CLAIM TO ANY PARTICULAR FONT, STYLE, SIZE, OR COLOR.

SER. NO. 78-841,189, FILED 3-20-2006.

CARYN GLASSER, EXAMINING ATTORNEY

**Int. Cl.: 20**

**Prior U.S. Cls.: 2, 13, 22, 25, 32 and 50**

**Reg. No. 3,453,774**

**United States Patent and Trademark Office**

**Registered June 24, 2008**

**TRADEMARK  
PRINCIPAL REGISTER**

**AEROLINEA**

VISUAL GRAPHIC SYSTEMS INC. (NEW YORK CORPORATION)  
500 TENTH AVENUE  
NEW YORK, NY 10018

FOR: CUSTOM DISPLAY FIXTURES MADE OF METAL, PLASTIC LAMINATE, ACRYLIC OR WOOD, NAMELY, DISPLAY BOARDS AND POINT OF PURCHASE DISPLAYS; METAL DISPLAY STANDS; UPRIGHT SIGN BOARDS OF METAL, PLASTIC OR WOOD., IN CLASS 20 (U.S. CLS. 2, 13, 22, 25, 32 AND 50).

FIRST USE 5-0-2002; IN COMMERCE 5-0-2002.

THE MARK CONSISTS OF STANDARD CHARACTERS WITHOUT CLAIM TO ANY PARTICULAR FONT, STYLE, SIZE, OR COLOR.

THE FOREIGN WORDING IN THE MARK TRANSLATES INTO ENGLISH AS "AIRLINE".

SER. NO. 78-842,675, FILED 3-21-2006.

JUSTINE D. PARKER, EXAMINING ATTORNEY

**Int. Cl.: 44**

**Prior U.S. Cls.: 100 and 101**

**United States Patent and Trademark Office**

**Reg. No. 3,453,775**

**Registered June 24, 2008**

**SERVICE MARK  
PRINCIPAL REGISTER**

**NOW EXPRESS CARE**

NOW CARE MEDICAL CENTERS, INC. (MINNE-  
SOTA CORPORATION)

2000 PLYMOUTH ROAD

MINNEAPOLIS, MN 55305

FOR: MEDICAL SERVICES, IN CLASS 44 (U.S.  
CLS. 100 AND 101).

FIRST USE 2-1-2006; IN COMMERCE 2-1-2006.

THE MARK CONSISTS OF STANDARD CHAR-  
ACTERS WITHOUT CLAIM TO ANY PARTICULAR  
FONT, STYLE, SIZE, OR COLOR.

NO CLAIM IS MADE TO THE EXCLUSIVE  
RIGHT TO USE "EXPRESS CARE", APART FROM  
THE MARK AS SHOWN.

SER. NO. 78-843,482, FILED 3-22-2006.

BRENDAN REGAN, EXAMINING ATTORNEY

**Int. Cl.: 5**

**Prior U.S. Cls.: 6, 18, 44, 46, 51 and 52**

**United States Patent and Trademark Office**

**Reg. No. 3,453,776**

**Registered June 24, 2008**

**TRADEMARK  
PRINCIPAL REGISTER**

**PYLERA**

AXCAN PHARMA INC. (CANADA CORPORATION)  
567 LAURIER BLVD.  
MONT-ST.-HILAIRE, CANADA J3H 6C4

FOR: PHARMACEUTICAL PREPARATIONS FOR  
THE ERADICATION OF HELICOBACTER PYLORI,  
IN CLASS 5 (U.S. CLS. 6, 18, 44, 46, 51 AND 52).

FIRST USE 5-17-2007; IN COMMERCE 5-17-2007.

THE MARK CONSISTS OF STANDARD CHARACTERS WITHOUT CLAIM TO ANY PARTICULAR FONT, STYLE, SIZE, OR COLOR.

PRIORITY CLAIMED UNDER SEC. 44(D) ON CANADA APPLICATION NO. 11293493, FILED 3-14-2006.

SER. NO. 78-846,616, FILED 3-27-2006.

ESTHER A. BORSUK, EXAMINING ATTORNEY



**Int. Cl.: 12**

**Prior U.S. Cls.: 19, 21, 23, 31, 35 and 44**

**Reg. No. 3,453,777**

**United States Patent and Trademark Office**

**Registered June 24, 2008**

**TRADEMARK  
PRINCIPAL REGISTER**

**Centurion World  
Championship Towboats**

FINELINE INDUSTRIES, INC. (CALIFORNIA CORPORATION)  
455 GROGAN AVENUE  
MERCED, CA 95340

FOR: WATERSPORTS MOTORBOATS SHORTER THAN 30 FEET IN LENGTH, NOT INCLUDING SAILING BOATS AND YACHTS, IN CLASS 12 (U.S. CLS. 19, 21, 23, 31, 35 AND 44).

FIRST USE 9-1-1984; IN COMMERCE 9-1-1984.

THE MARK CONSISTS OF STANDARD CHARACTERS WITHOUT CLAIM TO ANY PARTICULAR FONT, STYLE, SIZE, OR COLOR.

NO CLAIM IS MADE TO THE EXCLUSIVE RIGHT TO USE "TOWBOATS", APART FROM THE MARK AS SHOWN.

SER. NO. 78-847,622, FILED 3-28-2006.

LAURA HAMMEL, EXAMINING ATTORNEY

**Int. Cls.: 25 and 35**

**Prior U.S. Cls.: 22, 39, 100, 101 and 102**

**United States Patent and Trademark Office**

**Reg. No. 3,453,778**

**Registered June 24, 2008**

**TRADEMARK  
SERVICE MARK  
PRINCIPAL REGISTER**



SHOKO SPORTWEAR LTD. (ISRAEL CORPORATION)  
10 HASADNAOT STREET  
HERZELIYA PITUACH, ISRAEL

FOR: MEN'S, WOMEN'S AND CHILDREN'S CLOTHING, NAMELY, T-SHIRTS, PANTS, SHIRTS, SWEAT SHIRTS, SOCKS AND UNDERWEAR, IN CLASS 25 (U.S. CLS. 22 AND 39).

FOR: RETAIL AND WHOLESALE STORE SERVICES FEATURING CLOTHING, HEADGEAR AND FOOTWEAR; RETAIL CHAIN STORE SERVICES FEATURING CLOTHING, HEADGEAR AND FOOTWEAR; RETAIL CLOTHING, HEADGEAR AND FOOTWEAR CHAIN STORE SERVICES, IN CLASS 35 (U.S. CLS. 100, 101 AND 102).

OWNER OF ISRAEL REG. NO. 180420, DATED 11-7-2006, EXPIRES 5-1-2015.

OWNER OF ISRAEL REG. NO. 174882, DATED 9-6-2006, EXPIRES 9-20-2014.

NO CLAIM IS MADE TO THE EXCLUSIVE RIGHT TO USE "WEAR" , APART FROM THE MARK AS SHOWN.

THE COLOR(S) GREEN AND WHITE IS/ARE CLAIMED AS A FEATURE OF THE MARK.

THE MARK CONSISTS OF THE WORDING "S. WEAR" AND DESIGN. THE COLOR GREEN APPEARS IN THE RECTANGULAR BORDER AND BACKGROUND IN THE MARK; THE COLOR WHITE APPEARS IN THE STYLIZED WORDING "S. WEAR".

SER. NO. 78-849,648, FILED 3-30-2006.

JOHN SCHUYLER YARD, EXAMINING ATTORNEY

**Int. Cls.: 25 and 35**

**Prior U.S. Cls.: 22, 39, 100, 101 and 102**

**United States Patent and Trademark Office**

**Reg. No. 3,453,779**

**Registered June 24, 2008**

**TRADEMARK  
SERVICE MARK  
PRINCIPAL REGISTER**



SHOKO SPORTWEAR LTD. (ISRAEL CORPORATION)

10 HASADNAOT STREET

HERZELIYA PITUACH, ISRAEL

FOR: MEN'S, WOMEN'S AND CHILDREN'S CLOTHING, NAMELY, T-SHIRTS, PANTS, SHIRTS, SWEAT SHIRTS, SOCKS AND UNDERWEAR, IN CLASS 25 (U.S. CLS. 22 AND 39).

FOR: RETAIL AND WHOLESALE STORE SERVICES FEATURING CLOTHING, HEADGEAR AND FOOTWEAR; RETAIL CHAIN STORE SERVICES FEATURING CLOTHING, HEADGEAR AND FOOTWEAR; RETAIL CLOTHING, HEADGEAR AND FOOTWEAR CHAIN STORE SERVICES, IN CLASS 35 (U.S. CLS. 100, 101 AND 102).

OWNER OF ISRAEL REG. NO. 180419, DATED 11-7-2006, EXPIRES 5-1-2015.

OWNER OF ISRAEL REG. NO. 174881, DATED 9-6-2006, EXPIRES 9-20-2014.

NO CLAIM IS MADE TO THE EXCLUSIVE RIGHT TO USE "WEAR" , APART FROM THE MARK AS SHOWN.

THE COLOR(S) RED AND WHITE IS/ARE CLAIMED AS A FEATURE OF THE MARK.

THE MARK CONSISTS OF THE WORDING "S. WEAR" AND DESIGN. THE COLOR RED APPEARS IN THE RECTANGULAR BORDER AND BACKGROUND IN THE MARK; THE COLOR WHITE APPEARS IN THE STYLIZED WORDING "S. WEAR".

SER. NO. 78-849,649, FILED 3-30-2006.

JOHN SCHUYLER YARD, EXAMINING ATTORNEY

**Int. Cls.: 41, 44 and 45**

**Prior U.S. Cls.: 100, 101 and 107**

**United States Patent and Trademark Office**

**Reg. No. 3,453,780**

**Registered June 24, 2008**

**SERVICE MARK  
PRINCIPAL REGISTER**

**FOR YOUR BABY'S FIRST YEAR**

CBR SYSTEMS, INC. (CALIFORNIA CORPORATION)  
1200 BAYHILL DRIVE, SUITE 301  
SAN BRUNO, CA 940663006

FOR: PROVIDING NEWSLETTERS VIA EMAIL IN THE FIELD OF CHILDREN'S HEALTH AND CHILDREN'S SAFETY, IN CLASS 41 (U.S. CLS. 100, 101 AND 107).

FIRST USE 12-3-1999; IN COMMERCE 12-3-1999.

FOR: PROVIDING ON-LINE INFORMATION, TIPS AND RESOURCES REGARDING CHILDREN'S HEALTH; PROVIDING A WEB SITE FEATURING INFORMATION IN THE FIELD OF CHILDREN'S HEALTH, IN CLASS 44 (U.S. CLS. 100 AND 101).

FIRST USE 3-31-2006; IN COMMERCE 3-31-2006.

FOR: PROVIDING ON-LINE INFORMATION IN THE FIELD OF CHILDREN'S SAFETY; PROVIDING A WEB SITE FEATURING INFORMATION IN THE FIELD OF CHILDREN'S SAFETY, IN CLASS 45 (U.S. CLS. 100 AND 101).

FIRST USE 3-31-2006; IN COMMERCE 3-31-2006.

THE MARK CONSISTS OF STANDARD CHARACTERS WITHOUT CLAIM TO ANY PARTICULAR FONT, STYLE, SIZE, OR COLOR.

SER. NO. 78-851,802, FILED 3-31-2006.

INGA ERVIN, EXAMINING ATTORNEY

**Int. Cl.: 42**

**Prior U.S. Cls.: 100 and 101**

**United States Patent and Trademark Office**

**Reg. No. 3,453,781**

**Registered June 24, 2008**

**SERVICE MARK  
PRINCIPAL REGISTER**

**samfind**

DESKIN, SAMUEL, SOLOMON (CALIFORNIA  
SOLE PROPRIETORSHIP)  
SUITE 8  
16944 VENTURA BLVD  
ENCINO, CA 91316

FOR: COMPUTER SERVICES IN THE NATURE  
OF CUSTOMIZED WEB PAGES FEATURING USER-  
DEFINED INFORMATION, PERSONAL PROFILES  
AND INFORMATION. , IN CLASS 42 (U.S. CLS. 100  
AND 101).

FIRST USE 7-9-2005; IN COMMERCE 7-9-2005.

THE MARK CONSISTS OF STANDARD CHAR-  
ACTERS WITHOUT CLAIM TO ANY PARTICULAR  
FONT, STYLE, SIZE, OR COLOR.

SER. NO. 78-853,317, FILED 4-4-2006.

HOWARD B. LEVINE, EXAMINING ATTORNEY

**Int. Cl.: 41**

**Prior U.S. Cls.: 100, 101 and 107**

**United States Patent and Trademark Office**

**Reg. No. 3,453,782**

**Registered June 24, 2008**

**SERVICE MARK  
PRINCIPAL REGISTER**



The Children of the Earth Foundation

THE CHILDREN OF THE EARTH FOUNDATION  
(NEW JERSEY CORPORATION)  
SUITE 4  
816 LONG BEACH BOULEVARD  
SUITE 4, NJ 08008

FIRST USE 3-1-2001; IN COMMERCE 3-1-2001.

NO CLAIM IS MADE TO THE EXCLUSIVE  
RIGHT TO USE "FOUNDATION", APART FROM  
THE MARK AS SHOWN.

FOR: EDUCATION SERVICES FOR YOUTH AND  
COMMUNITIES, NAMELY, CLASSES AND WORK-  
SHOPS ABOUT WILDERNESS SURVIVAL, NAT-  
URE AWARENESS, TRACKING, LOST-PROOFING  
AND RITES OF PASSAGE, IN CLASS 41 (U.S. CLS.  
100, 101 AND 107).

SER. NO. 78-853,946, FILED 4-4-2006.

TRACY CROSS, EXAMINING ATTORNEY

**Int. Cl.: 9**

**Prior U.S. Cls.: 21, 23, 26, 36 and 38**

**Reg. No. 3,453,783**

**United States Patent and Trademark Office**

**Registered June 24, 2008**

**TRADEMARK  
PRINCIPAL REGISTER**

The logo for RMSynergy features the letters 'RMS' in a bold, sans-serif font, followed by 'Synergy' in a similar font. A horizontal line is positioned above the 'y' in 'Synergy', extending across the width of the text.

DAVIDSON-RICHARDS LIMITED (UNITED  
KINGDOM CORPORATION)  
THE PARKER CENTRE, MANSFIELD ROAD  
DERBY, UNITED KINGDOM DE21 4SZ

PRIORITY CLAIMED UNDER SEC. 44(D) ON  
UNITED KINGDOM APPLICATION NO. 2415878,  
FILED 3-7-2006, REG. NO. 2415878, DATED 3-7-2006,  
EXPIRES 3-7-2016.

FOR: ELECTRONIC POINT OF SALE SOFTWARE  
FOR USE IN RETAIL MANAGEMENT, STOCK  
CONTROL, DATA MANAGEMENT AND ELEC-  
TRONIC POINT OF SALE BUSINESS APPLICA-  
TIONS, IN CLASS 9 (U.S. CLS. 21, 23, 26, 36 AND 38).

SER. NO. 78-854,285, FILED 4-5-2006.

HOWARD B. LEVINE, EXAMINING ATTORNEY

Int. Cl.: 35

Prior U.S. Cls.: 100, 101 and 102

United States Patent and Trademark Office

Reg. No. 3,453,784

Registered June 24, 2008

**SERVICE MARK  
PRINCIPAL REGISTER**

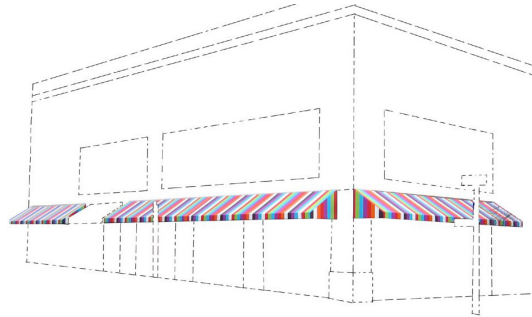

ALI WING, INC. (DELAWARE CORPORATION)  
2110 CHESTNUT STREET  
SAN FRANCISCO, CA 94123

FOR: RETAIL STORE SERVICES FEATURING INFANTS' AND CHILDREN'S FURNITURE, CLOTHING, BEDDING, BLANKETS AND THROWS, BOOKS, TOYS, CAR SEATS, STROLLERS, DIAPER BAGS, INFANT CARE PRODUCTS, HOUSEHOLD CLEANING PRODUCTS, INTERIOR PAINTS, LAUNDRY DETERGENT, IN CLASS 35 (U.S. CLS. 100, 101 AND 102).

FIRST USE 10-0-2003; IN COMMERCE 10-0-2003.

THE COLOR(S) ORANGE, WHITE, BLACK, PURPLE, BLUE, RED, AND GREEN IS/ARE CLAIMED AS A FEATURE OF THE MARK.

THE MARK CONSISTS OF A MULTI-COLORED, STRIPED AWNING WITH ALTERNATING STRIPES IN THE COLORS ORANGE, WHITE, BLACK, PURPLE, BLUE, RED, AND GREEN. THE MATTER SHOWN IN BROKEN LINES SERVES ONLY TO SHOW POSITIONING OF THE MARK AND IS NOT PART OF THE MARK.

SEC. 2(F).

SER. NO. 78-858,049, FILED 4-10-2006.

JIM RINGLE, EXAMINING ATTORNEY



Int. Cl.: 35

Prior U.S. Cls.: 100, 101 and 102

United States Patent and Trademark Office

Reg. No. 3,453,785

Registered June 24, 2008

SERVICE MARK  
PRINCIPAL REGISTER



**TEAMING WITH WILDLIFE**  
*a natural investment*

ASSOCIATION OF FISH AND WILDLIFE AGEN-  
CIES (D.C. CORPORATION)  
SUITE 725  
444 NORTH CAPITOL STREET, NW  
WASHINGTON, DC 20001

FOR: ASSOCIATION SERVICES, NAMELY, PRO-  
MOTING INCREASED STATE WILDLIFE GRANTS

AND OTHER FUNDING FOR WILDLIFE CONSER-  
VATION, IN CLASS 35 (U.S. CLS. 100, 101 AND 102).

FIRST USE 1-1-1996; IN COMMERCE 1-1-1996.

SER. NO. 78-861,057, FILED 4-13-2006.

GINA HAYES, EXAMINING ATTORNEY

**Int. Cl.: 9**

**Prior U.S. Cls.: 21, 23, 26, 36 and 38**

**Reg. No. 3,453,786**

**United States Patent and Trademark Office**

**Registered June 24, 2008**

---

**TRADEMARK  
PRINCIPAL REGISTER**

**FAIRIES ENIGMA**

UNIVERSAL DE DESARROLLOS ELECTRONI-  
COS, S.A. (SPAIN CORPORATION)  
CRTA. CASTELLAR, 298-302  
TERRASSA, BARCELONA, SPAIN 08226

FOR: SLOT MACHINES, IN CLASS 9 (U.S. CLS. 21,  
23, 26, 36 AND 38).

THE MARK CONSISTS OF STANDARD CHAR-  
ACTERS WITHOUT CLAIM TO ANY PARTICULAR  
FONT, STYLE, SIZE, OR COLOR.

PRIORITY CLAIMED UNDER SEC. 44(D) ON  
ERPNTY TM OFC APPLICATION NO.  
4973657, FILED 3-22-2006, REG. NO. 4973657, DATED  
5-3-2007, EXPIRES 3-22-2016.

NO CLAIM IS MADE TO THE EXCLUSIVE  
RIGHT TO USE "FAIRIES", APART FROM THE  
MARK AS SHOWN.

SER. NO. 78-863,079, FILED 4-17-2006.

BRIAN PINO, EXAMINING ATTORNEY

**Int. Cl.: 9**

**Prior U.S. Cls.: 21, 23, 26, 36 and 38**

**Reg. No. 3,453,787**

**United States Patent and Trademark Office**

**Registered June 24, 2008**

---

**TRADEMARK  
PRINCIPAL REGISTER**

**RANDOM BINGO**

UNIVERSAL DE DESARROLLOS ELECTRONI-  
COS, S.A. (SPAIN CORPORATION)  
CRTA. CASTELLAR, 298-302  
TERASSA, BARCELONA, SPAIN 08226

FOR: SLOT MACHINES, IN CLASS 9 (U.S. CLS. 21,  
23, 26, 36 AND 38).

THE MARK CONSISTS OF STANDARD CHAR-  
ACTERS WITHOUT CLAIM TO ANY PARTICULAR  
FONT, STYLE, SIZE, OR COLOR.

PRIORITY CLAIMED UNDER SEC. 44(D) ON  
ERPN CMNTY TM OFC APPLICATION NO.  
4973806, FILED 3-22-2006, REG. NO. 004973806, DA-  
TED 5-3-2007, EXPIRES 3-22-2016.

NO CLAIM IS MADE TO THE EXCLUSIVE  
RIGHT TO USE "BINGO", APART FROM THE  
MARK AS SHOWN.

SER. NO. 78-863,083, FILED 4-17-2006.

BRIAN PINO, EXAMINING ATTORNEY

**Int. Cl.: 9**

**Prior U.S. Cls.: 21, 23, 26, 36 and 38**

**Reg. No. 3,453,788**

**United States Patent and Trademark Office**

**Registered June 24, 2008**

---

**TRADEMARK  
PRINCIPAL REGISTER**

**SCANARRAY**

PERKINELMER LAS, INC. (DELAWARE CORPORATION)  
940 WINTER STREET  
WALTHAM, MA 02451

FOR: LABORATORY INSTRUMENTS, NAMELY, MICROARRAY SCANNERS; COMPUTER SOFTWARE PACKAGED AS A UNIT WITH MICROARRAY SCANNERS FOR CONTROLLING MICROARRAY SCANNERS, FOR QUANTITATING MICROARRAYS AND FOR VIEWING AND SAVING SCANNED MICROARRAY IMAGES AND QUANTITATION RESULTS; AND USER MANUALS

SOLD AS A UNIT WITH ALL THE FOREGOING GOODS, IN CLASS 9 (U.S. CLS. 21, 23, 26, 36 AND 38).

FIRST USE 6-5-1997; IN COMMERCE 6-5-1997.

THE MARK CONSISTS OF STANDARD CHARACTERS WITHOUT CLAIM TO ANY PARTICULAR FONT, STYLE, SIZE, OR COLOR.

SER. NO. 78-863,382, FILED 4-18-2006.

BERYL GARDNER, EXAMINING ATTORNEY

**Int. Cls.: 12 and 18**

**Prior U.S. Cls.: 1, 2, 3, 19, 21, 22, 23, 31, 35, 41 and 44**

**United States Patent and Trademark Office**

**Reg. No. 3,453,789**

**Registered June 24, 2008**

**TRADEMARK  
PRINCIPAL REGISTER**



MRM HOLDINGS LIMITED (MAURITIUS LTD  
LIAB CO)  
ST. JAMES COURT, ST. DENIS ST, SUITE 802  
PORT LOUIS, MAURITIUS

FOR: CARRIER BAGS FOR USE ON BICYCLES  
AND MOTORCYCLES, IN CLASS 12 (U.S. CLS. 19, 21,  
23, 31, 35 AND 44).

FIRST USE 9-0-2005; IN COMMERCE 9-0-2005.

FOR: BAGS, POUCHES, AND CASES FOR STO-  
RAGE AND/OR TRANSPORT OF PERSONAL  
ITEMS, NAMELY, LUGGAGE, ATHLETIC BAGS,  
CARRY-ALL BAGS, DUFFEL BAGS, HIKING BAGS,  
KIT BAGS, OVERNIGHT BAGS, SHOULDER BAGS,  
SPORTS BAGS, TOTE BAGS, TRAVEL BAGS, WAIST  
BAGS, CARRYING CASES, BRIEFCASES, AND  
DOCUMENT CASES; THEFT-RESISTANT AND  
TAMPER-RESISTANT BAGS, POUCHES, AND  
CASES FOR TRANSPORT OF PERSONAL ITEMS,  
NAMELY, LUGGAGE, ATHLETIC BAGS, CARRY-  
ALL BAGS, DUFFEL BAGS, HIKING BAGS, KIT

BAGS, OVERNIGHT BAGS, SHOULDER BAGS,  
SPORTS BAGS, TOTE BAGS, TRAVEL BAGS, WAIST  
BAGS, CARRYING CASES, BRIEFCASES, AND  
DOCUMENT CASES SOLD IN LOCKABLE AND/  
OR REINFORCED FORM; MESH BAGS AND NETS  
FOR HOLDING AND SECURING LUGGAGE, ATH-  
LETIC BAGS, CARRY-ALL BAGS, DUFFEL BAGS,  
HIKING BAGS, KIT BAGS, OVERNIGHT BAGS,  
SHOULDER BAGS, SPORTS BAGS, TOTE BAGS,  
TRAVEL BAGS, WAIST BAGS, CARRYING CASES,  
BRIEFCASES, AND DOCUMENT CASES; SLASH-  
RESISTANT STRAPS FOR LUGGAGE AND HAND-  
BAGS; ALL OF THE FOREGOING FOR USE IN  
TRAVEL, IN CLASS 18 (U.S. CLS. 1, 2, 3, 22 AND 41).

FIRST USE 0-0-2005; IN COMMERCE 0-0-2005.

OWNER OF U.S. REG. NO. 2,347,685.

SER. NO. 78-864,354, FILED 4-19-2006.

SUSAN RICHARDS, EXAMINING ATTORNEY

**Int. Cls.: 7, 10, 11 and 40**

**Prior U.S. Cls.: 13, 19, 21, 23, 26, 31, 34, 35, 39, 44,  
100, 103 and 106**

**Reg. No. 3,453,790**

**United States Patent and Trademark Office**

**Registered June 24, 2008**

**TRADEMARK  
SERVICE MARK  
PRINCIPAL REGISTER**

# CERAMTEC

CERAMTEC NORTH AMERICA INNOVATIVE  
CERAMIC ENGINEERING CORPORATION  
(DELAWARE CORPORATION)  
ONE TECHNOLOGY PLACE  
LAURENS, SC 29360

FOR: CERAMIC DIPPING MOLDS FOR USE WITH OR ACCESSORIES FOR FORMING MACHINE; COMPONENTS OF WELDING MACHINES; AND TEXTILE MACHINE GUIDES, AND FACE SEAL RINGS AND PUMP PISTONS MADE OF CERAMIC MATERIALS, NAMELY, FOR USE IN POWER ELECTRONICS, THERMO-ELECTRICAL APPLICATIONS, OPTOELECTRONICS, ELECTRICAL CONDUCTORS AND SENSORS, ELECTRONIC APPLICATIONS, IN CLASS 7 (U.S. CLS. 13, 19, 21, 23, 31, 34 AND 35).

FIRST USE 3-31-1985; IN COMMERCE 3-31-1985.

FOR: ENDOPROSTHESES FOR REPLACEMENT OF JOINTS AND BONES, IN CLASS 10 (U.S. CLS. 26, 39 AND 44).

FIRST USE 3-31-1985; IN COMMERCE 3-31-1985.

FOR: GAS BURNERS FOR HOUSEHOLD AND INDUSTRIAL APPLICATIONS; AND INSULATING COMPONENTS FOR HEATING EQUIPMENT, NAMELY, CRUSHABLE TUBES MADE OF ALUMINA, IN CLASS 11 (U.S. CLS. 13, 21, 23, 31 AND 34).

FIRST USE 3-31-1985; IN COMMERCE 3-31-1985.

FOR: LASER SCRIBING OF SUBSTRATES, LASER MACHINING OF METALS, LASER DRILLING

AND ANNEALING OF CERAMIC SUBSTRATES; FIRING AND CALCINING OF POWDERS AND POWDER COMPACTS, SPECIFICALLY THE REMOVAL OF ANY ORGANIC MATTER, WATER, AND BINDER MATERIALS BY THE ACTION OF HEAT AND ATMOSPHERE TO CHANGE THE MATERIAL'S CHEMICAL COMPOSITION, PHASES OR BOTH; PROCESSING OF MATERIALS, NAMELY, ALUMINA, MAGNESIUM ALUMINUM SILICATE, ZIRCON AND TITANIA IN POWDER FORM; CUSTOM MANUFACTURE FOR OTHERS OF CERAMIC AND METAL MATERIALS AND PRODUCTS FOR USE IN THE FIELDS OF LABORATORY RESEARCH, TELECOMMUNICATIONS, PETROLEUM EXPLORATION AND REFINING, POWER GENERATION AND DISTRIBUTION, AND CERAMICS MANUFACTURING, NAMELY, AUTOMOTIVE EQUIPMENT, ELECTRONIC COMPONENTS, MEDICAL TECHNOLOGY EQUIPMENT, AND APPLIANCE AND MACHINERY COMPONENTS, IN CLASS 40 (U.S. CLS. 100, 103 AND 106).

FIRST USE 3-31-1985; IN COMMERCE 3-31-1985.

THE MARK CONSISTS OF STANDARD CHARACTERS WITHOUT CLAIM TO ANY PARTICULAR FONT, STYLE, SIZE, OR COLOR.

SER. NO. 78-867,109, FILED 4-21-2006.

CHRISTOPHER BUONGIORNO, EXAMINING ATTORNEY

**Int. Cl.: 21**

**Prior U.S. Cls.: 2, 13, 23, 29, 30, 33, 40 and 50**

**United States Patent and Trademark Office**

**Reg. No. 3,453,791**

**Registered June 24, 2008**

---

**TRADEMARK  
PRINCIPAL REGISTER**

**SMART BOWL**

PREMIER PET PRODUCTS, LLC (VIRGINIA LTD  
LIAB CO)  
14201 SOMMERVILLE COURT  
MIDLOTHIAN, VA 23113

FOR: PET FEEDING DISHES, IN CLASS 21 (U.S.  
CLS. 2, 13, 23, 29, 30, 33, 40 AND 50).

FIRST USE 4-19-1999; IN COMMERCE 4-19-1999.

THE MARK CONSISTS OF STANDARD CHAR-  
ACTERS WITHOUT CLAIM TO ANY PARTICULAR  
FONT, STYLE, SIZE, OR COLOR.

OWNER OF U.S. REG. NO. 2,385,445.

NO CLAIM IS MADE TO THE EXCLUSIVE  
RIGHT TO USE "BOWL", APART FROM THE  
MARK AS SHOWN.

SER. NO. 78-868,075, FILED 4-24-2006.

KATHERINE CONNOLLY, EXAMINING ATTOR-  
NEY

**Int. Cls.: 39 and 43**

**Prior U.S. Cls.: 100, 101 and 105**

**United States Patent and Trademark Office**

**Reg. No. 3,453,792**

**Registered June 24, 2008**

**SERVICE MARK  
PRINCIPAL REGISTER**

**A BRIDGE TO CHINA**

WORLD ODYSSEYS, INC. (WASHINGTON CORPORATION)  
3409 E MADISON STREET  
SEATTLE, WA 98112

FOR: TRAVEL AND ACCOMMODATION SERVICES FOR ADOPTIVE PARENTS, NAMELY, MAKING AIR TRANSPORTATION RESERVATIONS FOR UNITED STATES' INDIVIDUALS AND GROUPS WHO HAVE ADOPTED CHILDREN FROM CHINA, INCLUDING MAKING AIR TRANSPORTATION RESERVATIONS FOR ON A CUSTOM BASIS FOR THE FOREGOING; MAKING CULTURAL RESERVATIONS FOR ADOPTIVE PARENTS FOR UNITED STATES' INDIVIDUALS AND GROUPS WHO HAVE ADOPTED CHILDREN FROM CHINA, NAMELY, MAKING TOUR TICKET RESERVATIONS FOR THE FOREGOING, IN CLASS 39 (U.S. CLS. 100 AND 105).

FIRST USE 11-21-2005; IN COMMERCE 2-1-2006.

FOR: TRAVEL AND ACCOMMODATION SERVICES FOR ADOPTIVE PARENTS, NAMELY, MAKING HOTEL RESERVATIONS FOR UNITED STATES' INDIVIDUALS AND GROUPS WHO HAVE ADOPTED CHILDREN FROM CHINA, IN CLASS 43 (U.S. CLS. 100 AND 101).

FIRST USE 11-21-2005; IN COMMERCE 2-1-2006.

THE MARK CONSISTS OF STANDARD CHARACTERS WITHOUT CLAIM TO ANY PARTICULAR FONT, STYLE, SIZE, OR COLOR.

NO CLAIM IS MADE TO THE EXCLUSIVE RIGHT TO USE "CHINA", APART FROM THE MARK AS SHOWN.

SER. NO. 78-871,443, FILED 4-27-2006.

JORDAN BAKER, EXAMINING ATTORNEY



**Int. Cls.: 35 and 42**

**Prior U.S. Cls.: 100, 101 and 102**

**United States Patent and Trademark Office**

**Reg. No. 3,453,793**

**Registered June 24, 2008**

**SERVICE MARK  
PRINCIPAL REGISTER**

**monsterDental**

MARVEL MANAGEMENT (NEVADA CORPORATION)  
3001 BRIDGE CREEK  
LAS VEGAS, NV 89117

FOR: MAIL ORDER CATALOG, ON-LINE CATALOG AND DISTRIBUTORSHIP SERVICES FEATURING DENTAL EQUIPMENT AND SUPPLIES; CONSULTING SERVICES IN THE FIELD OF DENTAL OFFICE MANAGEMENT; MARKETING SERVICES FOR OTHERS, IN CLASS 35 (U.S. CLS. 100, 101 AND 102).

FIRST USE 6-1-1998; IN COMMERCE 1-1-1999.

FOR: PLANNING AND LAYOUT DESIGN SERVICES FOR DENTAL OFFICES; WEBSITE DEVELOPMENT FOR OTHERS; SOFTWARE

DEVELOPMENT FOR OTHERS, IN CLASS 42 (U.S. CLS. 100 AND 101).

FIRST USE 6-1-1998; IN COMMERCE 1-1-1999.

THE COLOR(S) BLACK AND PURPLE IS/ARE CLAIMED AS A FEATURE OF THE MARK.

THE MARK CONSISTS OF THE WORD "MONSTER" IN BLACK AND THE WORD "DENTAL" IN PURPLE. IN THE WORD MONSTER A LOWER-CASE "M" IS USED AND IN THE WORD DENTAL THE "D" IS CAPITALIZED.

SER. NO. 78-873,921, FILED 5-1-2006.

ESTHER A. BORSUK, EXAMINING ATTORNEY

**Int. Cl.: 12**

**Prior U.S. Cls.: 19, 21, 23, 31, 35 and 44**

**Reg. No. 3,453,794**

**United States Patent and Trademark Office**

**Registered June 24, 2008**

**TRADEMARK  
PRINCIPAL REGISTER**

# Hummerbee

APIARIES & ORCHARD FORKLIFT, INC. (MI-  
CHIGAN CORPORATION)  
7948 N. SHERIDAN RD.  
EDMORE, MI 48829

FOR: FORKLIFT TRUCKS FOR AGRICULTUR-  
AL USE, NAMELY, FOR USE IN APIARIES, NUR-  
SERIES, LANDSCAPING, ORCHARDS AND  
FARMS, IN CLASS 12 (U.S. CLS. 19, 21, 23, 31, 35  
AND 44).

FIRST USE 1-7-2006; IN COMMERCE 1-15-2006.

THE MARK CONSISTS OF STANDARD CHAR-  
ACTERS WITHOUT CLAIM TO ANY PARTICULAR  
FONT, STYLE, SIZE, OR COLOR.

SER. NO. 78-875,409, FILED 5-3-2006.

BERYL GARDNER, EXAMINING ATTORNEY

**Int. Cls.: 35, 38, 39, 41 and 43**

**Prior U.S. Cls.: 100, 101, 102, 104, 105 and 107**

**Reg. No. 3,453,795**

**United States Patent and Trademark Office**

**Registered June 24, 2008**

**SERVICE MARK  
PRINCIPAL REGISTER**



VIRTUAL WINE LIMITED (UNITED KINGDOM  
PRIVATE LIMITED COMPANY)

83 MERTON HALL ROAD

LONDON, UNITED KINGDOM SW19 3PX

FOR: RETAIL SHOPS FEATURING FOOD, WINES, OTHER ALCOHOLIC AND NON-ALCOHOLIC BEVERAGES; MAIL ORDER RETAIL SERVICES FEATURING FOOD, WINES, OTHER ALCOHOLIC AND NON-ALCOHOLIC BEVERAGES; ON-LINE RETAIL STORE SERVICES FEATURING FOOD, WINES, OTHER ALCOHOLIC AND NON-ALCOHOLIC BEVERAGES; PROVISION OF CONSUMER PRODUCT INFORMATION AND RELATED CONSULTATION TO PROSPECTIVE PURCHASERS OF WINES AND OTHER ALCOHOLIC AND NON-ALCOHOLIC BEVERAGES BY WAY OF THE INTERNET OR PROVIDED BY OTHER MEANS; COMPILATION AND PROVISION OF TRADE AND BUSINESS PRICE AND STATISTICAL INFORMATION; PREPARING ADVERTISEMENTS FOR OTHERS FOR USE ON INTERNET WEB PAGES; AUCTIONEERING SERVICES; AUCTIONING WINES AND OTHER ALCOHOLIC AND NON-ALCOHOLIC BEVERAGES; ARRANGING AND CONDUCTING OF AUCTION SALES; ARRANGING FOR TICKET RESERVATIONS FOR ATTENDANCE AT AUCTIONS; ARRANGING AND ORGANIZING OF TRADE FAIRS FOR ECONOMIC OR ADVERTISING PURPOSES, ARRANGING OF STORAGE, WAREHOUSING, TRANSPORT AND DELIVERY OF FOOD AND OTHER ALCOHOLIC AND NON-ALCOHOLIC BEVERAGES, IN CLASS 35 (U.S. CLS. 100, 101 AND 102).

FOR: BROADCAST OF ENTERTAINMENT AND CULTURAL EVENTS BY WAY OF THE INTERNET; ELECTRONIC TRANSMISSION OF INFORMATION FOR WINES, ALCOHOLIC AND NON-ALCOHOLIC BEVERAGES AND THE WINE AND BREWING INDUSTRIES; PROVIDING ON-LINE CHAT ROOMS FOR TRANSMISSION OF MESSAGES AMONG COMPUTER USERS CONCERNING WINE AND FOOD, IN CLASS 38 (U.S. CLS. 100, 101 AND 104).

FOR: STORAGE, WAREHOUSING, TRANSPORT AND DELIVERY OF FOOD, WINES AND OTHER ALCOHOLIC AND NON-ALCOHOLIC BEVERAGES; WINE CLUB SERVICES FEATURING PERIODIC SHIPMENTS OF WINE TO MEMBERS , IN CLASS 39 (U.S. CLS. 100 AND 105).

FOR: ENTERTAINMENT SERVICES, NAMELY, WINE TASTING, CULINARY EVENTS AND COOKERY EVENTS; ORGANIZATION OF WINE TASTING; WINE TASTING EVENTS; WINE APPRECIATION COURSES; ORGANIZATION OF CONFERENCES, EXHIBITIONS, SHOWS, WORKSHOPS AND SEMINARS FOR EDUCATION, ENTERTAINMENT, CULTURAL OR COOKERY PURPOSES; PARTY PLANNING SERVICES; PUBLISHING OF PRINTED MATTER RELATING TO FOOD, WINES AND OTHER ALCOHOLIC AND NON-ALCOHOLIC BEVERAGES; PRODUCTION OF RADIO, TELEVISION AND VIDEO BROADCASTS RELATING TO FOOD AND WINE PROVIDED ON-LINE OR PROVIDED BY OTHER MEANS; PROVIDING ON-LINE ELECTRONIC PUBLICATIONS IN THE NATURE OF MAGAZINES, JOURNALS, PERIODICAL PUBLICATIONS,

NEWSPAPERS, NEWSLETTERS, PRICE LISTS, WINE LISTS, DIRECTORIES, CATALOGUES, INSTRUCTIONAL AND TEACHING MATERIAL, GUIDES AND BOOKS IN THE FIELD OF ENTERTAINMENT, FOOD, WINE OR OTHER ALCOHOLIC AND NON-ALCOHOLIC BEVERAGES, WINE APPRECIATION, SPIRITS AND COOKERY, TUITION AND EDUCATION IN THESE FIELDS; PUBLICATION OF ELECTRONIC BOOKS AND JOURNALS ON-LINE; PROVISION OF INFORMATION RELATING TO ALL OF THE AFORESAID SERVICES; PUBLICATION OF ELECTRONICALLY DISPLAYABLE TEXT, GRAPHIC, PICTURE AND SOUND INFORMATION IN RELATION TO FOOD, WINE, OTHER ALCOHOLIC AND NON-ALCOHOLIC BEVERAGES; SCHOOLS FOR WINE WAITERS AND CRITICS; ARRANGING FOR TICKET RESERVATIONS FOR ATTENDANCE AT ENTERTAINMENT AND CULTURE EVENTS, INCLUDING WINE TASTING, IN CLASS 41 (U.S. CLS. 100, 101 AND 107).

FOR: CONSULTANCY SERVICES IN THE FIELD OF WINES; WINE BAR SERVICES; WINE CLUB SERVICES FEATURING INFORMATION IN THE FIELD OF WINE, NAMELY, WINE CHARACTERISTICS AND WINE AND FOOD PAIRING; PROVIDING INFORMATION IN THE FIELD OF FOOD, WINES IN THE NATURE OF WINE CHARACTERISTICS AND WINE AND FOOD PAIRING, AND OTHER ALCOHOLIC AND NON-ALCOHOLIC BEVERAGES INCLUDING BY WAY OF THE INTERNET; CATERING FOR THE PREPARATION OF

FOOD AND DRINK; CATERING SERVICES; RESTAURANT SERVICES; CAFÉ AND CAFETERIA SERVICES; SNACK-BAR SERVICES; FAST-FOOD RESTAURANT SERVICES; RESERVATION AND BOOKINGS FOR HOTELS AND TEMPORARY ACCOMMODATION; RENTAL OF MEETING, CONFERENCE AND RECEPTION ROOMS, IN CLASS 43 (U.S. CLS. 100 AND 101).

PRIORITY CLAIMED UNDER SEC. 44(D) ON UNITED KINGDOM APPLICATION NO. 2420901, FILED 5-3-2006, REG. NO. 2420901, DATED 12-8-2006, EXPIRES 5-3-2016.

THE COLOR(S) RED, GREY AND WHITE IS/ARE CLAIMED AS A FEATURE OF THE MARK.

THE MARK CONSISTS OF THE COLOR RED APPEARS IN THE LOWER PORTION OF THE BOWL OF THE WINE GLASS AND IN THE WORD "TASTORIA", THE COLOR GREY APPEARS AS BACKGROUND TO THE WINE GLASS, AND THE COLOR WHITE APPEARS IN THE DESIGN OF THE WINE GLASS AND AS BACKGROUND TO THE WORD "TASTORIA".

SER. NO. 78-875,552, FILED 5-3-2006.

KATHLEEN M. VANSTON, EXAMINING ATTORNEY

**Int. Cl.: 36**

**Prior U.S. Cls.: 100, 101 and 102**

**United States Patent and Trademark Office**

**Reg. No. 3,453,796**

**Registered June 24, 2008**

**SERVICE MARK  
PRINCIPAL REGISTER**

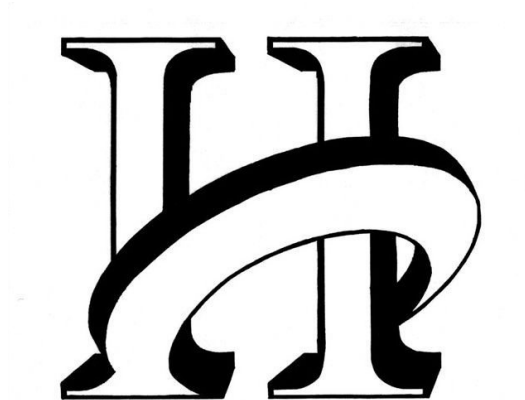

HEALTHCOR MANAGEMENT, L.P. (DELA-  
WARE LIMITED PARTNERSHIP)  
152 WEST 57TH STREET  
47TH FLOOR  
NEW YORK, NY 10019

THE MARK CONSISTS OF THE LETTERS "H"  
AND "C" IN STYLIZED COMBINATION.

FOR: FUND INVESTMENT SERVICES, IN CLASS  
36 (U.S. CLS. 100, 101 AND 102).

SER. NO. 78-876,969, FILED 5-4-2006.

FIRST USE 8-1-2005; IN COMMERCE 8-1-2005.

LAURIE KAUFMAN, EXAMINING ATTORNEY

**Int. Cl.: 33**

**Prior U.S. Cls.: 47 and 49**

**United States Patent and Trademark Office**

**Reg. No. 3,453,797**

**Registered June 24, 2008**

**TRADEMARK  
PRINCIPAL REGISTER**



WHITLEY NEILL LIMITED (ENGLAND PRIVATE LIMITED COMPANY)

11 LANSDOWNE ROAD

LONDON, UNITED KINGDOM SW208AN

FOR: DISTILLED SPIRITS; LIQUOR, IN CLASS 33 (U.S. CLS. 47 AND 49).

OWNER OF ERPN CMNTY TM OFC REG. NO. 4602009, DATED 7-20-2006, EXPIRES 9-27-2015.

THE MARK CONSISTS OF A STYLIZED REPRESENTATION OF A BAOBAB TREE.

SER. NO. 78-877,540, FILED 5-5-2006.

KAREN K. BUSH, EXAMINING ATTORNEY

**Int. Cl.: 33**

**Prior U.S. Cls.: 47 and 49**

**United States Patent and Trademark Office**

**Reg. No. 3,453,798**

**Registered June 24, 2008**

**TRADEMARK  
PRINCIPAL REGISTER**

**Doukenie**

BAZACO, GEORGE C (UNITED STATES INDIVIDUAL)  
14727 MOUNTAIN RD.  
PURCELLVILLE, VA 20132

THE MARK CONSISTS OF STANDARD CHARACTERS WITHOUT CLAIM TO ANY PARTICULAR FONT, STYLE, SIZE, OR COLOR.

FOR: GRAPE WINE, IN CLASS 33 (U.S. CLS. 47 AND 49).

SER. NO. 78-878,263, FILED 5-6-2006.

FIRST USE 0-0-2003; IN COMMERCE 0-0-2003.

KAREN K. BUSH, EXAMINING ATTORNEY

**Int. Cls.: 35 and 41**

**Prior U.S. Cls.: 100, 101, 102 and 107**

**United States Patent and Trademark Office**

**Reg. No. 3,453,799**

**Registered June 24, 2008**

**SERVICE MARK  
PRINCIPAL REGISTER**

# UnWind with Wine

LEE, MEEJA HANNA (REPUBLIC OF KOREA  
INDIVIDUAL)  
2373 BROADWAY #901  
NEW YORK, NY 10022

FOR: BUSINESS NETWORKING SERVICES, PRIMARILY AVAILABLE TO PROFESSIONAL WOMEN'S ORGANIZATIONS AND THEIR MEMBERS, IN CLASS 35 (U.S. CLS. 100, 101 AND 102).

FIRST USE 4-1-2006; IN COMMERCE 4-1-2006.

FOR: ENTERTAINMENT SERVICES, NAMELY, WINE TASTINGS, AND EDUCATIONAL SERVICES, NAMELY, CLASSES AND SEMINARS IN THE FIELD OF WINE MAKING AND WINE TASTING,

ALL OF WHICH ARE PRIMARILY AVAILABLE TO PROFESSIONAL WOMEN'S ORGANIZATIONS AND THEIR MEMBERS, IN CLASS 41 (U.S. CLS. 100, 101 AND 107).

FIRST USE 4-1-2006; IN COMMERCE 4-1-2006.

THE MARK CONSISTS OF STANDARD CHARACTERS WITHOUT CLAIM TO ANY PARTICULAR FONT, STYLE, SIZE, OR COLOR.

SER. NO. 78-879,820, FILED 5-9-2006.

ANDREA K. NADELMAN, EXAMINING ATTORNEY



**Int. Cls.: 1, 5, 31, 42 and 44**

**Prior U.S. Cls.: 1, 5, 6, 10, 18, 26, 44, 46, 51, 52, 100  
and 101**

**Reg. No. 3,453,800**

**United States Patent and Trademark Office**

**Registered June 24, 2008**

**TRADEMARK  
SERVICE MARK  
PRINCIPAL REGISTER**

The logo for Syngenta, featuring the word "syngenta" in a bold, lowercase, sans-serif font. A stylized leaf icon is positioned above the letter 'g'.

SYNGENTA PARTICIPATIONS AG (SWITZERLAND CORPORATION)

SCHWARZWALDALLEE 215

BASEL, SWITZERLAND CH-4058

FOR: CHEMICALS USED IN SCIENCE, AGRICULTURE, HORTICULTURE AND FORESTRY, NAMELY, CHEMICAL ADDITIVES FOR USE IN THE MANUFACTURE OF FUNGICIDES AND INSECTICIDES; CHEMICAL PREPARATIONS FOR SCIENTIFIC RESEARCH USE; CHEMICAL REAGENTS FOR SCIENTIFIC RESEARCH USE; CHEMICALS FOR USE IN THE MANUFACTURE OF AGRICULTURAL, HORTICULTURAL AND FORESTRY PRODUCTS; FERTILIZERS FOR AGRICULTURAL, COMMERCIAL AND DOMESTIC USE; CHEMICAL COMPOSITIONS, NAMELY, SEED PRESERVING SUBSTANCES; SOIL-CONDITIONING CHEMICALS; ANTI-SPROUTING PREPARATIONS FOR VEGETABLES; PREPARATIONS OF TRACE ELEMENTS FOR PLANTS; VEGETABLE PREPARATIONS AS FERTILIZER FOR AGRICULTURE; CHEMICAL ADDITIVES FOR USE IN THE MANUFACTURE OF FOOD; MANURES; ADJUVANTS FOR USE IN MANUFACTURING AGRICULTURAL PREPARATIONS; WOUND PASTES FOR TREES AND PLANTS; PLANT GROWTH REGULATING PREPARATIONS; CHEMICAL PLANT PROTECTION AGENTS FOR A PROPHYLACTIC NATURE; CHEMICAL PREPARATIONS TO PREVENT MILDEW; PREPARATIONS FOR ACTIVATING THE BIOLOGICAL RESISTANCE OF PLANTS AND SEEDLINGS AGAINST INSECTS, BACTERIA, FUNGUS DISEASE, PARASITES AND WEEDS; DEFOLIANTS; PLANT HORMONES FOR HASTENING THE RIPENING OF FRUITS; CHEMICAL REAGENTS FOR MEDICAL RESEARCH USE, IN CLASS 1 (U.S. CLS. 1, 5, 6, 10, 26 AND 46).

FIRST USE 12-1-1999; IN COMMERCE 12-1-1999.

FOR: FUNGICIDES, PARASITICIDE, PREPARATIONS FOR DESTROYING VERMIN, HERBICIDES, RODENTICIDES, PESTICIDES, INSECTICIDES, NEMATOCIDES, PARASITOCIDES, ALL FOR AGRICULTURAL, HORTICULTURAL AND FORESTRY USE; INSECT GROWTH REGULATORS FOR AGRICULTURAL, HORTICULTURAL AND FORESTRY USE; BIOCIDES FOR PROTECTING PLANTS AGAINST PLANT PATHOGENS; BACTERIAL AND BACTERIOLOGICAL PREPARATIONS FOR AGRICULTURAL, SCIENTIFIC, HORTICULTURAL AND FORESTRY USE; CHEMICAL PREPARATIONS FOR THE TREATMENT OF SEEDS AND PLANTS AGAINST PLANT PATHOGENS; PREPARATIONS FOR THE TREATMENT OF DEFICIENCY DISEASES IN PLANTS, IN CLASS 5 (U.S. CLS. 6, 18, 44, 46, 51 AND 52).

FIRST USE 12-1-1999; IN COMMERCE 12-1-1999.

FOR: FRESH, RAW AND UNPROCESSED BARLEY, BRAN, SOYBEAN, WHEAT, OATS, RYE, HOPS, CORN, SESAME, BULBS, CEREAL GRAINS, OILSEEDS, SUGAR BEET, SEED GRAINS, CORN SEEDS, FIELD SEEDS, SEEDLINGS; LIVING VINE PLANTS AND TREES; NON-ARTIFICIAL TURF; FLOWER BULBS; BRAN, CEREAL AND PROTEIN BASED FOODSTUFFS FOR ANIMALS; VEGETABLES SEEDS, FRUITS SEEDS AND FLOWER SEEDS FOR AGRICULTURAL, HORTICULTURAL, DOMESTIC AND COMMERCIAL USE; FRESH FRUITS AND VEGETABLES; LIVING PLANTS, YOUNG LIVE PLANTS AND NATURAL LIVE OR CUT FLOWERS, IN CLASS 31 (U.S. CLS. 1 AND 46).

FIRST USE 12-1-1999; IN COMMERCE 12-1-1999.

FOR: COMPUTER PROGRAMMING FOR OTHERS AND DEVELOPMENT OF SOFTWARE; MATERIAL TESTING; LICENSING OF INTELLECTUAL PROPERTY IN THE FIELD OF AGRICULTURE; TECHNOLOGICAL AND SCIENTIFIC CONSULTATION AND RESEARCH IN THE FIELD OF AGRICULTURE; AGRICULTURAL RESEARCH, NAMELY, CONDUCTING STUDIES AND ANALYSIS IN THE FIELD OF AGRICULTURE FOR OTHERS; DEVELOPMENT OF INTELLECTUAL PROPERTY FOR THE COMMERCIALIZATION OF THE FOREGOING PRODUCTS, NAMELY, PRODUCT DEVELOPMENT FOR OTHERS, IN CLASS 42 (U.S. CLS. 100 AND 101).

FIRST USE 12-1-1999; IN COMMERCE 12-1-1999.

FOR: CONSULTING AND ADVICE SERVICES IN THE FIELD OF AGRICULTURE; PRODUCTION OF FRUITS AND VEGETABLES FOR OTHERS, NAMELY, CONTRACT FARMING; TREE AND SEED BREEDING SERVICES, IN CLASS 44 (U.S. CLS. 100 AND 101).

FIRST USE 12-1-1999; IN COMMERCE 12-1-1999.

OWNER OF U.S. REG. NO. 3,036,058.

SER. NO. 78-884,739, FILED 5-16-2006.

THEODORE MCBRIDE, EXAMINING ATTORNEY

**Int. Cls.: 9 and 41**

**Prior U.S. Cls.: 21, 23, 26, 36, 38, 100, 101 and 107**

**United States Patent and Trademark Office**

**Reg. No. 3,453,801**

**Registered June 24, 2008**

**TRADEMARK  
SERVICE MARK  
PRINCIPAL REGISTER**



BIOVIGILANT SYSTEMS, INC. (DELAWARE CORPORATION)  
2015 W. RUTHRAUFF ROAD, SUITE 153  
TUCSON, AZ 85705

FOR: ELECTRICAL AND OPTICAL INSTRUMENTS FOR MONITORING AND TESTING AIR AND WATER FOR AGRICULTURE, CONSUMER, GOVERNMENTAL, MILITARY, HOMELAND SECURITY, RETAIL, TRANSPORTATION, ENTERTAINMENT, FOOD, LODGING, EDUCATION AND HEALTHCARE INDUSTRIES, FOR LABORATORY APPLICATIONS, AND FOR MANUFACTURING APPLICATIONS, NAMELY, PHARMACEUTICAL AND MEDICAL DEVICE MANUFACTURING, FOOD PROCESSING MANUFACTURING, SEMICONDUCTOR MANUFACTURING AND OPTICAL

MANUFACTURING, IN CLASS 9 (U.S. CLS. 21, 23, 26, 36 AND 38).

FIRST USE 3-31-2003; IN COMMERCE 1-31-2004.

FOR: PUBLISHING WHITE PAPERS IN THE FIELD OF AIR AND/OR WATER TESTING, ANALYSIS AND MONITORING SYSTEMS, IN CLASS 41 (U.S. CLS. 100, 101 AND 107).

FIRST USE 3-31-2003; IN COMMERCE 1-31-2004.

SER. NO. 78-886,321, FILED 5-17-2006.

NORA BUCHANAN WILL, EXAMINING ATTORNEY

**Int. Cls.: 35 and 45**

**Prior U.S. Cls.: 100, 101 and 102**

**United States Patent and Trademark Office**

**Reg. No. 3,453,802**

**Registered June 24, 2008**

**SERVICE MARK  
PRINCIPAL REGISTER**

**HSH**

PAYLER CORPORATION (NEW JERSEY CORPORATION)  
237 WEST PARKWAY  
POMPTON PLAINS, NJ 07444

FOR: ADVERTISING AND COMMERCIAL INFORMATION SERVICES IN THE FIELDS OF RESIDENTIAL AND COMMERCIAL REAL ESTATE, PERSONAL FINANCE, GENERAL BUSINESS NEWS, GENERAL NEWS IN THE NATURE OF CURRENT EVENTS, TAXES, INSURANCE, RETIREMENT, FINANCE, INVESTMENTS, BORROWING MONEY, LENDING MONEY, INFORMATION RELATING TO FINANCIAL CALCULATION TOOLS AND HISTORICAL AND CURRENT DATA PERTAINING TO RATES, TERMS, FEES, AND CONDITIONS RELATING TO FINANCIAL PRODUCTS, AND ADVERTISING FOR OTHERS; DISSEMINATION OF ADVERTISING MATTER; ON-LINE DIRECTORY INFORMATION SERVICES IN THE FIELDS OF RESIDENTIAL AND COMMERCIAL REAL ESTATE, PERSONAL FINANCE, GENERAL BUSINESS NEWS, GENERAL NEWS IN THE NATURE OF CURRENT EVENTS, TAXES, INSURANCE, RETIREMENT, FINANCE, INVESTMENTS, BORROWING MONEY, LENDING MONEY, IN-

FORMATION RELATING TO FINANCIAL CALCULATION TOOLS AND HISTORICAL AND CURRENT DATA PERTAINING TO RATES, TERMS, FEES, AND CONDITIONS RELATING TO FINANCIAL PRODUCTS; INCOME TAX PREPARATION AND CONSULTATION, IN CLASS 35 (U.S. CLS. 100, 101 AND 102).

FIRST USE 10-1-1979; IN COMMERCE 4-1-1980.

FOR: LICENSING OF ARCHITECTURAL DRAWINGS TO OTHERS, IN CLASS 45 (U.S. CLS. 100 AND 101).

FIRST USE 10-1-1979; IN COMMERCE 4-1-1980.

THE MARK CONSISTS OF STANDARD CHARACTERS WITHOUT CLAIM TO ANY PARTICULAR FONT, STYLE, SIZE, OR COLOR.

OWNER OF U.S. REG. NO. 2,812,720.

SER. NO. 78-892,882, FILED 5-25-2006.

DAVID HOFFMAN, EXAMINING ATTORNEY

**Int. Cls.: 9 and 28**

**Prior U.S. Cls.: 21, 22, 23, 26, 36, 38 and 50**

**United States Patent and Trademark Office**

**Reg. No. 3,453,803**

**Registered June 24, 2008**

**TRADEMARK  
PRINCIPAL REGISTER**

**WARRIOR LACROSSE**

WARRIOR SPORTS, INC. (MICHIGAN CORPORATION)  
32125 HOLLINGSWORTH AVE.  
WARREN, MI 48092

FOR: LACROSSE HELMETS, IN CLASS 9 (U.S. CLS. 21, 23, 26, 36 AND 38).

FIRST USE 12-0-1992; IN COMMERCE 12-0-1992.

FOR: LACROSSE STICKS, LACROSSE HANDLES, LACROSSE STICK HEADS, LACROSSE BALLS, LACROSSE GLOVES, IN CLASS 28 (U.S. CLS. 22, 23, 38 AND 50).

FIRST USE 12-0-1992; IN COMMERCE 12-0-1992.

THE MARK CONSISTS OF STANDARD CHARACTERS WITHOUT CLAIM TO ANY PARTICULAR FONT, STYLE, SIZE, OR COLOR.

OWNER OF U.S. REG. NO. 2,274,667.

NO CLAIM IS MADE TO THE EXCLUSIVE RIGHT TO USE "LACROSSE", APART FROM THE MARK AS SHOWN.

SER. NO. 78-893,115, FILED 5-25-2006.

LOURDES AYALA, EXAMINING ATTORNEY

**Int. Cl.: 5**

**Prior U.S. Cls.: 6, 18, 44, 46, 51 and 52**

**United States Patent and Trademark Office**

**Reg. No. 3,453,804**

**Registered June 24, 2008**

**TRADEMARK  
PRINCIPAL REGISTER**

**SYNERGY PRENATAL**

VITACOST.COM INC. (DELAWARE CORPORATION)  
352 S.W. 12TH AVE  
DEERFIELD BEACH, FL 33442

OWNER OF U.S. REG. NO. 2,970,843.

FOR: DIETARY AND NUTRITIONAL SUPPLEMENTS, IN CLASS 5 (U.S. CLS. 6, 18, 44, 46, 51 AND 52).

NO CLAIM IS MADE TO THE EXCLUSIVE RIGHT TO USE "PRENATAL", APART FROM THE MARK AS SHOWN.

FIRST USE 1-3-2003; IN COMMERCE 1-3-2003.

SER. NO. 78-893,705, FILED 5-26-2006.

THE MARK CONSISTS OF STANDARD CHARACTERS WITHOUT CLAIM TO ANY PARTICULAR FONT, STYLE, SIZE, OR COLOR.

HEATHER BIDDULPH, EXAMINING ATTORNEY

**Int. Cl.: 9**

**Prior U.S. Cls.: 21, 23, 26, 36 and 38**

**Reg. No. 3,453,805**

**United States Patent and Trademark Office**

**Registered June 24, 2008**

---

**TRADEMARK  
PRINCIPAL REGISTER**

**AXIS**

CAMPANA SYSTEMS INC. (CANADA CORPORATION)  
99 RANDALL DRIVE  
WATERLOO, CANADA N2V 1C5

FIRST USE 0-0-1986; IN COMMERCE 0-0-1986.

FOR: COMPUTER SOFTWARE FOR THE MANAGEMENT OF AN AUTOMOBILE CLUB OR TRAVEL CLUB USED TO STORE, CATALOGUE, INDEX AND ACCESS MEMBERSHIP DATA, ROAD SERVICE DATA, TOURING DATA, TRAVELERS CHECKS, AFFINITY PROGRAMS, TRAVEL AGENCY SERVICES, AND MEDICAL INSURANCE, IN CLASS 9 (U.S. CLS. 21, 23, 26, 36 AND 38).

THE MARK CONSISTS OF STANDARD CHARACTERS WITHOUT CLAIM TO ANY PARTICULAR FONT, STYLE, SIZE, OR COLOR.

SER. NO. 78-900,615, FILED 6-5-2006.

CHRISTOPHER BUONGIORNO, EXAMINING ATTORNEY

**Int. Cl.: 19**

**Prior U.S. Cls.: 1, 12, 33 and 50**

**United States Patent and Trademark Office**

**Reg. No. 3,453,806**

**Registered June 24, 2008**

**TRADEMARK  
PRINCIPAL REGISTER**

**ECO-RAP**

DELTALOK INTERNATIONAL INC. (SINGAPORE CORPORATION)

#03-06B

3 SHENTON WAY

SHENTON HOUSE, SINGAPORE 068805

FOR: SHORELINE AND UNDERWATER EROSION STRUCTURES, NAMELY, INTERLOCKING SOIL AND ROCK FILLED BAGS FOR THE REDUCTION OF EROSION AND THE STABILIZATION OF WATER AND SHORELINE AREAS, IN CLASS 19 (U.S. CLS. 1, 12, 33 AND 50).

THE MARK CONSISTS OF STANDARD CHARACTERS WITHOUT CLAIM TO ANY PARTICULAR FONT, STYLE, SIZE, OR COLOR.

PRIORITY CLAIMED UNDER SEC. 44(D) ON CANADA APPLICATION NO. 1282535, FILED 12-9-2005, REG. NO. 1282535, DATED 1-19-2007, EXPIRES 12-9-2017.

SER. NO. 78-901,031, FILED 6-5-2006.

SALLY SHIH, EXAMINING ATTORNEY



**Int. Cls.: 35, 41 and 42**

**Prior U.S. Cls.: 100, 101, 102 and 107**

**United States Patent and Trademark Office**

**Reg. No. 3,453,807**

**Registered June 24, 2008**

**SERVICE MARK  
PRINCIPAL REGISTER**



AUSTIN BOARD OF REALTORS (TEXAS NON-PROFIT CORPORATION)  
SUITE 100  
10900 STONELAKE BOULEVARD  
AUSTIN, TX 78759

FOR: REAL ESTATE ADVERTISING SERVICES,  
IN CLASS 35 (U.S. CLS. 100, 101 AND 102).

FIRST USE 8-31-2004; IN COMMERCE 8-31-2004.

FOR: EDUCATIONAL SERVICES, NAMELY,  
CONDUCTING CLASSES AND SEMINARS IN THE  
FIELD OF REAL ESTATE AND COURSE MATERI-  
ALS DISTRIBUTED IN CONNECTION THERE-  
WITH, IN CLASS 41 (U.S. CLS. 100, 101 AND 107).

FIRST USE 8-31-2004; IN COMMERCE 8-31-2004.

FOR: REAL ESTATE RESEARCH SERVICES; AL-  
TERNATE DISPUTE RESOLUTION SERVICES, IN  
CLASS 42 (U.S. CLS. 100 AND 101).

FIRST USE 8-31-2004; IN COMMERCE 8-31-2004.

NO CLAIM IS MADE TO THE EXCLUSIVE  
RIGHT TO USE "AUSTIN", APART FROM THE  
MARK AS SHOWN.

THE COLOR(S) BLUE AND YELLOW IS/ARE  
CLAIMED AS A FEATURE OF THE MARK.

THE MARK CONSISTS OF THE WORDING  
"AUSTIN BOARD OF REALTORS" ALL IN BLUE  
UNDER A TRIANGULAR DESIGN ELEMENT  
THAT IS BLUE AND YELLOW.

SER. NO. 78-904,648, FILED 6-9-2006.

SANJEEV VOHRA, EXAMINING ATTORNEY

**Int. Cls.: 35 and 42**

**Prior U.S. Cls.: 100, 101 and 102**

**United States Patent and Trademark Office**

**Reg. No. 3,453,808**

**Registered June 24, 2008**

**SERVICE MARK  
PRINCIPAL REGISTER**

**PHYTAGRO**

PHYTAGRO, INC. (DELAWARE CORPORATION)  
1209 ORANGE STREET  
WILMINGTON, DE 19801

FOR: INTELLECTUAL PROPERTY COMMERCIALIZATION SERVICES, NAMELY, CONSULTING WITH RESPECT TO THE LICENSING AND COMMERCIAL EXPLOITATION OF THE INTELLECTUAL PROPERTY IN NEW TECHNOLOGIES AND PRODUCTS, IN CLASS 35 (U.S. CLS. 100, 101 AND 102).

FOR: RESEARCH AND DEVELOPMENT IN THE FIELDS OF PLANT SCIENCES, PLANT GENES AND GENETIC TECHNOLOGIES, ANIMAL HEALTH, INSECT RESISTANCE, BIO-ENERGY, PHARMA-

CEUTICALS, VACCINES, DRUG AND VACCINE DELIVERY THROUGH PLANTS, IN CLASS 42 (U.S. CLS. 100 AND 101).

THE MARK CONSISTS OF STANDARD CHARACTERS WITHOUT CLAIM TO ANY PARTICULAR FONT, STYLE, SIZE, OR COLOR.

PRIORITY CLAIMED UNDER SEC. 44(D) ON NEW ZEALAND APPLICATION NO. 745625, FILED 3-31-2006, REG. NO. 745625, DATED 6-7-2007, EXPIRES 3-31-2016.

SER. NO. 78-905,187, FILED 6-9-2006.

JILL C. ALT, EXAMINING ATTORNEY

**Int. Cl.: 5**

**Prior U.S. Cls.: 6, 18, 44, 46, 51 and 52**

**Reg. No. 3,453,809**

**United States Patent and Trademark Office**

**Registered June 24, 2008**

**TRADEMARK  
PRINCIPAL REGISTER**

**FLY AWAY STICKS**

MADISON JAMES INC. (NEW YORK CORPORATION)  
NO. 1500  
150 WEST 28TH STEEET  
NEW YORK, NY 10001

FOR: INSECT REPELLANTS, NAMELY, INCENSE STICKS COMPOSED OF GROUNDED WOOD DIPPED IN ORANGE-CITRONELLA OIL FRAGRANCE INTENDED FOR NATURAL UNWANTED FLYING INSECT PROTECTION TO BE SOLD FOR USE IN AND AROUND THE HOME, IN CLASS 5 (U.S. CLS. 6, 18, 44, 46, 51 AND 52).

FIRST USE 5-4-2005; IN COMMERCE 6-25-2005.

THE MARK CONSISTS OF STANDARD CHARACTERS WITHOUT CLAIM TO ANY PARTICULAR FONT, STYLE, SIZE, OR COLOR.

NO CLAIM IS MADE TO THE EXCLUSIVE RIGHT TO USE "STICKS", APART FROM THE MARK AS SHOWN.

SER. NO. 78-906,779, FILED 6-13-2006.

DARRYL SPRUILL, EXAMINING ATTORNEY

**Int. Cl.: 29**

**Prior U.S. Cl.: 46**

**United States Patent and Trademark Office**

**Reg. No. 3,453,810**

**Registered June 24, 2008**

**TRADEMARK  
PRINCIPAL REGISTER**



DULCICH, INC. (OREGON CORPORATION)  
16797 SE 130TH  
CLACKAMAS, OR 97015

FOR: SEAFOOD; SHELLFISH, IN CLASS 29 (U.S.  
CL. 46).

FIRST USE 6-2-2006; IN COMMERCE 6-6-2006.

NO CLAIM IS MADE TO THE EXCLUSIVE  
RIGHT TO USE "GRILLED", APART FROM THE  
MARK AS SHOWN.

THE MARK CONSISTS OF A STYLIZED VER-  
SION OF THE LITERAL ELEMENT.

SER. NO. 78-906,944, FILED 6-13-2006.

FRANK LATTUCA, EXAMINING ATTORNEY

**Int. Cls.: 35 and 43**

**Prior U.S. Cls.: 100, 101 and 102**

**United States Patent and Trademark Office**

**Reg. No. 3,453,811**

**Registered June 24, 2008**

**SERVICE MARK  
PRINCIPAL REGISTER**

**AWASI**

CABO DE HORNOS S.A. (CHILE CORPORATION)  
EL REGIDOR NO 66, PISO 12 LAS CONDES  
SANTIAGO, CHILE

FOR: CONSULTATION IN THE FIELD OF HOTEL AND RESTAURANT MANAGEMENT; CONSULTATION IN THE FIELD OF HOTEL MANAGEMENT, IN CLASS 35 (U.S. CLS. 100, 101 AND 102).

FOR: RESTAURANT SERVICES, BEVERAGE SERVICES, NAMELY, PREPARATION OF BEVERAGES, SERVING OF BEVERAGES AND CATERING FOR THE PROVISION OF BEVERAGES; CAFETERIA, SELF-SERVICE RESTAURANT, CARRY-OUT RESTAURANT SERVICES; SNACK BAR, BAR, READY TO GO RESTAURANTS; CONSULTATION IN THE FIELD OF FOOD PREPARATION; HOTEL SERVICES; PROVIDING TEMPORARY ACCOMMODATION AND MAKING HOTEL RESERVATIONS FOR OTHERS; RENTAL OF ROOMS FOR MEETING

PURPOSES; RENTAL OF CHAIRS, TABLES, TABLE LINEN AND GLASSWARE, IN CLASS 43 (U.S. CLS. 100 AND 101).

THE MARK CONSISTS OF STANDARD CHARACTERS WITHOUT CLAIM TO ANY PARTICULAR FONT, STYLE, SIZE, OR COLOR.

OWNER OF CHILE REG. NO. 752.369, DATED 3-3-2006, EXPIRES 3-3-2016.

OWNER OF CHILE REG. NO. 752.367, DATED 3-3-2006, EXPIRES 3-3-2016.

"AWASI" HAS NO MEANING IN A FOREIGN LANGUAGE.

SER. NO. 78-908,280, FILED 6-14-2006.

SUE LAWRENCE, EXAMINING ATTORNEY

**Int. Cls.: 18, 25 and 28**

**Prior U.S. Cls.: 1, 2, 3, 22, 23, 38, 39, 41 and 50**

**United States Patent and Trademark Office**

**Reg. No. 3,453,812**

**Registered June 24, 2008**

**TRADEMARK  
PRINCIPAL REGISTER**

**MOKUHA WAI**

OGURA, MASAKI (JAPAN INDIVIDUAL)  
2-80-9 MOTOMACHI, NAKA-KU  
YOKOHAMA, JAPAN 231-0861

FOR: BAGS, NAMELY, TOTE BAGS, RUCK-  
SACKS, SHOE BAGS FOR TRAVEL, DAY BAGS  
AND TRAVEL BAGS, IN CLASS 18 (U.S. CLS. 1, 2, 3,  
22 AND 41).

FIRST USE 7-8-2004; IN COMMERCE 7-8-2004.

FOR: CLOTHING, NAMELY, SWEAT SHIRTS,  
JACKETS, T-SHIRTS, POLO SHIRTS, TANK TOPS,  
SHORTS, BATHING SUITS, HATS AND CAPS, IN  
CLASS 25 (U.S. CLS. 22 AND 39).

FIRST USE 7-8-2004; IN COMMERCE 7-8-2004.

FOR: SURF BOARDS, IN CLASS 28 (U.S. CLS. 22,  
23, 38 AND 50).

FIRST USE 7-8-2004; IN COMMERCE 7-8-2004.

THE MARK CONSISTS OF STANDARD CHAR-  
ACTERS WITHOUT CLAIM TO ANY PARTICULAR  
FONT, STYLE, SIZE, OR COLOR.

SER. NO. 78-908,931, FILED 6-15-2006.

MATTHEW PAPPAS, EXAMINING ATTORNEY

Int. Cl.: 14

Prior U.S. Cls.: 2, 27, 28 and 50

Reg. No. 3,453,813

United States Patent and Trademark Office

Registered June 24, 2008

TRADEMARK  
PRINCIPAL REGISTER

Sacred Signs



SACRED SIGNS (CALIFORNIA CORPORATION)  
320 RAMONA PL  
COSTA MESA, CA 92627

THE MARK CONSISTS OF A SMALL CIRCLE  
WITH AN "X" AND THE STYLIZED TEXT "SACRED  
SIGNS".

FOR: JEWELRY, IN CLASS 14 (U.S. CLS. 2, 27, 28  
AND 50).

SER. NO. 78-910,102, FILED 6-16-2006.

FIRST USE 6-4-2004; IN COMMERCE 6-22-2004.

ANNE FARRELL, EXAMINING ATTORNEY

**Int. Cl.: 42**

**Prior U.S. Cls.: 100 and 101**

**United States Patent and Trademark Office**

**Reg. No. 3,453,814**

**Registered June 24, 2008**

**SERVICE MARK  
PRINCIPAL REGISTER**

**SureTree**

2UNIFY LLC (PENNSYLVANIA LTD LIAB CO)  
3135 MARION AVENUE, SUITE 200  
LAURELDALE, PA 19605

FIRST USE 1-30-2006; IN COMMERCE 4-28-2006.

FOR: COMPUTER SERVICE, NAMELY, ACTING AS AN APPLICATION SERVICE PROVIDER IN THE FIELD OF KNOWLEDGE MANAGEMENT TO HOST COMPUTER APPLICATION SOFTWARE FOR THE COLLECTION, EDITING, ORGANIZING, MODIFYING, BOOK MARKING, TRANSMISSION, STORAGE AND SHARING OF DATA AND INFORMATION, IN CLASS 42 (U.S. CLS. 100 AND 101).

THE MARK CONSISTS OF STANDARD CHARACTERS WITHOUT CLAIM TO ANY PARTICULAR FONT, STYLE, SIZE, OR COLOR.

SER. NO. 78-910,177, FILED 6-16-2006.

AMY GEARIN, EXAMINING ATTORNEY



**Int. Cl.: 42**

**Prior U.S. Cls.: 100 and 101**

**United States Patent and Trademark Office**

**Reg. No. 3,453,815**

**Registered June 24, 2008**

**SERVICE MARK  
PRINCIPAL REGISTER**



2UNIFY LLC (PENNSYLVANIA LTD LIAB CO)  
3135 MARION AVENUE, SUITE 200  
LAURELDALE, PA 19605

THE COLOR(S) GREEN AND GRAY IS/ARE  
CLAIMED AS A FEATURE OF THE MARK.

FOR: COMPUTER SERVICE, NAMELY, ACTING  
AS AN APPLICATION SERVICE PROVIDER IN THE  
FIELD OF KNOWLEDGE MANAGEMENT TO  
HOST COMPUTER APPLICATION SOFTWARE  
FOR THE COLLECTION, EDITING, ORGANIZING,  
MODIFYING, BOOK MARKING, TRANSMISSION,  
STORAGE AND SHARING OF DATA AND INFOR-  
MATION, IN CLASS 42 (U.S. CLS. 100 AND 101).

THE MARK CONSISTS OF THREE DIFFERENT  
SIZED TREES WITH THE TWO SMALLER TREES  
SUPERIMPOSED OVER THE LARGEST TREE. THE  
TREES ARE GREEN. THE WORD "SURETREE" IS  
IN GRAY LETTERING AND IS POSITIONED TO  
THE RIGHT OF THE TREES.

FIRST USE 1-30-2006; IN COMMERCE 4-28-2006.

SER. NO. 78-910,222, FILED 6-16-2006.

AMY GEARIN, EXAMINING ATTORNEY

**Int. Cl.: 21**

**Prior U.S. Cls.: 2, 13, 23, 29, 30, 33, 40 and 50**

**Reg. No. 3,453,816**

**United States Patent and Trademark Office**

**Registered June 24, 2008**

**TRADEMARK  
PRINCIPAL REGISTER**

**WILD LEAF TEA CO**

WILTON INDUSTRIES, INC. (DELAWARE CORPORATION)  
2240 WEST 75TH STREET  
WOODRIDGE, IL 60517

FOR: TEA ACCESSORIES, NAMELY, TEA BALLS, INFUSERS, CUPS, MUGS, POTS AND SETS, IN CLASS 21 (U.S. CLS. 2, 13, 23, 29, 30, 33, 40 AND 50).

FIRST USE 10-1-2006; IN COMMERCE 10-1-2006.

THE MARK CONSISTS OF STANDARD CHARACTERS WITHOUT CLAIM TO ANY PARTICULAR FONT, STYLE, SIZE, OR COLOR.

NO CLAIM IS MADE TO THE EXCLUSIVE RIGHT TO USE "TEA CO", APART FROM THE MARK AS SHOWN.

SER. NO. 78-911,316, FILED 6-19-2006.

MARY ROSSMAN, EXAMINING ATTORNEY

**Int. Cls.: 35, 38, 41, 42 and 44**

**Prior U.S. Cls.: 100, 101, 102, 104 and 107**

**United States Patent and Trademark Office**

**Reg. No. 3,453,817**

**Registered June 24, 2008**

**SERVICE MARK  
PRINCIPAL REGISTER**

**CONSUMER GUIDE**

PUBLICATIONS INTERNATIONAL, LTD. (ILLINOIS CORPORATION)  
7373 NORTH CICERO AVENUE  
LINCOLNWOOD, IL 60646

FOR: INFORMATION SERVICES, NAMELY, PROVIDING INFORMATION IN THE FIELD OF PURCHASING CONSUMER ITEMS IN THE AREAS OF AUTOMOBILES, CAMERA AND PHOTOGRAPHY, COMPUTERS, ELECTRONICS, FITNESS AND RECREATION, HOME AND GARDEN, KIDS AND FAMILY, CLOTHING AND ACCESSORIES, FLOWERS AND GIFTS, HEALTH AND BEAUTY, MEDIA AND ENTERTAINMENT, VIA A GLOBAL COMPUTER NETWORK, IN CLASS 35 (U.S. CLS. 100, 101 AND 102).

FIRST USE 12-31-1995; IN COMMERCE 12-31-1995.

FOR: INFORMATION SERVICES, NAMELY, PROVIDING INFORMATION IN THE FIELD OF TELECOMMUNICATIONS, NAMELY, PHONE CARRIERS, INTERNET SERVICE PROVIDERS, TELEVISION, RADIO, VIA A GLOBAL COMPUTER NETWORK, IN CLASS 38 (U.S. CLS. 100, 101 AND 104).

FIRST USE 12-31-1995; IN COMMERCE 12-31-1995.

FOR: INFORMATION SERVICES, NAMELY, PROVIDING INFORMATION IN THE FIELD OF EDUCATIONAL SERVICES VIA A GLOBAL COMPUTER NETWORK, IN CLASS 41 (U.S. CLS. 100, 101 AND 107).

FIRST USE 12-31-1995; IN COMMERCE 12-31-1995.

FOR: INFORMATION SERVICES, NAMELY, PROVIDING INFORMATION IN THE FIELD OF COMPUTER TECHNOLOGY VIA A GLOBAL COMPUTER NETWORK, IN CLASS 42 (U.S. CLS. 100 AND 101).

FIRST USE 12-31-1995; IN COMMERCE 12-31-1995.

FOR: INFORMATION SERVICES, NAMELY, PROVIDING INFORMATION IN THE FIELD OF HEALTH VIA A GLOBAL COMPUTER NETWORK, IN CLASS 44 (U.S. CLS. 100 AND 101).

FIRST USE 12-31-1995; IN COMMERCE 12-31-1995.

THE MARK CONSISTS OF STANDARD CHARACTERS WITHOUT CLAIM TO ANY PARTICULAR FONT, STYLE, SIZE, OR COLOR.

OWNER OF U.S. REG. NO. 2,388,976.

NO CLAIM IS MADE TO THE EXCLUSIVE RIGHT TO USE "GUIDE", APART FROM THE MARK AS SHOWN.

SEC. 2(F) AS TO "CONSUMER".

SER. NO. 78-912,489, FILED 6-20-2006.

CARRIE GENOVESE, EXAMINING ATTORNEY

**Int. Cl.: 42**

**Prior U.S. Cls.: 100 and 101**

**United States Patent and Trademark Office**

**Reg. No. 3,453,818**

**Registered June 24, 2008**

**SERVICE MARK  
PRINCIPAL REGISTER**

**BCEGS**

INSURANCE SERVICES OFFICE, INC. (DELA-  
WARE CORPORATION)  
545 WASHINGTON BOULEVARD  
JERSEY CITY, NJ 07310

FOR: REVIEWING STANDARDS AND PRACTI-  
CES OF BUILDING DEPARTMENTS OF MUNICI-  
PALITIES TO DETERMINE AND EVALUATE  
THEIR COMPLIANCE WITH BUILDING CODES,  
FOR THE BENEFIT OF THE INSURANCE INDUS-  
TRY, IN CLASS 42 (U.S. CLS. 100 AND 101).

FIRST USE 1-0-1996; IN COMMERCE 1-0-1996.

THE MARK CONSISTS OF STANDARD CHAR-  
ACTERS WITHOUT CLAIM TO ANY PARTICULAR  
FONT, STYLE, SIZE, OR COLOR.

SER. NO. 78-912,620, FILED 6-20-2006.

SCOTT BIBB, EXAMINING ATTORNEY

**Int. Cls.: 35 and 45**

**Prior U.S. Cls.: 100, 101 and 102**

**United States Patent and Trademark Office**

**Reg. No. 3,453,819**

**Registered June 24, 2008**

**SERVICE MARK  
PRINCIPAL REGISTER**

# GlobalOptions

GLOBALOPTIONS GROUP, INC. (NEVADA CORPORATION)  
27TH FLOOR  
75 ROCKEFELLER PLAZA  
NEW YORK, NY 10019

FOR: BUSINESS RISK MANAGEMENT SERVICES, IN CLASS 35 (U.S. CLS. 100, 101 AND 102).

FIRST USE 1-31-1999; IN COMMERCE 1-31-1999.

FOR: PERSONAL AND CORPORATE FACILITIES AND PERSONNEL SECURITY AND INVESTIGA-

TION SERVICES, IN CLASS 45 (U.S. CLS. 100 AND 101).

FIRST USE 1-31-1999; IN COMMERCE 1-31-1999.

THE MARK CONSISTS OF STANDARD CHARACTERS WITHOUT CLAIM TO ANY PARTICULAR FONT, STYLE, SIZE, OR COLOR.

SER. NO. 78-913,950, FILED 6-22-2006.

BRIAN NEVILLE, EXAMINING ATTORNEY

**Int. Cl.: 39**

**Prior U.S. Cls.: 100 and 105**

**United States Patent and Trademark Office**

**Reg. No. 3,453,820**

**Registered June 24, 2008**

**SERVICE MARK  
PRINCIPAL REGISTER**

**ROCKIN' THE LOWEST PRICE  
EVERYDAY**

MOVEABLE CUBICLE, INC. (DELAWARE CORPORATION)  
193 AVENIDA LA PATA  
SAN CLEMENTE, CA 92673

FOR: LEASING AND RENTAL SERVICES IN THE FIELD OF PORTABLE STORAGE UNITS, NAMELY, CONTAINERS AND TRAILERS FOR INDUSTRIAL AND COMMERCIAL USE, IN CLASS 39 (U.S. CLS. 100 AND 105).

FIRST USE 1-1-2006; IN COMMERCE 1-1-2006.

THE MARK CONSISTS OF STANDARD CHARACTERS WITHOUT CLAIM TO ANY PARTICULAR FONT, STYLE, SIZE, OR COLOR.

SER. NO. 78-915,300, FILED 6-23-2006.

JERI J. FICKES, EXAMINING ATTORNEY

**Int. Cl.: 1**

**Prior U.S. Cls.: 1, 5, 6, 10, 26 and 46**

**United States Patent and Trademark Office**

**Reg. No. 3,453,821**

**Registered June 24, 2008**

---

**TRADEMARK  
PRINCIPAL REGISTER**

***FLEX H<sub>2</sub>O***

SIMPSON STRONG-TIE CO., INC. (CALIFORNIA  
CORPORATION)  
5956 W. LAS POSITAS BLVD.  
PLEASANTON, CA 94588

FIRST USE 11-6-2005; IN COMMERCE 4-1-2006.

SER. NO. 78-915,358, FILED 6-23-2006.

FOR: POLYURETHANE RESINS, IN CLASS 1 (U.S.  
CLS. 1, 5, 6, 10, 26 AND 46).

JEFFERY COWARD, EXAMINING ATTORNEY

**Int. Cl.: 9**

**Prior U.S. Cls.: 21, 23, 26, 36 and 38**

**Reg. No. 3,453,822**

**United States Patent and Trademark Office**

**Registered June 24, 2008**

**TRADEMARK  
PRINCIPAL REGISTER**



VIP EDUCATIONAL SYSTEMS, L.C. (NEVADA  
LIMITED LIABILITY COMPANY)  
8711 PINNACLE PEAK ROAD PMB #268  
SCOTTSDALE, AL 85255

FOR: PRE-RECORDED AUDIOTAPES FEATUR-  
ING EDUCATION IN THE FIELD OF HEALTHY  
LIFESTYLES INTENDED TO PROMOTE HEALTHY  
LIVING THROUGH THE USE OF NUTRITIONAL  
PROTOCOLS, IN CLASS 9 (U.S. CLS. 21, 23, 26, 36  
AND 38).

FIRST USE 0-0-1997; IN COMMERCE 0-0-1997.

OWNER OF U.S. REG. NO. 3,219,387.

THE MARK CONSISTS OF A MEDALLION WITH  
A RING AND WITH A BANNER HAVING THE  
LETTERS "VIP" AND A FLAME OVER THE "I" AND  
THE WORDS "VALUES INTEGRITY PEOPLE" IN  
THE RING.

SER. NO. 78-916,715, FILED 6-26-2006.

MATTHEW MCDOWELL, EXAMINING ATTOR-  
NEY



**Int. Cl.: 30**

**Prior U.S. Cl.: 46**

**United States Patent and Trademark Office**

**Reg. No. 3,453,823**

**Registered June 24, 2008**

**TRADEMARK  
PRINCIPAL REGISTER**



TASTEE NO. 38, INC. (LOUISIANA CORPORATION)  
2201 VETERANS BLVD.  
KENNER, LA 70065

FOR: BAKERY GOODS; CAKES; COOKIES; DONUTS; ICING; MIXES FOR BAKERY GOODS; PASTRIES; PIES; ROLLS, IN CLASS 30 (U.S. CL. 46).

FIRST USE 0-0-1924; IN COMMERCE 0-0-1924.

THE COLOR(S) GREEN AND WHITE IS/ARE CLAIMED AS A FEATURE OF THE MARK.

THE MARK CONSISTS OF "MCKENZIE'S" IN GREEN STYLIZED LETTERING UPON A WHITE BACKGROUND SURROUNDED BY A GREEN OVAL.

SEC. 2(F).

SER. NO. 78-918,098, FILED 6-27-2006.

CHRISTINA SOBRAL, EXAMINING ATTORNEY

**Int. Cls.: 9 and 11**

**Prior U.S. Cls.: 13, 21, 23, 26, 31, 34, 36 and 38**

**Reg. No. 3,453,824**

**United States Patent and Trademark Office**

**Registered June 24, 2008**

**TRADEMARK  
PRINCIPAL REGISTER**

**UNIVERSAL AIR FILTER**

UNIVERSAL AIR FILTER COMPANY (ILLINOIS  
CORPORATION)  
P.O. BOX 5006  
1624 SAUGET INDUSTRIAL PARKWAY  
SAUGET, IL 62206

FOR: AIR FILTERS FOR INTERNAL COOLING  
FANS FOR COMPUTERS, IN CLASS 9 (U.S. CLS. 21,  
23, 26, 36 AND 38).

FIRST USE 0-0-1959; IN COMMERCE 0-0-1959.

FOR: AIR FILTERS FOR INDUSTRIAL INSTAL-  
LATIONS IN THE TELECOM, DATACOM, MEDI-  
CAL, AND MILITARY INDUSTRIES, IN CLASS 11  
(U.S. CLS. 13, 21, 23, 31 AND 34).

FIRST USE 0-0-1959; IN COMMERCE 0-0-1959.

THE MARK CONSISTS OF STANDARD CHAR-  
ACTERS WITHOUT CLAIM TO ANY PARTICULAR  
FONT, STYLE, SIZE, OR COLOR.

NO CLAIM IS MADE TO THE EXCLUSIVE  
RIGHT TO USE "AIR FILTER", APART FROM  
THE MARK AS SHOWN.

SEC. 2(F).

SER. NO. 78-918,480, FILED 6-28-2006.

DAYNA BROWNE, EXAMINING ATTORNEY

Int. Cl.: 30

Prior U.S. Cl.: 46

United States Patent and Trademark Office

Reg. No. 3,453,825

Registered June 24, 2008

TRADEMARK  
PRINCIPAL REGISTER



COCAM CIA.DE CAFE SOLUVEL E DERIVADOS  
(BRAZIL CORPORATION)  
- CEP 15800-020, CATANDUVA  
RUA MARANHAO, NO. 10  
SAO PAULO (SP), BRAZIL 15800-020

FOR: SOLUBLE COFFEE; CAPPUCCINO; COFFEE CONCENTRATE EXTRACT; COFFEE-BASED PREPARATIONS FOR USE IN MAKING COFFEE DRINKS AND BEVERAGES; DECAFFEINATED GREEN COFFEE BEANS; PURE CAFFEINE FOR USE IN MAKING COFFEE BEVERAGES AND DRINKS, IN CLASS 30 (U.S. CL. 46).

FIRST USE 0-0-1960; IN COMMERCE 4-27-1993.

THE MARK CONSISTS OF THE WORD "COCAM" IN UPPER AND LOWER CASE STYLIZED LETTERS ENCLOSED IN AN OVAL SHAPE.

THE WORDING "COCAM" HAS NO MEANING IN A FOREIGN LANGUAGE.

SER. NO. 78-918,807, FILED 6-28-2006.

MARGARET POWER, EXAMINING ATTORNEY

**Int. Cl.: 36**

**Prior U.S. Cls.: 100, 101 and 102**

**United States Patent and Trademark Office**

**Reg. No. 3,453,826**

**Registered June 24, 2008**

**SERVICE MARK  
PRINCIPAL REGISTER**

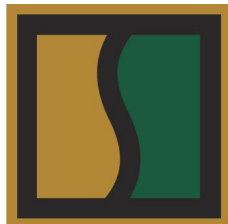

**SOUTHGROUP**  
INSURANCE AND FINANCIAL SERVICES

SOUTHGROUP INSURANCE AND FINANCIAL SERVICES, LLC (MISSISSIPPI LIMITED LIABILITY CORPORATION)  
795 WOODLANDS PKWY, SUITE 101  
RIDGELAND, MS 39157

FOR: INSURANCE AGENCIES, IN CLASS 36 (U.S. CLS. 100, 101 AND 102).

FIRST USE 1-1-2002; IN COMMERCE 1-1-2002.

NO CLAIM IS MADE TO THE EXCLUSIVE RIGHT TO USE "INSURANCE AND FINANCIAL SERVICES", APART FROM THE MARK AS SHOWN.

THE COLOR(S) BLACK, GOLD AND GREEN IS/ ARE CLAIMED AS A FEATURE OF THE MARK.

THE MARK CONSISTS OF A METALLIC GOLD BOX OUTLINING A BLACK BOX, WITH AN ELONGATED S INTERSECTING THE BOX, ENCLOSING METALLIC GOLD ON THE LEFT SIDE OF THE S AND GREEN ON THE RIGHT SIDE OF THE S, INCLUDING THE TERM SOUTHGROUP IN METALLIC GOLD AND BLACK UNDER THE BOX AND INSURANCE SERVICES IN BLACK UNDER THE TERM SOUTHGROUP.

SER. NO. 78-921,959, FILED 7-3-2006.

ESTHER A. BORSUK, EXAMINING ATTORNEY

**Int. Cl.: 28**

**Prior U.S. Cls.: 22, 23, 38 and 50**

**United States Patent and Trademark Office**

**Reg. No. 3,453,827**

**Registered June 24, 2008**

**TRADEMARK  
PRINCIPAL REGISTER**

**TAP BALL**

TAP BALL 2000 (FRANCE LTD LIAB JT ST CO)  
92, RUE BENOIT MALON  
94270 LE KREMLIN BICET, FRANCE

FOR: TOY BALLS, TOY PADDLES; TOY BALL  
AND PADDLE SETS; BALLOONS; INFLATABLE  
TOYS, IN CLASS 28 (U.S. CLS. 22, 23, 38 AND 50).

THE MARK CONSISTS OF STANDARD CHAR-  
ACTERS WITHOUT CLAIM TO ANY PARTICULAR  
FONT, STYLE, SIZE, OR COLOR.

PRIORITY CLAIMED UNDER SEC. 44(D) ON  
ERPN CMNTY TM OFC APPLICATION NO.  
004861944, FILED 1-10-2006, REG. NO. 004861944,  
DATED 1-10-2007, EXPIRES 1-10-2016.

NO CLAIM IS MADE TO THE EXCLUSIVE  
RIGHT TO USE "BALL", APART FROM THE MARK  
AS SHOWN.

SER. NO. 78-922,859, FILED 7-5-2006.

CHERYL CLAYTON, EXAMINING ATTORNEY

**Int. Cls.: 35 and 42**

**Prior U.S. Cls.: 100, 101 and 102**

**United States Patent and Trademark Office**

**Reg. No. 3,453,828**

**Registered June 24, 2008**

**SERVICE MARK  
PRINCIPAL REGISTER**

**A Refreshingly Different  
CRO**

CLINICAL TRIAL MANAGEMENT SERVICES,  
INC. (TENNESSEE CORPORATION)  
SUITE 950  
1241 VOLUNTEER PARKWAY  
BRISTOL, TN 376204661

FOR: PROVIDING BUSINESS ADMINISTRATION AND MANAGERIAL SERVICES ON BEHALF OF ENTITIES CONDUCTING CLINICAL TRIALS, NAMELY, RECRUITMENT OF SUBJECTS AND CLINICAL TRIAL MEDICAL INVESTIGATORS, IN CLASS 35 (U.S. CLS. 100, 101 AND 102).

FIRST USE 2-17-2005; IN COMMERCE 2-17-2005.

FOR: MEDICAL AND SCIENTIFIC RESEARCH, NAMELY, CONDUCTING CLINICAL TRIALS FOR PHARMACEUTICAL DRUGS AND PRODUCTS IN ESTABLISHED AND EMERGING THERAPEUTIC AREAS; CLINICAL DATA MANAGEMENT, ANALYSIS AND CONSULTING FOR CLINICAL TRIALS FOR PHARMACEUTICAL DRUGS AND PRODUCTS IN ESTABLISHED AND EMERGING THERAPEUTIC AREAS; CASE REPORT FORM DESIGN; PROVIDING QUALITY ASSURANCE SERVICES IN THE FIELD OF CLINICAL TRIALS FOR PHARMACEUTICAL DRUGS AND PRODUCTS IN ESTABLISHED AND EMERGING THERAPEUTIC AREAS, IN CLASS 42 (U.S. CLS. 100 AND 101).

FIRST USE 2-17-2005; IN COMMERCE 2-17-2005.

THE MARK CONSISTS OF STANDARD CHARACTERS WITHOUT CLAIM TO ANY PARTICULAR FONT, STYLE, SIZE, OR COLOR.

SER. NO. 78-924,197, FILED 7-7-2006.

AMY ALFIERI, EXAMINING ATTORNEY

**Int. Cls.: 35 and 44**

**Prior U.S. Cls.: 100, 101 and 102**

**United States Patent and Trademark Office**

**Reg. No. 3,453,829**

**Registered June 24, 2008**

**SERVICE MARK  
PRINCIPAL REGISTER**

**TOKYO LASH BAR**

L'OREAL (FRANCE SOCIETE ANONYME)  
14, RUE ROYALE  
PARIS, FRANCE 75008

FOR: RETAIL STORE SERVICES IN THE FIELD  
OF BEAUTY PRODUCTS AND PERSONAL  
GROOMING AIDS, IN CLASS 35 (U.S. CLS. 100, 101  
AND 102).

FIRST USE 6-0-2004; IN COMMERCE 6-0-2004.

FOR: PERSONALIZED EYELASH STYLING SER-  
VICES FEATURING REMOVAL OF EYE AND FACE  
MAKEUP, APPLICATION OF MAKEUP AND SE-  
LECTION OF SUITABLE MAKEUP PRODUCTS

FOR THE EYE AREA, IN CLASS 44 (U.S. CLS. 100  
AND 101).

FIRST USE 6-0-2004; IN COMMERCE 6-0-2004.

THE MARK CONSISTS OF STANDARD CHAR-  
ACTERS WITHOUT CLAIM TO ANY PARTICULAR  
FONT, STYLE, SIZE, OR COLOR.

NO CLAIM IS MADE TO THE EXCLUSIVE  
RIGHT TO USE "LASH", APART FROM THE MARK  
AS SHOWN.

SER. NO. 78-926,466, FILED 7-11-2006.

TRACY CROSS, EXAMINING ATTORNEY

**Int. Cls.: 6, 7, 11 and 42**

**Prior U.S. Cls.: 2, 12, 13, 14, 19, 21, 23, 25, 31, 34, 35,  
50, 100 and 101**

**Reg. No. 3,453,830**

**United States Patent and Trademark Office**

**Registered June 24, 2008**

**TRADEMARK  
SERVICE MARK  
PRINCIPAL REGISTER**



SURE ALLOY STEEL CORPORATION (OHIO CORPORATION)  
25880 COMMERCE DR.  
MADISON HEIGHTS, MI 48071

FOR: METALS, NAMELY, STEEL; METAL ALLOYS, NAMELY, STEEL ALLOYS AND CHROMIUM CARBIDE WELD ALLOYS FOR ABRASION RESISTANT APPLICATIONS IN FURTHER MANUFACTURING; METALLIC WELD OVERLAYS, NAMELY, CHROMIUM CARBIDE WELD OVERLAY MATERIALS FOR ABRASION RESISTANT APPLICATIONS IN FURTHER MANUFACTURING, IN CLASS 6 (U.S. CLS. 2, 12, 13, 14, 23, 25 AND 50).

FIRST USE 2-1-2006; IN COMMERCE 2-1-2006.

FOR: MACHINE PARTS MADE OF METALS AND METAL ALLOYS ALL FOR USE IN COAL PULVERIZING MACHINES AND COAL CRUSHING MACHINES FOR USE IN FOSSIL FUEL POWER PLANTS, NAMELY, COAL CLASSIFIERS, CONES FOR COAL CLASSIFIERS, BLADES FOR COAL CLASSIFIERS, MILL OUTLET DIFFUSERS, MULTI-OUTLET DIFFUSERS, STATIC CLASSIFIERS, VALVES, MILL BOTTOMS, VANE WHEELS, ADJUSTABLE ORIFICES, COAL SIZING GRIDS, COAL CHUTES, RECLAIM HOPPER GRATING AND CRUSHER HAMMERS, IN CLASS 7 (U.S. CLS. 13, 19, 21, 23, 31, 34 AND 35).

FIRST USE 2-1-2006; IN COMMERCE 2-1-2006.

FOR: PARTS FOR USE IN PULVERIZED COAL BURNERS AND PULVERIZED COAL EXHAUSTER FANS MADE OF METAL AND METAL ALLOYS FOR USE IN FOSSIL FUEL POWER PLANTS, NAMELY, NOZZLE TILTS, NOZZLES, TUBE CUFFS, ELBOW PATCHES, BURNER DIFFUSERS, MILL OUTLET DIFFUSERS, MULTI-OUTLET DIFFUSERS, PRE-RIFFLE DIFFUSERS, VALVES, ROTATING VANE WHEELS AND MILL BOTTOMS, IN CLASS 11 (U.S. CLS. 13, 21, 23, 31 AND 34).

FIRST USE 2-1-2006; IN COMMERCE 2-1-2006.

FOR: DESIGN AND TESTING OF NEW PRODUCTS FOR OTHER IN THE FIELD OF FOSSIL FUEL POWER PLANTS; DIAGNOSTIC TESTING SERVICES IN THE FIELD OF POWER PLANTS, NAMELY, ISOKINETIC FUEL PIPE SAMPLING AND COMBUSTION MONITORING; DESIGN, TESTING, AND ENGINEERING OF NEW PRODUCTS FOR OTHERS IN THE FIELD OF METALLURGY AND WELD OVERLAYS; DIAGNOSTIC SERVICES FOR OTHERS REGARDING THE OPTIMIZATION OF BROILER COMBUSTION, IN CLASS 42 (U.S. CLS. 100 AND 101).

FIRST USE 2-1-2006; IN COMMERCE 2-1-2006.

NO CLAIM IS MADE TO THE EXCLUSIVE RIGHT TO USE "GLOBAL POWER ADVANCEMENTS IN COAL PROCESSING & COMBUSTION", APART FROM THE MARK AS SHOWN.



THE MARK CONSISTS OF THE LETTERS "SAS"  
AND THE WORDS "GLOBAL POWER ADVANCE-  
MENTS IN COAL PROCESSING & COMBUSTION"  
OVERLAYING A DEPICTION OF A GLOBE.

SER. NO. 78-926,557, FILED 7-11-2006.

SUNG IN, EXAMINING ATTORNEY

**Int. Cl.: 36**

**Prior U.S. Cls.: 100, 101 and 102**

**United States Patent and Trademark Office**

**Reg. No. 3,453,831**

**Registered June 24, 2008**

**SERVICE MARK  
PRINCIPAL REGISTER**

**MQ SPECIALIST INVESTMENT  
MANAGEMENT**

MACQUARIE BANK LIMITED (AUSTRALIA CORPORATION)  
1 MARTIN PLACE  
SYDNEY, AUSTRALIA NSW 2000

FOR: FINANCIAL SERVICES, NAMELY, CORPORATE FINANCE SERVICES CONSISTING OF FINANCIAL CONSULTATION AND FINANCIAL MANAGEMENT, FINANCIAL DUE DILIGENCE IN THE NATURE OF CONDUCTING SUFFICIENT ANALYSIS BEFORE MAKING LOAN OR INVESTMENT RECOMMENDATIONS, FINANCIAL DECISION MAKING FOR CORPORATIONS, PROJECT FINANCE SERVICES, NAMELY, PROVIDING WORKING CAPITAL THROUGH LISTED AND UNLISTED EQUITY, HYBRID INSTRUMENTS AND DEBT, INVESTING FUNDS IN UNLISTED EQUITY FOR OTHERS, INVESTING FUNDS IN LISTED EQUITY FOR OTHERS, NAMELY, FLOATING PRIVATE COMPANIES, RAISING NEW EQUITY FOR LISTED COMPANIES AND BROKERAGE FEATURING EXISTING EQUITY, NAMELY, STOCKS AND OTHER SECURITIES, IN LISTED COMPANIES, INVESTING FUNDS IN HYBRID INSTRUMENTS FOR OTHERS, NAMELY, CONVERTIBLE BONDS AND PREFERENCE SHARES; BROKERAGE OF INCOME SECURITIES, AND RESET PREFERENCE SHARES; FINANCIAL ADVISORY SERVICES IN RELATION TO THE STRUCTURING AND THE RAISING OF EQUITY CAPITAL; FINANCIAL MARKET SERVICES, NAMELY, COMMODITIES TRADING FOR OTHERS, TRADING OF EQUITIES, DERIVATIVES TRADING, TREASURIES TRADING, NAMELY, TRADING IN FIXED INCOME SECURITIES, BONDS, FOREIGN EXCHANGE, DERIVATIVES AND MONEY MARKET DEPOSITS, DEBT TRADING AND FUTURES TRADING; TRADING, STRUCTURING AND FINANCING ALL IN RELATION TO COMMODITIES, NAMELY, FINANCING, HEDGING, NAMELY, PROVIDING INVESTMENT STRATEGIES, RESEARCH AND ANALYSIS RE-

LATING TO HEDGING AGAINST VARIOUS MARKET RISKS, COMMODITIES TRADING AND MARKET MAKING AND TAILORED FINANCIAL RISK MANAGEMENT SERVICES FOR COMMODITIES, THE AGRICULTURAL SECTOR AND THE ENERGY SECTOR; INVESTMENT SERVICES, NAMELY, CAPITAL INVESTMENT SERVICES CONSISTING OF INVESTMENT OF FUNDS FOR OTHERS; INVESTMENT BANKING SERVICES; INVESTMENT MANAGEMENT SERVICES TO CORPORATIONS, BUSINESSES AND INDIVIDUALS; FINANCIAL RISK MANAGEMENT SERVICES TO CORPORATIONS, BUSINESSES AND INDIVIDUALS; FINANCIAL RISK AND CAPITAL INVESTMENT FUND MANAGEMENT SERVICES FOR FINANCING LEASED ASSETS, PROPERTY INVESTMENT BANKING; FINANCIAL ADVISORY AND FINANCIAL MANAGEMENT SERVICES; WHOLESALE INVESTMENT MANAGEMENT SERVICES; FINANCIAL ADVICE IN RELATION TO MERGERS AND ACQUISITIONS; DEBT RESTRUCTURING AND TRANSACTION RESTRUCTURING NAMELY, FINANCING THROUGH CAPITAL MARKETS, BRIDGING ARRANGEMENTS, LONG AND SHORT TERM UNDERWRITINGS, BANK SYNDICATIONS, AND SUBORDINATED DEBT PLACEMENTS; INSTITUTIONAL STOCKBROKERAGE, NAMELY, ASSISTING OTHERS IN FACILITATING AND EXECUTING BROKERAGE OF CASH EQUITY, FINANCIAL ADVISORY SERVICES IN RELATION TO THE STRUCTURING OF EQUITY CAPITAL RAISINGS; STRUCTURING AND FINANCING IN RELATION TO COMMODITIES TRADING, NAMELY, FINANCING, HEDGING, NAMELY, PROVIDING INVESTMENT STRATEGIES, RESEARCH AND ANALYSIS RELATING TO HEDGING AGAINST VARIOUS MARKET RISKS, AND MARKET MAKING, TAILORED FINANCIAL RISK MANAGEMENT SERVICES; FOREIGN EXCHANGE SERVICES, NAMELY, PROVIDED IN RELATION TO STRUCTURED DERIVATIVE PRODUCTS, DEBT MARKETS, NAMELY, PROVIDING

FINANCIAL RISK MANAGEMENT VIA STRUCTURED SECURITIES AND DERIVATIVES RELATING TO CREDIT AND INTEREST RATE RISK; RESEARCH SERVICES, NAMELY, FINANCIAL RESEARCH SERVICES, ECONOMIC COMMODITY AND FINANCIAL TREND REVIEW, COMMENTARY, ANALYSIS AND FORECASTING; ASSET AND WEALTH MANAGEMENT SERVICES, NAMELY, RETAIL FINANCIAL SERVICES, NAMELY, CASH MANAGEMENT TRUST ADMINISTRATION SERVICES, RETAIL SUPERANNUATION SERVICES, NAMELY, PROVIDING PENSION PLANS ADMINISTRATION FOR NON-CORPORATE ENTITIES, ANNUITY UNDERWRITING AND ADMINISTRATION OF ANNUITY AND PENSION PLANS, ALTERNATIVE ASSET FUND FINANCIAL MANAGEMENT SERVICES, THIRD PARTY MANAGED FUND DISTRIBUTION SERVICES, STRATEGIC FINANCIAL PLANNING SERVICES, EXECUTIVE WEALTH MANAGEMENT SERVICES, PRIVATE FINANCIAL PORTFOLIO MANAGEMENT SERVICES, FINANCIAL ADVISORY SERVICES AND BROKERAGE SERVICES PROVIDED IN RELATION TO CURRENCIES, COMMODITIES, DERIVATIVES, BONDS AND CASH SECURITIES; PRIVATE AND TRADITIONAL FUNDS FINANCIAL MANAGEMENT, SECURITIES FUNDS FINANCIAL MANAGEMENT, NAMELY, PROVIDING A RANGE OF MANAGED FUNDS IN EQUITIES, ALTERNATIVE INVESTMENTS, CURRENCY, CASH, BALANCED FUNDS, FIXED INTEREST AND SMALL CAP EQUITIES, SPECIALIST FUNDS FINANCIAL MANAGEMENT SERVICES, PROPERTY FUNDS FINANCIAL MANAGEMENT SERVICES AND PRIVATE EQUITY FUNDS FINANCIAL MANAGEMENT SERVICES; BROKERAGE SERVICES, NAMELY, STOCK BROKERAGE SERVICES, PRIVATE CLIENT BROKERAGE SERVICES IN THE FIELD OF STOCK AND COMMODITIES; LEASE-

PURCHASE FINANCING SERVICES PROVIDED IN RELATION TO REAL ESTATE, INFRASTRUCTURE ASSETS BEING AIRPORTS, TOLL ROADS, PUBLIC UTILITIES, NAMELY, WATER, SEWERAGE, ELECTRICITY AND GAS, INFORMATION TECHNOLOGY EQUIPMENT, NAMELY, DESKTOPS, MONITORS, LAPTOPS, SERVERS, PRINTERS, COPIERS, COMPUTER NETWORK HUBS, SWITCHES, ROUTERS, AUDIO-VISUAL EQUIPMENT, MEDICAL EQUIPMENT, SCIENTIFIC EQUIPMENT, ELECTRONICS MANUFACTURING, MOTOR VEHICLE FLEETS, COMMERCIAL VEHICLES, EARTH MOVING EQUIPMENT, PLANT AND MACHINERY, TELECOMMUNICATIONS, JET AIRCRAFT ENGINES, VENDOR FINANCING, CAR PARKS; UNDERWRITING SERVICES, NAMELY, PROCURING SUBSCRIBERS OR PURCHASERS FOR DEBT, EQUITY OR OTHER SECURITIES OFFERED FOR ISSUE OR SUBSCRIPTION, IN CLASS 36 (U.S. CLS. 100, 101 AND 102).

THE MARK CONSISTS OF STANDARD CHARACTERS WITHOUT CLAIM TO ANY PARTICULAR FONT, STYLE, SIZE, OR COLOR.

PRIORITY CLAIMED UNDER SEC. 44(D) ON AUSTRALIA APPLICATION NO. 1124344, FILED 7-17-2006, REG. NO. 1124344, DATED 7-17-2006, EXPIRES 7-17-2016.

NO CLAIM IS MADE TO THE EXCLUSIVE RIGHT TO USE "SPECIALIST INVESTMENT MANAGEMENT", APART FROM THE MARK AS SHOWN.

SER. NO. 78-931,211, FILED 7-17-2006.

SARA THOMAS, EXAMINING ATTORNEY

**Int. Cls.: 35 and 38**

**Prior U.S. Cls.: 100, 101, 102 and 104**

**United States Patent and Trademark Office**

**Reg. No. 3,453,832**

**Registered June 24, 2008**

**SERVICE MARK  
PRINCIPAL REGISTER**

**SMARTREPLY**

SMARTREPLY, INC. (CALIFORNIA CORPORATION)  
114 PACIFICA, SUITE 290  
IRVINE, CA 92618

FOR: ADVERTISING AND BUSINESS SERVICES, NAMELY, TELEMARKETING; MOBILE MARKETING, NAMELY, DIRECT TARGET MARKETING PROVIDED VIA MOBILE PHONE MESSAGES; TEXT MESSAGING MARKETING, NAMELY, SALES ALERTS PROVIDED VIA TEXT MESSAGES; VOICE MESSAGING MARKETING, NAMELY, DISSEMINATING ADVERTISING IN THE FORM OF NOTIFICATIONS OF PROMOTIONS, SALES, COUPONS, PROGRAM LOYALTY INFORMATION, NEW PRODUCT INFORMATION, PRODUCT RECALL INFORMATION, STORE LOCATION INFORMATION PROVIDED VIA VOICE MESSAGING; EMAIL MARKETING, NAMELY, DISSEMINATING ADVERTISING IN THE FORM OF CONTEST REGISTRATIONS PROVIDED VIA EMAIL; CUSTOMER RELATIONSHIP MANAGEMENT; MARKETING RESEARCH SERVICES IN THE NATURE OF DATA MANAGEMENT AND ANALYSIS WITH REGARD TO MARKETING STRATEGY, MARKETING EFFECTIVENESS AND PREPARATION AND MAINTENANCE OF CUSTOMER LISTS, IN CLASS 35 (U.S. CLS. 100, 101 AND 102).

FIRST USE 7-0-2001; IN COMMERCE 7-0-2001.

FOR: VOICE MESSAGING MARKETING, NAMELY, TRANSMISSION OF NOTIFICATIONS OF PROMOTIONS, SALES, COUPONS, PROGRAM LOYALTY INFORMATION, NEW PRODUCT INFORMATION, PRODUCT RECALL INFORMATION, STORE LOCATION INFORMATION PROVIDED VIA VOICE MESSAGING; EMAIL MARKETING, NAMELY, TRANSMISSION OF CONTEST REGISTRATIONS PROVIDED VIA EMAIL, IN CLASS 38 (U.S. CLS. 100, 101 AND 104).

FIRST USE 7-0-2001; IN COMMERCE 7-0-2001.

THE MARK CONSISTS OF STANDARD CHARACTERS WITHOUT CLAIM TO ANY PARTICULAR FONT, STYLE, SIZE, OR COLOR.

OWNER OF U.S. REG. NO. 2,811,908.

SEC. 2(F).

SER. NO. 78-933,344, FILED 7-19-2006.

EUGENIA MARTIN, EXAMINING ATTORNEY

**Int. Cl.: 35**

**Prior U.S. Cls.: 100, 101 and 102**

**United States Patent and Trademark Office**

**Reg. No. 3,453,833**

**Registered June 24, 2008**

**SERVICE MARK  
PRINCIPAL REGISTER**

**VINGUARD**

CCC INFORMATION SERVICES INC. (DELA-  
WARE CORPORATION)  
222 MERCHANDISE MART PLAZA, SUITE 900  
CHICAGO, IL 60654

FOR: BUSINESS INFORMATION SERVICES,  
NAMELY, PROVIDING MOTOR VEHICLE IDENTI-  
FICATION AND VEHICLE HISTORY REPORTS  
FOR USE BY INSURANCE COMPANIES, COLLI-  
SION REPAIR FACILITIES, INDEPENDENT AP-  
PRAISERS AND SALVAGE FACILITIES DURING  
THE INSURANCE CLAIMS AND UNDERWRITING

PROCESSES, IN CLASS 35 (U.S. CLS. 100, 101 AND  
102).

FIRST USE 11-0-1984; IN COMMERCE 11-0-1984.

THE MARK CONSISTS OF STANDARD CHAR-  
ACTERS WITHOUT CLAIM TO ANY PARTICULAR  
FONT, STYLE, SIZE, OR COLOR.

SER. NO. 78-933,919, FILED 7-20-2006.

CAROLYN CATALDO, EXAMINING ATTORNEY

**Int. Cl.: 35**

**Prior U.S. Cls.: 100, 101 and 102**

**United States Patent and Trademark Office**

**Reg. No. 3,453,834**

**Registered June 24, 2008**

**SERVICE MARK  
PRINCIPAL REGISTER**

**MACHINEFINDER**

DEERE & COMPANY (DELAWARE CORPORATION)  
ONE JOHN DEERE PLACE  
PATENT DEPARTMENT  
MOLINE, IL 61265

FOR: ADVERTISING SERVICES, NAMELY, PROVIDING ONLINE LISTINGS OF AVAILABLE USED AGRICULTURAL, CONSTRUCTION AND COMMERCIAL EQUIPMENT VIA A GLOBAL COMPUTER NETWORK, IN CLASS 35 (U.S. CLS. 100, 101 AND 102).

FIRST USE 1-1-1999; IN COMMERCE 1-1-1999.

THE MARK CONSISTS OF STANDARD CHARACTERS WITHOUT CLAIM TO ANY PARTICULAR FONT, STYLE, SIZE, OR COLOR.

OWNER OF U.S. REG. NO. 2,286,824.

SEC. 2(F).

SER. NO. 78-933,994, FILED 7-20-2006.

FRED CARL, EXAMINING ATTORNEY

**Int. Cls.: 9 and 41**

**Prior U.S. Cls.: 21, 23, 26, 36, 38, 100, 101 and 107**

**United States Patent and Trademark Office**

**Reg. No. 3,453,835**

**Registered June 24, 2008**

**TRADEMARK  
SERVICE MARK  
PRINCIPAL REGISTER**

**21ST CENTURY BLUES**

KING, CHRIS THOMAS (UNITED STATES INDIVIDUAL)  
37309 SAINT MARIE AVENUE  
PRAIRIEVILLE, LA 70769

FOR: COMPACT DISCS FEATURING MUSICAL SOUND RECORDINGS; MOTION PICTURE FILMS ON A VARIETY OF SUBJECTS, IN CLASS 9 (U.S. CLS. 21, 23, 26, 36 AND 38).

FIRST USE 1-0-1994; IN COMMERCE 1-0-1994.

FOR: ENTERTAINMENT AND RECORD LABEL SERVICES, NAMELY, AUDIO RECORDING AND RECORD PRODUCTION; MOTION PICTURE FILM PRODUCTION, IN CLASS 41 (U.S. CLS. 100, 101 AND 107).

FIRST USE 1-0-1993; IN COMMERCE 1-0-1993.

THE MARK CONSISTS OF STANDARD CHARACTERS WITHOUT CLAIM TO ANY PARTICULAR FONT, STYLE, SIZE, OR COLOR.

NO CLAIM IS MADE TO THE EXCLUSIVE RIGHT TO USE "BLUES", APART FROM THE MARK AS SHOWN.

SER. NO. 78-934,174, FILED 7-20-2006.

KAELIE KUNG, EXAMINING ATTORNEY

**Int. Cls.: 9, 42 and 45**

**Prior U.S. Cls.: 21, 23, 26, 36, 38, 100 and 101**

**Reg. No. 3,453,836**

**United States Patent and Trademark Office**

**Registered June 24, 2008**

**TRADEMARK  
SERVICE MARK  
PRINCIPAL REGISTER**

# SPRITE BACKUP

SPRITE SOFTWARE LIMITED (NEW ZEALAND CORPORATION)  
LEVEL 2, 9 WILKINS ST., FREEMANS BAY  
AUCKLAND 1011, NEW ZEALAND

FOR: COMPUTER HARDWARE AND COMPUTER SOFTWARE FOR USE IN DATABASE MANAGEMENT; COMPUTER PRINTERS, COMPUTER WORK STATIONS, SERVERS, DESKTOP, LAPTOP, ELECTRONIC ORGANIZERS, ELECTRONIC NOTE-PADS, MOBILE TELEPHONES AND PAGERS, PERSONAL INFORMATION MANAGERS, NAMELY, PERSONAL DIGITAL ASSISTANTS AND MOBILE COMPUTING AND COMMUNICATIONS DEVICES, PORTABLE AND HANDHELD DIGITAL ELECTRONIC DEVICES, POCKET PC AND EXPANSION BOARDS; HARD DRIVE PC CARDS, STACKED MEMORY DEVICES, MEMORY MODULES, MEMORY CARDS, COMMUNICATION CARDS FOR COMPUTER; ETHERNET ADAPTERS, FLASH CARDS, COMPACT FLASH CARDS, FLASH DRIVES, MULTIMEDIA CARDS (MMC CARDS), SECURE DIGITAL CARDS (SD CARDS), USB FLASH DRIVES, USB DISK DRIVES, NETWORK ATTACHED STORAGE (NAS), SRAM CARDS, HARD DRIVES AND INTERNAL DESKTOP PC CARD DRIVES, DATA PROCESSING EQUIPMENT AND COMPUTERS; COMPUTER HARDWARE AND EMBEDDED SOFTWARE FOR USE IN ACCESSING, STORING, MANAGING, SYNCHRONIZING, TRANSFERRING, TRANSPORTING AND SHARING DIGITAL INFORMATION AND MUSIC, PHOTOS, VIDEOS, ADDRESS BOOKS, CALENDARS, E-MAIL, PIM DATA, PDA DATA, OFFICE AND PERSONAL DOCUMENTS, STREAMED AND MULTIMEDIA INFORMATION AND FILES OVER THE GLOBAL COMMUNICATIONS NETWORK AND OTHER NETWORKS AND/OR BETWEEN COMPUTERS, ELECTRONIC ORGANIZERS, MOBILE TELEPHONES AND PAGERS, PERSONAL INFORMATION MANAGERS, PERSONAL DIGI-

TAL ASSISTANTS AND MOBILE COMPUTING AND COMMUNICATION DEVICES; COMPUTER SOFTWARE FOR SYNCHRONIZATION OF DATA, INFORMATION AND FILES, FOR MOBILE COMMUNICATIONS AND FOR MOBILE COMPUTING, FOR PERSONAL INFORMATION MANAGEMENT, DATABASE MANAGEMENT AND SYNCHRONIZATION, FOR CHARACTER RECOGNITION, AND FOR SECURE DATA ACCESS, STORAGE AND TRANSFER; COMPUTER SOFTWARE FOR DATA AND FILE BACKUP AND STORAGE, AND FOR DUPLICATE FILE MANAGEMENT ACROSS MULTIPLE DEVICES; TELEPHONY MANAGEMENT SOFTWARE; ELECTRONIC MAIL AND MESSAGING SOFTWARE; PAGING SOFTWARE; MANUALS SOLD AS A UNIT THEREWITH, IN CLASS 9 (U.S. CLS. 21, 23, 26, 36 AND 38).

FIRST USE 10-31-2003; IN COMMERCE 12-10-2003.

FOR: COMPUTER HARDWARE AND SOFTWARE DESIGN DEVELOPMENT AND PROGRAMMING SERVICES IN THE FIELD OF MOBILE COMPUTERS, COMPUTER SOFTWARE AND ELECTRONIC COMMUNICATIONS DEVICES AND TECHNOLOGIES, INCLUDING THE DESIGN OF MOBILE AND HANDHELD COMPUTERS AND COMMUNICATIONS DEVICES, EMBEDDED COMPUTERS, HARDWARE AND SOFTWARE FOR DATA AND FILE BACKUP AND STORAGE, AND DUPLICATE FILE MANAGEMENT ACROSS MULTIPLE DEVICES; GRAPHIC DESIGN FOR THE COMPILATION OF WEB PAGES ON THE INTERNET; PROVIDING INFORMATION RELATING TO COMPUTER HARDWARE OR SOFTWARE, NAMELY, DATABASE MANAGEMENT PROVIDED ONLINE FROM A GLOBAL COMPUTER NETWORK OR THE INTERNET; PROVIDING AN INTERACTIVE WEB SITE FEATURING NEWS AND INFORMATION ABOUT HANDHELD COMPUTERS AND COMMUNICATIONS DEVICES, PROVIDING DIGI-



TAL TECHNOLOGIES AND WIRELESS SERVICES FOR HANDHELD COMPUTERS AND COMMUNICATIONS DEVICES VIA ELECTRONIC COMMUNICATIONS NETWORKS AND VIA A GLOBAL COMPUTER NETWORK OR THE INTERNET; APPLICATION SERVICE PROVIDER SERVICES FEATURING DATA SECURITY SOFTWARE APPLICATIONS WHICH SECURE, PROTECT, ENCRYPT, DECRYPT, AUTHENTICATE, MONITOR, TRACK AND TRANSMIT ELECTRONIC DATA, ELECTRONIC MAIL, VOICE, DATA, IMAGES, VIDEO SIGNALS, MESSAGES AND INFORMATION IN ELECTRONIC FORM, IN CLASS 42 (U.S. CLS. 100 AND 101).

FIRST USE 10-31-2003; IN COMMERCE 10-31-2003.

FOR: MONITORING OF COMPUTER SYSTEMS FOR COMPUTER SECURITY PURPOSES, IN CLASS 45 (U.S. CLS. 100 AND 101).

FIRST USE 10-31-2003; IN COMMERCE 10-31-2003.

THE MARK CONSISTS OF STANDARD CHARACTERS WITHOUT CLAIM TO ANY PARTICULAR FONT, STYLE, SIZE, OR COLOR.

NO CLAIM IS MADE TO THE EXCLUSIVE RIGHT TO USE "BACKUP", APART FROM THE MARK AS SHOWN.

SER. NO. 78-935,541, FILED 7-23-2006.

TIMOTHY FINNEGAN, EXAMINING ATTORNEY

**Int. Cl.: 39**

**Prior U.S. Cls.: 100 and 105**

**United States Patent and Trademark Office**

**Reg. No. 3,453,837**

**Registered June 24, 2008**

**SERVICE MARK  
PRINCIPAL REGISTER**

**BLUESKY**

TAIWAN MARITIME TRANSPORTATION CO.,  
LTD. (TAIWAN CORPORATION)  
12F, NO. 167, FU HSIN N. ROAD  
TAIPEI, TAIWAN

FOR: PROVIDING OCEAN TRANSPORTATION,  
STORAGE AND DELIVERY SERVICES; BARGE  
TRANSPORT, MARINE TRANSPORT, SHIP  
BROKERAGE, BOAT STORAGE, BOATHOUSE SER-  
VICES RELATING TO RENTAL OF BOATS, LEAS-  
ING AND RENTAL OF BOATS; CARGO SHIP  
TRANSPORT, CARGO LOADING AND UNLOAD-  
ING, HARBOR CRANE UNLOADING, STEVEDOR-  
ING SERVICES; WAREHOUSING SERVICES,  
NAMELY, STORAGE, DISTRIBUTION, TRANS-  
PORT, PICK-UP, AND PACKING FOR SHIPMENT

OF DOCUMENTS, PACKAGES, RAW MATERIALS,  
AND FREIGHTING FOR OTHERS, IN CLASS 39  
(U.S. CLS. 100 AND 105).

THE MARK CONSISTS OF STANDARD CHAR-  
ACTERS WITHOUT CLAIM TO ANY PARTICULAR  
FONT, STYLE, SIZE, OR COLOR.

OWNER OF TAIWAN REG. NO. 01251723, DATED  
2-16-2007, EXPIRES 2-15-2017.

SER. NO. 78-937,826, FILED 7-26-2006.

GEOFFREY FOSDICK, EXAMINING ATTORNEY

**Int. Cl.: 41**

**Prior U.S. Cls.: 100, 101 and 107**

**United States Patent and Trademark Office**

**Reg. No. 3,453,838**

**Registered June 24, 2008**

**SERVICE MARK  
PRINCIPAL REGISTER**

**Western Regional Mortgage  
Brokers Conference**

MORTGAGE CONFERENCES, LLC (ARIZONA  
LTD LIAB CO)

4234 N. WINFIELD SCOTT PLAZA

SCOTTSDALE, AZ 85251

FOR: EDUCATION SERVICES, NAMELY, PRO-  
VIDING EDUCATIONAL SEMINARS IN THE  
FIELD OF THE MORTGAGE INDUSTRY, IN CLASS  
41 (U.S. CLS. 100, 101 AND 107).

FIRST USE 9-28-1997; IN COMMERCE 9-28-1997.

THE MARK CONSISTS OF STANDARD CHAR-  
ACTERS WITHOUT CLAIM TO ANY PARTICULAR  
FONT, STYLE, SIZE, OR COLOR.

NO CLAIM IS MADE TO THE EXCLUSIVE  
RIGHT TO USE "MORTGAGE BROKERS CONFER-  
ENCE", APART FROM THE MARK AS SHOWN.

SEC. 2(F) AS TO "WESTERN REGIONAL".

SER. NO. 78-937,884, FILED 7-26-2006.

DAVID MURRAY, EXAMINING ATTORNEY

**Int. Cls.: 16 and 36**

**Prior U.S. Cls.: 2, 5, 22, 23, 29, 37, 38, 50, 100, 101 and 102**

**Reg. No. 3,453,839**

**United States Patent and Trademark Office**

**Registered June 24, 2008**

**TRADEMARK  
SERVICE MARK  
PRINCIPAL REGISTER**



JOHN R. WOOD, INC. (FLORIDA CORPORATION)  
3255 TAMiami TRAIL NORTH  
NAPLES, FL 34103

FOR: PUBLICATIONS, NAMELY, BOOKLETS, NEWSLETTERS, MAGAZINES, PAMPHLETS, LEAFLETS, MANUALS, BROCHURES, HANDBOOKS AND DIRECTORIES ALL OF THE FOREGOING ON TOPICS OF REAL ESTATE AGENCIES AND LISTING SERVICES AND REAL ESTATE INFORMATION; MAGAZINES, GUIDES, BOOKS, PAMPHLETS AND NEWSLETTERS ALL OF THE FOREGOING IN THE FIELD OF REAL ESTATE, IN CLASS 16 (U.S. CLS. 2, 5, 22, 23, 29, 37, 38 AND 50).

FIRST USE 12-0-2005; IN COMMERCE 12-0-2005.

FOR: REAL ESTATE AGENCIES SERVICES; REAL ESTATE LISTING SERVICES; OPERATING MARKETPLACES FOR SELLERS OF GOODS AND/OR SERVICES; PROVIDING INFORMATION IN THE FIELD OF REAL ESTATE BY LINKING THE WEB SITE TO OTHER WEB SITES FEATURING REAL ESTATE INFORMATION; REAL ESTATE BROKERAGE SERVICES; REAL ESTATE BROKERAGE AND REAL ESTATE AGENCY SERVICES FOR HOME BASED REAL ESTATE PROFESSIONALS; PROVIDING INFORMATION IN THE FIELD OF REAL ESTATE BROKERAGE AND REAL ESTATE AGENCIES; PROVIDING INFORMATION IN THE FIELD OF REAL ESTATE BROKERAGE AND REAL ESTATE AGENCIES VIA THE INTERNET; PROVIDING A WEBSITE FEATURING REAL ESTATE LISTINGS, INFORMATION IN THE FIELD OF REAL ESTATE, REAL ESTATE BROKERAGE SERVICES

AND REAL ESTATE BROKERAGE AND REAL ESTATE AGENCY SERVICES FOR HOME BASED REAL ESTATE PROFESSIONALS; MORTGAGE PROCUREMENT FOR OTHERS; MORTGAGE SERVICES, NAMELY, BUYER PRE-QUALIFICATION OF MORTGAGES FOR MORTGAGE BROKERS AND BANKS; MORTGAGE BROKERAGE; FINANCIAL SERVICES, NAMELY, CREDIT AND FINANCIAL CONSULTATION, FINANCIAL ANALYSIS AND CONSULTATION, FINANCIAL CONSULTATION, MONEY LENDING, MORTGAGE PLANNING, AND FINANCIAL VALUATION OF PERSONAL PROPERTY AND REAL ESTATE; FINANCIAL SERVICES, NAMELY, ISSUANCE AND MANAGEMENT OF CERTIFICATES BACKED BY LOAN PORTFOLIOS WHICH ARE SUBSEQUENTLY MANAGED TO INSURE THE INTEGRITY OF THE CERTIFICATES; FINANCIAL SERVICES IN THE NATURE OF CROSS COLLATERALIZATION, PLEDGED SECURITIES, PLEDGED CERTIFICATES OF DEPOSIT, NO INCOME AND ASSET VERIFICATION MORTGAGES, FOREIGN NATIONAL FINANCING, RESIDENTIAL LOT MORTGAGES, BRIDGE LOANS, PRIVATE MORTGAGES, RESIDENTIAL INVESTOR FINANCING, ZERO POINT LOANS, CONSTRUCTION PERMANENT FINANCING WITH FIXED OR ADJUSTABLE RATES LOCATED AT APPLICATION, NO INCOME VERIFICATION CONSTRUCTION LOANS, LOANS FOR CREDIT PROBLEM SITUATIONS, MORTGAGES FOR PROPERTY HELD IN THE NAME OF A TRUST, CORPORATION OR PARTNERSHIP, NEW CONDOMINIUM FINANCING, RESIDENTIAL MORTGAGES, UP TO 100% RESIDENTIAL FINANCING AND COMMERCIAL FINANCING

FOR TYPES OF REAL ESTATE; PROVIDING ON-LINE FINANCIAL CALCULATORS; PROVIDING FINANCIAL INFORMATION IN THE FIELDS OF MORTGAGES AND REAL ESTATE; FINANCIAL INFORMATION PROVIDED BY ELECTRONIC MEANS , IN CLASS 36 (U.S. CLS. 100, 101 AND 102).

FIRST USE 12-0-2005; IN COMMERCE 12-0-2005.

OWNER OF U.S. REG. NOS. 2,174,456, 2,238,023, AND 2,439,737.

NO CLAIM IS MADE TO THE EXCLUSIVE RIGHT TO USE "REALTORS EST. 1958", APART FROM THE MARK AS SHOWN.

THE NAME "JOHN R. WOOD" IDENTIFIES A LIVING INDIVIDUAL WHOSE CONSENT IS OF RECORD.

SER. NO. 78-940,916, FILED 7-31-2006.

DAVID YONTEF, EXAMINING ATTORNEY

**Int. Cl.: 25**

**Prior U.S. Cls.: 22 and 39**

**United States Patent and Trademark Office**

**Reg. No. 3,453,840**

**Registered June 24, 2008**

**TRADEMARK  
PRINCIPAL REGISTER**

**M  
G O D  
V  
E  
S**

JPRIZE (VIRGINIA LTD LIAB CO)  
1046 RIVIERA DRIVE  
VIRGINIA BEACH, VA 23464

THE MARK CONSISTS OF STYLIZED TEXT IN  
THE FORM OF A CROSS.

FOR: HATS; JACKETS; JEANS; SHIRTS; WRIST-  
BANDS, IN CLASS 25 (U.S. CLS. 22 AND 39).

SER. NO. 78-940,995, FILED 7-31-2006.

FIRST USE 11-1-2005; IN COMMERCE 2-1-2006.

BRENDAN MCCAULEY, EXAMINING ATTORNEY

**Int. Cl.: 35**

**Prior U.S. Cls.: 100, 101 and 102**

**United States Patent and Trademark Office**

**Reg. No. 3,453,841**

**Registered June 24, 2008**

**SERVICE MARK  
PRINCIPAL REGISTER**

**CAPTURE THE SOLUTION, NOT  
THE PROBLEM**

STRUCTURED RISK, INC. (CALIFORNIA COR-  
PORATION)  
SUITE 120  
2000 CROW CANYON PLACE  
SAN RAMON, CA 94583

THE MARK CONSISTS OF STANDARD CHAR-  
ACTERS WITHOUT CLAIM TO ANY PARTICULAR  
FONT, STYLE, SIZE, OR COLOR.

FOR: DATABASE MANAGEMENT, IN CLASS 35  
(U.S. CLS. 100, 101 AND 102).

SER. NO. 78-941,066, FILED 7-31-2006.

FIRST USE 6-15-2006; IN COMMERCE 6-15-2006.

COLLEEN KEARNEY, EXAMINING ATTORNEY

**Int. Cls.: 37 and 45**

**Prior U.S. Cls.: 100, 101, 103 and 106**

**United States Patent and Trademark Office**

**Reg. No. 3,453,842**

**Registered June 24, 2008**

**SERVICE MARK  
PRINCIPAL REGISTER**



**Ec Eclipse**

**FOR ENERGY SMART LIVING**

TOWNWOOD HOMES INC. (CANADA ONTARIO CORPORATION)  
1 BRADWICK DRIVE, SUITE 1, CONCORD  
ONTARIO, CANADA L4K 2T4

FOR: CONSTRUCTION OF ENERGY EFFICIENT HOMES, IN CLASS 37 (U.S. CLS. 100, 103 AND 106).

FOR: REVIEWING STANDARDS AND PRACTICES TO ASSURE COMPLIANCE WITH ENERGY EFFICIENCY REQUIREMENTS, GUIDELINES, LAWS AND REGULATIONS, IN CLASS 45 (U.S. CLS. 100 AND 101).

PRIORITY CLAIMED UNDER SEC. 44(D) ON CANADA APPLICATION NO. 1,288,872, FILED 2-6-

2006, REG. NO. TMA707370, DATED 2-13-2008, EXPIRES 2-6-2016.

NO CLAIM IS MADE TO THE EXCLUSIVE RIGHT TO USE "ENERGY SMART LIVING", APART FROM THE MARK AS SHOWN.

THE MARK CONSISTS OF STYLIZED DEPICTION OF A BUILDING, THE SUN AND A TULIP.

SER. NO. 78-941,243, FILED 7-31-2006.

JILL C. ALT, EXAMINING ATTORNEY



**Int. Cl.: 9**

**Prior U.S. Cls.: 21, 23, 26, 36 and 38**

**Reg. No. 3,453,843**

**United States Patent and Trademark Office**

**Registered June 24, 2008**

**TRADEMARK  
PRINCIPAL REGISTER**



SPOTLIGHT PTY LTD. (AUSTRALIA LTD LIAB  
CO)  
100 MARKET STREET  
SOUTH MELBOURNE, AUSTRALIA VIC 3205

FOR: COMPUTER SOFTWARE PROGRAMS FOR INSTRUCTIONAL USE IN THE DESIGNING OF HANDICRAFTS AND CRAFT PRODUCTS; COMPACT DISCS CONTAINING COMPUTER SOFTWARE FOR USE IN DESIGNING HANDICRAFTS AND CRAFT PRODUCTS; DIGITAL VIDEO DISCS, VIDEOTAPES, AUDIO CASSETTES, RECORDS AND RECORDING DISCS, COMPUTER DISCS AND CARTRIDGES, AND MAGNETIC DATA CARRIERS, ALL CONTAINING DIGITAL MAGAZINES AND NEWSLETTERS FEATURING INFORMATION FOR USE IN RELATION TO CRAFT AND CRAFT PRODUCTS; ELECTRONIC PUBLICATIONS, NAMELY, MAGAZINES AND NEWSLETTERS FEATURING INFORMATION FOR USE IN RELATION TO CRAFT AND CRAFT PRODUCTS

RECORDED ON COMPUTER MEDIA; COMPUTERS AND COMPUTER SOFTWARE FOR USE IN TRANSMISSION OF INFORMATION CONCERNING CRAFT AND CRAFT PRODUCTS VIA THE WORLD WIDE WEB; ALL BEING ASSOCIATED WITH A WEB SITE DIRECTED TOWARDS ART AND CRAFT ACTIVITIES FOR CHILDREN, IN CLASS 9 (U.S. CLS. 21, 23, 26, 36 AND 38).

PRIORITY CLAIMED UNDER SEC. 44(D) ON AUSTRALIA APPLICATION NO. 1115982, FILED 5-26-2006, REG. NO. 1115982, DATED 5-26-2006, EXPIRES 5-26-2017.

OWNER OF U.S. REG. NOS. 3,164,574, 3,352,338 AND OTHERS.

SER. NO. 78-941,815, FILED 7-31-2006.

HEATHER BIDDULPH, EXAMINING ATTORNEY

**Int. Cls.: 35 and 39**

**Prior U.S. Cls.: 100, 101, 102 and 105**

**United States Patent and Trademark Office**

**Reg. No. 3,453,844**

**Registered June 24, 2008**

**SERVICE MARK  
PRINCIPAL REGISTER**

**BULLION DIRECT**

BULLION DIRECT, INC. (TEXAS CORPORATION)  
SUITE 240  
2028 E. BEN WHITE BOULEVARD  
AUSTIN, TX 78741

FOR: PROVIDING A COMPUTERIZED ONLINE WEB SITE AT WHICH USERS CAN BUY GOODS OFFERED BY OTHERS IN THE FIELD OF PRECIOUS METALS; COMPUTERIZED ONLINE TRADING SERVICES WHICH PROVIDE TRADERS AND CONSUMERS WITH THE ABILITY TO COMPLETE TRADES IN THE FIELD OF PRECIOUS METALS; COMPUTERIZED ONLINE AUCTION SERVICES IN THE FIELD OF PRECIOUS METALS; COMPUTERIZED ONLINE CLEARANCE SERVICES, NAMELY, CONNECTING BUYERS AND SELLERS OF ASSETS IN THE NATURE OF PRECIOUS METALS, IN CLASS 35 (U.S. CLS. 100, 101 AND 102).

FIRST USE 5-17-2000; IN COMMERCE 5-17-2000.

FOR: STORAGE OF PRECIOUS METALS, IN CLASS 39 (U.S. CLS. 100 AND 105).

FIRST USE 5-17-2000; IN COMMERCE 5-17-2000.

THE MARK CONSISTS OF STANDARD CHARACTERS WITHOUT CLAIM TO ANY PARTICULAR FONT, STYLE, SIZE, OR COLOR.

OWNER OF U.S. REG. NO. 2,530,853.

NO CLAIM IS MADE TO THE EXCLUSIVE RIGHT TO USE "BULLION", APART FROM THE MARK AS SHOWN.

SEC. 2(F).

SER. NO. 78-942,339, FILED 8-1-2006.

AMY HELLA, EXAMINING ATTORNEY

**Int. Cls.: 11 and 21**

**Prior U.S. Cls.: 2, 13, 21, 23, 29, 30, 31, 33, 34, 40 and 50**

**Reg. No. 3,453,845**

**United States Patent and Trademark Office**

**Registered June 24, 2008**

**TRADEMARK  
PRINCIPAL REGISTER**



VAN HOUTTE INC. (CANADA CORPORATION)  
8300 19TH AVENUE  
MONTREAL, QUEBEC, CANADA H1Z 4J8

FOR: WATER COOLER; TEMPERATURE CONTROLLED WATER DISPENSER, IN CLASS 11 (U.S. CLS. 13, 21, 23, 31 AND 34).

FIRST USE 7-10-2006; IN COMMERCE 7-10-2006.

FOR: PLASTIC WATER BOTTLES SOLD EMPTY; PORTABLE WATER DISPENSER, IN CLASS 21 (U.S. CLS. 2, 13, 23, 29, 30, 33, 40 AND 50).

FIRST USE 7-10-2006; IN COMMERCE 7-10-2006.

PRIORITY CLAIMED UNDER SEC. 44(D) ON CANADA APPLICATION NO. 1310775, FILED 7-27-2006, REG. NO. TMA701,896, DATED 11-28-2007, EXPIRES 11-28-2022.

NO CLAIM IS MADE TO THE EXCLUSIVE RIGHT TO USE "H2O", APART FROM THE MARK AS SHOWN.

SER. NO. 78-942,435, FILED 8-1-2006.

JOHN SCHUYLER YARD, EXAMINING ATTORNEY

**Int. Cl.: 35**

**Prior U.S. Cls.: 100, 101 and 102**

**United States Patent and Trademark Office**

**Reg. No. 3,453,846**

**Registered June 24, 2008**

**SERVICE MARK  
PRINCIPAL REGISTER**



**BUILDERSOURCING**

BUILDER SOURCING CORPORATION, LLC  
(COLORADO LTD LIAB CO)  
BUILDING 600, SUITE 205  
200 QUEBEC STREET  
DENVER, CO 80230

FIRST USE 4-19-2004; IN COMMERCE 4-19-2004.

SER. NO. 78-942,590, FILED 8-1-2006.

FOR: MANAGEMENT OF SUPPLIER INCENTIVE  
PROGRAMS FOR BUILDERS, IN CLASS 35 (U.S.  
CLS. 100, 101 AND 102).

TERESA M. RUPP, EXAMINING ATTORNEY

**Int. Cl.: 41**

**Prior U.S. Cls.: 100, 101 and 107**

**United States Patent and Trademark Office**

**Reg. No. 3,453,847**

**Registered June 24, 2008**

**SERVICE MARK  
PRINCIPAL REGISTER**

**STATS HOSTED SOLUTION**

OLD STATS LLC (DELAWARE CORPORATION)  
8130 LEHIGH AVENUE  
MORTON GROVE, IL 60053

FOR: ENTERTAINMENT SERVICES, NAMELY,  
PROVIDING INFORMATION ABOUT SPORTS,  
SCORES, TEAMS AND INDIVIDUAL ATHLETIC  
PERFORMANCES, SCHEDULES AND NEWS AND  
INFORMATION ABOUT SPORTS VIA A GLOBAL  
COMPUTER NETWORK, IN CLASS 41 (U.S. CLS. 100,  
101 AND 107).

FIRST USE 7-27-2006; IN COMMERCE 7-27-2006.

THE MARK CONSISTS OF STANDARD CHAR-  
ACTERS WITHOUT CLAIM TO ANY PARTICULAR  
FONT, STYLE, SIZE, OR COLOR.

OWNER OF U.S. REG. NOS. 2,199,423, 2,843,912  
AND OTHERS.

NO CLAIM IS MADE TO THE EXCLUSIVE  
RIGHT TO USE "HOSTED SOLUTION", APART  
FROM THE MARK AS SHOWN.

SEC. 2(F) AS TO "STATS".

SER. NO. 78-943,261, FILED 8-2-2006.

PAM WILLIS, EXAMINING ATTORNEY

Int. Cl.: 41

Prior U.S. Cls.: 100, 101 and 107

United States Patent and Trademark Office

Reg. No. 3,453,848

Registered June 24, 2008

**SERVICE MARK  
PRINCIPAL REGISTER**



OLD STATS LLC (DELAWARE CORPORATION)  
8130 LEHIGH AVENUE  
MORTON GROVE, IL 60053

FOR: ENTERTAINMENT SERVICES, NAMELY,  
PROVIDING INFORMATION ABOUT SPORTS,  
SCORES, TEAMS AND INDIVIDUAL ATHLETIC  
PERFORMANCES, SCHEDULES AND NEWS AND  
INFORMATION ABOUT SPORTS VIA A GLOBAL  
COMPUTER NETWORK, IN CLASS 41 (U.S. CLS. 100,  
101 AND 107).

FIRST USE 7-27-2006; IN COMMERCE 7-27-2006.

OWNER OF U.S. REG. NOS. 2,199,423, 2,843,912  
AND OTHERS.

NO CLAIM IS MADE TO THE EXCLUSIVE  
RIGHT TO USE "HOSTED SOLUTION", APART  
FROM THE MARK AS SHOWN.

THE COLOR(S) RED, BLACK AND WHITE IS/  
ARE CLAIMED AS A FEATURE OF THE MARK.

THE MARK CONSISTS OF THE COLOR WHITE  
APPEARS IN THE WORDING "STATS HOSTED  
SOLUTION" AND THE COLORS RED AND BLACK  
APPEAR IN THE SPECIAL FORM PARALLELO-  
GRAM DESIGN.

SEC. 2(F) AS TO "STATS".

SER. NO. 78-943,295, FILED 8-2-2006.

PAM WILLIS, EXAMINING ATTORNEY

**Int. Cl.: 34**

**Prior U.S. Cls.: 2, 8, 9 and 17**

**United States Patent and Trademark Office**

**Reg. No. 3,453,849**

**Registered June 24, 2008**

**TRADEMARK  
PRINCIPAL REGISTER**

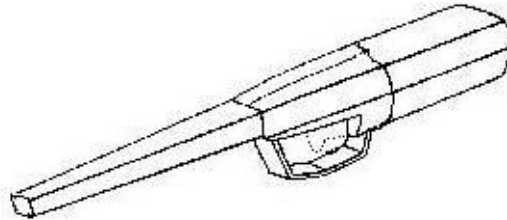

SCRIPTO-TOKAI CORPORATION (DELAWARE CORPORATION)  
2055 S. HAVEN AVENUE  
ONTARIO, CA 91761

FOR: UTILITY LIGHTERS, IN CLASS 34 (U.S. CLS. 2, 8, 9 AND 17).

FIRST USE 5-18-1985; IN COMMERCE 5-18-1985.

THE MARK CONSISTS OF ANGLED DESIGN OF LIGHTER. THE DOTTED LINES REPRESENT THE LOCATION OF THE TRIGGER ONLY AND DO NOT CONSTITUTE A PART OF THE MARK.

SEC. 2(F).

SER. NO. 78-943,455, FILED 8-2-2006.

CAROLYN CATALDO, EXAMINING ATTORNEY

**Int. Cl.: 16**

**Prior U.S. Cls.: 2, 5, 22, 23, 29, 37, 38 and 50**

**Reg. No. 3,453,850**

**United States Patent and Trademark Office**

**Registered June 24, 2008**

---

**TRADEMARK  
PRINCIPAL REGISTER**

**PRESSED PETALS**

DCWV ACQUISITION CORPORATION (DELA-  
WARE CORPORATION)  
C/O H.I.G. CAPITAL, LLC  
ONE MARKET – SPEAR TOWER  
SAN FRANCISCO, CA 94105

FOR: SCRAPBOOK, MEMORY, STATIONERY  
AND CRAFT PRODUCTS, NAMELY, SCRAP-  
BOOKS, SCRAPBOOK PAGES, CRAFT PAPER,  
STICKERS, DRAWING TEMPLATES, MEMORY  
BOOKS AND ALBUMS, IN CLASS 16 (U.S. CLS. 2, 5,  
22, 23, 29, 37, 38 AND 50).

FIRST USE 0-0-1993; IN COMMERCE 0-0-1993.

THE MARK CONSISTS OF STANDARD CHAR-  
ACTERS WITHOUT CLAIM TO ANY PARTICULAR  
FONT, STYLE, SIZE, OR COLOR.

SER. NO. 78-943,543, FILED 8-2-2006.

BILL DAWE, EXAMINING ATTORNEY



**Int. Cls.: 35 and 41**

**Prior U.S. Cls.: 100, 101, 102 and 107**

**United States Patent and Trademark Office**

**Reg. No. 3,453,851**

**Registered June 24, 2008**

**SERVICE MARK  
PRINCIPAL REGISTER**

**DEALMAKERS SUMMIT**

THE MARATHON CLUB FOR ENTREPRENEURSHIP (D.C. CORPORATION)  
SUITE 700  
1300 PENNSYLVANIA AVE., NW  
WASHINGTON, DC 20004

FOR: BUSINESS NETWORKING EVENTS, IN CLASS 35 (U.S. CLS. 100, 101 AND 102).

FIRST USE 7-12-2005; IN COMMERCE 7-12-2005.

FOR: EDUCATIONAL SERVICES, NAMELY, PROVIDING CLASSES, WORKSHOPS AND SEMINARS IN THE FIELDS OF ENTREPRENEURSHIP AND PRIVATE EQUITY CAPITAL; ARRANGING AND CONDUCTING EDUCATIONAL CONFERENCES IN THE FIELDS OF ENTREPRENEURSHIP

AND PRIVATE EQUITY CAPITAL, IN CLASS 41 (U.S. CLS. 100, 101 AND 107).

FIRST USE 7-12-2005; IN COMMERCE 7-12-2005.

THE MARK CONSISTS OF STANDARD CHARACTERS WITHOUT CLAIM TO ANY PARTICULAR FONT, STYLE, SIZE, OR COLOR.

NO CLAIM IS MADE TO THE EXCLUSIVE RIGHT TO USE "SUMMIT", APART FROM THE MARK AS SHOWN.

SER. NO. 78-946,275, FILED 8-7-2006.

REBECCA EISINGER, EXAMINING ATTORNEY

**Int. Cls.: 35, 36 and 42**

**Prior U.S. Cls.: 100, 101 and 102**

**United States Patent and Trademark Office**

**Reg. No. 3,453,852**

**Registered June 24, 2008**

**SERVICE MARK  
PRINCIPAL REGISTER**



ALLEGIANCE LEASING COMPANY, LLC (DE-  
LAWARE LTD LIAB CO)  
SUITE 300  
1322 WALNUT STREET  
WESTERN SPRINGS, IL 60558

FOR: LEASING OF RADIO FREQUENCY IDENTIFICATION EQUIPMENT AND RELATED EQUIPMENT FOR USE IN BUSINESS AND INDUSTRY, IN CLASS 35 (U.S. CLS. 100, 101 AND 102).

FIRST USE 8-1-2006; IN COMMERCE 8-1-2006.

FOR: FINANCING OF RADIO FREQUENCY IDENTIFICATION EQUIPMENT AND RELATED COMPUTER EQUIPMENT, IN CLASS 36 (U.S. CLS. 100, 101 AND 102).

FIRST USE 8-1-2006; IN COMMERCE 8-1-2006.

FOR: LEASING COMPUTERS FOR USE WITH RADIO FREQUENCY IDENTIFICATION EQUIPMENT, IN CLASS 42 (U.S. CLS. 100 AND 101).

FIRST USE 8-1-2006; IN COMMERCE 8-1-2006.

NO CLAIM IS MADE TO THE EXCLUSIVE RIGHT TO USE "RFID LEASING" , APART FROM THE MARK AS SHOWN.

THE MARK CONSISTS OF DRAWING OF A MAZE LIKE PATTERN ACCOMPANIED BY THE WORDS "RFID LEASING".

SER. NO. 78-947,062, FILED 8-8-2006.

LINDA MICKLEBURGH, EXAMINING ATTORNEY

**Int. Cls.: 9 and 35**

**Prior U.S. Cls.: 21, 23, 26, 36, 38, 100, 101 and 102**

**United States Patent and Trademark Office**

**Reg. No. 3,453,853**

**Registered June 24, 2008**

**TRADEMARK  
SERVICE MARK  
PRINCIPAL REGISTER**

# SUPERCIRCUITS

SUPERCIRCUITS, INC. (TEXAS CORPORATION)  
11000 N. MOPAC EXPRESSWAY  
SUITE 300  
AUSTIN, TX 78759

FOR: PHOTOGRAPHIC CAMERAS, VIDEO CAMERAS, CAMERA LENSES, CAMERA HOUSINGS, VCR RECORDERS, ELECTRIC SWITCHES, DIGITAL QUAD UNITS FOR VIEWING MULTIPLE VIDEO IMAGES ON ONE MONITOR, AUDIO MONITORS, VIDEO MONITORS, AUDIO TRANSMITTERS, VIDEO TRANSMITTERS, AUDIO RECEIVERS, VIDEO RECEIVERS, ANTENNAS, ROBOTS FOR PERSONAL AND/OR HOBBY USE, MICROPHONES, SECURITY EQUIPMENT, NAMELY, BURGLAR ALARMS, MOTION SENSORS, ELECTRONIC EQUIPMENT FOR ACCESS CONTROL; AND INTRUSION DETECTION EQUIPMENT, NAMELY, BURGLAR ALARMS, MOTION SENSORS, AND ELECTRONIC EQUIPMENT FOR ACCESS CONTROL, IN CLASS 9 (U.S. CLS. 21, 23, 26, 36 AND 38).

FIRST USE 6-30-1989; IN COMMERCE 6-30-1989.

FOR: RETAIL ELECTRONIC EQUIPMENT STORES; MAIL ORDER CATALOG SERVICES FEATURING PHOTOGRAPHIC CAMERAS, VIDEO CAMERAS, CAMERA LENSES, CAMERA HOUSINGS, VCR RECORDERS, ELECTRIC SWITCHES, DIGITAL QUAD UNITS FOR VIEWING MULTIPLE VIDEO IMAGES ON ONE MONITOR, AUDIO MONITORS, VIDEO MONITORS, AUDIO TRANSMITTERS, VIDEO TRANSMITTERS, AUDIO RECEIVERS, VIDEO RECEIVERS, ANTENNAS, ROBOTS FOR PERSONAL AND/OR HOBBY USE, MICROPHONES, SECURITY EQUIPMENT, NAMELY, BURGLAR ALARMS, MOTION SENSORS, ELECTRONIC EQUIPMENT FOR ACCESS CONTROL; AND INTRUSION DETECTION EQUIPMENT, NAMELY, BURGLAR ALARMS, MOTION SENSORS, AND ACCESS CONTROL, IN CLASS 35 (U.S. CLS. 100, 101 AND 102).

TURING PHOTOGRAPHIC CAMERAS, VIDEO CAMERAS, CAMERA LENSES, CAMERA HOUSINGS, VCR RECORDERS, ELECTRIC SWITCHES, DIGITAL QUAD UNITS, AUDIO MONITORS, VIDEO MONITORS, AUDIO TRANSMITTERS, VIDEO TRANSMITTERS, AUDIO RECEIVERS, VIDEO RECEIVERS, ANTENNAS, ROBOTS FOR PERSONAL AND/OR HOBBY USE, MICROPHONES, SECURITY EQUIPMENT, NAMELY, BURGLAR ALARMS, MOTION SENSORS, ACCESS CONTROL; AND INTRUSION DETECTION EQUIPMENT, NAMELY, BURGLAR ALARMS, MOTION SENSORS, AND ACCESS CONTROL, IN CLASS 35 (U.S. CLS. 100, 101 AND 102).

FIRST USE 6-30-1989; IN COMMERCE 6-30-1989.

THE MARK CONSISTS OF STANDARD CHARACTERS WITHOUT CLAIM TO ANY PARTICULAR FONT, STYLE, SIZE, OR COLOR.

OWNER OF U.S. REG. NO. 3,104,689.

SER. NO. 78-948,978, FILED 8-9-2006.

MARK PILARO, EXAMINING ATTORNEY

**Int. Cl.: 16**

**Prior U.S. Cls.: 2, 5, 22, 23, 29, 37, 38 and 50**

**Reg. No. 3,453,854**

**United States Patent and Trademark Office**

**Registered June 24, 2008**

**TRADEMARK  
PRINCIPAL REGISTER**

**FOOD STUDIOS**

KATHY CASEY, INC. (WASHINGTON CORPORATION)  
5130 BALLARD AVENUE N.W.  
SEATTLE, WA 98107

THE MARK CONSISTS OF STANDARD CHARACTERS WITHOUT CLAIM TO ANY PARTICULAR FONT, STYLE, SIZE, OR COLOR.

FOR: PAPER AND PRINTED MATERIALS, NAMELY, RECIPE BOOKS, INFORMATIONAL FLIERS, BROCHURES, PAMPHLETS, RECIPE CARDS, NEWSLETTERS IN THE FIELD OF CULINARY CONSULTING SERVICES, NAPKINS, MEMO PADS, IN CLASS 16 (U.S. CLS. 2, 5, 22, 23, 29, 37, 38 AND 50).

NO CLAIM IS MADE TO THE EXCLUSIVE RIGHT TO USE "FOOD", APART FROM THE MARK AS SHOWN.

SER. NO. 78-951,284, FILED 8-14-2006.

FIRST USE 1-1-1999; IN COMMERCE 1-1-1999.

LOURDES AYALA, EXAMINING ATTORNEY

**Int. Cl.: 16**

**Prior U.S. Cls.: 2, 5, 22, 23, 29, 37, 38 and 50**

**Reg. No. 3,453,855**

**United States Patent and Trademark Office**

**Registered June 24, 2008**

**TRADEMARK  
PRINCIPAL REGISTER**

**WATER JOURNAL**

M&FC HOLDING, LLC (DELAWARE LTD LIAB  
CO)  
1209 ORANGE STREET  
WILMINGTON, DE 19801

FOR: HOUSE ORGAN PUBLISHED FROM TIME  
TO TIME CONCERNING METERS, NAMELY, ME-  
TERING COMMUNICATIONS SYSTEM SOLU-  
TIONS THAT COMPRISE BOTH AUTOMATIC  
METER READING AND ADVANCED METERING  
INFRASTRUCTURE SYSTEMS, IN CLASS 16 (U.S.  
CLS. 2, 5, 22, 23, 29, 37, 38 AND 50).

FIRST USE 11-30-1950; IN COMMERCE 11-30-1950.

THE MARK CONSISTS OF STANDARD CHAR-  
ACTERS WITHOUT CLAIM TO ANY PARTICULAR  
FONT, STYLE, SIZE, OR COLOR.

NO CLAIM IS MADE TO THE EXCLUSIVE  
RIGHT TO USE "JOURNAL", APART FROM THE  
MARK AS SHOWN.

SEC. 2(F).

SER. NO. 78-951,961, FILED 8-15-2006.

CARYN GLASSER, EXAMINING ATTORNEY

Int. Cl.: 35

Prior U.S. Cls.: 100, 101 and 102

United States Patent and Trademark Office

Reg. No. 3,453,856

Registered June 24, 2008

**SERVICE MARK  
PRINCIPAL REGISTER**

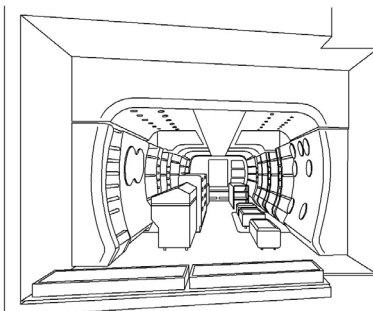

FLIGHT 001 HOLDINGS, INC. (CALIFORNIA CORPORATION)  
96 GREENWICH AVENUE  
NEW YORK, NY 10011

FOR: RETAIL STORE SERVICES FOR TRAVEL RELATED PRODUCTS, IN CLASS 35 (U.S. CLS. 100, 101 AND 102).

FIRST USE 4-17-1999; IN COMMERCE 4-17-1999.

THE MARK CONSISTS OF THREE-DIMENSIONAL TRADE DRESS DEPICTING THE INTERIOR OF A RETAIL STORE EVOKING THE THEME OF THE INTERIOR CABIN OF A COMMERCIAL AIRCRAFT AND 1960S-ERA AIRLINE TRAVEL, WITH CURVED

WALLS, A CLEARLY DEFINED CENTER AISLE, ITEMS ON EITHER SIDE OF THE AISLE, CUBICLE-STYLED SHELVING, WOOD PANELING, A COMMEMORATIVE FLIGHT ROUTE MAP, A RECTANGULAR LIGHT PANEL IN THE CEILING OVER THE CENTER AISLE, AND RECESSED LIGHTING ON THE CEILING ON EITHER SIDE OF THE RECTANGULAR LIGHT PANEL.

SEC. 2(F).

SER. NO. 78-952,067, FILED 8-15-2006.

KEVIN CORWIN, EXAMINING ATTORNEY

**Int. Cl.: 28**

**Prior U.S. Cls.: 22, 23, 38 and 50**

**United States Patent and Trademark Office**

**Reg. No. 3,453,857**

**Registered June 24, 2008**

**TRADEMARK  
PRINCIPAL REGISTER**



FRANZ SCHNEIDER GMBH & CO. KG (FED REP GERMANY CORPORATION)  
SIEMENSSTRASSE 13-19, NEUSTADT B.  
COBURG, FED REP GERMANY 96465

FOR: PEDAL OPERATED VEHICLES FOR CHILDREN, NAMELY, A TOY, RIDEABLE, FOUR-WHEEL TRACTOR BOTH WITH AND WITHOUT A TRAILER, FOR CHILDREN , IN CLASS 28 (U.S. CLS. 22, 23, 38 AND 50).

FIRST USE 8-31-2004; IN COMMERCE 8-31-2004.

OWNER OF U.S. REG. NOS. 1,969,845, 3,041,986 AND OTHERS.

THE COLOR(S) PURPLE GRAY BLACK GOLD WHITE RED IS/ARE CLAIMED AS A FEATURE OF THE MARK.

THE COLOR YELLOW APPEARS IN THE WORD "JUNIOR" WITH A THIN BLACK OUTLINE AROUND EACH LETTER AND A WHILE OUTER BORDER AROUND EACH LETTER, THE COLOR PURPLE APPEARS IN THE WORD "ROLLY" WITH A GRAY BORDER AND BACKGROUND, THE COLOR RED APPEARS IN THE LINE BELOW THE TERN "JUNIOR", AND THE COLOR BLACK APPEARS AS THE BACKGROUND.

SER. NO. 78-953,722, FILED 8-16-2006.

ASMAT KHAN, EXAMINING ATTORNEY

**Int. Cl.: 43**

**Prior U.S. Cls.: 100 and 101**

**United States Patent and Trademark Office**

**Reg. No. 3,453,858**

**Registered June 24, 2008**

**SERVICE MARK  
PRINCIPAL REGISTER**

**INN AT USC**

USC HOTEL INVESTMENTS, LLC (SOUTH CAROLINA LTD LIAB CO)

P.O. BOX 21427

COLUMBIA, SC 29221

FOR: HOTEL SERVICES, IN CLASS 43 (U.S. CLS. 100 AND 101).

FIRST USE 7-29-2005; IN COMMERCE 7-29-2005.

THE MARK CONSISTS OF STANDARD CHARACTERS WITHOUT CLAIM TO ANY PARTICULAR FONT, STYLE, SIZE, OR COLOR.

NO CLAIM IS MADE TO THE EXCLUSIVE RIGHT TO USE "INN", APART FROM THE MARK AS SHOWN.

SER. NO. 78-954,635, FILED 8-17-2006.

JENNY PARK, EXAMINING ATTORNEY



**Int. Cl.: 9**

**Prior U.S. Cls.: 21, 23, 26, 36 and 38**

**Reg. No. 3,453,859**

**United States Patent and Trademark Office**

**Registered June 24, 2008**

**TRADEMARK  
PRINCIPAL REGISTER**

**SHELBY SYSTEMS**

SHELBY SYSTEMS, INC. (TENNESSEE CORPORATION)  
SUITE 300  
51 GERMANTOWN COURT  
CORDOVA, TN 38018

FOR: CHURCH MANAGEMENT SOFTWARE AND PROGRAM MANUALS ALL SOLD AS A UNIT FOR USE IN CHURCH MANAGEMENT, NAMELY, MANAGEMENT OF CHURCH MEMBERSHIP, MANAGEMENT OF CHURCH DONATIONS, MANAGEMENT OF CHURCH DATABASES, MANAGEMENT OF CHURCH FINANCES, AND MANAGEMENT OF CHURCH ATTENDANCE, SECURITY, AND EVENT REGISTRATION, IN CLASS 9 (U.S. CLS. 21, 23, 26, 36 AND 38).

FIRST USE 6-1-1976; IN COMMERCE 6-1-1976.

THE MARK CONSISTS OF STANDARD CHARACTERS WITHOUT CLAIM TO ANY PARTICULAR FONT, STYLE, SIZE, OR COLOR.

NO CLAIM IS MADE TO THE EXCLUSIVE RIGHT TO USE "SYSTEMS", APART FROM THE MARK AS SHOWN.

SER. NO. 78-954,667, FILED 8-17-2006.

YAT SYE, LEE, EXAMINING ATTORNEY

**Int. Cl.: 16**

**Prior U.S. Cls.: 2, 5, 22, 23, 29, 37, 38 and 50**

**Reg. No. 3,453,860**

**United States Patent and Trademark Office**

**Registered June 24, 2008**

---

**TRADEMARK  
PRINCIPAL REGISTER**

**OIL MILL GAZETTEER**

INTERNATIONAL OIL MILL SUPERINTENDENTS ASSOCIATION (TEXAS UNINC. ASSOCIATION)  
940 MESA VISTA DRIVE  
CROWLEY, TX 76036

FOR: MAGAZINES FEATURING OIL MILL TRADE INFORMATION, IN CLASS 16 (U.S. CLS. 2, 5, 22, 23, 29, 37, 38 AND 50).

FIRST USE 12-31-1899; IN COMMERCE 12-31-1899.

THE MARK CONSISTS OF STANDARD CHARACTERS WITHOUT CLAIM TO ANY PARTICULAR FONT, STYLE, SIZE, OR COLOR.

SEC. 2(F).

SER. NO. 78-957,286, FILED 8-22-2006.

LA TONIA FISHER, EXAMINING ATTORNEY

**Int. Cl.: 9**

**Prior U.S. Cls.: 21, 23, 26, 36 and 38**

**Reg. No. 3,453,861**

**United States Patent and Trademark Office**

**Registered June 24, 2008**

---

**TRADEMARK  
PRINCIPAL REGISTER**

**TERRAFOIL-FP**

DAYSTAR TECHNOLOGIES INC. (DELAWARE  
CORPORATION)  
13 CORPORATE DRIVE  
HALFMOON, NY 12065

THE MARK CONSISTS OF STANDARD CHAR-  
ACTERS WITHOUT CLAIM TO ANY PARTICULAR  
FONT, STYLE, SIZE, OR COLOR.

FOR: SOLAR CELLS AND PHOTOVOLTAIC SO-  
LAR MODULES, IN CLASS 9 (U.S. CLS. 21, 23, 26, 36  
AND 38).

SER. NO. 78-957,422, FILED 8-22-2006.

FIRST USE 7-6-2006; IN COMMERCE 7-6-2006.

KRISTIN DAHLING, EXAMINING ATTORNEY

**Int. Cls.: 16 and 25**

**Prior U.S. Cls.: 2, 5, 22, 23, 29, 37, 38, 39 and 50**

**Reg. No. 3,453,862**

**United States Patent and Trademark Office**

**Registered June 24, 2008**

**TRADEMARK  
PRINCIPAL REGISTER**



FORT HAYS STATE UNIVERSITY (KANSAS  
EDUCATIONAL INSTITUTION)  
PRESIDENT'S OFFICE  
600 PARK STREET  
HAYS, KS 67601

FOR: STATIONERY, NOTEBOOKS, NOTEPAPER,  
PHOTOGRAPHS, AND OTHER PAPER PRODUCTS,  
NAMELY, INVITATIONS AND BLANK CARDS, IN  
CLASS 16 (U.S. CLS. 2, 5, 22, 23, 29, 37, 38 AND 50).

FIRST USE 4-3-2000; IN COMMERCE 4-3-2000.

FOR: SHIRTS, JACKETS, CAPS, AND SWEAT-  
SHIRTS, IN CLASS 25 (U.S. CLS. 22 AND 39).

FIRST USE 4-3-2000; IN COMMERCE 4-3-2000.

THE COLOR(S) BLACK AND GOLD AND WHITE  
IS/ARE CLAIMED AS A FEATURE OF THE MARK.

THE MARK CONSISTS OF A TIGER HEAD.  
BLACK APPEARS IN THE PUPILS, NOSE, INNER

MOUTH, SPACE BETWEEN LOWER LIP AND  
CHIN, FOREHEAD, TIPS OF THE WHISKERS OF  
THE TIGER HEAD, AREA SURROUNDING THE  
EAR, TWO HIGHLIGHTED PORTIONS BELOW  
THE NECK, AND STRIPES (ALTERNATING WITH  
GOLD AND WHITE) ON EITHER SIDE OF THE  
MANE. BLACK ALSO APPEARS IN THE BEARD.  
GOLD APPEARS IN THE EYEBROWS, A STRIPE IN  
THE SHAPE OF A "V" IN THE NECK BELOW THE  
CHIN, AND STRIPES (ALTERNATING WITH  
BLACK AND WHITE) ON EITHER SIDE OF THE  
MANE. WHITE IS USED FOR THE EYEBALLS,  
HIGHLIGHTED PORTIONS OF THE AREA IMME-  
DIATELY ABOVE AND BELOW THE NOSE AND  
SURROUNDING THE AREA BETWEEN THE  
MOUTH AND OUTER MANE, INNER PORTIONS  
OF THE WHISKERS, TEETH, CHIN AND STRIPES  
(ALTERNATING WITH BLACK AND GOLD) ON  
EITHER SIDE OF THE MANE.

SER. NO. 78-957,789, FILED 8-22-2006.

LA TONIA FISHER, EXAMINING ATTORNEY

**Int. Cl.: 29**

**Prior U.S. Cl.: 46**

**United States Patent and Trademark Office**

**Reg. No. 3,453,863**

**Registered June 24, 2008**

**TRADEMARK  
PRINCIPAL REGISTER**



OMSTEAD FOODS LIMITED (CANADA CORPORATION)  
ONE ERIE STREET SOUTH  
WHEATLEY, CANADA N0P 2P0

FOR: FRESH, FROZEN AND COOKED FISH, COOKED SCALLOPS, OYSTERS AND SHRIMP AND PRECOOKED FISH PRODUCTS, NAMELY, BREADED AND BATTERED FISH; FROZEN VEGETABLES, NAMELY, COOKED AND BREADED VEGETABLES; FROZEN FRUITS; FROZEN APPETIZERS, NAMELY, BREADED AND BATTERED VEGETABLES AND CHEESE, IN CLASS 29 (U.S. CL. 46).

PRIORITY CLAIMED UNDER SEC. 44(D) ON CANADA APPLICATION NO. 1313588, FILED 8-18-2006, REG. NO. TMA705488, DATED 1-23-2008, EXPIRES 1-23-2023.

OWNER OF U.S. REG. NOS. 1,105,246 AND 1,487,660.

SER. NO. 78-957,952, FILED 8-22-2006.

JOHN KELLY, EXAMINING ATTORNEY

**Int. Cl.: 28**

**Prior U.S. Cls.: 22, 23, 38 and 50**

**United States Patent and Trademark Office**

**Reg. No. 3,453,864**

**Registered June 24, 2008**

**TRADEMARK  
PRINCIPAL REGISTER**

**RED CARPET GLAM**

MATTEL, INC. (DELAWARE CORPORATION)  
MAIL STOP M1-1518  
333 CONTINENTAL BOULEVARD  
EL SEGUNDO, CA 90245

THE MARK CONSISTS OF STANDARD CHARACTERS WITHOUT CLAIM TO ANY PARTICULAR FONT, STYLE, SIZE, OR COLOR.

FOR: TOYS, GAMES AND PLAYTHINGS, NAME-  
LY, DOLLS, DOLL CLOTHING AND DOLL ACCES-  
SORIES, TOY FIGURES AND ACCESSORIES  
THEREFOR, IN CLASS 28 (U.S. CLS. 22, 23, 38 AND  
50).

OWNER OF U.S. REG. NO. 2,921,532.

SER. NO. 78-958,129, FILED 8-22-2006.

FIRST USE 2-22-2007; IN COMMERCE 2-22-2007.

ELIZABETH BEYER, EXAMINING ATTORNEY

**Int. Cls.: 35 and 41**

**Prior U.S. Cls.: 100, 101, 102 and 107**

**United States Patent and Trademark Office**

**Reg. No. 3,453,865**

**Registered June 24, 2008**

**SERVICE MARK  
PRINCIPAL REGISTER**

# FRUITQUAKE

FRUITQUAKE MEDIA, LLC (DELAWARE LTD  
LIAB CO)  
SUITE 18  
1601 MILLTOWN RD.  
WILMINGTON, DE 19808

FOR: ADVERTISING AND PUBLICITY SERVICES, NAMELY, PROMOTING THE GOODS, SERVICES, BRAND IDENTITY AND COMMERCIAL INFORMATION AND NEWS OF THIRD PARTIES THROUGH PRINT, AUDIO, VIDEO, DIGITAL AND ON-LINE MEDIUM; ON-LINE RETAIL STORE SERVICES FEATURING A WIDE VARIETY OF GOODS, NAMELY, BOOKS, MUSIC, DVDS, MOVIES, NUTRITIONAL PRODUCTS, WELLNESS PRODUCTS, ALTERNATIVE THERAPY DEVICES, ENVIRONMENTALLY FRIENDLY PRODUCTS, AND ENERGY EFFICIENCY PRODUCTS; ONLINE ADVERTISING AND MARKETING SERVICES; PROVIDING ON-LINE PRODUCT REVIEWS IN THE FIELD OF NUTRITIONAL PRODUCTS, WELLNESS PRODUCTS, ALTERNATIVE THERAPY DEVICES, ENVIRONMENTALLY FRIENDLY PRODUCTS AND ENERGY EFFICIENCY PRODUCTS, IN CLASS 35 (U.S. CLS. 100, 101 AND 102).

FIRST USE 8-11-2006; IN COMMERCE 8-11-2006.

FOR: ELECTRONIC PUBLISHING SERVICES, NAMELY, PUBLICATION OF TEXT AND GRAPHIC

WORKS OF OTHERS ON ON-LINE FEATURING HEALTH ISSUES, WELLNESS ISSUES, ENVIRONMENTAL ISSUES, SOCIAL ISSUES, PHILANTHROPIC ISSUES, AND PERSONAL DEVELOPMENT ISSUES; ENTERTAINMENT SERVICES, NAMELY, PROVIDING A TELEVISION PROGRAM IN THE FIELD OF VARIETY, NEWS AND COMEDY VIA A GLOBAL COMPUTER NETWORK; ENTERTAINMENT SERVICES, NAMELY, PROVIDING ON-LINE REVIEWS OF MOVIES, BOOKS, MUSIC, AND COMPUTER GAMES; ENTERTAINMENT, NAMELY A CONTINUING VARIETY, NEWS AND COMEDY SHOW BROADCAST OVER TELEVISION, SATELLITE, AUDIO, AND VIDEO MEDIA; ONLINE JOURNALS, NAMELY, BLOGS FEATURING PERSONAL INTERESTS, ENVIRONMENTAL TOPICS, PERSONAL HEALTH, AND CURRENT EVENTS, IN CLASS 41 (U.S. CLS. 100, 101 AND 107).

FIRST USE 8-11-2006; IN COMMERCE 8-11-2006.

THE MARK CONSISTS OF STANDARD CHARACTERS WITHOUT CLAIM TO ANY PARTICULAR FONT, STYLE, SIZE, OR COLOR.

SER. NO. 78-958,495, FILED 8-23-2006.

ELLEN PERKINS, EXAMINING ATTORNEY

**Int. Cl.: 35**

**Prior U.S. Cls.: 100, 101 and 102**

**United States Patent and Trademark Office**

**Reg. No. 3,453,866**

**Registered June 24, 2008**

---

**SERVICE MARK  
PRINCIPAL REGISTER**

**ACE**

KAHLER SLATER ARCHITECTS, INC. (WISCONSIN CORPORATION)  
111 WEST WISCONSIN AVENUE  
MILWAUKEE, WI 53202

THE MARK CONSISTS OF STANDARD CHARACTERS WITHOUT CLAIM TO ANY PARTICULAR FONT, STYLE, SIZE, OR COLOR.

FOR: CONSULTING SERVICES IN THE FIELD OF HIGHER EDUCATION ADMINISTRATION, IN CLASS 35 (U.S. CLS. 100, 101 AND 102).

SER. NO. 78-958,875, FILED 8-23-2006.

FIRST USE 6-27-2005; IN COMMERCE 6-27-2005.

ELI HELLMAN, EXAMINING ATTORNEY



**Int. Cl.: 16**

**Prior U.S. Cls.: 2, 5, 22, 23, 29, 37, 38 and 50**

**Reg. No. 3,453,867**

**United States Patent and Trademark Office**

**Registered June 24, 2008**

**TRADEMARK  
PRINCIPAL REGISTER**

**The Cross of Forgiveness**

THE 247 GROUP PTY LTD (AUSTRALIA CORPORATION)  
627 MILITARY ROAD  
MOSMAN, AUSTRALIA 2088

FOR: PAPER, NAMELY, GIFT WRAPPING, BOND, TYPING, DECORATED, COLOURED AND COPY PAPER; CARDBOARD, ; AND GOODS MADE OF PAPER AND CARDBOARD, NAMELY, ENVELOPES, GIFT BOXES AND PRESENTATION FOLDERS; PRINTED MATTER, NAMELY, GREETING AND POST CARDS, CARDS BEARING UNIVERSAL GREETINGS, PRINTED PERIODICALS AND PUBLICATIONS, NAMELY, BOOKS AND MAGAZINES IN THE FIELD OF PHILOSOPHY AND RELIGION; PHOTOGRAPHS; STATIONERY; ADHESIVES FOR STATIONERY OR HOUSEHOLD PURPOSES; ARTIST' MATERIALS; NAMELY, PENS, PENCILS CRAYONS AND PASTELS; PAINT BRUSHES; TYPEWRITERS AND OFFICE REQUISITES, NAMELY, PUNCHES, ERASERS, RUBBER BANDS, STAPLERS

AND STAPLES; PRINTED INSTRUCTIONAL AND TEACHING MATERIAL IN THE FIELD OF PHILOSOPHY AND RELIGION; PRINTER'S TYPE; PRINTING BLOCKS, IN CLASS 16 (U.S. CLS. 2, 5, 22, 23, 29, 37, 38 AND 50).

THE MARK CONSISTS OF STANDARD CHARACTERS WITHOUT CLAIM TO ANY PARTICULAR FONT, STYLE, SIZE, OR COLOR.

PRIORITY CLAIMED UNDER SEC. 44(D) ON AUSTRALIA APPLICATION NO. 1130161, FILED 8-16-2006, REG. NO. 1130161, DATED 8-16-2006, EXPIRES 8-16-2016.

OWNER OF U.S. REG. NO. 3,156,674.

SER. NO. 78-961,341, FILED 8-27-2006.

KAREN BRACEY, EXAMINING ATTORNEY

**Int. Cl.: 42**

**Prior U.S. Cls.: 100 and 101**

**United States Patent and Trademark Office**

**Reg. No. 3,453,868**

**Registered June 24, 2008**

**SERVICE MARK  
PRINCIPAL REGISTER**

**WOOLPERT**

WOOLPERT, INC. (OHIO CORPORATION)  
409 EAST MONUMENT AVENUE  
DAYTON, OH 45402

FOR: PROFESSIONAL ENGINEERING; SURVEY-  
ING; ARCHITECTURAL DESIGN; ARCHITECTUR-  
AL PLANNING; LANDSCAPE ARCHITECTURE;  
AERIAL PHOTOGRAPHY; PHOTOGRAMMETRY;  
GEOSPATIAL SERVICES UTILIZING GEOGRAPH-  
IC INFORMATION SYSTEMS, SURVEYING, GLO-  
BAL POSITIONING SYSTEMS AND  
PHOTOGRAMMETRY SERVICES; CONSULTING  
SERVICES IN THE FIELD OF GEOGRAPHIC IN-

FORMATION SYSTEMS, IN CLASS 42 (U.S. CLS. 100  
AND 101).

FIRST USE 0-0-1979; IN COMMERCE 0-0-1979.

THE MARK CONSISTS OF STANDARD CHAR-  
ACTERS WITHOUT CLAIM TO ANY PARTICULAR  
FONT, STYLE, SIZE, OR COLOR.

OWNER OF U.S. REG. NO. 1,710,572.

SER. NO. 78-963,686, FILED 8-30-2006.

DAVID I, EXAMINING ATTORNEY

**Int. Cl.: 41**

**Prior U.S. Cls.: 100, 101 and 107**

**United States Patent and Trademark Office**

**Reg. No. 3,453,869**

**Registered June 24, 2008**

**SERVICE MARK  
PRINCIPAL REGISTER**



PIANO LESSONS IN YOUR HOME, INC. (OHIO CORPORATION)  
6497 PROPRIETORS ROAD  
WORTHINGTON, OH 43085

FOR: PROVISION OF MUSIC, INSTRUMENT AND VOICE LESSONS BY INSTRUCTORS, IN CLASS 41 (U.S. CLS. 100, 101 AND 107).

FIRST USE 6-20-2006; IN COMMERCE 7-1-2006.

NO CLAIM IS MADE TO THE EXCLUSIVE RIGHT TO USE "PIANO LESSONS IN YOUR HOME", APART FROM THE MARK AS SHOWN.

THE MARK CONSISTS OF, IN CAPITALIZED BOLD PRINT, THE WORDS "PIANO LESSONS" ATOP A GRAND PIANO LID THAT IS SUPERIMPOSED ON A HOUSE, BELOW WHICH IS, IN CAPITALIZED BOLD PRINT, THE WORDS "IN YOUR HOME", WITH 48 PIANO KEYS DIRECTLY BELOW "IN YOUR HOME."

SER. NO. 78-965,264, FILED 8-31-2006.

DAVID TOOLEY, EXAMINING ATTORNEY

**Int. Cls.: 9, 16 and 40**

**Prior U.S. Cls.: 2, 5, 21, 22, 23, 26, 29, 36, 37, 38, 50,  
100, 103 and 106**

**Reg. No. 3,453,870**

**United States Patent and Trademark Office**

**Registered June 24, 2008**

**TRADEMARK  
SERVICE MARK  
PRINCIPAL REGISTER**



FORMATION, INC. (NEW JERSEY CORPORATION)  
121 WHITTENDALE DRIVE  
MOORESTOWN, NJ 08057

FOR: COMPUTER HARDWARE, NAMELY, COMPUTER TERMINALS, COMPUTER MEMORIES, MAGNETIC TAPE DRIVES AND CONTROLLERS WHICH PROVIDE THE ELECTRICAL INTERFACE TO COMPUTERS, MAGNETIC DISK DRIVES AND CONTROLLERS WHICH PROVIDE THE ELECTRICAL INTERFACE TO COMPUTERS, AND COMPONENT PARTS THEREFORE, COMPUTER TO COMPUTER AND COMPUTER TO TERMINAL INTERFACING UNITS IN THE NATURE OF WIFI WIRELESS HARDWARE AND INTERFACING ELECTRICAL CIRCUITRY FOR ETHERNET CONNECTIVITY, IN CLASS 9 (U.S. CLS. 21, 23, 26, 36 AND 38).

FIRST USE 9-20-1996; IN COMMERCE 9-20-1996.

FOR: PRINTED PUBLICATIONS, NAMELY, BROCHURES, PAMPHLETS, BOOKS, MANUALS, AND NEWSLETTERS IN THE FIELD OF CUSTOM ELECTRONIC COMPONENTS AND SYSTEMS, IN CLASS 16 (U.S. CLS. 2, 5, 22, 23, 29, 37, 38 AND 50).

FIRST USE 9-20-1996; IN COMMERCE 9-20-1996.

FOR: CUSTOM MANUFACTURE OF ELECTRONIC COMPONENTS AND SYSTEMS FOR OTHERS, IN CLASS 40 (U.S. CLS. 100, 103 AND 106).

FIRST USE 9-20-1996; IN COMMERCE 9-20-1996.

SER. NO. 78-965,309, FILED 8-31-2006.

ELLEN PERKINS, EXAMINING ATTORNEY

**Int. Cl.: 20**

**Prior U.S. Cls.: 2, 13, 22, 25, 32 and 50**

**Reg. No. 3,453,871**

**United States Patent and Trademark Office**

**Registered June 24, 2008**

**TRADEMARK  
PRINCIPAL REGISTER**

**THE PRAYER PIECE**

WITHERSPOON, SAMUEL L. (UNITED STATES  
INDIVIDUAL)

APT. 301

2110 1ST AVENUE

NEW YORK, NY 10029

FOR: FURNITURE, IN CLASS 20 (U.S. CLS. 2, 13,  
22, 25, 32 AND 50).

FIRST USE 6-1-2006; IN COMMERCE 6-1-2006.

THE MARK CONSISTS OF STANDARD CHAR-  
ACTERS WITHOUT CLAIM TO ANY PARTICULAR  
FONT, STYLE, SIZE, OR COLOR.

NO CLAIM IS MADE TO THE EXCLUSIVE  
RIGHT TO USE "PRAYER", APART FROM THE  
MARK AS SHOWN.

SER. NO. 78-968,121, FILED 9-6-2006.

ANTHONY RINKER, EXAMINING ATTORNEY

**Int. Cl.: 36**

**Prior U.S. Cls.: 100, 101 and 102**

**United States Patent and Trademark Office**

**Reg. No. 3,453,872**

**Registered June 24, 2008**

**SERVICE MARK  
PRINCIPAL REGISTER**

**LIVE WELL Program**

CROSSMARK FINANCIAL (CALIFORNIA CORPORATION)  
199  
1601 DOVE ST.  
NEWPORT BEACH, CA 92660

FOR: FINANCIAL SERVICES IN THE FIELD OF MONEY LENDING; ISSUANCE AND ADMINISTRATION OF ANNUITIES; MORTGAGE BROKERAGE, IN CLASS 36 (U.S. CLS. 100, 101 AND 102).

FIRST USE 6-0-2005; IN COMMERCE 11-4-2005.

THE MARK CONSISTS OF STANDARD CHARACTERS WITHOUT CLAIM TO ANY PARTICULAR FONT, STYLE, SIZE, OR COLOR.

NO CLAIM IS MADE TO THE EXCLUSIVE RIGHT TO USE "PROGRAM", APART FROM THE MARK AS SHOWN.

SER. NO. 78-968,192, FILED 9-6-2006.

RICHARD A. STRASER, EXAMINING ATTORNEY

**Int. Cl.: 41**

**Prior U.S. Cls.: 100, 101 and 107**

**United States Patent and Trademark Office**

**Reg. No. 3,453,873**

**Registered June 24, 2008**

**SERVICE MARK  
PRINCIPAL REGISTER**



QWEST COMMUNICATIONS INTERNATIONAL  
INC. (DELAWARE CORPORATION)  
1801 CALIFORNIA STREET  
DENVER, CO 80202

FOR: EDUCATIONAL SERVICES, NAMELY,  
PROVIDING A WEBSITE FEATURING COMPU-  
TER, TELECOMMUNICATION AND INTERNET  
TRAINING INFORMATION , IN CLASS 41 (U.S.  
CLS. 100, 101 AND 107).

FIRST USE 10-31-2006; IN COMMERCE 10-31-2006.

OWNER OF U.S. REG. NO. 3,177,692.

NO CLAIM IS MADE TO THE EXCLUSIVE  
RIGHT TO USE "INTERNET", APART FROM THE  
MARK AS SHOWN.

THE MARK CONSISTS OF A STYLIZED I.

SER. NO. 78-971,445, FILED 9-11-2006.

KATHLEEN LORENZO, EXAMINING ATTORNEY

**Int. Cl.: 7**

**Prior U.S. Cls.: 13, 19, 21, 23, 31, 34 and 35**

**United States Patent and Trademark Office**

**Reg. No. 3,453,874**

**Registered June 24, 2008**

**TRADEMARK  
PRINCIPAL REGISTER**

**HR Hardware Resources**

HARDWARE RESOURCES, INC. (LOUISIANA CORPORATION)  
4319 MARLENA STREET  
BOSSIER CITY, LA 71111

FOR: METAL TOOLS FOR USE IN FURNITURE ASSEMBLY, NAMELY, DRIVER BITS, NAMELY, POWER SCREW DRIVER BITS AND POWER DRILL DRIVER BITS, IN CLASS 7 (U.S. CLS. 13, 19, 21, 23, 31, 34 AND 35).

FIRST USE 9-0-1999; IN COMMERCE 9-0-1999.

THE MARK CONSISTS OF STANDARD CHARACTERS WITHOUT CLAIM TO ANY PARTICULAR FONT, STYLE, SIZE, OR COLOR.

NO CLAIM IS MADE TO THE EXCLUSIVE RIGHT TO USE "HARDWARE RESOURCES", APART FROM THE MARK AS SHOWN.

SER. NO. 78-972,412, FILED 9-12-2006.

MYRIAH HABEEB, EXAMINING ATTORNEY



**Int. Cl.: 7**

**Prior U.S. Cls.: 13, 19, 21, 23, 31, 34 and 35**

**United States Patent and Trademark Office**

**Reg. No. 3,453,875**

**Registered June 24, 2008**

**TRADEMARK  
PRINCIPAL REGISTER**

**Hardware  
HR  
Resources**

**HARDWARE RESOURCES, INC. (LOUISIANA  
CORPORATION)  
4319 MARLENA STREET  
BOSSIER CITY, LA 71111**

**FOR: METAL TOOLS FOR USE IN FURNITURE  
ASSEMBLY, NAMELY, DRIVER BITS, NAMELY,  
POWER SCREW DRIVER BITS AND POWER DRILL  
DRIVER BITS, IN CLASS 7 (U.S. CLS. 13, 19, 21, 23, 31,  
34 AND 35).**

**FIRST USE 9-0-1999; IN COMMERCE 9-0-1999.**

**NO CLAIM IS MADE TO THE EXCLUSIVE  
RIGHT TO USE "HARDWARE" AND "RESOUR-  
CES", APART FROM THE MARK AS SHOWN.**

**THE MARK CONSISTS OF THE WORDS "HARD-  
WARE" AND "RESOURCES" WITH A STYLIZED  
"HR" BETWEEN.**

**SER. NO. 78-972,416, FILED 9-12-2006.**

**MYRIAH HABEEB, EXAMINING ATTORNEY**

**Int. Cl.: 14**

**Prior U.S. Cls.: 2, 27, 28 and 50**

**United States Patent and Trademark Office**

**Reg. No. 3,453,876**

**Registered June 24, 2008**

**TRADEMARK  
PRINCIPAL REGISTER**

**Industry**

M. Z. BERGER & CO., INC (NEW YORK COR-  
PORATION)  
4TH FLOOR  
29-76 NORTHERN BLVD  
LONG ISLAND CITY, NY 11101

THE MARK CONSISTS OF STANDARD CHAR-  
ACTERS WITHOUT CLAIM TO ANY PARTICULAR  
FONT, STYLE, SIZE, OR COLOR.

FOR: WATCHES, IN CLASS 14 (U.S. CLS. 2, 27, 28  
AND 50).

SER. NO. 78-974,120, FILED 9-14-2006.

FIRST USE 12-1-2003; IN COMMERCE 12-1-2003.

H. M. FISHER, EXAMINING ATTORNEY

**Int. Cl.: 9**

**Prior U.S. Cls.: 21, 23, 26, 36 and 38**

**Reg. No. 3,453,877**

**United States Patent and Trademark Office**

**Registered June 24, 2008**

**TRADEMARK  
PRINCIPAL REGISTER**

# CPR Anytime

AMERICAN HEART ASSOCIATION, INC. (NEW  
YORK CORPORATION)  
7272 GREENVILLE AVENUE  
DALLAS, TX 752314596

THE MARK CONSISTS OF STANDARD CHAR-  
ACTERS WITHOUT CLAIM TO ANY PARTICULAR  
FONT, STYLE, SIZE, OR COLOR.

FOR: CARDIOPULMONARY RESUSCITATION  
COURSE KIT THAT TEACHES PEOPLE HOW TO  
PROVIDE CARDIOPULMONARY RESUSCITA-  
TION, COMPRISING A SPARE LUNG, MANNE-  
QUIN, DVD, AND INSTRUCTIONAL BOOKLET, IN  
CLASS 9 (U.S. CLS. 21, 23, 26, 36 AND 38).

NO CLAIM IS MADE TO THE EXCLUSIVE  
RIGHT TO USE "CPR", APART FROM THE MARK  
AS SHOWN.

SER. NO. 78-974,459, FILED 9-14-2006.

FIRST USE 9-22-2005; IN COMMERCE 9-22-2005.

PAUL E. FAHRENKOPF, EXAMINING ATTORNEY

**Int. Cl.: 16**

**Prior U.S. Cls.: 2, 5, 22, 23, 29, 37, 38 and 50**

**Reg. No. 3,453,878**

**United States Patent and Trademark Office**

**Registered June 24, 2008**

---

**TRADEMARK  
PRINCIPAL REGISTER**

**NO BAD DAYS**

SAMPLE, SCOTT THOMAS (UNITED STATES  
INDIVIDUAL)

40758 CARTIER ST.

MURRIETA, CA 92563

FOR: DECALS, IN CLASS 16 (U.S. CLS. 2, 5, 22, 23,  
29, 37, 38 AND 50).

FIRST USE 7-1-1998; IN COMMERCE 7-1-1998.

THE MARK CONSISTS OF STANDARD CHAR-  
ACTERS WITHOUT CLAIM TO ANY PARTICULAR  
FONT, STYLE, SIZE, OR COLOR.

OWNER OF U.S. REG. NO. 2,219,259.

SEC. 2(F).

SER. NO. 78-978,313, FILED 6-21-2006.

LINDA POWELL, EXAMINING ATTORNEY

**Int. Cl.: 43**

**Prior U.S. Cls.: 100 and 101**

**United States Patent and Trademark Office**

**Reg. No. 3,453,879**

**Registered June 24, 2008**

**SERVICE MARK  
PRINCIPAL REGISTER**

The logo consists of the letters 'E', 'P', and 'C' in a bold, serif font. Between the 'P' and 'C' is a stylized graphic element resembling a flame or a drop with a central vertical line and two curved sides.

D P PROPERTY HOLDING, LLC (FLORIDA LTD  
LIAB CO)  
2901 COLLINS AVENUE  
SUITE M  
MIAMI BEACH, FL 33140

FIRST USE 12-0-2005; IN COMMERCE 12-0-2005.

SER. NO. 78-979,526, FILED 4-18-2006.

FOR: HOTEL SERVICES, IN CLASS 43 (U.S. CLS.  
100 AND 101).

KATHERINE M. DUBRAY, EXAMINING ATTOR-  
NEY

Int. Cl.: 25

Prior U.S. Cls.: 22 and 39

United States Patent and Trademark Office

Reg. No. 3,453,880

Registered June 24, 2008

CERTIFICATION MARK  
PRINCIPAL REGISTER

A stylized, cursive logo for 'St. Moritz' in black ink. The letters are fluid and interconnected, with a prominent 'S' at the beginning and a long, sweeping tail for the 'z'.

KUR- UND VERKEHRSVEREIN ST. MORITZ  
(SWITZERLAND COLLECTIVE ORGANIZATION)  
GEMEINDEHAUS  
CH-7500 ST. MORITZ  
SWITZERLAND

FOR: CLOTHING, FOOTWEAR, HEADWEAR;  
ALL THE AFORESAID GOODS FROM SWITZERLAND,  
IN CLASS 25 (U.S. CLS. 22 AND 39).

OWNER OF INTERNATIONAL REGISTRATION  
0767899 DATED 9-20-2001, EXPIRES 9-20-2011.

OWNER OF U.S. REG. NOS. 1,453,708 AND  
2,809,624.

THE CERTIFIER HAS A BONA FIDE INTENTION  
TO EXERCISE LEGITIMATE CONTROL OVER THE  
USE OF THE CERTIFICATION MARK IN COMMERCE  
AS OF THE FILING DATE OF THE APPLICATION.  
THE CERTIFICATION MARK, AS USED BY PERSONS  
AUTHORIZED BY THE CERTIFIER, WILL CERTIFY  
THAT THE GOODS ORIGINATE FROM ST. MORITZ,  
SWITZERLAND. THE CERTIFIER WILL NOT ENGAGE  
IN THE PRODUCTION OR MARKETING OF THE  
GOODS TO WHICH THE MARK IS APPLIED

SER. NO. 79-002,829, FILED 1-26-2004.

ELISSA GARBER KON, EXAMINING ATTORNEY

**Int. Cl.: 1**

**Prior U.S. Cls.: 1, 5, 6, 10, 26 and 46**

**United States Patent and Trademark Office**

**Reg. No. 3,453,881**

**Registered June 24, 2008**

**TRADEMARK  
PRINCIPAL REGISTER**

**Nanocomp**

ITN NANOVAION AG (FED REP GERMANY  
JOINT-STOCK COMPANY)

UNTERTÜRKHEIMER STRAÙE 25

66117 SAARBRÜCKEN

FED REP GERMANY

THE MARK CONSISTS OF STANDARD CHAR-  
ACTERS WITHOUT CLAIM TO ANY PARTICULAR  
FONT, STYLE, SIZE, OR COLOR.

OWNER OF INTERNATIONAL REGISTRATION  
0830472 DATED 6-7-2004, EXPIRES 6-7-2014.

FOR: CHEMICALS USED IN INDUSTRY AND  
SCIENCE, UNPROCESSED ARTIFICIAL RESINS, IN  
CLASS 1 (U.S. CLS. 1, 5, 6, 10, 26 AND 46).

SER. NO. 79-004,335, FILED 6-7-2004.

CYNTHIA SLOAN, EXAMINING ATTORNEY

**Int. Cl.: 14**

**Prior U.S. Cls.: 2, 27, 28 and 50**

**United States Patent and Trademark Office**

**Reg. No. 3,453,882**

**Registered June 24, 2008**

**TRADEMARK  
PRINCIPAL REGISTER**

**OMEGA CONSTELLATION QUADRELLA**

OMEGA SA (OMEGA AG) (OMEGA LTD.) (SWITZERLAND JOINT STOCK COMPANY)  
JAKOB-STÄMPFLI-STRASSE 96  
CH-2502 BIEL/BIENNE, SWITZERLAND

FOR: PRECIOUS METALS AND THEIR ALLOYS AND GOODS IN PRECIOUS METALS OR COATED THEREWITH NAMELY LIGHTERS FOR SMOKERS, CIGAR CUTTERS, ASHTRAYS FOR SMOKERS, KEY RINGS, TROPHIES; JEWELRY, PRECIOUS STONES; HOROLOGICAL AND CHRONOMETRIC INSTRUMENTS, IN CLASS 14 (U.S. CLS. 2, 27, 28 AND 50).

THE MARK CONSISTS OF STANDARD CHARACTERS WITHOUT CLAIM TO ANY PARTICULAR FONT, STYLE, SIZE, OR COLOR.

PRIORITY DATE OF 5-17-2004 IS CLAIMED.

OWNER OF INTERNATIONAL REGISTRATION 0832083 DATED 8-11-2004, EXPIRES 8-11-2014.

OWNER OF U.S. REG. NOS. 25,036, 578,041, AND 734,891.

SER. NO. 79-004,915, FILED 8-11-2004.

TRACY WHITTAKER-BROWN, EXAMINING ATTORNEY



**Int. Cls.: 20, 24, 25, 35, 38 and 41**

**Prior U.S. Cls.: 2, 13, 22, 25, 32, 39, 42, 50, 100, 101, 102, 104 and 107**

**Reg. No. 3,453,883**

**United States Patent and Trademark Office**

**Registered June 24, 2008**

**TRADEMARK  
SERVICE MARK  
PRINCIPAL REGISTER**

# Tyband

KANDINSKY DEUTSCHLAND GMBH  
RONSDORFER STRAÙE 74 (LOFT 15)  
40233 DÜSSELDORF  
FED REP GERMANY

FOR: INFLATABLE PUBLICITY OBJECTS, IN CLASS 20 (U.S. CLS. 2, 13, 22, 25, 32 AND 50).

FOR: WEAVABLE FABRICS AND TEXTILES, NAMELY, MESH WOVEN FABRICS AND TOWELS OF TEXTILE; BED CLOTHS, NAMELY, BED SHEETS, BED BLANKETS, COVERLETS; TEXTILE TABLECLOTHS, IN CLASS 24 (U.S. CLS. 42 AND 50).

FOR: CLOTHING, NAMELY, SHIRTS, PANTS, STOCKINGS, T-SHIRTS, SWEATSHIRTS, SPORT SHORTS, BATHING SUITS, SUITS, TIES, SCARFS, HEAD SCARFS, SKIRTS, DRESSES, GOWNS; SHOES; HEAD GEAR, NAMELY, HATS, CAPS, IN CLASS 25 (U.S. CLS. 22 AND 39).

FOR: ADVERTISING, NAMELY, DIRECT MAIL ADVERTISING, TELEVISION ADVERTISING FOR OTHERS, DISSEMINATION OF ADVERTISING FOR OTHERS VIA ELECTRONIC MAIL ON THE INTERNET AND VIA TELEPHONE, IN CLASS 35 (U.S. CLS. 100, 101 AND 102).

FOR: INFORMATION TRANSMISSION VIA ELECTRONIC COMMUNICATIONS NETWORKS; PROVIDING ONLINE COMMUNICATION LINKS WHICH TRANSFER THE WEBSITE USER TO

OTHER LOCAL OR GLOBAL WEB PAGES; ELECTRONIC MAIL SERVICES; E-MAIL FORWARDING SERVICES; PROVIDING ONLINE CHAT ROOMS FOR TRANSMISSION OF MESSAGES AMONG COMPUTER USERS CONCERNING SPORTS, JOBS, BUSINESS, ECONOMY, LEISURE AND ENTERTAINMENT; PROVIDING MULTIPLE USER DIAL UP AND DEDICATED ACCESS TO THE INTERNET, IN CLASS 38 (U.S. CLS. 100, 101 AND 104).

FOR: EDUCATIONAL SERVICES, NAMELY, CONDUCTING CLASSES, SEMINARS, CONFERENCES, WORKSHOPS IN THE FIELD OF SCIENCE, MOVIES, TV, BROADCASTING, MARKETING AND MERCHANDISING; INSTRUCTION IN THE FIELD OF MUSIC, ART, AND BUSINESS; ENTERTAINMENT SERVICES, NAMELY, ORGANIZING COMMUNITY SPORTING AND CULTURAL EVENTS, IN CLASS 41 (U.S. CLS. 100, 101 AND 107).

THE MARK CONSISTS OF STANDARD CHARACTERS WITHOUT CLAIM TO ANY PARTICULAR FONT, STYLE, SIZE, OR COLOR.

OWNER OF INTERNATIONAL REGISTRATION 0837127 DATED 6-25-2004, EXPIRES 6-25-2014.

SER. NO. 79-006,716, FILED 6-25-2004.

ANDREW RHIM, EXAMINING ATTORNEY

**Int. Cls.: 9, 41 and 42**

**Prior U.S. Cls.: 21, 23, 26, 36, 38, 100, 101 and 107**

**United States Patent and Trademark Office**

**Reg. No. 3,453,884**

**Registered June 24, 2008**

**TRADEMARK  
SERVICE MARK  
PRINCIPAL REGISTER**



CyberConseil Validation Organization

**CYBERCONSEIL GROUPE (FRANCE CORPORATION)**

74, RUE DE BONNEL  
LYON, FRANCE 69003

FOR: DATABASE PROGRAM FOR FACILITATING, IN THE CHEMICAL AND PHARMACEUTICAL INDUSTRY, THE ENTIRE VALIDATION PROCESS FROM THE SELECTION OF THE INITIAL APPLICABLE REGULATORY TEXTS, THROUGH THE GENERATION OF PROTOCOLS, TO QUALIFICATION AND VALIDATION REPORTS ; AND FOR FACILITATING THE CONSULTATION OF ALL REGULATORY REQUIREMENTS AND THE SELECTION OF THE ARTICLES APPLICABLE TO A PROJECT., IN CLASS 9 (U.S. CLS. 21, 23, 26, 36 AND 38).

FOR: EDUCATION SERVICES FOR CHEMICAL AND PHARMACEUTICAL INDUSTRY IN THE NATURE OF CLASSES AND SEMINARS PERTAINING TO COMPUTERIZED SYSTEMS VALIDATION, EQUIPMENT AND PROCESS VALIDATION ; TO QUALITY SYSTEMS MANAGEMENT AND REGULATION COMPLIANCE ; TO ENGINEERING RELATED ACTIVITIES, NAMELY, PROJECT MANAGEMENT, SPECIFICATION MANAGEMENT, COMMISSIONING MANAGEMENT, IN CLASS 41 (U.S. CLS. 100, 101 AND 107).

FOR: CONSULTING SERVICES FOR CHEMICAL AND PHARMACEUTICAL INDUSTRY REGARDING COMPUTERIZED AND NON-COMPUTERIZED MACHINE, APPARATUS, AND INSTRUMENT TESTING, COMPUTER SYSTEMS

EQUIPMENT TESTING AND COMPUTER SYSTEMS OPERATING PROCESS ANALYSIS AND EVALUATION, QUALITY ASSURANCE SERVICES IN THE FIELD OF COMPUTER SYSTEMS OPERATION AND EQUIPMENT, REGULATION COMPLIANCE, ENGINEERING RELATED ACTIVITIES, NAMELY, COMPUTER PROJECT MANAGEMENT AND CONSTRUCTION PROJECT MANAGEMENT IN THE NATURE OF ARCHITECTURAL DESIGN SUPERVISION, AND REGARDING COMPUTER SYSTEMS USER REQUIREMENT SPECIFICATIONS, COMPUTER OPERATIONS FUNCTIONAL SPECIFICATION MANAGEMENT, SOFTWARE AND EQUIPMENT TESTS; REVIEWING STANDARDS AND PRACTICES TO ASSURE COMPLIANCE WITH UNITED STATES AND EUROPEAN CHEMICAL, PHARMACEUTICAL, FOOD, DRUG, MANUFACTURING, MEDICAL, ELECTRICAL ENGINEERING REGULATIONS, STANDARDS AND GUIDELINES; SOFTWARE DESIGN AND DEVELOPMENT FOR CHEMICAL AND PHARMACEUTICAL INDUSTRY FOR THE PURPOSES OF FACILITATING COMPUTERIZED SYSTEMS TESTING, COMPUTER SYSTEMS EQUIPMENT TESTING, AND COMPUTER SYSTEMS OPERATING PROCESS ANALYSIS AND EVALUATION, QUALITY ASSURANCE SERVICES IN THE FIELD OF COMPUTER SYSTEMS OPERATION AND EQUIPMENT, REGULATION COMPLIANCE, ENGINEERING RELATED ACTIVITIES, COMPUTER PROJECT MANAGEMENT AND CONSTRUCTION PROJECT MANAGEMENT, COMPUTER SYSTEMS SPECIFICATION MANAGEMENT, FACTORY ACCEPTANCE TESTING MANAGEMENT AND SITE

ACCEPTANCE TESTING MANAGEMENT, IN CLASS 42 (U.S. CLS. 100 AND 101).

OWNER OF INTERNATIONAL REGISTRATION 0843519 DATED 6-14-2004, EXPIRES 6-14-2014.

NO CLAIM IS MADE TO THE EXCLUSIVE RIGHT TO USE "VALIDATION ORGANIZATION", APART FROM THE MARK AS SHOWN.

THE COLOR(S) WHITE AND BLUE IS/ARE CLAIMED AS A FEATURE OF THE MARK.

"CVO" IS WRITTEN IN COMMON WHITE. THE COLORS PANTONE REFLEX BLUE "CV" APPEARS AS BACKGROUND OF MARK.

THE MARK CONSISTS OF THE COLOR BLUE IN USED IN THE SQUARE BACKGROUND FOR THE MARK AND FOR THE WORDS "CYBERCONSEIL VALIDATION ORGANIZATION." THE COLOR WHITE IS USED FOR THE LETTERS "CVO" AND AS BACKGROUND FOR THE BLUE PORTIONS OF THE MARK.

SER. NO. 79-008,953, FILED 6-14-2004.

JERI J. FICKES, EXAMINING ATTORNEY

**Int. Cls.: 9, 35 and 42**

**Prior U.S. Cls.: 21, 23, 26, 36, 38, 100, 101 and 102**

**Reg. No. 3,453,885**

**United States Patent and Trademark Office**

**Registered June 24, 2008**

**TRADEMARK  
SERVICE MARK  
PRINCIPAL REGISTER**

GEDAS AKTIENGESELLSCHAFT (FED REP  
GERMANY CORPORATION)

11, PASCALSTRASSE  
10587 BERLIN  
FED REP GERMANY

FOR: SCIENTIFIC, NAUTICAL, SURVEYING, ELECTRIC, PHOTOGRAPHIC, CINEMATOGRAPHIC, OPTICAL, WEIGHING, MEASURING, SIGNALING, SUPERVISORY, LIFE-SAVING AND TEACHING APPARATUS AND INSTRUMENTS, NAMELY, CONTACT LENSES, SPECTACLES, SPECTACLE CASES, BINOCULARS, MAGNIFYING GLASSES, SUNGLASSES, VEHICLE DRIVE TRAINING SIMULATORS FOR THE STEERING AND CONTROL OF VEHICLES, VOLTAGE REGULATORS FOR VEHICLES, VEHICLE BREAKDOWN WARNING TRIANGLES, CIGAR LIGHTERS FOR AUTOMOBILES, ALARMS, NAMELY, BURGLAR ALARMS NOT BEING FOR VEHICLES, BATTERIES AND THEIR PARTS, ELECTRIC ACCUMULATORS AND THEIR PARTS, FUEL CELLS AND THEIR PARTS, CHARGERS FOR BATTERIES, ELECTRIC THEFT PREVENTION APPARATUS FOR MOTOR CARS, SPEED INDICATORS, VEHICLE BREAKDOWN WARNING LAMPS, GRADUATED RULERS, REVOLUTION COUNTERS, LIFE SAVING APPARATUS AND EQUIPMENT, NAMELY, LIFE-SAVING RAFTS, FIRE ESCAPES, SAFETY NETS, LIFE BELTS, LIFE BUOYS, LIFE JACKETS, ACID HYDROMETERS, FUSES, ELECTRIC RELAYS; LASERS, NOT FOR MEDICAL PURPOSES, NAMELY, LASER POINTERS; REMOTE CONTROL APPARATUS, SOLAR BATTERIES, DIRECTIONAL COMPASSES, ELECTRONIC NAVIGATIONAL INSTRUMENTS, ELECTRONIC SPIRIT LEVELS, SCALES; APPARATUS AND INSTRUMENTS FOR CONDUCTING, SWITCHING, TRANSFORMING, ACCUMULATING, REGULATING OR CONTROLLING ELECTRICITY; AUTOMATIC VENDING MA-

CHINES AND MECHANISMS FOR COIN-OPERATED APPARATUS, NAMELY, AUTOMATIC DISTRIBUTION MACHINES, NAMELY, AUTOMATIC TELLER MACHINES, AUTOMATIC BANKING MACHINES; CASH REGISTERS, CALCULATING MACHINES, NAMELY, CALCULATORS, DATA PROCESSING APPARATUS, PERSONAL DIGITAL ASSISTANTS, COMPUTERS, NAMELY, ELECTRONIC CALENDARS AND ORGANIZERS, FACSIMILE MACHINES, COMPUTER MONITORS, COMPUTER PERIPHERALS, POCKET CALCULATORS; RECORDED COMPUTER PROGRAMS AND SOFTWARE AND COLLECTED DATA RECORDED ON DATA CARRIERS, NAMELY, DATABASE SPREADSHEET SOFTWARE; FIRE EXTINGUISHERS; APPARATUS FOR ELECTRONIC GAMES ADAPTED FOR USE WITH TELEVISION RECEIVERS AND VIDEO SCREENS ONLY, NAMELY, GAME CONSOLES IN THE NATURE OF VIDEO GAME INTERACTIVE REMOTE CONTROL UNITS, IN CLASS 9 (U.S. CLS. 21, 23, 26, 36 AND 38).

FOR: ARRANGING AND CONDUCTING TRADE SHOW EXHIBITIONS, NAMELY, BRINGING TOGETHER FOR THE BENEFIT OF OTHERS, EXCLUDING THE TRANSPORT THEREOF, A VARIETY OF MOTOR VEHICLES AND THEIR PARTS AND FITTINGS, ENABLING CUSTOMERS TO VIEW AND PURCHASE THEM; ADVERTISING; BUSINESS MANAGEMENT; BUSINESS ADMINISTRATION, IN CLASS 35 (U.S. CLS. 100, 101 AND 102).

FOR: PRODUCT DESIGN FOR OTHERS IN THE FIELDS OF SCIENCE AND TECHNOLOGY; LEGAL SERVICES, IN CLASS 42 (U.S. CLS. 100 AND 101).

THE MARK CONSISTS OF STANDARD CHARACTERS WITHOUT CLAIM TO ANY PARTICULAR FONT, STYLE, SIZE, OR COLOR.

PRIORITY DATE OF 10-29-2003 IS CLAIMED.

SER. NO. 79-010,276, FILED 4-27-2004.

OWNER OF INTERNATIONAL REGISTRATION  
0847582 DATED 4-27-2004, EXPIRES 4-27-2014.

TRACY WHITTAKER-BROWN, EXAMINING AT-  
TORNEY

**Int. Cl.: 3**

**Prior U.S. Cls.: 1, 4, 6, 50, 51 and 52**

**United States Patent and Trademark Office**

**Reg. No. 3,453,886**

**Registered June 24, 2008**

**TRADEMARK  
PRINCIPAL REGISTER**

**SECRET WISH**

MÜLHENS GMBH & CO. KG (FED REP GER-  
MANY GMBH & CO. KG)  
VENLOER STRASSE 241-245  
50823 KÖLN  
FED REP GERMANY

FOR: PERFUMES, ESSENTIAL OILS FOR PERSONAL USE, COSMETICS, NAMELY, EYE AND FACIAL MAKE-UP, NON-MEDICATED SKIN CARE PREPARATIONS, NAMELY, CREAMS, LOTIONS, MOISTURIZERS, TEXTURIZERS AND TONERS; BATH GELS, SHOWER GELS, BATH FOAMS, AND PERSONAL DEODORANTS; HAIR LOTIONS, DENTIFRICES, TOILET SOAPS, IN CLASS 3 (U.S. CLS. 1, 4, 6, 50, 51 AND 52).

THE MARK CONSISTS OF STANDARD CHARACTERS WITHOUT CLAIM TO ANY PARTICULAR FONT, STYLE, SIZE, OR COLOR.

PRIORITY DATE OF 7-20-2004 IS CLAIMED.

OWNER OF INTERNATIONAL REGISTRATION  
0852833 DATED 11-10-2004, EXPIRES 11-10-2014.

SER. NO. 79-011,944, FILED 11-10-2004.

ROBERT C. CLARK JR., EXAMINING ATTORNEY

**Int. Cls.: 29, 30, 31, 32 and 43**

**Prior U.S. Cls.: 1, 45, 46, 48, 100 and 101**

**Reg. No. 3,453,887**

**United States Patent and Trademark Office**

**Registered June 24, 2008**

**TRADEMARK  
SERVICE MARK  
PRINCIPAL REGISTER**



VILMARE GIACOMAZZI (ITALY SOCIÉTÉ IN-  
DIVIDUELLE)  
VIA PUCCINI, 23  
I-37050 OPPEANO (VR)  
ITALY

FOR: PRESERVED, DRIED AND COOKED  
FRUITS AND VEGETABLES, JAMS, COMPOTES;  
DAIRY PRODUCTS IN THE NATURE OF MILK,  
EGGS, BUTTER, CHEESE, YOGURT, EXCLUDING  
ICE CREAM, ICE MILK, AND FROZEN YOGURT;  
EDIBLE OILS AND FATS, IN CLASS 29 (U.S. CL. 46).

FOR: RICE, FLOURS, PREPARATIONS MADE  
FROM CEREALS IN THE NATURE OF CEREAL  
BASED SNACK FOOD, ICES IN THE NATURE OF  
FLAVORED ICES, FRUIT ICES; HONEY, IN CLASS  
30 (U.S. CL. 46).

FOR: FRESH FRUITS AND VEGETABLES, IN  
CLASS 31 (U.S. CLS. 1 AND 46).

FOR: FRUIT BEVERAGES AND FRUIT JUICES,  
SYRUPS AND OTHER PREPARATIONS FOR MAK-  
ING BEVERAGES IN THE NATURE OF FRUIT  
JUICES, IN CLASS 32 (U.S. CLS. 45, 46 AND 48).

FOR: PROVIDING OF FOOD AND DRINK; PRO-  
VIDING TEMPORARY ACCOMMODATION, IN  
CLASS 43 (U.S. CLS. 100 AND 101).

PRIORITY DATE OF 2-25-2005 IS CLAIMED.

OWNER OF INTERNATIONAL REGISTRATION  
0862552 DATED 3-18-2005, EXPIRES 3-18-2015.

NO CLAIM IS MADE TO THE EXCLUSIVE  
RIGHT TO USE "ITALIANO", APART FROM THE  
MARK AS SHOWN.

THE ENGLISH TRANSLATION OF THE WORD  
"VERO ITALIANO" IN THE MARK IS "TRUE  
ITALIAN".

SER. NO. 79-015,469, FILED 3-18-2005.

RAMONA ORTIGA, EXAMINING ATTORNEY

**Int. Cl.: 7**

**Prior U.S. Cls.: 13, 19, 21, 23, 31, 34 and 35**

**Reg. No. 3,453,888**

**United States Patent and Trademark Office**

**Registered June 24, 2008**

**TRADEMARK  
PRINCIPAL REGISTER**

**FLEXIMIX**

WIWA WILHELM WAGNER GMBH & CO. KG  
(FED REP GERMANY GMBH & CO. KG)  
GEWERBEGEBIET 1-3  
35633 LAHNAU  
FED REP GERMANY

TRIAL MACHINE PRESSES, NAMELY,  
PNEUMATIC, HYDRAULIC AND ELECTRIC  
GREASE PRESSES, IN CLASS 7 (U.S. CLS. 13, 19, 21,  
23, 31, 34 AND 35).

FOR: ELECTRONIC CONTROLS, SOLD AS A  
COMPONENT OF PAINT COATING AND PAINT  
COLOR SPRAYERS, ALL AFORESAID PRODUCTS  
NOT IN THE FIELD OF MACHINES, APPARATUS  
AND INSTRUMENTS FOR THE TREATMENT AND  
PROCESSING OF POWDERS AND POWDERY SUB-  
STANCES; PNEUMATIC GREASE GUNS; INDUS-

OWNER OF INTERNATIONAL REGISTRATION  
0873188 DATED 7-11-2005, EXPIRES 7-11-2015.

SER. NO. 79-019,570, FILED 7-11-2005.

MAUREEN DALL, EXAMINING ATTORNEY



**Int. Cls.: 7 and 12**

**Prior U.S. Cls.: 13, 19, 21, 23, 31, 34, 35 and 44**

**Reg. No. 3,453,889**

**United States Patent and Trademark Office**

**Registered June 24, 2008**

**TRADEMARK  
PRINCIPAL REGISTER**

**UM**

ULTRA MOTOR COMPANY LIMITED (UNITED KINGDOM LIMITED COMPANY)  
52 MOUNT PLEASANT; LIVERPOOL  
PO BOX 903  
MERSEYSIDE, UNITED KINGDOM L69 3FT

FOR: MOTORS AND ENGINES, NAMELY, AIRCRAFT ENGINES, BOAT ENGINES, DIESEL ENGINES FOR MACHINES, AIRPLANE MOTORS, BOAT MOTORS, ELECTRIC MOTORS FOR MACHINES WITH A DIGITAL SERVO DRIVE CONTROLLER; DIRECT CURRENT MOTORS, ELECTRIC MOTORS FOR MACHINES, ELEVATOR MOTORS, ENGINES AND MOTORS FOR THE GENERATION OF ELECTRICITY, LINEAR MOTORS, STARTER MOTORS; WINCH MOTORS, NAMELY, MOTORS FOR POWER WINCHES; HOISTS; MACHINES COUPLING AND POWER TRANSMISSION COMPONENTS FOR MACHINES, IN CLASS 7 (U.S. CLS. 13, 19, 21, 23, 31, 34 AND 35).

FOR: MOTORS AND ENGINES FOR LAND VEHICLES, CARS, BOATS, MOTORCYCLES, ELEC-

TRIC POWERED LAND VEHICLES, NAMELY, ELECTRIC POWERED BICYCLES, WHEELCHAIRS, MOPEDS, BUSES, VANS, CARS, COMMERCIAL TRUCKS AND LAND TRAMS; CARS; LAND VEHICLES; MOTORCYCLES; ELECTRIC POWERED LAND VEHICLES, ELECTRIC POWERED BICYCLES, WHEELCHAIRS, BOATS, MOPEDS, BUSES, VANS, COMMERCIAL TRUCKS, MACHINE COUPLING FOR TRAILERS AND TRANSMISSION COMPONENTS FOR LAND VEHICLES, IN CLASS 12 (U.S. CLS. 19, 21, 23, 31, 35 AND 44).

OWNER OF INTERNATIONAL REGISTRATION  
0874687 DATED 11-28-2005, EXPIRES 11-28-2015.

SER. NO. 79-020,107, FILED 11-28-2005.

ANDREA K. NADELMAN, EXAMINING ATTORNEY

Int. Cls.: 9, 38 and 42

Prior U.S. Cls.: 21, 23, 26, 36, 38, 100, 101 and 104

Reg. No. 3,453,890

United States Patent and Trademark Office

Registered June 24, 2008

**TRADEMARK  
SERVICE MARK  
PRINCIPAL REGISTER**



CHINA NETWORK COMMUNICATIONS;  
GROUP CORPORATION (CHINA CORPORATION)

BUILDING C, NO. 156 FUXINGMENNEI ST.

BEIJING 100031

CHINA

FOR: CALCULATING DISKS, NAMELY, REMOVABLE EXTERNAL STORAGE DISKS USING FLASH MEMORY MEDIA HAVING A UNIVERSAL WIRED OR WIRELESS INTERFACE; CALCULATING MACHINES; DATA PROCESSING APPARATUS, NAMELY, DATA PROCESSORS; COMPUTER PERIPHERAL DEVICES; COMPUTER SOFTWARE FOR CONNECTING COMPUTER NETWORK USERS, GLOBAL COMPUTER NETWORKS AND FOR THE CONTROL OF VOICE CONTROLLED INFORMATION AND COMMUNICATIONS DEVICES; MICROPROCESSORS; ENCODED SMART CARDS CONTAINING PROGRAMMING FOR CONNECTING COMPUTER NETWORK USERS, GLOBAL COMPUTER NETWORKS AND FOR THE CONTROL OF VOICE CONTROLLED INFORMATION AND COMMUNICATIONS DEVICES; PROCESSORS, NAMELY, CENTRAL PROCESSING UNITS; ANTENNAS; TELEPHONE RECEIVERS; TELECOMMUNICATION TRANSMITTING SETS CONTAINING TELEPHONE TRANSMITTERS, TELECOMMUNICATION TRANSMITTERS, AND DIGITAL TRANSMITTERS; TRANSMITTERS OF ELECTRONIC SIGNALS FOR TELEPHONE; RADIO TRANSMITTERS; MODEMS; VIDEO TELEPHONES; OPTICAL COMMUNICATION DEVICES, NAMELY, OPTICAL TRANSMITTERS AND RECEIVERS; AUTOMATIC SWITCHBOARDS FOR CONTROLLING TELEPHONES, IN CLASS 9 (U.S. CLS. 21, 23, 26, 36 AND 38).

FOR: RADIO BROADCASTING; TELEVISION BROADCASTING; CABLE TELEVISION BROADCASTING; SENDING OF TELEGRAMS, NAMELY, TELEGRAM TRANSMISSION; ELECTRONIC MESSAGE SENDING; TELEGRAPH SERVICES; TELEPHONE SERVICES, NAMELY, LOCAL AND LONG DISTANCE TRANSMISSION OF VOICE, DATA, GRAPHICS BY MEANS OF TELEPHONE, TELEGRAPHIC, CABLE, CELLULAR AND SATELLITE TRANSMISSIONS, PRIVATE LINE SERVICES, PROVIDING MULTIPLE USER DIAL-UP AND DEDICATED ACCESS TO THE INTERNET, PROVIDING FACILITIES FOR CUSTOMERS FOR THE COLLOCATION OF TELEPHONE TELECOMMUNICATION EQUIPMENT FOR THE PURPOSE OF CUSTOMERS RESELLING OF SCALEABLE TELECOMMUNICATIONS NETWORK CAPACITY, AND VOICE MESSAGING SERVICES; TRANSMISSION OF DATA BY TELETYPEWRITER; NEWS AGENCIES, NAMELY, GATHERING AND DISSEMINATION OF NEWS; MOBILE PHONE COMMUNICATION; COMMUNICATIONS BY COMPUTER TERMINALS; COMPUTER AIDED TRANSMISSION OF MESSAGES AND IMAGES; ELECTRONIC MAIL SERVICES; FACSIMILE TRANSMISSION; INFORMATION ABOUT TELECOMMUNICATION; RADIO AND TELEPHONE PAGING SERVICES; COMMUNICATIONS BY FIBER OPTIC NETWORKS; RENTAL OF MESSAGE SENDING APPARATUS; RENTAL OF TELEPHONES; SATELLITE TRANSMISSION; PROVIDING ON-LINE ELECTRONIC BULLETIN BOARDS FOR TRANSMISSION OF MESSAGES AMONG COMPUTER USERS CONCERNING HOSTING ON-LINE WEB FACILITIES FOR OTHERS FOR ORGANIZING AND CONDUCTING ONLINE MEETINGS, GATHERINGS, AND INTERACTIVE DISCUSSIONS; PROVIDING TELECOMMUNICATION CONNECTIONS TO A GLOBAL COMPUTER

NETWORK; TELECOMMUNICATION ROUTING AND JUNCTION SERVICES; AUDIO AND VIDEO TELECONFERENCING SERVICES; PROVIDING USER ACCESS TO A GLOBAL COMPUTER NETWORK, NAMELY, INTERNET SERVICE PROVIDER SERVICES, IN CLASS 38 (U.S. CLS. 100, 101 AND 104).

FOR: COMPUTER SOFTWARE DESIGN FOR OTHERS; COMPUTER SOFTWARE CONSULTANCY; COMPUTER SYSTEM ANALYSIS; HOSTING THE WEB SITES OF OTHERS ON A COMPUTER SERVER FOR A GLOBAL COMPUTER NETWORK; CREATING AND MAINTAINING WEB SITES FOR OTHERS; CONVERTING OF DATA OR DOCUMENTS FROM PHYSICAL TO ELECTRONIC MEDIA; COMPUTER SYSTEM DESIGN FOR OTHERS; INSTALLATION OF COMPUTER SOFTWARE; INTELLECTUAL PROPERTY WATCHING SERVICES; DATA CONVERSION OF COMPUTER PROGRAMS DATA, IN CLASS 42 (U.S. CLS. 100 AND 101).

OWNER OF INTERNATIONAL REGISTRATION 0882469 DATED 3-1-2006, EXPIRES 3-1-2016.

NO CLAIM IS MADE TO THE EXCLUSIVE RIGHT TO USE THE NON-LATIN CHARACTERS THAT MEAN "CHINA", APART FROM THE MARK AS SHOWN.

THE CHINESE CHARACTER THAT TRANSLITERATES TO "ZHONG" MEANS CENTER, MIDDLE; "GUO" MEANS STATE, NATION, COUNTRY; "WANG" MEANS NETWORK; "TONG" MEANS THROUGH, CONNECT. THE COMBINATION OF "ZHONG GUO" MEANS "CHINA" IN ENGLISH. THE REMAINING CHARACTERS IN THE MARK COMBINE TO TRANSLATE INTO "NETWORK COMMUNICATIONS" AS AN ACRONYM.

SER. NO. 79-022,909, FILED 3-1-2006.

DANIEL BRODY, EXAMINING ATTORNEY

**Int. Cls.: 9, 35, 36, 38 and 42**

**Prior U.S. Cls.: 21, 23, 26, 36, 38, 100, 101, 102 and 104**

**Reg. No. 3,453,891**

**United States Patent and Trademark Office**

**Registered June 24, 2008**

**TRADEMARK  
SERVICE MARK  
PRINCIPAL REGISTER**

# THE SEARCH WORKS

THE SEARCH WORKS INTERNATIONAL LTD  
(UNITED KINGDOM LIMITED COMPANY)  
16-18, RAMILLIES STREET  
LONDON, UNITED KINGDOM W1F 7LW

FOR: COMPUTER HARDWARE; COMPUTER SEARCH ENGINE SOFTWARE FOR USE IN SEARCHING AND RETRIEVING INFORMATION ACROSS A COMPUTER NETWORK; CENTRAL PROCESSING UNITS FOR PROCESSING INFORMATION, DATA, SOUND OR IMAGES; APPARATUS FOR RECORDING, TRANSMISSION OR REPRODUCTION OF SOUND AND IMAGES; DVD RECORDING APPARATUS; SOUND RECORDING APPARATUS; COMPUTER SOFTWARE FOR BUSINESS PURPOSES FOR PROCESSING MARKET INFORMATION; COMPUTER SOFTWARE FOR PROCESSING MARKET INFORMATION; DATA PROCESSING SOFTWARE, IN CLASS 9 (U.S. CLS. 21, 23, 26, 36 AND 38).

FOR: ON-LINE AUCTIONEERING SERVICES VIA THE INTERNET, ARRANGING AND CONDUCTING AUCTION SALES, AUCTIONEERING SERVICES, AND AUCTION MANAGEMENT SERVICES, NAMELY, MANAGEMENT OF ONLINE AUCTIONEERING ACCOUNTS, VIA A GLOBAL NETWORK, THE WORLD WIDE WEB AND THE INTERNET; BUSINESS INFORMATION SERVICES; BUSINESS ADMINISTRATION AND MANAGEMENT SERVICES; BUSINESS ENQUIRIES AND INVESTIGATIONS; BUSINESS RESEARCH; COMPUTERIZED BUSINESS RESEARCH; PROVIDING BUSINESS INFORMATION DIRECTORY SERVICES VIA A GLOBAL COMPUTER NETWORK; MANAGEMENT AND COMPILATION OF COMPUTERIZED DATABASES; COMPUTERIZED AND CENTRAL FILE MANAGEMENT AND BUSINESS FILE MANAGEMENT SERVICES; COST/PRICE ANALYSIS SERVICES; COMPUTERIZED ACCOUNTING SERVICES; ADVERTISING AND PROMOTION SERVICES AND RELATED CONSULTING SERVICES; COMPILATION OF ADVERTISEMENTS FOR USE AS WEB PAGES ON THE INTERNET; PROVISION OF BUSINESS MARKETING REPORTS; PROVISION OF BUSINESS STATISTICAL INFORMATION; COL-

LECTION OF MARKET RESEARCH INFORMATION; ANALYSIS OF MARKET RESEARCH DATA AND STATISTICS; MARKET RESEARCH BY MEANS OF A COMPUTER DATABASE; MARKET RESEARCH FOR ADVERTISING; PROVIDING MARKET RESEARCH INFORMATION; BUSINESS RESEARCH SERVICES RELATING TO ADVERTISING AND MARKETING; MARKET RESEARCH SERVICES RELATING TO ADVERTISING AND MARKETING; DISSEMINATION OF ADVERTISING MATTER; RENTAL OF ADVERTISING SPACE ON-LINE; PUBLICATION SERVICES, NAMELY, DISTRIBUTION AND DISSEMINATION OF PUBLICITY MATERIALS AND PUBLICATION OF PUBLICITY TEXTS; COMPILING AND PROVIDING BUSINESS STATISTICAL INFORMATION; COMPILING MARKETING STATISTICAL INFORMATION; COMPILING COMMERCIAL INFORMATION DIRECTORY PROVIDED OVER THE INTERNET; RENTAL OF SPACE ON WEB SITES FOR ADVERTISING GOODS AND SERVICES; ADVERTISING SERVICES, IN CLASS 35 (U.S. CLS. 100, 101 AND 102).

FOR: PROVISION OF FINANCIAL INFORMATION AND INVESTMENT ANALYSIS BY MEANS OF A GLOBAL COMPUTER NETWORK, IN CLASS 36 (U.S. CLS. 100, 101 AND 102).

FOR: TELECOMMUNICATION SERVICES, NAMELY, DATA TRANSMISSION AND RECEPTION SERVICES VIA TELECOMMUNICATION MEANS; TELECOMMUNICATIONS ACCESS SERVICES, NAMELY, PROVIDING ONLINE ACCESS TO COMMERCIAL INFORMATION, PRODUCT INFORMATION, FINANCIAL INFORMATION AND FINANCIAL SERVICES AND TRANSACTIONS STORED ELECTRONICALLY IN CENTRAL FILES FOR REMOTE CONSULTATION; TELECOMMUNICATIONS SERVICES, NAMELY, TRANSMISSION OF ADVERTISEMENTS, INFORMATION INCLUDING WEB PAGES, COMPUTER PROGRAMS, DATA AND IMAGES VIA TELECOMMUNICATIONS NETWORKS; TELECOMMUNICATION SERVICES, NAMELY, ELECTRONIC TRANSMISSION OF DATA FEATURING ADVERTISEMENTS, INFOR-

MATION AND IMAGES; ELECTRONIC TRANSMISSION OF DATA VIA A GLOBAL COMPUTER NETWORK; WIRELESS BROADBAND COMMUNICATION SERVICE; MOBILE TELEPHONE COMMUNICATIONS, IN CLASS 38 (U.S. CLS. 100, 101 AND 104).

FOR: COMPUTER PROGRAMMING FOR OTHERS; DESIGN, DEVELOPMENT, WRITING, INSTALLATION, MAINTENANCE, UPDATING AND UPGRADING OF COMPUTER SOFTWARE FOR OTHERS; DESIGN, MAINTENANCE AND UPDATING FOR OTHERS OF COMPUTER SOFTWARE FOR THE OPERATION OF SEARCH ENGINES ON THE INTERNET AND WORLD WIDE WEB; COMPUTER SOFTWARE ENGINEERING; COMPUTER SOFTWARE RENTAL SERVICES; COMPUTER SOFTWARE LICENSING; RENTAL OF COMPUTER SOFTWARE FOR READING A DATA STREAM; SCIENTIFIC AND TECHNICAL COMPUTER SOFTWARE RESEARCH; CUSTOM CONFIGURATION OF COMPUTER SOFTWARE; CUSTOM DESIGN OF SOFTWARE PACKAGES FOR OTHERS; COMPUTER SYSTEMS ANALYSIS; CREATION OF WEB PAGES ON THE INTERNET FOR OTHERS, NAMELY, DESIGN, DRAWING AND COMMISSIONED WRITING OF WEB PAGES; PROVIDING INFORMATION RELATING TO COMPUTER PROGRAMMING, THE DESIGN AND MAINTENANCE OF COMPUTER SOFTWARE, INCLUDING COMPUTER SOFTWARE FOR THE OPERATION OF

SEARCH ENGINES ON THE INTERNET AND THE WORLD WIDE WEB, DESIGN, CREATION, HOSTING AND MAINTENANCE OF INTERNET SITES AND WEBSITES FOR OTHERS; COMPUTER SOFTWARE DESIGN FOR OTHERS; GRAPHIC DESIGN SERVICES; PROVIDING SEARCH ENGINE SERVICES FOR OBTAINING DATA ON A GLOBAL COMPUTER NETWORK; ELECTRONIC NAVIGATION SERVICES, NAMELY, PROVIDING SEARCH ENGINE SERVICES FOR OBTAINING DATA VIA A GLOBAL COMPUTER NETWORK, IN CLASS 42 (U.S. CLS. 100 AND 101).

THE MARK CONSISTS OF STANDARD CHARACTERS WITHOUT CLAIM TO ANY PARTICULAR FONT, STYLE, SIZE, OR COLOR.

PRIORITY DATE OF 1-28-2005 IS CLAIMED.

OWNER OF INTERNATIONAL REGISTRATION 0882822 DATED 7-28-2005, EXPIRES 7-28-2015.

NO CLAIM IS MADE TO THE EXCLUSIVE RIGHT TO USE "SEARCH", APART FROM THE MARK AS SHOWN.

SER. NO. 79-023,071, FILED 7-28-2005.

LEIGH LOWRY, EXAMINING ATTORNEY

**Int. Cl.: 30**

**Prior U.S. Cl.: 46**

**United States Patent and Trademark Office**

**Reg. No. 3,453,892**

**Registered June 24, 2008**

**TRADEMARK  
PRINCIPAL REGISTER**



CHOCOLAFABRIKEN; LINDT & SPRÜNGLI  
AG (SWITZERLAND CORPORATION)  
SEESTRASSE 204  
CH-8802 KILCHBERG ZH, SWITZERLAND

FOR: CHOCOLATE, CHOCOLATE PRODUCTS,  
NAMELY, A CHOCOLATE BUNNY IN A FOIL  
WRAPPER, IN CLASS 30 (U.S. CL. 46).

OWNER OF INTERNATIONAL REGISTRATION  
0882978 DATED 3-28-2006, EXPIRES 3-28-2016.

THE COLOR(S) GOLD, BROWN AND RED IS/  
ARE CLAIMED AS A FEATURE OF THE MARK.

THE MARK CONSISTS OF A CONFIGURATION  
OF A BUNNY IN THE COLOR GOLD WITH BROWN  
INNER EARS, WHISKERS, EYES, NOSE AND IN-  
DIVIDUAL BROWN STRIPES ON ITS FEET TO  
INDICATE TOES AS WELL AS A RED RIBBON  
TIED IN A BOW AROUND ITS NECK.

SEC. 2(F).

SER. NO. 79-023,129, FILED 3-28-2006.

TARAH HARDY, EXAMINING ATTORNEY

**Int. Cl.: 7**

**Prior U.S. Cls.: 13, 19, 21, 23, 31, 34 and 35**

**United States Patent and Trademark Office**

**Reg. No. 3,453,893**

**Registered June 24, 2008**

**TRADEMARK  
PRINCIPAL REGISTER**



GARDNER ENERGY MANAGEMENT LIMITED  
(UNITED KINGDOM A COMPANY INCORPORATED IN THE UNITED KINGDOM)  
1 TAILOR'S COURT  
BROAD STREET; BRISTOL BS1 2EY  
UNITED KINGDOM

FOR: STEAM TRAPS, NAMELY, STEAM VALVES  
BEING PARTS OF STEAM PLANT OR MACHINERY, IN CLASS 7 (U.S. CLS. 13, 19, 21, 23, 31, 34 AND 35).

OWNER OF INTERNATIONAL REGISTRATION  
0885703 DATED 11-3-2005, EXPIRES 11-3-2015.

SER. NO. 79-024,143, FILED 11-3-2005.

SKYE YOUNG, EXAMINING ATTORNEY

**Int. Cl.: 6**

**Prior U.S. Cls.: 2, 12, 13, 14, 23, 25 and 50**

**Reg. No. 3,453,894**

**United States Patent and Trademark Office**

**Registered June 24, 2008**

**TRADEMARK  
PRINCIPAL REGISTER**

**NORAC**

NORAC AS (NORWAY STOCK COMPANY)  
P.O. BOX 1593  
STOA  
NORWAY

OWNER OF INTERNATIONAL REGISTRATION  
0885954 DATED 2-3-2006, EXPIRES 2-3-2016.

FOR: FIREPROOF INTERIOR WALL, DOOR AND  
CEILING PANELS OF METAL, IN CLASS 6 (U.S.  
CLS. 2, 12, 13, 14, 23, 25 AND 50).

SER. NO. 79-024,252, FILED 2-3-2006.

ESTHER BELENKER, EXAMINING ATTORNEY



**Int. Cls.: 16, 31 and 35**

**Prior U.S. Cls.: 1, 2, 5, 22, 23, 29, 37, 38, 46, 50, 100, 101 and 102**

**Reg. No. 3,453,895**

**United States Patent and Trademark Office**

**Registered June 24, 2008**

**TRADEMARK  
SERVICE MARK  
PRINCIPAL REGISTER**



METZ FACILITIES B.V. (NETHERLANDS BE-  
SLOTEN VENNOOTSCHAP)

MIDDEL BROEKWEG 29

NL-2675 KB HONSELERSDIJK

NETHERLANDS

FOR: PRINTED INSTRUCTIONAL AND TEACHING MATERIAL IN THE FIELD OF AGRICULTURAL, HORTICULTURAL AND FORESTRY PRODUCTS; PLASTIC AND PAPER MATERIALS FOR PACKAGING AND PRESENTATION, NAMELY, PAPER BAGS FOR PACKAGING AND PLASTIC BAGS FOR PACKAGING; POSTERS; ADVERTISEMENT BOARDS OF PAPER OR CARDBOARD, FIGURINES OF PAPER MÂCHÉ; FLOWERPOT COVERS OF PAPER; PAMPHLETS IN THE FIELD OF AGRICULTURAL, HORTICULTURAL AND FORESTRY PRODUCTS; CATALOGUES IN THE FIELD OF AGRICULTURAL, HORTICULTURAL AND FORESTRY PRODUCTS; BOXES OF CARDBOARD OR PAPER; ADHESIVE AND ADDRESS LABELS NOT OF TEXTILE; BUBBLE FOIL OF PLASTIC FOR PACKAGING OR FOR CONDITIONING; SHEETS OF RECLAIMED CELLULOSE FOR WRAPPING; ENVELOPES OF CARDBOARD OR PAPER; CALENDARS; CARDBOARD WRAPPERS; ANNOUNCEMENT CARDS; PAPER RIBBONS; PAPER COASTERS; PACKING PAPER; PLASTIC FILM FOR WRAPPING NOT FOR COMMERCIAL OR INDUSTRIAL PURPOSES; STICKERS; PAPER BOWS FOR GIFT WRAP; SIGN BOARDS OF PAPER OR CARDBOARD; PAPER SHEETS FOR NOTE TAKING; VISCOSE SHEETS FOR WRAPPING; BLOTTERS; GREETING CARDS; ENVELOPES AND POUCHES OF PAPER OR PLASTICS FOR PACKAGING; PAPER, PLASTIC AND FABRIC GIFT BAGS, NOT INCLUDING IN OTHER CLASSES; WRAP-

PING PAPER, IN CLASS 16 (U.S. CLS. 2, 5, 22, 23, 29, 37, 38 AND 50).

FOR: SEEDS AND FLOWER BULBS; LIVE NATURAL PLANTS AND FLOWERS; LIVE WREATHS OF NATURAL FLOWERS; DRIED FLOWERS FOR DECORATION; UNPROCESSED GRAINS; PINE CONES; DRIED PLANTS FOR DECORATION; LIVE NATURAL AND DRIED FLOWER AND PLANT ARRANGEMENTS; LIVE NATURAL AND DRIED VEGETABLE USED FOR OR IN COMBINATION WITH FLOWER AND PLANTS ARRANGEMENTS, IN CLASS 31 (U.S. CLS. 1 AND 46).

FOR: BUSINESS INTERMEDIARY FOR THE PURCHASE AND SALE OF PAPER AND CARDBOARD AND AGRICULTURAL, HORTICULTURAL AND FORESTRY PRODUCTS; IMPORT AND EXPORT AGENCIES IN THE FIELDS OF PAPER AND CARDBOARD AND AGRICULTURAL, HORTICULTURAL AND FORESTRY PRODUCTS; RETAIL STORE SERVICES IN THE FIELDS OF PAPER AND CARDBOARD AND AGRICULTURAL, HORTICULTURAL AND FORESTRY PRODUCTS; SHOP WINDOW DRESSING DISPLAY ARRANGEMENT SERVICES AND CONSULTANCY IN CONNECTION THEREWITH, IN CLASS 35 (U.S. CLS. 100, 101 AND 102).

PRIORITY DATE OF 6-17-2005 IS CLAIMED.

OWNER OF INTERNATIONAL REGISTRATION  
0886175 DATED 12-9-2005, EXPIRES 12-9-2015.

THE COLOR(S) GREEN, MAGENTA AND GOLD IS/ARE CLAIMED AS A FEATURE OF THE MARK.

THE COLOR GREEN APPEARS IN THE WORD-  
ING "SCALA VERDE" WITH THE "V" IN "VERDE"  
IN THE COLOR GOLD ON THE OUTERMOST "V"  
WITH GREEN AND MAGENTA LINES CON-  
TAINED THEREIN.

THE FOREIGN WORDING IN THE MARK  
TRANSLATES INTO ENGLISH AS GREEN SCALE.

SER. NO. 79-024,321, FILED 12-9-2005.

MARILYN IZZI, EXAMINING ATTORNEY

**Int. Cls.: 16, 41 and 42**

**Prior U.S. Cls.: 2, 5, 22, 23, 29, 37, 38, 50, 100, 101 and 107**

**Reg. No. 3,453,896**

**United States Patent and Trademark Office**

**Registered June 24, 2008**

**TRADEMARK  
SERVICE MARK  
PRINCIPAL REGISTER**

**ACTIM**

FOOTBALL DATACO LIMITED (UNITED KINGDOM ENGLISH LIMITED COMPANY)  
11 CONNAUGHT PLACE  
LONDON W2 2ET  
UNITED KINGDOM

FOR: PRINTED MATTER, NAMELY, MAGAZINES, PERIODICAL PUBLICATIONS, NEWSPAPERS, BOOKS, PRINTED STATIONERY, ART PRINTS AND PICTURES, BROCHURES, BOOKLETS, INFORMATION LEAFLETS, LETTERHEADS, ENVELOPES, PAPER; ALL THE FOREGOING RELATING TO SPORTS RESULTS, SPORTS PERSONALITIES, SPORTS AND SPORTING STATISTICS, SPORTS NEWS AND SPORTS EVENTS, MOVIES, THEATER, BASKETBALL, BASEBALL, FOOTBALL, HOCKEY AND SOCCER, IN CLASS 16 (U.S. CLS. 2, 5, 22, 23, 29, 37, 38 AND 50).

FOR: INFORMATION SERVICES RELATING TO SPORTS RESULTS, SPORTS PERSONALITIES, SPORTS AND SPORTING STATISTICS, SPORTS NEWS AND SPORTS EVENTS; ENTERTAINMENT, NAMELY, ENTERTAINMENT IN THE NATURE OF FOOTBALL GAMES, HOCKEY GAMES, SOCCER GAMES, BASEBALL GAMES AND BASKETBALL GAMES; ORGANIZING SPORTING AND CULTURAL ACTIVITIES, NAMELY, GAMES, HOCKEY GAMES, SOCCER GAMES, BASEBALL GAMES AND BASKETBALL GAMES; PUBLISHING OF MAGAZINES, PERIODICAL PUBLICATIONS, NEWSPAPERS, BOOKS, PRINTED STATIONERY,

ARTWORK, BROCHURES, BOOKLETS AND INFORMATION LEAFLETS FEATURING SPORTS INFORMATION RELATING TO SPORTS RESULTS, SPORTS PERSONALITIES, SPORTS AND SPORTING STATISTICS, SPORTS NEWS AND SPORTS EVENTS; CONSULTANCY SERVICES RELATING TO PROVIDING SPORTS INFORMATION INCLUDING INFORMATION RELATING TO SPORTS RESULTS, SPORTS PERSONALITIES, SPORTS AND SPORTING STATISTICS, SPORTS NEWS AND SPORTS EVENTS, ENTERTAINMENT, SPORTING AND CULTURAL ACTIVITIES; PROVISION OF INFORMATION ON-LINE FROM A COMPUTER DATABASE RELATING TO SPORTS RESULTS, SPORTS PERSONALITIES, SPORTS AND SPORTING STATISTICS, SPORTS NEWS AND SPORTS EVENTS, IN CLASS 41 (U.S. CLS. 100, 101 AND 107).

FOR: STATISTICAL DATA ANALYSIS SERVICES RELATING TO SPORTS RESULTS, SPORTS PERSONALITIES, SPORTS AND SPORTING STATISTICS, SPORTS NEWS AND SPORTS EVENTS, IN CLASS 42 (U.S. CLS. 100 AND 101).

OWNER OF INTERNATIONAL REGISTRATION 0888952 DATED 5-3-2006, EXPIRES 5-3-2016.

SER. NO. 79-025,384, FILED 5-3-2006.

SEAN CROWLEY, EXAMINING ATTORNEY

**Int. Cls.: 1, 7, 8, 9, 17, 35, 37 and 42**

**Prior U.S. Cls.: 1, 5, 6, 10, 12, 13, 19, 21, 23, 26, 28, 31, 34, 35, 36, 38, 44, 46, 50, 100, 101, 102, 103 and 106**

**Reg. No. 3,453,897**

**United States Patent and Trademark Office**

**Registered June 24, 2008**

**TRADEMARK  
SERVICE MARK  
PRINCIPAL REGISTER**

# BURCKHARDT

BURCKHARDT COMPRESSION AG (SWITZERLAND AKTIENGESELLSCHAFT)  
IM LINK 5  
CH-8404 WINTERTHUR  
SWITZERLAND

FOR: CHEMICAL PRODUCTS FOR USE IN INDUSTRY; PLASTICS IN THE RAW STATE; PLASTICS IN THE RAW STATE FOR SEALING ELEMENTS AND SEALING RINGS; PLASTIC MIXTURES IN THE RAW STATE AND PLASTIC MIXTURES IN THE RAW STATE WITH FIBRE COMPONENTS, IN CLASS 1 (U.S. CLS. 1, 5, 6, 10, 26 AND 46).

FOR: MACHINES, NAMELY, COMPRESSORS FOR COMPRESSING GAS AND HYDRAULIC LIQUIDS, PISTON COMPRESSORS, DRY RUNNING OR LUBRICATED RECIPROCATING PISTON COMPRESSORS, IN PARTICULAR CROSS HEAD PISTON COMPRESSORS, CROSS HEAD PISTON COMPRESSORS WITH RING SEALS, HYPER COMPRESSORS AND COMPRESSORS FOR HIGH PRESSURE FOR END PRESSURES OF AT LEAST 1000 BARS AND ALSO PARTS AND SPARE PARTS FOR THE NAMED COMPRESSOR MACHINES; MACHINE PARTS FOR THE GENERATION, PREPARATION, TREATMENT, CONDUCTION AND DISTRIBUTION OF PRESSURE MEDIA, IN PARTICULAR OF GASES AND HYDRAULIC LIQUIDS; MACHINE PARTS FOR COMPRESSORS FOR THE CONTROL AND REGULATION OF PRESSURE MEDIA PLANTS AND APPARATUSES, IN PARTICULAR OF PNEUMATIC AND HYDRAULIC PLANTS AND APPARATUSES; PNEUMATIC AND HYDRAULIC VALVES BEING PARTS OF COMPRESSOR MACHINES, PLATE VALVES BEING PARTS OF COMPRESSOR MACHINES, POPPET VALVES BEING PARTS OF COMPRESSOR MACHINES, RING VALVES BEING PARTS OF COMPRESSORS; CONTROL VALVES BEING PARTS OF COMPRESSOR MACHINES, NON-RETURN VALVES BEING PARTS OF COMPRESSOR MACHINES, OVERLOAD PROTECTION VALVES BEING PARTS OF COMPRESSORS, SAFETY

VALVES BEING PARTS OF COMPRESSORS, REGULATING VALVES BEING PARTS OF COMPRESSORS, THROTTLE VALVES BEING PARTS OF COMPRESSORS, CONTROL CYLINDERS VALVES BEING PARTS OF COMPRESSORS, MACHINE PARTS NAMELY WORKING CYLINDERS AND MACHINE PARTS NAMELY CYLINDERS; MACHINE PARTS NAMELY, PISTON-ROD-FREE CYLINDERS; DAMPERS AS PARTS OF COMPRESSORS; FILTERS FOR COMPRESSORS; CONDENSATION SEPARATORS; LUBRICATING APPARATUS FOR USE WITH COMPRESSORS; MACHINE PARTS FOR APPARATUSES FOR THE FORCED ACTUATION OF VALVES, IN PARTICULAR FOR APPARATUSES AND CONTROL DEVICES FOR THE FORCED OPENING OF AUTOMATIC COMPRESSOR VALVES; PISTON RINGS, PISTON GUIDE RINGS, MECHANICAL SEALS NAMELY, PISTON ROD SEALS AND SCRAPER RINGS FOR RECIPROCATING PISTON COMPRESSORS; DAMPERS FOR USE WITH COMPRESSORS; LUBRICATING APPARATUS FOR USE WITH COMPRESSORS, IN CLASS 7 (U.S. CLS. 13, 19, 21, 23, 31, 34 AND 35).

FOR: HAND ACTUATED TOOLS AND APPARATUSES FOR ASSEMBLING COMPRESSORS AND COMPRESSOR MACHINES, NAMELY, MANUALLY OPERATED HAMMERS, PLIERS, BOLT CUTTERS, HAND SHEARS FOR CUTTING METAL, SCREWDRIVERS, WRENCHES, CABLE AND WIRE CUTTERS, NUT DRIVERS, SPANNERS, FILES, HAND DRILLS AND BITS FOR HAND DRILLS, SHEET METAL PUNCHES, IN CLASS 8 (U.S. CLS. 23, 28 AND 44).

FOR: ELECTRICAL AND ELECTRONIC APPARATUSES, NAMELY, FOR THE ACTUATION AND CONTROL OF PNEUMATIC AND HYDRAULIC PLANTS AND APPARATUSES, IN PARTICULAR OF COMPRESSORS AND VALVES AND ELEMENTS NAMELY, SENSORS, VALVES, AND COMPUTERS FOR THE REGULATION AND MONITORING OF PNEUMATIC AND HYDRAULIC PLANTS AND APPARATUSES NAMELY, COMPRESSORS FOR

COMPRESSING GAS AND HYDRAULIC LIQUIDS, IN PARTICULAR OF COMPRESSORS AND VALVES; CONTROL OR MONITORING APPARATUS FOR THE GENERATION, PROCESSING, MONITORING, TREATMENT, CONDUCTION AND DISTRIBUTION OF PRESSURE MEDIA; CONTROL APPARATUS OR MONITORING APPARATUS FOR THE CONTROL, REGULATION AND MONITORING OF PRESSURE MEDIA PLANTS AND APPARATUSES; PIEZO-ELECTRICALLY ACTUATED AUTOMATIC VALVES; ANALOGUE AND DIGITAL ELECTRICAL AND ELECTRONIC CONTROL, ACTUATION, COMMUNICATION AND CONNECTION ELEMENTS AND UNITS, DIAGNOSTIC ELEMENTS AND DIAGNOSTIC UNITS NOT FOR MEDICAL PURPOSES; ELECTRICAL AND ELECTRONIC NETWORK ELEMENTS, NETWORK LINES AND NETWORK INTERFACES NAMELY, SWITCHES, ROUTERS, COMPONENTS IN THE NATURE OF REPLACEMENT PARTS FOR ALL OF THE AFOREMENTIONED; DOWNLOADABLE ELECTRONIC PUBLICATIONS IN THE NATURE OF BOOKS, NEWSLETTERS, TRADE JOURNALS, MANUALS IN THE FIELD OF COMPRESSION GAS; COMPUTER SOFTWARE AND DOWNLOADABLE COMPUTER SOFTWARE FOR SIZING, LAYOUT AND DESIGN OF COMPRESSORS; ELECTRICAL AND ELECTRONIC APPARATUSES AND ELEMENTS FOR THE ACTUATION AND CONTROL OF PNEUMATIC AND HYDRAULIC PLANTS AND APPARATUSES, IN PARTICULAR OF COMPRESSORS AND VALVES, IN CLASS 9 (U.S. CLS. 21, 23, 26, 36 AND 38).

FOR: SEALING PACKINGS, IN PARTICULAR FOR RECIPROCATING PISTON COMPRESSORS, IN CLASS 17 (U.S. CLS. 1, 5, 12, 13, 35 AND 50).

FOR: ADVERTISING; PROVISION OF INFORMATION AND ADVICE FOR CONSUMERS AND INFORMATION IN TRADING AND BUSINESS MATTERS; SYSTEMATIZATION AND COLLATION OF DATA IN COMPUTER DATA BANKS; ADMINISTRATION OF DATA BY MEANS OF COMPUTERS; COST-PRICE ANALYSIS; SALES PROMOTION; RETAIL TRADING, NAMELY, ONLINE TRADING SERVICES IN WHICH SELLER POSTS PRODUCTS TO BE AUCTIONED AND BIDDING IS DONE VIA THE INTERNET VIA GLOBAL COMPUTER NETWORKS INTERNET; PROVISION OF CONSUMER AND BUSINESS PURCHASING

ADVICE WITH RESPECT TO THE SELECTION AND LAYOUT OF MACHINES, IN PARTICULAR COMPRESSORS, PISTON COMPRESSORS AND THEIR PARTS, IN CLASS 35 (U.S. CLS. 100, 101 AND 102).

FOR: REPAIR SERVICES, IN PARTICULAR SERVICING, MAINTENANCE AND REPAIR OF PNEUMATIC AND HYDRAULIC PLANTS AND APPARATUSES, OF COMPRESSORS AND COMPRESSOR VALVES AND ALSO OF COMPONENTS OF THE NAMED GOODS; THE REPAIR, THE SERVICING AND THE MAINTENANCE OF MACHINES, IN PARTICULAR COMPRESSORS, PISTON COMPRESSORS AND THEIR PARTS; PROVISION OF ADVICE WITH RESPECT TO THE REPAIR, THE SERVICING AND THE MAINTENANCE OF MACHINES, IN PARTICULAR COMPRESSORS, PISTON COMPRESSORS AND THEIR PARTS, IN CLASS 37 (U.S. CLS. 100, 103 AND 106).

FOR: COMPUTER SYSTEM ANALYSES; CALCULATIONS, PLANNING, DESIGNING AT THE DRAWING BOARD OR WITH CAD PROGRAMS ON THE COMPUTER IN THE FIELD OF HYDRAULIC AND PNEUMATIC PLANTS AND APPARATUSES, IN PARTICULAR OF COMPRESSORS, OF HANDLING SYSTEMS AND ALSO OF COMPONENTS OF THE NAMED GOODS; PROVISION OF SPECIALIST OPINIONS AND COMMISSIONING AND TYPE APPROVAL TESTING OF HYDRAULIC AND PNEUMATIC PLANTS AND APPARATUSES, IN PARTICULAR OF COMPRESSORS, OF HANDLING SYSTEMS AND ALSO OF COMPONENTS OF THE NAMED GOODS; RENTAL OF DATA BASE SERVERS AND RENTAL OF WEB SERVERS, IN CLASS 42 (U.S. CLS. 100 AND 101).

PRIORITY DATE OF 11-10-2005 IS CLAIMED.

OWNER OF INTERNATIONAL REGISTRATION 0889604 DATED 5-2-2006, EXPIRES 5-2-2016.

SEC. 2(F).

SER. NO. 79-025,594, FILED 5-2-2006.

THOMAS MANOR, EXAMINING ATTORNEY

**Int. Cls.: 3 and 5**

**Prior U.S. Cls.: 1, 4, 6, 18, 44, 46, 50, 51 and 52**

**United States Patent and Trademark Office**

**Reg. No. 3,453,898**

**Registered June 24, 2008**

**TRADEMARK  
PRINCIPAL REGISTER**



EVERGREEN LAND (HONG KONG CORPORATION)

UNIT 3, 20TH FLOOR, GOLDEN CENTER  
188 DES VOEUX ROAD CENTRAL HONG KONG  
HONG KONG

FOR: SOAPS, PERFUMERY, ESSENTIAL OILS, COSMETICS, ALL THESE PRODUCTS HAVING A REPELLENT EFFECT ON MOSQUITOS, IN CLASS 3 (U.S. CLS. 1, 4, 6, 50, 51 AND 52).

FOR: PHARMACEUTICAL PREPARATIONS, NAMELY, DERMATOLOGICAL PRODUCTS; INSECTICIDE PRODUCTS AND MOSQUITO-REPELLENTS; INSECT REPELLENTS AND MOSQUITO REPELLENTS IN THE FORM OF BRACELETS, ANKLE RINGS, CHOKERS, COLLARS, AND INSECTICIDE TAGS MADE OF CLOTH, IN CLASS 5 (U.S. CLS. 6, 18, 44, 46, 51 AND 52).

OWNER OF INTERNATIONAL REGISTRATION 0889823 DATED 1-25-2006, EXPIRES 1-25-2016.

THE COLOR(S) ORANGE AND GREY IS/ARE CLAIMED AS A FEATURE OF THE MARK.

THE COLOR ORANGE APPEARS IN THE DESIGN OF A MOSQUITO FOUND INSIDE OF AN INCOMPLETE ORANGE OVAL OUTLINE. THE LITERAL ELEMENT OF THE MARK COMPLETES THE REMAINING PORTION OF THE OVAL OUTLINE, ALSO IN ORANGE. THE COLOR GREY APPEARS IN THE BACKGROUND, IN THE SHAPE OF AN OVAL.

SER. NO. 79-025,685, FILED 1-25-2006.

DAVID HOFFMAN, EXAMINING ATTORNEY

**Int. Cl.: 25**

**Prior U.S. Cls.: 22 and 39**

**United States Patent and Trademark Office**

**Reg. No. 3,453,899**

**Registered June 24, 2008**

**TRADEMARK  
PRINCIPAL REGISTER**



ACOTEL GROUP S.P.A. (ITALY CORPORATION)  
29/37, VIA DELLA VALLE DEI FONTANILI  
I-00168 ROMA, ITALY

OWNER OF INTERNATIONAL REGISTRATION  
0890353 DATED 4-3-2006, EXPIRES 4-3-2016.

FOR: CLOTHING, NAMELY, T-SHIRTS, SHIRTS,  
BLOUSES, PULLOVERS, SWEATSHIRTS, JUMP-  
SUITS, STOCKINGS, TIGHTS, SOCKS, WRIST-  
BANDS, JACKETS, COATS, TROUSERS, PANTS,  
SHORTS, GLOVES, NECKERCHIEFS, FOULARDS,  
RAINCOATS, NECKTIES, SKIRTS, SCARVES,  
FOOTWEAR, AND HEADWEAR, IN CLASS 25 (U.S.  
CLS. 22 AND 39).

THE WORD "FLYCELL" HAS NO MEANING IN A  
FOREIGN LANGUAGE.

SER. NO. 79-025,854, FILED 4-3-2006.

PRIORITY DATE OF 10-4-2005 IS CLAIMED.

INGRID C. EULIN, EXAMINING ATTORNEY

**Int. Cls.: 5 and 10**

**Prior U.S. Cls.: 6, 18, 26, 39, 44, 46, 51 and 52**

**United States Patent and Trademark Office**

**Reg. No. 3,453,900**

**Registered June 24, 2008**

**TRADEMARK  
PRINCIPAL REGISTER**

**FREEZE**

BIOMED EST. (LIECHTENSTEIN CORPORATION)  
AUSTR. 49  
FL-9490 VADUZ  
LIECHTENSTEIN

FOR: PHARMACEUTICAL PRODUCTS FOR THE TREATMENT OF DENTAL BONE DISEASES AND ORTHOPEDIC BONE DISEASES, IN CLASS 5 (U.S. CLS. 6, 18, 44, 46, 51 AND 52).

FOR: SURGICAL, ORTHOPEDIC, AND DENTAL IMPLANTS COMPRISING ARTIFICIAL MATERIAL, IN CLASS 10 (U.S. CLS. 26, 39 AND 44).

THE MARK CONSISTS OF STANDARD CHARACTERS WITHOUT CLAIM TO ANY PARTICULAR FONT, STYLE, SIZE, OR COLOR.

PRIORITY DATE OF 4-12-2006 IS CLAIMED.

OWNER OF INTERNATIONAL REGISTRATION 0891202 DATED 6-1-2006, EXPIRES 6-1-2016.

SER. NO. 79-026,176, FILED 6-1-2006.

JOHN GARTNER, EXAMINING ATTORNEY



Int. Cls.: 41, 43 and 44

Prior U.S. Cls.: 100, 101 and 107

United States Patent and Trademark Office

Reg. No. 3,453,901

Registered June 24, 2008

SERVICE MARK  
PRINCIPAL REGISTER



MEDICAL PARK  
CITY MED

EF VERMÖGENSVERWALTUNG GMBH (AUSTRIA LTD LIAB CO)  
MALINGASSE 12  
A-6370 KITZBÜHEL  
AUSTRIA

FOR: SUPERVISION OF ATHLETES, NAMELY, ESTABLISHMENT OF RECOMMENDED TRAINING SCHEDULE AND ROUTINES, IN CLASS 41 (U.S. CLS. 100, 101 AND 107).

FOR: TEMPORARY ACCOMMODATION, IN CLASS 43 (U.S. CLS. 100 AND 101).

FOR: MEDICAL AND CLINICAL TREATMENT SERVICES IN THE FIELDS OF ORTHOPAEDICS, RHEUMATOLOGY, TRAUMATOLOGY, SPORTS MEDICINE, INTERNAL MEDICINE, CARDIOLOGY, AND NEUROLOGY; PROVIDING NATUROPATHIC TREATMENT, NAMELY, MASSAGE AND EXERCISE THERAPY; OSTEOPATHIC TREATMENT; PERFORMING MEDICAL AND CLINICAL EXAMINATIONS, DIAGNOSIS AND THERAPY; MEDICAL SERVICES, NAMELY, PROVIDING DIAGNOSTIC TESTING AND ANALYSIS; PROVID-

ING PHYSICAL THERAPY; MEDICAL EVALUATION SERVICES; OPERATION OF A MEDICAL REHABILITATION CENTER; PROVIDING MEDICAL SERVICES IN SUPPORT OF HIGH-LEVEL ATHLETES, NAMELY, MEDICAL DIAGNOSTIC SERVICES RELATING TO ATHLETIC PERFORMANCE AND IN SUPPORT OF ATHLETIC TRAINING; NURSING SERVICES; AND HOSPITAL SERVICES FOR PATIENTS, IN CLASS 44 (U.S. CLS. 100 AND 101).

OWNER OF INTERNATIONAL REGISTRATION 0891238 DATED 1-12-2006, EXPIRES 1-12-2016.

OWNER OF U.S. REG. NO. 3,087,832.

NO CLAIM IS MADE TO THE EXCLUSIVE RIGHT TO USE "MEDICAL PARK CITY MED", APART FROM THE MARK AS SHOWN.

SER. NO. 79-026,188, FILED 1-12-2006.

DAYNA BROWNE, EXAMINING ATTORNEY

**Int. Cls.: 9, 14, 16, 18, 20, 21, 25, 28, 29, 30, 32 and 41**

**Prior U.S. Cls.: 1, 2, 3, 5, 13, 21, 22, 23, 25, 26, 27, 28, 29, 30, 32, 33, 36, 37, 38, 39, 40, 41, 45, 46, 48, 50, 100, 101 and 107**

**Reg. No. 3,453,902**

**United States Patent and Trademark Office**

**Registered June 24, 2008**

**TRADEMARK  
SERVICE MARK  
PRINCIPAL REGISTER**



WALLACE & GROMIT LIMITED (UNITED KINGDOM LIMITED COMPANY)  
GAS FERRY ROAD  
BRISTOL BS1 6UN  
UNITED KINGDOM

FOR: SOUND AND VIDEO RECORDINGS FEATURING RADIO, TELEVISION, CABLE AND SATELLITE PROGRAMS AND MOTION PICTURE FILMS ALL IN THE FIELDS OF MUSIC, ACTION, ADVENTURE, DRAMA, COMEDY, INTERVIEWS, DOCUMENTARIES, NEWS, CURRENT AFFAIRS, EXERCISE AND FITNESS, HEALTH, FICTION, SPORTS, LEISURE, MOTORING, RELIGION, LAW, CRIME, VIDEO GAMES, QUIZZES, COOKERY, NATURE, GARDENING, POLITICS, CULTURE, TRAVEL, NATURAL HISTORY, SOCIAL ISSUES, LANGUAGES, TEACHING, MATHEMATICS, GEOGRAPHY, HISTORY, GEOLOGY, BIOLOGY, TECHNOLOGY, HORROR, CLASSIC MOVIES AND WESTERN MOVIES, SCIENCE FICTION, DECORATING, INTERIOR DESIGN, SCIENCE AND THE ARTS; MEDIA FOR STORAGE AND REPRODUCTION OF SOUND AND VISUAL IMAGES, NAMELY, PORTABLE AND STATIONARY PLAYERS FOR SOUND, VIDEO AND DATA RECORDINGS ON CD-ROMS, MAGNETIC DISKS, OPTICAL DISKS, AUDIO AND VIDEO TAPE, AND RECORDERS AND PLAYERS FOR SOUND, VIDEO AND DATA RECORDINGS; BLANK CD-ROMS, CDS, DIGITAL VERSATILE DISKS (DVDS), MAGNETIC DISKS, OPTICAL DISKS, AUDIO AND VIDEO

TAPE; PRE-RECORDED DISCS, RECORDS, TAPES, CD-ROMS, CDS, DIGITAL VERSATILE DISKS (DVDS), SOUND AND VIDEO RECORDINGS IN THE FIELDS OF MUSIC, ACTION, ADVENTURE, DRAMA, COMEDY, INTERVIEWS, DOCUMENTARIES, NEWS, CURRENT AFFAIRS, EXERCISE AND FITNESS, HEALTH, FICTION, SPORTS, LEISURE, MOTORING, RELIGION, LAW, CRIME, VIDEO GAMES, QUIZZES, COOKERY, NATURE, GARDENING, POLITICS, CULTURE, TRAVEL, NATURAL HISTORY, SOCIAL ISSUES, LANGUAGES, TEACHING, MATHEMATICS, GEOGRAPHY, HISTORY, GEOLOGY, BIOLOGY, TECHNOLOGY, HORROR, CLASSIC MOVIES AND WESTERN MOVIES, SCIENCE FICTION, DECORATING, INTERIOR DESIGN, SCIENCE AND THE ARTS; INTERACTIVE, COMPUTER AND MULTI-MEDIA SOFTWARE FOR THE PURPOSES OF EDUCATION AND ENTERTAINMENT IN THE FIELDS OF ENTERTAINMENT AND ANIMATION, NAMELY, RADIO, TELEVISION, CABLE AND SATELLITE RECORDINGS AND FILMS IN THE FIELD OF MUSIC, ACTION, ADVENTURE, DRAMA, COMEDY, INTERVIEWS, DOCUMENTARIES, NEWS, CURRENT AFFAIRS, EXERCISE AND FITNESS, HEALTH, FICTION, SPORTS, LEISURE, MOTORING, RELIGION, LAW, CRIME, VIDEO GAMES, QUIZZES, COOKERY, NATURE, GARDENING, POLITICS, CULTURE, TRAVEL, NATURAL HISTORY, SOCIAL ISSUES, LANGUAGES, TEACHING, MATHEMATICS, GEOGRAPHY, HISTORY, GEOLOGY, BIOLOGY, TECHNOLOGY, HORROR, CLAS-

SIC MOVIES AND WESTERN MOVIES, SCIENCE FICTION, DECORATING, INTERIOR DESIGN, SCIENCE AND THE ARTS; DOWNLOADABLE PUBLICATIONS AND PUBLICATIONS RECORDED ON COMPUTER MEDIA IN ELECTRONIC FORM, NAMELY, BOOKS, MAGAZINES, COMICS, AND NEWSLETTERS RELATING TO RADIO, TELEVISION, CABLE AND SATELLITE RECORDINGS AND FILMS; CAMERAS; EYEGLASSES; CONTACT LENSES; EYEGLASSES CASES; SUNGLASSES; MOBILE PHONE STRAPS; MOUSE PADS AND OTHER PC ACCESSORIES, NAMELY, HOLDERS FOR COMPACT DISKS, DISK DRIVES, DUST COVERS FOR COMPUTERS, DIGITAL VERSATILE DISK (DVD) DRIVES, KEYBOARDS, MONITOR ARMS, MONITOR STANDS, MOUSE HOLDERS, MICE, MOUSEPENS, PRINTERS, PRINTER STANDS, SCANNERS, SPEAKERS AND PARTS AND FITTINGS FOR THESE GOODS; MOTORCYCLE HELMETS; TV GAMES, NAMELY, VIDEO GAMES AND COMPUTER GAMES SOFTWARE FOR USE WITH A TELEVISION SCREEN; AUDIO AND SPEAKER SETS FOR CARS; HOLDERS FOR COMPACT DISKS AND CASSETTE HOLDERS FOR CARS; FIRE EXTINGUISHERS FOR CARS; SUNGLASS HOLDERS FOR CARS; DECORATIVE MAGNETS, IN CLASS 9 (U.S. CLS. 21, 23, 26, 36 AND 38).

FOR: ARTICLES MADE OF OR COATED WITH PRECIOUS METAL, NAMELY, PINS, BROACHES, MONEY CLIPS, BELT BUCKLES FOR CLOTHING, BADGES, JEWELLERY BOXES, ASH TRAYS, KEY FOBS, KEY RINGS, KEY CHAINS, CUFFLINKS, BROACHES, WRIST BRACELETS, ANKLE BRACELETS, BANGLES, AMULETS, EARRINGS, NECKLACES, PENDANTS, MEDALLIONS, TRINKETS, CHARMS, CANDLE RINGS, NAPKIN RINGS, PERSONAL RINGS, WATCH STRAPS, TIE PINS, ORNAMENTAL PINS, JEWELLERY PINS, TIE CLIPS, NON-MONETARY COINS, HAT AND SHOE ORNAMENTS, STATUETTES, FIGURINES, FIGURES, JEWELLERY AND CIGARETTE CASES, COASTERS, NAPKIN RINGS, SERVING TRAYS, GOBLETTS, EGG CUPS, SALT CELLARS, PEPPER POTS, COFFEE SERVICES, TEA POTS, TEA STRAINERS, TEA CADDIES, DINNERWARE, NAMELY, PLATES, CUPS, MUGS, SAUCERS, BOWLS, SERVING PLATTERS AND TABLEWARE, NAMELY, CAKE SERVERS AND SALAD BOWLS, HOROLOGICAL AND CHRONOMETRIC INSTRUMENTS, NAMELY, WATCHES, CLOCKS, TIMEPIECES, CHRONOMETERS AND SUNDIALS, AND WRIST WATCHES; PRECIOUS AND SEMI-PRECIOUS STONES AND GEMSTONES, IN CLASS 14 (U.S. CLS. 2, 27, 28 AND 50).

FOR: PAPER, CARDBOARD AND GOODS MADE FROM THESE MATERIALS, NAMELY, PARTY BANNERS, CONE PAPER HATS, PAPER VISORS, CUTOUT FIGURES, PAPER PARTY DECORATIONS, PAPER CAKE DECORATIONS, GARLANDS, PAPER NAPKINS, TABLE COVERS, TREAT SACKS; BOOKBINDINGS; PHOTOGRAPHS; ARTISTS' MATERIALS, NAMELY, PAINT SETS AND PAINT BOXES AND MODELLING KITS; PAINT BRUSHES; PRINTED MATTER, NAMELY, BROCHURES, NEWSPAPERS, PERIODICALS, MA-

GAZINES AND BOOKS IN THE FIELDS OF ENTERTAINMENT AND ANIMATION, NAMELY, RADIO, TELEVISION, CABLE AND SATELLITE RECORDINGS AND FILMS IN THE FIELD OF MUSIC, ACTION, ADVENTURE, DRAMA, COMEDY, INTERVIEWS, DOCUMENTARIES, NEWS, CURRENT AFFAIRS, EXERCISE AND FITNESS, HEALTH, FICTION, SPORTS, LEISURE, MOTORING, RELIGION, LAW, CRIME, VIDEO GAMES, QUIZZES, COOKERY, NATURE, GARDENING, POLITICS, CULTURE, TRAVEL, NATURAL HISTORY, SOCIAL ISSUES, LANGUAGES, TEACHING, MATHEMATICS, GEOGRAPHY, HISTORY, GEOLOGY, BIOLOGY, TECHNOLOGY, HORROR, CLASSIC MOVIES AND WESTERN MOVIES, SCIENCE FICTION, DECORATING, INTERIOR DESIGN, SCIENCE AND THE ARTS; DIARIES, DESKTOP ORGANIZERS, ORGANIZERS FOR STATIONERY USE, PERSONAL ORGANIZERS; BOUND JOURNALS, ADDRESS BOOKS, TRADING CARDS, STICKERS, PHOTO ALBUMS, SCRAPBOOKS, GIFT BAGS, POSTCARDS, POSTERS, BOOK MARKERS, CALENDARS, WRAPPING PAPER; PHOTO STANDS; STATIONERY, NAMELY, INVITATIONS, ANNOUNCEMENT CARDS, PLACE CARDS, THANK YOU NOTES, STATIONERY SETS, FILES, PAPER, ENVELOPES, MEMO PADS, NOTE PADS, DRAWING PADS, GREETING CARDS, FOLDERS; PEN AND PENCIL CASES; ERASERS; PENCILS; PENCIL HOLDERS; ADHESIVES AND ADHESIVE TAPE FOR STATIONERY OR HOUSEHOLD PURPOSES; WRITING INSTRUMENTS; PENS; BALL-POINT PENS; FELT PENS; FIBRE-TIP PENS; CRAYONS; CHALKS; PENCIL SHARPENERS; TRACING PAPER; MODELLING MATERIALS, NAMELY, MODELLING CLAY; PHOTOGRAPHS; IRON-ON TRANSFERS; PLASTIC TRANSFERS; STICKERS; DECALCOMANIAS; COLOURING SETS CONSISTING OF COLOURING INSTRUMENTS AND COLOURING BOOKS; PAPER CRAFT SETS CONSISTING OF COLOURED PAPER FOR FOLDING AND INSTRUCTIONS FOR USE THEREWITH; PLASTIC TAX DISC HOLDERS FOR CARS AND MOTORCYCLES, IN CLASS 16 (U.S. CLS. 2, 5, 22, 23, 29, 37, 38 AND 50).

FOR: SHOULDER BAGS; RECORD BAGS; SATCHELS; RUCKSACKS; SPORTS BAGS; HANDBAGS; PURSES; TRUNKS; TRAVELLING BAGS; LEATHER AND IMITATIONS OF LEATHER AND GOODS MADE OF THESE MATERIALS, NAMELY, TRUNKS, TRAVELLING BAGS, ALL-PURPOSE CARRYING BAGS, RUCKSACKS, SPORTS BAGS, HANDBAGS AND PURSES; ANIMALS SKINS AND HIDES; UMBRELLAS; PARASOLS; WALKING STICKS; WHIPS; HARNESS AND SADDLERY; TOILETRY POUCHES SOLD EMPTY; DOG WARDROBES, NAMELY, CLOTHING AND HEADWEAR FOR DOGS, IN CLASS 18 (U.S. CLS. 1, 2, 3, 22 AND 41).

FOR: GOODS OF WOOD, CORK, REED, CANE, WICKER, HORN, BONE, IVORY, WHALEBONE, SHELL, AMBER, MOTHER-OF-PEARL, MEERSCHAUM AND SUBSTITUTES FOR ALL THESE MATERIALS, OR OF PLASTICS, NAMELY, FURNITURE, MIRRORS, PICTURE FRAMES, JEWELLERY

CASES, KEYRINGS, STATUETTES AND FIGURINES, IN CLASS 20 (U.S. CLS. 2, 13, 22, 25, 32 AND 50).

FOR: HOUSEHOLD OR KITCHEN UTENSILS AND CONTAINERS NOT OF PRECIOUS METAL OR COATED THEREWITH, NAMELY, GLOBES AND NON-METAL DECORATIVE BOXES MADE OF GLASS, PORCELAIN, EARTHENWARE, CHINA OR CRYSTAL, CONTAINERS FOR HOUSEHOLD OR KITCHEN USE; RESEALABLE PLASTIC CONTAINERS; MEAL TRAYS; BEVERAGE GLASSWARE; PORCELAIN AND EARTHENWARE, NAMELY, DINNERWARE, DISHES, VASES, PLANTERS; PANS; KETTLES; DISHES; LUNCH BOXES; WASTE BASKETS; GLASS DISHES; PLANTERS FOR FLOWERS AND PLANTS; VASES; CANDLE STANDS NOT MADE OF PRECIOUS METAL; SHOE-HORNS; TERRA-COTTA, PORCELAIN OR GLASS FIGURINES, IN CLASS 21 (U.S. CLS. 2, 13, 23, 29, 30, 33, 40 AND 50).

FOR: CLOTHING, NAMELY, T-SHIRTS, SHIRTS, BLOUSES, SWEATSHIRTS, SWEATERS, FLEECE TOPS, TROUSERS, SHORTS, SKIRTS, UNDERWEAR, BOXER SHORTS, BRIEFS, NIGHTDRESSES, NIGHTSHIRTS, DRESSING GOWNS, ROBES, WAISTCOATS, BRACES, VESTS, GLOVES, MITTENS, APRONS, SOCKS, SCARVES, NECKTIES, MUFFLERS, BELTS, DRESSES, COATS, SWIM SUITS, PYJAMAS; FOOTWEAR, NAMELY, SLIPPERS, SLIPPER SOCKS, TRAINING SHOES, SNEAKERS, SANDALS, BOOTS, SHOES, JAPANESE SLIPPERS; HEADGEAR, NAMELY, CAPS, HATS, BASEBALL CAPS, HEADSCARVES, VISORS, EAR MUFFS, HEADBANDS, SWEATBANDS; CLOTHING FOR MOTORCYCLISTS, NAMELY, LEATHER JACKETS, LEATHER TROUSERS, BOOTS, GLOVES AND WATERPROOF SUITS, IN CLASS 25 (U.S. CLS. 22 AND 39).

FOR: PUPPETS AND MODELS BASED ON CHARACTERS FROM TELEVISION, CABLE AND SATELLITE RECORDINGS AND FILMS; TOY MASKS BASED ON CHARACTERS FROM TELEVISION, CABLE AND SATELLITE RECORDINGS AND FILMS; TOYS, NAMELY, PLUSH TOYS OF A VARIETY OF MATERIALS; PLUSH DOLLS; TOY FIGURINES OF MOLDED PLASTIC AND RESIN; DOLLS; DOLL ACCESSORIES; NURSERY TOYS; RIDE-ON ANIMALS; RIDE-ON VEHICLES; GAMES AND PLAYTHINGS, NAMELY, BOARD GAMES, JIGSAW PUZZLES, PLASTICINE MODELLING KITS FOR MAKING TOY MODELS, PIÑATAS; SPORTING ARTICLES, NAMELY, BATS, HOCKEY STICKS, RACKETS FOR SPORTS, BALLS, SHUTTLECOCKS, FISHING TACKLE, FISHING REELS, FISHING RODS, LINES, LURES, HOOKS, GAFFS, CREELS, FLOATS, FLIES, SINKERS AND NETS AS RELATED TO SPORTS FISHING, GOLF CLUBS, GOLF BAGS AND TROLLEYS, GOLF GLOVES, BASEBALL GLOVES, BOXING GLOVES, FLIPPERS FOR SWIMMING, BODY BOARDS, SAILBOARDS, SURFBOARDS, ARCHERY ARM GUARDS, ARCHERY ARROWS, ARCHERY BOW CASES, ARCHERY BOWS, ARCHERY TARGETS, ARCHERY QUIVERS, ROLLER SKATES, ICE SKATES, IN-LINE SKATES, SKIS, DARTS, DISCUSES, PUNCH BAGS; PLAY-

GROUND ACTIVITY APPARATUS, NAMELY, SWINGS, BARS, CLIMBING FRAMES, SLIDES, ROUNDABOUTS; NON-ILLUMINATED DECORATIONS FOR CHRISTMAS TREES; PLAYING CARDS, IN CLASS 28 (U.S. CLS. 22, 23, 38 AND 50).

FOR: MEAT; FISH; POULTRY; GAME; MEAT EXTRACTS; PRESERVED, DRIED AND COOKED FRUIT; CANDIED, SHELLLED AND ROASTED NUTS; PICKLED, CANNED OR BOTTLED VEGETABLES THAT ARE WHOLE OR SLICED; JELLIES, JAMS, APPLESAUCE, CRANBERRY SAUCE, ORANGE SAUCE; EGGS; MILK AND MILK PRODUCTS, NAMELY, MILK, FLAVOURED MILK DRINKS, YOGURT; CHEESE, COTTAGE CHEESE; EDIBLE OILS; EDIBLE FATS; VEGETABLE AND POTATO SNACKS, IN CLASS 29 (U.S. CL. 46).

FOR: COFFEE; TEA; COCOA; SUGAR; RICE; TAPIOCA; SAGO; COFFEE SUBSTITUTE; FLOUR; CEREALS; BISCUITS; COOKIES; CEREAL BARS; BREADS; PASTRIES; CHOCOLATES; CANDY; SHAVED, FLAVORED ICES; HONEY; TREACLE; YEAST; BAKING-POWDER; SALT; MUSTARD; VINEGAR; SAUCES; CONDIMENTS, NAMELY, KETCHUP, MUSTARD, MAYONNAISE, RELISH; SPICES; ICE; SNACK FOODS, NAMELY, COOKIES, BISCUITS, CAKES AND CAKE MIXES, POPCORN, SALTED AND UNSALTED GRAIN AND CEREAL BASED SNACKS, IN CLASS 30 (U.S. CL. 46).

FOR: BEERS; MINERAL AND AERATED WATERS; CARBONATED SOFT DRINKS; BOTTLED WATERS; FRUIT DRINKS; FRUIT JUICES; SYRUPS AND CORDIALS FOR MAKING FRUIT-BASED AND FRUIT FLAVOURED DRINKS AND SOFT DRINKS, IN CLASS 32 (U.S. CLS. 45, 46 AND 48).

FOR: ENTERTAINMENT SERVICES FOR ADULTS AND CHILDREN, NAMELY, PRODUCTION, RECORDING AND DISTRIBUTION OF RADIO, TELEVISION, CABLE AND SATELLITE PROGRAMS AND FEATURE FILMS IN THE FIELDS OF ANIMATION, MUSIC, ACTION, ADVENTURE, DRAMA, COMEDY, INTERVIEWS, DOCUMENTARIES, NEWS, CURRENT AFFAIRS, EXERCISE AND FITNESS, HEALTH, FICTION, SPORTS, LEISURE, MOTORING, RELIGION, LAW, CRIME, VIDEO GAMES, QUIZZES, COOKERY, NATURE, GARDENING, POLITICS, CULTURE, TRAVEL, NATURAL HISTORY, SOCIAL ISSUES, LANGUAGES, TEACHING, MATHEMATICS, GEOGRAPHY, HISTORY, GEOLOGY, BIOLOGY, TECHNOLOGY, HORROR, CLASSIC MOVIES AND WESTERN MOVIES, SCIENCE FICTION, DECORATING, INTERIOR DESIGN, SCIENCE AND THE ARTS, SHORT CLIPS, NEWS, VARIETY, COMEDY, MUSIC, TALK, INTERVIEWS; CONDUCTING COMPETITIONS IN THE FIELDS OF ATHLETICS, SPELLING, GENERAL AND SPECIALIZED KNOWLEDGE; LIVE PERFORMANCES BY MUSICAL BANDS; LIVE MUSIC CONCERTS; SHOWS FEATURING CHARACTERS FROM RADIO AND TELEVISION PROGRAMS, VIDEO GAMES AND MOVIES; ROAD SHOWS AND STAGED EVENTS FEATURING CHARACTERS FROM RADIO AND TELEVISION PROGRAMS, VIDEO

GAMES AND MOVIES; PRODUCTION AND RECORDING OF FILMS, RADIO AND TELEVISION PROGRAMMES, VIDEO, AUDIO AND MULTIMEDIA RECORDINGS; DISTRIBUTION OF FILMS, RADIO AND TELEVISION PROGRAMMES FOR OTHERS; RECORDING STUDIO SERVICES; ANIMATION AND OTHER SPECIAL EFFECTS FOR RADIO, TELEVISION OR FILMS; PRODUCTION AND PRESENTATION OF LIVE PERFORMANCES; THEATRE SERVICES, NAMELY, THEATRICAL PERFORMANCES, PLAYS AND MUSICALS; PUBLICATION SERVICES, NAMELY, BOOK AND MUSIC PUBLISHING SERVICES; ELECTRONIC PUBLISHING SERVICES, NAMELY, PUBLICATION OF TEXTUAL, AUDIO, AUDIO-VISUAL AND GRAPHIC WORKS OF OTHERS ON OPTICAL DISKS, MAGNETIC DISKS AND TAPES, AND THROUGH A GLOBAL COMPUTER NETWORK FEATURING OR ASSOCIATED WITH TELEVISION AND RADIO PROGRAMS; ELECTRONIC GAMES SERVICES,

NAMELY, PROVISION OF GAMES OVER THE INTERNET; PROVIDING ON-LINE ELECTRONIC PUBLICATIONS, NAMELY, PROVIDING INFORMATION ABOUT TELEVISION AND RADIO PROGRAMMES AND FEATURE FILMS AND CHARACTERS FEATURED THEREIN; PROVIDING INFORMATION ABOUT ENTERTAINMENT, NAMELY, TIME AND DATE LISTINGS FOR PROGRAMMES AND PERFORMANCES, PROGRAMME INFORMATION, IN CLASS 41 (U.S. CLS. 100, 101 AND 107).

OWNER OF INTERNATIONAL REGISTRATION  
0891833 DATED 7-13-2005, EXPIRES 7-13-2015.

SER. NO. 79-026,381, FILED 7-13-2005.

JULIE GUTTADAURO, EXAMINING ATTORNEY

Int. Cl.: 39

Prior U.S. Cls.: 100 and 105

United States Patent and Trademark Office

Reg. No. 3,453,903

Registered June 24, 2008

SERVICE MARK  
PRINCIPAL REGISTER

ELYSAIR

ELYSAIR SERVICES SARL (FRANCE SOCIÉTÉ À  
RESPONSABILITÉ LIMITÉE)  
47 RUE DU FAUBOURG SAINT HONORÉ  
F-75008 PARIS  
FRANCE

FOR: AIRLINE TRANSPORTATION SERVICES;  
AIR TRANSPORTATION SERVICES, NAMELY,  
THE CARRIAGE OF PASSENGERS AND CARGO  
BY AIR; TRAVEL AGENCY SERVICES, NAMELY,  
MAKING RESERVATIONS AND BOOKINGS FOR  
TRANSPORTATION; AIR TRANSPORTATION SER-  
VICES FEATURING A FREQUENT FLYER PRO-  
GRAM; AND PROVIDING INFORMATION ABOUT  
AIR TRANSPORTATION VIA A WEBSITE ON THE  
INTERNET, IN CLASS 39 (U.S. CLS. 100 AND 105).

THE MARK CONSISTS OF STANDARD CHAR-  
ACTERS WITHOUT CLAIM TO ANY PARTICULAR  
FONT, STYLE, SIZE, OR COLOR.

OWNER OF INTERNATIONAL REGISTRATION  
0892462 DATED 6-1-2006, EXPIRES 6-1-2016.

THE ENGLISH TRANSLATION OF THE FOR-  
EIGN WORD(S) IN THE MARK IS "ELYSAIR".

SER. NO. 79-026,587, FILED 6-1-2006.

HOWARD SMIGA, EXAMINING ATTORNEY

**Int. Cls.: 7 and 12**

**Prior U.S. Cls.: 13, 19, 21, 23, 31, 34, 35 and 44**

**Reg. No. 3,453,904**

**United States Patent and Trademark Office**

**Registered June 24, 2008**

**TRADEMARK  
PRINCIPAL REGISTER**

# COUNTERTRACK

GKN DRIVELINE INTERNATIONAL GMBH  
(FED REP GERMANY LTD LIAB CO)  
HAUPTSTRASSE 130  
53797 LOHMAR, FED REP GERMANY

FOR: POWER TRANSMISSION AND GEARING FOR MACHINES AND PARTS THEREOF; COMPONENTS OF MACHINES AND ENGINES AND MOTORS OTHER THAN FOR LAND VEHICLES, NAMELY, DRIVE SHAFTS, BALL JOINTS, CONSTANT VELOCITY JOINTS, UNIVERSAL JOINTS, GEARS, COUPLINGS, CLUTCHES, BOOTS AND ADAPTORS FOR CV JOINTS, AND PARTS THEREOF; GEARS AND ENCLOSED DRIVES FOR INDUSTRIAL AND AGRICULTURAL MACHINERY; GEARBOXES OTHER THAN FOR LAND VEHICLES, IN CLASS 7 (U.S. CLS. 13, 19, 21, 23, 31, 34 AND 35).

FOR: POWER TRANSMISSION AND PARTS THEREOF FOR LAND VEHICLES; DRIVE SHAFTS FOR LAND VEHICLES; BALL JOINTS FOR LAND VEHICLES; CONSTANT VELOCITY JOINTS FOR LAND VEHICLES; UNIVERSAL JOINTS FOR LAND

VEHICLES; GEARS FOR LAND VEHICLES; COUPLINGS FOR LAND VEHICLES; CLUTCHES FOR LAND VEHICLES; BOOTS AND ADAPTORS FOR CV JOINTS FOR LAND VEHICLES; AND PARTS THEREOF, IN CLASS 12 (U.S. CLS. 19, 21, 23, 31, 35 AND 44).

THE MARK CONSISTS OF STANDARD CHARACTERS WITHOUT CLAIM TO ANY PARTICULAR FONT, STYLE, SIZE, OR COLOR.

PRIORITY DATE OF 12-16-2005 IS CLAIMED.

OWNER OF INTERNATIONAL REGISTRATION 0893809 DATED 6-16-2006, EXPIRES 6-16-2016.

SER. NO. 79-027,077, FILED 6-16-2006.

KATHLEEN M. VANSTON, EXAMINING ATTORNEY

**Int. Cls.: 7, 40 and 42**

**Prior U.S. Cls.: 13, 19, 21, 23, 31, 34, 35, 100, 101, 103  
and 106**

**Reg. No. 3,453,905**

**United States Patent and Trademark Office**

**Registered June 24, 2008**

**TRADEMARK  
SERVICE MARK  
PRINCIPAL REGISTER**

# ZIERSCH

ZIERSCH GMBH (FED REP GERMANY LIMITED COMPANY)  
AM VOGELHERD 26  
98693 ILMENAU  
FED REP GERMANY

FOR: MACHINES FOR THE METAL INDUSTRY AND ITS PARTS AS FAR AS CONTAINED IN THIS CLASS, NAMELY, MACHINE TOOLS, NAMELY, MILLING MACHINES, GRINDING MACHINES, CUTTERS BEING GEAR AND MILLING CUTTERS ELECTRIC GAS AND LASER WELDING MACHINES, MOLDING MACHINES PARTICULARLY FOR METAL, ENGRAVING MACHINES, PLANING MACHINES, PUNCHING MACHINES BEING PUNCHING PRESSES, METALWORKING MACHINES, DIE-STAMPING MACHINES; ACCESSORIES FOR THE AFOREMENTIONED MACHINES, AS FAR AS CONTAINED IN THIS CLASS, NAMELY, PROTOTYPES FOR STAMPED AND MOLDED PARTS, DIE-CASTING FORMS, MOLDS AND PROTOTYPES FOR PROCESSING OF POLYMERS; HAND-HELD TOOLS OTHER THAN HAND-OPERATED, NAMELY, ANGLE GRINDER HAND WELDING MACHINE, BELT GRINDER, HAND-HELD GRAVURE MILLING MACHINE, PORTABLE DRILLING MACHINE, IN CLASS 7 (U.S. CLS. 13, 19, 21, 23, 31, 34 AND 35).

FOR: METAL TREATING, PARTICULARLY MILLING BEING MILL WORKING, DRILLING, GRINDING, CARBIDE METAL WORKING AND DEEP HOLE DRILLING; PROVIDING INFORMATION IN THE FIELD OF MATERIAL TREATMENT

VIA THE INTERNET; PROVIDING METAL TREATING INFORMATION, IN CLASS 40 (U.S. CLS. 100, 103 AND 106).

FOR: RESEARCH AND DEVELOPMENT SERVICES REGARDING MECHANICAL CONSTRUCTION PLANNING IN THE FIELD OF MACHINE AND ENGINE CONSTRUCTION, TECHNICAL CONSULTANCY IN THE FIELD OF MACHINE AND ENGINE CONSTRUCTION TECHNOLOGY, CONDUCTING TECHNICAL PROJECT STUDIES; ENGINEERING; TECHNICAL CONSULTANCY IN THE FIELD OF MATERIAL TREATMENT TECHNOLOGY, IN CLASS 42 (U.S. CLS. 100 AND 101).

THE MARK CONSISTS OF STANDARD CHARACTERS WITHOUT CLAIM TO ANY PARTICULAR FONT, STYLE, SIZE, OR COLOR.

PRIORITY DATE OF 11-10-2005 IS CLAIMED.

OWNER OF INTERNATIONAL REGISTRATION 0893848 DATED 4-25-2006, EXPIRES 4-25-2016.

THE WORDING "ZIERSCH" HAS NO MEANING IN A FOREIGN LANGUAGE.

SER. NO. 79-027,090, FILED 4-25-2006.

RUDY R. SINGLETON, EXAMINING ATTORNEY



**Int. Cls.: 3, 14, 16, 18, 21, 25, 29, 30, 31, 32, 35 and 43**

**Prior U.S. Cls.: 1, 2, 3, 4, 5, 6, 13, 22, 23, 27, 28, 29, 30, 33, 37, 38, 39, 40, 41, 45, 46, 48, 50, 51, 52, 100, 101 and 102**

**Reg. No. 3,453,906**

**United States Patent and Trademark Office**

**Registered June 24, 2008**

**TRADEMARK  
SERVICE MARK  
PRINCIPAL REGISTER**

**wagamama**

WAGAMAMA LIMITED (UNITED KINGDOM COMPANY)

WAVERLEY HOUSE

7-12 NOEL STREET LONDON W1F 8GQ

UNITED KINGDOM

FOR: CLEANING, POLISHING, SCOURING AND ABRASIVE LIQUIDS AND POWDERS; BODY SOAP; PERFUMERY, ESSENTIAL OILS, COSMETICS, HAIR LOTIONS, IN CLASS 3 (U.S. CLS. 1, 4, 6, 50, 51 AND 52).

FOR: JEWELRY, PRECIOUS STONES; HOROLOGICAL AND CHRONOMETRIC INSTRUMENTS, IN CLASS 14 (U.S. CLS. 2, 27, 28 AND 50).

FOR: PAPER, CARDBOARD AND GOODS MADE FROM THESE MATERIALS, NAMELY, PAPER NAPKINS, PAPER OR CARD TABLE MATS, PAPER TOWELS, CHOPSTICK COVERS AND HOLDERS OF PAPER OR CARD; SHOPPING BAGS MADE OF PAPER AND PLASTIC; STAFF TRAINING MANUALS RELATING TO CONDUCTING BUSINESS AND COMMERCE; NON-FICTION BOOKS RELATING TO FOODS AND/OR COOKERY; PHOTOGRAPHS; STATIONERY; PLASTIC BAGS FOR PACKAGING; ARTISTS MATERIALS, NAMELY, CRAYONS AND PENCILS, IN CLASS 16 (U.S. CLS. 2, 5, 22, 23, 29, 37, 38 AND 50).

FOR: LEATHER AND IMITATIONS OF LEATHER, NAMELY, LUGGAGE, SHOULDER BAGS, HIP BAGS, SHOPPING BAGS, HAVERSACKS, WALLETTS, PURSES, TRAVEL BAGS, HANDBAGS, KNAPSACKS, VALISES, VANITY BAGS SOLD EMPTY, BRIEFCASE AND BRIEFCASE-TYPE PORTFOLIOS; TRUNKS AND TRAVELING BAGS;

UMBRELLAS; PARASOLS AND WALKING STICKS, IN CLASS 18 (U.S. CLS. 1, 2, 3, 22 AND 41).

FOR: HOUSEHOLD CONTAINERS, NAMELY, HOUSEHOLD CONTAINERS FOR FOODS, HOUSEHOLD CONTAINERS FOR STORAGE, BINS FOR HOUSEHOLD USE FOR STORING FOOD, THERMALLY INSULATED CONTAINERS FOR DRINK AND FOR FOOD; HOUSEHOLD UTENSILS, NAMELY, GRATERS, HAND OPERATED FOOD GRINDERS, SIEVES, SIFTERS, STIRRERS, STRAINERS; KITCHEN UTENSILS, NAMELY, ALUMINUM CAKE AND PASTRY MOULDS, SPATULAS, MEAT TENDERIZERS IN THE FORM OF KITCHEN MALLETTS, NON-ELECTRIC VEGETABLE PEELERS, TRAYS; KITCHEN CONTAINERS, NAMELY, PLASTIC CONTAINERS FOR STORAGE PURPOSES AND FOR FOOD PREPARATION PURPOSES; COMBS AND SPONGES; BRUSHES (EXCEPT PAINT BRUSHES); BRUSH-MAKING MATERIALS; ARTICLES FOR CLEANING PURPOSES, NAMELY, CLEANING PADS; STEEL WOOL; GOODS MADE OF UNWORKED OR SEMI-WORKED GLASS, GLASSWARE, PORCELAIN AND EARTHENWARE, NAMELY, BAKING CONTAINERS, BAKING DISHES, BOXES, CROCKERY, COOKING POTS, CUPS, DINNER SERVICES, DINNERWARE, DISHES, DRINKING GLASSES AND GLASSWARE FOR BEVERAGES, FIGURES AND FIGURINES, GARDEN GNOMES, JUGS, PLANT BASKETS AND HOLDERS, PLANTERS, PLAQUES, PLATES, SAUCEPANS, SERVING SPOONS, STATUES, STATUETTES, VASES, IN CLASS 21 (U.S. CLS. 2, 13, 23, 29, 30, 33, 40 AND 50).

FOR: CLOTHING, LEISUREWEAR AND HEADGEAR, NAMELY, CAPS, HATS, SWEAT SUITS, SWEATSHIRTS, SHIRTS, DRESSES, TROUSERS,

SWEAT PANTS, SCARVES, T-SHIRTS, SHORTS AND SOCKS; FOOTWEAR , IN CLASS 25 (U.S. CLS. 22 AND 39).

FOR: MEAT, FISH, POULTRY AND GAME; MEAT EXTRACTS; PRESERVED, DRIED AND COOKED FRUITS AND VEGETABLES; JELLIES AND JAMS; EGGS, MILK AND MILK PRODUCTS, NAMELY, BUTTER, BUTTERCREAM, CHEESE CREAM, WHIPPED CREAM, MILK BASED BEVERAGE CONSISTING PRIMARILY OF MILK AND FRUIT, WHEY; EDIBLE OILS AND FATS, IN CLASS 29 (U.S. CL. 46).

FOR: COFFEE, TEA, COCOA, SUGAR, RICE, TAPIOCA, SAGO, ARTIFICIAL COFFEE; FLOUR; CEREAL BASED SNACK FOODS; READY TO EAT CEREAL DERIVED FOOD BARS; BREAD; PASTRY; CONFECTIONERY; ICES; HONEY; TREACLE; YEAST, BAKING POWDER; SALT; MUSTARD; VINEGAR; CONDIMENTS, NAMELY, SAUCES; SPICES; ICE; NOODLES, IN CLASS 30 (U.S. CL. 46).

FOR: FRESH FRUITS AND VEGETABLES; SEEDS USED AS INGREDIENTS IN FOOD, NAMELY, PLANT SEEDS, FLOWER SEEDS, WHEAT SEEDS AND RICE SEEDS, IN CLASS 31 (U.S. CLS. 1 AND 46).

FOR: BEERS, MINERAL AND AERATED WATERS AND OTHER NON-ALCOHOLIC DRINKS, NAMELY, NON-ALCOHOLIC BEER AND SOFT DRINKS; FRUIT DRINKS AND FRUIT JUICES; SYRUPS AND OTHER PREPARATIONS FOR MAKING BEVERAGES, IN CLASS 32 (U.S. CLS. 45, 46 AND 48).

FOR: THE BRINGING TOGETHER, FOR THE BENEFIT OF OTHERS, OF A VARIETY OF GOODS,

ENABLING CUSTOMERS TO CONVENIENTLY VIEW AND PURCHASE THOSE GOODS FROM AN INTERNET WEBSITE SPECIALIZING IN MARKETING OF FOOD, DRINKS, GENERAL MERCHANDISE AND RESTAURANT SERVICES; RETAIL SERVICES, NAMELY, RETAIL STORE SERVICES, ONLINE RETAIL STORE SERVICES, AND MAIL ORDER SERVICES FEATURING FOOD AND DRINK; PROVIDING INFORMATION ABOUT THE SALE OF MERCHANDISE VIA ELECTRONIC NETWORKS, THE INTERNET AND PRINT MEDIA, IN CLASS 35 (U.S. CLS. 100, 101 AND 102).

FOR: PROVIDING FOOD AND DRINK; PROVIDING OF FOOD AND DRINK BY MEANS OF ONLINE ORDERING; FOOD AND DRINK TAKE OUT SERVICES; CAFES AND CAFETERIA SERVICES; CANTEEN SERVICES; CATERING SERVICES, RESTAURANTS AND SELF-SERVICE RESTAURANT SERVICES, SNACK BARS; SERVICES FOR PROVIDING FOOD AND DRINK; PROVIDING INFORMATION ABOUT THE SERVING OF FOOD AND DRINK; PROVIDING INFORMATION ABOUT FOOD AND BEVERAGE SERVICE VIA ELECTRONIC NETWORKS, THE INTERNET AND PRINT MEDIA, IN CLASS 43 (U.S. CLS. 100 AND 101).

PRIORITY DATE OF 8-31-2005 IS CLAIMED.

OWNER OF INTERNATIONAL REGISTRATION 0894674 DATED 2-9-2006, EXPIRES 2-9-2016.

SER. NO. 79-027,378, FILED 2-9-2006.

JACQUELINE A. LAVINE, EXAMINING ATTORNEY

**Int. Cls.: 9, 11 and 42**

**Prior U.S. Cls.: 13, 21, 23, 26, 31, 34, 36, 38, 100 and 101**

**Reg. No. 3,453,907**

**United States Patent and Trademark Office**

**Registered June 24, 2008**

**TRADEMARK  
SERVICE MARK  
PRINCIPAL REGISTER**



MA LIGHTING TECHNOLOGY GMBH (FED REP  
GERMANY LTD LIAB CO)  
DACHDECKERSTRABE 16  
97297 WALDBÜTTELBRUNN  
FED REP GERMANY

FOR: MEASURING, CONTROLLING, SIGNALING, CHECKING/SUPERVISION APPARATUS AND INSTRUMENTS, NAMELY LIGHTING CONSOLES, INTEGRATED MEDIA SERVERS AND SIGNAL PROCESSING TO CONTROL SHOW, STUDIO AND STAGE LIGHTING; APPARATUS FOR RECORDING, PROCESSING, TRANSMISSION AND REPRODUCTION OF SOUND, IMAGES, DATA AND LIGHTING EFFECTS; ELECTRIC AND ELECTRONIC CONTROL DEVICES AND CONTROL UNITS FOR LIGHTING INSTALLATIONS, SEARCHLIGHTS, LAMPS AND DIMMERS; LIGHTING CONSOLES AND CONTROL PANELS; DIGITAL DIMMERS, NAMELY LIGHT REGULATORS; ELECTRIC AND ELECTRONIC APPARATUS AND INSTALLATIONS FOR PROCESSING, AMPLIFICATION, DUPLICATION, MIXING, TRANSFORMING AND TRANSMISSION OF CONTROL DATA AND CONTROL SIGNALS FOR SHOW, STUDIO AND STAGE LIGHTING; STAGE LIGHTING REGULATORS; POWER SUPPLIES; ELECTRIC CURRENT DISTRIBUTORS; LIGHTING BALLASTS; ELECTRIFIED RAILS FOR MOUNTING SPOT LIGHTS; DATA PROCESSING APPARATUS, NAMELY CENTRAL AND DECENTRALIZED DATA PROCESSING UNITS FOR LIGHTING AND IMAGE SHOW DATA, AND COMPUTERS; RECORDED COMPUTER SOFTWARE FOR CONTROLLING LIGHT SIGNALS, LIGHTING EFFECTS AND LIGHT SHOWS; RECORDED COMPUTER SOFTWARE FOR THE

VISUALIZATION OF SHOWS AND FOR THE DESIGN OF THREE-DIMENSIONAL STAGE LAYOUTS, IN CLASS 9 (U.S. CLS. 21, 23, 26, 36 AND 38).

FOR: LIGHTING APPARATUS AND INSTALLATIONS, NAMELY ELECTRIC AND ELECTRONIC APPARATUS FOR CONTROLLING LIGHTING EFFECTS AND LIGHT SHOWS AND FOR CONTROLLING PERMANENTLY INSTALLED ARCHITECTURAL LIGHTING UNITS AND DIMMERS; LIGHTING SYSTEMS COMPRISED OF LIGHTING CONTROL UNITS, MEDIA SERVERS, DIMMERS, SIGNAL PROCESSING UNITS, LAMPS AND SEARCHLIGHTS FOR THEATER, STUDIO, TRADE FAIR, EXHIBITION AND STAGE APPLICATIONS; LAMPS; COLOR CHANGING APPARATUS FOR LIGHTING APPARATUS AND INSTALLATIONS, NAMELY COLOR FILTERS FOR USE IN LIGHTING DEVICES; GUARD DEVICES FOR LIGHTING, IN CLASS 11 (U.S. CLS. 13, 21, 23, 31 AND 34).

FOR: DESIGN, DEVELOPMENT AND UPDATING OF COMPUTER HARDWARE AND SOFTWARE; DESIGN AND DEVELOPMENT OF COMPUTER HARDWARE; CONSULTANCY IN THE FIELD OF COMPUTER HARDWARE AND SOFTWARE; IMPLEMENTATION OF COMPUTER PROGRAMS IN NETWORKS; CONFIGURATION OF COMPUTER NETWORKS USING SOFTWARE, IN CLASS 42 (U.S. CLS. 100 AND 101).

OWNER OF INTERNATIONAL REGISTRATION  
0895160 DATED 3-24-2006, EXPIRES 3-24-2016.

NO CLAIM IS MADE TO THE EXCLUSIVE  
RIGHT TO USE "LIGHTING", APART FROM THE  
MARK AS SHOWN.

SER. NO. 79-027,608, FILED 3-24-2006.

MATTHEW EINSTEIN, EXAMINING ATTORNEY

**Int. Cls.: 3, 5, 9, 16, 29, 30 and 41**

**Prior U.S. Cls.: 1, 2, 4, 5, 6, 18, 21, 22, 23, 26, 29, 36, 37, 38, 44, 46, 50, 51, 52, 100, 101 and 107**

**Reg. No. 3,453,908**

**United States Patent and Trademark Office**

**Registered June 24, 2008**

**TRADEMARK  
SERVICE MARK  
PRINCIPAL REGISTER**

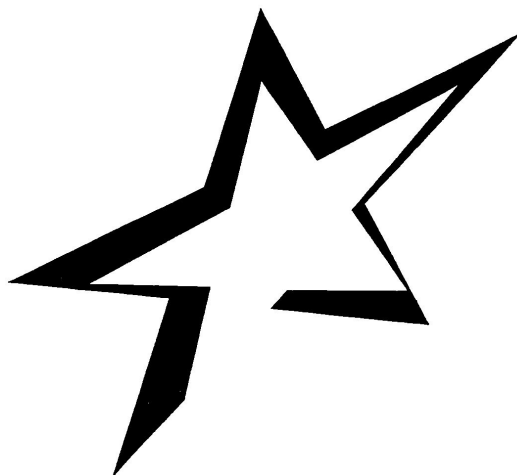

BIONORICA AG (FED REP GERMANY CORPORATION)  
KERSCHENSTEINERSTRASSE 11-15  
92318 NEUMARKT  
FED REP GERMANY

FOR: ESSENTIAL OILS, COSMETICS, HAIR LOTIONS, DENTIFRICES, IN CLASS 3 (U.S. CLS. 1, 4, 6, 50, 51 AND 52).

FOR: PHARMACEUTICAL PREPARATIONS FOR USE IN THE TREATMENT OF INFECTION OF RESPIRATORY TRACT, INFECTION OF URINARY TRACT, URINARY OBSTRUCTION, CHRONIC VENOUS INSUFFICIENCY, PROSTATE HYPERTROPHY, MUSCLE PAINS, SOFT TISSUE RHEUMATISM, MUSCULOSKELETAL DISEASE, LIVER DISEASE, HEPATITIS, CIRRHOSIS OF LIVER; PHARMACEUTICAL PREPARATIONS FOR THE USE IN THE TREATMENT OF ANGINA, ATHEROSCLEROSIS, BRONCHIAL ASTHMA, CIRCULATORY DISORDERS, CONSTIPATION, DIARRHEA, HEART FAILURE, HEART RHYTHM DISORDERS, HIGH BLOOD PRESSURE, INDIGESTION, INSOMNIA, MIGRAINE, MOTION SICKNESS, NAUSEA, PEPTIC ULCERS, VOMITING AND ALLERGY; PHARMACEUTICAL PREPARATIONS, NAMELY, PLANT EXTRACTS FOR USE AS AN ANTIDEPRESSANT, DIURETIC, HYPNOTIC, SEDATIVE, STIMULANT AND TRANQUILIZER; HEMORRHOIDAL OINT-

MENT, LAXATIVE, NASAL DECONGESTANT CAPSULES, NASAL SPRAY PREPARATION, NON-NARCOTIC ANALGESIC, THROAT LOZENGES; PHARMACEUTICAL PREPARATIONS FOR THE TREATMENT OF GYNECOLOGICAL DISORDERS, MENSTRUAL SYMPTOMS AND CIRCULATORY ORGAN DISORDERS; HORMONE PREPARATIONS, PREPARATIONS FOR THE TREATMENT OF URINARY, GENITAL AND ANAL ORGAN DISORDERS; MEDICINAL AGENTS FOR BLOOD CONDITIONS, NAMELY, PHARMACEUTICAL PREPARATIONS, NAMELY, A BLOOD CLOTTING AID AND DELIVERY SYSTEM FOR USE IN HUMAN AND VETERINARY MEDICINE, PHARMACEUTICAL PREPARATIONS FOR TREATING DIZZINESS AND THE IMMUNE SYSTEM; PHARMACEUTICAL PREPARATIONS AND MEDICINES FOR THE TREATMENT OF WOMEN'S DISEASES, NAMELY, MIGRAINE TREATMENT PREPARATIONS AND ANTIDEPRESSANTS; MEDICINES FOR THE TREATMENT OF BREAST PAIN; PHARMACEUTICAL PREPARATIONS AND MEDICINES FOR THE TREATMENT OF GYNECOLOGICAL DISORDERS AFFECTING MENSTRUATION, STERILITY, MENSTRUOUS SYNDROMES, MAMMAE, MASTOPATHY, MASTODYNIA, CLIMACTERIC COMPLAINTS, PREMENSTRUAL SYNDROME AND DYSMENORRHOEA; SANITARY PREPARATIONS FOR THE TREATMENT, CLEANING AND PROTECTION OF THE SKIN;

DIETETIC SUBSTANCES DERIVED FROM PLANTS, ADAPTED FOR MEDICAL USE, NAMELY FOOD FOR MEDICALLY RESTRICTED DIETS, FOOD FOR DIABETICS, DIETARY FOOD SUPPLEMENTS, AND VITAMIN AND MINERAL SUPPLEMENTS, HERB TEAS FOR MEDICINAL PURPOSES AND MEDICINAL TEAS; MEDICAL PLASTERS, MATERIALS FOR DRESSINGS, NAMELY GAUZE AND BANDAGES; ALL PURPOSE DISINFECTANTS; PLANT EXTRACTS IN LIQUID, SOLID OR GASEOUS FORM FOR MEDICAL, VETERINARY AND PHARMACEUTICAL PURPOSE; NUTRITIONAL ADDITIVES FOR USE IN FOODS AND DIETARY SUPPLEMENTS FOR HUMAN CONSUMPTION; DIETETIC FOOD SUPPLEMENTS; MINERAL FOOD SUPPLEMENTS, FOOD SUPPLEMENTS BASED ON AMINO ACIDS, MINERALS AND/OR TRACE ELEMENTS, IN CLASS 5 (U.S. CLS. 6, 18, 44, 46, 51 AND 52).

FOR: PROTECTIVE HELMETS, NAMELY, BICYCLE HELMETS; DOWNLOADABLE ELECTRONIC PUBLICATIONS IN THE NATURE OF MAGAZINES, JOURNALS, NEWSLETTERS, PERIODICALS, CATALOGS, BROCHURES, MANUALS, LEAFLETS AND PACKAGE INSERTS AND DOWNLOADABLE ELECTRONIC PUBLICATIONS IN THE NATURE OF PRESS RELEASES ALL FEATURING INFORMATION ON MEDICINE AND PHYTOPHARMACY; ADVERTISING MEDIUM, NAMELY, SMALL WEIGHING, MEASURING, SIGNALING, CHECKING AND SUPERVISION APPARATUS, NAMELY, POCKET CALCULATORS, SCALES, BALANCES, MEASURING RULES, THERMOMETERS, COMPUTER STORAGE DEVICES, NAMELY, FLASH DRIVES, THUMB DRIVES, FLASH MEMORY CARDS, MEMORY CARDS AND COMPUTER MEMORY HARDWARE, IN CLASS 9 (U.S. CLS. 21, 23, 26, 36 AND 38).

FOR: PRINTED MATTER, NAMELY, BOOKS, MAGAZINES, JOURNALS, NEWSPAPERS, PERIOD-

ICALS, CATALOGS AND BROCHURES IN THE FIELD OF MEDICINE AND PHYTOPHARMACY; STATIONERY; INSTRUCTIONAL AND TEACHING MATERIAL IN THE FIELD OF MEDICINE AND PHYTOPHARMACY; PAPER BAGS, ENVELOPES AND POUCHES FOR PACKAGING; PLASTIC BAGS AND BUBBLE PACKS FOR PACKAGING, IN CLASS 16 (U.S. CLS. 2, 5, 22, 23, 29, 37, 38 AND 50).

FOR: PROTEIN AND FAT BASED FOODS, NAMELY, DIETETIC FOOD OR FOOD SUPPLEMENTS FOR NON-MEDICAL PURPOSES CONTAINING FATTY SUBSTANCES, GREASES, FATTY ACIDS, VITAMINS, MINERALS AND TRACE ELEMENTS, EITHER SINGULAR OR IN COMBINATION, IN CLASS 29 (U.S. CL. 46).

FOR: DIETETIC FOOD OR FOOD SUPPLEMENTS FOR NON-MEDICAL PURPOSES CONTAINING CARBOHYDRATES, FIBER, VITAMINS, MINERALS AND TRACE ELEMENTS, EITHER SINGULAR OR IN COMBINATION, IN CLASS 30 (U.S. CL. 46).

FOR: ON-LINE AND ELECTRONIC PUBLICATION OF PUBLISHED AND PRINTED MATTERS, NAMELY, PUBLICATION OF BOOKS, MAGAZINES, JOURNALS, NEWSPAPERS, PERIODICALS, CATALOGS AND BROCHURES; PUBLICATION OF ELECTRONIC BOOKS AND JOURNALS ON-LINE, IN CLASS 41 (U.S. CLS. 100, 101 AND 107).

PRIORITY DATE OF 11-21-2005 IS CLAIMED.

OWNER OF INTERNATIONAL REGISTRATION 0895254 DATED 5-17-2006, EXPIRES 5-17-2016.

SER. NO. 79-027,636, FILED 5-17-2006.

CHARISMA HAMPTON, EXAMINING ATTORNEY

**Int. Cls.: 9, 38, 41 and 42**

**Prior U.S. Cls.: 21, 23, 26, 36, 38, 100, 101, 104 and 107**

**Reg. No. 3,453,909**

**United States Patent and Trademark Office**

**Registered June 24, 2008**

**TRADEMARK  
SERVICE MARK  
PRINCIPAL REGISTER**



MIDASPLAYER.COM LIMITED (UNITED KINGDOM GMBH)

3RD FLOOR, 35-37 GROSVENOR GARDENS  
LONDON SW1W 0BS  
UNITED KINGDOM

FOR: MULTIMEDIA SOFTWARE RECORDED ON CD-ROMS FEATURING INFORMATION IN THE FIELDS OF GAMING AND WAGERING; MAGNETIC ENCODERS; COMPUTER PROGRAMS AND COMPUTER SOFTWARE FOR USE IN GAMING AND WAGERING; PRE-RECORDED DVDS FEATURING INFORMATION IN THE FIELDS OF GAMING AND WAGERING; MOBILE TELEPHONES; PRE-RECORDED OPTICAL AND MAGNETIC DATA CARRIERS FEATURING INFORMATION IN THE FIELDS OF GAMING AND WAGERING; VIDEO GAME EQUIPMENT IN THE FIELDS OF GAMING AND WAGERING, NAMELY, VIDEO GAME MACHINES FOR USE WITH TELEVISIONS, VIDEO GAME SOFTWARE, INTERACTIVE VIDEO GAME PROGRAMS, VIDEO GAME DISCS, VIDEO GAME INTERACTIVE REMOTE CONTROL UNITS, IN CLASS 9 (U.S. CLS. 21, 23, 26, 36 AND 38).

FOR: PROVIDING ONLINE CHAT ROOMS AND FORUMS FOR TRANSMISSION OF MESSAGES AMONG COMPUTER USERS IN THE FIELDS OF GAMING AND WAGERING; INFORMATION TRANSMISSION VIA ELECTRONIC COMMUNICATIONS NETWORKS; PROVIDING ACCESS TO TELECOMMUNICATIONS NETWORKS AND DATABASES FOR THE TRANSMISSION OF TEXT, SOUND AND IMAGE DATA BY MEANS OF COMPUTER NETWORKS; TRANSMISSION OF ELECTRONIC MESSAGES AND NEWSLETTERS; TRANSMISSION OF ELECTRONIC MESSAGES TO PRE-DEFINED MAILING LISTS; INTERNET TELEPHONY SERVICES; RENTAL OF ACCESS TIME TO

GLOBAL COMPUTER NETWORKS, IN CLASS 38 (U.S. CLS. 100, 101 AND 104).

FOR: PROVIDING ONLINE PUBLICATIONS, NAMELY, NEWSLETTERS IN THE FIELDS OF GAMING AND WAGERING; PROVIDING FACILITIES FOR RECREATIONAL ACTIVITIES; PRESENTATION OF LIVE SHOW PERFORMANCES; PROVIDING FACILITIES FOR WAGERING AND GAMING; PUBLICATION OF PRINTED MATTER, NAMELY, NEWSLETTERS, MAILING LISTS, PERIODICALS, NEWSPAPERS, AND BOOKS IN ELECTRONIC FORM IN THE FIELDS OF GAMING AND WAGERING; ENTERTAINMENT SERVICES, NAMELY, PROVIDING ONLINE COMPUTER GAMES; PROVIDING ENTERTAINMENT INFORMATION IN THE FIELDS OF GAMING AND WAGERING; PRODUCTION OF INTERACTIVE TELEVISION PROGRAMS; ENTERTAINMENT SERVICES, NAMELY, PROVIDING ELECTRONIC GAMES THAT ARE PLAYED VIA TELEPHONES; WRITING OF CUSTOM TEXTS OTHER THAN PUBLICITY TEXTS, IN CLASS 41 (U.S. CLS. 100, 101 AND 107).

FOR: PROVIDING NON-DOWNLOADABLE SYSTEM SOFTWARE WITH REGARD TO INFRASTRUCTURES ON THE INTERNET, INTRANET AND EXTRANET IN THE FIELDS OF GAMING AND WAGERING; PROVIDING TEMPORARY USE OF NON-DOWNLOADABLE SOFTWARE FOR THE OPERATION OF GAMING AND WAGERING WEBSITES ON THE INTERNET; DESIGN, DEVELOPMENT AND MAINTENANCE OF COMPUTER SOFTWARE AND ONLINE GAME WEBSITES FOR OTHERS; COMPUTERIZED DATA MANAGEMENT; DESIGN, DEVELOPMENT AND MAINTENANCE OF COMPUTER SOFTWARE AND ONLINE GAME SITES; LICENSING OF COMPUTER SOFTWARE VIA NETWORKS; COMPUTER CONSULTA-

TION IN THE FIELD OF THE COLLECTION, SYSTEMATIC ORDERING, MANAGEMENT AND EXPLOITATION OF DATA, IN CLASS 42 (U.S. CLS. 100 AND 101).

OWNER OF INTERNATIONAL REGISTRATION  
0883473 DATED 12-19-2005, EXPIRES 12-19-2015.

SER. NO. 79-027,908, FILED 6-12-2006.

PRIORITY DATE OF 12-19-2005 IS CLAIMED.

ALICE BENMAMAN, EXAMINING ATTORNEY



**Int. Cls.: 12, 16 and 35**

**Prior U.S. Cls.: 2, 5, 19, 21, 22, 23, 29, 31, 35, 37, 38,  
44, 50, 100, 101 and 102**

**Reg. No. 3,453,910**

**United States Patent and Trademark Office**

**Registered June 24, 2008**

**TRADEMARK  
SERVICE MARK  
PRINCIPAL REGISTER**



NOKIAN TYRES PLC (FINLAND JOINT STOCK  
COMPANY)  
PIRKKALAISTIE 7  
FI-37100 NOKIA  
FINLAND

FOR: VEHICLE WHEEL INNER TUBES AND  
TIRES; REPAIR OUTFITS FOR INNER TUBES  
AND TIRES AND INNER TUBE AND TIRE PATCH-  
ING EQUIPMENT, NAMELY, TIRE PATCHING  
KITS COMPRISED OF TIRE PATCHES, TIRE  
PUMPS, VALVE STEMS FOR VEHICLE TIRES,  
VEHICLE TIRE VALVE STEM CAPS, TIRE LINERS,  
TIRE RETREADING CAPS, TIRE VALVES, ADHE-  
SIVE RUBBER PATCHES FOR REPAIRING TUBES  
OR TIRES, INNER TUBES FOR VEHICLE TIRES;  
RETREADED TIRES; TREADS USED TO RETREAD  
TIRES, IN CLASS 12 (U.S. CLS. 19, 21, 23, 31, 35 AND  
44).

FOR: PRINTED MATTER, NAMELY, BRO-  
CHURES, POSTERS, PAPER BANNERS, PHOTO-  
GRAPHS AND PRESS RELEASES IN THE FIELD  
OF TIRES; PRINTED INSTRUCTIONAL AND

TEACHING MATERIALS IN THE FIELD OF TIRES,  
NAMELY, MAGAZINES, BOOKS, MANUALS, AND  
PERIODICALS; AND PRINTED COURSE CORRE-  
SPONDENCE MATERIALS, NAMELY, INFORMA-  
TION SHEETS, BOOKLETS AND LEAFLETS IN THE  
FIELD OF TIRES, IN CLASS 16 (U.S. CLS. 2, 5, 22, 23,  
29, 37, 38 AND 50).

FOR: ADVERTISING; BUSINESS MANAGE-  
MENT; BUSINESS ADMINISTRATION; OFFICE  
FUNCTIONS, IN CLASS 35 (U.S. CLS. 100, 101 AND  
102).

PRIORITY DATE OF 6-13-2006 IS CLAIMED.

OWNER OF INTERNATIONAL REGISTRATION  
0896250 DATED 6-28-2006, EXPIRES 6-28-2016.

SER. NO. 79-028,013, FILED 6-28-2006.

WENDY GOODMAN, EXAMINING ATTORNEY

**Int. Cls.: 12, 16 and 35**

**Prior U.S. Cls.: 2, 5, 19, 21, 22, 23, 29, 31, 35, 37, 38,  
44, 50, 100, 101 and 102**

**Reg. No. 3,453,911**

**United States Patent and Trademark Office**

**Registered June 24, 2008**

**TRADEMARK  
SERVICE MARK  
PRINCIPAL REGISTER**



NOKIAN TYRES PLC (FINLAND JOINT STOCK  
COMPANY)  
PIRKKALAISTIE 7  
FI-37100 NOKIA  
FINLAND

FOR: VEHICLE WHEEL INNER TUBES AND  
TIRES; REPAIR OUTFITS FOR INNER TUBES  
AND TIRES AND INNER TUBE AND TIRE PATCH-  
ING EQUIPMENT, NAMELY, TIRE PATCHING  
KITS COMPRISED OF TIRE PATCHES, TIRE  
PUMPS, VALVE STEMS FOR VEHICLE TIRES,  
VEHICLE TIRE VALVE STEM CAPS, TIRE LINERS,  
TIRE RETREADING CAPS, TIRE VALVES, ADHE-  
SIVE RUBBER PATCHES FOR REPAIRING TUBES  
OR TIRES, INNER TUBES FOR VEHICLE TIRES;  
RETREADED TIRES; TREADS USED TO RETREAD  
TIRES, IN CLASS 12 (U.S. CLS. 19, 21, 23, 31, 35 AND  
44).

FOR: PRINTED MATTER, NAMELY, BRO-  
CHURES, POSTERS, PAPER BANNERS, PHOTO-  
GRAPHS AND PRESS RELEASES IN THE FIELD  
OF TIRES; PRINTED INSTRUCTIONAL AND

TEACHING MATERIALS IN THE FIELD OF TIRES,  
NAMELY, MAGAZINES, BOOKS, MANUALS, AND  
PERIODICALS; AND PRINTED COURSE CORRE-  
SPONDENCE MATERIALS, NAMELY, INFORMA-  
TION SHEETS, BOOKLETS AND LEAFLETS IN THE  
FIELD OF TIRES, IN CLASS 16 (U.S. CLS. 2, 5, 22, 23,  
29, 37, 38 AND 50).

FOR: ADVERTISING; BUSINESS MANAGE-  
MENT; BUSINESS ADMINISTRATION; OFFICE  
FUNCTIONS, IN CLASS 35 (U.S. CLS. 100, 101 AND  
102).

PRIORITY DATE OF 6-13-2006 IS CLAIMED.

OWNER OF INTERNATIONAL REGISTRATION  
0896252 DATED 6-28-2006, EXPIRES 6-28-2016.

SER. NO. 79-028,014, FILED 6-28-2006.

WENDY GOODMAN, EXAMINING ATTORNEY

**Int. Cl.: 25**

**Prior U.S. Cls.: 22 and 39**

**United States Patent and Trademark Office**

**Reg. No. 3,453,912**

**Registered June 24, 2008**

**TRADEMARK  
PRINCIPAL REGISTER**



MARCON DANIELE (ITALY INDIVIDUAL)  
VIA BASSANESE, 164  
I-31010 MASER (TV), ITALY

FOR: CLOTHING, NAMELY, T-SHIRTS, SOCKS, JEANS, JACKETS, ANORAKS, PARKAS, ASCOTS, SHIRTS, ALBS, COATS, BOW TIES, BIKINIS, BLAZERS, SHORTS, PANTS, TROUSERS, TRACKSUITS, SUITS, TIGHTS, TIES, SWEAT SHIRTS, SWEAT SUITS, SWEATERS, JERSEYS, GLOVES, SHORT, SKIRTS, SLIPS, SMOCKS, PANTS, SUSPENDERS, SCARVES, SUSPENDER BELTS, WRISTBANDS, VESTS, TOPS, POLO SHIRTS, RUGBY SHIRTS, GOLFSHIRTS, PULLOVERS, SKORTS, SLACKS, OVERCOATS, PANTIES, PANTYHOSE, MITTENS, OVERALLS, MAILLOTS, MANTLES, KILTS, HOSIERY, KNICKERS, FROCKS, CLOAKS, STOLE, KAFTANS, PARKAS, PONCHOS, KIMONOS, WAISTCOATS, WAISTBANDS, LEOTARDS, BLOUSONS, BIKINIS, SHAWLS, ROBES, WRIST BANDS, THONGS, TIGHTS, LAYETTES, TANK TOPS, STOCKINGS, UNITARDS, BLAZERS, BLOOMERS, BLOUSES, BOXER BRIEFS, BOB TIES, BREECHES, BRIEFS, BUSTIERS, CAMISOLES, UNDERPANTS, UNDERSHIRTS, UNDERSKIRTS, CARDIGANS,

LEGGINGS, JODHPURS, CHASUBLES, CORSELETS, COVERALLS, CRAVATES, CRAVATS, CUMMERBUNDS, DUNGAREES, PAREOS, SARIS, SARONGS, SERAPES, TWIN SETS, LEG WARMERS, FLEECE PULLOVERS; FOOTWEAR, NAMELY, SHOES, BOOTS, ZORI, SLIPPERS, SANDALS, SNEAKERS, CLOGS, FLIPFLOPS, PUMPS, RUBBERS, ESPADRILLES, HEELS, BOOTIES, GALOSHES AND EXCLUDING ORTHOPEDIC FOOTWEAR; HEADGEAR, NAMELY, BEANIES, SKULL CAPS, VISORS, HEAD BANDS, HATS, HEADBANDS, BANDANAS, BONNETS, BALACLAVAS, BERETS, IN CLASS 25 (U.S. CLS. 22 AND 39).

PRIORITY DATE OF 3-15-2006 IS CLAIMED.

OWNER OF INTERNATIONAL REGISTRATION  
0896321 DATED 6-5-2006, EXPIRES 6-5-2016.

SER. NO. 79-028,045, FILED 6-5-2006.

MARK SPARACINO, EXAMINING ATTORNEY

**Int. Cl.: 3**

**Prior U.S. Cls.: 1, 4, 6, 50, 51 and 52**

**Reg. No. 3,453,913**

**United States Patent and Trademark Office**

**Registered June 24, 2008**

**TRADEMARK  
PRINCIPAL REGISTER**



**AQUA TERRA**

OMEGA SA (OMEGA AG) (OMEGA LTD.) (SWITZERLAND SOCIÉTÉ ANONYME (JOINT STOCK COMPANY, SOCIEDAD ANONIMA))  
JAKOB-STÄMPFLI-STRASSE 96  
CH-2502 BIEL/BIENNE  
SWITZERLAND

FOR: SOAPS, PERFUMERY, COSMETICS EXCEPT COSMETICS FOR NAIL CARE, IN CLASS 3 (U.S. CLS. 1, 4, 6, 50, 51 AND 52).

PRIORITY DATE OF 3-31-2006 IS CLAIMED.

OWNER OF INTERNATIONAL REGISTRATION 0897207 DATED 8-30-2006, EXPIRES 8-30-2016.

THE ENGLISH TRANSLATION OF THE FOREIGN WORD(S) IN THE MARK IS: OMEGA WATER EARTH.

SER. NO. 79-028,404, FILED 8-30-2006.

DANIEL CAPSHAW, EXAMINING ATTORNEY

**Int. Cls.: 3 and 21**

**Prior U.S. Cls.: 1, 2, 4, 6, 13, 23, 29, 30, 33, 40, 50, 51  
and 52**

**Reg. No. 3,453,914**

**United States Patent and Trademark Office**

**Registered June 24, 2008**

**TRADEMARK  
PRINCIPAL REGISTER**

**GLAMOUR FACTORY**

GLAMOUR FACTORY (FRANCE CORPORATION)  
121 AVENUE DES CHAMPS-ÉLYSÉES  
F-75008 PARIS, FRANCE

FOR: SOAPS; PERFUMERY; ESSENTIAL OILS;  
COSMETICS; HAIR LOTIONS; DENTIFRICES, IN  
CLASS 3 (U.S. CLS. 1, 4, 6, 50, 51 AND 52).

FOR: COMBS; BATH SPONGES; COSMETIC BRUSHES;  
BRUSH-MAKING MATERIALS; GLASSWARE, PORCELAIN,  
AND EARTHENWARE NOT INCLUDED IN OTHER CLASSES,  
NAMESLY, GLASS BOXES, FIGURINES OF PORCELAIN OR  
GLASS; OPALINE GLASS; VASES NOT OF PRECIOUS METAL;  
TABLEWARE NOT OF PRECIOUS METAL, NAMESLY,  
PLATES, BEVERAGE GLASSWARE, BOWLS, GLASSES,  
NAMESLY, BEVERAGE GLASSWARE; FLASKS NOT OF  
PRECIOUS METAL; SOAP

HOLDERS; TOWEL HOLDERS NOT OF PRECIOUS METAL;  
POWDER COMPACTS SOLD EMPTY NOT OF PRECIOUS METAL;  
PERFUME VAPORIZERS SOLD EMPTY; PERFUME SPRAYERS  
SOLD EMPTY, IN CLASS 21 (U.S. CLS. 2, 13, 23, 29, 30,  
33, 40 AND 50).

THE MARK CONSISTS OF STANDARD CHARACTERS  
WITHOUT CLAIM TO ANY PARTICULAR FONT, STYLE,  
SIZE, OR COLOR.

OWNER OF INTERNATIONAL REGISTRATION  
0897654 DATED 8-21-2006, EXPIRES 8-21-2016.

SER. NO. 79-028,546, FILED 8-21-2006.

CORY BOONE, EXAMINING ATTORNEY

**Int. Cl.: 6**

**Prior U.S. Cls.: 2, 12, 13, 14, 23, 25 and 50**

**Reg. No. 3,453,915**

**United States Patent and Trademark Office**

**Registered June 24, 2008**

**TRADEMARK  
PRINCIPAL REGISTER**

# **ASCOMETAL**

ASCOMETAL (FRANCE SOCIÉTÉ ANONYME À  
DIRECTOIRE ET CONSEIL DE SURVEIL-  
LANCE)

IMMEUBLE LE COLISÉE

10 AVENUE DE L'ARCHE; FAUBOURG DE  
L'ARCHE

COURBEVOIE, FRANCE F92400

FOR: COMMON METALS, UNWROUGHT OR  
SEMI-WROUGHT, AND THEIR ALLOYS, NAMELY,  
CARBON ALLOYS, STAINLESS STEELS,  
THROUGH-HARDENING, FREE-CUTTING  
STEELS, CASE-HARDENING STEELS, BEARING  
STEELS, SPRING STEELS, SURFACE HARDENING  
STEELS, MICRO-ALLOYED STEELS, NITRIDING  
STEELS, STEELS WITH IMPROVED MACHINABIL-  
ITY, TOOL STEELS, HIGH CHROME STEELS,  
STEELS FOR HEAT TREATMENT; STEEL, STEEL  
ALLOYS, STEEL WIRES, CAST STEEL, STEEL  
SHEETS, STEEL TUBES, STEEL BARS AND PIPES  
OF STEEL, CARBON STEEL, ALLOYED STEELS;  
HOT ROLLED AND CAST MATERIALS, NAMELY,  
CAST STEEL ROTARY, CONTINUOUS CAST STEEL  
ROUNDS, STEEL BLOOMS, STEEL BILLETS AND  
ROUND BARS OF STEEL FOR FORGING, STEEL

BLOOMS, STEEL BILLETS, HOT ROLLED ROUND  
BARS OF STEEL, HOT ROLLED STEEL BILLETS,  
STEEL WIRE RODS, COLD DRAWN WIRE, PEELED  
ROUND BARS OF STEEL, DRAWN AND GROUND  
STEEL BARS, CYLINDRICAL AND TAPERED  
PEELED WIRE, HOT ROLLED STEEL FLAT BARS,  
TURNED STEEL BARS, COLD DRAWN STEEL  
BARS, GROUND STEEL BARS; NON-ELECTRIC  
CABLES WIRES AND WIRES OF COMMON MET-  
AL; STEEL IN THE FORM OF FORGED BARS,  
BORED BARS, WELDED AND PRE-MACHINED  
PARTS FOR STEERING RACK; STEEL FOR CAR  
INDUSTRY, FORGING INDUSTRY, BEARINGS,  
MECHANICAL ENGINEERING, SPRINGS, OIL  
AND GAS DRILLING AND MINING MARKETS,  
IN CLASS 6 (U.S. CLS. 2, 12, 13, 14, 23, 25 AND 50).

OWNER OF INTERNATIONAL REGISTRATION  
0503506 DATED 6-27-1986, EXPIRES 6-27-2016.

SER. NO. 79-028,694, FILED 6-28-2006.

WENDY GOODMAN, EXAMINING ATTORNEY

**Int. Cl.: 8**

**Prior U.S. Cls.: 23, 28 and 44**

**United States Patent and Trademark Office**

**Reg. No. 3,453,916**

**Registered June 24, 2008**

**TRADEMARK  
PRINCIPAL REGISTER**



**MANIAGO**

MONTAGNA LEADER S.C.A.R.L. (ITALY LIMITED RESPONSABILITY SOCIETY)  
VIA DELLE VITTORIA, 21  
I-33080 MANIAGO (PN)  
ITALY

FOR: HAND TOOLS, NAMELY, CORKSCREWS FOR PURPOSES OF BORING, SCISSORS, MULTI-PURPOSE SHEARS, SCRAPERS, SAWS, SCALPELS FOR ARTISTIC PURPOSES, CUTTING BLADES FOR SHEARS, SAWS, MEAT GRINDING, BUTCHERING, WOOD CUTTING, AND CONSTRUCTION,

SPATULAS USED FOR ARTISTIC PURPOSES, CHISELS, RASPS, LOOP TOOLS, TROWELS, AND KNIVES, IN CLASS 8 (U.S. CLS. 23, 28 AND 44).

OWNER OF INTERNATIONAL REGISTRATION 0898299 DATED 8-10-2006, EXPIRES 8-10-2016.

SER. NO. 79-028,822, FILED 8-10-2006.

ELI HELLMAN, EXAMINING ATTORNEY

**Int. Cl.: 8**

**Prior U.S. Cls.: 23, 28 and 44**

**Reg. No. 3,453,917**

**United States Patent and Trademark Office**

**Registered June 24, 2008**

**TRADEMARK  
PRINCIPAL REGISTER**



MONTAGNA LEADER S.C.A.R.L. (ITALY LIMITED RESPONSIBILITY SOCIETY)  
VIA DELLE VITTORIA, 21  
I-33080 MANIAGO (PN)  
ITALY

FOR: HAND TOOLS, NAMELY, CORKSCREWS FOR PURPOSES OF BORING, SCISSORS, MULTI-PURPOSE SHEARS, SCRAPERS, SAWS, SCALPELS FOR ARTISTIC PURPOSES, CUTTING BLADES FOR SHEARS, SAWS, MEAT GRINDING, BUTCHERING, WOOD CUTTING, AND CONSTRUCTION,

SPATULAS USED FOR ARTISTIC PURPOSES, CHISELS, RASPS, LOOP TOOLS, TROWELS, AND KNIVES, IN CLASS 8 (U.S. CLS. 23, 28 AND 44).

OWNER OF INTERNATIONAL REGISTRATION  
0898300 DATED 8-10-2006, EXPIRES 8-10-2016.

SER. NO. 79-028,823, FILED 8-10-2006.

ELI HELLMAN, EXAMINING ATTORNEY



**Int. Cl.: 9**

**Prior U.S. Cls.: 21, 23, 26, 36 and 38**

**Reg. No. 3,453,918**

**United States Patent and Trademark Office**

**Registered June 24, 2008**

**TRADEMARK  
PRINCIPAL REGISTER**



FOSHAN EAGLERISE; ELECTRIC & ELECTRONIC CO., LTD. (CHINA CORPORATION)  
NO. A3 GUICHENG SCIENCE & TECH. AREA  
JIANPING RD, NANHAI DISTRICT,; FOSHAN  
CITY; GUANGDON 528200  
CHINA

FOR: QUANTITY INDICATORS, NAMELY, INDICATORS FOR QUANTITY OF ELECTRIC CHARGE; PHOTOTELEGRAPHY APPARATUS; SIGNAL LIGHTS, NAMELY, SIGNAL LIGHTS FOR TRAFFIC; ELECTRO-DYNAMIC APPARATUS FOR THE REMOTE CONTROL OF SIGNALS, NAMELY, ELECTRIC TRANSFORMERS AND CONVERTERS FOR THE REMOTE CONTROL OF SIGNALS; LOUDSPEAKERS; VOLTAGE STABILIZERS FOR ELECTRICAL MEASURE; ELECTRIC MEASURING INSTRUMENTS, NAMELY, ELECTRIC VOLTAGE AND CURRENT MEASURING DEVICES FOR POWER SYSTEMS IN THE NATURE OF PORTABLE ELECTRONIC RECORDER FOR MEASURING AND RECORDING VOLTAGE AND CURRENT READINGS FROM VARIOUS TRANSDUCERS; ELECTRIC WIRES; RESISTANCE WIRES; PRINTED CIRCUITS; ELECTRIC COILS; VARIOMETERS; ELECTRIC CONVERTERS; FERRITE CORES FOR

ELECTRIC CONVERTERS, NAMELY, MAGNETIC CORES AND TRANSFORMER CORES; ELECTRIC LIGHT DIMMERS; ELECTRIC SWITCHES; CURRENT RECTIFIERS; LIGHTING BALLASTS; VOLTAGE STABILIZING POWER SUPPLY; CURRENT RECTIFYING APPARATUS, NAMELY, TRANSFORMERS AND POWER CONTROLLERS FOR RECTIFYING CURRENT; LIGHTNING ARRESTERS; ELECTROPLATING MACHINES; ELECTRONIC BURGLAR ALARMS; BATTERY CHARGERS; ELECTRIC DOOR CLOSERS, IN CLASS 9 (U.S. CLS. 21, 23, 26, 36 AND 38).

OWNER OF INTERNATIONAL REGISTRATION  
0900303 DATED 7-20-2006, EXPIRES 7-20-2016.

THE MARK CONSISTS OF THE WORDING "EAGLERISE" WITH THE SECOND LETTER "E" FORMING A STYLIZED DESIGN IN THE SHAPE OF AN EAGLE'S HEAD.

SER. NO. 79-029,525, FILED 7-20-2006.

AMY ALFIERI, EXAMINING ATTORNEY

**Int. Cls.: 1 and 2**

**Prior U.S. Cls.: 1, 5, 6, 10, 11, 16, 26 and 46**

**United States Patent and Trademark Office**

**Reg. No. 3,453,919**

**Registered June 24, 2008**

**TRADEMARK  
PRINCIPAL REGISTER**

# ARAFLOOR

HUNTSMAN ADVANCED MATERIALS (SWITZERLAND) GMBH (SWITZERLAND LIMITED COMPANY)  
KLYBECKSTRASSE 200  
CH-4057 BASEL  
SWITZERLAND

FOR: UNPROCESSED ARTIFICIAL RESINS AND PLASTICS, NAMELY, EPOXY, POLYURETHANE AND POLYESTER RESINS; CURING AGENTS TO BE USED IN CONJUNCTION WITH ARTIFICIAL AND SYNTHETIC RESINS FOR THE MANUFACTURE OF CLEAR COATS, ENAMELS AND PRIMERS; COMPOSITIONS OF CURING AGENTS AND ARTIFICIAL RESINS FOR THE MANUFACTURE OF CLEAR COATS, ENAMELS AND PRIMERS IN INDUSTRY; ADHESIVES FOR GENERAL INDUSTRIAL PURPOSES; UNPROCESSED POLYSTYRENE RESINS; STYRENE MONOMERS FOR INDUSTRIAL USE; EPOXY RESINS, UNPROCESSED, IN CLASS 1 (U.S. CLS. 1, 5, 6, 10, 26 AND 46).

FOR: PAINTS, VARNISHES, LACQUERS; ENAMEL PAINTS; RUST PRESERVATIVES; WOOD PRE-

SERVATIVES; RAW NATURAL RESINS FOR USE IN THE MANUFACTURE OF RESIN AND FOR GENERAL INDUSTRIAL USE; THINNERS FOR LACQUERS AND PAINTS; PAINTS TO BE USED ON FLOORS; EPOXY BASED PAINTS, IN CLASS 2 (U.S. CLS. 6, 11 AND 16).

THE MARK CONSISTS OF STANDARD CHARACTERS WITHOUT CLAIM TO ANY PARTICULAR FONT, STYLE, SIZE, OR COLOR.

PRIORITY DATE OF 7-31-2006 IS CLAIMED.

OWNER OF INTERNATIONAL REGISTRATION 0900674 DATED 10-5-2006, EXPIRES 10-5-2016.

SER. NO. 79-029,645, FILED 10-5-2006.

KHANH LE, EXAMINING ATTORNEY

**Int. Cls.: 6, 9, 19 and 37**

**Prior U.S. Cls.: 1, 2, 12, 13, 14, 21, 23, 25, 26, 33, 36,  
38, 50, 100, 103 and 106**

**Reg. No. 3,453,920**

**United States Patent and Trademark Office**

**Registered June 24, 2008**

**TRADEMARK  
SERVICE MARK  
PRINCIPAL REGISTER**

**effeff**

ASSA ABLOY SICHERHEITSTECHNIK GMBH  
(FED REP GERMANY GESELLSCHAFT MIT  
BESCHRÄNKTER HAFTUNG)  
BILDSTOCKSTR. 20  
72458 ALBSTADT  
FED REP GERMANY

FOR: METAL LOCK BOLTS, METAL LOCKS, METAL PADLOCKS, METAL BICYCLE LOCKS, METAL DOOR CLOSERS, METAL SELF-LOCKING PANIC/ANTI-PANIC LOCKS; METAL SECURITY LOCK CYLINDERS; METAL DOORS, NAMELY, SECURITY DOORS, FIRE DOORS, AND SMOKE DOORS, DOOR FRAMES OF METAL; METAL DOOR LOCKS; METAL DOOR BOLTS; METAL DOOR FITTINGS, NAMELY, PROTECTIVE FITTINGS IN THE NATURE OF PLATES AND COVERS FOR LOCKS; BUILDING SECURITY DEVICES, NAMELY, METAL LOCKABLE DOOR HANDLES, METAL DOOR BANDS, METAL DOOR FASTENERS, METAL DOOR FRAMES, METAL DOOR CASEMENT BOLTS; METAL LOCKABLE WINDOW HANDLES, METAL WINDOW BANDS, METAL WINDOW FASTENERS, METAL WINDOW FRAMES, METAL WINDOW CASEMENT BOLTS, METAL WINDOW PULLEYS; METAL SHUTTER LOCKS, METAL SHUTTER KEY SWITCHES, METAL LOCKABLE SHOOT BOLTS FOR SHUTTERS; METAL GRILLE LOCKS, METAL CLIP-ON RUNNERS FOR GRILLES, METAL RIVETS FOR GRILLES; METAL BANDS FOR INSTALLING WINDOW AND DOOR OPENING/CLOSING MECHANISMS, METAL EMERGENCY LOCK BOLTS, METAL FIRE PROTECTION BANDS; METAL DOOR-LOCKING SYSTEMS COMPRISING OF METAL LOCKS, METAL LOCK BOLTS; METAL DOOR SEALS, NAMELY, METAL FIRE DOOR SEALS; PARTS,

FITTINGS AND MATERIALS FOR DOORS AND WINDOWS, NAMELY, METAL LATCH BARS, METAL LATCHES, METAL PUSH LEVERS AND METAL DOOR LATCH FITTINGS TO ASSIST IN OPENING DOORS, IN CLASS 6 (U.S. CLS. 2, 12, 13, 14, 23, 25 AND 50).

FOR: MECHANICAL, ELECTRIC AND ELECTRONIC SECURITY DEVICES FOR DOORS, NAMELY, DOOR OPENERS, DOOR CLOSERS, DOOR LOCKS, FIRE ALARM CONTROLS, ACCESS CONTROLS, LOCKING AND UNLOCKING CONTROLS; DOOR LOCK INSTALLATIONS, NAMELY, ELECTRONIC CONTROLS FOR DOOR LOCKS THAT OPERATE VIA DIGITAL BUS INSTALLATIONS; EMERGENCY EXIT DEVICES FOR DOORS AND WINDOWS, NAMELY, EMERGENCY EXIT LATCHES AND PUSH LEVERS; MECHANICAL, ELECTRIC AND ELECTRONIC DEVICES FOR DOORS AND WINDOWS, NAMELY, DOOR LOCKS, ELECTRIC LOCKS; ELECTRIC AND ELECTRONIC DOOR OPENERS; ELECTRONIC DOOR CLOSERS; DOOR CLOSURE MAGNETS; INTRUDER WARNING ALARMS; FIRE ALARMS; SMOKE ALARMS; SAFETY EQUIPMENT, NAMELY, SMOKE SWITCHES FOR FIRE DOORS; ELECTRONIC AND ELECTRIC CODE LOCKS, NAMELY, SMOKE SWITCHES FOR FIRE DOORS; ELECTRONIC AND ELECTRIC CODE LOCKS, NAMELY, CODE LOCKS WITH KEYPADS, ELECTRIC CODE LOCKS WITH MAGNETIC ENTRY CARDS OR KEY RINGS, ELECTRONIC CODE LOCK WITH CONTACT FREE READERS; ACCESS CONTROLS FOR DOORS; MECHANICAL, ELECTRIC OR ELECTRONIC DOOR LOCKS; ACCESS CONTROL AND PERSON IDENTIFICATION INSTALLATIONS, NAMELY, BAR

CODE SCANNERS, SECURITY CARD READERS AND BIOMETRIC READERS AND COMPUTER HARDWARE ASSOCIATED THEREWITH, ACCESS KEY PADS AND COMPUTER HARDWARE ASSOCIATED THEREWITH AND INTERCOMMUNICATIONS SYSTEMS, COMPRISED OF INTERCOMS; FIRE ALARM INSTALLATIONS, NAMELY, SMOKE AND HEAT DETECTORS; ELECTRIC DOOR OPENERS AND DOOR CLOSERS AND REPLACEMENT AND COMPONENT PARTS THEREFOR; MECHANICALLY ACTIVATED OR ELECTRONICALLY CONTROLLED EMERGENCY DOOR LOCKS, NAMELY, PANIC/ANTI-PANIC DOOR LOCKS AND EMERGENCY EXIT LOCKS; EMERGENCY DOOR AND EXIT INSTALLATIONS, NAMELY, ELECTRIC, ELECTROMOTIVE OR MOTORIZED BOLTS, ELECTRONIC SWITCHES AND CONTROL CABINETS FOR REGULATING ELECTRIC, ELECTROMOTIVE OR MOTORIZED BOLTS AND ELECTRONIC SWITCHES; TIME-RECORDING APPARATUS, INSTRUMENTS AND INSTALLATIONS FOR STAFF TIME-RECORDING, PERFORMANCE RECORDING, PROJECT PLANNING, CAPACITY PLANNING, PROJECT CONTROL, PERSONNEL PLANNING, SERVICE AND SHIFT PLANNING, NAMELY, COMPUTERS, EVENT RECORDERS, TIME CLOCKS; APPARATUS, INSTRUMENTS, MACHINES AND INSTALLATIONS FOR HANDLING CASH, NAMELY, ACCOUNTING MACHINES, CURRENCY COUNTING MACHINES, WEIGHING MACHINES, CURRENCY SORTING MACHINES, COIN-CHECKING MACHINES IN THE NATURE OF COIN ACCEPTORS FOR SEPARATING GOOD COINS FROM COUNTERFEITS, COIN-CHANGES AND CURRENCY SORTING MACHINE IN THE NATURE OF A MACHINE FOR ROLLING COINS; SELF-SERVICE MACHINES, NAMELY, AUTOMATED DISPENSING MACHINES, PAYMENT TERMINALS, CASH MACHINES AND CASH DISPENSERS, BANKNOTE AND COIN-OPERATED MACHINES IN THE NATURE OF LOCKERS, GATES AND VENDING MACHINES, IN CLASS 9 (U.S. CLS. 21, 23, 26, 36 AND 38).

FOR: NON-METAL DOORS, NAMELY, NON-METAL SECURITY DOORS AND SMOKE DOORS; NON-METAL FIRE DOORS; NON-METAL FIRE CLOSURES IN THE NATURE OF PROTECTIVE DOORS FOR VENTILATION SYSTEMS; NON-METAL DOOR FRAMES; NON-METAL DOOR SEALS, NAMELY, NON-RUBBER FIRE DOOR SEALS NOT FOR INSULATION PURPOSES; AND REPLACEMENT PARTS FOR THE AFOREMENTIONED GOODS, IN CLASS 19 (U.S. CLS. 1, 12, 33 AND 50).

FOR: INSTALLATION, MAINTENANCE AND REPAIR OF LOCKS AND SAFETY DEVICES AND INSTALLATIONS, NAMELY, THE INSTALLATION, MAINTENANCE AND REPAIR OF SECURITY DEVICES FOR DOORS, DOOR LOCK INSTALLATIONS, DOOR CONTROLS, EMERGENCY DOOR EXIT DEVICES, DOOR LOCKS AND DOOR BOLTS, DOOR LOCKING DEVICES, LOCKS, PANIC/ANTI-PANIC LOCKS, LOCK CYLINDERS, DOOR OPENERS, DOOR CLOSERS, DOOR CLOSURE MAGNETS, FIRE DOOR SEALS, WARNING ALARM INSTALLATIONS, FIRE ALARM INSTALLATIONS, SMOKE ALARM INSTALLATIONS, BUILDING SECURITY INSTALLATIONS, EMERGENCY DOOR INSTALLATIONS, PANIC/ANTI-PANIC DOOR INSTALLATIONS, EMERGENCY EXIT INSTALLATIONS, CODE LOCKS, ACCESS CONTROL DEVICES, DOOR LOCKS, ACCESS CONTROL AND FIRE ALARM INSTALLATIONS, PERSON IDENTIFICATION INSTALLATIONS, ELECTRIC DOOR OPENERS AND DOOR CLOSERS, DOOR MECHANISMS, EMERGENCY DOOR CONTROLS AND MONITORING DEVICES IN THE NATURE OF PANIC/ANTI-PANIC DOOR CLOSURES AND EMERGENCY EXIT CLOSURES; INSTALLATION, MAINTENANCE AND REPAIR OF TIME-RECORDING APPARATUS, INSTRUMENTS AND INSTALLATIONS, NAMELY, APPARATUS, INSTALLATIONS AND INSTRUMENTS FOR STAFF TIME-RECORDING, PERFORMANCE RECORDING, PROJECT PLANNING, CAPACITY PLANNING, PROJECT CONTROL, PERSONNEL PLANNING, SERVICE AND SHIFT PLANNING; INSTALLATION, MAINTENANCE AND REPAIR OF APPARATUS, INSTALLATIONS, INSTRUMENTS AND MACHINES FOR SETTLING, COUNTING, ISOLATING, WEIGHING, SORTING, CHECKING, PACKING, ROLLING, SETTLING AND EXCHANGING MONEY; INSTALLATION, MAINTENANCE AND REPAIR OF SELF-SERVICE MACHINES, NAMELY, MACHINES FOR DISPENSING GOODS OR MONEY, PAYMENT TERMINALS, CASH MACHINES AND CASH DISPENSERS, BANKNOTE AND COIN-OPERATED MACHINES, IN CLASS 37 (U.S. CLS. 100, 103 AND 106).

PRIORITY DATE OF 10-28-2005 IS CLAIMED.

OWNER OF INTERNATIONAL REGISTRATION 0901001 DATED 11-21-2005, EXPIRES 11-21-2015.

SER. NO. 79-029,686, FILED 11-21-2005.

WANDA KAY PRICE, EXAMINING ATTORNEY

Int. Cl.: 9

Prior U.S. Cls.: 21, 23, 26, 36 and 38

United States Patent and Trademark Office

Reg. No. 3,453,921

Registered June 24, 2008

TRADEMARK  
PRINCIPAL REGISTER



CIPUNET HOLDING AG; C/N PETER BODMER  
(SWITZERLAND SOCIETE ANONYME)  
HALDENSTEIG 19  
CH-8708 MÄNNEDORF  
SWITZERLAND

FOR: MODEMS; MODEMS USED IN CONNECTION WITH THE TRANSFER OF VOICE AND DATA OVER ELECTRICAL POWER LINES; POWER SUPPLIES FOR MODEMS; VOLTAGE REGULATORS; APPARATUS AND DEVICES FOR RECORDING, TRANSMISSION OR REPRODUCTION OF SOUND OR IMAGES; COMPUTER HARDWARE AND SOFTWARE FOR ENABLING VOICE AND DATA COMMUNICATION OVER ELECTRICAL POWER LINES; COMPUTER HARDWARE AND SOFTWARE FOR ENABLING BROADBAND CAPACITY VOICE AND DATA COMMUNICATION OVER ELECTRICAL POWER LINES; SENSING AND SIGNALING DEVICES FOR THE MEASUREMENT AND CONTROL OF ELECTRICITY, NAMELY, ELECTRIC METERS; APPARATUS AND DEVICES FOR POWER LINE COMMUNICATION SYSTEMS, NAMELY, LOW AND MEDIUM VOLTAGE INDUCTIVE AND CAPACITIVE ELECTRIC CONNECTORS FOR USE WITH ELECTRICAL POWER LINES; AUTOMATED METER READING SYSTEMS, NAMELY, AUTOMATIC ELECTRONIC SYSTEMS FOR READING AND CONTROLLING ELECTRIC, GAS AND WATER UTILITY METERS; AUTOMATIC ELECTRONIC SYSTEMS FOR REMOTE MONITORING AND CONTROL OF ELECTRIC, GAS AND WATER UTILITY METERS, NAMELY, SPECTRUM ANALYZERS AND OSCILLOSCOPES, IMPE-

DANCE MEASUREMENT TOOLS, FREQUENCY ANALYZERS, AD CONVERTERS, NARROWBAND GENERATORS AND BROADBAND GENERATORS; POWER LINE COMMUNICATION TEST AND ANALYSIS SYSTEMS COMPRISED OF COMPUTER HARDWARE, SOFTWARE, ELECTRONIC SENSORS AND DIGITAL DISPLAYS FOR MONITORING AND ANALYZING THE TRANSMISSION OF VOICE AND DATA OVER ELECTRICAL POWER LINES; SOFTWARE FOR THE CONTROL OF POWER LINE COMMUNICATION SYSTEMS, IN CLASS 9 (U.S. CLS. 21, 23, 26, 36 AND 38).

OWNER OF INTERNATIONAL REGISTRATION  
0900746 DATED 8-3-2006, EXPIRES 8-3-2016.

THE COLOR(S) DARK BLUE IS/ARE CLAIMED AS A FEATURE OF THE MARK.

THE MARK CONSISTS OF THE COLOR DARK BLUE WHICH APPEARS IN THE LETTERS OF THE WORD "CIPUNET", IN THE LEFT SIDE OF THE SEMI-CIRCLE DESIGN, AND IN THE VERTICAL LINES THAT MAKE UP THE RIGHT SIDE OF THE SEMI-CIRCLE DESIGN.

SER. NO. 79-029,826, FILED 8-3-2006.

SAMUEL E. SHARPER JR., EXAMINING ATTORNEY

**Int. Cls.: 24 and 25**

**Prior U.S. Cls.: 22, 39, 42 and 50**

**United States Patent and Trademark Office**

**Reg. No. 3,453,922**

**Registered June 24, 2008**

**TRADEMARK  
PRINCIPAL REGISTER**

**c\_change**

SCHOELLER TEXTIL AG (SWITZERLAND CORPORATION)  
BAHNHOFSTRASSE  
CH-9475 SEVELEN  
SWITZERLAND

FOR: FABRICS USED IN THE MANUFACTURE OF SAFETY AND TECHNICAL TEXTILES; FABRICS USED IN THE MANUFACTURE OF FASHION AND LEISURE WEAR CLOTHING; FABRICS USED IN THE MANUFACTURE OF TEXTILES FINISHED WITH A COATING DESIGNED FOR DEPLOYING MEDICAL AND PHARMACEUTICAL EFFECTS ON THE WEARER'S SKIN AND EFFECTS DESIGNED FOR INCREASING THE WEARER'S HEALTH AND WELL-BEING FOR USE IN THE MANUFACTURE OF CLOTHING, FOOTWEAR, HELMETS FOR CAR RACES, SKI BOOTS, MATS FOR CAMPING, STADIUM SEATS; FABRICS USED IN THE MANUFACTURE OF TEXTILES BALANCING OUT TEMPERATURE PEAKS ABOVE AND BELOW THE WEARER'S PERSONAL COMFORT CLIMATE FOR USE IN THE MANUFACTURE OF CLOTHING, FOOTWEAR, HELMETS FOR CAR RACES, SKI BOOTS, MATS FOR CAMPING, STADIUM SEATS; HIGH PERFORMANCE, DURABLE, REFLECTING AND WEATHER-PROOF, WATER REPELLENT AND SOIL RESISTANT FABRICS AND FABRICS FREE OF HARMFUL SUBSTANCES, ALL FOR USE IN THE MANUFACTURE OF CLOTHING, FOOTWEAR, LUGGAGE, SEATS, TENTS, SPORTS EQUIPMENT AND TRAVEL-RELATED GEAR; BED COVERS IN THE NATURE OF BED LINEN, BED SPREADS AND BED BLANKETS; TABLE COVERS IN THE NATURE OF TABLE LINEN AND TABLE CLOTHS NOT OF PAPER, IN CLASS 24 (U.S. CLS. 42 AND 50).

FOR: CLOTHING NAMELY, SPORTSWEAR AND STREET WEAR CLOTHING, NAMELY, SNEAKERS; CLOTHING FOR GYMNASTICS, NAMELY, ATHLETIC SHORTS, SOCKS, LEGGINGS, BODY SUITS; SWIM WEAR, NAMELY, BATHING SUITS AND COVER-UPS; SLEEPWEAR, NAMELY, BATHROBES, PAJAMAS, NIGHTGOWNS; SHORTS, PANTS, SKIRTS, OVERALLS, TIGHTS, UNDERWEAR, UNDERPANTS, UNDERSHIRTS, SOCKS, SWEATERS, SWEAT PANTS, SWEAT SUITS, POLO SHIRTS, PULLOVERS, SHIRTS, BLOUSES, JACKETS, COATS, RAINCOATS, RAIN JACKETS, DRESSES, JEANS, JUMPERS, PANTS, WATERPROOF CLOTHING, NAMELY, WATERPROOF JACKETS, PANTS, TIES, SUITS, BELTS, GLOVES; HEADWEAR, NAMELY HATS, CAPS, VISORS AND EARMUFFS; FOOTWEAR, IN CLASS 25 (U.S. CLS. 22 AND 39).

THE MARK CONSISTS OF STANDARD CHARACTERS WITHOUT CLAIM TO ANY PARTICULAR FONT, STYLE, SIZE, OR COLOR.

PRIORITY DATE OF 3-22-2006 IS CLAIMED.

OWNER OF INTERNATIONAL REGISTRATION  
0901244 DATED 9-20-2006, EXPIRES 9-20-2016.

SER. NO. 79-029,989, FILED 9-20-2006.

COLLEEN KEARNEY, EXAMINING ATTORNEY

**Int. Cls.: 9, 35 and 42**

**Prior U.S. Cls.: 21, 23, 26, 36, 38, 100, 101 and 102**

**United States Patent and Trademark Office**

**Reg. No. 3,453,923**

**Registered June 24, 2008**

**TRADEMARK  
SERVICE MARK  
PRINCIPAL REGISTER**

***DIGIPROBE***

INTELLIGENCE FOCUS S.R.L. (ITALY A JOINT STOCK COMPANY WITH LIMITED LIABILITY ORGANIZED UNDER THE LAWS OF ITALY)

VIA CARDINAL FOSSATI, 4  
I-10141 TORINO (TO)  
ITALY

FOR: SCIENTIFIC APPARATUS AND INSTRUMENTS, NAMELY, COMPUTERS, SOFTWARE, NAMELY DATA MINING SOFTWARE, COMPUTER HARDWARE, COMPUTER PROGRAMS, NAMELY, DATA MINING PROGRAMS, IN CLASS 9 (U.S. CLS. 21, 23, 26, 36 AND 38).

FOR: BUSINESS MANAGEMENT; PROVIDING OFFICE FUNCTIONS, IN CLASS 35 (U.S. CLS. 100, 101 AND 102).

FOR: DESIGN AND DEVELOPMENT OF COMPUTER HARDWARE AND SOFTWARE, IN CLASS 42 (U.S. CLS. 100 AND 101).

THE MARK CONSISTS OF STANDARD CHARACTERS WITHOUT CLAIM TO ANY PARTICULAR FONT, STYLE, SIZE, OR COLOR.

PRIORITY DATE OF 3-28-2006 IS CLAIMED.

OWNER OF INTERNATIONAL REGISTRATION 0901913 DATED 5-22-2006, EXPIRES 5-22-2016.

SER. NO. 79-030,245, FILED 5-22-2006.

CHARISMA HAMPTON, EXAMINING ATTORNEY

**Int. Cl.: 11**

**Prior U.S. Cls.: 13, 21, 23, 31 and 34**

**United States Patent and Trademark Office**

**Reg. No. 3,453,924**

**Registered June 24, 2008**

**TRADEMARK  
PRINCIPAL REGISTER**

# **FUNPOOL**

HANS GROHE AG (FED REP GERMANY STOCK COMPANY)  
AUESTR. 5-9  
77761 SCHILTACH, FED REP GERMANY

FOR: APPARATUS FOR STEAM GENERATING, WATER SUPPLY AND SANITARY PURPOSES, NAMELY, STEAM GENERATORS, PLUMBING FITTINGS, NAMELY, VALVES, SHOWER SPRAYERS, MIXING VALVES AND WATER SUPPLY AND WATER OUTLET FITTINGS WITH MANUAL AND AUTOMATIC CONTROLS, NAMELY, MANUALLY AND AUTOMATICALLY OPERATED MIXING VALVES, MIXER TAPS FOR WASH STANDS, BIDETS, SINKS, BATH TUBS AND SHOWER TUBS; SANITARY TUBS AND BASINS IN THE NATURE OF BATH TUBS, SHOWER TUBS, WHIRLPOOL TUBS, BIDETS, SHOWER AND SHOWER SETS WITH ATTACHMENTS, NAMELY, OVERHEAD SHOWERS, LATERAL SHOWERS AND HAND SHOWERS; SHOWER NOZZLES, NAMELY, SHOW-

ER HEADS; PRE-ASSEMBLED MULTIFUNCTIONAL SHOWERS; SHOWER CABINS; SHOWERS AND SHOWER FITTINGS, NAMELY, VALVES, TUB AND SHOWER CONTROL VALVES, SPOUTS, WATER JET AERATORS; SHOWER HEAD HOLDERS, IN CLASS 11 (U.S. CLS. 13, 21, 23, 31 AND 34).

PRIORITY DATE OF 4-20-2006 IS CLAIMED.

OWNER OF INTERNATIONAL REGISTRATION 0902641 DATED 10-11-2006, EXPIRES 10-11-2016.

OWNER OF U.S. REG. NOS. 2,793,452 AND 3,102,925.

SER. NO. 79-030,568, FILED 10-11-2006.

KRISTINA MORRIS, EXAMINING ATTORNEY



**Int. Cls.: 11, 17 and 21**

**Prior U.S. Cls.: 1, 2, 5, 12, 13, 21, 23, 29, 30, 31, 33, 34, 35, 40 and 50**

**Reg. No. 3,453,925**

**United States Patent and Trademark Office**

**Registered June 24, 2008**

**TRADEMARK  
PRINCIPAL REGISTER**

# Hans

HANS GROHE AG (FED REP GERMANY AKTIENGESELLSCHAFT)  
AUESTR. 5-9  
77761 SCHILTACH  
FED REP GERMANY

FOR: APPARATUS FOR LIGHTING, NAMELY, ELECTRIC LIGHTING FIXTURES; WATER TREATMENT INSTALLATIONS, NAMELY, WASTE WATER PURIFICATION UNITS, WATER CONDITIONING UNITS, WATER PURIFICATION TANKS; WATER REFINEMENT INSTALLATIONS, NAMELY, WATER PURIFIERS; FILTERING INSTALLATIONS, NAMELY, WATER FILTERING UNITS FOR DOMESTIC AND COMMERCIAL USE; FILTERS, NAMELY, WATER FILTERS; PLUMBING FITTINGS, NAMELY, MIXING VALVES, MANUALLY AND AUTOMATICALLY OPERATED MIXING VALVES, MIXER TAPS FOR WASH STANDS, BIDETS, SINKS, BATH TUBS AND SHOWER TUBS; SANITARY TUBS, BATH TUBS, SHOWER TUBS, WHIRLPOOL TUBS; BIDETS; SHOWERS AND SHOWER CABINS; SHOWER AND SHOWER COMBINATIONS, NAMELY, OVERHEAD SHOWERS, LATERAL SHOWERS AND HAND SHOWERS; SHOWER NOZZLES AS PARTS OF SANITARY INSTALLATIONS, SHOWERS AND BATHS, NAMELY, NOZZLES FOR SHOWER HEADS, BATH TUBS; PRE-ASSEMBLED MULTIFUNCTIONAL SHOWERS; SUPPLY AND DISCHARGE FITTINGS FOR SANITARY BASINS, WASH STANDS, SINKS, BIDETS, BATH TUBS AND SHOWER TUBS, NAMELY, TRAPS, VALVES, TUB AND SHOWER CONTROL VALVES, SPOUTS, AERATORS FOR FAUCETS; PLUMBING FITTINGS, NAMELY, SIPHON TRAPS; SIPHON TRAPS FOR USE IN DRAWING WATER; SUPPLY AND DISCHARGE PIPES BEING PARTS OF SANITARY FACILITIES; ELECTRIC LIGHTING

FIXTURES FOR SANITARY FITMENTS; METAL COCKS, TRAPS, VALVES, SHOWER CONTROL VALVES, TUB CONTROL VALVES, SHOWER CONTROL VALVES, TUB CONTROL VALVES, ALL FOR PLUMBING; REPLACEMENT PARTS FOR THE AFORESAID GOODS, IN CLASS 11 (U.S. CLS. 13, 21, 23, 31 AND 34).

FOR: HOSES GENERALLY MADE OF NON-METALLIC MATERIALS, NAMELY, PLASTIC HOSES FOR PLUMBING USE, IN CLASS 17 (U.S. CLS. 1, 5, 12, 13, 35 AND 50).

FOR: SOAP DISHES, TOOTH BRUSH GLASSES, DRINKING GLASSES, TOWEL HOLDERS, WALL RODS, NAMELY, GLASS RODS FOR TOWELS, TOWEL RODS; TOILET ROLL AND BRUSH HOLDERS, HOLDERS AND WALL BRACKETS FOR BATH AND TOILET UTENSILS, APPARATUS FOR CLEANING AND MASSAGING TEETH AND GUMS IN THE FORM OF A HYDRAULIC WATER SPRAYER, IN CLASS 21 (U.S. CLS. 2, 13, 23, 29, 30, 33, 40 AND 50).

PRIORITY DATE OF 12-23-2005 IS CLAIMED.

OWNER OF INTERNATIONAL REGISTRATION 0903425 DATED 6-23-2006, EXPIRES 6-23-2016.

OWNER OF U.S. REG. NOS. 1,826,086, 3,256,539 AND OTHERS.

SER. NO. 79-030,901, FILED 6-23-2006.

KRISTINA MORRIS, EXAMINING ATTORNEY

**Int. Cls.: 7, 9 and 11**

**Prior U.S. Cls.: 13, 19, 21, 23, 26, 31, 34, 35, 36 and 38**

**United States Patent and Trademark Office**

**Reg. No. 3,453,926**

**Registered June 24, 2008**

**TRADEMARK  
PRINCIPAL REGISTER**

# HOME PUB

ANTONIO MERLONI S.P.A. (ITALY JOINT STOCK COMPANY)  
VIA V. VENETO, 116  
I-60044 FABRIANO (AN), ITALY

FOR: MACHINES, APPARATUS AND INSTRUMENTS FOR USE IN TAPPING, NAMELY, VACUUM PUMPS AND VALVES FOR TAPPING BEVERAGE CONTAINERS; MACHINE PARTS, NAMELY, PUMPS FOR BEVERAGE DISPENSING REFRIGERATORS; PARTS AND FITTINGS FOR ALL THE AFORESAID GOODS, IN CLASS 7 (U.S. CLS. 13, 19, 21, 23, 31, 34 AND 35).

FOR: MACHINES, APPARATUS AND INSTRUMENTS FOR USE IN DISPENSING BEVERAGES, NAMELY, VENDING MACHINES, IN CLASS 9 (U.S. CLS. 21, 23, 26, 36 AND 38).

FOR: INSTALLATIONS AND APPARATUS FOR THE COOLING, TAPPING AND DISPENSING OF BEVERAGES, NAMELY, REFRIGERATED DISPENSING UNITS FOR DRAFTED BEVERAGES; PARTS AND FITTINGS FOR ALL OF THE AFORESAID GOODS; REFRIGERATORS, FREEZERS, COMBINED REFRIGERATORS AND FREEZERS; MA-

CHINES, APPARATUS AND INSTRUMENTS FOR USE IN COOLING BEVERAGES, NAMELY, REFRIGERATING MACHINES AND BEVERAGES COOLING UNITS, IN CLASS 11 (U.S. CLS. 13, 21, 23, 31 AND 34).

THE MARK CONSISTS OF STANDARD CHARACTERS WITHOUT CLAIM TO ANY PARTICULAR FONT, STYLE, SIZE, OR COLOR.

PRIORITY DATE OF 1-18-2006 IS CLAIMED.

OWNER OF INTERNATIONAL REGISTRATION 0903824 DATED 2-21-2006, EXPIRES 2-21-2016.

NO CLAIM IS MADE TO THE EXCLUSIVE RIGHT TO USE "HOME", APART FROM THE MARK AS SHOWN.

SER. NO. 79-031,029, FILED 2-21-2006.

EDWARD FENNESSY, EXAMINING ATTORNEY

**Int. Cls.: 1, 5 and 31**

**Prior U.S. Cls.: 1, 5, 6, 10, 18, 26, 44, 46, 51 and 52**

**United States Patent and Trademark Office**

**Reg. No. 3,453,927**

**Registered June 24, 2008**

**TRADEMARK  
PRINCIPAL REGISTER**

**BLUE WATER**

PROCÉDÉS ROLAND PIGEON (FRANCE SOCI-  
ÉTÉ PAR ACTIONS SIMPLIFIÉE)  
7 RUE ARMAND MOISANT  
F-75015 PARIS  
FRANCE

FOR: CHEMICAL PREPARATIONS FOR USE IN  
AGRICULTURE, HORTICULTURE AND FOREST-  
RY, NAMELY, CHEMICAL PREPARATIONS FOR  
THE TREATMENT OF SEEDS AND FOR PLANT  
GROWTH, AND PREPARATIONS OF MICROBIAL  
INOCULANTS FOR PLANT DISEASE CONTROL;  
SOIL IMPROVING PREPARATIONS; SOIL FERTI-  
LIZERS, IN CLASS 1 (U.S. CLS. 1, 5, 6, 10, 26 AND 46).

FOR: PREPARATIONS FOR DESTROYING VER-  
MIN; FUNGICIDES, HERBICIDES, IN CLASS 5 (U.S.  
CLS. 6, 18, 44, 46, 51 AND 52).

FOR: AGRICULTURAL COATED GRAINS FOR  
PLANTING AND SOWING; COATED SEEDS FOR  
HORTICULTURAL PURPOSES, IN CLASS 31 (U.S.  
CLS. 1 AND 46).

THE MARK CONSISTS OF STANDARD CHAR-  
ACTERS WITHOUT CLAIM TO ANY PARTICULAR  
FONT, STYLE, SIZE, OR COLOR.

OWNER OF INTERNATIONAL REGISTRATION  
0871497 DATED 11-4-2005, EXPIRES 11-4-2015.

OWNER OF U.S. REG. NO. 2,474,760.

SER. NO. 79-031,082, FILED 8-30-2006.

ELIZABETH KAJUBI, EXAMINING ATTORNEY

**Int. Cls.: 5, 29, 30, 31, 32 and 33**

**Prior U.S. Cls.: 1, 6, 18, 44, 45, 46, 47, 48, 49, 51 and 52**

**Reg. No. 3,453,928**

**United States Patent and Trademark Office**

**Registered June 24, 2008**

**CERTIFICATION MARK  
PRINCIPAL REGISTER**



CHINA GREEN FOOD DEVELOPMENT CENTER  
(CHINA ORGANIZATION)  
NO. 59 XUEYUAN NAN LU,  
HAIDIAN DISTRICT; BEIJING  
CHINA

FOR: FOOD FOR BABIES, IN CLASS 5 (U.S. CLS. 6, 18, 44, 46, 51 AND 52).

FOR: MEAT; POULTRY; GAME; MEAT EXTRACTS; TINNED, PRESERVED, DRIED FRUIT AND VEGETABLES; EGGS, MILK; DAIRY PRODUCTS EXCLUDING ICE CREAM, ICE MILK AND FROZEN YOGURT; EDIBLE FATS; JELLIES FOR FOOD, AQUATIC PRODUCT, NAMELY, FISH AND SEAFOOD; HERRINGS; SALMON; SARDINES; TUNA FISH; FISH; FISH FILLETS; FOODS PREPARED FROM FISH; ISINGLASS FOR FOOD; CAVIAR; LOBSTERS; SPINY LOBSTERS; OYSTERS; MUSSELS; SHELLFISH FOR HUMAN CONSUMPTION; CRAYFISH; WEED EXTRACTS FOR FOOD; SHARKS FIN; FISH MAW; DRIED FISH, DRIED FISH FLOSS; SLEEVE-FISH; ICED SHRIMPS; ICED PRAWNS; DRIED SHRIMPS; DRIED SHRIMPS FLOSS; JELLY FISH HEAD; DRIED SHELLFISH; DRIED CLAM; DRIED RAZOR CLAM; LAYER; EDIBLE SEAWEED; KELP; KELP THREADS; SEAFOOD; SEA- CUCUMBERS, IN CLASS 29 (U.S. CL. 46).

FOR: WHEAT FLOUR; STEAMED STUFFED BUNS; SPRING ROLLS, HAMBURGER SANDWICHES; FRIED RICE; PORRIDGE; FISH STICK PASTRY; GLUTINOUS RICE CAKE; ZONGZI, NAMELY, A PYRAMID-SHAPED DUMPLING MADE OF GLUTINOUS RICE WRAPPED IN BAMBOO OR REED LEAVES, EATEN DURING THE DRAGON BOAT FESTIVAL; YE'ERBA, NAMELY, A STEAMED LEAF-WRAPPED CAKE; RICE GLUE BALL; INSTANT NOODLE; MAHUA, NAMELY, A FRIED DOUGH TWIST; THIN PANCAKE; EIGHT-TREASURE RICE PUDDING; SWEETENED BEAN

PASTE; COFFEE POWDER; COFFEE EXTRACT; COFFEE EXTRACT SUBSTITUTE; COFFEE TEA; CHOCOLATE-BASED BEVERAGES NOT BEING DAIRY-BASED OR VEGETABLE BASED; CEREAL PREPARATIONS, NAMELY, PROCESSED CEREALS; FLOUR-MILLING PRODUCTS, NAMELY, FLOUR; NOODLES; OATS, NAMELY, PROCESSED OATS; CORN FOODS, NAMELY, PROCESSED CORN AND CORN-BASED SNACKS; PIES; JIAOZI, NAMELY, DUMPLINGS; SANDWICHES; ESSENCES FOR FOODS, NAMELY, SEASONINGS AND SPICES; CAKE FLAVORINGS; BEVERAGE FLAVORINGS; FLAVORINGS FOR CONFECTIONERY; FLAVORINGS FOR CRYSTALLIZED FRUITS; MUSTARD; MONOSODIUM GLUTAMATE; DRESSINGS FOR SALAD, SAUCES; STIFFENING WHIPPED CREAM; MEAT TENDERIZER POWDER; MEAT TENDERIZERS, FOR HOUSEHOLD PURPOSES; LEAVEN, NAMELY, YEAST; TAPIOCA FLOUR FOR FOOD; STARCH PRODUCTS FOR FOOD, NAMELY, STARCH; ICE; ICE PRODUCTS, NAMELY, ICE BLOCKS; COOKING SALT; SOYA SAUCE; VINEGAR; COFFEE; COFFEE SUBSTITUTES; COCOA; TEA; SUGAR; SWEETMEATS, NANTANG, NAMELY, SOUTHERN-STYLE CHINESE CANDY; HONEY; BREAD; TREACLE; PASTRIES; RICE, IN CLASS 30 (U.S. CL. 46).

FOR: CEREAL AND AGRICULTURE PRODUCTS, NAMELY, UNPROCESSED CEREALS, UNPROCESSED GRAIN, AND UNPROCESSED RICE; LIVE ANIMALS AND PLANTS; FRUITS AND NUTS, NAMELY, UNPROCESSED FRESH FRUITS, UNPROCESSED GRAPES, UNPROCESSED CHESTNUTS, COCONUTS, UNPROCESSED PINE CONES, UNPROCESSED LEMONS, AND UNPROCESSED SUGARCANE; FRESH VEGETABLES; SEEDS FOR FRUITS AND VEGETABLES; PLANT SEEDS; STALL FOOD FOR ANIMALS, NAMELY, NON-MEDICATED ADDITIVES FOR ANIMAL FOODSTUFFS; MALT FOR BREWING AND DISTILLING, IN CLASS 31 (U.S. CLS. 1 AND 46).

FOR: BEERS; SELTZER WATER; AERATED WATER; NON-ALCOHOLIC BEVERAGES, NAMELY, FRUIT JUICES; FRUIT NECTARS AND JUICES; BEVERAGE POWDERS, NAMELY, FOR MAKING FRUIT JUICES; SYRUPS FOR BEVERAGES, IN CLASS 32 (U.S. CLS. 45, 46 AND 48).

FOR: ALCOHOLIC BEVERAGES, NAMELY, LIQUEURS, DISTILLED SPIRITS AND WINE, IN CLASS 33 (U.S. CLS. 47 AND 49).

OWNER OF INTERNATIONAL REGISTRATION 0903964 DATED 2-24-2006, EXPIRES 2-24-2016.

NO CLAIM IS MADE TO THE EXCLUSIVE RIGHT TO USE "GREEN FOOD" AND THE NON-LATIN CHARACTERS THAT MEAN "GREEN FOOD", APART FROM THE MARK AS SHOWN.

THE MARK CONSISTS OF THE STYLIZED CIRCULAR DESIGN, THE WORDING "GREEN FOOD" AND NON-LATIN CHARACTERS THAT TRANSLITERATE TO "LV SE SHI PAN".

THE NON-LATIN CHARACTERS IN THE MARK TRANSLITERATE TO "LV SE SHI PIN" AND THIS MEANS "GREEN FOOD" IN ENGLISH.

THE CERTIFICATION MARK, AS INTENDED TO BE USED BY PERSONS AUTHORIZED BY THE CERTIFIER, IS INTENDED TO CERTIFY THAT THE GOODS PROVIDED ARE NUTRITIOUS AND CONTAMINATION-FREE.

SER. NO. 79-031,103, FILED 2-24-2006.

DANIEL BRODY, EXAMINING ATTORNEY

**Int. Cls.: 6, 7 and 12**

**Prior U.S. Cls.: 2, 12, 13, 14, 19, 21, 23, 25, 31, 34, 35,  
44 and 50**

**Reg. No. 3,453,929**

**United States Patent and Trademark Office**

**Registered June 24, 2008**

**TRADEMARK  
PRINCIPAL REGISTER**

**WELLBOSS**

WIRELINE ENGINEERING LIMITED (SCOTLAND PRIVATE LIMITED COMPANY)  
TECHNOLOGY HOUSE  
BLACKBURN BUSINESS PARK; BLACKBURN  
ABERDEEN AB21 0PS, UNITED KINGDOM

FOR: METAL ROLLERS FOR USE WITH CABLES, RODS AND STRINGS IN THE OIL AND GAS WELL INDUSTRY; METAL ROLLERS FOR USE WITH CABLES, RODS AND STRINGS ON A DOWNHOLE APPARATUS FOR REDUCING FRICTION IN AN OIL OR GAS WELL, IN CLASS 6 (U.S. CLS. 2, 12, 13, 14, 23, 25 AND 50).

FOR: MOTORIZED OR MECHANIZED WELL INTERVENTION TOOLS HAVING FRICTION REDUCING DEVICES FOR THE PURPOSE OF LOWERING AND RAISING ITEMS IN AND OUT OF WELLS, NAMELY, DOWNHOLE CONVEYORS COMPRISING A METAL BODY HAVING AT LEAST ONE ROLLER, THE ROLLER BEING MOTORIZED OR MECHANIZED TO IMPART A DRIVING FORCE AND REDUCE FRICTION; MOTORIZED OR MECHANIZED WELL INTERVENTION ROLLER TOOLS FOR LOWERING AND RAISING ITEMS IN AND OUT OF WELLS, NAMELY, DOWNHOLE CONVEYORS COMPRISING A METAL BODY HAVING AT LEAST ONE ROLLER, THE ROLLER BEING MOTORIZED OR MECHANIZED TO IMPART A DRIVING FORCE; MOTORIZED OR MECHANIZED WELL INTERVENTION TOOLS HAVING WHEELS, ROLLERS, TRACKS OR RUNNERS FOR REDUCING FRICTION OF A STRING DURING THE LOWERING AND RAISING OF ITEMS IN AND OUT OF AN OIL OR GAS WELL, NAMELY, DOWNHOLE CONVEYORS COMPRISING A METAL BODY HAVING AT LEAST ONE WHEEL, ROLLER, TRACK OR RUNNER, THE WHEEL, ROLLER, TRACK OR RUNNER BEING MOTORIZED OR MECHANIZED TO REDUCE FRICTION; PARTS AND FITTINGS FOR THE AFORESAID GOODS, NAMELY, NON-METAL ROLLERS AND ROLLER SUBS FOR THE AFORE-

MENTIONED DOWNHOLE TUBES, TUBULAR JARS, NAMELY, DOWNHOLE TUBULAR TOOLS THAT CAN RELEASE STORED COMPRESSIVE OR TENSILE ENERGY SO AS TO GENERATE A SHOCK, LINEAR BEARINGS FOR MACHINES; MOTORIZED OR MECHANIZED WIRELINE SUBS, NAMELY, WELL INTERVENTION SUB-ASSEMBLIES FOR USE WITH WIRELINES; MAINTENANCE KITS AND REDRESS KITS FOR THE FOREGOING, NAMELY, KITS COMPRISING SEALING JOINTS, BEARINGS, WHEELS, ROLLERS, RUNNERS AND MOTORS, SOLD AS A UNIT, IN CLASS 7 (U.S. CLS. 13, 19, 21, 23, 31, 34 AND 35).

FOR: LOCOMOTIVES FOR USE IN PIPELINES AND IN OIL AND GAS WELLS; LAND VEHICLES FOR DOWNHOLE AND PIPELINE USE; PARTS AND FITTINGS FOR THE AFORESAID GOODS, NAMELY, WHEELS, SWIVELS FOR COUPLING LOCOMOTIVES AND LAND VEHICLES TO DOWNHOLE TOOLS AND STRINGS OF TOOLS; MAINTENANCE KITS AND REDRESS KITS FOR THE FOREGOING, NAMELY, KITS COMPRISING BEARINGS, WHEELS, ROLLERS, TRACKS, RUNNERS AND MOTORS, SOLD AS A UNIT, IN CLASS 12 (U.S. CLS. 19, 21, 23, 31, 35 AND 44).

THE MARK CONSISTS OF STANDARD CHARACTERS WITHOUT CLAIM TO ANY PARTICULAR FONT, STYLE, SIZE, OR COLOR.

PRIORITY DATE OF 1-19-2005 IS CLAIMED.

OWNER OF INTERNATIONAL REGISTRATION  
0904153 DATED 7-15-2005, EXPIRES 7-15-2015.

SER. NO. 79-031,175, FILED 7-15-2005.

DAVID HOFFMAN, EXAMINING ATTORNEY

**Int. Cls.: 1, 5 and 9**

**Prior U.S. Cls.: 1, 5, 6, 10, 18, 21, 23, 26, 36, 38, 44, 46,  
51 and 52**

**Reg. No. 3,453,930**

**United States Patent and Trademark Office**

**Registered June 24, 2008**

**TRADEMARK  
PRINCIPAL REGISTER**

# EASYXTAL

QIAGEN GMBH (FED REP GERMANY LTD  
LIAB CO)  
QIAGEN STRASSE 1  
40724 HILDEN  
FED REP GERMANY

FOR: CHEMICAL, BIOCHEMICAL AND BIOTECHNOLOGICAL PRODUCTS, NAMELY, NUCLEIC ACIDS, ENZYMES, PROTEINS, POLYMERASES, REAGENTS FOR STAINING AND MARKING, MOLECULAR PROBES, BUFFER, AQUEOUS AND NONAQUEOUS SOLUTIONS OF ALCOHOLS AND SALTS, CRYSTALLIZATION SOLUTIONS FOR CRYSTALLIZING PROTEINS, PRECIPITANTS IN THE NATURE OF REAGENTS FOR THE PURPOSE OF CATALYZING THE CRYSTALLIZATION OF PROTEINS, DISTILLED AND PURIFIED WATER, SILICA IN POWDERED, GRANULATE, AND GEL FORM, MAGNETIC PARTICLES IN FLUID FORM, MATERIALS FOR SEPARATION COLUMNS, ALL OF THE FOREGOING GOODS FOR INDUSTRIAL AND SCIENTIFIC PURPOSES AND NOT FOR MEDICAL OR VETERINARY PURPOSES; KITS COMPRISING NUCLEIC ACIDS, ENZYMES, PROTEINS, POLYMERASES, REAGENTS FOR STAINING AND MARKING, MOLECULAR PROBES, BUFFER, AQUEOUS AND NONAQUEOUS SOLUTIONS OF ALCOHOLS AND SALTS, CRYSTALLIZATION SOLUTIONS FOR CRYSTALLIZING PROTEINS, PRECIPITANTS IN THE NATURE OF REAGENTS FOR THE PURPOSE OF CATALYZING THE CRYSTALLIZATION OF PROTEINS, DISTILLED AND PURIFIED WATER, SILICA IN POWDERED, GRANULATE, AND GEL FORM, MAGNETIC PARTICLES IN FLUID FORM, AND MATERIALS FOR SEPARATION COLUMNS, ALL OF THE FOREGOING GOODS FOR INDUSTRIAL AND SCIENTIFIC PURPOSES AND NOT FOR MEDICAL OR VETERINARY PURPOSES, IN CLASS 1 (U.S. CLS. 1, 5, 6, 10, 26 AND 46).

FOR: CHEMICAL, BIOCHEMICAL AND BIOTECHNOLOGICAL PRODUCTS, NAMELY, NUCLEIC ACIDS, ENZYMES, PROTEINS, POLYMERASES, REAGENTS FOR STAINING AND MARKING, MO-

LECULAR PROBES, BUFFER, AQUEOUS AND NONAQUEOUS SOLUTIONS OF ALCOHOLS AND SALTS, CRYSTALLIZATION SOLUTIONS FOR CRYSTALLIZING PROTEINS, PRECIPITANTS IN THE NATURE OF REAGENTS FOR THE PURPOSE OF CATALYZING THE CRYSTALLIZATION OF PROTEINS, DISTILLED AND PURIFIED WATER, SILICA IN POWDERED, GRANULATE, AND GEL FORM, MAGNETIC PARTICLES IN FLUID FORM, MATERIALS FOR SEPARATION COLUMNS, ALL OF THE FOREGOING GOODS FOR MEDICAL AND VETERINARY PURPOSES; KITS COMPRISING NUCLEIC ACIDS, ENZYMES, PROTEINS, POLYMERASES, REAGENTS FOR STAINING AND MARKING, MOLECULAR PROBES, BUFFER, AQUEOUS AND NONAQUEOUS SOLUTIONS OF ALCOHOLS AND SALTS, CRYSTALLIZATION SOLUTIONS FOR CRYSTALLIZING PROTEINS, PRECIPITANTS IN THE NATURE OF REAGENTS FOR THE PURPOSE OF CATALYZING THE CRYSTALLIZATION OF PROTEINS, DISTILLED AND PURIFIED WATER, SILICA IN POWDERED, GRANULATE, AND GEL FORM, MAGNETIC PARTICLES IN FLUID FORM, MATERIALS FOR SEPARATION COLUMNS, ALL OF THE FOREGOING GOODS FOR MEDICAL AND VETERINARY PURPOSES, IN CLASS 5 (U.S. CLS. 6, 18, 44, 46, 51 AND 52).

FOR: SCIENTIFIC APPARATUS, INSTRUMENTS, AND EQUIPMENT, NAMELY, LABORATORY EQUIPMENT IN THE NATURE OF CHROMATOGRAPHY COLUMNS, LABORATORY EQUIPMENT IN THE NATURE OF ROBOTS AND SPARE PARTS AND ADD-ONS THEREFOR, NAMELY, PREPROGRAMMED SMART CARDS FOR DNA PURIFICATION PROTOCOLS AND AUTOMATED LABORATORY EQUIPMENT IN THE NATURE OF LIQUID HANDLING DEVICES, AUTOMATED PIPETTING DEVICES, AND DEVICES FOR AUTOMATED PROTEIN CRYSTALLIZATION SCREENINGS; LABORATORY EQUIPMENT, NAMELY, MICRO PLATES, PIPETTES, PIPETTE TIPS, PIPETTE TIP HOLDERS, SAMPLE CONTAINERS, REAGENT HOLDERS, FLASKS, REAGENT

TUBE HOLDERS, HOLDERS FOR MICRO CONTAINERS, MAGNETIC SYRINGES, BIOCHIPS FOR THE PURPOSE OF SCREENING LARGE NUMBERS OF BIOLOGICAL ANALYTES, THERMOCYCLERS FOR THE PURPOSE OF PERFORMING POLYMERASE CHAIN REACTIONS, HOMOGENIZERS FOR THE PURPOSE OF BREAKING UP CELL MEMBRANES AND MIXING THE RESULTING LIQUIDS, AND VACUUM VALVES FOR THE PURPOSE OF PERMITTING THE OPERATION OF LABORATORY PROCESSES UNDER SUBATMOSPHERIC PRESSURE, IN CLASS 9 (U.S. CLS. 21, 23, 26, 36 AND 38).

THE MARK CONSISTS OF STANDARD CHARACTERS WITHOUT CLAIM TO ANY PARTICULAR FONT, STYLE, SIZE, OR COLOR.

PRIORITY DATE OF 10-7-2005 IS CLAIMED.

OWNER OF INTERNATIONAL REGISTRATION 0904723 DATED 3-29-2006, EXPIRES 3-29-2016.

SER. NO. 79-031,391, FILED 3-29-2006.

SHAILA SETTLES, EXAMINING ATTORNEY



Int. Cl.: 33

Prior U.S. Cls.: 47 and 49

United States Patent and Trademark Office

Reg. No. 3,453,931

Registered June 24, 2008

TRADEMARK  
PRINCIPAL REGISTER



NEMIROFF INTELLECTUAL PROPERTY; ESTABLISHMENT (LIECHTENSTEIN LTD LIABILITY CO)  
STÄDTLE 31  
FL-9490 VADUZ  
LIECHTENSTEIN

FOR: ALCOHOLIC BEVERAGES, NAMELY, VODKA, IN CLASS 33 (U.S. CLS. 47 AND 49).

PRIORITY DATE OF 3-28-2006 IS CLAIMED.

OWNER OF INTERNATIONAL REGISTRATION 0904971 DATED 7-31-2006, EXPIRES 7-31-2016.

OWNER OF U.S. REG. NOS. 2,658,169 AND 3,076,835.

NO CLAIM IS MADE TO THE EXCLUSIVE RIGHT TO USE "HONEY PEPPER", APART FROM THE MARK AS SHOWN.

THE COLOR(S) BROWN, YELLOW AND RED IS/ARE CLAIMED AS A FEATURE OF THE MARK.

THE MARK CONSISTS OF THE WORDS "HONEY PEPPER" WITH A STYLIZED REPRESENTATION OF A HONEYCOMB AND A PEPPER. THE WORDING APPEARS IN THE COLOR BROWN; THE "O" IN THE WORD "HONEY" APPEARS IN YELLOW; AND THE PEPPER APPEARS IN THE COLOR RED.

SER. NO. 79-031,480, FILED 7-31-2006.

JERI J. FICKES, EXAMINING ATTORNEY

**Int. Cl.: 3**

**Prior U.S. Cls.: 1, 4, 6, 50, 51 and 52**

**United States Patent and Trademark Office**

**Reg. No. 3,453,932**

**Registered June 24, 2008**

**TRADEMARK  
PRINCIPAL REGISTER**

**SMART COSMETIC INGREDIENTS**

ETABLISSEMENTS B. ROSSOW ET CIE (FRANCE  
SOCIETE PAR ACTIONS SIMPLIFIEE)  
92, AVENUE DU GÉNÉRAL DE GAULLE  
F-92230 GENNEVILLIERS, FRANCE

PRIORITY DATE OF 4-14-2006 IS CLAIMED.

FOR: COSMETICS, COSMETIC CREAMS, MILKS  
AND CREAMS FOR MAKE-UP REMOVAL AND  
SKIN CLEANSING, TOILETRY OIL AND CLEANS-  
ING OIL FOR SKIN, FACE AND BODY, SYNTHET-  
IC OIL FOR COSMETIC USE, OILS FOR PERFUMES  
AND SCENTS, POMADES FOR COSMETIC PURPO-  
SES, RAW MATERIALS FOR COSMETIC USE,  
NAMELY, ALOE VERA IN GEL AND POWDER  
FORM, COSMETIC COCOA BUTTERS, COSMETIC  
OILS, IN CLASS 3 (U.S. CLS. 1, 4, 6, 50, 51 AND 52).

OWNER OF INTERNATIONAL REGISTRATION  
0905081 DATED 10-6-2006, EXPIRES 10-6-2016.

NO CLAIM IS MADE TO THE EXCLUSIVE  
RIGHT TO USE "COSMETIC INGREDIENTS",  
APART FROM THE MARK AS SHOWN.

THE MARK CONSISTS OF STANDARD CHAR-  
ACTERS WITHOUT CLAIM TO ANY PARTICULAR  
FONT, STYLE, SIZE, OR COLOR.

SER. NO. 79-031,572, FILED 10-6-2006.

ERNEST SHOSHO, EXAMINING ATTORNEY

**Int. Cls.: 35 and 42**

**Prior U.S. Cls.: 100, 101 and 102**

**United States Patent and Trademark Office**

**Reg. No. 3,453,933**

**Registered June 24, 2008**

**SERVICE MARK  
PRINCIPAL REGISTER**



**Point \* cafe**  
<http://www.pointcafe.jp/>

TRAFFIC GATE, LTD. (JAPAN CORPORATION)  
11-2 TORANOMON 5 CHOME  
MINATO-KU; TOKYO 105-0001  
JAPAN

OWNER OF INTERNATIONAL REGISTRATION  
0905360 DATED 6-27-2006, EXPIRES 6-27-2016.

FOR: ADVERTISING AND PUBLICITY SERVICES; RENTAL OF ADVERTISING SPACE ON INTERNET WEB SITES; MEDIATION OF CONTRACT FOR THE PURCHASE AND SALE OF MERCHANDISE VIA THE INTERNET; PROVIDING SALES INFORMATION VIA THE INTERNET; MERCHANDISING SERVICES FOR PROMOTING THE GOODS AND SERVICES OF OTHERS TO THE PURCHASING PUBLIC AND FOR INDUCING THE PURCHASING PUBLIC TO BUY THE GOODS AND SERVICES OF OTHERS THROUGH AN EXCHANGEABLE POINTS FOR GOODS AND SERVICES PROGRAM, IN CLASS 35 (U.S. CLS. 100, 101 AND 102).

NO CLAIM IS MADE TO THE EXCLUSIVE RIGHT TO USE "THE WORDING "POINT" AND "CASH BACK", APART FROM THE MARK AS SHOWN.

THE COLOR(S) BLUE, BLACK, BEIGE IS/ARE CLAIMED AS A FEATURE OF THE MARK.

FOR: COMPUTER SOFTWARE DESIGN AND COMPUTER PROGRAMMING FOR OTHERS, MAINTENANCE OF COMPUTER SOFTWARE; PROVIDING ON-LINE NON-DOWNLOADABLE SOFTWARE FOR MANAGING AN EXCHANGEABLE POINTS FOR GOODS AND SERVICES PROGRAM AND FOR USE IN DATABASE MANAGEMENT, IN CLASS 42 (U.S. CLS. 100 AND 101).

THE MARK CONSISTS OF THREE CONCENTRIC CIRCLES, THE FIRST OF WHICH CONTAINS THE OUTLINE OF A COMPUTER MOUSE, THE SECOND OF WHICH IS SHADED IN BLUE AND CONTAINS THE FOLLOWING WORDING IN WHITE: 'POINT CAFÉ,' AND 'CASH BACK' AND THREE STARS; AND TO THE RIGHT OF THE CIRCLES ARE THE WORDS, IN BLACK: 'POINT CAFÉ,' AND 'HTTP://WWW.POINTCAFE.JP/' IN BLACK, AND A BEIGE STAR BETWEEN THE WORDS, 'POINT CAFÉ' AND 'CAFÉ.'

SER. NO. 79-031,664, FILED 6-27-2006.

PRIORITY DATE OF 12-27-2005 IS CLAIMED.

EDWARD FENNESSY, EXAMINING ATTORNEY

**Int. Cls.: 38 and 42**

**Prior U.S. Cls.: 100, 101 and 104**

**United States Patent and Trademark Office**

**Reg. No. 3,453,934**

**Registered June 24, 2008**

**SERVICE MARK  
PRINCIPAL REGISTER**



GRUPO EMPRESARIAL IC, S.L. (SPAIN SOCIEDAD LIMITADA)  
C/ ALBAICÍN, 6  
E-41020 SEVILLA  
SPAIN

FOR: RENTAL OF ACCESS TIME TO GLOBAL COMPUTER NETWORKS; PROVIDING MULTIUSER ACCESS TO GLOBAL INFORMATION NETWORKS FOR THE REMOTE CONSULTATION OF DATABASES; COMMUNICATION SERVICES, NAMELY, VIA ELECTRONIC COMPUTER TERMINALS; PROVIDING A TELECOMMUNICATIONS CONNECTION TO GLOBAL COMPUTER NETWORKS; PROVIDING OF INFORMATION IN THE FIELD OF TELECOMMUNICATIONS; TRANSMISSION OF INFORMATION VIA ELECTRONIC COMMUNICATIONS NETWORKS; RENTAL OF TELECOMMUNICATION APPARATUS AND MODEMS, IN CLASS 38 (U.S. CLS. 100, 101 AND 104).

FOR: PROVIDING SPECIFIC INFORMATION AS REQUESTED BY CUSTOMERS VIA THE INTERNET; SERVICES OF EXTRACTION AND RECOVERY OF INFORMATION AND DATA GATHERED BY MEANS OF GLOBAL INFORMATION NETWORKS, NAMELY, RECOVERY OF COMPUTER DATA AND EXTRACTING AND PROVIDING SPECIFIC INFORMATION AS REQUESTED BY CUSTOMERS VIA THE INTERNET; COMPUTER SERVICES, NAMELY, CREATING INDEXES OF INFORMATION, SITES, AND OTHER RESOURCES AVAILABLE ON COMPUTER NETWORKS; PROVIDING SEARCH ENGINES AND DEVELOPING SEARCH STRATEGIES FOR ONLINE SEARCHING OF INFORMATION FROM EXPLORABLE INFORMATION INDEXES AND DATABASES, IN PARTICULAR TEXTS, ELECTRONIC DOCUMENTS,

DATABASES, GRAPHIC AND AUDIOVISUAL INFORMATION, BY MEANS OF GLOBAL COMPUTER INFORMATION NETWORKS; SERVICES OF DESIGN AND DEVELOPMENT OF COMPUTER SOFTWARE; SERVICES OF INSTALLATION, UPDATING AND MAINTENANCE OF COMPUTER SOFTWARE; CONVERSION OF DATA AND DOCUMENTS FROM PHYSICAL TO ELECTRONIC MEDIA; CREATING AND MAINTAINING WEB SITES FOR OTHERS; COMPUTER PROGRAM DESIGN SERVICES; COMPUTER CONSULTATION, IN CLASS 42 (U.S. CLS. 100 AND 101).

OWNER OF INTERNATIONAL REGISTRATION 0905535 DATED 10-23-2006, EXPIRES 10-23-2016.

THE COLOR(S) BLUE, WHITE AND ORANGE IS/ ARE CLAIMED AS A FEATURE OF THE MARK.

THE COLOR BLUE APPEARS IN THE WORDING "KLOOSION", ORANGE APPEARS IN THE BODY OF THE STYLIZED INSECT APPEARING OVER AND ABOVE THE THIRD LETTER "O", AND IN THE MOST INTERIOR SHADED DOTS WITHIN THE FIRST TWO LETTERS "O"; WHITE APPEARS IN THE MIDDLE RING OF THE TWO FIRST LETTERS "O", AND IN THE EYES, MOUTH, AND THE THREE RINGS OF THE STYLIZED INSECT'S UPPER BODY.

SER. NO. 79-031,731, FILED 10-23-2006.

REBECCA POVARCHUK, EXAMINING ATTORNEY

**Int. Cls.: 9 and 28**

**Prior U.S. Cls.: 21, 22, 23, 26, 36, 38 and 50**

**Reg. No. 3,453,935**

**United States Patent and Trademark Office**

**Registered June 24, 2008**

**TRADEMARK  
PRINCIPAL REGISTER**



ARISTOCRAT TECHNOLOGIES AUSTRALIA  
PTY LTD (AUSTRALIA AUSTRALIAN PRO-  
PRIETARY COMPANY, LIMITED BY  
SHARES)  
71 LONGUEVILLE ROAD  
LANE COVE NSW 2066  
AUSTRALIA

FOR: COMPUTER HARDWARE AND COMPU-  
TER SOFTWARE BEING COMPUTER HARDWARE  
AND COMPUTER SOFTWARE FOR GAMING PUR-  
POSES; GAMING MACHINES ADAPTED FOR USE  
WITH AN EXTERNAL DISPLAY SCREEN AND  
PARTS AND ACCESSORIES FOR GAMING MA-  
CHINES IN THIS CLASS, NAMELY SOFTWARE  
MODULES, STORAGE MEDIA AND COMPONENTS  
AND ERASABLE PROGRAMMABLE READ-ONLY  
MEMORY (EPROM) CHIPS; BLANK MAGNETIC  
DATA CARRIERS, RELATING TO GAMING, RE-  
CORDING DISCS RELATING TO GAMING, NAME-  
LY, BLANK COMPACT DISCS AND DVDS;  
APPARATUS FOR RECORDING, TRANSMISSION,  
REPRODUCTION OR DISPLAY OF SOUND OR  
IMAGES RELATING TO GAMING; STORAGE  
MEDIA RELATING TO GAMING NAMELY BLANK  
COMPACT DISCS, DIGITAL VIDEO DISCS; DATA  
PROCESSORS; ELECTRONIC SYSTEMS FOR LINK-  
ING GAMING AND POKER MACHINES, NAMELY  
ELECTRICAL CONTROLLERS, DISPLAYS, NAME-  
LY, LIQUID CRYSTAL DISPLAYS AND PLASMA  
DISPLAY PANELS, COMPUTER INTERFACE  
CARDS, COMPUTER BOARDS NAMELY, COMPU-  
TER ACCELERATOR BOARDS, COMPUTER EX-

PANSION BOARDS, COMPUTER GRAPHICS  
BOARDS AND COMPUTER INTERFACE BOARDS,  
ELECTRIC METERS, COMPUTER SOFTWARE  
AND FIRMWARE FOR LINKING GAMING AND  
POKER MACHINES, AND ELECTRICAL WIRES  
AND CABLES; COMPUTER PERIPHERALS, IN  
CLASS 9 (U.S. CLS. 21, 23, 26, 36 AND 38).

FOR: GAMING MACHINES OTHER THAN  
THOSE ADAPTED FOR USE WITH AN EXTERNAL  
DISPLAY SCREEN INCLUDING POKER MA-  
CHINES FEATURING GAMES OF CHANCE OR  
GAMES OF MIXED CHANCE AND SKILL OR  
PSEUDO SKILL; GAMING MACHINES OTHER  
THAN THOSE ADAPTED FOR USE WITH AN  
EXTERNAL DISPLAY SCREEN INCLUDING PO-  
KER MACHINES COMPRISED OF SOFTWARE  
MODULES AND COMPONENTS INCLUDING  
GAME SYMBOLS, MATHEMATICS, SOUND EF-  
FECTS AND OTHER CONFIGURABLE ITEMS EM-  
BEDDED IN ERASABLE PROGRAMMABLE READ-  
ONLY MEMORY, IN CLASS 28 (U.S. CLS. 22, 23, 38  
AND 50).

OWNER OF INTERNATIONAL REGISTRATION  
0905990 DATED 3-29-2006, EXPIRES 3-29-2016.

SER. NO. 79-031,806, FILED 3-29-2006.

BARBARA GAYNOR, EXAMINING ATTORNEY

**Int. Cls.: 17, 37 and 42**

**Prior U.S. Cls.: 1, 5, 12, 13, 35, 50, 100, 101, 103 and 106**

**Reg. No. 3,453,936**

**United States Patent and Trademark Office**

**Registered June 24, 2008**

**TRADEMARK  
SERVICE MARK  
PRINCIPAL REGISTER**



DURAPROOF DICHTUNGSSYSTEME GMBH  
(FED REP GERMANY LTD LIAB CO)  
EISENBAHNSTRASSE 24  
66687 WADERN-BÜSCHFELD  
FED REP GERMANY

OWNER OF INTERNATIONAL REGISTRATION  
0905773 DATED 4-11-2006, EXPIRES 4-11-2016.

FOR: SEALING SHEETS AND SEALING STRIPS FOR BUILDING PURPOSES FOR SEALING FLAT ROOFS AND WINDOW AND FACADE AREAS OF BUILDINGS; MOISTURE INSULATION FOR BUILDINGS, IN CLASS 17 (U.S. CLS. 1, 5, 12, 13, 35 AND 50).

THE COLOR(S) BLUE AND BLACK IS/ARE CLAIMED AS A FEATURE OF THE MARK.

FOR: CONSTRUCTION CONSULTANCY, IN THE FIELD OF SEALING FLAT ROOFS AND WINDOW AND FACADE AREAS OF BUILDINGS, AS WELL AS IN FIELDS OF WINDOWS AND DOORS SEALING AND THE FITTING THEREOF, IN CLASS 37 (U.S. CLS. 100, 103 AND 106).

THE COLOR BLACK APPEARS IN THE TOP HALF OF THE "DP" DESIGN AND THE COLOR BLUE APPEARS IN THE BOTTOM HALF OF THE "DP" DESIGN. THE "DURA" PORTION OF "DURAPROOF" IS IN THE COLOR BLACK AND THE "PROOF" PORTION OF "DURAPROOF" IS IN THE COLOR BLUE.

FOR: ENGINEERING, IN CLASS 42 (U.S. CLS. 100 AND 101).

SER. NO. 79-031,833, FILED 4-11-2006.

MICHAEL WEBSTER, EXAMINING ATTORNEY

**Int. Cl.: 25**

**Prior U.S. Cls.: 22 and 39**

**United States Patent and Trademark Office**

**Reg. No. 3,453,937**

**Registered June 24, 2008**

**TRADEMARK  
PRINCIPAL REGISTER**



GAULME (FRANCE SOCIETE ANONYME A DIRECTOIRE)  
325, RUE SAINT MARTIN  
F-75003 PARIS, FRANCE

FOR: APPAREL, NAMELY, FOOTWEAR EXCEPT ORTHOPEDIC FOOTWEAR, NAMELY, GYM SHOES, TENNIS SHOES, GOLF SHOES, BOATING SHOES, HIKING SHOES AND HIKING BOOTS; HEAD GEAR, NAMELY, HATS, CAPS AND SUN VISORS; BATHING SUITS; BATHROBES; SHOWER CAPS; SOCKS; SHIRTS; SCARVES; AND CLOTHING FOR GYMNASTICS AND SPORTS, NAMELY, WOMEN'S AND MEN'S GYM SHORTS AND GYM TOPS, SWEAT SUITS, RUNNING SHORTS, RUNNING SINGLETS, T-SHIRTS, RUNNING SUITS,

WIND RESISTANT JACKETS, SPORT JACKETS, SKIRTS; BLOUSES FOR RUNNING, TENNIS, GOLF AND HIKING, IN CLASS 25 (U.S. CLS. 22 AND 39).

OWNER OF INTERNATIONAL REGISTRATION 0905857 DATED 10-24-2006, EXPIRES 10-24-2016.

THE NAME "JEAN'S PAUL GAULTIER" IDENTIFIES A LIVING INDIVIDUAL WHOSE CONSENT IS OF RECORD.

SER. NO. 79-031,890, FILED 10-24-2006.

STEPHANIE ALI, EXAMINING ATTORNEY

**Int. Cls.: 6, 9 and 19**

**Prior U.S. Cls.: 1, 2, 12, 13, 14, 21, 23, 25, 26, 33, 36, 38  
and 50**

**Reg. No. 3,453,938**

**United States Patent and Trademark Office**

**Registered June 24, 2008**

**TRADEMARK  
PRINCIPAL REGISTER**

# FERMATIC

FERMOD (FRANCE SOCIÉTÉ ANONYME À  
CONSEIL D'ADMINISTRATION)  
3, AVENUE EUGÈNE GAZEAU  
F-60300 SENLIS, FRANCE

FOR: GOODS OF COMMON METAL NOT INCLUDED IN OTHER CLASSES, NAMELY, IRON-MONGERY AND SMALL ITEMS OF METAL HARDWARE, NAMELY, LOCKS OF METAL, SECURITY LOCKS OF METAL, METAL KEYS, FLAT BOLTS OF METAL, LOCK BOLTS OF METAL, PADLOCKS OF METAL, NUTS OF METAL; METAL SHORT LATCHES AND LATCHES, METAL HINGES, METAL PIVOT FRAMES FOR DOORS, METAL STRIKE PLATES, METAL DOOR FRAMES, DOOR BOLTS, METAL LOCKS, NON ELECTRICAL DEVICES FOR OPENING AND CLOSING DOORS, NAMELY, SLIDING SEALED DOORS, NAMELY, NON ELECTRIC DOOR OPENERS AND CLOSERS, METAL PUSH LEVERS FOR OPENING AND CLOSING DOORS; METAL DOOR PANELS, METAL DOORS, FLEXIBLE METAL DOORS, METAL DOOR HANDLES; RACKS, NAMELY, POT HOOKS OF METAL; METAL DOOR FITTINGS, NAMELY, PROTECTIVE FITTINGS, CHAINS, CLASPS; SUSPENSION DEVICES FOR SLIDING WATERTIGHT DOORS OF METAL, NAMELY, SUSPENSION TRACKS FOR SLIDING WATERTIGHT DOORS OF METAL; METAL RAILS FOR SLIDING DOORS; METAL FURNITURE FITTINGS, NAMELY, METAL PROTECTIVE FURNITURE FITTINGS, METAL VALVES, OTHER THAN PARTS OF MACHINES FOR EQUALIZING PRESSURE INSIDE COLD STORAGE ROOMS AND PREMISES, THE AFOREMENTIONED GOODS BEING EXCLUSIVELY INTENDED FOR EQUIPPING COLD STORAGE ROOMS, REFRIGERATED PREMISES AND COOLERS, IN CLASS 6 (U.S. CLS. 2, 12, 13, 14, 23, 25 AND 50).

FOR: ELECTRIC LOCKS, ELECTRIC OR ELECTRONIC DEVICES FOR OPENING AND CLOSING DOORS, NAMELY, ELECTRIC OR ELECTRONIC DOOR OPENING AND CLOSING SYSTEMS, ELECTRONIC CARD AND BADGE READERS FOR

OPENING AND CLOSING DOORS, ELECTRONICALLY ENCODED KEY CARDS FOR OPENING AND CLOSING DOORS, ELECTRONIC DIGITAL FINGERPRINT READERS FOR OPENING AND CLOSING DOORS, ELECTRIC VOICE RECOGNITION READERS FOR OPENING AND CLOSING DOORS, ELECTRONIC CHIP READERS FOR OPENING AND CLOSING DOORS, ELECTRIC AND ELECTRONIC LOCKS, ELECTRIC OR ELECTRONIC DOOR OPENERS AND CLOSERS, ELECTRIC OR ELECTRONIC DOOR OPENING AND CLOSING SYSTEMS INTEGRATED WITH FIRE ALARMS; APPARATUS AND INSTRUMENTS FOR REGULATING AND CONTROLLING THE OPENING AND CLOSING OF DOORS, NAMELY, DOOR OPENING REGULATORS, AND DOOR CLOSING REGULATORS; MEASURING, SIGNALING, CHECKING, AND SURVEILLANCE APPARATUS AND INSTRUMENTS, NAMELY, COMPUTER PROGRAMS TO CONTROL ACCESS TO DOORS AND LOCKS, ALARM LOCKS, FIRE AND SMOKE DETECTING APPARATUS, WARNING DEVICES, NAMELY, BELLS, ELECTRIC DOORBELLS, APPARATUS FOR WIRELESS TRANSMISSION OF VIDEO SIGNALS AND ACOUSTIC INFORMATION, RADIO TRANSMITTERS AND RECEIVERS FOR REMOTE CONTROLS; APPARATUS FOR CONTROLLING, REGULATING, AND MONITORING TEMPERATURE AND/OR PRESSURE, NAMELY, THERMOSTATS, THERMOMETERS, PRESSURE DETECTORS, AND SENSORS; PRESENCE OR DYNAMIC MOVEMENT DETECTORS, ELECTRIC AND/OR OPTIC MONITORING APPARATUS, NAMELY, ACCESS CONTROL AND ALARM MONITORING SYSTEMS, VIDEO AND PHOTOGRAPHIC SECURITY CAMERAS, AUDIO AND VIDEO TRANSMITTERS, AUDIO AND VIDEO RECEIVERS, FIRE OR BURGLAR ALARMS, AND WARNING SIGNAL TRANSMITTERS AND RECEIVERS; THE AFOREMENTIONED GOODS BEING EXCLUSIVELY INTENDED FOR EQUIPPING COLD STORAGE ROOMS, REFRIGERATED PREMISES AND COOLERS, IN CLASS 9 (U.S. CLS. 21, 23, 26, 36 AND 38).



FOR: NON-METALLIC DOOR PANELS, SUSPENSION DEVICES FOR NON-METALLIC SLIDING WATERTIGHT DOORS, NAMELY, NON METAL SUSPENSION TRACKS FOR NON METALLIC SLIDING WATERTIGHT DOORS; NON-METALLIC DOORCASINGS, NON-METALLIC FLEXIBLE DOORS, NON-METALLIC TRACKS FOR SLIDING DOORS, THE AFOREMENTIONED GOODS BEING EXCLUSIVELY INTENDED FOR EQUIPPING COLD STORAGE ROOMS, REFRIGERATED PREMISES AND COOLERS, IN CLASS 19 (U.S. CLS. 1, 12, 33 AND 50).

THE MARK CONSISTS OF STANDARD CHARACTERS WITHOUT CLAIM TO ANY PARTICULAR FONT, STYLE, SIZE, OR COLOR.

PRIORITY DATE OF 3-8-2006 IS CLAIMED.

OWNER OF INTERNATIONAL REGISTRATION 0907340 DATED 9-5-2006, EXPIRES 9-5-2016.

THE WORDING "FERMATIC" HAS NO MEANING IN A FOREIGN LANGUAGE.

SER. NO. 79-032,438, FILED 9-5-2006.

SHANNON TWOHIG, EXAMINING ATTORNEY

**Int. Cl.: 35**

**Prior U.S. Cls.: 100, 101 and 102**

**United States Patent and Trademark Office**

**Reg. No. 3,453,939**

**Registered June 24, 2008**

**SERVICE MARK  
PRINCIPAL REGISTER**



CCP HF., COMPANY NR. 450697-3469 (ICELAND  
LTD LIAB CO)  
GRANDAGARDOUR 8  
IS-101 REYKJAVÍK  
ICELAND

FOR: BUSINESS MANAGEMENT; THE BRING-  
ING TOGETHER, FOR THE BENEFIT OF OTHERS,  
OF A VARIETY OF GOODS, EXCLUDING THE  
TRANSPORT THEREOF, ENABLING CUSTOMERS  
TO CONVENIENTLY VIEW AND PURCHASE  
THOSE GOODS IN THE FIELDS OF COMPUTER  
GAMES, CLOTHING, BOOKS, MAGAZINES, TOYS,  
ACTION FIGURES, DOLLS, AND DVDS AND VI-  
DEOTAPES FEATURING MOVIES AND TELEVI-

SION PROGRAMS, IN CLASS 35 (U.S. CLS. 100, 101  
AND 102).

PRIORITY DATE OF 12-30-2005 IS CLAIMED.

OWNER OF INTERNATIONAL REGISTRATION  
0907571 DATED 6-9-2006, EXPIRES 6-9-2016.

SER. NO. 79-032,527, FILED 6-9-2006.

GILBERT SWIFT, EXAMINING ATTORNEY

**Int. Cls.: 4, 35, 40 and 42**

**Prior U.S. Cls.: 1, 6, 15, 100, 101, 102, 103 and 106**

**Reg. No. 3,453,940**

**United States Patent and Trademark Office**

**Registered June 24, 2008**

**TRADEMARK  
SERVICE MARK  
PRINCIPAL REGISTER**

**CROSSING ENERGY FRONTIERS**

STATOIL ASA (NORWAY A PUBLIC JOINT-STOCK COMPANY)  
FORUSBEEN 50  
N-4035 STAVANGER, NORWAY

FOR: INDUSTRIAL OILS AND GREASES; ALL PURPOSE AUTOMOTIVE, DRILLING, INDUSTRIAL LUBRICANTS; DUST ABSORBING, WETTING AND BINDING COMPOSITIONS; FUELS AND ILLUMINANTS, NAMELY, MOTOR SPIRIT LIQUID FUELS, GAS FOR LIGHTING; FUEL AND PETROLEUM PRODUCTS, NAMELY, PETROL, OIL, CRUDE OIL, REFINED OIL, FUEL-OIL AND FUELS, DRY GAS, LIQUEFIED NATURAL GAS, IN CLASS 4 (U.S. CLS. 1, 6 AND 15).

FOR: ADVERTISING; BUSINESS MANAGEMENT; BUSINESS ADMINISTRATION; OFFICE FUNCTIONS; MANAGEMENT OF PETROL STATIONS, MARKET SURVEYS AND MARKET ANALYSIS; ADVERTISING AND BUSINESS SERVICES, NAMELY, FORMULATION OF SALES STRATEGIES, PROMOTIONAL STRATEGIES, IDENTIFICATION OF TARGET MARKET AND ADVERTISING PROGRAMS RELATED THERETO, IN CLASS 35 (U.S. CLS. 100, 101 AND 102).

FOR: TREATMENT OF MATERIALS, NAMELY, REFINING OF CRUDE OIL AND PROCESSING OF THE PRODUCTS OF THAT REFINING, AS WELL AS PROCESSING OF DRY GAS, NATURAL GAS AND NATURAL GAS LIQUIDS, PROCESSING OF

PETRO-CHEMICAL PRODUCTS, IN CLASS 40 (U.S. CLS. 100, 103 AND 106).

FOR: SCIENTIFIC AND TECHNOLOGICAL SERVICES, NAMELY, RESEARCH AND DESIGN IN THE FIELD OF OIL AND GAS EXPLORATION; INDUSTRIAL ANALYSIS AND RESEARCH SERVICES IN THE FIELD OF OIL AND GAS EXPLORATION; DESIGN AND DEVELOPMENT OF COMPUTER HARDWARE AND SOFTWARE FOR OTHERS; ANALYSIS FOR THE EXPLOITATION OF OIL AND GAS FIELDS; ANALYSIS FOR OIL FIELD EXPLOITATION; ENGINEERING SERVICES AND RESEARCH RELATED TO DEEP-WATER TECHNOLOGY, PLANNING SERVICES RELATED TO BUILDING OF OIL-PLATFORMS; OIL-WELL TESTING, IN CLASS 42 (U.S. CLS. 100 AND 101).

THE MARK CONSISTS OF STANDARD CHARACTERS WITHOUT CLAIM TO ANY PARTICULAR FONT, STYLE, SIZE, OR COLOR.

PRIORITY DATE OF 6-13-2006 IS CLAIMED.

OWNER OF INTERNATIONAL REGISTRATION 0907733 DATED 9-6-2006, EXPIRES 9-6-2016.

SER. NO. 79-032,578, FILED 9-6-2006.

TRICIA SONNEBORN, EXAMINING ATTORNEY

**Int. Cls.: 1, 5, 9, 42 and 44**

**Prior U.S. Cls.: 1, 5, 6, 10, 18, 21, 23, 26, 36, 38, 44, 46, 51, 52, 100 and 101**

**Reg. No. 3,453,941**

**United States Patent and Trademark Office**

**Registered June 24, 2008**

**TRADEMARK  
SERVICE MARK  
PRINCIPAL REGISTER**

# CROPS

KEYGENE N.V. (NETHERLANDS SOCIÉTÉ ANONYME)

AGRO BUSINESS PARK 90

NL-6708 PW WAGENINGEN

NETHERLANDS

FOR: CHEMICAL AND DIAGNOSTIC PREPARATIONS AND REAGENTS FOR SCIENTIFIC USE AND RESEARCH PURPOSES; DIAGNOSTIC PREPARATIONS, OTHER THAN FOR MEDICAL OR VETERINARY USE; CHEMICALS FOR LABORATORY ANALYSIS, NOT FOR MEDICAL USE; CHEMICAL REAGENTS AND PRODUCTS FOR DETECTION, CHARACTERIZATION, SEQUENCING AND LABELING OF NUCLEIC ACIDS, NOT FOR MEDICAL USE; ENZYMES AND ENZYME PREPARATIONS, FOR INDUSTRIAL USE; BIOLOGICAL AND CHEMICAL PREPARATIONS AND REAGENTS, AND DIAGNOSTIC PRODUCTS, FOR USE IN THE BIOTECHNOLOGY FIELD, NOT FOR MEDICAL OR VETERINARY USE, FOR LABORATORY ANALYSIS; CHEMICAL PRODUCTS FOR LABORATORY ANALYSIS, IN THE BIOLOGY, MOLECULAR BIOLOGY, BIOINFORMATICS AND BIOTECHNOLOGY FIELDS, IN ANIMAL AND PLANT REPRODUCTION, USED IN RESEARCHING HEALTH CARE FOR HUMAN BEINGS AND ANIMALS, IN THE ENVIRONMENTAL FIELD, IN THE FIELD OF FOOD AND WATER HYGIENE, IN THE FERMENTATION FIELD ANALYSIS; OLIGONUCLEOTICIDES FOR LABORATORY ANALYSIS FOR THE DISCOVERY AND DETECTION OF POLYMORPHISMS, ALL THE AFORESAID PRODUCTS OTHER THAN FOR MEDICAL OR VETERINARY USE AND MOLECULAR GENETICS AND BIOTECHNOLOGY FOR THE PLANT AND PLANT BREEDING INDUSTRY, IN CLASS 1 (U.S. CLS. 1, 5, 6, 10, 26 AND 46).

FOR: CHEMICAL AND BIOLOGICAL PREPARATIONS, PRODUCTS AND REAGENTS FOR MEDICAL OR PHARMACEUTICAL USE; REAGENTS FOR MEDICAL USE; PHARMACEUTICAL AND VETERINARY PRODUCTS FOR LABORATORY ANALYSIS; DIAGNOSTIC AND ANALYSIS PRODUCTS FOR DNA LABORATORY ANALYSIS; OLIGONUCLEOTICIDES FOR LABORATORY ANALYSIS FOR THE DISCOVERY AND DETECTION OF POLYMORPHISMS, ALL FOR MEDICAL OR VETERINARY USE, IN CLASS 5 (U.S. CLS. 6, 18, 44, 46, 51 AND 52).

FOR: DIAGNOSTIC APPARATUS, NOT FOR MEDICAL OR VETERINARY USE, USED BY OTHERS IN THE FIELDS OF BIOLOGY, MOLECULAR BIOLOGY, BIOINFORMATICS, BIOTECHNOLOGY, AND FOR SCIENTIFIC RESEARCH IN THE MEDICAL, PHARMACEUTICAL AND VETERINARY FIELDS FOR DNA LABORATORY ANALYSIS; DIAGNOSTIC APPARATUS, NOT FOR MEDICAL OR VETERINARY USE, USED IN THE FIELDS OF ANIMAL AND PLANT REPRODUCTION, HEALTH CARE FOR HUMAN BEINGS AND ANIMALS, THE ENVIRONMENT, FOOD AND WATER HYGIENE, FERMENTATION AND IN THE MEDICAL-LEGAL FIELD USED FOR DNA LABORATORY ANALYSIS; COMPUTERS; COMPUTER SOFTWARE PACKAGES IN THE FIELD OF DNA ANALYSIS AND MAPPING AND MEDICAL IMAGING; DOWNLOADABLE ELECTRONIC DATABASES IN THE FIELD OF DNA ANALYSES AND MAPPING; MEDICAL AND SCIENTIFIC IMAGING SOFTWARE IN THE FIELD OF DNA ANALYSES AND MAPPING; SOFTWARE IN THE FIELD OF DNA RESEARCH FOR ACQUISITION, ANALYSIS AND PROCESSING OF SCIENTIFIC, PHARMACEUTICAL, BIOLOGICAL, BIOTECHNOLOGICAL AND VETERINARY DATA; SOFTWARE USED FOR ANALYSIS OF NUCLEIC ACID; ANALYSIS APPARATUS FOR

DNA LABORATORY ANALYSIS, NOT FOR MEDICAL USE, USED IN THE BIOLOGICAL, BIOTECHNOLOGICAL, PHARMACEUTICAL AND VETERINARY FIELDS, IN CLASS 9 (U.S. CLS. 21, 23, 26, 36 AND 38).

FOR: SCIENTIFIC AND TECHNOLOGICAL SERVICES IN THE FIELD OF DNA ANALYSIS AND MAPPING, AND RELATED RESEARCH AND DESIGN SERVICES CONCERNING DNA ANALYSIS AND MAPPING ANALYSIS AND RESEARCH SERVICES ALL THE AFORESAID SERVICES IN THE MEDICAL, PHARMACEUTICAL, VETERINARY, AGRICULTURAL, FORESTRY AND BIOLOGICAL FIELDS, CONCERNING ARTIFICIAL INSEMINATION AND IN VITRO FERTILIZATION, AND IN MOLECULAR BIOLOGY, BIOINFORMATICS, FERMENTATION, STOCK BREEDING, PLANT PRODUCTS, PLANT VARIETIES, AGRI-FOOD PRODUCTS, GENETIC THERAPY AND BIOTECHNOLOGY PRODUCTS; SERVICES OF SCIENTIFIC, TECHNOLOGICAL AND INDUSTRIAL ANALYSES CONCERNING NUCLEIC ACIDS; SCIENTIFIC AND TECHNOLOGICAL SERVICES FOR THE DEVELOPMENT OF DIAGNOSTIC PRODUCTS IN THE FIELD OF DNA ANALYSIS; SCIENTIFIC AND TECHNOLOGICAL RESEARCH IN THE FIELD OF CHEMISTRY; SCIENTIFIC RESEARCH CONCERNING PLANTS AND ANIMALS, MICROORGANISMS, RELATING TO HUMAN BEINGS AND RELATING TO NUTRITION, ANIMAL FEED, LIQUIDS AND BEVERAGES; CHEMICAL, BIOLOGICAL AND GENETIC SCIENTIFIC ANALYSES; QUALITY CONTROL FOR OTHERS, NAMELY, FOR USE OF PURITY TESTS; COMPUTER SOFTWARE DESIGN FOR

OTHERS; SOFTWARE UPDATING FOR OTHERS; SOFTWARE INSTALLATION; SOFTWARE MAINTENANCE; SOFTWARE RENTAL NAMELY, RENTAL OF APPLICATION SOFTWARE IN THE FIELD OF DNA ANALYSIS AND MAPPING AND MEDICAL IMAGING; COMPUTER PROGRAMMING; DATABASE RECONSTRUCTION, NAMELY, DATABASE DEVELOPMENT SERVICES IN THE FIELD OF DNA ANALYSIS AND RESEARCH, IN CLASS 42 (U.S. CLS. 100 AND 101).

FOR: MEDICAL SERVICES; VETERINARY SERVICES; AGRICULTURE, HORTICULTURE, FORESTRY AND SILVICULTURE SERVICES, IN THE FIELD OF DNA RESEARCH AND DNA GENETIC SELECTION, ALSO RELATING TO PLANT VARIETIES, IN VITRO FERTILIZATION AND ARTIFICIAL INSEMINATION, OTHER THAN ADVICE RELATING TO CROP PRODUCTION, IN CLASS 44 (U.S. CLS. 100 AND 101).

THE MARK CONSISTS OF STANDARD CHARACTERS WITHOUT CLAIM TO ANY PARTICULAR FONT, STYLE, SIZE, OR COLOR.

PRIORITY DATE OF 12-23-2005 IS CLAIMED.

OWNER OF INTERNATIONAL REGISTRATION 0907940 DATED 6-20-2006, EXPIRES 6-20-2016.

SER. NO. 79-032,664, FILED 6-20-2006.

NAKIA HENRY, EXAMINING ATTORNEY

**Int. Cl.: 3**

**Prior U.S. Cls.: 1, 4, 6, 50, 51 and 52**

**United States Patent and Trademark Office**

**Reg. No. 3,453,942**

**Registered June 24, 2008**

**TRADEMARK  
PRINCIPAL REGISTER**

# Alpaderm

JACZYNSKI (SWITZERLAND INDIVIDUAL)  
25 AVENUE DE LA GARE  
CH-1957 ARDON, SWITZERLAND

OWNER OF INTERNATIONAL REGISTRATION  
0907988 DATED 8-31-2006, EXPIRES 8-31-2016.

FOR: SOAPS, PERFUMERY, ESSENTIAL OILS,  
COSMETICS, HAIR LOTIONS, IN CLASS 3 (U.S. CLS.  
1, 4, 6, 50, 51 AND 52).

SER. NO. 79-032,680, FILED 8-31-2006.

THE MARK CONSISTS OF STANDARD CHAR-  
ACTERS WITHOUT CLAIM TO ANY PARTICULAR  
FONT, STYLE, SIZE, OR COLOR.

KATHERINE M. DUBRAY, EXAMINING ATTOR-  
NEY

**Int. Cls.: 35, 36, 41 and 42**

**Prior U.S. Cls.: 100, 101, 102 and 107**

**United States Patent and Trademark Office**

**Reg. No. 3,453,943**

**Registered June 24, 2008**

**SERVICE MARK  
PRINCIPAL REGISTER**

# attempto

BERNO BREITRUCK  
LAUFZORNER STRASSE 5  
81545 MÜNCHEN  
FED REP GERMANY

FOR: BUSINESS MANAGEMENT CONSULTATION; CONSULTING SERVICES IN THE FIELD OF QUESTIONS OF BUSINESS MANAGEMENT; CONSULTING SERVICES IN THE FIELD OF BUSINESS ECONOMICS; INVESTIGATIONS IN BUSINESS MATTERS; EXPERT EVALUATIONS AND REPORTS RELATING TO BUSINESS MATTERS; PROVISION OF INFORMATION IN TRADE AND BUSINESS MATTERS; BUSINESS MANAGEMENT FOR THIRD PARTIES; PROVISION OF INFORMATION IN BUSINESS MATTERS; RESEARCH IN BUSINESS MATTERS; PUBLIC RELATIONS WORK; ORGANIZATIONAL CONSULTING IN BUSINESS MATTERS; BUSINESS ORGANIZATIONAL CONSULTATION; BUSINESS PROJECT MANAGEMENT IN THE FIELD OF ELECTRONIC DATA PROCESSING; OUTSOURCING SERVICES; ORGANIZATIONAL PROJECT MANAGEMENT IN THE FIELD OF ELECTRONIC DATA PROCESSING; BUSINESS MANAGEMENT PLANNING; BUSINESS CONSULTING, IN CLASS 35 (U.S. CLS. 100, 101 AND 102).

FOR: FINANCIAL CONSULTING; FINANCIAL ADVICE IN THE NATURE OF INVESTMENT ADVICE; CONSULTING IN THE FIELD OF FINANCING, MERGER AND ACQUISITION BUSINESS, NAMELY, FINANCIAL CONSULTING IN THE PURCHASE OR SALE OF BUSINESSES AND EQUITY INVESTMENTS, IN CLASS 36 (U.S. CLS. 100, 101 AND 102).

FOR: PERSONAL COACHING SERVICES IN THE FIELD OF EDUCATION AND MANAGEMENT; PRACTICAL TRAINING IN THE FIELD BUSINESS AND COMPUTER PROGRAMMING; EDUCATION SERVICES, NAMELY, COURSES OF INSTRUCTION IN THE FIELD OF BUSINESS AND COMPUTER

PROGRAMMING; TRAINING SERVICES IN THE FIELD OF BUSINESS AND COMPUTER PROGRAMMING; EDUCATIONAL SERVICES, NAMELY, CONDUCTING DISTANCE LEARNING AT THE SECONDARY, COLLEGE, GRADUATE AND EXPERT LEVELS, IN CLASS 41 (U.S. CLS. 100, 101 AND 107).

FOR: UPDATE OF COMPUTER SOFTWARE, CONSULTING IN THE DESIGN OF HOMEPAGES AND INTERNET PAGES; COMPUTER CONSULTING SERVICES; COMPUTER SOFTWARE CONSULTING; DESIGN OF COMPUTER SOFTWARE; COMPUTER PROGRAMMING SERVICES, NAMELY, PROGRAMMING IN THE FIELD OF ELECTRONIC DATA PROCESSING; COMPUTER PROGRAMMING CONSULTATION IN THE FIELD OF PROGRAMMING FOR DATA PROCESSING; COMPUTER SOFTWARE DESIGN, NAMELY, DESIGNING SOFTWARE FOR DATA PROCESSING; COMPUTER SOFTWARE CONSULTATION AND CONSULTATION IN THE FIELD OF COMPUTER HARDWARE DESIGN; COMPUTER SERVICES, NAMELY, CONFIGURATION OF COMPUTER NETWORKS BY ADMINISTRATION OF SOFTWARE; INSTALLATION AND MAINTENANCE OF SOFTWARE FOR INTERNET ACCESS; INSTALLATION, MAINTENANCE AND REPAIR OF SOFTWARE FOR DATA SYSTEMS; INSTALLATION OF COMPUTER PROGRAMS; COMPUTER CODE CONVERSION FOR OTHERS; DUPLICATION OF COMPUTER PROGRAMS; UPDATE AND INSTALLATION OF SOFTWARE; TECHNICAL CONSULTATION IN THE TECHNOLOGY FIELD OF SOFTWARE FOR DATA PROCESSING AND COMPUTER HARDWARE SYSTEMS; PLANNING AND TECHNICAL SUPPORT OF ELECTRONIC COMMUNICATIONS NETWORKS IN THE FIELD OF ELECTRONIC DATA PROCESSING, IN CLASS 42 (U.S. CLS. 100 AND 101).

THE MARK CONSISTS OF STANDARD CHAR-  
ACTERS WITHOUT CLAIM TO ANY PARTICULAR  
FONT, STYLE, SIZE, OR COLOR.

OWNER OF INTERNATIONAL REGISTRATION  
0908319 DATED 11-15-2006, EXPIRES 11-15-2016.

SER. NO. 79-032,821, FILED 11-15-2006.

PRIORITY DATE OF 5-23-2006 IS CLAIMED.

COLLEEN KEARNEY, EXAMINING ATTORNEY



**Int. Cl.: 5**

**Prior U.S. Cls.: 6, 18, 44, 46, 51 and 52**

**United States Patent and Trademark Office**

**Reg. No. 3,453,944**

**Registered June 24, 2008**

**TRADEMARK  
PRINCIPAL REGISTER**



ASTELLAS PHARMA INC. (JAPAN CORPORATION)  
3-11, NIHONBASHI-HONCHO 2-CHOME,  
CHUO-KU; TOKYO 103-8411  
JAPAN

FOR: PHARMACEUTICAL PREPARATIONS  
AND SUBSTANCES FOR IMMUNOTHERAPY, IN  
CLASS 5 (U.S. CLS. 6, 18, 44, 46, 51 AND 52).

PRIORITY DATE OF 9-20-2006 IS CLAIMED.

OWNER OF INTERNATIONAL REGISTRATION  
0909107 DATED 12-1-2006, EXPIRES 12-1-2016.

THE COLOR(S) RED IS/ARE CLAIMED AS A  
FEATURE OF THE MARK.

THE COLOR RED APPEARS IN THE ENTIRE  
AREA OF THE DESIGN MARK, WITH THE EXCEP-  
TION OF TWO OPPOSED CURVED LINE POR-  
TIONS, THE TWO AREAS OF WHICH ARE  
TRANSPARENT.

SER. NO. 79-033,135, FILED 12-1-2006.

ESTHER A. BORSUK, EXAMINING ATTORNEY

**Int. Cls.: 16, 41 and 44**

**Prior U.S. Cls.: 2, 5, 22, 23, 29, 37, 38, 50, 100, 101 and 107**

**Reg. No. 3,453,945**

**United States Patent and Trademark Office**

**Registered June 24, 2008**

**TRADEMARK  
SERVICE MARK  
PRINCIPAL REGISTER**



LOISON ERIC  
L'ELUISET,  
150 ROUTE DE COPPETF-74580 VIRY  
FRANCE

FOR: INSTRUCTIONAL AND TEACHING MATERIALS, NAMELY, INSTRUCTION SHEETS IN THE FIELD OF PSYCHOLOGY, VISCERAL OSTEOPATHY, ANATOMY; INSTRUCTIONAL MANUALS IN THE FIELD OF PSYCHOLOGY, TEACHING TILES, PRINTING BLOCKS, WRITTEN COURSE MATERIAL AND PAMPHLETS ALL IN THE FIELD OF PSYCHOLOGY, IN CLASS 16 (U.S. CLS. 2, 5, 22, 23, 29, 37, 38 AND 50).

FOR: TRAINING SESSIONS IN VISCERAL OSTEOPATHY, MANUAL MANIPULATIONS, COURSES AND PRACTICAL TRAINING IN THE FIELD OF ANATOMY, OSTEOPATHY; ARRANGING AND CONDUCTING CONFERENCES CONCERNING PSYCHOLOGY, IN CLASS 41 (U.S. CLS. 100, 101 AND 107).

FOR: PSYCHOLOGY SERVICES PROVIDED BY A PSYCHOLOGIST USING VISCEROLOGY, SPECIFIC MANUAL MANIPULATIONS AIMED AT ELIMINATING PSYCHOLOGICAL DISORDERS AND RESTORING ORGANS TO APPROPRIATE PHYSICAL AND HORMONAL FUNCTION; THERAPEUTIC SERVICES, NAMELY, SPEECH, HEARING AND PHYSICAL THERAPY SERVICES, IN CLASS 44 (U.S. CLS. 100 AND 101).

PRIORITY DATE OF 6-25-2006 IS CLAIMED.

OWNER OF INTERNATIONAL REGISTRATION 0909140 DATED 11-9-2006, EXPIRES 11-9-2016.

THE WORDING "ETIOPSYCHOLOGIE" HAS NO MEANING IN ENGLISH

SER. NO. 79-033,149, FILED 11-9-2006.

SIMON TENG, EXAMINING ATTORNEY

**Int. Cls.: 11 and 42**

**Prior U.S. Cls.: 13, 21, 23, 31, 34, 100 and 101**

**United States Patent and Trademark Office**

**Reg. No. 3,453,946**

**Registered June 24, 2008**

**TRADEMARK  
SERVICE MARK  
PRINCIPAL REGISTER**

# LIME TRAP

KOWITEC INGENIEURGESELLSCHAFT FÜR  
WASSERTECHNIK; MBH (FED REP GERMA-  
NY LTD LIAB CO)  
AUGUSTENSTR. 50  
18055 ROSTOCK  
FED REP GERMANY AND  
MERI ENTSORGUNGSTECHNIK FÜR DIE PAPIER-  
INDUSTRIE; GMBH (FED REP GERMANY LTD  
LIAB CO)  
LEVELINGSTR. 18  
81673 MÜNCHEN  
FED REP GERMANY

FOR: WATER CONDUCTING APPARATUS,  
NAMELY, INTERCEPTORS FOR USE IN SEPARAT-  
ING SOLIDS AND LIQUIDS; WASTE WATER  
TREATMENT SYSTEMS, NAMELY, WATER FIL-  
TERS; WATER CLEANING TREATMENT SYS-  
TEMS, NAMELY, FLOTATION PLANTS,  
SEDIMENTATION PLANTS, BIOLOGICAL PURIFI-  
CATION PLANTS, MECHANICAL PURIFICATION  
PLANTS AND PRECIPITATION UNITS; WATER-  
PURIFYING APPARATUS, NAMELY, WATER  
TREATMENT SYSTEMS IN THE NATURE OF FLO-  
TATION PLANTS, SEDIMENTATION PLANTS, BIO-  
LOGICAL PURIFICATION PLANTS, MECHANICAL  
PURIFICATION PLANTS AND PRECIPITATION  
UNITS; WATER-PURIFYING MACHINES, NAME-

LY, WATER TREATMENT MACHINES IN THE  
NATURE OF FLOTATION PLANTS, SEDIMENTA-  
TION PLANTS, BIOLOGICAL PURIFICATION  
PLANTS, MECHANICAL PURIFICATION PLANTS  
AND PRECIPITATION UNITS, IN CLASS 11 (U.S.  
CLS. 13, 21, 23, 31 AND 34).

FOR: TECHNICAL PLANNING SERVICES FOR  
WASTE WATER AND INDUSTRIAL FLUID TREAT-  
ING AND CLEANING SYSTEMS, IN CLASS 42 (U.S.  
CLS. 100 AND 101).

PRIORITY DATE OF 9-22-2005 IS CLAIMED.

OWNER OF INTERNATIONAL REGISTRATION  
0910142 DATED 3-21-2006, EXPIRES 3-21-2016.

NO CLAIM IS MADE TO THE EXCLUSIVE  
RIGHT TO USE "LIME", APART FROM THE MARK  
AS SHOWN.

SER. NO. 79-033,516, FILED 3-21-2006.

SHAILA SETTLES, EXAMINING ATTORNEY

**Int. Cls.: 7, 9 and 12**

**Prior U.S. Cls.: 13, 19, 21, 23, 26, 31, 34, 35, 36, 38 and 44**

**Reg. No. 3,453,947**

**United States Patent and Trademark Office**

**Registered June 24, 2008**

**TRADEMARK  
PRINCIPAL REGISTER**



THE GATES CORPORATION (DELAWARE CORPORATION)  
1551 WEWATTA STREET  
DENVER, CO 80202

FOR: POWER TRANSMISSION BELTS FOR LAND VEHICLE ENGINES, NAMELY, VARIABLE SPEED BELTS; POWER TRANSMISSION BELTS FOR MACHINES AND MACHINE MOTORS AND ENGINES USED IN INDUSTRIAL APPLICATIONS INCLUDING VARIABLE SPEED BELTS, IN CLASS 7 (U.S. CLS. 13, 19, 21, 23, 31, 34 AND 35).

FOR: THERMOSTATS; THERMOSTATS FOR VEHICLES, IN CLASS 9 (U.S. CLS. 21, 23, 26, 36 AND 38).

FOR: POWER TRANSMISSION BELTS FOR LAND VEHICLES, NAMELY, VARIABLE SPEED

BELTS; WINDSHIELD WIPER BLADES FOR LAND VEHICLES, IN CLASS 12 (U.S. CLS. 19, 21, 23, 31, 35 AND 44).

PRIORITY DATE OF 7-5-2005 IS CLAIMED.

OWNER OF INTERNATIONAL REGISTRATION 0910199 DATED 1-3-2006, EXPIRES 1-3-2016.

OWNER OF U.S. REG. NO. 2,115,330.

SER. NO. 79-033,537, FILED 1-3-2006.

DAYNA BROWNE, EXAMINING ATTORNEY

**Int. Cl.: 9**

**Prior U.S. Cls.: 21, 23, 26, 36 and 38**

**United States Patent and Trademark Office**

**Reg. No. 3,453,948**

**Registered June 24, 2008**

**TRADEMARK  
PRINCIPAL REGISTER**



TEN HAAFT GMBH (FED REP GERMANY LTD  
LIAB CO)  
OBERER STRIETWEG 8  
75245 NEULINGEN  
FED REP GERMANY

FOR: APPARATUS FOR CONDUCTING, SWITCHING, TRANSFORMING, ACCUMULATING, REGULATING OR CONTROLLING ELECTRICITY, NAMELY, ELECTRIC ACCUMULATORS AND BATTERIES; ELECTRICITY CONDUITS, ADAPTERS, WINDING WIRES, ELECTRICAL CABLES, PHOTOVOLTAIC SOLAR MODULES, AND PHOTOVOLTAIC CLADDING PANELS; ELECTRIC POWER CONVERTERS AND INVERTERS; APPARATUS FOR RECORDING, TRANSMISSION OR REPRODUCTION OF SOUND, IMAGES AND DATA, NAMELY, RECEIVING APPARATUS FOR RECEPTION OF RADIO SIGNALS AND TELEVISION SIGNALS FROM SATELLITES FOR MOBILE USE IN CARAVANS, VEHICLES AND SHIPS; LOW-NOISE BLOCK CONVERTERS (LNB) FOR USE IN SATELLITE COMMUNICATIONS; AERIALS; TRANSMITTING AND RECEIVING APPARATUS FOR RADIO AND TELEVISION BROADCASTING AND FOR LONG-DISTANCE TRANSMISSION; VIDEO TRANSMISSION APPARATUS; MOBILE DATA RECEIVERS; RECEIVERS FOR TELEPHONE AND AUDIO; MANUAL AND ELECTRONIC CONTROLS FOR SATELLITE AERIALS AND TERRESTRIAL AERIALS; PHOTOVOLTAIC ELEMENTS AND SOLAR COLLECTORS FOR MOBILE USE IN CARAVANS, VEHICLES AND SHIPS; DATA PROCESSORS AND COMPUTERS FOR STORAGE AND PROCES-

SING OF IMAGES AND SOUND; RECORDED OR DOWNLOADABLE COMPUTER SOFTWARE FOR USE IN THE OPERATION OF SATELLITE SYSTEMS AND SOLAR ENERGY SYSTEMS, IN CLASS 9 (U.S. CLS. 21, 23, 26, 36 AND 38).

PRIORITY DATE OF 9-4-2006 IS CLAIMED.

OWNER OF INTERNATIONAL REGISTRATION 0910995 DATED 11-21-2006, EXPIRES 11-21-2016.

OWNER OF U.S. REG. NO. 3,051,196.

THE COLOR(S) BLUE, YELLOW, BLACK AND WHITE IS/ARE CLAIMED AS A FEATURE OF THE MARK.

THE COLOR BLUE APPEARS IN THE LETTERS "SAM Y S LAR +"; THE COLOR YELLOW APPEARS IN THE DESIGN OF THE SUN, THE COLOR BLACK APPEARS IN THE DESIGN OF THE ARROWS AND IN THE OUTLINES OF THE DESIGN OF THE SUN; THE COLOR WHITE APPEARS IN THE BACKGROUND AND IN THE DESIGN OF THE EYES OF THE SUN.

SER. NO. 79-033,635, FILED 11-21-2006.

DAVID YONTEF, EXAMINING ATTORNEY

**Int. Cls.: 6, 7 and 9**

**Prior U.S. Cls.: 2, 12, 13, 14, 19, 21, 23, 25, 26, 31, 34, 35, 36, 38 and 50**

**Reg. No. 3,453,949**

**United States Patent and Trademark Office**

**Registered June 24, 2008**

**TRADEMARK  
PRINCIPAL REGISTER**

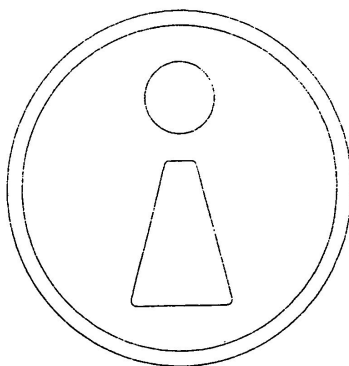

INARCA S.P.A. (ITALY JOINT STOCK COMPANY)  
VIA CÀ ZUSTO, 35  
I-35010 VIGODARZERE (PADOVA)  
ITALY

FOR: METALLIC FITTINGS, NAMELY, METAL CONNECTORS FOR WIRE TO WIRE TERMINATION CONSISTING OF CONNECTIONS BETWEEN A CONNECTOR AND TERMINAL, WIRE TO BOARD TERMINATIONS CONSISTING OF CONNECTIONS BETWEEN CONNECTOR WITH ONE OR MORE POLES AND AN ELECTRONIC BOARD OR TERMINAL BOARD, BOARD TO BOARD TERMINATION CONSISTING OF CONNECTORS WITH PLURAL POLES MOUNTED TO AN ELECTRONIC BOARD, DISCRETE WIRE TERMINATION CONSISTING OF CONNECTIONS WITH UNIPOLAR WIRES, METAL TERMINALS FOR WIRE TO WIRE TERMINATION CONSISTING OF CONNECTIONS BETWEEN A CONNECTOR AND TERMINAL, WIRE TO BOARD TERMINATION CONSISTING OF CONNECTIONS BETWEEN CONNECTOR WITH ONE OR MORE POLES AND AN ELECTRONIC BOARD OR TERMINAL BOARD, BOARD TO BOARD TERMINATION CONSISTING OF CONNECTORS WITH PLURAL POLES MOUNTED TO AN ELECTRONIC BOARD, DISCRETE WIRE TERMINATION CONSISTING OF CONNECTIONS WITH UNIPOLAR WIRE AND SPADE AND LOOP METAL LUGS FOR AN ELECTRICAL CONNECTOR TO SUPPORT THE CONNECTION OF A CABLE; BOLTS OF METAL; CHAINS OF METAL; NAILS; NUTS OF METAL; RIVETS OF METAL; METAL WELDING RODS; METAL SCREWS; ME-

TAL CABLE CLIPS AND CLAMPS; STEEL STRIPS; GUTTERS OF METAL; UNWROUGHT OR SEMI-WROUGHT COPPER; UNWROUGHT OR SEMI-WROUGHT STEEL; CAST IRON, IN CLASS 6 (U.S. CLS. 2, 12, 13, 14, 23, 25 AND 50).

FOR: CUTTING AND INCISING MACHINES FOR CABLES; WIRE AND CONNECTING FORMING MACHINES; PLANING MACHINES; ENGRAVING MACHINES; DRILLING MACHINES; THREADING MACHINES; METALWORKING MACHINES; RIVETING MACHINES; ELECTRIC WELDING MACHINES, IN CLASS 7 (U.S. CLS. 13, 19, 21, 23, 31, 34 AND 35).

FOR: ELECTRICAL CONNECTORS; ELECTRIC SWITCH PLATES; ELECTRIC CABLES; JUNCTION SLEEVES FOR ELECTRIC CABLES; ELECTRIC CELL SWITCHES; CIRCUIT BREAKERS; ELECTRIC CIRCUIT CLOSERS; ELECTRIC COILS; HOLDERS FOR ELECTRIC COILS; ELECTRICAL POWER DISTRIBUTION PRODUCTS, NAMELY, ELECTRIC COLLECTORS; ELECTRIC CONDUCTORS; ELECTRIC CONNECTION BOXES AND ELECTRICAL CABLES FOR USE IN CONNECTIONS; ELECTRIC CONTACTS; ELECTRIC CONVERTERS; ELECTRIC COUPLINGS; COVERS FOR ELECTRIC OUTLETS; CURRENT RECTIFIERS; ELECTRIC DISTRIBUTION CONSOLES; ELECTRIC INDUCTORS; ELECTRIC INVERTERS; ELECTRICAL PLUGS; ELECTRICAL SOCKETS; ELECTRIC RELAYS; ELECTRIC SOLDERING APPARATUS; ELECTRIC SWITCHES; ELECTRIC WIRES; WELDING ELECTRODES; WELDING TRANSFORMERS, IN CLASS 9 (U.S. CLS. 21, 23, 26, 36 AND 38).

OWNER OF INTERNATIONAL REGISTRATION  
0910498 DATED 5-5-2006, EXPIRES 5-5-2016.

WITHIN THE CIRCLE THE LETTER "I" IS DOTTED,  
AND IN FANCY CHARACTERS.

THE MARK CONSISTS OF A SIGN COMPOSED  
OF A CIRCLE WITH A DOUBLE OUTLINE AND

SER. NO. 79-033,681, FILED 5-5-2006.

MICHAEL WIENER, EXAMINING ATTORNEY

**Int. Cls.: 7 and 11**

**Prior U.S. Cls.: 13, 19, 21, 23, 31, 34 and 35**

**United States Patent and Trademark Office**

**Reg. No. 3,453,950**

**Registered June 24, 2008**

**TRADEMARK  
PRINCIPAL REGISTER**

# Novoflow

IP AG (SWITZERLAND AG)  
SEESTR. 334A  
CH-8706 FELDMEILEN, SWITZERLAND

FOR: VACUUM PUMPS FOR CLEANING PURPOSES; VACUUM CLEANERS; CENTRAL VACUUM CLEANERS; FILTERING MACHINES FOR THE FILTRATION OF FLUIDS, NAMELY, OILS, FUELS, FOOD AND CHEMICAL PROCESSING FLUIDS EXCLUDING WATER; FLUID FILTERING MACHINES FOR INDUSTRIES, NAMELY, CHEMICAL INDUSTRIES, PHARMACEUTICAL INDUSTRIES, BIOTECHNOLOGICAL ENTERPRISES, FOOD INDUSTRIES, BEVERAGE INDUSTRIES, WOOD PROCESSING, PLASTICS PROCESSING, AGRICULTURE INDUSTRIES, PROCESSING OF METAL, TEXTILE INDUSTRIES, ELECTRONIC INDUSTRIES, SUGAR INDUSTRIES ALL FOR THE FILTRATION OF FLUIDS EXCLUDING WATER; FILTERS AS PARTS OF CLOTHES WASHING MACHINES, DISH WASHING MACHINES, MACHINES USED FOR PROCESS FILTRATION IN THE PHARMACEUTICAL INDUSTRY, MILKING MACHINES, POLISHING MACHINES FOR USE IN GRINDING AND POLISHING METAL, WOOD, CERAMICS AND PLASTICS, PULPING MACHINES, SEMICONDUCTOR MANUFACTURING MACHINES, VEHICLE WASHING MACHINES, WASHING MACHINES FOR INDUSTRIAL PARTS, AND MOTORS, NAMELY, FOR THE FILTRATION OF FLUIDS EXCLUDING WATER; STRUCTURAL

PARTS OF FILTERING MACHINES, NAMELY, FILTER UNITS AND SPACERS USED TO SEPARATE FILTERING UNITS, IN CLASS 7 (U.S. CLS. 13, 19, 21, 23, 31, 34 AND 35).

FOR: AIR FILTER FOR DOMESTIC AND INDUSTRIAL INSTALLATION USE; AIR FILTERING DEVICES, NAMELY, AIR FILTERS FOR CLEANING OF AIR AT INDUSTRIAL AND COMMERCIAL WORKING PLACES; DRINKING WATER FILTER; WATER FILTRATION APPARATUS, NAMELY, WATER FILTERS AND WATER FILTERING MACHINES FOR USE IN INDUSTRY; SWIMMING POOL WATER CLEANING AND FILTERING UNITS; WATER CLEANING APPARATUS AND MACHINES; WATER FILTERS FOR SEWAGE PURIFICATION PLANTS, IN CLASS 11 (U.S. CLS. 13, 21, 23, 31 AND 34).

THE MARK CONSISTS OF STANDARD CHARACTERS WITHOUT CLAIM TO ANY PARTICULAR FONT, STYLE, SIZE, OR COLOR.

OWNER OF INTERNATIONAL REGISTRATION  
0910462 DATED 9-18-2006, EXPIRES 9-18-2016.

SER. NO. 79-033,724, FILED 9-18-2006.

WILLIAM ROSSMAN, EXAMINING ATTORNEY



**Int. Cls.: 35 and 36**

**Prior U.S. Cls.: 100, 101 and 102**

**United States Patent and Trademark Office**

**Reg. No. 3,453,951**

**Registered June 24, 2008**

**SERVICE MARK  
PRINCIPAL REGISTER**

**AVOX**

DEUTSCHE BÖRSE AG (FED REP GERMANY  
JOINT STOCK COMPANY)  
NEUE BÖRSENSTRASSE 1  
60487 FRANKFURT/MAIN  
FED REP GERMANY

FOR: SYSTEMATIZATION AND COMPILATION  
OF DATA CONCERNING BUSINESS AND FINAN-  
CIAL INFORMATION, IN CLASS 35 (U.S. CLS. 100,  
101 AND 102).

FOR: PROVIDING INFORMATION IN THE  
FIELDS OF FINANCE, FINANCIAL CONSULTING,  
AND FINANCIAL ANALYSIS, IN CLASS 36 (U.S.  
CLS. 100, 101 AND 102).

THE MARK CONSISTS OF STANDARD CHAR-  
ACTERS WITHOUT CLAIM TO ANY PARTICULAR  
FONT, STYLE, SIZE, OR COLOR.

PRIORITY DATE OF 3-3-2006 IS CLAIMED.

OWNER OF INTERNATIONAL REGISTRATION  
0911976 DATED 8-17-2006, EXPIRES 8-17-2016.

SER. NO. 79-034,081, FILED 8-17-2006.

ESTHER BELENKER, EXAMINING ATTORNEY

**Int. Cls.: 1, 5 and 9**

**Prior U.S. Cls.: 1, 5, 6, 10, 18, 21, 23, 26, 36, 38, 44, 46,  
51 and 52**

**Reg. No. 3,453,952**

**United States Patent and Trademark Office**

**Registered June 24, 2008**

**TRADEMARK  
PRINCIPAL REGISTER**

**MASS - SPEC - TURBO**

QIAGEN GMBH (FED REP GERMANY GMBH  
UNDER GERMAN LAW)  
QIAGEN STRASSE 1  
40724 HILDEN, FED REP GERMANY

FOR: CHEMICAL, BIOCHEMICAL AND BIOTECHNOLOGICAL PRODUCTS FOR INDUSTRIAL AND SCIENTIFIC PURPOSES INCLUDING BUT NOT LIMITED TO DIAGNOSTIC PREPARATIONS, EXCEPT FOR MEDICAL AND VETERINARY MEDICAL PURPOSES, NAMELY, ASSAYS AND REAGENTS FOR USE IN GENETIC RESEARCH, CHEMICALS FOR INDUSTRIAL PURPOSES, PRECURSORS FOR IN VITRO GENETIC ENGINEERING USE, BIOTECHNOLOGY FORMED GENES FOR USE IN THE PRODUCTION OF AGRICULTURAL SEEDS TO ENHANCE PLANTS GROWTH THEREFROM, REAGENTS AND SOLVENTS, IN PARTICULAR FOR THE PREPARATION OF BIOLOGICAL SAMPLES, THE MODIFICATION AND MANIPULATION OF BIOLOGICAL SAMPLES, AS WELL AS FOR PERFORMING MARKING, SEPARATION, ISOLATION, PURIFICATION, REPRODUCTION AND ANALYSIS METHODS FOR BIOPOLYMERS, IN PARTICULAR NUCLEIC ACIDS, PROTEINS, MACROMOLECULES AND BIOLOGICALLY ACTIVE SUBSTANCES, KITS COMPRISED OF CHEMICAL PRODUCTS FOR THE PREPARATION OF BIOLOGICAL SAMPLES, THE MODIFICATION AND MANIPULATION OF BIOLOGICAL SAMPLES, AS WELL AS FOR THE MARKING, SEPARATION, ISOLATION, PURIFICATION, REPRODUCTION AND THE ANALYSIS OF BIOPOLYMERS, IN PARTICULAR NUCLEIC ACIDS, PROTEINS, MACROMOLECULES, AND BIOLOGICALLY ACTIVE SUBSTANCES, IN PARTICULAR NUCLEIC ACIDS FROM BIOLOGICAL AND BIOCHEMICAL SAMPLE MATERIAL, IN CLASS 1 (U.S. CLS. 1, 5, 6, 10, 26 AND 46).

FOR: DIAGNOSTIC PREPARATIONS FOR MEDICAL AND VETERINARY MEDICAL PURPOSES FOR THE PREPARATION OF BIOLOGICAL SAMPLES, THE MODIFICATION AND MANIPULATION OF BIOLOGICAL SAMPLES AND FOR THE MARKING, SEPARATION, ISOLATION, PURIFICATION AND REPRODUCTION AND THE ANALYSIS OF

BIOPOLYMERS, IN PARTICULAR NUCLEIC ACIDS, PROTEINS, MACROMOLECULES AND BIOLOGICALLY ACTIVE SUBSTANCES; CHEMICAL, BIOCHEMICAL AND BIOTECHNOLOGICAL PREPARATIONS FOR MEDICAL AND VETERINARY MEDICAL PURPOSES, IN PARTICULAR REAGENTS AND SOLVENTS FOR THE PREPARATION OF BIOLOGICAL SAMPLES, THE MODIFICATION AND THE MANIPULATION OF BIOLOGICAL SAMPLES, AS WELL AS FOR PERFORMING MARKING, SEPARATION, ISOLATION, PURIFICATION, REPRODUCTION AND ANALYSIS METHODS FOR BIOPOLYMERS, IN PARTICULAR NUCLEIC ACIDS, PROTEINS, MACROMOLECULES AND BIOLOGICALLY ACTIVE SUBSTANCES FOR DIAGNOSTIC PURPOSES; KITS COMPRISED OF CHEMICAL PREPARATIONS FOR MEDICAL AND VETERINARY MEDICAL DIAGNOSTIC PURPOSES, IN PARTICULAR FOR THE PREPARATION OF BIOLOGICAL SAMPLES, THE MODIFICATION AND MANIPULATION OF BIOLOGICAL SAMPLES AND FOR MARKING, SEPARATION, ISOLATION, PURIFICATION, REPRODUCTION AND ANALYSIS OF BIOPOLYMERS, IN PARTICULAR NUCLEIC ACIDS, PROTEINS, MACROMOLECULES AND BIOLOGICALLY ACTIVE SUBSTANCES, IN PARTICULAR NUCLEIC ACIDS FROM BIOLOGICAL OR BIOCHEMICAL SAMPLE MATERIAL, IN CLASS 5 (U.S. CLS. 6, 18, 44, 46, 51 AND 52).

FOR: SCIENTIFIC APPARATUS, INSTRUMENTS AND EQUIPMENT, IN PARTICULAR FOR RESEARCH AND EXAMINATION PURPOSES, NAMELY, LABORATORY EQUIPMENT IN THE FORM OF CENTRIFUGES, LABORATORY GLASSWARE, LABORATORY PLASTICWARE, MAGNETS, MEDICAL RESEARCH EQUIPMENT, NAMELY, COMPUTERS, GAMMA CAMERAS, COLLIMATORS, APERTURE PLATES AND COMPUTER SOFTWARE, ALL SOLD TOGETHER AS A UNIT FOR USE IN HIGH RESOLUTION, HIGH SENSITIVITY TOMOGRAPHIC IMAGE PROCESSING AND IMAGING IN THE FIELD OF NUCLEAR MEDICINE, CRUCIBLES, TEST TUBES, MEASURING APPARATUS AND INSTRUMENTS FOR USE WITH PRODUCTS FOR MEDICAL OR VETERINARY

MEDICAL DIAGNOSTIC PURPOSES, IN PARTICULAR FOR THE PREPARATION OF BIOLOGICAL SAMPLES, THE MODIFICATION, MANIPULATION OF BIOLOGICAL SAMPLES AND FOR THE MARKING, SEPARATION, ISOLATION, PURIFICATION, REPRODUCTION AND ANALYSIS OF BIOPOLYMERS, IN PARTICULAR NUCLEIC ACIDS, PROTEINS, MACROMOLECULES AND BIOLOGICALLY ACTIVE SUBSTANCES, IN PARTICULAR NUCLEIC ACIDS FROM BIOLOGICAL OR BIOCHEMICAL SAMPLE MATERIAL, NAMELY, CLINICAL LABORATORY ANALYZERS FOR MEASURING, TESTING AND ANALYZING BIOLOGICAL MATERIAL AND FLUIDS, SCANNER FOR CAPTURING IMAGES FOR ANALYSIS FOR USE IN THE LIFE SCIENCE RESEARCH FIELD, MEASURING CUPS, RADIATION-MEASURING INSTRUMENTS, IN CLASS 9 (U.S. CLS. 21, 23, 26, 36 AND 38).

THE MARK CONSISTS OF STANDARD CHARACTERS WITHOUT CLAIM TO ANY PARTICULAR FONT, STYLE, SIZE, OR COLOR.

PRIORITY DATE OF 12-30-2005 IS CLAIMED.

OWNER OF INTERNATIONAL REGISTRATION 0912010 DATED 6-22-2006, EXPIRES 6-22-2016.

THE WORDING "MASS-SPEC-TURBO" HAS NO MEANING IN A FOREIGN LANGUAGE.

SER. NO. 79-034,091, FILED 6-22-2006.

BARBARA BROWN, EXAMINING ATTORNEY

**Int. Cls.: 1, 5 and 9**

**Prior U.S. Cls.: 1, 5, 6, 10, 18, 21, 23, 26, 36, 38, 44, 46,  
51 and 52**

**Reg. No. 3,453,953**

**United States Patent and Trademark Office**

**Registered June 24, 2008**

**TRADEMARK  
PRINCIPAL REGISTER**

# **MASS - SPEC - FOCUS**

QIAGEN GMBH (FED REP GERMANY GMBH  
UNDER GERMAN LAW)  
QIAGEN STRASSE 1  
40724 HILDEN, FED REP GERMANY

FOR: CHEMICAL, BIOCHEMICAL AND BIOTECHNOLOGICAL PRODUCTS FOR INDUSTRIAL AND SCIENTIFIC PURPOSES INCLUDING BUT NOT LIMITED TO DIAGNOSTIC PREPARATIONS, EXCEPT FOR MEDICAL AND VETERINARY MEDICAL PURPOSES, NAMELY, ASSAYS AND REAGENTS FOR USE IN GENETIC RESEARCH, CHEMICALS FOR INDUSTRIAL PURPOSES, PRECURSORS FOR IN VITRO GENETIC ENGINEERING USE, BIOTECHNOLOGY FORMED GENES FOR USE IN THE PRODUCTION OF AGRICULTURAL SEEDS TO ENHANCE PLANTS GROWTH THEREFROM, REAGENTS AND SOLVENTS, IN PARTICULAR FOR THE PREPARATION OF BIOLOGICAL SAMPLES, THE MODIFICATION AND MANIPULATION OF BIOLOGICAL SAMPLES, AS WELL AS FOR PERFORMING MARKING, SEPARATION, ISOLATION, PURIFICATION, REPRODUCTION AND ANALYSIS METHODS FOR BIOPOLYMERS, IN PARTICULAR NUCLEIC ACIDS, PROTEINS, MACROMOLECULES AND BIOLOGICALLY ACTIVE SUBSTANCES, KITS COMPRISED OF CHEMICAL PRODUCTS FOR THE PREPARATION OF BIOLOGICAL SAMPLES, THE MODIFICATION AND MANIPULATION OF BIOLOGICAL SAMPLES, AS WELL AS FOR THE MARKING, SEPARATION, ISOLATION, PURIFICATION, REPRODUCTION AND THE ANALYSIS OF BIOPOLYMERS, IN PARTICULAR NUCLEIC ACIDS, PROTEINS, MACROMOLECULES, AND BIOLOGICALLY ACTIVE SUBSTANCES, IN PARTICULAR NUCLEIC ACIDS FROM BIOLOGICAL AND BIOCHEMICAL SAMPLE MATERIAL, IN CLASS 1 (U.S. CLS. 1, 5, 6, 10, 26 AND 46).

FOR: DIAGNOSTIC PREPARATIONS FOR MEDICAL AND VETERINARY MEDICAL PURPOSES FOR THE PREPARATION OF BIOLOGICAL SAMPLES, THE MODIFICATION AND MANIPULATION OF BIOLOGICAL SAMPLES AND FOR THE MARKING, SEPARATION, ISOLATION, PURIFICATION AND REPRODUCTION AND THE ANALYSIS OF

BIOPOLYMERS, IN PARTICULAR NUCLEIC ACIDS, PROTEINS, MACROMOLECULES AND BIOLOGICALLY ACTIVE SUBSTANCES; CHEMICAL, BIOCHEMICAL AND BIOTECHNOLOGICAL PREPARATIONS FOR MEDICAL AND VETERINARY MEDICAL PURPOSES, IN PARTICULAR REAGENTS AND SOLVENTS FOR THE PREPARATION OF BIOLOGICAL SAMPLES, THE MODIFICATION AND THE MANIPULATION OF BIOLOGICAL SAMPLES, AS WELL AS FOR PERFORMING MARKING, SEPARATION, ISOLATION, PURIFICATION, REPRODUCTION AND ANALYSIS METHODS FOR BIOPOLYMERS, IN PARTICULAR NUCLEIC ACIDS, PROTEINS, MACROMOLECULES AND BIOLOGICALLY ACTIVE SUBSTANCES FOR DIAGNOSTIC PURPOSES; KITS COMPRISED OF CHEMICAL PREPARATIONS FOR MEDICAL AND VETERINARY MEDICAL DIAGNOSTIC PURPOSES, IN PARTICULAR FOR THE PREPARATION OF BIOLOGICAL SAMPLES, THE MODIFICATION AND MANIPULATION OF BIOLOGICAL SAMPLES AND FOR MARKING, SEPARATION, ISOLATION, PURIFICATION, REPRODUCTION AND ANALYSIS OF BIOPOLYMERS, IN PARTICULAR NUCLEIC ACIDS, PROTEINS, MACROMOLECULES AND BIOLOGICALLY ACTIVE SUBSTANCES, IN PARTICULAR NUCLEIC ACIDS FROM BIOLOGICAL OR BIOCHEMICAL SAMPLE MATERIAL, IN CLASS 5 (U.S. CLS. 6, 18, 44, 46, 51 AND 52).

FOR: SCIENTIFIC APPARATUS, INSTRUMENTS AND EQUIPMENT, IN PARTICULAR FOR RESEARCH AND EXAMINATION PURPOSES, NAMELY, LABORATORY EQUIPMENT IN THE FORM OF CENTRIFUGES, LABORATORY GLASSWARE, LABORATORY PLASTICWARE, MAGNETS, MEDICAL RESEARCH EQUIPMENT, NAMELY, COMPUTERS, GAMMA CAMERAS, COLLIMATORS, APERTURE PLATES AND COMPUTER SOFTWARE, ALL SOLD TOGETHER AS A UNIT FOR USE IN HIGH RESOLUTION, HIGH SENSITIVITY TOMOGRAPHIC IMAGE PROCESSING AND IMAGING IN THE FIELD OF NUCLEAR MEDICINE, CRUCIBLES, TEST TUBES, MEASURING APPARATUS AND INSTRUMENTS FOR USE WITH PRODUCTS FOR MEDICAL OR VETERINARY

MEDICAL DIAGNOSTIC PURPOSES, IN PARTICULAR FOR THE PREPARATION OF BIOLOGICAL SAMPLES, THE MODIFICATION, MANIPULATION OF BIOLOGICAL SAMPLES AND FOR THE MARKING, SEPARATION, ISOLATION, PURIFICATION, REPRODUCTION AND ANALYSIS OF BIOPOLYMERS, IN PARTICULAR NUCLEIC ACIDS, PROTEINS, MACROMOLECULES AND BIOLOGICALLY ACTIVE SUBSTANCES, IN PARTICULAR NUCLEIC ACIDS FROM BIOLOGICAL OR BIOCHEMICAL SAMPLE MATERIAL, NAMELY, CLINICAL LABORATORY ANALYZERS FOR MEASURING, TESTING AND ANALYZING BIOLOGICAL MATERIAL AND FLUIDS, SCANNER FOR CAPTURING IMAGES FOR ANALYSIS FOR USE IN THE LIFE SCIENCE RESEARCH FIELD, MEASURING CUPS, RADIATION-MEASURING INSTRUMENTS, IN CLASS 9 (U.S. CLS. 21, 23, 26, 36 AND 38).

THE MARK CONSISTS OF STANDARD CHARACTERS WITHOUT CLAIM TO ANY PARTICULAR FONT, STYLE, SIZE, OR COLOR.

PRIORITY DATE OF 12-30-2005 IS CLAIMED.

OWNER OF INTERNATIONAL REGISTRATION 0912021 DATED 6-22-2006, EXPIRES 6-22-2016.

THE WORDING "MASS-SPEC-FOCUS" HAS NO MEANING IN A FOREIGN LANGUAGE.

SER. NO. 79-034,097, FILED 6-22-2006.

BARBARA BROWN, EXAMINING ATTORNEY

**Int. Cls.: 1 and 17**

**Prior U.S. Cls.: 1, 5, 6, 10, 12, 13, 26, 35, 46 and 50**

**United States Patent and Trademark Office**

**Reg. No. 3,453,954**

**Registered June 24, 2008**

**TRADEMARK  
PRINCIPAL REGISTER**

# **BecFluid**

ALTANA ELECTRICAL INSULATION GMBH  
(FED REP GERMANY LTD LIAB CO)  
ABELSTRASSE 45  
46483 WESEL, FED REP GERMANY

FOR: CHEMICAL COOLANTS, CHEMICAL PRODUCTS, NAMELY, PENTAERYTHRITETETRA FATTY ACID ESTERS TO USE AS DIELECTRIC FLUID, IN CLASS 1 (U.S. CLS. 1, 5, 6, 10, 26 AND 46).

FOR: ELECTRICAL INSULATION MATERIALS, NAMELY, INSULATORS FOR ELECTRIC MAINS, INSULATING MATERIALS, NAMELY, ELECTRICAL INSULATING FLUIDS, INSULATION FOR WIRES, IN CLASS 17 (U.S. CLS. 1, 5, 12, 13, 35 AND 50).

THE MARK CONSISTS OF STANDARD CHARACTERS WITHOUT CLAIM TO ANY PARTICULAR FONT, STYLE, SIZE, OR COLOR.

PRIORITY DATE OF 4-21-2006 IS CLAIMED.

OWNER OF INTERNATIONAL REGISTRATION 0912251 DATED 10-20-2006, EXPIRES 10-20-2016.

SER. NO. 79-034,166, FILED 10-20-2006.

ELISSA GARBER KON, EXAMINING ATTORNEY

Int. Cl.: 30

Prior U.S. Cl.: 46

United States Patent and Trademark Office

Reg. No. 3,453,955

Registered June 24, 2008

TRADEMARK  
PRINCIPAL REGISTER



"DELIC-POL" SPÓLKA Z.O.O. (POLAND LTD  
LIAB CO)  
LINDÓW 34  
PL-42-165 LIPIE  
POLAND

FOR: CAKES, RICE CAKES, BREAD, RICE  
BREAD, BREAD ROLLS, SPONGE CAKES, PAS-  
TRIES, CHOCOLATE, BISCUITS, COOKIES,  
CRACKERS, GINGERBREAD, WAFFLES, WAFERS,  
BUNS, CANDIES, CANDY, RUSKS, BAKERY  
GOODS, IN CLASS 30 (U.S. CL. 46).

OWNER OF INTERNATIONAL REGISTRATION  
0912299 DATED 1-5-2007, EXPIRES 1-5-2017.

OWNER OF U.S. REG. NO. 3,055,587.

NO CLAIM IS MADE TO THE EXCLUSIVE  
RIGHT TO USE "1992", APART FROM THE MARK  
AS SHOWN.

THE COLOR(S) GREEN, DARK GREEN, YEL-  
LOW AND ORANGE IS/ARE CLAIMED AS A  
FEATURE OF THE MARK.

THE MARK CONSISTS OF A GREEN TWO-  
HEADED DRAGON OUTLINED AND CON-  
TOURED WITH A DARK GREEN LINE. ON THE  
RIGHT AND LEFT SIDE OF THE DRAGON THERE  
ARE TWO DARK GREEN CURVES. UNDER THE  
DRAGON, IN A YELLOW SHADED RECTANGLE  
WITH ORANGE CONCAVE EDGES THERE IS A  
DARK GREEN INSCRIPTION "DELIC-POL", AND  
UNDERNEATH THE YEAR "1992" MADE IN DARK  
GREEN NUMBERS. THE LOWER EDGE OF THE  
RECTANGLE IS MARKED WITH A DARK GREEN  
LINE. ALL ABOVE ELEMENTS ARE PLACED  
AGAINST A YELLOW, SHADED CIRCLE, LIGHT-  
EST IN THE VERY CENTRE, FADING INTO OR-  
ANGE AT THE EDGES.

SER. NO. 79-034,185, FILED 1-5-2007.

ELLEN PERKINS, EXAMINING ATTORNEY

**Int. Cls.: 18 and 25**

**Prior U.S. Cls.: 1, 2, 3, 22, 39 and 41**

**United States Patent and Trademark Office**

**Reg. No. 3,453,956**

**Registered June 24, 2008**

**TRADEMARK  
PRINCIPAL REGISTER**

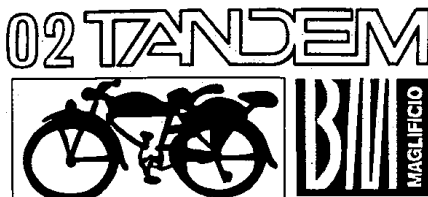

MAGLIFICIO BM, S.R.L. (ITALY PUBLIC LIMITED COMPANY)  
91, VIA XX SETTEMBRE  
I-21010 CARDANO AL CAMPO (VARESE)  
ITALY

FOR: BAGS, NAMELY, ALL PURPOSE SPORT BAGS, BEACH BAGS; HANDBAGS; UMBRELLAS; WALLETS; DOCUMENT WALLETS; DIPLOMATIC SUITCASES; PURSES; SUITCASES; TRAVELING TRUNKS; WALKING STICKS; LEATHER AND IMITATION LEATHER ARTICLES, NAMELY, BRIEFCASES, HANDBAGS, AND STRAPS, IN CLASS 18 (U.S. CLS. 1, 2, 3, 22 AND 41).

FOR: VESTS; KNITWEAR, NAMELY, KNIT SHIRTS AND KNITTED CAPS; UNDERWEAR; DRESSES MADE FROM SKINS; MEN'S, WOMEN'S AND CHILDREN'S CLOTHING, NAMELY, SHIRTS, PANTS; SHORT-SLEEVED SHIRTS; SKIRTS; SUITS; MORNING COATS; TROUSERS; SHORTS; PYJAMAS; SOCKS; KNITTED UNDERWEAR; BLOUSES; SUSPENDER BELTS; BRIEFS AND PANTS; COVERALLS; SLIPPERS; SHOES; SPORTS FOOTWEAR; BOOTS; HATS; NECK SCARVES; NECKTIES; WA-

TERPROOF CLOTHING, NAMELY, JACKETS, PANTS; OVERCOATS; COATS; SWIMMING COSTUMES; SPORTS OUTFITS, NAMELY, JERSEYS, SPORTS BRAS; ANORAKS; SKI TROUSERS; BELTS; FURS, NAMELY, FUR CLOAKS, FUR COATS; SCARVES; GLOVES; AND DRESSING GOWNS, IN CLASS 25 (U.S. CLS. 22 AND 39).

OWNER OF INTERNATIONAL REGISTRATION  
0633396 DATED 4-6-1995, EXPIRES 4-6-2015.

NO CLAIM IS MADE TO THE EXCLUSIVE RIGHT TO USE "MAGLIFICIO", APART FROM THE MARK AS SHOWN.

THE ENGLISH TRANSLATION OF THE WORD "MAGLIFICIO" IN THE MARK IS "THE FACTORY WHERE WOVEN CLOTH AND CLOTHING IS MANUFACTURED".

SER. NO. 79-034,215, FILED 5-16-2006.

MARCIE MILONE, EXAMINING ATTORNEY



**Int. Cls.: 9, 14, 16 and 20**

**Prior U.S. Cls.: 2, 5, 13, 21, 22, 23, 25, 26, 27, 28, 29, 32, 36, 37, 38 and 50**

**Reg. No. 3,453,957**

**United States Patent and Trademark Office**

**Registered June 24, 2008**

**TRADEMARK  
PRINCIPAL REGISTER**



MENNICA POLSKA S.A. (POLAND CORPORATION)  
UL. PERECA 21  
WARSAWA, POLAND PL00849

FOR: GAUGES FOR TESTING THE CONTENT OF PRECIOUS METALS, IN CLASS 9 (U.S. CLS. 21, 23, 26, 36 AND 38).

FOR: NON-MONETARY COINS; COLLECTIBLE COINS; MONETARY COINS FOR COLLECTING PURPOSES; COINS FOR COLLECTORS; COIN BLANKS; SETS OF MONETARY AND COLLECTIBLE COINS FOR COLLECTING PURPOSES; OCCASIONAL BADGES OF PRECIOUS AND NON-FERROUS METALS; TOKENS FOR PAY-PHONES MADE OF COPPER AND ITS ALLOYS; NATIONAL DISTINCTIONS, NAMELY, MEDALS, MEDALIONS, AND CROSSES; MEDALS; BADGES OF PRECIOUS AND NON-FERROUS METALS; PENDANTS; EMBLEMS OF NOBLE METALS, NAMELY, BADGES, INSIGNIAS, AND MEDALS; BARS OF NOBLE METALS, NAMELY, GOLD AND PLATINUM; PRECIOUS METAL MARKERS, NAMELY, ORNAMENTAL AND IDENTIFICATION TAGS, IN CLASS 14 (U.S. CLS. 2, 27, 28 AND 50).

FOR: IMPRESSION STAMPS; INK STAMPS; DATE-STAMPS AND REPLACEMENT PARTS

THEREFOR, IN CLASS 16 (U.S. CLS. 2, 5, 22, 23, 29, 37, 38 AND 50).

FOR: CONTAINERS OF WOOD AND PLASTIC FOR HOLDING COLLECTORS' COINS, NAMELY, WOODEN COIN BOXES, COIN CHESTS, COIN DISPLAY CASES, COIN STORAGE CASES, COIN CASKETS, AND PLASTIC COIN BOXES, COIN CHESTS, COIN DISPLAY CASES, COIN STORAGE CASES, AND COIN CASKETS, IN CLASS 20 (U.S. CLS. 2, 13, 22, 25, 32 AND 50).

OWNER OF INTERNATIONAL REGISTRATION 0914044 DATED 7-25-2006, EXPIRES 7-25-2016.

THE COLOR(S) GOLD AND WHITE IS/ARE CLAIMED AS A FEATURE OF THE MARK.

THE MARK CONSISTS OF A SINGLE LINE CIRCLE ENCOMPASSING A STYLIZED "M" ON TOP OF A STYLIZED "W". THE COLOR GOLD APPEARS IN THE STYLIZED "M W" AND IN THE OUTLINE OF THE CIRCLE. THE COLOR WHITE SERVES AS THE BACKGROUND FOR THE MARK.

SER. NO. 79-034,750, FILED 7-25-2006.

ELI HELLMAN, EXAMINING ATTORNEY

**Int. Cl.: 9**

**Prior U.S. Cls.: 21, 23, 26, 36 and 38**

**Reg. No. 3,453,958**

**United States Patent and Trademark Office**

**Registered June 24, 2008**

**TRADEMARK  
PRINCIPAL REGISTER**

**XYNA**

GIP AG; GESELLSCHAFT FÜR INDUSTRIEPHYSIK (FED REP GERMANY PUBLIC LIMITED COMPANY)  
GÖTTELMANNSTRASSE 17  
55130 MAINZ, FED REP GERMANY

BUSINESS-TO-BUSINESS COMMERCE, MESSAGING, GAMING, VOICEOVER IP AND EMAIL TO THEIR CUSTOMERS OR DIRECTED GROUPS OF CUSTOMERS, IN CLASS 9 (U.S. CLS. 21, 23, 26, 36 AND 38).

FOR: COMPUTER SOFTWARE FOR USE IN THE TELECOMMUNICATIONS INDUSTRY, NAMELY, SOFTWARE FOR TELECOMMUNICATIONS AND COMPUTER NETWORK SERVICE PROVIDERS FOR DEVELOPMENT AND AUTOMATION OF TECHNICAL AND COMMERCIAL ORDER PROCESSES USED TO MANAGE THE CONFIGURATION OF TELECOMMUNICATIONS NETWORKS IN THE AREA OF BUSINESS SUPPORT SYSTEMS AND OPERATIONS SUPPORT SYSTEMS; COMPUTER SOFTWARE FOR TELECOMMUNICATIONS NETWORK OPERATORS AND APPLICATION SERVICE PROVIDERS TO DEVELOP, DEPLOY, DELIVER AND SUPPORT NETWORKING SERVICES, NAMELY, TELEPHONY SERVICES, VIRTUAL PRIVATE NETWORKS, ELECTRONIC COMMERCE,

THE MARK CONSISTS OF STANDARD CHARACTERS WITHOUT CLAIM TO ANY PARTICULAR FONT, STYLE, SIZE, OR COLOR.

PRIORITY DATE OF 8-2-2006 IS CLAIMED.

OWNER OF INTERNATIONAL REGISTRATION 0914245 DATED 12-22-2006, EXPIRES 12-22-2016.

SER. NO. 79-034,797, FILED 12-22-2006.

JAMES STEIN, EXAMINING ATTORNEY

**Int. Cl.: 9**

**Prior U.S. Cls.: 21, 23, 26, 36 and 38**

**United States Patent and Trademark Office**

**Reg. No. 3,453,959**

**Registered June 24, 2008**

**TRADEMARK  
PRINCIPAL REGISTER**

**PROVOCO**

SONOVA HOLDING AG (SWITZERLAND CORPORATION)  
LAUBISRÜTISTRASSE 28  
CH-8712 STÄFA, SWITZERLAND

OWNER OF INTERNATIONAL REGISTRATION  
0914603 DATED 1-9-2007, EXPIRES 1-9-2017.

FOR: MICROPHONES, IN CLASS 9 (U.S. CLS. 21, 23, 26, 36 AND 38).

THE WORDING "PROVOCO" HAS NO MEANING IN A FOREIGN LANGUAGE.

THE MARK CONSISTS OF STANDARD CHARACTERS WITHOUT CLAIM TO ANY PARTICULAR FONT, STYLE, SIZE, OR COLOR.

SER. NO. 79-034,925, FILED 1-9-2007.

PRIORITY DATE OF 8-21-2006 IS CLAIMED.

JOHN KELLY, EXAMINING ATTORNEY

**Int. Cl.: 9**

**Prior U.S. Cls.: 21, 23, 26, 36 and 38**

**Reg. No. 3,453,960**

**United States Patent and Trademark Office**

**Registered June 24, 2008**

**TRADEMARK  
PRINCIPAL REGISTER**

**SWEETLETS**

PENTLAND FIRTH OHG (FED REP GERMANY  
PARTNERSHIP)  
ELISABETHSTR. 91  
80797 MÜNCHEN  
FED REP GERMANY

FOR: COMPUTER OPERATING PROGRAMS RECORDED ON DATA MEDIA; DOWNLOADABLE COMPUTER PROGRAMS FOR USE IN CORPORATE PORTALS TO TRACK AND ANALYZE USER BEHAVIOUR, TO INFORM USERS ABOUT LOCAL TIME, WEATHER AND HOLIDAY INFORMATION AND TO DISPLAY STOCK EXCHANGE RELATED INFORMATION IN A CORPORATE PORTAL; COMPUTER SOFTWARE RECORDED ON DATA MEDIA FOR USE IN CORPORATE PORTALS TO TRACK AND ANALYZE USER BEHAVIOUR, TO INFORM

USERS ABOUT LOCAL TIME WEATHER AND HOLIDAY INFORMATION AND TO DISPLAY STOCK EXCHANGE RELATED INFORMATION IN A CORPORATE PORTAL; DOWNLOADABLE ELECTRONIC PUBLICATIONS IN THE NATURE OF MANUALS IN THE FIELD OF BUSINESS, IN CLASS 9 (U.S. CLS. 21, 23, 26, 36 AND 38).

OWNER OF INTERNATIONAL REGISTRATION  
0915366 DATED 8-22-2006, EXPIRES 8-22-2016.

SER. NO. 79-035,183, FILED 8-22-2006.

MICHELE SWAIN, EXAMINING ATTORNEY

Int. Cl.: 7

Prior U.S. Cls.: 13, 19, 21, 23, 31, 34 and 35

United States Patent and Trademark Office

Reg. No. 3,453,961

Registered June 24, 2008

TRADEMARK  
PRINCIPAL REGISTER

**BIG-PLUS**

DAISHOWA SEIKI KABUSHIKI KAISHA; (BIG  
DAISHOWA SEIKI CO., LTD.) (JAPAN COR-  
PORATION)  
3-3-39 NISHIISHIKIRICHO  
HIGASHI-OSAKA-SHI  
OSAKA 579-8013, JAPAN

FOR: MACHINE TOOLS, NAMELY, LATHES,  
MILLING MACHINES, METALWORKING MA-  
CHINING CENTERS FOR CUTTING AND FORM-  
ING MATERIALS, MACHINE TOOLS FOR  
CUTTING AND FORMING MATERIALS, MA-  
CHINE TOOL HOLDERS FOR POWER OPERATED  
CUTTING TOOLS THAT ARE PARTS OF MA-  
CHINES, IN CLASS 7 (U.S. CLS. 13, 19, 21, 23, 31, 34  
AND 35).

PRIORITY DATE OF 7-31-2006 IS CLAIMED.

OWNER OF INTERNATIONAL REGISTRATION  
0916170 DATED 1-31-2007, EXPIRES 1-31-2017.

OWNER OF U.S. REG. NO. 2,603,301.

SER. NO. 79-035,460, FILED 1-31-2007.

MONIQUE MILLER, EXAMINING ATTORNEY

**Int. Cl.: 14**

**Prior U.S. Cls.: 2, 27, 28 and 50**

**United States Patent and Trademark Office**

**Reg. No. 3,453,962**

**Registered June 24, 2008**

**TRADEMARK  
PRINCIPAL REGISTER**

**MAGIE EN BLANC ET NOIR**

MONTBLANC-SIMPLO GMBH (FED REP GER-  
MANY GMBH)  
HELLGRUNDWEG 100  
22525 HAMBURG, FED REP GERMANY

OWNER OF INTERNATIONAL REGISTRATION  
0916651 DATED 1-31-2007, EXPIRES 1-31-2017.

FOR: WATCHES AND CLOCKS; TIMEKEEPERS,  
NAMELY, CHRONOMETERS; AND JEWELLER'S  
WARES, NAMELY, JEWELLERY, AND PRECIOUS  
STONES, IN CLASS 14 (U.S. CLS. 2, 27, 28 AND 50).

THE FOREIGN WORDING IN THE MARK  
TRANSLATES INTO ENGLISH AS MAGIC IN  
WHITE AND BLACK.

THE MARK CONSISTS OF STANDARD CHAR-  
ACTERS WITHOUT CLAIM TO ANY PARTICULAR  
FONT, STYLE, SIZE, OR COLOR.

SER. NO. 79-035,643, FILED 1-31-2007.

PRIORITY DATE OF 8-24-2006 IS CLAIMED.

LINDA LAVACHE, EXAMINING ATTORNEY

**Int. Cl.: 18**

**Prior U.S. Cls.: 1, 2, 3, 22 and 41**

**United States Patent and Trademark Office**

**Reg. No. 3,453,963**

**Registered June 24, 2008**

**TRADEMARK  
PRINCIPAL REGISTER**



XIAMEN INTERNATIONAL; TRADE & INDUSTRIAL CO., LTD. (CHINA CORPORATION)  
AB FLAT, 27TH FLOOR  
INTERNATIONAL TRADE BUILDING.; XIAMEN;  
FUJIAN  
CHINA

FOR: BACKPACKS; BRIEFCASES; ATTACHÉ CASES; TRAVELLING BAGS; VALISES; GARMENT BAGS FOR TRAVEL; HANDBAGS; POCKET WALLETS; BAGS FOR CLIMBERS AND SCHOOL BAGS, IN CLASS 18 (U.S. CLS. 1, 2, 3, 22 AND 41).

OWNER OF INTERNATIONAL REGISTRATION  
0916965 DATED 2-22-2007, EXPIRES 2-22-2017.

OWNER OF U.S. REG. NO. 3,112,203.

SER. NO. 79-035,763, FILED 2-22-2007.

AMEETA JORDAN, EXAMINING ATTORNEY

Int. Cl.: 43

Prior U.S. Cls.: 100 and 101

United States Patent and Trademark Office

Reg. No. 3,453,964

Registered June 24, 2008

SERVICE MARK  
PRINCIPAL REGISTER



RISTORANTE GIANNINO S.R.L. (ITALY LTD  
LIAB CO)  
PIAZZA BORROMEO, 10  
I-20123 MILANO, ITALY

FOR: PROVISION OF FOOD AND DRINK IN  
RESTAURANTS, NOT FEATURING HOME DELIV-  
ERY, IN CLASS 43 (U.S. CLS. 100 AND 101).

OWNER OF INTERNATIONAL REGISTRATION  
0917043 DATED 1-17-2007, EXPIRES 1-17-2017.

THE TRADEMARK IS MADE UP OF A PICTURE  
REPRODUCING A DECORATED STRUCTURE,  
THAT IS CHARACTERISED BY A COCK INSCRI-  
BED IN A CIRCLE, AND IT SUPPORTS AN OVAL  
SIGN REPRODUCING THE WRITING GIANNINO  
WITH A SAUCEPAN ON A FIRE.

SER. NO. 79-035,804, FILED 1-17-2007.

WENDY JUN, EXAMINING ATTORNEY



**Int. Cls.: 9 and 38**

**Prior U.S. Cls.: 21, 23, 26, 36, 38, 100, 101 and 104**

**Reg. No. 3,453,965**

**United States Patent and Trademark Office**

**Registered June 24, 2008**

**TRADEMARK  
SERVICE MARK  
PRINCIPAL REGISTER**

# vtalk

VOICEBOX COMMUNICATIONS PTY LTD (AUSTRALIA AUSTRALIAN CORPORATION)  
51 WILSON STREET  
NEWTOWN NSW 2042  
AUSTRALIA

FOR: COMMUNICATION EQUIPMENT, NAMELY, HANDSETS, MODEMS, COMPUTER ROUTERS; PORTABLE AND HANDHELD DIGITAL ELECTRONIC DEVICES FOR RECORDING, ORGANIZING, TRANSMITTING, MANIPULATING, AND REVIEWING TEXT, DATA, AND AUDIO FILES; COMPUTER HARDWARE, FIRMWARE AND SOFTWARE FOR USE IN ORGANIZING, TRANSMITTING, RECEIVING, COMMUNICATING, MANIPULATING, AND REVIEWING TEXT, DATA, AND AUDIO FILES THROUGH FIXED LINE, MOBILE AND WIRELESS DEVICES, NAMELY, PORTABLE AND HANDHELD DIGITAL ELECTRONIC DEVICES; COMPUTER HARDWARE, FIRMWARE AND SOFTWARE FOR USE IN ORGANIZING, TRANSMITTING, RECEIVING, COMMUNICATING, MANIPULATING, AND REVIEWING TEXT, DATA, AND AUDIO FILES THROUGH A GLOBAL INFORMATION NETWORK, NAMELY, VOICE OVER INTERNET PROTOCOL (VOIP) COMMUNICATION; HEADPHONES, EARPHONES, HEADPHONES WITH INTEGRATED AUDIO PLAYERS, PORTABLE AND HANDHELD DEVICES FOR PLAYING AUDIO FILES; DEVICES, NAMELY, MOBILE AND WIRELESS DEVICES, FOR COMMUNI-

CATIONS, NAMELY, TELEPHONES, HANDSETS, HEADSETS, SPEAKERS, MICROPHONES, EARPHONES, IN CLASS 9 (U.S. CLS. 21, 23, 26, 36 AND 38).

FOR: COMMUNICATION SERVICES, NAMELY, ELECTRONIC TRANSMISSION OF AUDIO, DATA AND DOCUMENTS AMONG USERS OF COMPUTERS; PROVIDING COMMUNICATION NETWORKS, NAMELY, COMMUNICATION NETWORKS FOR CONVERGED NETWORKS FOR TRANSMISSION OF AUDIO, DATA AND INFORMATION; VOICE OVER INTERNET PROTOCOL (VOIP) COMMUNICATION SERVICES, NAMELY, FIXED, WIRELESS AND MOBILE PHONE VOIP SERVICES, IN CLASS 38 (U.S. CLS. 100, 101 AND 104).

THE MARK CONSISTS OF STANDARD CHARACTERS WITHOUT CLAIM TO ANY PARTICULAR FONT, STYLE, SIZE, OR COLOR.

PRIORITY DATE OF 7-25-2006 IS CLAIMED.

OWNER OF INTERNATIONAL REGISTRATION 0917343 DATED 1-25-2007, EXPIRES 1-25-2017.

SER. NO. 79-035,913, FILED 1-25-2007.

SHANNON TWOHIG, EXAMINING ATTORNEY

**Int. Cls.: 9, 25 and 41**

**Prior U.S. Cls.: 21, 22, 23, 26, 36, 38, 39, 100, 101 and 107**

**Reg. No. 3,453,966**

**United States Patent and Trademark Office**

**Registered June 24, 2008**

**TRADEMARK  
SERVICE MARK  
PRINCIPAL REGISTER**

**SHE IS THE KING**

JACQUELINE FEILICH (AUSTRALIA INDIVIDUAL)  
17 KIPPARA ROAD  
DOVER HEIGHTS NSW 2030  
AUSTRALIA

FOR: APPARATUS FOR RECORDING, TRANSMISSION OR REPRODUCTION OF SOUND OR IMAGES; BLANK MAGNETIC DATA CARRIERS, NAMELY, MAGNETIC TAPE AND RECORDING DISCS; PHOTOGRAPHIC AND CINEMATOGRAPHIC APPARATUS AND EQUIPMENT, NAMELY, CAMERAS; DATA PROCESSING EQUIPMENT AND COMPUTERS, NAMELY, COMPUTER HARDWARE; VIDEO CAMERAS, RECORDERS AND PLAYERS; RADIOS AND TELEVISIONS; TAPE RECORDERS AND PLAYERS; BLANK LASER-READ DISCS FOR RECORDING AND PLAYING SOUND; COMPACT DISC PLAYERS AND RECORDERS; BLANK COMPUTER DISCS; LOUDSPEAKERS; MICROPHONES; COMPUTER MONITORS; VINYL RECORDS FEATURING MUSIC; RECORD PLAYERS; MUSICAL SOUND RECORDINGS; COMPUTER SOFTWARE FOR DATABASE MANAGEMENT, USE AS A SPREADSHEET; VIDEO GAME SOFTWARE; VIDEO GAME MACHINES FOR USE WITH TELEVISIONS; MULTI-MEDIA AND INTERACTIVE COMPUTER GAMES, COMPUTERS, COMPUTER PERIPHERALS, BLANK MAGNETIC DATA CARRIERS, IN CLASS 9 (U.S. CLS. 21, 23, 26, 36 AND 38).

FOR: CLOTHING, NAMELY, SHIRTS, SHORTS, T-SHIRTS, PANTS, JACKETS, DRESSES, PAJAMAS, NIGHT GOWNS, TIES, BELTS, SWEATERS, SCARVES, JEANS, SOCKS; FOOTWEAR, SHOES; HEADGEAR, NAMELY, HATS AND CAPS, IN CLASS 25 (U.S. CLS. 22 AND 39).

FOR: ENTERTAINMENT, NAMELY, LIVE MUSIC AND STAGE PERFORMANCES BY A SINGER ACCOMPANIED BY A MUSICAL GROUP, IN CLASS 41 (U.S. CLS. 100, 101 AND 107).

THE MARK CONSISTS OF STANDARD CHARACTERS WITHOUT CLAIM TO ANY PARTICULAR FONT, STYLE, SIZE, OR COLOR.

PRIORITY DATE OF 9-11-2006 IS CLAIMED.

OWNER OF INTERNATIONAL REGISTRATION 0918175 DATED 2-13-2007, EXPIRES 2-13-2017.

SER. NO. 79-036,264, FILED 2-13-2007.

CURTIS FRENCH, EXAMINING ATTORNEY

**Int. Cls.: 20, 21, 24 and 25**

**Prior U.S. Cls.: 2, 13, 22, 23, 25, 29, 30, 32, 33, 39, 40,  
42 and 50**

**Reg. No. 3,453,967**

**United States Patent and Trademark Office**

**Registered June 24, 2008**

**TRADEMARK  
PRINCIPAL REGISTER**

bébéjou

ATELIER 49 NEDERLAND B.V. (NETHERLANDS  
LIMITED LIABILITY COMPANY)  
WETHOUDER BUITENHUISSTRAAT 1  
NL-7951 SJ STAPHORST, NETHERLANDS

FOR: LINEN CONTAINERS NOT OF METAL FOR  
COMMERCIAL USE; THERMOPLASTIC COVERED  
CUSHIONS USED FOR BABY EQUIPMENT; TOY  
CHESTS; SLEEPING BAGS AND ARMCHAIRS  
USED FOR CHILDREN'S BEDS; FURNITURE FOR  
CHILDREN 'S BEDROOMS MADE OF WOOD,  
METAL AND SYNTHETIC MATERIALS; GOODS  
OF PLASTIC, NAMELY, CONTAINER CLOSURES  
OF PLASTIC, IN CLASS 20 (U.S. CLS. 2, 13, 22, 25, 32  
AND 50).

FOR: BABY CARE ARTICLE, NAMELY, CHAM-  
BER POTS, AND SUPPORTS FOR CHAMBER POTS;  
TEXTILE DIAPER PAILS; COTTON, NAMELY, COT-  
TON BALLS, SOAP BOXES, SOAP HOLDERS; CON-  
TAINERS FOR HOUSEHOLD OF KITCHEN USE  
NOT OF PRECIOUS METAL USED FOR VARIOUS  
TOILETRY ITEMS, NAMELY, OILS; CUPS AND  
PLATES USED FOR BABY FOOD; BREAD BOXES  
AND CONTAINERS FOR HOUSEHOLD USE NOT  
OF PRECIOUS METAL OR COATED THEREWITH,  
IN CLASS 21 (U.S. CLS. 2, 13, 23, 29, 30, 33, 40 AND 50).

FOR: TEXTILE TABLECLOTHS, NAMELY, TA-  
BLECLOTHS USED FOR BABY EQUIPMENT COVERED WITH THERMOPLASTIC SYNTHETIC SHEETING; TEXTILE GOODS FOR CHILDREN

BEDS AND PRAMS, NAMELY, BED COVERS, PIL-  
LOWCASES, WOOLEN BLANKETS; TEXTILES  
USED FOR BABIES, NAMELY, TERRY CLOTH  
FABRIC AND BATH LINEN, IN CLASS 24 (U.S.  
CLS. 42 AND 50).

FOR: BABY BUNTING BAGS OF TEXTILE, IN  
CLASS 25 (U.S. CLS. 22 AND 39).

PRIORITY DATE OF 4-13-2006 IS CLAIMED.

OWNER OF INTERNATIONAL REGISTRATION  
0918188 DATED 10-9-2006, EXPIRES 10-9-2016.

THE COLOR(S) BLUE IS/ARE CLAIMED AS A  
FEATURE OF THE MARK.

THE COLOR BLUE APPEARS IN THE WORDING  
"BEBE-JOU".

THE ENGLISH TRANSLATION OF THE FRENCH  
WORD "BEBE-JOU" IN THE MARK IS "BABY  
PLAY".

SER. NO. 79-036,269, FILED 10-9-2006.

WILLIAM ROSSMAN, EXAMINING ATTORNEY

**Int. Cls.: 9, 35, 38 and 42**

**Prior U.S. Cls.: 21, 23, 26, 36, 38, 100, 101, 102 and 104**

**United States Patent and Trademark Office**

**Reg. No. 3,453,968**

**Registered June 24, 2008**

**TRADEMARK  
SERVICE MARK  
PRINCIPAL REGISTER**

# AIRSCAPE

AIRSCAPE TECHNOLOGY PTY LIMITED (AUSTRALIA CORPORATION)

LEVEL 4

6 BRIDGE STREET; SYDNEY NSW 2000

AUSTRALIA

FOR: TELECOMMUNICATIONS AND COMMUNICATIONS EQUIPMENT, APPARATUS AND SYSTEMS, NAMELY, TELEPHONE APPARATUS AND TELEPHONE EQUIPMENT IN THE NATURE OF CALLER IDENTIFICATION BOXES; MOBILE TELEPHONES; ELECTRONIC MAPPING EQUIPMENT, APPARATUS AND SYSTEMS IN THE NATURE OF A GPS SATELLITE NAVIGATIONAL SYSTEM; COMPUTER EQUIPMENT, APPARATUS AND SYSTEMS, NAMELY, COMPUTER SOFTWARE FOR COMMUNICATIONS, COMPUTER HARDWARE AND MODEMS; ELECTRONIC APPARATUS FOR RECORDING, TRANSMISSION AND REPRODUCTION OF SOUND AND IMAGES; VIDEO AND AUDIO EQUIPMENT, APPARATUS AND SYSTEMS, NAMELY, TELEVISION RECEIVERS; RECORDED PROGRAMS FOR OPERATING COMPUTERS; BLANK MAGNETIC DATA CARRIERS; MAGNETICALLY CODED CARDS FOR USE IN BUSINESS TRANSACTIONS, BLANK SMART CARDS, MEMORY CARDS, BLANK COMPUTER CHIP CARDS, AND UPDATABLE MEMORY CARDS; PERIPHERAL EQUIPMENT IN THE NATURE OF ELECTRONIC CARD AND CHIP CARD READERS, IN CLASS 9 (U.S. CLS. 21, 23, 26, 36 AND 38).

FOR: INFOMEDIARY SERVICES, NAMELY, FACILITATING TRANSACTIONS BETWEEN BUYERS AND SELLERS THROUGH PROVIDING INFORMATION ABOUT PRODUCTS AND SERVICES VIA AN INTERACTIVE COMPUTER COMMUNICATIONS NETWORK; COMPUTERIZED ONLINE ORDERING SERVICES FEATURING GENERAL MERCHANDISE AND GENERAL CONSUMER GOODS AND ON-LINE RETAIL STORE SERVICES FEATURING GENERAL MERCHANDISE AND GENERAL CONSUMER GOODS, IN CLASS 35 (U.S. CLS. 100, 101 AND 102).

FOR: TELECOMMUNICATION AND COMMUNICATION SERVICES, NAMELY, MOBILE TELEPHONE COMMUNICATION; PROVIDING TRANSMISSION INFORMATION ABOUT TELECOMMUNICATION AND TELEPHONE COMMUNICATION SERVICES VIA WEB PAGES; BROADCASTING SERVICES, NAMELY, TELEVISION AND RADIO BROADCASTING; SATELLITE AND CABLE TELEVISION BROADCASTING SERVICES; INTERACTIVE TELEVISION BROADCASTING SERVICES; TELECOMMUNICATIONS DATA ROUTING SERVICES; DIGITAL COMMUNICATION VIA DIGITAL COMPUTER TERMINALS; TRANSMISSION OF MESSAGES, IMAGES AND INFORMATION BETWEEN AND AMONG DATA CARRIERS AND READERS BY TELEPHONE, SATELLITE, OPTICAL FIBRE AND OTHER MEANS; ELECTRONIC MAIL SERVICES; PROVIDING ACCESS TO COMPUTER DATABASES; PROVIDING MULTIPLE USER ACCESS TO A GLOBAL COMPUTER INFORMATION NETWORK; INTERNET TELEPHONY SERVICES; CONSULTANCY AND ADVISORY SERVICES IN THE FIELD OF TELECOMMUNICATIONS AND TRANSMISSION OF INTERNET COMMUNICATIONS, IN CLASS 38 (U.S. CLS. 100, 101 AND 104).

FOR: COMPUTER SERVICES, NAMELY, ONLINE COMPUTER DIAGNOSTIC SERVICES; COMPUTER TECHNICAL CONSULTANCY AND ADVICE, NAMELY, TROUBLESHOOTING OF COMPUTER HARDWARE AND SOFTWARE PROBLEMS; DESIGN AND DEVELOPMENT OF ELECTRICAL AND ELECTRONIC EQUIPMENT AND COMPUTER SOFTWARE; ANALYSIS AND TESTING OF ELECTRICAL AND ELECTRONIC EQUIPMENT AND COMPUTER SOFTWARE OF OTHERS FOR THE PURPOSE OF CERTIFICATION; COMPUTER SYSTEM DESIGN FOR OTHERS; DESIGN AND UPDATING OF COMPUTER SOFTWARE FOR OTHERS; LICENSING OF COMPUTER SOFTWARE; DEVELOPMENT AND MAINTENANCE OF SOFTWARE; REFORMATTING OF DATA IN THE NATURE OF CONVERSION OF DATA FROM PHYSICAL TO ELECTRONIC MEDIA AND/OR

FROM ONE ELECTRONIC PRESENTATION FORMAT TO ANOTHER, IN CLASS 42 (U.S. CLS. 100 AND 101).

THE MARK CONSISTS OF STANDARD CHARACTERS WITHOUT CLAIM TO ANY PARTICULAR FONT, STYLE, SIZE, OR COLOR.

PRIORITY DATE OF 6-16-2006 IS CLAIMED.

OWNER OF INTERNATIONAL REGISTRATION 0918405 DATED 12-14-2006, EXPIRES 12-14-2016.

"AIRSCAPE" HAS NO MEANING IN A FOREIGN LANGUAGE.

SER. NO. 79-036,354, FILED 12-14-2006.

PAULA MAHONEY, EXAMINING ATTORNEY

**Int. Cl.: 30**

**Prior U.S. Cl.: 46**

**United States Patent and Trademark Office**

**Reg. No. 3,453,969**

**Registered June 24, 2008**

**TRADEMARK  
PRINCIPAL REGISTER**

**GRIOTTE - UMJETNOST ZAVOĐENJA**

KRAS, PREHRAMBENA INDUSTRIJA, D.D.  
(CROATIA CORPORATION)  
RAVNICE 48  
HR-10000  
ZAGREB, CROATIA

OWNER OF INTERNATIONAL REGISTRATION  
0918509 DATED 2-14-2007, EXPIRES 2-14-2017.

FOR: DESSERTS WITH CHOCOLATE, NAMELY,  
CHOCOLATE BARS, CHOCOLATE CANDIES AND  
FILLED CHOCOLATE, IN CLASS 30 (U.S. CL. 46).

THE MARK DOES NOT HAVE ANY SIGNIFI-  
CANCE IN THE DESSERT TRADE OR INDUSTRY.  
IT HAS THE FOLLOWING MEANING IN CROA-  
TIAN LANGUAGE: "GRIOTTE THE ART OF THE  
SEDUCTION".

THE MARK CONSISTS OF STANDARD CHAR-  
ACTERS WITHOUT CLAIM TO ANY PARTICULAR  
FONT, STYLE, SIZE, OR COLOR.

SER. NO. 79-036,405, FILED 2-14-2007.

PRIORITY DATE OF 2-14-2007 IS CLAIMED.

MARCIE MILONE, EXAMINING ATTORNEY

**Int. Cl.: 27**

**Prior U.S. Cls.: 19, 20, 37, 42 and 50**

**Reg. No. 3,453,970**

**United States Patent and Trademark Office**

**Registered June 24, 2008**

**TRADEMARK  
PRINCIPAL REGISTER**

**ALTRO CONTRAX**

ALTRO LIMITED (UNITED KINGDOM LIMITED  
COMPANY)  
WORKS ROAD  
LETCHWORTH GARDEN CITY; HERTFORDSHIRE  
SG6 1NW  
UNITED KINGDOM

FOR: MATERIALS FOR COVERING FLOORS,  
WALLS AND STAIRS, NAMELY, RESILIENT HARD  
SURFACE COVERINGS FOR FLOORS, WALLS  
AND STAIRS, PROTECTIVE FLOOR COVERINGS,  
VINYL FLOOR AND WALL COVERINGS, DEC-  
ORATIVE SLIP-RESISTANT FLOOR COVERING IN  
SHEET FORM, IN CLASS 27 (U.S. CLS. 19, 20, 37, 42  
AND 50).

THE MARK CONSISTS OF STANDARD CHAR-  
ACTERS WITHOUT CLAIM TO ANY PARTICULAR  
FONT, STYLE, SIZE, OR COLOR.

PRIORITY DATE OF 9-19-2006 IS CLAIMED.

OWNER OF INTERNATIONAL REGISTRATION  
0919283 DATED 3-13-2007, EXPIRES 3-13-2017.

OWNER OF U.S. REG. NOS. 867,034 AND 867,088.

SER. NO. 79-036,653, FILED 3-13-2007.

STEVEN JACKSON, EXAMINING ATTORNEY

**Int. Cl.: 36**

**Prior U.S. Cls.: 100, 101 and 102**

**United States Patent and Trademark Office**

**Reg. No. 3,453,971**

**Registered June 24, 2008**

**SERVICE MARK  
PRINCIPAL REGISTER**

**spot-fac**

**BENFIELD HOLDINGS LIMITED (UNITED  
KINGDOM LLC)  
55 BISHOPSGATE  
LONDON EC2N 3BD  
UNITED KINGDOM**

**FOR: INSURANCE AND REINSURANCE SERVI-  
CES, NAMELY, REINSURANCE UNDERWRITING  
AND ADMINISTRATION AND INSURANCE AD-  
MINISTRATION, FINANCIAL ANALYSIS,  
BROKERAGE, CLAIMS PROCESSING, CONSULT-  
ING AND MANAGEMENT SERVICES; INSUR-  
ANCE AND REINSURANCE UNDERWRITING  
AGENCY SERVICES AND INSURANCE AND RE-  
INSURANCE AGENCY SERVICES IN THE FIELDS**

**OF HEALTH, LIFE, PROPERTY, CASUALTY AND  
WORKER'S COMPENSATION, IN CLASS 36 (U.S.  
CLS. 100, 101 AND 102).**

**PRIORITY DATE OF 9-29-2006 IS CLAIMED.**

**OWNER OF INTERNATIONAL REGISTRATION  
0919613 DATED 2-22-2007, EXPIRES 2-22-2017.**

**SER. NO. 79-036,734, FILED 2-22-2007.**

**STEVEN JACKSON, EXAMINING ATTORNEY**



**Int. Cl.: 9**

**Prior U.S. Cls.: 21, 23, 26, 36 and 38**

**United States Patent and Trademark Office**

**Reg. No. 3,453,972**

**Registered June 24, 2008**

**TRADEMARK  
PRINCIPAL REGISTER**

# Tmax ProPortal

TMAX SOFT CO., LTD. (REPUBLIC OF KOREA  
LIMITED COMPANY)

18F GLASS TOWER,

946-1, DAECHE-DONG,; KANGNAM-GU; SEOUL  
135-708

REPUBLIC OF KOREA

FOR: COMPUTER PROGRAMS FOR USE IN  
DATABASE MANAGEMENT; ENTERPRISE SOFT-  
WARE IN THE NATURE OF A DATABASE FOR  
NON-TRANSACTIONAL DATA AND A SEARCH  
ENGINE FOR DATABASE CONTENT; COMPUTER  
PROGRAMS FOR USE IN INTEGRATED BUSINESS  
MANAGEMENT OF CORPORATE INFORMATION,  
IN CLASS 9 (U.S. CLS. 21, 23, 26, 36 AND 38).

THE MARK CONSISTS OF STANDARD CHAR-  
ACTERS WITHOUT CLAIM TO ANY PARTICULAR  
FONT, STYLE, SIZE, OR COLOR.

PRIORITY DATE OF 3-14-2007 IS CLAIMED.

OWNER OF INTERNATIONAL REGISTRATION  
0920232 DATED 3-15-2007, EXPIRES 3-15-2017.

OWNER OF U.S. REG. NO. 2,900,092.

SER. NO. 79-036,993, FILED 3-15-2007.

CHRISIE B. KING, EXAMINING ATTORNEY

**Int. Cl.: 11**

**Prior U.S. Cls.: 13, 21, 23, 31 and 34**

**United States Patent and Trademark Office**

**Reg. No. 3,453,973**

**Registered June 24, 2008**

**TRADEMARK  
PRINCIPAL REGISTER**

The logo consists of the letters 'MCZ' in a bold, black, sans-serif font. The 'M' is stylized with a thick, slanted left stroke. The 'C' is a simple, rounded shape. The 'Z' is also bold and slanted to the right.

MCZ S.P.A. (ITALY JOINT STOCK COMPANY)  
VIA G. OBERDAN, 86  
FRAZIONE VIGONOVO  
I-33074 FONTANAFREDDA (PN), ITALY

PRIORITY DATE OF 12-6-2006 IS CLAIMED.

OWNER OF INTERNATIONAL REGISTRATION  
0920234 DATED 2-19-2007, EXPIRES 2-19-2017.

FOR: FIREPLACE INSERTS IN THE NATURE OF  
SOLID FUEL BURNERS; FIREPLACES; GAS  
STOVES; SOLID FUEL BURNING STOVES; WOOD  
BURNING STOVES , IN CLASS 11 (U.S. CLS. 13, 21,  
23, 31 AND 34).

SER. NO. 79-036,995, FILED 2-19-2007.

CHARISMA HAMPTON, EXAMINING ATTORNEY

**Int. Cls.: 6, 9 and 25**

**Prior U.S. Cls.: 2, 12, 13, 14, 21, 22, 23, 25, 26, 36, 38,  
39 and 50**

**Reg. No. 3,453,974**

**United States Patent and Trademark Office**

**Registered June 24, 2008**

**TRADEMARK  
PRINCIPAL REGISTER**

**alphamesh**

FRIEDRICH MÜNCH GMBH & CO. KG (FED  
REP GERMANY LTD LIAB CO)  
GOLDSHALDENSTRASSE 20  
75417 MÜHLACKER  
FED REP GERMANY

OVERALLS, VESTS, APRONS, SHIRTS, PANTS,  
CAPES, COATS, JACKETS, GLOVES, HEADWEAR,  
DRESSES, SKIRTS, SUITS, TIES, SCARVES, AND  
PULLOVERS; AND PARTS OF THE AFORESAID  
GOODS, IN CLASS 25 (U.S. CLS. 22 AND 39).

FOR: METAL RING MESH; METAL RING MESH  
AS SEMIFINISHED PRODUCTS FOR THE MANU-  
FACTURE OF PROTECTIVE CLOTHING, IN CLASS  
6 (U.S. CLS. 2, 12, 13, 14, 23, 25 AND 50).

THE MARK CONSISTS OF STANDARD CHAR-  
ACTERS WITHOUT CLAIM TO ANY PARTICULAR  
FONT, STYLE, SIZE, OR COLOR.

FOR: PROTECTIVE CLOTHING, IN PARTICU-  
LAR GLOVES, ARM GUARDS, TRUNK GUARDS,  
LEG GUARDS, AND APRONS; PROTECTIVE  
CLOTHING MADE PARTICULARLY OF METAL  
RING MESH OR BY USING METAL RING MESH;  
AND PARTS OF THE AFORESAID GOODS, IN  
CLASS 9 (U.S. CLS. 21, 23, 26, 36 AND 38).

PRIORITY DATE OF 6-12-2006 IS CLAIMED.

OWNER OF INTERNATIONAL REGISTRATION  
0920264 DATED 12-12-2006, EXPIRES 12-12-2016.

FOR: CLOTHING MADE OF METAL RING MESH  
OR USING METAL RING MESH, IN PARTICULAR

SER. NO. 79-037,004, FILED 12-12-2006.

WENDY JUN, EXAMINING ATTORNEY

**Int. Cl.: 9**

**Prior U.S. Cls.: 21, 23, 26, 36 and 38**

**United States Patent and Trademark Office**

**Reg. No. 3,453,975**

**Registered June 24, 2008**

**TRADEMARK  
PRINCIPAL REGISTER**

# **Tmax ProBus**

TMAX SOFT CO., LTD. (REPUBLIC OF KOREA  
LIMITED COMPANY)  
18F GLASS TOWER,  
946-1, DAECHI-DONG,; KANGNAM-GU; SEOUL  
135-708  
REPUBLIC OF KOREA

FOR: COMPUTER PROGRAMS FOR USE IN  
INTEGRATED BUSINESS MANAGEMENT OF  
CORPORATE INFORMATION; COMPUTER OPER-  
ATING PROGRAMS; COMPUTER PROGRAMS  
DOWNLOADABLE VIA NETWORK FOR USE IN  
INTEGRATED BUSINESS MANAGEMENT OF  
CORPORATE INFORMATION; COMPUTER PRO-  
GRAMS RECORDED IN A STORAGE MEDIUM  
FOR USE IN INTEGRATED BUSINESS MANAGE-  
MENT OF CORPORATE INFORMATION; COMPU-  
TER PROGRAMS FOR THE CONSTRUCTION OF A  
SERVER; COMPUTER SOFTWARE FOR USE AS A  
ENTERPRISE SERVICE BUS FOR UPDATING, CO-  
ORDINATING AND INTEGRATING APPLICA-  
TIONS OR DATABASES OF A BUSINESS  
ENTERPRISE IN A FIELD OF SERVICE ORIENTED

ARCHITECTURES; COMPUTER SOFTWARE FOR  
UPDATING, COORDINATING AND INTEGRAT-  
ING APPLICATIONS OR DATABASES OF A BUSI-  
NESS ENTERPRISE, IN CLASS 9 (U.S. CLS. 21, 23, 26,  
36 AND 38).

THE MARK CONSISTS OF STANDARD CHAR-  
ACTERS WITHOUT CLAIM TO ANY PARTICULAR  
FONT, STYLE, SIZE, OR COLOR.

PRIORITY DATE OF 2-5-2007 IS CLAIMED.

OWNER OF INTERNATIONAL REGISTRATION  
0920435 DATED 2-13-2007, EXPIRES 2-13-2017.

OWNER OF U.S. REG. NO. 2,900,092.

SER. NO. 79-037,072, FILED 2-13-2007.

CHRISIE B. KING, EXAMINING ATTORNEY

**Int. Cl.: 25**

**Prior U.S. Cls.: 22 and 39**

**United States Patent and Trademark Office**

**Reg. No. 3,453,976**

**Registered June 24, 2008**

**TRADEMARK  
PRINCIPAL REGISTER**



BTJ FASHIONS PTY LTD ATF BONZA COZZIE  
TRUST (AUSTRALIA TRUST)

C/- C & H ACCOUNTING

SUITE 14; 39 GRAND BOULEVARD

MONTMORENCY VIC 3084, AUSTRALIA AND

SCRAMCIOUS PTY LTD ATF MELINDA ILLE-  
VOLD; DISCRETIONARY TRUST (AUSTRALIA  
TRUST)

PO BOX 591

HEIDELBERG VIC 3084, AUSTRALIA AND

OZILLA PTY LTD ATF G MANTON FAMILY  
TRUST (AUSTRALIA TRUST)

C/- MR G BYRNE-JONES

45 WHITEHORSE ROAD

BALWYN VIC 3103, AUSTRALIA AND

TOBY WESTON CONE (UNITED STATES INDIVI-  
DUAL)

17 RICHMOND DRIVE

DARIEN, CT 06820

FOR: CLOTHING, NAMELY, DRESSES, SKIRTS,  
SWEATERS, JEANS, VESTS, JACKETS, JUMPERS, T-

SHIRTS, HATS, SHIRTS, BLOUSES, SHOES, ANOR-  
AKS, TROUSERS, CARGO PANTS, FLEECE TOPS,  
COATS, ROBES, BRASSIERES, UNDERWEAR, UN-  
DERGARMENTS, BOXER SHORTS, TANK TOPS,  
SWEATSHIRTS, SWEAT PANTS, BATHING SUITS,  
SWIM TRUNKS, SLEEPWEAR, LEGGINGS, CAPS,  
BELTS, SCARVES, BODYSUITS, WETSUITS FOR  
SURFING, IN CLASS 25 (U.S. CLS. 22 AND 39).

PRIORITY DATE OF 3-1-2007 IS CLAIMED.

OWNER OF INTERNATIONAL REGISTRATION  
0920634 DATED 3-27-2007, EXPIRES 3-27-2017.

SER. NO. 79-037,168, FILED 3-27-2007.

INGA ERVIN, EXAMINING ATTORNEY

Int. Cls.: 14, 18 and 25

Prior U.S. Cls.: 1, 2, 3, 22, 27, 28, 39, 41 and 50

Reg. No. 3,453,977

United States Patent and Trademark Office

Registered June 24, 2008

TRADEMARK  
PRINCIPAL REGISTER



RESTIR HOLDINGS INC. (JAPAN CORPORATION)

2-13-3, SHIMOYAMATE-DORI CHUO-KU

KOBE-SHI

HYOGO 650-0011, JAPAN

FOR: GOLD ALLOY INGOTS; GOLD INGOTS; CASTINGS, FOILS, POWDERS, AND ROLLED, DRAWN OR EXTRUDED SEMI-FINISHED PRODUCTS OF GOLD OR ITS ALLOYS; SILVER ALLOY INGOTS; SILVER INGOTS; CASTINGS, FOILS, POWDERS, AND ROLLED, DRAWN OR EXTRUDED SEMI-FINISHED PRODUCTS OF SILVER OR ITS ALLOYS; PLATINUM ALLOY INGOTS; PLATINUM INGOTS; CASTINGS, FOILS, POWDERS, AND ROLLED, DRAWN OR EXTRUDED SEMI-FINISHED PRODUCTS OF PLATINUM OR ITS ALLOYS; IRIIDIUM AND ITS ALLOYS; OSMIUM AND ITS ALLOYS; PALLADIUM AND ITS ALLOYS; RUTHEINIUM AND ITS ALLOYS; RHODIUM AND ITS ALLOYS; FANCY KEY RINGS OF PRECIOUS METALS, TRINKETS OR WATCH FOBS; JAPANESE STYLE TEA-SERVING POTS OF PRECIOUS METAL (KYUSU); NON-ELECTRIC COFFEE-POTS OF PRECIOUS METAL; DRINKING CUPS OF PRECIOUS METAL; SAKE CUPS OF PRECIOUS METAL; DISHES AND PLATES OF PRECIOUS METAL; SALAD BOWLS OF PRECIOUS METAL; SOUP BOWLS OF PRECIOUS METAL; JAPANESE RICE BOWLS OF PRECIOUS METAL (CHAWAN); TEAPOTS OF PRECIOUS METAL; JUGS OF PRECIOUS METAL; KITCHEN KEGS AND BARRELS OF PRECIOUS METAL; KITCHEN URNS OF PRECIOUS METAL; BREAD CASES FOR KITCHEN USE, OF PRECIOUS METAL; NUTCRACKERS, PEPPER POTS, SUGAR BOWLS, SALT SHAKERS, EGG CUPS, NAPKIN HOLDERS, NAPKIN RINGS, TRAYS AND TOOTHPICK HOLDERS OF PRECIOUS METAL; JEWEL CASES OF PRECIOUS METAL; FLOWER

VASES AND BOWLS OF PRECIOUS METAL; EARRINGS; INSIGNIAS OF PRECIOUS METAL; BELT BUCKLES OF PRECIOUS METAL; BADGES OF PRECIOUS METAL; BONNET PINS OF PRECIOUS METAL; TIE CLIPS; TIE PINS; NECKLACES; BRACELETS; PENDANTS; BROOCHES; JEWELRY; MEDALS; RINGS; MEDALLIONS; CUFF LINKS; PURSES AND WALLETS OF PRECIOUS METAL; EMERALD; TOPAZ; OLIVINE, PERIDOT; THREADS OF PRECIOUS METAL; CHALCEDONY; SAPPHIRE; CORAL JEWELRY; PEARL; ARTIFICIAL GEMSTONES; DIAMOND JEWELRY; OPAL; JADE JEWELRY; JASPER; AGATE AND SARDONYX JEWELRY; RUBY; UNWROUGHT DIAMOND; UNWROUGHT AGATE AND SARDONYX; POWDER COMPACTS OF PRECIOUS METAL; SHOE ORNAMENTS OF PRECIOUS METAL; WRISTWATCHES; TABLE CLOCKS; POCKET WATCHES; AUTOMOBILE CLOCKS; STOPWATCHES; WALL CLOCKS; ALARM CLOCKS; WATCH AND CLOCK SPRINGS; CASES FOR CLOCK AND WATCH-MAKING; WATCH CHAINS; WATCH GLASSES; WATCH BANDS AND STRAPS; CLOCK AND WATCH HANDS; PARTS FOR CLOCKS AND WATCHES, NAMELY, PENDULUMS AND DIALS; ASIAN LONG TOBACCO PIPES OF PRECIOUS METAL (KISERU); ASIAN LONG TOBACCO PIPE SHEATHS OF PRECIOUS METAL; TOBACCO POUCHES OF PRECIOUS METAL; CIGARETTE CASES OF PRECIOUS METAL; CIGARETTE HOLDERS OF PRECIOUS METAL; ASHTRAYS OF PRECIOUS METAL; TOBACCO PIPES OF PRECIOUS METAL, IN CLASS 14 (U.S. CLS. 2, 27, 28 AND 50).

FOR: HANDBAG FRAMES; PURSE FRAMES; LEATHER BAGS FOR MERCHANDISE PACKAGING; CLOTHING FOR DOMESTIC PETS; DOG SHOES; DOG COLLARS; DOG CLOTHING; FOLDING BRIEFCASES; SHOULDER BAGS; GLAD-

STONE BAGS; KORI WICKER TRUNKS; BRIEF-CASES; SUITCASES; CARRY-ON BAGS; TRUNKS; HANDBAGS; BOSTON BAGS; SCHOOL CHILDREN'S BACKPACKS; BACKPACKS, RUCKSACKS; CHARM BAGS (OMAMORI-IRE); CREDIT, BUSINESS AND NAME CARD CASES; TEXTILE SHOPPING BAGS, SHOPPING BAGS WITH WHEELS ATTACHED; PURSES, NOT OF PRECIOUS METAL; KEY CASES; WALLETS, NOT OF PRECIOUS METAL; WALLETS OF PRECIOUS METAL; JAPANESE UTILITY POUCHES (SHINGEN-BUKURO); COMMUTER PASS HOLDERS; BUSINESS CARD CASES; VANITY CASES, NOT FITTED AND SOLD EMPTY; TELESCOPIC UMBRELLAS; JAPANESE PAPER UMBRELLAS (KARAKASA); JAPANESE OILED-PAPER UMBRELLAS (JANOME-GASA); RAINPROOF PARASOLS; BEACH UMBRELLAS, BEACH PARASOLS; PARASOLS, NAMELY, SUN UMBRELLAS; UMBRELLAS; UMBRELLA COVERS; UMBRELLA HANDLES; METAL PARTS OF UMBRELLAS; FRAMES FOR UMBRELLAS; BAGS FOR UMBRELLAS; HORSE BLANKETS; RIDING SADDLES; SADDLE COVERS FOR HORSES; BLINKERS FOR HORSES, NAMELY, BLINDERS FOR HORSES; REINS, HARNESS; BITS; WHIPS; HORSE COLLARS; LEATHER STRAPS; RAWHIDES; RAW SKINS; TANNED LEATHER; FUR, IN CLASS 18 (U.S. CLS. 1, 2, 3, 22 AND 41).

FOR: EVENING DRESSES; SCHOOL UNIFORMS; CHILDREN'S WEAR, NAMELY, SHIRTS, SOCKS, TROUSERS AND SKIRTS; WORKING CLOTHING, NAMELY, OVERALLS, SHOES AND BOOTS; JACKETS; JOGGING PANTS; SWEAT PANTS; SUITS; SKIRTS; SKI JACKETS; SKI PANTS; TROUSERS; SMOCKS; FORMAL WEAR, NAMELY, TUXEDOS; OVERCOATS; TOPCOATS; MANTLES; RAINCOATS; CARDIGANS; SWEATERS; VESTS AND WAISTCOATS; OPEN-NECKED SHIRTS; CUFFS; REMOVABLE COLLARS FOR CLOTHING; SPORT SHIRTS; BLOUSES; POLO SHIRTS; SHIRTS FOR SUITS; UNDERWEAR; CAMISOLES; CORSETS; COMBINATIONS; UNDERSHIRTS; CHEMISES; UN-

DERPANTS; SLIPS; PANTIES, SHORTS AND BRIEFS; BRASSIERES; PETTICOATS; BANDANAS; HEADGEAR FOR CLOTHING, NAMELY, HATS AND CAPS; GARTERS; SOCK SUSPENDERS; SUSPENDERS, BRACES; WAISTBANDS; BELTS FOR CLOTHING; RAIN BOOTS; LACE BOOTS; TRAINING SHOES; OVERSHOES; FOOTWEAR MADE OF WOOD; WORK SHOES AND BOOTS; SANDALS; SHOES; BOOTS; HALF-BOOTS; WOMEN'S SHOES; WINTER BOOTS; HOSIERY SHOES; CANVAS SHOES; INFANTS SHOES AND BOOTS; SHOE DOWELS; SHOE PEGS; TONGUE OR PULLSTRAP FOR SHOES AND BOOTS; PROTECTIVE METAL MEMBERS FOR SHOES AND BOOTS; MASQUERADE COSTUMES; ANORAKS; KARATE SUITS; SPORTS OVERUNIFORMS; KENDO OUTFITS; JUDO SUITS; SKI SUITS FOR COMPETITION; HEADBANDS; WIND-JACKETS; UNIFORMS; STOCKINGS; WRISTBANDS; GOLF SHOES; SOCCER SHOES; SKI SHOES; GYMNASTIC SHOES; TENNIS SHOES; CLIMBING BOOTS, MOUNTAINEERING BOOTS; BASKETBALL SNEAKERS; VOLLEYBALL SHOES; HANDBALL SHOES; BOWLING SHOES; BOXING SHOES; HOCKEY SHOES; BASEBALL SHOES; RUGBY SHOES; FOOTWEAR FOR TRACK AND FIELD ATHLETICS; HORSE-RIDING BOOTS, IN CLASS 25 (U.S. CLS. 22 AND 39).

OWNER OF INTERNATIONAL REGISTRATION  
0920694 DATED 10-20-2006, EXPIRES 10-20-2016.

THE MARK "HEDDIE LOVU" DOES NOT IDENTIFY A LIVING INDIVIDUAL.

THE MARK CONSISTS OF A CHESS PIECE DESIGN OF A KNIGHT AND THE WORDING "HEDDIE LOVU".

SER. NO. 79-037,187, FILED 10-20-2006.

BERNICE MIDDLETON, EXAMINING ATTORNEY

**Int. Cl.: 36**

**Prior U.S. Cls.: 100, 101 and 102**

**United States Patent and Trademark Office**

**Reg. No. 3,453,978**

**Registered June 24, 2008**

**SERVICE MARK  
PRINCIPAL REGISTER**



VIETNAM HOLDING ASSET MANAGEMENT  
(SCHWEIZ) AG (SWITZERLAND SOCIÉTÉ  
ANONYME)  
GARTENSTRASSE 19  
CH-8022 ZÜRICH, SWITZERLAND

FOR: CAPITAL INVESTMENT, NAMELY, CAPITAL INVESTMENT CONSULTATION AND MANAGEMENT OF CAPITAL INVESTMENT FUNDS, IN CLASS 36 (U.S. CLS. 100, 101 AND 102).

OWNER OF INTERNATIONAL REGISTRATION  
0920960 DATED 3-29-2007, EXPIRES 3-29-2017.

THE MARK CONSISTS OF A BORDER CONSISTING OF DOUBLE CIRCLES SURROUNDING A SHADED DIAMOND AND DOME-SHAPED FIGURE.

SER. NO. 79-037,272, FILED 3-29-2007.

ERIN FALK, EXAMINING ATTORNEY



Int. Cl.: 3

Prior U.S. Cls.: 1, 4, 6, 50, 51 and 52

United States Patent and Trademark Office

Reg. No. 3,453,979

Registered June 24, 2008

TRADEMARK  
PRINCIPAL REGISTER

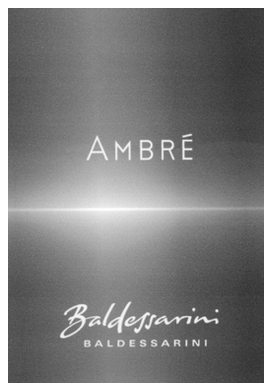

HUGO BOSS; TRADE MARK MANAGEMENT  
GMBH & CO. KG (FED REP GERMANY  
GMBH & CO. KG (LIMITED COMMERCIAL  
PARTNERSHIP))  
DIESELSTRASSE 12  
72555 METZINGEN  
FED REP GERMANY

FOR: PERFUMERY AND COSMETIC PREPARA-  
TIONS, NAMELY, TOILET SOAPS, PERFUMES,  
EAU DE PARFUM, EAU DE TOILETTE, AFTER-  
SHAVE, BODY, HAND AND SKIN CLEANSERS,  
LOTIONS AND CREAMS, ESSENTIAL OILS FOR  
PERSONAL USE AND DEODORANTS FOR PERSONAL  
USE, IN CLASS 3 (U.S. CLS. 1, 4, 6, 50, 51 AND  
52).

PRIORITY DATE OF 7-6-2006 IS CLAIMED.

OWNER OF INTERNATIONAL REGISTRATION  
0921022 DATED 1-4-2007, EXPIRES 1-4-2017.

OWNER OF U.S. REG. NO. 2,801,445.

NO CLAIM IS MADE TO THE EXCLUSIVE  
RIGHT TO USE "AMBRE", APART FROM THE  
MARK AS SHOWN.

THE FOREIGN WORDING "AMBRE" IN THE  
MARK TRANSLATES INTO ENGLISH AS "AM-  
BER". THE WORDING "BALDESSARINI" HAS NO  
MEANING IN A FOREIGN LANGUAGE.

SER. NO. 79-037,293, FILED 1-4-2007.

WILLIAM ROSSMAN, EXAMINING ATTORNEY

**Int. Cls.: 1, 3 and 40**

**Prior U.S. Cls.: 1, 4, 5, 6, 10, 26, 46, 50, 51, 52, 100, 103  
and 106**

**Reg. No. 3,453,980**

**United States Patent and Trademark Office**

**Registered June 24, 2008**

**TRADEMARK  
SERVICE MARK  
PRINCIPAL REGISTER**

# MICROABSOLUTE

QUEST INTERNATIONAL SERVICES B.V.  
(NETHERLANDS CORPORATION)  
HUIZERSTRAATWEG 28  
NL-1411 GP NAARDEN  
NETHERLANDS

FOR: CHEMICALS FOR USE IN INDUSTRY; AROMA CHEMICALS, NAMELY, CHEMICAL PREPARATIONS FOR USE IN THE MANUFACTURE OF FRAGRANCES, FRAGRANCE INGREDIENTS AND FRAGRANCE COMPOUNDS; CHEMICALS FOR USE IN THE FORMULATION OF FRAGRANCES; CHEMICALS FOR USE IN THE MANUFACTURE OF PERFUMES AND PERFUMED PRODUCTS; CHEMICALS FOR USE IN THE MANUFACTURE OF COSMETIC AND TOILET PREPARATIONS; CHEMICALS FOR USE IN THE MANUFACTURE OF AIR-FRESHENING AND DEODORIZING PREPARATIONS; CHEMICALS FOR USE AS FRAGRANCES AND FLAVORS FOR USE IN THE MANUFACTURE OF ORAL CARE PREPARATIONS; CHEMICALS FOR USE AS FRAGRANCES FOR IMPREGNATION IN TEXTILES; CHEMICALS FOR USE AS FRAGRANCES IN THE MANUFACTURE OF HOUSE-HOLD CLEANSERS, DEODORIZERS AND DISINFECTANTS; CHEMICAL ADDITIVES FOR USE IN THE MANUFACTURE OF FOOD AND BEVERAGES, NAMELY, CHEMICAL ADDITIVES FOR USE AS FRAGRANCES AND FLAVORINGS FOR FOODS AND BEVERAGES, IN CLASS 1 (U.S. CLS. 1, 5, 6, 10, 26 AND 46).

FOR: PERFUMES AND ESSENTIAL OILS; COSMETIC PREPARATIONS FOR HAND, FOOT, FACE AND BODY CARE; NON-MEDICATED TOILET PREPARATIONS, NAMELY, TOILET SOAP, TALCUM POWDER, SKIN MOISTURIZER, HAND, FOOT, FACE AND BODY CREAMS; DEODORANTS AND ANTIPERSPIRANT PREPARATIONS; PERFUMED SOAPS; BLEACHING PREPARATIONS FOR COSMETIC PURPOSES; DETERGENTS FOR HOUSEHOLD AND LAUNDRY PREPARATIONS; DEPILATORIES; DENTIFRICES; TOOTHPASTES; DYES FOR COSMETIC PURPOSES, NAMELY, HAIR DYES; ETHEREAL ESSENCES AND OILS FOR

PERSONAL USE; FLAVORINGS FOR BEVERAGES ALL BEING ESSENTIAL OILS; HAIR CARE PREPARATIONS; LAUNDRY PREPARATIONS, NAMELY, LAUNDRY DETERGENT, LAUNDRY BLEACH, FABRIC SOFTENERS FOR LAUNDRY USE, LAUNDRY STARCH, LAUNDRY SOAP, ESSENTIAL OILS AS PERFUME FOR LAUNDRY PURPOSES; LIPSTICKS, HAND AND BODY CREAMS AND LOTIONS; MAKE-UP REMOVING PREPARATIONS; MASCARA; BEAUTY MASKS; CLEANSING PREPARATIONS FOR PERSONAL USE, NAMELY, SKIN CLEANSERS; NAIL CARE PREPARATIONS; NAIL CARE SUBSTANCES, NAMELY, NAIL CREAM, NAIL ENAMEL, NAIL HARDENERS, NAIL BUFFING PREPARATIONS, AND NAIL-POLISH REMOVERS; MANICURE KITS COMPRISED OF NAIL CARE PREPARATIONS AND NAIL GROOMING PRODUCTS, NAMELY, TIPS, GLUE, LACQUER, AND GLITTER; COSMETIC PENCILS; EXFOLIANT PREPARATIONS FOR PERSONAL USE, NAMELY, EXFOLIANT PREPARATIONS FOR HAIR AND SKIN; SHAVING PREPARATIONS; SOAKING PREPARATIONS FOR LAUNDRY USE; STAIN REMOVERS, IN CLASS 3 (U.S. CLS. 1, 4, 6, 50, 51 AND 52).

FOR: SERVICES FOR TREATMENT OF MATERIALS FOR OTHERS, NAMELY, SERVICES TO SAMPLE AND THEN REPLICATE THE SMELLS, FLAVORS AND ODORS OF ORGANIC AND INORGANIC MATERIALS WITHIN AND OUTSIDE THE LABORATORY ENVIRONMENT, IN CLASS 40 (U.S. CLS. 100, 103 AND 106).

THE MARK CONSISTS OF STANDARD CHARACTERS WITHOUT CLAIM TO ANY PARTICULAR FONT, STYLE, SIZE, OR COLOR.

PRIORITY DATE OF 9-4-2006 IS CLAIMED.

OWNER OF INTERNATIONAL REGISTRATION  
0921198 DATED 2-28-2007, EXPIRES 2-28-2017.

SER. NO. 79-037,392, FILED 2-28-2007.

KEVIN CORWIN, EXAMINING ATTORNEY

**Int. Cls.: 9, 37 and 42**

**Prior U.S. Cls.: 21, 23, 26, 36, 38, 100, 101, 103 and 106**

**United States Patent and Trademark Office**

**Reg. No. 3,453,981**

**Registered June 24, 2008**

**TRADEMARK  
SERVICE MARK  
PRINCIPAL REGISTER**

# syngo iPerfusion

SIEMENS AG (FED REP GERMANY JOINT  
STOCK COMPANY)  
WITTELSBACHERPLATZ 2  
80333 MÜNCHEN, FED REP GERMANY

FOR: DATA PROCESSING PROGRAMS, NAME-  
LY, COMPUTER SOFTWARE FOR MEDICAL IN-  
FORMATION SYSTEMS, COMPUTER SOFTWARE  
FOR REPRODUCING, TRANSMITTING AND PRO-  
CESSING MEDICAL DATA, IMAGES AND SCAN  
ORDERS; COMMUNICATIONS SOFTWARE FOR  
CONNECTING COMPUTER USERS FOR USE BY  
HOSPITALS AND OTHER MEDICAL INSTITU-  
TIONS, IN CLASS 9 (U.S. CLS. 21, 23, 26, 36 AND 38).

FOR: COMPUTER HARDWARE UPGRADING  
FOR ELECTRO-MEDICAL IMAGING SYSTEMS,  
IN CLASS 37 (U.S. CLS. 100, 103 AND 106).

FOR: PROGRAMMING, DEVELOPMENT, CREA-  
TION AND IMPLEMENTATION OF SOFTWARE  
AND DATA PROCESSING PROGRAMS; CONSUL-  
TANCY IN THE FIELD OF DATA PROCESSING, IN  
PARTICULAR THE USE OF HARDWARE AND

SOFTWARE; CONSULTANT ENGINEER SERVI-  
CES; UPDATING AND UPGRADING OF SOFT-  
WARE FOR ELECTRO-MEDICAL IMAGING  
SYSTEMS FOR OTHERS, IN CLASS 42 (U.S. CLS.  
100 AND 101).

THE MARK CONSISTS OF STANDARD CHAR-  
ACTERS WITHOUT CLAIM TO ANY PARTICULAR  
FONT, STYLE, SIZE, OR COLOR.

PRIORITY DATE OF 9-29-2006 IS CLAIMED.

OWNER OF INTERNATIONAL REGISTRATION  
0921210 DATED 2-7-2007, EXPIRES 2-7-2017.

OWNER OF U.S. REG. NOS. 2,596,757, 2,623,451,  
AND 2,790,091.

SER. NO. 79-037,399, FILED 2-7-2007.

BERNICE MIDDLETON, EXAMINING ATTORNEY

**Int. Cls.: 9, 37 and 42**

**Prior U.S. Cls.: 21, 23, 26, 36, 38, 100, 101, 103 and 106**

**United States Patent and Trademark Office**

**Reg. No. 3,453,982**

**Registered June 24, 2008**

**TRADEMARK  
SERVICE MARK  
PRINCIPAL REGISTER**

**syngo iFuse**

SIEMENS AG (FED REP GERMANY JOINT STOCK COMPANY)  
WITTELSBACHERPLATZ 2  
80333 MÜNCHEN, FED REP GERMANY

FOR: DATA PROCESSING PROGRAMS, NAME-  
LY, COMPUTER SOFTWARE FOR MEDICAL IN-  
FORMATION SYSTEMS, COMPUTER SOFTWARE  
FOR REPRODUCING, TRANSMITTING AND PRO-  
CESSING MEDICAL DATA, IMAGES AND SCAN  
ORDERS; COMMUNICATIONS SOFTWARE FOR  
CONNECTING COMPUTER USERS FOR USE BY  
HOSPITALS AND OTHER MEDICAL INSTITU-  
TIONS, IN CLASS 9 (U.S. CLS. 21, 23, 26, 36 AND 38).

FOR: COMPUTER HARDWARE UPGRADING  
FOR ELECTRO-MEDICAL IMAGING SYSTEMS,  
IN CLASS 37 (U.S. CLS. 100, 103 AND 106).

FOR: PROGRAMMING, DEVELOPMENT, CREA-  
TION AND IMPLEMENTATION OF SOFTWARE  
AND DATA PROCESSING PROGRAMS; CONSUL-  
TANCY IN THE FIELD OF DATA PROCESSING, IN  
PARTICULAR THE USE OF HARDWARE AND

SOFTWARE; CONSULTANT ENGINEER SERVI-  
CES; UPDATING AND UPGRADING OF SOFT-  
WARE FOR ELECTRO-MEDICAL IMAGING  
SYSTEMS FOR OTHERS, IN CLASS 42 (U.S. CLS.  
100 AND 101).

THE MARK CONSISTS OF STANDARD CHAR-  
ACTERS WITHOUT CLAIM TO ANY PARTICULAR  
FONT, STYLE, SIZE, OR COLOR.

PRIORITY DATE OF 9-29-2006 IS CLAIMED.

OWNER OF INTERNATIONAL REGISTRATION  
0921211 DATED 2-7-2007, EXPIRES 2-7-2017.

OWNER OF U.S. REG. NOS. 2,596,757, 2,623,451,  
AND 2,790,091.

SER. NO. 79-037,400, FILED 2-7-2007.

BERNICE MIDDLETON, EXAMINING ATTORNEY

**Int. Cls.: 9, 37 and 42**

**Prior U.S. Cls.: 21, 23, 26, 36, 38, 100, 101, 103 and 106**

**Reg. No. 3,453,983**

**United States Patent and Trademark Office**

**Registered June 24, 2008**

**TRADEMARK  
SERVICE MARK  
PRINCIPAL REGISTER**

**syngo iQuant**

SIEMENS AG (FED REP GERMANY JOINT STOCK COMPANY)  
WITTELSBACHERPLATZ 2  
80333 MÜNCHEN, FED REP GERMANY

FOR: DATA PROCESSING PROGRAMS, NAME-  
LY, COMPUTER SOFTWARE FOR MEDICAL IN-  
FORMATION SYSTEMS, COMPUTER SOFTWARE  
FOR REPRODUCING, TRANSMITTING AND PRO-  
CESSING MEDICAL DATA, IMAGES AND SCAN  
ORDERS; COMMUNICATIONS SOFTWARE FOR  
CONNECTING COMPUTER USERS FOR USE BY  
HOSPITALS AND OTHER MEDICAL INSTITU-  
TIONS, IN CLASS 9 (U.S. CLS. 21, 23, 26, 36 AND 38).

FOR: COMPUTER HARDWARE UPGRADING  
FOR ELECTRO-MEDICAL IMAGING SYSTEMS,  
IN CLASS 37 (U.S. CLS. 100, 103 AND 106).

FOR: PROGRAMMING, DEVELOPMENT, CREA-  
TION AND IMPLEMENTATION OF SOFTWARE  
AND DATA PROCESSING PROGRAMS; CONSUL-  
TANCY IN THE FIELD OF DATA PROCESSING, IN  
PARTICULAR THE USE OF HARDWARE AND

SOFTWARE; CONSULTANT ENGINEER SERVI-  
CES; UPDATING AND UPGRADING OF SOFT-  
WARE FOR ELECTRO-MEDICAL IMAGING  
SYSTEMS FOR OTHERS, IN CLASS 42 (U.S. CLS.  
100 AND 101).

THE MARK CONSISTS OF STANDARD CHAR-  
ACTERS WITHOUT CLAIM TO ANY PARTICULAR  
FONT, STYLE, SIZE, OR COLOR.

PRIORITY DATE OF 9-29-2006 IS CLAIMED.

OWNER OF INTERNATIONAL REGISTRATION  
0921212 DATED 2-7-2007, EXPIRES 2-7-2017.

OWNER OF U.S. REG. NOS. 2,596,757, 2,623,451,  
AND 2,790,091.

SER. NO. 79-037,401, FILED 2-7-2007.

BERNICE MIDDLETON, EXAMINING ATTORNEY

**Int. Cls.: 9 and 42**

**Prior U.S. Cls.: 21, 23, 26, 36, 38, 100 and 101**

**United States Patent and Trademark Office**

**Reg. No. 3,453,984**

**Registered June 24, 2008**

**TRADEMARK  
SERVICE MARK  
PRINCIPAL REGISTER**

**gostai**

BAILLIE JEAN-CHRISTOPHE (FRANCE INDIVIDUAL)  
15, RUE VERNIAUD  
PARIS, FRANCE F75013

FOR: GAMING SOFTWARE; SOFTWARE PROGRAMS FOR CONTROL IN THE FIELDS OF ROBOTICS AND ARTIFICIAL INTELLIGENCE; SCIENTIFIC, MEASURING, SIGNALING, CHECKING AND INSPECTION, AND TEACHING APPARATUS AND INSTRUMENTS, NAMELY, LABORATORY ROBOTS AND ROBOTS FOR PERSONAL OR HOBBY USE; CALCULATING MACHINES, NAMELY, CALCULATORS; COMPUTER PERIPHERAL DEVICES; MEMORY CARDS, MICROPROCESSOR CARDS, IN CLASS 9 (U.S. CLS. 21, 23, 26, 36 AND 38).

FOR: ANALYSIS AND RESEARCH IN SCIENTIFIC AND TECHNOLOGICAL FIELDS, NAMELY, ROBOTICS, ARTIFICIAL INTELLIGENCE AND COMPUTING, PROVIDED BY ENGINEERS; DESIGN AND DEVELOPMENT OF COMPUTERS

AND SOFTWARE; RESEARCH AND DEVELOPMENT OF NEW PRODUCTS FOR THIRD PARTIES; TECHNICAL PROJECT STUDIES IN THE FIELDS OF ROBOTICS, ARTIFICIAL INTELLIGENCE AND COMPUTING; DEVELOPMENT, DESIGN, INSTALLATION, MAINTENANCE, UPDATING AND RENTAL OF SOFTWARE; COMPUTER PROGRAMMING, IN CLASS 42 (U.S. CLS. 100 AND 101).

THE MARK CONSISTS OF STANDARD CHARACTERS WITHOUT CLAIM TO ANY PARTICULAR FONT, STYLE, SIZE, OR COLOR.

OWNER OF INTERNATIONAL REGISTRATION  
0921273 DATED 11-3-2006, EXPIRES 11-3-2016.

SER. NO. 79-037,422, FILED 11-3-2006.

PETER B. BROMAGHIM, EXAMINING ATTORNEY

Int. Cl.: 26

Prior U.S. Cls.: 37, 39, 40, 42 and 50

United States Patent and Trademark Office

Reg. No. 3,453,985

Registered June 24, 2008

TRADEMARK  
PRINCIPAL REGISTER



DREAMSCO CO., LTD.  
11F. CHANG GYEONG BLDG,  
28-7, WONNAM-DONGJONGNO-GU, SEOUL  
REPUBLIC OF KOREA

FOR: BROOCHES, NOT OF PRECIOUS METAL,  
IN THE NATURE OF CLOTHING ACCESSORIES;  
DECORATIVE RIBBONS; HAIR GRIPS, HAIR  
SLIDES; HAIR BANDS; EYELETS FOR CLOTHING;  
SHOE HOOKS FOR DECORATIVE USE ON SHOES;  
SHOE BUCKLES; BUTTONS; LACE, EXCEPT EM-  
BROIDERY LACE; ORIENTAL HAIR PINS; PIN  
CUSHIONS; HAIR RIBBONS; HAIR NETS; HAIR  
PINS, IN CLASS 26 (U.S. CLS. 37, 39, 40, 42 AND 50).

OWNER OF INTERNATIONAL REGISTRATION  
0921346 DATED 1-31-2007, EXPIRES 1-31-2017.

OWNER OF U.S. REG. NOS. 3,154,274 AND  
3,158,966.

THE COLOR(S) ORANGE, YELLOW, BLUE,  
GREEN, RED, WHITE, AND BLACK IS/ARE  
CLAIMED AS A FEATURE OF THE MARK.

THE MARK CONSISTS OF THE COLOR ORANGE  
APPEARING IN THE OUTLINE OF THE WORDING

"CURLYSUE"; THE COLOR YELLOW APPEARING  
IN THE FACES, INNER EARS AND HANDS OF THE  
CATS AND HIPPOPOTAMUS AND THE INNER  
PORTION OF THE WORDING "CURLYSUE"; THE  
COLOR WHITE APPEARING IN THE EYES OF THE  
CATS AND HIPPOPOTAMUS AND THE INNER  
PORTION OF THE WORDING IN "CURLYSUE";  
THE COLOR BLUE APPEARING IN THE TWO  
PANELS OF THE HAT ON THE CAT; THE COLOR  
GREEN APPEARING IN THE HAT ON THE HIPPO-  
POTAMUS AND ON THE TOP BUTTON AND  
STRAP OF THE CAT'S HAT; THE COLOR PINK  
APPEARING IN THE RIBBON ON THE CAT'S  
HEAD, THE TONGUE OF THE HIPPOPOTAMUS  
AND THE CHEEKS OF THE CATS AND HIPPOPO-  
TAMUS; THE COLOR RED APPEARING IN THE  
VISOR, STRAP AND BUTTON ON THE HAT ON  
THE HIPPOPOTAMUS AND IN A PANEL AND THE  
VISOR OF THE CAT'S HAT; AND THE COLOR  
BLACK APPEARING IN THE EYES, EYELASHES,  
EARS, WHISKERS, NOSE, MOUTH AND SPOTTING  
ON THE TWO CATS AND THE EYES AND NOSE OF  
THE HIPPOPOTAMUS.

SER. NO. 79-037,441, FILED 1-31-2007.

REBECCA POVARCHUK, EXAMINING ATTOR-  
NEY



**Int. Cl.: 43**

**Prior U.S. Cls.: 100 and 101**

**United States Patent and Trademark Office**

**Reg. No. 3,453,986**

**Registered June 24, 2008**

**SERVICE MARK  
PRINCIPAL REGISTER**



DORCHESTER HOTEL LIMITED (UNITED  
KINGDOM LIMITED LIABILITY INCORPORATED COMPANY)  
53 PARK LANE  
LONDON, UNITED KINGDOM W1A 2HJ

FOR: PROVISION OF FOOD AND DRINK, RESTAURANT AND BAR SERVICES; TEMPORARY ACCOMMODATION, HOTEL SERVICES; PROVIDING FACILITIES FOR CONDUCTING CONFERENCES, FAIRS, EXHIBITIONS, PRIVATE PARTIES, WEDDINGS, BANQUETS AND MEETINGS, IN CLASS 43 (U.S. CLS. 100 AND 101).

PRIORITY DATE OF 10-20-2006 IS CLAIMED.

OWNER OF INTERNATIONAL REGISTRATION  
0921462 DATED 4-20-2007, EXPIRES 4-20-2017.

SER. NO. 79-037,491, FILED 4-20-2007.

ELLEN B. AWRICH, EXAMINING ATTORNEY

**Int. Cls.: 9 and 42**

**Prior U.S. Cls.: 21, 23, 26, 36, 38, 100 and 101**

**United States Patent and Trademark Office**

**Reg. No. 3,453,987**

**Registered June 24, 2008**

**TRADEMARK  
SERVICE MARK  
PRINCIPAL REGISTER**

# MACRO VARON

JOS. SCHNEIDER OPTISCHE WERKE GMBH  
(FED REP GERMANY GMBH)  
RINGSTRASSE 132  
55543 BAD KREUZNACH  
FED REP GERMANY

FOR: SCIENTIFIC, NAUTICAL, SURVEYING, ELECTRIC, ELECTRONIC, OPTO-ELECTRONIC, PHOTOGRAPHIC, CINEMATOGRAPHIC, WEIGHING, MEASURING, SIGNALING, CHECKING AND SUPERVISION APPARATUS AND INSTRUMENTS, NAMELY, OPTICAL DETECTORS IN THE NATURE OF OPTICAL CHARACTER READERS AND OPTICAL SCANNERS, OPTICAL LENSES FOR SCANNING OR READING CHARACTERS IN A TELEFAXING OR COPYING APPARATUS; PHOTOGRAPHIC, CINEMATOGRAPHIC AND PROJECTION OBJECTIVES, NAMELY, COMBINATIONS OF PHOTOGRAPHIC LENSES FOR USE WITH CAMERAS, ENLARGERS AND PROJECTORS; LIGHT METERS, OPTICAL REFLECTORS, CONDENSERS, DIAPHRAGMS FOR CAMERAS, OPTICAL POWER SPLITTERS, DIGITAL SIGNAL PROCESSORS; PROJECTOR LAMPS AND FLASH LAMPS FOR CAMERAS; APPARATUS FOR RECORDING, TRANSMISSION OR REPRODUCTION OF SOUND AND IMAGES, NAMELY, FILM CAMERAS, VIDEO CAMERAS, PHOTOGRAPHIC PROJECTORS, OPTICAL/ELECTRICAL TRANSDUCERS, ELECTRICAL/OPTICAL TRANSDUCERS, FLAT PANEL DISPLAY SCREENS, ELECTRIC LUMINESCENT DISPLAY PANELS; BLANK MAGNETIC DATA CARRIERS; DATA PROCESSING EQUIPMENT, NAMELY, COMPUTERS, COMPUTER INTERFACE BOARDS, OPTICAL COMPUTER INPUTS, NAMELY, INTERFACES; PRINTED CIRCUIT CARDS FOR INTERFACING COMPUTERS AND OPTICAL CHARACTER RECOGNITION DEVICES, NAMELY, INTERFACES; LENSES FOR USE WITH PHOTOGRAPHIC AND

CINEMATOGRAPHIC CAMERAS; LENSES FOR USE IN AND FOR USE WITH PHOTOGRAPHIC AND CINEMATOGRAPHIC PROJECTORS; OPTICAL GLASSES, OPTICAL FIBERS SOLD AS A COMPONENT OF FIBER OPTICAL CABLES, FILTERS, NAMELY, OPTICAL FILTERS, CAMERA FILTERS, IN CLASS 9 (U.S. CLS. 21, 23, 26, 36 AND 38).

FOR: DESIGN OF OBJECTIVES AND OF OPTICAL RECORDING, TRANSMISSION AND REPRODUCTION SYSTEMS FOR USERS, IN CLASS 42 (U.S. CLS. 100 AND 101).

THE MARK CONSISTS OF STANDARD CHARACTERS WITHOUT CLAIM TO ANY PARTICULAR FONT, STYLE, SIZE, OR COLOR.

PRIORITY DATE OF 8-11-2006 IS CLAIMED.

OWNER OF INTERNATIONAL REGISTRATION 0921698 DATED 9-20-2006, EXPIRES 9-20-2016.

OWNER OF U.S. REG. NO. 3,053,058.

NO CLAIM IS MADE TO THE EXCLUSIVE RIGHT TO USE "MACRO", APART FROM THE MARK AS SHOWN.

THE ENGLISH TRANSLATION OF THE WORD "VARON" IN THE MARK IS "HUSBAND" OR "MAN".

SER. NO. 79-037,583, FILED 9-20-2006.

PETER B. BROMAGHIM, EXAMINING ATTORNEY

Int. Cl.: 33

Prior U.S. Cls.: 47 and 49

United States Patent and Trademark Office

Reg. No. 3,453,988

Registered June 24, 2008

TRADEMARK  
PRINCIPAL REGISTER

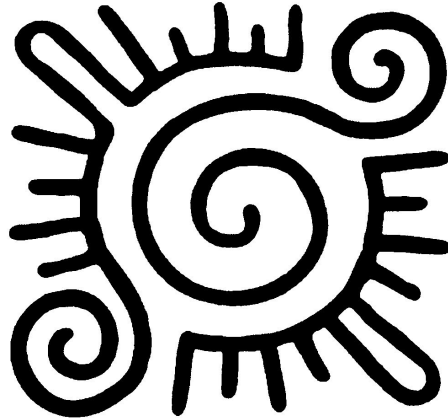

ESPIRITU DE CHILE LTD. (GREAT BRITAIN  
LIMITED COMPANY)  
10 UPPER BANK STREET  
LONDON E14 5JJ  
UNITED KINGDOM

FOR: ALCOHOLIC BEVERAGES FROM CHILE,  
NAMELY, WINE, LIQUOR, LIQUORS, CHAM-  
PAGNE, IN CLASS 33 (U.S. CLS. 47 AND 49).

PRIORITY DATE OF 1-3-2007 IS CLAIMED.

OWNER OF INTERNATIONAL REGISTRATION  
0921950 DATED 3-22-2007, EXPIRES 3-22-2017.

THE MARK CONSISTS OF A DESIGN ELEMENT  
COMPRISED OF THREE SWIRLED AND CURVED  
LINES FROM WHICH STRAIGHT LINES RADIATE  
OUTWARD, REPRESENTING A STYLIZED SUN.

SER. NO. 79-037,675, FILED 3-22-2007.

LAURIE KAUFMAN, EXAMINING ATTORNEY

**Int. Cl.: 12**

**Prior U.S. Cls.: 19, 21, 23, 31, 35 and 44**

**United States Patent and Trademark Office**

**Reg. No. 3,453,989**

**Registered June 24, 2008**

**TRADEMARK  
PRINCIPAL REGISTER**

# **Loadmaster**

AIRBUS S.A.S. (FRANCE JOINT STOCK COMPAN-  
NY)  
1, ROND POINT MAURICE BELLONTE  
F-31707 BLAGNAC CEDEX  
FRANCE

OWNER OF INTERNATIONAL REGISTRATION  
0921983 DATED 4-5-2007, EXPIRES 4-5-2017.

FOR: AIRPLANES AND STRUCTURAL PARTS  
THEREFOR, IN CLASS 12 (U.S. CLS. 19, 21, 23, 31, 35  
AND 44).

SER. NO. 79-037,686, FILED 4-5-2007.

PRIORITY DATE OF 10-9-2006 IS CLAIMED.

COLLEEN KEARNEY, EXAMINING ATTORNEY

**Int. Cls.: 1 and 2**

**Prior U.S. Cls.: 1, 5, 6, 10, 11, 16, 26 and 46**

**United States Patent and Trademark Office**

**Reg. No. 3,453,990**

**Registered June 24, 2008**

**TRADEMARK  
PRINCIPAL REGISTER**

**PREGEN**

FOR.TEX - S.R.L. (ITALY LTD LIAB CO)  
VIA AUGUADRI, 22  
I-22100 COMO  
ITALY

FOR: CHEMICAL AGENTS FOR IMPREGNATING, BINDING OR COATING OF TEXTILES, FURS AND LEATHER, NON-WOVENS AND FABRICS; CHEMICALS USED IN THE MANUFACTURE OF FABRIC OR TEXTILES; CHEMICALS FOR INDUSTRIAL PURPOSES, IN CLASS 1 (U.S. CLS. 1, 5, 6, 10, 26 AND 46).

FOR: COLORANTS, NAMELY, CHEMICAL COMPOUNDS FOR THE PRE-TREATMENT OF FABRICS BEFORE DIGITAL PRINTING THEREON; COLOR-

ANTS FOR USE IN THE MANUFACTURE OF PRINTING INK, IN CLASS 2 (U.S. CLS. 6, 11 AND 16).

THE MARK CONSISTS OF STANDARD CHARACTERS WITHOUT CLAIM TO ANY PARTICULAR FONT, STYLE, SIZE, OR COLOR.

PRIORITY DATE OF 1-29-2007 IS CLAIMED.

OWNER OF INTERNATIONAL REGISTRATION 0921998 DATED 3-9-2007, EXPIRES 3-9-2017.

SER. NO. 79-037,691, FILED 3-9-2007.

PAM WILLIS, EXAMINING ATTORNEY

**Int. Cl.: 41**

**Prior U.S. Cls.: 100, 101 and 107**

**Reg. No. 3,453,991**

**United States Patent and Trademark Office**

**Registered June 24, 2008**

**SERVICE MARK  
PRINCIPAL REGISTER**

# ACTING ANTICS

STRATHISLA INVESTMENTS PTY LTD (AUSTRALIA LTD LIAB CO)  
LEVEL 1  
SUITE 3; 67 INKERMAN STREET  
ST KILDA, VIC 3182, AUSTRALIA

FOR: EDUCATION SERVICES, NAMELY, CLASSES, SEMINARS, SYMPOSIUMS AND WORKSHOPS IN THE FIELD OF THEATER PRODUCTIONS; ENTERTAINMENT SERVICES IN THE FIELD OF THEATER PRODUCTIONS; CULTURAL ACTIVITIES IN THE FIELD OF THEATER PRODUCTIONS; ARRANGING AND CONDUCTING CONFERENCES, SEMINARS, SYMPOSIUMS, WORKSHOPS AND MEETINGS; PUBLICATION OF BOOKS; ORGANIZATION OF EDUCATIONAL COMPETITIONS; PRACTICAL TRAINING OF CHILDREN AND ADULTS IN THEATRICAL AND ARTISTIC DISCIPLINES; ORGANIZING EXHIBITIONS FOR CULTURAL AND EDUCATION PURPOSES, NAMELY, TO PROMOTE THE THEATRICAL, ACTING, AND PERFORMING ARTS DISCIPLINES; VOCATIONAL ADVICE; INSTRUCTION, DEMONSTRATION AND PRACTICAL ADVICE SERVICES RELATING TO PERFORMANCES, DANCE, PHYSICAL EDUCATION, ACTING, SINGING, PAINTING AND ARTISTIC WORKS; PRESENTATION OF LIVE THEATRICAL AND MUSICAL PERFORMANCES; IMPRESARIO SERVICES BEING THE ORGANIZA-

TION OF THEATRICAL AND MUSICAL SHOWS; DEMONSTRATION OF ACTING TECHNIQUES; PRODUCTION OF THEATRICAL AND MUSICAL SHOWS; PROVIDING ON-LINE ELECTRONIC PUBLICATIONS IN THE FORM OF ONLINE ARTICLES AND NEWSLETTERS IN THE EDUCATION AND ENTERTAINMENT FIELDS, IN CLASS 41 (U.S. CLS. 100, 101 AND 107).

THE MARK CONSISTS OF STANDARD CHARACTERS WITHOUT CLAIM TO ANY PARTICULAR FONT, STYLE, SIZE, OR COLOR.

PRIORITY DATE OF 10-2-2006 IS CLAIMED.

OWNER OF INTERNATIONAL REGISTRATION 0922095 DATED 3-30-2007, EXPIRES 3-30-2017.

NO CLAIM IS MADE TO THE EXCLUSIVE RIGHT TO USE "ACTING", APART FROM THE MARK AS SHOWN.

SER. NO. 79-037,740, FILED 3-30-2007.

MARK PILARO, EXAMINING ATTORNEY

Int. Cls.: 3, 9, 16, 18, 20, 24, 25 and 26

Prior U.S. Cls.: 1, 2, 3, 4, 5, 6, 13, 21, 22, 23, 25, 26, 29, 32, 36, 37, 38, 39, 40, 41, 42, 50, 51 and 52

Reg. No. 3,453,992

United States Patent and Trademark Office

Registered June 24, 2008

TRADEMARK  
PRINCIPAL REGISTER

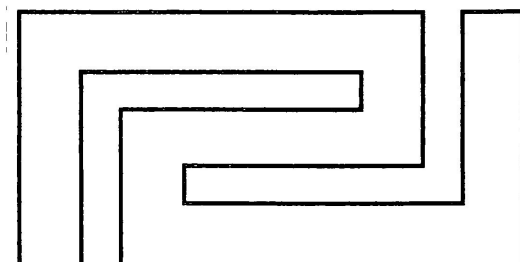

GIANNI VERSACE S.P.A. (ITALY CORPORATION)  
VIA A. MANZONI, 38  
I-20121 MILANO  
ITALY

FOR: COSMETICS, INCLUDING NIGHT AND DAY CREAMS, CLEANING PREPARATIONS FOR THE CARE OF THE FACE AND BODY, BATH FOAM, SHAVING FOAM, AFTER SHAVES, FOUNDATION MAKEUP, NAIL POLISH, DEODORANTS FOR MEN AND WOMEN, HAND AND BODY SOAPS, HAIR SHampoos AND RINSES, HAIR SPRAY, TOOTHPASTE AND FRAGRANCES, NAMELY, PERFUME, TOILET WATER AND ESSENTIAL OILS FOR PERSONAL USE FOR MEN AND WOMEN, IN CLASS 3 (U.S. CLS. 1, 4, 6, 50, 51 AND 52).

FOR: OPTICAL INSTRUMENTS, APPARATUS AND EQUIPMENT, NAMELY, GLASSES, SUNGLASSES, SPECTACLES, SPECTACLE FRAMES, MONOCLES, LORGNETTES, ACCESSORIES IN THE NATURE OF EYEGGLASS CHAINS, AND CASES FOR GLASSES, SUNGLASSES, SPECTACLES, MONOCLES, AND LORGNETTES, IN CLASS 9 (U.S. CLS. 21, 23, 26, 36 AND 38).

FOR: STATIONERY ARTICLES, NAMELY, PAPER, LETTER PAPER, LOOSE-LEAF PAPER, EXERCISE BOOKS, ADDRESS BOOKS AND NOTEBOOKS, REINFORCED STATIONERY TABS THAT ARE MARKED BY NUMBER OR ALPHABETICAL LETTER, ENVELOPES, GREETING CARDS, PHOTOGRAPH ALBUMS; WRITING AND MARKING INSTRUMENTS, NAMELY, PENS, FELT-TIPPED PENS, MARKING PENS, PENCILS AND PENCIL LEADS, INK REFILLS FOR PENS, ERASERS; PRINTING TYPE; PRINTED MATTER,

NAMELY, PERIODICAL MAGAZINES, BOOKS, AND LEAFLETS IN THE FIELD OF FASHION, INTERIOR DESIGN, COSMETICS, OPTICAL WEAR AND FASHION ACCESSORIES, IN CLASS 16 (U.S. CLS. 2, 5, 22, 23, 29, 37, 38 AND 50).

FOR: LEATHER AND IMITATION LEATHER GOODS, NAMELY, HANDBAGS, WALLETS, LUGGAGE, ATTACHÉ CASES, TOTE BAGS, BRIEFCASES, SPORT BAGS, TRAVELING TRUNKS, CARRY-ON BAGS, SHOULDER BAGS, GARMENT BAGS FOR TRAVELING, KEY CASES, UMBRELLAS, PARASOLS, WALKING STICKS, WHIPS, HARNESSES, SADDLERY, IN CLASS 18 (U.S. CLS. 1, 2, 3, 22 AND 41).

FOR: FURNITURE; MIRRORS, NAMELY, LOOKING GLASSES; PICTURE FRAMES; CHAIRS; CUPBOARDS; CUSHIONS; DESKS; DIVANS; PLASTIC AND WOOD DOORKNOBS; FIGURES OF BONE, IVORY, PLASTER, PLASTIC, WAX AND WOOD; PLASTIC AND WOOD FURNITURE HANDLES FOR DOORS; MAGAZINE RACKS; OFFICE FURNITURE; PILLOWS; PARTS AND FITTINGS FOR THE AFORESAID FURNITURE GOODS, NAMELY, FITTED FURNITURE COVERS NOT OF PAPER, IN CLASS 20 (U.S. CLS. 2, 13, 22, 25, 32 AND 50).

FOR: FABRIC FOR TEXTILE USE, FABRIC OF IMITATION ANIMAL SKINS, FABRIC FOR BOOTS AND SHOES, BATH LINEN; BED LINEN; BED BLANKETS; CURTAINS; UNFITTED FABRIC FURNITURE COVERS; HANDKERCHIEFS; KITCHEN TOWELS, IN CLASS 24 (U.S. CLS. 42 AND 50).

FOR: CLOTHING FOR MEN, WOMEN AND CHILDREN, NAMELY, BELTS, COATS, RAINCOATS, WAISTCOATS, BLOUSES AND PULL-OVERS, JACKETS, TROUSERS, SKIRTS, DRESSES,

SUITS, SHIRTS AND CHEMISES, T-SHIRTS, SWEATERS, UNDERWEAR, SOCKS AND STOCKINGS, GLOVES, TIES, SCARVES, HATS AND CAPS, BOOTS, SHOES AND SLIPPERS, IN CLASS 25 (U.S. CLS. 22 AND 39).

FOR: LACE AND EMBROIDERY, RIBBONS AND BRAID; CLOTHING BUTTONS, HOOKS AND EYES, SAFETY PINS AND NEEDLES; ARTIFICIAL FLOWERS, IN CLASS 26 (U.S. CLS. 37, 39, 40, 42 AND 50).

PRIORITY DATE OF 7-25-2006 IS CLAIMED.

OWNER OF INTERNATIONAL REGISTRATION  
0922170 DATED 10-10-2006, EXPIRES 10-10-2016.

SER. NO. 79-037,766, FILED 10-10-2006.

SHAILA SETTLES, EXAMINING ATTORNEY



**Int. Cls.: 16, 25, 28, 35 and 41**

**Prior U.S. Cls.: 2, 5, 22, 23, 29, 37, 38, 39, 50, 100, 101,  
102 and 107**

**Reg. No. 3,453,993**

**United States Patent and Trademark Office**

**Registered June 24, 2008**

---

**TRADEMARK  
SERVICE MARK  
PRINCIPAL REGISTER**

**LES ANIMAUX AMOUREUX**

MC4 (FRANCE SARL)  
2, RUE DU ROULE  
F-75001 PARIS  
FRANCE

FOR: PAPER; PHOTOGRAPHS, POSTERS, CALENDARS, GRAPHIC PRINTS; GLUES FOR STATIONERY AND HOUSEHOLD PURPOSES, IN CLASS 16 (U.S. CLS. 2, 5, 22, 23, 29, 37, 38 AND 50).

FOR: FOOTWEAR, BEACH FOOTWEAR; HOSIERY, IN CLASS 25 (U.S. CLS. 22 AND 39).

FOR: DECORATIONS FOR CHRISTMAS TREES EXCEPT LIGHTING ARTICLES, IN CLASS 28 (U.S. CLS. 22, 23, 38 AND 50).

FOR: ADVERTISING, OFFICE FUNCTIONS, IN CLASS 35 (U.S. CLS. 100, 101 AND 102).

FOR: VIDEOTAPE FILM PRODUCTION; ELECTRONIC PUBLISHING OF BOOKS AND PERIODICALS ON LINE, IN CLASS 41 (U.S. CLS. 100, 101 AND 107).

THE MARK CONSISTS OF STANDARD CHARACTERS WITHOUT CLAIM TO ANY PARTICULAR FONT, STYLE, SIZE, OR COLOR.

OWNER OF INTERNATIONAL REGISTRATION 0922171 DATED 10-16-2006, EXPIRES 10-16-2016.

THE ENGLISH TRANSLATION OF THE FOREIGN WORD(S) IN THE MARK IS ANIMALS IN LOVE.

SER. NO. 79-037,767, FILED 10-16-2006.

CHARISMA HAMPTON, EXAMINING ATTORNEY

**Int. Cl.: 21**

**Prior U.S. Cls.: 2, 13, 23, 29, 30, 33, 40 and 50**

**United States Patent and Trademark Office**

**Reg. No. 3,453,994**

**Registered June 24, 2008**

**TRADEMARK  
PRINCIPAL REGISTER**

# WineX

WINEX PTY LTD (AUSTRALIA CORPORATION)  
3/5 LEEWAY COURT  
OSBORNE PARK WA 6017  
AUSTRALIA

FOR: BAR AND WINE ACCESSORIES, NAMELY, WINE BOTTLE CRADLES, COCKTAIL SHAKERS, HIP FLASKS, WINE COOLING PAILS, ICE BUCKETS, WINE BUCKETS, DRYING RACKS FOR BEVERAGeware, WINE BOTTLE OPENERS, GLASS STOPPERS, CANDLESTICKS, CORKSCREWS, CHAMPAGNE BUCKETS, SELTZER BOTTLES, CLEANING BRUSHES FOR BEVERAGeware, WINE POURERS, VACUUM PUMPS FOR WINE BOTTLES, WINE COOLING PAILS, PLASTIC HOLDER FOR BEVERAGE CONTAINER TO BE AFFIXED TO WALLS, WINE STRAINERS, POLISHING CLOTHS, PORTABLE BEVERAGE COOLERS, BEER JUGS, BEVERAGE GLASSWARE, BEVERAGE STIRRERS, BOTTLE STANDS, BUCKETS, BUTLERS'

TRAYS, CLEANING CLOTHS, CLEANING SPONGES, DRINKING VESSELS, COCKTAIL PICKS, COOLERS FOR WINE, COOLING BUCKETS FOR WINE; GLASSWARE, NAMELY, DECANTERS, WINE GLASSES, SHOT GLASSES, BEER MUGS, DRINKING GLASSES, IN CLASS 21 (U.S. CLS. 2, 13, 23, 29, 30, 33, 40 AND 50).

THE MARK CONSISTS OF STANDARD CHARACTERS WITHOUT CLAIM TO ANY PARTICULAR FONT, STYLE, SIZE, OR COLOR.

OWNER OF INTERNATIONAL REGISTRATION  
0922174 DATED 1-22-2007, EXPIRES 1-22-2017.

SER. NO. 79-037,768, FILED 1-22-2007.

SHANNON TWOHIG, EXAMINING ATTORNEY

Int. Cl.: 21

Prior U.S. Cls.: 2, 13, 23, 29, 30, 33, 40 and 50

United States Patent and Trademark Office

Reg. No. 3,453,995

Registered June 24, 2008

TRADEMARK  
PRINCIPAL REGISTER

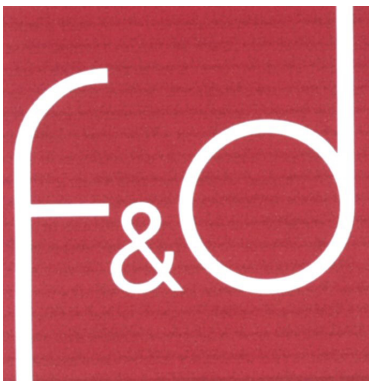

PASABAHCE CAM SANAYI VE TICARET ANONIM SIRKETI (TURKEY JOINT STOCK COMPANY)

IS KULELERI, KULE 3  
TR-34330 4. LEVENT  
ISTANBUL, TURKEY

FOR: BEVERAGE GLASSWARE; STEM BEVERAGE GLASSWARE; DRINKING GLASSES; MUGS, CUPS; COFFEE SERVICES; CAKE SERVICES, NAMELY, CAKE SERVERS; PLATES, SAUCERS, DISHES; TEA SERVICES; TEA GLASS SAUCERS; EPERGNES; BASINS, BOWL SETS, BOWLS, SAUCE BOWLS, SUGAR BOWLS, FRUIT BOWLS, ICE CREAM BOWLS; EGG CUPS; BOXES FOR KITCHEN AND HOUSEHOLD USE, NAMELY, GLASS BOXES, RECIPE BOXES, SANDWICH BOXES, BREAD BOXES, BOXES FOR SWEETMEAT, CANDY BOXES; CONTAINERS FOR HOUSEHOLD OR KITCHEN USE; CONTAINER SETS FOR HOUSEHOLD AND KITCHEN USE; SALT AND PEPPER SHAKERS; CRUETS; TRAYS FOR DOMESTIC PURPOSES; JARS, NAMELY, COOKIE JARS, GLASS JARS, PRESERVING JARS OF GLASS, LIDS, NAMELY, POT LIDS AND INSULATED LIDS FOR PLATES AND DISHES, COVERS, NAMELY, DISH COVER, CHEESE COVER, STOVE BURNER COVERS; GRILL COVER, POT LIDS; DECANTERS; STEW PANS, EARTHENWARE, NAMELY, EARTHENWARE MUGS, EARTHENWARE BASINS, EARTHENWARE

POTS; SAUCEPANS, COOKING POT SETS, COOKING POTS, PANS, CROCKERY, NAMELY, CUPS AND BOWLS; COOKERY MOLDS, CAKE AND BREAD MOLDS; POTS, KETTLES, TEA POTS; FLASKS, JUGS, BOTTLES SOLD EMPTY; LAMP GLASS BRUSHES; ICE BUCKETS; PORCELAIN WARE, NAMELY, MUGS AND BOWLS; DINNERWARE, NAMELY, PLATES, SAUCERS, DISHES, CUPS; BUTTER DISHES, BUTTER DISH COVERS; URNS, VASES; CANDLESTICKS, CANDLE RINGS, IN CLASS 21 (U.S. CLS. 2, 13, 23, 29, 30, 33, 40 AND 50).

PRIORITY DATE OF 12-7-2006 IS CLAIMED.

OWNER OF INTERNATIONAL REGISTRATION  
0922249 DATED 4-2-2007, EXPIRES 4-2-2017.

THE COLOR(S) RED AND WHITE IS/ARE CLAIMED AS A FEATURE OF THE MARK.

THE COLOR WHITE APPEARS IN THE WORDING "F&D" AGAINST A RED BACKGROUND.

SER. NO. 79-037,794, FILED 4-2-2007.

DAVID I, EXAMINING ATTORNEY

**Int. Cl.: 7**

**Prior U.S. Cls.: 13, 19, 21, 23, 31, 34 and 35**

**United States Patent and Trademark Office**

**Reg. No. 3,453,996**

**Registered June 24, 2008**

**TRADEMARK  
PRINCIPAL REGISTER**

**TWINTECH**

COVAL (FRANCE SOCIÉTÉ PAR ACTIONS SIM-  
PLIFIÉE)  
Z.A. DES PETITS CHAMPS  
F-26120 MONTELIER  
FRANCE

FOR: VACUUM GRIPPER AND VACUUM-  
BASED SUCTION CUP MANIPULATOR COM-  
PRISED OF SUCTION CUPS, VACUUM CONTROLS,  
PRESSURE REGULATORS, VACUUM SWITCHES  
AND VACUUM GENERATORS FOR USE IN  
TRANSPORTING, LIFTING AND HANDLING  
GOODS AND LOADS, IN CLASS 7 (U.S. CLS. 13, 19,  
21, 23, 31, 34 AND 35).

PRIORITY DATE OF 10-3-2006 IS CLAIMED.

OWNER OF INTERNATIONAL REGISTRATION  
0922271 DATED 4-3-2007, EXPIRES 4-3-2017.

SER. NO. 79-037,800, FILED 4-3-2007.

MARLENE BELL, EXAMINING ATTORNEY

**Int. Cl.: 36**

**Prior U.S. Cls.: 100, 101 and 102**

**United States Patent and Trademark Office**

**Reg. No. 3,453,997**

**Registered June 24, 2008**

**SERVICE MARK  
PRINCIPAL REGISTER**

**LEONARDO**

LEONARDO & CO. S.P.A.  
VIA BROLETTO, 46  
MILANO  
ITALY

PRIORITY DATE OF 12-12-2006 IS CLAIMED.

FOR: BANKING SERVICES; FINANCING SERVICES; CAPITAL INVESTMENT CONSULTATION; CREDIT AND FINANCIAL CONSULTATION; FINANCIAL ANALYSIS AND CONSULTATION; ONLINE BANKING SERVICES; PROVIDING FINANCIAL CONSULTATION AND INFORMATION; ISSUING CREDIT AND DEBIT CARDS, IN CLASS 36 (U.S. CLS. 100, 101 AND 102).

OWNER OF INTERNATIONAL REGISTRATION  
0922382 DATED 3-27-2007, EXPIRES 3-27-2017.

SER. NO. 79-037,837, FILED 3-27-2007.

INGA ERVIN, EXAMINING ATTORNEY

**Int. Cl.: 33**

**Prior U.S. Cls.: 47 and 49**

**United States Patent and Trademark Office**

**Reg. No. 3,453,998**

**Registered June 24, 2008**

**TRADEMARK  
PRINCIPAL REGISTER**

**STONELEIGH**

PERNOD RICARD NEW ZEALAND LIMITED  
(NEW ZEALAND COMPANY)  
171 PILKINGTON ROAD  
GLEN INNES  
AUCKLAND, NEW ZEALAND

OWNER OF INTERNATIONAL REGISTRATION  
0922685 DATED 4-13-2007, EXPIRES 4-13-2017.

FOR: WINES, IN CLASS 33 (U.S. CLS. 47 AND 49).

OWNER OF U.S. REG. NO. 2,554,683.

THE MARK CONSISTS OF STANDARD CHAR-  
ACTERS WITHOUT CLAIM TO ANY PARTICULAR  
FONT, STYLE, SIZE, OR COLOR.

SER. NO. 79-037,957, FILED 4-13-2007.

TANYA AMOS, EXAMINING ATTORNEY

**Int. Cls.: 7 and 8**

**Prior U.S. Cls.: 13, 19, 21, 23, 28, 31, 34, 35 and 44**

**United States Patent and Trademark Office**

**Reg. No. 3,453,999**

**Registered June 24, 2008**

**TRADEMARK  
PRINCIPAL REGISTER**

# **BEARGRIP**

BEARGRIP GEREEDSCHAPPENFABRIEK B.V.  
(NETHERLANDS LTD LIAB CO)  
VOOR DE BLANKEN 7  
NL-7963 ZG RUIJNEN  
NETHERLANDS

FOR: MACHINE TOOLS, NAMELY, BROACHES, CHASERS, GEAR CUTTERS, MILLING CUTTERS, DIES, HONES, LATHES, ELECTRIC PLANERS, AND GRINDERS, IN CLASS 7 (U.S. CLS. 13, 19, 21, 23, 31, 34 AND 35).

FOR: SOCKET WRENCHES, OPEN-END WRENCHES, HOLLOW WRENCHES, BOX WRENCHES, NUT WRENCHES, PINNERS, HAMMERS, TOOLS FOR ENGRAVING, NAMELY, CHISELS, SCALPES AND BURINS, AND SCISSORS, SCREWDRIVERS, BENDING PLIERS, CUTTING PLIERS, GIMLETS AND MANUAL DRILLS, AND HAND TOOLS,

NAMELY, AUGERS, AWLS, BOLT CUTTERS, CLAMPS, CRIMPING IRONS, DIES, FILES, HAND JACKS, HEXAGONAL KEY WRENCHES, BALL-ENDED HEXAGONAL KEY WRENCHES, BITS FOR HAND DRILLS, MAULS, NUT DRIVERS, PICKS, PLANES, PUNCHES, RIVETING PLIERS, SAWS, SCRAPERS, TORQUE KEY WRENCHES; THREADED INSERT PLIERS, VICES CHISELS, WIRE CUTTERS, AND WIRE STRIPPERS, IN CLASS 8 (U.S. CLS. 23, 28 AND 44).

OWNER OF INTERNATIONAL REGISTRATION  
0244020 DATED 6-6-1961, EXPIRES 6-6-2011.

SER. NO. 79-037,961, FILED 2-8-2007.

ADA HAN, EXAMINING ATTORNEY

**Int. Cls.: 3, 9, 14, 18 and 25**

**Prior U.S. Cls.: 1, 2, 3, 4, 6, 21, 22, 23, 26, 27, 28, 36,  
38, 39, 41, 50, 51 and 52**

**Reg. No. 3,454,000**

**United States Patent and Trademark Office**

**Registered June 24, 2008**

**TRADEMARK  
PRINCIPAL REGISTER**

# Paul Benz

M.G. DEMAND HOLDING AG (SWITZERLAND AG)  
SEIDENHOFSTRASSE 2  
CH-6002 LUZERN  
SWITZERLAND

FOR: PERFUMERY, COSMETICS, IN CLASS 3 (U.S. CLS. 1, 4, 6, 50, 51 AND 52).

FOR: EYE GLASSES, ESPECIALLY SUNGLASSES; SPECTACLE CASES, IN CLASS 9 (U.S. CLS. 21, 23, 26, 36 AND 38).

FOR: JEWELRY, HOROLOGICAL AND CHRONOMETRIC INSTRUMENTS, IN CLASS 14 (U.S. CLS. 2, 27, 28 AND 50).

FOR: PURSES, BAGS, NAMELY, BUSINESS BAGS IN THE NATURE OF ATTACHÉ CASES AND BRIEF CASES; FASHION BAGS, NAMELY, CHAIN MESH PURSES AND CLUTCH BAGS; BEACH BAGS, BAGS FOR CAMPERS, NAMELY, HIKING BAGS; SHOPPING BAGS, TRAVELING BAGS, SCHOOL BAGS, BAGS FOR SPORTS, WHEELED SHOPPING BAGS, ALL-PURPOSE ATHLETIC BAGS, GOODS MADE OF LEATHER AND IMITATIONS OF LEATHER, NAMELY, LEATHER BOOK BAGS, LEATHER PURSES, LEATHER WALLETS, KEY-CASES, TRUNKS AND TRAVELING BAGS, UMBRELLAS AND PARASOLS, IN CLASS 18 (U.S. CLS. 1, 2, 3, 22 AND 41).

FOR: CLOTHING, NAMELY, BUSINESS SHIRTS, SHIRTS, T-SHIRTS, SWEATSHIRTS, JOGGING SUITS, TROUSERS, JEANS, PANTS, SHORTS, TANK TOPS, RAINWEAR, CLOTH BIBS, SKIRTS, BLOUSES, DRESSES, SUSPENDERS, SWEATERS, JACKETS, COATS, RAINCOATS, SNOW SUITS, TIES, ROBES, BELTS, SCARVES, SLEEP WEAR, PAJAMAS, LINGERIE, UNDERWEAR, SOCKS; FOOTWEAR; HEADGEAR, NAMELY, HATS, CAPS AND VISORS, IN CLASS 25 (U.S. CLS. 22 AND 39).

THE MARK CONSISTS OF STANDARD CHARACTERS WITHOUT CLAIM TO ANY PARTICULAR FONT, STYLE, SIZE, OR COLOR.

PRIORITY DATE OF 8-16-2006 IS CLAIMED.

OWNER OF INTERNATIONAL REGISTRATION 0922746 DATED 2-16-2007, EXPIRES 2-16-2017.

OWNER OF U.S. REG. NO. 2,697,628.

"THE NAME(S), PORTRAIT(S), AND/OR SIGNATURE(S) SHOWN IN THE MARK IDENTIFIES PAUL BENZ, WHOSE CONSENT(S) TO REGISTER IS SUBMITTED."

SER. NO. 79-037,980, FILED 2-16-2007.

RON FAIRBANKS, EXAMINING ATTORNEY



**Int. Cls.: 3, 4 and 25**

**Prior U.S. Cls.: 1, 4, 6, 15, 22, 39, 50, 51 and 52**

**Reg. No. 3,454,001**

**United States Patent and Trademark Office**

**Registered June 24, 2008**

**TRADEMARK  
PRINCIPAL REGISTER**

**nature is our science**

EUROWELLNESS GMBH (FED REP GERMANY  
LIMITED COMPANY)  
PLANGE MÜHLE 2  
40221 DÜSSELDORF  
FED REP GERMANY

FOR: SOAPS; PERFUMERY, ESSENTIAL OILS,  
BODY CARE AND BEAUTY CARE PRODUCTS,  
HAIR TONIC, AROMATHERAPY OILS; DENTI-  
FRICE, IN CLASS 3 (U.S. CLS. 1, 4, 6, 50, 51 AND 52).

FOR: FUEL, AROMATIC FUEL, CANDLES AND  
WICKS FOR ILLUMINATING PURPOSES, AROMA-  
THERAPY CANDLES, IN CLASS 4 (U.S. CLS. 1, 6  
AND 15).

FOR: CLOTHING, NAMELY, PANTS, SHORTS,  
SHIRTS, JACKETS, SUITS, COATS, DRESSES,  
SKIRTS, BLOUSES, TIES, UNDERWEAR, SWIM  
WEAR, SLEEPWEAR, SOCKS, STOCKINGS, SPORT  
SHIRTS, SPORT JACKETS, SPORT COATS, SPORT  
DRESSES, SPORT CAPS, SKI SUITES, SKI TROU-

SERS, SKI CAPS, PLUS-FOURS, JOGGING DRES-  
SES, SPORT TRACK SUITS, GYMNASTIC DRESSES,  
SPORT SHORTS, GOLF SHIRTS, TRAINING UNI-  
FORMS, SHOES, HEALTH SHOES, SPORT SHOES  
AND SANDALS, IN CLASS 25 (U.S. CLS. 22 AND 39).

THE MARK CONSISTS OF STANDARD CHAR-  
ACTERS WITHOUT CLAIM TO ANY PARTICULAR  
FONT, STYLE, SIZE, OR COLOR.

PRIORITY DATE OF 8-21-2006 IS CLAIMED.

OWNER OF INTERNATIONAL REGISTRATION  
0922877 DATED 2-20-2007, EXPIRES 2-20-2017.

SER. NO. 79-038,036, FILED 2-20-2007.

RONALD AIKENS, EXAMINING ATTORNEY

Int. Cl.: 17

Prior U.S. Cls.: 1, 5, 12, 13, 35 and 50

United States Patent and Trademark Office

Reg. No. 3,454,002

Registered June 24, 2008

TRADEMARK  
PRINCIPAL REGISTER

CELLSEAL

NOK CORPORATION (JAPAN CORPORATION)  
12-15, SHIBADAIMON 1-CHOME  
MINATO-KU  
TOKYO 105-8585, JAPAN

FOR: NON-METAL GASKETS FOR MOTOR VEHICLES, GENERAL INDUSTRIAL MACHINES, ELECTRONIC AND ELECTRIC MACHINES AND INSTRUMENTS FOR USE IN GENERAL, HOUSEHOLD AND PERSONAL DIGITAL ASSISTANCE; PACKING MATERIAL FOR FORMING SEALS; OIL SEALS FOR MOTOR VEHICLES, GENERAL INDUSTRIAL MACHINES, ELECTRONIC AND ELECTRIC MACHINES AND INSTRUMENTS FOR USE IN GENERAL, HOUSEHOLD AND PERSONAL DIGITAL ASSISTANCE; NON-METAL O-RINGS FOR MOTOR VEHICLES, GENERAL INDUSTRIAL MA-

CHINES, ELECTRONIC AND ELECTRIC MACHINES AND INSTRUMENTS FOR USE IN GENERAL, HOUSEHOLD AND PERSONAL DIGITAL ASSISTANCE, IN CLASS 17 (U.S. CLS. 1, 5, 12, 13, 35 AND 50).

PRIORITY DATE OF 2-22-2007 IS CLAIMED.

OWNER OF INTERNATIONAL REGISTRATION  
0922878 DATED 3-22-2007, EXPIRES 3-22-2017.

SER. NO. 79-038,037, FILED 3-22-2007.

LAURIE KAUFMAN, EXAMINING ATTORNEY

**Int. Cls.: 4 and 21**

**Prior U.S. Cls.: 1, 2, 6, 13, 15, 23, 29, 30, 33, 40 and 50**

**United States Patent and Trademark Office**

**Reg. No. 3,454,003**

**Registered June 24, 2008**

**TRADEMARK  
PRINCIPAL REGISTER**

隆胜

**LONGSHENG**

ZHEJIANG XIANJU LONGSHENG; CRAFTS DEVELOPMENT CO., LTD (CHINA CORPORATION)

ZHONGQIAOTOU, XIAYUAN  
CHENGGUAN TOWN, XIANJU COUNTY; 317300  
ZHEJIANG PROVINCE

CHINA AND  
ZHEJIANG LONGSHENG; SPECIAL CRAFTS CO.,  
LTD (CHINA CORPORATION)

ZHONGQIAOTOU, XIAYUAN  
CHENGGUAN TOWN, XIANJU COUNTY; 317300  
ZHEJIANG PROVINCE

CHINA

FOR: CHRISTMAS TREE CANDLES, CANDLES, CERESINE, NAMELY, OZOCERITE, INDUSTRIAL WAX; WAXES; ILLUMINATING WAX; WICKS FOR CANDLES; CARNAUBA WAX; PARAFFIN; TAPERS, IN CLASS 4 (U.S. CLS. 1, 6 AND 15).

FOR: CHINA ORNAMENTS; WORKS OF ART, OF PORCELAIN, TERRA COTTA OR GLASS; POTTERY, NAMELY, VASES, CUPS AND BOWLS; PORCELAIN WARE, NAMELY, PLATES, BOWLS, KETTLES, CUPS AND BOTTLES; GLASS RECEPTACLES, NAMELY, DRINKING GLASSES, CUPS,

GLASS BOWLS AND SALAD BOWLS; CANDLESTICKS, NOT OF PRECIOUS METAL; NON-ELECTRIC CANDELABRA, NOT OF PRECIOUS METAL; CANDLE EXTINGUISHERS, NOT OF PRECIOUS METAL; CRYSTAL GLASSWARE; CANDLE RINGS, NOT OF PRECIOUS METAL, IN CLASS 21 (U.S. CLS. 2, 13, 23, 29, 30, 33, 40 AND 50).

OWNER OF INTERNATIONAL REGISTRATION  
0923165 DATED 4-16-2007, EXPIRES 4-16-2017.

THE ENGLISH TRANSLATION OF THE FOREIGN WORD(S) IN THE MARK IS: THE FIRST CHARACTER "LONG" MEANS GRAND; THE SECOND CHARACTER "SHENG" MEANS VICTORY.

THE TRANSLITERATION OF THE NON-LATIN CHARACTERS IN THE MARK IS "LONGSHENG".

SER. NO. 79-038,145, FILED 4-16-2007.

ALICE BENMAMAN, EXAMINING ATTORNEY

Int. Cl.: 11

Prior U.S. Cls.: 13, 21, 23, 31 and 34

United States Patent and Trademark Office

Reg. No. 3,454,004

Registered June 24, 2008

TRADEMARK  
PRINCIPAL REGISTER

CO 畅欧

CHAO'AN COUNTY ZHIRU; BUILDING CERAMICS CO., LIMITED; (CHAO'AN XIAN ZHIRU JIANZHU; TAOCHI YOUXIANGONGSI) (CHINA CORPORATION)

FUZHONG INDUSTRIAL ZONE, GUXIANG CHAO'AN COUNTY, GUANGDONG; (FUZHONG GONGYEOU, GUXIANG,; CHAO'AN XIAN, GUANGDONG)  
CHINA

FOR: BATH TUBS FOR SITZ BATHS; BIDETS; TOILET BOWLS; TOILET LIDS; SINKS; BATH INSTALLATIONS, NAMELY, BATHTUBS AND SHOWERS; WASH-HAND BOWLS BEING PARTS OF SANITARY INSTALLATIONS; TOILET SEATS; FLUSHING APPARATUS, NAMELY, FLUSHING LEVER; URINALS, IN CLASS 11 (U.S. CLS. 13, 21, 23, 31 AND 34).

OWNER OF INTERNATIONAL REGISTRATION 0923337 DATED 4-10-2007, EXPIRES 4-10-2017.

THE ENGLISH TRANSLATION OF THE FOREIGN WORD(S) IN THE MARK IS: "CO" CONSISTS OF THE LETTERS C AND O, NO SPECIAL MEANING; "CHANG" MEANS "NO OBSTACLE"; "OU" MEANS "EUROPE".

THE TANSLITERATION OF THE NON-LATIN CHARACTERS IN THE MARK IS: CHANG'OU.

SER. NO. 79-038,200, FILED 4-10-2007.

KIMBERLY FRYE, EXAMINING ATTORNEY

**Int. Cls.: 35 and 41**

**Prior U.S. Cls.: 100, 101, 102 and 107**

**United States Patent and Trademark Office**

**Reg. No. 3,454,005**

**Registered June 24, 2008**

**SERVICE MARK  
PRINCIPAL REGISTER**

**RON ORP**

RON ORP GMBH (SWITZERLAND SOCIÉTÉ À  
RÉSPONSABILITÉ LIMITÉE (GMBH))  
LIMMATSTRASSE 291  
CH-8005 ZÜRICH, SWITZERLAND

FOR: ADVERTISING SERVICES, NAMELY, PROMOTING THE GOODS AND SERVICES OF OTHERS THROUGH PRINT AND ON-LINE MEDIUM, IN CLASS 35 (U.S. CLS. 100, 101 AND 102).

FOR: PROVIDING NEWSLETTERS IN THE FIELD OF ENTERTAINMENT, NAMELY, ARTS, SPORTS AND LEISURE, VIA E-MAIL, IN CLASS 41 (U.S. CLS. 100, 101 AND 107).

THE MARK CONSISTS OF STANDARD CHARACTERS WITHOUT CLAIM TO ANY PARTICULAR FONT, STYLE, SIZE, OR COLOR.

OWNER OF INTERNATIONAL REGISTRATION  
0923438 DATED 3-27-2007, EXPIRES 3-27-2017.

THE NAME "RON ORP" DOES NOT IDENTIFY A LIVING INDIVIDUAL.

SER. NO. 79-038,227, FILED 3-27-2007.

LINDA ORNDORFF, EXAMINING ATTORNEY

**Int. Cl.: 36**

**Prior U.S. Cls.: 100, 101 and 102**

**United States Patent and Trademark Office**

**Reg. No. 3,454,006**

**Registered June 24, 2008**

**SERVICE MARK  
PRINCIPAL REGISTER**

**GOLDENPEAKS  
CAPITAL**

---

GOLDENPEAKS CAPITAL PARTNERS AG  
(SWITZERLAND AKTIENGESELLSCHAFT)  
BAARERSTRASSE 135  
CH-6300 ZUG  
SWITZERLAND

FOR: INTERNATIONAL FINANCIAL SERVICES,  
NAMELY, CAPITAL INVESTMENT CONSULTA-  
TION, CAPITAL INVESTMENT SERVICES, IN  
CLASS 36 (U.S. CLS. 100, 101 AND 102).

PRIORITY DATE OF 2-8-2007 IS CLAIMED.

OWNER OF INTERNATIONAL REGISTRATION  
0923481 DATED 4-5-2007, EXPIRES 4-5-2017.

NO CLAIM IS MADE TO THE EXCLUSIVE  
RIGHT TO USE "CAPITAL", APART FROM THE  
MARK AS SHOWN.

SER. NO. 79-038,245, FILED 4-5-2007.

ELI HELLMAN, EXAMINING ATTORNEY

**Int. Cls.: 19, 31 and 40**

**Prior U.S. Cls.: 1, 12, 33, 46, 50, 100, 103 and 106**

**United States Patent and Trademark Office**

**Reg. No. 3,454,007**

**Registered June 24, 2008**

**TRADEMARK  
SERVICE MARK  
PRINCIPAL REGISTER**



HD WOOD TECHNOLOGIES LIMITED (MALTA  
LIMITED COMPANY)  
7, FREDERICK STREET  
VALLETTA VLT03  
MALTA

FOR: WOOD AND WOOD PRODUCTS, NAMELY,  
SAWN TIMBER, PLYWOOD, HARDWOOD PLY-  
WOOD, ARCHITECTURAL PLYWOOD, FANCY  
PLYWOOD, WOOD BOARDS, DIMENSIONED TIM-  
BER AND FURNITURE PANELS OF SOLID WOOD,  
AND WOOD VENEERS, IN CLASS 19 (U.S. CLS. 1, 12,  
33 AND 50).

FOR: UNWORKED WOOD FIBER, WOOD CHIPS  
FOR THE MANUFACTURE OF WOOD-PULP, IN  
CLASS 31 (U.S. CLS. 1 AND 46).

FOR: TIMBER-FELLING AND PROCESSING,  
WOODWORKING, IN CLASS 40 (U.S. CLS. 100, 103  
AND 106).

OWNER OF INTERNATIONAL REGISTRATION  
0915052 DATED 11-9-2006, EXPIRES 11-9-2016.

THE COLOR(S) RED, WHITE IS/ARE CLAIMED  
AS A FEATURE OF THE MARK.

THE MARK CONSISTS OF BACKGROUND RED  
AND CHARACTER "V" WHITE.

SER. NO. 79-038,306, FILED 4-24-2007.

ALICE BENMAMAN, EXAMINING ATTORNEY

**Int. Cls.: 11 and 28**

**Prior U.S. Cls.: 13, 21, 22, 23, 31, 34, 38 and 50**

**United States Patent and Trademark Office**

**Reg. No. 3,454,008**

**Registered June 24, 2008**

**TRADEMARK  
PRINCIPAL REGISTER**

# teuco

TEUCO GUZZINI S.P.A. (ITALY JOINT STOCK COMPANY)  
VIA AVOGADRO, 12  
ZONA INDUSTRIALE E. FERMI  
I-62010 MONTELUPONE (MC), ITALY

FOR: HYGIENIC AND SANITARY APPARATUS, NAMELY, BATH TUBS, BATH TUBS WITH SHOWER CUBICLES, WHIRLPOOL BATHS, BATH TUBS EMITTING ULTRASOUNDS, BATH TUBS AND SPAS IN THE NATURE OF HEATED POOLS WITH OR WITHOUT WHIRLPOOL-JETS OR ULTRASOUNDS EMITTERS FOR USE IN HOTELS, IN GYMNASIUMS AND IN HEALTH RESORTS; SHOWERS, SHOWER CUBICLES, SHOWER TRAYS, SHOWER PANELS, SAUNAS, STEAM GENERATORS, TAP WATER FAUCETS; PLUMBING FITTINGS, NAMELY, BIBS, TAPS, AND VALVES, IN CLASS 11 (U.S. CLS. 13, 21, 23, 31 AND 34).

FOR: GYMNASIUM AND SPORTING EQUIPMENT, NAMELY, TREADMILLS FOR RUNNING, ROWING MACHINES, BARBELLS, DUMBBELLS, STATIONARY EXERCISE BICYCLES, HORIZONTAL BARS, EXERCISE BENCHES FOR DEVELOP-

ING PHYSICAL STRENGTH, AND STAIR-STEPPING MACHINES, IN CLASS 28 (U.S. CLS. 22, 23, 38 AND 50).

PRIORITY DATE OF 11-24-2006 IS CLAIMED.

OWNER OF INTERNATIONAL REGISTRATION 0923666 DATED 2-7-2007, EXPIRES 2-7-2017.

OWNER OF U.S. REG. NOS. 1,526,509 AND 2,947,781.

THE TRADEMARK CONSISTS OF THE FANCY WORDING "TEUCO" IN PARTICULAR SMALL BLOCK CHARACTERS.

THE MARK HAS NO MEANING IN A FOREIGN LANGUAGE.

SER. NO. 79-038,310, FILED 2-7-2007.

CHARLOTTE CORWIN, EXAMINING ATTORNEY



Int. Cl.: 9

Prior U.S. Cls.: 21, 23, 26, 36 and 38

United States Patent and Trademark Office

Reg. No. 3,454,009

Registered June 24, 2008

TRADEMARK  
PRINCIPAL REGISTER



PIRELLI & C. S.P.A. (ITALY JOINT STOCK COMPANY)  
VIA GAETANO NEGRI, 10  
I-20123 MILANO (MI)  
ITALY

FOR: CONTROL, DISTRIBUTION AND SIGNAL ADDRESSING APPARATUS, COMPRISED PRIMARILY OF AN OPTICAL ELECTRONIC UNIT CAPABLE OF ACCEPTING CLIENT SIGNALS AND TRANSFORMING AND DISTRIBUTING THEM IN A MULTI WAVELENGTH NET IN OPTICAL MULTIPLEXERS AND DEMULTIPLEXERS, SUPERVISION AND CONTROL APPARATUS, AND FEEDERS USED FOR TELECOMMUNICATIONS; APPARATUS FOR PROCESSING SIGNALS DESTINED TO AN OPTICAL FIBERS MULTI WAVELENGTH NETWORK BASED ON COARSE WAVELENGTH DIVISION MULTIPLEXING, USED FOR LOCAL OR REMOTE CONTROL AND SUPERVISION IN THE TELECOMMUNICATIONS INDUSTRY; POWER SUPPLY UNITS, IN CLASS 9 (U.S. CLS. 21, 23, 26, 36 AND 38).

PRIORITY DATE OF 10-11-2006 IS CLAIMED.

OWNER OF INTERNATIONAL REGISTRATION 0923730 DATED 12-12-2006, EXPIRES 12-12-2016.

THE COLOR(S) BLACK, PINK, RED, ORANGE, YELLOW, GREEN, LIGHT BLUE, BLUE AND VIOLET IS/ARE CLAIMED AS A FEATURE OF THE MARK.

THE MARK CONSISTS OF THE TRADEMARK CONSISTS OF THE WORD "LYTE" IN FANCY LOWER CASE LETTERS WITH THE INITIAL LETTER "L" WRITTEN IN UPPER CASE. THE COLOR BLACK APPEARS IN THE LETTERS "L", "T" AND "E". THE COLORS PINK, RED, ORANGE, YELLOW, GREEN, LIGHT BLUE, BLUE AND VIOLET APPEAR IN THE LETTER "Y".

SER. NO. 79-038,333, FILED 12-12-2006.

CIMMERIAN COLEMAN, EXAMINING ATTORNEY

**Int. Cl.: 1**

**Prior U.S. Cls.: 1, 5, 6, 10, 26 and 46**

**Reg. No. 3,454,010**

**United States Patent and Trademark Office**

**Registered June 24, 2008**

---

**TRADEMARK  
PRINCIPAL REGISTER**

**WANNATE**

YANTAI WANHUA POLYURETHANES CO., LTD  
(CHINA CORPORATION)  
7 XINGFU SOUTH ROAD  
YANTAI, SHANDONG 264002, CHINA

OWNER OF INTERNATIONAL REGISTRATION  
0923772 DATED 2-14-2007, EXPIRES 2-14-2017.

FOR: INDUSTRIAL CHEMICALS, NAMELY, ISO-  
CYANATE, ESTER, ACIDS, POLYURETHANE, ANI-  
LINE; ARTIFICIAL RESINS, UNPROCESSED;  
ADHESIVES FOR INDUSTRIAL PURPOSES , IN  
CLASS 1 (U.S. CLS. 1, 5, 6, 10, 26 AND 46).

THE WORDING "WANNATE" HAS NO MEAN-  
ING IN A FOREIGN LANGUAGE.

SER. NO. 79-038,349, FILED 2-14-2007.

JASON BLAIR, EXAMINING ATTORNEY

**Int. Cls.: 16 and 17**

**Prior U.S. Cls.: 1, 2, 5, 12, 13, 22, 23, 29, 35, 37, 38 and 50**

**Reg. No. 3,454,011**

**United States Patent and Trademark Office**

**Registered June 24, 2008**

**TRADEMARK  
PRINCIPAL REGISTER**



IMPRESS DECOR GMBH (FED REP GERMANY  
LTD LIAB CO)  
DORFSTRASSE 2  
63741 ASCHAFFENBURG  
FED REP GERMANY

FOR: PAPER AND CARDBOARD FOR USE IN INDUSTRIAL, CONSTRUCTION AND VEHICULAR APPLICATIONS, BUT NOT FOR USE IN FLEXIBLE PACKAGING MATERIALS; DECORATED PAPERS FOR USE IN INDUSTRIAL, CONSTRUCTION AND VEHICULAR APPLICATIONS, BUT NOT FOR USE IN FLEXIBLE PACKAGING MATERIALS; PRINTED AND UNPRINTED SPECIAL PAPERS, ALSO FOR FURTHER PROCESSING WITH PLASTICS, PLASTIC FOILS, BOARDS AND THE LIKE CARRIER MATERIALS; PRINTED AND UNPRINTED PAPERS AND CARDBOARDS AS SEMI-FINISHED PRODUCTS FOR MANUFACTURING OF FLOOR, ROOF, CEILING, WALL AND FURNITURE COATINGS, IN CLASS 16 (U.S. CLS. 2, 5, 22, 23, 29, 37, 38 AND 50).

FOR: GOODS MADE OF RUBBER, GUM AND THEIR SUBSTITUTES, NAMELY, PRINTED AND

UNPRINTED FOILS, IN PARTICULAR FOR DECORATION PURPOSES OR AS SEMI-FINISHED PRODUCTS FOR THE MANUFACTURE OF LAMINATES AS WELL AS FOR FLOOR, ROOF, CEILING, WALL AND FURNITURE COATINGS, IN CLASS 17 (U.S. CLS. 1, 5, 12, 13, 35 AND 50).

OWNER OF INTERNATIONAL REGISTRATION 0923837 DATED 3-8-2007, EXPIRES 3-8-2017.

THE COLOR(S) LIGHT BLUE AND BROWN IS/ ARE CLAIMED AS A FEATURE OF THE MARK.

THE COLOR BLUE APPEARS IN THE HORIZONTAL LINE ABOVE THE LETTER "I". THE COLOR BROWN APPEARS IN THE LETTERS OF THE WORD "IMPRESS".

SER. NO. 79-038,364, FILED 3-8-2007.

JASON BLAIR, EXAMINING ATTORNEY

**Int. Cls.: 1, 2, 17, 35 and 40**

**Prior U.S. Cls.: 1, 5, 6, 10, 11, 12, 13, 16, 26, 35, 46, 50,  
100, 101, 102, 103 and 106**

**Reg. No. 3,454,012**

**United States Patent and Trademark Office**

**Registered June 24, 2008**

**TRADEMARK  
SERVICE MARK  
PRINCIPAL REGISTER**

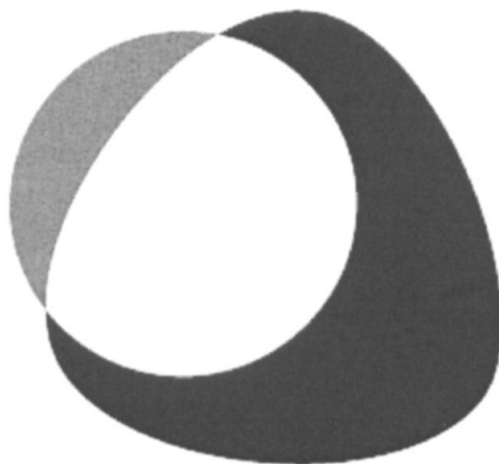

ALTANA CHEMIE AG (FED REP GERMANY  
AG)  
ABELSTRASSE 45  
46483 WESEL  
FED REP GERMANY

FOR: UNPROCESSED SYNTHETIC RESINS AND  
PLASTICS, IN CLASS 1 (U.S. CLS. 1, 5, 6, 10, 26 AND  
46).

FOR: PAINTS, VARNISHES, LACQUERS; PIG-  
MENTS, IN PARTICULAR IRON PIGMENTS,  
PEARL GLOSS PIGMENTS, METAL EFFECT PIG-  
MENTS, INTERFERENCE PIGMENTS; METALS IN  
FOILS AND METALS IN POWDER FORM FOR  
PAINTERS, DECORATORS, PRINTERS AND AR-  
TISTS; WIRE LACQUERS, IN CLASS 2 (U.S. CLS. 6, 11  
AND 16).

FOR: NATURAL RUBBER, GUTTA-PERCHA,  
RUBBER, MICA; LIQUID ELECTRICAL INSULAT-  
ING MATERIALS, IN CLASS 17 (U.S. CLS. 1, 5, 12, 13,  
35 AND 50).

FOR: ADVERTISING; BUSINESS MANAGE-  
MENT: BUSINESS ADMINISTRATION; OFFICE  
FUNCTIONS, IN CLASS 35 (U.S. CLS. 100, 101 AND  
102).

FOR: PROCESSING OF PIGMENTS INTO RAW  
LACQUERS, IN PARTICULAR BONDING OF POW-  
DER LACQUERS, AS SERVICE FOR THIRD PAR-  
TIES, IN CLASS 40 (U.S. CLS. 100, 103 AND 106).

PRIORITY DATE OF 8-24-2006 IS CLAIMED.

OWNER OF INTERNATIONAL REGISTRATION  
0923980 DATED 12-21-2006, EXPIRES 12-21-2016.

SER. NO. 79-038,421, FILED 12-21-2006.

DEBRA LEE, EXAMINING ATTORNEY

Int. Cl.: 28

Prior U.S. Cls.: 22, 23, 38 and 50

Reg. No. 3,454,013

United States Patent and Trademark Office

Registered June 24, 2008

TRADEMARK  
PRINCIPAL REGISTER

*Energize Your Life*

OMNI RESOURCES INTERNATIONAL; TRADING (TIANJIN) INC. (CHINA CORPORATION) ROOM. 202 SUITE 1, XINGANG BIG ROAD.; FREE TRADE ZONE; TIANJIN CHINA

FOR: BODY-TRAINING APPARATUS, NAMELY, ANKLE AND WRIST WEIGHT FOR EXERCISE, BARBELLS, DUMBBELLS, STRIKING BAGS, STRIKING SHIELDS, HAND WRAPS, ELLIPTICAL EXERCISE MACHINES, EXERCISE MACHINES, EXERCISE MACHINES INCORPORATING ELECTRONIC AND VIDEO GAME CONTROLLERS, EXERCISE BARS, EXERCISE BENCHES, ROWING MACHINES, EXERCISE TRAMPOLINES, EXERCISE TREADMILLS, EXERCISE WEIGHTS, EXERCISE WEIGHT CUFFS, EXERCISE WRIST WEIGHTS, EXERCISE WEIGHT LIFTING MACHINES, TRAMPOLINES, LEG WEIGHTS FOR EX-

ERCISING, YOGA MATS, WEIGHT LIFTING BENCHES AND BENCH ACCESSORIES; CHESS SETS, CHESS PIECES; BOARD GAMES; PLAYING BALLS, NAMELY, BEACH BALLS, BOWLING BALLS, FOOT BALLS; ARCHERY IMPLEMENTS, NAMELY, ARCHERY SETS; MACHINES FOR PHYSICAL EXERCISES; BATS FOR GAMES, NAMELY, BASEBALL BATS; GLOVES FOR GAMES, NAMELY, SOFT BALL GLOVES, BATTING GLOVES; FISHING TACKLE; PLAY SWIMMING POOLS, IN CLASS 28 (U.S. CLS. 22, 23, 38 AND 50).

OWNER OF INTERNATIONAL REGISTRATION 0924092 DATED 5-4-2007, EXPIRES 5-4-2017.

SER. NO. 79-038,448, FILED 5-4-2007.

APRIL ROACH, EXAMINING ATTORNEY

**Int. Cl.: 1**

**Prior U.S. Cls.: 1, 5, 6, 10, 26 and 46**

**Reg. No. 3,454,014**

**United States Patent and Trademark Office**

**Registered June 24, 2008**

**TRADEMARK  
PRINCIPAL REGISTER**

**PERFORM STi**

RHODIA CHIMIE (FRANCE SOCIÉTÉ PAR AC-  
TIONS SIMPLIFIÉE)  
40 RUE DE LA HAIE-COQ  
F-93300 AUBERVILLIERS  
FRANCE

OWNER OF INTERNATIONAL REGISTRATION  
0924579 DATED 3-12-2007, EXPIRES 3-12-2017.

FOR: CHEMICAL PRODUCTS DESIGNED FOR  
FLAME-RETARDANT TREATMENTS FOR USE IN  
THE TEXTILE INDUSTRY, IN CLASS 1 (U.S. CLS. 1,  
5, 6, 10, 26 AND 46).

SER. NO. 79-038,618, FILED 3-12-2007.

PRIORITY DATE OF 9-27-2006 IS CLAIMED.

MARY ROSSMAN, EXAMINING ATTORNEY

**Int. Cls.: 20, 35 and 39**

**Prior U.S. Cls.: 2, 13, 22, 25, 32, 50, 100, 101, 102 and 105**

**Reg. No. 3,454,015**

**United States Patent and Trademark Office**

**Registered June 24, 2008**

**TRADEMARK  
SERVICE MARK  
PRINCIPAL REGISTER**



SHANGHAI JUNYAO (GROUP); CO., LTD. (CHINA CORPORATION)  
PLOT NO.2, NO.4, NO.5  
HENGMIAN AREA, KANGQIAO INDUSTRIAL ZONE, PUDONG NEW AREA  
SHANGHAI, CHINA

FOR: GOODS MADE OF ANIMAL HORNS, UNWORKED OR SEMI-WORKED, NAMELY, DRAWER PULLS, BOOK RESTS, BUSTS, COSTUME DISPLAY STANDS, WARDROBES, FIGURINES; GOODS MADE OF ANIMAL TEETH, UNWORKED OR SEMI-WORKED, NAMELY, DRAWER PULLS, BOOK RESTS, BUSTS, COSTUME DISPLAY STANDS, WARDROBES, FIGURINES; GOODS MADE OF SEA SHELLS, UNWORKED OR SEMI-WORKED, NAMELY, DRAWER PULLS, BOOK RESTS, BUSTS, COSTUME DISPLAY STANDS, WARDROBES, FIGURINES; CRAFTWORK MADE OF RESIN, NAMELY, DRAWER PULLS, BOOK RESTS, CAST RESIN BUSTS, COSTUME DISPLAY STANDS, WARDROBES, FIGURINES; AIR PILLOWS, NOT FOR MEDICAL PURPOSES, IN CLASS 20 (U.S. CLS. 2, 13, 22, 25, 32 AND 50).

FOR: ADVERTISING AND ADVERTISEMENT SERVICES; ADVERTISING VIA ELECTRONIC MEDIA AND SPECIFICALLY THE INTERNET; SHOP WINDOW DISPLAY ARRANGEMENT SERVICES; PROVIDING ADVERTISING, MARKETING AND PROMOTIONAL SERVICES, NAMELY, DEVELOPMENT OF ADVERTISING CAMPAIGNS FOR TELEVISION, PRINT, CD-ROM, WEB DESIGN; AD-

VERTISING SERVICES OF A RADIO AND TELEVISION ADVERTISING AGENCY; IMPORT AND EXPORT AGENCIES; SALES PROMOTION SERVICES; PROCUREMENT SERVICES FOR OTHERS, NAMELY, PURCHASING GOODS AND SERVICES FOR OTHER BUSINESSES, IN CLASS 35 (U.S. CLS. 100, 101 AND 102).

FOR: FREIGHT BROKERAGE; TRANSPORT OF PASSENGERS; FREIGHT SHIP TRANSPORT; FREIGHT TRAIN TRANSPORT; FREIGHT AIR TRANSPORT; TRANSPORT RESERVATION SERVICES; AIR TRANSPORT; SHIP PILOTING; AMBULANCE TRANSPORT; RENTAL OF CARS; CAR PARKING; RENTAL OF STORAGE CONTAINERS; STORAGE OF GOODS; BOOKING OF SEATS FOR TRAVEL; TOURIST AGENCY SERVICES, IN CLASS 39 (U.S. CLS. 100 AND 105).

PRIORITY DATE OF 6-26-2006 IS CLAIMED.

OWNER OF INTERNATIONAL REGISTRATION 0924665 DATED 12-5-2006, EXPIRES 12-5-2016.

THE WORD "JUNEYAO" IN THE MARK HAS NO TRANSLATION IN ANY FOREIGN LANGUAGES.

SER. NO. 79-038,651, FILED 12-5-2006.

NAKWAMA ANKRAH, EXAMINING ATTORNEY

**Int. Cl.: 20**

**Prior U.S. Cls.: 2, 13, 22, 25, 32 and 50**

**United States Patent and Trademark Office**

**Reg. No. 3,454,016**

**Registered June 24, 2008**

**TRADEMARK  
PRINCIPAL REGISTER**

**ENDLESS**

VISPLAY INTERNATIONAL AG (SWITZER-  
LAND JOINT STOCK CORPORATION)  
KLÜNENFELDSTR. 22  
CH-4132 MUTTENZ  
SWITZERLAND

FOR: FURNITURE; SHOP FURNITURE, NAME-  
LY, SHELF UNITS FOR SHOPS, TABLES WITH  
LEVELS FOR SHELF UNITS, SHELVES, IN CLASS  
20 (U.S. CLS. 2, 13, 22, 25, 32 AND 50).

OWNER OF INTERNATIONAL REGISTRATION  
0924684 DATED 3-16-2007, EXPIRES 3-16-2017.

SER. NO. 79-038,661, FILED 3-16-2007.

KRISTINA MORRIS, EXAMINING ATTORNEY



**Int. Cls.: 20 and 39**

**Prior U.S. Cls.: 2, 13, 22, 25, 32, 50, 100 and 105**

**United States Patent and Trademark Office**

**Reg. No. 3,454,017**

**Registered June 24, 2008**

**TRADEMARK  
SERVICE MARK  
PRINCIPAL REGISTER**

**ESMENA**

ESMENA, S.L. (SPAIN S.L.)  
LA PICOTA S/N.  
E-33211 GIJÓN (ASTURIAS)  
SPAIN

OWNER OF INTERNATIONAL REGISTRATION  
0924766 DATED 3-20-2007, EXPIRES 3-20-2017.

FOR: SHELF UNITS, NAMELY, SHELVES AND  
BRACKETS SOLD AS A UNIT, IN CLASS 20 (U.S.  
CLS. 2, 13, 22, 25, 32 AND 50).

THE ENGLISH TRANSLATION OF THE WORD  
ESMENA IN THE MARK IS AMENDMENT.

SER. NO. 79-038,696, FILED 3-20-2007.

FOR: PACKAGING ARTICLES FOR TRANSPOR-  
TATION, IN CLASS 39 (U.S. CLS. 100 AND 105).

KRISTINA MORRIS, EXAMINING ATTORNEY

**Int. Cls.: 7 and 9**

**Prior U.S. Cls.: 13, 19, 21, 23, 26, 31, 34, 35, 36 and 38**

**United States Patent and Trademark Office**

**Reg. No. 3,454,018**

**Registered June 24, 2008**

**TRADEMARK  
PRINCIPAL REGISTER**

**DIPeX**

DINEX A/S (DENMARK LTD LIAB CO)  
FYNSVEJ 39  
DK-5500 MIDDELFART  
DENMARK

FOR: EXHAUST SYSTEMS AND EMISSION TECHNOLOGY APPARATUS AND INSTRUMENTS FOR INDUSTRIAL MACHINES COMPRISED OF EMISSION CONTROL SYSTEMS, FILTERING MACHINES, MACHINE MOTOR AND ENGINE FILTERS, PIPE JOINTS, MACHINE PRESSURE VALVES, MACHINE PUMPING SYSTEMS, SYSTEMS FOR RE-CIRCULATION OF EXHAUST GASES IN DIESEL ENGINES FOR INDUSTRIAL MACHINES, FILTER CLEANING APPARATUS, AND COMPONENT PARTS OF AND FITTINGS FOR ALL THE AFORESAID GOODS, EXHAUST SILENCERS AND EXHAUST PIPES FOR MOTORS AND ENGINES OF INDUSTRIAL MACHINES; EXHAUST SYSTEMS AND EMISSION TECHNOLOGY APPARATUS AND INSTRUMENTS FOR VEHICLES COMPRISED OF EMISSION CONTROL SYSTEMS, ENGINE FILTERS, FUEL FILTERS, OIL FILTERS, GAS AND PARTICULATE FILTERS, AIR INTAKE TUBES AND FILTERS FOR AFTERMARKET INSTALLATION OF AUTOMOTIVE ENGINES, PIPE JOINTS, ENGINE PRESSURE VALVES, EMISSION REDUCTION UNITS FOR MOTORS AND ENGINES, NAMELY, EGR VALVES, EMISSION REDUCTION UNITS FOR MOTORS AND ENGINES, NAMELY, PCV VALVES, PUMP CONTROL VALVES, VALVES FOR PUMPS, POWER VALVES FOR CARBURETORS, FUEL, OIL AND WATER PUMPING SYSTEMS, SYSTEMS FOR RE-CIRCULATION OF EXHAUST GASES IN DIESEL ENGINES FOR VEHICLES, AND COMPONENT PARTS OF AND FITTINGS FOR ALL THE AFORESAID GOODS, EXHAUST SILENCERS AND EXHAUST PIPES FOR LAND VEHICLES, IN CLASS 7 (U.S. CLS. 13, 19, 21, 23, 31, 34 AND 35).

FOR: COMPUTER SOFTWARE FOR VEHICLE AND INDUSTRIAL MACHINE EMISSION TECHNOLOGY AND EXHAUST SYSTEMS; COMPUTER HARDWARE; MEASURING, SIGNALING AND CHECKING APPARATUS AND INSTRUMENTS, NAMELY, ELECTRONIC VALVES FOR CONTROLLING GAS OR FLUIDS AND AUTOMOTIVE MEASURING INSTRUMENTS, NAMELY, WATER TEMPERATURE GAUGES, AIR FUEL/RATIO GAUGES, BOOST GAUGES, VACUUM GAUGES, AND EXHAUST GAS TEMPERATURE GAUGES; APPARATUS AND INSTRUMENTS FOR MONITORING AND CONTROLLING VEHICLE MOTORS AND ENGINES IN THE NATURE OF METERS AND SENSORS THAT MEASURE PRESSURE, TEMPERATURE, AND INCLUDES ALARMS AND REPORTING FUNCTIONS; APPARATUS AND INSTRUMENTS IN THE NATURE OF SENSORS AND ELECTRONIC TRANSMITTERS AND RECEIVERS FOR MONITORING PARTICLE FILTERS AND BACK-PRESSURE LEVELS FOR EXHAUST GASES, TEMPERATURE SENSORS FOR MEASURING THE TEMPERATURE OF EXHAUST GASES, IN CLASS 9 (U.S. CLS. 21, 23, 26, 36 AND 38).

THE MARK CONSISTS OF STANDARD CHARACTERS WITHOUT CLAIM TO ANY PARTICULAR FONT, STYLE, SIZE, OR COLOR.

PRIORITY DATE OF 3-10-2006 IS CLAIMED.

OWNER OF INTERNATIONAL REGISTRATION  
0925106 DATED 9-7-2006, EXPIRES 9-7-2016.

SER. NO. 79-038,847, FILED 9-7-2006.

PETER B. BROMAGHIM, EXAMINING ATTORNEY

**Int. Cl.: 32**

**Prior U.S. Cls.: 45, 46 and 48**

**United States Patent and Trademark Office**

**Reg. No. 3,454,019**

**Registered June 24, 2008**

**TRADEMARK  
PRINCIPAL REGISTER**

**BRAVA ITALIA**

AMA S.N.C. DI MASSIMO E; CARLO ALBERTO  
ROVERE (ITALY GENERAL PARTNERSHIP)  
VIA AURELIA, 102/1  
BOGLIASCO-GENOVA, ITALY I16031

OWNER OF INTERNATIONAL REGISTRATION  
0925132 DATED 1-15-2007, EXPIRES 1-15-2017.

FOR: NON-ALCOHOLIC DRINKS, NAMELY,  
LOW-CALORIE SOFT DRINKS; CARBONATED  
AND NON-CARBONATED ENERGY DRINKS, IN  
CLASS 32 (U.S. CLS. 45, 46 AND 48).

NO CLAIM IS MADE TO THE EXCLUSIVE  
RIGHT TO USE "ITALIA", APART FROM THE  
MARK AS SHOWN.

THE MARK CONSISTS OF STANDARD CHAR-  
ACTERS WITHOUT CLAIM TO ANY PARTICULAR  
FONT, STYLE, SIZE, OR COLOR.

THE ENGLISH TRANSLATION OF "BRAVA ITA-  
LIA" IS "GOOD ITALY."

PRIORITY DATE OF 7-20-2006 IS CLAIMED.

SER. NO. 79-038,855, FILED 1-15-2007.

MAUREEN DALL, EXAMINING ATTORNEY

**Int. Cls.: 16 and 41**

**Prior U.S. Cls.: 2, 5, 22, 23, 29, 37, 38, 50, 100, 101 and 107**

**Reg. No. 3,454,020**

**United States Patent and Trademark Office**

**Registered June 24, 2008**

**TRADEMARK  
SERVICE MARK  
PRINCIPAL REGISTER**

# watch-around

ARM JEAN-PHILIPPE (SWITZERLAND SOCIÉTÉ ANONYME)  
CHANTEMERLE 5  
CH-2000 NEUCHÂTEL  
SWITZERLAND

FOR: PAPER AND CARDBOARD; PRINTED MATTER, NAMELY, MAGAZINES, NEWSLETTERS, ADVERTISING BOARDS OF PAPER OR CARDBOARD, AGENDAS, CATALOGS, CHARTS, ILLUSTRATIONS, JOURNALS, AND PERIODICALS ALL IN THE FIELD OF WATCHES, CLOCKS, AND JEWELRY; BOOK BINDINGS; PHOTOGRAPHS; STATIONERY; ADHESIVES AND GLUES FOR STATIONERY OR HOUSEHOLD PURPOSES; PAINT-BRUSHES; PRINTED INSTRUCTIONAL AND TEACHING MATERIAL IN THE FIELD OF WATCHES, CLOCKS, AND JEWELRY; PLASTIC BAGS FOR PACKAGING; PRINTING TYPE; PRINTING BLOCKS, IN CLASS 16 (U.S. CLS. 2, 5, 22, 23, 29, 37, 38 AND 50).

FOR: EDUCATIONAL SERVICES, NAMELY, CONDUCTING CLASSES, CONFERENCES AND SEMINARS IN THE FIELD OF WATCHES, CLOCKS, AND JEWELRY; PROVIDING NEWS IN THE NATURE OF CURRENT EVENT AUDIOVISUAL REPORTING IN THE FIELD OF WATCHES, CLOCKS, AND JEWELRY; CONDUCTING TRAINING COURSES IN THE FIELD OF WATCHES, CLOCKS, AND

JEWELRY; ENTERTAINMENT SERVICES, NAMELY, ORGANIZING CULTURAL ACTIVITIES IN THE NATURE OF COMMUNITY CULTURAL EVENTS; PUBLISHING OF MAGAZINES, REVIEWS, WEB MAGAZINES AND ELECTRONIC PUBLICATIONS IN THE FIELD OF WATCHES, CLOCKS, AND JEWELRY; WRITING OF TEXTS AND ARTICLES FOR PERIODICALS AND JOURNALS OTHER THAN FOR ADVERTISING OR PUBLICITY IN THE FIELD OF WATCHES, CLOCKS, AND JEWELRY; ART EXHIBITIONS; WATCH EXHIBITIONS FOR CULTURAL OR EDUCATIONAL PURPOSES, IN CLASS 41 (U.S. CLS. 100, 101 AND 107).

THE MARK CONSISTS OF STANDARD CHARACTERS WITHOUT CLAIM TO ANY PARTICULAR FONT, STYLE, SIZE, OR COLOR.

PRIORITY DATE OF 9-27-2006 IS CLAIMED.

OWNER OF INTERNATIONAL REGISTRATION 0925147 DATED 3-22-2007, EXPIRES 3-22-2017.

SER. NO. 79-038,865, FILED 3-22-2007.

ESTHER A. BORSUK, EXAMINING ATTORNEY

**Int. Cl.: 24**

**Prior U.S. Cls.: 42 and 50**

**United States Patent and Trademark Office**

**Reg. No. 3,454,021**

**Registered June 24, 2008**

**TRADEMARK  
PRINCIPAL REGISTER**

# **BOTTEGA VENETA**

BOTTEGA VENETA INTERNATIONAL S.A.R.L.  
(LUXEMBOURG CORPORATION)  
12, RUE LÉON THYES  
L-2636 LUXEMBOURG, LUXEMBOURG

FOR: WOOLEN CLOTHS AND FABRICS, FABRICS, NAMELY, KNITTED FABRICS, FELT FABRICS AND NON-WOVEN TEXTILE FABRICS, LEATHER CLOTH, BED LINEN, BED BLANKETS, BED COVERS, MATTRESS COVERS, DUVET COVERS, WOVEN DRILL IN THE NATURE OF COTTON TWILL FABRIC, PILLOW CASES, TABLE NAPKINS OF TEXTILE, SHOWER CURTAINS, UNFITTED TEXTILE COVERS OF ALL TYPES FOR CHAIRS, WALL HANGINGS OF TEXTILE, CURTAINS, TEXTILE TABLE CLOTHS, DISHWASHING CLOTHS, IN CLASS 24 (U.S. CLS. 42 AND 50).

THE MARK CONSISTS OF STANDARD CHARACTERS WITHOUT CLAIM TO ANY PARTICULAR FONT, STYLE, SIZE, OR COLOR.

PRIORITY DATE OF 1-5-2007 IS CLAIMED.

OWNER OF INTERNATIONAL REGISTRATION 0925208 DATED 5-3-2007, EXPIRES 5-3-2017.

OWNER OF U.S. REG. NOS. 1,086,395 AND 3,207,024.

THE ENGLISH TRANSLATION OF THE WORD "BOTTEGA VENETA" IN THE MARK IS SHOP OF THE VENETO REGION.

SEC. 2(F).

SER. NO. 79-038,900, FILED 5-3-2007.

STEVEN PEREZ, EXAMINING ATTORNEY

**Int. Cls.: 6, 9 and 11**

**Prior U.S. Cls.: 2, 12, 13, 14, 21, 23, 25, 26, 31, 34, 36,  
38 and 50**

**Reg. No. 3,454,022**

**United States Patent and Trademark Office**

**Registered June 24, 2008**

**TRADEMARK  
PRINCIPAL REGISTER**

**VADU**

PINK GMBH VAKUUMTECHNIK (FED REP  
GERMANY LIMITED LIABILITY COMPANY)  
AM KESSLER 6  
97877 WERTHEIM  
FED REP GERMANY

FOR: COMMON METALS AND THEIR ALLOYS,  
UNWROUGHT AND SEMI-WORKED FOR FUR-  
THER MANUFACTURE; METAL BUILDING MA-  
TERIALS, NAMELY, METAL CHAMBERS THAT  
USE VACUUM AND ULTRAHIGH VACUUM  
EQUIPMENT; TRANSPORTABLE BUILDINGS OF  
METAL; MATERIALS OF METAL FOR RAILWAY  
TRACKS; NON-ELECTRIC CABLES AND WIRES OF  
COMMON METAL; METALLIC PIPES AND TUBES;  
METAL SAFES; COBALT, COPPER AND IRON  
ORES; METAL FLANGES; METAL PIPES; MANU-  
ALLY OPERATED METAL VALVES; METAL CON-  
DENSATION TRAPS; METAL GAS LOCKS FOR  
VACUUM AND ULTRAHIGH VACUUM INSTAL-  
LATIONS; METAL ADSORPTION TRAPS BEING  
COMPONENTS FOR VACUUM AND ULTRAHIGH  
VACUUM TANKS, IN CLASS 6 (U.S. CLS. 2, 12, 13, 14,  
23, 25 AND 50).

FOR: ELECTRIC MEASURING APPARATUS  
AND INSTRUMENTS, NAMELY, WATER TEM-  
PERATURE GAUGES, AIR FUEL/RATIO GAUGES,  
BOOST GAUGES, VACUUM GAUGES AND EX-  
HAUST GAS TEMPERATURE GAUGES; APPARA-  
TUS FOR RECORDING, TRANSMISSION AND  
REPRODUCTION OF SOUND AND IMAGES,  
BLANK MAGNETIC DATA-CARRIERS, BLANK  
RECORDING COMPUTER DISCS, DATA PROCES-  
SORS AND COMPUTERS, ALL FOR USE WITH  
VACUUM AND ULTRAHIGH VACUUM SYSTEMS;  
VACUUM AND ULTRAHIGH VACUUM EXPERI-  
MENTATION APPARATUS AND MANIPULATION

SYSTEMS, NAMELY, VACUUM DRYING OVENS,  
ULTRAHIGH VACUUM LAMINATORS, ULTRA-  
HIGH VACUUM SURFACE ANALYZING INSTAL-  
LATIONS, ALL FOR LABORATORY AND  
SCIENTIFIC USE; LEAK TESTING APPARATUS  
AND/OR SYSTEMS FOR VACUUM AND ULTRA-  
HIGH VACUUM INSTALLATIONS; LEAK TESTING  
SYSTEMS FOR VACUUM AND ULTRAHIGH VA-  
CUUM INSTALLATIONS; ELECTRIC CONTINU-  
OUS SOLDERING APPARATUS; ELECTRIC  
SMELTING FURNACES FOR LABORATORY EX-  
PERIMENTS; PARTICLE ACCELERATORS AND  
PARTS FOR PARTICLE ACCELERATORS, IN PAR-  
TICULAR BEAM LINES, IN CLASS 9 (U.S. CLS. 21,  
23, 26, 36 AND 38).

FOR: HIGH VACUUM THERMAL INSTALLA-  
TIONS COMPRISED OF LIGHTING, HEATING,  
STEAM GENERATING, COOKING, REFRIGERAT-  
ING, DRYING, VENTILATING AND/OR WATER  
SUPPLY APPARATUS FOR FUNCTIONAL TESTS  
OF ASSEMBLIES OR ELECTRIC COMPONENTS  
UNDER AEROSPACE CONDITIONS, CIRCULAT-  
ING AIR OVENS; HIGH-TEMPERATURE FURNA-  
CES; HEAT EXCHANGERS NOT BEING PARTS OF  
MACHINES; INDUSTRIAL OVENS USED FOR THE  
HEAT TREATMENT OF METALLIC GOODS FOR  
OTHERS; DRYING CHAMBERS FOR INDUSTRIAL  
USE, IN CLASS 11 (U.S. CLS. 13, 21, 23, 31 AND 34).

THE MARK CONSISTS OF STANDARD CHAR-  
ACTERS WITHOUT CLAIM TO ANY PARTICULAR  
FONT, STYLE, SIZE, OR COLOR.

OWNER OF INTERNATIONAL REGISTRATION  
0925286 DATED 4-13-2007, EXPIRES 4-13-2017.

"VADU" HAS NO MEANING IN A FOREIGN  
LANGUAGE.

SER. NO. 79-038,931, FILED 4-13-2007.

DANNEAN HETZEL, EXAMINING ATTORNEY

**Int. Cls.: 7 and 11**

**Prior U.S. Cls.: 13, 19, 21, 23, 31, 34 and 35**

**United States Patent and Trademark Office**

**Reg. No. 3,454,023**

**Registered June 24, 2008**

**TRADEMARK  
PRINCIPAL REGISTER**



NRF B.V. (NETHERLANDS CORPORATION)  
LANGENBOOMSEWEG 64  
NL-5451 JM MILL  
NETHERLANDS

FOR: RADIATORS FOR MOTORS AND ENGINES; RADIATORS FOR VEHICLES; VEHICLE ENGINE PARTS, NAMELY, OIL COOLERS; HEAT EXCHANGERS BEING PARTS OF MACHINES; AIR COMPRESSORS; AIR COMPRESSORS FOR VEHICLES; COMPRESSORS FOR MACHINES; LAND VEHICLE PARTS, NAMELY, INTERCOOLERS, IN CLASS 7 (U.S. CLS. 13, 19, 21, 23, 31, 34 AND 35).

FOR: COMPONENTS AND PARTS FOR AIR CONDITIONING INSTALLATIONS AND COOLING SYSTEMS IN VEHICLES, NAMELY, EVAPORATIVE AIR COOLERS; COOLING EVAPORATORS; CONDENSATORS FOR AUTOMOTIVE AIR CONDITIONING AND CLIMATE CONTROL IN VEHICLES; HEAT EXCHANGERS NOT BEING PARTS OF MACHINES; DRYERS FOR AUTOMOTIVE AIR CONDITIONING AND CLIMATE CONTROL IN VEHICLES; PARTS FOR HEATING AND AIR CONDITIONING SYSTEMS, NAMELY, HEA-

TER CORES FOR USE IN VEHICLES, IN CLASS 11 (U.S. CLS. 13, 21, 23, 31 AND 34).

PRIORITY DATE OF 3-16-2007 IS CLAIMED.

OWNER OF INTERNATIONAL REGISTRATION 0925391 DATED 3-30-2007, EXPIRES 3-30-2017.

THE COLOR(S) ORANGE AND BLACK IS/ARE CLAIMED AS A FEATURE OF THE MARK.

THE COLOR BLACK APPEARS IN THE WORDING "NRF" AND IN THE DESIGN OF THREE CIRCLES ABOVE THE WORDING, WHICH OVERLAYS A DIAMOND SHAPED GEOMETRIC DESIGN IN THE COLOR ORANGE.

THE WORDING "NRF" HAS NO MEANING IN A FOREIGN LANGUAGE.

SER. NO. 79-038,971, FILED 3-30-2007.

WENDY JUN, EXAMINING ATTORNEY



**Int. Cls.: 9, 18 and 25**

**Prior U.S. Cls.: 1, 2, 3, 21, 22, 23, 26, 36, 38, 39 and 41**

**Reg. No. 3,454,024**

**United States Patent and Trademark Office**

**Registered June 24, 2008**

**TRADEMARK  
PRINCIPAL REGISTER**

# **POWERTRAIL**

EIDER (FRANCE SOCIETE PAR ACTIONS SIMPLIFIEE)

2, RUE DU PRÉ FAUCON  
F-74940 ANNECY LE VIEUX  
FRANCE

FOR: OPTICAL SPECTACLES; OPTICAL GOODS, NAMELY, OPTICAL GLASSES; SPECTACLE CASES; SPECTACLE FRAMES, IN CLASS 9 (U.S. CLS. 21, 23, 26, 36 AND 38).

FOR: LEATHER AND IMITATION LEATHER, TRUNKS AND SUITCASES, UMBRELLAS, PARASOLS AND WALKING STICKS, WALLETS, PURSES NOT OF PRECIOUS METAL, HANDBAGS, RUCKSACKS, TOTE BAGS WITH WHEELS; ATHLETIC BAGS FOR CLIMBERS; ATHLETIC BAGS FOR CAMPERS; TRAVELING BAGS; BEACH BAGS; SCHOOL BAGS; LEATHER BAGS AND SMALL LEATHER BAGS IN THE NATURE OF ENVELOPES AND POUCHES FOR PACKING, NAMELY, SUITCASES, IN CLASS 18 (U.S. CLS. 1, 2, 3, 22 AND 41).

FOR: CLOTHING, NAMELY, CLOTHING FOR SKIING, IN THE NATURE OF PANTS, JACKETS, SHIRTS, BELTS, FURS, NAMELY, FUR COATS AND FUR JACKETS, TROUSERS, JUMPERS, COATS, GLOVES, SCARVES, SHOULDER WRAPS, HOSIERY, SOCKS, BOOT LINERS, BEACH, SKI AND SPORTS FOOTWEAR, UNDERWEAR, HEADGEAR, NAMELY, HATS AND CAPS, IN CLASS 25 (U.S. CLS. 22 AND 39).

PRIORITY DATE OF 11-3-2006 IS CLAIMED.

OWNER OF INTERNATIONAL REGISTRATION 0925584 DATED 4-30-2007, EXPIRES 4-30-2017.

"POWERTRAIL" HAS NO MEANING IN A FOREIGN LANGUAGE.

SER. NO. 79-039,049, FILED 4-30-2007.

COLLEEN DOMBROW, EXAMINING ATTORNEY

**Int. Cls.: 16, 25, 28 and 43**

**Prior U.S. Cls.: 2, 5, 22, 23, 29, 37, 38, 39, 50, 100 and 101**

**Reg. No. 3,454,025**

**United States Patent and Trademark Office**

**Registered June 24, 2008**

**TRADEMARK  
SERVICE MARK  
PRINCIPAL REGISTER**

*Mascalzone*  
*Vivace gusto italiano*

IT.RI. ITALIANA RISTORAZIONE S.R.L. (ITALY  
LTD LIAB CO)  
VIA FOSSE, 4  
I-41100 MODENA, ITALY

FOR: GOODS MADE OF PAPER AND CELLULOSE DERIVATIVES, NAMELY, TABLE CLOTHS AND PLACE MATS MADE OF PAPER, PAPER NAPKINS, IN CLASS 16 (U.S. CLS. 2, 5, 22, 23, 29, 37, 38 AND 50).

FOR: TEXTILE AND KNITTED CLOTHING, NAMELY, T-SHIRTS, SPORTS JERSEYS, SWEATERS, UNDERSHIRTS, SHIRTS, PANTS, APRONS, HEADSCARVES, SCARVES, HATS, CAPS, UNDERWEAR, BOOTS, SHOES AND SLIPPERS, IN CLASS 25 (U.S. CLS. 22 AND 39).

FOR: PLAYTHINGS AND TOYS, NAMELY, PUPPETS, SOFT STUFFED TOYS, IN CLASS 28 (U.S. CLS. 22, 23, 38 AND 50).

FOR: CATERING SERVICES FOR PROVIDING FOOD AND DRINK, NAMELY, RESTAURANTS, FAST-FOOD RESTAURANTS, SNACK BARS AND RESTAURANTS IN THE NATURE OF LUNCH BARS AND PIZZA RESTAURANTS, IN CLASS 43 (U.S. CLS. 100 AND 101).

PRIORITY DATE OF 11-21-2006 IS CLAIMED.

OWNER OF INTERNATIONAL REGISTRATION 0925637 DATED 2-23-2007, EXPIRES 2-23-2017.

THE COLOR(S) RED AND GREEN IS/ARE CLAIMED AS A FEATURE OF THE MARK.

THE MARK IS COMPOSED OF THE STYLISED GREEN WORDING "MASCALZONE". BEYOND IT, THERE IS THE STYLISED RED WORDING "VIVACE GUSTO ITALIANO" WHICH IS REPRODUCED IN SMALLER CHARACTERS.

THE ENGLISH TRANSLATION OF THE WORD "MASCALZONE" IN THE MARK IS RASCAL, SCOUNDREL OR NAUGHTY BOY, AND THE ENGLISH TRANSLATION OF THE WORDING "VIVACE GUSTO ITALIANO" IN THE MARK IS SPARKLING ITALIAN TASTE.

SER. NO. 79-039,072, FILED 2-23-2007.

KAELIE KUNG, EXAMINING ATTORNEY

**Int. Cls.: 9, 35 and 42**

**Prior U.S. Cls.: 21, 23, 26, 36, 38, 100, 101 and 102**

**United States Patent and Trademark Office**

**Reg. No. 3,454,026**

**Registered June 24, 2008**

**TRADEMARK  
SERVICE MARK  
PRINCIPAL REGISTER**

# Jeans-Doctor

PTT WARENHANDELS GMBH (FED REP GER-  
MANY GMBH (LIMITED COMPANY))  
INFANTERIESTR. 11A HAUS C  
80797 MÜNCHEN  
FED REP GERMANY

FOR: COMPUTER MONITORS; COMPUTERS;  
PHONOGRAPHS, IN CLASS 9 (U.S. CLS. 21, 23, 26,  
36 AND 38).

FOR: SERVICES OFFERED BY AN ADVERTIS-  
ING AGENCY; ONLINE ADVERTISING IN A COM-  
PUTER NETWORK; DATA SYSTEMATIZATION IN  
COMPUTER DATABASES; DUPLICATION OF  
DOCUMENTS; ADVERTISING; INTERNET AD-  
VERTISING FOR THIRD PARTIES, IN CLASS 35  
(U.S. CLS. 100, 101 AND 102).

FOR: DESIGN OF COMPUTER SOFTWARE;  
ELECTRONIC BACKUP OF DATA; ELECTRONIC  
STORAGE OF DATA; DEVELOPMENT OF DATA

MANAGEMENT PROGRAMS; DEVELOPMENT OF  
COMPUTER ANIMATED GRAPHICS; IMPLEMEN-  
TATION OF COMPUTER PROGRAMS IN NET-  
WORKS; INSTALLATION OF COMPUTER  
PROGRAMS, IN CLASS 42 (U.S. CLS. 100 AND 101).

THE MARK CONSISTS OF STANDARD CHAR-  
ACTERS WITHOUT CLAIM TO ANY PARTICULAR  
FONT, STYLE, SIZE, OR COLOR.

PRIORITY DATE OF 7-28-2006 IS CLAIMED.

OWNER OF INTERNATIONAL REGISTRATION  
0925663 DATED 1-4-2007, EXPIRES 1-4-2017.

SER. NO. 79-039,087, FILED 1-4-2007.

LAURIE KAUFMAN, EXAMINING ATTORNEY

Int. Cls.: 5, 25, 32 and 33

Prior U.S. Cls.: 6, 18, 22, 39, 44, 45, 46, 47, 48, 49, 51  
and 52

Reg. No. 3,454,027

United States Patent and Trademark Office

Registered June 24, 2008

TRADEMARK  
PRINCIPAL REGISTER



AMA S.N.C. DI MASSIMO E; CARLO ALBERTO  
ROVERE (ITALY GENERAL PARTNERSHIP)  
VIA AURELIA, 102/1  
I-16031 BOGLIASCO-GENOVA, ITALY

FOR: DIETETIC BEVERAGES AND ENERGY  
DRINKS ADAPTED FOR MEDICAL PURPOSES,  
IN CLASS 5 (U.S. CLS. 6, 18, 44, 46, 51 AND 52).

FOR: FOOTWEAR; CLOTHING AND HEAD-  
GEAR, NAMELY, SHORTS, UNDERPANTS, PANTS,  
VESTS, SWEATERS, DRESSES, T-SHIRTS, BLOUSES,  
SHIRTS, SKIRTS, COATS, JACKETS, TROUSERS,  
SUITS, RAINCOATS, TIES, SCARVES, GLOVES,  
BATHING SUITS, UNDERWEAR, NIGHTWEAR,  
HATS, CAPS, IN CLASS 25 (U.S. CLS. 22 AND 39).

FOR: BEERS, MINERAL AND AERATED WA-  
TERS AND OTHER NON-ALCOHOLIC DRINKS,  
NAMELY, SOFT DRINKS, LOW CALORIE SOFT  
DRINKS, CARBONATED BEVERAGES, ENERGY  
DRINKS; FRUIT DRINKS AND FRUIT JUICES;  
SYRUPS AND OTHER PREPARATIONS FOR MAK-  
ING FRUIT DRINKS AND SOFT DRINKS, IN  
CLASS 32 (U.S. CLS. 45, 46 AND 48).

FOR: WINES, DISTILLED SPIRITS, AND LI-  
QUEURS; ALCOHOLIC BEVERAGES, NAMELY,  
PREPARED ALCOHOLIC COCKTAILS, IN CLASS  
33 (U.S. CLS. 47 AND 49).

PRIORITY DATE OF 7-31-2006 IS CLAIMED.

OWNER OF INTERNATIONAL REGISTRATION  
0925701 DATED 1-15-2007, EXPIRES 1-15-2017.

NO CLAIM IS MADE TO THE EXCLUSIVE  
RIGHT TO USE "ITALIA", APART FROM THE  
MARK AS SHOWN.

THE COLOR(S) WHITE, RED, GREEN, AZURE,  
YELLOW AND BLACK IS/ARE CLAIMED AS A  
FEATURE OF THE MARK.

THE MARK CONSISTS OF THE WHITE PRINTED  
WRITING "BRA VA ITALIA" ON A RED BACK-  
GROUND, WHERE THE INITIALS "B" AND "I" ARE  
OF GREATER DIMENSIONS IN COMPARISON  
WITH THE OTHER LETTERS, AND THE WORD  
"ITALIA" IS PLACED AT A STAGGERED HEIGHT  
IN COMPARISON WITH THE WORD "BRAVA".  
UNDER THIS WORD, IN WHITE HANDWRITING  
ARE THE WORDS "WINNING ENERGY". BE-  
TWEEN THESE TWO WORDS, IS THE REPRESEN-  
TATION OF AN AZURE-DRESSED FOOTBALLER  
IN MOVEMENT AFTER HAVING THROWN A  
WHITE AND BLACK BALL THAT IS PLACED  
UNDER THE SECOND LETTER "A" OF THE WORD  
"ITALIA". THIS BALL IS FOLLOWED BY A TRACK  
OF YELLOW COLOUR. AT THE SIDE OF THE  
LETTER "B", THERE IS A YELLOW COLOURED  
SUN RISING FROM AN AZURE COLOURED HILL.  
OVER AND UNDER THIS REPRESENTATION,  
AND ON A GREEN BACKGROUND, THE SAME  
FOOTBALLER IS IN ACTION AND THE BALL  
TRAJECTORY IS INDICATED BY NUMEROUS  
BALLS PLACED IN THE VERTEXES OF A ZIG-  
ZAG DISTANCE AND CONNECTED BY A WHITE  
LINE WITH AN ARROW AS FAR AS THE GOAL,  
WHERE THE WORD "GOAL!" IS INDICATED IN  
BLACK. BETWEEN THE RED STRIPE AND THE  
GREEN STRIPES, THERE ARE TWO WHITE CO-  
LOURED STRIPES.

THE ENGLISH TRANSLATION OF "BRAVA ITALIA" IS GOOD ITALY.

SER. NO. 79-039,101, FILED 1-15-2007.

KIMBERLY FRYE, EXAMINING ATTORNEY

**Int. Cl.: 25**

**Prior U.S. Cls.: 22 and 39**

**United States Patent and Trademark Office**

**Reg. No. 3,454,028**

**Registered June 24, 2008**

**TRADEMARK  
PRINCIPAL REGISTER**

**SUSANNA ZETA**

MAVIMODE S.R.L. (ITALY LTD LIAB CO)  
VIA SVIZZERA, 2/E-2/F  
I-41012 CARPI (MODENA)  
ITALY

PRIORITY DATE OF 2-21-2007 IS CLAIMED.

FOR: PULLOVERS; CARDIGANS; JERSEYS;  
NECKWEAR; SWEATERS; TROUSERS; SKIRTS;  
JACKETS; SHIRTS; VESTS; WAISTCOATS; JUM-  
PERS; BLOUSES; JEANS; SWEAT PANTS; GYM  
SUITS; PANTS; SHORTS; T-SHIRTS; SWEAT-  
SHIRTS; SUITS AND DRESSES; OVERCOATS;  
COATS; BELTS; BEACHWEAR, IN CLASS 25 (U.S.  
CLS. 22 AND 39).

OWNER OF INTERNATIONAL REGISTRATION  
0925729 DATED 5-15-2007, EXPIRES 5-15-2017.

THE NAME(S), PORTRAIT(S), AND/OR SIGNA-  
TURE(S) SHOWN IN THE MARK DOES NOT IDEN-  
TIFY A PARTICULAR LIVING INDIVIDUAL.

THE MARK CONSISTS OF STANDARD CHAR-  
ACTERS WITHOUT CLAIM TO ANY PARTICULAR  
FONT, STYLE, SIZE, OR COLOR.

SER. NO. 79-039,111, FILED 5-15-2007.

CARYN GLASSER, EXAMINING ATTORNEY

Int. Cl.: 27

Prior U.S. Cls.: 19, 20, 37, 42 and 50

Reg. No. 3,454,029

United States Patent and Trademark Office

Registered June 24, 2008

TRADEMARK  
PRINCIPAL REGISTER



ENIA CARPET MANAGEMENT AG (SWITZERLAND SOCIÉTÉ ANONYME)  
INDUSTRIE SÜD  
CH-8755 ENNENDA  
SWITZERLAND

FOR: CARPETS AND RUGS; BATH FLOOR MATS; CARPETS, NAMELY, ARTIFICIAL TURF; FOOT SCRAPERS, NAMELY, DOOR MATS; LINOLEUM FOR USE ON FLOORS; MATS, NAMELY, TEXTILE WOVEN ROPE MATS FOR SKI RUNS; DOOR MATS; PAPER FOR HANGING, NAMELY, WALLPAPER; FLOOR COVERINGS; VINYL FLOOR COVERINGS; INSULATING AND NON-INSULATING FLOOR COVERINGS; REED MATS; CARPET UNDERLAY; NON-SLIP TUB MATS; GYMNASTIC MATS; MATS FOR AUTOMOBILES; BRISTLE

RUGS; NON-TEXTILE TAPESTRIES, NAMELY, WALL HANGINGS; INSULATING AND NON-INSULATING GROUND COVERINGS, NAMELY, FLOOR COVERINGS FOR OUTDOOR USE, IN CLASS 27 (U.S. CLS. 19, 20, 37, 42 AND 50).

PRIORITY DATE OF 1-8-2007 IS CLAIMED.

OWNER OF INTERNATIONAL REGISTRATION  
0925874 DATED 4-4-2007, EXPIRES 4-4-2017.

SER. NO. 79-039,170, FILED 4-4-2007.

WILLIAM ROSSMAN, EXAMINING ATTORNEY

**Int. Cl.: 36**

**Prior U.S. Cls.: 100, 101 and 102**

**United States Patent and Trademark Office**

**Reg. No. 3,454,030**

**Registered June 24, 2008**

**SERVICE MARK  
PRINCIPAL REGISTER**

**CLEARSUITE**

BNP PARIBAS (FRANCE SOCIÉTÉ ANONYME)  
16, BOULEVARD DES ITALIENS  
F-75009 PARIS  
FRANCE

FOR: BANKING SERVICES; FINANCING SERVICES, NAMELY, BANKING AND FINANCING SERVICES; FINANCIAL INFORMATION; FUND INVESTMENTS; STOCK EXCHANGE BROKERAGE; FOREIGN EXCHANGE OPERATIONS; FINANCIAL CLEARINGHOUSES; ELECTRONIC FUNDS TRANSFER; BANKING OPERATIONS; FINANCIAL SERVICES, NAMELY, ASSISTING OTHERS WITH THE COMPLETION OF FINANCIAL TRANSACTIONS FOR STOCKS, BONDS, SECURITIES AND EQUITIES; AND MONETARY SERVICES, NAMELY, COMPLETION OF FINANCIAL TRANSACTIONS FOR STOCKS, BONDS, SECURITIES AND EQUITIES VIA TELECOMMUNICATION NET-

WORKS, MOBILE TELEPHONES, TELEMATIC NETWORKS, THE INTERNET AND INTRANET SYSTEMS, IN CLASS 36 (U.S. CLS. 100, 101 AND 102).

THE MARK CONSISTS OF STANDARD CHARACTERS WITHOUT CLAIM TO ANY PARTICULAR FONT, STYLE, SIZE, OR COLOR.

PRIORITY DATE OF 9-13-2006 IS CLAIMED.

OWNER OF INTERNATIONAL REGISTRATION 0925984 DATED 2-27-2007, EXPIRES 2-27-2017.

SER. NO. 79-039,233, FILED 2-27-2007.

LINDA ESTRADA, EXAMINING ATTORNEY



**Int. Cl.: 18**

**Prior U.S. Cls.: 1, 2, 3, 22 and 41**

**Reg. No. 3,454,031**

**United States Patent and Trademark Office**

**Registered June 24, 2008**

**TRADEMARK  
PRINCIPAL REGISTER**

**CHEMINS BLANCS**

LENER FRÉDÉRIC (FRANCE INDIVIDUAL)  
39, RUE DE MERVILLE  
F-59529 HAZEBROUCK  
FRANCE

PRIORITY DATE OF 9-29-2006 IS CLAIMED.

OWNER OF INTERNATIONAL REGISTRATION  
0925993 DATED 3-9-2007, EXPIRES 3-9-2017.

OWNER OF U.S. REG. NO. 2,608,596.

THE ENGLISH TRANSLATION OF THE FOREIGN WORD(S) IN THE MARK IS "WHITE WAYS".

SER. NO. 79-039,241, FILED 3-9-2007.

FOR: LEATHER AND IMITATION LEATHER, KEY CASES, WALLETS, DOCUMENT CASES, LEATHER GOODS IN THE NATURE OF BRIEFCASES, SUITCASES, HANDBAGS, RUCKSACKS, BEACH BAGS, GARMENT BAGS FOR TRAVEL, TRAVELING BAGS, TRAVELLING SETS, NAMELY, SUITCASES WITH ROLLERS; UMBRELLAS, PARASOLS; WHIPS, HARNESS AND SADDLERY; PURSES NOT OF PRECIOUS METAL; UNFITTED VANITY CASES, IN CLASS 18 (U.S. CLS. 1, 2, 3, 22 AND 41).

LINDA ESTRADA, EXAMINING ATTORNEY

Int. Cl.: 43

Prior U.S. Cls.: 100 and 101

United States Patent and Trademark Office

Reg. No. 3,454,032

Registered June 24, 2008

SERVICE MARK  
PRINCIPAL REGISTER



PJB HOLDING SA (FRANCE CORPORATION)  
4 BOULEVARD DES CAPUCINES  
PARIS, FRANCE F75509

FOR: PROVIDING OF FOOD AND DRINK FOR GUESTS; PROVIDING TEMPORARY ACCOMMODATION; BAR SERVICES, CATERING SERVICES; HOTEL SERVICES; TEMPORARY ACCOMMODATION RESERVATION; DAY CARE CENTERS; PROVISION OF CAMPGROUND CAMPING SITES; RETIREMENT HOMES; BOARDING FOR ANIMALS, IN CLASS 43 (U.S. CLS. 100 AND 101).

PRIORITY DATE OF 1-31-2007 IS CLAIMED.

OWNER OF INTERNATIONAL REGISTRATION  
0926016 DATED 4-17-2007, EXPIRES 4-17-2017.

NO CLAIM IS MADE TO THE EXCLUSIVE RIGHT TO USE "RESTAURANT", APART FROM THE MARK AS SHOWN.

THE COLOR(S) YELLOW, BROWN, RED AND BLUE IS/ARE CLAIMED AS A FEATURE OF THE MARK.

THE MARK CONSIST OF THE SUN DESIGN APPEARS WITH A BROWN CENTER SURROUNDED BY YELLOW RAYS THAT ARE OUTLINED IN BROWN; THE WORD RESTAURANT APPEARS IN THE COLOR RED; AND THE WORDING LE SUD APPEARS IN THE COLOR BLUE.

THE ENGLISH TRANSLATION OF THE WORDING "LE SUD" IN THE MARK IS "THE SOUTH".

SER. NO. 79-039,251, FILED 4-17-2007.

VERNA BETH RIRIE, EXAMINING ATTORNEY

**Int. Cl.: 1**

**Prior U.S. Cls.: 1, 5, 6, 10, 26 and 46**

**Reg. No. 3,454,033**

**United States Patent and Trademark Office**

**Registered June 24, 2008**

**TRADEMARK  
PRINCIPAL REGISTER**

**LL BHF**

STELLA CHEMIFA CORPORATION (JAPAN CORPORATION)  
3-6-3, AWAJI-MACHI,  
CHUO-KU.; OSAKA-SHI; OSAKA 541-0047  
JAPAN

FOR: CHEMICALS USED IN INDUSTRY; CHEMICALS USED IN MANUFACTURING STRUCTURES OF SEMICONDUCTORS, INTEGRATED CIRCUITS, MICROSCALE AND NANO-SCALE AND FOR ACCELERATION OF ETCHING PROCESS AND FOR FORMING PATTERNS ON A SUBSTRATE; CHEMICALS USED IN MANUFACTURING SEMICONDUCTORS; CHEMICAL CLEANERS, NAMELY, ETCHING AGENTS FOR RINSING SEMICONDUCTORS; CHEMICALS TO BE USED FOR FORMING PATTERNS ON THE SUBSTRATES OF FLAT PANEL DISPLAY SUCH AS LIQUID CRYSTAL AND ELECTROLUMINESCENT (EL); CHEMICALS USED FOR MANUFACTURING OF FLAT PANEL DISPLAY; CHEMICAL CLEANS-

ER, NAMELY, ETCHING AGENT TO BE USED FOR MANUFACTURING OF FLAT PANEL DISPLAY, IN CLASS 1 (U.S. CLS. 1, 5, 6, 10, 26 AND 46).

THE MARK CONSISTS OF STANDARD CHARACTERS WITHOUT CLAIM TO ANY PARTICULAR FONT, STYLE, SIZE, OR COLOR.

OWNER OF INTERNATIONAL REGISTRATION 0926203 DATED 2-22-2007, EXPIRES 2-22-2017.

NO CLAIM IS MADE TO THE EXCLUSIVE RIGHT TO USE "BHF", APART FROM THE MARK AS SHOWN.

SER. NO. 79-039,319, FILED 2-22-2007.

REBECCA POVARCHUK, EXAMINING ATTORNEY

**Int. Cl.: 14**

**Prior U.S. Cls.: 2, 27, 28 and 50**

**United States Patent and Trademark Office**

**Reg. No. 3,454,034**

**Registered June 24, 2008**

**TRADEMARK  
PRINCIPAL REGISTER**

**CIELO**  
 **VENEZIA 1270**

WORLDGEM BRANDS S.R.L.; SOCIETA' CON  
UNICO SOCIO (ITALY LIMITED LIABILITY  
COMPANY WITH SOLE MEMBER)

VIA PIAZZON, 82

I-36051 OLMO DI CREAZZO (VI)

ITALY

FOR: ARTICLES OF JEWELRY, NAMELY,  
RINGS, EARRINGS, NECKLACES, BRACELETS,  
BROOCHES, PENDANTS; HOROLOGICAL INSTRU-  
MENTS, NAMELY, WATCHES; PEARLS; PRECIOUS  
METALS, NAMELY, GOLD, SILVER AND PLATI-  
NUM; PRECIOUS STONES, IN CLASS 14 (U.S. CLS. 2,  
27, 28 AND 50).

PRIORITY DATE OF 10-18-2006 IS CLAIMED.

OWNER OF INTERNATIONAL REGISTRATION  
0926228 DATED 4-18-2007, EXPIRES 4-18-2017.

OWNER OF U.S. REG. NO. 2,432,546.

NO CLAIM IS MADE TO THE EXCLUSIVE  
RIGHT TO USE "VENEZIA", APART FROM THE  
MARK AS SHOWN.

THE ENGLISH TRANSLATION OF THE MARK IS  
"SKY VENICE 1270."

SER. NO. 79-039,324, FILED 4-18-2007.

DAYNA BROWNE, EXAMINING ATTORNEY

**Int. Cl.: 14**

**Prior U.S. Cls.: 2, 27, 28 and 50**

**United States Patent and Trademark Office**

**Reg. No. 3,454,035**

**Registered June 24, 2008**

**TRADEMARK  
PRINCIPAL REGISTER**

**ETOILE SECRETE**

MONTBLANC-SIMPLO GMBH (FED REP GER-  
MANY GMBH)  
HELLGRUNDWEG 100  
22525 HAMBURG, FED REP GERMANY

FOR: CUFFLINKS; TIEPINS; JEWELRY, IN-  
CLUDING RINGS, BRACELETS, EARRINGS,  
NECKLACES, AND BROOCHES; WRISTWATCHES;  
CHRONOMETERS; CLOCKS AND ALARM  
CLOCKS; WATCH STRAPS; JEWELRY BOXES  
AND WATCH BOXES MADE OF PRECIOUS METAL  
FOR STORING WATCHES AND JEWELLERY, IN  
CLASS 14 (U.S. CLS. 2, 27, 28 AND 50).

THE MARK CONSISTS OF STANDARD CHAR-  
ACTERS WITHOUT CLAIM TO ANY PARTICULAR  
FONT, STYLE, SIZE, OR COLOR.

PRIORITY DATE OF 12-15-2006 IS CLAIMED.

OWNER OF INTERNATIONAL REGISTRATION  
0926324 DATED 4-15-2007, EXPIRES 4-15-2017.

THE FOREIGN WORDING IN THE MARK  
TRANSLATES INTO ENGLISH AS SECRET STAR.

SER. NO. 79-039,361, FILED 4-15-2007.

KATHERINE CONNOLLY, EXAMINING ATTOR-  
NEY

**Int. Cls.: 7 and 16**

**Prior U.S. Cls.: 2, 5, 13, 19, 21, 22, 23, 29, 31, 34, 35,  
37, 38 and 50**

**Reg. No. 3,454,036**

**United States Patent and Trademark Office**

**Registered June 24, 2008**

**TRADEMARK  
PRINCIPAL REGISTER**

**ARCA**

ARCA ETICHETTE SPA (ITALY JOINT STOCK  
COMPANY)  
VIA EDISON T., 119  
I-20010 MARCALLO CON CASONE (MILANO)  
ITALY

FOR: LABELLERS; AUTOMATIC LABELLING  
MACHINES AND LABELLING SYSTEMS MADE  
OF LABELLERS WITH DEVICES FOR PRODUCT  
HANDLING AND MOVEMENT, NAMELY,  
SPACERS, CHAIN ALIGNERS, STABILIZERS, PRO-  
DUCT EJECTORS, ADAPTERS; PRINTING MA-  
CHINES; ADHESIVE TAPE DISPENSING  
MACHINES; MACHINES FOR APPLYING LABELS;  
PRINT APPLY MACHINES; AUTOMATIC LABEL  
PRINTER APPLICATORS, IN CLASS 7 (U.S. CLS. 13,  
19, 21, 23, 31, 34 AND 35).

FOR: ADHESIVE LABELS OF PAPER AND POLY-  
PROPYLENE; LABELS, NOT OF TEXTILE OR PLAS-  
TIC; LABEL PAPER; BLANK OR PARTIALLY  
PRINTED PAPER LABELS; HOLOGRAPHIC LA-  
BELS; MULTI-PAGE SELF-ADHESIVE LABELS;  
BAR CODE LABELS; SELF-ADHESIVE COUPONS;  
PAPER SECURITY LABELS NOT MAGNETICALLY  
ENCODED; PAPER LABELS, NOT MAGNETIC OR  
ENCODED, FOR USE IN MARKING PRODUCTS  
FOR SECURITY; PAPER ANTI-COUNTERFEITING  
LABELS NOT MAGNETICALLY ENCODED; PAPER

IDENTIFICATION LABELS, NOT MAGNETIC OR  
ENCODED, FOR SECURITY; SECURITY LABELS  
FEATURING HOLOGRAMS; PRINTED SEALS; SE-  
CURITY SEALS NOT MAGNETICALLY ENCODED;  
LABEL PRINTING MACHINE RIBBONS; THER-  
MAL TRANSFER PAPER RIBBONS FOR PRINTING  
AND PACKAGING; RIBBONS FOR THERMAL  
TRANSFER PRINTERS, IN CLASS 16 (U.S. CLS. 2,  
5, 22, 23, 29, 37, 38 AND 50).

THE MARK CONSISTS OF STANDARD CHAR-  
ACTERS WITHOUT CLAIM TO ANY PARTICULAR  
FONT, STYLE, SIZE, OR COLOR.

PRIORITY DATE OF 12-19-2006 IS CLAIMED.

OWNER OF INTERNATIONAL REGISTRATION  
0926533 DATED 4-6-2007, EXPIRES 4-6-2017.

THE ENGLISH TRANSLATION OF THE FOR-  
EIGN WORD(S) IN THE MARK IS: ARK.

SER. NO. 79-039,435, FILED 4-6-2007.

BARBARA GAYNOR, EXAMINING ATTORNEY

**Int. Cl.: 40**

**Prior U.S. Cls.: 100, 103 and 106**

**United States Patent and Trademark Office**

**Reg. No. 3,454,037**

**Registered June 24, 2008**

**SERVICE MARK  
PRINCIPAL REGISTER**

The logo for ENICS is rendered in a bold, black, sans-serif typeface. The letter 'E' is stylized with a small square containing a white 'P' inside its top-left curve. The letters 'N', 'I', and 'C' are closely spaced, and the 'S' is a simple, thick stroke.

ENICS AG (SWITZERLAND CORPORATION)  
BROWN BOVERI STRASSE 12  
CH-5400 BADEN, SWITZERLAND

FOR: CUSTOM ASSEMBLING FOR OTHERS OF ELECTRICAL SUPPLIES, ELECTRICAL COMPONENTS, ELECTRONIC CONTROLS, REGULATING EQUIPMENT, AND ELECTRONIC SENSORS, NAMELY, TRANSFORMERS, TIMERS, CONTROLS, RELAY MODULES, SURGE VOLTAGE PROTECTORS, AND HIGH AND LOW FREQUENCY ELECTRICITY DISTRIBUTION MODULES, ALL OF THE AFOREMENTIONED DEALING WITH

SAFETY, LIFTS, LIGHTING, RAILWAYS, METERING, ACCUMULATING ENERGY, ACCESS CONTROL, HOME AUTOMATION INSTALLATIONS AND SAFETY OF PERSONS AND INDUSTRIAL GOODS, IN CLASS 40 (U.S. CLS. 100, 103 AND 106).

OWNER OF INTERNATIONAL REGISTRATION  
0926565 DATED 3-2-2007, EXPIRES 3-2-2017.

SER. NO. 79-039,443, FILED 3-2-2007.

LINDA ESTRADA, EXAMINING ATTORNEY

**Int. Cl.: 3**

**Prior U.S. Cls.: 1, 4, 6, 50, 51 and 52**

**Reg. No. 3,454,038**

**United States Patent and Trademark Office**

**Registered June 24, 2008**

---

**TRADEMARK  
PRINCIPAL REGISTER**

# Wax-cellence

ELEMI PTY LTD (AUSTRALIA COMPANY)  
115 JANE STREET  
WEST END QLD 4101  
AUSTRALIA

FOR: COSMETICS, PERFUMERY, HAIR STYLING FIXATIVE IN THE NATURE OF HAIR WAX, NON-MEDICATED TOILETRIES, SOAPS, ESSENTIAL OILS, HAIR LOTION AND DEPILATORY WAXING PREPARATIONS, NAMELY, WAX FOR REMOVING BODY HAIR, IN CLASS 3 (U.S. CLS. 1, 4, 6, 50, 51 AND 52).

THE MARK CONSISTS OF STANDARD CHARACTERS WITHOUT CLAIM TO ANY PARTICULAR FONT, STYLE, SIZE, OR COLOR.

OWNER OF INTERNATIONAL REGISTRATION  
0926599 DATED 5-3-2007, EXPIRES 5-3-2017.

SER. NO. 79-039,455, FILED 5-3-2007.

STEVEN PEREZ, EXAMINING ATTORNEY



**Int. Cl.: 25**

**Prior U.S. Cls.: 22 and 39**

**United States Patent and Trademark Office**

**Reg. No. 3,454,039**

**Registered June 24, 2008**

**TRADEMARK  
PRINCIPAL REGISTER**



RE.COM SRL (ITALY SRL)  
PIAZZA RISORGIMENTO, 41  
I-12037 SALUZZO (CN)  
ITALY

PERS, SANDALS, BEACHWEAR, BATHING SUITS,  
SLIPPERS, PAJAMAS, DRESSING GOWNS, NIGHT-  
GOWNS, SASHES FOR WEAR, SCARVES, IN CLASS  
25 (U.S. CLS. 22 AND 39).

FOR: CLOTHING AND CLOTHING FOR CHILDREN, NAMELY, BELTS, BRACES, HATS, GLOVES, STOCKING, SOCKS, TIGHTS, HOSIERY, UNDERWEAR, BRIEFS AND PANTS, T-SHIRTS, COATS, JACKETS, BLOUSONS, WATERPROOF JACKETS, WAISTCOATS, SHIRTS, FLEECE CLOTHING, NAMELY, FLEECE PULLOVERS, FLEECE GLOVES, FLEECE SCARVES, FLEECE JACKETS, FLEECE VESTS; FUR COATS, FUR JACKETS, FUR STOLES; SPORTSWEAR, NAMELY, OVERALLS, BODY WARMERS, SHORTS, UNDERSHIRTS; FOOTWEAR, BOOTS, HALF-BOOTS, SKIBOOTS, SLIP-

OWNER OF INTERNATIONAL REGISTRATION  
0836169 DATED 9-3-2004, EXPIRES 9-3-2014.

THE MARK COMPRISES THE WORD "IDEXE" IN SPECIAL FONT; WITHIN THE UPPER ENCLAVE OF THE LETTER "X", THERE IS A FULL CIRCLE.

SER. NO. 79-039,493, FILED 5-16-2007.

EDWARD NELSON, EXAMINING ATTORNEY

**Int. Cl.: 9**

**Prior U.S. Cls.: 21, 23, 26, 36 and 38**

**Reg. No. 3,454,040**

**United States Patent and Trademark Office**

**Registered June 24, 2008**

**TRADEMARK  
PRINCIPAL REGISTER**

**VEGAPULS**

VEGA GRIESHABER KG (FED REP GERMANY  
KG (LIMITED PARTNERSHIP))  
HAUPTSTRASSE 1-5  
77709 WOLFACH, FED REP GERMANY

CROWAVE LEVEL GAUGES; COMPUTER PRO-  
GRAMS FOR DATA PROCESSING, IN CLASS 9  
(U.S. CLS. 21, 23, 26, 36 AND 38).

FOR: MEASURING INSTRUMENTS, IN PARTI-  
CULAR FILLING LEVEL MEASURING INSTRU-  
MENTS, NAMELY, DEVICES FOR MEASURING  
AND CONTROLLING THE FILLING LEVEL OF  
TANKS AND CONTAINERS BY SIGNALING AND/  
OR ACTUATION AND CONTROL, NAMELY, ELEC-  
TRONIC, ELECTRO MECHANICAL, OPTICAL, LA-  
SER, CAPACITIVE, HYDROSTATIC, ULTRASONIC,  
RADIATION, RADAR, MICROWAVE AND VIBRA-  
TIONAL LEVEL DETECTION SENSORS AND DIS-  
PLAY PANELS; DISTANCE MEASURING  
APPARATUS AND SENSORS FOR THE DETERMI-  
NATION OF DISTANCES; GAUGE MEASURING  
INSTRUMENTS, NAMELY, LEVEL GAUGES, MI-

THE MARK CONSISTS OF STANDARD CHAR-  
ACTERS WITHOUT CLAIM TO ANY PARTICULAR  
FONT, STYLE, SIZE, OR COLOR.

PRIORITY DATE OF 12-22-2006 IS CLAIMED.

OWNER OF INTERNATIONAL REGISTRATION  
0926767 DATED 4-19-2007, EXPIRES 4-19-2017.

SER. NO. 79-039,532, FILED 4-19-2007.

CHERYL CLAYTON, EXAMINING ATTORNEY

**Int. Cl.: 14**

**Prior U.S. Cls.: 2, 27, 28 and 50**

**United States Patent and Trademark Office**

**Reg. No. 3,454,041**

**Registered June 24, 2008**

**TRADEMARK  
PRINCIPAL REGISTER**

**EBEL HEXAGON**

MGI LUXURY GROUP SA (SWITZERLAND SO-  
CIÉTÉ ANONYME)  
NIDAUGASSE 35  
CH-2502 BIENNE  
SWITZERLAND

FOR: HOROLOGICAL INSTRUMENTS AND  
CHRONOMETRICAL INSTRUMENTS, NAMELY,  
WATCHES, WRIST-WATCHES, STRAPS FOR  
WRIST-WATCHES, WATCHCASES, TRAVEL  
CLOCKS, CLOCKS AND PARTS THEREOF;  
CHRONOGRAPHS FOR USE AS WATCHES;  
CHRONOMETERS; JEWEL CASES MADE OF PRE-  
CIOUS METAL OR COATED THEREWITH; JEW-  
ELRY MADE OF PRECIOUS METAL OR COATED  
THEREWITH; PRECIOUS STONES, IN CLASS 14  
(U.S. CLS. 2, 27, 28 AND 50).

THE MARK CONSISTS OF STANDARD CHAR-  
ACTERS WITHOUT CLAIM TO ANY PARTICULAR  
FONT, STYLE, SIZE, OR COLOR.

PRIORITY DATE OF 12-22-2006 IS CLAIMED.

OWNER OF INTERNATIONAL REGISTRATION  
0926772 DATED 4-2-2007, EXPIRES 4-2-2017.

OWNER OF U.S. REG. NOS. 833,650, 3,084,067 AND  
OTHERS.

NO CLAIM IS MADE TO THE EXCLUSIVE  
RIGHT TO USE "HEXAGON", APART FROM THE  
MARK AS SHOWN.

SER. NO. 79-039,536, FILED 4-2-2007.

KAREN BRACEY, EXAMINING ATTORNEY

**Int. Cl.: 14**

**Prior U.S. Cls.: 2, 27, 28 and 50**

**United States Patent and Trademark Office**

**Reg. No. 3,454,042**

**Registered June 24, 2008**

**TRADEMARK  
PRINCIPAL REGISTER**

**ILEA**

RICHEMONT INTERNATIONAL SA (SWITZERLAND SOCIÉTÉ ANONYME (SA))

ROUTE DES BICHES 10

CH-1752 VILLARS-SUR-GLÂNE, SWITZERLAND

FOR: CUFF LINKS, TIE PINS, RINGS, BRACELETS, EARRINGS, NECKLACES, BROOCHES, KEY RINGS OF PRECIOUS METAL; WATCHES, CHRONOMETERS, WALL CLOCKS, WATCH BANDS, CASES OF PRECIOUS METAL FOR WATCHES AND JEWELLERY, IN CLASS 14 (U.S. CLS. 2, 27, 28 AND 50).

THE MARK CONSISTS OF STANDARD CHARACTERS WITHOUT CLAIM TO ANY PARTICULAR FONT, STYLE, SIZE, OR COLOR.

OWNER OF INTERNATIONAL REGISTRATION 0926880 DATED 5-3-2007, EXPIRES 5-3-2017.

"ILEA" HAS NO MEANING IN A FOREIGN LANGUAGE.

SER. NO. 79-039,583, FILED 5-3-2007.

STEVEN PEREZ, EXAMINING ATTORNEY

**Int. Cls.: 14 and 18**

**Prior U.S. Cls.: 1, 2, 3, 22, 27, 28, 41 and 50**

**Reg. No. 3,454,043**

**United States Patent and Trademark Office**

**Registered June 24, 2008**

**TRADEMARK  
PRINCIPAL REGISTER**



HOUSE OF ROMEO SA (SWITZERLAND SOCI-  
ÉTÉ ANONYME)  
RUE DE MORAT 14  
CH-2502 BIENNE  
SWITZERLAND

FOR: PRECIOUS METALS AND THEIR ALLOYS  
AND GOODS MADE OF OR COATED WITH THESE  
MATERIALS NOT INCLUDED IN OTHER CLASSES,  
NAMELY GOLD, SILVER, PLATINUM, ORNA-  
MENTS OF PRECIOUS METAL, WORKS OF ART  
OF PRECIOUS METAL; JEWELRY; PRECIOUS  
STONES; HOROLOGICAL AND CHRONOMETRIC  
INSTRUMENTS; WATCHES; CHRONOMETERS;  
DIALS IN THE NATURE OF CLOCK AND WATCH-  
MAKING ITEMS; NOVELTY KEY RINGS MADE OF  
PRECIOUS METAL; CIGAR AND CIGARETTE  
CASES OF PRECIOUS METAL; VASES OF PRE-  
CIOUS METAL, IN CLASS 14 (U.S. CLS. 2, 27, 28 AND  
50).

FOR: LEATHER AND IMITATIONS OF LEA-  
THER, AND GOODS, NAMELY, LEATHER SHOP-  
PING BAGS, PURSES AND WALLETS MADE OF  
THESE MATERIALS AND NOT INCLUDED IN  
OTHER CLASSES; TRUNKS AND SUITCASES; UM-  
BRELLAS, PARASOLS AND WALKING STICKS;  
SADDLERY; BACKPACKS; HANDBAGS; TRAVEL-  
ING BAGS; SPORT BAGS; ALL-PURPOSE CARRY-  
ING BAGS, IN CLASS 18 (U.S. CLS. 1, 2, 3, 22 AND 41).

PRIORITY DATE OF 11-28-2006 IS CLAIMED.

OWNER OF INTERNATIONAL REGISTRATION  
0926882 DATED 5-25-2007, EXPIRES 5-25-2017.

SER. NO. 79-039,584, FILED 5-25-2007.

LEIGH CAROLINE CASE, EXAMINING ATTOR-  
NEY

**Int. Cl.: 20**

**Prior U.S. Cls.: 2, 13, 22, 25, 32 and 50**

**United States Patent and Trademark Office**

**Reg. No. 3,454,044**

**Registered June 24, 2008**

**TRADEMARK  
PRINCIPAL REGISTER**

**ARKETIPO**

ARKETIPO S.P.A. (ITALY CORPORATION)  
VIALE VOLTA, 101  
I-50131 FIRENZE  
ITALY

OWNER OF INTERNATIONAL REGISTRATION  
0926889 DATED 4-17-2007, EXPIRES 4-17-2017.

FOR: FURNITURE, NAMELY, SOFAS, CHAIRS,  
SEATS, STOOLS, CHAISE LONGUES, COUCHES,  
BEDS, IN CLASS 20 (U.S. CLS. 2, 13, 22, 25, 32 AND 50).

"ARKETIPO" HAS NO MEANING IN A FOREIGN  
LANGUAGE.

THE MARK CONSISTS OF STANDARD CHAR-  
ACTERS WITHOUT CLAIM TO ANY PARTICULAR  
FONT, STYLE, SIZE, OR COLOR.

SER. NO. 79-039,589, FILED 4-17-2007.

VERNA BETH RIRIE, EXAMINING ATTORNEY

**Int. Cl.: 16**

**Prior U.S. Cls.: 2, 5, 22, 23, 29, 37, 38 and 50**

**United States Patent and Trademark Office**

**Reg. No. 3,454,045**

**Registered June 24, 2008**

**TRADEMARK  
PRINCIPAL REGISTER**



PREMEC SA (SWITZERLAND SOCIÉTÉ ANON-  
YME)  
VIA INDUSTRIA  
CH-6814 CADEMPINO  
SWITZERLAND

FOR: STATIONERY; ADHESIVES FOR STATION-  
ERY OR HOUSEHOLD PURPOSES; ARTISTS' MA-  
TERIALS, NAMELY, PENS, PENCILS, NIBS,  
PENCLIPS, BALLS FOR BALL-POINT PENS, BALL  
PEN TIPS, ROLLER PEN TIPS, GEL INK PEN TIPS;  
PAINTBRUSHES; TYPEWRITERS; PRINTING  
TYPE; PRINTING BLOCKS; INKS, NAMELY, INKS  
FOR PENS, FOR BALL-POINT PENS, FOR ROLLER

PENS AND FOR GEL INK PENS, IN CLASS 16 (U.S.  
CLS. 2, 5, 22, 23, 29, 37, 38 AND 50).

PRIORITY DATE OF 11-6-2006 IS CLAIMED.

OWNER OF INTERNATIONAL REGISTRATION  
0926930 DATED 4-30-2007, EXPIRES 4-30-2017.

SER. NO. 79-039,607, FILED 4-30-2007.

MELISSA VALLILLO, EXAMINING ATTORNEY

**Int. Cl.: 5**

**Prior U.S. Cls.: 6, 18, 44, 46, 51 and 52**

**Reg. No. 3,454,046**

**United States Patent and Trademark Office**

**Registered June 24, 2008**

**TRADEMARK  
PRINCIPAL REGISTER**

**CALMOFLEX**

PLANTES ET MEDECINES (FRANCE SOCIÉTÉ À  
RESPONSABILITÉ LIMITÉE)  
29 AVENUE DU SIDOBRE  
F-81100 CASTRES  
FRANCE

PRIORITY DATE OF 10-31-2006 IS CLAIMED.

FOR: MEDICINE FOR THE PREVENTION AND  
TREATMENT OF JOINT PAINS; FOOD SUPPLE-  
MENTS AND NUTRITIONAL SUPPLEMENTS FOR  
MEDICAL USE WHICH HELP RELIEVE JOINT  
PAINS, IN CLASS 5 (U.S. CLS. 6, 18, 44, 46, 51 AND 52).

OWNER OF INTERNATIONAL REGISTRATION  
0927188 DATED 4-23-2007, EXPIRES 4-23-2017.

SER. NO. 79-039,703, FILED 4-23-2007.

THE MARK CONSISTS OF STANDARD CHAR-  
ACTERS WITHOUT CLAIM TO ANY PARTICULAR  
FONT, STYLE, SIZE, OR COLOR.

JEAN IM, EXAMINING ATTORNEY



**Int. Cl.: 3**

**Prior U.S. Cls.: 1, 4, 6, 50, 51 and 52**

**United States Patent and Trademark Office**

**Reg. No. 3,454,047**

**Registered June 24, 2008**

**TRADEMARK  
PRINCIPAL REGISTER**



WHEELABRATOR-ALLEVARD (FRANCE SOCI-  
ÉTÉ ANONYME)  
F-38570 LE CHEYLAS  
FRANCE

FOR: CLEANING, POLISHING, SCOURING AND  
ABRASIVE PREPARATIONS, NAMELY ABRASIVE  
PARTICLES OF METALS AND MINERALS IN THE  
FORM OF GRAINS OR GRANULES, SHOTS USED  
FOR CLEANING AND TREATING METAL SURFA-  
CES OR OTHER MATERIALS, NAMELY STONE  
SURFACES, GLASS SURFACES, TILE SURFACES  
AND WOOD SURFACES, IN CLASS 3 (U.S. CLS. 1, 4,  
6, 50, 51 AND 52).

PRIORITY DATE OF 10-27-2006 IS CLAIMED.

OWNER OF INTERNATIONAL REGISTRATION  
0927190 DATED 4-20-2007, EXPIRES 4-20-2017.

THE TERM PROFILIUM DOES NOT HAVE A  
MEANING IN A FOREIGN LANGUAGE.

SER. NO. 79-039,704, FILED 4-20-2007.

MARLENE BELL, EXAMINING ATTORNEY

Int. Cls.: 29, 30 and 31

Prior U.S. Cls.: 1 and 46

United States Patent and Trademark Office

Reg. No. 3,454,048

Registered June 24, 2008

TRADEMARK  
PRINCIPAL REGISTER



*Corbari*

I SAPORI DI CORBARA S.R.L. (ITALY LTD LIAB  
CO)

VIA ANTONIO DE VITO, 14/B

I-84010 CORBARA (SA), ITALY

FOR: PRESERVED, PROCESSED AND COOKED  
VEGETABLES, NAMELY, CANNED AND BOTTLED  
TOMATOES, PEELED TOMATOES, CRUSHED TO-  
MATOES, TOMATO EXTRACTS AND PASTE, TO-  
MATO PUREE, IN CLASS 29 (U.S. CL. 46).

FOR: SAUCES, NAMELY, TOMATO SAUCE, IN  
CLASS 30 (U.S. CL. 46).

FOR: FRESH VEGETABLES, NAMELY, FRESH  
TOMATOES, IN CLASS 31 (U.S. CLS. 1 AND 46).

OWNER OF INTERNATIONAL REGISTRATION  
0927423 DATED 5-15-2007, EXPIRES 5-15-2017.

NO CLAIM IS MADE TO THE EXCLUSIVE  
RIGHT TO USE THE IMAGE OF THE VEGETABLE  
PLANT, APART FROM THE MARK AS SHOWN.

THE COLOR(S) BLUE, RED, GREEN AND YEL-  
LOW IS/ARE CLAIMED AS A FEATURE OF THE  
MARK.

THE MARK CONSISTS OF THE WORDING  
"CORBARI" AND AN IMAGE OF VEGETABLE  
PLANTS. THE WORD "CORBARI" IS IN BLUE,  
EXCEPT FOR THE ACCENT OVER THE "I", WHICH  
IS RED. THE IMAGE OF PLANTS DEPICTS GREEN  
LEAVES, VINES, AND STALKS, AND RED FRUITS.  
THE IMAGE IS CONTAINED WITHIN AN OVAL  
YELLOW BORDER.

SER. NO. 79-039,775, FILED 5-15-2007.

CORY BOONE, EXAMINING ATTORNEY

**Int. Cl.: 12**

**Prior U.S. Cls.: 19, 21, 23, 31, 35 and 44**

**United States Patent and Trademark Office**

**Reg. No. 3,454,049**

**Registered June 24, 2008**

**TRADEMARK  
PRINCIPAL REGISTER**

**ERGOGEL**

SELLE ROYAL S.P.A. (ITALY STOCK CORPORATION)  
VIA VITTORIO EMANUELE, 119  
I-36050 POZZOLEONE, ITALY

FOR: VEHICLES; APPARATUS FOR LOCOMOTION BY LAND, AIR OR WATER, NAMELY, BICYCLES; BICYCLE SADDLES, IN CLASS 12 (U.S. CLS. 19, 21, 23, 31, 35 AND 44).

THE MARK CONSISTS OF STANDARD CHARACTERS WITHOUT CLAIM TO ANY PARTICULAR FONT, STYLE, SIZE, OR COLOR.

PRIORITY DATE OF 12-28-2006 IS CLAIMED.

OWNER OF INTERNATIONAL REGISTRATION 0927518 DATED 2-19-2007, EXPIRES 2-19-2017.

SER. NO. 79-039,806, FILED 2-19-2007.

KRISTIN DAHLING, EXAMINING ATTORNEY

**Int. Cls.: 20 and 21**

**Prior U.S. Cls.: 2, 13, 22, 23, 25, 29, 30, 32, 33, 40 and 50**

**Reg. No. 3,454,050**

**United States Patent and Trademark Office**

**Registered June 24, 2008**

**TRADEMARK  
PRINCIPAL REGISTER**

**PELICAN**

PEKA-METALL AG (SWITZERLAND AKTIEN-  
GESELLSCHAFT)  
LUZERNERSTRASSE 19A  
CH-6295 MOSEN  
SWITZERLAND

FOR: GUIDING MEANS FOR KITCHEN WASTE  
BINS AND WASTE SORTING BINS, WITH AN  
OPENING AND CLOSING MECHANISM, SLIDE  
RAILS AND PEDALS, ALL AS PARTS OF KITCHEN  
FURNITURE, NAMELY, NON-METAL SLIDING  
RAILS, DOOR LATCHES AND DOOR RELEASES,  
IN CLASS 20 (U.S. CLS. 2, 13, 22, 25, 32 AND 50).

FOR: WASTE BINS AND WASTE SORTING BINS  
DESIGNED TO BE BUILT INTO KITCHEN FURNI-  
TURE, IN CLASS 21 (U.S. CLS. 2, 13, 23, 29, 30, 33, 40  
AND 50).

THE MARK CONSISTS OF STANDARD CHAR-  
ACTERS WITHOUT CLAIM TO ANY PARTICULAR  
FONT, STYLE, SIZE, OR COLOR.

PRIORITY DATE OF 1-18-2007 IS CLAIMED.

OWNER OF INTERNATIONAL REGISTRATION  
0927537 DATED 4-25-2007, EXPIRES 4-25-2017.

SER. NO. 79-039,813, FILED 4-25-2007.

TINA KUAN, EXAMINING ATTORNEY

**Int. Cls.: 7, 40 and 42**

**Prior U.S. Cls.: 13, 19, 21, 23, 31, 34, 35, 100, 101, 103  
and 106**

**Reg. No. 3,454,051**

**United States Patent and Trademark Office**

**Registered June 24, 2008**

**TRADEMARK  
SERVICE MARK  
PRINCIPAL REGISTER**

**PLENTYENERGY**

DIPL.-ING. THOMAS HERZOG (FED REP GER-  
MANY INDIVIDUAL)  
PAPPELWEG 4  
14547 BEELITZ  
FED REP GERMANY

FOR: ENGINES THAT WORK ON THE BASIS OF  
THE FLOW OF FLUIDS AND GASSES, WHICH  
GENERATE THRUST OR TORQUE, AS WELL AS  
THROUGH THE CONTROL OF MAGNETIC  
FIELDS, SO THAT THE FEEDING OF A ROTOR IS  
ACCOMPLISHED, NAMELY, ENGINES NOT FOR  
LAND VEHICLES, BLOCK TYPE THERMAL POW-  
ER STATION ENGINES FOR POWER GENERA-  
TION, AND BOAT ENGINES; MOTORS TO DRIVE  
GENERATORS FOR THE GENERATION OF ELEC-  
TRICITY; TURBINES TO DRIVE GENERATORS  
FOR THE GENERATION OF ELECTRICITY, AND  
TURBINES TO DRIVE A PROPELLER BLADE SYS-  
TEM TO ACCOMPLISH THRUST NOT IN LAND  
VEHICLES, IN CLASS 7 (U.S. CLS. 13, 19, 21, 23, 31, 34  
AND 35).

FOR: PRODUCTION OF ENERGY; ENERGY RE-  
CYCLING SERVICES, NAMELY, CAPTURING AND

CONVERSION OF WASTED ENERGY INTO ELEC-  
TRICITY BY A THERMODYNAMIC PROCESS, IN  
CLASS 40 (U.S. CLS. 100, 103 AND 106).

FOR: TECHNICAL DEVELOPMENT OF ENERGY  
GENERATING EQUIPMENT FOR OTHERS, IN  
CLASS 42 (U.S. CLS. 100 AND 101).

THE MARK CONSISTS OF STANDARD CHAR-  
ACTERS WITHOUT CLAIM TO ANY PARTICULAR  
FONT, STYLE, SIZE, OR COLOR.

PRIORITY DATE OF 10-30-2006 IS CLAIMED.

OWNER OF INTERNATIONAL REGISTRATION  
0927577 DATED 4-27-2007, EXPIRES 4-27-2017.

SER. NO. 79-039,835, FILED 4-27-2007.

ALYSSA PALADINO, EXAMINING ATTORNEY

Int. Cl.: 29

Prior U.S. Cl.: 46

United States Patent and Trademark Office

Reg. No. 3,454,052

Registered June 24, 2008

TRADEMARK  
PRINCIPAL REGISTER

御食园  
YU SHI YUAN

BEIJING YUSHIYUAN FOOD CO., LTD. (CHINA  
CORPORATION)  
7 QU, YANXI INDUSTRIAL ZONE  
HUAIROU DISTRICT, BEIJING  
CHINA

FOR: CRYSTALLIZED FRUITS; CANNED  
FRUITS; PREPARED PROCESSED NUTS; PROCES-  
SED EDIBLE SUNFLOWER SEEDS; PREPARED  
PISTACHIOS; RAISINS; MEAT; PROCESSED PEA-  
NUTS; PROCESSED CHESTNUTS ROASTED IN  
SAND WITH SUGAR; PROCESSED HAZELNUTS,  
IN CLASS 29 (U.S. CL. 46).

OWNER OF INTERNATIONAL REGISTRATION  
0927671 DATED 6-18-2007, EXPIRES 6-18-2017.

NO CLAIM IS MADE TO THE EXCLUSIVE  
RIGHT TO USE "SHI" AND THE NON-LATIN  
CHARACTER THAT TRANSLATES TO MEAN  
"FOOD", APART FROM THE MARK AS SHOWN.

THE ENGLISH TRANSLATION OF THE FOR-  
EIGN WORD(S) IN THE MARK IS: "IMPERIAL  
FOOD PARK".

THE NON-LATIN CHARACTERS IN THE MARK  
TRANSLITERATE TO "YU SHI YUAN" AND THIS  
MEANS "IMPERIAL FOOD PARK" IN ENGLISH.

SER. NO. 79-039,862, FILED 6-18-2007.

JAMES STEIN, EXAMINING ATTORNEY

**Int. Cls.: 35 and 41**

**Prior U.S. Cls.: 100, 101, 102 and 107**

**Reg. No. 3,454,053**

**United States Patent and Trademark Office**

**Registered June 24, 2008**

**SERVICE MARK  
PRINCIPAL REGISTER**

# Tornado Dance

VALBEX SA (SWITZERLAND SOCIÉTÉ ANON-  
YME)  
C/O MN TRUST, RUE DE SAINT-LÉGER 8  
CH-1205 GENÈVE  
SWITZERLAND

FOR: ADVERTISING SERVICES; BUSINESS MANAGEMENT; BUSINESS ADMINISTRATION; PROVIDING OFFICE FUNCTIONS; MARKETING AND PROMOTIONAL SERVICES; DISSEMINATION OF ADVERTISING MATERIAL; DISSEMINATION OF ADVERTISEMENTS, DISSEMINATION OF SAMPLES; DOCUMENT REPRODUCTION; BUSINESS ADVICE, COMMERCIAL INFORMATION; ON-LINE ADVERTISING ON A COMPUTER NETWORK; ORGANIZATION OF FAIRS AND EXHIBITIONS FOR COMMERCIAL OR ADVERTISING PURPOSES; ORGANIZATION AND CONDUCTING OF PROMOTIONAL EVENTS; ORGANIZATION AND CONDUCTING OF PRODUCT PRESENTATIONS FOR COMMERCIAL COMPANIES; RETAIL STORE SERVICES FEATURING STANDS AND SURFACES FOR SETTING UP STANDS, RENTAL OF OFFICE MACHINERY AND EQUIPMENT NAMELY, EQUIPMENT STANDS AND SURFACES FOR SETTING UP EQUIPMENT STANDS, IN CLASS 35 (U.S. CLS. 100, 101 AND 102).

FOR: ENTERTAINMENT SERVICES, NAMELY, CONDUCTING PARTIES AND CONTESTS; ORGANIZATION, PRODUCTION AND PERFORMANCE OF SHOWS, COMPETITIONS, EDUCATIONAL, SPORTING AND ENTERTAINMENT CONTESTS, GAMES, CONCERTS AND DANCING, SPORTING, AND THEATRICAL EVENTS; ORGANIZATION OF SPORTING AND CULTURAL ACTIVITIES; PUBLICATION OF BOOKS, MAGAZINES AND NEWSPAPERS; ORGANIZATION OF BALLS;

ORGANIZATION OF EXHIBITIONS AND OTHER EVENTS FOR CULTURAL OR EDUCATIONAL PURPOSES; ORGANIZATION OF ENTERTAINMENT EVENTS IN CONNECTION WITH TIMEPIECES AND JEWELRY; ARRANGING AND CONDUCTING OF EDUCATIONAL COLLOQUIUMS, CONFERENCES AND CONVENTIONS; BOOKING OF SEATS FOR SHOWS; GAMING AND INFORMATION RELATING THERETO PROVIDED ON LINE FROM A COMPUTER NETWORK; ELECTRONIC PUBLISHING OF NON-DOWNLOADABLE ON-LINE BOOKS AND PERIODICALS; ELECTRONIC DESKTOP PUBLISHING, NAMELY, PUBLICATION OF TEXT AND GRAPHIC WORKS OF OTHERS ON CD, DVD, AND ON-LINE, FEATURING ENTERTAINMENT, SPORTS AND MUSIC INFORMATION; ORGANIZATION OF SEMINARS FOR EDUCATIONAL PURPOSES; PROVIDING ENTERTAINMENT INFORMATION IN THE FIELD OF MUSIC, FILM, AND SPORTS, IN CLASS 41 (U.S. CLS. 100, 101 AND 107).

THE MARK CONSISTS OF STANDARD CHARACTERS WITHOUT CLAIM TO ANY PARTICULAR FONT, STYLE, SIZE, OR COLOR.

PRIORITY DATE OF 12-19-2006 IS CLAIMED.

OWNER OF INTERNATIONAL REGISTRATION  
0927725 DATED 3-15-2007, EXPIRES 3-15-2017.

SER. NO. 79-039,885, FILED 3-15-2007.

SHANNON TWOHIG, EXAMINING ATTORNEY

**Int. Cls.: 9, 42 and 44**

**Prior U.S. Cls.: 21, 23, 26, 36, 38, 100 and 101**

**Reg. No. 3,454,054**

**United States Patent and Trademark Office**

**Registered June 24, 2008**

**TRADEMARK  
SERVICE MARK  
PRINCIPAL REGISTER**



FONDAZIONE CENTRO; SAN RAFFAELE DEL  
MONTE TABOR (ITALY FOUNDATION)  
VIA OLGETTINA, 60  
I-20132 MILANO  
ITALY

FOR: SOFTWARE FOR THE MANAGEMENT OF  
A TECHNICAL-INFORMATIVE NETWORK  
AMONG DOCTORS, HEALTH CARE FIELD SUP-  
PLIERS, PATIENTS, PUBLIC ORGANIZATIONS  
AND PRIVATE FIRMS, TO SHARE INFORMATION  
AND DATA ABOUT NUTRITION, PHYSICAL AC-  
TIVITY AND HUMAN HEALTH PREVENTION  
AND PRESERVATION, IN CLASS 9 (U.S. CLS. 21,  
23, 26, 36 AND 38).

FOR: COMPUTER SERVICES, NAMELY, PLAN-  
NING AND MANAGING A GLOBAL COMPUTER  
NETWORK FOR OTHERS WHICH FEATURES A  
TECHNICAL-INFORMATIVE NETWORK AMONG  
DOCTORS, HEALTH CARE FIELD SUPPLIERS,  
CITIZENS, PUBLIC ORGANIZATIONS AND PRI-  
VATE FIRMS, TO SHARE INFORMATION, PRO-  
CESSES, PROFESSIONAL EXPERIENCES AND  
DATA ABOUT PHARMACEUTICAL AND FOOD  
PREPARATIONS, AND AIMING AT A CORRECT  
NUTRITIONAL EDUCATION, PHYSICAL AC-  
TIVITY AND AT HUMAN HEALTH PREVENTION  
AND PRESERVATION; DEVELOPMENT OF DATA-  
BASES FOR THE AFORESAID INFORMATION  
AND DATA SHARING; CREATION OF WEB SITES

FOR OTHERS ALLOWING THE AFORESAID IN-  
FORMATION AND DATA SHARING AND THEIR  
SPECIFIC TRACKING DOWN, AND HAVING THE  
PURPOSE TO MAKE EASIER THE RELATIONSHIP  
AMONG THE ABOVE MENTIONED SUBJECTS  
AND TO GUARANTEE A CORRECT INFORMA-  
TION IN THE NUTRITIONAL, PHYSICAL AC-  
TIVITY AND MEDICAL-SANITARY FIELDS, IN CLASS  
42 (U.S. CLS. 100 AND 101).

FOR: MEDICAL, SANITARY AND NUTRITION-  
AL CONSULTANCY SERVICES, ALSO RENDERED  
ONLINE, IN CLASS 44 (U.S. CLS. 100 AND 101).

PRIORITY DATE OF 10-2-2006 IS CLAIMED.

OWNER OF INTERNATIONAL REGISTRATION  
0927903 DATED 3-27-2007, EXPIRES 3-27-2017.

THE MARK CONSISTS OF A SPHERE SURROUN-  
DED BY THREE ARROWS POINTING TO A FREE  
REPRESENTATION OF THE MAN OF LEONARDO  
INSIDE THE SAME SPHERE.

SER. NO. 79-039,931, FILED 3-27-2007.

DANNAN HETZEL, EXAMINING ATTORNEY



**Int. Cls.: 7, 9, 11, 35 and 39**

**Prior U.S. Cls.: 13, 19, 21, 23, 26, 31, 34, 35, 36, 38,  
100, 101, 102 and 105**

**Reg. No. 3,454,055**

**United States Patent and Trademark Office**

**Registered June 24, 2008**

**TRADEMARK  
SERVICE MARK  
PRINCIPAL REGISTER**

# **CEGASA**

CELAYA, EMPARANZA Y GALDOS, S.A. (SPAIN  
SOCIEDAD ANONIMA)  
CALLE ARTAPADURA, 11  
E-01013 VITORIA (ALAVA)  
SPAIN

FOR: MACHINES, NAMELY, WINE PRESSES, COMPOSTERS, CANNING MACHINES, CHEESE MAKING MACHINE; MACHINE TOOLS, NAMELY, ROTARY DIES FOR CUTTING BOXES FOR PACKAGING INDUSTRY; ELECTRIC KITCHEN MACHINES, NAMELY, ELECTRIC STANDING MIXERS; ELECTRIC MIXERS FOR HOUSEHOLD USE; STEAM CLEANING APPLIANCES; ELECTRICAL VACUUM CLEANERS; MEAT MINCING MACHINES, NAMELY, ELECTRIC MEAT GRINDERS; ELECTRIC FRUIT PRESSES, NAMELY, JUICE EXTRACTORS FOR DOMESTIC USE; ELECTRIC COFFEE GRINDERS; ELECTRIC FOOD SLICERS, NAMELY, BREAD CUTTING MACHINES; WASHING MACHINES NAMELY, DISH WASHING MACHINES, FLOOR WASHING MACHINES; DISHWASHERS; DRYERS NAMELY, DRY CLEANING MACHINES; ELECTRIC CAN OPENERS; FILTERING MACHINES, NAMELY, FILTER ROD MAKING MACHINES; MIXERS FOR DOMESTIC USE; FILLETING MACHINES, NAMELY, ELECTRIC MEAT SLICERS; ELECTRIC FOOD GRINDERS AND ELECTRIC ICE CRUSHERS FOR HOUSEHOLD PURPOSES, IN CLASS 7 (U.S. CLS. 13, 19, 21, 23, 31, 34 AND 35).

FOR: ELECTRICAL CELLS AND BATTERIES; ELECTRIC ACCUMULATORS; APPARATUS, NAMELY, RECHARGERS FOR RECHARGING ELECTRIC CELLS, BATTERIES AND ACCUMULATORS; ROAD SIGNS, LUMINOUS OR MECHANICAL; LUMINOUS BEACONS SIGNAL LANTERNS, NAMELY, TRAFFIC-LIGHT APPARATUS, REFLECTORS FOR TRAFFIC SIGNALS; SAFETY EQUIPMENT, NAMELY, BEACON LIGHTS; ELECTRIC FENCES; APPARATUS FOR GAMES, NAME-

LY, VIDEO GAME MACHINES ADAPTED FOR USE WITH TELEVISION RECEIVERS ONLY; ELECTRICALLY HEATED HAIR-WAVING DEVICES, NAMELY, ELECTRIC HAIR CURLERS, ELECTRIC HAIR CURLING IRONS, ELECTRIC HAIR CRIMPERS AND ELECTRIC HAIR ROLLERS; ELECTRIC SOCKETS; POCKET CALCULATORS; ELECTRONIC AGENDAS; ELECTRICAL DOOR OPENERS; COMPUTER PERIPHERAL DEVICES, NAMELY, COMPUTER PERIPHERALS, COMPUTER MOUSE; MOBILE TELEPHONES; BATHROOM SCALES; SCALES FOR DOMESTIC USE; PERSONAL SCALES; MARKER BUOYS; LIFE BUOYS; SIGNALING BUOYS; LUMINOUS AND MECHANICAL SIGNALING BUOYS; VEHICLE BREAKDOWN WARNING TRIANGLES; BATTERIES FOR POCKET LAMPS; LUMINOUS SIGNALS, NAMELY, ROTATING LIGHTS; LUMINOUS SIGNALING PANELS, NAMELY, ELECTRIC LUMINESCENT DISPLAY PANELS; GARMENTS FOR PROTECTION AGAINST FIRE; CLOTHING, NAMELY, FIRE RESISTANT GLOVES AND SHOES FOR PROTECTION AGAINST ACCIDENTS, IRRADIATION AND FIRE; FIRE PROTECTION CLOTHES; GLOVES FOR PROTECTION AGAINST ACCIDENTS; THERMOMETERS; ELECTRIC IRONS; PRESSURE MEASURING APPARATUS, NAMELY, BEVELS, PRESSURE GAUGES, PRESSURE SENSORS FOR DOMESTIC USE; TELEPHONE APPARATUS; TELEVISION SETS; RADIOS; DIGITAL VIDEO RECORDERS; SOUND REPRODUCTION APPARATUS; AUTOMATIC DISTRIBUTION MACHINES NAMELY, CURRENCY COUNTING MACHINES, CURRENCY SORTING MACHINES; DATA PROCESSING APPARATUS, NAMELY, DATA PROCESSOR; COMPUTERS; FIRE EXTINGUISHERS, IN CLASS 9 (U.S. CLS. 21, 23, 26, 36 AND 38).

FOR: ELECTRIC LIGHT BULBS; LIGHT BULBS; OIL LANTERNS, ELECTRIC LANTERNS, PORTABLE PAPER LANTERNS; OIL LANTERNS FOR LIGHTING, ELECTRIC LANTERNS FOR LIGHT-

ING, PORTABLE PAPER LANTERNS FOR LIGHTING LANTERNS FOR LIGHTING; HOT AIR SPACE HEATING APPARATUS; HAIR DRYERS; BARBECUES; BEVERAGE COOLING APPARATUS, NAMELY, THERMOELECTRIC COOLER FOR BEVERAGES; ELECTRIC BOTTLE WARMERS, NAMELY, THERMOELECTRIC HEATER FOR BEVERAGES; TANNING APPLIANCES, NAMELY, TANNING BEDS AND LAMPS; ELECTRIC COFFEE PERCOLATORS; WARMING PANS FOR BEDS; AIR CONDITIONING APPARATUS; RADIATORS; ELECTRIC RADIATORS; COOKING APPARATUS, NAMELY, COMMERCIAL COOKING OVENS, COOKING RANGES, ELECTRIC COOKTOPS; ELECTRIC COOKING UTENSILS, NAMELY, ELECTRIC COFFEE MAKERS, ELECTRIC COFFEE POTS, ELECTRIC EGG BOILERS; ELECTRIC DEEP FRYERS; MICROWAVE OVENS; HAND DRYING APPARATUS FOR WASHROOMS, NAMELY, ELECTRIC HOT AIR HAND DRYERS; ELECTRIC BLANKETS, NOT FOR MEDICAL PURPOSES; ELECTRIC PRESSURE COOKERS; ELECTRIC BREAD TOASTERS; ELECTRIC YOGHURT MAKERS; GAS WATER HEATERS, FEED WATER HEATERS, HOT WATER HEATERS; ELECTRIC KETTLES; GAS STOVES, CERAMIC STOVES, WOOD BURNING STOVES; EXHAUST HOODS FOR RANGES; VENTILATORS FOR AIR CONDITIONING; REFRIGERATORS; ICE BOXES; FREEZERS; AIR FILTERS FOR DOMESTIC USE; ELECTRIC COFFEE FILTERS; COFFEE ROASTERS OVENS; HOT-AIR SPACE HEATING APPARATUS, NAMELY, AIR HEATERS; COOKERS, NAMELY, ELECTRIC BREAD COOKERS, ELECTRIC RICE COOKERS, ELECTRIC SLOW COOKERS; DRYERS, NAMELY, ELECTRIC HOT AIR HAND DRYERS, HAIR DRYERS, HAND-HELD ELECTRIC HAIR DRYERS AND CLOTHES DRYERS, IN CLASS 11 (U.S. CLS. 13, 21, 23, 31 AND 34).

FOR: PROCUREMENT SERVICES, NAMELY, PURCHASING OFFICE FURNITURE, LIGHTING FIXTURES, CLOTHING FOR OTHERS; ADVERTISING; ONLINE ADVERTISING ON A COMPUTER COMMUNICATION NETWORK; SALES PROMOTION SERVICES FOR OTHERS; SERVICES OF SUPPORT FOR THE OPERATION OF COMMERCIAL OR INDUSTRIAL COMPANIES, NAMELY, PROVIDING ASSISTANCE TO INDUSTRIAL OR COMMERCIAL ENTERPRISES IN THE RUNNING OF THEIR BUSINESS; IMPORT-EXPORT AGENCIES; COMMERCIAL AND EXCLUSIVE AGENCY REPRESENTATION FOR VISUAL ARTIST AND ATHLETES; RETAIL STORES FEATURING METAL SHEETS FOR WRAPPING AND PACKAGING, ALUMINUM FOILS, NON-LUMINOUS AND NON-MECHANICAL SIGNS OF METAL, UNWROUGHT OR SEMI-UNWROUGHT COMMON METALS, COMMON METAL ALLOYS, ZINC AND ZINC ALLOYS, MACHINES AND MACHINE TOOLS, ELECTRIC KITCHEN MACHINES, ELECTRIC WHISKS FOR HOUSEHOLD PURPOSES, STEAM CLEANING APPLIANCES, ELECTRICAL VACUUM CLEANERS, MEAT MINCING MACHINES, ELECTRIC FRUIT PRESSES FOR DOMESTIC USE, JUICE EXTRACTORS, COFFEE GRINDERS, OTHER THAN HAND OPERATED, BREAD CUTTING MACHINES, WASHING MACHINES, DISHWASHING MACHINES,

DISHWASHERS, ELECTRIC TIN OPENERS, FILTERING MACHINES, MIXERS FOR DOMESTIC USE, FILLETING MACHINES, ELECTRIC GRINDERS AND CRUSHERS FOR HOUSEHOLD PURPOSES, SHAVERS ELECTRIC OR NON-ELECTRIC, HAND-OPERATED HAND TOOLS, CUTLERY, KNIVES, FORKS AND SPOONS, RAZOR BLADES, ELECTRICAL CELLS AND BATTERIES, ELECTRICAL STORAGE BATTERIES, APPARATUS FOR RECHARGING ELECTRIC CELLS, BATTERIES OR ACCUMULATORS, LUMINOUS OR MECHANICAL ROAD SIGNS, BOLLARDS, LUMINOUS BEACONS, SIGNALING LANTERNS, ELECTRIC FENCES, APPARATUS FOR GAMES ADAPTED FOR USE WITH TELEVISION RECEIVERS ONLY, ELECTRICALLY HEATED HAIR-WAVING DEVICES, ELECTRIC APPLIANCES FOR REMOVING MAKE-UP, SOCKS, ELECTRICALLY HEATED, POCKET CALCULATORS, ELECTRONIC AGENDAS, ELECTRICAL DOOR OPENERS, COMPUTER PERIPHERAL DEVICES, MOBILE TELEPHONES, BATHROOM SCALES, SCALES FOR DOMESTIC USE, PERSONAL SCALES, WEIGHING APPARATUS, MARKING BUOYS, RESCUE BUOYS, EMERGENCY OR SIGNALING BUOYS, LUMINOUS OR MECHANICAL SIGNALING, VEHICLE BREAKDOWN WARNING TRIANGLES, BATTERIES FOR POCKET LAMPS, CELLS, LUMINOUS SIGNALS, SIGNALING PANELS, LUMINOUS OR MECHANICAL, GARMENTS FOR PROTECTION AGAINST FIRE, CLOTHING FOR PROTECTION AGAINST ACCIDENTS, IRRADIATION AND FIRE, FIRE PROTECTION CLOTHES, GLOVES FOR PROTECTION AGAINST ACCIDENTS, THERMOMETERS NOT FOR MEDICAL USE, ELECTRICAL IRONS, PRESSURE MEASURING APPARATUS FOR DOMESTIC USE, TELEPHONE SETS, TELEVISION SETS, RADIOS, VIDEO RECORDERS, SOUND REPRODUCTION DEVICES, AUTOMATIC DISTRIBUTION MACHINES, DATA PROCESSING APPARATUS, COMPUTERS, FIRE EXTINGUISHERS, ELECTRIC LIGHT BULBS, LIGHT BULBS, LANTERNS, LANTERNS FOR LIGHTING, HOT AIR GENERATORS, HAIR DRYERS, BARBECUES, BEVERAGES COOLING APPARATUS, ELECTRIC BOTTLE WARMERS, TANNING APPLIANCES, ELECTRICAL COFFEE PERCOLATORS, WARMING PANS, AIR CONDITIONING APPARATUS, HEATING RADIATORS, ELECTRIC RADIATORS, COOKING APPARATUS AND INSTALLATIONS, ELECTRIC COOKING UTENSILS, ELECTRIC FRYERS, MICROWAVE OVENS, KITCHEN APPARATUS, HAND DRYING APPARATUS FOR WASHROOMS, ELECTRIC BLANKETS, NOT FOR MEDICAL PURPOSES, ELECTRIC PRESSURE COOKERS, BREAD TOASTERS, ELECTRIC YOGURT MAKERS, KETTLES, ELECTRIC KETTLES, STOVES, HEATING APPARATUS, COOKING RINGS, EXHAUST HOODS FOR RANGES, AIR-CONDITIONING VENTILATORS, REFRIGERATORS, ICEBOXES, FREEZERS, FILTERS AS PARTS OF DOMESTIC INSTALLATIONS, ELECTRIC COFFEE FILTERS, COFFEE ROASTERS, AIR HEATERS, COOKERS, DRYERS, PRINTED MATTER, CATALOGUES, NON-TEXTILE LABELS, GARBAGE BAGS OF PAPER OR PLASTICS, FILMS OF PLASTIC MATERIALS FOR PACKAGING, PAPER COFFEE FILTERS, GLOVES FOR HOUSE-

HOLD PURPOSES, GARDENING GLOVES, UTENSILS FOR HOUSEHOLD PURPOSES, NOT OF PRECIOUS METAL, KITCHEN UTENSILS, NOT OF PRECIOUS METAL, NON-ELECTRIC COFFEE POTS, NON-ELECTRIC COFFEE FILTERS, SUPPORTS FOR IRONING BOARDS, IRONING BOARDS, IRONING BOARD COVERS AND CARPET SWEEPERS; ONLINE RETAIL STORE SERVICE FEATURING METAL SHEETS FOR WRAPPING AND PACKAGING, ALUMINUM FOILS, SIGNS NON-LUMINOUS AND NON-MECHANICAL OF METAL, UNWROUGHT OR SEMI-UNWROUGHT COMMON METALS, COMMON METAL ALLOYS, ZINC AND ZINC ALLOYS, MACHINES AND MACHINE TOOLS, ELECTRIC KITCHEN MACHINES, ELECTRIC WHISKS FOR HOUSEHOLD PURPOSES, STEAM CLEANING APPLIANCES, ELECTRICAL VACUUM CLEANERS, MEAT MINCING MACHINES, ELECTRIC FRUIT PRESSES FOR DOMESTIC USE, JUICE EXTRACTORS, COFFEE GRINDERS, OTHER THAN HAND OPERATED, BREAD CUTTING MACHINES, WASHING MACHINES, DISHWASHING MACHINES, DISHWASHERS, ELECTRIC TIN OPENERS, FILTERING MACHINES, MIXERS FOR DOMESTIC USE, FILLETING MACHINES, ELECTRIC GRINDERS AND CRUSHERS FOR HOUSEHOLD PURPOSES, SHAVERS ELECTRIC OR NON-ELECTRIC, HAND-OPERATED HAND TOOLS, CUTLERY, KNIVES, FORKS AND SPOONS, RAZOR BLADES, ELECTRICAL CELLS AND BATTERIES, ELECTRICAL STORAGE BATTERIES, APPARATUS FOR RECHARGING ELECTRIC CELLS, BATTERIES OR ACCUMULATORS, LUMINOUS OR MECHANICAL ROAD SIGNS, BOLLARDS, LUMINOUS BEACONS, SIGNALING LANTERNS, ELECTRIC FENCES, APPARATUS FOR GAMES ADAPTED FOR USE WITH TELEVISION RECEIVERS ONLY, ELECTRICALLY HEATED HAIR-WAVING DEVICES, ELECTRIC APPLIANCES FOR REMOVING MAKE-UP, SOCKS, ELECTRICALLY HEATED, POCKET CALCULATORS, ELECTRONIC AGENDAS, ELECTRICAL DOOR OPENERS, COMPUTER PERIPHERAL DEVICES, MOBILE TELEPHONES, BATHROOM SCALES, SCALES FOR DOMESTIC USE, PERSONAL SCALES, WEIGHING APPARATUS, MARKING BUOYS, RESCUE BUOYS, EMERGENCY OR SIGNALING BUOYS, LUMINOUS OR MECHANICAL SIGNALING, VEHICLE BREAKDOWN WARNING TRIANGLES, BATTERIES FOR POCKET LAMPS, CELLS, LUMINOUS SIGNALS, SIGNALING PANELS, LUMINOUS OR MECHANICAL, GARMENTS FOR PROTECTION AGAINST FIRE, CLOTHING FOR PROTECTION AGAINST ACCIDENTS, IRRADIATION AND FIRE, FIRE PROTECTION CLOTHES, GLOVES FOR PROTECTION AGAINST ACCIDENTS, THERMOMETERS NOT FOR MEDICAL USE, ELECTRICAL IRONS, PRESSURE MEASURING APPARATUS FOR DOMESTIC USE, TELEPHONE SETS, TELEVISION SETS, RADIOS, VIDEO RECORDERS, SOUND REPRODUCTION DEVICES, AUTOMATIC DISTRIBUTION MACHINES, DATA PROCESSING APPARATUS, COM-

PUTERS, FIRE EXTINGUISHERS, ELECTRIC LIGHT BULBS, LIGHT BULBS, LANTERNS, LANTERNS FOR LIGHTING, HOT AIR GENERATORS, HAIR DRYERS, BARBECUES, BEVERAGES COOLING APPARATUS, ELECTRIC BOTTLE WARMERS, TANNING APPLIANCES, ELECTRICAL COFFEE PERCOLATORS, WARMING PANS, AIR CONDITIONING APPARATUS, HEATING RADIATORS, ELECTRIC RADIATORS, COOKING APPARATUS AND INSTALLATIONS, ELECTRIC COOKING UTENSILS, ELECTRIC FRYERS, MICROWAVE OVENS, KITCHEN APPARATUS, HAND DRYING APPARATUS FOR WASHROOMS, ELECTRIC BLANKETS, NOT FOR MEDICAL PURPOSES, ELECTRIC PRESSURE COOKERS, BREAD TOASTERS, ELECTRIC YOGHURT MAKERS, KETTLES, ELECTRIC KETTLES, STOVES, HEATING APPARATUS, COOKING RINGS, EXHAUST HOODS FOR RANGES, AIR-CONDITIONING VENTILATORS, REFRIGERATORS, ICEBOXES, FREEZERS, FILTERS AS PARTS OF DOMESTIC INSTALLATIONS, ELECTRIC COFFEE FILTERS, COFFEE ROASTERS, AIR HEATERS, COOKERS, DRYERS, PRINTED MATTER, CATALOGUES, NON-TEXTILE LABELS, GARBAGE BAGS OF PAPER OR PLASTICS, FILMS OF PLASTIC MATERIALS FOR PACKAGING, PAPER COFFEE FILTERS, GLOVES FOR HOUSEHOLD PURPOSES, GARDENING GLOVES, UTENSILS FOR HOUSEHOLD PURPOSES, NOT OF PRECIOUS METAL, KITCHEN UTENSILS, NOT OF PRECIOUS METAL, NON-ELECTRIC COFFEE POTS, NON-ELECTRIC COFFEE FILTERS, SUPPORTS FOR IRONING BOARDS, IRONING BOARDS, IRONING BOARD COVERS AND CARPET SWEEPERS; FRANCHISING SERVICES, NAME- LY, OFFERING COMMERCIAL COMPANY OPERATIONAL AND MANAGEMENT ASSISTANCE IN THE ESTABLISHMENT OR OPERATION OF RETAIL STORES, FOR ALL TYPES OF ELECTRICAL HOUSEHOLD UTENSILS, ELECTRIC BATTERIES AND LANTERNS, IN CLASS 35 (U.S. CLS. 100, 101 AND 102).

FOR: DISTRIBUTION SERVICES, NAMELY, DELIVERY OF CLOTHING, AUTOMOTIVE PARTS AND COSMETICS; TRANSPORT OF GOODS; STORAGE OF FURNITURE, FURS AND CLOTHING, IN CLASS 39 (U.S. CLS. 100 AND 105).

PRIORITY DATE OF 11-22-2006 IS CLAIMED.

OWNER OF INTERNATIONAL REGISTRATION 0927933 DATED 2-27-2007, EXPIRES 2-27-2017.

OWNER OF U.S. REG. NOS. 1,361,511, 1,388,850 AND OTHERS.

SER. NO. 79-039,936, FILED 2-27-2007.

CHARISMA HAMPTON, EXAMINING ATTORNEY

**Int. Cls.: 7, 9, 11, 35 and 39**

**Prior U.S. Cls.: 13, 19, 21, 23, 26, 31, 34, 35, 36, 38,  
100, 101, 102 and 105**

**Reg. No. 3,454,056**

**United States Patent and Trademark Office**

**Registered June 24, 2008**

**TRADEMARK  
SERVICE MARK  
PRINCIPAL REGISTER**

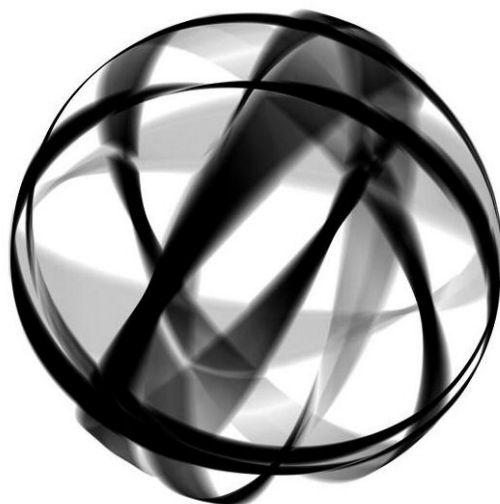

CELAYA, EMPARANZA Y GALDOS, S.A. (SPAIN  
SOCIEDAD ANONIMA)

CALLE ARTAPADURA, 11

E-01013 VITORIA (ALAVA)

SPAIN

FOR: MACHINES, NAMELY, WINE PRESSES, COMPOSTERS, CANNING MACHINES, CHEESE MAKING MACHINE; MACHINE TOOLS, NAMELY, ROTARY DIES FOR CUTTING BOXES FOR PACKAGING INDUSTRY; ELECTRIC KITCHEN MACHINES, NAMELY, ELECTRIC STANDING MIXERS; ELECTRIC MIXERS FOR HOUSEHOLD USE; STEAM CLEANING APPLIANCES; ELECTRICAL VACUUM CLEANERS; MEAT MINCING MACHINES, NAMELY, ELECTRIC MEAT GRINDERS; ELECTRIC FRUIT PRESSES, NAMELY, JUICE EXTRACTORS FOR DOMESTIC USE; ELECTRIC COFFEE GRINDERS; ELECTRIC FOOD SLICERS, NAMELY, BREAD CUTTING MACHINES; WASHING MACHINES, NAMELY, DISH WASHING MACHINES, FLOOR WASHING MACHINES; DISHWASHERS; DRYERS, NAMELY, DRY CLEANING MACHINES; ELECTRIC CAN OPENERS; FILTERING MACHINES, NAMELY, FILTER ROD MAKING MACHINES; MIXERS FOR DOMESTIC USE; FILLETING MACHINES, NAMELY, ELECTRIC MEAT SLICERS; ELECTRIC FOOD GRINDERS AND ELECTRIC ICE CRUSHERS FOR

HOUSEHOLD PURPOSES, IN CLASS 7 (U.S. CLS. 13, 19, 21, 23, 31, 34 AND 35).

FOR: ELECTRICAL CELLS AND BATTERIES; ELECTRIC ACCUMULATORS; APPARATUS, NAMELY, RECHARGERS FOR RECHARGING ELECTRIC CELLS, BATTERIES AND ACCUMULATORS; ROAD SIGNS, LUMINOUS OR MECHANICAL; LUMINOUS BEACONS SIGNAL LANTERNS, NAMELY, TRAFFIC-LIGHT APPARATUS, REFLECTORS FOR TRAFFIC SIGNALS; SAFETY EQUIPMENT, NAMELY, BEACON LIGHTS; ELECTRIC FENCES; APPARATUS FOR GAMES, NAMELY, VIDEO GAME MACHINES ADAPTED FOR USE WITH TELEVISION RECEIVERS ONLY; ELECTRICALLY HEATED HAIR-WAVING DEVICES, NAMELY, ELECTRIC HAIR CURLERS, ELECTRIC HAIR CURLING IRONS, ELECTRIC HAIR CRIMPERS AND ELECTRIC HAIR ROLLERS; ELECTRIC SOCKETS; POCKET CALCULATORS; ELECTRONIC AGENDAS; ELECTRICAL DOOR OPENERS; COMPUTER PERIPHERAL DEVICES, NAMELY, COMPUTER PERIPHERALS, COMPUTER MOUSE; MOBILE TELEPHONES; BATHROOM SCALES; SCALES FOR DOMESTIC USE; PERSONAL SCALES; MARKER BUOYS; LIFE BUOYS; SIGNALING BUOYS; LUMINOUS AND MECHANICAL SIGNALING BUOYS; VEHICLE BREAKDOWN WARNING TRIANGLES; BATTERIES FOR POCKET LAMPS; LUMINOUS SIGNALS, NAMELY, ROTATING

LIGHTS; LUMINOUS SIGNALING PANELS, NAME-  
LY, ELECTRIC LUMINESCENT DISPLAY PANELS;  
GARMENTS FOR PROTECTION AGAINST FIRE;  
CLOTHING, NAMELY, FIRE RESISTANT GLOVES  
AND SHOES FOR PROTECTION AGAINST ACCI-  
DENTS, IRRADIATION AND FIRE; FIRE PROTEC-  
TION CLOTHES; GLOVES FOR PROTECTION  
AGAINST ACCIDENTS; THERMOMETERS; ELEC-  
TRIC IRONS; PRESSURE MEASURING APPARA-  
TUS, NAMELY, BEVELS, PRESSURE GAUGES,  
PRESSURE SENSORS FOR DOMESTIC USE; TELE-  
PHONE APPARATUS; TELEVISION SETS; RADIOS;  
DIGITAL VIDEO RECORDERS; SOUND REPRO-  
DUCTION APPARATUS; AUTOMATIC DISTRIBUTI-  
ON MACHINES, NAMELY, CURRENCY  
COUNTING MACHINES, CURRENCY SORTING  
MACHINES; DATA PROCESSING APPARATUS,  
NAMELY, DATA PROCESSOR; COMPUTERS; FIRE  
EXTINGUISHERS, IN CLASS 9 (U.S. CLS. 21, 23, 26,  
36 AND 38).

FOR: ELECTRIC LIGHT BULBS; LIGHT BULBS;  
OIL LANTERNS, ELECTRIC LANTERNS, PORTA-  
BLE PAPER LANTERNS; OIL LANTERNS FOR  
LIGHTING, ELECTRIC LANTERNS FOR LIGHT-  
ING, PORTABLE PAPER LANTERNS FOR LIGHT-  
ING LANTERNS FOR LIGHTING; HOT AIR SPACE  
HEATING APPARATUSES; HAIR DRYERS; BAR-  
BECUES; BEVERAGE COOLING APPARATUS,  
NAMELY, THERMOELECTRIC COOLER FOR BEV-  
ERAGES; ELECTRIC BOTTLE WARMERS, NAME-  
LY, THERMOELECTRIC HEATER FOR  
BEVERAGES; TANNING APPLIANCES, NAMELY,  
TANNING BEDS AND LAMPS; ELECTRIC COFFEE  
PERCOLATORS; WARMING PANS FOR BEDS; AIR  
CONDITIONING APPARATUS; RADIATORS;  
ELECTRIC RADIATORS; COOKING APPARATUS,  
NAMELY, COMMERCIAL COOKING OVENS,  
COOKING RANGES, ELECTRIC COOKTOPS; ELEC-  
TRIC COOKING UTENSILS, NAMELY, ELECTRIC  
COFFEE MAKERS, ELECTRIC COFFEE POTS,  
ELECTRIC EGG BOILERS; ELECTRIC DEEP FRY-  
ERS; MICROWAVE OVENS; HAND DRYING APPA-  
RATUS FOR WASHROOMS, NAMELY, ELECTRIC  
HOT AIR HAND DRYERS; ELECTRIC BLANKETS,  
NOT FOR MEDICAL PURPOSES; ELECTRIC PRES-  
SURE COOKERS; ELECTRIC BREAD TOASTERS;  
ELECTRIC YOGURT MAKERS; GAS WATER HEA-  
TERS, FEED WATER HEATERS, HOT WATER  
HEATERS; ELECTRIC KETTLES; GAS STOVES,  
CERAMIC STOVES, WOOD BURNING STOVES;  
EXHAUST HOODS FOR RANGES; VENTILATORS  
FOR AIR CONDITIONING; REFRIGERATORS; ICE  
BOXES; FREEZERS; AIR FILTERS FOR DOMESTIC  
USE; ELECTRIC COFFEE FILTERS; COFFEE  
ROASTERS OVENS; HOT-AIR SPACE HEATING  
APPARATUS, NAMELY, AIR HEATERS; COOKERS,  
NAMELY, ELECTRIC BREAD COOKERS, ELEC-  
TRIC RICE COOKERS, ELECTRIC SLOW COO-  
KERS; DRYERS, NAMELY, ELECTRIC HOT AIR  
HAND DRYERS, HAIR DRYERS, HAND-HELD  
ELECTRIC HAIR DRYERS AND CLOTHES DRY-  
ERS, IN CLASS 11 (U.S. CLS. 13, 21, 23, 31 AND 34).

FOR: PROCUREMENT SERVICES, NAMELY,  
PURCHASING OFFICE FURNITURE, LIGHTING  
FIXTURES, CLOTHING FOR OTHERS; ADVERTIS-

ING; ONLINE ADVERTISING ON A COMPUTER  
COMMUNICATION NETWORK; SALES PROMOTI-  
ON SERVICES FOR OTHERS; SERVICES OF SUP-  
PORT FOR THE OPERATION OF COMMERCIAL  
OR INDUSTRIAL COMPANIES, NAMELY, PRO-  
VIDING ASSISTANCE TO INDUSTRIAL OR COM-  
MERCIAL ENTERPRISES IN THE RUNNING OF  
THEIR BUSINESS; IMPORT-EXPORT AGENCIES;  
COMMERCIAL AND EXCLUSIVE AGENCY RE-  
PRESENTATION FOR VISUAL ARTIST AND ATH-  
LETES; RETAIL STORES FEATURING METAL  
SHEETS FOR WRAPPING AND PACKAGING, ALU-  
MINUM FOILS, NON-LUMINOUS AND NON-ME-  
CHANICAL SIGNS OF METAL, UNWROUGHT OR  
SEMI-UNWROUGHT COMMON METALS, COM-  
MON METAL ALLOYS, ZINC AND ZINC ALLOYS,  
MACHINES AND MACHINE TOOLS, ELECTRIC  
KITCHEN MACHINES, ELECTRIC WHISKS FOR  
HOUSEHOLD PURPOSES, STEAM CLEANING AP-  
PLIANCES, ELECTRICAL VACUUM CLEANERS,  
MEAT MINCING MACHINES, ELECTRIC FRUIT  
PRESSES FOR DOMESTIC USE, JUICE EXTRAC-  
TORS, COFFEE GRINDERS, OTHER THAN HAND  
OPERATED, BREAD CUTTING MACHINES, WASH-  
ING MACHINES, DISH WASHING MACHINES,  
DISHWASHERS, ELECTRIC TIN OPENERS, FIL-  
TERING MACHINES, MIXERS FOR DOMESTIC  
USE, FILLETING MACHINES, ELECTRIC GRIN-  
DERS AND CRUSHERS FOR HOUSEHOLD PUR-  
POSES, SHAVERS ELECTRIC OR NON-ELECTRIC,  
HAND-OPERATED HAND TOOLS, CUTLERY, KNI-  
VES, FORKS AND SPOONS, RAZOR BLADES,  
ELECTRICAL CELLS AND BATTERIES, ELECTRI-  
CAL STORAGE BATTERIES, APPARATUS FOR  
RECHARGING ELECTRIC CELLS, BATTERIES OR  
ACCUMULATORS, LUMINOUS OR MECHANICAL  
ROAD SIGNS, BOLLARDS, LUMINOUS BEACONS,  
SIGNALING LANTERNS, ELECTRIC FENCES, AP-  
PARATUS FOR GAMES ADAPTED FOR USE WITH  
TELEVISION RECEIVERS ONLY, ELECTRICALLY  
HEATED HAIR-WAVING DEVICES, ELECTRIC AP-  
PLIANCES FOR REMOVING MAKE-UP, SOCKS,  
ELECTRICALLY HEATED, POCKET CALCULA-  
TORS, ELECTRONIC AGENDAS, ELECTRICAL  
DOOR OPENERS, COMPUTER PERIPHERAL DE-  
VICES, MOBILE TELEPHONES, BATHROOM  
SCALES, SCALES FOR DOMESTIC USE, PERSONAL  
SCALES, WEIGHING APPARATUS, MARKING  
BUOYS, RESCUE BUOYS, EMERGENCY OR SIG-  
NALING BUOYS, LUMINOUS OR MECHANICAL  
SIGNALING, VEHICLE BREAKDOWN WARNING  
TRIANGLES, BATTERIES FOR POCKET LAMPS,  
CELLS, LUMINOUS SIGNALS, SIGNALING PA-  
NELS, LUMINOUS OR MECHANICAL, GARMENTS  
FOR PROTECTION AGAINST FIRE, CLOTHING  
FOR PROTECTION AGAINST ACCIDENTS, IRRA-  
DIATION AND FIRE, FIRE PROTECTION  
CLOTHES, GLOVES FOR PROTECTION AGAINST  
ACCIDENTS, THERMOMETERS NOT FOR MEDI-  
CAL USE, ELECTRICAL IRONS, PRESSURE MEA-  
SURING APPARATUS FOR DOMESTIC USE,  
TELEPHONE SETS, TELEVISION SETS, RADIOS,  
VIDEO RECORDERS, SOUND REPRODUCTION  
DEVICES, AUTOMATIC DISTRIBUTION MA-  
CHINES, DATA PROCESSING APPARATUS, COM-  
PUTERS, FIRE EXTINGUISHERS, ELECTRIC  
LIGHT BULBS, LIGHT BULBS, LANTERNS, LAN-

TERNS FOR LIGHTING, HOT AIR GENERATORS, HAIR DRYERS, BARBECUES, BEVERAGES COOLING APPARATUS, ELECTRIC BOTTLE WARMERS, TANNING APPLIANCES, ELECTRICAL COFFEE PERCOLATORS, WARMING PANS, AIR CONDITIONING APPARATUS, HEATING RADIATORS, ELECTRIC RADIATORS, COOKING APPARATUS AND INSTALLATIONS, ELECTRIC COOKING UTENSILS, ELECTRIC FRYERS, MICROWAVE OVENS, KITCHEN APPARATUS, HAND DRYING APPARATUS FOR WASHROOMS, ELECTRIC BLANKETS, NOT FOR MEDICAL PURPOSES, ELECTRIC PRESSURE COOKERS, BREAD TOASTERS, ELECTRIC YOGURT MAKERS, KETTLES, ELECTRIC KETTLES, STOVES, HEATING APPARATUS, COOKING RINGS, EXHAUST HOODS FOR RANGES, AIR-CONDITIONING VENTILATORS, REFRIGERATORS, ICEBOXES, FREEZERS, FILTERS AS PARTS OF DOMESTIC INSTALLATIONS, ELECTRIC COFFEE FILTERS, COFFEE ROASTERS, AIR HEATERS, COOKERS, DRYERS, PRINTED MATTER, CATALOGUES, NON-TEXTILE LABELS, GARBAGE BAGS OF PAPER OR PLASTICS, FILMS OF PLASTIC MATERIALS FOR PACKAGING, PAPER COFFEE FILTERS, GLOVES FOR HOUSEHOLD PURPOSES, GARDENING GLOVES, UTENSILS FOR HOUSEHOLD PURPOSES, NOT OF PRECIOUS METAL, KITCHEN UTENSILS, NOT OF PRECIOUS METAL, NON-ELECTRIC COFFEE POTS, NON-ELECTRIC COFFEE FILTERS, SUPPORTS FOR IRONING BOARDS, IRONING BOARDS, IRONING BOARD COVERS AND CARPET SWEEPERS; ONLINE RETAIL STORE SERVICE FEATURING METAL SHEETS FOR WRAPPING AND PACKAGING, ALUMINUM FOILS, SIGNS NON-LUMINOUS AND NON-MECHANICAL OF METAL, UNWROUGHT OR SEMI-UNWROUGHT COMMON METALS, COMMON METAL ALLOYS, ZINC AND ZINC ALLOYS, MACHINES AND MACHINE TOOLS, ELECTRIC KITCHEN MACHINES, ELECTRIC WHISKS FOR HOUSEHOLD PURPOSES, STEAM CLEANING APPLIANCES, ELECTRICAL VACUUM CLEANERS, MEAT MINCING MACHINES, ELECTRIC FRUIT PRESSES FOR DOMESTIC USE, JUICE EXTRACTORS, COFFEE GRINDERS, OTHER THAN HAND OPERATED, BREAD CUTTING MACHINES, WASHING MACHINES, DISH WASHING MACHINES, DISHWASHERS, ELECTRIC TIN OPENERS, FILTERING MACHINES, MIXERS FOR DOMESTIC USE, FILLETING MACHINES, ELECTRIC GRINDERS AND CRUSHERS FOR HOUSEHOLD PURPOSES, SHAVERS ELECTRIC OR NON-ELECTRIC, HAND-OPERATED HAND TOOLS, CUTLERY, KNIVES, FORKS AND SPOONS, RAZOR BLADES, ELECTRICAL CELLS AND BATTERIES, ELECTRICAL STORAGE BATTERIES, APPARATUS FOR RECHARGING ELECTRIC CELLS, BATTERIES OR ACCUMULATORS, LUMINOUS OR MECHANICAL ROAD SIGNS, BOLLARDS, LUMINOUS BEACONS, SIGNALING LANTERNS, ELECTRIC FENCES, APPARATUS FOR GAMES ADAPTED FOR USE WITH TELEVISION RECEIVERS ONLY, ELECTRICALLY HEATED HAIR-WAVING DEVICES, ELECTRIC APPLIANCES FOR REMOVING MAKE-UP, SOCKS, ELECTRICALLY HEATED, POCKET CALCULATORS, ELECTRONIC AGENDAS, ELECTRICAL

DOOR OPENERS, COMPUTER PERIPHERAL DEVICES, MOBILE TELEPHONES, BATHROOM SCALES, SCALES FOR DOMESTIC USE, PERSONAL SCALES, WEIGHING APPARATUS, MARKING BUOYS, RESCUE BUOYS, EMERGENCY OR SIGNALING BUOYS, LUMINOUS OR MECHANICAL SIGNALING, VEHICLE BREAKDOWN WARNING TRIANGLES, BATTERIES FOR POCKET LAMPS, CELLS, LUMINOUS SIGNALS, SIGNALING PANELS, LUMINOUS OR MECHANICAL, GARMENTS FOR PROTECTION AGAINST FIRE, CLOTHING FOR PROTECTION AGAINST ACCIDENTS, IRRADIATION AND FIRE, FIRE PROTECTION CLOTHES, GLOVES FOR PROTECTION AGAINST ACCIDENTS, THERMOMETERS NOT FOR MEDICAL USE, ELECTRICAL IRONS, PRESSURE MEASURING APPARATUS FOR DOMESTIC USE, TELEPHONE SETS, TELEVISION SETS, RADIOS, VIDEO RECORDERS, SOUND REPRODUCTION DEVICES, AUTOMATIC DISTRIBUTION MACHINES, DATA PROCESSING APPARATUS, COMPUTERS, FIRE EXTINGUISHERS, ELECTRIC LIGHT BULBS, LIGHT BULBS, LANTERNS, LANTERNS FOR LIGHTING, HOT AIR GENERATORS, HAIR DRYERS, BARBECUES, BEVERAGES COOLING APPARATUS, ELECTRIC BOTTLE WARMERS, TANNING APPLIANCES, ELECTRICAL COFFEE PERCOLATORS, WARMING PANS, AIR CONDITIONING APPARATUS, HEATING RADIATORS, ELECTRIC RADIATORS, COOKING APPARATUS AND INSTALLATIONS, ELECTRIC COOKING UTENSILS, ELECTRIC FRYERS, MICROWAVE OVENS, KITCHEN APPARATUS, HAND DRYING APPARATUS FOR WASHROOMS, ELECTRIC BLANKETS, NOT FOR MEDICAL PURPOSES, ELECTRIC PRESSURE COOKERS, BREAD TOASTERS, ELECTRIC YOGURT MAKERS, KETTLES, ELECTRIC KETTLES, STOVES, HEATING APPARATUS, COOKING RINGS, EXHAUST HOODS FOR RANGES, AIR-CONDITIONING VENTILATORS, REFRIGERATORS, ICEBOXES, FREEZERS, FILTERS AS PARTS OF DOMESTIC INSTALLATIONS, ELECTRIC COFFEE FILTERS, COFFEE ROASTERS, AIR HEATERS, COOKERS, DRYERS, PRINTED MATTER, CATALOGUES, NON-TEXTILE LABELS, GARBAGE BAGS OF PAPER OR PLASTICS, FILMS OF PLASTIC MATERIALS FOR PACKAGING, PAPER COFFEE FILTERS, GLOVES FOR HOUSEHOLD PURPOSES, GARDENING GLOVES, UTENSILS FOR HOUSEHOLD PURPOSES, NOT OF PRECIOUS METAL, KITCHEN UTENSILS, NOT OF PRECIOUS METAL, NON-ELECTRIC COFFEE POTS, NON-ELECTRIC COFFEE FILTERS, SUPPORTS FOR IRONING BOARDS, IRONING BOARDS, IRONING BOARD COVERS AND CARPET SWEEPERS; FRANCHISING SERVICES, NAMELY, OFFERING COMMERCIAL COMPANY OPERATIONAL AND MANAGEMENT ASSISTANCE IN THE ESTABLISHMENT OR OPERATION OF RETAIL STORES, FOR ALL TYPES OF ELECTRICAL HOUSEHOLD UTENSILS, ELECTRIC BATTERIES AND LANTERNS, IN CLASS 35 (U.S. CLS. 100, 101 AND 102).

FOR: DISTRIBUTION SERVICES, NAMELY, DELIVERY OF CLOTHING, AUTOMOTIVE PARTS AND COSMETICS; TRANSPORT OF GOODS; STO-

RAGE OF FURNITURE, FURS AND CLOTHING, IN  
CLASS 39 (U.S. CLS. 100 AND 105).

PRIORITY DATE OF 11-22-2006 IS CLAIMED.

OWNER OF INTERNATIONAL REGISTRATION  
0927934 DATED 2-27-2007, EXPIRES 2-27-2017.

THE MARK CONSISTS OF STYLIZED SPHERE  
WITH INTERSECTING PARALLELS AND MERI-  
DIANS.

SER. NO. 79-039,937, FILED 2-27-2007.

CHARISMA HAMPTON, EXAMINING ATTORNEY

**Int. Cls.: 7, 9, 11, 35 and 39**

**Prior U.S. Cls.: 13, 19, 21, 23, 26, 31, 34, 35, 36, 38,  
100, 101, 102 and 105**

**Reg. No. 3,454,057**

**United States Patent and Trademark Office**

**Registered June 24, 2008**

**TRADEMARK  
SERVICE MARK  
PRINCIPAL REGISTER**



**CEGASA**

CELAYA, EMPARANZA Y GALDOS, S.A. (SPAIN  
SOCIEDAD ANONIMA)  
CALLE ARTAPADURA, 11  
E-01013 VITORIA (ALAVA)  
SPAIN

FOR: MACHINES, NAMELY, WINE PRESSES, COMPOSTERS, CANNING MACHINES, CHEESE MAKING MACHINE; MACHINE TOOLS, NAMELY, ROTARY DIES FOR CUTTING BOXES FOR PACKAGING INDUSTRY; ELECTRIC KITCHEN MACHINES, NAMELY, ELECTRIC STANDING MIXERS; ELECTRIC MIXERS FOR HOUSEHOLD USE; STEAM CLEANING APPLIANCES; ELECTRICAL VACUUM CLEANERS; MEAT MINCING MACHINES, NAMELY, ELECTRIC MEAT GRINDERS; ELECTRIC FRUIT PRESSES, NAMELY, JUICE EXTRACTORS FOR DOMESTIC USE; ELECTRIC COFFEE GRINDERS; ELECTRIC FOOD SLICERS, NAMELY, BREAD CUTTING MACHINES; WASHING MACHINES, NAMELY, DISH WASHING MACHINES, FLOOR WASHING MACHINES; DISHWASHERS; DRYERS, NAMELY, DRY CLEANING MACHINES; ELECTRIC CAN OPENERS; FILTERING MACHINES, NAMELY, FILTER ROD MAKING MACHINES; MIXERS FOR DOMESTIC USE; FILLETING MACHINES, NAMELY, ELECTRIC MEAT SLICERS; ELECTRIC FOOD GRINDERS AND ELECTRIC ICE CRUSHERS FOR HOUSEHOLD PURPOSES, IN CLASS 7 (U.S. CLS. 13, 19, 21, 23, 31, 34 AND 35).

FOR: ELECTRICAL CELLS AND BATTERIES; ELECTRIC ACCUMULATORS; APPARATUS,

NAMELY, RECHARGERS FOR RECHARGING ELECTRIC CELLS, BATTERIES AND ACCUMULATORS; ROAD SIGNS, LUMINOUS OR MECHANICAL; LUMINOUS BEACONS SIGNAL LANTERNS, NAMELY, TRAFFIC-LIGHT APPARATUS, REFLECTORS FOR TRAFFIC SIGNALS; SAFETY EQUIPMENT, NAMELY, BEACON LIGHTS; ELECTRIC FENCES; APPARATUS FOR GAMES, NAMELY, VIDEO GAME MACHINES ADAPTED FOR USE WITH TELEVISION RECEIVERS ONLY; ELECTRICALLY HEATED HAIR-WAVING DEVICES, NAMELY, ELECTRIC HAIR CURLERS, ELECTRIC HAIR CURLING IRONS, ELECTRIC HAIR CRIMPERS AND ELECTRIC HAIR ROLLERS; ELECTRIC SOCKETS; POCKET CALCULATORS; ELECTRONIC AGENDAS; ELECTRICAL DOOR OPENERS; COMPUTER PERIPHERAL DEVICES, NAMELY, COMPUTER PERIPHERALS, COMPUTER MOUSE; MOBILE TELEPHONES; BATHROOM SCALES; SCALES FOR DOMESTIC USE; PERSONAL SCALES; MARKER BUOYS; LIFE BUOYS; SIGNALING BUOYS; LUMINOUS AND MECHANICAL SIGNALING BUOYS; VEHICLE BREAKDOWN WARNING TRIANGLES; BATTERIES FOR POCKET LAMPS; LUMINOUS SIGNALS, NAMELY, ROTATING LIGHTS; LUMINOUS SIGNALING PANELS, NAMELY, ELECTRIC LUMINESCENT DISPLAY PANELS; GARMENTS FOR PROTECTION AGAINST FIRE; CLOTHING, NAMELY, FIRE RESISTANT GLOVES AND SHOES FOR PROTECTION AGAINST ACCIDENTS, IRRADIATION AND FIRE; FIRE PROTECTION CLOTHES; GLOVES FOR PROTECTION AGAINST ACCIDENTS; THERMOMETERS; ELECTRIC IRONS; PRESSURE MEASURING APPARA-



TUS, NAMELY, BEVELS, PRESSURE GAUGES, PRESSURE SENSORS FOR DOMESTIC USE; TELEPHONE APPARATUS; TELEVISION SETS; RADIOS; DIGITAL VIDEO RECORDERS; SOUND REPRODUCTION APPARATUS; AUTOMATIC DISTRIBUTION MACHINES, NAMELY, CURRENCY COUNTING MACHINES, CURRENCY SORTING MACHINES; DATA PROCESSING APPARATUS, NAMELY, DATA PROCESSOR; COMPUTERS; FIRE EXTINGUISHERS, IN CLASS 9 (U.S. CLS. 21, 23, 26, 36 AND 38).

FOR: ELECTRIC LIGHT BULBS; LIGHT BULBS; OIL LANTERNS, ELECTRIC LANTERNS, PORTABLE PAPER LANTERNS; OIL LANTERNS FOR LIGHTING, ELECTRIC LANTERNS FOR LIGHTING, PORTABLE PAPER LANTERNS FOR LIGHTING LANTERNS FOR LIGHTING; HOT AIR SPACE HEATING APPARATUSES; HAIR DRYERS; BARBECUES; BEVERAGE COOLING APPARATUS, NAMELY, THERMOELECTRIC COOLER FOR BEVERAGES; ELECTRIC BOTTLE WARMERS, NAMELY, THERMOELECTRIC HEATER FOR BEVERAGES; TANNING APPLIANCES, NAMELY, TANNING BEDS AND LAMPS; ELECTRIC COFFEE PERCOLATORS; WARMING PANS FOR BEDS; AIR CONDITIONING APPARATUS; RADIATORS; ELECTRIC RADIATORS; COOKING APPARATUS, NAMELY, COMMERCIAL COOKING OVENS, COOKING RANGES, ELECTRIC COOKTOPS; ELECTRIC COOKING UTENSILS, NAMELY, ELECTRIC COFFEE MAKERS, ELECTRIC COFFEE POTS, ELECTRIC EGG BOILERS; ELECTRIC DEEP FRYERS; MICROWAVE OVENS; HAND DRYING APPARATUS FOR WASHROOMS, NAMELY, ELECTRIC HOT AIR HAND DRYERS; ELECTRIC BLANKETS, NOT FOR MEDICAL PURPOSES; ELECTRIC PRESSURE COOKERS; ELECTRIC BREAD TOASTERS; ELECTRIC YOGURT MAKERS; GAS WATER HEATERS, FEED WATER HEATERS, HOT WATER HEATERS; ELECTRIC KETTLES; GAS STOVES, CERAMIC STOVES, WOOD BURNING STOVES; EXHAUST HOODS FOR RANGES; VENTILATORS FOR AIR CONDITIONING; REFRIGERATORS; ICE BOXES; FREEZERS; AIR FILTERS FOR DOMESTIC USE; ELECTRIC COFFEE FILTERS; COFFEE ROASTERS OVENS; HOT-AIR SPACE HEATING APPARATUS, NAMELY, AIR HEATERS; COOKERS, NAMELY, ELECTRIC BREAD COOKERS, ELECTRIC RICE COOKERS, ELECTRIC SLOW COOKERS; DRYERS, NAMELY, ELECTRIC HOT AIR HAND DRYERS, HAIR DRYERS, HAND-HELD ELECTRIC HAIR DRYERS AND CLOTHES DRYERS, IN CLASS 11 (U.S. CLS. 13, 21, 23, 31 AND 34).

FOR: PROCUREMENT SERVICES, NAMELY, PURCHASING OFFICE FURNITURE, LIGHTING FIXTURES, CLOTHING FOR OTHERS; ADVERTISING; ONLINE ADVERTISING ON A COMPUTER COMMUNICATION NETWORK; SALES PROMOTION SERVICES FOR OTHERS; SERVICES OF SUPPORT FOR THE OPERATION OF COMMERCIAL OR INDUSTRIAL COMPANIES NAMELY, PROVIDING ASSISTANCE TO INDUSTRIAL OR COMMERCIAL ENTERPRISES IN THE RUNNING OF THEIR BUSINESS; IMPORT-EXPORT AGENCIES; COMMERCIAL AND EXCLUSIVE AGENCY REPRESENTATION FOR VISUAL ARTIST AND ATHLETES; RETAIL STORES FEATURING METAL SHEETS FOR WRAPPING AND PACKAGING, ALUMINUM FOILS, NON-LUMINOUS AND NON-MECHANICAL SIGNS OF METAL, UNWROUGHT OR SEMI-UNWROUGHT COMMON METALS, COMMON METAL ALLOYS, ZINC AND ZINC ALLOYS, MACHINES AND MACHINE TOOLS, ELECTRIC KITCHEN MACHINES, ELECTRIC WHISKS FOR HOUSEHOLD PURPOSES, STEAM CLEANING APPLIANCES, ELECTRICAL VACUUM CLEANERS, MEAT MINCING MACHINES, ELECTRIC FRUIT PRESSES FOR DOMESTIC USE, JUICE EXTRACTORS, COFFEE GRINDERS, OTHER THAN HAND OPERATED, BREAD CUTTING MACHINES, WASHING MACHINES, DISH WASHING MACHINES, DISHWASHERS, ELECTRIC TIN OPENERS, FILTERING MACHINES, MIXERS FOR DOMESTIC USE, FILLETING MACHINES, ELECTRIC GRINDERS AND CRUSHERS FOR HOUSEHOLD PURPOSES, SHAVERS ELECTRIC OR NON-ELECTRIC, HAND-OPERATED HAND TOOLS, CUTLERY, KNIVES, FORKS AND SPOONS, RAZOR BLADES, ELECTRICAL CELLS AND BATTERIES, ELECTRICAL STORAGE BATTERIES, APPARATUS FOR RECHARGING ELECTRIC CELLS, BATTERIES OR ACCUMULATORS, LUMINOUS OR MECHANICAL ROAD SIGNS, BOLLARDS, LUMINOUS BEACONS, SIGNALING LANTERNS, ELECTRIC FENCES, APPARATUS FOR GAMES ADAPTED FOR USE WITH TELEVISION RECEIVERS ONLY, ELECTRICALLY HEATED HAIR-WAVING DEVICES, ELECTRIC APPLIANCES FOR REMOVING MAKE-UP, SOCKS, ELECTRICALLY HEATED, POCKET CALCULATORS, ELECTRONIC AGENDAS, ELECTRICAL DOOR OPENERS, COMPUTER PERIPHERAL DEVICES, MOBILE TELEPHONES, BATHROOM SCALES, SCALES FOR DOMESTIC USE, PERSONAL SCALES, WEIGHING APPARATUS, MARKING BUOYS, RESCUE BUOYS, EMERGENCY OR SIGNALING BUOYS, LUMINOUS OR MECHANICAL SIGNALING, VEHICLE BREAKDOWN WARNING TRIANGLES, BATTERIES FOR POCKET LAMPS, CELLS, LUMINOUS SIGNALS, SIGNALING PANELS, LUMINOUS OR MECHANICAL, GARMENTS FOR PROTECTION AGAINST FIRE, CLOTHING FOR PROTECTION AGAINST ACCIDENTS, IRRADIATION AND FIRE, FIRE PROTECTION CLOTHES, GLOVES FOR PROTECTION AGAINST ACCIDENTS, THERMOMETERS NOT FOR MEDICAL USE, ELECTRICAL IRONS, PRESSURE MEASURING APPARATUS FOR DOMESTIC USE, TELEPHONE SETS, TELEVISION SETS, RADIOS, VIDEO RECORDERS, SOUND REPRODUCTION DEVICES, AUTOMATIC DISTRIBUTION MACHINES, DATA PROCESSING APPARATUS, COMPUTERS, FIRE EXTINGUISHERS, ELECTRIC LIGHT BULBS, LIGHT BULBS, LANTERNS, LANTERNS FOR LIGHTING, HOT AIR GENERATORS, HAIR DRYERS, BARBECUES, BEVERAGES COOLING APPARATUS, ELECTRIC BOTTLE WARMERS, TANNING APPLIANCES, ELECTRICAL COFFEE PERCOLATORS, WARMING PANS, AIR CONDITIONING APPARATUS, HEATING RADIATORS, ELECTRIC RADIATORS, COOKING APPARATUS AND INSTALLATIONS, ELECTRIC COOKING UTENSILS, ELECTRIC FRYERS, MICROWAVE

OVENS, KITCHEN APPARATUS, HAND DRYING APPARATUS FOR WASHROOMS, ELECTRIC BLANKETS, NOT FOR MEDICAL PURPOSES, ELECTRIC PRESSURE COOKERS, BREAD TOASTERS, ELECTRIC YOGURT MAKERS, KETTLES, ELECTRIC KETTLES, STOVES, HEATING APPARATUS, COOKING RINGS, EXHAUST HOODS FOR RANGES, AIR-CONDITIONING VENTILATORS, REFRIGERATORS, ICEBOXES, FREEZERS, FILTERS AS PARTS OF DOMESTIC INSTALLATIONS, ELECTRIC COFFEE FILTERS, COFFEE ROASTERS, AIR HEATERS, COOKERS, DRYERS, PRINTED MATTER, CATALOGUES, NON-TEXTILE LABELS, GARBAGE BAGS OF PAPER OR PLASTICS, FILMS OF PLASTIC MATERIALS FOR PACKAGING, PAPER COFFEE FILTERS, GLOVES FOR HOUSEHOLD PURPOSES, GARDENING GLOVES, UTENSILS FOR HOUSEHOLD PURPOSES, NOT OF PRECIOUS METAL, KITCHEN UTENSILS, NOT OF PRECIOUS METAL, NON-ELECTRIC COFFEE POTS, NON-ELECTRIC COFFEE FILTERS, SUPPORTS FOR IRONING BOARDS, IRONING BOARDS, IRONING BOARD COVERS AND CARPET SWEEPERS; ONLINE RETAIL STORE SERVICE FEATURING METAL SHEETS FOR WRAPPING AND PACKAGING, ALUMINUM FOILS, SIGNS NON-LUMINOUS AND NON-MECHANICAL OF METAL, UNWROUGHT OR SEMI-UNWROUGHT COMMON METALS, COMMON METAL ALLOYS, ZINC AND ZINC ALLOYS, MACHINES AND MACHINE TOOLS, ELECTRIC KITCHEN MACHINES, ELECTRIC WHISKS FOR HOUSEHOLD PURPOSES, STEAM CLEANING APPLIANCES, ELECTRICAL VACUUM CLEANERS, MEAT MINCING MACHINES, ELECTRIC FRUIT PRESSES FOR DOMESTIC USE, JUICE EXTRACTORS, COFFEE GRINDERS, OTHER THAN HAND OPERATED, BREAD CUTTING MACHINES, WASHING MACHINES, DISH WASHING MACHINES, DISHWASHERS, ELECTRIC TIN OPENERS, FILTERING MACHINES, MIXERS FOR DOMESTIC USE, FILETING MACHINES, ELECTRIC GRINDERS AND CRUSHERS FOR HOUSEHOLD PURPOSES, SHAVERS ELECTRIC OR NON-ELECTRIC, HAND-OPERATED HAND TOOLS, CUTLERY, KNIVES, FORKS AND SPOONS, RAZOR BLADES, ELECTRICAL CELLS AND BATTERIES, ELECTRICAL STORAGE BATTERIES, APPARATUS FOR RECHARGING ELECTRIC CELLS, BATTERIES OR ACCUMULATORS, LUMINOUS OR MECHANICAL ROAD SIGNS, BOLLARDS, LUMINOUS BEACONS, SIGNALING LANTERNS, ELECTRIC FENCES, APPARATUS FOR GAMES ADAPTED FOR USE WITH TELEVISION RECEIVERS ONLY, ELECTRICALLY HEATED HAIR-WAVING DEVICES, ELECTRIC APPLIANCES FOR REMOVING MAKE-UP, SOCKS, ELECTRICALLY HEATED, POCKET CALCULATORS, ELECTRONIC AGENDAS, ELECTRICAL DOOR OPENERS, COMPUTER PERIPHERAL DEVICES, MOBILE TELEPHONES, BATHROOM SCALES, SCALES FOR DOMESTIC USE, PERSONAL SCALES, WEIGHING APPARATUS, MARKING BUOYS, RESCUE BUOYS, EMERGENCY OR SIGNALING BUOYS, LUMINOUS OR MECHANICAL SIGNALING, VEHICLE BREAKDOWN WARNING TRIANGLES, BATTERIES FOR POCKET LAMPS, CELLS, LUMINOUS SIGNALS, SIGNALING PA-

NELS, LUMINOUS OR MECHANICAL, GARMENTS FOR PROTECTION AGAINST FIRE, CLOTHING FOR PROTECTION AGAINST ACCIDENTS, IRRADIATION AND FIRE, FIRE PROTECTION CLOTHES, GLOVES FOR PROTECTION AGAINST ACCIDENTS, THERMOMETERS NOT FOR MEDICAL USE, ELECTRICAL IRONS, PRESSURE MEASURING APPARATUS FOR DOMESTIC USE, TELEPHONE SETS, TELEVISION SETS, RADIOS, VIDEO RECORDERS, SOUND REPRODUCTION DEVICES, AUTOMATIC DISTRIBUTION MACHINES, DATA PROCESSING APPARATUS, COMPUTERS, FIRE EXTINGUISHERS, ELECTRIC LIGHT BULBS, LIGHT BULBS, LANTERNS, LANTERNS FOR LIGHTING, HOT AIR GENERATORS, HAIR DRYERS, BARBECUES, BEVERAGES COOLING APPARATUS, ELECTRIC BOTTLE WARMERS, TANNING APPLIANCES, ELECTRICAL COFFEE PERCOLATORS, WARMING PANS, AIR CONDITIONING APPARATUS, HEATING RADIATORS, ELECTRIC RADIATORS, COOKING APPARATUS AND INSTALLATIONS, ELECTRIC COOKING UTENSILS, ELECTRIC FRYERS, MICROWAVE OVENS, KITCHEN APPARATUS, HAND DRYING APPARATUS FOR WASHROOMS, ELECTRIC BLANKETS, NOT FOR MEDICAL PURPOSES, ELECTRIC PRESSURE COOKERS, BREAD TOASTERS, ELECTRIC YOGHURT MAKERS, KETTLES, ELECTRIC KETTLES, STOVES, HEATING APPARATUS, COOKING RINGS, EXHAUST HOODS FOR RANGES, AIR-CONDITIONING VENTILATORS, REFRIGERATORS, ICEBOXES, FREEZERS, FILTERS AS PARTS OF DOMESTIC INSTALLATIONS, ELECTRIC COFFEE FILTERS, COFFEE ROASTERS, AIR HEATERS, COOKERS, DRYERS, PRINTED MATTER, CATALOGUES, NON-TEXTILE LABELS, GARBAGE BAGS OF PAPER OR PLASTICS, FILMS OF PLASTIC MATERIALS FOR PACKAGING, PAPER COFFEE FILTERS, GLOVES FOR HOUSEHOLD PURPOSES, GARDENING GLOVES, UTENSILS FOR HOUSEHOLD PURPOSES, NOT OF PRECIOUS METAL, KITCHEN UTENSILS, NOT OF PRECIOUS METAL, NON-ELECTRIC COFFEE POTS, NON-ELECTRIC COFFEE FILTERS, SUPPORTS FOR IRONING BOARDS, IRONING BOARDS, IRONING BOARD COVERS AND CARPET SWEEPERS; FRANCHISING SERVICES, NAMELY, OFFERING COMMERCIAL COMPANY OPERATIONAL AND MANAGEMENT ASSISTANCE IN THE ESTABLISHMENT OR OPERATION OF RETAIL STORES, FOR ALL TYPES OF ELECTRICAL HOUSEHOLD UTENSILS, ELECTRIC BATTERIES AND LANTERNS, IN CLASS 35 (U.S. CLS. 100, 101 AND 102).

FOR: DISTRIBUTION SERVICES, NAMELY, DELIVERY OF CLOTHING, AUTOMOTIVE PARTS AND COSMETICS; TRANSPORT OF GOODS; STORAGE OF FURNITURE, FURS AND CLOTHING, IN CLASS 39 (U.S. CLS. 100 AND 105).

PRIORITY DATE OF 11-22-2006 IS CLAIMED.

OWNER OF INTERNATIONAL REGISTRATION 0927935 DATED 2-27-2007, EXPIRES 2-27-2017.

OWNER OF U.S. REG. NOS. 1,361,511, 1,388,850  
AND OTHERS.

WITH INTERSECTING PARALLELS AND MERI-  
DIANS.

THE MARK CONSISTS OF THE WORD "CEGA-  
SA" FEATURED BELOW A STYLIZED SHERE

SER. NO. 79-039,938, FILED 2-27-2007.

CHARISMA HAMPTON, EXAMINING ATTORNEY

**Int. Cls.: 9, 17 and 19**

**Prior U.S. Cls.: 1, 5, 12, 13, 21, 23, 26, 33, 35, 36, 38  
and 50**

**Reg. No. 3,454,058**

**United States Patent and Trademark Office**

**Registered June 24, 2008**

**TRADEMARK  
PRINCIPAL REGISTER**

**SOPRASOLAR**

HOLDING SOPREMA (SOCIÉTÉ ANONYME)  
(FRANCE SOCIÉTÉ ANONYME)  
14 RUE DE SAINT-NAZAIRE  
F-67100 STRASBOURG  
FRANCE

FOR: PHOTOVOLTAIC CELLS; APPARATUS AND INSTRUMENTS FOR CONDUCTING, SWITCHING, TRANSFORMING, ACCUMULATING, REGULATING AND CONTROLLING ELECTRICITY, NAMELY, ELECTRONIC SWITCHES, TRANSFORMERS, REGULATORS, WEATHER MONITORING DEVICES, ELECTRONIC SENSORS FOR MEASURING TEMPERATURE, LIGHT, WIND, MOISTURE, AND COMPUTER HARDWARE AND SOFTWARE, ALL FOR USE IN CONNECTION WITH A PHOTOVOLTAIC ROOFING AND WEATHER RETARDANT SEALING SYSTEM, IN CLASS 9 (U.S. CLS. 21, 23, 26, 36 AND 38).

FOR: BUILDING INSULATING MATERIALS, NAMELY, MATERIAL USED IN CONNECTION WITH A PHOTOVOLTAIC ROOFING AND WEATHER RETARDANT SEALING SYSTEM, NAMELY, WATERPROOFING, INSULATING, CAULKING AND SEALING MEMBRANES MADE FROM FABRICS, FELTS, RUBBER, RESINS, PLASTICS, FIBER GLASS, GLASS, AND WOOLS, ALL USED AS BUILDING SEALING MATERIALS; SEALANTS MADE FROM FABRICS, FELTS, RUBBER, RESINS, PLASTICS, FIBER GLASS, GLASS, AND WOOLS; GUMMED STRIPS USED TO INSTALL INSULATING MATERIAL AND SOUND PROOF INSULATION; AND BUILDING SOUND BARRIERS MADE

FROM FABRICS, FELTS, RUBBER, RESINS, PLASTICS, FIBER GLASS, GLASS, AND WOOLS, IN CLASS 17 (U.S. CLS. 1, 5, 12, 13, 35 AND 50).

FOR: BUILDING MATERIALS, NAMELY, MATERIAL USED IN CONNECTION WITH A PHOTOVOLTAIC ROOFING AND WEATHER RETARDANT SEALING SYSTEM, NAMELY, ASPHALT, TARRED STRIPS, BITUMEN, BITUMINOUS SHEET PRODUCTS FOR BUILDING AND ROOF COVERINGS, FELTS FOR BUILDING, TAR, INSULATING GLASS PANELS, NON-METALIC FLOOR, WALL AND ROOFING PANELS AND CLADDINGS FOR BUILDINGS, AND GLAZING GLASS, IN CLASS 19 (U.S. CLS. 1, 12, 33 AND 50).

THE MARK CONSISTS OF STANDARD CHARACTERS WITHOUT CLAIM TO ANY PARTICULAR FONT, STYLE, SIZE, OR COLOR.

PRIORITY DATE OF 9-29-2006 IS CLAIMED.

OWNER OF INTERNATIONAL REGISTRATION 0927946 DATED 3-28-2007, EXPIRES 3-28-2017.

OWNER OF U.S. REG. NOS. 1,696,076, 2,785,387 AND OTHERS.

SER. NO. 79-039,940, FILED 3-28-2007.

SHANNON TWOHIG, EXAMINING ATTORNEY

**Int. Cls.: 9, 42 and 44**

**Prior U.S. Cls.: 21, 23, 26, 36, 38, 100 and 101**

**Reg. No. 3,454,059**

**United States Patent and Trademark Office**

**Registered June 24, 2008**

**TRADEMARK  
SERVICE MARK  
PRINCIPAL REGISTER**

**CULTEX**

MOHR, ULRICH, PROF. DR. MED. (FED REP  
GERMANY INDIVIDUAL)  
MUTHESIUSWEG 25  
30559 HANNOVER  
FED REP GERMANY

FOR: SCIENTIFIC INSTRUMENTS AND EQUIPMENT FOR MEDICAL OR BIOLOGICAL RESEARCH, FOR ANALYTICAL PURPOSES, FOR TOXICITY INVESTIGATIONS AND DIAGNOSTIC PURPOSES, NAMELY, MODULES FOR THE CULTIVATION AND EXPOSURE OF CULTIVATED CELLS OR BACTERIA TO GASES, PARTICLES AND COMPLEX MIXTURES; OPTICAL EQUIPMENT, NAMELY, MICROSCOPES; WEIGHING EQUIPMENT, NAMELY, SCALES AND BALANCES; DATA PROCESSING EQUIPMENT, NAMELY, DATA PROCESSORS AND COMPUTERS, PARTICULARLY IN CONNECTION WITH SCIENTIFIC EQUIPMENT FOR RESEARCH IN THE FIELDS OF MOLECULAR BIOLOGY, BIOCHEMISTRY AND/OR MEDICINE; MICROPOROUS MEMBRANES FOR SCIENTIFIC APPARATUS; PROBES FOR SCIENTIFIC PURPOSES, NAMELY, PROBES FOR USE IN CONNECTION WITH MODULES FOR THE CULTIVATION AND EXPOSURE OF CULTIVATED CELLS OR BACTERIA TO GASES, PARTICLES AND COMPLEX MIXTURES, IN CLASS 9 (U.S. CLS. 21, 23, 26, 36 AND 38).

FOR: SCIENTIFIC SERVICES AND RESEARCH WORK, NAMELY, BASIC RESEARCH IN THE FIELDS OF MEDICINE, BIOLOGY OR CHEMISTRY; TECHNOLOGICAL SERVICES AND RESEARCH WORK, NAMELY, DEVELOPMENT OF EQUIPMENT FOR RESEARCH IN THE FIELDS OF MEDICINE, BIOLOGY OR CHEMISTRY, AND PLANNING AND DESIGN USING 3D-CAD TECHNIQUES TO ENSURE FULL FEASIBILITY AND

IMPLEMENTABILITY IN CONJUNCTION WITH OPTIMISED FUNCTIONAL ASPECTS PRIOR TO PRODUCTION; INDUSTRIAL ANALYSIS AND RESEARCH SERVICES, NAMELY, RESEARCH AND ANALYSIS OF AIR POLLUTANTS, AEROSOLS AND OTHER TOXIC AND HAZARDOUS MATERIALS WITH RESPECT TO THE ENVIRONMENT, INDOOR ATMOSPHERES AND LIVING ORGANISMS; DESIGN AND DEVELOPMENT OF COMPUTER HARDWARE AND SOFTWARE; PROVISION OF SCIENTIFIC EXPERT OPINIONS IN CONNECTION WITH THE FIELDS OF MEDICINE, MOLECULAR BIOLOGY, BIOLOGY, BIOCHEMISTRY OR CHEMISTRY; EXECUTION OF SCIENTIFIC TESTS IN THE FIELDS OF MEDICINE, MOLECULAR BIOLOGY, BIOLOGY, BIOCHEMISTRY OR CHEMISTRY; CHEMICAL LABORATORY SERVICES; SCIENTIFIC RESEARCH FOR MEDICAL PURPOSES, IN CLASS 42 (U.S. CLS. 100 AND 101).

FOR: MEDICAL ANALYSIS SERVICES RELATING TO THE TREATMENT OF PERSONS, IN CLASS 44 (U.S. CLS. 100 AND 101).

THE MARK CONSISTS OF STANDARD CHARACTERS WITHOUT CLAIM TO ANY PARTICULAR FONT, STYLE, SIZE, OR COLOR.

PRIORITY DATE OF 9-13-2006 IS CLAIMED.

OWNER OF INTERNATIONAL REGISTRATION  
0928009 DATED 3-13-2007, EXPIRES 3-13-2017.

SER. NO. 79-039,966, FILED 3-13-2007.

FRANK LATTUCA, EXAMINING ATTORNEY

**Int. Cls.: 5 and 31**

**Prior U.S. Cls.: 1, 6, 18, 44, 46, 51 and 52**

**United States Patent and Trademark Office**

**Reg. No. 3,454,060**

**Registered June 24, 2008**

**TRADEMARK  
PRINCIPAL REGISTER**

# Geno Global

GENO (NORWAY UNINCORPORATED FARM-  
ERS' COOPERATIVE ASSOCIATION)  
STANGEV 111  
N-2326 HAMAR  
NORWAY

FOR: SEMEN FOR ARTIFICIAL INSEMINATION,  
IN CLASS 5 (U.S. CLS. 6, 18, 44, 46, 51 AND 52).

FOR: EMBRYO OF DOMESTIC ANIMALS, IN  
CLASS 31 (U.S. CLS. 1 AND 46).

THE MARK CONSISTS OF STANDARD CHAR-  
ACTERS WITHOUT CLAIM TO ANY PARTICULAR  
FONT, STYLE, SIZE, OR COLOR.

PRIORITY DATE OF 2-7-2007 IS CLAIMED.

OWNER OF INTERNATIONAL REGISTRATION  
0928099 DATED 4-10-2007, EXPIRES 4-10-2017.

OWNER OF U.S. REG. NO. 2,442,090.

NO CLAIM IS MADE TO THE EXCLUSIVE  
RIGHT TO USE "GLOBAL", APART FROM THE  
MARK AS SHOWN.

SER. NO. 79-039,983, FILED 4-10-2007.

JAMES GRIFFIN, EXAMINING ATTORNEY

**Int. Cl.: 42**

**Prior U.S. Cls.: 100 and 101**

**United States Patent and Trademark Office**

**Reg. No. 3,454,061**

**Registered June 24, 2008**

**SERVICE MARK  
PRINCIPAL REGISTER**

# EVIBODY

EVOGENIX LTD (AUSTRALIA CORPORATION)  
LEVEL 2  
37 BLIGH STREET; SYDNEY NSW 2000  
AUSTRALIA

FOR: SCIENTIFIC AND INDUSTRIAL RE-  
SEARCH SERVICES IN THE FIELD OF BIOTECH-  
NOLOGY; SCIENTIFIC AND TECHNICAL  
CONSULTANCY IN THE FIELD OF BIOTECHNOL-  
OGY, MATERIAL TESTING IN THE SCIENTIFIC,  
TECHNICAL, PHARMACEUTICAL, BIOLOGICAL,  
GENOMIC FIELDS AND IN RELATION TO PRO-  
TEINS AND PEPTIDES; COMPUTER SOFTWARE  
DEVELOPMENT, NAMELY, DEVELOPMENT OF  
INFORMATION PLATFORM SOFTWARE FOR

USE IN CREATING AN ELECTRONIC NETWORK  
FOR ELECTRONIC DELIVERY OF DATA, IN  
CLASS 42 (U.S. CLS. 100 AND 101).

THE MARK CONSISTS OF STANDARD CHAR-  
ACTERS WITHOUT CLAIM TO ANY PARTICULAR  
FONT, STYLE, SIZE, OR COLOR.

OWNER OF INTERNATIONAL REGISTRATION  
0928135 DATED 2-26-2007, EXPIRES 2-26-2017.

SER. NO. 79-039,993, FILED 2-26-2007.

KELLEY WELLS, EXAMINING ATTORNEY

**Int. Cls.: 1 and 2**

**Prior U.S. Cls.: 1, 5, 6, 10, 11, 16, 26 and 46**

**United States Patent and Trademark Office**

**Reg. No. 3,454,062**

**Registered June 24, 2008**

**TRADEMARK  
PRINCIPAL REGISTER**

**AQUENCE**

HENKEL KGAA (FED REP GERMANY KOM-  
MANDITGESELLSCHAFT AUF AKTIEN  
(KGAA))

HENKELSTRASSE 67  
40589 DÜSSELDORF  
FED REP GERMANY

FOR: CHEMICAL PREPARATIONS FOR INDUS-  
TRIAL PURPOSES; CHEMICAL PREPARATIONS  
FOR AUTODEPOSITION PROCESSES , IN CLASS 1  
(U.S. CLS. 1, 5, 6, 10, 26 AND 46).

FOR: COATING COMPOSITIONS FOR METALS  
AND PLASTICS IN THE NATURE OF LACQUERS,  
PAINTS, PRESERVATIVES AGAINST RUST; AUTO-  
DEPOSITION COATINGS, IN THE NATURE OF  
LACQUERS, PAINTS AND PRESERVATIVES

AGAINST RUST, IN CLASS 2 (U.S. CLS. 6, 11 AND  
16).

THE MARK CONSISTS OF STANDARD CHAR-  
ACTERS WITHOUT CLAIM TO ANY PARTICULAR  
FONT, STYLE, SIZE, OR COLOR.

PRIORITY DATE OF 6-20-2006 IS CLAIMED.

OWNER OF INTERNATIONAL REGISTRATION  
0928274 DATED 12-15-2006, EXPIRES 12-15-2016.

SER. NO. 79-040,033, FILED 12-15-2006.

KAREN K. BUSH, EXAMINING ATTORNEY



Int. Cls.: 29, 30 and 31

Prior U.S. Cls.: 1 and 46

United States Patent and Trademark Office

Reg. No. 3,454,063

Registered June 24, 2008

TRADEMARK  
PRINCIPAL REGISTER



KESKINOGLU TAVUKÇULUK; VE DAMIZLIK  
ISLETMELERI; SANAYI VE TICARET ANO-  
NIM SIRKETI (TURKEY JOINT STOCK COM-  
PANY)

KAYALIOGLU KASABASI  
TR-45200 AKHISAR-MANISA  
TURKEY

FOR: MEAT, FISH, POULTRY AND GAME;  
MEAT EXTRACTS; PRESERVED, DRIED AND  
COOKED FRUITS AND VEGETABLES; JELLIES,  
JAMS, COMPOTES; EGGS, MILK; EDIBLE OILS  
AND FATS; MILK PRODUCTS EXCLUDING ICE  
CREAM, ICE MILK AND FROZEN YOGURT, IN  
CLASS 29 (U.S. CL. 46).

FOR: COFFEE, TEA, COCOA, SUGAR, RICE,  
TAPIOCA, SAGO, ARTIFICIAL COFFEE; FLOUR,  
BREAD, PASTRY, FRUIT ICES; HONEY, TREACLE;  
YEAST, BAKING-POWDER; SALT, MUSTARD; VI-  
NEGAR, SAUCES; SPICES; ICE, IN CLASS 30 (U.S.  
CL. 46).

FOR: AGRICULTURAL, HORTICULTURAL  
AND FORESTRY GRAINS FOR PLANTING; LIVE  
ANIMALS; FRESH FRUITS AND VEGETABLES;  
SEEDS FOR AGRICULTURAL PURPOSES, LIVE

PLANTS AND FLOWERS; FOODSTUFFS FOR ANI-  
MALS; MALT FOR BREWING AND DISTILLING,  
IN CLASS 31 (U.S. CLS. 1 AND 46).

OWNER OF INTERNATIONAL REGISTRATION  
0928356 DATED 5-9-2007, EXPIRES 5-9-2017.

THE COLOR(S) RED, WHITE, BLACK, AND  
BROWN IS/ARE CLAIMED AS A FEATURE OF  
THE MARK.

THE MARK CONSISTS OF THE WORD "RAVI-  
KA" IN THE COLOR WHITE OVERLAYING A RED  
QUADRILATERAL BACKGROUND THAT IS OUT-  
LINED IN A WHITE, BLACK, AND BROWN BOR-  
DER.

THE WORDING "RAVIKA" HAS NO MEANING  
IN A FOREIGN LANGUAGE

SER. NO. 79-040,065, FILED 5-9-2007.

WENDY JUN, EXAMINING ATTORNEY

**Int. Cl.: 10**

**Prior U.S. Cls.: 26, 39 and 44**

**United States Patent and Trademark Office**

**Reg. No. 3,454,064**

**Registered June 24, 2008**

**TRADEMARK  
PRINCIPAL REGISTER**

**CISIS**

ALBERT DAXER (AUSTRIA INDIVIDUAL)  
SÜDTIROLER STRASSE 25  
A-4020 LINZ, AUSTRIA

PRIORITY DATE OF 11-2-2006 IS CLAIMED.

FOR: SURGICAL, MEDICAL, DENTAL AND VETERINARY APPARATUS AND INSTRUMENTS, NAMELY, KERATOMES; OPHTHALMOLOGICAL IMPLANTS, NAMELY, CORNEAL IMPLANTS COMPRISING ARTIFICIAL MATERIAL, IN CLASS 10 (U.S. CLS. 26, 39 AND 44).

OWNER OF INTERNATIONAL REGISTRATION  
0928477 DATED 4-19-2007, EXPIRES 4-19-2017.

THE MARK CONSISTS OF STANDARD CHARACTERS WITHOUT CLAIM TO ANY PARTICULAR FONT, STYLE, SIZE, OR COLOR.

SER. NO. 79-040,118, FILED 4-19-2007.

MICHAEL SOUDERS, EXAMINING ATTORNEY

**Int. Cls.: 6 and 20**

**Prior U.S. Cls.: 2, 12, 13, 14, 22, 23, 25, 32 and 50**

**United States Patent and Trademark Office**

**Reg. No. 3,454,065**

**Registered June 24, 2008**

**TRADEMARK  
PRINCIPAL REGISTER**

**TROAX**

GUNNEBO TROAX AB (SWEDEN AKTIEBOLAG)  
TYNGEL  
SE-330 33 HILLERSTORP  
SWEDEN

FOR: FREE STANDING METAL PANEL UNITS  
FOR PARTITIONING; METAL DOORS, METAL  
GATES; METAL GRATINGS; STRUCTURAL PARTS  
FOR THE AFORESAID GOODS; METAL WIRE  
MESHING , IN CLASS 6 (U.S. CLS. 2, 12, 13, 14, 23,  
25 AND 50).

FOR: SHELVES FOR STORAGE; NET SHELVES  
OF METAL, IN CLASS 20 (U.S. CLS. 2, 13, 22, 25, 32  
AND 50).

OWNER OF INTERNATIONAL REGISTRATION  
0928553 DATED 2-27-2007, EXPIRES 2-27-2017.

SER. NO. 79-040,139, FILED 2-27-2007.

KATHERINE E. HALMEN, EXAMINING ATTOR-  
NEY

Int. Cl.: 11

Prior U.S. Cls.: 13, 21, 23, 31 and 34

United States Patent and Trademark Office

Reg. No. 3,454,066

Registered June 24, 2008

TRADEMARK  
PRINCIPAL REGISTER

SVENNING ERICSSON (SWEDEN INDIVIDUAL)  
LÖNNRUNAN 54  
SE-423 46 TORSLANDA, SWEDEN

FOR: APPARATUS AND INSTALLATIONS FOR HEAT PUMPS, REFRIGERATION, COOLING, FREEZING, AIR-CONDITIONING, VENTILATING, AND DRYING, SOLD AS UNITS, COMPRISED OF: EVAPORATORS, CONDENSERS, HEAT EXCHANGERS, SIGHT GLASS ARMATURE, FILTERS, ELECTRONIC FLOW-CONTROLLERS, SELF-REGULATING FLOW CONTROLLERS, EJECTOR-PUMPS, CHECK VALVES, THROTTLE VALVES, FLOW CONTROL VALVES, DISC VALVES, ON/OFF VALVES, BYPASS VALVES, PADDLE VALVES, SHOE VALVES, BY-PASS VALVES, CONTROL VALVES, BALL VALVES, PRESSURE EQUALIZING VALVES, ROTARY VALVES, AIR VALVES, BUTTERFLY VALVES, NON-RETURN VALVES, EXPANSION VALVES, THERMOSTATIC EXPANSION

VALVES, ELECTRONIC OPERATED VALVES, PNEUMATICALLY OPERATED VALVES, SERVO OPERATED VALVES, PRESSURE EQUALIZING VALVES, FOOT VALVES, CONTROL VALVES, BALL VALVES, FLUID MIXING VALVES, ROTARY VALVES, AIR VALVES, IN CLASS 11 (U.S. CLS. 13, 21, 23, 31 AND 34).

THE MARK CONSISTS OF STANDARD CHARACTERS WITHOUT CLAIM TO ANY PARTICULAR FONT, STYLE, SIZE, OR COLOR.

OWNER OF INTERNATIONAL REGISTRATION  
0928593 DATED 12-29-2006, EXPIRES 12-29-2016.

SER. NO. 79-040,168, FILED 12-29-2006.

MARK PILARO, EXAMINING ATTORNEY

**Int. Cl.: 9**

**Prior U.S. Cls.: 21, 23, 26, 36 and 38**

**United States Patent and Trademark Office**

**Reg. No. 3,454,067**

**Registered June 24, 2008**

**TRADEMARK  
PRINCIPAL REGISTER**

The logo for 'TENCHU Z' is rendered in a bold, black, brush-stroke style. The letters 'T', 'E', 'N', 'C', 'H', 'U', and 'Z' are thick and irregular. The letter 'Z' is uniquely styled, with its bottom horizontal bar and the right vertical stroke filled with a vibrant red color, while the rest of the logo is black.

KABUSHIKI KAISHA FROM SOFTWARE; (ALSO  
TRADING AS FROMSOFTWARE, INC.) (JA-  
PAN CORPORATION)  
26-2, SASAZUKA 2-CHOME  
SHIBUYA-KU; TOKYO 151-0073  
JAPAN

FOR: COMPUTER GAME PROGRAMS RECOR-  
DED ON DVD-ROMS FOR CONSUMER VIDEO  
GAMES; COMPUTER GAME PROGRAMS FOR  
CONSUMER VIDEO GAMES, IN CLASS 9 (U.S.  
CLS. 21, 23, 26, 36 AND 38).

PRIORITY DATE OF 3-5-2007 IS CLAIMED.

OWNER OF INTERNATIONAL REGISTRATION  
0928603 DATED 3-13-2007, EXPIRES 3-13-2017.

THE COLOR(S) RED AND BLACK IS/ARE  
CLAIMED AS A FEATURE OF THE MARK.

THE WORDING TENCHU Z APPEARS IN BLACK  
WITH THE LETTER Z ALSO HAVING RED DE-  
SIGNS.

"THE FOREIGN WORDING IN THE MARK  
TRANSLATES INTO ENGLISH AS HEAVEN'S PUN-  
ISHMENT OR WELL-DESERVED PUNISHMENT."

SER. NO. 79-040,175, FILED 3-13-2007.

KAREN K. BUSH, EXAMINING ATTORNEY

**Int. Cl.: 14**

**Prior U.S. Cls.: 2, 27, 28 and 50**

**United States Patent and Trademark Office**

**Reg. No. 3,454,068**

**Registered June 24, 2008**

**TRADEMARK  
PRINCIPAL REGISTER**

**MACH ONE**

ELLICOTT S.A. (SWITZERLAND SOCIÉTÉ  
ANONYME (SA))  
RUE NUMA-DROZ 146  
CH-2301 LA CHAUX-DE-FONDS  
SWITZERLAND

FOR: HOROLOGICAL AND CHRONOMETRIC  
INSTRUMENTS, IN CLASS 14 (U.S. CLS. 2, 27, 28  
AND 50).

THE MARK CONSISTS OF STANDARD CHAR-  
ACTERS WITHOUT CLAIM TO ANY PARTICULAR  
FONT, STYLE, SIZE, OR COLOR.

PRIORITY DATE OF 11-3-2006 IS CLAIMED.

OWNER OF INTERNATIONAL REGISTRATION  
0928616 DATED 4-30-2007, EXPIRES 4-30-2017.

SER. NO. 79-040,182, FILED 4-30-2007.

MELISSA VALLILLO, EXAMINING ATTORNEY

**Int. Cls.: 1, 2 and 4**

**Prior U.S. Cls.: 1, 5, 6, 10, 11, 15, 16, 26 and 46**

**United States Patent and Trademark Office**

**Reg. No. 3,454,069**

**Registered June 24, 2008**

**TRADEMARK  
PRINCIPAL REGISTER**



**MOLYDAL S.A. (FRANCE SOCIÉTÉ ANONYME)  
Z.A.E.T., RUE PAUL LANGEVIN  
F-60740 SAINT-MAXIMIN  
FRANCE**

**FOR: CHEMICALS FOR INDUSTRIAL PURPOSES, IN CLASS 1 (U.S. CLS. 1, 5, 6, 10, 26 AND 46).**

**FOR: SOLID FILM LUBRICANTS, IN CLASS 2 (U.S. CLS. 6, 11 AND 16).**

**FOR: INDUSTRIAL LUBRICANTS, IN CLASS 4 (U.S. CLS. 1, 6 AND 15).**

**PRIORITY DATE OF 1-30-2007 IS CLAIMED.**

**OWNER OF INTERNATIONAL REGISTRATION  
0928665 DATED 5-24-2007, EXPIRES 5-24-2017.**

**OWNER OF U.S. REG. NO. 2,535,284.**

**SER. NO. 79-040,195, FILED 5-24-2007.**

**KELLY MCCOY, EXAMINING ATTORNEY**

**Int. Cl.: 9**

**Prior U.S. Cls.: 21, 23, 26, 36 and 38**

**United States Patent and Trademark Office**

**Reg. No. 3,454,070**

**Registered June 24, 2008**

**TRADEMARK  
PRINCIPAL REGISTER**

**LIONCUT**

BERKENHOFF GMBH (FED REP GERMANY  
GMBH)  
BERKENHOFFSTR. 14  
35452 HEUCHELHEIM, FED REP GERMANY

OWNER OF INTERNATIONAL REGISTRATION  
0928844 DATED 1-22-2007, EXPIRES 1-22-2017.

FOR: WIRES FOR SPARK EROSION; WIRE ELEC-  
TRODES; ELECTRODES FOR SPARK EROSION  
MACHINES; ELECTRIC CABLES; OPTICAL  
CABLES, IN CLASS 9 (U.S. CLS. 21, 23, 26, 36 AND 38).

SER. NO. 79-040,254, FILED 1-22-2007.

PRIORITY DATE OF 1-12-2007 IS CLAIMED.

DANIEL CAPSHAW, EXAMINING ATTORNEY



**Int. Cls.: 41 and 43**

**Prior U.S. Cls.: 100, 101 and 107**

**United States Patent and Trademark Office**

**Reg. No. 3,454,071**

**Registered June 24, 2008**

**SERVICE MARK  
PRINCIPAL REGISTER**



SAMUEL TREVES (PORTUGAL INDIVIDUAL)  
16 BOULEVARD D'ITALIE  
MC-98000 MONACO  
MONACO

FOR: NIGHT CLUBS; ORGANIZATION AND PRODUCTION OF SHOWS AND PARTIES, NAME-  
LY, DANCE SHOWS, MUSICAL SHOWS, AUDIOVI-  
SUAL SHOWS, THEME PARTIES AND  
CELEBRATIONS; ARRANGING OF COLLO-  
QUIUMS, CONFERENCES, SEMINARS; PARTY  
PLANNING, IN CLASS 41 (U.S. CLS. 100, 101 AND  
107).

FOR: BAR SERVICES; CAFÉS; RESTAURANTS;  
CAFETERIAS; RENTAL OF CONFERENCE

ROOMS; PROVIDING OF FOOD AND DRINK;  
CATERING SERVICES, IN CLASS 43 (U.S. CLS. 100  
AND 101).

OWNER OF INTERNATIONAL REGISTRATION  
0891199 DATED 4-20-2006, EXPIRES 4-20-2016.

NO CLAIM IS MADE TO THE EXCLUSIVE  
RIGHT TO USE "CAFE", APART FROM THE MARK  
AS SHOWN.

SER. NO. 79-040,311, FILED 5-31-2007.

DANIEL BRODY, EXAMINING ATTORNEY

**Int. Cls.: 9 and 42**

**Prior U.S. Cls.: 21, 23, 26, 36, 38, 100 and 101**

**United States Patent and Trademark Office**

**Reg. No. 3,454,072**

**Registered June 24, 2008**

**TRADEMARK  
SERVICE MARK  
PRINCIPAL REGISTER**



MODULPRODUKTER AS (NORWAY LTD LIAB  
CO)  
JONAS LIESVEI 62  
N-5053 BERGEN  
NORWAY

FOR: COMPUTER HARDWARE; ELECTRONIC  
INDICATOR PANELS IN LAND VEHICLES FOR  
DISPLAYING TEXT AND GRAPHICS FROM CEL-  
LULAR TELEPHONES, GLOBAL POSITIONING  
SYSTEMS AND VIDEO CAMERAS; COMPUTER  
SOFTWARE DESIGNED TO OPERATE THE FORE-  
GOING, IN CLASS 9 (U.S. CLS. 21, 23, 26, 36 AND 38).

FOR: DESIGN AND DEVELOPMENT OF COM-  
PUTER HARDWARE AND SOFTWARE, IN CLASS  
42 (U.S. CLS. 100 AND 101).

PRIORITY DATE OF 10-24-2006 IS CLAIMED.

OWNER OF INTERNATIONAL REGISTRATION  
0928984 DATED 4-12-2007, EXPIRES 4-12-2017.

NO CLAIM IS MADE TO THE EXCLUSIVE  
RIGHT TO USE "DRIVERS VISUAL COMFORT",  
APART FROM THE MARK AS SHOWN.

SER. NO. 79-040,329, FILED 4-12-2007.

REBECCA POVARCHUK, EXAMINING ATTOR-  
NEY

**Int. Cl.: 30**

**Prior U.S. Cl.: 46**

**United States Patent and Trademark Office**

**Reg. No. 3,454,073**

**Registered June 24, 2008**

**TRADEMARK  
PRINCIPAL REGISTER**



MISKO VIOMICHANIA ZIMARIKON; ANON-  
YMOS ETAIRIA (GREECE COMPANY)  
PAPPOU 26-AKRAGANTOS  
(AKADIMIA PLATONOS);GR-104 42 ATHENS  
ATHENS, GREECE GR104 42

FOR: COFFEE, TEA, COCOA, SUGAR, RICE,  
ARTIFICIAL COFFEE, FLOUR AND PRODUCTS  
MADE FROM CEREALS, NAMELY, BREAD, CORN  
FLAKES, BISCUITS, PASTA, TOASTED BREAD,  
FLOUR FOR FOOD, YEAST, PASTA IN GENERAL,  
BREAD, BISCUITS, PASTRY AND CONFECTION-  
ERY PRODUCTS, NAMELY, DONUTS, CANDY  
AND PASTRY, ICE CREAM, HONEY, TREACLE,  
YEAST, FLOUR CONTAINING YEAST, SALT, MUS-  
TARD, PEPPER, VINEGAR, SAUCES, SPICES AND  
ICE, IN CLASS 30 (U.S. CL. 46).

PRIORITY DATE OF 7-27-2006 IS CLAIMED.

OWNER OF INTERNATIONAL REGISTRATION  
0929154 DATED 9-1-2006, EXPIRES 9-1-2016.

OWNER OF U.S. REG. NO. 3,068,376.

NO CLAIM IS MADE TO THE EXCLUSIVE  
RIGHT TO USE THE NON-LATIN CHARACTERS  
("AITIO 1927") THAT MEAN "ESTABLISHED SINCE  
1927", APART FROM THE MARK AS SHOWN.

THE COLOR(S) RED, WHITE, YELLOW, BROWN,  
GREEN, LIGHT BLUE, GREY AND BLACK IS/ARE  
CLAIMED AS A FEATURE OF THE MARK.

THE MARK CONSISTS OF A TAPE OF RED AND  
YELLOW ON WHICH THE WORDS AND NUMBER  
"MISKO AITLO TO 1927" (WRITTEN WITH NON  
LATIN CHARACTERS) ARE WRITTEN WITH  
WHITE LETTERS. ABOVE THE TAPE THERE IS A  
SIGN WHICH DEPICTS A MONK ON A GREY  
DONKEY, OF WHICH ITS GRAY SHADOW IS  
VISIBLE. THE MONK WEARS A BLUE FROCK.  
ON HIS RIGHT AND LEFT THERE ARE TWO  
BASKETS OF YELLOW COLOR. THE BACK-  
GROUND CONSISTS OF TREES OF GREEN COLOR  
AND A LIGHT BLUE SKY WITH WHITE STRAY  
CLOUDS ON IT. UNDER THE ABOVE THERE ARE  
WRITTEN WITH YELLOW AND BROWN LETTERS  
THE WORDS "TASTES OF GREECE".

THE ENGLISH TRANSLATION OF "AITIO 1927"  
IS "ESTABLISHED SINCE 1927".

SER. NO. 79-040,399, FILED 9-1-2006.

JOHN HWANG, EXAMINING ATTORNEY

**Int. Cl.: 29**

**Prior U.S. Cl.: 46**

**United States Patent and Trademark Office**

**Reg. No. 3,454,074**

**Registered June 24, 2008**

**TRADEMARK  
PRINCIPAL REGISTER**

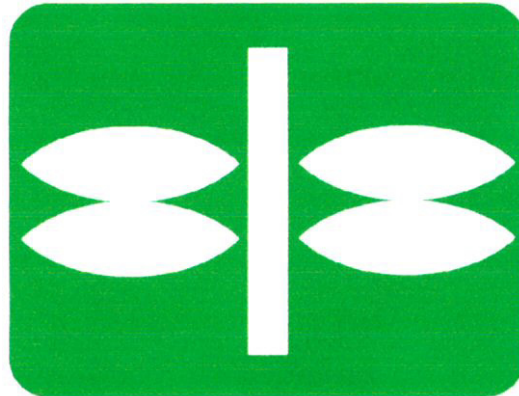

ZHONGLU (FUJIAN) AGRICULTURE; COMPREHENSIVE DEVELOPMENT CO.,LTD. (CHINA CORPORATION)  
WESTSIDE OF FUXIA ROAD  
XIAGUANG VILLAGE, LUOYANG TOWN,;  
HU'AN,QUANZHOU; FUJIAN  
CHINA

FOR: MEAT; CANNED FISH; CANNED VEGETABLES; TINNED VEGETABLES; FROZEN FRUITS; FRUIT PULP; PRESERVED VEGETABLES; VEGETABLE SOUP PREPARATIONS; PICKLES; DEEP FROZEN VEGETABLES; EGGS, IN CLASS 29 (U.S. CL. 46).

OWNER OF INTERNATIONAL REGISTRATION  
0929337 DATED 6-12-2007, EXPIRES 6-12-2017.

THE COLOR(S) GREEN AND WHITE IS/ARE CLAIMED AS A FEATURE OF THE MARK.

THE MARK CONSISTS OF THE COLOR GREEN APPEARS AS THE MARK'S BACKGROUND COLOR, AND THE COLOR WHITE APPEARS ON THE DESIGN OF THE BRANCH WITH LEAVES.

SER. NO. 79-040,476, FILED 6-12-2007.

DEBRA LEE, EXAMINING ATTORNEY

**Int. Cl.: 7**

**Prior U.S. Cls.: 13, 19, 21, 23, 31, 34 and 35**

**Reg. No. 3,454,075**

**United States Patent and Trademark Office**

**Registered June 24, 2008**

**TRADEMARK  
PRINCIPAL REGISTER**

# TAURION

PROVAC AKTIENGESELLSCHAFT (LIECHTEN-  
STEIN LTD LIAB CO)  
FÜHRENWEG 8  
FL-9496 BALZERS  
LIECHTENSTEIN

FOR: COATING EQUIPMENT, NAMELY, HIGH VACUUM PHYSICAL VAPOUR DEPOSITION (PVD) COATING EQUIPMENT FOR THE COATING OF THIN FILMS ON TECHNOLOGICAL SUBSTRATES SUCH AS OPTICAL, OR SEMICONDUCTOR PRODUCTS, USING ELECTRICALLY, INDUCTIVELY OR ELECTRON BEAM HEATED EVAPORATORS; VAPOUR DEPOSITION EQUIPMENT, NAMELY, HIGH VACUUM PHYSICAL VAPOUR DEPOSITION (PVD) COATING EQUIPMENT FOR THE COATING OF THIN FILMS ON TECHNOLOGICAL SUBSTRATES SUCH AS OPTICAL, OR SEMICONDUCTOR PRODUCTS, USING ELECTRICALLY OR ELECTRON BEAM HEATED EVAPORATORS; PLASMA-SUPPORTED HIGH VACUUM VAPOUR DEPOSITION INSTALLATIONS, NAMELY, RADIO FREQUENCY-PLASMA SUPPORTED HIGH VACUUM PHYSICAL VAPOUR DEPOSITION (PVD)

COATING EQUIPMENT; RADIO FREQUENCY-PLASMA-SUPPORTED HIGH VACUUM VAPOUR DEPOSITION, NAMELY, RADIO FREQUENCY PLASMA SUPPORTED HIGH VACUUM PHYSICAL VAPOUR DEPOSITION (PVD) COATING EQUIPMENT, IN CLASS 7 (U.S. CLS. 13, 19, 21, 23, 31, 34 AND 35).

THE MARK CONSISTS OF STANDARD CHARACTERS WITHOUT CLAIM TO ANY PARTICULAR FONT, STYLE, SIZE, OR COLOR.

PRIORITY DATE OF 10-24-2006 IS CLAIMED.

OWNER OF INTERNATIONAL REGISTRATION 0929421 DATED 4-3-2007, EXPIRES 4-3-2017.

SER. NO. 79-040,504, FILED 4-3-2007.

BERNICE MIDDLETON, EXAMINING ATTORNEY

**Int. Cls.: 6, 8, 9, 18, 25 and 28**

**Prior U.S. Cls.: 1, 2, 3, 12, 13, 14, 21, 22, 23, 25, 26, 28, 36, 38, 39, 41, 44 and 50**

**Reg. No. 3,454,076**

**United States Patent and Trademark Office**

**Registered June 24, 2008**

**TRADEMARK  
PRINCIPAL REGISTER**

# GRIVEL

GRIVEL S.R.L. (ITALY LTD LIAB CO)  
REG. LES FORGES, 6  
I-11013 COURMAYEUR (AO)  
ITALY

FOR: METAL ARTICLES FOR MOUNTAINEERING AND MOUNTAIN SPORTS, NAMELY, CRAMPONS, ROCK AND ICE ANCHORS, CARABINERS, PULLEYS, BELAY DEVICES, ROPE CLAMPS, DESCENDERS; BOLT HANGERS ALSO KNOWN AS "SPITS"; FERRULES OF METAL FOR MOUNTAINEERING POLES, IN CLASS 6 (U.S. CLS. 2, 12, 13, 14, 23, 25 AND 50).

FOR: TOOLS FOR CLIMBING ON ICE AND ROCK, NAMELY, ICE AXES AND HAMMERS FOR ICE AND ROCK; HAND TOOLS TO FIX ROCK AND ICE ANCHORS; SNOW SHOVELS, IN CLASS 8 (U.S. CLS. 23, 28 AND 44).

FOR: MOUNTAIN HELMETS, NAMELY, MOUNTAINEERING HELMETS, SKI HELMETS AND CLIMBING HELMETS; AVALANCHE SENSORS; AVALANCHE DETECTORS; PROTECTIVE GLASSES FOR MOUNTAINEERING, IN CLASS 9 (U.S. CLS. 21, 23, 26, 36 AND 38).

FOR: MOUNTAIN POLES, NAMELY, MOUNTAINEERING POLES, GRIPS FOR MOUNTAINEERING

POLES, RUCKSACKS, BACKPACKS, IN CLASS 18 (U.S. CLS. 1, 2, 3, 22 AND 41).

FOR: CLOTHING, SHOES AND GLOVES FOR MOUNTAINEERING AND SKIING, NAMELY, SWEATSUITS, JACKETS, TROUSERS, UNDERWEAR, GLOVES, SHOES AND BOOTS FOR MOUNTAINEERING AND SKIING, IN CLASS 25 (U.S. CLS. 22 AND 39).

FOR: ARTICLES FOR MOUNTAINEERING, CLIMBING AND SKI MOUNTAINEERING, NAMELY HARNESSES, ARTIFICIAL CLIMBING WALL AND HOLDS; SKIS; SNOWBOARDS; SKI COVERS, NAMELY SEAL SKINS; SNOWSHOES; SKI POLES, GRIPS FOR SKI POLES, IN CLASS 28 (U.S. CLS. 22, 23, 38 AND 50).

THE MARK CONSISTS OF STANDARD CHARACTERS WITHOUT CLAIM TO ANY PARTICULAR FONT, STYLE, SIZE, OR COLOR.

OWNER OF INTERNATIONAL REGISTRATION 0929441 DATED 11-9-2006, EXPIRES 11-9-2016.

SER. NO. 79-040,515, FILED 11-9-2006.

BARBARA GAYNOR, EXAMINING ATTORNEY

**Int. Cl.: 9**

**Prior U.S. Cls.: 21, 23, 26, 36 and 38**

**Reg. No. 3,454,077**

**United States Patent and Trademark Office**

**Registered June 24, 2008**

**TRADEMARK  
PRINCIPAL REGISTER**



X-FAB SEMICONDUCTOR FOUNDRIES AG  
(FED REP GERMANY AKTIENGESELL-  
SCHAFT)  
HAARBERGSTRASSE 67  
99097 ERFURT  
FED REP GERMANY

FOR: CHIPS IN THE NATURE OF INTEGRATED  
CIRCUITS; INTEGRATED CIRCUITS; SEMICON-  
DUCTORS; SILICON WAFERS, IN CLASS 9 (U.S.  
CLS. 21, 23, 26, 36 AND 38).

PRIORITY DATE OF 10-23-2006 IS CLAIMED.

OWNER OF INTERNATIONAL REGISTRATION  
0929970 DATED 4-2-2007, EXPIRES 4-2-2017.

OWNER OF U.S. REG. NO. 2,111,412.

NO CLAIM IS MADE TO THE EXCLUSIVE  
RIGHT TO USE "FAB MIXED-SIGNAL FOUNDRY  
EXPERTS", APART FROM THE MARK AS SHOWN.

THE COLOR(S) BLUE AND BLACK IS/ARE  
CLAIMED AS A FEATURE OF THE MARK.

THE COLOR BLACK APPEARS IN THE WORDS  
"FAB MIXED-SIGNAL FOUNDRY EXPERTS". THE  
COLOR BLUE APPEARS IN THE GEOMETRIC  
SHAPES WHICH FORM THE OUTLINE OF AN "X"  
SHAPE.

SER. NO. 79-040,743, FILED 4-2-2007.

ERNEST SHOSHO, EXAMINING ATTORNEY

**Int. Cls.: 18 and 25**

**Prior U.S. Cls.: 1, 2, 3, 22, 39 and 41**

**United States Patent and Trademark Office**

**Reg. No. 3,454,078**

**Registered June 24, 2008**

**TRADEMARK  
PRINCIPAL REGISTER**

**D.M.G**

DOMINGO CO., LTD. (JAPAN CORPORATION)  
1-13-4, KOJIMA-AKASAKI  
KURASHIKI-SHI; OKAYAMA 711-0931  
JAPAN

FOR: SHOULDER BAGS; TEXTILE SHOPPING BAGS; SPORTS BAGS; TRAVELING BAGS; VALISES; AND WALLETS, IN CLASS 18 (U.S. CLS. 1, 2, 3, 22 AND 41).

FOR: CLOTHING, NAMELY, TOPS, SHIRTS, T-SHIRTS, JEANS, PAINTER'S PANTS, PANTS, SKIRTS, TROUSERS, OVERALLS, PARKAS, BLOUSES, COATS, OVERCOATS, TOPCOATS, DRESS SHIRTS, OPEN-NECKED SHIRTS, SPORTS SHIRTS, POLO SHIRTS, SWEAT SHIRTS, SWEAT PANTS, SWEATERS, PULLOVERS, SOCKS, JACKETS, JUM-

PERS, SHORTS, VESTS, WIND RESISTANT JACKETS, ATHLETIC UNIFORMS; ATHLETIC FOOTWEAR; ATHLETIC SHOES; SHOES; BOOTS; HATS; CAPS; AND BERETS, IN CLASS 25 (U.S. CLS. 22 AND 39).

PRIORITY DATE OF 3-30-2007 IS CLAIMED.

OWNER OF INTERNATIONAL REGISTRATION 0930260 DATED 5-23-2007, EXPIRES 5-23-2017.

SER. NO. 79-040,842, FILED 5-23-2007.

REBECCA POVARCHUK, EXAMINING ATTORNEY



**Int. Cls.: 25 and 28**

**Prior U.S. Cls.: 22, 23, 38, 39 and 50**

**United States Patent and Trademark Office**

**Reg. No. 3,454,079**

**Registered June 24, 2008**

**TRADEMARK  
PRINCIPAL REGISTER**

**MINI COOPER**

BAYERISCHE MOTOREN WERKE AKTIENGE-  
SELLSCHAFT (FED REP GERMANY JOINT  
STOCK COMPANY)

PETUELRING 130

80809 MÜNCHEN, FED REP GERMANY

FOR: JACKETS, CAPS, T-SHIRTS, IN CLASS 25  
(U.S. CLS. 22 AND 39).

FOR: SCALE MODEL VEHICLES; TOY CARS, IN  
CLASS 28 (U.S. CLS. 22, 23, 38 AND 50).

OWNER OF INTERNATIONAL REGISTRATION  
0707800 DATED 9-16-1998, EXPIRES 9-16-2008.

OWNER OF U.S. REG. NOS. 2,376,477 AND  
2,557,534.

SER. NO. 79-040,913, FILED 12-21-2006.

KATHERINE E. HALMEN, EXAMINING ATTOR-  
NEY

**Int. Cl.: 43**

**Prior U.S. Cls.: 100 and 101**

**United States Patent and Trademark Office**

**Reg. No. 3,454,080**

**Registered June 24, 2008**

**SERVICE MARK  
PRINCIPAL REGISTER**

**SO FOOD**

ACCOR (FRANCE SOCIÉTÉ ANONYME)  
2 RUE DE LA MARE NEUVE  
F-91000 EVRY  
FRANCE

OWNER OF INTERNATIONAL REGISTRATION  
0812528 DATED 10-7-2003, EXPIRES 10-7-2013.

FOR: RESTAURANTS INCLUDING FAST FOOD  
AND SELF-SERVICE RESTAURANTS, CAFÉS, CA-  
FETERIAS, BARS, TEA ROOMS, CATERING SER-  
VICES, IN CLASS 43 (U.S. CLS. 100 AND 101).

NO CLAIM IS MADE TO THE EXCLUSIVE  
RIGHT TO USE "FOOD", APART FROM THE  
MARK AS SHOWN.

THE MARK CONSISTS OF STANDARD CHAR-  
ACTERS WITHOUT CLAIM TO ANY PARTICULAR  
FONT, STYLE, SIZE, OR COLOR.

SER. NO. 79-040,942, FILED 12-20-2006.

TINA L. SNAPP, EXAMINING ATTORNEY

**Int. Cl.: 28**

**Prior U.S. Cls.: 22, 23, 38 and 50**

**United States Patent and Trademark Office**

**Reg. No. 3,454,081**

**Registered June 24, 2008**

**TRADEMARK  
PRINCIPAL REGISTER**

***Hayabusa***

HAYABUSA FISHING; HOOKS CO., LTD. (JAPAN CORPORATION)  
341-23, OHATA  
YOKAWA-CHO.; MINO-GUN; HYOGO 673-1116  
JAPAN

THE FOREIGN WORDING IN THE MARK  
TRANSLATES INTO ENGLISH AS "PEREGRINE  
FALCON".

FOR: FISHING TACKLE, IN CLASS 28 (U.S. CLS.  
22, 23, 38 AND 50).

SER. NO. 79-040,946, FILED 4-11-2007.

OWNER OF INTERNATIONAL REGISTRATION  
0814907 DATED 11-4-2003, EXPIRES 11-4-2013.

ERNEST SHOSHO, EXAMINING ATTORNEY

**Int. Cl.: 25**

**Prior U.S. Cls.: 22 and 39**

**United States Patent and Trademark Office**

**Reg. No. 3,454,082**

**Registered June 24, 2008**

**TRADEMARK  
PRINCIPAL REGISTER**

**créatis**

GILLES, ANNE (FRANCE INDIVIDUAL)  
48 RUE FRANCIS DAVSO  
F-13001 MARSEILLE  
FRANCE

OWNER OF INTERNATIONAL REGISTRATION  
0930546 DATED 6-22-2007, EXPIRES 6-22-2017.

FOR: CLOTHING, NAMELY, SKIRTS, BLOUSES,  
VESTS, JEANS, CLOTHING TOPS, DRESSES, LIN-  
GERIE, SWIMWEAR, SHORTS, SWEAT SHIRTS,  
SWEAT PANTS, TIGHTS, PANTYHOSE, BELTS;  
FOOTWEAR, SHOES; HEAD WEAR, HATS, IN  
CLASS 25 (U.S. CLS. 22 AND 39).

CREATIS.

SER. NO. 79-041,022, FILED 6-22-2007.

PRIORITY DATE OF 6-20-2007 IS CLAIMED.

JILL C. ALT, EXAMINING ATTORNEY

**Int. Cls.: 10 and 20**

**Prior U.S. Cls.: 2, 13, 22, 25, 26, 32, 39, 44 and 50**

**United States Patent and Trademark Office**

**Reg. No. 3,454,083**

**Registered June 24, 2008**

**TRADEMARK  
PRINCIPAL REGISTER**

# VarioSitz

JOSEF GLÖCKL (FED REP GERMANY INDIVIDUAL)  
AMMERSEESTR. 6  
85551 KIRCHHEIM B.M.  
FED REP GERMANY

FOR: ORTHOPAEDIC ARTICLES, IN PARTICULAR ORTHOPAEDIC SEATS, IN CLASS 10 (U.S. CLS. 26, 39 AND 44).

FOR: FURNITURE OF ALL KINDS, IN PARTICULAR SEATS; SEATING FURNITURE; STANDING AIDS, NAMELY, A DEVICE THAT IS LONG ENOUGH TO ALLOW STANDING WHILE LEANING ON A TOP PORTION OF THE LEG, AND COMBINATIONS THEREOF; STOOLS, DESKS AND

WORK BENCHES, AND COMBINATIONS OF ALL THE AFORESAID GOODS, IN CLASS 20 (U.S. CLS. 2, 13, 22, 25, 32 AND 50).

PRIORITY DATE OF 2-2-2007 IS CLAIMED.

OWNER OF INTERNATIONAL REGISTRATION 0930972 DATED 7-17-2007, EXPIRES 7-17-2017.

SER. NO. 79-041,150, FILED 7-17-2007.

ANN E. SAPPENFIELD, EXAMINING ATTORNEY

**Int. Cls.: 19 and 20**

**Prior U.S. Cls.: 1, 2, 12, 13, 22, 25, 32, 33 and 50**

**Reg. No. 3,454,084**

**United States Patent and Trademark Office**

**Registered June 24, 2008**

**TRADEMARK  
PRINCIPAL REGISTER**



**faszination glas**

**GLAS+SPIEGEL-SCHULTZ GMBH & CO.KG  
(FED REP GERMANY GMBH & CO. KG)  
SEEKOPPELWEG 24  
24113 KIEL  
FED REP GERMANY**

**FOR: CONSTRUCTION AND BUILDING MATERIALS MADE OF GLASS, NAMELY, INSULATING GLASS, THERMALLY TOUGHENED SAFETY GLASS, LAMINATED SAFETY GLASS AND MIRROR GLASS, TRANSPORTABLE CONSTRUCTIONS MADE OF GLASS, NAMELY, ORDINARY SINGLE PANE GLASS, SAFETY TOUGHENED GLASS AND LAMINATED SAFETY GLASS, MONUMENTS MADE OF GLASS, STRUCTURAL GLASS PANELS, INSULATED GLASS, DOOR GLASS PANES, WINDOW GLASS, COMMON SHEET GLASS, SECURITY GLASS, NAMELY, THERMALLY TOUGHENED SAFETY GLASS, LAMINATED SAFETY GLASS AND FIRE PROTECTION GLASS, SAFETY GLASS FOR BUILDING PURPOSES, IN CLASS 19 (U.S. CLS. 1, 12, 33 AND 50).**

**FOR: FURNITURE, MIRRORS, PICTURE FRAMES, DISPLAY CASES AND SHOWCASES MADE OF GLASS, IN CLASS 20 (U.S. CLS. 2, 13, 22, 25, 32 AND 50).**

**OWNER OF INTERNATIONAL REGISTRATION  
0931076 DATED 6-26-2007, EXPIRES 6-26-2017.**

**NO CLAIM IS MADE TO THE EXCLUSIVE RIGHT TO USE "GLAS", APART FROM THE MARK AS SHOWN.**

**THE ENGLISH TRANSLATION OF "FASZINATION GLAS" IN THE MARK IS "FASCINATION GLASS".**

**SER. NO. 79-041,175, FILED 6-26-2007.**

**ANN E. SAPPENFIELD, EXAMINING ATTORNEY**

**Int. Cl.: 20**

**Prior U.S. Cls.: 2, 13, 22, 25, 32 and 50**

**United States Patent and Trademark Office**

**Reg. No. 3,454,085**

**Registered June 24, 2008**

**TRADEMARK  
PRINCIPAL REGISTER**

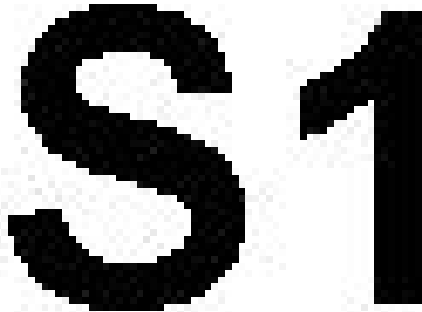

SIEMATIC MÖBELWERKE GMBH & CO. KG  
(FED REP GERMANY PARTNERSHIP LIMITED BY SHARES)  
AUGUST-SIEKMANN-STRABE 1-5  
32584 LÖHNE  
FED REP GERMANY

PRIORITY DATE OF 5-4-2007 IS CLAIMED.

OWNER OF INTERNATIONAL REGISTRATION  
0931549 DATED 7-16-2007, EXPIRES 7-16-2017.

FOR: FURNITURE, NAMELY, KITCHEN FURNITURE; FURNITURE PARTS FOR KITCHEN FURNITURE, IN CLASS 20 (U.S. CLS. 2, 13, 22, 25, 32 AND 50).

SER. NO. 79-041,356, FILED 7-16-2007.

WILLIAM ROSSMAN, EXAMINING ATTORNEY

**Int. Cl.: 29**

**Prior U.S. Cl.: 46**

**United States Patent and Trademark Office**

**Reg. No. 3,454,086**

**Registered June 24, 2008**

**TRADEMARK  
PRINCIPAL REGISTER**



21ST CENTURY DEVELOPMENTS PTY LTD  
(AUSTRALIA COMPANY)  
1 HIGH STREET  
KENSINGTON SA 5068  
AUSTRALIA

FOR: EDIBLE OILS AND FATS, NAMELY, OLIVE OIL; OLIVE DIPS, TAPENADES; PRESERVED, DRIED AND COOKED VEGETABLES, IN CLASS 29 (U.S. CL. 46).

OWNER OF INTERNATIONAL REGISTRATION  
0931671 DATED 6-14-2007, EXPIRES 6-14-2017.

NO CLAIM IS MADE TO THE EXCLUSIVE RIGHT TO USE "OLIO", APART FROM THE MARK AS SHOWN.

THE FOREIGN WORDING IN THE MARK TRANSLATES INTO ENGLISH AS OIL.

SER. NO. 79-041,406, FILED 6-14-2007.

LESLIE RICHARDS, EXAMINING ATTORNEY



**Int. Cl.: 28**

**Prior U.S. Cls.: 22, 23, 38 and 50**

**Reg. No. 3,454,087**

**United States Patent and Trademark Office**

**Registered June 24, 2008**

**TRADEMARK  
PRINCIPAL REGISTER**

# **OmniSelect**

ORANGE INTERNATIONAL TRADING; (TIANJIN) INC. (CHINA CORPORATION)  
ROOM. 202 SUITE 1  
155 XINGANG BIG ROAD.; FREE TRADE ZONE;  
TIANJIN  
CHINA

FOR: BODY-TRAINING APPARATUS, NAMELY, ANKLE AND WRIST WEIGHT FOR EXERCISE, BARBELLS, DUMBBELLS, STRIKING BAGS, STRIKING SHIELDS, HAND WRAPS, BATTING GLOVES, ELLIPTICAL EXERCISE MACHINES, EXERCISE MACHINES, EXERCISE MACHINES INCORPORATING ELECTRONIC AND VIDEO GAME CONTROLLERS, EXERCISE BARS, EXERCISE BENCHES, ROWING MACHINES, EXERCISE TRAMPOLINES, EXERCISE TREADMILLS, EXERCISE WEIGHTS, EXERCISE WEIGHT CUFFS, EXERCISE WRIST WEIGHTS, WEIGHT LIFTING MACHINES, TRAMPOLINES, LEG WEIGHTS FOR

EXERCISING, YOGA MATS, WEIGHT LIFTING BENCHES AND BENCH ACCESSORIES; CHECKERS; PLAYING BALLS, NAMELY, BEACH BALLS, BOWLING BALLS, FOOT BALLS; ARCHERY IMPLEMENTS, NAMELY, ARCHERY SETS; MACHINES FOR PHYSICAL EXERCISES; BATS FOR GAMES, NAMELY, BASEBALL BATS; GLOVES FOR GAMES, NAMELY, SOFT BALL GLOVES; FISHING TACKLE; PLAY SWIMMING POOLS, IN CLASS 28 (U.S. CLS. 22, 23, 38 AND 50).

OWNER OF INTERNATIONAL REGISTRATION  
0931691 DATED 7-23-2007, EXPIRES 7-23-2017.

SER. NO. 79-041,419, FILED 7-23-2007.

PAULA MAHONEY, EXAMINING ATTORNEY

**Int. Cl.: 25**

**Prior U.S. Cls.: 22 and 39**

**United States Patent and Trademark Office**

**Reg. No. 3,454,088**

**Registered June 24, 2008**

**TRADEMARK  
PRINCIPAL REGISTER**

**QUAI DE VALMY**

SERAPHIN (FRANCE SOCIÉTÉ PAR ACTIONS  
SIMPLIFIÉE)  
57 QUAI DE VALMY  
F-75010 PARIS  
FRANCE

FOR: LEATHER CLOTHING, NAMELY, BELTS,  
TROUSERS, JACKETS, SHORT COATS, PULL-  
OVERS, GLOVES, COATS, HATS, IN CLASS 25 (U.S.  
CLS. 22 AND 39).

THE MARK CONSISTS OF STANDARD CHAR-  
ACTERS WITHOUT CLAIM TO ANY PARTICULAR  
FONT, STYLE, SIZE, OR COLOR.

PRIORITY DATE OF 11-27-2006 IS CLAIMED.

OWNER OF INTERNATIONAL REGISTRATION  
0931769 DATED 5-22-2007, EXPIRES 5-22-2017.

THERE IS NO ENGLISH TRANSLATION OF  
QUAI DE VALMY

SER. NO. 79-041,458, FILED 5-22-2007.

JORDAN BAKER, EXAMINING ATTORNEY

**Int. Cls.: 16, 41 and 42**

**Prior U.S. Cls.: 2, 5, 22, 23, 29, 37, 38, 50, 100, 101 and 107**

**Reg. No. 3,454,089**

**United States Patent and Trademark Office**

**Registered June 24, 2008**

**TRADEMARK  
SERVICE MARK  
PRINCIPAL REGISTER**

# DataBar

GS1, ASSOCIATION INTERNATIONALE; SANS  
BUT LUCRATIF (BELGIUM NON-PROFIT IN-  
TERNATIONAL ASSOCIATION)

AVENUE LOUISE 326  
B-1050 BRUXELLES  
BELGIUM

FOR: PRINTED INSTRUCTIONAL, EDUCATION-  
AL AND TEACHING MATERIALS, NAMELY,  
TECHNICAL MANUALS, BROCHURES, BOOK-  
LETS AND LEAFLETS RELATING TO STANDAR-  
DIZED ELECTRONIC DATA INTERCHANGE  
MESSAGES AND GUIDELINES FOR USING THESE  
MESSAGES, IN CLASS 16 (U.S. CLS. 2, 5, 22, 23, 29, 37,  
38 AND 50).

FOR: EDUCATION SERVICES, NAMELY, CLAS-  
SES, WORKSHOPS AND SEMINARS IN THE FIELD  
OF STANDARDS FOR BARCODES; TRAINING IN  
THE FIELD OF STANDARDS FOR BARCODES;  
PUBLISHING OF ELECTRONIC PUBLICATIONS  
AND OF PRINTED MATTER, NAMELY, TECHNI-  
CAL MANUALS, BROCHURES, BOOKLETS AND  
LEAFLETS RELATED TO STANDARDIZED ELEC-  
TRONIC DATA INTERCHANGE MESSAGES AND  
GUIDELINES FOR USING THESE MESSAGES ALL

IN THE FIELD OF STANDARDS FOR BARCODES,  
IN CLASS 41 (U.S. CLS. 100, 101 AND 107).

FOR: QUALITY CONTROL FOR OTHERS,  
NAMELY, DEVELOPMENT AND REGULATORY  
CONTROL OF STANDARDS FOR BARCODES, AND  
PROVIDING TECHNICAL ADVICE CONCERNING  
THE APPLICATION OF THE AFORESAID STAND-  
DARDS, IN CLASS 42 (U.S. CLS. 100 AND 101).

THE MARK CONSISTS OF STANDARD CHAR-  
ACTERS WITHOUT CLAIM TO ANY PARTICULAR  
FONT, STYLE, SIZE, OR COLOR.

PRIORITY DATE OF 11-16-2006 IS CLAIMED.

OWNER OF INTERNATIONAL REGISTRATION  
0931943 DATED 3-13-2007, EXPIRES 3-13-2017.

SER. NO. 79-041,532, FILED 3-13-2007.

KRISTIN DAHLING, EXAMINING ATTORNEY

**Int. Cl.: 9**

**Prior U.S. Cls.: 21, 23, 26, 36 and 38**

**Reg. No. 3,454,090**

**United States Patent and Trademark Office**

**Registered June 24, 2008**

**TRADEMARK  
PRINCIPAL REGISTER**

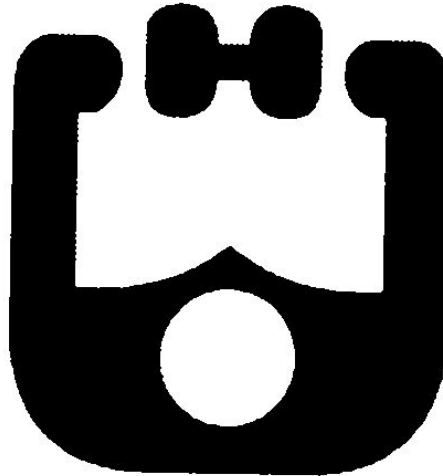

CIXI HONGYI; TEMPERATURE CONTROLLER  
FACTORY; (CIXISHI HONGYI WENKONGQI-  
CHANG) (CHINA PARTNERSHIP)  
INDUSTRY DEVELOPMENT AREA  
SHIQIAO TOWN, CIXI CITY; 315314 ZHEJIANG  
CHINA

FOR: AUTOMATIC TIME SWITCHES; ELECTRICAL WIRE CONNECTORS; ELECTRICAL CONNECTORS, NAMELY, SOCKETS, PLUGS AND OTHER CONTACTS; ELECTRICAL CELL SWITCHES; ELECTRIC SWITCHES; LEAKAGE PROTECTOR, NAMELY, VOLTAGE SURGE PROTECTORS; TEMPERATURE CONTROLLER, NAMELY, TEMPERATURE INDICATORS, TEMPERATURE SEN-

SORS, ENVIRONMENTAL MONITORING SYSTEM COMPRISED OF METERS AND SENSORS THAT MEASURE PRESSURE, HUMIDITY, TEMPERATURE AND INCLUDES ALARM AND REPORTING FUNCTIONS, IN CLASS 9 (U.S. CLS. 21, 23, 26, 36 AND 38).

OWNER OF INTERNATIONAL REGISTRATION  
0932191 DATED 6-11-2007, EXPIRES 6-11-2017.

SER. NO. 79-041,657, FILED 6-11-2007.

JEFF DEFORD, EXAMINING ATTORNEY

**Int. Cl.: 5**

**Prior U.S. Cls.: 6, 18, 44, 46, 51 and 52**

**United States Patent and Trademark Office**

**Reg. No. 3,454,091**

**Registered June 24, 2008**

**TRADEMARK  
PRINCIPAL REGISTER**

**AFOBAZOL**

ZAKRYTOE AKTSIONERNOE; OBSHCHESTVO  
"MASTERKLON" (RUSSIAN FED. CLOSED  
JOINT STOCK COMPANY)  
STR.2, 11, 1-Y VOLKONSKY PER.  
RU-127473 MOSCOW  
RUSSIAN FED.

FOR: PHARMACEUTICAL PREPARATIONS  
AND SUBSTANCES FOR THE TREATMENT OF  
ANXIETY DISORDERS AND CEREBRAL ISCHE-  
MIA, IN CLASS 5 (U.S. CLS. 6, 18, 44, 46, 51 AND 52).

THE MARK CONSISTS OF STANDARD CHAR-  
ACTERS WITHOUT CLAIM TO ANY PARTICULAR  
FONT, STYLE, SIZE, OR COLOR.

OWNER OF INTERNATIONAL REGISTRATION  
0902682 DATED 9-28-2006, EXPIRES 9-28-2016.

SER. NO. 79-041,688, FILED 5-31-2007.

GINA HAYES, EXAMINING ATTORNEY

**Int. Cl.: 9**

**Prior U.S. Cls.: 21, 23, 26, 36 and 38**

**Reg. No. 3,454,092**

**United States Patent and Trademark Office**

**Registered June 24, 2008**

**TRADEMARK  
PRINCIPAL REGISTER**

**GENEQUANT**

BIOCHROM LIMITED (UNITED KINGDOM  
CORPORATION)  
22 CAMBRIDGE SCIENCE PARK  
MILTON ROAD, CAMBRIDGE CB4 0FJ  
UNITED KINGDOM

FOR: PHOTOMETERS, SPECTROPHOTOM-  
ETERS, APPARATUS AND INSTRUMENTS FOR  
MEASURING THE RELATIVE INTENSITIES OF  
LIGHT IN DIFFERENT PARTS OF THE SPEC-  
TRUM; PARTS AND FITTINGS FOR ALL THE  
AFORESAID GOODS, IN CLASS 9 (U.S. CLS. 21, 23,  
26, 36 AND 38).

THE MARK CONSISTS OF STANDARD CHAR-  
ACTERS WITHOUT CLAIM TO ANY PARTICULAR  
FONT, STYLE, SIZE, OR COLOR.

OWNER OF INTERNATIONAL REGISTRATION  
0932355 DATED 7-3-2007, EXPIRES 7-3-2017.

SER. NO. 79-041,744, FILED 7-3-2007.

ALLISON HOLTZ, EXAMINING ATTORNEY

**Int. Cl.: 20**

**Prior U.S. Cls.: 2, 13, 22, 25, 32 and 50**

**United States Patent and Trademark Office**

**Reg. No. 3,454,093**

**Registered June 24, 2008**

**TRADEMARK  
PRINCIPAL REGISTER**

**LA BASILICA**

CASSINA S.P.A. (ITALY SOCIÉTÉ PAR ACTIONS)

VIA LUIGI BUSNELLI 1

I-20036 MEDA (MI)

ITALY

FOR: LIVING ROOM AND BEDROOM FURNITURE, GARDEN FURNITURE, UPHOLSTERED FURNITURE, OFFICE FURNITURE, CHAIRS, ARMCHAIRS, SOFAS, BOOKSHELVES, MIRRORS, WARDROBES AND SMALL FURNITURE; DIVANS; SOFA BEDS; SOFA; TABLES; WRITING DESKS; BEDS; CUSHIONS; PICTURE FRAMES, DISPLAY STANDS FOR PHOTOGRAPHS, IN CLASS 20 (U.S. CLS. 2, 13, 22, 25, 32 AND 50).

THE MARK CONSISTS OF STANDARD CHARACTERS WITHOUT CLAIM TO ANY PARTICULAR FONT, STYLE, SIZE, OR COLOR.

PRIORITY DATE OF 1-26-2007 IS CLAIMED.

OWNER OF INTERNATIONAL REGISTRATION 0932542 DATED 4-16-2007, EXPIRES 4-16-2017.

THE FOREIGN WORDING IN THE MARK TRANSLATES INTO ENGLISH AS "THE".

SER. NO. 79-041,823, FILED 4-16-2007.

DEBRA LEE, EXAMINING ATTORNEY

**Int. Cl.: 20**

**Prior U.S. Cls.: 2, 13, 22, 25, 32 and 50**

**Reg. No. 3,454,094**

**United States Patent and Trademark Office**

**Registered June 24, 2008**

**TRADEMARK  
PRINCIPAL REGISTER**

**NUVOLA ROSSA**

CASSINA S.P.A. (ITALY SOCIÉTÉ PAR ACTIONS)

VIA LUIGI BUSNELLI 1

I-20036 MEDA (MI)

ITALY

FOR: LIVING ROOM AND BEDROOM FURNITURE, GARDEN FURNITURE, UPHOLSTERED FURNITURE, OFFICE FURNITURE, CHAIRS, ARMCHAIRS, SOFAS, BOOKSHELVES, MIRRORS, WARDROBES AND SMALL FURNITURE; DIVANS; SOFA BEDS; SOFA; TABLES; WRITING DESKS; BEDS; CUSHIONS; PICTURE FRAMES, DISPLAY STANDS FOR PHOTOGRAPHS, IN CLASS 20 (U.S. CLS. 2, 13, 22, 25, 32 AND 50).

THE MARK CONSISTS OF STANDARD CHARACTERS WITHOUT CLAIM TO ANY PARTICULAR FONT, STYLE, SIZE, OR COLOR.

PRIORITY DATE OF 1-26-2007 IS CLAIMED.

OWNER OF INTERNATIONAL REGISTRATION 0932543 DATED 4-16-2007, EXPIRES 4-16-2017.

THE FOREIGN WORDING IN THE MARK TRANSLATES INTO ENGLISH AS "RED CLOUD".

SER. NO. 79-041,824, FILED 4-16-2007.

DEBRA LEE, EXAMINING ATTORNEY



**Int. Cls.: 35, 36 and 41**

**Prior U.S. Cls.: 100, 101, 102 and 107**

**United States Patent and Trademark Office**

**Reg. No. 3,454,095**

**Registered June 24, 2008**

**SERVICE MARK  
PRINCIPAL REGISTER**

**WFE WORLD FEDERATION OF EXCHANGES**

WORLD FEDERATION OF EXCHANGES  
(FRANCE NON-PROFIT ASSOCIATION)  
176, RUE DE RIVOLI  
F-75001 PARIS  
FRANCE

FOR: OPERATIONAL BUSINESS ASSISTANCE TO ENTERPRISES; BUSINESS CONSULTING, INFORMATION AND DATA COMPILING AND ANALYSING RELATING TO BUSINESS MANAGEMENT; STATISTICAL INFORMATION; MANAGEMENT OF COMPUTERIZED FILES CONTAINING INFORMATION ABOUT ORGANIZATION AND FUNCTIONING OF FINANCIAL MARKETS; BUSINESS STUDIES RELATING TO THE ORGANIZATION AND FUNCTION OF FINANCIAL MARKETS; REGISTRATION, COMPOSITION, COMPILATION AND SYSTEMATISATION OF STOCK EXCHANGE INDEX STATISTICS AND ALL INDEX FIGURES RELATING TO STOCK EXCHANGE PRICES, FINANCIAL INSTRUMENTS AND SECURITIES; SEARCH FOR COLLECTION, PROCESSING AND SYSTEMATIZATION OF ALL INFORMATION OR DATA REGARDING FINANCIAL INSTRUMENTS, SECURITIES, THE ISSUERS OF SUCH AS WELL AS OTHER MARKET PARTICIPANTS AND FINANCIAL INSTITUTIONS IN CONNECTION WITH SUCH ACTIVITIES; CALCULATION OF STATISTICS REGARDING STOCK EXCHANGE PRICES, FINANCIAL INSTRUMENTS AND SECURITIES; CALCULATION OF STATISTICS, IN CLASS 35 (U.S. CLS. 100, 101 AND 102).

FOR: STOCK EXCHANGE INDEX CALCULATIONS AND ALL INDEX FIGURES RELATING TO STOCK EXCHANGE PRICES, FINANCIAL INSTRUMENTS AND SECURITIES; PROVIDING PRICE QUOTATIONS SECURITIES ON THE STOCK EXCHANGE, PROVIDING PRICE QUOTATIONS FOR STOCKS, BONDS, WARRANTS, FUTURES, OPTIONS, OTHER STANDARDIZED FINANCIAL PRODUCTS TRADED ON-EXCHANGE; CASH

MANAGEMENT; ORGANIZATION AND IMPLEMENTATION OF STOCK MARKETS FOR THE BENEFIT OF THE TRADE OF STOCKS; CONSULTING REGARDING THE TRADING OF SECURITIES ON A STOCK EXCHANGE, FINANCIAL CONSULTING, PROVIDING INFORMATION ABOUT STOCK EXCHANGES, PROVIDING FINANCIAL INFORMATION, IN CLASS 36 (U.S. CLS. 100, 101 AND 102).

FOR: PUBLICATION OF BOOKS, REVIEWS, NEWSPAPERS ABOUT ORGANIZATION AND FUNCTIONING OF FINANCIAL MARKETS; PUBLICATION ON ALL TYPES OF MEDIA INCLUDING ELECTRONIC MEDIA OF MONTHLY NEWSLETTERS AND STATISTICS, REPORTS AND STUDIES, REPORTS ON MEETINGS RELATING TO FINANCIAL MARKETS, STOCK EXCHANGE STATISTICS AND INDICES AND ALL INDEX FIGURES RELATING TO STOCK EXCHANGE PRICES, FINANCIAL MARKETS, FINANCIAL INSTRUMENTS AND SECURITIES, IN CLASS 41 (U.S. CLS. 100, 101 AND 107).

THE MARK CONSISTS OF STANDARD CHARACTERS WITHOUT CLAIM TO ANY PARTICULAR FONT, STYLE, SIZE, OR COLOR.

PRIORITY DATE OF 9-20-2006 IS CLAIMED.

OWNER OF INTERNATIONAL REGISTRATION 0932834 DATED 2-23-2007, EXPIRES 2-23-2017.

NO CLAIM IS MADE TO THE EXCLUSIVE RIGHT TO USE "WORLD FEDERATION OF EXCHANGES", APART FROM THE MARK AS SHOWN.

SER. NO. 79-041,919, FILED 2-23-2007.

DEBRA LEE, EXAMINING ATTORNEY

**Int. Cls.: 9, 38 and 42**

**Prior U.S. Cls.: 21, 23, 26, 36, 38, 100, 101 and 104**

**United States Patent and Trademark Office**

**Reg. No. 3,454,096**

**Registered June 24, 2008**

**TRADEMARK  
SERVICE MARK  
PRINCIPAL REGISTER**

**flexive**

UNIQUE COMPUTING SOLUTIONS GMBH  
(AUSTRIA PRIVATE LIMITED COMPANY)  
LÖWENGASSE 2/8  
A-1030 WIEN  
AUSTRIA

FOR: SOFTWARE, NAMELY, COMPUTER SOFTWARE DEVELOPMENT TOOLS, COMPUTER SOFTWARE FOR COMPUTER SYSTEM AND APPLICATION DEVELOPMENT, DEPLOYMENT AND MANAGEMENT, WEBSITE DEVELOPMENT SOFTWARE, COMPUTER SOFTWARE FOR THE COLLECTION, EDITING, ORGANIZING, MODIFYING, BOOK MARKING, TRANSMISSION, STORAGE AND SHARING OF DATA AND INFORMATION; COMPUTER APPLICATION SOFTWARE FOR MOBILE PHONES, COMPUTER SOFTWARE FOR PROVIDING AN ON-LINE DATABASE IN THE FIELD OF TRANSACTION PROCESSING TO UPLOAD TRANSACTIONAL DATA, PROVIDE STATISTICAL ANALYSIS, AND PRODUCE NOTIFICATIONS AND REPORTS; COMPUTER E-COMMERCE SOFTWARE TO ALLOW USERS TO PERFORM ELECTRONIC BUSINESS TRANSACTIONS VIA A GLOBAL COMPUTER NETWORK; COMPUTER SOFTWARE FOR APPLICATION AND DATABASE INTEGRATION; COMPUTERS, HANDHELD COMPUTERS, PERSONAL DIGITAL ASSISTANTS, AND TELEPHONES, IN CLASS 9 (U.S. CLS. 21, 23, 26, 36 AND 38).

FOR: TELECOMMUNICATIONS, NAMELY, COMMUNICATIONS, DATA TRANSMISSION AND RECEPTION SERVICES VIA TELECOMMUNICATION MEANS, IN CLASS 38 (U.S. CLS. 100, 101 AND 104).

FOR: DESIGN AND DEVELOPMENT OF COMPUTER HARDWARE AND SOFTWARE, MAINTENANCE OF COMPUTER SOFTWARE, IN CLASS 42 (U.S. CLS. 100 AND 101).

THE MARK CONSISTS OF STANDARD CHARACTERS WITHOUT CLAIM TO ANY PARTICULAR FONT, STYLE, SIZE, OR COLOR.

PRIORITY DATE OF 3-23-2007 IS CLAIMED.

OWNER OF INTERNATIONAL REGISTRATION 0933139 DATED 4-26-2007, EXPIRES 4-26-2017.

FLEXIVE HAS NO FOREIGN MEANING.

SER. NO. 79-042,032, FILED 4-26-2007.

NAKIA HENRY, EXAMINING ATTORNEY

**Int. Cl.: 28**

**Prior U.S. Cls.: 22, 23, 38 and 50**

**United States Patent and Trademark Office**

**Reg. No. 3,454,097**

**Registered June 24, 2008**

**TRADEMARK  
PRINCIPAL REGISTER**

# **OmniTech**

ORANGE INTERNATIONAL TRADING; (TIANJIN) INC. (CHINA CORPORATION)  
ROOM. 202 SUITE 1  
155 XINGANG BIG ROAD.; FREE TRADE ZONE;-  
TIANJIN  
CHINA

FOR: BODY-TRAINING APPARATUS, NAMELY, ANKLE AND WRIST WEIGHT FOR EXERCISE, BARBELLS, DUMBBELLS, STRIKING BAGS, STRIKING SHIELDS, HAND WRAPS, BATTING GLOVES, ELLIPTICAL EXERCISE MACHINES, EXERCISE MACHINES, EXERCISE MACHINES INCORPORATING ELECTRONIC AND VIDEO GAME CONTROLLERS, EXERCISE BARS, EXERCISE BENCHES, ROWING MACHINES, EXERCISE TRAMPOLINES, EXERCISE TREADMILLS, EXERCISE WEIGHTS, EXERCISE WEIGHT CUFFS, EXERCISE WRIST WEIGHTS, WEIGHT LIFTING MACHINES, TRAMPOLINES, LEG WEIGHTS FOR

EXERCISING, YOGA MATS, WEIGHT LIFTING BENCHES AND BENCH ACCESSORIES; CHECKERS; PLAYING BALLS, NAMELY, BEACH BALLS, BOWLING BALLS, FOOT BALLS; ARCHERY IMPLEMENTS, NAMELY, ARCHERY SETS; MACHINES FOR PHYSICAL EXERCISES; BATS FOR GAMES, NAMELY, BASEBALL BATS; GLOVES FOR GAMES, NAMELY, SOFT BALL GLOVES; FISHING TACKLE; PLAY SWIMMING POOLS, IN CLASS 28 (U.S. CLS. 22, 23, 38 AND 50).

OWNER OF INTERNATIONAL REGISTRATION  
0933177 DATED 6-7-2007, EXPIRES 6-7-2017.

SER. NO. 79-042,053, FILED 6-7-2007.

PAULA MAHONEY, EXAMINING ATTORNEY

**Int. Cls.: 18 and 25**

**Prior U.S. Cls.: 1, 2, 3, 22, 39 and 41**

**United States Patent and Trademark Office**

**Reg. No. 3,454,098**

**Registered June 24, 2008**

**TRADEMARK  
PRINCIPAL REGISTER**

# **MONDIANA**

MONDIALPELLI S.P.A. (ITALY JOINT STOCK  
COMPANY)

VIA FIENO, 3

I-20123 MILANO, ITALY

FOR: LEATHER, LEATHER ARTICLES AND IMI-  
TATION THEREOF, NAMELY, SUITCASES AND  
TRAVELLING BAGS; FUR AND UMBRELLAS, IN  
CLASS 18 (U.S. CLS. 1, 2, 3, 22 AND 41).

FOR: CLOTHING ARTICLES, NAMELY, FUR  
STOLES, FUR COATS; CLOTHING ARTICLES COM-  
BINED WITH FURS AND CLOTHING ARTICLES  
COVERED WITH FURS, NAMELY, SHIRTS, COATS,  
PANTS AND SHOES, IN CLASS 25 (U.S. CLS. 22 AND  
39).

THE MARK CONSISTS OF STANDARD CHAR-  
ACTERS WITHOUT CLAIM TO ANY PARTICULAR  
FONT, STYLE, SIZE, OR COLOR.

PRIORITY DATE OF 2-14-2007 IS CLAIMED.

OWNER OF INTERNATIONAL REGISTRATION  
0933363 DATED 6-26-2007, EXPIRES 6-26-2017.

THE WORDING "MONDIANA" HAS NO MEAN-  
ING IN A FOREIGN LANGUAGE.

SER. NO. 79-042,126, FILED 6-26-2007.

INGRID C. EULIN, EXAMINING ATTORNEY

**Int. Cls.: 35, 39 and 43**

**Prior U.S. Cls.: 100, 101, 102 and 105**

**United States Patent and Trademark Office**

**Reg. No. 3,454,099**

**Registered June 24, 2008**

**SERVICE MARK  
PRINCIPAL REGISTER**

**VENERE**

VENERE NET S.P.A. (ITALY JOINT STOCK  
COMPANY)  
VIA DELLA CAMILLUCCIA 693  
I-00135 ROMA  
ITALY

FOR: BUSINESS CONSULTING AND MANAGE-  
MENT SERVICES IN THE FIELD OF TRAVEL,  
TRAVEL PLANNING AND TRAVEL RELATED  
BUSINESS; ON-LINE RETAIL STORE SERVICES IN  
THE FIELD OF TRAVEL; TRAVEL AND LODGING  
ADVERTISING, IN CLASS 35 (U.S. CLS. 100, 101 AND  
102).

FOR: TRAVEL AGENCY SERVICES, MAKING  
RESERVATIONS FOR TRANSPORTATION; PRO-  
VIDING INFORMATION CONCERNING TRAVELS;  
PROVIDING DIRECTORIES AND LISTINGS OF  
TRAVEL AND TOUR INFORMATION FOR USE  
BY TRAVELERS AVAILABLE ELECTRONICALLY  
VIA A GLOBAL COMPUTER NETWORK; PROVID-  
ING TRAVEL INFORMATION VIA A GLOBAL  
COMPUTER NETWORK, IN CLASS 39 (U.S. CLS.  
100 AND 105).

FOR: MAKING RESERVATIONS FOR OTHERS  
FOR TEMPORARY ACCOMMODATIONS, RES-  
TAURANTS AND MEALS, IN CLASS 43 (U.S. CLS.  
100 AND 101).

THE MARK CONSISTS OF STANDARD CHAR-  
ACTERS WITHOUT CLAIM TO ANY PARTICULAR  
FONT, STYLE, SIZE, OR COLOR.

PRIORITY DATE OF 6-12-2007 IS CLAIMED.

OWNER OF INTERNATIONAL REGISTRATION  
0933364 DATED 7-11-2007, EXPIRES 7-11-2017.

OWNER OF U.S. REG. NO. 3,129,986.

THE ENGLISH TRANSLATION OF THE WORD  
"VENERE" IS "VENUS".

SER. NO. 79-042,127, FILED 7-11-2007.

WILLIAM VERHOSEK, EXAMINING ATTORNEY

**Int. Cl.: 5**

**Prior U.S. Cls.: 6, 18, 44, 46, 51 and 52**

**United States Patent and Trademark Office**

**Reg. No. 3,454,100**

**Registered June 24, 2008**

**TRADEMARK  
PRINCIPAL REGISTER**

**ARICEPT ER**

EISAI R&D MANAGEMENT CO., LTD. (JAPAN CORPORATION)  
6-10, KOISHIKAWA 4 CHOME  
BUNKYO-KU; TOKYO 112-8088  
JAPAN

FOR: PHARMACEUTICAL PREPARATIONS FOR THE TREATMENT OF CEREBRAL AND NEUROLOGIC DISORDERS, DISEASES AND CONDITIONS; PHARMACEUTICAL PREPARATIONS FOR THE TREATMENT OF THE SYMPTOMS OF ALZHEIMER'S DISEASE, IN CLASS 5 (U.S. CLS. 6, 18, 44, 46, 51 AND 52).

THE MARK CONSISTS OF STANDARD CHARACTERS WITHOUT CLAIM TO ANY PARTICULAR FONT, STYLE, SIZE, OR COLOR.

PRIORITY DATE OF 5-17-2007 IS CLAIMED.

OWNER OF INTERNATIONAL REGISTRATION  
0933496 DATED 6-20-2007, EXPIRES 6-20-2017.

OWNER OF U.S. REG. NOS. 2,065,647, 3,059,219  
AND OTHERS.

NO CLAIM IS MADE TO THE EXCLUSIVE RIGHT TO USE "ER", APART FROM THE MARK AS SHOWN.

SER. NO. 79-042,193, FILED 6-20-2007.

ERNEST SHOSHO, EXAMINING ATTORNEY

**Int. Cls.: 20, 22 and 24**

**Prior U.S. Cls.: 1, 2, 7, 13, 19, 22, 25, 32, 42 and 50**

**United States Patent and Trademark Office**

**Reg. No. 3,454,101**

**Registered June 24, 2008**

**TRADEMARK  
PRINCIPAL REGISTER**



SHANDONG TAIPENG INDUSTRY CO., LTD  
(CHINA CORPORATION)  
HIGH AND NEW TECHNOLOGY  
DEVELOPMENT AREA., FEICHENG CITY;  
271600SHANDONG PROVINCE  
CHINA

FOR: FURNITURE; ARMCHAIRS; ROCKING  
CHAIRS; SCHOOL FURNITURE; BEDS; PLANT  
STANDS FOR FLOWER; MATTRESS; END TABLES;  
SLEEPING BAGS, IN CLASS 20 (U.S. CLS. 2, 13, 22, 25,  
32 AND 50).

FOR: TENTS; AWNINGS OF SYNTHETIC MATE-  
RIALS; HAMMOCKS; RAW FIBROUS TEXTILE  
MATERIALS; TEXTILE FIBERS; SILK FLOCK,  
NAMELY, SILK STUFFING FIBERS, SILK NET-  
TING, SILK FIBERS, SILK FLOSS, RAW SILK;  
AWNINGS OF FABRIC TEXTILE; PLASTIC FIBERS  
FOR TEXTILE USE, IN CLASS 22 (U.S. CLS. 1, 2, 7, 19,  
22, 42 AND 50).

FOR: CUSHIONS NOT OF PAPER, NAMELY,  
COVERS FOR CUSHIONS; CUSHIONS OF TEXTILE,  
IN CLASS 24 (U.S. CLS. 42 AND 50).

OWNER OF INTERNATIONAL REGISTRATION  
0933508 DATED 5-28-2007, EXPIRES 5-28-2017.

THE MARK CONSISTS OF A DESIGN OF A  
CIRCLE AND THREE TRIANGLES AND THE  
WORDING "TAIPENG".

THE ENGLISH WORD TAIPENG HAS NO  
MEANING IN A FOREIGN LANGUAGE.

SER. NO. 79-042,202, FILED 5-28-2007.

BERNICE MIDDLETON, EXAMINING ATTORNEY

**Int. Cl.: 9**

**Prior U.S. Cls.: 21, 23, 26, 36 and 38**

**Reg. No. 3,454,102**

**United States Patent and Trademark Office**

**Registered June 24, 2008**

**TRADEMARK  
PRINCIPAL REGISTER**



MARIUS MOREL FRANCE SAS (FRANCE SOCI-  
ÉTÉ PAR ACTIONS SIMPLIFIÉE)  
117 ROUTE DES BUCLETS  
F-39400 MORBIER  
FRANCE

SPECTACLES, CASES FOR PHOTSENSITIVE LEN-  
SES FOR SPECTACLES, CASES FOR SPECTACLE  
LENS BLANKS, CASES FOR SPECTACLE FRAMES,  
IN CLASS 9 (U.S. CLS. 21, 23, 26, 36 AND 38).

FOR: SPECTACLES; SUNGLASSES; NON-IM-  
PLANTABLE OPHTHALMIC LENSES; LENSES  
FOR SPECTACLES; COATED LENSES FOR SPEC-  
TACLES; LENSES FOR SUNGLASSES; TINTED  
LENSES FOR SPECTACLES; PHOTSENSITIVE  
LENSES FOR SPECTACLES; SPECTACLE LENS  
BLANKS; SPECTACLE FRAMES; CASES FOR SPEC-  
TACLES, CASES FOR SUNGLASSES, CASES FOR  
OPHTHALMIC LENSES, CASES FOR COATED LEN-  
SES FOR SPECTACLES, CASES FOR LENSES FOR  
SUNGLASSES, CASES FOR TINTED LENSES FOR

PRIORITY DATE OF 1-10-2007 IS CLAIMED.

OWNER OF INTERNATIONAL REGISTRATION  
0933607 DATED 7-9-2007, EXPIRES 7-9-2017.

SER. NO. 79-042,249, FILED 7-9-2007.

JANICE KIM, EXAMINING ATTORNEY



**Int. Cls.: 9, 35, 38, 41 and 42**

**Prior U.S. Cls.: 21, 23, 26, 36, 38, 100, 101, 102, 104  
and 107**

**Reg. No. 3,454,103**

**United States Patent and Trademark Office**

**Registered June 24, 2008**

**TRADEMARK  
SERVICE MARK  
PRINCIPAL REGISTER**

# FOODNAVIGATOR

DECISION NEWS MEDIA SAS (FRANCE SAS)  
LE BELEM -  
355 RUE VENDÉMIAIREF-34000 MONTPELLIER  
FRANCE

FOR: COMPUTER PROGRAMS AND SOFTWARE FOR CREATING, PUBLISHING AND MANAGING ONLINE CONTENT IN THE FORM OF MESSAGES, DATA, TEXTS, IMAGES AND VIDEOS, ALL RELATING TO THE PUBLICATION OF INFORMATION FOR PROFESSIONALS IN THE FOOD AND BEVERAGE MANUFACTURING INDUSTRY AND IN NUTRITION, DOWNLOADABLE FROM AN EXTERNAL COMPUTER NETWORK OR FROM THE INTERNET; DOWNLOADABLE ELECTRONIC PUBLICATIONS SUPPLIED FROM A DATABASE OR FROM THE INTERNET, NAMELY, NEWSLETTERS, MAGAZINES, JOURNALS, NEWS ARTICLES, TECHNICAL PAPERS, RESEARCH ANALYSIS, PRODUCT PRESENTATIONS, MARKET REPORTS, BUYERS GUIDES, EVENTS CALENDARS, INTERVIEWS, WHITE PAPERS, PRODUCT BROCHURES AND BUSINESS REVIEWS IN THE FIELD OF THE FOOD AND BEVERAGE MANUFACTURING INDUSTRY AND NUTRITION, IN CLASS 9 (U.S. CLS. 21, 23, 26, 36 AND 38).

FOR: ADVERTISING SERVICES; BUSINESS PROMOTION AND INFORMATION SERVICES FROM THE INTERNET; COMPILING BUSINESS ADVERTISEMENTS FOR THIRD PARTIES; RENTAL OF ADVERTISING SPACE ONLINE FOR PROMOTING GOODS AND SERVICES BETWEEN PROFESSIONALS, IN CLASS 35 (U.S. CLS. 100, 101 AND 102).

FOR: TELECOMMUNICATION AND ELECTRONIC MESSAGING SERVICES, NAMELY, TRANSMISSION OF ELECTRONIC MESSAGES VIA THE INTERNET FOR SCIENTIFIC, TECHNICAL AND INDUSTRIAL NEWS AND INFORMATION ABOUT FOOD AND BEVERAGE PRODUCTS AND NUTRITION; TRANSMISSION OF MESSAGES, DATA, TEXTS AND IMAGES BY ELECTRONIC MEANS;

COMMUNICATIONS BY COMPUTER TERMINALS; TRANSMISSION OF INFORMATION HELD IN A DATABASE OR ON THE INTERNET, IN CLASS 38 (U.S. CLS. 100, 101 AND 104).

FOR: PUBLISHING OF NEWSLETTERS, MAGAZINES, JOURNALS, NEWS ARTICLES, TECHNICAL PAPERS, RESEARCH ANALYSES, PRODUCT PRESENTATIONS, MARKET REPORTS, BUYERS GUIDES, EVENTS CALENDARS, INTERVIEWS, WHITE PAPERS, PRODUCT BROCHURES AND BUSINESS REVIEWS FOR SCIENTIFIC, INDUSTRIAL AND TECHNICAL INFORMATION AND NEWS FOR PROFESSIONALS IN THE FOOD AND BEVERAGE MANUFACTURING INDUSTRY INVOLVED IN RESEARCH, FORMULATION AND DEVELOPMENT OF FOOD AND BEVERAGE PRODUCTS, IN CLASS 41 (U.S. CLS. 100, 101 AND 107).

FOR: DESIGN AND DEVELOPMENT OF WEB SITES; COMPILATION OF WEB PAGES ON THE INTERNET, NAMELY, DISPLAYING THE WEB SITES AND IMAGES OF OTHERS ON A COMPUTER SERVER; PROVISION OF ACCESS TO A DATABASE SERVER CENTRE, NAMELY, RENTAL OF A DATABASE SERVER TO THIRD PARTIES, IN CLASS 42 (U.S. CLS. 100 AND 101).

THE MARK CONSISTS OF STANDARD CHARACTERS WITHOUT CLAIM TO ANY PARTICULAR FONT, STYLE, SIZE, OR COLOR.

PRIORITY DATE OF 9-25-2006 IS CLAIMED.

OWNER OF INTERNATIONAL REGISTRATION  
0934153 DATED 3-20-2007, EXPIRES 3-20-2017.

SER. NO. 79-042,470, FILED 3-20-2007.

REBECCA POVARCHUK, EXAMINING ATTORNEY

**Int. Cl.: 33**

**Prior U.S. Cls.: 47 and 49**

**United States Patent and Trademark Office**

**Reg. No. 3,454,104**

**Registered June 24, 2008**

**TRADEMARK  
PRINCIPAL REGISTER**

**SIERRA MILENIO**

BORCO-MARKEN-IMPORT; MATTHIESEN  
GMBH & CO. KG (FED REP GERMANY  
LIMITED PARTNERSHIP)  
WINSBERGRING 12-22  
22525 HAMBURG  
FED REP GERMANY

FOR: SPIRITS OF MEXICAN ORIGIN, NAMELY  
LIQUEUR MADE OF AGAVE, IN CLASS 33 (U.S.  
CLS. 47 AND 49).

THE MARK CONSISTS OF STANDARD CHAR-  
ACTERS WITHOUT CLAIM TO ANY PARTICULAR  
FONT, STYLE, SIZE, OR COLOR.

PRIORITY DATE OF 2-7-2007 IS CLAIMED.

OWNER OF INTERNATIONAL REGISTRATION  
0934270 DATED 7-26-2007, EXPIRES 7-26-2017.

OWNER OF U.S. REG. NOS. 1,891,299 AND  
3,209,367.

"THE FOREIGN WORDING IN THE MARK  
TRANSLATES INTO ENGLISH AS MILLENNIUM."

SER. NO. 79-042,533, FILED 7-26-2007.

LYDIA BELZER, EXAMINING ATTORNEY

**Int. Cl.: 29**

**Prior U.S. Cl.: 46**

**United States Patent and Trademark Office**

**Reg. No. 3,454,105**

**Registered June 24, 2008**

**TRADEMARK  
PRINCIPAL REGISTER**

**STOVIT**

GRUPO ANGEL CAMACHO, S.L. (SPAIN SOCIEDAD LIMITADA)  
AVENIDA DEL PILAR, 6  
E-41530 MORÓN DE LA FRONTERA (SEVILLA)  
SPAIN

OWNER OF INTERNATIONAL REGISTRATION  
0934476 DATED 7-16-2007, EXPIRES 7-16-2017.

FOR: MEAT, FISH, POULTRY AND GAME;  
MEAT EXTRACTS; PRESERVED, FROZEN, DRIED  
AND COOKED FRUITS AND VEGETABLES; JEL-  
LIES, JAMS, COMPOTES; EGGS, MILK AND DIARY  
PRODUCTS, EXCLUDING ICE CREAM, ICE MILK  
AND FROZEN YOGURT; EDIBLE OILS AND FATS,  
IN CLASS 29 (U.S. CL. 46).

THE WORDING "STOVIT" HAS NO MEANING IN  
A FOREIGN LANGUAGE

SER. NO. 79-042,612, FILED 7-16-2007.

WILLIAM ROSSMAN, EXAMINING ATTORNEY

Int. Cl.: 25

Prior U.S. Cls.: 22 and 39

United States Patent and Trademark Office

Reg. No. 3,454,106

Registered June 24, 2008

TRADEMARK  
PRINCIPAL REGISTER

BESOUL

HE WEI (CHINA INDIVIDUAL)

9A, 1 UNIT

DIHAIJINGJIAYUAN,; HOUHAI DADAO DONG,;  
NANSHAN DISTRICT; 518000 SHENZHEN,  
GUANGDONG

CHINA

FOR: GOWNS; COMBINATIONS; BEACHWEAR;  
PAJAMAS; SLEEPWEAR; BATH ROBES; UNDER-  
PANTS; LAYETTES; DRAWERS, IN CLASS 25 (U.S.  
CLS. 22 AND 39).

OWNER OF INTERNATIONAL REGISTRATION  
0934677 DATED 5-10-2007, EXPIRES 5-10-2017.

BESOUL.

THE MARK HAS NO MEANING IN A FOREIGN  
LANGUAGE.

SER. NO. 79-042,664, FILED 5-10-2007.

ROBERT STRUCK, EXAMINING ATTORNEY

Int. Cl.: 29

Prior U.S. Cl.: 46

United States Patent and Trademark Office

Reg. No. 3,454,107

Registered June 24, 2008

TRADEMARK  
PRINCIPAL REGISTER



SEÑORIO DE MONTANERA, S.L. (SPAIN SOCIEDAD LIMITADA)  
CTRA. RINCÓN DE CAYA, KM. 3,5  
APTDO. 335  
E-06080 BADAJOZ, SPAIN

FOR: MEAT, MEAT EXTRACTS, MEAT PRESERVES, MEAT DERIVATIVES, DELICATESSEN MEAT, HAMS; POULTRY AND GAME, IN CLASS 29 (U.S. CL. 46).

OWNER OF INTERNATIONAL REGISTRATION 0934946 DATED 3-9-2007, EXPIRES 3-9-2017.

THE COLOR(S) OCHRE AND DARK GREEN IS/ARE CLAIMED AS A FEATURE OF THE MARK.

THE MARK CONSISTS OF AN ELLIPSE CONTAINING ON AN OCHRE BACKGROUND A REPRESENTATION OF A HILL IN A DARK COLOUR WITH AT THE SUMMIT A REPRESENTATION OF A DARK GREEN TREE. THE PART REPRESENTING THE SKY IS OCHRE AND THE MOUNTAIN AND TREE ARE REPRESENTED IN DARK GREEN.

THE ENGLISH TRANSLATION OF THE FOREIGN WORD(S) IN THE MARK IS DOMINION OF "MONTANERA".

SER. NO. 79-042,733, FILED 3-9-2007.

PETER B. BROMAGHIM, EXAMINING ATTORNEY

**Int. Cl.: 32**

**Prior U.S. Cls.: 45, 46 and 48**

**United States Patent and Trademark Office**

**Reg. No. 3,454,108**

**Registered June 24, 2008**

**TRADEMARK  
PRINCIPAL REGISTER**



DIETER LEIPOLD (FED REP GERMANY INDIVIDUAL)

NORDHEIMER STRASSE 14

97645 OSTHEIM, FED REP GERMANY

FOR: NON-ALCOHOLIC BEVERAGES, NAMELY, BEERS, MINERAL AND AERATED WATERS, FRUIT DRINKS AND FRUIT JUICES, SPORTS DRINKS, SOFT DRINKS INCLUDING LEMONADES, AND IN PARTICULAR REFRESHMENT BEVERAGES PRODUCED BY A FERMENTATION PROCESS OF NATURAL ORGANIC INGREDIENTS WITH NATURAL FRUIT AND HERBAL ESSENCES; PREPARATIONS INCLUDING BEVERAGE CONCENTRATES FOR MAKING NON-ALCOHOLIC BEVERAGES, NAMELY, BEERS, MINERAL AND AERATED WATERS, FRUIT DRINKS AND FRUIT JUICES, SPORTS DRINKS, SOFT DRINKS INCLUDING LEMONADES, AND IN PARTICULAR REFRESHMENT BEVERAGES PRODUCED BY A FERMENTATION PROCESS OF NATURAL ORGANIC INGREDIENTS WITH NATURAL FRUIT AND HERBAL ESSENCES; NON-ALCOHOLIC MIXED BEER BEVERAGES, NAMELY, NON-ALCOHOLIC BEER AND LEMONADE; AND ALCOHOLIC MIXED BEER BEVERAGES CONTAINING LEMONADE, IN THE NATURE OF A BEER OR LEMONADE, IN CLASS 32 (U.S. CLS. 45, 46 AND 48).

OWNER OF INTERNATIONAL REGISTRATION 0935169 DATED 8-29-2007, EXPIRES 8-29-2017.

OWNER OF U.S. REG. NO. 3,344,533.

THE COLOR(S) BLUE, BLACK, RED AND WHITE IS/ARE CLAIMED AS A FEATURE OF THE MARK.

THE COLOR BLUE APPEARS IN THE RECTANGULAR BACKGROUND AND IN THE OUTER RECTANGULAR BORDER AROUND THE WHITE BORDER; THE COLOR BLACK APPEARS IN THE OUTERMOST RECTANGULAR BORDER AROUND THE MARK; THE COLOR RED APPEARS IN THE CIRCLE IN THE CENTER OF THE LETTER "O"; THE COLOR WHITE APPEARS IN THE TERM "BIONADE" AND IN THE MIDDLE RECTANGULAR BORDER BETWEEN THE INNER BLUE RECTANGULAR BACKGROUND AND THE OUTER BLUE RECTANGULAR BORDER.

THE WORDING "BIONADE" HAS NO MEANING IN A FOREIGN LANGUAGE.

SER. NO. 79-042,873, FILED 8-29-2007.

MYRIAH HABEEB, EXAMINING ATTORNEY

**Int. Cl.: 1**

**Prior U.S. Cls.: 1, 5, 6, 10, 26 and 46**

**Reg. No. 3,454,109**

**United States Patent and Trademark Office**

**Registered June 24, 2008**

**TRADEMARK  
PRINCIPAL REGISTER**

**SOFT-N-SAFE**

DANISCO A/S (DENMARK A PUBLIC LIMITED  
COMPANY)  
LANGEBROGADE 1  
P.O. BOX 17  
COPENHAGEN K, DENMARK DK1001

PRIORITY DATE OF 5-11-2007 IS CLAIMED.

FOR: EMULSIFIERS, NAMELY, FOR USE IN THE  
MANUFACTURE OF PLASTICS, IN CLASS 1 (U.S.  
CLS. 1, 5, 6, 10, 26 AND 46).

OWNER OF INTERNATIONAL REGISTRATION  
0935192 DATED 8-17-2007, EXPIRES 8-17-2017.

SER. NO. 79-042,881, FILED 8-17-2007.

THE MARK CONSISTS OF STANDARD CHAR-  
ACTERS WITHOUT CLAIM TO ANY PARTICULAR  
FONT, STYLE, SIZE, OR COLOR.

ANDREA K. NADELMAN, EXAMINING ATTOR-  
NEY

Int. Cl.: 25

Prior U.S. Cls.: 22 and 39

United States Patent and Trademark Office

Reg. No. 3,454,110

Registered June 24, 2008

TRADEMARK  
PRINCIPAL REGISTER

DELICIOUS GRAPHIC STORE

デリシャス グラフィック ストア

CREWZ COMPANY CO., LTD. (JAPAN CORPORATION)  
SENBA KICCHOU BLDG.  
1-10, KITA-KYUHOJI-MACHI 2 CHOME.; CHUOKU, OSAKA-SHI; OSAKA 541-0057  
JAPAN

FOR: CLOTHING, NAMELY, JACKETS, SUITS, COATS, PANTS, TROUSERS, DRESSES, SKIRTS, BLOUSES, CARDIGANS, VESTS, SWEATERS, SHIRTS, NIGHTWEAR, UNDERWEAR, RAINCOATS, SWIMWEAR, T-SHIRTS, SHORTS, SWIMMING CAPS; GARTERS; SOCK SUSPENDERS; SUSPENDERS; WAISTBANDS; BELTS FOR CLOTHING; FOOTWEAR; MASQUERADE COSTUMES; CLOTHES FOR SPORTS, NAMELY, SLEEVELESS SHIRTS, MUSCLE SHIRTS, TANK TOPS, A-SHIRTS, ATHLETIC PANTS, BRA TOPS, TRACKSUITS, SWEAT-SHIRTS, JERSEYS, TIGHTS, SKI JACKETS, SKI PANTS; BOOTS FOR SPORTS, IN CLASS 25 (U.S. CLS. 22 AND 39).

OWNER OF INTERNATIONAL REGISTRATION  
0935390 DATED 7-31-2007, EXPIRES 7-31-2017.

NO CLAIM IS MADE TO THE EXCLUSIVE RIGHT TO USE "GRAPHIC STORE", APART FROM THE MARK AS SHOWN.

THE ENGLISH TRANSLATION OF THE FOREIGN WORD(S) IN THE MARK IS: "DELICIOUS GRAPHIC STORE".

THE TRANSLITERATION OF THE NON-LATIN CHARACTERS IN THE MARK IS: "DERISHASU GURAFIKKU SUTOA".

SER. NO. 79-042,975, FILED 7-31-2007.

KELLY MCCOY, EXAMINING ATTORNEY



**Int. Cl.: 19**

**Prior U.S. Cls.: 1, 12, 33 and 50**

**United States Patent and Trademark Office**

**Reg. No. 3,454,111**

**Registered June 24, 2008**

**TRADEMARK  
PRINCIPAL REGISTER**

# VilboClear

VILLEROY & BOCH AG (FED REP GERMANY  
AG)  
SAARUFERSTR. 14-18  
66693 METTLACH  
FED REP GERMANY

FOR: NON-METALLIC TRANSPORTABLE BUILDINGS; NON-METALLIC RIGID PIPES FOR BUILDING; CABANAS, NOT OF METAL; FLOORS, NOT OF METAL; TILES FOR BUILDING, NOT OF METAL; WATER PIPES, NOT OF METAL; MOSAICS FOR BUILDING; FLOOR TILES, NOT OF METAL; TILES, NOT OF METAL; NON-METALLIC PARTITIONS FOR BATH AND SHOWER; WALL AND FLOOR PANELS OF CERAMIC MATERIAL AND NATURAL STONE, INCLUDING SMALL MOSAIC TILES AND BRICKS; PLATE GLASS WINDOWS FOR BUILDING; WINDOW GLASS, EXCEPT GLASS

FOR VEHICLE WINDOWS, IN CLASS 19 (U.S. CLS. 1, 12, 33 AND 50).

THE MARK CONSISTS OF STANDARD CHARACTERS WITHOUT CLAIM TO ANY PARTICULAR FONT, STYLE, SIZE, OR COLOR.

PRIORITY DATE OF 1-17-2007 IS CLAIMED.

OWNER OF INTERNATIONAL REGISTRATION  
0935968 DATED 6-21-2007, EXPIRES 6-21-2017.

SER. NO. 79-043,184, FILED 6-21-2007.

SHANNON TWOHIG, EXAMINING ATTORNEY

**Int. Cl.: 24**

**Prior U.S. Cls.: 42 and 50**

**United States Patent and Trademark Office**

**Reg. No. 3,454,112**

**Registered June 24, 2008**

**TRADEMARK  
PRINCIPAL REGISTER**



LIBECO-LAGAE,; NAAMLOZE VENNOOTSCHAP  
(BELGIUM NAAMLOZE VENNOOTSCHAP  
(LIMITED LIABILITY COMPANY))  
TIELTSTRAAT 112  
B-8760 MEULEBEKE, BELGIUM

FOR: FABRICS AND TEXTILE PRODUCTS,  
NAMELY, BED LINEN, TABLE CLOTHS, CUR-  
TAINS, BED AND TABLE COVERS, NOT OF PAPER;  
BED AND TABLE COVERS INSOFAR AS THESE  
ARE MADE OF LINEN, IN CLASS 24 (U.S. CLS. 42  
AND 50).

OWNER OF INTERNATIONAL REGISTRATION  
0600613 DATED 4-21-1993, EXPIRES 4-21-2013.

NO CLAIM IS MADE TO THE EXCLUSIVE  
RIGHT TO USE "ECO LINEN", APART FROM THE  
MARK AS SHOWN.

SER. NO. 79-043,216, FILED 6-4-2007.

ROSELLE HERRERA, EXAMINING ATTORNEY

**Int. Cls.: 10, 35 and 44**

**Prior U.S. Cls.: 26, 39, 44, 100, 101 and 102**

**United States Patent and Trademark Office**

**Reg. No. 3,454,113**

**Registered June 24, 2008**

**TRADEMARK  
SERVICE MARK  
PRINCIPAL REGISTER**

# BODYFLOW

BODYFLOW INTERNATIONAL PTY LIMITED  
(AUSTRALIA AUSTRALIAN PROPRIETARY  
COMPANY)

LEVEL 1

SUITE 10; 514 ST KILDA ROAD; MELBOURNE VIC  
3004  
AUSTRALIA

FOR: MEDICAL AND VETERINARY THERAPEUTIC DEVICE FEATURING ELECTRODES THAT ATTACH TO A PATIENT'S BODY, WHICH APPLY A MILD TRANSDERMAL ELECTRICAL STIMULUS TO TREAT LYMPH OEDEMA, HAEMATOMA, PERIPHERAL VASCULAR DISEASE, FLUID RETENTION, POLYTRAUMA, SOFT AND HARD TISSUE DAMAGE, SWELLING RELATED TO SPORTS INJURIES, PRE/POST INJURY, PAIN RELATED TO CIRCULATOR PROBLEMS AND/OR PREVENTION OF DEEP VAIN THROMBOSIS; PORTABLE PROGRAMMABLE MEDICAL DEVICES CONSISTING PRIMARILY OF ADHESIVE ELECTRODES THAT ATTACH TO THE BODY, CABLES AND BATTERY CHARGERS FOR TREATMENT OF POOR BLOOD CIRCULATION, IN CLASS 10 (U.S. CLS. 26, 39 AND 44).

FOR: RETAIL STORE SERVICES FEATURING MEDICAL AND VETERINARY DEVICES THAT TREAT LYMPHODEMA, HAEMATOMA, PERIPHERAL VASCULAR DISEASE, FLUID RETENTION, POLYTRAUMA, SOFT AND HARD TISSUE DAMAGE, SWELLING RELATED TO SPORTS INJURIES, PRE/POST SURGERY, PAIN RELATED TO CIRCULATORY PROBLEMS AND/OR PREVENTION OF DEEP VAIN THROMBOSIS; ADVERTIS-

ING AND MARKETING SERVICES FOR OTHERS RELATING TO MEDICAL DEVICES, VETERINARY DEVICES AND ELECTRICAL PULSE STIMULATION THERAPY; BUSINESS, MARKETING AND STRATEGIC SERVICES RELATING TO MEDICAL AND VETERINARY CLINICS, NAMELY, DEVELOPMENT OF MARKETING STRATEGIES AND CONCEPTS FOR OTHERS, IN CLASS 35 (U.S. CLS. 100, 101 AND 102).

FOR: MEDICAL SERVICES; MEDICAL SERVICES FEATURING THERAPEUTIC STIMULATION THERAPY AND ELECTRICAL PULSE STIMULATION THERAPY OF THE BODY; VETERINARY SERVICES; VETERINARY SERVICES FEATURING THERAPEUTIC STIMULATION THERAPY AND ELECTRICAL PULSE STIMULATION THERAPY FOR ANIMALS, IN CLASS 44 (U.S. CLS. 100 AND 101).

THE MARK CONSISTS OF STANDARD CHARACTERS WITHOUT CLAIM TO ANY PARTICULAR FONT, STYLE, SIZE, OR COLOR.

PRIORITY DATE OF 5-21-2007 IS CLAIMED.

OWNER OF INTERNATIONAL REGISTRATION  
0936878 DATED 5-30-2007, EXPIRES 5-30-2017.

SER. NO. 79-043,615, FILED 5-30-2007.

AMY GEARIN, EXAMINING ATTORNEY

**Int. Cl.: 24**

**Prior U.S. Cls.: 42 and 50**

**United States Patent and Trademark Office**

**Reg. No. 3,454,114**

**Registered June 24, 2008**

**TRADEMARK  
PRINCIPAL REGISTER**

**SAVON DE MARSEILLE**

DELORME HERVÉ (FRANCE INDIVIDUAL)  
50 RUE RAULIN  
F-69007 LYON  
FRANCE AND  
HUAULME MAUSSION RACHEL (FRANCE INDIVIDUAL)  
RUE MAURICE BALAY  
LIEU-DIT MEYLIEU; F-42210 MONTROND LES  
BAINS  
FRANCE

FOR: FABRICS FOR TEXTILE USE, NAMELY, TEXTILE FABRIC FOR THE MANUFACTURE OF CLOTHING; ELASTIC FABRICS FOR CLOTHING; VELVET; BED LINEN; HOUSEHOLD LINEN; TABLE LINEN NOT OF PAPER; BATH LINEN; TRAVELLING RUGS, NAMELY, LAP RUGS; WASHING MITTS; FACE TOWELS OF TEXTILE; FITTED COVERS FOR TOILET LIDS; TOILE, NAMELY, MESH-WOVEN FABRIC; TICKING FABRIC; SHEETING, NAMELY, BED SHEETS; UNFITTED FURNITURE

COVERINGS OF TEXTILE; COVERINGS FOR FURNITURE MADE OF PLASTIC; TEXTILE AND PLASTIC SHOWER CURTAINS; PLAID BED BLANKETS; TEXTILE HAND TOWELS; WOOLEN FABRICS; COVERS FOR CUSHIONS, IN CLASS 24 (U.S. CLS. 42 AND 50).

PRIORITY DATE OF 1-25-2007 IS CLAIMED.

OWNER OF INTERNATIONAL REGISTRATION  
0936966 DATED 7-19-2007, EXPIRES 7-19-2017.

THE ENGLISH TRANSLATION OF THE FOREIGN WORDING "SAVON DE" IN THE MARK IS "SOAP OF."

SER. NO. 79-043,651, FILED 7-19-2007.

CARRIE GENOVESE, EXAMINING ATTORNEY

**Int. Cl.: 33**

**Prior U.S. Cls.: 47 and 49**

**United States Patent and Trademark Office**

**Reg. No. 3,454,115**

**Registered June 24, 2008**

**TRADEMARK  
PRINCIPAL REGISTER**

**OMBRA**

GIOVANNI GREGOLETTO (ITALY INDIVIDUAL)  
VIA S. MARTINO, 49  
FRAZ. PREMAOR; I-31050 MIANE (TV)  
ITALY

FOR: WINE, IN CLASS 33 (U.S. CLS. 47 AND 49).

OWNER OF INTERNATIONAL REGISTRATION  
0937397 DATED 8-16-2007, EXPIRES 8-16-2017.

THE ENGLISH TRANSLATION OF "OMBRA" IN  
THE MARK IS SHADOW OR SHADE.

SER. NO. 79-043,829, FILED 8-16-2007.

ELI HELLMAN, EXAMINING ATTORNEY

**Int. Cl.: 38**

**Prior U.S. Cls.: 100, 101 and 104**

**United States Patent and Trademark Office**

**Reg. No. 3,454,116**

**Registered June 24, 2008**

**SERVICE MARK  
PRINCIPAL REGISTER**

# **FHOME**

ALTICAST CO., LTD. (REPUBLIC OF KOREA  
LIMITED COMPANY)  
16TH FLOOR, HANA CAPITAL BLDG., 1328-3  
SEOCHO-DONG, SEOCHO-GU  
SEOUL 137-070, REPUBLIC OF KOREA

FOR: DIGITAL TELEVISION BROADCASTING;  
DIGITAL RADIO BROADCASTING; WIRELESS IN-  
TERNET BROADCASTING; RENTAL OF BROAD-  
CASTING EQUIPMENT; SATELLITE DIGITAL  
RADIO BROADCASTING; SATELLITE DIGITAL  
TELEVISION BROADCASTING; SATELLITE  
RADIO BROADCASTING; SATELLITE TELEVI-  
SION BROADCASTING; CABLE TELEVISION  
BROADCASTING; INTERNET EDUCATION  
BROADCASTING; INTERNET RADIO BROAD-  
CASTING; INTERNET BROADCASTING; VIDEO-  
ON-DEMAND TRANSMISSION SERVICES; BROAD-  
CASTING SERVICES AND PROVISION OF TELE-  
COMMUNICATION ACCESS TO VIDEO AND  
AUDIO CONTENT PROVIDED VIA A VIDEO-ON-  
DEMAND SERVICE VIA TELEVISION; TRANSMIS-  
SION OF SHORT MESSAGES; ELECTRONIC DATA  
TELECOMMUNICATION, NAMELY, ELECTRONIC  
DATA TRANSMISSION; PAGING SERVICES BY  
RADIO, TELEPHONE OR OTHER MEANS OF

ELECTRONIC COMMUNICATION; ELECTRONIC  
MESSAGE TRANSMISSION; WIRELESS ELECTRO-  
NIC DATA TELECOMMUNICATION, NAMELY,  
WIRELESS ELECTRONIC DATA TRANSMISSION;  
PROVIDING ACCESS TO WIRELESS INTERNET;  
ELECTRONIC DATA TRANSMISSION AND RE-  
CEPTION SERVICES VIA INTERNET; INTERNET  
AIDED TRANSMISSION OF MESSAGE AND PIC-  
TURES, IN CLASS 38 (U.S. CLS. 100, 101 AND 104).

THE MARK CONSISTS OF STANDARD CHAR-  
ACTERS WITHOUT CLAIM TO ANY PARTICULAR  
FONT, STYLE, SIZE, OR COLOR.

PRIORITY DATE OF 1-24-2007 IS CLAIMED.

OWNER OF INTERNATIONAL REGISTRATION  
0937534 DATED 7-20-2007, EXPIRES 7-20-2017.

SER. NO. 79-043,863, FILED 7-20-2007.

KATHERINE E. HALMEN, EXAMINING ATTOR-  
NEY

**Int. Cl.: 9**

**Prior U.S. Cls.: 21, 23, 26, 36 and 38**

**Reg. No. 3,454,117**

**United States Patent and Trademark Office**

**Registered June 24, 2008**

**TRADEMARK  
PRINCIPAL REGISTER**

**OmniLine**

MARTIN AUDIO LIMITED (UNITED KINGDOM  
PRIVATE LIMITED COMPANY)  
CENTURY POINT  
HALIFAX ROAD; CRESSEX BUSINESS PARK;  
HIGH WYCOMBE, BUCKINGHAMSHIRE HP12  
3SL  
UNITED KINGDOM

FOR: LOUDSPEAKERS, LOUDSPEAKER HOUS-  
INGS IN THE NATURE OF CABINETS, LOUDSPEA-  
KER SYSTEMS; ELECTRONIC CONTROLLERS  
FOR LOUDSPEAKERS; AMPLIFIERS; APPARATUS  
FOR RECORDING, TRANSMISSION OR REPRO-  
DUCTION OF SOUND OR IMAGES; ELECTRONIC  
APPARATUS FOR AMPLIFYING, REINFORCING,  
MIXING, MODIFYING, CONTROLLING AND DIS-  
SEMINATING SOUND; COMPUTER SOFTWARE  
FOR OPERATING LOUDSPEAKER SYSTEMS AND  
PREDICTING THEIR PERFORMANCE, AND

STRUCTURAL PARTS THEREFOR, IN CLASS 9  
(U.S. CLS. 21, 23, 26, 36 AND 38).

THE MARK CONSISTS OF STANDARD CHAR-  
ACTERS WITHOUT CLAIM TO ANY PARTICULAR  
FONT, STYLE, SIZE, OR COLOR.

PRIORITY DATE OF 2-28-2007 IS CLAIMED.

OWNER OF INTERNATIONAL REGISTRATION  
0937787 DATED 8-22-2007, EXPIRES 8-22-2017.

SER. NO. 79-043,933, FILED 8-22-2007.

CARRIE GENOVESE, EXAMINING ATTORNEY

**Int. Cls.: 35, 38, 41 and 42**

**Prior U.S. Cls.: 100, 101, 102, 104 and 107**

**United States Patent and Trademark Office**

**Reg. No. 3,454,118**

**Registered June 24, 2008**

**SERVICE MARK  
PRINCIPAL REGISTER**

# Innotrans

MESSE BERLIN GMBH (FED REP GERMANY  
LIMITED COMPANY)  
MESSEDAMM 22  
14055 BERLIN  
FED REP GERMANY

FOR: GATHERING, COMPILATION AND PROVIDING OF BUSINESS DATA, INFORMATION, IMAGES AND TEXTS IN THE FIELD OF ADVERTISING ON COMPUTER NETWORKS AND THE INTERNET; COMPILATION, SYSTEMIZATION AND PROVIDING OF BUSINESS INFORMATION AND INFORMATION IN THE FIELD OF ADVERTISING USING DIGITAL, MULTIMEDIA AND VIRTUAL INFORMATION SYSTEMS; UPDATING OF BUSINESS INFORMATION AND INFORMATION IN THE FIELD OF ADVERTISING CONTAINED IN DIGITAL, MULTIMEDIA AND VIRTUAL INFORMATION SYSTEMS; ORGANIZATION OF TRADE FAIRS AND EXHIBITIONS FOR COMMERCIAL OR ADVERTISING PURPOSES, WHICH MAY BE ACCESSED VIA THE INTERNET; ORGANIZATION OF PARTICIPATION IN EXHIBITIONS FOR COMMERCIAL OR ADVERTISING PURPOSES; CONDUCTING ONLINE TRADE SHOWS VIA THE INTERNET IN THE FIELD OF TRANSPORTATION BUSINESS; SALES PROMOTION AND ONLINE BUSINESS NETWORKING SERVICES, NAMELY, BROKERING OF TRADE, SERVICE AND BUSINESS CONTACTS; INFOMEDIARY SERVICES, NAMELY, FACILITATING COMMERCIAL TRANSACTIONS FOR CONSUMER GOODS AND INDUSTRIAL PRODUCTS ON THE INTERNET BY MEANS OF A VIRTUAL TRADE FAIR BETWEEN BUYERS AND SELLERS THROUGH PROVIDING BUYERS WITH INFORMATION ABOUT SELLERS, GOODS, AND/OR SERVICES; PROVISION AND RENTAL OF BOOTHS AND EXHIBITION STANDS, INCLUDING ASSOCIATED EQUIPMENT; PUBLIC RELATIONS; ADVERTISING, PROVIDING AND RENTAL OF ADVERTISING AND PRESENTATION SPACE VIA THE INTERNET; MARKETING, MARKET RE-

SEARCH AND MARKET ANALYSIS, IN CLASS 35 (U.S. CLS. 100, 101 AND 102).

FOR: TELECOMMUNICATIONS ACCESS SERVICES; TRANSMISSION OF DATA, INFORMATION, IMAGES AND TEXTS VIA COMPUTER NETWORKS, TELECOMMUNICATIONS NETWORKS AND THE INTERNET; TECHNICAL TRANSMISSION OF INFORMATION USING DIGITAL, MULTIMEDIA AND VIRTUAL INFORMATION SYSTEMS, IN CLASS 38 (U.S. CLS. 100, 101 AND 104).

FOR: ORGANIZATION OF TRADE FAIRS AND EXHIBITIONS FOR CULTURAL, ENTERTAINMENT AND SPORTING PURPOSES, WHICH MAY BE ACCESSED VIA THE INTERNET; ARRANGING AND CONDUCTING OF EDUCATIONAL CONGRESSES, CONFERENCES, SEMINARS AND WORKSHOPS IN THE FIELD OF TRANSPORT TECHNOLOGY, VEHICLES AND TRANSPORT SYSTEMS, WHICH MAY BE ACCESSED VIA THE INTERNET; PUBLICATION OF PERIODICALS, CATALOGUES AND PROSPECTUSES, WHICH MAY BE ACCESSED VIA THE INTERNET, IN CLASS 41 (U.S. CLS. 100, 101 AND 107).

FOR: UPDATING AND ANALYZING OF DATA, INFORMATION, IMAGES AND TEXTS FOR TRADE FAIRS AND EXHIBITIONS REGARDING TRANSPORT TECHNOLOGY, VEHICLES AND TRANSPORT SYSTEMS, AVAILABLE ON COMPUTER NETWORKS AND THE INTERNET, IN CLASS 42 (U.S. CLS. 100 AND 101).

OWNER OF INTERNATIONAL REGISTRATION  
0938008 DATED 6-14-2007, EXPIRES 6-14-2017.

SER. NO. 79-043,999, FILED 6-14-2007.

ANTHONY RINKER, EXAMINING ATTORNEY



**Int. Cls.: 3, 9, 14, 16, 18, 24, 25 and 35**

**Prior U.S. Cls.: 1, 2, 3, 4, 5, 6, 21, 22, 23, 26, 27, 28, 29, 36, 37, 38, 39, 41, 42, 50, 51, 52, 100, 101 and 102**

**Reg. No. 3,454,119**

**United States Patent and Trademark Office**

**Registered June 24, 2008**

**TRADEMARK  
SERVICE MARK  
PRINCIPAL REGISTER**

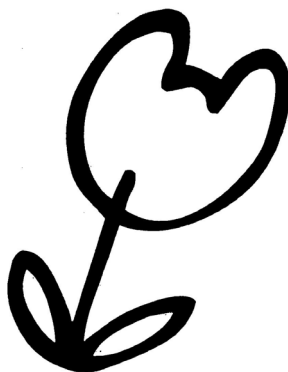

TESSILFORM SPA (ITALY JOINT STOCK COMPANY)  
VIA PIERO DELLA FRANCESCA, 39  
I-59100 PRATO  
ITALY

FOR: SKIN SOAPS, PERFUMERY, ESSENTIAL OILS, COSMETICS, HAIR LOTIONS, DENTIFRICES, IN CLASS 3 (U.S. CLS. 1, 4, 6, 50, 51 AND 52).

FOR: OPTICAL APPARATUS AND INSTRUMENTS, NAMELY, EYEGLASSES, SUNGLASSES, CHAINS AND CASES FOR EYEWEAR, IN CLASS 9 (U.S. CLS. 21, 23, 26, 36 AND 38).

FOR: JEWELRY, PRECIOUS STONES, TIMEPIECES AND CHRONOMETRIC INSTRUMENTS, IN CLASS 14 (U.S. CLS. 2, 27, 28 AND 50).

FOR: STATIONERY, IN CLASS 16 (U.S. CLS. 2, 5, 22, 23, 29, 37, 38 AND 50).

FOR: TRUNKS AND SUITCASES; PARASOLS AND WALKING STICKS, IN CLASS 18 (U.S. CLS. 1, 2, 3, 22 AND 41).

FOR: BED LINENS, NAMELY, BEDSPREADS, BLANKETS, SHEETS, THROW BLANKETS, DUVET AND DUVET COVERS, PILLOW COVERS, EIDERDOWN QUILTS AND EIDERDOWN COVERS; TABLE LINENS, TEXTILE TABLE CLOTHS, FABRIC NAPKINS, FABRIC COASTERS, FABRIC PLACEMATS, TEXTILE COVERS FOR SEAT CUSHIONS, BATH LINEN; CURTAINS MADE OF TEXTILE

FABRICS, UNFITTED FABRIC FURNITURE COVERS, IN CLASS 24 (U.S. CLS. 42 AND 50).

FOR: CLOTHING, NAMELY, SHIRTS, T-SHIRTS, BLOUSES, SKIRTS, SHORTS, TROUSERS, DRESSES, MEN SUITS, WOMEN'S SUITS, PANTS, COATS, OVERCOATS, RAINCOATS, OVERALLS, UNDERWEAR, TIES, JACKETS, SWEATERS, PULLOVERS, CARDIGANS, JUMPERS, SWEATSHIRTS, VESTS, PARKAS, RAINWEAR, SWIMWEAR, SHAWLS, SCARVES, GLOVES, BELTS, FOOTWEAR, NAMELY, SHOES, BOOTS, SANDALS, SLIPPERS, CLOGS; HEADGEAR, NAMELY, HATS AND CAPS, IN CLASS 25 (U.S. CLS. 22 AND 39).

FOR: RETAIL STORE SERVICES FEATURING SKIN SOAPS, PERFUMERY, ESSENTIAL OILS, COSMETICS, HAIR LOTION, EYEGLASSES, SUNGLASSES, CASES FOR EYEWEAR, WATCHES, TIMEPIECES AND CHRONOMETRIC INSTRUMENTS, JEWELRY, STATIONERY, HANDBAGS AND SHOULDER BAGS, SACHELS, BACKPACKS AND RUCKSACKS, BRIEFCASES AND DOCUMENT HOLDERS, TRUNKS AND SUITCASES, BED LINENS, NAMELY, BEDSPREADS, BLANKETS, SHEETS, THROW BLANKETS, DUVET AND DUVET COVERS, PILLOW COVERS, EIDERDOWN QUILTS AND EIDERDOWN COVERS, TABLE LINENS, TABLE CLOTHS, FABRIC NAPKINS, FABRIC COASTERS, FABRIC PLACEMATS, TEXTILE COVERS FOR SEAT CUSHIONS, BATH LINEN, CURTAINS MADE OF TEXTILE FABRICS, UNFITTED FABRIC FURNITURE COVERS, CLOTHING,

NAMELY, SHIRTS, T-SHIRTS, BLOUSES, SKIRTS, SHORTS, TROUSERS, DRESSES, MEN'S SUITS, WOMEN'S SUITS, PANTS, COATS, OVERCOATS, RAINCOATS, OVERALLS, UNDERWEAR, TIES, JACKETS, SWEATERS, PULLOVERS, CARDIGANS, JUMPERS, SWEATSHIRTS, VESTS, PARKAS, RAINWEAR, SWIMWEAR, SHAWLS, SCARVES, GLOVES, BELTS, FOOTWEAR, NAMELY, SHOES, BOOTS, SANDALS, SLIPPERS, CLOGS, HEADGEAR, NAMELY, HATS AND CAPS, IN CLASS 35 (U.S. CLS. 100, 101 AND 102).

PRIORITY DATE OF 5-4-2007 IS CLAIMED.

OWNER OF INTERNATIONAL REGISTRATION  
0938450 DATED 7-13-2007, EXPIRES 7-13-2017.

OWNER OF U.S. REG. NO. 3,181,197.

SER. NO. 79-044,204, FILED 7-13-2007.

GILBERT SWIFT, EXAMINING ATTORNEY

**Int. Cl.: 1**

**Prior U.S. Cls.: 1, 5, 6, 10, 26 and 46**

**United States Patent and Trademark Office**

**Reg. No. 3,454,120**

**Registered June 24, 2008**

**TRADEMARK  
PRINCIPAL REGISTER**

# UV-FAST

HUNTSMAN TEXTILE EFFECTS (BELGIUM)  
BVBA (BELGIUM BESLOTEN VENNOOTSCHAP MET BEPERKTE AANSPRAKELIJKHEID (BVBA))  
EVERSLAAN 45  
B-3078 EVERBERG  
BELGIUM

FOR: CHEMICAL AUXILIARY PRODUCTS FOR USE IN THE TEXTILE INDUSTRY TO IMPROVE THE LIGHT FASTNESS AND FIBER STABILIZATION OF TEXTILES; CHEMICAL PRODUCTS FOR THE TREATMENT OF TEXTILE FOR THE PROMOTION OF ABSORBING LIGHT AND UV RADIATION, IN CLASS 1 (U.S. CLS. 1, 5, 6, 10, 26 AND 46).

THE MARK CONSISTS OF STANDARD CHARACTERS WITHOUT CLAIM TO ANY PARTICULAR FONT, STYLE, SIZE, OR COLOR.

PRIORITY DATE OF 2-26-2007 IS CLAIMED.

OWNER OF INTERNATIONAL REGISTRATION 0938712 DATED 8-3-2007, EXPIRES 8-3-2017.

SER. NO. 79-044,295, FILED 8-3-2007.

FRANK LATTUCA, EXAMINING ATTORNEY

**Int. Cl.: 19**

**Prior U.S. Cls.: 1, 12, 33 and 50**

**United States Patent and Trademark Office**

**Reg. No. 3,454,121**

**Registered June 24, 2008**

**TRADEMARK  
PRINCIPAL REGISTER**



ADANA CIMENTO SANAYII T.A.S. (TURKEY  
JOINT STOCK COMPANY)  
CEYHAN YOLU 12 KM. P.K. 10  
TR-01321 INCIRLIK ADANA  
TURKEY

FOR: CEMENT, NAMELY PORTLAND BLAST-  
FURNACE SLAG CEMENT, PORTLAND CEMENT,  
SILICA CEMENT AND POZZOLANIC CEMENT, IN  
CLASS 19 (U.S. CLS. 1, 12, 33 AND 50).

OWNER OF INTERNATIONAL REGISTRATION  
0938721 DATED 7-13-2007, EXPIRES 7-13-2017.

NO CLAIM IS MADE TO THE EXCLUSIVE  
RIGHT TO USE "ADANA CIMENTO", APART  
FROM THE MARK AS SHOWN.

THE COLOR(S) GREY, RED, BLACK IS/ARE  
CLAIMED AS A FEATURE OF THE MARK.

THE TRADEMARK CONSISTS OF THE WORDS  
"OYAK" WRITTEN IN BLACK FONT, PLACED  
INSIDE A RED ELLIPTICAL SHAPED OBJECT,  
AND "AC ADANA CIMENTO", IN WHICH THE  
LETTER "A" IS WRITTEN IN GREY FONT AND  
LETTER "C" IN RED FONT; THE LETTERS "A"  
AND "C" ARE BIGGER THAN THE WORDS "ADA-  
NA CIMENTO", WHICH IS WRITTEN IN BLACK  
FONT, JUST ABOVE AND BELOW THE WORDS  
"AC ADANA CIMENTO" IS A BLACK STRAIGHT  
LINE.

THE ENGLISH TRANSLATION OF THE WORD  
CIMENTO IN THE MARK IS CEMENT.

SER. NO. 79-044,299, FILED 7-13-2007.

GILBERT SWIFT, EXAMINING ATTORNEY

Int. Cls.: 19 and 27

Prior U.S. Cls.: 1, 12, 19, 20, 33, 37, 42 and 50

United States Patent and Trademark Office

Reg. No. 3,454,122

Registered June 24, 2008

TRADEMARK  
PRINCIPAL REGISTER



COTTO VENETO, S.R.L. (ITALY ITALIAN LTD  
LIAB CO)  
VIA VICOLO TENTORI 12  
I-31030 CARBONERA  
ITALY

FOR: ENAMELLED GRES TILES, CERAMIC  
TILES, CERAMIC WALL PANELS, CEMENT AND  
CONCRETE STEPS FOR BUILDINGS, WALL TILES,  
AGED STONES, CERAMIC DOOR AND WINDOW  
FRAMES, CERAMIC FRAMES FOR WINDOW  
GLASS AND CERAMIC FRAMES FOR GLASS  
PANES, CERAMIC TILE FLOORING, CEMENT  
MIXES, ARTIFICIAL AND NATURAL STONES,  
GLASS TILES, GLASS PANELS AND PANES FOR  
BUILDING CONSTRUCTION PURPOSES AND TER-  
RA COTTA WALL, CEILING AND FLOOR TILES, IN  
CLASS 19 (U.S. CLS. 1, 12, 33 AND 50).

FOR: HARD SURFACE FLOOR COVERINGS, IN  
CLASS 27 (U.S. CLS. 19, 20, 37, 42 AND 50).

OWNER OF INTERNATIONAL REGISTRATION  
0637243 DATED 3-20-1995, EXPIRES 3-20-2015.

NO CLAIM IS MADE TO THE EXCLUSIVE  
RIGHT TO USE "SASSI" OR "PIAVE", APART FROM  
THE MARK AS SHOWN.

THE ENGLISH TRANSLATION OF I SASSI DEL  
PIAVE IS THE STONES OF PIAVE.

SER. NO. 79-044,406, FILED 2-21-2007.

BARBARA RUTLAND, EXAMINING ATTORNEY

**Int. Cls.: 9, 16 and 41**

**Prior U.S. Cls.: 2, 5, 21, 22, 23, 26, 29, 36, 37, 38, 50,  
100, 101 and 107**

**Reg. No. 3,454,123**

**United States Patent and Trademark Office**

**Registered June 24, 2008**

**TRADEMARK  
SERVICE MARK  
PRINCIPAL REGISTER**



CERAN LINGUA INTERNATIONAL,; EN  
ABRÉGE C.L.I., SOCIETE ANONYME (BEL-  
GIUM JOINT STOCK COMPANY)  
AVENUE DES PETITS SAPINS 27  
B-4900 SPA, BELGIUM

FOR: MAGNETIC DATA CARRIERS, NAMELY,  
PRERECORDED AUDIO TAPES, VIDEO TAPES,  
COMPACT DISCS, CD ROMS AND DVDS FOR  
USE IN TEACHING LANGUAGES; MULTIMEDIA  
SOFTWARE RECORDED ON DATA MEDIA FOR  
USE IN TEACHING LANGUAGES, IN CLASS 9 (U.S.  
CLS. 21, 23, 26, 36 AND 38).

FOR: TEACHING AND EDUCATIONAL MATE-  
RIALS, NAMELY, BOOKS, MANUALS AND BOOK-  
LETS FOR USE IN TEACHING LANGUAGES, IN  
CLASS 16 (U.S. CLS. 2, 5, 22, 23, 29, 37, 38 AND 50).

FOR: LANGUAGE TEACHING INSTRUCTION;  
LANGUAGE INSTRUCTION RENDERED VIA COR-  
RESPONDENCE COURSES, TELEPHONE COUR-

SES, RESIDENTIAL COURSES AND SEMINARS;  
ORGANIZATION OF COURSES AND SEMINARS  
IN THE FIELD OF TEACHING LANGUAGES, IN  
CLASS 41 (U.S. CLS. 100, 101 AND 107).

OWNER OF INTERNATIONAL REGISTRATION  
0674233 DATED 4-11-1997, EXPIRES 4-11-2017.

OWNER OF U.S. REG. NO. 2,233,310.

NO CLAIM IS MADE TO THE EXCLUSIVE  
RIGHT TO USE "LINGUA", APART FROM THE  
MARK AS SHOWN.

THE ENGLISH TRANSLATION OF THE WORD  
"LINGUA" IN THE MARK TRANSLATED INTO  
ENGLISH AS "LANGUAGE" OR "TONGUE".

SER. NO. 79-044,411, FILED 4-11-2007.

SHAILA SETTLES, EXAMINING ATTORNEY

**Int. Cl.: 2**

**Prior U.S. Cls.: 6, 11 and 16**

**United States Patent and Trademark Office**

**Reg. No. 3,454,124**

**Registered June 24, 2008**

**TRADEMARK  
PRINCIPAL REGISTER**

# LYOSPERSE

HUNTSMAN ADVANCED MATERIALS (SWITZERLAND) GMBH (BELGIUM BESLOTEN VENNOOTSCHAP MET BEPERKTE AANSPRAKELIJKHEID)

KLYBECKSTRASSE 200  
CH-4057 BASEL  
SWITZERLAND

FOR: COLORING MATTER, NAMELY, DYE-STUFFS, LACQUERS, PIGMENTS ALSO FOR DYEING AND PRINTING OF CELLULOSE FIBERS; COLORANTS; INKS FOR PRINTING, IN CLASS 2 (U.S. CLS. 6, 11 AND 16).

THE MARK CONSISTS OF STANDARD CHARACTERS WITHOUT CLAIM TO ANY PARTICULAR FONT, STYLE, SIZE, OR COLOR.

PRIORITY DATE OF 2-26-2007 IS CLAIMED.

OWNER OF INTERNATIONAL REGISTRATION 0939141 DATED 8-6-2007, EXPIRES 8-6-2017.

SER. NO. 79-044,493, FILED 8-6-2007.

FRANK LATTUCA, EXAMINING ATTORNEY

**Int. Cl.: 9**

**Prior U.S. Cls.: 21, 23, 26, 36 and 38**

**United States Patent and Trademark Office**

**Reg. No. 3,454,125**

**Registered June 24, 2008**

**TRADEMARK  
PRINCIPAL REGISTER**

# Advanide

ASSA ABLOY; IDENTIFICATION TECHNOLOGIES GMBH (FED REP GERMANY LIMITED COMPANY)  
AM KLINGENWEG 6A  
65396 WALLUF  
FED REP GERMANY

FOR: APPARATUS FOR STORAGE OF DATA, NAMELY, BLANK MAGNETIC DATA CARRIERS, BLANK OPTICAL DATA CARRIERS AND BLANK TAPES FOR STORAGE OF COMPUTER DATA; BLANK ELECTRONIC CHIP CARDS, BLANK SMART CARDS, PLASTIC MAGNETICALLY ENCODED CREDIT CARDS, MAGNETICALLY ENCODED SCRATCH-CARDS AND MAGNETICALLY ENCODED PREPAID-CARDS FOR USE AS TELEPHONE CALLING CARDS, HOME BANKING CARDS, ACCESS CARDS FOR BUILDINGS AND HEALTHCARE CARDS, MAGNETICALLY ENCODED CREDIT CARDS; READING DEVICES FOR THE AFOREMENTIONED CHIP CARDS AND DATA STORAGE CARDS, NAMELY, CARD READERS FOR CREDIT CARDS, ELECTRONIC COMPUTERIZED CREDIT CARD IMPRINTERS,

ELECTRONIC MACHINES FOR READING CREDIT CARDS AND RECORDING FINANCIAL OPERATIONS; RFID-READERS; RFID-TRANSPONDERS AND RFID-CARDS FOR CREDENTIALS; BIOMETRIC READERS; COMPUTER PROGRAMS FOR MAGNETIC, ELECTRONIC AND OPTICAL DATA STORAGE, READING, RETRIEVAL AND IMPRINTING, IN CLASS 9 (U.S. CLS. 21, 23, 26, 36 AND 38).

THE MARK CONSISTS OF STANDARD CHARACTERS WITHOUT CLAIM TO ANY PARTICULAR FONT, STYLE, SIZE, OR COLOR.

PRIORITY DATE OF 3-27-2007 IS CLAIMED.

OWNER OF INTERNATIONAL REGISTRATION 0939210 DATED 7-13-2007, EXPIRES 7-13-2017.

SER. NO. 79-044,518, FILED 7-13-2007.

SOPHIA S. KIM, EXAMINING ATTORNEY



**Int. Cl.: 2**

**Prior U.S. Cls.: 6, 11 and 16**

**United States Patent and Trademark Office**

**Reg. No. 3,454,126**

**Registered June 24, 2008**

**TRADEMARK  
PRINCIPAL REGISTER**

**SIKACOR**

SIKA AG (SWITZERLAND CORPORATION)

ZUGERSTRASSE 50

CH-6341 BAAR, SWITZERLAND

FOR: COLOR PIGMENTS, VARNISHES, LACQUERS; RUST-PROOFING AGENTS; PAINTS; RUST-PROOFING AND ANTI-CORROSIVE PREPARATIONS, NAMELY, RUST PREVENTATIVES IN THE NATURE OF A COATING; PROTECTIVE PREPARATIONS FOR METALS, COATINGS AND COATING AGENTS FOR PROTECTING METALS AND CONCRETE ALL IN THE FORM OR RUST PREVENTATIVES IN THE NATURE OF A COATING, IN CLASS 2 (U.S. CLS. 6, 11 AND 16).

THE MARK CONSISTS OF STANDARD CHARACTERS WITHOUT CLAIM TO ANY PARTICULAR FONT, STYLE, SIZE, OR COLOR.

PRIORITY DATE OF 6-6-2007 IS CLAIMED.

OWNER OF INTERNATIONAL REGISTRATION 0939282 DATED 9-11-2007, EXPIRES 9-11-2017.

OWNER OF U.S. REG. NOS. 3,079,856, 3,335,503 AND OTHERS.

SER. NO. 79-044,533, FILED 9-11-2007.

COLLEEN KEARNEY, EXAMINING ATTORNEY

**Int. Cl.: 2**

**Prior U.S. Cls.: 6, 11 and 16**

**United States Patent and Trademark Office**

**Reg. No. 3,454,127**

**Registered June 24, 2008**

**TRADEMARK  
PRINCIPAL REGISTER**

**SIKA POXICOLOR**

SIKA AG (SWITZERLAND CORPORATION)

ZUGERSTRASSE 50

CH-6341 BAAR, SWITZERLAND

FOR: COLOR PIGMENTS, VARNISHES, LAC-  
QUERS; RUST-PROOFING AGENTS; PAINTS;  
RUST-PROOFING AND ANTI-CORROSIVE PRE-  
PARATIONS, NAMELY, RUST PREVENTATIVES  
IN THE NATURE OF A COATING; PROTECTIVE  
PREPARATIONS FOR METALS, COATINGS AND  
COATING AGENTS FOR PROTECTING METALS  
AND CONCRETE ALL IN THE FORM OR RUST  
PREVENTATIVES IN THE NATURE OF A COAT-  
ING, IN CLASS 2 (U.S. CLS. 6, 11 AND 16).

THE MARK CONSISTS OF STANDARD CHAR-  
ACTERS WITHOUT CLAIM TO ANY PARTICULAR  
FONT, STYLE, SIZE, OR COLOR.

PRIORITY DATE OF 6-6-2007 IS CLAIMED.

OWNER OF INTERNATIONAL REGISTRATION  
0939283 DATED 9-11-2007, EXPIRES 9-11-2017.

OWNER OF U.S. REG. NOS. 3,079,856, 3,335,503  
AND OTHERS.

SER. NO. 79-044,534, FILED 9-11-2007.

COLLEEN KEARNEY, EXAMINING ATTORNEY

**Int. Cls.: 35 and 42**

**Prior U.S. Cls.: 100, 101 and 102**

**United States Patent and Trademark Office**

**Reg. No. 3,454,128**

**Registered June 24, 2008**

**SERVICE MARK  
PRINCIPAL REGISTER**

# SOLENTIVE

DESIGNAVENUE SOFTWARE PTY LTD (AUSTRALIA COMPANY)  
C/- TRADEMARK WORKS  
LEVEL 25 CHIFLEY TOWER 2; CHIFLEY SQUARE;  
SYDNEY, NSW 2000  
AUSTRALIA

FOR: BUSINESS CONSULTANCY; COMPUTERISED BUSINESS RESEARCH; BUSINESS MANAGEMENT; PROVIDING OFFICE FUNCTIONS; DATA ANALYSIS IN THE FIELD OF BUSINESS WORKFLOW MANAGEMENT; DATABASE MANAGEMENT; RETAIL STORE SERVICES, INCLUDING ONLINE RETAIL STORE SERVICES, FEATURING COMPUTER HARDWARE AND COMPUTER SOFTWARE, IN CLASS 35 (U.S. CLS. 100, 101 AND 102).

FOR: COMPUTER SOFTWARE DEVELOPMENT; COMPUTER SOFTWARE CONSULTANCY; COMPUTER PROGRAMMING AND SOFTWARE DESIGN FOR OTHERS; COMPUTER SYSTEM DESIGN FOR OTHERS; DATABASE DESIGN FOR OTHERS; COMPUTER SYSTEMS ANALYSIS; TECHNICAL DATA ANALYSIS SERVICES REGARDING COMPUTER PRODUCTS OR PROCESSES FOR THE PURPOSE OF MANAGING BUSINESS WORKFLOW PROCESSES; DESIGN, INSTALLATION, MAINTENANCE, DEVELOPMENT AND UPDATING OF

COMPUTER SOFTWARE; GRAPHIC ART DESIGN; WEB SITE DESIGN; COMPUTER PROJECT MANAGEMENT SERVICES; SOFTWARE ENGINEERING; COMPUTER SERVICES, NAMELY, ACTING AS AN ONLINE APPLICATION SERVICE PROVIDER IN THE FIELD OF BUSINESS WORKFLOW AND PROCESS MANAGEMENT, IN CLASS 42 (U.S. CLS. 100 AND 101).

THE MARK CONSISTS OF STANDARD CHARACTERS WITHOUT CLAIM TO ANY PARTICULAR FONT, STYLE, SIZE, OR COLOR.

PRIORITY DATE OF 3-6-2007 IS CLAIMED.

OWNER OF INTERNATIONAL REGISTRATION 0939520 DATED 5-29-2007, EXPIRES 5-29-2017.

"SOLENTIVE" HAS NO MEANING IN A FOREIGN LANGUAGE.

SER. NO. 79-044,595, FILED 5-29-2007.

SHAILA SETTLES, EXAMINING ATTORNEY

**Int. Cl.: 30**

**Prior U.S. Cl.: 46**

**United States Patent and Trademark Office**

**Reg. No. 3,454,129**

**Registered June 24, 2008**

**TRADEMARK  
PRINCIPAL REGISTER**

**BACI**

SOCIÉTÉ DES PRODUITS NESTLÉ S.A. (SWITZERLAND CORPORATION)  
CH-1800 VEVEY  
SWITZERLAND

FOR: CONFECTIONERY AND CHOCOLATE PRODUCTS, NAMELY, CANDIES, FROZEN CONFECTIONS, CHOCOLATE, CHOCOLATE BARS, CHOCOLATE CANDIES, IN CLASS 30 (U.S. CL. 46).

OWNER OF INTERNATIONAL REGISTRATION 0581412 DATED 1-15-1992, EXPIRES 1-15-2012.

OWNER OF U.S. REG. NOS. 1,558,281, 2,997,230 AND OTHERS.

THE ENGLISH TRANSLATION OF THE WORD BACI IN THE MARK IS "KISSES AS IN A CARESS WITH THE LIPS."

SER. NO. 79-044,657, FILED 5-22-2007.

SOPHIA S. KIM, EXAMINING ATTORNEY

**Int. Cls.: 18, 25 and 35**

**Prior U.S. Cls.: 1, 2, 3, 22, 39, 41, 100, 101 and 102**

**Reg. No. 3,454,130**

**United States Patent and Trademark Office**

**Registered June 24, 2008**

**TRADEMARK  
SERVICE MARK  
PRINCIPAL REGISTER**

**Q A M A Z Y**

EVITA TEKSTIL; SANAYI VE TICARET ANONIM SIRKETI (TURKEY JOINT STOCK COMPANY)  
SIRACEVIZLER CADDESİ  
ESEN SOKAK NO:9 BOMONTI; SISLI/ISTANBUL  
TURKEY

FOR: LEATHER AND IMITATION LEATHER, ANIMAL SKINS; ANIMAL HIDES, ARTIFICIAL LEATHERS, STOUT LEATHERS, LINING LEATHER; GOODS MADE OF LEATHER, IMITATION LEATHER OR SYNTHETIC MATERIALS, NAMELY, TRAVEL BAGS, VALISES, WALLETS, DOCUMENT PORTFOLIOS AND BABY CARRYING BAGS, LEATHER AND STOUT LEATHER BOXES FOR STORING GREETING CARDS, AND LEATHER HAT BOXES FOR TRAVEL; CHECKBOOK COVERS, MAKE-UP CASES SOLD EMPTY, TOILETRY BAGS SOLD EMPTY, VANITY CASES SOLD EMPTY, TOOL BAGS SOLD EMPTY, BOOK BAGS; CARRYING CASES FOR DOCUMENTS, WALLETS, BRIEFCASES, BACKPACKS, SCHOOL BAGS, LEATHER SHOPPING BAGS; UMBRELLAS, SUNSHADES, NAMELY, PARASOLS AND CANES; WHIPS, HARNESSES AND SADDLERY, STIRRUPS, HORSE BRIDLES, IN CLASS 18 (U.S. CLS. 1, 2, 3, 22 AND 41).

FOR: CLOTHING, NAMELY, PULLOVERS; SKIRTS; DRESSES; BLOUSES; JEANS; TROUSERS; JACKETS; COATS, RAINCOATS, ANORAKS; SPORTSWEAR, NAMELY, SHIRTS, SHORTS, PANTS AND JACKETS; SHIRTS; T-SHIRTS; SWEAT-SHIRTS; BEACH CLOTHES, NAMELY, BATHING

SUITS AND BEACH COVER-UPS; SHORTS; KNITWEAR, NAMELY, SHIRTS, SHORTS, SWEATERS AND SCARVES; OVERALLS; UNDERCLOTHES; BODICES; BRASSIERES; CAMISOLES; UNDERPANTS; DRESSING GOWNS; BATH ROBES; BATHING SUITS; PYJAMAS; GLOVES; SKI SUITS; HEADGEAR, NAMELY, HATS, CAPS, KNITTED CAPS, BERETS; FOOTWEAR, NAMELY, SHOES EXCLUDING ORTHOPEDIC SHOES, SLIPPERS, BOOTS, SANDALS, BEACH SHOES, SPORTS SHOES, LACE BOOTS, AND PARTS THEREOF, NAMELY, INSOLES, TONGUE OR PULLSTRAP, PROTECTIVE METAL MEMBERS; SHOE PARTS, NAMELY, HEELPIECES; HEELS; FOOTWEAR UPPERS; STOCKINGS; BELTS; TIES; NECKTIES; SHAWLS; SCARVES; MUFFLERS; NECK SCARVES; SARONGS; COLLARS FOR DRESSES; MANIPLES; MUFFS; SUSPENDERS; BRACES FOR CLOTHING; GARTERS; BANDANAS; HEADBANDS; CLOTHING FOR BABIES, NAMELY, BABIES' DIAPERS OF TEXTILE, IN CLASS 25 (U.S. CLS. 22 AND 39).

FOR: RETAIL CLOTHING STORE SERVICES, IN CLASS 35 (U.S. CLS. 100, 101 AND 102).

OWNER OF INTERNATIONAL REGISTRATION 0940014 DATED 7-12-2007, EXPIRES 7-12-2017.

SER. NO. 79-044,788, FILED 7-12-2007.

BARBARA GAYNOR, EXAMINING ATTORNEY

**Int. Cl.: 2**

**Prior U.S. Cls.: 6, 11 and 16**

**United States Patent and Trademark Office**

**Reg. No. 3,454,131**

**Registered June 24, 2008**

**TRADEMARK  
PRINCIPAL REGISTER**

**SIKA POXITAR**

SIKA AG (SWITZERLAND CORPORATION)

ZUGERSTRASSE 50

CH-6341 BAAR, SWITZERLAND

THE MARK CONSISTS OF STANDARD CHARACTERS WITHOUT CLAIM TO ANY PARTICULAR FONT, STYLE, SIZE, OR COLOR.

PRIORITY DATE OF 6-6-2007 IS CLAIMED.

FOR: COLOR PIGMENTS, VARNISHES, LACQUERS; RUST-PROOFING AGENTS; PAINTS; RUST-PROOFING AND ANTI-CORROSIVE PREPARATIONS, NAMELY, RUST PREVENTATIVES IN THE NATURE OF A COATING; PROTECTIVE PREPARATIONS FOR METALS, COATINGS AND COATING AGENTS FOR PROTECTING METALS AND CONCRETE ALL IN THE FORM OR RUST PREVENTATIVES IN THE NATURE OF A COATING, IN CLASS 2 (U.S. CLS. 6, 11 AND 16).

OWNER OF INTERNATIONAL REGISTRATION 0940113 DATED 9-11-2007, EXPIRES 9-11-2017.

OWNER OF U.S. REG. NOS. 3,079,856, 3,335,503 AND OTHERS.

SER. NO. 79-044,808, FILED 9-11-2007.

COLLEEN KEARNEY, EXAMINING ATTORNEY

**Int. Cl.: 20**

**Prior U.S. Cls.: 2, 13, 22, 25, 32 and 50**

**United States Patent and Trademark Office**

**Reg. No. 3,454,132**

**Registered June 24, 2008**

**TRADEMARK  
PRINCIPAL REGISTER**

# Time-Table

WILKHAHN WILKENING + HAHNE GMBH +  
CO. (FED REP GERMANY CORPORATION)  
FRITZ-HAHNE-STR. 8  
31848 BAD MÜNDE  
FED REP GERMANY

FOR: FURNITURE, IN CLASS 20 (U.S. CLS. 2, 13,  
22, 25, 32 AND 50).

THE MARK CONSISTS OF STANDARD CHAR-  
ACTERS WITHOUT CLAIM TO ANY PARTICULAR  
FONT, STYLE, SIZE, OR COLOR.

OWNER OF INTERNATIONAL REGISTRATION  
0752775 DATED 1-9-2001, EXPIRES 1-9-2011.

OWNER OF U.S. REG. NO. 2,569,075.

SER. NO. 79-044,886, FILED 7-20-2007.

MICHAEL TANNER, EXAMINING ATTORNEY

**Int. Cl.: 21**

**Prior U.S. Cls.: 2, 13, 23, 29, 30, 33, 40 and 50**

**Reg. No. 3,454,133**

**United States Patent and Trademark Office**

**Registered June 24, 2008**

**TRADEMARK  
PRINCIPAL REGISTER**

**SAFE LINE**

BALLARINI PAOLO & FIGLI S.P.A. (ITALY  
JOINT-STOCK COMPANY)  
VIA RISORGIMENTO, 3  
I-46017 RIVAROLO MANTOVANO  
ITALY

DECORATIONS AND VARNISHING OR OUTSIDE  
PAINTING, NAMELY, FOR THE PRESERVATION  
AND THE COOKING OF FOOD, IN CLASS 21 (U.S.  
CLS. 2, 13, 23, 29, 30, 33, 40 AND 50).

FOR: POTS, NON-ELECTRIC PRESSURE COO-  
KERS, SAUCEPANS, PANS AND OTHER COOKING  
CONTAINERS FOR HOUSEHOLD USE, NAMELY,  
FOR THE PRESERVATION AND THE COOKING  
OF FOOD; POTS WITH ANTI-ADHERENT COAT-  
ING, NON-ELECTRIC PRESSURE COOKERS WITH  
ANTI-ADHERENT COATING, SAUCEPANS WITH  
ANTI-ADHERENT COATING, PANS AND OTHER  
COOKING CONTAINERS FOR HOUSEHOLD USE  
WITH ANTI-ADHERENT COATING, NAMELY,  
FOR THE PRESERVATION AND THE COOKING  
OF FOOD; POTS WITH OUTSIDE DECORATIONS  
AND VARNISHING OR OUTSIDE PAINTING, NON-  
ELECTRIC PRESSURE COOKERS WITH OUTSIDE  
DECORATIONS AND VARNISHING OR OUTSIDE  
PAINTING, SAUCEPANS WITH OUTSIDE DEC-  
ORATIONS AND VARNISHING OR OUTSIDE  
PAINTING, PANS AND OTHER COOKING CON-  
TAINERS FOR HOUSEHOLD USE WITH OUTSIDE

THE MARK CONSISTS OF STANDARD CHAR-  
ACTERS WITHOUT CLAIM TO ANY PARTICULAR  
FONT, STYLE, SIZE, OR COLOR.

OWNER OF INTERNATIONAL REGISTRATION  
0940583 DATED 7-23-2007, EXPIRES 7-23-2017.

NO CLAIM IS MADE TO THE EXCLUSIVE  
RIGHT TO USE "LINE" , APART FROM THE MARK  
AS SHOWN.

THE WORDING "SAFE LINE" HAS NO MEAN-  
ING IN A FOREIGN LANGUAGE.

SER. NO. 79-045,077, FILED 7-23-2007.

JACLYN KIDWELL, EXAMINING ATTORNEY



**Int. Cl.: 11**

**Prior U.S. Cls.: 13, 21, 23, 31 and 34**

**United States Patent and Trademark Office**

**Reg. No. 3,454,134**

**Registered June 24, 2008**

**TRADEMARK  
PRINCIPAL REGISTER**

**Pastair**

CEKAB AB (SWEDEN LTD LIAB CO)  
MASKINVÄGEN 5  
SE-227 30 LUND  
SWEDEN

OWNER OF INTERNATIONAL REGISTRATION  
0940593 DATED 9-21-2007, EXPIRES 9-21-2017.

FOR: GAS PURIFYING APPARATUS, NAMELY,  
ELECTROCHEMICAL GAS GENERATORS, IN  
CLASS 11 (U.S. CLS. 13, 21, 23, 31 AND 34).

THE WORDING "PASTAIR" IN THE MARK HAS  
NO MEANING IN A FOREIGN LANGUAGE.

THE MARK CONSISTS OF STANDARD CHAR-  
ACTERS WITHOUT CLAIM TO ANY PARTICULAR  
FONT, STYLE, SIZE, OR COLOR.

SER. NO. 79-045,084, FILED 9-21-2007.

WILLIAM ROSSMAN, EXAMINING ATTORNEY

**Int. Cl.: 33**

**Prior U.S. Cls.: 47 and 49**

**United States Patent and Trademark Office**

**Reg. No. 3,454,135**

**Registered June 24, 2008**

**TRADEMARK  
PRINCIPAL REGISTER**



AZIENDA AGRICOLA LA TORDERA S.S.; DI  
VETTORETTI PIETRO & FIGLI (ITALY SOLE  
PROPRIETORSHIP)

VIA ALNE' BOSCO, 23  
I-31020 VIDOR (TV)  
ITALY

FOR: ALCOHOLIC BEVERAGES EXCEPT BEERS,  
IN CLASS 33 (U.S. CLS. 47 AND 49).

OWNER OF INTERNATIONAL REGISTRATION  
0940714 DATED 9-17-2007, EXPIRES 9-17-2017.

"THE FOREIGN WORDING IN THE MARK  
TRANSLATES INTO ENGLISH AS NO MEANING."

SER. NO. 79-045,135, FILED 9-17-2007.

TRACY CROSS, EXAMINING ATTORNEY

**Int. Cl.: 14**

**Prior U.S. Cls.: 2, 27, 28 and 50**

**United States Patent and Trademark Office**

**Reg. No. 3,454,136**

**Registered June 24, 2008**

**TRADEMARK  
PRINCIPAL REGISTER**

**TOLKOWSKY**

TOLKOWSKY JEAN PAUL (BELGIUM INDIVIDUAL)  
VAN PUTLEI 36  
B-2018 ANTWERPEN  
BELGIUM

PRIORITY DATE OF 5-9-2007 IS CLAIMED.

OWNER OF INTERNATIONAL REGISTRATION  
0940770 DATED 9-27-2007, EXPIRES 9-27-2017.

FOR: PRECIOUS METALS AND THEIR ALLOYS AND GOODS MADE OF OR COATED WITH THESE MATERIALS, NAMELY, GOLD, SILVER, PLATINUM; JEWELRY; JEWELS, PRECIOUS STONES; DIAMONDS; TIMEPIECES AND CHRONOMETRIC INSTRUMENTS, IN CLASS 14 (U.S. CLS. 2, 27, 28 AND 50).

OWNER OF U.S. REG. NOS. 2,824,423, 3,120,845 AND OTHERS.

THE MARK CONSISTS OF STANDARD CHARACTERS WITHOUT CLAIM TO ANY PARTICULAR FONT, STYLE, SIZE, OR COLOR.

SER. NO. 79-045,161, FILED 9-27-2007.

MARK T. MULLEN, EXAMINING ATTORNEY

Int. Cl.: 14

Prior U.S. Cls.: 2, 27, 28 and 50

United States Patent and Trademark Office

Reg. No. 3,454,137

Registered June 24, 2008

TRADEMARK  
PRINCIPAL REGISTER

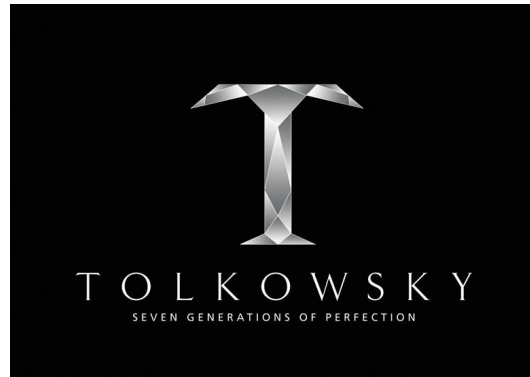

TOLKOWSKY JEAN PAUL (BELGIUM INDIVIDUAL)  
VAN PUTLEI 36  
B-2018 ANTWERPEN  
BELGIUM

FOR: PRECIOUS METALS AND THEIR ALLOYS AND GOODS MADE OF OR COATED WITH THESE MATERIALS, NAMELY, GOLD, SILVER, PLATINUM; JEWELRY; SEMI-PRECIOUS STONES; PRECIOUS STONES; DIAMONDS; TIMEPIECES AND CHRONOMETRIC INSTRUMENTS, IN CLASS 14 (U.S. CLS. 2, 27, 28 AND 50).

PRIORITY DATE OF 5-10-2007 IS CLAIMED.

OWNER OF INTERNATIONAL REGISTRATION 0940772 DATED 9-27-2007, EXPIRES 9-27-2017.

OWNER OF U.S. REG. NOS. 2,824,423, 3,120,845 AND OTHERS.

THE MARK IS NOT IN COLOR.

SER. NO. 79-045,162, FILED 9-27-2007.

MARK T. MULLEN, EXAMINING ATTORNEY

**Int. Cls.: 16, 35, 38, 39, 41 and 43**

**Prior U.S. Cls.: 2, 5, 22, 23, 29, 37, 38, 50, 100, 101, 102, 104, 105 and 107**

**Reg. No. 3,454,138**

**United States Patent and Trademark Office**

**Registered June 24, 2008**

**TRADEMARK  
SERVICE MARK  
PRINCIPAL REGISTER**

# TUI Travel

TUI AG (FED REP GERMANY JOINT STOCK COMPANY)

KARL-WIECHERT-ALLEE 4

30625 HANNOVER

FED REP GERMANY

FOR: PAPER, CARDBOARD AND GOODS MADE FROM THESE MATERIALS, NAMELY, STICKERS, CONTAINERS FOR STATIONERY, BEER MATS, PAPER AND PLASTIC PACKING BAGS, PAPER BAGS, PADS OF PAPER FOR WRITING AND WRITING PAPER; PRINTED MATTER, NAMELY, BOOKS, LEAFLETS, BROCHURES, NEWSPAPERS AND MAGAZINES IN THE FIELD OF BUSINESS MANAGEMENT, TRAVEL AND ENTERTAINMENT MANAGEMENT; PHOTOGRAPHS, POSTCARDS; PRINTED TICKETS, ENTRY TICKETS, CALENDARS, CARDS, NAMELY, NOTE CARDS, GREETING CARDS, BUSINESS CARDS AND BLANK CARDS, AND CATALOGUES IN THE FIELD OF TRAVEL AND TRAVEL MANAGEMENT; WRITING INSTRUMENTS, NAMELY, PENS, PENCILS AND FOUNTAIN PENS; ARTISTS' MATERIALS, NAMELY, PASTELS AND PAINT BRUSHES; OFFICE REQUISITES OTHER THAN FURNITURE, NAMELY, ADHESIVE TAPE DISPENSERS, CORRECTING FLUID FOR TYPE, STAPLERS, AND FRANKING MACHINES; PRINTED INSTRUCTIONAL AND TEACHING MATERIAL, NAMELY, WORKBOOKS AND WORKSHEETS DIRECTED TO THE FIELDS OF BUSINESS MANAGEMENT, BUSINESS OUTSOURCING, TRAVEL AND ENTERTAINMENT; CARDBOARD, PAPER AND PLASTIC MATERIALS FOR PACKAGING, NAMELY, PLASTIC BAGS, PLASTIC BUBBLE PACKS; PRINTERS' TYPE; PAPER FLAGS AND PENNANTS; BOOK-BINDING MATERIAL, NAMELY, CORDS, TAPE, WIRE, BOOK BINDS, AND CLOTH FOR BOOK-BINDING; ADHESIVES FOR STATIONERY PURPOSES, IN CLASS 16 (U.S. CLS. 2, 5, 22, 23, 29, 37, 38 AND 50).

FOR: ADVERTISING, INCLUDING ADVERTISING ON THE INTERNET, MARKETING, PUBLIC RELATIONS, ADVERTISING AND PROMOTIONAL SERVICES FOR THIRD PARTIES, RENTAL OF ADVERTISING MATERIAL, AND DIRECT MAIL ADVERTISING; MARKET RESEARCH INCLUDING PUBLIC OPINION POLLING AND MARKET ANALYSIS; BOOKKEEPING; BUSINESS AND BUSINESS ORGANIZATIONAL CONSULTANCY, ADVISORY AND COORDINATION SERVICES, IN PARTICULAR IN THE AREA OF DATA PROCESSING; HOTEL MANAGEMENT FOR THIRD PARTIES; BUSINESS ORGANIZATIONAL CONSULTANCY, MANAGEMENT ADVISORY AND ADMINISTRATIVE COORDINATION SERVICES FOR TRAVEL AGENCIES, FITNESS CLUBS AND SPORTS AND LEISURE FACILITIES; DISTRIBUTION OF SAMPLES FOR ADVERTISING PURPOSES, DUPLICATION OF DOCUMENTS; BUSINESS ORGANIZATIONAL CONSULTATION RELATING TO THE PREPARATION OF BUILDING PROJECTS AS A SERVICE OF A BUILDING CONTRACTOR; FRANCHISING SERVICES, NAMELY, CONSULTATION AND ASSISTANCE IN BUSINESS MANAGEMENT; RENTAL OF ADVERTISING SPACE ON THE INTERNET; SPONSORSHIP, NAMELY, PROMOTING THE GOODS AND SERVICES OF THIRD PARTIES BY ARRANGING FOR SPONSORS TO AFFILIATE THEIR GOODS AND SERVICES WITH AWARD PROGRAMS AND SPORTING ACTIVITIES; TELEMARKETING; COMMERCIAL ADVISORY SERVICES FOR CONSUMERS RELATED TO EXPORT PROMOTION INFORMATION; SALES PROMOTION FOR GOODS AND SERVICES OF THIRD PARTIES; RENTAL OF OFFICE EQUIPMENT; RECRUITMENT OF OFFICE STAFF; PROVIDING OF ADVERTISING SPACE AND ADVERTISING OF BUSINESS CONTACTS, IN PARTICULAR ON THE INTERNET; WEBVERTISING, NAMELY, MARKETING FOR THIRD PARTIES IN DIGITAL NETWORKS; AUCTIONEERING SERVICES, IN PARTICULAR ON THE INTERNET; ALL

THE ABOVE SERVICES IN PARTICULAR IN THE TRAVEL AND RECREATIONAL SECTOR; ORGANIZATION OF FAIRS AND EXHIBITIONS FOR COMMERCIAL OR FOR ADVERTISING PURPOSES; PROCURING OF CONTRACTS FOR THE PURCHASE AND SALE OF GOODS FOR THIRD PARTIES AND FOR THE PURCHASE AND SALE OF GOODS FOR THIRD PARTIES VIA A TELESHOPPING CHANNEL; PROCUREMENT OF CONTRACTS FOR THIRD PARTIES FOR THE PURCHASE AND SALE OF SERVICES VIA A TELESHOPPING CHANNEL; EMPLOYMENT RECRUITING AND HIRING FOR HOTLINES AND CALL CENTRES; ADMINISTRATIVE SERVICES, NAMELY, TAKING SALES ORDERS VIA HOTLINES AND CALL CENTRES FOR OTHERS; DATABASE MANAGEMENT, NAMELY, DATA UPDATING IN COMPUTER DATA BASES; DATA ENTRY IN COMPUTER DATA BASES FOR CUSTOMER LOYALTY PROGRAMS; BUSINESS ORGANIZATIONAL CONSULTANCY REGARDING CUSTOMER LOYALTY PROGRAMS; DEVELOPING MARKETING ACTIVITIES THAT INCLUDE THE PROVISION OF BONUSES; BUSINESS ORGANIZATIONAL CONSULTING FOR PROMOTING SALES BY IMPLEMENTING AWARD, BONUS AND CUSTOMER LOYALTY PROGRAMS, IN CLASS 35 (U.S. CLS. 100, 101 AND 102).

FOR: TELECOMMUNICATIONS SERVICES, NAMELY, ELECTRONIC TRANSMISSION OF MESSAGES AND DATA VIA COMPUTER, TELEPHONE, GLOBAL COMPUTER NETWORKS AND LOCAL AREA NETWORKS; ELECTRONIC COMMUNICATION SERVICES, NAMELY, TELEPHONE COMMUNICATION SERVICES AND COMMUNICATION BY ELECTRONIC COMPUTER TERMINALS; COMMUNICATION OF DATA, IN PARTICULAR OF OFFERS AND INFORMATION BY COMPUTER AND BY MEANS OF ELECTRONIC COMMUNICATION INCLUDING BY TELECOMMUNICATIONS, COMPUTER, TELEPHONE, INTERNET AND INTRANET; ONLINE SERVICES, NAMELY, ELECTRONIC TRANSMISSION OF DATA AND DOCUMENTS VIA THE INTERNET; PROVIDING OF ACCESS TO INTERNET PORTALS FOR THIRD PARTIES; PROVIDING OF ACCESS TO INTERNET; PROVIDING OF ACCESS TO E-COMMERCE PLATFORMS ON THE INTERNET; OPERATION OF CHAT ROOMS, CHAT LINES AND ON-LINE FORUMS FOR THE TRANSMISSION OF MESSAGES AMONG COMPUTER USERS CONCERNING TRAVEL; PROVIDING TELECOMMUNICATION CHANNELS FOR THE OPERATION OF A TELESHOPPING CHANNEL; RENTING OF TELECOMMUNICATION EQUIPMENT FOR HOTLINES AND CALL CENTRES; TELEPHONE SERVICES, NAMELY, TELEPHONE COMMUNICATION SERVICES AND CELLULAR TELEPHONE SERVICES; TRANSMISSION OF TRAFFIC INFORMATION VIA TELECOMMUNICATIONS MEANS, PARTICULARLY VIA ELECTRONIC COMMUNICATIONS NETWORKS; BROADCASTING OF RADIO AND TELEVISION PROGRAMMES; ALL ABOVE SERVICES IN THE TRAVEL AND RECREATIONAL SECTOR; TRANSMISSION OF TECHNICAL INFORMATION VIA TELECOMMUNICATIONS MEANS, NAMELY, VIA

ELECTRONIC COMMUNICATIONS NETWORKS; TELECOMMUNICATION SERVICES IN INTERNET CAFES, NAMELY, PROVIDING TELECOMMUNICATIONS CONNECTIONS TO THE INTERNET, IN CLASS 38 (U.S. CLS. 100, 101 AND 104).

FOR: TRANSPORT OF PERSONS, IN PARTICULAR, BY ROAD, RAIL, SEA AND AIR; PORTER SERVICES; TRAVEL ORGANIZATION, BOOKING AND ARRANGEMENT OF TRANSPORTATION; ARRANGEMENT OF TRANSPORT SERVICES, NAMELY, TRANSPORT OF PASSENGERS AND GOODS BY MEANS OF FERRY, BOAT, RAIL AND AIR; RENTAL OF DIVING SUITS; ORGANIZATION, BOOKING AND ARRANGEMENT OF EXCURSIONS, DAY TRIPS AND SIGHTSEEING TOURS; TRAVEL CONSULTANCY, NAMELY, PROVIDING INFORMATION, NEWS AND COMMENTARY IN THE FIELD OF TRAVEL AND ESCORTING OF TRAVELERS; RENTAL OF AIRCRAFT AND BOOKING OF AIRCRAFT TRANSPORTATION; RENTAL OF SHIPS AND BOOKING OF TRANSPORTATION BY SHIP, IN PARTICULAR ROWING AND MOTOR BOATS, SAILING VESSELS AND CANOES; RENTAL OF MOTOR VEHICLES, BICYCLES, HORSES AND DIVING SUITS, AND BOOKING OF TRANSPORTATION BY MOTOR VEHICLE, BICYCLE, AND HORSE; ORGANIZATION OF TRIPS, HOLIDAYS AND SIGHTSEEING TOURS; TRAVEL AGENCY SERVICES, NAMELY, MAKING RESERVATIONS AND BOOKINGS FOR TRANSPORTATION AND TRAVEL; PROVIDING INFORMATION ABOUT TRAVEL; RESERVATION SERVICES FOR TRAVEL; PROVIDING INFORMATION ABOUT TRAVEL ON THE INTERNET, IN PARTICULAR, ABOUT RESERVATION AND BOOKING IN THE TOURISM AND BUSINESS TRAVEL SECTOR; ALL THE ABOVE SERVICES, IN PARTICULAR IN THE TRAVEL AND RECREATIONAL SECTOR; DELIVERY, DISPATCHING AND DISTRIBUTION OF NEWSPAPERS AND MAGAZINES; PROVIDING INFORMATION IN THE FIELD OF TRAVEL, NAMELY, INFORMATION ABOUT TOURISM, TRANSPORT AND STORAGE PROVIDED BY TELEPHONE CALL CENTRES AND HOTLINES; VEHICLE ROUTING BY COMPUTER ON DATA NETWORKS, IN CLASS 39 (U.S. CLS. 100 AND 105).

FOR: EDUCATION AND CONTINUOUS TRAINING IN THE FIELD OF MUSIC, ART AND CULTURE RENDERED THROUGH WORKSHOPS, SEMINARS AND CLASSES; EDUCATIONAL CONSULTANCY IN THE FIELD OF HIGHER EDUCATION ADMINISTRATION; TEACHING, IN THE FIELD OF MUSIC, ART AND CULTURE RENDERED THROUGH CORRESPONDENCE COURSES AND LANGUAGE INSTRUCTION COURSES; ENTERTAINMENT SERVICES, NAMELY, ENTERTAINMENT IN THE NATURE OF LIVE PERFORMANCES BY THEATER GROUPS, ETHNIC FESTIVALS, LIGHT, FASHION, AND MUSIC SHOWS, LIVE THEATRICAL PERFORMANCES, AND BASEBALL, FOOTBALL AND BASKETBALL GAMES; FILM AND VIDEO FILM PRODUCTION, FILM AND VIDEO RENTAL; ENTERTAINMENT IN THE NATURE OF VISUAL AND AUDIO PERFORMANCES; ORGANIZATION OF SHOWS, NAMELY,

FASHION SHOWS AND MODELING SHOWS; ARTIST AGENCY SERVICES, NAMELY, BOOKING OF SEATS FOR SHOWS AND BOOKING OF THEATRE TICKETS; MODELING FOR ARTISTS; PRESENTATION OF MUSICAL PERFORMANCES; PRESENTATION OF CIRCUS PERFORMANCES; PUBLIC ENTERTAINMENT IN THE NATURE OF LIVE PERFORMANCES BY THEATRE GROUPS, ETHNIC FESTIVALS, LIGHT, FASHION, MUSICAL AND MUSIC SHOWS; PROVIDING ENTERTAINMENT IN THE NATURE OF THEATRICAL PERFORMANCES; ORGANIZATION AND PROVIDING OF AN AFTER SCHOOL CHILDREN'S ENTERTAINMENT CENTRE FEATURING EDUCATIONAL ENTERTAINMENT; ENTERTAINMENT SERVICES, NAMELY, HOLIDAY CAMP SERVICES; ARRANGING AND CONDUCTING OF CLASSES AND SEMINARS FOR TEACHING IN THE FIELD OF SPORTS, LANGUAGES, FILM AND MUSICAL PERFORMANCES; HEALTH CLUB SERVICES, NAMELY, PROVIDING EQUIPMENT AND INSTRUCTION IN THE FIELD OF PHYSICAL FITNESS, PROVIDING GYMNASTIC TRAINING CLUBS AND FITNESS CLUBS, GOLF COURSES, TENNIS COURTS, HORSEBACK RIDING FACILITIES, KINDERGARTENS, CINEMA THEATRE FACILITIES, DISCOTHEQUES, MUSEUMS, AMUSEMENT ARCADES, SPORTS CAMPS AND SPORTS FACILITIES, AND AMUSEMENT PARKS; RENTAL OF SKIN DIVING EQUIPMENT; ORGANIZATION OF SPORTS COMPETITIONS; ORGANIZATION AND ARRANGEMENT OF CULTURAL AND SPORTING EVENTS, NAMELY, SOCCER AND VOLLEYBALL COMPETITIONS; RESERVATION SERVICES, NAMELY, ARRANGING FOR TICKET RESERVATIONS FOR SPORTING, SCIENTIFIC AND CULTURAL EVENTS; PROVIDING INFORMATION VIA THE INTERNET IN THE FIELD OF ENTERTAINMENT AND IN THE FIELD OF CONTINUING EDUCATION; ENTERTAINMENT SERVICES, IN PARTICULAR, PROVIDING ON-LINE COMPUTER GAMES; RENTAL OF RECORDED DATA CARRIERS, NAMELY, VIDEOTAPES, SOUND RECORDINGS, DVDS, AND CD-ROMS FEATURING FILMS, MUSIC, AND GAMES, AND RENTAL OF OVERHEAD PROJECTORS; RENTAL OF NEWSPAPERS AND MAGAZINES, PUBLICATION OF BOOKS, NEWSPAPERS AND MAGAZINES AND OTHER PRINTED MATERIALS, NAMELY, JOURNALS AND LEAFLETS, AND INCLUDING CD-ROMS; PUBLICATION OF PRINTED MATTER, NAMELY, OF BOOKS, MAGAZINES, CATALOGUES IN THE FIELD OF CULTURE AND TRAVEL, AND NEWSPAPERS, AND PUBLICATION OF ELECTRONIC NEWSPAPERS, ESPECIALLY ONLINE; ORGANIZATION OF EXHIBITIONS FOR CULTURAL AND TEACHING PURPOSES; SERVICES OF A RECREATION AND AMUSEMENT PARK IN THE EDUCATION AND ENTERTAINMENT SECTOR; LANGUAGE INTER-

PRETATION AND LANGUAGE TRANSLATION; PHOTOGRAPHY SERVICES; RADIO ENTERTAINMENT, TELEVISION ENTERTAINMENT, NAMELY, PRODUCTION OF TELEVISION PROGRAMS; CONSULTATION SERVICES IN THE NATURE OF TICKET RESERVATION AND BOOKING SERVICES PROVIDED VIA TELEPHONE CALL CENTRES AND HOTLINES FOR EDUCATION, ENTERTAINMENT, SPORTING, SCIENTIFIC, AND CULTURAL EVENTS; PROVIDING INFORMATION ABOUT ENTERTAINMENT AND ENTERTAINMENT EVENTS VIA AN ONLINE NETWORK AND THE INTERNET, IN CLASS 41 (U.S. CLS. 100, 101 AND 107).

FOR: PROVIDING TEMPORARY ACCOMMODATION, PROVIDING OF FOOD AND DRINKS FOR GUESTS; ACCOMMODATION BUREAU SERVICES, NAMELY, RESERVATION SERVICES FOR TRAVELERS FOR ROOM ACCOMMODATION VIA TRAVEL AGENCIES AND BROKERS; PROVIDING ROOM RESERVATION AND HOTEL RESERVATION SERVICES, PROVIDING HOTEL, BOARDING HOUSE AND MOTEL SERVICES; CATERING; SERVICES OF BOARDING HOUSES, HOTELS AND MOTELS; RENTAL OF MEETING ROOMS; PROVIDING OF FOOD AND DRINKS IN RESTAURANTS AND BARS; PROVIDING FOOD AND DRINKS IN INTERNET CAFES; CONSULTATION SERVICES PROVIDED BY TELEPHONE CALL CENTRES AND HOTLINES, NAMELY, PROVIDING PERSONALIZED INFORMATION REGARDING TEMPORARY ROOM AND BOARD ACCOMMODATIONS; MAKING HOTEL RESERVATIONS FOR OTHERS AND PROVIDING TRAVEL ACCOMMODATION AND CATERING INFORMATION FOR GUESTS, IN CLASS 43 (U.S. CLS. 100 AND 101).

THE MARK CONSISTS OF STANDARD CHARACTERS WITHOUT CLAIM TO ANY PARTICULAR FONT, STYLE, SIZE, OR COLOR.

PRIORITY DATE OF 3-16-2007 IS CLAIMED.

OWNER OF INTERNATIONAL REGISTRATION 0940832 DATED 4-18-2007, EXPIRES 4-18-2017.

OWNER OF U.S. REG. NOS. 2,928,468 AND 2,975,052.

NO CLAIM IS MADE TO THE EXCLUSIVE RIGHT TO USE "TRAVEL", APART FROM THE MARK AS SHOWN.

SER. NO. 79-045,192, FILED 4-18-2007.

SHAILA SETTLES, EXAMINING ATTORNEY

**Int. Cl.: 24**

**Prior U.S. Cls.: 42 and 50**

**United States Patent and Trademark Office**

**Reg. No. 3,454,139**

**Registered June 24, 2008**

**TRADEMARK  
PRINCIPAL REGISTER**

**PREFER**

PREFER TECHNOLOGY (SINGAPORE PRIVATE  
LIMITED COMPANY)  
7 WATTEN DRIVE  
SINGAPORE 287643  
SINGAPORE

FOR: PILLOW CASES, DISPOSABLE PILLOWCA-  
SES, PILLOW COVERS, DISPOSABLE PILLOW COV-  
ERS, BED SHEETS, DISPOSABLE BED SHEETS,  
DISPOSABLE TOWELS OF TEXTILE, TABLE  
CLOTHS NOT OF PAPER, DISPOSABLE TABLE  
CLOTHS NOT OF PAPER, UNFITTED FURNITURE

COVERS NOT OF PAPER IN THE NATURE OF  
DISPOSABLE HEAD-REST COVERS FOR CHAIRS  
AND SOFAS, IN CLASS 24 (U.S. CLS. 42 AND 50).

OWNER OF INTERNATIONAL REGISTRATION  
0940887 DATED 7-25-2007, EXPIRES 7-25-2017.

SER. NO. 79-045,214, FILED 7-25-2007.

KALIE KUNG, EXAMINING ATTORNEY



Int. Cl.: 3

Prior U.S. Cls.: 1, 4, 6, 50, 51 and 52

United States Patent and Trademark Office

Reg. No. 3,454,140

Registered June 24, 2008

TRADEMARK  
PRINCIPAL REGISTER



BAIEIDO CO., LTD. (JAPAN JOINT-STOCK COMPANY)  
1-1-4 KURUMANO-CHO HIGASHI,  
SAKAI-KU., SAKAI-SHI; OSAKA 590-0943  
JAPAN

FOR: COSMETICS; ESSENTIAL OILS; ESSENTIAL OILS FOR FOOD FLAVORINGS; ESSENTIAL OILS FOR FLAVORING BEVERAGES; ESSENTIAL OILS FOR HOUSEHOLD USE; FRAGRANCES FOR AUTOMOBILES; FUMIGATING INCENSES (KUNKO); INCENSE; INCENSE STICKS; JOSS STICKS; PERFUMES; PERFUME OILS; PERFUMERY; PERFUMING SACHETS; ROOM FRAGRANCES; SOAPS AND DETERGENTS; SYNTHETIC PERFUMERY; SYNTHETIC MUSK, IN CLASS 3 (U.S. CLS. 1, 4, 6, 50, 51 AND 52).

OWNER OF INTERNATIONAL REGISTRATION  
0940924 DATED 8-10-2007, EXPIRES 8-10-2017.

NO CLAIM IS MADE TO THE EXCLUSIVE RIGHT TO USE "SINCE 1657", APART FROM THE MARK AS SHOWN.

THE DESIGN PORTION OF THE MARK CONSISTS OF A STYLIZED FLOWER INSIDE A RECTANGULAR BORDER WITH ANOTHER SMALLER FLOWER DESIGN ABOVE AND BELOW IT.

SER. NO. 79-045,230, FILED 8-10-2007.

REBECCA SMITH, EXAMINING ATTORNEY

**Int. Cl.: 3**

**Prior U.S. Cls.: 1, 4, 6, 50, 51 and 52**

**Reg. No. 3,454,141**

**United States Patent and Trademark Office**

**Registered June 24, 2008**

**TRADEMARK  
PRINCIPAL REGISTER**

# Baieido

BAIEIDO CO., LTD. (JAPAN JOINT-STOCK COMPANY)  
1-1-4 KURUMANO-CHO HIGASHI,  
SAKAI-KU.; SAKAI-SHI; OSAKA 590-0943  
JAPAN

OWNER OF INTERNATIONAL REGISTRATION  
0940925 DATED 8-10-2007, EXPIRES 8-10-2017.

FOR: COSMETICS; DENTIFRICES; ESSENTIAL OILS; ESSENTIAL OILS FOR FOOD FLAVORINGS; ESSENTIAL OILS FOR FLAVORING BEVERAGES; ESSENTIAL OILS FOR HOUSEHOLD USE; FRAGRANCES FOR AUTOMOBILES; FUMIGATING INCENSES (KUNKO); INCENSE; INCENSE STICKS; JOSS STICKS; PERFUMES; PERFUME OILS; PERFUMERY; PERFUMING SACHETS; ROOM FRAGRANCES; SOAPS AND DETERGENTS; SYNTHETIC PERFUMERY; SYNTHETIC MUSK, IN CLASS 3 (U.S. CLS. 1, 4, 6, 50, 51 AND 52).

THE ENGLISH TRANSLATION OF THE WORD "BAI" IS "UME TREE, JAPANESE APRICOT TREE", "EI" IS "GLORY" OR "PROSPERITY", AND "DO" IS THE SUFFIX TO BE ANNEXED TO A TRADE NAME.

SER. NO. 79-045,231, FILED 8-10-2007.

REBECCA SMITH, EXAMINING ATTORNEY

Int. Cl.: 3

Prior U.S. Cls.: 1, 4, 6, 50, 51 and 52

United States Patent and Trademark Office

Reg. No. 3,454,142

Registered June 24, 2008

TRADEMARK  
PRINCIPAL REGISTER

*Ellfiore*

ALAHE ZIAIE (FED REP GERMANY INDIVIDUAL)  
STRABBERGERSTRABE 42  
80809 MÜNCHEN  
FED REP GERMANY

FOR: SOAPS, PERFUMERY, ESSENTIAL OILS, COSMETICS, HAIR LOTIONS, DENTIFRICES, IN CLASS 3 (U.S. CLS. 1, 4, 6, 50, 51 AND 52).

OWNER OF INTERNATIONAL REGISTRATION 0941311 DATED 9-13-2007, EXPIRES 9-13-2017.

THE COLOR(S) RED IS/ARE CLAIMED AS A FEATURE OF THE MARK.

THE COLOR RED APPEARS IN THE WORDING "ELLFIORE".

ELLFIORE HAS NO MEANING IN A FOREIGN LANGUAGE.

SER. NO. 79-045,312, FILED 9-13-2007.

DEIRDRE ROBERTSON, EXAMINING ATTORNEY

**Int. Cl.: 9**

**Prior U.S. Cls.: 21, 23, 26, 36 and 38**

**Reg. No. 3,454,143**

**United States Patent and Trademark Office**

**Registered June 24, 2008**

**TRADEMARK  
PRINCIPAL REGISTER**

**KOERZIMAT**

FELIX FÖRSTER (FED REP GERMANY INDIVIDUAL)  
ERLENHOF  
72793 PFULLINGEN  
FED REP GERMANY

OWNER OF INTERNATIONAL REGISTRATION  
0441952 DATED 12-8-1978, EXPIRES 12-8-2008.

FOR: MAGNETIC MEASURING APPARATUS,  
NAMELY, ELECTROMAGNETIC APPARATUS  
USED TO GENERATE OR MEASURE MAGNETIC  
FIELDS, IN CLASS 9 (U.S. CLS. 21, 23, 26, 36 AND 38).

SER. NO. 79-045,321, FILED 9-14-2007.

SHARON MEIER, EXAMINING ATTORNEY

**Int. Cls.: 5 and 30**

**Prior U.S. Cls.: 6, 18, 44, 46, 51 and 52**

**United States Patent and Trademark Office**

**Reg. No. 3,454,144**

**Registered June 24, 2008**

**TRADEMARK  
PRINCIPAL REGISTER**

**RED BULL**

RED BULL GMBH (AUSTRIA LLC)  
AM BRUNNEN 1  
A-5330 FUSCHL AM SEE, AUSTRIA

FOR: CHEWING GUM, FRUIT GUMS, GUMS, CANDY, HARD CANDIES, LOZENGES, MINTS, BREATH MINTS, DISSOLVING BREATH MINT STRIPS AND SWEETS FOR MEDICAL USE, IN CLASS 5 (U.S. CLS. 6, 18, 44, 46, 51 AND 52).

FOR: EDIBLE AND FLAVORED ICES, COFFEE, TEA, COCOA DRINKS AND CHOCOLATE FOOD BEVERAGES NOT BEING DAIRY-BASED OR VEGETABLE BASED, ICED TEA; CONFECTIONERY, NAMELY, PASTILLES, SWEETS, CANDY, HARD CANDIES, NON-MEDICATED LOZENGES, CANDY MINTS, BREATH MINTS, DISSOLVING BREATH MINT STRIPS, FRUIT BUBBLE GUMS, CHOCOLATE, CHOCOLATE PRODUCTS, NAMELY, CHOCOLATE BAR, CHOCOLATE CANDIES, AND

CHOCOLATE CHIPS; CHEWING GUMS, SUGAR FREE CHEWING GUMS; FRUIT ICE BAR AND MUESLI BARS, IN CLASS 30 (U.S. CL. 46).

THE MARK CONSISTS OF STANDARD CHARACTERS WITHOUT CLAIM TO ANY PARTICULAR FONT, STYLE, SIZE, OR COLOR.

OWNER OF INTERNATIONAL REGISTRATION 0883431 DATED 5-13-2005, EXPIRES 5-13-2015.

OWNER OF U.S. REG. NOS. 2,494,093, 3,197,810 AND OTHERS.

SER. NO. 79-045,342, FILED 7-6-2007.

WARREN L. OLANDRIA, EXAMINING ATTORNEY

**Int. Cl.: 1**

**Prior U.S. Cls.: 1, 5, 6, 10, 26 and 46**

**Reg. No. 3,454,145**

**United States Patent and Trademark Office**

**Registered June 24, 2008**

**TRADEMARK  
PRINCIPAL REGISTER**

**MANNASTAR**

DANISCO A/S (DENMARK A PUBLIC LIMITED  
COMPANY)  
LANGEBROGADE 1  
P.O. BOX 17  
COPENHAGEN K, DENMARK DK1001

PRIORITY DATE OF 4-19-2007 IS CLAIMED.

FOR: CHEMICAL PRODUCTS USED IN INDUS-  
TRY, NAMELY, ENZYMES AND ENZYME PRE-  
PARATIONS USED IN THE MANUFACTURE OF  
DETERGENTS, CLEANING PRODUCTS, SOAP  
AND PERSONAL CARE PRODUCTS, IN CLASS 1  
(U.S. CLS. 1, 5, 6, 10, 26 AND 46).

OWNER OF INTERNATIONAL REGISTRATION  
0941534 DATED 10-11-2007, EXPIRES 10-11-2017.

SER. NO. 79-045,412, FILED 10-11-2007.

THE MARK CONSISTS OF STANDARD CHAR-  
ACTERS WITHOUT CLAIM TO ANY PARTICULAR  
FONT, STYLE, SIZE, OR COLOR.

ANDREA K. NADELMAN, EXAMINING ATTOR-  
NEY

**Int. Cl.: 5**

**Prior U.S. Cls.: 6, 18, 44, 46, 51 and 52**

**United States Patent and Trademark Office**

**Reg. No. 3,454,146**

**Registered June 24, 2008**

**TRADEMARK  
PRINCIPAL REGISTER**

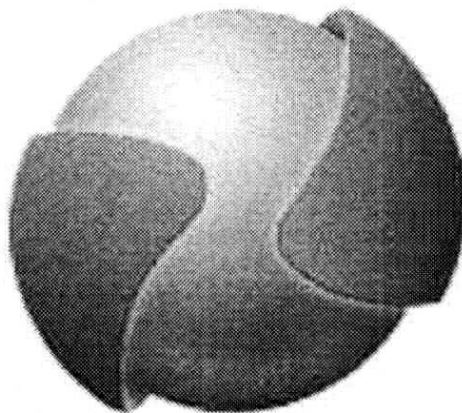

NOVARTIS AG (SWITZERLAND SOCIÉTÉ  
ANONYME)  
CH-4002 BASEL  
SWITZERLAND

FOR: PHARMACEUTICAL PREPARATIONS FOR THE PREVENTION OR TREATMENT OF DISEASES AND DISORDERS OF THE NERVOUS SYSTEM, THE IMMUNE SYSTEM, THE CARDIO-VASCULAR AND METABOLIC SYSTEM INCLUDING DIABETES, THE RESPIRATORY SYSTEM, THE GENITOURINARY SYSTEM, FOR DISORDERS OF THE MUSCULOSKELETAL SYSTEM AND FOR INFLAMMATORY DISORDERS; PHARMACEUTICAL PREPARATIONS FOR USE IN DERMATOLOGY, ONCOLOGY, HEMATOLOGY, OPHTHALMOLOGY AND IN TISSUE AND ORGAN TRANSPLANTATION; PHARMACEUTICAL PREPARATIONS FOR

GASTROENTEROLOGICAL DISORDERS; PHARMACEUTICAL PREPARATIONS FOR THE PREVENTION AND TREATMENT OF OCULAR DISORDERS OR DISEASES; ANTI-INFECTIVE, ANTIBIOTIC, ANTIVIRAL AND ANTIFUNGAL PREPARATIONS, ANTIBACTERIAL PHARMACEUTICALS, IN CLASS 5 (U.S. CLS. 6, 18, 44, 46, 51 AND 52).

OWNER OF INTERNATIONAL REGISTRATION  
0848077 DATED 4-13-2005, EXPIRES 4-13-2015.

SER. NO. 79-045,607, FILED 7-12-2007.

DEBRA LEE, EXAMINING ATTORNEY

**Int. Cls.: 35 and 41**

**Prior U.S. Cls.: 100, 101, 102 and 107**

**United States Patent and Trademark Office**

**Reg. No. 3,454,147**

**Registered June 24, 2008**

**SERVICE MARK  
PRINCIPAL REGISTER**

# **IMPROVABILITY**

DELTA DANSK ELEKTRONIK.; LYS & AKUS-  
TIK (DENMARK CORPORATION)  
VENLIGHEDSVEJ 4  
DK-2970 HØRSBOLM  
DENMARK

FOR: ASSISTANCE, ADVISORY SERVICES AND  
CONSULTANCY WITH REGARD TO BUSINESS  
AND PROJECT PLANNING, ANALYSIS, MANAGE-  
MENT, AND BUSINESS AND PROJECT ORGANI-  
ZATION, IN CLASS 35 (U.S. CLS. 100, 101 AND 102).

FOR: EDUCATION SERVICES IN THE NATURE  
OF COURSES, SEMINARS, SYMPOSIUMS AND  
CONFERENCES, ALL IN RELATION TO BUSINESS  
PLANNING, BUSINESS ANALYSIS, BUSINESS

MANAGEMENT, AND BUSINESS ORGANIZA-  
TION, IN CLASS 41 (U.S. CLS. 100, 101 AND 107).

THE MARK CONSISTS OF STANDARD CHAR-  
ACTERS WITHOUT CLAIM TO ANY PARTICULAR  
FONT, STYLE, SIZE, OR COLOR.

OWNER OF INTERNATIONAL REGISTRATION  
0923391 DATED 12-22-2006, EXPIRES 12-22-2016.

SER. NO. 79-045,624, FILED 9-18-2007.

LINDA ORNDORFF, EXAMINING ATTORNEY



Int. Cl.: 25

Prior U.S. Cls.: 22 and 39

United States Patent and Trademark Office

Reg. No. 3,454,148

Registered June 24, 2008

TRADEMARK  
PRINCIPAL REGISTER

凯慕狮  
*Kaimushi*

CHANGSHU KAIMUSHI APPAREL CO., LTD.  
(CHINA CORPORATION)  
ZHITANG INDUSTRIAL PARK  
CHANGSHU; JIANGSU  
CHINA

FOR: CLOTHING, NAMELY, COATS, JACKETS,  
OVERCOATS, TROUSERS, T-SHIRTS, PANTS,  
SWEATSHIRTS, SHIRTS, UNDERWEAR, DRESSES,  
SKIRTS, LAYETTES, DOWN JACKETS, DOWN-  
PADDED ANORAKS; SHOES; HATS; CAPS; TIES;  
GLOVES; HOSIERY; WEDDING GOWNS; WED-  
DING DRESSES, IN CLASS 25 (U.S. CLS. 22 AND 39).

OWNER OF INTERNATIONAL REGISTRATION  
0942142 DATED 10-24-2007, EXPIRES 10-24-2017.

THE MARK CONSISTS OF THREE CHINESE  
CHARACTERS AND EIGHT LATIN CHARACTERS  
"KAIMUSHI".

THE ENGLISH TRANSLATION OF THE FOR-  
EIGN WORD(S) IN THE MARK IS: THE TRANSLA-  
TION OF THE THREE CHINESE CHARACTERS IS  
"TRIUMPHANT", "ADMIRE" AND "LION" RESPEC-  
TIVELY; BUT THE THREE CHINESE CHARAC-  
TERS AS A WHOLE HAS NO MEANING IN A  
FOREIGN LANGUAGE; THE LATIN WORD "KAI-  
MUSHI" HAS NO MEANING IN A FOREIGN LAN-  
GUAGE.

THE TANSLITERATION OF THE NON-LATIN  
CHARACTERS IN THE MARK IS: "KAI", "MU" AND  
"SHI".

SER. NO. 79-045,673, FILED 10-24-2007.

ZACHARY BELLO, EXAMINING ATTORNEY

**Int. Cl.: 21**

**Prior U.S. Cls.: 2, 13, 23, 29, 30, 33, 40 and 50**

**Reg. No. 3,454,149**

**United States Patent and Trademark Office**

**Registered June 24, 2008**

---

**TRADEMARK  
PRINCIPAL REGISTER**

# Dead Wringers

ANDERSON BRYCE MEDIA LTD (UNITED  
KINGDOM LIMITED COMPANY)  
88 LANCASTER ROAD  
LONDON W11 1QS  
UNITED KINGDOM

FOR: HOUSEHOLD AND KITCHEN UTENSILS,  
NAMELY, SALT AND PEPPER GRINDERS, CORK-  
SCREWS, IN CLASS 21 (U.S. CLS. 2, 13, 23, 29, 30, 33, 40  
AND 50).

THE MARK CONSISTS OF STANDARD CHAR-  
ACTERS WITHOUT CLAIM TO ANY PARTICULAR  
FONT, STYLE, SIZE, OR COLOR.

OWNER OF INTERNATIONAL REGISTRATION  
0942209 DATED 7-12-2007, EXPIRES 7-12-2017.

SER. NO. 79-045,686, FILED 7-12-2007.

AISHA SALEM, EXAMINING ATTORNEY

**Int. Cl.: 6**

**Prior U.S. Cls.: 2, 12, 13, 14, 23, 25 and 50**

**Reg. No. 3,454,150**

**United States Patent and Trademark Office**

**Registered June 24, 2008**

**TRADEMARK  
PRINCIPAL REGISTER**

**友 发**

TIANJIN YOU FA STEEL PIPE; GROUP CO.,  
LTD. (CHINA CORPORATION)  
BAIYIYUAN INDUSTRIAL ZONE,  
DAQIUZHUANG, JINGHAI COUNTY; TIANJIN  
CHINA

THE NON-LATIN CHARACTERS IN THE MARK  
TRANSLITERATE TO "YOU" AND "FA" AND THIS  
MEANS "FRIENDLY" AND "DEVELOP" IN ENG-  
LISH.

FOR: STEEL PIPES AND TUBES, BRANCHING  
TUBES OF METAL FOR PIPELINES, CASINGS OF  
METAL FOR OILWELLS, METAL WATER PIPES,  
METAL GUTTER PIPES, METAL TUBES, IN CLASS  
6 (U.S. CLS. 2, 12, 13, 14, 23, 25 AND 50).

SER. NO. 79-045,807, FILED 10-22-2007.

OWNER OF INTERNATIONAL REGISTRATION  
0942528 DATED 10-22-2007, EXPIRES 10-22-2017.

DEBRA LEE, EXAMINING ATTORNEY

**Int. Cl.: 30**

**Prior U.S. Cl.: 46**

**United States Patent and Trademark Office**

**Reg. No. 3,454,151**

**Registered June 24, 2008**

**TRADEMARK  
PRINCIPAL REGISTER**

# De Conti

DECONTI CO. S.R.L. (ITALY LTD LIAB CO)  
VIA WASHINGTON, 5  
I-20146 MILANO  
ITALY

THE MARK CONSISTS OF STANDARD CHARACTERS WITHOUT CLAIM TO ANY PARTICULAR FONT, STYLE, SIZE, OR COLOR.

FOR: COFFEE, TEA, COCOA, SUGAR, RICE, TAPIOCA, COFFEE SURROGATES IN THE NAME OF GRAIN OR CHICORY BASED COFFEE SUBSTITUTES, BREAKFAST CEREALS, BREAD, BAKERY GOODS AND CONFECTIONERY IN THE NAME OF COOKIES, BISCUITS, ICE CREAM, HONEY, GOLDEN SYRUP, YEAST, BAKING POWDER, SALT, MUSTARD SAUCE, VINEGAR, SPICES; ICE, IN CLASS 30 (U.S. CL. 46).

OWNER OF INTERNATIONAL REGISTRATION  
0942725 DATED 7-30-2007, EXPIRES 7-30-2017.

SER. NO. 79-045,872, FILED 7-30-2007.

TASHIA BUNCH, EXAMINING ATTORNEY

**Int. Cl.: 11**

**Prior U.S. Cls.: 13, 21, 23, 31 and 34**

**United States Patent and Trademark Office**

**Reg. No. 3,454,152**

**Registered June 24, 2008**

**TRADEMARK  
PRINCIPAL REGISTER**

**COLOR-e-MOTION**

OSRAM; GESELLSCHAFT MIT BESCHRÄNKTER  
HAFTUNG (FED REP GERMANY LTD LIAB  
CO)

HELLABRUNNER STR. 1  
81543 MÜNCHEN  
FED REP GERMANY

OWNER OF INTERNATIONAL REGISTRATION  
0925926 DATED 6-4-2007, EXPIRES 6-4-2017.

SER. NO. 79-045,952, FILED 10-23-2007.

FOR: LIGHTING APPARATUS, NAMELY ELEC-  
TRIC LAMPS AND LUMINAIRES, AND STRUC-  
TURAL PARTS OF THE AFOREMENTIONED  
GOODS, IN CLASS 11 (U.S. CLS. 13, 21, 23, 31 AND 34).

AISHA SALEM, EXAMINING ATTORNEY

**Int. Cl.: 25**

**Prior U.S. Cls.: 22 and 39**

**United States Patent and Trademark Office**

**Reg. No. 3,454,153**

**Registered June 24, 2008**

**TRADEMARK  
PRINCIPAL REGISTER**

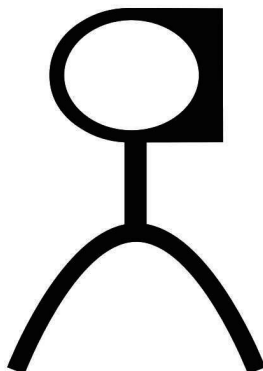

PAYA TORRES, ESMERALDA (SPAIN INDIVIDUAL)  
LA GOLETA, 3- BL. 1,  
PORTAL 1, 3 C; E-03540 ALICANTE  
SPAIN

FOR: CLOTHING FOR MEN, WOMEN AND CHILDREN, NAMELY, SOCKS, STOCKINGS, LINGERIE, HOSIERY, BRASSIERES, PANTIES, KNICKERS, OVERALLS, DRESSES, EVENING GOWNS, WEDDING GOWNS, TOPS, TANK TOPS, VESTS, UNDERSHIRTS, UNDERPANTS, PAJAMAS, NIGHTGOWNS, SWIMSUITS, TROUSERS, LEGGINGS, SHORTS, SKIRTS, SLACKS, SWEATPANTS, BLOUSES, SHIRTS, T-SHIRTS, SWEATSHIRTS, SWEATERS, WAISTCOATS, SHAWLS, PULLOVERS, CARDIGANS, JERSEYS, JACKETS, SUITS, TIES,

CRAVATS, OVERCOATS, COATS, HUNTING JACKETS, TRACKSUITS, RAINCOATS, GLOVES, SUSPENDERS, BELTS, STOLE AND PONCHOS; FOOTWEAR, NAMELY, SHOES, SANDALS, SLIPPERS, BOOTS, CANVAS SHOES, SNEAKERS, ESPADRILLES; HEADGEAR, NAMELY, HATS, SCARVES, CAPS AND HEADBANDS, IN CLASS 25 (U.S. CLS. 22 AND 39).

OWNER OF INTERNATIONAL REGISTRATION  
0943141 DATED 2-14-2007, EXPIRES 2-14-2017.

SER. NO. 79-046,078, FILED 2-14-2007.

RUSS HERMAN, EXAMINING ATTORNEY

**Int. Cls.: 6 and 20**

**Prior U.S. Cls.: 2, 12, 13, 14, 22, 23, 25, 32 and 50**

**United States Patent and Trademark Office**

**Reg. No. 3,454,154**

**Registered June 24, 2008**

**TRADEMARK  
PRINCIPAL REGISTER**

**FYBRLOAD**

ERIS (FRANCE SOCIÉTÉ À RESPONSABILITÉ  
LIMITÉE)  
"LES BLANCHES"  
F-31130 FLOURENS  
FRANCE

PRIORITY DATE OF 4-23-2007 IS CLAIMED.

OWNER OF INTERNATIONAL REGISTRATION  
0943372 DATED 10-23-2007, EXPIRES 10-23-2017.

FOR: METAL FASTENERS, NAMELY, RIVETS,  
IN CLASS 6 (U.S. CLS. 2, 12, 13, 14, 23, 25 AND 50).

SER. NO. 79-046,159, FILED 10-23-2007.

FOR: NON-METAL FASTENERS, NAMELY, RIV-  
ETS, IN CLASS 20 (U.S. CLS. 2, 13, 22, 25, 32 AND 50).

LINDSEY RUBIN, EXAMINING ATTORNEY

**Int. Cls.: 6 and 20**

**Prior U.S. Cls.: 2, 12, 13, 14, 22, 23, 25, 32 and 50**

**United States Patent and Trademark Office**

**Reg. No. 3,454,155**

**Registered June 24, 2008**

**TRADEMARK  
PRINCIPAL REGISTER**

**FYBRFLUSH**

ERIS (FRANCE SOCIÉTÉ À RESPONSABILITÉ  
LIMITÉE)  
"LES BLANCHES"  
F-31130 FLOURENS  
FRANCE

PRIORITY DATE OF 4-26-2007 IS CLAIMED.

OWNER OF INTERNATIONAL REGISTRATION  
0943373 DATED 10-23-2007, EXPIRES 10-23-2017.

FOR: METAL FASTENERS, NAMELY, RIVETS,  
ESPECIALLY FOR COMPOSITE MATERIALS, IN  
CLASS 6 (U.S. CLS. 2, 12, 13, 14, 23, 25 AND 50).

SER. NO. 79-046,160, FILED 10-23-2007.

FOR: NON-METAL FASTENERS, NAMELY, RIV-  
ETS, ESPECIALLY FOR COMPOSITE MATERIALS,  
IN CLASS 20 (U.S. CLS. 2, 13, 22, 25, 32 AND 50).

LINDSEY RUBIN, EXAMINING ATTORNEY



**Int. Cls.: 6 and 20**

**Prior U.S. Cls.: 2, 12, 13, 14, 22, 23, 25, 32 and 50**

**United States Patent and Trademark Office**

**Reg. No. 3,454,156**

**Registered June 24, 2008**

**TRADEMARK  
PRINCIPAL REGISTER**

**HI-CLAMP**

ERIS (FRANCE SOCIÉTÉ À RESPONSABILITÉ  
LIMITÉE)  
"LES BLANCHES"  
FLOURENS, FRANCE F31130

OWNER OF INTERNATIONAL REGISTRATION  
0943374 DATED 10-23-2007, EXPIRES 10-23-2017.

FOR: METAL FASTENERS, NAMELY, RIVETS,  
IN CLASS 6 (U.S. CLS. 2, 12, 13, 14, 23, 25 AND 50).

SER. NO. 79-046,161, FILED 10-23-2007.

FOR: NON-METAL FASTENERS, NAMELY, RIV-  
ETS, IN CLASS 20 (U.S. CLS. 2, 13, 22, 25, 32 AND 50).

PRIORITY DATE OF 4-23-2007 IS CLAIMED.

LINDSEY RUBIN, EXAMINING ATTORNEY

**Int. Cls.: 7 and 12**

**Prior U.S. Cls.: 13, 19, 21, 23, 31, 34, 35 and 44**

**United States Patent and Trademark Office**

**Reg. No. 3,454,157**

**Registered June 24, 2008**

**TRADEMARK  
PRINCIPAL REGISTER**

**FAUN**

FAUN UMWELTTECHNIK GMBH & CO. KG  
(FED REP GERMANY CORPORATION)  
FELDHORST 4  
27711 OSTERHOLZ-SCHARMBECK  
FED REP GERMANY

FOR: LAND VEHICLES FOR MUNICIPAL USE,  
NAMELY, ROAD SWEEPERS, VEHICLES FOR  
CLEANING SEWER PIPES; PARTS OF THE AFORE-  
SAID GOODS, IN CLASS 7 (U.S. CLS. 13, 19, 21, 23, 31,  
34 AND 35).

FOR: MOTOR-DRIVEN LAND VEHICLES,  
NAMELY, DUMPERS, REFUSE TRUCKS, MOTOR-

DRIVEN VEHICLES FOR MUNICIPAL USE, NAME-  
LY, STREET SPRAYERS, STREET CLEANERS;  
PARTS OF THE AFORESAID GOODS, IN CLASS 12  
(U.S. CLS. 19, 21, 23, 31, 35 AND 44).

OWNER OF INTERNATIONAL REGISTRATION  
0498931A DATED 8-2-1985, EXPIRES 8-2-2015.

SER. NO. 79-046,182, FILED 9-14-2007.

SHARON MEIER, EXAMINING ATTORNEY

**Int. Cl.: 5**

**Prior U.S. Cls.: 6, 18, 44, 46, 51 and 52**

**United States Patent and Trademark Office**

**Reg. No. 3,454,158**

**Registered June 24, 2008**

**TRADEMARK  
PRINCIPAL REGISTER**

**Z AFLUNOV**

NOVARTIS AG (SWITZERLAND CORPORATION)  
CH-4002 BASEL  
SWITZERLAND

FOR: VACCINES FOR HUMAN USE, IN CLASS 5  
(U.S. CLS. 6, 18, 44, 46, 51 AND 52).

THE MARK CONSISTS OF STANDARD CHARACTERS WITHOUT CLAIM TO ANY PARTICULAR FONT, STYLE, SIZE, OR COLOR.

PRIORITY DATE OF 7-3-2007 IS CLAIMED.

OWNER OF INTERNATIONAL REGISTRATION  
0943761 DATED 10-10-2007, EXPIRES 10-10-2017.

SER. NO. 79-046,348, FILED 10-10-2007.

DAYNA BROWNE, EXAMINING ATTORNEY

**Int. Cl.: 5**

**Prior U.S. Cls.: 6, 18, 44, 46, 51 and 52**

**United States Patent and Trademark Office**

**Reg. No. 3,454,159**

**Registered June 24, 2008**

**TRADEMARK  
PRINCIPAL REGISTER**

# AFINITORI

NOVARTIS AG (SWITZERLAND CORPORATION)  
CH-4002 BASEL  
SWITZERLAND

OWNER OF INTERNATIONAL REGISTRATION  
0943872 DATED 11-5-2007, EXPIRES 11-5-2017.

FOR: PHARMACEUTICAL PREPARATIONS FOR  
USE IN ONCOLOGY, IN CLASS 5 (U.S. CLS. 6, 18, 44,  
46, 51 AND 52).

OWNER OF U.S. REG. NOS. 3,216,046 AND  
3,216,047.

THE MARK CONSISTS OF STANDARD CHAR-  
ACTERS WITHOUT CLAIM TO ANY PARTICULAR  
FONT, STYLE, SIZE, OR COLOR.

SER. NO. 79-046,393, FILED 11-5-2007.

PRIORITY DATE OF 9-20-2007 IS CLAIMED.

DAYNA BROWNE, EXAMINING ATTORNEY

**Int. Cl.: 5**

**Prior U.S. Cls.: 6, 18, 44, 46, 51 and 52**

**United States Patent and Trademark Office**

**Reg. No. 3,454,160**

**Registered June 24, 2008**

**TRADEMARK  
PRINCIPAL REGISTER**

**AFINITOL**

NOVARTIS AG (SWITZERLAND CORPORATION)  
CH-4002 BASEL  
SWITZERLAND

OWNER OF INTERNATIONAL REGISTRATION  
0943873 DATED 11-5-2007, EXPIRES 11-5-2017.

FOR: PHARMACEUTICAL PREPARATIONS FOR  
USE IN ONCOLOGY, IN CLASS 5 (U.S. CLS. 6, 18, 44,  
46, 51 AND 52).

OWNER OF U.S. REG. NO. 3,216,047.

THE MARK CONSISTS OF STANDARD CHAR-  
ACTERS WITHOUT CLAIM TO ANY PARTICULAR  
FONT, STYLE, SIZE, OR COLOR.

SER. NO. 79-046,394, FILED 11-5-2007.

PRIORITY DATE OF 9-20-2007 IS CLAIMED.

DAYNA BROWNE, EXAMINING ATTORNEY

**Int. Cl.: 5**

**Prior U.S. Cls.: 6, 18, 44, 46, 51 and 52**

**United States Patent and Trademark Office**

**Reg. No. 3,454,161**

**Registered June 24, 2008**

**TRADEMARK  
PRINCIPAL REGISTER**

# AFIMTOR

NOVARTIS AG (SWITZERLAND CORPORATION)  
CH-4002 BASEL  
SWITZERLAND

OWNER OF INTERNATIONAL REGISTRATION  
0943874 DATED 11-5-2007, EXPIRES 11-5-2017.

FOR: PHARMACEUTICAL PREPARATIONS FOR  
USE IN ONCOLOGY, IN CLASS 5 (U.S. CLS. 6, 18, 44,  
46, 51 AND 52).

OWNER OF U.S. REG. NO. 3,216,047.

THE MARK CONSISTS OF STANDARD CHAR-  
ACTERS WITHOUT CLAIM TO ANY PARTICULAR  
FONT, STYLE, SIZE, OR COLOR.

SER. NO. 79-046,395, FILED 11-5-2007.

PRIORITY DATE OF 9-20-2007 IS CLAIMED.

DAYNA BROWNE, EXAMINING ATTORNEY

**Int. Cl.: 5**

**Prior U.S. Cls.: 6, 18, 44, 46, 51 and 52**

**United States Patent and Trademark Office**

**Reg. No. 3,454,162**

**Registered June 24, 2008**

**TRADEMARK  
PRINCIPAL REGISTER**

**AFINYTOR**

NOVARTIS AG (SWITZERLAND CORPORATION)  
CH-4002 BASEL  
SWITZERLAND

OWNER OF INTERNATIONAL REGISTRATION  
0943875 DATED 11-5-2007, EXPIRES 11-5-2017.

FOR: PHARMACEUTICAL PREPARATIONS FOR  
USE IN ONCOLOGY, IN CLASS 5 (U.S. CLS. 6, 18, 44,  
46, 51 AND 52).

OWNER OF U.S. REG. NOS. 3,216,046 AND  
3,216,047.

THE MARK CONSISTS OF STANDARD CHAR-  
ACTERS WITHOUT CLAIM TO ANY PARTICULAR  
FONT, STYLE, SIZE, OR COLOR.

SER. NO. 79-046,396, FILED 11-5-2007.

PRIORITY DATE OF 9-20-2007 IS CLAIMED.

DAYNA BROWNE, EXAMINING ATTORNEY

**Int. Cl.: 5**

**Prior U.S. Cls.: 6, 18, 44, 46, 51 and 52**

**United States Patent and Trademark Office**

**Reg. No. 3,454,163**

**Registered June 24, 2008**

**TRADEMARK  
PRINCIPAL REGISTER**

**AFINITALL**

NOVARTIS AG (SWITZERLAND CORPORATION)  
CH-4002 BASEL  
SWITZERLAND

OWNER OF INTERNATIONAL REGISTRATION  
0943876 DATED 11-5-2007, EXPIRES 11-5-2017.

FOR: PHARMACEUTICAL PREPARATIONS FOR  
USE IN ONCOLOGY, IN CLASS 5 (U.S. CLS. 6, 18, 44,  
46, 51 AND 52).

OWNER OF U.S. REG. NO. 3,216,047.

THE MARK CONSISTS OF STANDARD CHAR-  
ACTERS WITHOUT CLAIM TO ANY PARTICULAR  
FONT, STYLE, SIZE, OR COLOR.

SER. NO. 79-046,397, FILED 11-5-2007.

PRIORITY DATE OF 9-20-2007 IS CLAIMED.

DAYNA BROWNE, EXAMINING ATTORNEY



Int. Cl.: 33

Prior U.S. Cls.: 47 and 49

United States Patent and Trademark Office

Reg. No. 3,454,164

Registered June 24, 2008

TRADEMARK  
PRINCIPAL REGISTER

CASTELLO DI RONCADE



CIANI BASSETTI VINCENZO (ITALY INDIVIDUAL)  
VIA ROMA, 141  
I-31056 RONCADE (TV), ITALY

THE ENGLISH TRANSLATION OF THE WORD  
"CASTELLO DI" IN THE MARK IS CASTLE OF.

FOR: WINES, TABLE WINES, SPARKLING  
WINES, GRAPPA, LIQUEURS, IN CLASS 33 (U.S.  
CLS. 47 AND 49).

SER. NO. 79-046,434, FILED 4-10-2007.

OWNER OF INTERNATIONAL REGISTRATION  
0943967 DATED 4-10-2007, EXPIRES 4-10-2017.

WENDY JUN, EXAMINING ATTORNEY

**Int. Cl.: 16**

**Prior U.S. Cls.: 2, 5, 22, 23, 29, 37, 38 and 50**

**Reg. No. 3,454,165**

**United States Patent and Trademark Office**

**Registered June 24, 2008**

**TRADEMARK  
PRINCIPAL REGISTER**

**EMOZIONI IN MUSICA**

RICHEMONT ITALIA S.P.A. (ITALY JOINT  
STOCK COMPANY)  
VIA LUDOVICO DI BREME, 44  
I-20156 MILANO  
ITALY

FOR: WRITING INSTRUMENTS, NAMELY,  
FOUNTAIN PENS, BALLPOINT PENS, FELT-TIP  
PENS, ROLLER BALL PENS, DOCUMENT MAR-  
KER PENS, PENCILS, WRITING BRUSHES; VAR-  
IOUS PARTS OF THE AFOREMENTIONED  
WRITING INSTRUMENTS, IN PARTICULAR NIBS;  
WRITING INKS, REFILLS AND CARTRIDGES FOR  
THE AFOREMENTIONED VARIOUS TYPES OF  
WRITING INSTRUMENTS; POUCHES FOR WRIT-  
ING INSTRUMENTS, GIFT CASES FITTED FOR  
WRITING INSTRUMENTS; GIFT SETS COMPRISED  
OF THE VARIOUS AFOREMENTIONED WRITING  
INSTRUMENTS AND GIFT CASES FITTED THERE-  
FOR; PEN AND PENCIL HOLDERS, IN CLASS 16  
(U.S. CLS. 2, 5, 22, 23, 29, 37, 38 AND 50).

THE MARK CONSISTS OF STANDARD CHAR-  
ACTERS WITHOUT CLAIM TO ANY PARTICULAR  
FONT, STYLE, SIZE, OR COLOR.

PRIORITY DATE OF 7-10-2007 IS CLAIMED.

OWNER OF INTERNATIONAL REGISTRATION  
0944227 DATED 10-19-2007, EXPIRES 10-19-2017.

THE ENGLISH TRANSLATION OF THE FOR-  
EIGN WORD(S) IN THE MARK IS: EMOTIONS IN  
MUSIC.

SER. NO. 79-046,524, FILED 10-19-2007.

ANN E. SAPPENFIELD, EXAMINING ATTORNEY

**Int. Cl.: 25**

**Prior U.S. Cls.: 22 and 39**

**United States Patent and Trademark Office**

**Reg. No. 3,454,166**

**Registered June 24, 2008**

**TRADEMARK  
PRINCIPAL REGISTER**

# PART TWO

IC COMPANYS A/S (DENMARK PUBLIC LIMITED COMPANY)  
RAFFINADERIVEJ 10  
DK-2300 COPENHAGEN S  
DENMARK

FOR: MEN'S AND WOMEN'S JEANS, PANTS, SHORTS, SHIRTS, T-SHIRTS, SWEATSHIRTS, SWEATERS, BELTS, COATS, JACKETS, BLAZERS, COVER-ALLS, OVERALLS, VESTS, SHOES, TIES, SOCKS, SCARVES, SWIMWEAR, BOOTS, UNDERWEAR, SHIRT JACKETS, POLO SHIRTS, AND WOMEN'S SKIRTS, DRESSES, BLOUSES, SHAWLS, KNIT TOPS, AND STOCKINGS, IN CLASS 25 (U.S. CLS. 22 AND 39).

THE MARK CONSISTS OF STANDARD CHARACTERS WITHOUT CLAIM TO ANY PARTICULAR FONT, STYLE, SIZE, OR COLOR.

OWNER OF INTERNATIONAL REGISTRATION  
0909112 DATED 12-4-2006, EXPIRES 12-4-2016.

SER. NO. 79-046,699, FILED 10-26-2007.

MARK T. MULLEN, EXAMINING ATTORNEY

Int. Cls.: 29, 30 and 32

Prior U.S. Cls.: 45, 46 and 48

United States Patent and Trademark Office

Reg. No. 3,454,167

Registered June 24, 2008

TRADEMARK  
PRINCIPAL REGISTER



SOCIÉTÉ DES PRODUITS NESTLÉ S.A. (SWITZERLAND SOCIÉTÉ ANONYME)

CH-1800 VEVEY  
SWITZERLAND

FOR: PRESERVED, FROZEN, DRIED AND COOKED VEGETABLES, POTATOES AND FRUITS; PRESERVED, DRIED AND COOKED MUSHROOMS; MEAT, POULTRY, GAME, FISH AND SEAFOOD; MEAT EXTRACTS, JELLIES; FRUIT SPREADS; FRUIT PRESERVES; COOKED, DEEP-FROZEN AND DEHYDRATED ENTREES CONSISTING PRIMARILY OF MEAT, POULTRY, GAME, FISH AND SEAFOOD; JAMS; EGGS; MILK; CREAM; BUTTER; CHEESE; MILK PRODUCTS, NAMELY, HALF AND HALF, MILK PROTEINS AND MILK BEVERAGES WITH HIGH MILK CONTENT; PRESERVED SOY BEANS FOR HUMAN CONSUMPTION; EDIBLE OILS AND FATS; PROTEINS BEING FOODSTUFFS FOR HUMAN CONSUMPTION; NON-DAIRY CREAMER; SAUSAGES; CHARCUTERIE; PEANUT BUTTER; SOUPS; CONCENTRATED SOUPS; THICK SOUPS; BOUILLON CUBES; BOUILLONS; AND CLEAR SOUPS, IN CLASS 29 (U.S. CL. 46).

FOR: COFFEE; COFFEE EXTRACTS; COFFEE-BASED BEVERAGES; ICED COFFEE; ARTIFICIAL COFFEE; ARTIFICIAL COFFEE EXTRACTS; BEVERAGES MADE FROM ARTIFICIAL COFFEE; CHICORY; TEA; TEA EXTRACTS; TEA-BASED BEVERAGES; MALT FOR FOOD PURPOSES; COCOA; COCOA-BASED BEVERAGES; CHOCOLATE; HOT CHOCOLATE; CONFECTIONARY; SUGAR CONFECTIONARY; SWEETS; SUGAR; CHEWING GUM NOT FOR MEDICAL PURPOSES; NATURAL

SWEETENERS; BAKERY PRODUCTS; BREAD; YEAST; PASTRIES; BISCUITS; CAKES; COOKIES; WAFERS; CARAMELS; PUDDINGS; ICES; WATER ICES; SORBETS; ICE CONFECTIONARIES; ICED CAKES; ICE CREAMS, ICE DESSERTS; FROZEN YOGURT; HONEY AND HONEY SUBSTITUTES; BREAKFAST CEREALS; MUESLI, CORN FLAKES; READY-TO-EAT CEREAL DERIVED FOOD BARS; READY-TO-EAT PROCESSED CEREALS; RICE; PASTA; NOODLES; PREPARED ENTREES CONSISTING PRIMARILY OF RICE; PIZZAS; SANDWICHES; FARINACEOUS FOOD PASTES FOR HUMAN CONSUMPTION; CAKE PASTRY; SAUCES; SOYA SAUCE; KETCHUP; PRODUCTS FOR FLAVORING OR SEASONING FOODSTUFFS; EDIBLE SPICES; SALAD DRESSINGS; MAYONNAISE, MUSTARD AND VINEGAR, IN CLASS 30 (U.S. CL. 46).

FOR: BEER; STILL WATER; SPARKLING AND AERATED WATER; MINERAL WATER; FLAVORED WATER; FRUIT-FLAVORED BEVERAGES AND BEVERAGES MADE WITH FRUIT; FRUIT JUICES AND VEGETABLE JUICES; FRUIT NECTARS; LEMONADES; SOFT DRINKS; SYRUPS, CONCENTRATES AND POWDERS FOR MAKING SOFT DRINKS; AND ISOTONIC BEVERAGES, IN CLASS 32 (U.S. CLS. 45, 46 AND 48).

PRIORITY DATE OF 8-21-2007 IS CLAIMED.

OWNER OF INTERNATIONAL REGISTRATION  
0944685 DATED 10-24-2007, EXPIRES 10-24-2017.

SER. NO. 79-046,712, FILED 10-24-2007.

PATRICIA EVANKO, EXAMINING ATTORNEY

**Int. Cls.: 6 and 20**

**Prior U.S. Cls.: 2, 12, 13, 14, 22, 23, 25, 32 and 50**

**United States Patent and Trademark Office**

**Reg. No. 3,454,168**

**Registered June 24, 2008**

**TRADEMARK  
PRINCIPAL REGISTER**

**TI-LOAD**

ERIS (FRANCE SOCIÉTÉ À RESPONSABILITÉ  
LIMITÉE)  
"LES BLANCHES"  
F-31130 FLOURENS  
FRANCE

FOR: METAL FASTENERS, NAMELY, RIVETS,  
IN CLASS 6 (U.S. CLS. 2, 12, 13, 14, 23, 25 AND 50).

FOR: NON-METAL FASTENERS, NAMELY, RIV-  
ETS, IN CLASS 20 (U.S. CLS. 2, 13, 22, 25, 32 AND 50).

PRIORITY DATE OF 5-10-2007 IS CLAIMED.

OWNER OF INTERNATIONAL REGISTRATION  
0945248 DATED 11-7-2007, EXPIRES 11-7-2017.

SER. NO. 79-046,903, FILED 11-7-2007.

LINDSEY RUBIN, EXAMINING ATTORNEY

**Int. Cls.: 6 and 20**

**Prior U.S. Cls.: 2, 12, 13, 14, 22, 23, 25, 32 and 50**

**United States Patent and Trademark Office**

**Reg. No. 3,454,169**

**Registered June 24, 2008**

**TRADEMARK  
PRINCIPAL REGISTER**

**SWAGELOAD**

ERIS (FRANCE SOCIÉTÉ À RESPONSABILITÉ  
LIMITÉE)  
"LES BLANCHES"  
F-31130 FLOURENS  
FRANCE

PRIORITY DATE OF 5-21-2007 IS CLAIMED.

OWNER OF INTERNATIONAL REGISTRATION  
0945249 DATED 11-7-2007, EXPIRES 11-7-2017.

FOR: METAL FASTENERS, NAMELY, RIVETS,  
IN CLASS 6 (U.S. CLS. 2, 12, 13, 14, 23, 25 AND 50).

SER. NO. 79-046,904, FILED 11-7-2007.

FOR: NON-METAL FASTENERS, NAMELY, RIV-  
ETS, IN CLASS 20 (U.S. CLS. 2, 13, 22, 25, 32 AND 50).

LINDSEY RUBIN, EXAMINING ATTORNEY

**Int. Cl.: 25**

**Prior U.S. Cls.: 22 and 39**

**United States Patent and Trademark Office**

**Reg. No. 3,454,170**

**Registered June 24, 2008**

**TRADEMARK  
PRINCIPAL REGISTER**

**CUSTOM SHELL**

SALOMON S.A. (FRANCE SOCIÉTÉ ANONYME)  
LIEUDIT LES CROISELETS  
F-74370 METZ-TESSY  
FRANCE

FOR: NON-ORTHOPEDIC FOOTWEAR, SKI  
BOOTS, SURFBOARD BOOTS AND NON-ORTHO-  
PEDIC FOOTWEAR PARTS, NAMELY, INNER  
BOOTS AND REINFORCEMENTS FOR SKI BOOTS  
AND SURFBOARD BOOTS SOLD THEREWITH, IN  
CLASS 25 (U.S. CLS. 22 AND 39).

THE MARK CONSISTS OF STANDARD CHAR-  
ACTERS WITHOUT CLAIM TO ANY PARTICULAR  
FONT, STYLE, SIZE, OR COLOR.

PRIORITY DATE OF 6-1-2007 IS CLAIMED.

OWNER OF INTERNATIONAL REGISTRATION  
0945252 DATED 11-9-2007, EXPIRES 11-9-2017.

NO CLAIM IS MADE TO THE EXCLUSIVE  
RIGHT TO USE "CUSTOM", APART FROM THE  
MARK AS SHOWN.

SER. NO. 79-046,907, FILED 11-9-2007.

REBECCA SMITH, EXAMINING ATTORNEY



Int. Cl.: 25

Prior U.S. Cls.: 22 and 39

United States Patent and Trademark Office

Reg. No. 3,454,171

Registered June 24, 2008

TRADEMARK  
PRINCIPAL REGISTER



SALLY PATRICIA ALLEN (UNITED KINGDOM  
INDIVIDUAL)  
GLAMOUR 2 GO LTD, 68 THAMES ROAD  
CHISWICK, LONDON W4 3RE  
UNITED KINGDOM

FOR: WOMEN'S CLOTHING, NAMELY, SHIRTS,  
PANTS, SKIRTS, DRESSES, SWEATERS, LINGERIE,  
UNDER GARMENTS, JACKETS, COATS, SCARVES,  
SASHES, PANTYHOSE, TOPS, BOTTOMS, BRAS,  
BATHING SUITS, BATHROBES, BEACHWEAR,  
BELTS, BODY SHAPERS, BODY SUITS, WRAP-  
AROUNDS, COVERALLS, COVER-UPS, GOWNS,  
GYM SUITS, HEADWEAR, HOSIERY, JEANS,  
JUMPSUITS, JOGGING SUITS, JUMPERS, LOUN-  
GEWEAR, STOCKINGS, LEGGINGS, NECKWEAR,  
NIGHTWEAR, OVERALLS, PAJAMAS, SUITS,  
PULLOVERS, RAINWEAR, GLOVES, ROBES,  
SLACKS, SMOCKS, SWEATSHIRTS, SWEAT  
SHORTS, SWEAT SUITS, TIGHTS, TRAINING  
SUITS, TURTLENECKS, UNDERCLOTHES, UNI-  
TARDS, VESTS AND WRAPS, IN CLASS 25 (U.S.  
CLS. 22 AND 39).

OWNER OF INTERNATIONAL REGISTRATION  
0945321 DATED 9-21-2007, EXPIRES 9-21-2017.

NO CLAIM IS MADE TO THE EXCLUSIVE  
RIGHT TO USE "LONDON", APART FROM THE  
MARK AS SHOWN.

THE COLOR(S) FUCHSIA, PINK, WHITE AND  
BLACK IS/ARE CLAIMED AS A FEATURE OF THE  
MARK.

THE MARK CONSISTS OF A BLACK BACK-  
GROUND, THE WORD "GLAMOUR" IN PINK  
AND FUCHSIA LOWERCASE LETTERS AND THE  
WORD AND NUMBER "2 GO" IN WHITE AND THE  
WORD "LONDON" IN WHITE.

SER. NO. 79-046,929, FILED 9-21-2007.

MARK RADEMACHER, EXAMINING ATTORNEY

**Int. Cl.: 25**

**Prior U.S. Cls.: 22 and 39**

**United States Patent and Trademark Office**

**Reg. No. 3,454,172**

**Registered June 24, 2008**

**TRADEMARK  
PRINCIPAL REGISTER**



SALLY PATRICIA ALLEN (UNITED KINGDOM  
INDIVIDUAL)  
GLAMOUR 2 GO LTD, 68 THAMES ROAD  
CHISWICK, LONDON W4 3RE  
UNITED KINGDOM

FOR: WOMEN'S CLOTHING, NAMELY, SHIRTS,  
PANTS, SKIRTS, DRESSES, SWEATERS, LINGERIE,  
UNDER GARMENTS, JACKETS, COATS, SCARVES,  
SASHES, PANTYHOSE, TOPS, BOTTOMS, BRAS,  
BATHING SUITS, BATHROBES, BEACHWEAR,  
BELTS, BODY SHAPERS, BODY SUITS, WRAP-  
AROUNDS, COVERALLS, COVER-UPS, GOWNS,  
GYM SUITS, HEADWEAR, HOSIERY, JEANS,  
JUMPSUITS, JOGGING SUITS, JUMPERS, LOUN-  
GEWEAR, STOCKINGS, LEGGINGS, NECKWEAR,  
NIGHTWEAR, OVERALLS, PAJAMAS, SUITS,  
PULLOVERS, RAINWEAR, GLOVES, ROBES,  
SLACKS, SMOCKS, SWEATSHIRTS, SWEAT  
SHORTS, SWEAT SUITS, TIGHTS, TRAINING  
SUITS, TURTLENECKS, UNDERCLOTHES, UNI-  
TARDS, VESTS AND WRAPS, IN CLASS 25 (U.S.  
CLS. 22 AND 39).

OWNER OF INTERNATIONAL REGISTRATION  
0945322 DATED 9-21-2007, EXPIRES 9-21-2017.

THE COLOR(S) FUCHSIA, PINK, WHITE AND  
BLACK IS/ARE CLAIMED AS A FEATURE OF THE  
MARK.

BLACK BACKGROUND, "GLAMOUR" IN PINK  
AND FUCHSIA, "24/7" IN WHITE.

THE MARK CONSISTS OF A BLACK BACK-  
GROUND, THE WORD "GLAMOUR" IN PINK  
AND FUCHSIA LOWERCASE LETTERS AND THE  
NUMBERS "24/7" IN WHITE.

SER. NO. 79-046,930, FILED 9-21-2007.

MARK RADEMACHER, EXAMINING ATTORNEY

**Int. Cl.: 8**

**Prior U.S. Cls.: 23, 28 and 44**

**United States Patent and Trademark Office**

**Reg. No. 3,454,173**

**Registered June 24, 2008**

**TRADEMARK  
PRINCIPAL REGISTER**



CUMBO, S.R.L. (ITALY LTD LIAB CO)  
VIA MICHELANGELO BUONARROTI, 10  
I-20090 CESANO BOSCONI (MI), ITALY

OWNER OF INTERNATIONAL REGISTRATION  
0588113 DATED 7-29-1992, EXPIRES 7-29-2012.

FOR: CUTLERY, IN CLASS 8 (U.S. CLS. 23, 28 AND  
44).

SER. NO. 79-046,963, FILED 10-23-2007.

MICHAEL TANNER, EXAMINING ATTORNEY

**Int. Cl.: 11**

**Prior U.S. Cls.: 13, 21, 23, 31 and 34**

**United States Patent and Trademark Office**

**Reg. No. 3,454,174**

**Registered June 24, 2008**

**TRADEMARK  
PRINCIPAL REGISTER**

**MIRRAKEL**

POOLRITE RESEARCH PTY LTD (AUSTRALIA  
COMMON WEALTH OF AUSTRALIA)  
415 CREEK ROAD  
MOUNT GRAVATT QLD 4122  
AUSTRALIA

FOR: WATER TREATMENT APPARATUS BEING  
WATER FILTERING AND WATER PURIFICATION  
UNITS FOR PURIFYING, STERILIZING, DECON-  
TAMINATING AND CHLORINATING WATER IN  
SWIMMING POOLS, SPAS AND SPA BATHS, IN  
CLASS 11 (U.S. CLS. 13, 21, 23, 31 AND 34).

THE MARK CONSISTS OF STANDARD CHAR-  
ACTERS WITHOUT CLAIM TO ANY PARTICULAR  
FONT, STYLE, SIZE, OR COLOR.

PRIORITY DATE OF 8-7-2007 IS CLAIMED.

OWNER OF INTERNATIONAL REGISTRATION  
0945608 DATED 10-9-2007, EXPIRES 10-9-2017.

SER. NO. 79-047,042, FILED 10-9-2007.

VIVIAN MICZNIK FIRST, EXAMINING ATTOR-  
NEY

**Int. Cls.: 6 and 11**

**Prior U.S. Cls.: 2, 12, 13, 14, 21, 23, 25, 31, 34 and 50**

**United States Patent and Trademark Office**

**Reg. No. 3,454,175**

**Registered June 24, 2008**

**TRADEMARK  
PRINCIPAL REGISTER**

**LEGIOFLOW**

CALEFFI S.P.A. (ITALY SOCIETÀ PER AZIONI  
(SPA))

S.S. 229

I-28010 FONTANETO D'AGOGNA, NOVARA  
ITALY

FOR: VALVES NOT OF PRECIOUS METAL,  
NAMELY, METAL VALVES NOT BEING PARTS  
OF MACHINES, IN CLASS 6 (U.S. CLS. 2, 12, 13, 14, 23,  
25 AND 50).

FOR: VALVES NOT OF PRECIOUS METAL FOR  
SANITARY AND HEATING SYSTEMS, NAMELY,  
THERMOSTATIC VALVES, IN CLASS 11 (U.S. CLS.  
13, 21, 23, 31 AND 34).

THE MARK CONSISTS OF STANDARD CHAR-  
ACTERS WITHOUT CLAIM TO ANY PARTICULAR  
FONT, STYLE, SIZE, OR COLOR.

PRIORITY DATE OF 9-11-2007 IS CLAIMED.

OWNER OF INTERNATIONAL REGISTRATION  
0945624 DATED 10-12-2007, EXPIRES 10-12-2017.

OWNER OF U.S. REG. NO. 3,237,664.

SER. NO. 79-047,048, FILED 10-12-2007.

JAMES LOVELACE, EXAMINING ATTORNEY

**Int. Cl.: 1**

**Prior U.S. Cls.: 1, 5, 6, 10, 26 and 46**

**United States Patent and Trademark Office**

**Reg. No. 3,454,176**

**Registered June 24, 2008**

**TRADEMARK  
PRINCIPAL REGISTER**

**ANYPOL**

SH CHEMICAL CO., LTD. (REPUBLIC OF KOREA CORPORATION)  
25, SORYONG-DONG  
KUNSAN CITY; CHONLABUK-DO 573-879, REPUBLIC OF KOREA

FOR: POLYSTYRENE RESINS, UNPROCESSED; STYRENE ACRYLONITRILE RESINS, UNPROCESSED; POLY METHYL METHACRYLATE RESINS, UNPROCESSED; ACRYLONITRILE BUTADIENE RESINS, UNPROCESSED, IN CLASS 1 (U.S. CLS. 1, 5, 6, 10, 26 AND 46).

THE MARK CONSISTS OF STANDARD CHARACTERS WITHOUT CLAIM TO ANY PARTICULAR FONT, STYLE, SIZE, OR COLOR.

OWNER OF INTERNATIONAL REGISTRATION 0947700 DATED 10-22-2007, EXPIRES 10-22-2017.

SER. NO. 79-047,812, FILED 10-22-2007.

VERNA BETH RIRIE, EXAMINING ATTORNEY

**Int. Cls.: 9, 35 and 42**

**Prior U.S. Cls.: 21, 23, 26, 36, 38, 100, 101 and 102**

**United States Patent and Trademark Office**

**Reg. No. 3,454,177**

**Registered June 24, 2008**

**TRADEMARK  
SERVICE MARK  
PRINCIPAL REGISTER**

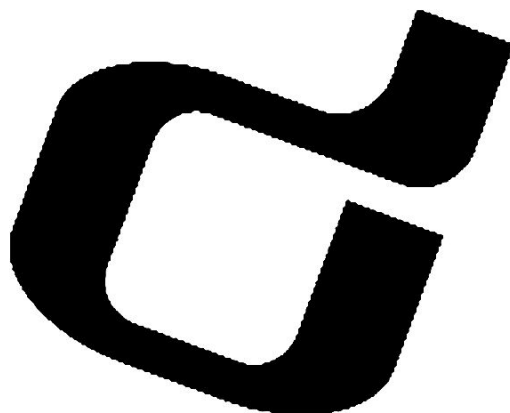

ESTSOFT CORP. (REPUBLIC OF KOREA LIMITED COMPANY)  
ESTSOFT R&D CENTER 867-12  
BONGCHEON 4 (SA)-DONG,; GWANAK-GU;  
SEOUL151-836  
REPUBLIC OF KOREA

FOR: RECORDED COMPUTER PROGRAMS FOR DATABASE MANAGEMENT; COMPUTER PROGRAMS RECORDED ON DATA MEDIA (SOFTWARE) DESIGNED FOR USE IN FILE COMPRESSION, ARCHIVING, VIRUS SCANNING AND COMPUTER FILE MANAGEMENT, IN CLASS 9 (U.S. CLS. 21, 23, 26, 36 AND 38).

FOR: ON-LINE ADVERTISING ON A COMPUTER COMMUNICATIONS NETWORK; MANAGEMENT

OF COMPUTERIZED FILES, IN CLASS 35 (U.S. CLS. 100, 101 AND 102).

FOR: COMPUTER PROGRAMMING; COMPUTER SOFTWARE DESIGN FOR OTHERS; HOSTING AND MAINTENANCE OF INTERNET WEBSITES FOR OTHERS; INSTALLATION OF COMPUTER SOFTWARE; MAINTENANCE OF COMPUTER SOFTWARE, IN CLASS 42 (U.S. CLS. 100 AND 101).

OWNER OF INTERNATIONAL REGISTRATION 0947707 DATED 10-24-2007, EXPIRES 10-24-2017.

SER. NO. 79-047,815, FILED 10-24-2007.

SHANNON TWOHIG, EXAMINING ATTORNEY

Int. Cl.: 25

Prior U.S. Cls.: 22 and 39

United States Patent and Trademark Office

Reg. No. 3,454,178

Registered June 24, 2008

TRADEMARK  
PRINCIPAL REGISTER



CHAOJIE GROUP CO., LTD. (CHINA CORPORATION)  
XIHE INDUSTRIAL ZONE  
HOZHAI STREET, YIWU CITY; 322000 ZHEJIANG  
PROVINCE  
CHINA

FOR: CLOTHING, NAMELY, DRESSES, JACKETS, SKIRTS, COATS; UNDERWEAR; SHIRTS; TROUSERS; KNITWEAR, NAMELY, KNITTED DRESSES, KNITTED JACKETS, KNITTED SKIRTS, KNITTED COATS; UNDERGARMENTS; UNDERPANTS; BABY BODYSUITS, IN CLASS 25 (U.S. CLS. 22 AND 39).

OWNER OF INTERNATIONAL REGISTRATION  
0947824 DATED 10-22-2007, EXPIRES 10-22-2017.

THE ENGLISH TRANSLATION OF THE FOREIGN WORD(S) IN THE MARK IS: THE FIRST CHINESE CHARACTER MEANS "DAGGER"; THE SECOND MEANS "MAPLE"; THE COMBINATION OF THE TWO CHARACTERS HAS NO MEANING.

THE TRANSLITERATION OF THE NON-LATIN CHARACTERS IN THE MARK IS: GE FENG.

SER. NO. 79-047,876, FILED 10-22-2007.

VERNA BETH RIRIE, EXAMINING ATTORNEY



**Int. Cls.: 29 and 33**

**Prior U.S. Cls.: 46, 47 and 49**

**United States Patent and Trademark Office**

**Reg. No. 3,454,179**

**Registered June 24, 2008**

**TRADEMARK  
PRINCIPAL REGISTER**

**PININO**

CAPSTON ITALIA S.R.L.; SOCIETÀ AGRICOLA  
(ITALY LTD LIAB CO)  
LOCALITÀ IL PININO, 327  
I-53024 MONTALCINO (SI)  
ITALY

FOR: EXTRA VIRGIN OLIVE OIL, IN CLASS 29  
(U.S. CL. 46).

FOR: ALCOHOLIC BEVERAGES EXCEPT BEERS,  
IN CLASS 33 (U.S. CLS. 47 AND 49).

THE MARK CONSISTS OF STANDARD CHAR-  
ACTERS WITHOUT CLAIM TO ANY PARTICULAR  
FONT, STYLE, SIZE, OR COLOR.

OWNER OF INTERNATIONAL REGISTRATION  
0947883 DATED 10-1-2007, EXPIRES 10-1-2017.

SER. NO. 79-047,895, FILED 10-1-2007.

BERNICE MIDDLETON, EXAMINING ATTORNEY

**Int. Cls.: 9 and 41**

**Prior U.S. Cls.: 21, 23, 26, 36, 38, 100, 101 and 107**

**United States Patent and Trademark Office**

**Reg. No. 3,454,180**

**Registered June 24, 2008**

**TRADEMARK  
SERVICE MARK  
PRINCIPAL REGISTER**

# CABAL Online

ESTSOFT CORP. (REPUBLIC OF KOREA LIMITED COMPANY)  
ESTSOFT R&D CENTER 867-12  
BONGCHEON 4 (SA)-DONG,; GWANAK-GU;  
SEOUL151-836  
REPUBLIC OF KOREA

FOR: DOWNLOADABLE COMPUTER PROGRAMS FEATURING POSITIONABLE GAME PIECE FIGURES FOR USE IN THE FIELD OF COMPUTER GAMES, IN CLASS 9 (U.S. CLS. 21, 23, 26, 36 AND 38).

FOR: ENTERTAINMENT SERVICES, NAMELY, PROVIDING AN ON-LINE COMPUTER GAME, IN CLASS 41 (U.S. CLS. 100, 101 AND 107).

THE MARK CONSISTS OF STANDARD CHARACTERS WITHOUT CLAIM TO ANY PARTICULAR FONT, STYLE, SIZE, OR COLOR.

OWNER OF INTERNATIONAL REGISTRATION 0948273 DATED 10-30-2007, EXPIRES 10-30-2017.

NO CLAIM IS MADE TO THE EXCLUSIVE RIGHT TO USE "ONLINE", APART FROM THE MARK AS SHOWN.

SER. NO. 79-048,036, FILED 10-30-2007.

SHANNON TWOHIG, EXAMINING ATTORNEY

**Int. Cl.: 20**

**Prior U.S. Cls.: 2, 13, 22, 25, 32 and 50**

**United States Patent and Trademark Office**

**Reg. No. 3,454,181**

**Registered June 24, 2008**

**TRADEMARK  
PRINCIPAL REGISTER**

**Modus**

**WILKHAHN WILKENING + HAHNE GMBH &  
CO. (FED REP GERMANY LIMITED PART-  
NERSHIP)**

**EIMBECKHAUSEN**

**FRITZ-HAHNE-STR. 8; 31848 BAD MÜNDER**

**FED REP GERMANY**

**THE MARK CONSISTS OF STANDARD CHAR-  
ACTERS WITHOUT CLAIM TO ANY PARTICULAR  
FONT, STYLE, SIZE, OR COLOR.**

**OWNER OF INTERNATIONAL REGISTRATION  
0771921 DATED 11-29-2001, EXPIRES 11-29-2011.**

**SER. NO. 79-048,054, FILED 7-17-2007.**

**FOR: FURNITURE, IN CLASS 20 (U.S. CLS. 2, 13,  
22, 25, 32 AND 50).**

**CHARISMA HAMPTON, EXAMINING ATTORNEY**

**Int. Cl.: 9**

**Prior U.S. Cls.: 21, 23, 26, 36 and 38**

**Reg. No. 3,454,182**

**United States Patent and Trademark Office**

**Registered June 24, 2008**

---

**TRADEMARK  
PRINCIPAL REGISTER**

**TECHXIV**

SUMCO CORPORATION (JAPAN CORPORATION)  
1-2-1 SHIBAURA, MINATO-KU  
TOKYO 105-8634, JAPAN

OWNER OF INTERNATIONAL REGISTRATION  
0948576 DATED 9-4-2007, EXPIRES 9-4-2017.

FOR: SEMI-CONDUCTOR WAFERS, IN CLASS 9  
(U.S. CLS. 21, 23, 26, 36 AND 38).

SER. NO. 79-048,153, FILED 9-4-2007.

WILLIAM ROSSMAN, EXAMINING ATTORNEY

**Int. Cl.: 9**

**Prior U.S. Cls.: 21, 23, 26, 36 and 38**

**Reg. No. 3,454,183**

**United States Patent and Trademark Office**

**Registered June 24, 2008**

**TRADEMARK  
PRINCIPAL REGISTER**

**SUNTOUCH**

ESSILOR INTERNATIONAL; (COMPAGNIE  
GENERALE D'OPTIQUE) (FRANCE SOCIÉTÉ  
ANONYME)

147 RUE DE PARIS  
F-94220 CHARENTON LE PONT  
FRANCE

FOR: OPHTHALMIC LENSES; SPECTACLE LENSES, NAMELY, PLASTICS LENSES, OPHTHALMIC LENSES, CORRECTIVE LENSES, PROGRESSIVE LENSES, SUNGLASS LENSES, POLARIZED LENSES, TINTED LENSES, COLOURED LENSES, LIGHT-SENSITIVE LENSES, PHOTOCHROMIC LENSES, TREATED LENSES, COATED LENSES, ANTI-REFLECTIVE LENSES, SEMI-FINISHED LENSES; SPECTACLE LENS BLANKS; SEMI-FINISHED SPECTACLE LENS BLANKS; OPHTHALMIC LENS

CASES; SPECTACLE LENS CASES, IN CLASS 9 (U.S. CLS. 21, 23, 26, 36 AND 38).

THE MARK CONSISTS OF STANDARD CHARACTERS WITHOUT CLAIM TO ANY PARTICULAR FONT, STYLE, SIZE, OR COLOR.

PRIORITY DATE OF 7-6-2007 IS CLAIMED.

OWNER OF INTERNATIONAL REGISTRATION  
0948779 DATED 8-13-2007, EXPIRES 8-13-2017.

SER. NO. 79-048,220, FILED 8-13-2007.

EUGENIA MARTIN, EXAMINING ATTORNEY

**Int. Cls.: 10 and 25**

**Prior U.S. Cls.: 22, 26, 39 and 44**

**United States Patent and Trademark Office**

**Reg. No. 3,454,184**

**Registered June 24, 2008**

**TRADEMARK  
PRINCIPAL REGISTER**

**HAPPYVEN**

GLORIA MAGLIERIA ELASTICA S.R.L. (ITALY  
CORPORATION)  
VIA DIAZ, 7  
I-22017 MENAGGIO (COMO)  
ITALY

FOR: ELASTIC STOCKINGS FOR MEDICAL  
PURPOSES; ELASTIC SUPPORTIVE BANDAGES  
FOR ANKLES AND KNEES; ELASTIC BANDAGES  
AND BANDS FOR ORTHOPEDIC USE; ABDOMIN-  
AL CORSETS; ELASTIC PANTIES FOR ORTHOPE-  
DIC USE, IN CLASS 10 (U.S. CLS. 26, 39 AND 44).

FOR: STOCKINGS, SOCKS, PANTYHOSE,  
TIGHTS, IN CLASS 25 (U.S. CLS. 22 AND 39).

THE MARK CONSISTS OF STANDARD CHAR-  
ACTERS WITHOUT CLAIM TO ANY PARTICULAR  
FONT, STYLE, SIZE, OR COLOR.

PRIORITY DATE OF 8-30-2007 IS CLAIMED.

OWNER OF INTERNATIONAL REGISTRATION  
0949723 DATED 10-16-2007, EXPIRES 10-16-2017.

SER. NO. 79-048,571, FILED 10-16-2007.

PETER B. BROMAGHIM, EXAMINING ATTORNEY

**Int. Cls.: 5, 9, 38, 41 and 42**

**Prior U.S. Cls.: 6, 18, 21, 23, 26, 36, 38, 44, 46, 51, 52,  
100, 101, 104 and 107**

**Reg. No. 3,454,185**

**United States Patent and Trademark Office**

**Registered June 24, 2008**

**TRADEMARK  
SERVICE MARK  
PRINCIPAL REGISTER**

# WHAT'S UP

SOCIÉTÉ DE CONSEILS DE RECHERCHES ET  
D'APPLICATIONS SCIENTIFIQUES  
(S.C.R.A.S.) (FRANCE SOCIÉTÉ PAR ACTIONS  
SIMPLIFIÉE)

42, RUE DU DOCTEUR BLANCHE  
F-75016 PARIS  
FRANCE

FOR: A FULL LINE OF PHARMACEUTICAL  
PREPARATIONS, FOOD FOR BABIES, MEDICAL  
PLASTERS, MATERIALS FOR DRESSINGS, NAME-  
LY, BANDAGES, WOUND DRESSINGS AND BURN  
DRESSINGS, MATERIALS FOR STOPPING TEE-  
THING AND DENTAL WAX, ALL PURPOSE DIS-  
INFECTANTS, IN CLASS 5 (U.S. CLS. 6, 18, 44, 46, 51  
AND 52).

FOR: PHOTOGRAPHIC, OPTICAL, TEACHING  
APPARATUS AND INSTRUMENTS, ALL FOR USE  
WITH TELECOMMUNICATIONS IN THE NATURE  
OF APPARATUS FOR RECORDING, TRANSMIT-  
TING AND PRODUCING SOUND, IMAGES, OR  
DATA, NAMELY, BLANK MAGNETIC AND OPTI-  
CAL DATA CARRIERS AND RECORDING DISCS,  
DATA PROCESSORS AND COMPUTERS; COMPU-  
TER SOFTWARE FOR PROVIDING ADVERTISING  
INFORMATION IN THE FIELDS OF SCIENCE,  
HEALTH, BEAUTY, MEDICINE, PHARMACY  
AND COSMETOLOGY, IN CLASS 9 (U.S. CLS. 21,  
23, 26, 36 AND 38).

FOR: TELECOMMUNICATION SERVICES,  
NAMELY, TRANSMISSION OF INFORMATION,  
DATA, IMAGES AND SOUNDS, VIA COMPUTER  
TERMINALS, AND THE INTERNET; ELECTRONIC  
MAIL SERVICES, IN CLASS 38 (U.S. CLS. 100, 101  
AND 104).

FOR: TRAINING SERVICES IN THE FIELDS OF  
SCIENCE, HEALTH, BEAUTY, MEDICINE, PHAR-  
MACY AND COSMETOLOGY; PUBLISHING OF  
BOOKS, PRINTED MATTER, MAGAZINES, NEWS-

PAPERS, BROCHURES, CD-ROMS, SOFTWARE,  
AND COMPUTER DATA FOR USE ON A COMPU-  
TER NETWORK; ARRANGING AND CONDUCT-  
ING OF COLLOQUIUMS, EDUCATIONAL  
CONFERENCES, EDUCATIONAL CONVENTIONS  
AND SEMINARS, SYMPOSIUMS WHICH MAY BY  
ACCOMPANIED OR ORGANIZED AROUND  
BREAKFAST OR LUNCH, IN CLASS 41 (U.S. CLS.  
100, 101 AND 107).

FOR: SCIENTIFIC, MEDICAL AND INDUSTRIAL  
RESEARCH SERVICES AND RESEARCH AND DE-  
VELOPMENT SERVICES FOR OTHERS FOR NEW  
PRODUCTS IN THE FIELD OF CHEMICALS, PHAR-  
MACEUTICAL PREPARATIONS AND COSMETICS;  
RESEARCH IN THE FIELDS OF BIOLOGY, BAC-  
TERIOLOGY, CHEMISTRY AND COSMETOLOGY;  
DESIGN FOR OTHERS OF CHEMICALS, PROPRI-  
ETARY DRUGS, PLANTS AND PHARMACEUTICAL  
PROCEDURES IN THE PRODUCTION OF PHAR-  
MACOLOGICALLY-ACTIVE SUBSTANCES AND  
PREPARATIONS, COSMETICS; TESTING AND DI-  
AGNOSTIC SERVICES FOR CHEMICALS, PHAR-  
MACEUTICAL PREPARATIONS AND COSMETICS,  
CHEMICAL, BIOLOGICAL AND BACTERIOLOGI-  
CAL ANALYSIS SERVICES; DESIGN AND DEVEL-  
OPMENT OF COMPUTER HARDWARE AND  
SOFTWARE, IN CLASS 42 (U.S. CLS. 100 AND 101).

THE MARK CONSISTS OF STANDARD CHAR-  
ACTERS WITHOUT CLAIM TO ANY PARTICULAR  
FONT, STYLE, SIZE, OR COLOR.

OWNER OF INTERNATIONAL REGISTRATION  
0840107 DATED 7-28-2004, EXPIRES 7-28-2014.

SER. NO. 79-975,026, FILED 2-17-2005.

RON FAIRBANKS, EXAMINING ATTORNEY

**Int. Cl.: 9**

**Prior U.S. Cls.: 21, 23, 26, 36, and 38**

**Reg. No. 3,454,186**

**United States Patent and Trademark Office**

**Registered June 24, 2008**

---

**TRADEMARK  
PRINCIPAL REGISTER**

**BLAZE**

HARLEQUIN ENTERPRISES LIMITED (CANADA CORPORATION)  
225 DUNCAN MILL ROAD  
DON MILLS, ONTARIO M3B 3K9, CANADA

FIRST USE 10-31-2005; IN COMMERCE 10-31-2005.

SN 75-741,599, FILED 6-30-1999.

FOR: DOWNLOADABLE ELECTRONIC PUBLICATIONS, NAMELY ROMANCE NOVELS, IN CLASS 9 (U.S. CLS. 21, 23, 26, 36 AND 38).

BENJAMIN OKEKE, EXAMINING ATTORNEY



**Int. Cl.: 41**

**Prior U.S. Cls.: 100, 101, and 107**

**United States Patent and Trademark Office**

**Reg. No. 3,454,187**

**Registered June 24, 2008**

**SERVICE MARK  
PRINCIPAL REGISTER**

**LEARN AT THE SPEED OF LIFE**

STUFF WITH MEANING, INC. (WASHINGTON CORPORATION)  
9792 EDMONDS WAY  
NO. 412  
EDMONDS, WA 98020

FOR: PROVIDING EDUCATIONAL COUNSELING BY MEANS OF OFFERING LEARNING ASSESSMENT QUESTIONNAIRES AND, BASED ON THE RESULTS OF THE LEARNING ASSESSMENTS, PROVIDING LEARNING STRATEGIES, REFERRALS AND RECOMMENDATIONS FOR MEAN-

INGFUL LEARNING OPPORTUNITIES, IN CLASS 41 (U.S. CLS. 100, 101 AND 107).

FIRST USE 7-1-2007; IN COMMERCE 7-1-2007.

THE MARK CONSISTS OF STANDARD CHARACTERS WITHOUT CLAIM TO ANY PARTICULAR FONT, STYLE, SIZE, OR COLOR.

SN 76-018,509, FILED 3-29-2000.

LINDA MICKLEBURGH, EXAMINING ATTORNEY

**Int. Cls.: 7 and 8**

**Prior U.S. Cls.: 13, 19, 21, 23, 28, 31, 34, 35, and 44**

**United States Patent and Trademark Office**

**Reg. No. 3,454,188**

**Registered June 24, 2008**

---

**TRADEMARK  
PRINCIPAL REGISTER**

**BIG MAX**

FLEET WHOLESALE SUPPLY CO., INC. (WIS-  
CONSIN CORPORATION)  
1300 SOUTH LYNNDAL DRIVE  
APPLETON, WI 54911

FOR: EMERGENCY AUTOMOBILE TIRE  
CHANGE KIT CONSISTING OF A HYDRAULIC  
CAR JACK, IN CLASS 7 (U.S. CLS. 13, 19, 21, 23, 31, 34  
AND 35).

FIRST USE 6-1-2000; IN COMMERCE 6-1-2000.

FOR: HAND TOOLS, NAMELY, LUG WREN-  
CHES, IN CLASS 8 (U.S. CLS. 23, 28 AND 44).

FIRST USE 6-1-2000; IN COMMERCE 6-1-2000.

SN 76-042,084, FILED 5-5-2000.

WILLIAM VERHOSEK, EXAMINING ATTORNEY

**Int. Cls.: 18, 20, 22, and 25**

**Prior U.S. Cls.: 1, 2, 3, 7, 13, 19, 22, 25, 32, 39, 41, 42,  
and 50**

**Reg. No. 3,454,189**

**United States Patent and Trademark Office**

**Registered June 24, 2008**

---

**TRADEMARK  
PRINCIPAL REGISTER**



MARMOT MOUNTAIN LTD. (NEVADA CORPORATION)  
2321 CIRCADIAN WAY  
SANTA ROSA, CA 95407

FOR: BACKPACKS, IN CLASS 18 (U.S. CLS. 1, 2, 3, 22 AND 41).

FIRST USE 8-0-2000; IN COMMERCE 8-0-2000.

FOR: SLEEPING BAGS , IN CLASS 20 (U.S. CLS. 2, 13, 22, 25, 32 AND 50).

FIRST USE 8-0-2000; IN COMMERCE 8-0-2000.

FOR: TENTS, IN CLASS 22 (U.S. CLS. 1, 2, 7, 19, 22, 42 AND 50).

FIRST USE 8-0-2000; IN COMMERCE 8-0-2000.

FOR: CLOTHING, NAMELY, SHORTS, SHIRTS, JACKETS, PANTS, SWEATERS, CLOTH BIBS, HATS, GLOVES, PARKAS AND FOOTWEAR, IN CLASS 25 (U.S. CLS. 22 AND 39).

FIRST USE 8-0-2000; IN COMMERCE 8-0-2000.

SN 76-112,629, FILED 8-18-2000.

JASON TURNER, EXAMINING ATTORNEY

**Int. Cls.: 35, 36, 38, and 42**

**Prior U.S. Cls.: 100, 101, 102, and 104**

**United States Patent and Trademark Office**

**Reg. No. 3,454,190**

**Registered June 24, 2008**

**SERVICE MARK  
PRINCIPAL REGISTER**

**ELECTRONIC RX NETWORK**

ERX NETWORK, LLC (TEXAS LTD LIAB CO),  
FORMERLY ELECTRONIC RX NETWORK,  
LLC,  
301 COMMERCE STREET  
SUITE 3150  
FORT WORTH, TX 76102

FOR: PROMOTING THE GOODS AND SERVICES OF OTHERS BY PROVIDING HYPERTEXT LINKS TO THE WEB SITES OF OTHERS; PROMOTING THE GOODS AND SERVICES OF OTHERS BY MEANS OF OPERATING AN ON-LINE SHOPPING MALL WITH LINKS TO THE RETAIL WEB SITES OF OTHERS; PROVIDING SPACE AT A WEB SITE FOR THE ADVERTISEMENT OF THE GOODS AND SERVICES OF OTHERS, IN CLASS 35 (U.S. CLS. 100, 101 AND 102).

FIRST USE 9-0-2001; IN COMMERCE 9-0-2001.

FOR: PROVIDING INFORMATION IN THE FIELD OF INSURANCE PLAN INFORMATION ALL VIA A GLOBAL COMPUTER NETWORK; INSURANCE CONSULTATION SERVICES, NAMELY, PRE-SCREENING PHARMACY CLAIMS FOR COMPLIANCE WITH INSURANCE PLAN REQUIREMENTS; INSURANCE MANAGEMENT SERVICES, NAMELY, INSURANCE PLAN RECONCILIATION AND FACTORING FOR OTHERS, IN CLASS 36 (U.S. CLS. 100, 101 AND 102).

FIRST USE 9-0-2001; IN COMMERCE 9-0-2001.

FOR: TELECOMMUNICATION SERVICES, NAMELY, DATA SWITCHING SERVICES FOR USE IN TRANSMITTING MEDICAL PRESCRIPTIONS BETWEEN PHARMACIES AND INSUR-

ANCE PROVIDERS AND PROVIDING MULTIPLE USER ACCESS FOR PHARMACIES AND INSURANCE PROVIDERS FOR USE IN AUTHORIZING AND FILLING PRESCRIPTIONS AND PRESCRIPTION REFILLS; PROVIDING MULTIPLE USER ACCESS TO AN ON-LINE DATABASE FEATURING DRUG AND PHARMACEUTICAL COMPLIANCE AND CUSTOMER ORDER STATUS INFORMATION ALL VIA A GLOBAL COMPUTER NETWORK, IN CLASS 38 (U.S. CLS. 100, 101 AND 104).

FIRST USE 9-0-2001; IN COMMERCE 9-0-2001.

FOR: PROVIDING MEDICAL AND PHYSICIAN INFORMATION ALL VIA A GLOBAL COMPUTER NETWORK; PROVIDING A SECURE DATABASE FEATURING PATIENT INFORMATION AND PRESCRIPTION HISTORIES VIA A GLOBAL COMPUTER NETWORK; PROVIDING INFORMATION TO PATIENTS IN THE FIELD OF DRUG AND PHARMACEUTICAL COMPLIANCE VIA A GLOBAL COMPUTER NETWORK, IN CLASS 42 (U.S. CLS. 100 AND 101).

FIRST USE 9-0-2001; IN COMMERCE 9-0-2001.

OWNER OF U.S. REG. NOS. 2,805,955, 2,886,947, AND 2,891,548.

NO CLAIM IS MADE TO THE EXCLUSIVE RIGHT TO USE "ELECTRONIC" AND "NETWORK", APART FROM THE MARK AS SHOWN.

SN 76-262,294, FILED 5-21-2001.

MICHAEL KEATING, EXAMINING ATTORNEY

**Int. Cl.: 30**

**Prior U.S. Cl.: 46**

**United States Patent and Trademark Office**

**Reg. No. 3,454,191**

**Registered June 24, 2008**

**TRADEMARK  
PRINCIPAL REGISTER**



BARBARA'S BAKERY, INC. (CALIFORNIA CORPORATION)  
3900 CYPRESS DRIVE  
PETALUMA, CA 94954

FOR: PROCESSED ORGANIC FOODS, NAMELY, COOKIES, CRACKERS, BREAKFAST CEREALS, CEREAL-BASED BARS; FOOD PRODUCTS, NAMELY, CEREAL-DERIVED FOOD BARS, GRANOLA-BASED SNACK BARS, COOKIES, BREAKFAST CEREALS, PUFFED CORN SNACKS, CRACKERS, IN CLASS 30 (U.S. CL. 46).

FIRST USE 0-0-2005; IN COMMERCE 0-0-2005.

OWNER OF U.S. REG. NO. 1,446,650.

NO CLAIM IS MADE TO THE EXCLUSIVE RIGHT TO USE "BAKERY", APART FROM THE MARK AS SHOWN.

SN 76-416,819, FILED 6-4-2002.

PAULA MAHONEY, EXAMINING ATTORNEY

**Int. Cl.: 29**

**Prior U.S. Cl.: 46**

**United States Patent and Trademark Office**

**Reg. No. 3,454,192**

**Registered June 24, 2008**

**TRADEMARK  
PRINCIPAL REGISTER**

**SURE CHEF**

BLUEBONNET FOODS L.P. (TEXAS LIMITED  
PARTNERSHIP)  
11122 NACOGDOCHES RD.  
SAN ANTONIO, TX 78212

SOUPS, AND SOUP MIXES , IN CLASS 29 (U.S. CL.  
46).

FIRST USE 11-1-2007; IN COMMERCE 11-1-2007.

FOR: PACKAGED ENTREES CONSISTING PRI-  
MARILY OF BEEF, CHICKEN, PORK, SAUSAGE,  
SHRIMP, VEGETABLES, EGG ROLLS, SPRING  
ROLLS, QUESADILLAS, TAQUITOS, TACOS,

SN 76-472,823, FILED 12-6-2002.

ROBERT LORENZO, EXAMINING ATTORNEY

**Int. Cls.: 1 and 3**

**Prior U.S. Cls.: 1, 4, 5, 6, 10, 26, 46, 50, 51, and 52**

**Reg. No. 3,454,193**

**United States Patent and Trademark Office**

**Registered June 24, 2008**

**TRADEMARK  
PRINCIPAL REGISTER**

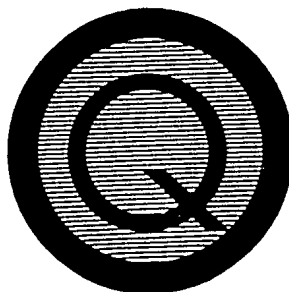

QUEST ENVIRONMENTAL & SAFETY PRODUCTS, INC. (INDIANA CORPORATION)  
9892 EAST 121ST STREET  
FISHERS, IN 46038

FOR: ADHESIVES PRODUCTS, NAMELY, SPRAY ADHESIVE, SPRAY GLUE, LIQUID PASTE, BONDING SPRAY, FOR INDUSTRIAL USE AND COMMERCIAL USE AND FOR USE IN THE ASBESTOS ABATEMENT FIELD, IN CLASS 1 (U.S. CLS. 1, 5, 6, 10, 26 AND 46).

FIRST USE 3-0-1997; IN COMMERCE 3-0-1997.

FOR: ADHESIVE REMOVAL PRODUCTS, NAMELY, MASTIC REMOVERS, IN THE NATURE OF TAN LATEX AND BLACK MASTIC REMOVERS,

FLOOR GLUE DISSOLVER, FLOOR TILE MASTIC REMOVERS, CARPET ADHESIVE REMOVERS, GLUE REMOVERS, AND ADHESIVE DISSOLVERS FOR INDUSTRIAL USE AND COMMERCIAL USE AND FOR USE IN THE ASBESTOS ABATEMENT FIELD, IN CLASS 3 (U.S. CLS. 1, 4, 6, 50, 51 AND 52).

FIRST USE 4-1-1997; IN COMMERCE 4-1-1997.

THE LINING IS A FEATURE OF THE MARK AND DOES NOT INDICATE COLOR.

SN 76-484,535, FILED 1-23-2003.

MARLENE BELL, EXAMINING ATTORNEY

**Int. Cl.: 9**

**Prior U.S. Cls.: 21, 23, 26, 36, and 38**

**Reg. No. 3,454,194**

**United States Patent and Trademark Office**

**Registered June 24, 2008**

**TRADEMARK  
PRINCIPAL REGISTER**

**PEACH RECORDS**

PEACH RECORDS ASSOCIATES, LLC (FLORIDA  
LIMITED LIABILITY CORPORATION)  
C/O CITRIN COOPERMAN & CO.  
529 FIFTH AVENUE, SECOND FLOOR  
NEW YORK, NY 10017

FIRST USE 7-31-2007; IN COMMERCE 7-31-2007.

NO CLAIM IS MADE TO THE EXCLUSIVE  
RIGHT TO USE "RECORDS", APART FROM THE  
MARK AS SHOWN.

FOR: MUSICAL SOUND RECORDINGS, NAME-  
LY, PHONOGRAPH RECORDS, PRE-RECORDED  
TAPES AND COMPACT DISCS; VIDEO RECORD-  
INGS, NAMELY, VIDEO TAPES AND DVDS FEA-  
TURING MUSIC, IN CLASS 9 (U.S. CLS. 21, 23, 26, 36  
AND 38).

SN 76-486,394, FILED 1-30-2003.

NELSON SNYDER, EXAMINING ATTORNEY



**Int. Cl.: 22**

**Prior U.S. Cls.: 1, 2, 7, 19, 22, 42, and 50**

**Reg. No. 3,454,195**

**United States Patent and Trademark Office**

**Registered June 24, 2008**

**TRADEMARK  
PRINCIPAL REGISTER**



DIELECTRIC SOLUTIONS, LLC (PENNSYLVANIA LTD LIAB CO)  
1655 ORR AVENUE  
KITTANNING, PA 16201

FOR: FABRIC MADE OF FIBER GLASS, IN CLASS 22 (U.S. CLS. 1, 2, 7, 19, 22, 42 AND 50).

FIRST USE 8-6-2002; IN COMMERCE 8-6-2002.

NO CLAIM IS MADE TO THE EXCLUSIVE RIGHT TO USE "DIELECTRIC", APART FROM THE MARK AS SHOWN.

THE COLOR(S) WHITE AND GREEN IS/ARE CLAIMED AS A FEATURE OF THE MARK.

THE MARK CONSISTS OF THE COLOR(S) GREEN APPEAR IN THE LINES, THE ROUND BALL AND THE WORDS "DIELECTRIC SOLUTIONS" AND THE COLOR WHITE APPEARS IN THE FOUR LINES WITH ROUND BALLS ON THE RIGHT SIDE OF THE MISCELLANEOUS DESIGN.

SN 76-488,452, FILED 2-10-2003.

NAAKWAMA ANKRAH, EXAMINING ATTORNEY

**Int. Cl.: 5**

**Prior U.S. Cls.: 6, 18, 44, 46, 51, and 52**

**United States Patent and Trademark Office**

**Reg. No. 3,454,196**

**Registered June 24, 2008**

**TRADEMARK  
PRINCIPAL REGISTER**

**OTHERA PHARMACEUTICALS INC.**

OTHERA HOLDING, INC. (DELAWARE CORPORATION)  
1011 CENTRE ROAD  
SUITE 322  
WILMINGTON, DE 19805

FOR: OCULAR PHARMACEUTICALS FOR USE IN THE PREVENTION AND TREATMENT OF CATARACTS, AGE-RELATED MACULAR DEGENERATION, CORNEAL DISEASE, AND GLAUCOMA, IN CLASS 5 (U.S. CLS. 6, 18, 44, 46, 51 AND 52).

FIRST USE 4-30-2008; IN COMMERCE 4-30-2008.

NO CLAIM IS MADE TO THE EXCLUSIVE RIGHT TO USE "PHARMACEUTICALS INC.", APART FROM THE MARK AS SHOWN.

SN 76-518,172, FILED 5-30-2003.

ELIZABETH HUGHITT, EXAMINING ATTORNEY

**Int. Cl.: 25**

**Prior U.S. Cls.: 22 and 39**

**United States Patent and Trademark Office**

**Reg. No. 3,454,197**

**Registered June 24, 2008**

**TRADEMARK  
PRINCIPAL REGISTER**

**O**

OVERSTOCK.COM, INC. (DELAWARE CORPORATION)  
6350 SOUTH 3000 EAST  
SALT LAKE CITY, UT 84121

FOR: FULL LINE OF MEN'S, WOMEN'S, AND CHILDREN'S APPAREL, NAMELY, BOOTS, HIKING BOOTS, HUNTING BOOTS, SNOW BOOTS, GARDEN SHOES, MOCCASINS, CLOGS, SANDALS, HOSIERY, TIGHTS, LEGGINGS, SWEATERS, CARDIGANS, TURTLENECKS, UNDERWEAR, PANTIES, BRAS, BUSTIERS, CAMISOLES, SLIPS, TAP PANTS, TEDDIES, BRIEFS, UNDER SHIRTS, SPORTS BRAS, BLOUSES, SKIRTS, DRESSES,

GOWNS, SWIMSUITS, JACKETS, BLAZERS, BICYCLE SHORTS, LEOTARDS, UNITARDS, PARKAS, JERSEYS, ANORAKS, SKI BIBS, SKI SUITS, GAITERS, ROBES, PAJAMAS, NIGHT SHIRTS, NIGHT GOWNS, SUITS AND SOLD SOLELY THROUGH AN ONLINE WEBSITE, IN CLASS 25 (U.S. CLS. 22 AND 39).

FIRST USE 3-7-2008; IN COMMERCE 3-7-2008.

SN 76-535,671, FILED 8-8-2003.

TAMARA FRAZIER, EXAMINING ATTORNEY

**Int. Cl.: 38**

**Prior U.S. Cls.: 100, 101, and 104**

**United States Patent and Trademark Office**

**Reg. No. 3,454,198**

**Registered June 24, 2008**

**SERVICE MARK  
PRINCIPAL REGISTER**

**ITOWN COMMUNICATIONS**

ITOWN COMMUNICATIONS, INC. (DELAWARE CORPORATION)  
1950 OLD GALLOWS ROAD, SUITE 201  
VIENNA, VA 22182

FOR: TELECOMMUNICATIONS SERVICES, NAMELY, LOCAL, LONG DISTANCE, AND INTERNATIONAL VOICE, TEXT, FACSIMILE, VIDEO AND DATA BY MEANS OF TELEPHONE; TELEGRAPHIC; RADIO; CABLE AND SATELLITE TRANSMISSIONS; FRAME RELAY TELECOMMUNICATIONS SERVICES, NAMELY, PROVIDING FRAME RELAY CONNECTIVITY SERVICES FOR DATA TRANSFER; VIRTUAL NETWORK TELECOMMUNICATIONS SERVICES, NAMELY, PROVIDING FIBER OPTIC NETWORK SERVICES; ELECTRONIC MAIL AND VOICE MAIL AND MESSAGING SERVICES; ELECTRONIC TRANSMISSION OF DATA; ELECTRONIC DATA TRANSMISSION PACKET SERVICES; COMPUTER AIDED TRANSMISSION OF MESSAGES AND IMAGES; AUDIO AND VIDEO TELECONFERENCING SERVICES; PRIVATE LINE VOICE, TEXT, FACSIMILE, VIDEO AND DATA TELECOMMUNICATIONS BY MEANS OF TELEPHONE, TELEGRAPHIC, RADIO, CABLE AND SATELLITE TRANSMISSIONS; INTEGRATED SERVICES DIGITAL NETWORK OR ISDN TELECOMMUNICATIONS SERVICES; TRANSMISSION OF VOICE, TEXT, FACSIMILE, VIDEO AND DATA VIA SATELLITE, RADIO, TERRESTRIAL AND UNDERSEA TELECOMMUNICATIONS LINKS; TELEVISION TRANSMISSION SERVICES; 800 TELEPHONE COMMUNICATIONS SERVICES; 900 TELEPHONE COMMUNICATIONS SERVICES; WORLDWIDE SWITCHED VOICE, DATA, VIDEO AND MULTIMEDIA TRANSMISSION SERVICES; LOCATION INDEPENDENT PERSONAL COMMUNICATIONS SERVICES COMPRISING MOBILE, VOICE, DATA AND FACSIMILE TRANSMISSION SERVICES; PROVIDING TELECOMMUNICATIONS CONNECTIONS TO WORLDWIDE GLOBAL COMPUTER NETWORKS, OTHER COMPUTER NETWORKS, ON-LINE SERVICES AND BULLETIN BOARDS

FEATURING A WIDE VARIETY OF FIELDS AND TOPICS; PROVIDING BACK BONE TELECOMMUNICATIONS NETWORK SERVICES TO OTHERS TO ENABLE THEM TO DISPLAY CONTENT ON WORLDWIDE GLOBAL COMPUTER NETWORKS, OTHER COMPUTER NETWORKS, ON-LINE SERVICES AND BULLETIN BOARDS BY PROVIDING TELECOMMUNICATIONS CONNECTIONS TO A GLOBAL COMPUTER NETWORK; PROVIDING TELECOMMUNICATIONS CONNECTIONS TO ON-LINE INFORMATION SERVICES BY PROVIDING A HIGH SPEED ACCESS TO AREA NETWORKS AND A GLOBAL COMPUTER INFORMATION NETWORK; CABLE RADIO AND TELEVISION TRANSMISSION OF ENTERTAINMENT SERVICES AND VOICE, VIDEO, DATA AND FACSIMILE TELEPHONY SERVICES; INTERNET ACCESS SERVICES TELECOMMUNICATIONS SERVICES, NAMELY, PROVIDING FIBER OPTIC NETWORK SERVICES; PROVIDING HIGH SPEED ACCESS TO AREA NETWORKS AND GLOBAL COMPUTER INFORMATION NETWORKS; PROVIDING HIGH-CAPACITY BANDWIDTH ACCESS TO COMMUNICATIONS NETWORKS CABLE TELEVISION TRANSMISSION SERVICES, NAMELY, TRANSMITTING TELEVISION PROGRAMMING AND TWO-WAY COMMUNICATION CAPABILITY TO CABLE COMPANIES AND OTHER MULTI-CHANNEL DISTRIBUTORS ENABLING CUSTOMERS OF THE DISTRIBUTORS TO SELECT PROGRAMMING AND CONDUCT OTHER TWO-WAY COMMUNICATION WITH THE DISTRIBUTOR, IN CLASS 38 (U.S. CLS. 100, 101 AND 104).

FIRST USE 1-1-2004; IN COMMERCE 1-1-2004.

NO CLAIM IS MADE TO THE EXCLUSIVE RIGHT TO USE "COMMUNICATIONS", APART FROM THE MARK AS SHOWN.

SN 76-539,846, FILED 8-8-2003.

TAMARA FRAZIER, EXAMINING ATTORNEY

**Int. Cl.: 42**

**Prior U.S. Cls.: 100 and 101**

**United States Patent and Trademark Office**

**Reg. No. 3,454,199**

**Registered June 24, 2008**

**SERVICE MARK  
PRINCIPAL REGISTER**

**ITOWN COMMUNICATIONS**

ITOWN COMMUNICATIONS, INC. (DELAWARE CORPORATION)  
1950 OLD GALLOWS ROAD, SUITE 201  
VIENNA, VA 22182

FOR: COMPUTER SERVICE, NAMELY, ACTING AS AN APPLICATION SERVICE PROVIDER IN THE FIELD OF KNOWLEDGE MANAGEMENT TO HOST COMPUTER APPLICATION SOFTWARE FOR SEARCHING AND RETRIEVING INFORMATION FROM DATABASES AND COMPUTER NETWORKS; COMPUTER SERVICES, NAMELY, CREATING INDEXES OF INFORMATION, SITES AND OTHER RESOURCES AVAILABLE ON COMPUTER NETWORKS; PROVIDING CUSTOMIZED ON-LINE WEB PAGES FEATURING USER-DEFINED INFORMATION, WHICH INCLUDES

SEARCH ENGINES AND ONLINE WEB LINKS TO OTHER WEB SITES; PROVIDING SPECIFIC INFORMATION AS REQUESTED BY CUSTOMERS VIA THE INTERNET FOR CUSTOMIZED SEARCHING, IN CLASS 42 (U.S. CLS. 100 AND 101).

FIRST USE 1-1-2004; IN COMMERCE 1-1-2004.

NO CLAIM IS MADE TO THE EXCLUSIVE RIGHT TO USE "COMMUNICATIONS", APART FROM THE MARK AS SHOWN.

SN 76-539,847, FILED 8-8-2003.

TAMARA FRAZIER, EXAMINING ATTORNEY

**Int. Cl.: 11**

**Prior U.S. Cls.: 13, 21, 23, 31, and 34**

**United States Patent and Trademark Office**

**Reg. No. 3,454,200**

**Registered June 24, 2008**

**TRADEMARK  
PRINCIPAL REGISTER**

**DIAL-A-TASTE**

PIONETICS CORPORATION (CALIFORNIA CORPORATION)  
151 OLD COUNTY ROAD SUITE H  
SAN CARLOS, CA 94070

FOR: WATER DEIONIZATION AND PURIFICATION SYSTEM COMPRISING AN ELECTROCHEMICAL CELL WITH A MEMBRANE AND AN ELECTRICAL POWER CONTROLLER TO CONTROL THE TYPE OR AMOUNT OF TOTAL DISSOLVED SOLIDS IN A FLUID PASSED THROUGH THE CELL; ELECTRICAL POWER CONTROLLER TO CONTROL TOTAL DISSOLVED SOLIDS IN A

FLUID, SOLD AS AN INTEGRAL COMPONENT OF A WATER DEIONIZATION AND PURIFICATION SYSTEM, IN CLASS 11 (U.S. CLS. 13, 21, 23, 31 AND 34).

FIRST USE 6-6-2003; IN COMMERCE 12-9-2004.

OWNER OF U.S. REG. NO. 2,789,653.

SN 76-541,775, FILED 8-25-2003.

BARBARA GAYNOR, EXAMINING ATTORNEY

**Int. Cl.: 12**

**Prior U.S. Cls.: 19, 21, 23, 31, 35, and 44**

**Reg. No. 3,454,201**

**United States Patent and Trademark Office**

**Registered June 24, 2008**

---

**TRADEMARK  
PRINCIPAL REGISTER**

The logo consists of the word "RAT" in a very bold, black, sans-serif font. The letters are slanted to the right, giving it an italicized appearance. The 'R' and 'A' are blocky, while the 'T' has a long, curved tail that extends downwards and to the right.

EXCEL TIRE & WHEEL CORP. (CALIFORNIA  
CORPORATION)  
P.O. BOX 1044  
WALNUT, CA 91788

THE MARK CONSISTS OF THE WORD "RAT" IN  
STYLIZED FORM.

FOR: TIRES ESPECIALLY DESIGNED FOR ALL  
TERRAIN VEHICLES, IN CLASS 12 (U.S. CLS. 19, 21,  
23, 31, 35 AND 44).

SN 76-558,081, FILED 11-7-2003.

FIRST USE 4-26-2003; IN COMMERCE 4-26-2003.

TEJBIR SINGH, EXAMINING ATTORNEY

**Int. Cl.: 16**

**Prior U.S. Cls.: 2, 5, 22, 23, 29, 37, 38, and 50**

**Reg. No. 3,454,202**

**United States Patent and Trademark Office**

**Registered June 24, 2008**

**TRADEMARK  
PRINCIPAL REGISTER**

**THE POEM CATCHER**

BLAKE, MEGAN (UNITED STATES INDIVIDUAL)  
11377 WEST OLYMPIC BLVD.  
C/O KIM SWARTZ  
LOS ANGELES, CA 90064

FOR: PRINTED MATERIALS, NAMELY, BOOKS, NOTEPADS CONTAINING PRINTED MATERIAL, NOTEBOOKS CONTAINING PRINTED MATERIAL, AND COLLECTIONS OF WRITINGS IN THE FIELD OF LITERATURE, AND POSTERS DISPLAYING LITERATURE AND ARTWORK, IN CLASS 16 (U.S. CLS. 2, 5, 22, 23, 29, 37, 38 AND 50).

FIRST USE 9-29-2006; IN COMMERCE 9-29-2006.

THE MARK CONSISTS OF STANDARD CHARACTERS WITHOUT CLAIM TO ANY PARTICULAR FONT, STYLE, SIZE, OR COLOR.

NO CLAIM IS MADE TO THE EXCLUSIVE RIGHT TO USE "POEM", APART FROM THE MARK AS SHOWN.

SN 76-569,418, FILED 1-2-2004.

KRISTIN DAHLING, EXAMINING ATTORNEY



**Int. Cl.: 21**

**Prior U.S. Cls.: 2, 13, 23, 29, 30, 33, 40, and 50**

**United States Patent and Trademark Office**

**Reg. No. 3,454,203**

**Registered June 24, 2008**

**TRADEMARK  
PRINCIPAL REGISTER**



IGLOO PRODUCTS CORP. (DELAWARE CORPORATION)  
777 IGLOO ROAD  
KATY, TX 77494

FOR: PORTABLE CONTAINERS FOR ICE, FOOD, AND BEVERAGES, AND PARTS THEREFOR; WATER AND BEVERAGE COOLERS; LUNCH KITS CONSISTING OF PORTABLE CONTAINERS HOUSING ONE OR MORE SMALLER UTILITY CONTAINERS SUCH AS PLASTIC SANDWICH BOXES AND BOTTLES, ALL FOR THE TEMPORARY STORAGE OF FOOD, BEVERAGES OR OTHER CON-

SUMABLE LIQUIDS; FREEZE BOTTLES; AND THERMAL INSULATED CONTAINERS FOR FOOD, BEVERAGE AND WATER CONTAINERS, IN CLASS 21 (U.S. CLS. 2, 13, 23, 29, 30, 33, 40 AND 50).

FIRST USE 3-1-2004; IN COMMERCE 3-1-2004.

OWNER OF U.S. REG. NO. 1,922,100.

SN 76-570,583, FILED 1-13-2004.

SHAUNIA CARLYLE, EXAMINING ATTORNEY

**Int. Cl.: 33**

**Prior U.S. Cls.: 47 and 49**

**United States Patent and Trademark Office**

**Reg. No. 3,454,204**

**Registered June 24, 2008**

**TRADEMARK  
PRINCIPAL REGISTER**

**FIREFLY RIDGE**

SAFEWAY INC. (DELAWARE CORPORATION)  
5918 STONERIDGE MALL ROAD  
PLEASANTON, CA 945882322

THE MARK CONSISTS OF STANDARD CHAR-  
ACTERS WITHOUT CLAIM TO ANY PARTICULAR  
FONT, STYLE, SIZE, OR COLOR.

FOR: WINE, IN CLASS 33 (U.S. CLS. 47 AND 49).

SN 76-572,598, FILED 1-28-2004.

FIRST USE 6-1-2004; IN COMMERCE 6-1-2004.

JENNIFER VASQUEZ, EXAMINING ATTORNEY

Int. Cl.: 25

Prior U.S. Cls.: 22 and 39

United States Patent and Trademark Office

Reg. No. 3,454,205

Registered June 24, 2008

TRADEMARK  
PRINCIPAL REGISTER

reel pure 

RATHBUN, ERIC (UNITED STATES INDIVIDUAL)  
18334 N.E. 103RD COURT  
REDMOND, WA 98052

FOR: CLOTHING, NAMELY, HEADWEAR, HATS; OUTERWEAR, NAMELY, JACKETS, FLEECE PULLOVERS; SHIRTS; THERMAL WEAR,

NAMELY, LONG UNDERWEAR, IN CLASS 25 (U.S. CLS. 22 AND 39).

FIRST USE 12-30-2007; IN COMMERCE 12-30-2007.

SN 76-577,839, FILED 2-26-2004.

JOHN DALIER, EXAMINING ATTORNEY

**Int. Cl.: 28**

**Prior U.S. Cls.: 22, 23, 38, and 50**

**United States Patent and Trademark Office**

**Reg. No. 3,454,206**

**Registered June 24, 2008**

**TRADEMARK  
PRINCIPAL REGISTER**

**DESTINA . . .**

DESTINA, INC. (NEW MEXICO CORPORATION)  
813 EL PUEBLO N.W.  
P.O. BOX 10268  
ALBUQUERQUE, NM 87184

FOR: BOARD GAMES, NAMELY, GAMES WHICH IMPART TO PARTICIPANTS INFORMATION ABOUT POPULAR CITIES AND OTHER LOCATIONS, IN CLASS 28 (U.S. CLS. 22, 23, 38 AND 50).

FIRST USE 3-11-2008; IN COMMERCE 3-11-2008.

THE MARK CONSISTS OF STANDARD CHARACTERS WITHOUT CLAIM TO ANY PARTICULAR FONT, STYLE, SIZE, OR COLOR.

SN 76-582,843, FILED 3-24-2004.

TRICIA SONNEBORN, EXAMINING ATTORNEY

**Int. Cl.: 12**

**Prior U.S. Cls.: 19, 21, 23, 31, 35, and 44**

**Reg. No. 3,454,207**

**United States Patent and Trademark Office**

**Registered June 24, 2008**

---

**TRADEMARK  
PRINCIPAL REGISTER**

**VECTRIX**

VECTRIX CORPORATION (DELAWARE CORPORATION)  
76 HAMMARLUND WAY  
TECH III PLAZA, SUITE 250  
MIDDLETOWN, RI 02842

THE MARK CONSISTS OF STANDARD CHARACTERS WITHOUT CLAIM TO ANY PARTICULAR FONT, STYLE, SIZE, OR COLOR.

FOR: MOTORIZED SCOOTERS, IN CLASS 12 (U.S. CLS. 19, 21, 23, 31, 35 AND 44).

SN 76-584,443, FILED 4-2-2004.

FIRST USE 7-31-2007; IN COMMERCE 7-31-2007.

DORITT L. CARROLL, EXAMINING ATTORNEY

**Int. Cl.: 35**

**Prior U.S. Cls.: 100, 101, and 102**

**United States Patent and Trademark Office**

**Reg. No. 3,454,208**

**Registered June 24, 2008**

**SERVICE MARK  
PRINCIPAL REGISTER**

**BRING NEFERTITI HOME**

RAGAB, MARIE-JOSÉ (UNITED STATES INDIVIDUAL)  
505 GLYNDON STREET, N.E.  
VIENNA, VA 22180

FOR: PROMOTING PUBLIC AWARENESS OF THE IMPORTANCE OF PROTECTING ANTIQUITIES FROM THEFT AND LOOTING, OF PREVENTING AND SUPPRESSING THE TRAFFIC IN STOLEN AND LOOTED ANTIQUITIES, AND OF REPATRIATING ANTIQUITIES REMOVED FROM CULTURAL AND GEOGRAPHIC SITES OF ORIGI-

NAL DISCOVERY, IN CLASS 35 (U.S. CLS. 100, 101 AND 102).

FIRST USE 4-9-2008; IN COMMERCE 4-9-2008.

THE MARK CONSISTS OF STANDARD CHARACTERS WITHOUT CLAIM TO ANY PARTICULAR FONT, STYLE, SIZE, OR COLOR.

SN 76-589,065, FILED 4-28-2004.

NAAKWAMA ANKRAH, EXAMINING ATTORNEY

**Int. Cl.: 16**

**Prior U.S. Cls.: 2, 5, 22, 23, 29, 37, 38, and 50**

**Reg. No. 3,454,209**

**United States Patent and Trademark Office**

**Registered June 24, 2008**

**TRADEMARK  
PRINCIPAL REGISTER**

**SHUGUMS THE LOVE GURU**

INTEGRATING, THE FILMS, LLC (NEVADA  
LTD LIAB CO)  
10300 WEST CHARLESTON BOULEVARD, #13-276  
LAS VEGAS, NV 89135

THE MARK CONSISTS OF STANDARD CHAR-  
ACTERS WITHOUT CLAIM TO ANY PARTICULAR  
FONT, STYLE, SIZE, OR COLOR.

FOR: BOOKS, PICTURE BOOKS; STORY BOOKS;  
CHILDREN'S BOOKS; COLORING BOOKS; CHIL-  
DREN'S ACTIVITY BOOKS; CRAYONS, IN CLASS  
16 (U.S. CLS. 2, 5, 22, 23, 29, 37, 38 AND 50).

SN 76-595,881, FILED 6-7-2004.

FIRST USE 4-15-2007; IN COMMERCE 4-15-2007.

MICHAEL ENGEL, EXAMINING ATTORNEY

**Int. Cls.: 37, 39, 41, 42, and 43**

**Prior U.S. Cls.: 100, 101, 103, 105, 106, and 107**

**United States Patent and Trademark Office**

**Reg. No. 3,454,210**

**Registered June 24, 2008**

**SERVICE MARK  
PRINCIPAL REGISTER**

**WANT IT. GET IT. FAST.**

RENT-A-CENTER WEST, INC. (DELAWARE CORPORATION)  
5501 HEADQUARTERS DRIVE  
PLANO, TX 75024

FOR: RENTAL SERVICES, NAMELY, RENTAL OF HOME APPLIANCES, NAMELY, CLOTHES WASHING MACHINES AND DRYERS FOR CLOTHES, IN CLASS 37 (U.S. CLS. 100, 103 AND 106).

FIRST USE 10-0-2006; IN COMMERCE 10-0-2006.

FOR: RENTAL SERVICES, NAMELY, RENTAL OF HOME APPLIANCES, NAMELY, FREEZERS AND REFRIGERATORS, IN CLASS 39 (U.S. CLS. 100 AND 105).

FIRST USE 10-0-2006; IN COMMERCE 10-0-2006.

FOR: RENTAL SERVICES IN THE FIELD OF CONSUMER ELECTRONICS AND HOME ENTERTAINMENT PRODUCTS, NAMELY, RENTAL OF TELEVISIONS, STEREOS, HOME THEATER WALL UNITS, CAMCORDERS, DVD PLAYERS, AND VIDEO GAME CONSOLES AND WALL HANGINGS, IN CLASS 41 (U.S. CLS. 100, 101 AND 107).

FIRST USE 10-0-2006; IN COMMERCE 10-0-2006.

FOR: RENTAL SERVICES, NAMELY, RENTAL OF COMPUTERS, IN CLASS 42 (U.S. CLS. 100 AND 101).

FIRST USE 10-0-2006; IN COMMERCE 10-0-2006.

FOR: RENTAL SERVICES, NAMELY, RENTAL OF FURNITURE AND HOME FURNISHINGS AND ACCESSORIES, NAMELY, BEDROOM FURNITURE, DINETTE SETS, LIVING ROOM FURNITURE, CHAIRS, TABLES AND LAMPS; RENTAL OF HOME APPLIANCES, NAMELY, RANGES, IN CLASS 43 (U.S. CLS. 100 AND 101).

FIRST USE 10-0-2006; IN COMMERCE 10-0-2006.

THE MARK CONSISTS OF STANDARD CHARACTERS WITHOUT CLAIM TO ANY PARTICULAR FONT, STYLE, SIZE, OR COLOR.

OWNER OF U.S. REG. NOS. 1,302,055 AND 2,850,252.

SN 76-601,395, FILED 7-8-2004.

CHRISTOPHER BUONGIORNO, EXAMINING ATTORNEY



**Int. Cl.: 21**

**Prior U.S. Cls.: 2, 13, 23, 29, 30, 33, 40, and 50**

**Reg. No. 3,454,211**

**United States Patent and Trademark Office**

**Registered June 24, 2008**

**TRADEMARK  
PRINCIPAL REGISTER**

**PREMIER**

RANIR, LLC (DELAWARE LTD LIAB CO)  
4701 EAST PARIS S.E.  
GRAND RAPIDS, MI 49512

THE MARK CONSISTS OF STANDARD CHAR-  
ACTERS WITHOUT CLAIM TO ANY PARTICULAR  
FONT, STYLE, SIZE, OR COLOR.

FOR: TOOTHBRUSHES, IN CLASS 21 (U.S. CLS. 2,  
13, 23, 29, 30, 33, 40 AND 50).

OWNER OF U.S. REG. NO. 2,319,259.

SN 76-603,655, FILED 7-22-2004.

FIRST USE 1-22-1999; IN COMMERCE 1-22-1999.

SUNG IN, EXAMINING ATTORNEY

**Int. Cl.: 9**

**Prior U.S. Cls.: 21, 23, 26, 36, and 38**

**Reg. No. 3,454,212**

**United States Patent and Trademark Office**

**Registered June 24, 2008**

**TRADEMARK  
PRINCIPAL REGISTER**

# **GAME POWER**

VECTOR PRODUCTS, INC. (FLORIDA CORPORATION)  
8100 S.W. 10TH STREET #3000  
PLANTATION, FL 33324

FOR: POWER INVERTERS, POWER INVERTERS WITH LCD SCREEN, AND POWER INVERTERS WITH LCD SCREEN AND DVD PLAYER, IN CLASS 9 (U.S. CLS. 21, 23, 26, 36 AND 38).

FIRST USE 7-15-2005; IN COMMERCE 7-15-2005.

THE MARK CONSISTS OF STANDARD CHARACTERS WITHOUT CLAIM TO ANY PARTICULAR FONT, STYLE, SIZE, OR COLOR.

NO CLAIM IS MADE TO THE EXCLUSIVE RIGHT TO USE "POWER", APART FROM THE MARK AS SHOWN.

SN 76-604,883, FILED 7-30-2004.

NAAKWAMA ANKRAH, EXAMINING ATTORNEY

**Int. Cl.: 3**

**Prior U.S. Cls.: 1, 4, 6, 50, 51, and 52**

**United States Patent and Trademark Office**

**Reg. No. 3,454,213**

**Registered June 24, 2008**

**TRADEMARK  
PRINCIPAL REGISTER**

**AQUASATE-P**

QUINTESSA CORPORATION (CALIFORNIA  
CORPORATION)  
34521 CALLE MONTE  
CAPISTRANO BEACH, CA 92624

THE MARK CONSISTS OF STANDARD CHAR-  
ACTERS WITHOUT CLAIM TO ANY PARTICULAR  
FONT, STYLE, SIZE, OR COLOR.

FOR: PRESERVED MOISTURIZING AND HEAL-  
ING ABSORPTION BASE FOR COSMETIC AND  
PHARMACEUTICAL PURPOSES, IN CLASS 3 (U.S.  
CLS. 1, 4, 6, 50, 51 AND 52).

SN 76-607,534, FILED 8-18-2004.

FIRST USE 7-24-2004; IN COMMERCE 7-27-2004.

CHERYL CLAYTON, EXAMINING ATTORNEY

**Int. Cls.: 1 and 3**

**Prior U.S. Cls.: 1, 4, 5, 6, 10, 26, 46, 50, 51, and 52**

**Reg. No. 3,454,214**

**United States Patent and Trademark Office**

**Registered June 24, 2008**

**TRADEMARK  
PRINCIPAL REGISTER**

**ECOPARADISE**

BARBARIAN CO. LTD. (JAPAN JOINT STOCK COMPANY)  
1-15, ZENPUKUJI 1-CHOME  
SUGINAMI-KU, TOKYO, JAPAN

FOR: CHEMICALS, NAMELY, ANTIOXIDANT SOLUTIONS FOR USE IN SOAPS, DETERGENTS, COSMETICS, NON-MEDICATED TOILETRIES, GERMICIDES, BIOCIDES, HERBICIDES, DENTAL MATERIALS AND THEIR INGREDIENTS TO HEIGHTEN THEIR EFFECTIVENESS FOR CLEANLINESS, DEODORIZATION, AND STERILIZATION FOR SANITARY, COSMETIC, HOUSEHOLD, AND MEDICAL PURPOSES; ANTIOXIDANT SOLUTIONS FOR USE IN PHARMACEUTICAL, VETERINARY, AND SANITARY PREPARATIONS TO USE FOR THE TREATMENT OR RELIEF OF ALLERGIC SYMPTOMS FOR USE IN THE MEDICAL FIELD; ANTIOXIDANT SOLUTIONS FOR USE IN CONSTRUCTION MATERIALS, OINTMENTS, AND ADDITIVES TO PREVENT BUILDINGS FROM DECAYING AND CORRODING IN THE FIELD OF CONSTRUCTION; ADHESIVES OTHER THAN FOR STATIONERY OR HOUSEHOLD PURPOSES; UN-

PROCESSED PLASTICS; PLASTICS IN PRIMARY FORM; AND ANTI-STATIC SPRAY FOR CLOTHING, IN CLASS 1 (U.S. CLS. 1, 5, 6, 10, 26 AND 46).

FIRST USE 4-1-2004; IN COMMERCE 2-20-2007.

FOR: SOAPS AND DETERGENTS; COSMETICS AND NON-MEDICATED TOILETRIES; DENTIFRICES; ANTI-STATIC PREPARATIONS FOR HOUSEHOLD PURPOSES, NAMELY, DRYER SHEETS; POLISHING PREPARATIONS, ALL FOR CONSUMER AND HOUSEHOLD USE, IN CLASS 3 (U.S. CLS. 1, 4, 6, 50, 51 AND 52).

FIRST USE 4-1-2004; IN COMMERCE 2-20-2007.

THE MARK CONSISTS OF STANDARD CHARACTERS WITHOUT CLAIM TO ANY PARTICULAR FONT, STYLE, SIZE, OR COLOR.

SN 76-608,831, FILED 8-26-2004.

TRICIA SONNEBORN, EXAMINING ATTORNEY

**Int. Cl.: 42**

**Prior U.S. Cls.: 100 and 101**

**United States Patent and Trademark Office**

**Reg. No. 3,454,215**

**Registered June 24, 2008**

**SERVICE MARK  
PRINCIPAL REGISTER**

**SIGN OF PASSION**

VETOQUINOL N.-A. INC. (CANADA CORPORATION)

2000, CHEMIN GEORGES

LAVALTRIE, PROVINCE OF QUEBEC, CANADA  
J5T 3S5

FOR: VETERINARY LABORATORY SERVICES,  
IN CLASS 42 (U.S. CLS. 100 AND 101).

FIRST USE 12-31-2006; IN COMMERCE 12-31-2006.

THE MARK CONSISTS OF STANDARD CHARACTERS WITHOUT CLAIM TO ANY PARTICULAR FONT, STYLE, SIZE, OR COLOR.

PRIORITY CLAIMED UNDER SEC. 44(D) ON CANADA APPLICATION NO. 1222620, FILED 6-29-2004, REG. NO. TMA662734, DATED 4-18-2006, EXPIRES 4-18-2021.

SN 76-610,127, FILED 8-20-2004.

ALICE BENMAMAN, EXAMINING ATTORNEY

**Int. Cl.: 7**

**Prior U.S. Cls.: 13, 19, 21, 23, 31, 34, and 35**

**United States Patent and Trademark Office**

**Reg. No. 3,454,216**

**Registered June 24, 2008**

**TRADEMARK  
PRINCIPAL REGISTER**



MANN + HUMMEL GMBH (FED REP GERMA-  
NY CORPORATION)  
HINDENBURGST. 45  
71638 LUDWIGSBURG, FED REP GERMANY

FOR: FILTERS FOR INDUSTRIAL PURPOSES,  
NAMELY, FOR MILLING, CUTTING, AND MA-  
CHINING TOOLS AND COOLANT SYSTEMS  
THEREFOR, NAMELY, VACUUM FILTERS; MAG-  
NETIC SEPARATORS; CONVEYOR APPARATUS  
CONSISTING OF FEED PUMPS, FEED CHANNELS,  
FEED PIPES, LIQUID DISTRIBUTOR APPARATUS,  
VALVES AND PIPELINES; CONVEYOR APPARA-  
TUS CONSISTING OF CONVEYOR CHAINS, ME-  
CHANICAL DISCHARGE DEVICES FOR FILTERS  
AND/OR FOR FILTERED OUT MATERIAL, AND  
CONVEYOR BELTS, IN CLASS 7 (U.S. CLS. 13, 19, 21,  
23, 31, 34 AND 35).

FIRST USE 5-30-2007; IN COMMERCE 5-30-2007.

THE COLOR(S) BLACK, GRAY, AND BLUE IS/  
ARE CLAIMED AS A FEATURE OF THE MARK.

THE COLOR BLACK APPEARS IN THE LETTER  
"H" AND IN THE BORDER OF THE MARK. THE  
COLOR GRAY APPEARS IN THE STYLIZED LET-  
TER "F". THE COLOR BLUE APPEARS IN THE  
WATER-DROP DESIGN.

SN 76-611,990, FILED 9-17-2004.

BRENDAN REGAN, EXAMINING ATTORNEY

**Int. Cls.: 35 and 42**

**Prior U.S. Cls.: 100, 101, and 102**

**United States Patent and Trademark Office**

**Reg. No. 3,454,217**

**Registered June 24, 2008**

**SERVICE MARK  
PRINCIPAL REGISTER**

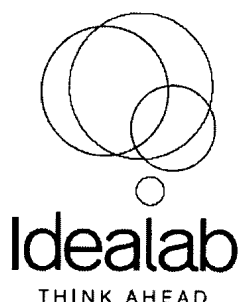

IDEALAB (CALIFORNIA CORPORATION)  
130 WEST UNION STREET  
PASADENA, CA 91103

FOR: BUSINESS DEVELOPMENT SERVICES, NAMELY, PROVIDING START-UP ACTIVITIES FOR BUSINESSES OF OTHERS; BUSINESS CONSULTATION SERVICES; BUSINESS MARKETING CONSULTATION SERVICES; ACCOUNTING SERVICES; HUMAN RESOURCES CONSULTATION AND MANAGEMENT SERVICES; PRODUCT MARKETING SERVICES; AND CREATION AND OPERATION OF TECHNOLOGY BUSINESSES FOR OTHERS, IN CLASS 35 (U.S. CLS. 100, 101 AND 102).

FIRST USE 3-20-2008; IN COMMERCE 3-20-2008.

FOR: GRAPHIC DESIGN SERVICES; PRODUCT DESIGN SERVICES, NAMELY, DESIGN AND TESTING OF NEW PRODUCTS FOR OTHERS; NEW PRODUCT AND SERVICE DEVELOPMENT SERVICES, IN CLASS 42 (U.S. CLS. 100 AND 101).

FIRST USE 3-20-2008; IN COMMERCE 3-20-2008.

OWNER OF U.S. REG. NO. 2,224,552.

SN 76-612,867, FILED 9-27-2004.

KATHRYN COWARD, EXAMINING ATTORNEY

**Int. Cl.: 1**

**Prior U.S. Cls.: 1, 5, 6, 10, 26, and 46**

**Reg. No. 3,454,218**

**United States Patent and Trademark Office**

**Registered June 24, 2008**

**TRADEMARK  
PRINCIPAL REGISTER**

**NU-EXPRESS**

MILLER CHEMICAL & FERTILIZER CORPORATION  
(PENNSYLVANIA CORPORATION)  
120 RADIO ROAD  
BOX 333  
HANOVER, PA 17331

FOR: DRY SOLUBLE FERTILIZERS FOR USE IN  
AGRICULTURE AND HORTICULTURE, IN CLASS  
1 (U.S. CLS. 1, 5, 6, 10, 26 AND 46).

FIRST USE 2-8-2008; IN COMMERCE 2-8-2008.

THE MARK CONSISTS OF STANDARD CHARACTERS WITHOUT CLAIM TO ANY PARTICULAR FONT, STYLE, SIZE, OR COLOR.

OWNER OF U.S. REG. NOS. 707,677, 2,163,115,  
AND OTHERS.

SN 76-613,658, FILED 9-20-2004.

BRENDAN MCCAULEY, EXAMINING ATTORNEY



**Int. Cls.: 35 and 42**

**Prior U.S. Cls.: 100, 101, and 102**

**United States Patent and Trademark Office**

**Reg. No. 3,454,219**

**Registered June 24, 2008**

**SERVICE MARK  
PRINCIPAL REGISTER**

**PALLADEO**

PALLADEO (CALIFORNIA CORPORATION)  
900 WESTERN AVENUE  
GLENDALE, CA 91201

FOR: BUSINESS MERCHANDISING DISPLAY SERVICES, NAMELY, DESIGN OF RETAIL MERCHANDISING DISPLAYS, IN CLASS 35 (U.S. CLS. 100, 101 AND 102).

FIRST USE 5-9-2008; IN COMMERCE 5-9-2008.

FOR: DESIGN OF SPECIALTY INTERIOR AND EXTERIOR ENVIRONMENT SETTINGS, NAMELY, DESIGN OF TRADE SHOW BOOTH INTERIORS, DESIGN OF RETAIL STORE INTERIOR DECOR

AND DESIGN OF RETAIL STORE EXTERIOR FACADES AND SIGNAGE; COMMERCIAL ARCHITECTURAL DESIGN; AND COMMERCIAL GRAPHIC DESIGN SERVICES, IN CLASS 42 (U.S. CLS. 100 AND 101).

FIRST USE 5-9-2008; IN COMMERCE 5-9-2008.

THE MARK CONSISTS OF STANDARD CHARACTERS WITHOUT CLAIM TO ANY PARTICULAR FONT, STYLE, SIZE, OR COLOR.

SN 76-617,242, FILED 10-20-2004.

CARRIE GENOVESE, EXAMINING ATTORNEY

**Int. Cls.: 7, 25, 37, and 40**

**Prior U.S. Cls.: 13, 19, 21, 22, 23, 31, 34, 35, 39, 100,  
103, and 106**

**Reg. No. 3,454,220**

**United States Patent and Trademark Office**

**Registered June 24, 2008**

**TRADEMARK  
SERVICE MARK  
PRINCIPAL REGISTER**

**WE SQUEEZE THE CRAP OUT OF WATER**

PRIME SOLUTION, INC. (MICHIGAN CORPORATION)  
215 BOND STREET  
ALLEGAN, MI 49010

FOR: MANUFACTURING MACHINERY, NAME-  
LY, LIQUID EXTRACTION MACHINES, IN CLASS 7  
(U.S. CLS. 13, 19, 21, 23, 31, 34 AND 35).

FIRST USE 10-31-2004; IN COMMERCE 10-31-2004.

FOR: T-SHIRTS, IN CLASS 25 (U.S. CLS. 22 AND  
39).

FIRST USE 10-31-2004; IN COMMERCE 10-31-2004.

FOR: LIQUID EXTRACTION MACHINE INSTAL-  
LATION SERVICES, IN CLASS 37 (U.S. CLS. 100, 103  
AND 106).

FIRST USE 10-31-2004; IN COMMERCE 10-31-2004.

FOR: LIQUID EXTRACTION SERVICES, NAME-  
LY, THE SERVICE OF REMOVING LIQUID FROM  
A MASS HAVING A LIQUID COMPONENT AND A  
SOLID COMPONENT, IN CLASS 40 (U.S. CLS. 100,  
103 AND 106).

FIRST USE 10-31-2004; IN COMMERCE 10-31-2004.

THE MARK CONSISTS OF STANDARD CHAR-  
ACTERS WITHOUT CLAIM TO ANY PARTICULAR  
FONT, STYLE, SIZE, OR COLOR.

SN 76-618,018, FILED 10-28-2004.

ALEX KEAM, EXAMINING ATTORNEY

Int. Cl.: 25

Prior U.S. Cls.: 22 and 39

United States Patent and Trademark Office

Reg. No. 3,454,221

Registered June 24, 2008

TRADEMARK  
PRINCIPAL REGISTER



URBAN COWBOY CLOTHING COMPANY, LLC  
(DELAWARE LTD LIAB CO)  
C/O CMW ENTERTAINMENT GROUP LLC  
57 WEST 38TH STREET - SUITE 600  
NEW YORK, NY 10018

FOR: MEN'S, WOMEN'S AND CHILDREN'S CLOTHING AND FASHION ACCESSORIES, NAMELY, DRESSES, COATS, SHORTS, SHIRTS, DRESS SHIRTS, PANTS, DRESS PANTS, JEANS, SWEATERS, JACKETS, SUITS, TUXEDOS, DINNER JACKETS, T-SHIRTS, BLOUSES, KNIT TOPS, HALTER TOPS, SMOCK TOPS, VESTS, WIND RESISTANT JACKETS, JOGGING SUITS, SWEATSHIRTS, SWEATPANTS, SKI JACKETS, SKI PANTS, MUFFLERS, HEAD BANDS, BELTS, GLOVES, SHAWLS, SCARVES, PONCHOS, SHOULDER WRAPS, NECKERCHIEFS, STOCKINGS, HOSIERY, SOCKS,

TIGHTS, LEGGINGS, LEOTARDS, PAJAMAS, ROBES, NIGHTGOWNS, PANTIES, BRAS, UNDERWEAR, UNDERSHIRTS, RAINWEAR, RAINCOATS, SWIMWEAR, BATHING SUITS, COVER-UPS, AND WOMEN'S LINGERIE; FOOTWEAR, HEADWEAR, TIES, CAPS, AND HATS, IN CLASS 25 (U.S. CLS. 22 AND 39).

FIRST USE 12-0-2004; IN COMMERCE 8-0-2005.

NO CLAIM IS MADE TO THE EXCLUSIVE RIGHT TO USE "COWBOY CLOTHING CO.", APART FROM THE MARK AS SHOWN.

SN 76-619,213, FILED 11-3-2004.

TAMARA FRAZIER, EXAMINING ATTORNEY

**Int. Cl.: 9**

**Prior U.S. Cls.: 21, 23, 26, 36, and 38**

**Reg. No. 3,454,222**

**United States Patent and Trademark Office**

**Registered June 24, 2008**

**TRADEMARK  
PRINCIPAL REGISTER**

**LEADLAG**

M.K PLASTICS CORPORATION (CANADA CORPORATION)  
3955 DE COURTRAI AVENUE  
MONTREAL, QUEBEC, CANADA H3W 1A6

THE MARK CONSISTS OF STANDARD CHARACTERS WITHOUT CLAIM TO ANY PARTICULAR FONT, STYLE, SIZE, OR COLOR.

FOR: ELECTRONIC SYSTEMS PRINCIPALLY COMPRISED OF PROGRAMMABLE LOGIC CONTROLLERS, OPERATING SOFTWARE, MICROPROCESSORS, ELECTRONIC SENSORS, AND ELECTRICAL CONTROLLERS, TO CONTROL THE OPERATION OF ROOF MOUNTED INDUCTION VENTURI FANS AND THE ISOLATION ON MODULATING DAMPERS, IN CLASS 9 (U.S. CLS. 21, 23, 26, 36 AND 38).

PRIORITY CLAIMED UNDER SEC. 44(D) ON CANADA APPLICATION NO. 1227962, FILED 8-23-2004, REG. NO. TMA682365, DATED 2-26-2007, EXPIRES 2-26-2022.

SN 76-625,420, FILED 12-22-2004.

FIRST USE 7-26-2007; IN COMMERCE 7-26-2007.

KATHY DE JONGE, EXAMINING ATTORNEY

**Int. Cl.: 9**

**Prior U.S. Cls.: 21, 23, 26, 36, and 38**

**Reg. No. 3,454,223**

**United States Patent and Trademark Office**

**Registered June 24, 2008**

**TRADEMARK  
PRINCIPAL REGISTER**



MOBINOTE TECHNOLOGY CORP. (TAIWAN CORPORATION)  
17F-3, NO. 186, JIANYI RD.  
CHUNG HO TAIPEI HSIEN, TAIWAN 23553

FOR: COMPUTER KEYBOARDS, COMPUTER MEMORY, COMPUTER READ ONLY MEMORY, MICROPROCESSORS BEING COMPUTER HARDWARE, DATA STORAGE MACHINE, NAMELY, COMPUTERS, CENTRAL PROCESSING UNIT, ELECTRIC DATA PROCESSORS, LAPTOP COMPUTER, HANDHELD COMPUTER, PERSONAL DIGITAL ASSISTANTS (PDA), COMPUTER TOUCH

SENSITIVE INPUT PANEL, ELECTRONIC DIGITAL WRITING PAD, ELECTRONIC NOTE PAD, ELECTRONIC DICTIONARY RECORDED ON COMPUTER MEDIA, ELECTRONIC BOOK TRANSCRIPTION MACHINE, BLANK MAGNETIC DATA CARRIERS, PORTABLE MULTIMEDIA PLAYER, IN CLASS 9 (U.S. CLS. 21, 23, 26, 36 AND 38).

FIRST USE 8-1-2003; IN COMMERCE 1-0-2005.

SN 76-626,606, FILED 1-3-2005.

MARY BOAGNI, EXAMINING ATTORNEY

**Int. Cl.: 40**

**Prior U.S. Cls.: 100, 103, and 106**

**Reg. No. 3,454,224**

**United States Patent and Trademark Office**

**Registered June 24, 2008**

---

**SERVICE MARK  
PRINCIPAL REGISTER**

**PRINTLIZARD**

MOD-PAC CORP (NEW YORK CORPORATION)  
1801 ELMWOOD AVENUE  
BUFFALO, NY 14207

THE MARK CONSISTS OF STANDARD CHAR-  
ACTERS WITHOUT CLAIM TO ANY PARTICULAR  
FONT, STYLE, SIZE, OR COLOR.

FOR: CUSTOM PRINTING SERVICES, IN CLASS  
40 (U.S. CLS. 100, 103 AND 106).

SN 76-626,684, FILED 1-3-2005.

FIRST USE 12-1-2005; IN COMMERCE 12-1-2005.

PATRICIA EVANKO, EXAMINING ATTORNEY

**Int. Cl.: 9**

**Prior U.S. Cls.: 21, 23, 26, 36, and 38**

**Reg. No. 3,454,225**

**United States Patent and Trademark Office**

**Registered June 24, 2008**

**TRADEMARK  
PRINCIPAL REGISTER**

**WEAPONS OF MASS INSTRUCTION**

WEAPONS OF MASS INSTRUCTION, INC. (CALIFORNIA CORPORATION)  
1504 FREEDOM BLVD., SUITE A  
WATSONVILLE, CA 95076

FOR: DIGITAL INSTRUCTION SYSTEM COMPOSED OF PRE-RECORDED MAGNETIC MEDIA INCLUDING CDS, DVDS, FLASH MEMORIES, CASSETTE TAPES AND OTHER MEDIA CAPABLE OF STORING AUDIO AND/OR TEXTUAL MATERIAL FOR USE WITH A DEVICE DESIGNED TO READ SAID MEDIA AND PRESENT SAID PRE-RECORDED AUDIO AND/OR TEXTUAL INSTRUCTIONAL LESSONS TO A USER IN THE FIELDS OF PIANO, GUITAR AND OTHER MUSICAL INSTRUMENTS

AND FOREIGN LANGUAGES AND ACCOMPANYING PRINTED INSTRUCTIONAL LESSONS FOR SELF STUDY SOLD AS A UNIT, IN CLASS 9 (U.S. CLS. 21, 23, 26, 36 AND 38).

FIRST USE 3-11-2008; IN COMMERCE 3-11-2008.

THE MARK CONSISTS OF STANDARD CHARACTERS WITHOUT CLAIM TO ANY PARTICULAR FONT, STYLE, SIZE, OR COLOR.

SN 76-630,730, FILED 2-8-2005.

AMY HELLA, EXAMINING ATTORNEY

**Int. Cls.: 10 and 25**

**Prior U.S. Cls.: 22, 26, 39, and 44**

**United States Patent and Trademark Office**

**Reg. No. 3,454,226**

**Registered June 24, 2008**

**TRADEMARK  
PRINCIPAL REGISTER**

**ANSWER 2**

HANGER PROSEHETICS & ORTHOTICS, INC.  
(DELAWARE CORPORATION)  
SUITE 1200  
TWO BETHESDA METRO CENTER  
BETHESDA, MD 20814

FOR: ORTHOTIC INSOLE INSERTS FOR SHOES,  
IN CLASS 10 (U.S. CLS. 26, 39 AND 44).

FIRST USE 8-0-2006; IN COMMERCE 8-0-2006.

FOR: INSOLE INSERTS FOR SHOES, IN CLASS 25  
(U.S. CLS. 22 AND 39).

FIRST USE 8-0-2006; IN COMMERCE 8-0-2006.

THE MARK CONSISTS OF STANDARD CHAR-  
ACTERS WITHOUT CLAIM TO ANY PARTICULAR  
FONT, STYLE, SIZE, OR COLOR.

SN 76-632,501, FILED 3-2-2005.

LEIGH LOWRY, EXAMINING ATTORNEY



Int. Cl.: 3

Prior U.S. Cls.: 1, 4, 6, 50, 51, and 52

Reg. No. 3,454,227

United States Patent and Trademark Office

Registered June 24, 2008

TRADEMARK  
PRINCIPAL REGISTER



ANGLADE, RUTH (HAITI INDIVIDUAL)  
38 GLEN COVE DRIVE  
GLEN HEAD, NY 11545

FIRST USE 7-1-2003; IN COMMERCE 7-1-2003.

NO CLAIM IS MADE TO THE EXCLUSIVE RIGHT TO USE "COSMETICS AND BEAUTY", APART FROM THE MARK AS SHOWN.

FOR: COSMETICS, NAMELY, LIPSTICKS, MASCARA, EYE SHADOWS, EYE LINER, FACE AND BODY POWDER, LIP GLOSS, LIP LINER, CONCEALERS, FOUNDATIONS, BRONZERS, FACE CREAM, FACE SERUM, FACE MASQUES, BODY CREAM, FACE AND BODY OIL, TANNING LOTIONS, AFTER SHAVE GEL BALM, GEL SHAVING CREAM, TONERS, HAND CREAM, FACE AND BODY EXFOLIATOR, HAIR TREATMENT, HAIR OILS, FACE AND BODY SOAPS, IN CLASS 3 (U.S. CLS. 1, 4, 6, 50, 51 AND 52).

THE MARK CONSISTS OF GRAPHIC LETTERING, BOLD BLACK AND WHITE GEOMETRIC SHAPES, AND THE WORDING "COSMETICS AND BEAUTY" ARE SHOWN IN UPPER CASE LETTERING BELOW THE LETTERS "LOVIA".

SN 76-635,839, FILED 4-11-2005.

RONALD AIKENS, EXAMINING ATTORNEY

**Int. Cl.: 16**

**Prior U.S. Cls.: 2, 5, 22, 23, 29, 37, 38, and 50**

**Reg. No. 3,454,228**

**United States Patent and Trademark Office**

**Registered June 24, 2008**

**TRADEMARK  
PRINCIPAL REGISTER**



EMBRY-RIDDLE AERONAUTICAL UNIVERSI-  
TY (FLORIDA CORPORATION)  
600 S. CLYDE MORRIS BLVD.  
DAYTONA BEACH, FL 321143900

FOR: PRINTED BI-ANNUAL MAGAZINE PRO-  
VIDED TO EMBRY-RIDDLE AERONAUTICAL  
UNIVERSITY ALUMNI FEATURING INFORMA-  
TION ABOUT UNIVERSITY INVOLVEMENT AND

FUNDRAISING, IN CLASS 16 (U.S. CLS. 2, 5, 22, 23,  
29, 37, 38 AND 50).

FIRST USE 4-1-2005; IN COMMERCE 10-1-2005.

SN 76-638,630, FILED 5-16-2005.

STEPHANIE ALI, EXAMINING ATTORNEY

**Int. Cl.: 14**

**Prior U.S. Cls.: 2, 27, 28, and 50**

**United States Patent and Trademark Office**

**Reg. No. 3,454,229**

**Registered June 24, 2008**

---

**TRADEMARK  
PRINCIPAL REGISTER**

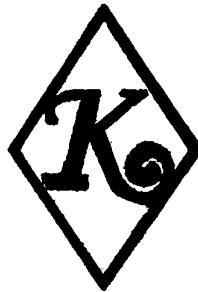

YANTAI KOMEX JEWELRY CO. LTD. (CHINA  
CORPORATION)  
NO. 88, HUANHAI ROAD  
YANTAI CITY SHANDONG PROVINCE, CHINA

FIRST USE 6-15-2005; IN COMMERCE 6-15-2005.

SN 76-640,798, FILED 6-9-2005.

FOR: JEWELRY, IN CLASS 14 (U.S. CLS. 2, 27, 28  
AND 50).

HOWARD B. LEVINE, EXAMINING ATTORNEY

**Int. Cl.: 33**

**Prior U.S. Cls.: 47 and 49**

**United States Patent and Trademark Office**

**Reg. No. 3,454,230**

**Registered June 24, 2008**

**TRADEMARK  
PRINCIPAL REGISTER**

**TREVITI**

THE TRUSTEES OF THE DONALD J. AND  
CHARLENE A. STOLO FAMILY TRUST (CALIFORNIA TRUST)  
545 BROOKLINE PLACE  
FULLERTON, CA 92835

THE MARK CONSISTS OF STANDARD CHARACTERS WITHOUT CLAIM TO ANY PARTICULAR FONT, STYLE, SIZE, OR COLOR.

FOR: WINE, IN CLASS 33 (U.S. CLS. 47 AND 49).

SN 76-641,725, FILED 6-27-2005.

FIRST USE 8-1-2005; IN COMMERCE 8-1-2005.

CHARLES L. JENKINS, EXAMINING ATTORNEY

**Int. Cls.: 35 and 36**

**Prior U.S. Cls.: 100, 101, and 102**

**United States Patent and Trademark Office**

**Reg. No. 3,454,231**

**Registered June 24, 2008**

**SERVICE MARK  
PRINCIPAL REGISTER**

**OAKLEAF**

THE HUTSON COMPANIES, LLC (FLORIDA  
LTD LIAB CO)  
SUITE 300  
3030 HARTLEY ROAD  
JACKSONVILLE, FL 32257

FOR: REAL ESTATE SERVICES, NAMELY, REAL ESTATE ADVERTISING AND MARKETING OF RESIDENTIAL AND COMMERCIAL PROPERTIES, AND RECREATIONAL AMENITIES; REAL ESTATE MARKETING SERVICES, NAMELY, ON-LINE SERVICES FEATURING TOURS AND/OR LISTINGS OF RESIDENTIAL AND COMMERCIAL PROPERTIES; AND REAL ESTATE SALES MANAGEMENT, IN CLASS 35 (U.S. CLS. 100, 101 AND 102).

FIRST USE 9-26-2002; IN COMMERCE 5-26-2003.

FOR: REAL ESTATE BROKERAGE AND LISTINGS; LEASING OF REAL ESTATE; AND REAL ESTATE AGENCIES, IN CLASS 36 (U.S. CLS. 100, 101 AND 102).

FIRST USE 5-26-2003; IN COMMERCE 5-26-2003.

THE MARK CONSISTS OF STANDARD CHARACTERS WITHOUT CLAIM TO ANY PARTICULAR FONT, STYLE, SIZE, OR COLOR.

OWNER OF U.S. REG. NOS. 2,765,238, 2,811,598, AND 2,826,183.

SN 76-641,895, FILED 6-29-2005.

AMY GEARIN, EXAMINING ATTORNEY

**Int. Cl.: 29**

**Prior U.S. Cl.: 46**

**United States Patent and Trademark Office**

**Reg. No. 3,454,232**

**Registered June 24, 2008**

**TRADEMARK  
PRINCIPAL REGISTER**

**STUFFED DAWG**

THE STUFFED DAWG COMPANY (ILLINOIS  
CORPORATION)  
212 ANTHONY ROAD  
BUFFALO GROVE, IL 60089

THE MARK CONSISTS OF STANDARD CHAR-  
ACTERS WITHOUT CLAIM TO ANY PARTICULAR  
FONT, STYLE, SIZE, OR COLOR.

FOR: FOOD PRODUCTS, NAMELY, FRANKFUR-  
TERS, WIENERS, HOT DOGS, SAUSAGES, BRAT-  
WURST, KNOCKWURST, AND BOLOGNA, IN  
CLASS 29 (U.S. CL. 46).

SN 76-644,193, FILED 8-3-2005.

FIRST USE 3-31-2008; IN COMMERCE 3-31-2008.

PAULA MAHONEY, EXAMINING ATTORNEY

**Int. Cl.: 5**

**Prior U.S. Cls.: 6, 18, 44, 46, 51, and 52**

**Reg. No. 3,454,233**

**United States Patent and Trademark Office**

**Registered June 24, 2008**

**TRADEMARK  
PRINCIPAL REGISTER**

**LACTIDENT**

GLOBAL HEALTH TRAX INC. (NEVADA COR-  
PORATION)  
2465 ASH ST.  
VISTA, CA 92081

THE MARK CONSISTS OF STANDARD CHAR-  
ACTERS WITHOUT CLAIM TO ANY PARTICULAR  
FONT, STYLE, SIZE, OR COLOR.

FOR: DIETARY SUPPLEMENTS, IN CLASS 5 (U.S.  
CLS. 6, 18, 44, 46, 51 AND 52).

SN 76-644,754, FILED 8-12-2005.

FIRST USE 5-8-2006; IN COMMERCE 5-8-2006.

REBECCA EISINGER, EXAMINING ATTORNEY

**Int. Cl.: 30**

**Prior U.S. Cl.: 46**

**United States Patent and Trademark Office**

**Reg. No. 3,454,234**

**Registered June 24, 2008**

**TRADEMARK  
PRINCIPAL REGISTER**

**THAT'S HOT**

SOLAFIDE, INC. (CALIFORNIA CORPORATION)  
14522 MYFORD ROAD  
IRVINE, CA 92606

FOR: NOODLES, NAMELY, INSTANT NOODLES,  
INSTANT NOODLES WITH SEASONINGS, AND  
RAMEN NOODLES WITH SEASONINGS; NOODLES  
WITH SOUP MIX SOLD IN UNITARY PACKAGE;  
NOODLES SERVED IN SOUP; PASTA , IN CLASS 30  
(U.S. CL. 46).

FIRST USE 1-22-2007; IN COMMERCE 1-22-2007.

THE MARK CONSISTS OF STANDARD CHAR-  
ACTERS WITHOUT CLAIM TO ANY PARTICULAR  
FONT, STYLE, SIZE, OR COLOR.

SN 76-644,955, FILED 8-15-2005.

RONALD AIKENS, EXAMINING ATTORNEY



**Int. Cl.: 5**

**Prior U.S. Cls.: 6, 18, 44, 46, 51, and 52**

**United States Patent and Trademark Office**

**Reg. No. 3,454,235**

**Registered June 24, 2008**

**TRADEMARK  
PRINCIPAL REGISTER**

**SORBION SACHET**

RIESINGER, BIRGIT (FED REP GERMANY IN-  
DIVIDUAL)  
ZUM HOLTkamp 3  
OSTBEVERN, FED REP GERMANY 48346

FOR: MEDICAL PLASTERS, BANDAGING AND  
COMPRESSES FOR DRESSINGS AND WOUND  
DRESSINGS, AND PHARMACEUTICAL PREPARA-  
TIONS; ALL THE AFOREMENTIONED ITEMS FOR  
TREATING SKIN DISORDERS, SECRETING  
WOUNDS, DECUBITUS ULCERS, CRURAL UL-  
CERS, BURN WOUNDS, PRULENT FISTULAS,  
DRAINAGES, GALLBLADDER FISTULAS, PAN-  
CREATIC FISTULAS, COECAL FISTULAS AND  
SIMIL DIABETIC FEET, OOZING LAPAROTOMY  
WOUNDS, AND SIMILAR SECRETING WOUNDS,  
IN CLASS 5 (U.S. CLS. 6, 18, 44, 46, 51 AND 52).

FIRST USE 1-8-2008; IN COMMERCE 1-8-2008.

THE MARK CONSISTS OF STANDARD CHAR-  
ACTERS WITHOUT CLAIM TO ANY PARTICULAR  
FONT, STYLE, SIZE, OR COLOR.

THE MARK "SORBION SACHET" DOES NOT  
IDENTIFY A LIVING INDIVIDUAL.

THE ENGLISH TRANSLATION OF THE FRENCH  
WORD "SACHET" IS "BAG".

SN 76-648,077, FILED 10-7-2005.

PAUL CROWLEY, EXAMINING ATTORNEY

**Int. Cl.: 9**

**Prior U.S. Cls.: 21, 23, 26, 36, and 38**

**United States Patent and Trademark Office**

**Reg. No. 3,454,236**

**Registered June 24, 2008**

**TRADEMARK  
PRINCIPAL REGISTER**

**AFRICAN BOLT ACTION**

I.P. HOLDINGS, INC. (TEXAS CORPORATION)  
805 W. N. CARRIER PARKWAY, SUITE 240  
GRAND PRAIRIE, TX 75050

FOR: PRERECORDED VIDEO TAPES, COMPACT  
DISCS, AND DVDS IN THE FIELD OF HUNTING,  
IN CLASS 9 (U.S. CLS. 21, 23, 26, 36 AND 38).

FIRST USE 7-1-2007; IN COMMERCE 7-1-2007.

THE MARK CONSISTS OF STANDARD CHAR-  
ACTERS WITHOUT CLAIM TO ANY PARTICULAR  
FONT, STYLE, SIZE, OR COLOR.

NO CLAIM IS MADE TO THE EXCLUSIVE  
RIGHT TO USE "AFRICAN", APART FROM THE  
MARK AS SHOWN.

SN 76-650,012, FILED 11-3-2005.

LOURDES AYALA, EXAMINING ATTORNEY

**Int. Cl.: 37**

**Prior U.S. Cls.: 100, 103, and 106**

**United States Patent and Trademark Office**

**Reg. No. 3,454,237**

**Registered June 24, 2008**

**SERVICE MARK  
PRINCIPAL REGISTER**



READY DECKS, INC. (LOUISIANA CORPORATION)  
1250 NEW NATCHITOCHESS ROAD  
WEST MONROE, LA 71292

OWNER OF U.S. REG. NO. 3,019,077.

FOR: CONSTRUCTION AND REPAIR OF WOODEN DECKS, IN CLASS 37 (U.S. CLS. 100, 103 AND 106).

NO CLAIM IS MADE TO THE EXCLUSIVE RIGHT TO USE "DECKS", APART FROM THE MARK AS SHOWN.

FIRST USE 5-1-2002; IN COMMERCE 2-1-2004.

SN 76-651,066, FILED 11-28-2005.

THE MARK CONSISTS OF STANDARD CHARACTERS WITHOUT CLAIM TO ANY PARTICULAR FONT, STYLE, SIZE, OR COLOR.

PAUL F. GAST, EXAMINING ATTORNEY

**Int. Cls.: 3 and 35**

**Prior U.S. Cls.: 1, 4, 6, 50, 51, 52, 100, 101, and 102**

**United States Patent and Trademark Office**

**Reg. No. 3,454,238**

**Registered June 24, 2008**

**TRADEMARK  
SERVICE MARK  
PRINCIPAL REGISTER**

**SHADES OF EXPRESSION**

LYNDI LTD. (IOWA CORPORATION)  
2419 5TH AVENUE SOUTH  
FORT DODGE, IA 50501

FOR: HAIR CARE AND COSMETIC PRODUCTS FOR THE HANDS AND BODY, NAMELY, HAIR SHAMPOOS, HAIR CONDITIONERS, COLD WAV-ING SOLUTIONS, HAIR WAVING LOTION, STY-ING AND SETTING LOTIONS FOR HAIR, HAIR AND BODY GELS, FOAMS FOR HAIR, BATH GELS AND FOAMS, HAIR SPRAYS, SKIN MOISTURI-ZERS, HAIR RINSES, HAIR COLORS, HAIR DYES, HAIR TINTS, PERMANENT WAVING SOLUTIONS FOR HAIR, COSMETIC SUN TANNING PREPARA-TIONS, SUN SCREEN, FACIAL TONERS, FACE AND SKIN CREAMS, FACIAL LOTION, SCRUBS, AND POWDERS; SKIN CARE PRODUCTS, NAME-LY, MOISTURIZERS, MASQUES, CLEANSERS AND COSMETIC ASTRINGENTS; AND COLOR COSMET-ICS, NAMELY, LIPSTICKS, EYE SHADOWS, FOUN-

DATION CREAMS, BLUSHES, FACE POWDER, EYE PENCILS, LIP PENCILS AND MASCARAS, IN CLASS 3 (U.S. CLS. 1, 4, 6, 50, 51 AND 52).

FIRST USE 1-1-2007; IN COMMERCE 1-1-2007.

FOR: RETAIL STORE SERVICES FEATURING HAIR CARE PRODUCTS AND COSMETICS, IN CLASS 35 (U.S. CLS. 100, 101 AND 102).

FIRST USE 1-1-2007; IN COMMERCE 1-1-2007.

THE MARK CONSISTS OF STANDARD CHAR-ACTERS WITHOUT CLAIM TO ANY PARTICULAR FONT, STYLE, SIZE, OR COLOR.

SN 76-651,169, FILED 11-30-2005.

ERNEST SHOSHO, EXAMINING ATTORNEY

**Int. Cl.: 44**

**Prior U.S. Cls.: 100 and 101**

**United States Patent and Trademark Office**

**Reg. No. 3,454,239**

**Registered June 24, 2008**

**SERVICE MARK  
PRINCIPAL REGISTER**

**GET LUCKY AT L.A. TAN**

L.A. TAN ENTERPRISES, INC. (ILLINOIS CORPORATION)  
3775 W. ARTHUR STREET  
LINCOLNWOOD, IL 60712

FOR: TANNING SALON SERVICES, IN CLASS 44  
(U.S. CLS. 100 AND 101).

FIRST USE 3-1-2006; IN COMMERCE 3-1-2006.

THE MARK CONSISTS OF STANDARD CHARACTERS WITHOUT CLAIM TO ANY PARTICULAR FONT, STYLE, SIZE, OR COLOR.

OWNER OF U.S. REG. NOS. 2,939,122 AND 2,965,503.

SN 76-652,203, FILED 12-20-2005.

TANYA AMOS, EXAMINING ATTORNEY

**Int. Cl.: 44**

**Prior U.S. Cls.: 100 and 101**

**United States Patent and Trademark Office**

**Reg. No. 3,454,240**

**Registered June 24, 2008**

**SERVICE MARK  
PRINCIPAL REGISTER**

**COCKTAIL TAN**

L.A. TAN ENTERPRISES, INC. (ILLINOIS CORPORATION)

3775 W. ARTHUR STREET

LINCOLNWOOD, IL 60712

FOR: TANNING SALON SERVICES, IN CLASS 44  
(U.S. CLS. 100 AND 101).

FIRST USE 6-4-2005; IN COMMERCE 6-4-2005.

THE MARK CONSISTS OF STANDARD CHARACTERS WITHOUT CLAIM TO ANY PARTICULAR FONT, STYLE, SIZE, OR COLOR.

NO CLAIM IS MADE TO THE EXCLUSIVE RIGHT TO USE "TAN", APART FROM THE MARK AS SHOWN.

SN 76-652,730, FILED 1-3-2006.

TANYA AMOS, EXAMINING ATTORNEY

**Int. Cl.: 11**

**Prior U.S. Cls.: 13, 21, 23, 31, and 34**

**Reg. No. 3,454,241**

**United States Patent and Trademark Office**

**Registered June 24, 2008**

---

**TRADEMARK  
PRINCIPAL REGISTER**

**TRIPLE PLAY BURNER SYSTEM**

MONESSEN HEARTH SYSTEMS COMPANY  
(KENTUCKY CORPORATION)  
149 CLEVELAND DRIVE  
PARIS, KY 40361

FOR: FIREPLACES, VENTED GAS FIREPLACE  
INSERTS, GAS LOGS, GAS LOG SETS, IN CLASS 11  
(U.S. CLS. 13, 21, 23, 31 AND 34).

FIRST USE 3-27-2008; IN COMMERCE 3-27-2008.

THE MARK CONSISTS OF STANDARD CHAR-  
ACTERS WITHOUT CLAIM TO ANY PARTICULAR  
FONT, STYLE, SIZE, OR COLOR.

NO CLAIM IS MADE TO THE EXCLUSIVE  
RIGHT TO USE "BURNER SYSTEM", APART FROM  
THE MARK AS SHOWN.

SN 76-653,222, FILED 1-10-2006.

AISHA CLARKE, EXAMINING ATTORNEY

**Int. Cl.: 39**

**Prior U.S. Cls.: 100 and 105**

**United States Patent and Trademark Office**

**Reg. No. 3,454,242**

**Registered June 24, 2008**

**SERVICE MARK  
PRINCIPAL REGISTER**



LONG, ANNE (UNITED STATES INDIVIDUAL)  
9300 FITZ FOLLY DRIVE  
GREAT FALLS, VA 22066

FOR: VALET PARKING; CAR PARKING; VEHICLE PARKING; PARKING GARAGE SERVICES; PARKING LOT SERVICES, IN CLASS 39 (U.S. CLS. 100 AND 105).

FIRST USE 4-1-2006; IN COMMERCE 4-1-2006.

NO CLAIM IS MADE TO THE EXCLUSIVE RIGHT TO USE "MANAGEMENT SERVICES, INC", APART FROM THE MARK AS SHOWN.

THE MARK CONSISTS, IN PART, OF THE LETTERING "MMSI" IN STYLIZED FORM WITH THE DOT IN THE LETTER "I" FORMED BY A SMALL CIRCLE.

SN 76-653,275, FILED 1-12-2006.

ZHALEH DELANEY, EXAMINING ATTORNEY



**Int. Cl.: 41**

**Prior U.S. Cls.: 100, 101, and 107**

**United States Patent and Trademark Office**

**Reg. No. 3,454,243**

**Registered June 24, 2008**

**SERVICE MARK  
PRINCIPAL REGISTER**

**CARING CONVERSATIONS**

CENTER FOR PRACTICAL BIOETHICS, INC.  
(MISSOURI NONPROFIT CORPORATION)  
1111 MAIN STREET, SUITE 500  
KANSAS CITY, MO 64105

FOR: EDUCATIONAL SERVICES IN THE FIELD OF HEALTHCARE, NAMELY, PROVIDING EDUCATIONAL PROGRAMS, TRAINING, WORKSHOPS, SEMINARS AND ONE-ON-ONE MENTORING REGARDING END-OF-LIFE HEALTHCARE ALTERNATIVES, ACCESSING HEALTHCARE IN A COST EFFECTIVE MANNER, AND USE OF ADVANCE DIRECTIVES AND MEDICAL POWERS OF ATTORNEY, AND DISTRIBUTING COURSE MATERIALS IN CONNECTION

THEREWITH, IN CLASS 41 (U.S. CLS. 100, 101 AND 107).

FIRST USE 3-0-2006; IN COMMERCE 3-0-2006.

THE MARK CONSISTS OF STANDARD CHARACTERS WITHOUT CLAIM TO ANY PARTICULAR FONT, STYLE, SIZE, OR COLOR.

OWNER OF U.S. REG. NO. 2,569,165.

SN 76-654,219, FILED 1-30-2006.

GINA FINK, EXAMINING ATTORNEY

**Int. Cls.: 6, 9, 12, 20, and 21**

**Prior U.S. Cls.: 2, 12, 13, 14, 19, 21, 22, 23, 25, 26, 29, 30, 31, 32, 33, 35, 36, 38, 40, 44, and 50**

**Reg. No. 3,454,244**

**United States Patent and Trademark Office**

**Registered June 24, 2008**

**TRADEMARK  
PRINCIPAL REGISTER**



ALLENTOWN, INC. (NEW JERSEY CORPORATION)  
165 ROUTE 526  
P.O. BOX 698  
ALLENTOWN, NJ 085010698

FOR: METAL CAGES FOR DOGS, CATS, PRIMATES, RABBITS, GUINEA PIGS AND RODENTS; VENTILATED RABBIT HOUSING MADE PRIMARILY OF METAL; METAL RACKS USED TO HOLD RODENT CAGES; POULTRY CAGES MADE OF METAL; METAL CAGE IDENTIFICATION CARD HOLDERS; METAL SIPPER TUBES AND CAPS AND METAL WIRE BAR LIDS FOR RODENT CAGES, IN CLASS 6 (U.S. CLS. 2, 12, 13, 14, 23, 25 AND 50).

FIRST USE 9-0-2006; IN COMMERCE 9-0-2006.

FOR: LABORATORY EQUIPMENT, NAMELY, INDIVIDUALLY VENTILATED CAGING SYSTEMS COMPRISED OF PLASTIC CAGES, METAL RACKS AND AIR DELIVERY AND EXTRACTION LINES SOLD AS A UNIT; LABORATORY EQUIPMENT, NAMELY, CAGES AND CAGING RACK SYSTEMS FOR RODENTS SOLD AS A UNIT; LABORATORY EQUIPMENT, NAMELY, BIOLOGICAL SAFETY CABINETS AND ANIMAL TRANSFER STATIONS; LABORATORY EQUIPMENT, NAMELY, ANIMAL BEDDING DISPOSAL STATIONS; ELECTRONIC AIRFLOW MEASUREMENT DETECTORS; LABORATORY AIRFLOW CONTROL EQUIPMENT, NAMELY, CAGE RACK CONTROL VALVES, RACK SIMULATOR VALVES, IRIS DAMPER VALVES AND THIMBLE CONNECTORS FOR DIRECT CONNECTION BETWEEN CAGE RACKS AND BUILDING EXHAUST SYSTEM, IN CLASS 9 (U.S. CLS. 21, 23, 26, 36 AND 38).

FIRST USE 1-0-2007; IN COMMERCE 1-0-2007.

FOR: WHEELED CABINETS FOR ANIMAL TRANSFER, IN CLASS 12 (U.S. CLS. 19, 21, 23, 31, 35 AND 44).

FIRST USE 1-0-2007; IN COMMERCE 1-0-2007.

FOR: DOG KENNELS MADE OF METAL; NON-METAL WATERING BOTTLE STOPPERS, IN CLASS 20 (U.S. CLS. 2, 13, 22, 25, 32 AND 50).

FIRST USE 9-0-2006; IN COMMERCE 9-0-2006.

FOR: WATERING BOTTLES MADE OF PLASTIC AND SIPPING TUBES MADE OF RUBBER AND PLASTIC; CAGES FOR RABBITS, GUINEA PIGS AND RODENTS MADE OF PLASTIC, IN CLASS 21 (U.S. CLS. 2, 13, 23, 29, 30, 33, 40 AND 50).

FIRST USE 9-0-2006; IN COMMERCE 9-0-2006.

THE COLOR(S) BLUE IS/ARE CLAIMED AS A FEATURE OF THE MARK.

THE COLOR BLUE APPEARS IN THE WORDING ALLENTOWN AND DESIGN.

SEC. 2(F) AS TO "ALLENTOWN".

SN 76-655,823, FILED 2-28-2006.

KEVIN DINALLO, EXAMINING ATTORNEY

Int. Cl.: 20

Prior U.S. Cls.: 2, 13, 22, 25, 32, and 50

Reg. No. 3,454,245

United States Patent and Trademark Office

Registered June 24, 2008

**TRADEMARK  
PRINCIPAL REGISTER**

*"...To him that overcometh will I give to eat of the hidden manna, and will give him a white stone, and in the stone a new name written which no man knoweth saving he that receiveth it..." (Rev. 2:17)*

*Your New Name!*

LEE, CONSTANCE (UNITED STATES INDIVIDUAL)  
P.O. BOX 659  
LITHONIA, GA 30058

FIRST USE 8-28-2007; IN COMMERCE 8-28-2007.

SN 76-656,492, FILED 3-13-2006.

FOR: STONE PLAQUES THAT HAVE QUOTATIONS, SAYINGS, AND BIBLE VERSES ENGRAVED ON THEM, PACKAGED WITH DISPLAY STAND, IN CLASS 20 (U.S. CLS. 2, 13, 22, 25, 32 AND 50).

CHRISIE B. KING, EXAMINING ATTORNEY

**Int. Cl.: 9**

**Prior U.S. Cls.: 21, 23, 26, 36, and 38**

**Reg. No. 3,454,246**

**United States Patent and Trademark Office**

**Registered June 24, 2008**

**TRADEMARK  
PRINCIPAL REGISTER**

**REAL SOCCER**

GAMELOFT S.A. (FRANCE SOCIETE ANONYME  
(CORPORATION))  
14 RUE AUBER  
PARIS, FRANCE 75009

FOR: COMPUTER SOFTWARE FOR ELECTRONIC GAMES AND ENTERTAINMENT, NAMELY, COMPUTER GAME SOFTWARE USED AND PLAYED ON MOBILE CELLULAR TELEPHONES, HANDHELD COMPUTERS, PERSONAL COMPUTERS AND PERSONAL DIGITAL ASSISTANTS; DOWNLOADABLE ELECTRONIC GAME PROGRAMS; DOWNLOADABLE RING TONES; DOWNLOADABLE VOICE RINGERS FOR MOBILE TELECOMMUNICATIONS DEVICES; COMPUTER SOFTWARE FOR WALL PAPERS, NAMELY, STILL IMAGES FOR USE IN BACKGROUNDS ON MOBILE PHONE SCREENS; COMPUTER SCREEN SAVER SOFTWARE; COMPUTER SOFTWARE FOR PROCESSING ANIMATED IMAGES FOR USE ON MOBILE PHONE SCREENS; AND PROGRAMS FOR DOWNLOADING IMAGES TO MOBILE TELECOMMUNICATION DEVICES, NAMELY, MOBILE AND

CELLULAR TELEPHONES, HANDHELD COMPUTERS, PERSONAL COMPUTERS AND PERSONAL DIGITAL ASSISTANTS VIA THE GLOBAL COMPUTER NETWORK AND WIRELESS DEVICES; AND COMPUTER SOFTWARE FOR USE IN THE DESIGN, DEVELOPMENT AND EXECUTION OF WIRELESS COMPUTER GAMES, IN CLASS 9 (U.S. CLS. 21, 23, 26, 36 AND 38).

FIRST USE 5-1-2005; IN COMMERCE 5-1-2005.

THE MARK CONSISTS OF STANDARD CHARACTERS WITHOUT CLAIM TO ANY PARTICULAR FONT, STYLE, SIZE, OR COLOR.

NO CLAIM IS MADE TO THE EXCLUSIVE RIGHT TO USE "SOCCER" , APART FROM THE MARK AS SHOWN.

SN 76-657,719, FILED 4-3-2006.

ROBIN CHOSID, EXAMINING ATTORNEY

**Int. Cl.: 5**

**Prior U.S. Cls.: 6, 18, 44, 46, 51, and 52**

**United States Patent and Trademark Office**

**Reg. No. 3,454,247**

**Registered June 24, 2008**

**TRADEMARK  
PRINCIPAL REGISTER**

**BIODEFENDER**

HEALTH KING ENTERPRISE & BALANCEUTI-  
CALS GROUP, INC. (ILLINOIS CORPORA-  
TION)  
238 W 31ST STREET  
CHICAGO, IL 60616

FOR: HERBAL DIETARY SUPPLEMENTS; PHAR-  
MACEUTICAL PREPARATIONS FOR USE IN TRA-  
DITIONAL CHINESE MEDICINE, IN THE FORM OF  
CAPSULES, FOR THE TREATMENT OF INFEC-  
TIONS CAUSED BY BACTERIA, VIRUSES, AND  
FUNGI, AND FOR USE AS A DIETARY SUPPLE-  
MENT, IN CLASS 5 (U.S. CLS. 6, 18, 44, 46, 51 AND 52).

FIRST USE 10-15-2007; IN COMMERCE 10-15-2007.

THE MARK CONSISTS OF STANDARD CHAR-  
ACTERS WITHOUT CLAIM TO ANY PARTICULAR  
FONT, STYLE, SIZE, OR COLOR.

SN 76-658,643, FILED 4-18-2006.

WANDA KAY PRICE, EXAMINING ATTORNEY

**Int. Cl.: 3**

**Prior U.S. Cls.: 1, 4, 6, 50, 51, and 52**

**Reg. No. 3,454,248**

**United States Patent and Trademark Office**

**Registered June 24, 2008**

**TRADEMARK  
PRINCIPAL REGISTER**

**PRESTIGE WONDER-FULL**

PRESTIGE COSMETICS (FLORIDA CORPORATION)  
1601 GREEN ROAD  
POMPANO BEACH, FL 33064

THE MARK CONSISTS OF STANDARD CHARACTERS WITHOUT CLAIM TO ANY PARTICULAR FONT, STYLE, SIZE, OR COLOR.

FOR: COLOR COSMETICS, NAMELY, LIP GLOSS, LIPSTICK, LIP LINER PENCILS, MASCARA, AND CONCEALER, IN CLASS 3 (U.S. CLS. 1, 4, 6, 50, 51 AND 52).

SN 76-659,644, FILED 5-5-2006.

FIRST USE 9-1-2006; IN COMMERCE 9-1-2006.

ANTHONY RINKER, EXAMINING ATTORNEY

Int. Cl.: 33

Prior U.S. Cls.: 47 and 49

United States Patent and Trademark Office

Reg. No. 3,454,249

Registered June 24, 2008

TRADEMARK  
PRINCIPAL REGISTER

*Runners*

MAKING TRACKS, INC. (NEVADA CORPORATION)  
P.O. BOX 4898  
CHATSWORTH, CA 91313

THE MARK CONSISTS OF STANDARD CHARACTERS WITHOUT CLAIM TO ANY PARTICULAR FONT, STYLE, SIZE, OR COLOR.

FOR: DISTILLED SPIRITS, IN CLASS 33 (U.S. CLS. 47 AND 49).

SN 76-659,769, FILED 5-9-2006.

FIRST USE 3-6-2008; IN COMMERCE 3-6-2008.

AMY HELLA, EXAMINING ATTORNEY

**Int. Cl.: 25**

**Prior U.S. Cls.: 22 and 39**

**United States Patent and Trademark Office**

**Reg. No. 3,454,250**

**Registered June 24, 2008**

**TRADEMARK  
PRINCIPAL REGISTER**

**SIR GUY**

BRADLEY, MICHAEL DAVID (UNITED STATES  
INDIVIDUAL)  
309 SIMONE AVE  
CARSON CITY, NV 89701

THE MARK CONSISTS OF STANDARD CHAR-  
ACTERS WITHOUT CLAIM TO ANY PARTICULAR  
FONT, STYLE, SIZE, OR COLOR.

FOR: MENS SPORT SHIRTS, IN CLASS 25 (U.S.  
CLS. 22 AND 39).

SN 76-662,114, FILED 6-26-2006.

FIRST USE 8-1-2006; IN COMMERCE 10-1-2006.

CHERYL CLAYTON, EXAMINING ATTORNEY



**Int. Cl.: 3**

**Prior U.S. Cls.: 1, 4, 6, 50, 51, and 52**

**United States Patent and Trademark Office**

**Reg. No. 3,454,251**

**Registered June 24, 2008**

**TRADEMARK  
PRINCIPAL REGISTER**

**DOMINICANA TOOBIE-DOOBIE**

POLANCO, YOMARE (UNITED STATES INDIVIDUAL)  
7 WEBER ROAD  
NORTH BRUNSWICK, NJ 08902

FOR: HAIR CARE PRODUCTS, NAMELY, SHAMPOO, HAIR RINSE AND CONDITIONER, IN CLASS 3 (U.S. CLS. 1, 4, 6, 50, 51 AND 52).

FIRST USE 12-22-2007; IN COMMERCE 12-22-2007.

THE MARK CONSISTS OF STANDARD CHARACTERS WITHOUT CLAIM TO ANY PARTICULAR FONT, STYLE, SIZE, OR COLOR.

NO CLAIM IS MADE TO THE EXCLUSIVE RIGHT TO USE "DOMINICANA", APART FROM THE MARK AS SHOWN.

THE ENGLISH TRANSLATION OF THE SPANISH WORDING "DOMINICANA" IS "DOMINICAN."

SN 76-662,623, FILED 6-29-2006.

CHARISMA HAMPTON, EXAMINING ATTORNEY

**Int. Cl.: 21**

**Prior U.S. Cls.: 2, 13, 23, 29, 30, 33, 40, and 50**

**Reg. No. 3,454,252**

**United States Patent and Trademark Office**

**Registered June 24, 2008**

**TRADEMARK  
PRINCIPAL REGISTER**

**BEER ON A STICK**

ED BOESEN AND MARVIN MORFORD (IOWA  
PARTNERSHIP)  
1815 ASHWORTH ROAD  
WEST DES MOINES, IA 50265

THE MARK CONSISTS OF STANDARD CHAR-  
ACTERS WITHOUT CLAIM TO ANY PARTICULAR  
FONT, STYLE, SIZE, OR COLOR.

FOR: INSULATING SLEEVE HOLDERS FOR  
BEVERAGE CONTAINERS, IN CLASS 21 (U.S. CLS.  
2, 13, 23, 29, 30, 33, 40 AND 50).

SN 76-663,134, FILED 7-17-2006.

FIRST USE 8-1-2007; IN COMMERCE 8-1-2007.

RONALD AIKENS, EXAMINING ATTORNEY

**Int. Cl.: 21**

**Prior U.S. Cls.: 2, 13, 23, 29, 30, 33, 40, and 50**

**Reg. No. 3,454,253**

**United States Patent and Trademark Office**

**Registered June 24, 2008**

---

**TRADEMARK  
PRINCIPAL REGISTER**

**NAVI - WIPE**

CHRISTENSON, JOHN R. (UNITED STATES IN-  
DIVIDUAL)  
5834 OAKDALE AVENUE  
WOODLAND HILLS, CA 91367

FIRST USE 8-15-2006; IN COMMERCE 8-15-2006.

SN 76-663,141, FILED 7-17-2006.

FOR: DISPOSABLE IMPREGNATED PAPER TIS-  
SUE FOR USE IN CLEANING OBJECTS AND  
SURFACES, IN CLASS 21 (U.S. CLS. 2, 13, 23, 29, 30,  
33, 40 AND 50).

RONALD AIKENS, EXAMINING ATTORNEY

**Int. Cl.: 28**

**Prior U.S. Cls.: 22, 23, 38, and 50**

**Reg. No. 3,454,254**

**United States Patent and Trademark Office**

**Registered June 24, 2008**

---

**TRADEMARK  
PRINCIPAL REGISTER**

**BUSY BALL CHOO CHOO**

HASBRO, INC. (RHODE ISLAND CORPORATION)  
1027 NEWPORT AVENUE  
PAWTUCKET, RI 02862

FOR: CHILDREN'S MULTIPLE ACTIVITY TOY  
TRAIN, IN CLASS 28 (U.S. CLS. 22, 23, 38 AND 50).

FIRST USE 7-11-2007; IN COMMERCE 7-11-2007.

THE MARK CONSISTS OF STANDARD CHARACTERS WITHOUT CLAIM TO ANY PARTICULAR FONT, STYLE, SIZE, OR COLOR.

OWNER OF U.S. REG. NO. 2,935,968.

SN 76-663,943, FILED 8-1-2006.

KIMBERLY PERRY, EXAMINING ATTORNEY

**Int. Cl.: 21**

**Prior U.S. Cls.: 2, 13, 23, 29, 30, 33, 40, and 50**

**United States Patent and Trademark Office**

**Reg. No. 3,454,255**

**Registered June 24, 2008**

**TRADEMARK  
PRINCIPAL REGISTER**

**DRINK ON A STICK**

ED BOESEN AND MARVIN MORFORD (IOWA  
PARTNERSHIP)  
1815 ASHWORTH ROAD  
WEST DES MOINES, IA 50265

THE MARK CONSISTS OF STANDARD CHAR-  
ACTERS WITHOUT CLAIM TO ANY PARTICULAR  
FONT, STYLE, SIZE, OR COLOR.

FOR: INSULATING SLEEVE HOLDERS FOR  
BEVERAGE CONTAINERS, IN CLASS 21 (U.S. CLS.  
2, 13, 23, 29, 30, 33, 40 AND 50).

SN 76-663,953, FILED 8-1-2006.

FIRST USE 8-1-2007; IN COMMERCE 8-1-2007.

RONALD AIKENS, EXAMINING ATTORNEY

**Int. Cl.: 10**

**Prior U.S. Cls.: 26, 39, and 44**

**United States Patent and Trademark Office**

**Reg. No. 3,454,256**

**Registered June 24, 2008**

**TRADEMARK  
PRINCIPAL REGISTER**

**VERSALOK**

JOHNSON & JOHNSON (NEW JERSEY CORPORATION)  
ONE JOHNSON & JOHNSON PLAZA  
NEW BRUNSWICK, NJ 089337001

THE MARK CONSISTS OF STANDARD CHARACTERS WITHOUT CLAIM TO ANY PARTICULAR FONT, STYLE, SIZE, OR COLOR.

FOR: SUTURE ANCHORS AND INSTRUMENTS  
FOR USE IN FIXATION OF SOFT TISSUE TO BONE,  
IN CLASS 10 (U.S. CLS. 26, 39 AND 44).

SN 76-664,069, FILED 8-3-2006.

FIRST USE 9-13-2006; IN COMMERCE 9-13-2006.

LINDA MICKLEBURGH, EXAMINING ATTORNEY

**Int. Cl.: 5**

**Prior U.S. Cls.: 6, 18, 44, 46, 51, and 52**

**United States Patent and Trademark Office**

**Reg. No. 3,454,257**

**Registered June 24, 2008**

**TRADEMARK  
PRINCIPAL REGISTER**

**ACTIVE NUTRITION FOR GIRLS**

MCNEIL NUTRITIONALS, LLC (DELAWARE  
LTD LIAB CO)

601 OFFICE DRIVE

FORT WASHINGTON, PA 19034

FOR: VITAMINS AND DIETARY SUPPLEMENTS,  
IN CLASS 5 (U.S. CLS. 6, 18, 44, 46, 51 AND 52).

FIRST USE 8-30-2006; IN COMMERCE 8-30-2006.

THE MARK CONSISTS OF STANDARD CHAR-  
ACTERS WITHOUT CLAIM TO ANY PARTICULAR  
FONT, STYLE, SIZE, OR COLOR.

NO CLAIM IS MADE TO THE EXCLUSIVE  
RIGHT TO USE "NUTRITION FOR GIRLS", APART  
FROM THE MARK AS SHOWN.

SN 76-664,494, FILED 8-11-2006.

ELISSA GARBER KON, EXAMINING ATTORNEY

**Int. Cl.: 9**

**Prior U.S. Cls.: 21, 23, 26, 36, and 38**

**United States Patent and Trademark Office**

**Reg. No. 3,454,258**

**Registered June 24, 2008**

**TRADEMARK  
PRINCIPAL REGISTER**

**RADIA ECLIPSE**

AMX LLC (DELAWARE LTD LIAB CO)  
3000 RESEARCH DRIVE  
RICHARDSON, TX 75081

FOR: ELECTRONIC MODULAR LIGHTING LEVEL CONTROLS FOR INCANDESCENT, FLUORESCENT, NEON, COLD-CATHODE AND MAGNETIC LOW-VOLTAGE LIGHTING, IN CLASS 9 (U.S. CLS. 21, 23, 26, 36 AND 38).

FIRST USE 5-0-2007; IN COMMERCE 5-0-2007.

THE MARK CONSISTS OF STANDARD CHARACTERS WITHOUT CLAIM TO ANY PARTICULAR FONT, STYLE, SIZE, OR COLOR.

OWNER OF U.S. REG. NO. 2,295,100.

SN 76-665,889, FILED 9-12-2006.

DARRYL SPRUILL, EXAMINING ATTORNEY



Int. Cl.: 5

Prior U.S. Cls.: 6, 18, 44, 46, 51, and 52

Reg. No. 3,454,259

United States Patent and Trademark Office

Registered June 24, 2008

TRADEMARK  
PRINCIPAL REGISTER

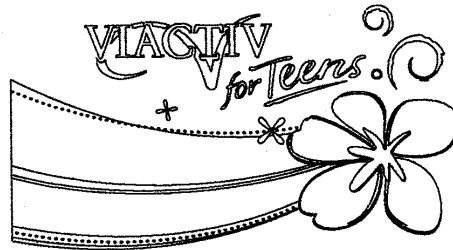

MCNEIL NUTRITIONALS, LLC (DELAWARE  
LTD LIAB CO)  
601 OFFICE DRIVE  
FORT WASHINGTON, PA 19034

FOR: VITAMINS AND DIETARY SUPPLEMENTS,  
IN CLASS 5 (U.S. CLS. 6, 18, 44, 46, 51 AND 52).

FIRST USE 8-30-2006; IN COMMERCE 8-30-2006.

OWNER OF U.S. REG. NOS. 2,248,302, 2,465,643,  
AND OTHERS.

NO CLAIM IS MADE TO THE EXCLUSIVE  
RIGHT TO USE "FOR TEENS", APART FROM THE  
MARK AS SHOWN.

SN 76-665,928, FILED 9-11-2006.

ELISSA GARBER KON, EXAMINING ATTORNEY

**Int. Cl.: 10**

**Prior U.S. Cls.: 26, 39, and 44**

**Reg. No. 3,454,260**

**United States Patent and Trademark Office**

**Registered June 24, 2008**

---

**TRADEMARK  
PRINCIPAL REGISTER**

**HARMONIC FOCUS**

JOHNSON & JOHNSON (NEW JERSEY CORPORATION)  
ONE JOHNSON & JOHNSON PLAZA  
NEW BRUNSWICK, NJ 089337001

THE MARK CONSISTS OF STANDARD CHARACTERS WITHOUT CLAIM TO ANY PARTICULAR FONT, STYLE, SIZE, OR COLOR.

FOR: ULTRASONIC SURGICAL INSTRUMENTS  
USED IN CUTTING AND COAGULATING SOFT  
TISSUE, IN CLASS 10 (U.S. CLS. 26, 39 AND 44).

SN 76-665,929, FILED 9-11-2006.

FIRST USE 10-23-2007; IN COMMERCE 10-23-2007.

LINDA MICKLEBURGH, EXAMINING ATTORNEY

**Int. Cl.: 3**

**Prior U.S. Cls.: 1, 4, 6, 50, 51, and 52**

**United States Patent and Trademark Office**

**Reg. No. 3,454,261**

**Registered June 24, 2008**

**TRADEMARK  
PRINCIPAL REGISTER**



VOODOO RIDE, LLC (DELAWARE LTD LIAB  
CO)  
325 W. HURON STREET, SUITE 404  
CHICAGO, IL 60610

FIRST USE 1-7-2008; IN COMMERCE 1-7-2008.

SN 76-666,207, FILED 9-18-2006.

FOR: AUTOMOTIVE SURFACE CARE PRO-  
DUCTS, NAMELY, AUTOMOBILE CLEANERS, AU-  
TOMOBILE POLISHES AND WAXES, IN CLASS 3  
(U.S. CLS. 1, 4, 6, 50, 51 AND 52).

KATHERINE CHANG, EXAMINING ATTORNEY

**Int. Cl.: 41**

**Prior U.S. Cls.: 100, 101, and 107**

**United States Patent and Trademark Office**

**Reg. No. 3,454,262**

**Registered June 24, 2008**

**SERVICE MARK  
PRINCIPAL REGISTER**



THE HEARING FOUNDATION OF CANADA  
(CANADA CORPORATION)  
80 RICHMOND STREET WEST, SUITE 1401  
ONTARIO, M5H 2A4, CANADA

FOR: EDUCATIONAL SERVICES, NAMELY,  
CONDUCTING PROGRAMS IN THE FIELD OF  
HEARING LOSS CONCERNING HEARING  
HEALTH AND HEARING LOSS ISSUES , IN CLASS  
41 (U.S. CLS. 100, 101 AND 107).

FIRST USE 10-20-2006; IN COMMERCE 10-20-2006.

NO CLAIM IS MADE TO THE EXCLUSIVE  
RIGHT TO USE "HEARING FOUNDATION OF  
CANADA", APART FROM THE MARK AS SHOWN.

SN 76-666,454, FILED 9-21-2006.

ADA HAN, EXAMINING ATTORNEY

**Int. Cl.: 5**

**Prior U.S. Cls.: 6, 18, 44, 46, 51, and 52**

**United States Patent and Trademark Office**

**Reg. No. 3,454,263**

**Registered June 24, 2008**

**TRADEMARK  
PRINCIPAL REGISTER**

**VITAROS**

NEXMED (U.S.A.), INC. (DELAWARE CORPORATION)  
89 TWIN RIVERS  
EAST WINDSOR, NJ 08520

THE MARK CONSISTS OF STANDARD CHARACTERS WITHOUT CLAIM TO ANY PARTICULAR FONT, STYLE, SIZE, OR COLOR.

FOR: PHARMACEUTICAL PREPARATIONS FOR THE TREATMENT OF SEXUAL DYSFUNCTION, IN CLASS 5 (U.S. CLS. 6, 18, 44, 46, 51 AND 52).

SN 76-666,974, FILED 10-4-2006.

FIRST USE 9-22-2007; IN COMMERCE 9-22-2007.

BRIAN NEVILLE, EXAMINING ATTORNEY

**Int. Cl.: 20**

**Prior U.S. Cls.: 2, 13, 22, 25, 32, and 50**

**Reg. No. 3,454,264**

**United States Patent and Trademark Office**

**Registered June 24, 2008**

---

**TRADEMARK  
PRINCIPAL REGISTER**

**MASTER-CLIP**

GOSS, INC. (PENNSYLVANIA CORPORATION)  
1511 ROUTE 8  
GLENSHAW, PA 15116

THE MARK CONSISTS OF STANDARD CHARACTERS WITHOUT CLAIM TO ANY PARTICULAR FONT, STYLE, SIZE, OR COLOR.

FOR: PLASTIC FASTENERS USED TO SECURE A WATER PIPE TO SUPPORTING STRUCTURES, IN CLASS 20 (U.S. CLS. 2, 13, 22, 25, 32 AND 50).

SN 76-667,079, FILED 10-6-2006.

FIRST USE 11-26-2007; IN COMMERCE 11-26-2007.

EMILY CARLSEN, EXAMINING ATTORNEY

Int. Cl.: 41

Prior U.S. Cls.: 100, 101, and 107

United States Patent and Trademark Office

Reg. No. 3,454,265

Registered June 24, 2008

**SERVICE MARK  
PRINCIPAL REGISTER**

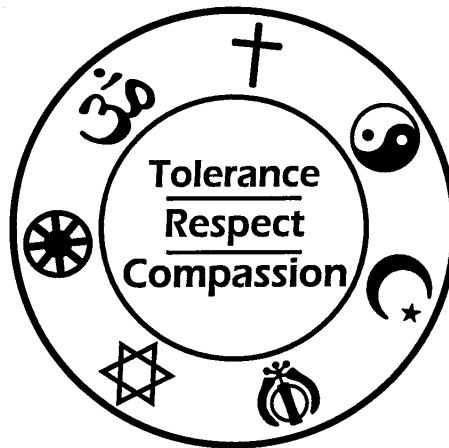

WILLIAM MARSH RICE UNIVERSITY (TEXAS  
NON-PROFIT CORPORATION)  
6100 MAIN STREET  
HOUSTON, TX 77005

FOR: EDUCATIONAL SERVICES, NAMELY,  
CONDUCTING LECTURES AND CONFERENCES  
REGARDING RELIGIOUS TOLERANCE AND DIS-  
TRIBUTING COURSE MATERIALS IN THE NAT-  
URE OF EDUCATOR RESOURCES IN  
CONNECTION THEREWITH; PUBLISHING AND  
ISSUING RESEARCH PAPERS REGARDING RELI-  
GIOUS TOLERANCE, IN CLASS 41 (U.S. CLS. 100, 101  
AND 107).

FIRST USE 6-0-2006; IN COMMERCE 6-0-2006.

NO CLAIM IS MADE TO THE EXCLUSIVE  
RIGHT TO USE "TOLERANCE, RESPECT, COMPAS-  
SION" AND THE STAR OF DAVID DESIGN, THE  
LATIN CROSS, AND THE CRESCENT MOON AND  
STAR SYMBOL, APART FROM THE MARK AS  
SHOWN.

SN 76-667,215, FILED 10-10-2006.

EMILY CHUO, EXAMINING ATTORNEY

**Int. Cl.: 25**

**Prior U.S. Cls.: 22 and 39**

**United States Patent and Trademark Office**

**Reg. No. 3,454,266**

**Registered June 24, 2008**

**TRADEMARK  
PRINCIPAL REGISTER**

**MISS MAJESTY**

ONE STEP UP LTD. (NEW YORK CORPORATION)  
1407 BROADWAY, 32ND FLOOR  
NEW YORK, NY 10018

THE MARK CONSISTS OF STANDARD CHARACTERS WITHOUT CLAIM TO ANY PARTICULAR FONT, STYLE, SIZE, OR COLOR.

FOR: WOMEN'S AND CHILDREN'S CLOTHING, NAMELY, DRESSES, SKIRTS, TROUSERS, BLOUSES, SWEATERS, TOPS, JACKETS, SHORTS AND JEANS, IN CLASS 25 (U.S. CLS. 22 AND 39).

SN 76-667,243, FILED 10-10-2006.

FIRST USE 12-14-2006; IN COMMERCE 12-14-2006.

JOHN DALIER, EXAMINING ATTORNEY



**Int. Cl.: 9**

**Prior U.S. Cls.: 21, 23, 26, 36, and 38**

**United States Patent and Trademark Office**

**Reg. No. 3,454,267**

**Registered June 24, 2008**

**TRADEMARK  
PRINCIPAL REGISTER**

**DOMINO FEVER**

GAMELOFT S.A. (FRANCE SOCIETE ANONYME  
(CORPORATION))  
14 RUE AUBER  
75009 PARIS, FRANCE

FOR: COMPUTER SOFTWARE FOR ELECTRONIC GAMES AND ENTERTAINMENT, NAMELY, SOFTWARE THAT IS DOWNLOADABLE FROM A REMOTE COMPUTER SITE VIA A GLOBAL COMPUTER NETWORK AND WIRELESS DEVICES, NAMELY, ELECTRONIC GAME PROGRAMS, RING TONES AND VOICE RINGERS FOR MOBILE TELECOMMUNICATIONS DEVICES, WALL PAPERS, SCREEN SAVERS, ANIMATED IMAGES AND COMPUTER SOFTWARE PROGRAMS FOR DOWNLOADING IMAGES TO MOBILE TELECOMMUNICATION DEVICES, NAMELY, MOBILE AND CELLULAR TELEPHONES, HANDHELD COMPUTERS, PERSONAL COMPUTERS AND PERSONAL DIGITAL ASSISTANTS; AND COMPUTER SOFTWARE, NAMELY, COMPUTER AIDED DESIGN

(CAD) SOFTWARE, FOR USE IN THE DESIGN, DEVELOPMENT AND EXECUTION OF WIRELESS COMPUTER GAMES, AND COMPUTER GAME SOFTWARE FOR USE WITH WIRELESS CONSOLE GAMING DEVICES AND PERSONAL COMPUTERS, IN CLASS 9 (U.S. CLS. 21, 23, 26, 36 AND 38).

FIRST USE 12-15-2006; IN COMMERCE 12-15-2006.

THE MARK CONSISTS OF STANDARD CHARACTERS WITHOUT CLAIM TO ANY PARTICULAR FONT, STYLE, SIZE, OR COLOR.

NO CLAIM IS MADE TO THE EXCLUSIVE RIGHT TO USE "DOMINO", APART FROM THE MARK AS SHOWN.

SN 76-668,015, FILED 10-25-2006.

JOHN E. MICHOS, EXAMINING ATTORNEY

**Int. Cl.: 9**

**Prior U.S. Cls.: 21, 23, 26, 36, and 38**

**United States Patent and Trademark Office**

**Reg. No. 3,454,268**

**Registered June 24, 2008**

**TRADEMARK  
PRINCIPAL REGISTER**

**INTENSITY**

BLACKMAGIC DESIGN PTY LTD (AUSTRALIA  
COMPANY)  
71 THISTLETHWAITE STREET  
SOUTH MELBOURNE, VICTORIA, AUSTRALIA  
3205

FOR: COMPUTER HARDWARE, NAMELY, VIDEO CARDS; AUDIO VISUAL EQUIPMENT, APPARATUS AND ACCESSORIES, NAMELY, MONITORS, TELEVISIONS, STEREOS AND VIDEO PROCESSORS; COMPUTER SOFTWARE FOR USE IN CONJUNCTION WITH VIDEO CARDS AND VIDEO EDITING FOR HIGH DEFINITION MULTIMEDIA INTERFACE EDITING; COMPUTER SOFTWARE FOR THE TRANSMISSION OF VIDEO AND IMAGES OVER COMPUTER NETWORKS, GLOBAL COMPUTER NETWORKS, AND THE WORLD WIDE

WEB; COMPUTER SOFTWARE FOR USE IN CONJUNCTION WITH AUDIO VISUAL APPLICATIONS, NAMELY, CONTROL AND PROCESSING COMPUTER SOFTWARE FOR AUDIO VISUAL APPLICATIONS, IN CLASS 9 (U.S. CLS. 21, 23, 26, 36 AND 38).

FIRST USE 9-8-2006; IN COMMERCE 9-8-2006.

THE MARK CONSISTS OF STANDARD CHARACTERS WITHOUT CLAIM TO ANY PARTICULAR FONT, STYLE, SIZE, OR COLOR.

SN 76-669,134, FILED 11-17-2006.

EMILY CARLSEN, EXAMINING ATTORNEY

**Int. Cl.: 9**

**Prior U.S. Cls.: 21, 23, 26, 36, and 38**

**United States Patent and Trademark Office**

**Reg. No. 3,454,269**

**Registered June 24, 2008**

**TRADEMARK  
PRINCIPAL REGISTER**

**MYSTERY MANSION PINBALL**

GAMELOFT S.A. (FRANCE SOCIETE ANONYME  
(CORPORATION))  
14 RUE AUBER  
75009 PARIS, FRANCE

FOR: COMPUTER SOFTWARE FOR ELECTRONIC GAMES AND ENTERTAINMENT, NAMELY, SOFTWARE THAT IS DOWNLOADABLE FROM A REMOTE COMPUTER SITE VIA A GLOBAL COMPUTER NETWORK AND WIRELESS DEVICES, NAMELY, ELECTRONIC GAME PROGRAMS, RING TONES AND VOICE RINGERS FOR MOBILE TELECOMMUNICATIONS DEVICES, WALL PAPERS, SCREEN SAVERS, ANIMATED IMAGES AND COMPUTER SOFTWARE PROGRAMS FOR DOWNLOADING IMAGES TO MOBILE TELECOMMUNICATION DEVICES, NAMELY, MOBILE AND CELLULAR TELEPHONES, HANDHELD COMPUTERS, PERSONAL COMPUTERS AND PERSONAL DIGITAL ASSISTANTS; AND COMPUTER SOFTWARE, NAMELY, COMPUTER AIDED DESIGN

(CAD) SOFTWARE, FOR USE IN THE DESIGN, DEVELOPMENT AND EXECUTION OF WIRELESS COMPUTER GAMES, AND COMPUTER GAME SOFTWARE FOR USE WITH WIRELESS CONSOLE GAMING DEVICES AND PERSONAL COMPUTERS, IN CLASS 9 (U.S. CLS. 21, 23, 26, 36 AND 38).

FIRST USE 12-1-2006; IN COMMERCE 12-1-2006.

THE MARK CONSISTS OF STANDARD CHARACTERS WITHOUT CLAIM TO ANY PARTICULAR FONT, STYLE, SIZE, OR COLOR.

NO CLAIM IS MADE TO THE EXCLUSIVE RIGHT TO USE "PINBALL", APART FROM THE MARK AS SHOWN.

SN 76-669,451, FILED 11-24-2006.

JOHN E. MICHOS, EXAMINING ATTORNEY

**Int. Cls.: 1 and 3**

**Prior U.S. Cls.: 1, 4, 5, 6, 10, 26, 46, 50, 51, and 52**

**United States Patent and Trademark Office**

**Reg. No. 3,454,270**

**Registered June 24, 2008**

**TRADEMARK  
PRINCIPAL REGISTER**



OILS BY NATURE, INC. (OHIO CORPORATION)  
30300 SOLON INDUSTRIAL PARKWAY  
SOLON, OH 44139

FOR: BOTANICAL EXTRACTS FOR USE IN  
MAKING COSMETICS; CHEMICAL ADDITIVES  
FOR USE IN THE MANUFACTURE OF COSMET-  
ICS, IN CLASS 1 (U.S. CLS. 1, 5, 6, 10, 26 AND 46).

FIRST USE 1-1-2008; IN COMMERCE 1-1-2008.

FOR: BATH OILS FOR COSMETIC PURPOSES;  
BODY AND BEAUTY CARE COSMETICS; COCOA  
BUTTER FOR COSMETIC PURPOSES; COSMETIC  
CREAMS FOR SKIN CARE; COSMETIC OILS; COS-  
METICS, IN CLASS 3 (U.S. CLS. 1, 4, 6, 50, 51 AND 52).

FIRST USE 1-1-2008; IN COMMERCE 1-1-2008.

SN 76-670,232, FILED 12-8-2006.

DAYNA BROWNE, EXAMINING ATTORNEY

**Int. Cls.: 1 and 3**

**Prior U.S. Cls.: 1, 4, 5, 6, 10, 26, 46, 50, 51, and 52**

**Reg. No. 3,454,271**

**United States Patent and Trademark Office**

**Registered June 24, 2008**

**TRADEMARK  
PRINCIPAL REGISTER**

**OBN**

OILS BY NATURE, INC. (OHIO CORPORATION)  
30300 SOLON INDUSTRIAL PARKWAY  
SOLON, OH 44139

FOR: BOTANICAL EXTRACTS FOR USE IN  
MAKING COSMETICS; CHEMICAL ADDITIVES  
FOR USE IN THE MANUFACTURE OF COSMET-  
ICS, IN CLASS 1 (U.S. CLS. 1, 5, 6, 10, 26 AND 46).

FIRST USE 1-1-2008; IN COMMERCE 1-1-2008.

FOR: BATH OILS FOR COSMETIC PURPOSES;  
BODY AND BEAUTY CARE COSMETICS; COCOA

BUTTER FOR COSMETIC PURPOSES; COSMETIC  
CREAMS FOR SKIN CARE; COSMETIC OILS; COS-  
METICS, IN CLASS 3 (U.S. CLS. 1, 4, 6, 50, 51 AND 52).

FIRST USE 1-1-2008; IN COMMERCE 1-1-2008.

THE MARK CONSISTS OF STANDARD CHAR-  
ACTERS WITHOUT CLAIM TO ANY PARTICULAR  
FONT, STYLE, SIZE, OR COLOR.

SN 76-670,233, FILED 12-11-2006.

DAYNA BROWNE, EXAMINING ATTORNEY

**Int. Cl.: 9**

**Prior U.S. Cls.: 21, 23, 26, 36, and 38**

**United States Patent and Trademark Office**

**Reg. No. 3,454,272**

**Registered June 24, 2008**

**TRADEMARK  
PRINCIPAL REGISTER**

**AUDIO FRENZY ENTERTAINMENT**

AUDIO FRENZY ENTERTAINMENT, L.L.C.  
(TENNESSEE LTD LIAB CO)  
115 PENN WARREN DRIVE, SUITE 300  
BOX 380  
BRENTWOOD, TN 37027

FIRST USE 12-0-2006; IN COMMERCE 4-1-2007.

NO CLAIM IS MADE TO THE EXCLUSIVE  
RIGHT TO USE "AUDIO" AND "ENTERTAIN-  
MENT", APART FROM THE MARK AS SHOWN.

FOR: PRE-RECORDED AUDIO AND VIDEO RE-  
CORDINGS FEATURING MUSIC; COMPACT DISCS  
AND DVDS FEATURING MUSIC; AND, DOWN-  
LOADABLE AUDIO RECORDINGS FEATURING  
MUSIC, IN CLASS 9 (U.S. CLS. 21, 23, 26, 36 AND 38).

SN 76-670,672, FILED 12-22-2006.

CARYN GLASSER, EXAMINING ATTORNEY

**Int. Cls.: 35 and 41**

**Prior U.S. Cls.: 100, 101, 102, and 107**

**United States Patent and Trademark Office**

**Reg. No. 3,454,273**

**Registered June 24, 2008**

**SERVICE MARK  
PRINCIPAL REGISTER**

**CALLPOWER**

CALLSOURCE (CALIFORNIA CORPORATION)  
31280 OAK CREST DRIVE  
WESTLAKE VILLAGE, CA 91361

FOR: BUSINESS CONSULTATION IN THE ANALYSIS OF TELEPHONE CALL RESPONSES TO CUSTOMER TELEPHONE INQUIRIES, IN CLASS 35 (U.S. CLS. 100, 101 AND 102).

FIRST USE 11-30-2007; IN COMMERCE 11-30-2007.

FOR: EDUCATIONAL SERVICES, NAMELY, PROVIDING EMPLOYEE TRAINING TO IMPROVE

CUSTOMER RELATIONSHIP BUILDING SKILLS, IN CLASS 41 (U.S. CLS. 100, 101 AND 107).

FIRST USE 11-30-2007; IN COMMERCE 11-30-2007.

THE MARK CONSISTS OF STANDARD CHARACTERS WITHOUT CLAIM TO ANY PARTICULAR FONT, STYLE, SIZE, OR COLOR.

OWNER OF U.S. REG. NO. 3,011,890.

SN 76-670,838, FILED 12-27-2006.

SETH A. RAPPAPORT, EXAMINING ATTORNEY

**Int. Cl.: 17**

**Prior U.S. Cls.: 1, 5, 12, 13, 35, and 50**

**United States Patent and Trademark Office**

**Reg. No. 3,454,274**

**Registered June 24, 2008**

**TRADEMARK  
PRINCIPAL REGISTER**



V X INC. (PENNSYLVANIA CORPORATION)  
109 GEIBY ROAD  
MANHEIM, PA 17545

THE COLOR(S) RED AND BLACK IS/ARE  
CLAIMED AS A FEATURE OF THE MARK.

FOR: RAW EXTRUDED VINYL TUBULAR AND  
LINEAR PLASTICS FOR USE IN THE MANUFAC-  
TURE AND FABRICATION OF VINYL FENCING  
COMPONENTS, NAMELY, POSTS, PANELS AND  
STAYS, IN CLASS 17 (U.S. CLS. 1, 5, 12, 13, 35 AND 50).

THE MARK CONSISTS OF THE COLOR RED IN  
THE WORDING VINYL EXPRESS AND THE COL-  
OR BLACK APPEARS IN THE WORDING "V X INC"  
AND IN THE HORIZONTAL LINING DESIGN.

FIRST USE 5-1-2007; IN COMMERCE 5-1-2007.

SN 76-671,558, FILED 1-19-2007.

NO CLAIM IS MADE TO THE EXCLUSIVE  
RIGHT TO USE "INC" OR "VINYL", APART FROM  
THE MARK AS SHOWN.

RUSS HERMAN, EXAMINING ATTORNEY



**Int. Cl.: 9**

**Prior U.S. Cls.: 21, 23, 26, 36, and 38**

**United States Patent and Trademark Office**

**Reg. No. 3,454,275**

**Registered June 24, 2008**

**TRADEMARK  
PRINCIPAL REGISTER**

**LIVE.LOVE.LISTEN**

SWEET G LLC (CALIFORNIA LTD LIAB CO)  
1524 CLOVERFIELD BLVD., SUITE G  
SANTA MONICA, CA 90404

THE MARK CONSISTS OF STANDARD CHAR-  
ACTERS WITHOUT CLAIM TO ANY PARTICULAR  
FONT, STYLE, SIZE, OR COLOR.

FOR: SERIES OF COMPACT DISCS FEATURING  
MUSICAL SOUND RECORDINGS, IN CLASS 9 (U.S.  
CLS. 21, 23, 26, 36 AND 38).

SN 76-671,704, FILED 1-19-2007.

FIRST USE 3-1-2007; IN COMMERCE 6-15-2007.

KAREN BRACEY, EXAMINING ATTORNEY

**Int. Cls.: 35 and 39**

**Prior U.S. Cls.: 100, 101, 102, and 105**

**United States Patent and Trademark Office**

**Reg. No. 3,454,276**

**Registered June 24, 2008**

**SERVICE MARK  
PRINCIPAL REGISTER**

The logo for 4Refuel features the number '4' in a bold, red, sans-serif font. To its right, the word 'Refuel' is written in a blue, italicized, sans-serif font. The '4' and 'R' are connected, with the '4' overlapping the 'R'.

4REFUEL CANADA LTD. (CANADA CORPORATION)  
UNIT 215, 9440 - 202ND STREET  
LANGLEY, CANADA V1M4A6

FOR: FRANCHISE SERVICES, NAMELY, OFFERING TECHNICAL AND BUSINESS MANAGEMENT ASSISTANCE IN THE ESTABLISHMENT AND OPERATION OF BUSINESSES AND OUTLETS INVOLVED IN ON-SITE RETAILING, WHOLESALING, TRANSPORTATION AND SUPPLY OF FUELS, OILS, LUBRICANTS AND GREASES; BUSINESS MANAGEMENT SERVICES FOR THE FUEL INDUSTRY, NAMELY, REPORTING ON FUEL CONSUMPTION, FUEL PRICES, AND AMOUNTS SPENT ON FUEL, IN CLASS 35 (U.S. CLS. 100, 101 AND 102).

FIRST USE 2-5-2007; IN COMMERCE 2-5-2007.

FOR: TRANSPORTATION AND DELIVERY OF FUELS, OILS, LUBRICANTS AND GREASES, IN CLASS 39 (U.S. CLS. 100 AND 105).

FIRST USE 2-5-2007; IN COMMERCE 2-5-2007.

NO CLAIM IS MADE TO THE EXCLUSIVE RIGHT TO USE "4REFUEL", APART FROM THE MARK AS SHOWN.

THE COLOR(S) RED AND BLUE IS/ARE CLAIMED AS A FEATURE OF THE MARK.

THE MARK CONSISTS OF THE INITIAL NUMBER "4" OF THE MARK "4REFUEL" APPEARS IN RED FOLLOWED THE REMAINING LETTERS IN BLUE.

SN 76-671,968, FILED 1-29-2007.

BRENDAN REGAN, EXAMINING ATTORNEY

**Int. Cl.: 35**

**Prior U.S. Cls.: 100, 101, and 102**

**United States Patent and Trademark Office**

**Reg. No. 3,454,277**

**Registered June 24, 2008**

---

**SERVICE MARK  
PRINCIPAL REGISTER**

**JOBBURNER.COM**

SIXFIRES, LLC (TEXAS LTD LIAB CO)  
17950 PRESTON ROAD  
SUITE 310  
DALLAS, TX 75252

FOR: PROVIDING ON-LINE EMPLOYMENT  
PLACEMENT SERVICES, NAMELY, PERSONALITY  
PROFILING, RESUME MATCHING AND JOB LIST-  
ING SERVICES VIA A GLOBAL COMPUTER NET-  
WORK, IN CLASS 35 (U.S. CLS. 100, 101 AND 102).

FIRST USE 10-10-2006; IN COMMERCE 11-1-2006.

THE MARK CONSISTS OF STANDARD CHAR-  
ACTERS WITHOUT CLAIM TO ANY PARTICULAR  
FONT, STYLE, SIZE, OR COLOR.

SN 76-672,319, FILED 2-7-2007.

BENJAMIN ALLEN, EXAMINING ATTORNEY

**Int. Cl.: 39**

**Prior U.S. Cls.: 100 and 105**

**United States Patent and Trademark Office**

**Reg. No. 3,454,278**

**Registered June 24, 2008**

**SERVICE MARK  
PRINCIPAL REGISTER**

**“ALWAYS TRUSTED...ALWAYS FRESH!”**

HARDIE'S FRUIT AND VEGETABLE COMPANY,  
LP (TEXAS LIMITED PARTNERSHIP)  
1005 NORTH COCKRELL HILL ROAD  
DALLAS, TX 75211

THE MARK CONSISTS OF STANDARD CHAR-  
ACTERS WITHOUT CLAIM TO ANY PARTICULAR  
FONT, STYLE, SIZE, OR COLOR.

FOR: DISTRIBUTION SERVICES, NAMELY, DE-  
LIVERY OF FRUITS AND VEGETABLES, IN CLASS  
39 (U.S. CLS. 100 AND 105).

SN 76-672,430, FILED 2-8-2007.

FIRST USE 6-15-2007; IN COMMERCE 6-15-2007.

KIMBERLY KREHELY, EXAMINING ATTORNEY

**Int. Cl.: 3**

**Prior U.S. Cls.: 1, 4, 6, 50, 51, and 52**

**Reg. No. 3,454,279**

**United States Patent and Trademark Office**

**Registered June 24, 2008**

---

**TRADEMARK  
PRINCIPAL REGISTER**

**FAST**

ZESTRON GMBH (FED REP GERMANY CORPORATION)  
BUNSENSTRASSE 6  
D-85053 INGOLSTADT, FED REP GERMANY

THE MARK CONSISTS OF STANDARD CHARACTERS WITHOUT CLAIM TO ANY PARTICULAR FONT, STYLE, SIZE, OR COLOR.

FOR: ALL PURPOSE INDUSTRIAL CLEANERS FOR HARD SURFACES, IN CLASS 3 (U.S. CLS. 1, 4, 6, 50, 51 AND 52).

SN 76-672,516, FILED 2-9-2007.

FIRST USE 3-26-2008; IN COMMERCE 3-26-2008.

MATTHEW EINSTEIN, EXAMINING ATTORNEY

**Int. Cl.: 10**

**Prior U.S. Cls.: 26, 39, and 44**

**Reg. No. 3,454,280**

**United States Patent and Trademark Office**

**Registered June 24, 2008**

**TRADEMARK  
PRINCIPAL REGISTER**

**DISTINCT**

SUPERMAX, INC. (ILLINOIS CORPORATION)  
2225 WHITE OAK CIRCLE  
WHITE OAK BUSINESS PARK  
AURORA, IL 60502

THE MARK CONSISTS OF STANDARD CHAR-  
ACTERS WITHOUT CLAIM TO ANY PARTICULAR  
FONT, STYLE, SIZE, OR COLOR.

FOR: MEDICAL GLOVES, SURGICAL GLOVES,  
EXAMINATION GLOVES, DENTAL GLOVES, IN  
CLASS 10 (U.S. CLS. 26, 39 AND 44).

SN 76-672,593, FILED 2-12-2007.

FIRST USE 6-1-2007; IN COMMERCE 6-1-2007.

STEVEN JACKSON, EXAMINING ATTORNEY

**Int. Cl.: 28**

**Prior U.S. Cls.: 22, 23, 38, and 50**

**United States Patent and Trademark Office**

**Reg. No. 3,454,281**

**Registered June 24, 2008**

**TRADEMARK  
PRINCIPAL REGISTER**

**BUSY LIL' LIFTOFF**

HASBRO, INC. (RHODE ISLAND CORPORATION)  
1027 NEWPORT AVENUE  
PAWTUCKET, RI 02862

FOR: PUSH TOYS, IN CLASS 28 (U.S. CLS. 22, 23, 38 AND 50).

FIRST USE 5-28-2007; IN COMMERCE 5-28-2007.

THE MARK CONSISTS OF STANDARD CHARACTERS WITHOUT CLAIM TO ANY PARTICULAR FONT, STYLE, SIZE, OR COLOR.

OWNER OF U.S. REG. NO. 2,935,968 AND OTHERS.

SN 76-673,360, FILED 2-28-2007.

DORITT L. CARROLL, EXAMINING ATTORNEY

**Int. Cl.: 28**

**Prior U.S. Cls.: 22, 23, 38, and 50**

**United States Patent and Trademark Office**

**Reg. No. 3,454,282**

**Registered June 24, 2008**

**TRADEMARK  
PRINCIPAL REGISTER**

**BUSY CHASE 'N CRAWL DUCKIES**

HASBRO, INC. (RHODE ISLAND CORPORATION)  
1027 NEWPORT AVENUE  
PAWTUCKET, RI 02862

OWNER OF U.S. REG. NO. 2,935,968 AND OTHERS.

FOR: CHILDREN'S MULTIPLE ACTIVITY TOYS,  
IN CLASS 28 (U.S. CLS. 22, 23, 38 AND 50).

NO CLAIM IS MADE TO THE EXCLUSIVE  
RIGHT TO USE "DUCKIES", APART FROM THE  
MARK AS SHOWN.

FIRST USE 10-31-2006; IN COMMERCE 10-31-2006.

SN 76-673,453, FILED 3-2-2007.

THE MARK CONSISTS OF STANDARD CHARACTERS  
WITHOUT CLAIM TO ANY PARTICULAR  
FONT, STYLE, SIZE, OR COLOR.

DORITT L. CARROLL, EXAMINING ATTORNEY



Int. Cl.: 35

Prior U.S. Cls.: 100, 101, and 102

United States Patent and Trademark Office

Reg. No. 3,454,283

Registered June 24, 2008

SERVICE MARK  
PRINCIPAL REGISTER



STELLAR GLOBAL, INC. (NEVADA CORPORATION)  
130 E. JOHN CARPENTER FREEWAY  
IRVING, TX 75062

FOR: OPERATION OF TELEPHONE COMMUNICATION CENTERS FOR OTHERS, INCLUDING CUSTOMER ASSISTANCE, TELEMARKETING, AND INFORMATION SERVICES; ELECTRONIC DOCUMENT MANAGEMENT SERVICES FOR OTHERS, NAMELY, DOCUMENT SCANNING, PROCESSING, AND TRACKING INCLUDING ACCOUNTS PAYABLE AND RECEIVABLE DATA AND DOCUMENTS, IN CLASS 35 (U.S. CLS. 100, 101 AND 102).

FIRST USE 7-1-2007; IN COMMERCE 7-1-2007.

THE MARK IS NOT LINED FOR COLOR.

THE MARK CONSISTS OF AN EIGHT POINT STAR WITHIN A LARGER EIGHT POINT STAR, SITUATED TO THE LEFT OF THE WORD "STELLAR" IN STYLIZED CHARACTERS. THE WORD "STELLAR" IS UNDERSCORED WITH A THIN LINE.

SN 76-673,456, FILED 3-2-2007.

CHRISTINA SOBRAL, EXAMINING ATTORNEY

**Int. Cls.: 18 and 25**

**Prior U.S. Cls.: 1, 2, 3, 22, 39, and 41**

**United States Patent and Trademark Office**

**Reg. No. 3,454,284**

**Registered June 24, 2008**

**TRADEMARK  
PRINCIPAL REGISTER**

**DIAMOND ICING**

LIPSTIK, INC. (CALIFORNIA CORPORATION)  
185 SOUTH MYERS STREET  
LOS ANGELES, CA 90033

FOR: HANDBAGS, TOTE BAGS, BACKPACKS, IN  
CLASS 18 (U.S. CLS. 1, 2, 3, 22 AND 41).

FIRST USE 8-3-2007; IN COMMERCE 8-3-2007.

FOR: BEACH WEAR, BLOUSES, COATS, COVER-  
ALLS, DRESSES, HEAD WEAR, JACKETS, JEANS,  
JOGGING SUITS, JUMPERS, LEG WARMERS, LEG-  
GINGS, LINGERIE, LOUNGEWEAR, NECKWEAR,

PANTS, SCARVES, SHIRTS, SKI WEAR, SLACKS,  
SLEEPWEAR, T-SHIRTS, TANK TOPS, SOCKS,  
VESTS, IN CLASS 25 (U.S. CLS. 22 AND 39).

FIRST USE 8-3-2007; IN COMMERCE 8-3-2007.

THE MARK CONSISTS OF STANDARD CHAR-  
ACTERS WITHOUT CLAIM TO ANY PARTICULAR  
FONT, STYLE, SIZE, OR COLOR.

SN 76-673,545, FILED 3-5-2007.

MARGERY A. TIERNEY, EXAMINING ATTORNEY

Int. Cls.: 28, 29, 30, and 31

Prior U.S. Cls.: 1, 22, 23, 38, 46, and 50

United States Patent and Trademark Office

Reg. No. 3,454,285

Registered June 24, 2008

TRADEMARK  
PRINCIPAL REGISTER

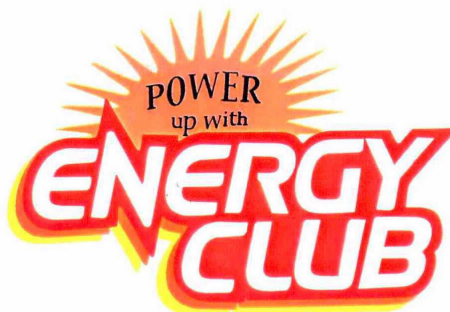

ENERGY CLUB, INC. (CALIFORNIA CORPORATION)

12950 PIERCE STREET

PACOIMA, CA 91331

FOR: TOYS SOLD IN CONJUNCTION WITH CANDY, NAMELY, TOY PUZZLES, TOY AIRPLANES, TOY VEHICLES, TOY MAGIC TRICK SETS, TOY SOLDIERS; TOY ANIMALS, NAMELY, TOY MONSTERS, DINOSAURS AND OTHER ANIMALS; TOY JEWELRY, TOY DOLLS, TOY CAP GUNS, TOY SETS OF CARPENTERS' TOOLS, TOY RACE CARS, TOY WATER GUNS, TOY MOTORCYCLES, TOY ROBOTS, TOY ROBOTS AND CIRCUS POP UP TOYS, IN CLASS 28 (U.S. CLS. 22, 23, 38 AND 50).

FIRST USE 7-17-2007; IN COMMERCE 7-17-2007.

FOR: SNACK MIX CONSISTING PRIMARILY OF PROCESSED FRUITS, PROCESSED NUTS AND/OR RAISINS, NAMELY, SWEET AND SALTY HONEY CASHEWS, TOFFEE PEANUTS, SMOKED ALMONDS, ROASTED SALTED CASHEWS AND PEANUTS, HOT AND SPICY PEANUTS, ROASTED SALTED PEANUTS, SWEET AND SALTY HONEY PEANUTS, CRUNCHY PEANUT SNACKS, ROASTED SALTED MIXED FRUITS, FRUIT AND NUT MIX; SNACK PEPPERED BEEF JERKY, RED HOT BEEF JERKY, SMOKED PEPPERED BEEF JERKY, CHILE LIMON BEEF JERKY; POTATO CHIPS, PORK RINDS AND PORK PUFFS, IN CLASS 29 (U.S. CL. 46).

FIRST USE 7-17-2007; IN COMMERCE 7-17-2007.

FOR: CANDIES; HARD AND SOFT CANDIES, NAMELY, CANDIES THAT ARE GUMMY AND SHAPED IN THE FORM OF FRUITS, FRUIT SLICES, BEARS, WORMS, APPLE RINGS, PEACH RINGS, JEWELRY, SHARKS, BEARS AND BEER BARRELS; HARD AND SOFT CANDIES, NAMELY, FRUIT SHAPED RUNTS, JUMBO CINNAMON BEARS, CHEWY SHAPED FISH AND SWEET CHERRY SOURS; RED LICORICE, BLACK LICORICE; CANDY WITH CARAMEL CREAM; CANDIES, NAMELY, HONEY CANDY, SWEET FRUIT SOURS, SWEET TROPICAL SOURS, CANDY GINGER CUTS; SOUR AND SWEET CANDIES; LOLLIPOPS, BUBBLE GUM; CARAMEL TOASTED CORN KERNELS; PEPPERMINTS AND WATER TOFFEE, IN CLASS 30 (U.S. CL. 46).

FIRST USE 7-17-2007; IN COMMERCE 7-17-2007.

FOR: UNPROCESSED PUMPKIN SEEDS; FLOWER SEEDS, NAMELY, SUNFLOWER SEEDS; RAW UNSALTED CASHEWS, RAW ALMONDS, RAW PEANUTS, RAW PISTACHIOS AND RAW NUTS; AND SNACK FOOD MIX OF RAW FRUITS, NUTS AND RAISINS, IN CLASS 31 (U.S. CLS. 1 AND 46).

FIRST USE 7-17-2007; IN COMMERCE 7-17-2007.

OWNER OF U.S. REG. NOS. 2,108,437 AND 3,170,464.

THE COLOR(S) WHITE, BLACK, YELLOW, ORANGE, AND RED IS/ARE CLAIMED AS A FEATURE OF THE MARK.

THE MARK CONSISTS OF THE WORDS "POWER UP WITH" IN BLACK STYLIZED LETTERING INSIDE A YELLOW SUN ABOVE THE WORDS "ENERGY CLUB" WHICH ARE IN WHITE BLOCK LETTERS OUTLINED IN YELLOW, ORANGE AND RED.

SN 76-673,633, FILED 3-5-2007.

SANJEEV VOHRA, EXAMINING ATTORNEY

**Int. Cl.: 9**

**Prior U.S. Cls.: 21, 23, 26, 36, and 38**

**Reg. No. 3,454,286**

**United States Patent and Trademark Office**

**Registered June 24, 2008**

**TRADEMARK  
PRINCIPAL REGISTER**



SWEET G LLC (CALIFORNIA LTD LIAB CO)  
1524 CLOVERFIELD BLVD., SUITE G  
SANTA MONICA, CA 90404

FOR: SERIES OF COMPACT DISCS FEATURING  
MUSICAL SOUND RECORDINGS, IN CLASS 9 (U.S.  
CLS. 21, 23, 26, 36 AND 38).

FIRST USE 3-1-2007; IN COMMERCE 6-15-2007.

THE MARK CONSISTS OF THE STANDARD  
PLAY AND PAUSE SYMBOLS ARE EACH IN A

CIRCLE AND ARE FOLLOWED BY THE WORDS  
"PLAY" AND "PAUSE" IN ALL CAPITAL LETTERS,  
WITH A VERTICAL LINE IN BETWEEN THEM,  
AND UNDERNEATH ARE THE WORDS "MUSIC  
FOR LIVING", "ORIGINAL MUSIC FOR EVERY  
MOMENT", "MUSIC FOR LIFE".

SN 76-673,805, FILED 3-8-2007.

KAREN BRACEY, EXAMINING ATTORNEY

**Int. Cl.: 35**

**Prior U.S. Cls.: 100, 101, and 102**

**United States Patent and Trademark Office**

**Reg. No. 3,454,287**

**Registered June 24, 2008**

**SERVICE MARK  
PRINCIPAL REGISTER**

**FOUNDATION POST**

FOUNDATION POST, INC. (ILLINOIS CORPORATION)  
200 E. OHIO STREET  
CHICAGO, IL 60611

THE MARK CONSISTS OF STANDARD CHARACTERS WITHOUT CLAIM TO ANY PARTICULAR FONT, STYLE, SIZE, OR COLOR.

FOR: POST PRODUCTION AND EDITORIAL SERVICES FOR TELEVISION COMMERCIALS, IN CLASS 35 (U.S. CLS. 100, 101 AND 102).

SN 76-673,979, FILED 3-12-2007.

FIRST USE 1-0-2004; IN COMMERCE 1-0-2004.

LINDSEY RUBIN, EXAMINING ATTORNEY

Int. Cls.: 35 and 41

Prior U.S. Cls.: 100, 101, 102, and 107

United States Patent and Trademark Office

Reg. No. 3,454,288

Registered June 24, 2008

SERVICE MARK  
PRINCIPAL REGISTER

**FOUNDATION**

FOUNDATION POST, INC. (ILLINOIS CORPORATION)  
200 E. OHIO STREET  
CHICAGO, IL 60611

FOR: PRODUCTION AND CREATIVE COPY WRITING, DIRECTING, AND CREATIVE EDITORIAL SERVICES FOR TELEVISION COMMERCIALS, IN CLASS 35 (U.S. CLS. 100, 101 AND 102).

FIRST USE 1-0-2004; IN COMMERCE 1-0-2004.

FOR: PRODUCTION AND CREATIVE COPY WRITING, DIRECTING, AND CREATIVE EDITOR-

IAL SERVICES FOR MUSIC VIDEOS AND FILM, IN CLASS 41 (U.S. CLS. 100, 101 AND 107).

FIRST USE 1-0-2004; IN COMMERCE 1-0-2004.

THE MARK CONSISTS OF STANDARD CHARACTERS WITHOUT CLAIM TO ANY PARTICULAR FONT, STYLE, SIZE, OR COLOR.

SN 76-673,980, FILED 3-12-2007.

LINDSEY RUBIN, EXAMINING ATTORNEY

**Int. Cl.: 35**

**Prior U.S. Cls.: 100, 101, and 102**

**United States Patent and Trademark Office**

**Reg. No. 3,454,289**

**Registered June 24, 2008**

**SERVICE MARK  
PRINCIPAL REGISTER**

*Every Child. Every Day. College Bound.*

MEMPHIS CITY SCHOOLS (TENNESSEE NON-  
PROFIT ORGANIZATION)  
2597 AVERY AVE  
MEMPHIS, TN 38112

FIRST USE 7-31-2006; IN COMMERCE 7-31-2006.

SN 76-674,286, FILED 3-19-2007.

FOR: PROMOTING THE PUBLIC AWARENESS  
OF THE NEED FOR SUPPORT FOR PUBLIC EDU-  
CATION, IN CLASS 35 (U.S. CLS. 100, 101 AND 102).

MARGERY A. TIERNEY, EXAMINING ATTORNEY



Int. Cls.: 35 and 41

Prior U.S. Cls.: 100, 101, 102, and 107

United States Patent and Trademark Office

Reg. No. 3,454,290

Registered June 24, 2008

SERVICE MARK  
PRINCIPAL REGISTER

**FOUNDATION CONTENT**

FOUNDATION POST, INC. (ILLINOIS CORPORATION)  
200 E. OHIO STREET  
CHICAGO, IL 60611

FOR: PRODUCTION AND CREATIVE COPY WRITING, DIRECTING, AND CREATIVE EDITORIAL SERVICES FOR TELEVISION COMMERCIALS, IN CLASS 35 (U.S. CLS. 100, 101 AND 102).

FIRST USE 3-0-2007; IN COMMERCE 3-0-2007.

FOR: PRODUCTION AND CREATIVE COPY WRITING, DIRECTING, AND CREATIVE EDITORIAL SERVICES FOR MUSIC VIDEOS AND FILM, IN CLASS 41 (U.S. CLS. 100, 101 AND 107).

FIRST USE 3-0-2007; IN COMMERCE 3-0-2007.

THE MARK CONSISTS OF STANDARD CHARACTERS WITHOUT CLAIM TO ANY PARTICULAR FONT, STYLE, SIZE, OR COLOR.

NO CLAIM IS MADE TO THE EXCLUSIVE RIGHT TO USE "CONTENT", APART FROM THE MARK AS SHOWN.

SN 76-674,289, FILED 3-19-2007.

LINDSEY RUBIN, EXAMINING ATTORNEY

**Int. Cl.: 25**

**Prior U.S. Cls.: 22 and 39**

**United States Patent and Trademark Office**

**Reg. No. 3,454,291**

**Registered June 24, 2008**

---

**TRADEMARK  
PRINCIPAL REGISTER**

**Justin**  
GYPSY

BOOT ROYALTY COMPANY, L.P. (DELAWARE  
LIMITED PARTNERSHIP)  
610 WEST DAGGETT AVENUE  
FORT WORTH, TX 76104

OWNER OF U.S. REG. NOS. 1,101,091, 3,190,673,  
AND OTHERS.

FOR: FOOTWEAR, NAMELY, WESTERN BOOTS  
FOR WOMEN, IN CLASS 25 (U.S. CLS. 22 AND 39).

SN 76-675,682, FILED 4-17-2007.

FIRST USE 8-17-2007; IN COMMERCE 8-17-2007.

TANYA AMOS, EXAMINING ATTORNEY

**Int. Cl.: 11**

**Prior U.S. Cls.: 13, 21, 23, 31, and 34**

**Reg. No. 3,454,292**

**United States Patent and Trademark Office**

**Registered June 24, 2008**

---

**TRADEMARK  
PRINCIPAL REGISTER**

**COCO**

BIO LIFE TECHNOLOGIES, L.L.C. (OKLAHOMA  
LTD LIAB CO)  
103 N. GRAND AVE.  
ENID, OK 73701

THE MARK CONSISTS OF STANDARD CHAR-  
ACTERS WITHOUT CLAIM TO ANY PARTICULAR  
FONT, STYLE, SIZE, OR COLOR.

FOR: BIDET, IN CLASS 11 (U.S. CLS. 13, 21, 23, 31  
AND 34).

SN 76-675,922, FILED 4-24-2007.

FIRST USE 9-19-2007; IN COMMERCE 9-19-2007.

TOBY BULLOFF, EXAMINING ATTORNEY

**Int. Cl.: 41**

**Prior U.S. Cls.: 100, 101, and 107**

**United States Patent and Trademark Office**

**Reg. No. 3,454,293**

**Registered June 24, 2008**

**SERVICE MARK  
PRINCIPAL REGISTER**

**IALETHIA  
WORLDWIDE**

IALETHIA WORLDWIDE, INC. (TEXAS NON-  
PROFIT CORPORATION)  
3900 SWISS AVE. #403  
DALLAS, TX 75204

FOR: PROVIDING EDUCATIONAL SERVICES,  
NAMELY, PROVIDING TRAINING THROUGH AC-  
CESS TO VIDEO AND AUDIO MEDIA IN THE  
FIELD OF THE CHRISTIAN FAITH AND TEACH-  
INGS, IN CLASS 41 (U.S. CLS. 100, 101 AND 107).

FIRST USE 6-1-2006; IN COMMERCE 12-1-2007.

THE MARK CONSISTS OF STANDARD CHAR-  
ACTERS WITHOUT CLAIM TO ANY PARTICULAR  
FONT, STYLE, SIZE, OR COLOR.

NO CLAIM IS MADE TO THE EXCLUSIVE  
RIGHT TO USE "WORLDWIDE", APART FROM  
THE MARK AS SHOWN.

SN 76-675,975, FILED 2-12-2007.

SALLY SHIH, EXAMINING ATTORNEY

**Int. Cl.: 36**

**Prior U.S. Cls.: 100, 101, and 102**

**United States Patent and Trademark Office**

**Reg. No. 3,454,294**

**Registered June 24, 2008**

---

**SERVICE MARK  
PRINCIPAL REGISTER**

**STILETTO STRUT**

THE NEIMAN MARCUS GROUP, INC. (DELA-  
WARE CORPORATION)  
1618 MAIN STREET  
DALLAS, TX 75201

FIRST USE 4-17-2008; IN COMMERCE 4-17-2008.

SN 76-676,701, FILED 5-11-2007.

FOR: CHARITABLE FUND RAISING, IN CLASS  
36 (U.S. CLS. 100, 101 AND 102).

ERNEST SHOSHO, EXAMINING ATTORNEY

Int. Cl.: 41

Prior U.S. Cls.: 100, 101, and 107

United States Patent and Trademark Office

Reg. No. 3,454,295

Registered June 24, 2008

SERVICE MARK  
PRINCIPAL REGISTER

# PRODUCT FIEND

ADVANCE MAGAZINE PUBLISHERS INC. (NEW  
YORK CORPORATION)  
FOUR TIMES SQUARE  
NEW YORK, NY 10036

FOR: ONLINE JOURNALS, NAMELY, BLOGS  
FEATURING INFORMATION CONCERNING COS-  
METICS AND BEAUTY PRODUCTS, IN CLASS 41  
(U.S. CLS. 100, 101 AND 107).

FIRST USE 3-17-2008; IN COMMERCE 3-17-2008.

THE MARK CONSISTS OF STANDARD CHAR-  
ACTERS WITHOUT CLAIM TO ANY PARTICULAR  
FONT, STYLE, SIZE, OR COLOR.

NO CLAIM IS MADE TO THE EXCLUSIVE  
RIGHT TO USE "PRODUCT", APART FROM THE  
MARK AS SHOWN.

SN 76-678,297, FILED 6-15-2007.

KELLEY WELLS, EXAMINING ATTORNEY

**Int. Cl.: 36**

**Prior U.S. Cls.: 100, 101, and 102**

**United States Patent and Trademark Office**

**Reg. No. 3,454,296**

**Registered June 24, 2008**

**SERVICE MARK  
PRINCIPAL REGISTER**

**SPOT REALTY**

CORUS HOME REALTY (VIRGINIA CORPORATION)

6726 CURRAN STREET

MCLEAN, VA 22101

FOR: REAL ESTATE BROKERAGE, IN CLASS 36  
(U.S. CLS. 100, 101 AND 102).

FIRST USE 8-1-2007; IN COMMERCE 8-1-2007.

THE MARK CONSISTS OF STANDARD CHARACTERS WITHOUT CLAIM TO ANY PARTICULAR FONT, STYLE, SIZE, OR COLOR.

NO CLAIM IS MADE TO THE EXCLUSIVE RIGHT TO USE "REALTY", APART FROM THE MARK AS SHOWN.

SN 76-678,310, FILED 6-15-2007.

MICHAEL TANNER, EXAMINING ATTORNEY

**Int. Cl.: 16**

**Prior U.S. Cls.: 2, 5, 22, 23, 29, 37, 38, and 50**

**United States Patent and Trademark Office**

**Reg. No. 3,454,297**

**Registered June 24, 2008**

**TRADEMARK  
PRINCIPAL REGISTER**

**SALCO R106E**

SALCO, INC. (NEW YORK CORPORATION)  
5930 FISHER ROAD  
SYRACUSE, NY 13057

FOR: ELECTRIC STAPLERS, IN CLASS 16 (U.S.  
CLS. 2, 5, 22, 23, 29, 37, 38 AND 50).

FIRST USE 4-11-2008; IN COMMERCE 4-11-2008.

THE MARK CONSISTS OF STANDARD CHAR-  
ACTERS WITHOUT CLAIM TO ANY PARTICULAR  
FONT, STYLE, SIZE, OR COLOR.

OWNER OF U.S. REG. NO. 1,300,154.

SN 76-678,443, FILED 6-20-2007.

KELLY BOULTON, EXAMINING ATTORNEY



**Int. Cl.: 16**

**Prior U.S. Cls.: 2, 5, 22, 23, 29, 37, 38, and 50**

**United States Patent and Trademark Office**

**Reg. No. 3,454,298**

**Registered June 24, 2008**

**TRADEMARK  
PRINCIPAL REGISTER**

**SALCO R105E**

SALCO, INC. (NEW YORK CORPORATION)  
5930 FISHER ROAD  
SYRACUSE, NY 13057

FOR: ELECTRIC STAPLERS, IN CLASS 16 (U.S.  
CLS. 2, 5, 22, 23, 29, 37, 38 AND 50).

FIRST USE 4-11-2008; IN COMMERCE 4-11-2008.

THE MARK CONSISTS OF STANDARD CHAR-  
ACTERS WITHOUT CLAIM TO ANY PARTICULAR  
FONT, STYLE, SIZE, OR COLOR.

OWNER OF U.S. REG. NO. 1,300,154.

SN 76-678,444, FILED 6-20-2007.

KELLY BOULTON, EXAMINING ATTORNEY

**Int. Cl.: 15**

**Prior U.S. Cls.: 2, 21, and 36**

**United States Patent and Trademark Office**

**Reg. No. 3,454,299**

**Registered June 24, 2008**

**TRADEMARK  
PRINCIPAL REGISTER**

**POWER TOUR**

HASBRO, INC. (RHODE ISLAND CORPORATION)  
1027 NEWPORT AVENUE  
PAWTUCKET, RI 02862

THE MARK CONSISTS OF STANDARD CHARACTERS WITHOUT CLAIM TO ANY PARTICULAR FONT, STYLE, SIZE, OR COLOR.

FOR: ELECTRIC GUITAR, IN CLASS 15 (U.S. CLS. 2, 21 AND 36).

SN 76-679,420, FILED 7-12-2007.

FIRST USE 6-29-2007; IN COMMERCE 6-29-2007.

JULIE GUTTADAURO, EXAMINING ATTORNEY

**Int. Cl.: 28**

**Prior U.S. Cls.: 22, 23, 38, and 50**

**Reg. No. 3,454,300**

**United States Patent and Trademark Office**

**Registered June 24, 2008**

---

**TRADEMARK  
PRINCIPAL REGISTER**

**PARTINI**

HASBRO, INC. (RHODE ISLAND CORPORATION)  
1027 NEWPORT AVENUE  
PAWTUCKET, RI 02862

THE MARK CONSISTS OF STANDARD CHARACTERS WITHOUT CLAIM TO ANY PARTICULAR FONT, STYLE, SIZE, OR COLOR.

FOR: PARLOR GAMES, IN CLASS 28 (U.S. CLS. 22, 23, 38 AND 50).

SN 76-680,278, FILED 8-2-2007.

FIRST USE 12-20-2007; IN COMMERCE 12-20-2007.

JULIE GUTTADAURO, EXAMINING ATTORNEY

**Int. Cl.: 41**

**Prior U.S. Cls.: 100, 101, and 107**

**United States Patent and Trademark Office**

**Reg. No. 3,454,301**

**Registered June 24, 2008**

**SERVICE MARK  
PRINCIPAL REGISTER**

**EL CIRCO**

SPANISH BROADCASTING SYSTEM, INC (DE-  
LAWARE CORPORATION)  
2601 SOUTH BAYSHORE DRIVE, PH 2  
COCONUT GROVE, FL 33133

FOR: ENTERTAINMENT SERVICES IN THE  
NATURE OF ON-GOING RADIO PROGRAMS FEATURING  
MUSIC, TALK AND VARIETY, IN CLASS  
41 (U.S. CLS. 100, 101 AND 107).

FIRST USE 1-4-2008; IN COMMERCE 1-8-2008.

THE MARK CONSISTS OF STANDARD CHARACTERS  
WITHOUT CLAIM TO ANY PARTICULAR  
FONT, STYLE, SIZE, OR COLOR.

THE SPANISH WORDS IN THE MARK TRANSLATE  
TO "THE CIRCUS".

SN 76-681,290, FILED 8-29-2007.

CARYN GLASSER, EXAMINING ATTORNEY

**Int. Cl.: 37**

**Prior U.S. Cls.: 100, 103, and 106**

**Reg. No. 3,454,302**

**United States Patent and Trademark Office**

**Registered June 24, 2008**

**SERVICE MARK  
PRINCIPAL REGISTER**



DISCOVERY LAND COMPANY LLC (DELA-  
WARE LTD LIAB CO)  
14605 NORTH 73RD STREET  
SCOTTSDALE, AZ 85260

FOR: REAL ESTATE DEVELOPMENT; PLAN-  
NING AND LAYING OUT GOLF COURSES, IN  
CLASS 37 (U.S. CLS. 100, 103 AND 106).

FIRST USE 10-16-2005; IN COMMERCE 10-16-2005.

NO CLAIM IS MADE TO THE EXCLUSIVE  
RIGHT TO USE "KOHANA'IKI" AND "GOLF &  
OCEAN CLUB", APART FROM THE MARK AS  
SHOWN.

THE STIPLING IS A FEATURE OF THE MARK.

SN 76-978,506, FILED 12-1-2005.

BERYL GARDNER, EXAMINING ATTORNEY

**Int. Cls.: 16, 25, 35, and 39**

**Prior U.S. Cls.: 2, 5, 22, 23, 29, 37, 38, 39, 50, 100, 101, 102, and 105**

**Reg. No. 3,454,303**

**United States Patent and Trademark Office**

**Registered June 24, 2008**

**TRADEMARK  
SERVICE MARK  
PRINCIPAL REGISTER**

**UTAH**  
**L I F E E L E V A T E D**

UTAH DIVISION OF TRAVEL DEVELOPMENT  
(UTAH STATE AGENCY)  
COUNCIL HALL/CAPITOL HILL  
300 N. STATE STREET  
SALT LAKE CITY, UT 84114

FOR: PRINTED PUBLICATIONS, NAMELY, BOOKS, PAMPHLETS AND BROCHURES FEATURING INFORMATION ABOUT THE STATE OF UTAH AND ITS EVENTS, ATTRACTIONS, HISTORY, PARKS, RECREATION OPPORTUNITIES, ENVIRONMENT AND GEOGRAPHY, IN CLASS 16 (U.S. CLS. 2, 5, 22, 23, 29, 37, 38 AND 50).

FIRST USE 4-15-2006; IN COMMERCE 4-15-2006.

FOR: CLOTHING, NAMELY, SHIRTS, COATS, JACKETS, HATS, CAPS, IN CLASS 25 (U.S. CLS. 22 AND 39).

FIRST USE 4-15-2006; IN COMMERCE 4-15-2006.

FOR: PROMOTING THE TOURISM-RELATED GOODS AND SERVICES OF OTHERS IN THE STATE OF UTAH VIA ADVERTISING IN PRINT, AUDIO, VIDEO, DIGITAL AND ON-LINE MEDIUM; PROMOTING THE TOURISM, RECREATION, BUSI-

NESS AND ECONOMIC DEVELOPMENT INTERESTS OF THE STATE OF UTAH; PROMOTING PUBLIC AWARENESS OF UTAH'S TOURIST ATTRACTIONS AND RECREATIONAL OPPORTUNITIES; PROVIDING INFORMATION IN THE FIELD OF BUSINESS AND ECONOMIC DEVELOPMENT IN THE STATE OF UTAH VIA GLOBAL COMMUNICATIONS NETWORKS, IN CLASS 35 (U.S. CLS. 100, 101 AND 102).

FIRST USE 4-15-2007; IN COMMERCE 4-15-2007.

FOR: PROVIDING INFORMATION IN THE FIELD OF TRAVEL AND TOURISM IN THE STATE OF UTAH, IN CLASS 39 (U.S. CLS. 100 AND 105).

FIRST USE 8-15-2006; IN COMMERCE 8-15-2006.

NO CLAIM IS MADE TO THE EXCLUSIVE RIGHT TO USE "UTAH", APART FROM THE MARK AS SHOWN.

SN 76-978,802, FILED 3-10-2006.

MICHAEL LEWIS, EXAMINING ATTORNEY

**Int. Cl.: 25**

**Prior U.S. Cls.: 22 and 39**

**United States Patent and Trademark Office**

**Reg. No. 3,454,304**

**Registered June 24, 2008**

**TRADEMARK  
PRINCIPAL REGISTER**

**GRETТА**

GRETТА ENTERPRISES, LLC (MASSACHU-  
SETTS LTD LIAB CO)  
19 KEARNEY ROAD  
NEEDHAM, MA 02494

FOR: CLOTHING, NAMELY, BLOUSES, SHIRTS,  
T-SHIRTS, JERSEYS, SWEATERS, JACKETS, SUITS,  
UNDERGARMENTS, SOCKS, PANTS, SLACKS,  
JEANS, SHOES, HATS, BATHING SUITS, BODY  
SUITS, GYM, JOGGING, SWEAT AND WARM-UP  
SUITS, COATS, GLOVES, BELTS, HOSIERY, DRES-  
SES, SKIRTS, SCARVES, FURS, NAMELY, COATS,  
JACKETS, STOLES AND HATS, SLIPS, PANTIES,  
TEDDIES, CAPS, WRAP-AROUNDS, SHAWLS, PA-  
JAMAS AND ROBES, IN CLASS 25 (U.S. CLS. 22 AND  
39).

FIRST USE 12-0-2007; IN COMMERCE 5-3-2008.

THE MARK CONSISTS OF STANDARD CHAR-  
ACTERS WITHOUT CLAIM TO ANY PARTICULAR  
FONT, STYLE, SIZE, OR COLOR.

OWNER OF U.S. REG. NO. 2,821,023.

THE NAME(S), PORTRAIT(S), AND/OR SIGNA-  
TURE(S) SHOWN IN THE MARK IDENTIFIES  
"GRETТА", WHOSE CONSENT(S) TO REGISTER IS  
SUBMITTED.

SN 76-978,828, FILED 4-19-2004.

STEVEN JACKSON, EXAMINING ATTORNEY

**Int. Cls.: 1, 2, 7, and 9**

**Prior U.S. Cls.: 1, 5, 6, 10, 11, 13, 16, 19, 21, 23, 26, 31, 34, 35, 36, 38, and 46**

**Reg. No. 3,454,305**

**United States Patent and Trademark Office**

**Registered June 24, 2008**

**TRADEMARK  
PRINCIPAL REGISTER**

# **RICOH**

RICOH COMPANY, LTD. (JAPAN CORPORATION)  
3-6, 1-CHOME NAKAMAGOME  
OHTA-KU, TOKYO, JAPAN

FOR: CHEMICALLY TREATED PHOTOGRAPHIC, DUPLICATING, COPYING AND PRINTING PAPERS, IN CLASS 1 (U.S. CLS. 1, 5, 6, 10, 26 AND 46).

FIRST USE 10-1-2005; IN COMMERCE 10-1-2006.

FOR: PRINTER'S INKS; INKS CONTAINED IN CARTRIDGES FOR INK JET PRINTERS; INKS CONTAINED IN ROLLER CASSETTE FOR INK JET PRINTERS; TONERS, TONER CARTRIDGES FOR USE IN COPYING MACHINES, FACSIMILE MACHINES, PRINTING MACHINES AND PRINTERS; TONER CONTAINED IN CARTRIDGES, IN CLASS 2 (U.S. CLS. 6, 11 AND 16).

FIRST USE 10-1-2005; IN COMMERCE 10-1-2006.

FOR: AUTOMATIC DOCUMENT SORTERS, AUTOMATIC DOCUMENT COLLATORS, AUTOMATIC DOCUMENT FEEDERS AND AUTOMATIC POWER STAPLER UNITS, IN CLASS 7 (U.S. CLS. 13, 19, 21, 23, 31, 34 AND 35).

FIRST USE 10-1-2005; IN COMMERCE 10-1-2006.

FOR: PRINTERS; DIGITAL CAMERAS; SEMI-CONDUCTORS, NAMELY, INTEGRATED CIR-

CUITS INCLUDING MONOLITHIC IC AND HYBRID IC, LSI AND VLSI; FACSIMILE MACHINES COMPUTER SOFTWARE FOR COMPUTER PROGRAMS, NAMELY, BUSINESS MANAGEMENT, DATABASE MANAGEMENT, EDUCATIONAL TRAINING AND SPORTS COACHING, CONTROLLING THE OPERATION OF COMPUTER PRINTERS AND SCANNERS, FACSIMILES AND COPIERS; DOCUMENT MANAGEMENT, COMMUNICATIONS, DESIGNING AND ENGINEERING BUILDINGS AND BUILDING COMPONENTS, CAMERA OPERATION, INPUT, OUTPUT STORAGE, RETRIEVAL OF DATA, PROCESSING, COMMUNICATION AUTHENTICATION, ENCRYPTION, DECRYPTION, DISPLAY OF PRINTING OF DATA; MULTIPLE-FUNCTION MACHINES FOR PRINTING, COPYING, SENDING AND/OR RECEIVING FACSIMILE MESSAGES; DIGITAL PRINTING MACHINES; IMAGE SCANNER, IN CLASS 9 (U.S. CLS. 21, 23, 26, 36 AND 38).

FIRST USE 10-1-2005; IN COMMERCE 10-1-2006.

OWNER OF U.S. REG. NOS. 1,054,884, 1,170,030, AND OTHERS.

SN 76-978,830, FILED 4-18-2005.

DOMINIC J. FERRAIUOLO, EXAMINING ATTORNEY



**Int. Cls.: 12, 14, 16, 18, and 24**

**Prior U.S. Cls.: 1, 2, 3, 5, 19, 21, 22, 23, 27, 28, 29, 31, 35, 37, 38, 41, 42, 44, and 50**

**Reg. No. 3,454,306**

**United States Patent and Trademark Office**

**Registered June 24, 2008**

**TRADEMARK  
PRINCIPAL REGISTER**



YOKOHAMA RUBBER COMPANY LIMITED,  
THE (JAPAN CORPORATION)  
36-11, SHIMBASHI 5-CHOME  
MINATO-KU, TOKYO 105-8685, JAPAN

FOR: AUTOMOBILE TIRES, WHEELS RIMS AND  
WHEELS FOR AUTOMOBILES , IN CLASS 12 (U.S.  
CLS. 19, 21, 23, 31, 35 AND 44).

FIRST USE 5-15-2005; IN COMMERCE 5-15-2005.

FOR: KEY RINGS OF PRECIOUS METAL,  
CLOCKS, WATCHES, TIE CLIPS, TIE PINS, AND  
CUFF LINKS, IN CLASS 14 (U.S. CLS. 2, 27, 28 AND  
50).

FIRST USE 12-1-2004; IN COMMERCE 7-1-2005.

FOR: POCKET MEMORANDUM BOOKS, NOTE  
BOOKS, WRITING PADS, ENVELOPS, PENCILS,  
FELT WRITING PENS, MECHANICAL PENCILS,  
BALLPOINT PENS, FOUNTAIN PENS, RUBBER  
ERASERS, UNDERLAYS FOR WRITING PAPER,  
DRAWING RULERS, POUCHES FOR WRITING  
INSTRUMENTS, PEN CASES, STICKERS, PAPER-  
WEIGHTS, PAPER KNIVES, PAPER NAME BAD-  
GES, IN CLASS 16 (U.S. CLS. 2, 5, 22, 23, 29, 37, 38 AND  
50).

FIRST USE 12-1-2004; IN COMMERCE 7-1-2005.

FOR: ALL PURPOSE SPORT BAGS, ALL PUR-  
POSE ATHLETIC BAGS, ALL PURPOSE CARRYING  
BAGS, ATHLETIC BAGS, BOOK BAGS, BOSTON  
BAGS, CARRY-ALL BAGS, CARRY-ON BAGS,  
CLUTCH BAGS, COSMETIC BAGS SOLD EMPTY,  
DUFFLE BAGS, DUFFLE BAGS FOR TRAVEL,  
FLEXIBLE BAGS FOR GARMENTS, GARMENT  
BAGS FOR TRAVEL, GLADSTONE BAGS, GYM  
BAGS, DRAWSTRING POUCHES, POUCHES OF  
LEATHER, TOOL POUCHES SOLD EMPTY, UM-  
BRELLAS, AND PARASOLS, IN CLASS 18 (U.S. CLS.  
1, 2, 3, 22 AND 41).

FIRST USE 12-1-2004; IN COMMERCE 7-1-2005.

FOR: TOWELS OF TEXTILES, IN CLASS 24 (U.S.  
CLS. 42 AND 50).

FIRST USE 12-1-2004; IN COMMERCE 7-1-2005.

OWNER OF U.S. REG. NOS. 2,001,737 AND  
2,915,212.

SN 76-978,831, FILED 11-1-2004.

JOHN GARTNER, EXAMINING ATTORNEY

**Int. Cl.: 9**

**Prior U.S. Cls.: 21, 23, 26, 36, and 38**

**Reg. No. 3,454,307**

**United States Patent and Trademark Office**

**Registered June 24, 2008**

**TRADEMARK  
PRINCIPAL REGISTER**

**DTS HD**

DTS, INC. (DELAWARE CORPORATION)  
5171 CLARETON DRIVE  
AGOURA HILLS, CA 91301

FOR: AUDIO AMPLIFIERS; AUDIO CASSETTE DECKS FOR AUTOMOBILES; AUDIO CASSETTE RECORDERS; AUDIO CASSETTES FEATURING MUSIC OR MOTION PICTURE SOUNDTRACKS; AUDIO CIRCUIT BOARDS; AUDIO DIGITAL TAPES FEATURING MUSIC OR MOTION PICTURE SOUNDTRACKS; AUDIO DISCS FEATURING MUSIC OR MOTION PICTURE SOUNDTRACKS; AUDIO DISKS FEATURING MULTI-CHANNEL DIGITAL AUDIO MUSIC, VOICE RECORDINGS OR MOTION PICTURE SOUNDTRACKS; AUDIO MIXERS; AUDIO RECORDERS AND EDITORS FOR RECORDING AND EDITING MULTICHANNEL AUDIO IN A DIGITAL FORMAT; AUDIO RECORDINGS FEATURING MUSIC OR MOTION PICTURE SOUNDTRACKS; AUDIO TAPE RECORDERS; AUDIO TAPES FEATURING MUSIC OR MOTION PICTURE SOUNDTRACKS; AUDIOVISUAL RECEIVERS; AUDIO-VIDEO RECEIVERS; CINEMATOGRAPHIC MACHINES AND APPARATUS; COMPACT DISC PLAYERS; COMPACT DISCS FEATURING MUSIC, VOICE RECORDINGS OR MOTION PICTURE SOUNDTRACKS; COMPACT DISKS FOR MOTION PICTURE SOUND TRACKS TO BE PLAYED IN SYNCHRONISM WITH THE MOTION PICTURE; PRERECORDED CDS AND DVDS FEATURING MULTICHANNEL DIGITAL AUDIO MUSIC, VOICE RECORDINGS OR MOTION PICTURE SOUNDTRACKS; COMPUTER CHIPS; COMPUTER GAME PROGRAMS; COMPUTER GAME SOFTWARE; COMPUTER PROGRAMS FOR USE IN AUDIO PROCESSING; COMPUTER PROGRAMS FOR PRE-RECORDED GAMES; COMPUTER SOFTWARE FOR USE IN AUDIO PROCESSING THAT MAY BE DOWNLOADED FROM A GLOBAL COMPUTER NETWORK; COMPUTER SOFTWARE FOR ENCODING OR DECODING AUDIO FOR USE WITH CDS, DVDS AND MULTI-MEDIA APPLICA-

TIONS; COMPUTER SOFTWARE FOR PROCESSING DIGITAL MUSIC FILES; COMPUTER SOFTWARE FOR ENCRYPTION; COMPUTER SOFTWARE TO ENHANCE THE AUDIO-VISUAL CAPABILITIES OF MULTIMEDIA APPLICATIONS, NAMELY, FOR THE INTEGRATION OF TEXT, AUDIO, GRAPHICS, STILL IMAGES AND MOVING PICTURES; DIGITAL AUDIO PLAYERS; DIGITAL AUDIO RECORDERS; DIGITAL AUDIO TAPE PLAYERS; DIGITAL AUDIO TAPE RECORDERS; DIGITAL SOUND PLAYBACK UNITS FOR MOTION PICTURE THEATER USE; DIGITAL VIDEO DISC DRIVES; DIGITAL VIDEO DISC PLAYERS; DIGITAL VIDEO RECORDERS; ENCODERS; HIGH DEFINITION TELEVISION RECEIVERS; HOME THEATER PRODUCTS, NAMELY DVD PLAYERS, AUDIO DECODERS AND AMPLIFIERS, AUDIO/VIDEO DECODERS FOR USE WITH AUDIO/VIDEO SYSTEMS; INTERACTIVE AUDIO GAME DISCS CONTAINING ACTION GAMES; LASER DISCS FEATURING MUSIC, MOTION PICTURE SOUNDTRACKS OR MOTION PICTURES; MOTION PICTURE FILMS WITH DIGITAL AUDIO ABOUT COMEDY, DRAMA, ACTION, ADVENTURE AND/OR ANIMATION; MOTION PICTURE FILMS WITH DIGITAL TIME CODES FOR SYNCHRONIZING WITH AN OFF-FILM DIGITAL SOUND SOURCE ABOUT COMEDY, DRAMA, ACTION, ADVENTURE AND/OR ANIMATION; MOVIE EDITING PROJECTORS; MOVIE PROJECTORS; MUSICAL SOUND RECORDINGS; PRERECORDED DVDS FEATURING MULTI-CHANNEL DIGITAL AUDIO; PRERECORDED DIGITAL AUDIO TAPE FEATURING MUSIC OR MOTION PICTURE SOUNDTRACKS; PRERECORDED DVD-R, DVD-RW, DVD-ROM, CD-R, AND CD-RW DISKS FEATURING MULTICHANNEL DIGITAL AUDIO MUSIC, VOICE RECORDINGS OR MOTION PICTURE SOUNDTRACKS; RECEIVERS, NAMELY, RADIO, SATELLITE, TELEVISION, AUDIO AND VIDEO; RECORD PLAYERS FOR DIGITAL COMPACT DISKS; RECORDING AND PLAYING DEVICES

FOR SOUND AND IMAGE CARRIERS; SATELLITE RECEIVERS; SIGNAL PROCESSORS AND TRANSMITTERS FOR RADIO AND OTHER AUDIO BROADCASTING, NAMELY, NETWORK STREAMING AND DOWNLOADING TO PORTABLE DEVICES; SIGNAL PROCESSORS AND TRANSMITTERS FOR CABLE OR SATELLITE BROADCASTING; SOFTWARE TO CONTROL AND IMPROVE AUDIO EQUIPMENT SOUND QUALITY; SOFTWARE FOR DIGITAL AUDIO ENCODING, RECORDING, DECODING AND PLAYBACK OF DIGITAL AUDIO; SOUND AMPLIFIERS; SOUND AND VIDEO RECORDING AND PLAYBACK MACHINES; SOUND MIXERS; SOUND MIXERS WITH INTEGRATED AMPLIFIERS; SOUND RECORDING APPARATUS AND INSTRUMENTS; SOUND RECORDINGS FEATURING MUSIC OR MOTION PICTURE SOUNDTRACKS; TELEVISION RECEIVERS; VISUAL RECORDINGS AND AUDIO VISUAL RECORDINGS FEATURING MUSIC AND ANIMATION; VIDEO DISCS FEATURING MUSIC OR MOTION PICTURE SOUNDTRACKS; VIDEO DISK PLAYERS; VIDEO DISKS AND VIDEO TAPES WITH RECORDED ANIMATED CARTOONS; VIDEO GAME CAR-

TRIDGES; VIDEO GAME DISCS; VIDEO GAME MACHINES FOR USE WITH TELEVISIONS; VIDEO-DISC PLAYERS, IN CLASS 9 (U.S. CLS. 21, 23, 26, 36 AND 38).

FIRST USE 6-30-2007; IN COMMERCE 6-30-2007.

THE MARK CONSISTS OF STANDARD CHARACTERS WITHOUT CLAIM TO ANY PARTICULAR FONT, STYLE, SIZE, OR COLOR.

OWNER OF U.S. REG. NOS. 1,936,747, 2,240,960, AND OTHERS.

NO CLAIM IS MADE TO THE EXCLUSIVE RIGHT TO USE "HD", APART FROM THE MARK AS SHOWN.

SEC. 2(F) DTS.

SN 76-978,832, FILED 2-24-2005.

LINDA ORNDORFF, EXAMINING ATTORNEY

**Int. Cls.: 35, 36, 38, and 42**

**Prior U.S. Cls.: 100, 101, 102, and 104**

**United States Patent and Trademark Office**

**Reg. No. 3,454,308**

**Registered June 24, 2008**

**SERVICE MARK  
PRINCIPAL REGISTER**



NEWTEK BUSINESS SERVICES, INC. (NEW YORK CORPORATION)

1440 BROADWAY  
17TH FLOOR  
NEW YORK, NY 10018

FOR: FINANCIAL ANALYSIS FOR BUSINESS; ACCOUNTING SERVICES; ONLINE ACCOUNTING SERVICES; COMPUTERIZED ACCOUNTING SERVICES; ACCOUNTING SERVICES FOR ELECTRONIC FUNDS SERVICES; ADMINISTRATION OF BUSINESS PAYROLL FOR OTHERS; PAYROLL PREPARATION; INTEGRATED TRACKING AND MANAGEMENT OF COMMERCIAL TRANSACTIONS ON A GLOBAL COMPUTER NETWORK; INCOME TAX CONSULTATION AND PREPARATION SERVICES; BUSINESS CONSULTATION; BUSINESS DEVELOPMENT SERVICES, NAMELY, PROVIDING START-UP SUPPORT FOR BUSINESSES OF OTHERS; BUSINESS MARKETING CONSULTING SERVICES; BUSINESS PLANNING; PREPARING BUSINESS REPORTS, IN CLASS 35 (U.S. CLS. 100, 101 AND 102).

FIRST USE 10-0-2006; IN COMMERCE 4-30-2008.

FOR: FINANCIAL ANALYSIS AND CONSULTATION SERVICES; BUSINESS FINANCE PROCUREMENT SERVICES; LOAN FINANCING AND LOAN PROGRAMS IN THE NATURE OF BUSINESS LOANS AND TEMPORARY LOANS; ELECTRONIC

PAYMENT, NAMELY, ELECTRONIC PROCESSING AND TRANSMISSION OF BILL PAYMENT DATA, IN CLASS 36 (U.S. CLS. 100, 101 AND 102).

FIRST USE 10-0-2006; IN COMMERCE 4-30-2008.

FOR: PROVIDING ELECTRONIC MAIL SERVICES FOR OTHERS, IN CLASS 38 (U.S. CLS. 100, 101 AND 104).

FIRST USE 10-0-2006; IN COMMERCE 4-30-2008.

FOR: PROVIDING TEMPORARY USE OF ONLINE NON-DOWNLOADABLE SOFTWARE TO ALLOW CUSTOMERS TO ACCESS ACCOUNT INFORMATION, REVIEW REFERRAL INFORMATION, AND INITIATE CONTACT REQUESTS, IN CLASS 42 (U.S. CLS. 100 AND 101).

FIRST USE 10-0-2006; IN COMMERCE 4-30-2008.

THE MARK CONSISTS OF THE WORDING "NEWTEK" WITH THE WORDING REFLECTED BENEATH. A STYLIZED NEWT WEARING A T-SHIRT WITH THE TERM "NEWT" ON IT STANDS TO THE LEFT OF THE LETTER "N".

SN 77-000,237, FILED 9-15-2006.

TARAH HARDY, EXAMINING ATTORNEY

**Int. Cls.: 35 and 42**

**Prior U.S. Cls.: 100, 101, and 102**

**United States Patent and Trademark Office**

**Reg. No. 3,454,309**

**Registered June 24, 2008**

**SERVICE MARK  
PRINCIPAL REGISTER**

**BIZEXEC**

NEWTEK BUSINESS SERVICES, INC. (NEW  
YORK CORPORATION)  
1440 BROADWAY  
17TH FLOOR  
NEW YORK, NY 10018

FOR: INTEGRATED TRACKING AND MANAGEMENT OF COMMERCIAL TRANSACTIONS ON A GLOBAL COMPUTER NETWORK; COMPUTER SERVICES, NAMELY, NOTIFICATION SERVICES TO BUSINESSES IN THE NATURE OF PROVIDING INFORMATION REGARDING BUSINESS FILING REQUIREMENTS AND FILING DATES VIA THE INTERNET AND EMAIL; BUSINESS CONSULTATION; BUSINESS DEVELOPMENT SERVICES, NAMELY, PROVIDING START-UP SUPPORT FOR BUSINESSES OF OTHERS; BUSINESS INVOICING SERVICES; CONDUCTING BUSINESS AND MARKET RESEARCH SURVEYS; BUSINESS MARKETING CONSULTING SERVICES, IN CLASS 35 (U.S. CLS. 100, 101 AND 102).

FIRST USE 10-0-2006; IN COMMERCE 10-0-2006.

FOR: PROVIDING TEMPORARY USE OF ON-LINE NON-DOWNLOADABLE SOFTWARE TO ALLOW CUSTOMERS TO ACCESS ACCOUNT INFORMATION, REVIEW REFERRAL INFORMATION, AND INITIATE CONTACT REQUESTS, IN CLASS 42 (U.S. CLS. 100 AND 101).

FIRST USE 10-0-2006; IN COMMERCE 10-0-2006.

THE MARK CONSISTS OF STANDARD CHARACTERS WITHOUT CLAIM TO ANY PARTICULAR FONT, STYLE, SIZE, OR COLOR.

SN 77-000,278, FILED 9-15-2006.

TARAH HARDY, EXAMINING ATTORNEY

**Int. Cl.: 1**

**Prior U.S. Cls.: 1, 5, 6, 10, 26, and 46**

**Reg. No. 3,454,310**

**United States Patent and Trademark Office**

**Registered June 24, 2008**

---

**TRADEMARK  
PRINCIPAL REGISTER**

**CERENOL**

E.I. DUPONT DE NEMOURS AND COMPANY  
(DELAWARE CORPORATION)  
1007 MARKET STREET  
WILMINGTON, DE 19898

THE MARK CONSISTS OF STANDARD CHARACTERS WITHOUT CLAIM TO ANY PARTICULAR FONT, STYLE, SIZE, OR COLOR.

FOR: CHEMICALS FOR USE IN MANUFACTURING LUBRICANTS, COATINGS, POLYEURTHANES, FIBERS, APPAREL AND COSMETICS, IN CLASS 1 (U.S. CLS. 1, 5, 6, 10, 26 AND 46).

SN 77-000,446, FILED 9-15-2006.

FIRST USE 4-8-2008; IN COMMERCE 4-8-2008.

ALEX KEAM, EXAMINING ATTORNEY

**Int. Cls.: 25 and 28**

**Prior U.S. Cls.: 22, 23, 38, 39, and 50**

**United States Patent and Trademark Office**

**Reg. No. 3,454,311**

**Registered June 24, 2008**

**TRADEMARK  
PRINCIPAL REGISTER**

**DRONKEY**

DREAMWORKS ANIMATION L.L.C. (DELA-  
WARE LTD LIAB CO)  
1000 FLOWER STREET  
GLENDALE, CA 91201

FOR: HALLOWEEN COSTUMES, IN CLASS 25  
(U.S. CLS. 22 AND 39).

FIRST USE 5-1-2007; IN COMMERCE 5-1-2007.

FOR: BEAN BAG DOLLS, PLUSH TOYS,  
STUFFED TOYS, IN CLASS 28 (U.S. CLS. 22, 23, 38  
AND 50).

FIRST USE 4-1-2007; IN COMMERCE 4-1-2007.

THE MARK CONSISTS OF STANDARD CHAR-  
ACTERS WITHOUT CLAIM TO ANY PARTICULAR  
FONT, STYLE, SIZE, OR COLOR.

SN 77-000,570, FILED 9-15-2006.

RENEE SERVANCE, EXAMINING ATTORNEY

**Int. Cl.: 5**

**Prior U.S. Cls.: 6, 18, 44, 46, 51, and 52**

**Reg. No. 3,454,312**

**United States Patent and Trademark Office**

**Registered June 24, 2008**

**TRADEMARK  
PRINCIPAL REGISTER**

**ORIGINAL CELEBRITY HOODIA  
DIET**

CELEBRITY PRODUCTS DIRECT, INC. (CALI-  
FORNIA CORPORATION)  
SUITE 705  
1990 SOUTH BUNDY DRIVE  
LOS ANGELES, CA 90025

OWNER OF U.S. REG. NO. 2,562,116.

FOR: DIETARY SUPPLEMENT FRUIT DRINKS,  
IN CLASS 5 (U.S. CLS. 6, 18, 44, 46, 51 AND 52).

NO CLAIM IS MADE TO THE EXCLUSIVE  
RIGHT TO USE "ORIGINAL" AND "HOODIA  
DIET", APART FROM THE MARK AS SHOWN.

FIRST USE 11-0-2006; IN COMMERCE 11-0-2006.

SN 77-001,038, FILED 9-15-2006.

THE MARK CONSISTS OF STANDARD CHAR-  
ACTERS WITHOUT CLAIM TO ANY PARTICULAR  
FONT, STYLE, SIZE, OR COLOR.

LAURIE KAUFMAN, EXAMINING ATTORNEY



**Int. Cls.: 9 and 45**

**Prior U.S. Cls.: 21, 23, 26, 36, 38, 100, and 101**

**United States Patent and Trademark Office**

**Reg. No. 3,454,313**

**Registered June 24, 2008**

**TRADEMARK  
SERVICE MARK  
PRINCIPAL REGISTER**

**YOLO**

TRILIBIS, INC. (CALIFORNIA CORPORATION)  
700 S. CLAREMONT STREET, SUITE 110  
SAN MATEO, CA 94402

FOR: COMPUTER SOFTWARE FOR COMMUNICATIONS, SCHEDULING, AND DATABASE MANAGEMENT FOR USE FOR PURPOSES OF ONLINE DATING, SOCIAL NETWORKING AND SOCIAL INTRODUCTIONS; COMPUTER SOFTWARE FOR USE IN LOCATING AND REPORTING THE PHYSICAL LOCATION OF INDIVIDUALS VIA HAND-HELD ELECTRONIC DEVICES, IN CLASS 9 (U.S. CLS. 21, 23, 26, 36 AND 38).

FIRST USE 1-19-2007; IN COMMERCE 1-19-2007.

FOR: INTERNET-BASED SOCIAL NETWORKING, INTRODUCTION, AND DATING SERVICES; INTERNET-BASED LOCATION SERVICES, NAMELY, SERVICES TO LOCATE AND REPORT THE PHYSICAL LOCATION OF INDIVIDUALS, IN CLASS 45 (U.S. CLS. 100 AND 101).

FIRST USE 1-19-2007; IN COMMERCE 1-19-2007.

THE MARK CONSISTS OF STANDARD CHARACTERS WITHOUT CLAIM TO ANY PARTICULAR FONT, STYLE, SIZE, OR COLOR.

SN 77-002,671, FILED 9-19-2006.

SETH A. RAPPAPORT, EXAMINING ATTORNEY

**Int. Cl.: 30**

**Prior U.S. Cl.: 46**

**United States Patent and Trademark Office**

**Reg. No. 3,454,314**

**Registered June 24, 2008**

**TRADEMARK  
PRINCIPAL REGISTER**

**AMAZON PLANET**

AMAZON PLANET, INC. (CALIFORNIA CORPORATION)

4260 MT. CULEBRA AVE.

SAN DIEGO, CA 92117

FOR: FROZEN FRUIT-BASED CONFECTIONS,  
IN CLASS 30 (U.S. CL. 46).

FIRST USE 2-25-2008; IN COMMERCE 2-25-2008.

THE MARK CONSISTS OF STANDARD CHARACTERS WITHOUT CLAIM TO ANY PARTICULAR FONT, STYLE, SIZE, OR COLOR.

NO CLAIM IS MADE TO THE EXCLUSIVE RIGHT TO USE "AMAZON", APART FROM THE MARK AS SHOWN.

SN 77-002,691, FILED 9-19-2006.

SUSAN LESLIE DUBOIS, EXAMINING ATTORNEY

Int. Cl.: 41

Prior U.S. Cls.: 100, 101, and 107

United States Patent and Trademark Office

Reg. No. 3,454,315

Registered June 24, 2008

**SERVICE MARK  
PRINCIPAL REGISTER**



WOODLANDS GYMNASTICS COMPLEX, LTD.  
(TEXAS LIMITED PARTNERSHIP)  
20100B HOLZWARTH ROAD  
SPRING, TX 77388

FOR: INSTRUCTION WITH RESPECT TO GYM-  
NASTICS, TUMBLING, SELF-DEFENSE, CHEER-  
LEADING, TRAMPOLINE, AND DANCE FOR  
CHILDREN AND ADULTS , IN CLASS 41 (U.S.  
CLS. 100, 101 AND 107).

FIRST USE 7-21-2007; IN COMMERCE 7-21-2007.

THE COLOR(S) RED, WHITE, BLUE, BLACK IS/  
ARE CLAIMED AS A FEATURE OF THE MARK.

THE COLOR BLACK APPEARS IN THE LETTERS  
"GWA", AS THE OUTLINES IN THE OVAL AND  
THE RECTANGULAR DESIGNS, AND IN THE  
SILHOUETTES OF THE REPRESENTATIONS OF A  
MAN AND WOMAN; THE COLOR RED APPEARS  
INSIDE THE OUTLINES OF THE OVAL DESIGN;  
THE COLOR WHITE APPEARS AS THE BACK-  
GROUND INSIDE THE OVAL DESIGN AND AS  
PART OF THE SHADING IN THE LETTERS "GWA",  
AND THE COLOR BLUE APPEARS AS THE BACK-  
GROUND INSIDE THE RECTANGULAR DESIGN.

SN 77-002,754, FILED 9-19-2006.

CARYN GLASSER, EXAMINING ATTORNEY

**Int. Cl.: 11**

**Prior U.S. Cls.: 13, 21, 23, 31, and 34**

**United States Patent and Trademark Office**

**Reg. No. 3,454,316**

**Registered June 24, 2008**

**TRADEMARK  
PRINCIPAL REGISTER**



TRUCK-LITE CO., INC. (NEW YORK CORPORATION)  
310 EAST ELMWOOD AVENUE  
FALCONER, NY 14733

FOR: LIGHTING PRODUCTS FOR VEHICLES, NAMELY, HEADLIGHTS; TAIL LIGHTS; MARKER LIGHTS; CLEARANCE LIGHTS; IDENTIFICATION LIGHTS; STOPPING LIGHTS; TURN LIGHTS; LIGHTING KITS COMPRISED OF LAMPS, GROMMETS, PLUGS, AND FLANGES; LICENSE PLATE LIGHTS; BACK-UP LIGHTS; INTERIOR AND UTILITY LIGHTS; SNOW PLOW LIGHTS; FOG AND DRIVING LIGHTS; DAYTIME RUNNING LIGHTS; COMPONENT PARTS FOR VEHICLE LIGHTS, NAMELY, BULBS, LENSES AND HOUSINGS; AND

VEHICLE REFLECTORS, IN CLASS 11 (U.S. CLS. 13, 21, 23, 31 AND 34).

FIRST USE 3-31-2002; IN COMMERCE 3-31-2002.

OWNER OF U.S. REG. NO. 366,340.

THE MARK CONSISTS OF TWO CURVED LINES WITH THE WORDS "SIGNAL-STAT" IN BETWEEN THEM.

SN 77-003,215, FILED 9-20-2006.

EMILY CHUO, EXAMINING ATTORNEY

**Int. Cl.: 9**

**Prior U.S. Cls.: 21, 23, 26, 36, and 38**

**United States Patent and Trademark Office**

**Reg. No. 3,454,317**

**Registered June 24, 2008**

**TRADEMARK  
PRINCIPAL REGISTER**



TRUCK-LITE CO., INC. (NEW YORK CORPORATION)  
310 EAST ELMWOOD AVENUE  
FALCONER, NY 14733

OWNER OF U.S. REG. NO. 366,340.

FOR: WARNING AND EMERGENCY LIGHTS FOR VEHICLES, ELECTRONIC COMPONENTS FOR CONTROLLING VEHICLE LIGHTS IN THE NATURE OF ELECTRICAL CONTROLLERS, IN CLASS 9 (U.S. CLS. 21, 23, 26, 36 AND 38).

THE MARK CONSISTS OF TWO CURVED LINES WITH THE WORDS "SIGNAL-STAT" IN BETWEEN THEM.

SN 77-003,238, FILED 9-20-2006.

FIRST USE 3-31-2002; IN COMMERCE 3-31-2002.

EMILY CHUO, EXAMINING ATTORNEY

**Int. Cl.: 36**

**Prior U.S. Cls.: 100, 101, and 102**

**United States Patent and Trademark Office**

**Reg. No. 3,454,318**

**Registered June 24, 2008**

**SERVICE MARK  
PRINCIPAL REGISTER**

**XVETI**

GAYNOR, HORACE (UNITED STATES INDIVIDUAL)  
506 JONES FALLS COURT  
BOWIE, MD 20721

FOR: ONLINE CHARITABLE FUND RAISING, NAMELY, DISTRIBUTING PROCEEDS FROM ONLINE FIXED PRICE SALES BY VARIOUS SELLERS TO SELECTED BENEFICIARIES; PHILANTHROPIC SERVICES CONCERNING MONETARY DONATIONS; ACCEPTING AND ADMINISTERING MONETARY CHARITABLE CONTRIBUTIONS, IN CLASS 36 (U.S. CLS. 100, 101 AND 102).

FIRST USE 3-19-2007; IN COMMERCE 3-19-2007.

THE MARK CONSISTS OF STANDARD CHARACTERS WITHOUT CLAIM TO ANY PARTICULAR FONT, STYLE, SIZE, OR COLOR.

SN 77-003,381, FILED 9-20-2006.

ROBERT C. CLARK JR., EXAMINING ATTORNEY

**Int. Cl.: 25**

**Prior U.S. Cls.: 22 and 39**

**United States Patent and Trademark Office**

**Reg. No. 3,454,319**

**Registered June 24, 2008**

**TRADEMARK  
PRINCIPAL REGISTER**



INCASSO INC. (NEW YORK CORPORATION)  
8 SOUTH STREET  
OSSINING, NY 10562

FOR: CLOTHING, NAMELY T-SHIRTS, SWEAT-SHIRTS, JACKETS, VESTS, HATS, PANTS, SWEAT-PANTS, SOCKS, HEADBANDS, TANK TOPS, BELTS, WRISTBANDS, COATS, IN CLASS 25 (U.S. CLS. 22 AND 39).

FIRST USE 8-30-2005; IN COMMERCE 1-20-2007.

THE MARK CONSISTS OF A STYLIZED LETTER "I".

SN 77-003,791, FILED 9-20-2006.

RENEE SERVANCE, EXAMINING ATTORNEY

**Int. Cls.: 5 and 10**

**Prior U.S. Cls.: 6, 18, 26, 39, 44, 46, 51, and 52**

**Reg. No. 3,454,320**

**United States Patent and Trademark Office**

**Registered June 24, 2008**

**TRADEMARK  
PRINCIPAL REGISTER**

# Venus

HERCULINKS CORPORATION (COLORADO CORPORATION)  
PO BOX 5894  
COLORADO SPRINGS, CO 80931

FOR: CONTRACEPTIVE SPONGES; PREGNANCY TEST KITS FOR HOME USE SOLD IN ADULT RETAIL STORES FEATURING ADULT SEXUAL PRODUCTS; HORMONAL CONTRACEPTIVES, IN CLASS 5 (U.S. CLS. 6, 18, 44, 46, 51 AND 52).

FIRST USE 1-29-2006; IN COMMERCE 1-29-2006.

FOR: ADULT SEXUAL AIDS, NAMELY, INFLATABLE LIFE-SIZED DOLLS USED IN SEXUAL ACTIVITY FOR HOME USE, CONDOMS, NIPPLE CLAMPS, CONDOM RINGS, CONSTRICTION RINGS FOR USE IN MAINTAINING PENILE RIGIDITY IN MEN WITH ERECTILE DYSFUNCTION, FLEXIBLE DEVICES AND RUBBER RINGS TO BE WORN ON THE PENIS, PENIS AND VAGINA PUMPS, BENWA BALLS, ARTIFICIAL VAGINAS AND PENISES, ENEMA DEVICES, ANUS PROLAPSE BANDS, BREAST PROSTHESES, PUMPS, AND BREAST SHIELDS; BIRTH CONTROL DEVICES, NAMELY, PROPHYLACTICS, NAMELY MALE AND FEMALE CONDOMS, DIAPHRAGMS FOR

CONTRACEPTION, CERVICAL CAPS; CONTRACEPTIVES; LICE COMBS; DISPOSABLE FINGER FITTING POLYETHYLENE SLEEVES FOR HYGIENIC INSERTION OF A TAMPON; ELECTRICAL WEIGHT LOSS BODY STRAP FOR HOUSEHOLD USE; BODY-FAT MONITORS FOR HOUSEHOLD USE; HOUSEHOLD EXERCISE MACHINES FOR THERAPEUTIC PURPOSES; THERAPEUTIC SAUNAS AND WHIRLPOOLS FOR HOUSEHOLD USE; ELECTRIC FOOT SPA MASSAGERS FOR HOUSEHOLD USE; BEAUTY AND COSMETIC STERILIZING POUCHES FOR HOUSEHOLD USE, IN CLASS 10 (U.S. CLS. 26, 39 AND 44).

FIRST USE 1-29-2006; IN COMMERCE 1-29-2006.

THE MARK CONSISTS OF STANDARD CHARACTERS WITHOUT CLAIM TO ANY PARTICULAR FONT, STYLE, SIZE, OR COLOR.

OWNER OF U.S. REG. NOS. 3,139,213 AND 3,139,217.

SN 77-003,856, FILED 9-21-2006.

SETH A. RAPPAPORT, EXAMINING ATTORNEY



**Int. Cl.: 31**

**Prior U.S. Cls.: 1 and 46**

**United States Patent and Trademark Office**

**Reg. No. 3,454,321**

**Registered June 24, 2008**

**TRADEMARK  
PRINCIPAL REGISTER**

**ELECTRIC GREEN**

YORKTOWN TECHNOLOGIES, L.P. (TEXAS  
LIMITED PARTNERSHIP)

6500 CHAMPION GRANDVIEW, STE. 40210

AUSTIN, TX 78750

FOR: LIVE FISH NOT FOR FOOD, IN CLASS 31  
(U.S. CLS. 1 AND 46).

FIRST USE 7-6-2007; IN COMMERCE 7-6-2007.

THE MARK CONSISTS OF STANDARD CHAR-  
ACTERS WITHOUT CLAIM TO ANY PARTICULAR  
FONT, STYLE, SIZE, OR COLOR.

NO CLAIM IS MADE TO THE EXCLUSIVE  
RIGHT TO USE "GREEN", APART FROM THE  
MARK AS SHOWN.

SN 77-003,933, FILED 9-21-2006.

KELLY BOULTON, EXAMINING ATTORNEY

**Int. Cl.: 31**

**Prior U.S. Cls.: 1 and 46**

**United States Patent and Trademark Office**

**Reg. No. 3,454,322**

**Registered June 24, 2008**

**TRADEMARK  
PRINCIPAL REGISTER**

**SUNBURST ORANGE**

YORKTOWN TECHNOLOGIES, L.P. (TEXAS  
LIMITED PARTNERSHIP)

6500 CHAMPION GRANDVIEW, STE. 40210

AUSTIN, TX 78750

FOR: LIVE FISH NOT FOR FOOD, IN CLASS 31  
(U.S. CLS. 1 AND 46).

FIRST USE 7-6-2007; IN COMMERCE 7-6-2007.

THE MARK CONSISTS OF STANDARD CHAR-  
ACTERS WITHOUT CLAIM TO ANY PARTICULAR  
FONT, STYLE, SIZE, OR COLOR.

NO CLAIM IS MADE TO THE EXCLUSIVE  
RIGHT TO USE "ORANGE", APART FROM THE  
MARK AS SHOWN.

SN 77-003,935, FILED 9-21-2006.

KELLY BOULTON, EXAMINING ATTORNEY

**Int. Cl.: 31**

**Prior U.S. Cls.: 1 and 46**

**United States Patent and Trademark Office**

**Reg. No. 3,454,323**

**Registered June 24, 2008**

**TRADEMARK  
PRINCIPAL REGISTER**

**STARFIRE RED**

YORKTOWN TECHNOLOGIES, L.P. (TEXAS  
LIMITED PARTNERSHIP)

6500 CHAMPION GRANDVIEW, STE. 40210

AUSTIN, TX 78750

FOR: LIVE FISH NOT FOR FOOD, IN CLASS 31  
(U.S. CLS. 1 AND 46).

FIRST USE 7-6-2007; IN COMMERCE 7-6-2007.

THE MARK CONSISTS OF STANDARD CHAR-  
ACTERS WITHOUT CLAIM TO ANY PARTICULAR  
FONT, STYLE, SIZE, OR COLOR.

NO CLAIM IS MADE TO THE EXCLUSIVE  
RIGHT TO USE "RED", APART FROM THE MARK  
AS SHOWN.

SN 77-003,937, FILED 9-21-2006.

KELLY BOULTON, EXAMINING ATTORNEY

**Int. Cls.: 35, 37, and 42**

**Prior U.S. Cls.: 100, 101, 102, 103, and 106**

**United States Patent and Trademark Office**

**Reg. No. 3,454,324**

**Registered June 24, 2008**

**SERVICE MARK  
PRINCIPAL REGISTER**



HDS IP HOLDING, LLC (NEVADA LTD LIAB  
CO)  
SUITE 850  
101 CONVENTION CENTER DRIVE  
LAS VEGAS, NV 89109

FOR: RETAIL STORE AND DISTRIBUTORSHIP SERVICES PROVIDED TO OTHER BUSINESSES FEATURING HOME IMPROVEMENT SERVICES PERFORMED BY OTHERS, WATER TREATMENT, SEWAGE, PLUMBING AND ELECTRICAL UTILITY SERVICES PERFORMED BY OTHERS, BUILDING AND CONSTRUCTION MATERIALS, CARPET CLEANING SERVICES PERFORMED BY OTHERS, HVAC EQUIPMENT, CONSTRUCTION, REPAIR AND RENOVATION SERVICES PERFORMED BY OTHERS, APPLIANCES, FASTENING AND INDUSTRIAL SUPPLIES, LIGHTING FIXTURES, HOME CONSTRUCTION SERVICES PERFORMED BY OTHERS, DECORATING AND HOME DESIGN SERVICES PERFORMED BY OTHERS, FLOORING, COUNTERTOPS, AND WINDOW COVERINGS, MAINTENANCE AND REPAIR SERVICES PERFORMED BY OTHERS, CONSTRUCTION HARDWARE EQUIPMENT AND TOOLS, SAFETY EQUIPMENT, AND WORK CLOTHING, IN CLASS 35 (U.S. CLS. 100, 101 AND 102).

FIRST USE 9-25-2006; IN COMMERCE 9-25-2006.

FOR: CONTRACTOR SERVICES IN THE FIELDS OF CARPENTRY, DRYWALL, ELECTRICAL, HEATING, HVAC, PLASTERING, PLUMBING, PEST CONTROL, GARDENING AND LANDSCAPING AND PAINTING; CUSTOM CONSTRUCTION OF HOMES; INSTALLATION AND REPAIR OF FLOORING, COUNTERTOPS AND WINDOW COVERINGS; MAINTENANCE AND REPAIR OF WATER TREATMENT FACILITIES AND SEWAGE AND PLUMBING FACILITIES; MAINTENANCE AND REPAIR OF ELECTRIC UTILITY FACILITIES; CONSTRUCTION

AND REPAIR OF BUILDINGS; CARPET CLEANING SERVICES; INSTALLATION, MAINTENANCE AND REPAIR OF HVAC EQUIPMENT, IN CLASS 37 (U.S. CLS. 100, 103 AND 106).

FIRST USE 9-25-2006; IN COMMERCE 9-25-2006.

FOR: INTERIOR DECORATING SERVICES, IN CLASS 42 (U.S. CLS. 100 AND 101).

FIRST USE 9-25-2006; IN COMMERCE 9-25-2006.

NO CLAIM IS MADE TO THE EXCLUSIVE RIGHT TO USE "SUPPLY" , APART FROM THE MARK AS SHOWN.

THE COLOR(S) MUSTARD YELLOW, BLACK AND WHITE IS/ARE CLAIMED AS A FEATURE OF THE MARK.

THE MARK CONSISTS OF THE SHAPE OF TWO RECTANGLES WITHIN A DOUBLE LINED BORDER, SEPARATED BY A SINGLE WHITE LINE. THE LETTERS "HD", WITH A CIRCLE IN THE CENTER OF THE LETTERS "HD", AND THE WORD "SUPPLY" APPEAR IN THE SMALLER RECTANGLE ON THE LEFT. THE LARGER RECTANGLE ON THE RIGHT HAND SIDE IS BLANK. THE COLOR MUSTARD YELLOW APPEARS IN THE LETTERS "HD"; THE COLOR WHITE APPEARS IN THE CIRCLE AT THE CENTER OF THE LETTERS "HD", IN THE WORD "SUPPLY" AND IN THE BORDER SURROUNDING THE RECTANGLE OF THE MARK; AND THE COLOR BLACK APPEARS AS A BACKGROUND FOR THE ENTIRE MARK.

SN 77-004,568, FILED 9-21-2006.

MARK T. MULLEN, EXAMINING ATTORNEY

**Int. Cls.: 38, 41, and 44**

**Prior U.S. Cls.: 100, 101, 104, and 107**

**United States Patent and Trademark Office**

**Reg. No. 3,454,325**

**Registered June 24, 2008**

**SERVICE MARK  
PRINCIPAL REGISTER**

# ParentZone

BABYZONE.COM, INC. (DELAWARE CORPORATION)  
288 WALNUT ST. SUITE 210  
NEWTON, MA 02460

FOR: PROVIDING ON-LINE CHAT ROOMS, ON-LINE INTERACTIVE FORUMS AND ELECTRONIC BULLETIN BOARDS FOR TRANSMISSION OF MESSAGES AMONG USERS IN THE FIELDS OF IN THE FIELDS OF CHILDREN'S AND YOUNG ADULTS' ISSUES, NAMELY, LOCAL PARENT RESOURCES AND EVENTS, CHILDREN'S AND YOUNG ADULTS' SAFETY, CHILDREN'S AND YOUNG ADULTS' HEALTH, CHILDREN'S AND YOUNG ADULTS' ACTIVITIES, CHILDREN'S AND YOUNG ADULTS' DEVELOPMENT, CHILDREN'S AND YOUNG ADULTS' SOCIAL SKILLS, CHILDREN'S AND YOUNG ADULTS' EDUCATION, CHILDREN'S AND YOUNG ADULTS' LEARNING DISABILITIES, CHILDREN'S AND YOUNG ADULTS' FITNESS, CHILDREN'S AND YOUNG ADULTS' NUTRITION, RELATIONSHIPS, FAMILY FINANCE, RECIPES, TRAVEL, SEXUALITY, AND WORK/FAMILY BALANCE, IN CLASS 38 (U.S. CLS. 100, 101 AND 104).

FIRST USE 2-1-2007; IN COMMERCE 2-1-2007.

FOR: PROVIDING EDUCATIONAL AND ENTERTAINMENT-RELATED INFORMATION VIA A GLOBAL COMPUTER NETWORK IN THE FIELDS OF LOCAL PARENT EDUCATIONAL AND ENTERTAINMENT RESOURCES AND EVENTS, LOCAL CHILDREN'S AND YOUNG ADULTS' ENTERTAINMENT ACTIVITIES, CHILDREN'S AND YOUNG ADULTS' EDUCATIONAL FACILITIES, CHILDREN'S AND YOUNG ADULTS' FITNESS, ONLINE PHOTO SHARING SERVICES AND ONLINE JOURNALS, NAMELY, BLOGS FEATURING INFORMATION IN THE FIELDS OF CHILDREN'S AND

YOUNG ADULTS' ISSUES NAMELY, LOCAL PARENT RESOURCES AND EVENTS, CHILDREN'S AND YOUNG ADULTS' SAFETY, CHILDREN'S AND YOUNG ADULTS' HEALTH, CHILDREN'S AND YOUNG ADULTS' ACTIVITIES, CHILDREN'S AND YOUNG ADULTS' DEVELOPMENT, CHILDREN'S AND YOUNG ADULTS' SOCIAL SKILLS, CHILDREN'S AND YOUNG ADULTS' EDUCATION, CHILDREN'S AND YOUNG ADULTS' LEARNING DISABILITIES, CHILDREN'S AND YOUNG ADULTS' FITNESS, CHILDREN'S AND YOUNG ADULTS' NUTRITION, RELATIONSHIPS, FAMILY FINANCE, RECIPES, TRAVEL, SEXUALITY, AND WORK/FAMILY BALANCE, IN CLASS 41 (U.S. CLS. 100, 101 AND 107).

FIRST USE 2-1-2007; IN COMMERCE 2-1-2007.

FOR: PROVIDING INFORMATION VIA A GLOBAL COMPUTER NETWORK IN THE FIELDS OF CHILDREN'S AND YOUNG ADULTS' HEALTH, CHILDREN'S AND YOUNG ADULTS' LEARNING DISABILITIES, CHILDREN'S AND YOUNG ADULTS' NUTRITION, AND CHILDREN'S AND YOUNG ADULTS' MENTAL HEALTH AS THEY RELATE TO RELATIONSHIPS, SOCIAL SKILLS, DEVELOPMENT, SEXUALITY, AND WORK/FAMILY BALANCE, IN CLASS 44 (U.S. CLS. 100 AND 101).

FIRST USE 2-1-2007; IN COMMERCE 2-1-2007.

THE MARK CONSISTS OF STANDARD CHARACTERS WITHOUT CLAIM TO ANY PARTICULAR FONT, STYLE, SIZE, OR COLOR.

SN 77-005,106, FILED 9-22-2006.

ELISSA GARBER KON, EXAMINING ATTORNEY

**Int. Cl.: 36**

**Prior U.S. Cls.: 100, 101, and 102**

**United States Patent and Trademark Office**

**Reg. No. 3,454,326**

**Registered June 24, 2008**

**SERVICE MARK  
PRINCIPAL REGISTER**

# Hope For You!

HOPE FOR YOU! CORPORATION (COLORADO CORPORATION)  
PO BOX 5894  
COLORADO SPRINGS, CO 80931

FOR: ACCEPTING AND ADMINISTERING MONETARY CHARITABLE CONTRIBUTIONS; ACCIDENT INSURANCE UNDERWRITING; ACCOUNTS PAYABLE DEBITING SERVICES; ACCOUNTS RECEIVABLES FINANCING; ACQUISITION AND TRANSFER OF MONETARY CLAIMS; ACTUARIAL SERVICES; ADMINISTRATION OF EMPLOYEE BENEFIT PLANS; ADMINISTRATION OF EMPLOYEE PENSION PLANS; ADMINISTRATION OF EMPLOYEE WELFARE BENEFIT PLANS; ADMINISTRATION OF PRE-PAID HEALTH CARE PLANS; ADMINISTRATION OF PREFERRED PROVIDER PLANS IN THE FIELDS OF FINANCE, HEALTH, MEDICINE, EDUCATION, ENTERTAINMENT; REAL ESTATE, LAW, INSURANCE, STOCKS, COMMODITIES AND FITNESS; ADMINISTRATION OF SAVINGS ACCOUNTS; ADVICE RELATING TO INVESTMENTS; AGENCIES FOR BROKERAGE OF SECURITIES TRADING IN OVERSEAS SECURITIES MARKETS AND OF TRANSACTIONS ON COMMISSION OF OVERSEAS MARKET SECURITIES FUTURES; AGENCIES FOR COMMODITY FUTURES TRADING; AGENCIES IN THE FIELD OF BONDS AND OTHER SECURITIES; AGENCIES IN THE FIELD OF CREDIT FOR FARMING; AGENCIES OR BROKERAGE FOR LEASING OR RENTING OF LAND; AGENCIES OR BROKERAGE FOR RENTING LAND; AGENCIES OR BROKERAGE FOR RENTING OF BUILDINGS; AGENCIES OR BROKERAGE FOR TRADING OF SECURITIES, SECURITIES INDEX FUTURES, SECURITIES OPTIONS, AND OVERSEAS MARKET SECURITIES FUTURES; AGRICULTURAL INSURANCE AGENCY; AIRCRAFT BROKERAGE; ANNUITY UNDERWRITING; APARTMENT HOUSE MANAGEMENT; APARTMENT LOCATING SERVICES FOR OTHERS; APPRAISAL OF REAL ESTATE;

APPRAISALS FOR INSURANCE CLAIMS OF PERSONAL PROPERTY; APPRAISALS FOR INSURANCE CLAIMS OF REAL ESTATE; ART BROKERAGE; ASSESSMENT AND MANAGEMENT OF REAL ESTATE; ASSUMING FINANCIAL RISK OF OTHERS BY ENTERING INTO OPTIONS AND SWAPS; AUTOMATED COIN COUNTING, SORTING AND CONVERTING SERVICES; AUTOMATED SECURITIES BROKERAGE; AUTOMATED TELLER MACHINE SERVICES; AUTOMOBILE APPRAISAL; BAIL BONDING; BANKING; BANKING CONSULTATION; BILL CONSOLIDATION SERVICES; BILL PAYMENT SERVICES; BONDING SERVICES; BROKERAGE FOR HIRE-PURCHASE; BROKERAGE HOUSES IN THE FIELD OF STOCKS, COMMODITIES, AND FUTURES; BROKERAGE IN THE FIELDS OF ART, EDUCATION, ENTERTAINMENT, INSURANCE, STOCKS, COMMODITIES, REAL ESTATE, FINANCE, RELIGION, HEALTH AND FITNESS; BROKERAGE OF ENERGY, NAMELY, GAS AND ELECTRICITY; BROKERAGE OF SHARES AND OTHER SECURITIES; BROKERAGE OF SHARES OR STOCKS AND OTHER SECURITIES; BUILDING LEASING; BUILDING MANAGEMENT; BUSINESS BROKERAGE; BUSINESS FINANCE PROCUREMENT SERVICES; BUSINESS LIQUIDATION SERVICES; BUSINESS, STOCK OPTION AND PENSION VALUATION SERVICES; CAPITAL INVESTMENT CONSULTATION; CASH AND FOREIGN EXCHANGE TRANSACTIONS; CASH MANAGEMENT; CASH REPLACEMENT RENDERED BY CREDIT CARD; CHARITABLE FUND RAISING; CHARITABLE FUND RAISING SERVICES, NAMELY, SHARING PROFITS FROM NEWSPAPER SUBSCRIPTION SALES WITH NOT-FOR-PROFIT ORGANIZATIONS; CHARITABLE FUND RAISING IN VIEW OF DISASTER PRECAUTIONS AND PREVENTION; CHARITABLE FUND RAISING SERVICES BY MEANS OF COLLECTING AND REDEEMING RECYCLABLES FOR DONATION OF REDEMPTION PROCEEDS TO CHARITABLE ORGANIZATIONS; CHECK CASHING; CHECK PRO-

CESSING; CHECK RECOVERY SERVICES; CHECK VERIFICATION; CHECKING ACCOUNT SERVICES; CLAIMS ADJUSTMENT IN THE FIELD OF INSURANCE; COIN APPRAISAL; COLLECTING LICENSE FEES ON BEHALF OF INDEPENDENT WRITERS AND PUBLISHERS AND MAKING PAYMENTS TO THE COPYRIGHT OWNERS OF THE MUSIC; COLLECTION AGENCIES; COLLECTION OF DEBTS; COMMERCIAL LENDING SERVICES; COMMODITIES EXCHANGE SERVICES; COMMODITY BROKERAGE; COMMODITY EXCHANGE; COMMODITY INVESTMENT ADVICE; COMMODITY QUOTATIONS; COMMODITY TRADING FOR OTHERS; CONSULTANCY CONCERNING FINANCING OF ENERGY PROJECTS; CONSULTATION RELATING TO THE APPRAISAL OF GOODS; CONSUMER CREDIT CONSULTATION; CONSUMER LENDING SERVICES; COOPERATIVE CREDIT ORGANIZATIONS; CORPORATE SAVINGS ACCOUNT SERVICES; CREDIT AGENCIES; CREDIT AGENCIES IN THE FIELD OF FARMING; CREDIT AND CASH CARD SERVICES; CREDIT AND FINANCIAL CONSULTATION; CREDIT BUREAUS; CREDIT CARD SERVICES; CREDIT CARD TRANSACTION PROCESSING SERVICES; CREDIT CARD VERIFICATION; CREDIT CONSULTATION; CREDIT INQUIRY AND CONSULTATION; CREDIT RATING SERVICES; CREDIT RECOVERY AND COLLECTION; CREDIT REPORTING AGENCY; CREDIT REPORTING SERVICES; CREDIT RISK MANAGEMENT; CREDIT UNIONS; CRUISE SHIP PROPERTY SERVICES, NAMELY, LISTING, LEASING, BROKERAGE, AND MANAGEMENT OF RESIDENTIAL AND COMMERCIAL UNITS ABOARD CRUISE SHIPS AND FINANCING OF SAME; CURRENCY EXCHANGE AND ADVICE; CUSTOMS BROKERAGE; DEBIT ACCOUNT SERVICES FEATURING A COMPUTER READABLE CARD, A SCANNABLE WRIST BAND, AND SCANNABLE DEVICES FOR MERCHANTS; DEBIT CARD SERVICES; DEBT CANCELLATION SERVICES USING PROCEEDS OF LIFE, DISABILITY AND UNEMPLOYMENT INSURANCE; DEBT COUNSELING SERVICES; DEBT MANAGEMENT CONSULTATION; DEBT RECOVERY AND COLLECTION AGENCIES; DENTAL HEALTH INSURANCE UNDERWRITING AND ADMINISTRATION; DENTAL HEALTH INSURANCE ADMINISTRATION; DISCOUNT BROKERAGE SERVICES; DUTY DRAWBACK SERVICES; ELECTRONIC CASH TRANSACTIONS; ELECTRONIC COMMERCE PAYMENT SERVICES, NAMELY, ESTABLISHING FUNDED ACCOUNTS USED TO PURCHASE GOODS AND SERVICES ON THE INTERNET; ELECTRONIC CREDIT CARD TRANSACTIONS; ELECTRONIC DEBIT TRANSACTIONS; ELECTRONIC FINANCIAL SERVICE FOR THE PURCHASE OF SAVINGS BONDS; ELECTRONIC FUNDS TRANSFER; ELECTRONIC FUNDS TRANSFER BY TELECOMMUNICATIONS; ELECTRONIC PAYMENT, NAMELY, ELECTRONIC PROCESSING AND TRANSMISSION OF BILL PAYMENT DATA; ELECTRONIC PROCESSING OF INSURANCE CLAIMS AND PAYMENT DATA; ELECTRONIC TOLL COLLECTION SERVICES; ELECTRONIC TRANSFER OF MONEY; ELECTRONIC TRANSFERS OF MONEY; ELEMOSYNARY SERVICES IN THE FIELD OF

MONETARY DONATIONS; ENERGY BROKERAGE SERVICES; EQUIPMENT FINANCING SERVICES; EQUIPMENT MAINTENANCE CLAIMS PAYMENT SERVICE FOR BUSINESS; EQUITY CAPITAL INVESTMENT; ESTABLISHING MUTUAL FUNDS FOR OTHERS; ESCROW SERVICES; ESTATE PLANNING; ESTATE TRUST MANAGEMENT; EVALUATION OF CREDIT BUREAU DATA; EVALUATION OF REAL PROPERTY; EVALUATION OF THE CREDIT WORTHINESS OF COMPANIES AND PRIVATE INDIVIDUALS; FACILITATING AND ARRANGING FOR THE FINANCING IN THE FIELDS OF EDUCATION, RELIGION, AUTOMOTIVE, HEALTH, LAW, FINANCE, INSURANCE, ENTERTAINMENT, AND TELECOMMUNICATIONS; FACTORING AGENCIES; FIDUCIARY REPRESENTATIVES; FIDUCIARY TAX PAYMENT PROCESSING SERVICES; FINANCIAL ANALYSIS AND CONSULTATION; FINANCIAL CLEARING HOUSES; FINANCIAL CONSULTATION; FINANCIAL DUE DILIGENCE; FINANCIAL EVALUATION FOR INSURANCE PURPOSES; FINANCIAL EXCHANGE; FINANCIAL FORECASTING; FINANCIAL GUARANTEE AND SURETY; FINANCIAL INFORMATION IN THE NATURE OF RATES OF EXCHANGE; FINANCIAL INFORMATION PROVIDED BY ELECTRONIC MEANS; FINANCIAL INFORMATION PROCESSING; FINANCIAL INVESTMENT IN THE FIELDS OF REAL ESTATE AND SECURITIES; FINANCIAL LOAN CONSULTATION; FINANCIAL MANAGEMENT; FINANCIAL PLANNING; FINANCIAL PLANNING CONSULTATION; FINANCIAL PLANNING, NAMELY THE CREATION OF PERSONALIZED STRATEGIES TO ACHIEVE FINANCIAL INDEPENDENCE; FINANCIAL PORTFOLIO MANAGEMENT; FINANCIAL RESEARCH; FINANCIAL RISK MANAGEMENT; FINANCIAL SERVICES IN THE NATURE OF AN INVESTMENT SECURITY; FINANCIAL SERVICES IN THE FIELD OF MONEY LENDING; FINANCIAL SERVICES, NAMELY PROVIDING ONLINE STORED VALUE ACCOUNTS IN AN ELECTRONIC ENVIRONMENT; FINANCIAL SERVICES, NAMELY MONEY LENDING; FINANCIAL SERVICES, NAMELY, INVESTMENT FUND TRANSFER AND TRANSACTION SERVICES; FINANCIAL SERVICES, NAMELY ASSISTING OTHERS WITH THE COMPLETION OF FINANCIAL TRANSACTIONS FOR STOCKS, BONDS, SECURITIES AND EQUITIES; FINANCIAL SERVICES, NAMELY, ISSUANCE AND MANAGEMENT OF CERTIFICATES BACKED BY LOAN PORTFOLIOS WHICH ARE SUBSEQUENTLY MANAGED TO INSURE THE INTEGRITY OF THE CERTIFICATES; FINANCIAL SERVICES, NAMELY, A TOTAL PORTFOLIO OFFERING FOR HIGH NET WORTH CLIENTS CONSISTING OF BOTH SEPARATE ACCOUNTS AND MUTUAL FUNDS FOR EQUITY AND FIXED INCOME INVESTMENTS; FINANCIAL SERVICES, NAMELY, SAVINGS PROGRAMS FOR YOUTHS; FINANCIAL SERVICES, NAMELY, THE PURCHASE OF RESIDENTIAL MORTGAGES ON BEHALF OF OTHERS AND THE ISSUANCE OF MORTGAGE-BACKED SECURITIES; FINANCIAL SERVICES, NAMELY, PROVIDING FOR THE EXCHANGE OF FOREIGN CURRENCY, COMMODITIES, FINANCIAL DERIVATIVES, INTEREST

RATE PRODUCTS, AND EQUITIES VIA THE INTERNET AND INTRANET SYSTEMS; FINANCIAL SERVICES, NAMELY PROVIDING INFORMATION IN THE FIELDS OF FOREIGN CURRENCY, COMMODITIES, FINANCIAL DERIVATIVES, INTEREST RATE PRODUCTS, AND EQUITIES VIA THE INTERNET AND INTRANET SYSTEMS; FINANCIAL SPONSORSHIP FOR NATURAL DISASTER VICTIMS, DISPLACED HOME OWNERS, HEALTH PROGRAMS, MEDICAL RESEARCH PROGRAMS, DISPLACED WORKERS, UNEMPLOYED SENIORS, EDUCATION PROGRAMS, RELIGIOUS PROGRAMS, YOUTH PROGRAMS, PROGRAMS FOR THE DISABLED; PROGRAMS FOR MILITARY VETERANS, SCHOLARSHIP PROGRAMS, AND PROGRAMS FOR THE HOMELESS; FINANCIAL TRUST OPERATIONS; FINANCIAL VALUATION OF PERSONAL PROPERTY AND REAL ESTATE; FINANCIALLY-GUARANTEED FINANCING; FINANCING OF INDUSTRIAL ACTIVITIES; FINANCING OF PURCHASES; FINANCING RELATING TO AUTOMOBILES; FINANCING SERVICES; FIRE INSURANCE UNDERWRITING; FISCAL ASSESSMENT AND EVALUATION; FISCAL VALUATIONS AND ASSESSMENTS; FOREIGN EXCHANGE INFORMATION SERVICES; FORMATION, BROKERAGE AND MANAGEMENT OF TIME SHARE INTERESTS IN AIRCRAFT; FORMATION, OFFERING AND MANAGEMENT OF LIMITED PARTNERSHIPS; FUND INVESTMENT CONSULTATION; FUNDS INVESTMENT; FUTURES EXCHANGE SERVICES; GUARANTEE AS- SUREANCE UNDERWRITING; HEDGE FUND INVESTMENT SERVICES; HIGHWAY TOLL COL- LECTION SERVICES; HOME APPRAISAL SERVIC- ES; HOME EQUITY LOANS; HOUSING AGENCIES; INSTALLMENT LOANS; INSURANCE ACTUARIAL SERVICES; INSURANCE ADMINIS- TRATION IN THE FIELDS OF HOME, ACCIDENT, WATER DAMAGE, AND FIRE; INSURANCE AD- MINISTRATION; INSURANCE AGENCIES; INSUR- ANCE AGENCIES IN THE FIELDS OF HOME, ACCIDENT, ANIMALS, FIRE, FLOODS, AND LIFE; INSURANCE AGENCY AND BROKERAGE; INSUR- ANCE BROKERAGE; INSURANCE BROKERAGE IN THE FIELDS OF ANIMAL INSURANCE, HOME INSURANCE, FIRE INSURANCE, FLOOD INSUR- ANCE, AND ACCIDENT INSURANCE; INSUR- ANCE CARRIER SERVICES; INSURANCE CLAIMS ADMINISTRATION; INSURANCE CLAIMS PROC- ESSING; INSURANCE CONSULTATION; INSUR- ANCE PREMIUM RATE COMPUTING; INSURANCE SERVICES, NAMELY, UNDERWRIT- ING EXTENDED WARRANTY CONTRACTS IN THE FIELDS OF AUTOMOBILES, STORES, AND SERVICES PERTAINING THERETO THE FINAN- CIAL INDUSTRY; INSURANCE SERVICES, NAME- LY, WRITING PROPERTY AND CASUALTY INSURANCE; INSURANCE SERVICES, NAMELY, UNDERWRITING, ISSUING AND ADMINIS- TRATION OF LIFE INSURANCE; INSURANCE SUBRO- GATION AND SALVAGE; INSURANCE SUBROGATION; INSURANCE UNDERWRITING IN THE FIELDS OF LIFE, HEALTH, ACCIDENT, FIRE; INSURANCE UNDERWRITING SERVICES FOR ALL TYPES OF INSURANCE; INSURANCE UNDERWRITING CONSULTATION; INVESTMENT

ADVICE; INVESTMENT ADVISORY SERVICES; IN- VESTMENT BANKING SERVICES; INVESTMENT BROKERAGE; INVESTMENT BY ELECTRONIC MEANS; INVESTMENT CLUBS; INVESTMENT CONSULTATION; INVESTMENT MANAGEMENT; INVESTMENT MANAGEMENT OF AND DISTRI- BUTION OF VARIABLE ANNUITIES; INVEST- MENT OF FUNDS FOR OTHERS; INVESTMENT SERVICES, NAMELY ASSET ACQUISITION, CON- SULTATION, DEVELOPMENT AND MANAGE- MENT SERVICES; ISSUANCE AND ADMINISTRATION OF ANNUITIES; ISSUANCE OF BANK CHECKS; ISSUE OF TRAVELLER'S CHE- QUES; ISSUING CREDIT CARDS; ISSUING OF BANK CHEQUES; ISSUING OF CHECKS AND LETTERS OF CREDIT; ISSUING OF CHEQUES; ISSUING STORED VALUE CARDS; JEWELRY AP- PRAISAL; LAND ACQUISITION, NAMELY, REAL ESTATE BROKERAGE; LAND LEASING; LEASE SECURITIZATION; LEASE-PURCHASE FINAN- CING; LEASE-PURCHASE LOANS; LEASING OF APARTMENTS; LEASING OF FARMS; LEASING OF LAND; LEASING OF OFFICE SPACE; LEASING OF REAL ESTATE; LEASING OF REAL PROPERTY; LEASING OF SHOPPING MALL SPACE; LEASING OR RENTING OF BUILDINGS; LEVERAGED BUY OUTS AND INVESTMENTS IN FINANCIALLY DIS- TRESSED OR UNDERPERFORMING COMPANIES; LIFE INSURANCE BROKERAGE; LIFE INSUR- ANCE UNDERWRITING; LOAN FINANCING; LOANS, FINANCING AND DISCOUNT OF BILLS; MAINTAINING ESCROW ACCOUNTS FOR IN- VESTMENTS; MAINTAINING MORTGAGE ESCROW ACCOUNTS; MAKING PAYMENTS ON PRE-PAID LONG DISTANCE CALLING CARDS FOR RECHARGING MINUTES; MANAGEMENT OF A CAPITAL INVESTMENT FUND; MANAGE- MENT OF PORTFOLIOS COMPRISING SECURI- TIES; MANAGEMENT OF PORTFOLIOS OF TRANSFERABLE SECURITIES; MARINE INSUR- ANCE UNDERWRITING; MEDICAL INSURANCE UNDERWRITING; MEMORIAL FUND RAISING; MONETARY EXCHANGE; MONEY ORDER PAY- MENT GUARANTEE SERVICES; MONEY ORDER SERVICES; MONEY TRANSFER; MORTGAGE BANKING; MORTGAGE BANKING SERVICES, NAMELY, ORIGINATION, ACQUISITION, SERVI- CING, SECURITIZATION AND BROKERAGE OF MORTGAGE LOANS; MORTGAGE BROKERAGE; MORTGAGE LENDING; MORTGAGE PROCURE- MENT FOR OTHERS; MORTGAGE SERVICES, NAMELY, BUYER PRE-QUALIFICATION OF MORTGAGES FOR MORTGAGE BROKERS AND BANKS; MORTGAGING OF SECURITIES FOR OTHERS; MUTUAL FUND BROKERAGE; MU- TUAL FUND DISTRIBUTION; MUTUAL FUND INVESTMENT; NUMISMATIC APPRAISAL; ON- LINE BANKING SERVICES; OPERATING MAR- KETPLACES FOR SELLERS OF GOODS AND REAL ESTATE SERVICES; ORGANIZATION OF STOCK EXCHANGES FOR THE BENEFIT OF THE TRADE OF STOCKS AND OTHER FINANCIAL VALUES; ORGANIZING PREFERRED PROVIDER PRO- GRAMS IN THE FIELDS OF HEALTH, FINANCE AND BUSINESS; ORGANIZING PRE-PAID HEALTH CARE PLANS; PAWN BROKERAGE; PAWN SHOPS; PAYROLL TAX DEBITING SERVI-



CES; PHARMACEUTICAL BENEFIT MANAGEMENT SERVICES; PHARMACY BENEFIT MANAGEMENT SERVICES; PHILANTHROPIC SERVICES CONCERNING MONETARY DONATIONS; POLITICAL FUND-RAISING SERVICES; PRECIOUS STONE APPRAISAL; PREPAID CARD SERVICES IN THE NATURE OF MAKING PAYMENT FOR ADDING AIRTIME TO PREPAID OR PAY-AS-YOU-GO WIRELESS SERVICES; PREPAID GAS CARD SERVICES; PREPAID PREVENTIVE MAINTENANCE SERVICE PLANS FOR HEATING, VENTILATING AND AIR CONDITIONING SYSTEMS; PREPAID TELECOMMUNICATIONS CALLING CARD SERVICES; PRE-PAID FUNERAL EXPENSE SERVICES; PRE-PAID PURCHASE CARD SERVICES NAMELY, PROCESSING ELECTRONIC PAYMENTS MADE THROUGH PREPAID CARDS; PRE-PAID PURCHASE CARD SERVICES, NAMELY PROCESSING ELECTRONIC PAYMENTS THROUGH PRE-PAID CARDS; PROJECT FINANCING; PROVIDING A WEB SITE WHERE USERS CAN POST RATINGS, REVIEWS AND RECOMMENDATIONS ON STOCKS, BONDS, MUTUAL FUNDS AND OTHER FINANCIAL INSTRUMENTS; PROVIDING BANK ACCOUNT INFORMATION BY TELEPHONE; PROVIDING COLLEGE SCHOLARSHIPS; PROVIDING EDUCATIONAL SCHOLARSHIPS; PROVIDING ELECTRONIC PROCESSING OF CREDIT CARD TRANSACTIONS AND ELECTRONIC PAYMENTS VIA A GLOBAL COMPUTER NETWORK; PROVIDING EXTENDED WARRANTIES ON CONSUMER GOODS; PROVIDING FUND RAISING SERVICES FOR OTHERS VIA A GLOBAL COMPUTER NETWORK; PROVIDING GRANTS TO SCHOOLS, CHURCHES, HOSPITALS, STUDENTS, AND NONPROFIT OR PROFIT ORGANIZATIONS; PROVIDING INFORMATION IN THE FIELD OF REAL ESTATE BY MEANS OF LINKING THE WEBSITE OF OTHER WEBSITES FEATURING REAL ESTATE INFORMATION; PROVIDING INFORMATION VIA A GLOBAL COMPUTER NETWORK ON THE SUBJECT OF NON-RESIDENTIAL BUILDING AND FACILITIES MANAGEMENT; PROVIDING INFORMATION IN INSURANCE MATTERS; PROVIDING LOANS SECURED BY COMMERCIAL PAPER; PROVIDING MULTIPLE PAYMENT OPTIONS BY MEANS OF CUSTOMER-OPERATED ELECTRONIC TERMINALS AVAILABLE ON-SITE IN RETAIL STORES; PROVIDING ON-LINE FINANCIAL CALCULATORS; PROVIDING REBATES AT PARTICIPATING ESTABLISHMENTS OF OTHERS THROUGH USE OF A MEMBERSHIP CARD; PROVIDING STOCK MARKET INFORMATION; PROVIDING STOCK AND SECURITIES MARKET INFORMATION; PROVIDING STUDENT LOAN INFORMATION; PROVIDING TEMPORARY LOANS; PROVIDING WORKING CAPITAL; REAL ESTATE ACQUISITION SERVICES; REAL ESTATE AGENCIES; REAL ESTATE APPRAISAL; REAL ESTATE BROKERAGE; REAL ESTATE CONSULTATION; REAL ESTATE CONSULTANCY; REAL ESTATE EQUITY SHARING, NAMELY, MANAGING AND ARRANGING FOR CO-OWNERSHIP OF REAL ESTATE; REAL ESTATE ESCROW SERVICES; REAL ESTATE INVESTMENT; REAL ESTATE LISTING; REAL ESTATE MANAGEMENT; REAL ESTATE

MANAGEMENT CONSULTATION; REAL ESTATE MULTIPLE LISTING SERVICES; REAL ESTATE PROCUREMENT FOR OTHERS; REAL ESTATE SERVICES, NAMELY, RENTAL OF VACATION HOMES, CONDOMINIUMS, CABINS, AND VILLAS USING PAY PER CLICK ADVERTISING ON A GLOBAL COMPUTER NETWORK; REAL ESTATE SYNDICATION; REAL ESTATE TIME-SHARING; REAL ESTATE TRUSTEE SERVICES; REAL ESTATE VALUATION SERVICES; REAL ESTATE VALUATIONS; RECLAMATION OF IMPORT DUTIES FOR OTHERS; REINSURANCE UNDERWRITING; RENT COLLECTION AGENCIES; RENTAL OF APARTMENTS; RENTAL OF CABINS; RENTAL OF CASH DISPENSERS OR AUTOMATED-TELLER MACHINES; RENTAL OF OFFICE SPACE; FINANCIAL ADMINISTRATION OF RETIREMENT PLANS; REVOLVING LOANS; RISK MANAGEMENT; RISK MANAGEMENT CONSULTATION; SAFE DEPOSIT BOX SERVICES; SAVINGS ACCOUNT SERVICES; SAVINGS AND LOAN ASSOCIATIONS; SAVINGS AND LOAN SERVICES; SAVINGS BANK SERVICES; SECURITIES ARBITRAGE SERVICES; SECURITY BROKERAGE; SECURITY SERVICES, NAMELY, GUARANTEEING LOANS; SHOPPING CENTER SERVICES, NAMELY, RENTAL OF SHOPPING CENTER SPACE; STAMP APPRAISAL; STOCK BROKERAGE; STOCK EXCHANGE PRICE QUOTATIONS; STUDENT LOAN SERVICES; SURETY SERVICES; TAX PAYMENT PROCESSING SERVICES; TELECOMMUNICATIONS AIR TIME BROKERAGE SERVICES; TELECOMMUNICATIONS RESELLER SERVICES, NAMELY, TELECOMMUNICATIONS AIR TIME BROKERAGE SERVICES; TELEPHONE CALLING CARD SERVICES; TEMPORARY LOANS; TITLE INSURANCE AGENCY; TRANSFER AGENCY SERVICES RENDERED TO ISSUERS OF INVESTMENT SECURITIES; TRAVEL AGENCY SERVICES, NAMELY, ISSUING TRAVELER'S CHECKS; TRAVELERS' CHECK ISSUANCE; TRUST MANAGEMENT ACCOUNTS; TRUST SERVICES, NAMELY, INVESTMENT AND TRUST COMPANY SERVICES; TRUSTEESHIP REPRESENTATIVES; UNDERWRITING INSURANCE FOR PRE-PAID HEALTH CARE; UNDERWRITING INSURANCE FOR PRE-PAID LEGAL SERVICES; UNDERWRITING WARRANTY PROGRAMS IN THE FIELDS OF APPLIANCES, AUTOMOBILES, STORES, FINANCE, CREDIT, AND INSURANCE; VACATION REAL ESTATE TIME-SHARING; VACATION REAL ESTATE TIME SHARE EXCHANGE SERVICES; VENTURE CAPITAL FUNDING SERVICES TO EMERGING AND START-UP COMPANIES; VENTURE CAPITAL SERVICES, NAMELY, PROVIDING FINANCING TO EMERGING AND START-UP COMPANIES; VIATICAL SETTLEMENT SERVICES; WARRANTY CLAIMS ADMINISTRATION SERVICES, NAMELY, PROCESSING WARRANTY CLAIMS FOR THE HEALTH, AUTOMOBILE, BANKING, INSURANCE, STORE, CREDIT CARD AND REAL ESTATE INDUSTRY; WIRELESS TELEPHONE PAYMENT SERVICES, NAMELY, WIRELESS MOBILE TELEPHONE RATE PLANS; WORKERS' COMPENSATION FINANCIAL SERVICES; YACHT BROKERAGE AND CONSULTANCY SERVICES AND ADVISORY SERVICES RELATING

TO ALL THE AFORESAID SERVICES, IN CLASS 36  
(U.S. CLS. 100, 101 AND 102).

FIRST USE 8-22-2001; IN COMMERCE 3-21-2008.

THE MARK CONSISTS OF STANDARD CHAR-  
ACTERS WITHOUT CLAIM TO ANY PARTICULAR  
FONT, STYLE, SIZE, OR COLOR.

OWNER OF U.S. REG. NOS. 3,031,759, 3,211,114,  
AND 3,213,027.

SN 77-005,292, FILED 9-22-2006.

TIMOTHY FINNEGAN, EXAMINING ATTORNEY

**Int. Cl.: 9**

**Prior U.S. Cls.: 21, 23, 26, 36, and 38**

**United States Patent and Trademark Office**

**Reg. No. 3,454,327**

**Registered June 24, 2008**

**TRADEMARK  
PRINCIPAL REGISTER**

**WINCHESTER**

OLIN CORPORATION (VIRGINIA CORPORATION)  
190 CARONDELET PLAZA, SUITE 1530  
ST. LOUIS, MO 63105

FOR: HEARING PROTECTORS, NAMELY, PROTECTIVE EAR COVERINGS, IN CLASS 9 (U.S. CLS. 21, 23, 26, 36 AND 38).

FIRST USE 1-16-2007; IN COMMERCE 1-16-2007.

THE MARK CONSISTS OF STANDARD CHARACTERS WITHOUT CLAIM TO ANY PARTICULAR FONT, STYLE, SIZE, OR COLOR.

OWNER OF U.S. REG. NOS. 2,698,391, 3,036,631, AND OTHERS.

SN 77-005,456, FILED 9-22-2006.

CORY BOONE, EXAMINING ATTORNEY

**Int. Cl.: 9**

**Prior U.S. Cls.: 21, 23, 26, 36, and 38**

**Reg. No. 3,454,328**

**United States Patent and Trademark Office**

**Registered June 24, 2008**

---

**TRADEMARK  
PRINCIPAL REGISTER**

**SXT**

OLIN CORPORATION (VIRGINIA CORPORATION)  
190 CARONDELET PLAZA, SUITE 1530  
ST. LOUIS, MO 63105

FOR: HEARING PROTECTORS, NAMELY, PROTECTIVE EAR COVERINGS, IN CLASS 9 (U.S. CLS. 21, 23, 26, 36 AND 38).

FIRST USE 1-16-2007; IN COMMERCE 1-16-2007.

THE MARK CONSISTS OF STANDARD CHARACTERS WITHOUT CLAIM TO ANY PARTICULAR FONT, STYLE, SIZE, OR COLOR.

OWNER OF U.S. REG. NO. 1,802,022.

SN 77-005,475, FILED 9-22-2006.

DAYNA BROWNE, EXAMINING ATTORNEY

**Int. Cls.: 24 and 28**

**Prior U.S. Cls.: 22, 23, 38, 42, and 50**

**Reg. No. 3,454,329**

**United States Patent and Trademark Office**

**Registered June 24, 2008**

---

**TRADEMARK  
PRINCIPAL REGISTER**

**KALI GOLF**

GRIFFIN INTERNATIONAL COMPANIES, INC.  
(MINNESOTA CORPORATION)  
BUTLER SQUARE, SUITE 300C  
100 NORTH 6TH STREET  
MINNEAPOLIS, MN 55403

FOR: GOLF ACCESSORIES, NAMELY, GOLF  
TOWELS, IN CLASS 24 (U.S. CLS. 42 AND 50).

FIRST USE 1-31-2007; IN COMMERCE 1-31-2007.

FOR: GOLF ACCESSORIES, NAMELY, TEES,  
BAGS, AND HEAD COVERS, IN CLASS 28 (U.S.  
CLS. 22, 23, 38 AND 50).

FIRST USE 1-31-2007; IN COMMERCE 1-31-2007.

THE MARK CONSISTS OF STANDARD CHAR-  
ACTERS WITHOUT CLAIM TO ANY PARTICULAR  
FONT, STYLE, SIZE, OR COLOR.

NO CLAIM IS MADE TO THE EXCLUSIVE  
RIGHT TO USE "GOLF", APART FROM THE MARK  
AS SHOWN.

SN 77-006,122, FILED 9-24-2006.

AMY HELLA, EXAMINING ATTORNEY

**Int. Cl.: 5**

**Prior U.S. Cls.: 6, 18, 44, 46, 51, and 52**

**Reg. No. 3,454,330**

**United States Patent and Trademark Office**

**Registered June 24, 2008**

---

**TRADEMARK  
PRINCIPAL REGISTER**

**AMNISCREEN**

DURAMED PHARMACEUTICALS, INC. (DELA-  
WARE CORPORATION)  
225 SUMMIT AVENUE  
MONTVALE, NJ 07645

FOR: NON-INVASIVE DETECTION AND DIAG-  
NOSTIC TEST KIT, NAMELY, A CHEMICALLY-  
TREATED PANTY LINER AND TRAY FOR THE  
DETECTION AND DIAGNOSIS OF AMNIOTIC  
FLUID LEAKAGE, IN CLASS 5 (U.S. CLS. 6, 18, 44,  
46, 51 AND 52).

FIRST USE 2-21-2008; IN COMMERCE 2-21-2008.

THE MARK CONSISTS OF STANDARD CHAR-  
ACTERS WITHOUT CLAIM TO ANY PARTICULAR  
FONT, STYLE, SIZE, OR COLOR.

SN 77-006,989, FILED 9-25-2006.

JENNIFER VASQUEZ, EXAMINING ATTORNEY

**Int. Cls.: 1, 6, 39, and 42**

**Prior U.S. Cls.: 1, 2, 5, 6, 10, 12, 13, 14, 23, 25, 26, 46,  
50, 100, 101, and 105**

**Reg. No. 3,454,331**

**United States Patent and Trademark Office**

**Registered June 24, 2008**

**TRADEMARK  
SERVICE MARK  
PRINCIPAL REGISTER**

**CO2DIRECT**

AIRGAS, INC. (DELAWARE CORPORATION)  
259 RADNOR-CHESTER ROAD  
RADNOR, PA 190874579

FOR: COMPRESSED CARBON DIOXIDE SOLD  
IN LIQUID FORM FOR USE IN THE FOOD AND  
BEVERAGE, SWIMMING POOL AND DRY CLEAN-  
ING INDUSTRIES, AND FOR LABORATORY USE,  
IN CLASS 1 (U.S. CLS. 1, 5, 6, 10, 26 AND 46).

FIRST USE 12-1-2006; IN COMMERCE 12-1-2006.

FOR: STORAGE UNITS, NAMELY, TANKS COM-  
POSED PRIMARILY OF METAL FOR STORING  
CARBON DIOXIDE, IN CLASS 6 (U.S. CLS. 2, 12, 13,  
14, 23, 25 AND 50).

FIRST USE 12-1-2006; IN COMMERCE 12-1-2006.

FOR: CARBON DIOXIDE DELIVERY SERVICES,  
NAMELY, DELIVERY BY TRUCK OF CARBON

DIOXIDE IN GASEOUS AND LIQUID FORMS, IN  
CLASS 39 (U.S. CLS. 100 AND 105).

FIRST USE 12-1-2006; IN COMMERCE 12-1-2006.

FOR: TANK LEVEL MONITORING SERVICES,  
NAMELY, TELEMETRY-BASED REMOTE MONI-  
TORING OF SUPPLY LEVELS IN CARBON DIOX-  
IDE STORAGE SYSTEMS OF OTHERS, IN CLASS 42  
(U.S. CLS. 100 AND 101).

FIRST USE 12-1-2006; IN COMMERCE 12-1-2006.

THE MARK CONSISTS OF STANDARD CHAR-  
ACTERS WITHOUT CLAIM TO ANY PARTICULAR  
FONT, STYLE, SIZE, OR COLOR.

SN 77-007,320, FILED 9-26-2006.

BARNEY CHARLON, EXAMINING ATTORNEY

**Int. Cls.: 1, 6, 39, and 42**

**Prior U.S. Cls.: 1, 2, 5, 6, 10, 12, 13, 14, 23, 25, 26, 46,  
50, 100, 101, and 105**

**Reg. No. 3,454,332**

**United States Patent and Trademark Office**

**Registered June 24, 2008**

**TRADEMARK  
SERVICE MARK  
PRINCIPAL REGISTER**

**CO2DIRECT REFRESHINGLY EASY**

AIRGAS, INC. (DELAWARE CORPORATION)  
259 RADNOR-CHESTER ROAD  
RADNOR, PA 190874579

FOR: COMPRESSED CARBON DIOXIDE SOLD  
IN LIQUID FORM FOR USE IN THE FOOD AND  
BEVERAGE, SWIMMING POOL AND DRY CLEAN-  
ING INDUSTRIES, AND FOR LABORATORY USE,  
IN CLASS 1 (U.S. CLS. 1, 5, 6, 10, 26 AND 46).

FIRST USE 12-1-2006; IN COMMERCE 12-1-2006.

FOR: STORAGE UNITS, NAMELY, TANKS COM-  
POSED PRIMARILY OF METAL FOR STORING  
CARBON DIOXIDE, IN CLASS 6 (U.S. CLS. 2, 12, 13,  
14, 23, 25 AND 50).

FIRST USE 12-1-2006; IN COMMERCE 12-1-2006.

FOR: CARBON DIOXIDE DELIVERY SERVICES,  
NAMELY, DELIVERY BY TRUCK OF CARBON

DIOXIDE IN GASEOUS AND LIQUID FORMS, IN  
CLASS 39 (U.S. CLS. 100 AND 105).

FIRST USE 12-1-2006; IN COMMERCE 12-1-2006.

FOR: TANK LEVEL MONITORING SERVICES,  
NAMELY, TELEMETRY-BASED REMOTE MONI-  
TORING OF SUPPLY LEVELS IN CARBON DIOX-  
IDE STORAGE SYSTEMS OF OTHERS, IN CLASS 42  
(U.S. CLS. 100 AND 101).

FIRST USE 12-1-2006; IN COMMERCE 12-1-2006.

THE MARK CONSISTS OF STANDARD CHAR-  
ACTERS WITHOUT CLAIM TO ANY PARTICULAR  
FONT, STYLE, SIZE, OR COLOR.

SN 77-007,353, FILED 9-26-2006.

BARNEY CHARLON, EXAMINING ATTORNEY



**Int. Cls.: 1, 6, 39, and 42**

**Prior U.S. Cls.: 1, 2, 5, 6, 10, 12, 13, 14, 23, 25, 26, 46,  
50, 100, 101, and 105**

**Reg. No. 3,454,333**

**United States Patent and Trademark Office**

**Registered June 24, 2008**

**TRADEMARK  
SERVICE MARK  
PRINCIPAL REGISTER**

**CO<sub>2</sub>Direct**

AIRGAS, INC. (DELAWARE CORPORATION)  
259 RADNOR-CHESTER ROAD  
RADNOR, PA 190874579

FOR: COMPRESSED CARBON DIOXIDE SOLD  
IN LIQUID FORM FOR USE IN THE FOOD AND  
BEVERAGE, SWIMMING POOL AND DRY CLEAN-  
ING INDUSTRIES, AND FOR LABORATORY USE,  
IN CLASS 1 (U.S. CLS. 1, 5, 6, 10, 26 AND 46).

FIRST USE 12-1-2006; IN COMMERCE 12-1-2006.

FOR: STORAGE UNITS, NAMELY, TANKS COM-  
POSED PRIMARILY OF METAL FOR STORING  
CARBON DIOXIDE, IN CLASS 6 (U.S. CLS. 2, 12, 13,  
14, 23, 25 AND 50).

FIRST USE 12-1-2006; IN COMMERCE 12-1-2006.

FOR: CARBON DIOXIDE DELIVERY SERVICES,  
NAMELY, DELIVERY BY TRUCK OF CARBON  
DIOXIDE IN GASEOUS AND LIQUID FORMS, IN  
CLASS 39 (U.S. CLS. 100 AND 105).

FIRST USE 12-1-2006; IN COMMERCE 12-1-2006.

FOR: TANK LEVEL MONITORING SERVICES,  
NAMELY, TELEMETRY-BASED REMOTE MONI-  
TORING OF SUPPLY LEVELS IN CARBON DIOX-  
IDE STORAGE SYSTEMS OF OTHERS, IN CLASS 42  
(U.S. CLS. 100 AND 101).

FIRST USE 12-1-2006; IN COMMERCE 12-1-2006.

SN 77-007,568, FILED 9-26-2006.

BARNEY CHARLON, EXAMINING ATTORNEY

**Int. Cls.: 35 and 40**

**Prior U.S. Cls.: 100, 101, 102, 103, and 106**

**United States Patent and Trademark Office**

**Reg. No. 3,454,334**

**Registered June 24, 2008**

**SERVICE MARK  
PRINCIPAL REGISTER**



I.C.E.D. MANAGEMENT, INC. (DELAWARE CORPORATION)  
103 FOULK ROAD  
WILMINGTON, DE 19803

FOR: COPYING OF DOCUMENTS FOR OTHERS, IN CLASS 35 (U.S. CLS. 100, 101 AND 102).

FIRST USE 12-31-2007; IN COMMERCE 12-31-2007.

FOR: BINDERY SERVICES FOR OTHERS, NAME-  
LY, COLLATING, FOLDING, STAPLING, PERFOR-  
ATING, CUTTING AND BINDING OF PRINTED,  
PHOTOCOPIED AND TYPEWRITTEN MATERIALS,  
IN CLASS 40 (U.S. CLS. 100, 103 AND 106).

FIRST USE 12-31-2007; IN COMMERCE 12-31-2007.

OWNER OF U.S. REG. NOS. 3,099,588, 3,099,589,  
AND 3,099,591.

THE MARK CONSISTS OF A FANCIFUL DESIGN  
OF A HUMAN FORM IN STRIDE WITH AN OUT-  
STRETCHED ARM HOLDING A PACKAGE.

SN 77-007,621, FILED 9-26-2006.

AMY MCMENAMIN, EXAMINING ATTORNEY

**Int. Cl.: 9**

**Prior U.S. Cls.: 21, 23, 26, 36, and 38**

**United States Patent and Trademark Office**

**Reg. No. 3,454,335**

**Registered June 24, 2008**

**TRADEMARK  
PRINCIPAL REGISTER**

**INSPIRED BY NATURE**

QUALCOMM MEMS TECHNOLOGIES, INC. (DE-  
LAWARE CORPORATION)  
ATTN: TRADEMARKS - PATENT DEPT.  
5775 MOREHOUSE DRIVE  
SAN DIEGO, CA 921211714

FOR: MICROELECTROMECHANICAL SYSTEMS  
DISPLAY DEVICES, NAMELY, FLAT PANEL DIS-  
PLAY SCREENS FOR USE IN MOBILE TELE-  
PHONES, COMPUTERS, MP3 PLAYERS, AND  
PORTABLE HAND HELD COMPUTER COMMUNI-  
CATION EQUIPMENT, IN CLASS 9 (U.S. CLS. 21, 23,  
26, 36 AND 38).

FIRST USE 12-7-2007; IN COMMERCE 12-7-2007.

THE MARK CONSISTS OF STANDARD CHAR-  
ACTERS WITHOUT CLAIM TO ANY PARTICULAR  
FONT, STYLE, SIZE, OR COLOR.

SN 77-008,091, FILED 9-26-2006.

AMY MCMENAMIN, EXAMINING ATTORNEY

**Int. Cls.: 5 and 10**

**Prior U.S. Cls.: 6, 18, 26, 39, 44, 46, 51, and 52**

**United States Patent and Trademark Office**

**Reg. No. 3,454,336**

**Registered June 24, 2008**

**TRADEMARK  
PRINCIPAL REGISTER**

**DR. LEONARD'S HOUSE CALLS**

DR. LEONARD'S HEALTHCARE CORP. (DELA-  
WARE CORPORATION)  
100 NIXON LANE  
EDISON, NJ 08837

FOR: DIABETIC SUPPLIES, NAMELY, MEDI-  
CALLY DIAGNOSTIC TEST STRIPS AND CON-  
TROL SOLUTIONS FOR USE TO MONITOR  
DIABETES, IN CLASS 5 (U.S. CLS. 6, 18, 44, 46, 51  
AND 52).

FIRST USE 10-6-2006; IN COMMERCE 11-6-2006.

FOR: DIABETIC SUPPLIES, NAMELY, MEDICAL  
TEST KITS IN THE NATURE OF METERS AND  
LANCETS FOR DIABETES MONITORING FOR  
HOME USE, IN CLASS 10 (U.S. CLS. 26, 39 AND 44).

FIRST USE 10-6-2006; IN COMMERCE 11-6-2006.

THE MARK CONSISTS OF STANDARD CHAR-  
ACTERS WITHOUT CLAIM TO ANY PARTICULAR  
FONT, STYLE, SIZE, OR COLOR.

OWNER OF U.S. REG. NO. 1,818,850.

THE NAME(S), PORTRAIT(S), AND/OR SIGNA-  
TURE(S) SHOWN IN THE MARK DOES NOT IDEN-  
TIFY A PARTICULAR LIVING INDIVIDUAL.

SN 77-008,517, FILED 9-27-2006.

GINA FINK, EXAMINING ATTORNEY

**Int. Cl.: 32**

**Prior U.S. Cls.: 45, 46, and 48**

**Reg. No. 3,454,337**

**United States Patent and Trademark Office**

**Registered June 24, 2008**

---

**TRADEMARK  
PRINCIPAL REGISTER**

**BOO KOO WET VITAMINS**

BOO KOO BEVERAGES, INC. (TEXAS CORPORATION)  
4951 AIRPORT PARKWAY  
ADDISON, TX 75001

FOR: NON-ALCOHOLIC BEVERAGES, NAMELY, FLAVORED WATER ENHANCED WITH VITAMINS, MINERALS, ENERGY-RELEASING NUTRIENTS, ANTIOXIDANTS, AND/OR DIETARY SUPPLEMENTS, IN CLASS 32 (U.S. CLS. 45, 46 AND 48).

FIRST USE 2-8-2008; IN COMMERCE 2-8-2008.

THE MARK CONSISTS OF STANDARD CHARACTERS WITHOUT CLAIM TO ANY PARTICULAR FONT, STYLE, SIZE, OR COLOR.

OWNER OF U.S. REG. NO. 3,117,993.

NO CLAIM IS MADE TO THE EXCLUSIVE RIGHT TO USE "VITAMINS", APART FROM THE MARK AS SHOWN.

SN 77-008,942, FILED 9-27-2006.

CHARISMA HAMPTON, EXAMINING ATTORNEY

**Int. Cls.: 9 and 25**

**Prior U.S. Cls.: 21, 22, 23, 26, 36, 38, and 39**

**United States Patent and Trademark Office**

**Reg. No. 3,454,338**

**Registered June 24, 2008**

**TRADEMARK  
PRINCIPAL REGISTER**

**GUNNAR**

GUNNAR OPTIKS, LLC (CALIFORNIA LTD  
LIAB CO)  
SUITE 440  
12626 HIGH BLUFF DRIVE  
SAN DIEGO, CA 92130

FOR: EYEWEAR ACCESSORIES, NAMELY,  
STRAPS, NECK CORDS AND HEAD STRAPS  
WHICH RESTRAIN EYEWEAR FROM MOVEMENT  
ON A WEARER; MAGNIFYING GLASSES; OPTI-  
CAL GLASSES; PROTECTIVE EYEWEAR; SAFETY  
EYEWEAR; SPORTS EYEWEAR, IN CLASS 9 (U.S.  
CLS. 21, 23, 26, 36 AND 38).

FIRST USE 6-15-2007; IN COMMERCE 12-15-2007.

FOR: HATS; PANTS; SHIRTS, IN CLASS 25 (U.S.  
CLS. 22 AND 39).

FIRST USE 10-15-2007; IN COMMERCE 12-15-2007.

THE MARK CONSISTS OF STANDARD CHAR-  
ACTERS WITHOUT CLAIM TO ANY PARTICULAR  
FONT, STYLE, SIZE, OR COLOR.

SN 77-009,696, FILED 9-28-2006.

LINDSEY RUBIN, EXAMINING ATTORNEY

**Int. Cl.: 41**

**Prior U.S. Cls.: 100, 101, and 107**

**United States Patent and Trademark Office**

**Reg. No. 3,454,339**

**Registered June 24, 2008**

**SERVICE MARK  
PRINCIPAL REGISTER**



AUDIO SCREENPLAY, INC. (CALIFORNIA CORPORATION)  
115  
200 MCNEIL LANE  
NEWPORT BEACH, CA 92663

FOR: AUDIO RECORDING AND PRODUCTION,  
IN CLASS 41 (U.S. CLS. 100, 101 AND 107).

FIRST USE 9-18-2006; IN COMMERCE 9-18-2006.

NO CLAIM IS MADE TO THE EXCLUSIVE  
RIGHT TO USE "AUDIO SCREENPLAY", APART  
FROM THE MARK AS SHOWN.

THE MARK CONSISTS OF THREE OPEN PARENTHESIS NEXT TO EACH OTHER IN TANDEM AND DECREASING IN SIZE FROM LEFT TO RIGHT. THE WORDS "AUDIO SCREENPLAY" ARE LOCATED TO THE RIGHT SIDE OF THE PARENTHESIS.

SN 77-009,874, FILED 9-28-2006.

ROBIN CHOSID, EXAMINING ATTORNEY

**Int. Cl.: 24**

**Prior U.S. Cls.: 42 and 50**

**United States Patent and Trademark Office**

**Reg. No. 3,454,340**

**Registered June 24, 2008**

**TRADEMARK  
PRINCIPAL REGISTER**

**SIMPLY MY STYLE**

FABRIC EDITIONS, LLC. (SOUTH CAROLINA  
CORPORATION)  
1 INDEPENDENCE POINTE, STUDIO 202  
GREENVILLE, SC 29615

THE MARK CONSISTS OF STANDARD CHAR-  
ACTERS WITHOUT CLAIM TO ANY PARTICULAR  
FONT, STYLE, SIZE, OR COLOR.

FOR: TEXTILE GOODS, NAMELY, FABRIC  
PATCHWORK PIECES FOR USE IN MAKING  
QUILTS, IN CLASS 24 (U.S. CLS. 42 AND 50).

SN 77-010,255, FILED 9-29-2006.

FIRST USE 4-18-2007; IN COMMERCE 4-18-2007.

JOHN WILKE, EXAMINING ATTORNEY



**Int. Cl.: 20**

**Prior U.S. Cls.: 2, 13, 22, 25, 32, and 50**

**Reg. No. 3,454,341**

**United States Patent and Trademark Office**

**Registered June 24, 2008**

---

**TRADEMARK  
PRINCIPAL REGISTER**

**STRATTON**

STAPLES THE OFFICE SUPERSTORE, LLC (DE-  
LAWARE LTD LIAB CO)  
500 STAPLES DRIVE  
FRAMINGHAM, MA 01702

THE MARK CONSISTS OF STANDARD CHAR-  
ACTERS WITHOUT CLAIM TO ANY PARTICULAR  
FONT, STYLE, SIZE, OR COLOR.

FOR: OFFICE CHAIRS, IN CLASS 20 (U.S. CLS. 2,  
13, 22, 25, 32 AND 50).

SN 77-010,363, FILED 9-29-2006.

FIRST USE 2-0-2007; IN COMMERCE 2-0-2007.

MARK PILARO, EXAMINING ATTORNEY

**Int. Cl.: 5**

**Prior U.S. Cls.: 6, 18, 44, 46, 51, and 52**

**Reg. No. 3,454,342**

**United States Patent and Trademark Office**

**Registered June 24, 2008**

**TRADEMARK  
PRINCIPAL REGISTER**



TRINITY THERAPEUTICS, INC. (CALIFORNIA CORPORATION)

3705 CAPSTAN CIRCLE

WESTLAKE VILLAGE, CA 91361

FOR: PHARMACEUTICAL PREPARATIONS FOR THE TREATMENT OF AUTOIMMUNE DISEASES, IN CLASS 5 (U.S. CLS. 6, 18, 44, 46, 51 AND 52).

FIRST USE 2-6-2008; IN COMMERCE 2-6-2008.

NO CLAIM IS MADE TO THE EXCLUSIVE RIGHT TO USE "THERAPEUTICS, INC.", APART FROM THE MARK AS SHOWN.

THE MARK CONSISTS OF THE WORDS "TRINITY THERAPEUTICS, INC." AND A STYLIZED REPRESENTATION OF A HUMAN ANTIBODY OR A IMMUNOGLOBULIN ANTIBODY.

SN 77-010,520, FILED 9-29-2006.

SUSAN RICHARDS, EXAMINING ATTORNEY

**Int. Cl.: 13**

**Prior U.S. Cls.: 2 and 9**

**United States Patent and Trademark Office**

**Reg. No. 3,454,343**

**Registered June 24, 2008**

**TRADEMARK  
PRINCIPAL REGISTER**

**I-BOLT**

SMITH & WESSON CORP (DELAWARE CORPORATION)  
2100 ROOSEVELT AVENUE  
SPRINGFIELD, MA 01102

FOR: FIREARMS, NAMELY, HANDGUNS, REVOLVERS, PISTOLS, RIFLES, SHOTGUNS, GUN CASES, HOLSTERS, AMMUNITION AND POUCHES FOR AMMUNITION, IN CLASS 13 (U.S. CLS. 2 AND 9).

FIRST USE 6-8-2007; IN COMMERCE 6-8-2007.

THE MARK CONSISTS OF STANDARD CHARACTERS WITHOUT CLAIM TO ANY PARTICULAR FONT, STYLE, SIZE, OR COLOR.

SN 77-010,641, FILED 9-29-2006.

KATHLEEN M. VANSTON, EXAMINING ATTORNEY

**Int. Cl.: 25**

**Prior U.S. Cls.: 22 and 39**

**United States Patent and Trademark Office**

**Reg. No. 3,454,344**

**Registered June 24, 2008**

**TRADEMARK  
PRINCIPAL REGISTER**

**Thin Her**

ITC GIRL (TEXAS LTD LIAB CO)  
10367 BROCKWOOD ROAD  
DALLAS, TX 75238

THE MARK CONSISTS OF STANDARD CHAR-  
ACTERS WITHOUT CLAIM TO ANY PARTICULAR  
FONT, STYLE, SIZE, OR COLOR.

FOR: CLOTHING, NAMELY, JEANS, SKIRTS,  
JACKETS, BLOUSES, SWEATERS, PANTS, VESTS,  
SKORTS, DRESSES, SHIRTS, IN CLASS 25 (U.S. CLS.  
22 AND 39).

SN 77-011,032, FILED 9-29-2006.

FIRST USE 1-1-2008; IN COMMERCE 1-1-2008.

SANJEEV VOHRA, EXAMINING ATTORNEY

**Int. Cl.: 43**

**Prior U.S. Cls.: 100 and 101**

**United States Patent and Trademark Office**

**Reg. No. 3,454,345**

**Registered June 24, 2008**

**SERVICE MARK  
PRINCIPAL REGISTER**

# HOTEL VISION

SABREMARK LIMITED PARTNERSHIP (DELA-  
WARE LIMITED PARTNERSHIP)  
3150 SABRE DRIVE  
SOUTHLAKE, TX 76092

FOR: PROVIDING AN ONLINE COMPUTER DA-  
TABASE IN THE FIELD OF HOTEL RESERVATION  
INFORMATION FOR USE IN MANAGING AND  
FORECASTING REVENUE, IN CLASS 43 (U.S. CLS.  
100 AND 101).

FIRST USE 9-15-2006; IN COMMERCE 9-15-2006.

THE MARK CONSISTS OF STANDARD CHAR-  
ACTERS WITHOUT CLAIM TO ANY PARTICULAR  
FONT, STYLE, SIZE, OR COLOR.

NO CLAIM IS MADE TO THE EXCLUSIVE  
RIGHT TO USE "HOTEL", APART FROM THE  
MARK AS SHOWN.

SN 77-011,898, FILED 10-2-2006.

BILL DAWE, EXAMINING ATTORNEY

**Int. Cls.: 9, 16, and 25**

**Prior U.S. Cls.: 2, 5, 21, 22, 23, 26, 29, 36, 37, 38, 39,  
and 50**

**Reg. No. 3,454,346**

**United States Patent and Trademark Office**

**Registered June 24, 2008**

**TRADEMARK  
PRINCIPAL REGISTER**



ANSWERS IN GENESIS OF KENTUCKY, INC.  
(KENTUCKY CORPORATION)  
P. O. BOX 510  
HEBRON, KY 41048

FOR: MAGNETS, IN CLASS 9 (U.S. CLS. 21, 23, 26,  
36 AND 38).

FIRST USE 4-1-2007; IN COMMERCE 4-1-2007.

FOR: POSTERS, NOTE CARDS, IN CLASS 16 (U.S.  
CLS. 2, 5, 22, 23, 29, 37, 38 AND 50).

FIRST USE 4-1-2007; IN COMMERCE 4-1-2007.

FOR: T-SHIRTS, IN CLASS 25 (U.S. CLS. 22 AND  
39).

FIRST USE 4-1-2007; IN COMMERCE 4-1-2007.

THE MARK CONSISTS OF A STYLIZED DESIGN  
OF A HUMAN SKULL, A PARTIAL PRESENTA-  
TION OF A HORSE AND RIDER WITH A SWORD,  
FLAMES, A DOVE HOLDING AN OLIVE BRANCH,  
AND AN ARCH AND ROADWAY LEADING TO  
THE ARCH.

SN 77-012,857, FILED 10-3-2006.

JENNY PARK, EXAMINING ATTORNEY

**Int. Cl.: 3**

**Prior U.S. Cls.: 1, 4, 6, 50, 51, and 52**

**United States Patent and Trademark Office**

**Reg. No. 3,454,347**

**Registered June 24, 2008**

**TRADEMARK  
PRINCIPAL REGISTER**

**SEPTIC BRITE**

FBK HOLDINGS, LLC (DELAWARE LTD LIAB  
CO)  
SUITE 352  
130 7TH AVENUE  
NEW YORK, NY 10011

THE MARK CONSISTS OF STANDARD CHAR-  
ACTERS WITHOUT CLAIM TO ANY PARTICULAR  
FONT, STYLE, SIZE, OR COLOR.

FOR: ENZYME-BASED LAUNDRY DETER-  
GENT, IN CLASS 3 (U.S. CLS. 1, 4, 6, 50, 51 AND 52).

SN 77-013,014, FILED 10-3-2006.

FIRST USE 1-20-2007; IN COMMERCE 1-20-2007.

NAAKWAMA ANKRAH, EXAMINING ATTORNEY

**Int. Cls.: 36, 37, and 42**

**Prior U.S. Cls.: 100, 101, 102, 103, and 106**

**United States Patent and Trademark Office**

**Reg. No. 3,454,348**

**Registered June 24, 2008**

**SERVICE MARK  
PRINCIPAL REGISTER**

**RCTC**

R.C. TEMME CORPORATION (CALIFORNIA CORPORATION)  
SUITE 201  
21777 VENTURA BOULEVARD  
WOODLAND HILLS, CA 91364

FOR: MORTGAGE BANKING SERVICES, NAME-  
LY, ORIGINATION, ACQUISITION, SERVICING,  
SECURITIZATION AND BROKERAGE OF MORT-  
GAGE LOANS; REAL ESTATE BROKERAGE SER-  
VICES; FINANCIAL SERVICES, NAMELY, A  
PORTFOLIO OFFERING OF INVESTMENTS CON-  
SISTING OF NOTES SECURED BY DEEDS OF  
TRUST, DIRECTLY OR INDIRECTLY THROUGH  
THE ISSUANCE OF SECURITIES; PROVIDING  
FORECLOSURE ADMINISTRATION SERVICES  
ON LOANS AND MORTGAGES; REAL ESTATE  
PROPERTY MANAGEMENT SERVICES, NAMELY,  
MANAGING COLLECTION OF RENTS FOR OTH-  
ERS, IN CLASS 36 (U.S. CLS. 100, 101 AND 102).

FIRST USE 10-1-1988; IN COMMERCE 10-1-1988.

FOR: REAL ESTATE PROPERTY MAINTEN-  
ANCE SERVICES ON BEHALF OF OTHERS, IN  
CLASS 37 (U.S. CLS. 100, 103 AND 106).

FIRST USE 10-1-1988; IN COMMERCE 10-1-1988.

FOR: TITLE SERVICES, NAMELY, ISSUING RE-  
CONVEYANCES OF DEEDS OF TRUST FOR OTH-  
ERS, IN CLASS 42 (U.S. CLS. 100 AND 101).

FIRST USE 10-1-1988; IN COMMERCE 10-1-1988.

THE MARK CONSISTS OF STANDARD CHAR-  
ACTERS WITHOUT CLAIM TO ANY PARTICULAR  
FONT, STYLE, SIZE, OR COLOR.

SN 77-013,229, FILED 10-4-2006.

RUSS HERMAN, EXAMINING ATTORNEY



**Int. Cl.: 3**

**Prior U.S. Cls.: 1, 4, 6, 50, 51, and 52**

**United States Patent and Trademark Office**

**Reg. No. 3,454,349**

**Registered June 24, 2008**

**TRADEMARK  
PRINCIPAL REGISTER**

**FOR EYES**

LENS CLEANER



FOR EYES OPTICAL COMPANY (PENNSYLVANIA CORPORATION)  
285 WEST 74TH PLACE  
HIALEAH, FL 33014

FOR: CARE PRODUCTS FOR OPTICAL DEVICES, NAMELY, SPRAY LENS CLEANER FOR OPTICAL LENSES AND EYEWEAR; DISPOSABLE WIPES IMPREGNATED WITH CHEMICALS OR COMPOUNDS FOR USE IN CLEANING OPTICAL LENSES AND EYEWEAR, IN CLASS 3 (U.S. CLS. 1, 4, 6, 50, 51 AND 52).

FIRST USE 6-1-2005; IN COMMERCE 6-1-2005.

OWNER OF U.S. REG. NOS. 1,132,442, 2,670,823, AND OTHERS.

NO CLAIM IS MADE TO THE EXCLUSIVE RIGHT TO USE "LENS CLEANER", APART FROM THE MARK AS SHOWN.

THE MARK CONSISTS OF FLOWER DESIGN.

SN 77-013,527, FILED 10-4-2006.

JOHN DALIER, EXAMINING ATTORNEY

**Int. Cl.: 35**

**Prior U.S. Cls.: 100, 101, and 102**

**United States Patent and Trademark Office**

**Reg. No. 3,454,350**

**Registered June 24, 2008**

**SERVICE MARK  
PRINCIPAL REGISTER**



ACCELLER, INC. (FLORIDA CORPORATION)  
815 NW 57TH AVENUE, SUITE 400  
MIAMI, FL 33126

THE COLOR(S) GREEN, LIGHT BLUE, LIGHTER GREEN, BROWN AND GRAY IS/ARE CLAIMED AS A FEATURE OF THE MARK.

FOR: COMPARATIVE MARKETING AND ADVERTISING SERVICES FOR PROVIDERS OF RESIDENTIAL AND BUSINESS TELECOMMUNICATIONS AND OTHER DIGITAL SERVICES, NAMELY, FOR PROVIDERS OF BROADBAND CABLE, DSL, FIBER-OPTIC AND SATELLITE INTERNET ACCESS SERVICES, CABLE AND SATELLITE TELEVISION, VOICE OVER IP, AND LONG-DISTANCE TELEPHONE SERVICES; OPERATION OF TELEPHONE CALL CENTERS FOR OTHERS FOR PURPOSES OF MARKETING OF TELECOMMUNICATIONS AND OTHER DIGITAL SERVICES AND MARKETING CONSULTING RELATED THERETO, IN CLASS 35 (U.S. CLS. 100, 101 AND 102).

THE COLOR GRAY APPEARS IN THE OUTLINE OF THE HOUSE, THE COLOR LIGHTER GREEN APPEARS IN THE CIRCLE IN THE UPPER LEFT CORNER OF THE HOUSE, THE COLOR BLUE APPEARS IN THE CIRCLE IN THE UPPER CORNER RIGHT OF THE HOUSE, THE COLOR BROWN APPEARS IN THE LOWER LEFT CIRCLE AND THE COLOR GREEN APPEARS IN THE LOWER RIGHT CIRCLE IN THE CORNER OF THE HOUSE.

SN 77-014,282, FILED 10-5-2006.

FIRST USE 1-1-1987; IN COMMERCE 1-1-1987.

CAROLINE WOOD, EXAMINING ATTORNEY

**Int. Cl.: 35**

**Prior U.S. Cls.: 100, 101, and 102**

**United States Patent and Trademark Office**

**Reg. No. 3,454,351**

**Registered June 24, 2008**

**SERVICE MARK  
PRINCIPAL REGISTER**



ACCELLER, INC. (FLORIDA CORPORATION)  
815 NW 57TH AVENUE, SUITE 400  
MIAMI, FL 33126

FOR: COMPARATIVE MARKETING AND ADVERTISING SERVICES FOR PROVIDERS OF RESIDENTIAL AND BUSINESS TELECOMMUNICATIONS AND OTHER DIGITAL SERVICES, NAMELY, FOR PROVIDERS OF BROADBAND CABLE, DSL, FIBER-OPTIC AND SATELLITE INTERNET ACCESS SERVICES, CABLE AND SATELLITE TELEVISION, VOICE OVER IP, AND LONG-DISTANCE TELEPHONE SERVICES; OPERATION OF TELEPHONE CALL CENTERS FOR OTHERS FOR PURPOSES OF MARKETING OF TELECOMMUNICATIONS AND OTHER DIGITAL SERVICES AND MARKETING CONSULTING RELATED THERETO, IN CLASS 35 (U.S. CLS. 100, 101 AND 102).

FIRST USE 10-31-2006; IN COMMERCE 7-25-2007.

THE COLOR(S) GREEN, BLUE, RED, YELLOW AND GRAY IS/ARE CLAIMED AS A FEATURE OF THE MARK.

THE COLOR GRAY APPEARS IN THE OUTLINE OF THE HOUSE, THE COLOR GREEN APPEARS IN THE CIRCLE IN THE UPPER LEFT CORNER OF THE HOUSE, THE COLOR BLUE APPEARS IN THE CIRCLE IN THE UPPER CORNER RIGHT OF THE HOUSE, THE COLOR RED APPEARS IN THE LOWER LEFT CIRCLE AND THE COLOR YELLOW APPEARS IN THE LOWER RIGHT CIRCLE IN THE CORNER OF THE HOUSE.

SN 77-014,297, FILED 10-5-2006.

CAROLINE WOOD, EXAMINING ATTORNEY

**Int. Cl.: 5**

**Prior U.S. Cls.: 6, 18, 44, 46, 51, and 52**

**United States Patent and Trademark Office**

**Reg. No. 3,454,352**

**Registered June 24, 2008**

**TRADEMARK  
PRINCIPAL REGISTER**

**LIQUID-FLEX**

RIDLEY U.S. HOLDINGS, INC. (DELAWARE  
CORPORATION)  
424 NORTH RIVERFRONT DRIVE  
MANKATO, MN 56002

THE MARK CONSISTS OF STANDARD CHAR-  
ACTERS WITHOUT CLAIM TO ANY PARTICULAR  
FONT, STYLE, SIZE, OR COLOR.

FOR: DIETARY JOINT SUPPLEMENT FOR  
HORSES, IN CLASS 5 (U.S. CLS. 6, 18, 44, 46, 51  
AND 52).

SN 77-014,428, FILED 10-5-2006.

FIRST USE 2-1-2008; IN COMMERCE 2-1-2008.

EDWARD NELSON, EXAMINING ATTORNEY

**Int. Cl.: 24**

**Prior U.S. Cls.: 42 and 50**

**United States Patent and Trademark Office**

**Reg. No. 3,454,353**

**Registered June 24, 2008**

**TRADEMARK  
PRINCIPAL REGISTER**

**ADORNABLES**

FABRIC EDITIONS, LLC. (SOUTH CAROLINA CORPORATION)  
1 INDEPENDENCE POINTE, STUDIO 202  
GREENVILLE, SC 29615

FOR: TEXTILE GOODS, NAMELY, FABRIC APPLIQUES FOR USE IN WEARABLE ART, IN CLASS 24 (U.S. CLS. 42 AND 50).

FIRST USE 7-10-2007; IN COMMERCE 7-10-2007.

THE MARK CONSISTS OF STANDARD CHARACTERS WITHOUT CLAIM TO ANY PARTICULAR FONT, STYLE, SIZE, OR COLOR.

SN 77-014,796, FILED 10-5-2006.

JOHN WILKE, EXAMINING ATTORNEY

**Int. Cl.: 9**

**Prior U.S. Cls.: 21, 23, 26, 36, and 38**

**Reg. No. 3,454,354**

**United States Patent and Trademark Office**

**Registered June 24, 2008**

---

**TRADEMARK  
PRINCIPAL REGISTER**

**ALPINE ADVENTURE**

WMS GAMING INC. (DELAWARE CORPORATION)  
800 SOUTH NORTHPOINT BOULEVARD  
WAUKEGAN, IL 60085

FOR: GAMING MACHINES THAT GENERATE OR DISPLAY WAGER OUTCOMES; GAMING SOFTWARE THAT GENERATES OR DISPLAYS WAGER OUTCOMES OF GAMING MACHINES, IN CLASS 9 (U.S. CLS. 21, 23, 26, 36 AND 38).

FIRST USE 10-17-2007; IN COMMERCE 10-17-2007.

THE MARK CONSISTS OF STANDARD CHARACTERS WITHOUT CLAIM TO ANY PARTICULAR FONT, STYLE, SIZE, OR COLOR.

SN 77-014,798, FILED 10-5-2006.

RICHARD A. STRASER, EXAMINING ATTORNEY

**Int. Cl.: 9**

**Prior U.S. Cls.: 21, 23, 26, 36, and 38**

**Reg. No. 3,454,355**

**United States Patent and Trademark Office**

**Registered June 24, 2008**

---

**TRADEMARK  
PRINCIPAL REGISTER**

**ROPE 'EM IN**

WMS GAMING INC. (DELAWARE CORPORATION)  
800 SOUTH NORTHPOINT BOULEVARD  
WAUKEGAN, IL 60085

FOR: GAMING MACHINES THAT GENERATE OR DISPLAY WAGER OUTCOMES; GAMING SOFTWARE THAT GENERATES OR DISPLAYS WAGER OUTCOMES OF GAMING MACHINES, IN CLASS 9 (U.S. CLS. 21, 23, 26, 36 AND 38).

FIRST USE 11-13-2007; IN COMMERCE 11-13-2007.

THE MARK CONSISTS OF STANDARD CHARACTERS WITHOUT CLAIM TO ANY PARTICULAR FONT, STYLE, SIZE, OR COLOR.

SN 77-015,419, FILED 10-6-2006.

RICHARD A. STRASER, EXAMINING ATTORNEY

**Int. Cl.: 12**

**Prior U.S. Cls.: 19, 21, 23, 31, 35, and 44**

**Reg. No. 3,454,356**

**United States Patent and Trademark Office**

**Registered June 24, 2008**

---

**TRADEMARK  
PRINCIPAL REGISTER**

**ROCKERTAIL**

H-D MICHIGAN, INC. (MICHIGAN CORPORATION)  
315 W. HURON, SUITE 400  
ANN ARBOR, MI 48103

THE MARK CONSISTS OF STANDARD CHARACTERS WITHOUT CLAIM TO ANY PARTICULAR FONT, STYLE, SIZE, OR COLOR.

FOR: STRUCTURAL PARTS FOR MOTORCYCLES, SOLD AS INTEGRAL COMPONENTS OF MOTORCYCLES, IN CLASS 12 (U.S. CLS. 19, 21, 23, 31, 35 AND 44).

SN 77-015,881, FILED 10-6-2006.

FIRST USE 7-0-2007; IN COMMERCE 7-0-2007.

RUDY R. SINGLETON, EXAMINING ATTORNEY



**Int. Cl.: 3**

**Prior U.S. Cls.: 1, 4, 6, 50, 51, and 52**

**United States Patent and Trademark Office**

**Reg. No. 3,454,357**

**Registered June 24, 2008**

**TRADEMARK  
PRINCIPAL REGISTER**

**WEAR 10**

COTY DEUTSCHLAND GMBH (FED REP GER-  
MANY GMBH)  
FORT MALAKOFF PARK  
GESCHAFTSZENTRUM 3.0, RHEINSTRASSE 4E  
MAINZ, FED REP GERMANY 55116

FOR: COSMETICS, NAMELY, NAIL POLISH, IN  
CLASS 3 (U.S. CLS. 1, 4, 6, 50, 51 AND 52).

FIRST USE 7-1-2007; IN COMMERCE 7-1-2007.

THE MARK CONSISTS OF STANDARD CHAR-  
ACTERS WITHOUT CLAIM TO ANY PARTICULAR  
FONT, STYLE, SIZE, OR COLOR.

SN 77-016,668, FILED 10-9-2006.

MARY MUNSON, EXAMINING ATTORNEY

**Int. Cl.: 9**

**Prior U.S. Cls.: 21, 23, 26, 36, and 38**

**United States Patent and Trademark Office**

**Reg. No. 3,454,358**

**Registered June 24, 2008**

**TRADEMARK  
PRINCIPAL REGISTER**

**ROSETTASTONE.COM**

ROSETTA STONE LTD (VIRGINIA CORPORATION)  
135 WEST MARKET STREET  
HARRISONBURG, VA 22801

FOR: COMPUTER SOFTWARE FOR TEACHING  
FOREIGN LANGUAGES; COMPUTER SOFTWARE  
FOR LEARNING FOREIGN LANGUAGES, IN  
CLASS 9 (U.S. CLS. 21, 23, 26, 36 AND 38).

FIRST USE 4-1-1999; IN COMMERCE 4-1-1999.

THE MARK CONSISTS OF STANDARD CHARACTERS WITHOUT CLAIM TO ANY PARTICULAR FONT, STYLE, SIZE, OR COLOR.

OWNER OF U.S. REG. NOS. 2,761,492 AND 2,781,324.

SN 77-017,274, FILED 10-9-2006.

RONALD AIKENS, EXAMINING ATTORNEY

**Int. Cl.: 11**

**Prior U.S. Cls.: 13, 21, 23, 31, and 34**

**United States Patent and Trademark Office**

**Reg. No. 3,454,359**

**Registered June 24, 2008**

**TRADEMARK  
PRINCIPAL REGISTER**

**SONIC**

HUNTER FAN COMPANY (DELAWARE COR-  
PORATION)  
2500 FRISCO AVENUE  
MEMPHIS, TN 38114

THE MARK CONSISTS OF STANDARD CHAR-  
ACTERS WITHOUT CLAIM TO ANY PARTICULAR  
FONT, STYLE, SIZE, OR COLOR.

FOR: CEILING FANS, IN CLASS 11 (U.S. CLS. 13,  
21, 23, 31 AND 34).

SN 77-017,929, FILED 10-10-2006.

FIRST USE 9-7-2007; IN COMMERCE 9-7-2007.

MICHAEL ENGEL, EXAMINING ATTORNEY

**Int. Cl.: 41**

**Prior U.S. Cls.: 100, 101, and 107**

**United States Patent and Trademark Office**

**Reg. No. 3,454,360**

**Registered June 24, 2008**

**SERVICE MARK  
PRINCIPAL REGISTER**

**REAL LIFE DIVAS**

BLACK ENTERTAINMENT TELEVISION LLC  
(D.C. LTD LIAB CO)  
ONE BET PLAZA, 1235 W STREET, N.E.  
LEGAL AFFAIRS  
WASHINGTON, DC 20018

FOR: ENTERTAINMENT IN THE NATURE OF  
AN ON-GOING REALITY PROGRAM DISTRIBUTED  
VIA THE INTERNET, TELEVISION, CABLE  
AND WIRELESS, IN CLASS 41 (U.S. CLS. 100, 101  
AND 107).

FIRST USE 4-13-2007; IN COMMERCE 4-13-2007.

THE MARK CONSISTS OF STANDARD CHAR-  
ACTERS WITHOUT CLAIM TO ANY PARTICULAR  
FONT, STYLE, SIZE, OR COLOR.

SN 77-018,069, FILED 10-10-2006.

TINA L. SNAPP, EXAMINING ATTORNEY

**Int. Cl.: 5**

**Prior U.S. Cls.: 6, 18, 44, 46, 51, and 52**

**Reg. No. 3,454,361**

**United States Patent and Trademark Office**

**Registered June 24, 2008**

---

**TRADEMARK  
PRINCIPAL REGISTER**

**CELLULAR ACTIVE**

BLUEBONNET NUTRITION CORP. (TEXAS  
CORPORATION)

12915 DAIRY ASHFORD

SUGAR LAND, TX 77478

FOR: NUTRITIONAL SUPPLEMENTS, IN CLASS  
5 (U.S. CLS. 6, 18, 44, 46, 51 AND 52).

FIRST USE 4-0-2008; IN COMMERCE 4-0-2008.

THE MARK CONSISTS OF STANDARD CHAR-  
ACTERS WITHOUT CLAIM TO ANY PARTICULAR  
FONT, STYLE, SIZE, OR COLOR.

NO CLAIM IS MADE TO THE EXCLUSIVE  
RIGHT TO USE "CELLULAR", APART FROM THE  
MARK AS SHOWN.

SN 77-018,172, FILED 10-10-2006.

LINDA ORNDORFF, EXAMINING ATTORNEY

**Int. Cl.: 16**

**Prior U.S. Cls.: 2, 5, 22, 23, 29, 37, 38, and 50**

**Reg. No. 3,454,362**

**United States Patent and Trademark Office**

**Registered June 24, 2008**

---

**TRADEMARK  
PRINCIPAL REGISTER**

**SynDaver**

ANIMAL REPLACEMENT TECHNOLOGIES,  
INC. (FLORIDA CORPORATION)  
2522 TRAILMATE DRIVE  
SARASOTA, FL 34243

FOR: ANATOMICAL MODELS FOR SCIENTIFIC,  
INSTRUCTIONAL, AND EDUCATIONAL PURPOSES  
IN THE NATURE OF SYNTHETIC HUMAN  
CADAVERS AND BODY PARTS, IN CLASS 16 (U.S.  
CLS. 2, 5, 22, 23, 29, 37, 38 AND 50).

FIRST USE 4-14-2008; IN COMMERCE 4-14-2008.

THE MARK CONSISTS OF STANDARD CHAR-  
ACTERS WITHOUT CLAIM TO ANY PARTICULAR  
FONT, STYLE, SIZE, OR COLOR.

THE WORDING "SYNDAVER" HAS NO MEAN-  
ING IN A FOREIGN LANGUAGE.

SN 77-019,452, FILED 10-12-2006.

KAPIL BHANOT, EXAMINING ATTORNEY

**Int. Cl.: 25**

**Prior U.S. Cls.: 22 and 39**

**United States Patent and Trademark Office**

**Reg. No. 3,454,363**

**Registered June 24, 2008**

**TRADEMARK  
PRINCIPAL REGISTER**

**ARMY STRONG**

DEPARTMENT OF THE ARMY (UNITED STATES GOVERNMENT AGENCY)  
JALS-IP  
901 N. STUART ST., STE. 700  
ARLINGTON, VA 222031837

FOR: MEN'S WOMEN'S, AND CHILDREN'S CLOTHING, NAMELY, SHIRTS, T-SHIRTS, SPORT SHIRTS, KNIT SHIRTS, POLO SHIRTS, GOLF SHIRTS, SWEAT SHIRTS, SWEAT PANTS, PANTS, SHORTS, JACKETS, SOCKS, HATS, CAPS, AND VISORS, IN CLASS 25 (U.S. CLS. 22 AND 39).

FIRST USE 10-16-2006; IN COMMERCE 6-0-2007.

THE MARK CONSISTS OF STANDARD CHARACTERS WITHOUT CLAIM TO ANY PARTICULAR FONT, STYLE, SIZE, OR COLOR.

OWNER OF U.S. REG. NOS. 2,401,763, 3,152,724, AND OTHERS.

SN 77-019,886, FILED 10-12-2006.

ELI HELLMAN, EXAMINING ATTORNEY

**Int. Cl.: 21**

**Prior U.S. Cls.: 2, 13, 23, 29, 30, 33, 40, and 50**

**United States Patent and Trademark Office**

**Reg. No. 3,454,364**

**Registered June 24, 2008**

**TRADEMARK  
PRINCIPAL REGISTER**

**ARMY STRONG**

DEPARTMENT OF THE ARMY (UNITED STATES GOVERNMENT AGENCY)

JALS-IP

901 N. STUART ST., STE. 700

ARLINGTON, VA 222031837

FOR: HOUSEWARES, NAMELY, CUPS, DRINKING GLASSES, MUGS, CANTEENS, CONTAINERS FOR STORING FOOD, INSULATED CONTAINERS FOR FOOD OR BEVERAGES, TANKARDS NOT OF PRECIOUS METAL, AND COASTERS MADE OF PLASTIC, CORK, WOOD, LEATHER, AND CERAMIC, IN CLASS 21 (U.S. CLS. 2, 13, 23, 29, 30, 33, 40 AND 50).

FIRST USE 10-16-2006; IN COMMERCE 6-0-2007.

THE MARK CONSISTS OF STANDARD CHARACTERS WITHOUT CLAIM TO ANY PARTICULAR FONT, STYLE, SIZE, OR COLOR.

OWNER OF U.S. REG. NOS. 2,703,479 AND 2,983,583.

SN 77-019,970, FILED 10-12-2006.

ELI HELLMAN, EXAMINING ATTORNEY



**Int. Cl.: 25**

**Prior U.S. Cls.: 22 and 39**

**United States Patent and Trademark Office**

**Reg. No. 3,454,365**

**Registered June 24, 2008**

**TRADEMARK  
PRINCIPAL REGISTER**

**Every chef needs some.**

LAU, PETI (UNITED STATES INDIVIDUAL)  
PO BOX 11057  
TEMPE, AZ 85284

THE MARK CONSISTS OF STANDARD CHAR-  
ACTERS WITHOUT CLAIM TO ANY PARTICULAR  
FONT, STYLE, SIZE, OR COLOR.

FOR: CHEF UNIFORMS, IN CLASS 25 (U.S. CLS.  
22 AND 39).

SN 77-020,125, FILED 10-12-2006.

FIRST USE 4-28-2006; IN COMMERCE 8-8-2006.

KATHERINE CHANG, EXAMINING ATTORNEY

Int. Cl.: 33

Prior U.S. Cls.: 47 and 49

United States Patent and Trademark Office

Reg. No. 3,454,366

Registered June 24, 2008

**TRADEMARK  
PRINCIPAL REGISTER**

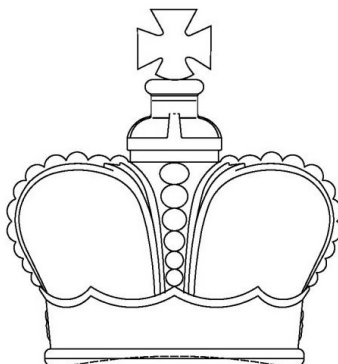

MORENO, LEONARDO RODRIGUEZ (MEXICO  
INDIVIDUAL)

#42

COL ARBOLEDAS ARBOLEDA DE LA HACIENDA  
MEXICO D.F, MEXICO 061100

FOR: ALCOHOLIC BEVERAGES, NAMELY, DIS-  
TILLED SPIRITS, IN CLASS 33 (U.S. CLS. 47 AND 49).

FIRST USE 6-0-1994; IN COMMERCE 11-0-1995.

THE MARK CONSISTS OF THE CONFIGURA-  
TION OF THE THREE DIMENSIONAL CONFIG-  
URATION OF THE BOTTLE FOR THE GOODS,  
WHICH IS GENERALLY SHAPED IN THE FORM  
OF A STYLIZED CROWN, WITH VERTICAL ROWS

OF RAISED SEMICIRCLES ORIGINATING FROM  
THE UPPER BASE OF THE CONTAINER TO THE  
LOWER NECK. THE TOP OF THE CONTAINER IS  
COMPRISED OF A STYLIZED CROSS. THE BRO-  
KEN LINES IN THE MARK ARE INTENDED TO  
SHOW THE GENERAL POSITION OF THE INTER-  
IOR PORTIONS OF THE BOTTLE AND ARE NOT A  
PART OF THE MARK AS SHOWN.

SEC. 2(F).

SN 77-020,400, FILED 10-13-2006.

RICHARD WHITE, EXAMINING ATTORNEY

**Int. Cl.: 9**

**Prior U.S. Cls.: 21, 23, 26, 36, and 38**

**Reg. No. 3,454,367**

**United States Patent and Trademark Office**

**Registered June 24, 2008**

**TRADEMARK  
PRINCIPAL REGISTER**

# ACTIVEMATRIX

TIBCO SOFTWARE INC. (DELAWARE CORPORATION)  
3303 HILLVIEW AVENUE  
PALO ALTO, CA 94304

FOR: COMPUTER SOFTWARE FOR ENTERPRISE APPLICATION INTEGRATION, COMMUNICATIONS SOFTWARE FOR CONNECTING COMPUTER NETWORK USERS AND GLOBAL COMPUTER NETWORKS, COMMUNICATIONS NETWORKING SOFTWARE FOR CONNECTING COMPUTER NETWORK USERS AND GLOBAL COMPUTER NETWORKS, SOFTWARE FOR USE IN INTEGRATING DATABASES AND APPLICATIONS, SOFTWARE FOR USE IN INTEGRATING COMPUTER DATABASES, COMPUTER SOFTWARE FOR MONITORING COMPUTER SYSTEMS AND NETWORKS, SOFTWARE FOR USE IN PROCESSING TRANSACTIONS IN E-BUSINESS AND ON-LINE TRANSACTIONS, WEB SITE DEVELOPMENT SOFTWARE FOR USE IN WEB SERVICES DEVELOPMENT, DEPLOYMENT AND ORCHESTRATION, COMPUTER OPERATING SYSTEM SOFTWARE, COMPUTER UTILITY SOFTWARE

FOR PERFORMING COMPUTER MAINTENANCE WORK, COMPUTER SOFTWARE FOR USE IN DEVELOPING AND DEPLOYING OTHER COMPUTER SOFTWARE, COMPUTER SOFTWARE THAT ALLOWS USERS TO CREATE, ASSEMBLE, DEPLOY, ADMINISTER, MONITOR, EXECUTE, AND MANAGE WEBSITE SERVICES, WEBSITE SERVICE RULES, AND/OR WEBSITE SERVICE POLICIES ACROSS HETEROGENEOUS AND DISTRIBUTED ENVIRONMENTS, AND USER MANUALS SUPPLIED AS A UNIT WITH THE FOREGOING, IN CLASS 9 (U.S. CLS. 21, 23, 26, 36 AND 38).

FIRST USE 11-24-2006; IN COMMERCE 11-24-2006.

THE MARK CONSISTS OF STANDARD CHARACTERS WITHOUT CLAIM TO ANY PARTICULAR FONT, STYLE, SIZE, OR COLOR.

SN 77-021,083, FILED 10-13-2006.

CAROL SPILS, EXAMINING ATTORNEY

**Int. Cl.: 30**

**Prior U.S. Cl.: 46**

**United States Patent and Trademark Office**

**Reg. No. 3,454,368**

**Registered June 24, 2008**

**TRADEMARK  
PRINCIPAL REGISTER**

**KELLOGG'S**

KELLOGG NORTH AMERICA COMPANY (DE-  
LAWARE CORPORATION)  
ONE KELLOGG SQUARE - P. O. BOX 3599  
BATTLE CREEK, MI 490163599

FOR: TABLE SYRUP; BREAKFAST MEAL KIT  
CONTAINING BREAKFAST CEREAL, JUICE AND  
TOASTER PASTRY OR OTHER CEREAL BASED  
SNACK FOOD, IN CLASS 30 (U.S. CL. 46).

FIRST USE 1-1-2005; IN COMMERCE 1-1-2005.

THE MARK CONSISTS OF STANDARD CHAR-  
ACTERS WITHOUT CLAIM TO ANY PARTICULAR  
FONT, STYLE, SIZE, OR COLOR.

OWNER OF U.S. REG. NOS. 147,458, 1,725,563,  
AND OTHERS.

SN 77-021,289, FILED 10-14-2006.

TIMOTHY FINNEGAN, EXAMINING ATTORNEY

**Int. Cl.: 36**

**Prior U.S. Cls.: 100, 101, and 102**

**United States Patent and Trademark Office**

**Reg. No. 3,454,369**

**Registered June 24, 2008**

**SERVICE MARK  
PRINCIPAL REGISTER**

# BOP ACCESS

SAFECO INSURANCE COMPANY OF AMERICA  
(WASHINGTON CORPORATION)  
SAFECO PLAZA, 4333 BROOKLYN AVENUE N.E.  
SEATTLE, WA 98185

FOR: INSURANCE SERVICES, NAMELY, PROPERTY AND CASUALTY INSURANCE UNDERWRITING SERVICES, IN CLASS 36 (U.S. CLS. 100, 101 AND 102).

FIRST USE 3-8-2007; IN COMMERCE 3-8-2007.

THE MARK CONSISTS OF STANDARD CHARACTERS WITHOUT CLAIM TO ANY PARTICULAR FONT, STYLE, SIZE, OR COLOR.

NO CLAIM IS MADE TO THE EXCLUSIVE RIGHT TO USE "BOP", APART FROM THE MARK AS SHOWN.

SN 77-021,728, FILED 10-16-2006.

JENNIFER VASQUEZ, EXAMINING ATTORNEY

**Int. Cls.: 36 and 37**

**Prior U.S. Cls.: 100, 101, 102, 103, and 106**

**United States Patent and Trademark Office**

**Reg. No. 3,454,370**

**Registered June 24, 2008**

**SERVICE MARK  
PRINCIPAL REGISTER**

# Power Loft

POWER LOFT LLC (DELAWARE LTD LIAB CO)  
SUITE 101  
7601 LEWINSVILLE RD  
MCLEAN, VA 22102

FOR: EVALUATION OF REAL PROPERTY;  
LAND ACQUISITION, NAMELY, REAL ESTATE  
BROKERAGE; REAL ESTATE ACQUISITION SER-  
VICES; REAL ESTATE PROCUREMENT FOR OTH-  
ERS; FINANCIAL INVESTMENT IN THE FIELD OF  
DATA CENTERS; LEASING OF REAL ESTATE;  
LEASING OF REAL PROPERTY; REAL ESTATE  
BROKERAGE; REAL ESTATE INVESTMENT; REAL  
ESTATE MANAGEMENT, IN CLASS 36 (U.S. CLS.  
100, 101 AND 102).

FIRST USE 3-20-2006; IN COMMERCE 3-20-2006.

FOR: REAL ESTATE DEVELOPMENT; REAL  
ESTATE SITE SELECTION, IN CLASS 37 (U.S. CLS.  
100, 103 AND 106).

FIRST USE 3-20-2006; IN COMMERCE 3-20-2006.

THE MARK CONSISTS OF STANDARD CHAR-  
ACTERS WITHOUT CLAIM TO ANY PARTICULAR  
FONT, STYLE, SIZE, OR COLOR.

SN 77-022,011, FILED 10-16-2006.

ARETHA SOMERVILLE, EXAMINING ATTORNEY

**Int. Cl.: 3**

**Prior U.S. Cls.: 1, 4, 6, 50, 51, and 52**

**Reg. No. 3,454,371**

**United States Patent and Trademark Office**

**Registered June 24, 2008**

---

**TRADEMARK  
PRINCIPAL REGISTER**

**TOUCH OF ALOE**

THE DIAL CORPORATION (DELAWARE COR-  
PORATION)

M.S. 2214

15501 NORTH DIAL BOULEVARD

SCOTTSDALE, AZ 852601619

FOR: DEODORANTS AND ANTIPERSPIRANTS,  
IN CLASS 3 (U.S. CLS. 1, 4, 6, 50, 51 AND 52).

FIRST USE 2-1-2007; IN COMMERCE 2-1-2007.

THE MARK CONSISTS OF STANDARD CHAR-  
ACTERS WITHOUT CLAIM TO ANY PARTICULAR  
FONT, STYLE, SIZE, OR COLOR.

NO CLAIM IS MADE TO THE EXCLUSIVE  
RIGHT TO USE "ALOE", APART FROM THE MARK  
AS SHOWN.

SN 77-022,704, FILED 10-17-2006.

FLORENTINA BLANDU, EXAMINING ATTORNEY

**Int. Cl.: 24**

**Prior U.S. Cls.: 42 and 50**

**United States Patent and Trademark Office**

**Reg. No. 3,454,372**

**Registered June 24, 2008**

**TRADEMARK  
PRINCIPAL REGISTER**

**PENTAMAX**

CHICOPEE, INC. (DELAWARE CORPORATION)  
SUITE 300  
9335 HARRIS CORNERS PARKWAY  
CHARLOTTE, NC 28269

THE MARK CONSISTS OF STANDARD CHAR-  
ACTERS WITHOUT CLAIM TO ANY PARTICULAR  
FONT, STYLE, SIZE, OR COLOR.

FOR: NONWOVEN COMPOSITE FABRICS MADE  
FROM POLYOLEFINS, IN CLASS 24 (U.S. CLS. 42  
AND 50).

SN 77-023,510, FILED 10-18-2006.

FIRST USE 1-22-2008; IN COMMERCE 1-22-2008.

BARBARA GAYNOR, EXAMINING ATTORNEY



**Int. Cl.: 21**

**Prior U.S. Cls.: 2, 13, 23, 29, 30, 33, 40, and 50**

**United States Patent and Trademark Office**

**Reg. No. 3,454,373**

**Registered June 24, 2008**

**TRADEMARK  
PRINCIPAL REGISTER**

The logo for "stowaway" is displayed in a bold, black, sans-serif font. The word "stow" is in lowercase, and "away" is in lowercase. A stylized graphic of the top of an ironing board is integrated into the letter 'a' in "away".

WHITNEY DESIGN, INC. (DELAWARE CORPORATION)  
13213 CORPORATE EXCHANGE DRIVE  
BRIDGETON, MO 63044

THE MARK CONSISTS OF THE WORD "STOW-AWAY" WITH A DRAWING OF THE TOP OF AN IRONING BOARD.

FOR: IRONING BOARDS WITH CABINET ENSEMBLES, IN CLASS 21 (U.S. CLS. 2, 13, 23, 29, 30, 33, 40 AND 50).

SN 77-023,716, FILED 10-18-2006.

FIRST USE 3-0-2007; IN COMMERCE 3-0-2007.

MARTHA FROMM, EXAMINING ATTORNEY

**Int. Cl.: 1**

**Prior U.S. Cls.: 1, 5, 6, 10, 26, and 46**

**Reg. No. 3,454,374**

**United States Patent and Trademark Office**

**Registered June 24, 2008**

---

**TRADEMARK  
PRINCIPAL REGISTER**

**TerraForma**

GENERAL HYDROPONICS, INC. (CALIFORNIA  
CORPORATION)  
P.O. BOX 1576  
SEBASTOPOL, CA 95473

THE MARK CONSISTS OF STANDARD CHAR-  
ACTERS WITHOUT CLAIM TO ANY PARTICULAR  
FONT, STYLE, SIZE, OR COLOR.

FOR: FERTILIZERS; PLANT FOOD; SOIL  
AMENDMENTS, IN CLASS 1 (U.S. CLS. 1, 5, 6, 10,  
26 AND 46).

SN 77-023,867, FILED 10-18-2006.

FIRST USE 5-8-2008; IN COMMERCE 5-8-2008.

KATHERINE CHANG, EXAMINING ATTORNEY

**Int. Cls.: 29 and 30**

**Prior U.S. Cl.: 46**

**United States Patent and Trademark Office**

**Reg. No. 3,454,375**

**Registered June 24, 2008**

**TRADEMARK  
PRINCIPAL REGISTER**

**DE TODITO**

PEPSICO, INC. (NORTH CAROLINA CORPORATION)  
700 ANDERSON HILL ROAD  
PURCHASE, NY 10577

FOR: POTATO CHIPS; POTATO CRISPS; PLANTAIN CHIPS; VEGETABLE BASED SNACK FOODS, IN CLASS 29 (U.S. CL. 46).

FIRST USE 2-0-2007; IN COMMERCE 2-0-2007.

FOR: CORN CHIPS; TORTILLA CHIPS; GRAIN BASED SNACK FOODS, IN CLASS 30 (U.S. CL. 46).

FIRST USE 2-0-2007; IN COMMERCE 2-0-2007.

THE MARK CONSISTS OF STANDARD CHARACTERS WITHOUT CLAIM TO ANY PARTICULAR FONT, STYLE, SIZE, OR COLOR.

THE FOREIGN WORDING IN THE MARK TRANSLATES INTO ENGLISH AS OF ALL.

SN 77-024,618, FILED 10-19-2006.

JOHN WILKE, EXAMINING ATTORNEY

**Int. Cl.: 9**

**Prior U.S. Cls.: 21, 23, 26, 36, and 38**

**United States Patent and Trademark Office**

**Reg. No. 3,454,376**

**Registered June 24, 2008**

**TRADEMARK  
PRINCIPAL REGISTER**

**SRS AUDIO SANDBOX**

SRS LABS, INC. (DELAWARE CORPORATION)  
2909 DAIMLER STREET  
SANTA ANA, CA 92705

FOR: COMPUTER SOFTWARE, NAMELY, COMPUTER SOFTWARE THAT PROVIDES AUDIO ENHANCEMENT AND SURROUND SOUND ON A PERSONAL COMPUTER, IN CLASS 9 (U.S. CLS. 21, 23, 26, 36 AND 38).

FIRST USE 9-14-2006; IN COMMERCE 9-14-2006.

THE MARK CONSISTS OF STANDARD CHARACTERS WITHOUT CLAIM TO ANY PARTICULAR FONT, STYLE, SIZE, OR COLOR.

OWNER OF U.S. REG. NOS. 1,501,111, 2,042,227, AND 2,044,183.

NO CLAIM IS MADE TO THE EXCLUSIVE RIGHT TO USE "AUDIO", APART FROM THE MARK AS SHOWN.

SN 77-024,751, FILED 10-19-2006.

LINDA E. BLOHM, EXAMINING ATTORNEY

**Int. Cl.: 21**

**Prior U.S. Cls.: 2, 13, 23, 29, 30, 33, 40, and 50**

**United States Patent and Trademark Office**

**Reg. No. 3,454,377**

**Registered June 24, 2008**

**TRADEMARK  
PRINCIPAL REGISTER**

**DRINK MY EXHAUST**

HONDA MOTOR CO., LTD. (JAPAN CORPORATION)  
NO. 1-1, 2-CHOME MINAMIAOYAMA, MINATOKU  
TOKYO, JAPAN 107-8556

FOR: DRINKING GLASSES; EYEGLASS CLEANING CLOTHS; PLASTIC WATER BOTTLES SOLD EMPTY, IN CLASS 21 (U.S. CLS. 2, 13, 23, 29, 30, 33, 40 AND 50).

FIRST USE 8-0-2007; IN COMMERCE 8-0-2007.

THE MARK CONSISTS OF STANDARD CHARACTERS WITHOUT CLAIM TO ANY PARTICULAR FONT, STYLE, SIZE, OR COLOR.

SN 77-025,207, FILED 10-19-2006.

RUSS HERMAN, EXAMINING ATTORNEY

**Int. Cl.: 33**

**Prior U.S. Cls.: 47 and 49**

**United States Patent and Trademark Office**

**Reg. No. 3,454,378**

**Registered June 24, 2008**

**TRADEMARK  
PRINCIPAL REGISTER**

AMERICANA

D'ACUNTO, VINCENT (UNITED STATES INDIVIDUAL)

1042 SINCLAIR AVENUE

STATEN ISLAND, NY 10309

FOR: VODKA, IN CLASS 33 (U.S. CLS. 47 AND 49).

FIRST USE 10-2-2007; IN COMMERCE 10-2-2007.

NO CLAIM IS MADE TO THE EXCLUSIVE RIGHT TO USE "VODKA" , APART FROM THE MARK AS SHOWN.

THE MARK CONSISTS OF STYLIZED TEXT OF THE WORDING "AMERICANA".

SN 77-025,657, FILED 10-20-2006.

SUSAN RICHARDS, EXAMINING ATTORNEY

**Int. Cl.: 36**

**Prior U.S. Cls.: 100, 101, and 102**

**United States Patent and Trademark Office**

**Reg. No. 3,454,379**

**Registered June 24, 2008**

**SERVICE MARK  
PRINCIPAL REGISTER**



SEASIDE NATIONAL BANK & TRUST (UNITED STATES ASSOCIATION)  
201 S. ORANGE AVE., SUITE 1350  
ORLANDO, FL 32801

FOR: FINANCIAL AND INSURANCE SERVICES, NAMELY, BANKING, INVESTMENT AND TRUST COMPANY SERVICES, INVESTMENT FUNDS MANAGEMENT, INVESTMENT BANKING, CORPORATE FINANCING, MORTGAGE LOAN, SECURITIES BROKERAGE AND INSURANCE AGENCY SERVICES, AND PROVIDING CONSULTING SERVICES IN ALL THE AFOREMENTIONED AREAS, IN CLASS 36 (U.S. CLS. 100, 101 AND 102).

FIRST USE 8-1-2006; IN COMMERCE 8-1-2006.

NO CLAIM IS MADE TO THE EXCLUSIVE RIGHT TO USE "NATIONAL BANK & TRUST", APART FROM THE MARK AS SHOWN.

THE COLOR(S) TAN AND BLUE IS/ARE CLAIMED AS A FEATURE OF THE MARK.

THE MARK CONSISTS OF TAN SHELL INSIDE A BLUE BOX AND THE WORDS "SEASIDE NATIONAL BANK & TRUST" IN BLUE LETTERING.

SN 77-025,706, FILED 10-20-2006.

PAUL F. GAST, EXAMINING ATTORNEY

**Int. Cl.: 25**

**Prior U.S. Cls.: 22 and 39**

**United States Patent and Trademark Office**

**Reg. No. 3,454,380**

**Registered June 24, 2008**

**TRADEMARK  
PRINCIPAL REGISTER**

**ETHNIX**

INGEAR FASHIONS, INC. (FLORIDA CORPORATION)  
4401 NW. 167 ST  
MIAMI, FL 33055

FOR: CLOTHING, NAMELY, BEACHWEAR, SWIMWEAR, SARONGS, COVER-UPS, WRAPS, SHIRTS, PANTS, SHORTS, CAPS, DRESSES, UNDERWEAR, SWEATERS, AND FOOTWEAR, IN CLASS 25 (U.S. CLS. 22 AND 39).

FIRST USE 1-31-2007; IN COMMERCE 1-31-2007.

THE MARK CONSISTS OF STANDARD CHARACTERS WITHOUT CLAIM TO ANY PARTICULAR FONT, STYLE, SIZE, OR COLOR.

SN 77-026,798, FILED 10-23-2006.

TANYA AMOS, EXAMINING ATTORNEY



**Int. Cl.: 28**

**Prior U.S. Cls.: 22, 23, 38, and 50**

**Reg. No. 3,454,381**

**United States Patent and Trademark Office**

**Registered June 24, 2008**

---

**TRADEMARK  
PRINCIPAL REGISTER**

**SAGI**

MATTEL, INC. (DELAWARE CORPORATION)  
MAIL STOP M1-1518  
333 CONTINENTAL BOULEVARD  
EL SEGUNDO, CA 90245

FIRST USE 6-20-2007; IN COMMERCE 6-20-2007.

FOR: TOYS, GAMES AND PLAYTHINGS, NAME-  
LY, TOY FIGURES, PLUSH TOYS, AND ACCES-  
SORIES FOR ALL OF THE FOREGOING, IN CLASS  
28 (U.S. CLS. 22, 23, 38 AND 50).

THE MARK CONSISTS OF STANDARD CHAR-  
ACTERS WITHOUT CLAIM TO ANY PARTICULAR  
FONT, STYLE, SIZE, OR COLOR.

SN 77-028,303, FILED 10-24-2006.

NAAKWAMA ANKRAH, EXAMINING ATTORNEY

**Int. Cl.: 28**

**Prior U.S. Cls.: 22, 23, 38, and 50**

**Reg. No. 3,454,382**

**United States Patent and Trademark Office**

**Registered June 24, 2008**

---

**TRADEMARK  
PRINCIPAL REGISTER**

**MAGICAL CASTLE VANITY**

MATTEL, INC. (DELAWARE CORPORATION)  
MAIL STOP M1-1518  
333 CONTINENTAL BOULEVARD  
EL SEGUNDO, CA 90245

FIRST USE 4-22-2008; IN COMMERCE 4-22-2008.

FOR: TOYS, GAMES AND PLAYTHINGS, NAME-  
LY, DOLLS, DOLL CLOTHING AND DOLL ACCES-  
SORIES, DOLL PLAYSETS, TOY FIGURES, TOY  
FURNITURE, AND ACCESSORIES FOR ALL OF  
THE FOREGOING, IN CLASS 28 (U.S. CLS. 22, 23, 38  
AND 50).

THE MARK CONSISTS OF STANDARD CHAR-  
ACTERS WITHOUT CLAIM TO ANY PARTICULAR  
FONT, STYLE, SIZE, OR COLOR.

SN 77-028,309, FILED 10-24-2006.

NAAKWAMA ANKRAH, EXAMINING ATTORNEY

**Int. Cl.: 24**

**Prior U.S. Cls.: 42 and 50**

**United States Patent and Trademark Office**

**Reg. No. 3,454,383**

**Registered June 24, 2008**

**TRADEMARK  
PRINCIPAL REGISTER**



CHICOPEE, INC. (DELAWARE CORPORATION)  
SUITE 300  
9335 HARRIS CORNERS PARKWAY  
CHARLOTTE, NC 28269

FIRST USE 1-22-2008; IN COMMERCE 1-22-2008.

SN 77-028,318, FILED 10-24-2006.

FOR: NONWOVEN COMPOSITE FABRICS MADE  
FROM POLYOLEFINS, IN CLASS 24 (U.S. CLS. 42  
AND 50).

BARBARA GAYNOR, EXAMINING ATTORNEY

**Int. Cl.: 5**

**Prior U.S. Cls.: 6, 18, 44, 46, 51, and 52**

**Reg. No. 3,454,384**

**United States Patent and Trademark Office**

**Registered June 24, 2008**

---

**TRADEMARK  
PRINCIPAL REGISTER**

# Ripped Tabs

SUPPLEMENT SYNERGY, INC. (FLORIDA CORPORATION), DBA IDS SPORTS,  
522 S. ECON CIRCLE  
SUITE 140  
OVIEDO, FL 32765

FOR: VITAMIN SUPPLEMENTS, IN CLASS 5 (U.S. CLS. 6, 18, 44, 46, 51 AND 52).

FIRST USE 11-30-2006; IN COMMERCE 11-30-2006.

THE MARK CONSISTS OF STANDARD CHARACTERS WITHOUT CLAIM TO ANY PARTICULAR FONT, STYLE, SIZE, OR COLOR.

NO CLAIM IS MADE TO THE EXCLUSIVE RIGHT TO USE "TABS", APART FROM THE MARK AS SHOWN.

SN 77-028,835, FILED 10-25-2006.

NAAKWAMA ANKRAH, EXAMINING ATTORNEY

**Int. Cl.: 5**

**Prior U.S. Cls.: 6, 18, 44, 46, 51, and 52**

**Reg. No. 3,454,385**

**United States Patent and Trademark Office**

**Registered June 24, 2008**

---

**TRADEMARK  
PRINCIPAL REGISTER**

**TIOXOFRESH**

PURETI INC. (DELAWARE CORPORATION)  
420 LEXINGTON AVENUE  
SUITE 2650  
NEW YORK, NY 101702699

FIRST USE 5-3-2007; IN COMMERCE 5-3-2007.

FOR: PREPARATIONS FOR NEUTRALIZING  
ODORS AND REMOVAL OF ORGANIC COM-  
POUNDS FOR USE ON CARPETING, UPHOLS-  
TERY, TEXTILES, FURS, LEATHER, NON-  
WEAVES AND FABRICS , IN CLASS 5 (U.S. CLS. 6,  
18, 44, 46, 51 AND 52).

THE MARK CONSISTS OF STANDARD CHAR-  
ACTERS WITHOUT CLAIM TO ANY PARTICULAR  
FONT, STYLE, SIZE, OR COLOR.

SN 77-028,912, FILED 10-25-2006.

ELIZABETH KAJUBI, EXAMINING ATTORNEY

**Int. Cl.: 44**

**Prior U.S. Cls.: 100 and 101**

**United States Patent and Trademark Office**

**Reg. No. 3,454,386**

**Registered June 24, 2008**

**SERVICE MARK  
PRINCIPAL REGISTER**

**MIRATE COMO CAMBIAS**

WEIGHT WATCHERS INTERNATIONAL, INC.  
(VIRGINIA CORPORATION)  
11 MADISON AVENUE  
NEW YORK, NY 10010

FOR: PROVIDING WEIGHT REDUCTION PLAN-  
NING, TREATMENT AND SUPERVISION  
THROUGH WEIGHT REDUCTION PROGRAMS  
FEATURING COUNSELING AND DIET PLANS;  
PROVIDING ADVICE, CONSULTATION AND IN-  
FORMATION IN THE FIELD OF WEIGHT CON-  
TROL AND NUTRITION, IN CLASS 44 (U.S. CLS. 100  
AND 101).

FIRST USE 2-1-2007; IN COMMERCE 2-1-2007.

THE MARK CONSISTS OF STANDARD CHAR-  
ACTERS WITHOUT CLAIM TO ANY PARTICULAR  
FONT, STYLE, SIZE, OR COLOR.

OWNER OF U.S. REG. NO. 3,047,040.

THE FOREIGN WORDING IN THE MARK  
TRANSLATES INTO ENGLISH AS WATCH YOUR-  
SELF CHANGE.

SN 77-029,352, FILED 10-25-2006.

TIMOTHY FINNEGAN, EXAMINING ATTORNEY

**Int. Cls.: 20 and 40**

**Prior U.S. Cls.: 2, 13, 22, 25, 32, 50, 100, 103, and 106**

**United States Patent and Trademark Office**

**Reg. No. 3,454,387**

**Registered June 24, 2008**

**TRADEMARK  
SERVICE MARK  
PRINCIPAL REGISTER**



MARSHALL TOWNE MILLWORK, LLC (WIS-  
CONSIN LTD LIAB CO)  
825 HUBBELL STREET  
MARSHALL, WI 53559

FOR: CABINETS, IN CLASS 20 (U.S. CLS. 2, 13, 22,  
25, 32 AND 50).

FIRST USE 1-1-2007; IN COMMERCE 1-1-2007.

FOR: CABINET MAKING, IN CLASS 40 (U.S. CLS.  
100, 103 AND 106).

FIRST USE 1-1-2007; IN COMMERCE 1-1-2007.

NO CLAIM IS MADE TO THE EXCLUSIVE  
RIGHT TO USE "EST. 1898", APART FROM THE  
MARK AS SHOWN.

THE MARK CONSISTS OF THE WORDS "AU-  
BURN RIDGE AND EST. 1898" IN A CIRCLE  
SURROUNDING A PINE TREE.

SN 77-029,360, FILED 10-25-2006.

SETH A. RAPPAPORT, EXAMINING ATTORNEY

**Int. Cl.: 9**

**Prior U.S. Cls.: 21, 23, 26, 36, and 38**

**Reg. No. 3,454,388**

**United States Patent and Trademark Office**

**Registered June 24, 2008**

**TRADEMARK  
PRINCIPAL REGISTER**

**mGAME**

MULTIMEDIA GAMES, INC. (TEXAS CORPORATION)  
206 WILD BASIN RD.  
S. BLDG B - 4TH FLR.  
AUSTIN, TX 78746

FOR: GAMING MACHINE CABINETS AND CONSOLES; GAMING MACHINE COMPUTER HARDWARE AND SOFTWARE, IN CLASS 9 (U.S. CLS. 21, 23, 26, 36 AND 38).

FIRST USE 11-14-2006; IN COMMERCE 11-14-2006.

THE MARK CONSISTS OF STANDARD CHARACTERS WITHOUT CLAIM TO ANY PARTICULAR FONT, STYLE, SIZE, OR COLOR.

OWNER OF U.S. REG. NOS. 2,989,993 AND 3,135,792.

SN 77-029,467, FILED 10-25-2006.

EMILY CARLSEN, EXAMINING ATTORNEY



Int. Cl.: 41

Prior U.S. Cls.: 100, 101, and 107

United States Patent and Trademark Office

Reg. No. 3,454,389

Registered June 24, 2008

SERVICE MARK  
PRINCIPAL REGISTER

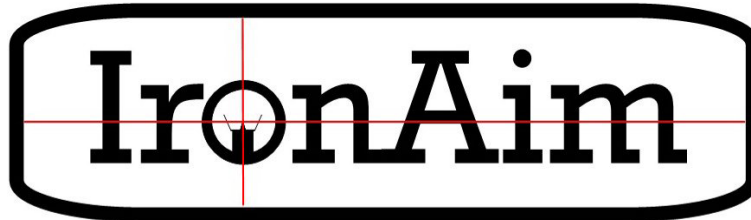

IRONAIM LLC (COLORADO LTD LIAB CO)  
P.O. BOX 260664  
HIGHLANDS RANCH, CO 80163

FOR: RECREATIONAL SERVICES, NAMELY,  
PROVIDING HUNTING PRESERVES, IN CLASS 41  
(U.S. CLS. 100, 101 AND 107).

FIRST USE 5-1-2007; IN COMMERCE 9-1-2007.

THE COLOR(S) RED AND BLACK IS/ARE  
CLAIMED AS A FEATURE OF THE MARK.

THE MARK CONSISTS OF A BLACK RECTAN-  
GLE WITH CURVED SIDES AROUND A RED  
CROSSHAIR INTERSECTING IN THE MIDDLE OF  
THE LETTER "O" IN "IRONAIM", THE CENTER OF  
THE LETTER "O" DEPICTS THE FRONT AND  
REAR SIGHT ALIGNMENT OF A RIFLE SIGHT  
PICTURE JUST BELOW THE INTERSECTING  
CROSSHAIRS. THE WORD "IRONAIM" IS IN  
BLACK AND THE RIFLE SIGHT IS ALSO IN  
BLACK.

SN 77-029,929, FILED 10-26-2006.

SARA THOMAS, EXAMINING ATTORNEY

**Int. Cl.: 9**

**Prior U.S. Cls.: 21, 23, 26, 36, and 38**

**United States Patent and Trademark Office**

**Reg. No. 3,454,390**

**Registered June 24, 2008**

**TRADEMARK  
PRINCIPAL REGISTER**

**RECORD OPTIMIZED STORAGE**

DATAUPIA CORPORATION (DELAWARE CORPORATION)  
ONE ALEWIFE CENTER  
CAMBRIDGE, MA 02140

FOR: COMPUTER HARDWARE USED FOR DATA STORAGE; COMPUTER SOFTWARE USED FOR DATA MANAGEMENT AND DATA STORAGE, IN CLASS 9 (U.S. CLS. 21, 23, 26, 36 AND 38).

FIRST USE 10-23-2007; IN COMMERCE 10-23-2007.

THE MARK CONSISTS OF STANDARD CHARACTERS WITHOUT CLAIM TO ANY PARTICULAR FONT, STYLE, SIZE, OR COLOR.

NO CLAIM IS MADE TO THE EXCLUSIVE RIGHT TO USE "RECORD" AND "STORAGE", APART FROM THE MARK AS SHOWN.

SN 77-030,503, FILED 10-26-2006.

DANIEL CAPSHAW, EXAMINING ATTORNEY

**Int. Cls.: 36 and 41**

**Prior U.S. Cls.: 100, 101, 102, and 107**

**United States Patent and Trademark Office**

**Reg. No. 3,454,391**

**Registered June 24, 2008**

**SERVICE MARK  
PRINCIPAL REGISTER**

# AMA RACING

AMERICAN MOTORCYCLIST ASSOCIATION  
(OHIO CORPORATION)  
13515 YARMOUTH DRIVE  
PICKERINGTON, OH 43147

FOR: FINANCIAL SPONSORSHIP OF PROFESSIONAL MOTORCYCLE RACING EVENTS AND FUNCTIONS, IN CLASS 36 (U.S. CLS. 100, 101 AND 102).

FIRST USE 2-28-2007; IN COMMERCE 2-28-2007.

FOR: ENTERTAINMENT IN THE NATURE OF PROFESSIONAL MOTORCYCLE RACING EVENTS AND FUNCTIONS; OFFICIATING AT PROFESSIONAL MOTORCYCLE RACING EVENTS; AND RULE MAKING FOR PROFESSIONAL MOTORCYCLE RACES, IN CLASS 41 (U.S. CLS. 100, 101 AND 107).

FIRST USE 2-28-2007; IN COMMERCE 2-28-2007.

THE MARK CONSISTS OF STANDARD CHARACTERS WITHOUT CLAIM TO ANY PARTICULAR FONT, STYLE, SIZE, OR COLOR.

OWNER OF U.S. REG. NOS. 2,649,508, 2,652,027, AND 2,827,891.

NO CLAIM IS MADE TO THE EXCLUSIVE RIGHT TO USE "RACING", APART FROM THE MARK AS SHOWN.

SN 77-031,034, FILED 10-27-2006.

SETH A. RAPPAPORT, EXAMINING ATTORNEY

**Int. Cl.: 5**

**Prior U.S. Cls.: 6, 18, 44, 46, 51, and 52**

**United States Patent and Trademark Office**

**Reg. No. 3,454,392**

**Registered June 24, 2008**

**TRADEMARK  
PRINCIPAL REGISTER**

**DIUBOLIC**

NUTRABOLICS, INC. (CANADA CORPORATION)  
170-13040 #2 ROAD  
RICHMOND, CANADA V7E2G1

THE MARK CONSISTS OF STANDARD CHARACTERS WITHOUT CLAIM TO ANY PARTICULAR FONT, STYLE, SIZE, OR COLOR.

FOR: VITAMINS, DIETARY AND NUTRITIONAL SUPPLEMENTS, IN CLASS 5 (U.S. CLS. 6, 18, 44, 46, 51 AND 52).

SN 77-031,496, FILED 10-27-2006.

FIRST USE 2-28-2007; IN COMMERCE 2-28-2007.

INGA ERVIN, EXAMINING ATTORNEY

**Int. Cl.: 25**

**Prior U.S. Cls.: 22 and 39**

**United States Patent and Trademark Office**

**Reg. No. 3,454,393**

**Registered June 24, 2008**

**TRADEMARK  
PRINCIPAL REGISTER**

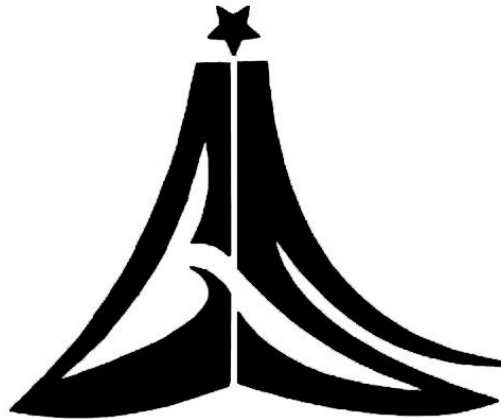

JOHN REYES (OREGON SOLE PROPRIETOR-  
SHIP)  
13368 SW MACBETH DR  
TIGARD, OR 97224

THE MARK CONSISTS OF THE LETTERING  
"CS", WHICH CREATES THE IMPRESSION OF A  
VOLCANO. THERE IS A STAR AT THE TOP OF THE  
VOLCANO DESIGN.

FOR: HATS; SHORT-SLEEVED OR LONG-  
SLEEVED T-SHIRTS; SHORT-SLEEVED SHIRTS, IN  
CLASS 25 (U.S. CLS. 22 AND 39).

SN 77-031,791, FILED 10-29-2006.

FIRST USE 12-25-2006; IN COMMERCE 12-25-2007.

LAURIE KAUFMAN, EXAMINING ATTORNEY

**Int. Cl.: 32**

**Prior U.S. Cls.: 45, 46, and 48**

**Reg. No. 3,454,394**

**United States Patent and Trademark Office**

**Registered June 24, 2008**

---

**TRADEMARK  
PRINCIPAL REGISTER**

**WET VITAMINS**

BOO KOO BEVERAGES, INC. (TEXAS CORPORATION)  
4951 AIRPORT PARKWAY  
ADDISON, TX 75001

FOR: NON-ALCOHOLIC BEVERAGES, NAMELY, FLAVORED WATER ENHANCED WITH VITAMINS, MINERALS, ENERGY-RELEASING NUTRIENTS, ANTIOXIDANTS, AND/OR DIETARY SUPPLEMENTS, IN CLASS 32 (U.S. CLS. 45, 46 AND 48).

FIRST USE 2-8-2008; IN COMMERCE 2-8-2008.

THE MARK CONSISTS OF STANDARD CHARACTERS WITHOUT CLAIM TO ANY PARTICULAR FONT, STYLE, SIZE, OR COLOR.

NO CLAIM IS MADE TO THE EXCLUSIVE RIGHT TO USE "VITAMINS", APART FROM THE MARK AS SHOWN.

SN 77-032,101, FILED 10-30-2006.

CHARISMA HAMPTON, EXAMINING ATTORNEY

**Int. Cl.: 20**

**Prior U.S. Cls.: 2, 13, 22, 25, 32, and 50**

**Reg. No. 3,454,395**

**United States Patent and Trademark Office**

**Registered June 24, 2008**

**TRADEMARK  
PRINCIPAL REGISTER**

**YOGURT VISI-SLIDE**

TRADE FIXTURES, LLC (DELAWARE LTD LIAB  
CO)  
SUITE 5  
1501 WESTPARK DRIVE  
LITTLE ROCK, AR 72204

FOR: PLASTIC MODULES FOR USE IN GRAV-  
ITY-FED MERCHANDISING SYSTEM, IN CLASS 20  
(U.S. CLS. 2, 13, 22, 25, 32 AND 50).

FIRST USE 10-0-2005; IN COMMERCE 10-0-2005.

THE MARK CONSISTS OF STANDARD CHAR-  
ACTERS WITHOUT CLAIM TO ANY PARTICULAR  
FONT, STYLE, SIZE, OR COLOR.

NO CLAIM IS MADE TO THE EXCLUSIVE  
RIGHT TO USE "YOGURT", APART FROM THE  
MARK AS SHOWN.

SN 77-032,285, FILED 10-30-2006.

STEPHANIE ALI, EXAMINING ATTORNEY

**Int. Cl.: 16**

**Prior U.S. Cls.: 2, 5, 22, 23, 29, 37, 38, and 50**

**Reg. No. 3,454,396**

**United States Patent and Trademark Office**

**Registered June 24, 2008**

---

**TRADEMARK  
PRINCIPAL REGISTER**

**STIK WITHIT MAX**

P. C. I. PAPER CONVERSIONS, INC. (NEW YORK  
CORPORATION)  
6761 THOMPSON ROAD NORTH  
SYRACUSE, NY 13211

FOR: ADHESIVE NOTE PADS, IN CLASS 16 (U.S.  
CLS. 2, 5, 22, 23, 29, 37, 38 AND 50).

FIRST USE 1-4-2007; IN COMMERCE 1-4-2007.

THE MARK CONSISTS OF STANDARD CHAR-  
ACTERS WITHOUT CLAIM TO ANY PARTICULAR  
FONT, STYLE, SIZE, OR COLOR.

OWNER OF U.S. REG. NO. 1,407,684.

SN 77-032,428, FILED 10-30-2006.

LIEF MARTIN, EXAMINING ATTORNEY



**Int. Cls.: 12, 25, and 28**

**Prior U.S. Cls.: 19, 21, 22, 23, 31, 35, 38, 39, 44, and 50**

**United States Patent and Trademark Office**

**Reg. No. 3,454,397**

**Registered June 24, 2008**

**TRADEMARK  
PRINCIPAL REGISTER**



TODD BRADLEY (HAWAII SOLE PROPRIETOR-SHIP)  
2809A1 LAI RD  
HONOLULU, HI 96816

FOR: CANOE PADDLES, IN CLASS 12 (U.S. CLS. 19, 21, 23, 31, 35 AND 44).

FIRST USE 1-1-2004; IN COMMERCE 1-2-2004.

FOR: SHORT-SLEEVED OR LONG-SLEEVED T-SHIRTS; BASEBALL CAPS; CAPS; CAPS WITH VISORS; GOLF CAPS; POLO SHIRTS; SPORT SHIRTS; SPORTS SHIRTS; T-SHIRTS, IN CLASS 25 (U.S. CLS. 22 AND 39).

FIRST USE 1-1-2004; IN COMMERCE 1-2-2004.

FOR: PADDLE BOARDS; SURFBOARDS; RECREATIONAL WATERCRAFT, NAMELY, STAND-UP BOARD, IN CLASS 28 (U.S. CLS. 22, 23, 38 AND 50).

FIRST USE 1-1-2004; IN COMMERCE 1-2-2004.

THE MARK CONSISTS OF PETROGLYPH LOGO CONSISTING OF AND PERSON HOLDING A PADDLE OVER HIS HEAD, WITH A SURFBOARD, SURFING A WAVE.

SN 77-032,820, FILED 10-31-2006.

RONALD AIKENS, EXAMINING ATTORNEY

**Int. Cl.: 35**

**Prior U.S. Cls.: 100, 101, and 102**

**United States Patent and Trademark Office**

**Reg. No. 3,454,398**

**Registered June 24, 2008**

**SERVICE MARK  
PRINCIPAL REGISTER**

**RiskTech 100**

CHARTIS RESEARCH LIMITED (GREAT BRIT-  
AIN LTD LIAB CO)  
788/790 FINCHLEY ROAD  
LONDON, ENGLAND NW117TJ

FOR: MARKET RESEARCH AND PROVIDING  
BUSINESS REPORTS TO CUSTOMERS, IN CLASS 35  
(U.S. CLS. 100, 101 AND 102).

FIRST USE 11-17-2006; IN COMMERCE 11-17-2006.

THE MARK CONSISTS OF STANDARD CHAR-  
ACTERS WITHOUT CLAIM TO ANY PARTICULAR  
FONT, STYLE, SIZE, OR COLOR.

NO CLAIM IS MADE TO THE EXCLUSIVE  
RIGHT TO USE "100", APART FROM THE MARK  
AS SHOWN.

SN 77-032,994, FILED 10-31-2006.

BRIAN NEVILLE, EXAMINING ATTORNEY

**Int. Cl.: 34**

**Prior U.S. Cls.: 2, 8, 9, and 17**

**United States Patent and Trademark Office**

**Reg. No. 3,454,399**

**Registered June 24, 2008**

**TRADEMARK  
PRINCIPAL REGISTER**

**Complete**

SKOOKUM CREEK TOBACCO CO., INC. (UNITED STATES A WHOLLY OWNED ENTERPRISE OF THE SQUAXIN ISLAND TRIBE, A FEDERALLY RECOGNIZED TRIBE, INCORPORATED UNDER TRIBAL LAW)

1041 STATE ROUTE 108  
SHELTON, WA 98584

FOR: CIGARETTES, IN CLASS 34 (U.S. CLS. 2, 8, 9 AND 17).

FIRST USE 3-31-2004; IN COMMERCE 4-25-2008.

THE MARK CONSISTS OF STANDARD CHARACTERS WITHOUT CLAIM TO ANY PARTICULAR FONT, STYLE, SIZE, OR COLOR.

OWNER OF U.S. REG. NO. 1,846,319.

SN 77-035,001, FILED 11-2-2006.

KELLEY WELLS, EXAMINING ATTORNEY

**Int. Cl.: 16**

**Prior U.S. Cls.: 2, 5, 22, 23, 29, 37, 38, and 50**

**Reg. No. 3,454,400**

**United States Patent and Trademark Office**

**Registered June 24, 2008**

---

**TRADEMARK  
PRINCIPAL REGISTER**

**FAST TOUCH**

STAPLES THE OFFICE SUPERSTORE, LLC (DE-  
LAWARE LTD LIAB CO)  
500 STAPLES DRIVE  
FRAMINGHAM, MA 01702

THE MARK CONSISTS OF STANDARD CHAR-  
ACTERS WITHOUT CLAIM TO ANY PARTICULAR  
FONT, STYLE, SIZE, OR COLOR.

FOR: PACKING TAPE DISPENSERS FOR HOUSE-  
HOLD, OFFICE, OR STATIONERY USE, IN CLASS  
16 (U.S. CLS. 2, 5, 22, 23, 29, 37, 38 AND 50).

SN 77-035,483, FILED 11-2-2006.

FIRST USE 3-0-2007; IN COMMERCE 3-0-2007.

HEATHER SAPP, EXAMINING ATTORNEY

**Int. Cls.: 41 and 44**

**Prior U.S. Cls.: 100, 101, and 107**

**United States Patent and Trademark Office**

**Reg. No. 3,454,401**

**Registered June 24, 2008**

**SERVICE MARK  
PRINCIPAL REGISTER**

**RESPECT EDUCATION SAFETY  
FROM SEXUAL ABUSE  
PREVENTION EVALUATION  
CONSULTATION TREATMENT**

OHEL CHILDREN'S HOME AND FAMILY SERVICES, INC. (NEW YORK NON-PROFIT CORPORATION)  
4510 16TH AVENUE  
BROOKLYN, NY 11204

FOR: EDUCATIONAL SERVICES, NAMELY, PROVIDING WORKSHOPS FEATURING PRESENTATIONS REGARDING THE PREVENTION OF SEXUAL ABUSE, IN CLASS 41 (U.S. CLS. 100, 101 AND 107).

FIRST USE 9-30-2006; IN COMMERCE 11-30-2006.

FOR: COMPREHENSIVE SEXUAL ABUSE COUNSELING, PREVENTION, AND TREATMENT SERVICES FOR VICTIMS, SURVIVORS, AND THEIR FAMILIES AND COMMUNITIES, AND PSYCHOLOGICAL CONSULTATIONS REGARDING THE PREVENTION AND TREATMENT OF SEXUAL ABUSE

FOR VICTIMS, SURVIVORS, AND THEIR FAMILIES AND COMMUNITIES, IN CLASS 44 (U.S. CLS. 100 AND 101).

FIRST USE 9-30-2006; IN COMMERCE 11-30-2006.

THE MARK CONSISTS OF STANDARD CHARACTERS WITHOUT CLAIM TO ANY PARTICULAR FONT, STYLE, SIZE, OR COLOR.

NO CLAIM IS MADE TO THE EXCLUSIVE RIGHT TO USE "EDUCATION SAFETY FROM SEXUAL ABUSE PREVENTION EVALUATION CONSULTATION TREATMENT", APART FROM THE MARK AS SHOWN.

SN 77-035,517, FILED 11-2-2006.

CHRISTINA SOBRAL, EXAMINING ATTORNEY

**Int. Cl.: 44**

**Prior U.S. Cls.: 100 and 101**

**United States Patent and Trademark Office**

**Reg. No. 3,454,402**

**Registered June 24, 2008**

**SERVICE MARK  
PRINCIPAL REGISTER**



INTERNATIONAL MULTIPLE SCLEROSIS  
Management Practice

INTERNATIONAL MULTIPLE SCLEROSIS MAN-  
AGEMENT PRACTICE (NEW YORK COR-  
PORATION)  
521 WEST 57TH STREET, 4TH FLOOR  
NEW YORK, NY 10019

FOR: MEDICAL SERVICES AND CONSULTA-  
TION SERVICES IN THE FIELD OF PREVENTION,  
DIAGNOSIS, TREATMENT AND CURE OF MULTI-  
PLE SCLEROSIS , IN CLASS 44 (U.S. CLS. 100 AND  
101).

FIRST USE 5-24-2006; IN COMMERCE 5-24-2006.

NO CLAIM IS MADE TO THE EXCLUSIVE  
RIGHT TO USE "INTERNATIONAL MULTIPLE  
SCLEROSIS MANAGEMENT PRACTICE", APART  
FROM THE MARK AS SHOWN.

THE MARK CONSISTS OF A COAT OF ARMS-  
LIKE SHIELD HAVING A RIBBON AROUND THE  
SHIELD AND WITH A WREATH WITHIN THE  
SHIELD AND A STAR.

SN 77-035,706, FILED 11-2-2006.

MICHELLE DUBOIS, EXAMINING ATTORNEY

**Int. Cl.: 42**

**Prior U.S. Cls.: 100 and 101**

**United States Patent and Trademark Office**

**Reg. No. 3,454,403**

**Registered June 24, 2008**

**SERVICE MARK  
PRINCIPAL REGISTER**



**INTERNATIONAL MULTIPLE SCLEROSIS  
Management Practice**

INTERNATIONAL MULTIPLE SCLEROSIS MAN-  
AGEMENT PRACTICE (NEW YORK COR-  
PORATION)  
521 WEST 57TH STREET, 4TH FLOOR  
NEW YORK, NY 10019

FOR: SCIENTIFIC RESEARCH FOR MEDICAL  
PURPOSES, NAMELY, RESEARCH IN THE AREA  
OF MULTIPLE SCLEROSIS AND NEURODEGEN-  
ERATIVE CONDITIONS, IN CLASS 42 (U.S. CLS. 100  
AND 101).

FIRST USE 5-24-2006; IN COMMERCE 5-24-2006.

NO CLAIM IS MADE TO THE EXCLUSIVE  
RIGHT TO USE "INTERNATIONAL MULTIPLE  
SCLEROSIS MANAGEMENT PRACTICE", APART  
FROM THE MARK AS SHOWN.

THE MARK CONSISTS OF A COAT OF ARMS-  
LIKE SHIELD HAVING A RIBBON AROUND THE  
SHIELD AND WITH A WREATH WITHIN THE  
SHIELD AND A STAR.

SN 77-035,717, FILED 11-2-2006.

MICHELLE DUBOIS, EXAMINING ATTORNEY

**Int. Cl.: 16**

**Prior U.S. Cls.: 2, 5, 22, 23, 29, 37, 38, and 50**

**Reg. No. 3,454,404**

**United States Patent and Trademark Office**

**Registered June 24, 2008**

**TRADEMARK  
PRINCIPAL REGISTER**

**DE BUEN HUMOR**

HALLMARK LICENSING, INC. (DELAWARE  
CORPORATION)  
2440 PERSHING ROAD  
MD 339  
KANSAS CITY, MO 64108

FOR: GREETING CARDS, IN CLASS 16 (U.S. CLS.  
2, 5, 22, 23, 29, 37, 38 AND 50).

FIRST USE 3-5-2007; IN COMMERCE 3-5-2007.

THE MARK CONSISTS OF STANDARD CHAR-  
ACTERS WITHOUT CLAIM TO ANY PARTICULAR  
FONT, STYLE, SIZE, OR COLOR.

NO CLAIM IS MADE TO THE EXCLUSIVE  
RIGHT TO USE "HUMOR", APART FROM THE  
MARK AS SHOWN.

THE FOREIGN WORDING IN THE MARK  
TRANSLATES INTO ENGLISH AS IN GOOD HU-  
MOR.

SN 77-036,435, FILED 11-3-2006.

PRISCILLA MILTON, EXAMINING ATTORNEY



**Int. Cl.: 41**

**Prior U.S. Cls.: 100, 101, and 107**

**United States Patent and Trademark Office**

**Reg. No. 3,454,405**

**Registered June 24, 2008**

**SERVICE MARK  
PRINCIPAL REGISTER**



BARBARA SEDERQUIST (UNITED STATES INDIVIDUAL)  
2485 KINGSGATE RD.  
PLACERVILLE, CA 95667 AND  
DAVID SEDERQUIST (UNITED STATES INDIVIDUAL)  
2485 KINGSGATE RD.  
PLACERVILLE, CA 95667

FOR: PUBLISHING OF WEB MAGAZINES, IN CLASS 41 (U.S. CLS. 100, 101 AND 107).

FIRST USE 12-1-2006; IN COMMERCE 5-27-2007.

NO CLAIM IS MADE TO THE EXCLUSIVE RIGHT TO USE "CALIFORNIA WINE MAGAZINE", APART FROM THE MARK AS SHOWN.

THE MARK CONSISTS OF A STYLIZED MISSION, VINEYARD AND MOUNTAIN WITH WORDS "CALIFORNIA WINE MAGAZINE" FOLLOWING.

SN 77-036,892, FILED 11-4-2006.

CHRISTOPHER BUONGIORNO, EXAMINING ATTORNEY

**Int. Cl.: 35**

**Prior U.S. Cls.: 100, 101, and 102**

**United States Patent and Trademark Office**

**Reg. No. 3,454,406**

**Registered June 24, 2008**

**SERVICE MARK  
PRINCIPAL REGISTER**

**EVO**

EVOLVER PROJECT, INC. (DELAWARE CORPORATION)  
1027 ABBOT KINNEY BLVD.  
VENICE, CA 90291

FOR: ONLINE NETWORKING SERVICES RELATING TO ECO-FRIENDLY PROVIDERS, NAMELY, REFERRING CONSUMERS TO ENVIRONMENTALLY CONSCIOUS BUSINESSES AND PROVIDING CONSUMERS WITH INFORMATION TO INCREASE ENVIRONMENTAL AWARENESS, IN CLASS 35 (U.S. CLS. 100, 101 AND 102).

FIRST USE 1-15-2006; IN COMMERCE 1-15-2006.

THE MARK CONSISTS OF STANDARD CHARACTERS WITHOUT CLAIM TO ANY PARTICULAR FONT, STYLE, SIZE, OR COLOR.

SN 77-037,119, FILED 11-5-2006.

JESSICA FATHY, EXAMINING ATTORNEY

**Int. Cl.: 10**

**Prior U.S. Cls.: 26, 39, and 44**

**United States Patent and Trademark Office**

**Reg. No. 3,454,407**

**Registered June 24, 2008**

**TRADEMARK  
PRINCIPAL REGISTER**

# EarlySense

EARLYSENSE LTD. (ISRAEL LTD LIAB CO)  
12 TZVI STREET  
RAMAT GAN, ISRAEL 52504

FOR: MEDICAL MONITORING AND DIAGNOSTIC DEVICE, NAMELY, APPARATUS FOR MONITORING RESPIRATORY, CARDIAC OR OTHER PHYSICAL CONDITIONS OF A PATIENT DURING SLEEP; ANALYTICAL APPARATUS FOR MEDICAL PURPOSES, NAMELY, MEDICAL APPARATUS FOR DETECTION AND WARNING OF ONSET OF A CHRONIC DISEASE EPISODE OR OTHER CLIN-

ICAL CONDITION REQUIRING THERAPY, IN CLASS 10 (U.S. CLS. 26, 39 AND 44).

FIRST USE 3-31-2007; IN COMMERCE 3-31-2007.

THE MARK CONSISTS OF STANDARD CHARACTERS WITHOUT CLAIM TO ANY PARTICULAR FONT, STYLE, SIZE, OR COLOR.

SN 77-037,537, FILED 11-6-2006.

BRIAN NEVILLE, EXAMINING ATTORNEY

**Int. Cl.: 44**

**Prior U.S. Cls.: 100 and 101**

**United States Patent and Trademark Office**

**Reg. No. 3,454,408**

**Registered June 24, 2008**

**SERVICE MARK  
PRINCIPAL REGISTER**

**TELEPAL**

THE LIAM LAWSON FOUNDATION (PENNSYLVANIA CORPORATION)  
672 EAST REECEVILLE ROAD  
COATESVILLE, PA 19320

FOR: TELEMEDICINE SERVICES, NAMELY, HOME-BASED MEDICAL CARE THROUGH INTERNET AND OTHER ELECTRONICALLY SOURCED MULTI-POINT VIDEO AND AUDIO CONFERENCING, IN CLASS 44 (U.S. CLS. 100 AND 101).

FIRST USE 1-10-2007; IN COMMERCE 1-10-2007.

THE MARK CONSISTS OF STANDARD CHARACTERS WITHOUT CLAIM TO ANY PARTICULAR FONT, STYLE, SIZE, OR COLOR.

SN 77-037,584, FILED 11-6-2006.

ELIZABETH KAJUBI, EXAMINING ATTORNEY

**Int. Cl.: 28**

**Prior U.S. Cls.: 22, 23, 38, and 50**

**United States Patent and Trademark Office**

**Reg. No. 3,454,409**

**Registered June 24, 2008**

**TRADEMARK  
PRINCIPAL REGISTER**

**HYPER DASH**

WILD PLANET ENTERTAINMENT, INC. (CALI-  
FORNIA CORPORATION)  
13TH FLOOR  
225 BUSH STREET  
SAN FRANCISCO, CA 94104

FOR: GAME EQUIPMENT FOR SETTING UP A  
RUNNING COURSE, CONSISTING OF AN ELEC-  
TRONIC DEVICE THAT ISSUES VOICE DIREC-  
TIONS FOR PLAYER ACTIONS AND GIVES  
AUDIBLE FEEDBACK ON PLAYER'S SPEED AND  
ACCURACY WHEN PLAYER STRIKES ELECTRO-

NICALLY TAGGED TARGETS, IN CLASS 28 (U.S.  
CLS. 22, 23, 38 AND 50).

FIRST USE 7-0-2007; IN COMMERCE 7-0-2007.

THE MARK CONSISTS OF STANDARD CHAR-  
ACTERS WITHOUT CLAIM TO ANY PARTICULAR  
FONT, STYLE, SIZE, OR COLOR.

SN 77-037,798, FILED 11-6-2006.

SALLY SHIH, EXAMINING ATTORNEY

**Int. Cl.: 13**

**Prior U.S. Cls.: 2 and 9**

**United States Patent and Trademark Office**

**Reg. No. 3,454,410**

**Registered June 24, 2008**

**TRADEMARK  
PRINCIPAL REGISTER**

**ELITE SERIES**

SMITH & WESSON CORP. (DELAWARE CORPORATION)

2100 ROOSEVELT AVENUE

SPRINGFIELD, MA 01102

FOR: AMMUNITION FOR FIREARMS; FIREARMS, IN CLASS 13 (U.S. CLS. 2 AND 9).

FIRST USE 2-12-2007; IN COMMERCE 2-12-2007.

THE MARK CONSISTS OF STANDARD CHARACTERS WITHOUT CLAIM TO ANY PARTICULAR FONT, STYLE, SIZE, OR COLOR.

NO CLAIM IS MADE TO THE EXCLUSIVE RIGHT TO USE "SERIES", APART FROM THE MARK AS SHOWN.

SN 77-038,337, FILED 11-7-2006.

RAMONA ORTIGA, EXAMINING ATTORNEY

**Int. Cl.: 35**

**Prior U.S. Cls.: 100, 101, and 102**

**United States Patent and Trademark Office**

**Reg. No. 3,454,411**

**Registered June 24, 2008**

---

**SERVICE MARK  
PRINCIPAL REGISTER**

**F & C FLOORING**

F & C FLOORING DISTRIBUTORS, INC. (WIS-  
CONSIN CORPORATION)  
N5761 COUNTY ROAD M  
PLYMOUTH, WI 53073

FOR: WHOLESALE DISTRIBUTORSHIPS FEATURING FLOORING MATERIALS, IN CLASS 35 (U.S. CLS. 100, 101 AND 102).

FIRST USE 12-31-2006; IN COMMERCE 12-31-2006.

THE MARK CONSISTS OF STANDARD CHARACTERS WITHOUT CLAIM TO ANY PARTICULAR FONT, STYLE, SIZE, OR COLOR.

NO CLAIM IS MADE TO THE EXCLUSIVE RIGHT TO USE "FLOORING", APART FROM THE MARK AS SHOWN.

SN 77-038,707, FILED 11-7-2006.

ROBERT C. CLARK JR., EXAMINING ATTORNEY

**Int. Cls.: 35, 36, and 44**

**Prior U.S. Cls.: 100, 101, and 102**

**United States Patent and Trademark Office**

**Reg. No. 3,454,412**

**Registered June 24, 2008**

**SERVICE MARK  
PRINCIPAL REGISTER**

# DESIGNRXclusive

DESIGN RX, L.L.C. (WYOMING LTD LIAB CO)  
SUITE 12  
942 EAST CHAMBERS STREET  
OGDEN, UT 84403

FOR: MANAGEMENT OF PHARMACY COSTS FOR PHARMACEUTICALS NOT COVERED BY INSURANCE; ASSISTING CONSUMERS IN THE MANAGEMENT OF PHARMACY COSTS FOR PHARMACEUTICALS NOT COVERED BY INSURANCE; HEALTH CARE COST MANAGEMENT SERVICES; MARKETING OF PHARMACEUTICAL PRODUCTS FOR OTHERS; ADMINISTRATION OF A DISCOUNT PROGRAM FOR PHARMACEUTICALS NOT COVERED BY INSURANCE, THROUGH USE OF A DISCOUNT CARD, FOR CONSUMERS, IN CLASS 35 (U.S. CLS. 100, 101 AND 102).

FIRST USE 1-1-2007; IN COMMERCE 1-1-2007.

FOR: PHARMACY BENEFITS MANAGEMENT SERVICES FOR PHARMACEUTICALS NOT COVERED BY INSURANCE; PHARMACY CLAIMS PRO-

CESSING SERVICES FOR PRESCRIPTION PHARMACEUTICALS NOT COVERED BY INSURANCE, IN CLASS 36 (U.S. CLS. 100, 101 AND 102).

FIRST USE 1-1-2007; IN COMMERCE 1-1-2007.

FOR: ON-LINE COMPUTER SERVICES, NAMELY, PROVIDING INFORMATION ABOUT PHARMACEUTICALS NOT COVERED BY INSURANCE, NAMELY, PHARMACEUTICAL AND PRESCRIPTION ADVICE AND INFORMATION ABOUT OBTAINING PRESCRIPTION PHARMACEUTICALS, IN CLASS 44 (U.S. CLS. 100 AND 101).

FIRST USE 1-1-2007; IN COMMERCE 1-1-2007.

THE MARK CONSISTS OF STANDARD CHARACTERS WITHOUT CLAIM TO ANY PARTICULAR FONT, STYLE, SIZE, OR COLOR.

SN 77-039,526, FILED 11-8-2006.

BENJAMIN OKEKE, EXAMINING ATTORNEY



Int. Cl.: 9

Prior U.S. Cls.: 21, 23, 26, 36, and 38

United States Patent and Trademark Office

Reg. No. 3,454,413

Registered June 24, 2008

TRADEMARK  
PRINCIPAL REGISTER



The image shows a handwritten trademark in blue ink. The word "I'mme" is written in a cursive, slanted font. Below it, the phrase "what's your gig?" is printed in a lowercase, sans-serif font.

I'MME, L.L.C. (PENNSYLVANIA LTD LIAB CO)  
138 MAIN ST.  
PECKVILLE, PA 18452

FOR: INTERACTIVE MULTIMEDIA COMPUTER PROGRAM FOR MESSAGING, PHOTO STORAGE AND SHARING, MUSIC STORAGE AND PLAYING, FILE STORAGE, AND INTERNET NAVIGATION, IN CLASS 9 (U.S. CLS. 21, 23, 26, 36 AND 38).

FIRST USE 1-1-2006; IN COMMERCE 6-1-2006.

THE COLOR(S) BLUE IS/ARE CLAIMED AS A FEATURE OF THE MARK.

THE MARK CONSISTS OF BLUE TEXT WITH THE WORDS "I'M ME" WRITTEN IN CURSIVE AND COMBINED INTO ONE WORD MOVING AT AN ANGLE ACROSS THE CENTER OF THE PAGE AND THE PHRASE "WHAT'S YOUR GIG?" PRINTED IN LOWERCASE BLUE LETTERS THAT STRETCH HORIZONTALLY ACROSS THE PAGE UNDERNEATH "I'MME".

SN 77-039,940, FILED 11-8-2006.

SANJEEV VOHRA, EXAMINING ATTORNEY

**Int. Cls.: 9 and 42**

**Prior U.S. Cls.: 21, 23, 26, 36, 38, 100, and 101**

**United States Patent and Trademark Office**

**Reg. No. 3,454,414**

**Registered June 24, 2008**

**TRADEMARK  
SERVICE MARK  
PRINCIPAL REGISTER**

**SOCCOMPOSER**

RAPID BRIDGE LLC (DELAWARE LTD LIAB  
CO)  
4350 LA JOLLA VILLAGE DR STE 450  
SAN DIEGO, CA 92122

FOR: COMPUTER SOFTWARE FOR CREATING  
INTEGRATED CIRCUITS, IN CLASS 9 (U.S. CLS. 21,  
23, 26, 36 AND 38).

FIRST USE 10-15-2006; IN COMMERCE 10-15-2006.

FOR: RESEARCH, DEVELOPMENT, DESIGN  
AND ENGINEERING OF INTEGRATED CIRCUITS  
FOR OTHERS; DEVELOPMENT OF TECHNOLO-  
GIES FOR THE FABRICATION OF INTEGRATED  
CIRCUITS; LICENSING OF PATENTED AND PRO-  
PRIETARY TECHNOLOGIES; CONSULTATION  
SERVICES IN THE FIELD OF INTEGRATED CIR-

CUITS; PRODUCT DEVELOPMENT CONSULTA-  
TION; DEVELOPING COMPUTER PROGRAMS  
RELATED TO INTEGRATED CIRCUITS, DATA-  
BASE DEVELOPMENT SERVICES; PROVIDING DA-  
TABASES FEATURING METHODOLOGIES  
RELATED TO INTEGRATED CIRCUITS, IN CLASS  
42 (U.S. CLS. 100 AND 101).

FIRST USE 10-15-2006; IN COMMERCE 10-15-2006.

THE MARK CONSISTS OF STANDARD CHAR-  
ACTERS WITHOUT CLAIM TO ANY PARTICULAR  
FONT, STYLE, SIZE, OR COLOR.

SN 77-040,211, FILED 11-9-2006.

PAM WILLIS, EXAMINING ATTORNEY

**Int. Cl.: 41**

**Prior U.S. Cls.: 100, 101, and 107**

**United States Patent and Trademark Office**

**Reg. No. 3,454,415**

**Registered June 24, 2008**

**SERVICE MARK  
PRINCIPAL REGISTER**

**WORKOUT ON YOUR TIME**

MORELLO, CAROL J. (UNITED STATES INDIVIDUAL)  
495 MAIN STREET  
WILBRAHAM, MA 01095

FOR: HEALTH CLUB SERVICES, NAMELY, PROVIDING INSTRUCTION AND EQUIPMENT IN THE FIELD OF PHYSICAL EXERCISE, IN CLASS 41 (U.S. CLS. 100, 101 AND 107).

FIRST USE 4-1-2007; IN COMMERCE 4-15-2007.

THE MARK CONSISTS OF STANDARD CHARACTERS WITHOUT CLAIM TO ANY PARTICULAR FONT, STYLE, SIZE, OR COLOR.

SN 77-040,476, FILED 11-9-2006.

NAAKWAMA ANKRAH, EXAMINING ATTORNEY

**Int. Cl.: 29**

**Prior U.S. Cl.: 46**

**United States Patent and Trademark Office**

**Reg. No. 3,454,416**

**Registered June 24, 2008**

**TRADEMARK  
PRINCIPAL REGISTER**

**ABBEY FARMS**

ABBEY SPECIALTY FOODS, LLC (MINNESOTA  
LTD LIAB CO)  
SUITE 201  
13 FAIRFIELD AVE  
LITTLE FALLS, NJ 07424

THE MARK CONSISTS OF STANDARD CHAR-  
ACTERS WITHOUT CLAIM TO ANY PARTICULAR  
FONT, STYLE, SIZE, OR COLOR.

NO CLAIM IS MADE TO THE EXCLUSIVE  
RIGHT TO USE "FARMS", APART FROM THE  
MARK AS SHOWN.

FOR: CHEESE, IN CLASS 29 (U.S. CL. 46).

SN 77-040,601, FILED 11-9-2006.

FIRST USE 4-26-2007; IN COMMERCE 4-26-2007.

SUSAN RICHARDS, EXAMINING ATTORNEY

**Int. Cl.: 9**

**Prior U.S. Cls.: 21, 23, 26, 36, and 38**

**United States Patent and Trademark Office**

**Reg. No. 3,454,417**

**Registered June 24, 2008**

**TRADEMARK  
PRINCIPAL REGISTER**

**Nano Ceramic**

HELEN OF TROY LIMITED (BARBADOS CORPORATION)  
13 8TH AVENUE, BELLEVILLE  
P.O. BOX 836E  
ST. MICHAEL, BARBADOS

THE MARK CONSISTS OF STANDARD CHARACTERS WITHOUT CLAIM TO ANY PARTICULAR FONT, STYLE, SIZE, OR COLOR.

FOR: ELECTRIC HAIR CURLING IRONS; ELECTRIC HAIR STRAIGHTENING IRONS, IN CLASS 9 (U.S. CLS. 21, 23, 26, 36 AND 38).

SN 77-040,864, FILED 11-9-2006.

FIRST USE 7-0-2007; IN COMMERCE 7-0-2007.

NAAKWAMA ANKRAH, EXAMINING ATTORNEY

**Int. Cl.: 41**

**Prior U.S. Cls.: 100, 101, and 107**

**United States Patent and Trademark Office**

**Reg. No. 3,454,418**

**Registered June 24, 2008**

**SERVICE MARK  
PRINCIPAL REGISTER**

**THE PULSE ON TOUR**

RHYTHM OF LIFE CORP. (NEW YORK CORPORATION), DBA BROADWAY DANCE CENTER CORPORATION,  
322 WEST 45 STREET  
NEW YORK, NY 10036

THE MARK CONSISTS OF STANDARD CHARACTERS WITHOUT CLAIM TO ANY PARTICULAR FONT, STYLE, SIZE, OR COLOR.

FOR: DANCE INSTRUCTION; CONDUCTING WORKSHOPS AND SEMINARS IN DANCE, IN CLASS 41 (U.S. CLS. 100, 101 AND 107).

SN 77-040,950, FILED 11-9-2006.

FIRST USE 11-0-2005; IN COMMERCE 11-0-2005.

KAREN SEVERSON, EXAMINING ATTORNEY

**Int. Cls.: 9, 36, 41, and 42**

**Prior U.S. Cls.: 21, 23, 26, 36, 38, 100, 101, 102, and 107**

**Reg. No. 3,454,419**

**United States Patent and Trademark Office**

**Registered June 24, 2008**

**TRADEMARK  
SERVICE MARK  
PRINCIPAL REGISTER**



QUADRAMED CORPORATION (DELAWARE CORPORATION)  
12110 SUNSET HILLS ROAD, SUITE 600  
RESTON, VA 20190

FOR: COMPUTER SOFTWARE USED IN RECORD MANAGEMENT, INFORMATION MANAGEMENT, BILLING, PAYMENTS, POSTING AND SECONDARY BILLING, MEDICAL TRANSCRIPTION, DOCUMENT IMAGING, ELECTRONIC DATA INTERCHANGE AND ELECTRONIC MESSAGING FOR THE HEALTHCARE INDUSTRY; COMPUTER SOFTWARE, SPECIFICALLY HOSPITAL INFORMATION SYSTEM SOFTWARE; COMPUTER SOFTWARE THAT ENABLES USERS TO COMPLY WITH HEALTHCARE REGULATIONS AND LAWS; COMPUTER SOFTWARE FOR MANAGING AND ANALYZING FINANCIAL INFORMATION OF HEALTHCARE PROVIDERS, IN CLASS 9 (U.S. CLS. 21, 23, 26, 36 AND 38).

FIRST USE 2-0-2007; IN COMMERCE 2-0-2007.

FOR: CONSULTING SERVICES IN THE FIELD OF FINANCIAL MANAGEMENT FOR HEALTHCARE PROVIDERS, IN CLASS 36 (U.S. CLS. 100, 101 AND 102).

FIRST USE 2-0-2007; IN COMMERCE 2-0-2007.

FOR: TRAINING SERVICES IN THE FIELD OF HEALTHCARE INFORMATION MANAGEMENT SYSTEMS, IN CLASS 41 (U.S. CLS. 100, 101 AND 107).

FIRST USE 2-0-2007; IN COMMERCE 2-0-2007.

FOR: COMPUTER-SOFTWARE INSTALLATION, INTEGRATION OF COMPUTER SYSTEMS AND NETWORKS, COMPUTER PROJECT MANAGEMENT, INFORMATION-TECHNOLOGY CONSULTING, AND CUSTOMER TECHNICAL SUPPORT, NAMELY, TROUBLESHOOTING OF COMPUTER SOFTWARE PROBLEMS, ALL IN THE FIELD OF HEALTHCARE INFORMATION MANAGEMENT SERVICES, IN CLASS 42 (U.S. CLS. 100 AND 101).

FIRST USE 2-0-2007; IN COMMERCE 2-0-2007.

OWNER OF U.S. REG. NOS. 2,001,481, 2,348,079, AND 3,014,551.

THE MARK CONSISTS OF THE MARK "QUADRAMED" AND FOUR CURVES FORMING A CIRCLE DESIGN.

SN 77-041,256, FILED 11-10-2006.

BRENDAN REGAN, EXAMINING ATTORNEY

**Int. Cl.: 5**

**Prior U.S. Cls.: 6, 18, 44, 46, 51, and 52**

**Reg. No. 3,454,420**

**United States Patent and Trademark Office**

**Registered June 24, 2008**

---

**TRADEMARK  
PRINCIPAL REGISTER**

**COLONGLIDE**

C & R PHARMACEUTICALS, INC. (DELAWARE  
CORPORATION)  
120 WOOD AVENUE SOUTH, SUITE 200  
ISELIN, NJ 08830

THE MARK CONSISTS OF STANDARD CHAR-  
ACTERS WITHOUT CLAIM TO ANY PARTICULAR  
FONT, STYLE, SIZE, OR COLOR.

FOR: MEDICAL LUBRICANT, NAMELY, LUBRI-  
CANT USED TO FACILITATE USE OF A COLONO-  
SCOPE, IN CLASS 5 (U.S. CLS. 6, 18, 44, 46, 51 AND 52).

SN 77-041,525, FILED 11-10-2006.

FIRST USE 6-15-2007; IN COMMERCE 6-15-2007.

MYRIAH HABEEB, EXAMINING ATTORNEY



Int. Cl.: 5

Prior U.S. Cls.: 6, 18, 44, 46, 51, and 52

Reg. No. 3,454,421

United States Patent and Trademark Office

Registered June 24, 2008

TRADEMARK  
PRINCIPAL REGISTER



SMITHKLINE BEECHAM CORPORATION  
(PENNSYLVANIA CORPORATION)  
ONE FRANKLIN PLAZA  
PHILADELPHIA, PA 19102

FOR: ANTACIDS AND CALCIUM SUPPLEMENTS, IN CLASS 5 (U.S. CLS. 6, 18, 44, 46, 51 AND 52).

FIRST USE 1-31-2007; IN COMMERCE 1-31-2007.

OWNER OF U.S. REG. NOS. 1,979,915, 3,137,170, AND OTHERS.

THE COLOR(S) WHITE, BLACK, BLUE AND GREY IS/ARE CLAIMED AS A FEATURE OF THE MARK.

THE MARK CONSISTS OF THE STYLIZED WORD "TUMS" IN THE COLOR WHITE WITHIN IN A BLUE OVAL WITH THE STYLIZED WORD "RACING" WITHIN A BLACK OVAL BELOW ON TOP OF BLACK AND WHITE CHECKERED FLAG BEHIND AND WITH THE STYLIZED WORDS "FAST RELIEF IS OUR SPECIALITY" BELOW IN WHITE WITH BLUE SHADOW SURROUNDING THESE WORDS. THE ENTIRE MARK IS OUTLINED WITH GREY SHADOWING.

SN 77-042,195, FILED 11-13-2006.

KEVIN DINALLO, EXAMINING ATTORNEY

**Int. Cls.: 3, 5, and 32**

**Prior U.S. Cls.: 1, 4, 6, 18, 44, 45, 46, 48, 50, 51, and 52**

**United States Patent and Trademark Office**

**Reg. No. 3,454,422**

**Registered June 24, 2008**

**TRADEMARK  
PRINCIPAL REGISTER**

**CORDYMA**

HAN KOOK SIN YAK PHARM CO., LTD. (RE-  
PUBLIC OF KOREA CORPORATION)  
805-15 JOONGSAN-RI  
YANGCHON-MYEON, NONSAN-SI  
CHOONGCHEONGNAM-DO, REPUBLIC OF KOR-  
EA 320-850

FOR: COSMETICS COMPRISING EXTRACTS OF  
VEGETABLE WORMS; VANISHING CREAMS;  
SHAVING CREAMS; CLEANSING CREAMS; SKIN  
WHITENING CREAMS; BEAUTY MASKS; PER-  
FUMES; ROSE OIL FOR COSMETIC PURPOSES;  
COSMETIC SOAPS; HAIR SHAMPOOS, IN CLASS 3  
(U.S. CLS. 1, 4, 6, 50, 51 AND 52).

FIRST USE 4-2-2008; IN COMMERCE 4-2-2008.

FOR: NATURAL FOOD SUPPLEMENTS COM-  
PRISING EXTRACTS OF VEGETABLE WORMS;  
DIETARY SUPPLEMENTS COMPRISING EX-  
TRACTS OF VEGETABLE WORMS; FUNCTIONAL  
FOOD SUPPLEMENTS FOR HEALTH, COMPRIS-  
ING EXTRACTS OF VEGETABLE WORMS;  
HEALTH FOOD SUPPLEMENTS COMPRISING EX-  
TRACTS OF VEGETABLE WORMS; NUTRITIONAL  
FOOD SUPPLEMENTS FOR NON-MEDICAL USE

COMPRISING EXTRACTS OF VEGETABLE  
WORMS; DIETARY SUPPLEMENT DRINKS COM-  
PRISING EXTRACTS OF VEGETABLE WORMS, IN  
CLASS 5 (U.S. CLS. 6, 18, 44, 46, 51 AND 52).

FIRST USE 4-2-2008; IN COMMERCE 4-2-2008.

FOR: BEVERAGES COMPRISING EXTRACTS OF  
VEGETABLE WORMS; NON-ALCOHOLIC BEV-  
ERAGES COMPRISING EXTRACTS OF VEGETA-  
BLE WORMS, IN CLASS 32 (U.S. CLS. 45, 46 AND 48).

FIRST USE 4-2-2008; IN COMMERCE 4-2-2008.

THE MARK CONSISTS OF STANDARD CHAR-  
ACTERS WITHOUT CLAIM TO ANY PARTICULAR  
FONT, STYLE, SIZE, OR COLOR.

THE WORDING "CORDYMA" HAS NO MEAN-  
ING IN A FOREIGN LANGUAGE.

SN 77-042,223, FILED 11-13-2006.

ODESSA BIBBINS, EXAMINING ATTORNEY

**Int. Cl.: 28**

**Prior U.S. Cls.: 22, 23, 38, and 50**

**United States Patent and Trademark Office**

**Reg. No. 3,454,423**

**Registered June 24, 2008**

**TRADEMARK  
PRINCIPAL REGISTER**

**SKY RUNNER**

PLAYCORE IP SUB, INC. (DELAWARE COR-  
PORATION)  
401 CHESTNUT STREET, SUITE 310  
CHATTANOOGA, TN 37402

THE MARK CONSISTS OF STANDARD CHAR-  
ACTERS WITHOUT CLAIM TO ANY PARTICULAR  
FONT, STYLE, SIZE, OR COLOR.

FOR: PLAYGROUND EQUIPMENT, NAMELY,  
MANUALLY ROTATABLE RIDES, IN CLASS 28  
(U.S. CLS. 22, 23, 38 AND 50).

SN 77-042,373, FILED 11-13-2006.

FIRST USE 10-0-2006; IN COMMERCE 10-0-2006.

SUSAN RICHARDS, EXAMINING ATTORNEY

**Int. Cl.: 16**

**Prior U.S. Cls.: 2, 5, 22, 23, 29, 37, 38, and 50**

**United States Patent and Trademark Office**

**Reg. No. 3,454,424**

**Registered June 24, 2008**

**TRADEMARK  
PRINCIPAL REGISTER**



SEALED AIR CORPORATION (US) (DELAWARE CORPORATION)  
200 RIVERFRONT BOULEVARD  
ELMWOOD PARK, NJ 07407 AND  
SEALED AIR CORPORATION (US) (DELAWARE CORPORATION)  
200 RIVERFRONT BOULEVARD  
ELMWOOD PARK, NJ 07407

FOR: PLASTIC PACKAGING OR WRAPPING MATERIAL WHICH CONTAINS ENCAPSULATED AIR CELLS, IN CLASS 16 (U.S. CLS. 2, 5, 22, 23, 29, 37, 38 AND 50).

FIRST USE 12-1-2006; IN COMMERCE 12-1-2006.

OWNER OF U.S. REG. NO. 1,247,076.

THE MARK CONSISTS OF A FLAG DESIGN CONTAINING ENCAPSULATED AIR CELLS.

SN 77-042,400, FILED 11-13-2006.

JOHN E. MICHOS, EXAMINING ATTORNEY

**Int. Cl.: 9**

**Prior U.S. Cls.: 21, 23, 26, 36, and 38**

**Reg. No. 3,454,425**

**United States Patent and Trademark Office**

**Registered June 24, 2008**

**TRADEMARK  
PRINCIPAL REGISTER**



QDS COMMUNICATIONS (COLORADO CORPORATION)  
SUITE D  
15373 E. HINDSDALE CIRCLE  
CENTENNIAL, CO 80112

FOR: EMERGENCY RADIO COMMUNICATION SYSTEM, NAMELY, RADIOS, RADIO BRIDGES, AND SUPPORTING COMPUTER HARDWARE AND SOFTWARE FOR FACILITATING RADIO COMMUNICATIONS BETWEEN SCHOOLS AND EMERGENCY RESPONDERS, IN CLASS 9 (U.S. CLS. 21, 23, 26, 36 AND 38).

FIRST USE 8-31-2007; IN COMMERCE 8-31-2007.

NO CLAIM IS MADE TO THE EXCLUSIVE RIGHT TO USE "COMMUNICATIONS", APART FROM THE MARK AS SHOWN.

THE MARK CONSISTS OF THE WORDS "SCHOOLS SAFE COMMUNICATIONS" AND THE DESIGN AS SHOWN IN THE DRAWING.

SN 77-042,597, FILED 11-13-2006.

ROBIN CHOSID, EXAMINING ATTORNEY

**Int. Cl.: 11**

**Prior U.S. Cls.: 13, 21, 23, 31, and 34**

**Reg. No. 3,454,426**

**United States Patent and Trademark Office**

**Registered June 24, 2008**

---

**TRADEMARK  
PRINCIPAL REGISTER**

**MAG-TEC**

AMTROL LICENSING INC. (RHODE ISLAND  
PASSIVE INVESTMENT COMPANY)  
1400 DIVISION ROAD  
WEST WARWICK, RI 02893

THE MARK CONSISTS OF STANDARD CHAR-  
ACTERS WITHOUT CLAIM TO ANY PARTICULAR  
FONT, STYLE, SIZE, OR COLOR.

FOR: PORTABLE WATER TREATMENT EQUIP-  
MENT, NAMELY, IRON REMOVAL UNITS, IN  
CLASS 11 (U.S. CLS. 13, 21, 23, 31 AND 34).

SN 77-042,639, FILED 11-13-2006.

FIRST USE 9-7-2006; IN COMMERCE 9-7-2006.

MICHELE SWAIN, EXAMINING ATTORNEY

**Int. Cl.: 41**

**Prior U.S. Cls.: 100, 101, and 107**

**United States Patent and Trademark Office**

**Reg. No. 3,454,427**

**Registered June 24, 2008**

---

**SERVICE MARK  
PRINCIPAL REGISTER**

**E-LIFE**

GENERAL COUNCIL OF THE ASSEMBLIES OF  
GOD (MISSOURI CORPORATION)  
1445 N BOONVILLE AVE  
SPRINGFIELD, MO 65802

THE MARK CONSISTS OF STANDARD CHAR-  
ACTERS WITHOUT CLAIM TO ANY PARTICULAR  
FONT, STYLE, SIZE, OR COLOR.

FOR: EDUCATIONAL PROGRAM FOR CHIL-  
DREN IN THE FIELD OF RELIGION, IN CLASS 41  
(U.S. CLS. 100, 101 AND 107).

SN 77-043,444, FILED 11-14-2006.

FIRST USE 2-1-2006; IN COMMERCE 1-2-2007.

TARAH HARDY, EXAMINING ATTORNEY

**Int. Cl.: 3**

**Prior U.S. Cls.: 1, 4, 6, 50, 51, and 52**

**United States Patent and Trademark Office**

**Reg. No. 3,454,428**

**Registered June 24, 2008**

**TRADEMARK  
PRINCIPAL REGISTER**

**JET-DRY TURBO DRY**

RECKITT BENCKISER N.V. (NETHERLANDS  
CORPORATION)  
SIRIUSDREEF 14 - 2132 WT  
HOOFDDORP, NETHERLANDS

FOR: PREPARATIONS FOR MACHINE DISH-  
WASHER USE, NAMELY, RINSE, DRYING AND  
ANTI-SPOTTING AGENTS; ALL AFOREMEN-  
TIONED GOODS WITH OR WITHOUT DISINFEC-  
TIVE COMPONENT, IN CLASS 3 (U.S. CLS. 1, 4, 6, 50,  
51 AND 52).

FIRST USE 6-23-2007; IN COMMERCE 6-23-2007.

THE MARK CONSISTS OF STANDARD CHAR-  
ACTERS WITHOUT CLAIM TO ANY PARTICULAR  
FONT, STYLE, SIZE, OR COLOR.

OWNER OF U.S. REG. NOS. 700,766, 2,675,161,  
AND 2,764,175.

NO CLAIM IS MADE TO THE EXCLUSIVE  
RIGHT TO USE "DRY", APART FROM THE MARK  
AS SHOWN.

SN 77-044,221, FILED 11-15-2006.

DAVID C. REIHNER, EXAMINING ATTORNEY



**Int. Cl.: 24**

**Prior U.S. Cls.: 42 and 50**

**United States Patent and Trademark Office**

**Reg. No. 3,454,429**

**Registered June 24, 2008**

**TRADEMARK  
PRINCIPAL REGISTER**

**FIREPLUG FABRICS**

STARENSIER INC. (DELAWARE CORPORATION)  
P.O. BOX 408  
10 MULLIKEN WAY  
NEWBURYPORT, MA 01950

FOR: FABRICS, NAMELY, FABRICS WITH A SPECIALIZED FINISH FOR USE IN THE MANUFACTURE OF FIREPROOF MATTRESSES, IN CLASS 24 (U.S. CLS. 42 AND 50).

FIRST USE 1-31-2008; IN COMMERCE 1-31-2008.

THE MARK CONSISTS OF STANDARD CHARACTERS WITHOUT CLAIM TO ANY PARTICULAR FONT, STYLE, SIZE, OR COLOR.

NO CLAIM IS MADE TO THE EXCLUSIVE RIGHT TO USE "FABRICS", APART FROM THE MARK AS SHOWN.

SN 77-044,496, FILED 11-15-2006.

MARGERY A. TIERNEY, EXAMINING ATTORNEY

**Int. Cl.: 1**

**Prior U.S. Cls.: 1, 5, 6, 10, 26, and 46**

**Reg. No. 3,454,430**

**United States Patent and Trademark Office**

**Registered June 24, 2008**

**TRADEMARK  
PRINCIPAL REGISTER**

**ASAHI KASEI Fine Soda**

ASAHI KASEI KABUSHIKI KAISHA (JAPAN  
CORPORATION)  
2-6, DOJIMAHAMA 1-CHOME, KITA-KU  
OSAKA, JAPAN

NO CLAIM IS MADE TO THE EXCLUSIVE  
RIGHT TO USE "FINE SODA", APART FROM THE  
MARK AS SHOWN.

FOR: CAUSTIC SODA, IN CLASS 1 (U.S. CLS. 1, 5,  
6, 10, 26 AND 46).

THE ENGLISH TRANSLATION OF "ASAHI" IS  
RISING SUN, AND OF "KASEI" IS CHEMICAL OR  
TRANSFORMATION.

FIRST USE 12-1-2006; IN COMMERCE 2-1-2008.

SN 77-044,787, FILED 11-15-2006.

THE MARK CONSISTS OF STANDARD CHAR-  
ACTERS WITHOUT CLAIM TO ANY PARTICULAR  
FONT, STYLE, SIZE, OR COLOR.

ALEX KEAM, EXAMINING ATTORNEY

**Int. Cls.: 35 and 41**

**Prior U.S. Cls.: 100, 101, 102, and 107**

**United States Patent and Trademark Office**

**Reg. No. 3,454,431**

**Registered June 24, 2008**

**SERVICE MARK  
PRINCIPAL REGISTER**

# RATEPOINT

RATEPOINT, INC. (DELAWARE CORPORATION)  
SUITE 2500  
100 LOWDER BROOK DRIVE  
WESTWOOD, MA 02090

FOR: PROVIDING CONSUMER PRODUCT AND SERVICES INFORMATION AND DESCRIPTIONS VIA THE INTERNET; PROVIDING A WEBSITE FEATURING PRODUCT RATINGS OF THE CONSUMER GOODS AND SERVICES OF OTHERS IN A WIDE VARIETY OF FIELDS; PROVIDING BUSINESS INFORMATION AND EVALUATIONS OF COMPANIES AND THE RANKINGS THEREOF ACCORDING TO SUCH BUSINESS ASSESSMENTS AND APPRAISALS, IN CLASS 35 (U.S. CLS. 100, 101 AND 102).

FIRST USE 12-16-2006; IN COMMERCE 12-16-2006.

FOR: ON-LINE BLOGS FEATURING INFORMATION, DESCRIPTIONS, ASSESSMENTS, EVALUATIONS, RANKINGS OF CONSUMER GOODS AND SERVICES, PERSONS OF INTEREST, CONSUMER WEB SITES, COMPANIES OF INTEREST AND PROVIDING USERS TO RESPOND THERETO, IN CLASS 41 (U.S. CLS. 100, 101 AND 107).

FIRST USE 12-16-2006; IN COMMERCE 12-16-2006.

THE MARK CONSISTS OF STANDARD CHARACTERS WITHOUT CLAIM TO ANY PARTICULAR FONT, STYLE, SIZE, OR COLOR.

SN 77-045,116, FILED 11-15-2006.

WILLIAM VERHOSEK, EXAMINING ATTORNEY

**Int. Cl.: 25**

**Prior U.S. Cls.: 22 and 39**

**United States Patent and Trademark Office**

**Reg. No. 3,454,432**

**Registered June 24, 2008**

**TRADEMARK  
PRINCIPAL REGISTER**

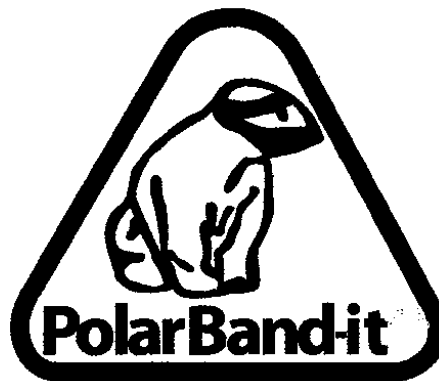

COHEN, MICHAEL (UNITED STATES INDIVIDUAL)  
P.O. BOX 991  
18 OWLS NEST ROAD  
SAUGERTIES, NY 12477

FOR: MUFFLERS, IN CLASS 25 (U.S. CLS. 22 AND 39).

FIRST USE 9-1-2001; IN COMMERCE 3-10-2008.

THE MARK CONSISTS OF ROUNDED TRIANGULAR OUTER BORDER. INSIDE OUTER BORDER IS A PICTURE OF A POLAR BEAR WEARING PATENTED HEAD GARMENT APPARATUS, AND BELOW POLAR BEAR IS THE WORDING, "POLAR BAND-IT".

SN 77-045,263, FILED 11-16-2006.

ARETHA SOMERVILLE, EXAMINING ATTORNEY

Int. Cl.: 38

Prior U.S. Cls.: 100, 101, and 104

United States Patent and Trademark Office

Reg. No. 3,454,433

Registered June 24, 2008

SERVICE MARK  
PRINCIPAL REGISTER



FONET GLOBAL, INC. (TEXAS CORPORATION)  
3131 MCKINNEY AV  
DALLAS, TX 75204

FOR: INTERNET TELEPHONY SERVICES, IN  
CLASS 38 (U.S. CLS. 100, 101 AND 104).

FIRST USE 1-1-2007; IN COMMERCE 1-1-2007.

NO CLAIM IS MADE TO THE EXCLUSIVE  
RIGHT TO USE "GLOBAL" , APART FROM THE  
MARK AS SHOWN.

THE MARK CONSISTS OF STYLIZED TEXT  
WITH ARCHING LINES.

SN 77-045,587, FILED 11-16-2006.

JACQUELINE A. LAVINE, EXAMINING ATTOR-  
NEY

**Int. Cl.: 33**

**Prior U.S. Cls.: 47 and 49**

**United States Patent and Trademark Office**

**Reg. No. 3,454,434**

**Registered June 24, 2008**

**TRADEMARK  
PRINCIPAL REGISTER**

**SIERRA LEGEND**

C. G. DI ARIE VINEYARD & WINERY (CALI-  
FORNIA PARTNERSHIP)  
P.O. BOX 589  
5200 DI ARIE ROAD  
MT. AUKUM, CA 95656

THE MARK CONSISTS OF STANDARD CHAR-  
ACTERS WITHOUT CLAIM TO ANY PARTICULAR  
FONT, STYLE, SIZE, OR COLOR.

FOR: WINE, IN CLASS 33 (U.S. CLS. 47 AND 49).

SN 77-046,066, FILED 11-16-2006.

FIRST USE 9-30-2007; IN COMMERCE 9-30-2007.

TRICIA SONNEBORN, EXAMINING ATTORNEY

**Int. Cl.: 30**

**Prior U.S. Cl.: 46**

**United States Patent and Trademark Office**

**Reg. No. 3,454,435**

**Registered June 24, 2008**

**TRADEMARK  
PRINCIPAL REGISTER**



MOLINOS DE EL SALVADOR, SOCIEDAD ANONIMA DE CAPITAL VARIABLE (EL SALVADOR SOCIEDAD ANONIMA)  
EJERCITO NACIONAL BLVD., 50 AVE. NORTE  
SAN SALVADOR, EL SALVADOR

FOR: COOKIES, IN CLASS 30 (U.S. CL. 46).

FIRST USE 3-14-2007; IN COMMERCE 3-14-2007.

NO CLAIM IS MADE TO THE EXCLUSIVE RIGHT TO USE "GALLETAS", APART FROM THE MARK AS SHOWN.

THE COLOR(S) DARK GREEN, LIGHT GREEN, YELLOW AND WHITE IS/ARE CLAIMED AS A FEATURE OF THE MARK.

THE MARK CONSISTS OF THE WORDING "GALLETAS", IN YELLOW, ABOVE THE WORDING "CHAVAS", IN WHITE OUTLINED IN GREEN WITH A YELLOW OUTER BORDER. THESE TWO WORDS ARE ENCLOSED WITHIN AN OVAL SHADED IN DARK AND LIGHT GREEN, WITH A YELLOW BORDER

THE ENGLISH TRANSLATION OF THE WORD "GALLETAS CHAVAS" IN THE MARK IS "GIRL COOKIES".

SN 77-046,069, FILED 11-16-2006.

RICHARD A. STRASER, EXAMINING ATTORNEY

Int. Cl.: 41

Prior U.S. Cls.: 100, 101, and 107

Reg. No. 3,454,436

United States Patent and Trademark Office

Registered June 24, 2008

SERVICE MARK  
PRINCIPAL REGISTER



CENTERSHOT MINISTRIES INC (WISCONSIN CORPORATION)  
2035 RILEY ROAD  
SPARTA, WI 546561460

FOR: EDUCATIONAL SERVICES, NAMELY, TEACHING ARCHERY, IN CLASS 41 (U.S. CLS. 100, 101 AND 107).

FIRST USE 1-31-2007; IN COMMERCE 1-31-2007.

THE MARK CONSISTS OF THE WORDING "CENTERSHOT MAKING CHRIST THE TARGET

OF OUR LIVES" AND A GRAPHICAL ARCHERY BOW FORMED IN-PART BY THE LAST "T" IN "CENTERSHOT," AND A GRAPHICAL ARCHERY ARROW RUNNING HORIZONTALLY THROUGH THE WORD "CENTERSHOT," AND A LATIN CROSS FORMING THE FIRST "T" IN THE WORD "CENTERSHOT".

SN 77-047,653, FILED 11-20-2006.

DAVID ELTON, EXAMINING ATTORNEY



**Int. Cl.: 17**

**Prior U.S. Cls.: 1, 5, 12, 13, 35, and 50**

**United States Patent and Trademark Office**

**Reg. No. 3,454,437**

**Registered June 24, 2008**

**TRADEMARK  
PRINCIPAL REGISTER**

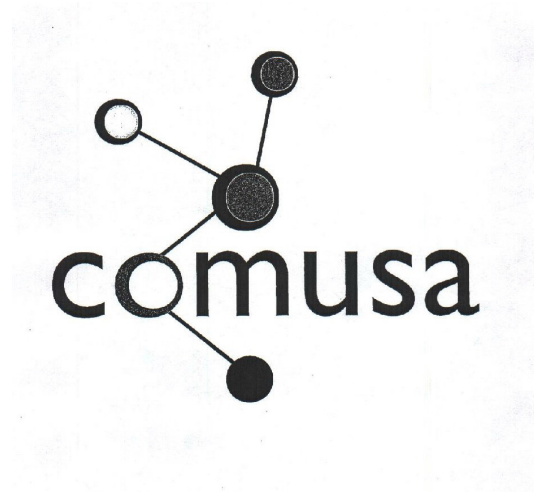

CHISSO CORPORATION (JAPAN CORPORATION)  
6-32, NAKANOSHIMA 3-CHOME, KITA-KU  
OSAKA, JAPAN

FOR: LONG FIBER REINFORCED PLASTICS IN  
THE FORM OF PELLETS FOR USE IN MANUFACTURING  
IN A VARIETY OF INDUSTRIES, IN  
CLASS 17 (U.S. CLS. 1, 5, 12, 13, 35 AND 50).

FIRST USE 4-20-2008; IN COMMERCE 4-20-2008.

THE STIPPLING IS FOR SHADING PURPOSES  
ONLY.

SN 77-047,878, FILED 11-20-2006.

DAWN HAN, EXAMINING ATTORNEY

**Int. Cl.: 36**

**Prior U.S. Cls.: 100, 101, and 102**

**United States Patent and Trademark Office**

**Reg. No. 3,454,438**

**Registered June 24, 2008**

**SERVICE MARK  
PRINCIPAL REGISTER**

**ALTA VISTA CREDIT UNION**

NORTON COMMUNITY CREDIT UNION (CALIFORNIA CREDIT UNION)  
295 S. TIPPECANOE AVENUE  
SAN BERNARDINO, CA 92408

FOR: CREDIT UNION SERVICES, SAFETY DEPOSIT BOX SERVICES, INTERNET BANKING SERVICES, AUTOMATIC TELLER MACHINE SERVICES, CHECKING AND SAVINGS ACCOUNT SERVICES, CONSUMER LENDING SERVICES, TRAVELERS CHECK ISSUANCE, CREDIT CARD SERVICES, PROVIDING BANK ACCOUNT INFORMATION BY TELEPHONE, ELECTRONIC DEBIT TRANSACTION SERVICES, AND ELECTRONIC FUNDS TRANSFER, IN CLASS 36 (U.S. CLS. 100, 101 AND 102).

FIRST USE 4-1-2007; IN COMMERCE 4-1-2007.

THE MARK CONSISTS OF STANDARD CHARACTERS WITHOUT CLAIM TO ANY PARTICULAR FONT, STYLE, SIZE, OR COLOR.

NO CLAIM IS MADE TO THE EXCLUSIVE RIGHT TO USE "CREDIT UNION", APART FROM THE MARK AS SHOWN.

THE FOREIGN WORDING IN THE MARK TRANSLATES INTO ENGLISH AS VIEW FROM ABOVE.

SN 77-047,938, FILED 11-20-2006.

DAVID ELTON, EXAMINING ATTORNEY

**Int. Cl.: 37**

**Prior U.S. Cls.: 100, 103, and 106**

**United States Patent and Trademark Office**

**Reg. No. 3,454,439**

**Registered June 24, 2008**

**SERVICE MARK  
PRINCIPAL REGISTER**

**Suncatcher Communities**

SUNCATCHER COMMUNITIES, LLC (TEXAS  
LTD LIAB CO)  
3217 SHADY GLEN DR.  
GRAPEVINE, TX 76051

FOR: LAND DEVELOPMENT AND REAL ES-  
TATE CONSTRUCTION OF ENERGY-EFFICIENT  
RESIDENTIAL AND COMMERCIAL PROPERTIES,  
IN CLASS 37 (U.S. CLS. 100, 103 AND 106).

FIRST USE 3-31-2008; IN COMMERCE 3-31-2008.

THE MARK CONSISTS OF STANDARD CHAR-  
ACTERS WITHOUT CLAIM TO ANY PARTICULAR  
FONT, STYLE, SIZE, OR COLOR.

NO CLAIM IS MADE TO THE EXCLUSIVE  
RIGHT TO USE "COMMUNITIES", APART FROM  
THE MARK AS SHOWN.

SN 77-048,022, FILED 11-20-2006.

JOHN E. MICHOS, EXAMINING ATTORNEY

**Int. Cls.: 24 and 25**

**Prior U.S. Cls.: 22, 39, 42, and 50**

**United States Patent and Trademark Office**

**Reg. No. 3,454,440**

**Registered June 24, 2008**

**TRADEMARK  
PRINCIPAL REGISTER**

**SMB TEXTILES**

SMB TEXTILES (CONNECTICUT CORPORATION)  
59 EDWARDS STREET  
NEW HAVEN, CT 06511

FOR: OVEN MITTS, POT HOLDERS, AND DISH TOWELS, IN CLASS 24 (U.S. CLS. 42 AND 50).

FIRST USE 8-3-2007; IN COMMERCE 8-3-2007.

FOR: APRONS , IN CLASS 25 (U.S. CLS. 22 AND 39).

FIRST USE 8-3-2007; IN COMMERCE 8-3-2007.

THE MARK CONSISTS OF STANDARD CHARACTERS WITHOUT CLAIM TO ANY PARTICULAR FONT, STYLE, SIZE, OR COLOR.

NO CLAIM IS MADE TO THE EXCLUSIVE RIGHT TO USE "TEXTILES", APART FROM THE MARK AS SHOWN.

SN 77-048,926, FILED 11-21-2006.

JERI J. FICKES, EXAMINING ATTORNEY

**Int. Cl.: 16**

**Prior U.S. Cls.: 2, 5, 22, 23, 29, 37, 38, and 50**

**Reg. No. 3,454,441**

**United States Patent and Trademark Office**

**Registered June 24, 2008**

**TRADEMARK  
PRINCIPAL REGISTER**



ADP OF NORTH AMERICA, INC. (DELAWARE  
CORPORATION)  
2603 CAMINO RAMON, SUITE 200  
SAN RAMON, CA 94583

FIRST USE 3-31-2007; IN COMMERCE 3-31-2007.

THE MARK CONSISTS OF TRIANGLE DESIGN.

FOR: PRINTED MATERIALS IN THE FIELD OF  
BUSINESS PAYROLL PROCESSING, NAMELY,  
PRINTED FORMS AND DOCUMENT COVERS, IN  
CLASS 16 (U.S. CLS. 2, 5, 22, 23, 29, 37, 38 AND 50).

SN 77-049,082, FILED 11-21-2006.

BRIAN NEVILLE, EXAMINING ATTORNEY

**Int. Cl.: 35**

**Prior U.S. Cls.: 100, 101, and 102**

**United States Patent and Trademark Office**

**Reg. No. 3,454,442**

**Registered June 24, 2008**

**SERVICE MARK  
PRINCIPAL REGISTER**



ADP OF NORTH AMERICA, INC. (DELAWARE CORPORATION)  
2603 CAMINO RAMON, SUITE 200  
SAN RAMON, CA 94583

FOR: PREPARATION AND ADMINISTRATION OF BUSINESS PAYROLL PROCESSING FOR OTHERS, IN CLASS 35 (U.S. CLS. 100, 101 AND 102).

FIRST USE 3-31-2007; IN COMMERCE 10-1-2007.

THE MARK CONSISTS OF TRIANGLE DESIGN.

SN 77-049,092, FILED 11-21-2006.

BRIAN NEVILLE, EXAMINING ATTORNEY

**Int. Cl.: 13**

**Prior U.S. Cls.: 2 and 9**

**United States Patent and Trademark Office**

**Reg. No. 3,454,443**

**Registered June 24, 2008**

**TRADEMARK  
PRINCIPAL REGISTER**

**FIRE CONTROL**

BATTENFELD TECHNOLOGIES, INC. (MISSOURI CORPORATION)  
5885 WEST VAN HORN TAVERN ROAD  
COLUMBIA, MO 65203

FOR: SUPPORT DEVICES FOR FIREARMS, NAMELY, SHOOTING STANDS AND BAGS; CARRYING CASES FOR SHOOTING STANDS; AND UPGRADE KITS FOR USE WITH SHOOTING STANDS, COMPRISED OF BASES, WINDAGE ADJUSTMENT MECHANISMS AND REPLACEMENT LEVELING FEET, IN CLASS 13 (U.S. CLS. 2 AND 9).

FIRST USE 3-26-2008; IN COMMERCE 3-26-2008.

THE MARK CONSISTS OF STANDARD CHARACTERS WITHOUT CLAIM TO ANY PARTICULAR FONT, STYLE, SIZE, OR COLOR.

SN 77-049,168, FILED 11-21-2006.

STEVEN JACKSON, EXAMINING ATTORNEY

**Int. Cl.: 42**

**Prior U.S. Cls.: 100 and 101**

**United States Patent and Trademark Office**

**Reg. No. 3,454,444**

**Registered June 24, 2008**

**SERVICE MARK  
PRINCIPAL REGISTER**



ONSITE NETWORK, INC (ILLINOIS CORPORATION)  
320 WEST OHIO  
STE. 600  
CHICAGO, IL 60610

FOR: HOSTING OF DIGITAL CONTENT ON THE  
INTERNET, IN CLASS 42 (U.S. CLS. 100 AND 101).

FIRST USE 6-1-2007; IN COMMERCE 6-1-2007.

THE COLOR(S) GREEN, YELLOW, AND WHITE  
IS/ARE CLAIMED AS A FEATURE OF THE MARK.

THE MARK CONSISTS OF THREE INTERSECTING  
WHITE RINGS IN A CIRCLE/SPHERE SHAD-  
DED YELLOW AND GREEN.

SN 77-049,416, FILED 11-22-2006.

STEVEN JACKSON, EXAMINING ATTORNEY



**Int. Cl.: 5**

**Prior U.S. Cls.: 6, 18, 44, 46, 51, and 52**

**Reg. No. 3,454,445**

**United States Patent and Trademark Office**

**Registered June 24, 2008**

---

**TRADEMARK  
PRINCIPAL REGISTER**

**JABS**

MARS, INCORPORATED (DELAWARE CORPORATION)  
6885 ELM STREET  
MCLEAN, VA 221013883

THE MARK CONSISTS OF STANDARD CHARACTERS WITHOUT CLAIM TO ANY PARTICULAR FONT, STYLE, SIZE, OR COLOR.

FOR: NUTRITIONALLY FORTIFIED ENERGY MIXES FOR USE AS A MEAL REPLACEMENT, IN CLASS 5 (U.S. CLS. 6, 18, 44, 46, 51 AND 52).

SN 77-049,424, FILED 11-22-2006.

FIRST USE 12-0-2006; IN COMMERCE 12-0-2006.

JOHN WILKE, EXAMINING ATTORNEY

**Int. Cl.: 1**

**Prior U.S. Cls.: 1, 5, 6, 10, 26, and 46**

**Reg. No. 3,454,446**

**United States Patent and Trademark Office**

**Registered June 24, 2008**

**TRADEMARK  
PRINCIPAL REGISTER**



NEWMAN, MATTHEW (UNITED STATES INDIVIDUAL)  
2261 MORGANZA HIGHWAY  
NEW ROADS, LA 70760

FOR: SOIL ADDITIVES FOR DOMESTIC AND HORTICULTURAL USE, IN CLASS 1 (U.S. CLS. 1, 5, 6, 10, 26 AND 46).

FIRST USE 8-1-2006; IN COMMERCE 8-1-2006.

OWNER OF U.S. REG. NO. 3,172,695.

NO CLAIM IS MADE TO THE EXCLUSIVE RIGHT TO USE "LIQUID CALCIUM", APART FROM THE MARK AS SHOWN.

THE MARK CONSISTS OF THE WORD "GAIN" WITH THE WORDS "LIQUID CALCIUM" IN A SMALL BOX UNDER THE WORD "GAIN", WITH LEAVES IN THE BACKGROUND ABOVE THE WORD "GAIN".

SN 77-050,105, FILED 11-22-2006.

STEVEN JACKSON, EXAMINING ATTORNEY

**Int. Cl.: 17**

**Prior U.S. Cls.: 1, 5, 12, 13, 35, and 50**

**Reg. No. 3,454,447**

**United States Patent and Trademark Office**

**Registered June 24, 2008**

---

**TRADEMARK  
PRINCIPAL REGISTER**

**Motoforge**

DAI, GUORONG (CHINA INDIVIDUAL)  
NO. 46 SHAZHOU, XIAOWANG VILLAGE  
BAILIAN TOWN, JIANGLE COUNTY  
FUJIAN PROVINCE, CHINA

FOR: TINTED, LAMINATED AND REFLECTIVE  
PLASTIC FILMS FOR USE IN HOME OR AUTO  
WINDOWS; RUBBER CORDS AND LACES; RESINS  
IN BARS, BLOCKS, PELLETS, RODS, SHEETS AND  
TUBES FOR GENERAL INDUSTRIAL USE; CHEMI-  
CAL FIBER THREAD AND YARN NOT FOR TEX-  
TILE USE; LATEX RUBBER FOR USE IN THE

MANUFACTURE OF CABLE, PAPER; ACOUSTIC  
AND THERMAL INSULATION FOR USE IN THE  
HVAC, APPLIANCE AND COMMERCIAL INTER-  
IOR INDUSTRIES, IN CLASS 17 (U.S. CLS. 1, 5, 12, 13,  
35 AND 50).

FIRST USE 5-6-2005; IN COMMERCE 5-6-2005.

SN 77-050,380, FILED 11-24-2006.

CYNTHIA SLOAN, EXAMINING ATTORNEY

**Int. Cl.: 35**

**Prior U.S. Cls.: 100, 101, and 102**

**United States Patent and Trademark Office**

**Reg. No. 3,454,448**

**Registered June 24, 2008**

**SERVICE MARK  
PRINCIPAL REGISTER**

**INNOCENT ART**

CUCHIARA, MICHAEL H. (UNITED STATES  
INDIVIDUAL)

3830 MESA GRANDE DR.

COLORADO SPRINGS, CO 80918

FOR: ART GALLERIES, IN CLASS 35 (U.S. CLS.  
100, 101 AND 102).

FIRST USE 2-1-2007; IN COMMERCE 2-1-2007.

THE MARK CONSISTS OF STANDARD CHAR-  
ACTERS WITHOUT CLAIM TO ANY PARTICULAR  
FONT, STYLE, SIZE, OR COLOR.

NO CLAIM IS MADE TO THE EXCLUSIVE  
RIGHT TO USE "ART", APART FROM THE MARK  
AS SHOWN.

SN 77-050,470, FILED 11-24-2006.

JASON ROTH, EXAMINING ATTORNEY

**Int. Cl.: 33**

**Prior U.S. Cls.: 47 and 49**

**United States Patent and Trademark Office**

**Reg. No. 3,454,449**

**Registered June 24, 2008**

**TRADEMARK  
PRINCIPAL REGISTER**

**TERRA BELLA**

TAYLOR FLADGATE & YEATMAN LIMITED  
(JERSEY LIMITED COMPANY)

LA MOTTE CHAMBERS

ST. HELIER, JERSEY

FOR: PORT WINES, IN CLASS 33 (U.S. CLS. 47  
AND 49).

FIRST USE 11-23-2007; IN COMMERCE 11-23-2007.

THE MARK CONSISTS OF STANDARD CHAR-  
ACTERS WITHOUT CLAIM TO ANY PARTICULAR  
FONT, STYLE, SIZE, OR COLOR.

THE FOREIGN WORDING IN THE MARK  
TRANSLATES INTO ENGLISH AS "BEAUTIFUL  
EARTH".

SN 77-051,843, FILED 11-28-2006.

MARK SPARACINO, EXAMINING ATTORNEY

**Int. Cl.: 14**

**Prior U.S. Cls.: 2, 27, 28, and 50**

**United States Patent and Trademark Office**

**Reg. No. 3,454,450**

**Registered June 24, 2008**

**TRADEMARK  
PRINCIPAL REGISTER**

**GUSTAV BECKER**

WU, WEN CHEN (UNITED STATES INDIVIDUAL)

15 SHORE ROAD

PORT WASHINGTON, NY 11050

FOR: CLOCKS; WATCHES, IN CLASS 14 (U.S. CLS. 2, 27, 28 AND 50).

FIRST USE 9-1-2007; IN COMMERCE 9-1-2007.

THE MARK CONSISTS OF STANDARD CHARACTERS WITHOUT CLAIM TO ANY PARTICULAR FONT, STYLE, SIZE, OR COLOR.

THE NAME(S), PORTRAIT(S), AND/OR SIGNATURE(S) SHOWN IN THE MARK DOES NOT IDENTIFY A PARTICULAR LIVING INDIVIDUAL.

SN 77-052,329, FILED 11-28-2006.

LOURDES AYALA, EXAMINING ATTORNEY

**Int. Cl.: 44**

**Prior U.S. Cls.: 100 and 101**

**United States Patent and Trademark Office**

**Reg. No. 3,454,451**

**Registered June 24, 2008**

**SERVICE MARK  
PRINCIPAL REGISTER**

**WIN**

SLIM AND TONE, LLC (PENNSYLVANIA LTD  
LIAB CO)  
SUITE 102  
25 SOUTH MAIN STREET  
YARDLEY, PA 19067

FOR: PROVIDING TREATMENT AND CONSULTATION FOR WEIGHT REDUCTION, OBESITY AND WEIGHT MANAGEMENT AND NUTRITION, IN CLASS 44 (U.S. CLS. 100 AND 101).

FIRST USE 9-1-2006; IN COMMERCE 9-1-2006.

THE MARK CONSISTS OF STANDARD CHARACTERS WITHOUT CLAIM TO ANY PARTICULAR FONT, STYLE, SIZE, OR COLOR.

SN 77-052,827, FILED 11-29-2006.

DAVID MILLER, EXAMINING ATTORNEY

**Int. Cl.: 29**

**Prior U.S. Cl.: 46**

**United States Patent and Trademark Office**

**Reg. No. 3,454,452**

**Registered June 24, 2008**

---

**TRADEMARK  
PRINCIPAL REGISTER**

**ZEEL**

ANDREW N. WESTLUND (UNITED STATES IN-  
DIVIDUAL)  
41154 RIDGE DRIVE  
SCIO, OR 97374

THE MARK CONSISTS OF STANDARD CHAR-  
ACTERS WITHOUT CLAIM TO ANY PARTICULAR  
FONT, STYLE, SIZE, OR COLOR.

FOR: BEEF, IN CLASS 29 (U.S. CL. 46).

SN 77-052,999, FILED 11-29-2006.

FIRST USE 2-1-2008; IN COMMERCE 2-1-2008.

ERNEST SHOSHO, EXAMINING ATTORNEY



**Int. Cl.: 7**

**Prior U.S. Cls.: 13, 19, 21, 23, 31, 34, and 35**

**Reg. No. 3,454,453**

**United States Patent and Trademark Office**

**Registered June 24, 2008**

**TRADEMARK  
PRINCIPAL REGISTER**

# Spa Broom

WATER TECH, LLC (DELAWARE LTD LIAB CO)  
SUITE A  
44 W. FERRIS STREET  
EAST BRUNSWICK, NJ 088162159

THE MARK CONSISTS OF STANDARD CHAR-  
ACTERS WITHOUT CLAIM TO ANY PARTICULAR  
FONT, STYLE, SIZE, OR COLOR.

FOR: SWIMMING POOL CLEANERS, NAMELY,  
POOL VACUUMS, IN CLASS 7 (U.S. CLS. 13, 19, 21,  
23, 31, 34 AND 35).

SN 77-053,192, FILED 11-29-2006.

FIRST USE 4-1-2008; IN COMMERCE 4-1-2008.

PAULA MAHONEY, EXAMINING ATTORNEY

**Int. Cl.: 9**

**Prior U.S. Cls.: 21, 23, 26, 36, and 38**

**United States Patent and Trademark Office**

**Reg. No. 3,454,454**

**Registered June 24, 2008**

**TRADEMARK  
PRINCIPAL REGISTER**

# TITLESMART

THE FIRST AMERICAN CORPORATION (CALIFORNIA CORPORATION)  
1 FIRST AMERICAN WAY  
SANTA ANA, CA 92707

FOR: AUTOMATED COMPUTER SYSTEM COMPRISED OF COMPUTERS, COMPUTER PROGRAMS AND COMPUTER SOFTWARE FOR PROVIDING REAL ESTATE TITLE AND RELATED INFORMATION , IN CLASS 9 (U.S. CLS. 21, 23, 26, 36 AND 38).

FIRST USE 2-22-2007; IN COMMERCE 2-22-2007.

THE MARK CONSISTS OF STANDARD CHARACTERS WITHOUT CLAIM TO ANY PARTICULAR FONT, STYLE, SIZE, OR COLOR.

OWNER OF U.S. REG. NO. 2,364,065.

SN 77-054,383, FILED 11-30-2006.

PAULA MAHONEY, EXAMINING ATTORNEY

**Int. Cl.: 36**

**Prior U.S. Cls.: 100, 101, and 102**

**United States Patent and Trademark Office**

**Reg. No. 3,454,455**

**Registered June 24, 2008**

**SERVICE MARK  
PRINCIPAL REGISTER**

**THE WILD BUNCH**

SANTA FE WILD WEST, INC. (NEW MEXICO  
CORPORATION)  
3 LOS PINOS ROAD  
SANTA FE, NM 87507

THE MARK CONSISTS OF STANDARD CHAR-  
ACTERS WITHOUT CLAIM TO ANY PARTICULAR  
FONT, STYLE, SIZE, OR COLOR.

FOR: REAL ESTATE BROKERAGE SERVICES, IN  
CLASS 36 (U.S. CLS. 100, 101 AND 102).

SN 77-054,413, FILED 11-30-2006.

FIRST USE 1-3-2007; IN COMMERCE 1-3-2007.

STEVEN JACKSON, EXAMINING ATTORNEY

**Int. Cl.: 36**

**Prior U.S. Cls.: 100, 101, and 102**

**United States Patent and Trademark Office**

**Reg. No. 3,454,456**

**Registered June 24, 2008**

**SERVICE MARK  
PRINCIPAL REGISTER**

**SANTA FE WILD WEST - A  
REAL ESTATE COMPANY**

SANTA FE WILD WEST, INC. (NEW MEXICO  
CORPORATION)  
3 LOS PINOS ROAD  
SANTA FE, NM 87507

FOR: REAL ESTATE BROKERAGE SERVICES, IN  
CLASS 36 (U.S. CLS. 100, 101 AND 102).

FIRST USE 9-0-2006; IN COMMERCE 9-0-2006.

THE MARK CONSISTS OF STANDARD CHAR-  
ACTERS WITHOUT CLAIM TO ANY PARTICULAR  
FONT, STYLE, SIZE, OR COLOR.

NO CLAIM IS MADE TO THE EXCLUSIVE  
RIGHT TO USE "SANTA FE" AND "REAL ESTATE  
COMPANY", APART FROM THE MARK AS  
SHOWN.

SN 77-054,447, FILED 11-30-2006.

STEVEN JACKSON, EXAMINING ATTORNEY

**Int. Cl.: 36**

**Prior U.S. Cls.: 100, 101, and 102**

**United States Patent and Trademark Office**

**Reg. No. 3,454,457**

**Registered June 24, 2008**

---

**SERVICE MARK  
PRINCIPAL REGISTER**

**SANTA FE WILD WEST**

SANTA FE WILD WEST, INC. (NEW MEXICO  
CORPORATION)

3 LOS PINOS ROAD

SANTA FE, NM 87507

FOR: REAL ESTATE BROKERAGE SERVICES, IN  
CLASS 36 (U.S. CLS. 100, 101 AND 102).

FIRST USE 9-0-2006; IN COMMERCE 9-0-2006.

THE MARK CONSISTS OF STANDARD CHAR-  
ACTERS WITHOUT CLAIM TO ANY PARTICULAR  
FONT, STYLE, SIZE, OR COLOR.

NO CLAIM IS MADE TO THE EXCLUSIVE  
RIGHT TO USE "SANTA FE", APART FROM THE  
MARK AS SHOWN.

SN 77-054,457, FILED 11-30-2006.

STEVEN JACKSON, EXAMINING ATTORNEY

**Int. Cl.: 41**

**Prior U.S. Cls.: 100, 101, and 107**

**United States Patent and Trademark Office**

**Reg. No. 3,454,458**

**Registered June 24, 2008**

---

**SERVICE MARK  
PRINCIPAL REGISTER**

**CHAMPIONS AMONG US**

MEREDITH CORPORATION (IOWA CORPORATION)  
1716 LOCUST STREET  
DES MOINES, IA 503093023

FOR: PROVIDING RECOGNITION BY WAY OF AN AWARD TO INDIVIDUALS WHO HAVE MADE SIGNIFICANT CONTRIBUTIONS TO IMPROVING THE LIVES OF CHILDREN, IN CLASS 41 (U.S. CLS. 100, 101 AND 107).

FIRST USE 1-9-2007; IN COMMERCE 1-9-2007.

THE MARK CONSISTS OF STANDARD CHARACTERS WITHOUT CLAIM TO ANY PARTICULAR FONT, STYLE, SIZE, OR COLOR.

SN 77-054,519, FILED 11-30-2006.

LAURIE KAUFMAN, EXAMINING ATTORNEY

**Int. Cl.: 6**

**Prior U.S. Cls.: 2, 12, 13, 14, 23, 25, and 50**

**Reg. No. 3,454,459**

**United States Patent and Trademark Office**

**Registered June 24, 2008**

---

**TRADEMARK  
PRINCIPAL REGISTER**

**SCREENSAVERS**

YUNDOKIDS INC. (FLORIDA CORPORATION)  
231 TRADEWINDS AVE.  
NAPLES, FL 34108

FIRST USE 9-1-2006; IN COMMERCE 9-1-2006.

FOR: REMOVABLE METAL PATIO AND LANIA  
SCREEN SYSTEMS COMPRISED OF A SCREEN  
ENCLOSURE HAVING CONTINUOUS SCREENING  
OR SCREEN PANELS AND SELECTIVELY REMO-  
VABLE SCREEN PANELS , IN CLASS 6 (U.S. CLS. 2,  
12, 13, 14, 23, 25 AND 50).

THE MARK CONSISTS OF STANDARD CHAR-  
ACTERS WITHOUT CLAIM TO ANY PARTICULAR  
FONT, STYLE, SIZE, OR COLOR.

SN 77-055,005, FILED 12-1-2006.

VERNA BETH RIRIE, EXAMINING ATTORNEY

**Int. Cl.: 1**

**Prior U.S. Cls.: 1, 5, 6, 10, 26, and 46**

**Reg. No. 3,454,460**

**United States Patent and Trademark Office**

**Registered June 24, 2008**

---

**TRADEMARK  
PRINCIPAL REGISTER**

**IBR-SNOWFLAKE**

I.B.R., ISRAELI BIOTECHNOLOGY RESEARCH  
LTD. (ISRAEL CORPORATION)  
7 JABOTINSKY STREET  
RAMAT GAN, ISRAEL 52520

THE MARK CONSISTS OF STANDARD CHAR-  
ACTERS WITHOUT CLAIM TO ANY PARTICULAR  
FONT, STYLE, SIZE, OR COLOR.

FOR: PLANT EXTRACT AS A RAW MATERIAL  
IN COSMETIC PREPARATIONS, IN CLASS 1 (U.S.  
CLS. 1, 5, 6, 10, 26 AND 46).

SN 77-056,277, FILED 12-4-2006.

FIRST USE 2-15-2007; IN COMMERCE 2-15-2007.

ARETHA SOMERVILLE, EXAMINING ATTORNEY



**Int. Cl.: 9**

**Prior U.S. Cls.: 21, 23, 26, 36, and 38**

**Reg. No. 3,454,461**

**United States Patent and Trademark Office**

**Registered June 24, 2008**

---

**TRADEMARK  
PRINCIPAL REGISTER**

**HYPERDIEDYNAMICS**

ALTAIR ENGINEERING, INC. (MICHIGAN CORPORATION)  
1820 E. BIG BEAVER ROAD  
TROY, MI 480832031

FOR: COMPUTER SOFTWARE FOR COMPUTER AIDED ENGINEERING COMPRISED OF A PRE, POST AND INTEGRATED SOLVER THAT SIMULATES PRESS MACHINERY AND DIE TOOLS USED IN SHEET METAL MANUFACTURING, IN CLASS 9 (U.S. CLS. 21, 23, 26, 36 AND 38).

FIRST USE 4-0-2007; IN COMMERCE 7-0-2007.

THE MARK CONSISTS OF STANDARD CHARACTERS WITHOUT CLAIM TO ANY PARTICULAR FONT, STYLE, SIZE, OR COLOR.

SN 77-056,508, FILED 12-4-2006.

DANNAN HETZEL, EXAMINING ATTORNEY

**Int. Cls.: 37, 42, and 44**

**Prior U.S. Cls.: 100, 101, 103, and 106**

**United States Patent and Trademark Office**

**Reg. No. 3,454,462**

**Registered June 24, 2008**

**SERVICE MARK  
PRINCIPAL REGISTER**



TRUSERVE GROUNDCARE INC. (CANADA CORPORATION)  
70 ESNA PARK DRIVE  
MARKHAM, ONTARIO, CANADA L3R1E3

FOR: LANDSCAPE CONSTRUCTION SERVICES; IRRIGATION MAINTENANCE SERVICES; SNOW PLOWING SERVICES; STREET AND ROADWAY CLEANING AND MAINTENANCE SERVICES, IN CLASS 37 (U.S. CLS. 100, 103 AND 106).

FIRST USE 12-19-2006; IN COMMERCE 12-19-2006.

FOR: LANDSCAPE AND ARCHITECTURAL DESIGN, IN CLASS 42 (U.S. CLS. 100 AND 101).

FIRST USE 12-19-2006; IN COMMERCE 12-19-2006.

FOR: LANDSCAPE GARDENING; LANDSCAPE GARDENING DESIGN; LAWN CARE; LAWN MOWING; LANDSCAPE GARDENING, NAMELY, VEGETATION CONTROL AND GARDEN MAINTENANCE, IN CLASS 44 (U.S. CLS. 100 AND 101).

FIRST USE 12-19-2006; IN COMMERCE 12-19-2006.

SN 77-056,545, FILED 12-4-2006.

MARK SPARACINO, EXAMINING ATTORNEY

**Int. Cl.: 44**

**Prior U.S. Cls.: 100 and 101**

**United States Patent and Trademark Office**

**Reg. No. 3,454,463**

**Registered June 24, 2008**

**SERVICE MARK  
PRINCIPAL REGISTER**

The logo for BioBalance 4 Men features the words "BioBalance" and "Men" in a bold, sans-serif font. A large, stylized numeral "4" is positioned between "BioBalance" and "Men". A horizontal line runs beneath the text, with a crooked line that loops under the "4" and extends to the right, crossing the horizontal line.

BIO-BALANCE FOR WOMEN, L.L.C. (MISSOURI  
LTD LIAB CO)  
10806 OLIVE BOULEVARD  
CREVE COEUR, MO 63141

FOR: PHYSICIAN SERVICES AND MEDICAL  
PROCEDURES, NAMELY, SUBCUTANEOUS IM-  
PLANTATION OF HORMONE DRUG PELLETS, IN  
CLASS 44 (U.S. CLS. 100 AND 101).

FIRST USE 7-1-2007; IN COMMERCE 7-1-2007.

OWNER OF U.S. REG. NOS. 2,937,754 AND  
2,937,755.

NO CLAIM IS MADE TO THE EXCLUSIVE  
RIGHT TO USE "FOR MEN", APART FROM THE  
MARK AS SHOWN.

THE MARK CONSISTS OF THE WORDS AND  
NUMERAL "BIOBALANCE", "4" AND "MEN" WITH  
A STRAIGHT LINE UNDERNEATH THE TEXT  
AND A CROOKED LINE ENTERTWINED WITH  
THE STRAIGHT LINE.

SN 77-057,125, FILED 12-5-2006.

ANDREA K. NADELMAN, EXAMINING ATTOR-  
NEY

**Int. Cl.: 35**

**Prior U.S. Cls.: 100, 101, and 102**

**United States Patent and Trademark Office**

**Reg. No. 3,454,464**

**Registered June 24, 2008**

**SERVICE MARK  
PRINCIPAL REGISTER**

**JAXIT**

SWAIN, DUDLEY (UNITED STATES INDIVIDUAL)  
4819 LINSOTT PLACE, SUITE 4  
LOS ANGELES, CA 90016

FOR: ADVERTISING AGENCIES, NAMELY, PROMOTING THE GOODS AND SERVICES OF OTHERS BY MEANS OF A VIDEO DISPLAY BUILT INTO A WEARABLE ARTICLE OF CLOTHING, IN CLASS 35 (U.S. CLS. 100, 101 AND 102).

FIRST USE 3-27-2008; IN COMMERCE 3-27-2008.

THE MARK CONSISTS OF STANDARD CHARACTERS WITHOUT CLAIM TO ANY PARTICULAR FONT, STYLE, SIZE, OR COLOR.

SN 77-057,154, FILED 12-5-2006.

ANNE E. GUSTASON, EXAMINING ATTORNEY

**Int. Cl.: 41**

**Prior U.S. Cls.: 100, 101, and 107**

**Reg. No. 3,454,465**

**United States Patent and Trademark Office**

**Registered June 24, 2008**

---

**SERVICE MARK  
PRINCIPAL REGISTER**



THE ACHIEVEMENT CENTRE INTERNATIONAL INC. (CANADA CORPORATION)  
#22-1601 RIVER ROAD EAST  
KITCHENER, CANADA N2A3Y4

PRIORITY CLAIMED UNDER SEC. 44(D) ON CANADA APPLICATION NO. 1,325,512, FILED 11-23-2006.

FOR: TRAINING AND COACHING SERVICES PROVIDED TO BUSINESSES, INCLUDING THEIR OWNERS, MANAGEMENT AND KEY PERSONNEL, IN THE FIELDS OF BUSINESS DEVELOPMENT, STRATEGY AND MANAGEMENT, IN CLASS 41 (U.S. CLS. 100, 101 AND 107).

NO CLAIM IS MADE TO THE EXCLUSIVE RIGHT TO USE "ACHIEVEMENT CENTRE", APART FROM THE MARK AS SHOWN.

SN 77-057,233, FILED 12-5-2006.

FIRST USE 4-16-2008; IN COMMERCE 4-16-2008.

STEVEN JACKSON, EXAMINING ATTORNEY

**Int. Cl.: 9**

**Prior U.S. Cls.: 21, 23, 26, 36, and 38**

**Reg. No. 3,454,466**

**United States Patent and Trademark Office**

**Registered June 24, 2008**

**TRADEMARK  
PRINCIPAL REGISTER**

**BAM**

SAMSUNG ELECTRO-MECHANICS CO., LTD.  
(REPUBLIC OF KOREA CORPORATION)  
314 MAETAN-DONG, YOUNGTONG-KU  
SUWON-SI, KYUNGKI-DO, REPUBLIC OF KOREA

FOR: PIEZOELECTRIC ACTUATOR FOR CELLULAR PHONES; CAMERA MODULES FOR CELLULAR PHONES, IN CLASS 9 (U.S. CLS. 21, 23, 26, 36 AND 38).

FIRST USE 5-1-2008; IN COMMERCE 5-1-2008.

THE MARK CONSISTS OF STANDARD CHARACTERS WITHOUT CLAIM TO ANY PARTICULAR FONT, STYLE, SIZE, OR COLOR.

PRIORITY CLAIMED UNDER SEC. 44(D) ON REPUBLIC OF KOREA APPLICATION NO. 2006-0038215, FILED 7-25-2006, REG. NO. 0704206, DATED 3-28-2007, EXPIRES 3-28-2017.

SN 77-057,525, FILED 12-5-2006.

BARBARA GAYNOR, EXAMINING ATTORNEY

**Int. Cl.: 42**

**Prior U.S. Cls.: 100 and 101**

**United States Patent and Trademark Office**

**Reg. No. 3,454,467**

**Registered June 24, 2008**

**SERVICE MARK  
PRINCIPAL REGISTER**



PROVIDE, LLC (DELAWARE LTD LIAB CO)  
100 PENCADER DRIVE  
NEWARK, DE 19702

ARTS DESIGNING, HOSTING COMPUTER SITES,  
CREATING AND MAINTAINING WEB SITES FOR  
OTHERS, IN CLASS 42 (U.S. CLS. 100 AND 101).

FOR: HOSTING THE WEB SITES OF OTHERS ON  
A COMPUTER SERVER FOR A GLOBAL COMPU-  
TER NETWORK, COMPUTER PROGRAMMING,  
CONVERSION OF DATA OR DOCUMENTS FROM  
PHYSICAL TO ELECTRONIC MEDIA, GRAPHIC

FIRST USE 10-0-2007; IN COMMERCE 12-0-2007.

SN 77-058,911, FILED 12-7-2006.

DANNEAN HETZEL, EXAMINING ATTORNEY

**Int. Cl.: 5**

**Prior U.S. Cls.: 6, 18, 44, 46, 51, and 52**

**Reg. No. 3,454,468**

**United States Patent and Trademark Office**

**Registered June 24, 2008**

---

**TRADEMARK  
PRINCIPAL REGISTER**

**FAVO**

HARVEST 2000 INTERNATIONAL, INC. (CALIFORNIA CORPORATION)  
1388 W. FOOTHILL BLVD.  
AZUSA, CA 91702

FOR: FUNCTIONAL FOODS, NAMELY, NUTRITIONALLY FORTIFIED SNACKS, NAMELY, CRUNCHES AND WAFERS, MEAL REPLACEMENTS IN THE FORM OF BARS, DRINKS, POWDERS AND SHAKES, DIETARY SUPPLEMENT DRINK MIXES IN LIQUID OR DRY FORMS; FUNCTIONAL FOOD ADDITIVES, NAMELY, DIETARY FIBER, VITAMINS, MINERALS, ANTIOXIDANTS, HERBALS, OMEGA-3 FOR USE AS

SUPPORT TO TOTAL WELL-BEING AND WEIGHT MANAGEMENT, IN CLASS 5 (U.S. CLS. 6, 18, 44, 46, 51 AND 52).

FIRST USE 1-0-2008; IN COMMERCE 1-0-2008.

THE MARK CONSISTS OF STANDARD CHARACTERS WITHOUT CLAIM TO ANY PARTICULAR FONT, STYLE, SIZE, OR COLOR.

SN 77-058,991, FILED 12-7-2006.

DOMINICK J. SALEMI, EXAMINING ATTORNEY



**Int. Cl.: 30**

**Prior U.S. Cl.: 46**

**United States Patent and Trademark Office**

**Reg. No. 3,454,469**

**Registered June 24, 2008**

**TRADEMARK  
PRINCIPAL REGISTER**

**STRAWBERRY FROSTY**

MEDERER GMBH (FED REP GERMANY LTD  
LIAB CO)  
OSTSTRASSE 94  
90763 FÜRTH, FED REP GERMANY

FOR: NON-MEDICATED CANDY MADE OF OR  
CONTAINING FRUIT GUM, NON-MEDICATED  
CANDY MADE OF OR CONTAINING FOAM SU-  
GAR, NON-MEDICATED CANDY MADE OF OR  
CONTAINING JELLY, NON-MEDICATED CANDY  
MADE OF OR CONTAINING LICORICE, IN CLASS  
30 (U.S. CL. 46).

FIRST USE 4-28-2007; IN COMMERCE 8-5-2007.

THE MARK CONSISTS OF STANDARD CHAR-  
ACTERS WITHOUT CLAIM TO ANY PARTICULAR  
FONT, STYLE, SIZE, OR COLOR.

NO CLAIM IS MADE TO THE EXCLUSIVE  
RIGHT TO USE "STRAWBERRY", APART FROM  
THE MARK AS SHOWN.

SN 77-059,336, FILED 12-7-2006.

ELLEN PERKINS, EXAMINING ATTORNEY

Int. Cl.: 36

Prior U.S. Cls.: 100, 101, and 102

United States Patent and Trademark Office

Reg. No. 3,454,470

Registered June 24, 2008

SERVICE MARK  
PRINCIPAL REGISTER



SANTA FE WILD WEST, INC. (NEW MEXICO CORPORATION)  
3 LOS PINOS ROAD  
SANTA FE, NM 87507

FOR: REAL ESTATE BROKERAGE SERVICES, IN CLASS 36 (U.S. CLS. 100, 101 AND 102).

FIRST USE 9-0-2006; IN COMMERCE 9-0-2006.

NO CLAIM IS MADE TO THE EXCLUSIVE RIGHT TO USE "SANTA FE" AND "REAL ESTATE COMPANY", APART FROM THE MARK AS SHOWN.

THE MARK CONSISTS OF THE STYLIZED WORDS "SANTA FE" INSIDE AN OVAL POSI-

TIONED ABOVE THE STYLIZED WORDS "WILD WEST" POSITIONED ABOVE THE WORDS "A REAL ESTATE COMPANY". THREE STARS ARE POSITIONED DIAGONALLY ABOVE THE WORD "WILD". THREE STARS ARE POSITIONED DIAGONALLY ABOVE THE WORD "WEST". LARGER STARS ARE PLACED TO THE LEFT OF THE WORD "WILD" AND TO THE RIGHT OF THE WORD "WEST". ALL OF THE WORDS AND STARS ARE CONTAINED WITHIN A STYLIZED BORDER.

SN 77-059,447, FILED 12-7-2006.

STEVEN JACKSON, EXAMINING ATTORNEY

**Int. Cl.: 35**

**Prior U.S. Cls.: 100, 101, and 102**

**United States Patent and Trademark Office**

**Reg. No. 3,454,471**

**Registered June 24, 2008**

**SERVICE MARK  
PRINCIPAL REGISTER**

WELLNESS INFORMATION ZONE

HUMANA INC. (DELAWARE CORPORATION)  
500 WEST MAIN STREET  
LOUISVILLE, KY 40202

FOR: PROMOTING PUBLIC AWARENESS OF  
THE ACCESSIBILITY OF INFORMATION IN THE  
FIELDS OF HEALTH, MEDICINE, MEDICAL PRACTICES,  
MEDICAL ETHICS, MEDICAL EDUCATION  
AND HEALTH CARE IN PUBLIC LIBRARIES, IN  
CLASS 35 (U.S. CLS. 100, 101 AND 102).

FIRST USE 2-28-2007; IN COMMERCE 2-28-2007.

THE MARK CONSISTS OF STANDARD CHARACTERS  
WITHOUT CLAIM TO ANY PARTICULAR  
FONT, STYLE, SIZE, OR COLOR.

NO CLAIM IS MADE TO THE EXCLUSIVE  
RIGHT TO USE "WELLNESS INFORMATION",  
APART FROM THE MARK AS SHOWN.

SN 77-059,865, FILED 12-8-2006.

CHRISTINA SOBRAL, EXAMINING ATTORNEY

**Int. Cl.: 13**

**Prior U.S. Cls.: 2 and 9**

**United States Patent and Trademark Office**

**Reg. No. 3,454,472**

**Registered June 24, 2008**

**TRADEMARK  
PRINCIPAL REGISTER**

**SNAP-N-PULL**

ALLIANT TECHSYSTEMS INC. (DELAWARE  
CORPORATION)  
5050 LINCOLN DRIVE  
EDINA, MN 55436

FOR: CLEANING IMPLEMENTS FOR FIRE-  
ARMS, NAMELY, CABLES, BRUSHES, GUN  
CLEANING MOPS, GUN CLEANING WIPES, AND  
GUN CLEANING TIPS AND JAGS, IN CLASS 13  
(U.S. CLS. 2 AND 9).

FIRST USE 11-8-2006; IN COMMERCE 3-2-2007.

THE MARK CONSISTS OF STANDARD CHAR-  
ACTERS WITHOUT CLAIM TO ANY PARTICULAR  
FONT, STYLE, SIZE, OR COLOR.

SN 77-059,931, FILED 12-8-2006.

DOMINIC FATHY, EXAMINING ATTORNEY

**Int. Cl.: 24**

**Prior U.S. Cls.: 42 and 50**

**United States Patent and Trademark Office**

**Reg. No. 3,454,473**

**Registered June 24, 2008**

**TRADEMARK  
PRINCIPAL REGISTER**

**NOVELTY QUARTERS**

FABRIC EDITIONS LLC (SOUTH CAROLINA  
CORPORATION)  
1 INDEPENDENCE POINTE, STUDIO 202  
GREENVILLE, SC 29615

THE MARK CONSISTS OF STANDARD CHAR-  
ACTERS WITHOUT CLAIM TO ANY PARTICULAR  
FONT, STYLE, SIZE, OR COLOR.

FOR: KITS COMPRISED OF FABRIC PATCH-  
WORK PIECES FOR MAKING QUILTS, IN CLASS 24  
(U.S. CLS. 42 AND 50).

SN 77-060,280, FILED 12-8-2006.

FIRST USE 10-15-2007; IN COMMERCE 10-15-2007.

JOHN WILKE, EXAMINING ATTORNEY

**Int. Cl.: 33**

**Prior U.S. Cls.: 47 and 49**

**United States Patent and Trademark Office**

**Reg. No. 3,454,474**

**Registered June 24, 2008**

**TRADEMARK  
PRINCIPAL REGISTER**

**RED C**

CHAIM LLC (CALIFORNIA LTD LIAB CO)  
930 NORTH CRANE AVENUE  
ST. HELENA, CA 94574

FOR: GRAPE WINE; TABLE WINES, IN CLASS 33  
(U.S. CLS. 47 AND 49).

FIRST USE 4-1-2008; IN COMMERCE 4-1-2008.

THE MARK CONSISTS OF STANDARD CHARACTERS WITHOUT CLAIM TO ANY PARTICULAR FONT, STYLE, SIZE, OR COLOR.

NO CLAIM IS MADE TO THE EXCLUSIVE RIGHT TO USE "RED", APART FROM THE MARK AS SHOWN.

SN 77-060,789, FILED 12-9-2006.

ANNE E. GUSTASON, EXAMINING ATTORNEY

**Int. Cl.: 3**

**Prior U.S. Cls.: 1, 4, 6, 50, 51, and 52**

**United States Patent and Trademark Office**

**Reg. No. 3,454,475**

**Registered June 24, 2008**

**TRADEMARK  
PRINCIPAL REGISTER**

DREAMING TOMMY HILFIGER

TOMMY HILFIGER LICENSING LLC (DELA-  
WARE LTD LIAB CO)  
601 W. 26TH STREET  
NEW YORK, NY 10001

FOR: BODY AND BEAUTY CARE PREPARA-  
TIONS; COSMETICS; FRAGRANCES FOR PERSO-  
NAL USE; NON-MEDICATED BATH  
PREPARATIONS; NON-MEDICATED SKIN CARE  
PREPARATIONS, IN CLASS 3 (U.S. CLS. 1, 4, 6, 50, 51  
AND 52).

FIRST USE 10-0-2007; IN COMMERCE 1-2-2008.

THE MARK CONSISTS OF STANDARD CHAR-  
ACTERS WITHOUT CLAIM TO ANY PARTICULAR  
FONT, STYLE, SIZE, OR COLOR.

OWNER OF U.S. REG. NOS. 1,398,612, 1,995,802,  
AND OTHERS.

THE NAME "TOMMY HILFIGER" IDENTIFIES A  
LIVING INDIVIDUAL WHOSE CONSENT IS OF  
RECORD.

SN 77-061,148, FILED 12-11-2006.

SCOTT BIBB, EXAMINING ATTORNEY

**Int. Cl.: 9**

**Prior U.S. Cls.: 21, 23, 26, 36, and 38**

**Reg. No. 3,454,476**

**United States Patent and Trademark Office**

**Registered June 24, 2008**

**TRADEMARK  
PRINCIPAL REGISTER**

**FOLLOW THE READER**

SIMON & SCHUSTER, INC. (NEW YORK CORPORATION)  
1230 AVENUE OF THE AMERICAS  
NEW YORK, NY 10020

THE MARK CONSISTS OF STANDARD CHARACTERS WITHOUT CLAIM TO ANY PARTICULAR FONT, STYLE, SIZE, OR COLOR.

FOR: INTERACTIVE VIDEO GAME PROGRAMS AND REMOTE CONTROL UNITS FOR USE TOGETHER WITH A SERIES OF CHILDREN'S BOOKS, IN CLASS 9 (U.S. CLS. 21, 23, 26, 36 AND 38).

SN 77-061,169, FILED 12-11-2006.

FIRST USE 10-23-2007; IN COMMERCE 10-23-2007.

MICHAEL ENGEL, EXAMINING ATTORNEY



**Int. Cl.: 11**

**Prior U.S. Cls.: 13, 21, 23, 31, and 34**

**United States Patent and Trademark Office**

**Reg. No. 3,454,477**

**Registered June 24, 2008**

**TRADEMARK  
PRINCIPAL REGISTER**

**MULTI-FLEX CRAFT FLOOR LAMP**

ENVIRONMENTAL LIGHTING CONCEPTS, INC.  
(DELAWARE CORPORATION)

1214 WEST CASS STREET

TAMPA, FL 33606

FOR: LIGHT BULBS; LIGHTING FIXTURES, IN  
CLASS 11 (U.S. CLS. 13, 21, 23, 31 AND 34).

FIRST USE 5-0-2007; IN COMMERCE 5-0-2007.

THE MARK CONSISTS OF STANDARD CHAR-  
ACTERS WITHOUT CLAIM TO ANY PARTICULAR  
FONT, STYLE, SIZE, OR COLOR.

NO CLAIM IS MADE TO THE EXCLUSIVE  
RIGHT TO USE "CRAFT FLOOR LAMP", APART  
FROM THE MARK AS SHOWN.

SN 77-061,514, FILED 12-11-2006.

KAREN SEVERSON, EXAMINING ATTORNEY

**Int. Cl.: 36**

**Prior U.S. Cls.: 100, 101, and 102**

**United States Patent and Trademark Office**

**Reg. No. 3,454,478**

**Registered June 24, 2008**

**SERVICE MARK  
PRINCIPAL REGISTER**

**GBFG**

THE GB FINANCIAL GROUP INC. (MASSACHU-  
SETTS CORPORATION)  
11 MAYO ROAD  
WELLESLEY, MA 02482

FOR: FINANCIAL SERVICES, NAMELY, FINAN-  
CIAL MANAGEMENT, FINANCIAL PLANNING,  
ESTATE PLANNING, FINANCIAL CONSULTA-  
TION IN THE FIELD OF EXECUTIVE COMPENSA-  
TION AND ASSET MANAGEMENT; FINANCIAL  
CONSULTATION SERVICES; LIFE INSURANCE  
BROKERAGE; INVESTMENT SERVICES, NAMELY,  
INVESTMENT CONSULTATION, INVESTMENT  
BROKERAGE AND INVESTMENT OF FUNDS

FOR OTHERS, IN CLASS 36 (U.S. CLS. 100, 101  
AND 102).

FIRST USE 9-1-2007; IN COMMERCE 9-1-2007.

THE MARK CONSISTS OF STANDARD CHAR-  
ACTERS WITHOUT CLAIM TO ANY PARTICULAR  
FONT, STYLE, SIZE, OR COLOR.

SN 77-061,517, FILED 12-11-2006.

KAREN SEVERSON, EXAMINING ATTORNEY

Int. Cl.: 35

Prior U.S. Cls.: 100, 101, and 102

United States Patent and Trademark Office

Reg. No. 3,454,479

Registered June 24, 2008

**SERVICE MARK  
PRINCIPAL REGISTER**

# City Residential

JONES, MICHAEL S. (CALIFORNIA SOLE PROPRIETORSHIP)  
PO BOX 7851  
BERKELEY, CA 94707

FOR: ADVERTISING AND ADVERTISEMENT SERVICES; ADVERTISING AND COMMERCIAL INFORMATION SERVICES, VIA THE INTERNET; ADVERTISING AND MARKETING; ADVERTISING PARTICULARLY SERVICES FOR THE PROMOTION OF GOODS; ADVERTISING SERVICES; DISSEMINATION OF ADVERTISING FOR OTHERS VIA AN ON-LINE COMMUNICATIONS NETWORK ON THE INTERNET; DISSEMINATION OF ADVERTISING FOR OTHERS VIA THE INTERNET; ELECTRONIC COMMERCE SERVICES, NAMELY, PROVIDING INFORMATION PRODUCTS VIA TELECOMMUNICATION NETWORKS FOR ADVERTISING AND SALES PURPOSES; INFOMEDIARY SERVICES, NAMELY, FACILITATING TRANSACTIONS BETWEEN BUYERS AND SELLERS THROUGH PROVIDING BUYERS WITH INFORMATION ABOUT SELLERS, GOODS, AND/OR SERVICES; ON-LINE ADVERTISING AND MARKETING SERVICES; ON-LINE ADVERTISING ON COMPUTER COMMUNICATION NETWORKS; OPERATING ON-LINE MARKETPLACES FOR SELLERS OF GOODS AND/OR SERVICES; PROMOTING THE GOODS AND SERVICES OF OTHERS VIA A GLOBAL COMPUTER NETWORK; PROVID-

ING A WEB SITE AT WHICH USERS CAN OFFER GOODS FOR SALE AND BUY GOODS OFFERED BY OTHERS; PROVIDING A WEB SITE THAT ENABLES USERS TO POST ITEMS FOR SALE THROUGH ON-LINE CLASSIFIED ADVERTISEMENTS; PROVIDING A WEB SITE WHICH FEATURES ADVERTISEMENTS FOR THE GOODS AND SERVICES OF OTHERS ON A GLOBAL COMPUTER NETWORK; PROVIDING CONSUMER PRODUCT INFORMATION VIA THE INTERNET; PROVIDING INFORMATION ABOUT THE GOODS AND SERVICES OF OTHERS VIA THE GLOBAL COMPUTER NETWORK; PROVIDING SPACE AT A WEB SITE FOR THE ADVERTISEMENT OF THE GOODS AND SERVICES OF OTHERS; PROVISION OF ADVERTISING SPACE BY ELECTRONIC MEANS AND GLOBAL INFORMATION NETWORKS, IN CLASS 35 (U.S. CLS. 100, 101 AND 102).

FIRST USE 7-27-2005; IN COMMERCE 5-25-2007.

THE MARK CONSISTS OF STANDARD CHARACTERS WITHOUT CLAIM TO ANY PARTICULAR FONT, STYLE, SIZE, OR COLOR.

SN 77-061,645, FILED 12-11-2006.

KIMBERLY PERRY, EXAMINING ATTORNEY

**Int. Cl.: 12**

**Prior U.S. Cls.: 19, 21, 23, 31, 35, and 44**

**Reg. No. 3,454,480**

**United States Patent and Trademark Office**

**Registered June 24, 2008**

---

**TRADEMARK  
PRINCIPAL REGISTER**

**Bagpax**

BAGPAX CARGO SYSTEMS E.K. (FED REP  
GERMANY SOLE PROPRIETORSHIP)  
GUTENBERSTRASSE 1  
SAARLOUIS, FED REP GERMANY 66740

THE MARK CONSISTS OF STANDARD CHAR-  
ACTERS WITHOUT CLAIM TO ANY PARTICULAR  
FONT, STYLE, SIZE, OR COLOR.

FOR: FITTED LINERS FOR THE CARGO AREA  
OF VEHICLES, IN CLASS 12 (U.S. CLS. 19, 21, 23, 31,  
35 AND 44).

SN 77-062,107, FILED 12-12-2006.

FIRST USE 6-1-2006; IN COMMERCE 6-1-2006.

TINA BROWN, EXAMINING ATTORNEY

**Int. Cl.: 25**

**Prior U.S. Cls.: 22 and 39**

**United States Patent and Trademark Office**

**Reg. No. 3,454,481**

**Registered June 24, 2008**

**TRADEMARK  
PRINCIPAL REGISTER**

**DIANA ONIHARA**

TOPSEVEN, INC. (CALIFORNIA CORPORATION), DBA BEROTEX,  
P.O. BOX 6433  
WOODLAND HILLS, CA 913656433

FOR: CLOTHING, NAMELY, SHIRTS, PANTS, T-SHIRTS, SHORTS, JACKETS, DRESSES AND SKIRTS, IN CLASS 25 (U.S. CLS. 22 AND 39).

FIRST USE 3-4-2007; IN COMMERCE 3-4-2007.

THE MARK CONSISTS OF STANDARD CHARACTERS WITHOUT CLAIM TO ANY PARTICULAR FONT, STYLE, SIZE, OR COLOR.

"THE NAME(S), PORTRAIT(S), AND/OR SIGNATURE(S) SHOWN IN THE MARK DOES NOT IDENTIFY A PARTICULAR LIVING INDIVIDUAL."

SN 77-062,386, FILED 12-12-2006.

ANNE E. GUSTASON, EXAMINING ATTORNEY

**Int. Cls.: 3 and 4**

**Prior U.S. Cls.: 1, 4, 6, 15, 50, 51, and 52**

**United States Patent and Trademark Office**

**Reg. No. 3,454,482**

**Registered June 24, 2008**

**TRADEMARK  
PRINCIPAL REGISTER**



LUXE ESSENTIALS, INC. (ILLINOIS CORPORATION)  
SUITE 864  
53 WEST JACKSON  
CHICAGO, IL 60604

FOR: PERSONAL CARE PRODUCTS, NAMELY, BODY SPRAY, BODY GLITTER SPRAY; SOAP PRODUCTS, NAMELY, LIQUID SOAP; LOTION PRODUCTS, NAMELY, BODY LOTION, HAND LOTION, BODY CREAM; BATH PRODUCTS, NAMELY, BATH FOAM, BATH CRYSTALS, BATH BEADS, BATH OIL, BODY SCRUB, BATH SCRUB, FOAMING BATH AND SHOWER CREAM, FOAMING SCRUB, BATH GEL; PERSONAL FRAGRANCE PRODUCTS, NAMELY, PERFUME OILS; HOME FRAGRANCE PRODUCTS, NAMELY, SACHET, LINEN SPRAY, ROOM SPRAY, AROMA CRYSTALS, AROMA BEADS, AROMATIC REED DIFFUSERS COMPRISING FRAGRANCE OILS, GLASS

CONTAINER AND REEDS ALL SOLD AS A UNIT, IN CLASS 3 (U.S. CLS. 1, 4, 6, 50, 51 AND 52).

FIRST USE 1-31-2008; IN COMMERCE 1-31-2008.

FOR: SCENTED CANDLES, IN CLASS 4 (U.S. CLS. 1, 6 AND 15).

FIRST USE 1-31-2008; IN COMMERCE 1-31-2008.

THE MARK CONSISTS OF A CRESCENT MOON SHAPE WITH POINTS DIRECTED UPWARD AND A VERTICAL WAVE SHAPE FLOATING ABOVE SAID CRESCENT MOON SHAPE WITH BOTH SHAPES ENCLOSED WITHIN A VERTICAL OVAL.

SN 77-062,403, FILED 12-12-2006.

CHRIS WELLS, EXAMINING ATTORNEY

**Int. Cl.: 25**

**Prior U.S. Cls.: 22 and 39**

**United States Patent and Trademark Office**

**Reg. No. 3,454,483**

**Registered June 24, 2008**

**TRADEMARK  
PRINCIPAL REGISTER**

**SELBORN**

TOPSEVEN, INC. DBA BEROTEX (CALIFORNIA  
CORPORATION)  
P.O. BOX 6433  
WOODLAND HILLS, CA 913656433

FOR: CLOTHING, NAMELY, SHIRTS, PANTS, T-  
SHIRTS, FOOTWEAR, SHORTS, SWIMWEAR, LIN-  
GERIE, UNDERWEAR, JACKETS, DRESSES AND  
SKIRTS; BELTS; SCARVES; GLOVES, IN CLASS 25  
(U.S. CLS. 22 AND 39).

FIRST USE 4-0-2007; IN COMMERCE 4-0-2007.

THE MARK CONSISTS OF STANDARD CHAR-  
ACTERS WITHOUT CLAIM TO ANY PARTICULAR  
FONT, STYLE, SIZE, OR COLOR.

SN 77-062,415, FILED 12-12-2006.

ANNE E. GUSTASON, EXAMINING ATTORNEY

**Int. Cls.: 38 and 41**

**Prior U.S. Cls.: 100, 101, 104, and 107**

**United States Patent and Trademark Office**

**Reg. No. 3,454,484**

**Registered June 24, 2008**

**SERVICE MARK  
PRINCIPAL REGISTER**

**DAME**

DAME MEDIA, LLC (DELAWARE LTD LIAB CO)  
2155 NORTH BELL STREET  
CHICAGO, IL 60647

FOR: PROVIDING ON-LINE ELECTRONIC BULLETIN BOARDS AND CHAT ROOMS FOR TRANSMISSION OF MESSAGES AND DATA AMONG COMPUTER USERS CONCERNING FINANCE, POLITICS, HOME REPAIR, LIFESTYLE, ENTERTAINMENT, BEAUTY, FASHION TRENDS, POP CULTURE, NEWS, FITNESS, FOOD, IN CLASS 38 (U.S. CLS. 100, 101 AND 104).

FIRST USE 7-0-2007; IN COMMERCE 7-0-2007.

FOR: ONLINE JOURNALS, NAMELY, BLOGS IN THE FIELD OF FINANCE, POLITICS, HOME REPAIR, LIFESTYLE, ENTERTAINMENT, BEAUTY,

FASHION TRENDS, POP CULTURE, NEWS, FITNESS, FOOD; PROVIDING AN ON-LINE MAGAZINE FEATURING INFORMATION RELATED TO FINANCE, POLITICS, HOME REPAIR, LIFESTYLE, ENTERTAINMENT, BEAUTY, FASHION TRENDS, POP CULTURE, NEWS, FITNESS, FOOD, IN CLASS 41 (U.S. CLS. 100, 101 AND 107).

FIRST USE 7-0-2007; IN COMMERCE 7-0-2007.

THE MARK CONSISTS OF STANDARD CHARACTERS WITHOUT CLAIM TO ANY PARTICULAR FONT, STYLE, SIZE, OR COLOR.

SN 77-062,633, FILED 12-12-2006.

TOBY BULLOFF, EXAMINING ATTORNEY



**Int. Cl.: 25**

**Prior U.S. Cls.: 22 and 39**

**United States Patent and Trademark Office**

**Reg. No. 3,454,485**

**Registered June 24, 2008**

**TRADEMARK  
PRINCIPAL REGISTER**

**KOM-TECH**

KOMBI LIMITED (CONNECTICUT CORPORATION)  
67 THOMPSON DRIVE  
ESSEX JUNCTION, VT 05451

FOR: GLOVES, SKI GLOVES AND HEADWEAR,  
NAMELY, HATS AND HEADBANDS, IN CLASS 25  
(U.S. CLS. 22 AND 39).

FIRST USE 8-10-2007; IN COMMERCE 8-10-2007.

THE MARK CONSISTS OF STANDARD CHARACTERS WITHOUT CLAIM TO ANY PARTICULAR FONT, STYLE, SIZE, OR COLOR.

OWNER OF U.S. REG. NO. 2,581,052.

SN 77-063,181, FILED 12-13-2006.

JAMES A. RAUEN, EXAMINING ATTORNEY

**Int. Cl.: 41**

**Prior U.S. Cls.: 100, 101, and 107**

**United States Patent and Trademark Office**

**Reg. No. 3,454,486**

**Registered June 24, 2008**

**SERVICE MARK  
PRINCIPAL REGISTER**

**L V AND NEVADA**

GARZA, RAYNALDO (UNITED STATES INDIVIDUAL)  
14 MONARCH BAY PLAZA, SUITE 475  
MONARCH BEACH, CA 92629

FOR: ENTERTAINMENT SERVICES, NAMELY, LIVE STAGE PERFORMANCES AND EVENTS BY FICTIONAL CHARACTERS, LV AND NEVADA; ENTERTAINMENT IN THE NATURE OF AN ONGOING TELEVISION VARIETY PROGRAM FEATURING FICTIONAL CHARACTERS L V AND NEVADA, IN CLASS 41 (U.S. CLS. 100, 101 AND 107).

FIRST USE 12-13-2006; IN COMMERCE 5-17-2007.

THE MARK CONSISTS OF STANDARD CHARACTERS WITHOUT CLAIM TO ANY PARTICULAR FONT, STYLE, SIZE, OR COLOR.

SN 77-063,297, FILED 12-13-2006.

TINA KUAN, EXAMINING ATTORNEY

**Int. Cl.: 28**

**Prior U.S. Cls.: 22, 23, 38, and 50**

**United States Patent and Trademark Office**

**Reg. No. 3,454,487**

**Registered June 24, 2008**

**TRADEMARK  
PRINCIPAL REGISTER**

**HANG GLIDER**

LANDSCAPE STRUCTURES, INC. (MINNESOTA  
CORPORATION)  
P.O. BOX 198  
601 7TH STREET SOUTH  
DELANO, MN 553280198

FOR: PLAYGROUND EQUIPMENT, NAMELY,  
DEVICES FOR SLIDING AND CLIMBING, NAME-  
LY, SLIDES, IN CLASS 28 (U.S. CLS. 22, 23, 38 AND  
50).

FIRST USE 12-7-2006; IN COMMERCE 12-7-2006.

THE MARK CONSISTS OF STANDARD CHAR-  
ACTERS WITHOUT CLAIM TO ANY PARTICULAR  
FONT, STYLE, SIZE, OR COLOR.

SN 77-063,647, FILED 12-13-2006.

STEVEN JACKSON, EXAMINING ATTORNEY

**Int. Cl.: 42**

**Prior U.S. Cls.: 100 and 101**

**United States Patent and Trademark Office**

**Reg. No. 3,454,488**

**Registered June 24, 2008**

**SERVICE MARK  
PRINCIPAL REGISTER**



TIM Y. TODA (UNITED STATES INDIVIDUAL)  
BOX #435  
1042 E FORT UNION  
MIDVALE, UT 84047

FOR: PROVIDING QUALITY ASSURANCE SERVICES IN THE FIELD OF SCIENCE, TECHNOLOGY, MEDICINE, AND HEALTH, AND RELATED ANALYSIS; QUALITY CONTROL FOR OTHERS; RESEARCH AND DEVELOPMENT AND CONSULTATION RELATED THERETO IN THE FIELD OF SCIENCE, TECHNOLOGY, MEDICINE, AND HEALTH, AND RELATED ANALYSIS, IN CLASS 42 (U.S. CLS. 100 AND 101).

FIRST USE 12-13-2006; IN COMMERCE 12-13-2006.

NO CLAIM IS MADE TO THE EXCLUSIVE RIGHT TO USE "CONSULTING", APART FROM THE MARK AS SHOWN.

THE COLOR(S) BLACK, GRAY AND WHITE IS/ARE CLAIMED AS A FEATURE OF THE MARK.

THE WORDING THIRD CONSULTING APPEARS IN BLACK, THE WORD GEN APPEARS IN GRAY, THE DESIGN OF THE ASIAN CHARACTER IN BLACK AND WHITE, AND THE SAME SYMBOL APPEARS AS A SHADOW IN GRAY AND WHITE AS A BACKDROP.

THE NON-LATIN CHARACTERS IN THE MARK transliterate to "SAN" AND THIS MEANS "THIRD" IN ENGLISH.

THE NON-LATIN CHARACTERS IN THE MARK transliterate to SAN AND THIS MEANS THIRD IN ENGLISH.

SN 77-063,771, FILED 12-13-2006.

ANNE E. GUSTASON, EXAMINING ATTORNEY

**Int. Cl.: 21**

**Prior U.S. Cls.: 2, 13, 23, 29, 30, 33, 40, and 50**

**Reg. No. 3,454,489**

**United States Patent and Trademark Office**

**Registered June 24, 2008**

**TRADEMARK  
PRINCIPAL REGISTER**

# Waccamaw

BRANDED LLC (GEORGIA LTD LIAB CO)  
3333 LEE PARKWAY SIXTH FLOOR  
DALLAS, TX 75219

FOR: CONTAINERS MADE OF NON-PRECIOUS METAL FOR HOUSEHOLD USE AND GLASS, PORCELAIN AND EARTHEN WARE FOR HOUSEHOLD AND KITCHEN USE, NAMELY, POTS AND PANS, DISHES, BOWLS, CUPS, BEVERAGE GLASSWARE, COFFEE POTS, TEAPOTS, TEA KETTLES, TRIVETS, TRAYS, SPICE RACKS, CANDLESTICKS, CANDLE HOLDERS NOT OF PRECIOUS METAL; COASTERS NOT OF PAPER BEING LEATHER AND PLASTIC; BASKETS OF WICKER AND WOOD FOR HOUSEHOLD USE; BUCKETS; CLOTHES AND DISH DRY-

ING RACKS; TOWEL HOLDERS; TRASH CANS, IN CLASS 21 (U.S. CLS. 2, 13, 23, 29, 30, 33, 40 AND 50).

FIRST USE 11-15-2007; IN COMMERCE 11-15-2007.

THE MARK CONSISTS OF STANDARD CHARACTERS WITHOUT CLAIM TO ANY PARTICULAR FONT, STYLE, SIZE, OR COLOR.

THE WORDING "WACCAMAW" HAS NO MEANING IN A FOREIGN LANGUAGE.

SN 77-063,875, FILED 12-13-2006.

B. PARADEWELAI, EXAMINING ATTORNEY

**Int. Cls.: 9, 18, and 25**

**Prior U.S. Cls.: 1, 2, 3, 21, 22, 23, 26, 36, 38, 39, and 41**

**Reg. No. 3,454,490**

**United States Patent and Trademark Office**

**Registered June 24, 2008**

**TRADEMARK  
PRINCIPAL REGISTER**

**Dear**

4004 INCORPORATED (PENNSYLVANIA CORPORATION)  
12 HARBOR PARK DRIVE  
PORT WASHINGTON, NY 11050

FOR: SUNGLASSES AND EYEWEAR ACCESSORIES, NAMELY, STRAPS, NECK CORDS AND HEAD STRAPS WHICH RESTRAIN EYEWEAR FROM MOVEMENT ON A WEARER, IN CLASS 9 (U.S. CLS. 21, 23, 26, 36 AND 38).

FIRST USE 5-15-2007; IN COMMERCE 8-16-2007.

FOR: WALLETTS, BOOKBAGS, CARRY ALL BAGS, TOTE BAGS, HANDBAGS, MESSENGER BAGS, POCKETBOOKS, CLUTCH PURSES, OVERNIGHT BAGS, BACKPACKS, AND PURSES, IN CLASS 18 (U.S. CLS. 1, 2, 3, 22 AND 41).

FIRST USE 5-15-2007; IN COMMERCE 8-16-2007.

FOR: PANTS, JEANS, SHIRTS, SKIRTS, SHORTS, DRESSES, SWEATERS, LINGERIE, HOSIERY, JACKETS, OUTERWEAR, NAMELY, RAINWEAR AND PARKAS, COATS, FOOTWEAR, HEADWEAR, GLOVES, SCARVES, SOCKS, TRACKSUITS, SWIMWEAR, BEACHWEAR, SLIPPERS, PAJAMAS, BELTS, BRAS, IN CLASS 25 (U.S. CLS. 22 AND 39).

FIRST USE 5-15-2007; IN COMMERCE 8-16-2007.

THE MARK CONSISTS OF STANDARD CHARACTERS WITHOUT CLAIM TO ANY PARTICULAR FONT, STYLE, SIZE, OR COLOR.

SN 77-063,926, FILED 12-14-2006.

WON TEAK OH, EXAMINING ATTORNEY

**Int. Cl.: 9**

**Prior U.S. Cls.: 21, 23, 26, 36, and 38**

**United States Patent and Trademark Office**

**Reg. No. 3,454,491**

**Registered June 24, 2008**

**TRADEMARK  
PRINCIPAL REGISTER**

**PRICING PARTNER**

SHESHUNOFF MANAGEMENT SERVICES  
(TEXAS CORPORATION)  
2801 VIA FORTUNA, SUITE 600  
AUSTIN, TX 78746

FOR: COMPUTER SOFTWARE, NAMELY, BANKING SOFTWARE TO FACILITATE AND TRACK LOAN WORK-FLOW, TERMS, VOLUME, RATE, FEES, DEPOSITS AND INCREMENTAL PROFIT AT FINANCIAL INSTITUTIONS; COMPUTER SOFTWARE, NAMELY, SOFTWARE FOR ANALYZING BANK TO BANK AND LOAN OFFICER TO LOAN OFFICER RELATIONSHIPS, ACTUAL VERSUS APPROVED METRICS PER RELATIONSHIP, AND TARGETED STRATEGIC GOALS; COMPUTER SOFTWARE, NAMELY, SOFTWARE FOR TRACKING PERFORMANCE AND INCENTIVE PAY AT FINANCIAL INSTITUTIONS; COMPUTER SOFTWARE, NAMELY, SOFTWARE FOR BANKING AND FINANCIAL INSTITUTION ORGANIZATION, FINANCIAL ANALYSIS AND REPORTING, FINANCIAL TRANSACTION PRO-

CESSING AND MANAGEMENT, FINANCIAL ACCOUNT PROCESSING AND MANAGEMENT, LOAN DATA CAPTURE, AND MANAGING LOAN PROCESSING WORK-FLOW CUSTOMER SERVICE ISSUES; COMPUTER SOFTWARE, NAMELY, SOFTWARE TO MONITOR, TRACK, REPORT AND DETERMINE LONG-TERM NET INTEREST INCOME AND IDENTIFY KEY LOAN INFORMATION IN EXISTING FINANCIAL INSTITUTION PORTFOLIOS, IN CLASS 9 (U.S. CLS. 21, 23, 26, 36 AND 38).

FIRST USE 7-0-2006; IN COMMERCE 8-16-2006.

THE MARK CONSISTS OF STANDARD CHARACTERS WITHOUT CLAIM TO ANY PARTICULAR FONT, STYLE, SIZE, OR COLOR.

SN 77-064,083, FILED 12-14-2006.

KATHERINE CHANG, EXAMINING ATTORNEY

**Int. Cl.: 35**

**Prior U.S. Cls.: 100, 101, and 102**

**United States Patent and Trademark Office**

**Reg. No. 3,454,492**

**Registered June 24, 2008**

**SERVICE MARK  
PRINCIPAL REGISTER**

**Dimensional Investigations**

HR ACUITY (NEW JERSEY LTD LIAB CO)  
SUITE 210  
641 SHUNPIKE ROAD,  
CHATHAM, NJ 07928

FOR: BUSINESS INVESTIGATIONS, IN CLASS 35  
(U.S. CLS. 100, 101 AND 102).

FIRST USE 6-5-2006; IN COMMERCE 6-5-2006.

THE MARK CONSISTS OF STANDARD CHAR-  
ACTERS WITHOUT CLAIM TO ANY PARTICULAR  
FONT, STYLE, SIZE, OR COLOR.

NO CLAIM IS MADE TO THE EXCLUSIVE  
RIGHT TO USE "INVESTIGATIONS", APART FROM  
THE MARK AS SHOWN.

SN 77-064,193, FILED 12-14-2006.

DORITT L. CARROLL, EXAMINING ATTORNEY



**Int. Cl.: 28**

**Prior U.S. Cls.: 22, 23, 38, and 50**

**United States Patent and Trademark Office**

**Reg. No. 3,454,493**

**Registered June 24, 2008**

**TRADEMARK  
PRINCIPAL REGISTER**

**ADVANZ** 

PACP INC. (CALIFORNIA CORPORATION)  
31 PAMARON WAY STE D  
NOVATO, CA 94949

FIRST USE 5-8-2007; IN COMMERCE 11-16-2007.

FOR: FISHING LINES; FISHING LURES; FISH-  
ING REELS; FISHING RODS; FISHING TACKLE;  
FISHING TACKLE BOXES, IN CLASS 28 (U.S. CLS.  
22, 23, 38 AND 50).

SN 77-065,322, FILED 12-15-2006.

GENE MACIOL, EXAMINING ATTORNEY

**Int. Cl.: 20**

**Prior U.S. Cls.: 2, 13, 22, 25, 32, and 50**

**Reg. No. 3,454,494**

**United States Patent and Trademark Office**

**Registered June 24, 2008**

**TRADEMARK  
PRINCIPAL REGISTER**

**PARC CENTRE**

LANDSCAPE FORMS, INC. (MICHIGAN CORPORATION)  
431 LAWNSDALE AVENUE  
KALAMAZOO, MI 49048

THE MARK CONSISTS OF STANDARD CHARACTERS WITHOUT CLAIM TO ANY PARTICULAR FONT, STYLE, SIZE, OR COLOR.

FOR: SITE FURNISHINGS, NAMELY, A CHAIR AND TABLE, IN CLASS 20 (U.S. CLS. 2, 13, 22, 25, 32 AND 50).

SN 77-065,434, FILED 12-15-2006.

FIRST USE 10-22-2007; IN COMMERCE 1-15-2008.

APRIL ROACH, EXAMINING ATTORNEY

**Int. Cl.: 36**

**Prior U.S. Cls.: 100, 101, and 102**

**United States Patent and Trademark Office**

**Reg. No. 3,454,495**

**Registered June 24, 2008**

**SERVICE MARK  
PRINCIPAL REGISTER**

**KEEN**

KEEN, INC. (DELAWARE CORPORATION)  
926 NW 13TH AVENUE, SUITE 210  
PORTLAND, OR 97209

FOR: CHARITABLE FUNDRAISING; PROVIDING GRANTS TO CHARITABLE ORGANIZATIONS; FINANCIAL SERVICES, NAMELY, CHARITABLE SERVICES IN THE FIELD OF MONETARY DONATIONS, IN CLASS 36 (U.S. CLS. 100, 101 AND 102).

FIRST USE 4-1-2008; IN COMMERCE 4-1-2008.

THE MARK CONSISTS OF STANDARD CHARACTERS WITHOUT CLAIM TO ANY PARTICULAR FONT, STYLE, SIZE, OR COLOR.

SN 77-065,753, FILED 12-15-2006.

VERNA BETH RIRIE, EXAMINING ATTORNEY

**Int. Cl.: 36**

**Prior U.S. Cls.: 100, 101, and 102**

**United States Patent and Trademark Office**

**Reg. No. 3,454,496**

**Registered June 24, 2008**

**SERVICE MARK  
PRINCIPAL REGISTER**

**FIRSTMERIT CREDIT SERVICES**

FIRSTMERIT CORPORATION (OHIO CORPORATION)  
III CASCADE PLAZA  
AKRON, OH 44308

OWNER OF U.S. REG. NOS. 1,877,966, 2,867,527,  
AND OTHERS.

FOR: BANKING; LEASE-PURCHASE FINANCING;  
LOAN FINANCING, IN CLASS 36 (U.S. CLS. 100,  
101 AND 102).

NO CLAIM IS MADE TO THE EXCLUSIVE  
RIGHT TO USE "CREDIT SERVICES", APART  
FROM THE MARK AS SHOWN.

FIRST USE 11-29-2006; IN COMMERCE 11-29-2006.

SN 77-065,830, FILED 12-16-2006.

THE MARK CONSISTS OF STANDARD CHARACTERS  
WITHOUT CLAIM TO ANY PARTICULAR FONT,  
STYLE, SIZE, OR COLOR.

MICHAEL TANNER, EXAMINING ATTORNEY

**Int. Cl.: 41**

**Prior U.S. Cls.: 100, 101, and 107**

**United States Patent and Trademark Office**

**Reg. No. 3,454,497**

**Registered June 24, 2008**

**SERVICE MARK  
PRINCIPAL REGISTER**

**MY GRAMMY MOMENT**

NATIONAL ACADEMY OF RECORDING ARTS  
& SCIENCES, INC. (DELAWARE CORPORATION)  
3402 PICO BOULEVARD  
SANTA MONICA, CA 90405

FOR: ENTERTAINMENT IN THE NATURE OF  
COMPETITIONS IN THE FIELD OF MUSIC; EN-  
TERTAINMENT SERVICES, NAMELY, LIVE AND  
TELEVISED PERFORMANCES BY MUSICAL AR-  
TISTS AND MUSICAL GROUPS; PROVIDING A  
WEBSITE FEATURING MUSICAL PERFORMAN-  
CES, PHOTOGRAPHS, NEWS, AND OTHER MULTI-  
MEDIA ARTICLES IN CONNECTION WITH THE  
MUSICAL COMPETITIONS, IN CLASS 41 (U.S. CLS.  
100, 101 AND 107).

FIRST USE 12-0-2006; IN COMMERCE 12-0-2006.

THE MARK CONSISTS OF STANDARD CHAR-  
ACTERS WITHOUT CLAIM TO ANY PARTICULAR  
FONT, STYLE, SIZE, OR COLOR.

OWNER OF U.S. REG. NOS. 2,332,258, 3,115,313,  
AND OTHERS.

SN 77-066,099, FILED 12-18-2006.

MICHAEL WEBSTER, EXAMINING ATTORNEY

**Int. Cls.: 9, 38, and 42**

**Prior U.S. Cls.: 21, 23, 26, 36, 38, 100, 101, and 104**

**United States Patent and Trademark Office**

**Reg. No. 3,454,498**

**Registered June 24, 2008**

**TRADEMARK  
SERVICE MARK  
PRINCIPAL REGISTER**

# OVERSTREAM

OVERSTREAM, INC. (DELAWARE CORPORATION)  
SUITE 600  
235 MONTGOMERY STREET  
SAN FRANCISCO, CA 94104

FOR: COMPUTER SOFTWARE FOR USE IN CUSTOMIZING VIDEOS, INCLUDING ADDING SUBTITLES, TEXT AND ADDITIONAL CONTENT TO THE VIDEOS, IN CLASS 9 (U.S. CLS. 21, 23, 26, 36 AND 38).

FIRST USE 12-12-2006; IN COMMERCE 12-12-2006.

FOR: VIDEO STREAMING SERVICES, IN CLASS 38 (U.S. CLS. 100, 101 AND 104).

FIRST USE 12-12-2006; IN COMMERCE 12-12-2006.

FOR: PROVIDING TEMPORARY USE OF ONLINE, NON-DOWNLOADABLE SOFTWARE FOR USE IN CUSTOMIZING VIDEOS, INCLUDING ADDING SUBTITLES, TEXT AND ADDITIONAL CONTENT TO THE VIDEOS; CONSULTING SERVICES IN THE FIELD OF CUSTOMIZING VIDEOS, INCLUDING ADDING SUBTITLES, TEXT AND ADDITIONAL CONTENT TO THE VIDEOS, IN CLASS 42 (U.S. CLS. 100 AND 101).

FIRST USE 12-12-2006; IN COMMERCE 12-12-2006.

THE MARK CONSISTS OF STANDARD CHARACTERS WITHOUT CLAIM TO ANY PARTICULAR FONT, STYLE, SIZE, OR COLOR.

SN 77-066,593, FILED 12-18-2006.

CHRISTINE COOPER, EXAMINING ATTORNEY

**Int. Cl.: 37**

**Prior U.S. Cls.: 100, 103, and 106**

**United States Patent and Trademark Office**

**Reg. No. 3,454,499**

**Registered June 24, 2008**

**SERVICE MARK  
PRINCIPAL REGISTER**

**Green Universe**

SUNCATCHER COMMUNITIES, LLC (TEXAS  
LTD LIAB CO)  
3217 SHADY GLEN DR.  
GRAPEVINE, TX 76051

FOR: LAND DEVELOPMENT AND REAL ES-  
TATE CONSTRUCTION OF ENERGY-EFFICIENT  
RESIDENTIAL AND COMMERCIAL PROPERTIES,  
IN CLASS 37 (U.S. CLS. 100, 103 AND 106).

FIRST USE 3-31-2008; IN COMMERCE 3-31-2008.

THE MARK CONSISTS OF STANDARD CHAR-  
ACTERS WITHOUT CLAIM TO ANY PARTICULAR  
FONT, STYLE, SIZE, OR COLOR.

NO CLAIM IS MADE TO THE EXCLUSIVE  
RIGHT TO USE "GREEN", APART FROM THE  
MARK AS SHOWN.

SN 77-066,776, FILED 12-18-2006.

JOHN E. MICHOS, EXAMINING ATTORNEY

**Int. Cl.: 41**

**Prior U.S. Cls.: 100, 101, and 107**

**United States Patent and Trademark Office**

**Reg. No. 3,454,500**

**Registered June 24, 2008**

**SERVICE MARK  
PRINCIPAL REGISTER**

**VOXPOP.TV**

VOXPOP NETWORK CORPORATION (DELA-  
WARE CORPORATION)  
PIER 9, SUITE 116  
SAN FRANCISCO, CA 94111

FOR: ENTERTAINMENT SERVICES, NAMELY  
PROVIDING A WEBSITE FEATURING INTERAC-  
TIVE ONLINE GAMES VIA A GLOBAL COMPUTER  
NETWORK, IN CLASS 41 (U.S. CLS. 100, 101 AND  
107).

FIRST USE 4-1-2006; IN COMMERCE 2-1-2007.

THE MARK CONSISTS OF STANDARD CHAR-  
ACTERS WITHOUT CLAIM TO ANY PARTICULAR  
FONT, STYLE, SIZE, OR COLOR.

SN 77-066,911, FILED 12-18-2006.

ALYSSA PALADINO, EXAMINING ATTORNEY



**Int. Cl.: 5**

**Prior U.S. Cls.: 6, 18, 44, 46, 51, and 52**

**Reg. No. 3,454,501**

**United States Patent and Trademark Office**

**Registered June 24, 2008**

**TRADEMARK  
PRINCIPAL REGISTER**



SMITHKLINE BEECHAM CORPORATION  
(PENNSYLVANIA CORPORATION)  
ONE FRANKLIN PLAZA  
PHILADELPHIA, PA 19102

FOR: ANTACIDS AND CALCIUM SUPPLEMENTS, IN CLASS 5 (U.S. CLS. 6, 18, 44, 46, 51 AND 52).

FIRST USE 1-31-2007; IN COMMERCE 1-31-2007.

OWNER OF U.S. REG. NOS. 1,979,915, 2,076,469, AND OTHERS.

THE COLOR(S) WHITE, BLACK, BLUE AND GREY IS/ARE CLAIMED AS A FEATURE OF THE MARK.

THE MARK CONSISTS OF THE STYLIZED WORD "TUMS" IN THE COLOR WHITE WITHIN A BLUE OVAL, WHITE OVAL AND DARK BLUE OVAL AND THE STYLIZED WORD "RACING" IN THE COLOR WHITE BELOW WITHIN A BLACK OVAL; ON TOP OF BLACK AND WHITE CHECKERED FLAG. THE ENTIRE MARK IS OUTLINED WITH GREY SHADOWING.

SN 77-068,027, FILED 12-20-2006.

KEVIN DINALLO, EXAMINING ATTORNEY

**Int. Cl.: 35**

**Prior U.S. Cls.: 100, 101, and 102**

**Reg. No. 3,454,502**

**United States Patent and Trademark Office**

**Registered June 24, 2008**

---

**SERVICE MARK  
PRINCIPAL REGISTER**

**AZJEANS**

J. C. PENNEY CORPORATION, INC. (DELA-  
WARE CORPORATION)  
6501 LEGACY DRIVE  
PLANO, TX 750243698

THE MARK CONSISTS OF STANDARD CHAR-  
ACTERS WITHOUT CLAIM TO ANY PARTICULAR  
FONT, STYLE, SIZE, OR COLOR.

FOR: ONLINE RETAIL DEPARTMENT STORE  
SERVICES, IN CLASS 35 (U.S. CLS. 100, 101 AND 102).

SN 77-068,147, FILED 12-20-2006.

FIRST USE 9-5-2007; IN COMMERCE 9-5-2007.

FLORENTINA BLANDU, EXAMINING ATTORNEY

**Int. Cls.: 20 and 21**

**Prior U.S. Cls.: 2, 13, 22, 23, 25, 29, 30, 32, 33, 40, and 50**

**Reg. No. 3,454,503**

**United States Patent and Trademark Office**

**Registered June 24, 2008**

---

**TRADEMARK  
PRINCIPAL REGISTER**

**STRAKX**

FAB-IND LIMITED (CANADA CORPORATION)  
UNIT #7  
153 BRIDGELAND AVENUE  
TORONTO, CANADA M6A2Y6

FOR: FURNITURE; SCULPTURES OF WOOD, IN CLASS 20 (U.S. CLS. 2, 13, 22, 25, 32 AND 50).

FIRST USE 10-0-2007; IN COMMERCE 10-0-2007.

FOR: FLOWER VASES, VESSELS, BOWLS, PLATES, AND SCULPTURES OF GLASS, IN CLASS 21 (U.S. CLS. 2, 13, 23, 29, 30, 33, 40 AND 50).

FIRST USE 10-0-2007; IN COMMERCE 10-0-2007.

THE MARK CONSISTS OF STANDARD CHARACTERS WITHOUT CLAIM TO ANY PARTICULAR FONT, STYLE, SIZE, OR COLOR.

SN 77-068,362, FILED 12-20-2006.

SANJEEV VOHRA, EXAMINING ATTORNEY

**Int. Cl.: 30**

**Prior U.S. Cl.: 46**

**United States Patent and Trademark Office**

**Reg. No. 3,454,504**

**Registered June 24, 2008**

**TRADEMARK  
PRINCIPAL REGISTER**

**ANNIE'S HOMEGROWN**

ANNIE'S HOMEGROWN (DELAWARE CORPORATION)  
564 GATEWAY DRIVE  
NAPA, CA 94558

FOR: BREAKFAST CEREAL, IN CLASS 30 (U.S. CL. 46).

FIRST USE 7-1-2007; IN COMMERCE 7-1-2007.

THE MARK CONSISTS OF STANDARD CHARACTERS WITHOUT CLAIM TO ANY PARTICULAR FONT, STYLE, SIZE, OR COLOR.

OWNER OF U.S. REG. NO. 2,023,195.

SN 77-068,363, FILED 12-20-2006.

SANJEEV VOHRA, EXAMINING ATTORNEY

**Int. Cl.: 41**

**Prior U.S. Cls.: 100, 101, and 107**

**Reg. No. 3,454,505**

**United States Patent and Trademark Office**

**Registered June 24, 2008**

**SERVICE MARK  
PRINCIPAL REGISTER**

**JUSTIN KREDIBLE**

WILLMAN, JUSTIN (UNITED STATES INDIVIDUAL)  
12351-1/2 RIVERSIDE DRIVE  
VALLEY VILLAGE, CA 91607

THE MARK CONSISTS OF STANDARD CHARACTERS WITHOUT CLAIM TO ANY PARTICULAR FONT, STYLE, SIZE, OR COLOR.

FOR: ENTERTAINMENT IN THE NATURE OF MAGIC SHOWS; ENTERTAINMENT SERVICES IN THE NATURE OF ON-GOING TELEVISION PROGRAMS IN THE FIELD OF CHILDREN'S ENTERTAINMENT, IN CLASS 41 (U.S. CLS. 100, 101 AND 107).

THE NAME "JUSTIN KREDIBLE" IDENTIFIES A LIVING INDIVIDUAL WHOSE CONSENT IS OF RECORD.

SN 77-068,680, FILED 12-20-2006.

FIRST USE 0-0-1995; IN COMMERCE 0-0-1995.

BENJAMIN ALLEN, EXAMINING ATTORNEY

**Int. Cl.: 9**

**Prior U.S. Cls.: 21, 23, 26, 36, and 38**

**Reg. No. 3,454,506**

**United States Patent and Trademark Office**

**Registered June 24, 2008**

**TRADEMARK  
PRINCIPAL REGISTER**



DIVITAS NETWORKS, INC. (DELAWARE CORPORATION)  
321 CASTRO STREET, SECOND FLOOR  
MOUNTAIN VIEW, CA 94041

FOR: COMPUTER HARDWARE FOR TELECOMMUNICATIONS AND SOFTWARE FOR USE IN MANAGING VOICE AND DATA COMMUNICATIONS BETWEEN A BUSINESS, GOVERNMENTAL, OR NONPROFIT ENTERPRISE AND INDIVIDUAL MOBILE DEVICES, IN CLASS 9 (U.S. CLS. 21, 23, 26, 36 AND 38).

FIRST USE 1-1-2008; IN COMMERCE 1-1-2008.

NO CLAIM IS MADE TO THE EXCLUSIVE RIGHT TO USE "NETWORKS", APART FROM THE MARK AS SHOWN.

THE COLOR(S) ORANGE, GOLD AND BLUE IS/ARE CLAIMED AS A FEATURE OF THE MARK.

THE MARK CONSISTS OF THE WORDS "DIVITAS NETWORKS" IN BLUE; TO THE LEFT OF THIS WORDING ARE STYLIZED LETTERS "D" AND "V" WHICH ARE STACKED UPON EACH OTHER; THE STYLIZED "D" APPEARS AT THE BOTTOM AND IS IN ORANGE; THE STYLIZED "V" IS AT THE TOP AND THE LEFT SIDE IS GOLD AND THE RIGHT SIDE IS ORANGE.

SN 77-069,401, FILED 12-21-2006.

MARY CRAWFORD, EXAMINING ATTORNEY

**Int. Cl.: 41**

**Prior U.S. Cls.: 100, 101, and 107**

**Reg. No. 3,454,507**

**United States Patent and Trademark Office**

**Registered June 24, 2008**

**SERVICE MARK  
PRINCIPAL REGISTER**

**enLeonardo**

THE LIBRARY SQUARE FOUNDATION FOR  
ART, CULTURE AND SCIENCE (UTAH  
NON-PROFIT CORPORATION)

C/O MAIN LIBRARY SUITE 14  
210 EAST 400 SOUTH  
SALT LAKE CITY, UT 84111

FOR: INFORMAL EDUCATIONAL SERVICES,  
NAMELY, PROVIDING CLASSES AND LEARNING  
PROGRAMS, WITH THE USE OF EXHIBITS, IN THE

FIELDS OF ART, CULTURE, AND SCIENCE, IN  
CLASS 41 (U.S. CLS. 100, 101 AND 107).

FIRST USE 3-31-2007; IN COMMERCE 3-31-2007.

SN 77-069,677, FILED 12-21-2006.

SHARON MEIER, EXAMINING ATTORNEY

**Int. Cl.: 19**

**Prior U.S. Cls.: 1, 12, 33, and 50**

**United States Patent and Trademark Office**

**Reg. No. 3,454,508**

**Registered June 24, 2008**

**TRADEMARK  
PRINCIPAL REGISTER**



CELULOSA ARAUCO Y CONSTITUCION S.A.  
(CHILE CORPORATION)  
AVDA. EL GOLF NO. 150, PISO 14  
LAS CONDES, CASILLA 880  
SANTIAGO, CHILE

FOR: PLYWOOD AND WOOD PANELS, IN CLASS  
19 (U.S. CLS. 1, 12, 33 AND 50).

FIRST USE 12-0-2007; IN COMMERCE 12-0-2007.

OWNER OF U.S. REG. NO. 1,216,731.

THE COLOR(S) ORANGE, BLACK AND WHITE  
IS/ARE CLAIMED AS A FEATURE OF THE MARK.

THE MARK CONSISTS OF THE FOLLOWING:  
THE COLOR WHITE APPEARS IN THE WORDING  
"ARAUCOPLY" AND THE COLORS BLACK AND  
ORANGE APPEAR IN THE RECTANGLE DESIGN  
ELEMENT.

SN 77-069,688, FILED 12-21-2006.

Laurie Kaufman, Examining Attorney



**Int. Cls.: 9, 10, and 25**

**Prior U.S. Cls.: 21, 22, 23, 26, 36, 38, 39, and 44**

**United States Patent and Trademark Office**

**Reg. No. 3,454,509**

**Registered June 24, 2008**

**TRADEMARK  
PRINCIPAL REGISTER**

**BIOSMART**

MILLIKEN & COMPANY (DELAWARE CORPORATION)  
920 MILLIKEN ROAD  
SPARTANBURG, SC 29303

FOR: PROTECTION MASKS, NAMELY, PROTECTIVE CLOTH MASKS FOR USE IN THE FOOD AND MEAT INDUSTRIES, IN CLASS 9 (U.S. CLS. 21, 23, 26, 36 AND 38).

FIRST USE 10-4-2007; IN COMMERCE 10-4-2007.

FOR: SURGICAL SCRUB SUITS; SURGICAL SHOE COVERS; SURGICAL GOWNS; PATIENT EXAMINATION GOWNS; MASKS FOR USE BY MEDICAL PERSONNEL, IN CLASS 10 (U.S. CLS. 26, 39 AND 44).

FIRST USE 10-4-2007; IN COMMERCE 10-4-2007.

FOR: CLOTHING, NAMELY, UNIFORMS, SHIRTS, JACKETS, SKIRTS, PANTS, SCRUBS NOT FOR MEDICAL PURPOSES, LAB COATS, TUNICS, VESTS, DRESSES, SMOCKS, SOCKS, SHOES, BOOTS, BOOTIES, HATS AND HEADWEAR, BUTCHER FROCKS, BUTCHER COATS, GLOVES, APRONS, BASE LAYER GARMENTS, NAMELY, FOUNDATION GARMENTS AND UNDER GARMENTS, IN CLASS 25 (U.S. CLS. 22 AND 39).

FIRST USE 10-4-2007; IN COMMERCE 10-4-2007.

THE MARK CONSISTS OF STANDARD CHARACTERS WITHOUT CLAIM TO ANY PARTICULAR FONT, STYLE, SIZE, OR COLOR.

SN 77-069,743, FILED 12-21-2006.

KATHERINE E. HALMEN, EXAMINING ATTORNEY

**Int. Cl.: 24**

**Prior U.S. Cls.: 42 and 50**

**United States Patent and Trademark Office**

**Reg. No. 3,454,510**

**Registered June 24, 2008**

**TRADEMARK  
PRINCIPAL REGISTER**

**BIOSMART**

MILLIKEN & COMPANY (DELAWARE CORPORATION)  
920 MILLIKEN ROAD  
SPARTANBURG, SC 29303

FOR: FABRICS HAVING ANTIMICROBIAL CHARACTERISTICS FOR USE IN THE MANUFACTURE OF CLOTHING, BEDSPREADS, BLANKETS, TOWELS, SHEETS, PILLOWCASES, ATHLETIC EQUIPMENT, NAPERY, OVEN MITTS, CURTAINS, CUBICLE CURTAINS, BAR MOPS, TABLE LINEN, TABLE SKIRTING, DRAPES AND WRAPS, AND UPHOLSTERY FABRIC, IN CLASS 24 (U.S. CLS. 42 AND 50).

FIRST USE 10-4-2007; IN COMMERCE 10-4-2007.

THE MARK CONSISTS OF STANDARD CHARACTERS WITHOUT CLAIM TO ANY PARTICULAR FONT, STYLE, SIZE, OR COLOR.

SN 77-069,773, FILED 12-21-2006.

KATHERINE E. HALMEN, EXAMINING ATTORNEY

**Int. Cls.: 9, 35, and 42**

**Prior U.S. Cls.: 21, 23, 26, 36, 38, 100, 101, and 102**

**United States Patent and Trademark Office**

**Reg. No. 3,454,511**

**Registered June 24, 2008**

**TRADEMARK  
SERVICE MARK  
PRINCIPAL REGISTER**

# ANSWERTIPS

ANSWERS CORPORATION (DELAWARE CORPORATION)  
237 W. 35TH STREET, SUITE 1101  
NEW YORK CITY, NY 10001

FOR: COMPUTER HARDWARE; COMPUTER SOFTWARE FOR SEARCHING AND RETRIEVING INFORMATION, SITES, AND OTHER RESOURCES ON COMPUTER NETWORKS, CELLULAR TELEPHONES; PAGERS; SMART HANDHELD DEVICES, NAMELY, HANDHELD PERSONAL COMPUTERS, PERSONAL DIGITAL ASSISTANTS, PERSONAL COMMUNICATIONS SERVICES HANDSETS; WEB COMPUTER TERMINALS; AND ELECTRONIC MAIL COMPUTER TERMINALS; COMPUTER SOFTWARE FOR USE IN BROADCASTING AND DELIVERY OF AUDIO, VIDEO, AND/OR MULTIMEDIA CONTENT; COMPUTER SOFTWARE FOR COMPILING, INDEXING AND ORGANIZING INFORMATION ON COMPUTER NETWORKS; COMPUTER SOFTWARE FOR CREATING INDEXES OF INFORMATION, INDEXES OF WEB SITES AND INDEXES OF OTHER INFORMATION RESOURCES; PRE-RECORDED COMPUTER SOFTWARE FEATURING A DIRECTORY OF INFORMATION, SITES, AND RESOURCES AVAILABLE ON COMPUTER NETWORKS; COMPUTER SOFTWARE FOR USE IN CREATING A WEB CATALOGUE; COMPUTER COMMUNICATIONS SOFTWARE FOR USE IN GAINING ACCESS TO GENERAL BUSINESS INFORMATION ON A GLOBAL COMPUTER NETWORK; COMPUTER MOUSE PADS, IN CLASS 9 (U.S. CLS. 21, 23, 26, 36 AND 38).

FIRST USE 5-15-2006; IN COMMERCE 5-15-2006.

FOR: ADVERTISING AND BUSINESS CONSULTATION SERVICES; PROMOTING THE GOODS AND SERVICES OF OTHERS BY PLACING ADVERTISEMENTS AND PROMOTIONAL DISPLAYS IN AN ELECTRONIC SITE ACCESSED THROUGH

COMPUTER NETWORKS; DISSEMINATION OF ADVERTISING FOR OTHERS, VIA THE INTERNET; ELECTRONIC RETAIL STORE SERVICES VIA COMPUTER FEATURING GENERAL CONSUMER MERCHANDISE; ONLINE RETAIL STORE SERVICES AND MAIL ORDER SERVICES, IN THE FIELD OF GENERAL CONSUMER MERCHANDISE; ONLINE COMPUTER SHOPPERS' GUIDE INFORMATION SERVICES, NAMELY, PROVIDING INFORMATION REGARDING THE GOODS AND SERVICES OF OTHERS IN THE NATURE OF A BUYERS' GUIDE, BY MEANS OF A GLOBAL COMPUTER NETWORK; ELECTRONIC COMMERCE SERVICES, NAMELY, PROVIDING INFORMATION PRODUCTS VIA TELECOMMUNICATION NETWORKS FOR ADVERTISING AND SALES PURPOSES, GIFT REGISTRY SERVICES; ONLINE AUCTION SERVICES, NAMELY, ORGANIZATION OF INTERNET AUCTIONS; PROVIDING ONLINE RETAIL, MAIL ORDER, AND AUCTION BUSINESS MANAGEMENT; ON-LINE BUSINESS DIRECTORY SERVICES TO HELP LOCATE PEOPLE, PLACES, ORGANIZATIONS, PHONE NUMBERS, HOME PAGES, AND ELECTRONIC MAIL ADDRESSES; PROMOTING THE WEB SITES OF OTHERS, NAMELY, PROMOTING THE GOODS AND SERVICES OF OTHERS BY PROVIDING HYPERTEXT LINKS TO THE WEB SITES OF OTHERS; ADVERTISING SERVICES, NAMELY, DISTRIBUTING ADVERTISING FOR OTHERS VIA AN ONLINE ELECTRONIC COMMUNICATIONS NETWORK; ADVERTISING, BUSINESS MANAGEMENT, BUSINESS MARKETING, AND DEVELOPING PROMOTIONAL CAMPAIGNS FOR BUSINESS SERVICES VIA THE INTERNET; ONLINE RETAIL STORE SERVICES IN THE FIELD OF ENTERTAINMENT VIDEOS, MUSIC, RING TONES, SOUND RECORDINGS, AND POSTERS; PROVIDING AN ONLINE COMMERCIAL INFORMATION DIRECTORY AND DIRECTORY INDICES ON THE INTERNET; PROVIDING ON-LINE DIREC-

TORY INFORMATION SERVICES ALSO FEATURING HYPERLINKS TO OTHER WEB SITES, IN CLASS 35 (U.S. CLS. 100, 101 AND 102).

FIRST USE 5-15-2006; IN COMMERCE 5-15-2006.

FOR: COMPUTER SERVICES AND ONLINE COMPUTER SERVICES, NAMELY, CREATING INDEXES OF INFORMATION, SITES AND OTHER RESOURCES AVAILABLE ON COMPUTER NETWORKS; PROVIDING SPECIFIC INFORMATION AS REQUESTED BY CUSTOMERS VIA THE INTERNET, NAMELY, CUSTOMIZED SEARCHING AND RETRIEVING INFORMATION FOR OTHERS; PROVIDING CUSTOMIZED ON-LINE WEB PAGES FEATURING USER-DEFINED INFORMATION, WHICH INCLUDES SEARCH ENGINES AND ON-LINE WEB LINKS TO OTHER WEB SITES IN THE FIELD OF NEWS, WEATHER, SPORTS, CURRENT EVENTS, AND REFERENCE MATERIALS; COMPUTER SERVICES, NAMELY, PROVIDING SEARCH ENGINES FOR SEARCHING, RETRIEVING, AND OBTAINING DATA ON A GLOBAL COMPUTER NETWORK IN A WIDE RANGE OF GENERAL INTEREST; COMPUTER SOFTWARE AUTHORING SERVICES, NAMELY, PROVIDING SOFTWARE INTERFACES

AVAILABLE OVER A NETWORK IN ORDER TO CREATE A PERSONALIZED ON-LINE INFORMATION SERVICE; DATA MINING, NAMELY, EXTRACTION AND RETRIEVAL OF INFORMATION BY MEANS OF GLOBAL COMPUTER NETWORKS; COMPUTER SERVICES, NAMELY, CREATING INDEXES OF INFORMATION, INDEXES OF WEB SITES AND INDEXES OF OTHER RESOURCES IN CONNECTION WITH GLOBAL COMPUTER NETWORKS AND PROVIDING SUCH INFORMATION FROM SEARCHABLE INDEXES AND DATABASES OF INFORMATION, INCLUDING TEXT, ELECTRONIC DOCUMENTS, DATABASES, GRAPHICS AND AUDIO VISUAL INFORMATION, BY MEANS OF GLOBAL COMPUTER INFORMATION NETWORKS, IN CLASS 42 (U.S. CLS. 100 AND 101).

FIRST USE 5-15-2006; IN COMMERCE 5-15-2006.

THE MARK CONSISTS OF STANDARD CHARACTERS WITHOUT CLAIM TO ANY PARTICULAR FONT, STYLE, SIZE, OR COLOR.

SN 77-069,786, FILED 12-21-2006.

ARETHA SOMERVILLE, EXAMINING ATTORNEY

**Int. Cl.: 10**

**Prior U.S. Cls.: 26, 39, and 44**

**United States Patent and Trademark Office**

**Reg. No. 3,454,512**

**Registered June 24, 2008**

**TRADEMARK  
PRINCIPAL REGISTER**

**Don't sit down without it!**

BACKJOY ORTHOTICS (CALIFORNIA LTD LIAB  
CO)  
PMB 198  
865 VIA DE LA PAZ  
PACIFIC PALISADES, CA 90272

THE MARK CONSISTS OF STANDARD CHAR-  
ACTERS WITHOUT CLAIM TO ANY PARTICULAR  
FONT, STYLE, SIZE, OR COLOR.

FOR: BACK PAIN RELIEF CUSHION, IN CLASS  
10 (U.S. CLS. 26, 39 AND 44).

SN 77-070,358, FILED 12-22-2006.

FIRST USE 5-1-2007; IN COMMERCE 11-21-2007.

PAUL E. FAHRENKOPF, EXAMINING ATTORNEY

**Int. Cl.: 5**

**Prior U.S. Cls.: 6, 18, 44, 46, 51, and 52**

**United States Patent and Trademark Office**

**Reg. No. 3,454,513**

**Registered June 24, 2008**

**TRADEMARK  
PRINCIPAL REGISTER**

**COLDWAR**

THOMPSON, NATHANAEL (NIGERIA INDIVIDUAL)  
5871 RED WINESAP WAY  
DUBLIN, OH 43016

THE MARK CONSISTS OF STANDARD CHARACTERS WITHOUT CLAIM TO ANY PARTICULAR FONT, STYLE, SIZE, OR COLOR.

FOR: DIETARY SUPPLEMENTS; HERBAL SUPPLEMENTS; PREPARATIONS FOR TREATING COLDS, IN CLASS 5 (U.S. CLS. 6, 18, 44, 46, 51 AND 52).

SN 77-070,375, FILED 12-22-2006.

FIRST USE 12-1-2006; IN COMMERCE 1-10-2007.

MICHAEL LITZAU, EXAMINING ATTORNEY

**Int. Cl.: 16**

**Prior U.S. Cls.: 2, 5, 22, 23, 29, 37, 38, and 50**

**Reg. No. 3,454,514**

**United States Patent and Trademark Office**

**Registered June 24, 2008**

---

**TRADEMARK  
PRINCIPAL REGISTER**

**TWIN TREES**

ENDEAVOUR CAPITAL, L.L.C. (OREGON LTD  
LIAB CO)  
SUITE 1400  
920 S.W. 5TH AVENUE  
PORTLAND, OR 97204

FIRST USE 5-31-2007; IN COMMERCE 5-31-2007.

THE MARK CONSISTS OF STANDARD CHAR-  
ACTERS WITHOUT CLAIM TO ANY PARTICULAR  
FONT, STYLE, SIZE, OR COLOR.

FOR: NEWSLETTERS, BROCHURES AND  
PAMPHLETS IN THE FIELD OF FINANCE, FINAN-  
CIAL INVESTMENTS, EQUITY FUNDS, BUSINESS  
DEVELOPMENT AND BUSINESS CONSULTING, IN  
CLASS 16 (U.S. CLS. 2, 5, 22, 23, 29, 37, 38 AND 50).

SN 77-070,473, FILED 12-22-2006.

SUNG IN, EXAMINING ATTORNEY

**Int. Cl.: 13**

**Prior U.S. Cls.: 2 and 9**

**United States Patent and Trademark Office**

**Reg. No. 3,454,515**

**Registered June 24, 2008**

**TRADEMARK  
PRINCIPAL REGISTER**

**FS STEEL**

ALLIANT TECHSYSTEMS INC. (DELAWARE  
CORPORATION)

5050 LINCOLN DRIVE

EDINA, MN 55436

FOR: AMMUNITION, IN CLASS 13 (U.S. CLS. 2  
AND 9).

FIRST USE 11-0-2006; IN COMMERCE 4-0-2007.

THE MARK CONSISTS OF STANDARD CHAR-  
ACTERS WITHOUT CLAIM TO ANY PARTICULAR  
FONT, STYLE, SIZE, OR COLOR.

NO CLAIM IS MADE TO THE EXCLUSIVE  
RIGHT TO USE "STEEL", APART FROM THE  
MARK AS SHOWN.

SN 77-070,601, FILED 12-22-2006.

DANIEL CAPSHAW, EXAMINING ATTORNEY



**Int. Cl.: 35**

**Prior U.S. Cls.: 100, 101, and 102**

**United States Patent and Trademark Office**

**Reg. No. 3,454,516**

**Registered June 24, 2008**

**SERVICE MARK  
PRINCIPAL REGISTER**

**KEYHIRES**

KEYHIRES INC. (ILLINOIS CORPORATION)  
SUITE 3  
227 NORTHGATE CENTER  
LAKE FOREST, IL 60045

FOR: EMPLOYMENT SEARCH, RECRUITING, STAFFING, AND CONSULTING SERVICES, NAME-  
LY, EMPLOYMENT STAFFING IDENTIFICATION  
SERVICES; RECRUITMENT STRATEGY DEVELOP-  
MENT, NAMELY, EMPLOYMENT RECRUITMENT;  
PERSONNEL SEARCH SERVICES, NAMELY, PER-  
SONNEL PLACEMENT AND RECRUITMENT; OC-  
CUPATIONAL, VOCATIONAL, AND  
EMPLOYMENT MATCHING SERVICES, NAMELY,  
EMPLOYMENT COUNSELING AND RECRUITING;  
PROVIDING AN ON-LINE SEARCHABLE DATA-  
BASE FEATURING CLASSIFIED AD LISTINGS  
AND EMPLOYMENT OPPORTUNITIES; CANDI-  
DATE TRACKING, EVALUATION, AND PERSON-

NEL SELECTION SERVICES, NAMELY,  
PERSONNEL CONSULTANCY AND EXPERT EVA-  
LUATIONS AND REPORTS RELATING TO EM-  
PLOYMENT MATTERS; EMPLOYMENT  
COUNSELING AND CONSULTING SERVICES RE-  
LATED THERETO, NAMELY, EMPLOYMENT  
COUNSELING AND RECRUITING, IN CLASS 35  
(U.S. CLS. 100, 101 AND 102).

FIRST USE 12-31-2007; IN COMMERCE 12-31-2007.

THE MARK CONSISTS OF STANDARD CHAR-  
ACTERS WITHOUT CLAIM TO ANY PARTICULAR  
FONT, STYLE, SIZE, OR COLOR.

SN 77-070,606, FILED 12-22-2006.

KAPIL BHANOT, EXAMINING ATTORNEY

**Int. Cl.: 1**

**Prior U.S. Cls.: 1, 5, 6, 10, 26, and 46**

**Reg. No. 3,454,517**

**United States Patent and Trademark Office**

**Registered June 24, 2008**

---

**TRADEMARK  
PRINCIPAL REGISTER**

**PURFORMSM**

CARDINAL ASSOCIATES (WASHINGTON CORPORATION), DBA BERGSTROM NUTRITION, 1000 W. 8TH STREET VANCOUVER, WA 98660

THE MARK CONSISTS OF STANDARD CHARACTERS WITHOUT CLAIM TO ANY PARTICULAR FONT, STYLE, SIZE, OR COLOR.

FOR: CHEMICALS FOR USE IN THE MANUFACTURE OF DIETARY SUPPLEMENTS, NAMELY, METHYLSULFONYLMETHANE, IN CLASS 1 (U.S. CLS. 1, 5, 6, 10, 26 AND 46).

SN 77-070,740, FILED 12-22-2006.

FIRST USE 6-1-2006; IN COMMERCE 6-1-2006.

ELIZABETH BEYER, EXAMINING ATTORNEY

**Int. Cl.: 5**

**Prior U.S. Cls.: 6, 18, 44, 46, 51, and 52**

**Reg. No. 3,454,518**

**United States Patent and Trademark Office**

**Registered June 24, 2008**

---

**TRADEMARK  
PRINCIPAL REGISTER**

**PURFORMSM**

CARDINAL ASSOCIATES (WASHINGTON CORPORATION), DBA BERGSTROM NUTRITION,  
1000 W. 8TH STREET  
VANCOUVER, WA 98660

THE MARK CONSISTS OF STANDARD CHARACTERS WITHOUT CLAIM TO ANY PARTICULAR FONT, STYLE, SIZE, OR COLOR.

FOR: DIETARY SUPPLEMENTS FOR ANIMALS,  
IN CLASS 5 (U.S. CLS. 6, 18, 44, 46, 51 AND 52).

SN 77-070,746, FILED 12-22-2006.

FIRST USE 6-1-2006; IN COMMERCE 6-1-2006.

ELIZABETH BEYER, EXAMINING ATTORNEY

**Int. Cl.: 8**

**Prior U.S. Cls.: 23, 28, and 44**

**Reg. No. 3,454,519**

**United States Patent and Trademark Office**

**Registered June 24, 2008**

**TRADEMARK  
PRINCIPAL REGISTER**



BERTO, JOSEPH (UNITED STATES INDIVIDUAL)  
10984 MEADOWS ROAD  
WHITE CITY, OR 97503

NO CLAIM IS MADE TO THE EXCLUSIVE RIGHT TO USE "FORK" , APART FROM THE MARK AS SHOWN.

FOR: MANURE SEPARATING FORK, IN CLASS 8 (U.S. CLS. 23, 28 AND 44).

SN 77-070,851, FILED 12-22-2006.

FIRST USE 3-25-2008; IN COMMERCE 3-25-2008.

ALLISON SCHRODY, EXAMINING ATTORNEY

**Int. Cls.: 35 and 43**

**Prior U.S. Cls.: 100, 101, and 102**

**United States Patent and Trademark Office**

**Reg. No. 3,454,520**

**Registered June 24, 2008**

**SERVICE MARK  
PRINCIPAL REGISTER**



FIGHTER PILOT UNIVERSITY LLC (MISSOURI  
LTD LIAB CO)  
1267 N.W. 355TH  
HOLDEN, MO 64040

FOR: ON-LINE RETAIL STORE SERVICES FEATURING CLOTHING, NAMELY, HATS, SPORT SHIRTS, T-SHIRTS, GOLF SHIRTS, DRESS SHIRTS, SWEAT SHIRTS, AND PULLOVERS, IN CLASS 35 (U.S. CLS. 100, 101 AND 102).

FIRST USE 9-28-2007; IN COMMERCE 9-28-2007.

FOR: BAR SERVICES, IN CLASS 43 (U.S. CLS. 100 AND 101).

FIRST USE 9-28-2007; IN COMMERCE 9-28-2007.

THE MARK CONSISTS OF STYLIZED TEXT OF THE WORDING "FIGHTER PILOT UNIVERSITY FU".

SN 77-070,861, FILED 12-22-2006.

RICHARD A. STRASER, EXAMINING ATTORNEY

**Int. Cl.: 4**

**Prior U.S. Cls.: 1, 6, and 15**

**United States Patent and Trademark Office**

**Reg. No. 3,454,521**

**Registered June 24, 2008**

**TRADEMARK  
PRINCIPAL REGISTER**



MI ENERGY CORPORATION (CHINA CORPORATION)  
2999# QINGNIAN STREET  
ECONOMIC DEVELOPMENT AREA  
SONGYUAN, CHINA 138000

FOR: ALL PURPOSE LUBRICANTS; ARTIFICIAL PETROLEUM; COAL TAR OIL; CRUDE OIL; CRUDE OILS; CUTTING OIL FOR INDUSTRIAL METAL WORKING; CUTTING OILS; DIESEL FUEL; ETHANOL FUELS; FUEL FOR AIRCRAFT/SHIPS; FUEL FOR MOTOR VEHICLES, NAMELY, GASOLINE AND DIESEL; FUEL FROM CRUDE OIL; FUEL OIL; FUELS; GASEOUS FUELS; GASOLINE; GEAR OILS; GUN BARREL OIL; HEAVY OILS; HYDRAULIC OILS; INDUSTRIAL OIL FOR BATTERIES; INDUSTRIAL OILS; KEROSENE; LAMP FUEL; LIGHT OILS; LIQUEFIED PETROLEUM GASES; LIQUEFIED PETROLEUM GASES TO BE USED FOR DOMESTIC AND INDUSTRIAL PURPOSES AND IN MOTOR VEHICLES; LIQUID FUELS; LUBRICATING GREASES; LUBRICATING OILS; MINERAL OIL FOR USE IN THE MANUFACTURE OF PAINT; MOTOR OIL; NAPHTHA; PETROLEUM BASED DUST ABSORBING COMPOSITIONS FOR USE IN ROAD BUILDING, SWEEP AND DUSTLAY-

ING; PETROLEUM JELLY FOR INDUSTRIAL PURPOSES; SOLID FUELS; SOYBEAN OIL FOR USE IN THE MANUFACTURE OF PAINTS AND OTHER COATINGS; VEGETABLE OIL FOR USE IN THE MANUFACTURE OF PAINTS AND/OR SOAPS, IN CLASS 4 (U.S. CLS. 1, 6 AND 15).

FIRST USE 1-8-2007; IN COMMERCE 3-3-2008.

THE COLOR(S) YELLOW, RED, WHITE AND BLACK IS/ARE CLAIMED AS A FEATURE OF THE MARK.

THE MARK CONSISTS OF THE COLOR YELLOW APPEARS IN THE SQUARE, THE COLOR WHITE APPEARS IN THE BACKGROUND OF THE CIRCLE WITHIN THE SQUARE, THE COLOR BLACK APPEARS IN THE TRIANGLE WITHIN THE CIRCLE AND THE COLOR RED APPEARS IN THE SEMI-CIRCLE ON TOP OF THE TRIANGLE WITHIN THE CIRCLE.

SN 77-070,908, FILED 12-22-2006.

ELIZABETH BEYER, EXAMINING ATTORNEY

Int. Cl.: 33

Prior U.S. Cls.: 47 and 49

United States Patent and Trademark Office

Reg. No. 3,454,522

Registered June 24, 2008

TRADEMARK  
PRINCIPAL REGISTER



BELLIZZI, FRANK J., JR. (UNITED STATES  
INDIVIDUAL)  
218 PRESIDIO AVENUE  
SAN FRANCISCO, CA 94115

ONE WITH EARS COVERED AND ONE WITH A  
MOUTH COVERED. THE THREE ELEMENTS OF  
THE MARK MAY APPEAR EITHER HORIZONTAL-  
LY OR VERTICALLY.

FOR: WINE, IN CLASS 33 (U.S. CLS. 47 AND 49).

FIRST USE 4-16-2008; IN COMMERCE 4-16-2008.

SN 77-071,296, FILED 12-26-2006.

THE MARK CONSISTS OF THREE FACIAL IMA-  
GES OF MONKEYS, ONE WITH EYES COVERED,

KAPIL BHANOT, EXAMINING ATTORNEY

**Int. Cl.: 11**

**Prior U.S. Cls.: 13, 21, 23, 31, and 34**

**Reg. No. 3,454,523**

**United States Patent and Trademark Office**

**Registered June 24, 2008**

---

**TRADEMARK  
PRINCIPAL REGISTER**

**Benni**

BENNI TECHNOLOGY INCORPORATION (CALIFORNIA CORPORATION)  
13090 CARNESI DRIVE  
RANCHO CUCAMONGA, CA 91739

THE MARK CONSISTS OF STANDARD CHARACTERS WITHOUT CLAIM TO ANY PARTICULAR FONT, STYLE, SIZE, OR COLOR.

FOR: OVEN GAS IGNITERS; SPARK IGNITERS FOR GAS APPLIANCES, IN CLASS 11 (U.S. CLS. 13, 21, 23, 31 AND 34).

SN 77-071,744, FILED 12-27-2006.

FIRST USE 4-1-2007; IN COMMERCE 6-1-2007.

ESTHER A. BORSUK, EXAMINING ATTORNEY



**Int. Cl.: 9**

**Prior U.S. Cls.: 21, 23, 26, 36, and 38**

**Reg. No. 3,454,524**

**United States Patent and Trademark Office**

**Registered June 24, 2008**

---

**TRADEMARK  
PRINCIPAL REGISTER**

**VISTA**

LINCOLN GLOBAL, INC. (DELAWARE COR-  
PORATION)  
17721 RAILROAD STREET  
CITY OF INDUSTRY, CA 91748

THE MARK CONSISTS OF STANDARD CHAR-  
ACTERS WITHOUT CLAIM TO ANY PARTICULAR  
FONT, STYLE, SIZE, OR COLOR.

FOR: WELDING HELMETS AND REPLACE-  
MENT PARTS THEREFOR, IN CLASS 9 (U.S. CLS.  
21, 23, 26, 36 AND 38).

SN 77-071,793, FILED 12-27-2006.

FIRST USE 3-0-2008; IN COMMERCE 3-0-2008.

EMILY CHUO, EXAMINING ATTORNEY

**Int. Cl.: 20**

**Prior U.S. Cls.: 2, 13, 22, 25, 32, and 50**

**Reg. No. 3,454,525**

**United States Patent and Trademark Office**

**Registered June 24, 2008**

**TRADEMARK  
PRINCIPAL REGISTER**

**SIGN AND SHO**

LEAGUE DESIGN PARTNERS, LLC (NEW JERSEY LTD LIAB CO)  
650 WEST COMMODORE BLVD.  
JACKSON, NJ 08527

THE MARK CONSISTS OF STANDARD CHARACTERS WITHOUT CLAIM TO ANY PARTICULAR FONT, STYLE, SIZE, OR COLOR.

FOR: DISPLAY DEVICE, NAMELY, A PORTABLE BOARD FOR HOLDING A SPORTING OBJECT, SUCH AS A BASEBALL, HOCKEY PUCK, TENNIS BALL OR GOLF BALL SO THAT IT CAN BE AUTOGRAPHED AND WHEREIN THE DISPLAY DEVICE ALSO FUNCTIONS AS A DISPLAY STAND, IN CLASS 20 (U.S. CLS. 2, 13, 22, 25, 32 AND 50).

NO CLAIM IS MADE TO THE EXCLUSIVE RIGHT TO USE "SHOW", APART FROM THE MARK AS SHOWN.

SN 77-071,908, FILED 12-27-2006.

FIRST USE 4-5-2007; IN COMMERCE 4-5-2007.

ANTHONY RINKER, EXAMINING ATTORNEY

**Int. Cl.: 11**

**Prior U.S. Cls.: 13, 21, 23, 31, and 34**

**United States Patent and Trademark Office**

**Reg. No. 3,454,526**

**Registered June 24, 2008**

**TRADEMARK  
PRINCIPAL REGISTER**

**DHRC**

MULTISTACK, LLC (MINNESOTA LTD LIAB  
CO)  
1065 MAPLE AVENUE  
SPARTA, WI 54656

FOR: AIR CONDITIONING MODULAR REFRIG-  
ERATION UNITS; AIR CONDITIONING SYSTEMS  
PRIMARILY COMPRISING MOTOR AND COM-  
PRESSOR UNITS; REFRIGERATING MACHINES,  
NAMELY CHILLERS; EVAPORATORS; AND HEAT  
EXCHANGERS, IN CLASS 11 (U.S. CLS. 13, 21, 23, 31  
AND 34).

FIRST USE 4-21-2008; IN COMMERCE 4-21-2008.

THE MARK CONSISTS OF STANDARD CHAR-  
ACTERS WITHOUT CLAIM TO ANY PARTICULAR  
FONT, STYLE, SIZE, OR COLOR.

SN 77-071,951, FILED 12-27-2006.

TOBY BULLOFF, EXAMINING ATTORNEY

**Int. Cl.: 38**

**Prior U.S. Cls.: 100, 101, and 104**

**United States Patent and Trademark Office**

**Reg. No. 3,454,527**

**Registered June 24, 2008**

**SERVICE MARK  
PRINCIPAL REGISTER**



JAY CORPORATION (NEVADA CORPORATION)  
108 EAST JOHN STREET  
CARSON CITY, NV 89706

FOR: PROVIDING ON-LINE FORUMS AND CHAT ROOMS FOR TRANSMISSION OF MESSAGES AMONG COMPUTER USERS CONCERNING BUSINESS AND PERSONAL RELATIONSHIPS; PROVIDING ON-LINE ELECTRONIC BULLETIN BOARDS FOR TRANSMISSION OF MESSAGES AMONG COMPUTER USERS CONCERNING BUSINESS AND PERSONAL RELATIONSHIPS AND NETWORKING AND CONNECTING WITH ONE ANOTHER, IN CLASS 38 (U.S. CLS. 100, 101 AND 104).

FIRST USE 5-31-2007; IN COMMERCE 5-31-2007.

THE COLOR(S) ORANGE AND BLUE IS/ARE CLAIMED AS A FEATURE OF THE MARK.

THE MARK CONSISTS OF ORANGE IN A SWOOSH OVER THE WORD "MATCHMATRIX" IN BLUE OVER ANOTHER SWOOSH IN BLUE.

SN 77-072,132, FILED 12-27-2006.

ALEX KEAM, EXAMINING ATTORNEY

**Int. Cl.: 41**

**Prior U.S. Cls.: 100, 101, and 107**

**United States Patent and Trademark Office**

**Reg. No. 3,454,528**

**Registered June 24, 2008**

**SERVICE MARK  
PRINCIPAL REGISTER**

**AMERICAN TRASH REPUBLIC**

AMERICAN TRASH REPUBLIC, LLC (COLOR-  
ADO LTD LIAB CO)  
1513 EAST 133RD AVENUE  
THORNTON, CO 80241

FOR: ENTERTAINMENT SERVICES, NAMELY,  
LIVE PERFORMANCES AND APPEARANCES BY A  
VOCAL AND INSTRUMENTAL BAND, AND LIVE  
PERFORMANCES AND APPEARANCES FEATUR-  
ING PRERECORDED MUSIC BY A VOCAL AND  
INSTRUMENTAL GROUP; FAN CLUB SERVICES;  
PROVIDING A WEBSITE FEATURING ENTER-  
TAINMENT INFORMATION, NAMELY, REVIEWS,  
ARTICLES, INTERVIEWS, MUSIC VIDEOS, MUSIC  
CHARTS, PERSONAL BIOGRAPHIES, DIARIES, IN-  
FORMATION ON MUSIC INSTRUMENTS, TOUR

DATES, GAMES, TRIVIA, ACCESS TO MEMOR-  
ABILIA, PHOTOGRAPHS, VIDEO CLIPS, AND  
AUDIO CLIPS, ALL AVAILABLE VIA A GLOBAL  
COMPUTER NETWORK, IN CLASS 41 (U.S. CLS. 100,  
101 AND 107).

FIRST USE 5-11-2005; IN COMMERCE 5-11-2005.

THE MARK CONSISTS OF STANDARD CHAR-  
ACTERS WITHOUT CLAIM TO ANY PARTICULAR  
FONT, STYLE, SIZE, OR COLOR.

SN 77-072,447, FILED 12-28-2006.

JANET LEE, EXAMINING ATTORNEY

**Int. Cl.: 9**

**Prior U.S. Cls.: 21, 23, 26, 36, and 38**

**Reg. No. 3,454,529**

**United States Patent and Trademark Office**

**Registered June 24, 2008**

---

**TRADEMARK  
PRINCIPAL REGISTER**

**LUCKY LURES**

NOVE GAMING, LLC (SOUTH CAROLINA LTD  
LIAB CO)  
220 NORTH MAIN STREET, STE. 600  
GREENVILLE, SC 29601

THE MARK CONSISTS OF STANDARD CHAR-  
ACTERS WITHOUT CLAIM TO ANY PARTICULAR  
FONT, STYLE, SIZE, OR COLOR.

FOR: COMPUTER SOFTWARE FOR USE WITH  
GAMING MACHINES; GAMING MACHINES, IN  
CLASS 9 (U.S. CLS. 21, 23, 26, 36 AND 38).

SN 77-072,683, FILED 12-28-2006.

FIRST USE 5-29-2007; IN COMMERCE 5-29-2007.

ANDREA K. NADELMAN, EXAMINING ATTOR-  
NEY

**Int. Cls.: 7 and 9**

**Prior U.S. Cls.: 13, 19, 21, 23, 26, 31, 34, 35, 36, and 38**

**Reg. No. 3,454,530**

**United States Patent and Trademark Office**

**Registered June 24, 2008**

**TRADEMARK  
PRINCIPAL REGISTER**

**VALUSEP**

XENOSEP TECHNOLOGIES LLC (NEW JERSEY  
LTD LIAB CO)  
508 MAIN STREET  
BOONTON, NJ 07005

FOR: SEPARATING EQUIPMENT, APPARATUS AND INSTRUMENTS USED IN CONNECTION WITH A MANUFACTURING PROCESS, NAMELY, SINGLE USE/DISPOSABLE FILTRATION AND SOLID-PHASE EXTRACTION COLUMNS, CARTRIDGES, SYRINGE-DRIVEN FILTERS, VACUUM FILTERS, PIPETTE FILTERS AND DISK FILTERS, ALL USED IN CONNECTION WITH THE SEPARATION OF CHEMICAL OR MOLECULAR SUBSTANCES OR COMPONENTS FROM ONE ANOTHER, IN CLASS 7 (U.S. CLS. 13, 19, 21, 23, 31, 34 AND 35).

FIRST USE 3-31-2007; IN COMMERCE 3-31-2007.

FOR: SEPARATING EQUIPMENT, APPARATUS AND INSTRUMENTS USED IN CONNECTION WITH A MANUFACTURING PROCESS, NAMELY, CHROMATOGRAPHIC COLUMNS AND CHROMATOGRAPHIC PLATES; EQUIPMENT, APPARATUS

AND INSTRUMENTS, NAMELY, CHROMATOGRAPHIC COLUMNS AND CHROMATOGRAPHIC PLATES AND SINGLE USE/DISPOSABLE FILTRATION AND SOLID-PHASE EXTRACTION COLUMNS, CARTRIDGES, SYRINGE-DRIVEN FILTERS, VACUUM FILTERS, PIPETTE FILTERS AND DISK FILTERS, ALL USED IN CONNECTION WITH THE SEPARATION OF CHEMICAL OR MOLECULAR SUBSTANCES OR COMPONENTS FROM ONE ANOTHER, IN LABORATORY AND RESEARCH FACILITIES, IN CLASS 9 (U.S. CLS. 21, 23, 26, 36 AND 38).

FIRST USE 3-31-2007; IN COMMERCE 3-31-2007.

THE MARK CONSISTS OF STANDARD CHARACTERS WITHOUT CLAIM TO ANY PARTICULAR FONT, STYLE, SIZE, OR COLOR.

SN 77-072,947, FILED 12-28-2006.

KAPIL BHANOT, EXAMINING ATTORNEY

**Int. Cls.: 16 and 18**

**Prior U.S. Cls.: 1, 2, 3, 5, 22, 23, 29, 37, 38, 41, and 50**

**Reg. No. 3,454,531**

**United States Patent and Trademark Office**

**Registered June 24, 2008**

**TRADEMARK  
PRINCIPAL REGISTER**

**Inner Peace For Your Inner  
Purse**

PROFFIT, JAELEN (UNITED STATES INDIVIDUAL)  
7718 PAGERWOOD LANE  
HOUSTON, TX 77063

FOR: PERSONAL ORGANIZERS, IN CLASS 16  
(U.S. CLS. 2, 5, 22, 23, 29, 37, 38 AND 50).

FIRST USE 7-11-2007; IN COMMERCE 7-11-2007.

FOR: CHANGE PURSES; CLUTCH PURSES;  
CLUTCHES; COIN PURSES; COIN PURSES NOT  
MADE OF PRECIOUS METAL; COIN PURSES, NOT  
OF PRECIOUS METALS; EVENING HANDBAGS;  
HANDBAG FRAMES; HANDBAGS; HANDBAGS  
FOR MEN; LEATHER HANDBAGS; LEATHER

PURSES; MULTI-PURPOSE PURSES; PURSE  
FRAMES; PURSES; PURSES; SMALL CLUTCH PURSES;  
SMALL PURSES; STRAPS FOR HANDBAGS, IN  
CLASS 18 (U.S. CLS. 1, 2, 3, 22 AND 41).

FIRST USE 7-11-2007; IN COMMERCE 7-11-2007.

THE MARK CONSISTS OF STANDARD CHARACTERS  
WITHOUT CLAIM TO ANY PARTICULAR  
FONT, STYLE, SIZE, OR COLOR.

SN 77-073,317, FILED 12-29-2006.

ANDREW RHIM, EXAMINING ATTORNEY



**Int. Cl.: 41**

**Prior U.S. Cls.: 100, 101, and 107**

**United States Patent and Trademark Office**

**Reg. No. 3,454,532**

**Registered June 24, 2008**

**SERVICE MARK  
PRINCIPAL REGISTER**

**COUNCIL OF THE UNIVERSE**

THE GOLDEN LIGHTS, LLC (FLORIDA LTD  
LIAB CO)  
6410 ABERFOYLE AVE  
COCOA, FL 32927

FOR: EDUCATIONAL AND ENTERTAINMENT  
SERVICES, NAMELY, PROVIDING MOTIVATION-  
AL AND EDUCATIONAL SPEAKERS, IN CLASS 41  
(U.S. CLS. 100, 101 AND 107).

FIRST USE 9-1-2006; IN COMMERCE 9-1-2006.

THE MARK CONSISTS OF STANDARD CHAR-  
ACTERS WITHOUT CLAIM TO ANY PARTICULAR  
FONT, STYLE, SIZE, OR COLOR.

SN 77-073,920, FILED 12-31-2006.

MARTHA FROMM, EXAMINING ATTORNEY

**Int. Cl.: 9**

**Prior U.S. Cls.: 21, 23, 26, 36, and 38**

**Reg. No. 3,454,533**

**United States Patent and Trademark Office**

**Registered June 24, 2008**

---

**TRADEMARK  
PRINCIPAL REGISTER**

**SILO**

DIOPTICS MEDICAL PRODUCTS, INC. (CALI-  
FORNIA CORPORATION)  
125 VENTURE DRIVE  
SAN LUIS OBISPO, CA 93401

THE MARK CONSISTS OF STANDARD CHAR-  
ACTERS WITHOUT CLAIM TO ANY PARTICULAR  
FONT, STYLE, SIZE, OR COLOR.

FOR: SUNGLASSES AND PROTECTIVE EYE-  
WEAR, IN CLASS 9 (U.S. CLS. 21, 23, 26, 36 AND 38).

SN 77-074,638, FILED 1-2-2007.

FIRST USE 8-16-2007; IN COMMERCE 8-16-2007.

TINA BROWN, EXAMINING ATTORNEY

**Int. Cl.: 11**

**Prior U.S. Cls.: 13, 21, 23, 31, and 34**

**United States Patent and Trademark Office**

**Reg. No. 3,454,534**

**Registered June 24, 2008**

**TRADEMARK  
PRINCIPAL REGISTER**



PHILIPS SOLID-STATE LIGHTING SOLUTIONS,  
INC. (DELAWARE CORPORATION)  
3 BURLINGTON WOODS DRIVE  
BURLINGTON, MA 01803

FOR: APPARATUS FOR LIGHTING, LIGHTING  
FIXTURES, COMPONENTS OF LIGHTING FIX-  
TURES, NAMELY, ELECTRIC LIGHTING FIX-  
TURES; ELECTRIC DEVICES USED TO CONTROL  
THE COLOR AND INTENSITY OF ARTIFICIAL  
LIGHT SOLD AS COMPONENTS OF LIGHTING  
FIXTURES; AND CONTROLLERS SOLD AS COM-

PONENTS OF LIGHTING FIXTURES, IN CLASS 11  
(U.S. CLS. 13, 21, 23, 31 AND 34).

FIRST USE 7-30-2007; IN COMMERCE 7-30-2007.

THE MARK CONSISTS OF THE STYLIZED LET-  
TERS, "CK".

SN 77-074,895, FILED 1-3-2007.

RICHARD A. STRASER, EXAMINING ATTORNEY

**Int. Cl.: 18**

**Prior U.S. Cls.: 1, 2, 3, 22, and 41**

**United States Patent and Trademark Office**

**Reg. No. 3,454,535**

**Registered June 24, 2008**

**TRADEMARK  
PRINCIPAL REGISTER**



**BY STAPLES**

STAPLES THE OFFICE SUPERSTORE, LLC (DE-  
LAWARE LTD LIAB CO)  
500 STAPLES DRIVE  
FRAMINGHAM, MA 01702

FOR: LUGGAGE, BRIEFCASES, KNAPSACKS,  
BOOK BAGS, BUSINESS CARD CASES, WALLETS,  
DUFFEL BAGS, DOCUMENT CASES, IN CLASS 18  
(U.S. CLS. 1, 2, 3, 22 AND 41).

FIRST USE 9-0-2007; IN COMMERCE 9-0-2007.

OWNER OF U.S. REG. NOS. 1,438,390, 1,891,487,  
AND OTHERS.

SN 77-075,218, FILED 1-3-2007.

HEATHER SAPP, EXAMINING ATTORNEY

**Int. Cl.: 28**

**Prior U.S. Cls.: 22, 23, 38, and 50**

**United States Patent and Trademark Office**

**Reg. No. 3,454,536**

**Registered June 24, 2008**

**TRADEMARK  
PRINCIPAL REGISTER**

**LIVING ADVENT CALENDAR**

FONG, PETER SUI LUN (CHINA INDIVIDUAL)  
297F SOUTH ATLANTIC BLVD.  
MONTEREY PARK, CA 91754

FOR: TOY TEDDY BEARS AND CHRISTMAS  
TREE DECORATIONS, IN CLASS 28 (U.S. CLS. 22, 23,  
38 AND 50).

FIRST USE 1-2-2007; IN COMMERCE 1-29-2007.

THE MARK CONSISTS OF STANDARD CHAR-  
ACTERS WITHOUT CLAIM TO ANY PARTICULAR  
FONT, STYLE, SIZE, OR COLOR.

NO CLAIM IS MADE TO THE EXCLUSIVE  
RIGHT TO USE "ADVENT CALENDAR", APART  
FROM THE MARK AS SHOWN.

SN 77-075,520, FILED 1-3-2007.

CARRIE GENOVESE, EXAMINING ATTORNEY

**Int. Cl.: 35**

**Prior U.S. Cls.: 100, 101, and 102**

**United States Patent and Trademark Office**

**Reg. No. 3,454,537**

**Registered June 24, 2008**

**SERVICE MARK  
PRINCIPAL REGISTER**

**Traffik**

REGIONAL MARKET RADIO, INC. (CONNECTI-  
CUT CORPORATION)  
FIFTH FLOOR  
100 PARK AVENUE  
NEW YORK, NY 10017

FOR: ADVERTISING CONSULTING SERVICES  
TO COMPANIES BUYING ADVERTISING IN ELEC-  
TRONIC COMMUNICATIONS MEDIA, IN CLASS 35  
(U.S. CLS. 100, 101 AND 102).

FIRST USE 12-20-2006; IN COMMERCE 12-20-2006.

THE MARK CONSISTS OF STANDARD CHAR-  
ACTERS WITHOUT CLAIM TO ANY PARTICULAR  
FONT, STYLE, SIZE, OR COLOR.

SN 77-075,816, FILED 1-4-2007.

LINDA E. BLOHM, EXAMINING ATTORNEY

**Int. Cl.: 10**

**Prior U.S. Cls.: 26, 39, and 44**

**Reg. No. 3,454,538**

**United States Patent and Trademark Office**

**Registered June 24, 2008**

---

**TRADEMARK  
PRINCIPAL REGISTER**

**RIGHTWAY**

ALBAHEALTH LLC (DELAWARE LTD LIAB CO)  
425 NORTH GATEWAY AVENUE  
ROCKWOOD, TN 37854

THE MARK CONSISTS OF STANDARD CHAR-  
ACTERS WITHOUT CLAIM TO ANY PARTICULAR  
FONT, STYLE, SIZE, OR COLOR.

FOR: MEDICAL COMPRESSION STOCKINGS  
AND ORTHOPEDIC FOOTWEAR, IN CLASS 10  
(U.S. CLS. 26, 39 AND 44).

SN 77-076,043, FILED 1-4-2007.

FIRST USE 4-1-2007; IN COMMERCE 4-1-2007.

HAI-LY LAM, EXAMINING ATTORNEY

**Int. Cls.: 9 and 42**

**Prior U.S. Cls.: 21, 23, 26, 36, 38, 100, and 101**

**United States Patent and Trademark Office**

**Reg. No. 3,454,539**

**Registered June 24, 2008**

**TRADEMARK  
SERVICE MARK  
PRINCIPAL REGISTER**

# FIRSTBEST

FIRSTBEST SYSTEMS, INC. (DELAWARE CORPORATION)  
420 BEDFORD STREET SUITE 300  
LEXINGTON, MA 02420

FOR: COMPUTER SOFTWARE FOR INSURANCE UNDERWRITING, IN CLASS 9 (U.S. CLS. 21, 23, 26, 36 AND 38).

FIRST USE 9-3-2007; IN COMMERCE 9-3-2007.

FOR: COMPUTER SOFTWARE DESIGN, COMPUTER PROGRAMMING OR MAINTENANCE OF COMPUTER SOFTWARE; TECHNICAL SUPPORT

SERVICES, NAMELY, TROUBLESHOOTING OF COMPUTER SOFTWARE PROBLEMS, IN CLASS 42 (U.S. CLS. 100 AND 101).

FIRST USE 9-3-2007; IN COMMERCE 9-3-2007.

THE MARK CONSISTS OF STANDARD CHARACTERS WITHOUT CLAIM TO ANY PARTICULAR FONT, STYLE, SIZE, OR COLOR.

SN 77-076,599, FILED 1-5-2007.

SANDRA MANIOS, EXAMINING ATTORNEY



**Int. Cl.: 3**

**Prior U.S. Cls.: 1, 4, 6, 50, 51, and 52**

**Reg. No. 3,454,540**

**United States Patent and Trademark Office**

**Registered June 24, 2008**

**TRADEMARK  
PRINCIPAL REGISTER**

**OUTDOOR HANDS**

CLINICAL SPECIALTIES, LLC (SOUTH CAROLINA LTD LIAB CO)  
3708-A EXECUTIVE CENTER DRIVE  
AUGUSTA, GA 30907

FOR: SKIN CARE PRODUCTS, NAMELY, HAND CREAM, FACIAL CREAM, BODY CREAM, LIP BALM, HAND LOTION, FACIAL LOTION, AND BODY LOTION, IN CLASS 3 (U.S. CLS. 1, 4, 6, 50, 51 AND 52).

FIRST USE 8-31-2007; IN COMMERCE 8-31-2007.

THE MARK CONSISTS OF STANDARD CHARACTERS WITHOUT CLAIM TO ANY PARTICULAR FONT, STYLE, SIZE, OR COLOR.

NO CLAIM IS MADE TO THE EXCLUSIVE RIGHT TO USE "HANDS", APART FROM THE MARK AS SHOWN.

SN 77-076,987, FILED 1-5-2007.

KATHLEEN M. VANSTON, EXAMINING ATTORNEY

**Int. Cl.: 29**

**Prior U.S. Cl.: 46**

**United States Patent and Trademark Office**

**Reg. No. 3,454,541**

**Registered June 24, 2008**

**TRADEMARK  
PRINCIPAL REGISTER**



PATCUD INVESTMENTS, INC. (DELAWARE  
CORPORATION)  
103 BAYNARD BUILDING  
3411 SILVERSIDE ROAD  
WILMINGTON, DE 19810

FOR: MEAT, IN CLASS 29 (U.S. CL. 46).

FIRST USE 1-1-2005; IN COMMERCE 1-1-2005.

OWNER OF U.S. REG. NO. 3,059,960.

NO CLAIM IS MADE TO THE EXCLUSIVE  
RIGHT TO USE "DELI COMPANY", APART FROM  
THE MARK AS SHOWN.

THE WORD "PAVONE" AS USED IN THE ITA-  
LIAN LANGUAGE MAY BE TRANSLATED AS  
"PEACOCK".

SN 77-077,040, FILED 1-5-2007.

MICHAEL ENGEL, EXAMINING ATTORNEY

**Int. Cls.: 42 and 44**

**Prior U.S. Cls.: 100 and 101**

**United States Patent and Trademark Office**

**Reg. No. 3,454,542**

**Registered June 24, 2008**

**SERVICE MARK  
PRINCIPAL REGISTER**

## Wildlife Is Our Game

JIMMY SANDERS, INC. (MISSISSIPPI CORPORATION)  
518 N SHARPE AVE  
CLEVELAND, MS 38732

FOR: WILDLIFE MANAGEMENT CONSULTING SERVICES, NAMELY, LAND USE PLANNING IN THE NATURE OF ADVICE FOR CREATING AND MAINTAINING WILDLIFE HABITATS, INFORMATION ON THE USE OF BIOTECHNOLOGY AND THE USE OF GPS MAPPING OF ACREAGE, IN CLASS 42 (U.S. CLS. 100 AND 101).

FIRST USE 4-14-2008; IN COMMERCE 4-14-2008.

FOR: WILDLIFE MANAGEMENT CONSULTING SERVICES, NAMELY, AGRICULTURAL ADVICE

IN THE NATURE OF RECOMMENDATIONS FOR SEED PLANTING, APPLICATIONS OF FERTILIZERS AND PESTICIDES, USE OF BIOTECHNOLOGY, SOIL SAMPLING, SOIL FERTILITY, IN CLASS 44 (U.S. CLS. 100 AND 101).

FIRST USE 4-14-2008; IN COMMERCE 4-14-2008.

THE MARK CONSISTS OF STANDARD CHARACTERS WITHOUT CLAIM TO ANY PARTICULAR FONT, STYLE, SIZE, OR COLOR.

SN 77-077,192, FILED 1-5-2007.

ANDREA K. NADELMAN, EXAMINING ATTORNEY

**Int. Cl.: 35**

**Prior U.S. Cls.: 100, 101, and 102**

**United States Patent and Trademark Office**

**Reg. No. 3,454,543**

**Registered June 24, 2008**

**SERVICE MARK  
PRINCIPAL REGISTER**

**MARKETVISUAL**

INTELLECTSPACE CORPORATION (WASHING-  
TON CORPORATION)  
SUITE 100  
133 QUEEN ANNE AVENUE NORTH  
SEATTLE, WA 98109

FOR: COMPUTERIZED DATA PROCESSING  
SERVICES RENDERED VIA COMPUTER NET-  
WORKS RELATING TO STORAGE, ANALYSIS,  
AND PRESENTATION TO INVESTORS AND IN-  
VESTMENT ANALYSTS OF INFORMATION  
ABOUT VARIOUS INTERRELATIONSHIPS IN SO-  
CIAL NETWORKS BETWEEN AND AMONG COR-  
PORATIONS AND INDIVIDUALS ASSOCIATED

WITH BUSINESS OWNERSHIP OR CONTROL, IN  
CLASS 35 (U.S. CLS. 100, 101 AND 102).

FIRST USE 9-0-2007; IN COMMERCE 9-0-2007.

THE MARK CONSISTS OF STANDARD CHAR-  
ACTERS WITHOUT CLAIM TO ANY PARTICULAR  
FONT, STYLE, SIZE, OR COLOR.

SN 77-077,283, FILED 1-5-2007.

EMILY CARLSEN, EXAMINING ATTORNEY

Int. Cl.: 33

Prior U.S. Cls.: 47 and 49

United States Patent and Trademark Office

Reg. No. 3,454,544

Registered June 24, 2008

TRADEMARK  
PRINCIPAL REGISTER

IKELLA

VIÑAS FAMILIA ARISTI S.A. (ARGENTINA  
CORPORATION)

GENERAL PAZ 1509

BRAGADO, ARGENTINA 6640

FOR: WINES, IN CLASS 33 (U.S. CLS. 47 AND 49).

FIRST USE 6-30-2007; IN COMMERCE 6-30-2007.

THE MARK CONSISTS OF STANDARD CHAR-  
ACTERS WITHOUT CLAIM TO ANY PARTICULAR  
FONT, STYLE, SIZE, OR COLOR.

THE WORDING "IKELLA" HAS NO MEANING  
IN A FOREIGN LANGUAGE.

SN 77-077,608, FILED 1-7-2007.

REBECCA EISINGER, EXAMINING ATTORNEY

**Int. Cl.: 28**

**Prior U.S. Cls.: 22, 23, 38, and 50**

**United States Patent and Trademark Office**

**Reg. No. 3,454,545**

**Registered June 24, 2008**

**TRADEMARK  
PRINCIPAL REGISTER**

**KUBIT2ME**

KUBIT2ME, INC. (ILLINOIS CORPORATION)  
6310 SURREY RIDGE ROAD  
LISLE, IL 60532

FIRST USE 8-31-2007; IN COMMERCE 9-28-2007.

FOR: CARD GAMES; EQUIPMENT SOLD AS A UNIT FOR PLAYING A MEMORY GAME; EQUIPMENT SOLD AS A UNIT FOR PLAYING CARD GAMES; INFANT DEVELOPMENT TOYS; PARLOR GAMES; PARTY GAMES, IN CLASS 28 (U.S. CLS. 22, 23, 38 AND 50).

THE MARK CONSISTS OF STANDARD CHARACTERS WITHOUT CLAIM TO ANY PARTICULAR FONT, STYLE, SIZE, OR COLOR.

SN 77-077,670, FILED 1-7-2007.

KAREN SEVERSON, EXAMINING ATTORNEY

**Int. Cl.: 35**

**Prior U.S. Cls.: 100, 101, and 102**

**United States Patent and Trademark Office**

**Reg. No. 3,454,546**

**Registered June 24, 2008**

**SERVICE MARK  
PRINCIPAL REGISTER**

**GABZIP**

GABZIP, INC. (NEW YORK CORPORATION)  
2763 STATE ROUTE 48  
MINETTO, NY 13115

THE MARK CONSISTS OF STANDARD CHAR-  
ACTERS WITHOUT CLAIM TO ANY PARTICULAR  
FONT, STYLE, SIZE, OR COLOR.

FOR: PROVIDING ONLINE ADVERTISING,  
MARKETING, AND PROMOTION OF GOODS  
AND SERVICES OF OTHERS, IN CLASS 35 (U.S.  
CLS. 100, 101 AND 102).

SN 77-077,715, FILED 1-8-2007.

FIRST USE 1-15-2008; IN COMMERCE 1-15-2008.

TRICIA SONNEBORN, EXAMINING ATTORNEY

**Int. Cl.: 28**

**Prior U.S. Cls.: 22, 23, 38, and 50**

**United States Patent and Trademark Office**

**Reg. No. 3,454,547**

**Registered June 24, 2008**

**TRADEMARK  
PRINCIPAL REGISTER**

**MAX GRAY PERFECTION SCALE  
MODELS**

GANSON, BARBARA ANNE (UNITED STATES  
INDIVIDUAL)  
1414 FLETCHER STREET  
HOLLYWOOD, FL 33020

FOR: ELECTRIC TOY TRAIN TRANSFORMERS;  
TOY MODEL TRAIN SETS; TOY TRAINS AND  
PARTS AND ACCESSORIES THEREFOR; TRAIN  
SET ACCESSORIES, NAMELY, ARTIFICIAL TREES,  
TURF, FOLIAGE, BALLAST, LICHEN AND GRASS,  
IN CLASS 28 (U.S. CLS. 22, 23, 38 AND 50).

FIRST USE 12-4-2007; IN COMMERCE 12-4-2007.

THE MARK CONSISTS OF STANDARD CHAR-  
ACTERS WITHOUT CLAIM TO ANY PARTICULAR  
FONT, STYLE, SIZE, OR COLOR.

NO CLAIM IS MADE TO THE EXCLUSIVE  
RIGHT TO USE "PERFECTION SCALE MODELS",  
APART FROM THE MARK AS SHOWN.

THE NAME "MAX GRAY" DOES NOT IDENTIFY  
A LIVING INDIVIDUAL.

SN 77-077,719, FILED 1-8-2007.

TRICIA SONNEBORN, EXAMINING ATTORNEY



**Int. Cl.: 41**

**Prior U.S. Cls.: 100, 101, and 107**

**United States Patent and Trademark Office**

**Reg. No. 3,454,548**

**Registered June 24, 2008**

**SERVICE MARK  
PRINCIPAL REGISTER**

**Dress Like The Big Fish**

LERNER, RICHARD A. (UNITED STATES INDIVIDUAL)  
1718 N. 131 AVE. CIR.  
OMAHA, NE 68154

FOR: CONDUCTING WORKSHOPS AND SEMINARS IN THE FIELD OF DRESSING FOR PROFESSIONAL, BUSINESS/CASUAL AND JOB INTERVIEWS, IN CLASS 41 (U.S. CLS. 100, 101 AND 107).

FIRST USE 11-16-2007; IN COMMERCE 11-16-2007.

THE MARK CONSISTS OF STANDARD CHARACTERS WITHOUT CLAIM TO ANY PARTICULAR FONT, STYLE, SIZE, OR COLOR.

SN 77-077,803, FILED 1-8-2007.

WANDA KAY PRICE, EXAMINING ATTORNEY

**Int. Cls.: 35 and 42**

**Prior U.S. Cls.: 100, 101, and 102**

**United States Patent and Trademark Office**

**Reg. No. 3,454,549**

**Registered June 24, 2008**

**SERVICE MARK  
PRINCIPAL REGISTER**

# SentiMetrix

SENTIMETRIX, INC. (MARYLAND CORPORATION)  
6017 SOUTHPORT DRIVE  
BETHESDA, MD 20814

FOR: ASSISTANCE, ADVISORY SERVICES AND CONSULTANCY WITH REGARD TO BUSINESS PLANNING, BUSINESS ANALYSIS, BUSINESS MANAGEMENT, AND BUSINESS ORGANIZATION; BUSINESS INVESTIGATIONS, EVALUATIONS, EXPERT APPRAISALS, INFORMATION AND RESEARCH; BUSINESS MANAGEMENT CONSULTANCY AS WELL AS DEVELOPMENT OF PROCESSES FOR THE ANALYSIS AND THE IMPLEMENTATION OF STRATEGY PLANS AND MANAGEMENT PROJECTS; CONDUCTING BUSINESS AND MARKET RESEARCH SURVEYS; CONSULTANCY SERVICES REGARDING BUSINESS STRATEGIES; CONSULTATION SERVICES IN THE FIELD OF COMPANY, BUSINESS SECTOR AND INDUSTRY DATA AND RESEARCH; CONSUMER RESEARCH; CREATION OF MARKETING TOOLS DESIGNED TO INCREASE A CLIENT COMPANY'S KNOWLEDGE OF CUSTOMER NEEDS, AND ITS COMPETITORS' PRODUCTS AND SERVICES, PRICING, ADVERTISING STRATEGY AND SALES STRATEGY; EXPERT EVALUATIONS AND REPORTS RELATING TO BUSINESS MATTERS; INFORMATION ABOUT POLITICAL ELECTIONS; INFORMATION, ADVISORY AND CONSULTANCY SERVICES RELATING TO BUSINESS AND MAN-

AGEMENT OR BUSINESS ADMINISTRATION, INCLUDING SUCH SERVICES PROVIDED ON LINE OR VIA THE INTERNET; MARKET ANALYSIS; MARKET MANIPULATION, RESEARCH AND ANALYSIS, WHETHER OR NOT VIA THE INTERNET; MARKET RESEARCH SERVICES; PUBLIC POLICY RESEARCH SERVICES; SERVICES RELATING TO THE ANALYSIS, EVALUATION, CREATION AND BRAND ESTABLISHMENT OF TRADEMARKS, TRADE NAMES AND DOMAIN NAMES; SERVICES WITH REGARD TO PRODUCT PRESENTATION TO THE PUBLIC, IN CLASS 35 (U.S. CLS. 100, 101 AND 102).

FIRST USE 8-1-2007; IN COMMERCE 8-1-2007.

FOR: RESEARCH IN THE FIELD OF INTELLIGENCE AND SECURITY, IN CLASS 42 (U.S. CLS. 100 AND 101).

FIRST USE 8-1-2007; IN COMMERCE 8-1-2007.

THE MARK CONSISTS OF STANDARD CHARACTERS WITHOUT CLAIM TO ANY PARTICULAR FONT, STYLE, SIZE, OR COLOR.

SN 77-078,685, FILED 1-9-2007.

ELIZABETH KAJUBI, EXAMINING ATTORNEY

**Int. Cl.: 21**

**Prior U.S. Cls.: 2, 13, 23, 29, 30, 33, 40, and 50**

**Reg. No. 3,454,550**

**United States Patent and Trademark Office**

**Registered June 24, 2008**

---

**TRADEMARK  
PRINCIPAL REGISTER**

**SCOPE**

THE PROCTER & GAMBLE COMPANY (OHIO  
CORPORATION)  
ONE PROCTER & GAMBLE PLAZA  
CINCINNATI, OH 45202

FOR: BREATH FRESHENER COMPONENT,  
SOLD AS PART OF DENTAL FLOSS, IN CLASS 21  
(U.S. CLS. 2, 13, 23, 29, 30, 33, 40 AND 50).

FIRST USE 9-24-2007; IN COMMERCE 9-24-2007.

THE MARK CONSISTS OF STANDARD CHAR-  
ACTERS WITHOUT CLAIM TO ANY PARTICULAR  
FONT, STYLE, SIZE, OR COLOR.

OWNER OF U.S. REG. NOS. 786,932, 2,724,324,  
AND 3,164,070.

SN 77-078,892, FILED 1-9-2007.

JASON ROTH, EXAMINING ATTORNEY

**Int. Cl.: 41**

**Prior U.S. Cls.: 100, 101, and 107**

**United States Patent and Trademark Office**

**Reg. No. 3,454,551**

**Registered June 24, 2008**

---

**SERVICE MARK  
PRINCIPAL REGISTER**

**Gussy Up Your Spirit**

HERGENROETHER, PATRICIA (UNITED STATES INDIVIDUAL)  
34530 MICHIGAN AVENUE  
WAYNE, MI 48184

THE MARK CONSISTS OF STANDARD CHARACTERS WITHOUT CLAIM TO ANY PARTICULAR FONT, STYLE, SIZE, OR COLOR.

FOR: EDUCATION SERVICES, NAMELY, PROVIDING SEMINARS, CONFERENCES, AND LECTURES IN THE FIELD OF SPIRITUALITY, IN CLASS 41 (U.S. CLS. 100, 101 AND 107).

SN 77-078,941, FILED 1-9-2007.

FIRST USE 10-13-2006; IN COMMERCE 10-13-2006.

ZHALEH DELANEY, EXAMINING ATTORNEY

Int. Cl.: 3

Prior U.S. Cls.: 1, 4, 6, 50, 51, and 52

Reg. No. 3,454,552

United States Patent and Trademark Office

Registered June 24, 2008

TRADEMARK  
PRINCIPAL REGISTER

HBL

USP, INC. (CALIFORNIA CORPORATION)  
1818 ORD WAY  
OCEANSIDE, CA 92056

FOR: AFTER-SHAVE CREAMS; AGE SPOT REDUCING CREAMS; ANTI-AGING CREAM; ANTI-FRECKLE CREAM; ANTI-WRINKLE CREAM; AROMATHERAPY CREAMS; BEAUTY CREAMS; BEAUTY CREAMS FOR BODY CARE; BODY CREAM; BODY CREAM SOAP; BODY MASK CREAM; CLEANSING CREAMS; COLD CREAM; COSMETIC CREAMS; CREAM SOAPS; CREAMS FOR CELLULITE REDUCTION; CUTICLE CREAM; CONCEALERS SPECIFICALLY FOR SKIN, FACE, AND BODY; COSMETIC CREAMS FOR SKIN CARE; COSMETIC PREPARATIONS FOR SKIN RENEWAL; COSMETIC PREPARATIONS IN THE FORM OF AEROSOLS FOR SKIN CARE; COSMETIC PREPARATIONS FOR EYE LASHES; DECORATIVE TRANSFERS AND SKIN JEWELS FOR COSMETIC PURPOSES; EXFOLIANTS SPECIFICALLY FOR HAIR, SKIN FACE, AND BODY; LOTIONS SPECIFICALLY FOR SKIN, HAIR, FACE, AND BODY; BATH SALTS; HAIR CARE PREPARATIONS; HAIR COLOR; HAIR COLOR REMOVERS; HAIR CONDITIONERS; HAIR DRESSINGS FOR MEN; HAIR DYE; HAIR EMOLLIENTS; HAIR FROSTS; HAIR GEL; HAIR LIGHTENERS; HAIR LOTIONS; HAIR MASCARA; HAIR MOUSSE; HAIR POMADES; HAIR RELAXERS; HAIR RELAXING PREPARATIONS; HAIR RINSES; HAIR SHAMPOO; HAIR SPRAY; HAIR STRAIGHTENING PREPARATIONS; HAIR STYLING PREPARATIONS; HAIR WAVING LOTION; MINERAL SALT IN THE NATURE OF BATH SALTS NOT FOR MEDICAL PURPOSES; SALT SCRUBS FOR THE SKIN; BODY AND BEAUTY CARE COSMETICS; BODY AND BEAUTY CARE PREPARATIONS; BODY EMULSIONS; BODY MASK LOTION; BODY MASK POWDER; BODY MASKS; BODY MILK; BODY OILS; BODY POWDER; BODY SCRUB; BODY SPRAY USED AS A PERSONAL DEODORANT AND AS A FRA-

GRANCE; BODY SPRAYS; COSMETIC PREPARATIONS FOR BODY CARE; DEODORANTS FOR BODY CARE; FACE AND BODY CREAMS; FACE AND BODY LOTIONS; FACE AND BODY MILK; LIQUID SOAPS FOR HANDS, FACE, AND BODY; LOTIONS FOR FACE AND BODY CARE; MAKE-UP PRODUCTS FOR THE FACE AND BODY; NON-MEDICATED BODY SOAKS; SCENTED BODY SPRAY; SOAPS FOR BODY CARE; TONING LOTION, FOR THE FACE, BODY, AND HANDS; WAX STRIPS FOR REMOVING BODY HAIR; AFTER-SUN LOTIONS; AGE RETARDANT LOTION; AROMATHERAPY LOTIONS; BABY LOTION; BATHING LOTIONS; BEAUTY LOTIONS; COSMETIC SUNTAN LOTIONS; EYE LOTIONS; FACIAL LOTION; HAIR CARE LOTIONS; HAND LOTIONS; LOTIONS FOR BEARDS; LOTIONS FOR CELLULITE REDUCTION; LOTIONS FOR STRENGTHENING THE NAILS; MAKE-UP REMOVING MILK, GEL, LOTIONS, AND CREAMS; NON-MEDICATED STIMULATING LOTIONS FOR THE SKIN; SHAVING LOTION; STYLING LOTIONS; SUN CARE LOTIONS; SUN TAN LOTION; SUN-BLOCK LOTIONS; TEETH CLEANING LOTIONS; FACIAL SCRUBS; SALT BODY SCRUB; SUGAR BODY SCRUB; DEPILATORY CREAMS; EXFOLIANT CREAMS; EYE CREAM; FACIAL CREAMS; FAIR COMPLEXION CREAM; HAIR CARE CREAMS; HAIR REMOVING CREAM; HAND CREAMS; LIP CREAM; NAIL CREAM; NIGHT CREAM; NON-MEDICATED FOOT CREAM; NON-MEDICATED SCALP TREATMENT CREAM; NON-MEDICATED SKIN CREAMS; PERFUMED CREAMS; PRE-SHAVE CREAMS; SHAVING CREAMS; SHOWER CREAMS; SKIN CLEANSING CREAM; SKIN CREAMS IN LIQUID AND IN SOLID FORM; SKIN LIGHTENING CREAMS; SKIN WHITENING CREAMS; VANISHING CREAM; TOPICAL HERBAL CREAM FOR FIRMING AND ENHANCING BREASTS; WRINKLE RESISTANT CREAM; EYE COMPRESSES FOR COSMETIC PURPOSES; EYE GELS; EYE LINER; EYE MAKEUP; EYE MAKEUP REMOVER; EYE PEN-

CILS; EYE SHADOW; EYES MAKE-UP; EYES PENCILS; EYE-SHADOW; EYELINERS; EYEBROW PENCILS; GEL FOR HAIR AND FOR SCULPTING HAIR; SACHET-LIKE EYE PILLOWS CONTAINING FRAGRANCES; UNDER-EYE ENHANCERS; HAIR TONICS; BODY TONICS; FACIAL MAKEUP; FOUNDATION MAKEUP; MAKEUP; THEATRICAL MAKEUP; FACIAL BEAUTY MASKS; FACIAL CLEANSERS; FACIAL CLEANSING MILK; FACIAL CONCEALER; FACIAL EMULSIONS; FACIAL MASKS; FACIAL WASHES; BATH GELS; BEAUTY MASKS; BLUSH; ROUGE; SKIN CREAMS; BODY LOTIONS; SKIN CLEANSING LOTIONS; SKIN CLEANSERS; SKIN MOISTURIZERS; SKIN TONERS; COSMETIC COMPACTS; COMPACTS CONTAINING MAKEUP; EYE CONCEALERS; SKIN CONCEALERS; COSMETIC PENCILS; FACE POWDERS; POWDER FOUNDATIONS; FOUNDATION MAKE-UP; LIP GLOSS; LIP LINERS; LIPSTICKS; MASCARA; NAIL ENAMELS; NAIL POLISH BASE COATS; NAIL POLISH REMOVERS; NAIL POLISH TOP COAT; PERFUME; SKIN CARE PREPARATIONS, NAMELY SOAPS, CLEANSERS, TONERS, OILS, CREAMS, MOISTURIZERS, AND MASKS; BATH CARE PRODUCTS, NAMELY SALTS, OILS, LOTIONS, RUBS, GELS, AND BALMS; ESSENTIAL OILS; OIL BLENDS AND DIFFUSERS FOR BODY CARE SOLD TOGETHER AS A UNIT; COSMETIC

OIL MISTS; COSMETIC OIL GELS; COSMETIC OIL BALMS; MASSAGE OILS; MOUSSE SPECIFICALLY FOR HAIR, SKIN, AND FACIAL; NON-MEDICATED SKIN CARE PREPARATIONS; PATCHES CONTAINING SUNSCREEN AND SUN BLOCK FOR USE ON THE SKIN; SKIN ABRASIVE PREPARATIONS; SKIN CARE PRODUCTS, NAMELY NON-MEDICATED SKIN CARE SERUMS; SKIN CLARIFIERS; SKIN CONDITIONERS; SKIN EMOLLIENTS; SKIN GELS FOR ACCELERATING, ENHANCING, OR EXTENDING TANS; SKIN MASKS; SKIN MOISTURIZER MASKS; SKIN POLISHING EXFOLIANTS AND ASTRINGENTS FOR COSMETIC PURPOSES; SKIN SOAP; SKIN TEXTURIZERS; SKIN WHITENING PREPARATIONS; TOPICAL SKIN SPRAYS FOR COSMETIC PURPOSES; WRINKLE REMOVING SKIN CARE PREPARATIONS, IN CLASS 3 (U.S. CLS. 1, 4, 6, 50, 51 AND 52).

FIRST USE 4-1-2008; IN COMMERCE 5-1-2008.

THE MARK CONSISTS OF STANDARD CHARACTERS WITHOUT CLAIM TO ANY PARTICULAR FONT, STYLE, SIZE, OR COLOR.

SN 77-079,290, FILED 1-9-2007.

ELIZABETH KAJUBI, EXAMINING ATTORNEY

**Int. Cl.: 18**

**Prior U.S. Cls.: 1, 2, 3, 22, and 41**

**United States Patent and Trademark Office**

**Reg. No. 3,454,553**

**Registered June 24, 2008**

**TRADEMARK  
PRINCIPAL REGISTER**

**WAIFER**

SAMSONITE CORPORATION (DELAWARE CORPORATION)  
575 WEST STREET, SUITE 110  
MANSFIELD, MA 02048

THE MARK CONSISTS OF STANDARD CHARACTERS WITHOUT CLAIM TO ANY PARTICULAR FONT, STYLE, SIZE, OR COLOR.

FOR: LUGGAGE, IN CLASS 18 (U.S. CLS. 1, 2, 3, 22 AND 41).

SN 77-079,516, FILED 1-10-2007.

FIRST USE 3-28-2008; IN COMMERCE 3-28-2008.

BENJAMIN ALLEN, EXAMINING ATTORNEY

**Int. Cl.: 9**

**Prior U.S. Cls.: 21, 23, 26, 36, and 38**

**United States Patent and Trademark Office**

**Reg. No. 3,454,554**

**Registered June 24, 2008**

**TRADEMARK  
PRINCIPAL REGISTER**

**PRO GRIPZ**

HARRIS, CURTIS J. (UNITED STATES INDIVIDUAL)

14701 SENECA RD

DARNESTOWN, MD 20874

FOR: COVER FOR A VIDEO GAME CONTROLLER, IN CLASS 9 (U.S. CLS. 21, 23, 26, 36 AND 38).

FIRST USE 11-20-2007; IN COMMERCE 4-28-2008.

THE MARK CONSISTS OF STANDARD CHARACTERS WITHOUT CLAIM TO ANY PARTICULAR FONT, STYLE, SIZE, OR COLOR.

NO CLAIM IS MADE TO THE EXCLUSIVE RIGHT TO USE "GRIPS", APART FROM THE MARK AS SHOWN.

SN 77-079,766, FILED 1-10-2007.

CHARLOTTE CORWIN, EXAMINING ATTORNEY



**Int. Cl.: 35**

**Prior U.S. Cls.: 100, 101, and 102**

**United States Patent and Trademark Office**

**Reg. No. 3,454,555**

**Registered June 24, 2008**

**SERVICE MARK  
PRINCIPAL REGISTER**

**DIVIDED WE FAIL**

AARP (D.C. NON-PROFIT CORPORATION)  
601 E STREET, N.W.  
WASHINGTON, DC 20049

FOR: PROVIDING INFORMATION ABOUT POLITICAL ELECTIONS; VOTER ADVOCACY SERVICES, NAMELY, PROVIDING INFORMATION ABOUT POLITICAL ELECTIONS, VOTING, AND POLITICAL OFFICE CANDIDATES; PUBLIC ADVOCACY SERVICES TO PROMOTE THE INTERESTS OF MATURE CITIZENS AND FAMILIES BY INCREASING PUBLIC AND GOVERNMENT INTEREST IN AND AWARENESS OF LEGISLATION, REGULATIONS, POLICIES AND ISSUES AFFECTING CITIZENS AND FAMILIES THROUGH MEETINGS WITH AND WRITTEN AND VERBAL COMMUNICATIONS TO LOCAL, STATE AND FEDERAL LEGISLATORS, GOVERNMENT BODIES,

GOVERNMENT OFFICIALS AND MEDIA OUTLETS, SPONSORSHIP OF PUBLIC EVENTS, COORDINATION OF GRASSROOTS VOTER ADVOCACY EFFORTS, AND COLLABORATION WITH OTHER ORGANIZATIONS AND COALITIONS IN SUPPORT OF CIVIL RIGHTS, SENIOR RIGHTS, AND THE WELL BEING OF MATURE CITIZENS AND FAMILIES, IN CLASS 35 (U.S. CLS. 100, 101 AND 102).

FIRST USE 6-1-2007; IN COMMERCE 6-1-2007.

THE MARK CONSISTS OF STANDARD CHARACTERS WITHOUT CLAIM TO ANY PARTICULAR FONT, STYLE, SIZE, OR COLOR.

SN 77-079,806, FILED 1-10-2007.

ROBERT LAVACHE, EXAMINING ATTORNEY

**Int. Cl.: 30**

**Prior U.S. Cl.: 46**

**United States Patent and Trademark Office**

**Reg. No. 3,454,556**

**Registered June 24, 2008**

**TRADEMARK  
PRINCIPAL REGISTER**

**ON THE ROCKS**

LILLIS, JOSEPH (UNITED STATES INDIVIDUAL)  
86 EAST BROOKLINE ST  
BOSTON, MA 02118

THE MARK CONSISTS OF STANDARD CHAR-  
ACTERS WITHOUT CLAIM TO ANY PARTICULAR  
FONT, STYLE, SIZE, OR COLOR.

FOR: PACKAGED ICE, IN CLASS 30 (U.S. CL. 46).

SN 77-080,391, FILED 1-10-2007.

FIRST USE 1-10-2007; IN COMMERCE 1-10-2007.

KATHY DE JONGE, EXAMINING ATTORNEY

**Int. Cl.: 43**

**Prior U.S. Cls.: 100 and 101**

**United States Patent and Trademark Office**

**Reg. No. 3,454,557**

**Registered June 24, 2008**

**SERVICE MARK  
PRINCIPAL REGISTER**

**CANARY HOTEL**

THE EDWARD THOMAS HOSPITALITY CORP.  
(CALIFORNIA CORPORATION)

9950 SANTA MONICA BLVD.

BEVERLY HILLS, CA 90212

FOR: HOTEL SERVICES, IN CLASS 43 (U.S. CLS.  
100 AND 101).

FIRST USE 1-31-2008; IN COMMERCE 1-31-2008.

THE MARK CONSISTS OF STANDARD CHAR-  
ACTERS WITHOUT CLAIM TO ANY PARTICULAR  
FONT, STYLE, SIZE, OR COLOR.

NO CLAIM IS MADE TO THE EXCLUSIVE  
RIGHT TO USE "HOTEL", APART FROM THE  
MARK AS SHOWN.

SN 77-080,427, FILED 1-10-2007.

WILLIAM VERHOSEK, EXAMINING ATTORNEY

**Int. Cl.: 11**

**Prior U.S. Cls.: 13, 21, 23, 31, and 34**

**United States Patent and Trademark Office**

**Reg. No. 3,454,558**

**Registered June 24, 2008**

**TRADEMARK  
PRINCIPAL REGISTER**

**MAREZIA**

HUNTER FAN COMPANY (DELAWARE COR-  
PORATION)  
2500 FRISCO AVENUE  
MEMPHIS, TN 38114

THE MARK CONSISTS OF STANDARD CHAR-  
ACTERS WITHOUT CLAIM TO ANY PARTICULAR  
FONT, STYLE, SIZE, OR COLOR.

FOR: CEILING FANS, IN CLASS 11 (U.S. CLS. 13,  
21, 23, 31 AND 34).

SN 77-080,641, FILED 1-11-2007.

FIRST USE 8-3-2007; IN COMMERCE 8-3-2007.

LAURIE KAUFMAN, EXAMINING ATTORNEY

**Int. Cls.: 35, 36, and 41**

**Prior U.S. Cls.: 100, 101, 102, and 107**

**United States Patent and Trademark Office**

**Reg. No. 3,454,559**

**Registered June 24, 2008**

**SERVICE MARK  
PRINCIPAL REGISTER**

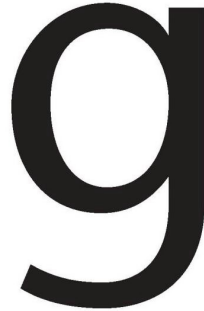

GEVITY HR, INC. (FLORIDA CORPORATION)  
9000 TOWN CENTER PARKWAY  
BRADENTON, FL 34202

FOR: PROFESSIONAL EMPLOYER ORGANIZATION AND HUMAN RESOURCE OUTSOURCING SERVICES, NAMELY HUMAN RESOURCE MANAGEMENT CONSULTING SERVICES; EMPLOYEE DEVELOPMENT SERVICES, NAMELY, PROVIDING REWARD AND RECOGNITION PROGRAMS, CONSULTATION, AND COUNSELING TO EMPLOYEES OF OTHERS TO PROMOTE EMPLOYEE RETENTION, CAREER GROWTH, AND INCREASED PRODUCTIVITY; BUSINESS AND FINANCIAL RECORDS MANAGEMENT; EMPLOYMENT-RELATED REGULATORY GUIDANCE SERVICES; HUMAN RESOURCE SUPPORT SERVICES, NAMELY, TRACKING OF EMPLOYEE SALARY, PERFORMANCE, COMPETENCIES, ABSENCES AND EMERGENCY CONTACTS, VIA AN INTERNET MANAGEMENT SYSTEM AND TECHNOLOGY PLATFORM; AND PROVIDING INFORMATION IN THE FIELD OF HUMAN RESOURCES VIA THE INTERNET, IN CLASS 35 (U.S. CLS. 100, 101 AND 102).

FIRST USE 4-11-2007; IN COMMERCE 4-11-2007.

FOR: PROFESSIONAL EMPLOYER ORGANIZATION SERVICES, NAMELY ADMINISTRATION OF EMPLOYEE BENEFIT PLANS, RISK MANAGEMENT SERVICES, PROVIDING PAYROLL PROCESSING, PAYROLL DIRECT-DEPOSIT AND ELECTRONIC FUND TRANSFER SERVICES, AND ADMINISTRATION OF WORKERS' COMPENSATION AND HEALTH INSURANCE, IN CLASS 36 (U.S. CLS. 100, 101 AND 102).

FIRST USE 4-11-2007; IN COMMERCE 4-11-2007.

FOR: PROVIDING ON-LINE TRAINING IN THE FIELD OF HUMAN RESOURCES, IN CLASS 41 (U.S. CLS. 100, 101 AND 107).

FIRST USE 4-11-2007; IN COMMERCE 4-11-2007.

THE MARK CONSISTS OF A STYLIZED LETTER G.

SN 77-080,673, FILED 1-11-2007.

ELLEN B. AWRICH, EXAMINING ATTORNEY

**Int. Cl.: 38**

**Prior U.S. Cls.: 100, 101, and 104**

**United States Patent and Trademark Office**

**Reg. No. 3,454,560**

**Registered June 24, 2008**

**SERVICE MARK  
PRINCIPAL REGISTER**



MYFISH, LLC (FLORIDA LTD LIAB CO)  
164 LOTT COUT  
WEST COLUMBIA, SC 29169

FIRST USE 1-31-2007; IN COMMERCE 1-31-2007.

FOR: PROVIDING ON-LINE CHAT ROOMS AND ELECTRONIC BULLETIN BOARDS FOR TRANSMISSION OF MESSAGES AMONG USERS IN THE FIELD OF GENERAL INTEREST; PROVIDING ON-LINE CHAT ROOMS FOR TRANSMISSION OF MESSAGES AMONG COMPUTER USERS CONCERNING FISHING, IN CLASS 38 (U.S. CLS. 100, 101 AND 104).

THE MARK CONSISTS OF A FISH-LIKE DESIGN BOTH SURROUNDING AND FORMING PART OF THE WORDS "MYFISH.COM".

SN 77-080,736, FILED 1-11-2007.

JUDITH HELFMAN, EXAMINING ATTORNEY

**Int. Cl.: 41**

**Prior U.S. Cls.: 100, 101, and 107**

**United States Patent and Trademark Office**

**Reg. No. 3,454,561**

**Registered June 24, 2008**

---

**SERVICE MARK  
PRINCIPAL REGISTER**

**CHILL**

THE BURTON FOUNDATION (VERMONT NOT-  
FOR-PROFIT CORPORATION)  
82 INDUSTRIAL PARKWAY  
BURLINGTON, VT 05401

FOR: TRAINING AND INSTRUCTION IN THE  
FIELD OF SPORTS; PROGRAMS FOR YOUTHS IN  
THE FIELD OF SPORTS AND PHYSICAL ACTIV-  
ITIES, IN CLASS 41 (U.S. CLS. 100, 101 AND 107).

FIRST USE 7-1-1997; IN COMMERCE 7-1-1997.

THE MARK CONSISTS OF STANDARD CHAR-  
ACTERS WITHOUT CLAIM TO ANY PARTICULAR  
FONT, STYLE, SIZE, OR COLOR.

OWNER OF U.S. REG. NO. 2,322,760.

SN 77-080,887, FILED 1-11-2007.

SHARON MEIER, EXAMINING ATTORNEY

**Int. Cl.: 39**

**Prior U.S. Cls.: 100 and 105**

**United States Patent and Trademark Office**

**Reg. No. 3,454,562**

**Registered June 24, 2008**

**SERVICE MARK  
PRINCIPAL REGISTER**

**CAR RE-CHECK**

CB TRAVEL CORP. (UTAH CORPORATION)  
SUITE 300  
5588 SOUTH GREEN STREET  
SALT LAKE CITY, UT 84123

FOR: CAR RESERVATION SERVICES FOR OTHERS, COMPRISING RESERVATION VERIFICATION AND RESERVATION RESCHEDULING WHEN A LOWER RATE IS IDENTIFIED, IN CLASS 39 (U.S. CLS. 100 AND 105).

FIRST USE 7-1-2007; IN COMMERCE 7-1-2007.

THE MARK CONSISTS OF STANDARD CHARACTERS WITHOUT CLAIM TO ANY PARTICULAR FONT, STYLE, SIZE, OR COLOR.

NO CLAIM IS MADE TO THE EXCLUSIVE RIGHT TO USE "CAR", APART FROM THE MARK AS SHOWN.

SN 77-081,010, FILED 1-11-2007.

ELIZABETH BEYER, EXAMINING ATTORNEY



**Int. Cl.: 35**

**Prior U.S. Cls.: 100, 101, and 102**

**United States Patent and Trademark Office**

**Reg. No. 3,454,563**

**Registered June 24, 2008**

**SERVICE MARK  
PRINCIPAL REGISTER**



TRADEKAY PVT. LIMITED (PAKISTAN PRIVATE LIMITED COMPANY)  
1001, 1002 PARK AVE. SHAHRAI FAISAL  
KARACHI, PAKISTAN

FOR: OPERATING ON-LINE MARKETPLACES FOR SELLERS OF GOODS AND/OR SERVICES; PROMOTING THE GOODS AND SERVICES OF OTHERS BY PROVIDING HYPERTEXT LINKS TO THE WEB SITES OF OTHERS; PROVIDING A WEBSITE PROMOTING THE GOODS AND SERVICES OF OTHERS FEATURING GENERAL BUSINESS NETWORKING REFERRALS; INFORMATION, ADVISORY AND CONSULTANCY SERVICES RELATING TO ALL THE AFORESAID SERVICES, IN CLASS 35 (U.S. CLS. 100, 101 AND 102).

FIRST USE 11-16-2007; IN COMMERCE 11-16-2007.

THE COLOR(S) BLUE, ORANGE IS/ARE CLAIMED AS A FEATURE OF THE MARK.

THE MARK CONSISTS OF THE GLOBE DESIGN AND THE WORDING "TRADE" AND "YOUR KEY TO GLOBAL TRADE" APPEARING IN BLUE; THE WORDING "KEY" AND THE CHEVRON DESIGN APPEARING IN ORANGE.

SN 77-081,508, FILED 1-11-2007.

JUSTINE D. PARKER, EXAMINING ATTORNEY

**Int. Cl.: 25**

**Prior U.S. Cls.: 22 and 39**

**United States Patent and Trademark Office**

**Reg. No. 3,454,564**

**Registered June 24, 2008**

**TRADEMARK  
PRINCIPAL REGISTER**

**POWDER FOR THE PEOPLE**

DELONG, JOHN R. (UNITED STATES INDIVIDUAL)  
295 COUNTRYSIDE CIRCLE  
PARK CITY, UT 84098 AND  
DELONG, HEATHER, L. (UNITED STATES INDIVIDUAL)  
295 COUNTRYSIDE CIRCLE  
PARK CITY, UT 84098

FOR: SHIRTS; SHORT-SLEEVED OR LONG-SLEEVED T-SHIRTS; SHORT-SLEEVED SHIRTS; SPORT SHIRTS; SPORTS SHIRTS; SPORTS SHIRTS

WITH SHORT SLEEVES; SWEAT SHIRTS; T-SHIRTS, IN CLASS 25 (U.S. CLS. 22 AND 39).

FIRST USE 11-1-1994; IN COMMERCE 5-2-2008.

THE MARK CONSISTS OF STANDARD CHARACTERS WITHOUT CLAIM TO ANY PARTICULAR FONT, STYLE, SIZE, OR COLOR.

SN 77-082,587, FILED 1-13-2007.

TARAH HARDY, EXAMINING ATTORNEY

**Int. Cls.: 36 and 45**

**Prior U.S. Cls.: 100, 101, and 102**

**United States Patent and Trademark Office**

**Reg. No. 3,454,565**

**Registered June 24, 2008**

**SERVICE MARK  
PRINCIPAL REGISTER**

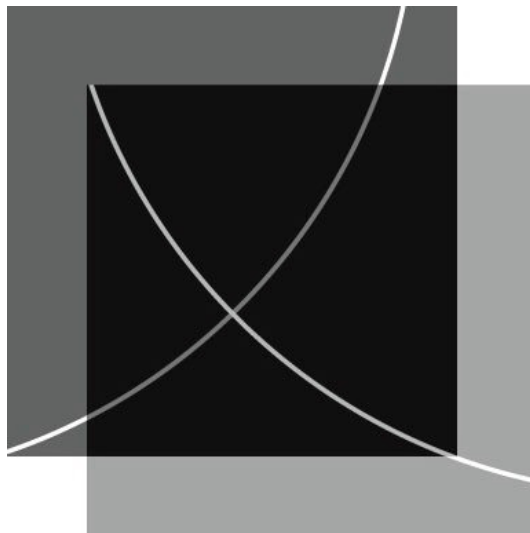

CHICAGO PARTNERS, L.L.C. (ILLINOIS LTD  
LIAB CO)  
140 SOUTH DEARBORN ST.  
CHICAGO, IL 60603

FOR: CONSULTATION SERVICES IN THE  
FIELDS OF ECONOMICS, FINANCE AND AC-  
COUNTING; FINANCIAL ANALYSIS AND CON-  
SULTATION, IN CLASS 36 (U.S. CLS. 100, 101 AND  
102).

FIRST USE 4-30-2007; IN COMMERCE 4-30-2007.

FOR: EXPERT WITNESS SERVICES IN THE  
FIELDS OF ECONOMICS, FINANCE AND AC-  
COUNTING, IN CLASS 45 (U.S. CLS. 100 AND 101).

FIRST USE 4-30-2007; IN COMMERCE 4-30-2007.

THE MARK CONSISTS OF TWO SHADED AND  
OVERLAPPING SQUARES, WITH A CURVED X  
DESIGN.

SN 77-082,862, FILED 1-15-2007.

NANCY CLARKE, EXAMINING ATTORNEY

Int. Cl.: 9

Prior U.S. Cls.: 21, 23, 26, 36, and 38

United States Patent and Trademark Office

Reg. No. 3,454,566

Registered June 24, 2008

TRADEMARK  
PRINCIPAL REGISTER



PNY TECHNOLOGIES, INC. (DELAWARE CORPORATION)  
299 WEBRO ROAD  
PARSIPPANY, NJ 07054

FOR: COMPUTER HARDWARE FOR TRANSMITTING, STORING AND TRANSPORTING ELECTRONIC DATA BETWEEN ELECTRONIC STORAGE DEVICES, IN CLASS 9 (U.S. CLS. 21, 23, 26, 36 AND 38).

FIRST USE 1-6-2007; IN COMMERCE 3-14-2007.

OWNER OF U.S. REG. NO. 2,944,947.

NO CLAIM IS MADE TO THE EXCLUSIVE RIGHT TO USE "SECURE", APART FROM THE MARK AS SHOWN.

SN 77-084,109, FILED 1-16-2007.

ANDREA K. NADELMAN, EXAMINING ATTORNEY

**Int. Cl.: 16**

**Prior U.S. Cls.: 2, 5, 22, 23, 29, 37, 38, and 50**

**Reg. No. 3,454,567**

**United States Patent and Trademark Office**

**Registered June 24, 2008**

**TRADEMARK  
PRINCIPAL REGISTER**

# Robin Hood's Music

RULE. GARY WILLIAM (UNITED STATES IN-  
DIVIDUAL)

APT. 288

520 RAILWAY AVE.

CAMPBELL, CA 95008

FOR: SHEET MUSIC; SHEET MUSIC BOOKS  
FEATURING COLLECTIONS OF INDIVIDUAL  
SHEET MUSIC, IN CLASS 16 (U.S. CLS. 2, 5, 22, 23,  
29, 37, 38 AND 50).

FIRST USE 6-1-2007; IN COMMERCE 6-1-2007.

THE MARK CONSISTS OF STANDARD CHAR-  
ACTERS WITHOUT CLAIM TO ANY PARTICULAR  
FONT, STYLE, SIZE, OR COLOR.

NO CLAIM IS MADE TO THE EXCLUSIVE  
RIGHT TO USE "MUSIC", APART FROM THE  
MARK AS SHOWN.

THE NAME "ROBIN HOOD" DOES NOT DENOTE  
A LIVING INDIVIDUAL.

SN 77-084,265, FILED 1-17-2007.

JOHN DALIER, EXAMINING ATTORNEY

**Int. Cl.: 19**

**Prior U.S. Cls.: 1, 12, 33, and 50**

**United States Patent and Trademark Office**

**Reg. No. 3,454,568**

**Registered June 24, 2008**

**TRADEMARK  
PRINCIPAL REGISTER**

The logo for the trademark 'TeQ::Flash' is displayed in a bold, sans-serif font. The word 'TeQ' is followed by two square blocks, and then the word 'Flash'. The entire logo is centered within a light gray rectangular background.

HENKEL KGAA (FED REP GERMANY PART-  
NERSHIP LIMITED BY SHARES)  
HENKELSTRASSE 67  
DUESSELDORF, FED REP GERMANY D-40191

THE MARK CONSISTS OF THE WORD "TEQ"  
FOLLOWED BY FOUR SQUARE BLOCKS AND  
THE WORD "FLASH".

FOR: NON-METAL BUILDING FLASHING WITH  
ADHESIVE BACKING, IN CLASS 19 (U.S. CLS. 1, 12,  
33 AND 50).

SN 77-084,977, FILED 1-17-2007.

FIRST USE 7-3-2007; IN COMMERCE 7-3-2007.

DAVID TOOLEY, EXAMINING ATTORNEY

**Int. Cl.: 9**

**Prior U.S. Cls.: 21, 23, 26, 36, and 38**

**Reg. No. 3,454,569**

**United States Patent and Trademark Office**

**Registered June 24, 2008**

**TRADEMARK  
PRINCIPAL REGISTER**

**E-MAN**

RAININ INSTRUMENT, LLC (DELAWARE LTD  
LIAB CO)  
7500 EDGEWATER DRIVE  
OAKLAND, CA 94621

THE MARK CONSISTS OF STANDARD CHAR-  
ACTERS WITHOUT CLAIM TO ANY PARTICULAR  
FONT, STYLE, SIZE, OR COLOR.

FOR: PIPETTES, IN CLASS 9 (U.S. CLS. 21, 23, 26, 36  
AND 38).

SN 77-085,155, FILED 1-17-2007.

FIRST USE 9-27-2007; IN COMMERCE 10-31-2007.

JOHN WILKE, EXAMINING ATTORNEY

**Int. Cls.: 8 and 21**

**Prior U.S. Cls.: 2, 13, 23, 28, 29, 30, 33, 40, 44, and 50**

**United States Patent and Trademark Office**

**Reg. No. 3,454,570**

**Registered June 24, 2008**

**TRADEMARK  
PRINCIPAL REGISTER**

# Everyday Kitchen

TABLETOPS UNLIMITED, INC. (CALIFORNIA CORPORATION)  
23000 AVALON BLVD  
CARSON, CA 90745

FOR: KNIVES, FORKS AND SPOONS, IN CLASS 8 (U.S. CLS. 23, 28 AND 44).

FIRST USE 9-18-2007; IN COMMERCE 9-18-2007.

FOR: BEVERAGE GLASSWARE, MUGS, DRINKING TUMBLERS, SERVING TRAYS NOT OF PRECIOUS METAL, SERVING PLATTERS, PLATES, DISHES AND SAUCERS, POTS, PANS; SERVING UTENSILS, NAMELY, SERVING SPOONS, SERVING FORKS, AND TONGS, IN CLASS 21 (U.S. CLS. 2, 13, 23, 29, 30, 33, 40 AND 50).

FIRST USE 8-11-2006; IN COMMERCE 8-11-2006.

THE MARK CONSISTS OF STANDARD CHARACTERS WITHOUT CLAIM TO ANY PARTICULAR FONT, STYLE, SIZE, OR COLOR.

NO CLAIM IS MADE TO THE EXCLUSIVE RIGHT TO USE "KITCHEN", APART FROM THE MARK AS SHOWN.

SN 77-086,582, FILED 1-19-2007.

EMILY CARLSEN, EXAMINING ATTORNEY



**Int. Cl.: 45**

**Prior U.S. Cls.: 100 and 101**

**United States Patent and Trademark Office**

**Reg. No. 3,454,571**

**Registered June 24, 2008**

**SERVICE MARK  
PRINCIPAL REGISTER**

**SpotLife**

HANSON, MICHAEL F. (UNITED STATES INDIVIDUAL)  
4390 PACES POINT CIRCLE SE  
SMYRNA, GA 30080

THE MARK CONSISTS OF STANDARD CHARACTERS WITHOUT CLAIM TO ANY PARTICULAR FONT, STYLE, SIZE, OR COLOR.

FOR: PROVIDING INFORMATION ABOUT SOCIAL NETWORKING, ON-LINE DATING, AND SOCIAL INTRODUCTION OF ADULTS, IN CLASS 45 (U.S. CLS. 100 AND 101).

SN 77-087,475, FILED 1-21-2007.

FIRST USE 4-16-2008; IN COMMERCE 4-16-2008.

DAVID C. REIHNER, EXAMINING ATTORNEY

**Int. Cl.: 45**

**Prior U.S. Cls.: 100 and 101**

**United States Patent and Trademark Office**

**Reg. No. 3,454,572**

**Registered June 24, 2008**

**SERVICE MARK  
PRINCIPAL REGISTER**

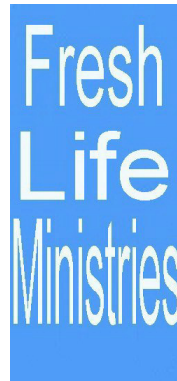

POSEY LESLIE T (UNITED STATES INDIVIDUAL)

605 E DR WOODRUFF PL

INDIANAPOLIS, IN 46201

FOR: PROVIDING PERSONAL SUPPORT SERVICES FOR FAMILIES OF PATIENTS WITH LIFE THREATENING DISORDERS, NAMELY, COMPANIONSHIP, HELP WITH MEDICAL FORMS, COUNSELING AND EMOTIONAL SUPPORT, IN CLASS 45 (U.S. CLS. 100 AND 101).

FIRST USE 5-8-2007; IN COMMERCE 5-8-2007.

NO CLAIM IS MADE TO THE EXCLUSIVE RIGHT TO USE "LIFE MINISTRIES", APART FROM THE MARK AS SHOWN.

THE COLOR(S) WHITE AND BLUE IS/ARE CLAIMED AS A FEATURE OF THE MARK.

THE COLOR WHITE APPEARS IN THE WORDING "FRESH LIFE MINISTRIES". THE COLOR BLUE APPEARS IN THE RECTANGLE DESIGN.

SN 77-087,485, FILED 1-21-2007.

LINDA ORNDORFF, EXAMINING ATTORNEY

**Int. Cls.: 3, 5, and 35**

**Prior U.S. Cls.: 1, 4, 6, 18, 44, 46, 50, 51, 52, 100, 101,  
and 102**

**Reg. No. 3,454,573**

**United States Patent and Trademark Office**

**Registered June 24, 2008**

**TRADEMARK  
SERVICE MARK  
PRINCIPAL REGISTER**

**DELLACURA**

DELLACURA LTD. (NEW YORK CORPORATION)  
P.O. BOX 211  
BRIARCLIFF MANOR, NY 10510

FOR: NON-MEDICATED SKIN-CARE PREPARATIONS, NAMELY, FACE AND HAND CREAMS, FACE AND HAND LOTIONS, LIP BALMS AND GLOSSES; ANTI-AGING CREAM; BAR AND LIQUID SOAPS FOR BODY, HAND AND FACE; NON-MEDICATED HAIR-CARE PREPARATIONS, NAMELY, HAIR LOTIONS, CONDITIONERS, MOISTURIZERS, SHAMPOOS, SPRAYS AND STYLING GELS; NON-MEDICATED BODY-CARE PREPARATIONS, NAMELY, BATH AND SHOWER GELS, BATH CREAMS, BATH LOTIONS, BATH AND MASSAGE OILS, BATH POWDERS, BATH BEADS, BATH SALTS, BUBBLE BATH, BATH MILKS, DEODORANTS, SUNSCREEN CREAMS; ESSENTIAL OILS AND AROMATHERAPY OILS FOR PERSONAL USE; PERFUMERIES, NAMELY, COLOGNES, EAU DE TOILETTES, SPLASHES, PERFUMES, IN CLASS 3 (U.S. CLS. 1, 4, 6, 50, 51 AND 52).

FIRST USE 1-28-2007; IN COMMERCE 1-28-2007.

FOR: THERAPEUTIC PREPARATIONS FOR THE BATH; AIR FRESHENERS AND ROOM DEODORIZERS; ANALGESIC BALMS FOR MEDICAL PUR-

POSES; MEDICATED LIP BALM; CREAMS AND LOTIONS FOR PHARMACEUTICAL PURPOSES FOR THE TREATMENT OF AGING AND ECZEMA; MEDICINAL OILS, NAMELY, HERBAL EXTRACTS FROM BOTANICALS FOR THE TREATMENT OF AGING AND SKIN BLEMISHES, IN CLASS 5 (U.S. CLS. 6, 18, 44, 46, 51 AND 52).

FIRST USE 1-28-2007; IN COMMERCE 1-28-2007.

FOR: MAIL ORDER CATALOG SERVICES, ONLINE RETAIL STORE SERVICES AND RETAIL AND WHOLESALE STORE SERVICES, ALL FEATURING BODY PREPARATIONS, COSMETICS, ESSENTIAL OILS, HAIR PREPARATIONS, PERFUMERY AND SOAPS, IN CLASS 35 (U.S. CLS. 100, 101 AND 102).

FIRST USE 1-28-2007; IN COMMERCE 1-28-2007.

THE MARK CONSISTS OF STANDARD CHARACTERS WITHOUT CLAIM TO ANY PARTICULAR FONT, STYLE, SIZE, OR COLOR.

SN 77-087,643, FILED 1-22-2007.

SCOTT BIBB, EXAMINING ATTORNEY

**Int. Cl.: 3**

**Prior U.S. Cls.: 1, 4, 6, 50, 51, and 52**

**Reg. No. 3,454,574**

**United States Patent and Trademark Office**

**Registered June 24, 2008**

---

**TRADEMARK  
PRINCIPAL REGISTER**

**ORGANIC WEAR**

PHYSICIANS FORMULA, INC. (NEW YORK CORPORATION)

1055 WEST 8TH STREET

AZUSA, CA 91702

FOR: ORGANIC COSMETICS, IN CLASS 3 (U.S. CLS. 1, 4, 6, 50, 51 AND 52).

FIRST USE 11-28-2007; IN COMMERCE 11-28-2007.

THE MARK CONSISTS OF STANDARD CHARACTERS WITHOUT CLAIM TO ANY PARTICULAR FONT, STYLE, SIZE, OR COLOR.

NO CLAIM IS MADE TO THE EXCLUSIVE RIGHT TO USE "ORGANIC", APART FROM THE MARK AS SHOWN.

SN 77-087,970, FILED 1-22-2007.

NELSON SNYDER, EXAMINING ATTORNEY

**Int. Cls.: 3, 5, and 35**

**Prior U.S. Cls.: 1, 4, 6, 18, 44, 46, 50, 51, 52, 100, 101, and 102**

**Reg. No. 3,454,575**

**United States Patent and Trademark Office**

**Registered June 24, 2008**

**TRADEMARK  
SERVICE MARK  
PRINCIPAL REGISTER**

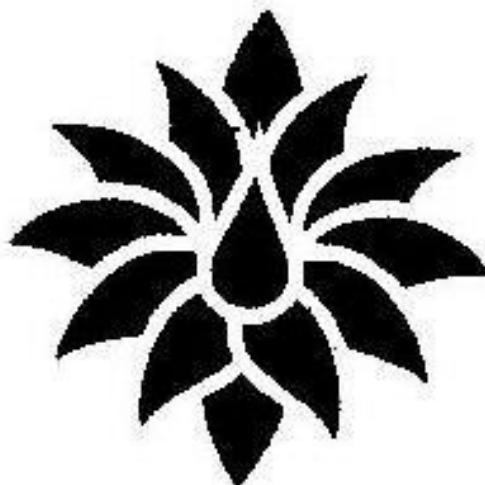

DELLACURA LTD. (NEW YORK CORPORATION)  
P.O. BOX 211  
BRIARCLIFF MANOR, NY 10510

FOR: NON-MEDICATED SKIN-CARE PREPARATIONS, NAMELY, FACE AND HAND CREAMS, FACE AND HAND LOTIONS, LIP BALMS AND GLOSSES; ANTI-AGING CREAM; BAR AND LIQUID SOAPS FOR BODY, HAND AND FACE; NON-MEDICATED HAIR-CARE PREPARATIONS, NAMELY, HAIR LOTIONS, CONDITIONERS, MOISTURIZERS, SHAMPOOS, SPRAYS AND STYLING GELS; NON-MEDICATED BODY-CARE PREPARATIONS, NAMELY, BATH AND SHOWER GELS, BATH CREAMS, BATH LOTIONS, BATH AND MASSAGE OILS, BATH POWDERS, BATH BEADS, BATH SALTS, BUBBLE BATH, BATH MILKS, DEODORANTS, SUNSCREEN CREAMS; ESSENTIAL OILS AND AROMATHERAPY OILS FOR PERSONAL USE; PERFUMERIES, NAMELY, COLOGNES, EAU DE TOILETTES, SPLASHES, PERFUMES, IN CLASS 3 (U.S. CLS. 1, 4, 6, 50, 51 AND 52).

FIRST USE 1-28-2007; IN COMMERCE 1-28-2007.

FOR: THERAPEUTIC PREPARATIONS FOR THE BATH; AIR FRESHENERS AND ROOM DEODOR-

IZERS; ANALGESIC BALMS FOR MEDICAL PURPOSES; MEDICATED LIP BALM; CREAMS AND LOTIONS FOR PHARMACEUTICAL PURPOSES FOR THE TREATMENT OF AGING AND ECZEMA; MEDICINAL OILS, NAMELY, HERBAL EXTRACTS FROM BOTANICALS FOR THE TREATMENT OF AGING AND SKIN BLEMISHES, IN CLASS 5 (U.S. CLS. 6, 18, 44, 46, 51 AND 52).

FIRST USE 1-28-2007; IN COMMERCE 1-28-2007.

FOR: MAIL ORDER CATALOG SERVICES, ONLINE RETAIL STORE SERVICES AND RETAIL AND WHOLESALE STORE SERVICES, ALL FEATURING BODY PREPARATIONS, COSMETICS, ESSENTIAL OILS, HAIR PREPARATIONS, PERFUMERY AND SOAPS, IN CLASS 35 (U.S. CLS. 100, 101 AND 102).

FIRST USE 1-28-2007; IN COMMERCE 1-28-2007.

THE MARK CONSISTS OF A LEAF GARLAND AND DROPLET DESIGN.

SN 77-087,983, FILED 1-22-2007.

SCOTT BIBB, EXAMINING ATTORNEY

**Int. Cl.: 9**

**Prior U.S. Cls.: 21, 23, 26, 36, and 38**

**United States Patent and Trademark Office**

**Reg. No. 3,454,576**

**Registered June 24, 2008**

**TRADEMARK  
PRINCIPAL REGISTER**

**KLEENGUARD**

KIMBERLY-CLARK WORLDWIDE, INC. (DELA-  
WARE CORPORATION)  
401 NORTH LAKE STREET  
NEENAH, WI 54947

FOR: SAFETY EYEWEAR, NAMELY, SAFETY  
GOGGLES, SAFETY EYEGASSES, SAFETY EYE  
SHIELDS, IN CLASS 9 (U.S. CLS. 21, 23, 26, 36 AND  
38).

FIRST USE 5-23-2007; IN COMMERCE 5-23-2007.

THE MARK CONSISTS OF STANDARD CHAR-  
ACTERS WITHOUT CLAIM TO ANY PARTICULAR  
FONT, STYLE, SIZE, OR COLOR.

OWNER OF U.S. REG. NOS. 1,311,166, 1,815,936,  
AND OTHERS.

SN 77-088,096, FILED 1-22-2007.

LINDSEY RUBIN, EXAMINING ATTORNEY

**Int. Cl.: 8**

**Prior U.S. Cls.: 23, 28, and 44**

**United States Patent and Trademark Office**

**Reg. No. 3,454,577**

**Registered June 24, 2008**

**TRADEMARK  
PRINCIPAL REGISTER**

**MIGHTY OAK**

TAYLOR BRANDS, LLC (TENNESSEE LTD LIAB  
CO)  
1043 FORDTOWN ROAD  
KINGSPORT, TN 37663

THE MARK CONSISTS OF STANDARD CHAR-  
ACTERS WITHOUT CLAIM TO ANY PARTICULAR  
FONT, STYLE, SIZE, OR COLOR.

FOR: KNIVES, NAMELY, POCKET KNIVES, UTI-  
LITY KNIVES, AND KITCHEN KNIVES, IN CLASS 8  
(U.S. CLS. 23, 28 AND 44).

SN 77-088,128, FILED 1-22-2007.

FIRST USE 3-10-2008; IN COMMERCE 3-10-2008.

APRIL ROACH, EXAMINING ATTORNEY

**Int. Cl.: 9**

**Prior U.S. Cls.: 21, 23, 26, 36, and 38**

**Reg. No. 3,454,578**

**United States Patent and Trademark Office**

**Registered June 24, 2008**

**TRADEMARK  
PRINCIPAL REGISTER**

**VTS WEBVIEW**

VEHICLE TRACKING SOLUTIONS, LLC (NEW  
YORK LTD LIAB CO)  
10 E. 5TH STREET  
DEER PARK, NY 11729

FOR: COMPUTER SOFTWARE FOR VEHICLE  
FLEET MANAGEMENT USING GLOBAL POSI-  
TIONING SYSTEM (GPS) TECHNOLOGY TO COL-  
LECT AND TRANSMIT VEHICLE DATA SUCH AS  
SPEED, LOCATION, DELIVERY AND SHIPPING  
STATUS, REFRIGERATION TEMPERATURE AND  
OTHER CONDITIONS, IN CLASS 9 (U.S. CLS. 21, 23,  
26, 36 AND 38).

FIRST USE 1-6-2006; IN COMMERCE 1-6-2006.

THE MARK CONSISTS OF STANDARD CHAR-  
ACTERS WITHOUT CLAIM TO ANY PARTICULAR  
FONT, STYLE, SIZE, OR COLOR.

NO CLAIM IS MADE TO THE EXCLUSIVE  
RIGHT TO USE "VTS", APART FROM THE MARK  
AS SHOWN.

SN 77-088,347, FILED 1-22-2007.

EVELYN BRADLEY, EXAMINING ATTORNEY



**Int. Cl.: 9**

**Prior U.S. Cls.: 21, 23, 26, 36, and 38**

**United States Patent and Trademark Office**

**Reg. No. 3,454,579**

**Registered June 24, 2008**

**TRADEMARK  
PRINCIPAL REGISTER**

**WE HELP YOU DRIVE  
PRODUCTIVITY**

VEHICLE TRACKING SOLUTIONS, LLC (NEW  
YORK LTD LIAB CO)  
10 E. 5TH STREET  
DEER PARK, NY 11729

FOR: COMPUTER SOFTWARE FOR VEHICLE  
FLEET MANAGEMENT USING GPS (GLOBAL PO-  
SITIONING SYSTEM) TECHNOLOGY TO COLLECT  
AND TRANSMIT VEHICLE DATA SUCH AS SPEED,  
LOCATION, DELIVERY AND SHIPPING STATUS,  
REFRIGERATION TEMPERATURE AND OTHER  
CONDITIONS, IN CLASS 9 (U.S. CLS. 21, 23, 26, 36  
AND 38).

FIRST USE 11-0-2007; IN COMMERCE 11-0-2007.

THE MARK CONSISTS OF STANDARD CHAR-  
ACTERS WITHOUT CLAIM TO ANY PARTICULAR  
FONT, STYLE, SIZE, OR COLOR.

SN 77-088,372, FILED 1-22-2007.

EVELYN BRADLEY, EXAMINING ATTORNEY

**Int. Cl.: 35**

**Prior U.S. Cls.: 100, 101, and 102**

**United States Patent and Trademark Office**

**Reg. No. 3,454,580**

**Registered June 24, 2008**

**SERVICE MARK  
PRINCIPAL REGISTER**

**JI WORLDWIDE**

JI WORLDWIDE, INC. (MARYLAND CORPORATION)  
4928 SAINT ELMO AVE., SUITE 200  
BETHESDA, MD 20814

FOR: ADVERTISING SERVICES, NAMELY, THE DISTRIBUTION OF PRODUCTS ADVERTISING THE GOODS AND SERVICES OF OTHERS, IN CLASS 35 (U.S. CLS. 100, 101 AND 102).

FIRST USE 1-1-2007; IN COMMERCE 1-1-2007.

THE MARK CONSISTS OF STANDARD CHARACTERS WITHOUT CLAIM TO ANY PARTICULAR FONT, STYLE, SIZE, OR COLOR.

NO CLAIM IS MADE TO THE EXCLUSIVE RIGHT TO USE "WORLDWIDE", APART FROM THE MARK AS SHOWN.

SN 77-088,630, FILED 1-23-2007.

AISHA CLARKE, EXAMINING ATTORNEY

**Int. Cl.: 35**

**Prior U.S. Cls.: 100, 101, and 102**

**United States Patent and Trademark Office**

**Reg. No. 3,454,581**

**Registered June 24, 2008**

**SERVICE MARK  
PRINCIPAL REGISTER**

**NAPADS**

JI WORLDWIDE, INC. (MARYLAND CORPORATION)  
4928 SAINT ELMO AVE., SUITE 200  
BETHESDA, MD 20814

THE MARK CONSISTS OF STANDARD CHARACTERS WITHOUT CLAIM TO ANY PARTICULAR FONT, STYLE, SIZE, OR COLOR.

FOR: ADVERTISING SERVICES, NAMELY, THE DISTRIBUTION OF PRODUCTS ADVERTISING THE GOODS AND SERVICES OF OTHERS, IN CLASS 35 (U.S. CLS. 100, 101 AND 102).

SN 77-088,642, FILED 1-23-2007.

FIRST USE 1-1-2007; IN COMMERCE 1-1-2007.

AISHA CLARKE, EXAMINING ATTORNEY

Int. Cl.: 38

Prior U.S. Cls.: 100, 101, and 104

United States Patent and Trademark Office

Reg. No. 3,454,582

Registered June 24, 2008

SERVICE MARK  
PRINCIPAL REGISTER



BOARD OF REGENTS OF THE UNIVERSITY  
SYSTEM OF GEORGIA (GEORGIA STATE  
AGENCY)  
270 WASHINGTON STREET, S.W.  
ATLANTA, GA 30334

FOR: ELECTRONIC TRANSMISSION OF LI-  
BRARY DATA AND DOCUMENTS VIA COMPU-  
TER TERMINALS FOR PROVIDING ELECTRONIC  
ACCESS TO LIBRARY DOCUMENTS, INCLUDING  
BOOKS, JOURNALS, CARD CATALOGS AND  
OTHER ELECTRONIC FILES, PROCESSING ELEC-  
TRONICALLY TRANSMITTED REQUESTS FOR  
CHECKOUT OF MATERIALS AND INTERLI-  
BRARY LOAN REQUESTS, ALL OF WHICH ARE

ACCOMPLISHED THROUGH ELECTRONIC DATA  
COMMUNICATION, IN CLASS 38 (U.S. CLS. 100, 101  
AND 104).

FIRST USE 2-8-2006; IN COMMERCE 2-8-2006.

THE MARK CONSISTS OF A DRAWING OF A  
PINE TREE BRANCH BETWEEN THE WORDS  
"EVER" AND "GREEN".

SN 77-088,756, FILED 1-23-2007.

H. M. FISHER, EXAMINING ATTORNEY

**Int. Cl.: 29**

**Prior U.S. Cl.: 46**

**United States Patent and Trademark Office**

**Reg. No. 3,454,583**

**Registered June 24, 2008**

**TRADEMARK  
PRINCIPAL REGISTER**



BALLESTER HERMANOS, INC. (PUERTO RICO CORPORATION)  
PO BOX 364548  
SAN JUAN, PUERTO RICO 009364548

FOR: SEAFOOD, IN CLASS 29 (U.S. CL. 46).

FIRST USE 4-19-2007; IN COMMERCE 4-19-2007.

NO CLAIM IS MADE TO THE EXCLUSIVE RIGHT TO USE "DEEP WATER SEAFOOD", APART FROM THE MARK AS SHOWN.

THE COLOR(S) BLUE, LIGHT BLUE, AND WHITE IS/ARE CLAIMED AS A FEATURE OF THE MARK.

THE COLOR WHITE APPEARS IN THE WORDS "DEEP WATER" AND "SEAFOOD", AND IN THE FISH DESIGN. THE COLOR BLUE APPEARS IN PART OF THE FISH, IN THE OVAL DESIGN AND IN THE BACKGROUND OF THE MARK. THE COLOR LIGHT BLUE APPEARS IN THE OUTER EDGES OF THE OVAL DESIGN AND IN THE BANNER THAT CONTAINS THE WORDS "DEEP WATER".

SN 77-088,794, FILED 1-23-2007.

EVELYN BRADLEY, EXAMINING ATTORNEY

**Int. Cl.: 9**

**Prior U.S. Cls.: 21, 23, 26, 36, and 38**

**Reg. No. 3,454,584**

**United States Patent and Trademark Office**

**Registered June 24, 2008**

**TRADEMARK  
PRINCIPAL REGISTER**

**fix8**

MOBINEX (CALIFORNIA LTD LIAB CO)  
SUITE 365  
15335 MORRISON STREET  
SHERMAN OAKS, CA 91403

FOR: DOWNLOADABLE ANIMATION SOFTWARE THAT UTILIZES FACIAL MOTION TRACKING, EXPRESSION ANALYSIS, TWO-DIMENSIONED, THREE-DIMENSIONED, PHOTO-REALISTIC GRAPHIC AND ANIMATED IMAGES, LIPSYNCING AND VOICE MASKING TECHNOLOGIES IN ASSOCIATION WITH A WEBCAM, AV STREAM, VIDEO FILES AND PICTURES FOR ADDED ENTERTAINMENT VALUE, IN CONNECTION

WITH USER GENERATED CONTENT FOR INSTANT MESSAGING AND OTHER INTERNET UPLOADABLE CONTENT BY USERS, IN CLASS 9 (U.S. CLS. 21, 23, 26, 36 AND 38).

FIRST USE 9-5-2006; IN COMMERCE 5-15-2007.

THE MARK CONSISTS OF STANDARD CHARACTERS WITHOUT CLAIM TO ANY PARTICULAR FONT, STYLE, SIZE, OR COLOR.

SN 77-089,308, FILED 1-23-2007.

THOMAS MANOR, EXAMINING ATTORNEY

**Int. Cl.: 35**

**Prior U.S. Cls.: 100, 101, and 102**

**United States Patent and Trademark Office**

**Reg. No. 3,454,585**

**Registered June 24, 2008**

---

**SERVICE MARK  
PRINCIPAL REGISTER**

**mattressharmony.com**

ART VAN FURNITURE, INC. (MICHIGAN CORPORATION)  
6500 FOURTEEN MILE ROAD  
WARREN, MI 48092

THE MARK CONSISTS OF STANDARD CHARACTERS WITHOUT CLAIM TO ANY PARTICULAR FONT, STYLE, SIZE, OR COLOR.

FOR: RETAIL FURNITURE STORES, IN CLASS 35 (U.S. CLS. 100, 101 AND 102).

SN 77-089,496, FILED 1-23-2007.

FIRST USE 1-1-2007; IN COMMERCE 5-5-2007.

BRIAN PINO, EXAMINING ATTORNEY

**Int. Cl.: 20**

**Prior U.S. Cls.: 2, 13, 22, 25, 32, and 50**

**Reg. No. 3,454,586**

**United States Patent and Trademark Office**

**Registered June 24, 2008**

---

**TRADEMARK  
PRINCIPAL REGISTER**

**MICHIGAN HOMES**

ART VAN FURNITURE, INC. (MICHIGAN CORPORATION)

6500 FOURTEEN MILE ROAD

WARREN, MI 48092

FOR: FURNITURE, IN CLASS 20 (U.S. CLS. 2, 13, 22, 25, 32 AND 50).

FIRST USE 1-1-2007; IN COMMERCE 1-1-2007.

THE MARK CONSISTS OF STANDARD CHARACTERS WITHOUT CLAIM TO ANY PARTICULAR FONT, STYLE, SIZE, OR COLOR.

NO CLAIM IS MADE TO THE EXCLUSIVE RIGHT TO USE "MICHIGAN", APART FROM THE MARK AS SHOWN.

SN 77-089,731, FILED 1-24-2007.

BRIAN PINO, EXAMINING ATTORNEY



**Int. Cl.: 35**

**Prior U.S. Cls.: 100, 101, and 102**

**United States Patent and Trademark Office**

**Reg. No. 3,454,587**

**Registered June 24, 2008**

**SERVICE MARK  
PRINCIPAL REGISTER**

**🕒 diabetes smart 🕒 TAKE CHARGE OF YOUR HEALTH**

NEWS AMERICA MARKETING PROPERTIES  
L.L.C. (DELAWARE LTD LIAB CO)  
303 E. WACKER DRIVE  
CHICAGO, IL 60601

FOR: PROMOTING THE GOODS AND SERVICES  
OF PARTICIPATING MERCHANTS BY ARRAN-  
GING FOR ADVERTISING IN CONJUNCTION  
WITH ANNUAL, NATIONALLY PROMOTED  
EVENTS , IN CLASS 35 (U.S. CLS. 100, 101 AND 102).

FIRST USE 3-4-2007; IN COMMERCE 3-4-2007.

NO CLAIM IS MADE TO THE EXCLUSIVE  
RIGHT TO USE "DIABETES", APART FROM THE  
MARK AS SHOWN.

SN 77-089,826, FILED 1-24-2007.

CHERYL CLAYTON, EXAMINING ATTORNEY

**Int. Cl.: 35**

**Prior U.S. Cls.: 100, 101, and 102**

**United States Patent and Trademark Office**

**Reg. No. 3,454,588**

**Registered June 24, 2008**

**SERVICE MARK  
PRINCIPAL REGISTER**



NEWS AMERICA MARKETING PROPERTIES  
L.L.C. (DELAWARE LTD LIAB CO)  
303 E. WACKER DRIVE  
CHICAGO, IL 60601

FOR: PROMOTING THE GOODS AND SERVICES  
OF PARTICIPATING MERCHANTS BY ARRAN-  
GING FOR ADVERTISING IN CONJUNCTION  
WITH ANNUAL, NATIONALLY PROMOTED  
EVENTS , IN CLASS 35 (U.S. CLS. 100, 101 AND 102).

FIRST USE 3-4-2007; IN COMMERCE 3-4-2007.

NO CLAIM IS MADE TO THE EXCLUSIVE  
RIGHT TO USE "DIABETES", APART FROM THE  
MARK AS SHOWN.

SN 77-089,840, FILED 1-24-2007.

CHERYL CLAYTON, EXAMINING ATTORNEY

**Int. Cl.: 32**

**Prior U.S. Cls.: 45, 46, and 48**

**Reg. No. 3,454,589**

**United States Patent and Trademark Office**

**Registered June 24, 2008**

---

**TRADEMARK  
PRINCIPAL REGISTER**

**BUCKBEAN BREWING**

BUCKBEAN BREWING COMPANY, LLC (NEVA-  
DA LTD LIAB CO)  
2248 MERIDIAN BOULEVARD, SUITE H  
MINDEN, NV 89423

FOR: BREWED MALT-BASED ALCOHOLIC BEV-  
ERAGE IN THE NATURE OF A BEER, IN CLASS 32  
(U.S. CLS. 45, 46 AND 48).

FIRST USE 1-1-2007; IN COMMERCE 4-27-2007.

THE MARK CONSISTS OF STANDARD CHAR-  
ACTERS WITHOUT CLAIM TO ANY PARTICULAR  
FONT, STYLE, SIZE, OR COLOR.

NO CLAIM IS MADE TO THE EXCLUSIVE  
RIGHT TO USE "BREWING", APART FROM THE  
MARK AS SHOWN.

SN 77-090,493, FILED 1-24-2007.

JOHN DALIER, EXAMINING ATTORNEY

**Int. Cl.: 9**

**Prior U.S. Cls.: 21, 23, 26, 36, and 38**

**Reg. No. 3,454,590**

**United States Patent and Trademark Office**

**Registered June 24, 2008**

**TRADEMARK  
PRINCIPAL REGISTER**

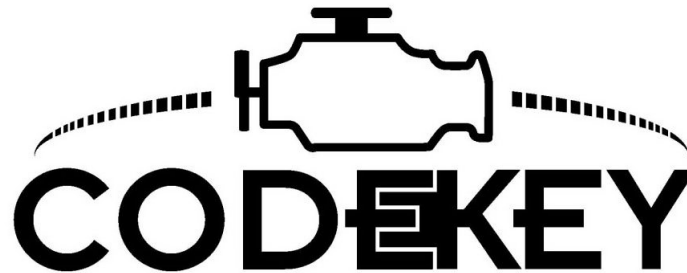

JS PRODUCTS, INC. (NEVADA CORPORATION)  
5440 S. PROCYON AVENUE  
LAS VEGAS, NV 89118

FOR: ELECTRONIC AUTOMOTIVE DIAGNOSTIC AND TESTING EQUIPMENT, NAMELY, DIGITAL INPUT AND OUTPUT SCANNERS FOR USE IN DIAGNOSTIC TESTING OF AUTOMOBILE ENGINES AND COMPUTERIZED AUTOMOBILE SYSTEMS, DIGITAL INPUT AND OUTPUT SCANNERS FOR USE IN CONDUCTING LIVE DATA RETRIEVAL FROM COMPUTERIZED AUTOMOBILE SYS-

TEMS; ELECTRONIC CODE READERS AND ELECTRONIC SENSORS FOR USE IN RETRIEVING AND CLEARING DIAGNOSTIC TROUBLE CODES GENERATED BY COMPUTERIZED AUTOMOBILE SYSTEMS, IN CLASS 9 (U.S. CLS. 21, 23, 26, 36 AND 38).

FIRST USE 12-31-2007; IN COMMERCE 12-31-2007.

SN 77-090,656, FILED 1-25-2007.

MICHAEL TANNER, EXAMINING ATTORNEY

**Int. Cl.: 9**

**Prior U.S. Cls.: 21, 23, 26, 36, and 38**

**Reg. No. 3,454,591**

**United States Patent and Trademark Office**

**Registered June 24, 2008**

**TRADEMARK  
PRINCIPAL REGISTER**



XCEED MOLECULAR CORPORATION (CANADA CORPORATION)  
1 MARMAC DRIVE  
TORONTO, CANADA M9W1E7

FOR: MULTIPLEX TEST ANALYSIS EQUIPMENT AND SOFTWARE FOR THE MEASUREMENT AND ANALYSIS OF GENE EXPRESSION, SINGLE NUCLEOTIDE POLYMORPHISMS, QUALITATIVE ASSAYS AND PROTEIN ARRAYS BY MEANS OF HYBRIDIZATION, IMAGING AND DATA QUANTIFICATION, IN CLASS 9 (U.S. CLS. 21, 23, 26, 36 AND 38).

FIRST USE 7-1-2007; IN COMMERCE 7-1-2007.

THE MARK CONSISTS OF FOUR THREE-DIMENSIONAL, FOUR-SIDED PARTIAL COLUMNS, SIDEWAYS IN A DIAMOND-LIKE ARRANGEMENT, TO THE LEFT OF THE WORD ZIPLEx.

SN 77-090,963, FILED 1-25-2007.

SALLY SHIH, EXAMINING ATTORNEY

**Int. Cl.: 7**

**Prior U.S. Cls.: 13, 19, 21, 23, 31, 34, and 35**

**Reg. No. 3,454,592**

**United States Patent and Trademark Office**

**Registered June 24, 2008**

**TRADEMARK  
PRINCIPAL REGISTER**

**NANO**

BLACK & DECKER CORPORATION, THE  
(MARYLAND CORPORATION)  
TW-199  
701 E. JOPPA ROAD  
TOWSON, MD 21286

FOR: DRILL/DRIVERS, RECIPROCATING SAWS,  
CIRCULAR SAWS, HAMMER DRILLS, JIG SAWS,  
IMPACT WRENCHES, ROTARY HAMMER AND  
CUT-OFF TOOLS , IN CLASS 7 (U.S. CLS. 13, 19, 21,  
23, 31, 34 AND 35).

FIRST USE 10-31-2007; IN COMMERCE 10-31-2007.

THE MARK CONSISTS OF STANDARD CHAR-  
ACTERS WITHOUT CLAIM TO ANY PARTICULAR  
FONT, STYLE, SIZE, OR COLOR.

SN 77-091,052, FILED 1-25-2007.

MARGERY A. TIERNEY, EXAMINING ATTORNEY

**Int. Cl.: 30**

**Prior U.S. Cl.: 46**

**United States Patent and Trademark Office**

**Reg. No. 3,454,593**

**Registered June 24, 2008**

**TRADEMARK  
PRINCIPAL REGISTER**

**"Three of a Kind"**

FOOD COURTS OF NEVADA, LLC (NEVADA  
LTD LIAB CO)  
300 S. 4TH ST., 11TH FLOOR  
C/O ADAM P. SEGAL, ESQ.  
LAS VEGAS, NV 89101

THE MARK CONSISTS OF STANDARD CHAR-  
ACTERS WITHOUT CLAIM TO ANY PARTICULAR  
FONT, STYLE, SIZE, OR COLOR.

FOR: HAMBURGER SANDWICHES, IN CLASS 30  
(U.S. CL. 46).

SN 77-091,129, FILED 1-25-2007.

FIRST USE 3-15-2007; IN COMMERCE 3-15-2007.

ELIZABETH BEYER, EXAMINING ATTORNEY

**Int. Cl.: 30**

**Prior U.S. Cl.: 46**

**United States Patent and Trademark Office**

**Reg. No. 3,454,594**

**Registered June 24, 2008**

**TRADEMARK  
PRINCIPAL REGISTER**

**"Triple Crown"**

FOOD COURTS OF NEVADA, LLC (NEVADA  
LTD LIAB CO)  
300 S. 4TH ST., 11TH FLOOR  
C/O ADAM P. SEGAL, ESQ.  
LAS VEGAS, NV 89101

THE MARK CONSISTS OF STANDARD CHAR-  
ACTERS WITHOUT CLAIM TO ANY PARTICULAR  
FONT, STYLE, SIZE, OR COLOR.

FOR: HAMBURGER SANDWICHES, IN CLASS 30  
(U.S. CL. 46).

SN 77-091,153, FILED 1-25-2007.

FIRST USE 3-15-2007; IN COMMERCE 3-15-2007.

ELIZABETH BEYER, EXAMINING ATTORNEY



**Int. Cl.: 8**

**Prior U.S. Cls.: 23, 28, and 44**

**United States Patent and Trademark Office**

**Reg. No. 3,454,595**

**Registered June 24, 2008**

**TRADEMARK  
PRINCIPAL REGISTER**

**BLACK ICE**

TAYLOR BRANDS, LLC (TENNESSEE LTD LIAB  
CO)  
1043 FORDTOWN ROAD  
KINGSPORT, TN 37663

THE MARK CONSISTS OF STANDARD CHAR-  
ACTERS WITHOUT CLAIM TO ANY PARTICULAR  
FONT, STYLE, SIZE, OR COLOR.

FOR: FOLDING POCKET KNIVES, IN CLASS 8  
(U.S. CLS. 23, 28 AND 44).

SN 77-091,820, FILED 1-26-2007.

FIRST USE 3-10-2008; IN COMMERCE 3-10-2008.

APRIL ROACH, EXAMINING ATTORNEY

**Int. Cl.: 20**

**Prior U.S. Cls.: 2, 13, 22, 25, 32, and 50**

**United States Patent and Trademark Office**

**Reg. No. 3,454,596**

**Registered June 24, 2008**

**TRADEMARK  
PRINCIPAL REGISTER**

**SKYLINE**

AS IP HOLDCO, LLC (DELAWARE LTD LIAB  
CO)  
11 HUNTINGTON AVE.  
BOSTON, MA 02199

THE MARK CONSISTS OF STANDARD CHAR-  
ACTERS WITHOUT CLAIM TO ANY PARTICULAR  
FONT, STYLE, SIZE, OR COLOR.

FOR: FURNITURE, NAMELY, FURNITURE FOR  
USE WITH SANITARY FIXTURES, NAMELY, LA-  
VATORIES, IN CLASS 20 (U.S. CLS. 2, 13, 22, 25, 32  
AND 50).

SN 77-092,224, FILED 1-26-2007.

FIRST USE 4-1-2007; IN COMMERCE 6-1-2007.

LINDA E. BLOHM, EXAMINING ATTORNEY

**Int. Cl.: 24**

**Prior U.S. Cls.: 42 and 50**

**United States Patent and Trademark Office**

**Reg. No. 3,454,597**

**Registered June 24, 2008**

**TRADEMARK  
PRINCIPAL REGISTER**

**CLOTHESLINE CRISP**

CGE ENTERPRISES, LLC (DELAWARE LTD  
LIAB CO)  
5650 MAIN STREET  
MANCHESTER CENTER, VT 05255

THE MARK CONSISTS OF STANDARD CHAR-  
ACTERS WITHOUT CLAIM TO ANY PARTICULAR  
FONT, STYLE, SIZE, OR COLOR.

FOR: BED SHEETS; PILLOWCASES, IN CLASS 24  
(U.S. CLS. 42 AND 50).

SN 77-092,289, FILED 1-26-2007.

FIRST USE 9-1-2007; IN COMMERCE 9-1-2007.

JOHN DALIER, EXAMINING ATTORNEY

**Int. Cl.: 41**

**Prior U.S. Cls.: 100, 101, and 107**

**United States Patent and Trademark Office**

**Reg. No. 3,454,598**

**Registered June 24, 2008**

**SERVICE MARK  
PRINCIPAL REGISTER**

Folger SHAKESPEARE LIBRARY  
Advancing knowledge & the arts

THE TRUSTEES OF AMHERST COLLEGE (MAS-  
SACHUSETTS CORPORATION), DBA THE  
FOLGER SHAKESPEARE LIBRARY,  
201 EAST CAPITOL STREET, S.E.  
WASHINGTON, DC 20003

FOR: LIBRARY SERVICES; MUSEUM SERVICES;  
EDUCATIONAL RESEARCH AND EDUCATIONAL  
SERVICES, NAMELY, CONDUCTING CLASSES,  
SEMINARS, AND WORKSHOPS ABOUT THE EAR-  
LY MODERN PERIOD AND WILLIAM SHAKE-  
SPEARE'S PLAYS, HISTORY, LIFE AND TIMES;  
ENTERTAINMENT SERVICES IN THE NATURE OF  
LIVE MUSICAL AND THEATRICAL PERFORMAN-  
CES, SPEECHES, AND READINGS, IN CLASS 41  
(U.S. CLS. 100, 101 AND 107).

FIRST USE 10-31-2007; IN COMMERCE 10-31-2007.

OWNER OF U.S. REG. NOS. 2,054,038 AND  
2,066,251.

NO CLAIM IS MADE TO THE EXCLUSIVE  
RIGHT TO USE "LIBRARY", APART FROM THE  
MARK AS SHOWN.

THE MARK CONSISTS OF "FOLGER SHAKE-  
SPEARE LIBRARY ADVANCING KNOWLEDGE &  
THE ARTS" (STYLIZED AND HORIZONTAL OR-  
IENTATION).

SN 77-092,509, FILED 1-26-2007.

SALLY SHIH, EXAMINING ATTORNEY

**Int. Cl.: 33**

**Prior U.S. Cls.: 47 and 49**

**United States Patent and Trademark Office**

**Reg. No. 3,454,599**

**Registered June 24, 2008**

**TRADEMARK  
PRINCIPAL REGISTER**

**Puntazo**

OLE IMPORTS, LLC (NEW YORK LTD LIAB CO)  
56 HARRISON STREET, SUITE 405  
NEW ROCHELLE, NY 10801

FOR: WINE, IN CLASS 33 (U.S. CLS. 47 AND 49).

FIRST USE 4-1-2008; IN COMMERCE 4-1-2008.

THE MARK CONSISTS OF STANDARD CHARACTERS WITHOUT CLAIM TO ANY PARTICULAR FONT, STYLE, SIZE, OR COLOR.

THE ENGLISH TRANSLATION OF THE WORD "PUNTAZO" IN THE MARK IS "WITTY"

SN 77-092,659, FILED 1-26-2007.

ODESSA BIBBINS, EXAMINING ATTORNEY

**Int. Cl.: 33**

**Prior U.S. Cls.: 47 and 49**

**United States Patent and Trademark Office**

**Reg. No. 3,454,600**

**Registered June 24, 2008**

**TRADEMARK  
PRINCIPAL REGISTER**

**DACU**

OLE IMPORTS, LLC (NEW YORK LTD LIAB CO)  
SUITE 405  
56 HARRISON ST.  
NEW ROCHELLE, NY 10801

FOR: WINE, IN CLASS 33 (U.S. CLS. 47 AND 49).

FIRST USE 4-1-2008; IN COMMERCE 4-1-2008.

THE MARK CONSISTS OF STANDARD CHARACTERS WITHOUT CLAIM TO ANY PARTICULAR FONT, STYLE, SIZE, OR COLOR.

THERE IS NO ENGLISH TRANSLATION OF THE TERM, "DACU"

SN 77-092,711, FILED 1-26-2007.

ODESSA BIBBINS, EXAMINING ATTORNEY

**Int. Cl.: 33**

**Prior U.S. Cls.: 47 and 49**

**United States Patent and Trademark Office**

**Reg. No. 3,454,601**

**Registered June 24, 2008**

**TRADEMARK  
PRINCIPAL REGISTER**

**Calma**

OLE IMPORTS, LLC (NEW YORK LTD LIAB CO)  
SUITE 405  
56 HARRISON ST.  
NEW ROCHELLE, NY 10801

FOR: WINE, IN CLASS 33 (U.S. CLS. 47 AND 49).

FIRST USE 4-1-2008; IN COMMERCE 4-1-2008.

THE MARK CONSISTS OF STANDARD CHARACTERS WITHOUT CLAIM TO ANY PARTICULAR FONT, STYLE, SIZE, OR COLOR.

THE FOREIGN WORDING, "CALMA" IN THE MARK TRANSLATES INTO ENGLISH AS "CALM"

SN 77-092,713, FILED 1-26-2007.

ODESSA BIBBINS, EXAMINING ATTORNEY

**Int. Cls.: 35, 36, 37, 41, and 43**

**Prior U.S. Cls.: 100, 101, 102, 103, 106, and 107**

**United States Patent and Trademark Office**

**Reg. No. 3,454,602**

**Registered June 24, 2008**

**SERVICE MARK  
PRINCIPAL REGISTER**

**JELD-WEN COMMUNITIES**

JELD-WEN, INC. (OREGON CORPORATION)  
3250 LAKEPORT BOULEVARD  
KLAMATH FALLS, OR 97601

FOR: REAL ESTATE MARKETING SERVICES, NAMELY, ADVERTISING REAL ESTATE AND RESORT ACCOMMODATIONS, IN CLASS 35 (U.S. CLS. 100, 101 AND 102).

FIRST USE 1-1-2007; IN COMMERCE 1-1-2007.

FOR: CONDOMINIUM RENTAL SERVICES; CONDOMINIUM MANAGEMENT SERVICES AND REAL ESTATE AGENCY SERVICES IN THE FIELD OF CONDOMINIUM TIME-SHARES, IN CLASS 36 (U.S. CLS. 100, 101 AND 102).

FIRST USE 1-1-2007; IN COMMERCE 1-1-2007.

FOR: REAL ESTATE DEVELOPMENT SERVICES AND CONSULTATION RELATED THERETO; LAND DEVELOPMENT SERVICES, NAMELY, PLANNING AND LAYING OUT OF RESIDENTIAL COMMUNITIES; CONSTRUCTION SERVICES, NAMELY, PLANNING, LAYING OUT AND CUSTOM CONSTRUCTION OF RESIDENTIAL COMMUNITIES, IN CLASS 37 (U.S. CLS. 100, 103 AND 106).

FIRST USE 1-1-2007; IN COMMERCE 1-1-2007.

FOR: PROVIDING FACILITIES FOR CANOEING, TENNIS, SWIMMING AND GOLF, IN CLASS 41 (U.S. CLS. 100, 101 AND 107).

FIRST USE 1-1-2007; IN COMMERCE 1-1-2007.

FOR: RESORT ACCOMMODATIONS, NAMELY, RESORT LODGING SERVICES; RESORT HOTEL AND RESTAURANT SERVICES AND PROVISION OF CONVENTION AND BANQUET FACILITIES; PROVIDING HORSE STABLE FACILITIES, IN CLASS 43 (U.S. CLS. 100 AND 101).

FIRST USE 1-1-2007; IN COMMERCE 1-1-2007.

THE MARK CONSISTS OF STANDARD CHARACTERS WITHOUT CLAIM TO ANY PARTICULAR FONT, STYLE, SIZE, OR COLOR.

OWNER OF U.S. REG. NOS. 1,388,339, 3,067,184, AND 3,072,535.

NO CLAIM IS MADE TO THE EXCLUSIVE RIGHT TO USE "COMMUNITIES", APART FROM THE MARK AS SHOWN.

SN 77-093,123, FILED 1-29-2007.

KEVIN CORWIN, EXAMINING ATTORNEY



**Int. Cl.: 35**

**Prior U.S. Cls.: 100, 101, and 102**

**United States Patent and Trademark Office**

**Reg. No. 3,454,603**

**Registered June 24, 2008**

---

**SERVICE MARK  
PRINCIPAL REGISTER**

**JONDO**

HARVEST PRODUCTIONS, LTD. (CALIFORNIA  
CORPORATION)  
8050 EAST CRYSTAL DRIVE  
ANAHEIM HILLS, CA 92807

FOR: PROMOTING THE GOODS AND SERVICES  
OF OTHERS THROUGH ON-LINE ORDERING,  
CATALOGING AND ORDER FULFILLMENT IN  
THE FIELD OF ART, IN CLASS 35 (U.S. CLS. 100, 101  
AND 102).

FIRST USE 1-29-2007; IN COMMERCE 8-30-2007.

THE MARK CONSISTS OF STANDARD CHAR-  
ACTERS WITHOUT CLAIM TO ANY PARTICULAR  
FONT, STYLE, SIZE, OR COLOR.

SN 77-093,400, FILED 1-29-2007.

MARK PILARO, EXAMINING ATTORNEY

**Int. Cl.: 36**

**Prior U.S. Cls.: 100, 101, and 102**

**United States Patent and Trademark Office**

**Reg. No. 3,454,604**

**Registered June 24, 2008**

---

**SERVICE MARK  
PRINCIPAL REGISTER**

**LOVE THAT SCHOOL**

AFC ENTERPRISES, INC. (MINNESOTA CORPORATION)  
SUITE 300  
5555 GLENRIDGE CONNECTOR, N.E.  
ATLANTA, GA 303424741

FOR: CHARITABLE FUND RAISING SERVICES, NAMELY, SHARING PROFITS FROM PREPARED FOODS SALES FOR CONSUMPTION ON OR OFF THE PREMISES WITH NOT-FOR-PROFIT ORGANIZATIONS, IN CLASS 36 (U.S. CLS. 100, 101 AND 102).

FIRST USE 5-0-2007; IN COMMERCE 5-0-2007.

THE MARK CONSISTS OF STANDARD CHARACTERS WITHOUT CLAIM TO ANY PARTICULAR FONT, STYLE, SIZE, OR COLOR.

SN 77-093,580, FILED 1-29-2007.

EMILY CARLSEN, EXAMINING ATTORNEY

**Int. Cl.: 35**

**Prior U.S. Cls.: 100, 101, and 102**

**United States Patent and Trademark Office**

**Reg. No. 3,454,605**

**Registered June 24, 2008**

**SERVICE MARK  
PRINCIPAL REGISTER**

**HEALTH / FINANCES /  
CONNECTING / GIVING /  
ENJOYING**

AARP (D.C. NON-PROFIT CORPORATION)  
601 E STREET, N.W.  
WASHINGTON, DC 20049

FOR: ASSOCIATION SERVICES, NAMELY, PROMOTING THE INTERESTS OF MATURE INDIVIDUALS; PROMOTING PUBLIC AWARENESS AND ADVOCACY IN THE FIELDS OF CAREGIVING, CHILDCARE, EDUCATION, MEDICAL SERVICES, ELDERCARE, EMPLOYMENT, ASSISTED CARE FACILITIES, LEGAL ASSISTANCE, BUSINESS, INSURANCE, REAL ESTATE, TRAVEL, ELDER ASSISTANCE, RETIREMENT, MATURE OR RETIRED LIFESTYLES, FINANCE, HEALTH, AGING, FAMILY RELATIONSHIPS, VOLUNTEER ACTIVITIES, CONSUMER ISSUES, ECONOMIC SECURITY, WORK, INDEPENDENT LIVING, EXERCISE, FITNESS, ATHLETICS AND SPORTS; CREDIT CARD AND REWARD CARD SERVICES, NAMELY, PROMOTING THE SALE OF GOODS AND SERVICES OF OTHERS THROUGH INCENTIVE AWARD PROGRAMS, AND ADMINISTRATION OF A DISCOUNT PROGRAM FOR ENABLING PARTICIPANTS TO OBTAIN DISCOUNTS ON GOODS AND SERVICES THROUGH USE OF A MEMBERSHIP CARD; COOPERATIVE MARKETING AND ADVERTISING SERVICES; REFERRAL SERVICES FOR ADOPTIONS, CAMPS, CARE GIVING, CHILDCARE, EDUCATION, MEDICAL SERVICES, HEALTH, ELDERCARE, EMPLOYMENT,

ASSISTED CARE FACILITIES, LEGAL ASSISTANCE, FINANCE, BUSINESS, INSURANCE, REAL ESTATE, TRAVEL AND ELDER ASSISTANCE; ONLINE ORDERING SERVICES AND ONLINE RETAIL STORE SERVICES FEATURING BOOKS, EDUCATIONAL MATERIALS, AND HEALTH AND MEDICAL PRODUCTS; PROVIDING CONSUMER INFORMATION IN THE FIELDS OF INSURANCE, HEALTH CARE, DISCOUNT AND SAVINGS PLANS, ELDERCARE, MEDICAL PRODUCTS, PHARMACEUTICAL PRODUCTS AND SERVICES AND HEALTH PLANS; INCOME TAX PREPARATION SERVICES; ARRANGING, CONDUCTING AND ORGANIZING TRADE SHOWS, TRADE CONVENTIONS AND TRADE EXPOSITIONS IN THE FIELD OF GOODS AND SERVICES INTENDED FOR MATURE PERSONS AND PERSONS PREPARING FOR RETIREMENT, IN CLASS 35 (U.S. CLS. 100, 101 AND 102).

FIRST USE 2-0-2007; IN COMMERCE 2-0-2007.

THE MARK CONSISTS OF STANDARD CHARACTERS WITHOUT CLAIM TO ANY PARTICULAR FONT, STYLE, SIZE, OR COLOR.

SN 77-093,695, FILED 1-29-2007.

ROBERT LAVACHE, EXAMINING ATTORNEY

Int. Cl.: 24

Prior U.S. Cls.: 42 and 50

United States Patent and Trademark Office

Reg. No. 3,454,606

Registered June 24, 2008

TRADEMARK  
PRINCIPAL REGISTER



DIVATEX HOME FASHION, INC. (NEW YORK CORPORATION)

295 FIFTH AVENUE  
NEW YORK, NY 10016

FOR: BEDDING AND LINENS, NAMELY, SHEET SETS, DUVETS, SHAMS, COMFORTERS AND PILLOW CASES, ALL MADE WITH FLANNEL FROM PORTUGAL, IN CLASS 24 (U.S. CLS. 42 AND 50).

FIRST USE 6-0-2007; IN COMMERCE 6-0-2007.

NO CLAIM IS MADE TO THE EXCLUSIVE RIGHT TO USE "SOFT FLANNEL" OR "PORTUGAL", APART FROM THE MARK AS SHOWN.

THE MARK CONSISTS OF THE WORDS "SOFT FLANNEL FROM PORTUGAL" AND 4 SNOWFLAKES.

SN 77-093,806, FILED 1-29-2007.

KATHERINE CONNOLLY, EXAMINING ATTORNEY

**Int. Cl.: 32**

**Prior U.S. Cls.: 45, 46, and 48**

**United States Patent and Trademark Office**

**Reg. No. 3,454,607**

**Registered June 24, 2008**

**TRADEMARK  
PRINCIPAL REGISTER**

**LOUISIANA TRUE**

ABITA BREWING CO., L.L.C. (LOUISIANA LTD  
LIAB CO)

P.O. BOX 1510

ABITA SPRINGS, LA 70420

FOR: BEER, ALE, MALT LIQUOR AND LAGER,  
IN CLASS 32 (U.S. CLS. 45, 46 AND 48).

FIRST USE 1-1-1995; IN COMMERCE 1-1-1995.

THE MARK CONSISTS OF STANDARD CHAR-  
ACTERS WITHOUT CLAIM TO ANY PARTICULAR  
FONT, STYLE, SIZE, OR COLOR.

NO CLAIM IS MADE TO THE EXCLUSIVE  
RIGHT TO USE "LOUISIANA", APART FROM THE  
MARK AS SHOWN.

SN 77-093,810, FILED 1-29-2007.

BERYL GARDNER, EXAMINING ATTORNEY

**Int. Cl.: 43**

**Prior U.S. Cls.: 100 and 101**

**United States Patent and Trademark Office**

**Reg. No. 3,454,608**

**Registered June 24, 2008**

**SERVICE MARK  
PRINCIPAL REGISTER**

**INSIEME**

LUCCA, LLC (DELAWARE LTD LIAB CO)

777 SEVENTH AVENUE

NEW YORK, NY 10019

FOR: RESTAURANT AND BAR SERVICES, IN  
CLASS 43 (U.S. CLS. 100 AND 101).

FIRST USE 4-16-2007; IN COMMERCE 4-16-2007.

THE MARK CONSISTS OF STANDARD CHAR-  
ACTERS WITHOUT CLAIM TO ANY PARTICULAR  
FONT, STYLE, SIZE, OR COLOR.

THE ENGLISH TRANSLATION OF THE WORD  
"INSIEME" IN THE MARK IS "TOGETHER".

SN 77-093,846, FILED 1-29-2007.

LEIGH CAROLINE CASE, EXAMINING ATTOR-  
NEY

**Int. Cl.: 41**

**Prior U.S. Cls.: 100, 101, and 107**

**United States Patent and Trademark Office**

**Reg. No. 3,454,609**

**Registered June 24, 2008**

**SERVICE MARK  
PRINCIPAL REGISTER**

**236.com**

COMEDY NEWS VENTURES, INC. (DELAWARE  
CORPORATION)  
560 BROADWAY, SUITE 304  
NEW YORK, NY 10012

FOR: PROVIDING WEBSITES IN THE FIELD OF  
HUMOR, NEWS, SATIRE, GOSSIP, PARODY, AND  
ENTERTAINMENT, NAMELY, ARTICLES,  
QUOTES, BLOGS, VIDEO CLIPS, AUDIO CLIPS,  
PICTURES, AND SLIDE SHOWS, IN CLASS 41 (U.S.  
CLS. 100, 101 AND 107).

FIRST USE 5-8-2007; IN COMMERCE 5-8-2007.

THE MARK CONSISTS OF STANDARD CHAR-  
ACTERS WITHOUT CLAIM TO ANY PARTICULAR  
FONT, STYLE, SIZE, OR COLOR.

SN 77-094,034, FILED 1-29-2007.

DANNAN HETZEL, EXAMINING ATTORNEY

**Int. Cl.: 9**

**Prior U.S. Cls.: 21, 23, 26, 36, and 38**

**Reg. No. 3,454,610**

**United States Patent and Trademark Office**

**Registered June 24, 2008**

**TRADEMARK  
PRINCIPAL REGISTER**



**INTERACTIVE HAIR DESIGN**

LYONS, MARK JACK (AUSTRALIA INDIVIDUAL)  
LEVEL 5, 203-233 NEW SOUTH HEAD ROAD  
EDGECLIFF, AUSTRALIA NSW 2027

FOR: APPARATUS FOR THE TRANSMISSION OR REPRODUCTION OF SOUND AND IMAGES, APPARATUS FOR RECORDINGS, RECORDING DISCS, NAMELY, CD'S, CD ROM'S, DVD'S FEATURING HAIRSTYLING AND HAIR COLOR MAKEOVER AND BEAUTY APPLICATIONS, COMPUTERS, MULTIMEDIA SOFTWARE RECORDED ON CD-ROM FEATURING HAIRSTYLING AND HAIR COLOR MAKEOVER AND BEAUTY APPLICATIONS, COMPUTER SOFTWARE PROGRAMS USED FOR DATABASE MANAGEMENT OF IMAGES, GRAPHICS AND TEXT INFORMATION, SOFTWARE PROGRAMS SPECIFICALLY USED FOR HAIRSTYLING AND HAIR COLOR MAKEOVER AND BEAUTY APPLICATIONS, AUDIO DIGITAL RECORDINGS FEATURING HAIRSTYLING AND HAIR COLOR MAKEOVER

AND BEAUTY APPLICATIONS, LASER DISCS FEATURING HAIRSTYLING AND HAIR COLOR MAKEOVER AND BEAUTY APPLICATIONS, MULTIMEDIA INTERACTIVE COMPUTER PROGRAMS FOR HAIRSTYLING AND HAIR COLOR MAKEOVER AND BEAUTY APPLICATIONS, ELECTRONIC DATABASES IN THE FIELD OF HAIRSTYLING AND HAIR COLOR MAKEOVER AND BEAUTY APPLICATIONS RECORDED ON COMPUTER MEDIA, IN CLASS 9 (U.S. CLS. 21, 23, 26, 36 AND 38).

FIRST USE 8-29-2007; IN COMMERCE 8-29-2007.

NO CLAIM IS MADE TO THE EXCLUSIVE RIGHT TO USE "INTERACTIVE HAIR DESIGN", APART FROM THE MARK AS SHOWN.

SN 77-094,133, FILED 1-30-2007.

LINDA ORNDORFF, EXAMINING ATTORNEY



**Int. Cls.: 35 and 37**

**Prior U.S. Cls.: 100, 101, 102, 103, and 106**

**Reg. No. 3,454,611**

**United States Patent and Trademark Office**

**Registered June 24, 2008**

---

**SERVICE MARK  
PRINCIPAL REGISTER**

# PRICE BLAST

BONGIORNO SUPERMARKET, INC. (CONNECTICUT CORPORATION)  
288 WEST AVE.  
STAMFORD, CT 06902

FOR: RETAIL STORE SERVICES FEATURING CONVENIENCE STORE ITEMS AND GASOLINE; RETAIL LIQUOR STORES; SUPERMARKETS, IN CLASS 35 (U.S. CLS. 100, 101 AND 102).

FIRST USE 7-18-2006; IN COMMERCE 7-18-2006.

FOR: VEHICLE WASHING, IN CLASS 37 (U.S. CLS. 100, 103 AND 106).

FIRST USE 7-18-2006; IN COMMERCE 7-18-2006.

THE MARK CONSISTS OF STANDARD CHARACTERS WITHOUT CLAIM TO ANY PARTICULAR FONT, STYLE, SIZE, OR COLOR.

NO CLAIM IS MADE TO THE EXCLUSIVE RIGHT TO USE "PRICE", APART FROM THE MARK AS SHOWN.

SN 77-094,185, FILED 1-30-2007.

MARY MUNSON, EXAMINING ATTORNEY

**Int. Cl.: 20**

**Prior U.S. Cls.: 2, 13, 22, 25, 32, and 50**

**United States Patent and Trademark Office**

**Reg. No. 3,454,612**

**Registered June 24, 2008**

**TRADEMARK  
PRINCIPAL REGISTER**



BYRON PALMCROSS, LLC. (ILLINOIS LTD LIAB  
CO)  
1241 E. 32ND AVENUE  
MILAN, IL 61264

FIRST USE 12-1-1997; IN COMMERCE 3-1-2008.

SN 77-094,735, FILED 1-30-2007.

FOR: CHRISTIAN FAITH BASED WOOD SCULP-  
TURES IN THE NATURE OF CROSSES, IN CLASS 20  
(U.S. CLS. 2, 13, 22, 25, 32 AND 50).

KAREN SEVERSON, EXAMINING ATTORNEY

**Int. Cl.: 3**

**Prior U.S. Cls.: 1, 4, 6, 50, 51, and 52**

**United States Patent and Trademark Office**

**Reg. No. 3,454,613**

**Registered June 24, 2008**

**TRADEMARK  
PRINCIPAL REGISTER**

**AQUA - FIX MATT**

JAFER LIMITED (BERMUDA CORPORATION)  
CLARENDON HOUSE, 2 CHURCH STREET  
HAMILTON, HM, BERMUDA

FOR: SKIN MOISTURIZER, WRINKLE REMOV-  
ING SKIN CARE PREPARATIONS, SKIN LOTIONS,  
SKIN TONERS, FACIAL CREAMS, FACIAL LO-  
TIONS, AND COSMETIC CREAMS, IN CLASS 3  
(U.S. CLS. 1, 4, 6, 50, 51 AND 52).

FIRST USE 12-31-2006; IN COMMERCE 4-15-2008.

THE MARK CONSISTS OF STANDARD CHAR-  
ACTERS WITHOUT CLAIM TO ANY PARTICULAR  
FONT, STYLE, SIZE, OR COLOR.

OWNER OF U.S. REG. NO. 2,948,120.

NO CLAIM IS MADE TO THE EXCLUSIVE  
RIGHT TO USE "MATT", APART FROM THE  
MARK AS SHOWN.

SN 77-095,098, FILED 1-30-2007.

TIMOTHY FINNEGAN, EXAMINING ATTORNEY

**Int. Cl.: 35**

**Prior U.S. Cls.: 100, 101, and 102**

**United States Patent and Trademark Office**

**Reg. No. 3,454,614**

**Registered June 24, 2008**

**SERVICE MARK  
PRINCIPAL REGISTER**

**MYFINEWINELIFE.COM**

NORRIS, VICKIE (UNITED STATES INDIVIDUAL)  
315 FIRST STREET  
HEALDSBURG, CA 95448

FOR: ONLINE RETAIL STORE SERVICES FEATURING ART PRINTS AND PICTORIAL ART RELATED TO WINE, MOUNTED OR UNMOUNTED PHOTOGRAPHS RELATED TO WINE, AND BOOKS RELATED TO WINE, WINE STORAGE AND ORGANIZATION SYSTEMS, CORK WINE STOPPERS OR IMITATION CORK WINE STOPPERS, AND WINE RACKS, WINE BEVERAGE GLASSWARE, WINE DECANTERS, WINE CORKSCREWS, CHAMPAGNE BUCKETS, COOLERS FOR WINE, PLATES FOR HORS D'OEUVRE WITH WINE BEVERAGE GLASS-

WARE, CHARMS FOR ATTACHMENT TO WINE BEVERAGE GLASSWARE FOR IDENTIFICATION PURPOSES, AND CHEESE CUTTING BOARDS WITH TOOLS, IN CLASS 35 (U.S. CLS. 100, 101 AND 102).

FIRST USE 2-28-2007; IN COMMERCE 2-28-2007.

THE MARK CONSISTS OF STANDARD CHARACTERS WITHOUT CLAIM TO ANY PARTICULAR FONT, STYLE, SIZE, OR COLOR.

SN 77-095,126, FILED 1-30-2007.

LINDA E. BLOHM, EXAMINING ATTORNEY

**Int. Cl.: 31**

**Prior U.S. Cls.: 1 and 46**

**United States Patent and Trademark Office**

**Reg. No. 3,454,615**

**Registered June 24, 2008**

**TRADEMARK  
PRINCIPAL REGISTER**

**RJ GOLD**

HILLTOP FRUIT TREES, LLC (MICHIGAN LTD  
LIAB CO)

60395 C.R. 681

HARTFORD, MI 49057

FOR: LIVE APPLE TREES, IN CLASS 31 (U.S. CLS.  
1 AND 46).

FIRST USE 4-30-2007; IN COMMERCE 4-30-2007.

THE MARK CONSISTS OF STANDARD CHAR-  
ACTERS WITHOUT CLAIM TO ANY PARTICULAR  
FONT, STYLE, SIZE, OR COLOR.

NO CLAIM IS MADE TO THE EXCLUSIVE  
RIGHT TO USE "GOLD", APART FROM THE  
MARK AS SHOWN.

SN 77-095,376, FILED 1-31-2007.

TINA BROWN, EXAMINING ATTORNEY

**Int. Cl.: 36**

**Prior U.S. Cls.: 100, 101, and 102**

**United States Patent and Trademark Office**

**Reg. No. 3,454,616**

**Registered June 24, 2008**

---

**SERVICE MARK  
PRINCIPAL REGISTER**

**AlphaDEX**

FIRST TRUST PORTFOLIOS L.P. (ILLINOIS LIMITED PARTNERSHIP)  
SUITE 300  
1001 WARRENVILLE ROAD  
LISLE, IL 60532

THE MARK CONSISTS OF STANDARD CHARACTERS WITHOUT CLAIM TO ANY PARTICULAR FONT, STYLE, SIZE, OR COLOR.

FOR: FINANCIAL SERVICES, NAMELY, FUNDS INVESTMENT SERVICES, IN CLASS 36 (U.S. CLS. 100, 101 AND 102).

SN 77-095,542, FILED 1-31-2007.

FIRST USE 5-0-2007; IN COMMERCE 5-0-2007.

JENNIFER MARTIN, EXAMINING ATTORNEY

**Int. Cl.: 14**

**Prior U.S. Cls.: 2, 27, 28, and 50**

**United States Patent and Trademark Office**

**Reg. No. 3,454,617**

**Registered June 24, 2008**

**TRADEMARK  
PRINCIPAL REGISTER**

**BIRKAT ELYON**

777 JEWELS LLC (NEW YORK LTD LIAB CO)  
410 PARK AVENUE, SUITE 1530  
NEW YORK, NY 10022

FOR: JEWELRY, NAMELY, RINGS, EARRINGS,  
PENDANTS, NECKLACES, BRACELETS AND  
BROACHES, IN CLASS 14 (U.S. CLS. 2, 27, 28 AND  
50).

FIRST USE 2-4-2008; IN COMMERCE 2-4-2008.

THE MARK CONSISTS OF STANDARD CHAR-  
ACTERS WITHOUT CLAIM TO ANY PARTICULAR  
FONT, STYLE, SIZE, OR COLOR.

THE ENGLISH TRANSLATION OF THE WORD  
"BIRKAT ELYON" IN THE MARK IS BLESSINGS  
FROM HEAVEN.

SN 77-095,552, FILED 1-31-2007.

ALICIA COLLINS, EXAMINING ATTORNEY

**Int. Cl.: 14**

**Prior U.S. Cls.: 2, 27, 28, and 50**

**United States Patent and Trademark Office**

**Reg. No. 3,454,618**

**Registered June 24, 2008**

**TRADEMARK  
PRINCIPAL REGISTER**



777 JEWELS LLC (NEW YORK LTD LIAB CO)  
410 PARK AVENUE, SUITE 1530  
NEW YORK, NY 10022

FIRST USE 2-4-2008; IN COMMERCE 2-4-2008.

FOR: JEWELRY, NAMELY, RINGS, EARRINGS,  
PENDANTS, NECKLACES, BRACELETS AND  
BROACHES, IN CLASS 14 (U.S. CLS. 2, 27, 28 AND  
50).

SN 77-095,586, FILED 1-31-2007.

ALICIA COLLINS, EXAMINING ATTORNEY



**Int. Cl.: 16**

**Prior U.S. Cls.: 2, 5, 22, 23, 29, 37, 38, and 50**

**Reg. No. 3,454,619**

**United States Patent and Trademark Office**

**Registered June 24, 2008**

---

**TRADEMARK  
PRINCIPAL REGISTER**

**MARTINI**

DPE LABEL HOLDING CORP. (NEW YORK  
CORPORATION)  
232 BROADWAY  
BROOKLYN, NY 11211

THE MARK CONSISTS OF STANDARD CHAR-  
ACTERS WITHOUT CLAIM TO ANY PARTICULAR  
FONT, STYLE, SIZE, OR COLOR.

FOR: PRE-PAID TELEPHONE CALLING CARDS,  
NOT MAGNETICALLY ENCODED, IN CLASS 16  
(U.S. CLS. 2, 5, 22, 23, 29, 37, 38 AND 50).

SN 77-095,628, FILED 1-31-2007.

FIRST USE 1-31-2007; IN COMMERCE 1-31-2007.

ALICIA COLLINS, EXAMINING ATTORNEY

**Int. Cl.: 5**

**Prior U.S. Cls.: 6, 18, 44, 46, 51, and 52**

**United States Patent and Trademark Office**

**Reg. No. 3,454,620**

**Registered June 24, 2008**

**TRADEMARK  
PRINCIPAL REGISTER**

# DIGEST 365

GREAT HEALTHWORKS, INC. (NEVADA CORPORATION)  
1890 N. UNIVERSITY DR. SUITE 205  
CORAL SPRINGS, FL 33071

THE MARK CONSISTS OF STANDARD CHARACTERS WITHOUT CLAIM TO ANY PARTICULAR FONT, STYLE, SIZE, OR COLOR.

FOR: DIETARY SUPPLEMENTS, IN CLASS 5 (U.S. CLS. 6, 18, 44, 46, 51 AND 52).

SN 77-095,652, FILED 1-31-2007.

FIRST USE 1-0-2007; IN COMMERCE 1-0-2007.

TANYA AMOS, EXAMINING ATTORNEY

**Int. Cl.: 28**

**Prior U.S. Cls.: 22, 23, 38, and 50**

**United States Patent and Trademark Office**

**Reg. No. 3,454,621**

**Registered June 24, 2008**

**TRADEMARK  
PRINCIPAL REGISTER**

**TELL ME MORE**

BIBLEQUEST L.P. (DELAWARE LIMITED PART-  
NERSHIP)  
2300 E. RANDOL MILL ROAD  
ARLINGTON, TX 76011

THE MARK CONSISTS OF STANDARD CHAR-  
ACTERS WITHOUT CLAIM TO ANY PARTICULAR  
FONT, STYLE, SIZE, OR COLOR.

FOR: BOARD GAMES; PUZZLES, IN CLASS 28  
(U.S. CLS. 22, 23, 38 AND 50).

SN 77-095,680, FILED 1-31-2007.

FIRST USE 6-25-2007; IN COMMERCE 6-25-2007.

BRENDAN REGAN, EXAMINING ATTORNEY

**Int. Cl.: 28**

**Prior U.S. Cls.: 22, 23, 38, and 50**

**United States Patent and Trademark Office**

**Reg. No. 3,454,622**

**Registered June 24, 2008**

**TRADEMARK  
PRINCIPAL REGISTER**



BIBLEQUEST L.P. (DELAWARE LIMITED PART-  
NERSHIP)  
2300 E. RANDOL MILL ROAD  
ARLINGTON, TX 76011

THE MARK CONSISTS OF A PUZZLE PIECE  
CIRCUMSCRIBING THE WORDS "TELL ME  
MORE".

FOR: BOARD GAMES; PUZZLES, IN CLASS 28  
(U.S. CLS. 22, 23, 38 AND 50).

SN 77-095,685, FILED 1-31-2007.

FIRST USE 6-25-2007; IN COMMERCE 6-25-2007.

BRENDAN REGAN, EXAMINING ATTORNEY

**Int. Cl.: 41**

**Prior U.S. Cls.: 100, 101, and 107**

**United States Patent and Trademark Office**

**Reg. No. 3,454,623**

**Registered June 24, 2008**

**SERVICE MARK  
PRINCIPAL REGISTER**

**FEDERAL EXPERIENCE**

ALLIANT TECHSYSTEMS INC. (DELAWARE  
CORPORATION)  
5050 LINCOLN DRIVE  
EDINA, MN 554367097

FOR: ENTERTAINMENT SERVICES, NAMELY, A  
TELEVISION SERIES IN THE FIELDS OF HUNT-  
ING, SHOOTING SPORTS, FISHING, AND OUT-  
DOOR SPORTS AND ACTIVITIES, IN CLASS 41 (U.S.  
CLS. 100, 101 AND 107).

FIRST USE 8-4-2007; IN COMMERCE 8-4-2007.

THE MARK CONSISTS OF STANDARD CHAR-  
ACTERS WITHOUT CLAIM TO ANY PARTICULAR  
FONT, STYLE, SIZE, OR COLOR.

SN 77-095,847, FILED 1-31-2007.

DANIEL CAPSHAW, EXAMINING ATTORNEY

**Int. Cl.: 28**

**Prior U.S. Cls.: 22, 23, 38, and 50**

**Reg. No. 3,454,624**

**United States Patent and Trademark Office**

**Registered June 24, 2008**

---

**TRADEMARK  
PRINCIPAL REGISTER**

**Metal, Magic and Lore**

5TH EPOCH PUBLISHING LLC (NEW YORK  
LTD LIAB CO)  
597 BELLEVUE AVENUE NORTH  
YONKERS, NY 10703

THE MARK CONSISTS OF STANDARD CHAR-  
ACTERS WITHOUT CLAIM TO ANY PARTICULAR  
FONT, STYLE, SIZE, OR COLOR.

FOR: ROLE PLAYING GAMES, IN CLASS 28 (U.S.  
CLS. 22, 23, 38 AND 50).

SN 77-096,085, FILED 1-31-2007.

FIRST USE 7-5-2007; IN COMMERCE 7-5-2007.

SUSAN STIGLITZ, EXAMINING ATTORNEY

**Int. Cl.: 43**

**Prior U.S. Cls.: 100 and 101**

**United States Patent and Trademark Office**

**Reg. No. 3,454,625**

**Registered June 24, 2008**

**SERVICE MARK  
PRINCIPAL REGISTER**

# Hotel Amaranano

LUCKY TOWN BURBANK, L.P. (DELAWARE  
LIMITED PARTNERSHIP)

3 BETHESDA METRO CENTER, SUITE 1200

BETHESDA, MD 20814

FOR: HOTEL SERVICES, IN CLASS 43 (U.S. CLS.  
100 AND 101).

FIRST USE 1-15-2007; IN COMMERCE 1-15-2007.

THE MARK CONSISTS OF STANDARD CHAR-  
ACTERS WITHOUT CLAIM TO ANY PARTICULAR  
FONT, STYLE, SIZE, OR COLOR.

NO CLAIM IS MADE TO THE EXCLUSIVE  
RIGHT TO USE "HOTEL", APART FROM THE  
MARK AS SHOWN.

SN 77-096,203, FILED 1-31-2007.

LIEF MARTIN, EXAMINING ATTORNEY

**Int. Cl.: 36**

**Prior U.S. Cls.: 100, 101, and 102**

**United States Patent and Trademark Office**

**Reg. No. 3,454,626**

**Registered June 24, 2008**

**SERVICE MARK  
PRINCIPAL REGISTER**



FIRST TRUST PORTFOLIOS L.P. (ILLINOIS LIMITED PARTNERSHIP)  
SUITE 300  
1001 WARRENVILLE ROAD  
LISLE, IL 60532

THE MARK CONSISTS OF A SPHERICAL DESIGN PROVIDING THE ALPHA SYMBOL, FOLLOWED BY THE WORD "ALPHADEX".

FOR: FINANCIAL SERVICES, NAMELY, FUNDS INVESTMENT SERVICES, IN CLASS 36 (U.S. CLS. 100, 101 AND 102).

SN 77-096,209, FILED 1-31-2007.

FIRST USE 4-27-2007; IN COMMERCE 4-27-2007.

JENNIFER MARTIN, EXAMINING ATTORNEY



**Int. Cl.: 36**

**Prior U.S. Cls.: 100, 101, and 102**

**United States Patent and Trademark Office**

**Reg. No. 3,454,627**

**Registered June 24, 2008**

**SERVICE MARK  
PRINCIPAL REGISTER**

**THE MCKENZIE FOUNDATION OF  
SAN FRANCISCO**

THE MCKENZIE FOUNDATION (CALIFORNIA  
CORPORATION)  
1160 BATTERY STREET, SUITE 30  
SAN FRANCISCO, CA 94111

FOR: PHILANTHROPIC SERVICES, NAMELY,  
MAKING MONETARY DONATIONS AND  
GRANTS TO IMPROVE HUMAN HEALTH AND  
WELFARE, TO FOSTER COMMUNITY DEVELOP-  
MENT, AND TO PROMOTE PUBLIC AWARENESS  
OF SOCIAL AND HEALTH ISSUES AFFECTING  
THE WELL-BEING OF OTHERS, IN CLASS 36 (U.S.  
CLS. 100, 101 AND 102).

FIRST USE 12-19-2007; IN COMMERCE 12-19-2007.

THE MARK CONSISTS OF STANDARD CHAR-  
ACTERS WITHOUT CLAIM TO ANY PARTICULAR  
FONT, STYLE, SIZE, OR COLOR.

NO CLAIM IS MADE TO THE EXCLUSIVE  
RIGHT TO USE "FOUNDATION OF SAN FRANCIS-  
CO", APART FROM THE MARK AS SHOWN.

SN 77-096,278, FILED 1-31-2007.

SCOTT BIBB, EXAMINING ATTORNEY

**Int. Cls.: 37 and 42**

**Prior U.S. Cls.: 100, 101, 103, and 106**

**United States Patent and Trademark Office**

**Reg. No. 3,454,628**

**Registered June 24, 2008**

**SERVICE MARK  
PRINCIPAL REGISTER**

**ANSWERS WHILE DRILLING**

BAKER HUGHES INCORPORATED (DELA-  
WARE CORPORATION)  
P.O. BOX 4740  
HOUSTON, TX 77210

FOR: OIL AND GAS WELL DRILLING, IN CLASS  
37 (U.S. CLS. 100, 103 AND 106).

FIRST USE 8-1-2003; IN COMMERCE 8-1-2003.

FOR: OIL AND GAS WELL LOGGING AND  
TESTING; ENGINEERING AND GEOLOGICAL  
EVALUATION FOR OIL AND GAS DRILLING  
AND PROSPECTING; DESIGN, PLANNING AND  
SURVEYING OF WELL DRILLING OPERATIONS  
AND WELLS; DATA EVALUATION AND ANALY-

SIS SERVICES IN THE FIELD OF OIL AND GAS  
LOGGING; OIL AND GAS WELL DRILLING SER-  
VICES, NAMELY, PROVIDING MEASUREMENTS  
AND DOWNHOLE TELEMETRY WHILE DRIL-  
LING, IN CLASS 42 (U.S. CLS. 100 AND 101).

FIRST USE 8-1-2003; IN COMMERCE 8-1-2003.

THE MARK CONSISTS OF STANDARD CHAR-  
ACTERS WITHOUT CLAIM TO ANY PARTICULAR  
FONT, STYLE, SIZE, OR COLOR.

SN 77-096,305, FILED 1-31-2007.

DAVID MILLER, EXAMINING ATTORNEY

Int. Cl.: 43

Prior U.S. Cls.: 100 and 101

United States Patent and Trademark Office

Reg. No. 3,454,629

Registered June 24, 2008

SERVICE MARK  
PRINCIPAL REGISTER



LUCKY TOWN BURBANK, L.P. (DELAWARE  
LIMITED PARTNERSHIP)

3 BETHESDA METRO CENTER, SUITE 1200  
BETHESDA, MD 20814

FOR: HOTEL SERVICES, IN CLASS 43 (U.S. CLS.  
100 AND 101).

FIRST USE 10-15-2007; IN COMMERCE 10-15-2007.

NO CLAIM IS MADE TO THE EXCLUSIVE  
RIGHT TO USE "HOTEL", APART FROM THE  
MARK AS SHOWN.

THE MARK CONSISTS OF THE WORDS HOTEL  
AMARANO WITH THE "A" IN AMARANO AP-  
PEARING OVER A SQUARE SHAPE.

SN 77-096,667, FILED 2-1-2007.

LIEF MARTIN, EXAMINING ATTORNEY

**Int. Cl.: 35**

**Prior U.S. Cls.: 100, 101, and 102**

**United States Patent and Trademark Office**

**Reg. No. 3,454,630**

**Registered June 24, 2008**

**SERVICE MARK  
PRINCIPAL REGISTER**

**WORLD-SOURCING INC.**

MERZ, WESLEY B. (UNITED STATES INDIVIDUAL)  
21-42 STEINWAY STREET  
ASTORIA, NY 11105

FOR: ADVISORY AND CONSULTANCY SERVICES RELATING TO EXPORT, EXPORT SERVICES, EXPORT PROMOTION INFORMATION AND SERVICES; EXPORT AND IMPORT AGENCIES, IN CLASS 35 (U.S. CLS. 100, 101 AND 102).

FIRST USE 6-0-2007; IN COMMERCE 9-0-2007.

THE MARK CONSISTS OF STANDARD CHARACTERS WITHOUT CLAIM TO ANY PARTICULAR FONT, STYLE, SIZE, OR COLOR.

NO CLAIM IS MADE TO THE EXCLUSIVE RIGHT TO USE "INC.", APART FROM THE MARK AS SHOWN.

SN 77-096,695, FILED 2-1-2007.

BENJAMIN ALLEN, EXAMINING ATTORNEY

**Int. Cl.: 20**

**Prior U.S. Cls.: 2, 13, 22, 25, 32, and 50**

**Reg. No. 3,454,631**

**United States Patent and Trademark Office**

**Registered June 24, 2008**

---

**TRADEMARK  
PRINCIPAL REGISTER**

**INTELLICLIP**

EDGETECH I.G., INC. (OHIO CORPORATION)  
800 COCHRAN AVE  
CAMBRIDGE, OH 43725

THE MARK CONSISTS OF STANDARD CHAR-  
ACTERS WITHOUT CLAIM TO ANY PARTICULAR  
FONT, STYLE, SIZE, OR COLOR.

FOR: NON-METAL MUNTIN CLIPS, IN CLASS 20  
(U.S. CLS. 2, 13, 22, 25, 32 AND 50).

SN 77-096,734, FILED 2-1-2007.

FIRST USE 8-31-2007; IN COMMERCE 8-31-2007.

CHRISTOPHER BUONGIORNO, EXAMINING AT-  
TORNEY

**Int. Cl.: 25**

**Prior U.S. Cls.: 22 and 39**

**United States Patent and Trademark Office**

**Reg. No. 3,454,632**

**Registered June 24, 2008**

**TRADEMARK  
PRINCIPAL REGISTER**



**TOKABEE**

JOO, BYONGJIN (REPUBLIC OF KOREA INDIVIDUAL)  
101-704 SEONGSAN WORLD TOWN DAELIM APT.  
601 SEONGSAN-DONG, MAPO-KU  
SEOUL, REPUBLIC OF KOREA

FOR: UNDERWEAR, NAMELY, UNDERSHIRTS, UNDERPANTS, BRASSIERES, NIGHT GOWNS, SLIPS; T-SHIRTS; SPORT SHIRTS, JEANS; JACKETS; TROUSERS; SOCKS; GLOVES; TIES; HATS; LEATHER BELTS, IN CLASS 25 (U.S. CLS. 22 AND 39).

FIRST USE 1-17-2007; IN COMMERCE 2-13-2007.

OWNER OF U.S. REG. NO. 2,291,379.

THE MARK CONSISTS OF A HIGHLY STYLIZED CARICATURE OF A DRAGON POSITIONED ABOVE THE LETTERS "TOKABEE".

THE WORDING IN THE MARK HAS NO TRANSLATION OR MEANING IN ANY FOREIGN LANGUAGE.

SN 77-096,771, FILED 2-1-2007.

CORY BOONE, EXAMINING ATTORNEY

**Int. Cl.: 25**

**Prior U.S. Cls.: 22 and 39**

**United States Patent and Trademark Office**

**Reg. No. 3,454,633**

**Registered June 24, 2008**

**TRADEMARK  
PRINCIPAL REGISTER**



**TOKABEE**

JOO, BYONGJIN (REPUBLIC OF KOREA INDIVIDUAL)  
101-704 SEONGSAN WORLD TOWN DAELIM APT.  
601 SEONGSAN-DONG, MAPO-KU  
SEOUL, REPUBLIC OF KOREA

FOR: UNDERWEAR, NAMELY, UNDERSHIRTS, UNDERPANTS, BRASSIERES, NIGHT GOWNS, SLIPS; T-SHIRTS; SPORT SHIRTS, JEANS; JACKETS; TROUSERS; SOCKS; GLOVES; TIES; HATS; LEATHER BELTS, IN CLASS 25 (U.S. CLS. 22 AND 39).

FIRST USE 1-17-2007; IN COMMERCE 2-13-2007.

OWNER OF U.S. REG. NO. 2,291,379.

THE MARK CONSISTS OF A HIGHLY STYLIZED FORM OF THE LETTER "T" POSITIONED ABOVE THE LETTERS "TOKABEE".

SN 77-096,802, FILED 2-1-2007.

CORY BOONE, EXAMINING ATTORNEY

Int. Cl.: 43

Prior U.S. Cls.: 100 and 101

United States Patent and Trademark Office

Reg. No. 3,454,634

Registered June 24, 2008

SERVICE MARK  
PRINCIPAL REGISTER



ORGANIC COMFORT FOOD CAFÉ, INC. (WASHINGTON CORPORATION)  
210 W. PIONEER #404  
PUYALLUP, WA 98371

FOR: RESTAURANTS, IN CLASS 43 (U.S. CLS. 100 AND 101).

FIRST USE 2-29-2008; IN COMMERCE 2-29-2008.

NO CLAIM IS MADE TO THE EXCLUSIVE RIGHT TO USE "ORGANIC" AND "CAFE", APART FROM THE MARK AS SHOWN.

THE MARK CONSISTS OF TOMATO APPEARING ABOVE WORDS ORGANIC "COMFORT FOOD CAFE" WITH VINES GROWING FROM THE BOTTOM OF "FOOD".

SN 77-096,966, FILED 2-1-2007.

KELLY BOULTON, EXAMINING ATTORNEY



**Int. Cl.: 9**

**Prior U.S. Cls.: 21, 23, 26, 36, and 38**

**Reg. No. 3,454,635**

**United States Patent and Trademark Office**

**Registered June 24, 2008**

---

**TRADEMARK  
PRINCIPAL REGISTER**

**GRIZZLY**

GRIZZLY INDUSTRIAL, INC. (WASHINGTON  
CORPORATION)  
1821 VALENCIA STREET  
BELLINGHAM, WA 98229

THE MARK CONSISTS OF STANDARD CHAR-  
ACTERS WITHOUT CLAIM TO ANY PARTICULAR  
FONT, STYLE, SIZE, OR COLOR.

FOR: OPTICAL APPARATUS AND INSTRU-  
MENTS, NAMELY, SPOTTING SCOPES, IN CLASS  
9 (U.S. CLS. 21, 23, 26, 36 AND 38).

SN 77-097,352, FILED 2-1-2007.

FIRST USE 1-8-2008; IN COMMERCE 1-14-2008.

DAWN HAN, EXAMINING ATTORNEY

**Int. Cl.: 30**

**Prior U.S. Cl.: 46**

**United States Patent and Trademark Office**

**Reg. No. 3,454,636**

**Registered June 24, 2008**

**TRADEMARK  
PRINCIPAL REGISTER**

**RALLINI**

AROMA ANTICO, INC. (NEW YORK CORPORATION)  
239 MERRICK ROAD  
LYNBROOK, NY 11563

THE MARK CONSISTS OF STANDARD CHARACTERS WITHOUT CLAIM TO ANY PARTICULAR FONT, STYLE, SIZE, OR COLOR.

FOR: BOILED AND BAKED WHEAT-BASED SNACK FOODS, IN CLASS 30 (U.S. CL. 46).

SN 77-097,564, FILED 2-2-2007.

FIRST USE 12-26-2006; IN COMMERCE 12-26-2006.

NATALIE POLZER, EXAMINING ATTORNEY

**Int. Cl.: 30**

**Prior U.S. Cl.: 46**

**United States Patent and Trademark Office**

**Reg. No. 3,454,637**

**Registered June 24, 2008**

**TRADEMARK  
PRINCIPAL REGISTER**

**AROMA ANTICO**

AROMA ANTICO, INC. (NEW YORK CORPORATION)  
239 MERRICK ROAD  
LYNBROOK, NY 11563

FOR: BOILED AND BAKED WHEAT-BASED  
SNACK FOODS, IN CLASS 30 (U.S. CL. 46).

FIRST USE 12-26-2006; IN COMMERCE 12-26-2006.

THE MARK CONSISTS OF STANDARD CHARACTERS WITHOUT CLAIM TO ANY PARTICULAR FONT, STYLE, SIZE, OR COLOR.

THE ENGLISH TRANSLATION OF THE WORD "AROMA ANTICO" IN THE MARK IS AS ANCIENT.

SN 77-097,596, FILED 2-2-2007.

NATALIE POLZER, EXAMINING ATTORNEY

**Int. Cl.: 25**

**Prior U.S. Cls.: 22 and 39**

**United States Patent and Trademark Office**

**Reg. No. 3,454,638**

**Registered June 24, 2008**

**TRADEMARK  
PRINCIPAL REGISTER**

**URBAN PRINTING COMPANY**

IMAGE MARKET (NEBRASKA CORPORATION)  
10045 SCOTT CIRCLE  
OMAHA, NE 68122

FOR: T-SHIRTS, IN CLASS 25 (U.S. CLS. 22 AND 39).

FIRST USE 8-7-2007; IN COMMERCE 8-7-2007.

THE MARK CONSISTS OF STANDARD CHARACTERS WITHOUT CLAIM TO ANY PARTICULAR FONT, STYLE, SIZE, OR COLOR.

NO CLAIM IS MADE TO THE EXCLUSIVE RIGHT TO USE "PRINTING COMPANY", APART FROM THE MARK AS SHOWN.

SN 77-097,814, FILED 2-2-2007.

SCOTT BIBB, EXAMINING ATTORNEY

**Int. Cl.: 44**

**Prior U.S. Cls.: 100 and 101**

**United States Patent and Trademark Office**

**Reg. No. 3,454,639**

**Registered June 24, 2008**

**SERVICE MARK  
PRINCIPAL REGISTER**

# HONEYMOON

GAUGHEN HOLDINGS LLC (CALIFORNIA LTD  
LIAB CO)  
4954 NAUTILUS ST.  
OXNARD, CA 93035

FOR: ACUPUNCTURE, ACUPUNCTURE SERVICES, ADDICTION TREATMENT SERVICES, AMBULANT MEDICAL CARE, ANIMAL GROOMING, AROMATHERAPY SERVICES, ARTIFICIAL INSEMINATION, BARBERSHOPS, BEAUTY SALONS, BODY PIECING SERVICES, BODYWORK THERAPY, CEMETERY PLOT PERPETUAL CARE SERVICES, CHIROPRACTIC SERVICES, COLOR ANALYSIS FOR COSMETIC PURPOSES, CONSULTING SERVICES IN THE FIELD OF MENTAL HEALTH AND WELLNESS, CONVALESCENT HOMES, COSMETIC ANALYSIS, COSMETIC AND PLASTIC SURGERY, COSMETIC ELECTROLYSIS, COSMETICIAN SERVICES, COSMETOLOGY SERVICES, DENTAL HYGIENIST SERVICES, DENTISTRY, DEPILATORY HAIR REMOVAL SERVICES, DIETARY AND NUTRITIONAL GUIDANCE, DISPENSING OF PHARMACEUTICALS, DOG WALKING SERVICES, DRUG TESTING FOR SUBSTANCE ABUSE, EMERGENCY MEDICAL ASSISTANCE, EYEGLOSS FITTING; FACIAL TREATMENT SERVICES, NAMELY, COSMETIC PEELS; FITTING OF CONTACT LENSES, FLOWER ARRANGING, FOOD NUTRITION CONSULTATION, GARDEN CARE SERVICES, GENE BANK SERVICES, GOLF COURSE DESIGN, GREENHOUSE SERVICES, GYNECOLOGICAL PAP EXAMINATION, HAIR CUTTING, HAIR IMPLANTATION; HAIR REPLACEMENT, HAIR ADDITION, AND HAIR EXTENSION SERVICES; HAIR STYLING, HAIRDRESSING SALONS, HEALTH CARE, HEALTH SPA SERVICES FOR HEALTH AND WELLNESS OF THE BODY AND SPIRIT OFFERED AT A RESORT, HOME HEALTH CARE SERVICES, HOME NURSING AID SERVICES, HORTICULTURE SERVICES, HOSPICES, HOSPITALS, HYPNOTHERAPY SERVICES, LANDSCAPE DESIGN, LEASING SKIN CARE EQUIPMENT,

MANAGED HEALTH CARE SERVICES, MANICURING, MASSAGE, MEDICAL AND PHARMACEUTICAL CONSULTATION, MEDICAL ASSISTANCE SERVICES, MEDICAL CLINICS, MEDICAL INFORMATION, MEDICAL SERVICES, MEDICAL TESTING, MENTAL HEALTH SERVICES, NAIL CARE SALONS, NURSING CARE, NURSING HOMES, OBSTETRIC AND GYNECOLOGY SERVICES, OPERATION OF SAUNA FACILITIES, OPHTHALMOLOGY SERVICES, OPTICIAN SERVICES, OPTOMETRY SERVICES, PERFORMING DIAGNOSIS OF DISEASES, PERMANENT HAIR REMOVAL AND REDUCTION; PET CARE SERVICES, NAMELY, DOG WALKING, DOG BATHING, NON-MEDICATED PET GROOMING; PET HOSPITAL SERVICES, PHYSICIAN SERVICES, PLANT CARE SERVICES, PLANT NURSERIES, PREPARATION AND DISPENSING OF MEDICATIONS, PROVIDING HEALTH CARE INFORMATION BY TELEPHONE AND THE INTERNET, PROVIDING INFORMATION ABOUT BEAUTY; PROVIDING LAVATORIES, BATHROOMS, CHANGING TABLES FOR BABIES AND SANITARY TOWEL DISPENSERS; PROVIDING MEDICAL INFORMATION, PROVIDING PHYSICAL REHABILITATION FACILITIES, PROVIDING TOILET SERVICES FOR INDIVIDUALS THROUGH THE USE OF PORTABLE TOILETS; REHABILITATION OF ALCOHOL ADDICTED PATIENTS, DRUG ADDICTED PATIENTS, AND NARCOTIC ADDICTED PATIENTS, OR ANY COMBINATION THEREOF; RENTAL MACHINES AND APPARATUS FOR USE IN BEAUTY SALONS OR BARBERS' SHOPS, RENTAL OF PORTABLE TOILETS, RENTAL OF POTTED PLANTS, RENTAL OF SANITATION FACILITIES, REST HOMES, SANITARIUMS, SERVICES OF MAKE-UP ARTISTS, SERVICES RENDERED BY A DIETICIAN, SKIN CARE SALONS, SPERM BANKS, TANNING SALONS, TATTOOING, TATTOOING OF PETS FOR IDENTIFICATION PURPOSES, TEETH WHITENING SERVICES, TREE CARE SERVICES, VERMIN EXTERMINATION FOR AGRICULTURE, VETER-

INARY SERVICES, VITAMIN THERAPY, WEED CONTROL, WEIGHT REDUCTION DIET PLANNING AND SUPERVISION, WREATH MAKING, YARD CARE SERVICES, IN CLASS 44 (U.S. CLS. 100 AND 101).

FIRST USE 8-1-2007; IN COMMERCE 2-7-2008.

THE MARK CONSISTS OF STANDARD CHARACTERS WITHOUT CLAIM TO ANY PARTICULAR FONT, STYLE, SIZE, OR COLOR.

OWNER OF U.S. REG. NOS. 2,692,857, 3,128,176, AND OTHERS.

SN 77-097,940, FILED 2-2-2007.

LINDSEY RUBIN, EXAMINING ATTORNEY

**Int. Cl.: 30**

**Prior U.S. Cl.: 46**

**United States Patent and Trademark Office**

**Reg. No. 3,454,640**

**Registered June 24, 2008**

**TRADEMARK  
PRINCIPAL REGISTER**

**RIP TIDE**

CRAWDAWG CATERING, LLC (GEORGIA LTD  
LIAB CO)  
11258 FORD AVENUE, SUITE 2  
RICHMOND HILL, GA 31324

THE MARK CONSISTS OF STANDARD CHAR-  
ACTERS WITHOUT CLAIM TO ANY PARTICULAR  
FONT, STYLE, SIZE, OR COLOR.

FOR: BARBECUE SAUCE, IN CLASS 30 (U.S. CL.  
46).

SN 77-098,173, FILED 2-2-2007.

FIRST USE 6-29-2007; IN COMMERCE 6-29-2007.

ROBERT C. CLARK JR., EXAMINING ATTORNEY

**Int. Cl.: 16**

**Prior U.S. Cls.: 2, 5, 22, 23, 29, 37, 38, and 50**

**Reg. No. 3,454,641**

**United States Patent and Trademark Office**

**Registered June 24, 2008**

**TRADEMARK  
PRINCIPAL REGISTER**

**LUV2BIKE**

LUV2, LLC (NEVADA LTD LIAB CO)  
2600 LOCHLEVEN WAY  
HENDERSON, NV 89044

TOPICS, IN CLASS 16 (U.S. CLS. 2, 5, 22, 23, 29, 37, 38  
AND 50).

FIRST USE 9-15-2007; IN COMMERCE 9-15-2007.

FOR: MAGAZINES IN THE FIELDS OF SPORTS,  
SPORTING EVENTS, SPORTING COMPETITIONS,  
SPORTS INSTRUCTION, ENTERTAINMENT,  
HEALTH, NUTRITION, FITNESS, ATHLETIC  
TRAINING AND CONDITIONING, SHOPPING,  
ATHLETIC AND SPORTS EQUIPMENT AND AC-  
CESSORIES, APPAREL, APPAREL ACCESSORIES,  
TRAVEL, LOCAL NEWS AND EVENTS, POPULAR  
CULTURE, LEISURE, AND GENERAL INTEREST

THE MARK CONSISTS OF STANDARD CHAR-  
ACTERS WITHOUT CLAIM TO ANY PARTICULAR  
FONT, STYLE, SIZE, OR COLOR.

SN 77-098,269, FILED 2-2-2007.

JASON LOTT, EXAMINING ATTORNEY



**Int. Cl.: 41**

**Prior U.S. Cls.: 100, 101, and 107**

**United States Patent and Trademark Office**

**Reg. No. 3,454,642**

**Registered June 24, 2008**

**SERVICE MARK  
PRINCIPAL REGISTER**

**SWIRLWIND TOUR**

DIAGEO NORTH AMERICA, INC. (CONNECTI-  
CUT CORPORATION)  
801 MAIN AVENUE  
NORWALK, CT 06851

FOR: ENTERTAINMENT SERVICES, NAMELY,  
WINE TASTINGS, IN CLASS 41 (U.S. CLS. 100, 101  
AND 107).

FIRST USE 3-13-2007; IN COMMERCE 3-13-2007.

THE MARK CONSISTS OF STANDARD CHAR-  
ACTERS WITHOUT CLAIM TO ANY PARTICULAR  
FONT, STYLE, SIZE, OR COLOR.

NO CLAIM IS MADE TO THE EXCLUSIVE  
RIGHT TO USE "TOUR", APART FROM THE  
MARK AS SHOWN.

SN 77-098,298, FILED 2-2-2007.

DAVID ELTON, EXAMINING ATTORNEY

**Int. Cl.: 41**

**Prior U.S. Cls.: 100, 101, and 107**

**United States Patent and Trademark Office**

**Reg. No. 3,454,643**

**Registered June 24, 2008**

**SERVICE MARK  
PRINCIPAL REGISTER**

**LUV2BIKE**

LUV2, LLC (NEVADA LTD LIAB CO)  
2600 LOCHLEVEN WAY  
HENDERSON, NV 89044

FOR: PROVIDING ONLINE NON-DOWNLOAD-  
ABLE MAGAZINES IN THE FIELDS OF SPORTS,  
SPORTING EVENTS, SPORTING COMPETITIONS,  
SPORTS INSTRUCTION, ENTERTAINMENT,  
HEALTH, NUTRITION, FITNESS, ATHLETIC  
TRAINING AND CONDITIONING, SHOPPING,  
ATHLETIC AND SPORTS EQUIPMENT AND AC-  
CESSORIES, APPAREL, APPAREL ACCESSORIES,  
TRAVEL, LOCAL NEWS AND EVENTS, POPULAR  
CULTURE, LEISURE, AND GENERAL INTEREST  
TOPICS; ENTERTAINMENT SERVICES IN THE

NATURE OF BICYCLING COMPETITIONS AND  
EVENTS; SPORTS AND ATHLETIC INSTRUCTION  
SERVICES IN THE FIELD OF BICYCLING, IN  
CLASS 41 (U.S. CLS. 100, 101 AND 107).

FIRST USE 9-15-2007; IN COMMERCE 9-15-2007.

THE MARK CONSISTS OF STANDARD CHAR-  
ACTERS WITHOUT CLAIM TO ANY PARTICULAR  
FONT, STYLE, SIZE, OR COLOR.

SN 77-098,329, FILED 2-2-2007.

JASON LOTT, EXAMINING ATTORNEY

**Int. Cl.: 37**

**Prior U.S. Cls.: 100, 103, and 106**

**United States Patent and Trademark Office**

**Reg. No. 3,454,644**

**Registered June 24, 2008**

**SERVICE MARK  
PRINCIPAL REGISTER**

**HDH HARD DRIVE HEROES**

HARD DRIVE HEROES LLC (NEW JERSEY LTD  
LIAB CO)  
201 TIMBERCREEK ROAD  
LINDENWOLD, NJ 08021

FOR: COMPUTER INSTALLATION AND REPAIR; INSTALLATION OF COMPUTER NETWORKS; INSTALLATION OF COMPUTER SYSTEMS; MAINTENANCE AND REPAIR OF COMPUTER HARDWARE; MAINTENANCE AND REPAIR OF COMPUTER NETWORKS; MAINTENANCE OF COMPUTER HARDWARE; REPAIR OF DAMAGED COMPUTERS; REPAIR OR MAINTENANCE OF COMPUTERS; UPDATING OF COMPUTER HARDWARE; UPGRADING OF COMPUTER HARDWARE, IN CLASS 37 (U.S. CLS. 100, 103 AND 106).

FIRST USE 1-15-2008; IN COMMERCE 1-15-2008.

THE MARK CONSISTS OF STANDARD CHARACTERS WITHOUT CLAIM TO ANY PARTICULAR FONT, STYLE, SIZE, OR COLOR.

NO CLAIM IS MADE TO THE EXCLUSIVE RIGHT TO USE "HARD DRIVE", APART FROM THE MARK AS SHOWN.

SN 77-098,527, FILED 2-2-2007.

JOHN GARTNER, EXAMINING ATTORNEY

**Int. Cl.: 5**

**Prior U.S. Cls.: 6, 18, 44, 46, 51, and 52**

**Reg. No. 3,454,645**

**United States Patent and Trademark Office**

**Registered June 24, 2008**

**TRADEMARK  
PRINCIPAL REGISTER**

# Scorks

ALBRECHT, JUDITH A (UNITED STATES INDIVIDUAL)  
3652 TAYLOR LANE  
ALEXANDRIA, MN 56308

THE MARK CONSISTS OF STANDARD CHARACTERS WITHOUT CLAIM TO ANY PARTICULAR FONT, STYLE, SIZE, OR COLOR.

FOR: SCENTED DECORATIVE AIR FRESHENERS MADE OUT OF CORKS, IN CLASS 5 (U.S. CLS. 6, 18, 44, 46, 51 AND 52).

SN 77-098,788, FILED 2-4-2007.

FIRST USE 8-19-2007; IN COMMERCE 8-19-2007.

HOWARD SMIGA, EXAMINING ATTORNEY

**Int. Cl.: 9**

**Prior U.S. Cls.: 21, 23, 26, 36, and 38**

**United States Patent and Trademark Office**

**Reg. No. 3,454,646**

**Registered June 24, 2008**

**TRADEMARK  
PRINCIPAL REGISTER**

**SPACES**

APPLE INC. (CALIFORNIA CORPORATION)

1 INFINITE LOOP

CUPERTINO, CA 95014

FOR: GRAPHICAL USER INTERFACE SOFTWARE, IN CLASS 9 (U.S. CLS. 21, 23, 26, 36 AND 38).

FIRST USE 8-7-2006; IN COMMERCE 10-26-2007.

THE MARK CONSISTS OF STANDARD CHARACTERS WITHOUT CLAIM TO ANY PARTICULAR FONT, STYLE, SIZE, OR COLOR.

PRIORITY CLAIMED UNDER SEC. 44(D) ON TRINIDAD/TOBAGO APPLICATION NO. 37561, FILED 8-4-2006.

SN 77-098,874, FILED 2-5-2007.

DANIEL CAPSHAW, EXAMINING ATTORNEY

**Int. Cl.: 35**

**Prior U.S. Cls.: 100, 101, and 102**

**United States Patent and Trademark Office**

**Reg. No. 3,454,647**

**Registered June 24, 2008**

**SERVICE MARK  
PRINCIPAL REGISTER**



ALLERGAN, INC. (DELAWARE CORPORATION)  
2525 DUPONT DRIVE  
IRVINE, CA 92612

FOR: PROVIDING INFORMATION AND ASSISTANCE TO PATIENTS AND THEIR HEALTHCARE PROVIDERS, NAMELY, PROVIDING INFORMATION ABOUT THE ADMINISTRATION OF PATIENT REIMBURSEMENT PROGRAMS , IN CLASS 35 (U.S. CLS. 100, 101 AND 102).

FIRST USE 11-14-2006; IN COMMERCE 2-13-2007.

OWNER OF U.S. REG. NOS. 1,692,384, 2,510,675, AND OTHERS.

SN 77-099,166, FILED 2-5-2007.

ELI HELLMAN, EXAMINING ATTORNEY

**Int. Cl.: 3**

**Prior U.S. Cls.: 1, 4, 6, 50, 51, and 52**

**Reg. No. 3,454,648**

**United States Patent and Trademark Office**

**Registered June 24, 2008**

---

**TRADEMARK  
PRINCIPAL REGISTER**

**CALM RELEASE**

THE PROCTER & GAMBLE COMPANY (OHIO  
CORPORATION)  
ONE PROCTER & GAMBLE PLAZA  
CINCINNATI, OH 45202

THE MARK CONSISTS OF STANDARD CHAR-  
ACTERS WITHOUT CLAIM TO ANY PARTICULAR  
FONT, STYLE, SIZE, OR COLOR.

FOR: BODY WASH AND BAR SOAP, IN CLASS 3  
(U.S. CLS. 1, 4, 6, 50, 51 AND 52).

SN 77-099,352, FILED 2-5-2007.

FIRST USE 7-23-2007; IN COMMERCE 7-23-2007.

JOSETTE BEVERLY, EXAMINING ATTORNEY

**Int. Cl.: 35**

**Prior U.S. Cls.: 100, 101, and 102**

**United States Patent and Trademark Office**

**Reg. No. 3,454,649**

**Registered June 24, 2008**

**SERVICE MARK  
PRINCIPAL REGISTER**

**WINEDRIP**

WINEDRIP, INC. (DELAWARE CORPORATION)  
ST. 20  
1376 COMMONWEALTH AVENUE  
ALLSTON, MA 02134

FOR: PROVIDING CONSUMER INFORMATION  
IN THE NATURE OF CONSUMER AND RETAIL  
PRODUCT AND RATING INFORMATION RELAT-  
ING TO WINE AND WINE RELATED PRODUCTS  
SUCH AS WINE BOTTLE OPENERS, WINE BOTTLE  
IDENTIFICATION TAGS, WINE BOTTLE RACKS,  
WINE BOTTLE STOPPERS, DECANTERS AND

OTHER WINE ACCESSORIES, IN CLASS 35 (U.S.  
CLS. 100, 101 AND 102).

FIRST USE 12-10-2007; IN COMMERCE 12-10-2007.

THE MARK CONSISTS OF STANDARD CHAR-  
ACTERS WITHOUT CLAIM TO ANY PARTICULAR  
FONT, STYLE, SIZE, OR COLOR.

SN 77-099,460, FILED 2-5-2007.

JAMES LOVELACE, EXAMINING ATTORNEY



**Int. Cl.: 18**

**Prior U.S. Cls.: 1, 2, 3, 22, and 41**

**United States Patent and Trademark Office**

**Reg. No. 3,454,650**

**Registered June 24, 2008**

**TRADEMARK  
PRINCIPAL REGISTER**

**BREATHEMESH**

INFANTINO, LLC (CALIFORNIA LTD LIAB CO)  
SUITE 200  
4920 CARROLL CANYON ROAD  
SAN DIEGO, CA 92121

THE MARK CONSISTS OF STANDARD CHAR-  
ACTERS WITHOUT CLAIM TO ANY PARTICULAR  
FONT, STYLE, SIZE, OR COLOR.

FOR: INFANT CARRIERS WORN ON THE BODY,  
IN CLASS 18 (U.S. CLS. 1, 2, 3, 22 AND 41).

SN 77-099,598, FILED 2-5-2007.

FIRST USE 9-30-2007; IN COMMERCE 9-30-2007.

CHRISTINE COOPER, EXAMINING ATTORNEY

Int. Cl.: 33

Prior U.S. Cls.: 47 and 49

United States Patent and Trademark Office

Reg. No. 3,454,651

Registered June 24, 2008

TRADEMARK  
PRINCIPAL REGISTER



BACARDI & COMPANY LIMITED (LIECHTEN-  
STEIN CORPORATION)  
AEULESTRASSE 5  
VADUZ, LIECHTENSTEIN FL-9490

FOR: DISTILLED SPIRITS, IN CLASS 33 (U.S. CLS.  
47 AND 49).

FIRST USE 7-30-2005; IN COMMERCE 7-30-2005.

OWNER OF U.S. REG. NO. 2,845,268.

THE MARK CONSISTS OF INTERTWINED  
SHEAVES OF GRAIN ENCIRCLED BY METAL  
BANDS USED TO SECURE CASKS, ABOVE THE  
WORDS "MARRIED IN OAK".

SN 77-099,815, FILED 2-5-2007.

GEORGE LORENZO, EXAMINING ATTORNEY

**Int. Cl.: 5**

**Prior U.S. Cls.: 6, 18, 44, 46, 51, and 52**

**Reg. No. 3,454,652**

**United States Patent and Trademark Office**

**Registered June 24, 2008**

**TRADEMARK  
PRINCIPAL REGISTER**

**VINETRA**

MUSCADINE NATURALS, INC. (NORTH CAROLINA CORPORATION)  
6400 SHALLOWFORD ROAD  
LEWISVILLE, NC 27023

THE MARK CONSISTS OF STANDARD CHARACTERS WITHOUT CLAIM TO ANY PARTICULAR FONT, STYLE, SIZE, OR COLOR.

FOR: DIETARY SUPPLEMENTS; NUTRACEUTICALS FOR USE AS A DIETARY SUPPLEMENT; NUTRITIONAL SUPPLEMENTS, IN CLASS 5 (U.S. CLS. 6, 18, 44, 46, 51 AND 52).

SN 77-100,012, FILED 2-6-2007.

FIRST USE 2-0-2007; IN COMMERCE 4-0-2007.

JOHN WILKE, EXAMINING ATTORNEY

**Int. Cl.: 44**

**Prior U.S. Cls.: 100 and 101**

**United States Patent and Trademark Office**

**Reg. No. 3,454,653**

**Registered June 24, 2008**

**SERVICE MARK  
PRINCIPAL REGISTER**

**CHOOSING A HOSPITAL COULD  
BE THE MOST IMPORTANT  
DECISION YOU'LL EVER MAKE**

WILLIAM BEAUMONT HOSPITAL (MICHIGAN  
CORPORATION)  
3601 WEST 13 MILE ROAD  
ROYAL OAK, MI 48073

THE MARK CONSISTS OF STANDARD CHAR-  
ACTERS WITHOUT CLAIM TO ANY PARTICULAR  
FONT, STYLE, SIZE, OR COLOR.

FOR: HEALTH CARE; MEDICAL SERVICES, IN  
CLASS 44 (U.S. CLS. 100 AND 101).

SN 77-100,526, FILED 2-6-2007.

FIRST USE 3-0-2008; IN COMMERCE 3-0-2008.

ELIZABETH KAJUBI, EXAMINING ATTORNEY

**Int. Cl.: 25**

**Prior U.S. Cls.: 22 and 39**

**United States Patent and Trademark Office**

**Reg. No. 3,454,654**

**Registered June 24, 2008**

**TRADEMARK  
PRINCIPAL REGISTER**

**IRIS & NAVY**

CDC APPAREL, INC. (CALIFORNIA CORPORATION)  
127 E 9TH STREET #906  
LOS ANGELES, CA 90015

THE MARK CONSISTS OF STANDARD CHARACTERS WITHOUT CLAIM TO ANY PARTICULAR FONT, STYLE, SIZE, OR COLOR.

FOR: CLOTHING, NAMELY, SHIRTS, SHORTS, PANTS, TOPS, DRESSES AND SKIRTS, IN CLASS 25 (U.S. CLS. 22 AND 39).

SN 77-100,787, FILED 2-6-2007.

FIRST USE 2-12-2007; IN COMMERCE 2-12-2007.

TANYA AMOS, EXAMINING ATTORNEY

**Int. Cl.: 42**

**Prior U.S. Cls.: 100 and 101**

**United States Patent and Trademark Office**

**Reg. No. 3,454,655**

**Registered June 24, 2008**

**SERVICE MARK  
PRINCIPAL REGISTER**

**IRONCHECK**

NATIONAL EQUIPMENT REGISTER, INC. (DE-  
LAWARE CORPORATION)  
20 EAST 46TH STREET  
NEW YORK, NY 10017

FOR: DATA VALIDATION SERVICES PROVIDED  
TO INSURANCE COMPANIES, LAW ENFORCE-  
MENT AGENCIES AND EQUIPMENT OWNERS,  
NAMELY, PROVIDING DATA TO VERIFY THE  
ACCURACY AND STATUS OF THE PRODUCT  
IDENTIFICATION NUMBER FOR EQUIPMENT  
ELECTRONICALLY OR VIA THE TELEPHONE, IN  
CLASS 42 (U.S. CLS. 100 AND 101).

FIRST USE 3-1-2008; IN COMMERCE 3-1-2008.

THE MARK CONSISTS OF STANDARD CHAR-  
ACTERS WITHOUT CLAIM TO ANY PARTICULAR  
FONT, STYLE, SIZE, OR COLOR.

SN 77-100,875, FILED 2-6-2007.

EMILY CARLSEN, EXAMINING ATTORNEY

**Int. Cl.: 43**

**Prior U.S. Cls.: 100 and 101**

**United States Patent and Trademark Office**

**Reg. No. 3,454,656**

**Registered June 24, 2008**

**SERVICE MARK  
PRINCIPAL REGISTER**

**YUM**

STARWOOD HOTELS & RESORTS WORLD-  
WIDE, INC. (MARYLAND CORPORATION)  
1111 WESTCHESTER AVENUE  
WHITE PLAINS, NY 10604

FOR: HOTEL SERVICES, MOTEL SERVICES, MO-  
TOR INN SERVICES, RESORT LODGING SERVI-  
CES; TEMPORARY ACCOMODATION SERVICES;  
PROVIDING FACILITIES FOR MEETINGS, CON-  
FERENCES AND EVENTS, IN CLASS 43 (U.S. CLS.  
100 AND 101).

FIRST USE 12-0-2004; IN COMMERCE 12-0-2004.

THE MARK CONSISTS OF STANDARD CHAR-  
ACTERS WITHOUT CLAIM TO ANY PARTICULAR  
FONT, STYLE, SIZE, OR COLOR.

SN 77-101,097, FILED 2-7-2007.

ROBIN MITTLER, EXAMINING ATTORNEY

**Int. Cl.: 16**

**Prior U.S. Cls.: 2, 5, 22, 23, 29, 37, 38, and 50**

**United States Patent and Trademark Office**

**Reg. No. 3,454,657**

**Registered June 24, 2008**

**TRADEMARK  
PRINCIPAL REGISTER**

**ZINGERS**

FUTURE IDEAS, INC. (FLORIDA CORPORATION)  
4655 TOWER HILL LANE #2416  
SARASOTA, FL 34242

THE MARK CONSISTS OF STANDARD CHARACTERS WITHOUT CLAIM TO ANY PARTICULAR FONT, STYLE, SIZE, OR COLOR.

FOR: CARDS, NAMELY, GREETING CARDS, NOTE CARDS, IN CLASS 16 (U.S. CLS. 2, 5, 22, 23, 29, 37, 38 AND 50).

SN 77-101,153, FILED 2-7-2007.

FIRST USE 3-1-2008; IN COMMERCE 3-1-2008.

JOHN DALIER, EXAMINING ATTORNEY



**Int. Cl.: 36**

**Prior U.S. Cls.: 100, 101, and 102**

**United States Patent and Trademark Office**

**Reg. No. 3,454,658**

**Registered June 24, 2008**

**SERVICE MARK  
PRINCIPAL REGISTER**

**KASAKEN CAPITAL**

KASAKEN CAPITAL, LLC (NEW JERSEY LTD  
LIAB CO)  
55 UNION PLACE  
SUMMIT, NJ 07901

FOR: EQUITY CAPITAL INVESTMENT; FINANCIAL INVESTMENT IN THE FIELD OF PRIVATE EQUITY; INVESTMENT MANAGEMENT; LEVERAGED BUY OUTS AND INVESTMENTS IN FINANCIALLY DISTRESSED OR UNDERPERFORMING COMPANIES; PUBLIC EQUITY INVESTMENT MANAGEMENT; VENTURE CAPITAL FUNDING SERVICES TO EMERGING AND START-UP COMPANIES; VENTURE CAPITAL SERVICES, NAMELY, PROVIDING FINANCING TO EMERGING AND START-UP COMPANIES, IN CLASS 36 (U.S. CLS. 100, 101 AND 102).

FIRST USE 1-19-2007; IN COMMERCE 6-1-2007.

THE MARK CONSISTS OF STANDARD CHARACTERS WITHOUT CLAIM TO ANY PARTICULAR FONT, STYLE, SIZE, OR COLOR.

NO CLAIM IS MADE TO THE EXCLUSIVE RIGHT TO USE "CAPITAL", APART FROM THE MARK AS SHOWN.

SN 77-101,458, FILED 2-7-2007.

LINDA ESTRADA, EXAMINING ATTORNEY

**Int. Cl.: 16**

**Prior U.S. Cls.: 2, 5, 22, 23, 29, 37, 38, and 50**

**Reg. No. 3,454,659**

**United States Patent and Trademark Office**

**Registered June 24, 2008**

**TRADEMARK  
PRINCIPAL REGISTER**

**GREEN BY DESIGN AND DESIRE**

GEORGIA-PACIFIC CONSUMER PRODUCTS LP  
(DELAWARE LIMITED PARTNERSHIP)  
133 PEACHTREE STREET, N.E.  
GA030-41N  
ATLANTA, GA 30303

THE MARK CONSISTS OF STANDARD CHAR-  
ACTERS WITHOUT CLAIM TO ANY PARTICULAR  
FONT, STYLE, SIZE, OR COLOR.

FOR: BATHROOM TISSUE; FACIAL TISSUE;  
PAPER NAPKINS; PAPER TOWELS, IN CLASS 16  
(U.S. CLS. 2, 5, 22, 23, 29, 37, 38 AND 50).

SN 77-101,491, FILED 2-7-2007.

FIRST USE 9-30-2007; IN COMMERCE 9-30-2007.

DANNEAN HETZEL, EXAMINING ATTORNEY

**Int. Cl.: 43**

**Prior U.S. Cls.: 100 and 101**

**United States Patent and Trademark Office**

**Reg. No. 3,454,660**

**Registered June 24, 2008**

**SERVICE MARK  
PRINCIPAL REGISTER**

**MOTU'S**

TAHITIAN NONI CAFE, INC. (UTAH CORPORATION)  
333 WEST RIVER PARK DRIVE  
PROVO, UT 84604

THE MARK CONSISTS OF STANDARD CHARACTERS WITHOUT CLAIM TO ANY PARTICULAR FONT, STYLE, SIZE, OR COLOR.

FOR: RESTAURANT SERVICES, IN CLASS 43 (U.S. CLS. 100 AND 101).

SN 77-101,951, FILED 2-7-2007.

FIRST USE 4-23-2007; IN COMMERCE 4-23-2007.

ELIZABETH BEYER, EXAMINING ATTORNEY

**Int. Cl.: 35**

**Prior U.S. Cls.: 100, 101, and 102**

**United States Patent and Trademark Office**

**Reg. No. 3,454,661**

**Registered June 24, 2008**

**SERVICE MARK  
PRINCIPAL REGISTER**



PEAK IMPACT INC. (CANADA CORPORATION)  
SUITE 204  
2 BEAVERBROOK ROAD  
OTTAWA, ONTARIO, CANADA K2K 1L1

FOR: BUSINESS MARKETING AND CONSULTING SERVICES, NAMELY, PROVIDING LEAD GENERATION SERVICES TO BUSINESSES AND INDIVIDUALS, NAMELY, CREATING AND IMPLEMENTING CUSTOMIZED REFERRAL AND LEAD GENERATION PROGRAMS FOR THIRD PARTIES AND CUSTOMIZED DATABASES FOR SALES, REFERRAL AND LEAD MANAGEMENT; BUSINESS MONITORING SERVICES, NAMELY, ANALYZING

ON-LINE DATA CREATED BY WEBSITE TRAFFIC FOR THE PURPOSE OF PROVIDING BUSINESS INTELLIGENCE; BUSINESS CONSULTING SERVICES, NAMELY, CREATING AND IMPLEMENTING PROCESSES FOR OPTIMIZING WEBSITE TRAFFIC, SEARCH ENGINE RESULTS AND RELATED ADVERTISMENT REVENUE, IN CLASS 35 (U.S. CLS. 100, 101 AND 102).

FIRST USE 7-31-2006; IN COMMERCE 7-31-2006.

SN 77-102,120, FILED 2-7-2007.

DOMINIC FATHY, EXAMINING ATTORNEY

**Int. Cl.: 33**

**Prior U.S. Cls.: 47 and 49**

**United States Patent and Trademark Office**

**Reg. No. 3,454,662**

**Registered June 24, 2008**

**TRADEMARK  
PRINCIPAL REGISTER**

**PROMENADE**

PROMENADE WINES, LLC (CALIFORNIA LTD  
LIAB CO)  
1517 NORTH POINT, #421  
SAN FRANCISCO, CA 94123

THE MARK CONSISTS OF STANDARD CHAR-  
ACTERS WITHOUT CLAIM TO ANY PARTICULAR  
FONT, STYLE, SIZE, OR COLOR.

FOR: WINE, IN CLASS 33 (U.S. CLS. 47 AND 49).

SN 77-102,457, FILED 2-8-2007.

FIRST USE 2-16-2008; IN COMMERCE 3-5-2008.

MARK SPARACINO, EXAMINING ATTORNEY

**Int. Cl.: 33**

**Prior U.S. Cls.: 47 and 49**

**United States Patent and Trademark Office**

**Reg. No. 3,454,663**

**Registered June 24, 2008**

**TRADEMARK  
PRINCIPAL REGISTER**

**IPRIMA**

PROMENADE WINES, LLC (CALIFORNIA LTD  
LIAB CO)  
1517 NORTH POINT, #421  
SAN FRANCISCO, CA 94123

THE MARK CONSISTS OF STANDARD CHAR-  
ACTERS WITHOUT CLAIM TO ANY PARTICULAR  
FONT, STYLE, SIZE, OR COLOR.

FOR: WINE, IN CLASS 33 (U.S. CLS. 47 AND 49).

SN 77-102,500, FILED 2-8-2007.

FIRST USE 2-16-2008; IN COMMERCE 3-5-2008.

MARK SPARACINO, EXAMINING ATTORNEY

**Int. Cl.: 32**

**Prior U.S. Cls.: 45, 46, and 48**

**United States Patent and Trademark Office**

**Reg. No. 3,454,664**

**Registered June 24, 2008**

**TRADEMARK  
PRINCIPAL REGISTER**

**T. GRAND**

T. GRAND INTERNATIONAL CO., LTD. (TAI-  
WAN CORPORATION)  
TAIPEI HSIEN  
3F, NO. 192-1, SEC. 3, CHUNG YANG RD.  
SAN CHUNG CITY, TAIWAN

FOR: FRUIT DRINKS AND JUICES, ENERGY  
DRINKS, SPORT DRINKS, FLAVORED WATERS,  
MINERAL AND AERATED WATERS, SOFT  
DRINKS, SYRUPS FOR MAKING BEVERAGES,  
CONCENTRATES AND POWDERS FOR MAKING

BEVERAGES, NAMELY, FLAVORED WATERS, IN  
CLASS 32 (U.S. CLS. 45, 46 AND 48).

FIRST USE 5-15-2005; IN COMMERCE 5-15-2005.

THE NAME "T. GRAND" DOES NOT IDENTIFY  
A LIVING INDIVIDUAL.

SN 77-102,926, FILED 2-8-2007.

KAREN K. BUSH, EXAMINING ATTORNEY

**Int. Cl.: 9**

**Prior U.S. Cls.: 21, 23, 26, 36, and 38**

**Reg. No. 3,454,665**

**United States Patent and Trademark Office**

**Registered June 24, 2008**

---

**TRADEMARK  
PRINCIPAL REGISTER**

**SOS Jackpot**

MULTIMEDIA GAMES, INC. (TEXAS CORPORATION)  
206 WILD BASIN RD., BLDG B - 4TH FLR  
AUSTIN, TX 78746

FOR: GAMING MACHINES, NAMELY, ELECTRONIC SLOT AND BINGO MACHINES; VIDEO LOTTERY TERMINALS, IN CLASS 9 (U.S. CLS. 21, 23, 26, 36 AND 38).

FIRST USE 11-15-2007; IN COMMERCE 11-15-2007.

THE MARK CONSISTS OF STANDARD CHARACTERS WITHOUT CLAIM TO ANY PARTICULAR FONT, STYLE, SIZE, OR COLOR.

NO CLAIM IS MADE TO THE EXCLUSIVE RIGHT TO USE "JACKPOT", APART FROM THE MARK AS SHOWN.

SN 77-103,010, FILED 2-8-2007.

ELIZABETH HUGHITT, EXAMINING ATTORNEY



**Int. Cl.: 3**

**Prior U.S. Cls.: 1, 4, 6, 50, 51, and 52**

**United States Patent and Trademark Office**

**Reg. No. 3,454,666**

**Registered June 24, 2008**

**TRADEMARK  
PRINCIPAL REGISTER**

**WILD FLOWER BLAST**

THE CLOROX COMPANY (DELAWARE COR-  
PORATION)  
1221 BROADWAY  
OAKLAND, CA 94612

THE MARK CONSISTS OF STANDARD CHAR-  
ACTERS WITHOUT CLAIM TO ANY PARTICULAR  
FONT, STYLE, SIZE, OR COLOR.

FOR: FRAGRANCE SOLD AS INTEGRAL PART  
OF GENERAL PURPOSE HOUSEHOLD CLEANER  
AND OF FLOOR CLEANER, IN CLASS 3 (U.S. CLS. 1,  
4, 6, 50, 51 AND 52).

SN 77-103,101, FILED 2-8-2007.

FIRST USE 1-31-2008; IN COMMERCE 1-31-2008.

BRENDAN MCCAULEY, EXAMINING ATTORNEY

Int. Cl.: 43

Prior U.S. Cls.: 100 and 101

United States Patent and Trademark Office

Reg. No. 3,454,667

Registered June 24, 2008

**SERVICE MARK  
PRINCIPAL REGISTER**



LIMAY VENTURES LLC (NEVADA LTD LIAB  
CO)  
PO BOX 4371  
INCLINE VILLAGE, NV 89450

FOR: CARRY OUT RESTAURANT SERVICES, IN  
CLASS 43 (U.S. CLS. 100 AND 101).

FIRST USE 11-11-2006; IN COMMERCE 11-11-2006.

OWNER OF U.S. REG. NOS. 2,203,898, 2,742,041,  
AND 2,764,314.

NO CLAIM IS MADE TO THE EXCLUSIVE  
RIGHT TO USE "TO GO" AND "LA BODEGUITA",  
APART FROM THE MARK AS SHOWN.

THE MARK CONSISTS OF A RECTANGLE OUT-  
LINE WITH THE WORDS "LA BO TO GO" IN A  
CROSS PATTERN. THE WORDS "LA BODEGUITA  
DEL MEDIO" APPEARS IN ANOTHER RECTAN-  
GLE IN THE BOTTOM LEFT HAND CORNER.

THE FOREIGN WORDING IN THE MARK  
TRANSLATES INTO ENGLISH AS "THE LITTLE  
RESTAURANT IN THE MIDDLE".

SN 77-103,149, FILED 2-8-2007.

JIM RINGLE, EXAMINING ATTORNEY

**Int. Cl.: 3**

**Prior U.S. Cls.: 1, 4, 6, 50, 51, and 52**

**United States Patent and Trademark Office**

**Reg. No. 3,454,668**

**Registered June 24, 2008**

---

**TRADEMARK  
PRINCIPAL REGISTER**

**What's your Virtue?**

VIRT-HUES, LLC (ARIZONA LTD LIAB CO)  
SUITE 501  
63 E MAIN ST  
MESA, AZ 85201

THE MARK CONSISTS OF STANDARD CHAR-  
ACTERS WITHOUT CLAIM TO ANY PARTICULAR  
FONT, STYLE, SIZE, OR COLOR.

FOR: COSMETICS, IN CLASS 3 (U.S. CLS. 1, 4, 6, 50,  
51 AND 52).

SN 77-103,256, FILED 2-9-2007.

FIRST USE 12-13-2007; IN COMMERCE 12-13-2007.

MICHAEL LITZAU, EXAMINING ATTORNEY

**Int. Cl.: 36**

**Prior U.S. Cls.: 100, 101, and 102**

**United States Patent and Trademark Office**

**Reg. No. 3,454,669**

**Registered June 24, 2008**

**SERVICE MARK  
PRINCIPAL REGISTER**



BOWEN, MICHAEL DAVID (UNITED STATES  
INDIVIDUAL)  
3536 LAKESTONE COURT  
MARTINEZ, GA 30907

FOR: PROVIDING REAL ESTATE LISTINGS AND  
REAL ESTATE INFORMATION VIA THE INTER-  
NET, IN CLASS 36 (U.S. CLS. 100, 101 AND 102).

FIRST USE 3-3-2008; IN COMMERCE 3-3-2008.

NO CLAIM IS MADE TO THE EXCLUSIVE  
RIGHT TO USE ".COM", APART FROM THE MARK  
AS SHOWN.

THE COLOR(S) BLACK, WHITE AND GREEN IS/  
ARE CLAIMED AS A FEATURE OF THE MARK.

THE MARK CONSISTS OF GREEN ON THE  
NUMERAL 4, CLOVER AND COM "SALEBYBUILD-  
ER" IS BLACK CLOVER IS PLACED BETWEEN  
BUILDER AND COM DOT WITHIN CLOVER IS  
BLACK

SN 77-103,326, FILED 2-9-2007.

NAAKWAMA ANKRAH, EXAMINING ATTORNEY

Int. Cl.: 30

Prior U.S. Cl.: 46

United States Patent and Trademark Office

Reg. No. 3,454,670

Registered June 24, 2008

TRADEMARK  
PRINCIPAL REGISTER



R. C. BIGELOW, INC. (CONNECTICUT CORPORATION)  
201 BLACK ROCK TURNPIKE  
FAIRFIELD, CT 06825

FOR: ICED TEA MIX, TEA, IN CLASS 30 (U.S. CL. 46).

FIRST USE 4-12-2007; IN COMMERCE 4-12-2007.

OWNER OF U.S. REG. NOS. 737,616, 2,112,970, AND OTHERS.

THE MARK CONSISTS OF THE WORD "BIGELOW" BELOW A REPRESENTATION OF A LEAF.

SN 77-103,654, FILED 2-9-2007.

LYDIA BELZER, EXAMINING ATTORNEY

**Int. Cls.: 29 and 30**

**Prior U.S. Cl.: 46**

**United States Patent and Trademark Office**

**Reg. No. 3,454,671**

**Registered June 24, 2008**

**TRADEMARK  
PRINCIPAL REGISTER**



KUWAIT INDO TRADING CO. LTD. (KUWAIT CORPORATION)  
P.O. BOX 2135  
SAFAT, KUWAIT 13022

FOR: POTATO BASED SNACK FOODS, IN CLASS 29 (U.S. CL. 46).

FIRST USE 3-0-2008; IN COMMERCE 3-0-2008.

FOR: BISCUITS, IN CLASS 30 (U.S. CL. 46).

FIRST USE 3-0-2008; IN COMMERCE 3-0-2008.

OWNER OF U.S. REG. NOS. 2,170,200, 2,255,328, AND OTHERS.

THE COLOR(S) RED, YELLOW AND WHITE IS/ARE CLAIMED AS A FEATURE OF THE MARK.

THE COLOR RED APPEARS IN THE STYLIZED WORDING "KITCO" AND IN THE OUTLINES OF AN OVAL AROUND THE STYLIZED WORDING. THE COLOR YELLOW APPEARS IN THE DESIGN OF AN OVAL AROUND THE STYLIZED WORDING. THE COLOR WHITE APPEARS IN THE SILHOUETTE OF A RABBIT HEAD WITHIN THE LETTER "O" IN THE STYLIZED WORDING "KITCO".

SN 77-103,917, FILED 2-9-2007.

JAY BESCH, EXAMINING ATTORNEY

**Int. Cl.: 3**

**Prior U.S. Cls.: 1, 4, 6, 50, 51, and 52**

**Reg. No. 3,454,672**

**United States Patent and Trademark Office**

**Registered June 24, 2008**

---

**TRADEMARK  
PRINCIPAL REGISTER**

**VEDA AROMA**

MAHARISHI AYUR-VED PRODUCTS INTERNATIONAL, INC. (COLORADO CORPORATION)  
1068 ELKTON DRIVE  
COLORADO SPRINGS, CO 80949

FOR: AROMATHERAPY OILS; ESSENTIAL OILS FOR PERSONAL USE; SCENTED OILS USED TO PRODUCE AROMAS WHEN HEATED, IN CLASS 3 (U.S. CLS. 1, 4, 6, 50, 51 AND 52).

FIRST USE 3-0-2008; IN COMMERCE 3-0-2008.

THE MARK CONSISTS OF STANDARD CHARACTERS WITHOUT CLAIM TO ANY PARTICULAR FONT, STYLE, SIZE, OR COLOR.

NO CLAIM IS MADE TO THE EXCLUSIVE RIGHT TO USE "AROMA", APART FROM THE MARK AS SHOWN.

SN 77-103,984, FILED 2-9-2007.

TOBY BULLOFF, EXAMINING ATTORNEY

**Int. Cls.: 35, 36, 37, and 42**

**Prior U.S. Cls.: 100, 101, 102, 103, and 106**

**United States Patent and Trademark Office**

**Reg. No. 3,454,673**

**Registered June 24, 2008**

**SERVICE MARK  
PRINCIPAL REGISTER**

**MEDKNOWLEDGE**

ALEXANDRIA REAL ESTATE EQUITIES, INC.  
(MARYLAND CORPORATION)  
385 E. COLORADO BLVD., SUITE 299  
PASADENA, CA 91101

FOR: BUSINESS ADMINISTRATION SERVICES; BUSINESS CONSULTING SERVICES; BUSINESS INCUBATOR SERVICES, NAMELY, BUSINESS MARKETING, BUSINESS MANAGEMENT, AND BUSINESS DEVELOPMENT SERVICES IN THE FORM OF START-UP SUPPORT FOR BUSINESSES OF OTHERS; RENTAL AND LEASING OF OFFICE MACHINERY AND EQUIPMENT, IN CLASS 35 (U.S. CLS. 100, 101 AND 102).

FIRST USE 6-0-2005; IN COMMERCE 6-0-2005.

FOR: FINANCIAL SERVICES, NAMELY, FINANCIAL CONSULTATION, FINANCIAL ANALYSIS, FINANCIAL PLANNING, FINANCIAL MANAGEMENT, PROVIDING DEBT AND EQUITY CAPITAL, AND TANGIBLE AND INTANGIBLE ASSET FINANCING; BUSINESS INCUBATOR SERVICES, NAMELY, PROVIDING EQUITY AND DEBT FINANCING TO EMERGING AND START-UP COMPANIES; REAL ESTATE SERVICES, NAMELY, REAL ESTATE BROKERAGE, ACQUISITION, RENTAL, LEASING, AND MANAGEMENT, IN CLASS 36 (U.S. CLS. 100, 101 AND 102).

FIRST USE 6-0-2005; IN COMMERCE 6-0-2005.

FOR: REAL ESTATE DEVELOPMENT; BUILDING CONSTRUCTION AND REPAIR; MAINTENANCE AND REPAIR OF BUILDINGS, ELECTRICAL SYSTEMS, HEATING AND AIR CONDITIONING SYSTEMS AND PLUMBING SYSTEMS, ALL IN THE FIELD OF REAL ESTATE, IN CLASS 37 (U.S. CLS. 100, 103 AND 106).

FIRST USE 6-0-2005; IN COMMERCE 6-0-2005.

FOR: ARCHITECTURAL DESIGN; ENGINEERING; RENTAL AND LEASING OF COMPUTERS, IN CLASS 42 (U.S. CLS. 100 AND 101).

FIRST USE 6-0-2005; IN COMMERCE 6-0-2005.

THE MARK CONSISTS OF STANDARD CHARACTERS WITHOUT CLAIM TO ANY PARTICULAR FONT, STYLE, SIZE, OR COLOR.

SN 77-104,162, FILED 2-9-2007.

RENEE MCCRAY, EXAMINING ATTORNEY



**Int. Cls.: 35, 36, 37, and 42**

**Prior U.S. Cls.: 100, 101, 102, 103, and 106**

**United States Patent and Trademark Office**

**Reg. No. 3,454,674**

**Registered June 24, 2008**

**SERVICE MARK  
PRINCIPAL REGISTER**

# BIOKNOWLEDGE

ALEXANDRIA REAL ESTATE EQUITIES, INC.  
(MARYLAND CORPORATION)  
385 E. COLORADO BLVD., SUITE 299  
PASADENA, CA 91101

FOR: BUSINESS ADMINISTRATION SERVICES; BUSINESS CONSULTING SERVICES; BUSINESS INCUBATOR SERVICES, NAMELY, BUSINESS MARKETING, BUSINESS MANAGEMENT, AND BUSINESS DEVELOPMENT SERVICES IN THE FORM OF START-UP SUPPORT FOR BUSINESSES OF OTHERS; RENTAL AND LEASING OF OFFICE MACHINERY AND EQUIPMENT, IN CLASS 35 (U.S. CLS. 100, 101 AND 102).

FIRST USE 6-0-2005; IN COMMERCE 6-0-2005.

FOR: FINANCIAL SERVICES, NAMELY, FINANCIAL CONSULTATION, FINANCIAL ANALYSIS, FINANCIAL PLANNING, FINANCIAL MANAGEMENT, PROVIDING DEBT AND EQUITY CAPITAL, AND TANGIBLE AND INTANGIBLE ASSET FINANCING; BUSINESS INCUBATOR SERVICES, NAMELY, PROVIDING EQUITY AND DEBT FINANCING TO EMERGING AND START-UP COMPANIES; REAL ESTATE SERVICES, NAMELY, REAL ESTATE BROKERAGE, ACQUISITION, RENTAL, LEASING, AND MANAGEMENT, IN CLASS 36 (U.S. CLS. 100, 101 AND 102).

FIRST USE 6-0-2005; IN COMMERCE 6-0-2005.

FOR: REAL ESTATE DEVELOPMENT; BUILDING CONSTRUCTION AND REPAIR; MAINTENANCE AND REPAIR OF BUILDINGS, ELECTRICAL SYSTEMS, HEATING AND AIR CONDITIONING SYSTEMS AND PLUMBING SYSTEMS, ALL IN THE FIELD OF REAL ESTATE, IN CLASS 37 (U.S. CLS. 100, 103 AND 106).

FIRST USE 6-0-2005; IN COMMERCE 6-0-2005.

FOR: ARCHITECTURAL DESIGN; ENGINEERING; RENTAL AND LEASING OF COMPUTERS, IN CLASS 42 (U.S. CLS. 100 AND 101).

FIRST USE 6-0-2005; IN COMMERCE 6-0-2005.

THE MARK CONSISTS OF STANDARD CHARACTERS WITHOUT CLAIM TO ANY PARTICULAR FONT, STYLE, SIZE, OR COLOR.

SN 77-104,165, FILED 2-9-2007.

RENEE MCCRAY, EXAMINING ATTORNEY

**Int. Cls.: 35, 36, 37, and 42**

**Prior U.S. Cls.: 100, 101, 102, 103, and 106**

**United States Patent and Trademark Office**

**Reg. No. 3,454,675**

**Registered June 24, 2008**

**SERVICE MARK  
PRINCIPAL REGISTER**

**BIOTECHKNOWLEDGE**

ALEXANDRIA REAL ESTATE EQUITIES, INC.  
(MARYLAND CORPORATION)  
385 E. COLORADO BLVD., SUITE 299  
PASADENA, CA 91101

FOR: BUSINESS ADMINISTRATION SERVICES; BUSINESS CONSULTING SERVICES; BUSINESS INCUBATOR SERVICES, NAMELY, BUSINESS MARKETING, BUSINESS MANAGEMENT, AND BUSINESS DEVELOPMENT SERVICES IN THE FORM OF START-UP SUPPORT FOR BUSINESSES OF OTHERS; RENTAL AND LEASING OF OFFICE MACHINERY AND EQUIPMENT, IN CLASS 35 (U.S. CLS. 100, 101 AND 102).

FIRST USE 6-0-2005; IN COMMERCE 6-0-2005.

FOR: FINANCIAL SERVICES, NAMELY, FINANCIAL CONSULTATION, FINANCIAL ANALYSIS, FINANCIAL PLANNING, FINANCIAL MANAGEMENT, PROVIDING DEBT AND EQUITY CAPITAL, AND TANGIBLE AND INTANGIBLE ASSET FINANCING; BUSINESS INCUBATOR SERVICES, NAMELY, PROVIDING EQUITY AND DEBT FINANCING TO EMERGING AND START-UP COMPANIES; REAL ESTATE SERVICES, NAMELY, REAL ESTATE BROKERAGE, ACQUISITION, RENTAL, LEASING, AND MANAGEMENT, IN CLASS 36 (U.S. CLS. 100, 101 AND 102).

FIRST USE 6-0-2005; IN COMMERCE 6-0-2005.

FOR: REAL ESTATE DEVELOPMENT; BUILDING CONSTRUCTION AND REPAIR; MAINTENANCE AND REPAIR OF BUILDINGS, ELECTRICAL SYSTEMS, HEATING AND AIR CONDITIONING SYSTEMS AND PLUMBING SYSTEMS, ALL IN THE FIELD OF REAL ESTATE, IN CLASS 37 (U.S. CLS. 100, 103 AND 106).

FIRST USE 6-0-2005; IN COMMERCE 6-0-2005.

FOR: ARCHITECTURAL DESIGN; ENGINEERING; RENTAL AND LEASING OF COMPUTERS, IN CLASS 42 (U.S. CLS. 100 AND 101).

FIRST USE 6-0-2005; IN COMMERCE 6-0-2005.

THE MARK CONSISTS OF STANDARD CHARACTERS WITHOUT CLAIM TO ANY PARTICULAR FONT, STYLE, SIZE, OR COLOR.

SN 77-104,171, FILED 2-9-2007.

RENEE MCCRAY, EXAMINING ATTORNEY

Int. Cl.: 33

Prior U.S. Cls.: 47 and 49

United States Patent and Trademark Office

Reg. No. 3,454,676

Registered June 24, 2008

TRADEMARK  
PRINCIPAL REGISTER

國  
窖  
1573

LUZHOU LAO JIAO CO., LTD. (CHINA LTD  
LIAB CO)  
GUO JIAO SQUARE  
LUZHOU, CHINA

FOR: ALCOHOLIC APERITIF BITTERS; ALCOHOLIC BEVERAGE PRODUCED FROM A BREWED MALT BASE WITH NATURAL FLAVORS; ALCOHOLIC BITTERS; ALCOHOLIC COFFEE-BASED BEVERAGE; ALCOHOLIC MALT COOLERS; ALCOHOLIC PUNCH; ALCOHOLIC TEA-BASED BEVERAGE; APERITIF WINES; APERITIFS WITH A DISTILLED ALCOHOLIC LIQUOR BASE; APERITIFS WITH A WINE BASE; ARRACK; BRANDY SPIRITS; DISTILLED SPIRITS; DISTILLED SPIRITS OF RICE (AWAMORI); EXTRACTS OF SPIRITOUS LIQUORS; FRUIT WINE; LIQUEURS; POTABLE SPIRITS; PREPARED ALCOHOLIC COCKTAIL; WINES, IN CLASS 33 (U.S. CLS. 47 AND 49).

FIRST USE 2-21-2002; IN COMMERCE 2-21-2002.

NO CLAIM IS MADE TO THE EXCLUSIVE RIGHT TO USE "1573 AND THE NON-LATIN LETTERS WHICH TRANSLITERATE TO JIAO", APART FROM THE MARK AS SHOWN.

THE MARK CONSISTS OF THE WORDING GUOJIAO IN CHINESE SCRIPT AND THE NUMBER 1573.

THE NON-LATIN CHARACTER(S) IN THE MARK TRANSLITERATE INTO GUOJIAO, AND THIS MEANS COUNTRY CELLAR IN ENGLISH.

SN 77-104,205, FILED 2-9-2007.

REBECCA GILBERT, EXAMINING ATTORNEY

**Int. Cl.: 14**

**Prior U.S. Cls.: 2, 27, 28, and 50**

**United States Patent and Trademark Office**

**Reg. No. 3,454,677**

**Registered June 24, 2008**

**TRADEMARK  
PRINCIPAL REGISTER**

**TWISTBANDS**

GARZA, RAYNALDO (UNITED STATES INDIVIDUAL)  
14 MONARCH BAY PLAZA, SUITE 475  
MONARCH BEACH, CA 92629

THE MARK CONSISTS OF STANDARD CHARACTERS WITHOUT CLAIM TO ANY PARTICULAR FONT, STYLE, SIZE, OR COLOR.

FOR: JEWELRY, IN CLASS 14 (U.S. CLS. 2, 27, 28 AND 50).

SN 77-104,470, FILED 2-10-2007.

FIRST USE 9-29-2006; IN COMMERCE 2-15-2007.

LINDA ORNDORFF, EXAMINING ATTORNEY

**Int. Cls.: 35 and 37**

**Prior U.S. Cls.: 100, 101, 102, 103, and 106**

**Reg. No. 3,454,678**

**United States Patent and Trademark Office**

**Registered June 24, 2008**

**SERVICE MARK  
PRINCIPAL REGISTER**



STATEWIDE, INC. (WASHINGTON CORPORATION)  
12303 CYRUS WAY  
MUKILTEO, WA 98275

NO CLAIM IS MADE TO THE EXCLUSIVE RIGHT TO USE WINDOWS, APART FROM THE MARK AS SHOWN.

FOR: RETAIL SERVICES BY DIRECT SOLICITATION BY SALES AGENTS IN THE FIELD OF REPLACEMENT WINDOWS, IN CLASS 35 (U.S. CLS. 100, 101 AND 102).

THE MARK CONSISTS OF THE SILHOUETTE OF A PENGUIN WITHIN A RECTANGLE AND WITH THE WORDS PENGUIN WINDOWS TO THE RIGHT OF IT.

FIRST USE 1-26-2007; IN COMMERCE 2-16-2007.

FOR: INSTALLATION OF REPLACEMENT WINDOWS, IN CLASS 37 (U.S. CLS. 100, 103 AND 106).

SN 77-104,991, FILED 2-12-2007.

FIRST USE 1-26-2007; IN COMMERCE 2-16-2007.

LYDIA BELZER, EXAMINING ATTORNEY

**Int. Cl.: 35**

**Prior U.S. Cls.: 100, 101, and 102**

**United States Patent and Trademark Office**

**Reg. No. 3,454,679**

**Registered June 24, 2008**

**SERVICE MARK  
PRINCIPAL REGISTER**

# Gymbids

GYMBIDS, LLC (ILLINOIS LTD LIAB CO)  
500 N MICHIGAN AVENUE SUITE # 300  
CHICAGO, IL 60611

FIRST USE 8-4-2007; IN COMMERCE 8-4-2007.

FOR: BUSINESS MARKETING SERVICES; MARKETING SERVICES, NAMELY, PROVIDING INFORMATIONAL WEB PAGES DESIGNED TO GENERATE SALES TRAFFIC VIA HYPERLINKS TO OTHER WEB SITES; ON-LINE ADVERTISING AND MARKETING SERVICES; PROMOTION AND MARKETING SERVICES AND RELATED CONSULTING, IN CLASS 35 (U.S. CLS. 100, 101 AND 102).

THE MARK CONSISTS OF STANDARD CHARACTERS WITHOUT CLAIM TO ANY PARTICULAR FONT, STYLE, SIZE, OR COLOR.

SN 77-105,020, FILED 2-12-2007.

KATHERINE E. HALMEN, EXAMINING ATTORNEY

**Int. Cl.: 9**

**Prior U.S. Cls.: 21, 23, 26, 36, and 38**

**United States Patent and Trademark Office**

**Reg. No. 3,454,680**

**Registered June 24, 2008**

**TRADEMARK  
PRINCIPAL REGISTER**

**THE FASTER. THE BETTER.**

VROOM WIRELESS SERVICES, LLC (COLORADO LTD LIAB CO)  
SUITE 205  
240 ST. PAUL STREET  
DENVER, CO 80206

FOR: CELLULAR TELEPHONES AND PERSONAL DIGITAL ASSISTANTS FEATURING CONNECTIVITY TO WIRELESS NETWORKS, IN CLASS 9 (U.S. CLS. 21, 23, 26, 36 AND 38).

FIRST USE 3-20-2007; IN COMMERCE 3-20-2007.

THE MARK CONSISTS OF STANDARD CHARACTERS WITHOUT CLAIM TO ANY PARTICULAR FONT, STYLE, SIZE, OR COLOR.

SN 77-105,212, FILED 2-12-2007.

TOBY BULLOFF, EXAMINING ATTORNEY

**Int. Cl.: 32**

**Prior U.S. Cls.: 45, 46, and 48**

**Reg. No. 3,454,681**

**United States Patent and Trademark Office**

**Registered June 24, 2008**

---

**TRADEMARK  
PRINCIPAL REGISTER**



INTERNATIONAL MOD CORP (CALIFORNIA  
CORPORATION), DBA MODMIX,  
704 1/2 WESTBOURNE DRIVE  
WEST HOLLYWOOD, CA 90069

OWNER OF U.S. REG. NO. 3,234,838.

FOR: NON-ALCOHOLIC COCKTAIL MIXES, IN  
CLASS 32 (U.S. CLS. 45, 46 AND 48).

SN 77-105,250, FILED 2-12-2007.

FIRST USE 8-31-2005; IN COMMERCE 8-31-2005.

WILLIAM VERHOSEK, EXAMINING ATTORNEY



**Int. Cl.: 25**

**Prior U.S. Cls.: 22 and 39**

**United States Patent and Trademark Office**

**Reg. No. 3,454,682**

**Registered June 24, 2008**

**TRADEMARK  
PRINCIPAL REGISTER**

**NOSTIC**

ECHELON DESIGNS, LLC (DELAWARE LTD  
LIAB CO)  
744 BROAD STREET, 16TH FLOOR  
NEWARK, NJ 07102

THE MARK CONSISTS OF STANDARD CHAR-  
ACTERS WITHOUT CLAIM TO ANY PARTICULAR  
FONT, STYLE, SIZE, OR COLOR.

FOR: BELTS; SHOES; SNEAKERS, IN CLASS 25  
(U.S. CLS. 22 AND 39).

SN 77-105,444, FILED 2-12-2007.

FIRST USE 9-6-2006; IN COMMERCE 9-6-2006.

MICHAEL TANNER, EXAMINING ATTORNEY

**Int. Cls.: 35, 38, and 42**

**Prior U.S. Cls.: 100, 101, 102, and 104**

**United States Patent and Trademark Office**

**Reg. No. 3,454,683**

**Registered June 24, 2008**

**SERVICE MARK  
PRINCIPAL REGISTER**

**STRUT YOUR HUT**

STRUT YOUR HUT, LLC (NEW YORK LTD LIAB  
CO)  
925 MITCHELL ST., #4  
ITHACA, NY 14850

FOR: REAL ESTATE MARKETING SERVICES,  
NAMELY, ON-LINE SERVICES FEATURING  
TOURS OF RESIDENTIAL AND COMMERCIAL  
REAL ESTATE, IN CLASS 35 (U.S. CLS. 100, 101  
AND 102).

FIRST USE 4-21-2007; IN COMMERCE 4-21-2007.

FOR: PROVIDING ON-LINE ELECTRONIC BUL-  
LETIN BOARDS FOR TRANSMISSION OF MESSA-  
GES AND IMAGES AMONG USERS IN THE FIELD  
OF REAL ESTATE; PROVIDING EMAIL SERVICES,  
IN CLASS 38 (U.S. CLS. 100, 101 AND 104).

FIRST USE 4-21-2007; IN COMMERCE 4-21-2007.

FOR: COMPUTER SERVICES, NAMELY, HOST-  
ING ONLINE WEB FACILITIES FOR OTHERS FOR  
ORGANIZING AND CONDUCTING ONLINE IN-  
TERACTIVE DISCUSSIONS; AND COMPUTER SER-  
VICES IN THE NATURE OF CUSTOMIZED WEB  
PAGES FEATURING USER-DEFINED INFORMA-  
TION, PERSONAL PROFILES AND INFORMATION  
IN THE FIELD OF REAL ESTATE, IN CLASS 42 (U.S.  
CLS. 100 AND 101).

FIRST USE 4-21-2007; IN COMMERCE 4-21-2007.

THE MARK CONSISTS OF STANDARD CHAR-  
ACTERS WITHOUT CLAIM TO ANY PARTICULAR  
FONT, STYLE, SIZE, OR COLOR.

SN 77-105,474, FILED 2-12-2007.

WILLIAM VERHOSEK, EXAMINING ATTORNEY

**Int. Cl.: 8**

**Prior U.S. Cls.: 23, 28, and 44**

**United States Patent and Trademark Office**

**Reg. No. 3,454,684**

**Registered June 24, 2008**

**TRADEMARK  
PRINCIPAL REGISTER**



DEXTER-RUSSELL, INC. (MASSACHUSETTS CORPORATION)  
44 RIVER STREET  
SOUTHBRIDGE, MA 01550

FOR: HAND TOOLS, NAMELY, FORGED KNIVES, IN CLASS 8 (U.S. CLS. 23, 28 AND 44).

FIRST USE 12-1-2007; IN COMMERCE 12-1-2007.

THE COLOR(S) WHITE, BLACK, LIGHT BLUE, AND TURQUOISE IS/ARE CLAIMED AS A FEATURE OF THE MARK.

THE MARK CONSISTS OF THE LETTERS "ICUT" IN STYLIZED LETTERING. THE LETTER "I" IS WHITE, THE LETTERS "CUT" ARE TURQUOISE AND ARE INTERSECTED BY A BLACK DIAGONAL OF VARYING WIDTHS, AND ALL OF THE LETTERS HAVE A BLUE BORDER. THE BACKGROUND IS TRANSPARENT.

SN 77-106,284, FILED 2-13-2007.

CURTIS FRENCH, EXAMINING ATTORNEY

**Int. Cl.: 35**

**Prior U.S. Cls.: 100, 101, and 102**

**United States Patent and Trademark Office**

**Reg. No. 3,454,685**

**Registered June 24, 2008**

**SERVICE MARK  
PRINCIPAL REGISTER**

**ALL THAT'S HEALTHY**

JOHNSON & JOHNSON (NEW JERSEY CORPORATION)  
ONE JOHNSON & JOHNSON PLAZA  
NEW BRUNSWICK, NJ 089337001

THE MARK CONSISTS OF STANDARD CHARACTERS WITHOUT CLAIM TO ANY PARTICULAR FONT, STYLE, SIZE, OR COLOR.

FOR: PROVIDING CONSUMER PRODUCT INFORMATION VIA THE INTERNET, IN CLASS 35 (U.S. CLS. 100, 101 AND 102).

SN 77-106,917, FILED 2-14-2007.

FIRST USE 5-22-2007; IN COMMERCE 5-22-2007.

GEOFFREY FOSDICK, EXAMINING ATTORNEY

**Int. Cl.: 16**

**Prior U.S. Cls.: 2, 5, 22, 23, 29, 37, 38, and 50**

**Reg. No. 3,454,686**

**United States Patent and Trademark Office**

**Registered June 24, 2008**

**TRADEMARK  
PRINCIPAL REGISTER**

**ALLI**

SMITHKLINE BEECHAM CORPORATION  
(PENNSYLVANIA CORPORATION)  
ONE FRANKLIN PLAZA  
PHILADELPHIA, PA 19102

FIRST USE 6-13-2007; IN COMMERCE 6-13-2007.

FOR: PRINTED MATERIALS, NAMELY, BOOKS,  
NEWSLETTERS, BROCHURES AND PAMPHLETS  
IN THE FIELD OF WEIGHT LOSS AND ASSOCI-  
ATED DIETARY, NUTRITIONAL AND FITNESS  
INFORMATION; RECIPE BOOKS, IN CLASS 16 (U.S.  
CLS. 2, 5, 22, 23, 29, 37, 38 AND 50).

THE MARK CONSISTS OF STANDARD CHAR-  
ACTERS WITHOUT CLAIM TO ANY PARTICULAR  
FONT, STYLE, SIZE, OR COLOR.

SN 77-107,051, FILED 2-14-2007.

CARRIE GENOVESE, EXAMINING ATTORNEY

**Int. Cl.: 4**

**Prior U.S. Cls.: 1, 6, and 15**

**United States Patent and Trademark Office**

**Reg. No. 3,454,687**

**Registered June 24, 2008**

**TRADEMARK  
PRINCIPAL REGISTER**

**PASSIONATELY PURE**

SMITH MOUNTAIN INDUSTRIES, INC. (VIRGINIA CORPORATION)  
1000 DILLARD DRIVE  
FOREST, VA 24551

THE MARK CONSISTS OF STANDARD CHARACTERS WITHOUT CLAIM TO ANY PARTICULAR FONT, STYLE, SIZE, OR COLOR.

FOR: SCENTED CANDLES, IN CLASS 4 (U.S. CLS. 1, 6 AND 15).

SN 77-107,073, FILED 2-14-2007.

FIRST USE 9-21-2007; IN COMMERCE 9-21-2007.

CARRIE GENOVESE, EXAMINING ATTORNEY

**Int. Cl.: 10**

**Prior U.S. Cls.: 26, 39, and 44**

**United States Patent and Trademark Office**

**Reg. No. 3,454,688**

**Registered June 24, 2008**

**TRADEMARK  
PRINCIPAL REGISTER**

**OSSEOGUARD**

BIOMET 3I, INC. (FLORIDA CORPORATION)  
4555 RIVERSIDE DRIVE  
PALM BEACH GARDENS, FL 33410

FOR: REGENERATIVE COLLAGEN MEMBRANES FOR USE IN DENTISTRY, IN CLASS 10 (U.S. CLS. 26, 39 AND 44).

FIRST USE 4-12-2007; IN COMMERCE 4-12-2007.

THE MARK CONSISTS OF STANDARD CHARACTERS WITHOUT CLAIM TO ANY PARTICULAR FONT, STYLE, SIZE, OR COLOR.

OWNER OF U.S. REG. NOS. 1,779,584, 2,838,519, AND OTHERS.

SN 77-107,280, FILED 2-14-2007.

PAUL CROWLEY, EXAMINING ATTORNEY

**Int. Cl.: 16**

**Prior U.S. Cls.: 2, 5, 22, 23, 29, 37, 38, and 50**

**Reg. No. 3,454,689**

**United States Patent and Trademark Office**

**Registered June 24, 2008**

**TRADEMARK  
PRINCIPAL REGISTER**

**REACHGLOBAL**

THE EVANGELICAL FREE CHURCH OF AMERICA (MINNESOTA NON-PROFIT CORPORATION)

901 EAST 78TH STREET  
MINNEAPOLIS, MN 554201300

FOR: PRINTED PUBLICATIONS, NAMELY, MAGAZINES, NEWSLETTERS, BROCHURES, BOOKS AND TEACHING MATERIALS IN THE FIELD OF EVANGELICAL CHRISTIAN MINISTRY, MISSIONS, RELIGION, RELIGIOUS WORSHIP, THEOLOGY, AND THE EVANGELICAL CHRISTIAN

FAITH, IN CLASS 16 (U.S. CLS. 2, 5, 22, 23, 29, 37, 38 AND 50).

FIRST USE 5-31-2007; IN COMMERCE 5-31-2007.

THE MARK CONSISTS OF STANDARD CHARACTERS WITHOUT CLAIM TO ANY PARTICULAR FONT, STYLE, SIZE, OR COLOR.

SN 77-107,764, FILED 2-14-2007.

TRICIA SONNEBORN, EXAMINING ATTORNEY



**Int. Cl.: 25**

**Prior U.S. Cls.: 22 and 39**

**United States Patent and Trademark Office**

**Reg. No. 3,454,690**

**Registered June 24, 2008**

**TRADEMARK  
PRINCIPAL REGISTER**

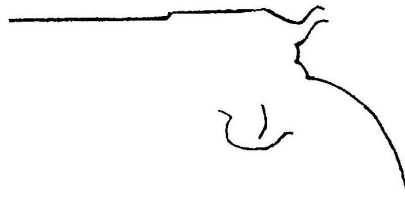

KEEFER, BRADLEY (UNITED STATES INDIVIDUAL)  
100 CALLE DE ESTABLO  
FORT WORTH, TX 76108

THE MARK CONSISTS OF A STYLIZED DEPICTION OF A "REVOLVER".

FOR: CLOTHING, NAMELY, SHIRTS, HATS, CAPS, JACKETS, IN CLASS 25 (U.S. CLS. 22 AND 39).

SN 77-108,291, FILED 2-15-2007.

FIRST USE 2-0-2008; IN COMMERCE 2-0-2008.

MARLENE BELL, EXAMINING ATTORNEY

**Int. Cl.: 25**

**Prior U.S. Cls.: 22 and 39**

**United States Patent and Trademark Office**

**Reg. No. 3,454,691**

**Registered June 24, 2008**

**TRADEMARK  
PRINCIPAL REGISTER**

**SWIFT SIX**

BRADLEY KEEFER (UNITED STATES INDIVIDUAL)  
100 CALLE DE ESTABLO  
FORT WORTH, TX 76108

THE MARK CONSISTS OF STANDARD CHARACTERS WITHOUT CLAIM TO ANY PARTICULAR FONT, STYLE, SIZE, OR COLOR.

FOR: CLOTHING, NAMELY, SHIRTS, HATS, CAPS, JACKETS, IN CLASS 25 (U.S. CLS. 22 AND 39).

SN 77-108,296, FILED 2-15-2007.

FIRST USE 2-0-2008; IN COMMERCE 2-0-2008.

MARLENE BELL, EXAMINING ATTORNEY

**Int. Cl.: 18**

**Prior U.S. Cls.: 1, 2, 3, 22, and 41**

**United States Patent and Trademark Office**

**Reg. No. 3,454,692**

**Registered June 24, 2008**

**TRADEMARK  
PRINCIPAL REGISTER**

**TRAVELLE**

HOLIDAY GROUP, INC. (CANADA CORPORATION)  
4875 BOUL. DES GRANDES PRAIRIES  
MONTREAL, QUEBEC H1R 1X4

FOR: LUGGAGE, SUITCASES, GARMENT BAGS FOR TRAVEL, ALL PURPOSE SPORTS BAGS, TOILETRY CASES SOLD EMPTY, SHOULDER BAGS, CARRYING CASES, TOTE BAGS, ROLLING TOTE BAGS, DUFFLE BAGS, ROLLING DUFFLE BAGS, BACKPACKS, ROLLING BACKPACKS, IN CLASS 18 (U.S. CLS. 1, 2, 3, 22 AND 41).

FIRST USE 2-22-2007; IN COMMERCE 7-19-2007.

THE MARK CONSISTS OF STANDARD CHARACTERS WITHOUT CLAIM TO ANY PARTICULAR FONT, STYLE, SIZE, OR COLOR.

SN 77-108,322, FILED 2-15-2007.

BRENDAN REGAN, EXAMINING ATTORNEY

**Int. Cl.: 12**

**Prior U.S. Cls.: 19, 21, 23, 31, 35, and 44**

**Reg. No. 3,454,693**

**United States Patent and Trademark Office**

**Registered June 24, 2008**

---

**TRADEMARK  
PRINCIPAL REGISTER**

**HARBOURVIEW**

PORTER, INC. (INDIANA CORPORATION)  
2200 WEST MONROE STREET  
DECATUR, IN 46733

THE MARK CONSISTS OF STANDARD CHAR-  
ACTERS WITHOUT CLAIM TO ANY PARTICULAR  
FONT, STYLE, SIZE, OR COLOR.

FOR: PORTLIGHTS AND WINDOW SCREENS  
FOR PORTHOLE, IN CLASS 12 (U.S. CLS. 19, 21, 23,  
31, 35 AND 44).

SN 77-108,357, FILED 2-15-2007.

FIRST USE 2-0-2006; IN COMMERCE 4-0-2007.

MICHAEL WEBSTER, EXAMINING ATTORNEY

**Int. Cl.: 44**

**Prior U.S. Cls.: 100 and 101**

**United States Patent and Trademark Office**

**Reg. No. 3,454,694**

**Registered June 24, 2008**

**SERVICE MARK  
PRINCIPAL REGISTER**

**H2U HEALTH, HAPPINESS, YOU**

NATIONAL ASSOCIATION OF SENIOR  
FRIENDS (MISSOURI CORPORATION)

P.O. BOX 1300

ONE PARK PLAZA (1-4E)

NASHVILLE, TN 37202

FOR: PROVIDING HEALTHY LIFESTYLE AND  
HEALTH INFORMATION; HEALTHCARE SERVI-  
CES; MEDICAL SERVICES; HEALTH CONSULTA-  
TION SERVICES, IN CLASS 44 (U.S. CLS. 100 AND  
101).

FIRST USE 4-9-2008; IN COMMERCE 4-9-2008.

THE MARK CONSISTS OF STANDARD CHAR-  
ACTERS WITHOUT CLAIM TO ANY PARTICULAR  
FONT, STYLE, SIZE, OR COLOR.

OWNER OF U.S. REG. NOS. 2,944,994, 2,978,782,  
AND 3,171,050.

NO CLAIM IS MADE TO THE EXCLUSIVE  
RIGHT TO USE "HEALTH", APART FROM THE  
MARK AS SHOWN.

SN 77-108,695, FILED 2-15-2007.

MICHAEL GAAFAR, EXAMINING ATTORNEY

**Int. Cl.: 16**

**Prior U.S. Cls.: 2, 5, 22, 23, 29, 37, 38, and 50**

**Reg. No. 3,454,695**

**United States Patent and Trademark Office**

**Registered June 24, 2008**

**TRADEMARK  
PRINCIPAL REGISTER**

# Taste of Tehachapi

MCDEMAS, ANTHONY (UNITED STATES INDIVIDUAL)  
22112 KNOB COURT  
TEHACHAPI, CA 93561

FOR: PRINTED MATERIALS, NAMELY, MAPS AND GUIDES FEATURING BUSINESS ESTABLISHMENTS AND PLACES OF INTEREST OF TEHACHAPI, CALIFORNIA, IN CLASS 16 (U.S. CLS. 2, 5, 22, 23, 29, 37, 38 AND 50).

FIRST USE 6-30-2007; IN COMMERCE 6-30-2007.

THE MARK CONSISTS OF STANDARD CHARACTERS WITHOUT CLAIM TO ANY PARTICULAR FONT, STYLE, SIZE, OR COLOR.

NO CLAIM IS MADE TO THE EXCLUSIVE RIGHT TO USE "TEHACHAPI", APART FROM THE MARK AS SHOWN.

SN 77-108,707, FILED 2-15-2007.

MICHAEL KEATING, EXAMINING ATTORNEY

**Int. Cl.: 11**

**Prior U.S. Cls.: 13, 21, 23, 31, and 34**

**Reg. No. 3,454,696**

**United States Patent and Trademark Office**

**Registered June 24, 2008**

**TRADEMARK  
PRINCIPAL REGISTER**

**VICLIGHT**

L.A. LIGHTER, INC. (CALIFORNIA CORPORATION)  
19805 HARRISON AVENUE  
CITY OF INDUSTRY, CA 91789

THE MARK CONSISTS OF STANDARD CHARACTERS WITHOUT CLAIM TO ANY PARTICULAR FONT, STYLE, SIZE, OR COLOR.

FOR: FLASHLIGHTS, IN CLASS 11 (U.S. CLS. 13, 21, 23, 31 AND 34).

SN 77-108,734, FILED 2-15-2007.

FIRST USE 1-0-2006; IN COMMERCE 1-0-2006.

SHANNON TWOHIG, EXAMINING ATTORNEY

**Int. Cl.: 7**

**Prior U.S. Cls.: 13, 19, 21, 23, 31, 34, and 35**

**United States Patent and Trademark Office**

**Reg. No. 3,454,697**

**Registered June 24, 2008**

---

**TRADEMARK  
PRINCIPAL REGISTER**

**INUTECH**

EG CHIX ADVANCED TECHNOLOGIES, S.A.S.  
(FRANCE CORPORATION)  
ZI DU VERN  
RUE DU PONTIC BP 50115  
LANDIVISIAU CEDEX, FRANCE 29401

FOR: AUTOMATIC HATCHERY SYSTEMS FOR CHICKS AND EGGS COMPRISED PRIMARILY OF CONVEYORS, CHICK AND EGG WASHERS, DEVICES FOR DETERMINING THE SEX OF CHICKS AND EGGS, AUTOMATIC VACCINATION APPARATUS AND NEEDLE-BASED AND NEEDLE-FREE INJECTION SYSTEMS FOR INJECTING CHICKS

AND EGGS, IN CLASS 7 (U.S. CLS. 13, 19, 21, 23, 31, 34 AND 35).

FIRST USE 5-1-2008; IN COMMERCE 5-1-2008.

THE MARK CONSISTS OF STANDARD CHARACTERS WITHOUT CLAIM TO ANY PARTICULAR FONT, STYLE, SIZE, OR COLOR.

SN 77-108,736, FILED 2-15-2007.

KELLEY WELLS, EXAMINING ATTORNEY



**Int. Cl.: 28**

**Prior U.S. Cls.: 22, 23, 38, and 50**

**United States Patent and Trademark Office**

**Reg. No. 3,454,698**

**Registered June 24, 2008**

**TRADEMARK  
PRINCIPAL REGISTER**

**BASHFUL BEAUTY DOLLS**

WEBB, JANICE G. (UNITED STATES INDIVIDUAL)

1712 WEST 65TH STREET

LOS ANGELES, CA 90047

FOR: DOLLS, IN CLASS 28 (U.S. CLS. 22, 23, 38 AND 50).

FIRST USE 12-1-2007; IN COMMERCE 12-1-2007.

THE MARK CONSISTS OF STANDARD CHARACTERS WITHOUT CLAIM TO ANY PARTICULAR FONT, STYLE, SIZE, OR COLOR.

NO CLAIM IS MADE TO THE EXCLUSIVE RIGHT TO USE "DOLLS", APART FROM THE MARK AS SHOWN.

SN 77-108,846, FILED 2-15-2007.

TINA BROWN, EXAMINING ATTORNEY

**Int. Cl.: 35**

**Prior U.S. Cls.: 100, 101, and 102**

**United States Patent and Trademark Office**

**Reg. No. 3,454,699**

**Registered June 24, 2008**

**SERVICE MARK  
PRINCIPAL REGISTER**

# Meet My

TRACY, CAROL L. (UNITED STATES INDIVIDUAL)  
5308 INDIAN RIVER RD.  
VIRGINIA BEACH, VA 23464

FOR: ADVERTISING AND PUBLICITY SERVICES, NAMELY, PROMOTING THE GOODS, SERVICES, BRAND IDENTITY AND COMMERCIAL INFORMATION AND NEWS OF THIRD PARTIES THROUGH AN ON-LINE MEDIUM; PROMOTING, ADVERTISING AND MARKETING OF THE ON-LINE WEBSITES OF OTHERS; DISSEMINATION OF ADVERTISING FOR OTHERS VIA AN ONLINE COMMUNICATIONS NETWORK ON THE INTERNET; PROVIDING A SEARCHABLE ONLINE ADVERTISING GUIDE FEATURING THE GOODS AND SERVICES OF OTHER ONLINE VENDORS

ON THE INTERNET; AND ADVERTISING BY TRANSMISSION OF ONLINE PUBLICITY FOR THIRD PARTIES THROUGH ELECTRONIC COMMUNICATIONS NETWORKS, IN CLASS 35 (U.S. CLS. 100, 101 AND 102).

FIRST USE 12-1-2006; IN COMMERCE 3-1-2007.

THE MARK CONSISTS OF STANDARD CHARACTERS WITHOUT CLAIM TO ANY PARTICULAR FONT, STYLE, SIZE, OR COLOR.

SN 77-109,158, FILED 2-16-2007.

JOHN SCHUYLER YARD, EXAMINING ATTORNEY

**Int. Cls.: 35 and 42**

**Prior U.S. Cls.: 100, 101, and 102**

**United States Patent and Trademark Office**

**Reg. No. 3,454,700**

**Registered June 24, 2008**

**SERVICE MARK  
PRINCIPAL REGISTER**

**IT'S YOUR WALLET. IT'S  
YOUR WORLD. SAVE THE  
WATTS.**

PROGRESS ENERGY SERVICE COMPANY, LLC  
(NORTH CAROLINA LTD LIAB CO)  
POST OFFICE BOX 1551  
RALEIGH, NC 27602

FOR: PROMOTING PUBLIC AWARENESS OF THE NEED FOR ENERGY CONSERVATION AND ENERGY EFFICIENCY; PROVIDING INFORMATION AND INCENTIVES TO COMMERCIAL AND RESIDENTIAL CUSTOMERS ON ENERGY EFFICIENT PRODUCTS; ENERGY AUDITING SERVICES; PROVIDING INFORMATION IN THE FIELD OF ENERGY EFFICIENCY TO BUILDERS FOR USE IN BUILDING ENERGY-EFFICIENT HOMES; ENERGY MANAGEMENT SERVICES, NAMELY, IMPLEMENTING AND MANAGING AN ENERGY ASSISTANCE PROGRAM TO ENABLE LOW INCOME CUSTOMERS TO SAVE ENERGY AND REDUCE THEIR ELECTRIC BILLS AND IMPLEMENTING AND MANAGING A LOAD REDUCTION PROGRAM THAT GIVES PARTICIPANTS A CREDIT ON THEIR ELECTRIC BILL AND ALLOWS FOR THE TEMPORARY INTERRUPTION OF APPLIANCES DURING PEAK PERI-

ODS; PROVIDING CUSTOMIZED ENERGY-EFFICIENCY SOLUTIONS TO COMMERCIAL/INDUSTRIAL CUSTOMERS BASED ON THEIR SPECIFIC INDUSTRY, IN CLASS 35 (U.S. CLS. 100, 101 AND 102).

FIRST USE 6-28-2007; IN COMMERCE 6-28-2007.

FOR: PROVIDING INFORMATION REGARDING EXPLORATION OF ALTERNATIVE AND RENEWABLE ENERGY SOURCES, IN CLASS 42 (U.S. CLS. 100 AND 101).

FIRST USE 6-28-2007; IN COMMERCE 6-28-2007.

THE MARK CONSISTS OF STANDARD CHARACTERS WITHOUT CLAIM TO ANY PARTICULAR FONT, STYLE, SIZE, OR COLOR.

SN 77-109,456, FILED 2-16-2007.

MICHAEL SOUDERS, EXAMINING ATTORNEY

**Int. Cls.: 9 and 12**

**Prior U.S. Cls.: 19, 21, 23, 26, 31, 35, 36, 38, and 44**

**United States Patent and Trademark Office**

**Reg. No. 3,454,701**

**Registered June 24, 2008**

**TRADEMARK  
PRINCIPAL REGISTER**

**FURION**

SPARTAN MOTORS CHASSIS, INC. (MICHIGAN CORPORATION)  
1000 REYNOLDS ROAD  
CHARLOTTE, MI 48813

FOR: FIRE TRUCKS; TRUCKS SPECIALLY EQUIPPED TO FIGHT FIRES AND PERFORM EMERGENCY AND EMERGENCY RESCUE OPERATIONS, IN CLASS 9 (U.S. CLS. 21, 23, 26, 36 AND 38).

FIRST USE 8-24-2007; IN COMMERCE 8-24-2007.

FOR: AMBULANCES, IN CLASS 12 (U.S. CLS. 19, 21, 23, 31, 35 AND 44).

FIRST USE 12-20-2007; IN COMMERCE 12-20-2007.

THE MARK CONSISTS OF STANDARD CHARACTERS WITHOUT CLAIM TO ANY PARTICULAR FONT, STYLE, SIZE, OR COLOR.

SN 77-109,504, FILED 2-16-2007.

ROBIN CHOSID, EXAMINING ATTORNEY

**Int. Cl.: 18**

**Prior U.S. Cls.: 1, 2, 3, 22, and 41**

**United States Patent and Trademark Office**

**Reg. No. 3,454,702**

**Registered June 24, 2008**

---

**TRADEMARK  
PRINCIPAL REGISTER**

**BANDABLING**

PET BLING, LLC (MARYLAND LTD LIAB CO)  
18 SEVERN RIVER ROAD  
SEVERNA PARK, MD 21146

THE MARK CONSISTS OF STANDARD CHAR-  
ACTERS WITHOUT CLAIM TO ANY PARTICULAR  
FONT, STYLE, SIZE, OR COLOR.

FOR: DECORATIVE AND FUNCTIONAL BAN-  
DANAS FOR DOGS AND CATS, IN CLASS 18 (U.S.  
CLS. 1, 2, 3, 22 AND 41).

SN 77-109,509, FILED 2-16-2007.

FIRST USE 2-1-2007; IN COMMERCE 4-1-2007.

KAREN K. BUSH, EXAMINING ATTORNEY

**Int. Cl.: 41**

**Prior U.S. Cls.: 100, 101, and 107**

**United States Patent and Trademark Office**

**Reg. No. 3,454,703**

**Registered June 24, 2008**

**SERVICE MARK  
PRINCIPAL REGISTER**

**FIGHT TO THE END**

MINNESOTA WILD HOCKEY CLUB, LP (MIN-  
NESOTA LIMITED PARTNERSHIP)  
317 WASHINGTON STREET  
SAINT PAUL, MN 55102

FOR: ENTERTAINMENT IN THE NATURE OF  
HOCKEY GAMES, IN CLASS 41 (U.S. CLS. 100, 101  
AND 107).

FIRST USE 3-20-2007; IN COMMERCE 3-20-2007.

THE MARK CONSISTS OF STANDARD CHAR-  
ACTERS WITHOUT CLAIM TO ANY PARTICULAR  
FONT, STYLE, SIZE, OR COLOR.

SN 77-109,689, FILED 2-16-2007.

SIMON TENG, EXAMINING ATTORNEY

**Int. Cl.: 25**

**Prior U.S. Cls.: 22 and 39**

**United States Patent and Trademark Office**

**Reg. No. 3,454,704**

**Registered June 24, 2008**

**TRADEMARK  
PRINCIPAL REGISTER**

**MADE BETTER BY NATURE**

MARMOT MOUNTAIN LLC (DELAWARE LTD  
LIAB CO)  
2321 CIRCADIAN WAY  
SANTA ROSA, CA 95407

THE MARK CONSISTS OF STANDARD CHAR-  
ACTERS WITHOUT CLAIM TO ANY PARTICULAR  
FONT, STYLE, SIZE, OR COLOR.

FOR: BASELAYER UNDERWEAR, IN CLASS 25  
(U.S. CLS. 22 AND 39).

SN 77-110,296, FILED 2-18-2007.

FIRST USE 7-0-2007; IN COMMERCE 7-0-2007.

BRENDAN MCCAULEY, EXAMINING ATTORNEY

**Int. Cl.: 24**

**Prior U.S. Cls.: 42 and 50**

**United States Patent and Trademark Office**

**Reg. No. 3,454,705**

**Registered June 24, 2008**

**TRADEMARK  
PRINCIPAL REGISTER**

**VISAENDURANCE**

MILLIKEN & COMPANY (DELAWARE CORPORATION)  
920 MILLIKEN ROAD  
SPARTANBURG, SC 29303

FOR: ODOR CONTROL FABRIC MADE OF NATURAL AND/OR SYNTHETIC FIBERS AND COMBINATIONS THEREOF, IN CLASS 24 (U.S. CLS. 42 AND 50).

FIRST USE 12-1-1999; IN COMMERCE 12-1-1999.

THE MARK CONSISTS OF STANDARD CHARACTERS WITHOUT CLAIM TO ANY PARTICULAR FONT, STYLE, SIZE, OR COLOR.

OWNER OF U.S. REG. NOS. 2,799,301 AND 2,815,101.

SN 77-110,467, FILED 2-19-2007.

KATHERINE E. HALMEN, EXAMINING ATTORNEY



**Int. Cl.: 25**

**Prior U.S. Cls.: 22 and 39**

**United States Patent and Trademark Office**

**Reg. No. 3,454,706**

**Registered June 24, 2008**

**TRADEMARK  
PRINCIPAL REGISTER**

**VISAENDURANCE**

MILLIKEN & COMPANY (DELAWARE CORPORATION)  
920 MILLIKEN ROAD  
SPARTANBURG, SC 29303

FOR: APPAREL CONTAINING ODOR CONTROL FABRIC, NAMELY, MEN'S, WOMEN'S AND CHILDREN'S PANTS, SHIRTS, SKIRTS, LINGERIE, UNDERWEAR, SOCKS, HATS, JACKETS, PARKAS, HOSIERY, SWIMWEAR, SLEEPWEAR AND LOUNGEWEAR, IN CLASS 25 (U.S. CLS. 22 AND 39).

FIRST USE 12-1-1999; IN COMMERCE 12-1-1999.

THE MARK CONSISTS OF STANDARD CHARACTERS WITHOUT CLAIM TO ANY PARTICULAR FONT, STYLE, SIZE, OR COLOR.

OWNER OF U.S. REG. NOS. 2,799,301 AND 2,815,101.

SN 77-110,481, FILED 2-19-2007.

KATHERINE E. HALMEN, EXAMINING ATTORNEY

**Int. Cls.: 38 and 41**

**Prior U.S. Cls.: 100, 101, 104, and 107**

**United States Patent and Trademark Office**

**Reg. No. 3,454,707**

**Registered June 24, 2008**

**SERVICE MARK  
PRINCIPAL REGISTER**

**THE REASON HDTV WAS  
INVENTED**

HDNET LLC (DELAWARE LTD LIAB CO)  
2909 TAYLOR STREET  
DALLAS, TX 75226

FOR: BROADCASTING MOVIES AND TELEVISION PROGRAMS VIA SATELLITE, CABLE, AND OTHER TELECOMMUNICATIONS NETWORKS, IN CLASS 38 (U.S. CLS. 100, 101 AND 104).

FIRST USE 4-1-2007; IN COMMERCE 4-1-2007.

FOR: ENTERTAINMENT IN THE NATURE OF MOVIES AND TELEVISION PROGRAMS IN THE

FIELD OF NEWS, COMEDY, DRAMA, MUSIC, SPORTS, AND DOCUMENTARIES, IN CLASS 41 (U.S. CLS. 100, 101 AND 107).

FIRST USE 8-23-2007; IN COMMERCE 8-23-2007.

THE MARK CONSISTS OF STANDARD CHARACTERS WITHOUT CLAIM TO ANY PARTICULAR FONT, STYLE, SIZE, OR COLOR.

SN 77-110,754, FILED 2-19-2007.

MICHELLE DUBOIS, EXAMINING ATTORNEY

**Int. Cl.: 32**

**Prior U.S. Cls.: 45, 46, and 48**

**Reg. No. 3,454,708**

**United States Patent and Trademark Office**

**Registered June 24, 2008**

---

**TRADEMARK  
PRINCIPAL REGISTER**

**modmix**

INTERNATIONAL MOD CORP (CALIFORNIA CORPORATION), DBA MODMIX,  
704 1/2 WESTBOURNE DRIVE  
WEST HOLLYWOOD, CA 90069

OWNER OF U.S. REG. NO. 3,234,838.

THE MARK CONSISTS OF MODMIX DESIGN.

FOR: NON-ALCOHOLIC COCKTAIL MIXES, IN CLASS 32 (U.S. CLS. 45, 46 AND 48).

SN 77-110,821, FILED 2-19-2007.

FIRST USE 8-31-2005; IN COMMERCE 8-31-2005.

WILLIAM VERHOSEK, EXAMINING ATTORNEY

**Int. Cl.: 25**

**Prior U.S. Cls.: 22 and 39**

**United States Patent and Trademark Office**

**Reg. No. 3,454,709**

**Registered June 24, 2008**

**TRADEMARK  
PRINCIPAL REGISTER**

**ANDO & FRIENDS**

THE ELECTRIC GRAPEVINE, INC. (CALIFORNIA CORPORATION)  
770 WEST 17TH STREET #1  
COSTA MESA, CA 92627

THE MARK CONSISTS OF STANDARD CHARACTERS WITHOUT CLAIM TO ANY PARTICULAR FONT, STYLE, SIZE, OR COLOR.

FOR: HATS; SHIRTS; T-SHIRTS, IN CLASS 25 (U.S. CLS. 22 AND 39).

SN 77-110,898, FILED 2-19-2007.

FIRST USE 1-15-2007; IN COMMERCE 1-15-2007.

CHRISIE B. KING, EXAMINING ATTORNEY

**Int. Cl.: 28**

**Prior U.S. Cls.: 22, 23, 38, and 50**

**United States Patent and Trademark Office**

**Reg. No. 3,454,710**

**Registered June 24, 2008**

**TRADEMARK  
PRINCIPAL REGISTER**

**PLAY4D**

COTTINGHAM, RANDY (UNITED STATES IN-  
DIVIDUAL)  
7777 FAY AVENUE, SUITE 205  
LA JOLLA, CA 92037

THE MARK CONSISTS OF STANDARD CHAR-  
ACTERS WITHOUT CLAIM TO ANY PARTICULAR  
FONT, STYLE, SIZE, OR COLOR.

FOR: PLAYING CARDS, IN CLASS 28 (U.S. CLS.  
22, 23, 38 AND 50).

SN 77-110,967, FILED 2-19-2007.

FIRST USE 4-15-2008; IN COMMERCE 4-15-2008.

LINDA MICKLEBURGH, EXAMINING ATTORNEY

**Int. Cl.: 42**

**Prior U.S. Cls.: 100 and 101**

**United States Patent and Trademark Office**

**Reg. No. 3,454,711**

**Registered June 24, 2008**

**SERVICE MARK  
PRINCIPAL REGISTER**

**TANDEM LABS**

TANDEM LABS, INC. (UTAH CORPORATION)  
1121 EAST 3900 SOUTH, SUITE C-210  
SALT LAKE CITY, UT 84124

FOR: SCIENTIFIC RESEARCH AND LABORATORY SERVICES IN THE FIELDS OF BIOLOGY, BIOCHEMISTRY, BIOPHARMACEUTICALS, AND PHARMACEUTICALS; SCIENTIFIC RESEARCH AND LABORATORY SERVICES, NAMELY, BIOANALYSIS, MASS SPECTROMETRY, IMMUNOANALYSIS, AND PHARMACOKINETICS, IN CLASS 42 (U.S. CLS. 100 AND 101).

FIRST USE 12-0-2002; IN COMMERCE 11-0-2003.

THE MARK CONSISTS OF STANDARD CHARACTERS WITHOUT CLAIM TO ANY PARTICULAR FONT, STYLE, SIZE, OR COLOR.

NO CLAIM IS MADE TO THE EXCLUSIVE RIGHT TO USE "LABS", APART FROM THE MARK AS SHOWN.

SN 77-111,209, FILED 2-20-2007.

JOHN DALIER, EXAMINING ATTORNEY

Int. Cl.: 11

Prior U.S. Cls.: 13, 21, 23, 31, and 34

United States Patent and Trademark Office

Reg. No. 3,454,712

Registered June 24, 2008

TRADEMARK  
PRINCIPAL REGISTER

i-Luminate

DONG GUAN BRIGHT YINHUEY LIGHTING  
CO., LTD. CHINA (CHINA CORPORATION)  
DA NING MANAGE DIST, DA PAN DI IND. ZONE  
DONG GUAN TOWNSHIP HUMEN TOWN, PUJIANG  
RD  
GUANG DONG, CHINA

FOR: TOILETS; SHOWER HEADS; LAMPS;  
LIGHT BULBS; MINIATURE LIGHT BULBS; VEHI-  
CLE TURN SIGNAL LIGHT BULBS; FLUORES-  
CENT LAMP TUBES; LAMP BASES; LAMP  
SHADES; ULTRAVIOLET LAMPS NOT FOR MEDI-

CAL PURPOSES, IN CLASS 11 (U.S. CLS. 13, 21, 23, 31  
AND 34).

FIRST USE 2-25-2008; IN COMMERCE 2-25-2008.

THE MARK CONSISTS OF STANDARD CHAR-  
ACTERS WITHOUT CLAIM TO ANY PARTICULAR  
FONT, STYLE, SIZE, OR COLOR.

SN 77-111,269, FILED 2-20-2007.

ZHALEH DELANEY, EXAMINING ATTORNEY

**Int. Cl.: 19**

**Prior U.S. Cls.: 1, 12, 33, and 50**

**United States Patent and Trademark Office**

**Reg. No. 3,454,713**

**Registered June 24, 2008**

**TRADEMARK  
PRINCIPAL REGISTER**

**CREO-BOARD**

PEACH STATE MFG., INC. (GEORGIA CORPORATION)  
4250 STACKS ROAD  
COLLEGE PARK, GA 30349

THE MARK CONSISTS OF STANDARD CHARACTERS WITHOUT CLAIM TO ANY PARTICULAR FONT, STYLE, SIZE, OR COLOR.

FOR: NON-METAL FENCE BOARDS, IN CLASS 19 (U.S. CLS. 1, 12, 33 AND 50).

SN 77-111,325, FILED 2-20-2007.

FIRST USE 10-17-2007; IN COMMERCE 10-17-2007.

CAROLYN CATALDO, EXAMINING ATTORNEY



Int. Cl.: 43

Prior U.S. Cls.: 100 and 101

**United States Patent and Trademark Office**

**Reg. No. 3,454,714**

Registered June 24, 2008

**SERVICE MARK  
PRINCIPAL REGISTER**



THE EDWARD THOMAS HOSPITALITY CORP.  
(CALIFORNIA CORPORATION)  
9950 SANTA MONICA BLVD.  
BEVERLY HILLS, CA 90212

NO CLAIM IS MADE TO THE EXCLUSIVE  
RIGHT TO USE "HOTEL", APART FROM THE  
MARK AS SHOWN.

FOR: HOTEL SERVICES; RESORT HOTELS, IN  
CLASS 43 (U.S. CLS. 100 AND 101).

SN 77-111,357, FILED 2-20-2007.

FIRST USE 1-31-2008; IN COMMERCE 1-31-2008.

WILLIAM VERHOSEK, EXAMINING ATTORNEY

Int. Cls.: 35 and 37

Prior U.S. Cls.: 100, 101, 102, 103, and 106

United States Patent and Trademark Office

Reg. No. 3,454,715

Registered June 24, 2008

SERVICE MARK  
PRINCIPAL REGISTER



AFFORDABLE CLASSICS, INC. (CALIFORNIA CORPORATION)  
19010 HAWTHORNE BLVD  
TORRANCE, CA 90503

FOR: AUTOMOBILE DEALERSHIP FEATURING CLASSIC CARS, IN CLASS 35 (U.S. CLS. 100, 101 AND 102).

FIRST USE 5-5-2008; IN COMMERCE 5-5-2008.

FOR: AUTOMOBILE BODY REPAIR, PAINTING, MAINTENANCE AND AUTOMOBILE UPHOLSTERY REPAIR; AUTOMOTIVE RESTORATION; MAINTENANCE AND REPAIR OF AUTOMOTIVE ENGINES, IN CLASS 37 (U.S. CLS. 100, 103 AND 106).

FIRST USE 0-0-1983; IN COMMERCE 0-0-1983.

OWNER OF U.S. REG. NO. 2,764,300.

NO CLAIM IS MADE TO THE EXCLUSIVE RIGHT TO USE "AFFORDABLE CLASSICS", APART FROM THE MARK AS SHOWN.

SN 77-111,439, FILED 2-20-2007.

JOHN SCHUYLER YARD, EXAMINING ATTORNEY

**Int. Cl.: 16**

**Prior U.S. Cls.: 2, 5, 22, 23, 29, 37, 38, and 50**

**United States Patent and Trademark Office**

**Reg. No. 3,454,716**

**Registered June 24, 2008**

**TRADEMARK  
PRINCIPAL REGISTER**

décorvelope

DENNIS, PAMELA M. (UNITED STATES INDIVIDUAL)  
11 GLENVILLE AVENUE  
GOOSE CREEK, SC 29445

THE MARK CONSISTS OF STANDARD CHARACTERS WITHOUT CLAIM TO ANY PARTICULAR FONT, STYLE, SIZE, OR COLOR.

FOR: ENVELOPES, IN CLASS 16 (U.S. CLS. 2, 5, 22, 23, 29, 37, 38 AND 50).

SN 77-111,687, FILED 2-20-2007.

FIRST USE 4-16-2008; IN COMMERCE 4-16-2008.

JILL PRATER, EXAMINING ATTORNEY

**Int. Cl.: 10**

**Prior U.S. Cls.: 26, 39, and 44**

**United States Patent and Trademark Office**

**Reg. No. 3,454,717**

**Registered June 24, 2008**

**TRADEMARK  
PRINCIPAL REGISTER**

**COOLBEAM**

ORMCO CORPORATION (DELAWARE COR-  
PORATION)  
1717 WEST COLLINS AVENUE  
ORANGE, CA 92867

THE MARK CONSISTS OF STANDARD CHAR-  
ACTERS WITHOUT CLAIM TO ANY PARTICULAR  
FONT, STYLE, SIZE, OR COLOR.

FOR: DENTAL CURING LIGHT, IN CLASS 10  
(U.S. CLS. 26, 39 AND 44).

SN 77-111,950, FILED 2-20-2007.

FIRST USE 10-1-2007; IN COMMERCE 10-1-2007.

KAREN K. BUSH, EXAMINING ATTORNEY

**Int. Cl.: 3**

**Prior U.S. Cls.: 1, 4, 6, 50, 51, and 52**

**United States Patent and Trademark Office**

**Reg. No. 3,454,718**

**Registered June 24, 2008**

**TRADEMARK  
PRINCIPAL REGISTER**

**NOURISHMINT**

AVEDA CORPORATION (DELAWARE CORPORATION)  
4000 PHEASANT RIDGE DRIVE  
MINNEAPOLIS, MN 55449

THE MARK CONSISTS OF STANDARD CHARACTERS WITHOUT CLAIM TO ANY PARTICULAR FONT, STYLE, SIZE, OR COLOR.

FOR: LIP BALM; LIPSTICK; NON-MEDICATED LIP CARE PREPARATIONS; NON-MEDICATED LIP PROTECTOR, IN CLASS 3 (U.S. CLS. 1, 4, 6, 50, 51 AND 52).

SN 77-112,125, FILED 2-21-2007.

FIRST USE 3-1-2008; IN COMMERCE 3-1-2008.

JOHN E. MICHOS, EXAMINING ATTORNEY

Int. Cls.: 3 and 16

Prior U.S. Cls.: 1, 2, 4, 5, 6, 22, 23, 29, 37, 38, 50, 51,  
and 52

Reg. No. 3,454,719

United States Patent and Trademark Office

Registered June 24, 2008

TRADEMARK  
PRINCIPAL REGISTER



WARNE, KRISTI K. (UNITED STATES INDIVIDUAL)  
107 IVY AVENUE SE  
RICHMOND, MN 56368

FOR: NON-MEDICATED TOILETRIES, IN CLASS 3 (U.S. CLS. 1, 4, 6, 50, 51 AND 52).

FIRST USE 4-1-2007; IN COMMERCE 9-30-2007.

FOR: PLASTIC OR PAPER BAGS FOR MERCHANDISE PACKAGING, IN CLASS 16 (U.S. CLS. 2, 5, 22, 23, 29, 37, 38 AND 50).

FIRST USE 4-1-2007; IN COMMERCE 9-30-2007.

NO CLAIM IS MADE TO THE EXCLUSIVE RIGHT TO USE "BAG", APART FROM THE MARK AS SHOWN.

THE MARK CONSISTS OF A LEFT HAND WITH THE PALM UP HOLDING A FETUS/BABY.

SN 77-112,295, FILED 2-21-2007.

ERNEST SHOSHO, EXAMINING ATTORNEY

**Int. Cl.: 12**

**Prior U.S. Cls.: 19, 21, 23, 31, 35, and 44**

**United States Patent and Trademark Office**

**Reg. No. 3,454,720**

**Registered June 24, 2008**

**TRADEMARK  
PRINCIPAL REGISTER**



VROOMM INC. (CANADA CORPORATION)  
112 PLEASANT BLVD.  
TORONTO, ONTARIO, CANADA M4T 1J8

FOR: AUTOMOBILE BODIES; AUTOMOBILE BUMPERS; AUTOMOBILE HOODS; BRAKE CALIPERS FOR LAND VEHICLES; BRAKE PADS FOR LAND VEHICLES; BRAKE ROTORS FOR LAND VEHICLES; BRAKING SYSTEMS FOR VEHICLES AND PARTS THEREOF; MIRRORS FOR VEHICLES, NAMELY, REARVIEW AND SIDE MIRRORS; SPOILERS FOR VEHICLES; TIRES; WHEEL RIMS;

WHEELS, IN CLASS 12 (U.S. CLS. 19, 21, 23, 31, 35 AND 44).

FIRST USE 3-10-2008; IN COMMERCE 3-10-2008.

THE MARK CONSISTS OF "CAROOMA" WITH A STYLIZED LETTER "C".

SN 77-112,556, FILED 2-21-2007.

PAULA MAHONEY, EXAMINING ATTORNEY

**Int. Cl.: 36**

**Prior U.S. Cls.: 100, 101, and 102**

**United States Patent and Trademark Office**

**Reg. No. 3,454,721**

**Registered June 24, 2008**

**SERVICE MARK  
PRINCIPAL REGISTER**

**SIX DEGREES**

SIX DEGREES CAPITAL MANAGEMENT L.L.C.  
(DELAWARE LTD LIAB CO)  
190 S. LASALLE ST., #3800  
LINCOLNSHIRE, IL 60069

FOR: FINANCIAL INVESTMENT IN THE FIELD  
OF STRUCTURED CREDIT AND ASSET MANAGE-  
MENT; INVESTMENT MANAGEMENT; INVEST-  
MENT OF FUNDS FOR OTHERS; MANAGEMENT  
OF A CAPITAL INVESTMENT FUND, IN CLASS 36  
(U.S. CLS. 100, 101 AND 102).

FIRST USE 2-28-2007; IN COMMERCE 2-28-2007.

THE MARK CONSISTS OF STANDARD CHAR-  
ACTERS WITHOUT CLAIM TO ANY PARTICULAR  
FONT, STYLE, SIZE, OR COLOR.

SN 77-112,864, FILED 2-21-2007.

MELVIN AXILBUND, EXAMINING ATTORNEY



**Int. Cl.: 36**

**Prior U.S. Cls.: 100, 101, and 102**

**United States Patent and Trademark Office**

**Reg. No. 3,454,722**

**Registered June 24, 2008**

**SERVICE MARK  
PRINCIPAL REGISTER**

**SDCM**

SIX DEGREES CAPITAL MANAGEMENT L.L.C.  
(DELAWARE LTD LIAB CO)  
190 S. LASALLE ST., #3800  
CHICAGO, IL 60603

FOR: FINANCIAL INVESTMENT IN THE FIELD  
OF STRUCTURED CREDIT AND ASSET MANAGE-  
MENT; INVESTMENT MANAGEMENT; INVEST-  
MENT OF FUNDS FOR OTHERS; MANAGEMENT  
OF A CAPITAL INVESTMENT FUND, IN CLASS 36  
(U.S. CLS. 100, 101 AND 102).

FIRST USE 2-28-2007; IN COMMERCE 2-28-2007.

THE MARK CONSISTS OF STANDARD CHAR-  
ACTERS WITHOUT CLAIM TO ANY PARTICULAR  
FONT, STYLE, SIZE, OR COLOR.

SN 77-112,869, FILED 2-21-2007.

MELVIN AXILBUND, EXAMINING ATTORNEY

**Int. Cl.: 7**

**Prior U.S. Cls.: 13, 19, 21, 23, 31, 34, and 35**

**Reg. No. 3,454,723**

**United States Patent and Trademark Office**

**Registered June 24, 2008**

---

**TRADEMARK  
PRINCIPAL REGISTER**

**KURV**

ROYAL APPLIANCE MFG. CO. (OHIO CORPORATION)  
7005 COCHRAN ROAD  
GLENWILLOW, OH 44139

THE MARK CONSISTS OF STANDARD CHARACTERS WITHOUT CLAIM TO ANY PARTICULAR FONT, STYLE, SIZE, OR COLOR.

FOR: ELECTRICAL VACUUM CLEANERS FOR BOTH DOMESTIC AND COMMERCIAL USE, IN CLASS 7 (U.S. CLS. 13, 19, 21, 23, 31, 34 AND 35).

SN 77-113,145, FILED 2-22-2007.

FIRST USE 6-11-2007; IN COMMERCE 6-11-2007.

MARGERY A. TIERNEY, EXAMINING ATTORNEY

**Int. Cl.: 41**

**Prior U.S. Cls.: 100, 101, and 107**

**United States Patent and Trademark Office**

**Reg. No. 3,454,724**

**Registered June 24, 2008**

**SERVICE MARK  
PRINCIPAL REGISTER**

**United States Pallino d'Oro**

DA VINCI BOCCE LLC (MICHIGAN LTD LIAB  
CO)  
2276 GARLAND  
SYLVAN LAKE, MI 48320

NO CLAIM IS MADE TO THE EXCLUSIVE  
RIGHT TO USE "UNITED STATES", APART FROM  
THE MARK AS SHOWN.

FOR: ENTERTAINMENT IN THE NATURE OF  
BOCCE BALL TOURNAMENTS; ORGANIZING  
SPORTING EVENTS, NAMELY, BOCCE BALL COM-  
PETITIONS, IN CLASS 41 (U.S. CLS. 100, 101 AND  
107).

THE FOREIGN WORDING IN THE MARK  
TRANSLATES INTO ENGLISH AS "GOLDEN BUL-  
LET".

FIRST USE 1-7-2007; IN COMMERCE 1-7-2007.

SN 77-113,217, FILED 2-22-2007.

THE MARK CONSISTS OF STANDARD CHAR-  
ACTERS WITHOUT CLAIM TO ANY PARTICULAR  
FONT, STYLE, SIZE, OR COLOR.

KAREN K. BUSH, EXAMINING ATTORNEY

**Int. Cl.: 20**

**Prior U.S. Cls.: 2, 13, 22, 25, 32, and 50**

**United States Patent and Trademark Office**

**Reg. No. 3,454,725**

**Registered June 24, 2008**

**TRADEMARK  
PRINCIPAL REGISTER**

**MICRO-STORAGE**

STORAGE2 SYSTEMS LLC (PENNSYLVANIA  
LTD LIAB CO)  
220 WEST FIFTH AVENUE  
COLLEGEVILLE, PA 19426

THE MARK CONSISTS OF STANDARD CHAR-  
ACTERS WITHOUT CLAIM TO ANY PARTICULAR  
FONT, STYLE, SIZE, OR COLOR.

FOR: FURNITURE, NAMELY, CABINETS AND  
STORAGE RACKS, IN CLASS 20 (U.S. CLS. 2, 13, 22,  
25, 32 AND 50).

SN 77-113,379, FILED 2-22-2007.

FIRST USE 10-31-2007; IN COMMERCE 10-31-2007.

KEVIN DINALLO, EXAMINING ATTORNEY

**Int. Cl.: 20**

**Prior U.S. Cls.: 2, 13, 22, 25, 32, and 50**

**United States Patent and Trademark Office**

**Reg. No. 3,454,726**

**Registered June 24, 2008**

**TRADEMARK  
PRINCIPAL REGISTER**

**MACRO-STORAGE**

STORAGE2 SYSTEMS LLC (PENNSYLVANIA  
LTD LIAB CO)  
220 WEST FIFTH AVENUE  
COLLEGEVILLE, PA 19426

THE MARK CONSISTS OF STANDARD CHAR-  
ACTERS WITHOUT CLAIM TO ANY PARTICULAR  
FONT, STYLE, SIZE, OR COLOR.

FOR: FURNITURE, NAMELY, CABINETS AND  
STORAGE RACKS, IN CLASS 20 (U.S. CLS. 2, 13, 22,  
25, 32 AND 50).

SN 77-113,387, FILED 2-22-2007.

FIRST USE 10-31-2007; IN COMMERCE 10-31-2007.

KEVIN DINALLO, EXAMINING ATTORNEY

**Int. Cl.: 29**

**Prior U.S. Cl.: 46**

**United States Patent and Trademark Office**

**Reg. No. 3,454,727**

**Registered June 24, 2008**

**TRADEMARK  
PRINCIPAL REGISTER**

**LITTLE SWEETIES**

MAID-RITE STEAK CO., INC. (PENNSYLVANIA  
CORPORATION)  
105 KEYSTONE INDUSTRIAL PARK  
DUNMORE, PA 18512

THE MARK CONSISTS OF STANDARD CHAR-  
ACTERS WITHOUT CLAIM TO ANY PARTICULAR  
FONT, STYLE, SIZE, OR COLOR.

FOR: SAUSAGE, NAMELY FULLY COOKED  
AND SEASONED PORK SAUSAGE BITES, IN CLASS  
29 (U.S. CL. 46).

SN 77-113,480, FILED 2-22-2007.

FIRST USE 5-28-2007; IN COMMERCE 5-28-2007.

COLLEEN DOMBROW, EXAMINING ATTORNEY

**Int. Cl.: 42**

**Prior U.S. Cls.: 100 and 101**

**United States Patent and Trademark Office**

**Reg. No. 3,454,728**

**Registered June 24, 2008**

**SERVICE MARK  
PRINCIPAL REGISTER**



**CHARGED SOFTWARE (MASSACHUSETTS  
SOLE PROPRIETORSHIP)  
61 ROMAN DRIVE  
SHREWSBURY, MA 01545**

FOR: APPLICATION SERVICE PROVIDER (ASP) FEATURING SOFTWARE IN THE FIELD OF ACCOUNTING; APPLICATION SERVICE PROVIDER (ASP), NAMELY, HOSTING COMPUTER SOFTWARE APPLICATIONS OF OTHERS; APPLICATION SERVICE PROVIDER FEATURING SOFTWARE FOR PROVIDING AN ON-LINE DATABASE IN THE FIELD OF TRANSACTION PROCESSING TO UPLOAD TRANSACTIONAL DATA, PROVIDE STATISTICAL ANALYSIS, AND PRODUCE NOTIFICATIONS AND REPORTS; APPLICATION SERVICE PROVIDER, NAMELY, PROVIDING, HOSTING, MANAGING, DEVELOPING, AND MAINTAINING APPLICATIONS, SOFTWARE, WEBSITES, AND DATABASES IN THE FIELDS OF PERSONAL PRODUCTIVITY, WIRELESS COMMUNICATION, MOBILE INFORMATION ACCESS, AND REMOTE DATA MANAGEMENT FOR WIRELESS DELIVERY OF CONTENT TO HANDHELD COMPUTERS, LAPTOPS AND MOBILE ELECTRONIC DEVICES; COMPUTER SERVICE, NAMELY, ACTING AS AN APPLICATION SERVICE PROVIDER IN THE FIELD OF KNOWLEDGE MANAGEMENT TO HOST COMPUTER APPLICATION SOFTWARE FOR CREATING SEARCHABLE DATABASES OF INFORMATION AND DATA; COMPUTER SERVICE, NAMELY, ACTING AS AN APPLICATION SERVICE PROVIDER IN THE FIELD OF KNOWLEDGE MANAGEMENT TO HOST COMPUTER APPLICATION SOFTWARE FOR SEARCHING AND RETRIEVING INFORMATION FROM DATABASES AND COMPUTER NETWORKS; COMPUTER SERVICE, NAMELY, ACTING AS AN APPLICATION SERVICE PROVIDER IN THE FIELD OF KNOWLEDGE MANAGEMENT TO HOST COMPUTER APPLICATION SOFTWARE FOR THE COLLECTION, EDITING, ORGANIZING, MODIFYING, BOOK

MARKING, TRANSMISSION, STORAGE AND SHARING OF DATA AND INFORMATION; COMPUTER SOFTWARE CONSULTANCY; COMPUTER SOFTWARE CONSULTATION; COMPUTER SOFTWARE DESIGN FOR OTHERS; COMPUTER SOFTWARE DESIGN, COMPUTER PROGRAMMING, OR MAINTENANCE OF COMPUTER SOFTWARE; COMPUTER SOFTWARE DEVELOPMENT; CONSULTANCY IN THE FIELD OF SOFTWARE DESIGN; CONSULTATION SERVICES IN THE FIELDS OF SELECTION, IMPLEMENTATION AND USE OF COMPUTER HARDWARE AND SOFTWARE SYSTEMS FOR OTHERS; CONSULTING SERVICES IN THE FIELD OF DESIGN, SELECTION, IMPLEMENTATION AND USE OF COMPUTER HARDWARE AND SOFTWARE SYSTEMS FOR OTHERS; CUSTOMIZATION OF COMPUTER HARDWARE AND SOFTWARE; DATA AUTOMATION AND COLLECTION SERVICE USING PROPRIETARY SOFTWARE TO EVALUATE, ANALYZE AND COLLECT SERVICE DATA; DESIGN AND DEVELOPMENT OF ON-LINE COMPUTER SOFTWARE SYSTEMS; DESIGN OF HOME PAGES, COMPUTER SOFTWARE AND WEB SITES; DESIGN, DEVELOPMENT AND IMPLEMENTATION OF SOFTWARE; DEVELOPMENT OF SOFTWARE FOR SECURE NETWORK OPERATIONS; DEVELOPMENT, UPDATING AND MAINTENANCE OF SOFTWARE AND DATA BASES; INSTALLATION OF COMPUTER SOFTWARE; MAINTENANCE OF COMPUTER SOFTWARE; MAINTENANCE OF COMPUTER SOFTWARE USED FOR OPERATING FILLING APPARATUS AND MACHINES; PERIODIC UPGRADING OF COMPUTER SOFTWARE FOR OTHERS; PROVIDING TEMPORARY USE OF NON-DOWNLOADABLE COMPUTER SOFTWARE FOR PREPARING INVOICES OVER COMPUTER NETWORKS, INTRANETS AND THE INTERNET; PROVIDING TEMPORARY USE OF NON-DOWNLOADABLE COMPUTER SOFTWARE FOR PREPARING SHIPPING DOCUMENTS OVER COMPUTER NETWORKS, INTRANETS AND THE IN-

TERNET; PROVIDING TEMPORARY USE OF NON-DOWNLOADABLE COMPUTER SOFTWARE FOR SHIPMENT PROCESSING OVER COMPUTER NETWORKS, INTRANETS AND THE INTERNET; PROVIDING TEMPORARY USE OF NON-DOWNLOADABLE COMPUTER SOFTWARE FOR TRACKING DOCUMENTS OVER COMPUTER NETWORKS, INTRANETS AND THE INTERNET; PROVIDING TEMPORARY USE OF NON-DOWNLOADABLE COMPUTER SOFTWARE FOR TRACKING FREIGHT OVER COMPUTER NETWORKS, INTRANETS AND THE INTERNET; PROVIDING TEMPORARY USE OF NON-DOWNLOADABLE COMPUTER SOFTWARE FOR TRACKING PACKAGES OVER COMPUTER NETWORKS, INTRANETS AND THE INTERNET; REPAIR OF COMPUTER SOFTWARE; SOFTWARE AUTHORIZING; UP-DATING OF COMPUTER SOFTWARE;

WARE; UPDATING OF COMPUTER SOFTWARE FOR OTHERS, IN CLASS 42 (U.S. CLS. 100 AND 101).

FIRST USE 6-1-2003; IN COMMERCE 8-29-2004.

NO CLAIM IS MADE TO THE EXCLUSIVE RIGHT TO USE "SOFTWARE", APART FROM THE MARK AS SHOWN.

THE MARK CONSISTS OF THE LETTER "S" ENCOMPASSED BY A SLIGHTLY LARGER LETTER "C". THE TEXT "CHARGED SOFTWARE" IS DISPLAYED TO THE RIGHT OF "CS".

SN 77-113,483, FILED 2-22-2007.

PAULA MAHONEY, EXAMINING ATTORNEY



**Int. Cl.: 9**

**Prior U.S. Cls.: 21, 23, 26, 36, and 38**

**Reg. No. 3,454,729**

**United States Patent and Trademark Office**

**Registered June 24, 2008**

**TRADEMARK  
PRINCIPAL REGISTER**

**ANAKAM IDENTITY SUITE**

ANAKAM, INC. (DELAWARE CORPORATION)  
5665 OBERLIN DRIVE, SUITE 106  
SAN DIEGO, CA 92122

FOR: COMPUTER SOFTWARE FOR CONTROL-  
LING AND MANAGING ACCESS TO SERVER  
APPLICATIONS, IN CLASS 9 (U.S. CLS. 21, 23, 26, 36  
AND 38).

FIRST USE 10-30-2007; IN COMMERCE 10-30-2007.

THE MARK CONSISTS OF STANDARD CHAR-  
ACTERS WITHOUT CLAIM TO ANY PARTICULAR  
FONT, STYLE, SIZE, OR COLOR.

NO CLAIM IS MADE TO THE EXCLUSIVE  
RIGHT TO USE "IDENTITY SUITE", APART FROM  
THE MARK AS SHOWN.

SN 77-113,678, FILED 2-22-2007.

G. MAYERSCHOFF, EXAMINING ATTORNEY

**Int. Cl.: 28**

**Prior U.S. Cls.: 22, 23, 38, and 50**

**Reg. No. 3,454,730**

**United States Patent and Trademark Office**

**Registered June 24, 2008**

---

**TRADEMARK  
PRINCIPAL REGISTER**

**Bombs Away**

FULGHAM, JAKE A. (UNITED STATES INDIVIDUAL)  
1112 TEAKWOOD LANE  
GLENWOOD SPRINGS, CO 81601

THE MARK CONSISTS OF STANDARD CHARACTERS WITHOUT CLAIM TO ANY PARTICULAR FONT, STYLE, SIZE, OR COLOR.

FOR: ELECTRONIC DART GAMES; OUTDOOR ACTIVITY GAMES IN THE NATURE OF ELECTRONIC LAWN DARTS, IN CLASS 28 (U.S. CLS. 22, 23, 38 AND 50).

SN 77-113,717, FILED 2-22-2007.

FIRST USE 4-10-2008; IN COMMERCE 4-10-2008.

MARK SPARACINO, EXAMINING ATTORNEY

**Int. Cl.: 14**

**Prior U.S. Cls.: 2, 27, 28, and 50**

**United States Patent and Trademark Office**

**Reg. No. 3,454,731**

**Registered June 24, 2008**

**TRADEMARK  
PRINCIPAL REGISTER**

**BSW**

DIAMOND DIRECT LLC (NEW YORK LTD LIAB  
CO)  
5TH FLOOR  
145 WEST 45TH STREET  
NEW YORK, NY 10036

THE MARK CONSISTS OF STANDARD CHAR-  
ACTERS WITHOUT CLAIM TO ANY PARTICULAR  
FONT, STYLE, SIZE, OR COLOR.

FOR: JEWELRY FEATURING DIAMONDS AND  
PRECIOUS STONES; DIAMONDS AND PRECIOUS  
STONES, IN CLASS 14 (U.S. CLS. 2, 27, 28 AND 50).

SN 77-113,781, FILED 2-22-2007.

FIRST USE 5-5-2008; IN COMMERCE 5-5-2008.

IRA J. GOODSaid, EXAMINING ATTORNEY

**Int. Cl.: 42**

**Prior U.S. Cls.: 100 and 101**

**United States Patent and Trademark Office**

**Reg. No. 3,454,732**

**Registered June 24, 2008**

**SERVICE MARK  
PRINCIPAL REGISTER**

**BIZAMAJIG**

CHANGES, INC. (NORTH CAROLINA CORPORATION), DBA BIZAMAJIG,  
P.O. BOX 1616  
ASHEVILLE, NC 28802

THE MARK CONSISTS OF STANDARD CHARACTERS WITHOUT CLAIM TO ANY PARTICULAR FONT, STYLE, SIZE, OR COLOR.

FOR: PROVIDING ON-LINE NON-DOWNLOADABLE SOFTWARE FOR PROCESS PORTAL MANAGEMENT, IN CLASS 42 (U.S. CLS. 100 AND 101).

SN 77-113,850, FILED 2-22-2007.

FIRST USE 5-9-2007; IN COMMERCE 5-9-2007.

LYDIA BELZER, EXAMINING ATTORNEY

**Int. Cl.: 9**

**Prior U.S. Cls.: 21, 23, 26, 36, and 38**

**United States Patent and Trademark Office**

**Reg. No. 3,454,733**

**Registered June 24, 2008**

**TRADEMARK  
PRINCIPAL REGISTER**

# Dragon Power

AINSWORTH GAME TECHNOLOGY (AUSTRALIA CORPORATION)  
10 HOLKER ST  
NEWINGTON, AUSTRALIA

FOR: COMPUTER SOFTWARE AND FIRMWARE FOR GAMES OF CHANCE ON ANY COMPUTERIZED PLATFORM, INCLUDING DEDICATED GAMING CONSOLES, VIDEO BASED SLOT MACHINES, REEL BASED SLOT MACHINES, AND VIDEO LOTTERY TERMINALS; GAMING SOFTWARE THAT GENERATES OR DISPLAYS WAGER OUTCOMES OF GAMING MACHINES, IN CLASS 9 (U.S. CLS. 21, 23, 26, 36 AND 38).

FIRST USE 8-1-2007; IN COMMERCE 8-1-2007.

THE MARK CONSISTS OF STANDARD CHARACTERS WITHOUT CLAIM TO ANY PARTICULAR FONT, STYLE, SIZE, OR COLOR.

SN 77-113,898, FILED 2-22-2007.

KATHERINE E. HALMEN, EXAMINING ATTORNEY

**Int. Cl.: 5**

**Prior U.S. Cls.: 6, 18, 44, 46, 51, and 52**

**United States Patent and Trademark Office**

**Reg. No. 3,454,734**

**Registered June 24, 2008**

**TRADEMARK  
PRINCIPAL REGISTER**

**GO GREENS**

BIOPHARMA SCIENTIFIC, INC. (NEVADA CORPORATION)  
9010 KENAMAR DRIVE, SUITE 101  
SAN DIEGO, CA 92121

FOR: DIETARY, NUTRITIONAL, VITAMIN AND FOOD SUPPLEMENTS, IN CLASS 5 (U.S. CLS. 6, 18, 44, 46, 51 AND 52).

FIRST USE 3-31-2007; IN COMMERCE 8-31-2007.

THE MARK CONSISTS OF STANDARD CHARACTERS WITHOUT CLAIM TO ANY PARTICULAR FONT, STYLE, SIZE, OR COLOR.

NO CLAIM IS MADE TO THE EXCLUSIVE RIGHT TO USE "GREENS", APART FROM THE MARK AS SHOWN.

SN 77-114,171, FILED 2-22-2007.

JANICE KIM, EXAMINING ATTORNEY

**Int. Cl.: 41**

**Prior U.S. Cls.: 100, 101, and 107**

**United States Patent and Trademark Office**

**Reg. No. 3,454,735**

**Registered June 24, 2008**

**SERVICE MARK  
PRINCIPAL REGISTER**



TOWNSEND, CRAIG J. (CALIFORNIA SOLE PROPRIETORSHIP)  
P.O. BOX 60930  
SACRAMENTO, CA 95860

FOR: EDUCATION SERVICES, NAMELY, PROVIDING SEMINARS AND LECTURES IN THE FIELD OF POLITICS, ECONOMICS AND PHILOSOPHY AND DISTRIBUTING COURSE MATERIALS, NAMELY, BOOKS, IN CONNECTION THEREWITH, IN CLASS 41 (U.S. CLS. 100, 101 AND 107).

FIRST USE 12-12-2006; IN COMMERCE 12-12-2006.

THE COLOR(S) FEDERAL BLUE, GOLD, ROSE, WHITE, GRAY, GREEN, AND BLACK IS/ARE CLAIMED AS A FEATURE OF THE MARK.

THE MARK CONSISTS OF A DOVE HOLDING A ROSE IN ITS BEAK STANDING IN A WHITE DISK

ON A BLUE FIELD WITH GOLD LAUREL WREATHS SURROUNDING THE WHITE DISK. THE COLOR BLUE APPEARS IN THE BACKGROUND OF THE RECTANGULAR SQUARE; THE COLOR GOLD APPEARS IN THE DESIGN OF THE WREATH AND IN THE BEAK OF THE DOVE; THE COLOR ROSE APPEARS IN THE ROSE; THE COLOR WHITE APPEARS IN THE BACKGROUND OF THE CIRCLE BEHIND THE DOVE; THE COLOR GRAY APPEARS IN THE DESIGN OF THE DOVE; THE COLOR GREEN APPEARS IN THE STEM AND LEAVES OF THE ROSE; AND THE COLOR BLACK APPEARS IN THE EYES, BEAK, AND FEET OF THE DOVE.

SN 77-114,176, FILED 2-22-2007.

SIMON TENG, EXAMINING ATTORNEY

**Int. Cl.: 9**

**Prior U.S. Cls.: 21, 23, 26, 36, and 38**

**United States Patent and Trademark Office**

**Reg. No. 3,454,736**

**Registered June 24, 2008**

**TRADEMARK  
PRINCIPAL REGISTER**

**CMR LEAD**

CERTIFIED MEDICAL REPRESENTATIVES INSTITUTE, INC., THE (VIRGINIA CORPORATION)  
SUITE 100  
4423 PHEASANT RIDGE ROAD  
ROANOKE, VA 24014

FOR: DOWNLOADABLE ELECTRONIC PUBLICATIONS IN THE NATURE OF TEXTBOOKS AND COURSE MATERIALS IN THE FIELDS OF HEALTH CARE AND BUSINESS MANAGEMENT; PRE-RECORDED MULTIMEDIA CD-ROMS FEATURING EDUCATIONAL MATERIALS IN THE FIELDS OF HEALTH CARE AND BUSINESS MANAGEMENT, IN CLASS 9 (U.S. CLS. 21, 23, 26, 36 AND 38).

FIRST USE 2-15-2007; IN COMMERCE 2-15-2007.

THE MARK CONSISTS OF STANDARD CHARACTERS WITHOUT CLAIM TO ANY PARTICULAR FONT, STYLE, SIZE, OR COLOR.

OWNER OF U.S. REG. NOS. 880,924 AND 1,577,732.

SN 77-114,655, FILED 2-23-2007.

MICHAEL WEBSTER, EXAMINING ATTORNEY



**Int. Cl.: 16**

**Prior U.S. Cls.: 2, 5, 22, 23, 29, 37, 38, and 50**

**United States Patent and Trademark Office**

**Reg. No. 3,454,737**

**Registered June 24, 2008**

**TRADEMARK  
PRINCIPAL REGISTER**

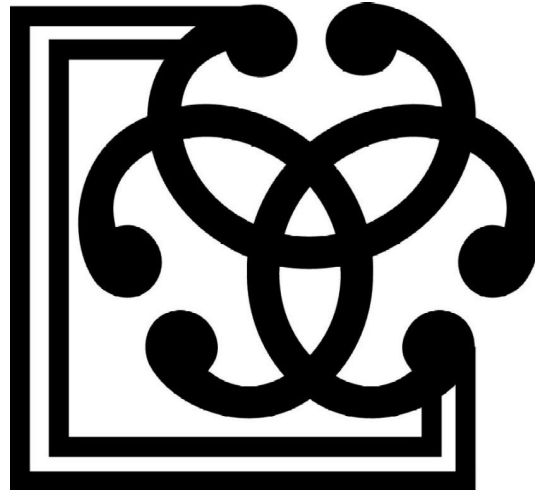

THE CERTIFIED MEDICAL REPRESENTATIVES  
INSTITUTE, INC. (VIRGINIA CORPORATION)  
SUITE 100  
4423 PHEASANT RIDGE ROAD  
ROANOKE, VA 24014

FOR: TRAINING TEXTBOOKS AND PRINTED  
COURSE MATERIALS FEATURING EDUCATION-  
AL MATERIALS IN THE FIELDS OF HEALTH  
CARE AND BUSINESS MANAGEMENT, IN CLASS  
16 (U.S. CLS. 2, 5, 22, 23, 29, 37, 38 AND 50).

FIRST USE 2-15-2007; IN COMMERCE 2-15-2007.

OWNER OF U.S. REG. NOS. 879,499, 1,581,455,  
AND 2,862,221.

THE MARK CONSISTS OF THREE LINKED  
CIRCULAR SHAPES WITHIN A PARTIAL RECTAN-  
GULAR DESIGN.

SN 77-114,691, FILED 2-23-2007.

ROBIN CHOSID, EXAMINING ATTORNEY

**Int. Cl.: 41**

**Prior U.S. Cls.: 100, 101, and 107**

**United States Patent and Trademark Office**

**Reg. No. 3,454,738**

**Registered June 24, 2008**

**SERVICE MARK  
PRINCIPAL REGISTER**

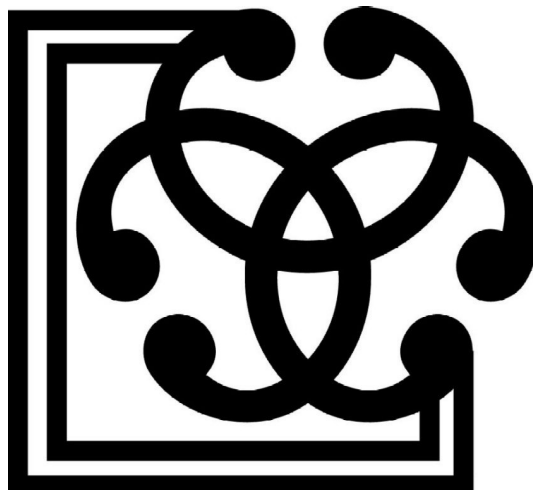

THE CERTIFIED MEDICAL REPRESENTATIVES  
INSTITUTE, INC. (VIRGINIA CORPORATION)  
SUITE 100  
4423 PHEASANT RIDGE ROAD  
ROANOKE, VA 24014

FOR: EDUCATIONAL SERVICES, NAMELY,  
PROVIDING COURSES IN THE FIELDS OF  
HEALTH CARE AND BUSINESS MANAGEMENT,  
AND DISTRIBUTING COURSE MATERIALS IN  
CONNECTION THEREWITH, IN CLASS 41 (U.S.  
CLS. 100, 101 AND 107).

FIRST USE 2-15-2007; IN COMMERCE 2-15-2007.

OWNER OF U.S. REG. NOS. 879,499, 1,581,455,  
AND 2,862,221.

THE MARK CONSISTS OF THREE LINKED  
CIRCULAR SHAPES WITHIN A PARTIAL RECTAN-  
GULAR DESIGN.

SN 77-114,699, FILED 2-23-2007.

ANTHONY RINKER, EXAMINING ATTORNEY

**Int. Cl.: 9**

**Prior U.S. Cls.: 21, 23, 26, 36, and 38**

**Reg. No. 3,454,739**

**United States Patent and Trademark Office**

**Registered June 24, 2008**

**TRADEMARK  
PRINCIPAL REGISTER**



CERTIFIED MEDICAL REPRESENTATIVES INSTITUTE, INC., THE (VIRGINIA CORPORATION)  
SUITE 100  
4423 PHEASANT RIDGE ROAD  
ROANOKE, VA 24014

FIRST USE 2-15-2007; IN COMMERCE 2-15-2007.

OWNER OF U.S. REG. NOS. 879,499, 880,924, AND 1,577,732.

FOR: DOWNLOADABLE ELECTRONIC PUBLICATIONS IN THE NATURE OF TEXTBOOKS AND COURSE MATERIALS IN THE FIELDS OF HEALTH CARE AND BUSINESS MANAGEMENT; PRE-RECORDED MULTIMEDIA CD-ROMS FEATURING EDUCATIONAL MATERIALS IN THE FIELDS OF HEALTH CARE AND BUSINESS MANAGEMENT, IN CLASS 9 (U.S. CLS. 21, 23, 26, 36 AND 38).

THE MARK CONSISTS OF THE WORDS "CMR LEAD", A HORIZONTAL LINE, AND THREE LINKED CIRCULAR SHAPES WITHIN A PARTIAL RECTANGULAR DESIGN.

SN 77-114,718, FILED 2-23-2007.

ROBIN CHOSID, EXAMINING ATTORNEY

**Int. Cls.: 35 and 42**

**Prior U.S. Cls.: 100, 101, and 102**

**United States Patent and Trademark Office**

**Reg. No. 3,454,740**

**Registered June 24, 2008**

**SERVICE MARK  
PRINCIPAL REGISTER**

**C3**

HY-KO PRODUCTS COMPANY (OHIO CORPORATION)  
60 MEADOW LANE  
NORTHFIELD, OH 44067

FOR: RETAIL STORE SERVICES IN THE FIELD OF KEYS, IN CLASS 35 (U.S. CLS. 100, 101 AND 102).

FIRST USE 9-3-2006; IN COMMERCE 9-3-2006.

FOR: SERVICES RELATED TO THE ELECTRONIC PROGRAMMING OF REPLACEMENT KEYS

AND TRANSPONDER KEYS, IN CLASS 42 (U.S. CLS. 100 AND 101).

FIRST USE 9-3-2006; IN COMMERCE 9-3-2006.

THE MARK CONSISTS OF STANDARD CHARACTERS WITHOUT CLAIM TO ANY PARTICULAR FONT, STYLE, SIZE, OR COLOR.

SN 77-114,738, FILED 2-23-2007.

ZACHARY BELLO, EXAMINING ATTORNEY

**Int. Cls.: 35 and 42**

**Prior U.S. Cls.: 100, 101, and 102**

**United States Patent and Trademark Office**

**Reg. No. 3,454,741**

**Registered June 24, 2008**

**SERVICE MARK  
PRINCIPAL REGISTER**



HY-KO PRODUCTS COMPANY (OHIO CORPORATION)  
60 MEADOW LANE  
NORTHFIELD, OH 44067

FOR: RETAIL STORE SERVICES IN THE FIELD OF KEYS, IN CLASS 35 (U.S. CLS. 100, 101 AND 102).

FIRST USE 12-1-2006; IN COMMERCE 12-1-2006.

FOR: SERVICES RELATED TO THE ELECTRONIC PROGRAMMING OF REPLACEMENT KEYS AND TRANSPONDER KEYS, IN CLASS 42 (U.S. CLS. 100 AND 101).

FIRST USE 12-1-2006; IN COMMERCE 12-1-2006.

SN 77-114,788, FILED 2-23-2007.

ZACHARY BELLO, EXAMINING ATTORNEY

**Int. Cl.: 35**

**Prior U.S. Cls.: 100, 101, and 102**

**United States Patent and Trademark Office**

**Reg. No. 3,454,742**

**Registered June 24, 2008**

---

**SERVICE MARK  
PRINCIPAL REGISTER**

**H-PASS**

REVENUE CYCLE SOLUTIONS, LLC (PENNSYLVANIA LTD LIAB CO)  
SUITE 223 700 RIVER AVENUE  
PITTSBURGH, PA 15212

FOR: OUTSOURCING SERVICE FOR PATIENT PRE-REGISTRATION, INSURANCE VERIFICATION AND FRONT-END COLLECTION OF CO-PAY AND DEDUCTIBLE PAYMENTS , IN CLASS 35 (U.S. CLS. 100, 101 AND 102).

FIRST USE 4-8-2008; IN COMMERCE 4-8-2008.

THE MARK CONSISTS OF STANDARD CHARACTERS WITHOUT CLAIM TO ANY PARTICULAR FONT, STYLE, SIZE, OR COLOR.

SN 77-114,826, FILED 2-23-2007.

BRIAN NEVILLE, EXAMINING ATTORNEY

**Int. Cl.: 35**

**Prior U.S. Cls.: 100, 101, and 102**

**United States Patent and Trademark Office**

**Reg. No. 3,454,743**

**Registered June 24, 2008**

**SERVICE MARK  
PRINCIPAL REGISTER**



REVENUE CYCLE SOLUTIONS, LLC (PENNSYLVANIA LTD LIAB CO)  
SUITE 223 700 RIVER AVENUE  
PITTSBURGH, PA 15212

FOR: OUTSOURCING SERVICE FOR PATIENT PRE-REGISTRATION, INSURANCE VERIFICATION AND FRONT-END COLLECTION OF CO-PAY AND DEDUCTIBLE PAYMENTS , IN CLASS 35 (U.S. CLS. 100, 101 AND 102).

FIRST USE 4-8-2008; IN COMMERCE 4-8-2008.

THE MARK CONSISTS OF THE LETTER "H" CENTERED IN A SQUARE ABOVE THE WORD "PASS" WITHIN A BORDER.

SN 77-114,838, FILED 2-23-2007.

BRIAN NEVILLE, EXAMINING ATTORNEY

**Int. Cl.: 30**

**Prior U.S. Cl.: 46**

**United States Patent and Trademark Office**

**Reg. No. 3,454,744**

**Registered June 24, 2008**

**TRADEMARK  
PRINCIPAL REGISTER**

**HORIZON ORGANIC**

WHITEWAVE FOODS COMPANY (DELAWARE  
CORPORATION)  
12002 AIRPORT WAY  
BROOMFIELD, CO 80021

OWNER OF U.S. REG. NOS. 1,975,824, 3,014,315,  
AND OTHERS.

FOR: ORGANIC ICE CREAM, IN CLASS 30 (U.S.  
CL. 46).

NO CLAIM IS MADE TO THE EXCLUSIVE  
RIGHT TO USE "ORGANIC", APART FROM THE  
MARK AS SHOWN.

FIRST USE 4-0-2007; IN COMMERCE 4-0-2007.

SN 77-114,848, FILED 2-23-2007.

THE MARK CONSISTS OF STANDARD CHAR-  
ACTERS WITHOUT CLAIM TO ANY PARTICULAR  
FONT, STYLE, SIZE, OR COLOR.

MORGAN WYNNE, EXAMINING ATTORNEY



**Int. Cl.: 36**

**Prior U.S. Cls.: 100, 101, and 102**

**United States Patent and Trademark Office**

**Reg. No. 3,454,745**

**Registered June 24, 2008**

**SERVICE MARK  
PRINCIPAL REGISTER**



MONEY BALL GAME, INC. (WASHINGTON CORPORATION)  
20130 106TH AVE NE  
BOTHELL, WA 98011

FOR: FINANCIAL ANALYSIS AND CONSULTATION; FINANCIAL EVALUATION FOR INSURANCE PURPOSES; FINANCIAL INFORMATION PROVIDED BY ELECTRONIC MEANS; FINANCIAL MANAGEMENT; FINANCIAL PLANNING; FINANCIAL PLANNING CONSULTATION; FINANCIAL PLANNING, NAMELY, THE CREATION OF PERSONALIZED STRATEGIES TO ACHIEVE FINANCIAL INDEPENDENCE; FINANCIAL PORTFOLIO MANAGEMENT; FINANCIAL RESEARCH; FINANCIAL SERVICES, NAMELY, ASSISTING OTHERS WITH THE COMPLETION OF FINANCIAL TRANSACTIONS FOR STOCKS, BONDS, SECURITIES AND EQUITIES; FINANCIAL SERVICES, NAMELY, SAVINGS PROGRAMS FOR YOUTHS; PROVIDING A WEB SITE WHERE USERS CAN POST RATINGS,

REVIEWS AND RECOMMENDATIONS ON STOCKS, BONDS, MUTUAL FUNDS AND OTHER FINANCIAL INSTRUMENTS; PROVIDING ON-LINE FINANCIAL CALCULATORS; PROVIDING ONLINE INFORMATION IN THE FIELD CHARITABLE MONETARY GIVING THROUGH FINANCIAL AND ESTATE PLANNING, IN CLASS 36 (U.S. CLS. 100, 101 AND 102).

FIRST USE 2-28-2007; IN COMMERCE 2-28-2007.

THE MARK CONSISTS OF A REPRESENTATION OF A BASEBALL DIAMOND THAT HAS A BASEBALL IN THE CENTER OF THE FIELD AND A DOLLAR SIGN IN THE CENTER OF THE BASEBALL.

SN 77-114,889, FILED 2-23-2007.

KAREN K. BUSH, EXAMINING ATTORNEY

**Int. Cl.: 43**

**Prior U.S. Cls.: 100 and 101**

**United States Patent and Trademark Office**

**Reg. No. 3,454,746**

**Registered June 24, 2008**

**SERVICE MARK  
PRINCIPAL REGISTER**

**STARFRUIT**

LIFEWAY FOODS, INC. (ILLINOIS CORPORATION)  
6431 WEST OAKTON  
MORTON GROVE, IL 60053

THE MARK CONSISTS OF STANDARD CHARACTERS WITHOUT CLAIM TO ANY PARTICULAR FONT, STYLE, SIZE, OR COLOR.

FOR: RESTAURANT SERVICES, IN CLASS 43 (U.S. CLS. 100 AND 101).

SN 77-115,045, FILED 2-23-2007.

FIRST USE 4-1-2008; IN COMMERCE 4-1-2008.

MARK SPARACINO, EXAMINING ATTORNEY

**Int. Cl.: 41**

**Prior U.S. Cls.: 100, 101, and 107**

**United States Patent and Trademark Office**

**Reg. No. 3,454,747**

**Registered June 24, 2008**

**SERVICE MARK  
PRINCIPAL REGISTER**

**FUTURE ARCHITECT**

FUTURE ARCHITECT, INC. (JAPAN CORPORATION)  
1-2-2 OSAKI, SHINAGAWA-KU  
ART VILLAGE, OSAKI CENTRAL TOWER  
TOKYO, JAPAN 141-0032

FOR: EDUCATIONAL SERVICES, NAMELY, CONDUCTING CLASSES, SEMINARS, CONFERENCES, AND WORKSHOPS IN THE FIELD OF TELECOMMUNICATIONS AND INFORMATION TECHNOLOGY AND DISTRIBUTION OF COURSE MATERIAL IN CONNECTION THEREWITH, IN CLASS 41 (U.S. CLS. 100, 101 AND 107).

FIRST USE 1-1-1997; IN COMMERCE 1-1-1997.

THE MARK CONSISTS OF STANDARD CHARACTERS WITHOUT CLAIM TO ANY PARTICULAR FONT, STYLE, SIZE, OR COLOR.

SN 77-115,104, FILED 2-23-2007.

MARCIE MILONE, EXAMINING ATTORNEY

**Int. Cl.: 3**

**Prior U.S. Cls.: 1, 4, 6, 50, 51, and 52**

**United States Patent and Trademark Office**

**Reg. No. 3,454,748**

**Registered June 24, 2008**

**TRADEMARK  
PRINCIPAL REGISTER**

**ZERRAN REFORM**

ZERRAN INTERNATIONAL CORPORATION  
(CALIFORNIA CORPORATION)  
12878 PIERCE STREET  
PACOIMA, CA 91331

FOR: HAIR STRAIGHTENING PREPARATIONS,  
IN CLASS 3 (U.S. CLS. 1, 4, 6, 50, 51 AND 52).

FIRST USE 7-3-2007; IN COMMERCE 8-9-2007.

THE MARK CONSISTS OF STANDARD CHAR-  
ACTERS WITHOUT CLAIM TO ANY PARTICULAR  
FONT, STYLE, SIZE, OR COLOR.

OWNER OF U.S. REG. NOS. 1,819,635, 2,235,272,  
AND 2,235,273.

SN 77-115,139, FILED 2-23-2007.

SHARON MEIER, EXAMINING ATTORNEY

**Int. Cl.: 10**

**Prior U.S. Cls.: 26, 39, and 44**

**United States Patent and Trademark Office**

**Reg. No. 3,454,749**

**Registered June 24, 2008**

**TRADEMARK  
PRINCIPAL REGISTER**

**EZLASE**

BIOLASE TECHNOLOGY, INC. (DELAWARE  
CORPORATION)  
4 CROMWELL  
IRVINE, CA 92618

FOR: ELECTROMAGNETIC ENERGY EMIT-  
TING DEVICES FOR MEDICAL USE, NAMELY,  
LASERS FOR MEDICAL USE, AND PARTS AND  
COMPONENTS THEREFORE, IN CLASS 10 (U.S.  
CLS. 26, 39 AND 44).

FIRST USE 12-31-2005; IN COMMERCE 12-31-2005.

THE MARK CONSISTS OF STANDARD CHAR-  
ACTERS WITHOUT CLAIM TO ANY PARTICULAR  
FONT, STYLE, SIZE, OR COLOR.

SN 77-115,378, FILED 2-23-2007.

MARK PILARO, EXAMINING ATTORNEY

**Int. Cl.: 5**

**Prior U.S. Cls.: 6, 18, 44, 46, 51, and 52**

**Reg. No. 3,454,750**

**United States Patent and Trademark Office**

**Registered June 24, 2008**

---

**TRADEMARK  
PRINCIPAL REGISTER**

**Loaded X**

JACKSON, JANET A. (UNITED STATES INDIVIDUAL)  
2247 EAST 3700 NORTH  
LAYTON, UT 84040

FOR: DIETARY AND NUTRITIONAL SUPPLEMENTS; HERBAL SUPPLEMENTS, IN CLASS 5 (U.S. CLS. 6, 18, 44, 46, 51 AND 52).

FIRST USE 12-6-2006; IN COMMERCE 7-5-2007.

THE MARK CONSISTS OF STANDARD CHARACTERS WITHOUT CLAIM TO ANY PARTICULAR FONT, STYLE, SIZE, OR COLOR.

OWNER OF U.S. REG. NO. 3,233,971.

SN 77-115,562, FILED 2-24-2007.

DAYNA BROWNE, EXAMINING ATTORNEY

**Int. Cl.: 10**

**Prior U.S. Cls.: 26, 39, and 44**

**United States Patent and Trademark Office**

**Reg. No. 3,454,751**

**Registered June 24, 2008**

**TRADEMARK  
PRINCIPAL REGISTER**

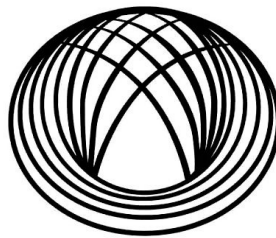

IDEV TECHNOLOGIES, INC. (DELAWARE CORPORATION)  
1120 NASA PARKWAY, SUITE 600  
HOUSTON, TX 77058

THE MARK CONSISTS OF A LINED SPHERICAL DESIGN.

FOR: MEDICAL STENT, NAMELY, SELF EXPANDABLE NITINOL STENT, IN CLASS 10 (U.S. CLS. 26, 39 AND 44).

SN 77-116,113, FILED 2-26-2007.

FIRST USE 2-4-2008; IN COMMERCE 2-4-2008.

DAVID ELTON, EXAMINING ATTORNEY

**Int. Cls.: 38 and 42**

**Prior U.S. Cls.: 100, 101, and 104**

**United States Patent and Trademark Office**

**Reg. No. 3,454,752**

**Registered June 24, 2008**

**SERVICE MARK  
PRINCIPAL REGISTER**

**Q SELF SERVICE**

QWEST COMMUNICATIONS INTERNATIONAL  
INC. (DELAWARE CORPORATION)  
1801 CALIFORNIA ST.  
DENVER, CO 80202

FOR: ELECTRONIC, ELECTRIC AND DIGITAL  
TRANSMISSION OF VOICE, DATA, IMAGES, SIG-  
NALS AND MESSAGES, IN CLASS 38 (U.S. CLS. 100,  
101 AND 104).

FIRST USE 6-30-2007; IN COMMERCE 6-30-2007.

FOR: DEVELOPMENT, UPDATING AND MAIN-  
TENANCE OF SOFTWARE AND DATABASES FOR  
TELECOMMUNICATIONS CONTACT CENTERS,  
IN CLASS 42 (U.S. CLS. 100 AND 101).

FIRST USE 6-30-2007; IN COMMERCE 6-30-2007.

THE MARK CONSISTS OF STANDARD CHAR-  
ACTERS WITHOUT CLAIM TO ANY PARTICULAR  
FONT, STYLE, SIZE, OR COLOR.

NO CLAIM IS MADE TO THE EXCLUSIVE  
RIGHT TO USE "SELF SERVICE", APART FROM  
THE MARK AS SHOWN.

SN 77-116,168, FILED 2-26-2007.

MARK SPARACINO, EXAMINING ATTORNEY



Int. Cl.: 36

Prior U.S. Cls.: 100, 101, and 102

United States Patent and Trademark Office

Reg. No. 3,454,753

Registered June 24, 2008

**SERVICE MARK  
PRINCIPAL REGISTER**



IRONSHORE INC. (CAYMAN ISLANDS CORPORATION)  
HUTCHINS DRIVE, PO BOX 2681  
CENTURY YARK, CRICKET SQUARE  
GEORGE TOWN, CAYMAN ISLANDS

FOR: ACCIDENT INSURANCE UNDERWRITING; FIRE INSURANCE UNDERWRITING; INSURANCE CARRIER SERVICES; INSURANCE CLAIMS ADMINISTRATION; INSURANCE CLAIMS PROCESSING; INSURANCE PREMIUM RATE COMPUTING; INSURANCE SERVICES, NAMELY, WRITING PROPERTY AND CASUALTY INSURANCE; INSURANCE SUBROGATION AND SALVAGE; INSURANCE UNDERWRITING IN THE FIELD OF ACCIDENT, MARINE, MEDICAL, PROPERTY AND CASUALTY; INSURANCE UNDERWRITING SERVICES FOR ALL TYPES OF INSURANCE; MARINE INSURANCE UNDER-

WRITING; MEDICAL INSURANCE UNDERWRITING, IN CLASS 36 (U.S. CLS. 100, 101 AND 102).

FIRST USE 4-28-2008; IN COMMERCE 4-28-2008.

THE COLOR(S) BLACK, BLUE AND ORANGE IS/ARE CLAIMED AS A FEATURE OF THE MARK.

THE MARK CONSISTS IN PART OF A CROWN ATOP A SCALLOPED SHELL DESIGN. "YOUR SAFE HARBOUR" IS BLACK. "SHORE" AND THE SCALLOPED SHELL LINES BENEATH THE CROWN ARE BLUE. "IRON" AND THE CROWN ARE ORANGE.

SN 77-116,444, FILED 2-26-2007.

IRA J. GOODSaid, EXAMINING ATTORNEY

Int. Cl.: 36

Prior U.S. Cls.: 100, 101, and 102

United States Patent and Trademark Office

Reg. No. 3,454,754

Registered June 24, 2008

SERVICE MARK  
PRINCIPAL REGISTER



IRONSHORE

*your safe harbour*

IRONSHORE INC. (CAYMAN ISLANDS CORPORATION)  
HUTCHINS DRIVE, PO BOX 2681 GT  
CENTURY YARD, CRICKET SQUARE  
GEORGE TOWN, CAYMAN ISLANDS

FOR: ACCIDENT INSURANCE UNDERWRITING; FIRE INSURANCE UNDERWRITING; INSURANCE CARRIER SERVICES; INSURANCE CLAIMS ADMINISTRATION; INSURANCE CLAIMS PROCESSING; INSURANCE PREMIUM RATE COMPUTING; INSURANCE SERVICES, NAMELY, WRITING PROPERTY AND CASUALTY INSURANCE; INSURANCE SUBROGATION AND SALVAGE; INSURANCE UNDERWRITING IN THE FIELD OF ACCIDENT, MARINE, MEDICAL, PROPERTY AND CASUALTY; INSURANCE UNDERWRITING SERVICES FOR ALL TYPES OF

INSURANCE; MARINE INSURANCE UNDERWRITING; MEDICAL INSURANCE UNDERWRITING, IN CLASS 36 (U.S. CLS. 100, 101 AND 102).

FIRST USE 4-28-2008; IN COMMERCE 4-28-2008.

THE MARK CONSISTS OF THE DESIGN OF A SCALLOPED SHELL WITH A CROWN ON TOP, WITH THE WORD "IRONSHORE" IN ALL CAPITAL LETTERS CENTERED BELOW THE DESIGN AND WITH THE WORDS "YOUR SAFE HARBOUR" CENTERED DIRECTLY BELOW THE WORD "IRONSHORE".

SN 77-116,463, FILED 2-26-2007.

IRA J. GOODSaid, EXAMINING ATTORNEY

Int. Cl.: 33

Prior U.S. Cls.: 47 and 49

**United States Patent and Trademark Office**

**Reg. No. 3,454,755**

Registered June 24, 2008

**TRADEMARK  
PRINCIPAL REGISTER**



GUENOC WINERY, INC. (DELAWARE CORPORATION)  
21000 BUTTS CANYON ROAD  
MIDDLETOWN, CA 95461

FOR: WINE, IN CLASS 33 (U.S. CLS. 47 AND 49).

FIRST USE 9-0-2007; IN COMMERCE 9-0-2007.

OWNER OF U.S. REG. NO. 1,883,855.

THE MARK CONSISTS OF A TREE DESIGN WITHOUT LEAVES WITH THREE ROCKS NEXT TO THE TREE TRUNK, AND THE WORD "LANGTRY" UNDERNEATH THE DESIGN.

SN 77-116,570, FILED 2-26-2007.

BRENDAN REGAN, EXAMINING ATTORNEY

**Int. Cl.: 33**

**Prior U.S. Cls.: 47 and 49**

**United States Patent and Trademark Office**

**Reg. No. 3,454,756**

**Registered June 24, 2008**

**TRADEMARK  
PRINCIPAL REGISTER**

**Plowbuster**

CARABELLA VINEYARD AND WINERY LLC  
(OREGON LTD LIAB CO)  
PO BOX 2180  
WILSONVILLE, OR 97070

THE MARK CONSISTS OF STANDARD CHAR-  
ACTERS WITHOUT CLAIM TO ANY PARTICULAR  
FONT, STYLE, SIZE, OR COLOR.

FOR: GRAPE WINE, IN CLASS 33 (U.S. CLS. 47  
AND 49).

SN 77-116,605, FILED 2-26-2007.

FIRST USE 9-7-2007; IN COMMERCE 9-7-2007.

DANIEL BRODY, EXAMINING ATTORNEY

**Int. Cl.: 25**

**Prior U.S. Cls.: 22 and 39**

**United States Patent and Trademark Office**

**Reg. No. 3,454,757**

**Registered June 24, 2008**

**TRADEMARK  
PRINCIPAL REGISTER**

**RUGGED EXPOSURE**

BIG 5 CORP. (DELAWARE CORPORATION)  
2525 EAST EL SEGUNDO BOULEVARD  
EL SEGUNDO, CA 90245

FOR: FISHING VESTS; SHIRTS, JACKETS AND  
PACKAWAY PANTS, IN CLASS 25 (U.S. CLS. 22 AND  
39).

FIRST USE 9-30-2002; IN COMMERCE 9-30-2002.

THE MARK CONSISTS OF STANDARD CHAR-  
ACTERS WITHOUT CLAIM TO ANY PARTICULAR  
FONT, STYLE, SIZE, OR COLOR.

OWNER OF U.S. REG. NOS. 2,034,859 AND  
2,137,720.

SN 77-116,698, FILED 2-26-2007.

RUDY R. SINGLETON, EXAMINING ATTORNEY

**Int. Cl.: 41**

**Prior U.S. Cls.: 100, 101, and 107**

**United States Patent and Trademark Office**

**Reg. No. 3,454,758**

**Registered June 24, 2008**

**SERVICE MARK  
PRINCIPAL REGISTER**

**VETUNES**

AMERICAN VETERANS AID FUND (NEW  
YORK NON-PROFIT CORPORATION)  
P.O. BOX 418  
CENTRAL VALLEY, NY 10917

FOR: ENTERTAINMENT IN THE NATURE OF  
CONDUCTING LIVE MUSICAL PERFORMANCES  
FEATURING VARIOUS SOLO RECORDING AR-

TISTS AND MUSICAL GROUPS , IN CLASS 41 (U.S.  
CLS. 100, 101 AND 107).

FIRST USE 4-23-2007; IN COMMERCE 4-23-2007.

SN 77-117,896, FILED 2-28-2007.

ROBIN CHOSID, EXAMINING ATTORNEY

**Int. Cl.: 3**

**Prior U.S. Cls.: 1, 4, 6, 50, 51, and 52**

**Reg. No. 3,454,759**

**United States Patent and Trademark Office**

**Registered June 24, 2008**

**TRADEMARK  
PRINCIPAL REGISTER**

**HERE COMES THE GROOMED**

ANTHONY FOR MEN, L.L.C. (MICHIGAN LTD  
LIAB CO)  
SUITE 503  
560 BROADWAY  
NEW YORK, NY 10012

FOR: PERSONAL CARE PRODUCTS FOR MEN,  
NAMELY, SHAVING CREAM, SHAVING GEL, PRE-  
SHAVING PREPARATIONS, NAMELY, OIL; NON-  
MEDICATED ASTRINGENT AFTER-SHAVE FOR  
COSMETIC PURPOSES, AFTER-SHAVE BALM,  
TOOTH PASTE, PERSONAL DEODORANT, FACIAL  
AND BODY SOAP, FACIAL CLEANSER, ANTI-  
WRINKLE CREAM, BODY CLEANSING GEL,  
BODY SCRUB, FACIAL SCRUB, SKIN TONER,  
HAND AND BODY LOTION, FACIAL LOTION,  
FACIAL MOISTURIZER, DEEP-PORE CLEANSING

CLAY FACIAL MASK, LIP CREAM, EYE CREAM,  
SHAMPOO, HAIR CONDITIONER, HAIR CREAM,  
HAIR GEL, TALCUM POWDER, SUN SCREEN,  
SELF TANNING LOTION, NON-MEDICATED MUS-  
CLE RUB, AND COLOGNE, IN CLASS 3 (U.S. CLS. 1,  
4, 6, 50, 51 AND 52).

FIRST USE 2-12-2008; IN COMMERCE 2-12-2008.

THE MARK CONSISTS OF STANDARD CHAR-  
ACTERS WITHOUT CLAIM TO ANY PARTICULAR  
FONT, STYLE, SIZE, OR COLOR.

SN 77-117,909, FILED 2-28-2007.

THEODORE MCBRIDE, EXAMINING ATTORNEY

**Int. Cl.: 35**

**Prior U.S. Cls.: 100, 101, and 102**

**United States Patent and Trademark Office**

**Reg. No. 3,454,760**

**Registered June 24, 2008**

**SERVICE MARK  
PRINCIPAL REGISTER**

**LET YOUR JOB REVOLVE  
AROUND YOUR LIFE**

AMTRUST BANK (UNITED STATES FEDERAL-  
LY CHARTERED SAVINGS BANK)  
1801 EAST NINTH STREET  
SUITE 200  
CLEVELAND, OH 44114

FOR: PERSONNEL RECRUITING AND EMPLOY-  
EE ENGAGEMENT, NAMELY, EMPLOYMENT AD-  
VERTISING AND PROVIDING A WEB SITE IN THE  
FIELD OF PERSONNEL RECRUITING, IN CLASS 35  
(U.S. CLS. 100, 101 AND 102).

FIRST USE 5-0-2007; IN COMMERCE 5-0-2007.

THE MARK CONSISTS OF STANDARD CHAR-  
ACTERS WITHOUT CLAIM TO ANY PARTICULAR  
FONT, STYLE, SIZE, OR COLOR.

SN 77-118,356, FILED 2-28-2007.

HANNO RITTNER, EXAMINING ATTORNEY



**Int. Cl.: 9**

**Prior U.S. Cls.: 21, 23, 26, 36, and 38**

**Reg. No. 3,454,761**

**United States Patent and Trademark Office**

**Registered June 24, 2008**

**TRADEMARK  
PRINCIPAL REGISTER**

**NOTHING SOUNDS SAFER**

CAVCOM, INC. (MISSOURI CORPORATION)  
P.O. BOX 1455  
WALKER, MN 56484

FIRST USE 2-1-2008; IN COMMERCE 3-1-2008.

FOR: EARPHONE SETS FOR HEARING PROTECTION; EARPHONE COMMUNICATION SYSTEM COMPRISING A TRANSMITTER, A RECEIVER, AND EARPHONES FOR USE IN TRANSMITTING AND RECEIVING OF INFORMATION, IN CLASS 9 (U.S. CLS. 21, 23, 26, 36 AND 38).

THE MARK CONSISTS OF STANDARD CHARACTERS WITHOUT CLAIM TO ANY PARTICULAR FONT, STYLE, SIZE, OR COLOR.

SN 77-118,943, FILED 2-28-2007.

NAAKWAMA ANKRAH, EXAMINING ATTORNEY

Int. Cl.: 29

Prior U.S. Cl.: 46

United States Patent and Trademark Office

Reg. No. 3,454,762

Registered June 24, 2008

TRADEMARK  
PRINCIPAL REGISTER



DISHAKA GOURMET IMPORTS, L.L.C. (TEXAS  
LTD LIAB CO)  
11300 S. SAM HOUSTON PKWY. W.  
HOUSTON, TX 77031

FOR: PROCESSED VEGETABLES AND FRUITS,  
POTATO-BASED SNACK FOODS, IN CLASS 29 (U.S.  
CL. 46).

FIRST USE 3-0-2008; IN COMMERCE 3-0-2008.

OWNER OF U.S. REG. NOS. 2,179,227 AND  
2,255,328.

THE COLOR(S) BLACK, YELLOW, ORANGE,  
RED, WHITE IS/ARE CLAIMED AS A FEATURE  
OF THE MARK.

THE MARK CONSISTS OF AN OVAL IN THE TOP  
RIGHT CORNER WHERE THE COLOR RED AP-

PEARS IN THE STYLIZED WORDING "KITCO"  
AND IN THE OUTLINES OF AN OVAL AROUND  
THE STYLIZED WORDING AND THE COLOR  
YELLOW APPEARS IN THE DESIGN OF AN OVAL  
AROUND THE STYLIZED WORDING, WITH THE  
COLOR WHITE APPEARING IN THE SILHOUETTE  
OF A RABBIT HEAD WITHIN THE LETTER "O",  
DIRECTLY ABOVE THE STYLIZED WORDING  
"STIX" IN THE COLORS YELLOW, WHITE AND  
ORANGE AND SLANTED UPWARD FROM LEFT  
TO RIGHT WITH A STYLIZED BUNNY BEHIND  
THE "S" HOLDING A YELLOW STICK AND HAV-  
ING A YELLOW BODY AND HEAD, BLACK EARS,  
WHISKERS, HAIR, SUNGLASSES AND BOW TIE,  
WITH RED INNER EARS AND SHIRT COLLAR  
OVER A WHITE SHIRT.

SN 77-118,949, FILED 2-28-2007.

NAAKWAMA ANKRAH, EXAMINING ATTORNEY

**Int. Cl.: 3**

**Prior U.S. Cls.: 1, 4, 6, 50, 51, and 52**

**United States Patent and Trademark Office**

**Reg. No. 3,454,763**

**Registered June 24, 2008**

**TRADEMARK  
PRINCIPAL REGISTER**

**MINERAL MATTERS**

PRODUCT QUEST MANUFACTURING, INC.  
(FLORIDA CORPORATION)

330 CARSWELL AVE.

HOLLY HILL, FL 32117

FOR: NON-MEDICATED SKIN CARE PREPARA-  
TIONS, IN CLASS 3 (U.S. CLS. 1, 4, 6, 50, 51 AND 52).

FIRST USE 8-15-2007; IN COMMERCE 8-15-2007.

THE MARK CONSISTS OF STANDARD CHAR-  
ACTERS WITHOUT CLAIM TO ANY PARTICULAR  
FONT, STYLE, SIZE, OR COLOR.

NO CLAIM IS MADE TO THE EXCLUSIVE  
RIGHT TO USE "MINERAL", APART FROM THE  
MARK AS SHOWN.

SN 77-119,546, FILED 3-1-2007.

KIMBERLY PERRY, EXAMINING ATTORNEY

**Int. Cl.: 25**

**Prior U.S. Cls.: 22 and 39**

**United States Patent and Trademark Office**

**Reg. No. 3,454,764**

**Registered June 24, 2008**

**TRADEMARK  
PRINCIPAL REGISTER**

**ROCKSTANCE**

EVANS, DONALD LEE (UNITED STATES INDIVIDUAL)  
1626 WILCOX AVENUE, #117  
HOLLYWOOD, CA 90028

THE MARK CONSISTS OF STANDARD CHARACTERS WITHOUT CLAIM TO ANY PARTICULAR FONT, STYLE, SIZE, OR COLOR.

FOR: CLOTHING, NAMELY, SWEATSHIRTS, T-SHIRTS, JACKETS, HATS AND SWEATPANTS, IN CLASS 25 (U.S. CLS. 22 AND 39).

SN 77-120,312, FILED 3-1-2007.

FIRST USE 10-1-2007; IN COMMERCE 10-1-2007.

JAMES GRIFFIN, EXAMINING ATTORNEY

**Int. Cl.: 41**

**Prior U.S. Cls.: 100, 101, and 107**

**United States Patent and Trademark Office**

**Reg. No. 3,454,765**

**Registered June 24, 2008**

---

**SERVICE MARK  
PRINCIPAL REGISTER**

**WHY DO YOU TRAIN?**

VELOCITY SPORTS PERFORMANCE FRANCHISE SYSTEMS, LLC (GEORGIA LTD LIABILITY CO)  
3666 NORTH PEACHTREE ROAD  
CHAMBLEE, GA 30341

FOR: OPERATING A PHYSICAL FITNESS AND SPORTS PERFORMANCE TRAINING CENTER AND PROVIDING PHYSICAL FITNESS AND SPORTS PERFORMANCE TRAINING , IN CLASS 41 (U.S. CLS. 100, 101 AND 107).

FIRST USE 8-6-2007; IN COMMERCE 8-6-2007.

THE MARK CONSISTS OF STANDARD CHARACTERS WITHOUT CLAIM TO ANY PARTICULAR FONT, STYLE, SIZE, OR COLOR.

SN 77-121,030, FILED 3-2-2007.

JULIE GUTTADAURO, EXAMINING ATTORNEY

**Int. Cls.: 25 and 41**

**Prior U.S. Cls.: 22, 39, 100, 101, and 107**

**United States Patent and Trademark Office**

**Reg. No. 3,454,766**

**Registered June 24, 2008**

**TRADEMARK  
SERVICE MARK  
PRINCIPAL REGISTER**

# TWINSPIRES

CHURCHILL DOWNS INCORPORATED (KENTUCKY CORPORATION)  
700 CENTRAL AVE.  
LOUISVILLE, KY 40208

FOR: HATS; CAPS; HEADWEAR; SHIRTS; T-SHIRTS; SWEATERS; PANTS; OUTERWEAR, NAMELY, JACKETS AND COATS; FLEECEWEAR, NAMELY, SHORTS, PANTS, PULLOVERS AND SWEAT SHIRTS; LOUNGEWEAR; NECKWEAR; NIGHTWEAR; RAINWEAR; BELTS; FOOTWEAR; GLOVES, IN CLASS 25 (U.S. CLS. 22 AND 39).

FIRST USE 3-1-2007; IN COMMERCE 3-1-2007.

FOR: GAMBLING SERVICES; WAGERING SERVICES; GAMBLING AND WAGERING SERVICES PROVIDED VIA A GLOBAL OR OTHER WIDE AREA COMPUTER NETWORK OR VIA TELECOMMUNICATIONS DEVICES, ENTERTAINMENT IN THE NATURE OF CONDUCTING HORSE RACES;

PROVIDING ONLINE ENTERTAINMENT IN THE NATURE OF CONDUCTING HORSE RACES; PROVIDING INFORMATION IN THE FIELD OF ENTERTAINMENT FEATURING HORSE RACES, HORSE RACING AND WAGERING ON HORSE RACES; PROVIDING AN ONLINE COMPUTER DATABASE IN THE FIELD OF ENTERTAINMENT FEATURING HORSE RACING EVENTS AND WAGERING ON HORSE RACING EVENTS, IN CLASS 41 (U.S. CLS. 100, 101 AND 107).

FIRST USE 3-1-2007; IN COMMERCE 3-1-2007.

THE MARK CONSISTS OF STANDARD CHARACTERS WITHOUT CLAIM TO ANY PARTICULAR FONT, STYLE, SIZE, OR COLOR.

SN 77-121,921, FILED 3-5-2007.

THOMAS MANOR, EXAMINING ATTORNEY

**Int. Cls.: 25 and 41**

**Prior U.S. Cls.: 22, 39, 100, 101, and 107**

**Reg. No. 3,454,767**

**United States Patent and Trademark Office**

**Registered June 24, 2008**

**TRADEMARK  
SERVICE MARK  
PRINCIPAL REGISTER**

The logo for 'twinspires' features the word in a bold, lowercase, sans-serif font. Above the 'i' and 's' are two stylized, black silhouettes of horse race towers or spires, each with a small flag on top.

CHURCHILL DOWNS INCORPORATED (KENTUCKY CORPORATION)  
700 CENTRAL AVENUE  
LOUISVILLE, KY 40208

FOR: HATS; CAPS; HEADWEAR; SHIRTS; T-SHIRTS; SWEATERS; PANTS; OUTERWEAR, NAMELY, JACKETS AND COATS; FLEECEWEAR, NAMELY, SHORTS, PANTS, PULLOVERS AND SWEAT SHIRTS; LOUNGEWEAR; NECKWEAR; NIGHTWEAR; RAINWEAR; BELTS; FOOTWEAR; GLOVES, IN CLASS 25 (U.S. CLS. 22 AND 39).

FIRST USE 3-1-2007; IN COMMERCE 3-1-2007.

FOR: GAMBLING SERVICES; WAGERING SERVICES; GAMBLING AND WAGERING SERVICES PROVIDED VIA A GLOBAL OR OTHER WIDE AREA COMPUTER NETWORK OR VIA TELECOM-

MUNICATIONS DEVICES, ENTERTAINMENT IN THE NATURE OF CONDUCTING HORSE RACES; PROVIDING ONLINE ENTERTAINMENT IN THE NATURE OF CONDUCTING HORSE RACES; PROVIDING INFORMATION IN THE FIELD OF ENTERTAINMENT FEATURING HORSE RACES, HORSE RACING AND WAGERING ON HORSE RACES; PROVIDING AN ONLINE COMPUTER DATABASE IN THE FIELD OF ENTERTAINMENT FEATURING HORSE RACING EVENTS AND WAGERING ON HORSE RACING EVENTS, IN CLASS 41 (U.S. CLS. 100, 101 AND 107).

FIRST USE 3-1-2007; IN COMMERCE 3-1-2007.

SN 77-121,932, FILED 3-5-2007.

THOMAS MANOR, EXAMINING ATTORNEY

**Int. Cl.: 5**

**Prior U.S. Cls.: 6, 18, 44, 46, 51, and 52**

**Reg. No. 3,454,768**

**United States Patent and Trademark Office**

**Registered June 24, 2008**

**TRADEMARK  
PRINCIPAL REGISTER**

**REVALESIO**

REVALESIO CORPORATION (DELAWARE CORPORATION)  
5102 20TH STREET E, STE 100  
TACOMA, WA 98424

FOR: EYE DROPS; MEDICATED EYE WETTING SOLUTIONS; SALINE SOLUTION FOR THE EYES FOR MEDICAL PURPOSES; TOPICAL EYE MEDICATIONS; CONTACT LENS WETTING SOLUTIONS; SALINE SOLUTIONS FOR CONTACT LENS USE; SALINE WASH FOR MEDICAL USE, IN CLASS 5 (U.S. CLS. 6, 18, 44, 46, 51 AND 52).

FIRST USE 1-31-2007; IN COMMERCE 1-31-2007.

THE MARK CONSISTS OF STANDARD CHARACTERS WITHOUT CLAIM TO ANY PARTICULAR FONT, STYLE, SIZE, OR COLOR.

SN 77-122,082, FILED 3-5-2007.

BARNEY CHARLON, EXAMINING ATTORNEY



**Int. Cl.: 28**

**Prior U.S. Cls.: 22, 23, 38, and 50**

**United States Patent and Trademark Office**

**Reg. No. 3,454,769**

**Registered June 24, 2008**

**TRADEMARK  
PRINCIPAL REGISTER**

**BOOGILY BUNNIES**

ROCKET USA, INC. (ILLINOIS CORPORATION)  
7775 VAN BUREN STREET  
FOREST PARK, IL 60301

FOR: PLUSH TOYS, IN CLASS 28 (U.S. CLS. 22, 23,  
38 AND 50).

FIRST USE 4-10-2007; IN COMMERCE 9-26-2007.

THE MARK CONSISTS OF STANDARD CHAR-  
ACTERS WITHOUT CLAIM TO ANY PARTICULAR  
FONT, STYLE, SIZE, OR COLOR.

NO CLAIM IS MADE TO THE EXCLUSIVE  
RIGHT TO USE "BUNNIES", APART FROM THE  
MARK AS SHOWN.

SN 77-122,273, FILED 3-5-2007.

JOHN WILKE, EXAMINING ATTORNEY

**Int. Cl.: 14**

**Prior U.S. Cls.: 2, 27, 28, and 50**

**United States Patent and Trademark Office**

**Reg. No. 3,454,770**

**Registered June 24, 2008**

**TRADEMARK  
PRINCIPAL REGISTER**

**M.Y. BEADS MAKE IT YOURS**

TXDC, L.P. (TEXAS LIMITED PARTNERSHIP)  
901 W. WALNUT HILL LANE  
IRVING, TX 75038

THE MARK CONSISTS OF STANDARD CHAR-  
ACTERS WITHOUT CLAIM TO ANY PARTICULAR  
FONT, STYLE, SIZE, OR COLOR.

FOR: JEWELRY, IN CLASS 14 (U.S. CLS. 2, 27, 28  
AND 50).

SN 77-122,577, FILED 3-5-2007.

FIRST USE 3-19-2007; IN COMMERCE 3-19-2007.

MARY CRAWFORD, EXAMINING ATTORNEY

**Int. Cl.: 42**

**Prior U.S. Cls.: 100 and 101**

**United States Patent and Trademark Office**

**Reg. No. 3,454,771**

**Registered June 24, 2008**

**SERVICE MARK  
PRINCIPAL REGISTER**

**ECOSYNERGY**

ECOSYNERGY, INC. (ILLINOIS CORPORATION)  
6499 W. 65TH STREET, UNIT B  
BEDFORD PARK, IL 60638

FOR: TESTING, ANALYSIS AND EVALUATION  
OF THE GOODS AND SERVICES OF OTHERS FOR  
THE PURPOSE OF CERTIFICATION REGARDING  
A PRODUCT'S ENVIRONMENTAL IMPACT, IN  
CLASS 42 (U.S. CLS. 100 AND 101).

FIRST USE 2-1-2007; IN COMMERCE 3-1-2007.

THE MARK CONSISTS OF STANDARD CHAR-  
ACTERS WITHOUT CLAIM TO ANY PARTICULAR  
FONT, STYLE, SIZE, OR COLOR.

SN 77-122,836, FILED 3-6-2007.

ALICIA COLLINS, EXAMINING ATTORNEY

**Int. Cls.: 32 and 33**

**Prior U.S. Cls.: 45, 46, 47, 48, and 49**

**Reg. No. 3,454,772**

**United States Patent and Trademark Office**

**Registered June 24, 2008**

---

**TRADEMARK  
PRINCIPAL REGISTER**

**WHERE GREAT COCKTAILS  
START**

AMERICAN BEVERAGE CORPORATION (DELA-  
WARE CORPORATION)  
ONE DAILY WAY  
VERONA, PA 15147

FOR: NON-ALCOHOLIC COCKTAIL MIXERS, IN  
CLASS 32 (U.S. CLS. 45, 46 AND 48).

FIRST USE 7-0-2007; IN COMMERCE 7-0-2007.

FOR: PREPARED ALCOHOLIC COCKTAILS , IN  
CLASS 33 (U.S. CLS. 47 AND 49).

FIRST USE 4-23-2008; IN COMMERCE 4-23-2008.

THE MARK CONSISTS OF STANDARD CHAR-  
ACTERS WITHOUT CLAIM TO ANY PARTICULAR  
FONT, STYLE, SIZE, OR COLOR.

SN 77-122,959, FILED 3-6-2007.

KRISTIN DAHLING, EXAMINING ATTORNEY

**Int. Cl.: 44**

**Prior U.S. Cls.: 100 and 101**

**United States Patent and Trademark Office**

**Reg. No. 3,454,773**

**Registered June 24, 2008**

**SERVICE MARK  
PRINCIPAL REGISTER**

**T-TOWN TATTOO**

T-TOWN TATTOO, INC. (OKLAHOMA CORPORATION)

7867 E. 71ST STREET

TULSA, OK 74133

FOR: TATTOOING; TATTOO PARLOR SERVICES, IN CLASS 44 (U.S. CLS. 100 AND 101).

FIRST USE 6-0-2007; IN COMMERCE 6-0-2007.

THE MARK CONSISTS OF STANDARD CHARACTERS WITHOUT CLAIM TO ANY PARTICULAR FONT, STYLE, SIZE, OR COLOR.

NO CLAIM IS MADE TO THE EXCLUSIVE RIGHT TO USE "TATTOO", APART FROM THE MARK AS SHOWN.

SN 77-123,078, FILED 3-6-2007.

JEAN IM, EXAMINING ATTORNEY

**Int. Cl.: 6**

**Prior U.S. Cls.: 2, 12, 13, 14, 23, 25, and 50**

**United States Patent and Trademark Office**

**Reg. No. 3,454,774**

**Registered June 24, 2008**

**TRADEMARK  
PRINCIPAL REGISTER**

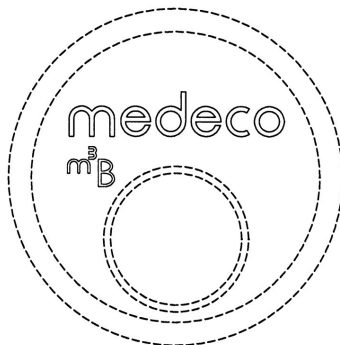

MEDECO SECURITY LOCKS, INC (VIRGINIA CORPORATION)  
PO BOX 3075  
SALEM, VA 24153

FOR: METAL LOCKS AND KEYS THEREFOR, IN CLASS 6 (U.S. CLS. 2, 12, 13, 14, 23, 25 AND 50).

FIRST USE 4-0-2007; IN COMMERCE 4-0-2007.

THE MARK CONSISTS OF THE LITERAL ELEMENT "MEDECO M3B" WITH DOTTED LINES SHOWING THE PLACEMENT OF THE MARK ON THE GOODS.

SN 77-123,100, FILED 3-6-2007.

ANGELA GAW, EXAMINING ATTORNEY

**Int. Cl.: 35**

**Prior U.S. Cls.: 100, 101, and 102**

**United States Patent and Trademark Office**

**Reg. No. 3,454,775**

**Registered June 24, 2008**

**SERVICE MARK  
PRINCIPAL REGISTER**

**OYT**

WORKFORCE STRATEGIES, INC. (MICHIGAN  
CORPORATION)  
3497 S. 9TH STREET  
KALAMAZOO, MI 49009

THE MARK CONSISTS OF STANDARD CHAR-  
ACTERS WITHOUT CLAIM TO ANY PARTICULAR  
FONT, STYLE, SIZE, OR COLOR.

FOR: EMPLOYMENT AGENCY SERVICES, IN  
CLASS 35 (U.S. CLS. 100, 101 AND 102).

SN 77-123,208, FILED 3-6-2007.

FIRST USE 3-11-2007; IN COMMERCE 4-30-2007.

EMILY CARLSEN, EXAMINING ATTORNEY

**Int. Cl.: 35**

**Prior U.S. Cls.: 100, 101, and 102**

**United States Patent and Trademark Office**

**Reg. No. 3,454,776**

**Registered June 24, 2008**

**SERVICE MARK  
PRINCIPAL REGISTER**



BOTTOM LINE RESULTS, LLC (VIRGINIA LTD  
LIAB CO)  
5500 WEST BAY ROAD  
MIDLOTHIAN, VA 231122508

FOR: BUSINESS CONSULTING SERVICES IN  
THE FIELD OF TEXTILES, IN CLASS 35 (U.S. CLS.  
100, 101 AND 102).

FIRST USE 1-3-2007; IN COMMERCE 3-9-2007.

THE COLOR(S) BLACK, WHITE, AND YELLOW  
IS/ARE CLAIMED AS A FEATURE OF THE MARK.

THE MARK CONSISTS OF THE LETTERS "BLR"  
RENDERED ON A BLACK SQUARE WITH A YEL-  
LOW OUTLINE, THE LETTERS "B" AND "L"  
ARE RENDERED IN WHITE, AND THE LETTER "R"  
IS RENDERED IN YELLOW.

SN 77-123,218, FILED 3-6-2007.

EMILY CARLSEN, EXAMINING ATTORNEY



**Int. Cl.: 35**

**Prior U.S. Cls.: 100, 101, and 102**

**United States Patent and Trademark Office**

**Reg. No. 3,454,777**

**Registered June 24, 2008**

**SERVICE MARK  
PRINCIPAL REGISTER**

**ON YOUR TERMS**

WORKFORCE STRATEGIES, INC. (MICHIGAN  
CORPORATION)  
3497 S. 9TH STREET  
KALAMAZOO, MI 49009

THE MARK CONSISTS OF STANDARD CHAR-  
ACTERS WITHOUT CLAIM TO ANY PARTICULAR  
FONT, STYLE, SIZE, OR COLOR.

FOR: EMPLOYMENT AGENCY SERVICES, IN  
CLASS 35 (U.S. CLS. 100, 101 AND 102).

SN 77-123,245, FILED 3-6-2007.

FIRST USE 3-11-2007; IN COMMERCE 4-30-2007.

EMILY CARLSEN, EXAMINING ATTORNEY

**Int. Cl.: 3**

**Prior U.S. Cls.: 1, 4, 6, 50, 51, and 52**

**United States Patent and Trademark Office**

**Reg. No. 3,454,778**

**Registered June 24, 2008**

**TRADEMARK  
PRINCIPAL REGISTER**

**AIR OF CONFIDENCE**

THE DIAL CORPORATION (DELAWARE CORPORATION)  
M.S. 2214  
15501 NORTH DIAL BOULEVARD  
SCOTTSDALE, AZ 852601619

THE MARK CONSISTS OF STANDARD CHARACTERS WITHOUT CLAIM TO ANY PARTICULAR FONT, STYLE, SIZE, OR COLOR.

FOR: BODY SPRAYS, IN CLASS 3 (U.S. CLS. 1, 4, 6, 50, 51 AND 52).

SN 77-123,379, FILED 3-6-2007.

FIRST USE 1-15-2007; IN COMMERCE 1-15-2007.

MARY MUNSON, EXAMINING ATTORNEY

**Int. Cl.: 30**

**Prior U.S. Cl.: 46**

**United States Patent and Trademark Office**

**Reg. No. 3,454,779**

**Registered June 24, 2008**

**TRADEMARK  
PRINCIPAL REGISTER**

**CLUST-R-BERRIES**

CEREAL INGREDIENTS, INC. (DELAWARE  
CORPORATION)  
4720 SOUTH 13TH STREET  
LEAVENWORTH, KS 66048

THE MARK CONSISTS OF STANDARD CHAR-  
ACTERS WITHOUT CLAIM TO ANY PARTICULAR  
FONT, STYLE, SIZE, OR COLOR.

FOR: WHOLE GRAIN, CEREAL-BASED FOOD  
PARTICLES USED AS AN INGREDIENT FOR COM-  
MERCIAL FOOD PRODUCTS, IN CLASS 30 (U.S. CL.  
46).

SN 77-123,475, FILED 3-6-2007.

FIRST USE 2-27-2008; IN COMMERCE 2-27-2008.

HAI-LY LAM, EXAMINING ATTORNEY

**Int. Cl.: 18**

**Prior U.S. Cls.: 1, 2, 3, 22, and 41**

**United States Patent and Trademark Office**

**Reg. No. 3,454,780**

**Registered June 24, 2008**

**TRADEMARK  
PRINCIPAL REGISTER**

**Cool Baby Make-up Bags**

BURNETT, JOYCE (UNITED STATES INDIVIDUAL)  
25222 DARLINGTON  
MISSION VIEJO, CA 92692

FOR: ALL-PURPOSE CARRYING BAGS; MAKE-UP BAGS SOLD EMPTY, IN CLASS 18 (U.S. CLS. 1, 2, 3, 22 AND 41).

FIRST USE 4-1-2008; IN COMMERCE 4-1-2008.

THE MARK CONSISTS OF STANDARD CHARACTERS WITHOUT CLAIM TO ANY PARTICULAR FONT, STYLE, SIZE, OR COLOR.

NO CLAIM IS MADE TO THE EXCLUSIVE RIGHT TO USE "MAKE-UP BAGS", APART FROM THE MARK AS SHOWN.

SN 77-123,735, FILED 3-6-2007.

RICHARD A. STRASER, EXAMINING ATTORNEY

**Int. Cl.: 25**

**Prior U.S. Cls.: 22 and 39**

**United States Patent and Trademark Office**

**Reg. No. 3,454,781**

**Registered June 24, 2008**

**TRADEMARK  
PRINCIPAL REGISTER**

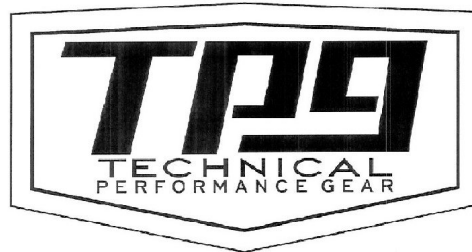

TUCKER-ROCKY CORPORATION, INC. (DELA-  
WARE CORPORATION)  
SUITE 202  
103 FOULK ROAD  
WILMINGTON, DE 19803

NO CLAIM IS MADE TO THE EXCLUSIVE  
RIGHT TO USE "TECHNICAL PERFORMANCE  
GEAR", APART FROM THE MARK AS SHOWN.

FOR: CLOTHING, NAMELY, PANTS, JACKETS  
AND SHIRTS, IN CLASS 25 (U.S. CLS. 22 AND 39).

SN 77-123,926, FILED 3-6-2007.

FIRST USE 8-7-2007; IN COMMERCE 8-7-2007.

JAMES LOVELACE, EXAMINING ATTORNEY

**Int. Cl.: 36**

**Prior U.S. Cls.: 100, 101, and 102**

**United States Patent and Trademark Office**

**Reg. No. 3,454,782**

**Registered June 24, 2008**

**SERVICE MARK  
PRINCIPAL REGISTER**

**MARQUIS BANK**

JEFFREY PERLOW (UNITED STATES INDIVIDUAL)  
SUITE 100  
18901 N.E. 29TH AVE  
AVENTURA, FL 33180

FOR: BANKING; SAVINGS BANK SERVICES, IN CLASS 36 (U.S. CLS. 100, 101 AND 102).

FIRST USE 1-1-2008; IN COMMERCE 1-1-2008.

THE MARK CONSISTS OF STANDARD CHARACTERS WITHOUT CLAIM TO ANY PARTICULAR FONT, STYLE, SIZE, OR COLOR.

NO CLAIM IS MADE TO THE EXCLUSIVE RIGHT TO USE "BANK", APART FROM THE MARK AS SHOWN.

SN 77-124,038, FILED 3-7-2007.

LINDA MICKLEBURGH, EXAMINING ATTORNEY

**Int. Cl.: 43**

**Prior U.S. Cls.: 100 and 101**

**United States Patent and Trademark Office**

**Reg. No. 3,454,783**

**Registered June 24, 2008**

**SERVICE MARK  
PRINCIPAL REGISTER**

**SWEET GREEN**

GREENS MANAGEMENT, LLC (DELAWARE  
LTD LIAB CO)  
3333 M STREET, NW  
WASHINGTON, DC 20007

THE MARK CONSISTS OF STANDARD CHAR-  
ACTERS WITHOUT CLAIM TO ANY PARTICULAR  
FONT, STYLE, SIZE, OR COLOR.

FOR: RESTAURANT SERVICES AND CATERING  
SERVICES, IN CLASS 43 (U.S. CLS. 100 AND 101).

SN 77-124,231, FILED 3-7-2007.

FIRST USE 8-1-2007; IN COMMERCE 8-1-2007.

SANDRA MANIOS, EXAMINING ATTORNEY

**Int. Cl.: 30**

**Prior U.S. Cl.: 46**

**United States Patent and Trademark Office**

**Reg. No. 3,454,784**

**Registered June 24, 2008**

**TRADEMARK  
PRINCIPAL REGISTER**



GRUMA CORPORATION (NEVADA CORPORATION)  
SUITE 200  
1159 COTTONWOOD LANE  
IRVING, TX 75038

THE MARK CONSISTS OF A MEXICAN MAN  
AND WOMAN.

SN 77-124,270, FILED 3-7-2007.

FOR: TORTILLAS, IN CLASS 30 (U.S. CL. 46).

FIRST USE 2-0-2008; IN COMMERCE 2-0-2008.

HOWARD B. LEVINE, EXAMINING ATTORNEY



**Int. Cl.: 38**

**Prior U.S. Cls.: 100, 101, and 104**

**United States Patent and Trademark Office**

**Reg. No. 3,454,785**

**Registered June 24, 2008**

**SERVICE MARK  
PRINCIPAL REGISTER**

**GOODRADIO.TV**

GOODMAN, DEAN (UNITED STATES INDIVIDUAL)  
525 S. FLAGLER DR. 21-A  
W. PALM BEACH, FL 33401

FOR: TELEVISION AND RADIO BROADCASTING SERVICES; AUDIO BROADCASTING; CABLE RADIO BROADCASTING; CABLE TELEVISION BROADCASTING; SATELLITE RADIO BROADCASTING; SATELLITE TELEVISION BROADCASTING; RADIO BROADCASTING VIA A GLOBAL COMPUTER NETWORK; TELEVISION BROAD-

CASTING VIA A GLOBAL COMPUTER NETWORK, IN CLASS 38 (U.S. CLS. 100, 101 AND 104).

FIRST USE 4-22-2008; IN COMMERCE 4-22-2008.

THE MARK CONSISTS OF STANDARD CHARACTERS WITHOUT CLAIM TO ANY PARTICULAR FONT, STYLE, SIZE, OR COLOR.

SN 77-125,227, FILED 3-8-2007.

PAULA MAHONEY, EXAMINING ATTORNEY

**Int. Cl.: 32**

**Prior U.S. Cls.: 45, 46, and 48**

**Reg. No. 3,454,786**

**United States Patent and Trademark Office**

**Registered June 24, 2008**

---

**TRADEMARK  
PRINCIPAL REGISTER**

**E-BLAST**

TURKEY HILL, L.P. (PENNSYLVANIA LIMITED  
PARTNERSHIP)  
2601 RIVER ROAD  
CONESTOGA, PA 17516

THE MARK CONSISTS OF STANDARD CHAR-  
ACTERS WITHOUT CLAIM TO ANY PARTICULAR  
FONT, STYLE, SIZE, OR COLOR.

FOR: ENERGY DRINKS, IN CLASS 32 (U.S. CLS.  
45, 46 AND 48).

SN 77-125,603, FILED 3-8-2007.

FIRST USE 1-1-2008; IN COMMERCE 1-1-2008.

KELLY BOULTON, EXAMINING ATTORNEY

**Int. Cl.: 44**

**Prior U.S. Cls.: 100 and 101**

**United States Patent and Trademark Office**

**Reg. No. 3,454,787**

**Registered June 24, 2008**

**SERVICE MARK  
PRINCIPAL REGISTER**

**EXPERIENCE THE MAGIC OF  
GARDENING!**

OMS INVESTMENTS, INC. (DELAWARE CORPORATION)  
10250 CONSTELLATION BLVD., SUITE 2800  
LOS ANGELES, CA 90067

FOR: PROVIDING ADVICE AND INFORMATION ON THE SUBJECTS OF LANDSCAPE AND CONTAINER GARDENING AND THE USE OF PRODUCTS RELATING TO LANDSCAPE AND CONTAINER GARDENING, INCLUDING PLANT FOODS, FERTILIZERS, PESTICIDES, FLOWER AND GARDEN SEEDS, POTTING SOIL, SOIL CONDITIONERS AND AMENDMENTS, MULCHES, AND LAWN AND GARDEN EQUIPMENT VIA PRINT, ADVERTISING, AND THE INTERNET; PROVIDING IN-STORE CONSULTING SERVICES ON THE SUBJECTS OF LANDSCAPE AND CONTAINER GARDENING AND THE USE OF PRO-

DUCTS RELATING TO LANDSCAPE AND CONTAINER GARDENING, INCLUDING PLANT FOODS, FERTILIZERS, PESTICIDES, FLOWER AND GARDEN SEEDS, POTTING SOIL, SOIL CONDITIONERS AND AMENDMENTS, MULCHES, AND LAWN AND GARDEN EQUIPMENT, IN CLASS 44 (U.S. CLS. 100 AND 101).

FIRST USE 4-1-2007; IN COMMERCE 4-1-2007.

THE MARK CONSISTS OF STANDARD CHARACTERS WITHOUT CLAIM TO ANY PARTICULAR FONT, STYLE, SIZE, OR COLOR.

SN 77-125,619, FILED 3-8-2007.

JOHN WILKE, EXAMINING ATTORNEY

**Int. Cl.: 12**

**Prior U.S. Cls.: 19, 21, 23, 31, 35, and 44**

**United States Patent and Trademark Office**

**Reg. No. 3,454,788**

**Registered June 24, 2008**

**TRADEMARK  
PRINCIPAL REGISTER**



**OPTIMA  
flex**

DOGA, S.A. (SPAIN JOINT STOCK COMPANY)  
AUTOVIA A-2, KM. 583  
08630-ABRERA(BARCELONA, SPAIN)

FIRST USE 9-21-2007; IN COMMERCE 9-21-2007.

SN 77-125,899, FILED 3-8-2007.

FOR: WINDSHIELD WIPER BLADES FOR VEHICLES, IN CLASS 12 (U.S. CLS. 19, 21, 23, 31, 35 AND 44).

MICHAEL TANNER, EXAMINING ATTORNEY

**Int. Cl.: 25**

**Prior U.S. Cls.: 22 and 39**

**United States Patent and Trademark Office**

**Reg. No. 3,454,789**

**Registered June 24, 2008**

**TRADEMARK  
PRINCIPAL REGISTER**

**SPIRITUAL WHIMSY**

SPIRITUAL WHIMSY, LLC (ARIZONA LTD LIAB  
CO)  
SUITE 1630-511  
21001 N. TATUM BLVD.  
PHOENIX, AZ 85050

FOR: ACTIVE WEAR, NAMELY, SHIRTS, T-  
SHIRTS, SWEATSHIRTS, SOCKS AND HATS, IN  
CLASS 25 (U.S. CLS. 22 AND 39).

FIRST USE 2-28-2007; IN COMMERCE 7-13-2007.

THE MARK CONSISTS OF STANDARD CHAR-  
ACTERS WITHOUT CLAIM TO ANY PARTICULAR  
FONT, STYLE, SIZE, OR COLOR.

SN 77-126,828, FILED 3-9-2007.

TRACY WHITTAKER-BROWN, EXAMINING AT-  
TORNEY

**Int. Cl.: 9**

**Prior U.S. Cls.: 21, 23, 26, 36, and 38**

**Reg. No. 3,454,790**

**United States Patent and Trademark Office**

**Registered June 24, 2008**

---

**TRADEMARK  
PRINCIPAL REGISTER**

**Abra Academy**

BIG FISH GAMES, INC. (WASHINGTON COR-  
PORATION)  
SUITE 800  
1501 4TH AVE  
SEATTLE, WA 98101

THE MARK CONSISTS OF STANDARD CHAR-  
ACTERS WITHOUT CLAIM TO ANY PARTICULAR  
FONT, STYLE, SIZE, OR COLOR.

FOR: ELECTRONIC GAME PROGRAMS, IN  
CLASS 9 (U.S. CLS. 21, 23, 26, 36 AND 38).

SN 77-126,978, FILED 3-9-2007.

FIRST USE 3-16-2007; IN COMMERCE 3-16-2007.

MARY CRAWFORD, EXAMINING ATTORNEY

**Int. Cl.: 36**

**Prior U.S. Cls.: 100, 101, and 102**

**United States Patent and Trademark Office**

**Reg. No. 3,454,791**

**Registered June 24, 2008**

**SERVICE MARK  
PRINCIPAL REGISTER**

# Envisioned Wealth

SOURCE ONE FINANCIAL (CALIFORNIA CORPORATION)  
717 16TH STREET, #2  
MODESTO, CA 95356

FOR: FINANCIAL PLANNING, NAMELY, THE CREATION OF PERSONALIZED STRATEGIES TO ACHIEVE FINANCIAL INDEPENDENCE, IN CLASS 36 (U.S. CLS. 100, 101 AND 102).

FIRST USE 7-6-2007; IN COMMERCE 7-6-2007.

THE MARK CONSISTS OF STANDARD CHARACTERS WITHOUT CLAIM TO ANY PARTICULAR FONT, STYLE, SIZE, OR COLOR.

NO CLAIM IS MADE TO THE EXCLUSIVE RIGHT TO USE "WEALTH", APART FROM THE MARK AS SHOWN.

SN 77-128,272, FILED 3-12-2007.

ALICIA COLLINS, EXAMINING ATTORNEY

**Int. Cl.: 20**

**Prior U.S. Cls.: 2, 13, 22, 25, 32, and 50**

**Reg. No. 3,454,792**

**United States Patent and Trademark Office**

**Registered June 24, 2008**

---

**TRADEMARK  
PRINCIPAL REGISTER**

**SLEEP MASTER**

ZINUS INC. (CALIFORNIA CORPORATION)  
7068 KOLL CENTER PARKWAY, SUITE 425  
PLEASANTON, CA 94566

THE MARK CONSISTS OF STANDARD CHAR-  
ACTERS WITHOUT CLAIM TO ANY PARTICULAR  
FONT, STYLE, SIZE, OR COLOR.

FOR: SLEEP PRODUCTS, NAMELY, MATTRES-  
SES, SPRING MATTRESSES, BOX SPRINGS AND  
MATTRESS FOUNDATIONS, IN CLASS 20 (U.S. CLS.  
2, 13, 22, 25, 32 AND 50).

SN 77-128,398, FILED 3-12-2007.

FIRST USE 4-30-2007; IN COMMERCE 4-30-2007.

BERNICE MIDDLETON, EXAMINING ATTORNEY



**Int. Cl.: 37**

**Prior U.S. Cls.: 100, 103, and 106**

**United States Patent and Trademark Office**

**Reg. No. 3,454,793**

**Registered June 24, 2008**

**SERVICE MARK  
PRINCIPAL REGISTER**

**MAINBRAIN**

MAINBRAIN, LLC (MARYLAND LTD LIAB CO)  
1105 BELLE VISTA COURT  
SEVERNA PARK, MD 21146

THE MARK CONSISTS OF STANDARD CHAR-  
ACTERS WITHOUT CLAIM TO ANY PARTICULAR  
FONT, STYLE, SIZE, OR COLOR.

FOR: MAINTENANCE AND REPAIR OF COM-  
PUTER HARDWARE; MAINTENANCE AND RE-  
PAIR OF COMPUTER NETWORKS, IN CLASS 37  
(U.S. CLS. 100, 103 AND 106).

SN 77-128,495, FILED 3-12-2007.

FIRST USE 6-15-2007; IN COMMERCE 6-15-2007.

KEVIN CORWIN, EXAMINING ATTORNEY

Int. Cls.: 30 and 35

Prior U.S. Cls.: 46, 100, 101, and 102

United States Patent and Trademark Office

Reg. No. 3,454,794

Registered June 24, 2008

TRADEMARK  
SERVICE MARK  
PRINCIPAL REGISTER



MILLER, STUART M. (OREGON SOLE PROPRIETORSHIP)  
300 S MAIN ST.  
TOLRDO, OR 97391

FOR: BARBECUE DRY RUB; BARBECUE SAUCE; SAUCES FOR BARBECUED MEAT, IN CLASS 30 (U.S. CL. 46).

FIRST USE 7-26-2007; IN COMMERCE 7-26-2007.

FOR: CONCESSION STANDS FEATURING BARBECUE FOODS AND CHICKEN WINGS; COMPUTERIZED ON-LINE ORDERING FEATURING GENERAL MERCHANDISE AND GENERAL CONSUMER GOODS; COMPUTERIZED ON-LINE ORDERING SERVICES IN THE FIELD OF BBQ SAUCES, RUBS, WING SAUCES, APPAREL; COMPUTERIZED ON-LINE RETAIL STORE SERVICES IN THE FIELD OF BBQ SAUCES, RUBS, WING SAUCES, APPAREL, IN CLASS 35 (U.S. CLS. 100, 101 AND 102).

FIRST USE 8-5-2007; IN COMMERCE 8-5-2007.

THE COLOR(S) RED, YELLOW, WHITE, BLACK AND PEACH IS/ARE CLAIMED AS A FEATURE OF THE MARK.

THE MARK CONSISTS OF A PEACH COLORED PIG WITH WHITE WINGS WEARING BLACK SUN GLASSES FLYING THROUGH A RED CIRCLE; THE WORDING APPEARS YELLOW WITH A BLACK OUTLINE; THE PIG HAS A TATTOO ON HIS SHOULDER CONSISTING OF A RED HEART, OUTLINED IN BLACK WITH A YELLOW BANNER; THE BACKGROUND OF THE MARK IS WHITE.

SN 77-128,920, FILED 3-12-2007.

JOHN WILKE, EXAMINING ATTORNEY

**Int. Cl.: 41**

**Prior U.S. Cls.: 100, 101, and 107**

**United States Patent and Trademark Office**

**Reg. No. 3,454,795**

**Registered June 24, 2008**

**SERVICE MARK  
PRINCIPAL REGISTER**

**GIRLS GIRLS GIRLS**

ORSINI, PATRICIA (UNITED STATES INDIVIDUAL)  
#2002  
50 MURRAY STREET  
NEW YORK, NY 10007

FOR: ENTERTAINMENT IN THE NATURE OF VISUAL AND AUDIO PERFORMANCES, NAMELY, MUSICAL BAND, ROCK GROUP, GYMNASTIC, DANCE, AND BALLET PERFORMANCES; ENTERTAINMENT, NAMELY, LIVE PERFORMANCES BY A MUSICAL BAND; ENTERTAINMENT SERVICES, NAMELY, AN ONLINE ACTIVITY WHERE YOU CREATE YOUR OWN MUSIC VIDEOS; ENTERTAINMENT SERVICES, NAMELY, PROVIDING A WEB SITE FEATURING MUSICAL PERFORMANCES, MUSICAL VIDEOS, RELATED FILM CLIPS, PHOTOGRAPHS, AND OTHER MULTIMEDIA MATERIALS; ENTERTAINMENT IN THE NATURE OF MUSICAL GROUP; ENTERTAINMENT SERVICES, NAMELY, PRESENTING NON-DOWNLOADABLE

RINGTONES, PRE-RECORDED MUSIC, VIDEO AND GRAPHICS TO MOBILE COMMUNICATIONS DEVICES VIA A GLOBAL COMPUTER NETWORK AND WIRELESS NETWORKS, IN CLASS 41 (U.S. CLS. 100, 101 AND 107).

FIRST USE 4-21-2007; IN COMMERCE 4-21-2007.

THE MARK CONSISTS OF STANDARD CHARACTERS WITHOUT CLAIM TO ANY PARTICULAR FONT, STYLE, SIZE, OR COLOR.

NO CLAIM IS MADE TO THE EXCLUSIVE RIGHT TO USE "GIRLS", APART FROM THE MARK AS SHOWN.

SN 77-129,068, FILED 3-12-2007.

DOMINIC J. FERRAIUOLO, EXAMINING ATTORNEY

**Int. Cl.: 16**

**Prior U.S. Cls.: 2, 5, 22, 23, 29, 37, 38, and 50**

**United States Patent and Trademark Office**

**Reg. No. 3,454,796**

**Registered June 24, 2008**

**TRADEMARK  
PRINCIPAL REGISTER**

**IRATIONS**

CUSTOM INK & ART (NEW YORK PARTNER-  
SHIP)  
15 MERIDIAN DRIVE  
BREWSTER, NY 10509

THE MARK CONSISTS OF STANDARD CHAR-  
ACTERS WITHOUT CLAIM TO ANY PARTICULAR  
FONT, STYLE, SIZE, OR COLOR.

FOR: COMIC STRIPS APPEARING IN PERIOD-  
ICALS AND BOOKS, IN CLASS 16 (U.S. CLS. 2, 5, 22,  
23, 29, 37, 38 AND 50).

SN 77-129,406, FILED 3-13-2007.

FIRST USE 1-16-2008; IN COMMERCE 1-16-2008.

ALICIA COLLINS, EXAMINING ATTORNEY

**Int. Cl.: 3**

**Prior U.S. Cls.: 1, 4, 6, 50, 51, and 52**

**Reg. No. 3,454,797**

**United States Patent and Trademark Office**

**Registered June 24, 2008**

**TRADEMARK  
PRINCIPAL REGISTER**

**KIM VO**

SYLMARK HOLDINGS LIMITED (IRELAND  
CORPORATION)  
17 EARLSFORT TERRACE  
DUBLIN 2, IRELAND

FOR: HAIR CARE KITS COMPRISING NON-  
MEDICATED HAIR CARE PREPARATIONS,  
NAMELY, HAIR SHAMPOOS, HAIR CONDITION-  
ERS, HAIR LOTIONS, HAIR CREAMS, HAIR  
SPRAYS AND HAIR GELS, IN CLASS 3 (U.S. CLS.  
1, 4, 6, 50, 51 AND 52).

FIRST USE 11-15-2007; IN COMMERCE 11-15-2007.

THE MARK CONSISTS OF STANDARD CHAR-  
ACTERS WITHOUT CLAIM TO ANY PARTICULAR  
FONT, STYLE, SIZE, OR COLOR.

OWNER OF U.S. REG. NO. 3,128,058.

THE NAME SHOWN IN THE MARK IDENTIFIES  
A PARTICULAR LIVING INDIVIDUAL, WHOSE  
CONSENT(S) TO REGISTER IS SUBMITTED.

SN 77-130,000, FILED 3-13-2007.

AMY HELLA, EXAMINING ATTORNEY

**Int. Cl.: 35**

**Prior U.S. Cls.: 100, 101, and 102**

**United States Patent and Trademark Office**

**Reg. No. 3,454,798**

**Registered June 24, 2008**

**SERVICE MARK  
PRINCIPAL REGISTER**



DEROSE INVESTMENTS, LLC (FLORIDA LTD  
LIAB CO)  
1950 SPECTRUM CIRCLE, SUITE 400  
MARIETTA, GA 30067

FOR: WHOLESALE DISTRIBUTORSHIP FEATURING WINE MAKING SUPPLIES AND GIFT ITEMS, IN CLASS 35 (U.S. CLS. 100, 101 AND 102).

FIRST USE 2-19-2004; IN COMMERCE 2-19-2004.

NO CLAIM IS MADE TO THE EXCLUSIVE RIGHT TO USE "AMERICAN WINEMAKING SUP-

PLIES & GIFTWARE", APART FROM THE MARK AS SHOWN.

THE MARK CONSISTS OF THE DESIGN OF AN "A" PARTIALLY MADE BY A STAR TO THE SIDE OF THE WORDING "AMERICAN WINEMAKING" ABOVE THE WORDING "SUPPLIES & GIFTWARE".

SN 77-130,226, FILED 3-13-2007.

JOHN SCHUYLER YARD, EXAMINING ATTORNEY

**Int. Cl.: 35**

**Prior U.S. Cls.: 100, 101, and 102**

**United States Patent and Trademark Office**

**Reg. No. 3,454,799**

**Registered June 24, 2008**

**SERVICE MARK  
PRINCIPAL REGISTER**

YOUR WORDS ARE IMPORTANT

D.C. JACOBSON & ASSOCIATES LLC (OREGON  
LTD LIAB CO)  
601 N. LARCH ST.  
SISTERS, OR 97759

THE MARK CONSISTS OF STANDARD CHAR-  
ACTERS WITHOUT CLAIM TO ANY PARTICULAR  
FONT, STYLE, SIZE, OR COLOR.

FOR: LITERARY AGENCY SERVICES, IN CLASS  
35 (U.S. CLS. 100, 101 AND 102).

SN 77-130,273, FILED 3-13-2007.

FIRST USE 5-18-2007; IN COMMERCE 5-18-2007.

JULIE GUTTADAURO, EXAMINING ATTORNEY

**Int. Cl.: 4**

**Prior U.S. Cls.: 1, 6, and 15**

**United States Patent and Trademark Office**

**Reg. No. 3,454,800**

**Registered June 24, 2008**

**TRADEMARK  
PRINCIPAL REGISTER**



PAPPATERRA, GABRIEL E. (UNITED STATES  
INDIVIDUAL)  
40 LYNBROOK DRIVE  
SOUND BEACH, NY 11789

FIRST USE 4-15-2008; IN COMMERCE 4-15-2008.

SN 77-130,800, FILED 3-14-2007.

FOR: LUBRICANTS FOR AUTOMOBILES, IN  
CLASS 4 (U.S. CLS. 1, 6 AND 15).

MIDGE BUTLER, EXAMINING ATTORNEY



Int. Cls.: 30 and 43

Prior U.S. Cls.: 46, 100, and 101

United States Patent and Trademark Office

Reg. No. 3,454,801

Registered June 24, 2008

TRADEMARK  
SERVICE MARK  
PRINCIPAL REGISTER



ZÜ COFFEE (MARYLAND LTD LIAB CO)  
2016 QUAY VILLAGE CT. #T2  
ANNAPOLIS, MD 21403

FOR: ROASTED COFFEE BEANS, IN CLASS 30  
(U.S. CL. 46).

FIRST USE 3-16-2007; IN COMMERCE 3-16-2007.

FOR: COFFEE SHOPS, IN CLASS 43 (U.S. CLS. 100  
AND 101).

FIRST USE 3-16-2007; IN COMMERCE 3-16-2007.

NO CLAIM IS MADE TO THE EXCLUSIVE  
RIGHT TO USE "COFFEE", APART FROM THE  
MARK AS SHOWN.

THE COLOR(S) BLACK, WHITE, VIOLET AND  
ORANGE IS/ARE CLAIMED AS A FEATURE OF  
THE MARK.

THE MARK CONSISTS OF A BLACK "ZÜ" (OUT-  
LINED BY WHITE), IN FRONT OF A ORANGE  
OVAL (OUTLINED BY BLACK), WHICH IS IN  
FRONT OF A LARGER VIOLET OVAL (OUTLINED  
BY BLACK). THE WORD "COFFEE" IN ORANGE  
AND OUTLINED BY BLACK IS CURVED IN THE  
LOWER PORTION OF THE PURPLE OVAL.

SN 77-131,452, FILED 3-14-2007.

STEVEN JACKSON, EXAMINING ATTORNEY

**Int. Cl.: 16**

**Prior U.S. Cls.: 2, 5, 22, 23, 29, 37, 38, and 50**

**Reg. No. 3,454,802**

**United States Patent and Trademark Office**

**Registered June 24, 2008**

**TRADEMARK  
PRINCIPAL REGISTER**

**WROX PROGRAMMER TO  
PROGRAMMER**

WILEY PUBLISHING, INC. (DELAWARE CORPORATION)  
10475 CROSSPOINT BLVD.  
INDIANAPOLIS, IN 46256 AND  
WILEY PUBLISHING, INC. (DELAWARE CORPORATION)  
10475 CROSSPOINT BLVD.  
INDIANAPOLIS, IN 46256

FOR: STATIONERY; BOOKS, MAGAZINES AND PERIODICALS, BROCHURES, FLY-SHEETS, LEAFLETS, CATALOGUES AND NEWSLETTERS, PRINTED INSTRUCTIONAL AND EDUCATIONAL AND TEACHING MATERIALS, ALL IN THE FIELD OF COMPUTERS AND COMPUTER PROGRAMMING, ELECTRONICS, BROADCASTING AND THE IN-

TERNET, IN CLASS 16 (U.S. CLS. 2, 5, 22, 23, 29, 37, 38 AND 50).

FIRST USE 1-1-2008; IN COMMERCE 1-1-2008.

THE MARK CONSISTS OF STANDARD CHARACTERS WITHOUT CLAIM TO ANY PARTICULAR FONT, STYLE, SIZE, OR COLOR.

OWNER OF U.S. REG. NO. 2,468,822.

SN 77-131,582, FILED 3-15-2007.

AISHA CLARKE, EXAMINING ATTORNEY

**Int. Cl.: 36**

**Prior U.S. Cls.: 100, 101, and 102**

**United States Patent and Trademark Office**

**Reg. No. 3,454,803**

**Registered June 24, 2008**

**SERVICE MARK  
PRINCIPAL REGISTER**

**CFRA ACCOUNTING LENS**

CENTER FOR FINANCIAL RESEARCH & ANALYSIS LLC (DELAWARE LTD LIAB CO)  
2099 GAITHER ROAD  
ROCKVILLE, MD 20850

FOR: FINANCIAL RESEARCH AND ANALYSIS OF CURRENT ISSUES AND EVENTS AFFECTING THE FIELD OF FINANCE AND ACCOUNTING TO ASSIST INVESTORS AND FINANCIAL INSTITUTIONS IN ASSESSING FINANCIAL AND REGULATORY RISK, IN CLASS 36 (U.S. CLS. 100, 101 AND 102).

FIRST USE 3-31-2007; IN COMMERCE 3-31-2007.

THE MARK CONSISTS OF STANDARD CHARACTERS WITHOUT CLAIM TO ANY PARTICULAR FONT, STYLE, SIZE, OR COLOR.

NO CLAIM IS MADE TO THE EXCLUSIVE RIGHT TO USE "ACCOUNTING", APART FROM THE MARK AS SHOWN.

SN 77-131,842, FILED 3-15-2007.

REBECCA POVARCHUK, EXAMINING ATTORNEY

**Int. Cls.: 35 and 42**

**Prior U.S. Cls.: 100, 101, and 102**

**United States Patent and Trademark Office**

**Reg. No. 3,454,804**

**Registered June 24, 2008**

**SERVICE MARK  
PRINCIPAL REGISTER**

**FIND.GET.KEEP**

TRUEPRESENCE, L.L.C. (MARYLAND LTD  
LIAB CO)  
SUITE 1000  
10 E. BALTIMORE ST.  
BALTIMORE, MD 21202

FOR: BUSINESS MARKETING CONSULTING  
SERVICES; MARKET RESEARCH CONSULTA-  
TION; ON-LINE ADVERTISING AND MARKETING  
SERVICES, IN CLASS 35 (U.S. CLS. 100, 101 AND 102).

FIRST USE 5-1-2007; IN COMMERCE 5-1-2007.

FOR: PROVIDING TEMPORARY USE OF ON-  
LINE NON-DOWNLOADABLE SOFTWARE FOR  
THE AUTOMATED HOSTING OF WEB SITES, FOR  
ENABLING USERS TO OPERATE ECOMMERCE

WEBSITES, AND FOR DESIGNING, DEPLOYING,  
MANAGING AND TRACKING E-MAIL AND  
SEARCH ENGINE MARKETING CAMPAIGNS; DE-  
SIGN, CREATION, HOSTING AND MAINTENANCE  
OF INTERNET SITES FOR THIRD PARTIES, IN  
CLASS 42 (U.S. CLS. 100 AND 101).

FIRST USE 5-1-2007; IN COMMERCE 5-1-2007.

THE MARK CONSISTS OF STANDARD CHAR-  
ACTERS WITHOUT CLAIM TO ANY PARTICULAR  
FONT, STYLE, SIZE, OR COLOR.

SN 77-132,747, FILED 3-16-2007.

PAUL E. FAHRENKOPF, EXAMINING ATTORNEY

**Int. Cls.: 36 and 45**

**Prior U.S. Cls.: 100, 101, and 102**

**United States Patent and Trademark Office**

**Reg. No. 3,454,805**

**Registered June 24, 2008**

**SERVICE MARK  
PRINCIPAL REGISTER**

# INSTISERVICES

I.C. SYSTEM, INC. (MINNESOTA CORPORATION)  
444 EAST HIGHWAY 96  
VADNAIS HEIGHTS, MN 55110

FOR: COLLECTION AGENCY SERVICES; CREDIT REPORTING SERVICES; EVALUATION OF THE CREDIT WORTHINESS OF PRIVATE COMPANIES AND INDIVIDUALS, IN CLASS 36 (U.S. CLS. 100, 101 AND 102).

FIRST USE 3-5-2007; IN COMMERCE 3-5-2007.

FOR: SKIP TRACING SERVICES; BACKGROUND INVESTIGATION AND RESEARCH SERVICES VIA

A GLOBAL COMPUTER NETWORK, IN CLASS 45 (U.S. CLS. 100 AND 101).

FIRST USE 3-5-2007; IN COMMERCE 3-5-2007.

THE MARK CONSISTS OF STANDARD CHARACTERS WITHOUT CLAIM TO ANY PARTICULAR FONT, STYLE, SIZE, OR COLOR.

OWNER OF U.S. REG. NO. 1,398,840.

SN 77-132,820, FILED 3-16-2007.

PAM WILLIS, EXAMINING ATTORNEY

**Int. Cl.: 44**

**Prior U.S. Cls.: 100 and 101**

**United States Patent and Trademark Office**

**Reg. No. 3,454,806**

**Registered June 24, 2008**

**SERVICE MARK  
PRINCIPAL REGISTER**

**GyneSpa**

KENT, DOLORES R. (UNITED STATES INDIVIDUAL)  
9201 SUNSET BLVD SUITE #416  
LOS ANGELES, CA 90265

FOR: OBSTETRIC AND GYNECOLOGY SERVICES; HEALTH SPA SERVICES, NAMELY, COSMETIC BODY CARE SERVICES; COSMETIC AND PLASTIC SURGERY, IN CLASS 44 (U.S. CLS. 100 AND 101).

FIRST USE 10-1-2007; IN COMMERCE 11-1-2007.

THE MARK CONSISTS OF STANDARD CHARACTERS WITHOUT CLAIM TO ANY PARTICULAR FONT, STYLE, SIZE, OR COLOR.

SN 77-133,063, FILED 3-16-2007.

LYDIA BELZER, EXAMINING ATTORNEY

**Int. Cl.: 28**

**Prior U.S. Cls.: 22, 23, 38, and 50**

**Reg. No. 3,454,807**

**United States Patent and Trademark Office**

**Registered June 24, 2008**

---

**TRADEMARK  
PRINCIPAL REGISTER**



JAX LTD., INC. (MINNESOTA CORPORATION)  
SUITE 100  
141 CHESHIRE LANE N.  
PLYMOUTH, MN 55441

FIRST USE 3-25-2008; IN COMMERCE 3-25-2008.

SN 77-133,292, FILED 3-16-2007.

FOR: BOARD GAMES, IN CLASS 28 (U.S. CLS. 22,  
23, 38 AND 50).

BARNEY CHARLON, EXAMINING ATTORNEY

**Int. Cl.: 29**

**Prior U.S. Cl.: 46**

**United States Patent and Trademark Office**

**Reg. No. 3,454,808**

**Registered June 24, 2008**

**TRADEMARK  
PRINCIPAL REGISTER**

**TASTY CATCH**

LUSAMERICA FOODS, INC. (CALIFORNIA  
CORPORATION)  
16480 RAILROAD AVENUE  
MORGAN HILL, CA 950375210

FOR: FRESH SEAFOOD THAT IS NOT LIVE AND  
FROZEN SEAFOOD; PREPARED FRESH AND FRO-  
ZEN SEAFOOD MEALS CONSISTING PRIMARILY  
OF SEAFOOD, IN CLASS 29 (U.S. CL. 46).

FIRST USE 11-15-2007; IN COMMERCE 11-15-2007.

THE MARK CONSISTS OF STANDARD CHAR-  
ACTERS WITHOUT CLAIM TO ANY PARTICULAR  
FONT, STYLE, SIZE, OR COLOR.

NO CLAIM IS MADE TO THE EXCLUSIVE  
RIGHT TO USE "TASTY", APART FROM THE  
MARK AS SHOWN.

SN 77-133,538, FILED 3-16-2007.

TANYA AMOS, EXAMINING ATTORNEY



**Int. Cl.: 20**

**Prior U.S. Cls.: 2, 13, 22, 25, 32, and 50**

**Reg. No. 3,454,809**

**United States Patent and Trademark Office**

**Registered June 24, 2008**

---

**TRADEMARK  
PRINCIPAL REGISTER**

# Charisma Audio

CHARISMA AUDIO (CANADA CORPORATION)  
SUITE 86  
4261, HIGHWAY 7  
MARKHAM, CANADA L3R9W6

FOR: AUDIO FURNITURE, NAMELY, SPEAKERS STANDS, IN CLASS 20 (U.S. CLS. 2, 13, 22, 25, 32 AND 50).

FIRST USE 2-6-2007; IN COMMERCE 11-13-2007.

THE MARK CONSISTS OF STANDARD CHARACTERS WITHOUT CLAIM TO ANY PARTICULAR FONT, STYLE, SIZE, OR COLOR.

NO CLAIM IS MADE TO THE EXCLUSIVE RIGHT TO USE "AUDIO", APART FROM THE MARK AS SHOWN.

SN 77-133,657, FILED 3-17-2007.

LINDSEY RUBIN, EXAMINING ATTORNEY

**Int. Cl.: 36**

**Prior U.S. Cls.: 100, 101, and 102**

**United States Patent and Trademark Office**

**Reg. No. 3,454,810**

**Registered June 24, 2008**

**SERVICE MARK  
PRINCIPAL REGISTER**

**FOREX CONNECTION**

VENTURA INVESTMENTS, INC (NEVADA CORPORATION)  
3540 SOUTH CRAIN HWY STE 302  
BOWIE, MD 20716

FOR: FINANCIAL SERVICES, NAMELY, PROVIDING INFORMATION IN THE FIELDS OF FOREIGN CURRENCY, COMMODITIES, FINANCIAL DERIVATIVES, INTEREST RATE PRODUCTS, AND EQUITIES VIA THE INTERNET AND INTRANET SYSTEMS, IN CLASS 36 (U.S. CLS. 100, 101 AND 102).

FIRST USE 3-1-2007; IN COMMERCE 3-1-2007.

THE MARK CONSISTS OF STANDARD CHARACTERS WITHOUT CLAIM TO ANY PARTICULAR FONT, STYLE, SIZE, OR COLOR.

NO CLAIM IS MADE TO THE EXCLUSIVE RIGHT TO USE "FOREX", APART FROM THE MARK AS SHOWN.

SN 77-133,832, FILED 3-18-2007.

MARGARET POWER, EXAMINING ATTORNEY

**Int. Cls.: 36 and 45**

**Prior U.S. Cls.: 100, 101, and 102**

**United States Patent and Trademark Office**

**Reg. No. 3,454,811**

**Registered June 24, 2008**

**SERVICE MARK  
PRINCIPAL REGISTER**

**FIERCELY INDEPENDENT**

NEIGHBORHOOD LAND TITLE, LLC (FLORIDA  
LTD LIAB CO)  
SUITE B  
965 E. MARTIN LUTHER KING JR. DRIVE  
TARPON SPRINGS, FL 34689

FOR: TITLE INSURANCE SERVICES, IN CLASS  
36 (U.S. CLS. 100, 101 AND 102).

FIRST USE 3-1-2006; IN COMMERCE 3-1-2006.

FOR: REAL ESTATE CLOSING SERVICES, IN  
CLASS 45 (U.S. CLS. 100 AND 101).

FIRST USE 3-1-2006; IN COMMERCE 3-1-2006.

THE MARK CONSISTS OF STANDARD CHAR-  
ACTERS WITHOUT CLAIM TO ANY PARTICULAR  
FONT, STYLE, SIZE, OR COLOR.

SN 77-134,005, FILED 3-19-2007.

AMY MCMENAMIN, EXAMINING ATTORNEY

**Int. Cl.: 35**

**Prior U.S. Cls.: 100, 101, and 102**

**United States Patent and Trademark Office**

**Reg. No. 3,454,812**

**Registered June 24, 2008**

**SERVICE MARK  
PRINCIPAL REGISTER**

# Mooch

MOOCH, LLC (DELAWARE LTD LIAB CO)  
725 PENN AVE. NE  
ATLANTA, GA 30308

THE MARK CONSISTS OF STANDARD CHAR-  
ACTERS WITHOUT CLAIM TO ANY PARTICULAR  
FONT, STYLE, SIZE, OR COLOR.

FOR: OPERATING ON-LINE MARKETPLACES  
FOR SELLERS OF GOODS AND/OR SERVICES, IN  
CLASS 35 (U.S. CLS. 100, 101 AND 102).

SN 77-134,223, FILED 3-19-2007.

FIRST USE 7-19-2004; IN COMMERCE 1-8-2008.

DAVID I, EXAMINING ATTORNEY

**Int. Cl.: 7**

**Prior U.S. Cls.: 13, 19, 21, 23, 31, 34, and 35**

**Reg. No. 3,454,813**

**United States Patent and Trademark Office**

**Registered June 24, 2008**

**TRADEMARK  
PRINCIPAL REGISTER**

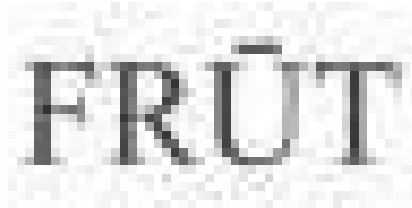

FRUT LLC (OHIO LTD LIAB CO)  
6087 WEATHERED OAK COURT  
WESTERVILLE, OH 43082

FIRST USE 3-23-2007; IN COMMERCE 11-15-2007.

FOR: ELECTRIC MIXER ACCESSORIES, NAME-  
LY, MULTI-PURPOSE MIXER BLADES FOR ELEC-  
TRIC KITCHEN MIXERS AND ELECTRIC PAINT  
MIXERS, IN CLASS 7 (U.S. CLS. 13, 19, 21, 23, 31, 34  
AND 35).

THE MARK CONSISTS OF "FRUT" WITH A  
LONG "U" SYMBOL OVER THE U.

SN 77-134,527, FILED 3-19-2007.

RICHARD A. STRASER, EXAMINING ATTORNEY

**Int. Cl.: 3**

**Prior U.S. Cls.: 1, 4, 6, 50, 51, and 52**

**Reg. No. 3,454,814**

**United States Patent and Trademark Office**

**Registered June 24, 2008**

---

**TRADEMARK  
PRINCIPAL REGISTER**

**EMPOWER MINT**

PHILOSOPHY, INC. (ARIZONA CORPORATION)  
3809 EAST WATKINS STREET  
PHOENIX, AZ 85034

FOR: BODY MASKS; SHAVING PREPARATIONS,  
IN CLASS 3 (U.S. CLS. 1, 4, 6, 50, 51 AND 52).

FIRST USE 4-11-2007; IN COMMERCE 4-11-2007.

THE MARK CONSISTS OF STANDARD CHAR-  
ACTERS WITHOUT CLAIM TO ANY PARTICULAR  
FONT, STYLE, SIZE, OR COLOR.

NO CLAIM IS MADE TO THE EXCLUSIVE  
RIGHT TO USE "MINT", APART FROM THE MARK  
AS SHOWN.

SN 77-134,533, FILED 3-19-2007.

EMILY CHUO, EXAMINING ATTORNEY

**Int. Cl.: 36**

**Prior U.S. Cls.: 100, 101, and 102**

**United States Patent and Trademark Office**

**Reg. No. 3,454,815**

**Registered June 24, 2008**

**SERVICE MARK  
PRINCIPAL REGISTER**

**EGISERVE**

D. R. SPARKS INSURANCE SERVICES, INC.  
(ILLINOIS CORPORATION)  
111 E. 4TH STREET  
ALTON, IL 62002

THE MARK CONSISTS OF STANDARD CHAR-  
ACTERS WITHOUT CLAIM TO ANY PARTICULAR  
FONT, STYLE, SIZE, OR COLOR.

FOR: PROPERTY, CASUALTY, LIFE, ACCIDENT  
AND HEALTH INSURANCE AGENCY SERVICES;  
INSURANCE RISK ASSESSMENT SERVICES, IN  
CLASS 36 (U.S. CLS. 100, 101 AND 102).

SN 77-134,745, FILED 3-19-2007.

FIRST USE 3-13-2008; IN COMMERCE 3-13-2008.

MELVIN AXILBUND, EXAMINING ATTORNEY

**Int. Cl.: 16**

**Prior U.S. Cls.: 2, 5, 22, 23, 29, 37, 38, and 50**

**Reg. No. 3,454,816**

**United States Patent and Trademark Office**

**Registered June 24, 2008**

---

**TRADEMARK  
PRINCIPAL REGISTER**

**ROADOGRAPH**

**CALLICANN CORPORATION (CALIFORNIA  
CORPORATION)  
7671 EASTBAY LANE  
SACRAMENTO, CA 95831**

**FIRST USE 3-31-2007; IN COMMERCE 5-23-2007.**

**FOR: PHOTOGRAPH HOLDERS FOR USE WITH  
MOTORIZED VEHICLES, NAMELY, CARS,  
TRUCKS, BOATS AND RECREATIONAL VEHI-  
CLES, IN CLASS 16 (U.S. CLS. 2, 5, 22, 23, 29, 37, 38  
AND 50).**

**THE MARK CONSISTS OF STANDARD CHAR-  
ACTERS WITHOUT CLAIM TO ANY PARTICULAR  
FONT, STYLE, SIZE, OR COLOR.**

**SN 77-135,305, FILED 3-20-2007.**

**MARGERY A. TIERNEY, EXAMINING ATTORNEY**



Int. Cl.: 5

Prior U.S. Cls.: 6, 18, 44, 46, 51, and 52

United States Patent and Trademark Office

Reg. No. 3,454,817

Registered June 24, 2008

TRADEMARK  
PRINCIPAL REGISTER



DAIICHI SANKYO, INC. (DELAWARE CORPORATION)  
TWO HILTON COURT  
PARSIPPANY, NJ 07054

FOR: PHARMACEUTICAL PREPARATIONS FOR THE REDUCTION OF ELEVATED CHOLESTEROL IN PATIENTS HAVING PRIMARY HYPERCHOLESTEROLEMIA; PHARMACEUTICAL PREPARATIONS FOR THE TREATMENT OF DIABETES, IN CLASS 5 (U.S. CLS. 6, 18, 44, 46, 51 AND 52).

FIRST USE 1-18-2008; IN COMMERCE 1-18-2008.

NO CLAIM IS MADE TO THE EXCLUSIVE RIGHT TO USE "TABLETS" AND "COLESEVELAM HCL", APART FROM THE MARK AS SHOWN.

THE COLOR(S) BLUE, GREEN, YELLOW AND GRAY IS/ARE CLAIMED AS A FEATURE OF THE MARK.

THE MARK CONSISTS OF TWO ARROWS WHICH APPEAR TO LEFT OF THE WORD "WELCHOL". THE LARGER, OUTER ARROW APPEARS

IN THE COLORS BLUE AND GREEN AND THE ARROW CONNECTS TO THE RIGHT-HAND PORTION OF THE LETTER "W" IN THE WORD "WELCHOL". THE SMALLER, INNER ARROW APPEARS IN THE COLORS YELLOW AND GREEN AND THE ARROW CONNECTS TO THE LEFT-HAND PORTION OF THE LETTER W IN "WELCHOL". BOTH ARROWS CONVERGE TO THE LEFT OF THE WORD "WELCHOL", SHARING THE SAME GREEN ARROWHEAD. THE WORDS "WELCHOL" AND "TABLETS" APPEAR IN THE COLOR GREEN. THE LETTER "W" IN "WELCHOL" IS CAPITALIZED. THE WORDS "COLESEVELAM HCL", ENCLOSED IN PARENTHESIS, APPEAR IN SMALL, DARK GRAY LETTERS, IMMEDIATELY BENEATH THE "LCHOL" PORTION OF THE WORD "WELCHOL". THE PARENTHESIS ARE ALSO DARK GRAY. THE WORD "TABLETS" APPEARS IN SMALL, CAPITAL LETTERS IMMEDIATELY ABOVE THE LETTER "O" IN "WELCHOL", WEDGED BETWEEN THE LETTERS "H" AND "L".

SN 77-135,420, FILED 3-20-2007.

ROBIN MITTLER, EXAMINING ATTORNEY

Int. Cl.: 5

Prior U.S. Cls.: 6, 18, 44, 46, 51, and 52

United States Patent and Trademark Office

Reg. No. 3,454,818

Registered June 24, 2008

TRADEMARK  
PRINCIPAL REGISTER



DAIICHI SANKYO, INC. (DELAWARE CORPORATION)  
TWO HILTON COURT  
PARSIPPANY, NJ 07054

FOR: PHARMACEUTICAL PREPARATIONS FOR THE REDUCTION OF ELEVATED CHOLESTEROL IN PATIENTS HAVING PRIMARY HYPERCHOLESTEROLEMIA; PHARMACEUTICAL PREPARATIONS FOR THE TREATMENT OF DIABETES, IN CLASS 5 (U.S. CLS. 6, 18, 44, 46, 51 AND 52).

FIRST USE 1-18-2008; IN COMMERCE 1-18-2008.

NO CLAIM IS MADE TO THE EXCLUSIVE RIGHT TO USE "TABLETS" AND "COLESEVELAM HCL", APART FROM THE MARK AS SHOWN.

THE MARK CONSISTS OF TWO ARROWS WHICH APPEAR TO LEFT OF THE WORD "WELCHOL". THE LARGER, OUTER ARROW CON-

NECTS TO THE RIGHT-HAND PORTION OF THE LETTER "W" IN THE WORD "WELCHOL". THE SMALLER, INNER ARROW CONNECTS TO THE LEFT-HAND PORTION OF THE LETTER "W" IN "WELCHOL". BOTH ARROWS CONVERGE TO THE LEFT OF THE WORD "WELCHOL", SHARING THE SAME ARROWHEAD. THE LETTER "W" IN "WELCHOL" IS CAPITALIZED. THE WORDS "COLESEVELAM HCL", ENCLOSED IN PARENTHESIS, APPEAR IN SMALL LETTERS, IMMEDIATELY BENEATH THE "CHOL" PORTION OF THE WORD "WELCHOL". THE WORD TABLETS APPEARS IN SMALL, CAPITAL LETTERS IMMEDIATELY ABOVE THE LETTER "O" IN "WELCHOL", WEDGED BETWEEN THE LETTERS "H" AND "L".

SN 77-135,424, FILED 3-20-2007.

ROBIN MITTLER, EXAMINING ATTORNEY

**Int. Cl.: 16**

**Prior U.S. Cls.: 2, 5, 22, 23, 29, 37, 38, and 50**

**Reg. No. 3,454,819**

**United States Patent and Trademark Office**

**Registered June 24, 2008**

**TRADEMARK  
PRINCIPAL REGISTER**

**SUGARCOAT**

SUGARCOAT (MINNESOTA SOLE PROPRIETORSHIP)  
2149 FAIRMOUNT AVE.  
ST. PAUL, MN 55105

THE MARK CONSISTS OF STANDARD CHARACTERS WITHOUT CLAIM TO ANY PARTICULAR FONT, STYLE, SIZE, OR COLOR.

FOR: APPLIQUES IN THE FORM OF DECALS, IN CLASS 16 (U.S. CLS. 2, 5, 22, 23, 29, 37, 38 AND 50).

SN 77-136,021, FILED 3-20-2007.

FIRST USE 3-15-2007; IN COMMERCE 4-3-2008.

MARGERY A. TIERNEY, EXAMINING ATTORNEY

**Int. Cl.: 25**

**Prior U.S. Cls.: 22 and 39**

**United States Patent and Trademark Office**

**Reg. No. 3,454,820**

**Registered June 24, 2008**

**TRADEMARK  
PRINCIPAL REGISTER**

**UltimateCamo**

CUTTITTA ENTERPRISES, LLC (MARYLAND  
LTD LIAB CO)  
27213 RIDGE ROAD  
DAMASCUS, MD 20872

FOR: CAPS; CLOTHING, NAMELY, HOODS;  
HUNTING VESTS; PANTS; SHIRTS; SHORT-  
SLEEVED OR LONG-SLEEVED T-SHIRTS; SHORT-  
SLEEVED SHIRTS; SWEAT SHIRTS; T-SHIRTS;  
GLOVES; HATS, IN CLASS 25 (U.S. CLS. 22 AND 39).

FIRST USE 9-15-2007; IN COMMERCE 12-20-2007.

THE MARK CONSISTS OF STANDARD CHAR-  
ACTERS WITHOUT CLAIM TO ANY PARTICULAR  
FONT, STYLE, SIZE, OR COLOR.

SN 77-136,098, FILED 3-20-2007.

JULIE GUTTADAURO, EXAMINING ATTORNEY

**Int. Cl.: 11**

**Prior U.S. Cls.: 13, 21, 23, 31, and 34**

**United States Patent and Trademark Office**

**Reg. No. 3,454,821**

**Registered June 24, 2008**

**TRADEMARK  
PRINCIPAL REGISTER**

**SYMPHONY**

AQUATIC INDUSTRIES, INC. (DELAWARE  
CORPORATION)  
11880 RR 2243  
LEANDER, TX 78641

THE MARK CONSISTS OF STANDARD CHAR-  
ACTERS WITHOUT CLAIM TO ANY PARTICULAR  
FONT, STYLE, SIZE, OR COLOR.

FOR: WHIRLPOOL BATH TUBS, AIR JETTED  
BATH TUBS, IN CLASS 11 (U.S. CLS. 13, 21, 23, 31  
AND 34).

SN 77-136,173, FILED 3-21-2007.

FIRST USE 6-1-2007; IN COMMERCE 7-1-2007.

KAREN BRACEY, EXAMINING ATTORNEY

**Int. Cl.: 16**

**Prior U.S. Cls.: 2, 5, 22, 23, 29, 37, 38, and 50**

**Reg. No. 3,454,822**

**United States Patent and Trademark Office**

**Registered June 24, 2008**

---

**TRADEMARK  
PRINCIPAL REGISTER**

# Vows of Oneness

SWIFT-WILKINSON, SHIRLEY (UNITED  
STATES INDIVIDUAL)  
8516 W.WILLOW AVENUE  
PEORIA, AZ 85381

THE MARK CONSISTS OF STANDARD CHAR-  
ACTERS WITHOUT CLAIM TO ANY PARTICULAR  
FONT, STYLE, SIZE, OR COLOR.

FOR: BOOKS IN THE FIELD OF SPIRITUALITY,  
IN CLASS 16 (U.S. CLS. 2, 5, 22, 23, 29, 37, 38 AND 50).

SN 77-137,616, FILED 3-22-2007.

FIRST USE 1-1-2006; IN COMMERCE 5-1-2008.

DOMINICK J. SALEMI, EXAMINING ATTORNEY

**Int. Cls.: 39 and 40**

**Prior U.S. Cls.: 100, 103, 105, and 106**

**Reg. No. 3,454,823**

**United States Patent and Trademark Office**

**Registered June 24, 2008**

**SERVICE MARK  
PRINCIPAL REGISTER**



M2 MIDSTREAM LLC (DELAWARE LTD LIAB  
CO)  
1099 MAIN AVE., SUITE 210  
DURANGO, CO 81301

THE COLOR(S) BLUE AND BLACK IS/ARE  
CLAIMED AS A FEATURE OF THE MARK.

FOR: TRANSMISSION OF OIL AND GAS  
THROUGH PIPELINES, IN CLASS 39 (U.S. CLS. 100  
AND 105).

THE WORD "MOMENTUM" IS BLACK. THE  
COLOR WHITE IN THE STYLIZED LETTER "M" IS  
NOT A FEATURE OF THE MARK BUT INSTEAD  
INDICATES AN AREA OF TRANSPARENCY. THE  
AREA AROUND THE LETTER "M" IS BLUE.

FIRST USE 2-1-2007; IN COMMERCE 2-1-2007.

FOR: OIL AND GAS PROCESSING, IN CLASS 40  
(U.S. CLS. 100, 103 AND 106).

SN 77-137,945, FILED 3-22-2007.

FIRST USE 2-1-2007; IN COMMERCE 2-1-2007.

MARY BOAGNI, EXAMINING ATTORNEY

**Int. Cl.: 42**

**Prior U.S. Cls.: 100 and 101**

**Reg. No. 3,454,824**

**United States Patent and Trademark Office**

**Registered June 24, 2008**

**SERVICE MARK  
PRINCIPAL REGISTER**



CANCER INTERNATIONAL RESEARCH GROUP  
(CANADA NON-PROFIT CORPORATION)  
SUITE 1100  
9925-109 STREET  
EDMONTON, ALBERTA T5K, CANADA

FOR: MEDICAL AND CLINICAL RESEARCH IN  
THE FIELD OF ONCOLOGY, IN CLASS 42 (U.S. CLS.  
100 AND 101).

FIRST USE 6-5-2007; IN COMMERCE 6-5-2007.

NO CLAIM IS MADE TO THE EXCLUSIVE  
RIGHT TO USE "TRANSLATIONAL RESEARCH  
IN ONCOLOGY", APART FROM THE MARK AS  
SHOWN.

THE MARK CONSISTS OF IN PART THE LETTER  
"O" IN THE WORD "TRIO" THAT INCLUDES A  
TRIANGULAR SPIRAL DESIGN ELEMENT.

SN 77-138,057, FILED 3-22-2007.

RICHARD A. STRASER, EXAMINING ATTORNEY



**Int. Cl.: 28**

**Prior U.S. Cls.: 22, 23, 38, and 50**

**United States Patent and Trademark Office**

**Reg. No. 3,454,825**

**Registered June 24, 2008**

**TRADEMARK  
PRINCIPAL REGISTER**

**IQUE**

ELOGIQ, INC. (PENNSYLVANIA CORPORATION)  
1018 W. 8TH AVENUE, SUITE G  
PHILADELPHIA, PA 19406

THE MARK CONSISTS OF STANDARD CHARACTERS WITHOUT CLAIM TO ANY PARTICULAR FONT, STYLE, SIZE, OR COLOR.

FOR: BOARD GAMES, IN CLASS 28 (U.S. CLS. 22, 23, 38 AND 50).

SN 77-138,404, FILED 3-23-2007.

FIRST USE 10-3-2007; IN COMMERCE 10-3-2007.

BENJAMIN ALLEN, EXAMINING ATTORNEY

**Int. Cl.: 35**

**Prior U.S. Cls.: 100, 101, and 102**

**United States Patent and Trademark Office**

**Reg. No. 3,454,826**

**Registered June 24, 2008**

**SERVICE MARK  
PRINCIPAL REGISTER**

**CARIBREW CLUB**

ARABICA FUNDING, INC. (DELAWARE CORPORATION)  
SUITE 120  
68 SOUTH SERVICE ROAD  
MELVILLE, NY 11747

FOR: RETAIL STORE SERVICES IN THE FIELD OF COFFEE, TEA, COFFEE AND TEA BREWING ACCESSORIES, FOOD, CANDY, AND BEVERAGEWARE FEATURING A BONUS INCENTIVE PROGRAM FOR CUSTOMERS, IN CLASS 35 (U.S. CLS. 100, 101 AND 102).

FIRST USE 5-21-2007; IN COMMERCE 5-21-2007.

THE MARK CONSISTS OF STANDARD CHARACTERS WITHOUT CLAIM TO ANY PARTICULAR FONT, STYLE, SIZE, OR COLOR.

NO CLAIM IS MADE TO THE EXCLUSIVE RIGHT TO USE "CLUB", APART FROM THE MARK AS SHOWN.

SN 77-138,423, FILED 3-23-2007.

DOMINICK J. SALEMI, EXAMINING ATTORNEY

**Int. Cls.: 9, 35, and 43**

**Prior U.S. Cls.: 21, 23, 26, 36, 38, 100, 101, and 102**

**United States Patent and Trademark Office**

**Reg. No. 3,454,827**

**Registered June 24, 2008**

**TRADEMARK  
SERVICE MARK  
PRINCIPAL REGISTER**

# ExpatMonitor

MERCER (US) INC. (DELAWARE CORPORATION)  
1166 AVENUE OF THE AMERICAS  
NEW YORK, NY 100362774

FOR: SOFTWARE FOR MANAGEMENT AND CALCULATION OF EXPATRIATE COMPENSATION; SOFTWARE FOR USE IN BENCHMARKING AND CONDUCTING COST ANALYSIS OF EXPATRIATE COMPENSATION, COST OF LIVING, QUALITY OF LIVING, HOUSING AND TAXATION, IN CLASS 9 (U.S. CLS. 21, 23, 26, 36 AND 38).

FIRST USE 3-20-2007; IN COMMERCE 3-20-2007.

FOR: PROVIDING AN ONLINE COMPUTER DATABASE FEATURING INFORMATION ON EXPATRIATE COMPENSATION, COST OF LIVING AND TAXATION, IN CLASS 35 (U.S. CLS. 100, 101 AND 102).

FIRST USE 3-20-2007; IN COMMERCE 3-20-2007.

FOR: PROVIDING AN ONLINE COMPUTER DATABASE FEATURING INFORMATION ON TEMPORARY HOUSING ACCOMMODATIONS, AND INFORMATION PERTAINING TO THE RENTAL OF FURNITURE AND HOUSEHOLD FURNISHINGS IN THE NATURE OF APPLIANCES AND ELECTRONIC EQUIPMENT FOR USE IN TEMPORARY HOUSING ACCOMMODATIONS, IN CLASS 43 (U.S. CLS. 100 AND 101).

FIRST USE 3-20-2007; IN COMMERCE 3-20-2007.

THE MARK CONSISTS OF STANDARD CHARACTERS WITHOUT CLAIM TO ANY PARTICULAR FONT, STYLE, SIZE, OR COLOR.

SN 77-138,753, FILED 3-23-2007.

WARREN L. OLANDRIA, EXAMINING ATTORNEY

**Int. Cl.: 42**

**Prior U.S. Cls.: 100 and 101**

**United States Patent and Trademark Office**

**Reg. No. 3,454,828**

**Registered June 24, 2008**

**SERVICE MARK  
PRINCIPAL REGISTER**

**Land Trust   
Accreditation Commission**

**An independent program of the Land Trust Alliance**

LAND TRUST ACCREDITATION COMMISSION  
(D.C. CORPORATION)  
112 SPRING STREET  
SARATOGA SPRINGS, NY 12866

FOR: ANALYSIS AND EVALUATION OF THE  
LAND CONSERVATION PRACTICES OF OTHERS  
FOR THE PURPOSE OF CERTIFICATION, IN  
CLASS 42 (U.S. CLS. 100 AND 101).

FIRST USE 4-0-2007; IN COMMERCE 4-0-2007.

OWNER OF U.S. REG. NO. 2,682,296.

NO CLAIM IS MADE TO THE EXCLUSIVE  
RIGHT TO USE "LAND TRUST ACCREDITATION

COMMISSION" AND "INDEPENDENT PROGRAM",  
APART FROM THE MARK AS SHOWN.

THE MARK CONSISTS OF THE WORDS LAND  
TRUST ACCREDITATION COMMISSION AN IN-  
DEPENDENT PROGRAM OF THE LAND TRUST  
ALLIANCE, PLUS AN INFINITY DESIGN.

SEC. 2(F) AS TO LAND TRUST ALLIANCE.

SN 77-138,778, FILED 3-23-2007.

STEVEN R. FINE, EXAMINING ATTORNEY

**Int. Cl.: 25**

**Prior U.S. Cls.: 22 and 39**

**United States Patent and Trademark Office**

**Reg. No. 3,454,829**

**Registered June 24, 2008**

**TRADEMARK  
PRINCIPAL REGISTER**

**VOJ**

BOLING, STEWART, B (UNITED STATES INDIVIDUAL)  
SUITE 14D  
1 GARDEN TERRACE  
NORTH ARLINGTON, NJ 07031

FOR: CLOTHING FOR WOMEN, MEN AND CHILDREN, NAMELY BELTS, COATS, RAINCOATS, WAISTCOATS, BLOUSES AND PULLOVERS, JACKETS, TROUSERS, SKIRTS, DRESSES, SUITS, SHIRTS AND CHEMISES, T-SHIRTS, JEANS, SWEATERS, UNDERWEAR, SOCKS AND STOCKINGS, GLOVES, TIES, SCARVES, HATS AND CAPS,

BOOTS, SHOES AND SLIPPERS, IN CLASS 25 (U.S. CLS. 22 AND 39).

FIRST USE 3-23-2007; IN COMMERCE 2-6-2008.

THE MARK CONSISTS OF STANDARD CHARACTERS WITHOUT CLAIM TO ANY PARTICULAR FONT, STYLE, SIZE, OR COLOR.

SN 77-138,796, FILED 3-23-2007.

MICHAEL SOUDERS, EXAMINING ATTORNEY

**Int. Cl.: 30**

**Prior U.S. Cl.: 46**

**United States Patent and Trademark Office**

**Reg. No. 3,454,830**

**Registered June 24, 2008**

**TRADEMARK  
PRINCIPAL REGISTER**

**MRS. GOODMUFFIN**

J&J SNACK FOODS CORP. (NEW JERSEY COR-  
PORATION)  
6000 CENTRAL HIGHWAY  
PENNSAUKEN, NJ 08109

THE MARK CONSISTS OF STANDARD CHAR-  
ACTERS WITHOUT CLAIM TO ANY PARTICULAR  
FONT, STYLE, SIZE, OR COLOR.

FOR: MUFFINS, IN CLASS 30 (U.S. CL. 46).

SN 77-138,846, FILED 3-23-2007.

FIRST USE 5-0-2007; IN COMMERCE 5-0-2007.

ANDREA SAUNDERS, EXAMINING ATTORNEY

**Int. Cl.: 9**

**Prior U.S. Cls.: 21, 23, 26, 36, and 38**

**Reg. No. 3,454,831**

**United States Patent and Trademark Office**

**Registered June 24, 2008**

**TRADEMARK  
PRINCIPAL REGISTER**

**METASTATION**

RIENSTRA, JANET (UNITED STATES INDIVIDUAL)  
405 NORTH LACUMBRA  
SANTA BARBARA, CA 93110

FOR: PRERECORDED RECORDS, AUDIO CASSETTES, COMPACT DISCS, DVDS, CD-ROMS, LASER DISCS AND VIDEO DISCS FEATURING MUSIC, MUSICAL PERFORMANCES, YOGA EXERCISE INSTRUCTION AND/OR YOGA EXERCISE DEMONSTRATION; SOUND AND VISUAL RECORDINGS AND DOWNLOADABLE SOUND AND VIDEO RECORDINGS FEATURING MUSIC, MUSICAL PERFORMANCES, YOGA EXERCISE INSTRUCTION AND/OR YOGA EXERCISE DEMONSTRATION; MULTIMEDIA SOFTWARE

RECORDED ON CD-ROM FEATURING MUSIC, MUSIC-BASED ENTERTAINMENT, YOGA EXERCISE INSTRUCTION AND/OR YOGA EXERCISE DEMONSTRATION, IN CLASS 9 (U.S. CLS. 21, 23, 26, 36 AND 38).

FIRST USE 11-20-2007; IN COMMERCE 11-20-2007.

THE MARK CONSISTS OF STANDARD CHARACTERS WITHOUT CLAIM TO ANY PARTICULAR FONT, STYLE, SIZE, OR COLOR.

SN 77-139,125, FILED 3-23-2007.

MICHELLE DUBOIS, EXAMINING ATTORNEY

**Int. Cl.: 9**

**Prior U.S. Cls.: 21, 23, 26, 36, and 38**

**Reg. No. 3,454,832**

**United States Patent and Trademark Office**

**Registered June 24, 2008**

---

**TRADEMARK  
PRINCIPAL REGISTER**

**HOTLOK**

UPSITE TECHNOLOGIES, INC. (DELAWARE  
CORPORATION)  
BUILDING 150  
2904 RODEO PARK DRIVE E  
SANTA FE, NM 87505

FOR: BLANKING PLATES, BLANKING PLATES  
HAVING THERMO-SENSITIVE TEMPERATURE  
INDICATOR STRIPS ALL FOR USE IN ELECTRO-  
NIC EQUIPMENT CABINETS, IN CLASS 9 (U.S. CLS.  
21, 23, 26, 36 AND 38).

FIRST USE 3-0-2008; IN COMMERCE 3-0-2008.

THE MARK CONSISTS OF STANDARD CHAR-  
ACTERS WITHOUT CLAIM TO ANY PARTICULAR  
FONT, STYLE, SIZE, OR COLOR.

SN 77-139,849, FILED 3-26-2007.

ELI HELLMAN, EXAMINING ATTORNEY



**Int. Cl.: 10**

**Prior U.S. Cls.: 26, 39, and 44**

**United States Patent and Trademark Office**

**Reg. No. 3,454,833**

**Registered June 24, 2008**

**TRADEMARK  
PRINCIPAL REGISTER**

# Shoulder Rx

PROTAS, EUGENE DAVID (UNITED STATES  
INDIVIDUAL)  
3886 SUMMER MANOR DR.  
LEAGUE CITY, TX 77573

FOR: EXERCISE MACHINES FOR THERAPEU-  
TIC PURPOSES, IN CLASS 10 (U.S. CLS. 26, 39 AND  
44).

FIRST USE 6-10-2007; IN COMMERCE 2-6-2008.

THE MARK CONSISTS OF STANDARD CHAR-  
ACTERS WITHOUT CLAIM TO ANY PARTICULAR  
FONT, STYLE, SIZE, OR COLOR.

NO CLAIM IS MADE TO THE EXCLUSIVE  
RIGHT TO USE "SHOULDER", APART FROM THE  
MARK AS SHOWN.

SN 77-140,179, FILED 3-26-2007.

TINA BROWN, EXAMINING ATTORNEY

**Int. Cl.: 16**

**Prior U.S. Cls.: 2, 5, 22, 23, 29, 37, 38, and 50**

**Reg. No. 3,454,834**

**United States Patent and Trademark Office**

**Registered June 24, 2008**

---

**TRADEMARK  
PRINCIPAL REGISTER**

**BANDA BIG BOOM**

HALLMARK LICENSING, INC. (DELAWARE  
CORPORATION)  
MD 339  
2440 PERSHING ROAD  
KANSAS CITY, MO 64108

FOR: GREETING CARDS, IN CLASS 16 (U.S. CLS.  
2, 5, 22, 23, 29, 37, 38 AND 50).

FIRST USE 5-31-2007; IN COMMERCE 5-31-2007.

THE MARK CONSISTS OF STANDARD CHAR-  
ACTERS WITHOUT CLAIM TO ANY PARTICULAR  
FONT, STYLE, SIZE, OR COLOR.

THE ENGLISH TRANSLATION OF THE WORD  
"BANDA" IN THE MARK IS "BAND."

SN 77-140,241, FILED 3-26-2007.

TANYA AMOS, EXAMINING ATTORNEY

**Int. Cl.: 42**

**Prior U.S. Cls.: 100 and 101**

**United States Patent and Trademark Office**

**Reg. No. 3,454,835**

**Registered June 24, 2008**

**SERVICE MARK  
PRINCIPAL REGISTER**

**S.O.S.**

VSM GROUP AKTIEBOLAG (SWEDEN CORPORATION)  
SE-561 84  
HUSKVARNA, SWEDEN

FOR: TECHNICAL SUPPORT SERVICES, NAME-  
LY, PROVIDING TROUBLESHOOTING ASSIS-  
TANCE FOR COMPUTER SOFTWARE ISSUES IN  
REGARD TO OPERATING COMPUTERIZED SEW-  
ING MACHINES, IN CLASS 42 (U.S. CLS. 100 AND  
101).

FIRST USE 4-1-2007; IN COMMERCE 4-1-2007.

THE MARK CONSISTS OF STANDARD CHAR-  
ACTERS WITHOUT CLAIM TO ANY PARTICULAR  
FONT, STYLE, SIZE, OR COLOR.

SN 77-140,548, FILED 3-26-2007.

ANDREA HACK, EXAMINING ATTORNEY

**Int. Cl.: 41**

**Prior U.S. Cls.: 100, 101, and 107**

**United States Patent and Trademark Office**

**Reg. No. 3,454,836**

**Registered June 24, 2008**

**SERVICE MARK  
PRINCIPAL REGISTER**



STOKELY-VAN CAMP, INC. (INDIANA CORPORATION)  
SUITE 11-10  
555 WEST MONROE STREET  
CHICAGO, IL 60661

FOR: EDUCATIONAL SERVICES, NAMELY, CLASSES, SEMINARS, CONFERENCES AND WORKSHIPS IN THE FIELD OF EXERCISE, SCIENCE AND SPORTS MEDICINE, IN CLASS 41 (U.S. CLS. 100, 101 AND 107).

FIRST USE 4-30-2007; IN COMMERCE 4-30-2007.

OWNER OF U.S. REG. NOS. 848,245, 2,895,559, AND OTHERS.

NO CLAIM IS MADE TO THE EXCLUSIVE RIGHT TO USE "SPORTS SCIENCE INSTITUTE", APART FROM THE MARK AS SHOWN.

SN 77-141,125, FILED 3-27-2007.

DAWN HAN, EXAMINING ATTORNEY

**Int. Cl.: 9**

**Prior U.S. Cls.: 21, 23, 26, 36, and 38**

**Reg. No. 3,454,837**

**United States Patent and Trademark Office**

**Registered June 24, 2008**

**TRADEMARK  
PRINCIPAL REGISTER**

**CAMSHARE**

CAMSHARE, L.L.C. (TEXAS LTD LIAB CO)  
400 WEST 15TH STREET  
SUITE 710  
AUSTIN, TX 78701

OVER COMPUTER NETWORKS, IN CLASS 9 (U.S.  
CLS. 21, 23, 26, 36 AND 38).

FIRST USE 12-15-2005; IN COMMERCE 12-25-2005.

FOR: COMPUTER PROGRAMS FOR PROVIDING  
AUDIO, VIDEO, TEXT, AND OTHER MULTIMEDIA  
MULTI-USER COMMUNICATIONS OVER COMPU-  
TER NETWORKS; COMPUTER SOFTWARE FOR  
PROVIDING AUDIO, VIDEO, TEXT, AND OTHER  
MULTIMEDIA MULTI-USER COMMUNICATIONS

THE MARK CONSISTS OF STANDARD CHAR-  
ACTERS WITHOUT CLAIM TO ANY PARTICULAR  
FONT, STYLE, SIZE, OR COLOR.

SN 77-141,138, FILED 3-27-2007.

NAAKWAMA ANKRAH, EXAMINING ATTORNEY

**Int. Cl.: 16**

**Prior U.S. Cls.: 2, 5, 22, 23, 29, 37, 38, and 50**

**Reg. No. 3,454,838**

**United States Patent and Trademark Office**

**Registered June 24, 2008**

**TRADEMARK  
PRINCIPAL REGISTER**

**Red Arcis Inc.**

STERLING, TAYLOR JAMES (UNITED STATES  
INDIVIDUAL)  
497 HARRISON ST  
PASSIC, NJ 07055

FOR: ORIGINAL ART COMIC BOOKS; ORIGINAL  
ART PRINTS; ORIGINAL ART PICTURES;  
ORIGINAL ART POSTERS; ORIGINAL ART  
SKETCH BOOKS, IN CLASS 16 (U.S. CLS. 2, 5, 22,  
23, 29, 37, 38 AND 50).

FIRST USE 4-17-2008; IN COMMERCE 4-17-2008.

THE MARK CONSISTS OF STANDARD CHAR-  
ACTERS WITHOUT CLAIM TO ANY PARTICULAR  
FONT, STYLE, SIZE, OR COLOR.

NO CLAIM IS MADE TO THE EXCLUSIVE  
RIGHT TO USE "INC.", APART FROM THE MARK  
AS SHOWN.

SN 77-142,159, FILED 3-28-2007.

CHRISTINE COOPER, EXAMINING ATTORNEY

**Int. Cl.: 12**

**Prior U.S. Cls.: 19, 21, 23, 31, 35, and 44**

**United States Patent and Trademark Office**

**Reg. No. 3,454,839**

**Registered June 24, 2008**

**TRADEMARK  
PRINCIPAL REGISTER**

**M860**

BRIDGESTONE CORPORATION (JAPAN CORPORATION)  
7-1, KYOBASHI 1-CHOME  
CHUO-KU, TOKYO, JAPAN 104-0031

FOR: TIRES, IN CLASS 12 (U.S. CLS. 19, 21, 23, 31, 35 AND 44).

FIRST USE 10-0-2006; IN COMMERCE 10-0-2006.

THE MARK CONSISTS OF STANDARD CHARACTERS WITHOUT CLAIM TO ANY PARTICULAR FONT, STYLE, SIZE, OR COLOR.

OWNER OF U.S. REG. NOS. 1,412,249 AND 1,412,250.

SN 77-142,214, FILED 3-28-2007.

KATHY DE JONGE, EXAMINING ATTORNEY

**Int. Cl.: 12**

**Prior U.S. Cls.: 19, 21, 23, 31, 35, and 44**

**United States Patent and Trademark Office**

**Reg. No. 3,454,840**

**Registered June 24, 2008**

**TRADEMARK  
PRINCIPAL REGISTER**

**M895**

BRIDGESTONE CORPORATION (JAPAN CORPORATION)  
7-1, KYOBASHI 1-CHOME  
CHUO-KU, TOKYO, JAPAN 104-0031

FOR: TIRES, IN CLASS 12 (U.S. CLS. 19, 21, 23, 31, 35 AND 44).

FIRST USE 0-0-2006; IN COMMERCE 0-0-2006.

THE MARK CONSISTS OF STANDARD CHARACTERS WITHOUT CLAIM TO ANY PARTICULAR FONT, STYLE, SIZE, OR COLOR.

OWNER OF U.S. REG. NOS. 1,412,249 AND 1,412,250.

SN 77-142,220, FILED 3-28-2007.

KATHY DE JONGE, EXAMINING ATTORNEY



**Int. Cl.: 28**

**Prior U.S. Cls.: 22, 23, 38, and 50**

**Reg. No. 3,454,841**

**United States Patent and Trademark Office**

**Registered June 24, 2008**

---

**TRADEMARK  
PRINCIPAL REGISTER**

**G/10**

KARSTEN MANUFACTURING CORPORATION  
(ARIZONA CORPORATION)  
LEGAL DEPARTMENT  
2201 WEST DESERT COVE  
PHOENIX, AZ 85029

FOR: GOLF CLUBS, IN CLASS 28 (U.S. CLS. 22, 23,  
38 AND 50).

FIRST USE 8-8-2007; IN COMMERCE 8-8-2007.

THE MARK CONSISTS OF STANDARD CHAR-  
ACTERS WITHOUT CLAIM TO ANY PARTICULAR  
FONT, STYLE, SIZE, OR COLOR.

OWNER OF U.S. REG. NO. 2,773,734.

SN 77-143,013, FILED 3-28-2007.

CARRIE GENOVESE, EXAMINING ATTORNEY

**Int. Cl.: 28**

**Prior U.S. Cls.: 22, 23, 38, and 50**

**United States Patent and Trademark Office**

**Reg. No. 3,454,842**

**Registered June 24, 2008**

**TRADEMARK  
PRINCIPAL REGISTER**

**PING G/10**

KARSTEN MANUFACTURING CORPORATION  
(ARIZONA CORPORATION)  
LEGAL DEPARTMENT  
2201 WEST DESERT COVE  
PHOENIX, AZ 85029

FOR: GOLF CLUBS, IN CLASS 28 (U.S. CLS. 22, 23,  
38 AND 50).

FIRST USE 8-8-2007; IN COMMERCE 8-8-2007.

THE MARK CONSISTS OF STANDARD CHAR-  
ACTERS WITHOUT CLAIM TO ANY PARTICULAR  
FONT, STYLE, SIZE, OR COLOR.

OWNER OF U.S. REG. NOS. 704,552, 1,637,647,  
AND OTHERS.

SN 77-143,027, FILED 3-28-2007.

CARRIE GENOVESE, EXAMINING ATTORNEY

**Int. Cl.: 43**

**Prior U.S. Cls.: 100 and 101**

**United States Patent and Trademark Office**

**Reg. No. 3,454,843**

**Registered June 24, 2008**

**SERVICE MARK  
PRINCIPAL REGISTER**



GREENS MANAGEMENT, LLC (DELAWARE  
LTD LIAB CO)  
3333 M STREET, NW  
WASHINGTON, D.C., DC 20007

FOR: RESTAURANT SERVICES AND CATERING  
SERVICES, IN CLASS 43 (U.S. CLS. 100 AND 101).

FIRST USE 8-1-2007; IN COMMERCE 8-1-2007.

THE APPLICANT CLAIMS COLOR AS A FEAT-  
TURE OF THE MARK, NAMELY, GREEN.

THE MARK CONSISTS OF TWO GREEN LEAVES  
CROSSED IN THE SHAPE OF A HEART.

SN 77-143,357, FILED 3-29-2007.

SANDRA MANIOS, EXAMINING ATTORNEY

**Int. Cl.: 9**

**Prior U.S. Cls.: 21, 23, 26, 36, and 38**

**Reg. No. 3,454,844**

**United States Patent and Trademark Office**

**Registered June 24, 2008**

**TRADEMARK  
PRINCIPAL REGISTER**

**LEVLOK**

LEVITON MANUFACTURING CO., INC. (DELA-  
WARE CORPORATION)  
59-25 LITTLE NECK PARKWAY  
LITTLE NECK, NY 11362

FOR: ELECTRONIC WIRING DEVICES COM-  
PRISED OF A WIRING MODULE THAT LOCKS  
AND LATCHES TO INTERNAL WIRING DEVICES,  
NAMELY, RECEPTACLES, SWITCHES, DIMMERS,  
SENSORS, LIGHTING CONTROLS, AND COMBI-  
NATIONS OF THE AFOREMENTIONED ITEMS, IN  
CLASS 9 (U.S. CLS. 21, 23, 26, 36 AND 38).

FIRST USE 5-1-2007; IN COMMERCE 11-29-2007.

THE MARK CONSISTS OF STANDARD CHAR-  
ACTERS WITHOUT CLAIM TO ANY PARTICULAR  
FONT, STYLE, SIZE, OR COLOR.

OWNER OF U.S. REG. NO. 2,867,614.

SN 77-143,444, FILED 3-29-2007.

KHANH LE, EXAMINING ATTORNEY

**Int. Cl.: 9**

**Prior U.S. Cls.: 21, 23, 26, 36, and 38**

**Reg. No. 3,454,845**

**United States Patent and Trademark Office**

**Registered June 24, 2008**

**TRADEMARK  
PRINCIPAL REGISTER**



LEVITON MANUFACTURING CO., INC. (DELA-  
WARE CORPORATION)  
59-25 LITTLE NECK PARKWAY  
LITTLE NECK, NY 11362

FOR: ELECTRONIC WIRING DEVICES COM-  
PRISED OF A WIRING MODULE THAT LOCKS  
AND LATCHES TO INTERNAL WIRING DEVICES,  
NAMELY, RECEPTACLES, SWITCHES, DIMMERS,  
SENSORS, LIGHTING CONTROLS, AND COMBI-

NATIONS OF THE AFOREMENTIONED ITEMS, IN  
CLASS 9 (U.S. CLS. 21, 23, 26, 36 AND 38).

FIRST USE 5-1-2007; IN COMMERCE 11-29-2007.

OWNER OF U.S. REG. NO. 2,867,614.

SN 77-143,467, FILED 3-29-2007.

KHANH LE, EXAMINING ATTORNEY

**Int. Cls.: 13 and 40**

**Prior U.S. Cls.: 2, 9, 100, 103, and 106**

**Reg. No. 3,454,846**

**United States Patent and Trademark Office**

**Registered June 24, 2008**

**TRADEMARK  
SERVICE MARK  
PRINCIPAL REGISTER**

**CONNEX**

GEODYNAMICS, INC. (DELAWARE CORPORATION)

10500 WEST INTERSTATE 20  
MILLSAP, TX 76066

FOR: PERFORATING EQUIPMENT FOR USE IN WELLS, NAMELY, EXPLOSIVE EQUIPMENT FOR COMPLETING OIL AND GAS WELLS, NAMELY, FRACTURING CHARGES AND SHAPED CHARGES FOR PERFORATING GUNS, IN CLASS 13 (U.S. CLS. 2 AND 9).

FIRST USE 4-0-2007; IN COMMERCE 8-0-2007.

FOR: OIL WELL PROSPECTING, NAMELY, THE USE OF EXPLOSIVE PERFORATING EQUIPMENT FOR COMPLETING OIL AND GAS WELLS, IN CLASS 40 (U.S. CLS. 100, 103 AND 106).

FIRST USE 4-0-2007; IN COMMERCE 8-0-2007.

THE MARK CONSISTS OF STANDARD CHARACTERS WITHOUT CLAIM TO ANY PARTICULAR FONT, STYLE, SIZE, OR COLOR.

SN 77-143,734, FILED 3-29-2007.

GIANCARLO CASTRO, EXAMINING ATTORNEY

**Int. Cl.: 28**

**Prior U.S. Cls.: 22, 23, 38, and 50**

**Reg. No. 3,454,847**

**United States Patent and Trademark Office**

**Registered June 24, 2008**

**TRADEMARK  
PRINCIPAL REGISTER**

**GOTCHI GEAR**

BANDAI AMERICA INCORPORATED (CALIFORNIA CORPORATION)  
5551 KATELLA AVENUE  
CYPRESS, CA 90630

THE MARK CONSISTS OF STANDARD CHARACTERS WITHOUT CLAIM TO ANY PARTICULAR FONT, STYLE, SIZE, OR COLOR.

FOR: TOY JEWELRY; TOY ACCESSORIES, NAMELY, TOY CHARMS AND POUCHES; CHILDREN'S ART ACTIVITY TOYS; PLUSH TOYS; TOYS, NAMELY, BATTERY POWERED COMPUTER GAME WITH LCD SCREEN WHICH FEATURES ANIMATION AND SOUND EFFECTS, IN CLASS 28 (U.S. CLS. 22, 23, 38 AND 50).

NO CLAIM IS MADE TO THE EXCLUSIVE RIGHT TO USE "GEAR", APART FROM THE MARK AS SHOWN.

SN 77-144,232, FILED 3-29-2007.

FIRST USE 7-15-2006; IN COMMERCE 7-15-2006.

B. PARADEWELAI, EXAMINING ATTORNEY

**Int. Cl.: 41**

**Prior U.S. Cls.: 100, 101, and 107**

**United States Patent and Trademark Office**

**Reg. No. 3,454,848**

**Registered June 24, 2008**

**SERVICE MARK  
PRINCIPAL REGISTER**



EMPLOYEE & FAMILY RESOURCES, INC. (IOWA CORPORATION)  
505 5TH AVENUE, SUITE 530  
DES MOINES, IA 50309

FIRST USE 6-1-2007; IN COMMERCE 6-1-2007.

FOR: LIFE COACHING, NAMELY, PERSONAL COACHING SERVICES IN THE FIELD OF PERSONAL, EMOTIONAL, BUSINESS, PSYCHOLOGICAL, AND SOCIAL DEVELOPMENT; PERSONAL COACHING SERVICES IN THE FIELD OF PERSONAL, EMOTIONAL, BUSINESS, PSYCHOLOGICAL, AND SOCIAL DEVELOPMENT, IN CLASS 41 (U.S. CLS. 100, 101 AND 107).

THE MARK CONSISTS OF THE WORDS "MY PLAN AFTER 50 NAVIGATING YOUR FUTURE" AND A HALF CIRCLE WITH COMPASS POINTS.

SN 77-144,540, FILED 3-30-2007.

GINA FINK, EXAMINING ATTORNEY



**Int. Cl.: 36**

**Prior U.S. Cls.: 100, 101, and 102**

**United States Patent and Trademark Office**

**Reg. No. 3,454,849**

**Registered June 24, 2008**

**SERVICE MARK  
PRINCIPAL REGISTER**

**TCF EXTRA**

TCF FINANCIAL CORPORATION (DELAWARE  
CORPORATION)  
200 LAKE STREET E.  
WAYZATA, MN 553911694

FOR: BANKING SERVICES, IN CLASS 36 (U.S.  
CLS. 100, 101 AND 102).

FIRST USE 3-28-2007; IN COMMERCE 3-28-2007.

THE MARK CONSISTS OF STANDARD CHAR-  
ACTERS WITHOUT CLAIM TO ANY PARTICULAR  
FONT, STYLE, SIZE, OR COLOR.

OWNER OF U.S. REG. NOS. 1,054,475, 2,931,622,  
AND OTHERS.

SN 77-144,547, FILED 3-30-2007.

MYRIAH HABEEB, EXAMINING ATTORNEY

**Int. Cl.: 3**

**Prior U.S. Cls.: 1, 4, 6, 50, 51, and 52**

**Reg. No. 3,454,850**

**United States Patent and Trademark Office**

**Registered June 24, 2008**

**TRADEMARK  
PRINCIPAL REGISTER**

**overshadow**

SHIPMAN ASSOCIATES, INC. (DELAWARE  
CORPORATION)  
2101 SACRAMENTO STREET, #402  
SAN FRANCISCO, CA 94109

THE MARK CONSISTS OF STANDARD CHAR-  
ACTERS WITHOUT CLAIM TO ANY PARTICULAR  
FONT, STYLE, SIZE, OR COLOR.

FOR: COSMETICS; EYESHADOW; EYE SHA-  
DOW, IN CLASS 3 (U.S. CLS. 1, 4, 6, 50, 51 AND 52).

SN 77-145,244, FILED 3-30-2007.

FIRST USE 6-25-2007; IN COMMERCE 6-25-2007.

SALLY SHIH, EXAMINING ATTORNEY

**Int. Cl.: 31**

**Prior U.S. Cls.: 1 and 46**

**United States Patent and Trademark Office**

**Reg. No. 3,454,851**

**Registered June 24, 2008**

**TRADEMARK  
PRINCIPAL REGISTER**

**CABERNET**

BAILEY NURSERIES, INC. (MINNESOTA CORPORATION)  
1325 BAILEY ROAD  
SAINT PAUL, MN 55119

THE MARK CONSISTS OF STANDARD CHARACTERS WITHOUT CLAIM TO ANY PARTICULAR FONT, STYLE, SIZE, OR COLOR.

FOR: LIVE PLANTS, NAMELY, BARBERIS THUNBERGII SHRUB, IN CLASS 31 (U.S. CLS. 1 AND 46).

SN 77-145,529, FILED 3-31-2007.

FIRST USE 5-15-2007; IN COMMERCE 5-15-2007.

FRED MANDIR, EXAMINING ATTORNEY

**Int. Cl.: 2**

**Prior U.S. Cls.: 6, 11, and 16**

**United States Patent and Trademark Office**

**Reg. No. 3,454,852**

**Registered June 24, 2008**

**TRADEMARK  
PRINCIPAL REGISTER**

**ACRYGUARD**

NATIONAL COATINGS CORPORATION (CALI-  
FORNIA CORPORATION)  
1201 CALLE SUERTE  
CAMARILLO, CA 93012

THE MARK CONSISTS OF STANDARD CHAR-  
ACTERS WITHOUT CLAIM TO ANY PARTICULAR  
FONT, STYLE, SIZE, OR COLOR.

FOR: ELASTOMERIC ROOF COATINGS, IN  
CLASS 2 (U.S. CLS. 6, 11 AND 16).

SN 77-145,837, FILED 4-2-2007.

FIRST USE 4-9-2007; IN COMMERCE 12-26-2007.

DAYNA BROWNE, EXAMINING ATTORNEY

**Int. Cl.: 38**

**Prior U.S. Cls.: 100, 101, and 104**

**United States Patent and Trademark Office**

**Reg. No. 3,454,853**

**Registered June 24, 2008**

**SERVICE MARK  
PRINCIPAL REGISTER**

**TELEPERFORMANCE GROUP**

TELEPERFORMANCE (FRANCE JOINT STOCK COMPANY)  
6-8 RUE FIRMIN GILLOT  
PARIS, FRANCE 75015

FOR: COMMUNICATION SERVICES, NAMELY, NEWS AGENCIES, NAMELY, THE TRANSMISSION OF NEWS ITEMS TO NEWS REPORTING ORGANIZATIONS; INFORMATION TRANSMISSION SERVICES BY MEANS OF RADIO, TELEPHONE, TELEGRAPH AND COMPUTER COMMUNICATION AND VIA ALL MEANS OF TELECOMPUTING, VIA INTERACTIVE VIDEOGRAPHY; ELECTRONIC TRANSMISSION OF TELEGRAMS AND MESSAGES; TELEX SERVICES; INFORMATION TRANSMISSION SERVICES BY COMPUTERS CONNECTED TO THE SAME TELEMATIC NETWORK; PUBLIC INFORMATION TRANSMISSION SERVICES PROVIDED THROUGH ELECTRONIC COMMUNICATION NETWORKS AND TELECOMMUNICATION NETWORKS; INFORMATION TRANSMISSION IN THE AUDIOVISUAL AND VIDEO COMMUNICATION SYSTEMS; TRANSMISSION OF INFORMATION TAKEN FROM

DATABANKS VIA ELECTRONIC COMMUNICATION NETWORKS; RENTAL OF TELECOMMUNICATION EQUIPMENT; TELECOMMUNICATIONS CONSULTATION, IN CLASS 38 (U.S. CLS. 100, 101 AND 104).

FIRST USE 0-0-2001; IN COMMERCE 0-0-2001.

THE MARK CONSISTS OF STANDARD CHARACTERS WITHOUT CLAIM TO ANY PARTICULAR FONT, STYLE, SIZE, OR COLOR.

OWNER OF U.S. REG. NOS. 1,781,132, 3,084,396, AND OTHERS.

NO CLAIM IS MADE TO THE EXCLUSIVE RIGHT TO USE "GROUP", APART FROM THE MARK AS SHOWN.

SN 77-146,193, FILED 4-2-2007.

JOHN WILKE, EXAMINING ATTORNEY

**Int. Cl.: 39**

**Prior U.S. Cls.: 100 and 105**

**United States Patent and Trademark Office**

**Reg. No. 3,454,854**

**Registered June 24, 2008**

**SERVICE MARK  
PRINCIPAL REGISTER**

**CHICKADEELIVERY**

BARTON, JEROME DOUGLAS (UNITED STATES  
INDIVIDUAL)  
6556 CUTTALOSSA ROAD  
NEW HOPE, PA 18938

FOR: DELIVERY OF PET FOODS, PET SUPPLIES,  
BIRDSEED, BIRD FEEDERS AND ASSOCIATED  
SUPPLIES, IN CLASS 39 (U.S. CLS. 100 AND 105).

FIRST USE 11-19-2007; IN COMMERCE 11-19-2007.

THE MARK CONSISTS OF STANDARD CHAR-  
ACTERS WITHOUT CLAIM TO ANY PARTICULAR  
FONT, STYLE, SIZE, OR COLOR.

SN 77-146,909, FILED 4-2-2007.

JOHN SCHUYLER YARD, EXAMINING ATTOR-  
NEY

**Int. Cl.: 19**

**Prior U.S. Cls.: 1, 12, 33, and 50**

**United States Patent and Trademark Office**

**Reg. No. 3,454,855**

**Registered June 24, 2008**

**TRADEMARK  
PRINCIPAL REGISTER**

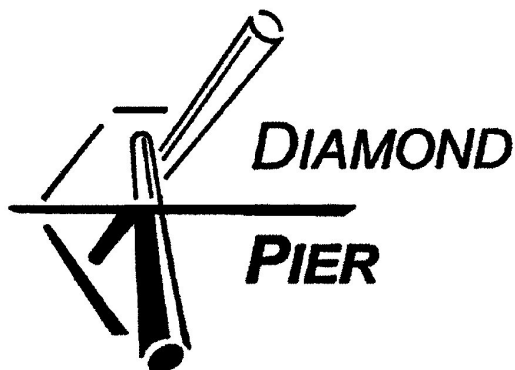

GAGLIANO, RICHARD J. (UNITED STATES IN-  
DIVIDUAL)  
PIN FOUNDATIONS, INC.  
8607 58TH AVE. NW  
GIG HARBOR, WA 983328419

FOR: PREFABRICATED CONCRETE COMPO-  
NENTS DESIGNED TO BE INTEGRATED WITH  
OR ATTACHED TO PIN PILES IN THE CONSTRUC-  
TION OF MINIMIZED-SITE-DISTURBANCE FOUN-  
DATIONS FOR BUILDINGS AND OTHER  
STRUCTURES, IN CLASS 19 (U.S. CLS. 1, 12, 33  
AND 50).

FIRST USE 1-16-2008; IN COMMERCE 1-16-2008.

NO CLAIM IS MADE TO THE EXCLUSIVE  
RIGHT TO USE "PIER", APART FROM THE MARK  
AS SHOWN.

THE MARK CONSISTS OF A STYLIZED REPRE-  
SENTATION OF PIN PILES BEING DRIVEN  
THROUGH THE FOUNDATION COMPONENT,  
FROM WHICH THE WORDS "DIAMOND PIER"  
EMERGE.

SEC. 2(F) AS TO "DIAMOND".

SN 77-147,315, FILED 4-3-2007.

JORDAN BAKER, EXAMINING ATTORNEY

**Int. Cl.: 20**

**Prior U.S. Cls.: 2, 13, 22, 25, 32, and 50**

**Reg. No. 3,454,856**

**United States Patent and Trademark Office**

**Registered June 24, 2008**

---

**TRADEMARK  
PRINCIPAL REGISTER**

**CONGRESSO**

MICHIGAN TUBE SWAGERS & FABRICATORS,  
INC. (MICHIGAN CORPORATION)  
7100 INDUSTRIAL DR.  
TEMPERANCE, MI 48182

THE MARK CONSISTS OF STANDARD CHAR-  
ACTERS WITHOUT CLAIM TO ANY PARTICULAR  
FONT, STYLE, SIZE, OR COLOR.

FOR: CHAIRS, IN CLASS 20 (U.S. CLS. 2, 13, 22, 25,  
32 AND 50).

SN 77-147,417, FILED 4-3-2007.

FIRST USE 3-28-2008; IN COMMERCE 3-28-2008.

THEODORE MCBRIDE, EXAMINING ATTORNEY



**Int. Cl.: 41**

**Prior U.S. Cls.: 100, 101, and 107**

**United States Patent and Trademark Office**

**Reg. No. 3,454,857**

**Registered June 24, 2008**

**SERVICE MARK  
PRINCIPAL REGISTER**

**JUMP 4 JOEY**

PARTY PLANET, LLC (GEORGIA LTD LIAB CO)  
245 VALLEYSIDE DRIVE  
DALLAS, GA 30157

FOR: AMUSEMENT CENTERS; CHILDREN'S ENTERTAINMENT AND AMUSEMENT CENTERS, NAMELY, INTERACTIVE PLAY AREAS; PROVIDING FACILITIES FOR RECREATION ACTIVITIES; ENTERTAINMENT SERVICES, NAMELY, CONDUCTING CHILDREN'S PARTIES; AND PROVIDING RECREATIONAL AREAS IN THE NATURE OF

CHILDREN'S PLAY AREAS, IN CLASS 41 (U.S. CLS. 100, 101 AND 107).

FIRST USE 4-11-2008; IN COMMERCE 4-11-2008.

THE MARK CONSISTS OF STANDARD CHARACTERS WITHOUT CLAIM TO ANY PARTICULAR FONT, STYLE, SIZE, OR COLOR.

SN 77-147,434, FILED 4-3-2007.

ELLEN B. AWRICH, EXAMINING ATTORNEY

**Int. Cl.: 33**

**Prior U.S. Cls.: 47 and 49**

**United States Patent and Trademark Office**

**Reg. No. 3,454,858**

**Registered June 24, 2008**

**TRADEMARK  
PRINCIPAL REGISTER**

**LEESE FITCH**

STEELBIRD GHETTO PROPERTIES LLC (CALI-  
FORNIA LTD LIAB CO)  
P. O. BOX 1248  
SONOMA, CA 95476

THE MARK CONSISTS OF STANDARD CHAR-  
ACTERS WITHOUT CLAIM TO ANY PARTICULAR  
FONT, STYLE, SIZE, OR COLOR.

FOR: WINE, IN CLASS 33 (U.S. CLS. 47 AND 49).

SN 77-147,443, FILED 4-3-2007.

FIRST USE 9-0-2007; IN COMMERCE 9-0-2007.

B. PARADEWELAI, EXAMINING ATTORNEY

**Int. Cls.: 39 and 42**

**Prior U.S. Cls.: 100, 101, and 105**

**United States Patent and Trademark Office**

**Reg. No. 3,454,859**

**Registered June 24, 2008**

**SERVICE MARK  
PRINCIPAL REGISTER**

**MYBOOKSHELF**

MYPUBLISHER, INC. (NEW YORK CORPORATION)  
DIAMOND CORPORATE PARK  
400 COLUMBUS AVENUE  
VALHALLA, NY 10595

FOR: ELECTRONIC STORAGE OF DIGITAL CONTENT, NAMELY, PHOTOGRAPHS, IMAGES, AND DIGITAL PHOTO ALBUMS, ACCESSIBLE THROUGH THE INTERNET, IN CLASS 39 (U.S. CLS. 100 AND 105).

FIRST USE 3-24-2008; IN COMMERCE 3-24-2008.

FOR: UPLOADING, POSTING, SHOWING, AND DISPLAYING PHOTOGRAPHS, IMAGES, AND DI-

GITAL PHOTO ALBUMS VIA THE INTERNET, IN CLASS 42 (U.S. CLS. 100 AND 101).

FIRST USE 3-24-2008; IN COMMERCE 3-24-2008.

THE MARK CONSISTS OF STANDARD CHARACTERS WITHOUT CLAIM TO ANY PARTICULAR FONT, STYLE, SIZE, OR COLOR.

OWNER OF U.S. REG. NOS. 2,658,767, 2,674,783, AND 2,986,529.

SN 77-147,692, FILED 4-3-2007.

JEAN IM, EXAMINING ATTORNEY

**Int. Cl.: 41**

**Prior U.S. Cls.: 100, 101, and 107**

**United States Patent and Trademark Office**

**Reg. No. 3,454,860**

**Registered June 24, 2008**

**SERVICE MARK  
PRINCIPAL REGISTER**

**THE NORTH FACE NEVER STOP  
EXPLORING SPEAKER SERIES**

THE NORTH FACE APPAREL CORP. (DELA-  
WARE CORPORATION)  
3411 SILVERSIDE ROAD  
WILMINGTON, DE 19810

FOR: ARRANGING SEMINARS AND LECTURES  
IN THE FIELDS OF ADVENTURE AND ENDUR-  
ANCE SPORTS, NAMELY, SKIING, SNOWBOARD-  
ING, RUNNING, CLIMBING, AND HIKING;  
CONDUCTING SEMINARS AND LECTURES IN  
THE FIELDS OF ADVENTURE AND ENDURANCE  
SPORTS, NAMELY, SKIING, SNOWBOARDING,  
RUNNING, CLIMBING, AND HIKING, IN CLASS  
41 (U.S. CLS. 100, 101 AND 107).

FIRST USE 4-26-2007; IN COMMERCE 4-26-2007.

THE MARK CONSISTS OF STANDARD CHAR-  
ACTERS WITHOUT CLAIM TO ANY PARTICULAR  
FONT, STYLE, SIZE, OR COLOR.

OWNER OF U.S. REG. NOS. 983,624, 2,897,197,  
AND OTHERS.

NO CLAIM IS MADE TO THE EXCLUSIVE  
RIGHT TO USE "SPEAKER SERIES", APART FROM  
THE MARK AS SHOWN.

SN 77-148,131, FILED 4-4-2007.

ROBIN CHOSID, EXAMINING ATTORNEY

**Int. Cl.: 7**

**Prior U.S. Cls.: 13, 19, 21, 23, 31, 34, and 35**

**Reg. No. 3,454,861**

**United States Patent and Trademark Office**

**Registered June 24, 2008**

**TRADEMARK  
PRINCIPAL REGISTER**

**NOMAD**

ROYAL APPLIANCE MFG. CO. (OHIO COR-  
PORATION)  
7005 COCHRAN ROAD  
GLENWILLOW, OH 44139

THE MARK CONSISTS OF STANDARD CHAR-  
ACTERS WITHOUT CLAIM TO ANY PARTICULAR  
FONT, STYLE, SIZE, OR COLOR.

FOR: POWER-OPERATED SPRAYERS, IN CLASS  
7 (U.S. CLS. 13, 19, 21, 23, 31, 34 AND 35).

SN 77-148,205, FILED 4-4-2007.

FIRST USE 3-17-2008; IN COMMERCE 3-17-2008.

MARGERY A. TIERNEY, EXAMINING ATTORNEY

**Int. Cls.: 35, 36, and 41**

**Prior U.S. Cls.: 100, 101, 102, and 107**

**United States Patent and Trademark Office**

**Reg. No. 3,454,862**

**Registered June 24, 2008**

**SERVICE MARK  
PRINCIPAL REGISTER**



LA84 FOUNDATION (CALIFORNIA NON-PROFIT CORPORATION)  
2141 W. ADAMS BLVD.  
LOS ANGELES, CA 90018

FOR: PROMOTING THE INTERESTS OF PEOPLE INVOLVED AND CONCERNED WITH YOUTH SPORTS, IN CLASS 35 (U.S. CLS. 100, 101 AND 102).

FIRST USE 6-6-2007; IN COMMERCE 6-6-2007.

FOR: PHILANTHROPIC SERVICES CONCERNING MONETARY DONATIONS, IN CLASS 36 (U.S. CLS. 100, 101 AND 102).

FIRST USE 6-6-2007; IN COMMERCE 6-6-2007.

FOR: EDUCATIONAL SERVICES, NAMELY, ENCOURAGING YOUTH AMATEUR SPORTS BY ORGANIZING, SUPPORTING, PROMOTING, SPONSORING, AND ADMINISTERING YOUTH ATHLETIC PROGRAMS AND ACTIVITIES TO IN-

CREASE PUBLIC UNDERSTANDING OF THE ROLE OF SPORTS IN SOCIETY; EDUCATIONAL SERVICES, NAMELY, PERSONAL COACHING EDUCATION PROGRAMS IN THE FIELD OF SPORTS; AMATEUR YOUTH SPORTS SERVICES, NAMELY, ORGANIZING, PROVIDING AND MANAGING YOUTH SPORTS ACTIVITIES, IN CLASS 41 (U.S. CLS. 100, 101 AND 107).

FIRST USE 6-6-2007; IN COMMERCE 6-6-2007.

NO CLAIM IS MADE TO THE EXCLUSIVE RIGHT TO USE "FOUNDATION", APART FROM THE MARK AS SHOWN.

THE MARK CONSISTS OF THE WORDS "LA 84 FOUNDATION" WITH A FLAME DESIGN.

SN 77-148,733, FILED 4-4-2007.

STEVEN JACKSON, EXAMINING ATTORNEY

**Int. Cl.: 41**

**Prior U.S. Cls.: 100, 101, and 107**

**United States Patent and Trademark Office**

**Reg. No. 3,454,863**

**Registered June 24, 2008**

**SERVICE MARK  
PRINCIPAL REGISTER**

**HBS@WORK**

PRESIDENT AND FELLOWS OF HARVARD  
COLLEGE (MASSACHUSETTS CHARITABLE  
CORPORATION)  
17 QUINCY STREET  
CAMBRIDGE, MA 021383805

FOR: EDUCATIONAL SERVICES, NAMELY,  
PROVIDING POST-GRADUATE, PROFESSIONAL  
AND EXECUTIVE LEVEL OF INSTRUCTION,  
CLASSES, SEMINARS, CONFERENCES, WEBINARS  
AND WORKSHOPS VIA ON-LINE AND INTERAC-  
TIVE PROGRAMS AND PRINTABLE MATERIALS  
DISTRIBUTED THEREWITH; PROVIDING EDUCA-

TIONAL MENTORING SERVICES AND PRO-  
GRAMS, IN CLASS 41 (U.S. CLS. 100, 101 AND 107).

FIRST USE 10-1-2007; IN COMMERCE 10-1-2007.

THE MARK CONSISTS OF STANDARD CHAR-  
ACTERS WITHOUT CLAIM TO ANY PARTICULAR  
FONT, STYLE, SIZE, OR COLOR.

SN 77-149,252, FILED 4-5-2007.

AISHA CLARKE, EXAMINING ATTORNEY

**Int. Cl.: 10**

**Prior U.S. Cls.: 26, 39, and 44**

**United States Patent and Trademark Office**

**Reg. No. 3,454,864**

**Registered June 24, 2008**

**TRADEMARK  
PRINCIPAL REGISTER**

**HARMONY**

ADVANCED BIONICS, LLC (DELAWARE CORPORATION)  
25129 RYE CANYON LOOP  
VALENCIA, CA 91355

FOR: COCHLEAR IMPLANT SYSTEM COMPRISING SPEECH PROCESSORS, EXTERNAL HEADPIECES, IMPLANTABLE COCHLEAR STIMULATORS, LEADS, ELECTRODES AND SOFTWARE FOR TESTING, MONITORING AND CONTROLLING THE APPARATUS ALL SOLD TOGETHER AS A KIT, AND PARTS THEREFOR, IN CLASS 10 (U.S. CLS. 26, 39 AND 44).

FIRST USE 12-6-2006; IN COMMERCE 12-6-2006.

THE MARK CONSISTS OF STANDARD CHARACTERS WITHOUT CLAIM TO ANY PARTICULAR FONT, STYLE, SIZE, OR COLOR.

OWNER OF U.S. REG. NO. 3,020,221.

SN 77-149,416, FILED 4-5-2007.

CHRISTINE COOPER, EXAMINING ATTORNEY



**Int. Cl.: 36**

**Prior U.S. Cls.: 100, 101, and 102**

**United States Patent and Trademark Office**

**Reg. No. 3,454,865**

**Registered June 24, 2008**

**SERVICE MARK  
PRINCIPAL REGISTER**



JELD-WEN, INC. (OREGON CORPORATION)  
3250 LAKEPORT BOULEVARD  
KLAMATH FALLS, OR 97601

FOR: REAL ESTATE EXCHANGE SERVICES,  
NAMELY, FACILITATING 1031 REAL ESTATE EX-  
CHANGES, IN CLASS 36 (U.S. CLS. 100, 101 AND 102).

FIRST USE 6-30-2007; IN COMMERCE 6-30-2007.

OWNER OF U.S. REG. NOS. 1,388,339, 3,072,535,  
AND OTHERS.

NO CLAIM IS MADE TO THE EXCLUSIVE  
RIGHT TO USE "1031", APART FROM THE MARK  
AS SHOWN.

THE MARK CONSISTS OF THE STYLIZED  
WORD "JELD-WEN" WITH DOUBLE LINES ON  
TOP OF THE WORD AND UNDERNEATH THE  
WORD. "1031" IS CENTERED UNDERNEATH THE  
WORD "JELD-WEN".

SN 77-149,799, FILED 4-5-2007.

JANET LEE, EXAMINING ATTORNEY

**Int. Cl.: 42**

**Prior U.S. Cls.: 100 and 101**

**United States Patent and Trademark Office**

**Reg. No. 3,454,866**

**Registered June 24, 2008**

**SERVICE MARK  
PRINCIPAL REGISTER**

# REVENUE360

PROVIDER ADVANTAGE NW, INC. (OREGON CORPORATION)  
3685 N.W. 183RD AVENUE  
PORTLAND, OR 97229

FOR: CLIENT SERVER APPLICATION SERVICE PROVIDER FEATURING SOFTWARE FOR ENABLING HOSPITAL PERSONNEL AND HEALTHCARE PROVIDERS TO ACCESS, COLLECT, TRANSMIT, STORE, SHARE, AND INTEGRATE ACCURATE PATIENT INFORMATION SUCH AS DEMOGRAPHIC DATA, INSURANCE ELIGIBILITY DATA AND FINANCIAL INFORMATION TO BE USED BY HOSPITAL PERSONNEL AND HEALTHCARE PROVIDERS FOR RECEIVING PAYMENT FOR MEDICAL SERVICES; APPLICATION SERVICE PROVIDER FEATURING SOFTWARE FOR ENABLING HOSPITAL PERSONNEL AND HEALTHCARE PROVIDERS TO ACCESS, COLLECT, TRANSMIT, STORE, SHARE, AND INTEGRATE ACCURATE PATIENT INFORMATION SUCH AS DEMOGRAPHIC DATA, INSURANCE ELIGIBILITY DATA AND FINANCIAL INFORMATION TO BE USED BY HOSPITAL PERSONNEL

AND HEALTHCARE PROVIDERS FOR RECEIVING PAYMENT FOR MEDICAL SERVICES; COMPUTER SOFTWARE CONSULTATION; COMPUTER SOFTWARE DEVELOPMENT; COMPUTER SOFTWARE DESIGN FOR OTHERS; DESIGN, DEVELOPMENT AND IMPLEMENTATION OF SOFTWARE; INSTALLATION OF COMPUTER SOFTWARE; MAINTENANCE OF COMPUTER SOFTWARE; REPAIR OF COMPUTER SOFTWARE; UP-DATING OF COMPUTER SOFTWARE FOR OTHERS; RENTAL OF COMPUTERS AND SOFTWARE, IN CLASS 42 (U.S. CLS. 100 AND 101).

FIRST USE 5-1-2007; IN COMMERCE 5-1-2007.

THE MARK CONSISTS OF STANDARD CHARACTERS WITHOUT CLAIM TO ANY PARTICULAR FONT, STYLE, SIZE, OR COLOR.

SN 77-151,048, FILED 4-6-2007.

ZHALEH DELANEY, EXAMINING ATTORNEY

Int. Cl.: 29

Prior U.S. Cl.: 46

**United States Patent and Trademark Office**

**Reg. No. 3,454,867**

Registered June 24, 2008

**TRADEMARK  
PRINCIPAL REGISTER**

**SAUSALITO**  
*Bar Essentials*

SAUSALITO FOODS LLC (OREGON LTD LIAB  
CO)  
10645 SW MEIER DR.  
TUALATIN, OR 97062

NO CLAIM IS MADE TO THE EXCLUSIVE  
RIGHT TO USE "SAUSALITO" , APART FROM  
THE MARK AS SHOWN.

FOR: PROCESSED ONIONS; MARASCHINO  
CHERRIES; PROCESSED OLIVES, IN CLASS 29  
(U.S. CL. 46).

SN 77-151,448, FILED 4-8-2007.

FIRST USE 4-1-2008; IN COMMERCE 4-1-2008.

NAKIA HENRY, EXAMINING ATTORNEY

**Int. Cls.: 35 and 41**

**Prior U.S. Cls.: 100, 101, 102, and 107**

**United States Patent and Trademark Office**

**Reg. No. 3,454,868**

**Registered June 24, 2008**

**SERVICE MARK  
PRINCIPAL REGISTER**

# CrossGlobal Link

INTERDENOMINATIONAL FOREIGN MISSION  
ASSOCIATION OF NORTH AMERICA INC.  
(ILLINOIS CORPORATION)

PO BOX 398  
WHEATON, IL 601890398

FOR: ASSOCIATION SERVICES, NAMELY, PROMOTING THE INTERESTS OF MEMBERS IN THEIR RELIGIOUS WORK , IN CLASS 35 (U.S. CLS. 100, 101 AND 102).

FIRST USE 9-29-2007; IN COMMERCE 9-29-2007.

FOR: EDUCATION SERVICES, NAMELY, PROVIDING SEMINARS AND WORKSHOPS IN THE

FIELDS OF MISSIONS AND RELIGION, IN CLASS 41 (U.S. CLS. 100, 101 AND 107).

FIRST USE 9-29-2007; IN COMMERCE 9-29-2007.

THE MARK CONSISTS OF STANDARD CHARACTERS WITHOUT CLAIM TO ANY PARTICULAR FONT, STYLE, SIZE, OR COLOR.

SN 77-152,424, FILED 4-9-2007.

LIEF MARTIN, EXAMINING ATTORNEY

**Int. Cl.: 9**

**Prior U.S. Cls.: 21, 23, 26, 36, and 38**

**United States Patent and Trademark Office**

**Reg. No. 3,454,869**

**Registered June 24, 2008**

**TRADEMARK  
PRINCIPAL REGISTER**

**RAPIDFIRE**

EKLIN MEDICAL SYSTEMS, INC. (CALIFORNIA  
CORPORATION)  
1605 WYATT DRIVE  
SANTA CLARA, CA 95054

THE MARK CONSISTS OF STANDARD CHAR-  
ACTERS WITHOUT CLAIM TO ANY PARTICULAR  
FONT, STYLE, SIZE, OR COLOR.

FOR: SOFTWARE FOR USE IN CAPTURING  
RADIOGRAPHIC IMAGES ONTO STORAGE MED-  
IA, IN CLASS 9 (U.S. CLS. 21, 23, 26, 36 AND 38).

SN 77-152,676, FILED 4-10-2007.

FIRST USE 7-20-2007; IN COMMERCE 7-20-2007.

SETH A. RAPPAPORT, EXAMINING ATTORNEY

**Int. Cl.: 41**

**Prior U.S. Cls.: 100, 101, and 107**

**United States Patent and Trademark Office**

**Reg. No. 3,454,870**

**Registered June 24, 2008**

**SERVICE MARK  
PRINCIPAL REGISTER**

# Heart Of Philly

DE CECCO KAREN A. (UNITED STATES INDIVIDUAL)  
28 CARAWAY CT.  
THOROFARE, NJ 08086

FOR: ENTERTAINMENT SERVICES IN THE NATURE OF AN ON-GOING REALITY BASED TELEVISION PROGRAM, IN CLASS 41 (U.S. CLS. 100, 101 AND 107).

FIRST USE 1-1-2004; IN COMMERCE 1-1-2004.

THE MARK CONSISTS OF STANDARD CHARACTERS WITHOUT CLAIM TO ANY PARTICULAR FONT, STYLE, SIZE, OR COLOR.

NO CLAIM IS MADE TO THE EXCLUSIVE RIGHT TO USE "PHILLY", APART FROM THE MARK AS SHOWN.

SN 77-153,040, FILED 4-10-2007.

SIMON TENG, EXAMINING ATTORNEY

**Int. Cl.: 18**

**Prior U.S. Cls.: 1, 2, 3, 22, and 41**

**United States Patent and Trademark Office**

**Reg. No. 3,454,871**

**Registered June 24, 2008**

**TRADEMARK  
PRINCIPAL REGISTER**



INDONESIAN IMPORTS, INC. (DELAWARE  
CORPORATION)  
440 ALABAMA STREET  
SAN FRANCISCO, CA 94110

FOR: PURSES, HANDBAGS, TOTE BAGS AND  
WALLETS, IN CLASS 18 (U.S. CLS. 1, 2, 3, 22 AND 41).

FIRST USE 8-31-2007; IN COMMERCE 3-31-2008.

OWNER OF U.S. REG. NOS. 2,387,283, 2,495,682,  
AND 2,495,683.

THE MARK CONSISTS OF DOVE SHAPED TAG  
WITH THE WORDING "THE SAK".

SN 77-153,306, FILED 4-10-2007.

RICHARD A. STRASER, EXAMINING ATTORNEY

**Int. Cl.: 5**

**Prior U.S. Cls.: 6, 18, 44, 46, 51, and 52**

**United States Patent and Trademark Office**

**Reg. No. 3,454,872**

**Registered June 24, 2008**

**TRADEMARK  
PRINCIPAL REGISTER**

**SEASIDE BREEZES**

DIAL BRANDS, INC. (ARIZONA CORPORATION)  
M.S. 2214  
15501 NORTH DIAL BOULEVARD  
SCOTTSDALE, AZ 852601619

FOR: AIR FRESHENERS, AROMATIC PREPARATIONS AND SUBSTANCES FOR FRESHENING THE AIR; PERFUMED AIR FRESHENING PREPARATIONS, IN CLASS 5 (U.S. CLS. 6, 18, 44, 46, 51 AND 52).

FIRST USE 1-14-2008; IN COMMERCE 1-14-2008.

THE MARK CONSISTS OF STANDARD CHARACTERS WITHOUT CLAIM TO ANY PARTICULAR FONT, STYLE, SIZE, OR COLOR.

SN 77-153,363, FILED 4-10-2007.

DAVID I, EXAMINING ATTORNEY



**Int. Cl.: 5**

**Prior U.S. Cls.: 6, 18, 44, 46, 51, and 52**

**Reg. No. 3,454,873**

**United States Patent and Trademark Office**

**Registered June 24, 2008**

---

**TRADEMARK  
PRINCIPAL REGISTER**

**OCEAN OASIS**

DIAL BRANDS, INC. (ARIZONA CORPORATION)  
M.S. 2214  
15501 NORTH DIAL BOULEVARD  
SCOTTSDALE, AZ 852601619

FIRST USE 1-14-2008; IN COMMERCE 1-14-2008.

THE MARK CONSISTS OF STANDARD CHARACTERS WITHOUT CLAIM TO ANY PARTICULAR FONT, STYLE, SIZE, OR COLOR.

FOR: AIR FRESHENERS, AROMATIC PREPARATIONS AND SUBSTANCES FOR FRESHENING THE AIR; PERFUMED AIR FRESHENING PREPARATIONS, IN CLASS 5 (U.S. CLS. 6, 18, 44, 46, 51 AND 52).

SN 77-153,374, FILED 4-10-2007.

DAVID I, EXAMINING ATTORNEY

**Int. Cl.: 25**

**Prior U.S. Cls.: 22 and 39**

**United States Patent and Trademark Office**

**Reg. No. 3,454,874**

**Registered June 24, 2008**

**TRADEMARK  
PRINCIPAL REGISTER**

**YATEEM**

STAR DESIGN INTERNATIONAL INC. (LOUISIANA CORPORATION)  
12 OLYMPIC STREET  
KENNER, LA 70065

THE MARK CONSISTS OF STANDARD CHARACTERS WITHOUT CLAIM TO ANY PARTICULAR FONT, STYLE, SIZE, OR COLOR.

FOR: CLOTHING, NAMELY, PANTS, SHORTS, SHIRTS, TEE-SHIRT, SOCKS, HATS, FOOTWEAR, HEADWEAR, TANKTOP, IN CLASS 25 (U.S. CLS. 22 AND 39).

SN 77-153,595, FILED 4-11-2007.

FIRST USE 7-1-2007; IN COMMERCE 7-1-2007.

MICHAEL WEBSTER, EXAMINING ATTORNEY

**Int. Cl.: 35**

**Prior U.S. Cls.: 100, 101, and 102**

**United States Patent and Trademark Office**

**Reg. No. 3,454,875**

**Registered June 24, 2008**

**SERVICE MARK  
PRINCIPAL REGISTER**

**SPEED-TO-MARKET  
COLLABORATION FOR RAPID  
EXECUTION**

CADBURY ADAMS USA LLC (DELAWARE LTD  
LIAB CO)  
389 INTERPACE PARKWAY  
PARSIPPANY, NJ 07054

FOR: CONSUMER RESEARCH CONDUCTED IN  
THE CONFECTIONERY RETAIL MARKET, IN  
CLASS 35 (U.S. CLS. 100, 101 AND 102).

FIRST USE 3-31-2007; IN COMMERCE 3-31-2007.

THE MARK CONSISTS OF STANDARD CHAR-  
ACTERS WITHOUT CLAIM TO ANY PARTICULAR  
FONT, STYLE, SIZE, OR COLOR.

SN 77-154,317, FILED 4-11-2007.

KATHERINE M. DUBRAY, EXAMINING ATTOR-  
NEY

**Int. Cl.: 8**

**Prior U.S. Cls.: 23, 28, and 44**

**United States Patent and Trademark Office**

**Reg. No. 3,454,876**

**Registered June 24, 2008**

**TRADEMARK  
PRINCIPAL REGISTER**

**POWER STEP**

AMES TRUE TEMPER PROPERTIES, INC. (MI-  
CHIGAN CORPORATION)  
300 DELAWARE AVENUE, SUITE 1704  
WILMINGTON, DE 19801

THE MARK CONSISTS OF STANDARD CHAR-  
ACTERS WITHOUT CLAIM TO ANY PARTICULAR  
FONT, STYLE, SIZE, OR COLOR.

FOR: MANUALLY OPERATED HAND TOOLS,  
NAMELY, SHOVELS AND SPADES, IN CLASS 8  
(U.S. CLS. 23, 28 AND 44).

SN 77-154,713, FILED 4-12-2007.

FIRST USE 11-1-2007; IN COMMERCE 11-1-2007.

ANNE E. GUSTASON, EXAMINING ATTORNEY

**Int. Cl.: 36**

**Prior U.S. Cls.: 100, 101, and 102**

**United States Patent and Trademark Office**

**Reg. No. 3,454,877**

**Registered June 24, 2008**

---

**SERVICE MARK  
PRINCIPAL REGISTER**

**I AM THE FUTURE. THE  
FUTURE IS NOW**

POWER FINANCIAL CREDIT UNION (FLORIDA  
CREDIT UNION)  
2020 NW 150TH AVENUE  
PEMBROKE PINES, FL 33028

THE MARK CONSISTS OF STANDARD CHAR-  
ACTERS WITHOUT CLAIM TO ANY PARTICULAR  
FONT, STYLE, SIZE, OR COLOR.

FOR: BANKING, IN CLASS 36 (U.S. CLS. 100, 101  
AND 102).

SN 77-155,005, FILED 4-12-2007.

FIRST USE 3-10-2008; IN COMMERCE 3-10-2008.

KRISTIN DAHLING, EXAMINING ATTORNEY

**Int. Cl.: 41**

**Prior U.S. Cls.: 100, 101, and 107**

**United States Patent and Trademark Office**

**Reg. No. 3,454,878**

**Registered June 24, 2008**

---

**SERVICE MARK  
PRINCIPAL REGISTER**

**18 KARAT ARCADE**

GNLV CORP. (NEVADA CORPORATION)  
129 E. FREMONT STREET  
LAS VEGAS, NV 89101

FOR: AMUSEMENT ARCADES, IN CLASS 41 (U.S.  
CLS. 100, 101 AND 107).

FIRST USE 5-8-2007; IN COMMERCE 5-8-2007.

THE MARK CONSISTS OF STANDARD CHAR-  
ACTERS WITHOUT CLAIM TO ANY PARTICULAR  
FONT, STYLE, SIZE, OR COLOR.

NO CLAIM IS MADE TO THE EXCLUSIVE  
RIGHT TO USE "ARCADE", APART FROM THE  
MARK AS SHOWN.

SN 77-155,394, FILED 4-12-2007.

MELVIN AXILBUND, EXAMINING ATTORNEY

**Int. Cl.: 36**

**Prior U.S. Cls.: 100, 101, and 102**

**United States Patent and Trademark Office**

**Reg. No. 3,454,879**

**Registered June 24, 2008**

**SERVICE MARK  
PRINCIPAL REGISTER**



MERRILL LYNCH, PIERCE, FENNER & SMITH  
INC. (DELAWARE CORPORATION)  
4 WORLD FINANCIAL CENTER  
NEW YORK, NY 10080

FOR: FINANCIAL SERVICES IN THE NATURE  
OF A DEBT SECURITY LINKED TO AN UNDER-  
LYING REFERENCE INDEX, IN CLASS 36 (U.S.  
CLS. 100, 101 AND 102).

FIRST USE 7-3-2007; IN COMMERCE 7-3-2007.

THE COLOR(S) GREEN, ORANGE, BLUE AND  
GRAY IS/ARE CLAIMED AS A FEATURE OF THE  
MARK.

THE MARK CONSISTS OF THREE COLUMNS OF  
BOXES IN ASCENDING ORDER FROM LEFT TO  
RIGHT AND THE WORD "ELEMENTS". THE  
BOXES IN THE LOWER LEFT AND UPPER RIGHT  
CORNERS ARE GREEN; THE BOX IN THE MIDDLE  
OF THE UPPER DIAGONAL LINE IS ORANGE; THE  
BOXES IN THE MIDDLE DIAGONAL LINE AND  
THE WORD "ELEMENTS" ARE BLUE AND THE  
BOX IN THE LOWER RIGHT CORNER IS GRAY.

SN 77-155,562, FILED 4-12-2007.

RONALD MCMORROW, EXAMINING ATTORNEY

**Int. Cl.: 36**

**Prior U.S. Cls.: 100, 101, and 102**

**United States Patent and Trademark Office**

**Reg. No. 3,454,880**

**Registered June 24, 2008**

**SERVICE MARK  
PRINCIPAL REGISTER**

 **ELEMENTS**

MERRILL LYNCH, PIERCE, FENNER & SMITH  
INC. (DELAWARE CORPORATION)  
4 WORLD FINANCIAL CENTER  
NEW YORK, NY 10080

FOR: FINANCIAL SERVICES IN THE NATURE  
OF A DEBT SECURITY LINKED TO AN UNDER-  
LYING REFERENCE INDEX, IN CLASS 36 (U.S.  
CLS. 100, 101 AND 102).

FIRST USE 7-3-2007; IN COMMERCE 7-3-2007.

THE COLOR(S) BLACK AND GRAY IS/ARE  
CLAIMED AS A FEATURE OF THE MARK.

THE MARK CONSISTS OF THREE COLUMNS OF  
BOXES IN ASCENDING ORDER FROM LEFT TO  
RIGHT AND THE WORD "ELEMENTS". THE  
BOXES ARE GRAY AND THE WORD "ELEMENTS"  
IS BLACK.

SN 77-155,573, FILED 4-12-2007.

RONALD MCMORROW, EXAMINING ATTORNEY



**Int. Cls.: 3, 5, and 32**

**Prior U.S. Cls.: 1, 4, 6, 18, 44, 45, 46, 48, 50, 51, and 52**

**United States Patent and Trademark Office**

**Reg. No. 3,454,881**

**Registered June 24, 2008**

**TRADEMARK  
PRINCIPAL REGISTER**

# H2O MEDICINE

BIO-LOGIC AQUA TECHNOLOGIES, INC. (DE-  
LAWARE CORPORATION)  
5001 LOWER RIVER ROAD  
GRANTS PASS, OR 97526

FOR: PURIFIED WATER USED TO WASH,  
MOISTURIZE, AND REFRESH THE SKIN; STERILE  
SPRING WATER USED AS A MOISTURIZER FOR  
THE MOUTH AND TONGUE, IN CLASS 3 (U.S. CLS.  
1, 4, 6, 50, 51 AND 52).

FIRST USE 6-4-2007; IN COMMERCE 6-4-2007.

FOR: PURIFIED WATER USED TO WASH,  
MOISTURIZE, AND REFRESH THE EYES FOR  
MEDICAL USE; PURIFIED LIQUID, NAMELY,  
HIGHLY PURIFIED WATER SUITABLE FOR FIRST  
AID AND MEDICAL USE; EYE WASH, NAMELY,  
PURIFIED WATER IN A SPRAY CONTAINER FOR  
REFRESHING TEAR FILM FOR MEDICAL USE, IN  
CLASS 5 (U.S. CLS. 6, 18, 44, 46, 51 AND 52).

FIRST USE 5-22-2007; IN COMMERCE 5-22-2007.

FOR: SPRING WATER, IN CLASS 32 (U.S. CLS. 45,  
46 AND 48).

FIRST USE 5-6-2008; IN COMMERCE 5-6-2008.

THE MARK CONSISTS OF STANDARD CHAR-  
ACTERS WITHOUT CLAIM TO ANY PARTICULAR  
FONT, STYLE, SIZE, OR COLOR.

NO CLAIM IS MADE TO THE EXCLUSIVE  
RIGHT TO USE "H2O", APART FROM THE MARK  
AS SHOWN.

SN 77-155,576, FILED 4-12-2007.

KRISTIN DAHLING, EXAMINING ATTORNEY

**Int. Cl.: 32**

**Prior U.S. Cls.: 45, 46, and 48**

**United States Patent and Trademark Office**

**Reg. No. 3,454,882**

**Registered June 24, 2008**

**TRADEMARK  
PRINCIPAL REGISTER**

PROPEL INVIGORATING WATER

STOKELY-VAN CAMP, INC. (INDIANA CORPORATION)

SUITE 11-10

555 WEST MONROE STREET

CHICAGO, IL 60661

FOR: NON-ALCOHOLIC, NON-CARBONATED FRUIT FLAVORED DRINKS AND POWDER FOR MAKING THE SAME, IN CLASS 32 (U.S. CLS. 45, 46 AND 48).

FIRST USE 4-4-2008; IN COMMERCE 4-4-2008.

THE MARK CONSISTS OF STANDARD CHARACTERS WITHOUT CLAIM TO ANY PARTICULAR FONT, STYLE, SIZE, OR COLOR.

OWNER OF U.S. REG. NOS. 2,384,101, 2,519,702, AND OTHERS.

NO CLAIM IS MADE TO THE EXCLUSIVE RIGHT TO USE "INVIGORATING WATER", APART FROM THE MARK AS SHOWN.

SN 77-155,826, FILED 4-13-2007.

DAWN HAN, EXAMINING ATTORNEY

**Int. Cl.: 44**

**Prior U.S. Cls.: 100 and 101**

**United States Patent and Trademark Office**

**Reg. No. 3,454,883**

**Registered June 24, 2008**

**SERVICE MARK  
PRINCIPAL REGISTER**



OLMSTEAD HEALTH CARE SERVICES, LLC  
(NEW MEXICO LTD LIAB CO)  
717 ENCINO PLACE NE, SUITE 16  
ALBUQUERQUE, NM 87102

FOR: PROVIDING HEALTH CARE SERVICES,  
CONSULTATIONS, AND INFORMATION IN THE  
FIELD OF TRAVEL HEALTH, IN CLASS 44 (U.S.  
CLS. 100 AND 101).

FIRST USE 12-0-2006; IN COMMERCE 12-0-2006.

NO CLAIM IS MADE TO THE EXCLUSIVE  
RIGHT TO USE "NM TRAVEL HEALTH" AND  
"HEALTH CARE SERVICES, LLC", APART FROM  
THE MARK AS SHOWN.

THE MARK CONSISTS OF A STYLIZED ZIA  
SYMBOL WITH A GLOBE IN THE CENTER OF  
FOUR GROUPS OF THREE PARALLEL LINES  
EMANATING FROM THE GLOBE, WITH THE  
WORDS "NM TRAVEL HEALTH" AND "OLM-  
STEAD HEALTH CARE SERVICES, LLC" LOCATED  
ABOVE AND BELOW THE GROUP OF LINES  
EMANATING TO THE RIGHT, RESPECTIVELY.

SN 77-155,971, FILED 4-13-2007.

ALEX KEAM, EXAMINING ATTORNEY

**Int. Cls.: 25 and 37**

**Prior U.S. Cls.: 22, 39, 100, 103, and 106**

**United States Patent and Trademark Office**

**Reg. No. 3,454,884**

**Registered June 24, 2008**

**TRADEMARK  
SERVICE MARK  
PRINCIPAL REGISTER**

**NO SLOWING DOWN**

SPEEDCO INC. (INDIANA CORPORATION)  
P. O. BOX 520  
CAYUGA, IN 47928

FOR: CLOTHING, NAMELY, T-SHIRTS, HATS  
AND JACKETS, IN CLASS 25 (U.S. CLS. 22 AND 39).

FIRST USE 3-14-2005; IN COMMERCE 3-14-2005.

FOR: TRUCK MAINTENANCE SERVICES,  
NAMELY, LUBRICATION, OIL CHANGE, TIRE  
CHANGE, ANTIFREEZE TESTING AND ANALYSIS

OF OIL FOR IMPURITIES, IN CLASS 37 (U.S. CLS.  
100, 103 AND 106).

FIRST USE 3-14-2005; IN COMMERCE 3-14-2005.

THE MARK CONSISTS OF STANDARD CHAR-  
ACTERS WITHOUT CLAIM TO ANY PARTICULAR  
FONT, STYLE, SIZE, OR COLOR.

SN 77-155,979, FILED 4-13-2007.

CARRIE GENOVESE, EXAMINING ATTORNEY

**Int. Cl.: 20**

**Prior U.S. Cls.: 2, 13, 22, 25, 32, and 50**

**Reg. No. 3,454,885**

**United States Patent and Trademark Office**

**Registered June 24, 2008**

---

**TRADEMARK  
PRINCIPAL REGISTER**

**SHARE - IT !**

INTEGRATED ID SYSTEMS, INC. (NORTH CAROLINA CORPORATION)  
SUITE 110  
6407 IDLEWILD ROAD  
CHARLOTTE, NC 28212

THE MARK CONSISTS OF STANDARD CHARACTERS WITHOUT CLAIM TO ANY PARTICULAR FONT, STYLE, SIZE, OR COLOR.

FOR: ORNAMENTAL PLASTIC TAGS WITH AN AFFINITY THEME, IN CLASS 20 (U.S. CLS. 2, 13, 22, 25, 32 AND 50).

SN 77-156,313, FILED 4-13-2007.

FIRST USE 5-14-2007; IN COMMERCE 5-14-2007.

WON TEAK OH, EXAMINING ATTORNEY

**Int. Cl.: 36**

**Prior U.S. Cls.: 100, 101, and 102**

**United States Patent and Trademark Office**

**Reg. No. 3,454,886**

**Registered June 24, 2008**

**SERVICE MARK  
PRINCIPAL REGISTER**

**ARUN ENTERPRISES**

ARUN ENTERPRISES, INC. (ILLINOIS CORPORATION)

2700 OAK BROOK ROAD

OAK BROOK, IL 60523

FOR: REAL ESTATE MANAGEMENT, IN CLASS 36 (U.S. CLS. 100, 101 AND 102).

FIRST USE 0-0-1979; IN COMMERCE 0-0-1983.

THE MARK CONSISTS OF STANDARD CHARACTERS WITHOUT CLAIM TO ANY PARTICULAR FONT, STYLE, SIZE, OR COLOR.

NO CLAIM IS MADE TO THE EXCLUSIVE RIGHT TO USE "ENTERPRISES", APART FROM THE MARK AS SHOWN.

SN 77-156,485, FILED 4-13-2007.

NICHOLAS ALTREE, EXAMINING ATTORNEY

**Int. Cl.: 25**

**Prior U.S. Cls.: 22 and 39**

**United States Patent and Trademark Office**

**Reg. No. 3,454,887**

**Registered June 24, 2008**

**TRADEMARK  
PRINCIPAL REGISTER**

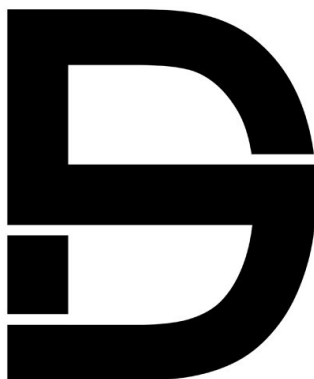

SPECTRUM DESIGNS LLC (VIRGINIA LTD LIAB  
CO)  
20 CHOWAN PLACE  
NEWPORT NEWS, VA 23608

FOR: BUTTON-FRONT ALOHA SHIRTS; CAPRI PANTS; CARGO PANTS; DENIM JACKETS; DENIMS; DOWN JACKETS; DRESS SHIRTS; FISHERMEN'S JACKETS; FUR COATS AND JACKETS; FUR HATS; FUR JACKETS; GLOVES; GOLF SHIRTS; HAT BANDS; HATS; HEAVY JACKETS; JACKET LINERS; JACKETS; JOGGING PANTS; KNIT SHIRTS; LEATHER JACKETS; LEATHER PANTS; LIGHT-REFLECTING JACKETS; LONG JACKETS; MEN AND WOMEN JACKETS, COATS, TROUSERS, VESTS; MOTORCYCLE GLOVES; NIGHT SHIRTS; OPEN-NECKED SHIRTS; PANTS; PETTI-PANTS; PIQUE SHIRTS; POLO SHIRTS; RAIN JACKETS; RAINPROOF JACKETS; RIDING GLOVES; SHIRT FRONTS; SHIRTS; SHIRTS FOR SUITS; SHORT-SLEEVED OR LONG-SLEEVED T-SHIRTS; SHORT-SLEEVED SHIRTS; SKI GLOVES; SKI JACKETS; SKI

PANTS; SLEEP SHIRTS; SLEEVED OR SLEEVELESS JACKETS; SMALL HATS; SNOW PANTS; SPORT SHIRTS; SPORTS JACKETS; SPORTS SHIRTS; SPORTS SHIRTS WITH SHORT SLEEVES; STUFF JACKETS; SUEDE JACKETS; SWEAT PANTS; SWEAT SHIRTS; T-SHIRTS; TAP PANTS; TOBOGGAN HATS, PANTS AND CAPS; TRACK PANTS; WATERPROOF JACKETS AND PANTS; WIND RESISTANT JACKETS; WIND SHIRTS; WIND-JACKETS; WOOLLY HATS, IN CLASS 25 (U.S. CLS. 22 AND 39).

FIRST USE 5-2-2007; IN COMMERCE 5-3-2007.

THE MARK CONSISTS OF A COMBINATION OF THE LETTER "S" AND "D", IN A UNIQUE DESIGN FORMAT.

SN 77-157,057, FILED 4-15-2007.

LINDSEY RUBIN, EXAMINING ATTORNEY

**Int. Cl.: 25**

**Prior U.S. Cls.: 22 and 39**

**United States Patent and Trademark Office**

**Reg. No. 3,454,888**

**Registered June 24, 2008**

**TRADEMARK  
PRINCIPAL REGISTER**

**WONDERFUL EDGE**

CUPID FOUNDATIONS, INC. (NEW YORK CORPORATION)  
475 PARK AVENUE SOUTH  
NEW YORK, NY 10016

FOR: SHAPE WEAR, NAMELY, CONTROL PANTIES, GIRDLES, BODY BRIEFS, AND FOUNDATION GARMENTS, INTIMATES, NAMELY, PANTIES, SLIPS, AND CAMISOLES, AND UNDERGARMENTS, IN CLASS 25 (U.S. CLS. 22 AND 39).

FIRST USE 4-1-2008; IN COMMERCE 4-1-2008.

THE MARK CONSISTS OF STANDARD CHARACTERS WITHOUT CLAIM TO ANY PARTICULAR FONT, STYLE, SIZE, OR COLOR.

SN 77-158,500, FILED 4-17-2007.

JAMES STEIN, EXAMINING ATTORNEY



**Int. Cl.: 3**

**Prior U.S. Cls.: 1, 4, 6, 50, 51, and 52**

**Reg. No. 3,454,889**

**United States Patent and Trademark Office**

**Registered June 24, 2008**

**TRADEMARK  
PRINCIPAL REGISTER**

**RESTORYL**

DREAM QUEST NUTRACEUTICALS (NEVADA  
CORPORATION)  
4660 AIRCENTER CIRCLE  
RENO, NV 895027917

THE MARK CONSISTS OF STANDARD CHAR-  
ACTERS WITHOUT CLAIM TO ANY PARTICULAR  
FONT, STYLE, SIZE, OR COLOR.

FOR: HAIR CARE PREPARATION, IN CLASS 3  
(U.S. CLS. 1, 4, 6, 50, 51 AND 52).

SN 77-158,536, FILED 4-17-2007.

FIRST USE 5-1-2008; IN COMMERCE 5-1-2008.

PAULA MAHONEY, EXAMINING ATTORNEY

**Int. Cl.: 3**

**Prior U.S. Cls.: 1, 4, 6, 50, 51, and 52**

**Reg. No. 3,454,890**

**United States Patent and Trademark Office**

**Registered June 24, 2008**

---

**TRADEMARK  
PRINCIPAL REGISTER**

**RECOVERYL**

DREAM QUEST NUTRACEUTICALS (NEVADA  
CORPORATION)  
4660 AIRCENTER CIRCLE  
RENO, NV 895027917

THE MARK CONSISTS OF STANDARD CHAR-  
ACTERS WITHOUT CLAIM TO ANY PARTICULAR  
FONT, STYLE, SIZE, OR COLOR.

FOR: HAIR CARE PREPARATION, IN CLASS 3  
(U.S. CLS. 1, 4, 6, 50, 51 AND 52).

SN 77-158,664, FILED 4-17-2007.

FIRST USE 5-1-2008; IN COMMERCE 5-1-2008.

PAULA MAHONEY, EXAMINING ATTORNEY

**Int. Cl.: 28**

**Prior U.S. Cls.: 22, 23, 38, and 50**

**Reg. No. 3,454,891**

**United States Patent and Trademark Office**

**Registered June 24, 2008**

**TRADEMARK  
PRINCIPAL REGISTER**

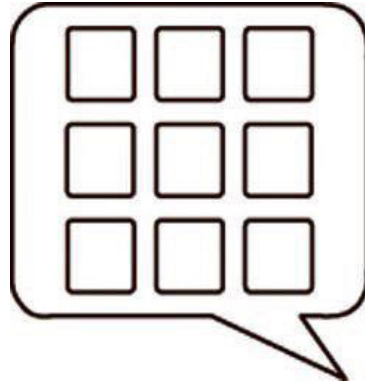

AUSTIN COLLINS (UNITED STATES INDIVIDUAL)  
1005 IVORY CREEK  
SCHERTZ, TX 78154

THE MARK CONSISTS OF A THOUGHT OR SPEECH SQUARE CLOUD BALLOON WITH NINE SMALLER SQUARES WITHIN THE BALLOON.

FOR: BOARD GAMES, IN CLASS 28 (U.S. CLS. 22, 23, 38 AND 50).

SN 77-159,117, FILED 4-18-2007.

FIRST USE 5-1-2007; IN COMMERCE 5-1-2007.

PAULA MAHONEY, EXAMINING ATTORNEY

**Int. Cl.: 25**

**Prior U.S. Cls.: 22 and 39**

**United States Patent and Trademark Office**

**Reg. No. 3,454,892**

**Registered June 24, 2008**

**TRADEMARK  
PRINCIPAL REGISTER**

**DARE TO TRI**

DARE TO TRI, LLC (WISCONSIN LTD LIAB CO)  
7337 W VALLEY RIDGE DR  
MADISON, WI 53719

THE MARK CONSISTS OF STANDARD CHAR-  
ACTERS WITHOUT CLAIM TO ANY PARTICULAR  
FONT, STYLE, SIZE, OR COLOR.

FOR: POLO SHIRTS; SHIRTS; SHORT-SLEEVED  
OR LONG-SLEEVED T-SHIRTS; SPORT SHIRTS; T-  
SHIRTS; HATS; SOCKS, IN CLASS 25 (U.S. CLS. 22  
AND 39).

SN 77-159,389, FILED 4-18-2007.

FIRST USE 9-6-2007; IN COMMERCE 9-6-2007.

JOHN E. MICHOS, EXAMINING ATTORNEY

Int. Cl.: 36

Prior U.S. Cls.: 100, 101, and 102

United States Patent and Trademark Office

Reg. No. 3,454,893

Registered June 24, 2008

**SERVICE MARK  
PRINCIPAL REGISTER**



RESEARCH AFFILIATES, LLC (CALIFORNIA  
LTD LIAB CO)  
SUITE 900  
155 N. LAKE AVENUE  
PASADENA, CA 91101

FOR: FINANCIAL SERVICES, NAMELY, COM-  
PILING AND MANAGING AN INDEX-BASED  
PORTFOLIO OF SECURITIES AND MANAGE-  
MENT OF FINANCIAL PORTFOLIOS, NAMELY,  
ELECTRONIC TRADED FUNDS PORTFOLIO MAN-  
AGEMENT, SEPARATE ACCOUNTS PORTFOLIO

MANAGEMENT, WRAP ACCOUNT PORTFOLIO  
MANAGEMENT AND MUTUAL FUNDS PORTFO-  
LIO MANAGEMENT, IN CLASS 36 (U.S. CLS. 100, 101  
AND 102).

FIRST USE 4-13-2007; IN COMMERCE 4-13-2007.

SN 77-160,499, FILED 4-19-2007.

STEVEN PEREZ, EXAMINING ATTORNEY

**Int. Cl.: 36**

**Prior U.S. Cls.: 100, 101, and 102**

**United States Patent and Trademark Office**

**Reg. No. 3,454,894**

**Registered June 24, 2008**

**SERVICE MARK  
PRINCIPAL REGISTER**

**TURTLE CREEK CAPITAL  
MANAGEMENT**

TURTLE CREEK INVESTMENT ADVISORS, LLC  
(DELAWARE LTD LIAB CO)  
630 FIFTH AVENUE, SUITE 2265  
C/O TURTLE CREEK CAPITAL MANAGEMENT,  
LLC  
NEW YORK, NY 10111

FOR: FINANCIAL MANAGEMENT; INVEST-  
MENT MANAGEMENT; INVESTMENT SERVICES,  
NAMELY, ASSET ACQUISITION AND MANAGE-  
MENT SERVICES; FINANCIAL CONSULTATION,  
IN CLASS 36 (U.S. CLS. 100, 101 AND 102).

FIRST USE 11-2-2007; IN COMMERCE 11-2-2007.

THE MARK CONSISTS OF STANDARD CHAR-  
ACTERS WITHOUT CLAIM TO ANY PARTICULAR  
FONT, STYLE, SIZE, OR COLOR.

NO CLAIM IS MADE TO THE EXCLUSIVE  
RIGHT TO USE "CAPITAL MANAGEMENT",  
APART FROM THE MARK AS SHOWN.

SN 77-161,573, FILED 4-20-2007.

ZHALEH DELANEY, EXAMINING ATTORNEY

**Int. Cl.: 41**

**Prior U.S. Cls.: 100, 101, and 107**

**United States Patent and Trademark Office**

**Reg. No. 3,454,895**

**Registered June 24, 2008**

**SERVICE MARK  
PRINCIPAL REGISTER**

**MR. PIN**

LUCKY STRIKE ENTERTAINMENT, LLC (DE-  
LAWARE LTD LIAB CO)  
SUITE 1110  
15260 VENTURA BOULEVARD  
SHERMAN OAKS, CA 91403

FOR: BOWLING ALLEY SERVICES AND CON-  
DUCTING PARTIES RELATED THERETO, IN  
CLASS 41 (U.S. CLS. 100, 101 AND 107).

FIRST USE 4-19-2007; IN COMMERCE 4-19-2007.

THE MARK CONSISTS OF STANDARD CHAR-  
ACTERS WITHOUT CLAIM TO ANY PARTICULAR  
FONT, STYLE, SIZE, OR COLOR.

SN 77-161,707, FILED 4-20-2007.

WARREN L. OLANDRIA, EXAMINING ATTOR-  
NEY

**Int. Cl.: 29**

**Prior U.S. Cl.: 46**

**United States Patent and Trademark Office**

**Reg. No. 3,454,896**

**Registered June 24, 2008**

**TRADEMARK  
PRINCIPAL REGISTER**

**OCEAN'S FINEST**

GOLDSMITH, IRA, M (UNITED STATES INDIVIDUAL)  
2100 W 76 TH STREET/#301  
HIALEAH, FL 33016

NO CLAIM IS MADE TO THE EXCLUSIVE RIGHT TO USE "FINEST", APART FROM THE MARK AS SHOWN.

FOR: SEAFOOD, IN CLASS 29 (U.S. CL. 46).

FIRST USE 9-7-2007; IN COMMERCE 9-7-2007.

SN 77-162,412, FILED 4-21-2007.

THE MARK CONSISTS OF STANDARD CHARACTERS WITHOUT CLAIM TO ANY PARTICULAR FONT, STYLE, SIZE, OR COLOR.

MICHELE SWAIN, EXAMINING ATTORNEY



**Int. Cl.: 25**

**Prior U.S. Cls.: 22 and 39**

**United States Patent and Trademark Office**

**Reg. No. 3,454,897**

**Registered June 24, 2008**

**TRADEMARK  
PRINCIPAL REGISTER**

**VELVET ANT**

WELCH, CHRISTOPHER J. (UNITED STATES  
INDIVIDUAL)  
637 GLENNEYRE #H  
LAGUNA BEACH, CA 92651

THE MARK CONSISTS OF STANDARD CHAR-  
ACTERS WITHOUT CLAIM TO ANY PARTICULAR  
FONT, STYLE, SIZE, OR COLOR.

FOR: SHORT-SLEEVED OR LONG-SLEEVED T-  
SHIRTS; T-SHIRTS; SHORTS; SWEAT PANTS; POLO  
SHIRTS; SWEAT SHIRTS; SWIM WEAR; JACKETS;  
WET SUITS; BELTS; JEANS; SLACKS; KNIT SHIRTS;  
TANK TOPS; SOCKS; SWEATERS; HATS; BEANIES;  
CAPS; FOOTWEAR; PANTS; WALKING SHORTS;  
DRESS SHIRTS, IN CLASS 25 (U.S. CLS. 22 AND 39).

NO CLAIM IS MADE TO THE EXCLUSIVE  
RIGHT TO USE "VELVET", APART FROM THE  
MARK AS SHOWN.

SN 77-162,593, FILED 4-22-2007.

FIRST USE 1-18-2008; IN COMMERCE 1-18-2008.

WILLIAM VERHOSEK, EXAMINING ATTORNEY

**Int. Cl.: 36**

**Prior U.S. Cls.: 100, 101, and 102**

**United States Patent and Trademark Office**

**Reg. No. 3,454,898**

**Registered June 24, 2008**

---

**SERVICE MARK  
PRINCIPAL REGISTER**

**GO FARTHER**

JANUS INTERNATIONAL HOLDING LLC (NEW  
MEXICO LTD LIAB CO)  
ATTN CHARLES FLEMING  
151 DETROIT STREET  
DENVER, CO 80206

THE MARK CONSISTS OF STANDARD CHAR-  
ACTERS WITHOUT CLAIM TO ANY PARTICULAR  
FONT, STYLE, SIZE, OR COLOR.

FOR: INVESTMENT ADVISORY SERVICES, IN  
CLASS 36 (U.S. CLS. 100, 101 AND 102).

SN 77-162,990, FILED 4-23-2007.

FIRST USE 4-1-2007; IN COMMERCE 4-1-2007.

B. PARADEWELAI, EXAMINING ATTORNEY

**Int. Cl.: 3**

**Prior U.S. Cls.: 1, 4, 6, 50, 51, and 52**

**Reg. No. 3,454,899**

**United States Patent and Trademark Office**

**Registered June 24, 2008**

---

**TRADEMARK  
PRINCIPAL REGISTER**

**OVERNIGHT TREAT**

L'OREAL USA CREATIVE, INC. (DELAWARE  
CORPORATION)

575 FIFTH AVENUE

NEW YORK, NY 10017

FOR: HAIR TREATMENT PREPARATION, IN  
CLASS 3 (U.S. CLS. 1, 4, 6, 50, 51 AND 52).

FIRST USE 5-1-2008; IN COMMERCE 5-1-2008.

THE MARK CONSISTS OF STANDARD CHAR-  
ACTERS WITHOUT CLAIM TO ANY PARTICULAR  
FONT, STYLE, SIZE, OR COLOR.

NO CLAIM IS MADE TO THE EXCLUSIVE  
RIGHT TO USE "OVERNIGHT", APART FROM  
THE MARK AS SHOWN.

SN 77-163,198, FILED 4-23-2007.

MICHAEL ENGEL, EXAMINING ATTORNEY

**Int. Cl.: 41**

**Prior U.S. Cls.: 100, 101, and 107**

**United States Patent and Trademark Office**

**Reg. No. 3,454,900**

**Registered June 24, 2008**

**SERVICE MARK  
PRINCIPAL REGISTER**

**PERSONAL ACCELERATION**

GINSBERG, HOWARD (UNITED STATES INDIVIDUAL)  
2620 21ST STREET  
SANTA MONICA, CA 90405

FOR: EDUCATIONAL SERVICES, NAMELY, CONDUCTING ONE ON ONE COACHING, CLASSES, SEMINARS, AND WORKSHOPS IN THE FIELD OF PERSONAL DEVELOPMENT, MIND, BODY, EMOTION, SPIRITUALITY, SEXUALITY, PHYSICAL FITNESS, BUSINESS, SALES, MANAGEMENT, FINANCES AND DISTRIBUTION OF COURSE MATERIAL IN CONNECTION THEREWITH; PERSONAL COACHING SERVICES IN THE FIELD OF PERSONAL DEVELOPMENT, MIND, BODY, EMOTION, SPIRITUALITY, SEXUALITY, PHYSICAL FITNESS, BUSINESS, SALES, MANAGEMENT,

AND FINANCES, IN CLASS 41 (U.S. CLS. 100, 101 AND 107).

FIRST USE 4-1-2007; IN COMMERCE 5-1-2007.

THE MARK CONSISTS OF STANDARD CHARACTERS WITHOUT CLAIM TO ANY PARTICULAR FONT, STYLE, SIZE, OR COLOR.

NO CLAIM IS MADE TO THE EXCLUSIVE RIGHT TO USE "PERSONAL", APART FROM THE MARK AS SHOWN.

SN 77-163,683, FILED 4-23-2007.

JEFF DEFORD, EXAMINING ATTORNEY

**Int. Cl.: 28**

**Prior U.S. Cls.: 22, 23, 38, and 50**

**United States Patent and Trademark Office**

**Reg. No. 3,454,901**

**Registered June 24, 2008**

**TRADEMARK  
PRINCIPAL REGISTER**

**INTERCEPTOR**

ESTES-COX CORP. (DELAWARE CORPORATION)  
1295 H STREET  
PENROSE, CO 81240

FOR: FLYING TOY MODEL ROCKETS AND PARTS AND ACCESSORIES THEREFOR, IN CLASS 28 (U.S. CLS. 22, 23, 38 AND 50).

FIRST USE 7-19-2007; IN COMMERCE 7-19-2007.

THE MARK CONSISTS OF STANDARD CHARACTERS WITHOUT CLAIM TO ANY PARTICULAR FONT, STYLE, SIZE, OR COLOR.

OWNER OF U.S. REG. NO. 3,072,153.

SN 77-163,918, FILED 4-24-2007.

NAAKWAMA ANKRAH, EXAMINING ATTORNEY

**Int. Cl.: 30**

**Prior U.S. Cl.: 46**

**United States Patent and Trademark Office**

**Reg. No. 3,454,902**

**Registered June 24, 2008**

**TRADEMARK  
PRINCIPAL REGISTER**

**Make Every Day...Bodacious!**

BODACIOUS FOOD COMPANY, INC (GEORGIA  
CORPORATION)  
339 GENNETT DRIVE  
JASPER, GA 30143

THE MARK CONSISTS OF STANDARD CHAR-  
ACTERS WITHOUT CLAIM TO ANY PARTICULAR  
FONT, STYLE, SIZE, OR COLOR.

FOR: COOKIES AND CHEESE STRAWS, IN  
CLASS 30 (U.S. CL. 46).

SN 77-164,016, FILED 4-24-2007.

FIRST USE 6-15-2007; IN COMMERCE 6-15-2007.

KATHY DE JONGE, EXAMINING ATTORNEY

**Int. Cl.: 35**

**Prior U.S. Cls.: 100, 101, and 102**

**United States Patent and Trademark Office**

**Reg. No. 3,454,903**

**Registered June 24, 2008**

**SERVICE MARK  
PRINCIPAL REGISTER**

**ENTERO**

LARSON, ROY (UNITED STATES INDIVIDUAL)  
17018 NEW MARKET DRIVE  
EDEN PRAIRIE, MN 55347

FOR: EMPLOYMENT AGENCIES; EMPLOY-  
MENT COUNSELING AND RECRUITING; EM-  
PLOYMENT HIRING, RECRUITING,  
PLACEMENT, STAFFING AND CAREER NET-  
WORKING SERVICES, IN CLASS 35 (U.S. CLS. 100,  
101 AND 102).

FIRST USE 5-1-2007; IN COMMERCE 5-1-2007.

THE MARK CONSISTS OF STANDARD CHAR-  
ACTERS WITHOUT CLAIM TO ANY PARTICULAR  
FONT, STYLE, SIZE, OR COLOR.

THE FOREIGN WORDING IN THE MARK  
TRANSLATES INTO ENGLISH AS ENTIRE,  
WHOLE, FLAWLESS, HONEST, UPRIGHT,  
STRONG.

SN 77-164,293, FILED 4-24-2007.

ELLEN B. AWRICH, EXAMINING ATTORNEY

**Int. Cl.: 36**

**Prior U.S. Cls.: 100, 101, and 102**

**United States Patent and Trademark Office**

**Reg. No. 3,454,904**

**Registered June 24, 2008**

**SERVICE MARK  
PRINCIPAL REGISTER**

**Southern Community Capital**

STANDER, NICHOLAS T. (UNITED STATES IN-  
DIVIDUAL)  
2233 ANN STREET  
HOUSTON, TX 77003

FOR: COMMUNITY DEVELOPMENT VENTURE  
CAPITAL, NAMELY, PROVIDING FINANCING TO  
EMERGING AND START-UP COMPANIES, IN  
CLASS 36 (U.S. CLS. 100, 101 AND 102).

FIRST USE 10-1-2007; IN COMMERCE 10-1-2007.

THE MARK CONSISTS OF STANDARD CHAR-  
ACTERS WITHOUT CLAIM TO ANY PARTICULAR  
FONT, STYLE, SIZE, OR COLOR.

NO CLAIM IS MADE TO THE EXCLUSIVE  
RIGHT TO USE "COMMUNITY CAPITAL", APART  
FROM THE MARK AS SHOWN.

SN 77-164,355, FILED 4-24-2007.

SUSAN STIGLITZ, EXAMINING ATTORNEY



**Int. Cl.: 10**

**Prior U.S. Cls.: 26, 39, and 44**

**United States Patent and Trademark Office**

**Reg. No. 3,454,905**

**Registered June 24, 2008**

**TRADEMARK  
PRINCIPAL REGISTER**

**THE LIFE YOU SAVE MAY BE  
YOUR OWN**

MEDICAL SAFETY TECHNOLOGIES, INC.  
(TEXAS CORPORATION)  
5412 N. 10TH ST.  
MCALLEN, TX 78504

FOR: DISPOSABLE SYRINGES; HYPODERMIC  
NEEDLES AND SYRINGES; INJECTION INSTRU-  
MENTS WITH NEEDLES; INJECTION NEEDLES;  
AND NEEDLE-BASED AND NEEDLE-FREE INJEC-  
TION SYSTEMS, IN CLASS 10 (U.S. CLS. 26, 39 AND  
44).

FIRST USE 3-6-2007; IN COMMERCE 3-6-2007.

THE MARK CONSISTS OF STANDARD CHAR-  
ACTERS WITHOUT CLAIM TO ANY PARTICULAR  
FONT, STYLE, SIZE, OR COLOR.

SN 77-164,372, FILED 4-24-2007.

ODESSA BIBBINS, EXAMINING ATTORNEY

Int. Cl.: 41

Prior U.S. Cls.: 100, 101, and 107

United States Patent and Trademark Office

Reg. No. 3,454,906

Registered June 24, 2008

SERVICE MARK  
PRINCIPAL REGISTER



ANDERSON, NATHAN (UNITED STATES INDIVIDUAL)  
3131 N. 70TH #1013N.  
SCOTTSDALE, AZ 85251

FOR: NEWS REPORTING AND PROVIDING NEWS IN THE NATURE OF CURRENT ISSUES REPORTING, IN CLASS 41 (U.S. CLS. 100, 101 AND 107).

FIRST USE 4-1-2008; IN COMMERCE 4-1-2008.

NO CLAIM IS MADE TO THE EXCLUSIVE RIGHT TO USE "REPORTER", APART FROM THE MARK AS SHOWN.

THE STIPPLING IS FOR SHADING PURPOSES ONLY.

THE MARK CONSISTS OF A LOGO COMPOSED OF A PAINTED IMAGE OF A FINGER TOUCHING SOMETHING WITH THE WORD REPOETER NEXT TO IT.

SN 77-164,734, FILED 4-24-2007.

BRENDAN REGAN, EXAMINING ATTORNEY

Int. Cl.: 36

Prior U.S. Cls.: 100, 101, and 102

United States Patent and Trademark Office

Reg. No. 3,454,907

Registered June 24, 2008

SERVICE MARK  
PRINCIPAL REGISTER



TIRITILLI, JOSEPH JOHN (UNITED STATES  
INDIVIDUAL)  
4116 N.W. 1 STREET  
DEERFIELD BEACH, FL 334428033

FOR: AIRCRAFT BROKERAGE, IN CLASS 36  
(U.S. CLS. 100, 101 AND 102).

FIRST USE 1-1-2007; IN COMMERCE 1-1-2008.

THE NAME "JOEY JET" IDENTIFIES A LIVING  
INDIVIDUAL WHOSE CONSENT IS OF RECORD.

"THE COLOR(S) RED, WHITE, BLUE, PURPLE,  
BLACK, AND GRAY IS/ARE CLAIMED AS A FEAT-  
TURE OF THE MARK."

THE COLOR RED APPEARS IN THE WORDING  
"JOEY JET" AND THE IMAGE OF AN OVAL  
FLIGHTPATH IN THE DESIGN; THE COLOR PUR-  
PLE APPEARS TOWARD THE END OF THE  
FLIGHT PATH WHERE IT FADES THE COLOR  
RED INTO THE COLOR BLUE THAT APPEARS IN  
THE AIRPLANE FLYING; THE COLORS WHITE,  
BLACK AND GRAY APPEAR THROUGHOUT THE  
MARK FOR SHADOWING AND HIGHLIGHTING  
PURPOSES.

SN 77-164,887, FILED 4-25-2007.

SKYE YOUNG, EXAMINING ATTORNEY

**Int. Cl.: 9**

**Prior U.S. Cls.: 21, 23, 26, 36, and 38**

**United States Patent and Trademark Office**

**Reg. No. 3,454,908**

**Registered June 24, 2008**

**TRADEMARK  
PRINCIPAL REGISTER**

**Your All-In-One Agency  
Software Solution**

GEN4 SYSTEMS, LLC (MARYLAND LTD LIAB  
CO)

8639 B 16TH ST., SUITE 221  
SILVER SPRING, MD 20910

FOR: COMPUTER SOFTWARE FOR INSURANCE  
AGENCY MANAGEMENT AND ADMINISTRATION,  
IN CLASS 9 (U.S. CLS. 21, 23, 26, 36 AND 38).

FIRST USE 1-1-2008; IN COMMERCE 1-1-2008.

THE MARK CONSISTS OF STANDARD CHAR-  
ACTERS WITHOUT CLAIM TO ANY PARTICULAR  
FONT, STYLE, SIZE, OR COLOR.

NO CLAIM IS MADE TO THE EXCLUSIVE  
RIGHT TO USE "AGENCY SOFTWARE SOLU-  
TION", APART FROM THE MARK AS SHOWN.

SN 77-165,209, FILED 4-25-2007.

MIDGE BUTLER, EXAMINING ATTORNEY

**Int. Cls.: 35 and 41**

**Prior U.S. Cls.: 100, 101, 102, and 107**

**United States Patent and Trademark Office**

**Reg. No. 3,454,909**

**Registered June 24, 2008**

**SERVICE MARK  
PRINCIPAL REGISTER**

**POWER TO THE PLAYERS**

ELBO INC. (DELAWARE CORPORATION)  
625 WESTPORT PARKWAY  
GRAPEVINE, TX 76051

FOR: RETAIL STORE SERVICES AND ONLINE RETAIL STORE SERVICES PROVIDED VIA A GLOBAL COMPUTER NETWORK FEATURING NEW AND USED COMPUTER, VIDEO AND ELECTRONIC GAMES, VIDEO GAME CONSOLES, HAND-HELD VIDEO GAME PLAYERS, DIGITAL MEDIA PLAYERS AND RECORDERS, VIDEOS, DVDS, MOVIES, ROLE-PLAYING CARDS, GAME CARDS, BOOKS, MAGAZINES, STRATEGY GUIDES, COMPUTER HARDWARE, COMPUTER ACCESSORIES, TOYS AND ACTION FIGURES; PROMOTING THE SALE OF GOODS OF OTHERS THROUGH THE ADMINISTRATION OF A CUSTOMER INCENTIVE AWARD AND DISCOUNT PROGRAM FEATURING DISCOUNTS ON NEW AND USED COMPUTER, VIDEO AND ELECTRONIC GAMES, VIDEO GAME CONSOLES, HAND-HELD VIDEO GAME PLAYERS, DIGITAL MEDIA PLAYERS AND RECORDERS, VIDEOS, DVDS, MOVIES, ROLE-PLAYING CARDS, GAME CARDS, BOOKS, MAGAZINES, STRATEGY GUIDES, COMPUTER HARDWARE, COMPUTER

ACCESSORIES, TOYS AND ACTION FIGURES, IN CLASS 35 (U.S. CLS. 100, 101 AND 102).

FIRST USE 5-31-2007; IN COMMERCE 5-31-2007.

FOR: PROVIDING A WEB SITE CONTAINING INFORMATION AND CONTENT ON NEW AND USED COMPUTER, VIDEO AND ELECTRONIC GAMES, VIDEO GAME CONSOLES, HAND-HELD VIDEO GAME PLAYERS, DIGITAL MEDIA PLAYERS AND RECORDERS, VIDEOS, DVDS, MOVIES, ROLE-PLAYING CARDS, GAME CARDS, BOOKS, MAGAZINES, STRATEGY GUIDES, COMPUTER GAME HARDWARE, COMPUTER GAME ACCESSORIES, TOYS AND ACTION FIGURE, IN CLASS 41 (U.S. CLS. 100, 101 AND 107).

FIRST USE 5-31-2007; IN COMMERCE 5-31-2007.

THE MARK CONSISTS OF STANDARD CHARACTERS WITHOUT CLAIM TO ANY PARTICULAR FONT, STYLE, SIZE, OR COLOR.

SN 77-166,241, FILED 4-26-2007.

RUSS HERMAN, EXAMINING ATTORNEY

**Int. Cl.: 7**

**Prior U.S. Cls.: 13, 19, 21, 23, 31, 34, and 35**

**Reg. No. 3,454,910**

**United States Patent and Trademark Office**

**Registered June 24, 2008**

**TRADEMARK  
PRINCIPAL REGISTER**

**KRUZ**

ROYAL APPLIANCE MFG. CO. (OHIO CORPORATION)  
7005 COCHRAN ROAD  
GLENWILLOW, OH 44139

THE MARK CONSISTS OF STANDARD CHARACTERS WITHOUT CLAIM TO ANY PARTICULAR FONT, STYLE, SIZE, OR COLOR.

FOR: ELECTRICAL VACUUM CLEANERS FOR DOMESTIC AND COMMERCIAL USE, IN CLASS 7 (U.S. CLS. 13, 19, 21, 23, 31, 34 AND 35).

SN 77-166,746, FILED 4-26-2007.

FIRST USE 7-31-2007; IN COMMERCE 7-31-2007.

MARGERY A. TIERNEY, EXAMINING ATTORNEY

**Int. Cl.: 16**

**Prior U.S. Cls.: 2, 5, 22, 23, 29, 37, 38, and 50**

**Reg. No. 3,454,911**

**United States Patent and Trademark Office**

**Registered June 24, 2008**

**TRADEMARK  
PRINCIPAL REGISTER**

**THE PAINTIN' BOSS**

GIALANELLA, GEORGE (UNITED STATES IN-  
DIVIDUAL)  
45 PILLOT PLACE  
WEST ORANGE, NJ 07052

FOR: PAINT BRUSH CARRIER THAT CAN EA-  
SILY TRANSPORT PAINT BRUSHES FROM ONE  
LOCATION TO ANOTHER WITHOUT DAMAGING  
BRUSHES, IN CLASS 16 (U.S. CLS. 2, 5, 22, 23, 29, 37,  
38 AND 50).

FIRST USE 7-20-2007; IN COMMERCE 7-20-2007.

THE MARK CONSISTS OF STANDARD CHAR-  
ACTERS WITHOUT CLAIM TO ANY PARTICULAR  
FONT, STYLE, SIZE, OR COLOR.

NO CLAIM IS MADE TO THE EXCLUSIVE  
RIGHT TO USE "PAINTING", APART FROM THE  
MARK AS SHOWN.

SN 77-166,982, FILED 4-26-2007.

HOWARD SMIGA, EXAMINING ATTORNEY

**Int. Cl.: 3**

**Prior U.S. Cls.: 1, 4, 6, 50, 51, and 52**

**United States Patent and Trademark Office**

**Reg. No. 3,454,912**

**Registered June 24, 2008**

**TRADEMARK  
PRINCIPAL REGISTER**

**XXL CURL POWER**

L'OREAL USA CREATIVE, INC. (DELAWARE  
CORPORATION)  
575 FIFTH AVENUE  
NEW YORK, NY 10017

FOR: COSMETICS, NAMELY, MASCARA, IN  
CLASS 3 (U.S. CLS. 1, 4, 6, 50, 51 AND 52).

FIRST USE 9-1-2007; IN COMMERCE 9-1-2007.

THE MARK CONSISTS OF STANDARD CHAR-  
ACTERS WITHOUT CLAIM TO ANY PARTICULAR  
FONT, STYLE, SIZE, OR COLOR.

OWNER OF U.S. REG. NOS. 2,954,282, 3,060,728,  
AND 3,117,768.

SN 77-167,168, FILED 4-27-2007.

MICHAEL ENGEL, EXAMINING ATTORNEY



**Int. Cl.: 2**

**Prior U.S. Cls.: 6, 11, and 16**

**United States Patent and Trademark Office**

**Reg. No. 3,454,913**

**Registered June 24, 2008**

**TRADEMARK  
PRINCIPAL REGISTER**

**TADOODLES**

CRAYOLA PROPERTIES, INC. (DELAWARE  
CORPORATION)  
2035 EDGEWOOD AVENUE  
EASTON, PA 18042

THE MARK CONSISTS OF STANDARD CHAR-  
ACTERS WITHOUT CLAIM TO ANY PARTICULAR  
FONT, STYLE, SIZE, OR COLOR.

FOR: PAINTS, IN CLASS 2 (U.S. CLS. 6, 11 AND 16).

SN 77-167,950, FILED 4-27-2007.

FIRST USE 7-31-2007; IN COMMERCE 7-31-2007.

EMILY CHUO, EXAMINING ATTORNEY

Prior U.S. Cl.: 200

United States Patent and Trademark Office

Reg. No. 3,454,914

Registered June 24, 2008

**COLLECTIVE MEMBERSHIP  
PRINCIPAL REGISTER**

**IRON SHIELDS Motorcycle  
Club**

IRON SHIELDS MC, INC. (NEW HAMPSHIRE  
CORPORATION)  
116 HOLLIS ST.  
MANCHESTER, NH 03101

FOR: INDICATING MEMBERSHIP IN A NON-  
PROFIT ORGANIZATION FOR SUCH PURPOSES  
AS SHALL PROMOTE A SPIRIT OF COOPERATION,  
MUTUAL SUPPORT AND FRATERNALISM  
AMONG MEMBERS OF THE MOTORCYCLE CLUB  
AND THE POLICE COMMUNITY, IN CLASS 200  
(U.S. CL. 200).

FIRST USE 3-30-2007; IN COMMERCE 1-22-2008.

THE MARK CONSISTS OF STANDARD CHAR-  
ACTERS WITHOUT CLAIM TO ANY PARTICULAR  
FONT, STYLE, SIZE, OR COLOR.

NO CLAIM IS MADE TO THE EXCLUSIVE  
RIGHT TO USE "MOTORCYCLE CLUB", APART  
FROM THE MARK AS SHOWN.

SN 77-168,884, FILED 4-30-2007.

KRISTIN DAHLING, EXAMINING ATTORNEY

**Int. Cl.: 35**

**Prior U.S. Cls.: 100, 101, and 102**

**United States Patent and Trademark Office**

**Reg. No. 3,454,915**

**Registered June 24, 2008**

**SERVICE MARK  
PRINCIPAL REGISTER**

**DISCOVERING THE WOW**

DIXON/SCHWABL ADVERTISING, INC. (NEW YORK CORPORATION)  
1595 MOSELEY ROAD  
VICTOR, NY 14564

FOR: SERVICES RELATING TO THE ANALYSIS, EVALUATION, CREATION AND BRAND ESTABLISHMENT OF TRADEMARKS, TRADE NAMES AND DOMAIN NAMES; ADVERTISING AGENCIES; ADVERTISING AGENCIES, NAMELY, PROMOTING THE GOODS AND SERVICES OF OTHERS; ADVERTISING AND ADVERTISEMENT SERVICES; ADVERTISING AND BUSINESS MANAGEMENT CONSULTANCY; ADVERTISING AND MARKETING; ADVERTISING AND PROMOTION SERVICES AND RELATED CONSULTING; ADVERTISING AND PUBLICITY SERVICES; ADVERTISING AND PUBLICITY SERVICES, NAMELY, PROMOTING THE GOODS, SERVICES, BRAND IDENTITY AND COMMERCIAL INFORMATION AND NEWS OF THIRD PARTIES THROUGH

PRINT, AUDIO, VIDEO, DIGITAL AND ON-LINE MEDIUM; ADVERTISING CONSULTATION; ADVERTISING SERVICES; ADVERTISING SERVICES, NAMELY, CREATING CORPORATE AND BRAND IDENTITY FOR OTHERS; ADVERTISING THROUGH ALL PUBLIC COMMUNICATION MEANS; ADVERTISING, MARKETING AND PROMOTION SERVICES; DESIGN OF ADVERTISING MATERIALS FOR OTHERS, IN CLASS 35 (U.S. CLS. 100, 101 AND 102).

FIRST USE 8-1-2007; IN COMMERCE 8-1-2007.

THE MARK CONSISTS OF STANDARD CHARACTERS WITHOUT CLAIM TO ANY PARTICULAR FONT, STYLE, SIZE, OR COLOR.

SN 77-169,262, FILED 4-30-2007.

ROBERT LAVACHE, EXAMINING ATTORNEY

**Int. Cl.: 18**

**Prior U.S. Cls.: 1, 2, 3, 22, and 41**

**United States Patent and Trademark Office**

**Reg. No. 3,454,916**

**Registered June 24, 2008**

**TRADEMARK  
PRINCIPAL REGISTER**

**LUGGAGE HUGGER**

BURNS, LUCIA L. (UNITED STATES INDIVIDUAL)  
11656 N. 135TH PLACE  
SCOTTSDALE, AZ 85259

FOR: FABRIC LUGGAGE BANDS OF VARIOUS COLORS AND DESIGNS WHICH MAKE IDENTIFYING LUGGAGE EASIER, IN CLASS 18 (U.S. CLS. 1, 2, 3, 22 AND 41).

FIRST USE 2-14-2007; IN COMMERCE 7-27-2007.

THE MARK CONSISTS OF STANDARD CHARACTERS WITHOUT CLAIM TO ANY PARTICULAR FONT, STYLE, SIZE, OR COLOR.

NO CLAIM IS MADE TO THE EXCLUSIVE RIGHT TO USE "LUGGAGE", APART FROM THE MARK AS SHOWN.

SN 77-169,480, FILED 4-30-2007.

MARY CRAWFORD, EXAMINING ATTORNEY

**Int. Cl.: 36**

**Prior U.S. Cls.: 100, 101, and 102**

**United States Patent and Trademark Office**

**Reg. No. 3,454,917**

**Registered June 24, 2008**

---

**SERVICE MARK  
PRINCIPAL REGISTER**

**STELLIAM**

STELLIAM INVESTMENT MANAGEMENT LP  
(DELAWARE LIMITED PARTNERSHIP)  
31 WEST 52ND STREET, 16TH FLOOR  
NEW YORK, NY 10019

THE MARK CONSISTS OF STANDARD CHAR-  
ACTERS WITHOUT CLAIM TO ANY PARTICULAR  
FONT, STYLE, SIZE, OR COLOR.

FOR: FINANCIAL SERVICES, NAMELY, INVEST-  
MENT ADVISORY SERVICES AND MANAGE-  
MENT OF INVESTMENT FUNDS, IN CLASS 36  
(U.S. CLS. 100, 101 AND 102).

SN 77-169,713, FILED 5-1-2007.

FIRST USE 3-25-2007; IN COMMERCE 3-25-2007.

GEOFFREY FOSDICK, EXAMINING ATTORNEY

**Int. Cl.: 6**

**Prior U.S. Cls.: 2, 12, 13, 14, 23, 25, and 50**

**Reg. No. 3,454,918**

**United States Patent and Trademark Office**

**Registered June 24, 2008**

**TRADEMARK  
PRINCIPAL REGISTER**



SHIN-MONE SCREW CO., LTD. (TAIWAN CORPORATION)  
NO. 7, CHIA-HWA RD., KANG-SHAN,  
KAOHSIUNG, TAIWAN

FIRST USE 9-3-2007; IN COMMERCE 9-3-2007.

FOR: METAL FASTENERS, NAMELY, BOLTS,  
NAILS, RIVETS, SCREWS; METAL HARDWARE,  
NAMELY, NUTS, IN CLASS 6 (U.S. CLS. 2, 12, 13, 14,  
23, 25 AND 50).

SN 77-170,265, FILED 5-1-2007.

LINDA MICKLEBURGH, EXAMINING ATTORNEY

**Int. Cl.: 36**

**Prior U.S. Cls.: 100, 101, and 102**

**United States Patent and Trademark Office**

**Reg. No. 3,454,919**

**Registered June 24, 2008**

**SERVICE MARK  
PRINCIPAL REGISTER**

**THE OPPORTUNITY IS YOURS**

BANK OF AMERICA CORPORATION (DELA-  
WARE CORPORATION)  
100 NORTH TRYON STREET  
CHARLOTTE, NC 28255

FOR: BANKING AND RELATED FINANCIAL  
SERVICES, IN CLASS 36 (U.S. CLS. 100, 101 AND 102).

FIRST USE 4-23-2007; IN COMMERCE 4-23-2007.

THE MARK CONSISTS OF STANDARD CHAR-  
ACTERS WITHOUT CLAIM TO ANY PARTICULAR  
FONT, STYLE, SIZE, OR COLOR.

SN 77-170,655, FILED 5-2-2007.

TINA BROWN, EXAMINING ATTORNEY

**Int. Cl.: 14**

**Prior U.S. Cls.: 2, 27, 28, and 50**

**United States Patent and Trademark Office**

**Reg. No. 3,454,920**

**Registered June 24, 2008**

**TRADEMARK  
PRINCIPAL REGISTER**

**deb guyot**

GUYOT, DEBORAH S. (UNITED STATES INDIVIDUAL)  
56 RIDGE SIDE DR  
POWELL, OH 43065

THE MARK CONSISTS OF STANDARD CHARACTERS WITHOUT CLAIM TO ANY PARTICULAR FONT, STYLE, SIZE, OR COLOR.

FOR: JEWELRY, IN CLASS 14 (U.S. CLS. 2, 27, 28 AND 50).

SN 77-170,951, FILED 5-2-2007.

FIRST USE 9-15-2007; IN COMMERCE 9-15-2007.

BARBARA GAYNOR, EXAMINING ATTORNEY



**Int. Cl.: 9**

**Prior U.S. Cls.: 21, 23, 26, 36, and 38**

**Reg. No. 3,454,921**

**United States Patent and Trademark Office**

**Registered June 24, 2008**

**TRADEMARK  
PRINCIPAL REGISTER**



TRUCK-LITE CO., INC. (NEW YORK CORPORATION)  
310 EAST ELMWOOD AVENUE  
FALCONER, NY 14733

FIRST USE 10-12-2004; IN COMMERCE 10-12-2004.

FOR: EMERGENCY WARNING LIGHTS FOR VEHICLES; ELECTRONIC COMPONENT PARTS FOR VEHICLE LIGHTS IN THE NATURE OF ELECTRICAL CONTROLLERS, IN CLASS 9 (U.S. CLS. 21, 23, 26, 36 AND 38).

THE MARK CONSISTS OF A STYLIZED TRUCK DESIGN.

SN 77-171,115, FILED 5-2-2007.

DAWN HAN, EXAMINING ATTORNEY

**Int. Cl.: 11**

**Prior U.S. Cls.: 13, 21, 23, 31, and 34**

**Reg. No. 3,454,922**

**United States Patent and Trademark Office**

**Registered June 24, 2008**

**TRADEMARK  
PRINCIPAL REGISTER**

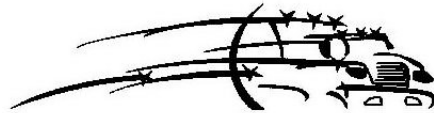

TRUCK-LITE CO., INC. (NEW YORK CORPORATION)  
310 EAST ELMWOOD AVENUE  
FALCONER, NY 14733

FOR: LIGHTING PRODUCTS FOR VEHICLES, NAMELY, HEADLIGHTS, TAIL LIGHTS, MARKER LIGHTS, CLEARANCE LIGHTS, IDENTIFICATION LIGHTS, STOPPING LIGHTS, TURN LIGHTS, LICENSE PLATE LIGHTS, BACK-UP LIGHTS, INTERIOR AND UTILITY LIGHTS, SNOW PLOW LIGHTS, FOG AND DRIVING LIGHTS, DAYTIME RUNNING LIGHTS, FLASHING LIGHTS, VEHICLE LIGHT REFLECTORS, AND LIGHTING KITS COM-

PRISED OF LAMPS, GROMMETS, PLUGS, AND FLANGES; VEHICLE LIGHT ASSEMBLIES CONSISTING OF LIGHT BULBS AND LIGHT HOUSINGS, IN CLASS 11 (U.S. CLS. 13, 21, 23, 31 AND 34).

FIRST USE 10-12-2004; IN COMMERCE 10-12-2004.

THE MARK CONSISTS OF A STYLIZED TRUCK DESIGN.

SN 77-171,121, FILED 5-2-2007.

DAWN HAN, EXAMINING ATTORNEY

**Int. Cl.: 12**

**Prior U.S. Cls.: 19, 21, 23, 31, 35, and 44**

**United States Patent and Trademark Office**

**Reg. No. 3,454,923**

**Registered June 24, 2008**

**TRADEMARK  
PRINCIPAL REGISTER**

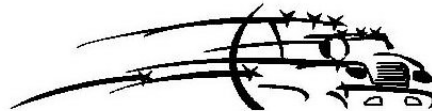

TRUCK-LITE CO., INC. (NEW YORK CORPORATION)  
310 EAST ELMWOOD AVENUE  
FALCONER, NY 14733

FOR: MIRRORS FOR VEHICLES, NAMELY, REAR-VIEW MIRRORS, SIDE-VIEW MIRRORS AND BLIND SPOT MIRRORS; VEHICLE STRUCTURAL PARTS FOR ATTACHING MIRRORS TO VEHICLES, IN CLASS 12 (U.S. CLS. 19, 21, 23, 31, 35 AND 44).

FIRST USE 10-12-2004; IN COMMERCE 10-12-2004.

THE MARK CONSISTS OF A STYLIZED TRUCK DESIGN.

SN 77-171,124, FILED 5-2-2007.

DAWN HAN, EXAMINING ATTORNEY

**Int. Cl.: 9**

**Prior U.S. Cls.: 21, 23, 26, 36, and 38**

**Reg. No. 3,454,924**

**United States Patent and Trademark Office**

**Registered June 24, 2008**

**TRADEMARK  
PRINCIPAL REGISTER**

**RHT-LINK**

MICROSTRAIN, INC. (VERMONT CORPORATION)  
310 HURRICANE LANE, SUITE 4  
WILLISTON, VT 05495

FOR: COMPUTER CHIPS; COMPUTER SOFTWARE FOR USE WITH ANALOG AND DIGITAL MEASURING DEVICES, DATA ACQUISITION TRANSCEIVERS AND WIRELESS SENSOR NETWORKS; CONVERTERS; ELECTRIC OR ELECTRONIC SENSORS FOR MEASURING TEMPERATURE AND RELATIVE HUMIDITY; MICROCONTROLLERS; MULTIPLEXERS; TEMPERATURE SEN-

SORS; TIMING SENSORS, IN CLASS 9 (U.S. CLS. 21, 23, 26, 36 AND 38).

FIRST USE 2-19-2008; IN COMMERCE 2-19-2008.

THE MARK CONSISTS OF STANDARD CHARACTERS WITHOUT CLAIM TO ANY PARTICULAR FONT, STYLE, SIZE, OR COLOR.

SN 77-171,660, FILED 5-3-2007.

AISHA CLARKE, EXAMINING ATTORNEY

**Int. Cl.: 25**

**Prior U.S. Cls.: 22 and 39**

**United States Patent and Trademark Office**

**Reg. No. 3,454,925**

**Registered June 24, 2008**

**TRADEMARK  
PRINCIPAL REGISTER**

**BLING L<sup>o</sup>**

HORTON, ANTHONY (UNITED STATES INDIVIDUAL)  
215 LONG TRAIL LANE  
ROCKVILLE, MD 20850

FIRST USE 3-1-2008; IN COMMERCE 3-1-2008.

SN 77-171,883, FILED 5-3-2007.

FOR: CLOTHING, NAMELY, CAPS, SHIRTS, SWEAT SHIRTS, AND T-SHIRTS, IN CLASS 25 (U.S. CLS. 22 AND 39).

COLLEEN DOMBROW, EXAMINING ATTORNEY

**Int. Cl.: 5**

**Prior U.S. Cls.: 6, 18, 44, 46, 51, and 52**

**Reg. No. 3,454,926**

**United States Patent and Trademark Office**

**Registered June 24, 2008**

---

**TRADEMARK  
PRINCIPAL REGISTER**

**Phat Phen**

MAXIMUM HUMAN PERFORMANCE, INC.  
(NEW JERSEY CORPORATION)  
21 DWIGHT PLACE  
FAIRFIELD, NJ 07004

THE MARK CONSISTS OF STANDARD CHAR-  
ACTERS WITHOUT CLAIM TO ANY PARTICULAR  
FONT, STYLE, SIZE, OR COLOR.

FOR: DIETARY SUPPLEMENTS, IN CLASS 5 (U.S.  
CLS. 6, 18, 44, 46, 51 AND 52).

SN 77-172,905, FILED 5-4-2007.

FIRST USE 1-1-2007; IN COMMERCE 1-1-2007.

YAT SYE, LEE, EXAMINING ATTORNEY

**Int. Cl.: 42**

**Prior U.S. Cls.: 100 and 101**

**United States Patent and Trademark Office**

**Reg. No. 3,454,927**

**Registered June 24, 2008**

**SERVICE MARK  
PRINCIPAL REGISTER**

# Page Progressive

DANIEL TRIMPEY (NORTH CAROLINA LTD  
LIAB CO)  
1800 SIERRA DRIVE  
RALEIGH, NC 27603

FOR: CREATION AND MAINTENANCE OF WEB  
SITES FOR OTHERS; GRAPHIC DESIGN SERVICES;  
WEB SITE HOSTING SERVICES, IN CLASS 42 (U.S.  
CLS. 100 AND 101).

FIRST USE 2-22-2008; IN COMMERCE 2-22-2008.

THE MARK CONSISTS OF STANDARD CHAR-  
ACTERS WITHOUT CLAIM TO ANY PARTICULAR  
FONT, STYLE, SIZE, OR COLOR.

NO CLAIM IS MADE TO THE EXCLUSIVE  
RIGHT TO USE "PAGE", APART FROM THE MARK  
AS SHOWN.

SN 77-173,472, FILED 5-4-2007.

JESSICA FATHY, EXAMINING ATTORNEY

**Int. Cl.: 16**

**Prior U.S. Cls.: 2, 5, 22, 23, 29, 37, 38, and 50**

**Reg. No. 3,454,928**

**United States Patent and Trademark Office**

**Registered June 24, 2008**

---

**TRADEMARK  
PRINCIPAL REGISTER**

# Tomato Palms

NANCY OGBURN (UNITED STATES INDIVIDUAL)

124 SIGNAL LANE

IRMO, SC 29063

FOR: RECIPE BOOKS, IN CLASS 16 (U.S. CLS. 2, 5, 22, 23, 29, 37, 38 AND 50).

FIRST USE 11-30-2007; IN COMMERCE 11-30-2007.

THE MARK CONSISTS OF STANDARD CHARACTERS WITHOUT CLAIM TO ANY PARTICULAR FONT, STYLE, SIZE, OR COLOR.

NO CLAIM IS MADE TO THE EXCLUSIVE RIGHT TO USE "TOMATO", APART FROM THE MARK AS SHOWN.

SN 77-173,777, FILED 5-5-2007.

JILL C. ALT, EXAMINING ATTORNEY



**Int. Cl.: 36**

**Prior U.S. Cls.: 100, 101, and 102**

**United States Patent and Trademark Office**

**Reg. No. 3,454,929**

**Registered June 24, 2008**

**SERVICE MARK  
PRINCIPAL REGISTER**

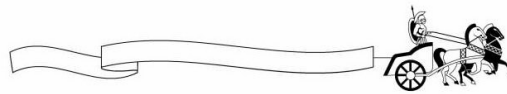

NEW CAPITAL MANAGEMENT, LLC (ILLINOIS  
LTD LIAB CO)  
646 N. EUCLID AVENUE  
OAK PARK, IL 60302

THE MARK CONSISTS OF HORSE DRAWN  
CHARIOT TRAILING BANNER.

FOR: INVESTMENT ADVISOR SERVICES, IN  
CLASS 36 (U.S. CLS. 100, 101 AND 102).

SN 77-174,129, FILED 5-7-2007.

FIRST USE 10-5-2007; IN COMMERCE 10-5-2007.

B. PARADEWELAI, EXAMINING ATTORNEY

**Int. Cl.: 35**

**Prior U.S. Cls.: 100, 101, and 102**

**United States Patent and Trademark Office**

**Reg. No. 3,454,930**

**Registered June 24, 2008**

**SERVICE MARK  
PRINCIPAL REGISTER**

**beriozkashop.com**

BERIOZKASHOP.COM, INC. (NEW YORK CORPORATION)  
4TH FLOOR  
304 HUDSON STREET  
NEW YORK, NY 10013

FOR: ONLINE INTERACTIVE RETAIL STORE SERVICES PROVIDED VIA COMPUTER AND THE INTERNET, FEATURING GENERAL MERCHANDISE; PROVIDING HOME SHOPPING SERVICES IN THE FIELD OF GENERAL MERCHANDISE BY MEANS OF INTERNET, TELEPHONE, AND POR-

TABLE HANDHELD DIGITAL AND ELECTRONIC DEVICES, IN CLASS 35 (U.S. CLS. 100, 101 AND 102).

FIRST USE 6-26-2007; IN COMMERCE 6-26-2007.

THE MARK CONSISTS OF STANDARD CHARACTERS WITHOUT CLAIM TO ANY PARTICULAR FONT, STYLE, SIZE, OR COLOR.

SN 77-174,503, FILED 5-7-2007.

SUSAN LESLIE DUBOIS, EXAMINING ATTORNEY

**Int. Cl.: 3**

**Prior U.S. Cls.: 1, 4, 6, 50, 51, and 52**

**Reg. No. 3,454,931**

**United States Patent and Trademark Office**

**Registered June 24, 2008**

**TRADEMARK  
PRINCIPAL REGISTER**

**TOTAL RESPONSE THERAPY**

GOLD CANYON CANDLES, L.L.C. (ARIZONA  
LTD LIAB CO)  
6205 SOUTH ARIZONA AVENUE  
CHANDLER, AZ 85248

FIRST USE 8-1-2007; IN COMMERCE 8-1-2007.

FOR: PERSONAL CARE PRODUCTS, NAMELY,  
SHOWER GELS, HAND, BODY, AND FOOT LO-  
TIONS, EXFOLIATORS, HAND SANITIZERS,  
HAND SOAP, AND BATH ADDITIVES, NAMELY,  
BATH LIQUIDS, BATH OILS, BATH LOTIONS,  
BATH GELS, AND AFTER BATH SPRAYS, IN  
CLASS 3 (U.S. CLS. 1, 4, 6, 50, 51 AND 52).

THE MARK CONSISTS OF STANDARD CHAR-  
ACTERS WITHOUT CLAIM TO ANY PARTICULAR  
FONT, STYLE, SIZE, OR COLOR.

SN 77-174,613, FILED 5-7-2007.

ALLISON HOLTZ, EXAMINING ATTORNEY

**Int. Cls.: 18 and 25**

**Prior U.S. Cls.: 1, 2, 3, 22, 39, and 41**

**Reg. No. 3,454,932**

**United States Patent and Trademark Office**

**Registered June 24, 2008**

**TRADEMARK  
PRINCIPAL REGISTER**

# Jillaroo Australia

RAINE, TAMMY (AUSTRALIA INDIVIDUAL)  
23 NETHERBY RISE  
SUNRISE BEACH, AUSTRALIA 4567

FOR: CHAIN MESH PURSES; CHANGE PURSES; CLUTCH PURSES; CLUTCHES; COIN PURSES; COIN PURSES NOT MADE OF PRECIOUS METAL; COIN PURSES, NOT OF PRECIOUS METALS; LEATHER PURSES; MULTI-PURPOSE PURSES; PURSE FRAMES; PURSES; PURSES; PURSES AND WALLETS OF PRECIOUS METAL; SMALL CLUTCH PURSES; SMALL PURSES; WRIST MOUNTED PURSES; ALL PURPOSE SPORT BAGS; ALL-PURPOSE ATHLETIC BAGS; ALL-PURPOSE CARRYING BAGS; ANIMAL GAME BAGS; ATHLETIC BAGS; BABY CARRYING BAGS; BAGS AND HOLDALLS FOR SPORTS CLOTHING; BAGS FOR CARRYING BABIES' ACCESSORIES; BAGS FOR SPORTS; BAGS FOR UMBRELLAS; BEACH BAGS; BELT BAGS; BOOK BAGS; CARRY-ALL BAGS; CARRY-ON BAGS; CLUTCH BAGS; COSMETIC BAGS SOLD EMPTY; DUFFEL BAGS; DUFFEL BAGS FOR TRAVEL; DUFFLE BAGS; FEED BAGS FOR ANIMALS; FLEXIBLE BAGS FOR GARMENTS; GARMENT BAGS FOR TRAVEL; GYM BAGS; HIKING BAGS; HORSE TAIL BAGS; HUNTERS' GAME BAGS; HUNTING BAGS; KEY BAGS; KIT BAGS; LEATHER AND IMITATION LEATHER BAGS; LEATHER BAGS FOR MERCHANDISE PACKAGING; LEATHER BAGS, SUITCASES AND WALLETS; LEATHER SHOPPING BAGS; MAKE-UP BAGS SOLD EMPTY; MESH SHOPPING BAGS; MESSENGER BAGS; OVERNIGHT BAGS; PET ACCESSORIES, NAMELY, CANVAS, VINYL AND LEATHER POUCHES FOR HOLDING DISPOSABLE BAGS TO PLACE PET WASTE IN; POMMEL BAGS; ROLL BAGS; SADDLE HORN BAGS; SADDLERY, NAMELY, HORN BAGS; SCHOOL BAGS; SCHOOL BOOK BAGS; SHOE BAGS FOR TRAVEL; SHOPPING BAGS MADE OF SKIN; SHOPPING BAGS WITH WHEELS ATTACHED; SHOULDER BAGS; SLING BAGS; SOUVENIR BAGS; SPORTS BAGS; STRING BAGS

FOR SHOPPING; SUIT BAGS; TOTE BAGS; TRAVEL BAGS; TRAVELING BAGS; TRAVELLING BAGS; WAIST BAGS; WASH BAGS FOR CARRYING TOILETRIES; WRIST MOUNTED CARRYALL BAGS; WRISTLET BAGS; ATTACHE CASES; BUSINESS CARD CASES; BUSINESS CASES; CALLING CARD CASES; CARRYING CASES; CARRYING CASES FOR DOCUMENTS; CATALOG CASES; CELLULOSE FOOD CASINGS; COSMETIC CASES SOLD EMPTY; CREDIT CARD CASES; DOCUMENT CASES; KEY CASE; KEY CASES; KEY-CASES OF LEATHER AND SKINS; LEATHER CASES; LEATHER CASES FOR KEYS; LEATHER KEY CASES; NAME CARD CASES; OVERNIGHT CASES; PAPER-REINFORCED CELLULOSE FOOD CASINGS; STRAPS FOR CARRYING CASES; TOILETRY CASES SOLD EMPTY; TRAVELLING CASES OF LEATHER; VANITY CASES SOLD EMPTY, IN CLASS 18 (U.S. CLS. 1, 2, 3, 22 AND 41).

FIRST USE 11-12-2007; IN COMMERCE 11-12-2007.

FOR: SHORT-SLEEVED OR LONG-SLEEVED T-SHIRTS; T-SHIRTS; FUR JACKETS; HEAVY JACKETS; JACKET LINERS; JACKETS; LEATHER JACKETS; LIGHT-REFLECTING JACKETS; A-SHIRTS; DRESS SHIRTS; KNIT SHIRTS; NIGHT SHIRTS; OPEN-NECKED SHIRTS; PIQUE SHIRTS; POLO SHIRTS; SHIRTS; SHORT-SLEEVED SHIRTS; SLEEP SHIRTS; SPORT SHIRTS; SPORTS SHIRTS; SPORTS SHIRTS WITH SHORT SLEEVES; SWEAT SHIRTS; WIND SHIRTS; LONG JACKETS; RAIN JACKETS; RAINPROOF JACKETS; SLEEVED OR SLEEVELESS JACKETS; SPORTS JACKETS; SUEDE JACKETS; WATERPROOF JACKETS AND PANTS; WIND RESISTANT JACKETS; WIND-JACKETS; BREECHES; SPORTS JERSEYS AND BREECHES FOR SPORTS; CAPRI PANTS; CARGO PANTS; DENIMS; JOGGING PANTS; LEATHER PANTS; PANTS; SWEAT PANTS; TRACK PANTS; FOOTWEAR; FOOTWEAR FOR MEN AND WOMEN; FOOTWEAR FOR TRACK AND FIELD ATHLETICS; FOOTWEAR FOR WO-

MEN; FOOTWEAR NOT FOR SPORTS; FOOTWEAR, NAMELY, RUBBERS; THONGS; MOCK TURTLE-NECK SWEATERS; SWEATERS; TURTLENECK SWEATERS; V-NECK SWEATERS; JUMPERS; ANKLE SOCKS; ANKLETS; ANTI-PERSPIRANT SOCKS; MEN'S SOCKS; SOCK SUSPENDERS; SOCKS; SOCKS AND STOCKINGS; THERMAL SOCKS; WATER SOCKS; WOOLLEN SOCKS; SLIPPERS; SLEEPWEAR; BELTS; BELTS MADE OF LEATHER; BELTS OF TEXTILE; FABRIC BELTS; GARTER BELTS; LEATHER BELTS; MONEY BELTS; SUSPENDER BELTS FOR WOMEN; TUXEDO BELTS; WAIST BELTS, IN CLASS 25 (U.S. CLS. 22 AND 39).

FIRST USE 11-12-2007; IN COMMERCE 11-12-2007.

THE MARK CONSISTS OF STANDARD CHARACTERS WITHOUT CLAIM TO ANY PARTICULAR FONT, STYLE, SIZE, OR COLOR.

NO CLAIM IS MADE TO THE EXCLUSIVE RIGHT TO USE "AUSTRALIA", APART FROM THE MARK AS SHOWN.

SN 77-175,966, FILED 5-8-2007.

SHAUNIA CARLYLE, EXAMINING ATTORNEY

**Int. Cl.: 24**

**Prior U.S. Cls.: 42 and 50**

**United States Patent and Trademark Office**

**Reg. No. 3,454,933**

**Registered June 24, 2008**

**TRADEMARK  
PRINCIPAL REGISTER**

**CHEERS**

MILLIKEN & COMPANY (DELAWARE CORPORATION)  
920 MILLIKEN ROAD  
SPARTANBURG, SC 29303

FOR: INDUSTRIALLY LAUNDERABLE, REUSABLE NONWOVEN TOWELS AND NONWOVEN FABRICS FOR MAKING INDUSTRIALLY LAUNDERABLE, REUSABLE NONWOVEN TOWELS, IN CLASS 24 (U.S. CLS. 42 AND 50).

FIRST USE 9-24-2007; IN COMMERCE 9-24-2007.

THE MARK CONSISTS OF STANDARD CHARACTERS WITHOUT CLAIM TO ANY PARTICULAR FONT, STYLE, SIZE, OR COLOR.

SN 77-176,595, FILED 5-9-2007.

RONALD AIKENS, EXAMINING ATTORNEY

**Int. Cl.: 25**

**Prior U.S. Cls.: 22 and 39**

**United States Patent and Trademark Office**

**Reg. No. 3,454,934**

**Registered June 24, 2008**

**TRADEMARK  
PRINCIPAL REGISTER**

INTERNATIONAL DIRECT GROUP INC. (NEW  
YORK CORPORATION)  
499 SEVENTH AVENUE  
NEW YORK, NY 10018

THE MARK CONSISTS OF STANDARD CHAR-  
ACTERS WITHOUT CLAIM TO ANY PARTICULAR  
FONT, STYLE, SIZE, OR COLOR.

FOR: WOMEN'S APPAREL, NAMELY, DRESSES,  
PANTS, JEANS, SHIRTS, SKIRTS, JACKETS, BLA-  
ZERS, T-SHIRTS, BLOUSES, SWEATSHIRTS AND  
SHORTS, IN CLASS 25 (U.S. CLS. 22 AND 39).

SN 77-177,256, FILED 5-10-2007.

FIRST USE 8-6-2007; IN COMMERCE 8-6-2007.

MONIQUE MILLER, EXAMINING ATTORNEY

**Int. Cl.: 16**

**Prior U.S. Cls.: 2, 5, 22, 23, 29, 37, 38, and 50**

**United States Patent and Trademark Office**

**Reg. No. 3,454,935**

**Registered June 24, 2008**

**TRADEMARK  
PRINCIPAL REGISTER**

**RECOLORITZ**

CRAYOLA PROPERTIES, INC. (DELAWARE  
CORPORATION)  
2035 EDGEWOOD AVENUE  
EASTON, PA 18042

THE MARK CONSISTS OF STANDARD CHAR-  
ACTERS WITHOUT CLAIM TO ANY PARTICULAR  
FONT, STYLE, SIZE, OR COLOR.

FOR: MARKERS; PLASTIC SHEETS FOR WRIT-  
ING, PRINTING, AND MARKING, IN CLASS 16  
(U.S. CLS. 2, 5, 22, 23, 29, 37, 38 AND 50).

SN 77-177,319, FILED 5-10-2007.

FIRST USE 11-29-2007; IN COMMERCE 11-29-2007.

EMILY CHUO, EXAMINING ATTORNEY



**Int. Cl.: 17**

**Prior U.S. Cls.: 1, 5, 12, 13, 35, and 50**

**Reg. No. 3,454,936**

**United States Patent and Trademark Office**

**Registered June 24, 2008**

---

**TRADEMARK  
PRINCIPAL REGISTER**

**X-PERM**

MARTINREA INDUSTRIES, INC. (DELAWARE  
CORPORATION)  
10495 MICHIGAN STATE ROAD 5  
MANCHESTER, MI 48158

THE MARK CONSISTS OF STANDARD CHAR-  
ACTERS WITHOUT CLAIM TO ANY PARTICULAR  
FONT, STYLE, SIZE, OR COLOR.

FOR: NON-METAL FLEXIBLE HOSE, PIPE AND  
TUBING FOR USE IN ENGINES FOR COMMER-  
CIAL AND INDUSTRIAL USE, IN CLASS 17 (U.S.  
CLS. 1, 5, 12, 13, 35 AND 50).

SN 77-177,368, FILED 5-10-2007.

FIRST USE 9-1-2007; IN COMMERCE 9-1-2007.

HENRY S. ZAK, EXAMINING ATTORNEY

**Int. Cl.: 24**

**Prior U.S. Cls.: 42 and 50**

**United States Patent and Trademark Office**

**Reg. No. 3,454,937**

**Registered June 24, 2008**

**TRADEMARK  
PRINCIPAL REGISTER**

**PALADIN**

MILLIKEN & COMPANY (DELAWARE CORPORATION)  
920 MILLIKEN ROAD  
SPARTANBURG, SC 29303

FOR: TEXTILE FABRICS HAVING FLAME RETARDANT PROPERTIES USED AS A PRINCIPAL COMPONENT OR AS AN INSULATING LAYER IN THE MANUFACTURE OF MATTRESSES, BOX SPRINGS, MATTRESS TOPPERS AND PILLOWS , IN CLASS 24 (U.S. CLS. 42 AND 50).

FIRST USE 3-14-2006; IN COMMERCE 3-14-2006.

THE MARK CONSISTS OF STANDARD CHARACTERS WITHOUT CLAIM TO ANY PARTICULAR FONT, STYLE, SIZE, OR COLOR.

SN 77-177,637, FILED 5-10-2007.

RONALD AIKENS, EXAMINING ATTORNEY

**Int. Cl.: 5**

**Prior U.S. Cls.: 6, 18, 44, 46, 51, and 52**

**Reg. No. 3,454,938**

**United States Patent and Trademark Office**

**Registered June 24, 2008**

---

**TRADEMARK  
PRINCIPAL REGISTER**

**RELAXING WAVES**

DIAL BRANDS, INC. (ARIZONA CORPORATION)  
M.S. 2214  
15501 NORTH DIAL BOULEVARD  
SCOTTSDALE, AZ 852601619

FIRST USE 1-14-2008; IN COMMERCE 1-14-2008.

THE MARK CONSISTS OF STANDARD CHARACTERS WITHOUT CLAIM TO ANY PARTICULAR FONT, STYLE, SIZE, OR COLOR.

FOR: AIR FRESHENERS, AROMATIC PREPARATIONS AND SUBSTANCES FOR FRESHENING THE AIR; PERFUMED AIR FRESHENING PREPARATIONS, IN CLASS 5 (U.S. CLS. 6, 18, 44, 46, 51 AND 52).

SN 77-178,254, FILED 5-10-2007.

DAVID I, EXAMINING ATTORNEY

Int. Cl.: 25

Prior U.S. Cls.: 22 and 39

United States Patent and Trademark Office

Reg. No. 3,454,939

Registered June 24, 2008

TRADEMARK  
PRINCIPAL REGISTER



THE ROGERS GROUP (MICHIGAN SOLE PROPRIETORSHIP)  
2239 BRENTHAVEN DR  
BLOOMFIELD HILLS, MI 48304

FOR: BELTS; BLAZERS; BOW TIES; CAPS; CUMMERBUNDS; DRESS SHIRTS; FLIP FLOPS; FOOTWEAR FOR MEN AND WOMEN; GOLF SHIRTS; JACKETS; MEN'S SOCKS; POLO SHIRTS; RAINWEAR; SHIRTS; SHOES; SHORT-SLEEVED OR LONG-SLEEVED T-SHIRTS; SOCKS; SPORT COATS; SPORT SHIRTS; SUSPENDERS; SWEATERS; T-SHIRTS; TIES; TURTLENECKS; VESTS, IN CLASS 25 (U.S. CLS. 22 AND 39).

FIRST USE 10-5-2007; IN COMMERCE 3-17-2008.

THE NAME "J. R.". IDENTIFIES A LIVING INDIVIDUAL WHOSE CONSENT IS OF RECORD.

THE MARK CONSISTS OF A POST ON EACH SIDE OF THE LITERAL ELEMENT, "J.R. FURLONG," WITH SEVEN HORIZONTAL STRIPES AND A BALL ON TOP OF EACH POST, THE FLOWER-LIKE DESIGN APPEARING BEHIND THE LITERAL ELEMENT, AND TWO HORIZONTAL BARS FRAMING THE LITERAL ELEMENT PLACED NEAR THE TOP OF EACH POST ON EACH SIDE OF THE LITERAL ELEMENT, "J.R.".

SN 77-178,326, FILED 5-10-2007.

JENNY PARK, EXAMINING ATTORNEY

**Int. Cls.: 9 and 42**

**Prior U.S. Cls.: 21, 23, 26, 36, 38, 100, and 101**

**United States Patent and Trademark Office**

**Reg. No. 3,454,940**

**Registered June 24, 2008**

**TRADEMARK  
SERVICE MARK  
PRINCIPAL REGISTER**

**CENTRIHEALTH**

CENTRIFYHEALTH, INC. (DELAWARE CORPORATION)  
SUITE 200  
102 WOODMONT BOULEVARD  
NASHVILLE, TN 37205

FOR: COMPUTER HARDWARE AND SOFTWARE FOR THE MANAGEMENT OF PATIENT HEALTHCARE DATA, IN CLASS 9 (U.S. CLS. 21, 23, 26, 36 AND 38).

FIRST USE 6-0-2007; IN COMMERCE 6-0-2007.

FOR: PROVIDING TEMPORARY USE OF ONLINE NON-DOWNLOADABLE SOFTWARE FOR

MANAGING PATIENT HEALTHCARE DATA, IN CLASS 42 (U.S. CLS. 100 AND 101).

FIRST USE 6-0-2007; IN COMMERCE 6-0-2007.

THE MARK CONSISTS OF STANDARD CHARACTERS WITHOUT CLAIM TO ANY PARTICULAR FONT, STYLE, SIZE, OR COLOR.

SN 77-178,472, FILED 5-11-2007.

MARK SPARACINO, EXAMINING ATTORNEY

Int. Cl.: 44

Prior U.S. Cls.: 100 and 101

United States Patent and Trademark Office

Reg. No. 3,454,941

Registered June 24, 2008

SERVICE MARK  
PRINCIPAL REGISTER



TENET HOSPITALS LIMITED (TEXAS LIMITED PARTNERSHIP), DBA DOCTORS HOSPITAL OF DALLAS,  
SUITE 100  
13737 NOEL ROAD  
DALLAS, TX 75240

FOR: HEALTH CARE, IN CLASS 44 (U.S. CLS. 100 AND 101).

FIRST USE 10-17-2007; IN COMMERCE 10-17-2007.

NO CLAIM IS MADE TO THE EXCLUSIVE RIGHT TO USE "DOCTORS HOSPITAL AT WHITE

ROCK LAKE", APART FROM THE MARK AS SHOWN.

THE MARK CONSISTS OF THE WORDS "DOCTORS HOSPITAL" OVER A WAVY LINE WITH THE WORDS "AT WHITE ROCK LAKE" PRINTED BELOW AND THE WAVY LINE PROCEEDING INTO A BOX TO THE RIGHT.

SN 77-179,886, FILED 5-14-2007.

MARK SPARACINO, EXAMINING ATTORNEY

**Int. Cl.: 3**

**Prior U.S. Cls.: 1, 4, 6, 50, 51, and 52**

**Reg. No. 3,454,942**

**United States Patent and Trademark Office**

**Registered June 24, 2008**

---

**TRADEMARK  
PRINCIPAL REGISTER**

**SHIMMER REFLECTS**

L'OREAL USA CREATIVE, INC. (DELAWARE  
CORPORATION)  
575 FIFTH AVENUE  
NEW YORK, NY 10017

THE MARK CONSISTS OF STANDARD CHAR-  
ACTERS WITHOUT CLAIM TO ANY PARTICULAR  
FONT, STYLE, SIZE, OR COLOR.

FOR: HAIR STYLING PREPARATIONS, IN  
CLASS 3 (U.S. CLS. 1, 4, 6, 50, 51 AND 52).

SN 77-179,909, FILED 5-14-2007.

FIRST USE 11-1-2007; IN COMMERCE 11-1-2007.

MICHAEL ENGEL, EXAMINING ATTORNEY

**Int. Cl.: 36**

**Prior U.S. Cls.: 100, 101, and 102**

**United States Patent and Trademark Office**

**Reg. No. 3,454,943**

**Registered June 24, 2008**

**SERVICE MARK  
PRINCIPAL REGISTER**

**DISTRICT ONE FIVE**

WTC-TRADE MART, L.P. (DELAWARE LIMITED  
PARTNERSHIP)  
2100 STEMMONS FREEWAY  
DALLAS, TX 75207

FOR: OPERATING MARKET PLACES FOR BUY-  
ERS AND SELLERS OF GOODS AND SERVICES,  
NAMELY CONTEMPORARY APPAREL AND AC-  
CESSORIES, IN CLASS 36 (U.S. CLS. 100, 101 AND  
102).

FIRST USE 1-24-2008; IN COMMERCE 1-24-2008.

THE MARK CONSISTS OF STANDARD CHAR-  
ACTERS WITHOUT CLAIM TO ANY PARTICULAR  
FONT, STYLE, SIZE, OR COLOR.

SN 77-179,994, FILED 5-14-2007.

MARK T. MULLEN, EXAMINING ATTORNEY



**Int. Cl.: 36**

**Prior U.S. Cls.: 100, 101, and 102**

**United States Patent and Trademark Office**

**Reg. No. 3,454,944**

**Registered June 24, 2008**

**SERVICE MARK  
PRINCIPAL REGISTER**

**D15TRICT**

WTC-TRADE MART, L.P. (DELAWARE LIMITED  
PARTNERSHIP)  
2100 STEMMONS FREEWAY  
DALLAS, TX 75207

FOR: OPERATING MARKET PLACES FOR BUY-  
ERS AND SELLERS OF GOODS AND SERVICES,  
NAMELY, CONTEMPORARY APPAREL AND AC-  
CESSORIES, IN CLASS 36 (U.S. CLS. 100, 101 AND  
102).

FIRST USE 1-24-2008; IN COMMERCE 1-24-2008.

THE MARK CONSISTS OF STANDARD CHAR-  
ACTERS WITHOUT CLAIM TO ANY PARTICULAR  
FONT, STYLE, SIZE, OR COLOR.

SN 77-180,018, FILED 5-14-2007.

MARK T. MULLEN, EXAMINING ATTORNEY

**Int. Cl.: 35**

**Prior U.S. Cls.: 100, 101, and 102**

**United States Patent and Trademark Office**

**Reg. No. 3,454,945**

**Registered June 24, 2008**

**SERVICE MARK  
PRINCIPAL REGISTER**



STAPLES THE OFFICE SUPERSTORE, LLC (DE-  
LAWARE LTD LIAB CO)  
500 STAPLES DRIVE  
FRAMINGHAM, MA 01702

FOR: RETAIL STORE SERVICES, MAIL ORDER  
CATALOG SERVICES, AND COMPUTERIZED ON-  
LINE RETAIL STORE SERVICES FEATURING OF-  
FICE SUPPLIES, OFFICE EQUIPMENT,  
INCLUDING COMPUTER HARDWARE, COPIERS  
AND TELEPHONES, AND OFFICE FURNITURE, IN  
CLASS 35 (U.S. CLS. 100, 101 AND 102).

FIRST USE 9-0-2007; IN COMMERCE 9-0-2007.

THE MARK CONSISTS OF THE STYLIZED  
WORD "STAPLES" IN A RECTANGLE TO THE  
TOP LEFT OF THE WORDS "ECO" AND "EASY"  
WITH THE STYLIZED IMAGE OF A PAPER CLIP  
AND LEAF.

SN 77-180,512, FILED 5-14-2007.

JACQUELINE A. LAVINE, EXAMINING ATTOR-  
NEY

**Int. Cl.: 25**

**Prior U.S. Cls.: 22 and 39**

**United States Patent and Trademark Office**

**Reg. No. 3,454,946**

**Registered June 24, 2008**

**TRADEMARK  
PRINCIPAL REGISTER**

**IJACKET**

ERMENEGILDO ZEGNA CORPORATION (NEW  
YORK CORPORATION)  
UNIT A  
100 WEST FOREST AVENUE  
ENGLEWOOD, NJ 07631

THE MARK CONSISTS OF STANDARD CHAR-  
ACTERS WITHOUT CLAIM TO ANY PARTICULAR  
FONT, STYLE, SIZE, OR COLOR.

FOR: CLOTHING, NAMELY, JACKETS, TOPS, IN  
CLASS 25 (U.S. CLS. 22 AND 39).

SN 77-181,388, FILED 5-15-2007.

FIRST USE 11-0-2006; IN COMMERCE 11-0-2006.

BRENDAN REGAN, EXAMINING ATTORNEY

**Int. Cl.: 32**

**Prior U.S. Cls.: 45, 46, and 48**

**Reg. No. 3,454,947**

**United States Patent and Trademark Office**

**Registered June 24, 2008**

---

**TRADEMARK  
PRINCIPAL REGISTER**

**EMBODI**

VITALITA NUTRITIONAL PRODUCTS LLC (IL-  
LINOIS LTD LIAB CO)  
SUITE 201  
213 NORTH RACINE AVE.  
CHICAGO, IL 60607

FOR: NON ALCOHOLIC FUNCTIONAL BEVERA-  
GES IN THE NATURE OF FRUIT DRINKS CON-  
TAINING BOTANICAL EXTRACTS AND HIGH IN  
ANTIOXIDANTS; FRUIT JUICES , IN CLASS 32 (U.S.  
CLS. 45, 46 AND 48).

FIRST USE 5-6-2008; IN COMMERCE 5-6-2008.

THE MARK CONSISTS OF STANDARD CHAR-  
ACTERS WITHOUT CLAIM TO ANY PARTICULAR  
FONT, STYLE, SIZE, OR COLOR.

SN 77-181,458, FILED 5-15-2007.

REBECCA EISINGER, EXAMINING ATTORNEY

**Int. Cl.: 16**

**Prior U.S. Cls.: 2, 5, 22, 23, 29, 37, 38, and 50**

**Reg. No. 3,454,948**

**United States Patent and Trademark Office**

**Registered June 24, 2008**

---

**TRADEMARK  
PRINCIPAL REGISTER**

**STRATA**

STAPLES THE OFFICE SUPERSTORE, LLC (DE-  
LAWARE LTD LIAB CO)  
500 STAPLES DRIVE  
FRAMINGHAM, MA 01702

FOR: PENS, IN CLASS 16 (U.S. CLS. 2, 5, 22, 23, 29,  
37, 38 AND 50).

FIRST USE 12-0-2007; IN COMMERCE 12-0-2007.

THE MARK CONSISTS OF STANDARD CHAR-  
ACTERS WITHOUT CLAIM TO ANY PARTICULAR  
FONT, STYLE, SIZE, OR COLOR.

SN 77-181,667, FILED 5-15-2007.

JACQUELINE A. LAVINE, EXAMINING ATTOR-  
NEY

**Int. Cl.: 45**

**Prior U.S. Cls.: 100 and 101**

**United States Patent and Trademark Office**

**Reg. No. 3,454,949**

**Registered June 24, 2008**

**SERVICE MARK  
PRINCIPAL REGISTER**

# MobileSecure

CONTIGO SYSTEMS INC. (CANADA CORPORATION)  
498-280 NELSON STREET  
VANCOUVER, CANADA

FOR: ELECTRONIC MONITORING SERVICES USING WIRELESS LOCATION TECHNOLOGY FOR USE IN LOCATING, TRACKING, MONITORING AND AIDING PERSONS AND PROPERTY VIA A COMPUTER NETWORK FOR SECURITY PURPOSES, IN CLASS 45 (U.S. CLS. 100 AND 101).

FIRST USE 5-24-2007; IN COMMERCE 4-1-2008.

THE MARK CONSISTS OF STANDARD CHARACTERS WITHOUT CLAIM TO ANY PARTICULAR FONT, STYLE, SIZE, OR COLOR.

OWNER OF U.S. REG. NO. 2,947,901.

SN 77-181,850, FILED 5-15-2007.

ALICE SUE CARRUTHERS, EXAMINING ATTORNEY

**Int. Cl.: 25**

**Prior U.S. Cls.: 22 and 39**

**United States Patent and Trademark Office**

**Reg. No. 3,454,950**

**Registered June 24, 2008**

**TRADEMARK  
PRINCIPAL REGISTER**



PARIS ACCESSORIES, INC. (NEW YORK CORPORATION)  
350 FIFTH AVENUE, 70TH FLOOR  
NEW YORK, NY 10018

FOR: GIRL'S HOSIERY, LEG WEAR, NAMELY,  
TIGHTS, IN CLASS 25 (U.S. CLS. 22 AND 39).

FIRST USE 4-24-2008; IN COMMERCE 4-24-2008.

NO CLAIM IS MADE TO THE EXCLUSIVE  
RIGHT TO USE "TIGHTS", APART FROM THE  
MARK AS SHOWN.

SN 77-182,123, FILED 5-16-2007.

KATHERINE M. DUBRAY, EXAMINING ATTORNEY

**Int. Cl.: 41**

**Prior U.S. Cls.: 100, 101, and 107**

**United States Patent and Trademark Office**

**Reg. No. 3,454,951**

**Registered June 24, 2008**

**SERVICE MARK  
PRINCIPAL REGISTER**



CLEARY BUILDING CORP. (WISCONSIN CORPORATION)

190 PAOLI STREET

VERONA, WI 53593

FOR: EDUCATION SERVICES, NAMELY, PROVIDING CLASSES IN THE FIELD OF CONSTRUCTION; EDUCATIONAL SERVICES, NAMELY, DEVELOPING CURRICULUM FOR OTHERS IN THE FIELD OF CONSTRUCTION, IN CLASS 41 (U.S. CLS. 100, 101 AND 107).

FIRST USE 4-1-2007; IN COMMERCE 4-1-2007.

OWNER OF U.S. REG. NO. 1,597,831.

NO CLAIM IS MADE TO THE EXCLUSIVE RIGHT TO USE "STEEL WOOD", APART FROM THE MARK AS SHOWN.

THE COLOR(S) GREEN, BLACK AND WHITE IS/ARE CLAIMED AS A FEATURE OF THE MARK.

THE MARK CONSISTS OF A GREEN SHAMROCK WITH THE LETTERS "S W U" IN WHITE, ONE LETTER IN EACH LEAF, ALL ABOVE THE WORDING "STEEL WOOD UNIVERSITY" IN BLACK.

SN 77-182,408, FILED 5-16-2007.

ELLEN BURNS, EXAMINING ATTORNEY



**Int. Cl.: 11**

**Prior U.S. Cls.: 13, 21, 23, 31, and 34**

**Reg. No. 3,454,952**

**United States Patent and Trademark Office**

**Registered June 24, 2008**

---

**TRADEMARK  
PRINCIPAL REGISTER**

**SAN LUCAS**

ANDERSON DAYMON WORLDWIDE, LLC (WA-  
SHINGTON LTD LIAB CO)  
SUITE 200  
845 LAKE DRIVE  
ISSAQUAH, WA 98027

THE MARK CONSISTS OF STANDARD CHAR-  
ACTERS WITHOUT CLAIM TO ANY PARTICULAR  
FONT, STYLE, SIZE, OR COLOR.

FOR: DECORATIVE FIRE PIT TABLES FOR OUT-  
DOOR USE, IN CLASS 11 (U.S. CLS. 13, 21, 23, 31 AND  
34).

SN 77-182,473, FILED 5-16-2007.

FIRST USE 11-0-2007; IN COMMERCE 11-0-2007.

SUSAN LESLIE DUBOIS, EXAMINING ATTORNEY

**Int. Cl.: 41**

**Prior U.S. Cls.: 100, 101, and 107**

**United States Patent and Trademark Office**

**Reg. No. 3,454,953**

**Registered June 24, 2008**

**SERVICE MARK  
PRINCIPAL REGISTER**

**STEEL WOOD UNIVERSITY**

CLEARY BUILDING CORP. (WISCONSIN CORPORATION)  
190 PAOLI STREET  
VERONA, WI 53593

FOR: EDUCATION SERVICES, NAMELY, PROVIDING CLASSES IN THE FIELD OF CONSTRUCTION; EDUCATIONAL SERVICES, NAMELY, DEVELOPING CURRICULUM FOR OTHERS IN THE FIELD OF CONSTRUCTION, IN CLASS 41 (U.S. CLS. 100, 101 AND 107).

FIRST USE 4-1-2007; IN COMMERCE 4-1-2007.

THE MARK CONSISTS OF STANDARD CHARACTERS WITHOUT CLAIM TO ANY PARTICULAR FONT, STYLE, SIZE, OR COLOR.

NO CLAIM IS MADE TO THE EXCLUSIVE RIGHT TO USE "STEEL WOOD", APART FROM THE MARK AS SHOWN.

SN 77-182,487, FILED 5-16-2007.

ELLEN BURNS, EXAMINING ATTORNEY

**Int. Cl.: 41**

**Prior U.S. Cls.: 100, 101, and 107**

**United States Patent and Trademark Office**

**Reg. No. 3,454,954**

**Registered June 24, 2008**

**SERVICE MARK  
PRINCIPAL REGISTER**

# ThriveScan

CLAY, CHARLES DON (UNITED STATES INDIVIDUAL)  
4045 S. BUFFALO, STE. A101-382  
LAS VEGAS, NV 89147

THE MARK CONSISTS OF STANDARD CHARACTERS WITHOUT CLAIM TO ANY PARTICULAR FONT, STYLE, SIZE, OR COLOR.

FOR: BUSINESS TRAINING, IN CLASS 41 (U.S. CLS. 100, 101 AND 107).

SN 77-182,555, FILED 5-16-2007.

FIRST USE 5-16-2007; IN COMMERCE 6-2-2007.

INGA ERVIN, EXAMINING ATTORNEY

**Int. Cl.: 28**

**Prior U.S. Cls.: 22, 23, 38, and 50**

**United States Patent and Trademark Office**

**Reg. No. 3,454,955**

**Registered June 24, 2008**

**TRADEMARK  
PRINCIPAL REGISTER**

**FIRE BUG**

ESTES-COX CORP. (DELAWARE CORPORATION)  
1295 H STREET  
PENROSE, CO 81240

THE MARK CONSISTS OF STANDARD CHARACTERS WITHOUT CLAIM TO ANY PARTICULAR FONT, STYLE, SIZE, OR COLOR.

FOR: TOY MODEL VEHICLES AND ACCESSORIES THEREFOR, IN CLASS 28 (U.S. CLS. 22, 23, 38 AND 50).

SN 77-182,631, FILED 5-16-2007.

FIRST USE 2-14-2008; IN COMMERCE 2-14-2008.

NAAKWAMA ANKRAH, EXAMINING ATTORNEY

**Int. Cl.: 35**

**Prior U.S. Cls.: 100, 101, and 102**

**United States Patent and Trademark Office**

**Reg. No. 3,454,956**

**Registered June 24, 2008**

**SERVICE MARK  
PRINCIPAL REGISTER**



LOVE ACQUISITIONS AND CONSULTING, LLC  
(FLORIDA LTD LIAB CO)  
5450 BRUCE B. DOWNS BOULEVARD, SUITE 375  
WESLEY CHAPEL, FL 33543

FOR: RETAIL STORE SERVICES FEATURING  
WIRELESS PRODUCTS, ACCESSORIES, AND CEL-  
LULAR PHONES, IN CLASS 35 (U.S. CLS. 100, 101  
AND 102).

FIRST USE 12-26-2007; IN COMMERCE 12-26-2007.

THE COLOR(S) BLACK AND RED IS/ARE  
CLAIMED AS A FEATURE OF THE MARK.

THE MARK CONSISTS OF TWO CURVED RED  
LINES AND ONE BLACK LINE OVER THE STY-  
LIZED LETTER "L" IN RED AND "W" IN BLACK,  
AND THE WORD "LOVE" IN RED AND THE WORD  
"WIRELESS" IN BLACK.

SN 77-183,524, FILED 5-17-2007.

WARREN L. OLANDRIA, EXAMINING ATTOR-  
NEY

**Int. Cl.: 45**

**Prior U.S. Cls.: 100 and 101**

**United States Patent and Trademark Office**

**Reg. No. 3,454,957**

**Registered June 24, 2008**

**SERVICE MARK  
PRINCIPAL REGISTER**

**GLOBAL STAR**

GENERAL ELECTRIC COMPANY (NEW YORK  
CORPORATION)  
1 RIVER ROAD  
SCHENECTADY, NY 12345

THE MARK CONSISTS OF STANDARD CHAR-  
ACTERS WITHOUT CLAIM TO ANY PARTICULAR  
FONT, STYLE, SIZE, OR COLOR.

FOR: CONSULTING IN THE FIELD OF WORK-  
PLACE SAFETY, IN CLASS 45 (U.S. CLS. 100 AND  
101).

SN 77-183,835, FILED 5-17-2007.

FIRST USE 10-6-1999; IN COMMERCE 10-6-1999.

CARRIE GENOVESE, EXAMINING ATTORNEY

**Int. Cl.: 11**

**Prior U.S. Cls.: 13, 21, 23, 31, and 34**

**Reg. No. 3,454,958**

**United States Patent and Trademark Office**

**Registered June 24, 2008**

---

**TRADEMARK  
PRINCIPAL REGISTER**

**VinoView**

THE WINE ENTHUSIAST, INC. (NEW YORK  
CORPORATION)  
103 FAIRVIEW PARK DRIVE  
ELMSFORD, NY 10523

THE MARK CONSISTS OF STANDARD CHAR-  
ACTERS WITHOUT CLAIM TO ANY PARTICULAR  
FONT, STYLE, SIZE, OR COLOR.

FOR: APPLIANCES FOR DOMESTIC USE, NAME-  
LY, TEMPERATURE CONTROLLED WINE CEL-  
LARS; REFRIGERATORS, IN CLASS 11 (U.S. CLS. 13,  
21, 23, 31 AND 34).

SN 77-183,838, FILED 5-17-2007.

FIRST USE 7-31-2007; IN COMMERCE 9-30-2007.

ALYSSA PALADINO, EXAMINING ATTORNEY

**Int. Cl.: 36**

**Prior U.S. Cls.: 100, 101, and 102**

**United States Patent and Trademark Office**

**Reg. No. 3,454,959**

**Registered June 24, 2008**

**SERVICE MARK  
PRINCIPAL REGISTER**

**NATIONWIDE ALTERNATIVE  
RESERVE VUL**

NATIONWIDE MUTUAL INSURANCE COMPAN-  
NY (OHIO CORPORATION)  
OFFICE OF GENERAL COUNSEL 1-07-14  
ONE NATIONWIDE PLAZA  
COLUMBUS, OH 432152220

FOR: INSURANCE SERVICES, NAMELY, UN-  
DERWRITING AND ADMINISTRATION OF UNI-  
VERSAL LIFE INSURANCE POLICIES, IN CLASS 36  
(U.S. CLS. 100, 101 AND 102).

FIRST USE 1-23-2008; IN COMMERCE 1-23-2008.

THE MARK CONSISTS OF STANDARD CHAR-  
ACTERS WITHOUT CLAIM TO ANY PARTICULAR  
FONT, STYLE, SIZE, OR COLOR.

OWNER OF U.S. REG. NOS. 854,888, 2,017,147,  
AND OTHERS.

NO CLAIM IS MADE TO THE EXCLUSIVE  
RIGHT TO USE "VUL", APART FROM THE MARK  
AS SHOWN.

SN 77-184,457, FILED 5-18-2007.

JEFFERY COWARD, EXAMINING ATTORNEY



**Int. Cl.: 35**

**Prior U.S. Cls.: 100, 101, and 102**

**United States Patent and Trademark Office**

**Reg. No. 3,454,960**

**Registered June 24, 2008**

**SERVICE MARK  
PRINCIPAL REGISTER**

**TURN IT INTO GREEN**

JEWELRY BUYERS OF AMERICA, INC. (NEW  
YORK CORPORATION)  
11 REGENT DRIVE  
LAWRENCE, NY 11559

THE MARK CONSISTS OF STANDARD CHAR-  
ACTERS WITHOUT CLAIM TO ANY PARTICULAR  
FONT, STYLE, SIZE, OR COLOR.

FOR: DEALERSHIPS FEATURING PRE-OWNED  
JEWELRY, IN CLASS 35 (U.S. CLS. 100, 101 AND 102).

SN 77-184,635, FILED 5-18-2007.

FIRST USE 8-15-2007; IN COMMERCE 8-15-2007.

APRIL ROACH, EXAMINING ATTORNEY

**Int. Cl.: 35**

**Prior U.S. Cls.: 100, 101, and 102**

**United States Patent and Trademark Office**

**Reg. No. 3,454,961**

**Registered June 24, 2008**

**SERVICE MARK  
PRINCIPAL REGISTER**

**WEZOG**

MARC USA, INC. (DELAWARE CORPORATION)  
225 W. STATION SQUARE DR.  
PITTSBURGH, PA 15219

FOR: ADVERTISING AGENCY SERVICES; PUBLIC RELATIONS SERVICES; WIRELESS AND DIGITAL INTERACTIVE ADVERTISING AGENCY AND BUSINESS MARKETING CONSULTING SERVICES; DIRECT MARKETING ADVERTISING SERVICES; BUSINESS MARKETING CONSULTING SERVICES; MARKET RESEARCH; SALES PROMOTION SERVICES; AND PLACING AND PREPARING ADVERTISING FOR OTHERS, PURCHASE AND PROCUREMENT OF MEDIA TIME FOR OTHERS,

PLANNING AND RESEARCH OF PRINT, RADIO, TELEVISION, AND ELECTRONIC ADVERTISING MEDIA USE FOR OTHERS, IN CLASS 35 (U.S. CLS. 100, 101 AND 102).

FIRST USE 10-1-2007; IN COMMERCE 10-1-2007.

THE MARK CONSISTS OF STANDARD CHARACTERS WITHOUT CLAIM TO ANY PARTICULAR FONT, STYLE, SIZE, OR COLOR.

SN 77-184,877, FILED 5-18-2007.

GEOFFREY FOSDICK, EXAMINING ATTORNEY

**Int. Cl.: 7**

**Prior U.S. Cls.: 13, 19, 21, 23, 31, 34, and 35**

**Reg. No. 3,454,962**

**United States Patent and Trademark Office**

**Registered June 24, 2008**

---

**TRADEMARK  
PRINCIPAL REGISTER**

**Jessie**

TACONY CORPORATION (MISSOURI CORPORATION)  
1760 GILSINN LANE  
FENTON, MO 63026

THE MARK CONSISTS OF STANDARD CHARACTERS WITHOUT CLAIM TO ANY PARTICULAR FONT, STYLE, SIZE, OR COLOR.

FOR: VACUUM CLEANERS, IN CLASS 7 (U.S. CLS. 13, 19, 21, 23, 31, 34 AND 35).

SN 77-185,704, FILED 5-21-2007.

FIRST USE 7-21-2007; IN COMMERCE 7-21-2007.

LESLIE RICHARDS, EXAMINING ATTORNEY

**Int. Cl.: 37**

**Prior U.S. Cls.: 100, 103, and 106**

**United States Patent and Trademark Office**

**Reg. No. 3,454,963**

**Registered June 24, 2008**

**SERVICE MARK  
PRINCIPAL REGISTER**

# Quicktricity Electric

SECCO, INCORPORATED (PENNSYLVANIA CORPORATION)

1111 PRIMEROSE AVENUE

CAMP HILL, PA 17011

FOR: ELECTRICAL CONTRACTOR SERVICES,  
IN CLASS 37 (U.S. CLS. 100, 103 AND 106).

FIRST USE 5-29-2007; IN COMMERCE 6-29-2007.

THE MARK CONSISTS OF STANDARD CHARACTERS WITHOUT CLAIM TO ANY PARTICULAR FONT, STYLE, SIZE, OR COLOR.

NO CLAIM IS MADE TO THE EXCLUSIVE RIGHT TO USE "ELECTRIC", APART FROM THE MARK AS SHOWN.

SN 77-185,946, FILED 5-21-2007.

JAMES LOVELACE, EXAMINING ATTORNEY

**Int. Cl.: 25**

**Prior U.S. Cls.: 22 and 39**

**United States Patent and Trademark Office**

**Reg. No. 3,454,964**

**Registered June 24, 2008**

**TRADEMARK  
PRINCIPAL REGISTER**

**DOMINATE & KONQUER**

ALVARADO, RICHARD (UNITED STATES INDIVIDUAL)  
1663 BUCKEYE DRIVE  
EL CAJON, CA 92021

THE MARK CONSISTS OF STANDARD CHARACTERS WITHOUT CLAIM TO ANY PARTICULAR FONT, STYLE, SIZE, OR COLOR.

FOR: BLOUSES; HATS; JERSEYS; PANTS; SHIRTS; SHOES; SKIRTS; SOCKS, IN CLASS 25 (U.S. CLS. 22 AND 39).

SN 77-186,046, FILED 5-21-2007.

FIRST USE 5-7-2008; IN COMMERCE 5-7-2008.

FLORENTINA BLANDU, EXAMINING ATTORNEY

**Int. Cl.: 25**

**Prior U.S. Cls.: 22 and 39**

**United States Patent and Trademark Office**

**Reg. No. 3,454,965**

**Registered June 24, 2008**

**TRADEMARK  
PRINCIPAL REGISTER**



ALVARADO, RICHARD (UNITED STATES INDIVIDUAL)  
1663 BUCKEYE DRIVE  
EL CAJON, CA 92021

THE MARK CONSISTS OF A CIRCLE WITH AN "I"-BEAM INSIDE.

FOR: BLOUSES; HATS; JERSEYS; PANTS; SHIRTS; SHOES; SKIRTS; SOCKS, IN CLASS 25 (U.S. CLS. 22 AND 39).

SN 77-186,061, FILED 5-21-2007.

FIRST USE 5-7-2008; IN COMMERCE 5-7-2008.

FLORENTINA BLANDU, EXAMINING ATTORNEY

**Int. Cl.: 37**

**Prior U.S. Cls.: 100, 103, and 106**

**United States Patent and Trademark Office**

**Reg. No. 3,454,966**

**Registered June 24, 2008**

**SERVICE MARK  
PRINCIPAL REGISTER**

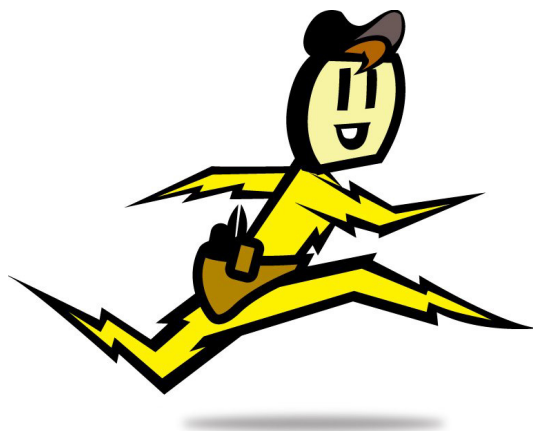

SECCO, INCORPORATED (PENNSYLVANIA CORPORATION)  
1111 PRIMEROSE AVENUE  
CAMP HILL, PA 17011

FOR: ELECTRICAL CONTRACTOR SERVICES,  
IN CLASS 37 (U.S. CLS. 100, 103 AND 106).

FIRST USE 5-29-2007; IN COMMERCE 6-11-2007.

THE COLOR(S) CREAM, YELLOW, BROWN, TAN, BLACK, PURPLE, WHITE AND GRAY IS/ARE CLAIMED AS A FEATURE OF THE MARK.

THE MARK CONSISTS OF A CARTOON DEPICTING ELECTRICAL CURRENT AS YELLOW IN THE SHAPE OF A PERSON WITH A TAN TOOL BELT CONTAINING BLACK TOOLS, WITH BLACK HAT WITH A PURPLE VISOR, BROWN HAIR, AND A CREAM FACE IN THE FORM OF AN ELECTRICAL OUTLET WITH A WHITE MOUTH ALL OUTLINED IN BLACK. THE CARTOON CHARACTER APPEARS ABOVE A GRAY SHADOW IN THE SHAPE OF A LINE.

SN 77-186,312, FILED 5-21-2007.

JAMES LOVELACE, EXAMINING ATTORNEY

**Int. Cl.: 37**

**Prior U.S. Cls.: 100, 103, and 106**

**United States Patent and Trademark Office**

**Reg. No. 3,454,967**

**Registered June 24, 2008**

---

**SERVICE MARK  
PRINCIPAL REGISTER**

**Quicktricity**

SECCO, INCORPORATED (PENNSYLVANIA  
CORPORATION)  
1111 PRIMEROSE AVENUE  
CAMP HILL, PA 17011

THE MARK CONSISTS OF STANDARD CHAR-  
ACTERS WITHOUT CLAIM TO ANY PARTICULAR  
FONT, STYLE, SIZE, OR COLOR.

FOR: ELECTRICAL CONTRACTOR SERVICES,  
IN CLASS 37 (U.S. CLS. 100, 103 AND 106).

SN 77-186,333, FILED 5-21-2007.

FIRST USE 5-29-2007; IN COMMERCE 6-11-2007.

JAMES LOVELACE, EXAMINING ATTORNEY



**Int. Cl.: 44**

**Prior U.S. Cls.: 100 and 101**

**United States Patent and Trademark Office**

**Reg. No. 3,454,968**

**Registered June 24, 2008**

**SERVICE MARK  
PRINCIPAL REGISTER**



PROMINIS MEDICAL SERVICES, PC (NEW YORK CORPORATION)  
381 5TH STREET  
BROOKLYN, NY 11215

FOR: HEALTH CARE; PHYSICIAN SERVICES, IN CLASS 44 (U.S. CLS. 100 AND 101).

FIRST USE 1-1-2008; IN COMMERCE 1-1-2008.

THE COLOR(S) RED AND WHITE IS/ARE CLAIMED AS A FEATURE OF THE MARK.

THE MARK CONSISTS OF A RED CIRCLE WITH A WHITE STETHOSCOPE FORMING THE SHAPE OF A HEART IN THE CIRCLE, WITH THE WORD "PROMINIS" DISPLAYED NEXT TO IT IN RED COLOR.

SN 77-187,020, FILED 5-22-2007.

HOWARD FRIEDMAN, EXAMINING ATTORNEY

**Int. Cl.: 9**

**Prior U.S. Cls.: 21, 23, 26, 36, and 38**

**Reg. No. 3,454,969**

**United States Patent and Trademark Office**

**Registered June 24, 2008**

---

**TRADEMARK  
PRINCIPAL REGISTER**

**USE WHAT THE PROS USE**

BELDEN TECHNOLOGIES, INC. (DELAWARE  
CORPORATION)  
7701 FORSYTH, SUITE 800  
ST. LOUIS, MO 63105

THE MARK CONSISTS OF STANDARD CHAR-  
ACTERS WITHOUT CLAIM TO ANY PARTICULAR  
FONT, STYLE, SIZE, OR COLOR.

FOR: ELECTRICAL AND ELECTRONIC WIRE  
AND CABLE, IN CLASS 9 (U.S. CLS. 21, 23, 26, 36  
AND 38).

SN 77-187,098, FILED 5-22-2007.

FIRST USE 4-2-2008; IN COMMERCE 4-2-2008.

MATTHEW EINSTEIN, EXAMINING ATTORNEY

**Int. Cl.: 34**

**Prior U.S. Cls.: 2, 8, 9, and 17**

**United States Patent and Trademark Office**

**Reg. No. 3,454,970**

**Registered June 24, 2008**

---

**TRADEMARK  
PRINCIPAL REGISTER**

**ZERO**

BLUNT WRAP U.S.A., INC (LOUISIANA CORPORATION)  
594 ASBURY DRIVE, SUITE C  
MANDEVILLE, LA 70471

FOR: TOBACCO PRODUCTS AND ACCESSORIES, NAMELY, CIGARS, ROLLING PAPERS MADE OUT OF PAPER AND/OR TOBACCO FOR CIGARETTES AND/OR CIGARS, AND PRE-ROLLED TOBACCO SHELLS, TOBACCO SHEETS, SNUFF, AND/OR CIGARETTE PAPERS, IN CLASS 34 (U.S. CLS. 2, 8, 9 AND 17).

FIRST USE 2-21-2008; IN COMMERCE 3-7-2008.

THE MARK CONSISTS OF STANDARD CHARACTERS WITHOUT CLAIM TO ANY PARTICULAR FONT, STYLE, SIZE, OR COLOR.

SN 77-187,434, FILED 5-22-2007.

HOWARD B. LEVINE, EXAMINING ATTORNEY

**Int. Cl.: 33**

**Prior U.S. Cls.: 47 and 49**

**United States Patent and Trademark Office**

**Reg. No. 3,454,971**

**Registered June 24, 2008**

**TRADEMARK  
PRINCIPAL REGISTER**



WINERY EXCHANGE, INC. (CALIFORNIA CORPORATION)  
35 LEVERONI COURT, SUITE 100  
NOVATO, CA 94949

THE MARK CONSISTS OF THE WORDS "NAPA FAMILY VINEYARDS" WITH THE LETTERS "N", "V" AND "F" IN THE BACKGROUND.

FOR: WINES, IN CLASS 33 (U.S. CLS. 47 AND 49).

FIRST USE 10-0-2007; IN COMMERCE 10-0-2007.

SN 77-187,766, FILED 5-22-2007.

NO CLAIM IS MADE TO THE EXCLUSIVE RIGHT TO USE "NAPA FAMILY VINEYARDS" , APART FROM THE MARK AS SHOWN.

JAY FLOWERS, EXAMINING ATTORNEY

**Int. Cls.: 3 and 4**

**Prior U.S. Cls.: 1, 4, 6, 15, 50, 51, and 52**

**United States Patent and Trademark Office**

**Reg. No. 3,454,972**

**Registered June 24, 2008**

**TRADEMARK  
PRINCIPAL REGISTER**

# Me Thyme

SHARP CHERRYL (NEW JERSEY CORPORATION)  
12 HANNAH MOUNT DRIVE  
CLARKSBURG, NJ 08510

FOR: AGE RETARDANT LOTION; ALMOND SOAPS; AROMATHERAPY LOTIONS; BAR SOAP; BATH LOTION; BATH SOAPS; BATHING LOTIONS; BEAUTY LOTIONS; BODY LOTION; BODY LOTIONS; HAIR CARE LOTIONS; HAND LOTIONS; SOAPS FOR BODY CARE, IN CLASS 3 (U.S. CLS. 1, 4, 6, 50, 51 AND 52).

FIRST USE 8-26-2007; IN COMMERCE 11-5-2007.

FOR: CANDLES FOR LIGHTING; SCENTED CANDLES, IN CLASS 4 (U.S. CLS. 1, 6 AND 15).

FIRST USE 8-26-2007; IN COMMERCE 11-5-2007.

THE MARK CONSISTS OF STANDARD CHARACTERS WITHOUT CLAIM TO ANY PARTICULAR FONT, STYLE, SIZE, OR COLOR.

SN 77-188,100, FILED 5-23-2007.

ESTHER A. BORSUK, EXAMINING ATTORNEY

**Int. Cl.: 18**

**Prior U.S. Cls.: 1, 2, 3, 22, and 41**

**United States Patent and Trademark Office**

**Reg. No. 3,454,973**

**Registered June 24, 2008**

**TRADEMARK  
PRINCIPAL REGISTER**

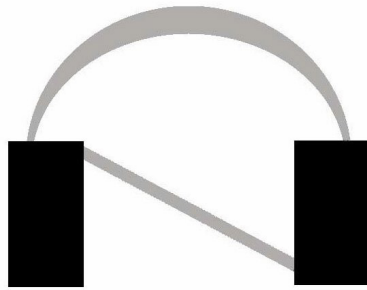

AN NENG, INC. (NEW YORK CORPORATION)  
119-16 20TH AVENUE  
COLLEGE POINT, NY 11356

FIRST USE 4-2-2008; IN COMMERCE 4-2-2008.

FOR: BRIEFCASES, HANDBAGS, PURSES, SUIT-  
CASES, WALLETS, IN CLASS 18 (U.S. CLS. 1, 2, 3, 22  
AND 41).

SN 77-189,286, FILED 5-24-2007.

SIMON TENG, EXAMINING ATTORNEY

**Int. Cl.: 41**

**Prior U.S. Cls.: 100, 101, and 107**

**United States Patent and Trademark Office**

**Reg. No. 3,454,974**

**Registered June 24, 2008**

**SERVICE MARK  
PRINCIPAL REGISTER**

**GET YOUR LIFE BACK**

KNIGHT, PEGGY L. (UNITED STATES INDIVIDUAL)  
SUITE B103  
1750 BRIDGEWAY  
SAUSALITO, CA 94965

FOR: EDUCATIONAL SERVICES, NAMELY, PROVIDING SEMINARS AND CLASSES THAT ADDRESS ISSUES FACED BY WOMEN UNDERGOING CHEMOTHERAPY, SKIN CARE, SPIRITUAL WELL-BEING, UNDERSTANDING AND MANAGING CANCER, AND CHANGES IN APPEARANCE, AND PRINTED MATERIALS PROVIDED IN CON-

NECTION THEREWITH, IN CLASS 41 (U.S. CLS. 100, 101 AND 107).

FIRST USE 6-13-2007; IN COMMERCE 6-13-2007.

THE MARK CONSISTS OF STANDARD CHARACTERS WITHOUT CLAIM TO ANY PARTICULAR FONT, STYLE, SIZE, OR COLOR.

SN 77-189,597, FILED 5-24-2007.

MICHAEL KAZAZIAN, EXAMINING ATTORNEY

**Int. Cl.: 39**

**Prior U.S. Cls.: 100 and 105**

**United States Patent and Trademark Office**

**Reg. No. 3,454,975**

**Registered June 24, 2008**

**SERVICE MARK  
PRINCIPAL REGISTER**

# TireLocker

TIRELOCKER, INC. (PENNSYLVANIA CORPORATION)  
PNC BANK BLDG.  
114 W. STATE ST., 2ND FL  
MEDIA, PA 19063

FOR: DELIVERY OF TIRES, WHEELS, AND RIMS BY GROUND TRANSPORTATION; STORAGE OF TIRES, WHEELS, AND RIMS, IN CLASS 39 (U.S. CLS. 100 AND 105).

FIRST USE 9-24-2007; IN COMMERCE 9-24-2007.

THE MARK CONSISTS OF STANDARD CHARACTERS WITHOUT CLAIM TO ANY PARTICULAR FONT, STYLE, SIZE, OR COLOR.

SN 77-191,484, FILED 5-28-2007.

COLLEEN DOMBROW, EXAMINING ATTORNEY



**Int. Cls.: 35, 36, and 42**

**Prior U.S. Cls.: 100, 101, and 102**

**United States Patent and Trademark Office**

**Reg. No. 3,454,976**

**Registered June 24, 2008**

**SERVICE MARK  
PRINCIPAL REGISTER**

# COFINITY

AETNA INC. (PENNSYLVANIA CORPORATION)  
980 JOLLY ROAD  
BLUE BELL, PA 19422

FOR: HEALTH CARE COST REVIEW AND COST CONTAINMENT SERVICES FOR MEDICAL, DENTAL, BEHAVIORAL HEALTH, AND PHARMACY BENEFIT PLANS OF OTHERS; ADMINISTRATION OF A DISCOUNT PROGRAM PROMOTING THE GOODS AND SERVICES OF OTHERS THROUGH THE DISTRIBUTION OF DISCOUNT CARDS; VERIFYING AND MONITORING THE CREDENTIALS OF PHYSICIANS AND OTHER HEALTH CARE PROFESSIONALS, IN CLASS 35 (U.S. CLS. 100, 101 AND 102).

FIRST USE 9-5-2007; IN COMMERCE 9-5-2007.

FOR: HEALTH INSURANCE ADMINISTRATION, NAMELY, ORGANIZING AND ADMINISTERING PROVIDER NETWORKS IN THE FIELD OF MEDICAL, DENTAL, PHARMACY, AND BEHAVIORAL HEALTH CARE; ADMINISTRATION SERVICES IN THE FIELD OF HEALTH CARE INSURANCE, NAMELY, PROVIDING INFORMATION REGARDING HEALTH CARE PROVIDER NETWORKS; ADMINISTRATION OF MEDICAL, DENTAL, PHARMACY, BEHAVIORAL HEALTH AND STOP-

LOSS INSURANCE SERVICES, INCLUDING PRE-PAID HEALTH CARE PLANS, HEALTH CARE INDEMNITY PLANS, HEALTH CARE PREFERRED PROVIDER PLANS AND CONSUMER-DIRECTED HEALTH PLANS, FOR OTHERS; HEALTH INSURANCE CLAIMS PROCESSING AND ADMINISTRATION, AND CLAIMS DATA ANALYSIS; PHARMACY BENEFIT MANAGEMENT SERVICES, IN CLASS 36 (U.S. CLS. 100, 101 AND 102).

FIRST USE 9-5-2007; IN COMMERCE 9-5-2007.

FOR: QUALITY CONTROL FOR OTHERS, NAMELY, FOR HEALTH CARE BENEFITS PROVIDERS, HOSPITALS, HEALTH CLINICS AND DOCTORS' OFFICES, IN CLASS 42 (U.S. CLS. 100 AND 101).

FIRST USE 9-5-2007; IN COMMERCE 9-5-2007.

THE MARK CONSISTS OF STANDARD CHARACTERS WITHOUT CLAIM TO ANY PARTICULAR FONT, STYLE, SIZE, OR COLOR.

SN 77-191,685, FILED 5-29-2007.

SANJEEV VOHRA, EXAMINING ATTORNEY

**Int. Cl.: 35**

**Prior U.S. Cls.: 100, 101, and 102**

**United States Patent and Trademark Office**

**Reg. No. 3,454,977**

**Registered June 24, 2008**

**SERVICE MARK  
PRINCIPAL REGISTER**

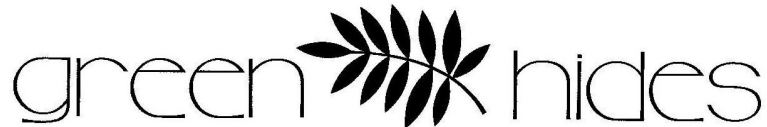

GREEN HIDES, LLC (NORTH CAROLINA LTD  
LIAB CO)  
4355 FEDERAL DRIVE, SUITE 110  
GREENSBORO, NC 27410

FOR: WHOLESALE AND RETAIL STORE SERVI-  
CES FEATURING LEATHER SOLD IN BULK, IN  
CLASS 35 (U.S. CLS. 100, 101 AND 102).

FIRST USE 6-0-2007; IN COMMERCE 6-0-2007.

NO CLAIM IS MADE TO THE EXCLUSIVE  
RIGHT TO USE "GREEN" OR "HIDES", APART  
FROM THE MARK AS SHOWN.

THE MARK CONSISTS OF A PALM FROND.

SN 77-191,884, FILED 5-29-2007.

ANNE E. GUSTASON, EXAMINING ATTORNEY

**Int. Cl.: 12**

**Prior U.S. Cls.: 19, 21, 23, 31, 35, and 44**

**Reg. No. 3,454,978**

**United States Patent and Trademark Office**

**Registered June 24, 2008**

---

**TRADEMARK  
PRINCIPAL REGISTER**



HERMANN, JIM (UNITED STATES INDIVIDUAL)  
PO BOX 422  
LEBANON, NJ 08833

FOR: REMOVABLE HAND AND ARM SUPPORT BARS FOR ATTACHMENT TO CARTS, DOLLIES AND MOBILE TOOL STANDS FOR PROVIDING LEVERAGE AND FOR FACILITATING SUPPORT DURING TRANSPORT, IN CLASS 12 (U.S. CLS. 19, 21, 23, 31, 35 AND 44).

FIRST USE 2-15-2008; IN COMMERCE 2-15-2008.

THE MARK CONSISTS OF IMAGE OF OX ABOVE THE WORDS "BLUE OX".

SN 77-192,025, FILED 5-29-2007.

RUSS HERMAN, EXAMINING ATTORNEY

**Int. Cl.: 41**

**Prior U.S. Cls.: 100, 101, and 107**

**United States Patent and Trademark Office**

**Reg. No. 3,454,979**

**Registered June 24, 2008**

**SERVICE MARK  
PRINCIPAL REGISTER**

**YOURTAKE.ORG**

TREGOE EDUCATION FORUM, INC. (NEW JERSEY NON-PROFIT CORPORATION)  
P.O. BOX 289  
PRINCETON, NJ 08542

FOR: EDUCATIONAL SERVICES, NAMELY, PROVIDING LIVE AND INTERACTIVE ONLINE WORKSHOPS AND TUTORIAL CLASSES CONCERNING SITUATION APPRAISAL AND COMPLEX PROBLEM SOLVING BY ASSESSING COMPLEX PROBLEMS AND DERIVING SOLUTIONS THERETO AND DISTRIBUTING COURSE

MATERIALS IN CONNECTION THEREWITH, IN CLASS 41 (U.S. CLS. 100, 101 AND 107).

FIRST USE 12-31-2006; IN COMMERCE 4-30-2007.

THE MARK CONSISTS OF STANDARD CHARACTERS WITHOUT CLAIM TO ANY PARTICULAR FONT, STYLE, SIZE, OR COLOR.

SN 77-192,069, FILED 5-29-2007.

MICHAEL TANNER, EXAMINING ATTORNEY

**Int. Cls.: 9 and 42**

**Prior U.S. Cls.: 21, 23, 26, 36, 38, 100, and 101**

**United States Patent and Trademark Office**

**Reg. No. 3,454,980**

**Registered June 24, 2008**

**TRADEMARK  
SERVICE MARK  
PRINCIPAL REGISTER**



RANDOLF, GUENTER (AUSTRIA INDIVIDUAL)  
500 UNIVERSITY AVE. 323  
HONOLULU, HI 96826

THE COLOR(S) BLUE, WHITE IS/ARE CLAIMED  
AS A FEATURE OF THE MARK.

FOR: ELECTRICAL CONTROLLING DEVICES;  
COMPUTER SOFTWARE FOR MEASUREMENT  
AND AUTOMATION, NAMELY, COMPUTER  
SOFTWARE FOR DATA ACQUISITION OF ELEC-  
TRICAL AND PHYSICAL PROPERTIES AND IN-  
DUSTRIAL PROCESS CONTROL AND TESTING  
DEVICES, IN CLASS 9 (U.S. CLS. 21, 23, 26, 36 AND  
38).

THE MARK CONSISTS OF THE WORD "GRAND-  
ALYTICS", WHERE THE FIRST AND SECOND  
LETTER "G, R" ARE CAPITAL; THE FIRST, SEC-  
OND AND FIFTH LETTERS "G, R, D" ARE HALF A  
LINE HIGHER THAN THE REMAINING LETTERS  
"A, N, A, L, Y, T, I, C, S"; ALL LETTERS ARE WHITE,  
EMBEDDED INTO THE BACKGROUND SHAPE,  
WHICH RESEMBLES AN X-RAY SPECTRUM WITH  
A SOFT PEAK AT THE BEGIN OVER THE LETTERS  
"G" AND "R" AND SHARP PEAKS OVER THE  
LETTERS "D, L, T AND I", WHERE THE HEIGHT  
OF THOSE SHARPER PEAKS IS DECREASING  
FROM "D TO I"; THE COLOR OF THE BACK-  
GROUND SHAPE IS BLUE WITH R/G/B VALUES OF  
11/47/120, THE COLOR IS FADING TOWARDS  
WHITE AT THE LEFT AND RIGHT EDGES OF  
THE MARK.

FIRST USE 10-26-2006; IN COMMERCE 10-26-2006.

FOR: INDUSTRIAL RESEARCH IN THE FIELD  
OF MEASUREMENT TECHNOLOGY AND SENSOR  
DEVELOPMENT; DESIGN, DEVELOPMENT AND  
IMPLEMENTATION OF SOFTWARE, IN CLASS 42  
(U.S. CLS. 100 AND 101).

FIRST USE 10-26-2006; IN COMMERCE 10-26-2006.

OWNER OF AUSTRIA REG. NO. 198142, DATED  
8-7-2001, EXPIRES 8-31-2011.

SN 77-193,843, FILED 5-31-2007.

SCOTT BIBB, EXAMINING ATTORNEY

**Int. Cl.: 41**

**Prior U.S. Cls.: 100, 101, and 107**

**United States Patent and Trademark Office**

**Reg. No. 3,454,981**

**Registered June 24, 2008**

**SERVICE MARK  
PRINCIPAL REGISTER**

**LITERARY GULAG**

SHEETS, DIANA E. (UNITED STATES INDIVIDUAL)  
617 HESSEL BOULEVARD  
CHAMPAIGN, IL 61820

FOR: ON-LINE JOURNALS, NAMELY, BLOGS FEATURING LITERARY CRITICISM AND POLITICAL COMMENTARY, IN CLASS 41 (U.S. CLS. 100, 101 AND 107).

FIRST USE 6-18-2007; IN COMMERCE 6-18-2007.

THE MARK CONSISTS OF STANDARD CHARACTERS WITHOUT CLAIM TO ANY PARTICULAR FONT, STYLE, SIZE, OR COLOR.

NO CLAIM IS MADE TO THE EXCLUSIVE RIGHT TO USE "LITERARY", APART FROM THE MARK AS SHOWN.

SN 77-193,993, FILED 5-31-2007.

ALICIA COLLINS, EXAMINING ATTORNEY

**Int. Cl.: 35**

**Prior U.S. Cls.: 100, 101, and 102**

**United States Patent and Trademark Office**

**Reg. No. 3,454,982**

**Registered June 24, 2008**

---

**SERVICE MARK  
PRINCIPAL REGISTER**

**SMI**

SURGEON'S MANAGEMENT, INC. (TEXAS  
CORPORATION)  
PO BOX 924587  
HOUSTON, TX 77292

THE MARK CONSISTS OF STANDARD CHAR-  
ACTERS WITHOUT CLAIM TO ANY PARTICULAR  
FONT, STYLE, SIZE, OR COLOR.

FOR: MANAGEMENT OF PHYSICIAN OFFICES  
AND PROVIDING OFFICE SUPPORT SERVICES TO  
SAME, IN CLASS 35 (U.S. CLS. 100, 101 AND 102).

SN 77-194,160, FILED 5-31-2007.

FIRST USE 8-1-2006; IN COMMERCE 8-1-2006.

EMILY CARLSEN, EXAMINING ATTORNEY

**Int. Cl.: 35**

**Prior U.S. Cls.: 100, 101, and 102**

**United States Patent and Trademark Office**

**Reg. No. 3,454,983**

**Registered June 24, 2008**

**SERVICE MARK  
PRINCIPAL REGISTER**



**SURGEON'S MANAGEMENT, INC. (TEXAS  
CORPORATION)  
PO BOX 924587  
HOUSTON, TX 77292**

**FIRST USE 8-1-2006; IN COMMERCE 8-1-2006.**

**SN 77-194,163, FILED 5-31-2007.**

**FOR: MANAGEMENT OF PHYSICIAN OFFICES  
AND PROVIDING OFFICE SUPPORT SERVICES TO  
SAME, IN CLASS 35 (U.S. CLS. 100, 101 AND 102).**

**EMILY CARLSEN, EXAMINING ATTORNEY**



**Int. Cl.: 25**

**Prior U.S. Cls.: 22 and 39**

**United States Patent and Trademark Office**

**Reg. No. 3,454,984**

**Registered June 24, 2008**

**TRADEMARK  
PRINCIPAL REGISTER**

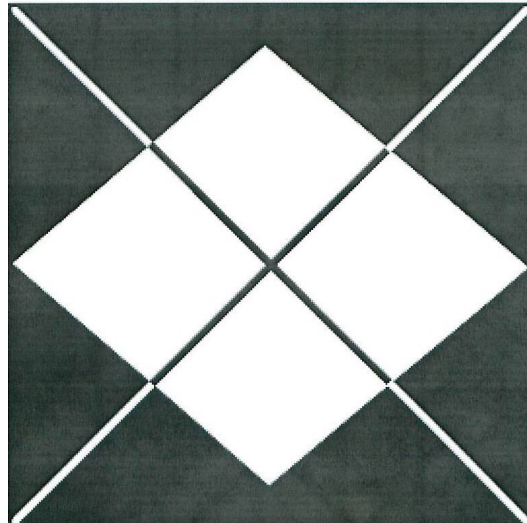

PARIS ACCESSORIES, INC. (NEW YORK CORPORATION)  
350 FIFTH AVENUE, 70TH FLOOR  
NEW YORK, NY 10018

FOR: FOOTWEAR, HOSIERY, LEG WEAR, NAMELY, TIGHTS, AND SOCKS, IN CLASS 25 (U.S. CLS. 22 AND 39).

FIRST USE 9-14-2007; IN COMMERCE 9-14-2007.

THE MARK CONSISTS OF DIAMOND ARGYLE DESIGN INSIDE A SQUARE.

SN 77-194,637, FILED 5-31-2007.

KATHERINE M. DUBRAY, EXAMINING ATTORNEY

**Int. Cl.: 44**

**Prior U.S. Cls.: 100 and 101**

**United States Patent and Trademark Office**

**Reg. No. 3,454,985**

**Registered June 24, 2008**

**SERVICE MARK  
PRINCIPAL REGISTER**

**Qualtex**

SOUTH TEXAS BLOOD & TISSUE CENTER  
(TEXAS CORPORATION)  
6211 IH-10 WEST  
SAN ANTONIO, TX 78201

FOR: BLOOD BANK; COLLECTION AND PRESERVATION OF HUMAN BLOOD, BLOOD PLASMA AND CORD BLOOD; MEDICAL TESTING; INFECTIOUS DISEASE TESTING; AND MEDICAL TESTING IN THE NATURE OF GENETIC TESTING, IN CLASS 44 (U.S. CLS. 100 AND 101).

FIRST USE 8-17-2007; IN COMMERCE 8-17-2007.

THE MARK CONSISTS OF STANDARD CHARACTERS WITHOUT CLAIM TO ANY PARTICULAR FONT, STYLE, SIZE, OR COLOR.

SN 77-194,854, FILED 5-31-2007.

MICHAEL ENGEL, EXAMINING ATTORNEY

**Int. Cl.: 25**

**Prior U.S. Cls.: 22 and 39**

**United States Patent and Trademark Office**

**Reg. No. 3,454,986**

**Registered June 24, 2008**

**TRADEMARK  
PRINCIPAL REGISTER**

**TALULA'S PICNIC**

ARITZIA LP (CANADA LIMITED PARTNER-  
SHIP)

611 ALEXANDER STREET

VANCOUVER, CANADA V6A1E1

FOR: DRESSES, SWEATERS, TOPS, IN CLASS 25  
(U.S. CLS. 22 AND 39).

FIRST USE 2-28-2008; IN COMMERCE 2-28-2008.

THE MARK CONSISTS OF STANDARD CHAR-  
ACTERS WITHOUT CLAIM TO ANY PARTICULAR  
FONT, STYLE, SIZE, OR COLOR.

THE NAME(S), PORTRAIT(S), AND/OR SIGNA-  
TURE(S) SHOWN IN THE MARK DOES NOT IDEN-  
TIFY A PARTICULAR LIVING INDIVIDUAL.

SN 77-195,031, FILED 5-31-2007.

SHAUNIA CARLYLE, EXAMINING ATTORNEY

**Int. Cl.: 25**

**Prior U.S. Cls.: 22 and 39**

**United States Patent and Trademark Office**

**Reg. No. 3,454,987**

**Registered June 24, 2008**

**TRADEMARK  
PRINCIPAL REGISTER**



PARIS ACCESSORIES, INC. (NEW YORK CORPORATION)  
350 FIFTH AVENUE, 70TH FLOOR  
NEW YORK, NY 10018

FOR: SOCKS, HOSIERY, LEG WEAR, NAMELY, TIGHTS, HATS AND GLOVES, IN CLASS 25 (U.S. CLS. 22 AND 39).

FIRST USE 3-6-2008; IN COMMERCE 3-6-2008.

THE MARK CONSISTS OF THE TERMS "SAVE OUR WORLD" AND "SAVE OUR WORLD" WHICH CIRCLES A GLOBE OF THE EARTH.

SN 77-195,632, FILED 6-1-2007.

KATHERINE M. DUBRAY, EXAMINING ATTORNEY

**Int. Cls.: 35, 36, and 42**

**Prior U.S. Cls.: 100, 101, and 102**

**United States Patent and Trademark Office**

**Reg. No. 3,454,988**

**Registered June 24, 2008**

**SERVICE MARK  
PRINCIPAL REGISTER**



AETNA INC. (PENNSYLVANIA CORPORATION)  
980 JOLLY ROAD  
BLUE BELL, PA 19422

FOR: HEALTH CARE COST REVIEW AND COST CONTAINMENT SERVICES FOR MEDICAL, DENTAL, BEHAVIORAL HEALTH, AND PHARMACY BENEFIT PLANS OF OTHERS; ADMINISTRATION OF A DISCOUNT PROGRAM PROMOTING THE GOODS AND SERVICES OF OTHERS THROUGH THE DISTRIBUTION OF DISCOUNT CARDS; VERIFYING AND MONITORING THE CREDENTIALS OF PHYSICIANS AND OTHER HEALTH CARE PROFESSIONALS, IN CLASS 35 (U.S. CLS. 100, 101 AND 102).

FIRST USE 9-5-2007; IN COMMERCE 9-5-2007.

FOR: HEALTH INSURANCE ADMINISTRATION, NAMELY, ORGANIZING AND ADMINISTERING PROVIDER NETWORKS IN THE FIELD OF MEDICAL, DENTAL, PHARMACY, AND BEHAVIORAL HEALTH CARE; ADMINISTRATION SERVICES IN THE FIELD OF HEALTH CARE INSURANCE, NAMELY, PROVIDING INFORMATION REGARDING HEALTH CARE PROVIDER NETWORKS; ADMINISTRATION OF MEDICAL, DENTAL, PHARMACY, BEHAVIORAL HEALTH AND STOP-

LOSS INSURANCE SERVICES, INCLUDING PREPAID HEALTH CARE PLANS, HEALTH CARE INDEMNITY PLANS, HEALTH CARE PREFERRED PROVIDER PLANS, AND CONSUMER-DIRECTED HEALTH PLANS, FOR OTHERS; HEALTH INSURANCE CLAIMS PROCESSING AND ADMINISTRATION, AND CLAIMS DATA ANALYSIS; PHARMACY BENEFIT MANAGEMENT SERVICES, IN CLASS 36 (U.S. CLS. 100, 101 AND 102).

FIRST USE 9-5-2007; IN COMMERCE 9-5-2007.

FOR: QUALITY CONTROL FOR OTHERS, NAMELY, FOR HEALTH CARE BENEFITS PROVIDERS, HOSPITALS, HEALTH CLINICS AND DOCTORS' OFFICES, IN CLASS 42 (U.S. CLS. 100 AND 101).

FIRST USE 9-5-2007; IN COMMERCE 9-5-2007.

THE MARK CONSISTS OF WORD "COFINITY" WITH BANDS OF A DIVIDED OVAL ABOVE AND BELOW IT.

SN 77-195,698, FILED 6-1-2007.

SANJEEV VOHRA, EXAMINING ATTORNEY

**Int. Cl.: 9**

**Prior U.S. Cls.: 21, 23, 26, 36, and 38**

**Reg. No. 3,454,989**

**United States Patent and Trademark Office**

**Registered June 24, 2008**

**TRADEMARK  
PRINCIPAL REGISTER**

# TIME GAMING

CYBERVIEW TECHNOLOGY (DELAWARE CORPORATION)  
BUILDING 2, SUITE 500  
3000 EL CAMINO REAL  
PALO ALTO, CA 94301

FOR: COMPUTER SOFTWARE AND FIRMWARE FOR GAMES OF CHANCE ON ANY COMPUTERIZED PLATFORM, INCLUDING DEDICATED GAMING CONSOLES, VIDEO BASED SLOT MACHINES, REEL BASED SLOT MACHINES, AND VIDEO LOTTERY TERMINALS; GAMING DEVICES, NAMELY, GAMING MACHINES, SLOT MACHINES, BINGO MACHINES, WITH OR WITHOUT VIDEO OUTPUT; GAMING EQUIPMENT, NAMELY, SLOT MACHINES WITH OR WITHOUT VIDEO OUTPUT; SLOT MACHINES; GAMING MACHINES; GAMING MACHINES THAT GENERATE OR DISPLAY WAGER OUTCOMES; GAMING MACHINES, NAMELY, ELECTRONIC SLOT AND BINGO MA-

CHINES; GAMING SOFTWARE THAT GENERATES OR DISPLAYS WAGER OUTCOMES OF GAMING MACHINES; MACHINES FOR PLAYING GAMES OF CHANCE, IN CLASS 9 (U.S. CLS. 21, 23, 26, 36 AND 38).

FIRST USE 10-19-2005; IN COMMERCE 11-17-2007.

THE MARK CONSISTS OF STANDARD CHARACTERS WITHOUT CLAIM TO ANY PARTICULAR FONT, STYLE, SIZE, OR COLOR.

NO CLAIM IS MADE TO THE EXCLUSIVE RIGHT TO USE "GAMING", APART FROM THE MARK AS SHOWN.

SN 77-196,663, FILED 6-4-2007.

ARETHA SOMERVILLE, EXAMINING ATTORNEY

**Int. Cls.: 35, 38, and 45**

**Prior U.S. Cls.: 100, 101, 102, and 104**

**United States Patent and Trademark Office**

**Reg. No. 3,454,990**

**Registered June 24, 2008**

**SERVICE MARK  
PRINCIPAL REGISTER**

**LAZERPHONE**

GLOBAL TEL\*LINK CORPORATION (DELA-  
WARE CORPORATION)  
2609 CAMERON STREET  
MOBILE, AL 36607

FOR: COMPUTERIZED DATABASE MANAGE-  
MENT, IN CLASS 35 (U.S. CLS. 100, 101 AND 102).

FIRST USE 10-25-1998; IN COMMERCE 10-25-1998.

FOR: DATA TRANSMISSION AND RECEPTION  
SERVICES VIA TELECOMMUNICATION MEANS;  
ELECTRONIC EXCHANGE OF DATA STORED IN  
DATABASES ACCESSIBLE VIA TELECOMMUNI-  
CATION NETWORKS; PROVIDING ELECTRONIC  
TELECOMMUNICATION CONNECTIONS; ELEC-  
TRONIC, ELECTRIC, AND DIGITAL TRANSMIS-  
SION OF VOICE, DATA, IMAGES, SIGNALS, AND  
MESSAGES; TRANSMISSION OF INFORMATION  
VIA NATIONAL AND INTERNATIONAL NET-  
WORKS; TRANSMISSION OF SOUND AND VISION  
VIA SATELLITE OR INTERACTIVE MULTIMEDIA  
NETWORKS; PROVIDING PRIVATE AND SECURE  
REAL TIME ELECTRONIC COMMUNICATION  
OVER A COMPUTER NETWORK; TRANSMISSION

OF DATABASE INFORMATION VIA TELECOM-  
MUNICATIONS NETWORKS, IN CLASS 38 (U.S.  
CLS. 100, 101 AND 104).

FIRST USE 10-25-1998; IN COMMERCE 10-25-1998.

FOR: ELECTRONIC MONITORING SERVICES  
FOR SECURITY PURPOSES IN THE FIELD OF  
BLOCKING, TERMINATING AND RECORDING  
PHONE CALLS IN CORRECTIONAL FACILITIES,  
IN CLASS 45 (U.S. CLS. 100 AND 101).

FIRST USE 10-25-1998; IN COMMERCE 10-25-1998.

THE MARK CONSISTS OF STANDARD CHAR-  
ACTERS WITHOUT CLAIM TO ANY PARTICULAR  
FONT, STYLE, SIZE, OR COLOR.

OWNER OF U.S. REG. NO. 2,448,631.

SN 77-196,665, FILED 6-4-2007.

SETH A. RAPPAPORT, EXAMINING ATTORNEY

**Int. Cls.: 36 and 41**

**Prior U.S. Cls.: 100, 101, 102, and 107**

**United States Patent and Trademark Office**

**Reg. No. 3,454,991**

**Registered June 24, 2008**

**SERVICE MARK  
PRINCIPAL REGISTER**

**SAVVY SOUND & SAFE**

OPPORTUNITY MORTGAGE NETWORK (PENNSYLVANIA CORPORATION)  
SUITE 572  
620 CHESTNUT STREET  
PHILADELPHIA, PA 19106

FOR: MORTGAGE LENDING SERVICES; FINANCIAL COUNSELING SERVICES, IN CLASS 36 (U.S. CLS. 100, 101 AND 102).

FIRST USE 7-0-2007; IN COMMERCE 7-0-2007.

FOR: EDUCATIONAL SERVICES, NAMELY, CLASSES IN THE FIELD OF FINANCIAL LITERA-

CY, DEBT, MONEY MANAGEMENT, CREDIT SCORES, AND IDENTITY FRAUD, IN CLASS 41 (U.S. CLS. 100, 101 AND 107).

FIRST USE 7-0-2007; IN COMMERCE 7-0-2007.

THE MARK CONSISTS OF STANDARD CHARACTERS WITHOUT CLAIM TO ANY PARTICULAR FONT, STYLE, SIZE, OR COLOR.

SN 77-196,699, FILED 6-4-2007.

DANIEL BRODY, EXAMINING ATTORNEY



**Int. Cl.: 9**

**Prior U.S. Cls.: 21, 23, 26, 36, and 38**

**Reg. No. 3,454,992**

**United States Patent and Trademark Office**

**Registered June 24, 2008**

**TRADEMARK  
PRINCIPAL REGISTER**

**DURANGO'S GOLD**

CYBERVIEW TECHNOLOGY (DELAWARE CORPORATION)  
3000 EL CAMINO REAL  
BUILDING 2, SUITE 500  
PALO ALTO, CA 94301

FOR: COMPUTER SOFTWARE AND FIRMWARE FOR GAMES OF CHANCE ON ANY COMPUTERIZED PLATFORM, INCLUDING DEDICATED GAMING CONSOLES, VIDEO BASED SLOT MACHINES, REEL BASED SLOT MACHINES, AND VIDEO LOTTERY TERMINALS; GAMING DEVICES, NAMELY, GAMING MACHINES, SLOT MACHINES, BINGO MACHINES, WITH OR WITHOUT VIDEO OUTPUT; GAMING EQUIPMENT, NAMELY, SLOT MACHINES WITH OR WITHOUT VIDEO OUTPUT; SLOT MACHINES; GAMING MACHINES; GAMING MACHINES THAT GENERATE OR DIS-

PLAY WAGER OUTCOMES; GAMING MACHINES, NAMELY, ELECTRONIC SLOT AND BINGO MACHINES; GAMING SOFTWARE THAT GENERATES OR DISPLAYS WAGER OUTCOMES OF GAMING MACHINES, IN CLASS 9 (U.S. CLS. 21, 23, 26, 36 AND 38).

FIRST USE 5-14-2006; IN COMMERCE 11-17-2007.

THE MARK CONSISTS OF STANDARD CHARACTERS WITHOUT CLAIM TO ANY PARTICULAR FONT, STYLE, SIZE, OR COLOR.

SN 77-196,706, FILED 6-4-2007.

ARETHA SOMERVILLE, EXAMINING ATTORNEY

**Int. Cl.: 35**

**Prior U.S. Cls.: 100, 101, and 102**

**United States Patent and Trademark Office**

**Reg. No. 3,454,993**

**Registered June 24, 2008**

---

**SERVICE MARK  
PRINCIPAL REGISTER**

**LOVE MUCH**

NEIGHBORHOOD ENGAGEMENT, INC. (KEN-  
TUCKY NON-PROFIT ORGANIZATION)  
13201 MAGESTERIAL DRIVE  
LOUISVILLE, KY 40223

FOR: CHARITABLE COMMUNITY RELIEF AS-  
SISTANCE SERVICES, NAMELY, ORGANIZING  
AND CONDUCTING VOLUNTEER PROGRAMS  
AND COMMUNITY SERVICE PROJECTS IN UN-  
DERDEVELOPED RURAL AND IMPOVERISHED  
URBAN AREAS, IN CLASS 35 (U.S. CLS. 100, 101  
AND 102).

FIRST USE 9-13-2006; IN COMMERCE 8-1-2007.

THE MARK CONSISTS OF STANDARD CHAR-  
ACTERS WITHOUT CLAIM TO ANY PARTICULAR  
FONT, STYLE, SIZE, OR COLOR.

SN 77-196,802, FILED 6-4-2007.

SEAN CROWLEY, EXAMINING ATTORNEY

**Int. Cl.: 9**

**Prior U.S. Cls.: 21, 23, 26, 36, and 38**

**Reg. No. 3,454,994**

**United States Patent and Trademark Office**

**Registered June 24, 2008**

---

**TRADEMARK  
PRINCIPAL REGISTER**

# Slush Fund

PRASSE, DAVID W. (UNITED STATES INDIVIDUAL)  
820 WOODLAND AVE SE  
ATLANTA, GA 30316

FOR: PRERECORDED AUDIO DISCS, AUDIO TAPES AND PHONOGRAPH RECORDS FEATURING MUSIC; DOWNLOADABLE MUSICAL SOUND RECORDINGS, IN CLASS 9 (U.S. CLS. 21, 23, 26, 36 AND 38).

FIRST USE 10-16-2007; IN COMMERCE 10-16-2007.

THE MARK CONSISTS OF STANDARD CHARACTERS WITHOUT CLAIM TO ANY PARTICULAR FONT, STYLE, SIZE, OR COLOR.

SN 77-196,894, FILED 6-4-2007.

JUSTINE D. PARKER, EXAMINING ATTORNEY

**Int. Cl.: 9**

**Prior U.S. Cls.: 21, 23, 26, 36, and 38**

**United States Patent and Trademark Office**

**Reg. No. 3,454,995**

**Registered June 24, 2008**

**TRADEMARK  
PRINCIPAL REGISTER**

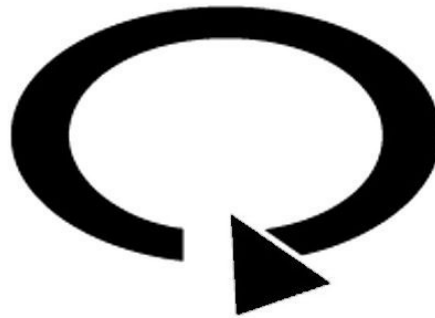

QUINTIC CORPORATION (CALIFORNIA CORPORATION)  
3211 SCOTT BLVD.  
SUITE 203  
SANTA CLARA, CA 95054

FOR: SEMICONDUCTOR DEVICES AND PRINTED CIRCUIT ASSEMBLIES, IN CLASS 9 (U.S. CLS. 21, 23, 26, 36 AND 38).

FIRST USE 6-13-2007; IN COMMERCE 6-13-2007.

THE MARK CONSISTS OF A STYLIZED "Q".

SN 77-197,292, FILED 6-4-2007.

FLORENTINA BLANDU, EXAMINING ATTORNEY

**Int. Cl.: 41**

**Prior U.S. Cls.: 100, 101, and 107**

**United States Patent and Trademark Office**

**Reg. No. 3,454,996**

**Registered June 24, 2008**

---

**SERVICE MARK  
PRINCIPAL REGISTER**

**OUT OF JIMMY'S HEAD**

THE CARTOON NETWORK, INC. (DELAWARE  
CORPORATION)  
C/O TURNER BROADCASTING SYSTEM, INC.  
ONE CNN CENTER, 13 NORTH  
ATLANTA, GA 30303

FOR: ENTERTAINMENT SERVICES, NAMELY,  
AN ANIMATED AND LIVE ACTION PROGRAM  
SERIES PROVIDED THROUGH CABLE TELEVI-  
SION, BROADCAST TELEVISION, INTERNET, VI-  
DEO-ON-DEMAND, AND OTHER BROADCAST-  
TYPE DISTRIBUTION PLATFORMS; PROVIDING  
INTERACTIVE COMPUTER GAMES PLAYED VIA  
GLOBAL COMPUTER NETWORKS AND GLOBAL

COMMUNICATIONS NETWORKS, IN CLASS 41  
(U.S. CLS. 100, 101 AND 107).

FIRST USE 9-14-2007; IN COMMERCE 9-14-2007.

THE MARK CONSISTS OF STANDARD CHAR-  
ACTERS WITHOUT CLAIM TO ANY PARTICULAR  
FONT, STYLE, SIZE, OR COLOR.

SN 77-198,201, FILED 6-5-2007.

ROBIN CHOSID, EXAMINING ATTORNEY

**Int. Cl.: 15**

**Prior U.S. Cls.: 2, 21, and 36**

**United States Patent and Trademark Office**

**Reg. No. 3,454,997**

**Registered June 24, 2008**

**TRADEMARK  
PRINCIPAL REGISTER**

**LIFTON**

BANANA GUITARS INC. (FLORIDA CORPORATION)  
4525 61ST TERRACE  
VERO BEACH, FL 32967

THE MARK CONSISTS OF STANDARD CHARACTERS WITHOUT CLAIM TO ANY PARTICULAR FONT, STYLE, SIZE, OR COLOR.

FOR: CARRYING CASES FOR MUSICAL INSTRUMENTS, IN CLASS 15 (U.S. CLS. 2, 21 AND 36).

SN 77-198,270, FILED 6-5-2007.

FIRST USE 8-0-2007; IN COMMERCE 8-0-2007.

JANET LEE, EXAMINING ATTORNEY

**Int. Cl.: 25**

**Prior U.S. Cls.: 22 and 39**

**United States Patent and Trademark Office**

**Reg. No. 3,454,998**

**Registered June 24, 2008**

**TRADEMARK  
PRINCIPAL REGISTER**

**METROLINE**

ATSCO FOOTWEAR LLC (MASSACHUSETTS  
LTD LIAB CO)  
500 BODWELL EXTENSION  
AVON, MA 02322

THE MARK CONSISTS OF STANDARD CHAR-  
ACTERS WITHOUT CLAIM TO ANY PARTICULAR  
FONT, STYLE, SIZE, OR COLOR.

FOR: FOOTWEAR, IN CLASS 25 (U.S. CLS. 22 AND  
39).

SN 77-198,724, FILED 6-6-2007.

FIRST USE 9-0-2007; IN COMMERCE 9-0-2007.

TINA L. SNAPP, EXAMINING ATTORNEY

**Int. Cl.: 41**

**Prior U.S. Cls.: 100, 101, and 107**

**United States Patent and Trademark Office**

**Reg. No. 3,454,999**

**Registered June 24, 2008**

**SERVICE MARK  
PRINCIPAL REGISTER**

**5 SCAR CINEMA**

OUTDOOR LIFE NETWORK, L.L.C. (DELA-  
WARE LTD LIAB CO), DBA VERSUS,  
TWO STAMFORD PLAZA  
281 TRESSER BOULEVARD  
STAMFORD, CT 06901

FOR: ENTERTAINMENT IN THE NATURE OF  
ON-GOING TELEVISION PROGRAMS IN THE  
FIELD OF MOTION PICTURE ENTERTAINMENT,  
IN CLASS 41 (U.S. CLS. 100, 101 AND 107).

FIRST USE 5-17-2007; IN COMMERCE 5-17-2007.

THE MARK CONSISTS OF STANDARD CHAR-  
ACTERS WITHOUT CLAIM TO ANY PARTICULAR  
FONT, STYLE, SIZE, OR COLOR.

NO CLAIM IS MADE TO THE EXCLUSIVE  
RIGHT TO USE "CINEMA", APART FROM THE  
MARK AS SHOWN.

SN 77-199,215, FILED 6-6-2007.

CHRISIE B. KING, EXAMINING ATTORNEY



**Int. Cl.: 41**

**Prior U.S. Cls.: 100, 101, and 107**

**United States Patent and Trademark Office**

**Reg. No. 3,455,000**

**Registered June 24, 2008**

**SERVICE MARK  
PRINCIPAL REGISTER**

**NOEL Y SU GRUPO TAURO**

SAN, NOEL (UNITED STATES INDIVIDUAL)  
3333 BROADWAY AVENUE, APT B8G  
NEW YORK, NY 10031

FOR: ENTERTAINMENT IN THE NATURE OF  
LIVE PERFORMANCES BY A MUSICAL GROUP, IN  
CLASS 41 (U.S. CLS. 100, 101 AND 107).

FIRST USE 4-12-2008; IN COMMERCE 4-12-2008.

THE MARK CONSISTS OF STANDARD CHAR-  
ACTERS WITHOUT CLAIM TO ANY PARTICULAR  
FONT, STYLE, SIZE, OR COLOR.

NO CLAIM IS MADE TO THE EXCLUSIVE  
RIGHT TO USE "GRUPO", APART FROM THE  
MARK AS SHOWN.

THE NAME "NOEL" IDENTIFIES A LIVING IN-  
DIVIDUAL WHOSE CONSENT IS OF RECORD.

THE FOREIGN WORDING IN THE MARK  
TRANSLATES INTO ENGLISH AS NOEL AND HIS  
GROUP TAURUS.

SN 77-199,402, FILED 6-6-2007.

B. PARADEWELAI, EXAMINING ATTORNEY

**Int. Cl.: 28**

**Prior U.S. Cls.: 22, 23, 38, and 50**

**Reg. No. 3,455,001**

**United States Patent and Trademark Office**

**Registered June 24, 2008**

**TRADEMARK  
PRINCIPAL REGISTER**



**KITTY DITTY BAGS**  
*For the Cat on the Go!*

LAPIN, LAUREN (UNITED STATES INDIVIDUAL)  
14 DONNA LANE  
WAYNE, PA 190873872

FOR: CATNIP FILLED PLAY TOYS FOR CATS, IN CLASS 28 (U.S. CLS. 22, 23, 38 AND 50).

FIRST USE 10-15-2007; IN COMMERCE 11-16-2007.

THE MARK CONSISTS OF A SMILING CAT STANDING IN A SAILBOAT REACHING OUT TO CATCH A DITTY BAG.

SN 77-199,763, FILED 6-6-2007.

JOHN SCHUYLER YARD, EXAMINING ATTORNEY

**Int. Cl.: 41**

**Prior U.S. Cls.: 100, 101, and 107**

**United States Patent and Trademark Office**

**Reg. No. 3,455,002**

**Registered June 24, 2008**

**SERVICE MARK  
PRINCIPAL REGISTER**

**WRITING MATTERS**

TEACHING MATTERS, INC. (NEW YORK CORPORATION)  
SUITE 1270  
475 RIVERSIDE DRIVE  
NEW YORK, NY 10015

FOR: EDUCATION SERVICES, NAMELY, PROVIDING LIVE AND ON-LINE SEMINARS AND WORKSHOPS IN THE FIELD OF WRITING INSTRUCTION; EDUCATION SERVICES, NAMELY, PROVIDING TUTORIAL SESSIONS IN THE FIELD(S) OF WRITING; EDUCATIONAL SERVICES, NAMELY, DEVELOPING CURRICULUM FOR OTHERS IN THE FIELD OF WRITING; ON-LINE JOURNALS, NAMELY, BLOGS FEATURING WRITING BY STUDENTS; ELECTRONIC PUBLISHING SERVICES, NAMELY, PUBLICATION OF TEXT AND GRAPHIC WORKS OF OTHERS ON A WEB SITE FEATURING WORKS BY STUDENTS, IN CLASS 41 (U.S. CLS. 100, 101 AND 107).

FIRST USE 11-15-2007; IN COMMERCE 11-15-2007.

THE MARK CONSISTS OF STANDARD CHARACTERS WITHOUT CLAIM TO ANY PARTICULAR FONT, STYLE, SIZE, OR COLOR.

OWNER OF U.S. REG. NOS. 2,321,787 AND 2,858,614.

NO CLAIM IS MADE TO THE EXCLUSIVE RIGHT TO USE "WRITING", APART FROM THE MARK AS SHOWN.

SN 77-199,929, FILED 6-7-2007.

HAI-LY LAM, EXAMINING ATTORNEY

**Int. Cl.: 24**

**Prior U.S. Cls.: 42 and 50**

**United States Patent and Trademark Office**

**Reg. No. 3,455,003**

**Registered June 24, 2008**

**TRADEMARK  
PRINCIPAL REGISTER**

**HEALTHY SKIN**

AMERICAN TEXTILE COMPANY (PENNSYLVANIA CORPORATION)  
10 NORTH LINDEN STREET, RIDC RIVERPLACE  
DUQUESNE, PA 15110

THE MARK CONSISTS OF STANDARD CHARACTERS WITHOUT CLAIM TO ANY PARTICULAR FONT, STYLE, SIZE, OR COLOR.

FOR: PILLOWCASES AND PILLOW COVERS, IN CLASS 24 (U.S. CLS. 42 AND 50).

SN 77-200,021, FILED 6-7-2007.

FIRST USE 1-1-2008; IN COMMERCE 1-1-2008.

HANNO RITTNER, EXAMINING ATTORNEY

**Int. Cl.: 28**

**Prior U.S. Cls.: 22, 23, 38, and 50**

**Reg. No. 3,455,004**

**United States Patent and Trademark Office**

**Registered June 24, 2008**

**TRADEMARK  
PRINCIPAL REGISTER**

**10x  
TENEX BEARINGS**

QUALIA CORP (CALIFORNIA CORPORATION)  
31 PAMARON WAY STE D  
NOVATO, CA 94949

FOR: BEARINGS SOLD AS A COMPONENT PART  
OF FISHING REELS, IN CLASS 28 (U.S. CLS. 22, 23, 38  
AND 50).

FIRST USE 6-20-2007; IN COMMERCE 12-7-2007.

NO CLAIM IS MADE TO THE EXCLUSIVE  
RIGHT TO USE "THE WORD BEARINGS", APART  
FROM THE MARK AS SHOWN.

THE MARK CONSISTS OF STYLIZED LETTERS  
READING "10X TENEX BEARINGS".

SN 77-200,262, FILED 6-7-2007.

BENJAMIN ALLEN, EXAMINING ATTORNEY

**Int. Cl.: 20**

**Prior U.S. Cls.: 2, 13, 22, 25, 32, and 50**

**Reg. No. 3,455,005**

**United States Patent and Trademark Office**

**Registered June 24, 2008**

**TRADEMARK  
PRINCIPAL REGISTER**

**PAKNAK**

PAKNAK, LLC (OREGON LTD LIAB CO)  
PMB #167 25 NW 23RD PLACE, SUITE 6  
PORTLAND, OR 97210

AND OTHER SOLID SURFACES, IN CLASS 20 (U.S.  
CLS. 2, 13, 22, 25, 32 AND 50).

FIRST USE 2-0-2007; IN COMMERCE 8-5-2007.

FOR: DETACHABLE SOFT POLYVINYL CHLOR-  
IDE (PVC) DECORATIVE ACCESSORIES, NAME-  
LY, APPLIQUES FOR ATTACHING TO  
BACKPACKS, LUNCHBOXES, LUNCHBAGS, CAR-  
RYING BAGS, MESSENGER BAGS, BINDERS AND  
NOTEBOOKS, CASTS, LOCKERS, BULLETIN  
BOARDS, HATS, COMPUTER STATIONS, BELTS,

THE MARK CONSISTS OF STANDARD CHAR-  
ACTERS WITHOUT CLAIM TO ANY PARTICULAR  
FONT, STYLE, SIZE, OR COLOR.

SN 77-200,355, FILED 6-7-2007.

ERNEST SHOSHO, EXAMINING ATTORNEY

**Int. Cl.: 10**

**Prior U.S. Cls.: 26, 39, and 44**

**Reg. No. 3,455,006**

**United States Patent and Trademark Office**

**Registered June 24, 2008**

---

**TRADEMARK  
PRINCIPAL REGISTER**

**IFORMA**

CONFORMIS, INC. (DELAWARE CORPORATION)  
2 FOURTH AVE.  
BURLINGTON, MA 01803

THE MARK CONSISTS OF STANDARD CHARACTERS WITHOUT CLAIM TO ANY PARTICULAR FONT, STYLE, SIZE, OR COLOR.

FOR: SURGICAL IMPLANTS COMPRISING ARTIFICIAL MATERIAL; BONE IMPLANTS COMPRISED OF ARTIFICIAL MATERIALS, IN CLASS 10 (U.S. CLS. 26, 39 AND 44).

SN 77-200,565, FILED 6-7-2007.

FIRST USE 6-1-2007; IN COMMERCE 7-17-2007.

DAVID MILLER, EXAMINING ATTORNEY

**Int. Cl.: 21**

**Prior U.S. Cls.: 2, 13, 23, 29, 30, 33, 40, and 50**

**Reg. No. 3,455,007**

**United States Patent and Trademark Office**

**Registered June 24, 2008**

**TRADEMARK  
PRINCIPAL REGISTER**



HEAVY COVER, LLC (ARIZONA LTD LIAB CO)  
43963 W BUCKHORN TRAIL  
MARICOPA, AZ 85239

THE MARK CONSISTS OF RENIFORM SHAPE  
WITH THE LETTERS "HC".

FOR: PLASTIC COVERS FOR CANTEEN CUPS,  
IN CLASS 21 (U.S. CLS. 2, 13, 23, 29, 30, 33, 40 AND 50).

SN 77-200,638, FILED 6-7-2007.

FIRST USE 4-15-2008; IN COMMERCE 4-15-2008.

MYRIAH HABEEB, EXAMINING ATTORNEY



**Int. Cls.: 18, 21, and 28**

**Prior U.S. Cls.: 1, 2, 3, 13, 22, 23, 29, 30, 33, 38, 40, 41,  
and 50**

**Reg. No. 3,455,008**

**United States Patent and Trademark Office**

**Registered June 24, 2008**

---

**TRADEMARK  
PRINCIPAL REGISTER**

**ZOOCCHINI**

HEIDI'S HOME DESIGN, LLC (DELAWARE LTD  
LIAB CO)  
40 EAST 67TH STREET  
NEW YORK, NY 10065

FOR: ANIMAL TOYS, NAMELY, STUFFED ANI-  
MALS; PLUSH TOYS, IN CLASS 28 (U.S. CLS. 22, 23,  
38 AND 50).

FOR: UMBRELLAS, IN CLASS 18 (U.S. CLS. 1, 2, 3,  
22 AND 41).

FIRST USE 4-15-2008; IN COMMERCE 4-15-2008.

FIRST USE 4-15-2008; IN COMMERCE 4-15-2008.

THE MARK CONSISTS OF STANDARD CHAR-  
ACTERS WITHOUT CLAIM TO ANY PARTICULAR  
FONT, STYLE, SIZE, OR COLOR.

FOR: DECORATIVE BUCKETS FOR USE IN  
HOLDING TOYS, IN CLASS 21 (U.S. CLS. 2, 13, 23,  
29, 30, 33, 40 AND 50).

SN 77-201,015, FILED 6-8-2007.

FIRST USE 4-15-2008; IN COMMERCE 4-15-2008.

HOWARD SMIGA, EXAMINING ATTORNEY

**Int. Cls.: 18, 21, and 28**

**Prior U.S. Cls.: 1, 2, 3, 13, 22, 23, 29, 30, 33, 38, 40, 41,  
and 50**

**Reg. No. 3,455,009**

**United States Patent and Trademark Office**

**Registered June 24, 2008**

**TRADEMARK  
PRINCIPAL REGISTER**



HEIDI'S HOME DESIGN, LLC (DELAWARE LTD  
LIAB CO)  
40 EAST 67TH STREET  
NEW YORK, NY 10065

FOR: UMBRELLAS, IN CLASS 18 (U.S. CLS. 1, 2, 3,  
22 AND 41).

FIRST USE 4-15-2008; IN COMMERCE 4-15-2008.

FOR: DECORATIVE BUCKETS FOR USE IN  
HOLDING TOYS, IN CLASS 21 (U.S. CLS. 2, 13, 23,  
29, 30, 33, 40 AND 50).

FIRST USE 4-15-2008; IN COMMERCE 4-15-2008.

FOR: ANIMAL TOYS, NAMELY, STUFFED ANI-  
MALS; PLUSH TOYS, IN CLASS 28 (U.S. CLS. 22, 23,  
38 AND 50).

FIRST USE 4-15-2008; IN COMMERCE 4-15-2008.

THE MARK CONSISTS OF THE WORD "ZOOC-  
CHINI" WITH TWO STYLIZED BUTTERFLIES IN  
OPPOSITE DIAGONAL CORNERS OF THE REC-  
TANGLE.

SN 77-201,021, FILED 6-8-2007.

HOWARD SMIGA, EXAMINING ATTORNEY

**Int. Cl.: 30**

**Prior U.S. Cl.: 46**

**United States Patent and Trademark Office**

**Reg. No. 3,455,010**

**Registered June 24, 2008**

**TRADEMARK  
PRINCIPAL REGISTER**

# LunchWell

WINDY ACQUISITIONS, LLC (MICHIGAN LTD  
LIAB CO)  
600 NORTH YORK ROAD  
BENSENVILLE, IL 60106

FOR: PRE-PACKAGED ENTREE MIXES CONSISTING PRIMARILY OF PASTA AND SEASONINGS, OR RICE AND SEASONINGS, TO BE SERVED WITH PROTEINS SUCH AS CHEESE, BEEF, CHICKEN, FISH, OR PORK; PACKAGED ENTREE MIXES CONSISTING PRIMARILY OF PASTA OR RICE WITH SPICE AND SAUCE MIXES, IN CLASS 30 (U.S. CL. 46).

FIRST USE 6-1-2007; IN COMMERCE 1-2-2008.

THE MARK CONSISTS OF STANDARD CHARACTERS WITHOUT CLAIM TO ANY PARTICULAR FONT, STYLE, SIZE, OR COLOR.

SN 77-201,149, FILED 6-8-2007.

RONALD AIKENS, EXAMINING ATTORNEY

**Int. Cl.: 29**

**Prior U.S. Cl.: 46**

**United States Patent and Trademark Office**

**Reg. No. 3,455,011**

**Registered June 24, 2008**

**TRADEMARK  
PRINCIPAL REGISTER**

**ALMOND DREAM**

WESTBRAE NATURAL, INC. (DELAWARE CORPORATION)  
58 SOUTH SERVICE ROAD, SUITE 250  
MELVILLE, NY 11747

FOR: ALMOND BASED FOOD BEVERAGE, IN CLASS 29 (U.S. CL. 46).

FIRST USE 1-10-2008; IN COMMERCE 1-10-2008.

THE MARK CONSISTS OF STANDARD CHARACTERS WITHOUT CLAIM TO ANY PARTICULAR FONT, STYLE, SIZE, OR COLOR.

OWNER OF U.S. REG. NOS. 2,230,155, 2,261,502, AND OTHERS.

NO CLAIM IS MADE TO THE EXCLUSIVE RIGHT TO USE "ALMOND", APART FROM THE MARK AS SHOWN.

SN 77-201,559, FILED 6-8-2007.

JERI J. FICKES, EXAMINING ATTORNEY

**Int. Cl.: 42**

**Prior U.S. Cls.: 100 and 101**

**United States Patent and Trademark Office**

**Reg. No. 3,455,012**

**Registered June 24, 2008**

**SERVICE MARK  
PRINCIPAL REGISTER**

# Caromsoft

TRIVITT, THOMAS (UNITED STATES INDIVIDUAL)  
4802 JAMES CIRCLE #C  
HUNTINGTON BEACH, CA 92649

THE MARK CONSISTS OF STANDARD CHARACTERS WITHOUT CLAIM TO ANY PARTICULAR FONT, STYLE, SIZE, OR COLOR.

FOR: DESIGN, DEVELOPMENT AND IMPLEMENTATION OF SOFTWARE, IN CLASS 42 (U.S. CLS. 100 AND 101).

SN 77-201,703, FILED 6-8-2007.

FIRST USE 9-12-2007; IN COMMERCE 9-12-2007.

JASON ROTH, EXAMINING ATTORNEY

**Int. Cl.: 21**

**Prior U.S. Cls.: 2, 13, 23, 29, 30, 33, 40, and 50**

**Reg. No. 3,455,013**

**United States Patent and Trademark Office**

**Registered June 24, 2008**

---

**TRADEMARK  
PRINCIPAL REGISTER**

**Accusilver**

HELEN OF TROY LIMITED (BARBADOS CORPORATION)  
13 8TH AVENUE, BELLEVILLE, P.O. BOX 836E  
ST. MICHAEL, BARBADOS

THE MARK CONSISTS OF STANDARD CHARACTERS WITHOUT CLAIM TO ANY PARTICULAR FONT, STYLE, SIZE, OR COLOR.

FOR: HAIR BRUSHES, IN CLASS 21 (U.S. CLS. 2, 13, 23, 29, 30, 33, 40 AND 50).

SN 77-201,746, FILED 6-8-2007.

FIRST USE 7-0-2006; IN COMMERCE 7-0-2006.

LAURA HAMMEL, EXAMINING ATTORNEY

**Int. Cl.: 41**

**Prior U.S. Cls.: 100, 101, and 107**

**United States Patent and Trademark Office**

**Reg. No. 3,455,014**

**Registered June 24, 2008**

**SERVICE MARK  
PRINCIPAL REGISTER**

THE RETURN OF JEZEBEL JAMES

TWENTIETH CENTURY FOX FILM CORPORATION (DELAWARE CORPORATION)  
10201 WEST PICO BOULEVARD  
LOS ANGELES, CA 90035

THE MARK CONSISTS OF STANDARD CHARACTERS WITHOUT CLAIM TO ANY PARTICULAR FONT, STYLE, SIZE, OR COLOR.

FOR: ENTERTAINMENT SERVICES IN THE NATURE OF A TELEVISION SERIES FEATURING COMEDY, IN CLASS 41 (U.S. CLS. 100, 101 AND 107).

SN 77-201,829, FILED 6-8-2007.

FIRST USE 3-14-2008; IN COMMERCE 3-14-2008.

MATTHEW EINSTEIN, EXAMINING ATTORNEY

Int. Cl.: 35

Prior U.S. Cls.: 100, 101, and 102

United States Patent and Trademark Office

Reg. No. 3,455,015

Registered June 24, 2008

SERVICE MARK  
PRINCIPAL REGISTER

jewelsonic

ROCK REVOLUTION, LLC (DELAWARE LTD  
LIAB CO)  
2123 CALIFORNIA ST., N.W., APT. C3  
WASHINGTON, DC 20008

FOR: ADVERTISING SERVICES, FOR THIRD PARTIES, IN CONNECTION WITH THE COMMERCIALIZATION AND SALE OF PERFUMERY AND COSMETIC ARTICLES, PRODUCTS FOR HOUSEHOLD PURPOSES, OPTICAL PRODUCTS, CLOCKS AND TIMEPIECES, JEWELLERY, FURNISHING ARTICLES; ADVERTISING AND COMMERCIAL INFORMATION SERVICES, VIA THE INTERNET; ADVERTISING VIA ELECTRONIC MEDIA AND SPECIFICALLY THE INTERNET; DISSEMINATION OF ADVERTISING FOR OTHERS VIA AN ON-LINE COMMUNICATIONS NETWORK ON THE INTERNET; DISSEMINATION OF ADVERTISING FOR

OTHERS VIA THE INTERNET; PROVIDING A SEARCHABLE ONLINE ADVERTISING GUIDE FEATURING THE GOODS AND SERVICES OF OTHER ON-LINE VENDORS ON THE INTERNET; PROVIDING AND RENTAL OF ADVERTISING SPACE ON THE INTERNET, IN CLASS 35 (U.S. CLS. 100, 101 AND 102).

FIRST USE 2-29-2008; IN COMMERCE 2-29-2008.

THE MARK CONSISTS OF STANDARD CHARACTERS WITHOUT CLAIM TO ANY PARTICULAR FONT, STYLE, SIZE, OR COLOR.

SN 77-202,307, FILED 6-10-2007.

NAAKWAMA ANKRAH, EXAMINING ATTORNEY



**Int. Cl.: 35**

**Prior U.S. Cls.: 100, 101, and 102**

**United States Patent and Trademark Office**

**Reg. No. 3,455,016**

**Registered June 24, 2008**

**SERVICE MARK  
PRINCIPAL REGISTER**

## A Jewelry Revolution

ROCK REVOLUTION, LLC (DELAWARE LTD  
LIAB CO)  
2123 CALIFORNIA ST., N.W., APT. C3  
WASHINGTON, DC 20008

FOR: ADVERTISING SERVICES FOR THIRD PARTIES, IN CONNECTION WITH THE COMMERCIALIZATION AND SALE OF PERFUMERY AND COSMETIC ARTICLES, PRODUCTS FOR HOUSEHOLD PURPOSES, OPTICAL PRODUCTS, CLOCKS AND TIMEPIECES, JEWELLERY, FURNISHING ARTICLES; ADVERTISING AND COMMERCIAL INFORMATION SERVICES, VIA THE INTERNET; ADVERTISING VIA ELECTRONIC MEDIA AND SPECIFICALLY THE INTERNET; DISSEMINATION OF ADVERTISING FOR OTHERS VIA AN ON-LINE COMMUNICATIONS NETWORK ON THE INTERNET; DISSEMINATION OF ADVERTISING FOR OTHERS VIA THE INTERNET; PROVIDING A SEARCHABLE ONLINE ADVERTISING GUIDE

FEATURING THE GOODS AND SERVICES OF OTHER ON-LINE VENDORS ON THE INTERNET; PROVIDING AND RENTAL OF ADVERTISING SPACE ON THE INTERNET, IN CLASS 35 (U.S. CLS. 100, 101 AND 102).

FIRST USE 2-29-2008; IN COMMERCE 2-29-2008.

THE MARK CONSISTS OF STANDARD CHARACTERS WITHOUT CLAIM TO ANY PARTICULAR FONT, STYLE, SIZE, OR COLOR.

NO CLAIM IS MADE TO THE EXCLUSIVE RIGHT TO USE "JEWELRY", APART FROM THE MARK AS SHOWN.

SN 77-202,313, FILED 6-10-2007.

NAAKWAMA ANKRAH, EXAMINING ATTORNEY

**Int. Cl.: 44**

**Prior U.S. Cls.: 100 and 101**

**United States Patent and Trademark Office**

**Reg. No. 3,455,017**

**Registered June 24, 2008**

**SERVICE MARK  
PRINCIPAL REGISTER**

# N8 Touch

N8 TOUCH, INC. (ARIZONA CORPORATION)  
9815 NORTH 95TH STREET  
SCOTTSDALE, AZ 85258

FOR: MASSAGE, IN CLASS 44 (U.S. CLS. 100 AND 101).

FIRST USE 4-18-2008; IN COMMERCE 4-18-2008.

THE MARK CONSISTS OF STANDARD CHARACTERS WITHOUT CLAIM TO ANY PARTICULAR FONT, STYLE, SIZE, OR COLOR.

NO CLAIM IS MADE TO THE EXCLUSIVE RIGHT TO USE "TOUCH", APART FROM THE MARK AS SHOWN.

SN 77-202,506, FILED 6-11-2007.

FRED MANDIR, EXAMINING ATTORNEY

**Int. Cl.: 37**

**Prior U.S. Cls.: 100, 103, and 106**

**Reg. No. 3,455,018**

**United States Patent and Trademark Office**

**Registered June 24, 2008**

**SERVICE MARK  
PRINCIPAL REGISTER**

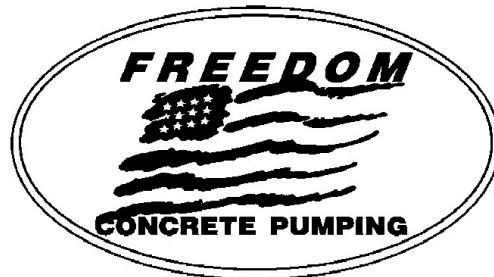

FREEDOM CONCRETE PUMPING, LLC (NEVA-  
DA LTD LIAB CO)  
812 GEORGETOWN STREET  
CANTON, MI 48188

FOR: PUMPING CONCRETE SERVICES, IN  
CLASS 37 (U.S. CLS. 100, 103 AND 106).

FIRST USE 1-2-2006; IN COMMERCE 1-16-2006.

NO CLAIM IS MADE TO THE EXCLUSIVE  
RIGHT TO USE CONCRETE PUMPING, APART  
FROM THE MARK AS SHOWN.

THE MARK IS COMPRISED OF CO-CENTRIC  
OVALS CONTAINING THE WORD FREEDOM,  
WITH A STYLIZED REPRESENTATION OF A FLAG  
UNDERNEATH, WITH THE WORDING, CON-  
CRETE PUMPING BELOW THE FLAG.

SN 77-202,573, FILED 6-11-2007.

ODESSA BIBBINS, EXAMINING ATTORNEY

**Int. Cl.: 36**

**Prior U.S. Cls.: 100, 101, and 102**

**United States Patent and Trademark Office**

**Reg. No. 3,455,019**

**Registered June 24, 2008**

**SERVICE MARK  
PRINCIPAL REGISTER**

**QPCconfirm**

QUALITY PLANNING CORPORATION (CALI-  
FORNIA CORPORATION)  
388 MARKET STREET  
SUITE 750  
SAN FRANCISCO, CA 94111

FOR: PROVIDING INFORMATION IN INSUR-  
ANCE MATTERS, NAMELY, PROVIDING DATA  
TO INSURANCE COMPANIES AT THE POINT-OF-  
SALE TO VERIFY APPLICANT-SUPPLIED PERSONAL  
DATA, NAMELY, ANNUAL MILEAGE DRIVEN,  
COMMUTE DISTANCE, BUSINESS USE OF A

VEHICLE, ZIP CODE AND SOCIAL SECURITY  
NUMBER, IN CLASS 36 (U.S. CLS. 100, 101 AND 102).

FIRST USE 8-0-2007; IN COMMERCE 2-0-2008.

THE MARK CONSISTS OF STANDARD CHAR-  
ACTERS WITHOUT CLAIM TO ANY PARTICULAR  
FONT, STYLE, SIZE, OR COLOR.

SN 77-203,051, FILED 6-11-2007.

KAPIL BHANOT, EXAMINING ATTORNEY

Int. Cl.: 45

Prior U.S. Cls.: 100 and 101

United States Patent and Trademark Office

Reg. No. 3,455,020

Registered June 24, 2008

**SERVICE MARK  
PRINCIPAL REGISTER**



SELECTIVE INSURANCE GROUP, INC. (NEW JERSEY CORPORATION)  
40 WANTAGE AVENUE  
BRANCHVILLE, NJ 07890

FOR: CONDUCTING WORKPLACE SAFETY SURVEYS; CONSULTING IN THE FIELD OF WORKPLACE SAFETY; PROVIDING INFORMATION IN THE FIELD OF WORKPLACE SAFETY, NAMELY, PREVENTING PERSONAL INJURY, BY MEANS OF PROVIDING ONLINE AND PRINTED INFORMATIONAL DOCUMENTS AND VIDEOS, IN CLASS 45 (U.S. CLS. 100 AND 101).

FIRST USE 10-0-2007; IN COMMERCE 10-0-2007.

NO CLAIM IS MADE TO THE EXCLUSIVE RIGHT TO USE "SAFETY MANAGEMENT" AND

"SOLUTIONS FOR A SAFER WORKPLACE", APART FROM THE MARK AS SHOWN.

THE MARK CONSISTS OF THE WORDS "SAFETY" AND "MANAGEMENT" HAVING INITIAL UPPERCASE LETTERS IN A LARGE FONT WITH "SAFETY" LOCATED ABOVE AND OFFSET TO THE LEFT OF THE WORD "MANAGEMENT", WITH AN ARCHED LINE OVER BOTH WORDS, AND THE WORDS "SOLUTIONS FOR A SAFER WORKPLACE", HAVING AN INITIAL UPPERCASE LETTER WITH THE REST OF THE LETTERS IN LOWERCASE, POSITIONED BENEATH THE WORD "MANAGEMENT".

SN 77-203,530, FILED 6-12-2007.

SANI KHOURI, EXAMINING ATTORNEY

**Int. Cls.: 20 and 24**

**Prior U.S. Cls.: 2, 13, 22, 25, 32, 42, and 50**

**United States Patent and Trademark Office**

**Reg. No. 3,455,021**

**Registered June 24, 2008**

**TRADEMARK  
PRINCIPAL REGISTER**

**Better Than Down**

BROOKSTONE PURCHASING, INC. (NEW  
HAMPSHIRE CORPORATION)  
ONE INNOVATION WAY  
MERRIMACK, NH 03054

FOR: PILLOWS; MATTRESS TOPPERS, IN CLASS  
20 (U.S. CLS. 2, 13, 22, 25, 32 AND 50).

FIRST USE 1-20-2008; IN COMMERCE 1-20-2008.

FOR: COMFORTERS; BED LINEN; BED BLAN-  
KETS; BLANKET THROWS; DUVET COVERS; DU-  
VETS, IN CLASS 24 (U.S. CLS. 42 AND 50).

FIRST USE 9-16-2007; IN COMMERCE 9-16-2007.

THE MARK CONSISTS OF STANDARD CHAR-  
ACTERS WITHOUT CLAIM TO ANY PARTICULAR  
FONT, STYLE, SIZE, OR COLOR.

SN 77-204,664, FILED 6-13-2007.

JAMES LOVELACE, EXAMINING ATTORNEY

**Int. Cl.: 43**

**Prior U.S. Cls.: 100 and 101**

**United States Patent and Trademark Office**

**Reg. No. 3,455,022**

**Registered June 24, 2008**

**SERVICE MARK  
PRINCIPAL REGISTER**

**Saul Good Restaurant & Pub**

PEREZ, ROB (UNITED STATES INDIVIDUAL)  
23 AVENUE OF CHAMPIONS  
NICHOLASVILLE, KY 40356

FOR: RESTAURANTS; PUBS, IN CLASS 43 (U.S.  
CLS. 100 AND 101).

FIRST USE 2-1-2008; IN COMMERCE 2-28-2008.

THE MARK CONSISTS OF STANDARD CHAR-  
ACTERS WITHOUT CLAIM TO ANY PARTICULAR  
FONT, STYLE, SIZE, OR COLOR.

NO CLAIM IS MADE TO THE EXCLUSIVE  
RIGHT TO USE "RESTAURANT & PUB", APART  
FROM THE MARK AS SHOWN.

THE NAME "SAUL GOOD" DOES NOT IDENTI-  
FY A LIVING INDIVIDUAL.

SN 77-204,941, FILED 6-13-2007.

EDWARD NELSON, EXAMINING ATTORNEY

**Int. Cl.: 30**

**Prior U.S. Cl.: 46**

**Reg. No. 3,455,023**

**United States Patent and Trademark Office**

**Registered June 24, 2008**

---

**TRADEMARK  
PRINCIPAL REGISTER**

**Coco-Zen**

KUSHNER, JOYCE L. DBA COCO-ZEN (CALI-  
FORNIA SOLE PROPRIETORSHIP)  
328 MAGELLAN DRIVE  
PACIFICA, CA 94044

THE MARK CONSISTS OF STANDARD CHAR-  
ACTERS WITHOUT CLAIM TO ANY PARTICULAR  
FONT, STYLE, SIZE, OR COLOR.

FOR: CHOCOLATE TRUFFLES; CHOCOLATE  
CANDIES, IN CLASS 30 (U.S. CL. 46).

SN 77-205,153, FILED 6-13-2007.

FIRST USE 3-31-2008; IN COMMERCE 3-31-2008.

DORITT L. CARROLL, EXAMINING ATTORNEY



**Int. Cl.: 44**

**Prior U.S. Cls.: 100 and 101**

**United States Patent and Trademark Office**

**Reg. No. 3,455,024**

**Registered June 24, 2008**

**SERVICE MARK  
PRINCIPAL REGISTER**

**THE BROWN PROCEDURE**

SURGEON'S MANAGEMENT, INC. (TEXAS  
CORPORATION)

PO BOX 924587

HOUSTON, TX 77292

FOR: MEDICAL SERVICES INVOLVING THE  
HANDS, IN CLASS 44 (U.S. CLS. 100 AND 101).

FIRST USE 1-0-1992; IN COMMERCE 1-0-1992.

THE MARK CONSISTS OF STANDARD CHAR-  
ACTERS WITHOUT CLAIM TO ANY PARTICULAR  
FONT, STYLE, SIZE, OR COLOR.

NO CLAIM IS MADE TO THE EXCLUSIVE  
RIGHT TO USE "PROCEDURE", APART FROM  
THE MARK AS SHOWN.

SN 77-205,296, FILED 6-13-2007.

MARK SPARACINO, EXAMINING ATTORNEY

**Int. Cl.: 16**

**Prior U.S. Cls.: 2, 5, 22, 23, 29, 37, 38, and 50**

**Reg. No. 3,455,025**

**United States Patent and Trademark Office**

**Registered June 24, 2008**

**TRADEMARK  
PRINCIPAL REGISTER**

# Recovery ID

BUILDER SOLUTIONS INC. (FLORIDA CORPORATION)  
P.O. BOX 353605  
PALM COAST, FL 321353605

FOR: ADHESIVE LABELS; ADDRESS LABELS; BAR CODE LABELS; BLANK OR PARTIALLY PRINTED PAPER LABELS; PAPER LABELS; PRINTED PAPER LABELS; SHIPPING LABELS , IN CLASS 16 (U.S. CLS. 2, 5, 22, 23, 29, 37, 38 AND 50).

FIRST USE 4-11-2007; IN COMMERCE 12-1-2007.

THE MARK CONSISTS OF STANDARD CHARACTERS WITHOUT CLAIM TO ANY PARTICULAR FONT, STYLE, SIZE, OR COLOR.

NO CLAIM IS MADE TO THE EXCLUSIVE RIGHT TO USE "ID", APART FROM THE MARK AS SHOWN.

SN 77-205,436, FILED 6-13-2007.

JEAN IM, EXAMINING ATTORNEY

**Int. Cl.: 25**

**Prior U.S. Cls.: 22 and 39**

**United States Patent and Trademark Office**

**Reg. No. 3,455,026**

**Registered June 24, 2008**

**TRADEMARK  
PRINCIPAL REGISTER**

**ily**s

SHINGAK, KANG (UNITED STATES INDIVIDUAL)  
26036 N. SANDBURG PLACE  
STEVENSON RANCH, CA 91381

FOR: UNDERPANTS; ANKLE SOCKS; ANKLETS; ANTI-PERSPIRANT SOCKS; MEN'S SOCKS; SOCKS; SOCKS AND STOCKINGS; THERMAL SOCKS; WOOLLEN SOCKS; LINGERIE; LINGERIE ACCESSORIES, NAMELY, REMOVABLE SILICONE BREAST ENHANCER PADS USED IN A BRA; MATERNITY LINGERIE; BRIEFS; KNITTED UNDERWEAR; LADIES' UNDERWEAR; THERMAL UNDERWEAR; UNDERWEAR; UNDERWEAR,

NAMELY, BOY SHORTS; WOMEN'S UNDERWEAR; WOVEN OR KNITTED UNDERWEAR, IN CLASS 25 (U.S. CLS. 22 AND 39).

FIRST USE 11-15-2007; IN COMMERCE 11-30-2007.

THE MARK CONSISTS OF STANDARD CHARACTERS WITHOUT CLAIM TO ANY PARTICULAR FONT, STYLE, SIZE, OR COLOR.

SN 77-205,689, FILED 6-14-2007.

ERNEST SHOSHO, EXAMINING ATTORNEY

**Int. Cl.: 37**

**Prior U.S. Cls.: 100, 103, and 106**

**United States Patent and Trademark Office**

**Reg. No. 3,455,027**

**Registered June 24, 2008**

---

**SERVICE MARK  
PRINCIPAL REGISTER**

# Hamatreya

POCALYKO, MICHAEL NICHOLAS (UNITED STATES INDIVIDUAL)  
SUITE 710  
11911 FREEDOM DRIVE  
RESTON, VA 201905629

THE MARK CONSISTS OF STANDARD CHARACTERS WITHOUT CLAIM TO ANY PARTICULAR FONT, STYLE, SIZE, OR COLOR.

FOR: CUSTOM CONSTRUCTION OF HOMES, IN CLASS 37 (U.S. CLS. 100, 103 AND 106).

SN 77-205,944, FILED 6-14-2007.

FIRST USE 7-15-2006; IN COMMERCE 3-1-2007.

BARNEY CHARLON, EXAMINING ATTORNEY

**Int. Cl.: 35**

**Prior U.S. Cls.: 100, 101, and 102**

**United States Patent and Trademark Office**

**Reg. No. 3,455,028**

**Registered June 24, 2008**

---

**SERVICE MARK  
PRINCIPAL REGISTER**

**ENCHOICE**

ICI SOLUTIONS, INC. (ARIZONA CORPORATION)  
7201 WEST OAKLAND, SUITE 2  
CHANDLER, AZ 85226

FOR: COMMERCIAL ASSISTANCE RELATING  
TO SYSTEM IMPLEMENTATION AND SYSTEM  
INTEGRATION, IN CLASS 35 (U.S. CLS. 100, 101  
AND 102).

FIRST USE 3-1-2008; IN COMMERCE 3-1-2008.

THE MARK CONSISTS OF STANDARD CHARACTERS WITHOUT CLAIM TO ANY PARTICULAR FONT, STYLE, SIZE, OR COLOR.

SN 77-206,721, FILED 6-14-2007.

LINDSEY RUBIN, EXAMINING ATTORNEY

**Int. Cl.: 44**

**Prior U.S. Cls.: 100 and 101**

**United States Patent and Trademark Office**

**Reg. No. 3,455,029**

**Registered June 24, 2008**

**SERVICE MARK  
PRINCIPAL REGISTER**

# DPR Physicians

MILLS, WILLIAM R. (UNITED STATES INDIVIDUAL)  
8401 CHAGRIN RD. , SUITE 5  
CHAGRIN FALLS, OH 44023

FOR: HEALTH CARE; HEALTH CARE SERVICES, NAMELY, DISEASE MANAGEMENT PROGRAMS; HEALTH CARE SERVICES, NAMELY, WELLNESS PROGRAMS; MEDICAL SERVICES, NAMELY, INTERNAL MEDICINE , IN CLASS 44 (U.S. CLS. 100 AND 101).

FIRST USE 11-30-2007; IN COMMERCE 11-30-2007.

THE MARK CONSISTS OF STANDARD CHARACTERS WITHOUT CLAIM TO ANY PARTICULAR FONT, STYLE, SIZE, OR COLOR.

NO CLAIM IS MADE TO THE EXCLUSIVE RIGHT TO USE "PHYSICIANS", APART FROM THE MARK AS SHOWN.

SN 77-208,244, FILED 6-18-2007.

ESTHER A. BORSUK, EXAMINING ATTORNEY

**Int. Cl.: 41**

**Prior U.S. Cls.: 100, 101, and 107**

**United States Patent and Trademark Office**

**Reg. No. 3,455,030**

**Registered June 24, 2008**

**SERVICE MARK  
PRINCIPAL REGISTER**

**GO OR GO HOME**

SPEED CHANNEL, INC. (DELAWARE CORPORATION)  
10201 WEST PICO BOULEVARD  
LOS ANGELES, CA 90035

THE MARK CONSISTS OF STANDARD CHARACTERS WITHOUT CLAIM TO ANY PARTICULAR FONT, STYLE, SIZE, OR COLOR.

FOR: ENTERTAINMENT SERVICES IN THE NATURE OF A TELEVISION SERIES FEATURING MOTORSPORTS, IN CLASS 41 (U.S. CLS. 100, 101 AND 107).

SN 77-208,465, FILED 6-18-2007.

FIRST USE 7-28-2007; IN COMMERCE 7-28-2007.

JOHN GARTNER, EXAMINING ATTORNEY

**Int. Cl.: 36**

**Prior U.S. Cls.: 100, 101, and 102**

**United States Patent and Trademark Office**

**Reg. No. 3,455,031**

**Registered June 24, 2008**

**SERVICE MARK  
PRINCIPAL REGISTER**

# Whole Life Express

MUTUAL OF OMAHA INSURANCE COMPANY  
(NEBRASKA CORPORATION)  
3 - LAW  
MUTUAL OF OMAHA PLAZA  
OMAHA, NE 68175

FOR: INSURANCE SERVICES, NAMELY, UNDERWRITING, ISSUING AND ADMINISTRATION OF LIFE INSURANCE, IN CLASS 36 (U.S. CLS. 100, 101 AND 102).

FIRST USE 8-8-2007; IN COMMERCE 8-8-2007.

THE MARK CONSISTS OF STANDARD CHARACTERS WITHOUT CLAIM TO ANY PARTICULAR FONT, STYLE, SIZE, OR COLOR.

NO CLAIM IS MADE TO THE EXCLUSIVE RIGHT TO USE "WHOLE LIFE", APART FROM THE MARK AS SHOWN.

SN 77-209,330, FILED 6-19-2007.

ARETHA SOMERVILLE, EXAMINING ATTORNEY



**Int. Cl.: 25**

**Prior U.S. Cls.: 22 and 39**

**United States Patent and Trademark Office**

**Reg. No. 3,455,032**

**Registered June 24, 2008**

**TRADEMARK  
PRINCIPAL REGISTER**



GUANGZHOU HONGCHI SPORTS GOODS  
CO.,LTD (CHINA CORPORATION)  
NO. 371-375 HUANSHIDONG RD., RM N1607  
YUEXIU DISTRICT, GUANGZHOU  
GUANGDONG, CHINA

FOR: SHOES; ATHLETIC SHOES; BEACH FOOT-  
WEAR; CANVAS SHOES; FOOTBALL SHOES; GYM-  
NASTIC SHOES; RUNNING SHOES; WOMEN'S  
SHOES; CLOTHING, NAMELY, SHIRTS, TROU-  
SERS, JACKETS, COATS, LEATHER COATS,  
SKIRTS, TOPCOATS, SINGLET, T-SHIRTS, UN-  
DERWEAR, WAISTCOATS, SPORTS JERSEYS,  
BRIEFS, VESTS, SMOCKS, GLOVES, HATS, HOSI-

ERY, SWIMSUITS; CLIMBING BOOTS, IN CLASS 25  
(U.S. CLS. 22 AND 39).

FIRST USE 3-1-2007; IN COMMERCE 7-30-2007.

THE MARK CONSISTS OF A REPRESENTATION  
OF MOUNTAIN PEAKS FRAMED BY A CRESCENT  
MOON, WITH THE WORD "CLORTS" BELOW IN A  
PARTICULAR STYLIZED FONT.

SN 77-210,040, FILED 6-19-2007.

AISHA CLARKE, EXAMINING ATTORNEY

**Int. Cl.: 31**

**Prior U.S. Cls.: 1 and 46**

**United States Patent and Trademark Office**

**Reg. No. 3,455,033**

**Registered June 24, 2008**

**TRADEMARK  
PRINCIPAL REGISTER**

**PLAYFUL LIFE**

SOCIETE DES PRODUITS NESTLE S.A. (SWIT-  
ZERLAND SOCIETE ANONYME)  
INTELLECTUAL PROPERTY DEPARTMENT  
CASE POSTALE 353  
VEVEY, SWITZERLAND 1800

THE MARK CONSISTS OF STANDARD CHAR-  
ACTERS WITHOUT CLAIM TO ANY PARTICULAR  
FONT, STYLE, SIZE, OR COLOR.

FOR: PET FOOD, IN CLASS 31 (U.S. CLS. 1 AND  
46).

SN 77-212,412, FILED 6-21-2007.

FIRST USE 2-1-2008; IN COMMERCE 2-1-2008.

ZACHARY BELLO, EXAMINING ATTORNEY

**Int. Cls.: 29 and 30**

**Prior U.S. Cl.: 46**

**United States Patent and Trademark Office**

**Reg. No. 3,455,034**

**Registered June 24, 2008**

**TRADEMARK  
PRINCIPAL REGISTER**

**NUTS & BOLTS**

GOLDEN WALNUT SPECIALTY FOODS, INC.  
(DELAWARE CORPORATION)  
3200 16TH STREET  
ZION, IL 60099

FOR: SNACK MIX CONSISTING PRIMARILY OF  
PROCESSED FRUITS, PROCESSED NUTS AND/OR  
RAISINS, IN CLASS 29 (U.S. CL. 46).

FIRST USE 8-9-2007; IN COMMERCE 8-9-2007.

FOR: SNACK MIX CONSISTING PRIMARILY OF  
CRACKERS, PRETZELS, CANDIED NUTS AND/OR  
POPPED POPCORN, IN CLASS 30 (U.S. CL. 46).

FIRST USE 8-9-2007; IN COMMERCE 8-9-2007.

THE MARK CONSISTS OF STANDARD CHAR-  
ACTERS WITHOUT CLAIM TO ANY PARTICULAR  
FONT, STYLE, SIZE, OR COLOR.

SN 77-212,832, FILED 6-22-2007.

JIM RINGLE, EXAMINING ATTORNEY

**Int. Cl.: 6**

**Prior U.S. Cls.: 2, 12, 13, 14, 23, 25, and 50**

**Reg. No. 3,455,035**

**United States Patent and Trademark Office**

**Registered June 24, 2008**

---

**TRADEMARK  
PRINCIPAL REGISTER**

**GUTTER SNAP**

WHOLESALE SIDING DEPOT, INC. (MISSOURI  
CORPORATION)  
9860 BIG BEND BOULEVARD  
ST. LOUIS, MO 63122

FOR: METAL FASTENERS, NAMELY, CLIPS  
AND STRIPS, IN CLASS 6 (U.S. CLS. 2, 12, 13, 14, 23,  
25 AND 50).

FIRST USE 8-1-2007; IN COMMERCE 8-1-2007.

THE MARK CONSISTS OF STANDARD CHAR-  
ACTERS WITHOUT CLAIM TO ANY PARTICULAR  
FONT, STYLE, SIZE, OR COLOR.

NO CLAIM IS MADE TO THE EXCLUSIVE  
RIGHT TO USE "GUTTER", APART FROM THE  
MARK AS SHOWN.

SN 77-213,317, FILED 6-22-2007.

JOHN GARTNER, EXAMINING ATTORNEY

**Int. Cl.: 14**

**Prior U.S. Cls.: 2, 27, 28, and 50**

**United States Patent and Trademark Office**

**Reg. No. 3,455,036**

**Registered June 24, 2008**

**TRADEMARK  
PRINCIPAL REGISTER**

**FREEDOM FIT**

FINDINGS INCORPORATED (NEW HAMPSHIRE  
CORPORATION)

160 WATER STREET

KEENE, NH 03431

FOR: JEWELRY, IN CLASS 14 (U.S. CLS. 2, 27, 28  
AND 50).

FIRST USE 0-0-2003; IN COMMERCE 0-0-2003.

THE MARK CONSISTS OF STANDARD CHAR-  
ACTERS WITHOUT CLAIM TO ANY PARTICULAR  
FONT, STYLE, SIZE, OR COLOR.

NO CLAIM IS MADE TO THE EXCLUSIVE  
RIGHT TO USE "FIT", APART FROM THE MARK  
AS SHOWN.

SN 77-213,454, FILED 6-22-2007.

ESTHER BELENKER, EXAMINING ATTORNEY

**Int. Cl.: 44**

**Prior U.S. Cls.: 100 and 101**

**United States Patent and Trademark Office**

**Reg. No. 3,455,037**

**Registered June 24, 2008**

**SERVICE MARK  
PRINCIPAL REGISTER**



HOUSTON NORTHWEST PARTNERS, LTD.  
(TEXAS LIMITED PARTNERSHIP)  
13737 NOEL RD., STE. 100  
DALLAS, TX 75240

FOR: HEALTH CARE, IN CLASS 44 (U.S. CLS. 100  
AND 101).

FIRST USE 4-15-2008; IN COMMERCE 4-15-2008.

NO CLAIM IS MADE TO THE EXCLUSIVE  
RIGHT TO USE "WINDROSE FAMILY MEDICINE",  
APART FROM THE MARK AS SHOWN.

THE COLOR(S) RED AND WHITE IS/ARE  
CLAIMED AS A FEATURE OF THE MARK.

THE MARK CONSISTS OF THE COLOR RED  
APPEARING IN THE WORDING "WINDROSE" AS  
THE BACKGROUND FOR THE WORDING "FA-  
MILY MEDICINE" AND IN THE DESIGN ELE-  
MENT. THE COLOR WHITE APPEARS IN THE  
WORDING "FAMILY MEDICINE"

SN 77-214,752, FILED 6-25-2007.

MARK PILARO, EXAMINING ATTORNEY

**Int. Cl.: 36**

**Prior U.S. Cls.: 100, 101, and 102**

**United States Patent and Trademark Office**

**Reg. No. 3,455,038**

**Registered June 24, 2008**

---

**SERVICE MARK  
PRINCIPAL REGISTER**

**LINK2LINKS**

GOLFSTYLE REALTY, LLC (FLORIDA LTD  
LIAB CO)  
5753 SANDY POINTE DRIVE  
SARASOTA, FL 34233

THE MARK CONSISTS OF STANDARD CHAR-  
ACTERS WITHOUT CLAIM TO ANY PARTICULAR  
FONT, STYLE, SIZE, OR COLOR.

FOR: REAL ESTATE LISTING SERVICES FOR  
RESIDENTIAL PROPERTIES, IN CLASS 36 (U.S.  
CLS. 100, 101 AND 102).

SN 77-216,013, FILED 6-26-2007.

FIRST USE 1-2-2008; IN COMMERCE 1-2-2008.

JIM RINGLE, EXAMINING ATTORNEY

**Int. Cl.: 25**

**Prior U.S. Cls.: 22 and 39**

**United States Patent and Trademark Office**

**Reg. No. 3,455,039**

**Registered June 24, 2008**

**TRADEMARK  
PRINCIPAL REGISTER**

**YOUR SLIP IS SHOWING**

YOUR SLIP IS SHOWING, LLC (WASHINGTON  
LTD LIAB CO)  
827 33RD AVE S  
SEATTLE, WA 98144

FOR: BLOUSES; FOUNDATION GARMENTS;  
SHORT-SLEEVED SHIRTS; SHORTS; TANK TOPS;  
SWEATERS; SKIRTS AND DRESSES; UNDER GAR-  
MENTS; HATS; SCARVES, IN CLASS 25 (U.S. CLS. 22  
AND 39).

FIRST USE 12-10-2006; IN COMMERCE 4-30-2007.

NO CLAIM IS MADE TO THE EXCLUSIVE  
RIGHT TO USE "SLIP", APART FROM THE MARK  
AS SHOWN.

THE MARK CONSISTS OF STYLIZED  
"Y", "O", "U", "R", "S", "L", "I", "P", "I", "S", "-  
S", "H", "O", "W", "I", "N", "G".

SN 77-216,027, FILED 6-26-2007.

RICHARD A. STRASER, EXAMINING ATTORNEY



**Int. Cl.: 25**

**Prior U.S. Cls.: 22 and 39**

**United States Patent and Trademark Office**

**Reg. No. 3,455,040**

**Registered June 24, 2008**

**TRADEMARK  
PRINCIPAL REGISTER**

**ESTOURO**

TLS INTERNATIONAL, LLC (MASSACHUSETTS  
LTD LIAB CO)  
76 BREWSTER DRIVE  
NEEDHAM, MA 02492

THE FOREIGN WORDING "ESTOURO" IN THE  
MARK TRANSLATES INTO ENGLISH AS STAM-  
PEDE.

FOR: HATS, IN CLASS 25 (U.S. CLS. 22 AND 39).

FIRST USE 8-31-2007; IN COMMERCE 8-31-2007.

SN 77-216,070, FILED 6-26-2007.

THE MARK CONSISTS OF STANDARD CHAR-  
ACTERS WITHOUT CLAIM TO ANY PARTICULAR  
FONT, STYLE, SIZE, OR COLOR.

HAI-LY LAM, EXAMINING ATTORNEY

**Int. Cl.: 25**

**Prior U.S. Cls.: 22 and 39**

**United States Patent and Trademark Office**

**Reg. No. 3,455,041**

**Registered June 24, 2008**

**TRADEMARK  
PRINCIPAL REGISTER**

HEADWEAR WITH AN ATTITUDE

TLS INTERNATIONAL, LLC (MASSACHUSETTS  
LTD LIAB CO)  
76 BREWSTER DRIVE  
NEEDHAM, MA 02492

THE MARK CONSISTS OF STANDARD CHAR-  
ACTERS WITHOUT CLAIM TO ANY PARTICULAR  
FONT, STYLE, SIZE, OR COLOR.

FOR: HATS, IN CLASS 25 (U.S. CLS. 22 AND 39).

SN 77-216,083, FILED 6-26-2007.

FIRST USE 9-30-2007; IN COMMERCE 9-30-2007.

HAI-LY LAM, EXAMINING ATTORNEY

**Int. Cl.: 18**

**Prior U.S. Cls.: 1, 2, 3, 22, and 41**

**Reg. No. 3,455,042**

**United States Patent and Trademark Office**

Registered June 24, 2008

---

**TRADEMARK  
PRINCIPAL REGISTER**

# Inner Peace

PROFFIT, JAELEN (UNITED STATES INDIVIDUAL)  
7718 PAGERWOOD LANE  
HOUSTON, TX 77063

FOR: CARRYING CASES, NAMELY, HANDBAGS, PURSES, CLUTCHES, SHOULDER BAGS, TOTE BAGS, DIAPER BAGS, BACKPACKS, BRIEF-CASE TYPE PORTFOLIOS, ATTACHÉ CASES, CARRY-ON BAGS, TEXTILE, LEATHER AND MESH SHOPPING BAGS, AND BRIEFCASES; ORGANIZERS FOR CARRYING CASES, NAMELY, HANDBAGS, PURSES, CLUTCHES, SHOULDER BAGS, TOTE BAGS, DIAPER BAGS, BACKPACKS, BRIEF-CASE TYPE PORTFOLIOS, ATTACHÉ CASES, CARRY-ON BAGS, TEXTILE, LEATHER AND MESH SHOPPING BAGS, AND BRIEFCASES; MODULAR ORGANIZERS FOR STORAGE AND REPOSITIONABLE PLACEMENT OF A PLURALITY OF PERSONAL OR BUSINESS ITEMS WITHIN CARRYING CASES, NAMELY, HANDBAGS, PURSES, CLUTCHES, SHOULDER BAGS, TOTE BAGS, DIAPER BAGS, BACKPACKS, BRIEF-CASE TYPE PORTFOLIOS, ATTACHÉ CASES, CARRY-ON BAGS, TEXTILE, LEATHER AND MESH SHOPPING BAGS, AND BRIEFCASES; MODULAR ORGANIZERS COMPRISING FABRIC OR PLASTIC POCKETS AND SUPPORTING PANELS FOR CARRYING CASES, NAMELY,

HANDBAGS, PURSES, CLUTCHES, SHOULDER BAGS, TOTE BAGS, DIAPER BAGS, BACKPACKS, BRIEF-CASE TYPE PORTFOLIOS, ATTACHÉ CASES, CARRY-ON BAGS, TEXTILE, LEATHER AND MESH SHOPPING BAGS, AND BRIEFCASES; MODULAR ORGANIZER THAT IS CAPABLE OF BEING USED AS A SEPARATE BRIEFCASE TYPE PORTFOLIO, PURSE OR CLUTCH FOR STORAGE AND REPOSITIONABLE PLACEMENT OF A PLURALITY OF PERSONAL OR BUSINESS ITEMS WITHIN CARRYING CASES, NAMELY, HANDBAGS, PURSES, CLUTCHES, SHOULDER BAGS, TOTE BAGS, DIAPER BAGS, BACKPACKS, BRIEF-CASE TYPE PORTFOLIOS, ATTACHÉ CASES, CARRY-ON BAGS, TEXTILE, LEATHER OR MESH SHOPPING BAGS AND BRIEFCASES, IN CLASS 18 (U.S. CLS. 1, 2, 3, 22 AND 41).

FIRST USE 7-11-2007; IN COMMERCE 7-11-2007.

THE MARK CONSISTS OF STANDARD CHARACTERS WITHOUT CLAIM TO ANY PARTICULAR FONT, STYLE, SIZE, OR COLOR.

SN 77-216,333, FILED 6-27-2007.

KATHY DE JONGE, EXAMINING ATTORNEY

Int. Cl.: 18

Prior U.S. Cls.: 1, 2, 3, 22, and 41

Reg. No. 3,455,043

United States Patent and Trademark Office

Registered June 24, 2008

TRADEMARK  
PRINCIPAL REGISTER



PROFFIT, JAELEN (UNITED STATES INDIVIDUAL)  
7718 PAGEDWOOD LANE  
HOUSTON, TX 77063

FOR: CARRYING CASES, NAMELY, HANDBAGS, PURSES, CLUTCHES, SHOULDER BAGS, TOTE BAGS, DIAPER BAGS, BACKPACKS, BRIEFCASE TYPE PORTFOLIOS, ATTACHÉ CASES, CARRY-ON BAGS, TEXTILE, LEATHER AND MESH SHOPPING BAGS, AND BRIEFCASES; ORGANIZERS FOR CARRYING CASES, NAMELY, HANDBAGS, PURSES, CLUTCHES, SHOULDER BAGS, TOTE BAGS, DIAPER BAGS, BACKPACKS, BRIEFCASE TYPE PORTFOLIOS, ATTACHÉ CASES, CARRY-ON BAGS, TEXTILE, LEATHER AND MESH SHOPPING BAGS, AND BRIEFCASES; MODULAR ORGANIZERS FOR STORAGE AND REPOSITIONABLE PLACEMENT OF A PLURALITY OF PERSONAL OR BUSINESS ITEMS WITHIN CARRYING CASES, NAMELY, HANDBAGS, PURSES, CLUTCHES, SHOULDER BAGS, TOTE BAGS, DIAPER BAGS, BACKPACKS, BRIEFCASE TYPE PORTFOLIOS, ATTACHÉ CASES, CARRY-ON BAGS, TEXTILE, LEATHER AND MESH SHOPPING BAGS, AND BRIEFCASES; MODULAR ORGANIZERS FOR STORAGE AND REPOSITIONABLE PLACEMENT OF A PLURALITY OF PERSONAL OR BUSINESS ITEMS WITHIN CARRYING CASES, NAMELY, HANDBAGS, PURSES, CLUTCHES, SHOULDER BAGS, TOTE BAGS, DIAPER BAGS, BACKPACKS, BRIEFCASE TYPE PORTFOLIOS, ATTACHÉ CASES, CARRY-ON BAGS, TEXTILE, LEATHER AND MESH SHOPPING BAGS, AND BRIEF CASES; ORGANIZERS COMPRISING

FABRIC OR PLASTIC POCKETS AND SUPPORTING PANELS FOR CARRYING CASES, NAMELY, HANDBAGS, PURSES, CLUTCHES, SHOULDER BAGS, TOTE BAGS, DIAPER BAGS, BACKPACKS, BRIEFCASE TYPE PORTFOLIOS, ATTACHÉ CASES, CARRY-ON BAGS, TEXTILE, LEATHER AND MESH SHOPPING BAGS, AND BRIEFCASES; MODULAR ORGANIZER THAT IS CAPABLE OF BEING USED AS A SEPARATE BRIEFCASE TYPE PORTFOLIO, PURSE OR CLUTCH FOR STORAGE AND REPOSITIONABLE PLACEMENT OF A PLURALITY OF PERSONAL OR BUSINESS ITEMS WITHIN CARRYING CASES, NAMELY, HANDBAGS, PURSES, CLUTCHES, SHOULDER BAGS, TOTE BAGS, DIAPER BAGS, BACKPACKS, BRIEFCASE TYPE PORTFOLIOS, ATTACHÉ CASES, CARRY-ON BAGS, TEXTILE, LEATHER OR MESH SHOPPING BAGS AND BRIEFCASES, IN CLASS 18 (U.S. CLS. 1, 2, 3, 22 AND 41).

FIRST USE 7-11-2007; IN COMMERCE 7-11-2007.

SN 77-216,334, FILED 6-27-2007.

KEVIN DINALLO, EXAMINING ATTORNEY

Int. Cl.: 41

Prior U.S. Cls.: 100, 101, and 107

United States Patent and Trademark Office

Reg. No. 3,455,044

Registered June 24, 2008

SERVICE MARK  
PRINCIPAL REGISTER

The logo features the word "The" in a cursive script, "CHEF'S" in a bold, outlined, sans-serif font, and "Kitchen" in a cursive script below it.

HYPE413, INC. (PENNSYLVANIA CORPORATION)  
SUITE 2121  
100 SOUTH BROAD STREET  
PHILADELPHIA, PA 19110

FIRST USE 1-1-2008; IN COMMERCE 1-1-2008.

THE MARK CONSISTS OF "THE CHEF'S KITCHEN" (STYLIZED).

FOR: ENTERTAINMENT IN THE NATURE OF ON-GOING TELEVISION PROGRAMS IN THE FIELD OF CULINARY ARTS, IN CLASS 41 (U.S. CLS. 100, 101 AND 107).

SN 77-216,476, FILED 6-27-2007.

PAM WILLIS, EXAMINING ATTORNEY

**Int. Cls.: 3 and 5**

**Prior U.S. Cls.: 1, 4, 6, 18, 44, 46, 50, 51, and 52**

**United States Patent and Trademark Office**

**Reg. No. 3,455,045**

**Registered June 24, 2008**

**TRADEMARK  
PRINCIPAL REGISTER**

**PURE THERAPY**

CCT NEWCO INC. (DELAWARE CORPORATION)  
1ST FLOOR  
4200 NORTHSIDE PARKWAY, BUILDING 5  
ATLANTA, GA 30327

FOR: HAIR CARE PRODUCTS, NAMELY, SHAMPOOS AND CONDITIONERS FOR WOMEN WITH PREMATURE HAIR LOSS OR FINE, THINNING HAIR, IN CLASS 3 (U.S. CLS. 1, 4, 6, 50, 51 AND 52).

FIRST USE 8-9-2007; IN COMMERCE 8-9-2007.

FOR: NUTRITIONAL SUPPLEMENTS FOR WOMEN WITH PREMATURE HAIR LOSS OR FINE, THINNING HAIR, IN CLASS 5 (U.S. CLS. 6, 18, 44, 46, 51 AND 52).

FIRST USE 8-9-2007; IN COMMERCE 8-9-2007.

THE MARK CONSISTS OF STANDARD CHARACTERS WITHOUT CLAIM TO ANY PARTICULAR FONT, STYLE, SIZE, OR COLOR.

NO CLAIM IS MADE TO THE EXCLUSIVE RIGHT TO USE "THERAPY", APART FROM THE MARK AS SHOWN.

SN 77-216,555, FILED 6-27-2007.

LINDSEY RUBIN, EXAMINING ATTORNEY

**Int. Cl.: 16**

**Prior U.S. Cls.: 2, 5, 22, 23, 29, 37, 38, and 50**

**Reg. No. 3,455,046**

**United States Patent and Trademark Office**

**Registered June 24, 2008**

---

**TRADEMARK  
PRINCIPAL REGISTER**

**DROP & GO**

STAPLES THE OFFICE SUPERSTORE, LLC (DE-  
LAWARE LTD LIAB CO)  
500 STAPLES DRIVE  
FRAMINGHAM, MA 01702

FOR: PAPER SHREDDERS, IN CLASS 16 (U.S.  
CLS. 2, 5, 22, 23, 29, 37, 38 AND 50).

FIRST USE 1-0-2008; IN COMMERCE 1-0-2008.

THE MARK CONSISTS OF STANDARD CHAR-  
ACTERS WITHOUT CLAIM TO ANY PARTICULAR  
FONT, STYLE, SIZE, OR COLOR.

SN 77-216,923, FILED 6-27-2007.

JACQUELINE A. LAVINE, EXAMINING ATTOR-  
NEY

**Int. Cl.: 41**

**Prior U.S. Cls.: 100, 101, and 107**

**United States Patent and Trademark Office**

**Reg. No. 3,455,047**

**Registered June 24, 2008**

**SERVICE MARK  
PRINCIPAL REGISTER**

**SOCCER BECKONS**

TWENTIETH CENTURY FOX FILM CORPORATION  
(DELAWARE CORPORATION)  
10201 WEST PICO BOULEVARD  
LOS ANGELES, CA 90035

FOR: ENTERTAINMENT SERVICES IN THE  
NATURE OF TELEVISION PROGRAMMING FEATURING  
SPORTS, IN CLASS 41 (U.S. CLS. 100, 101  
AND 107).

FIRST USE 4-9-2007; IN COMMERCE 4-9-2007.

THE MARK CONSISTS OF STANDARD CHARACTERS  
WITHOUT CLAIM TO ANY PARTICULAR FONT,  
STYLE, SIZE, OR COLOR.

NO CLAIM IS MADE TO THE EXCLUSIVE  
RIGHT TO USE "SOCCER", APART FROM THE  
MARK AS SHOWN.

SN 77-217,865, FILED 6-28-2007.

JANICE L. MCMORROW, EXAMINING ATTORNEY



**Int. Cls.: 35 and 45**

**Prior U.S. Cls.: 100, 101, and 102**

**United States Patent and Trademark Office**

**Reg. No. 3,455,048**

**Registered June 24, 2008**

**SERVICE MARK  
PRINCIPAL REGISTER**

# Opson

OPSON, INC. (DELAWARE CORPORATION)

#407

371 ELAN VILLAGE LANE  
SAN JOSE, CA 95134

FOR: CONSULTANCY OF PERSONNEL RECRUITMENT; MATCHING CONSUMERS WITH PROFESSIONALS IN THE FIELD OF RESIDENTIAL AND COMMERCIAL SERVICES VIA COMPUTER NETWORK; EMPLOYMENT COUNSELING AND RECRUITING; EMPLOYMENT HIRING, RECRUITING, PLACEMENT, STAFFING AND CAREER NETWORKING SERVICES; PERSONNEL PLACEMENT AND RECRUITMENT; RECRUITMENT ADVERTISEMENT SERVICES, NAMELY, POSTING OF CLINICAL TRIAL NOTICES FOR THE PURPOSE OF RECRUITING PATIENTS FOR PARTICIPATION IN CLINICAL TRIALS FOR THE TESTING OF DRUGS; ADVERTISING AND ADVERTISEMENT SERVICES; ADVERTISING AND COMMERCIAL INFORMATION SERVICES, VIA THE INTERNET; ADVERTISING VIA ELECTRONIC MEDIA AND SPECIFICALLY THE INTERNET; ADVERTISING, INCLUDING PROMOTION RELATING TO THE SALE OF ARTICLES AND SERVICES FOR THIRD PARTIES BY THE TRANSMISSION OF ADVERTISING MATERIAL AND THE DISSEMINATION OF ADVERTISING MESSAGES ON COMPUTER NETWORKS; ADVERTISING, MARKETING AND PROMOTION SERVICES; DESIGN OF INTERNET ADVERTISING; DISSEMINATION OF ADVERTISING FOR OTHERS VIA AN ON-LINE COMMUNICATIONS NETWORK ON THE INTERNET; DISSEMINATION OF ADVERTISING FOR OTHERS VIA THE INTERNET; ON-LINE ADVERTISING AND MARKETING SERVICES; ON-LINE ADVERTISING ON COMPUTER COMMUNICATION NETWORKS; ORGANISATION AND HOLDING OF FAIRS FOR COMMERCIAL OR ADVERTISING PURPOSES; PROMOTING THE GOODS AND SERVICES OF OTHERS BY DISTRIBUTING ADVERTISING MATERIALS THROUGH A VARIETY OF

METHODS; PROMOTING THE GOODS AND SERVICES OF OTHERS BY PREPARING AND PLACING ADVERTISEMENTS IN AN ELECTRONIC MAGAZINE ACCESSED THROUGH A GLOBAL COMPUTER NETWORK; PROMOTING, ADVERTISING AND MARKETING OF THE ON-LINE WEBSITES OF OTHERS; PROMOTION, ADVERTISING AND MARKETING OF ON-LINE WEBSITES; RENTAL OF ADVERTISING SPACE ON WEB SITES; CONSULTING SERVICES IN THE FIELD OF HUMAN RESOURCES DEVELOPMENT, NAMELY, FOR THE PROMOTION OF EMPLOYEE RETENTION, CAREER GROWTH, AND INCREASED PRODUCTIVITY FOR EMPLOYEES AND EMPLOYERS; EMPLOYMENT AGENCIES; EMPLOYMENT OUTPLACEMENT SERVICES; EMPLOYMENT VERIFICATION; PROVIDING AN ON-LINE SEARCHABLE DATABASE FEATURING CLASSIFIED AD LISTINGS AND EMPLOYMENT OPPORTUNITIES; TALENT AGENCIES; TEMPORARY EMPLOYMENT AGENCIES; TESTING TO DETERMINE EMPLOYMENT SKILLS; PROMOTING THE GOODS AND SERVICES OF OTHERS BY PROVIDING HYPERTEXT LINKS TO THE WEB SITES OF OTHERS; PROVIDING A WEB SITE AT WHICH USERS CAN OFFER GOODS FOR SALE AND BUY GOODS OFFERED BY OTHERS; PROVIDING A WEB SITE THAT ENABLES USERS TO POST ITEMS FOR SALE THROUGH ON-LINE CLASSIFIED ADVERTISEMENTS; PROVIDING A WEB SITE WHERE USERS CAN POST RATINGS, REVIEWS AND RECOMMENDATIONS ON PRODUCTS AND SERVICES; PROVIDING ON-LINE DIRECTORY INFORMATION SERVICES ALSO FEATURING HYPERLINKS TO OTHER WEB SITES; PROVIDING SPACE AT A WEB SITE FOR THE ADVERTISEMENT OF THE GOODS AND SERVICES OF OTHERS; PROVIDING AN ON-LINE SEARCHABLE DATABASE FEATURING EMPLOYMENT OPPORTUNITIES AND CONTENT RELEVANT TO PEOPLE 50 YEARS OF AGE AND OLDER, IN CLASS 35 (U.S. CLS. 100, 101 AND 102).

FIRST USE 9-1-2007; IN COMMERCE 9-1-2007.

FOR: INTERNET BASED SOCIAL NETWORKING, INTRODUCTION, AND DATING SERVICES; ONLINE SOCIAL NETWORKING SERVICES; PRE-EMPLOYMENT BACKGROUND INVESTIGATION SERVICES; PRE-EMPLOYMENT BACKGROUND SCREENING; WEB SITE SERVICES FEATURING ON-LINE DATING CLUB, IN CLASS 45 (U.S. CLS. 100 AND 101).

FIRST USE 9-1-2007; IN COMMERCE 9-1-2007.

THE MARK CONSISTS OF STANDARD CHARACTERS WITHOUT CLAIM TO ANY PARTICULAR FONT, STYLE, SIZE, OR COLOR.

SN 77-218,467, FILED 6-28-2007.

SANJEEV VOHRA, EXAMINING ATTORNEY

**Int. Cl.: 5**

**Prior U.S. Cls.: 6, 18, 44, 46, 51, and 52**

**Reg. No. 3,455,049**

**United States Patent and Trademark Office**

**Registered June 24, 2008**

**TRADEMARK  
PRINCIPAL REGISTER**

**ENERGY POTION**

HARCOS, INC. (CALIFORNIA CORPORATION)  
SUITE 205  
1610 COLORADO AVE.  
SANTA MONICA, CA 90404

THE MARK CONSISTS OF STANDARD CHARACTERS WITHOUT CLAIM TO ANY PARTICULAR FONT, STYLE, SIZE, OR COLOR.

FOR: DIETARY AND NUTRITIONAL SUPPLEMENTS; DIETARY SUPPLEMENTAL DRINKS; DIETARY SUPPLEMENTS; DIETARY SUPPLEMENTS FOR HUMAN CONSUMPTION; FOOD SUPPLEMENTS, NAMELY, ANTI-OXIDANTS; VITAMIN SUPPLEMENTS, IN CLASS 5 (U.S. CLS. 6, 18, 44, 46, 51 AND 52).

NO CLAIM IS MADE TO THE EXCLUSIVE RIGHT TO USE "ENERGY", APART FROM THE MARK AS SHOWN.

SN 77-218,612, FILED 6-29-2007.

FIRST USE 12-11-2007; IN COMMERCE 12-11-2007.

RENEE MCCRAY, EXAMINING ATTORNEY

**Int. Cl.: 11**

**Prior U.S. Cls.: 13, 21, 23, 31, and 34**

**Reg. No. 3,455,050**

**United States Patent and Trademark Office**

**Registered June 24, 2008**

---

**TRADEMARK  
PRINCIPAL REGISTER**

**COSMOS**

CRAFTMADE INTERNATIONAL INC. (DELA-  
WARE CORPORATION)  
650 SOUTH ROYAL LANE  
COPPELL, TX 75019

THE MARK CONSISTS OF STANDARD CHAR-  
ACTERS WITHOUT CLAIM TO ANY PARTICULAR  
FONT, STYLE, SIZE, OR COLOR.

FOR: CEILING FANS, IN CLASS 11 (U.S. CLS. 13,  
21, 23, 31 AND 34).

SN 77-220,282, FILED 7-2-2007.

FIRST USE 6-1-2007; IN COMMERCE 10-1-2007.

JAY FLOWERS, EXAMINING ATTORNEY

**Int. Cl.: 28**

**Prior U.S. Cls.: 22, 23, 38, and 50**

**Reg. No. 3,455,051**

**United States Patent and Trademark Office**

**Registered June 24, 2008**

**TRADEMARK  
PRINCIPAL REGISTER**

# Wedding Dust

PAC JENNIC INC. (NEW YORK CORPORATION)  
197 PRINCE STREET  
NEW YORK, NY 10012

FOR: A NON-CONSUMABLE, NON-TOXIC NOVELTY CONFETTI ITEM CONSISTING OF CONFETTI, OATS, GLITTER, GRAINS, AND CINNAMON ENCASED IN A DECORATIVE POUCH, IN CLASS 28 (U.S. CLS. 22, 23, 38 AND 50).

FIRST USE 4-19-2008; IN COMMERCE 4-19-2008.

THE MARK CONSISTS OF STANDARD CHARACTERS WITHOUT CLAIM TO ANY PARTICULAR FONT, STYLE, SIZE, OR COLOR.

NO CLAIM IS MADE TO THE EXCLUSIVE RIGHT TO USE "WEDDING", APART FROM THE MARK AS SHOWN.

SN 77-220,417, FILED 7-2-2007.

TOBY BULLOFF, EXAMINING ATTORNEY

**Int. Cl.: 5**

**Prior U.S. Cls.: 6, 18, 44, 46, 51, and 52**

**Reg. No. 3,455,052**

**United States Patent and Trademark Office**

**Registered June 24, 2008**

**TRADEMARK  
PRINCIPAL REGISTER**

# Gonesmoke

SCENTRIA CORPORATION (SOUTH CAROLINA  
CORPORATION)  
150 LAKE LYMAN HEIGHTS  
LYMAN, SC 29365

THE MARK CONSISTS OF STANDARD CHAR-  
ACTERS WITHOUT CLAIM TO ANY PARTICULAR  
FONT, STYLE, SIZE, OR COLOR.

FOR: ODOR NEUTRALIZING PREPARATIONS  
FOR USE ON TEXTILES, IN CLASS 5 (U.S. CLS. 6, 18,  
44, 46, 51 AND 52).

SN 77-220,538, FILED 7-2-2007.

FIRST USE 6-17-2007; IN COMMERCE 2-15-2008.

SUSAN LESLIE DUBOIS, EXAMINING ATTORNEY

**Int. Cl.: 41**

**Prior U.S. Cls.: 100, 101, and 107**

**United States Patent and Trademark Office**

**Reg. No. 3,455,053**

**Registered June 24, 2008**

**SERVICE MARK  
PRINCIPAL REGISTER**

**THE GOLD STANDARD IN CI  
TRAINING**

FULD GILAD HERRING ACADEMY OF COMPETITIVE INTELLIGENCE (MASSACHUSETTS LTD LIAB CO)  
126 CHARLES STREET  
CAMBRIDGE, MA 02141

FOR: EDUCATIONAL SERVICES, NAMELY, WORKSHOPS AND COURSES IN THE FIELD OF COMPETITIVE INTELLIGENCE, IN CLASS 41 (U.S. CLS. 100, 101 AND 107).

FIRST USE 6-1-2007; IN COMMERCE 6-1-2007.

THE MARK CONSISTS OF STANDARD CHARACTERS WITHOUT CLAIM TO ANY PARTICULAR FONT, STYLE, SIZE, OR COLOR.

SN 77-221,507, FILED 7-3-2007.

MICHAEL SOUDERS, EXAMINING ATTORNEY

Int. Cls.: 20 and 24

Prior U.S. Cls.: 2, 13, 22, 25, 32, 42, and 50

Reg. No. 3,455,054

United States Patent and Trademark Office

Registered June 24, 2008

TRADEMARK  
PRINCIPAL REGISTER



AMERICAN TEXTILE COMPANY (PENNSYLVANIA CORPORATION)  
10 NORTH LINDEN STREET, RIDC RIVERPLACE  
DUQUESNE, PA 15110

FOR: PILLOWS, IN CLASS 20 (U.S. CLS. 2, 13, 22, 25, 32 AND 50).

FIRST USE 11-1-2007; IN COMMERCE 11-1-2007.

FOR: PILLOW CASES AND SHEET SETS, IN CLASS 24 (U.S. CLS. 42 AND 50).

FIRST USE 11-1-2007; IN COMMERCE 11-1-2007.

THE MARK CONSISTS OF THE WORD "COOL" IN LARGE SCRIPT TYPESTYLE FOLLOWED BY AN IMAGE OF A WOMAN WITH HER ARM UPRAISED AND ELBOW BENT, WITH THE WORD "SENSATIONS" IN SMALL BLOCK TYPE UNDER THE WORD "COOL" AND THE IMAGE OF THE WOMAN.

SN 77-222,189, FILED 7-5-2007.

TARAH HARDY, EXAMINING ATTORNEY



**Int. Cl.: 10**

**Prior U.S. Cls.: 26, 39, and 44**

**United States Patent and Trademark Office**

**Reg. No. 3,455,055**

**Registered June 24, 2008**

**TRADEMARK  
PRINCIPAL REGISTER**

**COOLRAIL**

ATRICURE, INC. (DELAWARE CORPORATION)  
6033 SCHUMACHER PARK DRIVE  
WEST CHESTER, OH 45069

THE MARK CONSISTS OF STANDARD CHAR-  
ACTERS WITHOUT CLAIM TO ANY PARTICULAR  
FONT, STYLE, SIZE, OR COLOR.

FOR: MEDICAL DEVICES, NAMELY, SURGICAL  
DEVICES THAT FACILITATE THE IDENTIFICA-  
TION, SEPARATION OR ABLATION OF BIOLOGIC  
TISSUES, IN CLASS 10 (U.S. CLS. 26, 39 AND 44).

SN 77-222,333, FILED 7-5-2007.

FIRST USE 12-20-2007; IN COMMERCE 3-13-2008.

KRISTINA MORRIS, EXAMINING ATTORNEY

**Int. Cl.: 9**

**Prior U.S. Cls.: 21, 23, 26, 36, and 38**

**Reg. No. 3,455,056**

**United States Patent and Trademark Office**

**Registered June 24, 2008**

---

**TRADEMARK  
PRINCIPAL REGISTER**

## Where is My Package?

SCHEWANICK COMPUTER SERVICES INC (NE-  
VADA CORPORATION)  
4278 FARMDALE AVE.  
STUDIO CITY, CA 916042733

THE MARK CONSISTS OF STANDARD CHAR-  
ACTERS WITHOUT CLAIM TO ANY PARTICULAR  
FONT, STYLE, SIZE, OR COLOR.

FOR: COMPUTER SOFTWARE FOR COMPUTER  
SYSTEM AND APPLICATION DEVELOPMENT, DE-  
PLOYMENT AND MANAGEMENT, IN CLASS 9  
(U.S. CLS. 21, 23, 26, 36 AND 38).

SN 77-222,919, FILED 7-5-2007.

FIRST USE 10-1-2007; IN COMMERCE 10-1-2007.

SETH A. RAPPAPORT, EXAMINING ATTORNEY

**Int. Cl.: 40**

**Prior U.S. Cls.: 100, 103, and 106**

**United States Patent and Trademark Office**

**Reg. No. 3,455,057**

**Registered June 24, 2008**

**SERVICE MARK  
PRINCIPAL REGISTER**

**Lenticular, the Hi-Def of  
Print**

DIRECT MAIL TELEVISION, INC. DBA DMTV  
(CALIFORNIA CORPORATION)  
1240 INDIA STREET, SUITE 603  
SAN DIEGO, CA 92101

THE MARK CONSISTS OF STANDARD CHAR-  
ACTERS WITHOUT CLAIM TO ANY PARTICULAR  
FONT, STYLE, SIZE, OR COLOR.

FOR: PRINTING, IN CLASS 40 (U.S. CLS. 100, 103  
AND 106).

SN 77-222,974, FILED 7-5-2007.

FIRST USE 1-1-2007; IN COMMERCE 8-1-2007.

COLLEEN DOMBROW, EXAMINING ATTORNEY

**Int. Cls.: 5 and 29**

**Prior U.S. Cls.: 6, 18, 44, 46, 51, and 52**

**United States Patent and Trademark Office**

**Reg. No. 3,455,058**

**Registered June 24, 2008**

**TRADEMARK  
PRINCIPAL REGISTER**

**BABAJI**

GAGAN MATTA (CANADA INDIVIDUAL)  
BANSAL—ARUN@HOTMAIL.COM  
#48-13320 78 AVENUE  
SURREY, CANADA V3W0H6 AND  
VERKA FOOD PRODUCTS LTD. (CANADA COR-  
PORATION)  
BANSAL—ARUN@HOTMAIL.COM  
#48-13320 78 AVENUE  
SURREY, CANADA V3W0H6

FOR: BISCUITS, BREAD, BREAD ROLLS, CAKES,  
CEREAL PRODUCTS, CONFECTIONERY, CRACK-  
ERS, NOODLES, FISH SAUCE, RELISH, SAUCES,  
CEREAL-BASED SNACK-FOODS AND PREPARED  
DIETARY ITEMS THAT ARE GLUTEN-FREE TO  
ACCOMMODATE SPECIAL MEDICAL AND  
HEALTH CONDITIONS, IN CLASS 5 (U.S. CLS. 6,  
18, 44, 46, 51 AND 52).

FIRST USE 4-12-2008; IN COMMERCE 4-12-2008.

FOR: DAIRY PRODUCTS EXCLUDING ICE  
CREAM, ICE MILK AND FROZEN YOGURT, IN  
CLASS 29 (U.S. CL. 46).

FIRST USE 4-12-2008; IN COMMERCE 4-12-2008.

THE MARK CONSISTS OF STANDARD CHAR-  
ACTERS WITHOUT CLAIM TO ANY PARTICULAR  
FONT, STYLE, SIZE, OR COLOR.

SN 77-224,025, FILED 7-6-2007.

LINDA E. BLOHM, EXAMINING ATTORNEY

**Int. Cls.: 35 and 39**

**Prior U.S. Cls.: 100, 101, 102, and 105**

**United States Patent and Trademark Office**

**Reg. No. 3,455,059**

**Registered June 24, 2008**

**SERVICE MARK  
PRINCIPAL REGISTER**

# Allstar Movers

ALLSTAR MOVERS AND DELIVERY, LLC (WA-SHINGTON LTD LIAB CO)  
3410 160TH AVE EAST  
BONNEY LAKE, WA 98391

FOR: MOVING AND RELOCATION SERVICES, NAMELY, PLANNING AND IMPLEMENTING MOVES OF HOMES AND OFFICES, IN CLASS 35 (U.S. CLS. 100, 101 AND 102).

FIRST USE 12-16-2006; IN COMMERCE 12-16-2006.

FOR: FURNITURE MOVING; MOVING VAN SERVICES, IN CLASS 39 (U.S. CLS. 100 AND 105).

FIRST USE 12-16-2006; IN COMMERCE 12-16-2006.

THE MARK CONSISTS OF STANDARD CHARACTERS WITHOUT CLAIM TO ANY PARTICULAR FONT, STYLE, SIZE, OR COLOR.

NO CLAIM IS MADE TO THE EXCLUSIVE RIGHT TO USE "MOVERS", APART FROM THE MARK AS SHOWN.

SN 77-224,042, FILED 7-7-2007.

JOHN E. MICHOS, EXAMINING ATTORNEY

**Int. Cl.: 9**

**Prior U.S. Cls.: 21, 23, 26, 36, and 38**

**Reg. No. 3,455,060**

**United States Patent and Trademark Office**

**Registered June 24, 2008**

---

**TRADEMARK  
PRINCIPAL REGISTER**

**CUR<sub>X</sub>E Light**

HONEYWELL INTERNATIONAL INC. (DELA-  
WARE CORPORATION)  
101 COLUMBIA ROAD  
MORRISTOWN, NJ 07962

FIRST USE 8-31-2007; IN COMMERCE 3-31-2008.

FOR: ELECTRICAL WIRES AND CABLES; HOME  
THEATER AND HIGH DEFINITION MULTIMEDIA  
INTERFACE CABLES, IN CLASS 9 (U.S. CLS. 21, 23,  
26, 36 AND 38).

SN 77-224,819, FILED 7-9-2007.

MARK SPARACINO, EXAMINING ATTORNEY

**Int. Cl.: 30**

**Prior U.S. Cl.: 46**

**United States Patent and Trademark Office**

**Reg. No. 3,455,061**

**Registered June 24, 2008**

**TRADEMARK  
PRINCIPAL REGISTER**

**HONEY RIDGE FARMS**

HONEY CREEK FARMS, LLC (WASHINGTON  
LTD LIAB CO)  
12310 NE 245TH AVENUE  
BRUSH PRAIRIE, WA 98606

FOR: HONEY, NAMELY, PURE HONEY,  
CREAMED OR WHIPPED HONEY, HONEY BLEN-  
DED WITH FRUITS OR BERRIES, HONEY VINE-  
GARS, HONEY MUSTARD, HONEY WHIP, SALAD  
DRESSINGS, DIPPING AND COOKING SAUCES  
CONTAINING HONEY AS A MAIN INGREDIENT,  
IN CLASS 30 (U.S. CL. 46).

FIRST USE 11-26-2007; IN COMMERCE 1-13-2008.

THE MARK CONSISTS OF STANDARD CHAR-  
ACTERS WITHOUT CLAIM TO ANY PARTICULAR  
FONT, STYLE, SIZE, OR COLOR.

NO CLAIM IS MADE TO THE EXCLUSIVE  
RIGHT TO USE "HONEY" AND "FARMS", APART  
FROM THE MARK AS SHOWN.

SN 77-225,296, FILED 7-9-2007.

JESSICA FATHY, EXAMINING ATTORNEY

**Int. Cl.: 9**

**Prior U.S. Cls.: 21, 23, 26, 36, and 38**

**Reg. No. 3,455,062**

**United States Patent and Trademark Office**

**Registered June 24, 2008**

**TRADEMARK  
PRINCIPAL REGISTER**

**TRUEIAQ**

HONEYWELL INTERNATIONAL INC. (DELA-  
WARE CORPORATION)  
101 COLUMBIA ROAD  
MORRISTOWN, NJ 07962

THE MARK CONSISTS OF STANDARD CHAR-  
ACTERS WITHOUT CLAIM TO ANY PARTICULAR  
FONT, STYLE, SIZE, OR COLOR.

FOR: CONTROLLERS FOR RESIDENTIAL HVAC  
SYSTEMS, IN CLASS 9 (U.S. CLS. 21, 23, 26, 36 AND  
38).

SN 77-225,366, FILED 7-9-2007.

FIRST USE 11-30-2007; IN COMMERCE 11-30-2007.

MARK SPARACINO, EXAMINING ATTORNEY



**Int. Cl.: 9**

**Prior U.S. Cls.: 21, 23, 26, 36, and 38**

**Reg. No. 3,455,063**

**United States Patent and Trademark Office**

**Registered June 24, 2008**

---

**TRADEMARK  
PRINCIPAL REGISTER**

**MR. BRIGHT EYES**

KERR, JR., RICHARD A. (UNITED STATES IN-  
DIVIDUAL)  
1714 HERITAGE AVENUE  
PLACENTIA, CA 92870

THE MARK CONSISTS OF STANDARD CHAR-  
ACTERS WITHOUT CLAIM TO ANY PARTICULAR  
FONT, STYLE, SIZE, OR COLOR.

FOR: BATTERY TESTERS, IN CLASS 9 (U.S. CLS.  
21, 23, 26, 36 AND 38).

SN 77-225,832, FILED 7-10-2007.

FIRST USE 6-13-2007; IN COMMERCE 6-13-2007.

BENJAMIN ALLEN, EXAMINING ATTORNEY

**Int. Cl.: 35**

**Prior U.S. Cls.: 100, 101, and 102**

**United States Patent and Trademark Office**

**Reg. No. 3,455,064**

**Registered June 24, 2008**

**SERVICE MARK  
PRINCIPAL REGISTER**

**MAKE YOUR MATCH**

PRACTICEMATCH, INC. (MISSOURI CORPORATION)  
SUITE 450  
600 EMERSON  
ST. LOUIS, MO 63141

FOR: PROVIDING INFORMATION IN THE FIELD OF PROFESSIONAL HEALTHCARE RECRUITMENT, NAMELY, PROVIDING NAMES, CONTACT INFORMATION, AND PROFESSIONAL PROFILES OF HEALTHCARE PROFESSIONALS; RECRUITMENT OF HEALTHCARE PROFESSIONALS, IN CLASS 35 (U.S. CLS. 100, 101 AND 102).

FIRST USE 9-1-2007; IN COMMERCE 9-1-2007.

THE MARK CONSISTS OF STANDARD CHARACTERS WITHOUT CLAIM TO ANY PARTICULAR FONT, STYLE, SIZE, OR COLOR.

SN 77-226,098, FILED 7-10-2007.

LINDA ESTRADA, EXAMINING ATTORNEY

**Int. Cl.: 35**

**Prior U.S. Cls.: 100, 101, and 102**

**United States Patent and Trademark Office**

**Reg. No. 3,455,065**

**Registered June 24, 2008**

**SERVICE MARK  
PRINCIPAL REGISTER**

**PEMBERTON WHITEMAN &  
HILL**

THE PEMBERTON COMPANY, LLC (MISSOURI  
LTD LIAB CO)  
NO. 295  
6320 BROOKSIDE PLAZA  
KANSAS CITY, MO 64113

FOR: EMPLOYMENT HIRING, RECRUITING,  
PLACEMENT, STAFFING AND CAREER NET-  
WORKING SERVICES; TESTING TO DETERMINE  
EMPLOYMENT SKILLS; EXECUTIVE SEARCH  
AND PLACEMENT SERVICES; CONSULTANCY  
OF PERSONNEL RECRUITMENT; JOB AND PER-

SONNEL PLACEMENT, IN CLASS 35 (U.S. CLS. 100,  
101 AND 102).

FIRST USE 7-31-2007; IN COMMERCE 7-31-2007.

THE MARK CONSISTS OF STANDARD CHAR-  
ACTERS WITHOUT CLAIM TO ANY PARTICULAR  
FONT, STYLE, SIZE, OR COLOR.

SN 77-226,838, FILED 7-11-2007.

HOWARD SMIGA, EXAMINING ATTORNEY

Int. Cl.: 35

Prior U.S. Cls.: 100, 101, and 102

United States Patent and Trademark Office

Reg. No. 3,455,066

Registered June 24, 2008

SERVICE MARK  
PRINCIPAL REGISTER



PENNWELL CORPORATION (OKLAHOMA CORPORATION)  
1421 SOUTH SHERIDAN ROAD  
TULSA, OK 74112

FOR: ARRANGING AND CONDUCTING BUSINESS CONFERENCES AND TRADE SHOWS RELATING TO THE DEFENSE INDUSTRY, IN CLASS 35 (U.S. CLS. 100, 101 AND 102).

FIRST USE 7-26-2007; IN COMMERCE 8-31-2007.

NO CLAIM IS MADE TO THE EXCLUSIVE RIGHT TO USE "MILITARY & AEROSPACE ELECTRONICS FORUM", APART FROM THE MARK AS SHOWN.

SN 77-227,209, FILED 7-11-2007.

MICHAEL WIENER, EXAMINING ATTORNEY

**Int. Cl.: 9**

**Prior U.S. Cls.: 21, 23, 26, 36, and 38**

**Reg. No. 3,455,067**

**United States Patent and Trademark Office**

**Registered June 24, 2008**

---

**TRADEMARK  
PRINCIPAL REGISTER**

**ALLURE**

TAYMAC CORPORATION (ARIZONA CORPORATION)  
1343 N. TECH BLVD., STE. 119  
GILBERT, AZ 85233

THE MARK CONSISTS OF STANDARD CHARACTERS WITHOUT CLAIM TO ANY PARTICULAR FONT, STYLE, SIZE, OR COLOR.

FOR: ELECTRIC OUTLET COVERS; ELECTRIC SWITCH PLATES, IN CLASS 9 (U.S. CLS. 21, 23, 26, 36 AND 38).

SN 77-227,352, FILED 7-11-2007.

FIRST USE 11-12-2007; IN COMMERCE 11-12-2007.

EDWARD NELSON, EXAMINING ATTORNEY

**Int. Cl.: 9**

**Prior U.S. Cls.: 21, 23, 26, 36, and 38**

**Reg. No. 3,455,068**

**United States Patent and Trademark Office**

**Registered June 24, 2008**

**TRADEMARK  
PRINCIPAL REGISTER**

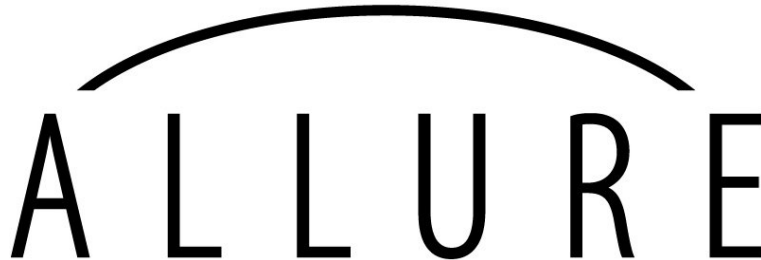

ALLURE

TAYMAC CORPORATION (ARIZONA CORPORATION)  
1343 N. TECH BLVD., STE. 119  
GILBERT, AZ 85233

THE MARK CONSISTS OF THE WORD "ALLURE" WITH A DECORATIVE ARC.

FOR: ELECTRIC OUTLET COVERS; ELECTRIC SWITCH PLATES, IN CLASS 9 (U.S. CLS. 21, 23, 26, 36 AND 38).

SN 77-227,399, FILED 7-11-2007.

FIRST USE 11-12-2007; IN COMMERCE 11-12-2007.

EDWARD NELSON, EXAMINING ATTORNEY

**Int. Cl.: 32**

**Prior U.S. Cls.: 45, 46, and 48**

**United States Patent and Trademark Office**

**Reg. No. 3,455,069**

**Registered June 24, 2008**

**TRADEMARK  
PRINCIPAL REGISTER**

**Y Not**

Y WATER, INC. (CALIFORNIA CORPORATION)  
5737 VENICE BOULEVARD  
LOS ANGELES, CA 90019

FOR: MINERAL ENHANCED SOFT DRINK BEVERAGES AND DRINKING WATER, VITAMIN ENHANCED SOFT DRINK BEVERAGES AND DRINKING WATER, AND BOTANICAL ENHANCED SOFT DRINK BEVERAGES AND DRINKING WATER, IN CLASS 32 (U.S. CLS. 45, 46 AND 48).

FIRST USE 9-28-2007; IN COMMERCE 9-28-2007.

THE MARK CONSISTS OF STANDARD CHARACTERS WITHOUT CLAIM TO ANY PARTICULAR FONT, STYLE, SIZE, OR COLOR.

SN 77-227,457, FILED 7-11-2007.

NAAKWAMA ANKRAH, EXAMINING ATTORNEY

Int. Cl.: 41

Prior U.S. Cls.: 100, 101, and 107

United States Patent and Trademark Office

Reg. No. 3,455,070

Registered June 24, 2008

SERVICE MARK  
PRINCIPAL REGISTER



FITNESS FOR KIDS, INC. (FLORIDA CORPORATION)  
3801 SW 160 AVE SUITE 202  
MIRAMAR, FL 33027

FOR: SUMMER CAMPS; PHYSICAL FITNESS CONDITIONING CLASSES; PHYSICAL FITNESS CONSULTATION; PHYSICAL FITNESS INSTRUCTION; CONTESTS AND INCENTIVE AWARD PROGRAMS TO ENCOURAGE STUDENTS AND ORGANIZATION MEMBERS TO SET UP AND ACHIEVE GOALS IN ACADEMICS, ATTENDANCE, CITIZENSHIP AND CONDUCT, IN CLASS 41 (U.S. CLS. 100, 101 AND 107).

FIRST USE 8-1-1998; IN COMMERCE 6-1-2005.

NO CLAIM IS MADE TO THE EXCLUSIVE RIGHT TO USE "FITNESS FOR KIDS", APART FROM THE MARK AS SHOWN.

THE MARK CONSISTS OF A DEPICTION OF A HEART JUMPING ON A JUMP ROPE WITH THE WORDS "FITNESS FOR KIDS" ON TOP AND THE WORDS "FITNESS FOR LIFE!" BELOW.

SN 77-227,701, FILED 7-12-2007.

JAMES LOVELACE, EXAMINING ATTORNEY



**Int. Cl.: 5**

**Prior U.S. Cls.: 6, 18, 44, 46, 51, and 52**

**Reg. No. 3,455,071**

**United States Patent and Trademark Office**

**Registered June 24, 2008**

---

**TRADEMARK  
PRINCIPAL REGISTER**

**Brighten Your Mind!**

MATTHEW G. DAVIDSON (UNITED STATES  
INDIVIDUAL)  
3280 MIDVALE AVENUE  
LOS ANGELES, CA 90034

THE MARK CONSISTS OF STANDARD CHAR-  
ACTERS WITHOUT CLAIM TO ANY PARTICULAR  
FONT, STYLE, SIZE, OR COLOR.

FOR: BREATH-FRESHENING CHEWING GUM  
FOR MEDICINAL PURPOSES; HERBAL CHEWING  
GUM PROVIDING MENTAL ALERTNESS, IN  
CLASS 5 (U.S. CLS. 6, 18, 44, 46, 51 AND 52).

SN 77-228,452, FILED 7-12-2007.

FIRST USE 3-29-2007; IN COMMERCE 10-4-2007.

CHARLES L. JENKINS, EXAMINING ATTORNEY

**Int. Cl.: 29**

**Prior U.S. Cl.: 46**

**United States Patent and Trademark Office**

**Reg. No. 3,455,072**

**Registered June 24, 2008**

**TRADEMARK  
PRINCIPAL REGISTER**

**BEACH BASH**

ENJOY LIFE NATURAL BRANDS, LLC (ILLI-  
NOIS LTD LIAB CO)  
3810 NORTH RIVER ROAD  
SCHILLER PARK, IL 60176

THE MARK CONSISTS OF STANDARD CHAR-  
ACTERS WITHOUT CLAIM TO ANY PARTICULAR  
FONT, STYLE, SIZE, OR COLOR.

FOR: SNACK MIX CONSISTING PRIMARILY OF  
PROCESSED FRUITS, PROCESSED NUTS AND/OR  
RAISINS, IN CLASS 29 (U.S. CL. 46).

SN 77-228,472, FILED 7-12-2007.

FIRST USE 7-12-2007; IN COMMERCE 10-19-2007.

MICHAEL KAZAZIAN, EXAMINING ATTORNEY

**Int. Cl.: 29**

**Prior U.S. Cl.: 46**

**Reg. No. 3,455,073**

**United States Patent and Trademark Office**

**Registered June 24, 2008**

---

**TRADEMARK  
PRINCIPAL REGISTER**

**MOUNTAIN MAMBO**

ENJOY LIFE NATURAL BRANDS, LLC (ILLI-  
NOIS LTD LIAB CO)  
3810 NORTH RIVER ROAD  
SCHILLER PARK, IL 60176

THE MARK CONSISTS OF STANDARD CHAR-  
ACTERS WITHOUT CLAIM TO ANY PARTICULAR  
FONT, STYLE, SIZE, OR COLOR.

FOR: SNACK MIX CONSISTING PRIMARILY OF  
PROCESSED FRUITS, PROCESSED NUTS AND/OR  
RAISINS, IN CLASS 29 (U.S. CL. 46).

SN 77-228,498, FILED 7-12-2007.

FIRST USE 7-12-2007; IN COMMERCE 10-1-2007.

MICHAEL KAZAZIAN, EXAMINING ATTORNEY

**Int. Cl.: 1**

**Prior U.S. Cls.: 1, 5, 6, 10, 26, and 46**

**Reg. No. 3,455,074**

**United States Patent and Trademark Office**

**Registered June 24, 2008**

---

**TRADEMARK  
PRINCIPAL REGISTER**

**TAU-MOD**

HALLIBURTON ENERGY SERVICES, INC. (DE-  
LAWARE CORPORATION)

1-B-121

2601 BELTLINE ROAD  
CARROLLTON, TX 75006

FOR: CHEMICAL ADDITIVES USED AS A  
RHEOLOGY MODIFIER FOR OIL AND GAS WELL  
DRILLING FLUIDS, IN CLASS 1 (U.S. CLS. 1, 5, 6, 10,  
26 AND 46).

FIRST USE 1-31-2008; IN COMMERCE 1-31-2008.

THE MARK CONSISTS OF STANDARD CHAR-  
ACTERS WITHOUT CLAIM TO ANY PARTICULAR  
FONT, STYLE, SIZE, OR COLOR.

SN 77-230,588, FILED 7-16-2007.

RONALD AIKENS, EXAMINING ATTORNEY

**Int. Cl.: 9**

**Prior U.S. Cls.: 21, 23, 26, 36, and 38**

**Reg. No. 3,455,075**

**United States Patent and Trademark Office**

**Registered June 24, 2008**

**TRADEMARK  
PRINCIPAL REGISTER**



MCR PHARMACEUTICALS INC (NEW YORK CORPORATION)  
6 DEVOE PLACE  
CHAPPAQUA, NY 10514

FOR: GLASSWARE FOR SCIENTIFIC EXPERIMENTS IN LABORATORIES, IN CLASS 9 (U.S. CLS. 21, 23, 26, 36 AND 38).

FIRST USE 1-15-2008; IN COMMERCE 1-21-2008.

THE COLOR(S) BLUE IS/ARE CLAIMED AS A FEATURE OF THE MARK.

THE COLOR BLUE APPEARS IN THE ENTIRE MARK WHICH CONSISTS OF THE WORDING "SYNTHGLASS" AND THE STYLIZED LETTERS "SG" WHICH FORM A DESIGN OF A FLASK.

SN 77-231,455, FILED 7-17-2007.

EVELYN BRADLEY, EXAMINING ATTORNEY

**Int. Cl.: 28**

**Prior U.S. Cls.: 22, 23, 38, and 50**

**United States Patent and Trademark Office**

**Reg. No. 3,455,076**

**Registered June 24, 2008**

**TRADEMARK  
PRINCIPAL REGISTER**

# Halloween Dust

PAC JENNIC INC. (NEW YORK CORPORATION)  
197 PRINCE STREET  
NEW YORK, NY 10012

FOR: A NON-CONSUMABLE, NON-TOXIC NOVELTY CONFETTI ITEM FOR CHILDREN CONSISTING OF CONFETTI, OATS, GLITTER, GRAINS, AND CINNAMON ENCASED IN A DECORATIVE POUCH, IN CLASS 28 (U.S. CLS. 22, 23, 38 AND 50).

FIRST USE 4-19-2008; IN COMMERCE 4-19-2008.

THE MARK CONSISTS OF STANDARD CHARACTERS WITHOUT CLAIM TO ANY PARTICULAR FONT, STYLE, SIZE, OR COLOR.

NO CLAIM IS MADE TO THE EXCLUSIVE RIGHT TO USE "HALLOWEEN", APART FROM THE MARK AS SHOWN.

SN 77-233,379, FILED 7-19-2007.

TOBY BULLOFF, EXAMINING ATTORNEY

**Int. Cl.: 33**

**Prior U.S. Cls.: 47 and 49**

**United States Patent and Trademark Office**

**Reg. No. 3,455,077**

**Registered June 24, 2008**

**TRADEMARK  
PRINCIPAL REGISTER**

KEEP YOUR JUDGEMENT PURE

FINLANDIA VODKA WORLDWIDE LTD. (FIN-  
LAND CORPORATION)  
PORKKALANKATU 24  
HELSINKI, FINLAND 00180

FOR: DISTILLED SPIRITS, IN CLASS 33 (U.S. CLS.  
47 AND 49).

FIRST USE 12-31-2005; IN COMMERCE 12-31-2005.

THE MARK CONSISTS OF STANDARD CHAR-  
ACTERS WITHOUT CLAIM TO ANY PARTICULAR  
FONT, STYLE, SIZE, OR COLOR.

SN 77-234,159, FILED 7-19-2007.

WARREN L. OLANDRIA, EXAMINING ATTOR-  
NEY

**Int. Cls.: 35 and 36**

**Prior U.S. Cls.: 100, 101, and 102**

**United States Patent and Trademark Office**

**Reg. No. 3,455,078**

**Registered June 24, 2008**

**SERVICE MARK  
PRINCIPAL REGISTER**



ANCHIN, BLOCK & ANCHIN LLP (NEW YORK  
LIMITED LIABILITY PARTNERSHIP)  
1375 BROADWAY  
NEW YORK, NY 10018

FOR: ACCOUNTING SERVICES; BUSINESS INFORMATION AND ACCOUNTING ADVISORY SERVICES; ACCOUNTING CONSULTATION; BUSINESS AUDITING SERVICES; FINANCIAL SERVICES, NAMELY, FINANCIAL RECORDS MANAGEMENT, PREPARING FINANCIAL REPORTS FOR OTHERS; FINANCIAL STATEMENT PREPARATION AND ANALYSIS FOR BUSINESSES; TAX PLANNING AND COMPLIANCE SERVICES; TAX AND TAXATION PLANNING, ADVICE, INFORMATION AND CONSULTANCY SERVICES; FORENSIC ACCOUNTING SERVICES; BUSINESS MANAGEMENT AND SUCCESSION ADVISORY SERVICES; BUSINESS DEVELOPMENT SERVICES, NAMELY, PROMOTING ECONOMIC AND BUSINESS DEVELOPMENT IN THE UNITED STATES; PROCURING FEDERAL, STATE AND LOCAL TAX INCENTIVES FOR BUSINESSES; ACQUISITION AND MERGER CONSULTATION SERVICES, IN CLASS 35 (U.S. CLS. 100, 101 AND 102).

FIRST USE 8-31-2007; IN COMMERCE 8-31-2007.

FOR: FINANCIAL SERVICES, NAMELY, FINANCIAL MANAGEMENT, FINANCIAL PLANNING; FINANCIAL CONSULTING SERVICES; WEALTH MANAGEMENT, NAMELY, INVESTMENT ADVICE AND CONSULTATION, BUSINESS VALUATION SERVICES; BUSINESS VALUATION CONSULTING AND ADVISORY SERVICES, IN CLASS 36 (U.S. CLS. 100, 101 AND 102).

FIRST USE 8-31-2007; IN COMMERCE 8-31-2007.

THE COLOR(S) RED AND BLACK IS/ARE CLAIMED AS A FEATURE OF THE MARK.

THE MARK CONSISTS OF THE WORD "ANCHIN" IN BLACK LETTERS OVER A RED ARC DESIGN WITH THE WORDS "YOUR EXPERT PARTNER" IN BLACK LETTERS.

SEC. 2(F) AS TO "ANCHIN".

SN 77-234,937, FILED 7-20-2007.

ALICIA COLLINS, EXAMINING ATTORNEY



**Int. Cls.: 35 and 42**

**Prior U.S. Cls.: 100, 101, and 102**

**United States Patent and Trademark Office**

**Reg. No. 3,455,079**

**Registered June 24, 2008**

**SERVICE MARK  
PRINCIPAL REGISTER**

**THE PLAY OF ART**

LUSORY.COM, INC. (DELAWARE CORPORATION)  
10311 YEARLING DRIVE  
ROCKVILLE, MD 20850

FOR: PROVIDING AN ON-LINE SHOWROOM FOR THE GOODS OF OTHERS IN THE FIELD OF FINE ART, GRAPHIC DESIGN, SCULPTURE AND OTHER MERCHANDISE FEATURING LICENSED CREATIVE WORKS; PROVIDING INFORMATION IN THE FIELD OF MARKETING AND ON-LINE MARKETING MEDIA VIA THE INTERNET; COMMERCIAL ADMINISTRATION OF THE LICENSING OF THE GOODS AND SERVICES OF OTHERS, IN CLASS 35 (U.S. CLS. 100, 101 AND 102).

FIRST USE 8-30-2007; IN COMMERCE 8-30-2007.

FOR: COMPUTER SERVICES, NAMELY, CREATING AN ONLINE COMMUNITY FOR REGISTERED USERS TO PARTICIPATE IN COMPETITIONS, SHOWCASE THEIR SKILLS, GET FEEDBACK FROM THEIR PEERS, FORM VIRTUAL COMMUNITIES, ENGAGE IN SOCIAL NETWORKING AND IMPROVE THEIR TALENT, IN CLASS 42 (U.S. CLS. 100 AND 101).

FIRST USE 8-30-2007; IN COMMERCE 8-30-2007.

THE MARK CONSISTS OF STANDARD CHARACTERS WITHOUT CLAIM TO ANY PARTICULAR FONT, STYLE, SIZE, OR COLOR.

SN 77-235,071, FILED 7-20-2007.

FLORENTINA BLANDU, EXAMINING ATTORNEY

**Int. Cl.: 42**

**Prior U.S. Cls.: 100 and 101**

**United States Patent and Trademark Office**

**Reg. No. 3,455,080**

**Registered June 24, 2008**

**SERVICE MARK  
PRINCIPAL REGISTER**

DOES YOUR PHONE HAVE ESP?

MYRAPIDMD CORP. (NEVADA CORPORATION)  
13428 MAXELLA AVENUE, #635  
MARINA DEL REY, CA 90292

FOR: MEDICAL DATA SERVICES, NAMELY,  
CREATING DATABASES OF PERSONAL MEDICAL  
DATA AND CONVERSION OF SAID DATA SO  
THAT IT CAN BE STORED AND RETRIEVED VIA  
HANDHELD PERSONAL ELECTRONIC DEVICES,  
IN CLASS 42 (U.S. CLS. 100 AND 101).

FIRST USE 9-1-2007; IN COMMERCE 9-1-2007.

THE MARK CONSISTS OF STANDARD CHAR-  
ACTERS WITHOUT CLAIM TO ANY PARTICULAR  
FONT, STYLE, SIZE, OR COLOR.

SN 77-235,718, FILED 7-23-2007.

AMY GEARIN, EXAMINING ATTORNEY

**Int. Cl.: 19**

**Prior U.S. Cls.: 1, 12, 33, and 50**

**Reg. No. 3,455,081**

**United States Patent and Trademark Office**

**Registered June 24, 2008**

---

**TRADEMARK  
PRINCIPAL REGISTER**

**MAXBRIC**

LEE MASONRY PRODUCTS, INC. (KENTUCKY  
CORPORATION)  
4301 INDUSTRIAL DRIVE  
BOWLING GREEN, KY 42101

THE MARK CONSISTS OF STANDARD CHAR-  
ACTERS WITHOUT CLAIM TO ANY PARTICULAR  
FONT, STYLE, SIZE, OR COLOR.

FOR: CONCRETE BUILDING MATERIALS,  
NAMELY, CONCRETE BLOCKS RESEMBLING  
BRICK, IN CLASS 19 (U.S. CLS. 1, 12, 33 AND 50).

SN 77-235,781, FILED 7-23-2007.

FIRST USE 10-24-2007; IN COMMERCE 10-24-2007.

JULIE GUTTADAURO, EXAMINING ATTORNEY

**Int. Cl.: 43**

**Prior U.S. Cls.: 100 and 101**

**United States Patent and Trademark Office**

**Reg. No. 3,455,082**

**Registered June 24, 2008**

---

**SERVICE MARK  
PRINCIPAL REGISTER**

**NICE RICE**

ASIA GO, INC. (OREGON CORPORATION)  
6755 SW SEAN MICHAEL PLACE  
PORTLAND, OR 97225

THE MARK CONSISTS OF STANDARD CHAR-  
ACTERS WITHOUT CLAIM TO ANY PARTICULAR  
FONT, STYLE, SIZE, OR COLOR.

FOR: FAST-FOOD RESTAURANTS, IN CLASS 43  
(U.S. CLS. 100 AND 101).

SN 77-236,053, FILED 7-23-2007.

FIRST USE 3-3-2008; IN COMMERCE 3-3-2008.

MYRIAH HABEEB, EXAMINING ATTORNEY

**Int. Cl.: 8**

**Prior U.S. Cls.: 23, 28, and 44**

**Reg. No. 3,455,083**

**United States Patent and Trademark Office**

**Registered June 24, 2008**

---

**TRADEMARK  
PRINCIPAL REGISTER**

**COWBOY UP**

TAYLOR BRANDS, LLC (TENNESSEE LTD LIAB  
CO)  
1043 FORDTOWN ROAD  
KINGSPORT, TN 37663

THE MARK CONSISTS OF STANDARD CHAR-  
ACTERS WITHOUT CLAIM TO ANY PARTICULAR  
FONT, STYLE, SIZE, OR COLOR.

FOR: KNIVES, IN CLASS 8 (U.S. CLS. 23, 28 AND  
44).

SN 77-236,283, FILED 7-23-2007.

FIRST USE 4-1-2008; IN COMMERCE 4-1-2008.

ALLISON SCHRODY, EXAMINING ATTORNEY

**Int. Cl.: 8**

**Prior U.S. Cls.: 23, 28, and 44**

**United States Patent and Trademark Office**

**Reg. No. 3,455,084**

**Registered June 24, 2008**

**TRADEMARK  
PRINCIPAL REGISTER**

**COWGIRL UP**

TAYLOR BRANDS, LLC (TENNESSEE LTD LIAB  
CO)  
1043 FORDTOWN ROAD  
KINGSPORT, TN 37663

THE MARK CONSISTS OF STANDARD CHAR-  
ACTERS WITHOUT CLAIM TO ANY PARTICULAR  
FONT, STYLE, SIZE, OR COLOR.

FOR: KNIVES, IN CLASS 8 (U.S. CLS. 23, 28 AND  
44).

SN 77-236,295, FILED 7-23-2007.

FIRST USE 4-1-2008; IN COMMERCE 4-1-2008.

ALLISON SCHRODY, EXAMINING ATTORNEY

**Int. Cl.: 33**

**Prior U.S. Cls.: 47 and 49**

**United States Patent and Trademark Office**

**Reg. No. 3,455,085**

**Registered June 24, 2008**

**TRADEMARK  
PRINCIPAL REGISTER**

**Greylock Gin**

BERKSHIRE MOUNTAIN DISTILLERS INC.  
(MASSACHUSETTS CORPORATION)  
640 HOME ROAD  
GREAT BARRINGTON, MA 01236

NO CLAIM IS MADE TO THE EXCLUSIVE  
RIGHT TO USE "GIN", APART FROM THE MARK  
AS SHOWN.

FOR: GIN, IN CLASS 33 (U.S. CLS. 47 AND 49).

FIRST USE 5-1-2008; IN COMMERCE 5-1-2008.

SN 77-236,502, FILED 7-23-2007.

THE MARK CONSISTS OF STANDARD CHAR-  
ACTERS WITHOUT CLAIM TO ANY PARTICULAR  
FONT, STYLE, SIZE, OR COLOR.

SHANNON TWOHIG, EXAMINING ATTORNEY

**Int. Cl.: 35**

**Prior U.S. Cls.: 100, 101, and 102**

**United States Patent and Trademark Office**

**Reg. No. 3,455,086**

**Registered June 24, 2008**

**SERVICE MARK  
PRINCIPAL REGISTER**

**WHAT ON EARTH YOU CAN DO**

ACCENT ENERGY GROUP LLC (DELAWARE  
LTD LIAB CO)  
6065 MEMORIAL DRIVE  
DUBLIN, OH 43017

THE MARK CONSISTS OF STANDARD CHAR-  
ACTERS WITHOUT CLAIM TO ANY PARTICULAR  
FONT, STYLE, SIZE, OR COLOR.

FOR: PROCUREMENT, NAMELY, PURCHASING  
RENEWABLE ENERGY CREDITS FOR OTHERS, IN  
CLASS 35 (U.S. CLS. 100, 101 AND 102).

SN 77-236,810, FILED 7-24-2007.

FIRST USE 8-28-2007; IN COMMERCE 8-28-2007.

ANDREA K. NADELMAN, EXAMINING ATTOR-  
NEY



**Int. Cl.: 29**

**Prior U.S. Cl.: 46**

**United States Patent and Trademark Office**

**Reg. No. 3,455,087**

**Registered June 24, 2008**

**TRADEMARK  
PRINCIPAL REGISTER**

**SPLENDID SPREADS**

SPLENDID SPREADS, LLC (MINNESOTA LTD  
LIAB CO)

1483 AUBURN COURT

EAGAN, MN 55122

FOR: SALMON ANTIPASTO, IN CLASS 29 (U.S.  
CL. 46).

FIRST USE 11-14-2007; IN COMMERCE 11-14-2007.

THE MARK CONSISTS OF STANDARD CHAR-  
ACTERS WITHOUT CLAIM TO ANY PARTICULAR  
FONT, STYLE, SIZE, OR COLOR.

NO CLAIM IS MADE TO THE EXCLUSIVE  
RIGHT TO USE "SPREADS", APART FROM THE  
MARK AS SHOWN.

SN 77-236,899, FILED 7-24-2007.

MICHELE SWAIN, EXAMINING ATTORNEY

**Int. Cl.: 38**

**Prior U.S. Cls.: 100, 101, and 104**

**United States Patent and Trademark Office**

**Reg. No. 3,455,088**

**Registered June 24, 2008**

**SERVICE MARK  
PRINCIPAL REGISTER**

**FREEDOM TO COMMUNICATE**

INTER-TEL (DELAWARE) INCORPORATED  
(DELAWARE CORPORATION), DBA FKA, IN-  
TER-TEL, INC.,  
7300 W. BOSTON STREET  
1615 S. 52ND STREET  
TEMPE, AZ 85281

FOR: TELECOMMUNICATION SERVICES,  
NAMELY, LOCAL AND LONG DISTANCE TRANS-  
MISSION OF VOICE, DATA, GRAPHICS BY MEANS  
OF TELEPHONE, TELEGRAPHIC, WIRED AND  
WIRELESS TRANSMISSIONS, IN CLASS 38 (U.S.  
CLS. 100, 101 AND 104).

FIRST USE 9-15-2007; IN COMMERCE 9-15-2007.

THE MARK CONSISTS OF STANDARD CHAR-  
ACTERS WITHOUT CLAIM TO ANY PARTICULAR  
FONT, STYLE, SIZE, OR COLOR.

SN 77-237,758, FILED 7-24-2007.

KAPIL BHANOT, EXAMINING ATTORNEY

**Int. Cl.: 41**

**Prior U.S. Cls.: 100, 101, and 107**

**United States Patent and Trademark Office**

**Reg. No. 3,455,089**

**Registered June 24, 2008**

**SERVICE MARK  
PRINCIPAL REGISTER**

**GOOD DAY CHICAGO**

FOX TELEVISION STATIONS, INC. (DELAWARE  
CORPORATION)  
10201 WEST PICO BOULEVARD  
LOS ANGELES, CA 90035

FOR: ENTERTAINMENT SERVICES IN THE  
NATURE OF A CONTINUING NEWS AND TALK  
TELEVISION PROGRAM; ENTERTAINMENT SER-  
VICES IN THE NATURE OF PROVIDING ON-LINE  
INFORMATION IN THE FIELD OF NEWS AND  
ENTERTAINMENT VIA THE INTERNET, IN CLASS  
41 (U.S. CLS. 100, 101 AND 107).

FIRST USE 9-1-2007; IN COMMERCE 9-1-2007.

THE MARK CONSISTS OF STANDARD CHAR-  
ACTERS WITHOUT CLAIM TO ANY PARTICULAR  
FONT, STYLE, SIZE, OR COLOR.

OWNER OF U.S. REG. NO. 2,686,769.

NO CLAIM IS MADE TO THE EXCLUSIVE  
RIGHT TO USE "CHICAGO", APART FROM THE  
MARK AS SHOWN.

SN 77-238,234, FILED 7-25-2007.

MICHAEL SOUDERS, EXAMINING ATTORNEY

**Int. Cl.: 25**

**Prior U.S. Cls.: 22 and 39**

**United States Patent and Trademark Office**

**Reg. No. 3,455,090**

**Registered June 24, 2008**

**TRADEMARK  
PRINCIPAL REGISTER**

**CAPTIVE EDITION**

LEVY INVESTMENT GROUP, INC. (FLORIDA  
CORPORATION)  
10833 NW 3RD COURT  
PEMBROKE PINES, FL 33026

THE MARK CONSISTS OF STANDARD CHAR-  
ACTERS WITHOUT CLAIM TO ANY PARTICULAR  
FONT, STYLE, SIZE, OR COLOR.

FOR: CLOTHING, NAMELY, T-SHIRTS, TANK  
TOPS, SWEATSHIRTS, IN CLASS 25 (U.S. CLS. 22  
AND 39).

SN 77-238,303, FILED 7-25-2007.

FIRST USE 11-7-2007; IN COMMERCE 5-1-2008.

KAREN SEVERSON, EXAMINING ATTORNEY

**Int. Cl.: 35**

**Prior U.S. Cls.: 100, 101, and 102**

**United States Patent and Trademark Office**

**Reg. No. 3,455,091**

**Registered June 24, 2008**

---

**SERVICE MARK  
PRINCIPAL REGISTER**

**AUDACITY**

FRAIKIN, GAETAN (BELGIUM INDIVIDUAL)  
11440 WEST BERNARDO COURT, SUITE 300  
SAN DIEGO, CA 92127

THE MARK CONSISTS OF STANDARD CHAR-  
ACTERS WITHOUT CLAIM TO ANY PARTICULAR  
FONT, STYLE, SIZE, OR COLOR.

FOR: BUSINESS AND MARKETING CONSULTA-  
TION, IN CLASS 35 (U.S. CLS. 100, 101 AND 102).

SN 77-238,319, FILED 7-25-2007.

FIRST USE 9-1-2007; IN COMMERCE 9-1-2007.

FLORENTINA BLANDU, EXAMINING ATTORNEY

**Int. Cl.: 41**

**Prior U.S. Cls.: 100, 101, and 107**

**United States Patent and Trademark Office**

**Reg. No. 3,455,092**

**Registered June 24, 2008**

**SERVICE MARK  
PRINCIPAL REGISTER**

**ADVANCE YOUR LIFE IN ABOUT  
A YEAR**

KIMC INVESTMENTS, INC. (DELAWARE CORPORATION)  
1401 FORUM WAY  
6TH FLOOR  
WEST PALM BEACH, FL 33401

FOR: EDUCATIONAL SERVICES, NAMELY, PROVIDING COURSES OF INSTRUCTION IN THE FIELDS OF NURSING PRACTICES, MEDICAL LABORATORY TECHNOLOGY, MEDICAL RECORDS MANAGEMENT AND MEDICAL OFFICE ADMINISTRATION; TRAINING SERVICES IN THE FIELD OF NURSING PRACTICES, MEDICAL LABORATORY TECHNOLOGY, MEDICAL RECORDS MAN-

AGEMENT AND MEDICAL OFFICE ADMINISTRATION, IN CLASS 41 (U.S. CLS. 100, 101 AND 107).

FIRST USE 4-18-2008; IN COMMERCE 4-18-2008.

THE MARK CONSISTS OF STANDARD CHARACTERS WITHOUT CLAIM TO ANY PARTICULAR FONT, STYLE, SIZE, OR COLOR.

SN 77-239,104, FILED 7-26-2007.

RONALD MCMORROW, EXAMINING ATTORNEY

**Int. Cl.: 9**

**Prior U.S. Cls.: 21, 23, 26, 36, and 38**

**Reg. No. 3,455,093**

**United States Patent and Trademark Office**

**Registered June 24, 2008**

**TRADEMARK  
PRINCIPAL REGISTER**

**INCLINEPRO**

INDUSTRIALIZED NATION LLC (UTAH LTD  
LIAB CO)  
1318 S 200 E  
SALT LAKE CITY, UT 84115

THE MARK CONSISTS OF STANDARD CHAR-  
ACTERS WITHOUT CLAIM TO ANY PARTICULAR  
FONT, STYLE, SIZE, OR COLOR.

FOR: COMPUTER STANDS DESIGNED FOR  
HOLDING A COMPUTER, IN CLASS 9 (U.S. CLS.  
21, 23, 26, 36 AND 38).

SN 77-239,779, FILED 7-26-2007.

FIRST USE 4-8-2008; IN COMMERCE 4-8-2008.

ROBIN CHOSID, EXAMINING ATTORNEY

**Int. Cl.: 17**

**Prior U.S. Cls.: 1, 5, 12, 13, 35, and 50**

**Reg. No. 3,455,094**

**United States Patent and Trademark Office**

**Registered June 24, 2008**

---

**TRADEMARK  
PRINCIPAL REGISTER**

**CORRITE**

I-CORE COMPOSITES, LLC (ALABAMA LTD  
LIAB CO)  
P.O. BOX 1675  
802 23RD STREET SW  
CULLMAN, AL 350561675

FIRST USE 11-29-2007; IN COMMERCE 11-29-2007.

THE MARK CONSISTS OF STANDARD CHAR-  
ACTERS WITHOUT CLAIM TO ANY PARTICULAR  
FONT, STYLE, SIZE, OR COLOR.

FOR: STRUCTURAL FOAM IN THE NATURE OF  
COMPOSITE MATERIALS IN THE FORM OF PRO-  
FILES, SHEETS, BLOCKS AND POWDER FOR USE  
IN MANUFACTURING , IN CLASS 17 (U.S. CLS. 1, 5,  
12, 13, 35 AND 50).

SN 77-239,957, FILED 7-26-2007.

BARNEY CHARLON, EXAMINING ATTORNEY



Int. Cl.: 35

Prior U.S. Cls.: 100, 101, and 102

United States Patent and Trademark Office

Reg. No. 3,455,095

Registered June 24, 2008

**SERVICE MARK  
PRINCIPAL REGISTER**



WORLD GOLD COUNCIL (SWITZERLAND ASSOCIATION)  
C/O PRICEWATERHOUSECOOPERS DEPT. FISCAL  
AVE GIUSEPPE-MOTTA 50, CASE POSTALE 2895  
GENEVA 2, SWITZERLAND CH-1211

FOR: ADVERTISING AND PROMOTING THE USE OF GOLD, IN CLASS 35 (U.S. CLS. 100, 101 AND 102).

FIRST USE 4-0-2007; IN COMMERCE 4-0-2007.

OWNER OF U.S. REG. NO. 2,639,750.

NO CLAIM IS MADE TO THE EXCLUSIVE RIGHT TO USE "GOLD", APART FROM THE MARK AS SHOWN.

THE COLOR(S) GOLD IS/ARE CLAIMED AS A FEATURE OF THE MARK.

THE MARK CONSISTS OF A REPRESENTATION OF A GOLD BAR UPON THE FACE OF WHICH ARE THE WORDS "ONLY GOLD", TOWARD THE TOP, AND THE WORD "GOLD" AND A CONCENTRIC CIRCLE DESIGN, TOWARD THE BOTTOM, ALL IN THE COLOR GOLD.

SN 77-240,060, FILED 7-26-2007.

LOURDES AYALA, EXAMINING ATTORNEY

**Int. Cl.: 33**

**Prior U.S. Cls.: 47 and 49**

**United States Patent and Trademark Office**

**Reg. No. 3,455,096**

**Registered June 24, 2008**

---

**TRADEMARK  
PRINCIPAL REGISTER**

**LINE 39**

CECCHETTI WINE COMPANY, INC. (CALIFORNIA CORPORATION)  
19696 7TH STREET EAST  
SONOMA, CA 95476

THE MARK CONSISTS OF STANDARD CHARACTERS WITHOUT CLAIM TO ANY PARTICULAR FONT, STYLE, SIZE, OR COLOR.

FOR: WINES, IN CLASS 33 (U.S. CLS. 47 AND 49).

SN 77-240,161, FILED 7-26-2007.

FIRST USE 1-0-2008; IN COMMERCE 1-0-2008.

NAAKWAMA ANKRAH, EXAMINING ATTORNEY

Int. Cl.: 16

Prior U.S. Cls.: 2, 5, 22, 23, 29, 37, 38, and 50

United States Patent and Trademark Office

Reg. No. 3,455,097

Registered June 24, 2008

TRADEMARK  
PRINCIPAL REGISTER



CAVACO, VANESSA (UNITED STATES INDIVIDUAL)  
53-15 FRANCIS LEWIS BLVD  
BAYSIDE, NY 11364

FOR: PRINTED INVITATIONS, IN CLASS 16 (U.S. CLS. 2, 5, 22, 23, 29, 37, 38 AND 50).

FIRST USE 12-1-2007; IN COMMERCE 12-1-2007.

THE COLOR(S) BLACK, WHITE AND HOT PINK IS/ARE CLAIMED AS A FEATURE OF THE MARK.

THE MARK CONSISTS OF A WHITE OVAL OUTLINED IN HOT PINK CONTAINING THE WORDING NASTEE NOTES FOR THE LIL' DEVIL INSIDE US IN BLACK. THE TWO EES CONTAIN A PUPIL DESIGN WITH TWO HOT PINK HORNS. UNDERNEATH THE WORDING IS A HOT PINK PITCH FORK. THE DESIGN IS OVER A BLACK RECTANGLE WITH WHITE POLKA DOTS.

SN 77-240,366, FILED 7-27-2007.

TARAH HARDY, EXAMINING ATTORNEY

**Int. Cl.: 41**

**Prior U.S. Cls.: 100, 101, and 107**

**United States Patent and Trademark Office**

**Reg. No. 3,455,098**

**Registered June 24, 2008**

---

**SERVICE MARK  
PRINCIPAL REGISTER**

**ORIGINAL SIGNAL**

MUSIC NATION, INC. (DELAWARE CORPORATION)  
455 BROADWAY, 4TH FLOOR  
NEW YORK, NY 10013

FOR: RECORD PRODUCTION; PRODUCTION  
OF SOUND AND MUSIC VIDEO RECORDINGS,  
IN CLASS 41 (U.S. CLS. 100, 101 AND 107).

FIRST USE 11-0-2007; IN COMMERCE 11-0-2007.

THE MARK CONSISTS OF STANDARD CHARACTERS WITHOUT CLAIM TO ANY PARTICULAR FONT, STYLE, SIZE, OR COLOR.

SN 77-240,573, FILED 7-27-2007.

KAPIL BHANOT, EXAMINING ATTORNEY

**Int. Cl.: 34**

**Prior U.S. Cls.: 2, 8, 9, and 17**

**United States Patent and Trademark Office**

**Reg. No. 3,455,099**

**Registered June 24, 2008**

**TRADEMARK  
PRINCIPAL REGISTER**



L.A. LIGHTER, INC. (CALIFORNIA CORPORATION)  
19805 EAST HARRISON AVE  
CITY OF INDUSTRY, CA 91789

FIRST USE 11-0-2007; IN COMMERCE 11-0-2007.

SN 77-240,674, FILED 7-27-2007.

FOR: CIGARETTE LIGHTERS NOT OF PRECIOUS METAL, IN CLASS 34 (U.S. CLS. 2, 8, 9 AND 17).

SHARON MEIER, EXAMINING ATTORNEY

**Int. Cl.: 35**

**Prior U.S. Cls.: 100, 101, and 102**

**United States Patent and Trademark Office**

**Reg. No. 3,455,100**

**Registered June 24, 2008**

**SERVICE MARK  
PRINCIPAL REGISTER**

**Radwelldirect.com**

RADWELL INTERATIONAL, INC. (PENNSYLVANIA CORPORATION), FORMERLY SPECK INDUSTRIAL CONTRÓLS, INC.,  
111 MOUNT HOLLY BY-PASS  
LUMBERTON, NJ 08048

FOR: ON-LINE ORDERING SERVICES FEATURING INDUSTRIAL AUTOMATION EQUIPMENT, IN CLASS 35 (U.S. CLS. 100, 101 AND 102).

FIRST USE 10-1-2007; IN COMMERCE 10-1-2007.

THE MARK CONSISTS OF STANDARD CHARACTERS WITHOUT CLAIM TO ANY PARTICULAR FONT, STYLE, SIZE, OR COLOR.

OWNER OF U.S. REG. NOS. 3,063,585 AND 3,192,391.

SN 77-240,965, FILED 7-27-2007.

TANYA AMOS, EXAMINING ATTORNEY

**Int. Cl.: 9**

**Prior U.S. Cls.: 21, 23, 26, 36, and 38**

**United States Patent and Trademark Office**

**Reg. No. 3,455,101**

**Registered June 24, 2008**

**TRADEMARK  
PRINCIPAL REGISTER**

**Bottom Line - Investment  
Property Analyzer**

NAVIGATOR HOLDINGS, LLC (ILLINOIS LTD  
LIAB CO)  
PO BOX 3132  
PEORIA, IL 616123132

FOR: COMPUTER SOFTWARE FOR REAL ES-  
TATE INVESTMENT ANALYSIS, IN CLASS 9 (U.S.  
CLS. 21, 23, 26, 36 AND 38).

FIRST USE 2-1-2008; IN COMMERCE 2-1-2008.

THE MARK CONSISTS OF STANDARD CHAR-  
ACTERS WITHOUT CLAIM TO ANY PARTICULAR  
FONT, STYLE, SIZE, OR COLOR.

NO CLAIM IS MADE TO THE EXCLUSIVE  
RIGHT TO USE "INVESTMENT PROPERTY ANA-  
LYZER", APART FROM THE MARK AS SHOWN.

SN 77-241,302, FILED 7-27-2007.

STEVEN JACKSON, EXAMINING ATTORNEY

**Int. Cl.: 35**

**Prior U.S. Cls.: 100, 101, and 102**

**United States Patent and Trademark Office**

**Reg. No. 3,455,102**

**Registered June 24, 2008**

**SERVICE MARK  
PRINCIPAL REGISTER**



ROCK REVOLUTION, LLC (DELAWARE LTD  
LIAB CO)  
2123 CALIFORNIA ST., N.W., APT C3  
WASHINGTON, DC 20008

FOR: ADVERTISING AND COMMERCIAL INFORMATION SERVICES, VIA THE INTERNET; ADVERTISING VIA ELECTRONIC MEDIA AND SPECIFICALLY THE INTERNET; DISSEMINATION OF ADVERTISING FOR OTHERS VIA AN ON-LINE COMMUNICATIONS NETWORK ON THE INTERNET; DISSEMINATION OF ADVERTISING FOR OTHERS VIA THE INTERNET; PROVIDING A SEARCHABLE ONLINE ADVERTISING GUIDE FEATURING THE GOODS AND SERVICES OF OTHER ON-LINE VENDORS ON THE INTERNET; PROVIDING AND RENTAL OF ADVERTISING SPACE ON THE INTERNET; ADVERTISING SERVICES, FOR THIRD PARTIES, IN CONNECTION WITH THE COMMERCIALIZATION AND SALE OF

PERFUMERY AND COSMETIC ARTICLES, PRODUCTS FOR HOUSEHOLD PURPOSES, OPTICAL PRODUCTS, CLOCKS AND TIMEPIECES, JEWELRY, FURNISHING ARTICLES, IN CLASS 35 (U.S. CLS. 100, 101 AND 102).

FIRST USE 2-29-2008; IN COMMERCE 2-29-2008.

THE COLOR(S) BLUE AND WHITE IS/ARE CLAIMED AS A FEATURE OF THE MARK.

THE MARK CONSISTS OF A BLUE RECTANGLE WITH WHITE AND BLUE BORDERS AND WITH WHITE LETTERS "J" AND "S" IN THE CENTER.

SN 77-241,486, FILED 7-29-2007.

NAAKWAMA ANKRAH, EXAMINING ATTORNEY



**Int. Cl.: 3**

**Prior U.S. Cls.: 1, 4, 6, 50, 51, and 52**

**Reg. No. 3,455,103**

**United States Patent and Trademark Office**

**Registered June 24, 2008**

---

**TRADEMARK  
PRINCIPAL REGISTER**

**DREFT**

THE PROCTER & GAMBLE COMPANY (OHIO  
CORPORATION)  
ONE PROCTER & GAMBLE PLAZA  
CINCINNATI, OH 45202

FOR: DISPOSABLE WIPES IMPREGNATED  
WITH CLEANSING COMPOUNDS FOR HOUSE-  
HOLD USE; ALL-PURPOSE CLEANING SPRAY;  
SCENTED FABRIC REFRESHER AND ODOR ELIM-  
INATOR SPRAY , IN CLASS 3 (U.S. CLS. 1, 4, 6, 50, 51  
AND 52).

FIRST USE 11-30-2007; IN COMMERCE 11-30-2007.

THE MARK CONSISTS OF STANDARD CHAR-  
ACTERS WITHOUT CLAIM TO ANY PARTICULAR  
FONT, STYLE, SIZE, OR COLOR.

SN 77-242,087, FILED 7-30-2007.

BRIAN NEVILLE, EXAMINING ATTORNEY

**Int. Cl.: 3**

**Prior U.S. Cls.: 1, 4, 6, 50, 51, and 52**

**Reg. No. 3,455,104**

**United States Patent and Trademark Office**

**Registered June 24, 2008**

---

**TRADEMARK  
PRINCIPAL REGISTER**

**EXTREMACEUTICALS**

GLC INTERNATIONAL CORPORATION (CALI-  
FORNIA CORPORATION)  
17870 SKYPARK CIRCLE  
SUITE 105  
IRVINE, CA 92614

THE MARK CONSISTS OF STANDARD CHAR-  
ACTERS WITHOUT CLAIM TO ANY PARTICULAR  
FONT, STYLE, SIZE, OR COLOR.

FOR: SKIN CARE PRODUCTS, NAMELY, SKIN  
CARE LOTIONS AND SKIN CARE CREAMS, IN  
CLASS 3 (U.S. CLS. 1, 4, 6, 50, 51 AND 52).

SN 77-242,485, FILED 7-30-2007.

FIRST USE 11-30-2007; IN COMMERCE 11-30-2007.

DARRYL SPRUILL, EXAMINING ATTORNEY

**Int. Cl.: 16**

**Prior U.S. Cls.: 2, 5, 22, 23, 29, 37, 38, and 50**

**Reg. No. 3,455,105**

**United States Patent and Trademark Office**

**Registered June 24, 2008**

---

**TRADEMARK  
PRINCIPAL REGISTER**

**NEW DESIGNS FOR GROWTH**

TRAVERSE CITY AREA CHAMBER OF COM-  
MERCE, INC. (MICHIGAN NON-PROFIT  
CORPORATION)  
202 E. GRANDVIEW PARKWAY  
TRAVERSE CITY, MI 496850707

FOR: PRINTED MATERIALS, NAMELY, PROMO-  
TIONAL MATERIALS AND GUIDEBOOKS FOR  
DEVELOPERS IN THE FIELD OF LAND USE DE-  
VELOPMENT, IN CLASS 16 (U.S. CLS. 2, 5, 22, 23, 29,  
37, 38 AND 50).

FIRST USE 12-31-2006; IN COMMERCE 12-31-2006.

THE MARK CONSISTS OF STANDARD CHAR-  
ACTERS WITHOUT CLAIM TO ANY PARTICULAR  
FONT, STYLE, SIZE, OR COLOR.

SN 77-242,840, FILED 7-31-2007.

TOBY BULLOFF, EXAMINING ATTORNEY

**Int. Cl.: 31**

**Prior U.S. Cls.: 1 and 46**

**United States Patent and Trademark Office**

**Reg. No. 3,455,106**

**Registered June 24, 2008**

**TRADEMARK  
PRINCIPAL REGISTER**

**POOLNATURALLY**

CREATIVE WATER SOLUTIONS, LLC (MINNE-  
SOTA LTD LIAB CO)  
1864 BERKSHIRE LANE NORTH  
PLYMOUTH, MN 55441

FOR: WATER TREATMENT PRODUCTS, NAME-  
LY, SPHAGNUM MOSS WHICH NATURALLY  
CONDITIONS WATER FOR USE IN POOLS, HOT  
TUBS AND SPAS, IN CLASS 31 (U.S. CLS. 1 AND 46).

FIRST USE 11-27-2007; IN COMMERCE 11-27-2007.

THE MARK CONSISTS OF STANDARD CHAR-  
ACTERS WITHOUT CLAIM TO ANY PARTICULAR  
FONT, STYLE, SIZE, OR COLOR.

OWNER OF U.S. REG. NO. 3,149,507.

SN 77-243,156, FILED 7-31-2007.

RONALD MCMORROW, EXAMINING ATTORNEY

**Int. Cl.: 5**

**Prior U.S. Cls.: 6, 18, 44, 46, 51, and 52**

**Reg. No. 3,455,107**

**United States Patent and Trademark Office**

**Registered June 24, 2008**

---

**TRADEMARK  
PRINCIPAL REGISTER**

**NUTRISCRIP**

NATURAL APPROACH USA, INC. (NEW YORK  
CORPORATION)  
13-17 ELIZABETH STREET  
STE 301, NY 10013

THE MARK CONSISTS OF STANDARD CHAR-  
ACTERS WITHOUT CLAIM TO ANY PARTICULAR  
FONT, STYLE, SIZE, OR COLOR.

FOR: DIETARY AND NUTRITIONAL SUPPLE-  
MENTS, IN CLASS 5 (U.S. CLS. 6, 18, 44, 46, 51 AND  
52).

SN 77-244,158, FILED 8-1-2007.

FIRST USE 9-17-2007; IN COMMERCE 10-15-2007.

LOURDES AYALA, EXAMINING ATTORNEY

**Int. Cl.: 36**

**Prior U.S. Cls.: 100, 101, and 102**

**United States Patent and Trademark Office**

**Reg. No. 3,455,108**

**Registered June 24, 2008**

**SERVICE MARK  
PRINCIPAL REGISTER**

**HELMSTAR GROUP**

THE LODESTAR GROUP (IDAHO LTD LIAB CO)  
720 PARK BLVD.  
SUITE 265  
BOISE, ID 83712

FOR: FINANCIAL SERVICES, NAMELY, INSURANCE SERVICES IN THE NATURE OF INSURANCE CONSULTATION AND PROVIDING INFORMATION IN INSURANCE MATTERS; WEALTH MANAGEMENT, NAMELY, FINANCIAL PLANNING; INVESTMENT MANAGEMENT, IN CLASS 36 (U.S. CLS. 100, 101 AND 102).

FIRST USE 9-1-2007; IN COMMERCE 9-1-2007.

THE MARK CONSISTS OF STANDARD CHARACTERS WITHOUT CLAIM TO ANY PARTICULAR FONT, STYLE, SIZE, OR COLOR.

NO CLAIM IS MADE TO THE EXCLUSIVE RIGHT TO USE "GROUP", APART FROM THE MARK AS SHOWN.

SN 77-244,361, FILED 8-1-2007.

MICHAEL TANNER, EXAMINING ATTORNEY

**Int. Cl.: 35**

**Prior U.S. Cls.: 100, 101, and 102**

**United States Patent and Trademark Office**

**Reg. No. 3,455,109**

**Registered June 24, 2008**

**SERVICE MARK  
PRINCIPAL REGISTER**



INDIANAPOLIS CONVENTION & VISITORS ASSOCIATION, INC. (INDIANA CORPORATION)  
ONE RCA DOME, SUITE 100  
INDIANAPOLIS, IN 46225

FOR: PROMOTION OF INDIVIDUAL AND GROUP TRAVEL TO THE CENTRAL INDIANA COMMUNITY, IN CLASS 35 (U.S. CLS. 100, 101 AND 102).

THE MARK CONSISTS OF A FANCIFUL FACE WITH RIGHT-CORNER OF SMILE ADJOINED TO RIGHT EYE AND WITH LIGHTER EYES AND SMILE FEATURES ON A COLORED BACKGROUND .

SN 77-244,570, FILED 8-1-2007.

FIRST USE 12-6-2007; IN COMMERCE 3-6-2008.

JAMES A. RAUEN, EXAMINING ATTORNEY

**Int. Cl.: 33**

**Prior U.S. Cls.: 47 and 49**

**United States Patent and Trademark Office**

**Reg. No. 3,455,110**

**Registered June 24, 2008**

**TRADEMARK  
PRINCIPAL REGISTER**

**ERIC GUERRA**

FREERUN PARTNERS, LLC (CALIFORNIA LTD  
LIAB CO)  
282 CAYETANO DRIVE  
WINDSOR, CA 95492

THE NAME "ERIC GUERRA" IDENTIFIES A  
LIVING INDIVIDUAL WHOSE CONSENT IS OF  
RECORD.

FOR: WINES, IN CLASS 33 (U.S. CLS. 47 AND 49).

FIRST USE 12-6-2007; IN COMMERCE 12-6-2007.

SN 77-244,862, FILED 8-1-2007.

THE MARK CONSISTS OF STANDARD CHAR-  
ACTERS WITHOUT CLAIM TO ANY PARTICULAR  
FONT, STYLE, SIZE, OR COLOR.

THEODORE MCBRIDE, EXAMINING ATTORNEY



**Int. Cl.: 32**

**Prior U.S. Cls.: 45, 46, and 48**

**United States Patent and Trademark Office**

**Reg. No. 3,455,111**

**Registered June 24, 2008**

**TRADEMARK  
PRINCIPAL REGISTER**

**COMOTION**

THE MONARCH BEVERAGE COMPANY, INC.  
(DELAWARE CORPORATION)  
SUITE 10  
1123 ZONOLITE ROAD NE  
ATLANTA, GA 30306

THE MARK CONSISTS OF STANDARD CHAR-  
ACTERS WITHOUT CLAIM TO ANY PARTICULAR  
FONT, STYLE, SIZE, OR COLOR.

FOR: SOFT DRINKS, IN CLASS 32 (U.S. CLS. 45, 46  
AND 48).

SN 77-245,072, FILED 8-2-2007.

FIRST USE 3-17-2008; IN COMMERCE 3-17-2008.

DANIEL BRODY, EXAMINING ATTORNEY

**Int. Cl.: 25**

**Prior U.S. Cls.: 22 and 39**

**United States Patent and Trademark Office**

**Reg. No. 3,455,112**

**Registered June 24, 2008**

**TRADEMARK  
PRINCIPAL REGISTER**

**LUCKY MONEY**

HANSON HOLDINGS, INC. (NEW YORK CORPORATION)  
113-110 CENTRAL PARK ROAD  
P.O. BOX 163  
PLAINVIEW, NY 11803

FOR: ATHLETIC FOOTWEAR; BEACH FOOTWEAR; FLIP FLOPS; FOOTWEAR; FOOTWEAR; FOOTWEAR FOR MEN; FOOTWEAR FOR MEN AND WOMEN; FOOTWEAR FOR TRACK AND FIELD ATHLETICS; FOOTWEAR FOR WOMEN; FOOTWEAR MADE OF WOOD; FOOTWEAR NOT FOR SPORTS; FOOTWEAR, NAMELY, PUMPS; FOOTWEAR, NAMELY, RUBBERS; JAPANESE

FOOTWEAR OF RICE STRAW (WARAJI); PUMPS; THONGS; TIPS FOR FOOTWEAR, IN CLASS 25 (U.S. CLS. 22 AND 39).

FIRST USE 2-22-2008; IN COMMERCE 2-22-2008.

THE MARK CONSISTS OF STANDARD CHARACTERS WITHOUT CLAIM TO ANY PARTICULAR FONT, STYLE, SIZE, OR COLOR.

SN 77-247,091, FILED 8-3-2007.

DORITT L. CARROLL, EXAMINING ATTORNEY

**Int. Cl.: 25**

**Prior U.S. Cls.: 22 and 39**

**United States Patent and Trademark Office**

**Reg. No. 3,455,113**

**Registered June 24, 2008**

**TRADEMARK  
PRINCIPAL REGISTER**

**LUCKY DICE**

HANSON HOLDINGS, INC. (NEW YORK CORPORATION)  
113-110 CENTRAL PARK ROAD  
P.O. BOX 163 PLAINVIEW  
PLAINVIEW, NY 11803

FOR: ATHLETIC FOOTWEAR; BEACH FOOTWEAR; FLIP FLOPS; FOOTWEAR; FOOTWEAR; FOOTWEAR FOR MEN; FOOTWEAR FOR MEN AND WOMEN; FOOTWEAR FOR TRACK AND FIELD ATHLETICS; FOOTWEAR FOR WOMEN; FOOTWEAR MADE OF WOOD; FOOTWEAR NOT FOR SPORTS; FOOTWEAR, NAMELY, PUMPS; FOOTWEAR, NAMELY, RUBBERS; JAPANESE FOOTWEAR OF RICE STRAW (WARAJI); JAPA-

NESE SPLIT-TOED WORK FOOTWEAR (JIKATABI); PUMPS; THONGS; TIPS FOR FOOTWEAR, IN CLASS 25 (U.S. CLS. 22 AND 39).

FIRST USE 2-20-2008; IN COMMERCE 2-20-2008.

THE MARK CONSISTS OF STANDARD CHARACTERS WITHOUT CLAIM TO ANY PARTICULAR FONT, STYLE, SIZE, OR COLOR.

SN 77-248,906, FILED 8-7-2007.

DORITT L. CARROLL, EXAMINING ATTORNEY

**Int. Cl.: 9**

**Prior U.S. Cls.: 21, 23, 26, 36, and 38**

**United States Patent and Trademark Office**

**Reg. No. 3,455,114**

**Registered June 24, 2008**

**TRADEMARK  
PRINCIPAL REGISTER**

**SONIC RIDERS ZERO GRAVITY**

KABUSHIKI KAISHA SEGA (JAPAN CORPORATION), DBA D/B/A SEGA CORPORATION,  
2-12, HANEDA 1-CHOME  
OHTA-KU, TOKYO, JAPAN

FOR: VIDEO GAME SOFTWARE, IN CLASS 9  
(U.S. CLS. 21, 23, 26, 36 AND 38).

FIRST USE 1-8-2008; IN COMMERCE 1-8-2008.

THE MARK CONSISTS OF STANDARD CHARACTERS WITHOUT CLAIM TO ANY PARTICULAR FONT, STYLE, SIZE, OR COLOR.

OWNER OF U.S. REG. NOS. 2,349,452, 3,009,472,  
AND OTHERS.

SN 77-249,143, FILED 8-7-2007.

JAMES GRIFFIN, EXAMINING ATTORNEY

**Int. Cl.: 36**

**Prior U.S. Cls.: 100, 101, and 102**

**United States Patent and Trademark Office**

**Reg. No. 3,455,115**

**Registered June 24, 2008**

**SERVICE MARK  
PRINCIPAL REGISTER**

# SUPPLY SHELF

BANK OF AMERICA CORPORATION (DELA-  
WARE CORPORATION)  
100 NORTH TRYON STREET  
CHARLOTTE, NC 28255

FOR: BANKING AND RELATED FINANCIAL  
SERVICES, NAMELY, A DEBIT CARD FOR USE  
IN PURCHASING CLASSROOM SUPPLIES, IN  
CLASS 36 (U.S. CLS. 100, 101 AND 102).

FIRST USE 8-3-2007; IN COMMERCE 8-3-2007.

THE MARK CONSISTS OF STANDARD CHAR-  
ACTERS WITHOUT CLAIM TO ANY PARTICULAR  
FONT, STYLE, SIZE, OR COLOR.

SN 77-249,846, FILED 8-8-2007.

B. PARADEWELAI, EXAMINING ATTORNEY

**Int. Cl.: 45**

**Prior U.S. Cls.: 100 and 101**

**United States Patent and Trademark Office**

**Reg. No. 3,455,116**

**Registered June 24, 2008**

**SERVICE MARK  
PRINCIPAL REGISTER**

**KICKSTART**

YAHOO! INC. (DELAWARE CORPORATION)  
701 FIRST AVE.  
SUNNYVALE, CA 94089

THE MARK CONSISTS OF STANDARD CHAR-  
ACTERS WITHOUT CLAIM TO ANY PARTICULAR  
FONT, STYLE, SIZE, OR COLOR.

FOR: ONLINE SOCIAL NETWORKING SERVI-  
CES, IN CLASS 45 (U.S. CLS. 100 AND 101).

SN 77-250,785, FILED 8-9-2007.

FIRST USE 11-4-2007; IN COMMERCE 11-4-2007.

ROBIN CHOSID, EXAMINING ATTORNEY

**Int. Cl.: 7**

**Prior U.S. Cls.: 13, 19, 21, 23, 31, 34, and 35**

**Reg. No. 3,455,117**

**United States Patent and Trademark Office**

**Registered June 24, 2008**

**TRADEMARK  
PRINCIPAL REGISTER**

**EZ START PROMISE**

MTD PRODUCTS INC (DELAWARE CORPORATION)  
5903 GRAFTON ROAD  
VALLEY CITY, OH 44280

THE MARK CONSISTS OF STANDARD CHARACTERS WITHOUT CLAIM TO ANY PARTICULAR FONT, STYLE, SIZE, OR COLOR.

FOR: LAWN MOWERS AND LAWN MOWER ENGINES, IN CLASS 7 (U.S. CLS. 13, 19, 21, 23, 31, 34 AND 35).

SN 77-250,895, FILED 8-9-2007.

FIRST USE 5-0-2000; IN COMMERCE 5-0-2000.

MARK SPARACINO, EXAMINING ATTORNEY

Int. Cl.: 43

Prior U.S. Cls.: 100 and 101

United States Patent and Trademark Office

Reg. No. 3,455,118

Registered June 24, 2008

SERVICE MARK  
PRINCIPAL REGISTER



GENNARO, JOHN (UNITED STATES INDIVIDUAL)  
109 LEFFERTS LANE  
CLARK, NJ 07066

FOR: CARRY-OUT RESTAURANTS; RESTAURANT AND BAR SERVICES, IN CLASS 43 (U.S. CLS. 100 AND 101).

FIRST USE 2-1-2008; IN COMMERCE 2-1-2008.

NO CLAIM IS MADE TO THE EXCLUSIVE RIGHT TO USE "CHICKEN", APART FROM THE MARK AS SHOWN.

THE MARK CONSISTS OF A DANCING CHICKEN COUPLE AND THE WORDS "ZAMBA CHICKEN".

THE ENGLISH TRANSLATION OF THE WORD "ZAMBA" IN THE MARK IS "MUSIC".

SN 77-251,157, FILED 8-9-2007.

NICHOLAS ALTREE, EXAMINING ATTORNEY



**Int. Cl.: 5**

**Prior U.S. Cls.: 6, 18, 44, 46, 51, and 52**

**Reg. No. 3,455,119**

**United States Patent and Trademark Office**

**Registered June 24, 2008**

---

**TRADEMARK  
PRINCIPAL REGISTER**

**MANTRA**

NUFARM AMERICAS INC. (ILLINOIS CORPORATION)  
SUITE 200  
150 HARVESTER DRIVE  
BURR RIDGE, IL 60527

THE MARK CONSISTS OF STANDARD CHARACTERS WITHOUT CLAIM TO ANY PARTICULAR FONT, STYLE, SIZE, OR COLOR.

FOR: PESTICIDES; INSECTICIDES; FUNGICIDES, IN CLASS 5 (U.S. CLS. 6, 18, 44, 46, 51 AND 52).

SN 77-251,176, FILED 8-9-2007.

FIRST USE 10-12-2007; IN COMMERCE 10-12-2007.

EDWARD NELSON, EXAMINING ATTORNEY

**Int. Cl.: 28**

**Prior U.S. Cls.: 22, 23, 38, and 50**

**United States Patent and Trademark Office**

**Reg. No. 3,455,120**

**Registered June 24, 2008**

**TRADEMARK  
PRINCIPAL REGISTER**



WRANGLER APPAREL CORP. (DELAWARE CORPORATION)  
3411 SILVERSIDE RD.  
WILMINGTON, DE 19810

OWNER OF U.S. REG. NO. 3,023,373.

FOR: TOY RODEO SIGNS SOLD AS AN INTEGRAL COMPONENT OF TOY RODEO SETS, IN CLASS 28 (U.S. CLS. 22, 23, 38 AND 50).

THE MARK CONSISTS OF THE NUMBER "20" ABOVE THE LETTER "X", STYLIZED.

SN 77-253,665, FILED 8-13-2007.

FIRST USE 6-9-2006; IN COMMERCE 6-9-2006.

RONALD MCMORROW, EXAMINING ATTORNEY

**Int. Cl.: 20**

**Prior U.S. Cls.: 2, 13, 22, 25, 32, and 50**

**Reg. No. 3,455,121**

**United States Patent and Trademark Office**

**Registered June 24, 2008**

---

**TRADEMARK  
PRINCIPAL REGISTER**

**HIS & HERS TWO PACK**

AMERICAN TEXTILE COMPANY (PENNSYLVANIA CORPORATION)

10 NORTH LINDEN STREET, RIDC RIVERPLACE  
DUQUESNE, PA 15110

FOR: PILLOWS, IN CLASS 20 (U.S. CLS. 2, 13, 22, 25, 32 AND 50).

FIRST USE 8-1-2007; IN COMMERCE 8-1-2007.

THE MARK CONSISTS OF STANDARD CHARACTERS WITHOUT CLAIM TO ANY PARTICULAR FONT, STYLE, SIZE, OR COLOR.

NO CLAIM IS MADE TO THE EXCLUSIVE RIGHT TO USE "TWO PACK", APART FROM THE MARK AS SHOWN.

SN 77-254,488, FILED 8-14-2007.

TARAH HARDY, EXAMINING ATTORNEY

**Int. Cl.: 10**

**Prior U.S. Cls.: 26, 39, and 44**

**Reg. No. 3,455,122**

**United States Patent and Trademark Office**

**Registered June 24, 2008**

**TRADEMARK  
PRINCIPAL REGISTER**

**WEE GO**

MARCUS & JOY LLC (CALIFORNIA LTD LIAB  
CO)  
STUDIO 200  
480 GATE 5 ROAD  
SAUSALITO, CA 94965

FOR: BABY BOTTLES; BABY BOTTLE PARTS  
AND ACCESSORIES, NAMELY, SLEEVES, HOLD-  
ERS, CAPS, AND NIPPLES, IN CLASS 10 (U.S. CLS.  
26, 39 AND 44).

FIRST USE 8-1-2007; IN COMMERCE 8-1-2007.

THE MARK CONSISTS OF STANDARD CHAR-  
ACTERS WITHOUT CLAIM TO ANY PARTICULAR  
FONT, STYLE, SIZE, OR COLOR.

SN 77-255,057, FILED 8-14-2007.

JUDITH HELFMAN, EXAMINING ATTORNEY

**Int. Cl.: 30**

**Prior U.S. Cl.: 46**

**United States Patent and Trademark Office**

**Reg. No. 3,455,123**

**Registered June 24, 2008**

**TRADEMARK  
PRINCIPAL REGISTER**

**SCHWAN'S SNACK ROLLS**

SCHWAN'S IP, LLC (MINNESOTA LTD LIAB CO)  
115 W. COLLEGE DRIVE  
MARSHALL, MN 56258

FOR: HAND-HELD APPETIZERS, NAMELY, EN-ROBED DOUGH WITH A FILLING CONSISTING PRIMARILY OF MEAT, NAMELY, BEEF, PORK OR POULTRY, CHEESE AND SAUCE, IN CLASS 30 (U.S. CL. 46).

FIRST USE 4-21-2008; IN COMMERCE 4-21-2008.

THE MARK CONSISTS OF STANDARD CHARACTERS WITHOUT CLAIM TO ANY PARTICULAR FONT, STYLE, SIZE, OR COLOR.

OWNER OF U.S. REG. NOS. 1,270,916, 2,907,191, AND OTHERS.

NO CLAIM IS MADE TO THE EXCLUSIVE RIGHT TO USE "SNACK ROLLS", APART FROM THE MARK AS SHOWN.

SN 77-256,083, FILED 8-15-2007.

THEODORE MCBRIDE, EXAMINING ATTORNEY

**Int. Cl.: 3**

**Prior U.S. Cls.: 1, 4, 6, 50, 51, and 52**

**United States Patent and Trademark Office**

**Reg. No. 3,455,124**

**Registered June 24, 2008**

**TRADEMARK  
PRINCIPAL REGISTER**

**COLOR BY CYNDE WATSON**

SUMMIT MARKETING GROUP, INC. (FLORIDA CORPORATION)  
234 VALENCIA CIRCLE  
ST. PETERSBURG, FL 33716

FOR: COSMETICS; BODY AND BEAUTY CARE COSMETICS; NON-MEDICATED SKIN CARE PREPARATIONS, IN CLASS 3 (U.S. CLS. 1, 4, 6, 50, 51 AND 52).

FIRST USE 9-28-2007; IN COMMERCE 9-28-2007.

THE MARK CONSISTS OF STANDARD CHARACTERS WITHOUT CLAIM TO ANY PARTICULAR FONT, STYLE, SIZE, OR COLOR.

NO CLAIM IS MADE TO THE EXCLUSIVE RIGHT TO USE "COLOR", APART FROM THE MARK AS SHOWN.

THE NAME(S), PORTRAIT(S), AND/OR SIGNATURE(S) SHOWN IN THE MARK IDENTIFIES "CYNDE WATSON", WHOSE CONSENT(S) TO REGISTER IS SUBMITTED.

SN 77-256,615, FILED 8-16-2007.

KELLY BOULTON, EXAMINING ATTORNEY

**Int. Cl.: 3**

**Prior U.S. Cls.: 1, 4, 6, 50, 51, and 52**

**Reg. No. 3,455,125**

**United States Patent and Trademark Office**

**Registered June 24, 2008**

---

**TRADEMARK  
PRINCIPAL REGISTER**

**PLUMP POTION**

PHYSICIANS FORMULA, INC. (NEW YORK  
CORPORATION)  
1055 WEST 8TH STREET  
AZUSA, CA 91702

THE MARK CONSISTS OF STANDARD CHAR-  
ACTERS WITHOUT CLAIM TO ANY PARTICULAR  
FONT, STYLE, SIZE, OR COLOR.

FOR: COSMETICS, IN CLASS 3 (U.S. CLS. 1, 4, 6, 50,  
51 AND 52).

SN 77-256,846, FILED 8-16-2007.

FIRST USE 11-15-2007; IN COMMERCE 11-15-2007.

DAWN HAN, EXAMINING ATTORNEY

**Int. Cl.: 28**

**Prior U.S. Cls.: 22, 23, 38, and 50**

**United States Patent and Trademark Office**

**Reg. No. 3,455,126**

**Registered June 24, 2008**

**TRADEMARK  
PRINCIPAL REGISTER**

**20X**

WRANGLER APPAREL CORP. (DELAWARE  
CORPORATION)  
3411 SILVERSIDE RD.  
WILMINGTON, DE 19810

FOR: TOY RODEO SIGNS SOLD AS A COMPO-  
NENT OF TOY RODEO SETS, IN CLASS 28 (U.S. CLS.  
22, 23, 38 AND 50).

FIRST USE 6-9-2006; IN COMMERCE 6-9-2006.

THE MARK CONSISTS OF STANDARD CHAR-  
ACTERS WITHOUT CLAIM TO ANY PARTICULAR  
FONT, STYLE, SIZE, OR COLOR.

OWNER OF U.S. REG. NO. 3,023,373.

SN 77-257,113, FILED 8-16-2007.

RONALD MCMORROW, EXAMINING ATTORNEY



**Int. Cl.: 35**

**Prior U.S. Cls.: 100, 101, and 102**

**United States Patent and Trademark Office**

**Reg. No. 3,455,127**

**Registered June 24, 2008**

**SERVICE MARK  
PRINCIPAL REGISTER**

**CELEBRATING RELATIONSHIPS  
SINCE 1905**

TXDC, L.P. (TEXAS LIMITED PARTNERSHIP)  
901 W. WALNUT HILL LANE  
IRVING, TX 75038

THE MARK CONSISTS OF STANDARD CHAR-  
ACTERS WITHOUT CLAIM TO ANY PARTICULAR  
FONT, STYLE, SIZE, OR COLOR.

FOR: RETAIL JEWELRY STORE SERVICES, IN  
CLASS 35 (U.S. CLS. 100, 101 AND 102).

SN 77-259,064, FILED 8-20-2007.

FIRST USE 11-0-2007; IN COMMERCE 11-0-2007.

ALICIA COLLINS, EXAMINING ATTORNEY

**Int. Cl.: 31**

**Prior U.S. Cls.: 1 and 46**

**United States Patent and Trademark Office**

**Reg. No. 3,455,128**

**Registered June 24, 2008**

**TRADEMARK  
PRINCIPAL REGISTER**

# SweeTango

REGENTS OF THE UNIVERSITY OF MINNESOTA (MINNESOTA CORPORATION)  
600 MCNAMARA ALUMNI CENTER  
200 OAK ST. SE  
MINNEAPOLIS, MN 55455

THE MARK CONSISTS OF STANDARD CHARACTERS WITHOUT CLAIM TO ANY PARTICULAR FONT, STYLE, SIZE, OR COLOR.

FOR: FRESH APPLES, IN CLASS 31 (U.S. CLS. 1 AND 46).

SN 77-262,481, FILED 8-23-2007.

FIRST USE 11-5-2007; IN COMMERCE 11-5-2007.

ANNE E. GUSTASON, EXAMINING ATTORNEY

**Int. Cl.: 10**

**Prior U.S. Cls.: 26, 39, and 44**

**United States Patent and Trademark Office**

**Reg. No. 3,455,129**

**Registered June 24, 2008**

**TRADEMARK  
PRINCIPAL REGISTER**

**SUPRIS**

COLOPLAST A/S (DENMARK CORPORATION)  
HOLTEDAM 1, LEGAL DEPARTMENT  
HUMLEBAEK, DENMARK 3050

FOR: MEDICAL DEVICES, NAMELY, ARTIFICIAL SUBURETHRAL SLING AND INSERTION TOOL FOR THE SURGICAL TREATMENT OF URINARY INCONTINENCE, IN CLASS 10 (U.S. CLS. 26, 39 AND 44).

FIRST USE 11-30-2007; IN COMMERCE 11-30-2007.

THE MARK CONSISTS OF STANDARD CHARACTERS WITHOUT CLAIM TO ANY PARTICULAR FONT, STYLE, SIZE, OR COLOR.

OWNER OF U.S. REG. NO. 3,131,084.

SN 77-264,726, FILED 8-27-2007.

AMY HELLA, EXAMINING ATTORNEY

**Int. Cl.: 43**

**Prior U.S. Cls.: 100 and 101**

**United States Patent and Trademark Office**

**Reg. No. 3,455,130**

**Registered June 24, 2008**

**SERVICE MARK  
PRINCIPAL REGISTER**



HARRAH'S LICENSE COMPANY, LLC (NEVADA  
LTD LIAB CO)

ONE HARRAH'S COURT  
LAS VEGAS, NV 89119

FOR: RESTAURANT SERVICES, IN CLASS 43  
(U.S. CLS. 100 AND 101).

FIRST USE 12-21-2007; IN COMMERCE 12-21-2007.

NO CLAIM IS MADE TO THE EXCLUSIVE  
RIGHT TO USE "BUFFET EXPERIENCE", APART  
FROM THE MARK AS SHOWN.

THE MARK CONSISTS OF THE WORDS "EAT UP  
BUFFET EXPERIENCE" WITH A STAR DESIGN  
AND A FORK DESIGN.

SN 77-265,856, FILED 8-28-2007.

ANDREW RHIM, EXAMINING ATTORNEY

**Int. Cl.: 12**

**Prior U.S. Cls.: 19, 21, 23, 31, 35, and 44**

**Reg. No. 3,455,131**

**United States Patent and Trademark Office**

**Registered June 24, 2008**

---

**TRADEMARK  
PRINCIPAL REGISTER**

**ESSENCE**

THOR TECH, INC. (NEVADA CORPORATION)  
653 SOUTH SAGINAW STREET, SUITE 310  
SAGINAW, MI 48502

THE MARK CONSISTS OF STANDARD CHAR-  
ACTERS WITHOUT CLAIM TO ANY PARTICULAR  
FONT, STYLE, SIZE, OR COLOR.

FOR: RECREATIONAL VEHICLES, NAMELY,  
MOTOR HOMES, IN CLASS 12 (U.S. CLS. 19, 21, 23,  
31, 35 AND 44).

SN 77-268,083, FILED 8-30-2007.

FIRST USE 0-0-2007; IN COMMERCE 0-0-2007.

EVELYN BRADLEY, EXAMINING ATTORNEY

**Int. Cl.: 43**

**Prior U.S. Cls.: 100 and 101**

**United States Patent and Trademark Office**

**Reg. No. 3,455,132**

**Registered June 24, 2008**

**SERVICE MARK  
PRINCIPAL REGISTER**

# Moonstone

GERBER GROUP, LP (NEW YORK LIMITED  
PARTNERSHIP)  
12TH FLOOR  
145 E 57TH STREET  
NEW YORK, NY 10022

THE MARK CONSISTS OF STANDARD CHAR-  
ACTERS WITHOUT CLAIM TO ANY PARTICULAR  
FONT, STYLE, SIZE, OR COLOR.

FOR: RESTAURANT AND BAR SERVICES, IN  
CLASS 43 (U.S. CLS. 100 AND 101).

SN 77-269,066, FILED 8-31-2007.

FIRST USE 1-3-2008; IN COMMERCE 1-3-2008.

BRENDAN REGAN, EXAMINING ATTORNEY

**Int. Cl.: 9**

**Prior U.S. Cls.: 21, 23, 26, 36, and 38**

**United States Patent and Trademark Office**

**Reg. No. 3,455,133**

**Registered June 24, 2008**

**TRADEMARK  
PRINCIPAL REGISTER**



WRANGLER APPAREL CORP. (DELAWARE CORPORATION)  
3411 SILVERSIDE RD.  
WILMINGTON, DE 19810

FOR: EYEWEAR, NAMELY, EYEGASSES, SUNGLASSES, CLIP-ON SUNGLASSES, AND READING GLASSES, IN CLASS 9 (U.S. CLS. 21, 23, 26, 36 AND 38).

FIRST USE 3-16-2005; IN COMMERCE 3-16-2005.

OWNER OF U.S. REG. NOS. 2,542,950, 3,238,420, AND OTHERS.

NO CLAIM IS MADE TO THE EXCLUSIVE RIGHT TO USE "CO ESTABLISHED 1947", APART FROM THE MARK AS SHOWN.

THE MARK CONSISTS OF THE WORD "WRANGLER" INSIDE A SMALL RECTANGLE THAT APPEARS ABOVE THE WORDS "JEANS CO" THAT APPEARS ABOVE THE WORDS, "ESTABLISHED 1947", ALL OF WHICH ARE INSIDE A LARGE SOLID BLACK RECTANGLE.

SN 77-282,135, FILED 9-18-2007.

THEODORE MCBRIDE, EXAMINING ATTORNEY

**Int. Cl.: 34**

**Prior U.S. Cls.: 2, 8, 9, and 17**

**United States Patent and Trademark Office**

**Reg. No. 3,455,134**

**Registered June 24, 2008**

**TRADEMARK  
PRINCIPAL REGISTER**

**JFC**

TROPICAL TOBACCO, INC. (FLORIDA CORPORATION)  
3010 N.W. 79TH STREET  
MIAMI, FL 33122

FOR: CIGARS, IN CLASS 34 (U.S. CLS. 2, 8, 9 AND 17).

FIRST USE 11-26-2007; IN COMMERCE 11-16-2007.

THE MARK CONSISTS OF STANDARD CHARACTERS WITHOUT CLAIM TO ANY PARTICULAR FONT, STYLE, SIZE, OR COLOR.

THE WORDING "JFC" HAS NO MEANING IN A FOREIGN LANGUAGE.

SN 77-285,293, FILED 9-21-2007.

DANIEL CAPSHAW, EXAMINING ATTORNEY



**Int. Cl.: 30**

**Prior U.S. Cl.: 46**

**United States Patent and Trademark Office**

**Reg. No. 3,455,135**

**Registered June 24, 2008**

**TRADEMARK  
PRINCIPAL REGISTER**

**SIGNATURE COFFEE BY BOB  
EVANS**

BOB EVANS RESTAURANTS OF MICHIGAN,  
INC. (DELAWARE CORPORATION)  
2232 S. MAIN STREET  
PMB 415  
ANN ARBOR, MI 48103

FOR: COFFEE; COFFEE FOR CONSUMPTION  
ON OR OFF THE PREMISES; PREPARED COFFEE  
AND COFFEE-BASED BEVERAGES, IN CLASS 30  
(U.S. CL. 46).

FIRST USE 1-3-2008; IN COMMERCE 1-3-2008.

THE MARK CONSISTS OF STANDARD CHAR-  
ACTERS WITHOUT CLAIM TO ANY PARTICULAR  
FONT, STYLE, SIZE, OR COLOR.

OWNER OF U.S. REG. NOS. 846,356, 846,357, AND  
992,146.

NO CLAIM IS MADE TO THE EXCLUSIVE  
RIGHT TO USE "COFFEE", APART FROM THE  
MARK AS SHOWN.

THE NAME(S), PORTRAIT(S), AND/OR SIGNA-  
TURE(S) SHOWN IN THE MARK DOES NOT IDENTI-  
FY A PARTICULAR LIVING INDIVIDUAL.

SN 77-291,813, FILED 9-28-2007.

FLORENTINA BLANDU, EXAMINING ATTORNEY

**Int. Cl.: 1**

**Prior U.S. Cls.: 1, 5, 6, 10, 26, and 46**

**Reg. No. 3,455,136**

**United States Patent and Trademark Office**

**Registered June 24, 2008**

**TRADEMARK  
PRINCIPAL REGISTER**

**BARLEY CLEAR**

MARS FISHCARE NORTH AMERICA, INC.  
(PENNSYLVANIA CORPORATION)  
50 E. HAMILTON STREET  
P.O. BOX 218  
CHALFONT, PA 18914

FOR: CHEMICAL AND BACTERIAL PREPARATIONS FOR CLEANING POND WATER, IN CLASS 1 (U.S. CLS. 1, 5, 6, 10, 26 AND 46).

FIRST USE 12-20-2007; IN COMMERCE 12-20-2007.

THE MARK CONSISTS OF STANDARD CHARACTERS WITHOUT CLAIM TO ANY PARTICULAR FONT, STYLE, SIZE, OR COLOR.

NO CLAIM IS MADE TO THE EXCLUSIVE RIGHT TO USE "BARLEY", APART FROM THE MARK AS SHOWN.

SN 77-309,006, FILED 10-19-2007.

BRENDAN MCCAULEY, EXAMINING ATTORNEY

**Int. Cl.: 41**

**Prior U.S. Cls.: 100, 101, and 107**

**United States Patent and Trademark Office**

**Reg. No. 3,455,137**

**Registered June 24, 2008**

**SERVICE MARK  
PRINCIPAL REGISTER**

**BIG SHOES PRODUCTIONS**

BIG SHOES PRODUCTION, INC. (WASHINGTON CORPORATION)  
901 FIFTH AVENUE  
SUITE 4100  
SEATTLE, WA 98164

FOR: ENTERTAINMENT SERVICES, NAMELY, PROVIDING A RADIO PROGRAM IN THE FIELDS OF MUSIC, HUMAN INTEREST STORIES, LIFESTYLE AND SELF-IMPROVEMENT OVER GLOBAL COMMUNICATIONS NETWORKS; PRODUCTION AND DISTRIBUTION OF TELEVISION PROGRAMS; PROVIDING A WEBSITE OVER A GLOBAL COMPUTER INFORMATION NETWORK FEATURING INFORMATION AND CONTENT ON A RADIO PROGRAM IN THE FIELDS OF MUSIC, HUMAN INTEREST STORIES, LIFESTYLE AND SELF-IMPROVEMENT; PUBLICATION OF BOOKS AND MAGAZINES IN THE FIELDS OF HUMAN

INTEREST STORIES, LIFESTYLE, SELF-IMPROVEMENT, FITNESS AND ARTS AND CRAFTS, IN CLASS 41 (U.S. CLS. 100, 101 AND 107).

FIRST USE 1-17-2008; IN COMMERCE 1-17-2008.

THE MARK CONSISTS OF STANDARD CHARACTERS WITHOUT CLAIM TO ANY PARTICULAR FONT, STYLE, SIZE, OR COLOR.

NO CLAIM IS MADE TO THE EXCLUSIVE RIGHT TO USE "PRODUCTIONS", APART FROM THE MARK AS SHOWN.

SN 77-975,316, FILED 11-3-2006.

CARRIE GENOVESE, EXAMINING ATTORNEY

**Int. Cls.: 25 and 35**

**Prior U.S. Cls.: 22, 39, 100, 101, and 102**

**Reg. No. 3,455,138**

**United States Patent and Trademark Office**

**Registered June 24, 2008**

**TRADEMARK  
SERVICE MARK  
PRINCIPAL REGISTER**

**VSX**

VICTORIA'S SECRET STORES BRAND MANAGEMENT, INC. (DELAWARE CORPORATION)  
FOUR LIMITED PARKWAY  
REYNOLDSBURG, OH 43068

FOR: CLOTHING, NAMELY, BODY SUITS, BOXER SHORTS, BRA TOPS, BRAS, CAPRIS, COATS, JACKETS, JOGGING SUITS, KNIT SHIRTS, KNIT TOPS, LEGGINGS, SHIRTS, PANTS, SHORTS, SWEAT PANTS, SWEAT SHIRTS, SWEAT SHORTS, SWEAT SUITS, T-SHIRTS, TANK TOPS, TIGHTS, VESTS, IN CLASS 25 (U.S. CLS. 22 AND 39).

FIRST USE 8-16-2007; IN COMMERCE 8-16-2007.

FOR: RETAIL STORE SERVICES, MAIL ORDER CATALOG SERVICES AND ON-LINE RETAIL STORE SERVICES FEATURING ACCESSORIES, BAGS, CLOTHING, IN CLASS 35 (U.S. CLS. 100, 101 AND 102).

FIRST USE 8-16-2007; IN COMMERCE 8-16-2007.

THE MARK CONSISTS OF STANDARD CHARACTERS WITHOUT CLAIM TO ANY PARTICULAR FONT, STYLE, SIZE, OR COLOR.

SN 77-975,456, FILED 12-22-2006.

ALICIA COLLINS, EXAMINING ATTORNEY

**Int. Cl.: 43**

**Prior U.S. Cls.: 100 and 101**

**United States Patent and Trademark Office**

**Reg. No. 3,455,139**

**Registered June 24, 2008**

**SERVICE MARK  
PRINCIPAL REGISTER**

# Sejal's Famous Pizza

SEJAL'S FAMOUS PIZZA LLC (NEW JERSEY  
LTD LIAB CO)  
5 YORKSHIRE VILLAGE ROAD  
LAWRENCEVILLE, NJ 08648

FOR: RESTAURANTS, IN CLASS 43 (U.S. CLS. 100  
AND 101).

FIRST USE 11-29-2006; IN COMMERCE 3-22-2008.

THE MARK CONSISTS OF STANDARD CHAR-  
ACTERS WITHOUT CLAIM TO ANY PARTICULAR  
FONT, STYLE, SIZE, OR COLOR.

NO CLAIM IS MADE TO THE EXCLUSIVE  
RIGHT TO USE "FAMOUS PIZZA", APART FROM  
THE MARK AS SHOWN.

THE NAME(S), PORTRAIT(S), AND/OR SIGNA-  
TURE(S) SHOWN IN THE MARK IDENTIFIES  
"SEJAL KETAN PATEL", WHOSE CONSENT(S) TO  
REGISTER IS SUBMITTED.

SN 77-975,467, FILED 11-29-2006.

JUSTINE D. PARKER, EXAMINING ATTORNEY

**Int. Cls.: 16, 35, 42, and 44**

**Prior U.S. Cls.: 2, 5, 22, 23, 29, 37, 38, 50, 100, 101, and 102**

**Reg. No. 3,455,140**

**United States Patent and Trademark Office**

**Registered June 24, 2008**

**TRADEMARK  
SERVICE MARK  
PRINCIPAL REGISTER**

# Catalyst Institute

CATALYST INSTITUTE, INC. (MASSACHUSETTS CORPORATION)  
465 MEDFORD STREET  
BOSTON, MA 02129

FOR: PRINTED INSTRUCTIONAL, TEACHING, AND RESOURCE MATERIALS AND REPORTS CONCERNING DENTAL AND ORAL HEALTH AND DENTAL AND ORAL HEALTH PRACTICE MANAGEMENT, IN CLASS 16 (U.S. CLS. 2, 5, 22, 23, 29, 37, 38 AND 50).

FIRST USE 10-31-2006; IN COMMERCE 10-31-2006.

FOR: CONSULTING SERVICES IN THE FIELD OF DENTAL AND ORAL HEALTH PRACTICE MANAGEMENT; CONSULTING SERVICES IN THE NATURE OF BUSINESS MANAGEMENT RESEARCH AND ANALYSIS IN THE FIELD OF DENTAL AND ORAL HEALTH PRACTICE MANAGEMENT, IN CLASS 35 (U.S. CLS. 100, 101 AND 102).

FIRST USE 12-11-2006; IN COMMERCE 12-11-2006.

FOR: SCIENTIFIC RESEARCH AND ANALYSIS IN THE FIELDS OF DENTAL AND ORAL HEALTH, IN CLASS 42 (U.S. CLS. 100 AND 101).

FIRST USE 11-9-2006; IN COMMERCE 11-9-2006.

FOR: PROVIDING A WEBSITE FEATURING ONLINE RESOURCE MATERIALS AND REPORTS CONCERNING DENTAL AND ORAL HEALTH, IN CLASS 44 (U.S. CLS. 100 AND 101).

FIRST USE 11-30-2006; IN COMMERCE 11-30-2006.

THE MARK CONSISTS OF STANDARD CHARACTERS WITHOUT CLAIM TO ANY PARTICULAR FONT, STYLE, SIZE, OR COLOR.

NO CLAIM IS MADE TO THE EXCLUSIVE RIGHT TO USE "INSTITUTE", APART FROM THE MARK AS SHOWN.

SN 77-975,495, FILED 11-9-2006.

ANTHONY RINKER, EXAMINING ATTORNEY

**Int. Cl.: 20**

**Prior U.S. Cls.: 2, 13, 22, 25, 32, and 50**

**Reg. No. 3,455,141**

**United States Patent and Trademark Office**

**Registered June 24, 2008**

---

**TRADEMARK  
PRINCIPAL REGISTER**

**MAKO BEACH**

MAHCO INC. (ARKANSAS CORPORATION)  
1202 MELISSA DRIVE  
BENTONVILLE, AR 72712

THE MARK CONSISTS OF STANDARD CHAR-  
ACTERS WITHOUT CLAIM TO ANY PARTICULAR  
FONT, STYLE, SIZE, OR COLOR.

FOR: OUTDOOR FURNITURE, IN CLASS 20 (U.S.  
CLS. 2, 13, 22, 25, 32 AND 50).

SN 77-975,512, FILED 2-15-2007.

FIRST USE 1-31-2008; IN COMMERCE 1-31-2008.

SUNG IN, EXAMINING ATTORNEY

**Int. Cls.: 9 and 25**

**Prior U.S. Cls.: 21, 22, 23, 26, 36, 38, and 39**

**United States Patent and Trademark Office**

**Reg. No. 3,455,142**

**Registered June 24, 2008**

**TRADEMARK  
PRINCIPAL REGISTER**

WEC HOLDINGS, LLC (DELAWARE LTD LIAB  
CO)  
SUITE 862  
12021 WILSHIRE BLVD.  
LOS ANGELES, CA 90025

FOR: COMPACT DISCS, LASER VIDEO DISCS,  
DIGITAL VERSATILE DISCS AND CD-ROM DISCS,  
ALL FEATURING SPORTS EVENTS AND MIXED  
MARTIAL ARTS , IN CLASS 9 (U.S. CLS. 21, 23, 26, 36  
AND 38).

FIRST USE 6-27-2006; IN COMMERCE 6-27-2006.

FOR: TEE SHIRTS AND SWEATSHIRTS, IN  
CLASS 25 (U.S. CLS. 22 AND 39).

FIRST USE 1-20-2007; IN COMMERCE 1-20-2007.

THE MARK CONSISTS OF STANDARD CHAR-  
ACTERS WITHOUT CLAIM TO ANY PARTICULAR  
FONT, STYLE, SIZE, OR COLOR.

SN 77-975,535, FILED 2-22-2007.

CARRIE GENOVESE, EXAMINING ATTORNEY



**Int. Cl.: 9**

**Prior U.S. Cls.: 21, 23, 26, 36, and 38**

**Reg. No. 3,455,143**

**United States Patent and Trademark Office**

**Registered June 24, 2008**

---

**TRADEMARK  
PRINCIPAL REGISTER**

**WEATHERGEAR**

JS PRODUCTS, INC. (NEVADA CORPORATION)  
5440 S. PROCYON AVENUE  
LAS VEGAS, NV 89118

FIRST USE 7-13-2007; IN COMMERCE 7-13-2007.

FOR: EMERGENCY, PORTABLE-POWERED WEATHER RELATED EQUIPMENT, NAMELY, BATTERY OR CRANK-POWERED RADIOS, TELEVISIONS, OR TWO WAY RADIOS; BATTERY OR CRANK-POWERED ELECTRICAL POWER SUPPLIES, IN CLASS 9 (U.S. CLS. 21, 23, 26, 36 AND 38).

THE MARK CONSISTS OF STANDARD CHARACTERS WITHOUT CLAIM TO ANY PARTICULAR FONT, STYLE, SIZE, OR COLOR.

SN 77-975,539, FILED 12-22-2006.

MICHAEL TANNER, EXAMINING ATTORNEY

**Int. Cl.: 1**

**Prior U.S. Cls.: 1, 5, 6, 10, 26, and 46**

**Reg. No. 3,455,144**

**United States Patent and Trademark Office**

**Registered June 24, 2008**

---

**TRADEMARK  
PRINCIPAL REGISTER**

**BARRACUDA**

ROMAN DECORATING PRODUCTS, INC. (NEW  
JERSEY CORPORATION)  
824 STATE STREET  
CALUMET CITY, IL 60409

THE MARK CONSISTS OF STANDARD CHAR-  
ACTERS WITHOUT CLAIM TO ANY PARTICULAR  
FONT, STYLE, SIZE, OR COLOR.

FOR: WALLPAPER REMOVAL PREPARATIONS,  
PASTE DISSOLVERS AND REMOVERS, IN CLASS 1  
(U.S. CLS. 1, 5, 6, 10, 26 AND 46).

SN 77-975,545, FILED 11-8-2006.

FIRST USE 3-18-2008; IN COMMERCE 3-18-2008.

AMY HELLA, EXAMINING ATTORNEY

**Int. Cl.: 10**

**Prior U.S. Cls.: 26, 39, and 44**

**United States Patent and Trademark Office**

**Reg. No. 3,455,145**

**Registered June 24, 2008**

**TRADEMARK  
PRINCIPAL REGISTER**

**PROPER ATTIRE**

PLANNED PARENTHOOD FEDERATION OF  
AMERICA, INC. (NEW YORK CORPORATION)  
434 WEST 33RD STREET  
NEW YORK, NY 10001

THE MARK CONSISTS OF STANDARD CHARACTERS WITHOUT CLAIM TO ANY PARTICULAR FONT, STYLE, SIZE, OR COLOR.

FOR: CONDOMS, IN CLASS 10 (U.S. CLS. 26, 39 AND 44).

SN 77-975,557, FILED 3-1-2007.

FIRST USE 1-17-2008; IN COMMERCE 1-17-2008.

MICHAEL TANNER, EXAMINING ATTORNEY

Int. Cl.: 34

Prior U.S. Cls.: 2, 8, 9, and 17

**United States Patent and Trademark Office**

**Reg. No. 3,455,146**

Registered June 24, 2008

**TRADEMARK  
PRINCIPAL REGISTER**

A handwritten signature in black ink that reads "Winston S. Churchill". The signature is written in a cursive style with a small mark above the 'i' in "Churchill".

CHURCHILL, WINSTON S. (UNITED KINGDOM  
INDIVIDUAL)  
4 BELGRAVE  
LONDON, ENGLAND SW1X8PH

FIRST USE 6-13-2007; IN COMMERCE 6-13-2007.

SN 77-975,568, FILED 12-11-2006.

FOR: CIGARS, IN CLASS 34 (U.S. CLS. 2, 8, 9 AND  
17).

TARAH HARDY, EXAMINING ATTORNEY

**Int. Cl.: 43**

**Prior U.S. Cls.: 100 and 101**

**United States Patent and Trademark Office**

**Reg. No. 3,455,147**

**Registered June 24, 2008**

---

**SERVICE MARK  
PRINCIPAL REGISTER**

**HOTEL**

LIVE! HOLDINGS, LLC (MARYLAND LTD LIAB  
CO)  
601 EAST PRATT STREET, 6TH FLOOR  
BALTIMORE, MD 21202

THE MARK CONSISTS OF STANDARD CHAR-  
ACTERS WITHOUT CLAIM TO ANY PARTICULAR  
FONT, STYLE, SIZE, OR COLOR.

FOR: BAR SERVICES, IN CLASS 43 (U.S. CLS. 100  
AND 101).

SN 77-975,569, FILED 10-24-2006.

FIRST USE 2-22-2008; IN COMMERCE 2-22-2008.

ELIZABETH KAJUBI, EXAMINING ATTORNEY

Int. Cl.: 41

Prior U.S. Cls.: 100, 101, and 107

United States Patent and Trademark Office

Reg. No. 3,455,148

Registered June 24, 2008

**SERVICE MARK  
PRINCIPAL REGISTER**



VARSITY SPIRIT CORPORATION (TENNESSEE CORPORATION)  
SUITE 300  
6745 LENNOX CENTER COURT  
MEMPHIS, TN 38115

FOR: ENTERTAINMENT SERVICES, NAMELY, PRODUCING CHEERLEADING, DANCE AND SPIRIT-RELATED COMPETITIONS AND EVENTS FOR OTHERS AND ESTABLISHING RULES FOR SANCTIONING AND PROVIDING GOVERNANCE FOR CHEERLEADING, DANCE AND SPIRIT-RELATED COMPETITIONS AND EVENTS, IN CLASS 41 (U.S. CLS. 100, 101 AND 107).

FIRST USE 12-12-2006; IN COMMERCE 12-12-2006.

NO CLAIM IS MADE TO THE EXCLUSIVE RIGHT TO USE "INTERNATIONAL" AND "ALL STAR FEDERATION", APART FROM THE MARK AS SHOWN.

THE COLOR(S) RED, WHITE, BLUE, ORANGE, BLACK, GOLD AND GRAY IS/ARE CLAIMED AS A FEATURE OF THE MARK.

THE MARK CONSISTS OF THE LETTERS "IASF" SUPERIMPOSED OVER A GRAY GLOBE WITH DARKER GRAY LAND MASSES. THE LETTER "I" IS RED AND ITS TOP AND RIGHT EDGES ARE LINED IN ORANGE AND THE ENTIRE LETTER IS OUTLINED IN BLACK. THE LETTERS "ASF" ARE BLUE WITH BLACK OUTLINING. THE CROSS BAR OF THE LETTER "A" IS FORMED BY A FIVE POINT YELLOW STAR THAT HAS AN ORANGE TAIL THAT GIVES THE STAR THE APPEARANCE OF A SHOOTING STAR. THE WORD "INTERNATIONAL" IS WHITE IN A GOLD-LINED BLACK BANNER LOCATED ABOVE THE GLOBE AND THERE ARE ORANGE STARS BEFORE AND AFTER THE WORD "INTERNATIONAL". THE WORDS "ALL STAR FEDERATION" ARE WHITE IN A GOLD-LINED BLACK BANNER LOCATED BELOW THE GLOBE AND THERE ARE ORANGE STARS BEFORE THE WORD "ALL" AND AFTER THE WORD "FEDERATION".

SN 77-975,571, FILED 9-27-2006.

DEIRDRE ROBERTSON, EXAMINING ATTORNEY

**Int. Cl.: 25**

**Prior U.S. Cls.: 22 and 39**

**United States Patent and Trademark Office**

**Reg. No. 3,455,149**

**Registered June 24, 2008**

**TRADEMARK  
PRINCIPAL REGISTER**

**WACOAL LUXE**

WACOAL AMERICA, INC. (DELAWARE CORPORATION)  
136 MADISON AVENUE  
NEW YORK, NY 10016

FOR: BRAS; PANTS; BIKINIS; THONGS; BOY-LEG, NAMELY, PANTIES CONTAINING BOY LEGS; HIPKINI, NAMELY, BIKINI-STYLE UNDERWEAR WORN ON THE HIPS, IN CLASS 25 (U.S. CLS. 22 AND 39).

FIRST USE 1-25-2008; IN COMMERCE 1-25-2008.

THE MARK CONSISTS OF STANDARD CHARACTERS WITHOUT CLAIM TO ANY PARTICULAR FONT, STYLE, SIZE, OR COLOR.

OWNER OF U.S. REG. NO. 2,860,779.

NO CLAIM IS MADE TO THE EXCLUSIVE RIGHT TO USE "LUXE", APART FROM THE MARK AS SHOWN.

SN 77-975,573, FILED 5-10-2007.

TANYA AMOS, EXAMINING ATTORNEY

**Int. Cl.: 41**

**Prior U.S. Cls.: 100, 101, and 107**

**United States Patent and Trademark Office**

**Reg. No. 3,455,150**

**Registered June 24, 2008**

**SERVICE MARK  
PRINCIPAL REGISTER**



**THRIVING CHILD  
CORPORATION**

THRIVING CHILD CORPORATION (COLORADO CORPORATION)  
445C EAST CHEYENNE BLVD., #101  
COLORADO SPRINGS, CO 80906

FOR: PHYSICAL FITNESS CONDITIONING CLASSES; PHYSICAL FITNESS CONSULTATION; PHYSICAL FITNESS INSTRUCTION; PROVIDING FITNESS AND EXERCISE FACILITIES; SWIMMING INSTRUCTION, IN CLASS 41 (U.S. CLS. 100, 101 AND 107).

FIRST USE 10-1-2006; IN COMMERCE 10-1-2006.

NO CLAIM IS MADE TO THE EXCLUSIVE RIGHT TO USE "CORPORATION", APART FROM THE MARK AS SHOWN.

THE MARK CONSISTS OF STYLIZED CHILD DIVING INTO A SWIMMING POOL.

SN 77-975,584, FILED 11-22-2006.

ZACHARY BELLO, EXAMINING ATTORNEY



**Int. Cl.: 36**

**Prior U.S. Cls.: 100, 101, and 102**

**United States Patent and Trademark Office**

**Reg. No. 3,455,151**

**Registered June 24, 2008**

---

**SERVICE MARK  
PRINCIPAL REGISTER**

**PROTECTED BY THE FORT**

HEALTH CARE SERVICE CORPORATION (ILLI-  
NOIS CORPORATION)  
300 EAST RANDOLPH STREET  
CHICAGO, IL 60601

THE MARK CONSISTS OF STANDARD CHAR-  
ACTERS WITHOUT CLAIM TO ANY PARTICULAR  
FONT, STYLE, SIZE, OR COLOR.

FOR: ANNUITY UNDERWRITING AND ADMIN-  
ISTERING SERVICES, IN CLASS 36 (U.S. CLS. 100,  
101 AND 102).

SN 77-975,597, FILED 7-20-2007.

FIRST USE 12-3-2007; IN COMMERCE 12-3-2007.

JUDITH HELFMAN, EXAMINING ATTORNEY

**Int. Cl.: 30**

**Prior U.S. Cl.: 46**

**United States Patent and Trademark Office**

**Reg. No. 3,455,152**

**Registered June 24, 2008**

**TRADEMARK  
PRINCIPAL REGISTER**

**MUSTARD GIRL**

MUSTARD GIRL, LLC (DELAWARE CORPORATION)  
302 NAUTILUS DRIVE, SUITE 301  
MADISON, WI 53705

NO CLAIM IS MADE TO THE EXCLUSIVE  
RIGHT TO USE MUSTARD, APART FROM THE  
MARK AS SHOWN.

FOR: MUSTARD, IN CLASS 30 (U.S. CL. 46).

FIRST USE 2-11-2007; IN COMMERCE 2-11-2007.

SN 77-975,600, FILED 12-8-2006.

THE MARK CONSISTS OF STANDARD CHARACTERS WITHOUT CLAIM TO ANY PARTICULAR FONT, STYLE, SIZE, OR COLOR.

LINDA E. BLOHM, EXAMINING ATTORNEY

**Int. Cl.: 30**

**Prior U.S. Cl.: 46**

**United States Patent and Trademark Office**

**Reg. No. 3,455,153**

**Registered June 24, 2008**

**TRADEMARK  
PRINCIPAL REGISTER**

**ALL-AMERICAN MUSTARDS**

MUSTARD GIRL, LLC (DELAWARE CORPORATION)  
302 NAUTILUS DRIVE, SUITE 301  
MADISON, WI 53705

NO CLAIM IS MADE TO THE EXCLUSIVE  
RIGHT TO USE MUSTARDS, APART FROM THE  
MARK AS SHOWN.

FOR: MUSTARD, IN CLASS 30 (U.S. CL. 46).

FIRST USE 2-11-2007; IN COMMERCE 2-11-2007.

SN 77-975,601, FILED 12-8-2006.

THE MARK CONSISTS OF STANDARD CHARACTERS WITHOUT CLAIM TO ANY PARTICULAR FONT, STYLE, SIZE, OR COLOR.

LINDA E. BLOHM, EXAMINING ATTORNEY

**Int. Cl.: 34**

**Prior U.S. Cls.: 2, 8, 9, and 17**

**United States Patent and Trademark Office**

**Reg. No. 3,455,154**

**Registered June 24, 2008**

**TRADEMARK  
PRINCIPAL REGISTER**



KING MAKER MARKETING, INC. (NEW JERSEY CORPORATION)  
12 ROUTE 17 NORTH, SUITE 304  
PARAMUS, NJ 07652

FIRST USE 0-0-2000; IN COMMERCE 0-0-2000.

SN 78-032,534, FILED 10-26-2000.

FOR: CIGARETTES, IN CLASS 34 (U.S. CLS. 2, 8, 9 AND 17).

DOMINIC J. FERRAIUOLO, EXAMINING ATTORNEY

**Int. Cl.: 24**

**Prior U.S. Cls.: 42 and 50**

**United States Patent and Trademark Office**

**Reg. No. 3,455,155**

**Registered June 24, 2008**

**TRADEMARK  
PRINCIPAL REGISTER**

**CRASHCADDY**

GAUGER, THOMAS (UNITED STATES INDIVIDUAL)  
23 AUBURN STREET  
BROOKLINE, MA 02446

FIRST USE 1-1-2005; IN COMMERCE 1-1-2005.

SN 78-164,226, FILED 9-15-2002.

FOR: CLOTH CADDY FOR SYMPHONY ORCHESTRA CYMBALS, IN CLASS 24 (U.S. CLS. 42 AND 50).

MICHELE SWAIN, EXAMINING ATTORNEY

**Int. Cl.: 33**

**Prior U.S. Cls.: 47 and 49**

**United States Patent and Trademark Office**

**Reg. No. 3,455,156**

**Registered June 24, 2008**

**TRADEMARK  
PRINCIPAL REGISTER**

**DOWNUNDER PLATINUM**

MR GAVIN H JONES (AUSTRALIA INDIVIDUAL)  
P.O. BOX 546  
COOROY, AUSTRALIA 4563

FIRST USE 1-15-2008; IN COMMERCE 1-15-2008.

SN 78-209,933, FILED 2-2-2003.

FOR: BOTTLED SPIRITS, NAMELY, A RUM  
PRODUCED AND BOTTLED IN QUEENSLAND,  
AUSTRALIA, IN CLASS 33 (U.S. CLS. 47 AND 49).

MARY I. SPARROW, EXAMINING ATTORNEY

**Int. Cl.: 16**

**Prior U.S. Cls.: 2, 5, 22, 23, 29, 37, 38, and 50**

**Reg. No. 3,455,157**

**United States Patent and Trademark Office**

**Registered June 24, 2008**

**TRADEMARK  
PRINCIPAL REGISTER**

**ASPIRE**

CTI PAPER GROUP, INC. (WISCONSIN CORPORATION)  
1545 CORPORATE CENTER DRIVE  
SUN PRAIRIE, WI 53590

ENVELOPES, IN CLASS 16 (U.S. CLS. 2, 5, 22, 23, 29, 37, 38 AND 50).

FIRST USE 11-0-2003; IN COMMERCE 11-0-2003.

FOR: PAPER, NAMELY, BOND, COPY, TRANSLUCENT, TRACING, DRAWING, ARTIST, SCRAPBOOK, PRINTING AND WRITING PAPER, AND

SN 78-222,237, FILED 3-6-2003.

MYRIAH HABEEB, EXAMINING ATTORNEY

**Int. Cl.: 16**

**Prior U.S. Cls.: 2, 5, 22, 23, 29, 37, 38, and 50**

**Reg. No. 3,455,158**

**United States Patent and Trademark Office**

**Registered June 24, 2008**

**TRADEMARK  
PRINCIPAL REGISTER**



FIRMENICH S.A. (SWITZERLAND SOCIETE  
ANONYME)  
ROUTE DES JEUNES 1; CASE POSTALE 239  
CASE POSTALE 239  
GENEVE 8, SWITZERLAND CH-1211

FIRST USE 6-28-2006; IN COMMERCE 6-28-2006.

THE MARK CONSISTS OF A STYLIZED SWIRL  
IN PLACE OF THE "O" IN "AROMASPHERE".

FOR: PRINTED INSTRUCTIONAL AND TEACH-  
ING MATERIAL IN THE FIELD OF THE CLASSIFI-  
CATION OF FLAVORS, IN CLASS 16 (U.S. CLS. 2, 5,  
22, 23, 29, 37, 38 AND 50).

SN 78-230,477, FILED 3-26-2003.

COLLEEN DOMBROW, EXAMINING ATTORNEY



**Int. Cl.: 25**

**Prior U.S. Cls.: 22 and 39**

**United States Patent and Trademark Office**

**Reg. No. 3,455,159**

**Registered June 24, 2008**

**TRADEMARK  
PRINCIPAL REGISTER**

**RIVERSPHERE**

THE ADMINISTRATORS OF THE TULANE EDUCATIONAL FUND (LOUISIANA CORPORATION)  
TULANE UNIVERSITY, 300 GIBSON HALL  
6823 ST. CHARLES AVENUE  
NEW ORLEANS, LA 70118

FIRST USE 12-17-2007; IN COMMERCE 12-17-2007.

SN 78-251,067, FILED 5-16-2003.

FOR: CLOTHING, NAMELY, CAPS, T-SHIRTS, IN CLASS 25 (U.S. CLS. 22 AND 39).

RICHARD WHITE, EXAMINING ATTORNEY

**Int. Cl.: 33**

**Prior U.S. Cls.: 47 and 49**

**United States Patent and Trademark Office**

**Reg. No. 3,455,160**

**Registered June 24, 2008**

**TRADEMARK  
PRINCIPAL REGISTER**

**THE BIRD**

DISTILLERY NO. 209 LTD. NAPA, CALIFORNIA  
(OREGON CORPORATION)  
2416 E. 37TH STREET NORTH  
WICHITA, KS 67219

FIRST USE 4-28-2008; IN COMMERCE 4-28-2008.

SN 78-260,640, FILED 6-10-2003.

FOR: DISTILLED SPIRITS, IN CLASS 33 (U.S. CLS.  
47 AND 49).

MICHAEL SOUDERS, EXAMINING ATTORNEY

**Int. Cl.: 10**

**Prior U.S. Cls.: 26, 39, and 44**

**Reg. No. 3,455,161**

**United States Patent and Trademark Office**

**Registered June 24, 2008**

---

**TRADEMARK  
PRINCIPAL REGISTER**

**SEDASYS**

JOHNSON & JOHNSON (NEW JERSEY CORPORATION)  
ONE JOHNSON & JOHNSON PLAZA  
NEW BRUNSWICK, NJ 089337001

AND PARTS THEREFORE, IN CLASS 10 (U.S. CLS. 26, 39 AND 44).

FIRST USE 5-15-2007; IN COMMERCE 5-15-2007.

FOR: MEDICAL DEVICE FOR USE IN SURGICAL SEDATION PROCEDURES, NAMELY, ANESTHETIC DELIVERY APPARATUS, INFUSION PUMP,

SN 78-283,422, FILED 8-5-2003.

ALICIA COLLINS, EXAMINING ATTORNEY

**Int. Cl.: 16**

**Prior U.S. Cls.: 2, 5, 22, 23, 29, 37, 38, and 50**

**Reg. No. 3,455,162**

**United States Patent and Trademark Office**

**Registered June 24, 2008**

---

**TRADEMARK  
PRINCIPAL REGISTER**



OWEN, MARY CLAIRE (UNITED STATES INDIVIDUAL)  
3924 NINTH ROAD  
ARLINGTON, VA 222044171

FIRST USE 4-2-2007; IN COMMERCE 7-19-2007.

SN 78-291,506, FILED 8-24-2003.

FOR: PRINTED BUMPER STICKERS, IN CLASS  
16 (U.S. CLS. 2, 5, 22, 23, 29, 37, 38 AND 50).

H. M. FISHER, EXAMINING ATTORNEY

**Int. Cl.: 25**

**Prior U.S. Cls.: 22 and 39**

**United States Patent and Trademark Office**

**Reg. No. 3,455,163**

**Registered June 24, 2008**

**TRADEMARK  
PRINCIPAL REGISTER**

**OUTRIGGER**

LANDS' END DIRECT MERCHANTS, INC. (DE-  
LAWARE CORPORATION)  
820 W. 78TH STREET  
RICHFIELD, MN 55423

FIRST USE 2-11-2004; IN COMMERCE 2-11-2004.

SN 78-297,419, FILED 9-8-2003.

FOR: CLOTHING, NAMELY, SHIRTS, IN CLASS  
25 (U.S. CLS. 22 AND 39).

TAMARA FRAZIER, EXAMINING ATTORNEY

**Int. Cl.: 3**

**Prior U.S. Cls.: 1, 4, 6, 50, 51, and 52**

**Reg. No. 3,455,164**

**United States Patent and Trademark Office**

**Registered June 24, 2008**

---

**TRADEMARK  
PRINCIPAL REGISTER**

**BOOT CAMP**

PHILOSOPHY, INC. (ARIZONA CORPORATION)  
3809 EAST WATKINS STREET  
PHOENIX, AZ 85034

FIRST USE 10-1-2007; IN COMMERCE 10-1-2007.

FOR: NON-MEDICATED SKIN CARE PRODUCTS, NAMELY, SCRUBS, EXFOLIATORS, AND SKIN CLARIFIER, IN CLASS 3 (U.S. CLS. 1, 4, 6, 50, 51 AND 52).

SN 78-298,766, FILED 9-10-2003.

JEFF DEFORD, EXAMINING ATTORNEY

**Int. Cl.: 42**

**Prior U.S. Cls.: 100 and 101**

**United States Patent and Trademark Office**

**Reg. No. 3,455,165**

**Registered June 24, 2008**

**SERVICE MARK  
PRINCIPAL REGISTER**

**GXP**

BAE SYSTEMS MISSION SOLUTIONS INC. (DE-  
LAWARE CORPORATION)  
10920 TECHNOLOGY PLACE  
SAN DIEGO, CA 92127

FIRST USE 11-1-2004; IN COMMERCE 11-1-2004.

SN 78-310,293, FILED 10-7-2003.

FOR: DATABASE DEVELOPMENT SERVICES IN  
THE FIELD OF GEOGRAPHIC DATA, IN CLASS 42  
(U.S. CLS. 100 AND 101).

MARK SPARACINO, EXAMINING ATTORNEY

**Int. Cl.: 10**

**Prior U.S. Cls.: 26, 39, and 44**

**United States Patent and Trademark Office**

**Reg. No. 3,455,166**

**Registered June 24, 2008**

**TRADEMARK  
PRINCIPAL REGISTER**

The logo for VIACOR features the word "VIACOR" in a bold, sans-serif font. The letters "V", "A", "C", and "O" are dark blue, while the letter "I" is a vibrant green. The "R" is also dark blue. The letters are closely spaced and have a slight shadow effect.

VIACOR, INC. (DELAWARE CORPORATION)  
260-B FORDHAM ROAD  
WILMINGTON, MA 01887

THE COLOR(S) BLUE AND GREEN IS/ARE  
CLAIMED AS A FEATURE OF THE MARK.

FOR: SURGICAL APPARATUS FOR TREATING  
DISORDERS OF THE CIRCULATORY SYSTEM,  
NAMELY, SURGICAL IMPLANTS CONSISTING  
OF ARTIFICIAL MATERIALS FOR RESHAPING  
ANATOMICAL STRUCTURES; AND CATHETERS ,  
IN CLASS 10 (U.S. CLS. 26, 39 AND 44).

THE MARK CONSISTS OF THE WORD "VIA-  
COR" WITH THE LETTERS "V","A","C","O" AND  
"R" PRESENTED IN BLUE AND THE LETTER "I"  
PRESENTED IN GREEN.

FIRST USE 7-1-2007; IN COMMERCE 7-1-2007.

SN 78-312,313, FILED 10-10-2003.

TANYA AMOS, EXAMINING ATTORNEY



**Int. Cls.: 5, 10, 16, and 41**

**Prior U.S. Cls.: 2, 5, 6, 18, 22, 23, 26, 29, 37, 38, 39, 44,  
46, 50, 51, 52, 100, 101, and 107**

**Reg. No. 3,455,167**

**United States Patent and Trademark Office**

**Registered June 24, 2008**

**TRADEMARK  
SERVICE MARK  
PRINCIPAL REGISTER**



STAAR SURGICAL COMPANY (DELAWARE CORPORATION)  
1911 WALKER AVENUE  
MONROVIA, CA 91016

FOR: SURGICAL IMPLANTS COMPRISING INGREDIENTS FROM LIVING TISSUE , IN CLASS 5 (U.S. CLS. 6, 18, 44, 46, 51 AND 52).

FIRST USE 12-22-2005; IN COMMERCE 12-22-2005.

FOR: SURGICAL OCULAR IMPLANTS, IN CLASS 10 (U.S. CLS. 26, 39 AND 44).

FIRST USE 12-22-2005; IN COMMERCE 12-22-2005.

FOR: PRINTED EDUCATIONAL MATERIALS, NAMELY, BOOKS, MANUALS, BOOKLETS, PAMPHLETS, AND BROCHURES FEATURING INFORMATION REGARDING REFRACTIVE SURGI-

CAL PROCEDURES, IN CLASS 16 (U.S. CLS. 2, 5, 22, 23, 29, 37, 38 AND 50).

FIRST USE 12-22-2005; IN COMMERCE 12-22-2005.

FOR: EDUCATION SERVICES, NAMELY, TRAINING DOCTORS TO PERFORM REFRACTIVE SURGICAL PROCEDURES, IN CLASS 41 (U.S. CLS. 100, 101 AND 107).

FIRST USE 12-22-2005; IN COMMERCE 12-22-2005.

NO CLAIM IS MADE TO THE EXCLUSIVE RIGHT TO USE "ICL", APART FROM THE MARK AS SHOWN.

SN 78-319,286, FILED 10-27-2003.

ELLEN B. AWRICH, EXAMINING ATTORNEY

**Int. Cl.: 36**

**Prior U.S. Cls.: 100, 101, and 102**

**United States Patent and Trademark Office**

**Reg. No. 3,455,168**

**Registered June 24, 2008**

**SERVICE MARK  
PRINCIPAL REGISTER**

**BIMINI MORTGAGE  
MANAGEMENT, INC.**

OPTEUM INC. (MARYLAND CORPORATION)  
3305 FLAMINGO DRIVE  
VERO BEACH, FL 32963

FOR: REAL ESTATE INVESTMENT TRUST SERVICES, IN CLASS 36 (U.S. CLS. 100, 101 AND 102).

FIRST USE 3-18-2004; IN COMMERCE 3-18-2004.

THE MARK CONSISTS OF STANDARD CHARACTERS WITHOUT CLAIM TO ANY PARTICULAR FONT, STYLE, SIZE, OR COLOR.

NO CLAIM IS MADE TO THE EXCLUSIVE RIGHT TO USE "MORTGAGE MANAGEMENT, INC.", APART FROM THE MARK AS SHOWN.

SN 78-322,922, FILED 11-4-2003.

LESLEY LAMOTHE, EXAMINING ATTORNEY

**Int. Cl.: 9**

**Prior U.S. Cls.: 21, 23, 26, 36, and 38**

**Reg. No. 3,455,169**

**United States Patent and Trademark Office**

**Registered June 24, 2008**

---

**TRADEMARK  
PRINCIPAL REGISTER**

**CENTURY**

DRESSER, INC. (DELAWARE CORPORATION)  
11TH FLOOR, MILLENNIUM 1  
15455 DALLAS PARKWAY  
ADDISON, TX 75001

THE MARK CONSISTS OF STANDARD CHARACTERS WITHOUT CLAIM TO ANY PARTICULAR FONT, STYLE, SIZE, OR COLOR.

FOR: FUEL DISPENSERS AND THEIR PARTS  
FOR SERVICE STATIONS, IN CLASS 9 (U.S. CLS. 21,  
23, 26, 36 AND 38).

SN 78-335,216, FILED 12-2-2003.

FIRST USE 8-0-1999; IN COMMERCE 8-0-1999.

DOMINICK J. SALEMI, EXAMINING ATTORNEY

**Int. Cl.: 36**

**Prior U.S. Cls.: 100, 101, and 102**

**United States Patent and Trademark Office**

**Reg. No. 3,455,170**

**Registered June 24, 2008**

**SERVICE MARK  
PRINCIPAL REGISTER**

**BEST COMPETITIVE  
PRICE GUARANTEE**

LUMP SUM CAPITAL, LLC (MARYLAND LTD  
LIAB CO)  
SUITE 300  
7920 NORFOLK AVENUE  
BETHESDA, MD 20814

FOR: FINANCIAL SERVICES, NAMELY, THE  
PURCHASE OF FUTURE PAYMENTS OF LOTTERY  
AND CONTEST WINNINGS AND STRUCTURED  
SETTLEMENTS OF OTHERS , IN CLASS 36 (U.S.  
CLS. 100, 101 AND 102).

FIRST USE 12-26-2003; IN COMMERCE 12-26-2003.

THE MARK CONSISTS OF STANDARD CHAR-  
ACTERS WITHOUT CLAIM TO ANY PARTICULAR  
FONT, STYLE, SIZE, OR COLOR.

NO CLAIM IS MADE TO THE EXCLUSIVE  
RIGHT TO USE "GUARANTEE", APART FROM  
THE MARK AS SHOWN.

SN 78-338,647, FILED 12-10-2003.

WANDA KAY PRICE, EXAMINING ATTORNEY

**Int. Cl.: 30**

**Prior U.S. Cl.: 46**

**United States Patent and Trademark Office**

**Reg. No. 3,455,171**

**Registered June 24, 2008**

**TRADEMARK  
PRINCIPAL REGISTER**

**ARCOR DELUXE MIX**

ARCOR S.A.I.C. (ARGENTINA CORPORATION)  
MAIPU 1210 PISOS 2 Y 3  
BUENOS AIRES, ARGENTINA 1006

OWNER OF U.S. REG. NOS. 904,806, 2,700,670,  
AND OTHERS.

FOR: CONFECTIONERY PRODUCTS, NAMELY,  
CANDIES, IN CLASS 30 (U.S. CL. 46).

NO CLAIM IS MADE TO THE EXCLUSIVE  
RIGHT TO USE "DELUXE MIX", APART FROM  
THE MARK AS SHOWN.

FIRST USE 4-30-2002; IN COMMERCE 8-31-2006.

SN 78-343,316, FILED 12-19-2003.

THE MARK CONSISTS OF STANDARD CHAR-  
ACTERS WITHOUT CLAIM TO ANY PARTICULAR  
FONT, STYLE, SIZE, OR COLOR.

NANCY CLARKE, EXAMINING ATTORNEY

**Int. Cl.: 21**

**Prior U.S. Cls.: 2, 13, 23, 29, 30, 33, 40, and 50**

**United States Patent and Trademark Office**

**Reg. No. 3,455,172**

**Registered June 24, 2008**

**TRADEMARK  
PRINCIPAL REGISTER**

**GERBER**

GERBER PRODUCTS COMPANY (MICHIGAN CORPORATION)  
445 STATE STREET  
FREMONT, MI 49413

OWNER OF U.S. REG. NOS. 405,310, 2,631,970,  
AND OTHERS.

FOR: ICE PACK FOR KEEPING FOOD AND DRINK COLD, IN CLASS 21 (U.S. CLS. 2, 13, 23, 29, 30, 33, 40 AND 50).

SEC. 2(F).

FIRST USE 11-30-2005; IN COMMERCE 11-30-2005.

SN 78-362,001, FILED 2-3-2004.

THE MARK CONSISTS OF STANDARD CHARACTERS WITHOUT CLAIM TO ANY PARTICULAR FONT, STYLE, SIZE, OR COLOR.

CAROLYN CATALDO, EXAMINING ATTORNEY

**Int. Cl.: 25**

**Prior U.S. Cls.: 22 and 39**

**United States Patent and Trademark Office**

**Reg. No. 3,455,173**

**Registered June 24, 2008**

**TRADEMARK  
PRINCIPAL REGISTER**

**Play It Fair!**

MACLEOD, ADAM (TRINIDAD/TOBAGO INDIVIDUAL)  
35055 N BANDOLIER DR  
QUEEN CREEK, AZ 85242

FIRST USE 3-3-2003; IN COMMERCE 4-2-2008.

SN 78-362,267, FILED 2-4-2004.

FOR: SPORTS WEAR, NAMELY, BASEBALL HATS, T-SHIRTS, SHORTS, SWEATPANTS, SWEATSHIRTS, TENNIS AND ATHLETIC SHOES, JACKETS, JERSEYS, IN CLASS 25 (U.S. CLS. 22 AND 39).

JAMES A. RAUEN, EXAMINING ATTORNEY

**Int. Cl.: 28**

**Prior U.S. Cls.: 22, 23, 38, and 50**

**Reg. No. 3,455,174**

**United States Patent and Trademark Office**

**Registered June 24, 2008**

---

**TRADEMARK  
PRINCIPAL REGISTER**

**EEK-ONOMY**

BELLAH, JAMES (UNITED STATES INDIVIDUAL)  
402 FERNWOOD DRIVE  
OXNARD, CA 93030

THE MARK CONSISTS OF STANDARD CHARACTERS WITHOUT CLAIM TO ANY PARTICULAR FONT, STYLE, SIZE, OR COLOR.

FOR: BOARD GAMES, IN CLASS 28 (U.S. CLS. 22, 23, 38 AND 50).

SN 78-364,292, FILED 2-7-2004.

FIRST USE 12-6-2007; IN COMMERCE 12-6-2007.

TAMARA FRAZIER, EXAMINING ATTORNEY



**Int. Cls.: 5 and 42**

**Prior U.S. Cls.: 6, 18, 44, 46, 51, 52, 100, and 101**

**United States Patent and Trademark Office**

**Reg. No. 3,455,175**

**Registered June 24, 2008**

**TRADEMARK  
SERVICE MARK  
PRINCIPAL REGISTER**



NEOTROPIX, INC. (DELAWARE CORPORATION)  
7461 ROSEWOOD MANNER LANE  
GAITHERSBURG, MD 20882

FOR: PHARMACEUTICAL AND BIOLOGICAL PREPARATIONS FOR USE IN THE TREATMENT OF CANCER, IN CLASS 5 (U.S. CLS. 6, 18, 44, 46, 51 AND 52).

FIRST USE 5-8-2006; IN COMMERCE 5-8-2006.

FOR: PHARMACEUTICAL AND BIOTECHNOLOGICAL RESEARCH AND DEVELOPMENT SERVICES, IN CLASS 42 (U.S. CLS. 100 AND 101).

FIRST USE 6-30-2004; IN COMMERCE 6-30-2004.

NO CLAIM IS MADE TO THE EXCLUSIVE RIGHT TO USE "THE VIROTHERAPY COMPANY", APART FROM THE MARK AS SHOWN.

THE COLOR(S) WHITE, BLACK, RED AND BURGUNDY IS/ARE CLAIMED AS A FEATURE OF THE MARK.

THE MARK CONSISTS OF THE COLOR RED APPEARS IN THE SMALL CIRCLE ENCOMPASSED INSIDE THE LARGER CIRCLE WITH THE REMAINDER OF THE LARGER CIRCLE IN BURGUNDY WITH SMALL BLACK DOTS SUPERIMPOSED THROUGHOUT. THE COLOR RED ALSO APPEARS IN THE DOTS AFTER THE WORDS "THE" AND "VIROTHERAPY" AS WELL AS IN THE LETTER "I" AND IN THE FIVE STYLIZED DOTS ABOVE THE LETTER "I". THE COLOR BLACK APPEARS IN THE LETTERS "TROP" AND "X" AND AS THE BACKGROUND IN THE RECTANGULAR DESIGN. THE COLOR WHITE APPEARS IN THE LETTERS "NEO" AND IN THE WORDS "THE VIROTHERAPY COMPANY".

SN 78-366,515, FILED 2-11-2004.

YONG KIM, EXAMINING ATTORNEY

**Int. Cl.: 9**

**Prior U.S. Cls.: 21, 23, 26, 36, and 38**

**United States Patent and Trademark Office**

**Reg. No. 3,455,176**

**Registered June 24, 2008**

**TRADEMARK  
PRINCIPAL REGISTER**

**PICTUREVIEW**

ASAP AUTOMATION, LLC (INDIANA LTD LIAB  
CO)  
12300 PLANTSIDE DRIVE  
LOUISVILLE, KY 40299

FOR: COMPUTER HARDWARE AND SOFTWARE FOR USE IN WAREHOUSE MANAGEMENT CONTROL; USER INTERFACE MODULES; AND INSTRUCTIONAL MANUALS SOLD AS A UNIT, IN CLASS 9 (U.S. CLS. 21, 23, 26, 36 AND 38).

FIRST USE 9-30-2005; IN COMMERCE 9-30-2005.

THE MARK CONSISTS OF STANDARD CHARACTERS WITHOUT CLAIM TO ANY PARTICULAR FONT, STYLE, SIZE, OR COLOR.

SN 78-372,884, FILED 2-24-2004.

INGA ERVIN, EXAMINING ATTORNEY

**Int. Cl.: 37**

**Prior U.S. Cls.: 100, 103, and 106**

**United States Patent and Trademark Office**

**Reg. No. 3,455,177**

**Registered June 24, 2008**

**SERVICE MARK  
PRINCIPAL REGISTER**

**DT CHAMP**

DRIVETIME SALES AND FINANCE CORPORATION (ARIZONA CORPORATION)  
4020 E. INDIAN SCHOOL ROAD  
PHOENIX, AZ 85018

FOR: AUTOMOBILE SERVICING, MAINTENANCE AND REPAIR SERVICES FEATURING INCENTIVE AWARD PROGRAMS FOR CUSTOMER SATISFACTION AND RETENTION , IN CLASS 37 (U.S. CLS. 100, 103 AND 106).

FIRST USE 8-1-2005; IN COMMERCE 8-1-2005.

THE MARK CONSISTS OF STANDARD CHARACTERS WITHOUT CLAIM TO ANY PARTICULAR FONT, STYLE, SIZE, OR COLOR.

SN 78-372,912, FILED 2-24-2004.

JEFFERY COWARD, EXAMINING ATTORNEY

**Int. Cl.: 16**

**Prior U.S. Cls.: 2, 5, 22, 23, 29, 37, 38, and 50**

**Reg. No. 3,455,178**

**United States Patent and Trademark Office**

**Registered June 24, 2008**

---

**TRADEMARK  
PRINCIPAL REGISTER**

**RedNeckPeckerwood**

BARNES, THOMAS G. (UNITED STATES INDIVIDUAL)  
18 THISTLEWOOD PLACE  
THE WOODLANDS, TX 77381

THE MARK CONSISTS OF STANDARD CHARACTERS WITHOUT CLAIM TO ANY PARTICULAR FONT, STYLE, SIZE, OR COLOR.

FOR: PRINTED FORMS, IN CLASS 16 (U.S. CLS. 2, 5, 22, 23, 29, 37, 38 AND 50).

SN 78-373,210, FILED 2-24-2004.

FIRST USE 4-8-2007; IN COMMERCE 4-8-2007.

YONG KIM, EXAMINING ATTORNEY

**Int. Cl.: 9**

**Prior U.S. Cls.: 21, 23, 26, 36, and 38**

**Reg. No. 3,455,179**

**United States Patent and Trademark Office**

**Registered June 24, 2008**

---

**TRADEMARK  
PRINCIPAL REGISTER**

**SolarPly**

NANOSOLAR, INC. (CALIFORNIA CORPORATION)  
5521 HELLYER AVENUE  
SAN JOST, CA 95138

THE MARK CONSISTS OF STANDARD CHARACTERS WITHOUT CLAIM TO ANY PARTICULAR FONT, STYLE, SIZE, OR COLOR.

FOR: APPARATUS FOR CONVERTING ELECTRONIC RADIATION TO ELECTRICAL ENERGY, NAMELY, PHOTOVOLTAIC SOLAR MODULES, IN CLASS 9 (U.S. CLS. 21, 23, 26, 36 AND 38).

SN 78-376,627, FILED 3-1-2004.

FIRST USE 3-14-2008; IN COMMERCE 3-14-2008.

KAREN SEVERSON, EXAMINING ATTORNEY

**Int. Cl.: 16**

**Prior U.S. Cls.: 2, 5, 22, 23, 29, 37, 38, and 50**

**Reg. No. 3,455,180**

**United States Patent and Trademark Office**

**Registered June 24, 2008**

**TRADEMARK  
PRINCIPAL REGISTER**

**DR. MONA LISA'S**

SCHULZ, MONA LISA (UNITED STATES INDIVIDUAL)  
PO BOX 452  
YARMOUTH, ME 04096

FOR: PRINTED MATERIALS, NAMELY, INSTRUCTIONAL, EDUCATIONAL, AND TEACHING MATERIALS AND GUIDES IN THE AREA OF EMOTIONAL WELL BEING, PRINTED DECK CARDS BEARING MOTIVATIONAL THOUGHTS AND SAYINGS; A SERIES OF BOOKS IN THE FIELD OF EMOTIONAL WELL BEING, IN CLASS 16 (U.S. CLS. 2, 5, 22, 23, 29, 37, 38 AND 50).

FIRST USE 1-11-2004; IN COMMERCE 1-11-2004.

THE MARK CONSISTS OF STANDARD CHARACTERS WITHOUT CLAIM TO ANY PARTICULAR FONT, STYLE, SIZE, OR COLOR.

OWNER OF U.S. REG. NO. 2,734,403.

NO CLAIM IS MADE TO THE EXCLUSIVE RIGHT TO USE "DR.", APART FROM THE MARK AS SHOWN.

SN 78-376,762, FILED 3-2-2004.

ALLISON HOLTZ, EXAMINING ATTORNEY

**Int. Cl.: 9**

**Prior U.S. Cls.: 21, 23, 26, 36, and 38**

**Reg. No. 3,455,181**

**United States Patent and Trademark Office**

**Registered June 24, 2008**

**TRADEMARK  
PRINCIPAL REGISTER**

**DUAL INTEGRITY**

SENSOR HIGHWAY LIMITED (UNITED KINGDOM LIMITED COMPANY)  
8TH FLOOR, SOUTH QUAY PLAZA 2  
183 MARSH WALL  
LONDON, UNITED KINGDOM E14 9SH

FOR: ELECTRICAL APPARATUS AND INSTRUMENTS, NAMELY, FIRE DETECTION SYSTEMS COMPRISED OF MONITORS, HEAT SENSORS, SENSORS TO INDICATE PHYSICAL CHANGES INCLUDING COMBUSTION, OBSCURATION, AND RATE OF TEMPERATURE RISE, EVENT LOCATION MONITORS AND ALARMS, COMPUTER SOFTWARE AND HARDWARE FOR OPERATION OF FIRE DETECTION SYSTEMS, AND PARTS THEREFORE; HEAT DETECTION SYSTEMS COMPRISED OF FIBER OPTIC LINEAR LOOP CONFIGURATIONS, HEAT DETECTORS, MONITORS, CODE ACCESS PANELS, WIRELESS KEYPAD ALARMS, HEAT SENSORS, SENSORS TO INDICATE PHYSICAL CHANGES, INCLUDING COMBUSTION, OBSCURATION, AND RATE OF TEMPERATURE RISE, MANUAL PULL STATIONS, TRANSPONDERS, CONTROL CONSOLES, PRINTERS AND AUDIO AND VISUAL ALARM INDICATORS, COMPUTER SOFTWARE AND HARDWARE FOR OPERATION OF HEAT DETECTION SYSTEMS, AND PARTS THEREFORE; VENTILATION CONTROL SYSTEMS COMPRISED OF FIBER OPTIC LINEAR LOOP CONFIGURATIONS, HEAT DETECTORS, MONITORS, CODE ACCESS PANELS, WIRELESS KEYPAD ALARMS, HEAT SENSORS, SENSORS TO INDICATE PHYSICAL CHANGES, INCLUDING COMBUSTION, OBSCURATION, AND RATE OF TEMPERATURE RISE, MANUAL PULL STATIONS, TRANSPONDERS, CONTROL CONSOLES, PRINTERS AND AUDIO AND VISUAL ALARM INDICATORS, COMPUTER SOFTWARE AND HARDWARE FOR OPERATION OF VENTILA-

TION CONTROL SYSTEMS, AND PARTS THEREFORE; ALARM SYSTEMS COMPRISED OF SMOKE DETECTORS, MONITORS, CODE ACCESS PANELS, WIRELESS KEYPAD ALARMS, HEAT SENSORS, SENSORS TO INDICATE PHYSICAL CHANGES INCLUDING COMBUSTION, OBSCURATION, AND RATE OF TEMPERATURE RISE, MANUAL PULL STATIONS, TRANSPONDERS, CONTROL CONSOLES, PRINTERS, AUDIO AND VISUAL ALARM INDICATORS, COMPUTER SOFTWARE AND HARDWARE FOR OPERATION OF FIRE DETECTION SYSTEMS AND PARTS THEREFORE; FOAM DEPLOYMENT SYSTEMS COMPRISED OF FIBER OPTIC LINEAR LOOP CONFIGURATIONS, HEAT DETECTORS, MONITORS, CODE ACCESS PANELS, WIRELESS KEYPAD ALARMS, HEAT SENSORS, SENSORS TO INDICATE PHYSICAL CHANGES, INCLUDING COMBUSTION, OBSCURATION, AND RATE OF TEMPERATURE RISE, MANUAL PULL STATIONS, TRANSPONDERS, CONTROL CONSOLES, PRINTERS AND AUDIO AND VISUAL ALARM INDICATORS, COMPUTER SOFTWARE AND HARDWARE FOR OPERATION OF FOAM DEPLOYMENT SYSTEMS, AND PARTS THEREFORE; APPARATUS AND EQUIPMENT FOR MEASURING, COLLECTING, RECORDING, STORING, TRANSMITTING AND REPRODUCING TEMPERATURE AND OTHER DATA, NAMELY, OPTICAL APPARATUS AND INSTRUMENTS IN THE NATURE OF FIBER OPTIC LINEAR SYSTEMS FOR THE MONITORING OF HEAT, TEMPERATURE, TIME AND FIRE; SIGNAL PROCESSORS AND ACOUSTIC COUPLERS; FIBER OPTIC CABLE; PRESSURE SENSORS; FIBER OPTIC SENSORS; TRANSMITTERS FOR LIGHT AND ELECTRICAL SIGNALS TO FIBER OPTIC CABLE; RECEIVERS FOR PROCESSING SIGNALS FOR FIBER OPTIC SENSORS; OPTICAL FIBERS AND OPTICAL FIBER CABLES; TUBES AND CASINGS

FOR OPTICAL FIBER; TERMINATION BOXES FOR OPTICAL FIBERS, CONNECTORS FOR OPTICAL FIBERS; OPTIC-ELECTRONIC TEMPERATURE AND PRESSURE TRANSDUCERS; TEMPERATURE SENSORS; APPARATUS AND INSTRUMENTS FOR MONITORING POWER CABLES, NAMELY, A LINEAR DETECTION SYSTEM COMPRISED OF FIBER OPTIC LINEAR LOOP CONFIGURATIONS, HEAT DETECTORS, MONITORS, CODE ACCESS PANELS, WIRELESS KEYPAD ALARMS, HEAT SENSORS, SENSORS TO INDICATE PHYSICAL CHANGES, INCLUDING COMBUSTION, OBSCURATION, AND RATE OF TEMPERATURE RISE, MANUAL PULL STATIONS, TRANSPONDERS, CONTROL CONSOLES, PRINTERS AND AUDIO AND VISUAL ALARM INDICATORS, COMPUTER SOFTWARE AND HARDWARE FOR OPERATION OF LINEAR DETECTION SYSTEMS, AND PARTS THEREFORE; APPARATUS AND EQUIPMENT FOR DETECTING WATER LEAKS, GAS LEAKS, CHEMICAL LEAKS, LIQUID LEAKS AND LIQUEFIED NATURAL GASES, NAMELY, A LINEAR DETECTION SYSTEM COMPRISED OF LEAK DETECTORS, MONITORS, CODE ACCESS PANELS, WIRELESS KEYPAD ALARMS, LEAK SENSORS, SENSORS TO INDICATE PHYSICAL CHANGES INDICATING LEAKS, MANUAL PULL STATIONS, TRANSPONDERS, CONTROL CONSOLES, PRINTERS AND AUDIO AND VISUAL ALARM INDICATORS, COMPUTER

SOFTWARE AND HARDWARE FOR OPERATION OF LINEAR DETECTION SYSTEMS, AND PARTS THEREFORE; FIRE DETECTORS; COMPUTER SOFTWARE FOR THE CONTROL OF LINEAR DETECTION SYSTEMS, FIRE DETECTION SYSTEMS, HEAT DETECTION SYSTEMS, ALARM SYSTEMS, VENTILATION SYSTEMS AND TIME SYSTEMS; COMPUTER HARDWARE FOR USE WITH LINEAR DETECTION SYSTEMS, FIRE DETECTION SYSTEMS, HEAT DETECTION SYSTEMS, ALARM SYSTEMS, VENTILATION SYSTEMS AND TIME SYSTEMS, IN CLASS 9 (U.S. CLS. 21, 23, 26, 36 AND 38).

FIRST USE 2-0-2007; IN COMMERCE 2-0-2007.

THE MARK CONSISTS OF STANDARD CHARACTERS WITHOUT CLAIM TO ANY PARTICULAR FONT, STYLE, SIZE, OR COLOR.

PRIORITY CLAIMED UNDER SEC. 44(D) ON ERPN CMNTY TM OFC APPLICATION NO. 3673993, FILED 3-2-2004, REG. NO. 3673993, DATED 12-13-2005, EXPIRES 3-2-2014.

SN 78-380,573, FILED 3-8-2004.

WON TEAK OH, EXAMINING ATTORNEY



**Int. Cl.: 36**

**Prior U.S. Cls.: 100, 101, and 102**

**United States Patent and Trademark Office**

**Reg. No. 3,455,182**

**Registered June 24, 2008**

**SERVICE MARK  
PRINCIPAL REGISTER**

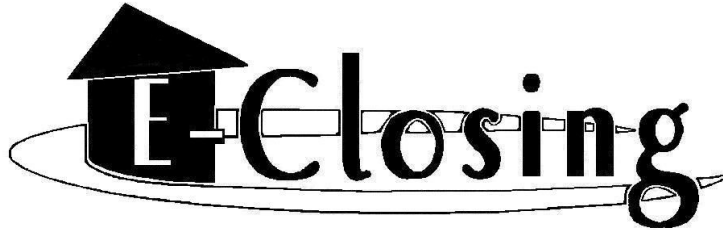

E-CLOSING, LLC. (NEW HAMPSHIRE LTD LIAB  
CO)  
P.O. BOX 93  
PEMBROKE, NH 03275

FIRST USE 6-1-2004; IN COMMERCE 6-1-2004.

FOR: CONSULTATION IN THE FIELDS OF REAL  
ESTATE, MORTGAGE, FINANCIAL AND CREDIT  
TRANSACTIONS; PROVIDING ASSISTANCE IN  
THE COMPLETION OF REAL ESTATE, MORT-  
GAGE, FINANCIAL AND CREDIT TRANSAC-  
TIONS, IN CLASS 36 (U.S. CLS. 100, 101 AND 102).

NO CLAIM IS MADE TO THE EXCLUSIVE  
RIGHT TO USE "E-CLOSING", APART FROM THE  
MARK AS SHOWN.

SN 78-382,007, FILED 3-10-2004.

MARCIE MILONE, EXAMINING ATTORNEY

**Int. Cls.: 37 and 42**

**Prior U.S. Cls.: 100, 101, 103, and 106**

**United States Patent and Trademark Office**

**Reg. No. 3,455,183**

**Registered June 24, 2008**

**SERVICE MARK  
PRINCIPAL REGISTER**

**POWER ARCHITECTURE**

INTERNATIONAL BUSINESS MACHINES CORPORATION (NEW YORK CORPORATION)  
NEW ORCHARD ROAD  
ARMONK, NY 10504

FOR: CUSTOM INSTALLATION, REPAIR AND MAINTENANCE OF COMPUTER HARDWARE, IN CLASS 37 (U.S. CLS. 100, 103 AND 106).

FIRST USE 4-11-2008; IN COMMERCE 4-11-2008.

FOR: COMPUTER PROJECT MANAGEMENT SERVICES; CONSULTING SERVICES CONCERNING DESIGN AND DEVELOPMENT OF COMPUTER SOFTWARE PROGRAMS AND ARCHITECTURE AND COMPUTER HARDWARE ARCHITECTURE; CONSULTING SERVICES IN THE FIELD OF DESIGNING, DEVELOPING AND USING COMPUTER HARDWARE AND COMPUTER SOFTWARE; TECHNICAL SUPPORT SERVICES, NAMELY, TROUBLESHOOTING OF COMPUTER HARDWARE AND COMPUTER SOFTWARE PROBLEMS; INTEGRATION OF COMPUTER HARDWARE AND SOFTWARE; COMPUTER SOFTWARE AND HARDWARE TESTING SERVI-

CES; INSTALLATION, UPDATING AND MAINTENANCE OF COMPUTER SOFTWARE; COMPUTER PROGRAMMING FOR OTHERS; COMPUTER CONSULTING SERVICES IN THE FIELD OF COMPUTER HARDWARE AND COMPUTER SOFTWARE FOR MANAGING HARDWARE AND SOFTWARE AND PROCESSES THAT EXIST WITHIN AN INFORMATION TECHNOLOGY ENVIRONMENT; AND COMPUTER SYSTEMS ANALYSIS, IN CLASS 42 (U.S. CLS. 100 AND 101).

FIRST USE 4-11-2008; IN COMMERCE 4-11-2008.

THE MARK CONSISTS OF STANDARD CHARACTERS WITHOUT CLAIM TO ANY PARTICULAR FONT, STYLE, SIZE, OR COLOR.

NO CLAIM IS MADE TO THE EXCLUSIVE RIGHT TO USE "ARCHITECTURE", APART FROM THE MARK AS SHOWN.

SN 78-383,268, FILED 3-12-2004.

JIM RINGLE, EXAMINING ATTORNEY

**Int. Cl.: 25**

**Prior U.S. Cls.: 22 and 39**

**United States Patent and Trademark Office**

**Reg. No. 3,455,184**

**Registered June 24, 2008**

**TRADEMARK  
PRINCIPAL REGISTER**

**GOAVA**

SCOUT PERFORMANCE, LLC (NEW YORK LIMITED LIABILITY CORPORATION)  
SUITE 1001  
347 W. 36TH STREET  
NEW YORK, NY 10018

FOR: WOMEN'S CLOTHING, NAMELY, HOODIE TOPS, CREW NECK TOPS, FULL ZIP JACKETS, CAPRI PANTS, CROPPED PANTS, FULL LENGTH PANTS AND OUTERWEAR, NAMELY, COATS, JACKETS AND VESTS, IN CLASS 25 (U.S. CLS. 22 AND 39).

FIRST USE 10-3-2007; IN COMMERCE 10-3-2007.

THE MARK CONSISTS OF STANDARD CHARACTERS WITHOUT CLAIM TO ANY PARTICULAR FONT, STYLE, SIZE, OR COLOR.

SN 78-387,310, FILED 3-19-2004.

PRISCILLA MILTON, EXAMINING ATTORNEY

**Int. Cl.: 12**

**Prior U.S. Cls.: 19, 21, 23, 31, 35, and 44**

**Reg. No. 3,455,185**

**United States Patent and Trademark Office**

**Registered June 24, 2008**

---

**TRADEMARK  
PRINCIPAL REGISTER**

**BLACKTAIL**

EXCEL TIRE & WHEEL CORP. (CALIFORNIA  
CORPORATION)  
P.O. BOX 1044  
WALNUT, CA 91788

THE MARK CONSISTS OF STANDARD CHAR-  
ACTERS WITHOUT CLAIM TO ANY PARTICULAR  
FONT, STYLE, SIZE, OR COLOR.

FOR: TIRES, IN CLASS 12 (U.S. CLS. 19, 21, 23, 31,  
35 AND 44).

SN 78-388,714, FILED 3-22-2004.

FIRST USE 3-1-2003; IN COMMERCE 3-1-2003.

TRICIA SONNEBORN, EXAMINING ATTORNEY

**Int. Cl.: 25**

**Prior U.S. Cls.: 22 and 39**

**United States Patent and Trademark Office**

**Reg. No. 3,455,186**

**Registered June 24, 2008**

**TRADEMARK  
PRINCIPAL REGISTER**

**ALL AMERICAN  
UNIFORMS**

NEW CHEF FASHION, INC. (CALIFORNIA COR-  
PORATION)  
3223 E. 46TH STREET  
LOS ANGELES, CA 90058

FOR: UNIFORMS AND UTILITY CLOTHING  
FOR THE CULINARY AND RESTAURANT  
TRADES, NAMELY, COATS, JACKETS, SHIRTS,  
PANTS, DRESSES, APRONS, VESTS, CAPS, HATS,  
AND TIES, IN CLASS 25 (U.S. CLS. 22 AND 39).

FIRST USE 5-0-1989; IN COMMERCE 1-0-2008.

THE MARK CONSISTS OF STANDARD CHAR-  
ACTERS WITHOUT CLAIM TO ANY PARTICULAR  
FONT, STYLE, SIZE, OR COLOR.

NO CLAIM IS MADE TO THE EXCLUSIVE  
RIGHT TO USE "UNIFORMS", APART FROM THE  
MARK AS SHOWN.

SN 78-394,320, FILED 3-31-2004.

ROBIN MITTLER, EXAMINING ATTORNEY

**Int. Cl.: 39**

**Prior U.S. Cls.: 100 and 105**

**Reg. No. 3,455,187**

**United States Patent and Trademark Office**

**Registered June 24, 2008**

---

**SERVICE MARK  
PRINCIPAL REGISTER**

**PURELY REFRESHING.  
PERSONALLY  
DELIVERED. EVERY  
TWO WEEKS.**

DS WATERS OF AMERICA, LP (DELAWARE  
LIMITED PARTNERSHIP)  
5660 NEW NORTHSIDE DRIVE, SUITE 500  
ATLANTA, GA 30328

THE MARK CONSISTS OF STANDARD CHAR-  
ACTERS WITHOUT CLAIM TO ANY PARTICULAR  
FONT, STYLE, SIZE, OR COLOR.

FOR: HOME AND OFFICE DELIVERY OF BOT-  
TLED WATER PRODUCTS, IN CLASS 39 (U.S. CLS.  
100 AND 105).

SN 78-394,936, FILED 4-1-2004.

FIRST USE 10-25-2004; IN COMMERCE 10-25-2004.

NAAKWAMA ANKRAH, EXAMINING ATTORNEY

**Int. Cl.: 3**

**Prior U.S. Cls.: 1, 4, 6, 50, 51, and 52**

**Reg. No. 3,455,188**

**United States Patent and Trademark Office**

**Registered June 24, 2008**

**TRADEMARK  
PRINCIPAL REGISTER**

**LEMONUP**

CGE ENTERPRISES, LLC (DELAWARE LTD  
LIAB CO)  
5650 MAIN STREET  
MANCHESTER CENTER, VT 05255

THE MARK CONSISTS OF STANDARD CHAR-  
ACTERS WITHOUT CLAIM TO ANY PARTICULAR  
FONT, STYLE, SIZE, OR COLOR.

FOR: HAIR CARE PRODUCTS, NAMELY, SHAM-  
POOS, IN CLASS 3 (U.S. CLS. 1, 4, 6, 50, 51 AND 52).

SN 78-398,462, FILED 4-8-2004.

FIRST USE 4-1-2008; IN COMMERCE 4-1-2008.

ESTHER A. BORSUK, EXAMINING ATTORNEY

**Int. Cl.: 3**

**Prior U.S. Cls.: 1, 4, 6, 50, 51, and 52**

**Reg. No. 3,455,189**

**United States Patent and Trademark Office**

**Registered June 24, 2008**

**TRADEMARK  
PRINCIPAL REGISTER**

**CELEBRITY SMILE**

KAYE, DEBRA (UNITED STATES INDIVIDUAL)  
6187 ROUTE 82  
P.O. BOX 132  
STANFORDVILLE, NY 12581 AND  
LOWENBERG & LITUCHY (NEW YORK PARTNER-  
SHIP)  
230 CENTRAL PARK SOUTH  
NEW YORK, NY 10019

FIRST USE 4-24-2008; IN COMMERCE 4-24-2008.

THE MARK CONSISTS OF STANDARD CHAR-  
ACTERS WITHOUT CLAIM TO ANY PARTICULAR  
FONT, STYLE, SIZE, OR COLOR.

SN 78-398,965, FILED 4-8-2004.

FOR: TEETH WHITENING GELS; TEETH POL-  
ISH, IN CLASS 3 (U.S. CLS. 1, 4, 6, 50, 51 AND 52).

RONALD MCMORROW, EXAMINING ATTORNEY



**Int. Cls.: 16 and 41**

**Prior U.S. Cls.: 2, 5, 22, 23, 29, 37, 38, 50, 100, 101, and 107**

**Reg. No. 3,455,190**

**United States Patent and Trademark Office**

**Registered June 24, 2008**

**TRADEMARK  
SERVICE MARK  
PRINCIPAL REGISTER**

**JOEY YAP FENG SHUI  
MASTERY SERIES**

MASTERY ACADEMY OF CHINESE METAPHYSICS SDN. BHD. (MALAYSIA CORPORATION)  
NO. 17-3, THE BOULEVARD, MID VALLEY CITY  
LINGKARAN SYED PUTRA  
KUALA LUMPUR, MALAYSIA 59200

FOR: GRAPHIC REPRESENTATIONS AND GRAPHIC REPRODUCTIONS IN THE NATURE OF POSTERS AND BANNERS; GREETING CARDS; HANDBOOKS AND WRITTEN MANUALS IN THE FIELD OF FENG SHUI, BAZI DESTINY, MIAN XIANG FACE READING, XUAN KONG FLYING STARS AND CHINESE METAPHYSICS STUDIES; NEWSPAPERS; NOTEBOOKS; PACKING PAPER; NOTE PADS; PAMPHLETS ABOUT FENG SHUI, BAZI DESTINY, MIANXIANG FACE READING, XUAN KONG FLYING STARS AND CHINESE METAPHYSICS STUDIES; WRITING PAPER; MAGAZINES ABOUT FENG SHUI, BAZI DESTINY, MIANXIANG FACE READING, XUAN KONG FLYING STARS AND CHINESE METAPHYSICS STUDIES; PLACECARDS OF PAPER OF CARDBOARD FOR PRESENTATION, SEMINARS, WORKSHOPS, COURSES, CLASSES; PRINTED MATTER, NAMELY, BROCHURES, WORKBOOKS, ADVERTISING MAILERS AND FLYERS; PRINTED PUBLICATIONS, NAMELY, MAGAZINES ABOUT FENG SHUI, BAZI DESTINY, MIANXIANG FACE READING, XUAN KONG FLYING STARS AND CHINESE METAPHYSICS STUDIES, IN CLASS 16 (U.S. CLS. 2, 5, 22, 23, 29, 37, 38 AND 50).

FIRST USE 5-6-2004; IN COMMERCE 5-1-2007.

FOR: EDUCATIONAL SERVICES, NAMELY, ACADEMIES, ARRANGING AND CONDUCTING OF EDUCATIONAL CONFERENCES, ARRANGING AND CONDUCTING OF EDUCATIONAL OF EDUCATIONAL CONGRESSES, ARRANGING AND CONDUCTING OF SEMINARS, ARRANGING AND CONDUCTING OF SYMPOSIUMS, ARRANGING AND CONDUCTING OF WORKSHOPS; INSTRUCTION AND CORRESPONDENCE COURSES ALL IN THE FIELD OF FENG SHUI, BAZI DESTINY, MIANXIANG FACE READING, XUAN KONG FLYING STARS AND CHINESE METAPHYSICS STUDIES; PROVIDING EDUCATIONAL TRAINING INFORMATION IN THE FIELD OF FENG SHUI, BAZI DESTINY, MIANXIANG FACE READING, XUAN KONG FLYING STARS AND CHINESE METAPHYSICS STUDIES; ORGANIZATIONS OF EXHIBITIONS FOR CULTURAL OR EDUCATIONAL PURPOSES IN THE FIELD OF FENG SHUI, BAZI DESTINY, MIANXIANG FACE READING, XUAN KONG FLYING STARS AND CHINESE METAPHYSICS STUDIES; PROVIDING ON-LINE NON-DOWNLOADABLE ELECTRONIC PUBLICATIONS, NAMELY, MAGAZINES IN THE FIELD OF FENG SHUI, BAZI DESTINY, MIANXIANG FACE READING, XUAN KONG FLYING STARS AND CHINESE METAPHYSICS STUDIES; PUBLICATION OF BOOKS; PUBLICATION OF ELECTRONIC BOOKS AND JOURNALS ON-LINE; PUBLICATION OF TEXT BOOKS; RECORDING STUDIO SERVICES; PRACTICAL TRAINING, NAMELY, EDUCATIONAL DEMONSTRATIONS; VIDEOTAPE EDITING, VIDEOTAPE FILM PRODUCTION; VIDEOTAPING;

VIDEO TAPE AND CD/VCD/DVD EDITING, DUB-  
BING AND PRODUCTION, IN CLASS 41 (U.S. CLS.  
100, 101 AND 107).

FIRST USE 5-6-2004; IN COMMERCE 6-11-2007.

THE MARK CONSISTS OF STANDARD CHAR-  
ACTERS WITHOUT CLAIM TO ANY PARTICULAR  
FONT, STYLE, SIZE, OR COLOR.

NO CLAIM IS MADE TO THE EXCLUSIVE  
RIGHT TO USE "FENG SHUI MASTERY SERIES",  
APART FROM THE MARK AS SHOWN.

THE NAME(S), PORTRAIT(S), AND/OR SIGNA-  
TURE(S) SHOWN IN THE MARK DOES NOT IDENTI-  
FY A PARTICULAR LIVING INDIVIDUAL.

SN 78-399,482, FILED 4-9-2004.

HOWARD B. LEVINE, EXAMINING ATTORNEY

**Int. Cl.: 9**

**Prior U.S. Cls.: 21, 23, 26, 36, and 38**

**United States Patent and Trademark Office**

**Reg. No. 3,455,191**

**Registered June 24, 2008**

**TRADEMARK  
PRINCIPAL REGISTER**

**PLAN > IT**

AB INITIO SOFTWARE CORPORATION (DELA-  
WARE CORPORATION)  
201 SPRING STREET  
LEXINGTON, MA 02421

THE MARK CONSISTS OF STANDARD CHAR-  
ACTERS WITHOUT CLAIM TO ANY PARTICULAR  
FONT, STYLE, SIZE, OR COLOR.

FOR: COMPUTER SOFTWARE FOR CONTROL-  
LING AND MONITORING COMPUTER PROCES-  
SES AND RESOURCES, IN CLASS 9 (U.S. CLS. 21, 23,  
26, 36 AND 38).

SN 78-399,504, FILED 4-9-2004.

FIRST USE 11-9-2005; IN COMMERCE 11-9-2005.

JOHN DALIER, EXAMINING ATTORNEY

**Int. Cl.: 9**

**Prior U.S. Cls.: 21, 23, 26, 36, and 38**

**Reg. No. 3,455,192**

**United States Patent and Trademark Office**

**Registered June 24, 2008**

---

**TRADEMARK  
PRINCIPAL REGISTER**

**SOUND PRO**

SOLUTIA INC. (DELAWARE CORPORATION)  
575 MARYVILLE CENTRE DRIVE  
ST. LOUIS, MO 25913

FOR: COMPUTER PROGRAMS AND SOFTWARE  
FOR USE IN THE DESIGN OF GLASS FOR BUILD-  
INGS AND VEHICLES, IN CLASS 9 (U.S. CLS. 21, 23,  
26, 36 AND 38).

FIRST USE 3-1-1999; IN COMMERCE 3-1-1999.

THE MARK CONSISTS OF STANDARD CHAR-  
ACTERS WITHOUT CLAIM TO ANY PARTICULAR  
FONT, STYLE, SIZE, OR COLOR.

NO CLAIM IS MADE TO THE EXCLUSIVE  
RIGHT TO USE "SOUND", APART FROM THE  
MARK AS SHOWN.

SN 78-401,026, FILED 4-13-2004.

DANIEL BRODY, EXAMINING ATTORNEY

**Int. Cl.: 42**

**Prior U.S. Cls.: 100 and 101**

**United States Patent and Trademark Office**

**Reg. No. 3,455,193**

**Registered June 24, 2008**

**SERVICE MARK  
PRINCIPAL REGISTER**

**ZYMO**

ZYMOGENETICS, INC. (WASHINGTON CORPORATION)  
1201 EASTLAKE AVE., E.  
SEATTLE, WA 98102

FOR: SCIENTIFIC SERVICES, NAMELY, DISCOVERY, AND TECHNICAL ANALYSIS AND PROCESS OPTIMIZATION, ALL IN THE FIELD OF BIOTECHNOLOGY; RESEARCH, DISCOVERY AND DEVELOPMENT OF THERAPEUTIC DRUGS FOR THE PREVENTION OR TREATMENT OF HUMAN DISEASES, IN CLASS 42 (U.S. CLS. 100 AND 101).

FIRST USE 5-15-2007; IN COMMERCE 5-15-2007.

THE MARK CONSISTS OF STANDARD CHARACTERS WITHOUT CLAIM TO ANY PARTICULAR FONT, STYLE, SIZE, OR COLOR.

OWNER OF U.S. REG. NOS. 1,345,375 AND 1,685,713.

SEC. 2(F).

SN 78-401,066, FILED 4-13-2004.

JULIE WATSON, EXAMINING ATTORNEY

**Int. Cl.: 9**

**Prior U.S. Cls.: 21, 23, 26, 36, and 38**

**United States Patent and Trademark Office**

**Reg. No. 3,455,194**

**Registered June 24, 2008**

**TRADEMARK  
PRINCIPAL REGISTER**

**BIG TIMES DRAW  
POKER**

IGT (NEVADA CORPORATION)  
9295 PROTOTYPE DRIVE  
RENO, NV 895218986

OWNER OF U.S. REG. NO. 2,727,320.

FOR: GAMING MACHINES, NAMELY, DEVICES  
WHICH ACCEPT A WAGER, IN CLASS 9 (U.S. CLS.  
21, 23, 26, 36 AND 38).

NO CLAIM IS MADE TO THE EXCLUSIVE  
RIGHT TO USE "DRAW POKER", APART FROM  
THE MARK AS SHOWN.

FIRST USE 4-24-2007; IN COMMERCE 4-24-2007.

SN 78-404,438, FILED 4-19-2004.

THE MARK CONSISTS OF STANDARD CHAR-  
ACTERS WITHOUT CLAIM TO ANY PARTICULAR  
FONT, STYLE, SIZE, OR COLOR.

BRENDAN REGAN, EXAMINING ATTORNEY

**Int. Cl.: 41**

**Prior U.S. Cls.: 100, 101, and 107**

**United States Patent and Trademark Office**

**Reg. No. 3,455,195**

**Registered June 24, 2008**

**SERVICE MARK  
PRINCIPAL REGISTER**

**WORLD SERIES OF  
GOLF CLUB  
CHAMPIONSHIP**

WORLD SERIES OF GOLF INC. (NEVADA CORPORATION)  
1613 NIGHT WIND DRIVE  
LAS VEGAS, NV 89117

FOR: ORGANIZING AND CONDUCTING A SERIES OF GOLF TOURNAMENTS, IN CLASS 41 (U.S. CLS. 100, 101 AND 107).

FIRST USE 9-1-2007; IN COMMERCE 9-1-2007.

THE MARK CONSISTS OF STANDARD CHARACTERS WITHOUT CLAIM TO ANY PARTICULAR FONT, STYLE, SIZE, OR COLOR.

NO CLAIM IS MADE TO THE EXCLUSIVE RIGHT TO USE "GOLF CLUB CHAMPIONSHIP", APART FROM THE MARK AS SHOWN.

SN 78-405,591, FILED 4-21-2004.

MICHAEL ENGEL, EXAMINING ATTORNEY

**Int. Cl.: 41**

**Prior U.S. Cls.: 100, 101, and 107**

**United States Patent and Trademark Office**

**Reg. No. 3,455,196**

**Registered June 24, 2008**

**SERVICE MARK  
PRINCIPAL REGISTER**

**RAISE YOUR PLAY IQ**

DUPAGE CHILDREN'S MUSEUM (ILLINOIS  
NOT-FOR-PROFIT CORPORATION)  
301 N. WASHINGTON STREET  
NAPERVILLE, IL 60540

THE MARK CONSISTS OF STANDARD CHAR-  
ACTERS WITHOUT CLAIM TO ANY PARTICULAR  
FONT, STYLE, SIZE, OR COLOR.

FOR: EDUCATIONAL SERVICES, NAMELY,  
CONDUCTING EXHIBITIONS AT THE PRIMARY  
LEVEL, IN CLASS 41 (U.S. CLS. 100, 101 AND 107).

SN 78-409,740, FILED 4-28-2004.

FIRST USE 7-10-2004; IN COMMERCE 7-10-2004.

GEOFFREY FOSDICK, EXAMINING ATTORNEY



**Int. Cl.: 5**

**Prior U.S. Cls.: 6, 18, 44, 46, 51, and 52**

**Reg. No. 3,455,197**

**United States Patent and Trademark Office**

**Registered June 24, 2008**

**TRADEMARK  
PRINCIPAL REGISTER**

**NUTRA CHEWS**

IMPROVITA HEALTH PRODUCTS, INC. (OHIO  
CORPORATION)  
10055 SWEET VALLEY DRIVE  
CLEVELAND, OH 44125

FOR: DIETARY FOOD SUPPLEMENTS CON-  
TAINING VITAMINS AND MINERALS, NOT FOR  
USE AS NUTRITIONAL SUPPLEMENTS FOR ANI-  
MALS OR PETS, IN CLASS 5 (U.S. CLS. 6, 18, 44, 46, 51  
AND 52).

FIRST USE 7-30-2005; IN COMMERCE 7-30-2005.

THE MARK CONSISTS OF STANDARD CHAR-  
ACTERS WITHOUT CLAIM TO ANY PARTICULAR  
FONT, STYLE, SIZE, OR COLOR.

NO CLAIM IS MADE TO THE EXCLUSIVE  
RIGHT TO USE "CHEWS", APART FROM THE  
MARK AS SHOWN.

SN 78-410,026, FILED 4-29-2004.

BARBARA GAYNOR, EXAMINING ATTORNEY

**Int. Cls.: 18 and 20**

**Prior U.S. Cls.: 1, 2, 3, 13, 22, 25, 32, 41, and 50**

**United States Patent and Trademark Office**

**Reg. No. 3,455,198**

**Registered June 24, 2008**

**TRADEMARK  
PRINCIPAL REGISTER**

**CAPTAIN MORGAN**

DIAGEO NORTH AMERICA, INC. (CONNECTI-  
CUT CORPORATION)  
801 MAIN AVE  
NORWALK, CT 06851

FOR: MESSENGER BAGS, CARRY-ON BAGS  
AND UMBRELLAS, IN CLASS 18 (U.S. CLS. 1, 2, 3,  
22 AND 41).

FIRST USE 1-0-2007; IN COMMERCE 1-0-2007.

FOR: MIRRORS AND DECK CHAIRS, IN CLASS  
20 (U.S. CLS. 2, 13, 22, 25, 32 AND 50).

FIRST USE 10-0-2005; IN COMMERCE 10-0-2005.

THE MARK CONSISTS OF STANDARD CHAR-  
ACTERS WITHOUT CLAIM TO ANY PARTICULAR  
FONT, STYLE, SIZE, OR COLOR.

THE NAME IN THE MARK DOES NOT IDENTI-  
FY A LIVING INDIVIDUAL.

SN 78-410,632, FILED 4-29-2004.

CHERYL CLAYTON, EXAMINING ATTORNEY

**Int. Cl.: 42**

**Prior U.S. Cls.: 100 and 101**

**United States Patent and Trademark Office**

**Reg. No. 3,455,199**

**Registered June 24, 2008**

**SERVICE MARK  
PRINCIPAL REGISTER**

**TRYVISTA**

WOLF, GEORGE T. II (UNITED STATES INDIVIDUAL)  
313 WEST LIBERTY STREET  
LANCASTER, PA 17603

FOR: PROVIDING TEMPORARY USE OF NON-DOWNLOADABLE SOFTWARE FOR BUSINESS MANAGEMENT PURPOSES, IN CLASS 42 (U.S. CLS. 100 AND 101).

FIRST USE 4-28-2008; IN COMMERCE 4-28-2008.

THE MARK CONSISTS OF STANDARD CHARACTERS WITHOUT CLAIM TO ANY PARTICULAR FONT, STYLE, SIZE, OR COLOR.

SN 78-410,954, FILED 4-30-2004.

JILL C. ALT, EXAMINING ATTORNEY

**Int. Cl.: 25**

**Prior U.S. Cls.: 22 and 39**

**United States Patent and Trademark Office**

**Reg. No. 3,455,200**

**Registered June 24, 2008**

**TRADEMARK  
PRINCIPAL REGISTER**

**HYDROTRAK**

THE NORTH FACE APPAREL CORP. (DELA-  
WARE CORPORATION)  
3411 SILVERSIDE RD.  
WILMINGTON, DE 19810

FOR: FOOTWEAR, NAMELY, TREKKING  
BOOTS AND SHOES; TRAIL RUNNING SHOES,  
HIKING BOOTS AND SHOES; ATHLETIC SHOES,  
CLIMBING SHOES, CLIMBING SLIPPERS, IN  
CLASS 25 (U.S. CLS. 22 AND 39).

FIRST USE 1-0-2005; IN COMMERCE 1-0-2005.

THE MARK CONSISTS OF STANDARD CHAR-  
ACTERS WITHOUT CLAIM TO ANY PARTICULAR  
FONT, STYLE, SIZE, OR COLOR.

SN 78-411,483, FILED 4-30-2004.

JOHN GARTNER, EXAMINING ATTORNEY

**Int. Cl.: 35**

**Prior U.S. Cls.: 100, 101, and 102**

**United States Patent and Trademark Office**

**Reg. No. 3,455,201**

**Registered June 24, 2008**

---

**SERVICE MARK  
PRINCIPAL REGISTER**

**Love and Roses**

SUTTLE, MARIA R. (UNITED STATES INDIVIDUAL)  
25261 JEFFERSON AVENUE  
MURRIETA, CA 92562

FOR: ON-LINE RETAIL STORE SERVICE FEATURING GIFTS, IN CLASS 35 (U.S. CLS. 100, 101 AND 102).

FIRST USE 5-2-2008; IN COMMERCE 5-2-2008.

THE MARK CONSISTS OF STANDARD CHARACTERS WITHOUT CLAIM TO ANY PARTICULAR FONT, STYLE, SIZE, OR COLOR.

NO CLAIM IS MADE TO THE EXCLUSIVE RIGHT TO USE "ROSES", APART FROM THE MARK AS SHOWN.

SN 78-411,578, FILED 4-30-2004.

ROBIN CHOSID, EXAMINING ATTORNEY

**Int. Cl.: 8**

**Prior U.S. Cls.: 23, 28, and 44**

**Reg. No. 3,455,202**

**United States Patent and Trademark Office**

**Registered June 24, 2008**

---

**TRADEMARK  
PRINCIPAL REGISTER**

**18-DELTA**

THE GREAT AMERICAN TOOL COMPANY,  
INC. (DELAWARE CORPORATION)  
665 HERTEL AVENUE  
BUFFALO, NY 14207

THE MARK CONSISTS OF STANDARD CHAR-  
ACTERS WITHOUT CLAIM TO ANY PARTICULAR  
FONT, STYLE, SIZE, OR COLOR.

FOR: MULTI-FUNCTION MANUALLY-OPER-  
ATED RESCUE TOOL WITH FIXED BLADES OR  
FOLDING BLADES AND GLASS-BREAKING  
TOOL, IN CLASS 8 (U.S. CLS. 23, 28 AND 44).

SN 78-413,957, FILED 5-6-2004.

FIRST USE 9-20-2007; IN COMMERCE 9-20-2007.

GEORGE LORENZO, EXAMINING ATTORNEY

**Int. Cl.: 3**

**Prior U.S. Cls.: 1, 4, 6, 50, 51, and 52**

**Reg. No. 3,455,203**

**United States Patent and Trademark Office**

**Registered June 24, 2008**

---

**TRADEMARK  
PRINCIPAL REGISTER**

**KELA CI'**

KELA CI INC. (CALIFORNIA CORPORATION)  
14006 VENTURA BLVD.  
SHERMAN OAKS, CA 91423

FOR: COSMETICS, SOAP, HAIR LOTION, PERFUME AND COLOGNE, SHOE CLEANERS AND SHOE TREATMENTS, NAMELY, SHOE POLISH AND SHOE CREAM, IN CLASS 3 (U.S. CLS. 1, 4, 6, 50, 51 AND 52).

FIRST USE 2-1-2008; IN COMMERCE 2-1-2008.

THE MARK CONSISTS OF STANDARD CHARACTERS WITHOUT CLAIM TO ANY PARTICULAR FONT, STYLE, SIZE, OR COLOR.

THE FOREIGN WORDING IN THE MARK TRANSLATES INTO ENGLISH AS "SUGGESTING STYLE" OR "CLASS".

SN 78-417,032, FILED 5-11-2004.

HOWARD SMIGA, EXAMINING ATTORNEY

**Int. Cl.: 9**

**Prior U.S. Cls.: 21, 23, 26, 36, and 38**

**Reg. No. 3,455,204**

**United States Patent and Trademark Office**

**Registered June 24, 2008**

---

**TRADEMARK  
PRINCIPAL REGISTER**

**WITTY BITS**

WITTY BIT WORLD, INC. (NORTH CAROLINA  
CORPORATION)  
143 POLO DRIVE  
SALISBURY, NC 28144

FOR: PRE-RECORDED VIDEOTAPE PROGRAMS  
FEATURING ANIMATION CHARACTERS  
FORMED STYLISTICALLY FROM LETTERS OF  
THE ALPHABET, IN CLASS 9 (U.S. CLS. 21, 23, 26,  
36 AND 38).

FIRST USE 9-25-2007; IN COMMERCE 9-25-2007.

THE MARK CONSISTS OF STANDARD CHAR-  
ACTERS WITHOUT CLAIM TO ANY PARTICULAR  
FONT, STYLE, SIZE, OR COLOR.

SN 78-422,138, FILED 5-20-2004.

TAMARA FRAZIER, EXAMINING ATTORNEY



**Int. Cl.: 35**

**Prior U.S. Cls.: 100, 101, and 102**

**United States Patent and Trademark Office**

**Reg. No. 3,455,205**

**Registered June 24, 2008**

**SERVICE MARK  
PRINCIPAL REGISTER**

**PROKARMA**

PROKARMA, INC. (DELAWARE CORPORATION)  
14780 SW OSPREY DRIVE, SUITE 285  
BEAVERTON, OR 97007

FOR: BUSINESS PROCESS OUTSOURCING, OUTSOURCING IN THE FIELD OF PROCUREMENT, HUMAN RESOURCES, FINANCE AND MANUFACTURING; EMPLOYMENT CONTRACTING AND TEMPORARY HELP SERVICES; RECRUITMENT AND PLACEMENT OF PERSONNEL ON A TEMPORARY, CONTRACT OR PERMANENT BASIS; BUSINESS CONSULTING SERVICES IN THE FIELD OF PROCUREMENT, HUMAN RESOURCES, FI-

NANCE AND MANUFACTURING, IN CLASS 35 (U.S. CLS. 100, 101 AND 102).

FIRST USE 4-1-2004; IN COMMERCE 4-1-2004.

THE MARK CONSISTS OF STANDARD CHARACTERS WITHOUT CLAIM TO ANY PARTICULAR FONT, STYLE, SIZE, OR COLOR.

SN 78-428,129, FILED 6-1-2004.

ESTHER A. BORSUK, EXAMINING ATTORNEY

**Int. Cl.: 25**

**Prior U.S. Cls.: 22 and 39**

**United States Patent and Trademark Office**

**Reg. No. 3,455,206**

**Registered June 24, 2008**

**TRADEMARK  
PRINCIPAL REGISTER**

**TRICLIMATE**

THE NORTH FACE APPAREL CORP. (DELA-  
WARE CORPORATION)  
3411 SILVERSIDE RD  
WILMINGTON, DE 19810

FOR: CLOTHING, NAMELY, JACKETS, PARKAS,  
AND SHELLS, IN CLASS 25 (U.S. CLS. 22 AND 39).

FIRST USE 7-0-2005; IN COMMERCE 7-0-2005.

THE MARK CONSISTS OF STANDARD CHAR-  
ACTERS WITHOUT CLAIM TO ANY PARTICULAR  
FONT, STYLE, SIZE, OR COLOR.

SN 78-428,586, FILED 6-2-2004.

ZACHARY BELLO, EXAMINING ATTORNEY

**Int. Cl.: 41**

**Prior U.S. Cls.: 100, 101, and 107**

**United States Patent and Trademark Office**

**Reg. No. 3,455,207**

**Registered June 24, 2008**

**SERVICE MARK  
PRINCIPAL REGISTER**

**WHAT'S THE "TAKE  
HOME"?**

CMPMEDICA LLC (DELAWARE LTD LIAB CO)  
600 HARRISON STREET  
SAN FRANCISCO, CA 94107

FOR: COMPUTER SERVICES, NAMELY, PROVIDING AN ONLINE MAGAZINE IN THE FIELD OF MEDICINE, MEDICAL DIAGNOSIS AND THERAPY, IN CLASS 41 (U.S. CLS. 100, 101 AND 107).

FIRST USE 10-17-2007; IN COMMERCE 10-17-2007.

THE MARK CONSISTS OF STANDARD CHARACTERS WITHOUT CLAIM TO ANY PARTICULAR FONT, STYLE, SIZE, OR COLOR.

SN 78-430,294, FILED 6-4-2004.

ROBERT C. CLARK JR., EXAMINING ATTORNEY

**Int. Cls.: 5 and 16**

**Prior U.S. Cls.: 2, 5, 6, 18, 22, 23, 29, 37, 38, 44, 46, 50, 51, and 52**

**Reg. No. 3,455,208**

**United States Patent and Trademark Office**

**Registered June 24, 2008**

**TRADEMARK  
PRINCIPAL REGISTER**



SUPERFOODS PARTNERS LLC (CALIFORNIA CORPORATION)  
405 OCEAN VIEW TERRACE  
ENCINITAS, CA 92024

FOR: FOOD SUPPLEMENTS AND VITAMINS, IN CLASS 5 (U.S. CLS. 6, 18, 44, 46, 51 AND 52).

FIRST USE 1-0-2006; IN COMMERCE 1-0-2006.

FOR: MAGAZINES, NEWSLETTERS AND POSTERS DIRECTED TO THE FIELD OF NUTRITION, IN CLASS 16 (U.S. CLS. 2, 5, 22, 23, 29, 37, 38 AND 50).

FIRST USE 1-0-2006; IN COMMERCE 1-0-2006.

NO CLAIM IS MADE TO THE EXCLUSIVE RIGHT TO USE "SUPER FOODS RX", APART FROM THE MARK AS SHOWN.

SN 78-437,350, FILED 6-17-2004.

BARBARA BROWN, EXAMINING ATTORNEY

**Int. Cls.: 35, 38, and 42**

**Prior U.S. Cls.: 100, 101, 102, and 104**

**United States Patent and Trademark Office**

**Reg. No. 3,455,209**

**Registered June 24, 2008**

**SERVICE MARK  
PRINCIPAL REGISTER**

**TRUITION**

TRUITION INC. (CANADA CORPORATION)  
860 RICHMOND STREET WEST  
TORONTO, ONTARIO M6J 1C9

FOR: CONSULTATION REGARDING THE TRACKING AND MONITORING OF ELECTRONIC COMMERCE TRANSACTIONS, IN CLASS 35 (U.S. CLS. 100, 101 AND 102).

FIRST USE 7-1-2004; IN COMMERCE 7-1-2004.

FOR: CONSULTATION REGARDING TRANSMISSION OF ELECTRONIC COMMERCE TRANSACTIONS, IN CLASS 38 (U.S. CLS. 100, 101 AND 104).

FIRST USE 7-1-2004; IN COMMERCE 7-1-2004.

FOR: CONSULTATION REGARDING THE MANAGEMENT OF COMPUTER SOFTWARE PLATFORMS FOR E-COMMERCE; COMPUTER PROGRAMMING AND SOFTWARE CUSTOMIZATION FOR E-COMMERCE; PROVIDING TEMPOR-

ARY USE OF ONLINE SOFTWARE PLATFORMS THAT ALLOW USERS TO PERFORM ELECTRONIC BUSINESS TRANSACTIONS IN THE FORM OF FIXED PRICE AND AUCTIONS AND TO ALLOW SOFTWARE OPERATORS TO MANAGE AND ADMINISTER SUCH TRANSACTIONS, IN CLASS 42 (U.S. CLS. 100 AND 101).

FIRST USE 7-1-2004; IN COMMERCE 7-1-2004.

THE MARK CONSISTS OF STANDARD CHARACTERS WITHOUT CLAIM TO ANY PARTICULAR FONT, STYLE, SIZE, OR COLOR.

PRIORITY CLAIMED UNDER SEC. 44(D) ON CANADA APPLICATION NO. 1220476, FILED 6-15-2004, REG. NO. TMA640989, DATED 6-1-2005, EXPIRES 6-1-2020.

SN 78-441,623, FILED 6-25-2004.

KIMBERLY FRYE, EXAMINING ATTORNEY

**Int. Cl.: 38**

**Prior U.S. Cls.: 100, 101, and 104**

**United States Patent and Trademark Office**

**Reg. No. 3,455,210**

**Registered June 24, 2008**

**SERVICE MARK  
PRINCIPAL REGISTER**

**hipSIP**

SIPCALL.COM, INC. (CALIFORNIA CORPORATION)  
1600 ADAMS DR STE 126  
MENLO PARK, CA 94025

THE MARK CONSISTS OF STANDARD CHARACTERS WITHOUT CLAIM TO ANY PARTICULAR FONT, STYLE, SIZE, OR COLOR.

FOR: INTERNET TELEPHONY SERVICES, IN CLASS 38 (U.S. CLS. 100, 101 AND 104).

SN 78-441,853, FILED 6-25-2004.

FIRST USE 2-1-2008; IN COMMERCE 2-1-2008.

MICHAEL ENGEL, EXAMINING ATTORNEY

**Int. Cl.: 3**

**Prior U.S. Cls.: 1, 4, 6, 50, 51, and 52**

**United States Patent and Trademark Office**

**Reg. No. 3,455,211**

**Registered June 24, 2008**

**TRADEMARK  
PRINCIPAL REGISTER**

**LIGHTFUL**

MAKE-UP ART COSMETICS INC. (DELAWARE  
CORPORATION)  
767 FIFTH AVENUE  
NEW YORK, NY 10153

THE MARK CONSISTS OF STANDARD CHAR-  
ACTERS WITHOUT CLAIM TO ANY PARTICULAR  
FONT, STYLE, SIZE, OR COLOR.

FOR: NON-MEDICATED SKIN CARE PREPARA-  
TIONS, IN CLASS 3 (U.S. CLS. 1, 4, 6, 50, 51 AND 52).

SN 78-448,343, FILED 7-9-2004.

FIRST USE 5-5-2007; IN COMMERCE 5-5-2007.

ANNE E. GUSTASON, EXAMINING ATTORNEY

**Int. Cls.: 3, 10, 14, 25, and 35**

**Prior U.S. Cls.: 1, 2, 4, 6, 22, 26, 27, 28, 39, 44, 50, 51, 52, 100, 101, and 102**

**Reg. No. 3,455,212**

**United States Patent and Trademark Office**

**Registered June 24, 2008**

**TRADEMARK  
SERVICE MARK  
PRINCIPAL REGISTER**

**JIMMYJANE**

JIMMYJANE, INC. (DELAWARE CORPORATION)  
702 15TH STREET  
SAN FRANCISCO, CA 94103

FOR: PERFUME, COLOGNE, COSMETICS, SHAVING PREPARATIONS, SUN TAN LOTIONS, SHOWER GEL, COSMETIC CREAMS FOR SKIN CARE, SOAPS, MASSAGE OILS, IN CLASS 3 (U.S. CLS. 1, 4, 6, 50, 51 AND 52).

FIRST USE 10-1-2004; IN COMMERCE 10-1-2004.

FOR: ADULT SEXUAL AIDS, NAMELY, VIBRATORS; PERSONAL MASSAGE UNITS; MASSAGE APPARATUS, NAMELY, SLEEVES FOR MASSAGE UNITS, IN CLASS 10 (U.S. CLS. 26, 39 AND 44).

FIRST USE 10-1-2004; IN COMMERCE 10-1-2004.

FOR: JEWELRY, WATCHES, IN CLASS 14 (U.S. CLS. 2, 27, 28 AND 50).

FIRST USE 10-1-2004; IN COMMERCE 10-1-2004.

FOR: LINGERIE; HEADGEAR, NAMELY, HATS AND CAPS; FOOTWEAR; PANTS, TOPS, VESTS,

AND UNDERWEAR MADE OF VINYL, LATEX OR LEATHER; BLINDFOLDS MADE OF TEXTILES FOR WEARING; STOCKINGS; UNDERWEAR, SHIRTS, PANTS, PAJAMAS, IN CLASS 25 (U.S. CLS. 22 AND 39).

FIRST USE 10-1-2004; IN COMMERCE 10-1-2004.

FOR: RETAIL STORE SERVICES, RETAIL CATALOG ORDERING SERVICES, ONLINE RETAIL STORE SERVICES AND RETAIL SHOP-AT-HOME PARTIES, ALL FEATURING CLOTHING AND ADULT ENTERTAINMENT PRODUCTS, IN CLASS 35 (U.S. CLS. 100, 101 AND 102).

FIRST USE 10-1-2004; IN COMMERCE 10-1-2004.

THE MARK CONSISTS OF STANDARD CHARACTERS WITHOUT CLAIM TO ANY PARTICULAR FONT, STYLE, SIZE, OR COLOR.

SN 78-452,110, FILED 7-16-2004.

MARK SPARACINO, EXAMINING ATTORNEY



**Int. Cl.: 10**

**Prior U.S. Cls.: 26, 39, and 44**

**United States Patent and Trademark Office**

**Reg. No. 3,455,213**

**Registered June 24, 2008**

**TRADEMARK  
PRINCIPAL REGISTER**

**TAKING A BITE OUT  
OF HEADACHE**

ELI, BRADLEY A. (UNITED STATES INDIVIDUAL)  
P.O. BOX 234213  
ENCINITAS, CA 92023

THE MARK CONSISTS OF STANDARD CHARACTERS WITHOUT CLAIM TO ANY PARTICULAR FONT, STYLE, SIZE, OR COLOR.

FOR: MOUTH GUARDS FOR MEDICAL PURPOSES, DENTAL ARTICULATORS, AND DENTAL BITE TRAYS, IN CLASS 10 (U.S. CLS. 26, 39 AND 44).

SN 78-453,554, FILED 7-20-2004.

FIRST USE 4-1-2008; IN COMMERCE 4-1-2008.

RUSS HERMAN, EXAMINING ATTORNEY

**Int. Cls.: 9 and 41**

**Prior U.S. Cls.: 21, 23, 26, 36, 38, 100, 101, and 107**

**United States Patent and Trademark Office**

**Reg. No. 3,455,214**

**Registered June 24, 2008**

**TRADEMARK  
SERVICE MARK  
PRINCIPAL REGISTER**

**CARIBOU**

SNAITH, DANIEL VICTOR (UNITED KINGDOM  
INDIVIDUAL)  
482 CALEDONIAN ROAD  
LONDON, UNITED KINGDOM N7 9RP

FOR: MUSICAL SOUND RECORDING AND MUSICAL VIDEO RECORDINGS IN ALL MEDIA; FILMS ABOUT MUSICAL GROUPS; RECORDED DATA CARRIERS, NAMELY, RECORDING DISCS, DISCS, MUSIC CASSETTES, VIDEO CASSETTES, AND DVDS ALL FEATURING PERFORMANCES BY A MUSICAL GROUP; CINEMATIC PRESENTATIONS IN THE NATURE OF FILMS FEATURING MEMBERS OF A MUSICAL GROUP, AND MULTIMEDIA PRESENTATIONS IN THE NATURE OF MULTIMEDIA SOFTWARE ON CD-ROMS FEATURING MEMBERS OF A MUSICAL GROUP, IN CLASS 9 (U.S. CLS. 21, 23, 26, 36 AND 38).

FIRST USE 3-7-2005; IN COMMERCE 3-22-2005.

FOR: ENTERTAINMENT, NAMELY, LIVE PERFORMANCES BY A MUSICAL GROUP, IN CLASS 41 (U.S. CLS. 100, 101 AND 107).

FIRST USE 3-7-2005; IN COMMERCE 3-22-2005.

THE MARK CONSISTS OF STANDARD CHARACTERS WITHOUT CLAIM TO ANY PARTICULAR FONT, STYLE, SIZE, OR COLOR.

SN 78-455,659, FILED 7-23-2004.

RUDY R. SINGLETON, EXAMINING ATTORNEY

**Int. Cl.: 14**

**Prior U.S. Cls.: 2, 27, 28, and 50**

**United States Patent and Trademark Office**

**Reg. No. 3,455,215**

**Registered June 24, 2008**

**TRADEMARK  
PRINCIPAL REGISTER**

**SWISS ILLUMINATED  
LUXURY**

XOSKELETON, INC. (MARYLAND CORPORATION)

10462 WATERFOWL TERRACE

COLUMBIA, MD 21044

FOR: JEWELRY; SWISS WATCHES AND CLOCKS, IN CLASS 14 (U.S. CLS. 2, 27, 28 AND 50).

FIRST USE 3-1-2007; IN COMMERCE 3-1-2007.

THE MARK CONSISTS OF STANDARD CHARACTERS WITHOUT CLAIM TO ANY PARTICULAR FONT, STYLE, SIZE, OR COLOR.

NO CLAIM IS MADE TO THE EXCLUSIVE RIGHT TO USE "SWISS ILLUMINATED", APART FROM THE MARK AS SHOWN.

SN 78-456,596, FILED 7-26-2004.

CHRISTINA SOBRAL, EXAMINING ATTORNEY

**Int. Cl.: 16**

**Prior U.S. Cls.: 2, 5, 22, 23, 29, 37, 38, and 50**

**Reg. No. 3,455,216**

**United States Patent and Trademark Office**

**Registered June 24, 2008**

**TRADEMARK  
PRINCIPAL REGISTER**



STAPLES THE OFFICE SUPERSTORE, LLC (DE-  
LAWARE LTD LIAB CO)  
500 STAPLES DRIVE  
FRAMINGHAM, MA 01702

FIRST USE 9-0-2004; IN COMMERCE 9-0-2004.

SN 78-461,138, FILED 8-3-2004.

FOR: PHOTOGRAPH PAPER, IN CLASS 16 (U.S.  
CLS. 2, 5, 22, 23, 29, 37, 38 AND 50).

JOHN DALIER, EXAMINING ATTORNEY

**Int. Cl.: 5**

**Prior U.S. Cls.: 6, 18, 44, 46, 51, and 52**

**United States Patent and Trademark Office**

**Reg. No. 3,455,217**

**Registered June 24, 2008**

**TRADEMARK  
PRINCIPAL REGISTER**

**BIONICA**

BIONICA INC. (CANADA CORPORATION)  
2207 DIXIE ROAD  
MISSISSAUGA, ONTARIO, CANADA L4Y 1Z8

FOR: TOPICALLY APPLIED PREPARATION TO REDUCE MUSCLE STIFFNESS AND ACHES AND PAINS AND TO PROMPT HEALING OF BRUISING AND MUSCULAR STRAINS; HOMEOPATHIC PREPARATION FOR TOPICAL APPLICATION TO ASSIST IN HEALING OF BRUISING AND MUSCULAR ACHES AND PAINS; TOPICAL PHARMACEUTICAL PREPARATION FOR USE AS AN ANALGESIC; WOUND AND BURN HEALING AGENT, NAMELY, PHARMACEUTICAL PREPARATIONS FOR TREATING WOUNDS AND BURNS AND PROVIDING WOUND AND BURN PAIN RELIEF; ANTI-INFLAMMATORY AGENT, NAMELY, ANTI-IN-

FLAMMATORIES; TOPICAL ANESTHETICS, IN CLASS 5 (U.S. CLS. 6, 18, 44, 46, 51 AND 52).

FIRST USE 2-0-2004; IN COMMERCE 5-0-2004.

THE MARK CONSISTS OF STANDARD CHARACTERS WITHOUT CLAIM TO ANY PARTICULAR FONT, STYLE, SIZE, OR COLOR.

PRIORITY CLAIMED UNDER SEC. 44(D) ON CANADA APPLICATION NO. 1,205,292, FILED 2-4-2004, REG. NO. TMA678374, DATED 12-11-2006, EXPIRES 12-11-2021.

SN 78-461,766, FILED 8-4-2004.

MICHAEL TANNER, EXAMINING ATTORNEY

**Int. Cl.: 30**

**Prior U.S. Cl.: 46**

**United States Patent and Trademark Office**

**Reg. No. 3,455,218**

**Registered June 24, 2008**

**TRADEMARK  
PRINCIPAL REGISTER**

**CHOCOLATE PEANUT  
BUTTER SHUDDER**

SARA LEE CORPORATION (MARYLAND COR-  
PORATION)  
3500 LACEY ROAD  
DOWNERS GROVE, IL 60515

NO CLAIM IS MADE TO THE EXCLUSIVE  
RIGHT TO USE "CHOCOLATE PEANUT BUTTER",  
APART FROM THE MARK AS SHOWN.

FOR: PIES, IN CLASS 30 (U.S. CL. 46).

FIRST USE 3-30-2005; IN COMMERCE 3-30-2005.

SN 78-464,825, FILED 8-10-2004.

THE MARK CONSISTS OF STANDARD CHAR-  
ACTERS WITHOUT CLAIM TO ANY PARTICULAR  
FONT, STYLE, SIZE, OR COLOR.

HOWARD SMIGA, EXAMINING ATTORNEY

**Int. Cl.: 35**

**Prior U.S. Cls.: 100, 101, and 102**

**United States Patent and Trademark Office**

**Reg. No. 3,455,219**

**Registered June 24, 2008**

**SERVICE MARK  
PRINCIPAL REGISTER**

**WOODMAN'S**

WOODMAN'S INC. (MASSACHUSETTS CORPORATION)  
MAIN STREET P.O. BOX 349  
ESSEX, MA 01929

THE MARK CONSISTS OF STANDARD CHARACTERS WITHOUT CLAIM TO ANY PARTICULAR FONT, STYLE, SIZE, OR COLOR.

FOR: MAIL ORDER AND RETAIL STORE SERVICES FEATURING A WIDE VARIETY OF CONSUMER GOODS, IN CLASS 35 (U.S. CLS. 100, 101 AND 102).

OWNER OF U.S. REG. NO. 2,268,370.

SN 78-469,554, FILED 8-18-2004.

FIRST USE 11-30-2006; IN COMMERCE 11-30-2006.

SALLY SHIH, EXAMINING ATTORNEY

**Int. Cl.: 35**

**Prior U.S. Cls.: 100, 101, and 102**

**United States Patent and Trademark Office**

**Reg. No. 3,455,220**

**Registered June 24, 2008**

**SERVICE MARK  
PRINCIPAL REGISTER**

**SOMETHING TO CHEW  
ON**

LEWECK, MELISSE (UNITED STATES INDIVIDUAL)  
15 CALLE VIVEZA  
SAN CLEMENTE, CA 92673

FOR: RETAIL STORE SERVICES, ON-LINE RETAIL STORE SERVICES, MAIL ORDER SERVICES AND CATALOG ORDERING SERVICES IN THE FIELD OF ANIMAL AND PET-RELATED PRODUCTS, SUPPLIES, GIFTS AND INFORMATION, IN CLASS 35 (U.S. CLS. 100, 101 AND 102).

FIRST USE 12-4-2004; IN COMMERCE 2-5-2005.

THE MARK CONSISTS OF STANDARD CHARACTERS WITHOUT CLAIM TO ANY PARTICULAR FONT, STYLE, SIZE, OR COLOR.

SN 78-479,002, FILED 9-4-2004.

WANDA KAY PRICE, EXAMINING ATTORNEY



**Int. Cl.: 35**

**Prior U.S. Cls.: 100, 101, and 102**

**United States Patent and Trademark Office**

**Reg. No. 3,455,221**

**Registered June 24, 2008**

**SERVICE MARK  
PRINCIPAL REGISTER**

**TOPSPOT**

FELLERS, JAMES D. (UNITED STATES INDIVIDUAL)  
16535 AVARANCHE WAY  
ROUND ROCK, TX 78681

FOR: ADVERTISING SERVICES, NAMELY, PROMOTING THE GOODS AND SERVICES OF OTHERS BY PREPARING AND PLACING ADVERTISEMENTS IN DIRECTORY LISTING DATABASES ACCESSED THROUGH A GLOBAL INFORMATION NETWORK; PROVIDING RETAIL STORE INFORMATION, SHOPPERS GUIDE INFORMATION AND BUSINESS LISTINGS BY ELECTRONIC MEANS; COMPUTER SERVICES, NAMELY, PROVIDING INFORMATION VIA A GLOBAL COMPUTER IN-

FORMATION NETWORK IN THE FIELD OF COMMERCIAL INFORMATION DIRECTORIES ABOUT BUSINESSES AND INDIVIDUALS, IN CLASS 35 (U.S. CLS. 100, 101 AND 102).

FIRST USE 3-1-1996; IN COMMERCE 3-1-1996.

THE MARK CONSISTS OF STANDARD CHARACTERS WITHOUT CLAIM TO ANY PARTICULAR FONT, STYLE, SIZE, OR COLOR.

SN 78-479,648, FILED 9-7-2004.

BRENDAN MCCAULEY, EXAMINING ATTORNEY

**Int. Cl.: 36**

**Prior U.S. Cls.: 100, 101, and 102**

**United States Patent and Trademark Office**

**Reg. No. 3,455,222**

**Registered June 24, 2008**

**SERVICE MARK  
PRINCIPAL REGISTER**

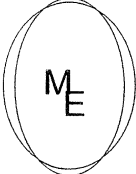
Let  Help You

MACK ENTERPRISES, L.L.C. (FLORIDA LIMITED LIABILITY COMPANY)  
7211 WEST ARACOMA DR.  
CINCINNATI, OH 45237

FIRST USE 0-0-2004; IN COMMERCE 0-0-2004.

SN 78-479,865, FILED 9-7-2004.

FOR: LEASING OF APARTMENTS, IN CLASS 36  
(U.S. CLS. 100, 101 AND 102).

PAUL E. FAHRENKOPF, EXAMINING ATTORNEY

**Int. Cl.: 2**

**Prior U.S. Cls.: 6, 11, and 16**

**United States Patent and Trademark Office**

**Reg. No. 3,455,223**

**Registered June 24, 2008**

**TRADEMARK  
PRINCIPAL REGISTER**

**ULTRALINK**

PPG INDUSTRIES OHIO, INC. (DELAWARE  
CORPORATION)  
3800 WEST 143RD STREET  
CLEVELAND, OH 44111

THE MARK CONSISTS OF STANDARD CHAR-  
ACTERS WITHOUT CLAIM TO ANY PARTICULAR  
FONT, STYLE, SIZE, OR COLOR.

FOR: COATING COMPOSITIONS IN THE NAT-  
URE OF PAINT FOR INDUSTRIAL AND MANU-  
FACTURING APPLICATIONS, IN CLASS 2 (U.S.  
CLS. 6, 11 AND 16).

SN 78-480,335, FILED 9-8-2004.

FIRST USE 4-29-2008; IN COMMERCE 4-29-2008.

JUDITH HELFMAN, EXAMINING ATTORNEY

**Int. Cl.: 37**

**Prior U.S. Cls.: 100, 103, and 106**

**United States Patent and Trademark Office**

**Reg. No. 3,455,224**

**Registered June 24, 2008**

**SERVICE MARK  
PRINCIPAL REGISTER**



BRADHAM ENTERPRISES, INC. (SOUTH CAROLINA CORPORATION)  
P.O. BOX 2833  
SUMMERVILLE, SC 29484

THE COLORS RED AND BLACK ARE CLAIMED AS A FEATURE OF THE MARK.

FOR: CLEANING AND RESTORATION OF BUILDINGS AFTER FLOODS, FIRE, OR OTHER DISASTERS, IN CLASS 37 (U.S. CLS. 100, 103 AND 106).

THE COLOR RED APPEARS IN THE ROOF. THE COLOR BLACK APPEARS IN THE WINDOWS, FLAMES, WAVES, WORDING, AND LINE.

FIRST USE 2-1-2006; IN COMMERCE 2-1-2006.

SN 78-488,190, FILED 9-23-2004.

NO CLAIM IS MADE TO THE EXCLUSIVE RIGHT TO USE "CLEANING AND RESTORATION", APART FROM THE MARK AS SHOWN.

KRISTINA MORRIS, EXAMINING ATTORNEY

**Int. Cl.: 5**

**Prior U.S. Cls.: 6, 18, 44, 46, 51, and 52**

**United States Patent and Trademark Office**

**Reg. No. 3,455,225**

**Registered June 24, 2008**

**TRADEMARK  
PRINCIPAL REGISTER**

**DELIVERING ON THE  
PROMISE OF RNAI  
THERAPEUTICS**

NUCLEONICS, INC. (DELAWARE CORPORATION)  
702 ELECTRONIC DRIVE  
HORSHAM, PA 19044

FOR: NUCLEIC BASED BIOPHARMACEUTICALS AND PREPARATIONS FOR RNAI BASED THERAPY, IN CLASS 5 (U.S. CLS. 6, 18, 44, 46, 51 AND 52).

FIRST USE 1-11-2005; IN COMMERCE 12-20-2007.

THE MARK CONSISTS OF STANDARD CHARACTERS WITHOUT CLAIM TO ANY PARTICULAR FONT, STYLE, SIZE, OR COLOR.

NO CLAIM IS MADE TO THE EXCLUSIVE RIGHT TO USE "RNAI THERAPEUTICS", APART FROM THE MARK AS SHOWN.

SN 78-489,867, FILED 9-27-2004.

JULIE GUTTADAURO, EXAMINING ATTORNEY

**Int. Cl.: 25**

**Prior U.S. Cls.: 22 and 39**

**United States Patent and Trademark Office**

**Reg. No. 3,455,226**

**Registered June 24, 2008**

**TRADEMARK  
PRINCIPAL REGISTER**

**NOSLERCUSTOM**

NOSLER, INC. (OREGON CORPORATION)  
107 SW COLUMBIA  
BEND, OR 97702

THE MARK CONSISTS OF STANDARD CHAR-  
ACTERS WITHOUT CLAIM TO ANY PARTICULAR  
FONT, STYLE, SIZE, OR COLOR.

FOR: SHIRTS, SWEATSHIRTS, T-SHIRTS, JACK-  
ETS, HATS, IN CLASS 25 (U.S. CLS. 22 AND 39).

SN 78-492,642, FILED 9-30-2004.

FIRST USE 3-7-2008; IN COMMERCE 3-7-2008.

INGA ERVIN, EXAMINING ATTORNEY

**Int. Cl.: 11**

**Prior U.S. Cls.: 13, 21, 23, 31, and 34**

**United States Patent and Trademark Office**

**Reg. No. 3,455,227**

**Registered June 24, 2008**

**TRADEMARK  
PRINCIPAL REGISTER**

**SPRAY BREEZE**

BONIS & COMPANY LTD. (CANADA LIMITED  
COMPANY), DBA VECTACOR (A DIVISION  
OF BONIS & COMPANY),  
P.O. BOX 307  
OWEN SOUND, ONTARIO, CANADA N4K 5P5

FOR: ELECTRIC FANS, AND CEILING FANS  
WITH A WATER MISTING FUNCTION, IN CLASS  
11 (U.S. CLS. 13, 21, 23, 31 AND 34).

FIRST USE 3-22-2005; IN COMMERCE 3-22-2005.

THE MARK CONSISTS OF STANDARD CHAR-  
ACTERS WITHOUT CLAIM TO ANY PARTICULAR  
FONT, STYLE, SIZE, OR COLOR.

PRIORITY CLAIMED UNDER SEC. 44(D) ON  
CANADA APPLICATION NO. 1215762, FILED 5-4-  
2004, REG. NO. TMA685,182, DATED 3-30-2007, EX-  
PIRES 3-30-2022.

NO CLAIM IS MADE TO THE EXCLUSIVE  
RIGHT TO USE "SPRAY", APART FROM THE  
MARK AS SHOWN.

SN 78-502,620, FILED 10-20-2004.

BARBARA RUTLAND, EXAMINING ATTORNEY

**Int. Cl.: 18**

**Prior U.S. Cls.: 1, 2, 3, 22, and 41**

**Reg. No. 3,455,228**

**United States Patent and Trademark Office**

**Registered June 24, 2008**

**TRADEMARK  
PRINCIPAL REGISTER**

# The Snurser

LEE-KLINE, KATHERINE (UNITED STATES INDIVIDUAL)

200 E. 27TH ST. #7F

NEW YORK, NY 10016 AND

KLINE, ROBERT C. (UNITED STATES INDIVIDUAL)

200 E. 27TH ST. #7F

NEW YORK, NY 10016 AND

EVERARD, DEAN W. (UNITED STATES INDIVIDUAL)

2575 PALISADE AVE. #6D

RIVERDALE, NY 10463 AND

BLEACHER, CATHERINE R. (UNITED STATES INDIVIDUAL)

2575 PALISADE AVENUE #6D

RIVERDALE, NY 10463

FOR: INFANT CARE ACCESSORIES, NAMELY, PADDED ARM SLEEVES FOR COMFORT WHILE BOTTLE FEEDING OR NURSING, IN CLASS 18 (U.S. CLS. 1, 2, 3, 22 AND 41).

FIRST USE 1-5-2008; IN COMMERCE 1-5-2008.

THE MARK CONSISTS OF STANDARD CHARACTERS WITHOUT CLAIM TO ANY PARTICULAR FONT, STYLE, SIZE, OR COLOR.

SN 78-509,739, FILED 11-2-2004.

AMOS T. MATTHEWS, JR., EXAMINING ATTORNEY



**Int. Cl.: 42**

**Prior U.S. Cls.: 100 and 101**

**United States Patent and Trademark Office**

**Reg. No. 3,455,229**

**Registered June 24, 2008**

**SERVICE MARK  
PRINCIPAL REGISTER**

**Whatever Comes  
Next**

WHATEVER COMES NEXT, INC. (GEORGIA  
CORPORATION)  
4080 FASTNET LANE  
DULUTH, GA 30096

THE MARK CONSISTS OF STANDARD CHAR-  
ACTERS WITHOUT CLAIM TO ANY PARTICULAR  
FONT, STYLE, SIZE, OR COLOR.

FOR: PRODUCT DEVELOPMENT, IN CLASS 42  
(U.S. CLS. 100 AND 101).

SN 78-513,443, FILED 11-8-2004.

FIRST USE 4-18-2008; IN COMMERCE 4-18-2008.

SHAUNIA CARLYLE, EXAMINING ATTORNEY

**Int. Cl.: 9**

**Prior U.S. Cls.: 21, 23, 26, 36, and 38**

**Reg. No. 3,455,230**

**United States Patent and Trademark Office**

**Registered June 24, 2008**

---

**TRADEMARK  
PRINCIPAL REGISTER**

**ASTA EASYPLAN**

ASTA DEVELOPMENT PLC (UNITED KINGDOM CORPORATION)  
10 PEARSON ROAD, CENTRAL PARK  
TELFORD, ENGLAND TF2 9TX

FOR: COMPUTER SOFTWARE FOR USE IN MANAGEMENT OF CONSTRUCTION DESIGN PROJECTS FOR TRADE CONTRACTORS AND CONSTRUCTION COMPANIES, IN CLASS 9 (U.S. CLS. 21, 23, 26, 36 AND 38).

FIRST USE 0-0-2005; IN COMMERCE 7-0-2005.

THE MARK CONSISTS OF STANDARD CHARACTERS WITHOUT CLAIM TO ANY PARTICULAR FONT, STYLE, SIZE, OR COLOR.

PRIORITY CLAIMED UNDER SEC. 44(D) ON ERPN CMNTY TM OFC APPLICATION NO. 003858065, FILED 5-21-2004, REG. NO. 003858065, DATED 9-27-2005, EXPIRES 5-21-2014.

SN 78-517,167, FILED 11-15-2004.

KAREN BRACEY, EXAMINING ATTORNEY

**Int. Cl.: 30**

**Prior U.S. Cl.: 46**

**United States Patent and Trademark Office**

**Reg. No. 3,455,231**

**Registered June 24, 2008**

**TRADEMARK  
PRINCIPAL REGISTER**



AMT GROUP, LLC (ILLINOIS LTD LIAB CO)  
8001 NORTH LINCOLN AVENUE SUITE 201  
SKOKIE, IL 60077

FIRST USE 3-1-2006; IN COMMERCE 3-1-2006.

FOR: COFFEE-BASED BEVERAGE CONTAIN-  
ING MILK, PREPARED COFFEE AND COFFEE-  
BASED BEVERAGES, BEVERAGES MADE OF COF-  
FEE, IN CLASS 30 (U.S. CL. 46).

SN 78-521,109, FILED 11-22-2004.

CHRIS WELLS, EXAMINING ATTORNEY

**Int. Cl.: 9**

**Prior U.S. Cls.: 21, 23, 26, 36, and 38**

**Reg. No. 3,455,232**

**United States Patent and Trademark Office**

**Registered June 24, 2008**

**TRADEMARK  
PRINCIPAL REGISTER**



INNOLUX DISPLAY CORPORATION (TAIWAN CORPORATION)  
NO. 160, KESYUE RD., CHU-NAN SITE  
HSINCHU SCIENCE PARK  
CHU-NAN 350, MIAO-LI COUNTY, TAIWAN

FOR: LIQUID CRYSTAL DISPLAYS FOR USE IN COMPUTER MONITORS, NOTEBOOK COMPUTERS, TELEVISIONS, DIGITAL CAMERAS, VIDEO GAME MACHINES FOR USE WITH TELEVISIONS, MOBILE PHONES, PERSONAL DIGITAL ASSIS-

TANTS AND GLOBAL POSITIONING SYSTEMS; LIQUID CRYSTAL DISPLAY MODULES; AND LIQUID CRYSTAL DISPLAY PANELS, IN CLASS 9 (U.S. CLS. 21, 23, 26, 36 AND 38).

FIRST USE 1-3-2006; IN COMMERCE 12-22-2007.

SN 78-521,507, FILED 11-23-2004.

MICHELLE DUBOIS, EXAMINING ATTORNEY

Int. Cl.: 40

Prior U.S. Cls.: 100, 103, and 106

United States Patent and Trademark Office

Reg. No. 3,455,233

Registered June 24, 2008

SERVICE MARK  
PRINCIPAL REGISTER



MEDQUEST PHARMACY, INC. (DELAWARE CORPORATION)  
669 WEST 900 NORTH  
NORTH SALT LAKE CITY, UT 84054

FOR: CUSTOM BLENDING OF PHARMACEUTICAL DRUGS AND NUTRITIONAL SUPPLEMENTS FEATURING THE CUSTOM COMPOUNDING OF MASS PRODUCED PHARMACEUTICALS AND NUTRITIONAL SUPPLEMENTS TO THE SPECIFICATION OF PHYSICIANS, IN CLASS 40 (U.S. CLS. 100, 103 AND 106).

FIRST USE 2-1-2005; IN COMMERCE 2-1-2005.

NO CLAIM IS MADE TO THE EXCLUSIVE RIGHT TO USE "PHARMACY", APART FROM THE MARK AS SHOWN.

SN 78-529,170, FILED 12-8-2004.

ADA HAN, EXAMINING ATTORNEY

**Int. Cl.: 5**

**Prior U.S. Cls.: 6, 18, 44, 46, 51, and 52**

**Reg. No. 3,455,234**

**United States Patent and Trademark Office**

**Registered June 24, 2008**

---

**TRADEMARK  
PRINCIPAL REGISTER**

The logo for Tygacil features the word "Tygacil" in a bold, italicized, sans-serif font. The letter "T" is stylized with a curved underline that sweeps under the "y" and "g".

WYETH (DELAWARE CORPORATION)  
FIVE GIRALDA FARMS  
MADISON, NJ 07940

FIRST USE 2-18-2008; IN COMMERCE 2-18-2008.

SN 78-530,600, FILED 12-10-2004.

FOR: PHARMACEUTICAL PREPARATIONS,  
NAMELY, AN ANTIBIOTIC, IN CLASS 5 (U.S. CLS.  
6, 18, 44, 46, 51 AND 52).

GEORGE LORENZO, EXAMINING ATTORNEY

**Int. Cls.: 7, 11, 16, 37, and 42**

**Prior U.S. Cls.: 2, 5, 13, 19, 21, 22, 23, 29, 31, 34, 35,  
37, 38, 50, 100, 101, 103, and 106**

**Reg. No. 3,455,235**

**United States Patent and Trademark Office**

**Registered June 24, 2008**

**TRADEMARK  
SERVICE MARK  
PRINCIPAL REGISTER**



FRANZ HAAS VERMOGENS- UND BETEILIGUNGS AKTIENGESELLSCHAFT (AUSTRIA AKTIENGESELLSCHAFT (AG))

PRAGERSTRASSE 124  
WIEN, AUSTRIA A-1210

FOR: EQUIPMENT FOR THE INDUSTRIAL AND COMMERCIAL PRODUCTION AND TREATMENT OF PRODUCTS OF THE BAKING AND PASTRY INDUSTRY, NAMELY, MACHINES FOR MAKING WAFERS, ICE CREAM CONES AND BISCUITS; MACHINES FOR THE PRODUCTION AND TREATMENT OF PRODUCTS OF THE INDUSTRIAL BREAD, ROLLS AND PASTRY INDUSTRY; ICE CREAM CONE SLEEVING MACHINES, STIRRING MACHINES, MIXING MACHINES; AUTOMATIC INGREDIENT METERING/DISPENSERS FOR THE AFOREMENTIONED MACHINES, DOUGH MOLDING MACHINES, DOUGH KNEADING MACHINES, DOUGH DIVIDERS AND ROUNDING MACHINES, IN CLASS 7 (U.S. CLS. 13, 19, 21, 23, 31, 34 AND 35).

FIRST USE 3-21-1968; IN COMMERCE 3-21-1968.

FOR: INDUSTRIAL OVENS AND OVENS FOR THE COMMERCIAL AND INDUSTRIAL BAKING AND HEAT TREATMENT OF PRODUCTS OF THE BAKING, PASTRY AND CONFECTIONERY INDUSTRY, NAMELY, WAFERS, BISCUITS, ICE CREAM CONES, WAFER ROLLS, CAKES; OVENS FOR THE INDUSTRIAL AND COMMERCIAL BREAD, ROLLS AND PASTRY PRODUCTION, NAMELY, BAKING CASES, RACK OVENS, DECK OVENS, STOREY OVENS; FERMENTATION CHAMBERS AND FERMENTATION ROOMS FOR THE LEAVENING OF

BAKERY PRODUCTS IN THE NATURE OF WAFERS, BISCUITS, ICE CREAM CONES, WAFER ROLLS, CAKES, BREAD, ROLLS AND PASTRIES; COOLING AND CONDITIONING EQUIPMENT IN THE NATURE OF EVAPORATIVE AND ELECTRIC AIR AND SPACE COOLING UNITS FOR BAKERY PRODUCTS IN THE NATURE OF WAFERS, BISCUITS, ICE CREAM CONES, WAFER ROLLS, CAKES, BREAD, ROLLS AND PASTRIES, IN CLASS 11 (U.S. CLS. 13, 21, 23, 31 AND 34).

FIRST USE 3-21-1968; IN COMMERCE 3-21-1968.

FOR: (BASED ON 44(E)) BIODEGRADABLE PACKAGING BOXES, CARTONS, TRAYS, BINS AND CUPS MADE OF FLOUR AND/OR STARCH AND/OR WAFER BATTER AND/OR STONE FLOUR AND/OR CELLULOSE THAT MAY BE EDIBLE OR RECYCLED TO SERVE AS FEED FOR LIVESTOCK, IN CLASS 16 (U.S. CLS. 2, 5, 22, 23, 29, 37, 38 AND 50).

FOR: INSTALLATION, MAINTENANCE AND REPAIR OF MACHINES FOR THE BAKERY, BREAD, PASTRY AND CONFECTIONERY INDUSTRY, IN CLASS 37 (U.S. CLS. 100, 103 AND 106).

FIRST USE 9-29-2004; IN COMMERCE 9-29-2004.

FOR: TECHNICAL ADVICE AND ENGINEERING SERVICES IN THE FIELD OF THE COMMERCIAL AND INDUSTRIAL MANUFACTURING OF PRODUCTS OF THE BAKERY, BREAD, ROLLS, PASTRY AND CONFECTIONERY INDUSTRY, NAMELY, WAFER MACHINES, ICE CREAM CONE MACHINES, BISCUIT MACHINES, OVENS FOR

BAKING BREAD, ROLLS AND PASTRY, ICE CREAM CONE SLEEVING MACHINES, STIRRING MACHINES, MIXERS, AUTOMATIC INGREDIENT METERING FOR THE AFOREMENTIONED MACHINES, DOUGH MOLDING MACHINES, DOUGH KNEADING MACHINES, DOUGH DIVIDERS AND ROUNDING MACHINES, FERMENTING CHAMBERS, FERMENTING ROOMS, COOLING AND CONDITIONING EQUIPMENT; TECHNICAL CONSULTING AND ENGINEERING SERVICES FOR THE PACKAGING INDUSTRY, IN CLASS 42 (U.S. CLS. 100 AND 101).

FIRST USE 9-29-2004; IN COMMERCE 9-29-2004.

PRIORITY CLAIMED UNDER SEC. 44(D) ON AUSTRIA APPLICATION NO. AM76322004, FILED 11-16-2004, REG. NO. 222592, DATED 1-19-2005, EXPIRES 1-19-2015.

THE MARK CONSISTS OF THE TERM "HAAS" INSIDE A TRIANGLE ALL SURROUNDED BY A LARGER TRIANGLE.

SN 78-533,933, FILED 12-16-2004.

KAPIL BHANOT, EXAMINING ATTORNEY



**Int. Cls.: 39 and 40**

**Prior U.S. Cls.: 100, 103, 105, and 106**

**United States Patent and Trademark Office**

**Reg. No. 3,455,236**

**Registered June 24, 2008**

---

**SERVICE MARK  
PRINCIPAL REGISTER**

**ETOOLS**

MYPRINT CORPORATION (CALIFORNIA CORPORATION)  
2772 MAIN STREET  
IRVINE, CA 92614

FOR: STORAGE OF ELECTRONIC MEDIA, NAMELY, LOGOS, ICONS, PHOTOS, TEXT, ART, GRAPHICS, MAPS, ANIMATIONS, VIDEOS, MOVIES, SOUNDS, AND TEMPLATES FOR USE IN PRINTING SERVICES, IN CLASS 39 (U.S. CLS. 100 AND 105).

FIRST USE 9-10-2004; IN COMMERCE 11-6-2004.

FOR: CUSTOMIZED ON-DEMAND PRINTING SERVICES, IN CLASS 40 (U.S. CLS. 100, 103 AND 106).

FIRST USE 9-10-2004; IN COMMERCE 11-6-2004.

THE MARK CONSISTS OF STANDARD CHARACTERS WITHOUT CLAIM TO ANY PARTICULAR FONT, STYLE, SIZE, OR COLOR.

SN 78-537,162, FILED 12-22-2004.

MELISSA VALLILLO, EXAMINING ATTORNEY

**Int. Cl.: 10**

**Prior U.S. Cls.: 26, 39, and 44**

**United States Patent and Trademark Office**

**Reg. No. 3,455,237**

**Registered June 24, 2008**

**TRADEMARK  
PRINCIPAL REGISTER**

**Mycoprene**

POLY-MED, INC. (SOUTH CAROLINA COR-  
PORATION)  
6309 HWY 187  
ANDERSON, SC 29625

THE MARK CONSISTS OF STANDARD CHAR-  
ACTERS WITHOUT CLAIM TO ANY PARTICULAR  
FONT, STYLE, SIZE, OR COLOR.

FOR: DRUG DELIVERY SYSTEM COMPRISING  
A POLYMERIC COMPOSITE FOR TREATING FUN-  
GAL INFECTIONS, IN CLASS 10 (U.S. CLS. 26, 39  
AND 44).

SN 78-542,505, FILED 1-5-2005.

FIRST USE 1-5-2005; IN COMMERCE 2-15-2007.

ROBIN CHOSID, EXAMINING ATTORNEY

**Int. Cl.: 36**

**Prior U.S. Cls.: 100, 101, and 102**

**United States Patent and Trademark Office**

**Reg. No. 3,455,238**

**Registered June 24, 2008**

**SERVICE MARK  
PRINCIPAL REGISTER**

**CONNECTIVA**

PREMERA BLUE CROSS (WASHINGTON CORPORATION)  
P.O. BOX 327, MAIL STOP 316  
SEATTLE, WA 981110327

FOR: ADMINISTRATION AND PROVIDING THE ORGANIZATION OF NEW AND EXISTING PREPAID AND/OR PREFERRED PROVIDER HEALTH, MEDICAL, DENTAL, HOSPITAL, PHARMACEUTICAL, PRESCRIPTION DRUG PLANS AND RELATED HEALTHCARE PLANS AND NETWORKS, NAMELY, ENROLLMENT PROCESSING AND REPORTING; DETERMINING INSURANCE ELIGIBILITY AND COVERAGE; INSURANCE CLAIMS PROCESSING; PROVIDING INSURANCE ELIGIBILITY AND BENEFIT INFORMATION; REMIT-

TANCE, NAMELY, INSURANCE BILL PAYMENT SERVICES; ADVISEMENT AND REPAIR OF INSURANCE CLAIMS, IN CLASS 36 (U.S. CLS. 100, 101 AND 102).

FIRST USE 7-31-2006; IN COMMERCE 7-31-2006.

THE MARK CONSISTS OF STANDARD CHARACTERS WITHOUT CLAIM TO ANY PARTICULAR FONT, STYLE, SIZE, OR COLOR.

SN 78-550,943, FILED 1-20-2005.

PAULA MAHONEY, EXAMINING ATTORNEY

**Int. Cl.: 42**

**Prior U.S. Cls.: 100 and 101**

**United States Patent and Trademark Office**

**Reg. No. 3,455,239**

**Registered June 24, 2008**

**SERVICE MARK  
PRINCIPAL REGISTER**

**SURGIMETRIX  
HEALTHCARE COMPLIANCE  
SYSTEMS**

KEYES, GEOFFREY R. (UNITED STATES INDIVIDUAL)  
SUITE 611  
9201 SUNSET BOULEVARD  
LOS ANGELES, CA 90069

FOR: PROVIDING ONLINE NON-DOWNLOADABLE COMPUTER SOFTWARE TO FACILITATE MEDICAL AND SURGICAL CARE COMPLIANCE BY HEALTHCARE PROVIDERS WITH ACCEPTED STANDARDS FOR HEALTHCARE DELIVERY, IN CLASS 42 (U.S. CLS. 100 AND 101).

FIRST USE 10-1-2006; IN COMMERCE 10-1-2006.

THE MARK CONSISTS OF STANDARD CHARACTERS WITHOUT CLAIM TO ANY PARTICULAR FONT, STYLE, SIZE, OR COLOR.

NO CLAIM IS MADE TO THE EXCLUSIVE RIGHT TO USE "HEALTHCARE COMPLIANCE SYSTEMS", APART FROM THE MARK AS SHOWN.

SN 78-551,459, FILED 1-21-2005.

BARBARA GAYNOR, EXAMINING ATTORNEY

**Int. Cl.: 9**

**Prior U.S. Cls.: 21, 23, 26, 36, and 38**

**United States Patent and Trademark Office**

**Reg. No. 3,455,240**

**Registered June 24, 2008**

**TRADEMARK  
PRINCIPAL REGISTER**

**EZboost**

ALPHA AND OMEGA SEMICONDUCTOR LIMITED (BERMUDA CORPORATION)  
CANON'S COURT, 22 VICTORIA STREET  
HAMILTON HM12, BERMUDA

FOR: SEMICONDUCTORS, SEMICONDUCTOR CHIPS, SEMICONDUCTOR DEVICES, SEMICONDUCTOR POWER ELEMENTS, ELECTRONIC INTEGRATED CIRCUITS, INTEGRATED CIRCUIT MODULE, INTEGRATED CIRCUITS, LARGE SCALE INTEGRATED CIRCUITS, CIRCUIT BOARDS PROVIDED WITH INTEGRATED CIRCUITS, PRINTED ELECTRONIC CIRCUITS FOR APPARATUS AND CARDS BEARING INTEGRA-

TED CIRCUITS, IN CLASS 9 (U.S. CLS. 21, 23, 26, 36 AND 38).

FIRST USE 2-8-2005; IN COMMERCE 3-12-2008.

THE MARK CONSISTS OF STANDARD CHARACTERS WITHOUT CLAIM TO ANY PARTICULAR FONT, STYLE, SIZE, OR COLOR.

SN 78-563,020, FILED 2-8-2005.

TIMOTHY FINNEGAN, EXAMINING ATTORNEY

**Int. Cl.: 35**

**Prior U.S. Cls.: 100, 101, and 102**

**United States Patent and Trademark Office**

**Reg. No. 3,455,241**

**Registered June 24, 2008**

**SERVICE MARK  
PRINCIPAL REGISTER**

**CLAN CONNOLLY**

CLAN CONNOLLY, LLC (FLORIDA LTD LIAB  
CO)  
4409 HOFFNER AVENUE  
SUITE 327  
ORLANDO, FL 32812

FIRST USE 3-31-2008; IN COMMERCE 3-31-2008.

THE MARK CONSISTS OF STANDARD CHAR-  
ACTERS WITHOUT CLAIM TO ANY PARTICULAR  
FONT, STYLE, SIZE, OR COLOR.

FOR: ORGANIZATION SERVICES IN THE NAT-  
URE OF PROMOTING THE INTERESTS OF AN  
ORGANIZATION OF PEOPLE OF A LIKE HERI-  
TAGE, GENEALOGY OR INTEREST, IN CLASS 35  
(U.S. CLS. 100, 101 AND 102).

SN 78-565,817, FILED 2-11-2005.

PAUL E. FAHRENKOPF, EXAMINING ATTORNEY

**Int. Cl.: 3**

**Prior U.S. Cls.: 1, 4, 6, 50, 51, and 52**

**Reg. No. 3,455,242**

**United States Patent and Trademark Office**

**Registered June 24, 2008**

---

**TRADEMARK  
PRINCIPAL REGISTER**

**MAGICK Mirror**

GABOURY, JESSICA (UNITED STATES INDIVIDUAL)  
2949 ALEXIS LANE  
TALLAHASSEE, FL 32308

THE MARK CONSISTS OF STANDARD CHARACTERS WITHOUT CLAIM TO ANY PARTICULAR FONT, STYLE, SIZE, OR COLOR.

FOR: COSMETICS AND CLEANING PREPARATIONS FOR THE SKIN, IN CLASS 3 (U.S. CLS. 1, 4, 6, 50, 51 AND 52).

SN 78-567,672, FILED 2-15-2005.

FIRST USE 11-18-2006; IN COMMERCE 11-18-2006.

KYLE PEETE, EXAMINING ATTORNEY

**Int. Cl.: 14**

**Prior U.S. Cls.: 2, 27, 28, and 50**

**United States Patent and Trademark Office**

**Reg. No. 3,455,243**

**Registered June 24, 2008**

**TRADEMARK  
PRINCIPAL REGISTER**

**FIRESTORM**

RICHLINE GROUP, INC (DELAWARE CORPORATION)  
516 FIFTH AVENUE  
NEW YORK, NY 10036

FOR: JEWELRY, WATCHES AND CHRONOMETERS AND PARTS THEREOF, WATCH CASES, WATCH BANDS, WATCH STRAPS, CIGARETTE LIGHTERS OF PRECIOUS METAL, MONEY CLIPS OF PRECIOUS METAL, TIE CLIPS, CUFF LINKS, HAT PINS OF PRECIOUS METAL, LAPEL PINS, BELT BUCKLES MADE IN WHOLE OR IN PART OF PRECIOUS METAL, TIE TACKS AND PINS, CLOCKS, AND CANDLESTICKS MADE IN WHOLE

OR IN PART OF PRECIOUS METAL, IN CLASS 14 (U.S. CLS. 2, 27, 28 AND 50).

FIRST USE 1-1-2008; IN COMMERCE 1-1-2008.

THE MARK CONSISTS OF STANDARD CHARACTERS WITHOUT CLAIM TO ANY PARTICULAR FONT, STYLE, SIZE, OR COLOR.

SN 78-569,757, FILED 2-17-2005.

BENJAMIN OKEKE, EXAMINING ATTORNEY



**Int. Cl.: 7**

**Prior U.S. Cls.: 13, 19, 21, 23, 31, 34, and 35**

**Reg. No. 3,455,244**

**United States Patent and Trademark Office**

**Registered June 24, 2008**

**TRADEMARK  
PRINCIPAL REGISTER**

**DIAMONIZED**

DIAMOND POWER INTERNATIONAL, INC. (DE-  
LAWARE CORPORATION)  
2600 EAST MAIN STREET  
LANCASTER, OH 43130

FOR: SURFACE TREATED BOILER CLEANING  
EQUIPMENT; WEAR SURFACE TREATED VALVE  
COMPONENTS, NAMELY, SHAFT SLEEVES FOR  
ROLL GRINDERS, SHAFT SLEEVES FOR CLINKER  
GRINDERS, VALVE FLAPS, VALVE BODIES,  
VALVE GATES, VALVE SEATS, COLLECTING  
TUBES, VANES AND GUIDE PIPES; ASH HAND-  
LING SYSTEM COMPONENTS, NAMELY, SHAFT  
SLEEVES FOR ROLL GRINDERS AND GATE

SEATS FOR VALVES, IN CLASS 7 (U.S. CLS. 13, 19,  
21, 23, 31, 34 AND 35).

FIRST USE 1-19-1995; IN COMMERCE 1-19-1995.

THE MARK CONSISTS OF STANDARD CHAR-  
ACTERS WITHOUT CLAIM TO ANY PARTICULAR  
FONT, STYLE, SIZE, OR COLOR.

OWNER OF U.S. REG. NO. 2,448,661.

SN 78-570,907, FILED 2-18-2005.

RONALD AIKENS, EXAMINING ATTORNEY

**Int. Cls.: 37, 41, and 44**

**Prior U.S. Cls.: 100, 101, 103, 106, and 107**

**United States Patent and Trademark Office**

**Reg. No. 3,455,245**

**Registered June 24, 2008**

**SERVICE MARK  
PRINCIPAL REGISTER**

**LIVING WATER  
INTERNATIONAL**

LIVING WATER INTERNATIONAL (TEXAS  
NON-PROFIT CORPORATION)  
214 S KESWICK CT  
SUGAR LAND, TX 774783950

FOR: WATER WELL DRILLING FOR OTHERS,  
IN CLASS 37 (U.S. CLS. 100, 103 AND 106).

FIRST USE 9-0-2002; IN COMMERCE 9-0-2002.

FOR: TRAINING CLASSES IN THE FIELD OF  
WATER EXPLORATION, DRILLING, RECOVERY,  
DISTRIBUTION, AND WATER MANAGEMENT, IN  
CLASS 41 (U.S. CLS. 100, 101 AND 107).

FIRST USE 9-0-2002; IN COMMERCE 9-0-2002.

FOR: CHARITABLE SERVICES, NAMELY, A  
NON-PROFIT ORGANIZATION THAT PROVIDES

SAFE DRINKING WATER AND MEDICAL ATTEN-  
TION TO THOSE IN DEVELOPING COUNTRIES, IN  
CLASS 44 (U.S. CLS. 100 AND 101).

FIRST USE 9-0-2002; IN COMMERCE 9-0-2002.

THE MARK CONSISTS OF STANDARD CHAR-  
ACTERS WITHOUT CLAIM TO ANY PARTICULAR  
FONT, STYLE, SIZE, OR COLOR.

NO CLAIM IS MADE TO THE EXCLUSIVE  
RIGHT TO USE "WATER INTERNATIONAL",  
APART FROM THE MARK AS SHOWN.

SN 78-572,209, FILED 2-22-2005.

SUSAN LESLIE DUBOIS, EXAMINING ATTORNEY

**Int. Cls.: 37, 41, and 44**

**Prior U.S. Cls.: 100, 101, 103, 106, and 107**

**United States Patent and Trademark Office**

**Reg. No. 3,455,246**

**Registered June 24, 2008**

**SERVICE MARK  
PRINCIPAL REGISTER**



LIVING WATER INTERNATIONAL (TEXAS  
NON-PROFIT CORPORATION)  
214 S KESWICK CT  
SUGAR LAND, TX 774783950

FOR: WATER WELL DRILLING FOR OTHERS,  
IN CLASS 37 (U.S. CLS. 100, 103 AND 106).

FIRST USE 9-0-2002; IN COMMERCE 9-0-2002.

FOR: TRAINING CLASSES IN THE FIELD OF  
WATER EXPLORATION, DRILLING, RECOVERY,  
DISTRIBUTION, AND WATER MANAGEMENT, IN  
CLASS 41 (U.S. CLS. 100, 101 AND 107).

FIRST USE 9-0-2002; IN COMMERCE 9-0-2002.

FOR: CHARITABLE SERVICES, NAMELY, A  
NON-PROFIT ORGANIZATION THAT PROVIDES  
SAFE DRINKING WATER AND MEDICAL ATTEN-  
TION TO THOSE IN DEVELOPING COUNTRIES, IN  
CLASS 44 (U.S. CLS. 100 AND 101).

FIRST USE 9-0-2002; IN COMMERCE 9-0-2002.

NO CLAIM IS MADE TO THE EXCLUSIVE  
RIGHT TO USE "WATER INTERNATIONAL",  
APART FROM THE MARK AS SHOWN.

SN 78-572,210, FILED 2-22-2005.

SUSAN LESLIE DUBOIS, EXAMINING ATTORNEY

Int. Cl.: 32

Prior U.S. Cls.: 45, 46, and 48

United States Patent and Trademark Office

Reg. No. 3,455,247

Registered June 24, 2008

TRADEMARK  
PRINCIPAL REGISTER



NORTON, JOSEPH J. (UNITED STATES INDIVIDUAL)  
770 GRAND RIVER, #2  
BRIGHTON, MI 48114

OWNER OF U.S. REG. NO. 2,202,350.

SEC. 2(F) AS TO "BUG JUICE".

FOR: FRUIT FLAVORED BEVERAGES, IN CLASS  
32 (U.S. CLS. 45, 46 AND 48).

SN 78-573,354, FILED 2-23-2005.

FIRST USE 1-0-1994; IN COMMERCE 1-0-1994.

HEATHER THOMPSON, EXAMINING ATTORNEY

**Int. Cl.: 44**

**Prior U.S. Cls.: 100 and 101**

**United States Patent and Trademark Office**

**Reg. No. 3,455,248**

**Registered June 24, 2008**

**SERVICE MARK  
PRINCIPAL REGISTER**

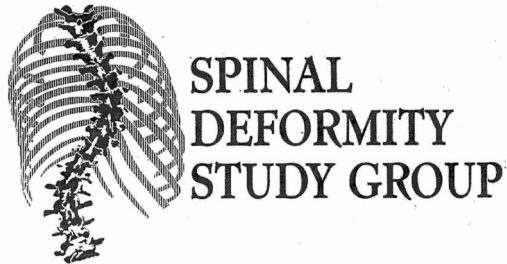

WARSAW ORTHOPEDIC, INC. (INDIANA CORPORATION)  
2500 SILVEUS CROSSING  
WARSAW, IN 46581

NO CLAIM IS MADE TO THE EXCLUSIVE RIGHT TO USE "SPINAL DEFORMITY STUDY GROUP", APART FROM THE MARK AS SHOWN.

FOR: PROVIDING MEDICAL INFORMATION IN THE FIELD OF SPINAL SURGERY TO MEDICAL PROFESSIONALS, IN CLASS 44 (U.S. CLS. 100 AND 101).

SN 78-587,108, FILED 3-15-2005.

FIRST USE 12-31-2005; IN COMMERCE 12-31-2005.

BERYL GARDNER, EXAMINING ATTORNEY

**Int. Cls.: 3 and 44**

**Prior U.S. Cls.: 1, 4, 6, 50, 51, 52, 100, and 101**

**United States Patent and Trademark Office**

**Reg. No. 3,455,249**

**Registered June 24, 2008**

**TRADEMARK  
SERVICE MARK  
PRINCIPAL REGISTER**

# SKIN QUOTIENT

MURRAY-ALLEN ENTERPRISES, LTD (ILLINOIS CORPORATION)  
3015 N. ASHLAND AVENUE  
CHICAGO, IL 60557

FOR: COSMETICS, BODY PRODUCTS, NAMELY, ESSENTIAL OILS AND CREAMS, LOTIONS, SCRUBS, POLISHES, WASHES, CREAMS, MASKS, HAND CREAMS, MUSCLE BALMS, JOINT BALMS, FOOT CREAMS, SUN BLOCK, SOAPS; BATH OILS, BATH GELS, BATH SALTS, AROMA THERAPY PRODUCTS, NAMELY, OILS, SACHET LIKE EYE PILLOWS, NECK PILLOWS AND BACK PILLOWS CONTAINING FRAGRANCES, CREAMS THAT REDUCE THE APPEARANCE OF CELLULITE, EYE CONTOUR CREAMS, MASSAGE OILS AND CREAMS, NAIL OIL, COLOGNES AND PERFUMES AND SKIN CARE PRODUCTS, NAMELY, CLEANSERS, EXFOLIANTS, POLISHES, EYE CARE, NAMELY, SACHET LIKE PILLOWS CONTAINING FRAGRANCES AND EYE CONTOUR CREAMS, MASKS, SERUM INTENSIVES, CREAMS, GELS, MISTS, MOISTURIZERS, ESSENTIAL OILS AND CREAMS, SUN BLOCK, COSMETICS, MAKEUP REMOVER, NIGHT CREAMS, LIGHTENERS, PEELS, LIP BALM, SHAMPOO, CONDITIONER, CO-

LOGNES AND PERFUMES, AFTER SHAVE, BUFFING LOTION AND GEL, IN CLASS 3 (U.S. CLS. 1, 4, 6, 50, 51 AND 52).

FIRST USE 3-16-2005; IN COMMERCE 10-1-2005.

FOR: HEALTH SPA SERVICES, NAMELY, COSMETIC BODY CARE SERVICES, COSMETIC FACE CARE SERVICES, MASSAGE; BEAUTY SALONS, IN CLASS 44 (U.S. CLS. 100 AND 101).

FIRST USE 3-16-2005; IN COMMERCE 10-1-2005.

THE MARK CONSISTS OF STANDARD CHARACTERS WITHOUT CLAIM TO ANY PARTICULAR FONT, STYLE, SIZE, OR COLOR.

NO CLAIM IS MADE TO THE EXCLUSIVE RIGHT TO USE "SKIN", APART FROM THE MARK AS SHOWN.

SN 78-588,259, FILED 3-16-2005.

MARK SPARACINO, EXAMINING ATTORNEY

**Int. Cl.: 35**

**Prior U.S. Cls.: 100, 101, and 102**

**United States Patent and Trademark Office**

**Reg. No. 3,455,250**

**Registered June 24, 2008**

---

**SERVICE MARK  
PRINCIPAL REGISTER**

**Coastal Cottage**

JURAS, JOSEPH (UNITED STATES INDIVIDUAL)  
2723 FORT STREET  
CHARLOTTE, NC 28205

THE MARK CONSISTS OF STANDARD CHARACTERS WITHOUT CLAIM TO ANY PARTICULAR FONT, STYLE, SIZE, OR COLOR.

FOR: RETAIL STORE SERVICES FEATURING FURNITURE, IN CLASS 35 (U.S. CLS. 100, 101 AND 102).

SN 78-588,978, FILED 3-16-2005.

FIRST USE 9-27-2007; IN COMMERCE 9-27-2007.

KATHERINE CHANG, EXAMINING ATTORNEY

**Int. Cls.: 29 and 30**

**Prior U.S. Cl.: 46**

**United States Patent and Trademark Office**

**Reg. No. 3,455,251**

**Registered June 24, 2008**

**TRADEMARK  
PRINCIPAL REGISTER**

**CHEEZY DOES IT**

TOPCO HOLDINGS, INC. (WISCONSIN CORPORATION)  
7711 GROSS POINT ROAD  
SKOKIE, IL 60077

THE MARK CONSISTS OF STANDARD CHARACTERS WITHOUT CLAIM TO ANY PARTICULAR FONT, STYLE, SIZE, OR COLOR.

FOR: CHEESE SPREAD, IN CLASS 29 (U.S. CL. 46).

OWNER OF U.S. REG. NO. 2,004,940.

FIRST USE 5-0-1997; IN COMMERCE 5-0-1997.

SN 78-589,283, FILED 3-17-2005.

FOR: CHEESE SAUCE, IN CLASS 30 (U.S. CL. 46).

FIRST USE 11-0-1998; IN COMMERCE 11-0-1998.

BARBARA A. GOLD, EXAMINING ATTORNEY



Int. Cl.: 33

Prior U.S. Cls.: 47 and 49

United States Patent and Trademark Office

Reg. No. 3,455,252

Registered June 24, 2008

TRADEMARK  
PRINCIPAL REGISTER

C1-SOJU

DAESUN DISTILLING CO., LTD. (REPUBLIC OF  
KOREA CORPORATION)  
154-2, SAJIK-DONG  
DONGRAE-KU, BUSAN, REPUBLIC OF KOREA

FOR: BUPJU, NAMELY, KOREAN TRADITION-  
AL RICE WINE; SOJU, NAMELY, KOREAN DIS-  
TILLED OR DILUTED LIQUEURS; YAG-JU,  
NAMELY, REFINED RICE WINE; TAG-JU, NAME-  
LY, UNSTRAINED RICE WINE; KOLIANG WINE,  
NAMELY, CHINESE AFRICAN-MILLET SPIRITS;  
CHINESE LIQUEURS, NAMELY, LAO LIQUOR  
AND ACANTHOPANAX WINE; HYROMEL, NAME-  
LY, MEAD; GINSENG LIQUEURS, SAKE, COM-  
POUND CLEAR RICE WINE, STRAWBERRY WINE,  
RUM, LIQUEURS, TONIC LIQUOR FLAVORED  
WITH PLUM EXTRACTS, WILD GRAPE WINE,  
PERRY, KIRSCH, VERMOUTH, VODKA, BRANDY,  
ALCOHOLIC BITTERS, HARD CIDER, CHAM-  
PAGNE, ANISE, ARAK, APERITIFS, ALCOHOLIC  
FRUIT EXTRACTS, ALCOHOLIC EXTRACTS, ABI-  
SINTHE, WINE COOLERS, WHISKY, CITRON  
WINE, GIN, PREPARED ALCOHOLIC COCKTAILS,  
CURACAO, WINE, VIPER LIQUOR, PEPPERMINT

LIQUEURS, TONIC LIQUOR CONTAINING HERB  
EXTRACTS, TONIC LIQUOR FLAVORED WITH  
PINE NEEDLE EXTRACTS, FLAVORED TONIC  
LIQUORS, TIGER BONE LIQUOR, IN CLASS 33  
(U.S. CLS. 47 AND 49).

FIRST USE 6-0-1996; IN COMMERCE 12-17-2007.

THE MARK CONSISTS OF STANDARD CHAR-  
ACTERS WITHOUT CLAIM TO ANY PARTICULAR  
FONT, STYLE, SIZE, OR COLOR.

NO CLAIM IS MADE TO THE EXCLUSIVE  
RIGHT TO USE "SOJU", APART FROM THE MARK  
AS SHOWN.

THE FOREIGN WORDING IN THE MARK  
TRANSLATES INTO ENGLISH AS DISTILLED LI-  
QUOR.

SN 78-592,609, FILED 3-22-2005.

SANJEEV VOHRA, EXAMINING ATTORNEY

**Int. Cl.: 41**

**Prior U.S. Cls.: 100, 101, and 107**

**United States Patent and Trademark Office**

**Reg. No. 3,455,253**

**Registered June 24, 2008**

**SERVICE MARK  
PRINCIPAL REGISTER**

**THE PRESIDENTIAL**

PRESIDENTIAL GOLF PARTNERS, LLC (VIRGINIA LTD LIAB CO)  
SUITE 160  
44330 MERCURE CIRCLE  
DULLES, VA 20166

FOR: GOLF CLUB SERVICES, IN CLASS 41 (U.S. CLS. 100, 101 AND 107).

FIRST USE 11-29-2007; IN COMMERCE 11-29-2007.

THE MARK CONSISTS OF STANDARD CHARACTERS WITHOUT CLAIM TO ANY PARTICULAR FONT, STYLE, SIZE, OR COLOR.

SN 78-593,437, FILED 3-23-2005.

HENRY S. ZAK, EXAMINING ATTORNEY

**Int. Cls.: 16, 38, 39, and 42**

**Prior U.S. Cls.: 2, 5, 22, 23, 29, 37, 38, 50, 100, 101, 104, and 105**

**Reg. No. 3,455,254**

**United States Patent and Trademark Office**

**Registered June 24, 2008**

**TRADEMARK  
SERVICE MARK  
PRINCIPAL REGISTER**



**Parus Interactive**

PARUS HOLDINGS, INC. (DELAWARE CORPORATION)  
3000 LAKESIDE DRIVE, SUITE 300N  
BANNOCKBURN, IL 60015

FOR: INSTRUCTION AND USER MANUALS FOR TELECOMMUNICATION AND SPEECH-ENABLED COMMUNICATION SOFTWARE AND OPERATING SYSTEMS, IN CLASS 16 (U.S. CLS. 2, 5, 22, 23, 29, 37, 38 AND 50).

FIRST USE 8-25-2006; IN COMMERCE 8-25-2006.

FOR: PROVIDING UNIFIED COMMUNICATIONS AND MESSAGING SERVICES FEATURING TELEPHONE, FACSIMILE, E-MAIL, AND TELEPHONE AND WEB CONFERENCING VIA GLOBAL COMPUTER AND TELECOMMUNICATIONS NETWORKS; PROVIDING UNIFIED COMMUNICATIONS AND MESSAGING SERVICES FEATURING SPEECH-ENABLED COMMUNICATIONS AND TELEPHONE VOICE AND WEB MESSAGING SERVICES THAT FACILITATE LOCAL AND LONG-DISTANCE TRANSMISSION OF VOICE, DATA, AND GRAPHICS BY MEANS OF GLOBAL COMPUTER AND TELECOMMUNICATIONS NETWORKS; PROVIDING UNIFIED COMMUNICATIONS AND MESSAGING SERVICES FEATURING SPEECH-ENABLED COMMUNICATIONS AND TELEPHONE VOICE AND WEB MESSAGING SERVICES BY WHICH A SINGLE USER MAY MANAGE AND RETRIEVE PERSONAL MESSAGES, CALENDAR ENTRIES, AND CONTACT INFORMATION VIA GLOBAL COMPUTER AND TELECOMMUNICATIONS NETWORKS; PROVIDING UNIFIED COMMUNICATIONS AND MESSAGING SERVICES FEATURING INTERNET TELEPHONY SERVICES, NAMELY, PROVIDING TELEPHONE, FACSIMILE, E-MAIL, AND TELEPHONE AND WEB CONFERENCE CALLING SERVICES VIA GLOBAL COMPU-

TER, IP TELEPHONY, AND TELECOMMUNICATIONS NETWORKS; TELECOMMUNICATIONS VOICE-ACTIVATED CALLING SERVICES, NAMELY, FIND-ME AND FOLLOW-ME CALL FORWARDING, CALL SCREENING, CALL WAITING, VOICE-ACTIVATED DIALING SERVICES, ELECTRONIC VOICE CONFERENCING, ELECTRONIC VOICE MESSAGING AND AUDIO VOICE BROADCASTING, NAMELY, THE RECORDING AND SUBSEQUENT TRANSMISSION OF VOICE MESSAGES BY GLOBAL COMPUTER AND TELECOMMUNICATIONS NETWORKS; E-MAIL AND FACSIMILE TRANSMISSION MANAGEMENT SERVICES FOR TEXT-TO-VOICE CONVERSION OF E-MAIL MESSAGES AND VOICE-ACTIVATED CONVERSION OF E-MAIL MESSAGES TO FACSIMILE MESSAGES AND FACSIMILE MESSAGES TO E-MAIL MESSAGES; TELECOMMUNICATIONS SERVICES PROVIDED VIA TELEPHONE AND COMPUTER TERMINALS THAT FACILITATE THE PROVISION BY OTHERS OF AUTOMATED, SPEECH-ENABLED CUSTOMER SELF-SERVICE INFORMATION TO BE OBTAINED VIA THE INTERNET AND THE TELEPHONE, IN CLASS 38 (U.S. CLS. 100, 101 AND 104).

FIRST USE 1-5-2005; IN COMMERCE 3-3-2005.

FOR: ELECTRONIC STORAGE AND ARCHIVING FOR OTHERS OF MESSAGES, DATA, FILES, DOCUMENTS, TEXT, AUDIO DATA, AND IMAGES, IN CLASS 39 (U.S. CLS. 100 AND 105).

FIRST USE 1-5-2005; IN COMMERCE 1-5-2005.

FOR: CONSULTING IN THE FIELD OF DESIGN, SELECTION, IMPLEMENTATION AND USE OF TELECOMMUNICATIONS AND SPEECH-ENABLED COMMUNICATIONS SOFTWARE; TECHNICAL SUPPORT SERVICES, NAMELY, TROUBLE

SHOOTING OF TELECOMMUNICATIONS AND SPEECH-ENABLED COMMUNICATIONS COMPUTER SOFTWARE SERVICES; INSTALLATION, MAINTENANCE, AND UPDATING OF COMPUTER SOFTWARE IN THE FIELD OF TELECOMMUNICATIONS AND SPEECH-ENABLED COMMUNICATIONS; TELECOMMUNICATIONS AND SPEECH-ENABLED COMMUNICATIONS COMPUTER SOFTWARE DESIGN AND DEVELOPMENT SERVICES FOR OTHERS; AND APPLICATION SERVICE PROVIDER, NAMELY, HOSTING COMPUTER SOFTWARE APPLICATIONS IN THE FIELD OF TELECOMMUNICATIONS FOR ENABLING TELEPHONE, FAX, EMAIL, AND WEB CONFERENCE CALLING VIA A GLOBAL COMPUTER NETWORK AND A TELECOMMUNICATIONS NETWORK; PROVIDING TEMPORARY USE OF NON-DOWNLOADABLE COMPUTER OPERATING SYSTEMS FOR TELECOMMUNICATION AND SPEECH-ENABLED COMMUNICATIONS SYSTEMS; PROVIDING TEMPORARY USE OF NON-DOWNLOADABLE COMPUTER SOFTWARE FOR

TELECOMMUNICATION AND SPEECH-ENABLED COMMUNICATION SYSTEMS, NAMELY, FOR OPERATING AUTOMATED TELEPHONY SIGNALING AND CALL PROCESSING SYSTEMS AND FOR USE IN DATABASE MANAGEMENT, IN CLASS 42 (U.S. CLS. 100 AND 101).

FIRST USE 12-15-2006; IN COMMERCE 12-15-2006.

NO CLAIM IS MADE TO THE EXCLUSIVE RIGHT TO USE "INTERACTIVE", APART FROM THE MARK AS SHOWN.

THE MARK CONSISTS OF A DESIGN OF A STYLIZED PARROT HEAD NEXT TO THE WORDS "PARUS" IN BOLD STYLIZED FONT AND "INTERACTIVE" IN STYLIZED FONT.

SN 78-594,479, FILED 3-24-2005.

ELISSA GARBER KON, EXAMINING ATTORNEY

**Int. Cl.: 40**

**Prior U.S. Cls.: 100, 103, and 106**

**United States Patent and Trademark Office**

**Reg. No. 3,455,255**

**Registered June 24, 2008**

**SERVICE MARK  
PRINCIPAL REGISTER**

**PERMAGLYDE**

ALL SEALS, INC. (CALIFORNIA CORPORATION)  
404 WEST ROWLAND AVENUE  
SANTA ANA, CA 92707

FOR: SURFACE TREATMENT SERVICES, NAMELY, BY TREATING RUBBER AND RUBBER-LIKE AND PLASTIC PRODUCTS BY CHANGING THE MOLECULAR STRUCTURE IN OR ON SURFACES OF PRODUCTS, OR BY SURFACE PREPARATION AND CREATION IN SITU, OR APPLICATION OF PROTECTIVE COATINGS IN THE NATURE OF FRICTION, WEAR AND TORQUE REDUCING COATINGS, AND APPLICATION OF PROTECTIVE COATING TO SEALS, RUBBER,

RUBBER-LIKE AND PLASTIC PRODUCTS FOR AUTOMOTIVE, INDUSTRIAL AND GENERAL USE, IN CLASS 40 (U.S. CLS. 100, 103 AND 106).

FIRST USE 4-5-2005; IN COMMERCE 4-5-2005.

THE MARK CONSISTS OF STANDARD CHARACTERS WITHOUT CLAIM TO ANY PARTICULAR FONT, STYLE, SIZE, OR COLOR.

SN 78-595,212, FILED 3-25-2005.

REBECCA SMITH, EXAMINING ATTORNEY

**Int. Cl.: 3**

**Prior U.S. Cls.: 1, 4, 6, 50, 51, and 52**

**United States Patent and Trademark Office**

**Reg. No. 3,455,256**

**Registered June 24, 2008**

**TRADEMARK  
PRINCIPAL REGISTER**

**BIJAN WICKED**

G.P.C. SALES, INC. (NEW YORK CORPORATION)  
35 SAWGRASS DRIVE  
SUITE 2  
BELLPORT, NY 11713

FOR: FRAGRANCES, NAMELY, PERFUMERY, COLOGNES, EAU DE TOILETTE, PERFUMED BATH PREPARATIONS, PERFUMED BODY MOISTURIZER, PERFUMED BODY LOTION, PERFUMED BODY POWDER, PERFUMED BATH GEL AND PERFUMED DEODORANT, IN CLASS 3 (U.S. CLS. 1, 4, 6, 50, 51 AND 52).

FIRST USE 9-1-2005; IN COMMERCE 9-1-2005.

THE MARK CONSISTS OF STANDARD CHARACTERS WITHOUT CLAIM TO ANY PARTICULAR FONT, STYLE, SIZE, OR COLOR.

SN 78-597,276, FILED 3-29-2005.

ALICE SUE CARRUTHERS, EXAMINING ATTORNEY

**Int. Cls.: 35 and 37**

**Prior U.S. Cls.: 100, 101, 102, 103, and 106**

**United States Patent and Trademark Office**

**Reg. No. 3,455,257**

**Registered June 24, 2008**

**SERVICE MARK  
PRINCIPAL REGISTER**

**WHITEWATER**

CROSLAND, LLC. (NORTH CAROLINA LTD  
LIAB CO)  
227 WEST TRADE STREET, SUITE 800  
CHARLOTTE, NC 28202

FOR: REAL ESTATE SALES MANAGEMENT,  
NAMELY, MANAGEMENT OF SALES OF LEASED  
AND DEVELOPED SPACE FOR OTHERS, IN CLASS  
35 (U.S. CLS. 100, 101 AND 102).

FIRST USE 12-1-2007; IN COMMERCE 12-1-2007.

FOR: REAL ESTATE DEVELOPMENT, IN CLASS  
37 (U.S. CLS. 100, 103 AND 106).

FIRST USE 12-1-2007; IN COMMERCE 12-1-2007.

THE MARK CONSISTS OF STANDARD CHAR-  
ACTERS WITHOUT CLAIM TO ANY PARTICULAR  
FONT, STYLE, SIZE, OR COLOR.

SN 78-597,985, FILED 3-30-2005.

SARA THOMAS, EXAMINING ATTORNEY

**Int. Cl.: 41**

**Prior U.S. Cls.: 100, 101, and 107**

**Reg. No. 3,455,258**

**United States Patent and Trademark Office**

**Registered June 24, 2008**

---

**SERVICE MARK  
PRINCIPAL REGISTER**

**PAUL LONDON**

WORLD WRESTLING ENTERTAINMENT, INC.  
(DELAWARE CORPORATION)  
1241 EAST MAIN STREET  
STAMFORD, CT 06902

THE MARK CONSISTS OF STANDARD CHARACTERS WITHOUT CLAIM TO ANY PARTICULAR FONT, STYLE, SIZE, OR COLOR.

FOR: ENTERTAINMENT SERVICES, NAMELY, WRESTLING EXHIBITIONS AND PERFORMANCES BY A PROFESSIONAL WRESTLER AND ENTERTAINER; PROVIDING WRESTLING NEWS AND INFORMATION VIA A GLOBAL COMPUTER NETWORK, IN CLASS 41 (U.S. CLS. 100, 101 AND 107).

"THE NAME IN THE MARK IDENTIFIES"PAUL LONDON", WHOSE CONSENT TO REGISTER IS SUBMITTED."

SN 78-598,204, FILED 3-30-2005.

FIRST USE 10-9-2003; IN COMMERCE 10-9-2003.

JOHN WILKE, EXAMINING ATTORNEY



**Int. Cl.: 28**

**Prior U.S. Cls.: 22, 23, 38, and 50**

**United States Patent and Trademark Office**

**Reg. No. 3,455,259**

**Registered June 24, 2008**

**TRADEMARK  
PRINCIPAL REGISTER**

**PAUL LONDON**

WORLD WRESTLING ENTERTAINMENT, INC.  
(DELAWARE CORPORATION)  
1241 EAST MAIN STREET  
STAMFORD, CT 06902

FOR: TOY ACTION FIGURES AND ACCESSORIES THEREFOR; CASES FOR ACTION FIGURES; TOY VEHICLES; BOARD GAMES; PLAYING CARDS; STAND ALONE VIDEO OUTPUT GAME MACHINES FEATURING WRESTLING; HAND-HELD UNITS FOR PLAYING ELECTRONIC GAME; TABLETOP ACTION SKILL GAMES RELATED TO WRESTLING; JIGSAW PUZZLES; TOY WRESTLING RINGS; DOLLS; BOBBLE-HEAD DOLLS; PUPPETS; STUFFED TOY ANIMALS; CARD GAMES; COSTUME MASKS; TOY BELTS, DOLL FURNITURE; SKATEBOARDS; WINDUP TOYS; TOY SCOOTERS; KNEE AND ELBOW PADS FOR ATHLETIC USE; YO-YO'S; PLASTIC MODEL KITS FOR MAKING

TOY VEHICLES; TOY FOAM HANDS, IN CLASS 28 (U.S. CLS. 22, 23, 38 AND 50).

FIRST USE 12-31-2004; IN COMMERCE 12-31-2004.

THE MARK CONSISTS OF STANDARD CHARACTERS WITHOUT CLAIM TO ANY PARTICULAR FONT, STYLE, SIZE, OR COLOR.

THE NAME(S), PORTRAIT(S), AND/OR SIGNATURE(S) SHOWN IN THE MARK IDENTIFIES "PAUL LONDON", WHOSE CONSENT(S) TO REGISTER IS SUBMITTED.

SN 78-598,231, FILED 3-30-2005.

MARK SPARACINO, EXAMINING ATTORNEY

**Int. Cls.: 9, 42, and 44**

**Prior U.S. Cls.: 21, 23, 26, 36, 38, 100, and 101**

**United States Patent and Trademark Office**

**Reg. No. 3,455,260**

**Registered June 24, 2008**

**TRADEMARK  
SERVICE MARK  
PRINCIPAL REGISTER**

**PREMATICS**

PREMATICS, INC. (DELAWARE CORPORATION)  
7315 WISCONSIN AVENUE  
SUITE 200  
BETHESDA, MD 20814

FOR: COMPUTER HARDWARE, INCLUDING PORTABLE DEVICES FOR PREPARING AND PROCESSING DRUG PRESCRIPTIONS, AND COMPUTER COMMUNICATIONS HARDWARE, IN CLASS 9 (U.S. CLS. 21, 23, 26, 36 AND 38).

FIRST USE 3-15-2007; IN COMMERCE 3-15-2007.

FOR: PROVIDING INTERACTIVE ONLINE SERVICES, NAMELY, ONLINE NONDOWNLOADABLE SOFTWARE, TO MEDICAL PROFESSIONALS FOR PREPARATION AND PROCESSING OF PRESCRIPTION DRUGS, IN CLASS 42 (U.S. CLS. 100 AND 101).

FIRST USE 3-15-2007; IN COMMERCE 3-15-2007.

FOR: PROVIDING ONLINE MEDICAL DATABASES FOR MAINTAINING PRESCRIPTION DRUG INFORMATION RELATED TO HEALTH PLAN PARTICIPANT INSURANCE COVERAGE INFORMATION, PATIENT RECORDS, DRUG INFORMATION, AND LABORATORY TEST RESULTS, IN CLASS 44 (U.S. CLS. 100 AND 101).

FIRST USE 3-15-2007; IN COMMERCE 3-15-2007.

THE MARK CONSISTS OF STANDARD CHARACTERS WITHOUT CLAIM TO ANY PARTICULAR FONT, STYLE, SIZE, OR COLOR.

SN 78-601,036, FILED 4-4-2005.

BRENDAN REGAN, EXAMINING ATTORNEY

**Int. Cl.: 14**

**Prior U.S. Cls.: 2, 27, 28, and 50**

**Reg. No. 3,455,261**

**United States Patent and Trademark Office**

**Registered June 24, 2008**

---

**TRADEMARK  
PRINCIPAL REGISTER**

**DIAMONDAURA**

NEXTTEN STAUER, LLC (MINNESOTA LTD  
LIAB CO)  
14101 SOUTHCROSS DRIVE WEST  
BURNSVILLE, MN 55337

THE MARK CONSISTS OF STANDARD CHAR-  
ACTERS WITHOUT CLAIM TO ANY PARTICULAR  
FONT, STYLE, SIZE, OR COLOR.

FOR: JEWELRY PRIMARILY COMPRISED OF  
SIMULATED DIAMONDS AND GEMSTONES, IN  
CLASS 14 (U.S. CLS. 2, 27, 28 AND 50).

SN 78-602,017, FILED 4-5-2005.

FIRST USE 1-0-2005; IN COMMERCE 1-0-2005.

KRISTIN DAHLING, EXAMINING ATTORNEY

**Int. Cl.: 44**

**Prior U.S. Cls.: 100 and 101**

**Reg. No. 3,455,262**

**United States Patent and Trademark Office**

**Registered June 24, 2008**

---

**SERVICE MARK  
PRINCIPAL REGISTER**

**SCIENCE & BEAUTY SPA**

Yael Halaas M.D. PLLC (NEW YORK PROFESSIONAL LIMITED LIABILITY COMPANY)  
114 EAST 71ST STREET  
NEW YORK, NY 10021

FOR: COSMETIC, PLASTIC AND RECONSTRUCTIVE MEDICAL SERVICES, IN CLASS 44 (U.S. CLS. 100 AND 101).

FIRST USE 3-1-2006; IN COMMERCE 3-1-2006.

THE MARK CONSISTS OF STANDARD CHARACTERS WITHOUT CLAIM TO ANY PARTICULAR FONT, STYLE, SIZE, OR COLOR.

NO CLAIM IS MADE TO THE EXCLUSIVE RIGHT TO USE "BEAUTY SPA", APART FROM THE MARK AS SHOWN.

SN 78-603,251, FILED 4-6-2005.

LYDIA BELZER, EXAMINING ATTORNEY

**Int. Cl.: 7**

**Prior U.S. Cls.: 13, 19, 21, 23, 31, 34, and 35**

**Reg. No. 3,455,263**

**United States Patent and Trademark Office**

**Registered June 24, 2008**

**TRADEMARK  
PRINCIPAL REGISTER**

**CHAMELEON**

THUT, BRUNO H. (SWITZERLAND INDIVIDUAL)  
16755 PARK CIRCLE DR.  
CHAGRIN FALLS, OH 44023

FIRST USE 10-1-2007; IN COMMERCE 10-1-2007.

FOR: SUBMERSIBLE PUMPS FOR PUMPING  
MOLTEN METAL AND PUMP COMPONENTS  
THEREFOR, NAMELY, BASES; POSTS; RISERS;  
CARTRIDGES INCLUDING BASE, POST AND RI-  
SER; SHAFTS; IMPELLERS; AND MECHANISMS  
FOR RAISING AND LOWERING SHAFTS, IN  
CLASS 7 (U.S. CLS. 13, 19, 21, 23, 31, 34 AND 35).

THE MARK CONSISTS OF STANDARD CHAR-  
ACTERS WITHOUT CLAIM TO ANY PARTICULAR  
FONT, STYLE, SIZE, OR COLOR.

SN 78-607,809, FILED 4-13-2005.

CAROLYN CATALDO, EXAMINING ATTORNEY

**Int. Cl.: 42**

**Prior U.S. Cls.: 100 and 101**

**United States Patent and Trademark Office**

**Reg. No. 3,455,264**

**Registered June 24, 2008**

**SERVICE MARK  
PRINCIPAL REGISTER**

CELATOR PHARMACEUTICALS

CELATOR PHARMACEUTICALS, INC. (DELA-  
WARE CORPORATION)  
303B COLLEGE ROAD EAST  
PRINCETON, NJ 08540

OWNER OF U.S. REG. NO. 2,776,160.

FOR: RESEARCH AND DEVELOPMENT SERVI-  
CES FOR THE DEVELOPMENT OF DIAGNOSTIC  
AND THERAPEUTIC AGENTS FOR DISEASES OF  
HUMANS, IN CLASS 42 (U.S. CLS. 100 AND 101).

NO CLAIM IS MADE TO THE EXCLUSIVE  
RIGHT TO USE "PHARMACEUTICALS", APART  
FROM THE MARK AS SHOWN.

FIRST USE 5-3-2005; IN COMMERCE 5-3-2005.

SN 78-609,685, FILED 4-15-2005.

THE MARK CONSISTS OF STANDARD CHAR-  
ACTERS WITHOUT CLAIM TO ANY PARTICULAR  
FONT, STYLE, SIZE, OR COLOR.

WARREN L. OLANDRIA, EXAMINING ATTOR-  
NEY

**Int. Cl.: 41**

**Prior U.S. Cls.: 100, 101, and 107**

**United States Patent and Trademark Office**

**Reg. No. 3,455,265**

**Registered June 24, 2008**

**SERVICE MARK  
PRINCIPAL REGISTER**



TEXAS AGRILIFE EXTENSION SERVICE  
(TEXAS STATE AGENCY)  
7101 TAMU  
TEXAS A&M UNIVERSITY SYSTEM  
COLLEGE STATION, TX 77843

FOR: EDUCATIONAL SERVICES, NAMELY,  
CONDUCTING SEMINARS IN THE FIELD OF  
COTTON PRODUCTION IN THE STATE OF TEXAS;  
PROVIDING ONLINE PUBLICATIONS IN THE  
NATURE OF GUIDES, FACT SHEETS AND RE-  
PORTS IN THE FIELD OF COTTON PRODUCTION

IN THE STATE OF TEXAS, IN CLASS 41 (U.S. CLS.  
100, 101 AND 107).

FIRST USE 6-0-2003; IN COMMERCE 6-0-2003.

NO CLAIM IS MADE TO THE EXCLUSIVE  
RIGHT TO USE "TEXAS" OR "COTTON" OR THE  
OUTLINE DESIGN OF THE STATE OF TEXAS,  
APART FROM THE MARK AS SHOWN.

SN 78-612,117, FILED 4-19-2005.

RUSS HERMAN, EXAMINING ATTORNEY

**Int. Cl.: 2**

**Prior U.S. Cls.: 6, 11, and 16**

**United States Patent and Trademark Office**

**Reg. No. 3,455,266**

**Registered June 24, 2008**

**TRADEMARK  
PRINCIPAL REGISTER**

**BEHR PREMIUM SELECT**

BEHR PROCESS CORPORATION (CALIFORNIA  
CORPORATION)  
3400 W. SEGERSTROM AVENUE  
SANTA ANA, CA 92704

FOR: INTERIOR AND EXTERIOR PAINTS AND  
PRIMERS, IN CLASS 2 (U.S. CLS. 6, 11 AND 16).

FIRST USE 1-8-2007; IN COMMERCE 1-8-2007.

THE MARK CONSISTS OF STANDARD CHAR-  
ACTERS WITHOUT CLAIM TO ANY PARTICULAR  
FONT, STYLE, SIZE, OR COLOR.

OWNER OF U.S. REG. NOS. 942,246, 2,734,152,  
AND OTHERS.

NO CLAIM IS MADE TO THE EXCLUSIVE  
RIGHT TO USE "PREMIUM SELECT", APART  
FROM THE MARK AS SHOWN.

SN 78-612,552, FILED 4-20-2005.

PAULA MAHONEY, EXAMINING ATTORNEY



**Int. Cl.: 9**

**Prior U.S. Cls.: 21, 23, 26, 36, and 38**

**Reg. No. 3,455,267**

**United States Patent and Trademark Office**

**Registered June 24, 2008**

**TRADEMARK  
PRINCIPAL REGISTER**

**ARMOR-LATCH**

MINE SAFETY APPLIANCES COMPANY (PENN-  
SYLVANIA CORPORATION)  
121 GAMMA DRIVE  
PITTSBURGH, PA 15238

THE MARK CONSISTS OF STANDARD CHAR-  
ACTERS WITHOUT CLAIM TO ANY PARTICULAR  
FONT, STYLE, SIZE, OR COLOR.

FOR: BALLISTIC RESISTANT CLOTHING, IN  
CLASS 9 (U.S. CLS. 21, 23, 26, 36 AND 38).

SN 78-616,178, FILED 4-25-2005.

FIRST USE 3-1-2008; IN COMMERCE 3-1-2008.

DAVID ELTON, EXAMINING ATTORNEY

**Int. Cls.: 38 and 41**

**Prior U.S. Cls.: 100, 101, 104, and 107**

**United States Patent and Trademark Office**

**Reg. No. 3,455,268**

**Registered June 24, 2008**

**SERVICE MARK  
PRINCIPAL REGISTER**



GLR SERVICES, INC. (DELAWARE CORPORATION)  
4770 BISCAYNE BLVD.  
SUITE 700  
MIAMI, FL 33137

FOR: RADIO BROADCASTING SERVICES OVER  
THE AIR AND VIA A GLOBAL COMPUTER NET-  
WORK, IN CLASS 38 (U.S. CLS. 100, 101 AND 104).

FIRST USE 8-30-2004; IN COMMERCE 8-30-2004.

FOR: ENTERTAINMENT SERVICES, NAMELY,  
PROVIDING SYNDICATED RADIO PROGRAMS IN  
THE FIELDS OF MUSIC, NEWS, FEATURES,  
SPORTS AND ENTERTAINMENT, IN CLASS 41  
(U.S. CLS. 100, 101 AND 107).

FIRST USE 8-30-2004; IN COMMERCE 8-30-2004.

SN 78-617,941, FILED 4-27-2005.

LA TONIA FISHER, EXAMINING ATTORNEY

**Int. Cls.: 16 and 28**

**Prior U.S. Cls.: 2, 5, 22, 23, 29, 37, 38, and 50**

**United States Patent and Trademark Office**

**Reg. No. 3,455,269**

**Registered June 24, 2008**

**TRADEMARK  
PRINCIPAL REGISTER**



LI & FUNG (B.V.I. LIMITED) (BR.VIRGIN ISLANDS LTD LIAB CO)  
P.O. BOX 957  
OFFSHORE INCORPORATIONS CENTRE  
ROAD TOWN, TORTOLA, BR.VIRGIN ISLANDS

FOR: INVITATION CARDS AND WRITING PADS, PAPER NAPKINS AND TABLECLOTHS, PAPER DISPOSABLE CARRIER BAGS; PAPER PARTY DECORATIONS, NAMELY, BATS, MONSTERS, SKELETONS, SCARECROWS, SPIDERS, VAMPIRES, WITCHES, IN CLASS 16 (U.S. CLS. 2, 5, 22, 23, 29, 37, 38 AND 50).

FIRST USE 12-31-1999; IN COMMERCE 9-30-2005.

FOR: TOY FIGURES, NAMELY, TOY GLOW-IN-THE-DARK SPIDERS, INSECTS, BATS; PARTY FAVORS IN THE NATURE OF SMALL TOYS; PARTY FAVORS IN THE NATURE OF PARTY POPPERS; BALLOONS; FALSE TEETH, TOY BROOMSTICKS,

TOY SWORDS AND TOY WEAPONS, IN CLASS 28 (U.S. CLS. 22, 23, 38 AND 50).

FIRST USE 12-31-1999; IN COMMERCE 9-30-2005.

OWNER OF U.S. REG. NOS. 828,730, 2,999,612, AND 2,999,953.

NO CLAIM IS MADE TO THE EXCLUSIVE RIGHT TO USE "BLACK CAT", APART FROM THE MARK AS SHOWN.

THE MARK CONSISTS OF A BLACK CAT HEAD WITH THE WORD "BLACK" ABOVE THE DESIGN AND THE WORD "CAT" BELOW THE DESIGN.

SN 78-619,418, FILED 4-28-2005.

ELIZABETH BEYER, EXAMINING ATTORNEY

**Int. Cl.: 5**

**Prior U.S. Cls.: 6, 18, 44, 46, 51, and 52**

**Reg. No. 3,455,270**

**United States Patent and Trademark Office**

**Registered June 24, 2008**

---

**TRADEMARK  
PRINCIPAL REGISTER**

**FLUFEND**

WYETH HOLDINGS CORPORATION (MAINE  
CORPORATION)  
FIVE GIRALDA FARMS  
MADISON, NJ 07940

THE MARK CONSISTS OF STANDARD CHAR-  
ACTERS WITHOUT CLAIM TO ANY PARTICULAR  
FONT, STYLE, SIZE, OR COLOR.

FOR: VETERINARY VACCINES, IN CLASS 5 (U.S.  
CLS. 6, 18, 44, 46, 51 AND 52).

SN 78-619,855, FILED 4-29-2005.

FIRST USE 3-14-2008; IN COMMERCE 3-14-2008.

EDWARD NELSON, EXAMINING ATTORNEY

**Int. Cl.: 12**

**Prior U.S. Cls.: 19, 21, 23, 31, 35, and 44**

**United States Patent and Trademark Office**

**Reg. No. 3,455,271**

**Registered June 24, 2008**

**TRADEMARK  
PRINCIPAL REGISTER**



VECTRIX CORPORATION (DELAWARE COR-  
PORATION)  
76 HAMMARLUND WAY  
TECH III PLAZA, SUITE 250  
MIDDLETOWN, RI 02842

THE MARK IS NOT IN COLOR.

SN 78-622,740, FILED 5-4-2005.

FOR: MOTORIZED SCOOTERS, IN CLASS 12 (U.S.  
CLS. 19, 21, 23, 31, 35 AND 44).

FIRST USE 7-31-2007; IN COMMERCE 7-31-2007.

KATHERINE CONNOLLY, EXAMINING ATTOR-  
NEY

**Int. Cl.: 34**

**Prior U.S. Cls.: 2, 8, 9, and 17**

**United States Patent and Trademark Office**

**Reg. No. 3,455,272**

**Registered June 24, 2008**

**TRADEMARK  
PRINCIPAL REGISTER**

**TABOKA**

PHILIP MORRIS USA INC. (VIRGINIA CORPORATION)  
6601 WEST BROAD STREET  
RICHMOND, VA 23230

THE MARK CONSISTS OF STANDARD CHARACTERS WITHOUT CLAIM TO ANY PARTICULAR FONT, STYLE, SIZE, OR COLOR.

FOR: MANUFACTURED TOBACCO, NAMELY, SMOKELESS TOBACCO, IN CLASS 34 (U.S. CLS. 2, 8, 9 AND 17).

SN 78-623,680, FILED 5-5-2005.

FIRST USE 6-30-2006; IN COMMERCE 6-30-2006.

NANCY CLARKE, EXAMINING ATTORNEY

**Int. Cl.: 4**

**Prior U.S. Cls.: 1, 6, and 15**

**United States Patent and Trademark Office**

**Reg. No. 3,455,273**

**Registered June 24, 2008**

**TRADEMARK  
PRINCIPAL REGISTER**



CHEVRON CORPORATION (DELAWARE CORPORATION)  
6001 BOLLINGER CANYON ROAD  
SAN RAMON, CA 94583

FOR: PETROLEUM AND PETROLEUM-DE-  
RIVED PRODUCTS FOR INDUSTRIAL AND AUTO-  
MOTIVE USE, NAMELY, MOTOR FUELS, MOTOR  
OILS AND ENGINE LUBRICANTS, LUBRICATING  
OILS AND GREASES, FUEL OIL, DIESEL FUEL;  
BASE OILS USED AS LUBRICANTS; AVIATION  
FUEL; INDUSTRIAL OILS AND LUBRICANTS;  
SYNTHETIC OILS AND LUBRICANTS; NATURAL  
GAS; LIQUEFIED NATURAL GAS; LUBRICANTS  
FOR MARINE USE; HYDRAULIC OILS, IN CLASS 4  
(U.S. CLS. 1, 6 AND 15).

FIRST USE 10-1-2007; IN COMMERCE 10-1-2007.

OWNER OF U.S. REG. NOS. 972,729, 2,727,275,  
AND OTHERS.

THE COLOR(S) BLUE AND RED IS/ARE  
CLAIMED AS A FEATURE OF THE MARK.

THE MARK CONSISTS OF THE WORD "CHEV-  
RON" IS BLUE. THE TOP RIBBON IS BLUE AND  
THE BOTTOM RIBBON IS RED.

SN 78-626,304, FILED 5-10-2005.

KAREN SEVERSON, EXAMINING ATTORNEY

**Int. Cl.: 35**

**Prior U.S. Cls.: 100, 101, and 102**

**United States Patent and Trademark Office**

**Reg. No. 3,455,274**

**Registered June 24, 2008**

**SERVICE MARK  
PRINCIPAL REGISTER**



CHEVRON CORPORATION (DELAWARE CORPORATION)  
6001 BOLLINGER CANYON ROAD  
SAN RAMON, CA 94583

FOR: RETAIL CONVENIENCE STORE SERVICES,  
IN CLASS 35 (U.S. CLS. 100, 101 AND 102).

FIRST USE 10-1-2005; IN COMMERCE 10-1-2005.

OWNER OF U.S. REG. NOS. 972,729, 2,727,275,  
AND OTHERS.

THE COLOR(S) RED AND BLUE IS/ARE  
CLAIMED AS A FEATURE OF THE MARK.

THE MARK CONSISTS OF THE WORD "CHEV-  
RON" IS BLUE. THE TOP RIBBON IS BLUE AND  
THE BOTTOM RIBBON IS RED.

SN 78-626,355, FILED 5-10-2005.

KAREN SEVERSON, EXAMINING ATTORNEY



**Int. Cls.: 9, 38, 39, 40, and 41**

**Prior U.S. Cls.: 21, 23, 26, 36, 38, 100, 101, 103, 104, 105, 106, and 107**

**Reg. No. 3,455,275**

**United States Patent and Trademark Office**

**Registered June 24, 2008**

**TRADEMARK  
SERVICE MARK  
PRINCIPAL REGISTER**

**FLICKR**

YAHOO! INC. (DELAWARE CORPORATION)  
701 FIRST AVENUE  
SUNNYVALE, CA 94089

FOR: COMPUTER SOFTWARE FOR USE IN DATABASE MANAGEMENT; COMPUTER SOFTWARE FOR UPLOADING, MANIPULATING, AND ENHANCING DIGITAL CONTENT, DOCUMENTS, PHOTOGRAPHS, IMAGES, VIDEO, AND AUDIO; COMPUTER SOFTWARE FOR LINKING METADATA TAGS WITH PHOTOGRAPHIC AND OTHER MEDIA FILES TO ENABLE SEARCH ENGINE RETRIEVAL AND DATABASE SOFTWARE COLLECTIONS OF FILES AND THEIR ON-LINE SHARING, AND FOR LINKING METADATA TAGS WITH WEB PAGES VISITED, TO CREATE LINKS WHICH USERS CAN MAINTAIN FOR THEMSELVES AND SHARE WITH ON-LINE GROUPS AND WEBSITE TAGGING, IN CLASS 9 (U.S. CLS. 21, 23, 26, 36 AND 38).

FIRST USE 2-28-2004; IN COMMERCE 2-28-2004.

FOR: COMMUNICATION SERVICES BY ELECTRONIC COMPUTER TERMINALS AND CELL PHONES; TELECOMMUNICATION SERVICES BY E-MAIL ELECTRONIC MAIL SERVICES; ELECTRONIC TRANSMISSION OF MESSAGES, IMAGES, AND VIA COMPUTER TERMINALS AND CELL PHONES; PROVIDING ONLINE FORUMS FOR DISCUSSION AND ELECTRONIC BULLETIN/MESSAGE BOARDS FOR TRANSMISSION OF MESSAGES AMONG USERS IN THE FIELD OF GENERAL INTEREST; PROVIDING ON-LINE ELECTRONIC BULLETIN BOARDS FOR TRANSMISSION OF MESSAGES AMONG COMPUTER

USERS CONCERNING PERSONAL PHOTOGRAPHS, IN CLASS 38 (U.S. CLS. 100, 101 AND 104).

FIRST USE 2-28-2004; IN COMMERCE 2-28-2004.

FOR: ELECTRONIC STORAGE OF DIGITAL CONTENT INCLUDING TEXT, PHOTOGRAPHS, IMAGES, VIDEO, AND AUDIO, IN CLASS 39 (U.S. CLS. 100 AND 105).

FIRST USE 2-28-2004; IN COMMERCE 2-28-2004.

FOR: DIGITAL ENHANCEMENT OF PHOTOGRAPHS; ALTERATION AND/OR RETOUCHING OF PHOTOGRAPHIC IMAGES, IN CLASS 40 (U.S. CLS. 100, 103 AND 106).

FIRST USE 11-29-2007; IN COMMERCE 12-5-2007.

FOR: ONLINE JOURNALS, NAMELY, BLOGS CONCERNING TOPICS OF GENERAL INTEREST TO THE BLOGGER; PHOTOGRAPHY SERVICES; PROVIDING INFORMATION IN THE FIELD OF PHOTOGRAPHY, IN CLASS 41 (U.S. CLS. 100, 101 AND 107).

FIRST USE 2-28-2004; IN COMMERCE 2-28-2004.

THE MARK CONSISTS OF STANDARD CHARACTERS WITHOUT CLAIM TO ANY PARTICULAR FONT, STYLE, SIZE, OR COLOR.

SN 78-626,807, FILED 5-10-2005.

DAWN HAN, EXAMINING ATTORNEY

Int. Cls.: 12 and 28

Prior U.S. Cls.: 19, 21, 22, 23, 31, 35, 38, 44, and 50

Reg. No. 3,455,276

United States Patent and Trademark Office

Registered June 24, 2008

TRADEMARK  
PRINCIPAL REGISTER



POWERMETAL TECHNOLOGIES INC. (NEVADA CORPORATION)  
2726 LOKER AVENUE  
CARLSBAD, CA 92010

FOR: BICYCLES, MOUNTAIN BICYCLES, RACING BICYCLES, TOURING BICYCLES, BICYCLE FRAMES, BICYCLE GEARS, BICYCLE WHEELS, RIMS FOR BICYCLE WHEELS, BICYCLE PARTS, NAMELY, DRIVE TRAINS, BICYCLE PARTS NAMELY FORKS, BICYCLE PARTS NAMELY GEAR, BICYCLE PARTS NAMELY SEAT POSTS, BICYCLE PARTS NAMELY, HANDLEBARS, BICYCLE PARTS NAMELY HANDLEBAR STEMS, BICYCLE BEARINGS, BOATS, BOAT HULLS, BOAT RUDDERS, STEERING GEARS AND RUDDERS FOR VESSELS, FISHING BOATS, PERSONAL WATERCRAFT, NAMELY, SMALL POWERBOATS, PERSONAL WATERCRAFT, NAMELY, PERSONAL JET BOATS, IN CLASS 12 (U.S. CLS. 19, 21, 23, 31, 35 AND 44).

FIRST USE 1-1-2008; IN COMMERCE 1-1-2008.

FOR: ARCHERY ARROWS, ARCHERY ARROW POINTS, ARCHERY BOWS, ARCHERY ARM GUARDS, HUNTING BOWS, BASEBALL BATS, SOFTBALL BATS, GOLF CLUBS, GOLF CLUB SHAFTS, GOLF CLUB HEADS, GOLF PUTTERS, GOLF TEES, GOLF IRONS, GOLF BALLS, HOCKEY STICKS, ICE HOCKEY STICKS, ICE SKATE BLADES, ICE SKATES, ICE HOCKEY SKATES, LA-CROSSE STICKS, TENNIS RACQUETS, TENNIS

RACKETS, RACQUET BALL RACQUETS, BADMINTON RACQUETS, SQUASH RACKETS, SAIL BOARDS, SAIL BOARD MASTS, IN-LINE ROLLER SKATES, ROLLER SKATES, SKATEBOARD DECKS, SKATEBOARD TRUCKS, SKATEBOARD RAILS, SKATEBOARD WHEELS, SKATEBOARDS, BALL BEARINGS FOR ROLLER SKATES, BALL BEARINGS FOR IN-LINE SKATES, SKI POLES, SKI BINDINGS, SKI EDGES, SNOW BOARDS, SNOW SKIS, SNOW BOARD BINDINGS, SNOW BOARD DECKS, ALPINE SKIS, CROSS COUNTRY SKIS, SKIS, WATER SKIS, SNOW SKIS, ARTIFICIAL FISHING LURES, FISHING LEADERS, FISHING HOOKS, FISHING LURE BOXES, FISHING FLIES, FISHING FLOATS, FISHING LURES, FISHING RODS, FISHING REELS, FISHING TACKLE BOXES, HANDHELD FISHING NETS, IN CLASS 28 (U.S. CLS. 22, 23, 38 AND 50).

FIRST USE 1-1-2008; IN COMMERCE 1-1-2008.

NO CLAIM IS MADE TO THE EXCLUSIVE RIGHT TO USE "TECHNOLOGIES, INC.", APART FROM THE MARK AS SHOWN.

THE MARK CONSISTS OF SIX HEXAGON SHAPES AND THE WORDS POWERMETAL TECHNOLOGIES INC.

SN 78-627,486, FILED 5-11-2005.

LINDA MICKLEBURGH, EXAMINING ATTORNEY

**Int. Cl.: 29**

**Prior U.S. Cl.: 46**

**United States Patent and Trademark Office**

**Reg. No. 3,455,277**

**Registered June 24, 2008**

**TRADEMARK  
PRINCIPAL REGISTER**

**BUFFALOED**

PIERRE FOODS, INC. (NORTH CAROLINA COR-  
PORATION)  
9990 PRINCETON ROAD  
CINCINNATI, OH 45246

THE MARK CONSISTS OF STANDARD CHAR-  
ACTERS WITHOUT CLAIM TO ANY PARTICULAR  
FONT, STYLE, SIZE, OR COLOR.

FOR: PROCESSED POULTRY AND PROCESSED  
MEAT, NAMELY, BEEF AND PORK, IN CLASS 29  
(U.S. CL. 46).

SN 78-630,890, FILED 5-16-2005.

FIRST USE 7-0-2006; IN COMMERCE 7-0-2006.

JOHN DALIER, EXAMINING ATTORNEY

**Int. Cl.: 41**

**Prior U.S. Cls.: 100, 101, and 107**

**United States Patent and Trademark Office**

**Reg. No. 3,455,278**

**Registered June 24, 2008**

**SERVICE MARK  
PRINCIPAL REGISTER**

**CRYSTAL BALL CASH**

GAMELOGIC INC. (DELAWARE CORPORATION)  
SUITE 312  
411 WAVERLY OAKS ROAD  
WALTHAM, MA 02451

FOR: ENTERTAINMENT SERVICES, NAMELY,  
PROVIDING ONLINE COMPUTER GAMING; AND  
ELECTRONIC CASINO GAMING SERVICES, IN  
CLASS 41 (U.S. CLS. 100, 101 AND 107).

FIRST USE 7-12-2005; IN COMMERCE 7-12-2005.

THE MARK CONSISTS OF STANDARD CHARACTERS WITHOUT CLAIM TO ANY PARTICULAR FONT, STYLE, SIZE, OR COLOR.

NO CLAIM IS MADE TO THE EXCLUSIVE RIGHT TO USE "CASH", APART FROM THE MARK AS SHOWN.

SN 78-631,337, FILED 5-17-2005.

JOHN E. MICHOS, EXAMINING ATTORNEY

**Int. Cl.: 9**

**Prior U.S. Cls.: 21, 23, 26, 36, and 38**

**Reg. No. 3,455,279**

**United States Patent and Trademark Office**

**Registered June 24, 2008**

---

**TRADEMARK  
PRINCIPAL REGISTER**

**CRYSTAL BALL CASH**

GAMELOGIC INC. (DELAWARE CORPORATION)  
SUITE 312  
411 WAVERLY OAKS ROAD  
WALTHAM, MA 02452

FOR: COMPUTER GAMING SOFTWARE, IN  
CLASS 9 (U.S. CLS. 21, 23, 26, 36 AND 38).

FIRST USE 7-12-2005; IN COMMERCE 7-12-2005.

THE MARK CONSISTS OF STANDARD CHARACTERS WITHOUT CLAIM TO ANY PARTICULAR FONT, STYLE, SIZE, OR COLOR.

NO CLAIM IS MADE TO THE EXCLUSIVE RIGHT TO USE "CASH", APART FROM THE MARK AS SHOWN.

SN 78-631,340, FILED 5-17-2005.

JOHN E. MICHOS, EXAMINING ATTORNEY

**Int. Cls.: 7 and 9**

**Prior U.S. Cls.: 13, 19, 21, 23, 26, 31, 34, 35, 36, and 38**

**United States Patent and Trademark Office**

**Reg. No. 3,455,280**

**Registered June 24, 2008**

**TRADEMARK  
PRINCIPAL REGISTER**



FRANKLIN ELECTRIC CO., INC. (INDIANA CORPORATION)  
400 EAST SPRING STREET  
BLUFFTON, IN 46714

FIRST USE 0-0-2005; IN COMMERCE 0-0-2005.

OWNER OF U.S. REG. NO. 1,080,789.

FOR: MACHINES, NAMELY, ELECTRICAL MOTORS NOT FOR LAND VEHICLES, PUMPS, NAMELY, CENTRIFUGAL PUMPS, ROTARY PUMPS, SUCTION PUMPS, SUMP PUMPS, PNEUMATIC PUMPS, SUBMERSIBLE PUMPS, ELECTRIC PUMPS, SLUDGE AND SILT PUMPS, HIGH PRESSURE CLEANING OR WASHING PUMPS, VERTICAL TURBINE PUMPS, OIL DRAIN PUMPS, AND FUEL PUMPS, PUMP MOTORS, AND PUMP/MOTOR ASSEMBLIES COMPRISING COMBINATIONS OF THE FOREGOING, IN CLASS 7 (U.S. CLS. 13, 19, 21, 23, 31, 34 AND 35).

NO CLAIM IS MADE TO THE EXCLUSIVE RIGHT TO USE "SYSTEM" AND "SOLUTIONS", APART FROM THE MARK AS SHOWN.

FIRST USE 0-0-2005; IN COMMERCE 0-0-2005.

FOR: ELECTRONIC CONTROLS FOR PUMPS AND MOTORS, LOAD SENSORS AND PUMP PROTECTION SYSTEMS COMPRISING METERS, GAUGES OR TESTERS FOR USE IN PUMPING WATER AND OTHER LIQUIDS, IN CLASS 9 (U.S. CLS. 21, 23, 26, 36 AND 38).

THE MARK CONSISTS OF A STYLIZED LETTERS "FE", SURROUNDED BY A CIRCULAR DESIGN INSIDE A STYLIZED DIAMOND SHAPE FORMED BY TWO TRIANGLES; THE STYLIZED DIAMOND SHAPE IS ENCLOSED WITHIN AN OUTER RIM FORMED BY CONCENTRIC CIRCLES CONTAINING THE WORDS "SYSTEM SOLUTIONS", WITH A SIMULATED WATER LINE EXTENDING HORIZONTALLY INSIDE AND NEAR THE TOP OF THE OUTER RIM.

SN 78-632,544, FILED 5-18-2005.

NAKIA HENRY, EXAMINING ATTORNEY

**Int. Cl.: 31**

**Prior U.S. Cls.: 1 and 46**

**United States Patent and Trademark Office**

**Reg. No. 3,455,281**

**Registered June 24, 2008**

**TRADEMARK  
PRINCIPAL REGISTER**

**DENTA CHEW**

NORMERICA INC. (CANADA CORPORATION)  
SUITE 600  
703 EVANS AVENUE  
TORONTO, ONTARIO, CANADA M9C 5E9

FOR: SIMULATED EDIBLE BONE CHEWS FOR  
DOGS, IN CLASS 31 (U.S. CLS. 1 AND 46).

FIRST USE 8-0-2005; IN COMMERCE 7-0-2007.

THE MARK CONSISTS OF STANDARD CHAR-  
ACTERS WITHOUT CLAIM TO ANY PARTICULAR  
FONT, STYLE, SIZE, OR COLOR.

OWNER OF CANADA REG. NO. TMA627411,  
DATED 12-3-2004, EXPIRES 12-30-2019.

SN 78-633,819, FILED 5-20-2005.

CHRISTOPHER BUONGIORNO, EXAMINING AT-  
TORNEY

**Int. Cl.: 5**

**Prior U.S. Cls.: 6, 18, 44, 46, 51, and 52**

**Reg. No. 3,455,282**

**United States Patent and Trademark Office**

**Registered June 24, 2008**

**TRADEMARK  
PRINCIPAL REGISTER**



PRISM PHARMACEUTICALS, INC. (DELAWARE CORPORATION)  
1150 FIRST AVENUE  
SUITE 1050  
KING OF PRUSSIA, PA 19406

FOR: PHARMACEUTICALS, NAMELY, PREPARATIONS IN INJECTABLE, SOLUTION AND TABLET FORM FOR THE PREVENTION, TREATMENT AND MANAGEMENT OF CARDIOVASCULAR DISEASES, IN CLASS 5 (U.S. CLS. 6, 18, 44, 46, 51 AND 52).

FIRST USE 4-11-2008; IN COMMERCE 4-11-2008.

NO CLAIM IS MADE TO THE EXCLUSIVE RIGHT TO USE "PHARMACEUTICALS", APART FROM THE MARK AS SHOWN.

THE COLOR(S) BLUE, BLACK AND WHITE IS/ARE CLAIMED AS A FEATURE OF THE MARK.

THE MARK CONSISTS OF THE WORDS "PRISM" IN BLACK TEXT. BENEATH THE TERM "PRISM" IS THE TERM "PHARMACEUTICALS" IN BLUE TEXT. TO THE LEFT OF THE TEXT IS A PYRAMID. THE LEFT SIDE OF THE PYRAMID IS BLUE AND THE RIGHT SIDE IS BLACK. THERE IS A WHITE LINE ON BOTH PARTS OF THE PYRAMID. PART OF THE WHITE LINE FORMS THE LEG OF A STYLIZED BLUE PERSON TO THE RIGHT OF THE PYRAMID.

SN 78-635,067, FILED 5-23-2005.

TRACY WHITTAKER-BROWN, EXAMINING ATTORNEY



**Int. Cl.: 9**

**Prior U.S. Cls.: 21, 23, 26, 36, and 38**

**Reg. No. 3,455,283**

**United States Patent and Trademark Office**

**Registered June 24, 2008**

**TRADEMARK  
PRINCIPAL REGISTER**

**BUDGET GURU**

KULASZEWICZ, ROBERT A. (UNITED STATES  
INDIVIDUAL)  
5900 CASTLE BROOK AVE. SE  
KENTWOOD, MI 49508

FOR: COMPUTER SOFTWARE THAT ALLOWS  
THE USER TO COMPILE INFORMATION AND  
CREATE A PERSONALIZED FAMILY BUDGET  
AND PROVIDES INSTRUCTIONS ON EXECUTING  
THAT FAMILY BUDGET, IN CLASS 9 (U.S. CLS. 21,  
23, 26, 36 AND 38).

FIRST USE 3-24-2008; IN COMMERCE 3-24-2008.

THE MARK CONSISTS OF STANDARD CHAR-  
ACTERS WITHOUT CLAIM TO ANY PARTICULAR  
FONT, STYLE, SIZE, OR COLOR.

NO CLAIM IS MADE TO THE EXCLUSIVE  
RIGHT TO USE "BUDGET", APART FROM THE  
MARK AS SHOWN.

SN 78-636,361, FILED 5-24-2005.

KIMBERLY PERRY, EXAMINING ATTORNEY

**Int. Cl.: 9**

**Prior U.S. Cls.: 21, 23, 26, 36, and 38**

**Reg. No. 3,455,284**

**United States Patent and Trademark Office**

**Registered June 24, 2008**

**TRADEMARK  
PRINCIPAL REGISTER**

**Midwest Optoelectronics**

MIDWEST OPTOELECTRONICS, LLC (OHIO  
LIMITED LIABILITY CORPORATION)  
2600 DORR STEET  
TOLEDO, OH 43607

FOR: PHOTOELECTROCHEMICAL SYSTEMS  
CONSISTING OF DEVICES AND MODULES,  
NAMELY, PHOTOVOLTAIC CELLS AND PANELS,  
ELECTROCHEMICAL ASSEMBLIES FOR SPLIT-  
TING WATER INTO HYDROGEN AND OXYGEN  
AND PHOTOELECTROCHEMICAL MODULES  
CONSISTING OF PHOTOVOLTAIC CELLS AND  
ELECTROCHEMICAL ASSEMBLIES, ALL FOR  
PRODUCING ELECTRICITY, IN CLASS 9 (U.S.  
CLS. 21, 23, 26, 36 AND 38).

FIRST USE 9-30-2006; IN COMMERCE 9-30-2006.

THE MARK CONSISTS OF STANDARD CHAR-  
ACTERS WITHOUT CLAIM TO ANY PARTICULAR  
FONT, STYLE, SIZE, OR COLOR.

NO CLAIM IS MADE TO THE EXCLUSIVE  
RIGHT TO USE "OPTOELECTRONICS", APART  
FROM THE MARK AS SHOWN.

SN 78-637,080, FILED 5-25-2005.

KARANENDRA S. CHHINA, EXAMINING ATTOR-  
NEY

**Int. Cl.: 9**

**Prior U.S. Cls.: 21, 23, 26, 36, and 38**

**Reg. No. 3,455,285**

**United States Patent and Trademark Office**

**Registered June 24, 2008**

**TRADEMARK  
PRINCIPAL REGISTER**

**MWOE**

MIDWEST OPTOELECTRONICS, LLC (OHIO  
LIMITED LIABILITY CORPORATION)  
2600 DORR STREET  
TOLEDO, OH 43607

FOR: PHOTOELECTROCHEMICAL SYSTEMS  
CONSISTING OF DEVICES AND MODULES,  
NAMELY, PHOTOVOLTAIC CELLS AND PANELS,  
ELECTROCHEMICAL ASSEMBLIES FOR SPLIT-  
TING WATER INTO HYDROGEN AND OXYGEN  
AND PHOTOELECTROCHEMICAL MODULES  
CONSISTING OF PHOTOVOLTAIC CELLS AND  
ELECTROCHEMICAL ASSEMBLIES, ALL FOR

PRODUCING ELECTRICITY, IN CLASS 9 (U.S.  
CLS. 21, 23, 26, 36 AND 38).

FIRST USE 7-1-2003; IN COMMERCE 7-1-2006.

THE MARK CONSISTS OF STANDARD CHAR-  
ACTERS WITHOUT CLAIM TO ANY PARTICULAR  
FONT, STYLE, SIZE, OR COLOR.

SN 78-637,105, FILED 5-25-2005.

AISHA CLARKE, EXAMINING ATTORNEY

**Int. Cls.: 9, 16, 35, 41, 43, and 45**

**Prior U.S. Cls.: 2, 5, 21, 22, 23, 26, 29, 36, 37, 38, 50,  
100, 101, 102, and 107**

**Reg. No. 3,455,286**

**United States Patent and Trademark Office**

**Registered June 24, 2008**

**TRADEMARK  
SERVICE MARK  
PRINCIPAL REGISTER**

**SOUTHERN CHRISTIAN  
LEADERSHIP CONFERENCE**

SOUTHERN CHRISTIAN LEADERSHIP CONFERENCE, INC. (GEORGIA CORPORATION)  
320 AUBURN AVENUE NE  
ATLANTA, GA 30303

FOR: AUDIO, VIDEO AND DVD RECORDINGS FEATURING CONFERENCES AND SEMINARS CONDUCTED BY AN ORGANIZATION AND FEATURING INFORMATION ALL IN THE FIELD OF CIVIL RIGHTS AND HUMAN RIGHTS, IN CLASS 9 (U.S. CLS. 21, 23, 26, 36 AND 38).

FIRST USE 7-31-2004; IN COMMERCE 7-31-2004.

FOR: (BASED ON USE IN COMMERCE) PRINTED PUBLICATIONS, NAMELY, MAGAZINE, BROCHURE, BOOKS AND PRINTED EDUCATIONAL MATERIALS IN THE FIELD OF NATIONAL AND INTERNATIONAL ISSUES AND EVENTS PERTAINING TO CIVIL RIGHTS AND HUMAN RIGHTS, IN CLASS 16 (U.S. CLS. 2, 5, 22, 23, 29, 37, 38 AND 50).

FIRST USE 2-14-1957; IN COMMERCE 2-14-1957.

FOR: (BASED ON USE IN COMMERCE) ASSOCIATION SERVICES, NAMELY, PROMOTING THE INTERESTS OF CIVIL RIGHTS AND HUMAN RIGHTS ORGANIZATIONS; ASSOCIATION SERVICES, NAMELY, PROMOTING THE INTERESTS OF DISADVANTAGED AND MINORITY PEOPLE IN THE FIELD OF CIVIL RIGHTS AND HUMAN RIGHTS, AND CIVIL RIGHTS AND HUMAN RIGHTS IN EDUCATION, VOTING, HOUSING, EMPLOYMENT AND ECONOMIC DEVELOPMENT; PROMOTING THE PUBLIC AWARENESS OF THE NEED FOR CIVIL RIGHTS AND HUMAN RIGHTS, AND CIVIL RIGHTS AND HUMAN RIGHTS IN EDUCATION, VOTING, HOUSING, EMPLOYMENT, AND ECONOMIC DEVELOPMENT; ADVOCACY SERVICES, NAMELY, PROMOTING CIVIL

RIGHTS AND HUMAN RIGHTS, AND CIVIL RIGHTS AND HUMAN RIGHTS IN EDUCATION, VOTING, HOUSING, EMPLOYMENT AND ECONOMIC OPPORTUNITY, IN CLASS 35 (U.S. CLS. 100, 101 AND 102).

FIRST USE 2-14-1957; IN COMMERCE 2-14-1957.

FOR: (BASED ON USE IN COMMERCE) EDUCATIONAL SERVICES, NAMELY, CONDUCTING CONFERENCES AND SEMINARS IN THE FIELD OF CIVIL RIGHTS AND HUMAN RIGHTS; PROVIDING EDUCATIONAL PROGRAMS FOR DISADVANTAGED YOUTHS IN THE FIELD OF COMPUTER TECHNOLOGY TO PROMOTE CIVIL RIGHTS AND HUMAN RIGHTS IN EDUCATION, IN CLASS 41 (U.S. CLS. 100, 101 AND 107).

FIRST USE 2-14-1957; IN COMMERCE 2-14-1957.

FOR: (BASED ON USE IN COMMERCE) ARRANGING TEMPORARY HOUSING ACCOMMODATIONS TO PROMOTE CIVIL RIGHTS AND HUMAN RIGHTS IN HOUSING, IN CLASS 43 (U.S. CLS. 100 AND 101).

FIRST USE 2-14-1957; IN COMMERCE 2-14-1957.

FOR: (BASED ON USE IN COMMERCE) PROVIDING INFORMATION VIA A GLOBAL COMMUNICATIONS NETWORK IN THE FIELD OF CIVIL RIGHTS AND HUMAN RIGHTS, IN CLASS 45 (U.S. CLS. 100 AND 101).

FIRST USE 2-14-1957; IN COMMERCE 2-14-1957.

THE MARK CONSISTS OF STANDARD CHARACTERS WITHOUT CLAIM TO ANY PARTICULAR FONT, STYLE, SIZE, OR COLOR.

NO CLAIM IS MADE TO THE EXCLUSIVE  
RIGHT TO USE "CONFERENCE", APART FROM  
THE MARK AS SHOWN.

SN 78-642,321, FILED 6-2-2005.

SEC. 2(F).

JEAN IM, EXAMINING ATTORNEY

**Int. Cl.: 42**

**Prior U.S. Cls.: 100 and 101**

**United States Patent and Trademark Office**

**Reg. No. 3,455,287**

**Registered June 24, 2008**

**SERVICE MARK  
PRINCIPAL REGISTER**

**RNS INTRAGROUPS**

RAINER, MICHAEL JOHN (UNITED KING-  
DOM INDIVIDUAL)  
5879 HUNTONWOOD DRIVE  
BROAD RUN, VA 20137

FOR: PROVIDING ONLINE NON-DOWNLOAD-  
ABLE SOFTWARE TO FACILITATE BUSINESS  
NETWORKING BETWEEN MEMBERS WITHIN A  
SPECIFIC ORGANIZATION FOR USE BY CHAM-  
BER OF COMMERCE MEMBERS, ASSOCIATIONS  
AND OTHER NON-PROFIT ORGANIZATIONS, IN  
CLASS 42 (U.S. CLS. 100 AND 101).

FIRST USE 11-7-2006; IN COMMERCE 11-7-2006.

THE MARK CONSISTS OF STANDARD CHAR-  
ACTERS WITHOUT CLAIM TO ANY PARTICULAR  
FONT, STYLE, SIZE, OR COLOR.

SN 78-643,677, FILED 6-3-2005.

CORY BOONE, EXAMINING ATTORNEY

**Int. Cl.: 35**

**Prior U.S. Cls.: 100, 101, and 102**

**United States Patent and Trademark Office**

**Reg. No. 3,455,288**

**Registered June 24, 2008**

**SERVICE MARK  
PRINCIPAL REGISTER**

**CHESTER**

DEE & G WEST, L.L.C. (GEORGIA LTD LIAB CO)  
P.O. BOX 606  
SASSER, GA 39885

THE MARK CONSISTS OF STANDARD CHAR-  
ACTERS WITHOUT CLAIM TO ANY PARTICULAR  
FONT, STYLE, SIZE, OR COLOR.

FOR: PROVIDING EXHIBITION STANDS AND  
BOOTHES FOR FLEA MARKET AND ANTIQUE  
MALL RETAIL MERCHANTS, IN CLASS 35 (U.S.  
CLS. 100, 101 AND 102).

SN 78-647,489, FILED 6-9-2005.

FIRST USE 3-20-2003; IN COMMERCE 3-20-2003.

LINDA ORNDORFF, EXAMINING ATTORNEY

**Int. Cl.: 25**

**Prior U.S. Cls.: 22 and 39**

**United States Patent and Trademark Office**

**Reg. No. 3,455,289**

**Registered June 24, 2008**

**TRADEMARK  
PRINCIPAL REGISTER**

**URBAN IVY**

DAVIS, CHARLENE ESSIE DIANE (UNITED STATES INDIVIDUAL)  
111 BUTTONWOOD DRIVE  
TRENTON, NJ 08638

FOR: HEADGEAR, NAMELY, CAPS, HATS, SUN VISORS; CLOTHING, NAMELY, SHORT SLEEVE AND LONG SLEEVE T-SHIRTS, TANK TOPS, JERSEYS, SHIRTS, JACKETS, COATS, SWEATSHIRTS, SHORTS, DRESSES, SKIRTS, JEANS, PANTS, SWEATSUITS, SOCKS, UNDERGARMENTS, PAJAMAS, BATHING SUITS; FOOTWEAR, NAMELY, SANDALS, FLIP FLOPS, SNEAKERS, AND SHOES, IN CLASS 25 (U.S. CLS. 22 AND 39).

FIRST USE 6-19-2006; IN COMMERCE 6-19-2006.

THE MARK CONSISTS OF STANDARD CHARACTERS WITHOUT CLAIM TO ANY PARTICULAR FONT, STYLE, SIZE, OR COLOR.

SN 78-649,013, FILED 6-13-2005.

ANDREA K. NADELMAN, EXAMINING ATTORNEY



Int. Cl.: 35

Prior U.S. Cls.: 100, 101, and 102

United States Patent and Trademark Office

Reg. No. 3,455,290

Registered June 24, 2008

SERVICE MARK  
PRINCIPAL REGISTER

RemoveMYbills.com

*all your financial needs in one place*

VALLE, ALEX (UNITED STATES INDIVIDUAL)  
35 W PINE ST #213  
ORLANDO, FL 32801

FOR: PROVIDING REAL ESTATE AND FINANCIAL SERVICES VIA COMPUTER, NAMELY, MATCHING REAL ESTATE PURCHASERS WITH REAL ESTATE BROKERS AND FINANCIAL INSTITUTIONS VIA COMPUTER, IN CLASS 35 (U.S. CLS. 100, 101 AND 102).

FIRST USE 1-1-2007; IN COMMERCE 1-1-2007.

THE COLOR(S) BLACK AND GREEN IS/ARE CLAIMED AS A FEATURE OF THE MARK.

THE MARK CONSISTS OF THE WORDING "REMOVEMYBILLS.COM ALL YOUR FINANCIAL NEEDS IN ONE PLACE" WITH THE WORDS "REMOVE" "BILLS.COM" IN BLACK AND THE WORDING "MY" AND "ALL YOUR FINANCIAL NEEDS IN ONE PLACE" IN GREEN.

SN 78-649,098, FILED 6-13-2005.

DAVID C. REIHNER, EXAMINING ATTORNEY

**Int. Cls.: 41, 43, and 45**

**Prior U.S. Cls.: 100, 101, and 107**

**United States Patent and Trademark Office**

**Reg. No. 3,455,291**

**Registered June 24, 2008**

**SERVICE MARK  
PRINCIPAL REGISTER**

**INSTANT EXPERT**

STONEBRIDGE BENEFIT SERVICES, INC. (DELAWARE CORPORATION)  
2700 WEST PLANO PARKWAY  
PLANO, TX 75075

FOR: ARRANGING FOR TICKET RESERVATIONS FOR SHOWS, SPORTING EVENTS AND OTHER ENTERTAINMENT EVENTS AND PROVIDING INFORMATION AND RECOMMENDATIONS FOR SUCH EVENTS VIA THE INTERNET AND A TELEPHONE INFORMATION SERVICE, IN CLASS 41 (U.S. CLS. 100, 101 AND 107).

FIRST USE 8-1-2005; IN COMMERCE 8-1-2005.

FOR: RESERVATIONS OF RESTAURANTS AND PROVIDING INFORMATION AND RECOMMENDATIONS FOR RESTAURANTS VIA THE INTERNET AND A TELEPHONE INFORMATION SERVICE, IN CLASS 43 (U.S. CLS. 100 AND 101).

FIRST USE 8-1-2005; IN COMMERCE 8-1-2005.

FOR: TRAVEL CONCIERGE SERVICES FOR OTHERS, NAMELY, MAKING REQUESTED PERSONAL ARRANGEMENTS AND RESERVATIONS AND PROVIDING CUSTOMER-SPECIFIC INFORMATION TO MEET INDIVIDUAL NEEDS RENDERED TOGETHER IN A HOME ENVIRONMENT AND BUSINESS ENVIRONMENT, ALL AS PART OF SHOPPING SERVICES AND GIFT BUYING ASSISTANCE; SHOPPING SERVICES, NAMELY, PERSONAL SHOPPING FOR OTHERS AND GIFT BUYING ASSISTANCE, IN CLASS 45 (U.S. CLS. 100 AND 101).

FIRST USE 8-1-2005; IN COMMERCE 8-1-2005.

THE MARK CONSISTS OF STANDARD CHARACTERS WITHOUT CLAIM TO ANY PARTICULAR FONT, STYLE, SIZE, OR COLOR.

SN 78-656,642, FILED 6-23-2005.

LYDIA BELZER, EXAMINING ATTORNEY

**Int. Cls.: 25 and 35**

**Prior U.S. Cls.: 22, 39, 100, 101, and 102**

**United States Patent and Trademark Office**

**Reg. No. 3,455,292**

**Registered June 24, 2008**

**TRADEMARK  
SERVICE MARK  
PRINCIPAL REGISTER**

**BOYD CODDINGTON'S HOT RODS  
AND COLLECTIBLES**

BOYD CODDINGTON'S HOT RODS AND COLLECTIBLES, INC. (CALIFORNIA CORPORATION)

811 E. LAMBERT ROAD  
LA HABRA, CA 90631

FOR: WEARING APPAREL, NAMELY, T-SHIRTS, SHIRTS, SHORTS, PANTS, SWEATSHIRTS, SWEATPANTS, HATS, VISORS, SHOES, SANDALS AND BELTS, IN CLASS 25 (U.S. CLS. 22 AND 39).

FIRST USE 1-0-2003; IN COMMERCE 1-0-2003.

FOR: AUTOMOBILE DEALERSHIPS FEATURING HOT RODS AND COLLECTIBLE CARS, IN CLASS 35 (U.S. CLS. 100, 101 AND 102).

FIRST USE 1-0-2003; IN COMMERCE 1-0-2003.

THE MARK CONSISTS OF STANDARD CHARACTERS WITHOUT CLAIM TO ANY PARTICULAR FONT, STYLE, SIZE, OR COLOR.

OWNER OF U.S. REG. NOS. 2,513,004, 2,550,283, AND 2,944,225.

NO CLAIM IS MADE TO THE EXCLUSIVE RIGHT TO USE "HOT RODS AND COLLECTIBLES", APART FROM THE MARK AS SHOWN.

THE NAME "BOYD CODDINGTON" IDENTIFIES A LIVING INDIVIDUAL WHOSE CONSENT IS OF RECORD.

SN 78-656,917, FILED 6-23-2005.

GIANCARLO CASTRO, EXAMINING ATTORNEY

**Int. Cl.: 9**

**Prior U.S. Cls.: 21, 23, 26, 36, and 38**

**Reg. No. 3,455,293**

**United States Patent and Trademark Office**

**Registered June 24, 2008**

**TRADEMARK  
PRINCIPAL REGISTER**

**DECIDE**

SSS RESEARCH, INC. (ILLINOIS CORPORATION)  
801 WARRENVILLE ROAD  
SUITE 50  
LISLE, IL 60532

FOR: COMPUTER SOFTWARE FOR INTELLIGENCE ANALYSIS AND DECISION-MAKING, NAMELY, COMPUTER SOFTWARE FOR USE IN THE INTELLIGENCE FIELD FOR DATA MINING, RESEARCH, MANIPULATION, MARSHALLING AND ANALYSIS, INFORMATION PATTERN AND RELATIONSHIP RECOGNITION, MODELING, SIMULATION, VISUALIZATION AND CREATING, CONSTRUCTING AND EVALUATING CONJEC-

TURES, ARGUMENTS, HYPOTHESES, SUB-HYPOTHESES, THEORIES AND CONCLUSIONS BASED ON SAME, IN CLASS 9 (U.S. CLS. 21, 23, 26, 36 AND 38).

FIRST USE 8-1-2007; IN COMMERCE 8-1-2007.

THE MARK CONSISTS OF STANDARD CHARACTERS WITHOUT CLAIM TO ANY PARTICULAR FONT, STYLE, SIZE, OR COLOR.

SN 78-658,763, FILED 6-27-2005.

DANNEAN HETZEL, EXAMINING ATTORNEY

**Int. Cl.: 36**

**Prior U.S. Cls.: 100, 101, and 102**

**United States Patent and Trademark Office**

**Reg. No. 3,455,294**

**Registered June 24, 2008**

**SERVICE MARK  
PRINCIPAL REGISTER**



RCI  
GOLD CROWN  
RESORT

RCI TM CORP. (DELAWARE CORPORATION)  
10750 WEST CHARLESTON BLVD.  
SUITE 130  
LAS VEGAS, NV 89135

FOR: VACATION REAL ESTATE TIME-SHAR-  
ING EXCHANGE SERVICES, IN CLASS 36 (U.S. CLS.  
100, 101 AND 102).

FIRST USE 1-22-2007; IN COMMERCE 1-22-2007.

OWNER OF U.S. REG. NOS. 2,535,152, 2,673,880,  
AND OTHERS.

NO CLAIM IS MADE TO THE EXCLUSIVE  
RIGHT TO USE "RESORT", APART FROM THE  
MARK AS SHOWN.

SN 78-659,569, FILED 6-28-2005.

AISHA CLARKE, EXAMINING ATTORNEY

**Int. Cl.: 1**

**Prior U.S. Cls.: 1, 5, 6, 10, 26, and 46**

**United States Patent and Trademark Office**

**Reg. No. 3,455,295**

**Registered June 24, 2008**

**TRADEMARK  
PRINCIPAL REGISTER**

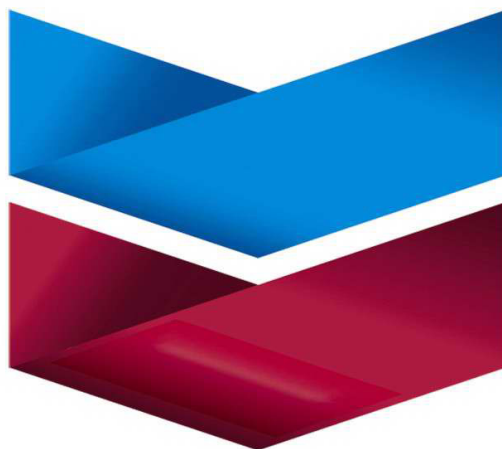

CHEVRON CORPORATION (DELAWARE CORPORATION)  
6001 BOLLINGER CANYON ROAD  
SAN RAMON, CA 94583

FOR: CHEMICALS AND CHEMICAL INTERMEDIATES FOR USE IN THE INDUSTRIAL ARTS, NAMELY, CATALYSTS USED IN THE MANUFACTURE OF DETERGENTS, SURFACTANTS, ENGINE LUBRICANTS AND BASE OILS; SURFACTANTS, ENGINE CORROSION INHIBITORS, CHEMICAL PREPARATIONS USED TO PREVENT THE FREEZING OF MOISTURE IN STORAGE TANKS AND THE FUEL SYSTEMS OF HEATING UNITS AND INTERNAL COMBUSTION ENGINES; MOTOR FUEL ADDITIVES FOR DEPOSIT CONTROL, DETERGENCY, AUTOMOTIVE COOLANTS; INDUSTRIAL COOLANTS, IN CLASS 1 (U.S. CLS. 1, 5, 6, 10, 26 AND 46).

FIRST USE 1-1-2008; IN COMMERCE 1-1-2008.

OWNER OF U.S. REG. NOS. 972,729, 2,727,275, AND OTHERS.

THE COLOR(S) BLUE AND RED IS/ARE CLAIMED AS A FEATURE OF THE MARK.

THE MARK CONSISTS OF THE TOP RIBBON IS BLUE AND THE BOTTOM RIBBON IS RED.

SN 78-661,179, FILED 6-29-2005.

KAREN SEVERSON, EXAMINING ATTORNEY

**Int. Cl.: 4**

**Prior U.S. Cls.: 1, 6, and 15**

**United States Patent and Trademark Office**

**Reg. No. 3,455,296**

**Registered June 24, 2008**

**TRADEMARK  
PRINCIPAL REGISTER**

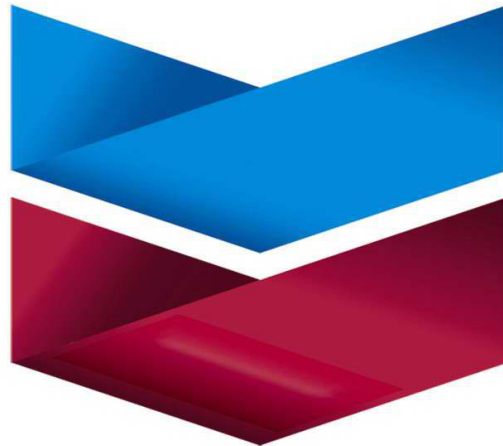

CHEVRON CORPORATION (DELAWARE CORPORATION)  
6001 BOLLINGER CANYON ROAD  
SAN RAMON, CA 94583

FOR: PETROLEUM AND PETROLEUM-DE-RIVED PRODUCTS FOR INDUSTRIAL AND AUTO-MOTIVE USE, NAMELY, MOTOR FUELS, MOTOR OILS AND ENGINE LUBRICANTS, LUBRICATING OILS AND GREASES, FUEL OIL, DIESEL FUEL; BASE OILS USED AS LUBRICANTS; AVIATION FUEL; INDUSTRIAL OILS AND LUBRICANTS; SYNTHETIC OILS AND LUBRICANTS; NATURAL GAS; LIQUEFIED NATURAL GAS; LUBRICANTS FOR MARINE USE; HYDRAULIC OILS, IN CLASS 4 (U.S. CLS. 1, 6 AND 15).

FIRST USE 10-1-2007; IN COMMERCE 10-1-2007.

OWNER OF U.S. REG. NOS. 972,729, 2,727,275, AND OTHERS.

THE COLOR(S) BLUE AND RED IS/ARE CLAIMED AS A FEATURE OF THE MARK.

THE MARK CONSISTS OF THE TOP RIBBON IS BLUE AND THE BOTTOM RIBBON IS RED.

SN 78-661,186, FILED 6-29-2005.

KAREN SEVERSON, EXAMINING ATTORNEY

**Int. Cl.: 36**

**Prior U.S. Cls.: 100, 101, and 102**

**United States Patent and Trademark Office**

**Reg. No. 3,455,297**

**Registered June 24, 2008**

**SERVICE MARK  
PRINCIPAL REGISTER**

**CORE REALTY HOLDINGS LLC**

CORE REALTY HOLDINGS, LLC (CALIFORNIA  
LTD LIAB CO)  
SUITE 210  
1600 DOVE STREET  
NEWPORT BEACH, CA 92660

FOR: REAL ESTATE EXCHANGE SERVICES,  
NAMELY, FACILITATING THE IDENTIFICATION  
AND ACQUISITION OF REAL ESTATE FOR THE  
COMPLETION OF 1031 TAX DEFERRED EXCHAN-  
GES, AND THE PROVISION OF TENANT-IN-COM-  
MON AGREEMENTS IN CONNECTION WITH  
SUCH EXCHANGES, AND CONSULTING WITH  
REGARD TO SUCH EXCHANGES, IN CLASS 36  
(U.S. CLS. 100, 101 AND 102).

FIRST USE 2-1-2005; IN COMMERCE 2-1-2005.

THE MARK CONSISTS OF STANDARD CHAR-  
ACTERS WITHOUT CLAIM TO ANY PARTICULAR  
FONT, STYLE, SIZE, OR COLOR.

NO CLAIM IS MADE TO THE EXCLUSIVE  
RIGHT TO USE "REALTY HOLDINGS LLC",  
APART FROM THE MARK AS SHOWN.

SN 78-662,269, FILED 6-30-2005.

ESTHER BELENKER, EXAMINING ATTORNEY



**Int. Cl.: 34**

**Prior U.S. Cls.: 2, 8, 9, and 17**

**Reg. No. 3,455,298**

**United States Patent and Trademark Office**

**Registered June 24, 2008**

---

**TRADEMARK  
PRINCIPAL REGISTER**

**Premis**

SKOOKUM CREEK TOBACCO (WASHINGTON  
CORPORATION)  
1041 W STATE ROUTE 108  
SHELTON, WA 98584

THE MARK CONSISTS OF STANDARD CHAR-  
ACTERS WITHOUT CLAIM TO ANY PARTICULAR  
FONT, STYLE, SIZE, OR COLOR.

FOR: CIGARETTES, IN CLASS 34 (U.S. CLS. 2, 8, 9  
AND 17).

SN 78-668,121, FILED 7-12-2005.

FIRST USE 3-31-2006; IN COMMERCE 4-25-2008.

NAAKWAMA ANKRAH, EXAMINING ATTORNEY

**Int. Cl.: 25**

**Prior U.S. Cls.: 22 and 39**

**United States Patent and Trademark Office**

**Reg. No. 3,455,299**

**Registered June 24, 2008**

**TRADEMARK  
PRINCIPAL REGISTER**

**HANG WITH JESUS**

NEMIA, JAMES (UNITED STATES INDIVIDUAL)  
370 LEXINGTON AVENUE SUITE 505  
NEW YORK, NY 10017

FOR: CLOTHING, NAMELY, T-SHIRTS, BASE-  
BALL SHIRTS, TANK TOPS, VISORS, CAPS, SWEAT-  
SHIRTS, IN CLASS 25 (U.S. CLS. 22 AND 39).

FIRST USE 6-20-2006; IN COMMERCE 6-20-2006.

THE MARK CONSISTS OF STANDARD CHAR-  
ACTERS WITHOUT CLAIM TO ANY PARTICULAR  
FONT, STYLE, SIZE, OR COLOR.

SN 78-669,346, FILED S.R. 7-13-2005; AM. P.R.  
4-28-2008.

ELLEN PERKINS, EXAMINING ATTORNEY

**Int. Cl.: 25**

**Prior U.S. Cls.: 22 and 39**

**United States Patent and Trademark Office**

**Reg. No. 3,455,300**

**Registered June 24, 2008**

**TRADEMARK  
PRINCIPAL REGISTER**

**SWEET 554**

GENESCO BRANDS INC. (DELAWARE COR-  
PORATION)  
300 DELAWARE AVENUE 9TH FLOOR DE5403  
WILMINGTON, DE 19801

THE MARK CONSISTS OF STANDARD CHAR-  
ACTERS WITHOUT CLAIM TO ANY PARTICULAR  
FONT, STYLE, SIZE, OR COLOR.

FOR: FOOTWEAR, IN CLASS 25 (U.S. CLS. 22 AND  
39).

SN 78-670,715, FILED 7-14-2005.

FIRST USE 6-0-2005; IN COMMERCE 10-0-2005.

ROBIN CHOSID, EXAMINING ATTORNEY

**Int. Cl.: 42**

**Prior U.S. Cls.: 100 and 101**

**United States Patent and Trademark Office**

**Reg. No. 3,455,301**

**Registered June 24, 2008**

**SERVICE MARK  
PRINCIPAL REGISTER**

**TECHNOLOGY FOR A HEALTHY  
WORLD**

MEDIDATA SOLUTIONS, INC. (NEW YORK  
CORPORATION)  
79 FIFTH AVENUE  
NEW YORK, NY 10003

FOR: COMPUTER SERVICE, NAMELY, ACTING  
AS AN APPLICATION SERVICE PROVIDER IN THE  
FIELD OF CLINICAL RESEARCH TO HOST COM-  
PUTER SOFTWARE FOR COLLECTING, ANALYZ-  
ING AND REPORTING CLINICAL DATA  
ENABLING CLINICAL RESEARCHERS TO CON-  
DUCT CLINICAL TRIALS, IN CLASS 42 (U.S. CLS.  
100 AND 101).

FIRST USE 6-26-2005; IN COMMERCE 6-26-2005.

THE MARK CONSISTS OF STANDARD CHAR-  
ACTERS WITHOUT CLAIM TO ANY PARTICULAR  
FONT, STYLE, SIZE, OR COLOR.

SN 78-670,922, FILED 7-14-2005.

PAUL CROWLEY, EXAMINING ATTORNEY

**Int. Cl.: 7**

**Prior U.S. Cls.: 13, 19, 21, 23, 31, 34, and 35**

**Reg. No. 3,455,302**

**United States Patent and Trademark Office**

**Registered June 24, 2008**

**TRADEMARK  
PRINCIPAL REGISTER**

ULTIMATE FOOD PREPARATION  
CENTER

CONAIR CORPORATION (DELAWARE COR-  
PORATION)  
ONE CUMMINGS POINT ROAD  
STAMFORD, CT 06902

FOR: ELECTRIC FOOD BLENDERS; ELECTRIC  
FOOD CHOPPERS; ELECTRIC FOOD GRINDERS  
FOR DOMESTIC USE, IN CLASS 7 (U.S. CLS. 13, 19,  
21, 23, 31, 34 AND 35).

FIRST USE 10-0-2005; IN COMMERCE 10-0-2005.

THE MARK CONSISTS OF STANDARD CHAR-  
ACTERS WITHOUT CLAIM TO ANY PARTICULAR  
FONT, STYLE, SIZE, OR COLOR.

NO CLAIM IS MADE TO THE EXCLUSIVE  
RIGHT TO USE "FOOD PREPARATION CENTER",  
APART FROM THE MARK AS SHOWN.

SN 78-676,295, FILED 7-22-2005.

DAWN HAN, EXAMINING ATTORNEY

**Int. Cl.: 35**

**Prior U.S. Cls.: 100, 101, and 102**

**United States Patent and Trademark Office**

**Reg. No. 3,455,303**

**Registered June 24, 2008**

**SERVICE MARK  
PRINCIPAL REGISTER**

**MLM INFORMATION SERVICES**

MLM INFORMATION SERVICES, LLC (DELA-  
WARE LTD LIAB CO)  
C/O WARBURG PINCUS LLC  
466 LEXINGTON AVENUE  
NEW YORK, NY 10017

FOR: BUSINESS ACQUISITION, MANAGEMENT  
AND OPERATION OF INFORMATION SERVICES  
BUSINESSES AND OTHER PRIVATE AND PUBLIC-  
LY HELD BUSINESSES FOR OTHERS, IN CLASS 35  
(U.S. CLS. 100, 101 AND 102).

FIRST USE 7-0-2005; IN COMMERCE 7-0-2005.

THE MARK CONSISTS OF STANDARD CHAR-  
ACTERS WITHOUT CLAIM TO ANY PARTICULAR  
FONT, STYLE, SIZE, OR COLOR.

NO CLAIM IS MADE TO THE EXCLUSIVE  
RIGHT TO USE "INFORMATION SERVICES",  
APART FROM THE MARK AS SHOWN.

SN 78-679,593, FILED 7-27-2005.

DAVID MILLER, EXAMINING ATTORNEY

**Int. Cls.: 38 and 45**

**Prior U.S. Cls.: 100, 101, and 104**

**United States Patent and Trademark Office**

**Reg. No. 3,455,304**

**Registered June 24, 2008**

**SERVICE MARK  
PRINCIPAL REGISTER**



**You're On The Right Path**

PATH, LLC (DELAWARE LTD LIAB CO)  
26 SUMMER STREET  
HINGHAM, MA 02043

FOR: PROVIDING ON-LINE COMMUNITY FORUMS AND CHAT ROOMS ALLOWING USERS TO TRANSMIT MESSAGES OVER COMMUNICATIONS NETWORKS, IN CLASS 38 (U.S. CLS. 100, 101 AND 104).

FIRST USE 12-31-2005; IN COMMERCE 12-31-2005.

FOR: COMMUNITY SERVICES, NAMELY, PROVIDING A SPECIALIZED WEBSITE AND ON-LINE COMMUNITY CONTAINING INFORMATION REGARDING ON-LINE DATING AND INTRODUCTION SERVICES, SINGLES AND PERSONAL RELATIONSHIPS, IN CLASS 45 (U.S. CLS. 100 AND 101).

FIRST USE 12-31-2005; IN COMMERCE 12-31-2005.

SN 78-680,606, FILED 7-28-2005.

JOHN DALIER, EXAMINING ATTORNEY

**Int. Cl.: 3**

**Prior U.S. Cls.: 1, 4, 6, 50, 51, and 52**

**United States Patent and Trademark Office**

**Reg. No. 3,455,305**

**Registered June 24, 2008**

**TRADEMARK  
PRINCIPAL REGISTER**

**Pure Touch**

NATURAL THOUGHTS, INC. (CALIFORNIA  
CORPORATION)  
4757 OLD CLIFFS ROAD  
SAN DIEGO, CA 92120

THE MARK CONSISTS OF STANDARD CHAR-  
ACTERS WITHOUT CLAIM TO ANY PARTICULAR  
FONT, STYLE, SIZE, OR COLOR.

FOR: MESSAGE PREPARATIONS, NAMELY,  
CREMES, IN CLASS 3 (U.S. CLS. 1, 4, 6, 50, 51 AND  
52).

SN 78-681,971, FILED 7-29-2005.

FIRST USE 5-5-2008; IN COMMERCE 5-5-2008.

MARK SPARACINO, EXAMINING ATTORNEY



Int. Cl.: 35

Prior U.S. Cls.: 100, 101, and 102

United States Patent and Trademark Office

Reg. No. 3,455,306

Registered June 24, 2008

**SERVICE MARK  
PRINCIPAL REGISTER**



**ADCONEXIÓN L.A.**

ADLINK EN TU IDIOMA

ADLINK CABLE ADVERTISING, LLC (DELA-  
WARE CORPORATION)  
11150 SANTA MONICA BOULEVARD, SUITE 1000  
LOS ANGELES, CA 90025

FOR: BUSINESS MARKETING SERVICES,  
NAMELY, CONSULTING SERVICES IN THE  
FIELDS OF STRATEGIC PLANNING, MARKETING  
AND PROMOTION OF PRODUCTS AND SERVICES;  
PROMOTING AND MARKETING THE GOODS  
AND SERVICES OF OTHERS BY THE DISSEMINA-  
TION OF ADVERTISING MATTER; DESIGNING  
AND CONDUCTING MARKETING SURVEYS, RE-  
SEARCH AND STUDIES FOR OTHERS; DESIGN-  
ING AND CONDUCTING MARKETING SURVEYS,  
RESEARCH AND STUDIES THAT BREAK DOWN  
ADVERTISING MARKETS INTO VARIOUS GEO-  
GRAPHIC, DEMOGRAPHIC AND OTHER MAR-  
KET SEGMENTS, ALLOWING ADVERTISERS TO

TARGET CERTAIN MARKET SEGMENTS BASED  
ON SPECIFIED FACTORS; PROVIDING PLANNING  
SERVICES AND PLANNING TOOLS TO ASSIST  
ADVERTISERS IN DETERMINING AND IMPLI-  
MENTING EFFICIENT AND EFFECTIVE PLANS  
FOR THE ALLOCATION OF ADVERTISING AND  
MARKETING RESOURCES, IN CLASS 35 (U.S. CLS.  
100, 101 AND 102).

FIRST USE 9-30-2005; IN COMMERCE 9-30-2005.

THE FOREIGN WORDING "ADCONEXION" IN  
THE MARK TRANSLATES INTO ENGLISH AS  
ADCONNECTION.

SN 78-682,644, FILED 8-1-2005.

RONALD AIKENS, EXAMINING ATTORNEY

**Int. Cl.: 5**

**Prior U.S. Cls.: 6, 18, 44, 46, 51, and 52**

**Reg. No. 3,455,307**

**United States Patent and Trademark Office**

**Registered June 24, 2008**

---

**TRADEMARK  
PRINCIPAL REGISTER**

**KOFF KOFF**

AMPHION LLC (MAINE LTD LIAB CO)  
SUITE #8  
26 BRICKYARD COURT  
YORK, ME 03909

FOR: DIETARY SUPPLEMENTS; HERBAL SUPPLEMENTS; NUTRITIONAL SUPPLEMENTS, IN CLASS 5 (U.S. CLS. 6, 18, 44, 46, 51 AND 52).

FIRST USE 4-25-2007; IN COMMERCE 4-25-2007.

THE MARK CONSISTS OF STANDARD CHARACTERS WITHOUT CLAIM TO ANY PARTICULAR FONT, STYLE, SIZE, OR COLOR.

NO CLAIM IS MADE TO THE EXCLUSIVE RIGHT TO USE "COUGH", APART FROM THE MARK AS SHOWN.

SN 78-684,767, FILED 8-3-2005.

JULIE WATSON, EXAMINING ATTORNEY

**Int. Cl.: 35**

**Prior U.S. Cls.: 100, 101, and 102**

**United States Patent and Trademark Office**

**Reg. No. 3,455,308**

**Registered June 24, 2008**

**SERVICE MARK  
PRINCIPAL REGISTER**

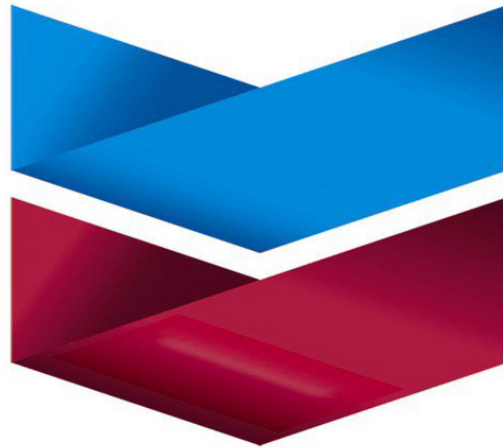

CHEVRON CORPORATION (DELAWARE CORPORATION)  
6001 BOLLINGER CANYON ROAD  
SAN RAMON, CA 94583

FOR: RETAIL CONVENIENCE STORE SERVICES,  
IN CLASS 35 (U.S. CLS. 100, 101 AND 102).

FIRST USE 10-1-2005; IN COMMERCE 10-1-2005.

OWNER OF U.S. REG. NOS. 972,729, 2,727,275,  
AND OTHERS.

THE COLOR(S) BLUE AND RED IS/ARE  
CLAIMED AS A FEATURE OF THE MARK.

THE TOP RIBBON IS BLUE AND THE BOTTOM  
RIBBON IS RED.

SN 78-684,829, FILED 8-3-2005.

ROBIN MITTLER, EXAMINING ATTORNEY

**Int. Cls.: 1 and 2**

**Prior U.S. Cls.: 1, 5, 6, 10, 11, 16, 26, and 46**

**United States Patent and Trademark Office**

**Reg. No. 3,455,309**

**Registered June 24, 2008**

**TRADEMARK  
PRINCIPAL REGISTER**

**ULTRA-DRI**

OMG UK LTD. (UNITED KINGDOM PRIVATE  
LIMITED LIABILITY COMPANY)

ASHTON NEW ROAD

CLAYTON, MANCHESTER M11, UNITED KING-  
DOM

FOR: HIGH PERFORMANCE CATALYSTS FOR  
USE IN THE MANUFACTURE OF INKS, IN CLASS 1  
(U.S. CLS. 1, 5, 6, 10, 26 AND 46).

FIRST USE 7-15-2007; IN COMMERCE 7-15-2007.

FOR: HIGH PERFORMANCE INK DRYING PRE-  
PARATIONS SOLD AS A COMPONENT OF INK, IN  
CLASS 2 (U.S. CLS. 6, 11 AND 16).

FIRST USE 7-15-2007; IN COMMERCE 7-15-2007.

THE MARK CONSISTS OF STANDARD CHAR-  
ACTERS WITHOUT CLAIM TO ANY PARTICULAR  
FONT, STYLE, SIZE, OR COLOR.

SN 78-685,431, FILED 8-4-2005.

EDWARD NELSON, EXAMINING ATTORNEY

**Int. Cls.: 3, 14, and 25**

**Prior U.S. Cls.: 1, 2, 4, 6, 22, 27, 28, 39, 50, 51, and 52**

**United States Patent and Trademark Office**

**Reg. No. 3,455,310**

**Registered June 24, 2008**

**TRADEMARK  
PRINCIPAL REGISTER**

**B.I.M.B.O. THREADS  
CLOTHING COMPANY**

PRZEWLOCKI, MICHAEL J. (UNITED STATES  
INDIVIDUAL)  
1212 E. DESERT FLOWER LANE  
PHOENIX, AZ 85048

FOR: PERFUME, NOT FOR USE IN CONNEC-  
TION WITH THE BAKING INDUSTRY, IN CLASS 3  
(U.S. CLS. 1, 4, 6, 50, 51 AND 52).

FIRST USE 5-5-2008; IN COMMERCE 5-5-2008.

FOR: JEWELRY, NOT FOR USE IN CONNEC-  
TION WITH THE BAKING INDUSTRY, IN CLASS 14  
(U.S. CLS. 2, 27, 28 AND 50).

FIRST USE 5-7-2008; IN COMMERCE 5-7-2008.

FOR: CLOTHING, NAMELY, T-SHIRTS, SWEAT-  
SHIRTS, PANTS, JEANS, DRESSES, HALTER TOPS,  
TUBE TOPS, JACKETS, TANK TOPS, PANTIES,

PAJAMAS, HATS, SHORTS, SWIMSUITS, SHIRTS,  
CAPRIS, INFANTWEAR, BELTS, SOCKS, SHOES,  
SANDALS, BOOTS AND FLIP FLOPS, NOT FOR USE  
IN CONNECTION WITH THE BAKING INDUSTRY,  
IN CLASS 25 (U.S. CLS. 22 AND 39).

FIRST USE 5-5-2008; IN COMMERCE 5-5-2008.

THE MARK CONSISTS OF STANDARD CHAR-  
ACTERS WITHOUT CLAIM TO ANY PARTICULAR  
FONT, STYLE, SIZE, OR COLOR.

NO CLAIM IS MADE TO THE EXCLUSIVE  
RIGHT TO USE "THREADS CLOTHING COMPA-  
NY", APART FROM THE MARK AS SHOWN.

SN 78-688,098, FILED 8-8-2005.

JOHN GARTNER, EXAMINING ATTORNEY

**Int. Cl.: 3**

**Prior U.S. Cls.: 1, 4, 6, 50, 51, and 52**

**Reg. No. 3,455,311**

**United States Patent and Trademark Office**

**Registered June 24, 2008**

---

**TRADEMARK  
PRINCIPAL REGISTER**

**sexy mother pucker**

BRANDHANDLING INTERNATIONAL LIMITED  
(BR.VIRGIN ISLANDS COMPANY)  
SUITE 6S, MILL MALL, WICKHAMS CAY 1  
ROAD TOWN, TORTOLA, BR.VIRGIN ISLANDS

THE MARK CONSISTS OF STANDARD CHAR-  
ACTERS WITHOUT CLAIM TO ANY PARTICULAR  
FONT, STYLE, SIZE, OR COLOR.

FOR: LIP PLUMPING GLOSSES, IN CLASS 3 (U.S.  
CLS. 1, 4, 6, 50, 51 AND 52).

SN 78-688,254, FILED 8-9-2005.

FIRST USE 8-15-2006; IN COMMERCE 8-15-2006.

NAAKWAMA ANKRAH, EXAMINING ATTORNEY

**Int. Cl.: 25**

**Prior U.S. Cls.: 22 and 39**

**United States Patent and Trademark Office**

**Reg. No. 3,455,312**

**Registered June 24, 2008**

**TRADEMARK  
PRINCIPAL REGISTER**

**BAILEY 44**

EMSALLEM, RUTHY (UNITED STATES INDIVIDUAL)  
SUITE 410  
860 SOUTH LOS ANGELES STREET  
LOS ANGELES, CA 90014

FOR: WOMEN'S AND GIRL'S CLOTHING, NAMELY, TOPS, BOTTOMS, SHIRTS, BLOUSES, DRESSES, SKIRTS, LINGERIE, JACKETS, PANTS AND SHORTS , IN CLASS 25 (U.S. CLS. 22 AND 39).

FIRST USE 12-31-2005; IN COMMERCE 12-31-2005.

THE MARK CONSISTS OF STANDARD CHARACTERS WITHOUT CLAIM TO ANY PARTICULAR FONT, STYLE, SIZE, OR COLOR.

SN 78-690,984, FILED 8-11-2005.

AMY MCMENAMIN, EXAMINING ATTORNEY

**Int. Cl.: 44**

**Prior U.S. Cls.: 100 and 101**

**United States Patent and Trademark Office**

**Reg. No. 3,455,313**

**Registered June 24, 2008**

**SERVICE MARK  
PRINCIPAL REGISTER**

**AGELESS MEDICAL CENTER**

BARBARA J. SCHELL M.D. PLLC (WASHING-  
TON LTD LIAB CO)  
601 NORTH 34TH STREET  
SUITE C  
SEATTLE, WA 98103

FOR: COSMETIC PROCEDURES AND SUR-  
GERY, NAMELY, LIPOSUCTION, LIPOSCULPTUR-  
ING, FAT TRANSPLANTATION, CARBON  
DIOXIDE LASER RESURFACING, YAG LASER  
RESURFACING, EYELIDS LIFTS, FACE AND  
NECK LIFTS; COSMETIC TREATMENT, NAMELY,  
PHOTOREJUVENATION, LASER HAIR REMOVAL,  
LASER TREATMENT OF LINES AND WRINKLES;  
LASER REMOVAL OF LEG VEINS, FACIAL CAPIL-  
LARIES, SUN SPOTS, TATTOOS, AND SCARS;  
FACIALS, EPICUREAN INTENSIVE LIFT, NAME-  
LY, A SPECIALIZED ENZYME PEEL THAT LIFTS  
AND TIGHTENS THE SKIN, BACK TREATMENT,  
NAMELY, SKIN PEELS, ACNE TREATMENT, MI-  
CRODERMABRASION, GLYCOLIC PEEL, SKIN  
FITNESS, NAMELY, A FACIAL THAT INCLUDES  
STEAM CLEANSING, ENZYME TREATMENT,  
MASSAGE, AND APPLICATION OF ANTI-AGING

CREAMS OR WRINKLE REDUCING CREAMS,  
BIOTONING, REJUVE TONE, NAMELY, USING  
MICRO-CURRENT TO INCREASE ENERGY IN  
THE SKIN BY TARGETING CERTAIN MUSCLE  
GROUPS, ACUPUNCTURE POINTS, OR MERI-  
DIANS, AND OXYGEN THERAPY, IN CLASS 44  
(U.S. CLS. 100 AND 101).

FIRST USE 5-1-2007; IN COMMERCE 5-1-2007.

THE MARK CONSISTS OF STANDARD CHAR-  
ACTERS WITHOUT CLAIM TO ANY PARTICULAR  
FONT, STYLE, SIZE, OR COLOR.

NO CLAIM IS MADE TO THE EXCLUSIVE  
RIGHT TO USE "MEDICAL CENTER" , APART  
FROM THE MARK AS SHOWN.

SN 78-692,002, FILED 8-12-2005.

KATHERINE M. DUBRAY, EXAMINING ATTOR-  
NEY



**Int. Cl.: 1**

**Prior U.S. Cls.: 1, 5, 6, 10, 26, and 46**

**Reg. No. 3,455,314**

**United States Patent and Trademark Office**

**Registered June 24, 2008**

**TRADEMARK  
PRINCIPAL REGISTER**

**NITROFLATE**

PRIMO SPORT, INC. (DELAWARE CORPORATION)  
814 INTERCHANGE BOULEVARD  
NEWARK, DE 19711

FOR: PRIMARILY NITROGEN BASED GAS MIXTURE FOR USE IN INFLATING ARTICLES, IN CLASS 1 (U.S. CLS. 1, 5, 6, 10, 26 AND 46).

FIRST USE 11-0-2005; IN COMMERCE 11-0-2005.

THE MARK CONSISTS OF STANDARD CHARACTERS WITHOUT CLAIM TO ANY PARTICULAR FONT, STYLE, SIZE, OR COLOR.

SN 78-692,378, FILED 8-15-2005.

JOHN SCHUYLER YARD, EXAMINING ATTORNEY

**Int. Cl.: 41**

**Prior U.S. Cls.: 100, 101, and 107**

**United States Patent and Trademark Office**

**Reg. No. 3,455,315**

**Registered June 24, 2008**

**SERVICE MARK  
PRINCIPAL REGISTER**



NATIONAL PAIN INSTITUTE, LLC (FLORIDA CORPORATION)  
SUITE 225  
951 BROKEN SOUND PARKWAY, N.W.  
BOCA RATON, FL 33487

FOR: PROVIDING VOCATIONAL REHABILITATION SERVICES IN THE NATURE OF TRAINING IN THE FIELDS OF EMPLOYMENT, JOB SKILLS, LIFE SKILLS, RESUME WRITING, JOB INTERVIEW SKILLS, AND PROVIDING GUIDANCE IN THE AREA OF COMMUNITY INTEGRATION FOR PERSONS WITH COGNITIVE OR PHYSICAL IMPAIRMENTS, MEDICAL ISSUES, OR ISSUES OF MENTAL HEALTH, IN CLASS 41 (U.S. CLS. 100, 101 AND 107).

FIRST USE 5-31-2005; IN COMMERCE 5-31-2005.

THE COLOR(S) YELLOW, ORANGE, LIGHT BROWN AND BLACK IS/ARE CLAIMED AS A FEATURE OF THE MARK.

THE MARK CONSISTS OF A YELLOW BALL WITH ORANGE AND LIGHT BROWN SHADING AT THE TOP AND TWO BLACK SILHOUETTES SUPERPOSED THEREIN.

SN 78-692,404, FILED 8-15-2005.

TARA PATE, EXAMINING ATTORNEY

**Int. Cl.: 41**

**Prior U.S. Cls.: 100, 101, and 107**

**United States Patent and Trademark Office**

**Reg. No. 3,455,316**

**Registered June 24, 2008**

**SERVICE MARK  
PRINCIPAL REGISTER**



**NATIONAL PAIN INSTITUTE**

NATIONAL PAIN INSTITUTE, LLC (FLORIDA  
LIMITED LIABILITY CORPORATION)  
SUITE 225  
951 BROKEN SOUND PARKWAY, N.W.  
BOCA RATON, FL 33487

FOR: PROVIDING VOCATIONAL REHABILITATION SERVICES IN THE NATURE OF TRAINING IN THE FIELDS OF EMPLOYMENT, JOB SKILLS, LIFE SKILLS, RESUME WRITING, JOB INTERVIEW SKILLS, AND PROVIDING GUIDANCE IN THE AREA OF COMMUNITY INTEGRATION FOR PERSONS WITH COGNITIVE OR PHYSICAL IMPAIRMENTS, MEDICAL ISSUES, OR ISSUES OF MENTAL HEALTH, IN CLASS 41 (U.S. CLS. 100, 101 AND 107).

FIRST USE 5-31-2005; IN COMMERCE 5-31-2005.

NO CLAIM IS MADE TO THE EXCLUSIVE RIGHT TO USE "NATIONAL PAIN INSTITUTE", APART FROM THE MARK AS SHOWN.

THE COLOR(S) YELLOW, ORANGE, LIGHT BROWN AND BLACK IS/ARE CLAIMED AS A FEATURE OF THE MARK.

THE MARK CONSISTS OF A YELLOW BALL WITH ORANGE AND LIGHT BROWN SHADING AT THE TOP AND TWO BLACK SILHOUETTES SUPERPOSED THEREIN. THE LITERAL ELEMENT OF THE MARK IS NOT LIMITED TO ANY PARTICULAR FONT, STYLE, SIZE OR COLOR.

SN 78-692,499, FILED 8-15-2005.

TARA PATE, EXAMINING ATTORNEY

**Int. Cl.: 16**

**Prior U.S. Cls.: 2, 5, 22, 23, 29, 37, 38, and 50**

**United States Patent and Trademark Office**

**Reg. No. 3,455,317**

**Registered June 24, 2008**

**TRADEMARK  
PRINCIPAL REGISTER**



VISA INTERNATIONAL SERVICE ASSOCIATION  
(DELAWARE CORPORATION)  
M1-11A  
900 METRO CENTER BOULEVARD  
FOSTER CITY, CA 94404

FIRST USE 9-1-2005; IN COMMERCE 9-1-2005.

THE COLOR(S) GOLD AND BLUE IS/ARE  
CLAIMED AS A FEATURE OF THE MARK.

FOR: NEWSLETTERS IN THE FIELD OF FINANCIAL INFORMATION AND PAYMENT PROGRAMS, NON-ADVERTISING BROCHURES ABOUT FINANCIAL INFORMATION AND PAYMENT PROGRAMS, PAMPHLETS IN THE FIELD OF FINANCIAL INFORMATION AND PAYMENT PROGRAMS, INFORMATIONAL FLYERS FEATURING FINANCIAL INFORMATION AND PAYMENT PROGRAMS, IN CLASS 16 (U.S. CLS. 2, 5, 22, 23, 29, 37, 38 AND 50).

THE MARK CONSISTS OF TWO STYLIZED TRIANGLES. THE COLOR GOLD APPEARS IN THE UPPER LEFT TRIANGLE, AND THE COLOR BLUE APPEARS IN THE LOWER RIGHT TRIANGLE.

SN 78-693,077, FILED 8-15-2005.

ALLISON SCHRODY, EXAMINING ATTORNEY

**Int. Cl.: 19**

**Prior U.S. Cls.: 1, 12, 33, and 50**

**United States Patent and Trademark Office**

**Reg. No. 3,455,318**

**Registered June 24, 2008**

**TRADEMARK  
PRINCIPAL REGISTER**

*simple*  
**SOLUTIONS**

PERGO (EUROPE) AB (SWEDEN CORPORATION)  
STRANDRIDAREGATAN 8  
TRELLEBORG, SWEDEN SE-231

FOR: HARD SURFACE FLOOR MOLDING,  
NAMELY, END PIECES, WALL BASE MOLDINGS,  
QUARTER ROUND MOLDINGS, TRANSITION  
MOLDINGS, STAIR NOSES, T-MOLDINGS AND  
END MOLDINGS, ALL MADE OF HIGH DENSITY

FIBERBOARD, IN CLASS 19 (U.S. CLS. 1, 12, 33 AND  
50).

FIRST USE 12-31-2003; IN COMMERCE 12-31-2003.

SN 78-693,729, FILED 8-16-2005.

ARETHA SOMERVILLE, EXAMINING ATTORNEY

**Int. Cl.: 37**

**Prior U.S. Cls.: 100, 103, and 106**

**United States Patent and Trademark Office**

**Reg. No. 3,455,319**

**Registered June 24, 2008**

**SERVICE MARK  
PRINCIPAL REGISTER**

**ANY SEWER OR DRAIN**

A \$49.95 ANY SEWER OR DRAIN, INC. (NEW YORK CORPORATION)  
130-30 90TH AVENUE  
RICHMOND HILL, NY 11418

FOR: MUNICIPAL, INDUSTRIAL, AND DOMESTIC SEWER, DRAIN, AND PIPE CLEANING SERVICES, NAMELY, MAIN SEWERS, LEADER LINES, SHOWER STALLS, GREASE SEPARATORS, TOILETS AUGURED, STORM SEWERS, YARD DRAINS, DISH WASHER LINES, BASEMENTS PUMPED, WASHING MACHINE LINES, KITCHEN SINKS, BATHTUBS, FROZEN PIPES, FLOOR DRAINS, VANITIES, STACK LINES, URINALS,

SLOP SINKS AND ROOF DRAINS, IN CLASS 37 (U.S. CLS. 100, 103 AND 106).

FIRST USE 1-1-2005; IN COMMERCE 1-1-2005.

THE MARK CONSISTS OF STANDARD CHARACTERS WITHOUT CLAIM TO ANY PARTICULAR FONT, STYLE, SIZE, OR COLOR.

SN 78-696,208, FILED 8-19-2005.

ROBIN CHOSID, EXAMINING ATTORNEY

**Int. Cl.: 11**

**Prior U.S. Cls.: 13, 21, 23, 31, and 34**

**United States Patent and Trademark Office**

**Reg. No. 3,455,320**

**Registered June 24, 2008**

**TRADEMARK  
PRINCIPAL REGISTER**

IT'S WHERE YOU WANT TO BE

EMERALD SPA CORPORATION (MICHIGAN  
CORPORATION)  
4150 EAST PARIS AVENUE  
KENTWOOD, MI 49512

THE MARK CONSISTS OF STANDARD CHAR-  
ACTERS WITHOUT CLAIM TO ANY PARTICULAR  
FONT, STYLE, SIZE, OR COLOR.

FOR: WHIRLPOOLS AND SPAS IN THE NATURE  
OF HEATED POOLS, IN CLASS 11 (U.S. CLS. 13, 21,  
23, 31 AND 34).

SN 78-697,656, FILED 8-22-2005.

FIRST USE 5-0-2005; IN COMMERCE 5-0-2005.

ARETHA SOMERVILLE, EXAMINING ATTORNEY

**Int. Cl.: 9**

**Prior U.S. Cls.: 21, 23, 26, 36, and 38**

**United States Patent and Trademark Office**

**Reg. No. 3,455,321**

**Registered June 24, 2008**

**TRADEMARK  
PRINCIPAL REGISTER**

**WARREN MILLER**

WARREN MILLER ENTERTAINMENT, INC.  
(DELAWARE CORPORATION)  
SUITE 200, ATTN: MIA SYKES  
C/O BONNIER CORP., 460 N. ORLANDO AVE.  
WINTER PARK, FL 32789

FOR: DOWNLOADABLE RING TONES, RING  
BACKS, SCREENSAVERS, GRAPHICS AND MUSIC  
VIA A GLOBAL COMPUTER NETWORK AND  
WIRELESS DEVICES; PRE-RECORDED AUDIO VI-  
SUAL RECORDINGS IN THE FIELD OF SKIING,  
WINTER SPORTS, AND LEISURE ACTIVITIES, IN  
CLASS 9 (U.S. CLS. 21, 23, 26, 36 AND 38).

FIRST USE 1-2-2006; IN COMMERCE 1-2-2006.

THE MARK CONSISTS OF STANDARD CHAR-  
ACTERS WITHOUT CLAIM TO ANY PARTICULAR  
FONT, STYLE, SIZE, OR COLOR.

OWNER OF U.S. REG. NOS. 2,192,419, 2,906,377,  
AND OTHERS.

THE NAME(S), PORTRAIT(S), AND/OR SIGNA-  
TURE(S) SHOWN IN THE MARK IDENTIFIES  
"WARREN MILLER", WHOSE CONSENT(S) TO  
REGISTER IS SUBMITTED.

SN 78-698,019, FILED 8-23-2005.

ALICIA COLLINS, EXAMINING ATTORNEY



**Int. Cl.: 25**

**Prior U.S. Cls.: 22 and 39**

**United States Patent and Trademark Office**

**Reg. No. 3,455,322**

**Registered June 24, 2008**

**TRADEMARK  
PRINCIPAL REGISTER**

**KIDIOMS**

KIDIOMS, LLC (MASSACHUSETTS LTD LIAB  
CO)  
453 WASHINGTON STREET  
GLOUCESTER, MA 01930

FOR: CLOTHING, NAMELY, CHILDREN'S AP-  
PAREL NAMELY, T-SHIRTS RANGING IN SIZE  
FROM 0-6 MONTHS TO 4T WITH SILK-SCREENED  
AND/OR DIRECT DYE SUBLIMATION PRINTING  
GRAPHICS; INFANT AND TODDLER ONE PIECE  
CLOTHING, IN CLASS 25 (U.S. CLS. 22 AND 39).

FIRST USE 10-20-2005; IN COMMERCE 10-20-2005.

THE MARK CONSISTS OF STANDARD CHAR-  
ACTERS WITHOUT CLAIM TO ANY PARTICULAR  
FONT, STYLE, SIZE, OR COLOR.

SN 78-698,384, FILED 8-23-2005.

BRIAN NEVILLE, EXAMINING ATTORNEY

**Int. Cl.: 9**

**Prior U.S. Cls.: 21, 23, 26, 36, and 38**

**Reg. No. 3,455,323**

**United States Patent and Trademark Office**

**Registered June 24, 2008**

---

**TRADEMARK  
PRINCIPAL REGISTER**

**ELIONIX**

ELIONIX INC. (JAPAN CORPORATION)  
7-6, 3-CHOME, MOTOYOKOYAMA-MACHI  
HACHIOUJI-CITY, TOKYO, JAPAN 192-0063

FIRST USE 3-4-1975; IN COMMERCE 5-22-2003.

FOR: MICROSCOPE; SURFACE ROUGHNESS  
ANALYZER; ELECTRON BEAM LITHOGRAPHY  
MACHINE; ELECTRON PROBE MICRO ANALY-  
ZER; ION BEAM ETCHING MACHINE; PLASMA  
ETCHING AND DEPOSITION MACHINE; INDEN-  
TATION TESTER; FOCUSED ION BEAM ETCHING  
MACHINE, IN CLASS 9 (U.S. CLS. 21, 23, 26, 36 AND  
38).

THE MARK CONSISTS OF STANDARD CHAR-  
ACTERS WITHOUT CLAIM TO ANY PARTICULAR  
FONT, STYLE, SIZE, OR COLOR.

SN 78-699,264, FILED 8-24-2005.

JERI J. FICKES, EXAMINING ATTORNEY

**Int. Cls.: 16 and 36**

**Prior U.S. Cls.: 2, 5, 22, 23, 29, 37, 38, 50, 100, 101, and 102**

**Reg. No. 3,455,324**

**United States Patent and Trademark Office**

**Registered June 24, 2008**

**TRADEMARK  
SERVICE MARK  
PRINCIPAL REGISTER**

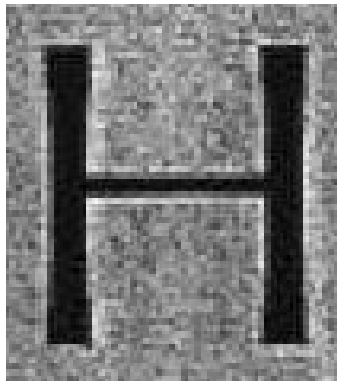

FRED HUTCHINSON CANCER RESEARCH  
CENTER (WASHINGTON PUBLIC BENEFIT  
CORPORATION)  
1100 FAIRVIEW AVE. N PO BOX 91024  
SEATTLE, WA 981096590

FOR: PRINTED PUBLICATIONS, NAMELY,  
NEWSLETTERS, PAMPHLETS, BROCHURES, MA-  
GAZINES, INSTRUCTION SHEETS AND MANUALS  
ON RESEARCH PREVENTION, DETECTION,  
TREATMENT AND CURES FOR CANCER, HIV/  
AIDS AND OTHER DISEASES AND PUBLIC  
HEALTH PROBLEMS, IN CLASS 16 (U.S. CLS. 2, 5,  
22, 23, 29, 37, 38 AND 50).

FIRST USE 6-30-2005; IN COMMERCE 6-30-2005.

FOR: CHARITABLE FUND RAISING, IN CLASS  
36 (U.S. CLS. 100, 101 AND 102).

FIRST USE 6-30-2005; IN COMMERCE 6-30-2005.

THE MARK CONSISTS OF A STYLIZED LETTER  
H.

SN 78-699,749, FILED 8-24-2005.

SUNG IN, EXAMINING ATTORNEY

**Int. Cl.: 3**

**Prior U.S. Cls.: 1, 4, 6, 50, 51, and 52**

**Reg. No. 3,455,325**

**United States Patent and Trademark Office**

**Registered June 24, 2008**

**TRADEMARK  
PRINCIPAL REGISTER**

**"WIRED TO LIVE"**

REVELATIONS PERFUME AND COSMETICS,  
INC. (DELAWARE CORPORATION)  
460 VEIT ROAD, SUITE E  
HUNTINGTON VALLEY, PA 19006

FOR: COSMETICS, NAMELY, COMPACTS; NON-MEDICATED LIP CARE PRODUCTS, NAMELY, NON-MEDICATED LIP CARE PREPARATIONS; HAIR CARE PRODUCTS, NAMELY, HAIR CARE PREPARATIONS; SKIN CARE LOTIONS; SUN TANNING AND SUN CARE PRODUCTS, NAMELY, SUN TAN LOTION, AFTER-SUN LOTION, SUN BLOCK, SUN SCREEN, SUN TAN OIL; BATH CARE PRODUCTS, NAMELY, BATH BEADS, BATH CRYSTALS, BATH FOAM, BATH GEL, BATH LOTION,

BATH MILK, BATH OIL, BATH POWDER, BATH SALTS, BUBBLE BATH; PERFUMES, IN CLASS 3 (U.S. CLS. 1, 4, 6, 50, 51 AND 52).

FIRST USE 3-31-2005; IN COMMERCE 3-31-2005.

THE MARK CONSISTS OF STANDARD CHARACTERS WITHOUT CLAIM TO ANY PARTICULAR FONT, STYLE, SIZE, OR COLOR.

SN 78-702,162, FILED 8-29-2005.

EMILY CARLSEN, EXAMINING ATTORNEY

**Int. Cl.: 42**

**Prior U.S. Cls.: 100 and 101**

**United States Patent and Trademark Office**

**Reg. No. 3,455,326**

**Registered June 24, 2008**

**SERVICE MARK  
PRINCIPAL REGISTER**

**The Olfactory Decor  
(T.O.D.)**

MOORE, TAMMIE Y. (UNITED STATES INDIVIDUAL)

20815 SWEETGLEN DRIVE

PORTER, TX 77365

FOR: SHOP INTERIOR DESIGN, IN CLASS 42  
(U.S. CLS. 100 AND 101).

FIRST USE 9-1-2005; IN COMMERCE 9-1-2005.

THE MARK CONSISTS OF STANDARD CHARACTERS WITHOUT CLAIM TO ANY PARTICULAR FONT, STYLE, SIZE, OR COLOR.

NO CLAIM IS MADE TO THE EXCLUSIVE RIGHT TO USE "DÉCOR", APART FROM THE MARK AS SHOWN.

SN 78-702,331, FILED 8-29-2005.

DOMINICK J. SALEMI, EXAMINING ATTORNEY

**Int. Cl.: 9**

**Prior U.S. Cls.: 21, 23, 26, 36, and 38**

**Reg. No. 3,455,327**

**United States Patent and Trademark Office**

**Registered June 24, 2008**

---

**TRADEMARK  
PRINCIPAL REGISTER**

**OCTA-PAC**

COOPER TECHNOLOGIES COMPANY (DELA-  
WARE CORPORATION)  
600 TRAVIS, SUITE 5800  
HOUSTON, TX 77002

THE MARK CONSISTS OF STANDARD CHAR-  
ACTERS WITHOUT CLAIM TO ANY PARTICULAR  
FONT, STYLE, SIZE, OR COLOR.

FOR: TRANSFORMERS AND INDUCTORS, IN  
CLASS 9 (U.S. CLS. 21, 23, 26, 36 AND 38).

SN 78-705,654, FILED 9-1-2005.

FIRST USE 11-1-1991; IN COMMERCE 11-1-1991.

MARK RADEMACHER, EXAMINING ATTORNEY

**Int. Cl.: 41**

**Prior U.S. Cls.: 100, 101, and 107**

**United States Patent and Trademark Office**

**Reg. No. 3,455,328**

**Registered June 24, 2008**

**SERVICE MARK  
PRINCIPAL REGISTER**

**WAGE-NET**

WMS GAMING INC. (DELAWARE CORPORATION)  
800 SOUTH NORTHPOINT BOULEVARD  
WAUKEGAN, IL 60085

FOR: ENTERTAINMENT SERVICES, NAMELY,  
PROVIDING GAMING CONTENT VIA SERVERS  
TO NETWORKED GAMING MACHINES, IN CLASS  
41 (U.S. CLS. 100, 101 AND 107).

FIRST USE 11-14-2006; IN COMMERCE 11-14-2006.

THE MARK CONSISTS OF STANDARD CHARACTERS WITHOUT CLAIM TO ANY PARTICULAR FONT, STYLE, SIZE, OR COLOR.

SN 78-709,670, FILED 9-9-2005.

DOMINIC J. FERRAIUOLO, EXAMINING ATTORNEY

**Int. Cl.: 3**

**Prior U.S. Cls.: 1, 4, 6, 50, 51, and 52**

**Reg. No. 3,455,329**

**United States Patent and Trademark Office**

**Registered June 24, 2008**

**TRADEMARK  
PRINCIPAL REGISTER**

**BLACKHAWK!**

FREEMAN, C. BLAINE (UNITED STATES INDIVIDUAL)  
6409 ALLWOOD  
N LITTLE ROCK, AR 72118

THE MARK CONSISTS OF STANDARD CHARACTERS WITHOUT CLAIM TO ANY PARTICULAR FONT, STYLE, SIZE, OR COLOR.

FOR: CLEANER FOR USE ON MOTORCYCLES,  
IN CLASS 3 (U.S. CLS. 1, 4, 6, 50, 51 AND 52).

SN 78-710,413, FILED 9-9-2005.

FIRST USE 11-1-2007; IN COMMERCE 11-1-2007.

WENDY JUN, EXAMINING ATTORNEY



**Int. Cl.: 9**

**Prior U.S. Cls.: 21, 23, 26, 36, and 38**

**Reg. No. 3,455,330**

**United States Patent and Trademark Office**

**Registered June 24, 2008**

**TRADEMARK  
PRINCIPAL REGISTER**

# SHOUT

THE SCO GROUP, INC. (DELAWARE CORPORATION)  
SUITE 100  
355 SOUTH 520 WEST  
LINDON, UT 84042

FOR: COMPUTER SOFTWARE FOR ENABLING THE TRANSMISSION OF INFORMATION TO USERS ON A COMPUTER NETWORK; COMPUTER SOFTWARE FOR PROVIDING INTERACTIVE COMMUNICATIONS THROUGH A COMPUTER NETWORK; COMPUTER SOFTWARE FOR PROVIDING COLLABORATION AMONG USERS ON A COMPUTER NETWORK; COMPUTER SOFTWARE FOR PROVIDING POLLS AMONG USERS ON A COMPUTER NETWORK; COMPUTER SOFTWARE FOR PROVIDING ON-LINE ELECTRONIC BULLETIN BOARD; COMPUTER SOFTWARE FOR PROVIDING ON-LINE CHAT ROOMS; COMPUTER SOFTWARE FOR PROVIDING INSTANT MESSAGING FOR TRANSMISSION OF MESSAGES AMONG COMPUTER USERS ON A COMPUTER

NETWORK; COMPUTER SOFTWARE FOR PROVIDING COLLABORATIVE COMMUNICATIONS IN A CORPORATE OR BUSINESS ENVIRONMENT; COMPUTER SOFTWARE FOR REMOTE CONTROL APPLICATIONS; COMPUTER SOFTWARE FOR SOFTWARE DEVELOPMENT; COMPUTER APPLICATION SOFTWARE FOR MOBILE DEVICES, NAMELY, CELLULAR TELEPHONES, PERSONAL DIGITAL ASSISTANTS "PDAS" AND SMART PHONES, IN CLASS 9 (U.S. CLS. 21, 23, 26, 36 AND 38).

FIRST USE 7-27-2005; IN COMMERCE 7-27-2005.

THE MARK CONSISTS OF STANDARD CHARACTERS WITHOUT CLAIM TO ANY PARTICULAR FONT, STYLE, SIZE, OR COLOR.

SN 78-711,220, FILED 9-12-2005.

TARAH HARDY, EXAMINING ATTORNEY

**Int. Cl.: 33**

**Prior U.S. Cls.: 47 and 49**

**United States Patent and Trademark Office**

**Reg. No. 3,455,331**

**Registered June 24, 2008**

**TRADEMARK  
PRINCIPAL REGISTER**

**ZIN MASTER**

TIZOL, JULIAN (UNITED STATES INDIVIDUAL)  
875 NE 195TH ST. #214  
NORTH MIAMI BEACH, FL 33179

FOR: ALCOHOLIC BEVERAGES, NAMELY, VODKA, IN CLASS 33 (U.S. CLS. 47 AND 49).

FIRST USE 2-10-2006; IN COMMERCE 3-11-2006.

THE MARK CONSISTS OF STANDARD CHARACTERS WITHOUT CLAIM TO ANY PARTICULAR FONT, STYLE, SIZE, OR COLOR.

SN 78-711,744, FILED 9-13-2005.

LEIGH CAROLINE CASE, EXAMINING ATTORNEY

**Int. Cl.: 16**

**Prior U.S. Cls.: 2, 5, 22, 23, 29, 37, 38, and 50**

**Reg. No. 3,455,332**

**United States Patent and Trademark Office**

**Registered June 24, 2008**

---

**TRADEMARK  
PRINCIPAL REGISTER**

**SOUNDPAPER**

BERKUN, KEN (UNITED STATES INDIVIDUAL),  
DBA LTT,  
230 ILIHAU STREET  
KAILUA, HI 96734

THE MARK CONSISTS OF STANDARD CHAR-  
ACTERS WITHOUT CLAIM TO ANY PARTICULAR  
FONT, STYLE, SIZE, OR COLOR.

FOR: ADHESIVE LABELS; BAR CODE LABELS;  
LABEL PRINTING MACHINES; PAPER LABELS, IN  
CLASS 16 (U.S. CLS. 2, 5, 22, 23, 29, 37, 38 AND 50).

SN 78-716,043, FILED 9-19-2005.

FIRST USE 4-7-2008; IN COMMERCE 4-7-2008.

JOHN E. MICHOS, EXAMINING ATTORNEY

**Int. Cl.: 16**

**Prior U.S. Cls.: 2, 5, 22, 23, 29, 37, 38, and 50**

**Reg. No. 3,455,333**

**United States Patent and Trademark Office**

**Registered June 24, 2008**

**TRADEMARK  
PRINCIPAL REGISTER**

**LABELS THAT TALK**

BERKUN, KEN (UNITED STATES INDIVIDUAL),  
DBA LTT,  
230 ILIHAU STREET  
KAILUA, HI 96734

FOR: ADHESIVE LABELS; BAR CODE LABELS;  
LABEL PRINTING MACHINES; PAPER LABELS, IN  
CLASS 16 (U.S. CLS. 2, 5, 22, 23, 29, 37, 38 AND 50).

FIRST USE 4-7-2008; IN COMMERCE 4-7-2008.

THE MARK CONSISTS OF STANDARD CHAR-  
ACTERS WITHOUT CLAIM TO ANY PARTICULAR  
FONT, STYLE, SIZE, OR COLOR.

NO CLAIM IS MADE TO THE EXCLUSIVE  
RIGHT TO USE "LABELS", APART FROM THE  
MARK AS SHOWN.

SN 78-716,047, FILED 9-19-2005.

JOHN E. MICHOS, EXAMINING ATTORNEY

**Int. Cl.: 36**

**Prior U.S. Cls.: 100, 101, and 102**

**United States Patent and Trademark Office**

**Reg. No. 3,455,334**

**Registered June 24, 2008**

**SERVICE MARK  
PRINCIPAL REGISTER**

**DRUM CAPITAL**

DRUM CAPITAL MANAGEMENT, LLC (CON-  
NECTICUT LTD LIAB CO)  
SUITE 330  
18 MARSHALL STREET  
SOUTH NORWALK, CT 06854

FOR: FINANCIAL SERVICES, NAMELY, INVEST-  
MENT ADVICE, INVESTMENT MANAGEMENT,  
INVESTMENT CONSULTATION AND INVEST-  
MENT OF FUNDS FOR OTHERS; FINANCIAL  
SERVICES IN THE FIELDS OF ALTERNATIVE  
INVESTMENTS AND PRIVATE EQUITY INVEST-  
MENT MANAGEMENT, AND CONSULTING SER-  
VICES RELATING THERETO, IN CLASS 36 (U.S.  
CLS. 100, 101 AND 102).

FIRST USE 4-30-2005; IN COMMERCE 4-30-2005.

THE MARK CONSISTS OF STANDARD CHAR-  
ACTERS WITHOUT CLAIM TO ANY PARTICULAR  
FONT, STYLE, SIZE, OR COLOR.

NO CLAIM IS MADE TO THE EXCLUSIVE  
RIGHT TO USE "CAPITAL", APART FROM THE  
MARK AS SHOWN.

SN 78-717,734, FILED 9-21-2005.

NAAKWAMA ANKRAH, EXAMINING ATTORNEY

**Int. Cl.: 9**

**Prior U.S. Cls.: 21, 23, 26, 36, and 38**

**Reg. No. 3,455,335**

**United States Patent and Trademark Office**

**Registered June 24, 2008**

**TRADEMARK  
PRINCIPAL REGISTER**

**PROXENSE**

GIOBBI, JOHN J. (UNITED STATES INDIVIDUAL)  
689 NW STONEPINE DRIVE  
BEND, OR 97701

FOR: TANGIBLE ELECTRONIC KEY STORING A SECURITY CODE, WHICH, WHEN ASSOCIATED WITH A COMPATIBLE UNLOCK CODE, UNLOCKS ACCESS TO DIGITAL CONTENT, IN CLASS 9 (U.S. CLS. 21, 23, 26, 36 AND 38).

FIRST USE 7-0-2007; IN COMMERCE 7-0-2007.

THE MARK CONSISTS OF STANDARD CHARACTERS WITHOUT CLAIM TO ANY PARTICULAR FONT, STYLE, SIZE, OR COLOR.

SN 78-720,273, FILED 9-26-2005.

PAUL E. FAHRENKOPF, EXAMINING ATTORNEY

Int. Cls.: 30 and 35

Prior U.S. Cls.: 46, 100, 101, and 102

United States Patent and Trademark Office

Reg. No. 3,455,336

Registered June 24, 2008

TRADEMARK  
SERVICE MARK  
PRINCIPAL REGISTER



MONARCA INC. (DELAWARE CORPORATION)  
6365 PACIFIC BLVD  
HUNTINGTON PARK, CA 90255

FOR: BAKERY PRODUCTS, IN CLASS 30 (U.S. CL. 46).

FIRST USE 2-14-2006; IN COMMERCE 2-14-2006.

FOR: RETAIL BAKERY SHOPS, IN CLASS 35 (U.S. CLS. 100, 101 AND 102).

FIRST USE 2-14-2006; IN COMMERCE 2-14-2006.

NO CLAIM IS MADE TO THE EXCLUSIVE RIGHT TO USE "BAKERY", APART FROM THE MARK AS SHOWN.

THE COLOR(S) YELLOW, ORANGE, BLACK AND WHITE IS/ARE CLAIMED AS A FEATURE OF THE MARK.

THE MARK CONSISTS OF A STYLIZED BUTTERFLY WITH BLACK OUTER EDGES THAT CONTAIN WHITE DOTTING AND YELLOW AND ORANGE IN THE INSIDE PART OF THE IMAGE. YELLOW IS REPRESENTED BY A SMALL CIRCLE IN THE TOP CENTER PART OF THE BUTTERFLY. THE SMALL YELLOW CIRCLE IS SURROUNDED BY ORANGE. THE BUTTERFLY IS ON TOP A WHITE CENTER CIRCLE, WHICH IS SURROUNDED BY AN ORANGE COLORED RING WITH THE WORDS "LA MONARCA BAKERY" THEREIN IN WHITE. THE ORANGE COLORED RING CONTAINS AN INTERIOR WHITE RING AND IS FURTHER SURROUNDED BY A NARROWER, BLACK COLORED RING.

THE FOREIGN WORDING IN THE MARK TRANSLATES INTO ENGLISH AS THE MONARCH.

SN 78-720,934, FILED 9-26-2005.

KARANENDRA S. CHHINA, EXAMINING ATTORNEY

**Int. Cl.: 35**

**Prior U.S. Cls.: 100, 101, and 102**

**United States Patent and Trademark Office**

**Reg. No. 3,455,337**

**Registered June 24, 2008**

**SERVICE MARK  
PRINCIPAL REGISTER**



ZILLOW, INC. (WASHINGTON CORPORATION)  
SUITE 4100  
999 3RD AVENUE  
SEATTLE, WA 98104

FOR: ADVERTISING AND MARKETING SERVICES IN THE FIELDS OF REAL ESTATE, CONSUMER GOODS AND CONSUMER SERVICES; ON-LINE ADVERTISING AND MARKETING SERVICES IN THE FIELDS OF REAL ESTATE, CONSUMER GOODS AND CONSUMER SERVICES; REAL ESTATE SALES MANAGEMENT; REAL ESTATE MARKETING SERVICES, NAMELY, ON-LINE SERVICES FEATURING TOURS OF REAL ESTATE; PROVIDING AN ON-LINE SHOWROOM FOR THE GOODS OF OTHERS IN THE FIELD OF REAL ESTATE; PROVIDING INFORMATION IN THE

FIELD OF CONSUMER GOODS FOR HOME MAINTENANCE, DECORATION AND SALES, AND CONSUMER SERVICES RELATING TO REAL ESTATE; PROMOTING THE GOODS AND SERVICES OF OTHERS BY MEANS OF LINKING THE WEB SITE TO OTHER WEB SITES FEATURING REAL ESTATE, CONSUMER GOODS AND CONSUMER SERVICES, IN CLASS 35 (U.S. CLS. 100, 101 AND 102).

FIRST USE 2-7-2006; IN COMMERCE 2-7-2006.

THE MARK CONSISTS OF THE LETTER "Z" WITHIN A HOUSE DESIGN.

SN 78-722,629, FILED 9-28-2005.

MICHAEL ENGEL, EXAMINING ATTORNEY



**Int. Cl.: 44**

**Prior U.S. Cls.: 100 and 101**

**United States Patent and Trademark Office**

**Reg. No. 3,455,338**

**Registered June 24, 2008**

**SERVICE MARK  
PRINCIPAL REGISTER**

HEALTH INDUSTRY INSIGHTS

INTERNATIONAL DATA GROUP, INC. (MASSACHUSETTS CORPORATION)  
5 SPEEN STREET  
FRAMINGHAM, MA 01701

FOR: PROVIDING INFORMATION VIA A WEBSITE IN THE FIELDS OF HEALTHCARE, IN CLASS 44 (U.S. CLS. 100 AND 101).

FIRST USE 9-21-2005; IN COMMERCE 9-21-2005.

THE MARK CONSISTS OF STANDARD CHARACTERS WITHOUT CLAIM TO ANY PARTICULAR FONT, STYLE, SIZE, OR COLOR.

NO CLAIM IS MADE TO THE EXCLUSIVE RIGHT TO USE "HEALTH INDUSTRY", APART FROM THE MARK AS SHOWN.

SN 78-722,906, FILED 9-29-2005.

PAM WILLIS, EXAMINING ATTORNEY

Int. Cl.: 14

Prior U.S. Cls.: 2, 27, 28, and 50

Reg. No. 3,455,339

United States Patent and Trademark Office

Registered June 24, 2008

TRADEMARK  
PRINCIPAL REGISTER



MIKE DALE JEWELERS, INC. (LOUISIANA CORPORATION)  
12 SAINT ANN DRIVE  
MANDEVILLE, LA 70471

FOR: JEWELRY, IN CLASS 14 (U.S. CLS. 2, 27, 28 AND 50).

FIRST USE 9-16-2005; IN COMMERCE 9-16-2005.

THE MARK CONSISTS OF THE DESIGN OF A CRESCENT MOON CONTAINING THE WORDS "I KNOW WHAT IT MEAN", ABOVE A HEART CONTAINING A FLEUR DE LIS ABOVE A BAR CONTAINING THE WORDS "NEW ORLEANS".

SN 78-723,165, FILED 9-29-2005.

ANDREA K. NADELMAN, EXAMINING ATTORNEY

**Int. Cl.: 29**

**Prior U.S. Cl.: 46**

**United States Patent and Trademark Office**

**Reg. No. 3,455,340**

**Registered June 24, 2008**

**TRADEMARK  
PRINCIPAL REGISTER**

**VARIETY PACK**

KELLOGG NORTH AMERICA COMPANY (DE-  
LAWARE CORPORATION)  
LEGAL DEPARTMENT  
ONE KELLOGG SQUARE, PO BOX 3599  
BATTLE CREEK, MI 490163599

FOR: YOGURT COATED FRUIT PIECES, FRUIT  
BASED SNACK FOOD, IN CLASS 29 (U.S. CL. 46).

FIRST USE 12-31-2005; IN COMMERCE 1-1-2006.

THE MARK CONSISTS OF STANDARD CHAR-  
ACTERS WITHOUT CLAIM TO ANY PARTICULAR  
FONT, STYLE, SIZE, OR COLOR.

OWNER OF U.S. REG. NO. 552,435.

NO CLAIM IS MADE TO THE EXCLUSIVE  
RIGHT TO USE "PACK", APART FROM THE MARK  
AS SHOWN.

SEC. 2(F) AS TO "VARIETY".

SN 78-725,234, FILED 10-3-2005.

WARREN L. OLANDRIA, EXAMINING ATTOR-  
NEY

**Int. Cl.: 12**

**Prior U.S. Cls.: 19, 21, 23, 31, 35, and 44**

**Reg. No. 3,455,341**

**United States Patent and Trademark Office**

**Registered June 24, 2008**

---

**TRADEMARK  
PRINCIPAL REGISTER**

# Mighty Lift!

AVM, INC. (SOUTH CAROLINA CORPORATION)  
BOX 729  
HIGHWAY 76 EAST  
MARION, SC 29571

FOR: LAND VEHICLES PARTS, NAMELY, GAS  
SPRINGS FOR SUPPORTING THE TRUNK OF A  
HATCHBACK AUTOMOBILE, IN CLASS 12 (U.S.  
CLS. 19, 21, 23, 31, 35 AND 44).

FIRST USE 1-1-2000; IN COMMERCE 1-1-2000.

THE MARK CONSISTS OF STANDARD CHAR-  
ACTERS WITHOUT CLAIM TO ANY PARTICULAR  
FONT, STYLE, SIZE, OR COLOR.

NO CLAIM IS MADE TO THE EXCLUSIVE  
RIGHT TO USE "LIFT", APART FROM THE MARK  
AS SHOWN.

SN 78-728,252, FILED 10-6-2005.

JORDAN BAKER, EXAMINING ATTORNEY

**Int. Cl.: 16**

**Prior U.S. Cls.: 2, 5, 22, 23, 29, 37, 38, and 50**

**Reg. No. 3,455,342**

**United States Patent and Trademark Office**

**Registered June 24, 2008**

**TRADEMARK  
PRINCIPAL REGISTER**

**DEVELOPING EXPERT READERS**

PROFESSIONAL DEVELOPMENT INSTITUTE  
INC. (WASHINGTON CORPORATION)  
3109 150TH PLACE SE  
MILL CREEK, WA 98012

THE MARK CONSISTS OF STANDARD CHAR-  
ACTERS WITHOUT CLAIM TO ANY PARTICULAR  
FONT, STYLE, SIZE, OR COLOR.

FOR: PRINTED PERIODICALS IN THE FIELD OF  
READING CURRICULUM, IN CLASS 16 (U.S. CLS. 2,  
5, 22, 23, 29, 37, 38 AND 50).

SN 78-728,923, FILED 10-7-2005.

FIRST USE 2-28-2006; IN COMMERCE 2-28-2006.

SANI KHOURI, EXAMINING ATTORNEY

**Int. Cl.: 41**

**Prior U.S. Cls.: 100, 101, and 107**

**United States Patent and Trademark Office**

**Reg. No. 3,455,343**

**Registered June 24, 2008**

**SERVICE MARK  
PRINCIPAL REGISTER**

**THE QUEEN OF SWING**

GRANT, KELLI (UNITED STATES INDIVIDUAL)  
1909 SILVER FALLS RD.  
LONGVIEW, TX 75604

THE MARK CONSISTS OF STANDARD CHAR-  
ACTERS WITHOUT CLAIM TO ANY PARTICULAR  
FONT, STYLE, SIZE, OR COLOR.

FOR: ENTERTAINMENT, NAMELY, LIVE MUSI-  
CAL PERFORMANCES, IN CLASS 41 (U.S. CLS. 100,  
101 AND 107).

SN 78-729,510, FILED 10-9-2005.

FIRST USE 6-0-1995; IN COMMERCE 7-0-2000.

RONALD AIKENS, EXAMINING ATTORNEY

**Int. Cl.: 9**

**Prior U.S. Cls.: 21, 23, 26, 36, and 38**

**Reg. No. 3,455,344**

**United States Patent and Trademark Office**

**Registered June 24, 2008**

**TRADEMARK  
PRINCIPAL REGISTER**

**DMSTN**

GAINTPLUS TECHNOLOGY CO., LTD (TAIWAN CORPORATION)  
NO. 15, INDUSTRIAL ROAD  
LU-CHU LI, TOUFEN  
MIAOLI, TAIWAN 351

FOR: COMPUTER HARDWARE; COMPUTER SOFTWARE USED IN DATABASE MANAGEMENT; LIQUID CRYSTAL DISPLAYS; COMPUTER MONITORS; COMPUTER MEMORIES; COMPUTERS; BLANK CD-ROM FOR SOUND AND VIDEO RECORDING; OPTICAL DISK FEATURING COMPUTER PROGRAMS; COMPUTER INTERFACE BOARDS; TELEPHONE ANSWERING MACHINES; FAX MACHINES; MOBILE TELEPHONES; VIDEO-TELEPHONES; DEVICE FOR INTERNET MEETING, NAMELY, WIRELESS INTERNET DEVICES, WHICH PROVIDE TELEMATIC SERVICES AND

HAVE A CELLULAR PHONE FUNCTION; INTERNET PHONES; COMPUTER CHIPS; ELECTRONIC SEMI-CONDUCTORS; ELECTRONIC INTEGRATED CIRCUITS; COMPUTER PROGRAM FOR AUTHENTICATING THE ID CODE, NAMELY, PASSWORD, IN CLASS 9 (U.S. CLS. 21, 23, 26, 36 AND 38).

FIRST USE 4-25-2005; IN COMMERCE 4-25-2005.

THE MARK CONSISTS OF STANDARD CHARACTERS WITHOUT CLAIM TO ANY PARTICULAR FONT, STYLE, SIZE, OR COLOR.

SN 78-733,039, FILED 10-13-2005.

ODESSA BIBBINS, EXAMINING ATTORNEY

**Int. Cl.: 30**

**Prior U.S. Cl.: 46**

**United States Patent and Trademark Office**

**Reg. No. 3,455,345**

**Registered June 24, 2008**

**TRADEMARK  
PRINCIPAL REGISTER**

**THE BETTER WAY TO BREW**

SARA LEE/DE N.V. (NETHERLANDS CORPORATION)  
VLEUTENSEVAART 100  
3532 AD UTRECHT, NETHERLANDS

FOR: COFFEE, IN CLASS 30 (U.S. CL. 46).

FIRST USE 11-7-2005; IN COMMERCE 11-7-2005.

THE MARK CONSISTS OF STANDARD CHARACTERS WITHOUT CLAIM TO ANY PARTICULAR FONT, STYLE, SIZE, OR COLOR.

SN 78-733,412, FILED 10-14-2005.

MARK SPARACINO, EXAMINING ATTORNEY



**Int. Cl.: 33**

**Prior U.S. Cls.: 47 and 49**

**United States Patent and Trademark Office**

**Reg. No. 3,455,346**

**Registered June 24, 2008**

**TRADEMARK  
PRINCIPAL REGISTER**

**ORANGEL**

DISTILLERIE FRANCIACORTA S.P.A. (ITALY  
JOINT STOCK COMPANY)  
VIA MANDOLOSSA, 80  
GUSSAGO (BRESCIA), ITALY 25064

THE MARK CONSISTS OF STANDARD CHAR-  
ACTERS WITHOUT CLAIM TO ANY PARTICULAR  
FONT, STYLE, SIZE, OR COLOR.

FOR: DISTILLED SPIRITS; DISTILLED SPIRITS  
CONTAINING FRUIT; LIQUEURS, IN CLASS 33  
(U.S. CLS. 47 AND 49).

SN 78-733,672, FILED 10-14-2005.

FIRST USE 10-13-2005; IN COMMERCE 10-13-2005.

SALLY SHIH, EXAMINING ATTORNEY

**Int. Cl.: 24**

**Prior U.S. Cls.: 42 and 50**

**United States Patent and Trademark Office**

**Reg. No. 3,455,347**

**Registered June 24, 2008**

**TRADEMARK  
PRINCIPAL REGISTER**

**GREAT OUTDOORS A HOLLY  
HUNT COLLECTION**

HOLLY HUNT LTD. (ILLINOIS CORPORATION)  
SUITE 700  
801 WEST ADAMS STREET  
CHICAGO, IL 60607

FOR: FABRICS FOR THE MANUFACTURE OF  
FURNITURE UPHOLSTERY; COTTON FABRICS  
FOR FURNITURE, IN CLASS 24 (U.S. CLS. 42 AND  
50).

FIRST USE 8-0-2007; IN COMMERCE 8-0-2007.

THE MARK CONSISTS OF STANDARD CHAR-  
ACTERS WITHOUT CLAIM TO ANY PARTICULAR  
FONT, STYLE, SIZE, OR COLOR.

OWNER OF U.S. REG. NOS. 2,878,614, 2,880,880,  
AND OTHERS.

THE NAME "HOLLY HUNT" IDENTIFIES A  
LIVING INDIVIDUAL WHOSE CONSENT IS OF  
RECORD.

SN 78-734,391, FILED 10-17-2005.

ADA HAN, EXAMINING ATTORNEY

**Int. Cl.: 36**

**Prior U.S. Cls.: 100, 101, and 102**

**United States Patent and Trademark Office**

**Reg. No. 3,455,348**

**Registered June 24, 2008**

**SERVICE MARK  
PRINCIPAL REGISTER**

*ConciergeClaim*

THE TRAVELERS INDEMNITY COMPANY  
(CONNECTICUT CORPORATION)  
ONE TOWER SQUARE  
HARFORD, CT 06183

FIRST USE 11-30-2005; IN COMMERCE 11-30-2005.

SN 78-736,386, FILED 10-19-2005.

FOR: INSURANCE SERVICES, NAMELY, INSURANCE CLAIMS PROCESSING, IN CLASS 36 (U.S. CLS. 100, 101 AND 102).

AMY MCMENAMIN, EXAMINING ATTORNEY

**Int. Cls.: 9, 35, 41, and 42**

**Prior U.S. Cls.: 21, 23, 26, 36, 38, 100, 101, 102, and 107**

**Reg. No. 3,455,349**

**United States Patent and Trademark Office**

**Registered June 24, 2008**

**TRADEMARK  
SERVICE MARK  
PRINCIPAL REGISTER**

# Big Spaceship

BIG SPACESHIP, LLC (DELAWARE LTD LIAB  
CO)  
45 MAIN STREET  
SUITE 716  
BROOKLYN, NY 11201

FOR: COMPUTER SOFTWARE FOR CREATING  
ENTERTAINMENT AND EDUCATIONAL SOFT-  
WARE, IN CLASS 9 (U.S. CLS. 21, 23, 26, 36 AND 38).

FIRST USE 6-11-2002; IN COMMERCE 1-1-2003.

FOR: ADVERTISING AGENCY SERVICES AND  
MARKETING COMMUNICATIONS CONSULT-  
ING SERVICES, IN CLASS 35 (U.S. CLS. 100, 101  
AND 102).

FIRST USE 1-1-2000; IN COMMERCE 1-1-2000.

FOR: PROVIDING ONLINE COMPUTER GAME  
PROGRAMS, IN CLASS 41 (U.S. CLS. 100, 101 AND  
107).

FIRST USE 1-1-2000; IN COMMERCE 1-1-2000.

FOR: MULTIMEDIA DESIGN SERVICES FOR  
OTHERS, NAMELY, DIGITAL COMMERCIAL ART-  
WORK DESIGN, CD-ROM DESIGN, GRAPHIC ART  
DESIGN, WEB SITE DESIGN, WEB SITE HOSTING  
ON A COMPUTER SERVER FOR A GLOBAL COM-  
PUTER NETWORK; PROGRAMMING AND IMPLE-  
MENTATION OF MULTIMEDIA APPLICATIONS  
FOR OTHERS; CUSTOM DESIGN OF COMPUTER  
SOFTWARE IN MULTIPLE FIELDS FOR OTHERS,  
IN CLASS 42 (U.S. CLS. 100 AND 101).

FIRST USE 1-1-2000; IN COMMERCE 1-1-2000.

THE MARK CONSISTS OF STANDARD CHAR-  
ACTERS WITHOUT CLAIM TO ANY PARTICULAR  
FONT, STYLE, SIZE, OR COLOR.

SN 78-736,493, FILED 10-19-2005.

WILLIAM VERHOSEK, EXAMINING ATTORNEY

**Int. Cl.: 40**

**Prior U.S. Cls.: 100, 103, and 106**

**United States Patent and Trademark Office**

**Reg. No. 3,455,350**

**Registered June 24, 2008**

---

**SERVICE MARK  
PRINCIPAL REGISTER**

**PSYCHOSYMMETROLYSIS**

SELTZER, ONDRE (UNITED KINGDOM INDIVIDUAL)  
37033 NORTH KOHUANA PLACE  
CAVE CREEK, AZ 85331

FOR: CUSTOM MANUFACTURING OF HEALTH CARE AND BEAUTY PRODUCTS, IN CLASS 40 (U.S. CLS. 100, 103 AND 106).

FIRST USE 3-31-2007; IN COMMERCE 3-31-2007.

THE MARK CONSISTS OF STANDARD CHARACTERS WITHOUT CLAIM TO ANY PARTICULAR FONT, STYLE, SIZE, OR COLOR.

SN 78-737,035, FILED 10-20-2005.

DAVID MILLER, EXAMINING ATTORNEY

**Int. Cl.: 35**

**Prior U.S. Cls.: 100, 101, and 102**

**United States Patent and Trademark Office**

**Reg. No. 3,455,351**

**Registered June 24, 2008**

**SERVICE MARK  
PRINCIPAL REGISTER**

**IT'S YOUR GAME**

THE UNITED STATES TENNIS ASSOCIATION  
INCORPORATED (NEW YORK NOT-FOR-  
PROFIT CORPORATION)  
70 WEST RED OAK LANE  
WHITE PLAINS, NY 10604

FOR: ASSOCIATION SERVICES, NAMELY, PRO-  
MOTING THE SPORT OF TENNIS BY PROVIDING  
INFORMATION REGARDING TENNIS INSTRU-  
CTION, TENNIS TOURNAMENTS, TENNIS FACIL-  
ITIES, TENNIS EQUIPMENT AND RELATED  
TRAVEL PACKAGES OFFERED BY OTHERS, IN  
CLASS 35 (U.S. CLS. 100, 101 AND 102).

FIRST USE 4-1-2006; IN COMMERCE 4-1-2006.

THE MARK CONSISTS OF STANDARD CHAR-  
ACTERS WITHOUT CLAIM TO ANY PARTICULAR  
FONT, STYLE, SIZE, OR COLOR.

SN 78-741,107, FILED 10-26-2005.

ELIZABETH BEYER, EXAMINING ATTORNEY

**Int. Cls.: 21 and 25**

**Prior U.S. Cls.: 2, 13, 22, 23, 29, 30, 33, 39, 40, and 50**

**United States Patent and Trademark Office**

**Reg. No. 3,455,352**

**Registered June 24, 2008**

**TRADEMARK  
PRINCIPAL REGISTER**



LARRY H. MILLER BASEBALL, INC. (UTAH CORPORATION)  
9350 SOUTH 150 EAST, SUITE 100  
SANDY, UT 84070

FOR: BEVERAGE CONTAINERS, NAMELY, DISPOSABLE DRINKING GLASSES AND CUPS, IN CLASS 21 (U.S. CLS. 2, 13, 23, 29, 30, 33, 40 AND 50).

FIRST USE 10-27-2005; IN COMMERCE 10-27-2005.

FOR: CLOTHING, NAMELY, CAPS, HATS, HEADWEAR, SHIRTS, T-SHIRTS, TURTLENECKS, SHORTS, PANTS, BASEBALL UNIFORMS, JERSEYS, SWEATSHIRTS, SWEATPANTS, SLEEPWEAR, JACKETS, FOOTWEAR, SOCKS, IN CLASS 25 (U.S. CLS. 22 AND 39).

FIRST USE 10-27-2005; IN COMMERCE 10-27-2005.

NO CLAIM IS MADE TO THE EXCLUSIVE RIGHT TO USE "SALT LAKE", APART FROM THE MARK AS SHOWN.

THE MARK CONSISTS OF "SALT LAKE BEES" & BUMBLE BEE WEARING BALL CAP AND HOLDING BASEBALL BAT.

SN 78-741,174, FILED 10-26-2005.

CAROLYN CATALDO, EXAMINING ATTORNEY

**Int. Cl.: 29**

**Prior U.S. Cl.: 46**

**United States Patent and Trademark Office**

**Reg. No. 3,455,353**

**Registered June 24, 2008**

**TRADEMARK  
PRINCIPAL REGISTER**

**TRADEMARK BRAND**

SHLESINGER, ARKWRIGHT & GARVEY, L.L.P.  
(VIRGINIA LIMITED LIABILITY PARTNER-  
SHIP)  
1420 KING STREET, SUITE 600  
ALEXANDRIA, VA 22314

FOR: SNACK FOODS, NAMELY, FRUIT BASED  
SNACK FOODS, DEHYDRATED FRUIT SNACKS,  
CANDIED FRUIT SNACKS, POTATO BASED  
SNACK FOODS, PROTEIN BASED, NUTRIENT-  
DENSE SNACK BARS, SNACK MIXES CONSISTING  
PRIMARILY OF PROCESSED FRUITS, PROCESSED  
NUTS AND/OR RAISINS, AND VEGETABLE BASED  
SNACK FOODS, IN CLASS 29 (U.S. CL. 46).

FIRST USE 5-5-2008; IN COMMERCE 5-5-2008.

THE MARK CONSISTS OF STANDARD CHAR-  
ACTERS WITHOUT CLAIM TO ANY PARTICULAR  
FONT, STYLE, SIZE, OR COLOR.

OWNER OF U.S. REG. NO. 2,832,487.

NO CLAIM IS MADE TO THE EXCLUSIVE  
RIGHT TO USE "BRAND", APART FROM THE  
MARK AS SHOWN.

SN 78-741,435, FILED 10-27-2005.

ERNEST SHOSHO, EXAMINING ATTORNEY



Int. Cl.: 33

Prior U.S. Cls.: 47 and 49

United States Patent and Trademark Office

Reg. No. 3,455,354

Registered June 24, 2008

TRADEMARK  
PRINCIPAL REGISTER

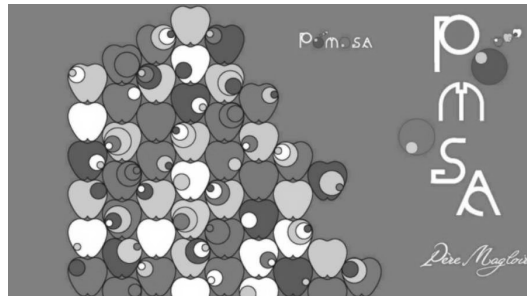

SA ETABLISSEMENTS DEBRISSE DULAC ET CIE  
(FRANCE COMPANY)  
RTE DE TROUVILLE  
14130 PONT L'EVEQUE, FRANCE

THE ENGLISH TRANSLATION OF THE WORD  
"PERE MAGLOIRE" IN THE MARK IS "FATHER  
MAGLOIRE".

FOR: DISTILLED SPIRITS, BRANDY SPIRITS,  
LIQUEURS AND ALCOHOLIC BEVERAGES,  
NAMELY, A LIQUOR OR APERITIF, IN CLASS 33  
(U.S. CLS. 47 AND 49).

SN 78-742,259, FILED 10-28-2005.

FIRST USE 1-1-2007; IN COMMERCE 1-2-2007.

LINDA E. BLOHM, EXAMINING ATTORNEY

**Int. Cl.: 42**

**Prior U.S. Cls.: 100 and 101**

**United States Patent and Trademark Office**

**Reg. No. 3,455,355**

**Registered June 24, 2008**

**SERVICE MARK  
PRINCIPAL REGISTER**

**PAYSCORE**

SALARY.COM (DELAWARE CORPORATION)  
SALARY.COM, INC.  
195 WEST STREET  
WALTHAM, MA 024511111

THE MARK CONSISTS OF STANDARD CHARACTERS WITHOUT CLAIM TO ANY PARTICULAR FONT, STYLE, SIZE, OR COLOR.

FOR: PROVIDING ON-LINE NON-DOWNLOADABLE SOFTWARE THAT ALLOWS FINANCIAL SERVICES FIRMS TO QUICKLY AND AUTOMATICALLY ACCESS THE VERACITY OF SALARY INFORMATION SUBMITTED BY INDIVIDUAL APPLICANTS AND COMPARE SALARY DATA, IN CLASS 42 (U.S. CLS. 100 AND 101).

NO CLAIM IS MADE TO THE EXCLUSIVE RIGHT TO USE "PAY", APART FROM THE MARK AS SHOWN.

SN 78-742,795, FILED 10-28-2005.

FIRST USE 3-15-2006; IN COMMERCE 3-15-2006.

RICHARD A. STRASER, EXAMINING ATTORNEY

**Int. Cl.: 9**

**Prior U.S. Cls.: 21, 23, 26, 36, and 38**

**United States Patent and Trademark Office**

**Reg. No. 3,455,356**

**Registered June 24, 2008**

**TRADEMARK  
PRINCIPAL REGISTER**

**VINAX**

INFINEON TECHNOLOGIES AG (FED REP GER-  
MANY CORPORATION)  
ST.-MARTIN-STR. 53  
81669 MUNCHEN, FED REP GERMANY

FOR: SEMICONDUCTOR COMPONENTS,  
NAMELY, INTEGRATED SEMICONDUCTOR  
COMPONENTS; INTEGRATED SEMICONDUCTOR  
COMPONENTS ICS, IN PARTICULAR STATIC AND  
DYNAMIC RANDOM ACCESS MEMORIES RAM,  
PROM, EPROM, EEPROM, POWER AMPLIFIERS,  
DIGITAL SIGNAL PROCESSORS, A/D CONVER-  
TERS, D/A CONVERTERS, S/D CONVERTERS;  
MODEMS; COMPUTER HARDWARE AND SOFT-  
WARE FOR TRANSMITTING AND RECEIVING  
FAXES; COMPUTER HARDWARE AND SOFT-  
WARE FOR DEVELOPING, MAINTAINING AND  
OPERATING LOCAL-AREA NETWORKS AND  
WIDE-AREA NETWORKS; COMPUTER HARD-  
WARE AND SOFTWARE FOR DEVELOPING,  
MAINTAINING AND OPERATING WIRED AND/  
OR WIRELESS TELECOMMUNICATION NET-

WORKS; COMPUTER HARDWARE AND SOFT-  
WARE FOR RECEIVING, INDICATING AND  
OPERATING VIDEO, AUDIO AND DIGITAL DATA  
SIGNALS, IN CLASS 9 (U.S. CLS. 21, 23, 26, 36 AND  
38).

FIRST USE 5-27-2005; IN COMMERCE 5-27-2005.

THE MARK CONSISTS OF STANDARD CHAR-  
ACTERS WITHOUT CLAIM TO ANY PARTICULAR  
FONT, STYLE, SIZE, OR COLOR.

PRIORITY CLAIMED UNDER SEC. 44(D) ON FED  
REP GERMANY APPLICATION NO. 30527594.1/0,  
FILED 5-12-2005, REG. NO. 30527594, DATED 9-22-  
2005, EXPIRES 5-31-2015.

SN 78-743,924, FILED 10-31-2005.

NAKIA HENRY, EXAMINING ATTORNEY

**Int. Cls.: 36 and 42**

**Prior U.S. Cls.: 100, 101, and 102**

**United States Patent and Trademark Office**

**Reg. No. 3,455,357**

**Registered June 24, 2008**

**SERVICE MARK  
PRINCIPAL REGISTER**



THE GUARDIAN LIFE INSURANCE COMPANY  
OF AMERICA (NEW YORK CORPORATION)  
7 HANOVER SQUARE  
NEW YORK, NY 10004

FOR: PROVIDING INFORMATION ON A WEBSITE ON A GLOBAL COMPUTER NETWORK FOR FINANCIAL PORTFOLIO MANAGEMENT, FINANCIAL VALUATION AND FINANCIAL RECORDS FOR INDIVIDUAL CLIENTS, INSURANCE AGENTS AND INSURANCE AGENCY PERSONNEL, IN CLASS 36 (U.S. CLS. 100, 101 AND 102).

FIRST USE 9-13-2005; IN COMMERCE 9-13-2005.

FOR: PROVIDING ON-LINE NON-DOWNLOADABLE COMPUTER SOFTWARE FOR FINANCIAL PORTFOLIO MANAGEMENT, FINANCIAL VALUATION, AND FINANCIAL RECORD ORGANIZATION FOR INDIVIDUAL CLIENTS, INSURANCE AGENTS AND INSURANCE AGENCY PERSONNEL, IN CLASS 42 (U.S. CLS. 100 AND 101).

FIRST USE 9-13-2005; IN COMMERCE 9-13-2005.

NO CLAIM IS MADE TO THE EXCLUSIVE RIGHT TO USE "BALANCE SHEET", APART FROM THE MARK AS SHOWN.

THE COLORS YELLOW, BLUE, RED, BLACK, WHITE AND GREEN ARE CLAIMED AS A FEATURE OF THE MARK.

THE MARK CONSISTS OF A DESIGN FEATURING THREE HORIZONTAL BARS TOGETHER MAKING THE SHAPE OF A SQUARE TO THE LEFT OF THE WORDING "THE LIVING BALANCE SHEET" THAT IS PRESENTED IN WHITE, AND THE ENTIRE BACKGROUND IS IN BLACK. THE TOP BAR IS YELLOW. THE MIDDLE BAR IS SPLIT IN HALF WITH THE LEFT SIDE BLUE AND THE RIGHT SIDE RED. THE BOTTOM BAR IS GREEN. THE BARS ARE CURVED TO CREATE A WAVING APPEARANCE.

SN 78-744,254, FILED 11-1-2005.

DOMINIC J. FERRAIUOLO, EXAMINING ATTORNEY

**Int. Cl.: 25**

**Prior U.S. Cls.: 22 and 39**

**United States Patent and Trademark Office**

**Reg. No. 3,455,358**

**Registered June 24, 2008**

**TRADEMARK  
PRINCIPAL REGISTER**

**CHRISTIAN CAGE**

RESO, WILLIAM JASON (CANADA INDIVIDUAL)  
C/O BWCS SPORTS/MEDIA  
9242 BEVERLY BLVD., SUITE 200  
BEVERLY HILLS, CA 90210

FOR: DENIMS; DRESS SHIRTS; GOLF SHIRTS; HATS; JACKETS; JOGGING PANTS; KNIT SHIRTS; OPEN-NECKED SHIRTS; PANTS; POLO SHIRTS; SHIRTS; SHIRTS FOR SUITS; SHOES; SHORT-SLEEVED OR LONG-SLEEVED T-SHIRTS; SHORT-SLEEVED SHIRTS; SHORTS; SLEEP SHIRTS; SPORT SHIRTS; SPORTS SHIRTS; SPORTS SHIRTS WITH SHORT SLEEVES; SWEAT PANTS; SWEAT SHIRTS;

T-SHIRTS; UNDERWEAR, IN CLASS 25 (U.S. CLS. 22 AND 39).

FIRST USE 11-7-2005; IN COMMERCE 11-7-2005.

THE MARK CONSISTS OF STANDARD CHARACTERS WITHOUT CLAIM TO ANY PARTICULAR FONT, STYLE, SIZE, OR COLOR.

OWNER OF U.S. REG. NO. 3,148,681.

SN 78-745,503, FILED 11-2-2005.

GINA FINK, EXAMINING ATTORNEY

**Int. Cl.: 9**

**Prior U.S. Cls.: 21, 23, 26, 36, and 38**

**United States Patent and Trademark Office**

**Reg. No. 3,455,359**

**Registered June 24, 2008**

**TRADEMARK  
PRINCIPAL REGISTER**

**AFOLUX**

ICP ELECTRONICS, INC. (TAIWAN CORPORATION)  
3F, NO. 22, CHUNG HSING RD.  
SHI-CHI CITY, TAIPEI HSIEN, 221, TAIWAN

FOR: COMPUTERS; COMPUTER TERMINATING MACHINES, NAMELY, COMPUTER TERMINALS; DIGITAL IMAGE STORAGE DEVICES, NAMELY, COMPUTER DISC DRIVES, DIGITAL DISC DRIVES, OPTICAL DISC DRIVES, AND DIGITAL VIDEO DISC DRIVES; COMPUTER SOFTWARE FOR COMPUTER SYSTEM AND APPLICATION DEVELOPMENT, IN CLASS 9 (U.S. CLS. 21, 23, 26, 36 AND 38).

FIRST USE 5-9-2007; IN COMMERCE 5-9-2007.

THE MARK CONSISTS OF STANDARD CHARACTERS WITHOUT CLAIM TO ANY PARTICULAR FONT, STYLE, SIZE, OR COLOR.

SN 78-746,177, FILED 11-3-2005.

SIMON TENG, EXAMINING ATTORNEY

**Int. Cl.: 44**

**Prior U.S. Cls.: 100 and 101**

**United States Patent and Trademark Office**

**Reg. No. 3,455,360**

**Registered June 24, 2008**

**SERVICE MARK  
PRINCIPAL REGISTER**

**CCM SELECT**

COMPREHENSIVE CARE MANAGEMENT COR-  
PORATION (NEW YORK CORPORATION)  
612 ALLERTON AVENUE  
BRONX, NY 10467

FOR: COORDINATION AND PROVISION OF  
MANAGED LONG-TERM HEALTHCARE SERVI-  
CES, IN CLASS 44 (U.S. CLS. 100 AND 101).

FIRST USE 10-31-2006; IN COMMERCE 10-31-2006.

THE MARK CONSISTS OF STANDARD CHAR-  
ACTERS WITHOUT CLAIM TO ANY PARTICULAR  
FONT, STYLE, SIZE, OR COLOR.

OWNER OF U.S. REG. NO. 1,606,895.

SN 78-746,576, FILED 11-3-2005.

SUSAN LESLIE DUBOIS, EXAMINING ATTORNEY

**Int. Cl.: 8**

**Prior U.S. Cls.: 23, 28, and 44**

**United States Patent and Trademark Office**

**Reg. No. 3,455,361**

**Registered June 24, 2008**

**TRADEMARK  
PRINCIPAL REGISTER**

**AEGIS**

SOG SPECIALTY KNIVES (WASHINGTON CORPORATION)  
6521 212TH STREET SOUTHWEST  
BELLINGHAM, WA 98036

FOR: HAND TOOLS, NAMELY, MULTIPLE FUNCTION FOLDING POCKET TOOL, COMPRISED OF SCREWDRIVERS, KNIVES, CAN OPENERS, FILE, PLIERS; KNIVES AS HAND TOOLS; KNIVES, NAMELY, FOLDING AND FIXED BLADE KNIVES FOR HUNTING, PARING, FISHING, AND SPORT, IN CLASS 8 (U.S. CLS. 23, 28 AND 44).

FIRST USE 2-5-2008; IN COMMERCE 2-5-2008.

THE MARK CONSISTS OF STANDARD CHARACTERS WITHOUT CLAIM TO ANY PARTICULAR FONT, STYLE, SIZE, OR COLOR.

SN 78-746,749, FILED 11-3-2005.

DOMINIC FATHY, EXAMINING ATTORNEY



**Int. Cl.: 7**

**Prior U.S. Cls.: 13, 19, 21, 23, 31, 34, and 35**

**Reg. No. 3,455,362**

**United States Patent and Trademark Office**

**Registered June 24, 2008**

**TRADEMARK  
PRINCIPAL REGISTER**

**HookCam**

PACIFIC SYSTEMS SOLUTIONS, LLC (HAWAII  
PARTNERSHIP)  
340 KUULEI RD. SUITE C  
KAILUA, HI 96734

FOR: CRANES; JIB CRANES; TOWER CRANES,  
IN CLASS 7 (U.S. CLS. 13, 19, 21, 23, 31, 34 AND 35).

FIRST USE 12-1-2005; IN COMMERCE 2-1-2006.

THE COLOR(S) YELLOW AND BLACK IS/ARE  
CLAIMED AS A FEATURE OF THE MARK.

THE MARK CONSISTS OF YELLOW TEXT (AR-  
IAL BLACK) WITH BLACK BORDER.

SN 78-746,945, FILED 11-4-2005.

TINA L. SNAPP, EXAMINING ATTORNEY

**Int. Cls.: 16 and 41**

**Prior U.S. Cls.: 2, 5, 22, 23, 29, 37, 38, 50, 100, 101, and 107**

**Reg. No. 3,455,363**

**United States Patent and Trademark Office**

**Registered June 24, 2008**

**TRADEMARK  
SERVICE MARK  
PRINCIPAL REGISTER**



TIMES PUBLISHING LIMITED (SINGAPORE CORPORATION)  
1 NEW INDUSTRIAL ROAD, TIMES CENTRE  
SINGAPORE, SINGAPORE 536196

FOR: PRINTED PUBLICATIONS, NAMELY, MAGAZINES, BOOKS, PERIODICALS AND DIRECTORIES IN THE FIELD OF TRAVEL, NATURE AND GARDENING, FOOD/COOKERY, CULTURE, HEALTH, LIFESTYLE, BUSINESS/MANAGEMENT, FICTION, BIOGRAPHIES, LANGUAGE, MATHEMATICS, SCIENCE, GEOGRAPHY, ART AND DESIGN AND ECONOMICS, IN CLASS 16 (U.S. CLS. 2, 5, 22, 23, 29, 37, 38 AND 50).

FIRST USE 8-1-2004; IN COMMERCE 8-1-2004.

FOR: PUBLICATION OF BOOKS, MAGAZINES, AND NEWSPAPERS; PUBLICATION OF TEXTS; PROVISION OF WORKSHOPS, SEMINARS, CONFERENCES IN THE FIELDS OF TRAVEL, NATURE AND GARDENING, FOOD/COOKERY, CULTURE, HEALTH, LIFESTYLE, BUSINESS/MANAGEMENT, ECONOMICS, FICTION, LANGUAGE, MATHEMATICS, SCIENCE, GEOGRAPHY, ART AND DESIGN; PROVISION OF LANGUAGE, BUSINESS AND MANAGEMENT TRAINING COURSES; ORGANIZATION OF WRITING COMPETITIONS, CON-

TESTS, GAMES AND QUIZZES; ELECTRONIC PUBLISHING SERVICES, NAMELY, PUBLICATION AND DISTRIBUTION OF TEXT AND GRAPHIC WORKS OF OTHERS ON COMPACT DISC AND CD-ROM FEATURING TRAVEL, NATURE AND GARDENING, FOOD/COOKERY, CULTURE, HEALTH, LIFESTYLE, BUSINESS/MANAGEMENT, FICTION, AND BIOGRAPHIES; ELECTRONIC PUBLISHING SERVICES, NAMELY, PUBLICATION AND DISTRIBUTION OF TEXT AND GRAPHIC WORKS OF OTHERS ON COMPACT DISC AND CD-ROM FEATURING INSTRUCTIONAL AND TEACHING MATERIAL IN THE FIELDS OF LANGUAGE, MATHEMATICS, SCIENCE, GEOGRAPHY, ART, DESIGN, ECONOMICS AND BUSINESS/MANAGEMENT, IN CLASS 41 (U.S. CLS. 100, 101 AND 107).

FIRST USE 8-1-2004; IN COMMERCE 8-1-2004.

THE MARK CONSISTS OF THE INTERCONNECTED LETTERS "MC" WITHIN A RECTANGULAR-SHAPED BOX WITH THREE ROUNDED CORNERS AND A RIGHT-ANGLED UPPER LEFT CORNER.

SN 78-747,554, FILED 11-4-2005.

LINDA LAVACHE, EXAMINING ATTORNEY

**Int. Cl.: 5**

**Prior U.S. Cls.: 6, 18, 44, 46, 51, and 52**

**United States Patent and Trademark Office**

**Reg. No. 3,455,364**

**Registered June 24, 2008**

**TRADEMARK  
PRINCIPAL REGISTER**

**NUTRAORIGIN WHERE WELLNESS  
BEGINS**

LBK GROUP, INC. (DELAWARE CORPORATION)  
90 WEST IVY HILL ROAD  
WOODSBURGH, NY 11598

THE MARK CONSISTS OF STANDARD CHARACTERS WITHOUT CLAIM TO ANY PARTICULAR FONT, STYLE, SIZE, OR COLOR.

FOR: NUTRITIONAL AND DIETARY SUPPLEMENTS, IN CLASS 5 (U.S. CLS. 6, 18, 44, 46, 51 AND 52).

SN 78-748,432, FILED 11-7-2005.

FIRST USE 4-19-2006; IN COMMERCE 5-19-2006.

MARCIE MILONE, EXAMINING ATTORNEY

**Int. Cl.: 36**

**Prior U.S. Cls.: 100, 101, and 102**

**United States Patent and Trademark Office**

**Reg. No. 3,455,365**

**Registered June 24, 2008**

**SERVICE MARK  
PRINCIPAL REGISTER**

**1903 EQUITY FUND, L.P.**

GORDON BROTHERS GROUP, LLC (DELA-  
WARE LTD LIAB CO)  
101 HUNTINGTON AVENUE, 10TH FLOOR  
BOSTON, MA 02199

FOR: MUTUAL FUND SERVICES, NAMELY,  
ESTABLISHING MUTUAL FUNDS FOR OTHERS;  
INVESTING THE FUNDS OF OTHERS; INVEST-  
MENT ADVISORY SERVICES , IN CLASS 36 (U.S.  
CLS. 100, 101 AND 102).

FIRST USE 2-28-2006; IN COMMERCE 2-28-2006.

THE MARK CONSISTS OF STANDARD CHAR-  
ACTERS WITHOUT CLAIM TO ANY PARTICULAR  
FONT, STYLE, SIZE, OR COLOR.

OWNER OF U.S. REG. NOS. 2,941,085 AND  
2,993,710.

NO CLAIM IS MADE TO THE EXCLUSIVE  
RIGHT TO USE "EQUITY FUND, L.P.", APART  
FROM THE MARK AS SHOWN.

SEC. 2(F) AS TO "1903".

SN 78-748,528, FILED 11-7-2005.

SIMON TENG, EXAMINING ATTORNEY

**Int. Cl.: 35**

**Prior U.S. Cls.: 100, 101, and 102**

**United States Patent and Trademark Office**

**Reg. No. 3,455,366**

**Registered June 24, 2008**

**SERVICE MARK  
PRINCIPAL REGISTER**

**CHINESE LONG-LIFE SYSTEM**

FUREY, MATT (UNITED STATES INDIVIDUAL)  
10339 BIRDWATCH DRIVE  
TAMPA, FL 33647

FOR: BUSINESS INFORMATION IN THE FIELD OF HEALTH, FITNESS AND WELLNESS; ON-LINE RETAIL STORE SERVICES FEATURING CLOTHING, EDUCATIONAL MATERIALS, WORKBOOKS, PRINTED LITERATURE, DVDS, CDS AND VIDEOS ALL IN THE FIELD OF HEALTH, FITNESS AND WELLNESS; PROMOTING THE GOODS AND SERVICES OF OTHERS BY PROVIDING A WEB SITE AT WHICH USERS CAN LINK TO IN THE FIELD OF HEALTH, FITNESS AND WELLNESS; PROVIDING INFORMATION ABOUT THE GOODS AND SERVICES OF OTHERS VIA THE GLOBAL COMPUTER NETWORK; PROVIDING ON-LINE DIRECTORY

INFORMATION SERVICES ALSO FEATURING HYPERLINKS TO OTHER WEB SITES, IN CLASS 35 (U.S. CLS. 100, 101 AND 102).

FIRST USE 9-0-2005; IN COMMERCE 12-0-2005.

THE MARK CONSISTS OF STANDARD CHARACTERS WITHOUT CLAIM TO ANY PARTICULAR FONT, STYLE, SIZE, OR COLOR.

NO CLAIM IS MADE TO THE EXCLUSIVE RIGHT TO USE "CHINESE" AND "SYSTEM", APART FROM THE MARK AS SHOWN.

SN 78-749,537, FILED 11-8-2005.

ALEX KEAM, EXAMINING ATTORNEY

**Int. Cl.: 17**

**Prior U.S. Cls.: 1, 5, 12, 13, 35, and 50**

**Reg. No. 3,455,367**

**United States Patent and Trademark Office**

**Registered June 24, 2008**

**TRADEMARK  
PRINCIPAL REGISTER**

**NATUR-TEC**

NORTHERN TECHNOLOGIES INTERNATIONAL CORPORATION (DELAWARE CORPORATION)  
23205 MERCANTILE ROAD  
BEACHWOOD, OH 44122

FOR: PLASTIC FILMS, SHEETS, AND WRAPPING MADE OF, OR FROM, ONE OR MORE BIODEGRADABLE AND/OR COMPOSTABLE POLYMER RESINS, AND/OR ONE OR MORE BLENDED, COMPOUNDED AND/OR ALLOYED MIXTURES OF BIODEGRADABLE AND/OR COMPOSTABLE POLYMER RESINS, FOR USE AS COMMERCIAL, INDUSTRIAL AND DOMESTIC PACKING AND/OR PACKAGING; OPEN CELL FOAM FOR USE IN MANUFACTURING OF CONSUMER PRODUCTS AND FOR USE AS INSULATION IN BUILDING AND CONSTRUCTION MADE OF, FROM OR CONTAINING ONE OR MORE BIODEGRADABLE AND/OR COMPOSTABLE POLYMER RESINS, AND/OR ONE OR MORE BLENDED, COMPOUNDED AND/

OR ALLOYED MIXTURES OF BIODEGRADABLE AND/OR COMPOSTABLE POLYMER RESINS; AND PACKING AND/OR PACKAGING FOAM IN ROLL FORM MADE OF, FROM OR CONTAINING ONE OR MORE BIODEGRADABLE AND/OR COMPOSTABLE POLYMER RESINS, AND/OR ONE OR MORE BLENDED, COMPOUNDED AND/OR ALLOYED MIXTURES OF BIODEGRADABLE AND/OR COMPOSTABLE POLYMER RESINS, IN CLASS 17 (U.S. CLS. 1, 5, 12, 13, 35 AND 50).

FIRST USE 9-0-2007; IN COMMERCE 9-0-2007.

THE MARK CONSISTS OF STANDARD CHARACTERS WITHOUT CLAIM TO ANY PARTICULAR FONT, STYLE, SIZE, OR COLOR.

SN 78-749,788, FILED 11-8-2005.

BARNEY CHARLON, EXAMINING ATTORNEY

**Int. Cl.: 40**

**Prior U.S. Cls.: 100, 103, and 106**

**United States Patent and Trademark Office**

**Reg. No. 3,455,368**

**Registered June 24, 2008**

**SERVICE MARK  
PRINCIPAL REGISTER**



PACKAGING DEVELOPMENT RESOURCES,  
INC. (NEW YORK CORPORATION)  
3702 W. CENTRAL AVE.  
SANTA ANA, CA 92704

FOR: CUSTOM MANUFACTURING OF PACKAGING FOR THIRD PARTIES FOR RETAIL AND FOOD ITEMS, IN CLASS 40 (U.S. CLS. 100, 103 AND 106).

FIRST USE 6-1-2006; IN COMMERCE 6-1-2006.

NO CLAIM IS MADE TO THE EXCLUSIVE RIGHT TO USE "PACKAGING DEVELOPMENT RESOURCES", APART FROM THE MARK AS SHOWN.

THE COLOR(S) BLACK, ORANGE, AND BROWN IS/ARE CLAIMED AS A FEATURE OF THE MARK.

THE COLOR BLACK APPEARS IN THE WORDING "PDR PACKAGING DEVELOPMENT RESOUR-

CES", THE COLOR BROWN APPEARS IN THE CRUST PORTION OF THE DESIGN ON THE OUTSIDE OF THE RIGHT-HALF OF THE DARKER SHADED PORTION OF THE CIRCLE DESIGN, AND THE COLOR ORANGE APPEARS WITHIN THE ENTIRE CIRCLE DESIGN IN A LIGHTER SHADE ON THE LEFT AND A DARKER SHADE ON THE RIGHT.

THE MARK CONSISTS OF WORDING "PDR PACKAGING DEVELOPMENT RESOURCES" AND A CIRCLE DESIGN THAT FEATURES A CRUST AROUND THE RIGHT HALF OF THE CIRCLE DESIGN.

SN 78-750,120, FILED 11-9-2005.

WARREN L. OLANDRIA, EXAMINING ATTORNEY

**Int. Cl.: 14**

**Prior U.S. Cls.: 2, 27, 28, and 50**

**United States Patent and Trademark Office**

**Reg. No. 3,455,369**

**Registered June 24, 2008**

**TRADEMARK  
PRINCIPAL REGISTER**

# CARDINALS

ST. LOUIS CARDINALS, LLC (MISSOURI LTD  
LIAB CO)  
700 CLARK STREET  
ST. LOUIS, MO 63102

FOR: JEWELRY, NAMELY, BRACELETS,  
CHARMS, EARRINGS, RINGS, BELLY RINGS,  
NECKLACES, PENDANTS, WATCHES, COSTUME  
JEWELRY, RUBBER OR SILICONE BRACELETS  
AND/OR WRISTBANDS, MEDALLIONS, ORNA-  
MENTAL METAL PINS, LAPEL PINS, TIE CLIPS,  
TIE FASTENERS, CUFF LINKS, METAL BELT  
BUCKLES OF PRECIOUS METAL, TIE TACKS, TIE  
PINS, MONEY CLIPS OF PRECIOUS METAL, ME-  
TAL KEY CHAINS, METAL KEY RINGS, CLOCKS,  
WALL CLOCKS, ALARM CLOCKS, FOB WATCHES,  
CLOCK KEY CHAINS, AND NON-MONETARY  
COINS OF PRECIOUS METAL, ALL OF THE FORE-

GOING RELATING TO BASEBALL OR A BASE-  
BALL TEAM, IN CLASS 14 (U.S. CLS. 2, 27, 28 AND  
50).

FIRST USE 0-0-1982; IN COMMERCE 0-0-1982.

THE MARK CONSISTS OF STANDARD CHAR-  
ACTERS WITHOUT CLAIM TO ANY PARTICULAR  
FONT, STYLE, SIZE, OR COLOR.

OWNER OF U.S. REG. NOS. 1,566,743 AND  
2,563,494.

SN 78-750,629, FILED 11-9-2005.

SALLY SHIH, EXAMINING ATTORNEY



**Int. Cl.: 9**

**Prior U.S. Cls.: 21, 23, 26, 36, and 38**

**United States Patent and Trademark Office**

**Reg. No. 3,455,370**

**Registered June 24, 2008**

**TRADEMARK  
PRINCIPAL REGISTER**

**WAVE WARRIORS**

ASTRODECK, INC. (CALIFORNIA CORPORATION)  
950 CALLE AMANECER, SUITE B  
SAN CLEMENTE, CA 92673

FOR: MOTION PICTURE FILMS FEATURING, SURFING AND SURFERS; PRERECORDED COMPACT DISKS FEATURING SURFING AND SURFERS; PRERECORDED VIDEOTAPES FEATURING SURFING AND SURFERS, IN CLASS 9 (U.S. CLS. 21, 23, 26, 36 AND 38).

FIRST USE 6-30-2007; IN COMMERCE 6-30-2007.

THE MARK CONSISTS OF STANDARD CHARACTERS WITHOUT CLAIM TO ANY PARTICULAR FONT, STYLE, SIZE, OR COLOR.

SN 78-751,525, FILED 11-10-2005.

ELLEN B. AWRICH, EXAMINING ATTORNEY

**Int. Cl.: 25**

**Prior U.S. Cls.: 22 and 39**

**United States Patent and Trademark Office**

**Reg. No. 3,455,371**

**Registered June 24, 2008**

**TRADEMARK  
PRINCIPAL REGISTER**

**WAVE WARRIORS**

ASTRODECK, INC. (CALIFORNIA CORPORATION)  
950 CALLE AMANECER, SUITE B  
SAN CLEMENTE, CA 92673

THE MARK CONSISTS OF STANDARD CHARACTERS WITHOUT CLAIM TO ANY PARTICULAR FONT, STYLE, SIZE, OR COLOR.

FOR: CLOTHING, NAMELY, SHIRTS, T-SHIRTS,  
IN CLASS 25 (U.S. CLS. 22 AND 39).

SN 78-752,398, FILED 11-11-2005.

FIRST USE 5-31-2006; IN COMMERCE 5-31-2006.

ELLEN B. AWRICH, EXAMINING ATTORNEY

**Int. Cl.: 3**

**Prior U.S. Cls.: 1, 4, 6, 50, 51, and 52**

**Reg. No. 3,455,372**

**United States Patent and Trademark Office**

**Registered June 24, 2008**

**TRADEMARK  
PRINCIPAL REGISTER**

**GARRYFLEX**

ATI GARRYSON LIMITED (ENGLAND CORPORATION)

SPRING ROAD, IBSTOCK

LEICESTERSHIRE LE67 6LR, ENGLAND

FOR: ABRASIVES AND ABRASIVE PRODUCTS, NAMELY, ABRASIVE DISCS, ABRASIVE ROLLS, ABRASIVE BLOCKS, AND ABRASIVE WHEELS; ALL-PURPOSE CLEANING, POLISHING AND SCOURING PREPARATIONS, IN CLASS 3 (U.S. CLS. 1, 4, 6, 50, 51 AND 52).

FIRST USE 0-0-1996; IN COMMERCE 0-0-1996.

THE MARK CONSISTS OF STANDARD CHARACTERS WITHOUT CLAIM TO ANY PARTICULAR FONT, STYLE, SIZE, OR COLOR.

OWNER OF UNITED KINGDOM REG. NO. 1437352, DATED 10-25-1991, RENEWED AS REG. NO. 1437352, DATED 8-25-2007, EXPIRES 8-25-2017.

OWNER OF UNITED KINGDOM REG. NO. 1437792, DATED 1-10-1992, RENEWED AS REG. NO. 1437792, DATED 8-22-2007, EXPIRES 8-22-2017.

SN 78-753,288, FILED 11-14-2005.

SARA THOMAS, EXAMINING ATTORNEY

**Int. Cl.: 25**

**Prior U.S. Cls.: 22 and 39**

**United States Patent and Trademark Office**

**Reg. No. 3,455,373**

**Registered June 24, 2008**

**TRADEMARK  
PRINCIPAL REGISTER**

# IOS Infinity Denim

TRAVELSMITH OUTFITTERS, INC (CALIFORNIA CORPORATION)  
60 LEVERONI COURT SUITE 1  
NOVATO, CA 94949

FOR: WOMEN'S CLOTHING, NAMELY, SHIRTS, JACKETS, PANTS, CAPRIS, SHORTS, TANK TOPS, JEANS, TUNICS, SHIRT JACKETS, DRESSES, SKIRTS, KIMONOS, VESTS, COATS; ACCESSORIES, NAMELY, BELTS, HATS; SHOES, NAMELY, BOOTS, SANDALS, TENNIS SHOES, SLIPPERS, MOCCASINS, MULES, IN CLASS 25 (U.S. CLS. 22 AND 39).

FIRST USE 4-0-2006; IN COMMERCE 4-0-2006.

THE MARK CONSISTS OF STANDARD CHARACTERS WITHOUT CLAIM TO ANY PARTICULAR FONT, STYLE, SIZE, OR COLOR.

NO CLAIM IS MADE TO THE EXCLUSIVE RIGHT TO USE "DENIM", APART FROM THE MARK AS SHOWN.

SN 78-754,114, FILED 11-15-2005.

DOMINIC J. FERRAIUOLO, EXAMINING ATTORNEY

**Int. Cl.: 9**

**Prior U.S. Cls.: 21, 23, 26, 36, and 38**

**Reg. No. 3,455,374**

**United States Patent and Trademark Office**

**Registered June 24, 2008**

**TRADEMARK  
PRINCIPAL REGISTER**

**SAFECOM**

SAFEMARK SYSTEMS, LP (DELAWARE CORPORATION)  
2101 PARK CENTER DRIVE, SUITE 125  
ORLANDO, FL 32835

THE MARK CONSISTS OF STANDARD CHARACTERS WITHOUT CLAIM TO ANY PARTICULAR FONT, STYLE, SIZE, OR COLOR.

FOR: ELECTRONIC SAFES INCORPORATING A USE-MONITORING FEATURE FOR USE IN THE HOSPITALITY AND RESORT INDUSTRY, IN CLASS 9 (U.S. CLS. 21, 23, 26, 36 AND 38).

SN 78-755,454, FILED 11-16-2005.

FIRST USE 4-0-2006; IN COMMERCE 6-0-2007.

MONIQUE MILLER, EXAMINING ATTORNEY

**Int. Cls.: 9 and 16**

**Prior U.S. Cls.: 2, 5, 21, 22, 23, 26, 29, 36, 37, 38, and 50**

**United States Patent and Trademark Office**

**Reg. No. 3,455,375**

**Registered June 24, 2008**

**TRADEMARK  
PRINCIPAL REGISTER**

**SSDS**

SELF STORAGE DATA SERVICES, INC. (CALIFORNIA CORPORATION)  
7470 NORTH FIGUEROA STREET, SUITE 301  
LOS ANGELES, CA 900411717

FOR: PUBLICATIONS, NAMELY, DOWNLOADABLE ELECTRONIC PUBLICATIONS IN THE NATURE OF NEWSLETTERS PROVIDING INFORMATION ABOUT THE SELF-STORAGE INDUSTRY, IN CLASS 9 (U.S. CLS. 21, 23, 26, 36 AND 38).

FIRST USE 1-1-2003; IN COMMERCE 1-1-2003.

FOR: PUBLICATIONS, NAMELY, PRINTED PUBLICATIONS IN THE NATURE OF NEWSLETTERS

PROVIDING INFORMATION ABOUT THE SELF-STORAGE INDUSTRY, IN CLASS 16 (U.S. CLS. 2, 5, 22, 23, 29, 37, 38 AND 50).

FIRST USE 1-1-1992; IN COMMERCE 1-1-1992.

THE MARK CONSISTS OF STANDARD CHARACTERS WITHOUT CLAIM TO ANY PARTICULAR FONT, STYLE, SIZE, OR COLOR.

SN 78-755,509, FILED 11-16-2005.

MARY MUNSON, EXAMINING ATTORNEY

**Int. Cl.: 36**

**Prior U.S. Cls.: 100, 101, and 102**

**United States Patent and Trademark Office**

**Reg. No. 3,455,376**

**Registered June 24, 2008**

**SERVICE MARK  
PRINCIPAL REGISTER**

**PRETIREMENT**

MEMBERS DEVELOPMENT COMPANY, LLC  
(WISCONSIN LTD LIAB CO)  
5910 MINERAL POINT ROAD  
MADISON, WI 53705

FOR: INVESTMENT ADVISORY AND FINANCIAL MANAGEMENT SERVICES, NAMELY, HELPING INDIVIDUALS UNDERSTAND THE IMPORTANCE OF INCLUDING RETIREMENT PLANNING AS PART OF THEIR OVERALL FINANCIAL PLANNING AND INVESTMENT EFFORTS NO MATTER WHAT THEIR AGE OR STAGE OF LIFE AND PROVIDING ON-GOING FINANCIAL ANALYSIS AND CONSULTATION RELATED TO SAVINGS, CREDIT AND INVESTMENT PRODUCTS

TO MAKE A FINANCIALLY SECURE RETIREMENT A REALITY, IN CLASS 36 (U.S. CLS. 100, 101 AND 102).

FIRST USE 10-29-2007; IN COMMERCE 10-29-2007.

THE MARK CONSISTS OF STANDARD CHARACTERS WITHOUT CLAIM TO ANY PARTICULAR FONT, STYLE, SIZE, OR COLOR.

SN 78-755,885, FILED 11-17-2005.

KEVIN DINALLO, EXAMINING ATTORNEY

**Int. Cl.: 5**

**Prior U.S. Cls.: 6, 18, 44, 46, 51, and 52**

**Reg. No. 3,455,377**

**United States Patent and Trademark Office**

**Registered June 24, 2008**

---

**TRADEMARK  
PRINCIPAL REGISTER**

**SUPPORT NUTRITION**

ELLA INTERNATIONAL, INC. (CALIFORNIA CORPORATION)  
27430 BOSTIK COURT, SUITE 102  
TEMECULA, CA 92590

FOR: VITAMINS, HERBAL SUPPLEMENTS, MINERAL SUPPLEMENTS, NUTRITIONAL SUPPLEMENTS, AND DIETARY SUPPLEMENTS, IN CLASS 5 (U.S. CLS. 6, 18, 44, 46, 51 AND 52).

FIRST USE 11-1-2006; IN COMMERCE 12-1-2006.

THE MARK CONSISTS OF STANDARD CHARACTERS WITHOUT CLAIM TO ANY PARTICULAR FONT, STYLE, SIZE, OR COLOR.

NO CLAIM IS MADE TO THE EXCLUSIVE RIGHT TO USE "NUTRITION", APART FROM THE MARK AS SHOWN.

SN 78-755,970, FILED 11-17-2005.

KELLY MCCOY, EXAMINING ATTORNEY



Int. Cl.: 9

Prior U.S. Cls.: 21, 23, 26, 36, and 38

Reg. No. 3,455,378

United States Patent and Trademark Office

Registered June 24, 2008

TRADEMARK  
PRINCIPAL REGISTER



LITE-ON IT CORPORATION (TAIWAN CORPORATION)  
15 F, NO. 392, RUEY KUANG ROAD, NEIHU DISTRICT,  
TAIPEI CITY, TAIWAN

FOR: CD-ROM DRIVES; DVD-ROM DRIVES; CD-RW DRIVES; EXTERNAL AND INTERNAL DVD RW DRIVES; BLUE LASER OPTICAL DISC DRIVE; COMPUTER DISC DRIVES; BLANK COMPUTER DISCS; BLANK COMPACT DISCS; BLANK VIDEO TAPES; BLANK VIDEO CASSETTES FOR THE RECORDING, TRANSMISSION OR REPRODUCTION OF SOUND AND IMAGES; DVD PLAYERS AND RECORDERS; COMPACT DISC PLAYERS AND RECORDERS; VIDEO DISC PLAYERS AND RECORDERS; WEB DVD PLAYERS; DVD RECORDER PLAYERS; PORTABLE DVD PLAYERS; MINI DISK PLAYERS; LASER DISC PLAYERS; VIDEO CASSETTE PLAYERS AND RECORDERS; AUDIO TAPE PLAYERS AND RECORDERS; VIDEO TAPE RECORDERS; DIGITAL VIDEO RECORDERS; VIDEO CASSETTE RECORDERS; OPTICAL SCANNERS; CAMCORDER; CAMERA; AUTOMOBILE AUDIO AND VIDEO COMPONENTS, NAMELY SPEAKERS, TAPE PLAYERS, COMPACT DISC PLAYERS, VIDEO DISC PLAYER; DVD PLAYERS, RADIOS, STEREO TUNERS AND RECEIVERS FOR TELEPHONE, AUDIO AND VIDEO, AMPLIFIERS, AND PREAMPLIFIERS; TELEPHONE; CELLULAR TELEPHONE ACCESSORIES, NAMELY, CELLULAR

TELEPHONE COVERS NOT MADE OF PAPER, ADAPTERS, CHARGERS, HEADSETS, CASES NOT MADE OF PAPER, RADIO HEADPHONES, RADIO SPEAKERS, COMPUTER SPEAKERS, STEREO SPEAKERS; TELEVISION SETS; VIDEO PROJECTORS; HEADPHONES AND HEADSETS FOR USE WITH COMPUTERS; COMPUTERS; COMPUTER MONITORS; VIDEO MONITORS; TV REMOTE CONTROL; STEREOS; STEREO PREAMPLIFIERS; AUDIO AND VOICE RECEIVERS; TV AND VIDEO CONVERTERS; APPARATUS FOR RECORDING, TRANSMISSION OR REPRODUCTION OF SOUND OR IMAGES; AUDIO SPEAKERS; HI-FI SYSTEMS COMPRISING OF MAIN LOUDSPEAKERS, SURROUND LOUDSPEAKERS, CENTER LOUDSPEAKERS, SUBWOOFERS, STEREO TUNERS, SOUND AMPLIFIERS, VIDEO DISC PLAYER; DVD PLAYERS, AUDIO CASSETTE DECKS FOR AUTOMOBILES, MICROPHONES, AUDIO ACCESSORIES, NAMELY, ELECTRICAL AUDIO CABLES AND ELECTRICAL AUDIO WIRES, VIDEO ACCESSORIES, NAMELY, ELECTRICAL VIDEO CABLES, AND ELECTRICAL VIDEO WIRES AND PARTS THEREOF, IN CLASS 9 (U.S. CLS. 21, 23, 26, 36 AND 38).

FIRST USE 1-12-2006; IN COMMERCE 1-12-2006.

SN 78-756,229, FILED 11-17-2005.

INGA ERVIN, EXAMINING ATTORNEY

**Int. Cl.: 20**

**Prior U.S. Cls.: 2, 13, 22, 25, 32, and 50**

**Reg. No. 3,455,379**

**United States Patent and Trademark Office**

**Registered June 24, 2008**

**TRADEMARK  
PRINCIPAL REGISTER**

**SIR PEDIC**

FURNITURE BARGAINS, L.L.C. (ILLINOIS LIMITED LIABILITY COMPANY)  
200 WEST MADISON STREET, SUITE 4200  
CHICAGO, IL 60606

THE MARK CONSISTS OF STANDARD CHARACTERS WITHOUT CLAIM TO ANY PARTICULAR FONT, STYLE, SIZE, OR COLOR.

FOR: MATTRESSES AND BOX SPRINGS, IN CLASS 20 (U.S. CLS. 2, 13, 22, 25, 32 AND 50).

SN 78-756,367, FILED 11-17-2005.

FIRST USE 11-0-2005; IN COMMERCE 1-0-2006.

SUSAN STIGLITZ, EXAMINING ATTORNEY

**Int. Cls.: 9 and 17**

**Prior U.S. Cls.: 1, 5, 12, 13, 21, 23, 26, 35, 36, 38, and 50**

**United States Patent and Trademark Office**

**Reg. No. 3,455,380**

**Registered June 24, 2008**

**TRADEMARK  
PRINCIPAL REGISTER**

**SUPERBUNDY**

FLINT TRADING, INC. (NORTH CAROLINA CORPORATION)  
115 TODD COURT  
THOMASVILLE, NC 27360

FOR: THERMOPLASTIC PAVEMENT MARKERS IN THE NATURE OF FINISHED SHEETS FOR SAFETY AND TRAFFIC CONTROL PURPOSES, IN CLASS 9 (U.S. CLS. 21, 23, 26, 36 AND 38).

FIRST USE 3-4-2008; IN COMMERCE 3-10-2008.

FOR: THERMOPLASTIC PAVEMENT MARKERS IN THE NATURE OF FINISHED SHEETS FOR

DECORATIVE PURPOSES, IN CLASS 17 (U.S. CLS. 1, 5, 12, 13, 35 AND 50).

FIRST USE 3-4-2008; IN COMMERCE 3-10-2008.

THE MARK CONSISTS OF STANDARD CHARACTERS WITHOUT CLAIM TO ANY PARTICULAR FONT, STYLE, SIZE, OR COLOR.

OWNER OF U.S. REG. NO. 1,990,666.

SN 78-757,998, FILED 11-21-2005.

DARRYL SPRUILL, EXAMINING ATTORNEY

**Int. Cls.: 38, 41, and 45**

**Prior U.S. Cls.: 100, 101, 104, and 107**

**United States Patent and Trademark Office**

**Reg. No. 3,455,381**

**Registered June 24, 2008**

**SERVICE MARK  
PRINCIPAL REGISTER**

# METROMOJO

METRO MOJO, LLC (KENTUCKY LTD LIAB CO)  
1190 E. BROADWAY  
LOUISVILLE, KY 40204

FOR: PROVIDING LOCALLY-FOCUSED ON-LINE FORUMS FOR TRANSMISSION OF PUBLIC MESSAGES AMONG COMPUTER USERS CONCERNING A BROAD RANGE OF SUBJECTS AND TOPICS OF GENERAL INTEREST TO USERS AND USER GROUPS; INSTANT MESSAGING SERVICES, IN CLASS 38 (U.S. CLS. 100, 101 AND 104).

FIRST USE 7-15-2003; IN COMMERCE 7-15-2003.

FOR: WRITER PUBLISHING SERVICES, NAME-  
LY, THE PUBLICATION OF USER-GENERATED  
TEXT AND GRAPHIC WORKS ON-LINE FEATUR-  
ING A BROAD RANGE OF SUBJECTS AND TOPICS,  
NAMELY, ART AND LITERATURE, AUTOMO-  
TIVE, BUSINESS AND NETWORKING, FILM AND  
TELEVISION, FOOD AND DINING, HEALTH AND  
BEAUTY, HOME AND GARDEN, MUSIC, PARENT-  
ING AND CHILDREN, PETS, POLITICS, TECHNOL-  
OGY AND VIDEO GAMES, SEASONAL TOPICS,

SPORTS, TRAVEL, JOBS, AND BUSINESS REVIEWS,  
IN CLASS 41 (U.S. CLS. 100, 101 AND 107).

FIRST USE 7-15-2003; IN COMMERCE 7-15-2003.

FOR: SOCIAL INTRODUCTION SERVICES,  
NAMELY, PROVIDING ON-LINE PERSONAL PRO-  
FILES INCLUDING AN ONLINE GALLERY TO  
ENABLE OTHERS TO DISPLAY PHOTOGRAPHS  
AND DETAILED INFORMATION TO GEOGRAPHI-  
CALLY-TARGETED USERS FOR THE PURPOSE OF  
SOCIAL INTERACTION, IN CLASS 45 (U.S. CLS. 100  
AND 101).

FIRST USE 7-15-2003; IN COMMERCE 7-15-2003.

THE MARK CONSISTS OF STANDARD CHAR-  
ACTERS WITHOUT CLAIM TO ANY PARTICULAR  
FONT, STYLE, SIZE, OR COLOR.

SN 78-758,503, FILED 11-21-2005.

SANDRA MANIOS, EXAMINING ATTORNEY

Int. Cls.: 9, 16, 25, 35, and 41

Prior U.S. Cls.: 2, 5, 21, 22, 23, 26, 29, 36, 37, 38, 39,  
50, 100, 101, 102, and 107

Reg. No. 3,455,382

United States Patent and Trademark Office

Registered June 24, 2008

**TRADEMARK  
SERVICE MARK  
PRINCIPAL REGISTER**

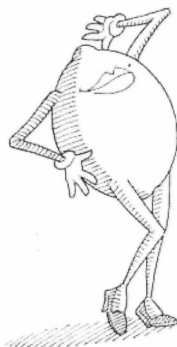

ZINDA, GAYLE M. (UNITED STATES INDIVIDUAL)  
3294 BROOKLYN DRIVE  
STOUGHTON, WI 53589 AND  
ZINDA, MICHAEL W. (UNITED STATES INDIVIDUAL)  
3294 BROOKLYN DRIVE  
STOUGHTON, WI 53589

FOR: PRE-RECORDED AUDIO AND VIDEO CASSETTES; COMPACT DISCS AND TAPES; CD-ROMS AND PRE-RECORDED DVDS AND DIGITAL DISCS ALL FEATURING INFORMATION ON DIET, EMOTIONAL STRESSES, EXERCISE, HEALTH, LIFESTYLE, PHYSICAL CHALLENGES AND PHYSICAL FITNESS, RELATIONSHIPS, SPIRITUALITY, AND CHARITABLE FUND RAISING ACTIVITIES, IN CLASS 9 (U.S. CLS. 21, 23, 26, 36 AND 38).

FIRST USE 11-22-2005; IN COMMERCE 11-22-2005.

FOR: PRINTED MATTER, NAMELY, BOOKLETS, BROCHURES, HANDBOOKS, JOURNALS, LEAFLETS, NEWSLETTERS, MAGAZINES AND TRAINING MANUALS ALL FEATURING DIET, EMOTIONAL STRESSES, EXERCISE, HEALTH, LIFESTYLE, PHYSICAL CHALLENGES AND PHYSICAL FITNESS, RELATIONSHIPS, SPIRITUALITY, AND CHARITABLE FUND RAISING ACTIVITIES; CALENDARS; DIARIES; GREETING CARDS; POSTCARDS; SERIES OF BOOKS IN THE FIELD OF DIET, EMOTIONAL STRESSES, EXERCISE, HEALTH, LIFESTYLE, PHYSICAL CHALLENGES

AND PHYSICAL FITNESS, RELATIONSHIPS, SPIRITUALITY, AND CHARITABLE FUND RAISING ACTIVITIES; MOUNTED AND UNMOUNTED PHOTOGRAPHS; STICKERS, IN CLASS 16 (U.S. CLS. 2, 5, 22, 23, 29, 37, 38 AND 50).

FIRST USE 11-22-2005; IN COMMERCE 11-22-2005.

FOR: CLOTHING, NAMELY, APRONS, BANDANAS, DRESSES, FOOTWEAR, HATS, HOSIERY, JEANS, PAJAMAS, PANTS, SHIRTS, SHORTS, SWEATERS, SWEATSHIRTS, T-SHIRTS, UNDERWEAR; BEACH CLOTHES, NAMELY, BATHING SUITS; OUTERWEAR, NAMELY, JACKETS; AND CLOTHING ACCESSORIES, NAMELY, BELTS, EAR MUFFS, MITTENS AND GLOVES, NECKTIES, SCARVES AND VISORS, IN CLASS 25 (U.S. CLS. 22 AND 39).

FIRST USE 11-22-2005; IN COMMERCE 11-22-2005.

FOR: RETAIL STORE SERVICES, MAIL ORDER CATALOG SERVICES, AND ELECTRONIC RETAILING SERVICES VIA A COMPUTER FEATURING BOOKS, CANES, CLOTHING, COSMETICS, HATS AND HEAD COVERINGS, JEWELRY, PERSONAL HYGIENE PRODUCTS, UNDERGARMENTS, PILLOWS, TAPES, THERAPY ITEMS, THERAPEUTIC PRODUCTS; BUSINESS CONSULTING IN THE FIELD OF DIET, EMOTIONAL STRESSES, EXERCISE, HEALTH, LIFESTYLE, PHYSICAL CHALLENGES AND PHYSICAL FITNESS, RELATIONSHIPS, SPIRITUALITY, AND CHARITABLE FUND RAIS-

ING ACTIVITIES, IN CLASS 35 (U.S. CLS. 100, 101 AND 102).

FIRST USE 11-22-2005; IN COMMERCE 11-22-2005.

FOR: EDUCATIONAL AND INSTRUCTIONAL SERVICES, NAMELY, ARRANGING AND CONDUCTING CLASSES, CONFERENCES, DISCUSSION GROUPS, SEMINARS AND WORKSHOPS IN THE FIELDS OF DIET, EMOTIONAL STRESSES, EXERCISE, HEALTH, LIFESTYLE, PHYSICAL CHALLENGES AND PHYSICAL FITNESS, RELATIONSHIPS, SPIRITUALITY AND CHARITABLE FUND RAISING ACTIVITIES; ENTERTAINMENT SERVICES, NAMELY, LIVE SPEAKING ENGAGEMENTS IN THE FIELDS OF DIET, EMOTIONAL STRESSES, EXERCISE, HEALTH, LIFESTYLE, PHYSICAL CHALLENGES AND PHYSICAL FITNESS, RELATIONSHIPS, SPIRITUALITY, AND CHARITABLE FUND RAISING ACTIVITIES; COACHING SERVI-

CES, IN THE FIELDS OF DIET, EMOTIONAL STRESSES, EXERCISE, HEALTH, LIFESTYLE, PHYSICAL CHALLENGES AND PHYSICAL FITNESS, RELATIONSHIPS, SPIRITUALITY, AND CHARITABLE FUND RAISING ACTIVITIES; AND DISSEMINATION OF EDUCATIONAL LITERATURE OF OTHERS IN THE FIELDS OF DIET, EMOTIONAL STRESSES, EXERCISE, HEALTH, LIFESTYLE, PHYSICAL CHALLENGES AND PHYSICAL FITNESS, RELATIONSHIPS, SPIRITUALITY AND CHARITABLE FUND RAISING ACTIVITIES, IN CLASS 41 (U.S. CLS. 100, 101 AND 107).

FIRST USE 11-22-2005; IN COMMERCE 11-22-2005.

THE MARK CONSISTS OF "GIRL LEMON".

SN 78-758,712, FILED 11-21-2005.

GILBERT SWIFT, EXAMINING ATTORNEY

Int. Cls.: 9, 16, 25, 35, and 41

Prior U.S. Cls.: 2, 5, 21, 22, 23, 26, 29, 36, 37, 38, 39,  
50, 100, 101, 102, and 107

Reg. No. 3,455,383

United States Patent and Trademark Office

Registered June 24, 2008

**TRADEMARK  
SERVICE MARK  
PRINCIPAL REGISTER**

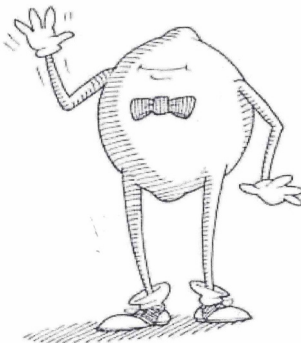

ZINDA, GAYLE M. (UNITED STATES INDIVIDUAL)  
3294 BROOKLYN DRIVE  
STOUGHTON, WI 53589 AND  
ZINDA, MICHAEL W. (UNITED STATES INDIVIDUAL)  
3294 BROOKLYN DRIVE  
STOUGHTON, WI 53589

FOR: PRE-RECORDED AUDIO AND VIDEO CASSETTES; COMPACT DISCS AND TAPES; CD-ROMS AND PRE-RECORDED DVDS AND DIGITAL DISCS ALL FEATURING INFORMATION ON DIET, EMOTIONAL STRESSES, EXERCISE, HEALTH, LIFESTYLE, PHYSICAL CHALLENGES AND PHYSICAL FITNESS, RELATIONSHIPS, SPIRITUALITY, AND CHARITABLE FUND RAISING ACTIVITIES, IN CLASS 9 (U.S. CLS. 21, 23, 26, 36 AND 38).

FIRST USE 11-22-2005; IN COMMERCE 11-22-2005.

FOR: PRINTED MATTER, NAMELY, BOOKLETS, BROCHURES, HANDBOOKS, JOURNALS, LEAFLETS, NEWSLETTERS, MAGAZINES AND TRAINING MANUALS ALL FEATURING DIET, EMOTIONAL STRESSES, EXERCISE, HEALTH, LIFESTYLE, PHYSICAL CHALLENGES AND PHYSICAL FITNESS, RELATIONSHIPS, SPIRITUALITY, AND CHARITABLE FUND RAISING ACTIVITIES; CALENDARS; DIARIES; GREETING CARDS; POSTCARDS; SERIES OF BOOKS IN THE FIELD OF DIET, EMOTIONAL STRESSES, EXERCISE, HEALTH, LIFESTYLE, PHYSICAL CHALLENGES

AND PHYSICAL FITNESS, RELATIONSHIPS, SPIRITUALITY, AND CHARITABLE FUND RAISING ACTIVITIES; MOUNTED AND UNMOUNTED PHOTOGRAPHS; STICKERS, IN CLASS 16 (U.S. CLS. 2, 5, 22, 23, 29, 37, 38 AND 50).

FIRST USE 11-22-2005; IN COMMERCE 11-22-2005.

FOR: CLOTHING, NAMELY, APRONS, BANDANAS, DRESSES, FOOTWEAR, HATS, HOSE, JEANS, PAJAMAS, PANTS, SHIRTS, SHORTS, SWEATERS, SWEATSHIRTS, T-SHIRTS, UNDERWEAR; BEACH CLOTHES, NAMELY, BATHING SUITS; OUTERWEAR, NAMELY, JACKETS; AND CLOTHING ACCESSORIES, NAMELY, BELTS, EAR MUFFS, MITTENS AND GLOVES, NECKTIES, SCARVES AND VISORS, IN CLASS 25 (U.S. CLS. 22 AND 39).

FIRST USE 11-22-2005; IN COMMERCE 11-22-2005.

FOR: RETAIL STORE SERVICES, MAIL ORDER CATALOG SERVICES, AND ELECTRONIC RETAILING SERVICES VIA A COMPUTER FEATURING BOOKS, CANES, CLOTHING, COSMETICS, HATS AND HEAD COVERINGS, JEWELRY, PERSONAL HYGIENE PRODUCTS, UNDERGARMENTS, PILLOWS, TAPES, THERAPY ITEMS, THERAPEUTIC PRODUCTS; BUSINESS CONSULTING IN THE FIELD OF DIET, EMOTIONAL STRESSES, EXERCISE, HEALTH, LIFESTYLE, PHYSICAL CHALLENGES AND PHYSICAL FITNESS, RELATIONSHIPS, SPIRITUALITY, AND CHARITABLE FUND RAIS-

ING ACTIVITIES, IN CLASS 35 (U.S. CLS. 100, 101 AND 102).

FIRST USE 11-22-2005; IN COMMERCE 11-22-2005.

FOR: EDUCATIONAL AND INSTRUCTIONAL SERVICES, NAMELY, ARRANGING AND CONDUCTING CLASSES, CONFERENCES, DISCUSSION GROUPS, SEMINARS AND WORKSHOPS IN THE FIELDS OF DIET, EMOTIONAL STRESSES, EXERCISE, HEALTH, LIFESTYLE, PHYSICAL CHALLENGES AND PHYSICAL FITNESS, RELATIONSHIPS, SPIRITUALITY AND CHARITABLE FUND RAISING ACTIVITIES; ENTERTAINMENT SERVICES, NAMELY, LIVE SPEAKING ENGAGEMENTS IN THE FIELDS OF DIET, EMOTIONAL STRESSES, EXERCISE, HEALTH, LIFESTYLE, PHYSICAL CHALLENGES AND PHYSICAL FITNESS, RELATIONSHIPS, SPIRITUALITY, AND CHARITABLE FUND RAISING ACTIVITIES; COACHING SERVI-

CES, IN THE FIELDS OF DIET, EMOTIONAL STRESSES, EXERCISE, HEALTH, LIFESTYLE, PHYSICAL CHALLENGES AND PHYSICAL FITNESS, RELATIONSHIPS, SPIRITUALITY, AND CHARITABLE FUND RAISING ACTIVITIES; AND DISSEMINATION OF EDUCATIONAL LITERATURE OF OTHERS IN THE FIELDS OF DIET, EMOTIONAL STRESSES, EXERCISE, HEALTH, LIFESTYLE, PHYSICAL CHALLENGES AND PHYSICAL FITNESS, RELATIONSHIPS, SPIRITUALITY AND CHARITABLE FUND RAISING ACTIVITIES, IN CLASS 41 (U.S. CLS. 100, 101 AND 107).

FIRST USE 11-22-2005; IN COMMERCE 11-22-2005.

THE MARK CONSISTS OF "BOY LEMON".

SN 78-758,756, FILED 11-21-2005.

GILBERT SWIFT, EXAMINING ATTORNEY



**Int. Cls.: 35, 36, and 39**

**Prior U.S. Cls.: 100, 101, 102, and 105**

**United States Patent and Trademark Office**

**Reg. No. 3,455,384**

**Registered June 24, 2008**

**SERVICE MARK  
PRINCIPAL REGISTER**



DUNBAR ARMORED, INC. (MARYLAND CORPORATION)  
50 SCHILLING ROAD  
HUNT VALLEY, MD 21030

FOR: COMPUTERIZED TRACKING AND TRACKING OF INTERNATIONAL PACKAGES IN TRANSIT VIA INTRANET AND INTERNET; CUSTOMS CLEARANCE SERVICES, IN CLASS 35 (U.S. CLS. 100, 101 AND 102).

FIRST USE 1-2-2007; IN COMMERCE 1-2-2007.

FOR: CASH MANAGEMENT SERVICES IN THE FIELD OF MONEY, JEWELS AND OTHER VALUABLES; CHECK PROCESSING, IN CLASS 36 (U.S. CLS. 100, 101 AND 102).

FIRST USE 1-2-2007; IN COMMERCE 1-2-2007.

FOR: ARMORED CAR TRANSPORT IN THE FIELD OF INTERNATIONAL TRANSACTIONS, IN CLASS 39 (U.S. CLS. 100 AND 105).

FIRST USE 1-2-2007; IN COMMERCE 1-2-2007.

OWNER OF U.S. REG. NOS. 2,108,425, 2,804,671, AND OTHERS.

NO CLAIM IS MADE TO THE EXCLUSIVE RIGHT TO USE "WORLDWIDE VALUABLES &

CASH IN TRANSIT TRACKING & DATA REPORTING", APART FROM THE MARK AS SHOWN.

THE COLORS RED, WHITE AND BLACK ARE CLAIMED AS A FEATURE OF THE MARK.

THE COLOR RED APPEARS IN THE BLOCK LETTERS OF THE NAME "DUNBAR" WITH THE COLOR WHITE AS THE HIGHLIGHT FOR THOSE BLOCK LETTERS. THE COLOR WHITE APPEARS IN THE SHOOTING STAR AND THE LINE INDICATING THE SHOOTING STAR. THE COLOR BLACK APPEARS IN THE BLOCK LETTERS FOR "GLOBAL-TRAK" WITH THE COLOR WHITE AS THE HIGHLIGHT FOR THOSE BLOCK LETTERS. THE COLOR BLACK APPEARS IN THE RECTANGULAR DESIGN UNDERSCORING THE WORDING "DUNBARGLOBAL-TRAK", AND THE COLOR WHITE APPEARS AS THE LETTERS FOR THE WORDS "WORLDWIDE VALUABLES & CASH IN TRANSIT TRACKING & DATA REPORTING" EMBEDDED IN THAT RECTANGULAR DESIGN.

SN 78-760,063, FILED 11-23-2005.

DAWN HAN, EXAMINING ATTORNEY

**Int. Cl.: 23**

**Prior U.S. Cl.: 43**

**United States Patent and Trademark Office**

**Reg. No. 3,455,385**

**Registered June 24, 2008**

**TRADEMARK  
PRINCIPAL REGISTER**

**Starfall**

PANCIL, LLC (CALIFORNIA LTD LIAB CO)  
PO BOX 1046  
LA JOLLA, CA 92038

FOR: YARN, IN CLASS 23 (U.S. CL. 43).

FIRST USE 8-10-2007; IN COMMERCE 8-15-2007.

THE MARK CONSISTS OF STANDARD CHARACTERS WITHOUT CLAIM TO ANY PARTICULAR FONT, STYLE, SIZE, OR COLOR.

OWNER OF U.S. REG. NOS. 2,721,805, 2,883,345, AND OTHERS.

SN 78-760,371, FILED 11-23-2005.

HEATHER THOMPSON, EXAMINING ATTORNEY

**Int. Cl.: 21**

**Prior U.S. Cls.: 2, 13, 23, 29, 30, 33, 40, and 50**

**United States Patent and Trademark Office**

**Reg. No. 3,455,386**

**Registered June 24, 2008**

**TRADEMARK  
PRINCIPAL REGISTER**

**INVISIBLE**

CRS DISTRIBUTORS, INC. (NEW YORK COR-  
PORATION)  
781 SUFFOLK AVENUE  
BRENTWOOD, NY 11717

THE MARK CONSISTS OF STANDARD CHAR-  
ACTERS WITHOUT CLAIM TO ANY PARTICULAR  
FONT, STYLE, SIZE, OR COLOR.

FOR: WINE GLASSES, BEVERAGE GLASSWARE,  
CARAFES, AND DECANTERS, IN CLASS 21 (U.S.  
CLS. 2, 13, 23, 29, 30, 33, 40 AND 50).

SN 78-761,384, FILED 11-28-2005.

FIRST USE 4-1-2008; IN COMMERCE 4-1-2008.

DOMINIC FATHY, EXAMINING ATTORNEY

**Int. Cl.: 16**

**Prior U.S. Cls.: 2, 5, 22, 23, 29, 37, 38, and 50**

**Reg. No. 3,455,387**

**United States Patent and Trademark Office**

**Registered June 24, 2008**

**TRADEMARK  
PRINCIPAL REGISTER**

**INKTENSE**

ACCO UK LIMITED (UNITED KINGDOM CORPORATION)  
OXFORD HOUSE, OXFORD ROAD, AYLESBURY  
BUCKINGHAMSHIRE, UNITED KINGDOM HP21  
8SZ

FOR: PENCILS; PENCILS AND PAINT BRUSHES  
FOR USE IN WATER COLOURS, WATER SOLUBLE  
SKETCHING PENCILS AND DRAWING PENCILS ,  
IN CLASS 16 (U.S. CLS. 2, 5, 22, 23, 29, 37, 38 AND 50).

FIRST USE 2-0-2006; IN COMMERCE 2-0-2006.

THE MARK CONSISTS OF STANDARD CHARACTERS WITHOUT CLAIM TO ANY PARTICULAR FONT, STYLE, SIZE, OR COLOR.

PRIORITY CLAIMED UNDER SEC. 44(D) ON  
ERPN CMNTY TM OFC APPLICATION NO.  
004715165, FILED 10-31-2005, REG. NO. 004715165,  
DATED 11-2-2006, EXPIRES 10-31-2015.

SN 78-761,497, FILED 11-28-2005.

DORITT L. CARROLL, EXAMINING ATTORNEY

**Int. Cl.: 16**

**Prior U.S. Cls.: 2, 5, 22, 23, 29, 37, 38, and 50**

**United States Patent and Trademark Office**

**Reg. No. 3,455,388**

**Registered June 24, 2008**

**TRADEMARK  
PRINCIPAL REGISTER**

**COLOURSOFT**

ACCO UK LIMITED (UNITED KINGDOM CORPORATION)

OXFORD HOUSE, OXFORD ROAD, AYLESBURY

BUCKINGHAMSHIRE, UNITED KINGDOM HP21  
8SZ

FOR: PENCILS; COLOURING PENCILS, IN  
CLASS 16 (U.S. CLS. 2, 5, 22, 23, 29, 37, 38 AND 50).

FIRST USE 11-0-2006; IN COMMERCE 11-0-2006.

THE MARK CONSISTS OF STANDARD CHARACTERS WITHOUT CLAIM TO ANY PARTICULAR FONT, STYLE, SIZE, OR COLOR.

PRIORITY CLAIMED UNDER SEC. 44(D) ON ERPN CMNTY TM OFC APPLICATION NO. 004703831, FILED 10-25-2005, REG. NO. 004703831, DATED 10-11-2006, EXPIRES 10-25-2015.

SN 78-762,016, FILED 11-28-2005.

DORITT L. CARROLL, EXAMINING ATTORNEY

**Int. Cl.: 5**

**Prior U.S. Cls.: 6, 18, 44, 46, 51, and 52**

**Reg. No. 3,455,389**

**United States Patent and Trademark Office**

**Registered June 24, 2008**

---

**TRADEMARK  
PRINCIPAL REGISTER**

**PHARMACY'S PRESCRIPTION**

AMERICAN CONSUMER PRODUCTS, LLC (CALIFORNIA LIMITED LIABILITY COMPANY)  
10883 KINROSS AVENUE, STE. B  
LOS ANGELES, CA 90024

FOR: HYDROGEN PEROXIDE FOR MEDICAL USE; RUBBING ALCOHOL; COUGH TREATMENT PREPARATIONS; PREPARATIONS FOR TREATING COLDS; TOPICAL ANALGESICS; ANTI-BACTERIAL CREAMS AND OINTMENTS, IN CLASS 5 (U.S. CLS. 6, 18, 44, 46, 51 AND 52).

FIRST USE 1-31-2006; IN COMMERCE 1-31-2006.

THE MARK CONSISTS OF STANDARD CHARACTERS WITHOUT CLAIM TO ANY PARTICULAR FONT, STYLE, SIZE, OR COLOR.

SN 78-763,520, FILED 11-30-2005.

BARBARA GAYNOR, EXAMINING ATTORNEY

**Int. Cl.: 6**

**Prior U.S. Cls.: 2, 12, 13, 14, 23, 25, and 50**

**Reg. No. 3,455,390**

**United States Patent and Trademark Office**

**Registered June 24, 2008**

---

**TRADEMARK  
PRINCIPAL REGISTER**

**Cool White**

WHIRLWIND STEEL BUILDINGS, INC. (DELA-  
WARE CORPORATION)  
8234 HANSEN ROAD  
HOUSTON, TX 77234

THE MARK CONSISTS OF STANDARD CHAR-  
ACTERS WITHOUT CLAIM TO ANY PARTICULAR  
FONT, STYLE, SIZE, OR COLOR.

FOR: METAL ROOFING AND WALL PANELS, IN  
CLASS 6 (U.S. CLS. 2, 12, 13, 14, 23, 25 AND 50).

SN 78-764,431, FILED 12-1-2005.

FIRST USE 4-1-2008; IN COMMERCE 4-1-2008.

ESTHER A. BORSUK, EXAMINING ATTORNEY

**Int. Cls.: 16, 36, 41, and 44**

**Prior U.S. Cls.: 2, 5, 22, 23, 29, 37, 38, 50, 100, 101, 102, and 107**

**Reg. No. 3,455,391**

**United States Patent and Trademark Office**

**Registered June 24, 2008**

**TRADEMARK  
SERVICE MARK  
PRINCIPAL REGISTER**



SIEMENS MEDICAL SOLUTIONS USA, INC.  
(DELAWARE CORPORATION)  
51 VALLEY STREAM PARKWAY  
MALVERN, PA 19355

FOR: MAGAZINES, NEWSLETTERS, PRINTED INSTRUCTIONAL MATERIALS AND MANUALS IN THE FIELD OF HEALTHCARE INFORMATION SYSTEMS AND SERVICES, IN CLASS 16 (U.S. CLS. 2, 5, 22, 23, 29, 37, 38 AND 50).

FIRST USE 5-1-2006; IN COMMERCE 5-1-2006.

FOR: PROVIDING A COMPREHENSIVE COMPUTER DATABASE COMPOSED OF FINANCIAL DATA FOR ALL PARTIES INVOLVED IN THE HEALTHCARE INDUSTRY, SUCH AS HEALTHCARE PROVIDERS, INSURANCE CARRIERS AND EMPLOYERS, AND CONSULTATION SERVICES RENDERED IN CONNECTION THEREWITH, IN CLASS 36 (U.S. CLS. 100, 101 AND 102).

FIRST USE 5-1-2006; IN COMMERCE 5-1-2006.

FOR: PROVIDING EDUCATIONAL LECTURES, SEMINARS, COURSES AND ON-THE-JOB TRAIN-

ING SERVICES IN THE FIELD OF HEALTHCARE INFORMATION SYSTEMS AND SERVICES, IN CLASS 41 (U.S. CLS. 100, 101 AND 107).

FIRST USE 5-1-2006; IN COMMERCE 5-1-2006.

FOR: PROVIDING A COMPREHENSIVE COMPUTER DATABASE COMPOSED OF MEDICAL PATIENT CLINICAL DATA FOR ALL PARTIES INVOLVED IN THE HEALTHCARE INDUSTRY, SUCH AS HEALTHCARE PROVIDERS, INSURANCE CARRIERS AND EMPLOYERS, AND CONSULTATION SERVICES RENDERED IN CONNECTION THEREWITH, IN CLASS 44 (U.S. CLS. 100 AND 101).

FIRST USE 5-1-2006; IN COMMERCE 5-1-2006.

THE MARK CONSISTS OF THE LETTERS "HDX" WITH AN ARBITRARY DESIGN.

SN 78-765,661, FILED 12-2-2005.

BRIAN NEVILLE, EXAMINING ATTORNEY



**Int. Cl.: 35**

**Prior U.S. Cls.: 100, 101, and 102**

**United States Patent and Trademark Office**

**Reg. No. 3,455,392**

**Registered June 24, 2008**

**SERVICE MARK  
PRINCIPAL REGISTER**

**NATURE'S TOUCH**

COLLECTIONS ETC., INC. (ILLINOIS CORPORATION)  
2521 BUSSE ROAD  
ELK GROVE VILLAGE, IL 600076118

FOR: ELECTRONIC CATALOG SERVICES AND MAIL ORDER CATALOG SERVICES FEATURING GARDEN ACCESSORIES, ALL EXCLUDING ARTIFICIAL FLOWERS WITH STEMS AND LIQUID LAWN AND SOIL CONDITIONERS AND FERTILIZERS, IN CLASS 35 (U.S. CLS. 100, 101 AND 102).

FIRST USE 4-7-2006; IN COMMERCE 4-7-2006.

THE MARK CONSISTS OF STANDARD CHARACTERS WITHOUT CLAIM TO ANY PARTICULAR FONT, STYLE, SIZE, OR COLOR.

SN 78-765,718, FILED 12-2-2005.

MARY ROSSMAN, EXAMINING ATTORNEY

**Int. Cls.: 16, 36, 41, and 44**

**Prior U.S. Cls.: 2, 5, 22, 23, 29, 37, 38, 50, 100, 101, 102, and 107**

**Reg. No. 3,455,393**

**United States Patent and Trademark Office**

**Registered June 24, 2008**

**TRADEMARK  
SERVICE MARK  
PRINCIPAL REGISTER**



SIEMENS MEDICAL SOLUTIONS USA, INC.  
(DELAWARE CORPORATION)  
51 VALLEY STREAM PARKWAY  
MALVERN, PA 19355

FOR: MAGAZINES, NEWSLETTERS, PRINTED INSTRUCTIONAL MATERIALS AND MANUALS IN THE FIELD OF HEALTHCARE INFORMATION SYSTEMS AND SERVICES, IN CLASS 16 (U.S. CLS. 2, 5, 22, 23, 29, 37, 38 AND 50).

FIRST USE 5-1-2006; IN COMMERCE 5-1-2006.

FOR: PROVIDING A COMPREHENSIVE COMPUTER DATABASE COMPOSED OF FINANCIAL DATA FOR ALL PARTIES INVOLVED IN THE HEALTHCARE INDUSTRY, SUCH AS HEALTHCARE PROVIDERS, INSURANCE CARRIERS AND EMPLOYERS, AND CONSULTATION SERVICES RENDERED IN CONNECTION THEREWITH, IN CLASS 36 (U.S. CLS. 100, 101 AND 102).

FIRST USE 5-1-2006; IN COMMERCE 5-1-2006.

FOR: PROVIDING EDUCATIONAL LECTURES, SEMINARS, COURSES AND ON-THE-JOB TRAINING SERVICES IN THE FIELD OF HEALTHCARE INFORMATION SYSTEMS AND SERVICES, IN CLASS 41 (U.S. CLS. 100, 101 AND 107).

FIRST USE 5-1-2006; IN COMMERCE 5-1-2006.

FOR: PROVIDING A COMPREHENSIVE COMPUTER DATABASE COMPOSED OF MEDICAL PATIENT CLINICAL DATA FOR ALL PARTIES INVOLVED IN THE HEALTHCARE INDUSTRY, SUCH AS HEALTHCARE PROVIDERS, INSURANCE CARRIERS AND EMPLOYERS, AND CONSULTATION SERVICES RENDERED IN CONNECTION THEREWITH, IN CLASS 44 (U.S. CLS. 100 AND 101).

FIRST USE 5-1-2006; IN COMMERCE 5-1-2006.

THE COLOR(S) BLUE, WHITE AND GRAY IS/ARE CLAIMED AS A FEATURE OF THE MARK.

THE MARK CONSISTS OF THE LETTERS "HDX" IN BLUE WITH AN ARBITRARY DESIGN IN BLUE AND GRAY SEPARATED BY A WHITE ARC.

SN 78-765,721, FILED 12-2-2005.

BRIAN NEVILLE, EXAMINING ATTORNEY

**Int. Cls.: 9, 16, and 19**

**Prior U.S. Cls.: 1, 2, 5, 12, 21, 22, 23, 26, 29, 33, 36, 37,  
38, and 50**

**Reg. No. 3,455,394**

**United States Patent and Trademark Office**

**Registered June 24, 2008**

**TRADEMARK  
PRINCIPAL REGISTER**

**CORNCARD USA**

ARTHUR BLANK & COMPANY, INC. (MASSACHUSETTS CORPORATION)  
225 RIVERMOOR STREET  
BOSTON, MA 02132

FOR: PLASTIC MAGNETICALLY ENCODED DEBIT CARDS, IN CLASS 9 (U.S. CLS. 21, 23, 26, 36 AND 38).

FIRST USE 1-2-2006; IN COMMERCE 1-2-2006.

FOR: PLASTIC NON-MAGNETICALLY ENCODED DEBIT CARDS, IN CLASS 16 (U.S. CLS. 2, 5, 22, 23, 29, 37, 38 AND 50).

FIRST USE 1-2-2006; IN COMMERCE 1-2-2006.

FOR: PLASTIC SIGNS THAT ARE NON-METAL, NON-LUMINOUS, AND NON-MECHANICAL, IN CLASS 19 (U.S. CLS. 1, 12, 33 AND 50).

FIRST USE 11-13-2005; IN COMMERCE 11-13-2005.

THE MARK CONSISTS OF STANDARD CHARACTERS WITHOUT CLAIM TO ANY PARTICULAR FONT, STYLE, SIZE, OR COLOR.

NO CLAIM IS MADE TO THE EXCLUSIVE RIGHT TO USE "USA", APART FROM THE MARK AS SHOWN.

SN 78-766,386, FILED 12-5-2005.

MAUREEN DALL, EXAMINING ATTORNEY

**Int. Cl.: 33**

**Prior U.S. Cls.: 47 and 49**

**United States Patent and Trademark Office**

**Reg. No. 3,455,395**

**Registered June 24, 2008**

**TRADEMARK  
PRINCIPAL REGISTER**

**CANTO DE FLORA**

VINEDOS ERRAZURIZ OVALLE S.A. (CHILE  
CORPORATION)  
AMUNATEGUI 178 PISO 7  
SANTIAGO, CHILE

THE FOREIGN WORDING IN THE MARK  
TRANSLATES INTO ENGLISH AS "SONG OF  
FLORA".

FOR: WINES, IN CLASS 33 (U.S. CLS. 47 AND 49).

FIRST USE 12-31-2005; IN COMMERCE 7-0-2007.

SN 78-767,117, FILED 12-5-2005.

THE MARK CONSISTS OF STANDARD CHAR-  
ACTERS WITHOUT CLAIM TO ANY PARTICULAR  
FONT, STYLE, SIZE, OR COLOR.

ELLEN PERKINS, EXAMINING ATTORNEY

**Int. Cl.: 12**

**Prior U.S. Cls.: 19, 21, 23, 31, 35, and 44**

**Reg. No. 3,455,396**

**United States Patent and Trademark Office**

**Registered June 24, 2008**

---

**TRADEMARK  
PRINCIPAL REGISTER**

**SNOW CHIEF**

CHRYSLER LLC (DELAWARE LTD LIAB CO)  
1000 CHRYSLER DRIVE  
CIM 483-02-19  
AUBURN HILLS, MI 48326

THE MARK CONSISTS OF STANDARD CHAR-  
ACTERS WITHOUT CLAIM TO ANY PARTICULAR  
FONT, STYLE, SIZE, OR COLOR.

FOR: MOTOR VEHICLES, NAMELY, TRUCKS, IN  
CLASS 12 (U.S. CLS. 19, 21, 23, 31, 35 AND 44).

SN 78-768,427, FILED 12-7-2005.

FIRST USE 7-0-2006; IN COMMERCE 7-0-2006.

SUSAN RICHARDS, EXAMINING ATTORNEY

**Int. Cls.: 10 and 42**

**Prior U.S. Cls.: 26, 39, 44, 100, and 101**

**Reg. No. 3,455,397**

**United States Patent and Trademark Office**

**Registered June 24, 2008**

**TRADEMARK  
SERVICE MARK  
PRINCIPAL REGISTER**

**cimex**  
**MEDICAL INNOVATIONS**

CIMEX MEDICAL INNOVATIONS LC (TEXAS  
LTD LIAB CO)  
72385 INDUSTRY PARK  
COVINGTON, LA 70435

FIRST USE 1-31-2008; IN COMMERCE 1-31-2008.

FOR: MEDICAL DEVICES, NAMELY, CRYOSUR-  
GICAL INSTRUMENTS, IN CLASS 10 (U.S. CLS. 26,  
39 AND 44).

OWNER OF U.S. REG. NO. 2,950,792.

FIRST USE 11-10-2007; IN COMMERCE 11-10-2007.

FOR: SCIENTIFIC RESEARCH; MEDICAL RE-  
SEARCH; RESEARCH AND DEVELOPMENT IN  
THE FIELD OF MEDICAL TREATMENTS AND  
TECHNIQUES, IN CLASS 42 (U.S. CLS. 100 AND 101).

NO CLAIM IS MADE TO THE EXCLUSIVE  
RIGHT TO USE "MEDICAL", APART FROM THE  
MARK AS SHOWN.

SN 78-768,516, FILED 12-7-2005.

TINA L. SNAPP, EXAMINING ATTORNEY

**Int. Cl.: 25**

**Prior U.S. Cls.: 22 and 39**

**United States Patent and Trademark Office**

**Reg. No. 3,455,398**

**Registered June 24, 2008**

**TRADEMARK  
PRINCIPAL REGISTER**

**PLATINUM SHAPE SYSTEM**

HBI BRANDED APPAREL ENTERPRISES, LLC  
(DELAWARE LTD LIAB CO)  
1000 EAST HANES MILL ROAD  
WINSTON-SALEM, NC 27105

FOR: FABRIC SOLD AS A COMPONENT OF  
BRAS, PANTIES, CAMISOLES AND GARMENTS  
WHICH SHAPE THE BODY, NAMELY, BODY  
SUITS, CONTROL BRIEFS AND THIGH HIGHS ,  
IN CLASS 25 (U.S. CLS. 22 AND 39).

FIRST USE 7-15-2006; IN COMMERCE 7-15-2006.

THE MARK CONSISTS OF STANDARD CHAR-  
ACTERS WITHOUT CLAIM TO ANY PARTICULAR  
FONT, STYLE, SIZE, OR COLOR.

NO CLAIM IS MADE TO THE EXCLUSIVE  
RIGHT TO USE "SHAPE SYSTEM", APART FROM  
THE MARK AS SHOWN.

SN 78-768,634, FILED 12-7-2005.

JULIE WATSON, EXAMINING ATTORNEY

**Int. Cl.: 14**

**Prior U.S. Cls.: 2, 27, 28, and 50**

**Reg. No. 3,455,399**

**United States Patent and Trademark Office**

**Registered June 24, 2008**

**TRADEMARK  
PRINCIPAL REGISTER**



**CHRYSOS**

CHRYSOS S.P.A. (ITALY CORPORATION)  
VIA ALBERTONI 10, 36060 ROMANO  
D'EZZELINO  
VICENZA, ITALY

FOR: ARTICLES OF GOLD, OTHER PRECIOUS  
AND NON-PRECIOUS METALS, WITH OR WITH-  
OUT PRECIOUS STONES, NAMELY, RINGS BEING  
JEWELRY, EARRINGS, NECKLACES, BRACELETS,

BROOCHES, PENDANTS AND WATCHES; KEY  
HOLDERS MADE OF PRECIOUS METAL, IN CLASS  
14 (U.S. CLS. 2, 27, 28 AND 50).

FIRST USE 12-0-1987; IN COMMERCE 1-0-1990.

SN 78-769,090, FILED 12-8-2005.

GINA HAYES, EXAMINING ATTORNEY



**Int. Cl.: 10**

**Prior U.S. Cls.: 26, 39, and 44**

**United States Patent and Trademark Office**

**Reg. No. 3,455,400**

**Registered June 24, 2008**

**TRADEMARK  
PRINCIPAL REGISTER**

**CLINITEK ADVANTUS**

SIEMENS HEALTHCARE DIAGNOSTICS INC.  
(CALIFORNIA CORPORATION)  
1717 DEERFIELD ROAD  
DEERFIELD, IL 60015

FOR: MEDICAL DIAGNOSTIC INSTRUMENTS  
FOR THE ANALYSIS OF BODY FLUIDS, NAMELY,  
URINE CHEMISTRY ANALYZERS, IN CLASS 10  
(U.S. CLS. 26, 39 AND 44).

FIRST USE 4-1-2007; IN COMMERCE 5-1-2007.

THE MARK CONSISTS OF STANDARD CHAR-  
ACTERS WITHOUT CLAIM TO ANY PARTICULAR  
FONT, STYLE, SIZE, OR COLOR.

OWNER OF U.S. REG. NOS. 1,019,268, 2,946,633,  
AND OTHERS.

SN 78-769,733, FILED 12-8-2005.

WARREN L. OLANDRIA, EXAMINING ATTOR-  
NEY

**Int. Cl.: 35**

**Prior U.S. Cls.: 100, 101, and 102**

**United States Patent and Trademark Office**

**Reg. No. 3,455,401**

**Registered June 24, 2008**

**SERVICE MARK  
PRINCIPAL REGISTER**



MYCOUNTERSPACE, INC. (CALIFORNIA CORPORATION)  
724 MENTONE AVENUE  
GROVER BEACH, CA 93433

FOR: ADVERTISING AND INFORMATION DISTRIBUTION SERVICES, NAMELY, PROVIDING CLASSIFIED ADVERTISING SPACE VIA THE GLOBAL COMPUTER NETWORK; PROMOTING THE GOODS AND SERVICES OF OTHERS VIA THE INTERNET; PROVIDING ON-LINE COMPUTER

DATABASES AND ON-LINE SEARCHABLE DATABASES FEATURING CLASSIFIED LISTINGS AND ADVERTISING, IN CLASS 35 (U.S. CLS. 100, 101 AND 102).

FIRST USE 11-5-2005; IN COMMERCE 4-7-2007.

SN 78-770,570, FILED 12-9-2005.

STEVEN PEREZ, EXAMINING ATTORNEY

Int. Cl.: 30

Prior U.S. Cl.: 46

United States Patent and Trademark Office

Reg. No. 3,455,402

Registered June 24, 2008

TRADEMARK  
PRINCIPAL REGISTER

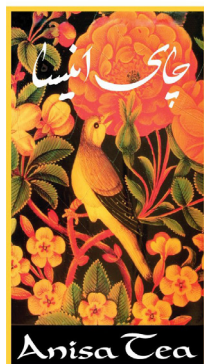

ANISA ENTERPRISES INC. (CANADA CORPORATION)  
16 BAYTREE CRESCENT  
TORONTO, CANADA M2L 2G3

FOR: SPECIALLY BLENDED TEA, IN CLASS 30  
(U.S. CL. 46).

FIRST USE 7-1-2005; IN COMMERCE 7-1-2005.

NO CLAIM IS MADE TO THE EXCLUSIVE  
RIGHT TO USE "TEA", APART FROM THE MARK  
AS SHOWN.

THE COLOR(S) YELLOW, RED, ORANGE,  
BROWN, GREEN, BLACK, AND WHITE IS/ARE  
CLAIMED AS A FEATURE OF THE MARK.

THE MARK CONSISTS OF A BROWN, YELLOW  
AND BLACK NIGHTINGALE PERCHED IN A ROSE

BUSH WHICH CONSISTS OF YELLOW AND OR-  
ANGE FLOWERS, GREEN LEAVES, AND RED  
STEMS. THE BACKGROUND COLOR IS BLACK.  
THE WORDS "ANISA TEA" AND "CHAI ANISA"  
(TRANSLITERATION OF NON-LATIN CHARAC-  
TERS) ARE WHITE.

THE ENGLISH TRANSLATION OF "CHAI ANI-  
SA" MEANS "ANISA TEA" IN ENGLISH.

THE NON-LATIN CHARACTER(S) IN THE  
MARK TRANSLITERATES INTO "CHAI ANISA".

SN 78-771,999, FILED 12-13-2005.

NAKWAMA ANKRAH, EXAMINING ATTORNEY

**Int. Cl.: 28**

**Prior U.S. Cls.: 22, 23, 38, and 50**

**United States Patent and Trademark Office**

**Reg. No. 3,455,403**

**Registered June 24, 2008**

**TRADEMARK  
PRINCIPAL REGISTER**

**ADIRONDACK GOLF**

HEIRLOOM SPORTS, INC. (RHODE ISLAND  
CORPORATION)  
580 THAMES STREET  
NEWPORT, RI 02840

FOR: OUTDOOR ACTIVITY GAME IN THE NAT-  
URE OF A GOLF-RELATED YARD GAME; EQUIP-  
MENT SOLD AS A UNIT FOR PLAYING GOLF-  
RELATED YARD GAMES, IN CLASS 28 (U.S. CLS.  
22, 23, 38 AND 50).

FIRST USE 3-10-2008; IN COMMERCE 4-8-2008.

THE MARK CONSISTS OF STANDARD CHAR-  
ACTERS WITHOUT CLAIM TO ANY PARTICULAR  
FONT, STYLE, SIZE, OR COLOR.

NO CLAIM IS MADE TO THE EXCLUSIVE  
RIGHT TO USE "GOLF", APART FROM THE MARK  
AS SHOWN.

SN 78-772,140, FILED 12-13-2005.

DAVID HOFFMAN, EXAMINING ATTORNEY

**Int. Cls.: 3 and 26**

**Prior U.S. Cls.: 1, 4, 6, 37, 39, 40, 42, 50, 51, and 52**

**United States Patent and Trademark Office**

**Reg. No. 3,455,404**

**Registered June 24, 2008**

**TRADEMARK  
PRINCIPAL REGISTER**

**VOLUMINATE**

THE WELLA CORPORATION (DELAWARE CORPORATION)  
6109 DESOTO AVENUE  
WOODLAND HILLS, CA 91367

FOR: HAIR CARE AND STYLING PREPARATIONS, IN CLASS 3 (U.S. CLS. 1, 4, 6, 50, 51 AND 52).

FIRST USE 10-31-2006; IN COMMERCE 10-31-2006.

FOR: HAIR STYLING IMPLEMENTS, NAMELY, NON-ELECTRIC HAIR ROLLERS AND CAPS USED

AS APPLICATORS FOR HAIR CONDITIONERS, IN CLASS 26 (U.S. CLS. 37, 39, 40, 42 AND 50).

FIRST USE 10-31-2006; IN COMMERCE 10-31-2006.

THE MARK CONSISTS OF STANDARD CHARACTERS WITHOUT CLAIM TO ANY PARTICULAR FONT, STYLE, SIZE, OR COLOR.

SN 78-772,379, FILED 12-13-2005.

ELLEN PERKINS, EXAMINING ATTORNEY

**Int. Cl.: 26**

**Prior U.S. Cls.: 37, 39, 40, 42, and 50**

**United States Patent and Trademark Office**

**Reg. No. 3,455,405**

**Registered June 24, 2008**

**TRADEMARK  
PRINCIPAL REGISTER**

**HI ART**

HIMO, INC. (REPUBLIC OF KOREA JOINT  
STOCK COMPANY)  
1364-11 SEOCHO-DONG, SEOCHO-GU  
SEOUL, REPUBLIC OF KOREA

FOR: WIGS, TOUPEES; HAIR PIECES AND AC-  
CESSORIES, NAMELY, BARRETTES, HAIR FROST-  
ING CAPS, HAIR NETS, HAIR CLIPS, HAIR PINS,  
HAIR RIBBONS, HAIR BOWS AND HAIR TAPES,  
NAMELY, TAPE FOR FIXING WIGS, IN CLASS 26  
(U.S. CLS. 37, 39, 40, 42 AND 50).

FIRST USE 11-16-2005; IN COMMERCE 11-16-2005.

THE MARK CONSISTS OF STANDARD CHAR-  
ACTERS WITHOUT CLAIM TO ANY PARTICULAR  
FONT, STYLE, SIZE, OR COLOR.

NO CLAIM IS MADE TO THE EXCLUSIVE  
RIGHT TO USE "ART", APART FROM THE MARK  
AS SHOWN.

SN 78-772,384, FILED 12-13-2005.

BARNEY CHARLON, EXAMINING ATTORNEY

Int. Cls.: 41 and 44

Prior U.S. Cls.: 100, 101, and 107

United States Patent and Trademark Office

Reg. No. 3,455,406

Registered June 24, 2008

SERVICE MARK  
PRINCIPAL REGISTER



INTER-CONTINENTAL HOTELS CORPORATION  
(DELAWARE CORPORATION)  
C/O THREE RAVINIA DRIVE  
ATLANTA, GA 303462149

FOR: HEALTH CLUB SERVICES, NAMELY, PROVIDING SWIMMING POOLS, AND CARDIO AND WEIGHT TRAINING EQUIPMENT FOR PHYSICAL EXERCISE, IN CLASS 41 (U.S. CLS. 100, 101 AND 107).

FIRST USE 8-0-2005; IN COMMERCE 8-0-2005.

FOR: HEALTH SPA SERVICES, NAMELY, COSMETIC BODY CARE SERVICES; PROVIDING WHIRLPOOL BATH FACILITIES; OPERATION OF MEN'S AND WOMEN'S STEAM AND SAUNA ROOMS, INDIVIDUAL AND COUPLE'S SPA SER-

VICE TREATMENT ROOMS, RESTORATIVE MASSAGE, FACIAL AND HYDROTHERAPY BODY TREATMENTS, IN CLASS 44 (U.S. CLS. 100 AND 101).

FIRST USE 8-0-2005; IN COMMERCE 8-0-2005.

OWNER OF U.S. REG. NO. 1,736,949.

THE MARK CONSISTS OF A STYLIZED "I" ENCLOSED IN AN OVAL AND THE WORD "SPA" IN STYLIZED LETTERS.

SN 78-772,434, FILED 12-13-2005.

ALYSSA PALADINO, EXAMINING ATTORNEY

**Int. Cl.: 25**

**Prior U.S. Cls.: 22 and 39**

**United States Patent and Trademark Office**

**Reg. No. 3,455,407**

**Registered June 24, 2008**

**TRADEMARK  
PRINCIPAL REGISTER**

**FROST HEAVES**

BUMP IN THE ROAD ENTERPRISES LLC (VER-  
MONT LTD LIAB CO)  
949 CIDER MILL ROAD  
CORNWALL, VT 05753

THE MARK CONSISTS OF STANDARD CHAR-  
ACTERS WITHOUT CLAIM TO ANY PARTICULAR  
FONT, STYLE, SIZE, OR COLOR.

FOR: CAPS; HATS; JACKETS; SHIRTS, SWEAT  
PANTS, IN CLASS 25 (U.S. CLS. 22 AND 39).

SN 78-772,809, FILED 12-14-2005.

FIRST USE 12-14-2005; IN COMMERCE 12-14-2005.

PETER B. BROMAGHIM, EXAMINING ATTORNEY



**Int. Cl.: 28**

**Prior U.S. Cls.: 22, 23, 38, and 50**

**Reg. No. 3,455,408**

**United States Patent and Trademark Office**

**Registered June 24, 2008**

---

**TRADEMARK  
PRINCIPAL REGISTER**

**SPRAY RACER**

RUDELL, ELLIOT (UNITED STATES INDIVIDUAL), DBA RUDELL DESIGN,  
1619 GRAMERCY AVENUE  
TORRANCE, CA 90501

FOR: A ROLLING TOY VEHICLE THAT IS POWERED BY WATER, IN CLASS 28 (U.S. CLS. 22, 23, 38 AND 50).

FIRST USE 12-15-2007; IN COMMERCE 12-15-2007.

THE MARK CONSISTS OF STANDARD CHARACTERS WITHOUT CLAIM TO ANY PARTICULAR FONT, STYLE, SIZE, OR COLOR.

NO CLAIM IS MADE TO THE EXCLUSIVE RIGHT TO USE "RACER", APART FROM THE MARK AS SHOWN.

SN 78-773,202, FILED 12-14-2005.

ROBERT STRUCK, EXAMINING ATTORNEY

**Int. Cl.: 6**

**Prior U.S. Cls.: 2, 12, 13, 14, 23, 25, and 50**

**Reg. No. 3,455,409**

**United States Patent and Trademark Office**

**Registered June 24, 2008**

---

**TRADEMARK  
PRINCIPAL REGISTER**

**TETON**

JELD-WEN, INC. (OREGON CORPORATION)  
3250 LAKEPORT BOULEVARD  
KLAMATH FALLS, OR 97601

THE MARK CONSISTS OF STANDARD CHAR-  
ACTERS WITHOUT CLAIM TO ANY PARTICULAR  
FONT, STYLE, SIZE, OR COLOR.

FOR: DECORATIVE GLASS PANELS SOLD AS  
AN INTEGRAL COMPONENT OF METAL DOORS,  
IN CLASS 6 (U.S. CLS. 2, 12, 13, 14, 23, 25 AND 50).

SN 78-773,848, FILED 12-15-2005.

FIRST USE 10-31-2005; IN COMMERCE 10-31-2005.

SUSAN LESLIE DUBOIS, EXAMINING ATTORNEY

**Int. Cl.: 14**

**Prior U.S. Cls.: 2, 27, 28, and 50**

**United States Patent and Trademark Office**

**Reg. No. 3,455,410**

**Registered June 24, 2008**

**TRADEMARK  
PRINCIPAL REGISTER**

**DEBONAIR**

LAZARETNIK, DANIEL (ISRAEL INDIVIDUAL)  
#660  
160 CENTRAL PARK SOUTH  
NEW YORK, NY 10019

THE MARK CONSISTS OF STANDARD CHAR-  
ACTERS WITHOUT CLAIM TO ANY PARTICULAR  
FONT, STYLE, SIZE, OR COLOR.

FOR: WATCHES, IN CLASS 14 (U.S. CLS. 2, 27, 28  
AND 50).

SN 78-773,989, FILED 12-15-2005.

FIRST USE 6-26-2006; IN COMMERCE 7-20-2006.

JOHN DWYER, EXAMINING ATTORNEY

**Int. Cl.: 21**

**Prior U.S. Cls.: 2, 13, 23, 29, 30, 33, 40, and 50**

**Reg. No. 3,455,411**

**United States Patent and Trademark Office**

**Registered June 24, 2008**

**TRADEMARK  
PRINCIPAL REGISTER**

**GARBAGE BOWL**

RAY MARKS CO. LLC (NEW YORK LTD LIAB  
CO)  
375 GREENWICH ST.  
C/O WATCH ENTERTAINMENT, INC.  
NEW YORK, NY 10013

FOR: KITCHENWARE, NAMELY, BOWLS, IN  
CLASS 21 (U.S. CLS. 2, 13, 23, 29, 30, 33, 40 AND 50).

FIRST USE 9-10-2007; IN COMMERCE 9-10-2007.

THE MARK CONSISTS OF STANDARD CHAR-  
ACTERS WITHOUT CLAIM TO ANY PARTICULAR  
FONT, STYLE, SIZE, OR COLOR.

NO CLAIM IS MADE TO THE EXCLUSIVE  
RIGHT TO USE "BOWL", APART FROM THE  
MARK AS SHOWN.

SN 78-774,097, FILED 12-15-2005.

NAAKWAMA ANKRAH, EXAMINING ATTORNEY

Int. Cls.: 21 and 25

Prior U.S. Cls.: 2, 13, 22, 23, 29, 30, 33, 39, 40, and 50

United States Patent and Trademark Office

Reg. No. 3,455,412

Registered June 24, 2008

TRADEMARK  
PRINCIPAL REGISTER

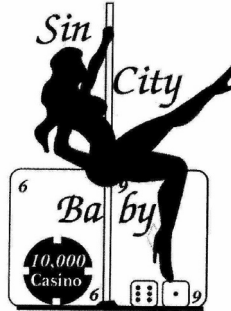

YATES, HERBERT W. (UNITED STATES INDIVIDUAL)  
412 SOUTH WILLOW  
SHERMAN, TX 75090

FOR: INSULATING SLEEVE HOLDERS FOR BEVERAGE CANS; THERMAL INSULATED WRAP FOR CANS TO KEEP THE CONTENTS COLD OR HOT, IN CLASS 21 (U.S. CLS. 2, 13, 23, 29, 30, 33, 40 AND 50).

FIRST USE 8-30-2007; IN COMMERCE 8-30-2007.

FOR: CAMISOLES; HEADGEAR, NAMELY, HATS, CAPS AND VISORS; SHORT-SLEEVED OR LONG-SLEEVED T-SHIRTS; T-SHIRTS; TANK-TOPS; THONGS; WOMEN'S UNDERWEAR, IN CLASS 25 (U.S. CLS. 22 AND 39).

FIRST USE 8-30-2007; IN COMMERCE 8-30-2007.

NO CLAIM IS MADE TO THE EXCLUSIVE RIGHT TO USE "SIN CITY" AND "CASINO", APART FROM THE MARK AS SHOWN.

THE MARK CONSISTS OF A DANCING FEMALE SILHOUETTED AGAINST A STRIPPER DANCE POLE, PLAYING CARDS, DICE, A POKER CHIP AND THE WORDS "SIN CITY BABY".

SN 78-774,646, FILED 12-15-2005.

WILLIAM VERHOSEK, EXAMINING ATTORNEY

**Int. Cl.: 5**

**Prior U.S. Cls.: 6, 18, 44, 46, 51, and 52**

**United States Patent and Trademark Office**

**Reg. No. 3,455,413**

**Registered June 24, 2008**

**TRADEMARK  
PRINCIPAL REGISTER**



SCHERING CORPORATION (NEW JERSEY CORPORATION)  
K-6-1 M1030  
2000 GALLOPING HILL ROAD  
KENILWORTH, NJ 070330530

OWNER OF U.S. REG. NO. 2,507,443.

FOR: LONG-ACTING BROAD SPECTRUM ANTI-VIRAL AND IMMUNOMODULATING AGENT, IN CLASS 5 (U.S. CLS. 6, 18, 44, 46, 51 AND 52).

THE MARK CONSISTS OF TWO CURVED LINES AND A CIRCLE.

SN 78-774,813, FILED 12-16-2005.

FIRST USE 4-1-2007; IN COMMERCE 4-1-2007.

DOMINICK J. SALEMI, EXAMINING ATTORNEY

**Int. Cls.: 35, 37, 41, and 42**

**Prior U.S. Cls.: 100, 101, 102, 103, 106, and 107**

**United States Patent and Trademark Office**

**Reg. No. 3,455,414**

**Registered June 24, 2008**

**SERVICE MARK  
PRINCIPAL REGISTER**

**GUARDIAN SELECT**

CURTISS-WRIGHT CONTROLS, INC. (DELA-  
WARE CORPORATION)  
SUITE 200  
15800 JOHN DELANEY DRIVE  
CHARLOTTE, NC 28277

FOR: LOGISTIC MANAGEMENT IN THE FIELD  
OF COMPUTERS, IN CLASS 35 (U.S. CLS. 100, 101  
AND 102).

FIRST USE 6-14-2006; IN COMMERCE 6-14-2006.

FOR: COMPUTER HARDWARE REPAIR AND  
MAINTENANCE, IN CLASS 37 (U.S. CLS. 100, 103  
AND 106).

FIRST USE 6-14-2006; IN COMMERCE 6-14-2006.

FOR: TRAINING CONSULTING SERVICES IN  
THE USE AND OPERATION OF COMPUTERS,  
PROCESSING CARDS, INTERFACE CARDS, COM-  
MUNICATION INTERFACES, COMPUTER CHAS-  
SIS AND ENCLOSURES, COMPUTING  
SUBSYSTEMS, RADAR AND VIDEO PROCESSING  
SUBSYSTEMS, MOTION CONTROL SUBSYSTEMS,  
ASSOCIATED DRIVER, TEST AND APPLICATION  
SOFTWARE, IN CLASS 41 (U.S. CLS. 100, 101 AND  
107).

FIRST USE 6-14-2006; IN COMMERCE 6-14-2006.

FOR: COMPUTER SOFTWARE REPAIR AND  
MAINTENANCE; PROTOTYPING AND LIFE-CY-  
CLE SOFTWARE REPAIR AND MAINTENANCE;  
AND TECHNICAL SUPPORT FOR COMPUTERS,  
PROCESSING CARDS, INTERFACE CARDS, COM-  
MUNICATION INTERFACES, COMPUTER CHAS-  
SIS AND ENCLOSURES, COMPUTING  
SUBSYSTEMS, RADAR AND VIDEO PROCESSING  
SUBSYSTEMS, MOTION CONTROL SUBSYSTEMS,  
ASSOCIATED DRIVER, TEST AND APPLICATION  
SOFTWARE; COMPUTER HARDWARE AND SOFT-  
WARE DEVELOPMENT; DESIGN OF COMPUTERS  
FOR OTHERS, IN CLASS 42 (U.S. CLS. 100 AND 101).

FIRST USE 6-14-2006; IN COMMERCE 6-14-2006.

THE MARK CONSISTS OF STANDARD CHAR-  
ACTERS WITHOUT CLAIM TO ANY PARTICULAR  
FONT, STYLE, SIZE, OR COLOR.

SN 78-776,281, FILED 12-19-2005.

NAKIA HENRY, EXAMINING ATTORNEY

**Int. Cl.: 24**

**Prior U.S. Cls.: 42 and 50**

**United States Patent and Trademark Office**

**Reg. No. 3,455,415**

**Registered June 24, 2008**

**TRADEMARK  
PRINCIPAL REGISTER**

**ACTICLEAN**

ACTICLEAN, INC. (CALIFORNIA CORPORATION)  
1201 LARRABEE STREET, SUITE 102  
WEST HOLLYWOOD, CA 90069

THE MARK CONSISTS OF STANDARD CHARACTERS WITHOUT CLAIM TO ANY PARTICULAR FONT, STYLE, SIZE, OR COLOR.

FOR: TOWELS, IN CLASS 24 (U.S. CLS. 42 AND 50).

SN 78-776,459, FILED 12-19-2005.

FIRST USE 4-20-2008; IN COMMERCE 4-20-2008.

DAVID MILLER, EXAMINING ATTORNEY



**Int. Cl.: 11**

**Prior U.S. Cls.: 13, 21, 23, 31, and 34**

**Reg. No. 3,455,416**

**United States Patent and Trademark Office**

**Registered June 24, 2008**

---

**TRADEMARK  
PRINCIPAL REGISTER**

**Maxxeon**

JORO MARKETING LTD. (CANADA CORPORATION)  
125 TURNBULL COURT, UNIT 8  
CAMBRIDGE, CANADA N1T1H8

THE MARK CONSISTS OF STANDARD CHARACTERS WITHOUT CLAIM TO ANY PARTICULAR FONT, STYLE, SIZE, OR COLOR.

FOR: PORTABLE LIGHTING EQUIPMENT, NAMELY, WORK LIGHTS, INSPECTION LIGHTS AND TASK LAMPS, IN CLASS 11 (U.S. CLS. 13, 21, 23, 31 AND 34).

SN 78-776,826, FILED 12-20-2005.

FIRST USE 1-2-2006; IN COMMERCE 1-2-2006.

MICHAEL SOUDERS, EXAMINING ATTORNEY

**Int. Cls.: 9, 16, and 19**

**Prior U.S. Cls.: 1, 2, 5, 12, 21, 22, 23, 26, 29, 33, 36, 37, 38, and 50**

**Reg. No. 3,455,417**

**United States Patent and Trademark Office**

**Registered June 24, 2008**

**TRADEMARK  
PRINCIPAL REGISTER**



ARTHUR BLANK & COMPANY, INC. (MASSACHUSETTS CORPORATION)  
225 RIVERMOOR STREET  
BOSTON, MA 02132

FOR: PLASTIC SIGNS THAT ARE NON-METAL, NON-LUMINOUS, AND NON-MECHANICAL, IN CLASS 19 (U.S. CLS. 1, 12, 33 AND 50).

FOR: PLASTIC MAGNETICALLY ENCODED DEBIT CARDS, IN CLASS 9 (U.S. CLS. 21, 23, 26, 36 AND 38).

FIRST USE 11-3-2005; IN COMMERCE 11-3-2005.

FIRST USE 1-2-2006; IN COMMERCE 1-2-2006.

THE MARK CONSISTS OF THE DESIGN OF AN EAR OF CORN.

FOR: PLASTIC NON-MAGNETICALLY ENCODED DEBIT CARDS, IN CLASS 16 (U.S. CLS. 2, 5, 22, 23, 29, 37, 38 AND 50).

SN 78-777,216, FILED 12-20-2005.

FIRST USE 1-2-2006; IN COMMERCE 1-2-2006.

MAUREEN DALL, EXAMINING ATTORNEY

**Int. Cls.: 41, 44, and 45**

**Prior U.S. Cls.: 100, 101, and 107**

**United States Patent and Trademark Office**

**Reg. No. 3,455,418**

**Registered June 24, 2008**

**SERVICE MARK  
PRINCIPAL REGISTER**

**REAL SAVVY MOMS**

MORPHOGENIX, LLC (DELAWARE CORPORATION)  
SUITE 2300 SW  
545 EIGHTH AVE  
NEW YORK, NY 10018

FOR: EDUCATIONAL SERVICES, NAMELY CONDUCTING SEMINARS IN THE FIELD OF HEALTH AND PARENTING; ENTERTAINMENT SERVICES, NAMELY, ONGOING TELEVISION PROGRAMS FEATURING INFORMATION ON HEALTH AND PARENTING; PROVIDING INFORMATION IN THE FIELD OF PARENTING CONCERNING EDUCATION OF CHILDREN VIA A WEBSITE, IN CLASS 41 (U.S. CLS. 100, 101 AND 107).

FIRST USE 9-0-2005; IN COMMERCE 9-0-2005.

FOR: PROVIDING HEALTH INFORMATION VIA A WEBSITE; PROVIDING INFORMATION IN THE FIELD OF PARENTING CONCERNING THE HEALTH OF CHILDREN VIA A WEBSITE, IN CLASS 44 (U.S. CLS. 100 AND 101).

FIRST USE 9-0-2005; IN COMMERCE 9-0-2005.

FOR: PROVIDING INFORMATION IN THE FIELD OF PARENTING CONCERNING THE SAFETY OF CHILDREN VIA A WEBSITE, IN CLASS 45 (U.S. CLS. 100 AND 101).

FIRST USE 9-0-2005; IN COMMERCE 9-0-2005.

THE MARK CONSISTS OF STANDARD CHARACTERS WITHOUT CLAIM TO ANY PARTICULAR FONT, STYLE, SIZE, OR COLOR.

NO CLAIM IS MADE TO THE EXCLUSIVE RIGHT TO USE "MOMS", APART FROM THE MARK AS SHOWN.

SN 78-777,415, FILED 12-20-2005.

SALLY SHIH, EXAMINING ATTORNEY

**Int. Cl.: 25**

**Prior U.S. Cls.: 22 and 39**

**United States Patent and Trademark Office**

**Reg. No. 3,455,419**

**Registered June 24, 2008**

**TRADEMARK  
PRINCIPAL REGISTER**

SO MANY PEOPLE OUT THERE  
FOCUSED ON CHANGING THE  
BODIES. WE DECIDED TO  
CHANGE THE BRA.

WARNACO U.S., INC. (DELAWARE CORPORATION)  
470 WHEELERS FARMS ROAD  
MILFORD, CT 06460

FOR: INTIMATE APPAREL AND FIGURE ENHANCING GARMENTS, NAMELY, BRAS, UNDERWEAR, UNDERGARMENTS, UNDERCLOTHES, LINGERIE, FOUNDATION GARMENTS, CAMISOLES, IN CLASS 25 (U.S. CLS. 22 AND 39).

FIRST USE 6-25-2006; IN COMMERCE 6-25-2006.

THE MARK CONSISTS OF STANDARD CHARACTERS WITHOUT CLAIM TO ANY PARTICULAR FONT, STYLE, SIZE, OR COLOR.

SN 78-780,298, FILED 12-23-2005.

MICHAEL SOUDERS, EXAMINING ATTORNEY

**Int. Cl.: 42**

**Prior U.S. Cls.: 100 and 101**

**United States Patent and Trademark Office**

**Reg. No. 3,455,420**

**Registered June 24, 2008**

**SERVICE MARK  
PRINCIPAL REGISTER**

**GEOSTORAGE**

GEOSTORAGE CORP. (NEW JERSEY CORPORATION)  
11 SAILERS WAY  
RUMSON, NJ 07760

THE MARK CONSISTS OF STANDARD CHARACTERS WITHOUT CLAIM TO ANY PARTICULAR FONT, STYLE, SIZE, OR COLOR.

FOR: PATENT LICENSING, IN CLASS 42 (U.S. CLS. 100 AND 101).

SN 78-784,118, FILED 1-3-2006.

FIRST USE 2-10-2006; IN COMMERCE 3-10-2006.

LINDA ESTRADA, EXAMINING ATTORNEY

**Int. Cl.: 1**

**Prior U.S. Cls.: 1, 5, 6, 10, 26, and 46**

**Reg. No. 3,455,421**

**United States Patent and Trademark Office**

**Registered June 24, 2008**

**TRADEMARK  
PRINCIPAL REGISTER**

**THIO-GOLD**

TESSENDERLO KERLEY, INC. (DELAWARE  
CORPORATION)  
2255 N. 44TH STREET,  
PHOENIX, AZ 85008

THE MARK CONSISTS OF STANDARD CHAR-  
ACTERS WITHOUT CLAIM TO ANY PARTICULAR  
FONT, STYLE, SIZE, OR COLOR.

FOR: CHEMICALS USED IN THE MINING IN-  
DUSTRY FOR EXTRACTION OF PRECIOUS ME-  
TALS FROM ORES, IN CLASS 1 (U.S. CLS. 1, 5, 6, 10,  
26 AND 46).

SN 78-784,822, FILED 1-4-2006.

FIRST USE 3-0-2007; IN COMMERCE 3-0-2007.

JASON BLAIR, EXAMINING ATTORNEY

**Int. Cl.: 19**

**Prior U.S. Cls.: 1, 12, 33, and 50**

**United States Patent and Trademark Office**

**Reg. No. 3,455,422**

**Registered June 24, 2008**

**TRADEMARK  
PRINCIPAL REGISTER**

**ENVIRO-SPAN**

SEMOTIUK, BOB (CANADA INDIVIDUAL)  
2633 TWEEDSMUIR AVENUE  
PRINCE GEORGE, CANADA V2N 1E8

THE MARK CONSISTS OF STANDARD CHAR-  
ACTERS WITHOUT CLAIM TO ANY PARTICULAR  
FONT, STYLE, SIZE, OR COLOR.

FOR: NON-METALLIC PIPE SYSTEMS FOR  
DRAINAGE, NAMELY, NON-METAL GUTTER  
PIPES, NON-METAL SEWER PIPES, NON-METAL  
WATER PIPES, AND FIBREGLASS CONDUITS, IN  
CLASS 19 (U.S. CLS. 1, 12, 33 AND 50).

SN 78-785,452, FILED 1-5-2006.

FIRST USE 7-14-2004; IN COMMERCE 7-14-2004.

ANDREA K. NADELMAN, EXAMINING ATTOR-  
NEY

**Int. Cl.: 37**

**Prior U.S. Cls.: 100, 103, and 106**

**United States Patent and Trademark Office**

**Reg. No. 3,455,423**

**Registered June 24, 2008**

**SERVICE MARK  
PRINCIPAL REGISTER**

**PACIFIC MIST**

RHODES DESIGN AND DEVELOPMENT CORP.  
(NEVADA CORPORATION)  
4730 SOUTH FORT APACHE ROAD  
LAS VEGAS, NV 89147

FOR: HOMEBUILDING SERVICES; DEVELOPMENT OF REAL PROPERTY FOR SINGLE-FAMILY AND MULTI-FAMILY RESIDENTIAL AND MASTER-PLANNED COMMUNITY PURPOSES , IN CLASS 37 (U.S. CLS. 100, 103 AND 106).

FIRST USE 1-1-2007; IN COMMERCE 1-1-2007.

THE MARK CONSISTS OF STANDARD CHARACTERS WITHOUT CLAIM TO ANY PARTICULAR FONT, STYLE, SIZE, OR COLOR.

SN 78-785,656, FILED 1-5-2006.

JENNIFER VASQUEZ, EXAMINING ATTORNEY



**Int. Cl.: 17**

**Prior U.S. Cls.: 1, 5, 12, 13, 35, and 50**

**Reg. No. 3,455,424**

**United States Patent and Trademark Office**

**Registered June 24, 2008**

**TRADEMARK  
PRINCIPAL REGISTER**

**CELLU-CUSHION PRO-TECTORS**

SEALED AIR CORPORATION (US) (DELAWARE CORPORATION)  
200 RIVERFRONT BOULEVARD  
ELMWOOD PARK, NJ 07407

OWNER OF U.S. REG. NO. 1,356,609.

FOR: POLYOLEFIN FOAM CORNERS FOR USE IN PACKAGING, IN CLASS 17 (U.S. CLS. 1, 5, 12, 13, 35 AND 50).

NO CLAIM IS MADE TO THE EXCLUSIVE RIGHT TO USE "PROTECTORS", APART FROM THE MARK AS SHOWN.

FIRST USE 12-24-2005; IN COMMERCE 12-24-2005.

SN 78-785,865, FILED 1-5-2006.

THE MARK CONSISTS OF STANDARD CHARACTERS WITHOUT CLAIM TO ANY PARTICULAR FONT, STYLE, SIZE, OR COLOR.

RUSS HERMAN, EXAMINING ATTORNEY

**Int. Cl.: 9**

**Prior U.S. Cls.: 21, 23, 26, 36, and 38**

**Reg. No. 3,455,425**

**United States Patent and Trademark Office**

**Registered June 24, 2008**

---

**TRADEMARK  
PRINCIPAL REGISTER**

**TWISTED SPINSTER**

IGT (NEVADA CORPORATION)  
9295 PROTOTYPE DRIVE  
RENO, NV 895218986

THE MARK CONSISTS OF STANDARD CHAR-  
ACTERS WITHOUT CLAIM TO ANY PARTICULAR  
FONT, STYLE, SIZE, OR COLOR.

FOR: GAMING MACHINES, NAMELY, DEVICES  
WHICH ACCEPT A WAGER, IN CLASS 9 (U.S. CLS.  
21, 23, 26, 36 AND 38).

SN 78-786,003, FILED 1-5-2006.

FIRST USE 8-31-2007; IN COMMERCE 10-24-2007.

SEAN CROWLEY, EXAMINING ATTORNEY

**Int. Cl.: 41**

**Prior U.S. Cls.: 100, 101, and 107**

**United States Patent and Trademark Office**

**Reg. No. 3,455,426**

**Registered June 24, 2008**

**SERVICE MARK  
PRINCIPAL REGISTER**

**FRANK**

PFIZER INC. (DELAWARE CORPORATION)  
235 EAST 42ND STREET  
NEW YORK, NY 10017

FOR: EDUCATIONAL SERVICES, NAMELY,  
PROVIDING CLASSES, SEMINARS AND WORK-  
SHOPS IN THE FIELD OF VETERINARY MEDI-  
CINE AND HANDOUTS, CDS AND DVDS  
PROVIDED IN CONNECTION THEREWITH , IN  
CLASS 41 (U.S. CLS. 100, 101 AND 107).

FIRST USE 11-30-2006; IN COMMERCE 11-30-2006.

THE MARK CONSISTS OF STANDARD CHAR-  
ACTERS WITHOUT CLAIM TO ANY PARTICULAR  
FONT, STYLE, SIZE, OR COLOR.

SN 78-786,475, FILED 1-6-2006.

CURTIS FRENCH, EXAMINING ATTORNEY

**Int. Cls.: 12, 16, 21, and 25**

**Prior U.S. Cls.: 2, 5, 13, 19, 21, 22, 23, 29, 30, 31, 33,  
35, 37, 38, 39, 40, 44, and 50**

**Reg. No. 3,455,427**

**United States Patent and Trademark Office**

**Registered June 24, 2008**

**TRADEMARK  
PRINCIPAL REGISTER**

# SEA FIGHTER

OFFICE OF NAVAL RESEARCH (UNITED  
STATES AGENCY OF THE GOVERNMENT)  
CODE 01CC  
875 NORTH RANDOLPH STREET, SUITE 1425  
ARLINGTON, VA 222031995

FOR: BOATS, IN CLASS 12 (U.S. CLS. 19, 21, 23, 31,  
35 AND 44).

FIRST USE 5-31-2005; IN COMMERCE 5-31-2005.

FOR: STICKERS, DECALS, IN CLASS 16 (U.S. CLS.  
2, 5, 22, 23, 29, 37, 38 AND 50).

FIRST USE 5-9-2007; IN COMMERCE 5-9-2007.

FOR: BEVERAGEWARE, IN CLASS 21 (U.S. CLS. 2,  
13, 23, 29, 30, 33, 40 AND 50).

FIRST USE 5-9-2007; IN COMMERCE 5-9-2007.

FOR: HATS, CAPS, GOLF SHIRTS, IN CLASS 25  
(U.S. CLS. 22 AND 39).

FIRST USE 5-9-2007; IN COMMERCE 5-9-2007.

THE MARK CONSISTS OF STANDARD CHAR-  
ACTERS WITHOUT CLAIM TO ANY PARTICULAR  
FONT, STYLE, SIZE, OR COLOR.

SN 78-788,099, FILED 1-10-2006.

PAULA MAHONEY, EXAMINING ATTORNEY

**Int. Cl.: 36**

**Prior U.S. Cls.: 100, 101, and 102**

**United States Patent and Trademark Office**

**Reg. No. 3,455,428**

**Registered June 24, 2008**

**SERVICE MARK  
PRINCIPAL REGISTER**

**富國全球匯達**

WELLS FARGO & COMPANY (DELAWARE  
CORPORATION)  
1700 WELLS FARGO CENTER, MAC N9305-176  
SIXTH AND MARQUETTE  
MINNEAPOLIS, MN 55479

FOR: MONEY TRANSFER SERVICES, IN CLASS  
36 (U.S. CLS. 100, 101 AND 102).

FIRST USE 7-12-2007; IN COMMERCE 7-12-2007.

NO CLAIM IS MADE TO THE EXCLUSIVE  
RIGHT TO USE QUAN QUI HUI THE TRANSLI-  
TERATION OF THE NON-LATIN CHARACTERS

THAT MEAN GLOBAL REMIT, APART FROM THE  
MARK AS SHOWN.

THE NON-LATIN CHARACTER(S) IN THE  
MARK TRANSLITERATES INTO FU GUO QUAN  
QUI HUI DA, AND THIS MEANS WELLS FARGO  
GLOBAL REMIT AND REACH IN ENGLISH.

SN 78-789,052, FILED 1-11-2006.

KAREN K. BUSH, EXAMINING ATTORNEY

**Int. Cl.: 35**

**Prior U.S. Cls.: 100, 101, and 102**

**United States Patent and Trademark Office**

**Reg. No. 3,455,429**

**Registered June 24, 2008**

**SERVICE MARK  
PRINCIPAL REGISTER**

**NPS**

SATMETRIX SYSTEMS, INC. (CALIFORNIA CORPORATION)  
950 TOWER LANE, SUITE 500  
FOSTER CITY, CA 94404 AND  
REICHHELD, FRED (UNITED STATES INDIVIDUAL)  
40 HAMPSHIRE ROAD  
WELLESLEY, MA 02481 AND  
BAIN & COMPANY, INC. (MASSACHUSETTS CORPORATION)  
131 DARTMOUTH STREET  
BOSTON, MA 02116

FOR: BUSINESS CONSULTING SERVICES, NAMELY, A CUSTOMER METRICS AND FEEDBACK PROCESS FOR PERFORMANCE IMPROVEMENT AND BUSINESS CONSULTING SERVICES IN THE NATURE OF CUSTOMER SATISFACTION

AND CUSTOMER LOYALTY SERVICES TO THE FINANCIAL SERVICES, INFORMATION TECHNOLOGY, AUTOMOTIVE, AEROSPACE AND DEFENSE, CHEMICALS, CONSTRUCTION AND BUILDING, MINING, REAL ESTATE AND CONSUMER PRODUCTS FIELDS, IN CLASS 35 (U.S. CLS. 100, 101 AND 102).

FIRST USE 11-0-2005; IN COMMERCE 11-0-2005.

THE MARK CONSISTS OF STANDARD CHARACTERS WITHOUT CLAIM TO ANY PARTICULAR FONT, STYLE, SIZE, OR COLOR.

SN 78-789,466, FILED 1-11-2006.

PAUL CROWLEY, EXAMINING ATTORNEY

**Int. Cl.: 35**

**Prior U.S. Cls.: 100, 101, and 102**

**United States Patent and Trademark Office**

**Reg. No. 3,455,430**

**Registered June 24, 2008**

**SERVICE MARK  
PRINCIPAL REGISTER**



FAVORITE HEALTHCARE STAFFING, INC.  
(KANSAS CORPORATION)  
7255 WEST 98TH TERRACE, SUITE 150  
BLDG. 5  
OVERLAND PARK, KS 66212

THE MARK CONSISTS OF THE LETTERS "F"  
AND "H" WITHIN A CIRCLE.

FOR: TEMPORARY EMPLOYMENT AGENCIES,  
IN CLASS 35 (U.S. CLS. 100, 101 AND 102).

SN 78-790,009, FILED 1-12-2006.

FIRST USE 2-26-2006; IN COMMERCE 2-26-2006.

ARETHA SOMERVILLE, EXAMINING ATTORNEY

**Int. Cl.: 26**

**Prior U.S. Cls.: 37, 39, 40, 42, and 50**

**United States Patent and Trademark Office**

**Reg. No. 3,455,431**

**Registered June 24, 2008**

**TRADEMARK  
PRINCIPAL REGISTER**

**LANGUAGE OF FLOWERS**

FLAT CREEK MOUNTAIN, INC. (NORTH CAROLINA CORPORATION)  
15 VILLAGE GREEN DRIVE  
ALEXANDER (28701), P.O. BOX 8344  
ASHEVILLE, NC 28814

FOR: ARTIFICIAL FLOWER ARRANGEMENTS; ARTIFICIAL FLOWER WREATHS; ARTIFICIAL FLOWERS; ARTIFICIAL GARLANDS; ARTIFICIAL PLANTS; AND ARTIFICIAL WREATHS, IN CLASS 26 (U.S. CLS. 37, 39, 40, 42 AND 50).

FIRST USE 8-21-2007; IN COMMERCE 8-21-2007.

THE MARK CONSISTS OF STANDARD CHARACTERS WITHOUT CLAIM TO ANY PARTICULAR FONT, STYLE, SIZE, OR COLOR.

OWNER OF U.S. REG. NOS. 1,389,310, 2,775,925, AND 2,987,649.

NO CLAIM IS MADE TO THE EXCLUSIVE RIGHT TO USE "FLOWERS", APART FROM THE MARK AS SHOWN.

SN 78-791,085, FILED 1-13-2006.

MARY MUNSON, EXAMINING ATTORNEY



**Int. Cl.: 36**

**Prior U.S. Cls.: 100, 101, and 102**

**United States Patent and Trademark Office**

**Reg. No. 3,455,432**

**Registered June 24, 2008**

**SERVICE MARK  
PRINCIPAL REGISTER**

**INFINITY AUTO INSURANCE  
COMPANY**

INFINITY INSURANCE COMPANY (INDIANA  
CORPORATION)  
3700 COLONNADE PARKWAY  
BIRMINGHAM, AL 35243

OWNER OF U.S. REG. NOS. 1,819,181, 2,472,418,  
AND OTHERS.

FOR: PROPERTY AND CASUALTY INSURANCE  
UNDERWRITING SERVICES, IN CLASS 36 (U.S.  
CLS. 100, 101 AND 102).

NO CLAIM IS MADE TO THE EXCLUSIVE  
RIGHT TO USE "AUTO INSURANCE COMPANY",  
APART FROM THE MARK AS SHOWN.

FIRST USE 6-4-2007; IN COMMERCE 6-4-2007.

SN 78-791,371, FILED 1-13-2006.

THE MARK CONSISTS OF STANDARD CHAR-  
ACTERS WITHOUT CLAIM TO ANY PARTICULAR  
FONT, STYLE, SIZE, OR COLOR.

MARY MUNSON, EXAMINING ATTORNEY

**Int. Cl.: 41**

**Prior U.S. Cls.: 100, 101, and 107**

**United States Patent and Trademark Office**

**Reg. No. 3,455,433**

**Registered June 24, 2008**

**SERVICE MARK  
PRINCIPAL REGISTER**

**GREENSTONE MEDIA**

GREENSTONE MEDIA, LLC (MARYLAND LTD  
LIAB CO)  
5505 DEVON ROAD  
BETHESDA, MD 20814

FOR: ENTERTAINMENT SERVICES, NAMELY,  
PROVIDING ENTERTAINMENT PROGRAMS IN  
THE FIELDS OF NEWS, WOMEN'S ISSUES, COM-  
MENTARY, LIFESTYLE, AND CULTURE VIA  
RADIO, THE INTERNET , IN CLASS 41 (U.S. CLS.  
100, 101 AND 107).

FIRST USE 3-2-2006; IN COMMERCE 3-2-2006.

THE MARK CONSISTS OF STANDARD CHAR-  
ACTERS WITHOUT CLAIM TO ANY PARTICULAR  
FONT, STYLE, SIZE, OR COLOR.

NO CLAIM IS MADE TO THE EXCLUSIVE  
RIGHT TO USE "MEDIA", APART FROM THE  
MARK AS SHOWN.

SN 78-791,689, FILED 1-13-2006.

DANNEAN HETZEL, EXAMINING ATTORNEY

**Int. Cl.: 30**

**Prior U.S. Cl.: 46**

**United States Patent and Trademark Office**

**Reg. No. 3,455,434**

**Registered June 24, 2008**

**TRADEMARK  
PRINCIPAL REGISTER**

**SONOMIC**

AMERICAN BEVERAGE GROUP INC. (CALI-  
FORNIA CORPORATION)  
613 2ND STREET  
PETALUMA, CA 94952

THE MARK CONSISTS OF STANDARD CHAR-  
ACTERS WITHOUT CLAIM TO ANY PARTICULAR  
FONT, STYLE, SIZE, OR COLOR.

FOR: VINEGAR; WINE VINEGAR, IN CLASS 30  
(U.S. CL. 46).

SN 78-791,744, FILED 1-13-2006.

FIRST USE 8-15-2007; IN COMMERCE 8-15-2007.

TARAH HARDY, EXAMINING ATTORNEY

**Int. Cl.: 8**

**Prior U.S. Cls.: 23, 28, and 44**

**United States Patent and Trademark Office**

**Reg. No. 3,455,435**

**Registered June 24, 2008**

**TRADEMARK  
PRINCIPAL REGISTER**

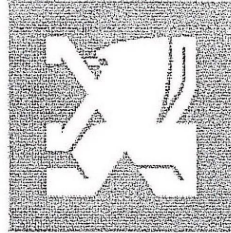

**Regent  
Sheffield**

REGENT-SHEFFIELD, LTD. (NEW YORK COR-  
PORATION)  
C/O CT CORPORATION SYSTEM  
NEW YORK, NY 10011

FOR: TABLE WEAR, NAMELY, KNIVES, FORKS  
AND SPOONS; KITCHEN KNIVES, IN CLASS 8 (U.S.  
CLS. 23, 28 AND 44).

FIRST USE 12-31-1963; IN COMMERCE 12-31-1986.

OWNER OF U.S. REG. NO. 2,063,290.

NO CLAIM IS MADE TO THE EXCLUSIVE  
RIGHT TO USE "SHEFFIELD", APART FROM THE  
MARK AS SHOWN.

SN 78-792,246, FILED 1-16-2006.

RUSS HERMAN, EXAMINING ATTORNEY

**Int. Cl.: 11**

**Prior U.S. Cls.: 13, 21, 23, 31, and 34**

**United States Patent and Trademark Office**

**Reg. No. 3,455,436**

**Registered June 24, 2008**

**TRADEMARK  
PRINCIPAL REGISTER**

**IDISCO**

TAI NAM INDUSTRIAL COMPANY LIMITED  
(HONG KONG CORPORATION)  
UNITS D-F, 26/F  
CDW BUILDING, 388 CASTLE PEAK ROAD  
TSUEN WAN, N.T., HONG KONG

THE MARK CONSISTS OF STANDARD CHAR-  
ACTERS WITHOUT CLAIM TO ANY PARTICULAR  
FONT, STYLE, SIZE, OR COLOR.

FOR: LIGHTED DISCO BALLS, IN CLASS 11 (U.S.  
CLS. 13, 21, 23, 31 AND 34).

SN 78-794,514, FILED 1-19-2006.

FIRST USE 10-1-2006; IN COMMERCE 10-1-2006.

DAWN HAN, EXAMINING ATTORNEY

**Int. Cl.: 9**

**Prior U.S. Cls.: 21, 23, 26, and 38**

**United States Patent and Trademark Office**

**Reg. No. 3,455,437**

**Registered June 24, 2008**

**TRADEMARK  
PRINCIPAL REGISTER**

**MAX BIOCHIP**

DECISION BIOMARKERS INCORPORATED (DE-  
LAWARE CORPORATION)  
150 BEAR HILL ROAD  
WALTHAM, MA 02451

FOR: REACTION CASSETTES FOR USE IN AU-  
TOMATED LABORATORY ANALYSIS INSTRU-  
MENTS FOR LABORATORY ANALYSIS OF  
CHEMICAL, BIOCHEMICAL, BIOTECHNOLOGI-  
CAL, AND BIOLOGICAL SAMPLES; PLATES,  
GLASS SLIDES, OR CHIPS HAVING ARRAYS FOR  
USE IN CHEMICAL ANALYSIS, BIOLOGICAL ANA-  
LYSIS, OR PATTERNING FOR SCIENTIFIC, LA-  
BORATORY OR MEDICAL RESEARCH USE, IN  
CLASS 9 (U.S. CLS. 21, 23, 26, 36 AND 38).

FIRST USE 1-28-2008; IN COMMERCE 1-28-2008.

THE MARK CONSISTS OF STANDARD CHAR-  
ACTERS WITHOUT CLAIM TO ANY PARTICULAR  
FONT, STYLE, SIZE, OR COLOR.

NO CLAIM IS MADE TO THE EXCLUSIVE  
RIGHT TO USE "BIOCHIP", APART FROM THE  
MARK AS SHOWN.

SN 78-794,820, FILED 1-19-2006.

KAREN K. BUSH, EXAMINING ATTORNEY

**Int. Cl.: 35**

**Prior U.S. Cls.: 100, 101, and 102**

**United States Patent and Trademark Office**

**Reg. No. 3,455,438**

**Registered June 24, 2008**

---

**SERVICE MARK  
PRINCIPAL REGISTER**



SMURFIT-STONE CONTAINER ENTERPRISES,  
INC. (DELAWARE CORPORATION)  
150 N. MICHIGAN AVENUE  
CHICAGO, IL 60601

FOR: BUSINESS MARKETING CONSULTING  
SERVICES IN THE FIELD OF PAPERBOARD PRO-  
DUCTS AND OTHER INDUSTRIAL AND COM-  
MERCIAL CONTAINERS; COMMERCIAL  
INFORMATION AGENCY PROVIDING BUSINESS  
INFORMATION REGARDING MARKETING AND  
DEMOGRAPHIC DATA IN THE FIELD OF PAPER-  
BOARD PRODUCTS AND OTHER INDUSTRIAL

AND COMMERCIAL CONTAINERS, IN CLASS 35  
(U.S. CLS. 100, 101 AND 102).

FIRST USE 1-23-2006; IN COMMERCE 1-23-2006.

OWNER OF U.S. REG. NOS. 2,540,794, 2,884,730,  
AND OTHERS.

SN 78-797,359, FILED 1-23-2006.

DORITT L. CARROLL, EXAMINING ATTORNEY

**Int. Cl.: 3**

**Prior U.S. Cls.: 1, 4, 6, 50, 51, and 52**

**United States Patent and Trademark Office**

**Reg. No. 3,455,439**

**Registered June 24, 2008**

**TRADEMARK  
PRINCIPAL REGISTER**

**DERMAGENICS**

THE KLINGER GROUP LLC (CALIFORNIA LTD  
LIAB CO)  
15332 ANTIOCH ST., #446  
PACIFIC PALISADES, CA 90272

FOR: SKIN CARE PRODUCTS AND FACIAL  
AND BODY TREATMENTS, NAMELY, DAY  
MOISTURIZING CREAM, NIGHT MOISTURIZING  
CREAM, NIGHTTIME UNDER-EYE CREAM, DAY-  
TIME UNDER-EYE CREAM, NON-MEDICATED  
SKIN CARE SERUM, SKIN CARE TONER, SKIN  
CARE MASK, SKIN CARE SCRUB/EXFOLIANT,  
BODY CREAM, HAND CREAM, NON-MEDICATED  
FOOT CREAM; BATH OILS; SOAPS; BUBBLE BATH;  
HAIR CARE PRODUCTS, NAMELY, SHAMPOO,  
HAIR CONDITIONER, NON-MEDICATED HAIR  
TREATMENT PREPARATIONS, HAIR CREAM

RINSE; MAKEUP, NAMELY, LIPSTICK, FOUNDA-  
TIONS, MASCARA, EYE SHADOW, IN CLASS 3 (U.S.  
CLS. 1, 4, 6, 50, 51 AND 52).

FIRST USE 8-10-2006; IN COMMERCE 8-10-2006.

THE MARK CONSISTS OF STANDARD CHAR-  
ACTERS WITHOUT CLAIM TO ANY PARTICULAR  
FONT, STYLE, SIZE, OR COLOR.

OWNER OF U.S. REG. NO. 1,097,832.

SN 78-797,524, FILED 1-23-2006.

DAVID MILLER, EXAMINING ATTORNEY



**Int. Cls.: 9 and 11**

**Prior U.S. Cls.: 13, 21, 23, 26, 31, 34, 36, and 38**

**United States Patent and Trademark Office**

**Reg. No. 3,455,440**

**Registered June 24, 2008**

**TRADEMARK  
PRINCIPAL REGISTER**

**GOLDLINE CONTROLS**

HAYWARD INDUSTRIES, INC. (NEW JERSEY CORPORATION)  
620 DIVISION STREET  
ELIZABETH, NJ 07207

FOR: ELECTRONIC CONTROLS FOR USE IN SWIMMING POOLS, SPAS, HOT TUBS, WHIRLPOOLS, AND OTHER BODIES OF WATER, IN CLASS 9 (U.S. CLS. 21, 23, 26, 36 AND 38).

FIRST USE 12-31-2000; IN COMMERCE 12-31-2000.

FOR: SALT AND CHLORINE GENERATORS, LIGHTS AND VALVES FOR USE IN SWIMMING POOLS, SPAS, HOT TUBS, WHIRLPOOLS, AND OTHER BODIES OF WATER, IN CLASS 11 (U.S. CLS. 13, 21, 23, 31 AND 34).

FIRST USE 9-1-2004; IN COMMERCE 9-1-2004.

THE MARK CONSISTS OF STANDARD CHARACTERS WITHOUT CLAIM TO ANY PARTICULAR FONT, STYLE, SIZE, OR COLOR.

OWNER OF U.S. REG. NO. 1,600,619.

NO CLAIM IS MADE TO THE EXCLUSIVE RIGHT TO USE "CONTROLS" , APART FROM THE MARK AS SHOWN.

SN 78-798,338, FILED 1-24-2006.

SANJEEV VOHRA, EXAMINING ATTORNEY

Int. Cl.: 25

Prior U.S. Cls.: 22 and 39

United States Patent and Trademark Office

Reg. No. 3,455,441

Registered June 24, 2008

TRADEMARK  
PRINCIPAL REGISTER



*divine wear*

KRISTINE MILLER (UNITED STATES INDIVIDUAL)  
C/O KOENIG & ASSOCIATES  
P.O. BOX 1140  
SANTA BARBARA, CA 93101

FOR: CLOTHING, NAMELY, BOTTOMS, PANTS, SWEATPANTS, SHORTS, SKIRTS, SHIRTS, NAMELY, T-SHIRTS, SWEATSHIRTS, KNIT SHIRTS, PULLOVERS, TOPS, SWEAT TOPS, CROP TOPS, HALTER TOPS, BRA TOPS, TANK TOPS; LEGGINGS, IN CLASS 25 (U.S. CLS. 22 AND 39).

FIRST USE 3-1-2005; IN COMMERCE 3-1-2005.

NO CLAIM IS MADE TO THE EXCLUSIVE RIGHT TO USE "WEAR", APART FROM THE MARK AS SHOWN.

THE MARK CONSISTS OF A STARLIKE FLOWER DESIGN ABOVE THE WORDS "DIVINE WEAR".

SN 78-799,334, FILED 1-25-2006.

ELLEN BURNS, EXAMINING ATTORNEY

**Int. Cl.: 5**

**Prior U.S. Cls.: 6, 18, 44, 46, 51, and 52**

**Reg. No. 3,455,442**

**United States Patent and Trademark Office**

**Registered June 24, 2008**

---

**TRADEMARK  
PRINCIPAL REGISTER**

**ENDIGO**

SYNGENTA PARTICIPATIONS AG (SWITZER-  
LAND CORPORATION)  
SCHWARZWALDALEE 215  
BASEL, SWITZERLAND CH-4058

THE MARK CONSISTS OF STANDARD CHAR-  
ACTERS WITHOUT CLAIM TO ANY PARTICULAR  
FONT, STYLE, SIZE, OR COLOR.

FOR: INSECTICIDE FOR AGRICULTURAL USE,  
IN CLASS 5 (U.S. CLS. 6, 18, 44, 46, 51 AND 52).

SN 78-799,762, FILED 1-26-2006.

FIRST USE 2-4-2008; IN COMMERCE 2-4-2008.

GILBERT SWIFT, EXAMINING ATTORNEY

**Int. Cl.: 33**

**Prior U.S. Cls.: 47 and 49**

**United States Patent and Trademark Office**

**Reg. No. 3,455,443**

**Registered June 24, 2008**

**TRADEMARK  
PRINCIPAL REGISTER**

**CARDINALS PEAK**

PATERNO IMPORTS, LTD. (ILLINOIS CORPORATION), DBA PATERNO WINES INTERNATIONAL,  
900 ARMOUR DRIVE  
LAKE BLUFF, IL 60044

THE MARK CONSISTS OF STANDARD CHARACTERS WITHOUT CLAIM TO ANY PARTICULAR FONT, STYLE, SIZE, OR COLOR.

FOR: WINE, IN CLASS 33 (U.S. CLS. 47 AND 49).

SN 78-799,788, FILED 1-26-2006.

FIRST USE 5-1-2008; IN COMMERCE 5-1-2008.

SALLY SHIH, EXAMINING ATTORNEY

**Int. Cl.: 9**

**Prior U.S. Cls.: 21, 23, 26, 36, and 38**

**Reg. No. 3,455,444**

**United States Patent and Trademark Office**

**Registered June 24, 2008**

---

**TRADEMARK  
PRINCIPAL REGISTER**

**Cookin' Rx: "Good Food is  
the Best Medicine."**

BOGUNOVICH, MARIANNE T. (UNITED  
STATES INDIVIDUAL)  
220 N. 9TH STREET  
ALLENTOWN, PA 18102

FOR: DOWNLOADABLE ELECTRONIC PUBLI-  
CATIONS IN THE NATURE OF GUIDES IN THE  
FIELD OF NUTRITIOUS MEAL PLANNING AND  
GROCERY SHOPPING, IN CLASS 9 (U.S. CLS. 21, 23,  
26, 36 AND 38).

FIRST USE 5-12-2008; IN COMMERCE 5-12-2008.

THE MARK CONSISTS OF STANDARD CHAR-  
ACTERS WITHOUT CLAIM TO ANY PARTICULAR  
FONT, STYLE, SIZE, OR COLOR.

SN 78-800,326, FILED 1-26-2006.

FRED MANDIR, EXAMINING ATTORNEY

**Int. Cl.: 12**

**Prior U.S. Cls.: 19, 21, 23, 31, 35, and 44**

**Reg. No. 3,455,445**

**United States Patent and Trademark Office**

**Registered June 24, 2008**

**TRADEMARK  
PRINCIPAL REGISTER**

**X Line**

PENNZOIL-QUAKER STATE COMPANY (DELA-  
WARE CORPORATION)  
700 MILAM STREET  
HOUSTON, TX 77002

FOR: AUTOMOTIVE ACCESSORIES, NAMELY,  
SEAT COVERS; SEAT CUSHIONS; STEERING  
WHEEL COVERS; SEAT BELT SHOULDER PADS;  
PLASTIC LITTER BAGS ESPECIALLY ADAPTED  
FOR USE IN VEHICLES; AUTOMOTIVE CD VISOR  
ORGANIZERS; AUTOMOTIVE VISOR ORGANI-  
ZERS; AUTOMOTIVE GLOVE BOX ORGANIZERS;  
BACKSEAT ORGANIZERS ESPECIALLY ADAPTED  
FOR USE IN VEHICLES; SEAT BELT CELL PHONE  
HOLDERS; DVD/VIDEO HOLDERS ESPECIALLY  
ADAPTED FOR USE IN VEHICLES; LICENSE

PLATE FRAMES; AUTOMOTIVE SUN PROTEC-  
TIVE SHADES; CAR COVERS AND TARPS IN THE  
NATURE OF CAR COVERS, IN CLASS 12 (U.S. CLS.  
19, 21, 23, 31, 35 AND 44).

FIRST USE 2-10-2006; IN COMMERCE 2-10-2006.

THE MARK CONSISTS OF STANDARD CHAR-  
ACTERS WITHOUT CLAIM TO ANY PARTICULAR  
FONT, STYLE, SIZE, OR COLOR.

SN 78-800,899, FILED 1-27-2006.

MARK T. MULLEN, EXAMINING ATTORNEY

**Int. Cl.: 1**

**Prior U.S. Cls.: 1, 5, 6, 10, 26, and 46**

**Reg. No. 3,455,446**

**United States Patent and Trademark Office**

**Registered June 24, 2008**

**TRADEMARK  
PRINCIPAL REGISTER**

**BIO TECH NUTRIENTS**

BIO TECH NUTRIENTS, LLC (NEVADA LTD  
LIAB CO)  
818 W. BROOKS AVENUE  
NORTH LAS VEGAS, NV 89030

FOR: FERTILIZERS; SOIL ADDITIVES; SOIL  
AMENDMENTS, IN CLASS 1 (U.S. CLS. 1, 5, 6, 10,  
26 AND 46).

FIRST USE 9-28-2005; IN COMMERCE 9-28-2005.

THE MARK CONSISTS OF STANDARD CHAR-  
ACTERS WITHOUT CLAIM TO ANY PARTICULAR  
FONT, STYLE, SIZE, OR COLOR.

NO CLAIM IS MADE TO THE EXCLUSIVE  
RIGHT TO USE "BIO" AND "NUTRIENTS", APART  
FROM THE MARK AS SHOWN.

SN 78-801,306, FILED 1-27-2006.

KRISTINA MORRIS, EXAMINING ATTORNEY

**Int. Cl.: 28**

**Prior U.S. Cls.: 22, 23, 38, and 50**

**Reg. No. 3,455,447**

**United States Patent and Trademark Office**

**Registered June 24, 2008**

---

**TRADEMARK  
PRINCIPAL REGISTER**

**DIESEL**

DIAMOND BASEBALL COMPANY, INC. (CALIFORNIA CORPORATION), DBA DIAMOND SPORTS CO., INC.,  
11130 WARLAND DRIVE  
CYPRESS, CA 90630

FOR: SPORTING EQUIPMENT, NAMELY, BASEBALL BATS, FIELDER'S GLOVES, NON-LEATHER BAGS SPECIALLY ADAPTED FOR SPORTS EQUIPMENT, NAMELY, BASEBALL AND SOFTBALL EQUIPMENT, CATCHER'S MITTS, FACE MASKS FOR BASEBALL AND SOFTBALL, CHEST PROTEC-

TORS FOR SPORTS, LEG GUARDS FOR ATHLETIC USE, IN CLASS 28 (U.S. CLS. 22, 23, 38 AND 50).

FIRST USE 6-7-2007; IN COMMERCE 6-7-2007.

THE MARK CONSISTS OF STANDARD CHARACTERS WITHOUT CLAIM TO ANY PARTICULAR FONT, STYLE, SIZE, OR COLOR.

SN 78-801,409, FILED 1-27-2006.

ELISSA GARBER KON, EXAMINING ATTORNEY



**Int. Cl.: 5**

**Prior U.S. Cls.: 6, 18, 44, 46, 51, and 52**

**Reg. No. 3,455,448**

**United States Patent and Trademark Office**

**Registered June 24, 2008**

---

**TRADEMARK  
PRINCIPAL REGISTER**

# Crystal Radiance

JAMES, TERRY L. (UNITED STATES INDIVIDUAL), DBA JAMIEO,  
1140 EMPIRE CENTRAL, SUITE 600  
DALLAS, TX 75247

THE MARK CONSISTS OF STANDARD CHARACTERS WITHOUT CLAIM TO ANY PARTICULAR FONT, STYLE, SIZE, OR COLOR.

FOR: SKIN CARE TREATMENT SYSTEMS, NAMELY, VITAMINS AND SYNTHETIC PEPTIDES FOR MEDICALLY TREATING SKIN DISORDERS, IN CLASS 5 (U.S. CLS. 6, 18, 44, 46, 51 AND 52).

SN 78-801,429, FILED 1-27-2006.

FIRST USE 10-1-2006; IN COMMERCE 10-1-2006.

ALEX KEAM, EXAMINING ATTORNEY

**Int. Cl.: 16**

**Prior U.S. Cls.: 2, 5, 22, 23, 29, 37, 38, and 50**

**Reg. No. 3,455,449**

**United States Patent and Trademark Office**

**Registered June 24, 2008**

---

**TRADEMARK  
PRINCIPAL REGISTER**

**your legal companion**

NOLO (CALIFORNIA CORPORATION)  
950 PARKER STREET  
BERKELEY, CA 94710

FOR: BOOKS IN THE FIELD OF LAW AND  
BUSINESS, IN CLASS 16 (U.S. CLS. 2, 5, 22, 23, 29,  
37, 38 AND 50).

FIRST USE 7-1-2006; IN COMMERCE 7-1-2006.

THE MARK CONSISTS OF STANDARD CHAR-  
ACTERS WITHOUT CLAIM TO ANY PARTICULAR  
FONT, STYLE, SIZE, OR COLOR.

NO CLAIM IS MADE TO THE EXCLUSIVE  
RIGHT TO USE "LEGAL", APART FROM THE  
MARK AS SHOWN.

SN 78-802,621, FILED 1-30-2006.

NAAKWAMA ANKRAH, EXAMINING ATTORNEY

**Int. Cl.: 36**

**Prior U.S. Cls.: 100, 101, and 102**

**United States Patent and Trademark Office**

**Reg. No. 3,455,450**

**Registered June 24, 2008**

**SERVICE MARK  
PRINCIPAL REGISTER**

**INSPIRADA**

SOUTH EDGE, LLC (NEVADA LIMITED LIABILITY COMPANY)  
SUITE 220  
3455 CLIFF SHADOWS PARKWAY  
LAS VEGAS, NV 89129

FOR: REAL ESTATE LISTINGS, LEASING AND BROKERAGE SERVICES, IN CLASS 36 (U.S. CLS. 100, 101 AND 102).

FIRST USE 1-30-2006; IN COMMERCE 1-30-2006.

THE MARK CONSISTS OF STANDARD CHARACTERS WITHOUT CLAIM TO ANY PARTICULAR FONT, STYLE, SIZE, OR COLOR.

THE ENGLISH TRANSLATION OF "INSPIRADA" IS "INSPIRED".

SN 78-802,677, FILED 1-30-2006.

LYDIA BELZER, EXAMINING ATTORNEY

**Int. Cl.: 37**

**Prior U.S. Cls.: 100, 103, and 106**

**United States Patent and Trademark Office**

**Reg. No. 3,455,451**

**Registered June 24, 2008**

**SERVICE MARK  
PRINCIPAL REGISTER**

**INSPIRADA**

SOUTH EDGE, LLC (NEVADA LIMITED LIABILITY COMPANY)  
SUITE 220  
3455 CLIFF SHADOWS PARKWAY  
LAS VEGAS, NV 89129

FOR: LAND DEVELOPMENT AND CONSTRUCTION SERVICES, NAMELY, PLANNING, DEVELOPMENT AND CONSTRUCTION OF RESIDENTIAL COMMUNITIES, CUSTOM LOT PROGRAMS, AND COMMERCIAL PROJECTS, IN CLASS 37 (U.S. CLS. 100, 103 AND 106).

FIRST USE 1-30-2006; IN COMMERCE 1-30-2006.

THE MARK CONSISTS OF STANDARD CHARACTERS WITHOUT CLAIM TO ANY PARTICULAR FONT, STYLE, SIZE, OR COLOR.

THE ENGLISH TRANSLATION OF "INSPIRADA" IS "INSPIRED".

SN 78-802,693, FILED 1-30-2006.

LYDIA BELZER, EXAMINING ATTORNEY

**Int. Cl.: 28**

**Prior U.S. Cls.: 22, 23, 38, and 50**

**United States Patent and Trademark Office**

**Reg. No. 3,455,452**

**Registered June 24, 2008**

**TRADEMARK  
PRINCIPAL REGISTER**



JAKKS PACIFIC, INC. (DELAWARE CORPORATION)  
22619 PACIFIC COAST HIGHWAY  
MALIBU, CA 90265

FOR: TOYS, GAMES AND PLAYTHINGS, NAME-  
LY, TOY VEHICLES, ACTION FIGURES, TOY FIG-  
URES, SPINNING TOYS, TOY GUNS, AND PLAY  
SETS AND ACCESSORIES FOR ALL OF THE  
AFOREMENTIONED, TOY FIGURE MOLDS, CHIL-  
DREN'S MULTIPLE ACTIVITY TOYS, CONSTRU-  
TION TOYS, WATER SQUIRTING TOYS, IN CLASS  
28 (U.S. CLS. 22, 23, 38 AND 50).

FIRST USE 1-31-2003; IN COMMERCE 1-31-2003.

OWNER OF U.S. REG. NO. 2,267,543.

THE COLOR(S) GRAY IS/ARE CLAIMED AS A  
FEATURE OF THE MARK.

THE MARK CONSISTS OF A GRAY SHADED  
STYLED NAME-PLATE WITH 4 SCREW-HEADS AT  
EACH CORNER; IN THE CENTER IS AN OVAL  
LOGO IN WHICH APPEAR THE WORDS "JAKKS  
PACIFIC" IN DARKER LETTERING.

SN 78-803,651, FILED 1-31-2006.

WENDY JUN, EXAMINING ATTORNEY

**Int. Cl.: 43**

**Prior U.S. Cls.: 100 and 101**

**United States Patent and Trademark Office**

**Reg. No. 3,455,453**

**Registered June 24, 2008**

**SERVICE MARK  
PRINCIPAL REGISTER**

**Beans Coffee Company**

KEYES, PERRY T. (UNITED STATES INDIVIDUAL)  
13030 HEATHER DR.  
WATERFORD, CA 95386 AND  
KEYES, CAMARON R. (UNITED STATES INDIVIDUAL)  
13030 HEATHER DR.  
WATERFORD, CA 95386

FOR: CAFE-RESTAURANTS, IN CLASS 43 (U.S. CLS. 100 AND 101).

FIRST USE 4-28-2008; IN COMMERCE 4-28-2008.

THE MARK CONSISTS OF STANDARD CHARACTERS WITHOUT CLAIM TO ANY PARTICULAR FONT, STYLE, SIZE, OR COLOR.

NO CLAIM IS MADE TO THE EXCLUSIVE RIGHT TO USE "COFFEE COMPANY", APART FROM THE MARK AS SHOWN.

SN 78-803,794, FILED 1-31-2006.

CARRIE GENOVESE, EXAMINING ATTORNEY

**Int. Cl.: 3**

**Prior U.S. Cls.: 1, 4, 6, 50, 51, and 52**

**United States Patent and Trademark Office**

**Reg. No. 3,455,454**

**Registered June 24, 2008**

**TRADEMARK  
PRINCIPAL REGISTER**

**(COLOUR)OLOGIE**

THE PROCTER & GAMBLE COMPANY (OHIO  
CORPORATION)  
ONE PROCTER & GAMBLE PLAZA  
CINCINNATI, OH 45202

FOR: HAIR CARE PREPARATIONS, IN CLASS 3  
(U.S. CLS. 1, 4, 6, 50, 51 AND 52).

FIRST USE 11-30-2006; IN COMMERCE 11-30-2006.

THE MARK CONSISTS OF STANDARD CHAR-  
ACTERS WITHOUT CLAIM TO ANY PARTICULAR  
FONT, STYLE, SIZE, OR COLOR.

OWNER OF U.S. REG. NO. 2,345,961.

SN 78-804,304, FILED 2-1-2006.

ANTHONY RINKER, EXAMINING ATTORNEY

**Int. Cl.: 30**

**Prior U.S. Cl.: 46**

**United States Patent and Trademark Office**

**Reg. No. 3,455,455**

**Registered June 24, 2008**

**TRADEMARK  
PRINCIPAL REGISTER**

**MOOSE MUNCH**

HARRY AND DAVID (OREGON CORPORATION)  
2500 SOUTH PACIFIC HWY  
P.O. BOX 712  
MEDFORD, OR 97501

THE MARK CONSISTS OF STANDARD CHARACTERS WITHOUT CLAIM TO ANY PARTICULAR FONT, STYLE, SIZE, OR COLOR.

OWNER OF U.S. REG. NOS. 2,000,672, 2,977,625, AND OTHERS.

FOR: COOKIE MIXES, IN CLASS 30 (U.S. CL. 46).

SN 78-804,842, FILED 2-1-2006.

FIRST USE 12-21-2007; IN COMMERCE 12-21-2007.

PAUL E. FAHRENKOPF, EXAMINING ATTORNEY



**Int. Cl.: 35**

**Prior U.S. Cls.: 100, 101, and 102**

**United States Patent and Trademark Office**

**Reg. No. 3,455,456**

**Registered June 24, 2008**

**SERVICE MARK  
PRINCIPAL REGISTER**

**TECHXTEND**

PROGRAMMER'S PARADISE, INC. (DELAWARE CORPORATION)  
1157 SHREWSBURY AVENUE  
SHREWSBURY, NJ 077024321

FOR: DISTRIBUTORSHIP AND DIRECT MARKETING SERVICES IN THE FIELD OF COMPUTER SOFTWARE; DISTRIBUTORSHIP AND DIRECT MARKETING CATALOG SERVICES IN THE FIELD OF COMPUTER HARDWARE; DISTRIBUTORSHIP AND DIRECT MARKETING CATALOG SERVICES IN THE FIELD OF COMPUTER PUBLICATIONS AND AUDIO-VISUAL MATERIALS; LICENSING SERVICES IN THE FIELD OF COMPUTER SOFTWARE; MAIL ORDER CATALOG SERVICES IN THE FIELD OF COMPUTER SOFTWARE AND

COMPUTER HARDWARE; TELEPHONE ORDER CATALOG SERVICES IN THE FIELD OF COMPUTER SOFTWARE AND COMPUTER HARDWARE, IN CLASS 35 (U.S. CLS. 100, 101 AND 102).

FIRST USE 6-28-2006; IN COMMERCE 6-28-2006.

THE MARK CONSISTS OF STANDARD CHARACTERS WITHOUT CLAIM TO ANY PARTICULAR FONT, STYLE, SIZE, OR COLOR.

SN 78-805,549, FILED 2-2-2006.

CHARLOTTE CORWIN, EXAMINING ATTORNEY

**Int. Cls.: 38 and 42**

**Prior U.S. Cls.: 100, 101, and 104**

**United States Patent and Trademark Office**

**Reg. No. 3,455,457**

**Registered June 24, 2008**

**SERVICE MARK  
PRINCIPAL REGISTER**

**REDISAT NETWORK**

SES AMERICOM, INC. (DELAWARE CORPORATION)  
FOUR RESEARCH WAY  
PRINCETON, NJ 08540

FOR: SATELLITE-BASED NETWORK COMMUNICATIONS SERVICES, NAMELY, PROVIDING ACCESS TO VOICE, DATA OR VIDEO SIGNALS, TELEVISION BROADCASTING, AND REMOTE ACCESS TO GLOBAL DATA NETWORKS, IN CLASS 38 (U.S. CLS. 100, 101 AND 104).

FIRST USE 7-0-2006; IN COMMERCE 7-0-2006.

FOR: COMPUTER DISASTER RECOVERY PLANNING IN THE FIELD OF SATELLITE-BASED NET-

WORK COMMUNICATIONS, IN CLASS 42 (U.S. CLS. 100 AND 101).

FIRST USE 7-0-2006; IN COMMERCE 7-0-2006.

THE MARK CONSISTS OF STANDARD CHARACTERS WITHOUT CLAIM TO ANY PARTICULAR FONT, STYLE, SIZE, OR COLOR.

NO CLAIM IS MADE TO THE EXCLUSIVE RIGHT TO USE "NETWORK", APART FROM THE MARK AS SHOWN.

SN 78-806,378, FILED 2-3-2006.

KHANH LE, EXAMINING ATTORNEY

**Int. Cl.: 9**

**Prior U.S. Cls.: 21, 23, 26, 36, and 38**

**Reg. No. 3,455,458**

**United States Patent and Trademark Office**

**Registered June 24, 2008**

---

**TRADEMARK  
PRINCIPAL REGISTER**

**HSA**

THE JOHNS HOPKINS UNIVERSITY (MARY-  
LAND CORPORATION)  
APPLIED PHYSICS LABORATORY  
11100 JOHNS HOPKINS ROAD  
LAUREL, MD 20723

FOR: MEDICAL SOFTWARE FOR ANALYZING  
HIP STRUCTURE IN BONE MINERAL DENSITY  
SCANNING, IN CLASS 9 (U.S. CLS. 21, 23, 26, 36 AND  
38).

FIRST USE 5-1-2007; IN COMMERCE 5-1-2007.

THE MARK CONSISTS OF STANDARD CHAR-  
ACTERS WITHOUT CLAIM TO ANY PARTICULAR  
FONT, STYLE, SIZE, OR COLOR.

SN 78-806,529, FILED 2-3-2006.

PAUL CROWLEY, EXAMINING ATTORNEY

**Int. Cl.: 44**

**Prior U.S. Cls.: 100 and 101**

**United States Patent and Trademark Office**

**Reg. No. 3,455,459**

**Registered June 24, 2008**

**SERVICE MARK  
PRINCIPAL REGISTER**

**STILL HUNGRY FOR A CURE**

PRADER-WILLI SYNDROME ASSOCIATION OF  
COLORADO, INC. (COLORADO CORPORATION)  
8290 S. YUKON WAY  
LITTLETON, CO 80128

FOR: PROVIDING MEDICAL INFORMATION  
ABOUT PRADER-WILLI SYNDROME IN ORDER  
TO EDUCATE AFFECTED FAMILIES, HEALTH-  
CARE PROFESSIONALS AND THE PUBLIC ABOUT  
THE DISORDER AND AVAILABLE SUPPORT SER-  
VICES, IN CLASS 44 (U.S. CLS. 100 AND 101).

FIRST USE 1-31-2006; IN COMMERCE 5-5-2006.

THE MARK CONSISTS OF STANDARD CHAR-  
ACTERS WITHOUT CLAIM TO ANY PARTICULAR  
FONT, STYLE, SIZE, OR COLOR.

SN 78-806,900, FILED 2-3-2006.

ALICIA COLLINS, EXAMINING ATTORNEY

**Int. Cl.: 37**

**Prior U.S. Cls.: 100, 103, and 106**

**United States Patent and Trademark Office**

**Reg. No. 3,455,460**

**Registered June 24, 2008**

**SERVICE MARK  
PRINCIPAL REGISTER**

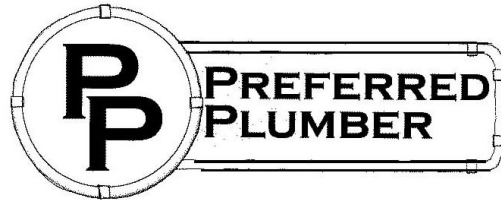

PLUMBERS' SUCCESS INTERNATIONAL, LLC  
(MISSOURI LTD LIAB CO)  
SUITE 1800  
7777 BONHOMME  
ST. LOUIS, MO 63105

FOR: REPAIR, MAINTENANCE, AND INSTAL-  
LATION SERVICES IN THE FIELD OF PLUMBING,  
IN CLASS 37 (U.S. CLS. 100, 103 AND 106).

FIRST USE 8-0-2007; IN COMMERCE 8-0-2007.

NO CLAIM IS MADE TO THE EXCLUSIVE  
RIGHT TO USE "PLUMBER", APART FROM THE  
MARK AS SHOWN.

THE STIPLING IS FOR SHADING PURPOSES  
ONLY.

SN 78-808,045, FILED 2-6-2006.

DANNEAN HETZEL, EXAMINING ATTORNEY

**Int. Cl.: 9**

**Prior U.S. Cls.: 21, 23, 26, 36, and 38**

**United States Patent and Trademark Office**

**Reg. No. 3,455,461**

**Registered June 24, 2008**

**TRADEMARK  
PRINCIPAL REGISTER**

**FROM RACETRACK TO ROADWAY**

HALLIDAY TECHNOLOGIES INC. (DELAWARE  
CORPORATION)  
8525 RAUSCH DRIVE  
PLAIN CITY, OH 43064

FOR: FRICTION METER FOR RECORDING AND  
TRANSMITTING CONTINUOUS ROAD SURFACE  
FRICTION MEASUREMENTS, MOUNTED VIA AN  
AXLE AND AXLE BRACKET UNDER A VEHICLE  
OR VIA AN AXLE AND AXLE BRACKET TOWED  
BY A VEHICLE, IN CLASS 9 (U.S. CLS. 21, 23, 26, 36  
AND 38).

FIRST USE 8-0-2007; IN COMMERCE 8-0-2007.

THE MARK CONSISTS OF STANDARD CHAR-  
ACTERS WITHOUT CLAIM TO ANY PARTICULAR  
FONT, STYLE, SIZE, OR COLOR.

SN 78-808,074, FILED 2-6-2006.

BARBARA GAYNOR, EXAMINING ATTORNEY

**Int. Cl.: 5**

**Prior U.S. Cls.: 6, 18, 44, 46, 51, and 52**

**United States Patent and Trademark Office**

**Reg. No. 3,455,462**

**Registered June 24, 2008**

**TRADEMARK  
PRINCIPAL REGISTER**

**THRIVE**

NOVARTIS AG (SWITZERLAND AKTIENGE-  
SELLSCHAFT)  
POSTFACH 4002  
BASEL, SWITZERLAND

THE MARK CONSISTS OF STANDARD CHAR-  
ACTERS WITHOUT CLAIM TO ANY PARTICULAR  
FONT, STYLE, SIZE, OR COLOR.

FOR: PHARMACEUTICAL PREPARATIONS,  
NAMELY, SMOKING CESSATION PREPARA-  
TIONS, IN CLASS 5 (U.S. CLS. 6, 18, 44, 46, 51 AND 52).

SN 78-808,875, FILED 2-7-2006.

FIRST USE 9-28-2007; IN COMMERCE 9-28-2007.

LINDA ORNDORFF, EXAMINING ATTORNEY

**Int. Cls.: 5 and 10**

**Prior U.S. Cls.: 6, 18, 26, 39, 44, 46, 51, and 52**

**United States Patent and Trademark Office**

**Reg. No. 3,455,463**

**Registered June 24, 2008**

**TRADEMARK  
PRINCIPAL REGISTER**

**XCLOSE**

ANULEX TECHNOLOGIES, INC. (MINNESOTA CORPORATION)  
5600 ROWLAND ROAD, SUITE 280  
MINNETONKA, MN 55343

FOR: FIXATION AND REPAIR LIVE IMPLANTS, AND DELIVERY INSTRUMENTS THEREFOR, SOLD AS A UNIT FOR THE REPAIR OF SOFT TISSUE OF THE SPINE, IN CLASS 5 (U.S. CLS. 6, 18, 44, 46, 51 AND 52).

FIRST USE 2-15-2007; IN COMMERCE 2-27-2007.

FOR: FIXATION AND REPAIR ARTIFICIAL / SYNTHETIC TISSUE IMPLANTS, AND DELIVERY

INSTRUMENTS THEREFOR, FOR THE REPAIR OF SOFT TISSUE OF THE SPINE, IN CLASS 10 (U.S. CLS. 26, 39 AND 44).

FIRST USE 2-15-2007; IN COMMERCE 2-27-2007.

THE MARK CONSISTS OF STANDARD CHARACTERS WITHOUT CLAIM TO ANY PARTICULAR FONT, STYLE, SIZE, OR COLOR.

SN 78-809,651, FILED 2-8-2006.

FLORENTINA BLANDU, EXAMINING ATTORNEY



**Int. Cl.: 9**

**Prior U.S. Cls.: 21, 23, 26, 36, and 38**

**United States Patent and Trademark Office**

**Reg. No. 3,455,464**

**Registered June 24, 2008**

**TRADEMARK  
PRINCIPAL REGISTER**

**APPDIRECTOR**

RADWARE LTD. (ISRAEL CORPORATION)  
22 RAOUL WALLENBERG ST.  
TEL AVIV, ISRAEL

FOR: DEDICATED COMPUTER HARDWARE AND COMPUTER SOFTWARE FOR OPTIMIZATION OF DELIVERING APPLICATIONS OVER INTERNET PROTOCOL (IP) NETWORKS THROUGH LOAD BALANCING, NETWORK TRAFFIC MANAGEMENT, BANDWIDTH MANAGEMENT, SECURE SOCKETS LAYER (SSL) OFF-LOADING, DEVICE, SERVER, AND APPLICATION-PATH MANAGEMENT, APPLICATION PERFORMANCE MONITORING, AND NETWORK TRAFFIC REDIRECTION, AND FOR THE PROVISION OF NET-

WORK SECURITY, IN CLASS 9 (U.S. CLS. 21, 23, 26, 36 AND 38).

FIRST USE 10-3-2005; IN COMMERCE 10-3-2005.

THE MARK CONSISTS OF STANDARD CHARACTERS WITHOUT CLAIM TO ANY PARTICULAR FONT, STYLE, SIZE, OR COLOR.

THE WORDING "APPDIRECTOR" HAS NO MEANING IN A FOREIGN LANGUAGE.

SN 78-809,735, FILED 2-8-2006.

ROBERT C. CLARK JR., EXAMINING ATTORNEY

**Int. Cl.: 9**

**Prior U.S. Cls.: 21, 23, 26, 36, and 38**

**Reg. No. 3,455,465**

**United States Patent and Trademark Office**

**Registered June 24, 2008**

**TRADEMARK  
PRINCIPAL REGISTER**

**APPXCEL**

RADWARE LTD. (ISRAEL CORPORATION)  
22 RAOUL WALLENBERG ST.  
TEL AVIV, ISRAEL

TRANSACTION AND WEB-APPLICATION SCALABILITY AND FOR PROVIDING NETWORK SECURITY, IN CLASS 9 (U.S. CLS. 21, 23, 26, 36 AND 38).

FOR: DEDICATED COMPUTER HARDWARE AND COMPUTER SOFTWARE USED FOR THE PROVIDING PERFORMANCE ACCELERATION OF NETWORKED APPLICATIONS THROUGH: APPLICATION ACCELERATION AND WIDE AREA NETWORK (WAN) OPTIMIZATION, REDUCED SERVER BANDWIDTH CONSUMPTION, OFF-LOADING OF SECURE SOCKETS LAYER (SSL) TRANSACTION PROCESSING AND CERTIFICATE MANAGEMENT, PROVIDING OF UNLIMITED

FIRST USE 10-3-2005; IN COMMERCE 10-3-2005.

THE MARK CONSISTS OF STANDARD CHARACTERS WITHOUT CLAIM TO ANY PARTICULAR FONT, STYLE, SIZE, OR COLOR.

SN 78-809,750, FILED 2-8-2006.

ROBERT C. CLARK JR., EXAMINING ATTORNEY

**Int. Cl.: 34**

**Prior U.S. Cls.: 2, 8, 9, and 17**

**United States Patent and Trademark Office**

**Reg. No. 3,455,466**

**Registered June 24, 2008**

**TRADEMARK  
PRINCIPAL REGISTER**

# DIPLOMA

G & R BRANDS, LLC (NEVADA LTD LIAB CO)  
6525 SOUTH BRUCE STREET  
LAS VEGAS, NV 89119

THE MARK CONSISTS OF STANDARD CHARACTERS WITHOUT CLAIM TO ANY PARTICULAR FONT, STYLE, SIZE, OR COLOR.

FOR: HAND-ROLLING TOBACCO; PIPE TOBACCO; ROLLING TOBACCO; SMOKING TOBACCO; TOBACCO; TOBACCO FILTERS; TOBACCO GRINDERS, IN CLASS 34 (U.S. CLS. 2, 8, 9 AND 17).

SN 78-810,381, FILED 2-8-2006.

FIRST USE 6-1-2006; IN COMMERCE 6-1-2006.

GILBERT SWIFT, EXAMINING ATTORNEY

**Int. Cl.: 42**

**Prior U.S. Cls.: 100 and 101**

**United States Patent and Trademark Office**

**Reg. No. 3,455,467**

**Registered June 24, 2008**

**SERVICE MARK  
PRINCIPAL REGISTER**



SPENCE, RYAN (UNITED STATES INDIVIDUAL)  
14382 REDHILL AVE #35  
TUSTIN, CA 92780

FIRST USE 12-1-2006; IN COMMERCE 12-1-2006.

FOR: GRAPHIC ART DESIGN AND COMPUTER  
GRAPHIC DESIGN SERVICES FOR USE ON WEB  
SITES, DIGITAL MEDIA, CLOTHING AND ALL  
PRINTABLE SURFACES, IN CLASS 42 (U.S. CLS. 100  
AND 101).

NO CLAIM IS MADE TO THE EXCLUSIVE  
RIGHT TO USE "ENTERTAINMENT", APART  
FROM THE MARK AS SHOWN.

SN 78-810,504, FILED 2-8-2006.

JASON LOTT, EXAMINING ATTORNEY

**Int. Cl.: 33**

**Prior U.S. Cls.: 47 and 49**

**United States Patent and Trademark Office**

**Reg. No. 3,455,468**

**Registered June 24, 2008**

**TRADEMARK  
PRINCIPAL REGISTER**

**DZL**

JOHN ZAPA, LTD. (ILLINOIS CORPORATION)  
9721 SOUTH RIDGELAND  
OAKLAWN, IL 60453

THE MARK CONSISTS OF STANDARD CHAR-  
ACTERS WITHOUT CLAIM TO ANY PARTICULAR  
FONT, STYLE, SIZE, OR COLOR.

FOR: ALCOHOLIC BEVERAGES, NAMELY VOD-  
KA, IN CLASS 33 (U.S. CLS. 47 AND 49).

SN 78-812,801, FILED 2-11-2006.

FIRST USE 3-12-2007; IN COMMERCE 3-12-2007.

ALEX KEAM, EXAMINING ATTORNEY

**Int. Cl.: 9**

**Prior U.S. Cls.: 21, 23, 26, 36, and 38**

**United States Patent and Trademark Office**

**Reg. No. 3,455,469**

**Registered June 24, 2008**

**TRADEMARK  
PRINCIPAL REGISTER**

**ARTSEEFARTSEE**

ARTSEE FARTSEE, INC. (MARYLAND CORPORATION)  
4407 NORWOOD RD.  
BALTIMORE, MD 21218

FOR: PRE-RECORDED COMPACT DISCS AND DVDS FEATURING AUDIOVISUAL AND AUDIO PROGRAMS, NAMELY, CLASSICAL MUSIC, PHOTOGRAPHIC IMAGES, GRAPHIC IMAGES, GAMES, EDUCATIONAL MATERIAL, AND ENTERTAINMENT AND LEARNING ACTIVITIES DESIGNED TO STIMULATE THE LEARNING

CAPABILITIES OF INFANTS AND YOUNG CHILDREN, IN CLASS 9 (U.S. CLS. 21, 23, 26, 36 AND 38).

FIRST USE 1-10-2007; IN COMMERCE 1-10-2007.

THE MARK CONSISTS OF STANDARD CHARACTERS WITHOUT CLAIM TO ANY PARTICULAR FONT, STYLE, SIZE, OR COLOR.

SN 78-813,063, FILED 2-13-2006.

PETER B. BROMAGHIM, EXAMINING ATTORNEY

**Int. Cls.: 5 and 44**

**Prior U.S. Cls.: 6, 18, 44, 46, 51, 52, 100, and 101**

**United States Patent and Trademark Office**

**Reg. No. 3,455,470**

**Registered June 24, 2008**

**TRADEMARK  
SERVICE MARK  
PRINCIPAL REGISTER**

**The Doctor's Choice for  
Nutritional Guidance**

HEALTHPRO NUTRIENT, LLC (CALIFORNIA  
LTD LIAB CO)  
20377 S.W. ACACIA STREET  
NEWPORT BEACH, CA 92660

FOR: DIETARY SUPPLEMENTS; FOOD SUPPLEMENTS; VITAMIN SUPPLEMENTS; NUTRITIONAL SUPPLEMENTS; HERBAL SUPPLEMENTS; HOMEOPATHIC SUPPLEMENTS; MINERAL SUPPLEMENTS; MEAL REPLACEMENT AND DIETARY SUPPLEMENT DRINK MIXES; MEDICINAL CREAMS FOR SKIN CARE; MEDICAL CLEANSERS FOR SKIN AND WOUNDS; NUTRITIONAL SUPPLEMENTS IN LOTION A FORM SOLD AS A COMPONENT FOR NUTRITIONAL SKIN CARE PRODUCTS; PHARMACEUTICAL PREPARATIONS FOR TREATING SKIN DISORDERS; AND PRODUCTS AND PREPARATIONS FOR CLEANSING THE SKIN FOR MEDICAL USE, IN CLASS 5 (U.S. CLS. 6, 18, 44, 46, 51 AND 52).

FIRST USE 6-1-2006; IN COMMERCE 6-1-2006.

FOR: DIETARY AND NUTRITIONAL GUIDANCE; AND PROVIDING INFORMATION ABOUT DIETARY SUPPLEMENTS AND NUTRITION, IN CLASS 44 (U.S. CLS. 100 AND 101).

FIRST USE 6-1-2006; IN COMMERCE 6-1-2006.

THE MARK CONSISTS OF STANDARD CHARACTERS WITHOUT CLAIM TO ANY PARTICULAR FONT, STYLE, SIZE, OR COLOR.

SN 78-813,431, FILED 2-13-2006.

TANYA AMOS, EXAMINING ATTORNEY

**Int. Cl.: 10**

**Prior U.S. Cls.: 26, 39, and 44**

**Reg. No. 3,455,471**

**United States Patent and Trademark Office**

**Registered June 24, 2008**

---

**TRADEMARK  
PRINCIPAL REGISTER**

**NAAK PAK**

MERIDIAN MEDICAL TECHNOLOGIES, INC.  
(DELAWARE CORPORATION)  
10240 OLD COLUMBIA ROAD  
COLUMBIA, MD 21046

FOR: NERVE AGENT ANTIDOTE KITS COM-  
PRISING A CASE, AN AUTO-INJECTOR, AND A  
NERVE AGENT ANTIDOTE, IN CLASS 10 (U.S. CLS.  
26, 39 AND 44).

FIRST USE 6-5-2007; IN COMMERCE 6-5-2007.

THE MARK CONSISTS OF STANDARD CHAR-  
ACTERS WITHOUT CLAIM TO ANY PARTICULAR  
FONT, STYLE, SIZE, OR COLOR.

NO CLAIM IS MADE TO THE EXCLUSIVE  
RIGHT TO USE "NAAK", APART FROM THE  
MARK AS SHOWN.

SN 78-813,481, FILED 2-13-2006.

JILL C. ALT, EXAMINING ATTORNEY



**Int. Cl.: 26**

**Prior U.S. Cls.: 37, 39, 40, 42, and 50**

**Reg. No. 3,455,472**

**United States Patent and Trademark Office**

**Registered June 24, 2008**

**TRADEMARK  
PRINCIPAL REGISTER**



H-D MICHIGAN, INC (MICHIGAN CORPORATION)  
315 W. HURON, SUITE 400  
ANN ARBOR, MI 48103

OWNER OF U.S. REG. NOS. 1,263,936, 3,082,869,  
AND OTHERS.

FOR: EMBROIDERED PATCHES FOR CLOTHING,  
IN CLASS 26 (U.S. CLS. 37, 39, 40, 42 AND 50).

SN 78-813,927, FILED 2-14-2006.

FIRST USE 7-0-2007; IN COMMERCE 7-0-2007.

ELI HELLMAN, EXAMINING ATTORNEY

**Int. Cl.: 35**

**Prior U.S. Cls.: 100, 101, and 102**

**United States Patent and Trademark Office**

**Reg. No. 3,455,473**

**Registered June 24, 2008**

**SERVICE MARK  
PRINCIPAL REGISTER**



CAREERBUILDER, LLC (DELAWARE LTD LIAB  
CO)  
200 NORTH LASALLE STREET, SUITE 1100  
CHICAGO, IL 60601

FOR: EMPLOYMENT HIRING, RECRUITING,  
PLACEMENT, STAFFING AND CAREER NET-  
WORKING SERVICES, IN CLASS 35 (U.S. CLS. 100,  
101 AND 102).

FIRST USE 2-6-2006; IN COMMERCE 2-6-2006.

THE COLOR(S) RED AND GRAY IS/ARE  
CLAIMED AS A FEATURE OF THE MARK.

THE MARK CONSISTS OF A CIRCLE CONTAIN-  
ING THE SILHOUETTE OF A FISH TO THE LEFT  
OF THE STYLIZED WORD "RIGHTFISH", WITH  
THE UPPER LEFT PORTION OF THE CIRCLE AND  
THE WORD "RIGHT" IN RED AND THE LOWER  
RIGHT PORTION OF THE CIRCLE AND THE  
WORD "FISH" IN GRAY.

SN 78-814,001, FILED 2-14-2006.

SETH A. RAPPAPORT, EXAMINING ATTORNEY

**Int. Cl.: 35**

**Prior U.S. Cls.: 100, 101, and 102**

**United States Patent and Trademark Office**

**Reg. No. 3,455,474**

**Registered June 24, 2008**

**SERVICE MARK  
PRINCIPAL REGISTER**

**PALIO GLOBALISTA PARTNERS**

INVENTIV COMMUNICATIONS, INC. (OHIO  
CORPORATION)  
500 OLDE WORTHINGTON ROAD  
WESTERVILLE, OH 43082

FOR: GLOBAL ADVERTISING AGENCY AND  
MARKETING SERVICES, NAMELY, BUSINESS  
MARKETING CONSULTING IN THE PHARMA-  
CEUTICAL AND HEALTHCARE INDUSTRIES , IN  
CLASS 35 (U.S. CLS. 100, 101 AND 102).

FIRST USE 3-0-2006; IN COMMERCE 3-0-2006.

THE MARK CONSISTS OF STANDARD CHAR-  
ACTERS WITHOUT CLAIM TO ANY PARTICULAR  
FONT, STYLE, SIZE, OR COLOR.

OWNER OF U.S. REG. NO. 2,909,870.

NO CLAIM IS MADE TO THE EXCLUSIVE  
RIGHT TO USE "PARTNERS", APART FROM THE  
MARK AS SHOWN.

THE FOREIGN WORDING IN THE MARK  
TRANSLATES INTO ENGLISH AS HORSERACE  
OR RACING SILK FROM ITALIAN AND CANOPY,  
DAIS, MANTLE, PALL, OR PALLIUM FROM SPAN-  
ISH.

SN 78-814,716, FILED 2-14-2006.

BARNEY CHARLON, EXAMINING ATTORNEY

**Int. Cl.: 9**

**Prior U.S. Cls.: 21, 23, 26, 36, and 38**

**United States Patent and Trademark Office**

**Reg. No. 3,455,475**

**Registered June 24, 2008**

**TRADEMARK  
PRINCIPAL REGISTER**

**GigaStorATX**

ISTOR NETWORKS, INC. (CALIFORNIA CORPORATION)  
SUITE 250  
7585 IRVINE CENTER DR.  
IRVINE, CA 92618

THE MARK CONSISTS OF STANDARD CHARACTERS WITHOUT CLAIM TO ANY PARTICULAR FONT, STYLE, SIZE, OR COLOR.

FOR: COMPUTER HARDWARE, IN CLASS 9 (U.S. CLS. 21, 23, 26, 36 AND 38).

SN 78-814,911, FILED 2-14-2006.

FIRST USE 2-1-2006; IN COMMERCE 2-1-2006.

DOMINIC FATHY, EXAMINING ATTORNEY

**Int. Cl.: 35**

**Prior U.S. Cls.: 100, 101, and 102**

**United States Patent and Trademark Office**

**Reg. No. 3,455,476**

**Registered June 24, 2008**

**SERVICE MARK  
PRINCIPAL REGISTER**

**CARS 4 PROFIT**

MCDUFFY GROUP, INC., THE (MASSACHU-  
SETTS CORPORATION)

191 ELM STREET, SUITE 10

SALISBURY, MA 01952

FOR: BUSINESS CONSULTATION, IN CLASS 35  
(U.S. CLS. 100, 101 AND 102).

FIRST USE 3-1-2008; IN COMMERCE 3-1-2008.

THE MARK CONSISTS OF STANDARD CHAR-  
ACTERS WITHOUT CLAIM TO ANY PARTICULAR  
FONT, STYLE, SIZE, OR COLOR.

NO CLAIM IS MADE TO THE EXCLUSIVE  
RIGHT TO USE "CARS", APART FROM THE MARK  
AS SHOWN.

SN 78-815,158, FILED 2-15-2006.

DAVID HOFFMAN, EXAMINING ATTORNEY

**Int. Cls.: 16, 18, 24, 25, and 28**

**Prior U.S. Cls.: 1, 2, 3, 5, 22, 23, 29, 37, 38, 39, 41, 42,  
and 50**

**Reg. No. 3,455,477**

**United States Patent and Trademark Office**

**Registered June 24, 2008**

**TRADEMARK  
PRINCIPAL REGISTER**

**VANISHYBRID**

VANISH CAMO, LLC (COLORADO LTD LIAB  
CO)  
104 S. FIRST STREET  
MONTROSE, CO 81401

FOR: PRINTED CAMOUFLAGE PATTERNS FOR  
HARD OR SOFT SURFACES AND FOR VARIOUS  
OTHER CAMOUFLAGE-DECORATED PRODUCTS,  
IN CLASS 16 (U.S. CLS. 2, 5, 22, 23, 29, 37, 38 AND 50).

FIRST USE 1-0-2007; IN COMMERCE 1-0-2007.

FOR: DAY PACKS, FANNY PACKS, IN CLASS 18  
(U.S. CLS. 1, 2, 3, 22 AND 41).

FIRST USE 2-0-2008; IN COMMERCE 2-0-2008.

FOR: FABRICS, NAMELY, COTTON AND  
POLYESTER FABRIC, AND FABRIC FOR THE  
MANUFACTURE OF COATS AND JACKETS,  
HUNTING VESTS, BIB OVERALLS, SHIRTS, PANTS,  
IN CLASS 24 (U.S. CLS. 42 AND 50).

FIRST USE 1-0-2007; IN COMMERCE 1-0-2007.

FOR: CLOTHING, NAMELY, SPORTS SHIRTS,  
SPORTS RAINWEAR, INCLUDING, CAPS AND  
HEADWEAR CONSISTING OF HATS AND FACE  
MASKS, GLOVES, SHIRTS, JACKETS, COATS,  
HUNTING VESTS, PANTS, BIB OVERALLS, IN  
CLASS 25 (U.S. CLS. 22 AND 39).

FIRST USE 1-0-2007; IN COMMERCE 1-0-2007.

FOR: ARCHERY EQUIPMENT, NAMELY, ARM  
GUARDS, AND QUIVERS; HUNTING STANDS, IN  
CLASS 28 (U.S. CLS. 22, 23, 38 AND 50).

FIRST USE 4-0-2007; IN COMMERCE 4-0-2007.

THE MARK CONSISTS OF STANDARD CHAR-  
ACTERS WITHOUT CLAIM TO ANY PARTICULAR  
FONT, STYLE, SIZE, OR COLOR.

SN 78-815,519, FILED 2-15-2006.

GEORGE LORENZO, EXAMINING ATTORNEY

Int. Cl.: 25

Prior U.S. Cls.: 22 and 39

United States Patent and Trademark Office

Reg. No. 3,455,478

Registered June 24, 2008

**TRADEMARK  
PRINCIPAL REGISTER**

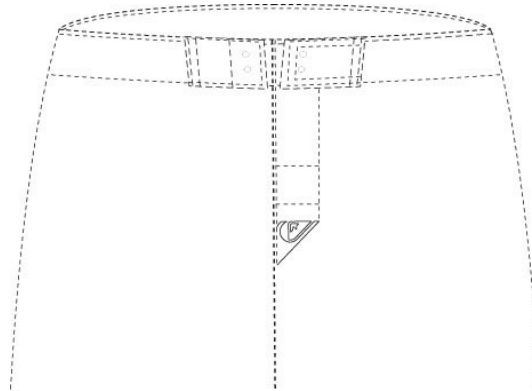

QUIKSILVER, INC. (DELAWARE CORPORATION)  
15202 GRAHAM STREET  
HUNTINGTON BEACH, CA 92649

FOR: SWIMWEAR AND BOARD SHORTS, IN CLASS 25 (U.S. CLS. 22 AND 39).

FIRST USE 1-1-2003; IN COMMERCE 1-1-2003.

THE MARK CONSISTS OF A TRIANGLE SHAPED DESIGN WITH A SMALLER TRIANGLE POSITIONED WITHIN THE LARGER TRIANGLE

DESIGN. THE MATTER SHOWN IN DOTTED LINES DO NOT FORM PART OF THE MARK, BUT MERELY SERVES TO SHOW THE PLACEMENT OF THE DESIGN.

SEC. 2(F).

SN 78-815,910, FILED 2-15-2006.

MIDGE BUTLER, EXAMINING ATTORNEY

Int. Cl.: 25

Prior U.S. Cls.: 22 and 39

United States Patent and Trademark Office

Reg. No. 3,455,479

Registered June 24, 2008

**TRADEMARK  
PRINCIPAL REGISTER**



FIFO THE BEAR

ROSE, HAYLEY (UNITED STATES INDIVIDUAL)  
SUITE 475  
1900 AVENUE OF THE STARS  
LOS ANGELES, CA 90067

FOR: CLOTHING ASSOCIATED WITH CHARACTERS OR THEMES DERIVED FROM BOOKS FOR CHILDREN FEATURING A BEAR CHARACTER, NAMELY, SHIRTS, BLOUSES, T-SHIRTS, PANTS, SHORTS, SKIRTS, DRESSES, SWEATSHIRTS, SWEATPANTS, JUMPERS, JACKETS, OVERALLS, RAIN SLICKERS, HATS, WARM UP SUITS, SNOWSUITS, SLEEPWEAR, BABY BIBS NOT OF PAPER, CLOTH BIBS, INFANT AND TODDLER ONE-PIECE CLOTHING, UNDERWEAR, MASQUERADE AND

HALLOWEEN COSTUMES AND MASKS SOLD IN CONNECTION THEREWITH, BOOTS, SHOES, SANDALS, APRONS, AND SLIPPERS, IN CLASS 25 (U.S. CLS. 22 AND 39).

FIRST USE 1-0-2007; IN COMMERCE 1-0-2007.

THE MARK CONSISTS OF A STYLIZED BEAR HOLDING A FISH AND THE WORDING "FIFO THE BEAR".

SN 78-815,954, FILED 2-15-2006.

LINDA ESTRADA, EXAMINING ATTORNEY



**Int. Cl.: 36**

**Prior U.S. Cls.: 100, 101, and 102**

**United States Patent and Trademark Office**

**Reg. No. 3,455,480**

**Registered June 24, 2008**

**SERVICE MARK  
PRINCIPAL REGISTER**

**KEYSTONE BANK**

KEYSTONE BUSINESS AND FINANCIAL SERVICES, INC. (ALABAMA CORPORATION)

P.O. BOX 3405

AUBURN, AL 36831

FOR: BANKING SERVICES, IN CLASS 36 (U.S. CLS. 100, 101 AND 102).

FIRST USE 3-2-2007; IN COMMERCE 3-2-2007.

THE MARK CONSISTS OF STANDARD CHARACTERS WITHOUT CLAIM TO ANY PARTICULAR FONT, STYLE, SIZE, OR COLOR.

NO CLAIM IS MADE TO THE EXCLUSIVE RIGHT TO USE "BANK", APART FROM THE MARK AS SHOWN.

SN 78-816,264, FILED 2-16-2006.

MICHAEL WIENER, EXAMINING ATTORNEY

**Int. Cl.: 29**

**Prior U.S. Cl.: 46**

**United States Patent and Trademark Office**

**Reg. No. 3,455,481**

**Registered June 24, 2008**

**TRADEMARK  
PRINCIPAL REGISTER**

**ISTARA P'TIT BASQUE**

SOCIETE DES CAVES ET DES PRODUCTEURS  
REUNIS DE ROQUEFORT SOCIETE DES  
CAVES (SCPR) (FRANCE JOINT STOCK COM-  
PANY)

2 AVENUE FRANCOIS GALTIER  
ROQUEFORT SUR SOULZON, FRANCE 12250

FOR: MILK AND MILK PRODUCTS, NAMELY,  
BUTTER, BUTTER CREAM, CHEESE, CREAM,  
WHIPPED CREAM , IN CLASS 29 (U.S. CL. 46).

FIRST USE 0-0-1998; IN COMMERCE 0-0-1998.

THE MARK CONSISTS OF STANDARD CHAR-  
ACTERS WITHOUT CLAIM TO ANY PARTICULAR  
FONT, STYLE, SIZE, OR COLOR.

NO CLAIM IS MADE TO THE EXCLUSIVE  
RIGHT TO USE "P'TIT BASQUE", APART FROM  
THE MARK AS SHOWN.

THE ENGLISH TRANSLATION OF THE WORD  
"P'TIT" IN THE MARK IS SMALL.

SN 78-816,707, FILED 2-16-2006.

TINA BROWN, EXAMINING ATTORNEY

**Int. Cl.: 35**

**Prior U.S. Cls.: 100, 101, and 102**

**United States Patent and Trademark Office**

**Reg. No. 3,455,482**

**Registered June 24, 2008**

---

**SERVICE MARK  
PRINCIPAL REGISTER**

**GET IT NEW**

MOTORSPORTS MARKETING, INC. (MISSOURI  
CORPORATION)  
13312 5TH STREET  
GRANDVIEW, MO 64030

THE MARK CONSISTS OF STANDARD CHAR-  
ACTERS WITHOUT CLAIM TO ANY PARTICULAR  
FONT, STYLE, SIZE, OR COLOR.

FOR: COMPUTERIZED ON-LINE RETAIL STORE  
SERVICES IN THE FIELDS OF AUTOMOTIVE COL-  
LECTIBLES, MEMORABILIA, AND APPAREL, IN  
CLASS 35 (U.S. CLS. 100, 101 AND 102).

SN 78-816,972, FILED 2-16-2006.

FIRST USE 7-2-2007; IN COMMERCE 7-2-2007.

RONALD AIKENS, EXAMINING ATTORNEY

**Int. Cl.: 3**

**Prior U.S. Cls.: 1, 4, 6, 50, 51, and 52**

**Reg. No. 3,455,483**

**United States Patent and Trademark Office**

**Registered June 24, 2008**

**TRADEMARK  
PRINCIPAL REGISTER**

**CARPET CPR**

WONDER MARKETING, INC. (CALIFORNIA CORPORATION)  
P.O. BOX 1140  
C/O KOENIG & ASSOCIATES  
SUMMERLAND, CA 93067

FOR: CARPET CLEANING PREPARATIONS, CLEANING AND CONDITIONING PREPARATIONS FOR HOUSEHOLD PURPOSES, IN CLASS 3 (U.S. CLS. 1, 4, 6, 50, 51 AND 52).

FIRST USE 9-10-2007; IN COMMERCE 9-10-2007.

THE MARK CONSISTS OF STANDARD CHARACTERS WITHOUT CLAIM TO ANY PARTICULAR FONT, STYLE, SIZE, OR COLOR.

NO CLAIM IS MADE TO THE EXCLUSIVE RIGHT TO USE "CARPET", APART FROM THE MARK AS SHOWN.

SN 78-818,211, FILED 2-17-2006.

KIMBERLY PERRY, EXAMINING ATTORNEY

**Int. Cl.: 10**

**Prior U.S. Cls.: 26, 39, and 44**

**Reg. No. 3,455,484**

**United States Patent and Trademark Office**

**Registered June 24, 2008**

---

**TRADEMARK  
PRINCIPAL REGISTER**

**Saf-T-Needle**

SAFETY MEDICAL INTERNATIONAL, INCORPORATED (PENNSYLVANIA CORPORATION)  
2055 SPRINT BOULEVARD  
APOPKA, FL 32703

THE MARK CONSISTS OF STANDARD CHARACTERS WITHOUT CLAIM TO ANY PARTICULAR FONT, STYLE, SIZE, OR COLOR.

FOR: HYPODERMIC SINGLE LUMEN NEEDLE,  
IN CLASS 10 (U.S. CLS. 26, 39 AND 44).

SN 78-818,439, FILED 2-18-2006.

FIRST USE 10-18-2007; IN COMMERCE 10-18-2007.

HANNO RITTNER, EXAMINING ATTORNEY

Int. Cl.: 9

Prior U.S. Cls.: 21, 23, 26, 36, and 38

Reg. No. 3,455,485

United States Patent and Trademark Office

Registered June 24, 2008

TRADEMARK  
PRINCIPAL REGISTER

The logo features a stylized, dark brown flourish above the word "CHERWELL" in a large, bold, serif font. Below "CHERWELL" is the phrase "SERVICE DESK" in a smaller, all-caps, serif font.

CHERWELL  
SERVICE DESK

CHERWELL SOFTWARE, INC. (COLORADO CORPORATION)  
12295 ORACLE BLVD.  
SUITE 200  
COLORADO SPRINGS, CO 80921

FOR: COMPUTER SOFTWARE AND INSTRUCTIONAL MANUALS SOLD AS A UNIT AND USED TO AUTOMATE THE PROCESSES RELATED TO EMPLOYEE HELP DESK SUPPORT FOR INFORMATION TECHNOLOGY, AND USED BY MARKETING, SALES AND CUSTOMER SERVICE PERSONNEL TO AUTOMATE THE PROCESSES RELATED TO CUSTOMER ACQUISITION AND RETENTION, INCLUDING MARKETING CAMPAIGNS, SALES LEAD GENERATION, SALES CALL

CONTACT AND FOLLOW-UP, CUSTOMER ORDERS AND ONGOING CUSTOMER SERVICE AND SUPPORT, IN CLASS 9 (U.S. CLS. 21, 23, 26, 36 AND 38).

FIRST USE 1-1-2006; IN COMMERCE 3-1-2006.

NO CLAIM IS MADE TO THE EXCLUSIVE RIGHT TO USE "SERVICE DESK", APART FROM THE MARK AS SHOWN.

SN 78-818,579, FILED 2-19-2006.

TOBY BULLOFF, EXAMINING ATTORNEY

**Int. Cl.: 3**

**Prior U.S. Cls.: 1, 4, 6, 50, 51, and 52**

**United States Patent and Trademark Office**

**Reg. No. 3,455,486**

**Registered June 24, 2008**

**TRADEMARK  
PRINCIPAL REGISTER**

**Replenish your World**

SAVE YOUR WORLD, LLC (NEW JERSEY LTD  
LIAB CO)  
P.O. BOX 745  
SHORT HILLS, NJ 07078

THE MARK CONSISTS OF STANDARD CHAR-  
ACTERS WITHOUT CLAIM TO ANY PARTICULAR  
FONT, STYLE, SIZE, OR COLOR.

FOR: SHAMPOO, HAIR CONDITIONER, SOAPS,  
FACE CREAM, IN CLASS 3 (U.S. CLS. 1, 4, 6, 50, 51  
AND 52).

SN 78-818,793, FILED 2-20-2006.

FIRST USE 9-13-2007; IN COMMERCE 9-13-2007.

BRENDAN REGAN, EXAMINING ATTORNEY

**Int. Cl.: 38**

**Prior U.S. Cls.: 100, 101, and 104**

**United States Patent and Trademark Office**

**Reg. No. 3,455,487**

**Registered June 24, 2008**

**SERVICE MARK  
PRINCIPAL REGISTER**

**MYNETWORKTV**

MYNETWORKTV, INC. (DELAWARE CORPORATION)  
10201 WEST PICO BOULEVARD  
LOS ANGELES, CA 90035

FOR: TELEVISION TRANSMISSION AND BROADCASTING SERVICES; STREAMING OF AUDIO MATERIALS ON THE INTERNET AND STREAMING OF VIDEO MATERIALS ON THE INTERNET, IN CLASS 38 (U.S. CLS. 100, 101 AND 104).

FIRST USE 9-5-2006; IN COMMERCE 9-5-2006.

THE MARK CONSISTS OF STANDARD CHARACTERS WITHOUT CLAIM TO ANY PARTICULAR FONT, STYLE, SIZE, OR COLOR.

SN 78-820,145, FILED 2-21-2006.

MARCIE MILONE, EXAMINING ATTORNEY



**Int. Cl.: 3**

**Prior U.S. Cls.: 1, 4, 6, 50, 51, and 52**

**Reg. No. 3,455,488**

**United States Patent and Trademark Office**

**Registered June 24, 2008**

**TRADEMARK  
PRINCIPAL REGISTER**

**GLAMOURAZZI**

BEAUTYBANK INC. (DELAWARE CORPORATION)  
767 FIFTH AVENUE  
NEW YORK, NY 10153

THE MARK CONSISTS OF STANDARD CHARACTERS WITHOUT CLAIM TO ANY PARTICULAR FONT, STYLE, SIZE, OR COLOR.

FOR: COSMETICS, IN CLASS 3 (U.S. CLS. 1, 4, 6, 50, 51 AND 52).

SN 78-821,413, FILED 2-23-2006.

FIRST USE 2-22-2008; IN COMMERCE 2-22-2008.

KIMBERLY PERRY, EXAMINING ATTORNEY

**Int. Cl.: 33**

**Prior U.S. Cls.: 47 and 49**

**United States Patent and Trademark Office**

**Reg. No. 3,455,489**

**Registered June 24, 2008**

**TRADEMARK  
PRINCIPAL REGISTER**

**KARIA**

STAG'S LEAP WINE CELLARS (CALIFORNIA  
LIMITED PARTNERSHIP)  
5766 SILVERADO TRAIL  
NAPA, CA 94558

FOR: STILL WINE FROM CALIFORNIA, IN  
CLASS 33 (U.S. CLS. 47 AND 49).

FIRST USE 9-1-2006; IN COMMERCE 9-1-2006.

THE MARK CONSISTS OF STANDARD CHAR-  
ACTERS WITHOUT CLAIM TO ANY PARTICULAR  
FONT, STYLE, SIZE, OR COLOR.

THE FOREIGN WORDING IN THE MARK  
TRANSLATES INTO ENGLISH AS "GRACEFUL".

SN 78-821,859, FILED 2-23-2006.

ROBERT LAVACHE, EXAMINING ATTORNEY

**Int. Cl.: 7**

**Prior U.S. Cls.: 13, 19, 21, 23, 31, 34, and 35**

**Reg. No. 3,455,490**

**United States Patent and Trademark Office**

**Registered June 24, 2008**

---

**TRADEMARK  
PRINCIPAL REGISTER**

**POWERBLEND TRIO**

CONAIR CORPORATION (DELAWARE CORPORATION)  
ONE CUMMINGS POINT ROAD  
STAMFORD, CT 06902

FOR: ELECTRIC KITCHEN APPLIANCES, NAMELY, BLENDERS WITH FOOD PROCESSOR ATTACHMENTS, IN CLASS 7 (U.S. CLS. 13, 19, 21, 23, 31, 34 AND 35).

FIRST USE 8-0-2006; IN COMMERCE 8-0-2006.

THE MARK CONSISTS OF STANDARD CHARACTERS WITHOUT CLAIM TO ANY PARTICULAR FONT, STYLE, SIZE, OR COLOR.

NO CLAIM IS MADE TO THE EXCLUSIVE RIGHT TO USE "TRIO", APART FROM THE MARK AS SHOWN.

SN 78-821,936, FILED 2-23-2006.

PAUL E. FAHRENKOPF, EXAMINING ATTORNEY

**Int. Cls.: 35 and 42**

**Prior U.S. Cls.: 100, 101, and 102**

**United States Patent and Trademark Office**

**Reg. No. 3,455,491**

**Registered June 24, 2008**

**SERVICE MARK  
PRINCIPAL REGISTER**

**INCISENT TECHNOLOGIES**

FIRST LOOK NETWORKS LLC (DELAWARE  
LTD LIAB CO)  
SUITE 500  
815 WEST VAN BUREN AVENUE  
CHICAGO, IL 60607

FOR: MANAGEMENT CONSULTING SERVICES  
TO BUSINESSES APPLYING ANALYTICS TO CRE-  
ATE BUSINESS INTELLIGENCE TO OPTIMIZE  
BUSINESS PERFORMANCE , IN CLASS 35 (U.S.  
CLS. 100, 101 AND 102).

FIRST USE 10-0-2007; IN COMMERCE 10-0-2007.

FOR: COMPUTER SOFTWARE CONSULTATION  
AND ADVISORY SERVICES IN THE FIELD OF  
BUSINESS INTELLIGENCE IN THE NATURE OF  
SOFTWARE DEVELOPMENT AND CUSTOMIZA-  
TION OF DATA STORAGE, RETRIEVAL, MAN-

AGEMENT, ANALYSIS AND REPORTING, AND  
INTEGRATION OF DATA STRUCTURES, IN CLASS  
42 (U.S. CLS. 100 AND 101).

FIRST USE 10-0-2007; IN COMMERCE 10-0-2007.

THE MARK CONSISTS OF STANDARD CHAR-  
ACTERS WITHOUT CLAIM TO ANY PARTICULAR  
FONT, STYLE, SIZE, OR COLOR.

NO CLAIM IS MADE TO THE EXCLUSIVE  
RIGHT TO USE "TECHNOLOGIES", APART FROM  
THE MARK AS SHOWN.

SN 78-822,585, FILED 2-24-2006.

MYRIAH HABEEB, EXAMINING ATTORNEY

**Int. Cl.: 13**

**Prior U.S. Cls.: 2 and 9**

**United States Patent and Trademark Office**

**Reg. No. 3,455,492**

**Registered June 24, 2008**

**TRADEMARK  
PRINCIPAL REGISTER**

**DNX**

DYNO NOBEL INC. (DELAWARE CORPORATION)  
2650 DECKER LAKE BLVD., SUITE 300  
SALT LAKE CITY, UT 84119

THE MARK CONSISTS OF STANDARD CHARACTERS WITHOUT CLAIM TO ANY PARTICULAR FONT, STYLE, SIZE, OR COLOR.

FOR: EXPLOSIVES, IN CLASS 13 (U.S. CLS. 2 AND 9).

SN 78-822,793, FILED 2-24-2006.

FIRST USE 3-3-2006; IN COMMERCE 3-3-2006.

SETH A. RAPPAPORT, EXAMINING ATTORNEY

**Int. Cl.: 9**

**Prior U.S. Cls.: 21, 23, 26, 36, and 38**

**United States Patent and Trademark Office**

**Reg. No. 3,455,493**

**Registered June 24, 2008**

**TRADEMARK  
PRINCIPAL REGISTER**

ENTER ANOTHER DIMENSION

CBS BROADCASTING INC. (NEW YORK CORPORATION)  
51 WEST 52ND STREET  
NEW YORK, NY 10019

FOR: CURRENCY AND CREDIT OPERATED SLOT MACHINES AND GAMING DEVICES, NAMELY, GAMING MACHINES FOR USE IN GAMING ESTABLISHMENTS, IN CLASS 9 (U.S. CLS. 21, 23, 26, 36 AND 38).

FIRST USE 11-6-2007; IN COMMERCE 11-6-2007.

THE MARK CONSISTS OF STANDARD CHARACTERS WITHOUT CLAIM TO ANY PARTICULAR FONT, STYLE, SIZE, OR COLOR.

SN 78-822,908, FILED 2-24-2006.

JEAN IM, EXAMINING ATTORNEY

Int. Cl.: 37

Prior U.S. Cls.: 100, 103, and 106

United States Patent and Trademark Office

Reg. No. 3,455,494

Registered June 24, 2008

**SERVICE MARK  
PRINCIPAL REGISTER**



ELECTRICIANS' SUCCESS INTERNATIONAL,  
LLC (FLORIDA LTD LIAB CO)  
7777 BONHOMME AVE.  
SUITE 1800  
ST. LOUIS, MO 63105

FOR: REPAIR, MAINTENANCE, AND INSTAL-  
LATION OF ELECTRICAL WIRING, OUTLETS,  
LIGHT FIXTURES, AND ELECTRICAL PANELS;  
ELECTRICAL CONTRACTING SERVICES, IN  
CLASS 37 (U.S. CLS. 100, 103 AND 106).

FIRST USE 6-0-2006; IN COMMERCE 6-0-2006.

NO CLAIM IS MADE TO THE EXCLUSIVE  
RIGHT TO USE "EXCELLENT ELECTRICIAN",  
APART FROM THE MARK AS SHOWN.

THE STIPLING IS FOR SHADING PURPOSES  
ONLY.

SN 78-822,968, FILED 2-24-2006.

AMY MCMENAMIN, EXAMINING ATTORNEY

**Int. Cls.: 39, 41, and 44**

**Prior U.S. Cls.: 100, 101, 105, and 107**

**United States Patent and Trademark Office**

**Reg. No. 3,455,495**

**Registered June 24, 2008**

**SERVICE MARK  
PRINCIPAL REGISTER**

# Skunk Haven

CIPRIANI, DEBORAH K (UNITED STATES INDIVIDUAL)  
32072 CENTER RIDGE ROAD  
NORTH RIDGEVILLE, OH 44039

FOR: PET RESCUE SERVICES, NAMELY, ASSISTING IN THE RESCUE OF UNWANTED OR NEGLECTED DOMESTIC SKUNKS; PROVIDING INFORMATION ON SKUNK RESCUE SERVICES, IN CLASS 39 (U.S. CLS. 100 AND 105).

FIRST USE 3-22-2004; IN COMMERCE 3-22-2004.

FOR: EDUCATION SERVICES, NAMELY, CONDUCTING CLASSES, SEMINARS, CONFERENCES, AND WORKSHOPS, FOR THE GENERAL PUBLIC, VETERINARIANS, AND GOVERNMENT OFFICIALS ABOUT KEEPING SKUNKS AS DOMESTIC PETS, IN CLASS 41 (U.S. CLS. 100, 101 AND 107).

FIRST USE 5-1-2005; IN COMMERCE 5-1-2006.

FOR: PET CARE SERVICES, NAMELY, PROVIDING VETERINARY CARE FOR DOMESTIC

SKUNKS; PROVIDING INFORMATION ON DOMESTIC SKUNK CARE; PROVIDING INFORMATION ON PHYSICAL REHABILITATION SERVICES FOR SKUNKS; ANIMAL REHABILITATION SERVICES, NAMELY, PHYSICAL REHABILITATION SERVICES FOR SKUNKS, IN CLASS 44 (U.S. CLS. 100 AND 101).

FIRST USE 3-22-2005; IN COMMERCE 3-22-2005.

THE MARK CONSISTS OF STANDARD CHARACTERS WITHOUT CLAIM TO ANY PARTICULAR FONT, STYLE, SIZE, OR COLOR.

NO CLAIM IS MADE TO THE EXCLUSIVE RIGHT TO USE "SKUNK", APART FROM THE MARK AS SHOWN.

SN 78-824,249, FILED 2-27-2006.

JORDAN BAKER, EXAMINING ATTORNEY



**Int. Cl.: 25**

**Prior U.S. Cls.: 22 and 39**

**United States Patent and Trademark Office**

**Reg. No. 3,455,496**

**Registered June 24, 2008**

**TRADEMARK  
PRINCIPAL REGISTER**

# Pampour

MARTIN, VANESSA D. (UNITED STATES INDIVIDUAL)  
456 W. 148TH ST. # 2A  
NEW YORK, NY 10031 AND  
VM DESIGNS, LLC (LOUISIANA LTD LIAB CO)  
456 W. 148TH ST. # 2A  
NEW YORK, NY 10031

FOR: NIGHT GOWNS; NIGHT SHIRTS; PAJAMAS; ROBES; SLEEPWEAR; BLAZERS; BLOUSES; BRAS; COATS FOR MEN AND WOMEN; DRESSING GOWNS; EVENING GOWNS; GOWNS; LADIES' UNDERWEAR; LOUNGEWEAR; MEN AND WOMEN JACKETS, COATS, TROUSERS, VESTS; MEN'S SUITS, WOMEN'S SUITS; SCARVES; SHAWLS;

SHAWLS AND STOLE; SILK SCARVES; THONGS; WEDDING GOWNS; WOMEN'S UNDERWEAR, IN CLASS 25 (U.S. CLS. 22 AND 39).

FIRST USE 11-13-2003; IN COMMERCE 1-26-2004.

THE MARK CONSISTS OF STANDARD CHARACTERS WITHOUT CLAIM TO ANY PARTICULAR FONT, STYLE, SIZE, OR COLOR.

SN 78-825,937, FILED 3-1-2006.

NAAKWAMA ANKRAH, EXAMINING ATTORNEY

**Int. Cl.: 36**

**Prior U.S. Cls.: 100, 101, and 102**

**United States Patent and Trademark Office**

**Reg. No. 3,455,497**

**Registered June 24, 2008**

**SERVICE MARK  
PRINCIPAL REGISTER**

**ADVANCED RETIREMENT  
RESOURCES**

ADVANCED RETIREMENT RESOURCES, INC.  
(MINNESOTA CORPORATION)  
SUITE 400  
1221 NICOLLET AVENUE  
MINNEAPOLIS, MN 55403

FOR: FINANCIAL PLANNING; FINANCIAL  
MANAGEMENT; ESTATE PLANNING, IN CLASS  
36 (U.S. CLS. 100, 101 AND 102).

FIRST USE 4-10-2008; IN COMMERCE 4-10-2008.

THE MARK CONSISTS OF STANDARD CHAR-  
ACTERS WITHOUT CLAIM TO ANY PARTICULAR  
FONT, STYLE, SIZE, OR COLOR.

NO CLAIM IS MADE TO THE EXCLUSIVE  
RIGHT TO USE "RETIREMENT RESOURCES",  
APART FROM THE MARK AS SHOWN.

SN 78-826,617, FILED 3-1-2006.

MARY MUNSON, EXAMINING ATTORNEY

Int. Cl.: 37

Prior U.S. Cls.: 100, 103, and 106

United States Patent and Trademark Office

Reg. No. 3,455,498

Registered June 24, 2008

**SERVICE MARK  
PRINCIPAL REGISTER**

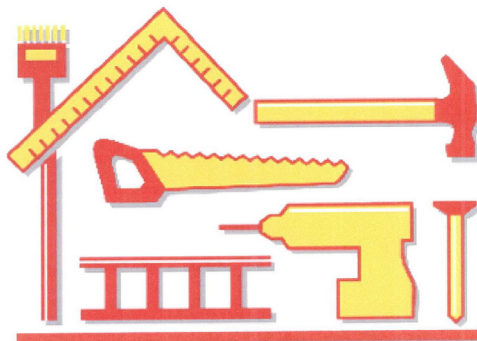

NATIONAL URBAN CONSTRUCTION (TEXAS CORPORATION)  
P.O. BOX 1879  
ATTN: WANDA DOZIER  
WALLER, TX 77484

FOR: RESIDENTIAL AND COMMERCIAL BUILDING CONSTRUCTION, AND GENERAL CONSTRUCTION CONTRACTING SERVICES, IN CLASS 37 (U.S. CLS. 100, 103 AND 106).

FIRST USE 8-1-2007; IN COMMERCE 8-1-2007.

THE COLOR(S) RED AND YELLOW IS/ARE CLAIMED AS A FEATURE OF THE MARK.

THE MARK CONSISTS OF A BROOM - BRISTLES OF BROOM ARE YELLOW. SMALL SQUARE INSIDE BROOM IS YELLOW SURROUNDING

SQUARE OF SAME AREA IS RED AND STICK OF BROOM IS RED. LEVEL - CENTER IS YELLOW OUTLINED IN RED WITH RED LINES TO MARK MEASUREMENTS OF LEVEL. HAND SAW - HANDLE IS RED. SAW BLADE IS YELLOW OUTLINED IN RED. HAMMER - HEAD IS RED HANDLE IS YELLOW OUTLINED IN RED. NAIL - HEAD IS RED NAIL SHAFT IS YELLOW OUTLINED IN RED. DRILL - CENTER IS YELLOW OUTLINED IN RED. LADDER - ALL RED. BOTTOM LINE TO HOUSE AND SIDE LINE OF RIGHT SIDE OF HOUSE ARE BOTH RED. THE COLOR WHITE CONSTITUTES BACKGROUND AND IS NOT PART OF THE MARK.

SN 78-826,623, FILED 3-1-2006.

LINDA ESTRADA, EXAMINING ATTORNEY

Prior U.S. Cl.: A

United States Patent and Trademark Office

Reg. No. 3,455,499

Registered June 24, 2008

**CERTIFICATION MARK  
GOODS  
PRINCIPAL REGISTER**

ALIMENTOS ARGENTINOS, UNA  
ELECCION NATURAL

SECRETARIA DE AGRICULTURA, GANADERIA,  
PESCA Y ALIMENTOS (ARGENTINA  
GOVERNMENT ADMINISTRATIVE AGENCY)  
PASEO COLÓN 982  
BUENOS AIRES, ARGENTINA

FOR: FOOD PRODUCTS OF ANIMAL ORIGIN;  
MEAT; FISH; POULTRY; MOLLUSCA AND CRUSTACEA;  
GAME; MEAT PREPARATIONS; FISH PREPARATIONS;  
MOLLUSCA PREPARATIONS; CRUSTACEA PREPARATIONS;  
MILK; MILK PRODUCTS; MILK BEVERAGES; TEA;  
SPICES; EGGS; HONEY; CEREALS; CEREALS PREPARED  
FOR HUMAN CONSUMPTION; PROCESSED AND UNPROCESSED  
CEREALS; VINEGAR; PREPARATIONS MADE FROM CEREALS;  
BEVERAGES WITH COFFEE, COCOA OR CHOCOLATE BASE;  
RICE; VEGETABLE EXTRACTS; AGRICULTURAL PRODUCTS  
AND COMMODITIES; RAW CEREALS; HORTICULTURAL  
PRODUCTS; FORESTRY PRODUCTS; GRAINS; FOODSTUFFS  
FOR ANIMALS; LIVING ANIMALS; LIVING PLANTS;  
RAW WOODS; FRESH FRUITS AND VEGETABLES; SEEDS;  
NATURAL PLANTS AND FLOWERS; FRUIT JUICES,

FRUIT BASED DRINKS; ALCOHOLIC BEVERAGES;  
WINES, IN CLASS A (U.S. CL. A).

FIRST USE 4-30-2007; IN COMMERCE 7-31-2007.

THE MARK CONSISTS OF STANDARD CHARACTERS  
WITHOUT CLAIM TO ANY PARTICULAR FONT, STYLE,  
SIZE, OR COLOR.

NO CLAIM IS MADE TO THE EXCLUSIVE RIGHT TO  
USE "ALIMENTOS", APART FROM THE MARK AS SHOWN.

THE FOREIGN WORDING IN THE MARK TRANSLATES  
INTO ENGLISH AS ARGENTINE FOODS, A NATURAL  
CHOICE.

THE CERTIFICATION MARK CERTIFIES THAT THE  
PRODUCTS COME OR ORIGINATE FROM ARGENTINA.

SN 78-826,698, FILED 3-1-2006.

SARA THOMAS, EXAMINING ATTORNEY

**Int. Cls.: 35 and 43**

**Prior U.S. Cls.: 100, 101, and 102**

**United States Patent and Trademark Office**

**Reg. No. 3,455,500**

**Registered June 24, 2008**

**SERVICE MARK  
PRINCIPAL REGISTER**

**COCO NOCHE**

ALLEN, NATALIE (UNITED STATES INDIVIDUAL)  
857 8TH STREET  
MANHATTAN BEACH, CA 90266

FOR: RETAIL STORE SERVICES FEATURING FOODS, BEVERAGES AND GIFT ITEMS, IN CLASS 35 (U.S. CLS. 100, 101 AND 102).

FIRST USE 1-0-2006; IN COMMERCE 1-0-2006.

FOR: RESTAURANT SERVICES, IN CLASS 43 (U.S. CLS. 100 AND 101).

FIRST USE 1-0-2006; IN COMMERCE 1-0-2006.

THE MARK CONSISTS OF STANDARD CHARACTERS WITHOUT CLAIM TO ANY PARTICULAR FONT, STYLE, SIZE, OR COLOR.

"THE FOREIGN WORDING IN THE MARK TRANSLATES INTO ENGLISH AS COCONUT (IN FRENCH AND PORTUGUESE) AND NIGHT (IN SPANISH)."

SN 78-826,802, FILED 3-1-2006.

LAURIE KAUFMAN, EXAMINING ATTORNEY

**Int. Cls.: 9, 37, and 42**

**Prior U.S. Cls.: 21, 23, 26, 36, 38, 100, 101, 103, and 106**

**Reg. No. 3,455,501**

**United States Patent and Trademark Office**

**Registered June 24, 2008**

**TRADEMARK  
SERVICE MARK  
PRINCIPAL REGISTER**

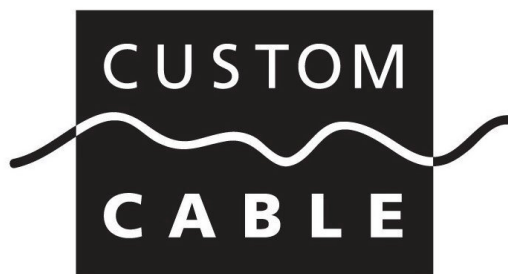

STEELCASE INC. (MICHIGAN CORPORATION)  
901 44TH STREET SE  
PO BOX 1967  
GRAND RAPIDS, MI 49501

FOR: COMPUTER CABLES AND WIRE HARNESSES, AND PRINTER CABLES, IN CLASS 9 (U.S. CLS. 21, 23, 26, 36 AND 38).

FIRST USE 3-0-2006; IN COMMERCE 3-0-2006.

FOR: INSTALLATION OF TELEPHONE, NETWORK AND WIRELESS SYSTEMS, NAMELY, INSTALLATION OF COMPUTER CABLES, WIRE HARNESSES AND PRINTER CABLES, IN CLASS 37 (U.S. CLS. 100, 103 AND 106).

FIRST USE 3-0-2006; IN COMMERCE 3-0-2006.

FOR: DESIGN OF TELEPHONE, NETWORK AND WIRELESS SYSTEMS, NAMELY, DESIGN OF COMPUTER CABLES, WIRE HARNESSES AND PRINTER CABLES, IN CLASS 42 (U.S. CLS. 100 AND 101).

FIRST USE 3-0-2006; IN COMMERCE 3-0-2006.

NO CLAIM IS MADE TO THE EXCLUSIVE RIGHT TO USE "CUSTOM CABLE", APART FROM THE MARK AS SHOWN.

THE MARK CONSISTS OF DESIGN OF A CABLE/WIRE BIFURCATING A SQUARE.

SN 78-827,352, FILED 3-2-2006.

DOMINIC J. FERRAIUOLO, EXAMINING ATTORNEY

**Int. Cl.: 43**

**Prior U.S. Cls.: 100 and 101**

**United States Patent and Trademark Office**

**Reg. No. 3,455,502**

**Registered June 24, 2008**

**SERVICE MARK  
PRINCIPAL REGISTER**

**THOMPSON BEVERLY HILLS**

THOMPSON HOTELS LLC (DELAWARE LIMITED LIABILITY COMPANY)

100 VANDAM STREET, 4TH FLOOR

NEW YORK, NY 10013

FOR: HOTEL SERVICES, IN CLASS 43 (U.S. CLS. 100 AND 101).

FIRST USE 1-1-2008; IN COMMERCE 1-1-2008.

THE MARK CONSISTS OF STANDARD CHARACTERS WITHOUT CLAIM TO ANY PARTICULAR FONT, STYLE, SIZE, OR COLOR.

NO CLAIM IS MADE TO THE EXCLUSIVE RIGHT TO USE "BEVERLY HILLS", APART FROM THE MARK AS SHOWN.

SN 78-827,571, FILED 3-2-2006.

SEAN CROWLEY, EXAMINING ATTORNEY

**Int. Cl.: 43**

**Prior U.S. Cls.: 100 and 101**

**United States Patent and Trademark Office**

**Reg. No. 3,455,503**

**Registered June 24, 2008**

**SERVICE MARK  
PRINCIPAL REGISTER**

**VINE BUYS**

WHOLE FOODS MARKET IP, L.P. (DELAWARE  
LIMITED PARTNERSHIP)  
6TH FLOOR  
550 BOWIE STREET  
AUSTIN, TX 78703

FOR: PROVIDING ADVICE ON WINE, AND  
WINE AND FOOD PAIRING; PROVIDING INFOR-  
MATION ABOUT WINE CHARACTERISTICS, IN  
CLASS 43 (U.S. CLS. 100 AND 101).

FIRST USE 9-0-2006; IN COMMERCE 9-0-2006.

THE MARK CONSISTS OF STANDARD CHAR-  
ACTERS WITHOUT CLAIM TO ANY PARTICULAR  
FONT, STYLE, SIZE, OR COLOR.

NO CLAIM IS MADE TO THE EXCLUSIVE  
RIGHT TO USE "BUYS", APART FROM THE MARK  
AS SHOWN.

SN 78-827,607, FILED 3-2-2006.

SARA THOMAS, EXAMINING ATTORNEY



**Int. Cl.: 17**

**Prior U.S. Cls.: 1, 5, 12, 13, 35, and 50**

**Reg. No. 3,455,504**

**United States Patent and Trademark Office**

**Registered June 24, 2008**

**TRADEMARK  
PRINCIPAL REGISTER**

**BLACK-MAX**

O.G. SUPPLY, INC. (CALIFORNIA CORPORATION)  
150 VANDER STREET  
CORONA, CA 928801751

THE MARK CONSISTS OF STANDARD CHARACTERS WITHOUT CLAIM TO ANY PARTICULAR FONT, STYLE, SIZE, OR COLOR.

FOR: NONMETALLIC GASKETS FOR SEALING INSPECTION PLATES IN PRESSURE VESSELS, NAMELY, BOILERS, STEAM GENERATORS, WATER HEATERS, STEAM HUMIDIFIERS AND PAPER MILL DRYER CANS, IN CLASS 17 (U.S. CLS. 1, 5, 12, 13, 35 AND 50).

OWNER OF U.S. REG. NO. 1,522,622.

SN 78-827,907, FILED 3-2-2006.

FIRST USE 3-15-2007; IN COMMERCE 3-12-2007.

KAPIL BHANOT, EXAMINING ATTORNEY

**Int. Cl.: 41**

**Prior U.S. Cls.: 100, 101, and 107**

**United States Patent and Trademark Office**

**Reg. No. 3,455,505**

**Registered June 24, 2008**

**SERVICE MARK  
PRINCIPAL REGISTER**



APPLERA CORPORATION (DELAWARE CORPORATION)  
850 LINCOLN CENTRE DRIVE  
FOSTER CITY, CA 94404

FOR: CONDUCTING SEMINARS, CONFERENCES AND WORKSHOPS IN THE FIELD OF FORENSICS, GENETIC ANALYSIS, HUMAN IDENTIFICATION AND POLYMERASE CHAIN REACTION (PCR), IN CLASS 41 (U.S. CLS. 100, 101 AND 107).

FIRST USE 2-7-2006; IN COMMERCE 2-7-2006.

THE MARK CONSISTS OF THE WORD "HID" WITH A CIRCLE DESIGN ON THE RIGHT HAND SIDE OF THE MARK FEATURING ZIGZAGGING LINES.

SN 78-827,953, FILED 3-2-2006.

WARREN L. OLANDRIA, EXAMINING ATTORNEY

**Int. Cl.: 35**

**Prior U.S. Cls.: 100, 101, and 102**

**United States Patent and Trademark Office**

**Reg. No. 3,455,506**

**Registered June 24, 2008**

**SERVICE MARK  
PRINCIPAL REGISTER**

**INSTANT FOCUS**

IMPROVE, INC. (NEW JERSEY CORPORATION)  
P.O. BOX 43443  
UPPER MONTCLAIR, NJ 07043

FOR: BUSINESS LEADERSHIP DEVELOPMENT;  
BUSINESS MANAGEMENT; BUSINESS MANAGE-  
MENT AND ADVICE; BUSINESS MANAGEMENT  
AND CONSULTATION; BUSINESS MANAGEMENT  
CONSULTANCY SERVICES; BUSINESS MANAGE-  
MENT CONSULTATION; BUSINESS MANAGE-  
MENT CONSULTING AND ADVISORY SERVICES;  
BUSINESS MANAGEMENT INFORMATION ON A  
WIDE VARIETY OF TOPICS TO SERVICE PROVID-  
ING PROFESSIONALS; BUSINESS MANAGEMENT  
PLANNING; BUSINESS NETWORKING; BUSINESS

ORGANISATION AND MANAGEMENT CONSULT-  
ING SERVICES, IN CLASS 35 (U.S. CLS. 100, 101 AND  
102).

FIRST USE 6-9-2006; IN COMMERCE 6-9-2006.

THE MARK CONSISTS OF STANDARD CHAR-  
ACTERS WITHOUT CLAIM TO ANY PARTICULAR  
FONT, STYLE, SIZE, OR COLOR.

SN 78-831,026, FILED 3-7-2006.

KATHERINE CONNOLLY, EXAMINING ATTOR-  
NEY

**Int. Cl.: 41**

**Prior U.S. Cls.: 100, 101, and 107**

**United States Patent and Trademark Office**

**Reg. No. 3,455,507**

**Registered June 24, 2008**

---

**SERVICE MARK  
PRINCIPAL REGISTER**

**PSYCH**

UNIVERSAL TV DISTRIBUTION HOLDINGS  
LLC (DELAWARE LTD LIAB CO)  
100 UNIVERSAL CITY PLAZA  
UNIVERSAL CITY, CA 91608

THE MARK CONSISTS OF STANDARD CHAR-  
ACTERS WITHOUT CLAIM TO ANY PARTICULAR  
FONT, STYLE, SIZE, OR COLOR.

FOR: ENTERTAINMENT SERVICES IN THE  
NATURE OF AN ON-GOING DRAMATIC TELEVI-  
SION SERIES, IN CLASS 41 (U.S. CLS. 100, 101 AND  
107).

SN 78-831,607, FILED 3-7-2006.

FIRST USE 7-7-2006; IN COMMERCE 7-7-2006.

JASON ROTH, EXAMINING ATTORNEY

Int. Cl.: 21

Prior U.S. Cls.: 2, 13, 23, 29, 30, 33, 40, and 50

United States Patent and Trademark Office

Reg. No. 3,455,508

Registered June 24, 2008

TRADEMARK  
PRINCIPAL REGISTER



COMPANIA INDUSTRIAL PLASVIC, S.A. DE  
C.V. (MEXICO CORPORATION)  
COLONIA PRO-HOGAR  
CALLE 15 NO. 304  
DELEGACION AZCAPOTZALCO, MEXICO CP 02600

FOR: HOUSEHOLD UTENSILS, NAMELY, SUGAR BOWLS NOT OF PRECIOUS METAL, BUCKETS, SERVING TRAYS FOR DOMESTIC USE NOT OF PRECIOUS METAL, COOKING POT SETS, NON-ELECTRIC BEATERS, DRINKING VESSELS, HEAT INSULATED BEVERAGE CONTAINERS, BOTTLES, SHOE HORNS, LAUNDRY BASKETS, SPATULAS, LARGE TOOTH COMBS FOR HAIR, COMB CASES, SOAP DISPENSERS, SOAP DISHES, EPERGNE NOT OF PRECIOUS METAL, CLOTHES PINS, COASTERS NOT OF PAPER AND OTHER THAN TABLE LINEN, TOILET UTENSILS, NAMELY, TOILET BRUSH HOLDERS, TOILET PAPER DISPENSERS AND TOILET SPONGES; KITCHEN UTENSILS, NAMELY, BOWLS, REFRIGERATING BOTTLES, CLOSURES FOR COOKING POT LIDS, DISH COVERS, COOKING POT LIDS, STEW PANS, COOKING POTS, BOXES OF METAL FOR DISPENSING PAPER TOWELS, CAULDRONS, CHEESE-DISH COVERS, BUTTER DISHES, BUTTER-DISH COVERS, BREAD BASKETS, FITTED PICNIC BASKETS INCLUDING DISHES, JUGS NOT OF PRECIOUS METAL, BOTTLE GOURDS, BEER MUGS, BASKETS FOR DOMESTIC USE NOT OF PRECIOUS METAL, COOKING POT SETS, KITCHEN CONTAINERS NOT OF PRECIOUS METAL, COOKERY MOLDS, COCKTAIL SHAKERS AND MIXING CUPS, COOKING STRAINERS NOT OF PRECIOUS METAL, COOKING STRAINERS, TEA-STRAINERS NOT OF PRECIOUS METAL, CUPS, FRUIT CUPS, CUPS NOT

OF PRECIOUS METAL, TRAYS, BASTING SPOONS FOR KITCHEN USES, KNIFE RESTS FOR THE TABLE, BASINS, ROLLING PINS, CAKE MOLDS, FUNNELS, SALAD BOWLS NOT OF PRECIOUS METAL, BROOMS, SPICE RACKS, LEMON SQUEEZERS, FLASKS NOT OF PRECIOUS METAL, FRUIT PRESSES NON-ELECTRIC FOR HOUSEHOLD PURPOSES, BASINS, CARBOYS, ICE MOULDS, EGG CUPS NOT OF PRECIOUS METAL, JUGS NOT OF PRECIOUS METAL, AUTOCLAVE COVERS, SCOOPS, TOOTHPICKS NOT OF PRECIOUS METAL, PIE SERVERS, PEPPER POTS NOT OF PRECIOUS METAL, TABLE PLATES NOT OF PRECIOUS METAL, GRATERS, HEAT-INSULATED CONTAINERS, SALT CELLARS NOT OF PRECIOUS METAL, SAUCE CONTAINERS NOT OF PRECIOUS METAL, NAPKIN RINGS NOT OF PRECIOUS METAL, SOUP BOWLS NOT OF PRECIOUS METAL, WASHING BOARDS, BREAD BOARDS, SIEVES, CINDER SIFTERS, DISH COVERS, DUST BINS, WHISKS, VASES NOT OF PRECIOUS METAL, CRUET STANDS FOR OIL AND VINEGAR NOT OF PRECIOUS METAL; BRUSHES, NAMELY, TABLEWARE WASHING BRUSHES, BATH BRUSHES, TOOTHBRUSHES, TOILET BRUSHES, SCRUBBING BRUSHES AND POT CLEANING BRUSHES, PADS OF METAL FOR CLEANING; PORCELAIN, GLASS AND EARTHENWARE CUPS, DISHES, PLATES AND BEVERAGE GLASSWARE, IN CLASS 21 (U.S. CLS. 2, 13, 23, 29, 30, 33, 40 AND 50).

FIRST USE 7-13-2007; IN COMMERCE 7-13-2007.

THE MARK CONSISTS OF A PANTHER SITTING UPON A SILHOUETTE OF AN INJECTION MOLD-

ING MACHINE WITH THE TERM "PLASVIC"  
WITHIN THE SILHOUETTE OF THE MACHINE.

SN 78-832,301, FILED 3-8-2006.

JOHN HWANG, EXAMINING ATTORNEY

**Int. Cl.: 7**

**Prior U.S. Cls.: 13, 19, 21, 23, 31, 34, and 35**

**Reg. No. 3,455,509**

**United States Patent and Trademark Office**

**Registered June 24, 2008**

**TRADEMARK  
PRINCIPAL REGISTER**

**ENERGY ISLAND**

ELECTRICIANS' SUCCESS INTERNATIONAL,  
LLC (FLORIDA LTD LIAB CO)  
7777 BONHOMME AVE.  
SUITE 1800  
ST. LOUIS, MO 63105

FOR: ELECTRIC GENERATORS; POWER GENERATION SYSTEM COMPRISED PRIMARILY OF ELECTRIC GENERATORS AND POWER SURGE PROTECTORS, IN CLASS 7 (U.S. CLS. 13, 19, 21, 23, 31, 34 AND 35).

FIRST USE 4-0-2007; IN COMMERCE 4-0-2007.

THE MARK CONSISTS OF STANDARD CHARACTERS WITHOUT CLAIM TO ANY PARTICULAR FONT, STYLE, SIZE, OR COLOR.

NO CLAIM IS MADE TO THE EXCLUSIVE RIGHT TO USE "ENERGY", APART FROM THE MARK AS SHOWN.

SN 78-832,655, FILED 3-8-2006.

MELISSA VALLILLO, EXAMINING ATTORNEY

Int. Cl.: 7

Prior U.S. Cls.: 13, 19, 21, 23, 31, 34, and 35

United States Patent and Trademark Office

Reg. No. 3,455,510

Registered June 24, 2008

TRADEMARK  
PRINCIPAL REGISTER



ELECTRICIANS' SUCCESS INTERNATIONAL,  
LLC (FLORIDA LTD LIAB CO)  
SUITE 1800  
7777 BONHOMME AVE.  
ST. LOUIS, MO 63105

FIRST USE 4-0-2007; IN COMMERCE 4-0-2007.

NO CLAIM IS MADE TO THE EXCLUSIVE  
RIGHT TO USE "ENERGY" AND "PERSONAL POW-  
ER SUPPLY", APART FROM THE MARK AS  
SHOWN.

FOR: ELECTRIC GENERATORS; POWER GEN-  
ERATION SYSTEM COMPRISED PRIMARILY OF  
ELECTRIC GENERATORS AND POWER SURGE  
PROTECTORS, IN CLASS 7 (U.S. CLS. 13, 19, 21, 23, 31,  
34 AND 35).

SN 78-832,677, FILED 3-8-2006.

MELISSA VALLILLO, EXAMINING ATTORNEY



**Int. Cl.: 35**

**Prior U.S. Cls.: 100, 101, and 102**

**United States Patent and Trademark Office**

**Reg. No. 3,455,511**

**Registered June 24, 2008**

**SERVICE MARK  
PRINCIPAL REGISTER**



XFISH (NEVADA CORPORATION)  
723 S. CASINO CENTER BLVD.  
LAS VEGAS, NV 89101

FOR: EMPLOYMENT HIRING, RECRUITING,  
PLACEMENT, STAFFING AND CAREER NET-  
WORKING SERVICES, IN CLASS 35 (U.S. CLS. 100,  
101 AND 102).

FIRST USE 2-1-2000; IN COMMERCE 2-1-2004.

THE MARK CONSISTS OF DESIGN PLUS  
WORDS, LETTERS, AND/OR NUMBERS.

SN 78-832,867, FILED 3-8-2006.

KYLE PEETE, EXAMINING ATTORNEY

**Int. Cl.: 9**

**Prior U.S. Cls.: 21, 23, 26, 36, and 38**

**Reg. No. 3,455,512**

**United States Patent and Trademark Office**

**Registered June 24, 2008**

**TRADEMARK  
PRINCIPAL REGISTER**

**MEDIA GATEWAY**

VIKING ELECTRONIC SERVICES (PENNSYLVANIA CORPORATION)  
620 ALLENDALE ROAD  
KING OF PRUSSIA, PA 19406

FOR: FIRE PROTECTION SYSTEM HARDWARE, NAMELY, A FIRE PROTECTION SYSTEM CONTROLLER FOR INTERFACING A FIRE PROTECTION SYSTEM WITH A CONTROL SYSTEM FOR DESIGNING, CONTROLLING, PROVIDING PROGRAMMING ACCESS, REPORTING, TESTING, REPAIRING, AND MONITORING A FIRE PROTECTION SYSTEM, IN CLASS 9 (U.S. CLS. 21, 23, 26, 36 AND 38).

FIRST USE 8-21-2002; IN COMMERCE 1-5-2004.

THE MARK CONSISTS OF STANDARD CHARACTERS WITHOUT CLAIM TO ANY PARTICULAR FONT, STYLE, SIZE, OR COLOR.

NO CLAIM IS MADE TO THE EXCLUSIVE RIGHT TO USE "GATEWAY", APART FROM THE MARK AS SHOWN.

SN 78-833,058, FILED 3-9-2006.

PRISCILLA MILTON, EXAMINING ATTORNEY

**Int. Cl.: 35**

**Prior U.S. Cls.: 100, 101, and 102**

**United States Patent and Trademark Office**

**Reg. No. 3,455,513**

**Registered June 24, 2008**

**SERVICE MARK  
PRINCIPAL REGISTER**



FILM LIAISONS IN CALIFORNIA STATEWIDE  
(CALIFORNIA CORPORATION)  
SUITE 100  
1201 RESEARCH PARK DRIVE  
RIVERSIDE, CA 92057

FOR: PROMOTING THE ECONOMIC DEVELOPMENT IN THE STATE OF CALIFORNIA SPECIFICALLY AS RELATED TO THE PRODUCTION OF FILM AND MEDIA, IN CLASS 35 (U.S. CLS. 100, 101 AND 102).

FIRST USE 11-15-2006; IN COMMERCE 11-15-2006.

NO CLAIM IS MADE TO THE EXCLUSIVE RIGHT TO USE "FILM LIAISONS IN CALIFORNIA STATEWIDE" AND THE PICTORIAL REPRESENTATION OF THE STATE OF CALIFORNIA, APART FROM THE MARK AS SHOWN.

THE COLOR(S) BLACK, WHITE AND GOLD IS/ARE CLAIMED AS A FEATURE OF THE MARK.

THE MARK CONSISTS OF A WHITE BACKGROUND: A GOLD RECTANGLE WITH BLACK SPROCKET HOLES DOWN EACH SIDE TO SIMULATE A FRAME OF MOTION PICTURE FILM CONTAINING THE GOLD OUTLINE OF THE STATE OF CALIFORNIA, TO THE LEFT OF THE LARGE BLACK CAPITAL LETTERS "FLICS" ABOVE THE SMALL BLACK CAPITAL LETTERS SPELLING OUT "FILM LIAISONS IN CALIFORNIA STATEWIDE".

SN 78-833,280, FILED 3-9-2006.

DAVID MURRAY, EXAMINING ATTORNEY

**Int. Cls.: 8 and 16**

**Prior U.S. Cls.: 2, 5, 22, 23, 28, 29, 37, 38, 44, and 50**

**Reg. No. 3,455,514**

**United States Patent and Trademark Office**

**Registered June 24, 2008**

---

**TRADEMARK  
PRINCIPAL REGISTER**

**OLAN**

FOREVER CO., LTD. (JAPAN CORPORATION)  
3-19, 1 CHOME SAKAE-CHO, SAITAMA-KEN  
KAWAGUCHI-SHI, JAPAN

FOR: KITCHEN KNIVES, HUNTING KNIVES,  
FOLDING KNIVES, CHEF KNIVES, RAZOR KNI-  
VES, BOX CUTTERS, IN CLASS 8 (U.S. CLS. 23, 28  
AND 44).

FIRST USE 7-1-2007; IN COMMERCE 12-1-2007.

FOR: PAPER CUTTERS, IN CLASS 16 (U.S. CLS. 2,  
5, 22, 23, 29, 37, 38 AND 50).

FIRST USE 7-1-2007; IN COMMERCE 12-1-2007.

THE MARK CONSISTS OF STANDARD CHAR-  
ACTERS WITHOUT CLAIM TO ANY PARTICULAR  
FONT, STYLE, SIZE, OR COLOR.

SN 78-833,934, FILED 3-9-2006.

THEODORE MCBRIDE, EXAMINING ATTORNEY

**Int. Cl.: 17**

**Prior U.S. Cls.: 1, 5, 12, 13, 35, and 50**

**United States Patent and Trademark Office**

**Reg. No. 3,455,515**

**Registered June 24, 2008**

**TRADEMARK  
PRINCIPAL REGISTER**

**FLO-LOK**

GIBSON & BARNES (CALIFORNIA CORPORATION)  
1900-140 WELD BLVD  
EL CAJON, CA 92020

FOR: NON-METAL CONNECTORS, NAMELY, NON-METAL COUPLINGS THAT FACILITATE TRANSFER LIQUIDS OR GASES BETWEEN HEAT-TRANSFER CLOTHING AND COOLING OR HEATING SOURCES, ALLOWING FLOW WHEN CONNECTED AND STOPPING FLOW WHEN DISCONNECTED, IN CLASS 17 (U.S. CLS. 1, 5, 12, 13, 35 AND 50).

FIRST USE 1-2-2007; IN COMMERCE 1-2-2007.

THE MARK CONSISTS OF STANDARD CHARACTERS WITHOUT CLAIM TO ANY PARTICULAR FONT, STYLE, SIZE, OR COLOR.

SN 78-835,277, FILED 3-13-2006.

KATINA MISTER, EXAMINING ATTORNEY

**Int. Cls.: 35 and 44**

**Prior U.S. Cls.: 100, 101, and 102**

**United States Patent and Trademark Office**

**Reg. No. 3,455,516**

**Registered June 24, 2008**

**SERVICE MARK  
PRINCIPAL REGISTER**

# PRESCRIPTIVES

ESTEE LAUDER INC. (DELAWARE CORPORATION)  
TRADEMARK DEPARTMENT  
767 FIFTH AVENUE  
NEW YORK, NY 10153

FOR: ONLINE RETAIL STORE SERVICES OFFERED VIA A GLOBAL COMMUNICATION NETWORK FEATURING PERSONAL CARE PRODUCTS, COSMETICS, TOILETRIES, PERFUMERY, BATH AND BODY PRODUCTS, AND SKIN CARE PRODUCTS; RETAIL STORE SERVICES FOR THE SALE OF PERSONAL CARE PRODUCTS, COSMETICS, TOILETRIES, PERFUMERY, BATH AND BODY PRODUCTS, AND SKIN CARE PRODUCTS; MAIL ORDER SERVICES FEATURING PERSONAL CARE PRODUCTS, COSMETICS, TOILETRIES, PERFUMERY, BATH AND BODY PRODUCTS, AND SKIN CARE PRODUCTS, IN CLASS 35 (U.S. CLS. 100, 101 AND 102).

FIRST USE 9-8-2003; IN COMMERCE 9-8-2003.

FOR: BEAUTY CONSULTATION SERVICES REGARDING THE SELECTION AND USE OF PERSONAL CARE PRODUCTS, COSMETICS, TOILETRIES, PERFUMERY, BATH AND BODY PRODUCTS, SKIN CARE PRODUCTS, AND PERSONAL APPEARANCE, IN CLASS 44 (U.S. CLS. 100 AND 101).

FIRST USE 9-8-2003; IN COMMERCE 9-8-2003.

THE MARK CONSISTS OF STANDARD CHARACTERS WITHOUT CLAIM TO ANY PARTICULAR FONT, STYLE, SIZE, OR COLOR.

OWNER OF U.S. REG. NOS. 1,116,537, 2,406,017, AND OTHERS.

SN 78-835,890, FILED 3-13-2006.

REBECCA EISINGER, EXAMINING ATTORNEY

Int. Cl.: 25

Prior U.S. Cls.: 22 and 39

United States Patent and Trademark Office

Reg. No. 3,455,517

Registered June 24, 2008

TRADEMARK  
PRINCIPAL REGISTER



HUFF, AL-HAKA A (UNITED STATES INDIVIDUAL)  
SUITE 16E  
320 SOUTH HARRISON  
EAST ORANGE, NJ 07018

FOR: CLOTHING, NAMELY, SHIRTS, PANTS, JACKETS, HATS, SHORTS, DRESSES, SKIRTS, SCARVES, BELTS, SUITS, SOCKS, COATS, UNDERWEAR, AND SWEAT SUITS, IN CLASS 25 (U.S. CLS. 22 AND 39).

FIRST USE 1-1-2007; IN COMMERCE 1-1-2007.

THE MARK CONSISTS OF ONE BIG STYLIZED "M" THAT IS SHADED BLACK WITH THE WORD "MIKIATA" ON THE BOTTOM AND THAT IS ALSO SHADED.

SN 78-837,660, FILED 3-15-2006.

JULIE WATSON, EXAMINING ATTORNEY

**Int. Cls.: 14 and 18**

**Prior U.S. Cls.: 1, 2, 3, 22, 27, 28, 41, and 50**

**Reg. No. 3,455,518**

**United States Patent and Trademark Office**

**Registered June 24, 2008**

**TRADEMARK  
PRINCIPAL REGISTER**

# Pocci

NAKAI, OSAMU (JAPAN INDIVIDUAL)  
446-11, OSAWA, SASAYAMA-SHI  
HYOGO-KEN, JAPAN

FOR: PRECIOUS METALS; JEWELRY; UNWROUGHT AND SEMI-WROUGHT PRECIOUS STONES AND THEIR IMITATIONS; CLOCKS AND WATCHES; KEYRINGS, TRINKETS, FOBS, DISHES, SERVING PLATTERS AND TRAYS, NUTCRACKERS, PEPPER POTS, SUGAR BOWLS, SALT SHAKERS, EGG CUPS, NAPKIN HOLDERS, NAPKIN RINGS, TOOTHPICK HOLDERS, BOXES FOR NEEDLES, CANDLE EXTINGUISHERS AND CANDLESTICKS, JEWEL CASES, FLOWER VASES AND BOWLS, TROPHIES, PRIZE CUPS, COMMEMORATIVE SHIELDS, ORNAMENTS, PURSES AND WALLETTS, POWDER COMPACTS, SHOE ORNAMENTS, ASHTRAYS, CIGAR AND CIGARETTE HOLDERS, ALL OF PRECIOUS METAL, IN CLASS 14 (U.S. CLS. 2, 27, 28 AND 50).

FIRST USE 11-5-2007; IN COMMERCE 11-5-2007.

FOR: ALL PURPOSE CARRYING BAGS, HANDBAGS, SHOULDER BAGS, TOTE BAGS, BUSINESS

BAGS, BOSTON BAGS, PURSES, BUSINESS CARD CASES, KEY CASES AND VANITY CASES SOLD EMPTY, ALL MADE OF LEATHER AND CLOTH; FELT POUCHES; LEATHER POUCHES; HANDBAG FRAMES; PURSE FRAMES; LEATHER CASES; CLOTHING FOR DOMESTIC PETS; UMBRELLAS AND THEIR PARTS; WALKING STICKS; CANES; METAL PARTS OF CANES AND WALKINGSTICKS; WALKING CANE HANDLES; SADDLERY; UNWORKED AND SEMI-WORKED LEATHER, IN CLASS 18 (U.S. CLS. 1, 2, 3, 22 AND 41).

FIRST USE 11-5-2007; IN COMMERCE 11-5-2007.

THE MARK CONSISTS OF STANDARD CHARACTERS WITHOUT CLAIM TO ANY PARTICULAR FONT, STYLE, SIZE, OR COLOR.

"POCCI" HAS NO MEANING IN A FOREIGN LANGUAGE.

SN 78-838,697, FILED 3-16-2006.

IRA J. GOODSaid, EXAMINING ATTORNEY



**Int. Cl.: 12**

**Prior U.S. Cls.: 19, 21, 23, 31, 35, and 44**

**United States Patent and Trademark Office**

**Reg. No. 3,455,519**

**Registered June 24, 2008**

**TRADEMARK  
PRINCIPAL REGISTER**



KATZKIN LEATHER INTERIORS, INC. (CALI-  
FORNIA CORPORATION)  
6868 ACCO STREET  
MONTEBELLO, CA 90640

FIRST USE 3-1-2005; IN COMMERCE 3-4-2005.

SN 78-839,406, FILED 3-16-2006.

FOR: AUTOMOTIVE INTERIOR TRIM OF LEA-  
THER AND VINYL FOR CARS AND TRUCKS;  
UPHOLSTERY FOR CARS AND TRUCKS, IN CLASS  
12 (U.S. CLS. 19, 21, 23, 31, 35 AND 44).

MARK PILARO, EXAMINING ATTORNEY

**Int. Cl.: 35**

**Prior U.S. Cls.: 100, 101, and 102**

**United States Patent and Trademark Office**

**Reg. No. 3,455,520**

**Registered June 24, 2008**

**SERVICE MARK  
PRINCIPAL REGISTER**

**ONECODE ACS**

UNITED STATES POSTAL SERVICE (UNITED STATES INDEPENDENT ESTABLISHMENT OF THE EXECUTIVE BRANCH OF THE GOVERNMENT OF THE UNITED STATES)

475 L'ENFANT PLAZA, SW  
WASHINGTON, DC 202601136

FOR: PROVIDING COMPUTERIZED ADDRESS CORRECTION AND UPDATING SERVICES, AND RELATED INFORMATION CONCERNING MAIL ITEMS, NAMELY, PROVIDING MAILERS ELECTRONIC NOTIFICATION OF CUSTOMER CHANGE-OF-ADDRESS OCCURRENCES OR REASONS WHY THE MAIL WAS UNDELIVERABLE-AS-

ADDRESSED USING BAR CODES VIA A GLOBAL COMPUTER INFORMATION NETWORK, IN CLASS 35 (U.S. CLS. 100, 101 AND 102).

FIRST USE 9-1-2006; IN COMMERCE 9-1-2006.

THE MARK CONSISTS OF STANDARD CHARACTERS WITHOUT CLAIM TO ANY PARTICULAR FONT, STYLE, SIZE, OR COLOR.

SN 78-840,932, FILED 3-20-2006.

JEFFERY COWARD, EXAMINING ATTORNEY

**Int. Cl.: 33**

**Prior U.S. Cls.: 47 and 49**

**United States Patent and Trademark Office**

**Reg. No. 3,455,521**

**Registered June 24, 2008**

**TRADEMARK  
PRINCIPAL REGISTER**

**VRAC**

VILLAGE WINE IMPORTS, LTD. (NEW YORK  
CORPORATION)  
14 EAST 4TH STREET  
SUITE 604  
NEW YORK, NY 10012

THE MARK CONSISTS OF STANDARD CHAR-  
ACTERS WITHOUT CLAIM TO ANY PARTICULAR  
FONT, STYLE, SIZE, OR COLOR.

FOR: WINE, IN CLASS 33 (U.S. CLS. 47 AND 49).

SN 78-842,025, FILED 3-21-2006.

FIRST USE 7-31-2006; IN COMMERCE 7-31-2006.

SETH A. RAPPAPORT, EXAMINING ATTORNEY

**Int. Cls.: 16, 35, and 41**

**Prior U.S. Cls.: 2, 5, 22, 23, 29, 37, 38, 50, 100, 101, 102, and 107**

**Reg. No. 3,455,522**

**United States Patent and Trademark Office**

**Registered June 24, 2008**

**TRADEMARK  
SERVICE MARK  
PRINCIPAL REGISTER**

**SALON CITY**

SC COMMUNICATIONS (CALIFORNIA PART-  
NERSHIP)  
P.O. BOX 2385  
BEVERLY HILLS, CA 90213

FOR: MAGAZINES FEATURING BEAUTY, EN-  
TERTAINMENT AND FASHION, IN CLASS 16 (U.S.  
CLS. 2, 5, 22, 23, 29, 37, 38 AND 50).

FIRST USE 1-31-2000; IN COMMERCE 1-31-2000.

FOR: RETAIL ONLINE CATALOG ORDERING  
SERVICES FEATURING BEAUTY SUPPLIES; ASSO-  
CIATION SERVICES, NAMELY, PROMOTING THE  
INTERESTS OF BEAUTY SALONS; PROVIDING  
REFERRALS RELATED TO THE BEAUTY INDUS-  
TRY; PROVIDING A WEBSITE IN THE FORM OF  
AN ONLINE BUSINESS DIRECTORY FEATURING  
BEAUTY SALONS, ENTERTAINMENT AND FASH-  
ION; PLANNING AND CONDUCTING OF AWARD  
PROGRAMS AND PROMOTIONAL EVENTS, AND  
PRESENTATIONS FOR ECONOMIC OR ADVERTIS-  
ING PURPOSES; PROVIDING PUBLIC RELATIONS  
SERVICES THROUGH CLUBS ASSOCIATED WITH  
THE BEAUTY SALON INDUSTRY, IN CLASS 35  
(U.S. CLS. 100, 101 AND 102).

FIRST USE 11-7-2007; IN COMMERCE 11-7-2007.

FOR: ENTERTAINMENT IN THE NATURE OF  
AN ONGOING TELEVISION PROGRAM AND ON-  
GOING SEGMENTS OF TELEVISION PROGRAMS  
FEATURING BEAUTY AND FASHION WHICH  
ARE WEBCAST; PROVIDING A WEBSITE FEATUR-  
ING INFORMATION ON ENTERTAINMENT, IN  
CLASS 41 (U.S. CLS. 100, 101 AND 107).

FIRST USE 12-31-2000; IN COMMERCE 12-31-2000.

THE MARK CONSISTS OF STANDARD CHAR-  
ACTERS WITHOUT CLAIM TO ANY PARTICULAR  
FONT, STYLE, SIZE, OR COLOR.

NO CLAIM IS MADE TO THE EXCLUSIVE  
RIGHT TO USE "SALON", APART FROM THE  
MARK AS SHOWN.

SN 78-842,986, FILED 3-22-2006.

ANDREA SAUNDERS, EXAMINING ATTORNEY

**Int. Cl.: 3**

**Prior U.S. Cls.: 1, 4, 6, 50, 51, and 52**

**Reg. No. 3,455,523**

**United States Patent and Trademark Office**

**Registered June 24, 2008**

**TRADEMARK  
PRINCIPAL REGISTER**

**EUPHORIA BLOSSOM**

WILLIN LLC (NEVADA LTD LIAB CO)  
9901 TRAILWOOD DRIVE, #2105  
LAS VEGAS, NV 89134

FOR: PERFUMERY, NAMELY, PERFUME, EAU DE TOILETTE, PERFUME GEL, SCENTED SERUMS, SCENTED SACHETS, FRAGRANCE STICKS, POTS AND BALMS; POTPOURRI, TOILET WATER, AFTERSHAVE, COLOGNE; ESSENTIAL OILS; AROMATHERAPY PRODUCTS NOT FOR MEDICAL USE, NAMELY, ESSENTIAL OILS, MASSAGE OILS, AND SKIN SCRUBS; DEODORANTS AND ANTI-PERSPIRANTS; SOAPS, NAMELY, DEODORANT SOAPS, SKIN SOAPS, TOILET SOAPS, LIQUID SOAP FOR HAND, FACE AND BODY AND BODY WASH; SKIN CLEANING PREPARATIONS; BATH AND SHOWER PREPARATIONS, NAMELY, BATH AND SHOWER GEL, BATH OIL, BATH OIL CAPSULES,

BODY WASH, BATH CRYSTALS AND BEADS AND BUBBLE BATH; SKIN CARE PREPARATIONS; OILS, CREAMS AND LOTIONS FOR THE SKIN; SHAVING PREPARATIONS; PRE-SHAVE AND AFTERSHAVE PREPARATIONS, IN CLASS 3 (U.S. CLS. 1, 4, 6, 50, 51 AND 52).

FIRST USE 1-0-2007; IN COMMERCE 1-0-2007.

THE MARK CONSISTS OF STANDARD CHARACTERS WITHOUT CLAIM TO ANY PARTICULAR FONT, STYLE, SIZE, OR COLOR.

OWNER OF U.S. REG. NO. 2,768,507.

SN 78-843,898, FILED 3-22-2006.

RAUL CORDOVA, EXAMINING ATTORNEY

**Int. Cl.: 11**

**Prior U.S. Cls.: 13, 21, 23, 31, and 34**

**United States Patent and Trademark Office**

**Reg. No. 3,455,524**

**Registered June 24, 2008**

**TRADEMARK  
PRINCIPAL REGISTER**

**AUTO AQ**

AERUS CONCEPTS, L.P. (TEXAS PARTNERSHIP)  
5420 LBJ FREEWAY, SUITE 800  
DALLAS, TX 75240

THE MARK CONSISTS OF STANDARD CHARACTERS WITHOUT CLAIM TO ANY PARTICULAR FONT, STYLE, SIZE, OR COLOR.

FOR: AIR PURIFIERS AND PARTS AND ACCESSORIES THEREFOR, IN CLASS 11 (U.S. CLS. 13, 21, 23, 31 AND 34).

SN 78-845,345, FILED 3-24-2006.

FIRST USE 10-1-2006; IN COMMERCE 10-1-2006.

INGA ERVIN, EXAMINING ATTORNEY

**Int. Cls.: 18 and 35**

**Prior U.S. Cls.: 1, 2, 3, 22, 41, 100, 101, and 102**

**United States Patent and Trademark Office**

**Reg. No. 3,455,525**

**Registered June 24, 2008**

**TRADEMARK  
SERVICE MARK  
PRINCIPAL REGISTER**

**BEAUTY AVALANCHE**

BATH & BODY WORK BRAND MANAGEMENT,  
INC. (DELAWARE CORPORATION)  
7 LIMITED PARKWAY EAST  
REYNOLDSBURG, OH 43068

FOR: COSMETIC BAGS SOLD EMPTY, CLUTCHES, PURSES, CLOTH SHOPPING TOTE BAGS, IN CLASS 18 (U.S. CLS. 1, 2, 3, 22 AND 41).

FIRST USE 10-31-2006; IN COMMERCE 10-31-2006.

FOR: RETAIL STORE SERVICES, MAIL ORDER RETAIL SERVICES AND ONLINE RETAIL STORE SERVICES ALL IN THE FIELD OF PERSONAL CARE PRODUCTS, COSMETICS, HOME FRAGRANCE PRODUCTS AND ACCESSORIES, IN CLASS 35 (U.S. CLS. 100, 101 AND 102).

FIRST USE 10-31-2006; IN COMMERCE 10-31-2006.

THE MARK CONSISTS OF STANDARD CHARACTERS WITHOUT CLAIM TO ANY PARTICULAR FONT, STYLE, SIZE, OR COLOR.

NO CLAIM IS MADE TO THE EXCLUSIVE RIGHT TO USE "BEAUTY", APART FROM THE MARK AS SHOWN.

SN 78-845,375, FILED 3-24-2006.

KATHERINE M. DUBRAY, EXAMINING ATTORNEY

**Int. Cl.: 9**

**Prior U.S. Cls.: 21, 23, 26, 36, and 38**

**United States Patent and Trademark Office**

**Reg. No. 3,455,526**

**Registered June 24, 2008**

**TRADEMARK  
PRINCIPAL REGISTER**

**firstronic**

PARAGON AG (FED REP GERMANY AKTIEN-  
GESELLSCHAFT (AG))  
SCHWALBENWEG 29  
DELBRUCK, FED REP GERMANY 33129

FOR: ELECTRICAL AND ELECTRONIC INDUS-  
TRIAL CONTROL SYSTEMS COMPRISED OF  
SWITCHES, THERMOSTATS, COMPUTERS, ELEC-  
TRIC CONTROL PANELS, ELECTRONIC INDICA-  
TOR AND CIRCUIT BOARDS, PRINTED CIRCUIT  
BOARDS, THE FOREGOING FOR HEATING AND  
AIR CONDITIONING SYSTEMS IN AUTOMOBILES,  
FOR LIGHTING SYSTEMS, FOR TELECOMMUNI-  
CATION EQUIPMENT, FOR MEDICAL EQUIP-  
MENT, IN CLASS 9 (U.S. CLS. 21, 23, 26, 36 AND 38).

FIRST USE 1-31-2006; IN COMMERCE 1-31-2006.

THE MARK CONSISTS OF STANDARD CHAR-  
ACTERS WITHOUT CLAIM TO ANY PARTICULAR  
FONT, STYLE, SIZE, OR COLOR.

OWNER OF FED REP GERMANY REG. NO.  
30405990, DATED 4-23-2004, EXPIRES 2-28-2014.

SN 78-845,409, FILED 3-24-2006.

ELI HELLMAN, EXAMINING ATTORNEY



**Int. Cl.: 35**

**Prior U.S. Cls.: 100, 101, and 102**

**United States Patent and Trademark Office**

**Reg. No. 3,455,527**

**Registered June 24, 2008**

**SERVICE MARK  
PRINCIPAL REGISTER**

# SourceView

TRADECARD, INC. (DELAWARE CORPORATION)  
75 MAIDEN LANE, 12TH FLOOR  
NEW YORK, NY 10038

FOR: BUSINESS MANAGEMENT SERVICES, NAMELY, PROVIDING TO OTHERS, COMPUTERIZED PROCESSING, DOCUMENTATION AND MONITORING OF BUY/SELL TRANSACTIONS, COMPUTERIZED MONITORING OF THE STATUS OF BUY/SELL TRANSACTIONS, COMPUTERIZED DETERMINATION OF COMPLIANCE WITH TERMS OF SAID TRANSACTIONS; DATABASE MAINTENANCE AND MANAGEMENT AT A CENTRAL LOCATION FOR SAID TRANSACTIONS; COMPUTERIZED NOTIFICATION CONCERNING

SAID TERMS OR COMPLIANCE THEREWITH, ALL IN CONNECTION WITH FACILITATING BUSINESS-TO-BUSINESS TRANSACTIONS, IN CLASS 35 (U.S. CLS. 100, 101 AND 102).

FIRST USE 4-30-2006; IN COMMERCE 4-30-2006.

THE MARK CONSISTS OF STANDARD CHARACTERS WITHOUT CLAIM TO ANY PARTICULAR FONT, STYLE, SIZE, OR COLOR.

SN 78-845,719, FILED 3-24-2006.

PATRICIA EVANKO, EXAMINING ATTORNEY

**Int. Cls.: 35 and 36**

**Prior U.S. Cls.: 100, 101, and 102**

**United States Patent and Trademark Office**

**Reg. No. 3,455,528**

**Registered June 24, 2008**

**SERVICE MARK  
PRINCIPAL REGISTER**

**NOVAQUEST**

PHARMABIO DEVELOPMENT INC. (NORTH  
CAROLINA CORPORATION)  
SUITE 200  
4709 CREEKSTONE DRIVE  
DURHAM, NC 27703

FOR: BUSINESS SERVICES IN THE PHARMA-  
CEUTICAL, BIOTECHNOLOGY AND LIFE SCIEN-  
CES FIELDS, NAMELY, PROVIDING BUSINESS  
ADVICE TO CLIENTS AND INVESTORS REGARD-  
ING THE DEVELOPMENT AND COMMERCIALI-  
ZATION OF PRODUCTS AND BUSINESS  
MANAGEMENT OF PRODUCT PORTFOLIOS  
AND PROVIDING BUSINESS ADVICE TO CLIENTS  
AND INVESTORS IN MANAGING COMMERCIAL  
ALLIANCE RELATIONSHIPS, IN CLASS 35 (U.S.  
CLS. 100, 101 AND 102).

FIRST USE 5-11-2006; IN COMMERCE 6-1-2006.

FOR: PROVIDING FINANCIAL SERVICES IN  
THE PHARMACEUTICAL, BIOTECHNOLOGY  
AND LIFE SCIENCES FIELDS, NAMELY, PROVID-  
ING FINANCING TO PHARMACEUTICAL, BIO-  
TECHNOLOGY AND LIFE SCIENCES  
COMPANIES FOR PRODUCT DEVELOPMENT  
AND COMMERCIALIZATION, MAKING ACQUISI-

TIONS OF PRODUCTS AND PRODUCT RIGHTS OF  
AND INVESTMENTS IN PHARMACEUTICAL, BIO-  
TECHNOLOGY AND LIFE SCIENCES COMPANIES;  
CAPITAL FUNDING SERVICES TO PHARMACEU-  
TICAL, BIOTECHNOLOGY AND LIFE SCIENCES  
COMPANIES FOR THE DEVELOPMENT AND  
COMMERCIALIZATION OF NEW PRODUCTS,  
MANAGEMENT OF PRODUCT PORTFOLIOS,  
PRIORITIZATION OF FINANCIAL RESOURCES  
AND ACHIEVEMENT OF FINANCIAL OBJEC-  
TIVES; AND PROVIDING FINANCIAL CONSULTA-  
TION IN CONNECTION WITH ALL OF THE ABOVE  
, IN CLASS 36 (U.S. CLS. 100, 101 AND 102).

FIRST USE 5-11-2006; IN COMMERCE 6-1-2006.

THE MARK CONSISTS OF STANDARD CHAR-  
ACTERS WITHOUT CLAIM TO ANY PARTICULAR  
FONT, STYLE, SIZE, OR COLOR.

OWNER OF U.S. REG. NO. 2,231,124.

SN 78-845,818, FILED 3-24-2006.

CHARLOTTE CORWIN, EXAMINING ATTORNEY

Int. Cl.: 16

Prior U.S. Cls.: 2, 5, 22, 23, 29, 37, 38, and 50

United States Patent and Trademark Office

Reg. No. 3,455,529

Registered June 24, 2008

TRADEMARK  
PRINCIPAL REGISTER



ARCIDIACONO, SUSAN M. (UNITED STATES  
INDIVIDUAL)  
720 S. MARIPOSA STREET  
BURBANK, CA 91506

FOR: PICTURE BOOKS AND CHILDREN'S  
BOOKS, IN CLASS 16 (U.S. CLS. 2, 5, 22, 23, 29, 37, 38  
AND 50).

FIRST USE 1-1-2007; IN COMMERCE 1-1-2007.

THE COLOR(S) RED, YELLOW, PURPLE, WHITE,  
BLUE, PEACH, BLACK AND PINK IS/ARE  
CLAIMED AS A FEATURE OF THE MARK.

THE MARK CONSISTS OF A STYLIZED GIRL'S  
HEAD WITH YELLOW HAIR IN PIGTAILS WITH

RED CLIPS, THE CENTER OF THE GIRL'S EYES  
ARE BLUE WITH BLACK PUPILS AND THE REST  
OF THE EYES ARE WHITE, THE SKIN OF THE  
GIRL'S FACE IS PEACH, HER TEETH ARE WHITE  
AND HER LIPS ARE PINK, WITH THE ENTIRE  
HEAD AND ALL FEATURES OUTLINED IN  
BLACK. TO THE RIGHT OF THE GIRL'S HEAD IS  
THE WORD "FRANKIE" IN RED AND OUTLINED  
IN BLACK AND THE WORDS "& HER LITTLE  
PALS" IN WHITE ON A PURPLE BANNER THAT IS  
OUTLINED IN BLACK.

SN 78-846,237, FILED 3-25-2006.

JAMES LOVELACE, EXAMINING ATTORNEY

**Int. Cl.: 12**

**Prior U.S. Cls.: 19, 21, 23, 31, 35, and 44**

**Reg. No. 3,455,530**

**United States Patent and Trademark Office**

**Registered June 24, 2008**

**TRADEMARK  
PRINCIPAL REGISTER**



JONES, VINCENT C II (UNITED STATES INDIVIDUAL)  
4100 GALLOWS ROAD  
ANNANDALE, VA 22003

THE MARK CONSISTS OF THE LETTER "G" WITH TWO HORIZONTAL LINES SUPERPOSED THEREON.

FOR: THRUSTERS FOR VEHICLES, IN CLASS 12 (U.S. CLS. 19, 21, 23, 31, 35 AND 44).

SN 78-846,344, FILED 3-26-2006.

FIRST USE 4-12-2008; IN COMMERCE 4-12-2008.

JENNIFER VASQUEZ, EXAMINING ATTORNEY

**Int. Cl.: 3**

**Prior U.S. Cls.: 1, 4, 6, 50, 51, and 52**

**Reg. No. 3,455,531**

**United States Patent and Trademark Office**

**Registered June 24, 2008**

---

**TRADEMARK  
PRINCIPAL REGISTER**

**MOANA**

BATH & BODY WORK BRAND MANAGEMENT,  
INC. (DELAWARE CORPORATION)  
7 LIMITED PARKWAY EAST  
REYNOLDSBURG, OH 43068

FOR: PERSONAL CARE PRODUCTS, NAMELY,  
BODY WASH, IN CLASS 3 (U.S. CLS. 1, 4, 6, 50, 51  
AND 52).

FIRST USE 1-31-2007; IN COMMERCE 1-31-2007.

THE MARK CONSISTS OF STANDARD CHAR-  
ACTERS WITHOUT CLAIM TO ANY PARTICULAR  
FONT, STYLE, SIZE, OR COLOR.

THE ENGLISH TRANSLATION OF "MOANA" IS  
OCEAN.

SN 78-846,954, FILED 3-27-2006.

PAULA MAHONEY, EXAMINING ATTORNEY

**Int. Cls.: 41 and 44**

**Prior U.S. Cls.: 100, 101, and 107**

**United States Patent and Trademark Office**

**Reg. No. 3,455,532**

**Registered June 24, 2008**

**SERVICE MARK  
PRINCIPAL REGISTER**

***SPORTCARE***

TENNIS CORPORATION OF AMERICA (DELA-  
WARE CORPORATION)  
3611 N. KEDZIE AVE.  
CHICAGO, IL 60618

FOR: PROVIDING COURSES AND SEMINARS IN  
THE FIELD OF SPORTS, PHYSICAL FITNESS AND  
CONDITIONING, AND CONSULTATION SERVI-  
CES RELATING THERETO , IN CLASS 41 (U.S.  
CLS. 100, 101 AND 107).

FIRST USE 3-10-2008; IN COMMERCE 3-10-2008.

FOR: PHYSICAL REHABILITATION SERVICES  
AND PHYSICAL THERAPY SERVICES, IN CLASS 44  
(U.S. CLS. 100 AND 101).

FIRST USE 3-10-2008; IN COMMERCE 3-10-2008.

OWNER OF U.S. REG. NOS. 1,677,913 AND  
1,685,714.

SN 78-846,956, FILED 3-27-2006.

KATHERINE CHANG, EXAMINING ATTORNEY

**Int. Cls.: 35 and 37**

**Prior U.S. Cls.: 100, 101, 102, 103, and 106**

**United States Patent and Trademark Office**

**Reg. No. 3,455,533**

**Registered June 24, 2008**

**SERVICE MARK  
PRINCIPAL REGISTER**



TCG INTERNATIONAL, INC. (CANADA CORPORATION)  
28TH FLOOR, 4710 KINGSWAY  
BURNABY V5H 4M2, CANADA

FOR: FRANCHISING, NAMELY, OFFERING TECHNICAL AID AND ASSISTANCE TO OTHERS IN THE ESTABLISHMENT AND OPERATION OF BUSINESSES IN THE FIELD OF AUTOMOTIVE GLASS REPAIR AND REPLACEMENT, IN CLASS 35 (U.S. CLS. 100, 101 AND 102).

FIRST USE 4-15-2007; IN COMMERCE 4-15-2007.

FOR: AUTOMOBILE GLASS REPAIR AND REPLACEMENT SERVICES RENDERED VIA REPAIR SHOPS AND MOBILE VEHICLES, IN CLASS 37 (U.S. CLS. 100, 103 AND 106).

FIRST USE 11-28-2006; IN COMMERCE 11-28-2006.

OWNER OF U.S. REG. NOS. 1,295,361, 2,105,684, AND OTHERS.

NO CLAIM IS MADE TO THE EXCLUSIVE RIGHT TO USE "GLASS", APART FROM THE MARK AS SHOWN.

THE COLOR(S) RED, WHITE AND BLUE IS/ARE CLAIMED AS A FEATURE OF THE MARK.

THE MARK CONSISTS OF THE COLOR RED (PANTONE 199) APPEARS IN THE LOWER HALF OF THE QUADRILATERAL AND THE WORD "GLASS" AND AS A BORDER AROUND THE QUADRILATERAL, THE COLOR BLUE (PANTONE 286) APPEARS IN THE UPPER HALF OF THE QUADRILATERAL, WHILE THE COLOR WHITE APPEARS IN THE WORD "NOVUS" AND THE FIVE VERTICAL BARS ON THE LEFT OF THE QUADRILATERAL AND AS A BORDER AROUND THE WORD "GLASS", AND AS A LINE THAT HORIZONTALLY SEPARATES THE QUADRILATERAL.

SN 78-848,143, FILED 3-28-2006.

KELLY MCCOY, EXAMINING ATTORNEY

**Int. Cl.: 27**

**Prior U.S. Cls.: 19, 20, 37, 42, and 50**

**United States Patent and Trademark Office**

**Reg. No. 3,455,534**

**Registered June 24, 2008**

**TRADEMARK  
PRINCIPAL REGISTER**

**TARAFLEX EVOLUTION**

GERFLOR (FRANCE SOCIETE ANONYME)  
50 COURS DE LA REPUBLIQUE  
VILLEURBANNE, FRANCE 69100

FOR: NON METALLIC WALL COVERING; NON METALLIC FLOOR COVERINGS ESPECIALLY FOR ARENA, GYMNASIUM, BASKETBALL COURT, VOLLEYBALL COURT, MULTI SPORTS GROUND, FITNESS AND AEROBIC GROUND; WALL COVERING; FLOOR COVERINGS ESPECIALLY FOR ARENA, GYMNASIUM, BASKETBALL COURT, VOLLEYBALL COURT, MULTI SPORTS GROUND, FITNESS AND AEROBIC

GROUND, IN PLASTIC MATERIAL, IN CLASS 27 (U.S. CLS. 19, 20, 37, 42 AND 50).

FIRST USE 12-0-2006; IN COMMERCE 12-0-2006.

THE MARK CONSISTS OF STANDARD CHARACTERS WITHOUT CLAIM TO ANY PARTICULAR FONT, STYLE, SIZE, OR COLOR.

OWNER OF U.S. REG. NO. 1,215,968.

SN 78-848,679, FILED 3-29-2006.

ARETHA SOMERVILLE, EXAMINING ATTORNEY



**Int. Cl.: 1**

**Prior U.S. Cls.: 1, 5, 6, 10, 26, and 46**

**Reg. No. 3,455,535**

**United States Patent and Trademark Office**

**Registered June 24, 2008**

**TRADEMARK  
PRINCIPAL REGISTER**

**Natur-Tec**

NORTHERN TECHNOLOGIES INTERNATIONAL CORPORATION (DELAWARE CORPORATION)

23205 MERCANTILE ROAD  
BEACHWOOD, OH 44122

FOR: BIODEGRADABLE AND/OR COMPOSTABLE POLYMER RESINS; BLENDED, COMPOUNDED AND/OR ALLOYED MIXTURES OF BIODEGRADABLE AND/OR COMPOSTABLE POLYMER RESINS; AND BIODEGRADABLE AND/OR COMPOSTABLE POLYMER BASE COMPOSITIONS, ALL USED IN THE MANUFACTURE OF COMMERCIAL, INDUSTRIAL AND DOMESTIC GOODS, IN CLASS 1 (U.S. CLS. 1, 5, 6, 10, 26 AND 46).

FIRST USE 4-10-2007; IN COMMERCE 4-10-2007.

THE COLORS GREEN AND WHITE ARE CLAIMED AS A FEATURE OF THE MARK.

THE COLOR GREEN APPEARS IN THE MARK'S WORDING AND IN THE LEAF DESIGN; THE COLOR WHITE APPEARS IN A STRIPE IN THE MIDDLE OF THE LEAF DESIGN.

SN 78-848,762, FILED 3-29-2006.

BARNEY CHARLON, EXAMINING ATTORNEY

**Int. Cl.: 16**

**Prior U.S. Cls.: 2, 5, 22, 23, 29, 37, 38, and 50**

**Reg. No. 3,455,536**

**United States Patent and Trademark Office**

**Registered June 24, 2008**

**TRADEMARK  
PRINCIPAL REGISTER**

**Natur-Tec**

NORTHERN TECHNOLOGIES INTERNATIONAL CORPORATION (DELAWARE CORPORATION)  
23205 MERCANTILE ROAD  
BEACHWOOD, OH 44122

FOR: PLASTIC FILMS, SHEETS AND WRAPPING MADE OF, OR FROM, ONE OR MORE BIODEGRADABLE AND/OR COMPOSTABLE POLYMER RESINS, AND/OR ONE OR MORE BLENDED, COMPOUNDED AND/OR ALLOYED MIXTURES OF BIODEGRADABLE AND/OR COMPOSTABLE POLYMER RESINS, FOR USE AS COMMERCIAL, INDUSTRIAL AND DOMESTIC PACKING AND/OR PACKAGING; OPEN CELL FOAM FOR USE IN MANUFACTURING OF CONSUMER PRODUCTS AND FOR USE AS INSULATION IN BUILDING AND CONSTRUCTION MADE UP, FROM OR CONTAINING ONE OR MORE BIODEGRADABLE AND/OR COMPOSTABLE POLYMER RESINS, AND/OR ONE OR MORE BLENDED, COMPOUNDED AND/OR ALLOYED MIXTURES OF BIODEGRADABLE AND/OR COMPOSTABLE POLYMER RESINS; AND PACKING AND/OR PACKAGING FOAM IN ROLL

FORM MADE OF, FROM OR CONTAINING ONE OR MORE BIODEGRADABLE AND/OR COMPOSTABLE POLYMER RESINS, AND/OR ONE OR MORE BLENDED, COMPOUNDED AND/OR ALLOYED MIXTURES OF BIODEGRADABLE AND/OR COMPOSTABLE POLYMER RESINS, IN CLASS 16 (U.S. CLS. 2, 5, 22, 23, 29, 37, 38 AND 50).

FIRST USE 9-0-2007; IN COMMERCE 9-0-2007.

THE COLOR(S) GREEN IS/ARE CLAIMED AS A FEATURE OF THE MARK.

THE COLOR GREEN APPEARS IN THE MARK'S WORDING AND IN THE LEAF DESIGN; THE COLOR WHITE APPEARS IN A STRIPE IN THE MIDDLE OF THE LEAF DESIGN.

SN 78-848,783, FILED 3-29-2006.

BARNEY CHARLON, EXAMINING ATTORNEY

Int. Cl.: 17

Prior U.S. Cls.: 1, 5, 12, 13, 35, and 50

Reg. No. 3,455,537

United States Patent and Trademark Office

Registered June 24, 2008

TRADEMARK  
PRINCIPAL REGISTER

Natur-Tec

NORTHERN TECHNOLOGIES INTERNATIONAL CORPORATION (DELAWARE CORPORATION)

23205 MERCANTILE ROAD  
BEACHWOOD, OH 44122

FOR: PLASTIC FILMS, SHEETS AND WRAPPING MADE OF, OR FROM, ONE OR MORE BIODEGRADABLE AND/OR COMPOSTABLE POLYMER RESINS, AND/OR ONE OR MORE BLENDED, COMPOUNDED AND/OR ALLOYED MIXTURES OF BIODEGRADABLE AND/OR COMPOSTABLE POLYMER RESINS, FOR USE AS COMMERCIAL, INDUSTRIAL AND DOMESTIC PACKING AND/OR PACKAGING; OPEN CELL FOAM FOR USE IN MANUFACTURING OF CONSUMER PRODUCTS AND FOR USE AS INSULATION IN BUILDING AND CONSTRUCTION MADE UP, FROM OR CONTAINING ONE OR MORE BIODEGRADABLE AND/OR COMPOSTABLE POLYMER RESINS, AND/OR ONE OR MORE BLENDED, COMPOUNDED AND/OR ALLOYED MIXTURES OF BIODEGRADABLE AND/OR COMPOSTABLE POLYMER RESINS; AND PACKING AND/OR PACKAGING FOAM IN ROLL

FORM MADE OF, FROM OR CONTAINING ONE OR MORE BIODEGRADABLE AND/OR COMPOSTABLE POLYMER RESINS, AND/OR ONE OR MORE BLENDED, COMPOUNDED AND/OR ALLOYED MIXTURES OF BIODEGRADABLE AND/OR COMPOSTABLE POLYMER RESINS, IN CLASS 17 (U.S. CLS. 1, 5, 12, 13, 35 AND 50).

FIRST USE 9-0-2007; IN COMMERCE 9-0-2007.

THE COLOR(S) GREEN IS/ARE CLAIMED AS A FEATURE OF THE MARK.

THE COLOR GREEN APPEARS IN THE MARK'S WORDING AND IN THE LEAF DESIGN; THE COLOR WHITE APPEARS IN A STRIPE IN THE MIDDLE OF THE LEAF DESIGN.

SN 78-848,852, FILED 3-29-2006.

BARNEY CHARLON, EXAMINING ATTORNEY

Int. Cl.: 35

Prior U.S. Cls.: 100, 101, and 102

United States Patent and Trademark Office

Reg. No. 3,455,538

Registered June 24, 2008

SERVICE MARK  
PRINCIPAL REGISTER



MAZZONETTO, ANDREA (UNITED STATES INDIVIDUAL)  
89 MAIN STREET APT. A1  
TARRYTOWN, NY 10591

FOR: RETAIL STORE SERVICES FEATURING ICE CREAM AND FROZEN CONFECTIONS, IN CLASS 35 (U.S. CLS. 100, 101 AND 102).

FIRST USE 5-31-2007; IN COMMERCE 5-31-2007.

NO CLAIM IS MADE TO THE EXCLUSIVE RIGHT TO USE "ARTISAN GELATO", APART FROM THE MARK AS SHOWN.

THE COLOR(S) RED, LIGHT GREEN, DARK GREEN, YELLOW, ORANGE, BROWN, WHITE, BLACK IS/ARE CLAIMED AS A FEATURE OF THE MARK.

THE MARK CONSISTS OF FOUR BROWN AND WHITE LATTICED ICE CREAM CONES, THE FIRST WITH A RED AND DARK GREEN STRAWBERRY ON TOP, THE SECOND WITH A LIME GREEN APPLE ON TOP, THE THIRD WITH A YELLOW, DARK GREEN AND ORANGE PINEAPPLE ON TOP, THE FOURTH WITH A LIGHT GREEN AND DARK GREEN WATERMELON ON TOP, AFTER WHICH THERE IS A BLACK VERTICAL LINE. THIS IS FOLLOWED BY THE WORD "GELATISSIMO" IN STYLIZED BLACK LETTERING WITH THE WORDS "ARTISAN GELATO" UNDERNEATH IN BROWN STYLIZED LETTERING.

SN 78-848,857, FILED 3-29-2006.

ODESSA BIBBINS, EXAMINING ATTORNEY

**Int. Cl.: 35**

**Prior U.S. Cls.: 100, 101, and 102**

**United States Patent and Trademark Office**

**Reg. No. 3,455,539**

**Registered June 24, 2008**

**SERVICE MARK  
PRINCIPAL REGISTER**

**YOUR WORLDWIDE CONNECTION  
TO VIRTUAL PROFESSIONALS**

INTERNATIONAL VIRTUAL ASSISTANTS ASSO-  
CIATION (NEVADA NON-PROFIT CORPORA-  
TION)  
561 KEYSTONE AVENUE, SUITE 309  
RENO, NV 89503

FOR: ASSOCIATION SERVICES, NAMELY, PRO-  
MOTING THE INTERESTS OF ONLINE ASSIS-  
TANTS, IN CLASS 35 (U.S. CLS. 100, 101 AND 102).

FIRST USE 2-28-2006; IN COMMERCE 3-29-2008.

THE MARK CONSISTS OF STANDARD CHAR-  
ACTERS WITHOUT CLAIM TO ANY PARTICULAR  
FONT, STYLE, SIZE, OR COLOR.

SN 78-849,667, FILED 3-30-2006.

AMY MCMENAMIN, EXAMINING ATTORNEY

**Int. Cl.: 33**

**Prior U.S. Cls.: 47 and 49**

**United States Patent and Trademark Office**

**Reg. No. 3,455,540**

**Registered June 24, 2008**

**TRADEMARK  
PRINCIPAL REGISTER**

**IOTA**

IOTA CELLARS, LLC (OREGON LTD LIAB CO)  
7875 SE AMITY ROAD  
AMITY, OR 97101

THE MARK CONSISTS OF STANDARD CHAR-  
ACTERS WITHOUT CLAIM TO ANY PARTICULAR  
FONT, STYLE, SIZE, OR COLOR.

FOR: WINE, IN CLASS 33 (U.S. CLS. 47 AND 49).

SN 78-850,170, FILED 3-30-2006.

FIRST USE 4-16-2008; IN COMMERCE 4-16-2008.

THOMAS MANOR, EXAMINING ATTORNEY

**Int. Cls.: 3 and 9**

**Prior U.S. Cls.: 1, 4, 6, 21, 23, 26, 36, 38, 50, 51, and 52**

**Reg. No. 3,455,541**

**United States Patent and Trademark Office**

**Registered June 24, 2008**

**TRADEMARK  
PRINCIPAL REGISTER**

**SCREEN YO BODY**

LINDER, RICHARD N., JR. (UNITED STATES  
INDIVIDUAL)  
804 POLO RUN DRIVE  
COLLIERVILLE, TN 38017 AND  
LOTTERHOS, WILLIAM CHRISTOPHER (UNITED  
STATES INDIVIDUAL)  
1407 BERN HILL DRIVE  
SPRING HILL, TN 37174

FOR: SKIN LOTIONS SOLD IN VENDING MA-  
CHINES FOR THE APPLICATION OF LIQUIDS  
AND LOTIONS, IN CLASS 3 (U.S. CLS. 1, 4, 6, 50, 51  
AND 52).

FIRST USE 11-19-2005; IN COMMERCE 11-19-2005.

FOR: VENDING MACHINES, NAMELY, FOR  
THE APPLICATION OF LIQUIDS AND LOTIONS  
OF VARIOUS PROPERTIES TO THE SKIN, IN  
CLASS 9 (U.S. CLS. 21, 23, 26, 36 AND 38).

FIRST USE 11-19-2005; IN COMMERCE 11-19-2005.

THE MARK CONSISTS OF STANDARD CHAR-  
ACTERS WITHOUT CLAIM TO ANY PARTICULAR  
FONT, STYLE, SIZE, OR COLOR.

SN 78-850,202, FILED 3-30-2006.

DAYNA BROWNE, EXAMINING ATTORNEY

**Int. Cl.: 11**

**Prior U.S. Cls.: 13, 21, 23, 31, and 34**

**United States Patent and Trademark Office**

**Reg. No. 3,455,542**

**Registered June 24, 2008**

**TRADEMARK  
PRINCIPAL REGISTER**

**BREWWIZARD**

BUNN-O-MATIC CORPORATION (DELAWARE  
CORPORATION)  
1400 STEVENSON DRIVE  
SPRINGFIELD, IL 62703

THE MARK CONSISTS OF STANDARD CHAR-  
ACTERS WITHOUT CLAIM TO ANY PARTICULAR  
FONT, STYLE, SIZE, OR COLOR.

FOR: TEMPERATURE CONTROLLED BEVER-  
AGE DISPENSERS AND COMPONENTS THEREOF;  
ELECTRIC COFFEE AND TEA MAKERS, IN CLASS  
11 (U.S. CLS. 13, 21, 23, 31 AND 34).

SN 78-850,344, FILED 3-30-2006.

FIRST USE 6-22-2006; IN COMMERCE 6-22-2006.

LAURA HAMMEL, EXAMINING ATTORNEY



**Int. Cl.: 37**

**Prior U.S. Cls.: 100, 103, and 106**

**United States Patent and Trademark Office**

**Reg. No. 3,455,543**

**Registered June 24, 2008**

**SERVICE MARK  
PRINCIPAL REGISTER**

**ZIMETIZE**

ZIMEK TECHNOLOGIES IP, LLC (FLORIDA LTD  
LIAB CO)  
5043 WINWOOD WAY  
ORLANDO, FL 32819

FOR: CLEANING OF INDUSTRIAL PREMISES  
AND RESIDENTIAL HOUSES, NAMELY, CLEAN-  
ING AND DISINFECTING OF ENCLOSED SPACES  
AND ENCLOSED AREAS PERFORMED FOR OTH-  
ERS, IN CLASS 37 (U.S. CLS. 100, 103 AND 106).

FIRST USE 4-25-2008; IN COMMERCE 4-25-2008.

THE MARK CONSISTS OF STANDARD CHAR-  
ACTERS WITHOUT CLAIM TO ANY PARTICULAR  
FONT, STYLE, SIZE, OR COLOR.

SN 78-851,349, FILED 3-31-2006.

TINA BROWN, EXAMINING ATTORNEY

**Int. Cls.: 1 and 9**

**Prior U.S. Cls.: 1, 5, 6, 10, 21, 23, 26, 36, 38, and 46**

**Reg. No. 3,455,544**

**United States Patent and Trademark Office**

**Registered June 24, 2008**

**TRADEMARK  
PRINCIPAL REGISTER**

**IC**

DAICEL CHEMICAL INDUSTRIES, LTD. (JAPAN  
CORPORATION)  
1, TEPPU-CHO, SAKAI  
OSAKA, JAPAN

FIRST USE 2-26-2007; IN COMMERCE 2-26-2007.

FOR: PACKING MATERIALS FOR USE IN LI-  
QUID CHROMATOGRAPHY COLUMNS, IN CLASS  
1 (U.S. CLS. 1, 5, 6, 10, 26 AND 46).

THE MARK CONSISTS OF STANDARD CHAR-  
ACTERS WITHOUT CLAIM TO ANY PARTICULAR  
FONT, STYLE, SIZE, OR COLOR.

FIRST USE 2-26-2007; IN COMMERCE 2-26-2007.

SN 78-851,593, FILED 3-31-2006.

FOR: COLUMNS FOR USE IN LIQUID CHRO-  
MATOGRAPHY, IN CLASS 9 (U.S. CLS. 21, 23, 26, 36  
AND 38).

BARBARA A. GOLD, EXAMINING ATTORNEY

**Int. Cl.: 25**

**Prior U.S. Cls.: 22 and 39**

**United States Patent and Trademark Office**

**Reg. No. 3,455,545**

**Registered June 24, 2008**

**TRADEMARK  
PRINCIPAL REGISTER**

**FORTEN AND JAMES**

FU DA INTERNATIONAL, LTD. (NEW YORK  
CORPORATION)  
23RD FLOOR  
525 SEVENTH AVENUE  
NEW YORK, NY 100184901

FOR: WOMEN'S, MEN'S AND CHILDREN'S  
CLOTHING, SPORTSWEAR, OUTERWEAR, AND  
ACTIVEWEAR, NAMELY, SUITS, JACKETS,  
COATS, JOGGING SUITS, DRESSES, SWEATERS,  
SHIRTS, BLOUSES, SKIRTS, SHORTS, PANTS, TOPS  
AND BOTTOMS, UNDERWEAR, SOCKS, BELTS,

TIES, SCARVES, SWIMWEAR, FOOTWEAR, HATS,  
IN CLASS 25 (U.S. CLS. 22 AND 39).

FIRST USE 10-1-2007; IN COMMERCE 10-1-2007.

THE MARK CONSISTS OF STANDARD CHAR-  
ACTERS WITHOUT CLAIM TO ANY PARTICULAR  
FONT, STYLE, SIZE, OR COLOR.

SN 78-851,820, FILED 3-31-2006.

RAMONA ORTIGA, EXAMINING ATTORNEY

**Int. Cls.: 2 and 9**

**Prior U.S. Cls.: 6, 11, 16, 21, 23, 26, 36, and 38**

**United States Patent and Trademark Office**

**Reg. No. 3,455,546**

**Registered June 24, 2008**

**TRADEMARK  
PRINCIPAL REGISTER**

**ISLAND  
INKJET**

ISLAND INK-JET SYSTEMS INC. (CANADA  
CORPORATION)  
244 - 4TH STREET  
COURTENAY, B.C., CANADA V9N 1G6

FOR: INK JET PRINTER INK; AND INK JET  
PRINTER REFILL KITS COMPRISED PRIMARILY  
OF INK JET PRINTER INK, IN CLASS 2 (U.S. CLS. 6,  
11 AND 16).

FIRST USE 2-0-2006; IN COMMERCE 2-0-2006.

FOR: PRINT HEAD CLEANING CARTRIDGES  
FOR COMPUTER PRINTERS, IN CLASS 9 (U.S. CLS.  
21, 23, 26, 36 AND 38).

FIRST USE 2-0-2006; IN COMMERCE 2-0-2006.

OWNER OF U.S. REG. NOS. 2,785,602, 3,106,114,  
AND OTHERS.

NO CLAIM IS MADE TO THE EXCLUSIVE  
RIGHT TO USE "INK JET", APART FROM THE  
MARK AS SHOWN.

SN 78-853,695, FILED 4-4-2006.

MICHAEL WEBSTER, EXAMINING ATTORNEY

**Int. Cl.: 43**

**Prior U.S. Cls.: 100 and 101**

**United States Patent and Trademark Office**

**Reg. No. 3,455,547**

**Registered June 24, 2008**

**SERVICE MARK  
PRINCIPAL REGISTER**

**WILDERNESS AT THE SMOKIES**

WILDERNESS HOTEL & RESORT, INC. (WIS-  
CONSIN CORPORATION)

511 E. ADAMS STREET

WISCONSIN DELLS, WI 53965

FOR: RESORT HOTELS, IN CLASS 43 (U.S. CLS.  
100 AND 101).

FIRST USE 1-1-2007; IN COMMERCE 1-1-2007.

THE MARK CONSISTS OF STANDARD CHAR-  
ACTERS WITHOUT CLAIM TO ANY PARTICULAR  
FONT, STYLE, SIZE, OR COLOR.

NO CLAIM IS MADE TO THE EXCLUSIVE  
RIGHT TO USE "AT THE SMOKIES", APART FROM  
THE MARK AS SHOWN.

SN 78-856,048, FILED 4-6-2006.

ZHALEH DELANEY, EXAMINING ATTORNEY

**Int. Cl.: 36**

**Prior U.S. Cls.: 100, 101, and 102**

**United States Patent and Trademark Office**

**Reg. No. 3,455,548**

**Registered June 24, 2008**

---

**SERVICE MARK  
PRINCIPAL REGISTER**

**ESQUIRE**

ESQUIRE, LLC (NEW JERSEY CORPORATION)  
SUITE 1104  
26 COURT STREET  
BROOKLYN, NY 11242

THE MARK CONSISTS OF STANDARD CHAR-  
ACTERS WITHOUT CLAIM TO ANY PARTICULAR  
FONT, STYLE, SIZE, OR COLOR.

FOR: BANKING SERVICES, IN CLASS 36 (U.S.  
CLS. 100, 101 AND 102).

SN 78-856,582, FILED 4-7-2006.

FIRST USE 11-1-2006; IN COMMERCE 11-1-2006.

RUDY R. SINGLETON, EXAMINING ATTORNEY

**Int. Cl.: 33**

**Prior U.S. Cls.: 47 and 49**

**United States Patent and Trademark Office**

**Reg. No. 3,455,549**

**Registered June 24, 2008**

**TRADEMARK  
PRINCIPAL REGISTER**

**PALOMITA**

PALOMA VINEYARD, LLC (CALIFORNIA LTD  
LIAB CO)  
4013 SPRING MOUNTAIN ROAD  
ST HELENA, CA 94574

OWNER OF U.S. REG. NO. 2,046,491.

FOR: WINE, IN CLASS 33 (U.S. CLS. 47 AND 49).

THE FOREIGN WORDING IN THE MARK  
TRANSLATES INTO ENGLISH AS LITTLE DOVE.

FIRST USE 10-4-2007; IN COMMERCE 11-15-2007.

SN 78-856,694, FILED 4-7-2006.

THE MARK CONSISTS OF STANDARD CHAR-  
ACTERS WITHOUT CLAIM TO ANY PARTICULAR  
FONT, STYLE, SIZE, OR COLOR.

LEIGH LOWRY, EXAMINING ATTORNEY

**Int. Cls.: 35 and 37**

**Prior U.S. Cls.: 100, 101, 102, 103, and 106**

**United States Patent and Trademark Office**

**Reg. No. 3,455,550**

**Registered June 24, 2008**

**SERVICE MARK  
PRINCIPAL REGISTER**

**FIRESTONE COMPLETE AUTO  
CARE SINCE 1926**

BFS BRANDS, LLC (DELAWARE LTD LIAB CO)  
535 MARRIOTT DRIVE  
NASHVILLE, TN 37214

FOR: RETAIL TIRE AND AUTOMOTIVE PARTS  
AND ACCESSORIES STORE, IN CLASS 35 (U.S. CLS.  
100, 101 AND 102).

FIRST USE 6-30-2005; IN COMMERCE 10-31-2005.

FOR: AUTOMOTIVE SERVICES, NAMELY, AU-  
TOMOBILE REPAIR AND MAINTENANCE, IN  
CLASS 37 (U.S. CLS. 100, 103 AND 106).

FIRST USE 6-30-2005; IN COMMERCE 10-31-2005.

THE MARK CONSISTS OF STANDARD CHAR-  
ACTERS WITHOUT CLAIM TO ANY PARTICULAR  
FONT, STYLE, SIZE, OR COLOR.

OWNER OF U.S. REG. NOS. 140,804, 1,387,468,  
AND OTHERS.

NO CLAIM IS MADE TO THE EXCLUSIVE  
RIGHT TO USE "COMPLETE AUTO CARE SINCE  
1926", APART FROM THE MARK AS SHOWN.

SN 78-857,452, FILED 4-10-2006.

MARK PILARO, EXAMINING ATTORNEY



**Int. Cl.: 42**

**Prior U.S. Cls.: 100 and 101**

**United States Patent and Trademark Office**

**Reg. No. 3,455,551**

**Registered June 24, 2008**

**SERVICE MARK  
PRINCIPAL REGISTER**

**ON THE ROAD**

THE USAA EDUCATIONAL FOUNDATION  
(TEXAS NON-PROFIT CORPORATION)  
USAA BUILDING, 9800 FREDERICKSBURG ROAD  
SAN ANTONIO, TX 78288

FOR: PROVIDING ONLINE NON-DOWNLOAD-  
ABLE VEHICLE DRIVING SIMULATION PRO-  
GRAMS TO TEACH DRIVING SAFETY TO TEENS,  
IN CLASS 42 (U.S. CLS. 100 AND 101).

FIRST USE 11-1-2004; IN COMMERCE 11-1-2004.

THE MARK CONSISTS OF STANDARD CHAR-  
ACTERS WITHOUT CLAIM TO ANY PARTICULAR  
FONT, STYLE, SIZE, OR COLOR.

SN 78-857,977, FILED 4-10-2006.

MICHAEL KAZAZIAN, EXAMINING ATTORNEY

**Int. Cls.: 6, 8, 9, 18, and 20**

**Prior U.S. Cls.: 1, 2, 3, 12, 13, 14, 21, 22, 23, 25, 26, 28, 32, 36, 38, 41, 44, and 50**

**Reg. No. 3,455,552**

**United States Patent and Trademark Office**

**Registered June 24, 2008**

**TRADEMARK  
PRINCIPAL REGISTER**

**ARSENAL**

ERGODYNE CORPORATION (MINNESOTA CORPORATION)  
1021 BANDANA BOULEVARD EAST  
SUITE 220  
ST. PAUL, MN 55108

FOR: CASES FOR TOOLS IN THE NATURE OF METAL TOOLBOXES , IN CLASS 6 (U.S. CLS. 2, 12, 13, 14, 23, 25 AND 50).

FIRST USE 2-14-2008; IN COMMERCE 2-14-2008.

FOR: TOOL BELTS; TOOL POUCHES FOR ATTACHMENT TO TOOL BELTS; TOOL APRONS; TOOL HOLDERS, IN CLASS 8 (U.S. CLS. 23, 28 AND 44).

FIRST USE 2-14-2008; IN COMMERCE 2-14-2008.

FOR: BAGS AND CASES SPECIALLY CONFIGURED FOR STORING AND CARRYING SCIENTIFIC INSTRUMENTS, NAMELY, MICROSCOPES, CENTRIFUGES, AND TELESCOPES, IN CLASS 9 (U.S. CLS. 21, 23, 26, 36 AND 38).

FIRST USE 2-14-2008; IN COMMERCE 2-14-2008.

FOR: FANNY PACKS FOR HOLDING TOOLS SOLD EMPTY; WAIST PACKS FOR HOLDING TOOLS SOLD EMPTY; TOOL POUCHES SOLD EMPTY; BAGS FOR TOOLS SOLD EMPTY, IN CLASS 18 (U.S. CLS. 1, 2, 3, 22 AND 41).

FIRST USE 2-14-2008; IN COMMERCE 2-14-2008.

FOR: CASES FOR TOOLS IN THE NATURE OF NON-METAL BOXES, IN CLASS 20 (U.S. CLS. 2, 13, 22, 25, 32 AND 50).

FIRST USE 2-14-2008; IN COMMERCE 2-14-2008.

THE MARK CONSISTS OF STANDARD CHARACTERS WITHOUT CLAIM TO ANY PARTICULAR FONT, STYLE, SIZE, OR COLOR.

SN 78-858,241, FILED 4-10-2006.

KAREN BRACEY, EXAMINING ATTORNEY

**Int. Cl.: 42**

**Prior U.S. Cls.: 100 and 101**

**United States Patent and Trademark Office**

**Reg. No. 3,455,553**

**Registered June 24, 2008**

**SERVICE MARK  
PRINCIPAL REGISTER**



CDA (MASSACHUSETTS CORPORATION)  
437 TURNPIKE STREET  
CANTON, MA 02021

FOR: ENGINEERING, IN CLASS 42 (U.S. CLS. 100  
AND 101).

FIRST USE 9-1-2006; IN COMMERCE 3-1-2007.

NO CLAIM IS MADE TO THE EXCLUSIVE  
RIGHT TO USE "COMMUNICATIONS DESIGN  
ASSOCIATES", APART FROM THE MARK AS  
SHOWN.

THE COLOR(S) BLUE AND WHITE IS/ARE  
CLAIMED AS A FEATURE OF THE MARK.

THE MARK CONSISTS OF AN ENERGY BLAST  
MOVING INTO STYLIZED LETTERS "CDA" ABOVE  
THE WORDS "COMMUNICATIONS DESIGN",  
WHICH IS UNDERLINED, AND ABOVE THE  
WORD "ASSOCIATES". THE COLOR BLUE AP-  
PEARS IN THE CIRCLE, IN THE WORDING "CDA  
COMMUNICATIONS DESIGN ASSOCIATES" AND  
IN THE UNDERLINE. THE COLOR WHITE AP-  
PEARS IN THE CENTER OF THE CIRCLE, AS A  
HORIZONTAL LINE GOING THROUGH THE LET-  
TERS "CDA," AND IN THE ENERGY SPLASH  
LINES.

SN 78-858,679, FILED 4-11-2006.

JASON BLAIR, EXAMINING ATTORNEY

**Int. Cl.: 28**

**Prior U.S. Cls.: 22, 23, 38, and 50**

**Reg. No. 3,455,554**

**United States Patent and Trademark Office**

**Registered June 24, 2008**

---

**TRADEMARK  
PRINCIPAL REGISTER**

**IBUDDIES**

SBH INTIMATES INC. (NEW YORK CORPORATION)  
1411 BROADWAY, 8TH FLOOR  
NEW YORK, NY 10018

THE MARK CONSISTS OF STANDARD CHARACTERS WITHOUT CLAIM TO ANY PARTICULAR FONT, STYLE, SIZE, OR COLOR.

FOR: TOY ANIMALS, FANTASY CHARACTER TOYS, AND DOLLS ALL CONTAINING STEREO SPEAKERS, IN CLASS 28 (U.S. CLS. 22, 23, 38 AND 50).

SN 78-858,735, FILED 4-11-2006.

FIRST USE 11-9-2006; IN COMMERCE 11-9-2006.

LIEF MARTIN, EXAMINING ATTORNEY

**Int. Cl.: 37**

**Prior U.S. Cls.: 100, 103, and 106**

**United States Patent and Trademark Office**

**Reg. No. 3,455,555**

**Registered June 24, 2008**

**SERVICE MARK  
PRINCIPAL REGISTER**

**EMISSION COMPLIANCE WITH  
CONFIDENCE**

IRONMAN PARTS & SERVICES (CALIFORNIA  
CORPORATION)  
2535 ANSELMO DR.  
CORONA, CA 92879

FOR: MACHINERY RETROFIT AND CONVER-  
SION SERVICES, IN CLASS 37 (U.S. CLS. 100, 103  
AND 106).

FIRST USE 1-1-2005; IN COMMERCE 1-1-2006.

THE MARK CONSISTS OF STANDARD CHAR-  
ACTERS WITHOUT CLAIM TO ANY PARTICULAR  
FONT, STYLE, SIZE, OR COLOR.

NO CLAIM IS MADE TO THE EXCLUSIVE  
RIGHT TO USE "EMISSION COMPLIANCE",  
APART FROM THE MARK AS SHOWN.

SN 78-859,266, FILED 4-11-2006.

FLORENTINA BLANDU, EXAMINING ATTORNEY

**Int. Cls.: 35 and 42**

**Prior U.S. Cls.: 100, 101, and 102**

**United States Patent and Trademark Office**

**Reg. No. 3,455,556**

**Registered June 24, 2008**

**SERVICE MARK  
PRINCIPAL REGISTER**



BIZ360 INC. (CALIFORNIA CORPORATION)  
2855 CAMPUS DRIVE, SUITE 100  
SAN MATEO, CA 94403

FOR: BUSINESS CONSULTING SERVICES IN THE FIELD OF MARKET INTELLIGENCE; DATA ANALYSIS IN THE NATURE OF MARKET ANALYSIS OF ADVERTISING, MARKETING, AND CORPORATE COMMUNICATIONS, IN CLASS 35 (U.S. CLS. 100, 101 AND 102).

FIRST USE 2-15-2005; IN COMMERCE 2-15-2005.

FOR: COMPUTER SERVICES, NAMELY, DESIGN AND DEVELOPMENT OF COMPUTER SOFTWARE FOR SEARCHING, RETRIEVING OR ANALYZING INFORMATION, SITES, DATABASES AND OTHER RESOURCES ON COMPUTER NETWORKS; APPLI-

CATION SERVICE PROVIDER FEATURING AUTOMATED SOFTWARE IN THE FIELD OF MEASURING THE EFFECTIVENESS OF CORPORATE COMMUNICATIONS AND PUBLIC RELATION MARKETING CAMPAIGNS; DATA MINING IN THE FIELDS OF ADVERTISING, MARKETING, AND CORPORATE COMMUNICATIONS, IN CLASS 42 (U.S. CLS. 100 AND 101).

FIRST USE 2-15-2005; IN COMMERCE 2-15-2005.

OWNER OF U.S. REG. NOS. 2,574,294 AND 2,654,137.

SN 78-860,330, FILED 4-12-2006.

LYDIA BELZER, EXAMINING ATTORNEY

**Int. Cl.: 21**

**Prior U.S. Cls.: 2, 13, 23, 29, 30, 33, 40, and 50**

**United States Patent and Trademark Office**

**Reg. No. 3,455,557**

**Registered June 24, 2008**

**TRADEMARK  
PRINCIPAL REGISTER**

**FILTER CHEF**

FILTER DADDY, LLC (KENTUCKY LTD LIAB  
CO)  
1053 STRINGER LANE  
MOUNT WASHINGTON, KY 40047

FOR: HOUSEHOLD CONTAINERS FOR FILTER-  
ING AND STORING COOKING OIL, IN CLASS 21  
(U.S. CLS. 2, 13, 23, 29, 30, 33, 40 AND 50).

FIRST USE 4-29-2008; IN COMMERCE 4-29-2008.

THE MARK CONSISTS OF STANDARD CHAR-  
ACTERS WITHOUT CLAIM TO ANY PARTICULAR  
FONT, STYLE, SIZE, OR COLOR.

NO CLAIM IS MADE TO THE EXCLUSIVE  
RIGHT TO USE "FILTER", APART FROM THE  
MARK AS SHOWN.

SN 78-860,705, FILED 4-13-2006.

ROBERT STRUCK, EXAMINING ATTORNEY

**Int. Cl.: 9**

**Prior U.S. Cls.: 21, 23, 26, 36, and 38**

**United States Patent and Trademark Office**

**Reg. No. 3,455,558**

**Registered June 24, 2008**

**TRADEMARK  
PRINCIPAL REGISTER**

**ECONOMIC LEARNINGPATH**

CENGAGE LEARNING, INC. (DELAWARE CORPORATION)  
200 FIRST STAMFORD PLACE  
STAMFORD, CT 06902

OWNER OF U.S. REG. NOS. 2,439,597 AND 2,846,993.

FOR: PRE-RECORDED VIDEOS FOR USE AS SUPPLEMENTS TO ECONOMIC TEXTBOOKS, IN CLASS 9 (U.S. CLS. 21, 23, 26, 36 AND 38).

NO CLAIM IS MADE TO THE EXCLUSIVE RIGHT TO USE "ECONOMIC", APART FROM THE MARK AS SHOWN.

FIRST USE 9-15-2006; IN COMMERCE 9-15-2006.

SN 78-861,108, FILED 4-13-2006.

THE MARK CONSISTS OF STANDARD CHARACTERS WITHOUT CLAIM TO ANY PARTICULAR FONT, STYLE, SIZE, OR COLOR.

JEFF DEFORD, EXAMINING ATTORNEY



Int. Cl.: 3

Prior U.S. Cls.: 1, 4, 6, 50, 51, and 52

Reg. No. 3,455,559

United States Patent and Trademark Office

Registered June 24, 2008

TRADEMARK  
PRINCIPAL REGISTER

*Dottoressa Reynaldi*

REYNALDI S.R.L. (ITALY LTD LIAB CO)  
VIA FERRERO 21  
RIVOLI (TO), ITALY 10098

FOR: FACE DETERGENTS, EYE-MAKEUP REMOVERS, PERIOULAR COSMETICS, TONIC LOTIONS FOR SKIN, FACE AND BODY; SKIN-MOISTURIZING CREAMS, SKIN-NOURISHING CREAMS, ANTI-AGING CREAMS, FACE CREAMS, NECK FIRING CREAMS, BEAUTY MASKS, NON-MEDICATED PREPARATIONS FOR SKIN IMPURITIES, FACE MAKE-UP PREPARATIONS; SKIN-SOFTENING CREAMS, CREAMS FOR CELLULITE REDUCTION IN THE NATURE OF ANTI-CELLU-

LITES, FIRING CREAMS IN THE NATURE OF TOPICAL HERBAL CREAMS FOR FIRING AND ENHANCING BREASTS, IN CLASS 3 (U.S. CLS. 1, 4, 6, 50, 51 AND 52).

FIRST USE 12-0-2005; IN COMMERCE 12-0-2005.

THE NAME "DOTTORESSA REYNALDI" IDENTIFIES A LIVING INDIVIDUAL WHOSE CONSENT IS OF RECORD.

SN 78-861,133, FILED 4-13-2006.

BRENDAN REGAN, EXAMINING ATTORNEY

**Int. Cl.: 1**

**Prior U.S. Cls.: 1, 5, 6, 10, 26, and 46**

**Reg. No. 3,455,560**

**United States Patent and Trademark Office**

**Registered June 24, 2008**

---

**TRADEMARK  
PRINCIPAL REGISTER**

**AFEX**

A-LINE PRODUCTS CORPORATION (MICHIGAN CORPORATION)  
2955 BELLEVUE  
DETROIT, MI 48207

THE MARK CONSISTS OF STANDARD CHARACTERS WITHOUT CLAIM TO ANY PARTICULAR FONT, STYLE, SIZE, OR COLOR.

FOR: FUNCTIONALIZED OILS FOR USE AS CHEMICAL INTERMEDIATES AND ADDITIVES USED IN THE MANUFACTURE OF CHEMICALS, IN CLASS 1 (U.S. CLS. 1, 5, 6, 10, 26 AND 46).

SN 78-861,190, FILED 4-13-2006.

FIRST USE 6-15-2006; IN COMMERCE 4-11-2007.

JOHN GARTNER, EXAMINING ATTORNEY

**Int. Cl.: 44**

**Prior U.S. Cls.: 100 and 101**

**United States Patent and Trademark Office**

**Reg. No. 3,455,561**

**Registered June 24, 2008**

**SERVICE MARK  
PRINCIPAL REGISTER**

**WEEKEND ACNE CURE**

DR. HARLAN'S PRODUCTS, LTD. (IOWA CORPORATION)  
8131 UNIVERSITY BLVD  
CLIVE, IA 50325

FOR: MEDICAL SERVICES, NAMELY, PHOTODYNAMIC THERAPY, IN CLASS 44 (U.S. CLS. 100 AND 101).

FIRST USE 12-1-2007; IN COMMERCE 12-1-2007.

THE MARK CONSISTS OF STANDARD CHARACTERS WITHOUT CLAIM TO ANY PARTICULAR FONT, STYLE, SIZE, OR COLOR.

NO CLAIM IS MADE TO THE EXCLUSIVE RIGHT TO USE "ACNE CURE", APART FROM THE MARK AS SHOWN.

SN 78-862,494, FILED 4-17-2006.

MICHAEL KAZAZIAN, EXAMINING ATTORNEY

**Int. Cl.: 45**

**Prior U.S. Cls.: 100 and 101**

**United States Patent and Trademark Office**

**Reg. No. 3,455,562**

**Registered June 24, 2008**

**SERVICE MARK  
PRINCIPAL REGISTER**

**CRUSHORFLUSH**

ICEBREAKER, INC (CAYMAN ISLANDS CORPORATION)  
PO BOX 309GT  
UGLAND HOUSE, S. CHURCH ST  
GEORGE TOWN, CAYMAN ISLANDS GRAND CAY

FOR: SOCIAL NETWORKING SERVICES, NAME-  
LY, PROVIDING INTRODUCTION AND NET-  
WORKING SERVICES VIA MOBILE DEVICES,  
MOBILE PHONES AND ONLINE, AND PROVIDING  
A DATABASE FEATURING INFORMATION RE-  
GARDING PERSONAL ADS, NETWORKING,  
LOVE, ROMANCE, AND DATING ALSO VIA MO-

BILE DEVICES, MOBILE PHONES AND ONLINE, IN  
CLASS 45 (U.S. CLS. 100 AND 101).

FIRST USE 8-31-2006; IN COMMERCE 8-31-2006.

THE MARK CONSISTS OF STANDARD CHAR-  
ACTERS WITHOUT CLAIM TO ANY PARTICULAR  
FONT, STYLE, SIZE, OR COLOR.

SN 78-862,885, FILED 4-17-2006.

LINDA LAVACHE, EXAMINING ATTORNEY

**Int. Cl.: 9**

**Prior U.S. Cls.: 21, 23, 26, 36, and 38**

**Reg. No. 3,455,563**

**United States Patent and Trademark Office**

**Registered June 24, 2008**

**TRADEMARK  
PRINCIPAL REGISTER**

**TRIVIA ARCADE**

SNAP TV, INC. (DELAWARE CORPORATION)  
SUITE 1000  
WEST 2450 COLORADO AVENUE  
SANTA MONICA, CA 90404

FOR: ELECTRONIC GAME PROGRAMS AND  
SOFTWARE; VIDEO GAME PROGRAMS AND  
SOFTWARE; COMPUTER AND VIDEO GAME PRO-  
GRAMS IN THE FORM OF DVDS , IN CLASS 9 (U.S.  
CLS. 21, 23, 26, 36 AND 38).

FIRST USE 2-26-2007; IN COMMERCE 2-26-2007.

THE MARK CONSISTS OF STANDARD CHAR-  
ACTERS WITHOUT CLAIM TO ANY PARTICULAR  
FONT, STYLE, SIZE, OR COLOR.

NO CLAIM IS MADE TO THE EXCLUSIVE  
RIGHT TO USE "TRIVIA", APART FROM THE  
MARK AS SHOWN.

SN 78-863,584, FILED 4-18-2006.

MARK SPARACINO, EXAMINING ATTORNEY

**Int. Cls.: 7 and 8**

**Prior U.S. Cls.: 13, 19, 21, 23, 28, 31, 34, 35, and 44**

**United States Patent and Trademark Office**

**Reg. No. 3,455,564**

**Registered June 24, 2008**

**TRADEMARK  
PRINCIPAL REGISTER**

# EVOLUTION

EVOLUTION POWER TOOLS LIMITED (GREAT  
BRITAIN CORPORATION)  
HOLBROOK INDUSTRIAL ESTATE  
EVOLUTION HOUSE, NEW STREET  
SHEFFIELD, ENGLAND S20 3GH

FOR: PORTABLE ELECTRIC/PNEUMATIC POWER TOOLS, NAMELY, POWER CIRCULAR SAWS; POWER MITRE SAWS; POWER CUT OFF SAWS; PORTABLE ELECTRIC DRILL/DRIVERS; POWER HAMMER DRILLS, SANDERS AND SAWS; POWER GRINDERS, ANGLE GRINDERS, ROUTERS; POWER GRINDING TOOLS; ELECTRIC SCREWDRIVERS; POWER DRILL CHUCKS, DRILL/DRIVERS; POWER TOOLS WHICH COMBINE THE FUNCTION OF A POWER DRILL/DRIVER OR A POWER SCREWDRIVER; POWER OPERATED TOOLS, NAMELY, HAMMERS, PNEUMATIC HAMMERS, ROTARY HAMMERS, PERCUSSION DRILL/DRIVERS, HAMMER DRILLS, NIBBLERS; POWER STAPLERS AND NAIL GUNS; AND POWER TOOL ACCESSORIES FOR ALL THE AFORESAID GOODS, NAMELY, CIRCULAR SAW BLADES; DIAMOND

SAW BLADES; AND MITRE SAW STANDS, IN CLASS 7 (U.S. CLS. 13, 19, 21, 23, 31, 34 AND 35).

FIRST USE 2-28-2005; IN COMMERCE 6-30-2006.

FOR: TOOL ACCESSORIES, NAMELY, SAW BLADES, DIAMOND SAW BLADES, DRILL BITS, CUTTING TOOLS, SCREWDRIVER BITS, ROUTER BITS, GRINDING WHEELS AND DISCS, ABRASIVE TOOLS AND FILES, ALL OF THE ABOVE BEING HAND OPERATED TOOLS OR PART OF HAND OPERATED TOOLS, IN CLASS 8 (U.S. CLS. 23, 28 AND 44).

FIRST USE 2-28-2005; IN COMMERCE 6-30-2006.

THE MARK CONSISTS OF STANDARD CHARACTERS WITHOUT CLAIM TO ANY PARTICULAR FONT, STYLE, SIZE, OR COLOR.

SN 78-863,798, FILED 4-18-2006.

SUNG IN, EXAMINING ATTORNEY

**Int. Cl.: 9**

**Prior U.S. Cls.: 21, 23, 26, 36, and 38**

**United States Patent and Trademark Office**

**Reg. No. 3,455,565**

**Registered June 24, 2008**

**TRADEMARK  
PRINCIPAL REGISTER**

**GX DRIVER**

KYOCERA MITA CORPORATION (JAPAN CORPORATION)

2-28, 1-CHOME, TAMATSUKURI

CHUO-KU, OSAKA, JAPAN 540-8585

FOR: COMPUTER OPERATING PROGRAMS, IN CLASS 9 (U.S. CLS. 21, 23, 26, 36 AND 38).

FIRST USE 3-1-2006; IN COMMERCE 3-1-2006.

THE MARK CONSISTS OF STANDARD CHARACTERS WITHOUT CLAIM TO ANY PARTICULAR FONT, STYLE, SIZE, OR COLOR.

NO CLAIM IS MADE TO THE EXCLUSIVE RIGHT TO USE "DRIVER", APART FROM THE MARK AS SHOWN.

SN 78-863,967, FILED 4-18-2006.

RONALD MCMORROW, EXAMINING ATTORNEY

**Int. Cl.: 10**

**Prior U.S. Cls.: 26, 39, and 44**

**United States Patent and Trademark Office**

**Reg. No. 3,455,566**

**Registered June 24, 2008**

**TRADEMARK  
PRINCIPAL REGISTER**



ALCON, INC. (SWITZERLAND CORPORATION)  
BOSCH 69  
HUNENBERG, SWITZERLAND CH6331

FIRST USE 10-31-2007; IN COMMERCE 10-31-2007.

FOR: OPHTHALMIC SURGICAL APPARATUS  
FOR USE IN CATARACT, VITRECTOMY AND  
REFRACTIVE SURGERY, IN CLASS 10 (U.S. CLS.  
26, 39 AND 44).

SN 78-865,101, FILED 4-19-2006.

CHERYL CLAYTON, EXAMINING ATTORNEY



**Int. Cls.: 35, 39, and 43**

**Prior U.S. Cls.: 100, 101, 102, and 105**

**United States Patent and Trademark Office**

**Reg. No. 3,455,567**

**Registered June 24, 2008**

**SERVICE MARK  
PRINCIPAL REGISTER**

**TRAVEL TICKER**

HOTWIRE, INC. (DELAWARE CORPORATION)  
SUITE 100  
333 MARKET STREET  
SAN FRANCISCO, CA 94105

FOR: PROMOTING THE GOODS AND SERVICES OF OTHERS THROUGH THE OFFER OF TRAVEL GOODS AND SERVICES; PROVIDING CONSUMER INFORMATION REGARDING TRAVEL GOODS AND TRAVEL SERVICES; PROVIDING CONSUMER INFORMATION ABOUT SPECIAL OFFERS RELATING TO ACCOMMODATION AND LODGING, IN CLASS 35 (U.S. CLS. 100, 101 AND 102).

FIRST USE 6-28-2006; IN COMMERCE 6-28-2006.

FOR: PROVIDING TRAVEL INFORMATION AND INFORMATION ABOUT TRAVEL OFFERS OVER COMPUTER NETWORKS AND GLOBAL COMMUNICATION NETWORKS, IN CLASS 39 (U.S. CLS. 100 AND 105).

FIRST USE 6-28-2006; IN COMMERCE 6-28-2006.

FOR: PROVIDING TRAVEL LODGING AND ACCOMMODATION INFORMATION SERVICES AND PROVIDING TRAVEL NEWS REGARDING ACCOMMODATIONS AND TEMPORARY LODGING VIA AN ON-LINE GLOBAL COMMUNICATIONS NETWORK, IN CLASS 43 (U.S. CLS. 100 AND 101).

FIRST USE 6-28-2006; IN COMMERCE 6-28-2006.

THE MARK CONSISTS OF STANDARD CHARACTERS WITHOUT CLAIM TO ANY PARTICULAR FONT, STYLE, SIZE, OR COLOR.

NO CLAIM IS MADE TO THE EXCLUSIVE RIGHT TO USE "TRAVEL", APART FROM THE MARK AS SHOWN.

SN 78-866,048, FILED 4-20-2006.

PAM WILLIS, EXAMINING ATTORNEY

**Int. Cl.: 41**

**Prior U.S. Cls.: 100, 101, and 107**

**United States Patent and Trademark Office**

**Reg. No. 3,455,568**

**Registered June 24, 2008**

**SERVICE MARK  
PRINCIPAL REGISTER**



ORGANIZING NEIGHBORHOOD EQUITY (D.C.  
NON-PROFIT CORPORATION)  
614 S STREET, NW  
WASHINGTON, DC 20001

FIRST USE 5-1-2006; IN COMMERCE 5-1-2006.

FOR: EDUCATIONAL SERVICES, NAMELY,  
PROVIDING COURSES, INSTRUCTION, INFOR-  
MATION, PROGRAMS, TRAINING, SEMINARS,  
CONFERENCES AND WORKSHOPS IN THE FIELD  
OF COMMUNITY ORGANIZING, COMMUNITY  
SERVICE, AND YOUTH ADVOCACY, IN CLASS 41  
(U.S. CLS. 100, 101 AND 107).

NO CLAIM IS MADE TO THE EXCLUSIVE  
RIGHT TO USE "DC", APART FROM THE MARK  
AS SHOWN.

SN 78-866,126, FILED 4-20-2006.

MARK SPARACINO, EXAMINING ATTORNEY

**Int. Cl.: 29**

**Prior U.S. Cl.: 46**

**United States Patent and Trademark Office**

**Reg. No. 3,455,569**

**Registered June 24, 2008**

**TRADEMARK  
PRINCIPAL REGISTER**

**Sonoma Grille**

GLOBAL FOOD INNOVATIONS, INC. (DELA-  
WARE CORPORATION)

11427 REED HARTMAN HIGHWAY

CINCINNATI, OH 45241

FOR: MEAT PRODUCTS, NAMELY, BEEF, PORK  
AND CHICKEN, IN CLASS 29 (U.S. CL. 46).

FIRST USE 8-10-2006; IN COMMERCE 8-10-2006.

THE MARK CONSISTS OF STANDARD CHAR-  
ACTERS WITHOUT CLAIM TO ANY PARTICULAR  
FONT, STYLE, SIZE, OR COLOR.

NO CLAIM IS MADE TO THE EXCLUSIVE  
RIGHT TO USE "GRILLE", APART FROM THE  
MARK AS SHOWN.

SN 78-866,513, FILED 4-21-2006.

ALEX KEAM, EXAMINING ATTORNEY

**Int. Cl.: 11**

**Prior U.S. Cls.: 13, 21, 23, 31, and 34**

**Reg. No. 3,455,570**

**United States Patent and Trademark Office**

**Registered June 24, 2008**

**TRADEMARK  
PRINCIPAL REGISTER**

**MEADOWHAWK**

AGRIMOND, LLC (DELAWARE LIMITED LIABILITY CORPORATION)  
8910 ASTRONAUT BLVD.  
CAPE CANAVERAL, FL 32920

FIRST USE 8-2-2005; IN COMMERCE 9-8-2005.

FOR: PORTABLE TOILETS, NAMELY, SELF-CONTAINED PORTABLE TOILETS USING CARTRIDGE FILTRATION UNITS, CHEMICAL-FREE DISINFECTION UNITS, OZONE DISINFECTION UNITS, CHLORINE DISINFECTION UNITS, AND ULTRAVIOLET DISINFECTION UNITS, IN CLASS 11 (U.S. CLS. 13, 21, 23, 31 AND 34).

THE MARK CONSISTS OF STANDARD CHARACTERS WITHOUT CLAIM TO ANY PARTICULAR FONT, STYLE, SIZE, OR COLOR.

SN 78-866,769, FILED 4-21-2006.

ROBERT C. CLARK JR., EXAMINING ATTORNEY

Int. Cl.: 33

Prior U.S. Cls.: 47 and 49

United States Patent and Trademark Office

Reg. No. 3,455,571

Registered June 24, 2008

TRADEMARK  
PRINCIPAL REGISTER

KLOPP RANCH

KLOPP III, THEODORE W. (UNITED STATES  
INDIVIDUAL)  
P.O. BOX 391  
GRATON, CA 95444 AND  
KLOPP, KATHRYN (UNITED STATES INDIVI-  
DUAL)  
P.O. BOX 391  
GRATON, CA 95444

THE MARK CONSISTS OF STANDARD CHAR-  
ACTERS WITHOUT CLAIM TO ANY PARTICULAR  
FONT, STYLE, SIZE, OR COLOR.

NO CLAIM IS MADE TO THE EXCLUSIVE  
RIGHT TO USE "RANCH", APART FROM THE  
MARK AS SHOWN.

FOR: WINES, IN CLASS 33 (U.S. CLS. 47 AND 49).

SN 78-868,571, FILED 4-24-2006.

FIRST USE 7-2-2001; IN COMMERCE 7-2-2001.

ELIZABETH KAJUBI, EXAMINING ATTORNEY

**Int. Cls.: 9 and 42**

**Prior U.S. Cls.: 21, 23, 26, 36, 38, 100, and 101**

**Reg. No. 3,455,572**

**United States Patent and Trademark Office**

**Registered June 24, 2008**

**TRADEMARK  
SERVICE MARK  
PRINCIPAL REGISTER**

**PERCEPTION SOFTWARE**

PERCEPTION SOFTWARE, INC. (DELAWARE CORPORATION)  
105 W. RIVERSIDE DRIVE  
AUSTIN, TX 78704

FOR: COMPUTER SOFTWARE FOR MANAGING, SEARCHING, REPORTING, AND VIEWING ENGINEERING DATA; COMPUTER SOFTWARE FOR INTEGRATING ELECTRONIC DESIGN AUTOMATION (EDA) DATA AND MECHANICAL COMPUTER AIDED DESIGN DATA WITH ENTERPRISE PRODUCT LIFECYCLE MANAGEMENT AND PRODUCT DATA MANAGEMENT SYSTEMS; COMPUTER SOFTWARE FOR PROVIDING PROJECT MANAGEMENT AND COLLABORATION FOR ELECTRICAL AND MECHANICAL DESIGN ENGINEERS; ELECTRONIC DESIGN AUTOMATION (EDA) SOFTWARE, IN CLASS 9 (U.S. CLS. 21, 23, 26, 36 AND 38).

FIRST USE 1-0-2006; IN COMMERCE 1-0-2006.

FOR: CONSULTATION SERVICES IN THE FIELD OF PRODUCT DATA MANAGEMENT SOFTWARE AND PRODUCT LIFECYCLE MANAGEMENT SOFTWARE, NAMELY, INSTALLATION AND SETUP SERVICES AND ADVISING ON BEST PRACTICES RELATED TO THE USE AND INSTALLATION OF DATA MANAGEMENT SOFTWARE AND PRODUCT LIFECYCLE MANAGEMENT SOFTWARE, IN CLASS 42 (U.S. CLS. 100 AND 101).

FIRST USE 1-0-2006; IN COMMERCE 1-0-2006.

THE MARK CONSISTS OF STANDARD CHARACTERS WITHOUT CLAIM TO ANY PARTICULAR FONT, STYLE, SIZE, OR COLOR.

SN 78-869,307, FILED 4-25-2006.

KRISTIN DAHLING, EXAMINING ATTORNEY

**Int. Cl.: 29**

**Prior U.S. Cl.: 46**

**United States Patent and Trademark Office**

**Reg. No. 3,455,573**

**Registered June 24, 2008**

**TRADEMARK  
PRINCIPAL REGISTER**



LACTEOS DEL NORTE, S.A. DE C.V. (MEXICO CORPORATION)  
NO. 130  
MATEO BERLANGA  
SABINAS HIDALGO, MEXICO

FOR: MILK PRODUCTS EXCLUDING ICE CREAM, ICE MILK AND FROZEN YOGURT, IN CLASS 29 (U.S. CL. 46).

FIRST USE 5-0-2007; IN COMMERCE 5-0-2007.

OWNER OF U.S. REG. NO. 1,729,624.

THE COLORS GREEN AND WHITE ARE CLAIMED AS A FEATURE OF THE MARK.

THE MARK CONSISTS OF A COW HEAD OUTLINED IN THE COLOR GREEN ON A WHITE BACKGROUND, CIRCLE IN THE COLOR GREEN WITH THE WORD "NORTENITA" IN WHITE.

THE ENGLISH TRANSLATION OF THE WORD "NORTENITA" IN THE MARK IS SOMEONE OR SOMETHING FROM THE NORTH.

SN 78-870,150, FILED 4-26-2006.

JILL C. ALT, EXAMINING ATTORNEY

Int. Cl.: 29

Prior U.S. Cl.: 46

United States Patent and Trademark Office

Reg. No. 3,455,574

Registered June 24, 2008

TRADEMARK  
PRINCIPAL REGISTER



LACTEOS DEL NORTE, S.A. DE C.V. (MEXICO CORPORATION)  
MATEO BERLANGA  
NO. 130  
SABINAS HIDALGO, NUEVO LEON, MEXICO

FOR: MILK PRODUCTS EXCLUDING ICE CREAM, ICE MILK AND FROZEN YOGURT, IN CLASS 29 (U.S. CL. 46).

FIRST USE 5-0-2007; IN COMMERCE 5-0-2007.

OWNER OF U.S. REG. NO. 1,729,624.

THE COLORS GREEN AND WHITE ARE CLAIMED AS A FEATURE OF THE MARK.

THE MARK CONSISTS OF A COW HEAD OUTLINED IN THE COLOR GREEN ON A WHITE BACKGROUND WITH THE WORD "NORTENITA" IN GREEN.

THE ENGLISH TRANSLATION OF THE WORD "NORTENITA" IN THE MARK IS SOMEONE OR SOMETHING FROM THE NORTH.

SN 78-870,161, FILED 4-26-2006.

JILL C. ALT, EXAMINING ATTORNEY



**Int. Cl.: 6**

**Prior U.S. Cls.: 2, 12, 13, 14, 23, 25, and 50**

**Reg. No. 3,455,575**

**United States Patent and Trademark Office**

**Registered June 24, 2008**

**TRADEMARK  
PRINCIPAL REGISTER**

**NICHIHA**

NICHIHA CORPORATION (JAPAN CORPORATION)  
12 SHIODOME-CHO, MINATO-KU  
NAGOYA-SHI, JAPAN 455-8550

FOR: METAL BUILDING MATERIALS, NAME-  
LY, J-CHANNELS, FLASHINGS, MOLDINGS FOR  
WINDOWS, AND MODESTY PANELS; AND METAL  
HARDWARE, NAMELY, FASTENING MEMBERS ,  
IN CLASS 6 (U.S. CLS. 2, 12, 13, 14, 23, 25 AND 50).

FIRST USE 4-1-1988; IN COMMERCE 5-1-1998.

THE MARK CONSISTS OF STANDARD CHAR-  
ACTERS WITHOUT CLAIM TO ANY PARTICULAR  
FONT, STYLE, SIZE, OR COLOR.

OWNER OF U.S. REG. NOS. 2,307,765 AND  
2,503,376.

SN 78-870,289, FILED 4-26-2006.

MONIQUE MILLER, EXAMINING ATTORNEY

Int. Cl.: 35

Prior U.S. Cls.: 100, 101, and 102

United States Patent and Trademark Office

Reg. No. 3,455,576

Registered June 24, 2008

SERVICE MARK  
PRINCIPAL REGISTER



G. MOORE ASSOCIATES, LLC (MISSOURI LIMITED LIABILITY COMPANY)  
2507 MONARCH TERRACE DRIVE  
KATY, TX 77494

FOR: CONSULTING SERVICES IN THE FIELD OF HUMAN RESOURCES AND BUSINESS MANAGEMENT, IN CLASS 35 (U.S. CLS. 100, 101 AND 102).

FIRST USE 7-0-2006; IN COMMERCE 7-0-2006.

NO CLAIM IS MADE TO THE EXCLUSIVE RIGHT TO USE "QUALITY PEOPLE," "RELIABLE PROCESSES", "QUALITY PRODUCTS", AND "BUSINESS", APART FROM THE MARK AS SHOWN.

THE MARK CONSISTS OF A SPHERE WITH THE CAPITAL LETTER "P" IN THE CENTER, THE WORD "QUAD" APPEARING BELOW THE LETTER P IN SUBSCRIPT, THE PHRASE "EXPERIENCE THE POWER" IN THE LOWER RIGHT QUADRANT OF THE SPHERE, AND THE PHRASES "QUALITY PEOPLE", "RELIABLE PROCESSES", "QUALITY PRODUCTS", AND "HIGH PERFORMANCE BUSINESS" AROUND THE OUTER CIRCUMFERENCE OF THE SPHERE WITH SMALL CIRCLES SEPARATING EACH PHRASE.

SN 78-870,391, FILED 4-26-2006.

LINDA M. KING, EXAMINING ATTORNEY

**Int. Cl.: 36**

**Prior U.S. Cls.: 100, 101, and 102**

**United States Patent and Trademark Office**

**Reg. No. 3,455,577**

**Registered June 24, 2008**

**SERVICE MARK  
PRINCIPAL REGISTER**

**ESQUIREBANK.COM**

ESQUIRE, LLC (NEW JERSEY CORPORATION)  
SUITE 1104  
26 COURT STREET  
BROOKLYN, NY 11242

THE MARK CONSISTS OF STANDARD CHARACTERS WITHOUT CLAIM TO ANY PARTICULAR FONT, STYLE, SIZE, OR COLOR.

FOR: BANKING SERVICES; FINANCIAL SERVICES, NAMELY, MONEY LENDING, IN CLASS 36 (U.S. CLS. 100, 101 AND 102).

SN 78-870,696, FILED 4-27-2006.

FIRST USE 11-1-2006; IN COMMERCE 11-1-2006.

RUDY R. SINGLETON, EXAMINING ATTORNEY

**Int. Cl.: 25**

**Prior U.S. Cls.: 22 and 39**

**United States Patent and Trademark Office**

**Reg. No. 3,455,578**

**Registered June 24, 2008**

**TRADEMARK  
PRINCIPAL REGISTER**

# Lucky Star

MANOLI, JOHN (UNITED STATES INDIVIDUAL)  
34 HEMLOCK STREET  
NEEDHAM, MA 02492

THE MARK CONSISTS OF STANDARD CHARACTERS WITHOUT CLAIM TO ANY PARTICULAR FONT, STYLE, SIZE, OR COLOR.

FOR: FOOTWEAR, IN CLASS 25 (U.S. CLS. 22 AND 39).

SN 78-871,358, FILED 4-27-2006.

FIRST USE 9-1-2006; IN COMMERCE 11-1-2006.

BARNEY CHARLON, EXAMINING ATTORNEY

**Int. Cl.: 29**

**Prior U.S. Cl.: 46**

**United States Patent and Trademark Office**

**Reg. No. 3,455,579**

**Registered June 24, 2008**

**TRADEMARK  
PRINCIPAL REGISTER**

**KWIK'PAK**

KWIKPAK FISHERIES LLC (ALASKA LTD LIAB  
CO)  
301 CALISTA COURT, SUITE C  
ANCHORAGE, AK 99518

FOR: FISH; SEAFOOD, IN CLASS 29 (U.S. CL. 46).

FIRST USE 6-30-2004; IN COMMERCE 6-30-2004.

THE MARK CONSISTS OF STANDARD CHAR-  
ACTERS WITHOUT CLAIM TO ANY PARTICULAR  
FONT, STYLE, SIZE, OR COLOR.

SN 78-871,413, FILED 4-27-2006.

KATHERINE M. DUBRAY, EXAMINING ATTOR-  
NEY

**Int. Cl.: 39**

**Prior U.S. Cls.: 100 and 105**

**United States Patent and Trademark Office**

**Reg. No. 3,455,580**

**Registered June 24, 2008**

**SERVICE MARK  
PRINCIPAL REGISTER**



TRANSOPTIONS, INC. (NEW JERSEY CORPORATION)  
2 RIDGEDALE AVENUE, SUITE 200  
CEDAR KNOLLS, NJ 07927

FOR: CHARITABLE SERVICES, NAMELY, PROVIDING TRANSPORTATION TO THE ELDERLY OR HANDICAPPED PERSONS, IN CLASS 39 (U.S. CLS. 100 AND 105).

FIRST USE 11-1-2006; IN COMMERCE 11-1-2006.

THE COLOR(S) NAVY BLUE, LIGHT BLUE AND WHITE IS/ARE CLAIMED AS A FEATURE OF THE MARK.

THE COLOR WHITE APPEARS IN THE BACKGROUND OF THE MARK. THE COLOR NAVY BLUE APPEARS IN THE RIGHT POLYGON IN THE DESIGN IN THE LEFT CORNER OF THE MARK, IN THE TERM "TRANS" AND IN THE WORDING "MANAGING YOUR WAYS TO WORK... AND MORE!" THE COLOR LIGHT BLUE APPEARS IN THE TWO LEFT QUADRILATERALS IN THE DESIGN IN THE LEFT CORNER OF THE MARK AND IN THE WORD "OPTIONS" IN THE MARK.

SN 78-873,350, FILED 5-1-2006.

MAUREEN DALL, EXAMINING ATTORNEY

**Int. Cls.: 9 and 28**

**Prior U.S. Cls.: 21, 22, 23, 26, 36, 38, and 50**

**Reg. No. 3,455,581**

**United States Patent and Trademark Office**

**Registered June 24, 2008**

**TRADEMARK  
PRINCIPAL REGISTER**

**Dangerous High School  
Girls in Trouble!**

NEMITZ, KEITH, G. (UNITED STATES INDIVIDUAL)  
4329 SALEM ST.  
EMERYVILLE, CA 94608

FOR: COMPUTER GAME PROGRAMS; COMPUTER GAME SOFTWARE; DOWNLOADABLE MULTIMEDIA FILE CONTAINING ARTWORK, TEXT, AUDIO, VIDEO, GAMES, AND INTERNET WEB LINKS RELATING TO ADVENTURE GAMES, ROLE-PLAYING GAMES, STORY GAMES; ELECTRONIC GAME PROGRAMS; ELECTRONIC GAME SOFTWARE FOR CELLULAR TELEPHONES; ELECTRONIC GAME SOFTWARE FOR HANDHELD ELECTRONIC DEVICES; ELECTRONIC GAME SOFTWARE FOR WIRELESS DEVICES; GAME SOFTWARE; INTERACTIVE AUDIO GAME DISCS CONTAINING ADVENTURE GAMES, ROLE-PLAYING GAMES, STORY GAMES; INTERACTIVE MULTIMEDIA COMPUTER GAME PROGRAM; INTERACTIVE VIDEO GAME PROGRAMS; INTERACTIVE VIDEO GAMES OF VIRTUAL REALITY COMPRISED OF COMPUTER HARDWARE AND SOFTWARE; VIDEO GAME SOFTWARE; VIRTUAL REALITY GAME SOFTWARE, IN CLASS 9 (U.S. CLS. 21, 23, 26, 36 AND 38).

FIRST USE 9-15-2006; IN COMMERCE 1-30-2008.

FOR: ARCADE GAMES; ARCADE-TYPE ELECTRONIC EDUCATION VIDEO GAMES; ARCADE-TYPE ELECTRONIC VIDEO GAMES; BOARD GAMES; CARD GAMES; DICE GAMES; EQUIPMENT SOLD AS A UNIT FOR PLAYING BOARD GAMES; EQUIPMENT SOLD AS A UNIT FOR PLAYING CARD GAMES; FLOOR-STANDING UNITS FOR PLAYING ELECTRONIC GAMES OTHER THAN IN CONJUNCTION WITH A TELEVISION OR COMPUTER; HAND HELD UNIT FOR PLAYING ELECTRONIC GAMES; HAND HELD UNIT FOR PLAYING VIDEO GAMES; HAND-HELD GAMES WITH LIQUID CRYSTAL DISPLAYS; MANIPULATIVE GAMES; PARLOR GAMES; PARTY GAMES; PINBALL GAMES; PINBALL-TYPE GAMES; PROMOTIONAL GAME CARDS; PROMOTIONAL GAME MATERIALS; ROLE PLAYING GAMES; TRADING CARD GAMES, IN CLASS 28 (U.S. CLS. 22, 23, 38 AND 50).

FIRST USE 9-15-2006; IN COMMERCE 1-30-2008.

THE MARK CONSISTS OF STANDARD CHARACTERS WITHOUT CLAIM TO ANY PARTICULAR FONT, STYLE, SIZE, OR COLOR.

SN 78-873,539, FILED 5-1-2006.

DARRYL SPRUILL, EXAMINING ATTORNEY

**Int. Cls.: 36 and 37**

**Prior U.S. Cls.: 100, 101, 102, 103, and 106**

**United States Patent and Trademark Office**

**Reg. No. 3,455,582**

**Registered June 24, 2008**

**SERVICE MARK  
PRINCIPAL REGISTER**

**SOUTH FLORIDA LIFE SCIENCE  
ACCELERATOR**

ALEXANDRIA REAL ESTATE EQUITIES, INC.  
(MARYLAND CORPORATION)  
385 E. COLORADO BLVD., SUITE 299  
PASADENA, CA 91101

FOR: REAL ESTATE SERVICES, NAMELY, REAL ESTATE BROKERAGE, ACQUISITION, RENTAL, LEASING AND MANAGEMENT OF OFFICE, RESEARCH AND LABORATORY PROPERTIES; FINANCIAL SERVICES, NAMELY, FINANCIAL CONSULTATION AND FINANCING SERVICES, IN CLASS 36 (U.S. CLS. 100, 101 AND 102).

FIRST USE 7-0-2006; IN COMMERCE 7-0-2006.

FOR: REAL ESTATE DEVELOPMENT SERVICES; BUILDING CONSTRUCTION, MAINTENANCE

AND REPAIR SERVICES, IN CLASS 37 (U.S. CLS. 100, 103 AND 106).

FIRST USE 7-0-2006; IN COMMERCE 7-0-2006.

THE MARK CONSISTS OF STANDARD CHARACTERS WITHOUT CLAIM TO ANY PARTICULAR FONT, STYLE, SIZE, OR COLOR.

NO CLAIM IS MADE TO THE EXCLUSIVE RIGHT TO USE "SOUTH FLORIDA LIFE SCIENCE", APART FROM THE MARK AS SHOWN.

SN 78-873,897, FILED 5-1-2006.

REBECCA EISINGER, EXAMINING ATTORNEY



**Int. Cl.: 1**

**Prior U.S. Cls.: 1, 5, 6, 10, 26, and 46**

**Reg. No. 3,455,583**

**United States Patent and Trademark Office**

**Registered June 24, 2008**

**TRADEMARK  
PRINCIPAL REGISTER**

# Proofing-Sorb

AMSENG (ILLINOIS CORPORATION)  
676G BONDED PARKWAY  
STREAMWOOD, IL 60107

FOR: FOOD GRADE SILICA BASED EXCIPIENTS; SILICA BASED CHEMICALS FOR BEER-CLARIFYING; SILICA BASED CHEMICALS FOR PROTEIN REMOVAL FROM FOOD AND INDUSTRIAL CONSUMABLE PRODUCTS; CHEMICAL ADDITIVES TO REMOVE PROTEIN FROM FOOD AND INDUSTRIAL CONSUMABLE PRODUCTS; SILICA IN GENERAL INDUSTRIAL USES; REAGENTS FOR COMMERCIAL AND SCIENTIFIC USES, NAMELY, SILICA BASED CHEMICALS FOR USE IN THE MANUFACTURE OF PROCESSED FOODS AND BEVERAGES; CHEMICALS FOR DIAGNOSTIC AND ANALYSIS TESTS FOR FOODS AND BEVERAGES, NAMELY, SILICA; SYNTHETIC AMORPHOUS SILICA GEL FOR FURTHER PROCESSING IN CONNECTION WITH THE MANUFACTURE OF PRESERVING AGENTS; BEER AND WINE CLARIFYING AND PRESERVING AGENTS; BEER AND WINE PROOFING AGENTS, NAMELY, AGENTS FOR REMOVING HAZE FORMING PRO-

TEINS AND DERIVED TOXINS; CHEMICAL PREPARATIONS IN THE NATURE OF FILTERING MATERIALS FOR THE BEVERAGE INDUSTRY; CHEMICALS FOR COMMERCIAL PURPOSES, NAMELY, SILICA; SILICA AND SILICA COMPOUNDS FOR CLARIFYING SUBSTANCES, OR REMOVING PROTEINS FROM SUBSTANCES, FOOD SUPPLEMENTS AND BEVERAGES; AND SILICA AND SILICA COMPOUNDS FOR PROOFING SUBSTANCES, NAMELY, AGENTS FOR REMOVING HAZE FORMING PROTEINS AND DERIVED TOXINS; SILICA FOR USE IN THE BREWING INDUSTRY, IN CLASS 1 (U.S. CLS. 1, 5, 6, 10, 26 AND 46).

FIRST USE 10-0-2006; IN COMMERCE 10-0-2006.

THE MARK CONSISTS OF STANDARD CHARACTERS WITHOUT CLAIM TO ANY PARTICULAR FONT, STYLE, SIZE, OR COLOR.

SN 78-874,429, FILED 5-2-2006.

JAMES LOVELACE, EXAMINING ATTORNEY

**Int. Cl.: 35**

**Prior U.S. Cls.: 100, 101, and 102**

**United States Patent and Trademark Office**

**Reg. No. 3,455,584**

**Registered June 24, 2008**

**SERVICE MARK  
PRINCIPAL REGISTER**

**YOUR PERSONAL BARGAIN  
HUNTER**

SMARTBARGINS.COM LP (DELAWARE LIMITED PARTNERSHIP)  
10TH FLOOR  
10 MILK STREET  
BOSTON, MA 02108

FOR: ONLINE RETAIL STORE SERVICES AND CATALOG, TELEPHONE AND MAIL ORDER SERVICES, FEATURING OFF-PRICE, CLOSE-OUT, LIQUIDATION, AND MARKED-DOWN GENERAL MERCHANDISE, FOOTWEAR, HEADWEAR, CLOTHING AND ACCESSORIES, JEWELRY, WATCHES, LUGGAGE, SPORTING GOODS AND EQUIPMENT, HOME FURNISHINGS AND DECOR, HOME IMPROVEMENT GOODS, BATH LINENS AND ACCESSORIES, BED LINENS AND ACCESSORIES, CHINA, CRYSTAL, SILVER, KITCHEN AND DINING APPLIANCES AND ACCESSORIES, ELECTRONIC GOODS, TOYS, CAMERAS, AUDIO EQUIPMENT, HOUSEWARES, COMPUTERS, TELEPHONES, CAMCORDERS, ART AND WALL DEC-

OR, FRAGRANCES, COSMETICS, SUNGLASSES, ATTACHE CASES, BRIEFCASES, LEATHER GOODS, FURNITURE, TELESCOPES, BINOCULARS, VIDEO GAMES, COOKWARE, BEVERAGEWARE, DINNERWARE, AND CUTLERY, IN CLASS 35 (U.S. CLS. 100, 101 AND 102).

FIRST USE 9-6-2006; IN COMMERCE 9-6-2006.

THE MARK CONSISTS OF STANDARD CHARACTERS WITHOUT CLAIM TO ANY PARTICULAR FONT, STYLE, SIZE, OR COLOR.

NO CLAIM IS MADE TO THE EXCLUSIVE RIGHT TO USE "BARGAIN HUNTER", APART FROM THE MARK AS SHOWN.

SN 78-874,996, FILED 5-3-2006.

GILBERT SWIFT, EXAMINING ATTORNEY

Int. Cl.: 3

Prior U.S. Cls.: 1, 4, 6, 50, 51, and 52

Reg. No. 3,455,585

United States Patent and Trademark Office

Registered June 24, 2008

TRADEMARK  
PRINCIPAL REGISTER



SO COZY, LLC (NEW YORK LTD LIAB CO)  
448 AMSTERDAM AVENUE  
NEW YORK, NY 10024

FOR: 3-IN-1 HAIR CONDITIONERS; HAIR CARE  
PREPARATIONS; HAIR CONDITIONER, IN CLASS  
3 (U.S. CLS. 1, 4, 6, 50, 51 AND 52).

FIRST USE 5-18-2006; IN COMMERCE 6-18-2006.

NO CLAIM IS MADE TO THE EXCLUSIVE  
RIGHT TO USE "CONDITIONER", APART FROM  
THE MARK AS SHOWN.

THE MARK CONSISTS OF THE WORD "BOO"  
AND EXCLAMATION POINT. BOTH LETTERS "O"  
APPEARING IN THE MARK ARE REPRESENTA-  
TIVE OF TWO EYES, WHILE THE EXCLAMATION  
POINT IS FIGURATIVE OF A GHOST.

SN 78-875,088, FILED 5-3-2006.

WILLIAM VERHOSEK, EXAMINING ATTORNEY

**Int. Cl.: 7**

**Prior U.S. Cls.: 13, 19, 21, 23, 31, 34, and 35**

**Reg. No. 3,455,586**

**United States Patent and Trademark Office**

**Registered June 24, 2008**

---

**TRADEMARK  
PRINCIPAL REGISTER**

**ALLERGUARD FILTRATION**

AERUS CONCEPTS, L.P. (TEXAS PARTNERSHIP)  
5420 LBJ FREEWAY, SUITE 800  
DALLAS, TX 75240

FOR: VACUUM CLEANERS, PARTS AND ACCESSORIES THEREFOR; VACUUM CLEANER BAGS; VACUUM CLEANER FILTERS, IN CLASS 7 (U.S. CLS. 13, 19, 21, 23, 31, 34 AND 35).

FIRST USE 6-30-2006; IN COMMERCE 6-30-2006.

THE MARK CONSISTS OF STANDARD CHARACTERS WITHOUT CLAIM TO ANY PARTICULAR FONT, STYLE, SIZE, OR COLOR.

NO CLAIM IS MADE TO THE EXCLUSIVE RIGHT TO USE "FILTRATION", APART FROM THE MARK AS SHOWN.

SN 78-875,303, FILED 5-3-2006.

INGA ERVIN, EXAMINING ATTORNEY

**Int. Cl.: 10**

**Prior U.S. Cls.: 26, 39, and 44**

**Reg. No. 3,455,587**

**United States Patent and Trademark Office**

**Registered June 24, 2008**

---

**TRADEMARK  
PRINCIPAL REGISTER**

**EVOLUTION**

QUANTUM MEDICAL CONCEPTS LLC (ORE-  
GON LTD LIAB CO)  
3900 FAIRVIEW  
HOOD RIVER, OR 97031

FOR: ORTHOPEDIC DEVICES AND ACCESSOR-  
IES, NAMELY, TRAYS FOR ORGANIZING AND  
STORING SURGICAL INSTRUMENTS, SURGICAL  
TOOLS, AND COMPONENTS OF ORTHOPEDIC  
FIXATION SYSTEMS, AND ASSOCIATED COMPO-  
NENT PARTS THEREFOR, IN CLASS 10 (U.S. CLS.  
26, 39 AND 44).

FIRST USE 5-14-2003; IN COMMERCE 2-23-2004.

THE MARK CONSISTS OF STANDARD CHAR-  
ACTERS WITHOUT CLAIM TO ANY PARTICULAR  
FONT, STYLE, SIZE, OR COLOR.

SN 78-875,412, FILED 5-3-2006.

KATHERINE CONNOLLY, EXAMINING ATTOR-  
NEY

**Int. Cl.: 16**

**Prior U.S. Cls.: 2, 5, 22, 23, 29, 37, 38, and 50**

**Reg. No. 3,455,588**

**United States Patent and Trademark Office**

**Registered June 24, 2008**

**TRADEMARK  
PRINCIPAL REGISTER**

**MORNING LIGHT**

MORNING LIGHT FOUNDATION, INC. (IDAHO  
CORPORATION)  
ONE COLDWATER CREEK ROAD  
SANDPOINT, ID 83864

THE MARK CONSISTS OF STANDARD CHAR-  
ACTERS WITHOUT CLAIM TO ANY PARTICULAR  
FONT, STYLE, SIZE, OR COLOR.

FOR: BOOKS IN THE FIELD OF SPIRITUAL  
AWAKENING OF THE SOUL, IN CLASS 16 (U.S.  
CLS. 2, 5, 22, 23, 29, 37, 38 AND 50).

SN 78-875,452, FILED 5-3-2006.

FIRST USE 3-1-2003; IN COMMERCE 3-1-2003.

ELLEN B. AWRICH, EXAMINING ATTORNEY

**Int. Cl.: 9**

**Prior U.S. Cls.: 21, 23, 26, 36, and 38**

**Reg. No. 3,455,589**

**United States Patent and Trademark Office**

**Registered June 24, 2008**

**TRADEMARK  
PRINCIPAL REGISTER**

# Cleanose

MOORE, JOSEPH K (UNITED STATES INDIVIDUAL)  
3442 DELLEFIELD ST  
NEWPORT RICHEY, FL 34655

THE MARK CONSISTS OF STANDARD CHARACTERS WITHOUT CLAIM TO ANY PARTICULAR FONT, STYLE, SIZE, OR COLOR.

FOR: FILTERS FOR RESPIRATORY MASKS; LABORATORY FILTERS, IN CLASS 9 (U.S. CLS. 21, 23, 26, 36 AND 38).

SN 78-875,483, FILED 5-3-2006.

FIRST USE 1-5-2007; IN COMMERCE 1-5-2007.

CORY BOONE, EXAMINING ATTORNEY

**Int. Cl.: 19**

**Prior U.S. Cls.: 1, 12, 33, and 50**

**United States Patent and Trademark Office**

**Reg. No. 3,455,590**

**Registered June 24, 2008**

**TRADEMARK  
PRINCIPAL REGISTER**

**CON-STRUCT-LITE**

U.S. CONCRETE, INC. (DELAWARE CORPORATION)  
SUITE 1050  
2925 BRIARPARK DRIVE  
HOUSTON, TX 77042

THE MARK CONSISTS OF STANDARD CHARACTERS WITHOUT CLAIM TO ANY PARTICULAR FONT, STYLE, SIZE, OR COLOR.

FOR: READY-MIX CONCRETE, IN CLASS 19 (U.S. CLS. 1, 12, 33 AND 50).

SN 78-875,712, FILED 5-3-2006.

FIRST USE 8-3-2005; IN COMMERCE 8-3-2005.

CURTIS FRENCH, EXAMINING ATTORNEY



**Int. Cls.: 10 and 44**

**Prior U.S. Cls.: 26, 39, 44, 100, and 101**

**United States Patent and Trademark Office**

**Reg. No. 3,455,591**

**Registered June 24, 2008**

**TRADEMARK  
SERVICE MARK  
PRINCIPAL REGISTER**

# HEALTHKIT

LIFEWATCH SERVICES INC. (DELAWARE CORPORATION)  
1351 A ABBOTT COURT  
BUFFALO GROVE, IL 60089

FOR: VITAL SIGNS MONITORING SYSTEM COMPRISED OF THE FOLLOWING: A ONE-LEAD ECG, A WEIGHT SCALE, A BLOOD PRESSURE MONITOR, AND A PULSE OXIMETER FOR USE WITH A PDA FOR BIOMETRIC MEASURING AND WIRELESS TRANSMISSION OF DATA TO A REMOTE MONITORING SERVICE, IN CLASS 10 (U.S. CLS. 26, 39 AND 44).

FIRST USE 1-0-2007; IN COMMERCE 1-0-2007.

FOR: REMOTE MONITORING SERVICE FEATURING A VITAL SIGNS BIOMETRIC MONITOR-

ING SYSTEM THAT ALLOWS FOR TRACKING, RECORDING, AND ANALYSIS OF BIOMETRIC DATA AND TRANSMITS THAT DATA TO A REMOTE NETWORK FOR VIEWING ON A WEB PAGE, IN CLASS 44 (U.S. CLS. 100 AND 101).

FIRST USE 1-0-2007; IN COMMERCE 1-0-2007.

THE MARK CONSISTS OF STANDARD CHARACTERS WITHOUT CLAIM TO ANY PARTICULAR FONT, STYLE, SIZE, OR COLOR.

SN 78-877,813, FILED 5-5-2006.

FLORENTINA BLANDU, EXAMINING ATTORNEY

**Int. Cl.: 36**

**Prior U.S. Cls.: 100, 101, and 102**

**United States Patent and Trademark Office**

**Reg. No. 3,455,592**

**Registered June 24, 2008**

**SERVICE MARK  
PRINCIPAL REGISTER**

# Carbon Free

CARBONFUND.ORG FOUNDATION (DELA-  
WARE CHARITABLE, NON-PROFIT COR-  
PORATION)  
1320 FENWICK LANE  
SUITE 206  
SILVER SPRING, MD 20910

FOR: CHARITABLE FUNDRAISING SERVICES,  
NAMELY, FUNDRAISING TO SUPPORT THE RE-  
DUCTION OR OFFSET OF CARBON DIOXIDE  
EMISSIONS AND OTHER GREENHOUSE GASES  
BY SUPPORTING RENEWABLE ENERGY, ENER-  
GY EFFICIENCY AND SEQUESTRATION VIA EDU-  
CATION, OFFSETS AND GREEN POWER, AND  
OUTREACH, IN CLASS 36 (U.S. CLS. 100, 101 AND  
102).

FIRST USE 5-5-2006; IN COMMERCE 6-23-2006.

THE MARK CONSISTS OF STANDARD CHAR-  
ACTERS WITHOUT CLAIM TO ANY PARTICULAR  
FONT, STYLE, SIZE, OR COLOR.

NO CLAIM IS MADE TO THE EXCLUSIVE  
RIGHT TO USE "CARBON", APART FROM THE  
MARK AS SHOWN.

SN 78-877,905, FILED 5-5-2006.

RONALD MCMORROW, EXAMINING ATTORNEY

**Int. Cls.: 10 and 44**

**Prior U.S. Cls.: 26, 39, 44, 100, and 101**

**United States Patent and Trademark Office**

**Reg. No. 3,455,593**

**Registered June 24, 2008**

**TRADEMARK  
SERVICE MARK  
PRINCIPAL REGISTER**

# LIFESTAR ACT

LIFEWATCH SERVICES INC. (DELAWARE CORPORATION)  
1351 A ABBOTT COURT  
BUFFALO GROVE, IL 60089

FOR: CARDIAC MONITORING SYSTEM COMPRISED OF A SENSOR, ELECTRODES, AND A CELLULAR PHONE FOR DETECTING AND MEASURING BIOMETRIC DATA AND WIRELESS TRANSMISSION OF DATA TO A REMOTE MONITORING SERVICE, IN CLASS 10 (U.S. CLS. 26, 39 AND 44).

FIRST USE 11-0-2006; IN COMMERCE 11-0-2006.

FOR: REMOTE MONITORING SERVICE FEATURING A VITAL SIGNS BIOMETRIC MONITOR-

ING SYSTEM THAT ALLOWS FOR TRACKING, RECORDING, AND ANALYSIS OF BIOMETRIC DATA AND PROVIDES NOTIFICATION TO MEDICAL AND EMERGENCY PERSONNEL, IN CLASS 44 (U.S. CLS. 100 AND 101).

FIRST USE 11-0-2006; IN COMMERCE 11-0-2006.

THE MARK CONSISTS OF STANDARD CHARACTERS WITHOUT CLAIM TO ANY PARTICULAR FONT, STYLE, SIZE, OR COLOR.

SN 78-877,956, FILED 5-5-2006.

FLORENTINA BLANDU, EXAMINING ATTORNEY

**Int. Cl.: 11**

**Prior U.S. Cls.: 13, 21, 23, 31, and 34**

**United States Patent and Trademark Office**

**Reg. No. 3,455,594**

**Registered June 24, 2008**

**TRADEMARK  
PRINCIPAL REGISTER**

**AQ BRIGHT BULB**

AERUS CONCEPTS, L.P. (TEXAS PARTNERSHIP)  
5420 LBJ FREEWAY, SUITE 800  
DALLAS, TX 75240

FOR: LIGHT BULB THAT FILTERS THE AIR, IN  
CLASS 11 (U.S. CLS. 13, 21, 23, 31 AND 34).

FIRST USE 11-30-2006; IN COMMERCE 11-30-2006.

THE MARK CONSISTS OF STANDARD CHAR-  
ACTERS WITHOUT CLAIM TO ANY PARTICULAR  
FONT, STYLE, SIZE, OR COLOR.

NO CLAIM IS MADE TO THE EXCLUSIVE  
RIGHT TO USE "BULB", APART FROM THE MARK  
AS SHOWN.

SN 78-878,037, FILED 5-5-2006.

INGA ERVIN, EXAMINING ATTORNEY

**Int. Cl.: 42**

**Prior U.S. Cls.: 100 and 101**

**United States Patent and Trademark Office**

**Reg. No. 3,455,595**

**Registered June 24, 2008**

**SERVICE MARK  
PRINCIPAL REGISTER**

**SIMS**

PERFORMANCE SCIENCES, INC. (COLORADO  
CORPORATION)  
P.O. BOX 190  
EVERGREEN, CO 804370190

THE MARK CONSISTS OF STANDARD CHAR-  
ACTERS WITHOUT CLAIM TO ANY PARTICULAR  
FONT, STYLE, SIZE, OR COLOR.

FOR: TECHNOLOGICAL CONSULTING SERVI-  
CES, NAMELY, ANALYSIS OF OIL FIELDS  
THROUGH FULL INJECTION RESERVOIR MOD-  
ELING, IN CLASS 42 (U.S. CLS. 100 AND 101).

SN 78-878,378, FILED 5-7-2006.

FIRST USE 3-0-2006; IN COMMERCE 3-0-2006.

JASON LOTT, EXAMINING ATTORNEY

**Int. Cl.: 5**

**Prior U.S. Cls.: 6, 18, 44, 46, 51, and 52**

**Reg. No. 3,455,596**

**United States Patent and Trademark Office**

**Registered June 24, 2008**

**TRADEMARK  
PRINCIPAL REGISTER**



CR TECHNOLOGIES LLP (GREAT BRITAIN  
LIMITED LIABILITY PARTNERSHIP)

405 KINGS ROAD

CHELSEA, GREAT BRITAIN SW10 0BB

FOR: DIETARY SUPPLEMENTS; VITAMIN AND  
MINERAL PREPARATIONS FOR USE AS INGRE-  
DIENTS IN THE FOOD INDUSTRY, IN CLASS 5  
(U.S. CLS. 6, 18, 44, 46, 51 AND 52).

FIRST USE 10-6-2007; IN COMMERCE 10-6-2007.

NO CLAIM IS MADE TO THE EXCLUSIVE  
RIGHT TO USE "CR" AND "TECHNOLOGIES",  
APART FROM THE MARK AS SHOWN.

THE MARK CONSISTS OF THE LETTERS "CR,"  
HAVING THE WORD "TECHNOLOGIES" BE-  
NEATH, AND HAVING CIRCLES IN A CIRCLE  
ABOVE, ALL ENCOMPASSED IN A SQUARE.

SN 78-878,560, FILED 5-8-2006.

KATHERINE CONNOLLY, EXAMINING ATTOR-  
NEY

**Int. Cl.: 29**

**Prior U.S. Cl.: 46**

**United States Patent and Trademark Office**

**Reg. No. 3,455,597**

**Registered June 24, 2008**

**TRADEMARK  
PRINCIPAL REGISTER**

**BESTLIFE**

BEST LIFE CORPORATION (DELAWARE CORPORATION)  
1303 CORONA AVENUE  
THE VILLAGES, FL 32159

THE MARK CONSISTS OF STANDARD CHARACTERS WITHOUT CLAIM TO ANY PARTICULAR FONT, STYLE, SIZE, OR COLOR.

FOR: PREPARED SOUPS; PREPARED ENTREES CONSISTING PRIMARILY OF POULTRY, FISH, SEAFOOD, BEEF, PORK AND/OR VEGETABLES, IN CLASS 29 (U.S. CL. 46).

SN 78-878,625, FILED 5-8-2006.

FIRST USE 1-0-2007; IN COMMERCE 1-0-2007.

ALEX KEAM, EXAMINING ATTORNEY

**Int. Cl.: 30**

**Prior U.S. Cl.: 46**

**United States Patent and Trademark Office**

**Reg. No. 3,455,598**

**Registered June 24, 2008**

**TRADEMARK  
PRINCIPAL REGISTER**

**BESTLIFE**

BEST LIFE CORPORATION (DELAWARE CORPORATION)  
1303 CORONA AVENUE  
THE VILLAGES, FL 32159

FOR: PREPARED FOODS, NAMELY, PREPARATIONS MADE FROM CEREALS, NAMELY, CEREAL-BASED SNACK FOODS, MUFFINS, GRANOLA, PROCESSED CEREALS; PREPARED ENTREES CONSISTING PRIMARILY OF PASTA OR RICE; BREAD, SALAD DRESSINGS, IN CLASS 30 (U.S. CL. 46).

FIRST USE 1-0-2007; IN COMMERCE 1-0-2007.

THE MARK CONSISTS OF STANDARD CHARACTERS WITHOUT CLAIM TO ANY PARTICULAR FONT, STYLE, SIZE, OR COLOR.

SN 78-878,628, FILED 5-8-2006.

ALEX KEAM, EXAMINING ATTORNEY



**Int. Cl.: 9**

**Prior U.S. Cls.: 21, 23, 26, 36, and 38**

**United States Patent and Trademark Office**

**Reg. No. 3,455,599**

**Registered June 24, 2008**

**TRADEMARK  
PRINCIPAL REGISTER**

**GRID FX**

SOFTWARE FX, INC. (FLORIDA CORPORATION)  
5901 BROKEN SOUND PKWY, NW, STE 400  
BOCA RATON, FL 33487

FOR: SOFTWARE APPLICATION IN THE FIELD OF DATA VISUALIZATION AND CHARTING, NAMELY, FOR USE IN CREATING CHARTS, GRAPHS AND MAPS , IN CLASS 9 (U.S. CLS. 21, 23, 26, 36 AND 38).

FIRST USE 3-31-2007; IN COMMERCE 3-31-2007.

THE MARK CONSISTS OF STANDARD CHARACTERS WITHOUT CLAIM TO ANY PARTICULAR FONT, STYLE, SIZE, OR COLOR.

OWNER OF U.S. REG. NO. 1,993,797.

NO CLAIM IS MADE TO THE EXCLUSIVE RIGHT TO USE "GRID", APART FROM THE MARK AS SHOWN.

THE WORDING "FX" HAS NO MEANING IN A FOREIGN LANGUAGE.

SN 78-879,107, FILED 5-8-2006.

Laurie Kaufman, Examining Attorney

**Int. Cl.: 10**

**Prior U.S. Cls.: 26, 39, and 44**

**United States Patent and Trademark Office**

**Reg. No. 3,455,600**

**Registered June 24, 2008**

**TRADEMARK  
PRINCIPAL REGISTER**

**HALCYON**

BUXCO ELECTRONICS, INC. (CONNECTICUT  
CORPORATION)  
95 WESTWOODS RD. #2  
SHARON, CT 06069

FOR: PLETHYSMOGRAPHS, NAMELY, INSTRUMENTS FOR THE MEASUREMENT OF RESPIRATORY PATTERNS OF LABORATORY TEST SUBJECTS IN A RESEARCH ENVIRONMENT, IN CLASS 10 (U.S. CLS. 26, 39 AND 44).

FIRST USE 10-1-2007; IN COMMERCE 10-1-2007.

THE MARK CONSISTS OF STANDARD CHARACTERS WITHOUT CLAIM TO ANY PARTICULAR FONT, STYLE, SIZE, OR COLOR.

SN 78-880,376, FILED 5-10-2006.

DAYNA BROWNE, EXAMINING ATTORNEY

**Int. Cl.: 35**

**Prior U.S. Cls.: 100, 101, and 102**

**United States Patent and Trademark Office**

**Reg. No. 3,455,601**

**Registered June 24, 2008**

**SERVICE MARK  
PRINCIPAL REGISTER**

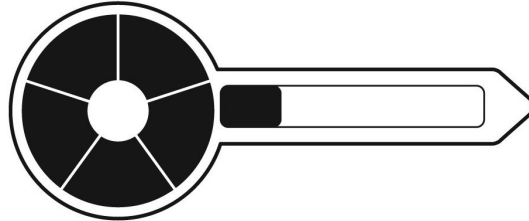

THE KROGER CO. OF MICHIGAN (MICHIGAN CORPORATION)  
18334 LAUREL PARK DRIVE NORTH  
LIVONIA, MI 481522686

FOR: PROVIDING CONSUMER INFORMATION ABOUT FOODS AND BEVERAGES, IN CLASS 35 (U.S. CLS. 100, 101 AND 102).

FIRST USE 3-1-2007; IN COMMERCE 3-1-2007.

THE MARK CONSISTS OF KEY DESIGN.

SN 78-880,933, FILED 5-10-2006.

JESSICA FATHY, EXAMINING ATTORNEY

**Int. Cl.: 16**

**Prior U.S. Cls.: 2, 5, 22, 23, 29, 37, 38, and 50**

**Reg. No. 3,455,602**

**United States Patent and Trademark Office**

**Registered June 24, 2008**

**TRADEMARK  
PRINCIPAL REGISTER**

**TUMMYWISE**

CALIFORNIA DRIED PLUM BOARD (CALIFORNIA MARKETING ORDER NON-PROFIT INSTRUMENTALITY OF A GOVERNMENTAL AGENCY OF THE STATE OF CALIFORNIA)  
3840 ROSIN COURT, SUITE 170  
SACRAMENTO, CA 95834

FOR: PRINTED PUBLICATIONS AND EDUCATIONAL PUBLICATIONS, NAMELY, NEWSLETTERS, BROCHURES, AND LEAFLETS, ALL FEATURING INFORMATION AND ADVICE ABOUT DIGESTIVE HEALTH, LIFESTYLE, EXERCISE, DIET, HEALTHY EATING, RECIPES AND

NUTRITION, IN CLASS 16 (U.S. CLS. 2, 5, 22, 23, 29, 37, 38 AND 50).

FIRST USE 9-17-2006; IN COMMERCE 9-17-2006.

THE MARK CONSISTS OF STANDARD CHARACTERS WITHOUT CLAIM TO ANY PARTICULAR FONT, STYLE, SIZE, OR COLOR.

SN 78-881,796, FILED 5-11-2006.

ZACHARY BELLO, EXAMINING ATTORNEY

**Int. Cl.: 7**

**Prior U.S. Cls.: 13, 19, 21, 23, 31, 34, and 35**

**Reg. No. 3,455,603**

**United States Patent and Trademark Office**

**Registered June 24, 2008**

---

**TRADEMARK  
PRINCIPAL REGISTER**

# BIOSEALER

SARTORIUS STEDIM BIOTECH GMBH (FED  
REP GERMANY CORPORATION)  
AUGUST-SPINDLER-STRASSE 11  
GOTTINGEN, FED REP GERMANY 37079

FOR: EQUIPMENT FOR WELDING AND SEPAR-  
ATING PLASTICS, NAMELY, ELECTRIC WELDING  
MACHINES FOR THE STERILE CONNECTION OF  
PLASTIC VESSELS, SUCH AS PLASTIC HOSES,  
TUBES, BAGS AND CONTAINERS, IN CLASS 7  
(U.S. CLS. 13, 19, 21, 23, 31, 34 AND 35).

FIRST USE 11-1-2006; IN COMMERCE 11-1-2006.

THE MARK CONSISTS OF STANDARD CHAR-  
ACTERS WITHOUT CLAIM TO ANY PARTICULAR  
FONT, STYLE, SIZE, OR COLOR.

SN 78-882,161, FILED 5-12-2006.

SUSAN STIGLITZ, EXAMINING ATTORNEY

**Int. Cl.: 35**

**Prior U.S. Cls.: 100, 101, and 102**

**United States Patent and Trademark Office**

**Reg. No. 3,455,604**

**Registered June 24, 2008**

**SERVICE MARK  
PRINCIPAL REGISTER**

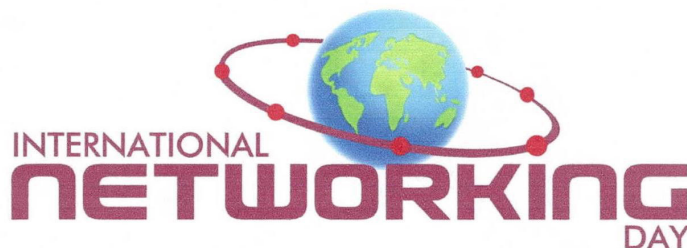

BNI ENTERPRISES, INC. (CALIFORNIA CORPORATION)  
545 COLLEGE COMMERCE WAY  
UPLAND, CA 91786

FOR: BUSINESS SEMINARS AND MEETINGS, NAMELY, BUSINESS ORIENTED SPECIAL EVENTS FEATURING BUSINESS NETWORKING, HOW TO NETWORK AND THE IMPORTANCE OF NETWORKING THROUGH EXCHANGE OF REFERRALS; BRINGING TOGETHER REPRESENTATIVES OF GOVERNMENT, BUSINESS AND THE COMMUNITY TO NETWORK WITH EACH OTHER, FOR DISCUSSIONS AND SEMINARS ON HOW BUSINESS CAN GROW AND SUCCEED THROUGH GOOD NETWORKING PRACTICES, IN CLASS 35 (U.S. CLS. 100, 101 AND 102).

FIRST USE 2-4-2008; IN COMMERCE 2-4-2008.

NO CLAIM IS MADE TO THE EXCLUSIVE RIGHT TO USE "INTERNATIONAL NETWORKING DAY", APART FROM THE MARK AS SHOWN.

THE COLOR(S) RED, BLUE GREEN AND BROWN IS/ARE CLAIMED AS A FEATURE OF THE MARK.

THE COLOR BROWN APPEARS IN ALL WORDING AND THE ORBIT DESIGN; THE COLOR RED APPEARS IN THE CIRCLES IN THE ORBIT DESIGN; THE COLORS BLUE AND GREEN APPEAR IN THE GLOBE DESIGN, ON THE SEAS AND CONTINENTS.

SN 78-882,193, FILED 5-12-2006.

HENRY S. ZAK, EXAMINING ATTORNEY

Int. Cl.: 3

Prior U.S. Cls.: 1, 4, 6, 50, 51, and 52

Reg. No. 3,455,605

United States Patent and Trademark Office

Registered June 24, 2008

TRADEMARK  
PRINCIPAL REGISTER

JAMES ROMAN

NICKOLAI, JAMES R. (UNITED STATES INDIVIDUAL)  
1021 STATE STREET SUITE B  
SANTA BARBARA, CA 93101

FOR: ANTIBACTERIAL SKIN SOAPS; BEAUTY CREAMS FOR BODY CARE; BODY AND BEAUTY CARE COSMETICS; BODY AND BEAUTY CARE PREPARATIONS; CONCEALERS FOR SKIN; CONDITIONERS ; COSMETIC CREAMS FOR SKIN CARE; COSMETIC PREPARATIONS FOR SKIN RENEWAL; EXFOLIANTS FOR SKIN; HAIR CARE CREAMS; HAIR CARE LOTIONS; HAIR CARE PREPARATIONS; LOTIONS FOR FACE AND BODY CARE; MOUSSE FOR SKIN; NON-MEDICATED SKIN CARE PREPARATIONS; NON-MEDICATED SKIN CREAMS; SKIN ABRASIVE PREPARATIONS; SKIN CARE PRODUCTS, NAMELY, NON-MEDICATED SKIN SERUM; SKIN CLARIFIERS; SKIN CLEANSERS; SKIN CLEANSING CREAM; SKIN CLEANSING LOTION; SKIN CONDITIONERS; SKIN CREAM; SKIN CREAMS; SKIN CREAMS IN LIQUID AND SOLID; SKIN CREAMS IN LIQUID AND SOLID FORM; SKIN EMOLLIENTS; SKIN

GELS FOR ACCELERATING, ENHANCING OR EXTENDING TANS; SKIN LIGHTENERS; SKIN LIGHTENING CREAMS; SKIN LOTION; SKIN LOTIONS; SKIN MASKS; SKIN MOISTURIZER; SKIN MOISTURIZER MASKS; SKIN POLISHING RICE BRAN (ARAI-NUKA); SKIN SOAP; SKIN TEXTURIZERS; SKIN TONERS; SKIN WHITENING CREAMS; SKIN WHITENING PREPARATIONS; SOAPS FOR BODY CARE; WRINKLE REMOVING SKIN CARE PREPARATIONS, IN CLASS 3 (U.S. CLS. 1, 4, 6, 50, 51 AND 52).

FIRST USE 12-1-2005; IN COMMERCE 12-1-2005.

THE NAME(S), PORTRAIT(S), AND/OR SIGNATURE(S) SHOWN IN THE MARK IDENTIFIES "JAMES ROMAN NICKOLAI" , WHOSE CONSENT(S) TO REGISTER IS SUBMITTED.

SN 78-882,767, FILED 5-12-2006.

ESTHER BELENKER, EXAMINING ATTORNEY

**Int. Cl.: 31**

**Prior U.S. Cls.: 1 and 46**

**United States Patent and Trademark Office**

**Reg. No. 3,455,606**

**Registered June 24, 2008**

**TRADEMARK  
PRINCIPAL REGISTER**

**FARMER'S MARKET FRESH**

AEROGROW INTERNATIONAL, INC. (NEVADA CORPORATION)  
6075 LONGBOW DRIVE  
SUITE 200  
BOULDER, CO 80301

FOR: GARDENING SEED KITS USEFUL WITH AEROPONICS OR HYDROPONICS DEVICES FOR HOUSEHOLD OR COMMERCIAL AGRICULTURAL AND HORTICULTURAL PLANT GROWTH, CONSISTING OF SEEDS, SPONGE-LIKE GROWTH MATRICES, AND PLANT FOOD ALL HOUSED IN SEED POD UNITS, USEFUL FOR RAPIDLY GROWING HEALTHY AND FRESH VEGETABLES,

FRUITS, FLOWERS, HERBS, AND/OR HOUSE-PLANTS, IN AN INDOOR OR OUTDOOR LOCATION, IN CLASS 31 (U.S. CLS. 1 AND 46).

FIRST USE 3-1-2006; IN COMMERCE 3-1-2006.

THE MARK CONSISTS OF STANDARD CHARACTERS WITHOUT CLAIM TO ANY PARTICULAR FONT, STYLE, SIZE, OR COLOR.

SN 78-882,877, FILED 5-12-2006.

SANDRA MANIOS, EXAMINING ATTORNEY



**Int. Cl.: 35**

**Prior U.S. Cls.: 100, 101, and 102**

**United States Patent and Trademark Office**

**Reg. No. 3,455,607**

**Registered June 24, 2008**

---

**SERVICE MARK  
PRINCIPAL REGISTER**

**HANGINWAVES**

USEFUL HEALTH INFO, LLC (NEW JERSEY  
LTD LIAB CO)  
PM 306, 531 ROUTE 22 EAST  
WHITEHOUSE STATION, NJ 08889

THE MARK CONSISTS OF STANDARD CHAR-  
ACTERS WITHOUT CLAIM TO ANY PARTICULAR  
FONT, STYLE, SIZE, OR COLOR.

FOR: BUSINESS MARKETING AND MARKET  
RESEARCH AND RELATED CONSULTING SERVI-  
CES, IN CLASS 35 (U.S. CLS. 100, 101 AND 102).

SN 78-883,083, FILED 5-13-2006.

FIRST USE 4-1-2006; IN COMMERCE 8-15-2006.

AMY HELLA, EXAMINING ATTORNEY

**Int. Cl.: 9**

**Prior U.S. Cls.: 21, 23, 26, 36, and 38**

**Reg. No. 3,455,608**

**United States Patent and Trademark Office**

**Registered June 24, 2008**

---

**TRADEMARK  
PRINCIPAL REGISTER**

**SUNTOUCH**

PENTAIR WATER POOL AND SPA, INC. (DELA-  
WARE CORPORATION)  
1620 HAWKINS AVENUE  
SANFORD, NC 27330

THE MARK CONSISTS OF STANDARD CHAR-  
ACTERS WITHOUT CLAIM TO ANY PARTICULAR  
FONT, STYLE, SIZE, OR COLOR.

FOR: REMOTE CONTROL UNITS FOR CON-  
TROLLING THE OPERATION OF POOLS AND  
SPAS, IN CLASS 9 (U.S. CLS. 21, 23, 26, 36 AND 38).

SN 78-883,237, FILED 5-15-2006.

FIRST USE 10-1-2007; IN COMMERCE 10-1-2007.

JASON BLAIR, EXAMINING ATTORNEY

**Int. Cl.: 35**

**Prior U.S. Cls.: 100, 101, and 102**

**United States Patent and Trademark Office**

**Reg. No. 3,455,609**

**Registered June 24, 2008**

**SERVICE MARK  
PRINCIPAL REGISTER**

**Celebrating Early Childhood**

HIGHLIGHTS FOR CHILDREN, INC. (DELA-  
WARE CORPORATION)  
1800 WATERMARK DRIVE  
COLUMBUS, OH 43215

FOR: ADVERTISING SLOGAN LICENSING FOR  
EARLY CHILDHOOD MAGAZINE, IN CLASS 35  
(U.S. CLS. 100, 101 AND 102).

FIRST USE 1-1-2007; IN COMMERCE 1-1-2007.

THE MARK CONSISTS OF STANDARD CHAR-  
ACTERS WITHOUT CLAIM TO ANY PARTICULAR  
FONT, STYLE, SIZE, OR COLOR.

NO CLAIM IS MADE TO THE EXCLUSIVE  
RIGHT TO USE "EARLY CHILDHOOD", APART  
FROM THE MARK AS SHOWN.

SN 78-883,535, FILED 5-15-2006.

NAAKWAMA ANKRAH, EXAMINING ATTORNEY

**Int. Cl.: 9**

**Prior U.S. Cls.: 21, 23, 26, 36, and 38**

**United States Patent and Trademark Office**

**Reg. No. 3,455,610**

**Registered June 24, 2008**

**TRADEMARK  
PRINCIPAL REGISTER**



NIPPON DENKI KABUSHIKI KAISHA (JAPAN CORPORATION), DBA NEC CORPORATION, 7-1, SHIBA 5 - CHOME, MINATO-KU TOKYO, JAPAN

FOR: COMPUTER SOFTWARE FOR USE IN MONITORING AND MANAGING ELECTRONIC COMPUTERS INTER-CONNECTED WITH GLOBAL AND LOCAL COMPUTER INFORMATION NETWORKS AND FOR USE IN SECURELY TRANSFERRING THE DATA INFORMATION THERE BETWEEN, IN CLASS 9 (U.S. CLS. 21, 23, 26, 36 AND 38).

FIRST USE 10-31-2007; IN COMMERCE 10-31-2007.

THE MARK CONSISTS OF A STYLIZED LETTER "C" INTERCONNECTED WITH A STYLIZED LETTER "P" WITHIN AN OVAL.

SN 78-884,194, FILED 5-16-2006.

BENJAMIN OKEKE, EXAMINING ATTORNEY

**Int. Cl.: 9**

**Prior U.S. Cls.: 21, 23, 26, 36, and 38**

**Reg. No. 3,455,611**

**United States Patent and Trademark Office**

**Registered June 24, 2008**

---

**TRADEMARK  
PRINCIPAL REGISTER**

**DISCPAINTER**

SANFORD, L.P. (ILLINOIS LIMITED PARTNER-  
SHIP)  
2707 BUTTERFIELD ROAD  
OAK BROOK, IL 60523

THE MARK CONSISTS OF STANDARD CHAR-  
ACTERS WITHOUT CLAIM TO ANY PARTICULAR  
FONT, STYLE, SIZE, OR COLOR.

FOR: PRINTER THAT LABELS BY PRINTING  
DIRECTLY ON COMPACT DISKS AND DVDS, IN  
CLASS 9 (U.S. CLS. 21, 23, 26, 36 AND 38).

SN 78-884,775, FILED 5-16-2006.

FIRST USE 10-30-2007; IN COMMERCE 10-30-2007.

AMY GEARIN, EXAMINING ATTORNEY

**Int. Cls.: 17 and 20**

**Prior U.S. Cls.: 1, 2, 5, 12, 13, 22, 25, 32, 35, and 50**

**United States Patent and Trademark Office**

**Reg. No. 3,455,612**

**Registered June 24, 2008**

**TRADEMARK  
PRINCIPAL REGISTER**

**TYGOPURE**

SAINT-GOBAIN PERFORMANCE PLASTICS  
CORPORATION (CALIFORNIA CORPORATION)  
1199 CHILLICOTHE ROAD  
AURORA, OH 44202

FOR: FLEXIBLE PLASTIC AND SILICONE TUBING USED FOR TRANSPORT OF LIQUIDS AND BIOLOGICALS FOR USE IN THE PHARMACEUTICAL AND MEDICAL INDUSTRIES, IN CLASS 17 (U.S. CLS. 1, 5, 12, 13, 35 AND 50).

FIRST USE 10-0-1996; IN COMMERCE 10-0-1996.

FOR: GENERAL USE PLASTIC FITTINGS FOR USE WITH FLEXIBLE TUBING IN THE PHARMA-

CEUTICAL AND MEDICAL INDUSTRIES, IN CLASS 20 (U.S. CLS. 2, 13, 22, 25, 32 AND 50).

FIRST USE 0-0-1995; IN COMMERCE 0-0-1995.

THE MARK CONSISTS OF STANDARD CHARACTERS WITHOUT CLAIM TO ANY PARTICULAR FONT, STYLE, SIZE, OR COLOR.

OWNER OF U.S. REG. NOS. 612,056, 1,505,905, AND 1,600,643.

SN 78-884,782, FILED 5-16-2006.

PAUL CROWLEY, EXAMINING ATTORNEY

**Int. Cl.: 6**

**Prior U.S. Cls.: 2, 12, 13, 14, 23, 25, and 50**

**Reg. No. 3,455,613**

**United States Patent and Trademark Office**

**Registered June 24, 2008**

---

**TRADEMARK  
PRINCIPAL REGISTER**

**TOOLIES**

THE BANDANA CO., INC. (KENTUCKY COR-  
PORATION)  
2921 SOUTH SECOND STREET  
LOUISVILLE, KY 40208

THE MARK CONSISTS OF STANDARD CHAR-  
ACTERS WITHOUT CLAIM TO ANY PARTICULAR  
FONT, STYLE, SIZE, OR COLOR.

FOR: METAL SCULPTURES, IN CLASS 6 (U.S.  
CLS. 2, 12, 13, 14, 23, 25 AND 50).

SN 78-885,473, FILED 5-17-2006.

FIRST USE 7-7-2006; IN COMMERCE 7-7-2006.

PAM WILLIS, EXAMINING ATTORNEY

**Int. Cl.: 41**

**Prior U.S. Cls.: 100, 101, and 107**

**United States Patent and Trademark Office**

**Reg. No. 3,455,614**

**Registered June 24, 2008**

**SERVICE MARK  
PRINCIPAL REGISTER**

**TURBO**

DISCOVERY COMMUNICATIONS, LLC (DELA-  
WARE LTD LIAB CO)  
ONE DISCOVERY PLACE  
SILVER SPRING, MD 20910

FOR: ENTERTAINMENT SERVICES IN THE  
NATURE OF ONGOING TELEVISION PROGRAMS  
ON THE SUBJECTS OF TRANSPORTATION, MA-  
CHINES, VEHICLES AND AIRCRAFT, DISTRIBU-  
TED VIA AUDIO-VISUAL MEDIA IN THE NATURE  
OF CABLE TELEVISION, SATELLITE, WIRELESS,  
BROADBAND, VIDEO-ON-DEMAND, STREAMING

AND A GLOBAL COMPUTER NETWORK, IN  
CLASS 41 (U.S. CLS. 100, 101 AND 107).

FIRST USE 7-4-2006; IN COMMERCE 7-4-2006.

THE MARK CONSISTS OF STANDARD CHAR-  
ACTERS WITHOUT CLAIM TO ANY PARTICULAR  
FONT, STYLE, SIZE, OR COLOR.

SN 78-886,783, FILED 5-18-2006.

MICHAEL KAZAZIAN, EXAMINING ATTORNEY



**Int. Cl.: 41**

**Prior U.S. Cls.: 100, 101, and 107**

**United States Patent and Trademark Office**

**Reg. No. 3,455,615**

**Registered June 24, 2008**

**SERVICE MARK  
PRINCIPAL REGISTER**

**SATURDAY NIGHT OUT**

SUNDANCE CHANNEL LLC (DELAWARE LTD  
LIAB CO)  
1633 BROADWAY  
NEW YORK, NY 10019

FOR: ENTERTAINMENT SERVICES IN THE  
NATURE OF TELEVISION PROGRAMMING SER-  
VICES DISTRIBUTED VIA CABLE AND SATEL-  
LITE-DELIVERED TELEVISION, IN CLASS 41 (U.S.  
CLS. 100, 101 AND 107).

FIRST USE 5-27-2006; IN COMMERCE 5-27-2006.

THE MARK CONSISTS OF STANDARD CHAR-  
ACTERS WITHOUT CLAIM TO ANY PARTICULAR  
FONT, STYLE, SIZE, OR COLOR.

NO CLAIM IS MADE TO THE EXCLUSIVE  
RIGHT TO USE "SATURDAY NIGHT", APART  
FROM THE MARK AS SHOWN.

SN 78-887,024, FILED 5-18-2006.

ANNE E. GUSTASON, EXAMINING ATTORNEY

**Int. Cl.: 41**

**Prior U.S. Cls.: 100, 101, and 107**

**United States Patent and Trademark Office**

**Reg. No. 3,455,616**

**Registered June 24, 2008**

**SERVICE MARK  
PRINCIPAL REGISTER**

**READY TO WATCH**

SUNDANCE CHANNEL LLC (DELAWARE LTD  
LIAB CO)  
1633 BROADWAY  
NEW YORK, NY 10019

FOR: ENTERTAINMENT SERVICES IN THE  
NATURE OF TELEVISION PROGRAMMING SER-  
VICES DISTRIBUTED VIA CABLE, SATELLITE-DE-  
LIVERED AND FREE TELEVISION, IN CLASS 41  
(U.S. CLS. 100, 101 AND 107).

FIRST USE 8-20-2007; IN COMMERCE 8-20-2007.

THE MARK CONSISTS OF STANDARD CHAR-  
ACTERS WITHOUT CLAIM TO ANY PARTICULAR  
FONT, STYLE, SIZE, OR COLOR.

SN 78-887,156, FILED 5-18-2006.

ANNE E. GUSTASON, EXAMINING ATTORNEY

**Int. Cl.: 25**

**Prior U.S. Cls.: 22 and 39**

**United States Patent and Trademark Office**

**Reg. No. 3,455,617**

**Registered June 24, 2008**

**TRADEMARK  
PRINCIPAL REGISTER**



**CRAZED CLOTHING LLC (CALIFORNIA LIMITED LIABILITY COMPANY)  
3181 GARRETSON AVE.  
CORONA, CA 92881**

**FIRST USE 3-12-2008; IN COMMERCE 3-12-2008.**

**SN 78-887,181, FILED 5-18-2006.**

**FOR: CLOTHING, NAMELY, SHIRTS, SHORTS, PANTS, SWEATSHIRTS, AND HATS, IN CLASS 25 (U.S. CLS. 22 AND 39).**

**STEVEN JACKSON, EXAMINING ATTORNEY**

**Int. Cl.: 29**

**Prior U.S. Cl.: 46**

**United States Patent and Trademark Office**

**Reg. No. 3,455,618**

**Registered June 24, 2008**

**TRADEMARK  
PRINCIPAL REGISTER**

**Amaze-o-Mix**

TEAL, DARIN (UNITED STATES INDIVIDUAL)  
PO BOX 20880  
KEIZER, OR 97307

FOR: MILK-BASED POWDER, CONSISTING OF A NON-DAIRY CREAMER AND A MIX OF NON-NUTRITIONAL COLOR AND FLAVORING ADDITIVES, FOR USE IN NON-ALCOHOLIC BEVERAGES, NAMELY, MILKSHAKES, SMOOTHIES, COFFEE AND TEA BASED DRINKS, IN CLASS 29 (U.S. CL. 46).

FIRST USE 7-31-2006; IN COMMERCE 7-31-2006.

THE MARK CONSISTS OF STANDARD CHARACTERS WITHOUT CLAIM TO ANY PARTICULAR FONT, STYLE, SIZE, OR COLOR.

SN 78-887,294, FILED 5-18-2006.

EDWARD NELSON, EXAMINING ATTORNEY

**Int. Cl.: 5**

**Prior U.S. Cls.: 6, 18, 44, 46, 51, and 52**

**Reg. No. 3,455,619**

**United States Patent and Trademark Office**

**Registered June 24, 2008**

**TRADEMARK  
PRINCIPAL REGISTER**

**DPP**

CHEMBIO DIAGNOSTIC SYSTEMS, INC. (DELA-  
WARE CORPORATION)  
3661 HORSEBLOCK ROAD  
MEDFORD, NY 11763

FOR: RAPID DIAGNOSTIC TESTS CONSISTING  
PRIMARILY OF TEST STRIPS FOR A WIDE RANGE  
OF MEDICAL DISEASES OR CONDITIONS FOR  
HOME USE AND MEDICAL LABORATORY USE ,  
IN CLASS 5 (U.S. CLS. 6, 18, 44, 46, 51 AND 52).

FIRST USE 3-1-2008; IN COMMERCE 3-1-2008.

THE MARK CONSISTS OF STANDARD CHAR-  
ACTERS WITHOUT CLAIM TO ANY PARTICULAR  
FONT, STYLE, SIZE, OR COLOR.

SN 78-887,935, FILED 5-19-2006.

LYDIA BELZER, EXAMINING ATTORNEY

**Int. Cl.: 30**

**Prior U.S. Cl.: 46**

**United States Patent and Trademark Office**

**Reg. No. 3,455,620**

**Registered June 24, 2008**

**TRADEMARK  
PRINCIPAL REGISTER**

**PASSAGE WEST**

THE COCA-COLA COMPANY (DELAWARE  
CORPORATION)  
ONE COCA-COLA PLAZA  
ATLANTA, GA 30313

THE MARK CONSISTS OF STANDARD CHAR-  
ACTERS WITHOUT CLAIM TO ANY PARTICULAR  
FONT, STYLE, SIZE, OR COLOR.

FOR: COFFEE, IN CLASS 30 (U.S. CL. 46).

SN 78-888,137, FILED 5-19-2006.

FIRST USE 5-8-2007; IN COMMERCE 5-8-2007.

JOHN DALIER, EXAMINING ATTORNEY

**Int. Cl.: 30**

**Prior U.S. Cl.: 46**

**United States Patent and Trademark Office**

**Reg. No. 3,455,621**

**Registered June 24, 2008**

**TRADEMARK  
PRINCIPAL REGISTER**

**OPALE NOIRE**

THE COCA-COLA COMPANY (DELAWARE  
CORPORATION)  
ONE COCA-COLA PLAZA  
ATLANTA, GA 30313

THE ENGLISH TRANSLATION OF "OPALE" IS  
"OPAL" AND THE ENGLISH TRANSLATION OF  
"NOIRE" IS "BLACK."

FOR: COFFEE, IN CLASS 30 (U.S. CL. 46).

FIRST USE 5-8-2007; IN COMMERCE 5-8-2007.

SN 78-888,144, FILED 5-19-2006.

THE MARK CONSISTS OF STANDARD CHAR-  
ACTERS WITHOUT CLAIM TO ANY PARTICULAR  
FONT, STYLE, SIZE, OR COLOR.

JOHN DALIER, EXAMINING ATTORNEY

**Int. Cl.: 30**

**Prior U.S. Cl.: 46**

**United States Patent and Trademark Office**

**Reg. No. 3,455,622**

**Registered June 24, 2008**

**TRADEMARK  
PRINCIPAL REGISTER**

**PERSKTEE**

THE COCA-COLA COMPANY (DELAWARE  
CORPORATION)  
ONE COCA-COLA PLAZA  
ATLANTA, GA 30313

THE MARK CONSISTS OF STANDARD CHAR-  
ACTERS WITHOUT CLAIM TO ANY PARTICULAR  
FONT, STYLE, SIZE, OR COLOR.

FOR: TEA, FLAVORED TEA, ALL FOR NON-  
MEDICINAL PURPOSES, IN CLASS 30 (U.S. CL. 46).

SN 78-888,201, FILED 5-19-2006.

FIRST USE 5-8-2007; IN COMMERCE 5-8-2007.

MICHAEL WEBSTER, EXAMINING ATTORNEY



**Int. Cl.: 9**

**Prior U.S. Cls.: 21, 23, 26, 36, and 38**

**Reg. No. 3,455,623**

**United States Patent and Trademark Office**

**Registered June 24, 2008**

**TRADEMARK  
PRINCIPAL REGISTER**

**SCRIBA XML**

PUBLISHING CONNECTIONS INC. (MARY-  
LAND CORPORATION)  
SUITE 206  
12204 SELINE WAY  
POTOMAC, MD 20854

FOR: COMPUTER SOFTWARE WHICH ALLOWS  
DATA, TEXT AND CONTENT TO BE EXTRACTED  
FROM DIGITAL FILES AND CONVERTED INTO  
XML (EXTENSIBLE MARKUP LANGUAGE) , IN  
CLASS 9 (U.S. CLS. 21, 23, 26, 36 AND 38).

FIRST USE 8-1-2005; IN COMMERCE 8-1-2005.

THE MARK CONSISTS OF STANDARD CHAR-  
ACTERS WITHOUT CLAIM TO ANY PARTICULAR  
FONT, STYLE, SIZE, OR COLOR.

NO CLAIM IS MADE TO THE EXCLUSIVE  
RIGHT TO USE "XML", APART FROM THE MARK  
AS SHOWN.

SN 78-889,431, FILED 5-22-2006.

TINA L. SNAPP, EXAMINING ATTORNEY

**Int. Cl.: 9**

**Prior U.S. Cls.: 21, 23, 26, 36, and 38**

**Reg. No. 3,455,624**

**United States Patent and Trademark Office**

**Registered June 24, 2008**

---

**TRADEMARK  
PRINCIPAL REGISTER**

**SCRIBAPDF**

PUBLISHING CONNECTIONS INC. (MARY-  
LAND CORPORATION)  
SUITE 206  
12204 SELINE WAY  
POTOMAC, MD 20854

FOR: COMPUTER SOFTWARE WHICH ALLOWS  
DATA, TEXT AND CONTENT TO BE EXTRACTED  
FROM DIGITAL FILES AND CONVERTED INTO  
XML (EXTENSIBLE MARKUP LANGUAGE) , IN  
CLASS 9 (U.S. CLS. 21, 23, 26, 36 AND 38).

FIRST USE 8-1-2005; IN COMMERCE 8-1-2005.

THE MARK CONSISTS OF STANDARD CHAR-  
ACTERS WITHOUT CLAIM TO ANY PARTICULAR  
FONT, STYLE, SIZE, OR COLOR.

SN 78-889,440, FILED 5-22-2006.

TINA L. SNAPP, EXAMINING ATTORNEY

**Int. Cl.: 42**

**Prior U.S. Cls.: 100 and 101**

**United States Patent and Trademark Office**

**Reg. No. 3,455,625**

**Registered June 24, 2008**

**SERVICE MARK  
PRINCIPAL REGISTER**

**PAINT YOUR PLACE**

BEHR PROCESS CORPORATION (CALIFORNIA  
CORPORATION)  
3400 W. SEGERSTROM AVENUE  
SANTA ANA, CA 92704

FOR: PROVIDING TEMPORARY USE OF ON-  
LINE NON-DOWNLOADABLE SOFTWARE FOR  
USE IN UPLOADING PHOTO IMAGES TO A WEB-  
SITE SO THAT PAINT COLORS MAY BE PRE-  
VIEWED IN CONSUMERS' OWN PHOTO, IN  
CLASS 42 (U.S. CLS. 100 AND 101).

FIRST USE 4-14-2007; IN COMMERCE 4-14-2007.

THE MARK CONSISTS OF STANDARD CHAR-  
ACTERS WITHOUT CLAIM TO ANY PARTICULAR  
FONT, STYLE, SIZE, OR COLOR.

SN 78-890,193, FILED 5-23-2006.

RONALD AIKENS, EXAMINING ATTORNEY

**Int. Cls.: 9, 16, and 41**

**Prior U.S. Cls.: 2, 5, 21, 22, 23, 26, 29, 36, 37, 38, 50,  
100, 101, and 107**

**Reg. No. 3,455,626**

**United States Patent and Trademark Office**

**Registered June 24, 2008**

**TRADEMARK  
SERVICE MARK  
PRINCIPAL REGISTER**

# Body Jolt

WYNDHAM, ANDREW C. (UNITED STATES  
INDIVIDUAL)  
P.O. BOX 34  
HARRISVILLE, NH 03450

FOR: PRE-RECORDED CDS, INSTRUCTIONAL  
DVDS AND VIDEO CASSETTES IN THE FIELD OF  
EXERCISE AND MULTI-LEVEL MARKETING  
BUSINESS SERVICES, IN CLASS 9 (U.S. CLS. 21, 23,  
26, 36 AND 38).

FIRST USE 2-20-2007; IN COMMERCE 2-20-2007.

FOR: BOOKLETS, MAGAZINES AND A SERIES  
OF NON-FICTION BOOKS ON THE SUBJECTS OF  
EXERCISE AND MULTI-LEVEL MARKETING  
BUSINESS SERVICES, IN CLASS 16 (U.S. CLS. 2, 5,  
22, 23, 29, 37, 38 AND 50).

FIRST USE 2-19-2007; IN COMMERCE 2-19-2007.

FOR: CONDUCTING SEMINARS AND CONFER-  
ENCES IN THE FIELDS OF EXERCISE AND MULTI-  
LEVEL MARKETING BUSINESS SERVICES; PRO-  
VIDING A WEBSITE FEATURING INFORMATION  
RELATED TO EXERCISE, IN CLASS 41 (U.S. CLS.  
100, 101 AND 107).

FIRST USE 3-24-2007; IN COMMERCE 3-24-2007.

THE MARK CONSISTS OF STANDARD CHAR-  
ACTERS WITHOUT CLAIM TO ANY PARTICULAR  
FONT, STYLE, SIZE, OR COLOR.

SN 78-890,387, FILED 5-23-2006.

JULIE GUTTADAURO, EXAMINING ATTORNEY

**Int. Cls.: 35, 41, and 42**

**Prior U.S. Cls.: 100, 101, 102, and 107**

**United States Patent and Trademark Office**

**Reg. No. 3,455,627**

**Registered June 24, 2008**

**SERVICE MARK  
PRINCIPAL REGISTER**



DIGITAL LEGAL SERVICES LLC (DELAWARE  
LTD LIAB CO)  
1001 JEFFERSON PLAZA, SUITE 100  
WILMINGTON, DE 19801

FOR: BUSINESS SERVICES, NAMELY, FACILITIES MANAGEMENT OF TECHNICAL OPERATIONS; DOCUMENT AND RECORDS MANAGEMENT AND INDEXING SERVICES; DATABASE MANAGEMENT, NAMELY, DATABASE CODING SERVICES, IN CLASS 35 (U.S. CLS. 100, 101 AND 102).

FIRST USE 5-0-2006; IN COMMERCE 5-0-2006.

FOR: DIGITAL IMAGING SERVICES, IN CLASS 41 (U.S. CLS. 100, 101 AND 107).

FIRST USE 5-0-2006; IN COMMERCE 5-0-2006.

FOR: LITIGATION SUPPORT SERVICES; LITIGATION CONSULTANCY; DOCUMENTS AND RECORDS RETRIEVAL; ELECTRONIC DISCOVERY SERVICES; DATABASE DEVELOPMENT SERVICES; MEDIA COMPUTER DESIGN FOR OTHERS, AND GRAPHICS DESIGN SERVICES, IN CLASS 42 (U.S. CLS. 100 AND 101).

FIRST USE 5-0-2006; IN COMMERCE 5-0-2006.

NO CLAIM IS MADE TO THE EXCLUSIVE RIGHT TO USE "DIGITAL LEGAL", APART FROM THE MARK AS SHOWN.

THE MARK CONSISTS OF A STYLIZED DOUBLE ARCH OVER THE LITERAL ELEMENT OF THE MARK.

SN 78-891,291, FILED 5-24-2006.

CAROL SPILS, EXAMINING ATTORNEY

Int. Cl.: 9

Prior U.S. Cls.: 21, 23, 26, 36, and 38

United States Patent and Trademark Office

Reg. No. 3,455,628

Registered June 24, 2008

TRADEMARK  
PRINCIPAL REGISTER

*n*Fusion

STARKEY LABORATORIES, INC. (MINNESOTA CORPORATION)  
6600 WASHINGTON AVENUE SOUTH  
EDEN PRAIRIE, MN 55344

FOR: INTEGRATED CIRCUITS PROTOCOL FOR HEARING COMMUNICATION DEVICES, NAMELY, ELECTRONIC INTEGRATED CIRCUITS FOR BEAMFORMING RELATED TO HEARING COMMUNICATION DEVICES TO PROVIDE CLEAR, HEALTHY, NATURAL HEARING THROUGH FASTER, MORE POWERFUL TECHNOLOGY AND SOFTWARE THAT MAKES FITTING COMFORTA-

BLE, EASY AND ACCURATE, IN CLASS 9 (U.S. CLS. 21, 23, 26, 36 AND 38).

FIRST USE 4-4-2006; IN COMMERCE 4-4-2006.

THE MARK CONSISTS OF THE WORDING "FUSION" WITH A SUPERSCRIPIT "N" DIRECTLY IN FRONT OF THE TERM "FUSION".

SN 78-891,718, FILED 5-24-2006.

NAKIA HENRY, EXAMINING ATTORNEY

**Int. Cl.: 21**

**Prior U.S. Cls.: 2, 13, 23, 29, 30, 33, 40, and 50**

**Reg. No. 3,455,629**

**United States Patent and Trademark Office**

**Registered June 24, 2008**

**TRADEMARK  
PRINCIPAL REGISTER**



GOOD THINGS INTERNATIONAL LTD. (TAI-  
WAN CORPORATION)  
21 FL.-3, NO. 189, SECTION 2, KEELUNG RD  
TAIPEI CITY, TAIWAN 110

FOR: BAKEWARE, BAKING DISHES, CAKE  
MOLDS, CAKE PANS, CAKE RESTS, CAKE SER-  
VERS, CAKE STANDS, CASSEROLE DISHES, CHO-  
COLATE MOLDS, COOKERY MOLDS, COOKIE  
CUTTERS, COOKIE SHEETS, COOKING POTS,  
COOKING SKEWERS, COOKING UTENSILS,  
NAMELY, GRILLS, WIRE BASKETS; COOKWARE,  
NAMELY, ROASTING PANS, STEAMERS; EGG  
CUPS, EGG POACHERS, EGG SEPARATORS, FRY-  
ING PANS, METAL COOKING PANS, METAL  
PANS, NON-ELECTRIC GRIDDLES, NON-ELEC-  
TRIC PRESSURE COOKERS, NON-ELECTRIC  
PRESSURE COOKING SAUCEPANS, PASTRY CUT-

TERS, PASTRY MOLDS, PIE PANS, POTS, PUD-  
DING MOLDS, ROLLING PINS, SAUCEPAN  
SCOURERS INCLUDING METAL, SAUCEPANS,  
STEAMER BASKETS, UTENSILS FOR BARBECUES,  
NAMELY, FORKS, TONGS, TURNERS; NON-ELEC-  
TRIC WOKS, IN CLASS 21 (U.S. CLS. 2, 13, 23, 29, 30,  
33, 40 AND 50).

FIRST USE 8-13-2007; IN COMMERCE 8-13-2007.

NO CLAIM IS MADE TO THE EXCLUSIVE  
RIGHT TO USE "SF", APART FROM THE MARK  
AS SHOWN.

SN 78-891,725, FILED 5-24-2006.

MIDGE BUTLER, EXAMINING ATTORNEY

**Int. Cl.: 9**

**Prior U.S. Cls.: 21, 23, 26, 36, and 38**

**United States Patent and Trademark Office**

**Reg. No. 3,455,630**

**Registered June 24, 2008**

**TRADEMARK  
PRINCIPAL REGISTER**

**RED HOT JACKPOTS**

IGT (NEVADA CORPORATION)  
9295 PROTOTYPE DRIVE  
RENO, NV 895218986

OWNER OF U.S. REG. NOS. 1,969,540, 2,622,513,  
AND OTHERS.

FOR: GAMING MACHINES, NAMELY, DEVICES  
WHICH ACCEPT A WAGER, IN CLASS 9 (U.S. CLS.  
21, 23, 26, 36 AND 38).

NO CLAIM IS MADE TO THE EXCLUSIVE  
RIGHT TO USE "JACKPOTS", APART FROM THE  
MARK AS SHOWN.

FIRST USE 8-25-2006; IN COMMERCE 8-25-2006.

SN 78-892,110, FILED 5-24-2006.

THE MARK CONSISTS OF STANDARD CHAR-  
ACTERS WITHOUT CLAIM TO ANY PARTICULAR  
FONT, STYLE, SIZE, OR COLOR.

HEATHER SAPP, EXAMINING ATTORNEY



**Int. Cl.: 6**

**Prior U.S. Cls.: 2, 12, 13, 14, 23, 25, and 50**

**Reg. No. 3,455,631**

**United States Patent and Trademark Office**

**Registered June 24, 2008**

**TRADEMARK  
PRINCIPAL REGISTER**

**JENNIFER**

FRENCHPORTE, LLC (MARYLAND LTD LIAB  
CO)  
PENTHOUSE SUITE  
121 CONGRESSIONAL LANE  
ROCKVILLE, MD 20852

THE MARK CONSISTS OF STANDARD CHAR-  
ACTERS WITHOUT CLAIM TO ANY PARTICULAR  
FONT, STYLE, SIZE, OR COLOR.

FOR: METAL GARAGE DOORS AND PARTS  
THEREOF, IN CLASS 6 (U.S. CLS. 2, 12, 13, 14, 23, 25  
AND 50).

SN 78-892,444, FILED 5-25-2006.

FIRST USE 3-18-2006; IN COMMERCE 3-18-2006.

ESTHER A. BORSUK, EXAMINING ATTORNEY

**Int. Cl.: 29**

**Prior U.S. Cl.: 46**

**Reg. No. 3,455,632**

**United States Patent and Trademark Office**

**Registered June 24, 2008**

**TRADEMARK  
PRINCIPAL REGISTER**

**LIFE SNACKS**

MARIANI PACKING CO., INC. (CALIFORNIA CORPORATION)  
500 CROCKER DRIVE  
VACAVILLE, CA 95688

FOR: FRUIT BASED SNACK FOODS, FEATURING, DRIED FRUIT, NUTS AND SEEDS; SWEETENED FRUIT BASED SNACK FOODS AND FRUIT BASED FLAVORED SNACK FOODS, IN CLASS 29 (U.S. CL. 46).

FIRST USE 4-29-2007; IN COMMERCE 4-29-2007.

THE MARK CONSISTS OF STANDARD CHARACTERS WITHOUT CLAIM TO ANY PARTICULAR FONT, STYLE, SIZE, OR COLOR.

NO CLAIM IS MADE TO THE EXCLUSIVE RIGHT TO USE "SNACKS", APART FROM THE MARK AS SHOWN.

SN 78-892,674, FILED 5-25-2006.

EDWARD NELSON, EXAMINING ATTORNEY

**Int. Cl.: 9**

**Prior U.S. Cls.: 21, 23, 26, 36, and 38**

**Reg. No. 3,455,633**

**United States Patent and Trademark Office**

**Registered June 24, 2008**

---

**TRADEMARK  
PRINCIPAL REGISTER**

**P.H.S.**

MAK-SYSTEM CORP. (DELAWARE CORPORATION)  
2720 RIVER ROAD, SUITE 225  
DES PLAINES, IL 60018

FOR: PATIENT HEALTH SOFTWARE, NAMELY,  
COMPUTER SOFTWARE FOR CONTROLLING  
AND MANAGING PATIENT MEDICAL INFORMATION  
FOR HOSPITALS AND TRANSFUSION CENTERS,  
IN CLASS 9 (U.S. CLS. 21, 23, 26, 36 AND 38).

FIRST USE 6-11-2004; IN COMMERCE 6-11-2004.

THE MARK CONSISTS OF STANDARD CHARACTERS  
WITHOUT CLAIM TO ANY PARTICULAR FONT,  
STYLE, SIZE, OR COLOR.

SN 78-893,707, FILED 5-26-2006.

ALLISON HOLTZ, EXAMINING ATTORNEY

**Int. Cl.: 9**

**Prior U.S. Cls.: 21, 23, 26, 36, and 38**

**Reg. No. 3,455,634**

**United States Patent and Trademark Office**

**Registered June 24, 2008**

---

**TRADEMARK  
PRINCIPAL REGISTER**

**THE WORLD'S MOST HOSTILE  
ENVIRONMENTS ARE OUR  
PROVING GROUNDS**

A.P.M. HEXSEAL CORPORATION (NEW JERSEY  
CORPORATION)  
44 HONECK STREET  
ENGLEWOOD, NJ 07631

THE MARK CONSISTS OF STANDARD CHAR-  
ACTERS WITHOUT CLAIM TO ANY PARTICULAR  
FONT, STYLE, SIZE, OR COLOR.

FOR: ELECTRICAL SWITCHES; PROTECTIVE  
SEALING BOOTS FOR ELECTRICAL EQUIPMENT  
AND SWITCHES, IN CLASS 9 (U.S. CLS. 21, 23, 26, 36  
AND 38).

SN 78-894,050, FILED 5-26-2006.

FIRST USE 9-0-2005; IN COMMERCE 9-0-2005.

RUSS HERMAN, EXAMINING ATTORNEY

**Int. Cl.: 41**

**Prior U.S. Cls.: 100, 101, and 107**

**United States Patent and Trademark Office**

**Reg. No. 3,455,635**

**Registered June 24, 2008**

---

**SERVICE MARK  
PRINCIPAL REGISTER**

**ExecuCoach**

PICHARDO, NORMA PROVENCIO (UNITED STATES INDIVIDUAL)  
5204 WILLMONTE AVE.  
TEMPLE CITY, CA 91780

THE MARK CONSISTS OF STANDARD CHARACTERS WITHOUT CLAIM TO ANY PARTICULAR FONT, STYLE, SIZE, OR COLOR.

FOR: PERSONAL COACHING SERVICES IN THE FIELD OF PROFESSIONAL DEVELOPMENT AND EMPOWERMENT, IN CLASS 41 (U.S. CLS. 100, 101 AND 107).

SN 78-894,158, FILED 5-26-2006.

FIRST USE 3-20-2007; IN COMMERCE 3-20-2007.

GIANCARLO CASTRO, EXAMINING ATTORNEY

**Int. Cl.: 29**

**Prior U.S. Cl.: 46**

**United States Patent and Trademark Office**

**Reg. No. 3,455,636**

**Registered June 24, 2008**

**TRADEMARK  
PRINCIPAL REGISTER**

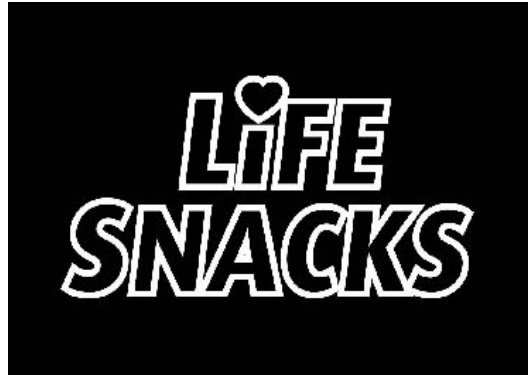

MARIANI PACKING CO., INC. (CALIFORNIA CORPORATION)  
500 CROCKER DRIVE  
VACAVILLE, CA 95688

FOR: FRUIT BASED SNACK FOODS, FEATURING, DRIED FRUIT, NUTS AND SEEDS; SWEETENED FRUIT BASED SNACK FOODS AND FRUIT BASED FLAVORED SNACK FOODS, IN CLASS 29 (U.S. CL. 46).

FIRST USE 4-29-2007; IN COMMERCE 4-29-2007.

NO CLAIM IS MADE TO THE EXCLUSIVE RIGHT TO USE "SNACKS", APART FROM THE MARK AS SHOWN.

SN 78-894,254, FILED 5-26-2006.

EDWARD NELSON, EXAMINING ATTORNEY

**Int. Cl.: 41**

**Prior U.S. Cls.: 100, 101, and 107**

**United States Patent and Trademark Office**

**Reg. No. 3,455,637**

**Registered June 24, 2008**

**SERVICE MARK  
PRINCIPAL REGISTER**

# Meditation for Life

CHOI, PAUL H (UNITED STATES INDIVIDUAL)  
171 NW 60TH ST  
SEATTLE, WA 98107

FOR: MEDITATION TRAINING, IN CLASS 41  
(U.S. CLS. 100, 101 AND 107).

FIRST USE 1-15-2007; IN COMMERCE 1-15-2007.

THE MARK CONSISTS OF STANDARD CHARACTERS WITHOUT CLAIM TO ANY PARTICULAR FONT, STYLE, SIZE, OR COLOR.

NO CLAIM IS MADE TO THE EXCLUSIVE RIGHT TO USE "MEDITATION", APART FROM THE MARK AS SHOWN.

SN 78-894,554, FILED 5-26-2006.

INGA ERVIN, EXAMINING ATTORNEY

**Int. Cl.: 29**

**Prior U.S. Cl.: 46**

**United States Patent and Trademark Office**

**Reg. No. 3,455,638**

**Registered June 24, 2008**

**TRADEMARK  
PRINCIPAL REGISTER**

**A KICK IN THE CAN**

VIETTI FOODS COMPANY, INC. (TENNESSEE  
CORPORATION)  
636 SOUTHGATE AVENUE  
NASHVILLE, TN 37203

THE MARK CONSISTS OF STANDARD CHAR-  
ACTERS WITHOUT CLAIM TO ANY PARTICULAR  
FONT, STYLE, SIZE, OR COLOR.

FOR: CANNED FOOD PRODUCTS, NAMELY,  
CHILI, IN CLASS 29 (U.S. CL. 46).

SN 78-895,396, FILED 5-30-2006.

FIRST USE 9-0-2005; IN COMMERCE 9-0-2005.

ALICIA COLLINS, EXAMINING ATTORNEY



**Int. Cl.: 8**

**Prior U.S. Cls.: 23, 28, and 44**

**Reg. No. 3,455,639**

**United States Patent and Trademark Office**

**Registered June 24, 2008**

**TRADEMARK  
PRINCIPAL REGISTER**



THE GILLETTE COMPANY (DELAWARE CORPORATION)  
PRUDENTIAL TOWER BUILDING  
BOSTON, MA 02199

FOR: RAZORS AND RAZOR BLADES; DISPENSERS, CASSETTES, HOLDERS AND CARTRIDGES ALL CONTAINING BLADES; AND STRUCTURAL PARTS THEREFOR, IN CLASS 8 (U.S. CLS. 23, 28 AND 44).

FIRST USE 4-2-2007; IN COMMERCE 4-2-2007.

NO CLAIM IS MADE TO THE EXCLUSIVE RIGHT TO USE "FRESH BLADE" AND "BETTER SHAVE", APART FROM THE MARK AS SHOWN.

THE COLOR GRAY IN THE DRAWING IS INTENDED TO INDICATE SHADING AND CONTRAST ONLY.

SN 78-895,991, FILED 5-30-2006.

ELLEN PERKINS, EXAMINING ATTORNEY

**Int. Cl.: 25**

**Prior U.S. Cls.: 22 and 39**

**United States Patent and Trademark Office**

**Reg. No. 3,455,640**

**Registered June 24, 2008**

**TRADEMARK  
PRINCIPAL REGISTER**

**DON DANTE**

ROBERTSON, WILL (UNITED STATES INDIVIDUAL)  
4901 SYCAMORE DR  
CULVER CITY, CA 90230

THE MARK CONSISTS OF STANDARD CHARACTERS WITHOUT CLAIM TO ANY PARTICULAR FONT, STYLE, SIZE, OR COLOR.

FOR: BANDANAS; DRESSES; HATS; JACKETS; PANTS; SHIRTS; SHOES; SHORTS; SOCKS; SWEAT BANDS; SWEAT PANTS; SWEAT SHIRTS; TANK-TOPS, IN CLASS 25 (U.S. CLS. 22 AND 39).

SN 78-896,321, FILED 5-30-2006.

FIRST USE 3-27-2007; IN COMMERCE 4-20-2008.

THEODORE MCBRIDE, EXAMINING ATTORNEY

**Int. Cl.: 28**

**Prior U.S. Cls.: 22, 23, 38, and 50**

**United States Patent and Trademark Office**

**Reg. No. 3,455,641**

**Registered June 24, 2008**

**TRADEMARK  
PRINCIPAL REGISTER**

**TV LINGO**

RAPID DISPLAYS, INC. (ILLINOIS CORPORATION)  
4300 WEST 47TH STREET  
CHICAGO, IL 60632

FOR: BOARD GAMES NOT HAVING AS THEIR SUBJECT MATTER TELEVISION RESOLUTION, TELEVISION NETWORKS, PROGRAMMING PRACTICES, NETWORK TERMS, TELEVISIONS, TELEVISION CHARACTERS, TELEVISION HISTORY OR THE TELEVISION INDUSTRY, IN CLASS 28 (U.S. CLS. 22, 23, 38 AND 50).

FIRST USE 6-0-2006; IN COMMERCE 6-0-2006.

THE MARK CONSISTS OF STANDARD CHARACTERS WITHOUT CLAIM TO ANY PARTICULAR FONT, STYLE, SIZE, OR COLOR.

NO CLAIM IS MADE TO THE EXCLUSIVE RIGHT TO USE "LINGO", APART FROM THE MARK AS SHOWN.

SN 78-896,518, FILED 5-31-2006.

AISHA CLARKE, EXAMINING ATTORNEY

**Int. Cl.: 36**

**Prior U.S. Cls.: 100, 101, and 102**

**United States Patent and Trademark Office**

**Reg. No. 3,455,642**

**Registered June 24, 2008**

**SERVICE MARK  
PRINCIPAL REGISTER**

**COLUMBUS FIRST BANK**

COLUMBUS FIRST BANK (OHIO CORPORATION)  
6877 NORTH HIGH STREET  
SUITE 101  
WORTHINGTON, OH 43085

FOR: BANKING SERVICES, IN CLASS 36 (U.S. CLS. 100, 101 AND 102).

FIRST USE 8-13-2007; IN COMMERCE 8-13-2007.

THE MARK CONSISTS OF STANDARD CHARACTERS WITHOUT CLAIM TO ANY PARTICULAR FONT, STYLE, SIZE, OR COLOR.

NO CLAIM IS MADE TO THE EXCLUSIVE RIGHT TO USE "COLUMBUS" AND "BANK", APART FROM THE MARK AS SHOWN.

SN 78-897,383, FILED 5-31-2006.

BRIAN NEVILLE, EXAMINING ATTORNEY

**Int. Cl.: 2**

**Prior U.S. Cls.: 6, 11, and 16**

**United States Patent and Trademark Office**

**Reg. No. 3,455,643**

**Registered June 24, 2008**

**TRADEMARK  
PRINCIPAL REGISTER**



GOOD THINGS INTERNATIONAL LTD. (TAI-  
WAN CORPORATION)  
21 FL.-3, NO. 189, SECTION 2, KEELUNG RD  
TAIPEI CITY, TAIWAN 110

FOR: BLACKS COLORANTS AND PAINTS,  
NAMELY, COLORANTS FOR USE IN THE MANU-  
FACTURE OF PAINT, COLORANT DISPERSIONS  
FOR USE IN SURFACE COATING COMPOSITIONS,  
PIGMENTED COATINGS USED IN THE NATURE  
OF PAINT, HOUSE PAINT, FABRIC PAINTS; DYES  
FOR USE IN THE MANUFACTURE OF LEATHER,  
FUR, WOOD; PERMANENT COLOR REFINISH  
FOR LEATHER AND VINYL; PAINTS; CERAMIC  
PAINTS; PAINT THINNERS; COATING COMPOSI-  
TIONS IN THE NATURE OF PAINT FOR INDUS-

TRIAL APPLICATIONS; LIME WASH PAINTS;  
STICKY CHEMICAL DOPES IN THE NATURE OF  
LACQUERS FOR INADHESIVE USE; WATER-  
PROOF PAINTS, IN CLASS 2 (U.S. CLS. 6, 11 AND 16).

FIRST USE 8-13-2007; IN COMMERCE 8-13-2007.

NO CLAIM IS MADE TO THE EXCLUSIVE  
RIGHT TO USE "SF", APART FROM THE MARK  
AS SHOWN.

SN 78-897,482, FILED 5-31-2006.

MIDGE BUTLER, EXAMINING ATTORNEY

**Int. Cl.: 2**

**Prior U.S. Cls.: 6, 11, and 16**

**United States Patent and Trademark Office**

**Reg. No. 3,455,644**

**Registered June 24, 2008**

**TRADEMARK  
PRINCIPAL REGISTER**



GOOD THINGS INTERNATIONAL LTD. (TAI-  
WAN CORPORATION)  
21 FL.-3, NO. 189, SECTION 2, KEELUNG RD  
TAIPEI CITY, TAIWAN 110

FOR: BLACKS COLORANTS AND PAINTS,  
NAMELY, COLORANTS FOR USE IN THE MANU-  
FACTURE OF PAINT, COLORANT DISPERSIONS  
FOR USE IN SURFACE COATING COMPOSITIONS,  
PIGMENTED COATINGS USED IN THE NATURE  
OF PAINT, HOUSE PAINT, FABRIC PAINTS; DYES  
FOR USE IN THE MANUFACTURE OF LEATHER,  
FUR, WOOD; PERMANENT COLOR REFINISH  
FOR LEATHER AND VINYL; PAINTS; CERAMIC

PAINTS; PAINT THINNERS; COATING COMPOSI-  
TIONS IN THE NATURE OF PAINT FOR INDUS-  
TRIAL APPLICATIONS; LIME WASH PAINTS;  
STICKY CHEMICAL DOPES IN THE NATURE OF  
LACQUERS FOR IN ADHESIVE USE; WATER-  
PROOF PAINTS, IN CLASS 2 (U.S. CLS. 6, 11 AND 16).

FIRST USE 8-13-2007; IN COMMERCE 8-13-2007.

SN 78-897,484, FILED 5-31-2006.

MIDGE BUTLER, EXAMINING ATTORNEY

**Int. Cl.: 11**

**Prior U.S. Cls.: 13, 21, 23, 31, and 34**

**United States Patent and Trademark Office**

**Reg. No. 3,455,645**

**Registered June 24, 2008**

**TRADEMARK  
PRINCIPAL REGISTER**

**PERMLIGHT**

PERMLIGHT PRODUCTS, INC. (CALIFORNIA CORPORATION)  
422 W. SIXTH STREET  
TUSTIN, CA 92780

FOR: ILLUMINATION DEVICES, NAMELY, LIGHT-EMITTING DIODE (LED)-BASED LIGHT FIXTURES FOR RESIDENTIAL HOMES AND/OR COMMERCIAL BUILDINGS; MODULAR LED-BASED LIGHTING UNITS; INTERCONNECTED LED-BASED LUMINAIRES FOR USE IN ILLUMINATED SIGNAGE AND DISPLAY LIGHTING; LED-BASED LOW AMBIENT LIGHTING FOR ILLUMI-

NATING FLOORS AND/OR CEILINGS, IN CLASS 11 (U.S. CLS. 13, 21, 23, 31 AND 34).

FIRST USE 12-31-2007; IN COMMERCE 12-31-2007.

THE MARK CONSISTS OF STANDARD CHARACTERS WITHOUT CLAIM TO ANY PARTICULAR FONT, STYLE, SIZE, OR COLOR.

SN 78-897,532, FILED 5-31-2006.

JOHN E. MICHOS, EXAMINING ATTORNEY

**Int. Cl.: 11**

**Prior U.S. Cls.: 13, 21, 23, 31, and 34**

**Reg. No. 3,455,646**

**United States Patent and Trademark Office**

**Registered June 24, 2008**

**TRADEMARK  
PRINCIPAL REGISTER**

**PERMLIGHT**

PERMLIGHT PRODUCTS, INC. (CALIFORNIA CORPORATION)  
422 W. SIXTH STREET  
TUSTIN, CA 92780

FOR: ILLUMINATION DEVICES, NAMELY, LIGHT-EMITTING DIODE (LED)-BASED LIGHT FIXTURES FOR RESIDENTIAL HOMES AND/OR COMMERCIAL BUILDINGS; MODULAR LED-BASED LIGHTING UNITS; INTERCONNECTED LED-BASED LUMINAIRES FOR USE IN ILLUMI-

NATED SIGNAGE AND DISPLAY LIGHTING; LED-BASED LOW AMBIENT LIGHTING FOR ILLUMINATING FLOORS AND/OR CEILINGS, IN CLASS 11 (U.S. CLS. 13, 21, 23, 31 AND 34).

FIRST USE 12-31-1997; IN COMMERCE 12-31-1997.

SN 78-897,536, FILED 5-31-2006.

JOHN E. MICHOS, EXAMINING ATTORNEY



**Int. Cl.: 5**

**Prior U.S. Cls.: 6, 18, 44, 46, 51, and 52**

**United States Patent and Trademark Office**

**Reg. No. 3,455,647**

**Registered June 24, 2008**

**TRADEMARK  
PRINCIPAL REGISTER**

**RX ANALYTIC**

GOLDSTEIN, MICHAEL (UNITED STATES INDIVIDUAL)  
6 BOB HILL ROAD  
RIDGEFIELD, CT 06877

FOR: PHARMACEUTICAL EVALUATION AND PREPARATIONS FOR THE TREATMENT OF IMMUNOGENIC AND PATHOGENIC DISEASE; DRUG DELIVERY AGENTS CONSISTING OF NANO-PHARMACEUTICAL COMPOUNDS THAT FACILITATE A WIDE RANGE FOR PHARMACEUTICALS, IN CLASS 5 (U.S. CLS. 6, 18, 44, 46, 51 AND 52).

FIRST USE 0-0-2006; IN COMMERCE 0-0-2006.

THE MARK CONSISTS OF STANDARD CHARACTERS WITHOUT CLAIM TO ANY PARTICULAR FONT, STYLE, SIZE, OR COLOR.

NO CLAIM IS MADE TO THE EXCLUSIVE RIGHT TO USE "RX", APART FROM THE MARK AS SHOWN.

SN 78-897,971, FILED 6-1-2006.

MARGERY A. TIERNEY, EXAMINING ATTORNEY

**Int. Cl.: 8**

**Prior U.S. Cls.: 23, 28, and 44**

**United States Patent and Trademark Office**

**Reg. No. 3,455,648**

**Registered June 24, 2008**

**TRADEMARK  
PRINCIPAL REGISTER**

**PHANTOM**

THE GILLETTE COMPANY (DELAWARE CORPORATION)  
PRUDENTIAL TOWER BUILDING  
BOSTON, MA 02199

FOR: RAZORS AND RAZOR BLADES; DISPENSERS, CASSETTES, HOLDERS AND CARTRIDGES ALL CONTAINING BLADES; AND STRUCTURAL PARTS THEREFOR, IN CLASS 8 (U.S. CLS. 23, 28 AND 44).

FIRST USE 1-22-2007; IN COMMERCE 1-22-2007.

THE MARK CONSISTS OF STANDARD CHARACTERS WITHOUT CLAIM TO ANY PARTICULAR FONT, STYLE, SIZE, OR COLOR.

SN 78-898,842, FILED 6-2-2006.

ELLEN PERKINS, EXAMINING ATTORNEY

**Int. Cl.: 35**

**Prior U.S. Cls.: 100, 101, and 102**

**United States Patent and Trademark Office**

**Reg. No. 3,455,649**

**Registered June 24, 2008**

**SERVICE MARK  
PRINCIPAL REGISTER**

WHEN YOU'RE READY TO WELD

AIRGAS, INC. (DELAWARE CORPORATION)  
259 RADNOR-CHESTER ROAD  
RADNOR, PA 190874579

FIRST USE 8-1-2006; IN COMMERCE 8-1-2006.

FOR: COMPUTERIZED ONLINE RETAIL STORE SERVICES, COMPUTERIZED ONLINE CATALOG SERVICES, CATALOG ORDERING SERVICES, RETAIL STORE SERVICES, AND DISTRIBUTORSHIP SERVICES, ALL FEATURING WELDING EQUIPMENT AND WELDING SUPPLIES, IN CLASS 35 (U.S. CLS. 100, 101 AND 102).

THE MARK CONSISTS OF STANDARD CHARACTERS WITHOUT CLAIM TO ANY PARTICULAR FONT, STYLE, SIZE, OR COLOR.

SN 78-900,146, FILED 6-5-2006.

BARNEY CHARLON, EXAMINING ATTORNEY

**Int. Cl.: 9**

**Prior U.S. Cls.: 21, 23, 26, 36, and 38**

**Reg. No. 3,455,650**

**United States Patent and Trademark Office**

**Registered June 24, 2008**

---

**TRADEMARK  
PRINCIPAL REGISTER**

**Killer**

BIGFOOT NETWORKS (TEXAS CORPORATION)  
3925 WEST BRAKER LANE, 3RD FLOOR  
AUSTIN, TX 78759

THE MARK CONSISTS OF STANDARD CHAR-  
ACTERS WITHOUT CLAIM TO ANY PARTICULAR  
FONT, STYLE, SIZE, OR COLOR.

FOR: COMPUTER NETWORKING HARDWARE,  
IN CLASS 9 (U.S. CLS. 21, 23, 26, 36 AND 38).

SN 78-900,569, FILED 6-5-2006.

FIRST USE 7-13-2006; IN COMMERCE 7-13-2006.

ANTHONY RINKER, EXAMINING ATTORNEY

**Int. Cl.: 20**

**Prior U.S. Cls.: 2, 13, 22, 25, 32, and 50**

**Reg. No. 3,455,651**

**United States Patent and Trademark Office**

**Registered June 24, 2008**

---

**TRADEMARK  
PRINCIPAL REGISTER**

**POP N' SHAKE**

ERIE COUNTY PLASTICS CORPORATION  
(PENNSYLVANIA CORPORATION)  
844 ROUTE 6  
CORRY, PA 16407

THE MARK CONSISTS OF STANDARD CHAR-  
ACTERS WITHOUT CLAIM TO ANY PARTICULAR  
FONT, STYLE, SIZE, OR COLOR.

FOR: CONTAINER CLOSURES OF PLASTIC, IN  
CLASS 20 (U.S. CLS. 2, 13, 22, 25, 32 AND 50).

SN 78-900,764, FILED 6-5-2006.

FIRST USE 4-1-2007; IN COMMERCE 4-1-2007.

LESLEY LAMOTHE, EXAMINING ATTORNEY

**Int. Cls.: 5 and 10**

**Prior U.S. Cls.: 6, 18, 26, 39, 44, 46, 51, and 52**

**United States Patent and Trademark Office**

**Reg. No. 3,455,652**

**Registered June 24, 2008**

**TRADEMARK  
PRINCIPAL REGISTER**

**PROSPERA**

NOVASPINE, LLC (NEW YORK LTD LIAB CO)  
15 HERITAGE COURT  
TARRYTOWN, NY 10591

FOR: WOUND TREATMENT PRODUCTS,  
NAMELY, KITS, BANDAGES, DRESSINGS, GAUZE,  
OINTMENTS, CREAMS, ADHESIVE TAPE, AND  
WOUND CARE PREPARATIONS FOR NEGATIVE  
PRESSURE WOUND TREATMENT, IN CLASS 5  
(U.S. CLS. 6, 18, 44, 46, 51 AND 52).

FIRST USE 1-0-2007; IN COMMERCE 1-0-2007.

FOR: MEDICAL APPARATUS AND INSTRU-  
MENTS, NAMELY, VACUUM PUMPS, SUCTION

DEVICES AND DRAINAGE TUBES, IN CLASS 10  
(U.S. CLS. 26, 39 AND 44).

FIRST USE 2-0-2007; IN COMMERCE 2-0-2007.

THE MARK CONSISTS OF STANDARD CHAR-  
ACTERS WITHOUT CLAIM TO ANY PARTICULAR  
FONT, STYLE, SIZE, OR COLOR.

THE ENGLISH TRANSLATION OF THE WORD  
"PROSPERA" IN THE MARK IS PROSPER.

SN 78-900,935, FILED 6-5-2006.

NAAKWAMA ANKRAH, EXAMINING ATTORNEY

**Int. Cl.: 35**

**Prior U.S. Cls.: 100, 101, and 102**

**United States Patent and Trademark Office**

**Reg. No. 3,455,653**

**Registered June 24, 2008**

---

**SERVICE MARK  
PRINCIPAL REGISTER**

**YOUR WORLD INFLUENCED**

MARKETINGWORKS, INC. (CALIFORNIA CORPORATION)  
7000 ROMAINE STREET, SUITE 200  
LOS ANGELES, CA 90038

FOR: BUSINESS MARKETING SERVICES FOR OTHERS USING STATE-OF-THE-ART ONLINE METRICS TECHNIQUES AND INTELLIGENCE ABOUT CONSUMERS AND BUSINESSES, IN CLASS 35 (U.S. CLS. 100, 101 AND 102).

FIRST USE 5-30-2006; IN COMMERCE 5-30-2006.

THE MARK CONSISTS OF STANDARD CHARACTERS WITHOUT CLAIM TO ANY PARTICULAR FONT, STYLE, SIZE, OR COLOR.

SN 78-900,967, FILED 6-5-2006.

JIM RINGLE, EXAMINING ATTORNEY

Int. Cl.: 42

Prior U.S. Cls.: 100 and 101

United States Patent and Trademark Office

Reg. No. 3,455,654

Registered June 24, 2008

SERVICE MARK  
PRINCIPAL REGISTER



JOHNSON, THOMASINE (UNITED STATES INDIVIDUAL)  
3318 BRECKINRIDGE LN  
MISSOURI CITY, TX 77459

FOR: INTERIOR AND EXTERIOR DESIGN SERVICES, IN CLASS 42 (U.S. CLS. 100 AND 101).

FIRST USE 2-12-2003; IN COMMERCE 2-12-2003.

NO CLAIM IS MADE TO THE EXCLUSIVE RIGHT TO USE "DESIGNS", APART FROM THE MARK AS SHOWN.

THE COLORS, RED, BLACK, GREY, AND WHITE, ARE CLAIMED AS A FEATURE OF THE MARK.

THE COLOR, RED, APPEARS IN THE STYLIZED LETTER, "J", AND IN THE PUNCTUATION SIGN; THE COLOR, BLACK, APPEARS IN THE RECTANGLE AND IN THE WORDING, "EN TERIOR DESIGNS"; THE COLOR, GREY, APPEARS IN THE SMALLER RECTANGLE DESIGN; AND THE COLOR, WHITE, APPEARS IN THE BACKGROUND OF THE MARK.

SN 78-901,333, FILED 6-6-2006.

RICHARD A. STRASER, EXAMINING ATTORNEY



**Int. Cl.: 7**

**Prior U.S. Cls.: 13, 19, 21, 23, 31, 34, and 35**

**United States Patent and Trademark Office**

**Reg. No. 3,455,655**

**Registered June 24, 2008**

**TRADEMARK  
PRINCIPAL REGISTER**

**SINGER** | Inspiration

KSIN LUXEMBOURG III, S.AR.L. (LUXEM-  
BOURG CORPORATION)  
1, RUE DES GLACIS  
L-1628, LUXEMBOURG

FOR: SEWING MACHINES, IN CLASS 7 (U.S. CLS.  
13, 19, 21, 23, 31, 34 AND 35).

FIRST USE 12-31-2006; IN COMMERCE 12-31-2006.

OWNER OF U.S. REG. NOS. 49,599, 2,990,313, AND  
OTHERS.

SN 78-901,363, FILED 6-6-2006.

JOHN SCHUYLER YARD, EXAMINING ATTOR-  
NEY

**Int. Cl.: 9**

**Prior U.S. Cls.: 21, 23, 26, 36, and 38**

**Reg. No. 3,455,656**

**United States Patent and Trademark Office**

**Registered June 24, 2008**

**TRADEMARK  
PRINCIPAL REGISTER**

**QUAIL DIGITAL**

QUAIL LIMITED (UNITED KINGDOM LIMITED  
COMPANY)  
92 LOTS ROAD  
LONDON, ENGLAND, UNITED KINGDOM SW10  
0QD

FOR: HEADSET COMMUNICATION SYSTEMS  
COMPRISED OF A BELTPACK TRANSCEIVER,  
CHARGER UNITS, PRIMARY OR BASE STATIONS,  
A ROAD LOOP INTERFACE UNIT, SPEAKER POST  
ASSEMBLY AND INTERFACE, SPEAKER POST  
AND HEADSET; KEYPADS, TOUCHSCREENS  
AND CONTROL SOFTWARE, IN CLASS 9 (U.S.  
CLS. 21, 23, 26, 36 AND 38).

FIRST USE 6-0-2003; IN COMMERCE 7-0-2006.

THE MARK CONSISTS OF STANDARD CHAR-  
ACTERS WITHOUT CLAIM TO ANY PARTICULAR  
FONT, STYLE, SIZE, OR COLOR.

NO CLAIM IS MADE TO THE EXCLUSIVE  
RIGHT TO USE "DIGITAL", APART FROM THE  
MARK AS SHOWN.

SN 78-901,401, FILED 6-6-2006.

WON TEAK OH, EXAMINING ATTORNEY

**Int. Cls.: 3, 5, 8, 16, 20, and 21**

**Prior U.S. Cls.: 1, 2, 4, 5, 6, 13, 18, 22, 23, 25, 28, 29, 30, 32, 33, 37, 38, 40, 44, 46, 50, 51, and 52**

**Reg. No. 3,455,657**

**United States Patent and Trademark Office**

**Registered June 24, 2008**

**TRADEMARK  
PRINCIPAL REGISTER**

**CERTO**

EASTERN BAG & PAPER COMPANY, INC (CONNECTICUT CORPORATION)  
200 RESEARCH DRIVE  
MILFORD, CT 06450

FOR: HAND SOAP; ALL PURPOSE CLEANERS; FLOOR POLISH; FLOOR FINISHING PREPARATIONS; FLOOR WAX, IN CLASS 3 (U.S. CLS. 1, 4, 6, 50, 51 AND 52).

FIRST USE 4-30-2006; IN COMMERCE 4-30-2006.

FOR: AIR FRESHENERS; SANITIZING WIPES, IN CLASS 5 (U.S. CLS. 6, 18, 44, 46, 51 AND 52).

FIRST USE 4-30-2006; IN COMMERCE 4-30-2006.

FOR: CUTLERY, NAMELY, KNIVES, FORKS, AND SPOONS MADE OF PLASTIC, IN CLASS 8 (U.S. CLS. 23, 28 AND 44).

FIRST USE 4-30-2006; IN COMMERCE 4-30-2006.

FOR: PAPER NAPKINS; PAPER TOWELS; TOILET PAPER; FACIAL TISSUE; PAPER AND GENERAL PURPOSE PLASTIC BAGS; PAPER TOILET SEAT

COVERS; PLASTIC WRAP, IN CLASS 16 (U.S. CLS. 2, 5, 22, 23, 29, 37, 38 AND 50).

FIRST USE 4-30-2006; IN COMMERCE 4-30-2006.

FOR: DRINKING STRAWS, IN CLASS 20 (U.S. CLS. 2, 13, 22, 25, 32 AND 50).

FIRST USE 4-30-2006; IN COMMERCE 4-30-2006.

FOR: CUPS; PLATES; BOWLS; BEVERAGE STIRRERS; PLASTIC STORAGE CONTAINERS FOR DOMESTIC USE; DISPOSABLE LATEX GLOVES FOR GENERAL USE, IN CLASS 21 (U.S. CLS. 2, 13, 23, 29, 30, 33, 40 AND 50).

FIRST USE 4-30-2006; IN COMMERCE 4-30-2006.

THE MARK CONSISTS OF STANDARD CHARACTERS WITHOUT CLAIM TO ANY PARTICULAR FONT, STYLE, SIZE, OR COLOR.

SN 78-901,489, FILED 6-6-2006.

MIDGE BUTLER, EXAMINING ATTORNEY

**Int. Cl.: 9**

**Prior U.S. Cls.: 21, 23, 26, 36, and 38**

**Reg. No. 3,455,658**

**United States Patent and Trademark Office**

**Registered June 24, 2008**

**TRADEMARK  
PRINCIPAL REGISTER**

**PANDA PERIO**

ZYBUTZ, MICHAEL (UNITED KINGDOM INDIVIDUAL)  
8 LANCHESTER ROAD  
LONDON, UNITED KINGDOM N6 4TA

FOR: COMPUTER SOFTWARE FOR USE BY PERIODONTIC PROFESSIONALS TO DIGITALLY CHART PATIENT INFORMATION, DIAGNOSE PERIODONTAL PROBLEMS, AND GENERATE REPORTING LETTERS, IN CLASS 9 (U.S. CLS. 21, 23, 26, 36 AND 38).

FIRST USE 9-0-2006; IN COMMERCE 9-0-2006.

THE MARK CONSISTS OF STANDARD CHARACTERS WITHOUT CLAIM TO ANY PARTICULAR FONT, STYLE, SIZE, OR COLOR.

NO CLAIM IS MADE TO THE EXCLUSIVE RIGHT TO USE "PERIO", APART FROM THE MARK AS SHOWN.

SN 78-902,161, FILED 6-6-2006.

DAWN HAN, EXAMINING ATTORNEY

**Int. Cl.: 20**

**Prior U.S. Cls.: 2, 13, 22, 25, 32, and 50**

**Reg. No. 3,455,659**

**United States Patent and Trademark Office**

**Registered June 24, 2008**

---

**TRADEMARK  
PRINCIPAL REGISTER**

**FUN N' FUNCTIONAL**

ERIE COUNTY PLASTICS CORPORATION  
(PENNSYLVANIA CORPORATION)  
844 ROUTE 6  
CORRY, PA 16407

THE MARK CONSISTS OF STANDARD CHAR-  
ACTERS WITHOUT CLAIM TO ANY PARTICULAR  
FONT, STYLE, SIZE, OR COLOR.

FOR: CONTAINER CLOSURES OF PLASTIC, IN  
CLASS 20 (U.S. CLS. 2, 13, 22, 25, 32 AND 50).

SN 78-902,474, FILED 6-7-2006.

FIRST USE 9-1-2007; IN COMMERCE 9-1-2007.

LESLEY LAMOTHE, EXAMINING ATTORNEY

**Int. Cl.: 20**

**Prior U.S. Cls.: 2, 13, 22, 25, 32, and 50**

**United States Patent and Trademark Office**

**Reg. No. 3,455,660**

**Registered June 24, 2008**

**TRADEMARK  
PRINCIPAL REGISTER**

**CARIBBEAN**

AMERICAN SIGNATURE, INC. (OHIO CORPORATION)  
1800 MOLER ROAD  
COLUMBUS, OH 43207

FOR: FURNITURE, NAMELY, BEDS, DRESSERS, DRESSER MIRRORS, NIGHTSTANDS, CHESTS, BENCHES, ARMOIRES, DINING TABLES, CHAIRS, HUTCHES, SIDEBOARDS, SERVING TABLES, OCCASIONAL TABLES, COCKTAIL TABLES, END TABLES, SOFA TABLES, CURIO CABINETS, IN CLASS 20 (U.S. CLS. 2, 13, 22, 25, 32 AND 50).

FIRST USE 3-0-2007; IN COMMERCE 3-0-2007.

THE MARK CONSISTS OF STANDARD CHARACTERS WITHOUT CLAIM TO ANY PARTICULAR FONT, STYLE, SIZE, OR COLOR.

SN 78-902,577, FILED 6-7-2006.

ROBIN CHOSID, EXAMINING ATTORNEY

**Int. Cl.: 36**

**Prior U.S. Cls.: 100, 101, and 102**

**United States Patent and Trademark Office**

**Reg. No. 3,455,661**

**Registered June 24, 2008**

**SERVICE MARK  
PRINCIPAL REGISTER**



**MONTECITO  
MEDICAL**

MONTECITO INVESTMENT COMPANY, LLC  
(FLORIDA LTD LIAB CO)  
SUITE 200  
7785 BAYMEADOWS WAY  
JACKSONVILLE, FL 32256

FOR: REAL ESTATE MANAGEMENT, IN CLASS  
36 (U.S. CLS. 100, 101 AND 102).

FIRST USE 4-30-2006; IN COMMERCE 4-30-2006.

NO CLAIM IS MADE TO THE EXCLUSIVE  
RIGHT TO USE "MEDICAL" AND THE REPRESENTATION

OF THE CADUCEUS, APART FROM THE  
MARK AS SHOWN.

THE MARK CONSISTS OF THE DESIGN OF A  
CADUCEUS SUPERIMPOSED OVER THE FACADE  
OF A BUILDING WITH TWO COLUMNS WITH THE  
WORDS "MONTECITO MEDICAL" BELOW THE  
DESIGN.

SN 78-903,094, FILED 6-7-2006.

INGA ERVIN, EXAMINING ATTORNEY

**Int. Cl.: 37**

**Prior U.S. Cls.: 100, 103, and 106**

**Reg. No. 3,455,662**

**United States Patent and Trademark Office**

**Registered June 24, 2008**

**SERVICE MARK  
PRINCIPAL REGISTER**



**MONTECITO  
MEDICAL**

MONTECITO INVESTMENT COMPANY, LLC  
(FLORIDA LTD LIAB CO)  
SUITE 200  
7785 BAYMEADOWS WAY  
JACKSONVILLE, FL 32256

FOR: REAL ESTATE DEVELOPMENT, IN CLASS  
37 (U.S. CLS. 100, 103 AND 106).

FIRST USE 4-30-2006; IN COMMERCE 4-30-2006.

NO CLAIM IS MADE TO THE EXCLUSIVE  
RIGHT TO USE "MEDICAL" AND THE REPRESENTATION

OF THE CADUCEUS, APART FROM THE  
MARK AS SHOWN.

THE MARK CONSISTS OF THE DESIGN OF A  
CADUCEUS SUPERIMPOSED OVER THE FACADE  
OF A BUILDING WITH TWO COLUMNS WITH THE  
WORDS "MONTECITO MEDICAL" BELOW THE  
DESIGN.

SN 78-903,114, FILED 6-7-2006.

INGA ERVIN, EXAMINING ATTORNEY



**Int. Cl.: 25**

**Prior U.S. Cls.: 22 and 39**

**United States Patent and Trademark Office**

**Reg. No. 3,455,663**

**Registered June 24, 2008**

**TRADEMARK  
PRINCIPAL REGISTER**



JBS FISHING LINE, LLC (ALABAMA LTD LIAB  
CO)  
2632 MARTIN STREET SOUTH  
PELL CITY, AL 35128

THE MARK CONSISTS OF DESIGN OF A FISH  
WITH AN OPEN MOUTH.

FOR: SHORTS, IN CLASS 25 (U.S. CLS. 22 AND 39).

SN 78-903,545, FILED 6-8-2006.

FIRST USE 2-18-2008; IN COMMERCE 2-18-2008.

CAROL SPILS, EXAMINING ATTORNEY

**Int. Cl.: 35**

**Prior U.S. Cls.: 100, 101, and 102**

**United States Patent and Trademark Office**

**Reg. No. 3,455,664**

**Registered June 24, 2008**

**SERVICE MARK  
PRINCIPAL REGISTER**

THE FIRST NAME IN HEALTHY  
HOMES

AERUS CONCEPTS, L.P. (TEXAS LIMITED  
PARTNERSHIP)  
LEGAL DEPARTMENT  
5420 LBJ FREEWAY, SUITE 800  
DALLAS, TX 75240

FOR: PROMOTING THE SALE OF GOODS AND  
SERVICES OF OTHERS IN THE HOME WELLNESS  
AND FLOOR CARE INDUSTRY THROUGH THE  
DISTRIBUTION AND DISSEMINATION OF PRO-  
MOTIONAL MATERIALS AND CONSUMER PRO-  
DUCT INFORMATION IN PRINT AND ON THE  
INTERNET, IN CLASS 35 (U.S. CLS. 100, 101 AND  
102).

FIRST USE 9-30-2006; IN COMMERCE 9-30-2006.

THE MARK CONSISTS OF STANDARD CHAR-  
ACTERS WITHOUT CLAIM TO ANY PARTICULAR  
FONT, STYLE, SIZE, OR COLOR.

NO CLAIM IS MADE TO THE EXCLUSIVE  
RIGHT TO USE "HEALTHY HOMES", APART  
FROM THE MARK AS SHOWN.

SN 78-904,183, FILED 6-8-2006.

INGA ERVIN, EXAMINING ATTORNEY

**Int. Cl.: 35**

**Prior U.S. Cls.: 100, 101, and 102**

**United States Patent and Trademark Office**

**Reg. No. 3,455,665**

**Registered June 24, 2008**

---

**SERVICE MARK  
PRINCIPAL REGISTER**

**STRATERRA**

STRATERRA (WASHINGTON PARTNERSHIP)  
#284  
7683 SE 27TH STREET  
MERCER ISLAND, WA 98040

THE MARK CONSISTS OF STANDARD CHAR-  
ACTERS WITHOUT CLAIM TO ANY PARTICULAR  
FONT, STYLE, SIZE, OR COLOR.

FOR: BUSINESS CONSULTING AND BUSINESS  
INFORMATION FOR ENTERPRISES, IN CLASS 35  
(U.S. CLS. 100, 101 AND 102).

SN 78-904,273, FILED 6-8-2006.

FIRST USE 5-5-2008; IN COMMERCE 5-5-2008.

JIM RINGLE, EXAMINING ATTORNEY

**Int. Cl.: 25**

**Prior U.S. Cls.: 22 and 39**

**United States Patent and Trademark Office**

**Reg. No. 3,455,666**

**Registered June 24, 2008**

**TRADEMARK  
PRINCIPAL REGISTER**



**Blue Aristocrat**

BEYZAVIE, SEKINEH (IRAN INDIVIDUAL)  
170 SOUTH BEVERLY DRIVE #316  
BEVERLY HILLS, CA 90210

NO CLAIM IS MADE TO THE EXCLUSIVE  
RIGHT TO USE "BLUE", APART FROM THE MARK  
AS SHOWN.

FOR: MEN'S AND WOMEN'S JEANS, PANTS,  
SHIRTS, JACKETS, SHORTS, SKIRTS, TOPS, BLOU-  
SES, COATS, CAPRI PANTS, AND CROPPED  
PANTS, IN CLASS 25 (U.S. CLS. 22 AND 39).

SN 78-904,414, FILED 6-9-2006.

FIRST USE 3-20-2005; IN COMMERCE 3-20-2005.

PAUL E. FAHRENKOPF, EXAMINING ATTORNEY

**Int. Cl.: 35**

**Prior U.S. Cls.: 100, 101, and 102**

**United States Patent and Trademark Office**

**Reg. No. 3,455,667**

**Registered June 24, 2008**

**SERVICE MARK  
PRINCIPAL REGISTER**



INTERNATIONAL TRUCK INTELLECTUAL  
PROPERTY COMPANY, LLC (ILLINOIS LTD  
LIAB CO)  
LAW DEPARTMENT  
4201 WINFIELD ROAD  
WARRENVILLE, IL 60555

FIRST USE 7-1-2006; IN COMMERCE 7-1-2006.

SN 78-904,710, FILED 6-9-2006.

FOR: INVENTORY CONTROL SYSTEM FOR  
TRUCKS AND PARTS, IN CLASS 35 (U.S. CLS. 100,  
101 AND 102).

NAAKWAMA ANKRAH, EXAMINING ATTORNEY

**Int. Cl.: 27**

**Prior U.S. Cls.: 19, 20, 37, 42, and 50**

**United States Patent and Trademark Office**

**Reg. No. 3,455,668**

**Registered June 24, 2008**

**TRADEMARK  
PRINCIPAL REGISTER**

**MOHAWK EASYCHOICE**

MOHAWK BRANDS, INC. (DELAWARE CORPORATION)  
103 FOULK RD., SUITE 202  
WILMINGTON, DE 19803

FOR: CARPETING, IN CLASS 27 (U.S. CLS. 19, 20, 37, 42 AND 50).

FIRST USE 12-2-2006; IN COMMERCE 12-2-2006.

THE MARK CONSISTS OF STANDARD CHARACTERS WITHOUT CLAIM TO ANY PARTICULAR FONT, STYLE, SIZE, OR COLOR.

OWNER OF U.S. REG. NOS. 1,099,660, 2,955,748, AND OTHERS.

SN 78-905,599, FILED 6-12-2006.

KELLY BOULTON, EXAMINING ATTORNEY

**Int. Cl.: 37**

**Prior U.S. Cls.: 100, 103, and 106**

**United States Patent and Trademark Office**

**Reg. No. 3,455,669**

**Registered June 24, 2008**

**SERVICE MARK  
PRINCIPAL REGISTER**

**WIMBLEDON PROPERTIES**

WIMBLEDON PROPERTIES, LLC (TENNESSEE  
LTD LIAB CO)

5000 CLAYTON ROAD

MARYVILLE, TN 37804

FOR: DEVELOPMENT OF RESIDENTIAL REAL  
ESTATE, IN CLASS 37 (U.S. CLS. 100, 103 AND 106).

FIRST USE 6-0-2006; IN COMMERCE 6-0-2006.

THE MARK CONSISTS OF STANDARD CHAR-  
ACTERS WITHOUT CLAIM TO ANY PARTICULAR  
FONT, STYLE, SIZE, OR COLOR.

NO CLAIM IS MADE TO THE EXCLUSIVE  
RIGHT TO USE "PROPERTIES", APART FROM  
THE MARK AS SHOWN.

SN 78-906,170, FILED 6-12-2006.

REBECCA EISINGER, EXAMINING ATTORNEY

**Int. Cls.: 36, 37, 42, and 44**

**Prior U.S. Cls.: 100, 101, 102, 103, and 106**

**United States Patent and Trademark Office**

**Reg. No. 3,455,670**

**Registered June 24, 2008**

**SERVICE MARK  
PRINCIPAL REGISTER**

# TUCKER HILL

SOUTHERN LAND COMPANY, LLC (TENNESSEE LTD LIAB CO)  
SUITE 200  
501 CORPORATE CENTER DRIVE  
FRANKLIN, TN 37067

FOR: REAL ESTATE BROKERAGE SERVICES; LEASING OF REAL ESTATE; REAL ESTATE MANAGEMENT; APARTMENT COMPLEX LEASING, COMMERCIAL OFFICE AND RETAIL SPACE LEASING, IN CLASS 36 (U.S. CLS. 100, 101 AND 102).

FIRST USE 3-0-2007; IN COMMERCE 3-0-2007.

FOR: REAL ESTATE DEVELOPMENT; LAND DEVELOPMENT SERVICES, NAMELY, MASTER PLANNING AND LAYING OUT OF RESIDENTIAL AND/OR COMMERCIAL COMMUNITIES; RESIDENTIAL AND COMMERCIAL BUILDING CONSTRUCTION AND CONSTRUCTION MANAGEMENT SERVICES; GOLF COURSE CONSTRUCTION; LANDSCAPE LIGHTING INSTALLATION SERVICES; INSTALLATION OF LANDSCAPE IRRIGATION SYSTEMS; DEVELOPMENT OF MIXED-USE COMMERCIAL AND RESIDENTIAL REAL ESTATE PROPERTIES AND SHOPPING MALLS, IN CLASS 37 (U.S. CLS. 100, 103 AND 106).

FIRST USE 3-0-2007; IN COMMERCE 3-0-2007.

FOR: INTERIOR DECORATING; ARCHITECTURAL DESIGN; ARCHITECTURAL DRAFTING SERVICES, IN CLASS 42 (U.S. CLS. 100 AND 101).

FIRST USE 3-0-2007; IN COMMERCE 3-0-2007.

FOR: LANDSCAPE GARDENING DESIGN FOR OTHERS; LANDSCAPE MAINTENANCE SERVICES, NAMELY, LAWN AND PLANT CARE; LANDSCAPE INSTALLATION SERVICES, LANDSCAPE GARDENING, IN CLASS 44 (U.S. CLS. 100 AND 101).

FIRST USE 3-0-2007; IN COMMERCE 3-0-2007.

THE MARK CONSISTS OF STANDARD CHARACTERS WITHOUT CLAIM TO ANY PARTICULAR FONT, STYLE, SIZE, OR COLOR.

THE NAME(S), PORTRAIT(S), AND/OR SIGNATURE(S) SHOWN IN THE MARK DOES NOT IDENTIFY A PARTICULAR LIVING INDIVIDUAL.

SN 78-906,223, FILED 6-12-2006.

EDWARD NELSON, EXAMINING ATTORNEY



**Int. Cl.: 16**

**Prior U.S. Cls.: 2, 5, 22, 23, 29, 37, 38, and 50**

**Reg. No. 3,455,671**

**United States Patent and Trademark Office**

**Registered June 24, 2008**

**TRADEMARK  
PRINCIPAL REGISTER**

**HONOR SOUL IN HEAVEN**

LOEW, GERALD (UNITED STATES INDIVIDUAL)  
10 IPSWICH AVENUE  
GREAT NECK, NY 11021

THE MARK CONSISTS OF STANDARD CHARACTERS WITHOUT CLAIM TO ANY PARTICULAR FONT, STYLE, SIZE, OR COLOR.

FOR: BUMPER STICKERS, IN CLASS 16 (U.S. CLS. 2, 5, 22, 23, 29, 37, 38 AND 50).

SN 78-907,015, FILED 6-13-2006.

FIRST USE 1-15-2007; IN COMMERCE 4-22-2007.

DANIEL BRODY, EXAMINING ATTORNEY

**Int. Cls.: 9 and 16**

**Prior U.S. Cls.: 2, 5, 21, 22, 23, 26, 29, 36, 37, 38, and 50**

**United States Patent and Trademark Office**

**Reg. No. 3,455,672**

**Registered June 24, 2008**

**TRADEMARK  
PRINCIPAL REGISTER**

**FREEZE**marker

TEMPTIME CORPORATION (DELAWARE CORPORATION)  
116 AMERICAN ROAD  
MORRIS PLAINS, NJ 07950

FOR: TIME-TEMPERATURE SENSITIVE LABELS THAT MONITOR THE CONDITION OF THERMALLY SENSITIVE PRODUCTS, IN CLASS 9 (U.S. CLS. 21, 23, 26, 36 AND 38).

FIRST USE 2-15-2008; IN COMMERCE 2-15-2008.

FOR: PAPER HEAT SENSITIVE AND TIME SENSITIVE LABELS USED TO ENSURE THAT PERISHABLE GOODS ARE FRESH AND NOT PAST THEIR

SELL-BY DATES, IN CLASS 16 (U.S. CLS. 2, 5, 22, 23, 29, 37, 38 AND 50).

FIRST USE 2-15-2008; IN COMMERCE 2-15-2008.

THE MARK CONSISTS OF STANDARD CHARACTERS WITHOUT CLAIM TO ANY PARTICULAR FONT, STYLE, SIZE, OR COLOR.

OWNER OF U.S. REG. NOS. 2,064,872 AND 2,816,032.

SN 78-907,132, FILED 6-13-2006.

ALEX KEAM, EXAMINING ATTORNEY

**Int. Cl.: 33**

**Prior U.S. Cls.: 47 and 49**

**United States Patent and Trademark Office**

**Reg. No. 3,455,673**

**Registered June 24, 2008**

**TRADEMARK  
PRINCIPAL REGISTER**

**SANDOWN**

BRATASIUK, ROMAN (AUSTRALIA INDIVIDUAL)  
363 THE PARADE  
KENSINGTON PARK, SOUTH AUSTRALIA, AUSTRALIA 5065

FOR: TABLE WINES; WINE, IN CLASS 33 (U.S. CLS. 47 AND 49).

FIRST USE 0-0-1999; IN COMMERCE 0-0-1999.

THE MARK CONSISTS OF STANDARD CHARACTERS WITHOUT CLAIM TO ANY PARTICULAR FONT, STYLE, SIZE, OR COLOR.

SN 78-907,577, FILED 6-14-2006.

MICHAEL WEBSTER, EXAMINING ATTORNEY

**Int. Cl.: 33**

**Prior U.S. Cls.: 47 and 49**

**United States Patent and Trademark Office**

**Reg. No. 3,455,674**

**Registered June 24, 2008**

**TRADEMARK  
PRINCIPAL REGISTER**

**ASTRALIS**

BRATASIUK, ROMAN (AUSTRALIA INDIVIDUAL)  
363 THE PARADE  
KENSINGTON PARK, AUSTRALIA 5065

FOR: TABLE WINES; WINE, IN CLASS 33 (U.S. CLS. 47 AND 49).

FIRST USE 0-0-1996; IN COMMERCE 0-0-1996.

THE MARK CONSISTS OF STANDARD CHARACTERS WITHOUT CLAIM TO ANY PARTICULAR FONT, STYLE, SIZE, OR COLOR.

THE WORDING "ASTRALIS" HAS NO MEANING OTHER THAN TRADEMARK SIGNIFICANCE.

SN 78-907,578, FILED 6-14-2006.

MICHAEL WEBSTER, EXAMINING ATTORNEY

**Int. Cl.: 33**

**Prior U.S. Cls.: 47 and 49**

**United States Patent and Trademark Office**

**Reg. No. 3,455,675**

**Registered June 24, 2008**

**TRADEMARK  
PRINCIPAL REGISTER**

**LIANDRA**

BRATASIUK, ROMAN (AUSTRALIA INDIVIDUAL)  
363 THE PARADE  
KENSINGTON PARK, AUSTRALIA 5065

FOR: TABLE WINES; WINE, IN CLASS 33 (U.S. CLS. 47 AND 49).

FIRST USE 0-0-1996; IN COMMERCE 0-0-1996.

THE MARK CONSISTS OF STANDARD CHARACTERS WITHOUT CLAIM TO ANY PARTICULAR FONT, STYLE, SIZE, OR COLOR.

THE WORDING "LIANDRA" HAS NO MEANING OTHER THAN TRADEMARK SIGNIFICANCE.

SN 78-907,581, FILED 6-14-2006.

MICHAEL WEBSTER, EXAMINING ATTORNEY

**Int. Cl.: 33**

**Prior U.S. Cls.: 47 and 49**

**United States Patent and Trademark Office**

**Reg. No. 3,455,676**

**Registered June 24, 2008**

**TRADEMARK  
PRINCIPAL REGISTER**

**BAKERS GULLY**

BRATASIUK, ROMAN (AUSTRALIA INDIVIDUAL)  
363 THE PARADE  
KENSINGTON PARK, SOUTH AUSTRALIA, AUSTRALIA 5065

FOR: TABLE WINES; WINE, IN CLASS 33 (U.S. CLS. 47 AND 49).

FIRST USE 0-0-2004; IN COMMERCE 0-0-2004.

THE MARK CONSISTS OF STANDARD CHARACTERS WITHOUT CLAIM TO ANY PARTICULAR FONT, STYLE, SIZE, OR COLOR.

SN 78-907,583, FILED 6-14-2006.

MICHAEL WEBSTER, EXAMINING ATTORNEY

**Int. Cl.: 33**

**Prior U.S. Cls.: 47 and 49**

**United States Patent and Trademark Office**

**Reg. No. 3,455,677**

**Registered June 24, 2008**

**TRADEMARK  
PRINCIPAL REGISTER**

**PIGGOTT RANGE**

BRATASIUK, ROMAN (AUSTRALIA INDIVIDUAL)  
363 THE PARADE  
KENSINGTON PARK, AUSTRALIA 5065

THE MARK CONSISTS OF STANDARD CHARACTERS WITHOUT CLAIM TO ANY PARTICULAR FONT, STYLE, SIZE, OR COLOR.

FOR: TABLE WINES; WINE, IN CLASS 33 (U.S. CLS. 47 AND 49).

SN 78-907,585, FILED 6-14-2006.

FIRST USE 0-0-1998; IN COMMERCE 0-0-1998.

KAPIL BHANOT, EXAMINING ATTORNEY

**Int. Cls.: 36 and 45**

**Prior U.S. Cls.: 100, 101, and 102**

**United States Patent and Trademark Office**

**Reg. No. 3,455,678**

**Registered June 24, 2008**

**SERVICE MARK  
PRINCIPAL REGISTER**

**RELATED SIGNATURE SERVICES**

THE RELATED COMPANIES, L.P. (NEW YORK  
LIMITED PARTNERSHIP)  
625 MADISON AVENUE  
NEW YORK, NY 10022

FOR: REAL ESTATE BROKERAGE, LEASING  
AND MANAGEMENT, IN CLASS 36 (U.S. CLS. 100,  
101 AND 102).

FIRST USE 5-0-2006; IN COMMERCE 5-0-2006.

FOR: PERSONALIZED CONCIERGE SERVICES  
FOR OTHERS, NAMELY, MAKING REQUESTED  
PERSONAL ARRANGEMENTS, ERRANDS AND  
RESERVATIONS, AND PROVIDING CUSTOMER-  
SPECIFIC INFORMATION TO MEET INDIVIDUAL  
NEEDS RENDERED TOGETHER IN AN APART-  
MENT COMPLEX, IN CLASS 45 (U.S. CLS. 100 AND  
101).

FIRST USE 5-0-2006; IN COMMERCE 5-0-2006.

THE MARK CONSISTS OF STANDARD CHAR-  
ACTERS WITHOUT CLAIM TO ANY PARTICULAR  
FONT, STYLE, SIZE, OR COLOR.

OWNER OF U.S. REG. NOS. 2,964,804, 2,964,806,  
AND OTHERS.

NO CLAIM IS MADE TO THE EXCLUSIVE  
RIGHT TO USE "SERVICES", APART FROM THE  
MARK AS SHOWN.

SN 78-907,768, FILED 6-14-2006.

JAMES LOVELACE, EXAMINING ATTORNEY



**Int. Cl.: 26**

**Prior U.S. Cls.: 37, 39, 40, 42, and 50**

**Reg. No. 3,455,679**

**United States Patent and Trademark Office**

**Registered June 24, 2008**

---

**TRADEMARK  
PRINCIPAL REGISTER**

# PhatClips

MOUNCE, DANNY A. (UNITED STATES INDIVIDUAL)  
108G WINDING WAY  
COVINGTON, KY 41011

THE MARK CONSISTS OF STANDARD CHARACTERS WITHOUT CLAIM TO ANY PARTICULAR FONT, STYLE, SIZE, OR COLOR.

FOR: ORNAMENTAL NOVELTY HAT CLIPS, IN CLASS 26 (U.S. CLS. 37, 39, 40, 42 AND 50).

SN 78-908,471, FILED 6-14-2006.

FIRST USE 2-28-2006; IN COMMERCE 2-28-2006.

DANIEL CAPSHAW, EXAMINING ATTORNEY

**Int. Cl.: 26**

**Prior U.S. Cls.: 37, 39, 40, 42, and 50**

**Reg. No. 3,455,680**

**United States Patent and Trademark Office**

**Registered June 24, 2008**

---

**TRADEMARK  
PRINCIPAL REGISTER**

# Wear the Bobble

MOUNCE, DANNY A. (UNITED STATES INDIVIDUAL)

108G WINDING WAY

COVINGTON, KY 41011

FOR: ORNAMENTAL NOVELTY HAT CLIPS, IN CLASS 26 (U.S. CLS. 37, 39, 40, 42 AND 50).

FIRST USE 2-28-2006; IN COMMERCE 2-28-2006.

THE MARK CONSISTS OF STANDARD CHARACTERS WITHOUT CLAIM TO ANY PARTICULAR FONT, STYLE, SIZE, OR COLOR.

NO CLAIM IS MADE TO THE EXCLUSIVE RIGHT TO USE "BOBBLE", APART FROM THE MARK AS SHOWN.

SN 78-908,484, FILED 6-14-2006.

DANIEL CAPSHAW, EXAMINING ATTORNEY

**Int. Cl.: 26**

**Prior U.S. Cls.: 37, 39, 40, 42, and 50**

**United States Patent and Trademark Office**

**Reg. No. 3,455,681**

**Registered June 24, 2008**

**TRADEMARK  
PRINCIPAL REGISTER**



MOUNCE, DANNY A. (UNITED STATES INDIVIDUAL)  
108G WINDING WAY  
COVINGTON, KY 41011

THE RECTANGULAR BACKGROUND IS BLACK, THE WORDING IS WHITE, THE UNDERLINE AND ARCH DESIGNS ARE BLUE.

FOR: ORNAMENTAL NOVELTY HAT CLIPS, IN CLASS 26 (U.S. CLS. 37, 39, 40, 42 AND 50).

SN 78-908,498, FILED 6-14-2006.

FIRST USE 2-28-2006; IN COMMERCE 2-28-2006.

THE COLOR(S) WHITE, BLACK AND BLUE IS/ARE CLAIMED AS A FEATURE OF THE MARK.

DANIEL CAPSHAW, EXAMINING ATTORNEY

**Int. Cl.: 41**

**Prior U.S. Cls.: 100, 101, and 107**

**United States Patent and Trademark Office**

**Reg. No. 3,455,682**

**Registered June 24, 2008**

**SERVICE MARK  
PRINCIPAL REGISTER**

**START AT HOME**

SCRIPPS NETWORKS, INC. (DELAWARE CORPORATION)  
9721 SHERRILL BOULEVARD  
KNOXVILLE, TN 37932

FOR: PRODUCTION AND DISTRIBUTION OF AUDIO-VISUAL ENTERTAINMENT IN THE NATURE OF TELEVISION PROGRAMS; AUDIO-VISUAL PROGRAMMING SERVICES, NAMELY, TELEVISION PROGRAMMING AND PROGRAMMING ON A GLOBAL COMPUTER NETWORK; PROVIDING INFORMATION VIA A GLOBAL COMPUTER INFORMATION NETWORK IN THE FIELDS OF TELEVISION PROGRAMMING, CRAFTS AND HOBBIES, SEWING AND QUILTING

AS A HOBBY, AND COLLECTING FURNITURE AND ANTIQUES AS A HOBBY, IN CLASS 41 (U.S. CLS. 100, 101 AND 107).

FIRST USE 2-28-2007; IN COMMERCE 2-28-2007.

THE MARK CONSISTS OF STANDARD CHARACTERS WITHOUT CLAIM TO ANY PARTICULAR FONT, STYLE, SIZE, OR COLOR.

SN 78-908,981, FILED 6-15-2006.

CARRIE GENOVESE, EXAMINING ATTORNEY

**Int. Cl.: 11**

**Prior U.S. Cls.: 13, 21, 23, 31, and 34**

**United States Patent and Trademark Office**

**Reg. No. 3,455,683**

**Registered June 24, 2008**

**TRADEMARK  
PRINCIPAL REGISTER**

**OPTI-BAR**

TOWER COMPONENTS, INC. (NORTH CAROLINA CORPORATION)  
5960 US HIGHWAY 64 EAST  
RAMSEUR, NC 27316

FOR: EVAPORATIVE COOLING TOWER COMPONENT PARTS, NAMELY, SPLASH-TYPE FILL MEDIA COMPRISING HIGH DENSITY POLYETHYLENE OR POLYPROPYLENE CO-POLYMERS FOR CROSS-FLOW AND COUNTERFLOW HEAT AND MASS TRANSFER APPLICATION IN EVAPORATIVE COOLING TOWERS, IN CLASS 11 (U.S. CLS. 13, 21, 23, 31 AND 34).

FIRST USE 4-30-1993; IN COMMERCE 4-11-2008.

THE MARK CONSISTS OF STANDARD CHARACTERS WITHOUT CLAIM TO ANY PARTICULAR FONT, STYLE, SIZE, OR COLOR.

SN 78-909,241, FILED 6-15-2006.

TANYA AMOS, EXAMINING ATTORNEY

**Int. Cl.: 7**

**Prior U.S. Cls.: 13, 19, 21, 23, 31, 34, and 35**

**Reg. No. 3,455,684**

**United States Patent and Trademark Office**

**Registered June 24, 2008**

**TRADEMARK  
PRINCIPAL REGISTER**

**ULTRA**

MARATHON EQUIPMENT COMPANY (DELA-  
WARE) (DELAWARE CORPORATION)  
COUNTY HWY 9 - SOUTH  
VERNON, AL 35592

FOR: WASTE DISPOSAL EQUIPMENT, NAMELY,  
COMPACTORS, IN CLASS 7 (U.S. CLS. 13, 19, 21, 23,  
31, 34 AND 35).

FIRST USE 11-1-2004; IN COMMERCE 2-26-2008.

THE MARK CONSISTS OF STANDARD CHAR-  
ACTERS WITHOUT CLAIM TO ANY PARTICULAR  
FONT, STYLE, SIZE, OR COLOR.

OWNER OF U.S. REG. NO. 3,140,312.

SN 78-909,367, FILED 6-15-2006.

LAURIE KAUFMAN, EXAMINING ATTORNEY

**Int. Cl.: 43**

**Prior U.S. Cls.: 100 and 101**

**United States Patent and Trademark Office**

**Reg. No. 3,455,685**

**Registered June 24, 2008**

**SERVICE MARK  
PRINCIPAL REGISTER**

**EPL-TO-GO**

EL POLLO LOCO, INC. (DELAWARE CORPORATION)  
3535 HARBOR BLVD.  
SUITE 100  
COSTA MESA, CA 92626

FOR: CATERING SERVICES, IN CLASS 43 (U.S. CLS. 100 AND 101).

FIRST USE 5-1-2008; IN COMMERCE 5-1-2008.

THE MARK CONSISTS OF STANDARD CHARACTERS WITHOUT CLAIM TO ANY PARTICULAR FONT, STYLE, SIZE, OR COLOR.

SN 78-910,372, FILED 6-16-2006.

JACQUELINE A. LAVINE, EXAMINING ATTORNEY

**Int. Cl.: 35**

**Prior U.S. Cls.: 100, 101, and 102**

**United States Patent and Trademark Office**

**Reg. No. 3,455,686**

**Registered June 24, 2008**

**SERVICE MARK  
PRINCIPAL REGISTER**

**NPDC**

AON CONSULTING, INC. (NEW JERSEY CORPORATION)  
200 E. RANDOLPH STREET  
AON CENTER - 8TH FLOOR LAW DEPARTMENT  
CHICAGO, IL 60601

FOR: BUSINESS CONSULTATION SERVICES PROVIDED TO MEMBER COMPANIES IN THE FIELD OF PRESCRIPTION DRUG COST MANAGEMENT; BUSINESS MANAGEMENT CONSULTATION, NAMELY, PROVIDING MEMBER COMPANIES WITH DATA ANALYSIS, CLINICAL AND PHARMACOLOGICAL COST MANAGEMENT SERVICES TO ASSIST IN THE MANAGEMENT OF EXPENDITURES WITH RESPECT TO EMPLOYEE BENEFIT DRUG PROGRAMS; SOURCING AND PROCUREMENT SERVICES, NAMELY, PROVIDING METHODOLOGIES AND CONSULTING SERVICES

TO MEMBER COMPANIES FOR USE IN CHOOSING SUPPLIERS AND MANAGING PURCHASES; PROCUREMENT SERVICES, NAMELY, SUPPLIER NEGOTIATIONS AND VENDOR MANAGEMENT IN THE FIELD OF PRESCRIPTION DRUGS, IN CLASS 35 (U.S. CLS. 100, 101 AND 102).

FIRST USE 4-30-2008; IN COMMERCE 4-30-2008.

THE MARK CONSISTS OF STANDARD CHARACTERS WITHOUT CLAIM TO ANY PARTICULAR FONT, STYLE, SIZE, OR COLOR.

SN 78-910,403, FILED 6-16-2006.

JULIE WATSON, EXAMINING ATTORNEY



**Int. Cl.: 21**

**Prior U.S. Cls.: 2, 13, 23, 29, 30, 33, 40, and 50**

**Reg. No. 3,455,687**

**United States Patent and Trademark Office**

**Registered June 24, 2008**

---

**TRADEMARK  
PRINCIPAL REGISTER**

**SAFEGUARDS**

SCHNEIDER SADDLERY CO., INC. (OHIO CORPORATION)  
8255 EAST WASHINGTON STREET  
CHAGRIN FALLS, OH 44023

FOR: PROTECTIVE SLEEVE-TYPE COVERINGS FOR THE HOOK-ENDS OF BUCKET OR PAIL HANDLES TO PREVENT INJURY TO ANIMALS AND HUMANS, IN CLASS 21 (U.S. CLS. 2, 13, 23, 29, 30, 33, 40 AND 50).

FIRST USE 7-1-2006; IN COMMERCE 8-1-2006.

THE MARK CONSISTS OF STANDARD CHARACTERS WITHOUT CLAIM TO ANY PARTICULAR FONT, STYLE, SIZE, OR COLOR.

SN 78-910,867, FILED 6-19-2006.

CHARISMA HAMPTON, EXAMINING ATTORNEY

**Int. Cl.: 9**

**Prior U.S. Cls.: 21, 23, 26, 36, and 38**

**Reg. No. 3,455,688**

**United States Patent and Trademark Office**

**Registered June 24, 2008**

---

**TRADEMARK  
PRINCIPAL REGISTER**

**SULLY**

PROPARTS LLC (MARYLAND LTD LIAB CO)  
1100 WILSO DRIVE  
BALTIMORE, MD 21223

DETERMINING THE RATE OF MOTION FOR A  
VEHICLE, IN CLASS 9 (U.S. CLS. 21, 23, 26, 36 AND  
38).

FOR: VEHICLE INSTRUMENTS AND INSTRUMENTATION, NAMELY, TACHOMETERS FOR VEHICLES, AND SPEEDOMETERS FOR VEHICLES; VEHICLE LOCATING, TRACKING AND SECURITY SYSTEM COMPRISED OF AN ANTENNA AND RADIO TRANSMITTER TO BE PLACED IN A VEHICLE; NAVIGATION APPARATUS FOR VEHICLES IN THE NATURE OF ON-BOARD COMPUTERS; VEHICLE MOUNTED GPS SENSOR FOR

FIRST USE 0-0-2007; IN COMMERCE 0-0-2007.

THE MARK CONSISTS OF STANDARD CHARACTERS WITHOUT CLAIM TO ANY PARTICULAR FONT, STYLE, SIZE, OR COLOR.

SN 78-911,144, FILED 6-19-2006.

SANDRA MANIOS, EXAMINING ATTORNEY

**Int. Cl.: 30**

**Prior U.S. Cl.: 46**

**United States Patent and Trademark Office**

**Reg. No. 3,455,689**

**Registered June 24, 2008**

**TRADEMARK  
PRINCIPAL REGISTER**

# POP ROCKS

ZETA ESPACIAL S.A. (SPAIN CORPORATION)  
AVDA. DE LAS OLIMPIADAS S/N.  
POLIGONO INDUSTRIAL CAN ROSES  
RUBI (BARCELONA), SPAIN 08191

FOR: CANDY, CHEWING-GUM, BUBBLE-GUM,  
LOLLIPOPS, FROSTINGS, FROZEN CONFEC-  
TIONS, FROZEN CUSTARDS, FROZEN YOGURT,  
FRUIT ICE, ICE CREAMS, FLAVORED ICES, MILK  
ICE, CANDY-COATED POPCORN, TEAS, CHOCO-  
LATE TOPPINGS, SYRUP TOPPINGS, IN CLASS 30  
(U.S. CL. 46).

FIRST USE 6-17-1985; IN COMMERCE 6-17-1985.

THE MARK CONSISTS OF STANDARD CHAR-  
ACTERS WITHOUT CLAIM TO ANY PARTICULAR  
FONT, STYLE, SIZE, OR COLOR.

OWNER OF U.S. REG. NOS. 1,380,669, 2,776,423,  
AND OTHERS.

NO CLAIM IS MADE TO THE EXCLUSIVE  
RIGHT TO USE "POP", APART FROM THE MARK  
AS SHOWN.

SN 78-911,163, FILED 6-19-2006.

MARY CRAWFORD, EXAMINING ATTORNEY

**Int. Cl.: 14**

**Prior U.S. Cls.: 2, 27, 28, and 50**

**United States Patent and Trademark Office**

**Reg. No. 3,455,690**

**Registered June 24, 2008**

**TRADEMARK  
PRINCIPAL REGISTER**

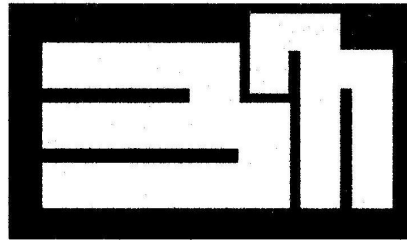

CLVR ACQUISITION, INC. (NEW YORK CORPORATION)  
233 SPRING STREET  
NEW YORK, NY 10013

FOR: JEWELRY, IN CLASS 14 (U.S. CLS. 2, 27, 28 AND 50).

FIRST USE 8-1-2006; IN COMMERCE 8-1-2006.

THE MARK CONSISTS OF THREE SOLID, HORIZONTAL RECTANGLES STACKED ON TOP OF EACH OTHER. THE FIRST RECTANGLE IS SHORTER THAN THE SECOND AND THIRD, AND ALL

THREE ARE CONNECTED ON THE RIGHT END IN THE APPEARANCE OF A STEP. THREE SIMILARLY ARRANGED VERTICAL RECTANGLES APPEAR TO THE RIGHT OF THE HORIZONTAL RECTANGLES. THE EDGE OF THE SHORT VERTICAL RECTANGLE RUNS ALONG THE STEP CREATED BY THE THREE HORIZONTAL RECTANGLES. THE ENTIRE DESIGN APPEARS ON A SOLID RECTANGULAR BACKGROUND.

SN 78-911,178, FILED 6-19-2006.

SANDRA MANIOS, EXAMINING ATTORNEY

**Int. Cl.: 28**

**Prior U.S. Cls.: 22, 23, 38, and 50**

**Reg. No. 3,455,691**

**United States Patent and Trademark Office**

**Registered June 24, 2008**

---

**TRADEMARK  
PRINCIPAL REGISTER**

**MEGAPHYSICS**

MANTLEY, CLAY (UNITED STATES INDIVIDUAL)  
4121 LONGRIDGE AVENUE  
SHERMAN OAKS, CA 91423

THE MARK CONSISTS OF STANDARD CHARACTERS WITHOUT CLAIM TO ANY PARTICULAR FONT, STYLE, SIZE, OR COLOR.

FOR: EQUIPMENT SOLD AS A UNIT FOR PLAYING BOARD GAMES, IN CLASS 28 (U.S. CLS. 22, 23, 38 AND 50).

SN 78-911,811, FILED 6-19-2006.

FIRST USE 4-14-2008; IN COMMERCE 4-14-2008.

CHRIS WELLS, EXAMINING ATTORNEY

**Int. Cl.: 16**

**Prior U.S. Cls.: 2, 5, 22, 23, 29, 37, 38, and 50**

**United States Patent and Trademark Office**

**Reg. No. 3,455,692**

**Registered June 24, 2008**

**TRADEMARK  
PRINCIPAL REGISTER**

The logo for "Night Time" features the words "Night Time" in a bold, sans-serif font, slanted upwards. The word "Night" is followed by a crescent moon symbol, and "Time" is followed by a star symbol. There are also stars at the beginning and end of the phrase.

KIMBERLY-CLARK WORLDWIDE, INC. (DELA-  
WARE CORPORATION)  
401 NORTH LAKE STREET  
NEENAH, WI 54956

FOR: DISPOSABLE TRAINING PANTS, IN CLASS  
16 (U.S. CLS. 2, 5, 22, 23, 29, 37, 38 AND 50).

FIRST USE 3-31-2006; IN COMMERCE 3-31-2006.

NO CLAIM IS MADE TO THE EXCLUSIVE  
RIGHT TO USE "NIGHT TIME", APART FROM  
THE MARK AS SHOWN.

THE MARK CONSISTS OF WORDS, MOON, AND  
STARS.

SN 78-912,111, FILED 6-20-2006.

ALEX KEAM, EXAMINING ATTORNEY

**Int. Cls.: 9 and 41**

**Prior U.S. Cls.: 21, 23, 26, 36, 38, 100, 101, and 107**

**Reg. No. 3,455,693**

**United States Patent and Trademark Office**

**Registered June 24, 2008**

---

**TRADEMARK  
SERVICE MARK  
PRINCIPAL REGISTER**

**PAY TRUTH FORWARD**

KING PRODUCTIONS INTERNATIONAL, INC.  
(FLORIDA CORPORATION)  
821 49TH STREET SOUTH  
GULFPORT, FL 33707

FOR: PRE-RECORDED CD'S AND AUDIO/VIDEO RECORDINGS FEATURING ISSUES RELATING TO WELLNESS OF THE SPIRIT, NAMELY, TRUTHFULNESS, IN CLASS 9 (U.S. CLS. 21, 23, 26, 36 AND 38).

FIRST USE 5-12-2006; IN COMMERCE 5-12-2006.

FOR: EDUCATIONAL SERVICES, NAMELY, PROVIDING LECTURES IN THE FIELD OF

TRUTHFULNESS, IN CLASS 41 (U.S. CLS. 100, 101 AND 107).

FIRST USE 5-12-2006; IN COMMERCE 5-12-2006.

THE MARK CONSISTS OF STANDARD CHARACTERS WITHOUT CLAIM TO ANY PARTICULAR FONT, STYLE, SIZE, OR COLOR.

SN 78-912,455, FILED 6-20-2006.

CARYN GLASSER, EXAMINING ATTORNEY

**Int. Cl.: 9**

**Prior U.S. Cls.: 21, 23, 26, 36, and 38**

**Reg. No. 3,455,694**

**United States Patent and Trademark Office**

**Registered June 24, 2008**

---

**TRADEMARK  
PRINCIPAL REGISTER**

**EAGLE EYE**

JOHN ABRAHAM KOTZE (SOUTH AFRICA IN-  
DIVIDUAL)  
36 ROWAN STREET  
STELLENBOSCH 7600, SOUTH AFRICA

THE MARK CONSISTS OF STANDARD CHAR-  
ACTERS WITHOUT CLAIM TO ANY PARTICULAR  
FONT, STYLE, SIZE, OR COLOR.

FOR: OPTICAL APPARATUS AND INSTRU-  
MENTS, NAMELY, REFLECTIVE DEVICES FOR  
DETECTING ANIMALS, IN PARTICULAR BIRDS,  
IN CLASS 9 (U.S. CLS. 21, 23, 26, 36 AND 38).

SN 78-912,529, FILED 6-20-2006.

FIRST USE 1-1-2006; IN COMMERCE 5-29-2007.

MARLENE BELL, EXAMINING ATTORNEY



**Int. Cl.: 42**

**Prior U.S. Cls.: 100 and 101**

**United States Patent and Trademark Office**

**Reg. No. 3,455,695**

**Registered June 24, 2008**

---

**SERVICE MARK  
PRINCIPAL REGISTER**

**PREVISTAR**

PREVISTAR, INC. (DELAWARE CORPORATION)  
1729 KING STREET, SUITE 300  
ALEXANDRIA, VA 22314

FIRST USE 11-0-2006; IN COMMERCE 11-0-2006.

FOR: CONSULTING SERVICES IN THE FIELD OF DESIGN, SELECTION, IMPLEMENTATION AND USE OF COMPUTER HARDWARE AND SOFTWARE SYSTEMS FOR OTHERS TO PREPARE FOR, RESPOND TO, AND MANAGE RESOURCES DURING THE COURSE OF NATURAL AND MAN-MADE EMERGENCIES, IN CLASS 42 (U.S. CLS. 100 AND 101).

THE MARK CONSISTS OF STANDARD CHARACTERS WITHOUT CLAIM TO ANY PARTICULAR FONT, STYLE, SIZE, OR COLOR.

SN 78-912,591, FILED 6-20-2006.

TINA BROWN, EXAMINING ATTORNEY

**Int. Cl.: 21**

**Prior U.S. Cls.: 2, 13, 23, 29, 30, 33, 40, and 50**

**United States Patent and Trademark Office**

**Reg. No. 3,455,696**

**Registered June 24, 2008**

**TRADEMARK  
PRINCIPAL REGISTER**

**DELICATE DROPS**

MAINYTIME, INC. (TEXAS CORPORATION)  
SUITE 27  
3508 GREENVILLE AVE.  
DALLAS, TX 75206

THE MARK CONSISTS OF STANDARD CHAR-  
ACTERS WITHOUT CLAIM TO ANY PARTICULAR  
FONT, STYLE, SIZE, OR COLOR.

FOR: PLASTIC HOLDER FOR CLEANING AND  
STORING BRASSIERES, IN CLASS 21 (U.S. CLS. 2, 13,  
23, 29, 30, 33, 40 AND 50).

SN 78-912,635, FILED 6-20-2006.

FIRST USE 5-29-2006; IN COMMERCE 9-5-2006.

BRIAN NEVILLE, EXAMINING ATTORNEY

**Int. Cl.: 4**

**Prior U.S. Cls.: 1, 6, and 15**

**United States Patent and Trademark Office**

**Reg. No. 3,455,697**

**Registered June 24, 2008**

**TRADEMARK  
PRINCIPAL REGISTER**

**ATLANTIS**

ALLIANCE SALES & MARKETING, LLC (PENNSYLVANIA LTD LIAB CO)  
6 GEOFFREY ROAD  
FAIRLESS HILLS, PA 19030

THE MARK CONSISTS OF STANDARD CHARACTERS WITHOUT CLAIM TO ANY PARTICULAR FONT, STYLE, SIZE, OR COLOR.

FOR: LUBRICANTS FOR INDUSTRIAL MACHINERY, IN CLASS 4 (U.S. CLS. 1, 6 AND 15).

SN 78-912,892, FILED 6-21-2006.

FIRST USE 3-5-2007; IN COMMERCE 3-5-2007.

CORY BOONE, EXAMINING ATTORNEY

**Int. Cl.: 39**

**Prior U.S. Cls.: 100 and 105**

**United States Patent and Trademark Office**

**Reg. No. 3,455,698**

**Registered June 24, 2008**

**SERVICE MARK  
PRINCIPAL REGISTER**

**Blackbeard's Pirate Tours**

KITTY HAWK KITES, INC. (NORTH CAROLINA  
CORPORATION)

P.O. BOX 1839

NAGS HEAD, NC 27959

FOR: TOUR CONDUCTING SERVICES, IN CLASS  
39 (U.S. CLS. 100 AND 105).

FIRST USE 5-2-2008; IN COMMERCE 5-2-2008.

THE MARK CONSISTS OF STANDARD CHAR-  
ACTERS WITHOUT CLAIM TO ANY PARTICULAR  
FONT, STYLE, SIZE, OR COLOR.

NO CLAIM IS MADE TO THE EXCLUSIVE  
RIGHT TO USE "TOURS", APART FROM THE  
MARK AS SHOWN.

SN 78-913,013, FILED 6-21-2006.

LOURDES AYALA, EXAMINING ATTORNEY

**Int. Cl.: 9**

**Prior U.S. Cls.: 21, 23, 26, 36, and 38**

**Reg. No. 3,455,699**

**United States Patent and Trademark Office**

**Registered June 24, 2008**

---

**TRADEMARK  
PRINCIPAL REGISTER**

**Pick-MAX**

INNOVATIVE PICKING TECHNOLOGIES, INC.  
(WISCONSIN CORPORATION)  
W1236 INDUSTRIAL DRIVE  
IXONIA, WI 53036

FIRST USE 4-20-2003; IN COMMERCE 6-22-2006.

FOR: LIGHT DIRECTED ORDER FULFILLMENT SYSTEM COMPRISED PRIMARILY OF COMPUTER HARDWARE AND SOFTWARE, A LIGHT EMITTING DIODE DISPLAYS, AND A MODULAR SNAP-IN BUS DESIGN ALL SOLD AS A UNIT FOR USE IN LIGHT DIRECTED ORDER FULFILLMENT, IN CLASS 9 (U.S. CLS. 21, 23, 26, 36 AND 38).

THE MARK CONSISTS OF STANDARD CHARACTERS WITHOUT CLAIM TO ANY PARTICULAR FONT, STYLE, SIZE, OR COLOR.

SN 78-913,014, FILED 6-21-2006.

RONALD MCMORROW, EXAMINING ATTORNEY

**Int. Cl.: 9**

**Prior U.S. Cls.: 21, 23, 26, 36, and 38**

**Reg. No. 3,455,700**

**United States Patent and Trademark Office**

**Registered June 24, 2008**

**TRADEMARK  
PRINCIPAL REGISTER**

**Pick-MAX<sup>2</sup>**

INNOVATIVE PICKING TECHNOLOGIES, INC.  
(WISCONSIN CORPORATION)  
W1236 INDUSTRIAL DRIVE  
IXONIA, WI 53036

LIGHT DIRECTED ORDER FULFILLMENT, IN  
CLASS 9 (U.S. CLS. 21, 23, 26, 36 AND 38).

FIRST USE 1-12-2005; IN COMMERCE 10-26-2006.

FOR: LIGHT DIRECTED ORDER FULFILLMENT  
SYSTEM COMPRISED PRIMARILY OF COMPUTER  
HARDWARE AND SOFTWARE, A LIGHT EMIT-  
TING DIODE DISPLAYS, AND A MODULAR SNAP-  
IN BUS DESIGN ALL SOLD AS A UNIT FOR USE IN

SN 78-913,064, FILED 6-21-2006.

RONALD MCMORROW, EXAMINING ATTORNEY

**Int. Cl.: 40**

**Prior U.S. Cls.: 100, 103, and 106**

**United States Patent and Trademark Office**

**Reg. No. 3,455,701**

**Registered June 24, 2008**

**SERVICE MARK  
PRINCIPAL REGISTER**

**LASER TAPESTRY**

LASER TAPESTRY INC (NEW YORK CORPORATION)  
193 PLEASANT RIDGE RD.  
POUGHQUAG, NY 12570

FOR: ETCHING OF STONE, MARBLE, GRANITE,  
TILE, GLASS, MIRROR, SLATE, WOOD, PAPER,  
LEATHER, IN CLASS 40 (U.S. CLS. 100, 103 AND 106).

FIRST USE 7-21-2006; IN COMMERCE 7-21-2006.

THE MARK CONSISTS OF STANDARD CHARACTERS WITHOUT CLAIM TO ANY PARTICULAR FONT, STYLE, SIZE, OR COLOR.

NO CLAIM IS MADE TO THE EXCLUSIVE RIGHT TO USE "LASER", APART FROM THE MARK AS SHOWN.

SN 78-913,544, FILED 6-21-2006.

JULIE WATSON, EXAMINING ATTORNEY

**Int. Cl.: 33**

**Prior U.S. Cls.: 47 and 49**

**United States Patent and Trademark Office**

**Reg. No. 3,455,702**

**Registered June 24, 2008**

**TRADEMARK  
PRINCIPAL REGISTER**

**LA CROIX DU PRIEURE**

BERNARD MAGREZ (FRANCE JOINT STOCK  
COMPANY)

CHATEAU PAPE CLEMENT

216 AVENUE DU DR. NANCEL PENARD

33600 PESSAC, FRANCE

FOR: WINE, IN CLASS 33 (U.S. CLS. 47 AND 49).

FIRST USE 3-1-2004; IN COMMERCE 3-1-2004.

THE MARK CONSISTS OF STANDARD CHAR-  
ACTERS WITHOUT CLAIM TO ANY PARTICULAR  
FONT, STYLE, SIZE, OR COLOR.

THE FOREIGN WORDING IN THE MARK  
TRANSLATES INTO ENGLISH AS THE CROSS OF  
THE PRIORESS.

SN 78-914,673, FILED 6-22-2006.

MARY CRAWFORD, EXAMINING ATTORNEY



Int. Cl.: 33

Prior U.S. Cls.: 47 and 49

United States Patent and Trademark Office

Reg. No. 3,455,703

Registered June 24, 2008

TRADEMARK  
PRINCIPAL REGISTER

KAHINA

BERNARD MAGREZ (FRANCE JOINT STOCK  
COMPANY)  
216 AVENUE DU DOCTEUR NANCEL PENARD  
CHATEAU PAPE CLEMENT  
PESSAC, FRANCE 33600

FOR: WINE, IN CLASS 33 (U.S. CLS. 47 AND 49).

FIRST USE 3-1-2004; IN COMMERCE 3-1-2004.

THE MARK CONSISTS OF STANDARD CHAR-  
ACTERS WITHOUT CLAIM TO ANY PARTICULAR  
FONT, STYLE, SIZE, OR COLOR.

THE FOREIGN WORDING IN THE MARK  
TRANSLATES INTO ENGLISH AS FEMALE SEER.

SN 78-914,764, FILED 6-22-2006.

MARY CRAWFORD, EXAMINING ATTORNEY

**Int. Cl.: 33**

**Prior U.S. Cls.: 47 and 49**

**United States Patent and Trademark Office**

**Reg. No. 3,455,704**

**Registered June 24, 2008**

**TRADEMARK  
PRINCIPAL REGISTER**

**CASA MAGREZ**

BERNARD MAGREZ (FRANCE JOINT STOCK  
COMPANY)  
216 AVENUE DU DOCTEUR NANCEL PENARD  
CHATEAU PAPE CLEMENT  
PESSAC, FRANCE 33600

FOR: WINE, IN CLASS 33 (U.S. CLS. 47 AND 49).

FIRST USE 3-1-2004; IN COMMERCE 3-1-2004.

THE MARK CONSISTS OF STANDARD CHAR-  
ACTERS WITHOUT CLAIM TO ANY PARTICULAR  
FONT, STYLE, SIZE, OR COLOR.

THE ENGLISH TRANSLATION OF THE WORD  
"CASA" IN THE MARK IS HOUSE.

SN 78-914,818, FILED 6-22-2006.

MARY CRAWFORD, EXAMINING ATTORNEY

**Int. Cl.: 36**

**Prior U.S. Cls.: 100, 101, and 102**

**United States Patent and Trademark Office**

**Reg. No. 3,455,705**

**Registered June 24, 2008**

---

**SERVICE MARK  
PRINCIPAL REGISTER**

**FUNDVANTAGE**

PFPC, INC. (DELAWARE CORPORATION)  
400 BELLEVUE PARKWAY  
WILMINGTON, DE 19809

FOR: FUND MANAGEMENT SERVICES; INVESTMENT MANAGEMENT SERVICES, IN CLASS 36 (U.S. CLS. 100, 101 AND 102).

FIRST USE 6-1-2007; IN COMMERCE 6-1-2007.

THE MARK CONSISTS OF STANDARD CHARACTERS WITHOUT CLAIM TO ANY PARTICULAR FONT, STYLE, SIZE, OR COLOR.

SN 78-914,857, FILED 6-22-2006.

DOMINIC J. FERRAIUOLO, EXAMINING ATTORNEY

**Int. Cl.: 1**

**Prior U.S. Cls.: 1, 5, 6, 10, 26, and 46**

**Reg. No. 3,455,706**

**United States Patent and Trademark Office**

**Registered June 24, 2008**

**TRADEMARK  
PRINCIPAL REGISTER**

# CodeStream

FUJIFILM HUNT CHEMICALS U.S.A., INC. (DE-  
LAWARE CORPORATION)  
40 BOROLINE ROAD  
ALLENDALE, NJ 07401

FOR: CHEMICALS, POLYMER COATING  
AGENTS AND CHEMICAL ADDITIVES USED IN  
THE MANUFACTURE OF SPECIALIZED CHEMI-  
CALS, NAMELY, THOSE USED FOR THE LASER  
RADIATION IMAGING, MARKING AND CODING  
OF PLASTICS, PAPER, CARDBOARD, METAL,  
GLASS AND FOIL, IN CLASS 1 (U.S. CLS. 1, 5, 6, 10,  
26 AND 46).

FIRST USE 3-26-2007; IN COMMERCE 3-26-2007.

THE MARK CONSISTS OF STANDARD CHAR-  
ACTERS WITHOUT CLAIM TO ANY PARTICULAR  
FONT, STYLE, SIZE, OR COLOR.

SN 78-914,893, FILED 6-22-2006.

MONIQUE MILLER, EXAMINING ATTORNEY

**Int. Cl.: 42**

**Prior U.S. Cls.: 100 and 101**

**United States Patent and Trademark Office**

**Reg. No. 3,455,707**

**Registered June 24, 2008**

**SERVICE MARK  
PRINCIPAL REGISTER**

**DON'T WAIT TO BE GREAT...  
COLLABORATE!**

VOLUNTARY INTERINDUSTRY COMMERCE  
SOLUTIONS ASSOCIATION (DELAWARE  
CORPORATION)  
PRINCETON PIKE CORPORATE CENTER  
1009 LENOX DRIVE, SUITE 202  
LAWRENCEVILLE, NJ 08648

FOR: PROVIDING INFORMATION ON DATA  
SHARING TECHNIQUES AND COMPUTER SYS-  
TEM PROCESSES FOR USE BY TRADING PART-  
NERS IN INDUSTRY, IN CLASS 42 (U.S. CLS. 100  
AND 101).

FIRST USE 4-25-2006; IN COMMERCE 4-25-2006.

THE MARK CONSISTS OF STANDARD CHAR-  
ACTERS WITHOUT CLAIM TO ANY PARTICULAR  
FONT, STYLE, SIZE, OR COLOR.

SN 78-915,218, FILED 6-23-2006.

LANA PHAM, EXAMINING ATTORNEY

**Int. Cl.: 16**

**Prior U.S. Cls.: 2, 5, 22, 23, 29, 37, 38, and 50**

**Reg. No. 3,455,708**

**United States Patent and Trademark Office**

**Registered June 24, 2008**

**TRADEMARK  
PRINCIPAL REGISTER**



GRANDUCA OPERATING COMPANY, LP  
(TEXAS LIMITED PARTNERSHIP)  
SUITE 1200  
1400 POST OAK BLVD.  
HOUSTON, TX 77056

FOR: STATIONERY AND PRINTED MATTER,  
NAMELY, STATIONERY, HOTEL SERVICE BIN-  
DERS, ENVELOPES AND NOTEPAPER, IN CLASS  
16 (U.S. CLS. 2, 5, 22, 23, 29, 37, 38 AND 50).

FIRST USE 9-0-2006; IN COMMERCE 9-0-2006.

THE MARK CONSISTS OF CROWN ABOVE  
CREST; CREST CONTAINING A LION, FLEUR DE  
LIS, AND HORIZONTAL LINES; A SCROLL BELOW  
THE CREST WITH THE WORD "GRANDUCA".

THE FOREIGN WORDING IN THE MARK  
TRANSLATES INTO ENGLISH AS GRAND DUKE.

SN 78-915,505, FILED 6-23-2006.

JILL C. ALT, EXAMINING ATTORNEY

**Int. Cl.: 18**

**Prior U.S. Cls.: 1, 2, 3, 22, and 41**

**Reg. No. 3,455,709**

**United States Patent and Trademark Office**

**Registered June 24, 2008**

---

**TRADEMARK  
PRINCIPAL REGISTER**



GRANDUCA OPERATING COMPANY, LP  
(TEXAS LIMITED PARTNERSHIP)  
SUITE 1200  
1400 POST OAK BLVD  
HOUSTON, TX 77056

THE MARK CONSISTS OF CROWN ABOVE  
CREST; CREST CONTAINING A LION, FLEUR DE  
LIS, AND HORIZONTAL LINES.

FOR: TRAVELING BAGS AND LUGGAGE TAGS,  
IN CLASS 18 (U.S. CLS. 1, 2, 3, 22 AND 41).

SN 78-915,507, FILED 6-23-2006.

FIRST USE 10-0-2006; IN COMMERCE 10-0-2006.

JILL C. ALT, EXAMINING ATTORNEY

**Int. Cl.: 35**

**Prior U.S. Cls.: 100, 101, and 102**

**United States Patent and Trademark Office**

**Reg. No. 3,455,710**

**Registered June 24, 2008**

**SERVICE MARK  
PRINCIPAL REGISTER**

**AdvanceMarketWoRx**

ELLEN HOENIG CARLSON CONSULTING, LLC  
(NEW JERSEY LTD LIAB CO)  
340 PROVINCE LINE ROAD  
SKILLMAN, NJ 08558

FOR: STRATEGY AND MARKETING CONSULTING SERVICES IN THE FIELD OF HEALTHCARE, CONSUMER GOODS AND CONSUMER SERVICES; CONSUMER, PHYSICIAN/HEALTHCARE AND CUSTOMER MARKET RESEARCH AND ANALYSIS; DIRECT TO CONSUMER/PATIENT, PHYSICIAN AND CUSTOMER ADVERTISING, MARKETING AND COMMUNICATIONS; DIRECT TO CONSUMER/PATIENT, PHYSICIAN AND CUSTOMER ADVERTISING, MARKETING AND COMMUNICATIONS ON-LINE VIA A GLOBAL COMPUTER NETWORK; CUSTOMER RELATIONSHIP MARKETING STRATEGY AND IMPLEMENTATION; COMPETITIVE MARKET ANALYSIS, STRATEGY AND PLANNING; CREATION AND USE OF MARKETING STRATEGY AND ANALYSIS

TOOLS TO HELP CLIENTS BETTER UNDERSTAND THEIR CUSTOMER(S) AND BUSINESS; CONSULTING SERVICES REGARDING BUSINESS DEVELOPMENT OPPORTUNITY EVALUATION; DEVELOPMENT OF CORPORATE AND BRAND MARKETING STRATEGIES AND IMPLEMENTATION; BUSINESS TO BUSINESS MARKETING AND CONSULTING SERVICES, IN CLASS 35 (U.S. CLS. 100, 101 AND 102).

FIRST USE 4-28-2008; IN COMMERCE 4-28-2008.

THE MARK CONSISTS OF STANDARD CHARACTERS WITHOUT CLAIM TO ANY PARTICULAR FONT, STYLE, SIZE, OR COLOR.

SN 78-916,713, FILED 6-26-2006.

CYNTHIA SLOAN, EXAMINING ATTORNEY



Int. Cl.: 35

Prior U.S. Cls.: 100, 101, and 102

United States Patent and Trademark Office

Reg. No. 3,455,711

Registered June 24, 2008

SERVICE MARK  
PRINCIPAL REGISTER



ELLEN HOENIG CARLSON CONSULTING, LLC  
(NEW JERSEY LTD LIAB CO)  
340 PROVINCE LINE ROAD  
SKILLMAN, NJ 08558

FOR: STRATEGY AND MARKETING CONSULTING SERVICES IN THE FIELD OF HEALTHCARE, CONSUMER GOODS AND CONSUMER SERVICES; CONSUMER, PHYSICIAN/HEALTHCARE AND CUSTOMER MARKET RESEARCH AND ANALYSIS; DIRECT TO CONSUMER/PATIENT, PHYSICIAN AND CUSTOMER ADVERTISING, MARKETING AND COMMUNICATIONS; DIRECT TO CONSUMER/PATIENT, PHYSICIAN AND CUSTOMER ADVERTISING, MARKETING AND COMMUNICATIONS ON-LINE VIA A GLOBAL COMPUTER NETWORK; CUSTOMER RELATIONSHIP MARKETING STRATEGY AND IMPLEMENTATION; COMPETITIVE MARKET ANALYSIS, STRATEGY AND PLANNING; CREATION AND USE OF MARKETING STRATEGY AND ANALYSIS TOOLS TO HELP CLIENTS BETTER UNDERSTAND THEIR CUSTOMER(S) AND BUSINESS; CONSULTING SERVICES REGARDING BUSINESS DEVELOPMENT OPPORTUNITY EVALUATION;

DEVELOPMENT OF CORPORATE AND BRAND MARKETING STRATEGIES AND IMPLEMENTATION; BUSINESS TO BUSINESS MARKETING AND CONSULTING SERVICES, IN CLASS 35 (U.S. CLS. 100, 101 AND 102).

FIRST USE 4-28-2008; IN COMMERCE 4-28-2008.

NO CLAIM IS MADE TO THE EXCLUSIVE RIGHT TO USE "HEALTHCARE AND CONSUMER DISCIPLINES", APART FROM THE MARK AS SHOWN.

THE MARK CONSISTS OF THE STYLIZED LETTERS H AND C WITHIN A SQUARE BOX AND THE WORDS ADVANCEMARKETWORX HEALTHCARE AND CONSUMER DISCIPLINES.

SN 78-916,720, FILED 6-26-2006.

CYNTHIA SLOAN, EXAMINING ATTORNEY

**Int. Cl.: 10**

**Prior U.S. Cls.: 26, 39, and 44**

**Reg. No. 3,455,712**

**United States Patent and Trademark Office**

**Registered June 24, 2008**

---

**TRADEMARK  
PRINCIPAL REGISTER**

**SUPERA**

IDEV TECHNOLOGIES, INC. (DELAWARE CORPORATION)  
1120 NASA ROAD ONE, SUITE 600  
HOUSTON, TX 77058

THE MARK CONSISTS OF STANDARD CHARACTERS WITHOUT CLAIM TO ANY PARTICULAR FONT, STYLE, SIZE, OR COLOR.

FOR: MEDICAL STENT, NAMELY, SELF EXPANDABLE NITINOL STENT, IN CLASS 10 (U.S. CLS. 26, 39 AND 44).

SN 78-917,486, FILED 6-27-2006.

FIRST USE 2-4-2008; IN COMMERCE 2-4-2008.

TARA PATE, EXAMINING ATTORNEY

**Int. Cls.: 10 and 21**

**Prior U.S. Cls.: 2, 13, 23, 26, 29, 30, 33, 39, 40, 44, and 50**

**Reg. No. 3,455,713**

**United States Patent and Trademark Office**

**Registered June 24, 2008**

---

**TRADEMARK  
PRINCIPAL REGISTER**

**QUALASHEER**

QRP, INCORPORATED (ARIZONA CORPORATION)

P. O. BOX 28802

3925 N. RUNWAY DRIVE

TUCSON, AZ 85726

FOR: VINYL MEDICAL GLOVES FOR MEDICAL EXAMINATIONS, IN CLASS 10 (U.S. CLS. 26, 39 AND 44).

FIRST USE 6-23-2006; IN COMMERCE 6-27-2007.

FOR: DISPOSABLE PLASTIC GLOVES FOR USE IN THE FOOD SERVICE INDUSTRY, IN CLASS 21 (U.S. CLS. 2, 13, 23, 29, 30, 33, 40 AND 50).

FIRST USE 6-23-2006; IN COMMERCE 6-27-2007.

THE MARK CONSISTS OF STANDARD CHARACTERS WITHOUT CLAIM TO ANY PARTICULAR FONT, STYLE, SIZE, OR COLOR.

SN 78-917,724, FILED 6-27-2006.

GEORGE LORENZO, EXAMINING ATTORNEY

**Int. Cl.: 36**

**Prior U.S. Cls.: 100, 101, and 102**

**United States Patent and Trademark Office**

**Reg. No. 3,455,714**

**Registered June 24, 2008**

**SERVICE MARK  
PRINCIPAL REGISTER**

**APARTMENTX**

APARTMENT RENTAL EXPERTS LLC (MASSACHUSETTS LTD LIAB CO)  
921 MASSACHUSETTS AVENUE  
CAMBRIDGE, MA 02139

THE MARK CONSISTS OF STANDARD CHARACTERS WITHOUT CLAIM TO ANY PARTICULAR FONT, STYLE, SIZE, OR COLOR.

FOR: REAL ESTATE BROKERAGE, IN CLASS 36 (U.S. CLS. 100, 101 AND 102).

SN 78-918,550, FILED 6-28-2006.

FIRST USE 10-25-2007; IN COMMERCE 10-25-2007.

BARBARA GAYNOR, EXAMINING ATTORNEY

Int. Cl.: 25

Prior U.S. Cls.: 22 and 39

United States Patent and Trademark Office

Reg. No. 3,455,715

Registered June 24, 2008

TRADEMARK  
PRINCIPAL REGISTER

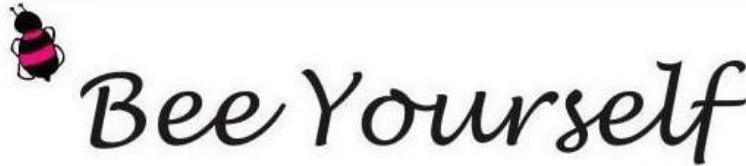

BURNS, CINDY (FLORIDA INDIVIDUAL)  
P.O. BOX 691428  
ORLANDO, FL 32869

THE COLOR BLACK APPEARS AS THE TEXT  
AND THE COLORS BLACK AND FUSCIA APPEAR  
IN THE "BEE" DESIGN.

FOR: CLOTHING, NAMELY, TANK TOPS AND  
SHIRTS, IN CLASS 25 (U.S. CLS. 22 AND 39).

FIRST USE 4-15-2007; IN COMMERCE 4-15-2007.

SN 78-918,716, FILED 6-28-2006.

THE COLOR(S) BLACK AND FUSCIA IS/ARE  
CLAIMED AS A FEATURE OF THE MARK.

RONALD AIKENS, EXAMINING ATTORNEY

**Int. Cl.: 41**

**Prior U.S. Cls.: 100, 101, and 107**

**United States Patent and Trademark Office**

**Reg. No. 3,455,716**

**Registered June 24, 2008**

**SERVICE MARK  
PRINCIPAL REGISTER**

**BED O' ROSES**

THE NEW YORK RACING ASSOCIATION INC.  
(NEW YORK CORPORATION)  
P.O. BOX 90  
JAMAICA, NY 11417

THE MARK CONSISTS OF STANDARD CHAR-  
ACTERS WITHOUT CLAIM TO ANY PARTICULAR  
FONT, STYLE, SIZE, OR COLOR.

FOR: ENTERTAINMENT IN THE NATURE OF  
HORSERACES, IN CLASS 41 (U.S. CLS. 100, 101 AND  
107).

SN 78-919,009, FILED 6-28-2006.

FIRST USE 0-0-1957; IN COMMERCE 0-0-1957.

CORY BOONE, EXAMINING ATTORNEY

**Int. Cl.: 35**

**Prior U.S. Cls.: 100, 101, and 102**

**United States Patent and Trademark Office**

**Reg. No. 3,455,717**

**Registered June 24, 2008**

**SERVICE MARK  
PRINCIPAL REGISTER**



---

CALIFORNIA NUT COMMISSION (CALIFORNIA CORPORATION)  
1540 RIVER PARK DRIVE  
SACRAMENTO, CA 95815

FOR: PROMOTING THE GOODS OF OTHERS, NAMELY, WALNUTS FROM THE STATE OF CALIFORNIA, BY DISTRIBUTING ADVERTISING MATERIALS THROUGH A VARIETY OF METHODS, IN CLASS 35 (U.S. CLS. 100, 101 AND 102).

FIRST USE 10-0-2005; IN COMMERCE 10-0-2005.

THE MARK CONSISTS OF A SALUTING WALNUT WEARING A BASEBALL CAP AND GLASSES.

SN 78-919,804, FILED 6-29-2006.

ANNE E. GUSTASON, EXAMINING ATTORNEY

**Int. Cl.: 35**

**Prior U.S. Cls.: 100, 101, and 102**

**United States Patent and Trademark Office**

**Reg. No. 3,455,718**

**Registered June 24, 2008**

**SERVICE MARK  
PRINCIPAL REGISTER**

**EASY WRITERS**

MAKEPEACE, CLAYTON (UNITED STATES IN-  
DIVIDUAL)  
4374 SOUTH LOCKWOOD RIDGE ROAD  
SARASOTA, FL 34231

FOR: CLUB FOR WRITERS THAT PROVIDES  
NETWORKING OPPORTUNITIES TO MEMBERS,  
IN CLASS 35 (U.S. CLS. 100, 101 AND 102).

FIRST USE 8-8-2006; IN COMMERCE 8-8-2006.

THE MARK CONSISTS OF STANDARD CHAR-  
ACTERS WITHOUT CLAIM TO ANY PARTICULAR  
FONT, STYLE, SIZE, OR COLOR.

SN 78-919,940, FILED 6-29-2006.

NAKIA HENRY, EXAMINING ATTORNEY



**Int. Cl.: 25**

**Prior U.S. Cls.: 22 and 39**

**United States Patent and Trademark Office**

**Reg. No. 3,455,719**

**Registered June 24, 2008**

**TRADEMARK  
PRINCIPAL REGISTER**

**roforo**

YONGSHOU, LIU (CHINA INDIVIDUAL)  
RM 707 FENGHUANG JIARI  
NO.578 QUANXIU ROAD, FENGZE DISTRICT  
QUANZHOU FUJIAN 362000, CHINA

FOR: BEACH CLOTHES, NAMELY, BATHING SUITS AND BEACH COVER-UPS; BEACH SHOES; BOOTS; BOOTS FOR SPORTS; CAPS; CLOTHING, NAMELY, SHIRTS, PANTS, DRESSES; CLOTHING FOR WEAR IN GYMNASTICS; FOOTBALL BOOTS; FOOTBALL SHOES; FOOTWEAR; GLOVES; GYM-NASTIC SHOES; INNER SOLES; JACKETS; JERSEYS; LAYETTES; LEATHER CLOTHING, NAMELY, COATS, PANTS, SHOES; LINEN GARMENTS, NAMELY, COATS, PANTS, SHIRTS; PANTS, SANDALS, SHIRTS, SHOES, SKI BOOTS,

SLIPPERS, SOCKS, SPORTS JERSEYS, SPORTS SHOES, T-SHIRTS, UNDERWEAR, WATERPROOF CLOTHING, NAMELY, JACKETS AND PANTS; WOODEN SHOES, IN CLASS 25 (U.S. CLS. 22 AND 39).

FIRST USE 10-1-2007; IN COMMERCE 10-1-2007.

THE MARK CONSISTS OF STANDARD CHARACTERS WITHOUT CLAIM TO ANY PARTICULAR FONT, STYLE, SIZE, OR COLOR.

SN 78-920,534, FILED 6-30-2006.

KATHERINE CONNOLLY, EXAMINING ATTORNEY

**Int. Cl.: 22**

**Prior U.S. Cls.: 1, 2, 7, 19, 22, 42, and 50**

**Reg. No. 3,455,720**

**United States Patent and Trademark Office**

**Registered June 24, 2008**

---

**TRADEMARK  
PRINCIPAL REGISTER**

**GRIZZLY SPLICE**

SHERRILL, INC. (NORTH CAROLINA COR-  
PORATION)  
200 E. SENECA RD.  
GREENSBORO, NC 27406

THE MARK CONSISTS OF STANDARD CHAR-  
ACTERS WITHOUT CLAIM TO ANY PARTICULAR  
FONT, STYLE, SIZE, OR COLOR.

FOR: ROPE FOR TREE CLIMBING, IN CLASS 22  
(U.S. CLS. 1, 2, 7, 19, 22, 42 AND 50).

SN 78-921,511, FILED 6-30-2006.

FIRST USE 1-1-2007; IN COMMERCE 1-1-2007.

TINA L. SNAPP, EXAMINING ATTORNEY

**Int. Cls.: 9 and 42**

**Prior U.S. Cls.: 21, 23, 26, 36, 38, 100, and 101**

**United States Patent and Trademark Office**

**Reg. No. 3,455,721**

**Registered June 24, 2008**

**TRADEMARK  
SERVICE MARK  
PRINCIPAL REGISTER**

**REDDOT LIVESERVER**

REDDOT SOLUTIONS CORP. (NEW YORK CORPORATION)  
ONE BATTERY PARK PLAZA  
NEW YORK, NY 10004

FOR: WEBSITE DEVELOPMENT AND WEB CONTENT MANAGEMENT SOFTWARE, NAMELY, COMPUTER SOFTWARE FOR DEVELOPING, EDITING, MANAGING AND CENTRALIZING INFORMATION ON INTERNET, INTRANET AND EXTRANET SITES, FOR MODIFYING SOFTWARE APPLICATIONS ACCESSIBLE FOR INTERNET, INTRANET AND EXTRANET SITES, FOR MANAGING SOFTWARE APPLICATIONS THAT COLLECT AND PROVIDE DATA TO INTERNET, INTRANET AND EXTRANET SITES, AND FOR ENSURING WEBSITE COMPLIANCE WITH INDUSTRY, REGULATORY AND INTERNAL REQUIREMENTS, IN CLASS 9 (U.S. CLS. 21, 23, 26, 36 AND 38).

FIRST USE 9-1-2004; IN COMMERCE 9-1-2004.

FOR: COMPUTER CONSULTATION AND COMPUTER PROGRAMMING SERVICES , IN CLASS 42 (U.S. CLS. 100 AND 101).

FIRST USE 9-1-2004; IN COMMERCE 9-1-2004.

THE MARK CONSISTS OF STANDARD CHARACTERS WITHOUT CLAIM TO ANY PARTICULAR FONT, STYLE, SIZE, OR COLOR.

OWNER OF U.S. REG. NOS. 3,033,978 AND 3,052,665.

SN 78-922,093, FILED 7-3-2006.

JULIE GUTTADAURO, EXAMINING ATTORNEY

**Int. Cl.: 5**

**Prior U.S. Cls.: 6, 18, 44, 46, 51, and 52**

**Reg. No. 3,455,722**

**United States Patent and Trademark Office**

**Registered June 24, 2008**

**TRADEMARK  
PRINCIPAL REGISTER**

**STANDARD BIOLOGICS**

STANDARD BIOLOGICS, INC. (MARYLAND CORPORATION)  
66 CHARLES STREET  
ELKTON, MD 21921

FOR: THERAPEUTIC BIOLOGICAL PREPARATIONS FOR MEDICAL PURPOSES; BIOLOGICAL COMPOUND PREPARATIONS FOR MEDICAL PURPOSES; COMPLEX NUTRACEUTICALS FOR DNA STABILIZATION, ACCURATE GENE EXPRESSION AND CELL DIFFERENTIATION AND FOR THE TREATMENT OF ACUTE AND/OR CHRONIC INFLAMMATION, IN CLASS 5 (U.S. CLS. 6, 18, 44, 46, 51 AND 52).

FIRST USE 12-31-2006; IN COMMERCE 3-31-2008.

THE MARK CONSISTS OF STANDARD CHARACTERS WITHOUT CLAIM TO ANY PARTICULAR FONT, STYLE, SIZE, OR COLOR.

NO CLAIM IS MADE TO THE EXCLUSIVE RIGHT TO USE "BIOLOGICS", APART FROM THE MARK AS SHOWN.

SN 78-922,305, FILED 7-5-2006.

CHERYL CLAYTON, EXAMINING ATTORNEY

**Int. Cl.: 36**

**Prior U.S. Cls.: 100, 101, and 102**

**United States Patent and Trademark Office**

**Reg. No. 3,455,723**

**Registered June 24, 2008**

**SERVICE MARK  
PRINCIPAL REGISTER**

**ROLLING THUNDER FUNDING**

CASTLE & MOSEY II, LLC (NEW YORK LTD  
LIAB CO)  
9700 MAIN STREET  
CLARENCE, NY 14031

FOR: FINANCIAL SERVICES IN THE NATURE  
OF PROCURING OR PURCHASING DEBT FOR  
OTHERS, IN CLASS 36 (U.S. CLS. 100, 101 AND 102).

FIRST USE 7-0-2005; IN COMMERCE 7-0-2005.

THE MARK CONSISTS OF STANDARD CHAR-  
ACTERS WITHOUT CLAIM TO ANY PARTICULAR  
FONT, STYLE, SIZE, OR COLOR.

NO CLAIM IS MADE TO THE EXCLUSIVE  
RIGHT TO USE "FUNDING", APART FROM THE  
MARK AS SHOWN.

SN 78-922,334, FILED 7-5-2006.

ZHALEH DELANEY, EXAMINING ATTORNEY

**Int. Cl.: 3**

**Prior U.S. Cls.: 1, 4, 6, 50, 51, and 52**

**Reg. No. 3,455,724**

**United States Patent and Trademark Office**

**Registered June 24, 2008**

**TRADEMARK  
PRINCIPAL REGISTER**

**LONG WEAR DETOX**

BIO THERM (MONACO SOCIETE ANONYME  
MONEGASQUE)

"LE NEPTUNE"

11 AVENUE ALBERT II

MONACO, MONACO MC-98000

FOR: MAKE-UP PREPARATIONS, IN CLASS 3  
(U.S. CLS. 1, 4, 6, 50, 51 AND 52).

FIRST USE 3-0-2007; IN COMMERCE 3-0-2007.

THE MARK CONSISTS OF STANDARD CHAR-  
ACTERS WITHOUT CLAIM TO ANY PARTICULAR  
FONT, STYLE, SIZE, OR COLOR.

NO CLAIM IS MADE TO THE EXCLUSIVE  
RIGHT TO USE "LONG WEAR", APART FROM  
THE MARK AS SHOWN.

SN 78-922,520, FILED 7-5-2006.

ROBERT LAVACHE, EXAMINING ATTORNEY

**Int. Cls.: 9 and 10**

**Prior U.S. Cls.: 21, 23, 26, 36, 38, 39, and 44**

**United States Patent and Trademark Office**

**Reg. No. 3,455,725**

**Registered June 24, 2008**

**TRADEMARK  
PRINCIPAL REGISTER**

**AMIGO**

OTICON A/S (DENMARK JOINT STOCK COMPANY)  
KONGEBAKKEN 9  
SMORUM, DENMARK DK-2765

FOR: FM RECEIVERS AND TRANSMITTERS AND WIRELESS FM RECEIVERS AND TRANSMITTERS FOR USE IN CONNECTION WITH ELECTRO-ACOUSTICAL APPARATUSES FOR USE BY THE HEARING IMPAIRED, IN CLASS 9 (U.S. CLS. 21, 23, 26, 36 AND 38).

FIRST USE 8-0-2006; IN COMMERCE 8-0-2006.

FOR: ELECTO-ACOUSTICAL APPARATUSES FOR USE BY THE HEARING IMPAIRED, IN CLASS 10 (U.S. CLS. 26, 39 AND 44).

FIRST USE 8-0-2006; IN COMMERCE 8-0-2006.

THE MARK CONSISTS OF STANDARD CHARACTERS WITHOUT CLAIM TO ANY PARTICULAR FONT, STYLE, SIZE, OR COLOR.

PRIORITY CLAIMED UNDER SEC. 44(D) ON DENMARK APPLICATION NO. VA200600808, FILED 2-16-2006, REG. NO. VR200601537, DATED 4-28-2006, EXPIRES 4-28-2016.

SN 78-922,657, FILED 7-5-2006.

WON TEAK OH, EXAMINING ATTORNEY

**Int. Cl.: 35**

**Prior U.S. Cls.: 100, 101, and 102**

**United States Patent and Trademark Office**

**Reg. No. 3,455,726**

**Registered June 24, 2008**

**SERVICE MARK  
PRINCIPAL REGISTER**

**CLEAN.NEAT.EASY.**

ORGANIZE.COM, INC. (CALIFORNIA CORPORATION)  
6727 COLUMBUS STREET  
RIVERSIDE, CA 92504

FOR: RETAIL STORE SERVICES AND ON-LINE RETAIL STORE SERVICES IN THE AREA OF HOUSEHOLD AND OFFICE ACCESSORIES, STORAGE ITEMS, STORAGE SYSTEMS AND SPACE ORGANIZERS, AND RELATED GOODS; MAIL ORDER CATALOG SERVICES IN THE AREA OF HOUSEHOLD AND OFFICE ACCESSORIES, STORAGE ITEMS, STORAGE SYSTEMS AND SPACE ORGANIZERS, AND RELATED GOODS; RETAIL STORE SERVICES FEATURING PHONE IN ORDERS IN THE AREA OF HOUSEHOLD AND OFFICE ACCESSORIES, STORAGE ITEMS, STORAGE SYSTEMS AND SPACE ORGANIZERS, AND RELA-

TED GOODS; AND RETAIL STORE SERVICES FEATURING FACSIMILE ORDERS IN THE AREA OF HOUSEHOLD AND OFFICE ACCESSORIES, STORAGE ITEMS, STORAGE SYSTEMS AND SPACE ORGANIZERS, AND RELATED GOODS , IN CLASS 35 (U.S. CLS. 100, 101 AND 102).

FIRST USE 12-1-2006; IN COMMERCE 12-1-2006.

THE MARK CONSISTS OF STANDARD CHARACTERS WITHOUT CLAIM TO ANY PARTICULAR FONT, STYLE, SIZE, OR COLOR.

SN 78-923,965, FILED 7-6-2006.

ELIZABETH HUGHITT, EXAMINING ATTORNEY



**Int. Cl.: 21**

**Prior U.S. Cls.: 2, 13, 23, 29, 30, 33, 40, and 50**

**Reg. No. 3,455,727**

**United States Patent and Trademark Office**

**Registered June 24, 2008**

**TRADEMARK  
PRINCIPAL REGISTER**

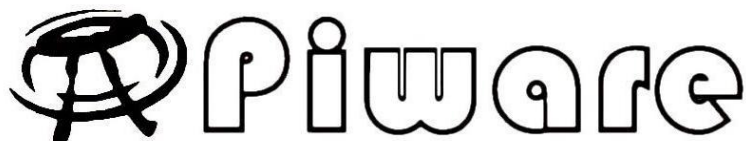

PIWARE INTERNATIONAL HOLDING L.L.C.  
(DELAWARE LTD LIAB CO)  
15 EAST NORTH STREET  
DOVER, DE 19901

FOR: SMALL HAND-OPERATED HOUSEHOLD OR KITCHEN UTENSILS, NAMELY, CUTTING BOARDS, BASTING SPOONS, CONFECTIONERS' DECORATING BAGS, COOKIE CUTTERS, GARLIC PRESSES, ICE CREAM SCOOPS, LADLES FOR KITCHEN USE, LEMON SQUEEZERS, MELON BALLERS, MIXING SPOONS, PASTRY CUTTERS, SERVING TONGS, SERVING SPOONS, SERVING LADLES, SOUP LADLES, SERVING FORKS, SLOTTED SPOONS, NON-ELECTRIC COFFEE POTS, BEVERAGE GLASSWARE, GLASS MIXING BOWLS, GLASS SERVING BOWLS, GLASS PLATES, DRINKING GLASSES, CUT CRYSTAL GLASSWARE, NAMELY, SERVING PLATES, SALAD BOWLS, JAM DISHES, CERAMIC SCULPTURES, VASES, VESSELS, BOWLS, PLATES AND POTS, STATUES AND FIGURINES OF GLASS AND CRYSTAL, ALL

PURPOSE PORTABLE HOUSEHOLD CONTAINERS AND CANISTER SETS, FRYING PANS, SPOONS USED AS SERVING PIECES, STAINLESS STEEL POTS AND PANS, CAKE PANS, CUPS, COFFEE CUPS, PLATES, MEAL TRAYS, BAKEWARE, AND PLASTIC BEVERAGE CUP HOLDERS, NOT FOR VEHICULAR USE, FOR HOLDING PAPER AND PLASTIC DRINKING CUPS, IN CLASS 21 (U.S. CLS. 2, 13, 23, 29, 30, 33, 40 AND 50).

FIRST USE 11-1-2007; IN COMMERCE 3-4-2008.

THE MARK CONSISTS OF THE INVENTED WORD "PIWARE" AND A PI SYMBOL INCLUDED IN AN ELLIPSE DESIGN.

SN 78-924,226, FILED 7-7-2006.

KATHERINE M. DUBRAY, EXAMINING ATTORNEY

**Int. Cl.: 9**

**Prior U.S. Cls.: 21, 23, 26, 36, and 38**

**Reg. No. 3,455,728**

**United States Patent and Trademark Office**

**Registered June 24, 2008**

**TRADEMARK  
PRINCIPAL REGISTER**

**LEADER BOARD**

DUKANE CORPORATION (ILLINOIS CORPORATION)  
2900 DUKANE DRIVE  
ST. CHARLES, IL 60714

FOR: ELECTRONIC PRESENTATION SYSTEMS  
CONSISTING OF INTERACTIVE ELECTRONIC  
WHITEBOARDS AND RELATED SOFTWARE FOR  
SHOWING AND PRESENTING PRESENTATIONS  
OF INTERACTIVE TEXT, DATA GRAPHICS AND  
IMAGES, IN CLASS 9 (U.S. CLS. 21, 23, 26, 36 AND 38).

FIRST USE 10-1-2006; IN COMMERCE 10-1-2006.

THE MARK CONSISTS OF STANDARD CHARACTERS WITHOUT CLAIM TO ANY PARTICULAR FONT, STYLE, SIZE, OR COLOR.

SN 78-924,782, FILED 7-7-2006.

JENNIFER VASQUEZ, EXAMINING ATTORNEY

**Int. Cl.: 42**

**Prior U.S. Cls.: 100 and 101**

**United States Patent and Trademark Office**

**Reg. No. 3,455,729**

**Registered June 24, 2008**

**SERVICE MARK  
PRINCIPAL REGISTER**

**MAKESHOP**

KOREACENTER.COM, INC. (REPUBLIC OF  
KOREA CORPORATION)  
A-1401 WOORIM LIONS VALLEY  
371-28 GASAN-DONG, GEUMCHEON-GU  
SEOUL, REPUBLIC OF KOREA

FOR: WEB SITE HOSTING SERVICES; CREAT-  
ING AND MAINTAINING WEB SITES FOR OTH-  
ERS; COMPUTER SYSTEM DESIGN FOR OTHERS;  
COMPUTER SOFTWARE DESIGN; UPDATING OF  
COMPUTER SOFTWARE FOR OTHERS; MAINTE-  
NANCE OF COMPUTER SOFTWARE, IN CLASS 42  
(U.S. CLS. 100 AND 101).

FIRST USE 4-4-2008; IN COMMERCE 4-4-2008.

THE MARK CONSISTS OF STANDARD CHAR-  
ACTERS WITHOUT CLAIM TO ANY PARTICULAR  
FONT, STYLE, SIZE, OR COLOR.

SN 78-924,838, FILED 7-7-2006.

SKYE YOUNG, EXAMINING ATTORNEY

**Int. Cl.: 25**

**Prior U.S. Cls.: 22 and 39**

**United States Patent and Trademark Office**

**Reg. No. 3,455,730**

**Registered June 24, 2008**

**TRADEMARK  
PRINCIPAL REGISTER**

**Chief Daddy Officer**

DEMENT, DANIEL GLEN (UNITED STATES IN-  
DIVIDUAL)  
6547 VIA ALCAZAR  
CARLSBAD, CA 92009

FOR: CLOTHING AND APPAREL, NAMELY, T-  
SHIRTS, SWEATSHIRTS, COLLARED SHIRTS,  
NECKTIES, JACKETS, AND HEADGEAR, NAME-  
LY, HATS, VISORS, CAPS AND BEANIES, IN CLASS  
25 (U.S. CLS. 22 AND 39).

FIRST USE 6-27-2006; IN COMMERCE 2-13-2008.

THE MARK CONSISTS OF STANDARD CHAR-  
ACTERS WITHOUT CLAIM TO ANY PARTICULAR  
FONT, STYLE, SIZE, OR COLOR.

SN 78-925,286, FILED 7-9-2006.

JASON TURNER, EXAMINING ATTORNEY

**Int. Cl.: 37**

**Prior U.S. Cls.: 100, 103, and 106**

**United States Patent and Trademark Office**

**Reg. No. 3,455,731**

**Registered June 24, 2008**

**SERVICE MARK  
PRINCIPAL REGISTER**

**CAPRON LAKES**

ST. LUCIE LAND, LTD. (FLORIDA LIMITED  
PARTNERSHIP)  
450 E. LAS OLAS BLVD., 15TH FLOOR  
FT. LAUDERDALE, FL 33301

FOR: REAL ESTATE DEVELOPMENT, SITE SE-  
LECTION, CONSTRUCTION PLANNING, CON-  
STRUCTION MANAGEMENT AND SUPERVISION,  
CONSTRUCTION SERVICES, NAMELY, PLAN-  
NING, LAYING OUT AND CUSTOM CONSTRUC-  
TION OF RESIDENTIAL AND COMMERCIAL  
REAL ESTATE, IN CLASS 37 (U.S. CLS. 100, 103  
AND 106).

FIRST USE 5-25-2006; IN COMMERCE 5-25-2006.

THE MARK CONSISTS OF STANDARD CHAR-  
ACTERS WITHOUT CLAIM TO ANY PARTICULAR  
FONT, STYLE, SIZE, OR COLOR.

SN 78-925,571, FILED 7-10-2006.

KEVIN DINALLO, EXAMINING ATTORNEY

**Int. Cl.: 11**

**Prior U.S. Cls.: 13, 21, 23, 31, and 34**

**United States Patent and Trademark Office**

**Reg. No. 3,455,732**

**Registered June 24, 2008**

---

**TRADEMARK  
PRINCIPAL REGISTER**

**NEVER TRIP**

INNOVATIVE PIPING SOLUTIONS, LLC (DELA-  
WARE LTD LIAB CO)  
571 KYHBER LANE  
VENICE, FL 34293

THE MARK CONSISTS OF STANDARD CHAR-  
ACTERS WITHOUT CLAIM TO ANY PARTICULAR  
FONT, STYLE, SIZE, OR COLOR.

FOR: PLUMBING FITTINGS, NAMELY, DRAIN  
VALVE ASSEMBLY AND COLLECTION PORT FOR  
COLLECTING CONDENSATE, IN CLASS 11 (U.S.  
CLS. 13, 21, 23, 31 AND 34).

SN 78-925,782, FILED 7-10-2006.

FIRST USE 1-26-2007; IN COMMERCE 4-25-2007.

HAI-LY LAM, EXAMINING ATTORNEY

**Int. Cl.: 36**

**Prior U.S. Cls.: 100, 101, and 102**

**United States Patent and Trademark Office**

**Reg. No. 3,455,733**

**Registered June 24, 2008**

**SERVICE MARK  
PRINCIPAL REGISTER**

**PAYMENT PROTECTION  
ADVANTAGE**

EDS CREDIT UNION (TEXAS CHARTERED  
CREDIT UNION)  
5640 DEMOCRACY DRIVE  
PLANO, TX 75024

FOR: CREDIT UNION SERVICES IN THE FIELD  
OF LOAN PROTECTION, NAMELY, DEBT CAN-  
CELLATION SERVICES, IN CLASS 36 (U.S. CLS. 100,  
101 AND 102).

FIRST USE 9-1-2006; IN COMMERCE 9-1-2006.

THE MARK CONSISTS OF STANDARD CHAR-  
ACTERS WITHOUT CLAIM TO ANY PARTICULAR  
FONT, STYLE, SIZE, OR COLOR.

NO CLAIM IS MADE TO THE EXCLUSIVE  
RIGHT TO USE "PAYMENT PROTECTION", APART  
FROM THE MARK AS SHOWN.

SN 78-926,074, FILED 7-10-2006.

JOHN GARTNER, EXAMINING ATTORNEY

**Int. Cl.: 16**

**Prior U.S. Cls.: 2, 5, 22, 23, 29, 37, 38, and 50**

**Reg. No. 3,455,734**

**United States Patent and Trademark Office**

**Registered June 24, 2008**

**TRADEMARK  
PRINCIPAL REGISTER**

**The Four-Legged Socialite**

ANN ARBOR PET BOUTIQUE, INC. (MICHIGAN CORPORATION), DBA THE FOUR-LEGGED SOCIALITE,  
1352 TAMMY LN  
ANN ARBOR, MI 48103

FIRST USE 8-1-2006; IN COMMERCE 8-1-2006.

THE MARK CONSISTS OF STANDARD CHARACTERS WITHOUT CLAIM TO ANY PARTICULAR FONT, STYLE, SIZE, OR COLOR.

FOR: PRINTED PUBLICATIONS, NAMELY, MAGAZINES, NEWSLETTERS AND CALENDARS IN THE FIELD OF PETS; DECALS AND STICKERS, IN CLASS 16 (U.S. CLS. 2, 5, 22, 23, 29, 37, 38 AND 50).

SN 78-926,168, FILED 7-10-2006.

TRICIA SONNEBORN, EXAMINING ATTORNEY



**Int. Cl.: 41**

**Prior U.S. Cls.: 100, 101, and 107**

**United States Patent and Trademark Office**

**Reg. No. 3,455,735**

**Registered June 24, 2008**

**SERVICE MARK  
PRINCIPAL REGISTER**

**THE HILL RAISING THE ROOF  
ON D.C.**

SUNDANCE CHANNEL LLC (DELAWARE LTD  
LIAB CO)  
1633 BROADWAY  
NEW YORK, NY 10019

FOR: ENTERTAINMENT SERVICES IN THE  
NATURE OF A DOCUMENTARY TELEVISION  
SERIES, IN CLASS 41 (U.S. CLS. 100, 101 AND 107).

FIRST USE 8-1-2006; IN COMMERCE 8-1-2006.

THE MARK CONSISTS OF STANDARD CHAR-  
ACTERS WITHOUT CLAIM TO ANY PARTICULAR  
FONT, STYLE, SIZE, OR COLOR.

NO CLAIM IS MADE TO THE EXCLUSIVE  
RIGHT TO USE "D.C.", APART FROM THE MARK  
AS SHOWN.

SN 78-926,296, FILED 7-10-2006.

ANNE E. GUSTASON, EXAMINING ATTORNEY

**Int. Cl.: 11**

**Prior U.S. Cls.: 13, 21, 23, 31, and 34**

**United States Patent and Trademark Office**

**Reg. No. 3,455,736**

**Registered June 24, 2008**

**TRADEMARK  
PRINCIPAL REGISTER**

**NEVER ♦ TRIP**

INNOVATIVE PIPING SOLUTIONS, LLC (DELA-  
WARE LTD LIAB CO)  
571 KYHBER LANE  
VENICE, FL 34293

FIRST USE 1-26-2007; IN COMMERCE 4-25-2007.

FOR: PLUMBING FITTINGS, NAMELY, DRAIN  
VALVE ASSEMBLY AND COLLECTION PORT FOR  
COLLECTING CONDENSATE, IN CLASS 11 (U.S.  
CLS. 13, 21, 23, 31 AND 34).

SN 78-926,773, FILED 7-11-2006.

HAI-LY LAM, EXAMINING ATTORNEY

**Int. Cl.: 29**

**Prior U.S. Cl.: 46**

**Reg. No. 3,455,737**

**United States Patent and Trademark Office**

**Registered June 24, 2008**

**TRADEMARK  
PRINCIPAL REGISTER**

  
Ultrafresh

SIX L'S PACKING COMPANY, INC. (FLORIDA  
CORPORATION)  
315 EAST NEW MARKET ROAD  
IMMOKALEE, FL 34142

FOR: PROCESSED VEGETABLES AND FRUITS,  
IN CLASS 29 (U.S. CL. 46).

FIRST USE 11-20-2006; IN COMMERCE 11-20-2006.

NO CLAIM IS MADE TO THE EXCLUSIVE  
RIGHT TO USE "ULTRAFRESH PRODUCE",  
APART FROM THE MARK AS SHOWN.

THE MARK CONSISTS OF THE WORD "ULTRA-  
FRESH" WITH A LEAF ABOVE AND BETWEEN  
THE LETTER "T" AND "R" OF ULTRA AND THE  
WORD "PRODUCE" IN ALL CAPS ABOVE AND  
BETWEEN THE "F" AND "H" OF FRESH.

SN 78-926,970, FILED 7-11-2006.

MARY CRAWFORD, EXAMINING ATTORNEY

**Int. Cl.: 33**

**Prior U.S. Cls.: 47 and 49**

**United States Patent and Trademark Office**

**Reg. No. 3,455,738**

**Registered June 24, 2008**

**TRADEMARK  
PRINCIPAL REGISTER**

**DUC DE VALOIS**

VARICHON ET CLERC (FRANCE CORPORATION)

LES SEYCHALLETS

SEYSSEL, FRANCE 01420

FOR: WINES; SPARKLING WINES, IN CLASS 33  
(U.S. CLS. 47 AND 49).

FIRST USE 8-1-1999; IN COMMERCE 8-1-1999.

THE MARK CONSISTS OF STANDARD CHARACTERS WITHOUT CLAIM TO ANY PARTICULAR FONT, STYLE, SIZE, OR COLOR.

THE NAME(S), PORTRAIT(S), AND/OR SIGNATURE(S) SHOWN IN THE MARK DOES NOT IDENTIFY A PARTICULAR LIVING INDIVIDUAL.

SN 78-927,013, FILED 7-11-2006.

ROBIN CHOSID, EXAMINING ATTORNEY

**Int. Cl.: 6**

**Prior U.S. Cls.: 2, 12, 13, 14, 23, 25, and 50**

**Reg. No. 3,455,739**

**United States Patent and Trademark Office**

**Registered June 24, 2008**

**TRADEMARK  
PRINCIPAL REGISTER**

**SURE-STRIKE**

WMW INNOVATION COMPANY (TEXAS CORPORATION)  
C/O CHALKER FLORES, LLP  
2711 LBJ FREEWAY, SUITE 1036  
DALLAS, TX 75234

HOUSING, METAL COVER PLATE, SCREWS, AND DEADBOLT ASSEMBLY, LOCK SETS AND REPLACEMENT PARTS THEREFORE, IN CLASS 6 (U.S. CLS. 2, 12, 13, 14, 23, 25 AND 50).

FOR: METAL HARDWARE FOR DOORS, NAME-  
LY, DOOR LOCKS, STRIKE PLATES, STRIKE  
PLATE KITS COMPRISED OF STRIKE PLATE  
HOUSING, METAL COVER PLATE, SCREWS,  
DOOR LOCK KITS COMPRISED OF STRIKE PLATE

FIRST USE 11-5-2007; IN COMMERCE 11-5-2007.

SN 78-927,235, FILED 7-11-2006.

PAUL CROWLEY, EXAMINING ATTORNEY

**Int. Cl.: 14**

**Prior U.S. Cls.: 2, 27, 28, and 50**

**United States Patent and Trademark Office**

**Reg. No. 3,455,740**

**Registered June 24, 2008**

**TRADEMARK  
PRINCIPAL REGISTER**

**AMBER NIGHTS**

DESIGNS BY FMC, INC. (NEW YORK COR-  
PORATION)

1533 60TH STREET

BROOKLYN, NY 11219

FOR: PRECIOUS GEMS, JEWELRY AND  
WATCHES, IN CLASS 14 (U.S. CLS. 2, 27, 28 AND 50).

FIRST USE 2-28-2007; IN COMMERCE 2-28-2007.

THE MARK CONSISTS OF STANDARD CHAR-  
ACTERS WITHOUT CLAIM TO ANY PARTICULAR  
FONT, STYLE, SIZE, OR COLOR.

NO CLAIM IS MADE TO THE EXCLUSIVE  
RIGHT TO USE "AMBER", APART FROM THE  
MARK AS SHOWN.

SN 78-927,670, FILED 7-12-2006.

ELIZABETH BEYER, EXAMINING ATTORNEY

**Int. Cl.: 42**

**Prior U.S. Cls.: 100 and 101**

**United States Patent and Trademark Office**

**Reg. No. 3,455,741**

**Registered June 24, 2008**

**SERVICE MARK  
PRINCIPAL REGISTER**

**NEWTEK REFERRAL SYSTEM**

NEWTEK BUSINESS SERVICES, INC. (NEW  
YORK CORPORATION)  
1440 BROADWAY  
17TH FLOOR  
NEW YORK, NY 10018

FOR: PROVIDING TEMPORARY USE OF ON-  
LINE NON-DOWNLOADABLE SOFTWARE TO AL-  
LOW CUSTOMERS TO ACCESS ACCOUNT INFOR-  
MATION, REVIEW REFERRAL INFORMATION,  
AND INITIATE CONTACT REQUESTS, IN CLASS  
42 (U.S. CLS. 100 AND 101).

FIRST USE 6-0-2003; IN COMMERCE 6-0-2003.

THE MARK CONSISTS OF STANDARD CHAR-  
ACTERS WITHOUT CLAIM TO ANY PARTICULAR  
FONT, STYLE, SIZE, OR COLOR.

NO CLAIM IS MADE TO THE EXCLUSIVE  
RIGHT TO USE "REFERRAL SYSTEM", APART  
FROM THE MARK AS SHOWN.

SN 78-927,807, FILED 7-12-2006.

KAREN K. BUSH, EXAMINING ATTORNEY

**Int. Cl.: 42**

**Prior U.S. Cls.: 100 and 101**

**United States Patent and Trademark Office**

**Reg. No. 3,455,742**

**Registered June 24, 2008**

**SERVICE MARK  
PRINCIPAL REGISTER**

**NEWTRACKER**

NEWTEK BUSINESS SERVICES, INC. (NEW  
YORK CORPORATION)  
1440 BROADWAY 17TH FLOOR  
NEW YORK, NY 10018

FOR: PROVIDING TEMPORARY USE OF ON-  
LINE NON-DOWNLOADABLE SOFTWARE TO AL-  
LOW CUSTOMERS TO ACCESS ACCOUNT INFOR-  
MATION, REVIEW REFERRAL INFORMATION,  
AND INITIATE CONTACT REQUESTS, IN CLASS  
42 (U.S. CLS. 100 AND 101).

FIRST USE 8-0-2006; IN COMMERCE 8-0-2006.

THE MARK CONSISTS OF STANDARD CHAR-  
ACTERS WITHOUT CLAIM TO ANY PARTICULAR  
FONT, STYLE, SIZE, OR COLOR.

SN 78-927,856, FILED 7-12-2006.

KAREN K. BUSH, EXAMINING ATTORNEY



**Int. Cl.: 33**

**Prior U.S. Cls.: 47 and 49**

**United States Patent and Trademark Office**

**Reg. No. 3,455,743**

**Registered June 24, 2008**

**TRADEMARK  
PRINCIPAL REGISTER**

**THERE IS A RIGHT WAY**

ALTAMAR BRANDS, LLC (CALIFORNIA LTD  
LIAB CO)  
2101 EAST COAST HIGHWAY, SUITE 250  
CORONA DEL MAR, CA 92625

THE MARK CONSISTS OF STANDARD CHAR-  
ACTERS WITHOUT CLAIM TO ANY PARTICULAR  
FONT, STYLE, SIZE, OR COLOR.

FOR: ALCOHOLIC BEVERAGES, NAMELY, DIS-  
TILLED SPIRITS, IN CLASS 33 (U.S. CLS. 47 AND 49).

SN 78-927,917, FILED 7-12-2006.

FIRST USE 2-0-2008; IN COMMERCE 2-0-2008.

HOWARD FRIEDMAN, EXAMINING ATTORNEY

**Int. Cl.: 5**

**Prior U.S. Cls.: 6, 18, 44, 46, 51, and 52**

**Reg. No. 3,455,744**

**United States Patent and Trademark Office**

**Registered June 24, 2008**

**TRADEMARK  
PRINCIPAL REGISTER**

# McMerlin

MERLIN GROUP LP (TEXAS LIMITED PART-  
NERSHIP)  
SUITE A  
1610 W. POLO ROAD  
GRAND PRAIRIE, TX 75052

FOR: DENTAL PRODUCTS, NAMELY, DENTAL  
RINSE; DENTURE ADHESIVES; DIETARY SUPPLE-  
MENTS; MEDICINAL CREAMS FOR SKIN CARE;  
ORAL WOUND DRESSINGS; PHARMACEUTI-  
CALS, NAMELY, ANTIBACTERIAL PHARMACEU-  
TICALS AND PHARMACEUTICAL  
PREPARATIONS FOR WOUNDS; SURGICAL  
WOUND DRESSINGS; TOPICAL WOUND DRES-  
SINGS; VACCINES; VETERINARY PRODUCTS,

NAMELY, ANTIINFECTIVE PRODUCTS FOR VE-  
TERINARY USE, IN CLASS 5 (U.S. CLS. 6, 18, 44, 46,  
51 AND 52).

FIRST USE 8-1-2006; IN COMMERCE 4-1-2007.

THE MARK CONSISTS OF STANDARD CHAR-  
ACTERS WITHOUT CLAIM TO ANY PARTICULAR  
FONT, STYLE, SIZE, OR COLOR.

SN 78-927,948, FILED 7-12-2006.

HEATHER SAPP, EXAMINING ATTORNEY

**Int. Cl.: 9**

**Prior U.S. Cls.: 21, 23, 26, 36, and 38**

**United States Patent and Trademark Office**

**Reg. No. 3,455,745**

**Registered June 24, 2008**

**TRADEMARK  
PRINCIPAL REGISTER**

**IA**

CAST IRON SYSTEM INC. (DELAWARE CORPORATION)  
2593 COAST AVENUE, SUITE 200  
MOUNTAIN VIEW, CA 94043

FOR: COMPUTER HARDWARE; COMPUTER SOFTWARE CONTAINING INTEGRATION APPLIANCES FOR INTEGRATING, DEPLOYING, AND SUPPORTING THE INTEGRATION OF INTERNET AND NETWORK BASED APPLICATIONS AND APPLICATION DATA, IN CLASS 9 (U.S. CLS. 21, 23, 26, 36 AND 38).

FIRST USE 5-26-2006; IN COMMERCE 5-26-2006.

THE MARK CONSISTS OF STANDARD CHARACTERS WITHOUT CLAIM TO ANY PARTICULAR FONT, STYLE, SIZE, OR COLOR.

SN 78-928,094, FILED 7-12-2006.

DORITT L. CARROLL, EXAMINING ATTORNEY

**Int. Cl.: 3**

**Prior U.S. Cls.: 1, 4, 6, 50, 51, and 52**

**Reg. No. 3,455,746**

**United States Patent and Trademark Office**

**Registered June 24, 2008**

**TRADEMARK  
PRINCIPAL REGISTER**

# MOOD-SCENTS

INNOVATIVE ANALYSIS, INC. (MARYLAND CORPORATION)  
7040 BEMBE BEACH ROAD  
ANNAPOLIS, MD 21403

FOR: COSMETICS AND SKIN CARE PREPARATIONS, NAMELY, FACE, BODY, HAND AND FOOT MOISTURIZERS; FACE, BODY, HAND AND FOOT SCRUBS; FACE, BODY, HAND, AND FOOT TONERS; FACE, BODY, HAND, AND FOOT ASTRINGENTS FOR COSMETIC PURPOSES; NON-MEDICATED POWDERS FOR THE FACE, BODY AND HANDS; AFTER SHOWER SKIN LOTIONS; SKIN CLEANSERS, NAIL POLISH, NAIL POLISH REMOVER; HAND SOAP, BODY SOAP, FACE SOAP, PERFUME, COLOGNE, EAU DE TOILETTE; MASCARA, BLUSH, EYE SHADOW, LIP STICK, LIP GLOSS, MAKE-UP, MAKE-UP REMOVER, EYE CREAM, SHAVING CREAMS, SHAVING GELS, AFTER SHAVE LOTIONS AND GELS; DEODORANT AND ANTIPERSPIRANTS FOR PERSONAL USE; SKIN LOTIONS; ESSENTIAL OILS FOR PER-

SONAL USE; SCENTED OILS AND LOTIONS USED TO PRODUCE AROMAS WHEN HEATED; ROOM FRAGRANCES; SUNTANNING PREPARATIONS, SUN SCREEN PREPARATIONS, SUN BLOCK PREPARATIONS; HAIR CARE AND STYLING PREPARATIONS, NAMELY, SHAMPOOS, CONDITIONERS, SPRAYS, GELS, MOUSSES AND TONICS; BATH PRODUCTS, NAMELY, NON-MEDICATED BATH SALTS, BATH CRYSTALS, BATH OILS, BATH BEADS, BATH GELS, BUBBLE BATH, IN CLASS 3 (U.S. CLS. 1, 4, 6, 50, 51 AND 52).

FIRST USE 2-0-2007; IN COMMERCE 2-0-2007.

THE MARK CONSISTS OF STANDARD CHARACTERS WITHOUT CLAIM TO ANY PARTICULAR FONT, STYLE, SIZE, OR COLOR.

SN 78-928,162, FILED 7-12-2006.

JULIE GUTTADAURO, EXAMINING ATTORNEY

**Int. Cl.: 20**

**Prior U.S. Cls.: 2, 13, 22, 25, 32, and 50**

**Reg. No. 3,455,747**

**United States Patent and Trademark Office**

**Registered June 24, 2008**

**TRADEMARK  
PRINCIPAL REGISTER**

**ARTEMISA**

DECO LAV, INC. (FLORIDA CORPORATION)  
424 S.W. 12TH AVENUE  
DEERFIELD BEACH, FL 33442

THE MARK CONSISTS OF STANDARD CHAR-  
ACTERS WITHOUT CLAIM TO ANY PARTICULAR  
FONT, STYLE, SIZE, OR COLOR.

FOR: BATHROOM FURNITURE, NAMELY,  
BATHROOM VANITIES, COUNTERTOPS, VANITY  
TOPS, CABINETS, SHELVES, IN CLASS 20 (U.S. CLS.  
2, 13, 22, 25, 32 AND 50).

SN 78-928,193, FILED 7-12-2006.

FIRST USE 1-0-2008; IN COMMERCE 1-0-2008.

WARREN L. OLANDRIA, EXAMINING ATTOR-  
NEY

**Int. Cl.: 14**

**Prior U.S. Cls.: 2, 27, 28, and 50**

**United States Patent and Trademark Office**

**Reg. No. 3,455,748**

**Registered June 24, 2008**

**TRADEMARK  
PRINCIPAL REGISTER**

**BEADS BY THE INCH**

BEADLUXE, LLC (NEW JERSEY LTD LIAB CO)  
319 SPRINGFIELD AVENUE  
SUMMIT, NJ 07901

FOR: BEADS FOR USE IN THE MANUFACTURE  
OF JEWELRY, IN CLASS 14 (U.S. CLS. 2, 27, 28 AND  
50).

FIRST USE 6-11-2007; IN COMMERCE 6-11-2007.

THE MARK CONSISTS OF STANDARD CHAR-  
ACTERS WITHOUT CLAIM TO ANY PARTICULAR  
FONT, STYLE, SIZE, OR COLOR.

NO CLAIM IS MADE TO THE EXCLUSIVE  
RIGHT TO USE "BEADS", APART FROM THE  
MARK AS SHOWN.

SN 78-928,283, FILED 7-12-2006.

NAAKWAMA ANKRAH, EXAMINING ATTORNEY

**Int. Cl.: 9**

**Prior U.S. Cls.: 21, 23, 26, 36, and 38**

**Reg. No. 3,455,749**

**United States Patent and Trademark Office**

**Registered June 24, 2008**

**TRADEMARK  
PRINCIPAL REGISTER**

# Nutrition Mentor

VALDEZ & ASSOCIATES (CALIFORNIA SOLE  
PROPRIETORSHIP)  
201 SAN ANTONIO CIRCLE, SUITE 152  
MOUNTAIN VIEW, CA 94040

FOR: EDUCATIONAL SOFTWARE FEATURING  
INSTRUCTION IN NUTRITION EDUCATION; IN-  
TERACTIVE MULTIMEDIA COMPUTER PRO-  
GRAM FOR NUTRITION EDUCATION , IN CLASS  
9 (U.S. CLS. 21, 23, 26, 36 AND 38).

FIRST USE 7-30-2007; IN COMMERCE 7-30-2007.

THE MARK CONSISTS OF STANDARD CHAR-  
ACTERS WITHOUT CLAIM TO ANY PARTICULAR  
FONT, STYLE, SIZE, OR COLOR.

NO CLAIM IS MADE TO THE EXCLUSIVE  
RIGHT TO USE "NUTRITION", APART FROM  
THE MARK AS SHOWN.

SN 78-928,294, FILED 7-12-2006.

PAULA MAHONEY, EXAMINING ATTORNEY

**Int. Cls.: 1 and 4**

**Prior U.S. Cls.: 1, 5, 6, 10, 15, 26, and 46**

**United States Patent and Trademark Office**

**Reg. No. 3,455,750**

**Registered June 24, 2008**

**TRADEMARK  
PRINCIPAL REGISTER**

**TRANSAQUA**

CASTROL LIMITED (UNITED KINGDOM LTD  
LIAB CO)  
WAKEFIELD HOUSE, PIPERS WAY  
SWINDON, WILTSHIRE, UNITED KINGDOM SN3  
1RE

FOR: FLUIDS FOR HYDRAULIC CIRCUITS; HY-  
DRAULIC FLUIDS; TRANSMISSION FLUIDS, IN  
CLASS 1 (U.S. CLS. 1, 5, 6, 10, 26 AND 46).

FIRST USE 12-31-1997; IN COMMERCE 12-31-1997.

FOR: MARINE LUBRICANTS; LUBRICATING  
OILS; HYDRAULIC OILS; INDUSTRIAL OILS,

NAMELY, TRANSMISSION OILS, IN CLASS 4 (U.S.  
CLS. 1, 6 AND 15).

FIRST USE 12-31-1997; IN COMMERCE 12-31-1997.

THE MARK CONSISTS OF STANDARD CHAR-  
ACTERS WITHOUT CLAIM TO ANY PARTICULAR  
FONT, STYLE, SIZE, OR COLOR.

SN 78-928,451, FILED 7-13-2006.

GILBERT SWIFT, EXAMINING ATTORNEY



**Int. Cls.: 9 and 16**

**Prior U.S. Cls.: 2, 5, 21, 22, 23, 26, 29, 36, 37, 38, and 50**

**Reg. No. 3,455,751**

**United States Patent and Trademark Office**

**Registered June 24, 2008**

**TRADEMARK  
PRINCIPAL REGISTER**



DYNAMO FILMS, INC. (NEW JERSEY CORPORATION)  
C/O DANIEL STEPHEN  
160 TOOKER AVE  
SPRINGFIELD, NJ 07081

FOR: MOTION PICTURE FILMS ABOUT A FICTIONAL HERO KNOWN AS RED HAIR, IN CLASS 9 (U.S. CLS. 21, 23, 26, 36 AND 38).

FIRST USE 2-2-2006; IN COMMERCE 2-2-2007.

FOR: COMIC BOOKS; COMIC STRIPS, IN CLASS 16 (U.S. CLS. 2, 5, 22, 23, 29, 37, 38 AND 50).

FIRST USE 2-2-2006; IN COMMERCE 11-20-2007.

THE COLOR(S) RED, YELLOW, ORANGE AND BLACK IS/ARE CLAIMED AS A FEATURE OF THE MARK.

THE MARK CONSISTS OF THE WORDS "LEGEND OF" IN ALL CAPITAL LETTERS WITH SHADOWING AND STYLIZED LETTERING OF THE WORDS "RED HAIR" AT THE BOTTOM. THE COLOR BLACK APPEARS IN THE WORDING "LEGEND OF". THE STYLIZED LETTERING OF THE WORDS "RED HAIR" ARE RED IN COLOR AT THE TOP AND THE COLOR GRADUALLY CHANGES TO ORANGE AND THEN YELLOW AS IT MOVES TOWARD THE BOTTOM OF THE WORD.

SN 78-928,804, FILED 7-13-2006.

HOWARD SMIGA, EXAMINING ATTORNEY

**Int. Cl.: 15**

**Prior U.S. Cls.: 2, 21, and 36**

**United States Patent and Trademark Office**

**Reg. No. 3,455,752**

**Registered June 24, 2008**

**TRADEMARK  
PRINCIPAL REGISTER**

**OCEAN**

GUITAR CENTER, INC. (DELAWARE CORPORATION)  
5795 LINDERO CANYON ROAD  
WESTLAKE VILLAGE, CA 91362

THE MARK CONSISTS OF STANDARD CHARACTERS WITHOUT CLAIM TO ANY PARTICULAR FONT, STYLE, SIZE, OR COLOR.

FOR: BASS GUITARS, IN CLASS 15 (U.S. CLS. 2, 21 AND 36).

SN 78-928,970, FILED 7-13-2006.

FIRST USE 5-15-2007; IN COMMERCE 5-15-2007.

SUSAN LESLIE DUBOIS, EXAMINING ATTORNEY

**Int. Cl.: 12**

**Prior U.S. Cls.: 19, 21, 23, 31, 35, and 44**

**Reg. No. 3,455,753**

**United States Patent and Trademark Office**

**Registered June 24, 2008**

---

**TRADEMARK  
PRINCIPAL REGISTER**

**SUNEW**

BEST CHOICE INTERNATIONAL TRADE CO.,  
LTD. (CHINA CORPORATION)  
CHAO YANG DISTRICT  
15 BEI SAN HUAN EAST ROAD  
BEIJING, CHINA

FIRST USE 8-28-2007; IN COMMERCE 8-28-2007.

FOR: TIRES, NAMELY, SOLID TIRES FOR VEHICLE WHEELS, TIRES FOR VEHICLE WHEELS, CASINGS FOR PNEUMATIC TIRES, AIRPLANE TIRES, PNEUMATIC TIRES, AUTOMOBILE TIRES, INNER TUBES FOR PNEUMATIC TIRES, AND BICYCLE TIRES, IN CLASS 12 (U.S. CLS. 19, 21, 23, 31, 35 AND 44).

THE MARK CONSISTS OF STANDARD CHARACTERS WITHOUT CLAIM TO ANY PARTICULAR FONT, STYLE, SIZE, OR COLOR.

SN 78-929,620, FILED 7-14-2006.

RAMONA ORTIGA, EXAMINING ATTORNEY

Int. Cl.: 41

Prior U.S. Cls.: 100, 101, and 107

Reg. No. 3,455,754

United States Patent and Trademark Office

Registered June 24, 2008

SERVICE MARK  
PRINCIPAL REGISTER



MACFADDEN PROTECH, LLC (DELAWARE  
LTD LIAB CO)  
SUITE 200  
4108 S. 8TH STREET  
LOUISVILLE, KY 40203

FOR: ENTERTAINMENT IN THE NATURE OF  
COMPETITIONS IN THE FIELD OF COOKING, IN  
CLASS 41 (U.S. CLS. 100, 101 AND 107).

FIRST USE 11-0-2006; IN COMMERCE 11-0-2006.

NO CLAIM IS MADE TO THE EXCLUSIVE  
RIGHT TO USE "INTERNATIONAL PIZZA CHAL-  
LENGE", APART FROM THE MARK AS SHOWN.

THE MARK CONSISTS OF IMAGE OF A MAN  
TOSSING A PIZZA INSIDE A CIRCULAR BORDER,  
WITH THE WORD "INTERNATIONAL" INSIDE  
THE BORDER AND ABOVE THE IMAGE AND  
THE WORDS "PIZZA CHALLENGE" INSIDE THE  
BORDER AND BELOW THE IMAGE.

SN 78-930,105, FILED 7-14-2006.

ALLISON HOLTZ, EXAMINING ATTORNEY

**Int. Cl.: 25**

**Prior U.S. Cls.: 22 and 39**

**United States Patent and Trademark Office**

**Reg. No. 3,455,755**

**Registered June 24, 2008**

**TRADEMARK  
PRINCIPAL REGISTER**

**HARPER FELIX**

HARPER, JILL (UNITED STATES INDIVIDUAL)  
34441 CAMINO EL MOLINO  
CAPISTRANO BEACH, CA 92624

FOR: CLOTHING, NAMELY, T-SHIRTS, SHIRTS,  
JACKETS, COATS, PANTS, SKIRTS AND DRESSES,  
IN CLASS 25 (U.S. CLS. 22 AND 39).

FIRST USE 6-2-2006; IN COMMERCE 4-14-2007.

THE MARK CONSISTS OF STANDARD CHAR-  
ACTERS WITHOUT CLAIM TO ANY PARTICULAR  
FONT, STYLE, SIZE, OR COLOR.

THE NAME(S), PORTRAIT(S), AND/OR SIGNA-  
TURE(S) SHOWN IN THE MARK DOES NOT IDENTI-  
FY A PARTICULAR LIVING INDIVIDUAL.

SN 78-930,282, FILED 7-14-2006.

KRISTINA MORRIS, EXAMINING ATTORNEY

**Int. Cl.: 38**

**Prior U.S. Cls.: 100, 101, and 104**

**United States Patent and Trademark Office**

**Reg. No. 3,455,756**

**Registered June 24, 2008**

**SERVICE MARK  
PRINCIPAL REGISTER**

**BESO**

CLEAR CHANNEL BROADCASTING, INC. (NE-  
VADA CORPORATION)  
200 EAST BASSE ROAD  
SAN ANTONIO, TX 78209

FOR: RADIO BROADCASTING SERVICES VIA  
HIGH DEFINITION, SATELLITE, GLOBAL COM-  
MUNICATIONS NETWORK, CABLE, COMPUTER,  
WIRELESS, TELEPHONE AND TERRESTRIAL  
MEANS; PROVIDING STREAMING OF DOWN-  
LOADABLE AUDIO AND VIDEO PROGRAMS ON  
THE INTERNET, IN CLASS 38 (U.S. CLS. 100, 101  
AND 104).

FIRST USE 2-0-2006; IN COMMERCE 2-0-2006.

THE MARK CONSISTS OF STANDARD CHAR-  
ACTERS WITHOUT CLAIM TO ANY PARTICULAR  
FONT, STYLE, SIZE, OR COLOR.

THE FOREIGN WORDING IN THE MARK  
TRANSLATES INTO ENGLISH AS "KISS".

SN 78-930,325, FILED 7-15-2006.

KAREN SEVERSON, EXAMINING ATTORNEY

**Int. Cl.: 30**

**Prior U.S. Cl.: 46**

**United States Patent and Trademark Office**

**Reg. No. 3,455,757**

**Registered June 24, 2008**

**TRADEMARK  
PRINCIPAL REGISTER**

**DURUWHITE**

THE PILLSBURY COMPANY (DELAWARE COR-  
PORATION)  
NUMBER ONE GENERAL MILLS BOULEVARD  
MINNEAPOLIS, MN 55426

THE MARK CONSISTS OF STANDARD CHAR-  
ACTERS WITHOUT CLAIM TO ANY PARTICULAR  
FONT, STYLE, SIZE, OR COLOR.

FOR: BREAD MIX; BREAD, IN CLASS 30 (U.S. CL.  
46).

SN 78-931,624, FILED 7-18-2006.

FIRST USE 8-10-2005; IN COMMERCE 8-10-2005.

NAKIA HENRY, EXAMINING ATTORNEY

**Int. Cl.: 41**

**Prior U.S. Cls.: 100, 101, and 107**

**United States Patent and Trademark Office**

**Reg. No. 3,455,758**

**Registered June 24, 2008**

**SERVICE MARK  
PRINCIPAL REGISTER**

**HOME FIELD ADVANTAGE**

METZGER, DEBRA J. (UNITED STATES INDIVIDUAL)  
9461 COLUMBUS ROAD  
LOUISVILLE, OH 44641

FOR: WEEKLY ENTERTAINMENT TELEVISION SHOW SHOWING LOCALS AS WELL AS VISITORS RECREATIONAL RESOURCES BEFORE AND AFTER ANY SPORTING EVENT, IN CLASS 41 (U.S. CLS. 100, 101 AND 107).

FIRST USE 8-1-2006; IN COMMERCE 8-1-2006.

THE MARK CONSISTS OF STANDARD CHARACTERS WITHOUT CLAIM TO ANY PARTICULAR FONT, STYLE, SIZE, OR COLOR.

SN 78-931,717, FILED 7-18-2006.

RICHARD A. STRASER, EXAMINING ATTORNEY



**Int. Cl.: 16**

**Prior U.S. Cls.: 2, 5, 22, 23, 29, 37, 38, and 50**

**Reg. No. 3,455,759**

**United States Patent and Trademark Office**

**Registered June 24, 2008**

**TRADEMARK  
PRINCIPAL REGISTER**

**DESIGNER BOUTIQUE**

DESIGNER GREETINGS, INC. (NEW YORK  
CORPORATION)

P.O. BOX 140729

STATEN ISLAND, NY 10314

FOR: GREETING CARDS, IN CLASS 16 (U.S. CLS.  
2, 5, 22, 23, 29, 37, 38 AND 50).

FIRST USE 11-2-2007; IN COMMERCE 11-2-2007.

THE MARK CONSISTS OF STANDARD CHAR-  
ACTERS WITHOUT CLAIM TO ANY PARTICULAR  
FONT, STYLE, SIZE, OR COLOR.

NO CLAIM IS MADE TO THE EXCLUSIVE  
RIGHT TO USE "BOUTIQUE", APART FROM THE  
MARK AS SHOWN.

SN 78-931,754, FILED 7-18-2006.

SANDRA MANIOS, EXAMINING ATTORNEY

**Int. Cl.: 9**

**Prior U.S. Cls.: 21, 23, 26, 36, and 38**

**Reg. No. 3,455,760**

**United States Patent and Trademark Office**

**Registered June 24, 2008**

**TRADEMARK  
PRINCIPAL REGISTER**

**Managing Your World of  
Information**

CUADRA ASSOCIATES, INC. (CALIFORNIA CORPORATION)  
11835 W. OLYMPIC BLVD., SUITE 855  
LOS ANGELES, CA 90064

FOR: COMPUTER SOFTWARE FOR KNOWLEDGE MANAGEMENT APPLICATIONS, NAMELY, PROVIDING FOR THE CAPTURE, INDEXING, AND STORING OF DESCRIPTIVE INFORMATION AND ELECTRONIC FILES SUCH AS THOSE COMMON IN ARCHIVES, LIBRARIES, MUSEUMS, MARKETING INTELLIGENCE AND RESEARCH UNITS, AND PROVIDING FOR PRECISE, CONTENT-BASED INFORMATION RETRIEVAL AND FLEX-

IBLE REPORT GENERATION, IN CLASS 9 (U.S. CLS. 21, 23, 26, 36 AND 38).

FIRST USE 7-18-2006; IN COMMERCE 4-9-2008.

THE MARK CONSISTS OF STANDARD CHARACTERS WITHOUT CLAIM TO ANY PARTICULAR FONT, STYLE, SIZE, OR COLOR.

SN 78-932,320, FILED 7-18-2006.

JOHN GARTNER, EXAMINING ATTORNEY

**Int. Cl.: 35**

**Prior U.S. Cls.: 100, 101, and 102**

**United States Patent and Trademark Office**

**Reg. No. 3,455,761**

**Registered June 24, 2008**

**SERVICE MARK  
PRINCIPAL REGISTER**

**ALIGNED MANAGEMENT  
SOLUTIONS**

KESTREL MANAGEMENT SERVICES, LLC (WIS-  
CONSIN LTD LIAB CO)  
199 E. BADGER ROAD, SUITE 200  
MADISON, WI 53713 AND  
CATTERMOLE & ASSOCIATES, LLC (COLORADO  
LTD LIAB CO)  
4909 PEARL STREET EAST, SUITE 201  
BOULDER, CO 80301

FOR: BUSINESS MANAGEMENT CONSULTING  
AND ADVISORY SERVICES; BUSINESS PROCESS  
RE-ENGINEERING SERVICES; BUSINESS RISK  
MANAGEMENT, IN CLASS 35 (U.S. CLS. 100, 101  
AND 102).

FIRST USE 4-4-2008; IN COMMERCE 4-4-2008.

THE MARK CONSISTS OF STANDARD CHAR-  
ACTERS WITHOUT CLAIM TO ANY PARTICULAR  
FONT, STYLE, SIZE, OR COLOR.

NO CLAIM IS MADE TO THE EXCLUSIVE  
RIGHT TO USE "MANAGEMENT SOLUTIONS",  
APART FROM THE MARK AS SHOWN.

SN 78-932,450, FILED 7-19-2006.

NAKIA HENRY, EXAMINING ATTORNEY

**Int. Cl.: 41**

**Prior U.S. Cls.: 100, 101, and 107**

**United States Patent and Trademark Office**

**Reg. No. 3,455,762**

**Registered June 24, 2008**

**SERVICE MARK  
PRINCIPAL REGISTER**

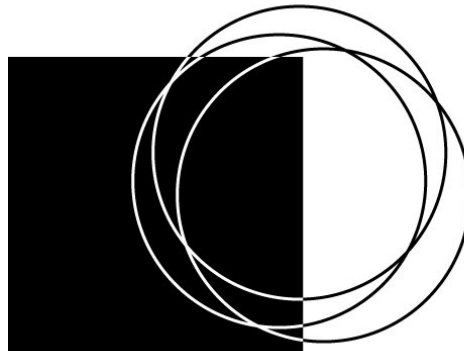

**COMSTOCK**

COMSTOCK, PAUL L. (UNITED STATES INDIVIDUAL)  
TWO RIVERWAY, SUITE 1000  
HOUSTON, TX 77056

AND INVESTMENT PLANNING, IN CLASS 41 (U.S. CLS. 100, 101 AND 107).

FIRST USE 8-26-2006; IN COMMERCE 8-26-2006.

FOR: EDUCATIONAL SERVICES, NAMELY, SEMINARS, CLASSES, AND WORKSHOPS IN THE FIELD OF STRATEGIC ESTATE SUCCESSORSHIP

SN 78-932,701, FILED 7-19-2006.

MARLENE BELL, EXAMINING ATTORNEY

**Int. Cl.: 42**

**Prior U.S. Cls.: 100 and 101**

**United States Patent and Trademark Office**

**Reg. No. 3,455,763**

**Registered June 24, 2008**

**SERVICE MARK  
PRINCIPAL REGISTER**

**WRITTENINC**

THE VENER GROUP, LLC (CALIFORNIA LTD  
LIAB CO)  
40042 PORTSMOUTH ROAD  
TEMECULA, CA 92591

THE MARK CONSISTS OF STANDARD CHAR-  
ACTERS WITHOUT CLAIM TO ANY PARTICULAR  
FONT, STYLE, SIZE, OR COLOR.

FOR: HANDWRITING ANALYSIS SERVICES, IN  
CLASS 42 (U.S. CLS. 100 AND 101).

SN 78-932,973, FILED 7-19-2006.

FIRST USE 9-15-2005; IN COMMERCE 9-15-2005.

MARK T. MULLEN, EXAMINING ATTORNEY

Int. Cl.: 33

Prior U.S. Cls.: 47 and 49

United States Patent and Trademark Office

Reg. No. 3,455,764

Registered June 24, 2008

TRADEMARK  
PRINCIPAL REGISTER

*Dos Maderas*

BODEGAS WILLIAMS & HUMBERT, S.A. (SPAIN  
CORPORATION)  
CTRA. NACIONAL IV, KM.641,75  
11408 JEREZ DE LA FRONTERA  
(CADIZ), SPAIN

THE ENGLISH TRANSLATION OF THE TERM  
"DOS MADERAS" IN THE MARK IS "TWO  
WOODS".

FOR: RUM, IN CLASS 33 (U.S. CLS. 47 AND 49).

SN 78-933,084, FILED 7-19-2006.

FIRST USE 0-0-2003; IN COMMERCE 12-28-2007.

NAAKWAMA ANKRAH, EXAMINING ATTORNEY

**Int. Cl.: 8**

**Prior U.S. Cls.: 23, 28, and 44**

**Reg. No. 3,455,765**

**United States Patent and Trademark Office**

**Registered June 24, 2008**

**TRADEMARK  
PRINCIPAL REGISTER**

**GRIP IT & STRIP IT!**

KHOURI, LOUIE (UNITED STATES INDIVIDUAL)  
8TH FLOOR  
964 THIRD AVE  
NEW YORK, NY 10022

THE MARK CONSISTS OF STANDARD CHARACTERS WITHOUT CLAIM TO ANY PARTICULAR FONT, STYLE, SIZE, OR COLOR.

FOR: HAND TOOLS, NAMELY, SAWS; HAND TOOLS, NAMELY, SANDERS, IN CLASS 8 (U.S. CLS. 23, 28 AND 44).

SN 78-933,803, FILED 7-20-2006.

FIRST USE 7-31-2006; IN COMMERCE 7-31-2006.

ASMAT KHAN, EXAMINING ATTORNEY

**Int. Cl.: 42**

**Prior U.S. Cls.: 100 and 101**

**United States Patent and Trademark Office**

**Reg. No. 3,455,766**

**Registered June 24, 2008**

**SERVICE MARK  
PRINCIPAL REGISTER**

**JUGGLE MY STUFF**

JUGGLESOFT, INC. (CALIFORNIA CORPORATION)  
450 MARIN DRIVE  
BURLINGAME, CA 94010

FOR: PROVIDING ONLINE NON-DOWNLOADABLE SOFTWARE ON A SUBSCRIPTION BASIS THAT INTEGRATES COLLABORATION, AND PERSONAL TIME MANAGEMENT, IN CLASS 42 (U.S. CLS. 100 AND 101).

FIRST USE 12-1-2007; IN COMMERCE 2-1-2008.

THE MARK CONSISTS OF STANDARD CHARACTERS WITHOUT CLAIM TO ANY PARTICULAR FONT, STYLE, SIZE, OR COLOR.

SN 78-933,851, FILED 7-20-2006.

LINDA E. BLOHM, EXAMINING ATTORNEY



**Int. Cl.: 9**

**Prior U.S. Cls.: 21, 23, 26, 36, and 38**

**United States Patent and Trademark Office**

**Reg. No. 3,455,767**

**Registered June 24, 2008**

**TRADEMARK  
PRINCIPAL REGISTER**

**I.S.O.U.K.**

DIAMONDBACK TACTICAL, LLLP (COLORADO  
LIMITED LIABILITY LIMITED PARTNER-  
SHIP)

#150

16661 N. 84TH AVE.  
PEORIA, AZ 85382

FOR: MILITARY AND LAW ENFORCEMENT  
ARMORED VEST COMPONENT KITS CONSISTING  
OF A CUMMERBUND, ADAPTER AND STRAPS,  
DESIGNED TO ENHANCE FUNCTIONALITY AND  
PERFORMANCE OF SUCH VESTS, IN CLASS 9 (U.S.  
CLS. 21, 23, 26, 36 AND 38).

FIRST USE 7-31-2006; IN COMMERCE 7-31-2006.

THE MARK CONSISTS OF STANDARD CHAR-  
ACTERS WITHOUT CLAIM TO ANY PARTICULAR  
FONT, STYLE, SIZE, OR COLOR.

SN 78-935,186, FILED 7-21-2006.

DAWN HAN, EXAMINING ATTORNEY

**Int. Cl.: 28**

**Prior U.S. Cls.: 22, 23, 38, and 50**

**United States Patent and Trademark Office**

**Reg. No. 3,455,768**

**Registered June 24, 2008**

**TRADEMARK  
PRINCIPAL REGISTER**

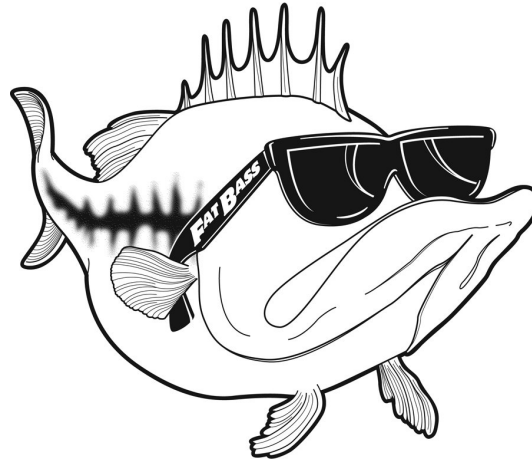

FAT BASS CUSTOM BAIT, LLC (ARIZONA LTD  
LIAB CO)  
722 N. 102ND PLACE  
MESA, AZ 85207

FOR: FISHING LURES, IN CLASS 28 (U.S. CLS. 22,  
23, 38 AND 50).

FIRST USE 1-28-2007; IN COMMERCE 1-28-2007.

NO CLAIM IS MADE TO THE EXCLUSIVE  
RIGHT TO USE "BASS", APART FROM THE MARK  
AS SHOWN.

THE MARK CONSISTS OF A FISH WITH SUN-  
GLASSES.

SN 78-935,248, FILED 7-21-2006.

LIEF MARTIN, EXAMINING ATTORNEY

**Int. Cl.: 28**

**Prior U.S. Cls.: 22, 23, 38, and 50**

**United States Patent and Trademark Office**

**Reg. No. 3,455,769**

**Registered June 24, 2008**

**TRADEMARK  
PRINCIPAL REGISTER**

**PIRATES CHEST**

SMART INDUSTRIES CORPORATION (IOWA  
CORPORATION)  
1626 DELAWARE AVENUE  
DES MOINES, IA 50317

THE MARK CONSISTS OF STANDARD CHAR-  
ACTERS WITHOUT CLAIM TO ANY PARTICULAR  
FONT, STYLE, SIZE, OR COLOR.

FOR: ARCADE GAMES, IN CLASS 28 (U.S. CLS.  
22, 23, 38 AND 50).

SN 78-935,780, FILED 7-24-2006.

FIRST USE 9-29-2006; IN COMMERCE 9-29-2006.

DAVID MILLER, EXAMINING ATTORNEY

**Int. Cl.: 35**

**Prior U.S. Cls.: 100, 101, and 102**

**United States Patent and Trademark Office**

**Reg. No. 3,455,770**

**Registered June 24, 2008**

**SERVICE MARK  
PRINCIPAL REGISTER**



SEASONTICKETRIGHTS.COM, LLC (TEXAS CORPORATION)  
SUITE 3300  
3200 SOUTHWEST FREEWAY, SUITE 3300  
HOUSTON, TX 770277526

NO CLAIM IS MADE TO THE EXCLUSIVE RIGHT TO USE "SEASON TICKET RIGHTS", APART FROM THE MARK AS SHOWN.

FOR: OPERATING AN ONLINE MARKETPLACE FOR BUYERS AND SELLERS OF SEAT LICENSES, IN CLASS 35 (U.S. CLS. 100, 101 AND 102).

SN 78-935,892, FILED 7-24-2006.

FIRST USE 5-26-2006; IN COMMERCE 10-9-2006.

LINDA E. BLOHM, EXAMINING ATTORNEY

**Int. Cl.: 29**

**Prior U.S. Cl.: 46**

**United States Patent and Trademark Office**

**Reg. No. 3,455,771**

**Registered June 24, 2008**

**TRADEMARK  
PRINCIPAL REGISTER**



JONMOR INVESTMENTS, INC. (DELAWARE CORPORATION)  
103 BAYNARD BUILDING  
3411 SILVERSIDE ROAD  
WILMINGTON, DE 19810

FOR: MEATS, IN CLASS 29 (U.S. CL. 46).

FIRST USE 11-1-2007; IN COMMERCE 11-1-2007.

OWNER OF U.S. REG. NOS. 733,876, 1,738,518,  
AND 2,313,605.

NO CLAIM IS MADE TO THE EXCLUSIVE RIGHT TO USE "FARM" AND "BRAND", APART FROM THE MARK AS SHOWN.

THE MARK CONSISTS OF A STYLIZED FARM SCENE, SURROUNDED BY THE WORDING "YORKSHIRE FARM BRAND" ON GEOMETRIC BACKGROUNDS.

SN 78-936,129, FILED 7-24-2006.

JASON LOTT, EXAMINING ATTORNEY

**Int. Cl.: 9**

**Prior U.S. Cls.: 21, 23, 26, 36, and 38**

**Reg. No. 3,455,772**

**United States Patent and Trademark Office**

**Registered June 24, 2008**

---

**TRADEMARK  
PRINCIPAL REGISTER**

**BET MORE WIN MORE!**

MULTIMEDIA GAMES, INC. (TEXAS CORPORATION)  
206 WILD BASIN RD., BLDG B - 4TH FLR  
AUSTIN, TX 78746

FOR: GAMING MACHINES, NAMELY, ELECTRONIC SLOT AND BINGO MACHINES; VIDEO LOTTERY TERMINALS, IN CLASS 9 (U.S. CLS. 21, 23, 26, 36 AND 38).

FIRST USE 10-3-2006; IN COMMERCE 10-3-2006.

THE MARK CONSISTS OF STANDARD CHARACTERS WITHOUT CLAIM TO ANY PARTICULAR FONT, STYLE, SIZE, OR COLOR.

SN 78-936,296, FILED 7-24-2006.

COLLEEN DOMBROW, EXAMINING ATTORNEY

**Int. Cl.: 19**

**Prior U.S. Cls.: 1, 12, 33, and 50**

**United States Patent and Trademark Office**

**Reg. No. 3,455,773**

**Registered June 24, 2008**

**TRADEMARK  
PRINCIPAL REGISTER**

**Mida Hydro-Trac**

OCTAGON ENTERPRISES, LLC (MARYLAND  
LTD LIAB CO)  
7970 WHITETAIL PLACE  
LAPLATA, MD 20646

THE MARK CONSISTS OF STANDARD CHAR-  
ACTERS WITHOUT CLAIM TO ANY PARTICULAR  
FONT, STYLE, SIZE, OR COLOR.

FOR: DRAINAGE SYSTEM COMPRISED OF  
PLASTIC DRAINAGE CONDUITS FOR REMOVING  
WATER AND DRYING FOUNDATION WALLS, IN  
CLASS 19 (U.S. CLS. 1, 12, 33 AND 50).

SN 78-936,770, FILED 7-25-2006.

FIRST USE 7-31-2006; IN COMMERCE 7-31-2006.

JOHN DWYER, EXAMINING ATTORNEY

**Int. Cl.: 16**

**Prior U.S. Cls.: 2, 5, 22, 23, 29, 37, 38, and 50**

**Reg. No. 3,455,774**

**United States Patent and Trademark Office**

**Registered June 24, 2008**

**TRADEMARK  
PRINCIPAL REGISTER**

**VALLEY PIVOTPOINT**

VALMONT INDUSTRIES, INC. (DELAWARE  
CORPORATION)  
ONE VALMONT PLAZA  
OMAHA, NE 68154

FOR: NEWSLETTERS IN THE FIELD OF AGRICULTURAL IRRIGATION, IN CLASS 16 (U.S. CLS. 2, 5, 22, 23, 29, 37, 38 AND 50).

FIRST USE 11-0-2006; IN COMMERCE 11-0-2006.

THE MARK CONSISTS OF STANDARD CHARACTERS WITHOUT CLAIM TO ANY PARTICULAR FONT, STYLE, SIZE, OR COLOR.

OWNER OF U.S. REG. NOS. 846,914, 1,151,611, AND 1,172,144.

SN 78-937,532, FILED 7-26-2006.

RONALD AIKENS, EXAMINING ATTORNEY



**Int. Cl.: 18**

**Prior U.S. Cls.: 1, 2, 3, 22, and 41**

**United States Patent and Trademark Office**

**Reg. No. 3,455,775**

**Registered June 24, 2008**

**TRADEMARK  
PRINCIPAL REGISTER**

**ST. BARRY**

TOP'S HANDBAG, INC. (CALIFORNIA CORPORATION)

C

1159 S. MAIN STREET  
LOS ANGELES, CA 90015

FOR: HANDBAGS; LEATHER HANDBAGS, IN CLASS 18 (U.S. CLS. 1, 2, 3, 22 AND 41).

FIRST USE 8-15-2007; IN COMMERCE 8-15-2007.

THE MARK CONSISTS OF STANDARD CHARACTERS WITHOUT CLAIM TO ANY PARTICULAR FONT, STYLE, SIZE, OR COLOR.

THE NAME "ST. BARRY" DOES NOT IDENTIFY A LIVING INDIVIDUAL.

SN 78-937,908, FILED 7-26-2006.

HOWARD SMIGA, EXAMINING ATTORNEY

**Int. Cl.: 12**

**Prior U.S. Cls.: 19, 21, 23, 31, 35, and 44**

**Reg. No. 3,455,776**

**United States Patent and Trademark Office**

**Registered June 24, 2008**

**TRADEMARK  
PRINCIPAL REGISTER**

**NexTrac**

BORGWARNER INC. (DELAWARE CORPORATION)  
3850 HAMLIN ROAD  
AUBURN HILLS, MI 48326

FOR: TRACTION CONTROL ASSEMBLIES, COMPRISED OF A CLUTCH, SENSORS, AND CONTROLLERS, FOR REGULATING THE TRANSFER OF TORQUE IN A VEHICLE DRIVELINE OF AUTOMOBILES, SPORT UTILITY VEHICLES, AND PASSENGER TRUCKS, IN CLASS 12 (U.S. CLS. 19, 21, 23, 31, 35 AND 44).

FIRST USE 3-12-2008; IN COMMERCE 3-12-2008.

THE MARK CONSISTS OF STANDARD CHARACTERS WITHOUT CLAIM TO ANY PARTICULAR FONT, STYLE, SIZE, OR COLOR.

SN 78-937,945, FILED 7-26-2006.

MARY MUNSON, EXAMINING ATTORNEY

**Int. Cl.: 12**

**Prior U.S. Cls.: 19, 21, 23, 31, 35, and 44**

**United States Patent and Trademark Office**

**Reg. No. 3,455,777**

**Registered June 24, 2008**

**TRADEMARK  
PRINCIPAL REGISTER**

**i-Trac**

BORGWARNER INC. (DELAWARE CORPORATION)  
3850 HAMLIN ROAD  
AUBURN HILLS, MI 48326

FOR: TRACTION CONTROL ASSEMBLIES, COMPRISED OF A CLUTCH, SENSORS, AND CONTROLLERS, FOR REGULATING THE TRANSFER OF TORQUE IN A VEHICLE DRIVELINE OF AUTOMOBILES, SPORT UTILITY VEHICLES, AND PASSENGER TRUCKS, IN CLASS 12 (U.S. CLS. 19, 21, 23, 31, 35 AND 44).

FIRST USE 3-12-2008; IN COMMERCE 3-12-2008.

THE MARK CONSISTS OF STANDARD CHARACTERS WITHOUT CLAIM TO ANY PARTICULAR FONT, STYLE, SIZE, OR COLOR.

SN 78-937,958, FILED 7-26-2006.

MARY MUNSON, EXAMINING ATTORNEY

**Int. Cl.: 9**

**Prior U.S. Cls.: 21, 23, 26, 36, and 38**

**United States Patent and Trademark Office**

**Reg. No. 3,455,778**

**Registered June 24, 2008**

**TRADEMARK  
PRINCIPAL REGISTER**

**BENDPLUS**

CRC-EVANS PIPELINE INTERNATIONAL, INC.  
(DELAWARE CORPORATION)  
11601 N. HOUSTON-ROSSLYN RD.  
HOUSTON, TX 77086

FIRST USE 5-19-2006; IN COMMERCE 5-19-2006.

FOR: ELECTRONIC APPARATUS, NAMELY,  
COMPRISING A SINGLE PROCESSOR, WHICH  
RECEIVES SENSOR INPUT, MONITOR AND A  
TOUCH PANEL INTERFACE INSTALLED TO EX-  
ISTING PIPE BENDING MACHINES TO INCREASE  
EFFICIENCY, ACCURACY AND STANDARDIZA-  
TION OF THE PIPE BENDING PROCESS, IN CLASS  
9 (U.S. CLS. 21, 23, 26, 36 AND 38).

THE MARK CONSISTS OF STANDARD CHAR-  
ACTERS WITHOUT CLAIM TO ANY PARTICULAR  
FONT, STYLE, SIZE, OR COLOR.

SN 78-938,020, FILED 7-26-2006.

DANIEL BRODY, EXAMINING ATTORNEY

**Int. Cl.: 41**

**Prior U.S. Cls.: 100, 101, and 107**

**United States Patent and Trademark Office**

**Reg. No. 3,455,779**

**Registered June 24, 2008**

**SERVICE MARK  
PRINCIPAL REGISTER**

**WARNER PREMIERE**

WARNER BROS. ENTERTAINMENT INC. (DE-  
LAWARE CORPORATION)  
4000 WARNER BOULEVARD  
BURBANK, CA 91522

FOR: PRODUCTION AND DISTRIBUTION OF  
LIVE-ACTION, COMEDY, DRAMA AND ANIMA-  
TED MOTION PICTURE FILMS; PROVIDING IN-  
FORMATION FOR AND ACTUAL  
ENTERTAINMENT VIA AN ELECTRONIC GLO-  
BAL COMMUNICATIONS NETWORK IN THE NAT-  
URE OF LIVE-ACTION, COMEDY, DRAMA AND  
ANIMATED PROGRAMS, IN CLASS 41 (U.S. CLS.  
100, 101 AND 107).

FIRST USE 3-4-2007; IN COMMERCE 3-4-2007.

THE MARK CONSISTS OF STANDARD CHAR-  
ACTERS WITHOUT CLAIM TO ANY PARTICULAR  
FONT, STYLE, SIZE, OR COLOR.

OWNER OF U.S. REG. NO. 3,087,859.

SN 78-938,347, FILED 7-26-2006.

ANDREA BUTLER, EXAMINING ATTORNEY

**Int. Cl.: 28**

**Prior U.S. Cls.: 22, 23, 38, and 50**

**United States Patent and Trademark Office**

**Reg. No. 3,455,780**

**Registered June 24, 2008**

**TRADEMARK  
PRINCIPAL REGISTER**

**COLOR DOTZ**

EMAK WORLDWIDE, INC. (DELAWARE CORPORATION)  
6330 SAN VICENTE BLVD.  
LOS ANGELES, CA 90048

FOR: TOYS, GAMES AND PLAYTHINGS, NAME-  
LY, BATHTUB TOYS, BATH ACTIVITY TOYS,  
CHILDREN'S MULTIPLE ACTIVITY TOYS, WATER  
SQUIRTING TOYS, SWIMMING FLOATS FOR RE-  
CREATIONAL USE; FOAM TOYS, NAMELY, FOAM  
BATH TOYS, FOAM BLOCKS, FOAM LETTERS OF  
THE ALPHABET AND FOAM TOY FIGURES; BUB-  
BLE MAKING WAND AND SOLUTION SETS, IN  
CLASS 28 (U.S. CLS. 22, 23, 38 AND 50).

FIRST USE 9-28-2006; IN COMMERCE 10-30-2006.

THE MARK CONSISTS OF STANDARD CHAR-  
ACTERS WITHOUT CLAIM TO ANY PARTICULAR  
FONT, STYLE, SIZE, OR COLOR.

NO CLAIM IS MADE TO THE EXCLUSIVE  
RIGHT TO USE "COLOR", APART FROM THE  
MARK AS SHOWN.

SN 78-938,383, FILED 7-26-2006.

IRA J. GOODSaid, EXAMINING ATTORNEY

**Int. Cl.: 16**

**Prior U.S. Cls.: 2, 5, 22, 23, 29, 37, 38, and 50**

**Reg. No. 3,455,781**

**United States Patent and Trademark Office**

**Registered June 24, 2008**

**TRADEMARK  
PRINCIPAL REGISTER**

**SENIORSUCCESS**

ABBOTT LABORATORIES (ILLINOIS CORPORATION)  
100 ABBOTT PARK ROAD  
ABBOTT PARK, IL 60064

FOR: PRINTED MATERIALS, NAMELY, BROCHURES, PAMPHLETS, NEWSLETTERS FOR HEALTHCARE PROFESSIONALS REGARDING SPECIAL NEEDS OF OLDER ADULTS AS RELATED TO OPTIMIZING HEALTHCARE, IN CLASS 16 (U.S. CLS. 2, 5, 22, 23, 29, 37, 38 AND 50).

FIRST USE 12-1-2006; IN COMMERCE 12-1-2006.

THE MARK CONSISTS OF STANDARD CHARACTERS WITHOUT CLAIM TO ANY PARTICULAR FONT, STYLE, SIZE, OR COLOR.

SN 78-939,002, FILED 7-27-2006.

ELISSA GARBER KON, EXAMINING ATTORNEY

**Int. Cl.: 16**

**Prior U.S. Cls.: 2, 5, 22, 23, 29, 37, 38, and 50**

**Reg. No. 3,455,782**

**United States Patent and Trademark Office**

**Registered June 24, 2008**

**TRADEMARK  
PRINCIPAL REGISTER**



MARTHA STEWART LIVING OMNIMEDIA, INC.  
(DELAWARE CORPORATION)  
11 WEST 42ND STREET  
NEW YORK, NY 10036

FOR: PAPER PRODUCTS, NAMELY, GREETING CARDS, PHOTO GREETING CARDS, STATIONERY, INVITATIONS, NOTE CARDS, NOTE PADS, PLACE CARDS, POSTCARDS, PHOTO MATS, NEWSLETTERS IN THE FIELD OF DOMESTIC ARTS, CALENDARS, PHOTO ALBUMS, GIFT TAGS, STICKERS, SELF ADHESIVE DECORATIVE SEALS, PRINTED SHEETS OF CLIP ART; EMBELLISHMENTS, NAMELY, CRAFT PAPER, PAPER TAGS, PAPER RIBBONS, ADHESIVE FOIL STATIONERY, DECORATIVE PAPER CUT OUTS, AND INK STAMPS; PAPER FAVOR BOXES, PAPER FAVOR

BAGS AND MAILING LABELS, IN CLASS 16 (U.S. CLS. 2, 5, 22, 23, 29, 37, 38 AND 50).

FIRST USE 5-3-2007; IN COMMERCE 5-3-2007.

OWNER OF U.S. REG. NOS. 2,339,976, 2,793,077, AND OTHERS.

"THE NAME(S), PORTRAIT(S), AND/OR SIGNATURE(S) SHOWN IN THE MARK IDENTIFIES "MARTHA STEWART" , WHOSE CONSENT(S) TO REGISTER IS SUBMITTED."

SN 78-939,389, FILED 7-27-2006.

KATHERINE CONNOLLY, EXAMINING ATTORNEY



**Int. Cls.: 9, 16, and 41**

**Prior U.S. Cls.: 2, 5, 21, 22, 23, 26, 29, 36, 37, 38, 50,  
100, 101, and 107**

**Reg. No. 3,455,783**

**United States Patent and Trademark Office**

**Registered June 24, 2008**

**TRADEMARK  
SERVICE MARK  
PRINCIPAL REGISTER**

**SOLO-ING**

MILLER, LAURI (UNITED STATES INDIVIDUAL)  
9819 WALNUT GROVE LANE  
MAPLE GROVE, MN 55311

FOR: DOWNLOADABLE ELECTRONIC, PUBLICATIONS IN THE NATURE OF MAGAZINES, MAGAZINES COLUMNS ARTICLES, NEWSLETTERS, JOURNALS, BOOKS, PAMPHLETS, LEAFLETS, AND BROCHURES IN THE FIELD OF SINGLE, UNMARRIED LIFESTYLE, IN CLASS 9 (U.S. CLS. 21, 23, 26, 36 AND 38).

FIRST USE 9-30-2007; IN COMMERCE 9-30-2007.

FOR: PUBLICATIONS, NAMELY, MAGAZINES, MAGAZINE COLUMNS, ARTICLES, NEWSLETTERS, JOURNALS, BOOKS, PAMPHLETS, LEAFLETS, BROCHURES DEDICATED TO THE SINGLE, UNMARRIED LIFESTYLE, IN CLASS 16 (U.S. CLS. 2, 5, 22, 23, 29, 37, 38 AND 50).

FIRST USE 9-30-2007; IN COMMERCE 9-30-2007.

FOR: PROVIDING ENTERTAINMENT RELATED INFORMATION VIA THE GLOBAL TELECOMMUNICATIONS NETWORK, TV, RADIO, AND OTHER COMMUNICATION TECHNOLOGY DIRECTED TO THOSE LIVING THE SINGLE UNMARRIED LIFESTYLE, IN CLASS 41 (U.S. CLS. 100, 101 AND 107).

FIRST USE 9-30-2007; IN COMMERCE 9-30-2007.

THE MARK CONSISTS OF STANDARD CHARACTERS WITHOUT CLAIM TO ANY PARTICULAR FONT, STYLE, SIZE, OR COLOR.

SN 78-939,837, FILED 7-28-2006.

PAM WILLIS, EXAMINING ATTORNEY

**Int. Cl.: 29**

**Prior U.S. Cl.: 46**

**United States Patent and Trademark Office**

**Reg. No. 3,455,784**

**Registered June 24, 2008**

**TRADEMARK  
PRINCIPAL REGISTER**

**MOUNT THABOR**

PETROSSIAN, INC. (NEW YORK CORPORATION)  
419 W. 13TH STREET  
NEW YORK, NY 10014

THE MARK CONSISTS OF STANDARD CHARACTERS WITHOUT CLAIM TO ANY PARTICULAR FONT, STYLE, SIZE, OR COLOR.

FOR: CAVIAR, IN CLASS 29 (U.S. CL. 46).

SN 78-940,014, FILED 7-28-2006.

FIRST USE 10-0-2006; IN COMMERCE 10-0-2006.

LESLEY LAMOTHE, EXAMINING ATTORNEY

**Int. Cl.: 10**

**Prior U.S. Cls.: 26, 39, and 44**

**United States Patent and Trademark Office**

**Reg. No. 3,455,785**

**Registered June 24, 2008**

**TRADEMARK  
PRINCIPAL REGISTER**

**BIOCLEAT**

ARTHROSCOPIC INNOVATIONS LLC (MASSACHUSETTS LTD LIAB CO)  
65 WINTER STREET  
WEYMOUTH, MA 02188

THE MARK CONSISTS OF STANDARD CHARACTERS WITHOUT CLAIM TO ANY PARTICULAR FONT, STYLE, SIZE, OR COLOR.

FOR: SURGICAL IMPLANTS COMPRISING ARTIFICIAL MATERIAL FOR HOLDING SUTURES IN PLACE, IN CLASS 10 (U.S. CLS. 26, 39 AND 44).

SN 78-940,226, FILED 7-28-2006.

FIRST USE 9-22-2007; IN COMMERCE 9-22-2007.

DAVID I, EXAMINING ATTORNEY

**Int. Cls.: 35 and 36**

**Prior U.S. Cls.: 100, 101, and 102**

**United States Patent and Trademark Office**

**Reg. No. 3,455,786**

**Registered June 24, 2008**

**SERVICE MARK  
PRINCIPAL REGISTER**

**A NEW DIRECTION IN HEALTH**

INTRO HEALTH INC. (NEW YORK CORPORATION)  
180 EAST MAIN ST.  
PATCHOGUE, NY 11797

FOR: PROMOTING THE GOODS AND SERVICES OF OTHERS, NAMELY, HEALTH INSURANCE, IN CLASS 35 (U.S. CLS. 100, 101 AND 102).

FIRST USE 9-5-2007; IN COMMERCE 9-5-2007.

FOR: ADMINISTRATION OF PRE-PAID HEALTH CARE PLANS, IN CLASS 36 (U.S. CLS. 100, 101 AND 102).

FIRST USE 9-5-2007; IN COMMERCE 9-5-2007.

THE MARK CONSISTS OF STANDARD CHARACTERS WITHOUT CLAIM TO ANY PARTICULAR FONT, STYLE, SIZE, OR COLOR.

NO CLAIM IS MADE TO THE EXCLUSIVE RIGHT TO USE "HEALTH", APART FROM THE MARK AS SHOWN.

SN 78-940,261, FILED 7-28-2006.

ANNE E. GUSTASON, EXAMINING ATTORNEY

**Int. Cl.: 9**

**Prior U.S. Cls.: 21, 23, 26, 36, and 38**

**Reg. No. 3,455,787**

**United States Patent and Trademark Office**

**Registered June 24, 2008**

**TRADEMARK  
PRINCIPAL REGISTER**

**SIBYL**

SIBYLSOURCE, INC. (PENNSYLVANIA CORPORATION)  
2413 PANAMA STREET  
PHILADELPHIA, PA 19103

FOR: BUSINESS AND PERSONAL PRODUCTIVITY COMPUTER SOFTWARE, NAMELY, OPEN-SOURCE SOFTWARE FOR WORD PROCESSING, FINANCIAL MANAGEMENT, DATABASES FOR USE AS A BLANK DATABASE OR SPREADSHEET, TWO DIMENSIONAL IMAGE RENDERING AND EDITING, INTERNET CONNECTIVITY, PERSONAL COMPUTER SECURITY, PERSONAL COMPUTER OPERATING SYSTEM UTILITIES, AND ENTERTAINMENT SOFTWARE FEATURING COMPUTER

GAMES AND PRE-RECORDED MUSIC AND VIDEOS, IN CLASS 9 (U.S. CLS. 21, 23, 26, 36 AND 38).

FIRST USE 10-27-2006; IN COMMERCE 10-27-2006.

THE MARK CONSISTS OF STANDARD CHARACTERS WITHOUT CLAIM TO ANY PARTICULAR FONT, STYLE, SIZE, OR COLOR.

THE NAME "SIBYL" DOES NOT IDENTIFY A LIVING INDIVIDUAL.

SN 78-941,413, FILED 7-31-2006.

KAPIL BHANOT, EXAMINING ATTORNEY

**Int. Cl.: 9**

**Prior U.S. Cls.: 21, 23, 26, 36, and 38**

**Reg. No. 3,455,788**

**United States Patent and Trademark Office**

**Registered June 24, 2008**

**TRADEMARK  
PRINCIPAL REGISTER**

**SOFTWARE INSPIRED BY  
LIBERTY**

SIBYLSOURCE, INC. (PENNSYLVANIA CORPORATION)  
2413 PANAMA STREET  
PHILADELPHIA, PA 19103

FOR: BUSINESS AND PERSONAL PRODUCTIVITY COMPUTER SOFTWARE, NAMELY, OPEN-SOURCE SOFTWARE FOR WORD PROCESSING, FINANCIAL MANAGEMENT, DATABASES FOR USE AS A BLANK DATABASE OR SPREADSHEET, TWO DIMENSIONAL IMAGE RENDERING AND EDITING, INTERNET CONNECTIVITY, PERSONAL COMPUTER SECURITY, PERSONAL COMPUTER OPERATING SYSTEM UTILITIES, AND ENTER-

TAINMENT SOFTWARE FEATURING COMPUTER GAMES AND PRE-RECORDED MUSIC AND VIDEOS, IN CLASS 9 (U.S. CLS. 21, 23, 26, 36 AND 38).

FIRST USE 10-27-2006; IN COMMERCE 10-27-2006.

THE MARK CONSISTS OF STANDARD CHARACTERS WITHOUT CLAIM TO ANY PARTICULAR FONT, STYLE, SIZE, OR COLOR.

SN 78-941,426, FILED 7-31-2006.

KAPIL BHANOT, EXAMINING ATTORNEY

**Int. Cl.: 11**

**Prior U.S. Cls.: 13, 21, 23, 31, and 34**

**United States Patent and Trademark Office**

**Reg. No. 3,455,789**

**Registered June 24, 2008**

**TRADEMARK  
PRINCIPAL REGISTER**

# Thera Shower

OVERBREAK, LLC (NEVADA LTD LIAB CO)  
9420 CHIVERS AVENUE  
SUN VALLEY, CA 91352

FOR: SHOWER HEADS FEATURING MECHANISMS FOR FILTERING WATER AND DISPENSING AROMATHERAPY PRODUCTS, IN CLASS 11 (U.S. CLS. 13, 21, 23, 31 AND 34).

FIRST USE 8-1-2006; IN COMMERCE 10-1-2006.

THE MARK CONSISTS OF STANDARD CHARACTERS WITHOUT CLAIM TO ANY PARTICULAR FONT, STYLE, SIZE, OR COLOR.

NO CLAIM IS MADE TO THE EXCLUSIVE RIGHT TO USE "SHOWER", APART FROM THE MARK AS SHOWN.

SN 78-942,147, FILED 8-1-2006.

KAREN SEVERSON, EXAMINING ATTORNEY

**Int. Cl.: 9**

**Prior U.S. Cls.: 21, 23, 26, 36, and 38**

**Reg. No. 3,455,790**

**United States Patent and Trademark Office**

**Registered June 24, 2008**

**TRADEMARK  
PRINCIPAL REGISTER**

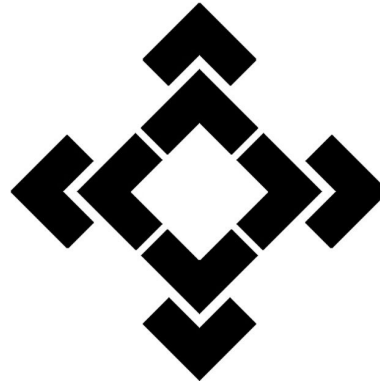

SIBYLSOURCE, INC. (PENNSYLVANIA CORPORATION)  
2413 PANAMA STREET  
PHILADELPHIA, PA 19103

FOR: BUSINESS AND PERSONAL PRODUCTIVITY COMPUTER SOFTWARE, NAMELY, OPEN-SOURCE SOFTWARE FOR WORD PROCESSING, FINANCIAL MANAGEMENT, DATABASES FOR USE AS A BLANK DATABASE OR SPREADSHEET, TWO DIMENSIONAL IMAGE RENDERING AND EDITING, INTERNET CONNECTIVITY, PERSONAL

COMPUTER SECURITY, PERSONAL COMPUTER OPERATING SYSTEM UTILITIES, AND ENTERTAINMENT SOFTWARE FEATURING COMPUTER GAMES AND PRE-RECORDED MUSIC AND VIDEOS, IN CLASS 9 (U.S. CLS. 21, 23, 26, 36 AND 38).

FIRST USE 10-27-2006; IN COMMERCE 10-27-2006.

SN 78-942,176, FILED 8-1-2006.

KAPIL BHANOT, EXAMINING ATTORNEY



**Int. Cl.: 5**

**Prior U.S. Cls.: 6, 18, 44, 46, 51, and 52**

**Reg. No. 3,455,791**

**United States Patent and Trademark Office**

**Registered June 24, 2008**

---

**TRADEMARK  
PRINCIPAL REGISTER**

**GB-40**

STRATECHEM, LLC (NEW MEXICO LTD LIAB  
CO)  
433 PASEO DE PERALTA  
SANTA FE, NM 87501

THE MARK CONSISTS OF STANDARD CHAR-  
ACTERS WITHOUT CLAIM TO ANY PARTICULAR  
FONT, STYLE, SIZE, OR COLOR.

FOR: TERMITICIDE FOR DOMESTIC USE, IN  
CLASS 5 (U.S. CLS. 6, 18, 44, 46, 51 AND 52).

SN 78-942,416, FILED 8-1-2006.

FIRST USE 4-15-2008; IN COMMERCE 4-15-2008.

VERNA BETH RIRIE, EXAMINING ATTORNEY

**Int. Cl.: 12**

**Prior U.S. Cls.: 19, 21, 23, 31, 35, and 44**

**Reg. No. 3,455,792**

**United States Patent and Trademark Office**

**Registered June 24, 2008**

**TRADEMARK  
PRINCIPAL REGISTER**

# CITY STORM

GIANT MANUFACTURING CO., LTD. (TAIWAN CORPORATION)  
19, SHUN FARN ROAD, LONG CHUAN LI  
TAICHIA, TAICHUNG HSIEN, TAIWAN

FOR: BICYCLES, COLLAPSIBLE BICYCLES, ELECTRIC BICYCLES AND ELECTRIC COLLAPSIBLE BICYCLES, AND STRUCTURAL PARTS THEREOF; ACCESSORIES FOR BICYCLES, COLLAPSIBLE BICYCLES, ELECTRIC BICYCLES AND ELECTRIC COLLAPSIBLE BICYCLES, NAMELY, FRAMES, HANDLEBARS, HANDLEBAR STEMS, DERAILLEUR'S GEARS, SADDLES, SADDLE COVERS, SADDLE BAGS, SEAT POSTS, SEAT TUBES, PEDALS, CRANKS, TIRES, WHEELS, TUBES, SPOKES, PUMPS, FORKS, CARRIERS, BICYCLE MUD-GUARDS, CHAINS, CHAINGUARDS, BELTS, HUBS, BRAKES AND LEVERS, TOE STRAPS AND CLIPS, VEHICLE LUGGAGE RACKS ADAPTED FOR BICYCLES; REAR VEHICLE RACKS FOR BICYCLES; BICYCLE BELLS; BICYCLE MUD-GUARDS; BICYCLE STOP STANDS; REARVIEW MIRRORS; TIRE PATCHES; BABY CARRIAGES;

BICYCLE CANTEEN RACKS; BICYCLE TIRE MENDING DEVICE, NAMELY, TIRE PATCHES; BICYCLE PUMPS; BICYCLE HOLDERS FOR VEHICLES; BAGS ADAPTED FOR BICYCLES; CAR-TOP LUGGAGE CARRIERS; BICYCLE HANDLE-BAR GRIP COVERS; BICYCLE HANDLE-BAR GRIP STRIPS; TRAILERS; BASKETS ADAPTED FOR BICYCLES; BICYCLE PROTECTIVE WHEELS; BICYCLE TRAINING DEVICE, NAMELY, TRAINING WHEELS, IN CLASS 12 (U.S. CLS. 19, 21, 23, 31, 35 AND 44).

FIRST USE 7-1-2007; IN COMMERCE 12-28-2007.

THE MARK CONSISTS OF STANDARD CHARACTERS WITHOUT CLAIM TO ANY PARTICULAR FONT, STYLE, SIZE, OR COLOR.

SN 78-943,177, FILED 8-2-2006.

CAROL SPILS, EXAMINING ATTORNEY

**Int. Cl.: 16**

**Prior U.S. Cls.: 2, 5, 22, 23, 29, 37, 38, and 50**

**Reg. No. 3,455,793**

**United States Patent and Trademark Office**

**Registered June 24, 2008**

**TRADEMARK  
PRINCIPAL REGISTER**

**EL ABOGADO EN SUS MANOS**

EL ABOGADO, INC. (FLORIDA CORPORATION)  
351 N.W. LEJEUNE ROAD, STE. 202  
MIAMI, FL 33126

FOR: NEWSPAPERS, MAGAZINES AND MAGAZINE COLUMNS IN THE FIELD OF CURRENT EVENTS, GENERAL LEGAL ISSUES, AND CLASSIFIED ADVERTISEMENTS, IN CLASS 16 (U.S. CLS. 2, 5, 22, 23, 29, 37, 38 AND 50).

FIRST USE 2-1-2008; IN COMMERCE 2-1-2008.

THE MARK CONSISTS OF STANDARD CHARACTERS WITHOUT CLAIM TO ANY PARTICULAR FONT, STYLE, SIZE, OR COLOR.

THE ENGLISH TRANSLATION OF "EL ABOGADO EN SUS MANOS" IS THE ATTORNEY IN YOUR HANDS.

SN 78-944,877, FILED 8-4-2006.

PAM WILLIS, EXAMINING ATTORNEY

**Int. Cls.: 35 and 41**

**Prior U.S. Cls.: 100, 101, 102, and 107**

**United States Patent and Trademark Office**

**Reg. No. 3,455,794**

**Registered June 24, 2008**

**SERVICE MARK  
PRINCIPAL REGISTER**

**INSTITUTE FOR A  
COMPETITIVE WORKFORCE**

THE CHAMBER OF COMMERCE OF THE UNITED STATES OF AMERICA (D.C. CORPORATION)  
1615 H STREET NW  
WASHINGTON, DC 20062

FOR: PROMOTING PUBLIC AWARENESS OF WORKFORCE EDUCATION AND WORKFORCE DEVELOPMENT ISSUES AMONG BUSINESSES, LOCAL BUSINESS ASSOCIATIONS AND LOCAL COMMUNITIES; PROVIDING BUSINESS INFORMATION ON THE TOPIC OF WORKFORCE EDUCATION AND WORKFORCE DEVELOPMENT AMONG BUSINESSES, LOCAL BUSINESS ASSOCIATIONS AND LOCAL COMMUNITIES; PROMOTING PUBLIC AWARENESS OF THE NEED FOR WORKFORCE EDUCATION AND TRAINING INITIATIVES AMONG BUSINESSES, LOCAL BUSINESS ASSOCIATIONS AND LOCAL COMMUNITIES; DEVELOPING MATERIALS FOR OTHERS TO PROMOTE THE NEED FOR WORKFORCE EDUCATION AND WORKFORCE DEVELOPMENT, IN CLASS 35 (U.S. CLS. 100, 101 AND 102).

FIRST USE 10-4-2006; IN COMMERCE 10-4-2006.

FOR: CONDUCTING WORKSHOPS AND SEMINARS ON THE TOPIC OF WORKFORCE EDUCATION AND WORKFORCE DEVELOPMENT AMONG BUSINESSES, LOCAL BUSINESS ASSOCIATIONS AND LOCAL COMMUNITIES, IN CLASS 41 (U.S. CLS. 100, 101 AND 107).

FIRST USE 10-4-2006; IN COMMERCE 10-4-2006.

THE MARK CONSISTS OF STANDARD CHARACTERS WITHOUT CLAIM TO ANY PARTICULAR FONT, STYLE, SIZE, OR COLOR.

NO CLAIM IS MADE TO THE EXCLUSIVE RIGHT TO USE "INSTITUTE" AND "WORKFORCE", APART FROM THE MARK AS SHOWN.

SN 78-944,987, FILED 8-4-2006.

ELLEN PERKINS, EXAMINING ATTORNEY

**Int. Cl.: 2**

**Prior U.S. Cls.: 6, 11, and 16**

**United States Patent and Trademark Office**

**Reg. No. 3,455,795**

**Registered June 24, 2008**

**TRADEMARK  
PRINCIPAL REGISTER**

**PAVERPOL**

PAUL ADRIANUS EUGENIE MARIA VERSIJP  
(NETHERLANDS INDIVIDUAL)  
CANADALAAN 12  
HG BERGEN OP ZOOM, NETHERLANDS NL-4624

FOR: PAINTS FOR ARTISTS, PAINT THINNERS,  
VARNISHES, GLAZES, POWDERS FOR COLOR-  
ING, NAMELY, COLOR PIGMENTS, OIL COLORS,  
PAINT PRIMERS, PAINT SEALERS, SHELLAC,  
WOOD STAINS, CLEAR AND PIGMENTED COAT-  
INGS USED IN THE NATURE OF PAINT, IN CLASS  
2 (U.S. CLS. 6, 11 AND 16).

FIRST USE 2-0-1998; IN COMMERCE 4-0-2004.

THE MARK CONSISTS OF STANDARD CHAR-  
ACTERS WITHOUT CLAIM TO ANY PARTICULAR  
FONT, STYLE, SIZE, OR COLOR.

OWNER OF U.S. REG. NO. 3,194,503.

SN 78-945,087, FILED 8-4-2006.

PAUL MORENO, EXAMINING ATTORNEY

**Int. Cl.: 27**

**Prior U.S. Cls.: 19, 20, 37, 42, and 50**

**United States Patent and Trademark Office**

**Reg. No. 3,455,796**

**Registered June 24, 2008**

**TRADEMARK  
PRINCIPAL REGISTER**

# Chassis Girl

S.L. DIVERSIONS, LLC (OKLAHOMA LTD LIAB  
CO)  
5777 S.E. 12TH STREET  
MIDWEST CITY, OK 73110

FOR: CARPETS; CARPETS FOR AUTOMOBILES;  
CARPETS, RUGS, MATS AND MATTING, LINO-  
LEUM FOR COVERING EXISTING FLOORS; DOOR  
MATS; DOOR MATS OF TEXTILE; FLOOR COVER-  
INGS; FLOOR MATS; FLOOR MATS FOR VEHI-  
CLES; PROTECTIVE FLOOR COVERINGS; RUBBER  
MATS; RUGS, IN CLASS 27 (U.S. CLS. 19, 20, 37, 42  
AND 50).

FIRST USE 10-1-2006; IN COMMERCE 6-15-2007.

THE MARK CONSISTS OF STANDARD CHAR-  
ACTERS WITHOUT CLAIM TO ANY PARTICULAR  
FONT, STYLE, SIZE, OR COLOR.

SN 78-946,715, FILED 8-7-2006.

JOHN SCHUYLER YARD, EXAMINING ATTOR-  
NEY

**Int. Cl.: 12**

**Prior U.S. Cls.: 19, 21, 23, 31, 35, and 44**

**United States Patent and Trademark Office**

**Reg. No. 3,455,797**

**Registered June 24, 2008**

**TRADEMARK  
PRINCIPAL REGISTER**

# Topless Choppers

TOPLESS CHOPPERS, INC. (PENNSYLVANIA CORPORATION)  
1019 RIVERVIEW DRIVE  
FINLEYVILLE, PA 15332

FOR: MOTORCYCLE PARTS AND ACCESSORIES, NAMELY, TIMER COVERS, DERBY COVERS, PRIMARY COVERS, HEAD BOLT COVERS, LICENSE PLATE COVERS, BRAKE LEVERS, CLUTCH LEVERS, REAR VIEW MIRRORS, FLOOR BOARDS, WHEELS, SHIFT PEGS, HIGHWAY PEGS, FOOT PEGS, SISSY BARS, BRAKE CALIPER INSERTS, BALANCING WEIGHTS FOR VEHICLE WHEELS, AND TIRE VALVE STEM CAPS, IN CLASS 12 (U.S. CLS. 19, 21, 23, 31, 35 AND 44).

FIRST USE 1-22-2007; IN COMMERCE 11-8-2007.

THE MARK CONSISTS OF STANDARD CHARACTERS WITHOUT CLAIM TO ANY PARTICULAR FONT, STYLE, SIZE, OR COLOR.

NO CLAIM IS MADE TO THE EXCLUSIVE RIGHT TO USE "CHOPPERS", APART FROM THE MARK AS SHOWN.

SN 78-946,965, FILED 8-8-2006.

DOMINICK J. SALEMI, EXAMINING ATTORNEY

**Int. Cl.: 35**

**Prior U.S. Cls.: 100, 101, and 102**

**United States Patent and Trademark Office**

**Reg. No. 3,455,798**

**Registered June 24, 2008**

**SERVICE MARK  
PRINCIPAL REGISTER**

**LIZARDS EYE**

LEGGETT, BRIT (UNITED STATES INDIVIDUAL)  
6601 S. SHIELDS  
OKLAHOMA CITY, OK 73149

THE MARK CONSISTS OF STANDARD CHARACTERS WITHOUT CLAIM TO ANY PARTICULAR FONT, STYLE, SIZE, OR COLOR.

FOR: ON-LINE RETAIL GIFT SHOP SERVICES,  
IN CLASS 35 (U.S. CLS. 100, 101 AND 102).

SN 78-947,458, FILED 8-8-2006.

FIRST USE 1-1-2007; IN COMMERCE 1-1-2007.

PAUL CROWLEY, EXAMINING ATTORNEY



**Int. Cls.: 25 and 26**

**Prior U.S. Cls.: 22, 37, 39, 40, 42, and 50**

**Reg. No. 3,455,799**

**United States Patent and Trademark Office**

**Registered June 24, 2008**

**TRADEMARK  
PRINCIPAL REGISTER**

**XOXO**

GLOBAL BRAND HOLDINGS, LLC (NEW YORK  
LIMITED LIABILITY CORPORATION)  
1407 BROADWAY  
NEW YORK, NY 10018

FOR: CLOTHING FOR HUMANS IN THE NATURE OF BABY DOLL PAJAMAS, BRAS, BOXER SHORTS, CAMISOLES, CHEMISES, DRESSES, HEADBANDS, LINGERIE, LOUNGEWEAR, PAJAMAS, PANTIES, SHORTS AND BRIEFS BEING UNDERWEAR, ROBES, SKIRTS, SLEEPWEAR AND TANK TOPS; HEADBANDS, IN CLASS 25 (U.S. CLS. 22 AND 39).

FIRST USE 2-16-2005; IN COMMERCE 2-16-2005.

FOR: HAIR ACCESSORIES, NAMELY, BARR-ETTES, BOBBY PINS, HAIR BANDS, HAIR SLIDES, HAIR STICKS, HAIR ORNAMENTS IN THE FORM

OF COMBS, HAIR PINS, HAIR ORNAMENTS, HAIR WRAPS, PONYTAIL HOLDERS, SALON HAIR CLIPS, AND SNAP CLIPS, IN CLASS 26 (U.S. CLS. 37, 39, 40, 42 AND 50).

FIRST USE 11-5-2006; IN COMMERCE 11-5-2006.

THE MARK CONSISTS OF STANDARD CHARACTERS WITHOUT CLAIM TO ANY PARTICULAR FONT, STYLE, SIZE, OR COLOR.

OWNER OF U.S. REG. NOS. 2,009,243, 2,436,377, AND 2,960,690.

SN 78-947,585, FILED 8-8-2006.

BRENDAN REGAN, EXAMINING ATTORNEY

**Int. Cl.: 9**

**Prior U.S. Cls.: 21, 23, 26, 36, and 38**

**Reg. No. 3,455,800**

**United States Patent and Trademark Office**

**Registered June 24, 2008**

---

**TRADEMARK  
PRINCIPAL REGISTER**

**DEFENSICS**

CODENOMICON, INC. (CALIFORNIA CORPORATION)  
101 METRO DRIVE, SUITE 660  
SAN JOSE, CA 95110

THE MARK CONSISTS OF STANDARD CHARACTERS WITHOUT CLAIM TO ANY PARTICULAR FONT, STYLE, SIZE, OR COLOR.

FOR: COMPUTER SOFTWARE DEVELOPMENT TOOLS USED TO TEST, EVALUATE AND IMPROVE INFORMATION AND NETWORK SECURITY, IN CLASS 9 (U.S. CLS. 21, 23, 26, 36 AND 38).

SN 78-948,131, FILED 8-9-2006.

FIRST USE 1-1-2007; IN COMMERCE 3-1-2007.

STEVEN R. FOSTER, EXAMINING ATTORNEY

**Int. Cl.: 3**

**Prior U.S. Cls.: 1, 4, 6, 50, 51, and 52**

**United States Patent and Trademark Office**

**Reg. No. 3,455,801**

**Registered June 24, 2008**

**TRADEMARK  
PRINCIPAL REGISTER**

 **ART-VISAGE**

ART-VISAGE HOLDING LTD (RUSSIAN FED.  
CORPORATION)  
D.24/1, STR.3, UL.PETROVKA  
103051 MOSCOW, RUSSIAN FED.

FOR: MAKE-UP; EYEBROW PENCILS; COSMETIC PENCILS; COSMETIC CREAMS; NAIL VARNISH FOR COSMETIC PURPOSES; COSMETIC KITS COMPRISED OF LIPSTICK, EYE SHADOW, BLUSH, MAKE-UP POWDER, MASCARA; LIPSTICKS; POMADES FOR COSMETIC PURPOSES; MAKE-UP REMOVING PREPARATIONS; VARNISH-REMOVING PREPARATIONS FOR NAILS; NAIL CARE PREPARATIONS; COSMETIC PREPARATIONS FOR SKIN CARE; MAKE-UP POWDER; EYEBROW COSMETICS; MAKE-UP PREPARATIONS; COS-

METIC PREPARATIONS FOR EYELASHES; COSMETICS; MASCARA, IN CLASS 3 (U.S. CLS. 1, 4, 6, 50, 51 AND 52).

FIRST USE 0-0-1999; IN COMMERCE 3-20-2008.

OWNER OF ERPN CMNTY TM OFC REG. NO. 004140786, DATED 4-21-2006, EXPIRES 11-23-2014.

THE ENGLISH TRANSLATION OF THE WORD "VISAGE" IN THE MARK IS FACE.

SN 78-948,175, FILED 8-9-2006.

CARYN GLASSER, EXAMINING ATTORNEY

**Int. Cls.: 9, 36, 38, and 42**

**Prior U.S. Cls.: 21, 23, 26, 36, 38, 100, 101, 102, and 104**

**Reg. No. 3,455,802**

**United States Patent and Trademark Office**

**Registered June 24, 2008**

**TRADEMARK  
SERVICE MARK  
PRINCIPAL REGISTER**

**ECOMMLINK**

E-COMMLINK, INC. (DELAWARE CORPORATION)  
325 E. WARM SPRINGS  
LAS VEGAS, NV 89119

FOR: ELECTRONIC PAYMENT SOFTWARE FOR USE BY INDIVIDUALS, MERCHANTS, AND FINANCIAL INSTITUTIONS, IN CLASS 9 (U.S. CLS. 21, 23, 26, 36 AND 38).

FIRST USE 8-20-1996; IN COMMERCE 4-30-2006.

FOR: ELECTRONIC PAYMENT PROCESSING SERVICES FOR STORED VALUE CARD PRODUCTS, IN CLASS 36 (U.S. CLS. 100, 101 AND 102).

FIRST USE 8-20-1996; IN COMMERCE 8-20-1996.

FOR: COMPUTER SERVICES, NAMELY, PROVIDING MULTIPLE USER ELECTRONIC ACCESS FOR USE ON A MULTIPLE USER ELECTRONIC GLOBAL COMPUTER INFORMATION NETWORK FOR THE TRANSFER AND DISSEMINATION OF A WIDE RANGE OF BANKING AND FINANCIAL INFORMATION, IN CLASS 38 (U.S. CLS. 100, 101 AND 104).

FIRST USE 8-20-1996; IN COMMERCE 4-30-2006.

FOR: PROVIDING TEMPORARY USE OF NON-DOWNLOADABLE USER INTERFACE SOFTWARE THAT ALLOWS USERS TO ACCESS THEIR ACCOUNT INFORMATION ONLINE; COMPUTER SERVICES, NAMELY, COMPUTER SOFTWARE DESIGN AND COMPUTER SITE DESIGN FOR USE ON AN ON-LINE GLOBAL COMMUNICATIONS NETWORK, OFFERED TO COMMERCIAL BUSINESSES, BANKING AND FINANCIAL INSTITUTIONS, AND OTHER INSTITUTIONS, IN CLASS 42 (U.S. CLS. 100 AND 101).

FIRST USE 8-20-1996; IN COMMERCE 4-30-2006.

THE MARK CONSISTS OF STANDARD CHARACTERS WITHOUT CLAIM TO ANY PARTICULAR FONT, STYLE, SIZE, OR COLOR.

OWNER OF U.S. REG. NO. 3,015,339.

SN 78-948,854, FILED 8-9-2006.

CARRIE GENOVESE, EXAMINING ATTORNEY

**Int. Cl.: 5**

**Prior U.S. Cls.: 6, 18, 44, 46, 51, and 52**

**Reg. No. 3,455,803**

**United States Patent and Trademark Office**

**Registered June 24, 2008**

**TRADEMARK  
PRINCIPAL REGISTER**

**Libera-Tone Advantage**

DIRECT NUTRITIONAL ADVANTAGE, LLC  
(NEW YORK LTD LIAB CO)  
110 ROUTE 110, SUITE 205  
SOUTH HUNTINGTON, NY 11746

THE MARK CONSISTS OF STANDARD CHAR-  
ACTERS WITHOUT CLAIM TO ANY PARTICULAR  
FONT, STYLE, SIZE, OR COLOR.

FOR: DIETARY SUPPLEMENTS, IN CLASS 5 (U.S.  
CLS. 6, 18, 44, 46, 51 AND 52).

SN 78-949,393, FILED 8-10-2006.

FIRST USE 3-19-2007; IN COMMERCE 5-31-2007.

JAMES MACFARLANE, EXAMINING ATTORNEY

**Int. Cl.: 4**

**Prior U.S. Cls.: 1, 6, and 15**

**United States Patent and Trademark Office**

**Reg. No. 3,455,804**

**Registered June 24, 2008**

**TRADEMARK  
PRINCIPAL REGISTER**

**SURE2BURN**

W.C. BRADLEY COMPANY (GEORGIA CORPORATION)  
1017 FRONT AVENUE  
COLUMBUS, GA 31904

FOR: SOLID FIRE STARTERS, IN CLASS 4 (U.S. CLS. 1, 6 AND 15).

FIRST USE 2-28-2007; IN COMMERCE 2-28-2007.

THE MARK CONSISTS OF STANDARD CHARACTERS WITHOUT CLAIM TO ANY PARTICULAR FONT, STYLE, SIZE, OR COLOR.

SN 78-950,606, FILED 8-11-2006.

KATHERINE M. DUBRAY, EXAMINING ATTORNEY

**Int. Cl.: 35**

**Prior U.S. Cls.: 100, 101, and 102**

**United States Patent and Trademark Office**

**Reg. No. 3,455,805**

**Registered June 24, 2008**

**SERVICE MARK  
PRINCIPAL REGISTER**

**INFRASULTS**

NIELSON, MARK K. (UNITED STATES INDIVIDUAL)  
508 HANBURY LANE  
FOSTER CITY, CA 94404

FOR: ASSISTANCE, ADVISORY SERVICES AND CONSULTANCY WITH REGARD TO BUSINESS PLANNING, BUSINESS ANALYSIS, BUSINESS MANAGEMENT, AND BUSINESS ORGANIZATION, IN CLASS 35 (U.S. CLS. 100, 101 AND 102).

FIRST USE 7-1-2007; IN COMMERCE 7-1-2007.

THE MARK CONSISTS OF STANDARD CHARACTERS WITHOUT CLAIM TO ANY PARTICULAR FONT, STYLE, SIZE, OR COLOR.

THE WORDING "INFRASULTS" HAS NO MEANING IN A FOREIGN LANGUAGE.

SN 78-950,788, FILED 8-11-2006.

ELLEN PERKINS, EXAMINING ATTORNEY

**Int. Cl.: 9**

**Prior U.S. Cls.: 21, 23, 26, 36, and 38**

**United States Patent and Trademark Office**

**Reg. No. 3,455,806**

**Registered June 24, 2008**

**TRADEMARK  
PRINCIPAL REGISTER**

**MAILTRUSTS**

IDALIS SOFTWARE, INC. (DELAWARE CORPORATION)  
P.O. BOX 512  
FAIRFAX, VA 220380512

FOR: COMPUTER SOFTWARE FOR CREATING AND MAINTAINING A LIST OF SAFE OR OTHERWISE ACCEPTED E-MAIL SYSTEMS' IP ADDRESSES OR DOMAIN NAMES WHICH DO NOT REQUIRE ANY FORM OF FILTERING FOR MESSAGE DELIVERY, SUCH SOFTWARE PROVIDED ON TANGIBLE MEDIA AND DOWNLOADABLE

VIA THE INTERNET, IN CLASS 9 (U.S. CLS. 21, 23, 26, 36 AND 38).

FIRST USE 2-4-2007; IN COMMERCE 2-4-2007.

THE MARK CONSISTS OF STANDARD CHARACTERS WITHOUT CLAIM TO ANY PARTICULAR FONT, STYLE, SIZE, OR COLOR.

SN 78-951,268, FILED 8-14-2006.

KATHERINE CHANG, EXAMINING ATTORNEY



**Int. Cl.: 25**

**Prior U.S. Cls.: 22 and 39**

**United States Patent and Trademark Office**

**Reg. No. 3,455,807**

**Registered June 24, 2008**

**TRADEMARK  
PRINCIPAL REGISTER**

plushknit.

QVC, INC. (DELAWARE CORPORATION)  
STUDIO PARK  
WEST CHESTER, PA 19380

FOR: CARDIGANS; SWEATERS; TANK TOPS, IN  
CLASS 25 (U.S. CLS. 22 AND 39).

FIRST USE 11-30-2006; IN COMMERCE 11-30-2006.

THE STIPPLING IS FOR SHADING PURPOSES  
ONLY.

THE MARK CONSISTS OF THE WORDS "PLUSH-  
KNIT" IN STYLIZED FORM.

SN 78-951,415, FILED 8-14-2006.

NAKWAMA ANKRAH, EXAMINING ATTORNEY

**Int. Cls.: 9 and 41**

**Prior U.S. Cls.: 21, 23, 26, 36, 38, 100, 101, and 107**

**United States Patent and Trademark Office**

**Reg. No. 3,455,808**

**Registered June 24, 2008**

**TRADEMARK  
SERVICE MARK  
PRINCIPAL REGISTER**

**LABYRINTH OF THE MINOTAUR**

ELECTRONIC ARTS INC. (DELAWARE CORPORATION)  
209 REDWOOD SHORES PARKWAY  
REDWOOD CITY, CA 94065

FOR: COMPUTER GAME PROGRAMS; COMPUTER GAME SOFTWARE; INTERACTIVE MULTIMEDIA COMPUTER GAME PROGRAM; VIDEO GAME SOFTWARE; VIRTUAL REALITY GAME SOFTWARE, IN CLASS 9 (U.S. CLS. 21, 23, 26, 36 AND 38).

FIRST USE 10-31-2006; IN COMMERCE 10-31-2006.

FOR: ENTERTAINMENT SERVICES, NAMELY, PROVIDING ON-LINE COMPUTER GAMES; PRO-

VIDING INFORMATION ON-LINE RELATING TO COMPUTER GAMES AND COMPUTER ENHANCEMENTS FOR GAMES, IN CLASS 41 (U.S. CLS. 100, 101 AND 107).

FIRST USE 10-31-2006; IN COMMERCE 10-31-2006.

THE MARK CONSISTS OF STANDARD CHARACTERS WITHOUT CLAIM TO ANY PARTICULAR FONT, STYLE, SIZE, OR COLOR.

SN 78-952,947, FILED 8-15-2006.

ROBERT STRUCK, EXAMINING ATTORNEY

**Int. Cl.: 36**

**Prior U.S. Cls.: 100, 101, and 102**

**United States Patent and Trademark Office**

**Reg. No. 3,455,809**

**Registered June 24, 2008**

**SERVICE MARK  
PRINCIPAL REGISTER**

**EPACK EZ**

CNA FINANCIAL CORPORATION (DELAWARE  
CORPORATION)  
333 S. WABASH AVENUE  
CHICAGO, IL 60604

FOR: INSURANCE UNDERWRITING SERVICES  
THAT COMBINE VARIOUS TYPES OF COVERAGE  
IN THE FIELDS OF EMPLOYMENT PRACTICES  
LIABILITY, DIRECTORS AND OFFICERS LIABILITY,  
AND FIDUCIARY LIABILITY, IN CLASS 36  
(U.S. CLS. 100, 101 AND 102).

FIRST USE 5-31-2006; IN COMMERCE 5-31-2006.

THE MARK CONSISTS OF STANDARD CHAR-  
ACTERS WITHOUT CLAIM TO ANY PARTICULAR  
FONT, STYLE, SIZE, OR COLOR.

SN 78-953,017, FILED 8-16-2006.

DAWN HAN, EXAMINING ATTORNEY

**Int. Cl.: 25**

**Prior U.S. Cls.: 22 and 39**

**United States Patent and Trademark Office**

**Reg. No. 3,455,810**

**Registered June 24, 2008**

**TRADEMARK  
PRINCIPAL REGISTER**

ANNTAYLOR LOFTMATERNITY

ANNCO, INC. (DELAWARE CORPORATION)

7 TIMES SQUARE

NEW YORK, NY 10036

FOR: CLOTHING, NAMELY, DRESSES, SKIRTS, SUITS, JEANS, SWEATERS, SHIRTS, T-SHIRTS, TANK TOPS, JUMPERS, VESTS, SLEEP WEAR, ROBES, BLOUSES, PANTS, SHORTS, JACKETS, COATS, IN CLASS 25 (U.S. CLS. 22 AND 39).

FIRST USE 3-3-2008; IN COMMERCE 3-3-2008.

THE MARK CONSISTS OF STANDARD CHARACTERS WITHOUT CLAIM TO ANY PARTICULAR FONT, STYLE, SIZE, OR COLOR.

OWNER OF U.S. REG. NOS. 2,334,051, 3,078,844, AND OTHERS.

THE NAME(S), PORTRAIT(S), AND/OR SIGNATURE(S) SHOWN IN THE MARK DOES NOT IDENTIFY A PARTICULAR LIVING INDIVIDUAL.

SN 78-953,051, FILED 8-16-2006.

AISHA CLARKE, EXAMINING ATTORNEY

**Int. Cl.: 5**

**Prior U.S. Cls.: 6, 18, 44, 46, 51, and 52**

**Reg. No. 3,455,811**

**United States Patent and Trademark Office**

**Registered June 24, 2008**

**TRADEMARK  
PRINCIPAL REGISTER**

**EARVANTAGE**

AMDM GROUP, LLC (TEXAS LTD LIAB CO)  
32 REMINGTON DR.  
HIGHLAND VILLAGE, TX 75077

FIRST USE 8-16-2006; IN COMMERCE 6-11-2007.

FOR: HOMEOPATHIC PHARMACEUTICALS  
FOR USE IN THE TREATMENT OF CANINE OTITIS  
EXTERNA, BACTERIAL INFECTIONS OF THE  
EAR, YEAST INFECTIONS OF THE EAR, AND  
EAR CHEMISTRY IMBALANCES, INFLAMMA-  
TION AND ITCHING, IN CLASS 5 (U.S. CLS. 6, 18,  
44, 46, 51 AND 52).

THE MARK CONSISTS OF STANDARD CHAR-  
ACTERS WITHOUT CLAIM TO ANY PARTICULAR  
FONT, STYLE, SIZE, OR COLOR.

SN 78-953,807, FILED 8-16-2006.

REBECCA EISINGER, EXAMINING ATTORNEY

Int. Cl.: 33

Prior U.S. Cls.: 47 and 49

**United States Patent and Trademark Office**

**Reg. No. 3,455,812**

Registered June 24, 2008

**TRADEMARK  
PRINCIPAL REGISTER**

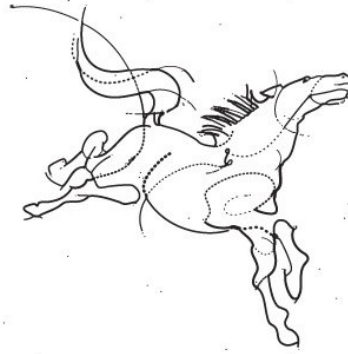

*Dancing Stallion*  
VINEYARDS

DANCING STALLION VINEYARDS (CALIFORNIA CORPORATION)  
4550 DEL MAR LANE  
PASO ROBLES, CA 93446

NO CLAIM IS MADE TO THE EXCLUSIVE RIGHT TO USE "VINEYARDS" , APART FROM THE MARK AS SHOWN.

FOR: WINES, IN CLASS 33 (U.S. CLS. 47 AND 49).

SN 78-953,921, FILED 8-16-2006.

FIRST USE 9-1-2007; IN COMMERCE 9-1-2007.

DAVID HOFFMAN, EXAMINING ATTORNEY

Int. Cl.: 41

Prior U.S. Cls.: 100, 101, and 107

United States Patent and Trademark Office

Reg. No. 3,455,813

Registered June 24, 2008

**SERVICE MARK  
PRINCIPAL REGISTER**



ASSOCIATED STUDENTS INCORPORATED,  
CSUS (CALIFORNIA CORPORATION)  
3RD FLOOR UNION  
6000 J. STREET  
SACRAMENTO, CA 958196011

FOR: EDUCATIONAL SERVICES, NAMELY,  
PROVIDING WORKSHOPS AND COURSES IN  
THE FIELDS OF GOVERNMENT, CHILD CARE  
AND OUTDOOR RECREATION; PROVIDING FA-  
CILITIES FOR RECREATION ACTIVITIES, IN  
CLASS 41 (U.S. CLS. 100, 101 AND 107).

FIRST USE 4-6-2006; IN COMMERCE 4-6-2006.

NO CLAIM IS MADE TO THE EXCLUSIVE  
RIGHT TO USE "ASSOCIATED STUDENTS SACRA-  
MENTO STATE", APART FROM THE MARK AS  
SHOWN.

THE COLOR(S) GREEN, TAN AND WHITE IS/  
ARE CLAIMED AS A FEATURE OF THE MARK.

THE MARK CONTAINS CONCENTRIC CIRCLES  
WITH THE OUTER CIRCLE BEING TAN WITH THE  
CONCENTRIC CIRCLES INSIDE BEING WHITE,  
GREEN, WHITE, TAN, WHITE WITH A GREEN  
CENTER. THE WORDING "ASSOCIATED STU-  
DENTS SACRAMENTO STATE" APPEARS IN  
WHITE. THE S-SHAPED DESIGN AT THE CENTER  
IS WHITE AND TAN.

SN 78-954,131, FILED 8-17-2006.

MICHAEL SOUDERS, EXAMINING ATTORNEY

**Int. Cl.: 33**

**Prior U.S. Cls.: 47 and 49**

**United States Patent and Trademark Office**

**Reg. No. 3,455,814**

**Registered June 24, 2008**

**TRADEMARK  
PRINCIPAL REGISTER**

**EMPRENDEDOR TEQUILERO**

LOZANO, JOSE EDUARDO (MEXICO INDIVIDUAL)  
AV. MEXICO 3370  
GUADALAJARA, MEXICO 44690

FOR: TEQUILA, IN CLASS 33 (U.S. CLS. 47 AND 49).

FIRST USE 1-20-2008; IN COMMERCE 1-20-2008.

THE MARK CONSISTS OF STANDARD CHARACTERS WITHOUT CLAIM TO ANY PARTICULAR FONT, STYLE, SIZE, OR COLOR.

NO CLAIM IS MADE TO THE EXCLUSIVE RIGHT TO USE "TEQUILERO", APART FROM THE MARK AS SHOWN.

THE FOREIGN WORDING IN THE MARK TRANSLATES INTO ENGLISH AS "ENTERPRISING TEQUILA PRODUCER".

SN 78-955,603, FILED 8-18-2006.

ELLEN BURNS, EXAMINING ATTORNEY



**Int. Cl.: 5**

**Prior U.S. Cls.: 6, 18, 44, 46, 51, and 52**

**United States Patent and Trademark Office**

**Reg. No. 3,455,815**

**Registered June 24, 2008**

**TRADEMARK  
PRINCIPAL REGISTER**

**EXCEDRIN GO**

NOVARTIS AG (SWITZERLAND AKTIENGE-  
SELLSCHAFT (AG))  
POSTFACH 4002  
BASEL, SWITZERLAND

FOR: PHARMACEUTICAL PREPARATIONS,  
NAMELY, ANALGESICS, IN CLASS 5 (U.S. CLS. 6,  
18, 44, 46, 51 AND 52).

FIRST USE 1-31-2007; IN COMMERCE 1-31-2007.

THE MARK CONSISTS OF STANDARD CHAR-  
ACTERS WITHOUT CLAIM TO ANY PARTICULAR  
FONT, STYLE, SIZE, OR COLOR.

OWNER OF U.S. REG. NOS. 696,323, 2,148,120,  
AND OTHERS.

SN 78-956,779, FILED 8-21-2006.

JENNIFER MARTIN, EXAMINING ATTORNEY

**Int. Cl.: 3**

**Prior U.S. Cls.: 1, 4, 6, 50, 51, and 52**

**United States Patent and Trademark Office**

**Reg. No. 3,455,816**

**Registered June 24, 2008**

**TRADEMARK  
PRINCIPAL REGISTER**

**IB PURIFIER**

JONATHAN PRODUCT LLC (DELAWARE LTD  
LIAB CO)

979 CORPORATE BOULEVARD

LINTHICUM HEIGHTS, MD 21090

FOR: HAIR CARE PRODUCTS, NAMELY, SHAM-  
POOS, IN CLASS 3 (U.S. CLS. 1, 4, 6, 50, 51 AND 52).

FIRST USE 8-0-2007; IN COMMERCE 8-0-2007.

THE MARK CONSISTS OF STANDARD CHAR-  
ACTERS WITHOUT CLAIM TO ANY PARTICULAR  
FONT, STYLE, SIZE, OR COLOR.

NO CLAIM IS MADE TO THE EXCLUSIVE  
RIGHT TO USE "PURIFIER", APART FROM THE  
MARK AS SHOWN.

SN 78-957,225, FILED 8-22-2006.

JAY FLOWERS, EXAMINING ATTORNEY

**Int. Cl.: 41**

**Prior U.S. Cls.: 100, 101, and 107**

**United States Patent and Trademark Office**

**Reg. No. 3,455,817**

**Registered June 24, 2008**

---

**SERVICE MARK  
PRINCIPAL REGISTER**

**THERE'S HOPE AMERICA**

THERE'S HOPE, INC. (GEORGIA CORPORATION)  
2135 OLD ALPHARETTA ROAD  
CUMMING, GA 30041

THE MARK CONSISTS OF STANDARD CHARACTERS WITHOUT CLAIM TO ANY PARTICULAR FONT, STYLE, SIZE, OR COLOR.

FOR: A CONTINUING RELIGIOUS PROGRAM BROADCAST OVER TELEVISION, SATELLITE, AUDIO AND VIDEO MEDIA, IN CLASS 41 (U.S. CLS. 100, 101 AND 107).

SN 78-958,332, FILED 8-23-2006.

FIRST USE 2-18-2007; IN COMMERCE 2-18-2007.

TOBY BULLOFF, EXAMINING ATTORNEY

**Int. Cl.: 20**

**Prior U.S. Cls.: 2, 13, 22, 25, 32, and 50**

**Reg. No. 3,455,818**

**United States Patent and Trademark Office**

**Registered June 24, 2008**

---

**TRADEMARK  
PRINCIPAL REGISTER**

**SYNERGY SERIES**

BORROUGHS CORPORATION (MICHIGAN  
CORPORATION)  
3002 N BURDICK STREET  
KALAMAZOO, MI 490043483

FOR: MOVABLE STORAGE SYSTEMS COM-  
PRISED PRIMARILY OF SHELVING FOR USE IN  
COMMERCIAL SETTINGS AND INSTITUTIONAL  
SETTINGS, IN CLASS 20 (U.S. CLS. 2, 13, 22, 25, 32  
AND 50).

FIRST USE 2-16-2007; IN COMMERCE 2-16-2007.

THE MARK CONSISTS OF STANDARD CHAR-  
ACTERS WITHOUT CLAIM TO ANY PARTICULAR  
FONT, STYLE, SIZE, OR COLOR.

NO CLAIM IS MADE TO THE EXCLUSIVE  
RIGHT TO USE "SERIES", APART FROM THE  
MARK AS SHOWN.

SN 78-958,524, FILED 8-23-2006.

JOHN DALIER, EXAMINING ATTORNEY

**Int. Cl.: 32**

**Prior U.S. Cls.: 45, 46, and 48**

**Reg. No. 3,455,819**

**United States Patent and Trademark Office**

**Registered June 24, 2008**

---

**TRADEMARK  
PRINCIPAL REGISTER**

**MÉRYA**

LANGER JUICE COMPANY, INC. (CALIFORNIA  
CORPORATION)  
16195 STEPHENS STREET  
CITY OF INDUSTRY, CA 91745

THE MARK CONSISTS OF STANDARD CHAR-  
ACTERS WITHOUT CLAIM TO ANY PARTICULAR  
FONT, STYLE, SIZE, OR COLOR.

FOR: BOTTLED WATER, IN CLASS 32 (U.S. CLS.  
45, 46 AND 48).

SN 78-958,544, FILED 8-23-2006.

FIRST USE 3-14-2008; IN COMMERCE 3-14-2008.

NAKIA HENRY, EXAMINING ATTORNEY

Int. Cl.: 32

Prior U.S. Cls.: 45, 46, and 48

United States Patent and Trademark Office

Reg. No. 3,455,820

Registered June 24, 2008

TRADEMARK  
PRINCIPAL REGISTER

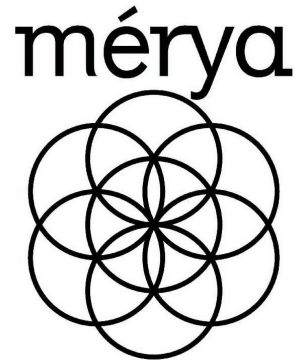

LANGER JUICE COMPANY, INC. (CALIFORNIA CORPORATION)  
16195 STEPHENS STREET  
CITY OF INDUSTRY, CA 91745

THE MARK CONSISTS OF THE WORDING "MERYA" WITH SEVEN INTERTWINED CIRCLES THAT MEET IN THE CENTER.

FOR: BOTTLED WATER, IN CLASS 32 (U.S. CLS. 45, 46 AND 48).

SN 78-958,556, FILED 8-23-2006.

FIRST USE 3-14-2008; IN COMMERCE 3-14-2008.

NAKIA HENRY, EXAMINING ATTORNEY

**Int. Cl.: 44**

**Prior U.S. Cls.: 100 and 101**

**United States Patent and Trademark Office**

**Reg. No. 3,455,821**

**Registered June 24, 2008**

**SERVICE MARK  
PRINCIPAL REGISTER**

**ASERA CARE HOME HEALTH**

GOLDEN GATE ANCILLARY LLC (DELAWARE  
LTD LIAB CO)

1000 BEVERLY WAY

FORT SMITH, AR 72919

FOR: HOME HEALTH CARE SERVICES, IN  
CLASS 44 (U.S. CLS. 100 AND 101).

FIRST USE 4-22-2004; IN COMMERCE 4-22-2004.

THE MARK CONSISTS OF STANDARD CHAR-  
ACTERS WITHOUT CLAIM TO ANY PARTICULAR  
FONT, STYLE, SIZE, OR COLOR.

NO CLAIM IS MADE TO THE EXCLUSIVE  
RIGHT TO USE "CARE HOME HEALTH", APART  
FROM THE MARK AS SHOWN.

SN 78-958,939, FILED 8-23-2006.

CHRISIE B. KING, EXAMINING ATTORNEY

**Int. Cl.: 24**

**Prior U.S. Cls.: 42 and 50**

**United States Patent and Trademark Office**

**Reg. No. 3,455,822**

**Registered June 24, 2008**

**TRADEMARK  
PRINCIPAL REGISTER**

**Precisé**

ASAHI KASEI FIBERS CORPORATION (JAPAN  
CORPORATION)  
2-6, DOJIMAHAMA 1-CHOME, KITA-KU  
OSAKA, JAPAN

FOR: NON-WOVEN FABRICS FOR USE IN THE  
MANUFACTURE OF MEMBRANE SUBSTRATE,  
INDUSTRIAL FILTERS, BACKING CLOTH OF SE-  
PARATOR, MEDICAL TAPE, FILTER MEDIA FOR  
BEVERAGES, PACKAGING MATERIAL OF DESIC-  
CANT, MATERIALS FOR AUTOMOTIVE PARTS  
AND BLINDS, IN CLASS 24 (U.S. CLS. 42 AND 50).

FIRST USE 8-22-2006; IN COMMERCE 3-13-2007.

THE MARK CONSISTS OF STANDARD CHAR-  
ACTERS WITHOUT CLAIM TO ANY PARTICULAR  
FONT, STYLE, SIZE, OR COLOR.

SN 78-958,999, FILED 8-23-2006.

SANI KHOURI, EXAMINING ATTORNEY



**Int. Cl.: 9**

**Prior U.S. Cls.: 21, 23, 26, 36, and 38**

**Reg. No. 3,455,823**

**United States Patent and Trademark Office**

**Registered June 24, 2008**

**TRADEMARK  
PRINCIPAL REGISTER**

BORN IN THE GLAMOROUS USA

JUICY COUTURE, INC. (CALIFORNIA CORPORATION)  
12720 WENTWORTH STREET  
PACOIMA, CA 91331

THE MARK CONSISTS OF STANDARD CHARACTERS WITHOUT CLAIM TO ANY PARTICULAR FONT, STYLE, SIZE, OR COLOR.

FOR: EYEWEAR AND ACCESSORIES, NAMELY, EYEGLASSES, SUNGLASSES, EYEWEAR CASES, EYEWEAR FRAMES, IN CLASS 9 (U.S. CLS. 21, 23, 26, 36 AND 38).

SN 78-959,713, FILED 8-24-2006.

FIRST USE 2-0-2006; IN COMMERCE 2-0-2006.

COLLEEN DOMBROW, EXAMINING ATTORNEY

Int. Cl.: 24

Prior U.S. Cls.: 42 and 50

United States Patent and Trademark Office

Reg. No. 3,455,824

Registered June 24, 2008

TRADEMARK  
PRINCIPAL REGISTER



CHICOPEE, INC. (DELAWARE CORPORATION)  
SUITE 300  
9335 HARRIS CORNERS PARKWAY  
CHARLOTTE, NC 28269

FOR: NONWOVEN FABRICS MADE FROM  
POLYOLEFINS, IN CLASS 24 (U.S. CLS. 42 AND 50).

FIRST USE 1-22-2008; IN COMMERCE 1-22-2008.

NO CLAIM IS MADE TO THE EXCLUSIVE  
RIGHT TO USE "LIGHT", APART FROM THE  
MARK AS SHOWN.

THE MARK CONSISTS OF THE WORDS "POLY-  
BREATHE LIGHT" IN STYLIZED FONTS EN-  
CLOSED WITHIN AN OVAL.

SN 78-962,044, FILED 8-28-2006.

BARBARA GAYNOR, EXAMINING ATTORNEY

**Int. Cl.: 16**

**Prior U.S. Cls.: 2, 5, 22, 23, 29, 37, 38, and 50**

**Reg. No. 3,455,825**

**United States Patent and Trademark Office**

**Registered June 24, 2008**

---

**TRADEMARK  
PRINCIPAL REGISTER**

**TAKERITE**

O'ROURKE, IAN (UNITED STATES INDIVIDUAL)  
686 IDLEBERRY  
SAN RAFAEL, CA 94903

THE MARK CONSISTS OF STANDARD CHARACTERS WITHOUT CLAIM TO ANY PARTICULAR FONT, STYLE, SIZE, OR COLOR.

FOR: STICKERS USED FOR LABELING MEDICATION CONTAINERS, IN CLASS 16 (U.S. CLS. 2, 5, 22, 23, 29, 37, 38 AND 50).

SN 78-962,744, FILED 8-29-2006.

FIRST USE 12-14-2005; IN COMMERCE 4-7-2006.

PAUL CROWLEY, EXAMINING ATTORNEY

**Int. Cl.: 9**

**Prior U.S. Cls.: 21, 23, 26, 36, and 38**

**Reg. No. 3,455,826**

**United States Patent and Trademark Office**

**Registered June 24, 2008**

**TRADEMARK  
PRINCIPAL REGISTER**

**TOMLAB**

TOMLAB OPTIMIZATION INC. (DELAWARE  
CORPORATION)  
1260 SE BISHOP BLVD  
STE E  
PULLMAN, CA 991635451

FIRST USE 1-17-2007; IN COMMERCE 1-17-2007.

THE MARK CONSISTS OF STANDARD CHAR-  
ACTERS WITHOUT CLAIM TO ANY PARTICULAR  
FONT, STYLE, SIZE, OR COLOR.

FOR: COMPUTER SOFTWARE DEVELOPMENT  
TOOLS; COMPUTER SOFTWARE PLATFORMS  
FOR OPTIMIZATION, IN CLASS 9 (U.S. CLS. 21, 23,  
26, 36 AND 38).

SN 78-963,318, FILED 8-29-2006.

ELLEN PERKINS, EXAMINING ATTORNEY

**Int. Cl.: 7**

**Prior U.S. Cls.: 13, 19, 21, 23, 31, 34, and 35**

**Reg. No. 3,455,827**

**United States Patent and Trademark Office**

**Registered June 24, 2008**

**TRADEMARK  
PRINCIPAL REGISTER**



BULLDOG WINCH CO., LLC (ARIZONA LTD  
LIAB CO)  
STE#46  
1725 W WILLIAMS DR.  
PHOENIX, AZ 85027

FOR: WINCHES, IN CLASS 7 (U.S. CLS. 13, 19, 21,  
23, 31, 34 AND 35).

FIRST USE 8-0-2006; IN COMMERCE 11-0-2006.

NO CLAIM IS MADE TO THE EXCLUSIVE  
RIGHT TO USE "WINCH", APART FROM THE  
MARK AS SHOWN.

THE MARK CONSISTS OF A BULLDOG'S FACE;  
WITH THE STYLIZED TEXT OF THE WORDING  
"BULLDOG" WITHIN A RECTANGLE WITH TWO  
CURVED EDGES, BELOW THE FACE; WITH THE  
STYLIZED TEXT OF THE WORD, "WINCH" BELOW  
THE RECTANGLE CONTAINING "BULLDOG".

SN 78-963,365, FILED 8-29-2006.

ODESSA BIBBINS, EXAMINING ATTORNEY

**Int. Cl.: 9**

**Prior U.S. Cls.: 21, 23, 26, 36, and 38**

**United States Patent and Trademark Office**

**Reg. No. 3,455,828**

**Registered June 24, 2008**

**TRADEMARK  
PRINCIPAL REGISTER**

**DANCE DANCE REVOLUTION  
UNIVERSE**

KONAMI DIGITAL ENTERTAINMENT CO.,  
LTD. (JAPAN CORPORATION)  
9-7-2, AKASAKA, MINATO-KU  
TOKYO, JAPAN

FOR: VIDEO GAME SOFTWARE; VIDEO GAME PROGRAMS; VIDEO GAME CD-ROMS; VIDEO GAME DIGITAL VERSATILE DISC-ROMS; COMPUTER GAME PROGRAMS; COMPUTER GAME CD-ROMS; COMPUTER GAME DIGITAL VERSATILE DISC-ROMS; ELECTRONIC GAME PROGRAMS; ELECTRONIC GAME CD-ROMS; ELECTRONIC GAME DIGITAL VERSATILE DISC-ROMS; DOWNLOADABLE COMPUTER GAME SOFTWARE AND DOWNLOADABLE VIDEO GAME SOFTWARE; VIDEO GAME CONTROLLER

FOR ELECTRONIC VIDEO GAME MACHINES, IN CLASS 9 (U.S. CLS. 21, 23, 26, 36 AND 38).

FIRST USE 2-27-2007; IN COMMERCE 2-27-2007.

THE MARK CONSISTS OF STANDARD CHARACTERS WITHOUT CLAIM TO ANY PARTICULAR FONT, STYLE, SIZE, OR COLOR.

OWNER OF U.S. REG. NOS. 2,849,077, 2,914,919, AND OTHERS.

SN 78-963,548, FILED 8-30-2006.

CARRIE GENOVESE, EXAMINING ATTORNEY

**Int. Cl.: 3**

**Prior U.S. Cls.: 1, 4, 6, 50, 51, and 52**

**Reg. No. 3,455,829**

**United States Patent and Trademark Office**

**Registered June 24, 2008**

**TRADEMARK  
PRINCIPAL REGISTER**

**INNOVATIVE BRANDS**

INNOVATIVE BRANDS, LLC (DELAWARE LIMITED LIABILITY CORPORATION)  
C/O THE NAJAFI COMPANIES  
2525 E. CAMELBACK ROAD - SUITE 850  
PHOENIX, AZ 85016

FOR: HAIR CARE PREPARATIONS, NAMELY, SHAMPOO AND CONDITIONER; PERSONAL DEODORANT AND ANTI-PERSPIRANT , IN CLASS 3 (U.S. CLS. 1, 4, 6, 50, 51 AND 52).

FIRST USE 2-4-2008; IN COMMERCE 2-4-2008.

THE MARK CONSISTS OF STANDARD CHARACTERS WITHOUT CLAIM TO ANY PARTICULAR FONT, STYLE, SIZE, OR COLOR.

NO CLAIM IS MADE TO THE EXCLUSIVE RIGHT TO USE "BRANDS", APART FROM THE MARK AS SHOWN.

SN 78-963,800, FILED 8-30-2006.

EMILY CARLSEN, EXAMINING ATTORNEY

**Int. Cl.: 9**

**Prior U.S. Cls.: 21, 23, 26, 36, and 38**

**United States Patent and Trademark Office**

**Reg. No. 3,455,830**

**Registered June 24, 2008**

**TRADEMARK  
PRINCIPAL REGISTER**

**SRS HEADPHONE PRO**

SRS LABS, INC. (DELAWARE CORPORATION)  
2909 DAIMLER STREET  
SANTA ANA, CA 92705

FOR: MONO, STEREO, AND MULTICHANNEL  
SURROUND SOUND PROCESSOR FOR HEAD-  
PHONES, EARBUDS, SPEAKERS, VEHICLE ENTER-  
TAINMENT SYSTEMS, GAMING DEVICES, HOME  
ENTERTAINMENT DEVICES, DIGITAL MEDIA  
PLAYERS, AND MOBILE PHONES, IN CLASS 9  
(U.S. CLS. 21, 23, 26, 36 AND 38).

FIRST USE 6-9-2006; IN COMMERCE 6-9-2006.

THE MARK CONSISTS OF STANDARD CHAR-  
ACTERS WITHOUT CLAIM TO ANY PARTICULAR  
FONT, STYLE, SIZE, OR COLOR.

OWNER OF U.S. REG. NOS. 1,501,111, 2,042,227,  
AND 2,044,183.

NO CLAIM IS MADE TO THE EXCLUSIVE  
RIGHT TO USE "HEADPHONE", APART FROM  
THE MARK AS SHOWN.

SN 78-963,826, FILED 8-30-2006.

LINDA E. BLOHM, EXAMINING ATTORNEY



**Int. Cl.: 3**

**Prior U.S. Cls.: 1, 4, 6, 50, 51, and 52**

**United States Patent and Trademark Office**

**Reg. No. 3,455,831**

**Registered June 24, 2008**

**TRADEMARK  
PRINCIPAL REGISTER**

**AQUA CREAM**

AMARTÉ USA HOLDINGS, INC. (DELAWARE  
CORPORATION)  
SUITE 2450  
101 CALIFORNIA STREET  
SAN FRANCISCO, CA 94111

FOR: FACIAL SKIN CREAMS, IN CLASS 3 (U.S.  
CLS. 1, 4, 6, 50, 51 AND 52).

FIRST USE 7-9-2007; IN COMMERCE 7-9-2007.

THE MARK CONSISTS OF STANDARD CHAR-  
ACTERS WITHOUT CLAIM TO ANY PARTICULAR  
FONT, STYLE, SIZE, OR COLOR.

NO CLAIM IS MADE TO THE EXCLUSIVE  
RIGHT TO USE "CREAM", APART FROM THE  
MARK AS SHOWN.

SN 78-964,139, FILED 8-30-2006.

SUSAN STIGLITZ, EXAMINING ATTORNEY

**Int. Cl.: 29**

**Prior U.S. Cl.: 46**

**United States Patent and Trademark Office**

**Reg. No. 3,455,832**

**Registered June 24, 2008**

**TRADEMARK  
PRINCIPAL REGISTER**

**CHIQUITA GRAPE & APPLE  
BITES**

CHIQUITA BRANDS L.L.C. (DELAWARE LTD  
LIAB CO)  
250 EAST FIFTH STREET  
CINCINNATI, OH 45202

FOR: CUT FRUITS, IN CLASS 29 (U.S. CL. 46).

FIRST USE 2-1-2007; IN COMMERCE 2-1-2007.

THE MARK CONSISTS OF STANDARD CHAR-  
ACTERS WITHOUT CLAIM TO ANY PARTICULAR  
FONT, STYLE, SIZE, OR COLOR.

OWNER OF U.S. REG. NOS. 670,320, 2,422,224,  
AND OTHERS.

NO CLAIM IS MADE TO THE EXCLUSIVE  
RIGHT TO USE "GRAPE & APPLE BITES", APART  
FROM THE MARK AS SHOWN.

THE FOREIGN WORDING IN THE MARK  
TRANSLATES INTO ENGLISH AS LITTLE GIRL.

SN 78-964,733, FILED 8-31-2006.

JIM RINGLE, EXAMINING ATTORNEY

Int. Cl.: 33

Prior U.S. Cls.: 47 and 49

**United States Patent and Trademark Office**

**Reg. No. 3,455,833**

Registered June 24, 2008

**TRADEMARK  
PRINCIPAL REGISTER**

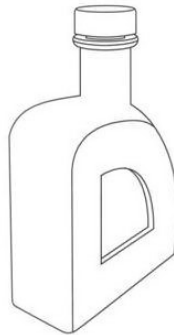

DESTILADOS OLE SA DE CV (MEXICO CORPORATION)

LUIS DONALDO COLOSIO #1

MAZATLAN, MEXICO 82160

FOR: TEQUILA, IN CLASS 33 (U.S. CLS. 47 AND 49).

FIRST USE 10-18-2006; IN COMMERCE 10-18-2006.

THE MARK CONSISTS OF A THREE-DIMENSIONAL SHAPED BOTTLE THAT HAS A THREE-SIDED BODY, WITH TWO STRAIGHT SIDES AND ONE CURVED SIDE, AND A KNOB-LIKE BOTTLE CAP NEAR THE TOP OF THE CURVED SIDE OF THE BOTTLE.

SN 78-965,387, FILED 8-31-2006.

ATTIYA MALIK, EXAMINING ATTORNEY

**Int. Cl.: 42**

**Prior U.S. Cls.: 100 and 101**

**United States Patent and Trademark Office**

**Reg. No. 3,455,834**

**Registered June 24, 2008**

**SERVICE MARK  
PRINCIPAL REGISTER**

**TRACM**

TAMPA ARMATURE WORKS (FLORIDA CORPORATION)  
440 SOUTH 78TH STREET  
TAMPA, FL 33619

FOR: PROVIDING TEMPORARY USE OF ON-LINE NON-DOWNLOADABLE EQUIPMENT MAINTENANCE AND SERVICING TRACKING SOFTWARE ACCESSIBLE OVER A GLOBAL NETWORK CONNECTION FOR IDENTIFYING EQUIPMENT MAINTENANCE AND SERVICING NEEDS REMOTELY OVER THE INTERNET, IN CLASS 42 (U.S. CLS. 100 AND 101).

FIRST USE 7-5-2006; IN COMMERCE 7-6-2006.

THE MARK CONSISTS OF STANDARD CHARACTERS WITHOUT CLAIM TO ANY PARTICULAR FONT, STYLE, SIZE, OR COLOR.

SN 78-965,696, FILED 9-1-2006.

ELLEN PERKINS, EXAMINING ATTORNEY

**Int. Cls.: 5 and 10**

**Prior U.S. Cls.: 6, 18, 26, 39, 44, 46, 51, and 52**

**United States Patent and Trademark Office**

**Reg. No. 3,455,835**

**Registered June 24, 2008**

**TRADEMARK  
PRINCIPAL REGISTER**



ANULEX TECHNOLOGIES, INC. (MINNESOTA CORPORATION)  
5600 ROWLAND ROAD, SUITE 280  
MINNETONKA, MN 55343

FOR: FIXATION AND REPAIR LIVE IMPLANTS, AND DELIVERY INSTRUMENTS THEREFOR SOLD AS A UNIT, FOR THE REPAIR OF SOFT TISSUE OF THE SPINE, IN CLASS 5 (U.S. CLS. 6, 18, 44, 46, 51 AND 52).

FIRST USE 2-15-2007; IN COMMERCE 2-27-2007.

FOR: FIXATION AND REPAIR ARTIFICIAL AND SYNTHETIC TISSUE IMPLANTS, AND DELIVERY INSTRUMENTS THEREFOR SOLD AS A UNIT, FOR THE REPAIR OF SOFT TISSUE OF THE SPINE, IN CLASS 10 (U.S. CLS. 26, 39 AND 44).

FIRST USE 2-15-2007; IN COMMERCE 2-27-2007.

THE COLOR(S) LIGHT BLUE AND DARK BLUE IS/ARE CLAIMED AS A FEATURE OF THE MARK.

THE COLOR LIGHT BLUE APPEARS IN THE FOREGROUND OF THE LETTER "X". THE COLOR DARK BLUE APPEARS IN THE LETTERING "CLOSE" AND IN THE BACKGROUND HIGHLIGHTING OF THE LETTER "X".

SN 78-965,758, FILED 9-1-2006.

JAMES MACFARLANE, EXAMINING ATTORNEY

**Int. Cl.: 41**

**Prior U.S. Cls.: 100, 101, and 107**

**United States Patent and Trademark Office**

**Reg. No. 3,455,836**

**Registered June 24, 2008**

**SERVICE MARK  
PRINCIPAL REGISTER**

# Key Moment Cinema

BLUE WORLD STUDIOS, INC. (NEVADA CORPORATION)

3453 GREYSTONE DRIVE

LOGANVILLE, GA 30052

FOR: CINEMA STUDIOS, IN CLASS 41 (U.S. CLS. 100, 101 AND 107).

FIRST USE 7-7-2007; IN COMMERCE 7-7-2007.

THE MARK CONSISTS OF STANDARD CHARACTERS WITHOUT CLAIM TO ANY PARTICULAR FONT, STYLE, SIZE, OR COLOR.

NO CLAIM IS MADE TO THE EXCLUSIVE RIGHT TO USE "CINEMA", APART FROM THE MARK AS SHOWN.

SN 78-966,579, FILED 9-2-2006.

SUSAN RICHARDS, EXAMINING ATTORNEY

**Int. Cl.: 9**

**Prior U.S. Cls.: 21, 23, 26, 36, and 38**

**Reg. No. 3,455,837**

**United States Patent and Trademark Office**

**Registered June 24, 2008**

**TRADEMARK  
PRINCIPAL REGISTER**

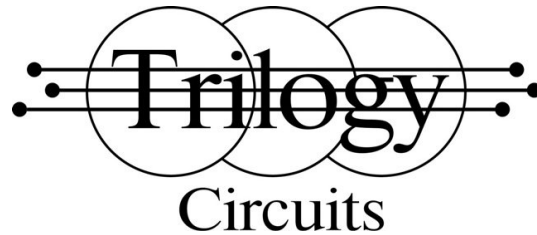

TRILOGY CIRCUITS, INC. (TEXAS CORPORATION)  
1717 FIRMAN DRIVE  
SUITE 200  
RICHARDSON, TX 75081

NO CLAIM IS MADE TO THE EXCLUSIVE  
RIGHT TO USE "CIRCUITS", APART FROM THE  
MARK AS SHOWN.

FOR: CIRCUIT BOARDS, NAMELY, ELECTRONIC  
AND PRINTED CIRCUIT BOARDS, IN CLASS 9  
(U.S. CLS. 21, 23, 26, 36 AND 38).

SN 78-966,906, FILED 9-5-2006.

FIRST USE 7-0-2003; IN COMMERCE 12-0-2003.

CHRIS WELLS, EXAMINING ATTORNEY

**Int. Cl.: 5**

**Prior U.S. Cls.: 6, 18, 44, 46, 51, and 52**

**Reg. No. 3,455,838**

**United States Patent and Trademark Office**

**Registered June 24, 2008**

---

**TRADEMARK  
PRINCIPAL REGISTER**

**CITRUSWIRX**

RTS COMPANIES INC. (CANADA CORPORATION)  
650 RUPERT STREET  
WATERLOO, ONTARIO, CANADA N2V 2R8

FOR: PRE-MOISTENED ANTI-BACTERIAL  
CLEANING DISPOSABLE WIPES, IN CLASS 5 (U.S.  
CLS. 6, 18, 44, 46, 51 AND 52).

FIRST USE 9-0-2006; IN COMMERCE 9-0-2006.

THE MARK CONSISTS OF STANDARD CHARACTERS WITHOUT CLAIM TO ANY PARTICULAR FONT, STYLE, SIZE, OR COLOR.

PRIORITY CLAIMED UNDER SEC. 44(D) ON CANADA APPLICATION NO. 1,311,033, FILED 7-28-2006.

SN 78-967,245, FILED 9-5-2006.

SCOTT BIBB, EXAMINING ATTORNEY



**Int. Cl.: 16**

**Prior U.S. Cls.: 2, 5, 22, 23, 29, 37, 38, and 50**

**Reg. No. 3,455,839**

**United States Patent and Trademark Office**

**Registered June 24, 2008**

**TRADEMARK  
PRINCIPAL REGISTER**

**RHYME RASCALS**

RAYBURN, PAMELA I. (UNITED STATES INDIVIDUAL)  
12757 WAGGONER RD.  
FESTUS, MO 63028

FOR: CHILDREN'S BOOKS, IN CLASS 16 (U.S. CLS. 2, 5, 22, 23, 29, 37, 38 AND 50).

FIRST USE 12-1-2007; IN COMMERCE 12-1-2007.

THE MARK CONSISTS OF STANDARD CHARACTERS WITHOUT CLAIM TO ANY PARTICULAR FONT, STYLE, SIZE, OR COLOR.

SN 78-967,279, FILED 9-5-2006.

KATHLEEN M. VANSTON, EXAMINING ATTORNEY

**Int. Cls.: 9 and 11**

**Prior U.S. Cls.: 13, 21, 23, 26, 31, 34, 36, and 38**

**United States Patent and Trademark Office**

**Reg. No. 3,455,840**

**Registered June 24, 2008**

**TRADEMARK  
PRINCIPAL REGISTER**

**FREEWATT**

CLIMATE ENERGY, LLC (MASSACHUSETTS  
LTD LIAB CO)  
93 WEST STREET  
MEDFIELD, MA 02052

FOR: COMPUTER SOFTWARE AND FIRMWARE  
FOR CONTROLLING HEATING, COOLING, AIR-  
CONDITIONING AND ELECTRIC GENERATION  
SYSTEMS; CLIMATE CONTROL SYSTEMS CON-  
SISTING OF ANALOG/DIGITAL THERMO-STATS,  
AIR-CONDITIONING, HEATING, VENTILATING  
AND DRYING CONTROL DEVICES, IN CLASS 9  
(U.S. CLS. 21, 23, 26, 36 AND 38).

FIRST USE 4-1-2007; IN COMMERCE 4-1-2007.

FOR: SYSTEMS FOR HEATING, CONSISTING OF  
FURNACES, BOILERS, HUMIDIFIERS, CIRCULAT-

ING PUMPS, AND FEATURING BUILT-IN ELEC-  
TRIC GENERATORS; SYSTEMS FOR COOLING  
CONSISTING OF AIR CONDITIONING UNITS FEAT-  
URING BUILT-IN ELECTRIC GENERATORS, IN  
CLASS 11 (U.S. CLS. 13, 21, 23, 31 AND 34).

FIRST USE 4-1-2007; IN COMMERCE 4-1-2007.

THE MARK CONSISTS OF STANDARD CHAR-  
ACTERS WITHOUT CLAIM TO ANY PARTICULAR  
FONT, STYLE, SIZE, OR COLOR.

SN 78-967,335, FILED 9-5-2006.

CHRISTINE COOPER, EXAMINING ATTORNEY

**Int. Cl.: 21**

**Prior U.S. Cls.: 2, 13, 23, 29, 30, 33, 40, and 50**

**Reg. No. 3,455,841**

**United States Patent and Trademark Office**

**Registered June 24, 2008**

**TRADEMARK  
PRINCIPAL REGISTER**

**MACS**

ALTERNATIVE DESIGN MANUFACTURING  
AND SUPPLY, INC. (ARKANSAS CORPORATION)  
3055 CHERI WHITLOCK DRIVE  
SILOAM SPRINGS, AR 72761

FOR: ANIMAL CAGES WHICH ARE USED FOR  
HOLDING MULTIPLE NUMBERS OF POULTRY,  
RODENTS AND OTHER SMALL ANIMALS IN  
SEPARATE COMPARTMENTS FOR PURPOSES OF  
TESTING, BREEDING, ISOLATION AND GENER-

AL HOUSING AND WHICH INCORPORATE AN  
ELECTRONIC VENTILATION AND AIR FILTRA-  
TION SYSTEM, IN CLASS 21 (U.S. CLS. 2, 13, 23, 29,  
30, 33, 40 AND 50).

FIRST USE 9-0-2006; IN COMMERCE 9-0-2006.

SN 78-967,890, FILED 9-6-2006.

ZACHARY BELLO, EXAMINING ATTORNEY

**Int. Cl.: 43**

**Prior U.S. Cls.: 100 and 101**

**United States Patent and Trademark Office**

**Reg. No. 3,455,842**

**Registered June 24, 2008**

---

**SERVICE MARK  
PRINCIPAL REGISTER**

**ADVENTURES BY THE CUP**

THE COCA-COLA COMPANY (DELAWARE  
CORPORATION)  
ONE COCA-COLA PLAZA  
ATLANTA, GA 30313

FOR: SERVICES FOR PROVIDING FOOD AND  
DRINK, NAMELY, RESTAURANT, BAR, COFFEE  
SHOP, CAFE AND CAFETERIA SERVICES, IN  
CLASS 43 (U.S. CLS. 100 AND 101).

FIRST USE 5-8-2007; IN COMMERCE 5-8-2007.

THE MARK CONSISTS OF STANDARD CHAR-  
ACTERS WITHOUT CLAIM TO ANY PARTICULAR  
FONT, STYLE, SIZE, OR COLOR.

SN 78-968,183, FILED 9-6-2006.

JESSICA FATHY, EXAMINING ATTORNEY

**Int. Cl.: 5**

**Prior U.S. Cls.: 6, 18, 44, 46, 51, and 52**

**Reg. No. 3,455,843**

**United States Patent and Trademark Office**

**Registered June 24, 2008**

**TRADEMARK  
PRINCIPAL REGISTER**

**ELEMENT**

DOW AGROSCIENCES LLC (DELAWARE LTD  
LIAB CO)  
TRADEMARK & COPYRIGHT DEPARTMENT  
9330 ZIONSVILLE ROAD  
INDIANAPOLIS, IN 46268

FOR: PESTICIDES AND PREPARATIONS FOR  
DESTROYING VERMIN, NAMELY, HERBICIDES,  
INSECTICIDES AND FUNGICIDES FOR AGRICUL-  
TURE, HORTICULTURE, FORESTRY, TURF AND  
ORNAMENTAL, COMMERCIAL, INDUSTRIAL  
AND DOMESTIC USE, IN CLASS 5 (U.S. CLS. 6, 18,  
44, 46, 51 AND 52).

FIRST USE 1-3-2007; IN COMMERCE 1-3-2007.

THE MARK CONSISTS OF STANDARD CHAR-  
ACTERS WITHOUT CLAIM TO ANY PARTICULAR  
FONT, STYLE, SIZE, OR COLOR.

SN 78-968,711, FILED 9-7-2006.

WARREN L. OLANDRIA, EXAMINING ATTOR-  
NEY

**Int. Cl.: 36**

**Prior U.S. Cls.: 100, 101, and 102**

**United States Patent and Trademark Office**

**Reg. No. 3,455,844**

**Registered June 24, 2008**

**SERVICE MARK  
PRINCIPAL REGISTER**

**ALTA ALLIANCE BANK**

WESTERN ALLIANCE BANCORPORATION (NE-  
VADA CORPORATION)  
2700 W. SAHARA AVENUE  
LAS VEGAS, NV 89102

FOR: FINANCIAL SERVICES, NAMELY, BANK-  
ING; CREDIT CARD SERVICES; ELECTRONIC  
CREDIT CARD TRANSACTIONS; COMMERCIAL  
AND CONSUMER LENDING AND FINANCING;  
REAL ESTATE AND MORTGAGE BROKERAGE;  
TRUST, ESTATE, AND FIDUCIARY MANAGE-  
MENT, PLANNING AND CONSULTING; INVEST-  
MENT ADVISORY AND CONSULTING SERVICES;  
PROVIDING SECURE FINANCIAL TRANSAC-  
TIONS IN THE NATURE OF ELECTRONIC CASH  
TRANSACTIONS, ELECTRONIC CREDIT CARD  
TRANSACTIONS, ELECTRONIC DEBIT TRANSAC-  
TIONS, ELECTRONIC CHECK PROCESSING  
TRANSACTIONS AND ELECTRONIC TRANSMIS-  
SION OF BILL PAYMENT DATA VIA A GLOBAL  
COMPUTER NETWORK; INSURANCE SERVICES,

NAMELY, UNDERWRITING AND BROKERAGE  
OF PROPERTY; PROVIDING FINANCIAL NEWS  
AND INFORMATION VIA WEBSITE ON A GLOBAL  
NETWORK, IN CLASS 36 (U.S. CLS. 100, 101 AND  
102).

FIRST USE 10-16-2006; IN COMMERCE 10-16-2006.

THE MARK CONSISTS OF STANDARD CHAR-  
ACTERS WITHOUT CLAIM TO ANY PARTICULAR  
FONT, STYLE, SIZE, OR COLOR.

NO CLAIM IS MADE TO THE EXCLUSIVE  
RIGHT TO USE "BANK", APART FROM THE  
MARK AS SHOWN.

SN 78-968,855, FILED 9-7-2006.

JULIE WATSON, EXAMINING ATTORNEY

**Int. Cl.: 28**

**Prior U.S. Cls.: 22, 23, 38, and 50**

**Reg. No. 3,455,845**

**United States Patent and Trademark Office**

**Registered June 24, 2008**

---

**TRADEMARK  
PRINCIPAL REGISTER**

**BUR BUR AND FRIENDS**

FARMER'S HAT PRODUCTIONS, LLC (MINNE-  
SOTA LTD LIAB CO)  
951 SPRING HILL ROAD  
WAYZATA, MN 55391

FOR: TOYS, NAMELY, PLUSH DOLLS, TOY  
BOATS; BOARD GAMES, CARD GAMES; PUZZLES,  
ADVENTURE BOARD GAMES; SPORTING GOODS,  
NAMELY, FISHING RODS, FISHING REELS, FISH-  
ING LURES, BASEBALLS, BASEBALL BATS, AND  
BASEBALL GLOVES; GOLF CLUBS AND GOLF  
BAG; SOCCER BALLS, SHIN GUARDS FOR ATH-

LETIC USE, BASKETBALLS, IN CLASS 28 (U.S. CLS.  
22, 23, 38 AND 50).

FIRST USE 7-7-2007; IN COMMERCE 7-7-2007.

THE MARK CONSISTS OF STANDARD CHAR-  
ACTERS WITHOUT CLAIM TO ANY PARTICULAR  
FONT, STYLE, SIZE, OR COLOR.

SN 78-969,798, FILED 9-8-2006.

WON TEAK OH, EXAMINING ATTORNEY

**Int. Cl.: 30**

**Prior U.S. Cl.: 46**

**United States Patent and Trademark Office**

**Reg. No. 3,455,846**

**Registered June 24, 2008**

**TRADEMARK  
PRINCIPAL REGISTER**

**BELLATORIA**

BERNATELLO'S PIZZA, INC. (MINNESOTA  
CORPORATION)  
220 CONGRESS STREET  
MAPLE LAKE, MN 55358

THE MARK CONSISTS OF STANDARD CHAR-  
ACTERS WITHOUT CLAIM TO ANY PARTICULAR  
FONT, STYLE, SIZE, OR COLOR.

FOR: PIZZA, IN CLASS 30 (U.S. CL. 46).

SN 78-970,282, FILED 9-8-2006.

FIRST USE 11-21-2006; IN COMMERCE 11-21-2006.

THOMAS MANOR, EXAMINING ATTORNEY



**Int. Cls.: 1 and 16**

**Prior U.S. Cls.: 1, 2, 5, 6, 10, 22, 23, 26, 29, 37, 38, 46,  
and 50**

**Reg. No. 3,455,847**

**United States Patent and Trademark Office**

**Registered June 24, 2008**

**TRADEMARK  
PRINCIPAL REGISTER**

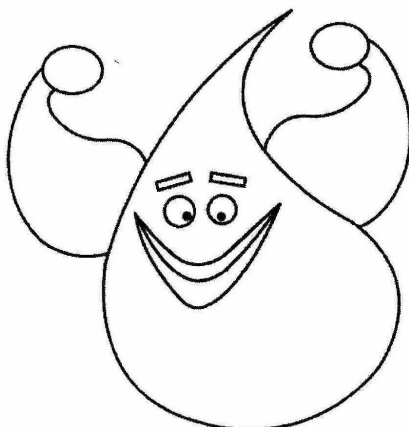

KOLALOKA INDUSTRIES, LP (TEXAS LIMITED  
PARTNERSHIP)  
SUITE 111  
3100 CARLISLE STREET  
DALLAS, TX 75204

FOR: ADHESIVES FOR THE AUTOMOTIVE IN-  
DUSTRY, AUTOMOTIVE REPAIR INDUSTRY,  
FOOTWEAR INDUSTRY, PLASTICS INDUSTRY,  
TOY INDUSTRY AND FURNITURE INDUSTRY;  
GLUE FOR USE IN THE AUTOMOTIVE INDUS-  
TRY, AUTOMOTIVE REPAIR INDUSTRY, FOOT-  
WEAR INDUSTRY, PLASTICS INDUSTRY, TOY  
INDUSTRY AND FURNITURE INDUSTRY, IN  
CLASS 1 (U.S. CLS. 1, 5, 6, 10, 26 AND 46).

FIRST USE 12-10-2007; IN COMMERCE 12-10-2007.

FOR: GLUE FOR STATIONERY OR HOUSE-  
HOLD USE, IN CLASS 16 (U.S. CLS. 2, 5, 22, 23, 29,  
37, 38 AND 50).

FIRST USE 12-10-2007; IN COMMERCE 12-10-2007.

THE MARK CONSISTS OF A FANCIFUL DROP  
WITH FLEXED BICEPS.

SN 78-970,708, FILED 9-9-2006.

CHRISTOPHER BUONGIORNO, EXAMINING AT-  
TORNEY

**Int. Cl.: 36**

**Prior U.S. Cls.: 100, 101, and 102**

**United States Patent and Trademark Office**

**Reg. No. 3,455,848**

**Registered June 24, 2008**

**SERVICE MARK  
PRINCIPAL REGISTER**

**CAPITAL PEAK ADVISORS**

CAPITAL PEAK ADVISORS, LLC (COLORADO  
LIMITED LIABILITY COMPANY)  
1942 BROADWAY SUITE 200  
BOULDER, CO 80302

FOR: CONSULTING IN THE FIELD OF INVEST-  
MENT FUND MANAGEMENT; FINANCIAL SER-  
VICES, NAMELY, INVESTMENT FUND  
MANAGEMENT, IN CLASS 36 (U.S. CLS. 100, 101  
AND 102).

FIRST USE 9-22-2006; IN COMMERCE 9-22-2006.

THE MARK CONSISTS OF STANDARD CHAR-  
ACTERS WITHOUT CLAIM TO ANY PARTICULAR  
FONT, STYLE, SIZE, OR COLOR.

NO CLAIM IS MADE TO THE EXCLUSIVE  
RIGHT TO USE "CAPITAL" AND "ADVISORS",  
APART FROM THE MARK AS SHOWN.

SN 78-971,462, FILED 9-11-2006.

LINDA LAVACHE, EXAMINING ATTORNEY

**Int. Cl.: 6**

**Prior U.S. Cls.: 2, 12, 13, 14, 23, 25, and 50**

**Reg. No. 3,455,849**

**United States Patent and Trademark Office**

**Registered June 24, 2008**

---

**TRADEMARK  
PRINCIPAL REGISTER**

**EZ-LOADER**

DELTA CONSOLIDATED INDUSTRIES, INC.  
(ARKANSAS CORPORATION)  
P.O. BOX 1846  
JONESBORO, AR 72403

FIRST USE 2-1-2008; IN COMMERCE 2-1-2008.

FOR: BOLSTERS, ALSO KNOWN AS SUPPORT  
STRUCTURE MOUNTED TO THE BOTTOM SUR-  
FACE OF A CONTAINER, FOR METAL STORAGE  
CONTAINERS, IN CLASS 6 (U.S. CLS. 2, 12, 13, 14, 23,  
25 AND 50).

THE MARK CONSISTS OF STANDARD CHAR-  
ACTERS WITHOUT CLAIM TO ANY PARTICULAR  
FONT, STYLE, SIZE, OR COLOR.

SN 78-971,547, FILED 9-11-2006.

RONALD AIKENS, EXAMINING ATTORNEY

**Int. Cls.: 29 and 30**

**Prior U.S. Cl.: 46**

**United States Patent and Trademark Office**

**Reg. No. 3,455,850**

**Registered June 24, 2008**

**TRADEMARK  
PRINCIPAL REGISTER**

# SunMeadow

G.A. FOOD SERVICES OF PINELLAS COUNTY,  
INC. (FLORIDA CORPORATION)  
12200 32ND COURT NORTH  
ST. PETERSBURG, FL 33716

FOR: FROZEN FRUIT CUPS AND FROZEN PRE-  
PARED MEALS, MEAL COURSES AND DISHES  
COMPOSED PRINCIPALLY OF ONE OF THE FOL-  
LOWING; MEAT, POULTRY, SEAFOOD AND VE-  
GETABLES , IN CLASS 29 (U.S. CL. 46).

FIRST USE 12-1-1980; IN COMMERCE 12-1-1980.

FOR: SANDWICHES, IN CLASS 30 (U.S. CL. 46).

FIRST USE 12-1-1980; IN COMMERCE 12-1-1980.

THE MARK CONSISTS OF STANDARD CHAR-  
ACTERS WITHOUT CLAIM TO ANY PARTICULAR  
FONT, STYLE, SIZE, OR COLOR.

OWNER OF U.S. REG. NOS. 2,702,396 AND  
2,731,403.

SN 78-972,123, FILED 9-12-2006.

ELLEN PERKINS, EXAMINING ATTORNEY

**Int. Cl.: 30**

**Prior U.S. Cl.: 46**

**United States Patent and Trademark Office**

**Reg. No. 3,455,851**

**Registered June 24, 2008**

**TRADEMARK  
PRINCIPAL REGISTER**

**SOLO**

THE LOW SODIUM SEA SALT CO. LIMITED  
(UNITED KINGDOM PRIVATE LIMITED  
COMPANY)  
101-103 PALACE ROAD  
BROMLEY KENT, UNITED KINGDOM BR13JX

THE MARK CONSISTS OF STANDARD CHAR-  
ACTERS WITHOUT CLAIM TO ANY PARTICULAR  
FONT, STYLE, SIZE, OR COLOR.

FOR: SALT, IN CLASS 30 (U.S. CL. 46).

SN 78-973,080, FILED 9-13-2006.

FIRST USE 12-31-1999; IN COMMERCE 7-31-2006.

DAVID YONTEF, EXAMINING ATTORNEY

**Int. Cl.: 41**

**Prior U.S. Cls.: 100, 101, and 107**

**United States Patent and Trademark Office**

**Reg. No. 3,455,852**

**Registered June 24, 2008**

**SERVICE MARK  
PRINCIPAL REGISTER**

**THINKING AHEAD**

APOLLO GROUP, INC. (ARIZONA CORPORATION)  
4025 S. RIVERPOINT PARKWAY  
PHOENIX, AZ 85040

FOR: EDUCATION SERVICES, NAMELY, PROVIDING COURSES OF INSTRUCTION AT THE POST-SECONDARY LEVEL, IN CLASS 41 (U.S. CLS. 100, 101 AND 107).

FIRST USE 1-23-2008; IN COMMERCE 1-23-2008.

THE MARK CONSISTS OF STANDARD CHARACTERS WITHOUT CLAIM TO ANY PARTICULAR FONT, STYLE, SIZE, OR COLOR.

SN 78-973,296, FILED 9-13-2006.

COLLEEN DOMBROW, EXAMINING ATTORNEY

**Int. Cl.: 29**

**Prior U.S. Cl.: 46**

**United States Patent and Trademark Office**

**Reg. No. 3,455,853**

**Registered June 24, 2008**

**TRADEMARK  
PRINCIPAL REGISTER**

**BUNDINOS**

PAULUCCI, LUIGINO F. (UNITED STATES INDIVIDUAL)  
201 WEST FIRST STREET  
SANFORD, FL 32771

FOR: PREPARED, FROZEN OR PACKAGED APETIZERS CONSISTING PRIMARILY OF MEAT, POULTRY, PROCESSED FRUIT AND CHEESE; PREPARED, FROZEN OR PACKAGED FRUIT-BASED SNACK FOOD; PREPARED, FROZEN OR PACKAGED SNACK FOOD PACKAGE COMBINATIONS CONSISTING PRIMARILY OF MEAT, POULTRY, PROCESSED FRUIT AND CHEESE, IN CLASS 29 (U.S. CL. 46).

FIRST USE 2-1-2008; IN COMMERCE 2-1-2008.

THE MARK CONSISTS OF STANDARD CHARACTERS WITHOUT CLAIM TO ANY PARTICULAR FONT, STYLE, SIZE, OR COLOR.

"BUNDINOS" HAS NO MEANING IN A FOREIGN LANGUAGE.

SN 78-973,379, FILED 9-13-2006.

TRICIA SONNEBORN, EXAMINING ATTORNEY

**Int. Cl.: 30**

**Prior U.S. Cl.: 46**

**United States Patent and Trademark Office**

**Reg. No. 3,455,854**

**Registered June 24, 2008**

**TRADEMARK  
PRINCIPAL REGISTER**



PERFETTI VAN MELLE BENELUX B.V. (NETHERLANDS CORPORATION)  
ZOETE INVAL 20  
BREDA, NETHERLANDS 4815 HK

FOR: CANDY AND GUM SWEETS, IN CLASS 30  
(U.S. CL. 46).

FIRST USE 12-31-1996; IN COMMERCE 12-31-1996.

OWNER OF U.S. REG. NOS. 2,025,354, 2,595,212,  
AND OTHERS.

THE MARK CONSISTS OF A BALLOON WITH A  
SMILING FACE.

SN 78-974,654, FILED 9-14-2006.

ROBERT C. CLARK JR., EXAMINING ATTORNEY



**Int. Cl.: 30**

**Prior U.S. Cl.: 46**

**United States Patent and Trademark Office**

**Reg. No. 3,455,855**

**Registered June 24, 2008**

**TRADEMARK  
PRINCIPAL REGISTER**



PERFETTI VAN MELLE BENELUX B.V. (NETHERLANDS CORPORATION)  
ZOETE INVAL 20  
BREDA, NETHERLANDS 4815 HK

FOR: CANDY AND GUM SWEETS, IN CLASS 30  
(U.S. CL. 46).

FIRST USE 12-31-1996; IN COMMERCE 12-31-1996.

OWNER OF U.S. REG. NOS. 2,025,354, 2,595,212,  
AND OTHERS.

THE COLOR(S) RED AND WHITE IS/ARE  
CLAIMED AS A FEATURE OF THE MARK.

THE COLOR RED APPEARS IN THE BALLOON  
AND THE COLOR WHITE APPEARS IN THE SMILE,  
NOSE EYES AND SHADING ON THE LEFT HAND  
SIDE.

THE MARK CONSISTS OF BALLOON WITH A  
SMILING FACE.

SN 78-974,692, FILED 9-14-2006.

ROBERT C. CLARK JR., EXAMINING ATTORNEY

**Int. Cl.: 38**

**Prior U.S. Cls.: 100, 101, and 104**

**United States Patent and Trademark Office**

**Reg. No. 3,455,856**

**Registered June 24, 2008**

**SERVICE MARK  
PRINCIPAL REGISTER**

**HORIZON**

HORIZON CHRISTIAN FELLOWSHIP (CALI-  
FORNIA CORPORATION)  
5331 MT. ALIFAN DRIVE  
SAN DIEGO, CA 92111

THE MARK CONSISTS OF STANDARD CHAR-  
ACTERS WITHOUT CLAIM TO ANY PARTICULAR  
FONT, STYLE, SIZE, OR COLOR.

FOR: RADIO PROGRAM BROADCASTING, IN  
CLASS 38 (U.S. CLS. 100, 101 AND 104).

SN 78-974,884, FILED 9-14-2006.

FIRST USE 12-31-1978; IN COMMERCE 12-31-1978.

JOHN DALIER, EXAMINING ATTORNEY

**Int. Cl.: 9**

**Prior U.S. Cls.: 21, 23, 26, 36, and 38**

**Reg. No. 3,455,857**

**United States Patent and Trademark Office**

**Registered June 24, 2008**

**TRADEMARK  
PRINCIPAL REGISTER**

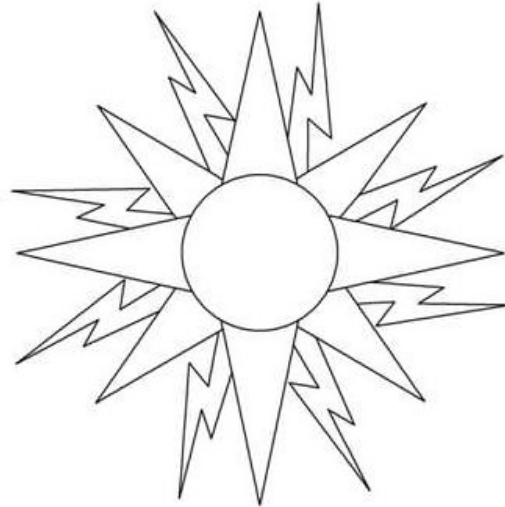

HELIOVOLT CORPORATION (DELAWARE CORPORATION)  
8201 E. RIVERSIDE DR SUITE 600  
AUSTIN, TX 787441604

FOR: PHOTOVOLTAIC INTEGRATED CIRCUITS; APPARATUS FOR CONVERTING ELECTRONIC RADIATION TO ELECTRICAL ENERGY FOR THE GENERATION OF ELECTRICAL ENERGY FROM PHOTOVOLTAIC AND/OR SOLAR SOURCES, NAMELY, PHOTOVOLTAIC SOLAR MODULES, ARRAYS AND SOLAR PANELS ALL CONTAINING

PHOTOVOLTAIC INTEGRATED CIRCUITS, IN CLASS 9 (U.S. CLS. 21, 23, 26, 36 AND 38).

FIRST USE 7-31-2007; IN COMMERCE 7-31-2007.

THE MARK CONSISTS OF STAR DESIGN WITH LIGHTING BOLTS.

SN 78-978,744, FILED 10-31-2005.

DARRYL SPRUILL, EXAMINING ATTORNEY

**Int. Cls.: 3 and 5**

**Prior U.S. Cls.: 1, 4, 6, 18, 44, 46, 50, 51, and 52**

**Reg. No. 3,455,858**

**United States Patent and Trademark Office**

**Registered June 24, 2008**

---

**TRADEMARK  
PRINCIPAL REGISTER**

**REVANCE**

REVANCE THERAPEUTICS, INC. (DELAWARE CORPORATION)  
2400 BAYSHORE PARKWAY, SUITE 100  
MOUNTAIN VIEW, CA 94043

FIRST USE 3-22-2007; IN COMMERCE 4-30-2007.

FOR: EYE GELS AND CREAMS, FACE CREAMS AND LOTIONS FOR COSMETIC USES, IN CLASS 3 (U.S. CLS. 1, 4, 6, 50, 51 AND 52).

THE MARK CONSISTS OF STANDARD CHARACTERS WITHOUT CLAIM TO ANY PARTICULAR FONT, STYLE, SIZE, OR COLOR.

FIRST USE 3-22-2007; IN COMMERCE 4-30-2007.

SN 78-978,867, FILED 10-5-2005.

FOR: EYE GELS AND CREAMS, FACE CREAMS AND LOTIONS FOR MEDICAL PURPOSES, IN CLASS 5 (U.S. CLS. 6, 18, 44, 46, 51 AND 52).

JASON TURNER, EXAMINING ATTORNEY

Int. Cl.: 11

Prior U.S. Cls.: 13, 21, 23, 31, and 34

Reg. No. 3,455,859

United States Patent and Trademark Office

Registered June 24, 2008

TRADEMARK  
PRINCIPAL REGISTER

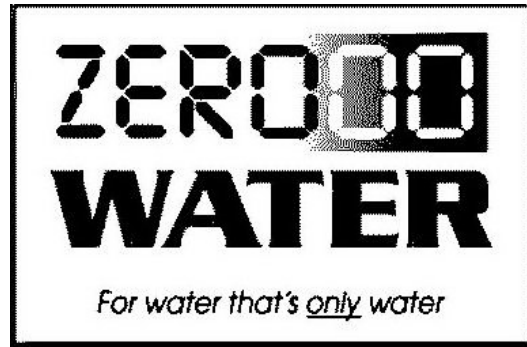

ZERO TECHNOLOGIES, LLC (DELAWARE LTD  
LIAB CO)  
4510 E. ADAMS CIRCLE  
BENSALEM, PA 19020

NO CLAIM IS MADE TO THE EXCLUSIVE  
RIGHT TO USE "WATER", APART FROM THE  
MARK AS SHOWN.

FOR: WATER FILTERING UNITS FOR HOUSE-  
HOLD USE, IN CLASS 11 (U.S. CLS. 13, 21, 23, 31 AND  
34).

SN 78-979,344, FILED 5-15-2006.

FIRST USE 10-23-2007; IN COMMERCE 10-23-2007.

WILLIAM ROSSMAN, EXAMINING ATTORNEY

**Int. Cls.: 14 and 18**

**Prior U.S. Cls.: 1, 2, 3, 22, 27, 28, 41, and 50**

**United States Patent and Trademark Office**

**Reg. No. 3,455,860**

**Registered June 24, 2008**

**TRADEMARK  
PRINCIPAL REGISTER**



ERMENEGILDO ZEGNA CORPORATION (NEW YORK CORPORATION)  
100 WEST FOREST AVENUE, UNIT A  
ENGLEWOOD, NJ 07631

CASES, TIE CASES FOR TRAVELING, COSMETIC CASES SOLD EMPTY, KEY CHAINS, KEY CASES, IN CLASS 18 (U.S. CLS. 1, 2, 3, 22 AND 41).

FOR: CUFFLINKS, IN CLASS 14 (U.S. CLS. 2, 27, 28 AND 50).

FIRST USE 11-0-2005; IN COMMERCE 11-0-2005.

FIRST USE 11-0-2005; IN COMMERCE 11-0-2005.

SN 78-979,776, FILED 1-30-2006.

FOR: LEATHER GOODS, NAMELY, WALLETS, CREDIT CARD HOLDERS, BUSINESS CARD

PRISCILLA MILTON, EXAMINING ATTORNEY

**Int. Cl.: 35**

**Prior U.S. Cls.: 100, 101, and 102**

**United States Patent and Trademark Office**

**Reg. No. 3,455,861**

**Registered June 24, 2008**

**SERVICE MARK  
PRINCIPAL REGISTER**

**BELIEVE IN THE ONE THAT  
BELIEVES IN YOU**

MICHAEL RODRIGUEZ (UNITED STATES IN-  
DIVIDUAL)  
765 W. PAUL  
CLOVIS, CA 93612 AND  
JODI RODRIGUEZ (UNITED STATES INDIVI-  
DUAL)  
765 W. PAUL  
CLOVIS, CA 93612

THE MARK CONSISTS OF STANDARD CHAR-  
ACTERS WITHOUT CLAIM TO ANY PARTICULAR  
FONT, STYLE, SIZE, OR COLOR.

SEC. 2(F).

FOR: PROMOTING PUBLIC AWARENESS OF  
RELIGIOUS BELIEFS; SPECIFICALLY, CHRIS-  
TIANITY, IN CLASS 35 (U.S. CLS. 100, 101 AND 102).

SN 78-980,121, FILED 3-24-2006.

FIRST USE 6-21-2007; IN COMMERCE 6-21-2007.

RONALD AIKENS, EXAMINING ATTORNEY

**Int. Cl.: 20**

**Prior U.S. Cls.: 2, 13, 22, 25, 32, and 50**

**Reg. No. 3,455,862**

**United States Patent and Trademark Office**

**Registered June 24, 2008**

---

**TRADEMARK  
PRINCIPAL REGISTER**

**DISNEYLAND**

DISNEY ENTERPRISES, INC. (DELAWARE CORPORATION)  
500 SOUTH BUENA VISTA STREET  
BURBANK, CA 91521

OWNER OF U.S. REG. NOS. 857,667, 1,037,788,  
AND 1,838,246.

FOR: PICTURE FRAMES, IN CLASS 20 (U.S. CLS.  
2, 13, 22, 25, 32 AND 50).

SN 78-980,158, FILED 9-26-2003.

FIRST USE 5-0-2003; IN COMMERCE 5-0-2003.

CHRIS WELLS, EXAMINING ATTORNEY



**Int. Cl.: 16**

**Prior U.S. Cls.: 2, 5, 22, 23, 29, 37, 38, and 50**

**Reg. No. 3,455,863**

**United States Patent and Trademark Office**

**Registered June 24, 2008**

**TRADEMARK  
PRINCIPAL REGISTER**

**WORLD SERIES**

OFFICE OF THE COMMISSIONER OF BASEBALL (NEW YORK UNINCORPORATED ASSOCIATION)  
245 PARK AVENUE  
NEW YORK, NY 10167

FOR: PAPER GOODS AND PRINTED MATTER, NAMELY, TRADING CARDS, POSTERS, STICKERS, DECALS, BUMPER STICKERS, SCORE BOOKS, SCORECARDS, PRINTED BASEBALL GAME PROGRAMS, MAGAZINES AND BOOKS FEATURING BASEBALL, STATIONERY-TYPE PORTFOLIOS, STATIONERY FOLDERS, STATIONERY SETS, NAMELY, CARDS, AND ENVELOPES, CALENDARS, POSTCARDS, CHECKBOOK COVERS, COLLECTIBLE STAMPS, COMMEMORATIVE STAMPS, MOUNTED AND UN-MOUNTED PHOTOGRAPHS, PHOTOGRAPH ALBUMS, LITHOGRAPHS, PLASTIC BASEBALL CARD HOLDERS

AND PAPERWEIGHTS, PENS, TICKET HOLDERS, PAPER TICKET HOLDERS AND NON-METAL LANYARDS FOR PAPER TICKET HOLDERS ALL SOLD AS A UNIT, IN CLASS 16 (U.S. CLS. 2, 5, 22, 23, 29, 37, 38 AND 50).

FIRST USE 0-0-1911; IN COMMERCE 0-0-1911.

THE MARK CONSISTS OF STANDARD CHARACTERS WITHOUT CLAIM TO ANY PARTICULAR FONT, STYLE, SIZE, OR COLOR.

OWNER OF U.S. REG. NOS. 1,178,547, 1,615,625, AND OTHERS.

SN 78-980,174, FILED 11-21-2005.

MICHAEL SOUDERS, EXAMINING ATTORNEY

Int. Cl.: 30

Prior U.S. Cl.: 46

Reg. No. 3,455,864

United States Patent and Trademark Office

Registered June 24, 2008

TRADEMARK  
PRINCIPAL REGISTER



GENERAL MILLS FOODS ASIA LIMITED  
(HONG KONG LTD LIAB CO)  
THE GATEWAY, NO 25 CANTON ROAD, TST  
SUITE 08-12, 23 A/F, TOWER ONE  
KOWLOON, HONG KONG MS-GA75

THE NON-LATIN CHARACTER(S) IN THE  
MARK TRANSLITERATES INTO WANCHAI MA  
TOU, AND THIS MEANS WANCHAI PIER IN  
ENGLISH.

FOR: RICE, SEASONINGS, AND FLAVORINGS  
COMBINED IN UNITARY PACKAGES, IN CLASS 30  
(U.S. CL. 46).

SN 78-980,188, FILED 8-28-2006.

FIRST USE 5-28-2007; IN COMMERCE 5-28-2007.

KAPIL BHANOT, EXAMINING ATTORNEY

Int. Cl.: 25

Prior U.S. Cls.: 22 and 39

United States Patent and Trademark Office

Reg. No. 3,455,865

Registered June 24, 2008

TRADEMARK  
PRINCIPAL REGISTER



WITH YOU, INC. (CALIFORNIA CORPORATION)

C/O DAVID LEVIN CPA, ESQ.  
200 WEST 57TH STREET, SUITE 1101  
NEW YORK, NY 10019

FOR: ATHLETIC SHOES; BATHING SUITS; BEACHWEAR; BELTS; BLAZERS; BLOUSES; BODY SUITS; BOOTS; BRAS; BRASSIERES; BRIEFS; BUSTIERS; CAMISOLES; CAPES; CAPS; CARDIGANS; CARGO PANTS; COATS; COVERALLS; CROP TOPS; CULOTTES; DENIM JEANS; DRESSES; FLEECE TOPS; FLEECE VESTS; FLIP-FLOPS; FOOTWEAR; GLOVES; GOWNS; HALTER TOPS; HATS; HEADBANDS; HEADWEAR; HOSIERY; JACKETS; JEANS; JERSEYS; JOGGING SUITS; JUMP SUITS; JUMPERS; KNEE HIGHS; LEG WARMERS; LEGGINGS; LINGERIE; LOUNGEWEAR; MITTENS; NECKWEAR; NEGLIGEES; NIGHT GOWNS; NIGHT SHIRTS; OVERALLS; PAJAMAS; PANTIES; PANTS; PANTYHOSE; PARKAS; POLO SHIRTS; PONCHOS; PULLOVERS; RAINWEAR; REVERSIBLE JACKETS; ROBES; RUGBY SHIRTS; SANDALS; SCARVES;

SHIRTS; SHOES; SHORTS; SKIRTS; SLACKS; SLEEPERS; SLEEPWEAR; SLIPPERS; SOCKS; SPORTS BRAS; STOCKINGS; SUITS; SURF WEAR; SWEAT PANTS; SWEAT SHIRTS; SWEAT SHORTS; SWEATERS; SWIM AND BATHING TRUNKS; SWIMWEAR; TANK TOPS; TEDDIES; TENNIS WEAR; TIGHTS; TOPS; T-SHIRTS; TURTLENECKS; UNDER SHIRTS; UNDERCLOTHES; UNDERWEAR; VESTS; VISORS; WARM-UP SUITS; WRAPS, IN CLASS 25 (U.S. CLS. 22 AND 39).

FIRST USE 8-19-2005; IN COMMERCE 9-26-2005.

OWNER OF U.S. REG. NO. 2,793,751.

THE NAME "JESSICA SIMPSON" IDENTIFIES A LIVING INDIVIDUAL WHOSE CONSENT IS OF RECORD.

SN 78-980,204, FILED 6-13-2006.

CURTIS FRENCH, EXAMINING ATTORNEY

**Int. Cls.: 35 and 45**

**Prior U.S. Cls.: 100, 101, and 102**

**United States Patent and Trademark Office**

**Reg. No. 3,455,866**

**Registered June 24, 2008**

**SERVICE MARK  
PRINCIPAL REGISTER**



GAP (APPAREL) LLC (CALIFORNIA LTD LIAB  
CO)  
2 FOLSOM STREET  
SAN FRANCISCO, CA 94105

FOR: ON-LINE RETAIL STORE SERVICES FEATURING FOOTWEAR, IN CLASS 35 (U.S. CLS. 100, 101 AND 102).

FIRST USE 10-15-2006; IN COMMERCE 10-15-2006.

FOR: PROVIDING INFORMATION ABOUT FASHION; FASHION CONSULTING SERVICES; CONSULTING IN THE FIELD OF APPAREL AND FOOTWEAR STYLES AND FIT, IN CLASS 45 (U.S. CLS. 100 AND 101).

FIRST USE 10-15-2006; IN COMMERCE 10-15-2006.

THE COLOR(S) WHITE AND LIME GREEN IS/ ARE CLAIMED AS A FEATURE OF THE MARK.

THE COLORS WHITE AND LIME GREEN APPEAR IN THE STYLIZED LIME CROSS SECTION DESIGN.

THE MARK CONSISTS OF A STYLIZED DRAWING OF A LIME CROSS SECTION.

SN 78-980,208, FILED 6-1-2006.

DAVID MILLER, EXAMINING ATTORNEY

**Int. Cl.: 30**

**Prior U.S. Cl.: 46**

**United States Patent and Trademark Office**

**Reg. No. 3,455,867**

**Registered June 24, 2008**

**TRADEMARK  
PRINCIPAL REGISTER**

**WANCHAI FERRY**

GENERAL MILLS FOODS ASIA LIMITED  
(HONG KONG LTD LIAB CO)  
THE GATEWAY, NO 25 CANTON ROAD, TST  
SUITE 08-12, 23 A/F, TOWER ONE  
KOWLOON, HONG KONG MS-GA75

THE MARK CONSISTS OF STANDARD CHAR-  
ACTERS WITHOUT CLAIM TO ANY PARTICULAR  
FONT, STYLE, SIZE, OR COLOR.

FOR: RICE, SEASONINGS, AND FLAVORINGS  
COMBINED IN UNITARY PACKAGES, IN CLASS 30  
(U.S. CL. 46).

SN 78-980,210, FILED 8-28-2006.

FIRST USE 3-28-2007; IN COMMERCE 3-28-2007.

KAPIL BHANOT, EXAMINING ATTORNEY

**Int. Cl.: 9**

**Prior U.S. Cls.: 21, 23, 26, 36, and 38**

**Reg. No. 3,455,868**

**United States Patent and Trademark Office**

**Registered June 24, 2008**

---

**TRADEMARK  
PRINCIPAL REGISTER**

**MR. DO'S CASTLE**

ARUZE CORPORATION (JAPAN CORPORATION)  
1-25, ARIAKE 3-CHOME  
KOTOKU, TOKYO, JAPAN

THE MARK CONSISTS OF STANDARD CHARACTERS WITHOUT CLAIM TO ANY PARTICULAR FONT, STYLE, SIZE, OR COLOR.

FOR: DOWNLOADABLE ELECTRONIC GAME PROGRAMS FOR PORTABLE PHONES, IN CLASS 9 (U.S. CLS. 21, 23, 26, 36 AND 38).

SN 78-980,230, FILED 5-25-2006.

FIRST USE 2-11-2008; IN COMMERCE 2-11-2008.

DAWN HAN, EXAMINING ATTORNEY

**Int. Cl.: 9**

**Prior U.S. Cls.: 21, 23, 26, 36, and 38**

**Reg. No. 3,455,869**

**United States Patent and Trademark Office**

**Registered June 24, 2008**

---

**TRADEMARK  
PRINCIPAL REGISTER**

**MR. DO!**

ARUZE CORPORATION (JAPAN CORPORATION)  
1-25, ARIAKE 3-CHOME  
KOTOKU, TOKYO, JAPAN

THE MARK CONSISTS OF STANDARD CHARACTERS WITHOUT CLAIM TO ANY PARTICULAR FONT, STYLE, SIZE, OR COLOR.

FOR: DOWNLOADABLE ELECTRONIC GAME PROGRAMS FOR PORTABLE PHONES, IN CLASS 9 (U.S. CLS. 21, 23, 26, 36 AND 38).

SN 78-980,241, FILED 5-25-2006.

FIRST USE 2-11-2008; IN COMMERCE 2-11-2008.

DAWN HAN, EXAMINING ATTORNEY

Int. Cl.: 14

Prior U.S. Cls.: 2, 27, 28, and 50

Reg. No. 3,455,870

United States Patent and Trademark Office

Registered June 24, 2008

TRADEMARK  
PRINCIPAL REGISTER



WITH YOU, INC. (CALIFORNIA CORPORATION)

C/O DAVID LEVIN CPA, ESQ.  
200 WEST 57TH STREET, SUITE 1101  
NEW YORK, NY 10019

FOR: ALARM CLOCKS; ANKLE BRACELETS; ASHTRAYS OF PRECIOUS METAL; BADGES OF PRECIOUS METAL; BELT BUCKLES OF PRECIOUS METAL; BOLO TIES WITH PRECIOUS METAL TIPS; BOOK MARKERS OF PRECIOUS METAL; BOTTLE CLOSURES OF PRECIOUS METAL; BRACELETS; BROOCHES; BUSTS, FIGURES, FIGURINES, SCULPTURE, STATUES, STATUETTES AND STIRRING RODS OF PRECIOUS METAL; CANDLESTICKS, CANDLE HOLDERS, CANDLE RINGS AND CANDLE HOLDERS OF PRECIOUS METAL; NECK CHAINS; CHARMS; CIGARETTE HOLDERS AND LIGHTERS OF PRECIOUS METAL; CLOCKS; CLOCKS INCORPORATING RADIOS; COFFEE SERVICES, TEA SERVICES AND TOOTHPICK HOLDERS OF PRECIOUS METAL; COSTUME JEWELRY; CRUET STANDS FOR OIL OR VINEGAR OF PRECIOUS METAL; CRUETS OF PRECIOUS METAL; CUFF-LINKS; EAR CLIPS; EARRINGS; FLOWER BOWLS OF PRECIOUS METAL; HAT ORNAMENTS AND HAT PINS OF PRECIOUS METAL; HOLIDAY ORNAMENTS OF PRECIOUS METAL; JEWELRY; JEWELRY BOXES AND CASES OF PRECIOUS METAL; JEWELRY CHAINS; JEWELRY PINS FOR USE ON HATS; LAPEL PINS; LETTER

OPENERS OF PRECIOUS METAL; MATCH BOXES AND HOLDERS OF PRECIOUS METAL; NECKLACES; NON-ELECTRIC CANDELABRAS MADE OF PRECIOUS METAL; ORNAMENTAL LAPEL PINS; ORNAMENTAL PINS; PENDANTS; PIGGY BANKS MADE OF PRECIOUS METAL; PINS BEING JEWELRY; POCKET WATCHES; POTPOURRI DISHES MADE IN WHOLE OR IN PART OF PRECIOUS METAL; PRECIOUS METAL MONEY CLIPS; RINGS BEING JEWELRY; SHOE ORNAMENTS MADE OF PRECIOUS METAL; SNUFF BOXES AND SERVIETTE RINGS OF PRECIOUS METAL; STOP WATCHES; TIE PINS AND CLIPS; VASES OF PRECIOUS METAL; WALL CLOCKS; WATCH CASES; WATCH CHAINS AND FOBS; WATCH STRAPS AND BANDS; WATCHES; WRISTWATCHES, IN CLASS 14 (U.S. CLS. 2, 27, 28 AND 50).

FIRST USE 4-30-2007; IN COMMERCE 8-8-2007.

OWNER OF U.S. REG. NO. 2,793,751.

THE NAME "JESSICA SIMPSON" IDENTIFIES A LIVING INDIVIDUAL WHOSE CONSENT IS OF RECORD.

SN 78-980,247, FILED 6-13-2006.

CURTIS FRENCH, EXAMINING ATTORNEY



**Int. Cl.: 10**

**Prior U.S. Cls.: 26, 39, and 44**

**Reg. No. 3,455,871**

**United States Patent and Trademark Office**

**Registered June 24, 2008**

**TRADEMARK  
PRINCIPAL REGISTER**

**EPOC**

EPOCAL INC. (CANADA CORPORATION)  
2935 CONROY ROAD  
OTTAWA, CANADA

THE MARK CONSISTS OF STANDARD CHARACTERS WITHOUT CLAIM TO ANY PARTICULAR FONT, STYLE, SIZE, OR COLOR.

FOR: BLOOD ANALYSIS APPARATUS CONSISTING OF BLOOD TEST CARDS, BLOOD TEST CARD READERS, COMPUTER INTERFACE AND COMPUTER INTERFACE EQUIPMENT, IN CLASS 10 (U.S. CLS. 26, 39 AND 44).

OWNER OF U.S. REG. NOS. 2,852,472 AND 2,852,473.

SN 78-980,249, FILED 6-30-2006.

FIRST USE 4-17-2007; IN COMMERCE 7-30-2007.

WON TEAK OH, EXAMINING ATTORNEY

**Int. Cl.: 8**

**Prior U.S. Cls.: 23, 28, and 44**

**Reg. No. 3,455,872**

**United States Patent and Trademark Office**

**Registered June 24, 2008**

---

**TRADEMARK  
PRINCIPAL REGISTER**

**DIAL-O-MATIC**

RONCO ACQUISITION CORPORATION (DELA-  
WARE CORPORATION)  
SUITE 2370  
2121 ROSECRANS AVENUE  
EL SEGUNDO, CA 90245

THE MARK CONSISTS OF STANDARD CHAR-  
ACTERS WITHOUT CLAIM TO ANY PARTICULAR  
FONT, STYLE, SIZE, OR COLOR.

FOR: HAND-OPERATED NON-ELECTRICAL  
FOOD SLICERS, IN CLASS 8 (U.S. CLS. 23, 28 AND  
44).

SN 78-980,255, FILED 4-13-2006.

FIRST USE 12-1-1950; IN COMMERCE 12-1-1950.

KAPIL BHANOT, EXAMINING ATTORNEY

**Int. Cl.: 25**

**Prior U.S. Cls.: 22 and 39**

**United States Patent and Trademark Office**

**Reg. No. 3,455,873**

**Registered June 24, 2008**

**TRADEMARK  
PRINCIPAL REGISTER**

**COOPERSTOWN COLLECTION**

MAJOR LEAGUE BASEBALL PROPERTIES, INC.  
(NEW YORK CORPORATION)

245 PARK AVENUE

NEW YORK, NY 10167

FOR: CLOTHING, NAMELY, CAPS, HATS,  
SHIRTS, T-SHIRTS, BASEBALL UNIFORMS, JER-  
SEYS, SWEATSHIRTS, WRISTBANDS, FOOTWEAR,  
SOCKS, HOSIERY, IN CLASS 25 (U.S. CLS. 22 AND  
39).

FIRST USE 12-0-1988; IN COMMERCE 12-0-1988.

THE MARK CONSISTS OF STANDARD CHAR-  
ACTERS WITHOUT CLAIM TO ANY PARTICULAR  
FONT, STYLE, SIZE, OR COLOR.

OWNER OF U.S. REG. NOS. 1,577,874 AND  
1,580,204.

NO CLAIM IS MADE TO THE EXCLUSIVE  
RIGHT TO USE "COLLECTION", APART FROM  
THE MARK AS SHOWN.

SN 78-980,273, FILED 5-19-2005.

LOURDES AYALA, EXAMINING ATTORNEY

**Int. Cl.: 9**

**Prior U.S. Cls.: 21, 23, 26, 36, and 38**

**Reg. No. 3,455,874**

**United States Patent and Trademark Office**

**Registered June 24, 2008**

**TRADEMARK  
PRINCIPAL REGISTER**

**ALL-STAR GAME**

OFFICE OF THE COMMISSIONER OF BASEBALL (NEW YORK UNINCORPORATED ASSOCIATION)

245 PARK AVENUE  
NEW YORK, NY 10167

FOR: ELECTRICAL AND SCIENTIFIC APPARATUS, NAMELY, PRE-RECORDED VIDEODISCS RELATING TO BASEBALL; DECORATIVE MAGNETS; VIDEO AND COMPUTER GAME CARTRIDGES, VIDEO AND COMPUTER GAME DISCS, VIDEO AND COMPUTER GAME CASSETTES COMPUTER ACCESSORIES, NAMELY, MOUSE PADS COMPUTER SOFTWARE, NAMELY, COMPUTER GAME PROGRAMS, ALL RELATING TO OR PROMOTING

THE SPORT OF BASEBALL, IN CLASS 9 (U.S. CLS. 21, 23, 26, 36 AND 38).

FIRST USE 6-0-2001; IN COMMERCE 6-0-2001.

THE MARK CONSISTS OF STANDARD CHARACTERS WITHOUT CLAIM TO ANY PARTICULAR FONT, STYLE, SIZE, OR COLOR.

OWNER OF U.S. REG. NOS. 1,286,486, 2,596,423, AND OTHERS.

SN 78-980,279, FILED 11-21-2005.

MICHAEL SOUDERS, EXAMINING ATTORNEY

**Int. Cl.: 20**

**Prior U.S. Cls.: 2, 13, 22, 25, 32, and 50**

**Reg. No. 3,455,875**

**United States Patent and Trademark Office**

**Registered June 24, 2008**

---

**TRADEMARK  
PRINCIPAL REGISTER**

**BABY EINSTEIN**

THE BABY EINSTEIN COMPANY, LLC (COLOR-  
ADO LTD LIAB CO)  
500 SOUTH BUENA VISTA STREET  
BURBANK, CA 91521

FOR: SEATS; DECORATIVE MOBILES; MIR-  
RORS; PLAY PENS; AND BABY NESTING BOXES,  
IN CLASS 20 (U.S. CLS. 2, 13, 22, 25, 32 AND 50).

FIRST USE 10-26-2006; IN COMMERCE 10-26-2007.

THE MARK CONSISTS OF STANDARD CHAR-  
ACTERS WITHOUT CLAIM TO ANY PARTICULAR  
FONT, STYLE, SIZE, OR COLOR.

OWNER OF U.S. REG. NO. 2,380,650.

SN 78-980,284, FILED 4-7-2005.

JOHN HWANG, EXAMINING ATTORNEY

**Int. Cl.: 29**

**Prior U.S. Cl.: 46**

**United States Patent and Trademark Office**

**Reg. No. 3,455,876**

**Registered June 24, 2008**

**TRADEMARK  
PRINCIPAL REGISTER**

**MAMINA**

DYNAMIC IMPORT-EXPORT, INC. (FLORIDA  
CORPORATION)  
14604 S.W. 57 TERRACE  
MIAMI, FL 33183

THE ENGLISH TRANSLATION OF THE WORD  
"MAMINA" IN THE MARK IS "TINY MOTHER" OR  
"TINY GRANDMOTHER".

FOR: DRIED BEANS, IN CLASS 29 (U.S. CL. 46).

FIRST USE 6-22-2007; IN COMMERCE 6-22-2007.

SN 78-980,287, FILED 10-31-2005.

THE MARK CONSISTS OF STANDARD CHAR-  
ACTERS WITHOUT CLAIM TO ANY PARTICULAR  
FONT, STYLE, SIZE, OR COLOR.

JIM RINGLE, EXAMINING ATTORNEY

**Int. Cls.: 6 and 7**

**Prior U.S. Cls.: 2, 12, 13, 14, 19, 21, 23, 25, 31, 34, 35,  
and 50**

**Reg. No. 3,455,877**

**United States Patent and Trademark Office**

**Registered June 24, 2008**

**TRADEMARK  
PRINCIPAL REGISTER**



PREFERRED PUMP & EQUIPMENT, L.P. (TEXAS  
LIMITED PARTNERSHIP)  
2201 SCOTT AVE.  
FORT WORTH, TX 76102

FOR: METAL PIPE FITTINGS, IN CLASS 6 (U.S.  
CLS. 2, 12, 13, 14, 23, 25 AND 50).

FIRST USE 11-21-2006; IN COMMERCE 4-17-2008.

FOR: VARIABLE SPEED DRIVES FOR USE WITH  
FLUID PUMPING SYSTEMS; WATER WELL PUMP-

ING SYSTEMS COMPRISED PRINCIPALLY OF  
PARTS THEREFORE, NAMELY, PRESSURE GAU-  
GES, TANK TEES, WELL CAPS AND PUMP CON-  
TROL VALVES, IN CLASS 7 (U.S. CLS. 13, 19, 21, 23,  
31, 34 AND 35).

FIRST USE 9-27-2006; IN COMMERCE 10-11-2006.

SN 78-980,290, FILED 7-13-2006.

TINA KUAN, EXAMINING ATTORNEY

**Int. Cl.: 43**

**Prior U.S. Cls.: 100 and 101**

**United States Patent and Trademark Office**

**Reg. No. 3,455,878**

**Registered June 24, 2008**

**SERVICE MARK  
PRINCIPAL REGISTER**

**DAPHNE'S GREEK EXPRESS**

FILI ENTERPRISES, INC. (CALIFORNIA CORPORATION)  
SUITE 100  
6125 CORNERSTONE COURT EAST  
SAN DIEGO, CA 92121

FOR: CAFE-RESTAURANTS; CARRY-OUT RESTAURANTS; FAST-FOOD RESTAURANTS; FAST-FOOD RESTAURANTS AND SNACKBARS; RESTAURANT SERVICES; RESTAURANTS; RESTAURANTS FEATURING HOME DELIVERY; TAKE-OUT RESTAURANT SERVICES, IN CLASS 43 (U.S. CLS. 100 AND 101).

FIRST USE 8-13-2007; IN COMMERCE 8-13-2007.

THE MARK CONSISTS OF STANDARD CHARACTERS WITHOUT CLAIM TO ANY PARTICULAR FONT, STYLE, SIZE, OR COLOR.

OWNER OF U.S. REG. NOS. 2,201,545 AND 2,206,916.

NO CLAIM IS MADE TO THE EXCLUSIVE RIGHT TO USE "GREEK EXPRESS", APART FROM THE MARK AS SHOWN.

THE NAME(S), PORTRAIT(S), AND/OR SIGNATURE(S) SHOWN IN THE MARK DOES NOT IDENTIFY A PARTICULAR LIVING INDIVIDUAL.

SN 78-980,306, FILED 7-19-2005.

ALYSSA PALADINO, EXAMINING ATTORNEY



**Int. Cls.: 39, 42, and 44**

**Prior U.S. Cls.: 100, 101, and 105**

**United States Patent and Trademark Office**

**Reg. No. 3,455,879**

**Registered June 24, 2008**

**SERVICE MARK  
PRINCIPAL REGISTER**

# CONVERSANT

CONVERSANT HEALTHCARE SYSTEMS, INC.  
(ALABAMA CORPORATION)  
P. O. BOX 18428  
HUNTSVILLE, AL 358048428

FOR: BIOMEDICAL SERVICES, NAMELY, THE STORAGE OF HUMAN BIOLOGICAL SPECIMENS FOR MEDICAL USE, IN CLASS 39 (U.S. CLS. 100 AND 105).

FIRST USE 3-31-2005; IN COMMERCE 3-31-2005.

FOR: MEDICAL AND SCIENTIFIC RESEARCH SERVICES, IN CLASS 42 (U.S. CLS. 100 AND 101).

FIRST USE 3-31-2005; IN COMMERCE 3-31-2005.

FOR: HEALTH CARE SERVICES; PROVIDING MEDICAL INFORMATION; MAINTAINING PERSONAL MEDICAL HISTORY RECORDS AND FILES, IN CLASS 44 (U.S. CLS. 100 AND 101).

FIRST USE 3-31-2005; IN COMMERCE 3-31-2005.

THE MARK CONSISTS OF STANDARD CHARACTERS WITHOUT CLAIM TO ANY PARTICULAR FONT, STYLE, SIZE, OR COLOR.

THE WORDING "CONVERSANT" HAS NO MEANING IN A FOREIGN LANGUAGE.

SN 78-980,308, FILED 7-22-2006.

SETH A. RAPPAPORT, EXAMINING ATTORNEY

**Int. Cls.: 9 and 35**

**Prior U.S. Cls.: 21, 23, 26, 36, 38, 100, 101, and 102**

**United States Patent and Trademark Office**

**Reg. No. 3,455,880**

**Registered June 24, 2008**

**TRADEMARK  
SERVICE MARK  
PRINCIPAL REGISTER**

**ASCENT BATTERY  
SUPPLY**

BATTERIES PLUS, LLC (WISCONSIN LTD LIAB  
CO)  
925 WALNUT RIDGE DRIVE  
HARTLAND, WI 53029

FOR: BATTERIES, IN CLASS 9 (U.S. CLS. 21, 23, 26,  
36 AND 38).

FIRST USE 6-2-2003; IN COMMERCE 6-2-2003.

FOR: DISTRIBUTORSHIP SERVICES IN THE  
FIELD OF BATTERIES, IN CLASS 35 (U.S. CLS. 100,  
101 AND 102).

FIRST USE 6-2-2003; IN COMMERCE 6-2-2003.

THE MARK CONSISTS OF STANDARD CHAR-  
ACTERS WITHOUT CLAIM TO ANY PARTICULAR  
FONT, STYLE, SIZE, OR COLOR.

NO CLAIM IS MADE TO THE EXCLUSIVE  
RIGHT TO USE "BATTERY SUPPLY", APART  
FROM THE MARK AS SHOWN.

SN 78-980,311, FILED 11-24-2004.

FLORENTINA BLANDU, EXAMINING ATTORNEY

**Int. Cl.: 34**

**Prior U.S. Cls.: 2, 8, 9, and 17**

**United States Patent and Trademark Office**

**Reg. No. 3,455,881**

**Registered June 24, 2008**

**TRADEMARK  
SUPPLEMENTAL REGISTER**

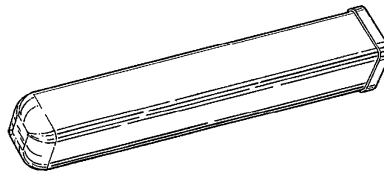

C.A.O. INTERNATIONAL, INC. (TENNESSEE CORPORATION)  
6172 COCKRILL BEND CIRCLE  
NASHVILLE, TN 37209

FOR: CIGARS, IN CLASS 34 (U.S. CLS. 2, 8, 9 AND 17).

FIRST USE 8-15-2001; IN COMMERCE 8-15-2001.

THE MARK CONSISTS OF A SQUARE ALUMINUM TUBE WITH ROUNDED EDGES. ONE END

CONTAINS A REMOVABLE CAP WHILE THE OTHER END FORMS A POINT WHICH HAS BEEN ROUNDED OFF, LEAVING AN ALMOST SQUARE FORM AT THE END FROM WHERE THE FOUR CORNERS OF THE TUBE MEET.

SER. NO. 76-301,426, FILED P.R. 8-16-2001; AM. S.R. 5-5-2006.

B. PARADEWELAI, EXAMINING ATTORNEY

Int. Cl.: 20

Prior U.S. Cls.: 2, 13, 22, 25, 32, and 50

United States Patent and Trademark Office

Reg. No. 3,455,882

Registered June 24, 2008

TRADEMARK  
SUPPLEMENTAL REGISTER

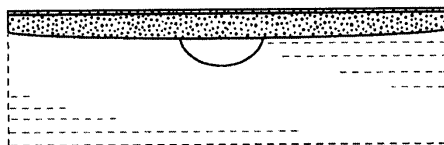

KLN STEEL PRODUCTS COMPANY, LTD.  
(TEXAS LIMITED PARTNERSHIP)  
TWO WINNCO DRIVE  
P.O. BOX 34690  
SAN ANTONIO, TX 78265

FOR: FURNITURE, NAMELY, BEDROOM FURNITURE USED IN DORMITORIES, RESIDENCE HALLS AND INSTITUTIONAL, IN CLASS 20 (U.S. CLS. 2, 13, 22, 25, 32 AND 50).

FIRST USE 4-9-1996; IN COMMERCE 4-9-1996.

THE LINING AND STIPPLING IN THE MARK IS FOR SHADING AND CONTRAST AND IS PART OF THE MARK.

THE MARK CONSISTS OF THE CONFIGURATION OF A DRAWER PULL WITH OVERLAPPING

CURVED PORTIONS AND A RECESSED ARCUATE SECTION. THE UPPER CURVED SECTION EXTENDS FROM THE SIDE EDGE OF THE DRAWER TO BELOW THE CENTER OF THE DRAWER TOP. THE SECOND CURVED PORTION HAS A RADIUS THAT EXTENDS BELOW THE RADIUS OF THE UPPER CURVED PORTION. THE AREA IN BROKEN LINES IS FOR POSITIONARY PURPOSES AND CONTRAST ONLY AND IS NOT PART OF THE MARK, AND THE STIPPLING IS FOR SHADING PURPOSES ONLY AND IS NOT PART OF THE MARK.

SER. NO. 76-405,349, FILED P.R. 5-9-2002; AM. S.R. 8-30-2007.

STEPHANIE ALI, EXAMINING ATTORNEY

**Int. Cl.: 9**

**Prior U.S. Cls.: 21, 23, 26, 36, and 38**

**Reg. No. 3,455,883**

**United States Patent and Trademark Office**

**Registered June 24, 2008**

**TRADEMARK  
SUPPLEMENTAL REGISTER**

**ENERGY SURVEILLANCE SYSTEM**

EG ENERGY CONTROLS LTD (CANADA CORPORATION)  
1328 HIGHWAY #6 WARREN  
AMHERST, CANADA B4H 3Y2

FOR: COMPUTERS, SERVERS, COMPUTER SOFTWARE AND CONTROL BOXES FOR MANAGING BUILDING ENERGY POWER SYSTEMS, NAMELY, LIGHTING AND ELECTRICITY; COMPUTERS, SERVERS, COMPUTER SOFTWARE AND CONTROL BOXES FOR MONITORING AND CONTROLLING LIGHT LEVELS, VOLTAGE AND ELECTRIC POWER CONSUMPTION, THROUGH ON-LINE ACCESS VIA COMPUTER AND COMMUNICATIONS NETWORKS; COMPUTERS, SERVERS, COMPUTER SOFTWARE AND CONTROL BOXES FOR AUTOMATED ELECTRONIC BUILDING POWER MANAGEMENT, NAMELY, MONITORING AND CONTROLLING VOLTAGE AND ELECTRIC POWER CONSUMPTION; COMPUTERS, SERVERS, COMPUTER SOFTWARE AND CONTROL BOXES FOR AUTOMATED ELECTRONIC LIGHTING POWER MANAGEMENT, NAMELY, MONITORING AND CONTROLLING LIGHT LEVELS, VOLTAGE AND ELECTRIC POWER CONSUMPTION; COMPU-

TERS, SERVERS, COMPUTER SOFTWARE AND CONTROL BOXES FOR AUTOMATED ELECTRICAL TRANSMISSION AND INTERCONNECTION, NAMELY, MONITORING AND CONTROLLING VOLTAGE AND ELECTRIC POWER CONSUMPTION; COMPUTERS, SERVERS, COMPUTER SOFTWARE AND CONTROL BOXES FOR AUTOMATED ELECTRONIC MULTI-LEVEL LIGHTING POWER MANAGEMENT; COMPUTERS, SERVERS, COMPUTER SOFTWARE AND CONTROL BOXES FOR AUTOMATED ELECTRONIC BI-LEVEL POWER MANAGEMENT, IN CLASS 9 (U.S. CLS. 21, 23, 26, 36 AND 38).

THE MARK CONSISTS OF STANDARD CHARACTERS WITHOUT CLAIM TO ANY PARTICULAR FONT, STYLE, SIZE, OR COLOR.

OWNER OF CANADA REG. NO. TMA690,930, DATED 6-27-2007, EXPIRES 6-27-2022.

SER. NO. 76-568,777, FILED P.R. 1-2-2004; AM. S.R. 5-13-2008.

DAVID C. REIHNER, EXAMINING ATTORNEY

**Int. Cl.: 16**

**Prior U.S. Cls.: 2, 5, 22, 23, 29, 37, 38, and 50**

**United States Patent and Trademark Office**

**Reg. No. 3,455,884**

**Registered June 24, 2008**

**TRADEMARK  
SUPPLEMENTAL REGISTER**

**MICHELLE ELIZABETH GLEN**

GIBBS, KAREN M. (UNITED STATES INDIVIDUAL)  
205 W. RANDOLPH, SUITE 1245  
CHICAGO, IL 60606

FOR: SPIRITUAL BOOKS, SELF-HELP BOOKS, CHILDREN'S BOOKS, NON-FICTIONAL BOOKS AND BOOKS OF GENERAL INTEREST FOR MEN AND WOMEN; AND FICTIONAL BOOKS AND BOOKS OF GENERAL INTEREST FOR MEN AND WOMEN, IN CLASS 16 (U.S. CLS. 2, 5, 22, 23, 29, 37, 38 AND 50).

FIRST USE 5-1-2006; IN COMMERCE 5-1-2006.

THE NAME "MICHELLE ELIZABETH GLENN" IDENTIFIES A LIVING INDIVIDUAL WHOSE CONSENT IS OF RECORD.

SER. NO. 76-574,941, FILED P.R. 2-9-2004; AM. S.R. 5-22-2008.

NATALIE POLZER, EXAMINING ATTORNEY

**Int. Cl.: 21**

**Prior U.S. Cls.: 2, 13, 23, 29, 30, 33, 40, and 50**

**Reg. No. 3,455,885**

**United States Patent and Trademark Office**

**Registered June 24, 2008**

**TRADEMARK  
SUPPLEMENTAL REGISTER**

**LID LOCK**

SIMPLEHUMAN LLC (CALIFORNIA LTD LIAB  
CO)  
19801 S. VERMONT  
TORRANCE, CA 90502

FOR: TRASH CANS, CONTAINERS FOR HOUSE-  
HOLD USE SOLD EMPTY, NAMELY, CONTAINERS  
FOR STORING RECYCLABLE HOUSEHOLD  
WASTE AND RECYCLABLE MATERIALS, IN  
CLASS 21 (U.S. CLS. 2, 13, 23, 29, 30, 33, 40 AND 50).

FIRST USE 3-1-2008; IN COMMERCE 3-1-2008.

THE MARK CONSISTS OF STANDARD CHAR-  
ACTERS WITHOUT CLAIM TO ANY PARTICULAR  
FONT, STYLE, SIZE, OR COLOR.

SER. NO. 76-634,939, FILED P.R. 3-31-2005; AM. S.R.  
3-17-2008.

SONYA STEPHENS, EXAMINING ATTORNEY

**Int. Cl.: 25**

**Prior U.S. Cls.: 22 and 39**

**United States Patent and Trademark Office**

**Reg. No. 3,455,886**

**Registered June 24, 2008**

**TRADEMARK  
SUPPLEMENTAL REGISTER**

**THAYER**

THAYER NYC INC (NEW YORK CORPORATION), DBA THAYER,  
SUITE 1  
142 WEST 4TH STREET  
NEW YORK, NY 10012

FIRST USE 12-14-2006; IN COMMERCE 12-14-2006.

SER. NO. 76-672,063, FILED P.R. 1-31-2007; AM. S.R.  
5-19-2008.

FOR: DRESSES, SHIRTS, SHORTS, SKIRTS,  
PANTS, SWIM WEAR, AND JACKETS, IN CLASS  
25 (U.S. CLS. 22 AND 39).

GINA HAYES, EXAMINING ATTORNEY



**Int. Cl.: 9**

**Prior U.S. Cls.: 21, 23, 26, 36, and 38**

**Reg. No. 3,455,887**

**United States Patent and Trademark Office**

**Registered June 24, 2008**

**TRADEMARK  
SUPPLEMENTAL REGISTER**

**POWERSTORAGE**

YAMAHA CORPORATION (JAPAN CORPORATION)  
10-1, NAKAZAWA-CHO  
HAMAMATSU-SHI, SHIZUOKA, JAPAN

THE MARK CONSISTS OF STANDARD CHARACTERS WITHOUT CLAIM TO ANY PARTICULAR FONT, STYLE, SIZE, OR COLOR.

FOR: LOUDSPEAKERS, IN CLASS 9 (U.S. CLS. 21, 23, 26, 36 AND 38).

SER. NO. 76-672,066, FILED P.R. 1-31-2007; AM. S.R. 4-24-2008.

FIRST USE 4-28-2007; IN COMMERCE 4-28-2007.

CHARLES L. JENKINS, EXAMINING ATTORNEY

**Int. Cl.: 25**

**Prior U.S. Cls.: 22 and 39**

**United States Patent and Trademark Office**

**Reg. No. 3,455,888**

**Registered June 24, 2008**

**TRADEMARK  
SUPPLEMENTAL REGISTER**

**KROWETAHI**

KROWETAHI INDUSTRIES, INC. (INDIANA CORPORATION)  
6455 S. 070 E.  
WOLCOTTVILLE, IN 46795

FOR: CLOTHING, NAMELY, T-SHIRTS, SWEAT-SHIRTS AND UNDERGARMENTS, IN CLASS 25 (U.S. CLS. 22 AND 39).

FIRST USE 5-1-2007; IN COMMERCE 5-1-2007.

THE MARK CONSISTS OF STANDARD CHARACTERS WITHOUT CLAIM TO ANY PARTICULAR FONT, STYLE, SIZE, OR COLOR.

THE WORDING "KROWETAHI" HAS NO MEANING IN ANY FOREIGN LANGUAGE.

SER. NO. 76-677,514, FILED P.R. 5-29-2007; AM. S.R. 4-24-2008.

CARYN GLASSER, EXAMINING ATTORNEY

**Int. Cl.: 30**

**Prior U.S. Cl.: 46**

**United States Patent and Trademark Office**

**Reg. No. 3,455,889**

**Registered June 24, 2008**

**TRADEMARK  
SUPPLEMENTAL REGISTER**

**CHARLESTON BREAKFAST**

R. C. BIGELOW, INC. (CONNECTICUT CORPORATION)

201 BLACK ROCK TURNPIKE

FAIRFIELD, CT 06430

FOR: TEA, IN CLASS 30 (U.S. CL. 46).

FIRST USE 5-2-2007; IN COMMERCE 5-2-2007.

THE MARK CONSISTS OF STANDARD CHARACTERS WITHOUT CLAIM TO ANY PARTICULAR FONT, STYLE, SIZE, OR COLOR.

OWNER OF U.S. REG. NO. 3,104,349.

SER. NO. 76-678,229, FILED P.R. 6-14-2007; AM. S.R. 5-16-2008.

KEVIN DINALLO, EXAMINING ATTORNEY

**Int. Cl.: 28**

**Prior U.S. Cls.: 22, 23, 38, and 50**

**United States Patent and Trademark Office**

**Reg. No. 3,455,890**

**Registered June 24, 2008**

**TRADEMARK  
SUPPLEMENTAL REGISTER**

**TWIST POPPER**

UNIQUE INDUSTRIES, INC. (PENNSYLVANIA  
CORPORATION)  
4750 LEAGUE ISLAND BLVD.  
PHILADELPHIA, PA 191121222

FOR: TOY IN THE NATURE OF A MANUALLY  
OPERATE TUBE THAT DISPENSES CONFETTI  
AND STREAMERS, IN CLASS 28 (U.S. CLS. 22, 23,  
38 AND 50).

FIRST USE 2-20-2008; IN COMMERCE 2-20-2008.

THE MARK CONSISTS OF STANDARD CHAR-  
ACTERS WITHOUT CLAIM TO ANY PARTICULAR  
FONT, STYLE, SIZE, OR COLOR.

NO CLAIM IS MADE TO THE EXCLUSIVE  
RIGHT TO USE "POPPER", APART FROM THE  
MARK AS SHOWN.

SER. NO. 76-681,584, FILED P.R. 9-6-2007; AM. S.R.  
5-12-2008.

MICHAEL KEATING, EXAMINING ATTORNEY

**Int. Cl.: 36**

**Prior U.S. Cls.: 100, 101, and 102**

**United States Patent and Trademark Office**

**Reg. No. 3,455,891**

**Registered June 24, 2008**

**SERVICE MARK  
SUPPLEMENTAL REGISTER**

**Collateral Investment  
Management, Ltd.**

COLLATERAL INVESTMENT MANAGEMENT,  
LTD. (OHIO LTD LIAB CO)  
SUITE 1300  
600 SUPERIOR AVENUE  
CLEVELAND, OH 44114

FOR: INVESTMENT MANAGEMENT, IN CLASS  
36 (U.S. CLS. 100, 101 AND 102).

FIRST USE 4-28-2006; IN COMMERCE 4-28-2006.

THE MARK CONSISTS OF STANDARD CHAR-  
ACTERS WITHOUT CLAIM TO ANY PARTICULAR  
FONT, STYLE, SIZE, OR COLOR.

NO CLAIM IS MADE TO THE EXCLUSIVE  
RIGHT TO USE "INVESTMENT MANAGEMENT,  
LTD.", APART FROM THE MARK AS SHOWN.

SER. NO. 77-007,521, FILED P.R. 9-26-2006; AM. S.R.  
8-21-2007.

BENJAMIN ALLEN, EXAMINING ATTORNEY

**Int. Cl.: 43**

**Prior U.S. Cls.: 100 and 101**

**United States Patent and Trademark Office**

**Reg. No. 3,455,892**

**Registered June 24, 2008**

**SERVICE MARK  
SUPPLEMENTAL REGISTER**

**SUKIYA**

KABUSHIKI KAISHA ZENSHO (JAPAN CORPORATION), AKA ZENSHO CO., LTD.,  
5-10, KONAN 2-CHOME  
MINATO-KU, TOKYO, JAPAN

FOR: SERVING FOOD AND BEVERAGES; PROVIDING TEMPORARY ACCOMMODATION; ACCOMMODATION BUREAU, NAMELY, ARRANGING TEMPORARY HOUSING ACCOMMODATIONS; PROVIDING CONFERENCE ROOMS; PROVIDING FACILITIES FOR EXHIBITIONS; RENTAL OF FOOD SERVICE EQUIPMENT, NAMELY, RENTAL OF INDUSTRIAL COOKING EQUIPMENT, NON-ELECTRIC COOKING HEATERS, KITCHEN WORKTOPS, INDUSTRIAL DISH

DRYING MACHINES, INDUSTRIAL DISH WASHING MACHINES, AND SINKS, IN CLASS 43 (U.S. CLS. 100 AND 101).

THE MARK CONSISTS OF STANDARD CHARACTERS WITHOUT CLAIM TO ANY PARTICULAR FONT, STYLE, SIZE, OR COLOR.

OWNER OF JAPAN REG. NO. 4952326, DATED 5-12-2006, EXPIRES 5-12-2016.

SER. NO. 77-012,703, FILED P.R. 10-3-2006; AM. S.R. 4-28-2008.

NELSON SNYDER, EXAMINING ATTORNEY

**Int. Cl.: 19**

**Prior U.S. Cls.: 1, 12, 33, and 50**

**United States Patent and Trademark Office**

**Reg. No. 3,455,893**

**Registered June 24, 2008**

**TRADEMARK  
SUPPLEMENTAL REGISTER**

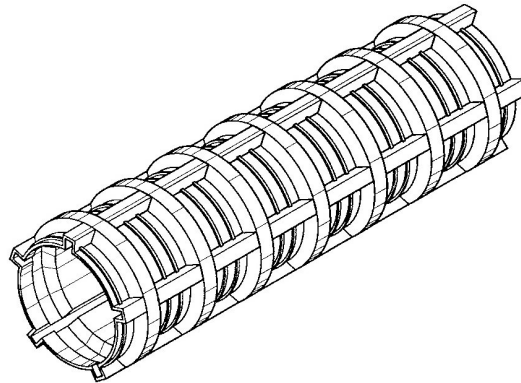

GENERAL TECHNOLOGIES, INC. (TEXAS CORPORATION)  
P.O. BOX 1503  
STAFFORD, TX 77497

FOR: PLASTIC DUCTS FOR ENCAPSULATING AND RECEIVING POST-TENSION METAL CABLES IN MULTI-STRAND POST-TENSION CONSTRUCTION OF CONCRETE STRUCTURES, IN CLASS 19 (U.S. CLS. 1, 12, 33 AND 50).

FIRST USE 0-0-2007; IN COMMERCE 0-0-2007.

SER. NO. 77-033,675, FILED P.R. 10-31-2006; AM. S.R. 4-17-2008.

JULIE GUTTADAURO, EXAMINING ATTORNEY

**Int. Cl.: 9**

**Prior U.S. Cls.: 21, 23, 26, 36, and 38**

**Reg. No. 3,455,894**

**United States Patent and Trademark Office**

**Registered June 24, 2008**

**TRADEMARK  
SUPPLEMENTAL REGISTER**

**NETWORK MODELER**

THE TRIZETTO GROUP, INC. (DELAWARE  
CORPORATION)  
567 SAN NICOLAS DRIVE  
SUITE 360  
NEWPORT BEACH, CA 92660

FOR: COMPUTER SOFTWARE FOR HEALTH  
CARE PLAN MANAGEMENT AND ADMINISTRATION;  
COMPUTER SOFTWARE FOR HEALTH  
CARE PLAN NETWORK MANAGEMENT , IN  
CLASS 9 (U.S. CLS. 21, 23, 26, 36 AND 38).

FIRST USE 11-0-2004; IN COMMERCE 11-0-2004.

THE MARK CONSISTS OF STANDARD CHAR-  
ACTERS WITHOUT CLAIM TO ANY PARTICULAR  
FONT, STYLE, SIZE, OR COLOR.

SER. NO. 77-039,243, FILED P.R. 11-8-2006; AM. S.R.  
5-14-2008.

DEIRDRE ROBERTSON, EXAMINING ATTORNEY



**Int. Cl.: 42**

**Prior U.S. Cls.: 100 and 101**

**United States Patent and Trademark Office**

**Reg. No. 3,455,895**

**Registered June 24, 2008**

**SERVICE MARK  
SUPPLEMENTAL REGISTER**

**NETWORX MODELER**

THE TRIZETTO GROUP, INC. (DELAWARE  
CORPORATION)  
567 SAN NICOLAS DRIVE  
SUITE 360  
NEWPORT BEACH, CA 92660

FOR: APPLICATION SERVICE PROVIDER (ASP)  
FEATURING SOFTWARE FOR HEALTH CARE  
PLAN MANAGEMENT AND ADMINISTRATION;  
IMPLEMENTATION, MAINTENANCE AND SUP-  
PORT OF COMPUTER SOFTWARE; APPLICATION  
SERVICE PROVIDER (ASP) FEATURING SOFT-  
WARE FOR HEALTH CARE PLAN NETWORK

MANAGEMENT, IN CLASS 42 (U.S. CLS. 100 AND  
101).

FIRST USE 11-0-2004; IN COMMERCE 11-0-2004.

THE MARK CONSISTS OF STANDARD CHAR-  
ACTERS WITHOUT CLAIM TO ANY PARTICULAR  
FONT, STYLE, SIZE, OR COLOR.

SER. NO. 77-039,246, FILED P.R. 11-8-2006; AM. S.R.  
5-14-2008.

DEIRDRE ROBERTSON, EXAMINING ATTORNEY

**Int. Cl.: 42**

**Prior U.S. Cls.: 100 and 101**

**United States Patent and Trademark Office**

**Reg. No. 3,455,896**

**Registered June 24, 2008**

**SERVICE MARK  
SUPPLEMENTAL REGISTER**

**ACS WEBSERVICE**

BRIVO SYSTEMS, LLC (DELAWARE LTD LIAB  
CO)  
4350 EAST-WEST HIGHWAY, SUITE 201  
BETHESDA, MD 20814

FOR: PROVIDING THE TEMPORARY USE OF  
ON-LINE NON-DOWNLOADABLE SOFTWARE  
FOR MONITORING, PROVIDING AND RESTRICT-  
ING ACCESS TO ELECTRONICALLY MONITORED  
AND SECURED ENCLOSURES; COMPUTER MON-  
ITORING SERVICE WHICH TRACKS SYSTEM  
HARDWARE PERFORMANCE EVENTS AND

SENDS OUT HISTORICAL REPORTS AND ALERTS,  
IN CLASS 42 (U.S. CLS. 100 AND 101).

FIRST USE 7-0-2006; IN COMMERCE 7-0-2006.

THE MARK CONSISTS OF STANDARD CHAR-  
ACTERS WITHOUT CLAIM TO ANY PARTICULAR  
FONT, STYLE, SIZE, OR COLOR.

SER. NO. 77-041,312, FILED P.R. 11-10-2006; AM.  
S.R. 5-20-2008.

CHARLOTTE CORWIN, EXAMINING ATTORNEY

**Int. Cl.: 28**

**Prior U.S. Cls.: 22, 23, 38, and 50**

**United States Patent and Trademark Office**

**Reg. No. 3,455,897**

**Registered June 24, 2008**

**TRADEMARK  
SUPPLEMENTAL REGISTER**

**JACKPOT BLACKJACK**

BOWKER, LAUREN R. (UNITED STATES INDIVIDUAL)

21530 ALMADEN ROAD

SAN JOSE, CA 95120

FOR: CASINO CARD GAMES, NAMELY, VARIATIONS OF BLACKJACK, IN CLASS 28 (U.S. CLS. 22, 23, 38 AND 50).

FIRST USE 10-15-1995; IN COMMERCE 10-15-1995.

THE MARK CONSISTS OF STANDARD CHARACTERS WITHOUT CLAIM TO ANY PARTICULAR FONT, STYLE, SIZE, OR COLOR.

NO CLAIM IS MADE TO THE EXCLUSIVE RIGHT TO USE "BLACKJACK", APART FROM THE MARK AS SHOWN.

SER. NO. 77-041,616, FILED P.R. 11-10-2006; AM. S.R. 5-5-2008.

MICHAEL LEWIS, EXAMINING ATTORNEY

**Int. Cl.: 41**

**Prior U.S. Cls.: 100, 101, and 107**

**United States Patent and Trademark Office**

**Reg. No. 3,455,898**

**Registered June 24, 2008**

**SERVICE MARK  
SUPPLEMENTAL REGISTER**

**WYLIE**

WYLIE, MARK J. (UNITED STATES INDIVIDUAL)

1340 LINCOLN RD. APT. 202  
MIAMI BEACH, FL 33139

FOR: EDUCATIONAL SERVICES, NAMELY, CONDUCTING WORKSHOPS, PUBLIC SPEAKING EVENTS, SEMINARS, AND ONE-ONE-ONE CLASSES IN THE FIELD OF HEALTH, FITNESS AND EXERCISE; PHYSICAL FITNESS CONSULTATION, IN CLASS 41 (U.S. CLS. 100, 101 AND 107).

FIRST USE 0-0-2007; IN COMMERCE 0-0-2007.

THE MARK CONSISTS OF STANDARD CHARACTERS WITHOUT CLAIM TO ANY PARTICULAR FONT, STYLE, SIZE, OR COLOR.

THE NAME(S), PORTRAIT(S), AND/OR SIGNATURE(S) SHOWN IN THE MARK IDENTIFIES "MARK J. WYLIE" , WHOSE CONSENT(S) TO REGISTER IS SUBMITTED.

SER. NO. 77-046,590, FILED P.R. 11-17-2006; AM. S.R. 3-26-2008.

VIVIAN MICZNIK FIRST, EXAMINING ATTORNEY

Int. Cl.: 41

Prior U.S. Cls.: 100, 101, and 107

Reg. No. 3,455,899

United States Patent and Trademark Office

Registered June 24, 2008

---

SERVICE MARK  
SUPPLEMENTAL REGISTER

EXECUTIVE BLACK BELT

EXECUTIVE BLACKBELT PROGRAM, L.L.C.  
(TEXAS LTD LIAB CO)  
425 THIS WAY  
LAKE JACKSON, TX 77566

FOR: MARTIAL ARTS INSTRUCTION, NAMELY,  
CERTIFICATION PROGRAMS TO TEACH MAR-  
TIAL ARTS SKILLS TO BUSINESS LEADERS, IN  
CLASS 41 (U.S. CLS. 100, 101 AND 107).

FIRST USE 11-30-2006; IN COMMERCE 11-30-2006.

THE MARK CONSISTS OF STANDARD CHAR-  
ACTERS WITHOUT CLAIM TO ANY PARTICULAR  
FONT, STYLE, SIZE, OR COLOR.

NO CLAIM IS MADE TO THE EXCLUSIVE  
RIGHT TO USE "BLACK BELT", APART FROM  
THE MARK AS SHOWN.

SER. NO. 77-062,556, FILED P.R. 12-12-2006; AM.  
S.R. 4-11-2008.

TINA BROWN, EXAMINING ATTORNEY

**Int. Cl.: 9**

**Prior U.S. Cls.: 21, 23, 26, 36, and 38**

**Reg. No. 3,455,900**

**United States Patent and Trademark Office**

**Registered June 24, 2008**

**TRADEMARK  
SUPPLEMENTAL REGISTER**

**DEVICELINX**

LANTRONIX, INC. (DELAWARE CORPORATION)  
15353 BARRANCA PARKWAY  
IRVINE, CA 92618

FOR: COMPUTER NETWORKING HARDWARE, NAMELY, EMBEDDED ETHERNET DEVICE SERVERS, MODULAR NETWORK COMMUNICATION PORTS, MODULAR COMMUNICATION MODULES WITH EMBEDDED PROCESSORS, EMBEDDED NETWORKING DEVICE SERVERS WITH WIRELESS CAPABILITY, EMBEDDED DEVICE SERVER MICROPROCESSOR CHIPS, EMBEDDED ETHERNET DEVICE GATEWAYS, EXTERNAL DEVICE

SERVERS, WIRELESS EXTERNAL DEVICE SERVERS, IN CLASS 9 (U.S. CLS. 21, 23, 26, 36 AND 38).

FIRST USE 7-20-2007; IN COMMERCE 7-20-2007.

THE MARK CONSISTS OF STANDARD CHARACTERS WITHOUT CLAIM TO ANY PARTICULAR FONT, STYLE, SIZE, OR COLOR.

SER. NO. 77-062,743, FILED P.R. 12-12-2006; AM. S.R. 5-9-2008.

MARK SPARACINO, EXAMINING ATTORNEY

**Int. Cl.: 35**

**Prior U.S. Cls.: 100, 101, and 102**

**United States Patent and Trademark Office**

**Reg. No. 3,455,901**

**Registered June 24, 2008**

**SERVICE MARK  
SUPPLEMENTAL REGISTER**

**PROFILE-ON-DEMAND**

CLARITAS, INC. (DELAWARE CORPORATION)  
5375 MIRA SORRENTO PLACE, SUITE 400  
SAN DIEGO, CA 92121

FOR: MARKET RESEARCH; STATISTICAL EVALUATIONS OF MARKETING DATA; RESEARCH AND CONSULTING SERVICES IN THE FIELD OF MARKETING, DEMOGRAPHIC FORECASTING, GEOGRAPHIC AND DEMOGRAPHIC MARKET ANALYSIS; COMPUTERIZED DATABASE MANAGEMENT SERVICES; PROVIDING AN ONLINE COMPUTER DATABASE IN THE FIELD OF DEMOGRAPHIC RESEARCH; PROVIDING MARKETING

REPORTS AND STUDIES; MARKET ANALYSIS SERVICES, IN CLASS 35 (U.S. CLS. 100, 101 AND 102).

FIRST USE 10-23-2007; IN COMMERCE 10-23-2007.

THE MARK CONSISTS OF STANDARD CHARACTERS WITHOUT CLAIM TO ANY PARTICULAR FONT, STYLE, SIZE, OR COLOR.

SER. NO. 77-068,828, FILED P.R. 12-20-2006; AM. S.R. 10-23-2007.

SETH A. RAPPAPORT, EXAMINING ATTORNEY

**Int. Cl.: 24**

**Prior U.S. Cls.: 42 and 50**

**United States Patent and Trademark Office**

**Reg. No. 3,455,902**

**Registered June 24, 2008**

**TRADEMARK  
SUPPLEMENTAL REGISTER**

**BIRDSEYE KNIT**

A. LYONS & COMPANY, INC. (MASSACHU-  
SETTS CORPORATION)  
SUITE 105  
40 BEACH STREET  
MANCHESTER, MA 01944

FOR: FABRIC FOR BOOTS AND SHOES, IN  
CLASS 24 (U.S. CLS. 42 AND 50).

FIRST USE 12-18-2006; IN COMMERCE 12-18-2006.

THE MARK CONSISTS OF STANDARD CHAR-  
ACTERS WITHOUT CLAIM TO ANY PARTICULAR  
FONT, STYLE, SIZE, OR COLOR.

SER. NO. 77-071,831, FILED P.R. 12-27-2006; AM.  
S.R. 5-22-2008.

RICHARD WHITE, EXAMINING ATTORNEY



**Int. Cl.: 16**

**Prior U.S. Cls.: 2, 5, 22, 23, 29, 37, 38, and 50**

**Reg. No. 3,455,903**

**United States Patent and Trademark Office**

**Registered June 24, 2008**

---

**TRADEMARK  
SUPPLEMENTAL REGISTER**

**IMPROPER SIGHTINGS**

IMPROPER PUBLICATIONS, INC. (MASSACHU-  
SETTS CORPORATION)  
142 BERKELEY ST., 3RD FLOOR  
BOSTON, MA 02116

THE MARK CONSISTS OF STANDARD CHAR-  
ACTERS WITHOUT CLAIM TO ANY PARTICULAR  
FONT, STYLE, SIZE, OR COLOR.

FOR: MAGAZINE COLUMN IN THE FIELD OF  
TRAVEL, ENTERTAINMENT, AND SOCIAL  
EVENTS, IN CLASS 16 (U.S. CLS. 2, 5, 22, 23, 29, 37,  
38 AND 50).

SER. NO. 77-073,097, FILED 12-29-2006.

FIRST USE 7-15-1998; IN COMMERCE 7-15-1998.

MARILYN IZZI, EXAMINING ATTORNEY

**Int. Cl.: 16**

**Prior U.S. Cls.: 2, 5, 22, 23, 29, 37, 38, and 50**

**Reg. No. 3,455,904**

**United States Patent and Trademark Office**

**Registered June 24, 2008**

---

**TRADEMARK  
SUPPLEMENTAL REGISTER**

**IMPROPERAZZI**

IMPROPER PUBLICATIONS, INC. (MASSACHU-  
SETTS CORPORATION)  
142 BERKELEY ST., 3RD FLOOR  
BOSTON, MA 02116

THE MARK CONSISTS OF STANDARD CHAR-  
ACTERS WITHOUT CLAIM TO ANY PARTICULAR  
FONT, STYLE, SIZE, OR COLOR.

FOR: MAGAZINE COLUMN IN THE FIELD OF  
ENTERTAINMENT, BUSINESS, AND SOCIAL  
EVENTS, IN CLASS 16 (U.S. CLS. 2, 5, 22, 23, 29, 37,  
38 AND 50).

SER. NO. 77-073,099, FILED 12-29-2006.

FIRST USE 8-11-1999; IN COMMERCE 8-11-1999.

MARILYN IZZI, EXAMINING ATTORNEY

**Int. Cls.: 9, 25, and 41**

**Prior U.S. Cls.: 21, 22, 23, 26, 36, 38, 39, 100, 101, and 107**

**Reg. No. 3,455,905**

**United States Patent and Trademark Office**

**Registered June 24, 2008**

**TRADEMARK  
SERVICE MARK  
SUPPLEMENTAL REGISTER**

**INTERNATIONAL SELF-DEFENSE**

AVALANCHE COMPANY, LLC (CALIFORNIA  
LTD LIAB CO)  
12657 POWAY ROAD  
POWAY, CA 92064

FOR: PRE-RECORDED DVDS RELATING TO  
INSTRUCTIONS AND DOCUMENTARIES IN THE  
FIELD OF MARTIAL ARTS , IN CLASS 9 (U.S. CLS.  
21, 23, 26, 36 AND 38).

FIRST USE 12-21-2007; IN COMMERCE 12-21-2007.

FOR: CLOTHING, NAMELY T-SHIRTS, BASE-  
BALL CAPS, SWEATSHIRTS, ATHLETIC AND  
TRAINING PANTS, AND JACKETS, IN CLASS 25  
(U.S. CLS. 22 AND 39).

FIRST USE 4-17-2008; IN COMMERCE 4-17-2008.

FOR: PROVIDING INSTRUCTIONS IN THE  
AREA OF SELF-DEFENSE, IN CLASS 41 (U.S. CLS.  
100, 101 AND 107).

FIRST USE 11-29-2000; IN COMMERCE 11-29-2000.

THE MARK CONSISTS OF STANDARD CHAR-  
ACTERS WITHOUT CLAIM TO ANY PARTICULAR  
FONT, STYLE, SIZE, OR COLOR.

SER. NO. 77-073,349, FILED P.R. 12-29-2006; AM.  
S.R. 5-21-2008.

HENRY S. ZAK, EXAMINING ATTORNEY

**Int. Cls.: 35 and 41**

**Prior U.S. Cls.: 100, 101, 102, and 107**

**United States Patent and Trademark Office**

**Reg. No. 3,455,906**

**Registered June 24, 2008**

**SERVICE MARK  
SUPPLEMENTAL REGISTER**

**MOUNTAIN RUNNING TEAM**

LA SPORTIVA N.A., INC. (COLORADO CORPORATION)  
3850 FRONTIER AVE, #100  
BOULDER, CO 80301

FOR: SPORTS RECRUITING SERVICES FOR AMATEUR AND SEMI-PROFESSIONAL ATHLETES; SPORTS MANAGEMENT, NAMELY, BUSINESS MANAGEMENT FOR SPORTS TEAMS; MANAGEMENT OF AMATEUR AND SEMI-PROFESSIONAL ATHLETES, IN CLASS 35 (U.S. CLS. 100, 101 AND 102).

FIRST USE 6-1-2002; IN COMMERCE 1-22-2003.

FOR: ORGANIZING AND CONDUCTING SPORTING EVENTS, NAMELY, RUNNING EVENTS AND COMPETITIONS; PERSONAL AND PROFESSIONAL COACHING SERVICES IN THE FIELD OF PREPARING ATHLETES FOR RUNNING COMPETITIONS; ENCOURAGING AMATEUR AND SEMI-PROFESSIONAL SPORTS BY ORGANIZING, PROMOTING, SPONSORING, CONDUCTING, AND AD-

MINISTERING ATHLETIC PROGRAMS AND ACTIVITIES IN THE NATURE OF RUNNING COMPETITIONS, IN CLASS 41 (U.S. CLS. 100, 101 AND 107).

FIRST USE 6-1-2002; IN COMMERCE 1-22-2003.

THE MARK CONSISTS OF STANDARD CHARACTERS WITHOUT CLAIM TO ANY PARTICULAR FONT, STYLE, SIZE, OR COLOR.

OWNER OF U.S. REG. NO. 2,588,635.

NO CLAIM IS MADE TO THE EXCLUSIVE RIGHT TO USE "RUNNING", APART FROM THE MARK AS SHOWN.

SER. NO. 77-080,908, FILED P.R. 1-11-2007; AM. S.R. 10-7-2007.

KATHERINE M. DUBRAY, EXAMINING ATTORNEY

**Int. Cls.: 35 and 41**

**Prior U.S. Cls.: 100, 101, 102, and 107**

**United States Patent and Trademark Office**

**Reg. No. 3,455,907**

**Registered June 24, 2008**

**SERVICE MARK  
SUPPLEMENTAL REGISTER**

**LOS ANGELES INTERNATIONAL  
WINE & SPIRITS COMPETITION**

LOS ANGELES COUNTY FAIR ASSOCIATION  
(CALIFORNIA CORPORATION)  
1101 W. MCKINLEY AVE.  
POMONA, CA 91768

FOR: ADVERTISING AND BUSINESS SERVICES, NAMELY, ARRANGING AND CONDUCTING TRADE SHOWS IN THE FIELD OF WINE AND SPIRITS FOR EXHIBITORS, OFFICIALS, AND PROFESSIONAL ORGANIZATIONS IN THE INTERNATIONAL WINE AND SPIRITS INDUSTRIES; ENTERTAINMENT SERVICES, NAMELY, WINE AND SPIRITS TASTINGS FOR EXHIBITORS, OFFICIALS, AND PROFESSIONAL ORGANIZATIONS IN THE INTERNATIONAL WINE AND SPIRITS INDUSTRIES, IN CLASS 35 (U.S. CLS. 100, 101 AND 102).

FIRST USE 3-25-2007; IN COMMERCE 3-25-2007.

FOR: ARRANGING AND CONDUCTING OF EXHIBITIONS, CONFERENCES, WORKSHOPS, AND

SEMINARS IN THE FIELD OF WINE AND SPIRITS FOR EXHIBITORS, OFFICIALS, PROFESSIONAL ORGANIZATIONS IN THE INTERNATIONAL WINE AND SPIRITS INDUSTRIES, IN CLASS 41 (U.S. CLS. 100, 101 AND 107).

FIRST USE 5-16-2007; IN COMMERCE 5-16-2007.

THE MARK CONSISTS OF STANDARD CHARACTERS WITHOUT CLAIM TO ANY PARTICULAR FONT, STYLE, SIZE, OR COLOR.

NO CLAIM IS MADE TO THE EXCLUSIVE RIGHT TO USE "WINE & SPIRITS COMPETITION", APART FROM THE MARK AS SHOWN.

SER. NO. 77-082,541, FILED P.R. 1-13-2007; AM. S.R. 4-8-2008.

DAVID MILLER, EXAMINING ATTORNEY

**Int. Cl.: 41**

**Prior U.S. Cls.: 100, 101, and 107**

**United States Patent and Trademark Office**

**Reg. No. 3,455,908**

**Registered June 24, 2008**

---

**SERVICE MARK  
SUPPLEMENTAL REGISTER**

**3D Dentist**

IMAC DESIGN, INC. (CANADA CORPORATION)  
73 RICHMOND STREET WEST, SUITE 312  
ONTARIO, CANADA M5H-1Z4

FOR: TRAINING IN THE FIELD OF DENTISTRY,  
IN CLASS 41 (U.S. CLS. 100, 101 AND 107).

FIRST USE 3-6-2006; IN COMMERCE 3-6-2006.

THE MARK CONSISTS OF STANDARD CHAR-  
ACTERS WITHOUT CLAIM TO ANY PARTICULAR  
FONT, STYLE, SIZE, OR COLOR.

NO CLAIM IS MADE TO THE EXCLUSIVE  
RIGHT TO USE "DENTIST", APART FROM THE  
MARK AS SHOWN.

SER. NO. 77-083,344, FILED P.R. 1-15-2007; AM. S.R.  
10-29-2007.

ZACHARY BELLO, EXAMINING ATTORNEY

**Int. Cl.: 9**

**Prior U.S. Cls.: 21, 23, 26, 36, and 38**

**Reg. No. 3,455,909**

**United States Patent and Trademark Office**

**Registered June 24, 2008**

---

**TRADEMARK  
SUPPLEMENTAL REGISTER**

**HI-REZ STUDIOS**

HI-REZ STUDIOS, INC. (GEORGIA CORPORATION)  
3905 BROOKSIDE PARKWAY  
ALPHARETTA, GA 30022

FOR: COMPUTER GAME AND ELECTRONIC GAME ENTERTAINMENT SOFTWARE FOR PERSONAL COMPUTERS AND HOME VIDEO GAME CONSOLES; DOWNLOADABLE COMPUTER GAME SOFTWARE, IN CLASS 9 (U.S. CLS. 21, 23, 26, 36 AND 38).

FIRST USE 6-0-2005; IN COMMERCE 6-0-2005.

THE MARK CONSISTS OF STANDARD CHARACTERS WITHOUT CLAIM TO ANY PARTICULAR FONT, STYLE, SIZE, OR COLOR.

SER. NO. 77-086,676, FILED P.R. 1-19-2007; AM. S.R. 5-16-2008.

JOHN DWYER, EXAMINING ATTORNEY

**Int. Cl.: 41**

**Prior U.S. Cls.: 100, 101, and 107**

**United States Patent and Trademark Office**

**Reg. No. 3,455,910**

**Registered June 24, 2008**

**SERVICE MARK  
SUPPLEMENTAL REGISTER**

**HI-REZ STUDIOS**

HI-REZ STUDIOS, INC. (GEORGIA CORPORATION)  
3905 BROOKSIDE PARKWAY  
ALPHARETTA, GA 30022

FOR: ENTERTAINMENT SERVICES IN THE NATURE OF AN ONLINE INTERACTIVE GAME PROVIDED BY MEANS OF A GLOBAL COMPUTER NETWORK; PROVIDING INFORMATION ONLINE RELATING TO COMPUTER GAMES, ONLINE COMPUTER GAMES, COMPUTER GAME ENTERTAINMENT AND AMUSEMENT ACTIVITIES, AND MULTI-PLAYER ONLINE COMPUTER GAME CO-

OPERATION AND COMPETITIONS, IN CLASS 41 (U.S. CLS. 100, 101 AND 107).

FIRST USE 6-0-2005; IN COMMERCE 6-0-2005.

THE MARK CONSISTS OF STANDARD CHARACTERS WITHOUT CLAIM TO ANY PARTICULAR FONT, STYLE, SIZE, OR COLOR.

SER. NO. 77-086,677, FILED P.R. 1-19-2007; AM. S.R. 5-16-2008.

JOHN DWYER, EXAMINING ATTORNEY



**Int. Cl.: 41**

**Prior U.S. Cls.: 100, 101, and 107**

**United States Patent and Trademark Office**

**Reg. No. 3,455,911**

**Registered June 24, 2008**

**SERVICE MARK  
SUPPLEMENTAL REGISTER**

**SHADOW TEACHER**

SABIS EDUCATIONAL SYSTEMS, INC. (MINNESOTA CORPORATION)  
6385 BEACH ROAD  
EDEN PRAIRIE, MN 55344

FOR: EDUCATIONAL SERVICES, NAMELY, PROVIDING CLASSES, PERSONAL INSTRUCTION AND SEMINARS DIRECTED TOWARD INDIVIDUALS AND GROUPS DESIGNED TO CHALLENGE STUDENTS TO RISE TO NEW ACADEMIC HEIGHTS IN THE FIELDS OF PUBLIC SPEAKING, PERSONAL PRESENTATION, AND TEACHING SKILLS, IN CLASS 41 (U.S. CLS. 100, 101 AND 107).

FIRST USE 2-28-2007; IN COMMERCE 2-28-2007.

THE MARK CONSISTS OF STANDARD CHARACTERS WITHOUT CLAIM TO ANY PARTICULAR FONT, STYLE, SIZE, OR COLOR.

SER. NO. 77-087,909, FILED P.R. 1-22-2007; AM. S.R. 11-13-2007.

JIM RINGLE, EXAMINING ATTORNEY

**Int. Cl.: 35**

**Prior U.S. Cls.: 100, 101, and 102**

**United States Patent and Trademark Office**

**Reg. No. 3,455,912**

**Registered June 24, 2008**

**SERVICE MARK  
SUPPLEMENTAL REGISTER**

**IMMIGRANT CHEX**

MEDVED, PAUL N. (UNITED STATES INDIVIDUAL)  
555 WEST FIFTH STREET, SUITE 3100  
LOS ANGELES, CA 90013

FOR: EMPLOYMENT VERIFICATION, NAMELY, MANAGING COMPLETION OF REQUIRED FORMS AND DOCUMENTS, AND DETECTING FRAUDULENT USE OF DOCUMENTS IN THE EMPLOYMENT VERIFICATION PROCESS; BUSINESS AUDITING, NAMELY, CONDUCTING AUDITS AND ESTABLISHING A PROTOCOL FOR RESPONDING TO NO-MATCH LETTERS RECEIVED FROM THE SOCIAL SECURITY ADMIN-

ISTRATION, IN CLASS 35 (U.S. CLS. 100, 101 AND 102).

FIRST USE 5-15-2008; IN COMMERCE 5-15-2008.

THE MARK CONSISTS OF STANDARD CHARACTERS WITHOUT CLAIM TO ANY PARTICULAR FONT, STYLE, SIZE, OR COLOR.

SER. NO. 77-097,983, FILED P.R. 2-2-2007; AM. S.R. 5-15-2008.

LINDSEY RUBIN, EXAMINING ATTORNEY

**Int. Cl.: 35**

**Prior U.S. Cls.: 100, 101, and 102**

**United States Patent and Trademark Office**

**Reg. No. 3,455,913**

**Registered June 24, 2008**

**SERVICE MARK  
SUPPLEMENTAL REGISTER**

**NATIONAL ACADEMY OF MEDIA  
ARTS AND SCIENCES**

NATIONAL ACADEMY OF TELEVISION ARTS &  
SCIENCES (NEW YORK UNINC. ASSOCIA-  
TION)  
111 WEST 57TH STREET, SUITE 600  
NEW YORK, NY 10019

FOR: ASSOCIATION SERVICES, NAMELY, PRO-  
MOTING THE INTERESTS OF INDIVIDUALS  
WORKING IN THE PRINT AND ELECTRONIC  
MEDIA, ADVERTISING AND MARKETING IN-  
DUSTRIES BY PROMOTING NEW MEDIA  
THROUGH EVENTS AND PROGRAMS, IN CLASS  
35 (U.S. CLS. 100, 101 AND 102).

FIRST USE 6-1-2007; IN COMMERCE 6-1-2007.

THE MARK CONSISTS OF STANDARD CHAR-  
ACTERS WITHOUT CLAIM TO ANY PARTICULAR  
FONT, STYLE, SIZE, OR COLOR.

NO CLAIM IS MADE TO THE EXCLUSIVE  
RIGHT TO USE "ACADEMY", APART FROM THE  
MARK AS SHOWN.

SER. NO. 77-102,748, FILED P.R. 2-8-2007; AM. S.R.  
12-10-2007.

MARY CRAWFORD, EXAMINING ATTORNEY

**Int. Cls.: 3 and 5**

**Prior U.S. Cls.: 1, 4, 6, 18, 44, 46, 50, 51, and 52**

**Reg. No. 3,455,914**

**United States Patent and Trademark Office**

**Registered June 24, 2008**

**TRADEMARK  
SUPPLEMENTAL REGISTER**

**THE ORIGINAL ESSENTIAL OIL  
TOWELETTE**

HERBAN ESSENTIALS, INC. (CALIFORNIA CORPORATION)  
815 EAST MASON STREET  
SANTA BARBARA, CA 93103

FOR: PRE-MOISTENED COSMETIC TOWELETES; AROMATHERAPY OILS; ESSENTIAL OILS FOR PERSONAL PURPOSES, IN CLASS 3 (U.S. CLS. 1, 4, 6, 50, 51 AND 52).

FIRST USE 8-1-2007; IN COMMERCE 8-1-2007.

FOR: PRE-MOISTENED MEDICATED TOWELETES FOR PERSONAL AND PET USE AND ESSENTIAL OILS FOR MEDICINAL, THERAPEUTIC, AND VETERINARY PURPOSES, IN CLASS 5 (U.S. CLS. 6, 18, 44, 46, 51 AND 52).

FIRST USE 8-1-2007; IN COMMERCE 8-1-2007.

THE MARK CONSISTS OF STANDARD CHARACTERS WITHOUT CLAIM TO ANY PARTICULAR FONT, STYLE, SIZE, OR COLOR.

NO CLAIM IS MADE TO THE EXCLUSIVE RIGHT TO USE "ESSENTIAL OIL TOWELETTE", APART FROM THE MARK AS SHOWN.

SER. NO. 77-103,032, FILED P.R. 2-8-2007; AM. S.R. 4-10-2008.

BRIDGETT SMITH, EXAMINING ATTORNEY

**Int. Cl.: 14**

**Prior U.S. Cls.: 2, 27, 28, and 50**

**United States Patent and Trademark Office**

**Reg. No. 3,455,915**

**Registered June 24, 2008**

**TRADEMARK  
SUPPLEMENTAL REGISTER**

**CERAMIC DIAMOND**

MILLER, GLENN A. (UNITED STATES INDIVIDUAL)

SUITE 500

4909 LAKEWOOD BOULEVARD

LAKWOOD, CA 90712

FOR: RINGS, IN CLASS 14 (U.S. CLS. 2, 27, 28 AND 50).

FIRST USE 3-0-2007; IN COMMERCE 3-0-2007.

THE MARK CONSISTS OF STANDARD CHARACTERS WITHOUT CLAIM TO ANY PARTICULAR FONT, STYLE, SIZE, OR COLOR.

NO CLAIM IS MADE TO THE EXCLUSIVE RIGHT TO USE "DIAMOND", APART FROM THE MARK AS SHOWN.

SER. NO. 77-113,904, FILED P.R. 2-22-2007; AM. S.R. 12-14-2007.

KRISTINA MORRIS, EXAMINING ATTORNEY

**Int. Cl.: 36**

**Prior U.S. Cls.: 100, 101, and 102**

**United States Patent and Trademark Office**

**Reg. No. 3,455,916**

**Registered June 24, 2008**

**SERVICE MARK  
SUPPLEMENTAL REGISTER**

**FRATERNIDAD INTERNACIONAL  
DE CRISTIANOS Y JUDÍOS**

INTERNATIONAL FELLOWSHIP OF CHRIS-  
TIANOS & JEWS, INC. (ILLINOIS NON-PROFIT  
CORPORATION)  
30 N. LASALLE STREET, SUITE 2600  
CHICAGO, IL 60602

FOR: CHARITABLE FUNDRAISING SERVICES;  
PROVIDING MONETARY GRANTS TO CHARITA-  
BLE ORGANIZATIONS , IN CLASS 36 (U.S. CLS. 100,  
101 AND 102).

FIRST USE 3-0-2005; IN COMMERCE 3-0-2005.

THE MARK CONSISTS OF STANDARD CHAR-  
ACTERS WITHOUT CLAIM TO ANY PARTICULAR  
FONT, STYLE, SIZE, OR COLOR.

NO CLAIM IS MADE TO THE EXCLUSIVE  
RIGHT TO USE "FRATERNIDAD", APART FROM  
THE MARK AS SHOWN.

THE FOREIGN WORDING IN THE MARK  
TRANSLATES INTO ENGLISH AS INTERNATION-  
AL FELLOWSHIP OF CHRISTIANS AND JEWS.

SER. NO. 77-114,397, FILED P.R. 2-23-2007; AM. S.R.  
10-18-2007.

SEAN CROWLEY, EXAMINING ATTORNEY

**Int. Cls.: 41 and 45**

**Prior U.S. Cls.: 100, 101, and 107**

**United States Patent and Trademark Office**

**Reg. No. 3,455,917**

**Registered June 24, 2008**

**SERVICE MARK  
SUPPLEMENTAL REGISTER**

**FRATERNIDAD INTERNACIONAL  
DE CRISTIANOS Y JUDÍOS**

INTERNATIONAL FELLOWSHIP OF CHRISTIANS & JEWS, INC. (ILLINOIS NON-PROFIT CORPORATION)  
30 N. LASALLE STREET, SUITE 2600  
CHICAGO, IL 60602

FOR: RELIGIOUS EDUCATIONAL SERVICES, NAMELY, CONDUCTING SEMINARS, MEETINGS AND CONFERENCES, AND DISTRIBUTING COURSE MATERIALS IN THE NATURE OF TAPES, NEWSLETTERS, BOOKS, PAMPHLETS, LEAFLETS; PROVIDING INFORMATION VIA A GLOBAL COMMUNICATIONS NETWORK IN THE FIELD OF ISRAELI HISTORY, IN CLASS 41 (U.S. CLS. 100, 101 AND 107).

FIRST USE 3-0-2005; IN COMMERCE 3-0-2005.

FOR: PROVIDING INFORMATION VIA A GLOBAL COMMUNICATIONS NETWORK IN THE FIELD OF JUDAISM, CHRISTIANITY, RELIGION AND ISRAELI CULTURE, IN CLASS 45 (U.S. CLS. 100 AND 101).

FIRST USE 3-0-2005; IN COMMERCE 3-0-2005.

THE MARK CONSISTS OF STANDARD CHARACTERS WITHOUT CLAIM TO ANY PARTICULAR FONT, STYLE, SIZE, OR COLOR.

NO CLAIM IS MADE TO THE EXCLUSIVE RIGHT TO USE "FRATERNIDAD", APART FROM THE MARK AS SHOWN.

THE ENGLISH TRANSLATION OF THE WORD "FRATERNIDAD INTERNACIONAL DE CRISTIANOS Y JUDIOS" IN THE MARK IS INTERNATIONAL FELLOWSHIP OF CHRISTIANS AND JEWS.

SER. NO. 77-114,406, FILED P.R. 2-23-2007; AM. S.R. 10-18-2007.

SEAN CROWLEY, EXAMINING ATTORNEY

**Int. Cl.: 9**

**Prior U.S. Cls.: 21, 23, 26, 36, and 38**

**United States Patent and Trademark Office**

**Reg. No. 3,455,918**

**Registered June 24, 2008**

**TRADEMARK  
SUPPLEMENTAL REGISTER**

**FORCE ON FORCE**

ALLIANT TECHSYSTEMS INC. (DELAWARE  
CORPORATION)  
5050 LINCOLN DRIVE  
EDINA, MN 554367097

THE MARK CONSISTS OF STANDARD CHAR-  
ACTERS WITHOUT CLAIM TO ANY PARTICULAR  
FONT, STYLE, SIZE, OR COLOR.

FOR: PERSONAL BODY PROTECTIVE WEAR  
AND ARMOR; PROTECTIVE CLOTHING; PROTEC-  
TIVE EYEWEAR, IN CLASS 9 (U.S. CLS. 21, 23, 26, 36  
AND 38).

SER. NO. 77-117,591, FILED P.R. 2-27-2007; AM. S.R.  
5-6-2008.

FIRST USE 12-0-2007; IN COMMERCE 12-0-2007.

DANIEL CAPSHAW, EXAMINING ATTORNEY



**Int. Cl.: 25**

**Prior U.S. Cls.: 22 and 39**

**United States Patent and Trademark Office**

**Reg. No. 3,455,919**

**Registered June 24, 2008**

**TRADEMARK  
SUPPLEMENTAL REGISTER**

**QUITELIGHT**

AHNU, INC. (DELAWARE CORPORATION)  
SUITE 201  
1826 CLEMENT AVE.  
ALAMEDA, CA 94501

THE MARK CONSISTS OF STANDARD CHAR-  
ACTERS WITHOUT CLAIM TO ANY PARTICULAR  
FONT, STYLE, SIZE, OR COLOR.

FOR: FOOTWEAR, IN CLASS 25 (U.S. CLS. 22 AND  
39).

SER. NO. 77-117,627, FILED P.R. 2-27-2007; AM. S.R.  
5-21-2008.

FIRST USE 4-0-2007; IN COMMERCE 4-0-2007.

KRISTIN DAHLING, EXAMINING ATTORNEY

**Int. Cl.: 16**

**Prior U.S. Cls.: 2, 5, 22, 23, 29, 37, 38, and 50**

**Reg. No. 3,455,920**

**United States Patent and Trademark Office**

**Registered June 24, 2008**

---

**TRADEMARK  
SUPPLEMENTAL REGISTER**

**PRINT PROFESSIONAL**

NORTH AMERICAN PUBLISHING COMPANY  
(PENNSYLVANIA CORPORATION)  
SUITE 1200  
1500 SPRING GARDEN STREET  
PHILADELPHIA, PA 191304094

FIRST USE 6-1-2007; IN COMMERCE 7-26-2007.

THE MARK CONSISTS OF STANDARD CHARACTERS WITHOUT CLAIM TO ANY PARTICULAR FONT, STYLE, SIZE, OR COLOR.

FOR: MAGAZINES FEATURING INFORMATION IN THE FIELD OF DISTRIBUTORSHIP AND MANUFACTURE OF PRINTED PRODUCTS , IN CLASS 16 (U.S. CLS. 2, 5, 22, 23, 29, 37, 38 AND 50).

SER. NO. 77-121,922, FILED P.R. 3-5-2007; AM. S.R. 5-20-2008.

KEVIN DINALLO, EXAMINING ATTORNEY

**Int. Cls.: 14 and 25**

**Prior U.S. Cls.: 2, 22, 27, 28, 39, and 50**

**United States Patent and Trademark Office**

**Reg. No. 3,455,921**

**Registered June 24, 2008**

**TRADEMARK  
SUPPLEMENTAL REGISTER**

**Until They All Have A Home**

ADAMS, BARBARA (UNITED STATES INDIVIDUAL)  
1943 CAMINO SOLEDAD  
YUMA, AZ 85364

FOR: BRACELETS, IN CLASS 14 (U.S. CLS. 2, 27, 28 AND 50).

FIRST USE 1-1-2005; IN COMMERCE 1-1-2005.

FOR: T-SHIRTS, IN CLASS 25 (U.S. CLS. 22 AND 39).

FIRST USE 1-1-2005; IN COMMERCE 1-1-2005.

THE MARK CONSISTS OF STANDARD CHARACTERS WITHOUT CLAIM TO ANY PARTICULAR FONT, STYLE, SIZE, OR COLOR.

SER. NO. 77-124,955, FILED P.R. 3-7-2007; AM. S.R. 4-8-2008.

SUNG IN, EXAMINING ATTORNEY

Int. Cl.: 16

Prior U.S. Cls.: 2, 5, 22, 23, 29, 37, 38, and 50

United States Patent and Trademark Office

Reg. No. 3,455,922

Registered June 24, 2008

**TRADEMARK  
SUPPLEMENTAL REGISTER**

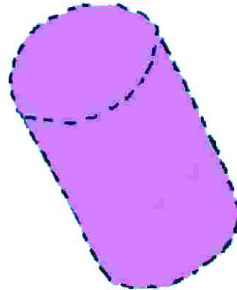

V.P. FOOTWEAR, INC. (CALIFORNIA CORPORATION)  
10322 E. RUSH ST.  
EL MONTE, CA 91733

FOR: PLASTIC BAGS FOR DISPOSING OF PET WASTE, IN CLASS 16 (U.S. CLS. 2, 5, 22, 23, 29, 37, 38 AND 50).

FIRST USE 0-0-2006; IN COMMERCE 0-0-2006.

THE COLOR(S) PURPLE IS/ARE CLAIMED AS A FEATURE OF THE MARK.

THE MARK CONSISTS OF THE COLOR PURPLE AS APPLIED TO "PLASTIC BAGS" FOR DISPOSING OF PET WASTE. THE DOTTED OUTLINE OF THE GOODS IS INTENDED TO SHOW THE POSITION OF THE MARK ON THE GOODS AND IS NOT PART OF THE MARK.

SER. NO. 77-133,658, FILED 3-17-2007.

MICHAEL TANNER, EXAMINING ATTORNEY

**Int. Cls.: 35, 39, 42, and 45**

**Prior U.S. Cls.: 100, 101, 102, and 105**

**United States Patent and Trademark Office**

**Reg. No. 3,455,923**

**Registered June 24, 2008**

**SERVICE MARK  
SUPPLEMENTAL REGISTER**

# iRescue

IRESCUE INC. (FLORIDA CHARITABLE NON-PROFIT CORPORATION)  
STE 401  
7929 WEST DR.  
NORTH BAY VILLAGE, FL 33141

FOR: BUSINESS CONSULTATION SERVICES TO ASSIST NON-PROFIT ORGANIZATIONS IN PLANNING, MANAGING, AND CONDUCTING FUND RAISING ACTIVITIES VIA A GLOBAL COMPUTER NETWORK; PROMOTING THE GOODS AND SERVICES OF OTHERS BY CREATING CAUSE-BASED MARKETING LICENSING PROGRAMS THAT PROVIDE AID TO WILDLIFE AND ENVIRONMENTAL NON-PROFIT ORGANIZATIONS; PROMOTING THE GOODS AND SERVICES OF OTHERS THROUGH THE USE OF ADVERTISING AND CAUSE-BASED MARKETING CAMPAIGNS; MARKETING SERVICES FOR CHARITABLE WILDLIFE AND ENVIRONMENTAL NON-PROFIT PURPOSES; CHARITABLE FUNDRAISING SERVICES FOR ANIMAL WELFARE AND ENVIRONMENTAL PROTECTION, NAMELY, PROMOTING THE GOODS AND SERVICES OF OTHERS THROUGH THE USE OF CAUSE-BASED ADVERTISING AND MARKETING CAMPAIGNS; PROVIDING A WEBSITE FEATURING CHARITABLE FUNDRAISING SERVICES FOR ANIMAL WELFARE AND ENVIRONMENTAL PROTECTION, NAMELY, PROMOTING THE GOODS AND SERVICES OF OTHERS THROUGH THE USE OF CAUSE-BASED ADVERTISING AND MARKETING CAMPAIGNS; PROMOTING THE INTERESTS OF INDIVIDUALS CONCERNED WITH ANIMAL CARE, ANIMAL PROTECTION AND HUMAN ETHICS CAMPAIGNS, IN CLASS 35 (U.S. CLS. 100, 101 AND 102).

FIRST USE 4-7-2006; IN COMMERCE 3-1-2007.

FOR: ANIMAL PROTECTION SERVICES, NAMELY, RESCUE SERVICES, IN CLASS 39 (U.S. CLS. 100 AND 105).

FIRST USE 4-7-2006; IN COMMERCE 3-1-2007.

FOR: RESEARCH IN THE FIELD OF ENVIRONMENTAL PROTECTION, IN CLASS 42 (U.S. CLS. 100 AND 101).

FIRST USE 4-7-2006; IN COMMERCE 3-1-2007.

FOR: PROVIDING CUSTOM LICENSING AGREEMENTS FOR USE IN COMMERCE ENVIRONMENTS TO PARTICIPATE IN CAUSE-BASED LICENSING SPONSORSHIP PROGRAMS DESIGNED TO PROVIDE MONETARY AID TO WILDLIFE AND ENVIRONMENTAL NON-PROFIT ORGANIZATIONS; LICENSING OF THE CONCEPT OF PROMOTING ANIMAL WELFARE AND ENVIRONMENTAL PROTECTION WORLDWIDE THROUGH THE USE OF A CAUSE-BASED LICENSING SPONSORSHIP PROGRAM AVAILABLE TO ANY MERCHANT OF GOODS AND/OR SERVICES AND DESIGNED TO PROVIDE MONETARY AID TO WILDLIFE AND ENVIRONMENTAL NON-PROFIT ORGANIZATIONS PARTICIPATING IN THE CAUSE-BASED LICENSING SPONSORSHIP PROGRAM THROUGH A DONATION DERIVED FROM A PORTION OF EACH SALE FROM EACH PARTICIPATING MERCHANT'S SPONSORED PRODUCTS, IN CLASS 45 (U.S. CLS. 100 AND 101).

FIRST USE 4-7-2006; IN COMMERCE 3-1-2007.

THE MARK CONSISTS OF STANDARD CHARACTERS WITHOUT CLAIM TO ANY PARTICULAR FONT, STYLE, SIZE, OR COLOR.

SER. NO. 77-145,720, FILED P.R. 4-1-2007; AM. S.R. 4-17-2008.

JEFF DEFORD, EXAMINING ATTORNEY

**Int. Cl.: 9**

**Prior U.S. Cls.: 21, 23, 26, 36, and 38**

**Reg. No. 3,455,924**

**United States Patent and Trademark Office**

**Registered June 24, 2008**

**TRADEMARK  
SUPPLEMENTAL REGISTER**

**THE BUSINESS JOURNAL OF  
HISPANIC RESEARCH**

NATIONAL SOCIETY OF HISPANIC MBAS (CALIFORNIA NON-PROFIT CORPORATION)  
1303 WALNUT HILL LANE, SUITE 100  
DALLAS, TX 75038

FOR: DOWNLOADABLE ELECTRONIC PUBLICATIONS, NAMELY, JOURNALS IN THE FIELD OF BUSINESS FOR HISPANIC PROFESSIONALS, MANAGERS AND EXECUTIVES , IN CLASS 9 (U.S. CLS. 21, 23, 26, 36 AND 38).

FIRST USE 2-12-2008; IN COMMERCE 2-12-2008.

THE MARK CONSISTS OF STANDARD CHARACTERS WITHOUT CLAIM TO ANY PARTICULAR FONT, STYLE, SIZE, OR COLOR.

NO CLAIM IS MADE TO THE EXCLUSIVE RIGHT TO USE "BUSINESS JOURNAL" AND "RESEARCH", APART FROM THE MARK AS SHOWN.

SER. NO. 77-147,009, FILED P.R. 4-3-2007; AM. S.R. 5-19-2008.

ANTHONY RINKER, EXAMINING ATTORNEY

Int. Cl.: 29

Prior U.S. Cl.: 46

United States Patent and Trademark Office

Reg. No. 3,455,925

Registered June 24, 2008

TRADEMARK  
SUPPLEMENTAL REGISTER



OAKHURST DAIRY (MAINE CORPORATION)  
364 FOREST AVENUE  
PORTLAND, ME 04101

FOR: DAIRY PRODUCTS, NAMELY, FLUID MILK; BUTTERMILK; FLUID CREAM; AERATED CREAM; EGG NOG; FLAVORED FLUID MILK; SOUR CREAM; COTTAGE CHEESE; BUTTER; HALF-AND-HALF; AND DAIRY CREAMERS, IN CLASS 29 (U.S. CL. 46).

FIRST USE 5-1-2007; IN COMMERCE 5-1-2007.

THE COLOR(S) YELLOW, WHITE, GREEN, LIGHT GREEN AND DARK GREEN IS/ARE CLAIMED AS A FEATURE OF THE MARK.

THE MARK CONSISTS OF THE WORD "NATURALLY" IN YELLOW OVER THE WORD "NUTRIENT", WHICH IS IN WHITE, OUTLINED IN DARK GREEN, OVER THE WORD "RICH" IN YELLOW, ALL CONTAINED WITHIN A GREEN-SHADED OVAL, PARTIALLY BORDERED BY A WHITE EDGE, WHICH IS ITSELF BORDERED BY A LIGHT GREEN EDGE.

SER. NO. 77-151,588, FILED P.R. 4-9-2007; AM. S.R. 1-25-2008.

LINDA LAVACHE, EXAMINING ATTORNEY

**Int. Cl.: 30**

**Prior U.S. Cl.: 46**

**United States Patent and Trademark Office**

**Reg. No. 3,455,926**

**Registered June 24, 2008**

**TRADEMARK  
SUPPLEMENTAL REGISTER**

**L.A. MINIS**

L.A. MINIS, LLC (CALIFORNIA LTD LIAB CO)  
11080 E. ARTESIA BLVD. F  
CERRITOS, CA 90703

FOR: PREPARED FOODS, NAMELY, FROZEN  
ENTREES CONSISTING PRIMARILY OF FROZEN  
SANDWICHES, IN CLASS 30 (U.S. CL. 46).

FIRST USE 5-0-2007; IN COMMERCE 5-0-2007.

THE MARK CONSISTS OF STANDARD CHAR-  
ACTERS WITHOUT CLAIM TO ANY PARTICULAR  
FONT, STYLE, SIZE, OR COLOR.

SER. NO. 77-154,026, FILED P.R. 4-11-2007; AM. S.R.  
4-18-2008.

MICHAEL LEWIS, EXAMINING ATTORNEY



**Int. Cl.: 16**

**Prior U.S. Cls.: 2, 5, 22, 23, 29, 37, 38, and 50**

**Reg. No. 3,455,927**

**United States Patent and Trademark Office**

**Registered June 24, 2008**

**TRADEMARK  
SUPPLEMENTAL REGISTER**



COMMUNITY COLLEGE OF CENTRAL NEW  
MEXICO (NEW MEXICO EDUCATIONAL IN-  
STITUTION)  
525 BUENA VISTA SE  
ALBUQUERQUE, NM 87106

FIRST USE 11-13-2007; IN COMMERCE 11-13-2007.

SER. NO. 77-156,483, FILED P.R. 4-13-2007; AM. S.R.  
4-21-2008.

FOR: EDUCATIONAL PUBLICATIONS, NAME-  
LY, TRAINING MANUALS IN THE FIELD OF  
INCOME TAX PREPARATION, IN CLASS 16 (U.S.  
CLS. 2, 5, 22, 23, 29, 37, 38 AND 50).

AMY MCMENAMIN, EXAMINING ATTORNEY

**Int. Cl.: 35**

**Prior U.S. Cls.: 100, 101, and 102**

**United States Patent and Trademark Office**

**Reg. No. 3,455,928**

**Registered June 24, 2008**

---

**SERVICE MARK  
SUPPLEMENTAL REGISTER**

**STOREFRONT NETWORK**

THE BAND, INC. (COLORADO CORPORATION)  
1023 S. GAYLORD ST.  
DENVER, CO 80209

FOR: OPERATING AN ONLINE SHOPPING SITE  
IN THE FIELD OF GENERAL MERCHANDISE BY  
MEANS OF THE INTERNET AND TELEVISION;  
PROMOTING THE PRODUCTS AND SERVICES OF  
OTHERS BY DISTRIBUTING ADVERTISING MA-  
TERIAL VIA INTERNET AND TELEVISION; PRO-  
VIDING CONSUMER INFORMATION  
FEATURING THE GOODS AND SERVICES OF

OTHERS VIA THE INTERNET AND TELEVISION,  
IN CLASS 35 (U.S. CLS. 100, 101 AND 102).

FIRST USE 12-12-2007; IN COMMERCE 12-12-2007.

THE MARK CONSISTS OF STANDARD CHAR-  
ACTERS WITHOUT CLAIM TO ANY PARTICULAR  
FONT, STYLE, SIZE, OR COLOR.

SER. NO. 77-159,950, FILED P.R. 4-18-2007; AM. S.R.  
1-30-2008.

TARAH HARDY, EXAMINING ATTORNEY

**Int. Cl.: 38**

**Prior U.S. Cls.: 100, 101, and 104**

**United States Patent and Trademark Office**

**Reg. No. 3,455,929**

**Registered June 24, 2008**

**SERVICE MARK  
SUPPLEMENTAL REGISTER**

**ACTIVAR**

BRYDELS JR., JOHN (UNITED STATES INDIVIDUAL)  
549 KENILWORTH BLVD  
BATON ROUGE, LA 70808

FOR: LOCAL AND LONG DISTANCE TELEPHONE SERVICES; PREPAID LOCAL AND LONG DISTANCE TELEPHONE SERVICES, IN CLASS 38 (U.S. CLS. 100, 101 AND 104).

FIRST USE 1-16-2008; IN COMMERCE 1-16-2008.

THE MARK CONSISTS OF STANDARD CHARACTERS WITHOUT CLAIM TO ANY PARTICULAR FONT, STYLE, SIZE, OR COLOR.

THE ENGLISH TRANSLATION OF "ACTIVAR" IS "ACTIVATE".

SER. NO. 77-163,518, FILED P.R. 4-23-2007; AM. S.R. 5-18-2008.

EMILY CHUO, EXAMINING ATTORNEY

**Int. Cl.: 41**

**Prior U.S. Cls.: 100, 101, and 107**

**United States Patent and Trademark Office**

**Reg. No. 3,455,930**

**Registered June 24, 2008**

**SERVICE MARK  
SUPPLEMENTAL REGISTER**

# Naked Classes

CARTER, BRENT (UNITED STATES INDIVIDUAL)  
8501 CAMERON ST.  
SILVER SPRING, MD 20910

FOR: EDUCATIONAL SERVICES, NAMELY, CONDUCTING DISTANCE LEARNING INSTRUCTION AT THE SECONDARY, COLLEGE AND GRADUATE LEVELS, IN CLASS 41 (U.S. CLS. 100, 101 AND 107).

FIRST USE 4-17-2007; IN COMMERCE 4-17-2007.

THE MARK CONSISTS OF STANDARD CHARACTERS WITHOUT CLAIM TO ANY PARTICULAR FONT, STYLE, SIZE, OR COLOR.

NO CLAIM IS MADE TO THE EXCLUSIVE RIGHT TO USE "CLASSES", APART FROM THE MARK AS SHOWN.

SER. NO. 77-164,774, FILED P.R. 4-24-2007; AM. S.R. 5-19-2008.

MICHELE SWAIN, EXAMINING ATTORNEY

**Int. Cl.: 36**

**Prior U.S. Cls.: 100, 101, and 102**

**United States Patent and Trademark Office**

**Reg. No. 3,455,931**

**Registered June 24, 2008**

**SERVICE MARK  
SUPPLEMENTAL REGISTER**

**CORPORATE PROPERTY  
DISPOSITIONS**

CORPORATE PROPERTY DISPOSITIONS (GEOR-  
GIA LTD LIAB CO)

#395

6400 POWERS FERRY RD.

ATLANTA, GA 30339

FOR: REAL ESTATE CONSULTATION, REAL  
ESTATE LISTING, REAL ESTATE BROKERAGE,  
REAL ESTATE VALUATION AND ACQUISITION  
SERVICES, IN CLASS 36 (U.S. CLS. 100, 101 AND 102).

FIRST USE 6-1-2005; IN COMMERCE 6-1-2005.

THE MARK CONSISTS OF STANDARD CHAR-  
ACTERS WITHOUT CLAIM TO ANY PARTICULAR  
FONT, STYLE, SIZE, OR COLOR.

NO CLAIM IS MADE TO THE EXCLUSIVE  
RIGHT TO USE "PROPERTY", APART FROM THE  
MARK AS SHOWN.

SER. NO. 77-171,360, FILED P.R. 5-2-2007; AM. S.R.  
11-12-2007.

CARYN GLASSER, EXAMINING ATTORNEY

Int. Cl.: 12

Prior U.S. Cls.: 19, 21, 23, 31, 35, and 44

United States Patent and Trademark Office

Reg. No. 3,455,932

Registered June 24, 2008

**TRADEMARK  
SUPPLEMENTAL REGISTER**

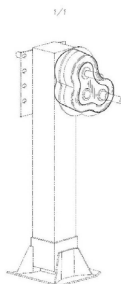

BUTLER PRODUCTS CORPORATION (KENTUCKY CORPORATION)  
71 CAVALIER BLVD., SUITE 313  
FLORENCE, KY 41042

FOR: GEARBOXES, NAMELY, GEARBOXES FOR LANDING GEAR, INDUSTRIAL EQUIPMENT, AND AGRICULTURAL EQUIPMENT, IN CLASS 12 (U.S. CLS. 19, 21, 23, 31, 35 AND 44).

FIRST USE 4-1-2007; IN COMMERCE 4-1-2007.

THE MARK CONSISTS OF A PRODUCT DESIGN CONFIGURATION OF THE OUTER CASE OF A GEARBOX SYSTEM. THE OUTERCASE IS IN A

CLOVER LEAF DESIGN. THE OUTER CASE IS ATTACHED TO A POST. ONLY THE OUTER CASE OF THE GEARBOX IS CLAIMED. NEITHER THE HOLES WITHIN THE SPACE INSIDE THE CASE NOR THE POST ARE CLAIMED. THE BROKEN LINES INDICATE THE PLACEMENT OF THE MARK ON THE GOODS AND ARE NOT FEATURES OF THE MARK. THE DRAWING DEPICTS THE PRODUCT CONFIGURATION AND NO LIMITATION ON SIZE IS INTENDED.

SER. NO. 77-182,358, FILED P.R. 5-16-2007; AM. S.R. 5-15-2008.

LINDSEY RUBIN, EXAMINING ATTORNEY

**Int. Cl.: 41**

**Prior U.S. Cls.: 100, 101, and 107**

**United States Patent and Trademark Office**

**Reg. No. 3,455,933**

**Registered June 24, 2008**

**SERVICE MARK  
SUPPLEMENTAL REGISTER**

**Maximum Value Home Selling  
System**

HAROLD WARE (UNITED STATES INDIVIDUAL)  
1700 BARTON CREEK BLVD.  
AUSTIN, TX 78735

FOR: EDUCATIONAL SERVICES, NAMELY, CONDUCTING PROGRAMS IN THE FIELD OF RESIDENTIAL REAL ESTATE, IN CLASS 41 (U.S. CLS. 100, 101 AND 107).

FIRST USE 10-9-2007; IN COMMERCE 10-9-2007.

THE MARK CONSISTS OF STANDARD CHARACTERS WITHOUT CLAIM TO ANY PARTICULAR FONT, STYLE, SIZE, OR COLOR.

NO CLAIM IS MADE TO THE EXCLUSIVE RIGHT TO USE "SYSTEM", APART FROM THE MARK AS SHOWN.

SER. NO. 77-182,410, FILED P.R. 5-16-2007; AM. S.R. 3-4-2008.

MARCIE MILONE, EXAMINING ATTORNEY

**Int. Cl.: 41**

**Prior U.S. Cls.: 100, 101, and 107**

**United States Patent and Trademark Office**

**Reg. No. 3,455,934**

**Registered June 24, 2008**

**SERVICE MARK  
SUPPLEMENTAL REGISTER**

**PENETRATION SELLING**

FRISCH, HARRY S. (UNITED STATES INDIVIDUAL)  
1429 FOREST ROAD  
CLEARWATER, FL 33755 AND  
FRISCH, NANCY R. (UNITED STATES INDIVIDUAL)  
1429 FOREST ROAD  
CLEARWATER, FL 33755

FOR: EDUCATIONAL SERVICES, NAMELY, CONDUCTING MENTORING, HOME-STUDY INSTRUCTION, CLASS-ROOM COURSES, ON-LINE COURSES, SEMINARS AND WORKSHOPS IN THE FIELD OF HOW TO SELL AND DISTRIBUTION OF

COURSE MATERIAL IN CONNECTION THEREWITH, IN CLASS 41 (U.S. CLS. 100, 101 AND 107).

FIRST USE 1-8-2007; IN COMMERCE 5-17-2007.

THE MARK CONSISTS OF STANDARD CHARACTERS WITHOUT CLAIM TO ANY PARTICULAR FONT, STYLE, SIZE, OR COLOR.

SER. NO. 77-184,529, FILED P.R. 5-18-2007; AM. S.R. 4-2-2008.

TRACY CROSS, EXAMINING ATTORNEY



**Int. Cl.: 9**

**Prior U.S. Cls.: 21, 23, 26, 36, and 38**

**United States Patent and Trademark Office**

**Reg. No. 3,455,935**

**Registered June 24, 2008**

**TRADEMARK  
SUPPLEMENTAL REGISTER**

# TRUCK PC

DRIVERTECH, LLC (DELAWARE LTD LIAB CO)  
SUITE B  
1960 SOUTH MILESTONE DRIVE  
SALT LAKE CITY, UT 84104

FOR: COMPUTER SYSTEM THAT IS INSTALLED IN VEHICLES COMPRISING HARDWARE AND SOFTWARE THAT COMPILES INFORMATION REGARDING THE VEHICLE'S OPERATION AND ALLOWS THE DRIVER AND PASSENGERS ACCESS TO ON-BOARD COMPUTER RESOURCES, ACCESS TO ON-BOARD SYSTEMS, ACCESS TO DOCUMENT SCANNING AND TRANSMISSION, ACCESS TO ON-BOARD MAPPING, ACCESS TO HOME OFFICE DISPATCHES AND WORK ORDERS, AND THE ABILITY TO SEND AND RECEIVE DATA, INFORMATION AND DIGITAL MEDIA VIA SA-

TELLITE, CELLULAR AND WI-FI, IN CLASS 9 (U.S. CLS. 21, 23, 26, 36 AND 38).

FIRST USE 12-31-1998; IN COMMERCE 12-31-1998.

THE MARK CONSISTS OF STANDARD CHARACTERS WITHOUT CLAIM TO ANY PARTICULAR FONT, STYLE, SIZE, OR COLOR.

NO CLAIM IS MADE TO THE EXCLUSIVE RIGHT TO USE "PC", APART FROM THE MARK AS SHOWN.

SER. NO. 77-186,778, FILED P.R. 5-22-2007; AM. S.R. 5-20-2008.

LINDA M. KING, EXAMINING ATTORNEY

**Int. Cl.: 40**

**Prior U.S. Cls.: 100, 103, and 106**

**United States Patent and Trademark Office**

**Reg. No. 3,455,936**

**Registered June 24, 2008**

**SERVICE MARK  
SUPPLEMENTAL REGISTER**

**thelab**

THE DEN HOLDINGS LLC (NEW YORK LTD  
LIAB CO)

3FL  
6 EAST 32ND ST  
NEW YORK, NY 10016

FOR: IMAGING, SCANNING, DIGITIZING, AL-  
TERATION AND/OR RETOUCHING OF VISUAL  
ELEMENTS IN THE NATURE OF DIGITAL PHOTO-  
GRAPHIC IMAGES, IN CLASS 40 (U.S. CLS. 100, 103  
AND 106).

FIRST USE 7-17-2002; IN COMMERCE 7-17-2002.

THE MARK CONSISTS OF STANDARD CHAR-  
ACTERS WITHOUT CLAIM TO ANY PARTICULAR  
FONT, STYLE, SIZE, OR COLOR.

SER. NO. 77-188,009, FILED P.R. 5-23-2007; AM. S.R.  
5-14-2008.

CURTIS FRENCH, EXAMINING ATTORNEY

**Int. Cl.: 29**

**Prior U.S. Cl.: 46**

**United States Patent and Trademark Office**

**Reg. No. 3,455,937**

**Registered June 24, 2008**

**TRADEMARK  
SUPPLEMENTAL REGISTER**



SIGMA ALIMENTOS, S.A. DE C.V. (MEXICO CORPORATION)  
COLONIA CARRIZALEJO  
AVENIDA GOMEZ MORIN NO. 1111  
SAN PEDRO GRAZA GARCIA, MEXICO 66254

FOR: PROCESSED MEAT, NAMELY, MEAT COMBINED WITH TEXTURED VEGETABLE PROTEIN FOR USE AS A MEAT SUBSTITUTE, IN CLASS 29 (U.S. CL. 46).

OWNER OF MEXICO REG. NO. 885098, DATED 6-9-2005, EXPIRES 6-9-2015.

THE MARK CONSISTS OF STYLIZED WORD "GUTEN" WITH A RIBBON BACKGROUND.

THE ENGLISH TRANSLATION OF THE WORD "GUTEN" IN THE MARK IS GOOD.

SER. NO. 77-192,105, FILED P.R. 5-29-2007; AM. S.R. 5-19-2008.

DOMINICK J. SALEMI, EXAMINING ATTORNEY

**Int. Cl.: 9**

**Prior U.S. Cls.: 21, 23, 26, 36, and 38**

**United States Patent and Trademark Office**

**Reg. No. 3,455,938**

**Registered June 24, 2008**

**TRADEMARK  
SUPPLEMENTAL REGISTER**

**AUDIOGEAR**

LOGICAL CHOICE TECHNOLOGIES, INC.  
(GEORGIA CORPORATION)  
SUITE 200  
3305 BRECKINRIDGE BLVD.  
DULUTH, GA 30096

FOR: PUBLIC-ADDRESS SYSTEMS CONSISTING OF AUDIO AMPLIFIERS, AUDIO MIXERS, AUDIO SPEAKERS, AUDIO RECEIVERS, AUDIO TRANSMITTERS, AUDIO EQUALIZERS, AND MICROPHONES, USED AS A PERIPHERAL DEVICE TO AND IN CONJUNCTION WITH ELECTRONIC WHITEBOARDS, FOR USE BY EDUCATIONAL

INSTITUTIONS IN CLASSROOMS, IN CLASS 9 (U.S. CLS. 21, 23, 26, 36 AND 38).

FIRST USE 10-1-2006; IN COMMERCE 11-10-2006.

THE MARK CONSISTS OF STANDARD CHARACTERS WITHOUT CLAIM TO ANY PARTICULAR FONT, STYLE, SIZE, OR COLOR.

SER. NO. 77-193,368, FILED P.R. 5-30-2007; AM. S.R. 4-23-2008.

TINA BROWN, EXAMINING ATTORNEY

**Int. Cl.: 38**

**Prior U.S. Cls.: 100, 101, and 104**

**United States Patent and Trademark Office**

**Reg. No. 3,455,939**

**Registered June 24, 2008**

**SERVICE MARK  
SUPPLEMENTAL REGISTER**

**800PHONEUSA**

GODA COMMUNICATIONS, LLC (ARIZONA  
LTD LIAB CO)  
P.M.B. 316, 11445 E. VIA LINDA #2  
SCOTTSDALE, AZ 85259

THE MARK CONSISTS OF STANDARD CHAR-  
ACTERS WITHOUT CLAIM TO ANY PARTICULAR  
FONT, STYLE, SIZE, OR COLOR.

FOR: INTERNATIONAL TELEPHONE SERVICES;  
LONG DISTANCE TELEPHONE COMMUNICA-  
TION SERVICES, IN CLASS 38 (U.S. CLS. 100, 101  
AND 104).

SER. NO. 77-197,152, FILED P.R. 6-4-2007; AM. S.R.  
3-14-2008.

FIRST USE 6-14-2005; IN COMMERCE 1-19-2007.

ASMAT KHAN, EXAMINING ATTORNEY

**Int. Cl.: 9**

**Prior U.S. Cls.: 21, 23, 26, 36, and 38**

**United States Patent and Trademark Office**

**Reg. No. 3,455,940**

**Registered June 24, 2008**

**TRADEMARK  
SUPPLEMENTAL REGISTER**

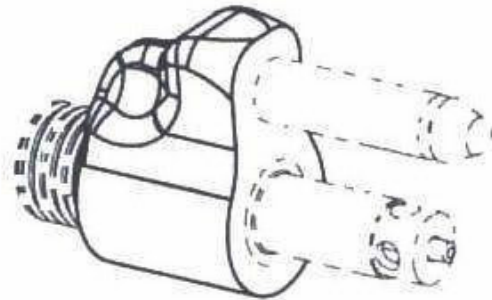

SCEPTER CORPORATION (CANADA CORPORATION)  
170 MIDWEST ROAD  
SCARBOROUGH, ONTARIO, CANADA M1P3A9

FOR: FUEL TANK CONNECTORS FOR WATER-CRAFT, IN CLASS 9 (U.S. CLS. 21, 23, 26, 36 AND 38).

FIRST USE 9-17-2006; IN COMMERCE 9-17-2006.

THE MARK CONSISTS OF THE DESIGN OF A FUEL TANK CONNECTOR. THE MATTER SHOWN IN BROKEN LINES IS NOT PART OF THE MARK.

SER. NO. 77-199,033, FILED P.R. 6-6-2007; AM. S.R. 3-24-2008.

WANDA KAY PRICE, EXAMINING ATTORNEY

**Int. Cl.: 41**

**Prior U.S. Cls.: 100, 101, and 107**

**United States Patent and Trademark Office**

**Reg. No. 3,455,941**

**Registered June 24, 2008**

**SERVICE MARK  
SUPPLEMENTAL REGISTER**

**bizSanDiego**

BIZSANDIEGO, LLC (ARIZONA LTD LIAB CO)  
80 E. RIO SALADO PKWY, #711  
TEMPE, AZ 85281

FOR: PUBLICATION OF MAGAZINES AND ON-  
LINE PUBLICATION OF MAGAZINES, IN CLASS 41  
(U.S. CLS. 100, 101 AND 107).

FIRST USE 7-15-2006; IN COMMERCE 10-15-2006.

THE MARK CONSISTS OF STANDARD CHAR-  
ACTERS WITHOUT CLAIM TO ANY PARTICULAR  
FONT, STYLE, SIZE, OR COLOR.

SER. NO. 77-199,769, FILED P.R. 6-6-2007; AM. S.R.  
3-7-2008.

JOHN SCHUYLER YARD, EXAMINING ATTOR-  
NEY

**Int. Cl.: 19**

**Prior U.S. Cls.: 1, 12, 33, and 50**

**United States Patent and Trademark Office**

**Reg. No. 3,455,942**

**Registered June 24, 2008**

**TRADEMARK  
SUPPLEMENTAL REGISTER**

**WEED TRAP**

AMES TRUE TEMPER PROPERTIES, INC. (MI-  
CHIGAN CORPORATION)

300 DELAWARE AVENUE, SUITE 1704

WILMINGTON, DE 19801

FOR: GEOTEXTILES, NAMELY, FABRIC AND  
SHEETING FOR LANDSCAPING, IN CLASS 19 (U.S.  
CLS. 1, 12, 33 AND 50).

FIRST USE 1-1-2008; IN COMMERCE 1-1-2008.

THE MARK CONSISTS OF STANDARD CHAR-  
ACTERS WITHOUT CLAIM TO ANY PARTICULAR  
FONT, STYLE, SIZE, OR COLOR.

NO CLAIM IS MADE TO THE EXCLUSIVE  
RIGHT TO USE "TRAP", APART FROM THE MARK  
AS SHOWN.

SER. NO. 77-206,269, FILED P.R. 6-14-2007; AM. S.R.  
3-21-2008.

MICHELE SWAIN, EXAMINING ATTORNEY



Int. Cl.: 16

Prior U.S. Cls.: 2, 5, 22, 23, 29, 37, 38, and 50

United States Patent and Trademark Office

Reg. No. 3,455,943

Registered June 24, 2008

TRADEMARK  
SUPPLEMENTAL REGISTER



AMERICAN ARTHRITIS SOCIETY, INC. (DELA-  
WARE CORPORATION)

SUITE 1100

28 STATE STREET

BOSTON, MA 02109

FOR: NEWSLETTERS AND MAGAZINES IN THE  
FIELD OF HEALTH, IN CLASS 16 (U.S. CLS. 2, 5, 22,  
23, 29, 37, 38 AND 50).

FIRST USE 7-1-2004; IN COMMERCE 7-1-2004.

OWNER OF U.S. REG. NO. 2,983,098.

NO CLAIM IS MADE TO THE EXCLUSIVE  
RIGHT TO USE "ARTHRITIS", APART FROM THE  
MARK AS SHOWN.

THE COLOR(S) RED AND BLUE IS/ARE  
CLAIMED AS A FEATURE OF THE MARK.

THE MARK CONSISTS OF THE WORD "ARTHRI-  
TIS" IN BLUE AND THE STYLIZED WORD "INFO"  
IN RED.

SER. NO. 77-206,967, FILED P.R. 6-15-2007; AM. S.R.  
5-13-2008.

CHRIS WELLS, EXAMINING ATTORNEY

**Int. Cl.: 25**

**Prior U.S. Cls.: 22 and 39**

**United States Patent and Trademark Office**

**Reg. No. 3,455,944**

**Registered June 24, 2008**

**TRADEMARK  
SUPPLEMENTAL REGISTER**

**EXPEDITION FLEECE**

BASS PRO TRADEMARKS, L.L.C. (MISSOURI  
LTD LIAB CO)

2500 EAST KEARNEY

SPRINGFIELD, MO 65898

FOR: HUNTING CLOTHING, NAMELY, JACK-  
ETS, PANTS, AND CAPS, IN CLASS 25 (U.S. CLS. 22  
AND 39).

FIRST USE 6-0-2005; IN COMMERCE 6-0-2005.

THE MARK CONSISTS OF STANDARD CHAR-  
ACTERS WITHOUT CLAIM TO ANY PARTICULAR  
FONT, STYLE, SIZE, OR COLOR.

NO CLAIM IS MADE TO THE EXCLUSIVE  
RIGHT TO USE "FLEECE", APART FROM THE  
MARK AS SHOWN.

SER. NO. 77-208,507, FILED P.R. 6-18-2007; AM. S.R.  
5-13-2008.

KATHY DE JONGE, EXAMINING ATTORNEY

**Int. Cl.: 44**

**Prior U.S. Cls.: 100 and 101**

**United States Patent and Trademark Office**

**Reg. No. 3,455,945**

**Registered June 24, 2008**

**SERVICE MARK  
SUPPLEMENTAL REGISTER**

**A FACE LIFT WITH A LASER??**

SOUTH COAST MANAGEMENT SERVICES, INC.  
(CALIFORNIA CORPORATION)  
2901 W. COAST HIGHWAY, SUITE 150  
NEWPORT BEACH, CA 92663

THE MARK CONSISTS OF STANDARD CHARACTERS WITHOUT CLAIM TO ANY PARTICULAR FONT, STYLE, SIZE, OR COLOR.

FOR: AESTHETIC MEDICAL SERVICES, NAME-  
LY, COSMETIC LASER TREATMENT PROCE-  
DURES, IN CLASS 44 (U.S. CLS. 100 AND 101).

SER. NO. 77-208,543, FILED P.R. 6-18-2007; AM. S.R.  
3-24-2008.

FIRST USE 7-0-2007; IN COMMERCE 7-0-2007.

PAUL E. FAHRENKOPF, EXAMINING ATTORNEY

**Int. Cls.: 35 and 41**

**Prior U.S. Cls.: 100, 101, 102, and 107**

**United States Patent and Trademark Office**

**Reg. No. 3,455,946**

**Registered June 24, 2008**

**SERVICE MARK  
SUPPLEMENTAL REGISTER**

**America's  
Beauty Show**

CHICAGO COSMETOLOGISTS ASSOCIATION,  
INC. (ILLINOIS CORPORATION)  
401 NORTH MICHIGAN AVENUE  
CHICAGO, IL 60611

FOR: ASSOCIATION SERVICES, NAMELY, PRO-  
MOTING THE INTERESTS OF AN ORGANIZATION  
OF COSMETOLOGISTS, IN CLASS 35 (U.S. CLS. 100,  
101 AND 102).

FIRST USE 5-2-2007; IN COMMERCE 5-2-2007.

FOR: EDUCATIONAL SERVICES, NAMELY,  
CONDUCTING WORKSHOPS, SEMINARS, AND  
CLASSES IN THE FIELD OF COSMETOLOGY, IN  
CLASS 41 (U.S. CLS. 100, 101 AND 107).

FIRST USE 5-2-2007; IN COMMERCE 5-2-2007.

OWNER OF U.S. REG. NO. 2,619,109.

NO CLAIM IS MADE TO THE EXCLUSIVE  
RIGHT TO USE "BEAUTY SHOW", APART FROM  
THE MARK AS SHOWN.

THE COLOR(S) RED AND PURPLE IS/ARE  
CLAIMED AS A FEATURE OF THE MARK.

THE MARK CONSISTS OF "AMERICA'S" IN RED  
AND "BEAUTY SHOW" IN PURPLE.

SER. NO. 77-215,499, FILED P.R. 6-26-2007; AM. S.R.  
3-25-2008.

ASMAT KHAN, EXAMINING ATTORNEY

**Int. Cl.: 18**

**Prior U.S. Cls.: 1, 2, 3, 22, and 41**

**United States Patent and Trademark Office**

**Reg. No. 3,455,947**

**Registered June 24, 2008**

**TRADEMARK  
SUPPLEMENTAL REGISTER**

**THE BEST BAG**

PERFORMANCE PACKAGING OF NEVADA  
(NEVADA LTD LIAB CO)  
6430 MEDICAL CENTER STREET, SUITE 102  
LAS VEGAS, NV 89148

FOR: ALL-PURPOSE CARRYING BAGS, IN  
CLASS 18 (U.S. CLS. 1, 2, 3, 22 AND 41).

FIRST USE 11-1-2007; IN COMMERCE 11-1-2007.

THE MARK CONSISTS OF STANDARD CHAR-  
ACTERS WITHOUT CLAIM TO ANY PARTICULAR  
FONT, STYLE, SIZE, OR COLOR.

NO CLAIM IS MADE TO THE EXCLUSIVE  
RIGHT TO USE "BAG", APART FROM THE MARK  
AS SHOWN.

SER. NO. 77-218,267, FILED P.R. 6-28-2007; AM. S.R.  
3-31-2008.

WILLIAM BRECKENFELD, EXAMINING ATTOR-  
NEY

Int. Cl.: 41

Prior U.S. Cls.: 100, 101, and 107

United States Patent and Trademark Office

Reg. No. 3,455,948

Registered June 24, 2008

**SERVICE MARK  
SUPPLEMENTAL REGISTER**



BABSON, JAMES HILTON (UNITED STATES  
INDIVIDUAL)  
SUITE 35  
868 GULLEY DRIVE  
CLAYTON, NC 27528

FOR: PRODUCING EDUCATIONAL RESOURCES,  
NAMESLY VIDEOS, DISTRIBUTED VIA THE  
INTERNET FOR PROVIDING CAREER INFORMATION  
FOR HIGH SCHOOL AND COLLEGE STUDENTS,  
IN CLASS 41 (U.S. CLS. 100, 101 AND 107).

FIRST USE 7-15-2007; IN COMMERCE 7-15-2007.

NO CLAIM IS MADE TO THE EXCLUSIVE  
RIGHT TO USE "EDUCATIONAL SERVICES",  
APART FROM THE MARK AS SHOWN.

SER. NO. 77-221,150, FILED P.R. 7-3-2007; AM. S.R.  
2-27-2008.

MARY BOAGNI, EXAMINING ATTORNEY

**Int. Cl.: 36**

**Prior U.S. Cls.: 100, 101, and 102**

**United States Patent and Trademark Office**

**Reg. No. 3,455,949**

**Registered June 24, 2008**

**SERVICE MARK  
SUPPLEMENTAL REGISTER**

**LIFE ANALYTICS**

LIFE ANALYTICS, LLC (NORTH CAROLINA  
LTD LIAB CO)  
SUITE 1200  
6000 FAIRVIEW RD, SOUTHPARK TOWERS  
CHARLOTTE, NC 28210

FOR: PROVIDING INFORMATION IN INSUR-  
ANCE MATTERS, IN CLASS 36 (U.S. CLS. 100, 101  
AND 102).

FIRST USE 4-7-2008; IN COMMERCE 4-7-2008.

THE MARK CONSISTS OF STANDARD CHAR-  
ACTERS WITHOUT CLAIM TO ANY PARTICULAR  
FONT, STYLE, SIZE, OR COLOR.

SER. NO. 77-221,473, FILED P.R. 7-3-2007; AM. S.R.  
4-8-2008.

PAUL E. FAHRENKOPF, EXAMINING ATTORNEY

**Int. Cl.: 36**

**Prior U.S. Cls.: 100, 101, and 102**

**United States Patent and Trademark Office**

**Reg. No. 3,455,950**

**Registered June 24, 2008**

**SERVICE MARK  
SUPPLEMENTAL REGISTER**

**FOUNDATION FOR HEALTH  
COVERAGE EDUCATION**

FOUNDATION FOR HEALTH COVERAGE EDUCATION (CALIFORNIA NON-PROFIT PUBLIC BENEFIT CORPORATION)

SUITE 250  
101 METRO DRIVE  
SAN JOSE, CA 95110

FOR: PROVIDING INFORMATION TO HEALTH CARE PROFESSIONALS, EMPLOYERS, BROKERS AND INDIVIDUALS REGARDING PUBLIC AND PRIVATE HEALTH INSURANCE AND REGARDING HEALTH CARE PROVIDERS AVAILABLE THROUGH HEALTH INSURANCE PROGRAMS, IN CLASS 36 (U.S. CLS. 100, 101 AND 102).

FIRST USE 12-31-2003; IN COMMERCE 12-31-2003.

THE MARK CONSISTS OF STANDARD CHARACTERS WITHOUT CLAIM TO ANY PARTICULAR FONT, STYLE, SIZE, OR COLOR.

NO CLAIM IS MADE TO THE EXCLUSIVE RIGHT TO USE "HEALTH COVERAGE", APART FROM THE MARK AS SHOWN.

SER. NO. 77-226,923, FILED P.R. 7-11-2007; AM. S.R. 4-15-2008.

AISHA CLARKE, EXAMINING ATTORNEY



**Int. Cl.: 41**

**Prior U.S. Cls.: 100, 101, and 107**

**United States Patent and Trademark Office**

**Reg. No. 3,455,951**

**Registered June 24, 2008**

**SERVICE MARK  
SUPPLEMENTAL REGISTER**

**Certified Peace Teacher**

TEACH PEACE FOUNDATION (CALIFORNIA  
CORPORATION)  
539 J STREET  
DAVIS, CA 95616

FOR: EDUCATIONAL SERVICES, NAMELY,  
CONDUCTING PROGRAMS IN THE FIELD OF  
PEACE, IN CLASS 41 (U.S. CLS. 100, 101 AND 107).

FIRST USE 7-0-2007; IN COMMERCE 7-0-2007.

THE MARK CONSISTS OF STANDARD CHAR-  
ACTERS WITHOUT CLAIM TO ANY PARTICULAR  
FONT, STYLE, SIZE, OR COLOR.

SER. NO. 77-235,458, FILED P.R. 7-21-2007; AM. S.R.  
4-25-2008.

DORITT L. CARROLL, EXAMINING ATTORNEY

**Int. Cls.: 17 and 19**

**Prior U.S. Cls.: 1, 5, 12, 13, 33, 35, and 50**

**United States Patent and Trademark Office**

**Reg. No. 3,455,952**

**Registered June 24, 2008**

**TRADEMARK  
SUPPLEMENTAL REGISTER**

**READY BUILDING PRODUCTS**

READY BUILDING PRODUCTS, INC. (FLORIDA  
CORPORATION)  
SUITE 104  
6220 TAYLOR ROAD  
NAPLES, FL 34109

FOR: JOINTING MATERIAL FOR MASONRY, IN  
CLASS 17 (U.S. CLS. 1, 5, 12, 13, 35 AND 50).

FIRST USE 2-15-2008; IN COMMERCE 2-15-2008.

FOR: CONCRETE MIX, MORTAR MIX, SAND  
MIX, SAND, STUCCO MIX AND GROUT MIX, IN  
CLASS 19 (U.S. CLS. 1, 12, 33 AND 50).

FIRST USE 2-15-2008; IN COMMERCE 2-15-2008.

THE MARK CONSISTS OF STANDARD CHAR-  
ACTERS WITHOUT CLAIM TO ANY PARTICULAR  
FONT, STYLE, SIZE, OR COLOR.

NO CLAIM IS MADE TO THE EXCLUSIVE  
RIGHT TO USE "BUILDING PRODUCTS", APART  
FROM THE MARK AS SHOWN.

SER. NO. 77-237,286, FILED P.R. 7-24-2007; AM. S.R.  
4-7-2008.

DANIEL CAPSHAW, EXAMINING ATTORNEY

Int. Cl.: 25

Prior U.S. Cls.: 22 and 39

United States Patent and Trademark Office

Reg. No. 3,455,953

Registered June 24, 2008

TRADEMARK  
SUPPLEMENTAL REGISTER

LORICK

LORICK APPAREL, INC. (NEW YORK CORPORATION)  
350 1ST AVE  
NEW YORK, NY 10010

FOR: DRESSES; SHORTS; BELTS; PANTS;  
SCARVES; SKIRTS; BLOUSES; TIES; JACKETS;  
TOPS; SHIRTS; BOTTOMS, IN CLASS 25 (U.S. CLS.  
22 AND 39).

FIRST USE 0-0-2007; IN COMMERCE 0-0-2007.

SER. NO. 77-237,888, FILED P.R. 7-25-2007; AM. S.R.  
5-2-2008.

KRISTINA MORRIS, EXAMINING ATTORNEY

**Int. Cl.: 43**

**Prior U.S. Cls.: 100 and 101**

**United States Patent and Trademark Office**

**Reg. No. 3,455,954**

**Registered June 24, 2008**

**SERVICE MARK  
SUPPLEMENTAL REGISTER**

**BLOOMINGTON CHOPHOUSE**

THE MARCUS CORPORATION (WISCONSIN  
CORPORATION)  
100 E. WISCONSIN AVENUE, SUITE 1900  
MILWAUKEE, WI 53202

FOR: RESTAURANT SERVICES, IN CLASS 43  
(U.S. CLS. 100 AND 101).

FIRST USE 1-27-2008; IN COMMERCE 1-27-2008.

THE MARK CONSISTS OF STANDARD CHAR-  
ACTERS WITHOUT CLAIM TO ANY PARTICULAR  
FONT, STYLE, SIZE, OR COLOR.

OWNER OF U.S. REG. NOS. 2,828,412 AND  
3,204,741.

NO CLAIM IS MADE TO THE EXCLUSIVE  
RIGHT TO USE "CHOPHOUSE", APART FROM  
THE MARK AS SHOWN.

SER. NO. 77-238,509, FILED P.R. 7-25-2007; AM. S.R.  
5-16-2008.

KATHRYN COWARD, EXAMINING ATTORNEY

**Int. Cl.: 36**

**Prior U.S. Cls.: 100, 101, and 102**

**United States Patent and Trademark Office**

**Reg. No. 3,455,955**

**Registered June 24, 2008**

**SERVICE MARK  
SUPPLEMENTAL REGISTER**

**SOUTHERN CALIFORNIA  
VACATION RENTALS**

SCVR, CORPORATION (CALIFORNIA CORPORATION)  
5666 LA JOLLA BLVD #113  
LA JOLLA, CA 92037

FOR: REAL ESTATE SERVICES, NAMELY, RENTAL OF VACATION HOMES, CONDOMINIUMS, CABINS, AND VILLAS; REAL ESTATE RENTAL LISTING, IN CLASS 36 (U.S. CLS. 100, 101 AND 102).

FIRST USE 1-1-2002; IN COMMERCE 1-1-2002.

THE MARK CONSISTS OF STANDARD CHARACTERS WITHOUT CLAIM TO ANY PARTICULAR FONT, STYLE, SIZE, OR COLOR.

NO CLAIM IS MADE TO THE EXCLUSIVE RIGHT TO USE "VACATION RENTALS", APART FROM THE MARK AS SHOWN.

SER. NO. 77-240,582, FILED P.R. 7-27-2007; AM. S.R. 3-19-2008.

GINA HAYES, EXAMINING ATTORNEY

**Int. Cl.: 41**

**Prior U.S. Cls.: 100, 101, and 107**

**United States Patent and Trademark Office**

**Reg. No. 3,455,956**

**Registered June 24, 2008**

**SERVICE MARK  
SUPPLEMENTAL REGISTER**

**Atlanta Salon and Spa**

FAHEY, THOMAS, D (ANGOLA INDIVIDUAL)  
1343 MIDDLESEX AVE. NE  
ATLANTA, GA 30306

FOR: PUBLICATION OF MAGAZINES; PUBLICATION OF ELECTRONIC MAGAZINES; PUBLISHING OF WEB MAGAZINES, IN CLASS 41 (U.S. CLS. 100, 101 AND 107).

FIRST USE 4-1-2007; IN COMMERCE 7-1-2007.

THE MARK CONSISTS OF STANDARD CHARACTERS WITHOUT CLAIM TO ANY PARTICULAR FONT, STYLE, SIZE, OR COLOR.

NO CLAIM IS MADE TO THE EXCLUSIVE RIGHT TO USE "SALON" AND "SPA", APART FROM THE MARK AS SHOWN.

SER. NO. 77-243,384, FILED 7-31-2007.

HEATHER SAPP, EXAMINING ATTORNEY

**Int. Cl.: 36**

**Prior U.S. Cls.: 100, 101, and 102**

**United States Patent and Trademark Office**

**Reg. No. 3,455,957**

**Registered June 24, 2008**

**SERVICE MARK  
SUPPLEMENTAL REGISTER**

**GREENHOMEFINDER**

GREEN HOME FINDER, LLC (COLORADO LTD  
LIAB CO)  
13348 PEARL CIRCLE  
THORNTON, CO 80241

FIRST USE 7-28-2006; IN COMMERCE 7-28-2006.

THE MARK CONSISTS OF STANDARD CHAR-  
ACTERS WITHOUT CLAIM TO ANY PARTICULAR  
FONT, STYLE, SIZE, OR COLOR.

FOR: PROVIDING REAL ESTATE LISTINGS AND  
REAL ESTATE INFORMATION VIA THE INTER-  
NET SPECIFICALLY IN THE AREA OF SUSTAIN-  
A B L E , E N E R G Y E F F I C I E N T ,  
ENVIRONMENTALLY RESPONSIBLE RESIDEN-  
TIAL AND COMMERCIAL PROPERTIES, IN CLASS  
36 (U.S. CLS. 100, 101 AND 102).

SER. NO. 77-243,824, FILED P.R. 8-1-2007; AM. S.R.  
5-12-2008.

DAWN FELDMAN, EXAMINING ATTORNEY

**Int. Cl.: 35**

**Prior U.S. Cls.: 100, 101, and 102**

**United States Patent and Trademark Office**

**Reg. No. 3,455,958**

**Registered June 24, 2008**

**SERVICE MARK  
SUPPLEMENTAL REGISTER**

# Senior Staffer

SENIOR STAFF LLC (VIRGINIA LTD LIAB CO)  
P.O. BOX 1454  
ASHBURN, VA 20146

THE MARK CONSISTS OF STANDARD CHARACTERS WITHOUT CLAIM TO ANY PARTICULAR FONT, STYLE, SIZE, OR COLOR.

FOR: PROVIDING AN ONLINE SEARCHABLE DATABASE FEATURING EMPLOYMENT OPPORTUNITIES AND CONTENT RELEVANT TO PEOPLE 50 YEARS OF AGE AND OLDER, IN CLASS 35 (U.S. CLS. 100, 101 AND 102).

SER. NO. 77-245,061, FILED P.R. 8-2-2007; AM. S.R. 5-14-2008.

FIRST USE 4-2-2008; IN COMMERCE 4-2-2008.

LINDA E. BLOHM, EXAMINING ATTORNEY



**Int. Cl.: 16**

**Prior U.S. Cls.: 2, 5, 22, 23, 29, 37, 38, and 50**

**United States Patent and Trademark Office**

**Reg. No. 3,455,959**

**Registered June 24, 2008**

**TRADEMARK  
SUPPLEMENTAL REGISTER**

# Brinkley Books

JOHNSON, LAURA LEAH (UNITED STATES IN-  
DIVIDUAL)

PO BOX 1753

HEALDSBURG, CA 95448

FOR: CHILDREN'S BOOKS, IN CLASS 16 (U.S.  
CLS. 2, 5, 22, 23, 29, 37, 38 AND 50).

FIRST USE 5-17-2007; IN COMMERCE 5-17-2007.

THE MARK CONSISTS OF STANDARD CHAR-  
ACTERS WITHOUT CLAIM TO ANY PARTICULAR  
FONT, STYLE, SIZE, OR COLOR.

NO CLAIM IS MADE TO THE EXCLUSIVE  
RIGHT TO USE "BOOKS", APART FROM THE  
MARK AS SHOWN.

SER. NO. 77-245,235, FILED P.R. 8-2-2007; AM. S.R.  
5-13-2008.

ALEX KEAM, EXAMINING ATTORNEY

**Int. Cl.: 42**

**Prior U.S. Cls.: 100 and 101**

**United States Patent and Trademark Office**

**Reg. No. 3,455,960**

**Registered June 24, 2008**

**SERVICE MARK  
SUPPLEMENTAL REGISTER**

**BRIDGEWATCH**

USENGINEERING SOLUTIONS CORPORATION  
(DELAWARE CORPORATION)  
179 ALLYN STREET #407  
HARTFORD, CT 06103

FOR: APPLICATION SERVICE PROVIDER (ASP)  
FEATURING SOFTWARE FOR USE IN REAL-TIME  
MONITORING OF BRIDGES, BRIDGE INFRA-  
STRUCTURE, AND THE ENVIRONMENT  
AROUND BRIDGES AND DAM INFRASTRUC-  
TURE, IN CLASS 42 (U.S. CLS. 100 AND 101).

FIRST USE 5-18-2007; IN COMMERCE 12-3-2007.

THE MARK CONSISTS OF STANDARD CHAR-  
ACTERS WITHOUT CLAIM TO ANY PARTICULAR  
FONT, STYLE, SIZE, OR COLOR.

SER. NO. 77-246,088, FILED P.R. 8-2-2007; AM. S.R.  
5-16-2008.

BRIAN CALLAGHAN, EXAMINING ATTORNEY

**Int. Cl.: 39**

**Prior U.S. Cls.: 100 and 105**

**United States Patent and Trademark Office**

**Reg. No. 3,455,961**

**Registered June 24, 2008**

**SERVICE MARK  
SUPPLEMENTAL REGISTER**

# Valet Express

AMERIPARK, INC. (GEORGIA CORPORATION)  
SUITE 300  
359 E. PACES FERRY RD.  
ATLANTA, GA 30305

FOR: EXPEDITED VALET PARKING SERVICE  
BY USE OF A REMOTE SIGNALING DEVICE TO  
INDICATE OWNER'S READINESS FOR VEHICLE,  
IN CLASS 39 (U.S. CLS. 100 AND 105).

FIRST USE 7-1-2005; IN COMMERCE 7-1-2005.

THE MARK CONSISTS OF STANDARD CHAR-  
ACTERS WITHOUT CLAIM TO ANY PARTICULAR  
FONT, STYLE, SIZE, OR COLOR.

NO CLAIM IS MADE TO THE EXCLUSIVE  
RIGHT TO USE "VALET", APART FROM THE  
MARK AS SHOWN.

SER. NO. 77-247,588, FILED P.R. 8-6-2007; AM. S.R.  
4-25-2008.

JOHN E. MICHOS, EXAMINING ATTORNEY

**Int. Cl.: 36**

**Prior U.S. Cls.: 100, 101, and 102**

**United States Patent and Trademark Office**

**Reg. No. 3,455,962**

**Registered June 24, 2008**

**SERVICE MARK  
SUPPLEMENTAL REGISTER**

**CELL PHONES FOR SOLDIERS**

CELL PHONES FOR SOLDIERS, INC. (MASSACHUSETTS NON-PROFIT CORPORATION)  
243 WINTER STREET  
NORWELL, MA 02061

FOR: CHARITABLE SERVICES, NAMELY, COLLECTING MONETARY DONATIONS AND DONATED CELL PHONES THAT ARE THEN SOLD, WITH THE COMBINED PROCEEDS OF THE MONETARY DONATIONS AND SALE OF THE DONATED CELL PHONES GOING TO PREPAID TELEPHONE CALLING CARDS FOR SOLDIERS, IN CLASS 36 (U.S. CLS. 100, 101 AND 102).

FIRST USE 4-0-2004; IN COMMERCE 4-0-2004.

THE MARK CONSISTS OF STANDARD CHARACTERS WITHOUT CLAIM TO ANY PARTICULAR FONT, STYLE, SIZE, OR COLOR.

SER. NO. 77-247,619, FILED P.R. 8-6-2007; AM. S.R. 4-3-2008.

DAVID COLLIER, EXAMINING ATTORNEY

**Int. Cls.: 7, 9, and 11**

**Prior U.S. Cls.: 13, 19, 21, 23, 26, 31, 34, 35, 36, and 38**

**Reg. No. 3,455,963**

**United States Patent and Trademark Office**

**Registered June 24, 2008**

**TRADEMARK  
SUPPLEMENTAL REGISTER**

# STEEL CITY

STEEL CITY TOOL WORKS, LLC (PENNSYLVANIA LTD LIAB CO)  
P.O. BOX 10529  
MURFREESBORO, TN 37129

FOR: POWER-OPERATED TABLE SAWS, POWER-OPERATED BAND SAWS, POWER-OPERATED JOINTERS AND WOOD JOINING MACHINES, NAMELY, THICKNESS PLANERS, WOOD PLANING MACHINES, 15-INCH AND 20-INCH ELECTRIC PLANERS, POWER-OPERATED PLANERS, POWER OPERATED PLANER-JOINTERS, DRILL PRESSES WITH 17-INCH SWING AND GRINDERS WITH 8 INCH AND 10 INCH DIAMETER WHEELS, NAMELY, POWER-OPERATED GRINDING WHEELS, POWER-OPERATED TOOLS IN THE NATURE OF GRINDERS AND MORTISERS, NAMELY, WOOD-WORKING MACHINES IN THE NATURE OF HOLLOW CHISEL MORTISERS; DUST COLLECTORS, NAMELY, VACUUM CLEANERS FOR INDUSTRIAL WOOD-WORKING CHIP REMOVAL PURPOSES, DUST COLLECTORS AS STRUCTURAL PARTS OF WOOD-WORKING MACHINES AND OTHER DUST PRODUCING POWER TOOLS, POWER-OPERATED LATHES, SHAPERS, NAMELY, WOOD-WORKING MACHINES IN THE NATURE OF SPINDLE SHAPERS, WOOD-WORKING MACHINES IN THE NATURE OF WOOD TURNING LATHES, ABRASIVE MACHINES, NAMELY, OSCILLATING SPINDLE SANDERS, OSCILLATING EDGE SANDERS, POWERED DUAL DRUM SANDERS, NONCLAMPING ACCESSORIES FOR USE WITH WOOD-WORKING MACHINERY, NAMELY, CARBIDE TIPPED SAW BLADES FOR USE WITH POWER-OPERATED TABLE SAWS, POWER SAW

BLADES, AIR SUCTION MACHINES IN THE NATURE OF DUST AND CHIP EXTRACTORS SPECIFICALLY DESIGNED FOR WOOD-WORKING MACHINES, IN CLASS 7 (U.S. CLS. 13, 19, 21, 23, 31, 34 AND 35).

FIRST USE 8-31-2006; IN COMMERCE 8-31-2006.

FOR: NON-CLAMPING ACCESSORIES FOR USE WITH WOOD-WORKING MACHINERY, NAMELY, LASER DEVICES FOR PROJECTING A VISIBLE LINE ON A WORK PIECE TO BE DRILLED BY A DRILL PRESS, IN CLASS 9 (U.S. CLS. 21, 23, 26, 36 AND 38).

FIRST USE 8-31-2006; IN COMMERCE 8-31-2006.

FOR: DUST COLLECTORS AND AIR CLEANERS, NAMELY, AMBIENT AIR CLEANING UNITS, AIR FILTERING INSTALLATIONS, AIR PURIFYING APPARATUS AND MACHINES, AIR FILTERS FOR INDUSTRIAL APPLICATIONS, IN CLASS 11 (U.S. CLS. 13, 21, 23, 31 AND 34).

FIRST USE 8-31-2006; IN COMMERCE 8-31-2006.

THE MARK CONSISTS OF STANDARD CHARACTERS WITHOUT CLAIM TO ANY PARTICULAR FONT, STYLE, SIZE, OR COLOR.

SER. NO. 77-247,681, FILED P.R. 8-6-2007; AM. S.R. 5-19-2008.

MICHAEL TANNER, EXAMINING ATTORNEY

**Int. Cl.: 25**

**Prior U.S. Cls.: 22 and 39**

**United States Patent and Trademark Office**

**Reg. No. 3,455,964**

**Registered June 24, 2008**

**TRADEMARK  
SUPPLEMENTAL REGISTER**

**Warmth Management System**

PRAIS ACCESSORIES, INC (NEW YORK CORPORATION)  
350 FIFTH AVENUE 70TH FLOOR  
NEW YORK, NY 10018

FOR: HATS, GLOVES AND SCARVES, IN CLASS  
25 (U.S. CLS. 22 AND 39).

FIRST USE 5-9-2008; IN COMMERCE 5-9-2008.

THE MARK CONSISTS OF STANDARD CHARACTERS WITHOUT CLAIM TO ANY PARTICULAR FONT, STYLE, SIZE, OR COLOR.

SER. NO. 77-247,989, FILED P.R. 8-6-2007; AM. S.R. 5-12-2008.

KAREN K. BUSH, EXAMINING ATTORNEY

**Int. Cl.: 36**

**Prior U.S. Cls.: 100, 101, and 102**

**United States Patent and Trademark Office**

**Reg. No. 3,455,965**

**Registered June 24, 2008**

**SERVICE MARK  
SUPPLEMENTAL REGISTER**

**The Nation's Settlement  
Advisor**

NAF FUNDING, LLC (NEW YORK LTD LIAB  
CO)  
105 MADISON AVENUE  
NEW YORK, NY 10016

FOR: FINANCIAL SERVICES, NAMELY, LIFE  
SETTLEMENT SERVICES, IN CLASS 36 (U.S. CLS.  
100, 101 AND 102).

FIRST USE 7-1-2007; IN COMMERCE 7-1-2007.

THE MARK CONSISTS OF STANDARD CHAR-  
ACTERS WITHOUT CLAIM TO ANY PARTICULAR  
FONT, STYLE, SIZE, OR COLOR.

NO CLAIM IS MADE TO THE EXCLUSIVE  
RIGHT TO USE "SETTLEMENT ADVISOR", APART  
FROM THE MARK AS SHOWN.

SER. NO. 77-250,746, FILED 8-8-2007.

MARK SPARACINO, EXAMINING ATTORNEY

**Int. Cl.: 41**

**Prior U.S. Cls.: 100, 101, and 107**

**United States Patent and Trademark Office**

**Reg. No. 3,455,966**

**Registered June 24, 2008**

**SERVICE MARK  
SUPPLEMENTAL REGISTER**

**UNIVERSITY OF MEDICINE AND  
HEALTH SCIENCES – ST. KITTS**

ROSS, DR. ROBERT (UNITED STATES INDIVIDUAL)  
12TH FLOOR  
460 W. 34TH STREET  
NEW YORK, NY 10001

FOR: EDUCATING AT UNIVERSITY OR COLLEGES; EDUCATIONAL SERVICES, NAMELY, PROVIDING COURSES OF INSTRUCTION AT THE UNIVERSITY, COLLEGE AND VOCATIONAL LEVEL AND DISTRIBUTION OF COURSE MATERIAL IN CONNECTION THEREWITH; EDUCATION SERVICES, NAMELY, PROVIDING COURSES AND INSTRUCTION TO STUDENTS TO BECOME MEDICAL DOCTORS, NURSES, NURSE'S AIDES, LABORATORY TECHNICIANS, RADIOLOGY TECHNICIANS AND OTHER PROFESSIONALS IN

THE FIELD OF HEALTH AND SCIENCE, IN CLASS 41 (U.S. CLS. 100, 101 AND 107).

FIRST USE 9-12-2007; IN COMMERCE 9-12-2007.

THE MARK CONSISTS OF STANDARD CHARACTERS WITHOUT CLAIM TO ANY PARTICULAR FONT, STYLE, SIZE, OR COLOR.

NO CLAIM IS MADE TO THE EXCLUSIVE RIGHT TO USE "UNIVERSITY", APART FROM THE MARK AS SHOWN.

SER. NO. 77-251,795, FILED P.R. 8-9-2007; AM. S.R. 5-13-2008.

JULIE WATSON, EXAMINING ATTORNEY



**Int. Cl.: 28**

**Prior U.S. Cls.: 22, 23, 38, and 50**

**United States Patent and Trademark Office**

**Reg. No. 3,455,967**

**Registered June 24, 2008**

**TRADEMARK  
SUPPLEMENTAL REGISTER**

**THE FEEDER SCREEN**

FARR OUTDOORS (TEXAS CORPORATION)  
4598 US HIGHWAY 190  
TEMPLE, TX 76501

FOR: SPORTING GOODS, NAMELY, A FILTER  
FOR ANIMAL FEED FOR USE IN CONJUNCTION  
WITH LURES FOR HUNTING, IN CLASS 28 (U.S.  
CLS. 22, 23, 38 AND 50).

FIRST USE 5-1-2004; IN COMMERCE 5-1-2004.

THE MARK CONSISTS OF STANDARD CHAR-  
ACTERS WITHOUT CLAIM TO ANY PARTICULAR  
FONT, STYLE, SIZE, OR COLOR.

SER. NO. 77-258,992, FILED P.R. 8-20-2007; AM. S.R.  
5-16-2008.

RICHARD WHITE, EXAMINING ATTORNEY

**Int. Cl.: 41**

**Prior U.S. Cls.: 100, 101, and 107**

**United States Patent and Trademark Office**

**Reg. No. 3,455,968**

**Registered June 24, 2008**

**SERVICE MARK  
SUPPLEMENTAL REGISTER**

**THE TRAVELING PHOTO BOOTH**

THE TRAVELING PHOTO BOOTH, INC (MINNE-  
SOTA CORPORATION)  
7600 WEST 27TH STREET  
SUITE 210  
ST. LOUIS PARK, MN 55426

FOR: RENTAL OF PHOTOGRAPHIC EQUIP-  
MENT, IN CLASS 41 (U.S. CLS. 100, 101 AND 107).

FIRST USE 7-30-2005; IN COMMERCE 7-30-2005.

THE MARK CONSISTS OF STANDARD CHAR-  
ACTERS WITHOUT CLAIM TO ANY PARTICULAR  
FONT, STYLE, SIZE, OR COLOR.

OWNER OF U.S. REG. NO. 3,212,965.

NO CLAIM IS MADE TO THE EXCLUSIVE  
RIGHT TO USE "PHOTO BOOTH", APART FROM  
THE MARK AS SHOWN.

SER. NO. 77-259,637, FILED P.R. 8-20-2007; AM. S.R.  
5-5-2008.

B. PARADEWELAI, EXAMINING ATTORNEY

**Int. Cl.: 33**

**Prior U.S. Cls.: 47 and 49**

**United States Patent and Trademark Office**

**Reg. No. 3,455,969**

**Registered June 24, 2008**

**TRADEMARK  
SUPPLEMENTAL REGISTER**

# Cuvée Manseng

CHESTER GAP CELLARS, LLC (VIRGINIA CORPORATION)  
PO BOX 108  
FRONT ROYAL, VA 22630

FOR: WINE; WINES, IN CLASS 33 (U.S. CLS. 47 AND 49).

FIRST USE 2-0-2007; IN COMMERCE 4-0-2007.

THE MARK CONSISTS OF STANDARD CHARACTERS WITHOUT CLAIM TO ANY PARTICULAR FONT, STYLE, SIZE, OR COLOR.

NO CLAIM IS MADE TO THE EXCLUSIVE RIGHT TO USE "MANSENG", APART FROM THE MARK AS SHOWN.

THE FOREIGN WORDING IN THE MARK TRANSLATES INTO ENGLISH AS "VINTAGE" OR "BATCH OR VAT OF WINE" OR "BLEND".

SER. NO. 77-262,721, FILED P.R. 8-23-2007; AM. S.R. 4-21-2008.

SETH A. RAPPAPORT, EXAMINING ATTORNEY

**Int. Cls.: 9 and 41**

**Prior U.S. Cls.: 21, 23, 26, 36, 38, 100, 101, and 107**

**United States Patent and Trademark Office**

**Reg. No. 3,455,970**

**Registered June 24, 2008**

**TRADEMARK  
SERVICE MARK  
SUPPLEMENTAL REGISTER**

**INTEGRATED LISTENING  
SYSTEMS**

INTEGRATED LISTENING SYSTEMS, L.L.C.  
(COLORADO LTD LIAB CO)  
SUITE 303  
5655 SOUTH YOSEMITE STREET  
GREENWOOD VILLAGE, CO 80111

FOR: PSYCHOACOUSTICAL PROGRAMS COMPRISING, AUDIO PROCESSING EQUIPMENT, SOUND RECORDINGS, WRITTEN PROGRAM MATERIALS WITH VISUAL AND MOTOR ACTIVITY COMPONENTS, SOLD AS A PACKAGE FOR USE IN AUDITORY, VISUAL AND VESTIBULAR THERAPY AND DEVELOPMENT, IN CLASS 9 (U.S. CLS. 21, 23, 26, 36 AND 38).

FIRST USE 8-7-2007; IN COMMERCE 8-7-2007.

FOR: EDUCATIONAL SERVICES IN THE FIELD OF AUDITORY, VISUAL AND VESTIBULAR THER-

APY AND DEVELOPMENT, IN CLASS 41 (U.S. CLS. 100, 101 AND 107).

FIRST USE 9-19-2007; IN COMMERCE 10-5-2007.

THE MARK CONSISTS OF STANDARD CHARACTERS WITHOUT CLAIM TO ANY PARTICULAR FONT, STYLE, SIZE, OR COLOR.

NO CLAIM IS MADE TO THE EXCLUSIVE RIGHT TO USE "SYSTEMS", APART FROM THE MARK AS SHOWN.

SER. NO. 77-262,937, FILED P.R. 8-23-2007; AM. S.R. 5-7-2008.

CHRIS DONINGER, EXAMINING ATTORNEY

**Int. Cls.: 16 and 35**

**Prior U.S. Cls.: 2, 5, 22, 23, 29, 37, 38, 50, 100, 101, and 102**

**Reg. No. 3,455,971**

**United States Patent and Trademark Office**

**Registered June 24, 2008**

**TRADEMARK  
SERVICE MARK  
SUPPLEMENTAL REGISTER**

**LOGISTICS LEADERSHIP BOARD**

THE CORPORATE EXECUTIVE BOARD COMPAN-  
NY (DELAWARE CORPORATION)  
SUITE 6000  
2000 PENNSYLVANIA AVENUE NW  
WASHINGTON, DC 20006

FOR: PRINTED PUBLICATIONS, NAMELY, RE-  
PORTS, HANDBOOKS AND PAMPHLETS IN THE  
FIELD OF BEST PRACTICES TOOLS AND BUSI-  
NESS CASE INSIGHT, DISTRIBUTION NETWORK  
DESIGN, INFRASTRUCTURE MANAGEMENT, IN-  
FORMATION TECHNOLOGY, REGULATORY  
COMPLIANCE AND LEADERSHIP DEVELOP-  
MENT, RELATING TO LOGISTICS, IN CLASS 16  
(U.S. CLS. 2, 5, 22, 23, 29, 37, 38 AND 50).

FIRST USE 8-0-2007; IN COMMERCE 8-0-2007.

FOR: PROVIDING BUSINESS RESEARCH AND  
INFORMATION FOR OTHERS IN THE FIELD OF  
BEST PRACTICE TOOLS AND BUSINESS CASE  
INSIGHT, DISTRIBUTION NETWORK DESIGN, IN-  
FRASTRUCTURE MANAGEMENT, INFORMA-

TION TECHNOLOGY, REGULATORY  
COMPLIANCE AND LEADERSHIP DEVELOP-  
MENT, RELATING TO LOGISTICS; PROVIDING  
BUSINESS RESEARCH SERVICES DELIVERED VIA  
A GLOBAL COMPUTER NETWORK IN THE FIELD  
OF STRATEGIC, ORGANIZATIONAL AND GEN-  
ERAL MANAGEMENT ISSUES, RELATING TO  
LOGISTICS, IN CLASS 35 (U.S. CLS. 100, 101 AND  
102).

FIRST USE 8-0-2007; IN COMMERCE 8-0-2007.

THE MARK CONSISTS OF STANDARD CHAR-  
ACTERS WITHOUT CLAIM TO ANY PARTICULAR  
FONT, STYLE, SIZE, OR COLOR.

OWNER OF U.S. REG. NOS. 3,074,883, 3,140,662,  
AND OTHERS.

SER. NO. 77-265,188, FILED P.R. 8-27-2007; AM. S.R.  
4-24-2008.

TAMARA FRAZIER, EXAMINING ATTORNEY

**Int. Cls.: 35 and 41**

**Prior U.S. Cls.: 100, 101, 102, and 107**

**United States Patent and Trademark Office**

**Reg. No. 3,455,972**

**Registered June 24, 2008**

**SERVICE MARK  
SUPPLEMENTAL REGISTER**

# Yoga Month

JOHANNES R. FISSLINGER (UNITED STATES  
INDIVIDUAL)  
14013 CAPTAINS ROW # 304  
MARINA DEL REY, CA 90292

FOR: PROVIDING ADVERTISING, MARKETING  
AND PROMOTIONAL SERVICES, NAMELY, DE-  
VELOPMENT OF ADVERTISING CAMPAIGNS FOR  
TELEVISION, RADIO, PRINT, MOBILE, INTERNET  
AND DIGITAL PLATFORMS, IN CLASS 35 (U.S.  
CLS. 100, 101 AND 102).

FIRST USE 5-10-2007; IN COMMERCE 5-10-2007.

FOR: EDUCATIONAL SERVICES, NAMELY,  
CONDUCTING LIVE AND ONLINE LECTURES,

SEMINARS, CONFERENCES OR CLASSES IN THE  
FIELD OF YOGA, HEALTH AND CONSCIOUS  
ACTIVISM AND DISTRIBUTION OF COURSE MA-  
TERIAL IN CONNECTION THEREWITH, IN CLASS  
41 (U.S. CLS. 100, 101 AND 107).

FIRST USE 5-10-2007; IN COMMERCE 5-10-2007.

THE MARK CONSISTS OF STANDARD CHAR-  
ACTERS WITHOUT CLAIM TO ANY PARTICULAR  
FONT, STYLE, SIZE, OR COLOR.

SER. NO. 77-265,510, FILED P.R. 8-27-2007; AM. S.R.  
5-16-2008.

LINDA MICKLEBURGH, EXAMINING ATTORNEY

**Int. Cl.: 41**

**Prior U.S. Cls.: 100, 101, and 107**

**United States Patent and Trademark Office**

**Reg. No. 3,455,973**

**Registered June 24, 2008**

**SERVICE MARK  
SUPPLEMENTAL REGISTER**

**SUBRO COLLEGE**

NATIONAL ASSOCIATION OF SUBROGATION  
PROFESSIONALS (MINNESOTA NON-PROFIT  
ASSOCIATION)  
7301 OHMS LANE, SUITE 205  
EDINA, MN 55439

FOR: EDUCATIONAL SERVICES NAMELY CON-  
DUCTING TRAINING COURSES IN THE FIELD OF  
INSURANCE AND SUBROGATION, IN CLASS 41  
(U.S. CLS. 100, 101 AND 107).

FIRST USE 2-6-2008; IN COMMERCE 2-6-2008.

THE MARK CONSISTS OF STANDARD CHAR-  
ACTERS WITHOUT CLAIM TO ANY PARTICULAR  
FONT, STYLE, SIZE, OR COLOR.

NO CLAIM IS MADE TO THE EXCLUSIVE  
RIGHT TO USE "COLLEGE", APART FROM THE  
MARK AS SHOWN.

SER. NO. 77-268,099, FILED P.R. 8-30-2007; AM. S.R.  
4-22-2008.

JAY BESCH, EXAMINING ATTORNEY

**Int. Cls.: 35 and 41**

**Prior U.S. Cls.: 100, 101, 102, and 107**

**United States Patent and Trademark Office**

**Reg. No. 3,455,974**

**Registered June 24, 2008**

**SERVICE MARK  
SUPPLEMENTAL REGISTER**

**Los Angeles International  
Extra Virgin Olive Oil  
Competition**

LOS ANGELES COUNTY FAIR ASSOCIATION  
(CALIFORNIA CORPORATION)  
1101 W. MCKINLEY AVE.  
POMONA, CA 91768

FOR: ADVERTISING AND BUSINESS SERVICES, NAMELY, ARRANGING AND CONDUCTING TRADE SHOWS IN THE NATURE OF BUSINESS COMPETITIONS IN THE FIELD OF EXTRA VIRGIN OLIVE OIL FOR EXHIBITORS, OFFICIALS, AND PROFESSIONAL ORGANIZATIONS IN THE INTERNATIONAL EXTRA VIRGIN OLIVE OIL INDUSTRIES, IN CLASS 35 (U.S. CLS. 100, 101 AND 102).

FIRST USE 3-1-2007; IN COMMERCE 3-1-2007.

FOR: ENTERTAINMENT SERVICES, NAMELY, EXTRA VIRGIN OLIVE OIL TASTINGS FOR EXHIBITORS, OFFICIALS, PROFESSIONAL ORGANIZA-

TIONS IN THE INTERNATIONAL EXTRA VIRGIN OLIVE OIL INDUSTRIES AND THE PUBLIC, IN CLASS 41 (U.S. CLS. 100, 101 AND 107).

FIRST USE 5-15-2007; IN COMMERCE 5-15-2007.

THE MARK CONSISTS OF STANDARD CHARACTERS WITHOUT CLAIM TO ANY PARTICULAR FONT, STYLE, SIZE, OR COLOR.

NO CLAIM IS MADE TO THE EXCLUSIVE RIGHT TO USE "EXTRA VIRGIN OLIVE OIL COMPETITION", APART FROM THE MARK AS SHOWN.

SER. NO. 77-269,832, FILED 8-31-2007.

LAURA HAMMEL, EXAMINING ATTORNEY



**Int. Cl.: 9**

**Prior U.S. Cls.: 21, 23, 26, 36, and 38**

**United States Patent and Trademark Office**

**Reg. No. 3,455,975**

**Registered June 24, 2008**

**TRADEMARK  
SUPPLEMENTAL REGISTER**

**Oncology Nursing News**

U.S. HEALTHCARE COMMUNICATIONS, INC.  
(DELAWARE CORPORATION)  
1521 WESTBRANCH DRIVE  
SUITE 200  
MCLEAN, VA 22102

FOR: PROVIDING DOWNLOADABLE ELECTRONIC NEWSLETTERS IN THE FIELD OF HEMATOLOGY AND ONCOLOGY, IN CLASS 9 (U.S. CLS. 21, 23, 26, 36 AND 38).

FIRST USE 4-26-2007; IN COMMERCE 4-26-2007.

THE MARK CONSISTS OF STANDARD CHARACTERS WITHOUT CLAIM TO ANY PARTICULAR FONT, STYLE, SIZE, OR COLOR.

NO CLAIM IS MADE TO THE EXCLUSIVE RIGHT TO USE "NEWS", APART FROM THE MARK AS SHOWN.

SER. NO. 77-270,395, FILED P.R. 9-3-2007; AM. S.R. 5-20-2008.

BRENDAN REGAN, EXAMINING ATTORNEY

**Int. Cl.: 35**

**Prior U.S. Cls.: 100, 101, and 102**

**United States Patent and Trademark Office**

**Reg. No. 3,455,976**

**Registered June 24, 2008**

**SERVICE MARK  
SUPPLEMENTAL REGISTER**

**WOMEN IN CHILDREN'S MEDIA**

WOMEN IN CHILDREN'S MEDIA, INC. (DELA-  
WARE CORPORATION)  
PO BOX BOX 231480  
ANSONIA STATION  
NEW YORK, NY 10023

FOR: BUSINESS NETWORKING FOR WOMEN  
WORKING IN THE CHILDREN'S MEDIA, ENTER-  
TAINMENT, LICENSING, TELEVISION AND PUB-  
LISHING INDUSTRIES, AND ASSOCIATED  
SERVICES, NAMELY, PROMOTING THE INTER-  
ESTS OF WOMEN IN THE CHILDREN'S MEDIA,  
ENTERTAINMENT, LICENSING, TELEVISION  
AND PUBLISHING INDUSTRIES BY PROMOTING

THE ACHIEVEMENTS OF SUCH WOMEN, IN  
CLASS 35 (U.S. CLS. 100, 101 AND 102).

FIRST USE 11-20-2004; IN COMMERCE 11-20-2004.

THE MARK CONSISTS OF STANDARD CHAR-  
ACTERS WITHOUT CLAIM TO ANY PARTICULAR  
FONT, STYLE, SIZE, OR COLOR.

SER. NO. 77-271,769, FILED P.R. 9-5-2007; AM. S.R.  
5-22-2008.

GINA HAYES, EXAMINING ATTORNEY

**Int. Cl.: 16**

**Prior U.S. Cls.: 2, 5, 22, 23, 29, 37, 38, and 50**

**Reg. No. 3,455,977**

**United States Patent and Trademark Office**

**Registered June 24, 2008**

**TRADEMARK  
SUPPLEMENTAL REGISTER**

**MONEY 70**

TIME INC. (DELAWARE CORPORATION)  
1271 AVENUE OF THE AMERICAS  
NEW YORK, NY 10020

THE MARK CONSISTS OF STANDARD CHARACTERS WITHOUT CLAIM TO ANY PARTICULAR FONT, STYLE, SIZE, OR COLOR.

FOR: MAGAZINE SECTIONS ON THE TOPIC OF INVESTMENTS AND MUTUAL FUNDS; MAGAZINE FEATURES ON THE TOPIC OF INVESTMENTS AND MUTUAL FUNDS , IN CLASS 16 (U.S. CLS. 2, 5, 22, 23, 29, 37, 38 AND 50).

OWNER OF U.S. REG. NOS. 1,001,798, 1,901,711, AND 3,060,419.

SER. NO. 77-274,479, FILED P.R. 9-7-2007; AM. S.R. 4-25-2008.

FIRST USE 1-31-2007; IN COMMERCE 1-31-2007.

KRISTINA MORRIS, EXAMINING ATTORNEY

**Int. Cl.: 9**

**Prior U.S. Cls.: 21, 23, 26, 36, and 38**

**United States Patent and Trademark Office**

**Reg. No. 3,455,978**

**Registered June 24, 2008**

**TRADEMARK  
SUPPLEMENTAL REGISTER**

# CatCam

PERTHOLD, JUERGEN (FED REP GERMANY  
INDIVIDUAL)  
216 NORTHRIDGE DRIVE  
ANDERSON, SC 29621

FOR: CAMERAS FOR US WITH PETS AND  
SURVEILLANCE SYSTEMS, CAMERAS FOR IM-  
AGE AND POSITION RECORDING, IN CLASS 9  
(U.S. CLS. 21, 23, 26, 36 AND 38).

FIRST USE 6-2-2007; IN COMMERCE 7-24-2007.

THE MARK CONSISTS OF STANDARD CHAR-  
ACTERS WITHOUT CLAIM TO ANY PARTICULAR  
FONT, STYLE, SIZE, OR COLOR.

SER. NO. 77-293,531, FILED P.R. 10-2-2007; AM. S.R.  
5-15-2008.

BRIAN PINO, EXAMINING ATTORNEY

**Int. Cl.: 44**

**Prior U.S. Cls.: 100 and 101**

**United States Patent and Trademark Office**

**Reg. No. 3,455,979**

**Registered June 24, 2008**

**SERVICE MARK  
SUPPLEMENTAL REGISTER**

**PALLIATIVE CARE PARTNERS**

TIDEWELL HOSPICE AND PALLIATIVE CARE,  
INC. (FLORIDA NON-PROFIT CORPORATION)

5955 RAND BOULEVARD

SARASOTA, FL 34238

FOR: HOSPICE AND PALLIATIVE CARE SERVICES, IN CLASS 44 (U.S. CLS. 100 AND 101).

FIRST USE 10-0-2007; IN COMMERCE 10-0-2007.

THE MARK CONSISTS OF STANDARD CHARACTERS WITHOUT CLAIM TO ANY PARTICULAR FONT, STYLE, SIZE, OR COLOR.

NO CLAIM IS MADE TO THE EXCLUSIVE RIGHT TO USE "PARTNERS", APART FROM THE MARK AS SHOWN.

SER. NO. 77-303,633, FILED P.R. 10-14-2007; AM. S.R. 4-23-2008.

JESSICA A. POWERS, EXAMINING ATTORNEY

**Int. Cl.: 41**

**Prior U.S. Cls.: 100, 101, and 107**

**United States Patent and Trademark Office**

**Reg. No. 3,455,980**

**Registered June 24, 2008**

**SERVICE MARK  
SUPPLEMENTAL REGISTER**

**The Home Biz Teacher**

HOWARD, JOSH (UNITED STATES INDIVIDUAL)  
1100 HEATHROW DRIVE  
FRISCO, TX 75034

FOR: EDUCATION SERVICES, NAMELY, MENTORING IN THE FIELD OF ENTREPRENEURSHIP AND HOME BUSINESS BUILDING, IN CLASS 41 (U.S. CLS. 100, 101 AND 107).

FIRST USE 4-4-2007; IN COMMERCE 4-4-2007.

THE MARK CONSISTS OF STANDARD CHARACTERS WITHOUT CLAIM TO ANY PARTICULAR FONT, STYLE, SIZE, OR COLOR.

SER. NO. 77-304,609, FILED P.R. 10-15-2007; AM. S.R. 2-20-2008.

CHRISTINE COOPER, EXAMINING ATTORNEY

**Int. Cls.: 16 and 42**

**Prior U.S. Cls.: 2, 5, 22, 23, 29, 37, 38, 50, 100, and 101**

**Reg. No. 3,455,981**

**United States Patent and Trademark Office**

**Registered June 24, 2008**

**TRADEMARK  
SERVICE MARK  
SUPPLEMENTAL REGISTER**

**MANAGING PERFORMANCE  
PRIORITIES**

TARGET TRAINING INTERNATIONAL, LTD.  
(IOWA CORPORATION)  
16020 N. 77TH STREET  
SCOTTSDALE, AZ 85260

FOR: PRINTED REPORTS FEATURING INFORMATION REGARDING A PROGRESS ASSESSMENT OF WORK TASKS AND DUTIES FOR MANAGERS AND EMPLOYEES, IN CLASS 16 (U.S. CLS. 2, 5, 22, 23, 29, 37, 38 AND 50).

FIRST USE 8-8-2007; IN COMMERCE 8-8-2007.

FOR: ON-LINE, NON-DOWNLOADABLE SOFTWARE FOR USE TO ASSESS PROGRESS OF WORK

TASKS AND DUTIES OF MANAGERS AND EMPLOYEES, IN CLASS 42 (U.S. CLS. 100 AND 101).

FIRST USE 8-8-2007; IN COMMERCE 8-8-2007.

THE MARK CONSISTS OF STANDARD CHARACTERS WITHOUT CLAIM TO ANY PARTICULAR FONT, STYLE, SIZE, OR COLOR.

SER. NO. 77-304,919, FILED P.R. 10-16-2007; AM. S.R. 5-20-2008.

ASMAT KHAN, EXAMINING ATTORNEY

**Int. Cls.: 3 and 5**

**Prior U.S. Cls.: 1, 4, 6, 18, 44, 46, 50, 51, and 52**

**United States Patent and Trademark Office**

**Reg. No. 3,455,982**

**Registered June 24, 2008**

**TRADEMARK  
SUPPLEMENTAL REGISTER**

**BERCHICK**

BERNARD GROUP TECHNOLOGIES, LLC  
(FLORIDA LTD LIAB CO)  
20201 N.E. 15TH COURT  
MIAMI, FL 33179

FOR: HAND LOTIONS; HAND SOAPS, IN CLASS  
3 (U.S. CLS. 1, 4, 6, 50, 51 AND 52).

FIRST USE 10-31-2007; IN COMMERCE 10-31-2007.

FOR: ANTIBACTERIAL HAND LOTIONS; ANTI-  
BACTERIAL HANDWASH, IN CLASS 5 (U.S. CLS. 6,  
18, 44, 46, 51 AND 52).

FIRST USE 10-31-2007; IN COMMERCE 10-31-2007.

THE MARK CONSISTS OF STANDARD CHAR-  
ACTERS WITHOUT CLAIM TO ANY PARTICULAR  
FONT, STYLE, SIZE, OR COLOR.

SER. NO. 77-307,598, FILED P.R. 10-18-2007; AM.  
S.R. 5-20-2008.

TARAH HARDY, EXAMINING ATTORNEY



**Int. Cl.: 25**

**Prior U.S. Cls.: 22 and 39**

**United States Patent and Trademark Office**

**Reg. No. 3,455,983**

**Registered June 24, 2008**

**TRADEMARK  
SUPPLEMENTAL REGISTER**

# Saints and Vipers

WINCHELL, JERRY, A (UNITED STATES INDIVIDUAL)  
7240 FORBES AVE  
VAN NUYS, CA 91406

THE MARK CONSISTS OF STANDARD CHARACTERS WITHOUT CLAIM TO ANY PARTICULAR FONT, STYLE, SIZE, OR COLOR.

FOR: T-SHIRTS, IN CLASS 25 (U.S. CLS. 22 AND 39).

SER. NO. 77-310,317, FILED P.R. 10-22-2007; AM. S.R. 5-12-2008.

FIRST USE 1-15-2005; IN COMMERCE 1-16-2005.

TINA KUAN, EXAMINING ATTORNEY

**Int. Cl.: 21**

**Prior U.S. Cls.: 2, 13, 23, 29, 30, 33, 40, and 50**

**United States Patent and Trademark Office**

**Reg. No. 3,455,984**

**Registered June 24, 2008**

**TRADEMARK  
SUPPLEMENTAL REGISTER**

**MAGNESIUM BRUSH**

TURBO POWER, INC. (NEW YORK CORPORATION)

31-40 DOWNING STREET

FLUSHING, NY 11354

FOR: HAND-HELD HAIR STYLING BRUSHES,  
IN CLASS 21 (U.S. CLS. 2, 13, 23, 29, 30, 33, 40 AND 50).

FIRST USE 1-15-2008; IN COMMERCE 1-15-2008.

THE MARK CONSISTS OF STANDARD CHARACTERS WITHOUT CLAIM TO ANY PARTICULAR FONT, STYLE, SIZE, OR COLOR.

NO CLAIM IS MADE TO THE EXCLUSIVE RIGHT TO USE "BRUSH", APART FROM THE MARK AS SHOWN.

SER. NO. 77-312,202, FILED P.R. 10-24-2007; AM. S.R. 3-27-2008.

BRENDAN REGAN, EXAMINING ATTORNEY

**Int. Cl.: 9**

**Prior U.S. Cls.: 21, 23, 26, 36, and 38**

**United States Patent and Trademark Office**

**Reg. No. 3,455,985**

**Registered June 24, 2008**

**TRADEMARK  
SUPPLEMENTAL REGISTER**

**REAR ACTIVE STEER**

NISSAN JIDOSHA KABUSHIKI KAISHA (JAPAN CORPORATION), DBA NISSAN MOTOR CO., LTD.,  
NO. 2 TAKARACHO, KANAGAWA-KU  
YOKOHAMI-SHI, JAPAN

FOR: ELECTRONIC SYSTEM FOR ENHANCING HIGH SPEED STABILITY AND TURNING RESPONSE IN AUTOMOBILES, COMPRISED OF AN ELECTRONIC ACTUATOR AND A CONTROL UNIT, WHICH ADJUST THE TOE ALIGNMENT OF VEHICLE WHEELS, SOLD AS AN INTEGRAL COMPONENT OF VEHICLES, IN CLASS 9 (U.S. CLS. 21, 23, 26, 36 AND 38).

FIRST USE 2-23-2005; IN COMMERCE 2-23-2005.

THE MARK CONSISTS OF STANDARD CHARACTERS WITHOUT CLAIM TO ANY PARTICULAR FONT, STYLE, SIZE, OR COLOR.

SER. NO. 77-314,196, FILED P.R. 10-26-2007; AM. S.R. 5-7-2008.

KEVIN DINALLO, EXAMINING ATTORNEY

**Int. Cl.: 41**

**Prior U.S. Cls.: 100, 101, and 107**

**United States Patent and Trademark Office**

**Reg. No. 3,455,986**

**Registered June 24, 2008**

**SERVICE MARK  
SUPPLEMENTAL REGISTER**

**CELEBRITY REHAB WITH DR.  
DREW**

VIACOM INTERNATIONAL INC. (DELAWARE  
CORPORATION)  
34TH FLOOR  
1515 BROADWAY  
NEW YORK, NY 10036

FOR: ENTERTAINMENT SERVICES IN THE  
NATURE OF TELEVISION SERIES, FEATURING  
LIVE ACTION, COMEDY AND DRAMA; PROVID-  
ING ONLINE INFORMATION IN THE FIELD OF  
ENTERTAINMENT CONCERNING TELEVISION  
PROGRAMS, IN CLASS 41 (U.S. CLS. 100, 101 AND  
107).

FIRST USE 1-10-2008; IN COMMERCE 1-10-2008.

THE MARK CONSISTS OF STANDARD CHAR-  
ACTERS WITHOUT CLAIM TO ANY PARTICULAR  
FONT, STYLE, SIZE, OR COLOR.

THE NAME "DR. DREW" IDENTIFIES A LIVING  
INDIVIDUAL WHOSE CONSENT IS OF RECORD.

SER. NO. 77-315,799, FILED P.R. 10-29-2007; AM.  
S.R. 5-19-2008.

JILL C. ALT, EXAMINING ATTORNEY

**Int. Cl.: 41**

**Prior U.S. Cls.: 100, 101, and 107**

**United States Patent and Trademark Office**

**Reg. No. 3,455,987**

**Registered June 24, 2008**

**SERVICE MARK  
SUPPLEMENTAL REGISTER**

# Competitive Golf Association

CAYNOR, JOHN H (UNITED STATES INDIVIDUAL)  
608 WEST LAKE CIRCLE  
CHESAPEAKE, VA 23322

FOR: ARRANGING AND CONDUCTING ATHLETIC COMPETITIONS; ENTERTAINMENT IN THE NATURE OF GOLF TOURNAMENTS; GOLF COURSES; ORGANISATION OF SPORTS COMPETITIONS; ORGANIZING SPORTING EVENTS, NAMELY, GOLF; PROVIDING A WEBSITE THROUGH WHICH GOLFERS LOCATE INFORMATION ABOUT GOLF COURSES AND GOLF TOURNAMENTS; PROVIDING NEWS AND INFORMATION ON THE SPORT OF GOLF; PROVIDING VARIOUS FACILITIES FOR AN ARRAY OF SPORTING EVENTS, SPORTS AND ATHLETIC COMPETITIONS

AND AWARDS PROGRAMMES, IN CLASS 41 (U.S. CLS. 100, 101 AND 107).

FIRST USE 1-17-2008; IN COMMERCE 1-17-2008.

THE MARK CONSISTS OF STANDARD CHARACTERS WITHOUT CLAIM TO ANY PARTICULAR FONT, STYLE, SIZE, OR COLOR.

NO CLAIM IS MADE TO THE EXCLUSIVE RIGHT TO USE "ASSOCIATION", APART FROM THE MARK AS SHOWN.

SER. NO. 77-317,660, FILED P.R. 10-31-2007; AM. S.R. 5-15-2008.

TARAH HARDY, EXAMINING ATTORNEY

**Int. Cl.: 41**

**Prior U.S. Cls.: 100, 101, and 107**

**United States Patent and Trademark Office**

**Reg. No. 3,455,988**

**Registered June 24, 2008**

**SERVICE MARK  
SUPPLEMENTAL REGISTER**

**CERTIFIED FEMALE FRIENDLY**

CERTIFIED FEMALE FRIENDLY (CALIFORNIA  
LTD LIAB CO)  
7353 INTERNATIONAL PLACE, SUITE 307  
SARASOTA, FL 34240

FOR: PROVIDING ON-LINE TRAINING WORK-  
SHOPS IN THE FIELD OF AUTOMOBILE SALES, IN  
CLASS 41 (U.S. CLS. 100, 101 AND 107).

FIRST USE 11-1-2007; IN COMMERCE 11-1-2007.

THE MARK CONSISTS OF STANDARD CHAR-  
ACTERS WITHOUT CLAIM TO ANY PARTICULAR  
FONT, STYLE, SIZE, OR COLOR.

SER. NO. 77-322,233, FILED P.R. 11-6-2007; AM. S.R.  
4-18-2008.

LAURA HAMMEL, EXAMINING ATTORNEY

**Int. Cl.: 41**

**Prior U.S. Cls.: 100, 101, and 107**

**United States Patent and Trademark Office**

**Reg. No. 3,455,989**

**Registered June 24, 2008**

**SERVICE MARK  
SUPPLEMENTAL REGISTER**

**TAMALEWOOD**

LEONARD J. SANCHEZ (UNITED STATES INDIVIDUAL)  
772 CALLE ALTAMIRA  
SANTA FE, NM 87501

FOR: PRODUCTION SERVICES, NAMELY, PRODUCTION SERVICES OF MOTION PICTURE FILMS, AND SOUND AND VIDEO RECORDINGS, IN CLASS 41 (U.S. CLS. 100, 101 AND 107).

FIRST USE 11-15-2005; IN COMMERCE 8-9-2006.

THE MARK CONSISTS OF STANDARD CHARACTERS WITHOUT CLAIM TO ANY PARTICULAR FONT, STYLE, SIZE, OR COLOR.

SER. NO. 77-324,017, FILED P.R. 11-7-2007; AM. S.R. 4-25-2008.

ARETHA SOMERVILLE, EXAMINING ATTORNEY

**Int. Cl.: 35**

**Prior U.S. Cls.: 100, 101, and 102**

**United States Patent and Trademark Office**

**Reg. No. 3,455,990**

**Registered June 24, 2008**

**SERVICE MARK  
SUPPLEMENTAL REGISTER**

**ROIC analytics**

JORDAN, DANIELLE S. (UNITED STATES INDIVIDUAL)  
13427 W. SILVERBROOK DR.  
BOISE, ID 83713

FOR: BUSINESS MANAGEMENT CONSULTANCY AS WELL AS DEVELOPMENT OF PROCESSES FOR THE ANALYSIS AND THE IMPLEMENTATION OF STRATEGY PLANS AND MANAGEMENT PROJECTS; MARKET RESEARCH CONSULTATION; MARKET RESEARCH SERVICES; MARKET RESEARCH STUDIES, IN CLASS 35 (U.S. CLS. 100, 101 AND 102).

FIRST USE 11-1-2007; IN COMMERCE 12-1-2007.

THE MARK CONSISTS OF STANDARD CHARACTERS WITHOUT CLAIM TO ANY PARTICULAR FONT, STYLE, SIZE, OR COLOR.

NO CLAIM IS MADE TO THE EXCLUSIVE RIGHT TO USE "ANALYTICS", APART FROM THE MARK AS SHOWN.

SER. NO. 77-327,347, FILED P.R. 11-12-2007; AM. S.R. 5-1-2008.

B. PARADEWELAI, EXAMINING ATTORNEY



**Int. Cl.: 9**

**Prior U.S. Cls.: 21, 23, 26, 36, and 38**

**Reg. No. 3,455,991**

**United States Patent and Trademark Office**

**Registered June 24, 2008**

---

**TRADEMARK  
SUPPLEMENTAL REGISTER**

**ESTIMATE TRANSLATOR**

ASSURED PERFORMANCE NETWORK (MINNE-  
SOTA CORPORATION)  
CAPITOL PROF BLDG  
590 PARK STREET #6  
ST. PAUL, MN 55103

FOR: COMPUTER SOFTWARE FOR GENERAT-  
ING QUOTES FOR COSTS FOR VEHICLE REPAIR  
AND MAINTENANCE, IN CLASS 9 (U.S. CLS. 21, 23,  
26, 36 AND 38).

FIRST USE 9-13-2007; IN COMMERCE 9-13-2007.

THE MARK CONSISTS OF STANDARD CHAR-  
ACTERS WITHOUT CLAIM TO ANY PARTICULAR  
FONT, STYLE, SIZE, OR COLOR.

SER. NO. 77-327,785, FILED P.R. 11-13-2007; AM.  
S.R. 4-8-2008.

PAULA MAHONEY, EXAMINING ATTORNEY

**Int. Cl.: 21**

**Prior U.S. Cls.: 2, 13, 23, 29, 30, 33, 40, and 50**

**Reg. No. 3,455,992**

**United States Patent and Trademark Office**

**Registered June 24, 2008**

---

**TRADEMARK  
SUPPLEMENTAL REGISTER**

**SoilWrap**

BALL HORTICULTURAL COMPANY (ILLINOIS  
CORPORATION)  
622 TOWN ROAD  
WEST CHICAGO, IL 60185

THE MARK CONSISTS OF STANDARD CHAR-  
ACTERS WITHOUT CLAIM TO ANY PARTICULAR  
FONT, STYLE, SIZE, OR COLOR.

FOR: BIODEGRADABLE POTS, HOLDERS FOR  
FLOWERS AND PLANTS, NAMELY, PLANT  
SLEEVES, IN CLASS 21 (U.S. CLS. 2, 13, 23, 29, 30,  
33, 40 AND 50).

SER. NO. 77-331,948, FILED P.R. 11-16-2007; AM.  
S.R. 5-19-2008.

FIRST USE 2-29-2008; IN COMMERCE 2-29-2008.

KEVIN DINALLO, EXAMINING ATTORNEY

**Int. Cl.: 29**

**Prior U.S. Cl.: 46**

**United States Patent and Trademark Office**

**Reg. No. 3,455,993**

**Registered June 24, 2008**

**TRADEMARK  
SUPPLEMENTAL REGISTER**

**COCOA ROAST**

DIAMOND FOODS, INC. (DELAWARE COR-  
PORATION)  
1050 S. DIAMOND STREET  
STOCKTON, CA 95205

THE MARK CONSISTS OF STANDARD CHAR-  
ACTERS WITHOUT CLAIM TO ANY PARTICULAR  
FONT, STYLE, SIZE, OR COLOR.

FOR: PROCESSED NUTS, IN CLASS 29 (U.S. CL.  
46).

SER. NO. 77-333,563, FILED P.R. 11-19-2007; AM.  
S.R. 5-12-2008.

FIRST USE 3-0-2008; IN COMMERCE 3-0-2008.

MARGERY A. TIERNEY, EXAMINING ATTORNEY

Int. Cl.: 45

Prior U.S. Cls.: 100 and 101

United States Patent and Trademark Office

Reg. No. 3,455,994

Registered June 24, 2008

SERVICE MARK  
SUPPLEMENTAL REGISTER

*CompletelyOnline.com*

COMPLETELYONLINE.COM (CALIFORNIA CORPORATION)

11712 MOORPARK ST. #205  
STUDIO CITY, CA 91604

FOR: IDENTIFICATION VERIFICATION SERVICES, NAMELY, PROVIDING AUTHENTICATION OF PERSONAL IDENTIFICATION INFORMATION VIA SECURE STORAGE AND TRANSMITTING SUCH INFORMATION VIA THE INTERNET, IN CLASS 45 (U.S. CLS. 100 AND 101).

FIRST USE 12-10-2004; IN COMMERCE 1-28-2005.

THE COLOR(S) RED AND BLUE IS/ARE CLAIMED AS A FEATURE OF THE MARK.

THE MARK CONSISTS OF THE WORDING"-COMPLETELYONLINE.COM". THE COLOR RED APPEARS IN THE WORDING "COMPLETELY" AND ".COM". THE COLOR BLUE APPEARS IN THE WORDING "ONLINE".

SER. NO. 77-337,996, FILED P.R. 11-27-2007; AM. S.R. 5-19-2008.

TINA BROWN, EXAMINING ATTORNEY

**Int. Cl.: 9**

**Prior U.S. Cls.: 21, 23, 26, 36, and 38**

**Reg. No. 3,455,995**

**United States Patent and Trademark Office**

**Registered June 24, 2008**

---

**TRADEMARK  
SUPPLEMENTAL REGISTER**

**BATTERY BALANCING ON DEMAND**

O2MICRO, INC. (CALIFORNIA CORPORATION)  
3118 PATRICK HENRY DRIVE  
SANTA CLARA, CA 95054

FIRST USE 5-5-2008; IN COMMERCE 5-5-2008.

FOR: ELECTRONIC INTEGRATED CIRCUITS,  
COMPUTER SOFTWARE, NAMELY, COMPUTER  
ARCHITECTURE FOR POWER MANAGEMENT IN  
ELECTRONIC VEHICLES, IN PORTABLE ELEC-  
TRONIC DEVICES AND EQUIPMENT, IN POWER  
ADAPTERS AND BATTERY CHARGERS, IN CLASS  
9 (U.S. CLS. 21, 23, 26, 36 AND 38).

THE MARK CONSISTS OF STANDARD CHAR-  
ACTERS WITHOUT CLAIM TO ANY PARTICULAR  
FONT, STYLE, SIZE, OR COLOR.

SER. NO. 77-344,576, FILED P.R. 12-5-2007; AM. S.R.  
5-6-2008.

NATALIE POLZER, EXAMINING ATTORNEY

**Int. Cl.: 35**

**Prior U.S. Cls.: 100, 101, and 102**

**United States Patent and Trademark Office**

**Reg. No. 3,455,996**

**Registered June 24, 2008**

**SERVICE MARK  
SUPPLEMENTAL REGISTER**

**Cashing Out Advisory  
Council**

RHONA SACKS (UNITED STATES INDIVIDUAL)  
8636 IBIS COVE CIRCLE  
NAPLES, FL 34119

FOR: BUSINESS SUCCESSION PLANNING, IN  
CLASS 35 (U.S. CLS. 100, 101 AND 102).

FIRST USE 8-16-2007; IN COMMERCE 8-16-2007.

THE MARK CONSISTS OF STANDARD CHAR-  
ACTERS WITHOUT CLAIM TO ANY PARTICULAR  
FONT, STYLE, SIZE, OR COLOR.

NO CLAIM IS MADE TO THE EXCLUSIVE  
RIGHT TO USE "ADVISORY COUNCIL", APART  
FROM THE MARK AS SHOWN.

SER. NO. 77-353,910, FILED P.R. 12-17-2007; AM.  
S.R. 4-15-2008.

STEVEN R. FINE, EXAMINING ATTORNEY

**Int. Cl.: 36**

**Prior U.S. Cls.: 100, 101, and 102**

**United States Patent and Trademark Office**

**Reg. No. 3,455,997**

**Registered June 24, 2008**

**SERVICE MARK  
SUPPLEMENTAL REGISTER**

**Donor Advised Annuity**

PEDIGO, JAMES P. (UNITED STATES INDIVIDUAL)  
2019 ALAQUA LAKES BLVD  
LONGWOOD, FL 32779

FOR: ANNUITY UNDERWRITING; INVESTMENT MANAGEMENT OF AND DISTRIBUTION OF ANNUITIES; INVESTMENT MANAGEMENT OF AND DISTRIBUTION OF VARIABLE ANNUITIES; ISSUANCE AND ADMINISTRATION OF ANNUITIES, IN CLASS 36 (U.S. CLS. 100, 101 AND 102).

FIRST USE 12-13-2007; IN COMMERCE 12-13-2007.

THE MARK CONSISTS OF STANDARD CHARACTERS WITHOUT CLAIM TO ANY PARTICULAR FONT, STYLE, SIZE, OR COLOR.

NO CLAIM IS MADE TO THE EXCLUSIVE RIGHT TO USE "ANNUITY", APART FROM THE MARK AS SHOWN.

SER. NO. 77-353,912, FILED P.R. 12-17-2007; AM. S.R. 5-16-2008.

STEVEN R. FINE, EXAMINING ATTORNEY

**Int. Cls.: 29 and 30**

**Prior U.S. Cl.: 46**

**United States Patent and Trademark Office**

**Reg. No. 3,455,998**

**Registered June 24, 2008**

**TRADEMARK  
SUPPLEMENTAL REGISTER**

**PICANTE SABROSO**

DILLMAN FARM, INC. (INDIANA CORPORATION), DBA DILLMAN FARM,  
4955 WEST STATE ROAD 45  
BLOOMINGTON, IN 47403

FOR: FRUIT PRESERVES; FRUIT-BASED SPREADS; JELLIES; JAMS, IN CLASS 29 (U.S. CL. 46).

FIRST USE 9-8-2006; IN COMMERCE 9-8-2006.

FOR: SALSA; SAUCES; BREAD; CONDIMENT, NAMELY PEPPER SAUCE, IN CLASS 30 (U.S. CL. 46).

FIRST USE 9-8-2006; IN COMMERCE 9-8-2006.

THE MARK CONSISTS OF STANDARD CHARACTERS WITHOUT CLAIM TO ANY PARTICULAR FONT, STYLE, SIZE, OR COLOR.

THE FOREIGN WORDING IN THE MARK TRANSLATES INTO ENGLISH AS "SPICY SAVORY".

SER. NO. 77-357,088, FILED P.R. 12-20-2007; AM. S.R. 5-16-2008.

MARGERY A. TIERNEY, EXAMINING ATTORNEY



**Int. Cls.: 29 and 30**

**Prior U.S. Cl.: 46**

**United States Patent and Trademark Office**

**Reg. No. 3,455,999**

**Registered June 24, 2008**

**TRADEMARK  
SUPPLEMENTAL REGISTER**

**MUY PICOSO**

DILLMAN FARM, INC. (INDIANA CORPORATION), DBA DILLMAN FARM,  
4955 WEST STATE ROAD 45  
BLOOMINGTON, IN 47403

FOR: FRUIT PRESERVES; FRUIT-BASED SPREADS; JELLIES; JAMS, IN CLASS 29 (U.S. CL. 46).

FIRST USE 9-8-2006; IN COMMERCE 9-8-2006.

FOR: SALSA; SAUCES; BREAD; CONDIMENT, NAMELY, PEPPER SAUCE, IN CLASS 30 (U.S. CL. 46).

FIRST USE 9-8-2006; IN COMMERCE 9-8-2006.

THE MARK CONSISTS OF STANDARD CHARACTERS WITHOUT CLAIM TO ANY PARTICULAR FONT, STYLE, SIZE, OR COLOR.

THE FOREIGN WORDING IN THE MARK TRANSLATES INTO ENGLISH AS VERY SPICY.

SER. NO. 77-358,188, FILED P.R. 12-21-2007; AM. S.R. 5-16-2008.

MARGERY A. TIERNEY, EXAMINING ATTORNEY

**Int. Cl.: 39**

**Prior U.S. Cls.: 100 and 105**

**United States Patent and Trademark Office**

**Reg. No. 3,456,000**

**Registered June 24, 2008**

**SERVICE MARK  
SUPPLEMENTAL REGISTER**

**travelRSS**

TRAVELSCREAM, INC. (COLORADO CORPORATION)  
P O BOX 3851  
AVON, CO 81620

FOR: PROVIDING AN ON-LINE COMPUTER DATABASE IN THE FIELD OF TRAVEL INFORMATION SERVICES, IN CLASS 39 (U.S. CLS. 100 AND 105).

FIRST USE 7-0-2007; IN COMMERCE 7-0-2007.

THE MARK CONSISTS OF STANDARD CHARACTERS WITHOUT CLAIM TO ANY PARTICULAR FONT, STYLE, SIZE, OR COLOR.

SER. NO. 77-360,059, FILED P.R. 12-27-2007; AM. S.R. 5-19-2008.

SUNG IN, EXAMINING ATTORNEY

**Int. Cl.: 9**

**Prior U.S. Cls.: 21, 23, 26, 36, and 38**

**United States Patent and Trademark Office**

**Reg. No. 3,456,001**

**Registered June 24, 2008**

**TRADEMARK  
SUPPLEMENTAL REGISTER**

**PLATE-IDENT**

KOENIG & BAUER AKTIENGESELLSCHAFT  
(FED REP GERMANY CORPORATION)  
POSTFACH 60 60  
FRIEDRICH-KOENIG-STR. 4  
WURZBURG, FED REP GERMANY 97080

FOR: PRINTING PLATE IDENTIFICATION AND  
PRINTING SYSTEMS COMPRISED PRIMARILY OF  
ELECTRONIC IDENTIFICATION INSTRUMENTS  
USING IMAGE PROCESSING FOR MONITORING  
PRINTING PLATE ALLOCATION IN A PRINTING  
PRESS, IN CLASS 9 (U.S. CLS. 21, 23, 26, 36 AND 38).

FIRST USE 8-21-2007; IN COMMERCE 8-21-2007.

THE MARK CONSISTS OF STANDARD CHAR-  
ACTERS WITHOUT CLAIM TO ANY PARTICULAR  
FONT, STYLE, SIZE, OR COLOR.

SER. NO. 77-361,125, FILED 12-28-2007.

MARY MUNSON, EXAMINING ATTORNEY

**Int. Cl.: 26**

**Prior U.S. Cls.: 37, 39, 40, 42, and 50**

**Reg. No. 3,456,002**

**United States Patent and Trademark Office**

**Registered June 24, 2008**

---

**TRADEMARK  
SUPPLEMENTAL REGISTER**

# Lace Closure

ROYAL IMEX, INC. (CALIFORNIA CORPORATION)  
12605 E. CLARK ST.  
SANTA FE SPRINGS, CA 90670

THE MARK CONSISTS OF STANDARD CHARACTERS WITHOUT CLAIM TO ANY PARTICULAR FONT, STYLE, SIZE, OR COLOR.

FOR: HAIR EXTENSIONS, IN CLASS 26 (U.S. CLS. 37, 39, 40, 42 AND 50).

SER. NO. 77-370,054, FILED P.R. 1-11-2008; AM. S.R. 4-28-2008.

FIRST USE 2-5-2008; IN COMMERCE 2-5-2008.

SUNG IN, EXAMINING ATTORNEY

**Int. Cl.: 26**

**Prior U.S. Cls.: 37, 39, 40, 42, and 50**

**Reg. No. 3,456,003**

**United States Patent and Trademark Office**

**Registered June 24, 2008**

---

**TRADEMARK  
SUPPLEMENTAL REGISTER**

**Lace Weave**

ROYAL IMEX, INC. (CALIFORNIA CORPORATION)  
12605 E. CLARK ST.  
SANTA FE SPRINGS, CA 90670

THE MARK CONSISTS OF STANDARD CHARACTERS WITHOUT CLAIM TO ANY PARTICULAR FONT, STYLE, SIZE, OR COLOR.

FOR: HAIR EXTENSIONS, IN CLASS 26 (U.S. CLS. 37, 39, 40, 42 AND 50).

SER. NO. 77-370,055, FILED P.R. 1-11-2008; AM. S.R. 4-28-2008.

FIRST USE 2-5-2008; IN COMMERCE 2-5-2008.

SUNG IN, EXAMINING ATTORNEY

**Int. Cl.: 41**

**Prior U.S. Cls.: 100, 101, and 107**

**United States Patent and Trademark Office**

**Reg. No. 3,456,004**

**Registered June 24, 2008**

**SERVICE MARK  
SUPPLEMENTAL REGISTER**

**CENTER FOR HEALTHY  
COMMUNITIES**

THE CALIFORNIA ENDOWMENT (CALIFORNIA CORPORATION)  
1000 NORTH ALAMEDA STREET  
LOS ANGELES, CA 90012

FOR: EDUCATIONAL SERVICES, NAMELY, ARRANGING AND CONDUCTING EDUCATIONAL CONFERENCES, EXHIBITS, SEMINARS, WORKSHOPS, LECTURES, FESTIVALS, TRAINING, AND ONLINE LEARNING PROGRAMS IN THE FIELD OF COMMUNITY HEALTH AND HEALTH CARE ISSUES, IN CLASS 41 (U.S. CLS. 100, 101 AND 107).

FIRST USE 4-6-2006; IN COMMERCE 4-6-2006.

THE MARK CONSISTS OF STANDARD CHARACTERS WITHOUT CLAIM TO ANY PARTICULAR FONT, STYLE, SIZE, OR COLOR.

SER. NO. 77-373,530, FILED P.R. 1-16-2008; AM. S.R. 5-15-2008.

WILLIAM BRECKENFELD, EXAMINING ATTORNEY

**Int. Cl.: 41**

**Prior U.S. Cls.: 100, 101, and 107**

**United States Patent and Trademark Office**

**Reg. No. 3,456,005**

**Registered June 24, 2008**

**SERVICE MARK  
SUPPLEMENTAL REGISTER**

**ULTIMATE REVIEW**

FRONTRUNNERS PUBLISHING (CALIFORNIA  
SOLE PROPRIETORSHIP), DBA FRONTRUN-  
NERS AND FRONTRUNNERS BOARD RE-  
VIEW,  
27292 RYAN DR  
LAGUNA NIGUEL, CA 92677

FOR: EDUCATION IN THE FIELD OF MEDICINE  
RENDERED THROUGH CORRESPONDENCE  
COURSES; EDUCATION SERVICES, NAMELY,  
PROVIDING LIVE AND ON-LINE REVIEW COUR-  
SES IN THE FIELD OF MEDICINE; EDUCATIONAL  
SERVICES, NAMELY, CONDUCTING INFORMAL  
ON-LINE PROGRAMS IN THE FIELDS OF MEDI-  
CINE, AND PRINTABLE MATERIALS DISTRIBU-  
TED THEREWITH, IN CLASS 41 (U.S. CLS. 100, 101  
AND 107).

FIRST USE 5-7-2004; IN COMMERCE 5-7-2004.

THE MARK CONSISTS OF STANDARD CHAR-  
ACTERS WITHOUT CLAIM TO ANY PARTICULAR  
FONT, STYLE, SIZE, OR COLOR.

NO CLAIM IS MADE TO THE EXCLUSIVE  
RIGHT TO USE "REVIEW", APART FROM THE  
MARK AS SHOWN.

SER. NO. 77-376,027, FILED P.R. 1-19-2008; AM. S.R.  
5-13-2008.

MARY MUNSON, EXAMINING ATTORNEY

**Int. Cl.: 41**

**Prior U.S. Cls.: 100, 101, and 107**

**United States Patent and Trademark Office**

**Reg. No. 3,456,006**

**Registered June 24, 2008**

**SERVICE MARK  
SUPPLEMENTAL REGISTER**

# World Jiu-Jitsu Championship

ANDRE LUIZ MACHADO FERNANDES (BRA-  
ZIL INDIVIDUAL)

23 SPECTRUM POINTE DRIVE #205

LAKE FOREST, CA 92630

FOR: ENTERTAINMENT IN THE NATURE OF  
JIU-JITSU TOURNAMENTS, IN CLASS 41 (U.S. CLS.  
100, 101 AND 107).

FIRST USE 1-20-1996; IN COMMERCE 1-20-1996.

THE MARK CONSISTS OF STANDARD CHAR-  
ACTERS WITHOUT CLAIM TO ANY PARTICULAR  
FONT, STYLE, SIZE, OR COLOR.

NO CLAIM IS MADE TO THE EXCLUSIVE  
RIGHT TO USE "JIU-JITSU CHAMPIONSHIP",  
APART FROM THE MARK AS SHOWN.

SER. NO. 77-376,176, FILED P.R. 1-20-2008; AM. S.R.  
5-15-2008.

ELLEN BURNS, EXAMINING ATTORNEY



**Int. Cl.: 16**

**Prior U.S. Cls.: 2, 5, 22, 23, 29, 37, 38, and 50**

**United States Patent and Trademark Office**

**Reg. No. 3,456,007**

**Registered June 24, 2008**

**TRADEMARK  
SUPPLEMENTAL REGISTER**

# MathMatch

DYNASTUDY, INC. (TEXAS CORPORATION)  
P.O. BOX 1767  
LEAGUE CITY, TX 77574

FIRST USE 12-15-2007; IN COMMERCE 1-23-2008.

FOR: EDUCATIONAL PUBLICATIONS, NAME-  
LY, EDUCATIONAL LEARNING CARDS, FLASH  
CARDS, ACTIVITY CARDS, WORKBOOKS, TEXT-  
BOOKS, ACTIVITY BOOKS, STORY BOOKS, PUZ-  
ZLE BOOKS, PUZZLES, TEACHER GUIDES,  
MANUALS, POSTERS, EDUCATIONAL CARD  
GAMES AND EDUCATIONAL BOOKLETS IN THE  
FIELD OF MATHEMATICS, IN CLASS 16 (U.S. CLS.  
2, 5, 22, 23, 29, 37, 38 AND 50).

THE MARK CONSISTS OF STANDARD CHAR-  
ACTERS WITHOUT CLAIM TO ANY PARTICULAR  
FONT, STYLE, SIZE, OR COLOR.

SER. NO. 77-379,880, FILED P.R. 1-24-2008; AM. S.R.  
5-16-2008.

LOURDES AYALA, EXAMINING ATTORNEY

**Int. Cl.: 41**

**Prior U.S. Cls.: 100, 101, and 107**

**United States Patent and Trademark Office**

**Reg. No. 3,456,008**

**Registered June 24, 2008**

**SERVICE MARK  
SUPPLEMENTAL REGISTER**

**AVIATION RESILIENCY PROJECT**

SERVICE INSTITUTE, INC (WASHINGTON CORPORATION)  
310 MOREY AVENUE  
BELLINGHAM, WA 98225

FOR: EDUCATION SERVICES, NAMELY, PROVIDING WORKSHOPS AND SEMINARS IN THE FIELD OF RESILIENCY SKILL DEVELOPMENT FOR AVIATION EMPLOYEES, IN CLASS 41 (U.S. CLS. 100, 101 AND 107).

FIRST USE 1-25-2008; IN COMMERCE 1-25-2008.

THE MARK CONSISTS OF STANDARD CHARACTERS WITHOUT CLAIM TO ANY PARTICULAR FONT, STYLE, SIZE, OR COLOR.

NO CLAIM IS MADE TO THE EXCLUSIVE RIGHT TO USE "PROJECT", APART FROM THE MARK AS SHOWN.

SER. NO. 77-381,587, FILED P.R. 1-27-2008; AM. S.R. 5-13-2008.

BRIDGETT SMITH, EXAMINING ATTORNEY

Int. Cl.: 36

Prior U.S. Cls.: 100, 101, and 102

United States Patent and Trademark Office

Reg. No. 3,456,009

Registered June 24, 2008

SERVICE MARK  
SUPPLEMENTAL REGISTER

The logo features a large red number '1' with a red hash symbol '#' to its left. To the right of the '1' is the word 'HomeSales' in a black, cursive script font. A thick black underline is positioned beneath the word 'HomeSales'.

QUINN, JENNIFFER (UNITED STATES INDIVIDUAL)  
31037 WATER AVENUE  
NUEVO, CA 92567

FOR: REAL ESTATE BROKERAGE; REAL ESTATE LISTING; REAL ESTATE AGENCIES, IN CLASS 36 (U.S. CLS. 100, 101 AND 102).

FIRST USE 6-0-2007; IN COMMERCE 6-0-2007.

OWNER OF U.S. REG. NOS. 2,367,287 AND 3,227,646.

NO CLAIM IS MADE TO THE EXCLUSIVE RIGHT TO USE "HOME SALES", APART FROM THE MARK AS SHOWN.

THE COLOR(S) RED AND BLACK IS/ARE CLAIMED AS A FEATURE OF THE MARK.

THE MARK CONSISTS OF THE TERM "#1 HOME SALES" IN A STYLIZED FONT WITH THE TERM "#1" IN THE COLOR RED AND THE WORDS "HOME SALES" IN THE COLOR BLACK.

SER. NO. 77-382,787, FILED P.R. 1-29-2008; AM. S.R. 5-19-2008.

MARCIE MILONE, EXAMINING ATTORNEY

**Int. Cl.: 28**

**Prior U.S. Cls.: 22, 23, 38, and 50**

**United States Patent and Trademark Office**

**Reg. No. 3,456,010**

**Registered June 24, 2008**

**TRADEMARK  
SUPPLEMENTAL REGISTER**

**MAKE IT A LIFE CHANGE**

SPECIALTY ADVERTISING, INC. (FLORIDA  
CORPORATION)  
4317 REDDING ROAD, #A  
BOYNTON BEACH, FL 33436

THE MARK CONSISTS OF STANDARD CHAR-  
ACTERS WITHOUT CLAIM TO ANY PARTICULAR  
FONT, STYLE, SIZE, OR COLOR.

FOR: PLAYING CARDS WITH ENVIRONMEN-  
TAL MESSAGES, IN CLASS 28 (U.S. CLS. 22, 23, 38  
AND 50).

SER. NO. 77-385,179, FILED P.R. 1-31-2008; AM. S.R.  
5-16-2008.

FIRST USE 10-1-2007; IN COMMERCE 10-1-2007.

NICHOLAS ALTREE, EXAMINING ATTORNEY

**Int. Cl.: 39**

**Prior U.S. Cls.: 100 and 105**

**United States Patent and Trademark Office**

**Reg. No. 3,456,011**

**Registered June 24, 2008**

**SERVICE MARK  
SUPPLEMENTAL REGISTER**

**Northern Neck Kayak**

NORTHERN NECK KAYAK LLC (VIRGINIA  
LTD LIAB CO)  
481 LONG LANE FARM  
WHITESTONE, VA 22578

FOR: KAYAK RENTALS; CONDUCTING  
KAYAKING TOURS; CONDUCTING KAYAKING  
FISHING TOURS, IN CLASS 39 (U.S. CLS. 100 AND  
105).

FIRST USE 11-15-2007; IN COMMERCE 1-5-2008.

THE MARK CONSISTS OF STANDARD CHAR-  
ACTERS WITHOUT CLAIM TO ANY PARTICULAR  
FONT, STYLE, SIZE, OR COLOR.

NO CLAIM IS MADE TO THE EXCLUSIVE  
RIGHT TO USE "KAYAK", APART FROM THE  
MARK AS SHOWN.

SER. NO. 77-387,019, FILED P.R. 2-1-2008; AM. S.R.  
5-12-2008.

ESTHER BELENKER, EXAMINING ATTORNEY

**Int. Cls.: 35 and 41**

**Prior U.S. Cls.: 100, 101, 102, and 107**

**United States Patent and Trademark Office**

**Reg. No. 3,456,012**

**Registered June 24, 2008**

**SERVICE MARK  
SUPPLEMENTAL REGISTER**

**THE CHINA BUSINESS NETWORK**

THE CHINA BUSINESS NETWORK LTD. (DELA-  
WARE CORPORATION)  
13 GREGORY LANE  
LOUDONVILLE, NY 12211

FOR: ADVERTISING AND PUBLICITY SERVI-  
CES, NAMELY, PROMOTING THE GOODS, SERVI-  
CES, BRAND IDENTITY AND COMMERCIAL  
INFORMATION AND NEWS OF THIRD PARTIES  
THROUGH PRINT, AUDIO, VIDEO, DIGITAL AND  
ON-LINE MEDIUM, IN CLASS 35 (U.S. CLS. 100, 101  
AND 102).

FIRST USE 4-2-2007; IN COMMERCE 4-2-2007.

FOR: EDUCATION SERVICES, NAMELY, PRO-  
VIDING PODCASTS IN THE FIELD OF DOING

BUSINESS IN CHINA, IN CLASS 41 (U.S. CLS. 100,  
101 AND 107).

FIRST USE 4-2-2007; IN COMMERCE 4-2-2007.

THE MARK CONSISTS OF STANDARD CHAR-  
ACTERS WITHOUT CLAIM TO ANY PARTICULAR  
FONT, STYLE, SIZE, OR COLOR.

NO CLAIM IS MADE TO THE EXCLUSIVE  
RIGHT TO USE "NETWORK" , APART FROM THE  
MARK AS SHOWN.

SER. NO. 77-388,192, FILED P.R. 2-4-2008; AM. S.R.  
5-20-2008.

MICHAEL KEATING, EXAMINING ATTORNEY

**Int. Cl.: 36**

**Prior U.S. Cls.: 100, 101, and 102**

**United States Patent and Trademark Office**

**Reg. No. 3,456,013**

**Registered June 24, 2008**

**SERVICE MARK  
SUPPLEMENTAL REGISTER**

**HOLLYWOOD**

HOLLYWOOD INC. (CALIFORNIA CORPORATION)  
3857 PELL PLACE #301  
SAN DIEGO, CA 92130

FOR: CREDIT CARD AND DEBIT CARD SERVICES, IN CLASS 36 (U.S. CLS. 100, 101 AND 102).

FIRST USE 1-30-2008; IN COMMERCE 1-30-2008.

THE MARK CONSISTS OF STANDARD CHARACTERS WITHOUT CLAIM TO ANY PARTICULAR FONT, STYLE, SIZE, OR COLOR.

SER. NO. 77-388,417, FILED P.R. 2-5-2008; AM. S.R. 5-15-2008.

ALICIA COLLINS, EXAMINING ATTORNEY

**Int. Cl.: 44**

**Prior U.S. Cls.: 100 and 101**

**United States Patent and Trademark Office**

**Reg. No. 3,456,014**

**Registered June 24, 2008**

**SERVICE MARK  
SUPPLEMENTAL REGISTER**

**ARIZONA HEALTH CENTERS**

ARIZONA HEALTH CENTERS, INC. (NEVADA  
CORPORATION)  
6362 WEST LINDA LANE  
CHANDLER, AZ 85226

FOR: CHIROPRACTIC SERVICES; HEALTH CARE SERVICES, NAMELY, MASSAGE THERAPY, POSTURAL ANALYSIS, BONE DENSITY SCREENING, BODY COMPOSITION ANALYSIS, BLOOD PRESSURE AND HEART RATE MEASUREMENTS; PROVIDING ASSISTANCE AND CONSULTATION TO CORPORATE CLIENTS TO HELP THEIR EMPLOYEES MAKE HEALTH, WELLNESS AND NUTRITIONAL CHANGES IN THEIR DAILY LIVING TO IMPROVE HEALTH, IN CLASS 44 (U.S. CLS. 100 AND 101).

FIRST USE 0-0-2005; IN COMMERCE 0-0-2005.

THE MARK CONSISTS OF STANDARD CHARACTERS WITHOUT CLAIM TO ANY PARTICULAR FONT, STYLE, SIZE, OR COLOR.

NO CLAIM IS MADE TO THE EXCLUSIVE RIGHT TO USE "HEALTH CENTERS", APART FROM THE MARK AS SHOWN.

SER. NO. 77-388,799, FILED P.R. 2-5-2008; AM. S.R. 5-19-2008.

RENEE MCCRAY, EXAMINING ATTORNEY



**Int. Cl.: 41**

**Prior U.S. Cls.: 100, 101, and 107**

**United States Patent and Trademark Office**

**Reg. No. 3,456,015**

**Registered June 24, 2008**

**SERVICE MARK  
SUPPLEMENTAL REGISTER**

**Great Lakes Bellydance  
Convention**

MAGDALEN SARANTIS RODRIGUEZ (UNITED STATES INDIVIDUAL)  
953 AMELITH RD.  
FREELAND, MI 48623

FOR: EDUCATIONAL SERVICES, NAMELY, CONDUCTING WORKSHOPS AND SEMINARS IN THE FIELD OF DANCING, IN CLASS 41 (U.S. CLS. 100, 101 AND 107).

FIRST USE 11-1-2006; IN COMMERCE 11-1-2006.

THE MARK CONSISTS OF STANDARD CHARACTERS WITHOUT CLAIM TO ANY PARTICULAR FONT, STYLE, SIZE, OR COLOR.

NO CLAIM IS MADE TO THE EXCLUSIVE RIGHT TO USE "BELLYDANCE CONVENTION", APART FROM THE MARK AS SHOWN.

SER. NO. 77-389,233, FILED P.R. 2-5-2008; AM. S.R. 2-5-2008.

JENNY PARK, EXAMINING ATTORNEY

**Int. Cl.: 35**

**Prior U.S. Cls.: 100, 101, and 102**

**United States Patent and Trademark Office**

**Reg. No. 3,456,016**

**Registered June 24, 2008**

**SERVICE MARK  
SUPPLEMENTAL REGISTER**

**MEDDEVICEJOBS.COM**

INSURGICA LLC (ARIZONA LTD LIAB CO)  
#280  
7950 E. REDFIELD RD.  
SCOTTSDALE, AZ 85260

FIRST USE 9-2-2004; IN COMMERCE 9-2-2004.

THE MARK CONSISTS OF STANDARD CHARACTERS WITHOUT CLAIM TO ANY PARTICULAR FONT, STYLE, SIZE, OR COLOR.

FOR: PROVIDING A WEB SITE FEATURING EMPLOYMENT OPPORTUNITIES FOR BOTH INDIVIDUAL APPLICANTS AND EMPLOYERS SEEKING TO HIRE EXPERIENCED PEOPLE FROM THE MEDICAL DEVICE FIELD , IN CLASS 35 (U.S. CLS. 100, 101 AND 102).

SER. NO. 77-389,277, FILED P.R. 2-5-2008; AM. S.R. 5-16-2008.

ANDREA HACK, EXAMINING ATTORNEY

**Int. Cl.: 35**

**Prior U.S. Cls.: 100, 101, and 102**

**United States Patent and Trademark Office**

**Reg. No. 3,456,017**

**Registered June 24, 2008**

**SERVICE MARK  
SUPPLEMENTAL REGISTER**

**PREMIUM WARES FOR THE  
KITCHEN ENTHUSIAST!**

THE VERMONT BUTCHER BLOCK & BOARD  
COMPANY, LLC (VERMONT LTD LIAB CO)  
2260 SOUTH ROAD  
WILLISTON, VT 05495

FOR: ON-LINE RETAIL STORE SERVICES FEATURING PREMIUM KITCHEN ITEMS, NAMELY, WOOD SPOONS, CUTTING BOARDS, BUTCHER BLOCKS, WINE RACKS, SUSHI BOARDS, WINE COASTERS, CHEESE BOARDS, PLATES, CHARCUTERIE TRAYS, CHOCOLATE TRAYS, LAZY SUSANS AND SALT AND PEPPER MILLS; RETAIL STORE SERVICES FEATURING PREMIUM KITCHEN ITEMS, NAMELY, WOOD SPOONS, CUTTING BOARDS, BUTCHER BLOCKS, WINE RACKS, SUSHI BOARDS, WINE COASTERS, CHEESE BOARDS, PLATES, CHARCUTERIE TRAYS, CHOCOLATE

TRAYS, LAZY SUSANS AND SALT AND PEPPER MILLS, IN CLASS 35 (U.S. CLS. 100, 101 AND 102).

FIRST USE 1-1-2008; IN COMMERCE 1-1-2008.

THE MARK CONSISTS OF STANDARD CHARACTERS WITHOUT CLAIM TO ANY PARTICULAR FONT, STYLE, SIZE, OR COLOR.

NO CLAIM IS MADE TO THE EXCLUSIVE RIGHT TO USE "PREMIUM WARES", APART FROM THE MARK AS SHOWN.

SER. NO. 77-389,392, FILED P.R. 2-5-2008; AM. S.R. 5-16-2008.

EMILY CHUO, EXAMINING ATTORNEY

**Int. Cl.: 35**

**Prior U.S. Cls.: 100, 101, and 102**

**United States Patent and Trademark Office**

**Reg. No. 3,456,018**

**Registered June 24, 2008**

**SERVICE MARK  
SUPPLEMENTAL REGISTER**

**HOBBY GIFT BASKETS**

GUN DEPOT, INC. (NEW YORK CORPORATION)  
1330 ROUTE 44  
PLEASANT VALLEY, NY 12569

FOR: ON-LINE RETAIL STORE SERVICES FEATURING GIFT ITEMS IN HOBBY-THEMED PACKAGES, IN CLASS 35 (U.S. CLS. 100, 101 AND 102).

FIRST USE 12-13-2007; IN COMMERCE 12-13-2007.

THE MARK CONSISTS OF STANDARD CHARACTERS WITHOUT CLAIM TO ANY PARTICULAR FONT, STYLE, SIZE, OR COLOR.

NO CLAIM IS MADE TO THE EXCLUSIVE RIGHT TO USE "GIFT BASKETS", APART FROM THE MARK AS SHOWN.

SER. NO. 77-389,454, FILED 2-5-2008.

TARAH HARDY, EXAMINING ATTORNEY

**Int. Cl.: 35**

**Prior U.S. Cls.: 100, 101, and 102**

**United States Patent and Trademark Office**

**Reg. No. 3,456,019**

**Registered June 24, 2008**

**SERVICE MARK  
SUPPLEMENTAL REGISTER**

**GAINESVILLE COINS**

GAINESVILLE COINS, INC. (FLORIDA CORPORATION)

P. O. BOX 2721

LUTZ, FL 33548

FOR: ONLINE RETAIL SERVICES IN THE FIELD OF NUMISMATICS, IN CLASS 35 (U.S. CLS. 100, 101 AND 102).

FIRST USE 7-0-2007; IN COMMERCE 7-0-2007.

THE MARK CONSISTS OF STANDARD CHARACTERS WITHOUT CLAIM TO ANY PARTICULAR FONT, STYLE, SIZE, OR COLOR.

NO CLAIM IS MADE TO THE EXCLUSIVE RIGHT TO USE "COINS", APART FROM THE MARK AS SHOWN.

SER. NO. 77-390,047, FILED P.R. 2-6-2008; AM. S.R. 5-17-2008.

JOHN HWANG, EXAMINING ATTORNEY

**Int. Cl.: 41**

**Prior U.S. Cls.: 100, 101, and 107**

**United States Patent and Trademark Office**

**Reg. No. 3,456,020**

**Registered June 24, 2008**

**SERVICE MARK  
SUPPLEMENTAL REGISTER**

WORLD CLIMATE CHANGE REPORT

THE BUREAU OF NATIONAL AFFAIRS, INC.  
(DELAWARE CORPORATION)  
SUITE 11211  
1801 S. BELL STREET  
ARLINGTON, VA 22202

FOR: PROVIDING ONLINE PUBLICATIONS IN THE NATURE OF REPORTS FEATURING NEWS, INFORMATION, AND ANALYSIS IN THE FIELD OF CLIMATE CHANGE LEGISLATION, REGULATION, POLICY, LEGAL DEVELOPMENTS AND TRENDS, IN CLASS 41 (U.S. CLS. 100, 101 AND 107).

FIRST USE 1-8-2008; IN COMMERCE 1-8-2008.

THE MARK CONSISTS OF STANDARD CHARACTERS WITHOUT CLAIM TO ANY PARTICULAR FONT, STYLE, SIZE, OR COLOR.

NO CLAIM IS MADE TO THE EXCLUSIVE RIGHT TO USE "REPORT", APART FROM THE MARK AS SHOWN.

SER. NO. 77-390,382, FILED P.R. 2-6-2008; AM. S.R. 5-21-2008.

IRA J. GOODSaid, EXAMINING ATTORNEY

**Int. Cl.: 36**

**Prior U.S. Cls.: 100, 101, and 102**

**United States Patent and Trademark Office**

**Reg. No. 3,456,021**

**Registered June 24, 2008**

**SERVICE MARK  
SUPPLEMENTAL REGISTER**

**Streeterville Properties**

RESOURCE ONE REALTY GROUP, INC. (ILLINOIS CORPORATION), DBA D/B/A STREETERVILLE PROPERTIES,

432 E GRAND AVENUE

CHICAGO, IL 60611

FOR: REAL ESTATE BROKERAGE, IN CLASS 36 (U.S. CLS. 100, 101 AND 102).

FIRST USE 6-1-2006; IN COMMERCE 6-1-2006.

THE MARK CONSISTS OF STANDARD CHARACTERS WITHOUT CLAIM TO ANY PARTICULAR FONT, STYLE, SIZE, OR COLOR.

NO CLAIM IS MADE TO THE EXCLUSIVE RIGHT TO USE "PROPERTIES", APART FROM THE MARK AS SHOWN.

SER. NO. 77-392,325, FILED P.R. 2-8-2008; AM. S.R. 5-21-2008.

ANDREW RHIM, EXAMINING ATTORNEY

**Int. Cl.: 25**

**Prior U.S. Cls.: 22 and 39**

**United States Patent and Trademark Office**

**Reg. No. 3,456,022**

**Registered June 24, 2008**

**TRADEMARK  
SUPPLEMENTAL REGISTER**



PESCADOR BRAND APPAREL CO., LLC (SOUTH  
CAROLINA LTD LIAB CO)  
2540 GLENWOOD RD  
COLUMBIA, SC 29204

FOR: BERMUDA SHORTS; BOARD SHORTS;  
BOXER SHORTS; GYM SHORTS; SHORT TROU-  
SERS; SHORT-SLEEVED OR LONG-SLEEVED T-  
SHIRTS; SHORT-SLEEVED SHIRTS; SPORTS  
SHIRTS WITH SHORT SLEEVES; WALKING  
SHORTS; KNIT SHIRTS; LONG-SLEEVED SHIRTS;  
POLO SHIRTS; SPORT SHIRTS; SPORTS SHIRTS; T-  
SHIRTS; TEE SHIRTS; WIND SHIRTS, IN CLASS 25  
(U.S. CLS. 22 AND 39).

FIRST USE 1-1-2005; IN COMMERCE 4-1-2005.

NO CLAIM IS MADE TO THE EXCLUSIVE  
RIGHT TO USE "BRAND", APART FROM THE  
MARK AS SHOWN.

THE MARK CONSISTS OF A CUSTOM CREA-  
TION THAT HAS A FISH LIKE FORM CONVERT-  
ING INTO A FISH HOOK WITH THE WORD  
"PESCADOR" IN THE MIDDLE AND THE WORD  
"BRAND" UNDERNEATH.

THE ENGLISH TRANSLATION OF THE WORD  
"PESCADOR" IN THE MARK IS "FISHERMAN".

SER. NO. 77-394,154, FILED P.R. 2-11-2008; AM. S.R.  
5-21-2008.

DAVID MURRAY, EXAMINING ATTORNEY



**Int. Cl.: 44**

**Prior U.S. Cls.: 100 and 101**

**United States Patent and Trademark Office**

**Reg. No. 3,456,023**

**Registered June 24, 2008**

**SERVICE MARK  
SUPPLEMENTAL REGISTER**

COMMUNITY EMERGENCY CENTER

ST. LUKE'S EPISCOPAL HEALTH SYSTEM  
(TEXAS NON-PROFIT CORPORATION)

6720 BERNTER AVE.

HOUSTON, TX 77030

FOR: MEDICAL SERVICES, NAMELY, EMER-  
GENCY CARE SERVICES, IN CLASS 44 (U.S. CLS.  
100 AND 101).

FIRST USE 2-22-2008; IN COMMERCE 2-22-2008.

THE MARK CONSISTS OF STANDARD CHAR-  
ACTERS WITHOUT CLAIM TO ANY PARTICULAR  
FONT, STYLE, SIZE, OR COLOR.

NO CLAIM IS MADE TO THE EXCLUSIVE  
RIGHT TO USE "EMERGENCY CENTER", APART  
FROM THE MARK AS SHOWN.

SER. NO. 77-418,880, FILED P.R. 3-11-2008; AM. S.R.  
5-13-2008.

EMILY CHUO, EXAMINING ATTORNEY

**Int. Cl.: 25**

**Prior U.S. Cls.: 22 and 39**

**United States Patent and Trademark Office**

**Reg. No. 3,456,024**

**Registered June 24, 2008**

**TRADEMARK  
SUPPLEMENTAL REGISTER**

**STRANGE ANGELL**

CANDELLA, CHRISTOPHER A. (UNITED STATES INDIVIDUAL), DBA STRANGE ANGELL,  
3471 PATY DR.  
HONOLULU, HI 96822

THE MARK CONSISTS OF STANDARD CHARACTERS WITHOUT CLAIM TO ANY PARTICULAR FONT, STYLE, SIZE, OR COLOR.

FOR: BASEBALL CAPS; AND SHORT-SLEEVED AND LONG SLEEVED T-SHIRTS, IN CLASS 25 (U.S. CLS. 22 AND 39).

SER. NO. 77-463,133, FILED 5-1-2008.

FIRST USE 5-1-2007; IN COMMERCE 11-1-2007.

CHRIS DONINGER, EXAMINING ATTORNEY

**Int. Cl.: 35**

**Prior U.S. Cls.: 100, 101, and 102**

**United States Patent and Trademark Office**

**Reg. No. 3,456,025**

**Registered June 24, 2008**

**SERVICE MARK  
SUPPLEMENTAL REGISTER**

**PALLADIUM ALLIANCE  
INTERNATIONAL**

PALLADIUM ALLIANCE INTERNATIONAL  
(UNITED KINGDOM CORPORATION)  
P.O. BOX 81511  
BILLINGS, MT 59108

FOR: ASSOCIATION SERVICES, NAMELY, PROMOTING THE INTERESTS OF JEWELRY MANUFACTURERS AND DESIGNERS AND MANUFACTURERS OF ALLOYS OF PRECIOUS METALS USED FOR JEWELRY; PROVIDING ASSOCIATION INFORMATION TO ASSOCIATION MEMBERS IN THE FIELD OF MARKETING FOR JEWELRY MANUFACTURERS, DESIGNERS AND MANUFACTURERS OF PRECIOUS METAL ALLOYS USED FOR JEWELRY; PROVIDING ADVERTISING, MARKETING AND PROMOTIONAL SERVICES, NAMELY, DEVELOPMENT OF ADVERTISING CAMPAIGNS ABOUT THE USE OF PRECIOUS METALS FOR JEWELRY FOR PRINT AND THE INTERNET; CONDUCTING TRADE SHOWS

IN THE FIELD OF JEWELRY MANUFACTURING, DESIGNING AND MANUFACTURING PRECIOUS METAL ALLOYS FOR JEWELRY, IN CLASS 35 (U.S. CLS. 100, 101 AND 102).

FIRST USE 5-0-2006; IN COMMERCE 5-0-2006.

THE MARK CONSISTS OF STANDARD CHARACTERS WITHOUT CLAIM TO ANY PARTICULAR FONT, STYLE, SIZE, OR COLOR.

NO CLAIM IS MADE TO THE EXCLUSIVE RIGHT TO USE "PALLADIUM" AND "INTERNATIONAL", APART FROM THE MARK AS SHOWN.

SER. NO. 77-975,380, FILED P.R. 6-5-2007; AM. S.R. 3-6-2008.

JASON TURNER, EXAMINING ATTORNEY

**Int. Cls.: 35 and 41**

**Prior U.S. Cls.: 100, 101, 102, and 107**

**United States Patent and Trademark Office**

**Reg. No. 3,456,026**

**Registered June 24, 2008**

**SERVICE MARK  
SUPPLEMENTAL REGISTER**

**THE ASSOCIATION FOR  
INSURED RETIREMENT  
SOLUTIONS**

NAVA, INC. (CONNECTICUT NON-PROFIT CORPORATION)  
11710 PLAZA AMERICA DRIVE, SUITE 100  
RESTON, VA 20190

FOR: PROMOTING THE GOODS AND SERVICES OF OTHERS BY DISTRIBUTING ADVERTISING MATERIALS IN THE NATURE OF PRINTED, AUDIO, TELEVISION, AND GLOBAL COMPUTER NETWORK PROMOTIONAL ADS THROUGH A VARIETY OF METHODS; PROMOTIONAL SERVICES FOR OTHERS, NAMELY, PROMOTING THE LIFE INSURANCE UNDERWRITING AND BROKERAGE IN THE FIELD OF VARIABLE ANNUITIES OF OTHERS BY DISTRIBUTING ADVERTISING MATERIALS IN THE NATURE OF PRINTED, AUDIO, TELEVISION, AND GLOBAL COMPUTER NETWORK PROMOTIONAL ADS THROUGH A VARIETY OF METHODS; TRADE ASSOCIATION SERVICES, NAMELY, PROMOTING THE INTERESTS OF THE LIFE INSURANCE AND VARIABLE ANNUITIES INDUSTRIES THROUGH LEGISLATIVE AND REGULATORY ACTIVISM IN THE NATURE OF LOBBYING, IN CLASS 35 (U.S. CLS. 100, 101 AND 102).

FIRST USE 12-15-2006; IN COMMERCE 12-15-2006.

FOR: EDUCATIONAL SERVICES, NAMELY, PROVIDING CONFERENCES ON THE SUBJECTS OF LIFE INSURANCE AND VARIABLE ANNUITIES, AND DISTRIBUTING COURSE MATERIALS IN CONNECTION THEREWITH; AND ASSOCIATION SERVICES, NAMELY, CONDUCTING FINANCIAL PLANNING SEMINARS IN THE FIELD OF RETIREMENT PLANNING, IN CLASS 41 (U.S. CLS. 100, 101 AND 107).

FIRST USE 12-15-2006; IN COMMERCE 12-15-2006.

THE MARK CONSISTS OF STANDARD CHARACTERS WITHOUT CLAIM TO ANY PARTICULAR FONT, STYLE, SIZE, OR COLOR.

NO CLAIM IS MADE TO THE EXCLUSIVE RIGHT TO USE "ASSOCIATION", APART FROM THE MARK AS SHOWN.

SER. NO. 77-975,448, FILED P.R. 11-29-2006; AM. S.R. 9-25-2007.

ELLEN PERKINS, EXAMINING ATTORNEY

**Int. Cls.: 9, 16, 40, and 41**

**Prior U.S. Cls.: 2, 5, 21, 22, 23, 26, 29, 36, 37, 38, 50,  
100, 101, 103, 106, and 107**

**Reg. No. 3,456,027**

**United States Patent and Trademark Office**

**Registered June 24, 2008**

**TRADEMARK  
SERVICE MARK  
SUPPLEMENTAL REGISTER**

# AUDIO PAPER

TOPPAN FORMS CO., LTD. (JAPAN CORPORATION)  
7-3, HIGASHI-SHIMBASHI 1-CHOME, MINATO-K  
U  
TOKYO, JAPAN

FOR: BATTERIES AND CELLS, NAMELY, DRY BATTERIES AND DRY CELLS, WET BATTERIES AND WET CELLS, ACCUMULATORS AND PHOTO VOLTAIC CELLS; ELECTRIC WIRES AND CABLES; SOUND RECORDING APPARATUS AND INSTRUMENTS, NAMELY, ANALOG TAPE RECORDERS, DIGITAL TAPE RECORDERS, MINI DISC RECORDERS, DVD RECORDERS AND MICROPHONES; SOUND REPRODUCTION APPARATUS, NAMELY, STEREO SOUND PLAYBACK SYSTEMS COMPRISING SPEAKERS, STEREO RECEIVERS, STEREO AMPLIFIERS, CD PLAYERS, ANALOG RECORD PLAYERS, ANALOG TAPE RECORDERS, DIGITAL TAPE RECORDERS AND MINI DISC PLAYERS; SOUND RECORDING AND PLAYBACK APPARATUS WITH INTEGRATED CIRCUIT MEMORIES, NAMELY, DIGITAL AUDIO RECORDERS AND PLAYERS; LOUDSPEAKERS; MICROPHONES; AUDIO FREQUENCY MACHINES AND APPARATUS, NAMELY, PUBLIC-ADDRESS SYSTEMS AND INSTRUMENTS, COMPACT DISC PLAYERS, JUKE BOXES, TAPE RECORDERS, ELECTRIC PHONOGRAPHS, RECORD PLAYERS, MINI DISC RECORDERS AND PLAYERS AND MP3 RECORDERS; INFRARED-RAY SENSORS; INFRARED-RAY RECEIVERS; INFRARED-RAY TRANSMITTERS; ELECTRICAL CONTROLLERS FOR THE REMOTE CONTROL OF INDUSTRIAL EQUIPMENT AND

MACHINES; ELECTRIC TERMINALS; ELECTRIC RESISTORS; SOUND RECORDING MEDIA, NAMELY, BLANK OPTICAL DISCS, BLANK INTEGRATED CIRCUIT (IC) MEMORIES; AUDIO AND VIDEO RECORDING MEDIA WITH COMPUTER PROGRAMS, NAMELY, COMPUTER SOFTWARE RECORDED ON OPTICAL DISCS, HARD DISCS AND IC MEMORIES FEATURING ELECTRONIC BOOKS IN THE FIELD OF GREETING CARDS, MUSICAL AND CHILDREN'S ANIMATION; INTEGRATED CIRCUIT CHIPS; INTEGRATED CIRCUITS; DATA MEDIA, NAMELY, BLANK OPTICAL DISCS, BLANK INTEGRATED CIRCUIT MEMORIES AND BLANK COMPUTER HARD DISCS; DIODES; PRINTED CIRCUITS; SEMI-CONDUCTOR ELEMENTS, NAMELY, MEMORY UNITS; SEMI-CONDUCTORS, TRANSISTORS, CONSUMER VIDEO GAMES CARTRIDGES AND SOFTWARE; ELECTRONIC INTEGRATED CIRCUITS WITH PROGRAMS FOR HAND HELD VIDEO GAMES WITH LIQUID CRYSTAL DISPLAYS AND CD-ROMS RECORDED WITH PROGRAMS FOR HAND HELD VIDEO GAMES WITH LIQUID CRYSTAL DISPLAYS; PRERECORDED COMPUTER MEDIA, NAMELY, ELECTRONIC PUBLICATIONS, NAMELY, BOOKS AND MAGAZINES IN THE FIELD OF GREETING CARDS, ARTS, ENTERTAINMENT, BUSINESS, TECHNOLOGY, HEALTH, SPIRITUALITY, FAMILY COMMUNICATIONS, HOME DECORATING, HIKING, CHILD DEVELOPMENT AND TEEN ENTERTAINMENT; PRERECORDED VIDEO DISCS AND VIDEO TAPES IN THE FIELD OF GREETING CARDS, ARTS, ENTERTAINMENT, BUSINESS, TECHNOLOGY, HEALTH, SPIRITUAL-

ITY, FAMILY COMMUNICATIONS, HOME DECORATING, HIKING, CHILD DEVELOPMENT AND TEEN ENTERTAINMENT; DOWNLOADABLE ELECTRONIC PUBLICATIONS IN THE NATURE OF BOOKS AND MAGAZINES IN THE FIELD OF GREETING CARDS, ARTS, ENTERTAINMENT, BUSINESS, TECHNOLOGY, HEALTH, SPIRITUALITY, FAMILY COMMUNICATIONS, HOME DECORATING, HIKING, CHILD DEVELOPMENT AND TEEN ENTERTAINMENT; MAGNETIC ENCODER; INTEGRATED CIRCUITS MEMORY READER AND WRITER, IN CLASS 9 (U.S. CLS. 21, 23, 26, 36 AND 38).

FOR: INDUSTRIAL PACKAGING CONTAINERS OF PAPER; FOOD WRAPPING PLASTIC FILM FOR HOUSEHOLD USE; BANNERS OF PAPER; FLAGS OF PAPER; HYGIENIC PAPER; TOWELS OF PAPER; TABLE NAPKINS OF PAPER; HAND TOWELS OF PAPER; HANDKERCHIEFS OF PAPER; PAPER BAGGAGE TAGS; PRINTED LOTTERY TICKETS OTHER THAN TOYS; TABLE CLOTHS OF PAPER; PAPER AND CARDBOARD, NAMELY, PRINTING PAPER, INDIA PAPER, CARBON PAPER, GLASSINE PAPER, NEWSPRINT PAPER, BLOTTER PAPER, TYPEWRITING PAPER, TOILET PAPER, WRITING PAPER, WRAPPING PAPER, RICE PAPER, PARCHMENT PAPER, FILTER PAPER, JAPANESE PAPER, MULCH PAPER, OILED PAPER FOR PAPER UMBRELLAS, GUNPOWDER WRAPPING PAPER, TISSUE PAPER FOR USE AS MATERIAL OF STENCIL PAPER, JAPANESE HANDCRAFT PAPER, PAPER MADE FROM PAPER MULBERRY, NAMELY, KOHZO-GAMI, PAPER FOR USE AS MATERIAL OF STOCK CERTIFICATES, PAPER FOR JAPANESE SLIDING SCREENS, CALLIGRAPHY PAPER, CARDBOARD MADE FROM PAPER MULBERRY, NAMELY, SENKASI, COARSE TISSUE, PAPER MADE FROM PAPER MULBERRY, NAMELY, TENGUJOSI, STENCIL PAPER, NAPKIN PAPER, DUPLICATING PAPER, THICK JAPANESE PAPER, PROCESSED PAPER, PAPER LACE, IMITATION LEATHER PAPER, PERFORATED CARDS FOR JACQUARD LOOMS, ACID-RESISTANT PAPER, CORRUGATED CARDBOARD, PARAFFINED PAPER, PAPER FOR JAPANESE INDOOR SLIDING PARTITIONS, MILDEW PROOF PAPER, WATER-PROOF PAPER, ANTI-RUST PAPER, OIL PROOF PAPER, LUMINOUS PAPER, CELLOPHANE PAPER, SYNTHETIC PAPER, MANIFOLD PAPER, DECALCOMANIAS, RULED PAPER, WAXED PAPER, XUAN PAPER FOR CHINESE PAINTING AND CALLIGRAPHY, ALUMINUM FOIL LAMINATED PAPER FOR PRINTING PURPOSES, IVORY MANILA BOARD, COLORED PAPERBOARD, STRAWPAPER, WHITE PAPERBOARD, FLUTING PAPER, LINER BOARD FOR CORRUGATED CARDBOARD, CHIPBOARD PAPER, MILLBOARD, POSTCARD PAPER, KRAFT PAPER FOR ROOFING; PAPER STATIONERY, NAMELY, ADDRESS BOOKS; POCKET MEMORANDUM BOOKS; NOTE BOOKS; LOOSE-LEAF NOTEBOOKS AND THEIR BINDERS AND PADS; SCRAPBOOKS; SKETCHBOOKS; SCORE-BOOKS; WRITING OR DRAWING BOOKS; SHEET MUSIC NOTE BOOKS; PERSONAL ORGANIZERS AND THEIR COVERS AND REFILLS; PHOTOGRAPH ALBUMS; BUSINESS FORMS; LETTER PAPER; WRITING PADS AND

THEIR FOLDERS; BUSINESS CARD PAPER; MUSIC SHEET PAPER; PERSONAL HISTORY WRITING PAPER; SOUND RECORDABLE GREETING CARDS; GREETING CARDS; BLANK CARDS; NAME CARDS; BUSINESS CARDS; SCORE-CARDS; DATA-SHEET CARDS, NAMELY, INSTRUCTION SHEETS; INDEX BOOKS; SEALS; PAPER LABELS; DRAWING SHIELDS; ENVELOPES; BOOK COVERS; STATIONERY, NAMELY, BOOKMARKS; PAPER FOLDERS; STICKERS; STRIPS OF FANCY PAPER, NAMELY, PAPER RIBBONS; TERRESTRIAL GLOBES FOR STUDY USE; CELESTIAL GLOBES FOR STUDY USE; PRICE TAGS; NOTICE BILLS, NAMELY, INFORMATION FLYERS FEATURING INFORMATION REGARDING GREETING CARDS; CLIPBOARDS; BINDERS; DOCUMENT FILES; FILE BOXES; PAINTER'S ARTICLES, NAMELY, DRAWING PADS; PRINTED MATTER, NAMELY, POSTCARDS AND PICTURE POSTCARDS; POSTAGE STAMPS; SHEET MUSIC; SONG BOOKS; CATALOGUES IN THE FIELD OF GREETING CARDS; CALENDARS; MAGAZINES IN THE FIELD OF GREETING CARDS, ARTS, ENTERTAINMENT, BUSINESS, TECHNOLOGY, HEALTH, SPIRITUALITY, FAMILY COMMUNICATIONS, HOME DECORATING, HIKING, CHILD DEVELOPMENT AND TEEN ENTERTAINMENT; PRINTED TIMETABLES; BOOKS IN THE FIELD OF GREETING CARDS, ARTS, ENTERTAINMENT, BUSINESS, TECHNOLOGY, HEALTH, SPIRITUALITY, FAMILY COMMUNICATIONS, HOME DECORATING, HIKING, CHILD DEVELOPMENT AND TEEN ENTERTAINMENT; NEWSPAPERS; GEOGRAPHICAL MAPS; DIARIES; NEWSLETTERS IN THE FIELD OF LOCAL NEWS, DOMESTIC NEWS, WORLD NEWS, BUSINESS, ENTERTAINMENT, SPORTS, TECHNOLOGY, POLITICS, SCIENCE, HEALTH, WEATHER, AUDIO AND VIDEO TECHNOLOGY; PAMPHLETS IN THE FIELD OF GREETING CARDS; POSTERS; MANUALS IN THE FIELD OF USING GREETING CARDS CONTAINING INTEGRATED SOUND RECORDERS AND PLAYERS AND MANUALS IN THE FIELD OF PRINTING PRESS OPERATION; PRINTED TICKETS; TRADING CARDS; DICTIONARIES, ENCYCLOPEDIAS; PROGRAMS FOR CONCERT AND OTHER EVENTS; HOUSEHOLD ACCOUNT BOOKS; PRINTED COLLECTIONS OF PAINTINGS; NEWS BULLETINS; SEA CHARTS; PRINTED COLLECTIONS OF POEMS; DIRECTORIES IN THE FIELD OF GREETING CARDS; PICTURE BOOKS FOR CHILDREN; CELESTIAL MAPS; BRAILLE PRINTINGS IN FIELD OF GREETING CARDS, ARTS, ENTERTAINMENT, BUSINESS, TECHNOLOGY, HEALTH, SPIRITUALITY, FAMILY COMMUNICATIONS, HOME DECORATING, HIKING, CHILD DEVELOPMENT AND TEEN ENTERTAINMENT; ALMANACS; GREETING CARDS SAMPLE BOOKS; COMIC BOOKS AND COMIC MAGAZINES; PHOTOGRAPHS; PHOTOGRAPH STANDS AND CARDBOARD FOLDERS; DESKTOP CARD EMBOSSERS; DESKTOP COLOR TOPPING MACHINES FOR LETTERS EMBOSSED ON CARDS; DESKTOP LAMINATING MACHINES FOR HOME AND OFFICE USE, IN CLASS 16 (U.S. CLS. 2, 5, 22, 23, 29, 37, 38 AND 50).

FOR: PLASTIC PROCESSING SERVICES, NAME-  
LY, PROCESSING PLASTIC CARDS AND PLASTIC  
FILM TO THE ORDER OR SPECIFICATION OF  
OTHERS; PAPER TREATMENT, NAMELY,  
SPREADING OF PASTE, PERFORATION, PUNCH-  
ING, CUTTING, SEPARATION, CRIMPING AND  
FOLDING; PHOTOGRAPHIC ENLARGING; BOOK-  
BINDING; PHOTOGRAVURE; PRINTING SERVI-  
CES INCLUDING PLANO GRAPHIC PRINTING,  
OFFSET PRINTING, INTAGLIO PRINTING, PHO-  
TOGRAVURE PRINTING, STENCIL PRINTING,  
AND SCREEN PRINTING; ELECTRONIC PRINT-  
ING USING COMPUTERS AND COMPUTER DEVI-  
CES; BUSINESS FORM PRINTING; PROCESSING  
OF BUSINESS FORMS, NAMELY, CUTTING, SE-  
PARATION, CRIMPING, FOLDING, SPREADING  
OF PASTE, PERFORATION AND PUNCHING; REN-  
TAL OF MACHINES AND APPARATUS FOR  
PRINTING; RENTAL OF MACHINES AND APPA-  
RATUS FOR PROCESSING OF BUSINESS FORMS;  
RENTAL OF MACHINES AND APPARATUS FOR  
PROCESSING OF CARDS; RENTAL OF MACHINES  
AND APPARATUS FOR PAPER TREATING AND  
WORKING, IN CLASS 40 (U.S. CLS. 100, 103 AND  
106).

FOR: AUDIO AND VIDEO PRODUCTION,  
NAMELY, RECORDING, PROCESSING OR EDIT-  
ING OF SOUND OR IMAGES INTO ELECTRONIC  
CIRCUITS AND OTHER DATA MEDIA, NAMELY,  
BLANK OPTICAL DISCS, BLANK AUDIO TAPES,  
BLANK VIDEO TAPES, INTEGRATED CIRCUIT  
MEMORIES AND HARD DISCS; MULTIMEDIA  
ENTERTAINMENT SOFTWARE AND VIDEO TAPE  
PRODUCTION SERVICES, NAMELY, PRODUC-  
TION OF VIDEO-TAPE FILM, DVDS, CD-IS, CD-  
ROMS AND OPTICAL DISCS IN THE FIELDS OF  
EDUCATION, CULTURE, AMUSEMENT, MUSIC  
AND SPORTS, NOT BEING IN THE NATURE OF  
MOVIES, RADIO OR TELEVISION PROGRAMS  
AND NOT FOR ADVERTISING AND PUBLICITY  
PURPOSES; MULTIMEDIA ENTERTAINMENT  
SOFTWARE PRODUCTION SERVICES, NAMELY,  
PRODUCTION OF DATA MEDIA RECORDED  
WITH IMAGES, AUDIO-VISUALS, SOUND OR MU-  
SIC; PHOTOGRAPHY SERVICES; EDUCATIONAL

AND INSTRUCTION SERVICES, NAMELY, CLAS-  
SES, WORKSHOPS, SEMINARS AND PRIVATE LES-  
SONS, RELATING TO THE USE AND  
PREPARATION OF SOUND-RECORDED GREET-  
ING CARDS OR OTHER PAPER PRODUCTS EQUIP-  
PED WITH INTEGRATED CIRCUITS CHIPS;  
ORGANIZATION, MANAGEMENT OR ARRANGE-  
MENT OF SEMINARS, PUBLISHING OF ELECTRO-  
NIC PUBLICATIONS; ENTERTAINMENT  
SERVICES, NAMELY, PROVIDING A WEB SITE  
FEATURING MUSICAL PERFORMANCES, MUSI-  
CAL VIDEOS, AUDIO-VISUAL CLIPS, PHOTO-  
GRAPHS, ONLINE VIDEO AND KARAOKE  
GAMES AND OTHER MULTIMEDIA MATERIALS;  
PROVIDING INFORMATION IN THE FIELDS OF  
EDUCATION, ART EXHIBITION AND SPORTING  
RESULTS; ENTERTAINMENT SERVICES, NAME-  
LY, PROVIDING OF INFORMATION ON CON-  
TENTS AND RANKING OF MOVIES, SHOWS,  
PLAYS OR MUSIC; PROVIDING INFORMATION  
ON THE ORGANIZATION, MANAGEMENT AND  
ARRANGEMENT OF SPORTS COMPETITIONS;  
RENTAL OF MAGNETIC TAPES OR DVDS CON-  
TAINING RECORDED IMAGES; RENTAL OF PHO-  
TOGRAPHIC NEGATIVES AND POSITIVES;  
RENTAL OF PAINTINGS AND CALLIGRAPHIC  
WORKS, IN CLASS 41 (U.S. CLS. 100, 101 AND 107).

THE MARK CONSISTS OF STANDARD CHAR-  
ACTERS WITHOUT CLAIM TO ANY PARTICULAR  
FONT, STYLE, SIZE, OR COLOR.

PRIORITY CLAIMED UNDER SEC. 44(D) ON  
JAPAN APPLICATION NO. 2004-56760, FILED 6-18-  
2004, REG. NO. 4971435, DATED 7-21-2006, EXPIRES  
7-21-2016.

NO CLAIM IS MADE TO THE EXCLUSIVE  
RIGHT TO USE "AUDIO" IN CLASSES 9 AND 41  
OR "PAPER" IN CLASSES 16 OR 40, APART FROM  
THE MARK AS SHOWN.

SER. NO. 78-535,793, FILED P.R. 12-20-2004; AM.  
S.R. 12-12-2007.

STEVEN PEREZ, EXAMINING ATTORNEY

**Int. Cl.: 17**

**Prior U.S. Cls.: 1, 5, 12, 13, 35, and 50**

**Reg. No. 3,456,028**

**United States Patent and Trademark Office**

**Registered June 24, 2008**

**TRADEMARK  
SUPPLEMENTAL REGISTER**

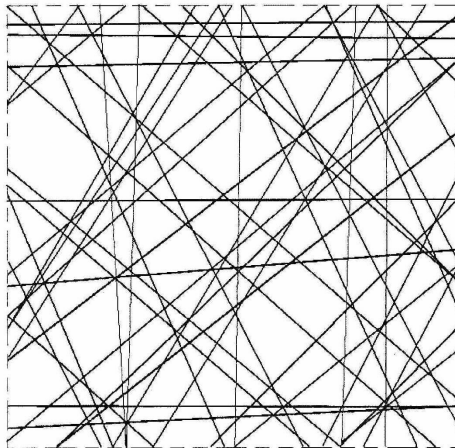

THE DILLER CORPORATION (ILLINOIS CORPORATION)  
C/O FORMICA CORPORATION CHEMED CENTER  
255 EAST FIFTH STREET  
CINCINNATI, OH 45202

FIRST USE 6-0-1999; IN COMMERCE 6-0-1999.

THE MARK CONSISTS OF A CROSS HATCHED DESIGN PATTERN. THE MARK IS NOT IN COLOR.

FOR: LAMINATES MADE PREDOMINANTLY OF PLASTIC FOR USE IN THE MANUFACTURE OF COUNTERTOPS, VANITY TOPS, TABLE TOPS, WALL PANELING, AND FURNITURE, IN CLASS 17 (U.S. CLS. 1, 5, 12, 13, 35 AND 50).

SER. NO. 78-561,321, FILED P.R. 2-5-2005; AM. S.R. 3-31-2008.

MARILYN IZZI, EXAMINING ATTORNEY



**Int. Cl.: 25**

**Prior U.S. Cls.: 22 and 39**

**United States Patent and Trademark Office**

**Reg. No. 3,456,029**

**Registered June 24, 2008**

**TRADEMARK  
SUPPLEMENTAL REGISTER**



FLEET FEET, INC. (NORTH CAROLINA CORPORATION)  
SUITE 200  
110 E. MAIN ST.  
CARRBORO, NC 27510

FOR: T-SHIRTS, GOLF SHIRTS, SWEATSHIRTS, SHIRTS, JACKETS, PANTS, SHORTS, HATS, HEAD BANDS, WRIST BANDS, SOCKS, AND SHOES, IN CLASS 25 (U.S. CLS. 22 AND 39).

FIRST USE 9-30-2005; IN COMMERCE 9-30-2005.

OWNER OF U.S. REG. NOS. 1,210,491, 2,364,606, AND OTHERS.

NO CLAIM IS MADE TO THE EXCLUSIVE RIGHT TO USE "FEET SPORTS EST. 1976", APART FROM THE MARK AS SHOWN.

THE MARK CONSISTS OF A WINGED SHOE INSIDE A SHIELD DESIGN WITH THE LITERAL ELEMENTS SUPERIMPOSED THEREON.

SER. NO. 78-719,090, FILED P.R. 9-23-2005; AM. S.R. 4-30-2008.

VIVIAN MICZNIK FIRST, EXAMINING ATTORNEY

**Int. Cl.: 45**

**Prior U.S. Cl.: B**

**United States Patent and Trademark Office**

**Reg. No. 3,456,030**

**Registered June 24, 2008**

**CERTIFICATION MARK  
SERVICES  
SUPPLEMENTAL REGISTER**

**CERTIFIED MERGER &  
ACQUISITION ADVISOR**

THE ALLIANCE FOR CORPORATE WEALTH,  
LLC (DELAWARE LTD LIAB CO)  
SUITE 2700  
150 NORTH MICHIGAN AVENUE  
CHICAGO, IL 60601

FOR: MERGERS AND ACQUISITIONS ADVISORY SERVICES, IN CLASS B (U.S. CL. B).

FIRST USE 11-1-2005; IN COMMERCE 11-1-2005.

THE MARK CONSISTS OF STANDARD CHARACTERS WITHOUT CLAIM TO ANY PARTICULAR FONT, STYLE, SIZE, OR COLOR.

THE PERSON DISPLAYING SAID MARK HAS COMPLETED EDUCATIONAL COURSE WORK REQUIREMENTS AND WORK EXPERIENCE REQUIREMENTS OF THE CERTIFIER, HAS COMPLETED EXAMINATIONS ADMINISTERED BY THE CERTIFIER IN A SATISFACTORY MANNER, HAS AGREED TO ADHERE TO THE CERTIFIER'S STANDARDS FOR PROFESSIONAL RESPONSIBILITY, CONTINUING EDUCATION, AND OTHER POST-CERTIFICATION REQUIREMENTS.

SER. NO. 78-761,916, FILED P.R. 11-28-2005; AM. S.R. 12-4-2006.

LA TONIA FISHER, EXAMINING ATTORNEY

**Int. Cl.: 9**

**Prior U.S. Cls.: 21, 23, 26, 36, and 38**

**United States Patent and Trademark Office**

**Reg. No. 3,456,031**

**Registered June 24, 2008**

**TRADEMARK  
SUPPLEMENTAL REGISTER**

**netlivemusic.com**

KRAUSE, JEREMY C. (UNITED STATES INDIVIDUAL)  
5580 LA JOLLA BLVD. # 34  
LA JOLLA, CA 92037

THE MARK CONSISTS OF STANDARD CHARACTERS WITHOUT CLAIM TO ANY PARTICULAR FONT, STYLE, SIZE, OR COLOR.

FOR: DOWNLOADABLE MUSIC SOUND RECORDINGS, IN CLASS 9 (U.S. CLS. 21, 23, 26, 36 AND 38).

SER. NO. 78-798,620, FILED P.R. 1-24-2006; AM. S.R. 12-15-2006.

FIRST USE 2-1-2001; IN COMMERCE 5-1-2001.

JUSTINE D. PARKER, EXAMINING ATTORNEY

**Int. Cl.: 9**

**Prior U.S. Cls.: 21, 23, 26, 36, and 38**

**United States Patent and Trademark Office**

**Reg. No. 3,456,032**

**Registered June 24, 2008**

**TRADEMARK  
SUPPLEMENTAL REGISTER**

**TRACK SCANNER**

TRACK SCAN INC. (NORTH CAROLINA COR-  
PORATION)  
255 RACEWAY DRIVE  
MOORESVILLE, NC 28117

FOR: RADIO SCANNERS, IN CLASS 9 (U.S. CLS.  
21, 23, 26, 36 AND 38).

FIRST USE 2-0-2006; IN COMMERCE 2-0-2006.

THE MARK CONSISTS OF STANDARD CHAR-  
ACTERS WITHOUT CLAIM TO ANY PARTICULAR  
FONT, STYLE, SIZE, OR COLOR.

OWNER OF U.S. REG. NO. 2,447,590.

SER. NO. 78-803,364, FILED P.R. 1-31-2006; AM. S.R.  
4-22-2008.

PAUL E. FAHRENKOPF, EXAMINING ATTORNEY

**Int. Cl.: 38**

**Prior U.S. Cls.: 100, 101, and 104**

**United States Patent and Trademark Office**

**Reg. No. 3,456,033**

**Registered June 24, 2008**

**SERVICE MARK  
SUPPLEMENTAL REGISTER**

**FAMILY ALERT!**

DISNEY ENTERPRISES, INC. (DELAWARE CORPORATION)  
500 SOUTH BUENA VISTA STREET  
BURBANK, CA 91521

FOR: MOBILE AND WIRELESS TELEPHONE COMMUNICATION SERVICES; WIRELESS DIGITAL MESSAGING SERVICES, IN CLASS 38 (U.S. CLS. 100, 101 AND 104).

FIRST USE 6-9-2006; IN COMMERCE 6-9-2006.

THE MARK CONSISTS OF STANDARD CHARACTERS WITHOUT CLAIM TO ANY PARTICULAR FONT, STYLE, SIZE, OR COLOR.

SER. NO. 78-862,107, FILED P.R. 4-14-2006; AM. S.R. 4-16-2008.

MARK PILARO, EXAMINING ATTORNEY

**Int. Cl.: 5**

**Prior U.S. Cls.: 6, 18, 44, 46, 51, and 52**

**Reg. No. 3,456,034**

**United States Patent and Trademark Office**

**Registered June 24, 2008**

**TRADEMARK  
SUPPLEMENTAL REGISTER**

**PURE OCEAN WATER FROM A  
PURE OCEAN**

THE PURE OCEAN WATER COMPANY (FLOR-  
IDA CORPORATION)

10307 MATCHLOCK DR.

ORLANDO, FL 32821

FOR: OCEAN WATER FOR TOPICAL TREAT-  
MENT TO THE SKIN, IN CLASS 5 (U.S. CLS. 6, 18, 44,  
46, 51 AND 52).

FIRST USE 8-1-2007; IN COMMERCE 8-1-2007.

THE MARK CONSISTS OF STANDARD CHAR-  
ACTERS WITHOUT CLAIM TO ANY PARTICULAR  
FONT, STYLE, SIZE, OR COLOR.

NO CLAIM IS MADE TO THE EXCLUSIVE  
RIGHT TO USE "OCEAN WATER", APART FROM  
THE MARK AS SHOWN.

SER. NO. 78-868,521, FILED P.R. 4-24-2006; AM. S.R.  
4-23-2008.

CIMMERIAN COLEMAN, EXAMINING ATTOR-  
NEY

**Int. Cl.: 25**

**Prior U.S. Cls.: 22 and 39**

**United States Patent and Trademark Office**

**Reg. No. 3,456,035**

**Registered June 24, 2008**

**TRADEMARK  
SUPPLEMENTAL REGISTER**

**STADIUMWRAP**

ISABEL SUMMERS, INC. (NEW YORK COR-  
PORATION)  
300 MERCER STREET  
NEW YORK, NY 10003

THE MARK CONSISTS OF STANDARD CHAR-  
ACTERS WITHOUT CLAIM TO ANY PARTICULAR  
FONT, STYLE, SIZE, OR COLOR.

FOR: APPAREL, NAMELY, A HOODED CAPE  
INCORPORATING A SEATING PAD, IN CLASS 25  
(U.S. CLS. 22 AND 39).

SER. NO. 78-882,754, FILED P.R. 5-12-2006; AM. S.R.  
4-29-2008.

FIRST USE 10-6-2006; IN COMMERCE 10-6-2006.

DAVID MILLER, EXAMINING ATTORNEY

**Int. Cl.: 5**

**Prior U.S. Cls.: 6, 18, 44, 46, 51, and 52**

**Reg. No. 3,456,036**

**United States Patent and Trademark Office**

**Registered June 24, 2008**

---

**TRADEMARK  
SUPPLEMENTAL REGISTER**

**BIOACTIVE COLLAGEN PEPTIDES**

GELITA HEALTH PRODUCTS, INC. (DELA-  
WARE CORPORATION)  
2445 PORT NEAL INDUSTRIAL ROAD  
SERGEANT BLUFF, IA 51054

THE MARK CONSISTS OF STANDARD CHAR-  
ACTERS WITHOUT CLAIM TO ANY PARTICULAR  
FONT, STYLE, SIZE, OR COLOR.

FOR: PROTEINS SOLD AS AN INTEGRAL COM-  
PONENT FEATURE OF NUTRITIONAL SUPPLE-  
MENTS, IN CLASS 5 (U.S. CLS. 6, 18, 44, 46, 51 AND  
52).

SER. NO. 78-885,325, FILED P.R. 5-17-2006; AM. S.R.  
5-15-2008.

FIRST USE 7-0-2007; IN COMMERCE 7-0-2007.

MARIAM MAHMOUDI, EXAMINING ATTORNEY



**Int. Cl.: 45**

**Prior U.S. Cl.: B**

**United States Patent and Trademark Office**

**Reg. No. 3,456,037**

**Registered June 24, 2008**

**CERTIFICATION MARK  
SERVICES  
SUPPLEMENTAL REGISTER**

**WORLD-CLASS FRANCHISE**

JOHNSON FRANCHISE CONSULTING, INC.  
(NEBRASKA CORPORATION)  
2330 SOUTH 75TH STREET  
LINCOLN, NE 68506

FOR: BUSINESS ASSESSMENT SERVICES CONSISTING OF EVALUATION OF FRANCHISE OPPORTUNITIES, IN CLASS B (U.S. CL. B).

FIRST USE 11-1-2004; IN COMMERCE 11-1-2004.

THE MARK CONSISTS OF STANDARD CHARACTERS WITHOUT CLAIM TO ANY PARTICULAR FONT, STYLE, SIZE, OR COLOR.

NO CLAIM IS MADE TO THE EXCLUSIVE RIGHT TO USE "FRANCHISE", APART FROM THE MARK AS SHOWN.

THE CERTIFICATION MARK, AS USED BY PERSONS AUTHORIZED BY THE CERTIFIER,

CERTIFIES THAT THE SERVICES PROVIDED BY THE FRANCHISOR HAVE MET STANDARDS ESTABLISHED BY APPLICANT THAT DEMONSTRATE FRANCHISOR'S EXCELLENCE THROUGH A COMMITMENT TO SUPPORTING AND ASSISTING THEIR FRANCHISEES. IN ORDER TO RECEIVE AND USE THE CERTIFICATION MARK, THE APPLICANT REQUIRES A SURVEY TO BE COMPLETED BY AT LEAST 70% OF THE FRANCHISOR'S FRANCHISEES AND RESPONSES TO THE SURVEY MUST REFLECT POSITIVE RESPONSES FROM AT LEAST TWO-THIRDS OF THE FRANCHISEES ON EACH OF SEVEN QUESTIONS WHICH MEASURE SATISFACTION.

SER. NO. 78-952,628, FILED P.R. 8-15-2006; AM. S.R. 5-14-2007.

KHANH LE, EXAMINING ATTORNEY

**Int. Cls.: 6 and 19**

**Prior U.S. Cls.: 1, 2, 12, 13, 14, 23, 25, 33, and 50**

**United States Patent and Trademark Office**

**Reg. No. 3,456,038**

**Registered June 24, 2008**

**TRADEMARK  
SUPPLEMENTAL REGISTER**

**PET PORTALS**

CLASSY CUSTOM, INC. (WASHINGTON CORPORATION)  
P.O. BOX 350  
RAINIER, WA 98576

FOR: METAL PET DOORS AND REMOVABLE METAL PET DOOR FRAMES, IN CLASS 6 (U.S. CLS. 2, 12, 13, 14, 23, 25 AND 50).

FIRST USE 12-0-2006; IN COMMERCE 12-0-2006.

FOR: NONMETAL PET DOORS AND REMOVABLE NONMETAL PET DOOR FRAMES, IN CLASS 19 (U.S. CLS. 1, 12, 33 AND 50).

FIRST USE 12-0-2006; IN COMMERCE 12-0-2006.

THE MARK CONSISTS OF STANDARD CHARACTERS WITHOUT CLAIM TO ANY PARTICULAR FONT, STYLE, SIZE, OR COLOR.

SER. NO. 78-978,886, FILED P.R. 8-17-2006; AM. S.R. 11-14-2007.

SIMON TENG, EXAMINING ATTORNEY